

2019



Scheibenbremsen Disc Brakes  
Bremsen-Ersatzteilprogramm Brake Parts Program



# Scheibenbremsen Disc Brakes

2019

Bremsen-Ersatzteilprogramm

Brake Parts Program



Brakethrough Technology





## Erstklassig First-class

### Besser ist besser

Wenn es um Qualität geht, genügt uns ein „sehr gut“ noch lange nicht. Wir erfüllen hohe Ansprüche an das Qualitätsmanagement und die europäische Sicherheitsnorm ECE-R90 wird von ATE sogar übertroffen. Zudem führen wir zahlreiche zusätzliche Tests durch, unter anderem zu Verschleiß und Wärmeleistung.

Auch Nachhaltigkeit ist uns wichtig: Wir stellen die Mischungen für ATE Bremsbeläge auf kupferfreie Materialien um und setzen bei ATE Ceramic auf geringen Abrieb. Nutzen ausschließlich umweltfreundliches Material für die Beschichtung von Bremsscheiben. Und bereiten Produkte wie Bremsattel wieder auf.

### Better is better

When it comes to quality, “very good” is simply not good enough for us. We meet high standards of quality management – and ATE even exceeds the European safety standard ECE-R90. We also perform many additional tests, including wear and thermal performance.

Sustainability is also important to us: we convert the compounds for ATE brake pads to copperfree materials and opt for low abrasion with ATE Ceramic. We only use environmentally friendly material for the coating of brake discs – and we remanufacture products like brake callipers.



## Original? Mit Sicherheit

Qualität ist für uns nicht nur während der Produktentwicklung und vor der Auslieferung ein Thema. Nach dem Kauf können Sie jederzeit überprüfen, ob Sie ein Original ATE Produkt vor sich haben – über ein zweistufiges Sicherheitsetikett.

Die erste Stufe ist der tesa Priospot®. Hier wurden die Merkmale des tesa Holospot® – der nach wie vor höchste Sicherheit bietet – noch weiter entwickelt. Die fälschungssichere Holografie-Technik mit verschiedenen Prüf- und Sicherheitsmechanismen schützt sogar das Etikett selbst vor Nachahmern.

Die zweite Stufe ist ein DataMatrix-Code, kurz MAPP-Code. Dessen letzte vier Ziffern werden auch im Holospot® bzw. Priospot® dargestellt – für ein Höchstmaß an Sicherheit.

Der Code kann per Scanner oder durch manuelle Eingabe auf der ATE Website überprüft werden und zeigt sofort an, ob es sich bei dem Produkt um ein Originalteil handelt. In Verbindung mit entsprechender Software wie der ATE App ist auch die Abfrage per Smartphone möglich.



Mehrstufiges ATE Sicherheits-etikett mit DataMatrix-Code (Mitte) und Tesa Priospot® (oben rechts).

Multi-stage ATE security label with Data Matrix code (centre) and tesa Priospot® (top right).

Zur Online-Abfrage und zum App-Download:  
[www.ate.de/original](http://www.ate.de/original)

To online verification and app download:  
[www.ate-brakes.com/original](http://www.ate-brakes.com/original)



Wir engagieren uns bei MAPP –  
Manufacturers against Product Piracy.

We are committed to MAPP –  
Manufacturers against Product Piracy.

## Einfach mehr Tests: ATE Bremsbeläge More tests: ATE brake pads

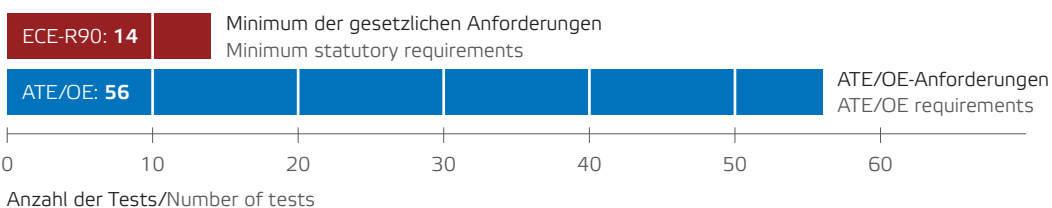



# Bremsbeläge

## Eine Klasse für sich

Brake pads

A class of their own

### ATE Original Bremsbeläge

Andere Hersteller nutzen für Bremsbeläge zehn verschiedene Belagmischungen. Bei uns sind es mehr als 150 und unsere internen Tests sind weit strenger, als es die gesetzlichen Bestimmungen erfordern. So bieten wir für jeden Fahrzeugtyp den optimalen Bremsbelag – mit 98 Prozent Abdeckung in Europa, und das überwiegend mit Original-Erstausrüster-Mischungen. Dabei können sich die Autofahrer auf maximale Sicherheit ebenso verlassen wie auf maximalen Komfort. Es gibt eben nur ein Original.

### ATE Original brake pads

Other manufacturers use ten different compounds for their brake pads. We use more than 150 – and our internal tests are far more stringent than required by the regulations. That's why we offer the optimum brake pad for every type of vehicle – with 98 per cent coverage in Europe, mainly with original equipment manufacturer compounds. So motorists can rely on maximum safety and maximum comfort. There is only one original.

### ATE Ceramic Bremsbeläge

Wirklich eine saubere Sache. Durch die innovative Belagmischung entsteht bei ATE Ceramic Bremsbelägen nur sehr wenig Abrieb, der zudem kaum haftet. Deshalb setzt sich praktisch kein Bremsstaub ab und schöne Felgen behalten viel länger ihren Glanz. Ceramic Bremsbeläge sind so sicher wie ein konventioneller Belag, besonders langlebig und ideal in Kombination mit den beschichteten ATE Bremsscheiben. Und es gibt noch einen weiteren Vorteil: Sie lassen sich ganz einfach statt der üblichen Bremsbeläge einbauen.

### ATE Ceramic brake pads

A clean solution. The innovative ATE Ceramic formula produces very few abraded particles, and they have hardly any adhesive characteristics. This means that hardly any brake dust settles and shiny wheel rims retain their lustre much longer. Ceramic brake pads are as safe as conventional pads, are particularly durable and ideal when used in combination with the coated ATE brake discs. Yet another advantage? They can be easily installed instead of the usual brake pads.

Auf unserer Website [www.ate.de/originalbelag](http://www.ate.de/originalbelag) können Sie sich näher informieren.

Learn more on our website at [www.ate-brakes.com/originalpad](http://www.ate-brakes.com/originalpad)

Auf unserer Website [www.ate.de/ceramic](http://www.ate.de/ceramic) erfahren Sie mehr.

Learn more on our website at [www.ate-brakes.com/ceramic](http://www.ate-brakes.com/ceramic)





## Bremsverhalten von Original ATE Bremsbelägen

### Braking behaviour of ATE Original brake pads

**Reibwert beim ersten Einbremsen der Beläge**  
Coefficient of friction at first application of the pads



**Reibwert bei kaltem Bremssystem**  
Coefficient of friction with cold braking system



**Reibwert beim Herunterbremsen aus hohen Geschwindigkeiten**  
Coefficient of friction when slowing from high speeds



**Reibwert, wenn zum ersten Mal im Hochtemperaturbereich gebremst wird**  
Coefficient of friction when first used at high temperature



■ ATE Original Bremsbeläge / ATE Original brake pads  
■ Standardbelag eines Wettbewerbers / Competitor's standard brake pads





# Bremsscheiben Für jeden Anspruch die Richtige

Brake discs

The right one for every requirement

Die Details zu ATE Bremsscheiben finden Sie auf unserer Website  
[www.ate.de/produkte/scheibenbremsen/original-ate-bremsscheiben](http://www.ate.de/produkte/scheibenbremsen/original-ate-bremsscheiben)

You'll find more details about the ATE brake discs on our website at  
[www.ate-brakes.com/products/disc-brakes/ate-original-brake-pads](http://www.ate-brakes.com/products/disc-brakes/ate-original-brake-pads)





## Alles für die optimale Bremsleistung

Es gibt so viele unterschiedliche Fahrzeugmodelle und Anforderungen – ATE hat für jeden Bedarf die richtigen Bremscheiben. Präzise gefertigt aus hervorragenden Erstausrüster-Materialien und in einer Qualität, die die ECE-R90-Norm schon heute im nahezu gesamten Portfolio übertrifft. Besser gehts nicht.

## Original ATE Bremscheiben

In Original ATE Bremscheiben stecken durchdachte Technologie, hochwertige Materialien und unser ganzes Know-how. Sie entsprechen genau den Bremscheiben, die vom Hersteller verbaut wurden: Ob glatt, gelocht oder genutet, hochgekohlt, einteilig, gestiftet oder genietet, mit oder ohne Radlager – wir haben immer die passende Lösung für sicheres und komfortables Bremsen. Und auch den passenden Belag dazu. Eine gute Kombination sind zum Beispiel beschichtete Bremscheiben und die staubarmen ATE Ceramic Bremsbeläge oder natürlich unsere Original Bremsbeläge. Die Original ATE Bremscheiben sind mit 98 Prozent Abdeckung in Europa verfügbar und auch – wenn der Fahrzeughersteller es vorgibt – mit Befestigungsschrauben erhältlich.

## Everything for optimal braking performance

There are so many different vehicle models and requirements – and ATE has the right brake disc for each one. Precisely manufactured from excellent OEM materials, the quality of which already surpasses the ECE-R90 standard throughout most of our portfolio. It just couldn't get any better.

## Original ATE brake discs

ATE brake discs are packed full of sophisticated technology, high-quality materials and our entire expertise. They correspond exactly to the brake discs originally installed by the manufacturer. Whether smooth, perforated or grooved, high-carbon, one-piece, pinned or riveted and with or without wheel bearings – we always have the right solution for safe and comfortable braking. With the matching brake pad too. One good combination, for example – our coated brake discs and the low-dust ATE Ceramic brake pads, or our Original brake pads of course. Original ATE brake discs are available in 98 per cent of European countries and are also available with wheel bearings or – if prescribed by the vehicle manufacturer – with fixing screws.



**ATE PowerDisc**  
ATE PowerDisc



**Beschichtete Bremscheibe mit Befestigungsschrauben**  
Coated brake disc with fixing screws



**Beschichtete zweiteilige Bremscheibe**  
Coated two-piece brake disc



**Bremscheibe mit Radlager**  
Brake discs with wheel





# Mehr als sicher More than safe

## Bremsflüssigkeiten

ATE hat für jedes Fahrzeugmodell und jede Fahrweise die optimale Bremsflüssigkeit. Und alle lassen die gesetzlichen und technischen Standards weit hinter sich. Das Highlight für elektronische Bremssysteme: ATE SL.6. Die dünnflüssige Textur sorgt bei Niedrigtemperaturen für eine schnelle Reaktion von ABS oder ESP® – und so für höchste Sicherheit.

## Brake fluids

ATE has the optimal brake fluid for every vehicle model and every driving style – and all our fluids leave the legal and technical standards far behind. Our highlight for electronic braking systems – the ATE SL.6. The low-viscosity texture ensures a quick response from ABS or ESP® at low temperatures, guaranteeing maximum safety.

## Die Eigenschaften von ATE Bremsflüssigkeiten

### The properties of ATE brake fluids

	Siedepunkt Boiling point	Nass-Siedepunkt Wet boiling point	Viskosität bei -40°C Viscosity at -40°C	Wechselintervall Replacement interval
<b>ATE G DOT 3</b>	min. 245°C	min. 150°C	max. 1.500 mm <sup>2</sup> /s max. 1,500 mm <sup>2</sup> /s	bis 1 Jahr up to 1 year
<b>ATE SL DOT 4</b>	min. 260°C	min. 165°C	max. 1.400 mm <sup>2</sup> /s max. 1,400 mm <sup>2</sup> /s	bis 1 Jahr up to 1 year
<b>ATE SL.6 DOT 4</b> Ideal für/Ideal for ESP®, ABS, ASR	min. 265°C	min. 175°C	max. 700 mm <sup>2</sup> /s	bis 2 Jahre up to 2 years
<b>ATE TYP 200 DOT 4</b> New Racing Quality	min. 280°C	min. 198°C	max. 1.400 mm <sup>2</sup> /s max. 1,400 mm <sup>2</sup> /s	bis 3 Jahre up to 3 years
<b>ATE SUPER DOT 4</b>	min. 260°C	min. 180°C	max. 1.400 mm <sup>2</sup> /s max. 1,400 mm <sup>2</sup> /s	bis 2 Jahre up to 2 years



Typ Type	ATE Sachnummer ATE partnumber	EAN-Nr. 4006633 EAN-No. 4006633	Gebinde Container size	Paletteneinheit* Pallet unit*
<b>G</b> SAE Spezifikation J1703 FMVSS §571.116/DOT 3	705302 03.9901-5302.2/02	10199 8	1 l	D
	705303 03.9901-5303.2/02	10201 8	5 l	F
größere Gebinde auf Anfrage – Bigger container sizes on demand				
<b>SL</b> SAE Spezifikation J1704 FMVSS §571.116/DOT 4	705808 03.9901-5808.2/02	49000 9	1/4 l	A
	705801 03.9901-5801.2/02	49001 6	1/2 l	B
	705802 03.9901-5802.2/02	49002 3	1 l	D
	705803 03.9901-5803.2/02	49003 0	5 l	F
	705811 03.9901-5811.2/02	29907 7	20 l	R
	705820 03.9901-5820.2/01	10824 9	30 l	H
	705814 03.9901-5814.2/01	10366 4	50 l	P
	705805 03.9901-5805.2/01	49005 4	200 l	S
<b>SL.6</b> SAE Spezifikation J1704 FMVSS §571.116/ DOT 4 ISO 4925. Klasse 6 – niedrigviskos	706408 03.9901-6408.2/02	22762 9	1/4 l	A
	706402 03.9901-6402.2/02	20746 1	1 l	D
	706403 03.9901-6403.2/02	20748 5	5 l	F
	706411 03.9901-6411.2/02	20750 8	20 l	R
	706420 03.9901-6420.2/02	23120 6	30 l	H
	706414 03.9901-6414.2/02	23005 6	50 l	P
	706405 03.9901-6405.2/02	23121 3	200 l	S
<b>TYP 200</b> <b>New racing quality</b> SAE Spezifikation J1704 FMVSS §571.116/DOT 4	706202 03.9901-6202.2/02	10825 6	1 l	D
	706203 03.9901-6203.2/02	12166 8	5 l	F
	706220 03.9901-6220.2/01	12780 6	30 l	H
	706214 03.9901-6214.2/01	12779 0	50 l	P
	706205 03.9901-6205.2/01	12778 3	200 l	S
<b>SUPER DOT 4</b> SAE Spezifikation J1704 FMVSS §571.116/DOT 4	706003 03.9901-6003.2/02	06249 7	5 l	F
	706020 03.9901-6020.2/01	14544 2	30 l	H
	706005 03.9901-6005.2/01	07769 9	200 l	S
<b>ATE Bremszylinder-Paste</b> ATE Brake Cylinder Paste	700009 03.9902-05XX.2/02	13536 8	180 g	L
	700010 03.9902-0503.2/01	13532 0	5 kg	K
	700011 03.9902-0504.2/01	13530 6	40 kg	P
<b>ATE Prüfflüssigkeit</b> ATE Testing Fluid	700002 03.9902-0116.2/02	10374 9	5 l	F
<b>ATE plastilube™</b>	700014 03.9902-1001.2/02	05176 7	35 ml	I
	700015 03.9902-1002.2/02	05184 2	75 ml	J
<b>ATE Leerkanne</b> ATE neutral empty container	740169 03.9302-1474.1/01	07782 8	25 l	S
<b>Ausgiesser für 5-l-Kanne</b> Spout for 5l container	760070 03.9314-5940.3/01	07786 6	1 St.	S
<b>Kannen-Auslass-Hahn für 5-l- und 20-l-Kanne</b> Tap for 5l and 20l tin	760153 03.9314-5960.3/02	30855 7	1 St.	S

**\*Paletteneinheit:**

A =	1.728 Kannen je Palette	(24 Kannen je Karton)
B =	1.200 Kannen je Palette	(20 Kannen je Karton)
D =	600 Kannen je Palette	(10 Kannen je Karton)
E =	360 Kannen je Palette	(10 Kannen je Karton)
F =	144 Kannen je Palette	( 4 Kannen je Karton)
G =	50 Kannen je Palette	
H =	22 Kannen je Palette	
I =	5.040 Tuben je Palette	(24 Tuben je Karton)
J =	1.728 Tuben je Palette	(12 Tuben je Karton)
K =	60 Eimer je Palette	
L =	1.800 Tuben je Palette	(40 Tuben je Karton)
M =	18 Kannen je Palette	
N =	300 Kannen je Palette	(10 Kannen je Karton)
O =	64 Kannen je Palette	( 4 Kannen je Karton)
P =	12 Kannen je Palette	
R =	36 Kannen je Palette	
S =	1 Stück	

**\*Pallet unit:**

A =	1.728 containers per pallet	(24 containers per box)
B =	1.200 containers per pallet	(20 containers per box)
D =	600 containers per pallet	(10 containers per box)
E =	360 containers per pallet	(10 containers per box)
F =	144 containers per pallet	( 4 containers per box)
G =	50 containers per pallet	
H =	22 containers per pallet	
I =	5.040 tubes per pallet	(24 tubes per box)
J =	1.728 tubes per pallet	(12 tubes per box)
K =	60 buckets per pallet	
L =	1.800 tubes per pallet	(40 tubes per box)
M =	18 containers per pallet	
N =	300 containers per pallet	(10 tubes per box)
O =	64 containers per pallet	( 4 containers per box)
P =	12 containers per pallet	
R =	36 containers per pallet	
S =	1 piece	



# Mit sicherer Hand With a steady hand

Einen Überblick über alle Geräte und Werkzeuge bietet Ihnen unser Werkzeugkatalog unter [www.ate-info.de](http://www.ate-info.de)

For an overview of all the equipment and tools, see our tool catalogue at [www.ate-info.de](http://www.ate-info.de)



## Test- und Prüfgeräte

Ob Sie Bremsflüssigkeit, Sensoren oder andere Komponenten testen: ATE Geräte und die passenden Werkzeuge sind exakt und zuverlässig – das macht die Bremsendiagnose einfacher.

## Test and inspection equipment

Whether you're testing brake fluid, sensors or other components, ATE devices and their matching tools are accurate and reliable – and that makes brake diagnosis much easier.



## Entlüftungsgeräte

Bremsen schnell und effektiv entlüften: Sie haben die Wahl unter verschiedenen Geräten für unterschiedliche Fahrzeugtypen und Bremssysteme – auch mit integrierter Absauganlage.

## Brake bleeding units

Bleeding brakes quickly and effectively: choose from different units for different vehicle models and braking systems – integrated exhaust extraction systems are also available.

## Professionelle Ausstattung

Werkzeuge und Geräte von ATE sind genau auf unsere Produkte und Services abgestimmt. Das erleichtert Ihnen die Arbeit und gibt Ihnen die Sicherheit, immer einen zuverlässigen Job zu machen. Und wenn es um Fahrzeugelektronik geht, sind VDO Ersatzteile und Services die ideale Ergänzung.

## Professional equipment

ATE tools and devices are customised to exactly match our products and services. This makes your work easier and gives you the assurance that you're doing a dependable job. When it comes to vehicle electronics, VDO spare parts and services are also the perfect additions to your equipment.



## Entsorgungsgeräte

Um gebrauchte Bremsflüssigkeit umwelt-schonend und kostengünstig zu entsorgen, muss sie zunächst sortenrein gesammelt werden. Kein Problem mit unseren Entsorgungssystemen.

## Disposal devices

To dispose of used brake fluid in an environmentally friendly and cost-effective way, it must first be sorted into different types. That's no problem with our disposal systems.



## Spezial-Werkzeuge

Bei ATE finden Sie alles, was Sie für den Einbau und die Wartung der verschiedenen Bremskomponenten brauchen – in Top-Qualität und genau auf die Anwendung abgestimmt.

## Special tools

At ATE, you'll find everything you need for the installation and maintenance of different brake components – all in top quality and exactly tailored to suit their purpose.



# Noch besser sein

## Be even better

### Technische Trainings für ATE

Alles, was Sie zum Thema Bremsen-wartung und -diagnose wissen müssen, anschaulich und praxis-orientiert vermittelt. Zum Beispiel:

- | Diagnose und Instandhaltung moderner Bremsanlagen
- | Direktannahme: So nutzen Sie Potenziale für Ihr Geschäft
- | Fahrerassistenzsysteme

### Technische Trainings für VDO

In Fahrzeugen werden immer mehr Elektronik- und Mechatronik-Teile verbaut – bleiben Sie auf dem Laufenden. Einige Themen:

- | Elektrische Grundlagenpraxis am Beispiel ATE/VDO
- | Digitales Serviceheft
- | Diesel: moderne Common-Rail-Einspritzsysteme

### Produkt- und Verkaufstrainings

Steigern Sie Ihren Geschäftserfolg durch motivierte Mitarbeiter und neue Angebote für Ihre Kunden. Unter anderem mit diesen Trainings:

- | Qualifizierungen für Hochvolt-Fahrzeuge
- | Sachkundetrainings für Airbag, Klima-anlagen und Abgasuntersuchung
- | Mitarbeiterführung und Entwicklung für Kfz-Betriebe

#### Die Vorteile für ATE BremsenCenter

Sie nehmen an speziellen Informationsveranstaltungen und Trainings teil, die eigens für ATE BremsenCenter konzipiert wurden. Regelmäßige fach-spezifische Qualifikationen für Sie und Ihre Mitarbeiter sind kostenfrei.

#### The benefits for ATE BrakeCenters

You take part in special information events and training courses that have been specially designed for ATE BrakeCenters. Regular training for you and your employees is free of charge.



Unter [www.morecontinental.com](http://www.morecontinental.com) finden Sie eine Auswahl aus dem aktuellen Trainingsprogramm.

A selection from the current training programme is available at [www.morecontinental.com](http://www.morecontinental.com)



## Technical ATE training courses

Everything you need to know about brake maintenance and diagnosis, presented clearly and with a practical emphasis. For example:

- | Diagnosis and maintenance of modern brake systems
- | Service reception bay: helping you to utilise all the potential opportunities for your business
- | Driver assistance systems

## Technical VDO training courses

More and more electronic and mecha-  
tronic parts are being installed in  
today's vehicles – stay up to date!  
Some topics:

- | Basic electrical practice using ATE/  
VDO as an example
- | Digital service book
- | Diesel: modern common-rail injection  
systems

## Product and sales training courses

Increase your business success  
through motivated employees and  
new offers for your customers –  
with these training courses (and more):

- | Qualification to work on high-voltage  
systems
- | Trainings for airbag, air conditioning  
systems and emissions inspection
- | Leadership and development  
for vehicle workshops





## DE Inhaltsverzeichnis

Neue Artikel	15
Ersetzte Artikel	21
Fahrzeugregister	23
Fahrzeugverwendungen	34
Abbildungen Scheibenbremsbeläge	1676
Abbildungen Bremsbelag-Einbausätze	2017
Abbildungen Warnkontakte	2035
Abmessungen Bremsscheiben	2079
Vergleichsliste WVA → ATE	2103
Vergleichsliste ATE → WVA	2111
Technische Übersetzungen	2119

## EN Table of contents

New parts	15
Replaced parts	21
Index of vehicles	23
Applications of vehicles	34
Illustrations disc brake pads	1676
Illustrations brake pad installation kits	2017
Illustrations wear indicators	2035
Dimensions brake discs	2079
Cross reference list WVA → ATE	2103
Cross reference list ATE → WVA	2111
Technical translations	2119

## ES Índice

Nuevas referencias	15
Referencias de sustitución	21
Índice de vehículos	23
Aplicaciones	34
Ilustraciones de pastillas	1676
Ilustraciones juegos de montaje pastillas	2017
Ilustraciones contactos de desgaste	2035
Medidas disco de freno	2079
Lista referencias WVA → ATE	2103
Lista referencias ATE → WVA	2111
Traducciones técnicas	2119

## FR Table des matières

Nouvelles références	15
Références remplacées	21
Liste des véhicules	23
Applications	34
Illustrations Plaquettes de frein à disque	1676
Illustrations Lots de montage pour plaquettes de frein à disque	2017
Illustrations témoins d'usure	2035
Dimensions Disques de frein	2079
Liste des correspondances WVA → ATE	2103
Liste des correspondances ATE → WVA	2111
Traductions techniques	2119

## IT Sommario

Codici nuovi	15
Codici sostitutivi	21
Indice autovetture	23
Applicazioni autoveicoli	34
Illustrazioni Pastiglie Freno	1676
Illustrazioni kit installazione pastiglie freno	2017
Illustrazioni rilevatori usura	2035
Misure dischi freno	2079
Tabella di conversione codici WVA → ATE	2103
Tabella di conversione codici ATE → WVA	2111
Traduzioni tecniche	2119









- DE** Neue Artikel
- EN** New parts
- ES** Nuevas referencias
- FR** Nouvelles références
- IT** Codici nuovi

2019



# Neue Artikel

New parts - Nuevas referencias - Nouvelles références - Codici nuovi





					
13.0460-2601.2	602601 BMW	2 Active Tourer (F45)	13.0460-4016.2	604016 PORSCHE	911
13.0460-2601.2	602601 BMW	2 Gran Tourer (F46)	13.0460-4016.2	604016 PORSCHE	911 (964)
13.0460-2601.2	602601 BMW	X1 (F48)	13.0460-4016.2	604016 PORSCHE	911 (993)
13.0460-2601.2	602601 BMW	X2 (F39)	13.0460-4016.2	604016 PORSCHE	911 Cabriolet (964)
13.0460-2601.2	602601 MINI	MINI CLUBMAN (F54)	13.0460-4016.2	604016 PORSCHE	911 Cabriolet (993)
13.0460-2601.2	602601 MINI	MINI COUNTRYMAN (F60)	13.0460-4016.2	604016 PORSCHE	911 Speedster (964)
13.0460-2602.2	602602 FIAT	500X (334_)	13.0460-4016.2	604016 PORSCHE	911 Targa
13.0460-2602.2	602602 JEEP	RENEGADE Geländewagen geschlossen (BU, B1)	13.0460-4016.2	604016 PORSCHE	911 Targa (964)
13.0460-2603.2	602603 CITROËN	C4 II (B7)	13.0460-4016.2	604016 PORSCHE	911 Targa (993)
13.0460-2609.2	602609 VW	CADDY IV Kasten (SAA, SAH)	13.0460-4016.2	604016 PORSCHE	928
13.0460-2609.2	602609 VW	CADDY IV Kombi (SAB, SAJ)	13.0460-4016.2	604016 PORSCHE	944
13.0460-2609.2	602609 VW	CADDY ALLTRACK Kasten (SAA)	13.0460-4016.2	604016 PORSCHE	944 Cabriolet
13.0460-2609.2	602609 VW	CADDY ALLTRACK Kombi (SAB)	13.0460-4016.2	604016 PORSCHE	968
13.0460-2609.2	602609 VW	LOAD UP (121, 122, BL1, BL2)	13.0460-4016.2	604016 PORSCHE	968 Cabriolet
13.0460-2609.2	602609 VW	UP (121, 122, BL1, BL2)	13.0460-4887.2	604887 LEXUS	IS II (_E2_)
13.0460-2612.2	602612 SKODA	FABIA II (542)	13.0460-4889.2	604889 CITROËN	JUMPER Bus
13.0460-2612.2	602612 SKODA	FABIA II Combi (545)	13.0460-4889.2	604889 CITROËN	JUMPER Kasten
13.0460-2613.2	602613 BMW	2 Active Tourer (F45)	13.0460-4889.2	604889 CITROËN	JUMPER Pritsche/Fahrgestell
13.0460-2613.2	602613 BMW	2 Gran Tourer (F46)	13.0460-4889.2	604889 FIAT	DUCATO Bus (250_, 290_)
13.0460-2613.2	602613 MINI	MINI (F55)	13.0460-4889.2	604889 FIAT	DUCATO Kasten (250_, 290_)
13.0460-2613.2	602613 MINI	MINI (F56)	13.0460-4889.2	604889 FIAT	DUCATO Pritsche/Fahrgestell (250_, 290_)
13.0460-2613.2	602613 MINI	MINI Cabriolet (F57)	13.0460-4889.2	604889 PEUGEOT	BOXER Bus
13.0460-2613.2	602613 MINI	MINI CLUBMAN (F54)	13.0460-4889.2	604889 PEUGEOT	BOXER Kasten
13.0460-2613.2	602613 MINI	MINI COUNTRYMAN (F60)	13.0460-4889.2	604889 PEUGEOT	BOXER Pritsche/Fahrgestell
13.0460-2615.2	602615 OPEL	ASTRA K (B16)	13.0460-4890.2	604890 CITROËN	JUMPER Bus
13.0460-2615.2	602615 OPEL	ASTRA K Sports Tourer (B16)	13.0460-4890.2	604890 CITROËN	JUMPER Kasten
13.0460-2615.2	602615 VAUXHALL	ASTRA Mk VII (K) (B16)	13.0460-4890.2	604890 CITROËN	JUMPER Pritsche/Fahrgestell
13.0460-2615.2	602615 VAUXHALL	ASTRA Mk VII (K) Kombi (B16)	13.0460-4890.2	604890 FIAT	DUCATO Bus (250_, 290_)
13.0460-2619.2	602619 MITSUBISHI	COLT VI (Z3_A, Z2_A)	13.0460-4890.2	604890 FIAT	DUCATO Kasten (250_, 290_)
13.0460-2619.2	602619 MITSUBISHI	COLT CZC Cabriolet (RG)	13.0460-4890.2	604890 FIAT	DUCATO Pritsche/Fahrgestell (250_, 290_)
13.0460-2619.2	602619 SMART	FORFOUR (454)	13.0460-4890.2	604890 PEUGEOT	BOXER Bus
13.0460-2621.2	602621 SKODA	OCTAVIA III (5E3, NL3, NR3)	13.0460-4890.2	604890 PEUGEOT	BOXER Kasten
13.0460-2621.2	602621 SKODA	OCTAVIA III Combi (5E5)	13.0460-5647.2	605647 HYUNDAI	BOXER Pritsche/Fahrgestell
13.0460-2621.2	602621 VW	CC (358)	13.0460-5647.2	605647 HYUNDAI	i40 (VF)
13.0460-2621.2	602621 VW	PASSAT (3C2)	13.0460-5647.2	605647 HYUNDAI	i40 CW (VF)
13.0460-2621.2	602621 VW	PASSAT (362)	13.0460-5647.2	605647 KIA	OPTIMA
13.0460-2621.2	602621 VW	PASSAT ALLTRACK (365)	13.0460-5647.2	605647 KIA	OPTIMA Sportswagon (JF)
13.0460-2621.2	602621 VW	PASSAT CC (357)	13.0460-5647.2	605647 KIA	SOUL II (PS)
13.0460-2621.2	602621 VW	PASSAT Variant (3C5)	13.0460-5650.2	605650 HYUNDAI	ACCENT IV (RB)
13.0460-2621.2	602621 VW	PASSAT Variant (365)	13.0460-5650.2	605650 HYUNDAI	ACCENT IV Stufenheck (RB)
13.0460-2796.2	602796 AUDI	A4 (8W2, B9)	13.0460-5650.2	605650 HYUNDAI	ELANTRA Stufenheck (MD, UD)
13.0460-2796.2	602796 AUDI	A4 Allroad (8WH, B9)	13.0460-5650.2	605650 HYUNDAI	i10 (BA, IA)
13.0460-2796.2	602796 AUDI	A4 Avant (8W5, B9)	13.0460-5650.2	605650 HYUNDAI	i10 Stufenheck
13.0460-2796.2	602796 AUDI	A5 (F53)	13.0460-5650.2	605650 HYUNDAI	i20 (GB, IB)
13.0460-2796.2	602796 AUDI	A5 Cabriolet (F57)	13.0460-5650.2	605650 HYUNDAI	i20 ACTIVE (IB, GB)
13.0460-2796.2	602796 AUDI	A5 Sportback (F5A)	13.0460-5650.2	605650 HYUNDAI	i20 Coupe (GB)
13.0460-2796.2	602796 AUDI	Q5 (FYB)	13.0460-5650.2	605650 HYUNDAI	i30 (GD)
13.0460-2796.2	602796 AUDI	Q7 (4MB)	13.0460-5650.2	605650 HYUNDAI	i30 Coupe
13.0460-2799.2	602799 PORSCHE	MACAN (95B)	13.0460-5650.2	605650 HYUNDAI	i30 Kombi (GD)
13.0460-3869.2	603869 PEUGEOT	308 II	13.0460-5650.2	605650 HYUNDAI	i40 (VF)
13.0460-3869.2	603869 PEUGEOT	308 SW II	13.0460-5650.2	605650 HYUNDAI	i40 CW (VF)
13.0460-3874.2	603874 TOYOTA	AVENSIS Kombi (_T27_)	13.0460-5650.2	605650 HYUNDAI	ix35 (LM, EL, ELH)
13.0460-3874.2	603874 TOYOTA	AVENSIS Stufenheck (_T27_)	13.0460-5650.2	605650 HYUNDAI	TUCSON (TL)
13.0460-3874.2	603874 TOYOTA	VERSO (_R2_)	13.0460-5650.2	605650 HYUNDAI	VELOSTER (FS)
13.0460-3876.2	603876 PEUGEOT	308 II	13.0460-5650.2	605650 KIA	CARENS IV
13.0460-3876.2	603876 PEUGEOT	308 SW II	13.0460-5650.2	605650 KIA	CEE'D (JD)
13.0460-3877.2	603877 VW	AMAROK (2HA, 2HB, S1B, S6B, S7A, S7B)	13.0460-5650.2	605650 KIA	CEE'D Sportswagon (JD)
13.0460-3877.2	603877 VW	AMAROK Pritsche/Fahrgestell (S1B)	13.0460-5650.2	605650 KIA	NIRO
			13.0460-5650.2	605650 KIA	OPTIMA
			13.0460-5650.2	605650 KIA	OPTIMA
			13.0460-5650.2	605650 KIA	OPTIMA Sportswagon (JF)
			13.0460-5650.2	605650 KIA	PRO CEE'D (JD)
			13.0460-5650.2	605650 KIA	RIO III (UB)









# Neue Artikel

New parts - Nuevas referencias - Nouvelles références - Codici nuovi

			
13.0460-5650.2	605650 KIA RIO III Stufenheck (UB)	13.0460-7314.2	607314 AUDI A5 Cabriolet (F57)
13.0460-5650.2	605650 KIA SOUL II (PS)	13.0460-7314.2	607314 AUDI A5 Sportback (F5A)
13.0460-5650.2	605650 KIA SPORTAGE (QL, QLE)	13.0460-7316.2	607316 MERCEDES-BENZ C-CLASS Coupe (C205)
13.0460-5651.2	605651 HYUNDAI i30 (GD)	13.0460-7316.2	607316 MERCEDES-BENZ C-CLASS T-Model (S205)
13.0460-5651.2	605651 HYUNDAI i30 Coupe	13.0460-7316.2	607316 MERCEDES-BENZ GLC (X253)
13.0460-5651.2	605651 HYUNDAI i30 Kombi (GD)	13.0460-7316.2	607316 MERCEDES-BENZ GLC Coupe (C253)
13.0460-5651.2	605654 KIA CEE'D (JD)	13.0460-7320.2	607320 FORD GALAXY
13.0460-5651.2	605651 KIA CEE'D Sportswagon (JD)	13.0460-7320.2	607320 FORD KUGA II (DM2)
13.0460-5651.2	605651 KIA PRO CEE'D (JD)	13.0460-7320.2	607320 FORD KUGA II Van
13.0460-5653.2	605653 HYUNDAI i10 (BA, IA)	13.0460-7320.2	607320 FORD MONDEO V Schrägheck
13.0460-5653.2	605653 HYUNDAI i10 Stufenheck	13.0460-7320.2	607320 FORD MONDEO V Stufenheck
13.0460-5654.2	605654 CITROËN C4 AIRCROSS	13.0460-7320.2	607320 FORD MONDEO V Turnier
13.0460-5654.2	605654 MAZDA 6 Kombi (GJ, GL)	13.0460-7320.2	607320 FORD S-MAX
13.0460-5654.2	605654 MAZDA 6 Stufenheck (GJ, GL)	13.0460-7320.2	607320 FORD USA EDGE
13.0460-5654.2	605654 MITSUBISHI ASX (GA_W_)	13.0460-7324.2	607324 OPEL ASTRA K (B16)
13.0460-5654.2	605654 MITSUBISHI ASX Van (GA_W_)	13.0460-7324.2	607324 OPEL ASTRA K Sports Tourer (B16)
13.0460-5654.2	605654 MITSUBISHI OUTLANDER III (GG_W, GF_W, ZJ)	13.0460-7324.2	607324 VAUXHALL ASTRA Mk VII (K) (B16)
13.0460-5654.2	605654 PEUGEOT 4008	13.0460-7324.2	607324 VAUXHALL ASTRA Mk VII (K) Kombi (B16)
13.0460-5655.2	605655 SUZUKI SWIFT IV (FZ, NZ)	13.0460-7325.2	607325 OPEL ASTRA K (B16)
13.0460-5655.2	605655 SUZUKI SX4 S-Cross (JY)	13.0460-7325.2	607325 OPEL ASTRA K Sports Tourer (B16)
13.0460-5655.2	605655 SUZUKI VITARA (LY)	13.0460-7325.2	607325 VAUXHALL ASTRA Mk VII (K) (B16)
13.0460-5656.2	605656 SUZUKI SX4 S-Cross (JY)	13.0460-7325.2	607325 VAUXHALL ASTRA Mk VII (K) Kombi (B16)
13.0460-5656.2	605656 SUZUKI VITARA (LY)	13.0460-7326.2	607326 JAGUAR E-PACE (X540)
13.0460-5657.2	605657 MAZDA 3 (BM, BN)	13.0460-7326.2	607326 JAGUAR F-PACE (X761)
13.0460-5657.2	605657 MAZDA 3 Stufenheck (BM, BN)	13.0460-7326.2	607326 JAGUAR XE (X760)
13.0460-5659.2	605659 HYUNDAI i30 Coupe	13.0460-7326.2	607326 JAGUAR XF (X260)
13.0460-5659.2	605659 KIA CEE'D (JD)	13.0460-7326.2	607326 JAGUAR XF SPORTBRAKE (X260)
13.0460-5659.2	605659 KIA CEE'D Sportswagon (JD)	13.0460-7326.2	607326 LAND ROVER DISCOVERY SPORT (L550)
13.0460-5659.2	605659 KIA CERATO KOUP (TD)	13.0460-7326.2	607326 LAND ROVER RANGE ROVER EVOQUE (L538)
13.0460-5659.2	605659 KIA OPTIMA	13.0460-7326.2	607326 LAND ROVER RANGE ROVER EVOQUE Cabriolet (L538)
13.0460-5659.2	605659 KIA PRO CEE'D (JD)	13.0460-7326.2	607326 VOLVO S90 II (234)
13.0460-5660.2	605660 KIA OPTIMA	13.0460-7326.2	607326 VOLVO V90 II Kombi (235, 236)
13.0460-5661.2	605661 KIA CARENS IV	13.0460-7326.2	607326 VOLVO XC60 II (246)
13.0460-5662.2	605662 FIAT 500X (334_)	13.0460-7326.2	607326 VOLVO XC90 II (256)
13.0460-5662.2	605662 JEEP RENEGADE Geländewagen geschlossen (BU, B1)	13.0460-7327.2	607327 VOLVO XC60 (156)
13.0460-5663.2	605663 CHEVROLET LACETTI (J200)	13.0460-7328.2	607328 VOLVO S90 II (234)
13.0460-5663.2	605663 CHEVROLET LACETTI Kombi (J200)	13.0460-7328.2	607328 VOLVO V90 II Kombi (235, 236)
13.0460-5663.2	605663 CHEVROLET LACETTI Stufenheck (J200)	13.0460-7328.2	607328 VOLVO XC40 (536)
13.0460-5663.2	605663 CHEVROLET NUBIRA Kombi	13.0460-7328.2	607328 VOLVO XC60 II (246)
13.0460-5663.2	605663 CHEVROLET NUBIRA Stufenheck	13.0460-7328.2	607328 VOLVO XC90 II (256)
13.0460-5663.2	605663 DAEWOO GENTRA Stufenheck	13.0460-7330.2	607330 LAND ROVER DISCOVERY SPORT (L550)
13.0460-5664.2	605664 MAZDA CX-3 (DK)	13.0460-7330.2	607330 LAND ROVER RANGE ROVER EVOQUE (L538)
13.0460-5664.2	605664 MAZDA CX-5 (KE, GH)	13.0460-7330.2	607330 LAND ROVER RANGE ROVER EVOQUE Cabriolet (L538)
13.0460-5673.2	605673 OPEL KARL (C16)	13.0460-7331.2	607331 CITROËN JUMPY (VA_, VE_)
13.0460-5673.2	605673 VAUXHALL VIVA (C16)	13.0460-7331.2	607331 CITROËN JUMPY Kasten
13.0460-5674.2	605674 MAZDA 2 (DL, DJ)	13.0460-7331.2	607331 CITROËN JUMPY Pritsche/Fahrgestell
13.0460-5679.2	605679 FIAT TIPO Kombi (357_)	13.0460-7331.2	607331 CITROËN SPACETOURER
13.0460-5679.2	605679 FIAT TIPO Schrägheck (357_)	13.0460-7331.2	607331 PEUGEOT EXPERT Kasten
13.0460-5679.2	605679 FIAT TIPO Stufenheck (356_)	13.0460-7331.2	607331 PEUGEOT EXPERT Pritsche/Fahrgestell
13.0460-5683.2	605683 SUZUKI BALENO (FW, EW)	13.0460-7331.2	607331 PEUGEOT TRAVELLER
13.0460-5781.2	605781 HYUNDAI ix20 (JC)	13.0470-2613.2	LD2613 BMW 2 Active Tourer (F45)
13.0460-5781.2	605781 HYUNDAI TUCSON (TL)	13.0470-2613.2	LD2613 BMW 2 Gran Tourer (F46)
13.0460-5781.2	605781 KIA PICANTO (TA)	13.0470-2613.2	LD2613 MINI MINI (F55)
13.0460-5781.2	605781 KIA SPORTAGE (QL, QLE)	13.0470-2613.2	LD2613 MINI MINI (F56)
13.0460-7291.2	607291 HONDA ACCORD VIII (CU)	13.0470-2613.2	LD2613 MINI MINI Cabriolet (F57)
13.0460-7291.2	607291 HONDA ACCORD VIII Kombi (CW)	13.0470-2613.2	LD2613 MINI MINI CLUBMAN (F54)
13.0460-7311.2	607311 FIAT 500X (334_)	13.0470-2613.2	LD2613 MINI MINI COUNTRYMAN (F60)
13.0460-7311.2	607311 JEEP RENEGADE Geländewagen geschlossen (BU, B1)		
13.0460-7313.2	607313 FORD GALAXY		
13.0460-7313.2	607313 FORD MONDEO V Schrägheck		
13.0460-7313.2	607313 FORD MONDEO V Stufenheck		
13.0460-7313.2	607313 FORD MONDEO V Turnier		
13.0460-7313.2	607313 FORD S-MAX		
13.0460-7314.2	607314 AUDI A4 (8W2, B9)		
13.0460-7314.2	607314 AUDI A4 Allroad (8WH, B9)		
13.0460-7314.2	607314 AUDI A4 Avant (8W5, B9)		
13.0460-7314.2	607314 AUDI A5 (F53)		





# Neue Artikel

New parts - Nuevas referencias - Nouvelles références - Codici nuovi

					
13.0470-2615.2	LD2615 OPEL	ASTRA K (B16)	13.0470-4883.2	LD4883 MERCEDES- BENZ	GLC Coupe (C253)
13.0470-2615.2	LD2615 OPEL	ASTRA K Sports Tourer (B16)	13.0470-5651.2	LD5651 HYUNDAI	i30 (GD)
13.0470-2615.2	LD2615 VAUXHALL	ASTRA Mk VII (K) (B16)	13.0470-5651.2	LD5651 HYUNDAI	i30 Coupe
13.0470-2615.2	LD2615 VAUXHALL	ASTRA Mk VII (K) Kombi (B16)	13.0470-5651.2	LD5651 HYUNDAI	i30 Kombi (GD)
13.0470-2621.2	LD2621 SKODA	OCTAVIA III (5E3, NL3, NR3)	13.0470-5651.2	LD5651 KIA	CEE'D (JD)
13.0470-2621.2	LD2621 SKODA	OCTAVIA III Combi (5E5)	13.0470-5651.2	LD5651 KIA	CEE'D Sportswagon (JD)
13.0470-2621.2	LD2621 VW	CC (358)	13.0470-5664.2	LD5664 MAZDA	PRO CEE'D (JD)
13.0470-2621.2	LD2621 VW	PASSAT (3C2)	13.0470-5664.2	LD5664 MAZDA	CX-3 (DK)
13.0470-2621.2	LD2621 VW	PASSAT (362)	13.0470-7279.2	LD7279 CITROËN	CX-5 (KE, GH)
13.0470-2621.2	LD2621 VW	PASSAT ALLTRACK (365)	13.0470-7279.2	LD7279 CITROËN	C5 III (RD_)
13.0470-2621.2	LD2621 VW	PASSAT CC (357)	13.0470-7279.2	LD7279 CITROËN	C5 III Break (RW_)
13.0470-2621.2	LD2621 VW	PASSAT Variant (3C5)	13.0470-7279.2	LD7279 CITROËN	C6 (TD_)
13.0470-2621.2	LD2621 VW	PASSAT Variant (365)	13.0470-7279.2	LD7279 CITROËN	DS4
13.0470-2795.2	LD2795 BMW	2 Active Tourer (F45)	13.0470-7279.2	LD7279 DS	DS5
13.0470-2795.2	LD2795 MINI	MINI (F55)	13.0470-7279.2	LD7279 DS	DS 4 / DS 4 CROSSBACK
13.0470-2795.2	LD2795 MINI	MINI (F56)	13.0470-7279.2	LD7279 PEUGEOT	308 (4A_, 4C_)
13.0470-2795.2	LD2795 MINI	MINI Cabriolet (F57)	13.0470-7279.2	LD7279 PEUGEOT	308 CC (4B_)
13.0470-2795.2	LD2795 MINI	MINI CLUBMAN (F54)	13.0470-7279.2	LD7279 PEUGEOT	407 (6D_)
13.0470-2799.2	LD2799 PORSCHE	MACAN (95B)	13.0470-7279.2	LD7279 PEUGEOT	407 Coupe (6C_)
13.0470-3855.2	LD3855 CITROËN	C3 II (SC_)	13.0470-7279.2	LD7279 PEUGEOT	407 SW (6E_)
13.0470-3855.2	LD3855 CITROËN	C3 Picasso	13.0470-7279.2	LD7279 PEUGEOT	508 I (8D_)
13.0470-3855.2	LD3855 CITROËN	DS3	13.0470-7279.2	LD7279 PEUGEOT	508 SW I (8E_)
13.0470-3855.2	LD3855 CITROËN	DS3 Cabriolet	13.0470-7279.2	LD7279 PEUGEOT	RCZ
13.0470-3855.2	LD3855 DS	DS 3	13.0470-7298.2	LD7298 DACIA	LOGAN II
13.0470-3855.2	LD3855 DS	DS 3 Cabriolet	13.0470-7298.2	LD7298 DACIA	LOGAN MCV II
13.0470-3855.2	LD3855 PEUGEOT	2008 (CU_)	13.0470-7298.2	LD7298 DACIA	SANDERO II
13.0470-3861.2	LD3861 ALFA ROMEO	MITO (955_)	13.0470-7298.2	LD7298 RENAULT	CLIO IV (BH_)
13.0470-3861.2	LD3861 CHRYSLER	DELTA	13.0470-7298.2	LD7298 RENAULT	CLIO IV Kasten
13.0470-3861.2	LD3861 FIAT	BRAVO II (198_)	13.0470-7298.2	LD7298 RENAULT	LOGAN II (L8_)
13.0470-3861.2	LD3861 FIAT	MULTIPLA (186_)	13.0470-7298.2	LD7298 RENAULT	LOGAN II Kombi (K8_)
13.0470-3861.2	LD3861 FIAT	STILO (192_)	13.0470-7298.2	LD7298 RENAULT	SANDERO/STEPWAY II (B8_)
13.0470-3861.2	LD3861 FIAT	STILO Multi Wagon (192_)	13.0470-7298.2	LD7298 RENAULT	THALIA II (LU1/2_)
13.0470-3861.2	LD3861 LANCIA	DELTA III (844_)	13.0470-7298.2	LD7298 RENAULT	THALIA III (L8_)
13.0470-3869.2	LD3869 PEUGEOT	308 II	13.0470-7298.2	LD7298 RENAULT	TWINGO III (BCM_)
13.0470-3869.2	LD3869 PEUGEOT	308 SW II	13.0470-7298.2	LD7298 SMART	FORFOUR Schrägheck (453)
13.0470-4875.2	LD4875 BMW	1 (F20)	13.0470-7298.2	LD7298 SMART	FORTWO Cabriolet (453)
13.0470-4875.2	LD4875 BMW	1 (F21)	13.0470-7298.2	LD7298 SMART	FORTWO Coupe (453)
13.0470-4875.2	LD4875 BMW	2 Cabriolet (F23)	13.0470-7299.2	LD7299 FORD	FOCUS III
13.0470-4875.2	LD4875 BMW	2 Coupe (F22, F87)	13.0470-7299.2	LD7299 FORD	FOCUS III Stufenheck
13.0470-4875.2	LD4875 BMW	3 (F30, F80)	13.0470-7299.2	LD7299 FORD	FOCUS III Turnier
13.0470-4875.2	LD4875 BMW	3 Gran Turismo (F34)	13.0470-7299.2	LD7299 FORD	KUGA II (DM2)
13.0470-4875.2	LD4875 BMW	3 Touring (F31)	13.0470-7299.2	LD7299 FORD	KUGA II Van
13.0470-4875.2	LD4875 BMW	4 Cabriolet (F33, F83)	13.0470-7299.2	LD7299 FORD	TOURNEO CONNECT / GRAND TOURNEO
13.0470-4875.2	LD4875 BMW	4 Coupe (F32, F82)	13.0470-7299.2	LD7299 FORD	CONNECT Kombi
13.0470-4875.2	LD4875 BMW	4 Gran Coupe (F36)	13.0470-7299.2	LD7299 FORD	TRANSIT CONNECT Kasten
13.0470-4883.2	LD4883 MERCEDES- BENZ	C-CLASS (W205)	13.0470-7299.2	LD7299 FORD	TRANSIT CONNECT Kombi
13.0470-4883.2	LD4883 MERCEDES- BENZ	C-CLASS Cabriolet (A205)	13.0470-7314.2	LD7314 AUDI	A4 (8W2, B9)
13.0470-4883.2	LD4883 MERCEDES- BENZ	C-CLASS Coupe (C205)	13.0470-7314.2	LD7314 AUDI	A4 Allroad (8WH, B9)
13.0470-4883.2	LD4883 MERCEDES- BENZ	C-CLASS T-Model (S205)	13.0470-7314.2	LD7314 AUDI	A4 Avant (8W5, B9)
13.0470-4883.2	LD4883 MERCEDES- BENZ	CLS (C257)	13.0470-7314.2	LD7314 AUDI	A5 (F53)
13.0470-4883.2	LD4883 MERCEDES- BENZ	E-CLASS (W213)	13.0470-7314.2	LD7314 AUDI	A5 Cabriolet (F57)
13.0470-4883.2	LD4883 MERCEDES- BENZ	E-CLASS All-Terrain (S213)	13.0470-7314.2	LD7314 AUDI	A5 Sportback (F5A)
13.0470-4883.2	LD4883 MERCEDES- BENZ	E-CLASS Cabriolet (A238)	13.0470-7316.2	LD7316 MERCEDES- BENZ	C-CLASS Coupe (C205)
13.0470-4883.2	LD4883 MERCEDES- BENZ	E-CLASS Coupe (C238)	13.0470-7316.2	LD7316 MERCEDES- BENZ	C-CLASS T-Model (S205)
13.0470-4883.2	LD4883 MERCEDES- BENZ	E-CLASS T-Model (S213)	13.0470-7316.2	LD7316 MERCEDES- BENZ	GLC (X253)
13.0470-4883.2	LD4883 MERCEDES- BENZ	GLC (X253)	13.0470-7316.2	LD7316 MERCEDES- BENZ	GLC Coupe (C253)
			13.0470-7320.2	LD7320 FORD	GALAXY
			13.0470-7320.2	LD7320 FORD	KUGA II (DM2)
			13.0470-7320.2	LD7320 FORD	KUGA II Van
			13.0470-7320.2	LD7320 FORD	MONDEO V Schrägheck
			13.0470-7320.2	LD7320 FORD	MONDEO V Stufenheck

# Neue Artikel

New parts - Nuevas referencias - Nouvelles références - Codici nuovi

			
13.0470-7320.2	LD7320 FORD MONDEO V Turnier	24.0122-0293.1	422293 KIA RIO IV Stufenheck (SC, FB)
13.0470-7320.2	LD7320 FORD S-MAX	24.0122-0294.1	422294 HYUNDAI i20 (GB, IB)
13.0470-7320.2	LD7320 FORD USA EDGE	24.0122-0294.1	422294 HYUNDAI i20 ACTIVE (IB, GB)
13.0470-7324.2	LD7324 OPEL ASTRA K (B16)	24.0122-0294.1	422294 HYUNDAI i20 Coupe (GB)
13.0470-7324.2	LD7324 OPEL ASTRA K Sports Tourer (B16)	24.0122-0294.1	422294 KIA RIO III (UB)
13.0470-7324.2	LD7324 VAUXHALL ASTRA Mk VII (K) (B16)	24.0122-0294.1	422294 KIA RIO III Stufenheck (UB)
13.0470-7324.2	LD7324 VAUXHALL ASTRA Mk VII (K) Kombi (B16)	24.0122-0294.1	422294 KIA RIO IV (YB, SC)
13.0470-7325.2	LD7325 OPEL ASTRA K (B16)	24.0124-0262.2	424262 BMW 5 (G30, F90)
13.0470-7325.2	LD7325 OPEL ASTRA K Sports Tourer (B16)	24.0124-0262.2	424262 BMW 5 Touring (G31)
13.0470-7325.2	LD7325 VAUXHALL ASTRA Mk VII (K) (B16)	24.0124-0262.2	424262 BMW 6 Gran Turismo (G32)
13.0470-7325.2	LD7325 VAUXHALL ASTRA Mk VII (K) Kombi (B16)	24.0124-0262.2	424262 BMW 7 (G11, G12)
13.0470-7327.2	LD7327 VOLVO XC60 (156)	24.0124-0262.2	424262 BMW X3 (G01)
13.0470-7333.2	LD7333 ALFA ROMEO GIULIA (952_)	24.0124-0262.2	424262 BMW X4 (G02)
24.0110-0404.1	410404 OPEL ASTRA K (B16)	24.0124-0300.1	424300 MERCEDES-BENZ C-CLASS (W205)
24.0110-0404.1	410404 OPEL ASTRA K Sports Tourer (B16)	24.0124-0300.1	424300 MERCEDES-BENZ C-CLASS Cabriolet (A205)
24.0110-0404.1	410404 VAUXHALL ASTRA Mk VII (K) (B16)	24.0124-0300.1	424300 MERCEDES-BENZ C-CLASS Coupe (C205)
24.0110-0404.1	410404 VAUXHALL ASTRA Mk VII (K) Kombi (B16)	24.0124-0300.1	424300 MERCEDES-BENZ C-CLASS T-Model (S205)
24.0112-0217.2	412217 OPEL VIVARO B Combi (X82)	24.0125-0202.1	425202 FORD TOURNEO CONNECT / GRAND TOURNEO CONNECT Kombi
24.0112-0217.2	412217 OPEL VIVARO B Kasten (X82)	24.0125-0202.1	425202 FORD TRANSIT CONNECT Kasten
24.0112-0217.2	412217 OPEL VIVARO B Pritsche/Fahrgestell (X82)	24.0125-0202.1	425202 FORD TRANSIT CONNECT Kombi
24.0112-0217.2	412217 RENAULT TRAFIC III Bus (JG_)	24.0125-0213.1	425213 HYUNDAI i30 (PDE, PD)
24.0112-0217.2	412217 RENAULT TRAFIC III Kasten (FG_)	24.0125-0213.1	425213 HYUNDAI i30 FASTBACK (PDE)
24.0112-0217.2	412217 RENAULT TRAFIC III Pritsche/Fahrgestell (EG_)	24.0125-0213.1	425213 HYUNDAI i30 Kombi (PDE)
24.0112-0217.2	412217 VAUXHALL VIVARO Combi (X82)	24.0125-0213.1	425213 HYUNDAI TUCSON (TL)
24.0112-0217.2	412217 VAUXHALL VIVARO Kasten (X82)	24.0125-0213.1	425213 KIA SPORTAGE (QL, QLE)
24.0112-0217.2	412217 VAUXHALL VIVARO Pritsche/Fahrgestell (X82)	24.0125-0214.1	425214 MAZDA 3 (BM, BN)
24.0112-0218.1	412218 AUDI A4 (8W2, B9)	24.0125-0214.1	425214 MAZDA 3 Stufenheck (BM, BN)
24.0112-0218.1	412218 AUDI A4 Allroad (8WH, B9)	24.0126-0187.1	426187 OPEL ASTRA K (B16)
24.0112-0218.1	412218 AUDI A4 Avant (8W5, B9)	24.0126-0187.1	426187 OPEL ASTRA K Sports Tourer (B16)
24.0112-0218.1	412218 AUDI A5 (F53)	24.0126-0187.1	426187 VAUXHALL ASTRA Mk VII (K) (B16)
24.0112-0218.1	412218 AUDI A5 Cabriolet (F57)	24.0126-0187.1	426187 VAUXHALL ASTRA Mk VII (K) Kombi (B16)
24.0112-0218.1	412218 AUDI A5 Sportback (F5A)	24.0126-0188.1	426188 OPEL ASTRA K (B16)
24.0112-0218.1	412218 AUDI Q5 (FYB)	24.0126-0188.1	426188 OPEL ASTRA K Sports Tourer (B16)
24.0112-0300.1	412300 MERCEDES-BENZ C-CLASS (W205)	24.0126-0188.1	426188 VAUXHALL ASTRA Mk VII (K) (B16)
24.0112-0300.1	412300 MERCEDES-BENZ C-CLASS Cabriolet (A205)	24.0126-0188.1	426188 VAUXHALL ASTRA Mk VII (K) Kombi (B16)
24.0112-0300.1	412300 MERCEDES-BENZ C-CLASS Coupe (C205)	24.0128-0290.1	428290 FIAT FREEMONT (345_)
24.0112-0300.1	412300 MERCEDES-BENZ C-CLASS T-Model (S205)	24.0128-0292.1	428292 FIAT 500X (334_)
24.0116-0216.1	416216 FORD TRANSIT Bus (FD_ , FB_ , FS_ , FZ_ , FC_ )	24.0128-0292.1	428292 JEEP RENEGADE Geländewagen geschlossen (BU, B1)
24.0116-0216.1	416216 FORD TRANSIT Kasten (FA_ )	24.0128-0330.1	428330 MERCEDES-BENZ C-CLASS (W205)
24.0116-0216.1	416216 FORD TRANSIT Pritsche/Fahrgestell (FM_ , FN_ )	24.0128-0330.1	428330 MERCEDES-BENZ C-CLASS Cabriolet (A205)
24.0116-0216.1	416216 FORD TRANSIT TOURNEO	24.0128-0330.1	428330 MERCEDES-BENZ C-CLASS Coupe (C205)
24.0120-0244.1	420244 BMW 2 Active Tourer (F45)	24.0128-0330.1	428330 MERCEDES-BENZ C-CLASS T-Model (S205)
24.0120-0244.1	420244 BMW 2 Gran Tourer (F46)	24.0128-0330.1	428330 MERCEDES-BENZ E-CLASS (W213)
24.0120-0244.1	420244 BMW X1 (F48)	24.0128-0330.1	428330 MERCEDES-BENZ E-CLASS Cabriolet (A238)
24.0120-0244.1	420244 BMW X2 (F39)	24.0128-0330.1	428330 MERCEDES-BENZ E-CLASS Coupe (C238)
24.0120-0244.1	420244 MINI MINI CLUBMAN (F54)	24.0128-0330.1	428330 MERCEDES-BENZ E-CLASS T-Model (S213)
24.0120-0244.1	420244 MINI MINI COUNTRYMAN (F60)	24.0130-0235.1	430235 AUDI Q5 (8RB)
24.0120-0247.1	420247 VOLVO XC90 II (256)	24.0130-0242.1	430242 VOLVO XC60 II (246)
24.0120-0249.1	420249 OPEL KARL (C16)	24.0130-0242.1	430242 VOLVO XC90 II (256)
24.0120-0249.1	420249 VAUXHALL VIVA (C16)	24.0130-0243.1	430243 VOLVO S90 II (234)
24.0122-0293.1	422293 HYUNDAI i20 (GB, IB)	24.0130-0243.1	430243 VOLVO V90 II Kombi (235, 236)
24.0122-0293.1	422293 HYUNDAI i20 ACTIVE (IB, GB)		
24.0122-0293.1	422293 HYUNDAI i20 Coupe (GB)		
24.0122-0293.1	422293 HYUNDAI SOLARIS Stufenheck		
24.0122-0293.1	422293 KIA RIO IV (YB, SC)		



# Neue Artikel

New parts - Nuevas referencias - Nouvelles références - Codici nuovi



24.0130-0243.1	430243	VOLVO	XC40 (536)
24.0130-0243.1	430243	VOLVO	XC60 II (246)
24.0130-0243.1	430243	VOLVO	XC90 II (256)
24.0130-0244.1	430244	AUDI	A4 (8W2, B9)
24.0130-0244.1	430244	AUDI	A4 Allroad (8WH, B9)
24.0130-0244.1	430244	AUDI	A4 Avant (8W5, B9)
24.0130-0244.1	430244	AUDI	A5 (F53)
24.0130-0244.1	430244	AUDI	A5 Cabriolet (F57)
24.0130-0244.1	430244	AUDI	A5 Sportback (F5A)
24.0130-0244.1	430244	AUDI	Q5 (FYB)
24.0131-0100.1	431100	FORD	TRANSIT Bus
24.0131-0100.1	431100	FORD	TRANSIT Kasten
24.0131-0100.1	431100	FORD	TRANSIT Pritsche/Fahrge- stell
24.0132-0187.1	432187	TOYOTA	LAND CRUISER 200 (_J2_)
24.0132-0187.1	432187	TOYOTA	LAND CRUISER PRADO (_J15_)
24.0136-0132.2	436132	BMW	5 (G30, F90)
24.0136-0132.2	436132	BMW	5 Touring (G31)
24.0136-0132.2	436132	BMW	6 Gran Turismo (G32)
24.0136-0132.2	436132	BMW	7 (G11, G12)
24.0136-0132.2	436132	BMW	X3 (G01)
24.0136-0132.2	436132	BMW	X4 (G02)
24.0136-0132.2	436132	BMW	X5 (G05)
24.0136-0132.2	436132	MINI	MINI (F55)
24.0136-0133.2	436133	BMW	5 (G30, F90)
24.0136-0133.2	436133	BMW	5 Touring (G31)
24.0136-0133.2	436133	BMW	6 Gran Turismo (G32)
24.0136-0133.2	436133	BMW	7 (G11, G12)
24.0136-0133.2	436133	BMW	X3 (G01)
24.0136-0133.2	436133	BMW	X4 (G02)
24.0136-0133.2	436133	BMW	X5 (G05)
24.0136-0133.2	436133	MINI	MINI (F55)
24.8190-0961.2	620961	MERCEDES- BENZ	M-CLASS (W163)
24.8190-0962.2	620962	PORSCHE	MACAN (95B)
24.8190-0963.2	620963	AUDI	A8 (4H2, 4H8, 4HC, 4HL)
24.8190-0964.2	620964	AUDI	A8 (4N2, 4N8)
24.8190-0964.2	620964	AUDI	Q7 (4MB)
24.8190-0964.2	620964	VW	TOUAREG (CR7)
24.8190-0965.2	620965	PORSCHE	MACAN (95B)
24.8190-0967.2	620967	AUDI	A7 Sportback (4KA)
24.8190-0967.2	620967	PORSCHE	MACAN (95B)
24.8190-0968.2	620968	AUDI	A8 (4H2, 4H8, 4HC, 4HL)
24.8190-0970.2	620970	JAGUAR	XJ (X300, X330)
24.8190-0970.2	620970	JAGUAR	XJ (XJ40, XJ81)
24.8190-0970.2	620970	JAGUAR	XJ Coupe
24.8190-0970.2	620970	JAGUAR	XJSC Convertible (X27)
24.8190-0971.2	620971	AUDI	R8 (4S3)
24.8190-0971.2	620971	AUDI	R8 (422, 423)
24.8190-0971.2	620971	AUDI	R8 Spyder (4S9)
24.8190-0971.2	620971	AUDI	R8 Spyder (427, 429)
24.8190-0973.2	620973	LAND ROVER	RANGE ROVER III (L322)
24.8190-0976.2	620976	AUDI	Q7 (4MB)
24.8190-0976.2	620976	VW	TOUAREG (CR7)
24.8190-0977.2	620977	AUDI	A8 (4N2, 4N8)
24.8190-0977.2	620977	AUDI	Q7 (4MB)





- DE** Ersetzte Artikel
- EN** Replaced parts
- ES** Referencias de sustitución
- FR** Références remplacées
- IT** Codici sostitutivi

2019



# Ersetzte Artikel

Replaced parts - Referencias de sustitución - Références remplacées - Codici sostitutivi

 <b>Vorgänger Nr.</b> Replaced No. Codice precedente Ancienne référence Número anterior	 <b>Nachfolge Nr.</b> Replacing No. Codice nuovo Nouvelle référence Número posterior	 <b>Vorgänger Nr.</b> Replaced No. Codice precedente Ancienne référence Número anterior	 <b>Nachfolge Nr.</b> Replacing No. Codice nuovo Nouvelle référence Número posterior
<b>13.0470-2823.2</b> LD2823	<b>13.0470-2820.2</b> LD2820		
<b>13.0470-3812.2</b> LD3812	<b>13.0470-3861.2</b> LD3861		
<b>24.0116-0116.2</b> 416116	<b>24.0116-0216.1</b> 416216		
<b>24.0128-0300.1</b> 428300	<b>24.0128-0330.1</b> 428330		
<b>24.0132-0174.1</b> 432174	<b>24.0132-0187.1</b> 432187		







- DE** Fahrzeugregister
- EN** Index of vehicles
- ES** Índice de vehículos
- FR** Liste des véhicules
- IT** Indice autovettura

2019



**ABARTH 35**

124 Spider (348_)	35
500 / 595 / 695 (312_)	35
500C / 595C / 695C (312_)	35
GRANDE PUNTO (199_)	35
PUNTO (199_)	36
PUNTO EVO (199_)	36

**ALFA ROMEO 36**

145 (930_)	36
146 (930_)	37
147 (937_)	38
155 (167_)	39
156 (932_)	40
156 Sportwagon (932_)	43
159 (939_)	45
159 Sportwagon (939_)	46
164 (164_)	47
166 (936_)	48
BRERA (939_)	48
GIULIA (952_)	49
GIULIETTA (940_)	49
GT (937_)	50
GTV (916_)	51
MITO (955_)	51
SPIDER (916_)	53
SPIDER (939_)	54

**ASTON MARTIN 54**

CYGNET	54
--------	----

**AUDI 54**

80 Avant (8C5, B4)	54
A1 (8X1, 8XK)	55
A1 Sportback (8XA, 8XF)	57
A2 (8Z0)	59
A3 (8L1)	59
A3 (8P1)	61
A3 (8V1, 8VK)	68
A3 Cabriolet (8P7)	70
A3 Cabriolet (8V7, 8VE)	70
A3 Limousine (8VS, 8VM)	71
A3 Sportback (8PA)	73
A3 Sportback (8VA, 8VF)	79
A4 (8D2, B5)	81
A4 (8E2, B6)	85
A4 (8EC, B7)	88
A4 (8K2, B8)	92
A4 (8W2, B9)	94
A4 Allroad (8KH, B8)	94
A4 Allroad (8WH, B9)	95
A4 Avant (8D5, B5)	95
A4 Avant (8E5, B6)	98
A4 Avant (8ED, B7)	100
A4 Avant (8K5, B8)	104
A4 Avant (8W5, B9)	107
A4 Cabriolet (8H7, B6, 8HE, B7)	108
A5 (8T3)	111
A5 (F53)	115
A5 Cabriolet (8F7)	115
A5 Cabriolet (F57)	118
A5 Sportback (8TA)	118
A5 Sportback (F5A)	120
A6 (4A2, C4)	120
A6 (4B2, C5)	121
A6 (4F2, C6)	125
A6 (4G2, 4GC, C7)	130
A6 Allroad (4FH, C6)	133
A6 Allroad (4GH, 4GJ)	134
A6 Avant (4A5, C4)	135
A6 Avant (4B5, C5)	135
A6 Avant (4F5, C6)	139
A6 Avant (4G5, 4GD, C7)	141
A7 Sportback (4GA, 4GF)	144
A7 Sportback (4KA)	147
A8 (4D2, 4D8)	147
A8 (4E2, 4E8)	150
A8 (4H2, 4H8, 4HC, 4HL)	152

**AUDI 54**

A8 (4N2, 4N8)	154
ALLROAD (4BH, C5)	154
CABRIOLET (8G7, B4)	155
COUPE (89, 8B)	155
Q2 (GAB)	156
Q3 (8UB, 8UG)	156
Q5 (8RB)	157
Q5 (FYB)	160
Q7 (4LB)	160
Q7 (4MB)	161
R8 (422, 423)	162
R8 (4S3)	161
R8 Spyder (427, 429)	162
R8 Spyder (4S9)	162
TT (8J3)	162
TT (8N3)	164
TT (FV3)	165
TT Roadster (8J9)	165
TT Roadster (8N9)	167
TT Roadster (FV9)	168

**BENTLEY 169**

ARNAGE (RBS_)	169
AZURE	169
CONTINENTAL	169
CONTINENTAL Coupe (3W_)	169

**BMW 169**

1 (E81)	169
1 (E87)	174
1 (F20)	180
1 (F21)	183
1 Cabriolet (E88)	186
1 Coupe (E82)	188
2 Active Tourer (F45)	191
2 Cabriolet (F23)	192
2 Coupe (F22, F87)	194
2 Gran Tourer (F46)	196
3 (E36)	197
3 (E46)	198
3 (E90)	200
3 (F30, F80)	214
3 Cabriolet (E36)	219
3 Cabriolet (E46)	220
3 Cabriolet (E93)	221
3 Compact (E36)	225
3 Compact (E46)	226
3 Coupe (E36)	226
3 Coupe (E46)	227
3 Coupe (E92)	229
3 Gran Turismo (F34)	237
3 Touring (E36)	240
3 Touring (E46)	240
3 Touring (E91)	241
3 Touring (F31)	253
4 Cabriolet (F33, F83)	260
4 Coupe (F32, F82)	262
4 Gran Coupe (F36)	265
5 (E39)	267
5 (E60)	271
5 (F10)	280
5 (G30, F90)	286
5 Gran Turismo (F07)	287
5 Touring (E34)	289
5 Touring (E39)	290
5 Touring (E61)	292
5 Touring (F11)	302
5 Touring (G31)	309
6 (E63)	309
6 Cabriolet (E64)	310
6 Cabriolet (F12)	311
6 Coupe (F13)	313
6 Gran Coupe (F06)	314
6 Gran Turismo (G32)	315
7 (E38)	315
7 (E65, E66, E67)	317
7 (F01, F02, F03, F04)	319
7 (G11, G12)	321

**BMW 169**

8 (E31)	322
i3 (I01)	322
i8 (I12)	322
i8 Roadster (I15)	322
X1 (E84)	322
X1 (F48)	325
X2 (F39)	326
X3 (E83)	326
X3 (F25)	328
X3 (G01)	329
X4 (F26)	330
X4 (G02)	330
X5 (E53)	331
X5 (E70)	332
X5 (F15, F85)	335
X5 (G05)	336
X6 (E71, E72)	336
X6 (F16, F86)	339
Z3 Coupe (E36)	340
Z3 Roadster (E36)	341
Z4 Coupe (E86)	342
Z4 Roadster (E85)	343
Z4 Roadster (E89)	344
Z8 Roadster (E52)	345

**CHEVROLET 345**

ASTRA Schrägheck	345
ASTRA Stufenheck	345
AVEO / KALOS Schrägheck (T200)	346
AVEO / KALOS Stufenheck (T200)	346
AVEO Schrägheck (T250, T255)	346
AVEO Schrägheck (T300)	346
AVEO Stufenheck (T250, T255)	347
AVEO Stufenheck (T300)	347
CAMARO	347
CAPTIVA (C100, C140)	348
COBALT	348
CRUZE (J300)	349
CRUZE Schrägheck (J305)	349
CRUZE Station Wagon (J308)	350
EPICA (KL1_)	350
EVANDA	350
IMPALA Stufenheck	350
LACETTI (J200)	350
LACETTI Kombi (J200)	351
LACETTI Stufenheck (J200)	351
LANOS Stufenheck	351
MALIBU (V300)	351
MATIZ (M200, M250)	352
MONTE CARLO Coupe	352
NUBIRA Kombi	352
NUBIRA Stufenheck	352
ORLANDO (J309)	353
REZZO Großraumlimousine (U100)	353
SPARK	353
SPARK (M300)	354
TIGRA	354
TRANS SPORT	354
TRAX	354
VECTRA	354
VOLT	355

**CHRYSLER 355**

300C	355
300 C (LX, LE)	355
300 C Touring (LX, LE)	355
300 M (LR)	355
CONCORDE	356
CROSSFIRE	356
CROSSFIRE Roadster	356
DELTA	356
GRAND VOYAGER V (RT)	357
NEON (PL)	357
NEON II	357
NEW YORKER	357
PT CRUISER (PT_)	357
PT CRUISER Cabriolet	358
SEBRING (JR)	358



**CHRYSLER****355**

SEBRING (JS)	358
SEBRING Cabriolet (JR)	359
SEBRING Cabriolet (JS)	359
STRATUS (JA)	359
STRATUS Cabriolet (JX)	359
VISION	359
VOYAGER / GRAND VOYAGER III (GS)	359
VOYAGER IV (RG, RS)	360
YPSILON	360

**CITROËN****360**

AX (ZA-)	360
BERLINGO / BERLINGO FIRST Großraumlimousine (MF, GJK, GFK)	361
BERLINGO / BERLINGO FIRST Kasten (M_)	363
BERLINGO (B9)	364
BERLINGO Kasten (B9)	365
BERLINGO Pritsche/Fahrgestell (B9)	365
C1 (PM_, PN_)	366
C15 (VD-)	387
C15 Kombi	387
C1 II (PA_, PS_)	366
C2 (JM_)	366
C2 ENTERPRISE (JG_)	367
C3 AIRCROSS II	370
C3 I (FC_, FN_)	367
C3 II (SC_)	369
C3 III (SX)	369
C3 Picasso	370
C3 Pluriel (HB_)	370
C4 AIRCROSS	375
C4 CACTUS	375
C4 Coupe (LA_)	375
C4 Grand Picasso I (UA_)	378
C4 Grand Picasso II	379
C4 I (LC_)	371
C4 II (B7)	374
C4 Picasso I Großraumlimousine (UD_)	379
C4 Picasso II	380
C4 SPACETOURER	381
C4 Stufenheck	381
C5 I (DC_)	382
C5 I Break (DE_)	383
C5 II (RC_)	383
C5 II Break (RE_)	384
C5 III (RD_)	384
C5 III Break (RW_)	385
C6 (TD_)	386
C8 (EA_, EB_)	386
C-CROSSER (EP_)	387
C-CROSSER ENTERPRISE	388
C-ELYSEE	388
C-ZERO	388
DS3	388
DS3 Cabriolet	390
DS4	390
DS5	392
EVASION Großraumlimousine (22, U6)	393
GRAND C4 SPACETOURER	394
JUMPER Bus	394
JUMPER Bus (230P)	395
JUMPER Bus (244, Z_)	397
JUMPER Kasten	397
JUMPER Kasten (230L)	398
JUMPER Kasten (244)	400
JUMPER Pritsche/Fahrgestell	400
JUMPER Pritsche/Fahrgestell (230)	401
JUMPER Pritsche/Fahrgestell (244)	402
JUMPY (U6U)	403
JUMPY (VA_, VE_)	403
JUMPY (VF7)	403
JUMPY Kasten	404
JUMPY Kasten (BS_, BT_, BY_, BZ_)	404
JUMPY Pritsche/Fahrgestell	405
JUMPY Pritsche/Fahrgestell (BU_, BV_, BW_, BX_)	405
NEMO Kasten (AA_)	406
NEMO Kombi	406
SAXO (S0, S1)	406

**CITROËN****360**

SPACETOURER	407
XANTIA (X1_, X2_)	407
XANTIA Break (X1_, X2_)	408
XM (Y4)	409
XM Break (Y4)	409
XSARA (N1)	410
XSARA Break (N2)	412
XSARA Coupe (N0)	413
XSARA Kasten/Kombi	415
XSARA Kasten/Schrägheck (N3_)	415
XSARA PICASSO (N68)	416
ZX (N2)	418
ZX Break (N2)	420

**DACIA****420**

DOKKER	420
DOKKER Express	421
DUSTER	421
DUSTER Kasten	422
LODGY	423
LOGAN (LS_)	423
LOGAN EXPRESS (FS_)	424
LOGAN II	424
LOGAN MCV (KS_)	424
LOGAN MCV II	425
LOGAN Pick-up (US_)	425
SANDERO	426
SANDERO II	426

**DAEWOO****427**

ARANOS	427
CIELO	427
ESPERO (KLEJ)	427
EVANDA (KLAL)	427
GENTRA Stufenheck	427
KALOS (KLAS)	428
KALOS Stufenheck (KLAS)	428
KORANDO (KJ)	428
KORANDO Cabrio (KJ)	428
LACETTI Schrägheck (KLAN)	428
LACETTI Stufenheck	428
LANOS (KLAT)	429
LANOS Stufenheck (KLAT)	429
LEGANZA (KLAV)	429
MAGNUS	430
MATIZ (M100, M150)	430
MATIZ (M200, M250)	430
MATIZ Kasten (KLA4)	430
MUSSO (FJ)	431
NEXIA	431
NEXIA Stufenheck	431
NUBIRA (J100)	431
NUBIRA (J150)	431
NUBIRA Kombi (J150)	432
NUBIRA Stufenheck (J100)	432
NUBIRA Stufenheck (J150)	432
NUBIRA Stufenheck (J200)	433
NUBIRA Wagon (J100)	433
NUBIRA Wagon (J200)	434
RACER Schrägheck	434
REXTON (GAB_)	434
REZZO (U100)	434
TOSCA	434

**DAIHATSU****434**

APPLAUSE II Schrägheck (A101)	435
APPLAUSE I Schrägheck (A101, A111)	434
CHARADE	435
CHARADE IV (G200, G202)	435
CHARADE IV Stufenheck (G203)	435
COPEN (L880_, L881_)	435
CUORE IV (L501)	435
CUORE V (L7_)	436
CUORE VI (L251, L250_, L260_)	436
CUORE VII (L275_, L285_, L276_)	436
FEROZA Hard Top (F300)	436
FEROZA Soft Top (F300)	436

**DAIHATSU****434**

GRAN MOVE (G3)	436
MATERIA (M4_)	437
MOVE (L6_)	437
MOVE (L9_)	437
ROCKY Hard Top (F7, F8)	437
ROCKY Soft Top (F7, F8)	437
SIRION (M1)	437
SIRION (M3_)	437
TERIOS (J1_)	438
TERIOS (J2_)	438
TREVIS	438
YRV (M2)	438

**DS****439**

DS 3	439
DS 3 Cabriolet	440
DS 4 / DS 4 CROSSBACK	440
DS5	439

**FIAT****441**

124 Spider (348_)	441
500 (312_)	441
500 C (312_)	442
500L (351_, 352_)	443
500X (334_)	443
BARCETTA (183_)	443
BRAVA (182_)	444
BRAVO I (182_)	444
BRAVO II (198_)	445
CINQUECENTO (170_)	446
COUPE (175_)	446
CROMA (154_)	447
CROMA (194_)	448
DOBLO Cargo (223_)	449
DOBLO Großraumlimousine (119_, 223_)	449
DOBLO Kasten/Kombi (263_)	450
DOBLO Kombi (263_)	451
DOBLO Pritsche/Fahrgestell (263_)	451
DUCATO Bus (230_)	451
DUCATO Bus (244_)	453
DUCATO Bus (250_, 290_)	454
DUCATO Kasten (230_)	455
DUCATO Kasten (244_)	456
DUCATO Kasten (250_, 290_)	457
DUCATO Pritsche/Fahrgestell (230_)	458
DUCATO Pritsche/Fahrgestell (244_)	460
DUCATO Pritsche/Fahrgestell (250_, 290_)	460
ELBA (146_)	461
FIORINO Kasten/Kombi (225_)	461
FIORINO Kasten (146_)	462
FIORINO Pick up (146_)	462
FREEMONT (345_)	462
GRANDE PUNTO (199_)	463
GRANDE PUNTO Van (199_)	464
IDEA (350_)	464
LINEA (323_, 110_)	465
MAREA (185_)	465
MAREA Weekend (185_)	466
MULTIPLA (186_)	467
PALIO (178_)	468
PALIO Weekend (178_)	469
PANDA (141_)	470
PANDA (169_)	470
PANDA (312_, 319_)	471
PANDA Van (141_)	472
PANDA Van (169_)	472
PANDA VAN (312_, 519_)	473
PREMIO	474
PUNTO (176_)	474
PUNTO (188_)	474
PUNTO (199_)	476
PUNTO Cabriolet (176_)	476
PUNTO EVO (199_)	476
PUNTO EVO Van (199_)	477
PUNTO Van (176_)	477
PUNTO Van (188_)	478
PUNTO Van (199_)	478
QUBO (225_)	479



**FIAT****441**

SCUDO (270_, 272_)	479
SCUDO Combinato (220_)	479
SCUDO Kasten (220_)	480
SCUDO Kasten (270_, 272_)	480
SCUDO Pritsche/Fahrgestell (220_)	481
SCUDO Pritsche/Fahrgestell (270_, 272_)	481
SEDICI (FY_)	481
SEICENTO / 600 (187_)	482
SEICENTO / 600 Van (287_)	482
SIENA (178_, 172_)	482
STILO (192_)	483
STILO Multi Wagon (192_)	484
STRADA Pick-up (178_)	485
STRADA Pick-up (278_)	485
TALENTO Bus (296_)	485
TALENTO Kasten/Kombi (296_)	485
TALENTO Kasten (296_)	485
TALENTO Pritsche/Fahrgestell (296_)	486
TEMPRA (159_)	486
TEMPRA S.W. (159_)	487
TIPO Kombi (357_)	488
TIPO Schrägheck (357_)	488
TIPO Stufenheck (356_)	488
ULYSSE (179_)	489
ULYSSE (220_)	489
UNO (146_)	490
UNO Kasten (146_)	490

**FORD****490**

B-MAX (JK)	490
B-MAX Van	491
C-MAX (DM2)	491
C-MAX II (DXA/CB7, DXA/CEU)	491
C-MAX II Van	492
COUGAR (EC_)	493
COURIER Kasten (F3L, F5L)	493
COURIER Kasten (J5_, J3_)	493
ECOSPORT	494
ESCORT '95 Express (AVL)	494
ESCORT CLASSIC (AAL, ABL)	497
ESCORT CLASSIC Turnier (ANL)	497
ESCORT VII (GAL, AAL, ABL)	494
ESCORT VII Cabriolet (ALL)	495
ESCORT VII Stufenheck (GAL, AFL)	496
ESCORT VII Turnier (GAL, ANL)	496
FIESTA III (GFJ)	497
FIESTA IV (JA_, JB_)	498
FIESTA Kasten (JV_)	501
FIESTA V (JH_, JD_)	499
FIESTA VI (CB1, CCN)	499
FIESTA VI Van	501
FIESTA V Van	499
FOCUS (DAW, DBW)	501
FOCUS C-MAX	510
FOCUS II (DA_, HCP, DP)	502
FOCUS II Cabriolet	503
FOCUS III	505
FOCUS III Kasten/Kombi	506
FOCUS III Kasten/Schrägheck	507
FOCUS III Stufenheck	508
FOCUS III Turnier	509
FOCUS II Stufenheck (DB_, FCH, DH)	503
FOCUS II Turnier (DA_, FFS, DS)	504
FOCUS Stufenheck (DFW)	511
FOCUS Turnier (DNW)	511
FUSION (JU_)	511
GALAXY	512
GALAXY (WA6)	512
GALAXY (WGR)	513
GRAND C-MAX (DXA/CB7, DXA/CEU)	515
GRAND C-MAX Van	515
KA (RB_)	515
KA (RU8)	516
KA+	516
KA+ Stufenheck	516
KA Van (RB)	516
KUGA I	516
KUGA II (DM2)	517
KUGA II Van	518

**FORD****490**

MAVERICK	518
MAVERICK (UDS, UNS)	518
MAVERICK VAN	519
MONDEO I (GBP)	519
MONDEO II (BAP)	521
MONDEO III (B5Y)	523
MONDEO III Stufenheck (B4Y)	524
MONDEO III Turnier (BWY)	524
MONDEO II Stufenheck (BFP)	522
MONDEO II Turnier (BNP)	522
MONDEO I Stufenheck (GBP)	519
MONDEO I Turnier (BNP)	520
MONDEO IV (BA7)	525
MONDEO IV Stufenheck (BA7)	526
MONDEO IV Turnier (BA7)	527
MONDEO V Schrägheck	528
MONDEO V Stufenheck	528
MONDEO V Turnier	529
PUMA (EC_)	529
RANGER (ER, EQ)	530
RANGER (ET)	530
RANGER (TKE)	530
SCORPIO II (GFR, GGR)	530
SCORPIO II Turnier (GNR, GGR)	531
S-MAX	531
S-MAX (WA6)	531
STREET KA (RL2)	532
TOURNEO CONNECT	532
TOURNEO CONNECT / GRAND	532
TOURNEO CONNECT Kombi	533
TOURNEO COURIER Kombi	533
TOURNEO CUSTOM Bus	533
TRANSIT Bus	533
TRANSIT Bus (E_)	534
TRANSIT Bus (FD_, FB_, FS_, FZ_, FC_)	535
TRANSIT CONNECT (P65_, P70_, P80_)	536
TRANSIT CONNECT Kasten	536
TRANSIT CONNECT Kombi	537
TRANSIT COURIER Kasten	537
TRANSIT COURIER Kombi	538
TRANSIT CUSTOM Bus	538
TRANSIT CUSTOM Kasten	538
TRANSIT Kasten	538
TRANSIT Kasten (E_)	539
TRANSIT Kasten (FA_)	539
TRANSIT Pritsche/Fahrgestell	541
TRANSIT Pritsche/Fahrgestell (E_)	541
TRANSIT Pritsche/Fahrgestell (FM_, FN_)	542
TRANSIT TOURNEO	543

**FORD USA****544**

EDGE	544
PROBE II (ECP)	544

**HONDA****544**

ACCORD IX Stufenheck (CR)	548
ACCORD V (CC, CD)	544
ACCORD V (CE, CF_)	545
ACCORD V Aerodeck (CE)	545
ACCORD V Coupe (CD)	545
ACCORD VI (CK, CG, CH, CF8)	546
ACCORD VI Coupe (CG)	546
ACCORD VI Hatchback (CH, CL)	546
ACCORD VII (CL, CN)	547
ACCORD VII (CM)	547
ACCORD VIII (CU)	547
ACCORD VIII TOURER (CW)	548
ACCORD VII Tourer (CM, CN)	547
CITY Stufenheck (GM2, GM3)	548
CIVIC IX (FK)	555
CIVIC IX Stufenheck (FB, FG)	555
CIVIC IX Tourer (FK)	556
CIVIC V Coupe (EJ)	548
CIVIC VI Aerodeck (MB, MC)	548
CIVIC VI Coupe (EJ, EM1)	549
CIVIC VI Fastback (MA, MB)	549

**HONDA****544**

CIVIC VI Hatchback (EJ, EK)	550
CIVIC VII Coupe (EM2)	552
CIVIC VII Hatchback (EU, EP, EV)	553
CIVIC VIII Hatchback (FN, FK)	554
CIVIC VIII Stufenheck (FD, FA)	555
CIVIC VII Stufenheck (ES, ET)	553
CIVIC VI Stufenheck (EJ, EK)	552
CIVIC X Schrägheck (FC_, FK)	556
CIVIC X Stufenheck (FC_)	556
CR-V I (RD)	556
CR-V II (RD_)	556
CR-V III (RE_)	557
CR-V IV (RM_)	557
CRX III (EH, EG)	557
FR-V (BE)	558
HR-V (GH)	558
INSIGHT (ZE_)	558
INSIGHT (ZE)	558
INTEGRA Coupe (DC2, DC4)	558
JAZZ II (GD_, GE3, GE2)	559
JAZZ III (GE_, GG_, GP_)	559
JAZZ IV (GK_)	559
JAZZ Stufenheck (GD_)	560
LEGEND II (KA)	560
LEGEND II Coupe (KA)	560
LEGEND III (KA)	560
LOGO (GA)	560
NSX I Cabriolet (NA)	560
NSX I Coupe (NA)	561
ODYSSEY Großraumlimousine (RA_)	561
PRELUDE IV (BB_)	561
PRELUDE V (BB_)	561
S2000 (AP)	561
SHUTTLE (RA)	562
STREAM (RN)	562

**HYUNDAI****562**

ACCENT I (X-3)	562
ACCENT II (LC)	562
ACCENT III (MC)	563
ACCENT III Stufenheck (MC)	563
ACCENT II Stufenheck (LC)	563
ACCENT IV (RB)	563
ACCENT IV Stufenheck (RB)	563
ACCENT Stufenheck (X-3)	564
ATOS (MX)	564
COUPE (GK)	564
COUPE (RD)	565
CRETA	565
ELANTRA (XD)	565
ELANTRA Stufenheck (AD)	566
ELANTRA Stufenheck (HD)	566
ELANTRA Stufenheck (MD, UD)	566
ELANTRA Stufenheck (XD)	566
EQUUS / CENTENNIAL	567
EQUUS / CENTENNIAL (JS)	567
GALLOPER II (JK-01)	567
GENESIS Coupe	567
GETZ (TB)	568
GRANDEUR (HG)	568
GRANDEUR (TG)	568
GRAND SANTA FÉ	569
H-1 / STAREX Großraumlimousine (A1)	569
H100 Bus (P)	571
H100 Kasten	571
H100 Pick-up	571
H100 Pritsche/Fahrgestell	571
H-1 Cargo (TQ)	570
H-1 Kasten (A1)	570
H-1 Pritsche/Fahrgestell	570
H-1 Travel (TQ)	571
HIGHWAY VAN	572
i10 (BA, IA)	572
i10 (PA)	572
i10 Stufenheck	573
i20 (GB, IB)	573
i20 (PB, PBT)	573
i20 ACTIVE (IB, GB)	574
i20 Coupe (GB)	574



**HYUNDAI****562**

i30 (FD)	574
i30 (GD)	574
i30 (PDE, PD)	575
i30 Coupe	576
i30 FASTBACK (PDE)	576
i30 Kombi (FD)	576
i30 Kombi (GD)	577
i30 Kombi (PDE)	577
i40 (VF)	577
i40 CW (VF)	578
IONIQ (AE)	578
ix20 (JC)	578
ix35 (LM, EL, ELH)	578
ix55	579
KONA (OS)	580
LANTRA II (J-2)	580
LANTRA II Kombi (J-2)	580
MATRIX (FC)	581
SANTA FÉ I (SM)	581
SANTA FÉ II (CM)	582
SANTA FÉ III (DM)	582
SANTAMO	583
S COUPE (SLC)	583
SOLARIS Stufenheck	583
SONATA III (Y-3)	583
SONATA IV (EF)	583
SONATA V (NF)	584
SONATA VI (YF)	584
SONATA VII (LF)	585
TERRACAN (HP)	585
TIBURON Coupe	585
TRAJET (FO)	585
TUCSON (JM)	586
TUCSON (TL)	587
VELOSTER (FS)	587
XG (XG)	587
XG Stufenheck	588

**INFINITI****588**

EX	588
FX	588
G Cabriolet	588
G Coupe	588
G Stufenheck	588
M (Y51)	588
M35	589
M37	589
Q50	589
Q60 Cabriolet	589
Q60 Coupe	589
Q70 (Y51)	589
QX50	589

**ISUZU****589**

TROOPER II (UB)	589
TROOPER II Geländewagen offen (UB)	590
TROOPER III	590
TROOPER III Geländewagen offen	590

**IVECO****590**

DAILY II Bus	590
DAILY III Kasten/Kombi	593
DAILY III Pritsche/Fahrgestell	595
DAILY II Kasten/Kombi	590
DAILY II Kipper	592
DAILY II Pritsche/Fahrgestell	592
DAILY IV Bus	596
DAILY IV Kasten/Kombi	596
DAILY IV Kipper	597
DAILY IV Pritsche/Fahrgestell	598
DAILY V Kasten/Kombi	598
DAILY V Kipper	599
DAILY V Pritsche/Fahrgestell	599
MASSIF Pick-up	600
MASSIF Single Cab	600
MASSIF Station Wagon	600

**JAGUAR****600**

E-PACE (X540)	600
F-PACE (X761)	600
S-TYPE (X200)	600
XE (X760)	601
XF (X250)	601
XF (X260)	602
XF SPORTBRAKE (X250)	602
XF SPORTBRAKE (X260)	603
XJ (X300, X330)	603
XJ (X308)	603
XJ (X350)	604
XJ (X351)	604
XJ Coupe	604
XJSC Convertible (X27)	605
XK 8 Convertible (X100)	605
XK 8 Coupe (X100)	606
XK Cabriolet (X150)	606
XK Coupe (X150)	606
X-TYPE (X400)	607
X-TYPE Kombi (X400)	608

**JEEP****608**

CHEROKEE (KJ)	608
CHEROKEE (KK)	608
CHEROKEE (KL)	608
CHEROKEE (XJ)	609
COMANCHE (MJ)	609
COMMANDER (XK, XH)	609
COMPASS (MK49)	609
GRAND CHEROKEE I (ZJ)	609
GRAND CHEROKEE II (WJ, WG)	610
GRAND CHEROKEE III (WH, WK)	610
GRAND CHEROKEE IV (WK, WK2)	610
PATRIOT (MK74)	610
RENEGADE Geländewagen geschlossen (BU, B1)	611
WRANGLER I (YJ, SJ_)	611
WRANGLER II (TJ)	611
WRANGLER III (JK)	611

**KIA****612**

BESTA Bus	612
BESTA Kasten	612
BONGO Pritsche/Fahrgestell	612
CARENS I (FC)	612
CARENS II Großraumlimousine (FJ)	612
CARENS III Großraumlimousine (UN)	612
CARENS IV	613
CARNIVAL / GRAND CARNIVAL III (VQ)	613
CARNIVAL I (UP)	613
CARNIVAL II (GQ)	613
CEE'D (JD)	614
CEE'D Schrägheck (ED)	615
CEE'D Sportswagon (JD)	615
CEE'D SW (ED)	616
CERATO II Stufenheck (TD)	616
CERATO KOUP (TD)	616
CERATO KOUP (YD)	617
CERATO Schrägheck (LD)	617
CERATO Stufenheck	617
CERATO Stufenheck (LD)	617
CLARUS (K9A)	618
CLARUS Kombi (GC)	618
JOICE	618
MAGENTIS (GD, MS)	618
MAGENTIS (MG)	619
NIRO	619
OPIRUS (GH)	619
OPTIMA	619
OPTIMA Sportswagon (JF)	620
PICANTO (JA)	621
PICANTO (SA)	621
PICANTO (TA)	621
PREGIO Bus	621
PREGIO Kasten (TB)	621
PRIDE (DA)	622
PRIDE Kombi	622
PRIDE Van (DA)	622

**KIA****612**

PRO CEE'D (JD)	622
PRO CEE'D (ED)	623
RETONA (CE)	623
RIO II (JB)	623
RIO III (UB)	623
RIO III Stufenheck (UB)	624
RIO II Stufenheck (JB)	623
RIO IV (YB, SC)	624
RIO IV Stufenheck (SC, FB)	624
RIO Kombi (DC)	625
RIO Stufenheck (DC_)	625
SEPHIA (FA)	625
SEPHIA Stufenheck (FA)	625
SHUMA (FB)	626
SHUMA II (FB)	626
SHUMA II Stufenheck (FB)	626
SHUMA Stufenheck (FB)	626
SORENTO I (JC)	626
SORENTO II (XM)	627
SORENTO III (UM)	627
SOUL (AM)	627
SOUL II (PS)	628
SPORTAGE (JE_, KM_)	629
SPORTAGE (K00)	629
SPORTAGE (QL, QLE)	629
SPORTAGE (SL)	630
STONIC (YB)	631
VENGA (YN)	631

**LADA****631**

110 (2110)	631
111 (2111)	631
112 (2112)	632
1200-1600	632
KALINA Kombi (1117)	632
KALINA Kombi (2194)	632
KALINA Schrägheck (1119)	632
KALINA Schrägheck (2192)	633
KALINA Stufenheck (1118)	633
NIVA Geländewagen geschlossen (2121, 2131)	633
NOVA (2105)	633
NOVA Kombi (2104)	633
PRIORA Kombi (2171)	634
PRIORA Schrägheck (2172)	634
PRIORA Stufenheck (2170)	634
SAMARA (2108, 2109, 2115, 2113, 2114)	634
SAMARA FORMA Stufenheck (21099, 2115)	634
TAIGA II (2123)	634
TOSCANA (2107)	635

**LANCIA****635**

DEDRA (835_)	635
DEDRA SW (835_)	636
DELTA II (836_)	637
DELTA III (844_)	638
FLAVIA Cabriolet (JS_)	639
KAPPA (838_)	639
KAPPA Coupe (838_)	639
KAPPA SW (838_)	640
LYBRA (839_)	640
LYBRA SW (839_)	641
MUSA (350_)	641
PHEDRA (179_)	642
THESIS (841_)	642
Y (840_)	643
YPSILON (312_)	643
YPSILON (843_)	644
ZETA (22_)	644

**LAND ROVER****644**

DEFENDER Cabrio (L316)	644
DEFENDER Pick-up (L316)	646
DEFENDER Pritsche/Fahrgestell (L316)	647
DEFENDER Station Wagon (L316)	647
DISCOVERY I (LJ)	648
DISCOVERY II (L318)	649

**LAND ROVER 644**

DISCOVERY III (L319)	649
DISCOVERY IV (L319)	650
DISCOVERY SPORT (L550)	651
DISCOVERY V (L462)	650
FREELANDER (L314)	651
FREELANDER 2 (L359)	651
FREELANDER Soft Top (L314)	652
RANGE ROVER EVOQUE (L538)	654
RANGE ROVER EVOQUE Cabriolet (L538)	655
RANGE ROVER II (P38A)	652
RANGE ROVER III (L322)	652
RANGE ROVER IV (L405)	654
RANGE ROVER SPORT (L320)	655
RANGE ROVER SPORT (L494)	656

**LEXUS 656**

CT (ZWA10_)	657
ES (_V4_)	657
ES (_V6_)	657
ES (MCV_, VZV_)	657
GS (_L1_)	657
GS (_S16_)	658
GS (_S19_)	658
GX (_J12_)	658
GX (URJ15_)	658
IS C (GSE2_)	659
IS I (_E1_)	659
IS II (_E2_)	659
IS III (_E3_)	659
IS SportCross (_E1_)	659
LS (_F4_)	660
LX	660
LX (_J2_)	660
LX (UZJ100)	660
NX (_Z1_)	660
RC (_C1_)	660
RX (_L1_)	661
RX (_U3_)	661
RX (MCU15)	661
SC Cabriolet (UZZ40_)	661

**MAYBACH 662**

57 (240_)	662
-----------	-----

**MAZDA 662**

121 II (DB)	670
121 III (JASM, JBSM)	670
2 (DE_, DH_3)	662
2 (DL, DJ)	662
2 (DY)	662
3 (BK)	662
3 (BL)	663
3 (BM, BN)	664
323 C IV (BG)	671
323 C V (BA)	671
323 F V (BA)	671
323 F VI (BJ)	672
323 P V (BA)	672
323 S IV (BG)	673
323 S V (BA)	673
323 S VI (BJ)	673
3 Stufenheck (BK)	664
3 Stufenheck (BL)	665
3 Stufenheck (BM, BN)	666
5 (CR19)	666
5 (CW)	666
626 III Station Wagon (GV)	674
626 IV (GE)	675
626 IV Hatchback (GE)	675
626 V (GF)	675
626 V Hatchback (GF)	676
626 V Station Wagon (GW)	676
6 Hatchback (GG)	667
6 Kombi (GJ, GL)	667
6 Sport (GH)	667
6 Sport Kombi (GH)	668
6 Station Wagon (GY)	668

**MAZDA 662**

6 Stufenheck (GG)	669
6 Stufenheck (GH)	669
6 Stufenheck (GJ, GL)	670
B-SERIE (UN)	677
BT-50 Pick-up (CD, UN)	677
BT-50 Pritsche/Fahrgestell (CD, UN)	677
CX-3 (DK)	677
CX-5 (KE, GH)	677
CX-5 (KF)	678
CX-7 (ER)	678
CX-9 (TB)	678
DEMIO (DW)	679
E-SERIE Bus	679
E-SERIE Kasten (SR2)	679
E-SERIE Pritsche/Fahrgestell (SD1)	679
MPV I (LV)	679
MPV II (LW)	679
MX-3 (EC)	680
MX-5 I (NA)	680
MX-5 II (NB)	680
MX-5 III (NC)	681
MX-5 IV (ND)	681
MX-5 RF Targa (ND)	681
MX-6 (GE)	681
PREMACY (CP)	681
RX-8 (SE, FE)	682
TRIBUTE (EP)	682
XEDOS 6 (CA)	683
XEDOS 9 (TA)	683

**MERCEDES-BENZ 683**

100 Bus (631)	683
100 Kasten (631)	683
100 Pritsche/Fahrgestell (631)	684
A-KLASSE (W168)	684
A-KLASSE (W169)	686
A-KLASSE (W176)	687
A-KLASSE (W177)	689
B-KLASSE (W245)	689
B-KLASSE (W246, W242)	690
CITAN Kasten (415)	692
CITAN Kombi / Tourer (415)	692
CITAN Mixto (415)	692
C-KLASSE (W202)	693
C-KLASSE (W203)	696
C-KLASSE (W204)	701
C-KLASSE (W205)	706
C-KLASSE Cabriolet (A205)	709
C-KLASSE Coupe (C204)	711
C-KLASSE Coupe (C205)	712
C-KLASSE Sportcoupe (CL203)	714
C-KLASSE T-Model (S202)	717
C-KLASSE T-Model (S203)	719
C-KLASSE T-Model (S204)	723
C-KLASSE T-Model (S205)	728
CLA Coupe (C117)	730
CLA Shooting Brake (X117)	732
CLC-KLASSE (CL203)	733
CLK (C208)	734
CLK (C209)	736
CLK Cabriolet (A208)	739
CLK Cabriolet (A209)	740
CLS (C218)	743
CLS (C219)	745
CLS (C257)	746
CLS Shooting Brake (X218)	746
E-KLASSE (W210)	748
E-KLASSE (W211)	753
E-KLASSE (W212)	757
E-KLASSE (W213)	762
E-KLASSE All-Terrain (S213)	763
E-KLASSE Cabriolet (A124)	763
E-KLASSE Cabriolet (A207)	764
E-KLASSE Cabriolet (A238)	766
E-KLASSE Coupe (C124)	766
E-KLASSE Coupe (C207)	767
E-KLASSE Coupe (C238)	770
E-KLASSE T-Model (S124)	770
E-KLASSE T-Model (S210)	772

**MERCEDES-BENZ 683**

E-KLASSE T-Model (S211)	776
E-KLASSE T-Model (S212)	780
E-KLASSE T-Model (S213)	784
G-KLASSE (W461)	785
G-KLASSE (W463)	786
G-KLASSE Cabrio (W463)	788
GLA-KLASSE (X156)	788
GLC (X253)	789
GLC Coupe (C253)	790
GLE (W166)	790
GLE Coupe (C292)	791
GLK-KLASSE (X204)	792
GL-KLASSE (X164)	793
GL-KLASSE (X166)	794
GLS (X166)	795
M-KLASSE (W163)	795
M-KLASSE (W164)	797
M-KLASSE (W166)	799
R-KLASSE (W251, V251)	800
S-KLASSE (W140)	802
S-KLASSE (W220)	804
S-KLASSE (W221)	808
S-KLASSE (W222, V222, X222)	811
S-KLASSE Cabriolet (A217)	812
S-KLASSE Coupe (C140)	813
S-KLASSE Coupe (C215)	814
S-KLASSE Coupe (C216)	814
S-KLASSE Coupe (C217)	815
SL (R129)	815
SL (R230)	817
SL (R231)	819
SLC (R172)	819
SLK (R170)	820
SLK (R171)	821
SLK (R172)	823
SLR (R199)	824
SLR Roadster (R199)	824
SLS AMG (C197)	824
SLS AMG Roadster (R197)	824
SPRINTER 2-t Bus (901, 902)	824
SPRINTER 2-t Kasten (901, 902)	825
SPRINTER 2-t Pritsche/Fahrgestell (901, 902)	825
SPRINTER 3,5-t Bus (906)	826
SPRINTER 3,5-t Kasten (906)	828
SPRINTER 3,5-t Pritsche/Fahrgestell (906)	830
SPRINTER 3-t Bus (903)	832
SPRINTER 3-t Bus (906)	834
SPRINTER 3-t Kasten (903)	834
SPRINTER 3-t Kasten (906)	835
SPRINTER 3-t Pritsche/Fahrgestell (903)	836
SPRINTER 3-t Pritsche/Fahrgestell (906)	837
SPRINTER 4,6-t Kasten (906)	839
SPRINTER 4,6-t Pritsche/Fahrgestell (906)	839
SPRINTER 4-t Bus (904)	840
SPRINTER 4-t Kasten (904)	840
SPRINTER 4-t Pritsche/Fahrgestell (904)	842
SPRINTER 5-t Bus	843
SPRINTER 5-t Kasten (906)	843
SPRINTER 5-t Pritsche/Fahrgestell (905)	845
SPRINTER 5-t Pritsche/Fahrgestell (906)	845
SPRINTER CLASSIC 3,5-t Kasten (909)	847
SPRINTER CLASSIC 4,6-t Bus (909)	848
SPRINTER Kipper (905)	848
T1 Bus (601)	848
T1 Bus (602)	849
T1 Kasten (601, 611)	849
T1 Kasten (602)	849
T1 Pritsche/Fahrgestell (601)	850
T1 Pritsche/Fahrgestell (602)	850
VANEO (414)	850
VARIO Bus	851
VARIO Kasten/Kombi	851
VARIO Kipper	853
VARIO Pritsche/Fahrgestell	854
VARIO Triebkopf	856
VIANO (W639)	857
VITO / MIXTO Kasten (W639)	858
VITO Bus (638)	860
VITO Bus (W639)	860
VITO Kasten (638)	862





**MERCEDES-BENZ 683**

VITO Kasten (W447)	863
VITO Mixto (W447)	864
VITO Tourer (W447)	865
V-KLASSE (638/2)	866
V-KLASSE (W447)	866

**MG 867**

EXPRESS Kasten	867
MGF (RD)	867
MG TF	867
MG ZR	868
MG ZS	868
MG ZS Hatchback	868
MG ZT	868
MG ZT- T	869

**MINI 869**

MINI (F55)	869
MINI (F56)	871
MINI (R50, R53)	871
MINI (R56)	872
MINI Cabriolet (F57)	875
MINI Cabriolet (R52)	876
MINI Cabriolet (R57)	877
MINI CLUBMAN (F54)	879
MINI CLUBMAN (R55)	880
MINI CLUBVAN (R55)	881
MINI COUNTRYMAN (F60)	882
MINI COUNTRYMAN (R60)	883
MINI Coupe (R58)	884
MINI PACEMAN (R61)	885
MINI Roadster (R59)	886

**MITSUBISHI 886**

ASX (GA_W_)	886
ASX Van (GA_W_)	887
ATTRAGE Stufenheck (A1_A)	887
CARISMA (DA_)	887
CARISMA Stufenheck (DA_)	888
COLT CZC Cabriolet (RG)	890
COLT IV (CA_A)	889
COLT V (CJ_, CP_)	890
COLT VI (Z3_A, Z2_A)	890
DELICA / SPACE GEAR	890
ECLIPSE CROSS (GK_)	891
ECLIPSE II (D3_A)	891
FTO Coupe (DE_A)	891
GALANT Stufenheck (DJ_, ED_, EF_)	894
GALANT V (E5_A, E7_A, E8_A)	891
GALANT VI (EA_)	892
GALANT VI Kombi (EA_)	893
GALANT V Stufenheck (E5_A, E7_A, E8_A)	891
GALLOPER (JK-01)	894
GRANDIS (NA_W)	894
i (HA_)	894
L 200 / TRITON (KA_T, KB_T)	895
L 200 / TRITON Pritsche/Fahrgestell (KA_T, KB_T)	895
L 200 (K3_T, K2_T, K1_T, K0_T)	895
L 200 (K7_T, K6_T)	895
L200 (KJ_, KK_, KL_)	894
L 300 III Bus (P0_W, P1_W, P2_W)	896
L 300 III Kasten (P0_V, P1_V, P2_V)	896
L 300 III Pritsche/Fahrgestell (P1_T)	896
L 400 Bus (PD_W, PC_W, PA_V, PB_V, PA_W)	896
L 400 Kasten (PD_W, PC_W, PB_V, PA_W, PA_V)	897
LANCER V (CB_A, CD_A, CE_A)	897
LANCER VI (CJ-CP_)	898
LANCER VII (CS_A, CT_A)	898
LANCER VIII (CY_A, CZ_A)	899
LANCER VIII Sportback (CX_A)	900
LANCER VII Kombi (CS_W, CT_W)	899
LANCER V Station Wagon (CB_W, CD_W)	898
MIRAGE Schrägheck (CJ_A)	900
MIRAGE Stufenheck (CK_A)	900

**MITSUBISHI 886**

OUTLANDER I (CU_W)	901
OUTLANDER II (CW_W)	901
OUTLANDER III (GG_W, GF_W, ZJ)	902
PAJERO CLASSIC (V2_W)	907
PAJERO II (V3_W, V2_W, V4_W)	903
PAJERO II (V3_W)	903
PAJERO II Canvas Top (V2_W, V4_W)	904
PAJERO III (V7_W, V6_W)	904
PAJERO III Canvas Top (V6_W, V7_W)	905
PAJERO IV (V8_W, V9_W)	905
PAJERO IV Van (V90, V80, V8_V)	906
PAJERO PININ (H6_W, H7_W)	907
PAJERO SPORT I (K7_, K9_)	908
PAJERO SPORT II (KH_, KG_)	908
PAJERO SPORT VAN I (K90)	908
SANTAMO	909
SIGMA (F2_A, F1_A)	909
SIGMA Station Wagon (F0_W)	909
SPACE RUNNER (N1_W, N2_W)	909
SPACE RUNNER (N6_W)	910
SPACE STAR Großraumlimousine (DG_A)	910
SPACE STAR Schrägheck (A0_A)	910
SPACE WAGON (N3_W, N4_W)	910
SPACE WAGON (N9_W, N8_W)	911

**NISSAN 912**

200 SX (S14)	912
350 Z Coupe (Z33)	912
350 Z Roadster (Z33)	912
ALMERA I (N15)	912
ALMERA I Hatchback (N15)	913
ALMERA II (N16)	914
ALMERA II Hatchback (N16)	914
ALMERA TINO (V10)	915
CABSTAR (F23, H41, H42)	916
CABSTAR (F24M, F24W)	916
CABSTAR E (TL_, VL_)	917
CEFIRO III Stufenheck (A33)	917
CUBE (Z12)	918
EVALLIA Bus	918
INTERSTAR Bus (X70)	918
INTERSTAR Kasten (X70)	919
INTERSTAR Pritsche/Fahrgestell	919
JUKE (F15)	919
KUBISTAR Kasten (X76)	920
LEAF (ZE0)	920
LEAF (ZE1)	920
MAXIMA / MAXIMA QX V (A33)	921
MICRA C+ C III (K12)	922
MICRA II (K11)	921
MICRA III (K12)	921
MICRA IV (K13)	922
MICRA V (K14)	922
MURANO I (Z50)	922
MURANO II (Z51)	922
NAVARA (D21)	923
NAVARA (D22_)	923
NAVARA Pritsche/Fahrgestell (D22)	923
NOTE (E11, NE11)	923
NOTE (E12)	923
NP300 NAVARA (D40)	924
NP300 NAVARA Pritsche/Fahrgestell (D40)	924
NP300 PICKUP (D22)	924
NT400 CABSTAR (F24F)	924
NV200 Kasten/Kombi	925
NV300 Kasten (X82)	925
NV300 Kombi (X82)	925
NV300 Pritsche/Fahrgestell (X82)	925
NV400 Bus (X62, X62B)	925
NV400 Kasten (X62, X62B)	926
NV400 Pritsche/Fahrgestell (X62, X62B)	926
PATHFINDER II (R50)	927
PATHFINDER III (R51)	927
PATROL GR IV (Y60, GR)	927
PATROL GR V Pritsche/Fahrgestell (Y61)	928
PATROL GR V Wagon (Y61)	928
PATROL III/2 Hardtop (K260)	928
PATROL III/2 Station Wagon (W260)	928
PICK UP (D21)	928

**NISSAN 912**

PICK UP (D22)	929
PIXO (UA0)	929
PRIMASTAR Bus (X83)	929
PRIMASTAR Kasten (X83)	930
PRIMASTAR Pritsche/Fahrgestell (X83)	930
PRIMERA (P10)	930
PRIMERA (P11)	931
PRIMERA (P12)	932
PRIMERA Hatchback (P10)	932
PRIMERA Hatchback (P11)	933
PRIMERA Hatchback (P12)	934
PRIMERA Traveller (W10)	934
PRIMERA Traveller (WP11)	935
PRIMERA Traveller (WP12)	935
PULSAR Schrägheck (C13)	936
QASHQAI / QASHQAI +2 I (J10, JJ10)	936
QASHQAI II Geländewagen geschlossen (J11, J11_)	937
SENTRA VII (B17)	938
SERENA (C23)	938
SUNNY III Kasten (Y10)	938
SUNNY III Traveller (Y10)	938
TEANA I (J31)	938
TERRANO (D10)	938
TERRANO I (WD21)	938
TERRANO II (R20)	939
TERRANO II Van (R20)	939
TIIDA Schrägheck (C11)	939
TIIDA Stufenheck (SC11)	939
TRADE Pritsche/Fahrgestell	940
URVAN Bus (E24)	940
URVAN Kasten (E24)	940
VANETTE CARGO Bus (HC 23)	940
VANETTE CARGO Kasten (HC 23)	940
X-TRAIL (T30)	940
X-TRAIL (T31)	941
X-TRAIL (T32_)	942

**OPEL 942**

ADAM (M13)	942
AGILA (A) (H00)	942
AGILA (B) (H08)	943
AMPERA (R12)	943
ANTARA (L07)	943
ARENA Bus (A97)	944
ARENA Combi (A97)	944
ARENA Kasten (A97)	944
ARENA Kasten (TB, TF)	944
ASTRA CLASSIC Schrägheck (A04)	945
ASTRA F (T92)	945
ASTRA F Cabriolet (T92)	946
ASTRA F Caravan (T92)	947
ASTRA F CC (T92)	948
ASTRA F CLASSIC Caravan (T92)	950
ASTRA F CLASSIC CC (T92)	950
ASTRA F CLASSIC Stufenheck (T92)	951
ASTRA F Van (T92)	951
ASTRA G Cabriolet (T98)	952
ASTRA G Caravan (T98)	953
ASTRA G CC (T98)	956
ASTRA G Coupe (T98)	958
ASTRA G Kasten (F70)	959
ASTRA G Stufenheck (T98)	960
ASTRA H (A04)	962
ASTRA H Caravan (A04)	964
ASTRA H GTC (A04)	965
ASTRA H Kasten (L70)	967
ASTRA H Stufenheck (A04)	968
ASTRA H TwinTop (A04)	969
ASTRA J (P10)	970
ASTRA J Caravan (P10)	970
ASTRA J GTC	971
ASTRA J Stufenheck	972
ASTRA K (B16)	972
ASTRA K Sports Tourer (B16)	973
CALIBRA A (C89)	973
CAMPO (TF0, TF1)	973
CASCADA (W13)	974
COMBO (71_)	974



**OPEL 942**

COMBO Combi / Tour (X12)	975
COMBO Kasten/Kombi	975
COMBO Kasten/Kombi (X12)	976
COMBO Pritsche/Fahrgestell (X12)	976
COMBO Tour	976
CORSA B (S93)	977
CORSA B Caravan (S93)	978
CORSA B Kasten (S93)	978
CORSA C (X01)	979
CORSA C Kasten (X01)	979
CORSA D (S07)	980
CORSA D Van (S07)	981
CORSA E (X15)	982
CORSA E Van (X15)	983
CROSSLAND X (P17)	983
FRONTERA A (U92)	984
FRONTERA A Sport (U92)	984
FRONTERA B (U99)	984
GT Cabriolet (M07)	985
INSIGNIA A (G09)	985
INSIGNIA A Country Tourer (G09)	987
INSIGNIA A Stufenheck (G09)	987
INSIGNIA Caravan	989
KARL (C16)	990
MERIVA A Großraumlimousine (X03)	990
MERIVA B Großraumlimousine (S10)	991
MOKKA / MOKKA X (J13)	992
MONTEREY A (M92)	992
MONTEREY B (M98)	992
MOVANO B Bus (X62)	992
MOVANO B Kasten (X62)	993
MOVANO B Pritsche/Fahrgestell (X62)	993
MOVANO B Kasten (X62)	993
MOVANO B Pritsche/Fahrgestell (X62)	993
MOVANO Combi (X70)	994
MOVANO Kasten (X70)	995
MOVANO Kipper (X70)	996
MOVANO Pritsche/Fahrgestell (X70)	997
OMEGA B (V94)	997
OMEGA B Caravan (V94)	999
SIGNUM CC (Z03)	1000
SINTRA (APV)	1002
SPEEDSTER (E01)	1002
TIGRA (S93)	1003
TIGRA TwinTop (X04)	1003
VECTRA B (J96)	1003
VECTRA B Caravan (J96)	1004
VECTRA B CC (J96)	1006
VECTRA C (Z02)	1007
VECTRA C Caravan (Z02)	1010
VECTRA C CC (Z02)	1012
VIVARO A Combi (X83)	1014
VIVARO A Kasten (X83)	1015
VIVARO A Pritsche/Fahrgestell (X83)	1015
VIVARO B Combi (X82)	1016
VIVARO B Kasten (X82)	1016
VIVARO B Pritsche/Fahrgestell (X82)	1016
ZAFIRA A Großraumlimousine (T98)	1016
ZAFIRA B (A05)	1018
ZAFIRA B Van (A05)	1019
ZAFIRA TOURER C (P12)	1019

**PEUGEOT 1020**

1007 (KM_)	1073
106 I (1A, 1C)	1020
106 II (1)	1021
106 Van (1_)	1022
107	1022
108	1023
2008 (CU_)	1073
205 II (20A/C)	1023
205 Kasten	1024
206+ (2L_, 2M_)	1029
206 CC (2D)	1025
206 Schrägheck (2A/C)	1025
206 Stufenheck	1027
206 SW (2E/K)	1028
206 Van	1028
207 (WA_, WC_)	1029
207 CC (WD_)	1030
207 Stufenheck	1031

**PEUGEOT 1020**

207 SW (WK_)	1031
207 Van	1032
208 (CA_, CC_)	1033
208 Kasten (CR_)	1034
3008 Großraumlimousine (0U_)	1074
3008 SUV (M_)	1075
301	1034
306 (7B, N3, N5)	1034
306 Break (7E, N3, N5)	1037
306 Cabriolet (7D, N3, N5)	1038
306 Kasten/Kombi (N_, 7_)	1039
306 Kasten/Schrägheck	1039
306 Schrägheck (7A, 7C, N3, N5)	1040
307 (3A/C)	1043
307 Break (3E)	1047
307 CC (3B)	1049
307 SW (3H)	1051
308 (4A_, 4C_)	1053
308 CC (4B_)	1056
308 II	1054
308 SW (4E_, 4H_)	1057
308 SW II	1058
4007 (GP_)	1075
4008	1075
405 II (4B)	1060
405 II Break (4E)	1060
406 (8B)	1061
406 Break (8E/F)	1062
406 Coupe (8C)	1063
407 (6D_)	1064
407 Coupe (6C_)	1066
407 SW (6E_)	1066
5008 (0U_, 0E_)	1075
5008 II	1076
508 I (8D_)	1067
508 SW I (8E_)	1068
605 (6B)	1069
607 (9D, 9U)	1070
806 (221)	1071
807 (E)	1072
BIPPER (AA_)	1076
BIPPER Tepee	1076
BOXER Bus	1077
BOXER Bus (230P)	1077
BOXER Bus (244, Z_)	1080
BOXER Kasten	1080
BOXER Kasten (230L)	1081
BOXER Kasten (244)	1083
BOXER Pritsche/Fahrgestell	1083
BOXER Pritsche/Fahrgestell (244)	1084
BOXER Pritsche/Fahrgestell (ZCT_)	1084
EXPERT (224_)	1086
EXPERT Kasten	1087
EXPERT Kasten (222)	1087
EXPERT Kasten (VF3A_, VF3U_, VF3X_)	1087
EXPERT Pritsche/Fahrgestell	1088
EXPERT Pritsche/Fahrgestell (223)	1088
EXPERT Tepee (VF3X_)	1088
ION	1089
PARTNER Combispace (5F)	1089
PARTNER Kasten	1091
PARTNER Kasten (5)	1092
PARTNER Pritsche/Fahrgestell	1093
PARTNER Tepee	1094
RCZ	1095
RIFTER	1095
TRAVELLER	1095

**PONTIAC 1095**

TRANS SPORT	1096
-------------	------

**PORSCHE 1096**

718 BOXSTER (982)	1096
718 CAYMAN (982)	1096
911 (991)	1096
911 (993)	1097
911 (996)	1097
911 (997)	1099

**PORSCHE 1096**

911 Cabriolet (991)	1101
911 Cabriolet (993)	1102
911 Cabriolet (996)	1102
911 Cabriolet (997)	1103
911 Targa (991)	1105
911 Targa (993)	1105
911 Targa (996)	1105
911 Targa (997)	1105
BOXSTER (981)	1106
BOXSTER (986)	1106
BOXSTER (987)	1107
BOXSTER Spyder (981)	1108
BOXSTER Spyder (987)	1108
CARRERA GT (980)	1109
CAYENNE (92A)	1116
CAYENNE (9PA)	1109
CAYMAN (981)	1119
CAYMAN (987)	1119
MACAN (95B)	1120
PANAMERA (970)	1121
PANAMERA (971)	1122

**PROTON 1122**

JUMBUCK Pick-up	1122
PERSONA 300 (C9_M)	1122
PERSONA 400 (C9_S)	1122
PERSONA 400 Hatchback (C9_C, C9_S)	1123
SATRIA (C9_M)	1123
SATRIA NEO	1123
WIRA	1124
WIRA Hatchback	1124

**PUCH 1124**

G-MODELL (W 463)	1124
------------------	------

**RENAULT 1124**

19 II Cabriolet (D53_, 853_)	1124
AVANTIME (DE0_)	1125
CAPTUR (J5_, H5_)	1125
CLIO Grandtour (KR0/1_)	1133
CLIO I (B/C57_, 5/357_)	1125
CLIO II (BB_, CB_)	1128
CLIO III (BR0/1, CR0/1)	1130
CLIO III Kasten (SB_, SR_)	1132
CLIO II Kasten (SB0/1/2_)	1130
CLIO I Kasten (S57_)	1127
CLIO IV (BH_)	1132
CLIO IV Grandtour (KH_)	1133
CLIO IV Kasten	1133
DOKKER	1134
DUSTER (HS_)	1134
ESPACE II (J/S63_)	1134
ESPACE III (JE0_)	1135
ESPACE IV (JK0/1_)	1136
ESPACE V (JR_)	1136
EXPRESS Kasten/Kombi	1136
EXPRESS Pick-up	1137
FLUENCE (L3_)	1137
GRAND SCÉNIC II (JM0/1_)	1137
GRAND SCÉNIC III (JZ0/1_)	1138
GRAND SCÉNIC IV (R9_)	1139
KADJAR (HA_, HL_)	1139
KANGOO / GRAND KANGOO (KW0/1_)	1140
KANGOO (KC0/1_)	1140
KANGOO BE BOP (KW0/1_)	1141
KANGOO Express (FW0/1_)	1142
KANGOO Rapid (FC0/1_)	1142
KOLEOS I (HY_)	1143
KOLEOS II	1143
LAGUNA Coupe (DT0/1)	1154
LAGUNA I (B56_, 556_)	1144
LAGUNA I Grandtour (K56_)	1147
LAGUNA II (BG0/1_)	1149
LAGUNA II Grandtour (KG0/1_)	1150
LAGUNA III (BT0/1)	1152
LAGUNA III Grandtour (KT0/1)	1153
LATITUDE (L70_)	1154



**RENAULT 1124**

LOGAN EXPRESS (US_)	1156
LOGAN I (LS_)	1155
LOGAN II (L8_)	1155
LOGAN II Kombi (K8_)	1156
LOGAN I Kombi (KS_)	1155
MASTER I Bus (T_)	1156
MASTER II Bus (JD)	1157
MASTER III Bus (JV)	1158
MASTER III Kasten (FV)	1159
MASTER III Pritsche/Fahrgestell (EV, HV, UV)	1160
MASTER II Kasten (FD)	1157
MASTER II Pritsche/Fahrgestell (ED/HD/UD)	1158
MASTER I Kasten (T_)	1156
MASTER I Pritsche/Fahrgestell (P_)	1156
MEGANE CC (EZ0/1_)	1181
MEGANE I (BA0/1_)	1160
MEGANE I Cabriolet (EA0/1_)	1162
MEGANE I Classic (LA0/1_)	1163
MEGANE I Coach (DA0/1_)	1165
MEGANE I Grandtour (KA0/1_)	1167
MEGANE II (BM0/1_, CM0/1_)	1167
MEGANE II Coupé-Cabriolet (EM0/1_)	1170
MEGANE II Grandtour (KM0/1_)	1171
MEGANE III Coupe (DZ0/1_)	1177
MEGANE III Grandtour (KZ0/1)	1178
MEGANE III Schrägheck (BZ0/1_)	1179
MEGANE II Stufenheck (LM0/1_)	1174
MEGANE IV Grandtour (K9A/M/N_)	1180
MEGANE IV Schrägheck (B9A/M/N_)	1180
MEGANE IV Stufenheck	1181
MEGANE Scenic (JA0/1_)	1182
MODUS / GRAND MODUS (F/J/P0_)	1183
RAPID	1184
RAPID Kasten (F40_, G40_)	1184
SAFRANE I (B54_)	1185
SAFRANE II (B54_)	1186
SANDERO/STEPWAY I (BS_)	1187
SANDERO/STEPWAY II (B8_)	1187
SCÉNIC I Großraumlimousine (JA0/1_, FA0_)	1187
SCÉNIC II (JM0/1_)	1188
SCÉNIC III (JZ0/1_)	1190
SCÉNIC IV (J9_)	1192
SUPER 5 (B/C40_)	1192
SUPER 5 Kasten (S40_)	1193
THALIA I (LB_)	1193
THALIA II (LU1/2_)	1193
THALIA III (L8_)	1194
TRAFIC Bus (TXW)	1196
TRAFIC II Bus (JL)	1194
TRAFIC III Bus (JG_)	1195
TRAFIC III Kasten (FG_)	1196
TRAFIC III Pritsche/Fahrgestell (EG_)	1196
TRAFIC II Kasten (FL)	1194
TRAFIC II Pritsche/Fahrgestell (EL)	1195
TRAFIC Kasten (TXX)	1196
TRAFIC Pritsche/Fahrgestell (PXX)	1197
TWINGO I (C06_)	1197
TWINGO II (CN0_)	1198
TWINGO III (BCM_)	1198
TWINGO I Kasten (S06_)	1197
VEL SATIS (BJ0_)	1198
WIND (E4M_)	1199
ZOE (BFM_)	1199

**RENAULT TRUCKS 1199**

MASCOTT Kasten/Kombi	1199
MASCOTT Kipper	1200
MASCOTT Pritsche/Fahrgestell	1200

**ROLLS-ROYCE 1200**

SILVER SERAPH	1200
---------------	------

**ROVER 1200**

100 / METRO Schrägheck (XP)	1202
-----------------------------	------

**ROVER 1200**

100 Cabriolet (XP)	1202
200 Cabriolet (XW)	1202
200 Coupe (XW)	1203
200 Schrägheck (RF)	1203
25 Schrägheck (RF)	1200
400 (RT)	1204
400 Schrägheck (RT)	1205
400 Tourer (XW)	1205
45 Schrägheck (RT)	1201
45 Stufenheck (RT)	1201
600 (RH)	1206
75 (RJ)	1201
75 Tourer (RJ)	1202
800 (XS)	1206
800 Coupe	1206
800 Schrägheck (XS)	1207
COUPE	1207
MINI Schrägheck	1207
STREETWISE Schrägheck	1207

**SAAB 1207**

9000	1224
9000 Schrägheck	1225
900 II	1222
900 II Cabriolet	1223
900 II Coupe	1223
9-3 (YS3D)	1207
9-3 (YS3F)	1208
9-3 Cabriolet (YS3D)	1212
9-3 Cabriolet (YS3F)	1212
9-3 Kombi (YS3F)	1215
9-3X	1217
9-5 (YS3E)	1218
9-5 (YS3G)	1220
9-5 Kombi (YS3E)	1220

**SEAT 1225**

ALHAMBRA (710, 711)	1227
ALHAMBRA (7V8, 7V9)	1225
ALTEA (5P1)	1227
ALTEA XL (5P5, 5P8)	1228
ARONA (KJ7)	1229
AROSA (6H)	1230
ATECA (KH7)	1230
CORDOBA (6K1, 6K2)	1231
CORDOBA (6L2)	1236
CORDOBA Vario (6K5)	1237
EXEO (3R2)	1240
EXEO ST (3R5)	1242
IBIZA II (6K1)	1243
IBIZA III (6L1)	1250
IBIZA IV (6J5, 6P1)	1251
IBIZA IV SPORTCOUPE (6J1, 6P5)	1255
IBIZA IV ST (6J8, 6P8)	1258
IBIZA V (KJ1)	1260
INCA (6K9)	1261
LEON (1M1)	1261
LEON (1P1)	1263
LEON (5F1)	1266
LEON Kasten/Schrägheck (5F1)	1269
LEON SC (5F5)	1271
LEON ST (5F8)	1274
LEON ST Kasten/Kombi (5F8)	1277
MARBELLA (28)	1280
Mii (KF1)	1280
TERRA (24)	1280
TOLEDO I (1L)	1280
TOLEDO II (1M2)	1285
TOLEDO III (5P2)	1287
TOLEDO IV (KG3)	1288

**SKODA 1288**

CITIGO	1288
FABIA I (6Y2)	1289
FABIA I Kombi (6Y5)	1291
FABIA II (542)	1295
FABIA II Kombi (545)	1297

**SKODA 1288**

FABIA III (NJ3)	1299
FABIA III Kombi (NJ5)	1299
FABIA I Praktik (6Y5)	1292
FABIA I Stufenheck (6Y3)	1293
FAVORIT Pick-up (787)	1300
FELICIA Cube Van (6U5)	1301
FELICIA I (6U1)	1300
FELICIA II (6U1)	1301
FELICIA II Kombi (6U5)	1301
FELICIA I Kombi (6U5)	1300
FELICIA I Pick-up (6UF, 6U7)	1300
KAROQ (NU7)	1301
KODIAQ (NS7)	1301
OCTAVIA I (1U2)	1302
OCTAVIA I Kombi (1U5)	1305
OCTAVIA II (1Z3)	1308
OCTAVIA II Kombi (1Z5)	1311
OCTAVIA III (5E3, NL3, NR3)	1315
OCTAVIA III Kombi (5E5)	1316
RAPID (NH3)	1318
RAPID Spaceback (NH1)	1319
ROOMSTER (5J)	1320
ROOMSTER Praktik (5J)	1321
SUPERB I (3U4)	1322
SUPERB II (3T4)	1323
SUPERB III (3V3)	1328
SUPERB III Kombi (3V5)	1329
SUPERB II Kombi (3T5)	1325
YETI (5L)	1329

**SMART 1332**

CABRIO (450)	1332
CITY-COUPE (450)	1332
CROSSBLADE (450)	1332
FORFOUR (454)	1333
FORFOUR Schrägheck (453)	1333
FORTWO Cabrio (450)	1333
FORTWO Cabrio (451)	1333
FORTWO Cabriolet (453)	1334
FORTWO Coupe (450)	1334
FORTWO Coupe (451)	1334
FORTWO Coupe (453)	1335
ROADSTER (452)	1335
ROADSTER Coupe (452)	1335

**SSANGYONG 1335**

ACTYON I	1336
ACTYON SPORTS I (QJ)	1336
ACTYON SPORTS II	1336
KORANDO (KJ)	1336
KORANDO Cabrio (KJ)	1336
KYRON	1336
MUSSO (FJ)	1336
MUSSO SPORTS	1336
REXTON (GAB_)	1336
REXTON W	1337
RODIUS	1337
RODIUS II	1337

**SUBARU 1337**

BRZ	1337
FORESTER (SF_)	1337
FORESTER (SG_)	1338
FORESTER (SH_)	1338
FORESTER (SJ_)	1338
IMPREZA Coupe (GFC)	1339
IMPREZA Schrägheck (GP)	1339
IMPREZA Schrägheck (GR, GH, G3)	1339
IMPREZA Station Wagon (GF)	1340
IMPREZA Station Wagon (GG)	1341
IMPREZA Stufenheck (GC)	1341
IMPREZA Stufenheck (GD)	1342
IMPREZA Stufenheck (GJ)	1343
IMPREZA Stufenheck (GR)	1343
JUSTY II (JMA, MS)	1344
JUSTY III (G3X)	1344
JUSTY IV	1344

**SUBARU****1337**

LEGACY II (BD)	1344
LEGACY III (BE)	1345
LEGACY III Station Wagon (BH)	1345
LEGACY II Station Wagon (BG)	1345
LEGACY IV (BL)	1346
LEGACY IV Station Wagon (BP)	1346
LEGACY OUTBACK (BG)	1347
LEGACY V (BM)	1346
LEGACY V Station Wagon (BR)	1347
OUTBACK (BE, BH)	1347
OUTBACK (BL, BP)	1347
OUTBACK (BR)	1348
OUTBACK (BS)	1348
TREZIA	1348
TRIBECA (B9)	1348
XV (GP)	1348
XV (GT)	1348

**SUZUKI****1348**

ALTO (EF)	1349
ALTO (FF)	1349
ALTO (GF)	1349
ALTO (HA12, HA23)	1349
BALENO (EG)	1349
BALENO (FW, EW)	1349
BALENO Kombi (EG)	1350
BALENO Schrägheck (EG)	1350
GRAND VITARA I (FT, HT)	1351
GRAND VITARA I Cabriolet (GT)	1351
GRAND VITARA II (JT, TE, TD)	1352
IGNIS I (FH)	1352
IGNIS II (MH)	1352
JIMNY Geländewagen geschlossen (SN)	1352
JIMNY Geländewagen offen (SN)	1353
KIZASHI (FR)	1353
LIANA (ER, RH)	1353
LIANA Schrägheck	1353
SAMURAI Geländewagen geschlossen (SJ)	1354
SPLASH (EX)	1354
SUPER CARRY Bus (ED)	1354
SWIFT III (MZ, EZ)	1355
SWIFT II Schrägheck (EA, MA)	1354
SWIFT IV (FZ, NZ)	1355
SX4 (EY, GY)	1356
SX4 S-Cross (JY)	1356
SX4 Stufenheck (GY)	1356
VITARA (ET, TA)	1357
VITARA (LY)	1357
VITARA Cabrio (ET, TA)	1357
WAGON R+ Schrägheck (EM)	1358
WAGON R+ Schrägheck (MM)	1358
WAGON R Schrägheck	1357
X-90 (EL)	1358

**TOYOTA****1358**

4 RUNNER (_N1_)	1358
4 RUNNER (_N18_)	1358
ALPHARD / VELLFIRE (_H2_)	1359
ALTEZZA (_E1_)	1359
ALTEZZA GITA Kombi (_XE1_)	1359
AURIS (_E15_)	1359
AURIS (_E18_)	1360
AURIS TOURING SPORTS Kombi (_E18_)	1360
AURIS VAN Kasten (_E18_)	1361
AVENSIS (_T22_)	1361
AVENSIS (_T25_)	1362
AVENSIS Kombi (_T25_)	1362
AVENSIS Kombi (_T22_)	1363
AVENSIS Kombi (_T27_)	1364
AVENSIS Liftback (_T22_)	1364
AVENSIS Stufenheck (_T25_)	1365
AVENSIS Stufenheck (_T27_)	1366
AVENSIS VERSO (_M2_)	1366
AYGO (_B1_)	1366
AYGO (_B4_)	1366
CAMRY (_V1_)	1367
CAMRY (_V2_)	1367
CAMRY Kombi (_V1_)	1367

**TOYOTA****1358**

CAMRY Stufenheck (_V3_)	1367
CAMRY Stufenheck (_V4_)	1367
CAMRY Stufenheck (_V5_)	1368
CARINA E (_T19_)	1368
CARINA E Station Wagon (_T19_)	1368
CARINA E Stufenheck (_T19_)	1369
CELICA Cabriolet (_T20_)	1369
CELICA Coupe (_T20_)	1369
CELICA Coupe (_T23_)	1370
COROLLA (_E10_)	1370
COROLLA (_E11_)	1370
COROLLA (_E12_)	1371
COROLLA Combi (_E12_)	1373
COROLLA Compact (_E10_)	1374
COROLLA Compact (_E11_)	1374
COROLLA Kombi (_E10_)	1375
COROLLA Kombi (_E11_)	1376
COROLLA LEVIN Coupe (_E10_)	1377
COROLLA Liftback (_E10_)	1377
COROLLA Liftback (_E11_)	1377
COROLLA Stufenheck (_E12_)	1378
COROLLA Stufenheck (_E15_)	1379
COROLLA Stufenheck (_E18_, ZRE1_)	1380
COROLLA Verso (_E12_)	1380
COROLLA Verso (ZER_, ZZE12_, R1_)	1380
DYNA Pritsche/Fahrgestell (KD_, LY_, _Y2_, _U3_, _U4_)	1381
FJ CRUISER (GSJ1_)	1381
HARRIER (_U3_)	1381
HIACE / COMMUTER V (TRH2_, KDH2_)	1381
HIACE III Wagon (_H1_)	1382
HIACE IV Bus (_H1_, _H2_)	1382
HIACE IV Kasten (LXH1_, RZH1_, LH1_)	1382
HIACE V Kasten (TRH2_, KDH2_)	1383
HILUX Geländewagen geschlossen (LN_, KZN1_, VZN1_)	1385
HILUX Pritsche/Fahrgestell (_N1_, _N2_)	1385
HILUX VII Pick-up (_N1_, _N2_, _N3_)	1384
HILUX VI Pick-up (_N1_)	1384
HILUX V Pick-up (_N_, KZN1_, VZN1_)	1383
IQ (_J1_)	1385
LAND CRUISER (_J7_)	1385
LAND CRUISER 100 (_J1_)	1386
LAND CRUISER 200 (_J2_)	1386
LAND CRUISER 80 (_J8_)	1386
LAND CRUISER 90 (_J9_)	1386
LAND CRUISER Hardtop (_J7_)	1387
LAND CRUISER Pick-up (_J7_)	1387
LAND CRUISER PRADO (_J12_)	1387
LAND CRUISER PRADO (_J15_)	1388
MATRIX (_E13_)	1388
MIRAI (JPD1_)	1389
MR 2 II (SW2_)	1389
MR 2 III (ZZW3_)	1389
PASEO Cabriolet (EL54_)	1389
PASEO Coupe (EL54_)	1389
PICNIC (_XM1_)	1389
PREVIA (_R1_, _R2_)	1389
PREVIA (_R3_)	1390
PREVIA III (_R2_, _R5_)	1390
PRIUS (_W3_)	1390
PRIUS (_W5_)	1390
PRIUS C (NHP10_)	1390
PRIUS Liftback (_W2_)	1390
PRIUS PHV (_W52_)	1391
PRIUS PLUS (_W4_)	1391
PRIUS Stufenheck (_W1_)	1391
PROACE Bus (MPY_)	1391
PROACE Kasten/Kombi (MDX_)	1391
PROACE Kasten (MDZ_)	1391
PROACE Pritsche/Fahrgestell (MDZ_)	1391
PROACE VERSO (MPY_)	1392
RAV 4 I (_A1_)	1392
RAV 4 I Cabrio (_A1_)	1392
RAV 4 II (_A2_)	1392
RAV 4 III (_A3_)	1392
RAV 4 IV (_A4_)	1393
STARLET (_P8_)	1393
STARLET (_P9_)	1394
URBAN CRUISER (_P1_)	1394
VERSO (_R2_)	1394

**TOYOTA****1358**

VERSO S (_P12_)	1394
YARIS / VIOS Stufenheck (_P9_)	1395
YARIS (_P1_)	1395
YARIS (_P13_)	1397
YARIS (_P9_)	1396
YARIS VERSO (_P2_)	1398

**VAUXHALL****1398**

ADAM (M13)	1398
AGILA Mk I (A) (H00)	1399
AGILA Mk II (B) (H08)	1399
AMPERA (R12)	1400
ANTARA (L07)	1400
ARENA Combi (A97)	1401
ARENA Van (A97)	1401
ASTRA Mk III (F) Cabriolet (T92)	1401
ASTRA Mk III (F) CC (T92)	1402
ASTRA Mk III (F) Kombi (T92)	1403
ASTRA Mk III (F) Stufenheck (T92)	1404
ASTRA Mk IV (G) Cabriolet (T98)	1406
ASTRA Mk IV (G) CC (T98)	1407
ASTRA Mk IV (G) Coupe (T98)	1409
ASTRA Mk IV (G) Kombi (T98)	1410
ASTRA Mk IV (G) Stufenheck (T98)	1413
ASTRA Mk V (H) CC (A04)	1414
ASTRA Mk V (H) Convertible (A04)	1418
ASTRA Mk V (H) Kombi (A04)	1419
ASTRA Mk VI (J) (P10)	1421
ASTRA Mk VI (J) CC (P10)	1422
ASTRA Mk VI (J) Kombi (P10)	1422
ASTRA Mk VI (J) Stufenheck (P10)	1423
ASTRA Mk VII (K) (B16)	1424
ASTRA Mk VII (K) Kombi (B16)	1424
ASTRAVAN Mk III (F) (T92)	1424
ASTRAVAN Mk IV (G) (T98)	1425
ASTRAVAN Mk V (H) (A04)	1426
BRAVA Pick-up (TF0, TF1)	1427
CALIBRA (C89)	1427
CASCADA Cabriolet (W13)	1428
COMBO Mk I (B) (S93)	1428
COMBO Mk II (C) Kasten/Kombi (F25)	1428
COMBO Mk III (D) Kasten/Kombi (X12)	1430
COMBO TOUR Mk II (C) (F25)	1430
CORSA Mk I (B) (S93)	1431
CORSA Mk II (C) (X01)	1432
CORSA Mk III (D) (S07)	1433
CORSA Mk IV (E) (X15)	1435
CORSAVAN Mk I (B) (S93)	1435
CORSAVAN Mk II (C) (X01)	1435
CORSAVAN Mk III (D) (S07)	1436
CORSAVAN Mk IV (E) (X15)	1436
CROSSLAND X (P17)	1437
FRONTERA Mk I (A) (U92)	1437
FRONTERA Mk I (A) Sport (U92)	1438
FRONTERA Mk II (B) (U99)	1438
INSIGNIA Mk I (A) Estate	1438
INSIGNIA Mk I (A) Schrägheck (G09)	1440
INSIGNIA Mk I (A) Stufenheck (G09)	1442
MERIVA Mk I (A) (X03)	1444
MERIVA Mk II (B) (S10)	1446
MOKKA / MOKKA X (J13)	1446
MONTEREY (M92)	1447
MONTEREY Mk II (M98)	1447
MOVANO Mk I (A) Chassis/Cab (X70)	1447
MOVANO Mk I (A) Kombi (X70)	1448
MOVANO Mk I (A) Van (X70)	1449
MOVANO Mk II (B) Chassis/Cab (X62)	1449
MOVANO Mk II (B) Kombi (X62)	1450
MOVANO Mk II (B) VAN (X62)	1450
OMEGA (B) Kombi (V94)	1451
OMEGA (B) Stufenheck (V94)	1452
SIGNUM (Z03)	1453
SINTRA (APV)	1456
SPEEDSTER (E01)	1456
TIGRA Convertible (X04)	1456
TIGRA Mk I (S93)	1456
VECTRA (B) CC (J96)	1456
VECTRA (B) Kombi (J96)	1458
VECTRA (B) Stufenheck (J96)	1459





**VAUXHALL 1398**

VECTRA Mk II (C) (Z02)	1461
VECTRA Mk II (C) CC (Z02)	1464
VECTRA Mk II (C) Kombi (Z02)	1466
VIVA (C16)	1468
VIVARO Combi (X82)	1468
VIVARO Combi (X83)	1468
VIVARO Kasten (X82)	1469
VIVARO Kasten (X83)	1469
VIVARO Pritsche/Fahrgestell (X82)	1469
VIVARO Pritsche/Fahrgestell (X83)	1470
VX220 Cabriolet (E01)	1470
ZAFIRA Mk I (A) (T98)	1470
ZAFIRA Mk II (B) (A05)	1472
ZAFIRA Mk III (P12)	1474

**VOLVO 1474**

440 K (445)	1474
460 L (464)	1475
480 E (482)	1475
850 (854)	1476
850 Kombi (855)	1476
940 II (944)	1477
940 II Kombi (945)	1477
960 II (964)	1478
960 II Kombi (965)	1478
C30 (533)	1478
C70 I Cabriolet (873)	1479
C70 I Coupe (872)	1480
C70 II Cabriolet (542)	1480
S40 I (644)	1481
S40 II (544)	1481
S60 I (384)	1482
S60 II (134)	1485
S70 (874)	1488
S80 I (184)	1489
S80 II (124)	1490
S90 (964)	1491
S90 II (234)	1491
V40 Kombi (645)	1491
V40 Schrägheck (525, 526)	1492
V50 (545)	1494
V60 (155, 157)	1494
V70 I (875, 876)	1498
V70 II (285)	1501
V70 III (135)	1504
V90 II Kombi (235, 236)	1509
V90 Kombi (965)	1509
XC40 (536)	1509
XC60 (156)	1510
XC60 II (246)	1511
XC70 CROSS COUNTRY (295)	1514
XC70 II (136)	1511
XC90 I (275)	1514
XC90 II (256)	1515

**VW 1515**

AMAROK (2HA, 2HB, S1B, S6B, S7A, S7B)	1516
AMAROK Pritsche/Fahrgestell (S1B)	1516
ARTEON (3H7)	1516
BEETLE (5C1, 5C2)	1517
BEETLE Cabriolet (5C7, 5C8)	1519
BORA (1J2)	1521
BORA Variant (1J6)	1526
CADDY ALLTRACK Kasten (SAA)	1537
CADDY ALLTRACK Kombi (SAB)	1537
CADDY III Kasten (2KA, 2KH, 2CA, 2CH)	1529
CADDY III Kombi (2KB, 2KJ, 2CB, 2CJ)	1533
CADDY II Kasten (9K9A)	1529
CADDY II Kombi (9K9B)	1529
CADDY II Pick-up (9U7)	1529
CADDY IV Kasten (SAA, SAH)	1536
CADDY IV Kombi (SAB, SAJ)	1536
CC (358)	1537
CRAFTER 30-35 Bus (2E_)	1538
CRAFTER 30-50 Kasten (2E_)	1539
CRAFTER 30-50 Pritsche/Fahrgestell (2F_)	1540
EOS (1F7, 1F8)	1542
FOX (5Z1, 5Z3)	1543

**VW 1515**

GOLF ALLTRACK (BA5, BV5)	1577
GOLF III (1H1)	1543
GOLF III Cabriolet (1E7)	1547
GOLF III Van (1H1)	1547
GOLF III Variant (1H5)	1548
GOLF IV (1J1)	1549
GOLF IV Cabriolet (1E7)	1556
GOLF IV Van (1J1)	1557
GOLF IV Variant (1J5)	1558
GOLF PLUS (5M1, 521)	1577
GOLF SPORTSVAN (AM1)	1579
GOLF V (1K1)	1561
GOLF VI (5K1)	1568
GOLF VI Cabriolet (517)	1570
GOLF VII (5G1, BQ1, BE1, BE2)	1572
GOLF VII Variant (BA5, BV5)	1575
GOLF VI Variant (AJ5)	1571
GOLF V Variant (1K5)	1567
JETTA III (1K2)	1580
JETTA IV (162, 163)	1581
LOAD UP (121, 122, BL1, BL2)	1582
LT 28-35 I Bus (281-363)	1583
LT 28-35 II Bus (2DB, 2DE, 2DK)	1584
LT 28-35 I Kasten (281-363)	1583
LT 28-35 I Pritsche/Fahrgestell (281-363)	1583
LT 28-46 II Kasten (2DA, 2DD, 2DH)	1585
LT 28-46 II Pritsche/Fahrgestell (2DC, 2DF, 2DG, 2DL, 2DM)	1586
LT 40-55 I Kasten (291-512)	1587
LT 40-55 I Pritsche/Fahrgestell (293-909)	1587
LUPO (6X1, 6E1)	1587
MULTIVAN T5 (7HM, 7HN, 7HF, 7EF, 7EM, 7EN)	1588
MULTIVAN T6 (SGF, SGM, SGN)	1589
NEW BEETLE (9C1, 1C1)	1590
NEW BEETLE Cabriolet (1Y7)	1591
PASSAT (362)	1603
PASSAT (3A2, 351)	1592
PASSAT (3B2)	1594
PASSAT (3B3)	1598
PASSAT (3C2)	1600
PASSAT (3G2)	1602
PASSAT ALLTRACK (365)	1604
PASSAT ALLTRACK (3G5)	1604
PASSAT CC (357)	1605
PASSAT Variant (365)	1617
PASSAT Variant (3A5, 351)	1606
PASSAT Variant (3B5)	1608
PASSAT Variant (3B6)	1612
PASSAT Variant (3C5)	1614
PASSAT Variant (3G5)	1616
PHAETON (3D1, 3D2, 3D3, 3D4, 3D6, 3D7, 3D8, 3D9)	1619
POLO (6N1)	1619
POLO (6N2)	1621
POLO (6R1, 6C1)	1622
POLO (9N_)	1625
POLO (AW1, BZ1)	1628
POLO CLASSIC (6V2)	1629
POLO Stufenheck (602, 604, 612, 614)	1631
POLO Stufenheck (9A4, 9A2, 9N2)	1630
POLO Van (6R)	1632
POLO Van Kasten/Schrägheck (6N1)	1633
POLO Variant (6V5)	1634
SCIROCCO (137, 138)	1635
SHARAN (7M8, 7M9, 7M6)	1638
SHARAN (7N1, 7N2)	1640
TARO	1641
TIGUAN (5N_)	1641
TIGUAN (AD1)	1642
TIGUAN ALLSPACE (BW2)	1643
TOUAREG (7LA, 7L6, 7L7)	1644
TOUAREG (7P5, 7P6)	1650
TOUAREG (CR7)	1652
TOURAN (1T1, 1T2)	1652
TOURAN (1T3)	1654
TOURAN (5T1)	1655
TRANSPORTER T4 Bus (70B, 70C, 7DB, 7DK, 70J, 70K, 7DC, 7DJ)	1656
TRANSPORTER T4 Kasten (70A, 70H, 7DA, 7DH)	1659

**VW 1515**

TRANSPORTER T4 Pritsche/Fahrgestell (70E, 70L, 70M, 7DE, 7DL)	1662
TRANSPORTER T5 Bus (7HB, 7HJ, 7EB, 7EJ, 7EF, 7EG, 7HF, 7EC)	1665
TRANSPORTER T5 Kasten (7HA, 7HH, 7EA, 7EH)	1667
TRANSPORTER T5 Pritsche/Fahrgestell (7JD, 7JE, 7JL, 7JY, 7JZ)	1669
TRANSPORTER T6 Bus (SGB, SGG, SGJ)	1671
TRANSPORTER T6 Kasten (SGA, SGH)	1671
TRANSPORTER T6 Pritsche/Fahrgestell (SFD, SFE, SFL, SFZ)	1671
T-ROC (A11)	1672
UP (121, 122, BL1, BL2)	1672
VENTO (1H2)	1673





**DE** Fahrzeugverwendungen















**EN** Applications of vehicles













**ES** Aplicaciones







**FR** Applications

**IT** Applicazioni autoveicoli









**2019**











	kw			 	! #		
<b>ABARTH - 124 Spider (348_) 03/16→</b>							
 <b>Bremsbelagsatz, Scheibenbremse</b>							
1.4	125	03/16→	→		13.0460-5762.2	605762	AKE 24298 14,0 + WK + Zub
<b>ABARTH - 500 / 595 / 695 (312_) 01/08→</b>							
 <b>Bremsbelagsatz, Scheibenbremse</b>							
1.4 (312.AXD1A)	99	08/08→	←		13.0460-3827.2	603827	BOS 23709 19,6 + WK + Zub
1.4 (312.AXF11, 312.AXF1A, 312.AXD1A)	118	08/08→	←		13.0460-3864.2	603864	BOS 23709 19,6 + WK + Zub
1.4 (312.AXF1A, 312.AXD1A)	103	05/10→	→		13.0470-3827.2	LD3827	BOS 23709 19,6 + WK + Zub Ceramic
1.4 (312.AXF1A, 312.AXD1A)	107	05/16→	→		13.0460-2879.2	602879	TRW 23601 13,7 - WE / - WK
1.4 (312.AXY11, 312.AXY1A)	121	05/16→			13.0470-2879.2	LD2879	TRW 23601 13,7 - WE / - WK Ceramic
1.4 (312.AXZ11)	120	06/16→					
1.4 (312.AXF11, 312.AXF1A)	132	08/08→	→		13.0460-2879.2	602879	TRW 23601 13,7 - WE / - WK
1.4 (312.AXT1A)	139	06/15→			13.0470-2879.2	LD2879	TRW 23601 13,7 - WE / - WK Ceramic
1.4 (312.AXT1A)	140	08/08→					
 <b>Bremsscheibe</b>							
1.4 (312.AXD1A)	99	08/08→	←	- Kit ESSEESSE	24.0122-0147.1	422147	Ø 284 22 20,2 V
1.4 (312.AXF11, 312.AXF1A, 312.AXD1A)	118	08/08→	←	+ Kit ESSEESSE	24.0122-0283.1	422283	Ø 284 22 20,2 V•
1.4 (312.AXF1A, 312.AXD1A)	103	05/10→	→	- Kit ESSEESSE	24.0111-0119.1	411119	Ø 240,5 11 9,2
1.4 (312.AXF1A, 312.AXD1A)	107	05/16→	→	+ Kit ESSEESSE	24.0111-0176.1	411176	Ø 240,5 11 9,2 •
1.4 (312.AXY11, 312.AXY1A)	121	05/16→					
1.4 (312.AXZ11)	120	06/16→					
1.4 (312.AYB11, 312.AYB1A)	120	06/16→					
<b>ABARTH - 500C / 595C / 695C (312_) 09/09→</b>							
 <b>Bremsbelagsatz, Scheibenbremse</b>							
1.4 (312.AXD1A)	99	01/11→	←		13.0460-3827.2	603827	BOS 23709 19,6 + WK + Zub
1.4 (312.AXF11)	132	06/10→			13.0460-3864.2	603864	BOS 23709 19,6 + WK + Zub
1.4 (312.AXF1A, 312.AXD1A)	118	05/11→			13.0470-3827.2	LD3827	BOS 23709 19,6 + WK + Zub Ceramic
1.4 (312.AXF1A, 312.AXD1A)	103	09/09→					
1.4 (312.AXF1A, 312AXF11, 312AXD1A)	107	05/16→					
1.4 (312.AXY1A)	121	05/16→					
1.4 (312.AXZ1A)	121	05/16→					
 <b>Bremsscheibe</b>							
1.4 (312.AXD1A)	99	01/11→	←	- Kit ESSEESSE	24.0122-0147.1	422147	Ø 284 22 20,2 V
1.4 (312.AXF11)	132	06/10→			24.0122-0283.1	422283	Ø 284 22 20,2 V•
1.4 (312.AXF1A, 312.AXD1A)	118	05/11→	←	+ Kit ESSEESSE	24.0111-0119.1	411119	Ø 240,5 11 9,2
1.4 (312.AXF1A, 312.AXD1A)	103	09/09→	→	- Kit ESSEESSE	24.0111-0176.1	411176	Ø 240,5 11 9,2 •
1.4 (312.AXF1A, 312AXF11, 312AXD1A)	107	05/16→	→	+ Kit ESSEESSE			
1.4 (312.AXY1A)	121	05/16→					
1.4 (312.AXZ1A)	121	05/16→					
<b>ABARTH - GRANDE PUNTO (199_) 12/07→12/12</b>							
 <b>Bremsbelagsatz, Scheibenbremse</b>							
1.4 (199.AXN1B)	114	12/07→06/10	←		13.0460-4853.2	604853	BRE 24162 15,2 + WK
			→		13.0470-4853.2	LD4853	BRE 24162 15,2 + WK Ceramic
			→		13.0460-3828.2	603828	BOS 24349 17,5 - WE / - WK
			→		13.0470-3828.2	LD3828	BOS 24349 17,5 - WE / - WK Ceramic
1.4 (199.AXX1B)	132	12/07→12/12	←	→ 01/11	13.0460-4853.2	604853	BRE 24162 15,2 + WK
			→	→ 01/11	13.0470-4853.2	LD4853	BRE 24162 15,2 + WK Ceramic
			←	→ 01/11	13.0460-3828.2	603828	BOS 24349 17,5 - WE / - WK
			→	→ 01/11	13.0470-3828.2	LD3828	BOS 24349 17,5 - WE / - WK Ceramic
 <b>Bremsscheibe</b>							
1.4 (199.AXN1B)	114	12/07→06/10	←		24.0128-0219.1	428219	Ø 305 28 26 V
			→		24.0110-0323.1	410323	Ø 264 10 8
1.4 (199.AXX1B)	132	12/07→12/12	←	→ 01/11	24.0128-0219.1	428219	Ø 305 28 26 V
			→	→ 01/11	24.0110-0323.1	410323	Ø 264 10 8











	kw					! #		
<b>ABARTH - PUNTO (199_) 03/12→02/12</b>								
 <b>Bremsbelagsatz, Scheibenbremse</b>								
1.4 (199.AXX1B)	120	03/12→02/12	←			13.0460-4853.2	604853	BRE 24162 15,2 + WK
1.4 (199.AXX1B)	132	03/12→02/12	←			13.0470-4853.2	LD4853	BRE 24162 15,2 + WK Ceramic
			→			13.0460-3862.2	603862	BOS 24349 17,6 + WK + Zub
 <b>Bremsscheibe</b>								
1.4 (199.AXX1B)	120	03/12→02/12	←			24.0128-0219.1	428219	Ø 305 28 26 V
1.4 (199.AXX1B)	132	03/12→02/12	←			24.0110-0323.1	410323	Ø 264 10 8
			→					
<b>ABARTH - PUNTO EVO (199_) 07/08→02/12</b>								
 <b>Bremsbelagsatz, Scheibenbremse</b>								
1.4 (199.AXX1B)	120	10/09→02/12	←			13.0460-4853.2	604853	BRE 24162 15,2 + WK
1.4 (199.AXX1B)	132	07/08→02/12	←			13.0470-4853.2	LD4853	BRE 24162 15,2 + WK Ceramic
			→			13.0460-3862.2	603862	BOS 24349 17,6 + WK + Zub
 <b>Bremsscheibe</b>								
1.4 (199.AXX1B)	120	10/09→02/12	←			24.0128-0219.1	428219	Ø 305 28 26 V
1.4 (199.AXX1B)	132	07/08→02/12	←			24.0110-0323.1	410323	Ø 264 10 8
			→					
<b>ALFA ROMEO - 145 (930_) 07/94→01/01</b>								
 <b>Bremsbelagsatz, Scheibenbremse</b>								
1.4 i.e. (930.A3)	66	07/94→12/96	←			13.0460-2949.2	602949	TRW 20833 17,0 + WK
1.6 i.e. (930.A2)	76	10/94→12/96	→	+ ABS; ALU		13.0460-2826.2	602826	TRW 23177 14,2 - WK
			→	+ ABS; GG		13.0460-2951.2	602951	TRW 21103 14,2 - WK
1.4 i.e. 16V T.S. (930.A3A)	76	12/96→01/01	←	01/97→		13.0460-7067.2	607067	ATE 21927 17,9 + WK
1.6 i.e. 16V T.S. (930.A2)	88	12/96→01/01	→	01/97→; + ABS; ALU		13.0460-2826.2	602826	TRW 23177 14,2 - WK
			→	01/97→; + ABS; GG		13.0460-2951.2	602951	TRW 21103 14,2 - WK
1.6 16V T.S. (930.A2C)	82	09/97→12/00	←			13.0460-7067.2	607067	ATE 21927 17,9 + WK
1.9 JTD (930.A4B)	77	02/99→01/01	→	+ ABS; ALU		13.0460-2826.2	602826	TRW 23177 14,2 - WK
			→	+ ABS; GG		13.0460-2951.2	602951	TRW 21103 14,2 - WK
1.7 i.e. 16V (930.A1)	95	10/94→12/96	←			13.0460-2949.2	602949	TRW 20833 17,0 + WK
			→	ALU		13.0460-2826.2	602826	TRW 23177 14,2 - WK
			→	GG		13.0460-2951.2	602951	TRW 21103 14,2 - WK
1.8 i.e. 16V (930.A1A)	106	03/98→01/01	←			13.0460-7069.2	607069	ATE 21636 19,3 + WK
2.0 16V (930.A5)	114	03/98→01/01	→	ALU		13.0460-2826.2	602826	TRW 23177 14,2 - WK
2.0 16V T.S. (930.A5)	110	10/95→01/01	→	GG		13.0460-2951.2	602951	TRW 21103 14,2 - WK
1.8 i.e. 16V T.S. (930.A1A)	103	12/96→12/98	←	01/97→		13.0460-7069.2	607069	ATE 21636 19,3 + WK
			→	01/97→; ALU		13.0460-2826.2	602826	TRW 23177 14,2 - WK
			→	01/97→; GG		13.0460-2951.2	602951	TRW 21103 14,2 - WK
1.9 TD (930.A4)	66	10/94→02/99	←	→ 12/96		13.0460-2949.2	602949	TRW 20833 17,0 + WK
			←	01/97→		13.0460-7067.2	607067	ATE 21927 17,9 + WK
			→	+ ABS; ALU		13.0460-2826.2	602826	TRW 23177 14,2 - WK
			→	+ ABS; GG		13.0460-2951.2	602951	TRW 21103 14,2 - WK
<b>Zubehörsatz, Scheibenbremsbelag</b>								
1.4 i.e. (930.A3)	66	07/94→12/96	→	+ ABS; GG		13.0460-0072.2	610072	TRW
1.6 16V T.S. (930.A2C)	82	09/97→12/00						
1.6 i.e. (930.A2)	76	10/94→12/96						
1.9 JTD (930.A4B)	77	02/99→01/01						
1.9 TD (930.A4)	66	10/94→02/99						
1.4 i.e. 16V T.S. (930.A3A)	76	12/96→01/01	→	01/97→; + ABS; GG		13.0460-0072.2	610072	TRW
1.6 i.e. 16V T.S. (930.A2)	88	12/96→01/01						
1.7 i.e. 16V (930.A1)	95	10/94→12/96	→	GG		13.0460-0072.2	610072	TRW
1.8 i.e. 16V (930.A1A)	106	03/98→01/01						
2.0 16V (930.A5)	114	03/98→01/01						
2.0 16V T.S. (930.A5)	110	10/95→01/01						
1.8 i.e. 16V T.S. (930.A1A)	103	12/96→12/98	→	01/97→; GG		13.0460-0072.2	610072	TRW
↓								









	kw			 	! #		
<b>ALFA ROMEO - 145 (930_) 07/94→01/01</b>							
<b>Bremsscheibe</b>							
1.4 i.e. (930.A3)	66	07/94→12/96	←			24.0112-0127.1 412127	Ø 257,5 12 10,2
1.6 i.e. (930.A2)	76	10/94→12/96	→	+ ABS		24.0111-0149.1 411149	Ø 240,5 11 9,2
1.4 i.e. 16V T.S. (930.A3A)	76	12/96→01/01	←	01/97→		24.0120-0142.1 420142	Ø 257,5 20 18,2 V
1.6 i.e. 16V T.S. (930.A2)	88	12/96→01/01	→	01/97→; + ABS		24.0320-0142.1 520142	Ø 257,5 20 18,2 V
1.6 16V T.S. (930.A2C)	82	09/97→12/00	←			24.0120-0142.1 420142	Ø 257,5 20 18,2 V
1.9 JTD (930.A4B)	77	02/99→01/01	→	+ ABS		24.0320-0142.1 520142	Ø 257,5 20 18,2 V
1.7 i.e. 16V (930.A1)	95	10/94→12/96	←			24.0120-0142.1 420142	Ø 257,5 20 18,2 V
			→			24.0320-0142.1 520142	Ø 257,5 20 18,2 V
			→			24.0111-0149.1 411149	Ø 240,5 11 9,2
1.8 i.e. 16V (930.A1A)	106	03/98→01/01	←			24.0122-0107.1 422107	Ø 284 22 20,2 V
			→			24.0111-0149.1 411149	Ø 240,5 11 9,2
1.8 i.e. 16V T.S. (930.A1A)	103	12/96→12/98	←	01/97→		24.0122-0107.1 422107	Ø 284 22 20,2 V
			→	01/97→		24.0111-0149.1 411149	Ø 240,5 11 9,2
1.9 TD (930.A4)	66	10/94→02/99	←	→ 12/96		24.0112-0127.1 412127	Ø 257,5 12 10,2
			←	01/97→		24.0120-0142.1 420142	Ø 257,5 20 18,2 V
			→	+ ABS		24.0320-0142.1 520142	Ø 257,5 20 18,2 V
			→	+ ABS		24.0111-0149.1 411149	Ø 240,5 11 9,2
2.0 16V (930.A5)	114	03/98→01/01	←			24.0122-0107.1 422107	Ø 284 22 20,2 V
2.0 16V T.S. (930.A5)	110	10/95→01/01	→			24.0111-0119.1 411119	Ø 240,5 11 9,2
			→			24.0111-0149.1 411149	Ø 240,5 11 9,2
<b>ALFA ROMEO - 146 (930_) 12/94→10/01</b>							
<b>Bremsbelagsatz, Scheibenbremse</b>							
1.4 i.e. (930.B3)	66	12/94→12/96	←			13.0460-2949.2 602949	TRW 20833 17,0 + WK
1.6 i.e. (930.B2)	76	12/94→12/96	→	+ ABS; ALU		13.0460-2826.2 602826	TRW 23177 14,2 - WK
			→	+ ABS; GG		13.0460-2951.2 602951	TRW 21103 14,2 - WK
1.4 i.e. 16V T.S. (930.B3A)	76	11/96→01/01	←	01/97→		13.0460-7067.2 607067	ATE 21927 17,9 + WK
1.6 i.e. 16V T.S. (930.B2B, 930.B2C)	88	11/96→10/01	→	01/97→; + ABS; ALU		13.0460-2826.2 602826	TRW 23177 14,2 - WK
			→	01/97→; + ABS; GG		13.0460-2951.2 602951	TRW 21103 14,2 - WK
1.6 16V T.S. (930.B2C)	82	09/97→12/00	←			13.0460-7067.2 607067	ATE 21927 17,9 + WK
1.9 JTD (930.B4B)	77	02/99→01/01	→	+ ABS; ALU		13.0460-2826.2 602826	TRW 23177 14,2 - WK
			→	+ ABS; GG		13.0460-2951.2 602951	TRW 21103 14,2 - WK
1.7 i.e. 16V (930.B1)	95	12/94→12/96	←			13.0460-2949.2 602949	TRW 20833 17,0 + WK
			→	ALU		13.0460-2826.2 602826	TRW 23177 14,2 - WK
			→	GG		13.0460-2951.2 602951	TRW 21103 14,2 - WK
1.8 i.e. 16V T.S. (930.B1A)	103	11/96→01/01	←	01/97→		13.0460-7069.2 607069	ATE 21636 19,3 + WK
			→	01/97→; ALU		13.0460-2826.2 602826	TRW 23177 14,2 - WK
			→	01/97→; GG		13.0460-2951.2 602951	TRW 21103 14,2 - WK
1.8 i.e. 16V T.S. (930.B1A)	106	03/98→01/01	←			13.0460-7069.2 607069	ATE 21636 19,3 + WK
2.0 16V (930.B5)	114	03/97→10/01	→	ALU		13.0460-2826.2 602826	TRW 23177 14,2 - WK
2.0 16V T.S. (930.B5)	110	10/95→01/01	→	GG		13.0460-2951.2 602951	TRW 21103 14,2 - WK
1.9 TD (930.B4A)	66	12/94→02/99	←	→ 12/96		13.0460-2949.2 602949	TRW 20833 17,0 + WK
			←	01/97→		13.0460-7067.2 607067	ATE 21927 17,9 + WK
			→	+ ABS; ALU		13.0460-2826.2 602826	TRW 23177 14,2 - WK
			→	+ ABS; GG		13.0460-2951.2 602951	TRW 21103 14,2 - WK
<b>Zubehörsatz, Scheibenbremsbelag</b>							
1.4 i.e. (930.B3)	66	12/94→12/96	→	+ ABS; GG		13.0460-0072.2 610072	TRW
1.6 16V T.S. (930.B2C)	82	09/97→12/00					
1.6 i.e. (930.B2)	76	12/94→12/96					
1.9 JTD (930.B4B)	77	02/99→01/01					
1.9 TD (930.B4A)	66	12/94→02/99					
1.4 i.e. 16V T.S. (930.B3A)	76	11/96→01/01	→	01/97→; + ABS; GG		13.0460-0072.2 610072	TRW
1.6 i.e. 16V T.S. (930.B2B, 930.B2C)	88	11/96→10/01					
			↓				











	kw			 	! #		
<b>ALFA ROMEO - 146 (930_) 12/94→10/01</b>							
<b>Zubehörsatz, Scheibenbremsbelag</b>							
1.7 i.e. 16V (930.B1) 1.8 i.e. 16V T.S. (930.B1A) 2.0 16V (930.B5) 2.0 16V T.S. (930.B5)	95 106 114 110	12/94→12/96 03/98→01/01 03/97→10/01 10/95→01/01	➡	GG		13.0460-0072.2 610072	TRW
1.8 i.e. 16V T.S. (930.B1A)	103	11/96→01/01	➡	01/97→; GG		13.0460-0072.2 610072	TRW
<b> Bremsscheibe</b>							
1.4 i.e. (930.B3) 1.6 i.e. (930.B2)	66 76	12/94→12/96 12/94→12/96	←			24.0112-0127.1 412127	Ø 257,5 12 10,2
			➡	+ ABS		24.0111-0149.1 411149	Ø 240,5 11 9,2
1.4 i.e. 16V T.S. (930.B3A) 1.6 i.e. 16V T.S. (930.B2B, 930.B2C)	76 88	11/96→01/01 11/96→10/01	←	01/97→		24.0120-0142.1 420142	Ø 257,5 20 18,2 V
			➡	01/97→; + ABS		24.0111-0149.1 411149	Ø 240,5 11 9,2
1.6 16V T.S. (930.B2C) 1.9 JTD (930.B4B)	82 77	09/97→12/00 02/99→01/01	←			24.0120-0142.1 420142	Ø 257,5 20 18,2 V
			➡	+ ABS		24.0111-0149.1 411149	Ø 240,5 11 9,2
1.7 i.e. 16V (930.B1)	95	12/94→12/96	←			24.0120-0142.1 420142	Ø 257,5 20 18,2 V
			➡			24.0320-0142.1 520142	Ø 257,5 20 18,2 V
			➡			24.0111-0149.1 411149	Ø 240,5 11 9,2
1.8 i.e. 16V T.S. (930.B1A)	103	11/96→01/01	←	01/97→		24.0122-0107.1 422107	Ø 284 22 20,2 V
			➡	01/97→		24.0111-0149.1 411149	Ø 240,5 11 9,2
1.8 i.e. 16V T.S. (930.B1A)	106	03/98→01/01	←			24.0122-0107.1 422107	Ø 284 22 20,2 V
			➡			24.0111-0149.1 411149	Ø 240,5 11 9,2
1.9 TD (930.B4A)	66	12/94→02/99	←	→ 12/96		24.0112-0127.1 412127	Ø 257,5 12 10,2
			←	01/97→		24.0120-0142.1 420142	Ø 257,5 20 18,2 V
			➡			24.0320-0142.1 520142	Ø 257,5 20 18,2 V
			➡	+ ABS		24.0111-0149.1 411149	Ø 240,5 11 9,2
2.0 16V (930.B5) 2.0 16V T.S. (930.B5)	114 110	03/97→10/01 10/95→01/01	←			24.0122-0107.1 422107	Ø 284 22 20,2 V
			➡			24.0111-0119.1 411119	Ø 240,5 11 9,2
			➡			24.0111-0149.1 411149	Ø 240,5 11 9,2
<b>ALFA ROMEO - 147 (937_) 11/00→12/10</b>							
<b> Bremsbelagsatz, Scheibenbremse</b>							
1.6 16V T.SPARK (937.AXA1A, 937.AXB1A, 937.BXB1A) 1.9 JTD (937.AXD1A, 937.BXD1A) 1.9 JTD (937.AXF1A, 937.BXF1A) 1.9 JTD 16V (937.AXG1B, 937.BXG1B) 1.9 JTD 16V (937.AXG1B, 937.BXG1B) 1.9 JTD 16V (937.AXM1B, 937.AXS1B) 1.9 JTDM 16V (937.AXN1B, 937.AXZ1B) 1.9 JTDM 8V (937.AXD1A, 937.AXU1A, 937.BXU1A) 2.0 16V T.SPARK (937.AXA1, 937.AXC1, 937.BXC1)	88 85 74 93 103 100 125 88 110	01/01→03/10 04/01→03/10 06/03→03/10 09/03→09/04 11/02→03/10 10/04→03/10 06/08→03/10 07/05→03/10 01/01→03/10	←			13.0460-7140.2 607140 13.0470-7140.2 LD7140	ATE 21637 19,3 + WK ATE 21637 19,3 + WK Ceramic
			➡			13.0460-2867.2 602867 13.0470-2867.2 LD2867	TRW 23517 16,6 - WE / - WK TRW 23517 16,6 - WE / - WK Ceramic
1.6 16V T.SPARK ECO (937.AXA1A, 937.BXA1A)	77	01/01→03/10	←	→VET 3021488		13.0460-7139.2 607139 13.0470-7139.2 LD7139	ATE 23140 19,4 + WK ATE 23140 19,4 + WK Ceramic
			←	VET 3021489→		13.0460-7140.2 607140 13.0470-7140.2 LD7140	ATE 21637 19,3 + WK ATE 21637 19,3 + WK Ceramic
			➡			13.0460-2867.2 602867 13.0470-2867.2 LD2867	TRW 23517 16,6 - WE / - WK TRW 23517 16,6 - WE / - WK Ceramic
↓							









	kW			 	! #		
<b>ALFA ROMEO - 147 (937_) 11/00→12/10</b>							
 <b>Bremsbelagsatz, Scheibenbremse</b>							
1.9 JTDM (937.AXD1A, 937.AXV1A, 937.BXB1A)	85	10/04→03/10	←	07/05→		<b>13.0460-7140.2 607140</b>	ATE 21637 19,3 + WK
			→			<b>13.0470-7140.2 LD7140</b>	ATE 21637 19,3 + WK Ceramic
1.9 JTDM 16V (937.AXN1B, 937.BXN1B)	110	09/04→03/10	→	07/05→		<b>13.0460-2867.2 602867</b>	TRW 23517 16,6 - WE / - WK
						<b>13.0470-2867.2 LD2867</b>	TRW 23517 16,6 - WE / - WK Ceramic
3.2 GTA (937.AXL1)	184	02/03→03/10	←	→ 12/03		<b>13.0460-4985.2 604985</b>	BRE 21381 18,0 + WK
			→			<b>13.0460-2867.2 602867</b>	TRW 23517 16,6 - WE / - WK
						<b>13.0470-2867.2 LD2867</b>	TRW 23517 16,6 - WE / - WK Ceramic
<b>Zubehörsatz, Scheibenbremsbelag</b>							
3.2 GTA (937.AXL1)	184	02/03→03/10	←	→ 12/03		<b>13.0460-0254.2 610254</b>	
 <b>Bremsscheibe</b>							
1.6 16V T.SPARK (937.AXA1A, 937.AXB1A, 937.BXB1A)	88	01/01→03/10	←			<b>24.0122-0145.1 422145</b>	Ø 284 22 20,2 V
			→			<b>24.0110-0209.1 410209</b>	Ø 251,4 10 9
1.9 JTD (937.AXD1A, 937.BXD1A)	85	04/01→03/10					
1.9 JTD (937.AXF1A, 937.BXF1A)	74	06/03→03/10					
1.9 JTD 16V (937.AXG1B, 937.BXG1B)	93	09/03→09/04					
1.9 JTD 16V (937.AXG1B, 937.BXG1B)	103	11/02→03/10					
1.9 JTD 16V (937.AXM1B, 937.AXS1B)	100	10/04→03/10					
1.9 JTDM 16V (937.AXN1B, 937.AXZ1B)	125	06/08→03/10					
1.9 JTDM 8V (937.AXD1A, 937.AXU1A, 937.BXU1A)	88	07/05→03/10					
2.0 16V T.SPARK (937.AXA1, 937.AXC1, 937.BXC1)	110	01/01→03/10					
1.6 16V T.SPARK ECO (937.AXA1A, 937.BXA1A)	77	01/01→03/10	←	→VET 3021488		<b>24.0115-0108.1 415108</b>	Ø 281 15 13,2
			←	VET 3021489→		<b>24.0122-0145.1 422145</b>	Ø 284 22 20,2 V
			→			<b>24.0110-0209.1 410209</b>	Ø 251,4 10 9
1.9 JTDM (937.AXD1A, 937.AXV1A, 937.BXB1A)	85	10/04→03/10	←	07/05→		<b>24.0122-0145.1 422145</b>	Ø 284 22 20,2 V
			→	07/05→		<b>24.0110-0209.1 410209</b>	Ø 251,4 10 9
1.9 JTDM 16V (937.AXN1B, 937.BXN1B)	110	09/04→03/10					
3.2 GTA (937.AXL1)	184	02/03→03/10	←	→ 09/03		<b>24.0128-0119.1 428119</b>	Ø 305 28 26 V
			←	10/03→		<b>24.0132-0129.1 432129</b>	Ø 330 32 30 V
			→			<b>24.0110-0283.1 410283</b>	Ø 276 10 9
<b>ALFA ROMEO - 155 (167_) 01/92→12/97</b>							
 <b>Bremsbelagsatz, Scheibenbremse</b>							
1.6 16V T.S. (167.A6A)	88	05/96→12/97	←			<b>13.0460-2949.2 602949</b>	TRW 20833 17,0 + WK
1.7 T.S. (167.A4D, 167.A4H)	85	04/93→04/96	→	ALU		<b>13.0460-2826.2 602826</b>	TRW 23177 14,2 - WK
1.7 T.S. (167.A4G)	83	04/93→04/96	→	GG		<b>13.0460-2951.2 602951</b>	TRW 21103 14,2 - WK
1.7 T.S. 16V (167.A4N)	103	05/96→12/97					
1.9 TD (167.A3B, 167.A3)	66	04/93→12/97					
1.8 T.S. (167.A4C, 167.A)	77	02/92→12/97	←	05/92→		<b>13.0460-2949.2 602949</b>	TRW 20833 17,0 + WK
1.8 T.S. Sport (167.A4A, 167.A4C, 167.A4E)	93	03/92→12/96	→	05/92→; ALU		<b>13.0460-2826.2 602826</b>	TRW 23177 14,2 - WK
			→	05/92→; GG		<b>13.0460-2951.2 602951</b>	TRW 21103 14,2 - WK
2.0 16V Turbo Q4 (167.A2B, 167.A2C, 167.A2E)	137	01/92→12/97	←	11/92→		<b>13.0460-2979.2 602979</b>	TRW 21147 19,0 + WK
			→	11/92→; ALU		<b>13.0460-2826.2 602826</b>	TRW 23177 14,2 - WK
2.0 16V Turbo Q4 (167.A2B, 167.A2C, 167.A2E)	140	03/92→12/97	→	11/92→; GG		<b>13.0460-2951.2 602951</b>	TRW 21103 14,2 - WK
↓							









	kw			 	! #		
<b>ALFA ROMEO - 155 (167_) 01/92→12/97</b>							
<b> Bremsbelagsatz, Scheibenbremse</b>							
2.0 T.S. 16V (167.A2G)	110	03/95→12/97	←			<b>13.0460-2987.2 602987</b>	TRW 21147 19,0 + WK
			→	ALU		<b>13.0460-2826.2 602826</b>	TRW 23177 14,2 - WK
			→	GG		<b>13.0460-2951.2 602951</b>	TRW 21103 14,2 - WK
2.5 TD (167.A1A, 167.A1G)	92	04/93→12/97	←	→ 10/97		<b>13.0460-2979.2 602979</b>	TRW 21147 19,0 + WK
			→	ALU		<b>13.0460-2826.2 602826</b>	TRW 23177 14,2 - WK
			→	GG		<b>13.0460-2951.2 602951</b>	TRW 21103 14,2 - WK
2.5 V6 (167.A1C, 167.A1E)	120	09/92→12/97	←			<b>13.0460-2979.2 602979</b>	TRW 21147 19,0 + WK
			→	ALU		<b>13.0460-2826.2 602826</b>	TRW 23177 14,2 - WK
			→	GG		<b>13.0460-2951.2 602951</b>	TRW 21103 14,2 - WK
<b>Zubehörsatz, Scheibenbremsbelag</b>							
1.6 16V T.S. (167.A6A)	88	05/96→12/97	→	GG		<b>13.0460-0072.2 610072</b>	TRW
1.7 T.S. (167.A4D, 167.A4H)	85	04/93→04/96					
1.7 T.S. (167.A4G)	83	04/93→04/96					
1.7 T.S. 16V (167.A4N)	103	05/96→12/97					
1.9 TD (167.A3B, 167.A3)	66	04/93→12/97					
2.0 T.S. 16V (167.A2G)	110	03/95→12/97					
2.5 TD (167.A1A, 167.A1G)	92	04/93→12/97					
2.5 V6 (167.A1C, 167.A1E)	120	09/92→12/97					
1.8 T.S. (167.A4C, 167.A)	77	02/92→12/97	→	05/92→; GG		<b>13.0460-0072.2 610072</b>	TRW
1.8 T.S. Sport (167.A4A, 167.A4C, 167.A4E)	93	03/92→12/96					
2.0 16V Turbo Q4 (167.A2B, 167.A2C, 167.A2E)	137	01/92→12/97	→	11/92→; GG		<b>13.0460-0072.2 610072</b>	TRW
2.0 16V Turbo Q4 (167.A2B, 167.A2C, 167.A2E)	140	03/92→12/97					
<b> Bremsscheibe</b>							
1.6 16V T.S. (167.A6A)	88	05/96→12/97	←			<b>24.0120-0142.1 420142</b>	Ø 257,5 20 18,2 V
1.7 T.S. (167.A4D, 167.A4H)	85	04/93→04/96				<b>24.0320-0142.1 520142</b>	Ø 257,5 20 18,2 V
1.7 T.S. (167.A4G)	83	04/93→04/96	→			<b>24.0111-0149.1 411149</b>	Ø 240,5 11 9,2
1.7 T.S. 16V (167.A4N)	103	05/96→12/97					
1.8 T.S. (167.A4C, 167.A)	77	02/92→12/97	←	05/92→		<b>24.0120-0142.1 420142</b>	Ø 257,5 20 18,2 V
1.8 T.S. Sport (167.A4A, 167.A4C, 167.A4E)	93	03/92→12/96				<b>24.0320-0142.1 520142</b>	Ø 257,5 20 18,2 V
			→	05/92→		<b>24.0111-0149.1 411149</b>	Ø 240,5 11 9,2
1.9 TD (167.A3B, 167.A3)	66	04/93→12/97	←			<b>24.0112-0127.1 412127</b>	Ø 257,5 12 10,2
			→			<b>24.0111-0149.1 411149</b>	Ø 240,5 11 9,2
2.0 16V Turbo Q4 (167.A2B, 167.A2C, 167.A2E)	137	01/92→12/97	←	11/92→		<b>24.0122-0147.1 422147</b>	Ø 284 22 20,2 V
2.0 16V Turbo Q4 (167.A2B, 167.A2C, 167.A2E)	140	03/92→12/97	→	11/92→		<b>24.0111-0149.1 411149</b>	Ø 240,5 11 9,2
2.0 T.S. 16V (167.A2G)	110	03/95→12/97	←	11/95→		<b>24.0122-0107.1 422107</b>	Ø 284 22 20,2 V
			→			<b>24.0111-0149.1 411149</b>	Ø 240,5 11 9,2
2.5 TD (167.A1A, 167.A1G)	92	04/93→12/97	←			<b>24.0112-0127.1 412127</b>	Ø 257,5 12 10,2
			→			<b>24.0122-0147.1 422147</b>	Ø 284 22 20,2 V
			→			<b>24.0111-0149.1 411149</b>	Ø 240,5 11 9,2
2.5 V6 (167.A1C, 167.A1E)	120	09/92→12/97	←			<b>24.0122-0147.1 422147</b>	Ø 284 22 20,2 V
			→			<b>24.0111-0149.1 411149</b>	Ø 240,5 11 9,2
<b>ALFA ROMEO - 156 (932_) 09/97→10/05</b>							
<b> Bremsbelagsatz, Scheibenbremse</b>							
1.6 16V T.SPARK (932.A4, 932.A4100)	88	09/97→09/05	←	10/97→ 02/00		<b>13.0460-7105.2 607105</b>	ATE 23140 19,4 + WK
1.6 16V T.SPARK (932A4)	82	09/97→09/05	←	03/00→ 02/01		<b>13.0460-7139.2 607139</b>	ATE 23140 19,4 + WK
			←	03/01→ 07/05		<b>13.0470-7139.2 LD7139</b>	ATE 23140 19,4 + WK Ceramic
			←			<b>13.0460-7140.2 607140</b>	ATE 21637 19,3 + WK
			→	10/97→ 02/02		<b>13.0470-7140.2 LD7140</b>	ATE 21637 19,3 + WK Ceramic
			→			<b>13.0460-2827.2 602827</b>	TRW 21606 16,7 - WK
↓							







	kw			 	! #		
<b>ALFA ROMEO - 156 (932_) 09/97→10/05</b>							
<b> Bremsbelagsatz, Scheibenbremse</b>							
1.6 16V T.SPARK (932.A4, 932.A4100)	88	09/97→09/05	➡	03/02→ 07/05		<b>13.0460-2867.2 602867</b>	TRW 23517 16,6 - WE / - WK
1.6 16V T.SPARK (932A4)	82	09/97→09/05				<b>13.0470-2867.2 LD2867</b>	TRW 23517 16,6 - WE / - WK Ceramic
1.8 16V T.SPARK (932.A3)	106	09/97→10/00	⬅	10/97→ 02/00		<b>13.0460-7105.2 607105</b>	ATE 23140 19,4 + WK
1.9 JTD (932B2)	77	09/97→10/00	⬅	03/00→		<b>13.0460-7139.2 607139</b>	ATE 23140 19,4 + WK
			➡	10/97→		<b>13.0470-7139.2 LD7139</b>	ATE 23140 19,4 + WK Ceramic
			➡	10/97→		<b>13.0460-2827.2 602827</b>	TRW 21606 16,7 - WK
1.8 16V T.SPARK (932.A3100)	103	10/00→09/05	⬅	→ 02/01		<b>13.0460-7139.2 607139</b>	ATE 23140 19,4 + WK
			⬅	03/01→ 07/05		<b>13.0470-7139.2 LD7139</b>	ATE 23140 19,4 + WK Ceramic
			⬅	03/01→ 07/05		<b>13.0460-7140.2 607140</b>	ATE 21637 19,3 + WK
			⬅	03/01→ 07/05		<b>13.0470-7140.2 LD7140</b>	ATE 21637 19,3 + WK Ceramic
			➡	→ 02/02		<b>13.0460-2827.2 602827</b>	TRW 21606 16,7 - WK
			➡	03/02→ 07/05		<b>13.0460-2867.2 602867</b>	TRW 23517 16,6 - WE / - WK
			➡	03/02→ 07/05		<b>13.0470-2867.2 LD2867</b>	TRW 23517 16,6 - WE / - WK Ceramic
1.9 JTD	93	11/03→09/05	⬅	→ 07/05		<b>13.0460-7140.2 607140</b>	ATE 21637 19,3 + WK
1.9 JTD (932.AXN00, 932.BXE00)	110	07/04→09/05				<b>13.0470-7140.2 LD7140</b>	ATE 21637 19,3 + WK Ceramic
1.9 JTD 16V	103	11/02→09/05	➡	→ 07/05		<b>13.0460-2867.2 602867</b>	TRW 23517 16,6 - WE / - WK
2.0 JTS (932AXA)	122	03/02→09/05				<b>13.0470-2867.2 LD2867</b>	TRW 23517 16,6 - WE / - WK Ceramic
1.9 JTD	100	11/02→11/04	⬅			<b>13.0460-7140.2 607140</b>	ATE 21637 19,3 + WK
			⬅			<b>13.0470-7140.2 LD7140</b>	ATE 21637 19,3 + WK Ceramic
			➡			<b>13.0460-2867.2 602867</b>	TRW 23517 16,6 - WE / - WK
			➡			<b>13.0470-2867.2 LD2867</b>	TRW 23517 16,6 - WE / - WK Ceramic
1.9 JTD (932.A2B00, 932.A2C00)	85	05/01→09/05	⬅	→ 07/05		<b>13.0460-7140.2 607140</b>	ATE 21637 19,3 + WK
2.0 JTS	119	01/02→09/05				<b>13.0470-7140.2 LD7140</b>	ATE 21637 19,3 + WK Ceramic
2.4 JTD (932A1B_)	103	10/00→09/05	➡	→ 02/02		<b>13.0460-2827.2 602827</b>	TRW 21606 16,7 - WK
2.5 V6 24V (932A11_)	141	10/00→09/05	➡	03/02→ 07/05		<b>13.0460-2867.2 602867</b>	TRW 23517 16,6 - WE / - WK
			➡	03/02→ 07/05		<b>13.0470-2867.2 LD2867</b>	TRW 23517 16,6 - WE / - WK Ceramic
1.9 JTD (932.A2B00)	81	10/00→05/01	⬅	→ 02/01		<b>13.0460-7139.2 607139</b>	ATE 23140 19,4 + WK
			⬅	03/01→		<b>13.0470-7139.2 LD7139</b>	ATE 23140 19,4 + WK Ceramic
			⬅	03/01→		<b>13.0460-7140.2 607140</b>	ATE 21637 19,3 + WK
			⬅	03/01→		<b>13.0470-7140.2 LD7140</b>	ATE 21637 19,3 + WK Ceramic
			➡			<b>13.0460-2827.2 602827</b>	TRW 21606 16,7 - WK
2.0 16V T.SPARK (932A2)	114	09/97→06/02	⬅	10/97→ 02/00		<b>13.0460-7069.2 607069</b>	ATE 21636 19,3 + WK
			⬅	03/00→		<b>13.0460-7140.2 607140</b>	ATE 21637 19,3 + WK
			⬅	03/00→		<b>13.0470-7140.2 LD7140</b>	ATE 21637 19,3 + WK Ceramic
			➡	10/97→ 02/02		<b>13.0460-2827.2 602827</b>	TRW 21606 16,7 - WK
			➡	03/02→		<b>13.0460-2867.2 602867</b>	TRW 23517 16,6 - WE / - WK
			➡	03/02→		<b>13.0470-2867.2 LD2867</b>	TRW 23517 16,6 - WE / - WK Ceramic
2.0 16V T.SPARK (932A21_)	110	10/00→03/02	⬅			<b>13.0460-7140.2 607140</b>	ATE 21637 19,3 + WK
			⬅			<b>13.0470-7140.2 LD7140</b>	ATE 21637 19,3 + WK Ceramic
			➡	→ 02/02		<b>13.0460-2827.2 602827</b>	TRW 21606 16,7 - WK
			➡	03/02→		<b>13.0460-2867.2 602867</b>	TRW 23517 16,6 - WE / - WK
			➡	03/02→		<b>13.0470-2867.2 LD2867</b>	TRW 23517 16,6 - WE / - WK Ceramic
2.4 JTD	120	06/03→09/05	⬅	10/03→ 07/05		<b>13.0460-7180.2 607180</b>	ATE 21637 19,3 + WK
			➡	10/03→ 07/05		<b>13.0460-2867.2 602867</b>	TRW 23517 16,6 - WE / - WK
			➡	10/03→ 07/05		<b>13.0470-2867.2 LD2867</b>	TRW 23517 16,6 - WE / - WK Ceramic
2.4 JTD	129	10/03→09/05	⬅	→ 07/05		<b>13.0460-7180.2 607180</b>	ATE 21637 19,3 + WK
2.4 JTD (932AXC)	110	03/02→09/05	➡	→ 07/05		<b>13.0460-2867.2 602867</b>	TRW 23517 16,6 - WE / - WK
			➡	→ 07/05		<b>13.0470-2867.2 LD2867</b>	TRW 23517 16,6 - WE / - WK Ceramic
2.4 JTD (932B1)	100	09/97→09/03	⬅	10/97→ 02/00		<b>13.0460-7069.2 607069</b>	ATE 21636 19,3 + WK
			⬅	03/00→ 10/00		<b>13.0460-7140.2 607140</b>	ATE 21637 19,3 + WK
			⬅	03/00→ 10/00		<b>13.0470-7140.2 LD7140</b>	ATE 21637 19,3 + WK Ceramic
			➡	10/97→ 10/00		<b>13.0460-2827.2 602827</b>	TRW 21606 16,7 - WK
↓							









	kw			 	! #			
<b>ALFA ROMEO - 156 (932_) 09/97→10/05</b>								
<b> Bremsbelagsatz, Scheibenbremse</b>								
2.5 V6 24V (932A1)	140	09/97→09/02	←	10/97→ 02/00		<b>13.0460-7069.2 607069</b>	ATE 21636 19,3 + WK	
			←	03/00→		<b>13.0460-7140.2 607140</b>	ATE 21637 19,3 + WK	
			→	10/97→		<b>13.0470-7140.2 LD7140</b>	ATE 21637 19,3 + WK Ceramic	
			→	03/02→		<b>13.0460-2827.2 602827</b>	TRW 21606 16,7 - WK	
3.2 GTA (932AXB)	184	03/02→09/05	←	→ 07/05		<b>13.0460-4985.2 604985</b>	BRE 21381 18,0 + WK	
			→	→ 07/05		<b>13.0460-2867.2 602867</b>	TRW 23517 16,6 - WE / - WK	
						<b>13.0470-2867.2 LD2867</b>	TRW 23517 16,6 - WE / - WK Ceramic	
<b>Zubehörsatz, Scheibenbremsbelag</b>								
3.2 GTA (932AXB)	184	03/02→09/05	←	→ 07/05		<b>13.0460-0254.2 610254</b>		
<b> Bremsscheibe</b>								
1.6 16V T.SPARK (932.A4, 932.A4100)	88	09/97→09/05	←	10/97→ 07/05		<b>24.0115-0108.1 415108</b>	Ø 281 15 13,2	
	82		→	10/97→ 02/02		<b>24.0110-0209.1 410209</b>	Ø 251,4 10 9	
1.6 16V T.SPARK (932A4)		09/97→09/05	→	03/02→ 07/05		<b>24.0110-0283.1 410283</b>	Ø 276 10 9	
1.8 16V T.SPARK (932.A3)	106	09/97→10/00	←	10/97→		<b>24.0115-0108.1 415108</b>	Ø 281 15 13,2	
			→	10/97→		<b>24.0122-0145.1 422145</b>	Ø 284 22 20,2 V	
1.8 16V T.SPARK (932.A3100)	103	10/00→09/05	←	→ 07/05		<b>24.0115-0108.1 415108</b>	Ø 281 15 13,2	
			→	→ 02/02		<b>24.0122-0145.1 422145</b>	Ø 284 22 20,2 V	
			→	03/02→ 07/05		<b>24.0110-0209.1 410209</b>	Ø 251,4 10 9	
1.9 JTD	93	11/03→09/05	←	→ 07/05		<b>24.0115-0108.1 415108</b>	Ø 281 15 13,2	
	110		07/04→09/05	→	→ 07/05		<b>24.0110-0283.1 410283</b>	Ø 276 10 9
1.9 JTD (932.A2B00, 932.A2C00)	85	05/01→09/05	←	→ 07/05		<b>24.0115-0108.1 415108</b>	Ø 281 15 13,2	
			→	→ 02/02		<b>24.0110-0209.1 410209</b>	Ø 251,4 10 9	
1.9 JTD (932.A2B00)	81	10/00→05/01	→	03/02→ 07/05		<b>24.0110-0283.1 410283</b>	Ø 276 10 9	
1.9 JTD (932B2)	77	09/97→10/00	←	→ 07/05		<b>24.0115-0108.1 415108</b>	Ø 281 15 13,2	
			→	10/97→		<b>24.0110-0209.1 410209</b>	Ø 251,4 10 9	
1.9 JTD 16V	103	11/02→09/05	←	→ 07/05		<b>24.0122-0145.1 422145</b>	Ø 284 22 20,2 V	
	122		03/02→09/05	→	→ 07/05		<b>24.0110-0283.1 410283</b>	Ø 276 10 9
	129		10/03→09/05					
2.0 16V T.SPARK (932A2)	114	09/97→06/02	→	03/02→ 07/05		<b>24.0110-0283.1 410283</b>	Ø 276 10 9	
			←	10/97→		<b>24.0122-0145.1 422145</b>	Ø 284 22 20,2 V	
			→	10/97→ 02/02		<b>24.0110-0209.1 410209</b>	Ø 251,4 10 9	
2.0 16V T.SPARK (932A21__)	110	10/00→03/02	→	03/02→		<b>24.0110-0283.1 410283</b>	Ø 276 10 9	
			←	→ 02/02		<b>24.0122-0145.1 422145</b>	Ø 284 22 20,2 V	
			→	03/02→		<b>24.0110-0209.1 410209</b>	Ø 251,4 10 9	
2.0 JTS	119	01/02→09/05	←	→ 07/05		<b>24.0122-0145.1 422145</b>	Ø 284 22 20,2 V	
	103		10/00→09/05	→	→ 02/02		<b>24.0110-0209.1 410209</b>	Ø 251,4 10 9
	141		10/00→09/05	→	03/02→ 07/05		<b>24.0110-0283.1 410283</b>	Ø 276 10 9
2.4 JTD (932A1B__)	120	06/03→09/05	←	10/03→ 07/05		<b>24.0122-0145.1 422145</b>	Ø 284 22 20,2 V	
			→	10/03→ 07/05		<b>24.0110-0283.1 410283</b>	Ø 276 10 9	
2.4 JTD (932B1)	100	09/97→09/03	←	10/97→ 10/00		<b>24.0122-0145.1 422145</b>	Ø 284 22 20,2 V	
			→	10/97→ 10/00		<b>24.0110-0209.1 410209</b>	Ø 251,4 10 9	
2.5 V6 24V (932A1)	140	09/97→09/02	←	10/97→		<b>24.0122-0145.1 422145</b>	Ø 284 22 20,2 V	
			→	10/97→		<b>24.0110-0209.1 410209</b>	Ø 251,4 10 9	
			→	03/02→		<b>24.0110-0283.1 410283</b>	Ø 276 10 9	
↓								











	kW			 	! #			
<b>ALFA ROMEO - 156 (932_) 09/97→10/05</b>								
<b> Bremsscheibe</b>								
3.2 GTA (932AXB)	184	03/02→09/05	←	→ 09/03		24.0128-0119.1	428119	Ø 305 28 26 V
			←	10/03→ 07/05		24.0132-0129.1	432129	Ø 330 32 30 V
			→	→ 07/05		24.0110-0283.1	410283	Ø 276 10 9
<b>ALFA ROMEO - 156 Sportwagon (932_) 02/97→05/06</b>								
<b> Bremsbelagsatz, Scheibenbremse</b>								
1.6 16V T.SPARK. (932.B4B00)	81	07/00→07/05	←	→ 02/01		13.0460-7139.2	607139	ATE 23140 19,4 + WK
						13.0470-7139.2	LD7139	ATE 23140 19,4 + WK Ceramic
			←	03/01→		13.0460-7140.2	607140	ATE 21637 19,3 + WK
						13.0470-7140.2	LD7140	ATE 21637 19,3 + WK Ceramic
1.6 16V T.SPARK. (932A4)	88	05/00→05/06	←	→ 02/01		13.0460-7139.2	607139	ATE 23140 19,4 + WK
						13.0470-7139.2	LD7139	ATE 23140 19,4 + WK Ceramic
			←	03/01→ 07/05		13.0460-7140.2	607140	ATE 21637 19,3 + WK
						13.0470-7140.2	LD7140	ATE 21637 19,3 + WK Ceramic
1.6 16V T.SPARK (932A4)	82	01/00→09/05	←	→ 02/00		13.0460-7105.2	607105	ATE 23140 19,4 + WK
			←	03/00→ 02/01		13.0460-7139.2	607139	ATE 23140 19,4 + WK
						13.0470-7139.2	LD7139	ATE 23140 19,4 + WK Ceramic
			←	03/01→ 07/05		13.0460-7140.2	607140	ATE 21637 19,3 + WK
1.8 16V T.SPARK (932A3) 1.9 JTD (932B2)	106	05/00→10/00	←			13.0460-7139.2	607139	ATE 23140 19,4 + WK
						13.0470-7139.2	LD7139	ATE 23140 19,4 + WK Ceramic
	77	05/00→10/00	→			13.0460-2827.2	602827	TRW 21606 16,7 - WK
1.8 16V T.SPARK (932B31__)	103	02/97→05/06	←	10/97→ 02/00		13.0460-7105.2	607105	ATE 23140 19,4 + WK
			←	→ 02/01		13.0460-7139.2	607139	ATE 23140 19,4 + WK
						13.0470-7139.2	LD7139	ATE 23140 19,4 + WK Ceramic
			←	03/01→ 07/05		13.0460-7140.2	607140	ATE 21637 19,3 + WK
						13.0470-7140.2	LD7140	ATE 21637 19,3 + WK Ceramic
			→	→ 02/02		13.0460-2827.2	602827	TRW 21606 16,7 - WK
1.9 JTD 1.9 JTD 16V 2.0 JTS (932BXA) 2.0 JTS (932BXD00, 932BXD01)	93	11/03→05/06	←	→ 07/05		13.0460-7140.2	607140	ATE 21637 19,3 + WK
						13.0470-7140.2	LD7140	ATE 21637 19,3 + WK Ceramic
	122	03/02→05/06	→	→ 07/05		13.0460-2867.2	602867	TRW 23517 16,6 - WE / - WK
						13.0470-2867.2	LD2867	TRW 23517 16,6 - WE / - WK Ceramic
1.9 JTD	100	11/02→11/04	←			13.0460-7140.2	607140	ATE 21637 19,3 + WK
						13.0470-7140.2	LD7140	ATE 21637 19,3 + WK Ceramic
			→			13.0460-2867.2	602867	TRW 23517 16,6 - WE / - WK
						13.0470-2867.2	LD2867	TRW 23517 16,6 - WE / - WK Ceramic
1.9 JTD 1.9 JTD 16V Q4	110	03/05→05/06 07/04→05/06	←	→ 07/05		13.0460-4803.2	604803	BRE 23092 15,6 + WK + Zub
						13.0470-4803.2	LD4803	BRE 23092 15,6 + WK + Zub Ceramic
			→	→ 07/05		13.0460-2867.2	602867	TRW 23517 16,6 - WE / - WK
						13.0470-2867.2	LD2867	TRW 23517 16,6 - WE / - WK Ceramic
1.9 JTD (932.B2B00)	81	10/00→05/01	←	→ 02/01		13.0460-7139.2	607139	ATE 23140 19,4 + WK
						13.0470-7139.2	LD7139	ATE 23140 19,4 + WK Ceramic
			←	03/01→		13.0460-7140.2	607140	ATE 21637 19,3 + WK











	kW			 	! #		
<b>ALFA ROMEO - 156 Sportwagon (932_) 02/97→05/06</b>							
<b> Bremsbelagsatz, Scheibenbremse</b>							
1.9 JTD (932.B2B00)	81	10/00→05/01	←	03/01→		<b>13.0470-7140.2 LD7140</b>	ATE 21637 19,3 + WK Ceramic
			→			<b>13.0460-2827.2 602827</b>	TRW 21606 16,7 - WK
1.9 JTD (932B2B, 932B2C)	85	05/01→05/06	←	→ 07/05		<b>13.0460-7140.2 607140</b>	ATE 21637 19,3 + WK
2.4 JTD (932.B1B00)	103	10/00→05/06	←			<b>13.0470-7140.2 LD7140</b>	ATE 21637 19,3 + WK Ceramic
			→	→ 02/02		<b>13.0460-2827.2 602827</b>	TRW 21606 16,7 - WK
			→	03/02→ 07/05		<b>13.0460-2867.2 602867</b>	TRW 23517 16,6 - WE / - WK
			→			<b>13.0470-2867.2 LD2867</b>	TRW 23517 16,6 - WE / - WK Ceramic
2.0 16V T.SPARK (932A2)	114	05/00→06/02	←			<b>13.0460-7140.2 607140</b>	ATE 21637 19,3 + WK
2.0 16V T.SPARK (932B21__)	110	10/00→03/02	←			<b>13.0470-7140.2 LD7140</b>	ATE 21637 19,3 + WK Ceramic
			→	→ 02/02		<b>13.0460-2827.2 602827</b>	TRW 21606 16,7 - WK
			→	03/02→		<b>13.0460-2867.2 602867</b>	TRW 23517 16,6 - WE / - WK
			→			<b>13.0470-2867.2 LD2867</b>	TRW 23517 16,6 - WE / - WK Ceramic
2.4 JTD	120	06/03→05/06	←	10/03→ 07/05		<b>13.0460-7180.2 607180</b>	ATE 21637 19,3 + WK
			→	10/03→ 07/05		<b>13.0460-2867.2 602867</b>	TRW 23517 16,6 - WE / - WK
			→			<b>13.0470-2867.2 LD2867</b>	TRW 23517 16,6 - WE / - WK Ceramic
2.4 JTD	129	10/03→05/06	←	→ 07/05		<b>13.0460-7180.2 607180</b>	ATE 21637 19,3 + WK
2.4 JTD (932.BXC00)	110	03/02→05/06	←	→ 07/05		<b>13.0460-2867.2 602867</b>	TRW 23517 16,6 - WE / - WK
			→	→ 07/05		<b>13.0470-2867.2 LD2867</b>	TRW 23517 16,6 - WE / - WK Ceramic
2.4 JTD (932B1)	100	05/00→09/03	←	→ 10/00		<b>13.0460-7140.2 607140</b>	ATE 21637 19,3 + WK
			→	→ 10/00		<b>13.0470-7140.2 LD7140</b>	ATE 21637 19,3 + WK Ceramic
			→			<b>13.0460-2827.2 602827</b>	TRW 21606 16,7 - WK
2.5 V6 24V (932A1)	140	02/97→08/03	←	10/97→ 02/00		<b>13.0460-7069.2 607069</b>	ATE 21636 19,3 + WK
			←			<b>13.0460-7140.2 607140</b>	ATE 21637 19,3 + WK
			←			<b>13.0470-7140.2 LD7140</b>	ATE 21637 19,3 + WK Ceramic
			→	→ 02/02		<b>13.0460-2827.2 602827</b>	TRW 21606 16,7 - WK
			→	03/02→		<b>13.0460-2867.2 602867</b>	TRW 23517 16,6 - WE / - WK
			→			<b>13.0470-2867.2 LD2867</b>	TRW 23517 16,6 - WE / - WK Ceramic
2.5 V6 24V (932B1100)	141	02/97→05/06	←	10/97→ 02/00		<b>13.0460-7069.2 607069</b>	ATE 21636 19,3 + WK
			←	→ 07/05		<b>13.0460-7140.2 607140</b>	ATE 21637 19,3 + WK
			←			<b>13.0470-7140.2 LD7140</b>	ATE 21637 19,3 + WK Ceramic
			→	→ 02/02		<b>13.0460-2827.2 602827</b>	TRW 21606 16,7 - WK
			→	03/02→ 07/05		<b>13.0460-2867.2 602867</b>	TRW 23517 16,6 - WE / - WK
			→			<b>13.0470-2867.2 LD2867</b>	TRW 23517 16,6 - WE / - WK Ceramic
3.2 GTA (932.BXB00)	184	03/02→05/06	←	→ 07/05		<b>13.0460-4985.2 604985</b>	BRE 21381 18,0 + WK
			→	→ 07/05		<b>13.0460-2867.2 602867</b>	TRW 23517 16,6 - WE / - WK
			→			<b>13.0470-2867.2 LD2867</b>	TRW 23517 16,6 - WE / - WK Ceramic
<b>Zubehörsatz, Scheibenbremsbelag</b>							
3.2 GTA (932.BXB00)	184	03/02→05/06	←	→ 07/05		<b>13.0460-0254.2 610254</b>	
<b> Bremsscheibe</b>							
1.6 16V T.SPARK. (932.B4B00)	81	07/00→07/05	←			<b>24.0115-0108.1 415108</b>	Ø 281 15 13,2
			→	→ 02/02		<b>24.0110-0209.1 410209</b>	Ø 251,4 10 9
			→	03/02→		<b>24.0110-0283.1 410283</b>	Ø 276 10 9
1.6 16V T.SPARK. (932A4)	88	05/00→05/06	←	→ 07/05		<b>24.0115-0108.1 415108</b>	Ø 281 15 13,2
1.6 16V T.SPARK (932A4)	82	01/00→09/05	←	→ 02/02		<b>24.0110-0209.1 410209</b>	Ø 251,4 10 9
1.9 JTD (932B2B, 932B2C)	85	05/01→05/06	←	03/02→ 07/05		<b>24.0110-0283.1 410283</b>	Ø 276 10 9
1.8 16V T.SPARK (932A3)	106	05/00→10/00	←			<b>24.0115-0108.1 415108</b>	Ø 281 15 13,2
			→			<b>24.0122-0145.1 422145</b>	Ø 284 22 20,2 V
			→			<b>24.0110-0209.1 410209</b>	Ø 251,4 10 9
1.8 16V T.SPARK (932B31__)	103	02/97→05/06	←	→ 07/05		<b>24.0115-0108.1 415108</b>	Ø 281 15 13,2
			→			<b>24.0122-0145.1 422145</b>	Ø 284 22 20,2 V
↓							











	kW			 	! #		
<b>ALFA ROMEO - 156 Sportwagon (932_) 02/97→05/06</b>							
<b>Bremsscheibe</b>							
1.8 16V T.SPARK (932B31__)	103	02/97→05/06	➔	→ 02/02		24.0110-0209.1 410209	Ø 251,4 10 9
			➔	03/02→ 07/05		24.0110-0283.1 410283	Ø 276 10 9
1.9 JTD	93	11/03→05/06	➔	→ 07/05		24.0115-0108.1 415108	Ø 281 15 13,2
			➔	→ 07/05		24.0110-0283.1 410283	Ø 276 10 9
1.9 JTD	100	11/02→11/04	➔			24.0115-0108.1 415108	Ø 281 15 13,2
			➔			24.0110-0283.1 410283	Ø 276 10 9
1.9 JTD	110	03/05→05/06	➔	→ 07/05		24.0132-0129.1 432129	Ø 330 32 30 V
1.9 JTD 16V Q4	110	07/04→05/06	➔	→ 07/05		24.0110-0283.1 410283	Ø 276 10 9
1.9 JTD (932.B2B00)	81	10/00→05/01	➔			24.0115-0108.1 415108	Ø 281 15 13,2
1.9 JTD (932B2)	77	05/00→10/00	➔			24.0110-0209.1 410209	Ø 251,4 10 9
1.9 JTD 16V	103	11/02→05/06	➔	→ 07/05		24.0122-0145.1 422145	Ø 284 22 20,2 V
2.0 JTS (932BXA)	122	03/02→05/06	➔	→ 07/05		24.0110-0283.1 410283	Ø 276 10 9
2.0 JTS (932BXD00, 932BXD01)	119	03/02→05/06	➔	→ 07/05			
2.4 JTD	129	10/03→05/06					
2.4 JTD (932.BXC00)	110	03/02→05/06					
2.0 16V T.SPARK (932A2)	114	05/00→06/02	➔			24.0122-0145.1 422145	Ø 284 22 20,2 V
2.0 16V T.SPARK (932B21__)	110	10/00→03/02	➔	→ 02/02		24.0110-0209.1 410209	Ø 251,4 10 9
2.5 V6 24V (932A1)	140	02/97→08/03	➔	03/02→		24.0110-0283.1 410283	Ø 276 10 9
2.4 JTD	120	06/03→05/06	➔	10/03→ 07/05		24.0122-0145.1 422145	Ø 284 22 20,2 V
			➔	10/03→ 07/05		24.0110-0283.1 410283	Ø 276 10 9
2.4 JTD (932.B1B00)	103	10/00→05/06	➔	→ 07/05		24.0122-0145.1 422145	Ø 284 22 20,2 V
2.5 V6 24V (932B1100)	141	02/97→05/06	➔	→ 02/02		24.0110-0209.1 410209	Ø 251,4 10 9
			➔	03/02→ 07/05		24.0110-0283.1 410283	Ø 276 10 9
2.4 JTD (932B1)	100	05/00→09/03	➔	→ 10/00		24.0122-0145.1 422145	Ø 284 22 20,2 V
			➔	→ 10/00		24.0110-0209.1 410209	Ø 251,4 10 9
3.2 GTA (932.BXB00)	184	03/02→05/06	➔	→ 09/03		24.0128-0119.1 428119	Ø 305 28 26 V
			➔	10/03→ 07/05		24.0132-0129.1 432129	Ø 330 32 30 V
			➔	→ 07/05		24.0110-0283.1 410283	Ø 276 10 9
<b>ALFA ROMEO - 159 (939_) 06/05→12/12</b>							
<b>Bremsbelagsatz, Scheibenbremse</b>							
1.8 MPI (939AXL1A)	103	06/05→11/11	➔	→ 10/11		13.0460-7211.2 607211	ATE 24339 20,5 + WK
1.9 JTS (939AXA1B)	118	09/05→11/11				13.0470-7211.2 LD7211	ATE 24339 20,5 + WK Ceramic
2.2 JTS (939AXB1B, 939AXB11)	136	09/05→11/11	➔	→ 10/11		13.0460-2707.2 602707	TRW 23760 17,7 - WE / - WK
						13.0470-2707.2 LD2707	TRW 23760 17,7 - WE / - WK Ceramic
1.8 Tbi (939.AXN1B)	147	05/09→12/12	➔	→ 10/11; für Fahrzeuge mit Sportpaket		13.0460-4851.2 604851	BRE 23092 16,0 + WK
1.9 JTDM 16V (939AXC1B, 939AXC12)	110	09/05→11/11				13.0470-4851.2 LD4851	BRE 23092 16,0 + WK Ceramic
1.9 JTDM 16V (939AXF1B, 939AXC1B)	100	09/05→11/11	➔	→ 10/11; für Fahrzeuge ohne Sportpaket		13.0460-4867.2 604867	BRE 24852 16,0 + WK
1.9 JTDM 8V (939AXE1B)	85	09/05→11/11	➔	→ 10/11		13.0470-4867.2 LD4867	BRE 24852 16,0 + WK Ceramic
1.9 JTDM 8V (939AXE1B)	88	09/05→11/11	➔	→ 10/11		13.0460-2707.2 602707	TRW 23760 17,7 - WE / - WK
2.0 JTDM (939AXP1B)	125	05/09→11/11				13.0470-2707.2 LD2707	TRW 23760 17,7 - WE / - WK Ceramic
2.0 JTDM (939AXQ1B)	120	05/09→11/11					
2.0 JTDM (939AXR1B)	100	06/10→11/11					
2.4 JTDM (939AXD)	154	07/07→11/11	➔	→ 10/11		13.0460-4851.2 604851	BRE 23092 16,0 + WK
2.4 JTDM Q4 (939AXMB2)	154	05/07→11/11				13.0470-4851.2 LD4851	BRE 23092 16,0 + WK Ceramic
3.2 JTS (939AXG2B)	191	01/08→11/11	➔	→ 10/11		13.0460-2707.2 602707	TRW 23760 17,7 - WE / - WK
						13.0470-2707.2 LD2707	TRW 23760 17,7 - WE / - WK Ceramic
2.4 JTDM (939AXD12, 939AXD1B)	147	09/05→11/11	➔	01/07→ 10/11		13.0460-4851.2 604851	BRE 23092 16,0 + WK
3.2 JTS Q4 (939AXH1B, 939AXG22)	191	12/05→11/11	➔	→ 12/06		13.0460-4971.2 604971	BRE 23092 16,0 + WK
						13.0470-4971.2 LD4971	BRE 23092 16,0 + WK Ceramic
			➔	→ 10/11		13.0460-2707.2 602707	TRW 23760 17,7 - WE / - WK
						13.0470-2707.2 LD2707	TRW 23760 17,7 - WE / - WK Ceramic













	kw			 	! #		
<b>ALFA ROMEO - 159 (939_) 06/05→12/12</b>							
<b>Bremsscheibe</b>							
1.8 MPI (939AXL1A)	103	06/05→11/11	←	→ 10/11		24.0128-0192.1 428192	Ø 305 28 26 V + S
2.0 JTDM (939AXR1B)	100	06/10→11/11	→	→ 10/11		24.0112-0170.1 412170	Ø 278 12 10 + S
2.2 JTS (939AXB1B, 939AXB11)	136	09/05→11/11	→	→ 10/11			
1.8 TBi (939.AXN1B)	147	05/09→12/12	←	→ 10/11; für Fahrzeuge mit Sportpaket		24.0128-0191.1 428191	Ø 330 28 26 V + S
			←	→ 10/11; für Fahrzeuge ohne Sportpaket		24.0128-0192.1 428192	Ø 305 28 26 V + S
			→	→ 10/11		24.0122-0233.1 422233	Ø 292 22 20 V + S
1.9 JTDM 16V (939AXC1B, 939AXC12)	110	09/05→11/11	←	→ 10/11; für Fahrzeuge mit Sportpaket		24.0128-0191.1 428191	Ø 330 28 26 V + S
1.9 JTDM 16V (939AXF1B, 939AXC1B)	100	09/05→11/11	←	→ 10/11; für Fahrzeuge ohne Sportpaket		24.0128-0192.1 428192	Ø 305 28 26 V + S
1.9 JTDM 8V (939AXE1B)	85	09/05→11/11	→	→ 10/11		24.0112-0170.1 412170	Ø 278 12 10 + S
1.9 JTDM 8V (939AXE1B)	88	09/05→11/11					
2.0 JTDM (939AXP1B)	125	05/09→11/11					
2.0 JTDM (939AXQ1B)	120	05/09→11/11					
1.9 JTS (939AXA1B)	118	09/05→11/11	←	→ 10/11; für Fahrzeuge mit Sportpaket		24.0128-0191.1 428191	Ø 330 28 26 V + S
			←	→ 10/11		24.0128-0192.1 428192	Ø 305 28 26 V + S
			→	→ 10/11		24.0112-0170.1 412170	Ø 278 12 10 + S
2.4 JTDM (939AXD)	154	07/07→11/11	←	→ 10/11		24.0128-0191.1 428191	Ø 330 28 26 V + S
2.4 JTDM (939AXD12, 939AXD1B)	147	09/05→11/11	→	→ 10/11		24.0122-0233.1 422233	Ø 292 22 20 V + S
2.4 JTDM Q4 (939AXMB2)	154	05/07→11/11					
3.2 JTS (939AXG2B)	191	01/08→11/11					
3.2 JTS Q4 (939AXH1B, 939AXG22)	191	12/05→11/11					
<b>ALFA ROMEO - 159 Sportwagon (939_) 06/05→12/12</b>							
<b>Bremsbelagsatz, Scheibenbremse</b>							
1.8 MPI (939BXL1A)	103	06/05→11/11	←	→ 10/11		13.0460-7211.2 607211	ATE 24339 20,5 + WK
1.9 JTS (939BXA1B)	118	03/06→11/11				13.0470-7211.2 LD7211	ATE 24339 20,5 + WK Ceramic
2.2 JTS (939BXB1B, 939BXB11)	136	03/06→11/11	→	→ 10/11		13.0460-2707.2 602707	TRW 23760 17,7 - WE / - WK
						13.0470-2707.2 LD2707	TRW 23760 17,7 - WE / - WK Ceramic
1.8 TBi (939BXN1B)	147	07/09→11/11	←	→ 10/11; für Fahrzeuge mit Sportpaket		13.0460-4851.2 604851	BRE 23092 16,0 + WK
1.9 JTDM 16V (939BXC1B, 939BXC12)	110	03/06→11/11				13.0470-4851.2 LD4851	BRE 23092 16,0 + WK Ceramic
1.9 JTDM 16V (939BXC1B)	100	03/06→11/11	←	→ 10/11; für Fahrzeuge ohne Sportpaket		13.0460-4867.2 604867	BRE 24852 16,0 + WK
1.9 JTDM 8V (939BXE1B)	85	03/06→11/11				13.0470-4867.2 LD4867	BRE 24852 16,0 + WK Ceramic
1.9 JTDM 8V (939BXE1B)	88	03/06→11/11	→	→ 10/11		13.0460-2707.2 602707	TRW 23760 17,7 - WE / - WK
2.0 JTDM (939BXP1B)	125	07/09→11/11				13.0470-2707.2 LD2707	TRW 23760 17,7 - WE / - WK Ceramic
2.0 JTDM (939BXQ1B)	120	05/09→11/11					
2.0 JTDM (939BXR1B)	100	06/10→11/11					
2.4 JTDM (939.BXM1B)	154	05/07→12/12	←	→ 10/11		13.0460-4851.2 604851	BRE 23092 16,0 + WK
2.4 JTDM Q4 (939BXM2B)	154	05/07→11/11				13.0470-4851.2 LD4851	BRE 23092 16,0 + WK Ceramic
3.2 JTS (939BXH1B)	191	02/08→11/11	→	→ 10/11		13.0460-2707.2 602707	TRW 23760 17,7 - WE / - WK
						13.0470-2707.2 LD2707	TRW 23760 17,7 - WE / - WK Ceramic
2.4 JTDM (939BXD1B, 939BXD12)	147	03/06→11/11	←	01/07→ 10/11		13.0460-4851.2 604851	BRE 23092 16,0 + WK
3.2 JTS Q4 (939BXG2B, 939BXG22)	191	03/06→11/11	←	→ 12/06		13.0460-4971.2 604971	BRE 23092 16,0 + WK
						13.0470-4971.2 LD4971	BRE 23092 16,0 + WK Ceramic
			→	→ 10/11		13.0460-2707.2 602707	TRW 23760 17,7 - WE / - WK
						13.0470-2707.2 LD2707	TRW 23760 17,7 - WE / - WK Ceramic
<b>Bremsscheibe</b>							
1.8 MPI (939BXL1A)	103	06/05→11/11	←	→ 10/11		24.0128-0192.1 428192	Ø 305 28 26 V + S
2.0 JTDM (939BXR1B)	100	06/10→11/11	→	→ 10/11		24.0112-0170.1 412170	Ø 278 12 10 + S
2.2 JTS (939BXB1B, 939BXB11)	136	03/06→11/11	→	→ 10/11			
1.8 TBi (939BXN1B)	147	07/09→11/11	←	→ 10/11; für Fahrzeuge mit Sportpaket		24.0128-0191.1 428191	Ø 330 28 26 V + S
			←	→ 10/11; für Fahrzeuge ohne Sportpaket		24.0128-0192.1 428192	Ø 305 28 26 V + S
			→	→ 10/11		24.0122-0233.1 422233	Ø 292 22 20 V + S
1.9 JTDM 16V (939BXC1B, 939BXC12)	110	03/06→11/11	←	→ 10/11; für Fahrzeuge mit Sportpaket		24.0128-0191.1 428191	Ø 330 28 26 V + S
1.9 JTDM 16V (939BXC1B)	100	03/06→11/11	←	→ 10/11; für Fahrzeuge ohne Sportpaket		24.0128-0192.1 428192	Ø 305 28 26 V + S













	kw			 	! #		
<b>ALFA ROMEO - 159 Sportwagon (939_) 06/05→12/12</b>							
 <b>Bremsscheibe</b>							
1.9 JTDM 8V 1.9 JTDM 8V (939BXE1B) 2.0 JTDM (939BXP1B) 2.0 JTDM (939BXQ1B)	85 88 125 120	03/06→11/11 03/06→11/11 07/09→11/11 05/09→11/11	→ → → →	→ 10/11		24.0112-0170.1 412170	Ø 278 12 10 + S
1.9 JTS (939BXA1B)	118	03/06→11/11	← ← →	→ 10/11; für Fahrzeuge mit Sportpaket → 10/11 → 10/11		24.0128-0191.1 428191 24.0128-0192.1 428192 24.0112-0170.1 412170	Ø 330 28 26 V + S Ø 305 28 26 V + S Ø 278 12 10 + S
2.4 JTDM (939.BXM1B) 2.4 JTDM (939BXD1B, 939BXD12) 2.4 JTDM Q4 (939BXM2B) 3.2 JTS (939BXH1B) 3.2 JTS Q4 (939BXG2B, 939BXG22)	154 147 154 191 191	05/07→12/12 03/06→11/11 05/07→11/11 02/08→11/11 03/06→11/11	← → ← →	→ 10/11 → 10/11		24.0128-0191.1 428191 24.0122-0233.1 422233	Ø 330 28 26 V + S Ø 292 22 20 V + S
<b>ALFA ROMEO - 164 (164_) 01/87→10/98</b>							
 <b>Bremsbelagsatz, Scheibenbremse</b>							
2.0 Turbo	128	10/87→09/98	← ←	09/91→ → 08/91		13.0460-2980.2 602980 13.0460-2980.2 602980	TRW 21147 19,0 + WK TRW 21147 19,0 + WK
2.0 V6 Turbo (164.K3) 2.5 TD (164.K2A, 164.K2B) 2.5 V6 3.0 3.0 24V (164K1_)	148 92 120 170 154	09/92→09/98 09/92→09/98 09/92→09/98 03/95→08/97 03/95→10/97	← ← ← ← ←			13.0460-2980.2 602980	TRW 21147 19,0 + WK
3.0 24V (164.K1) 3.0 24V QV (164.H1)	155 171	09/92→09/98 09/92→09/98	← ←	12/92→		13.0460-2980.2 602980	TRW 21147 19,0 + WK
3.0 24V Q4 (164.K1M, 164.K1C) 3.0 24V QV Allrad	170 171	02/94→09/98 11/92→10/97	← →	04/94→ 04/94→		13.0460-2980.2 602980 13.0460-2827.2 602827	TRW 21147 19,0 + WK TRW 21606 16,7 - WK
3.0 V6 (164.H1A, 164.H1B, 164.K1P)	132	09/92→09/98	←	→ 11/92		13.0460-2980.2 602980	TRW 21147 19,0 + WK
<b>Zubehörsatz, Scheibenbremsbelag</b>							
2.0	102	06/87→09/98	→	09/87→ 08/91		13.0460-0072.2 610072	TRW
2.0 T.S. (164.H3) 2.0 V6 Turbo (164.K3) 2.5 TD (164.K2A, 164.K2B) 2.5 V6 3.0 3.0 24V (164K1_)	106 148 92 120 170 154	09/92→09/98 09/92→09/98 09/92→09/98 09/92→09/98 03/95→08/97 03/95→10/97	→ → → → → →			13.0460-0072.2 610072	TRW
2.0 Turbo	128	10/87→09/98	→	→ 08/91		13.0460-0072.2 610072	TRW
3.0 24V (164.K1) 3.0 24V QV (164.H1)	155 171	09/92→09/98 09/92→09/98	→ →	12/92→		13.0460-0072.2 610072	TRW
3.0 V6 (164.H1A, 164.H1B, 164.K1P)	132	09/92→09/98	→	→ 11/92		13.0460-0072.2 610072	TRW
 <b>Bremsscheibe</b>							
2.0	102	06/87→09/98	← →	→ 08/91; 6.142.574→ 09/87→ 08/91		24.0122-0130.1 422130 24.0110-0190.1 410190	Ø 257,2 22 20,2 V Ø 251,5 10 9
2.0 T.S. (164.H3)	106	09/92→09/98	← →			24.0122-0130.1 422130 24.0110-0190.1 410190	Ø 257,2 22 20,2 V Ø 251,5 10 9
2.0 Turbo	128	10/87→09/98	← ← → → →	→ 08/91 09/91→ 09/91→ → 08/91		24.0122-0145.1 422145 24.0126-0103.1 426103 24.0110-0209.1 410209 24.0110-0209.1 410209	Ø 284 22 20,2 V Ø 281 26 24,2 V Ø 251,4 10 9 Ø 251,4 10 9
2.0 V6 Turbo (164.K3)	148	09/92→09/98	← →			24.0122-0145.1 422145 24.0110-0209.1 410209	Ø 284 22 20,2 V Ø 251,4 10 9
2.5 TD (164.K2A, 164.K2B) 2.5 V6 3.0 3.0 24V (164K1_)	92 120 170 154	09/92→09/98 09/92→09/98 03/95→08/97 03/95→10/97	← → → → →			24.0126-0103.1 426103 24.0110-0209.1 410209	Ø 281 26 24,2 V Ø 251,4 10 9
3.0 24V (164.K1) 3.0 24V QV (164.H1)	155 171	09/92→09/98 09/92→09/98	← →	12/92→		24.0126-0103.1 426103 24.0110-0209.1 410209	Ø 281 26 24,2 V Ø 251,4 10 9
↓							









	kw			 	! #		
<b>ALFA ROMEO - 164 (164_) 01/87→10/98</b>							
 <b>Bremsscheibe</b>							
3.0 24V Q4 (164.K1M, 164.K1C)	170	02/94→09/98	←	04/94→		24.0126-0103.1 426103	Ø 281 26 24,2 V
3.0 24V QV Allrad	171	11/92→10/97					
3.0 V6 (164.H1A, 164.H1B, 164.K1P)	132	09/92→09/98	←	→ 11/92		24.0126-0103.1 426103	Ø 281 26 24,2 V
			→	→ 11/92		24.0110-0209.1 410209	Ø 251,4 10 9
<b>ALFA ROMEO - 166 (936_) 09/98→06/07</b>							
 <b>Bremsbelagsatz, Scheibenbremse</b>							
2.0 T.Spark (936A3A_)	114	09/98→10/00	←	10/98→		13.0460-7112.2 607112	ATE 21637 19,3 + WK
2.4 JTD (936A2A_)	100	09/98→10/00	→	10/98→		13.0460-2827.2 602827	TRW 21606 16,7 - WK
2.0 T.Spark (936A3B00)	110	10/00→06/07	←			13.0460-7112.2 607112	ATE 21637 19,3 + WK
2.4 JTD	110	04/02→06/07					
2.4 JTD	120	10/03→06/07	→			13.0460-2827.2 602827	TRW 21606 16,7 - WK
2.4 JTD	132	07/06→06/07					
2.4 JTD	136	07/05→06/07					
2.4 JTD (936A2B_)	103	10/00→06/07					
2.0 V6 (936A3_)	151	09/98→10/00	←	10/98→		13.0460-4971.2 604971	BRE 23092 16,0 + WK
2.5 V6 24V (936A2_)	140	09/98→12/06				13.0470-4971.2 LD4971	BRE 23092 16,0 + WK Ceramic
3.0 V6 24V (936A1000, 936A1001)	166	09/98→06/07	→	10/98→		13.0460-2827.2 602827	TRW 21606 16,7 - WK
2.4 JTD	129	10/03→06/07	←			13.0460-4971.2 604971	BRE 23092 16,0 + WK
2.5 V6 24V (936A21_)	138	10/00→06/07				13.0470-4971.2 LD4971	BRE 23092 16,0 + WK Ceramic
3.0 V6 24V (936A11_)	162	10/00→06/07					
3.2 V6 24V	176	10/03→06/07	→			13.0460-2827.2 602827	TRW 21606 16,7 - WK
 <b>Bremsscheibe</b>							
2.0 T.Spark (936A3A_)	114	09/98→10/00	←	10/98→		24.0126-0133.1 426133	Ø 281 26 24,2 V
2.4 JTD (936A2A_)	100	09/98→10/00	→	10/98→		24.0110-0290.1 410290	Ø 276 10 9
2.0 T.Spark (936A3B00)	110	10/00→06/07	←			24.0126-0133.1 426133	Ø 281 26 24,2 V
2.4 JTD	110	04/02→06/07					
2.4 JTD	120	10/03→06/07	→			24.0110-0290.1 410290	Ø 276 10 9
2.4 JTD	132	07/06→06/07					
2.4 JTD	136	07/05→06/07					
2.4 JTD (936A2B_)	103	10/00→06/07					
2.0 V6 (936A3_)	151	09/98→10/00	←	10/98→		24.0128-0118.1 428118	Ø 310 28 26 V
2.5 V6 24V (936A2_)	140	09/98→12/06					
3.0 V6 24V (936A1000, 936A1001)	166	09/98→06/07	→	10/98→		24.0110-0290.1 410290	Ø 276 10 9
2.4 JTD	129	10/03→06/07	←			24.0128-0118.1 428118	Ø 310 28 26 V
2.5 V6 24V (936A21_)	138	10/00→06/07					
3.0 V6 24V (936A11_)	162	10/00→06/07	→			24.0110-0290.1 410290	Ø 276 10 9
3.2 V6 24V	176	10/03→06/07					
<b>ALFA ROMEO - BRERA (939_) 01/06→05/11</b>							
 <b>Bremsbelagsatz, Scheibenbremse</b>							
1.8 Tbi	147	05/09→06/10	←			13.0460-4971.2 604971	BRE 23092 16,0 + WK
2.4 JTDM 20V	147	01/06→06/10				13.0470-4971.2 LD4971	BRE 23092 16,0 + WK Ceramic
2.4 JTDM 20V	154	05/07→06/10					
3.2 JTS	191	03/08→06/10	→			13.0460-2707.2 602707	TRW 23760 17,7 - WE / - WK
						13.0470-2707.2 LD2707	TRW 23760 17,7 - WE / - WK Ceramic
3.2 JTS Q4 (939.DXG22)	191	01/06→05/11					
2.0 JTDM	120	03/08→06/10	←	05/09→		13.0460-4867.2 604867	BRE 24852 16,0 + WK
						13.0470-4867.2 LD4867	BRE 24852 16,0 + WK Ceramic
			→	05/09→		13.0460-2707.2 602707	TRW 23760 17,7 - WE / - WK
					13.0470-2707.2 LD2707	TRW 23760 17,7 - WE / - WK Ceramic	
2.0 JTDM	125	05/09→06/10	←			13.0460-4867.2 604867	BRE 24852 16,0 + WK
						13.0470-4867.2 LD4867	BRE 24852 16,0 + WK Ceramic
			→			13.0460-2707.2 602707	TRW 23760 17,7 - WE / - WK
					13.0470-2707.2 LD2707	TRW 23760 17,7 - WE / - WK Ceramic	
2.2 JTS (939.DXB11)	136	01/06→05/11	←	für Fahrzeuge mit Sportfahrwerk		13.0460-4971.2 604971	BRE 23092 16,0 + WK
						13.0470-4971.2 LD4971	BRE 23092 16,0 + WK Ceramic
			←	für Fahrzeuge ohne Sportfahrwerk		13.0460-7211.2 607211	ATE 24339 20,5 + WK
					13.0470-7211.2 LD7211	ATE 24339 20,5 + WK Ceramic	
			→			13.0460-2707.2 602707	TRW 23760 17,7 - WE / - WK
						13.0470-2707.2 LD2707	TRW 23760 17,7 - WE / - WK Ceramic
↓							

	kw			 	! #				
<b>ALFA ROMEO - BRERA (939_) 01/06→05/11</b>									
 <b>Bremsscheibe</b>									
1.8 TBi	147	05/09→06/10	←			24.0128-0191.1 428191	Ø 330 28 26 V + S		
2.4 JTDM 20V	147	01/06→06/10	→			24.0122-0233.1 422233	Ø 292 22 20 V + S		
2.4 JTDM 20V	154	05/07→06/10							
3.2 JTS	191	03/08→06/10							
3.2 JTS Q4 (939.DXG22)	191	01/06→05/11							
2.0 JTDM	120	03/08→06/10	←	05/09→		24.0128-0192.1 428192	Ø 305 28 26 V + S		
			→	05/09→		24.0112-0170.1 412170	Ø 278 12 10 + S		
2.0 JTDM	125	05/09→06/10	←			24.0128-0192.1 428192	Ø 305 28 26 V + S		
			→			24.0112-0170.1 412170	Ø 278 12 10 + S		
2.2 JTS (939.DXB11)	136	01/06→05/11	←	für Fahrzeuge mit Sportfahrwerk		24.0128-0191.1 428191	Ø 330 28 26 V + S		
			←	für Fahrzeuge ohne Sportfahrwerk		24.0128-0192.1 428192	Ø 305 28 26 V + S		
			→	für Fahrzeuge ohne Sportfahrwerk		24.0112-0170.1 412170	Ø 278 12 10 + S		
			→	für Fahrzeuge mit Sportfahrwerk		24.0122-0233.1 422233	Ø 292 22 20 V + S		
<b>ALFA ROMEO - GIULIA (952_) 10/15→</b>									
 <b>Bremsbelagsatz, Scheibenbremse</b>									
2.0 (952ABA25B)	147	08/16→	→			13.0470-7333.2 LD7333	ATE 22141 16,5 + WK Ceramic		
2.0 (952ACA25)	206	08/16→							
2.0 Q4 (952ACA45)	206	08/16→							
2.2 D Q4 (952AFA45M)	132	04/17→							
2.2 D Q4 (952AHA45)	154	11/16→							
2.2 D (952AEM250, 952AEA250)	110	10/15→	→	05/16→		13.0470-7333.2 LD7333	ATE 22141 16,5 + WK Ceramic		
2.2 D (952AFA25, 952AFM25, 952ALA25)	132	10/15→							
2.2 D (952AGA250, 952AGM250)	100	10/15→							
<b>ALFA ROMEO - GIULIETTA (940_) 04/10→</b>									
 <b>Bremsbelagsatz, Scheibenbremse</b>									
1.4 BiFuel	88	12/11→	←	→ 04/12;		13.0460-4854.2 604854	BRE 23092 16,3 + WK		
1.4 TB	85	04/10→		für Fahrzeuge mit verstärkter Bremse		13.0470-4854.2 LD4854	BRE 23092 16,3 + WK Ceramic		
1.4 TB (940FXA1A)	88	04/10→		←	05/12→;		13.0460-4971.2 604971	BRE 23092 16,0 + WK	
1.6 JTDM (940FXD1A)	77	04/10→			für Fahrzeuge mit verstärkter Bremse		13.0470-4971.2 LD4971	BRE 23092 16,0 + WK Ceramic	
					←	nicht für Fahrzeuge mit verstärkter Bremse		13.0460-7273.2 607273	ATE 24538 19,4 + WK
					←	nicht für Fahrzeuge mit verstärkter Bremse		13.0470-7273.2 LD7273	ATE 24538 19,4 + WK Ceramic
			→	nicht für Fahrzeuge mit verstärkter Bremse		13.0460-2767.2 602767	TRW 25156 17,4 + WK + Zub Ceramic		
			→	für Fahrzeuge mit verstärkter Bremse		13.0470-2767.2 LD2767	TRW 25156 17,4 + WK + Zub Ceramic		
			→	für Fahrzeuge mit verstärkter Bremse		13.0460-2768.2 602768	TRW 23811 17,7 + WK		
			→	für Fahrzeuge mit verstärkter Bremse		13.0470-2768.2 LD2768	TRW 23811 17,7 + WK Ceramic		
1.4 TB	77	04/11→	←	→ 04/12		13.0460-4854.2 604854	BRE 23092 16,3 + WK		
1.4 TB	120	04/10→					13.0470-4854.2 LD4854	BRE 23092 16,3 + WK Ceramic	
1.8 TBi	169	04/10→09/13	←	05/12→		13.0460-4971.2 604971	BRE 23092 16,0 + WK		
1.8 TBi (940FXC1A)	173	04/10→					13.0470-4971.2 LD4971	BRE 23092 16,0 + WK Ceramic	
				→			13.0460-2768.2 602768	TRW 23811 17,7 + WK	
				→			13.0470-2768.2 LD2768	TRW 23811 17,7 + WK Ceramic	
1.4 TB	110	09/14→	←			13.0460-4971.2 604971	BRE 23092 16,0 + WK		
1.8 TBi (940FXR11)	177	09/13→					13.0470-4971.2 LD4971	BRE 23092 16,0 + WK Ceramic	
			→			13.0460-2768.2 602768	TRW 23811 17,7 + WK		
			→			13.0470-2768.2 LD2768	TRW 23811 17,7 + WK Ceramic		
1.4 TB (940FXB1A)	125	04/10→	←	→ 04/12		13.0460-4854.2 604854	BRE 23092 16,3 + WK		
			←			13.0470-4854.2 LD4854	BRE 23092 16,3 + WK Ceramic		
			←	05/12→		13.0460-4971.2 604971	BRE 23092 16,0 + WK		
			←			13.0470-4971.2 LD4971	BRE 23092 16,0 + WK Ceramic		
			→	nicht für Fahrzeuge mit verstärkter Bremse		13.0460-2767.2 602767	TRW 25156 17,4 + WK + Zub Ceramic		
			→	nicht für Fahrzeuge mit verstärkter Bremse		13.0470-2767.2 LD2767	TRW 25156 17,4 + WK + Zub Ceramic		
			→	für Fahrzeuge mit verstärkter Bremse		13.0460-2768.2 602768	TRW 23811 17,7 + WK		
			→	für Fahrzeuge mit verstärkter Bremse		13.0470-2768.2 LD2768	TRW 23811 17,7 + WK Ceramic		
1.6 JTDM (940.FYB1_)	88	02/15→	←	für Fahrzeuge mit verstärkter Bremse		13.0460-4971.2 604971	BRE 23092 16,0 + WK		
1.6 JTDM (940.FYE1_)	85	09/15→					13.0470-4971.2 LD4971	BRE 23092 16,0 + WK Ceramic	
				←	nicht für Fahrzeuge mit verstärkter Bremse		13.0460-7273.2 607273	ATE 24538 19,4 + WK	
				←	nicht für Fahrzeuge mit verstärkter Bremse		13.0470-7273.2 LD7273	ATE 24538 19,4 + WK Ceramic	



	kw			 	! #		
<b>ALFA ROMEO - GIULIETTA (940_) 04/10→</b>							
 <b>Bremsbelagsatz, Scheibenbremse</b>							
1.6 JTDM (940.FYB1_) 1.6 JTDM (940.FYE1_)	88 85	02/15→ 09/15→	➔	nicht für Fahrzeuge mit verstärkter Bremse		13.0460-2767.2 602767 13.0470-2767.2 LD2767	TRW 25156 17,4 + WK + Zub TRW 25156 17,4 + WK + Zub Ceramic
			➔	für Fahrzeuge mit verstärkter Bremse		13.0460-2768.2 602768 13.0470-2768.2 LD2768	TRW 23811 17,7 + WK TRW 23811 17,7 + WK Ceramic
2.0 JTDM 2.0 JTDM 2.0 JTDM 2.0 JTDM (940.FXL1A)	100 120 125 103	04/10→ 04/10→ 04/10→ 04/10→	➔	→ 04/12; für Fahrzeuge mit verstärkter Bremse		13.0460-4854.2 604854 13.0470-4854.2 LD4854	BRE 23092 16,3 + WK BRE 23092 16,3 + WK Ceramic
			➔	05/12→; für Fahrzeuge mit verstärkter Bremse		13.0460-4971.2 604971 13.0470-4971.2 LD4971	BRE 23092 16,0 + WK BRE 23092 16,0 + WK Ceramic
			➔	nicht für Fahrzeuge mit verstärkter Bremse		13.0460-7269.2 607269 13.0470-7269.2 LD7269	ATE 24339 19,5 + WK ATE 24339 19,5 + WK Ceramic
			➔	nicht für Fahrzeuge mit verstärkter Bremse		13.0460-2767.2 602767 13.0470-2767.2 LD2767	TRW 25156 17,4 + WK + Zub TRW 25156 17,4 + WK + Zub Ceramic
			➔	für Fahrzeuge mit verstärkter Bremse		13.0460-2768.2 602768 13.0470-2768.2 LD2768	TRW 23811 17,7 + WK TRW 23811 17,7 + WK Ceramic
2.0 JTDM 2.0 JTDM (940.FYC1A, 940.FXQ1A)	129 110	11/13→ 08/13→	➔	für Fahrzeuge mit verstärkter Bremse		13.0460-4971.2 604971 13.0470-4971.2 LD4971	BRE 23092 16,0 + WK BRE 23092 16,0 + WK Ceramic
			➔	nicht für Fahrzeuge mit verstärkter Bremse		13.0460-7269.2 607269 13.0470-7269.2 LD7269	ATE 24339 19,5 + WK ATE 24339 19,5 + WK Ceramic
			➔	nicht für Fahrzeuge mit verstärkter Bremse		13.0460-2767.2 602767 13.0470-2767.2 LD2767	TRW 25156 17,4 + WK + Zub TRW 25156 17,4 + WK + Zub Ceramic
			➔	für Fahrzeuge mit verstärkter Bremse		13.0460-2768.2 602768 13.0470-2768.2 LD2768	TRW 23811 17,7 + WK TRW 23811 17,7 + WK Ceramic
 <b>Bremsscheibe</b>							
1.4 BiFuel 1.4 TB 1.4 TB (940FXA1A) 1.6 JTDM (940.FYB1_) 1.6 JTDM (940.FYE1_) 1.6 JTDM (940FXD1A)	88 85 88 88 85 77	12/11→ 04/10→ 04/10→ 02/15→ 09/15→ 04/10→	➔			24.0126-0168.1 426168 24.0110-0359.1 410359 24.0112-0170.1 412170	∅ 281 26,2 24,2 V + S ∅ 264 10 8 + S ∅ 278 12 10 + S
1.4 TB	77	04/11→	➔			24.0126-0168.1 426168 24.0112-0170.1 412170	∅ 281 26,2 24,2 V + S ∅ 278 12 10 + S
1.4 TB 1.4 TB 1.8 TBi 1.8 TBi (940FXC1A) 1.8 TBi (940FXR11)	110 120 169 173 177	09/14→ 04/10→ 04/10→09/13 04/10→ 09/13→	➔			24.0128-0191.1 428191 24.0112-0170.1 412170	∅ 330 28 26 V + S ∅ 278 12 10 + S
1.4 TB (940FXB1A)	125	04/10→	➔			24.0128-0191.1 428191 24.0110-0359.1 410359 24.0112-0170.1 412170	∅ 330 28 26 V + S ∅ 264 10 8 + S ∅ 278 12 10 + S
2.0 JTDM 2.0 JTDM 2.0 JTDM 2.0 JTDM 2.0 JTDM (940.FXL1A) 2.0 JTDM (940.FYC1A, 940.FXQ1A)	100 120 125 129 103 110	04/10→ 04/10→ 04/10→ 11/13→ 04/10→ 08/13→	➔	für Fahrzeuge mit verstärkter Bremse		24.0128-0191.1 428191 24.0128-0192.1 428192 24.0110-0359.1 410359 24.0112-0170.1 412170	∅ 330 28 26 V + S ∅ 305 28 26 V + S ∅ 264 10 8 + S ∅ 278 12 10 + S
<b>ALFA ROMEO - GT (937_) 11/03→09/10</b>							
 <b>Bremsbelagsatz, Scheibenbremse</b>							
1.8 TS 1.9 JTD 2.0 JTS 2.0 JTS (937CXH1A, 937CXH11)	103 110 119 121	11/03→09/10 11/03→09/10 12/06→09/10 11/03→09/10	➔	3286798→; → 07/10		13.0460-7140.2 607140 13.0470-7140.2 LD7140 13.0460-7181.2 607181 13.0470-7181.2 LD7181	ATE 21637 19,3 + WK ATE 21637 19,3 + WK Ceramic ATE 21636 19,3 + WK ATE 21636 19,3 + WK Ceramic
			➔	→ 07/10		13.0460-2867.2 602867 13.0470-2867.2 LD2867	TRW 23517 16,6 - WE / - WK TRW 23517 16,6 - WE / - WK Ceramic
1.9 JTD	125	05/08→09/10	➔	→ 07/10		13.0460-7140.2 607140 13.0470-7140.2 LD7140 13.0460-2867.2 602867 13.0470-2867.2 LD2867	ATE 21637 19,3 + WK ATE 21637 19,3 + WK Ceramic TRW 23517 16,6 - WE / - WK TRW 23517 16,6 - WE / - WK Ceramic
↓							

	kw			 	! #		
<b>ALFA ROMEO - GT (937_) 11/03→09/10</b>							
 <b>Bremsbelagsatz, Scheibenbremse</b>							
3.2 GTA	176	11/03→09/10	←	→ 07/10		<b>13.0460-4991.2 604991</b>	BRE 23092 16,0 + WK
			→	→ 07/10		<b>13.0460-2867.2 602867</b>	TRW 23517 16,6 - WE / - WK
						<b>13.0470-2867.2 LD2867</b>	TRW 23517 16,6 - WE / - WK Ceramic
 <b>Bremsscheibe</b>							
1.8 TS	103	11/03→09/10	←	→ 07/10		<b>24.0122-0145.1 422145</b>	Ø 284 22 20,2 V
1.9 JTD	110	11/03→09/10					
1.9 JTD	125	05/08→09/10	→	→ 07/10		<b>24.0110-0283.1 410283</b>	Ø 276 10 9
2.0 JTS	119	12/06→09/10					
2.0 JTS (937CXH1A, 937CXH11)	121	11/03→09/10					
3.2 GTA	176	11/03→09/10	←	→ 07/10		<b>24.0132-0129.1 432129</b>	Ø 330 32 30 V
			→	→ 07/10		<b>24.0110-0283.1 410283</b>	Ø 276 10 9
<b>ALFA ROMEO - GTV (916_) 09/94→10/05</b>							
 <b>Bremsbelagsatz, Scheibenbremse</b>							
1.8 16V (916C3)	106	05/98→10/05	←			<b>13.0460-7069.2 607069</b>	ATE 21636 19,3 + WK
2.0 JTS	121	04/03→10/05					
2.0 T.SPARK 16V (916C2C)	114	09/97→03/03	→	ALU		<b>13.0460-2826.2 602826</b>	TRW 23177 14,2 - WK
			→	GG		<b>13.0460-2951.2 602951</b>	TRW 21103 14,2 - WK
2.0 T.SPARK 16V (916.C2_, 916C2C00)	110	06/95→10/05	←	→ 06/95		<b>13.0460-2987.2 602987</b>	TRW 21147 19,0 + WK
2.0 V6 Turbo (916.C2A)	148	06/95→09/98	←	07/95→		<b>13.0460-7069.2 607069</b>	ATE 21636 19,3 + WK
			→	ALU		<b>13.0460-2826.2 602826</b>	TRW 23177 14,2 - WK
			→	GG		<b>13.0460-2951.2 602951</b>	TRW 21103 14,2 - WK
3.0 V6 24V (916.C1)	162	10/96→10/00	←			<b>13.0460-4968.2 604968</b>	BRE 21381 18,0 + WK
3.0 V6 24V (916.C1B_)	160	10/00→10/05					
3.2 V6 24V	176	04/03→10/05	→	ALU		<b>13.0460-2826.2 602826</b>	TRW 23177 14,2 - WK
			→	GG		<b>13.0460-2951.2 602951</b>	TRW 21103 14,2 - WK
<b>Zubehörsatz, Scheibenbremsbelag</b>							
1.8 16V (916C3)	106	05/98→10/05	→	GG		<b>13.0460-0072.2 610072</b>	TRW
2.0 JTS	121	04/03→10/05					
2.0 T.SPARK 16V (916.C2_, 916C2C00)	110	06/95→10/05					
2.0 T.SPARK 16V (916C2C)	114	09/97→03/03					
2.0 V6 Turbo (916.C2A)	148	06/95→09/98					
3.0 V6 24V (916.C1)	162	10/96→10/00					
3.0 V6 24V (916.C1B_)	160	10/00→10/05					
3.2 V6 24V	176	04/03→10/05					
 <b>Bremsscheibe</b>							
1.8 16V (916C3)	106	05/98→10/05	←			<b>24.0122-0225.1 422225</b>	Ø 284 22 20,2 V
2.0 JTS	121	04/03→10/05					
2.0 T.SPARK 16V (916.C2_, 916C2C00)	110	06/95→10/05	→			<b>24.0111-0142.1 411142</b>	Ø 240,5 11 9,2
2.0 T.SPARK 16V (916C2C)	114	09/97→03/03					
2.0 V6 Turbo (916.C2A)	148	06/95→09/98	←			<b>24.0122-0145.1 422145</b>	Ø 284 22 20,2 V
			→			<b>24.0111-0142.1 411142</b>	Ø 240,5 11 9,2
3.0 V6 24V (916.C1)	162	10/96→10/00	←			<b>24.0128-0119.1 428119</b>	Ø 305 28 26 V
3.0 V6 24V (916.C1B_)	160	10/00→10/05					
3.2 V6 24V	176	04/03→10/05	→			<b>24.0111-0142.1 411142</b>	Ø 240,5 11 9,2
<b>ALFA ROMEO - MITO (955_) 08/08→</b>							
 <b>Bremsbelagsatz, Scheibenbremse</b>							
0.9	74	12/13→	←			<b>13.0460-3863.2 603863</b>	BOS 23706 18,0 + WK + Zub
0.9 TwinAir	63	07/11→					
0.9 TwinAir (955AXY1B)	77	04/13→	→	nicht für Fahrzeuge mit verstärkter Bremse		<b>13.0460-2763.2 602763</b>	TRW 23517 17,2 + WK + Zub
			→	für Fahrzeuge mit verstärkter Bremse		<b>13.0460-3861.2 603861</b>	BOS 23714 17,6 + WK + Zub
						<b>13.0460-3991.2 603991</b>	BOS 23714 16,6 - WE / - WK
						<b>13.0470-3861.2 LD3861</b>	BOS + WK + Zub Ceramic
1.3 MultiJet	59	12/13→	←			<b>13.0460-3984.2 603984</b>	BOS 23711 19,4 + WK
1.3 MultiJet	62	01/11→					
1.3 MultiJet	66	09/08→				<b>13.0470-3984.2 LD3984</b>	BOS 23711 19,4 + WK Ceramic
1.3 MultiJet	70	10/09→	→	nicht für Fahrzeuge mit verstärkter Bremse		<b>13.0460-2763.2 602763</b>	TRW 23517 17,2 + WK + Zub
1.4 Bifuel	88	07/11→					
1.4 Bifuel (955.AXG1A)	88	04/16→	→	für Fahrzeuge mit verstärkter Bremse		<b>13.0460-3861.2 603861</b>	BOS 23714 17,6 + WK + Zub
1.4 TB	103	12/13→				<b>13.0460-3991.2 603991</b>	BOS 23714 16,6 - WE / - WK

	kW			 	! #		
<b>ALFA ROMEO - MITO (955_) 08/08→</b>							
<b> Bremsbelagsatz, Scheibenbremse</b>							
1.4 TJet (955AXG1A) 1.4 Turbo MultiAir (955AXM1A, 955AXR11) 1.6 JTDM (955AXC1B)	88 99 88	08/08→ 10/09→ 08/08→	➔	für Fahrzeuge mit verstärkter Bremse		<b>13.0470-3861.2 LD3861</b>	BOS + WK + Zub Ceramic
1.4 1.4 (955AXB1B) 1.4 (955AXB1B)	51 70 57 58	05/11→ 09/08→ 03/11→ 08/08→	➔	nicht für Fahrzeuge mit verstärkter Bremse		<b>13.0460-3826.2 603826</b> <b>13.0470-3826.2 LD3826</b>	BOS 23706 18,0 + WK + Zub BOS 23706 18,0 + WK + Zub Ceramic
			➔	für Fahrzeuge mit verstärkter Bremse		<b>13.0460-3861.2 603861</b> <b>13.0460-3991.2 603991</b> <b>13.0470-3861.2 LD3861</b>	BOS 23714 17,6 + WK + Zub BOS 23714 16,6 - WE / - WK BOS + WK + Zub Ceramic
1.4 (955.AXB1B, 955.AXU1A)	57	03/11→	➔	05/11→		<b>13.0460-3826.2 603826</b> <b>13.0470-3826.2 LD3826</b>	BOS 23706 18,0 + WK + Zub BOS 23706 18,0 + WK + Zub Ceramic
			➔	05/11→; nicht für Fahrzeuge mit verstärkter Bremse		<b>13.0460-2763.2 602763</b>	TRW 23517 17,2 + WK + Zub
			➔	05/11→; für Fahrzeuge mit verstärkter Bremse		<b>13.0460-3861.2 603861</b> <b>13.0460-3991.2 603991</b> <b>13.0470-3861.2 LD3861</b>	BOS 23714 17,6 + WK + Zub BOS 23714 16,6 - WE / - WK BOS + WK + Zub Ceramic
1.4 MultiAir (955AXL1B)	77	09/09→	➔			<b>13.0460-3863.2 603863</b>	BOS 23706 18,0 + WK + Zub
			➔	nicht für Fahrzeuge mit verstärkter Bremse		<b>13.0460-2763.2 602763</b>	TRW 23517 17,2 + WK + Zub
			➔	für Fahrzeuge mit verstärkter Bremse		<b>13.0460-3861.2 603861</b> <b>13.0460-3991.2 603991</b>	BOS 23714 17,6 + WK + Zub BOS 23714 16,6 - WE / - WK
			➔	08/10→; für Fahrzeuge mit verstärkter Bremse		<b>13.0470-3861.2 LD3861</b>	BOS + WK + Zub Ceramic
1.4 MultiAir (955AXN1B)	125	09/09→	➔			<b>13.0460-4853.2 604853</b> <b>13.0470-4853.2 LD4853</b>	BRE 24162 15,2 + WK BRE 24162 15,2 + WK Ceramic
			➔	nicht für Fahrzeuge mit verstärkter Bremse		<b>13.0460-2763.2 602763</b>	TRW 23517 17,2 + WK + Zub
			➔	für Fahrzeuge mit verstärkter Bremse		<b>13.0460-3861.2 603861</b> <b>13.0460-3991.2 603991</b>	BOS 23714 17,6 + WK + Zub BOS 23714 16,6 - WE / - WK
			➔	10/09→; für Fahrzeuge mit verstärkter Bremse		<b>13.0470-3861.2 LD3861</b>	BOS + WK + Zub Ceramic
1.4 TJet 1.4 TJet (955AXA1B) 1.4 Turbo MultiAir	110 114 120	09/08→ 08/08→ 10/09→	➔			<b>13.0460-4853.2 604853</b> <b>13.0470-4853.2 LD4853</b>	BRE 24162 15,2 + WK BRE 24162 15,2 + WK Ceramic
			➔	nicht für Fahrzeuge mit verstärkter Bremse		<b>13.0460-2763.2 602763</b>	TRW 23517 17,2 + WK + Zub
			➔	für Fahrzeuge mit verstärkter Bremse		<b>13.0460-3861.2 603861</b> <b>13.0460-3991.2 603991</b> <b>13.0470-3861.2 LD3861</b>	BOS 23714 17,6 + WK + Zub BOS 23714 16,6 - WE / - WK BOS + WK + Zub Ceramic
1.6 JTDM	85	09/08→	➔			<b>13.0460-3984.2 603984</b> <b>13.0470-3984.2 LD3984</b>	BOS 23711 19,4 + WK BOS 23711 19,4 + WK Ceramic
			➔	09/09→; nicht für Fahrzeuge mit verstärkter Bremse		<b>13.0460-2763.2 602763</b>	TRW 23517 17,2 + WK + Zub
			➔	09/09→; für Fahrzeuge mit verstärkter Bremse		<b>13.0460-3861.2 603861</b> <b>13.0460-3991.2 603991</b> <b>13.0470-3861.2 LD3861</b>	BOS 23714 17,6 + WK + Zub BOS 23714 16,6 - WE / - WK BOS + WK + Zub Ceramic
<b>Zubehörsatz, Scheibenbremsbelag</b>							
1.4 MultiAir (955AXN1B) 1.4 TJet 1.4 TJet (955AXA1B) 1.4 Turbo MultiAir	125 110 114 120	09/09→ 09/08→ 08/08→ 10/09→	➔			<b>13.0460-0175.2 610175</b>	BRE
<b> Bremsscheibe</b>							
0.9 0.9 TwinAir 0.9 TwinAir (955AXY1B)	74 63 77	12/13→ 07/11→ 04/13→	➔			<b>24.0122-0197.1 422197</b> <b>24.0322-0197.1 522197</b>	Ø 257,5 22 20,2 V Ø 257,5 22 20,2 V
1.4 1.4 1.4 (955AXB1B) 1.4 (955AXB1B) 1.4 MultiAir (955AXL1B)	51 70 57 58 77	05/11→ 09/08→ 03/11→ 08/08→ 09/09→	➔			<b>24.0110-0349.1 410349</b> <b>24.0310-0349.1 510349</b>	Ø 251 10 9 Ø 251 10 9
1.3 MultiJet 1.3 MultiJet 1.3 MultiJet 1.3 MultiJet	59 62 66 70	12/13→ 01/11→ 09/08→ 10/09→	➔			<b>24.0126-0125.1 426125</b> <b>24.0110-0349.1 410349</b> <b>24.0310-0349.1 510349</b>	Ø 281 26 24,2 V Ø 251 10 9 Ø 251 10 9



**ALFA ROMEO - MITO (955\_) 08/08→**

**Bremsscheibe**

1.4 Bifuel	88	07/11→	←		24.0126-0125.1	426125	Ø 281 26 24,2 V
1.4 Bifuel (955.AXG1A)	88	04/16→	→		24.0110-0349.1	410349	Ø 251 10 9
1.4 TB	103	12/13→				24.0310-0349.1	510349
1.4 TJet (955AXG1A)	88	08/08→	→				
1.4 Turbo MultiAir (955AXM1A, 955AXR11)	99	10/09→					
1.6 JTDM	85	09/08→	→				
1.6 JTDM (955AXC1B)	88	08/08→					
1.4 (955.AXB1B, 955.AXU1A)	57	03/11→	←	05/11→	24.0122-0197.1	422197	Ø 257,5 22 20,2 V
			→	05/11→	24.0322-0197.1	522197	Ø 257,5 22 20,2 V
1.4 MultiAir (955AXN1B)	110	09/08→	←		24.0110-0349.1	410349	Ø 251 10 9
			→		24.0310-0349.1	510349	Ø 251 10 9
			→		24.0128-0231.1	428231	Ø 305 28 26 V
1.4 TJet (955AXA1B)	114	08/08→	→		24.0110-0349.1	410349	Ø 251 10 9
1.4 Turbo MultiAir	120	10/09→	→		24.0310-0349.1	510349	Ø 251 10 9

**ALFA ROMEO - SPIDER (916\_) 09/94→04/05**

**Bremsbelagsatz, Scheibenbremse**

1.8 16V (916S3)	106	05/98→04/05	←		13.0460-7069.2	607069	ATE 21636 19,3 + WK	
2.0 JTS	121	04/03→04/05	→	ALU	13.0460-2826.2	602826	TRW 23177 14,2 - WK	
2.0 T.SPARK 16V (916S2B)	114	05/98→08/00		GG	13.0460-2951.2	602951	TRW 21103 14,2 - WK	
2.0 V6 Turbo (916S2A)	148	05/98→04/05	→					
2.0 T.SPARK 16V (916S2C00)	110	06/95→04/05		→	10/95	13.0460-2987.2	602987	TRW 21147 19,0 + WK
				←	11/95→	13.0460-7069.2	607069	ATE 21636 19,3 + WK
				→	ALU	13.0460-2826.2	602826	TRW 23177 14,2 - WK
				→	GG	13.0460-2951.2	602951	TRW 21103 14,2 - WK
				→				
3.0 V6 (916S1)	141	06/95→04/05	←	→ 06/95	13.0460-2987.2	602987	TRW 21147 19,0 + WK	
			←	07/95→	13.0460-4968.2	604968	BRE 21381 18,0 + WK	
			→	ALU	13.0460-2826.2	602826	TRW 23177 14,2 - WK	
			→	GG	13.0460-2951.2	602951	TRW 21103 14,2 - WK	
3.0 V6 (916S1B00)	160	09/94→04/05	←	10/00→	13.0460-4968.2	604968	BRE 21381 18,0 + WK	
			→	10/00→; ALU	13.0460-2826.2	602826	TRW 23177 14,2 - WK	
			→	10/00→; GG	13.0460-2951.2	602951	TRW 21103 14,2 - WK	
3.0 V6 24V (916S1)	162	01/99→10/03	←		13.0460-4968.2	604968	BRE 21381 18,0 + WK	
			→	ALU	13.0460-2826.2	602826	TRW 23177 14,2 - WK	
			→	GG	13.0460-2951.2	602951	TRW 21103 14,2 - WK	
3.2 V6 24V	176	04/03→04/05						













**Zubehörsatz, Scheibenbremsbelag**

1.8 16V (916S3)	106	05/98→04/05	→	GG	13.0460-0072.2	610072	TRW	
2.0 JTS	121	04/03→04/05	→					
2.0 T.SPARK 16V (916S2B)	114	05/98→08/00						
2.0 T.SPARK 16V (916S2C00)	110	06/95→04/05	→					
2.0 V6 Turbo (916S2A)	148	05/98→04/05						
3.0 V6 (916S1)	141	06/95→04/05						
3.0 V6 24V (916S1)	162	01/99→10/03						
3.2 V6 24V	176	04/03→04/05						
3.0 V6 (916S1B00)	160	09/94→04/05			10/00→; GG	13.0460-0072.2	610072	TRW

**Bremsscheibe**

1.8 16V (916S3)	106	05/98→04/05	←		24.0122-0225.1	422225	Ø 284 22 20,2 V
2.0 JTS	121	04/03→04/05	→		24.0111-0142.1	411142	Ø 240,5 11 9,2
2.0 T.SPARK 16V (916S2B)	114	05/98→08/00					
2.0 T.SPARK 16V (916S2C00)	110	06/95→04/05	←	→ 10/95	24.0120-0159.1	420159	Ø 257 20 18,2 V
			←	11/95→	24.0122-0225.1	422225	Ø 284 22 20,2 V
			→		24.0111-0142.1	411142	Ø 240,5 11 9,2
2.0 V6 Turbo (916S2A)	148	05/98→04/05	←		24.0122-0145.1	422145	Ø 284 22 20,2 V
			→		24.0111-0142.1	411142	Ø 240,5 11 9,2
3.0 V6 (916S1)	141	06/95→04/05	←		24.0128-0119.1	428119	Ø 305 28 26 V
3.0 V6 24V (916S1)	162	01/99→10/03	→		24.0111-0142.1	411142	Ø 240,5 11 9,2
3.2 V6 24V	176	04/03→04/05					
3.0 V6 (916S1B00)	160	09/94→04/05	←	10/00→	24.0128-0119.1	428119	Ø 305 28 26 V
			→	10/00→	24.0111-0142.1	411142	Ø 240,5 11 9,2



	kW			 	! #		
<b>ALFA ROMEO - SPIDER (939_) 03/06→03/11</b>							
 <b>Bremsbelagsatz, Scheibenbremse</b>							
1.8 TBi (939DXN1B) 2.4 JTDM 2.4 JTDM 3.2 JTS (939EXG2B)	147 147 154 191	05/09→03/11 04/07→06/10 03/08→06/10 03/08→03/11	← ← ← →			13.0460-4971.2 604971 13.0470-4971.2 LD4971 13.0460-2707.2 602707 13.0470-2707.2 LD2707	BRE 23092 16,0 + WK BRE 23092 16,0 + WK Ceramic TRW 23760 17,7 - WE / - WK TRW 23760 17,7 - WE / - WK Ceramic
2.0 JTDM 2.0 JTDM	120 125	04/09→06/10 05/09→06/10	← →			13.0460-4867.2 604867 13.0470-4867.2 LD4867 13.0460-2707.2 602707 13.0470-2707.2 LD2707	BRE 24852 16,0 + WK BRE 24852 16,0 + WK Ceramic TRW 23760 17,7 - WE / - WK TRW 23760 17,7 - WE / - WK Ceramic
2.2 JTS	136	03/06→03/11	←	03/08→		13.0460-4867.2 604867 13.0470-4867.2 LD4867	BRE 24852 16,0 + WK BRE 24852 16,0 + WK Ceramic
			←	04/06→ 02/08		13.0460-7211.2 607211 13.0470-7211.2 LD7211	ATE 24339 20,5 + WK ATE 24339 20,5 + WK Ceramic
			→	04/06→		13.0460-2707.2 602707 13.0470-2707.2 LD2707	TRW 23760 17,7 - WE / - WK TRW 23760 17,7 - WE / - WK Ceramic
3.2 JTS Q4	191	03/06→03/11	←	04/06→		13.0460-4971.2 604971 13.0470-4971.2 LD4971	BRE 23092 16,0 + WK BRE 23092 16,0 + WK Ceramic
			→	04/06→		13.0460-2707.2 602707 13.0470-2707.2 LD2707	TRW 23760 17,7 - WE / - WK TRW 23760 17,7 - WE / - WK Ceramic
 <b>Bremsscheibe</b>							
1.8 TBi (939DXN1B) 2.4 JTDM 2.4 JTDM 3.2 JTS (939EXG2B)	147 147 154 191	05/09→03/11 04/07→06/10 03/08→06/10 03/08→03/11	← ← → →			24.0128-0191.1 428191 24.0122-0233.1 422233	∅ 330 28 26 V + S ∅ 292 22 20 V + S
2.0 JTDM 2.0 JTDM	120 125	04/09→06/10 05/09→06/10	← →			24.0128-0192.1 428192 24.0112-0170.1 412170	∅ 305 28 26 V + S ∅ 278 12 10 + S
2.2 JTS	136	03/06→03/11	←	04/06→		24.0128-0192.1 428192 24.0112-0170.1 412170	∅ 305 28 26 V + S ∅ 278 12 10 + S
			→	04/06→		24.0128-0191.1 428191 24.0122-0233.1 422233	∅ 330 28 26 V + S ∅ 292 22 20 V + S
3.2 JTS Q4	191	03/06→03/11	←	04/06→		24.0128-0191.1 428191 24.0122-0233.1 422233	∅ 330 28 26 V + S ∅ 292 22 20 V + S
			→	04/06→		24.0128-0191.1 428191 24.0122-0233.1 422233	∅ 330 28 26 V + S ∅ 292 22 20 V + S
<b>ASTON MARTIN - CYGNET 04/11→10/13</b>							
 <b>Bremsscheibe</b>							
1.3	72	04/11→10/13	← →			24.0120-0219.1 420219 24.0109-0156.1 409156	∅ 255 20 18 V ∅ 259 9 7,5
<b>AUDI - 80 Avant (8C5, B4) 09/91→01/96</b>							
 <b>Bremsbelagsatz, Scheibenbremse</b>							
1.6 E 1.9 TDI 2.0	74 66 66	06/93→01/96 07/92→01/96 07/92→01/96	← ← →	→ 12/95		13.0460-2925.2 602925 13.0460-2934.2 602934 13.0460-3602.2 603602	TRW 20669 19,0 + WK TRW 20669 19,0 - WK TRW 21144 15,8 - WK
			→	8C-P-050000; + ABS		13.0460-3602.2 603602	TRW 21144 15,8 - WK
			→	8C-P-050001→; → 12/95		13.0460-3602.2 603602	TRW 21144 15,8 - WK
2.0 E 2.0 E 16V 2.3 E	85 103 98	07/92→01/96 02/93→01/96 07/92→01/96	← ← →	→ 12/95		13.0460-2925.2 602925 13.0460-2934.2 602934 13.0460-3602.2 603602	TRW 20669 19,0 + WK TRW 20669 19,0 - WK TRW 21144 15,8 - WK
2.0 quattro	79	11/93→01/96	← →	→ 12/95		13.0460-2934.2 602934 13.0460-3602.2 603602	TRW 20669 19,0 - WK TRW 21144 15,8 - WK
2.6	110	07/92→01/96	← →	→ 12/95 08/92→ 12/95		13.0460-2925.2 602925 13.0460-2934.2 602934 13.0460-3602.2 603602	TRW 20669 19,0 + WK TRW 20669 19,0 - WK TRW 21144 15,8 - WK
2.8	128	09/91→01/96	← →	→ 12/95		13.0460-2963.2 602963 13.0460-3602.2 603602	TRW 21138 18,8 + WK TRW 21144 15,8 - WK
 <b>Bremsscheibe</b>							
1.6 E	74	06/93→01/96	← ←	→ 8C-N-300000 8C-P-000001→; → 12/95		24.0122-0108.1 422108 24.0122-0139.1 422139	∅ 256 22 20 V ∅ 280 22 20 V
↓							









### AUDI - 80 Avant (8C5, B4) 09/91→01/96

<b>Bremsscheibe</b>							
1.6 E	74	06/93→01/96	➔	→ 8C-P-050000; + ABS	24.0110-0178.1	410178	Ø 245 10 8
			➔	→ 8C-P-050001→; → 12/95	24.0110-0178.1	410178	Ø 245 10 8
1.9 TDI	66	07/92→01/96	➔	→ 8C-P-000001	24.0113-0166.1	413166	Ø 256 13 11
			➔	→ 8C-P-000001→; → 12/95	24.0113-0179.1	413179	Ø 280 13 11
			➔	→ 8C-P-050000; + ABS	24.0110-0178.1	410178	Ø 245 10 8
			➔	→ 8C-P-050001→; → 12/95	24.0110-0178.1	410178	Ø 245 10 8
2.0	66	07/92→01/96	➔	→ 8C-P-000001; Schaltgetriebe	24.0113-0166.1	413166	Ø 256 13 11
			➔	→ 8C-P-000001→; → 12/95; Schaltgetriebe	24.0113-0179.1	413179	Ø 280 13 11
			➔	→ 8C-N-300000; Vollautomatik	24.0122-0108.1	422108	Ø 256 22 20 V
			➔	→ 8C-P-000001→; → 12/95; Vollautomatik	24.0122-0139.1	422139	Ø 280 22 20 V
			➔	→ 8C-P-050000; + ABS	24.0110-0178.1	410178	Ø 245 10 8
			➔	→ 8C-P-050001→; → 12/95	24.0110-0178.1	410178	Ø 245 10 8
2.0 E 2.3 E	85 98	07/92→01/96 07/92→01/96	➔	→ 8C-N-300000	24.0122-0108.1	422108	Ø 256 22 20 V
			➔	→ 8C-P-000001→; → 12/95	24.0122-0139.1	422139	Ø 280 22 20 V
			➔	→ 12/95	24.0110-0178.1	410178	Ø 245 10 8
2.0 E 16V	103	02/93→01/96	➔	→ 8C-P-000001→; → 12/95	24.0122-0139.1	422139	Ø 280 22 20 V
			➔	→ 12/95	24.0110-0178.1	410178	Ø 245 10 8
2.0 quattro	79	11/93→01/96	➔	→ 8C-N-300000	24.0122-0108.1	422108	Ø 256 22 20 V
			➔	→ 8C-P-000001→; → 12/95	24.0122-0139.1	422139	Ø 280 22 20 V
			➔	→ 12/95	24.0110-0182.1	410182	Ø 245 10 8
2.6	110	07/92→01/96	➔	→ 08/92→ 12/95	24.0122-0139.1	422139	Ø 280 22 20 V
			➔	→ 08/92→ 12/95	24.0110-0178.1	410178	Ø 245 10 8
2.8	128	09/91→01/96	➔	→ 12/95	24.0125-0106.1	425106	Ø 276 25 23 V
			➔	→ 12/95	24.0110-0178.1	410178	Ø 245 10 8

### AUDI - A1 (8X1, 8XK) 05/10→10/18

<b>Bremsbelagsatz, Scheibenbremse</b>							
1.0 TFSI 1.0 TFSI 1.8 TFSI	60 70 141	01/16→10/18 03/15→10/18 02/15→10/18	➔	+PR 1ZG	13.0460-7111.2	607111	VW 23130 19,6 - WE / - WK
			➔		13.0470-7111.2	LD7111	VW 23130 19,6 - WE / - WK Ceramic
			➔	+PR 1ZC	13.0460-7184.2	607184	ATE 23587 20,6 + WK
			➔		13.0470-7184.2	LD7184	ATE 23587 20,6 + WK Ceramic
			➔	+PR 1ZM,1ZN,1ZS	13.0460-7285.2	607285	ATE 23587 20,6 - WE / - WK
			➔		13.0470-7285.2	LD7285	ATE 23587 20,6 - WE / - WK Ceramic
			➔	+PR 1KT	13.0460-2787.2	602787	TRW 23554 17,3 - WK / - WE
			➔		13.0460-2860.2	602860	TRW 23554 16,4 - WK / + WE
			➔		13.0470-2860.2	LD2860	TRW 23554 16,4 - WK / + WE Ceramic
			➔	+PR 1KF,1KX	13.0460-2790.2	602790	TRW 25110 17,5 - WE / - WK
			➔		13.0470-2790.2	LD2790	TRW 25110 17,5 - WE / - WK Ceramic
			➔				
1.2 TFSI 1.4 TFSI 1.4 TFSI 1.4 TFSI 1.6 TDI 1.6 TDI 2.0 TDI 2.0 TDI	63 90 103 136 66 77 100 105	05/10→04/15 05/10→04/15 04/12→04/15 01/11→04/15 03/11→04/15 05/10→04/15 05/12→04/15 09/11→04/15	➔	+PR 1ZG	13.0460-7111.2	607111	VW 23130 19,6 - WE / - WK
			➔		13.0470-7111.2	LD7111	VW 23130 19,6 - WE / - WK Ceramic
			➔	+PR 1ZC	13.0460-7184.2	607184	ATE 23587 20,6 + WK
			➔		13.0470-7184.2	LD7184	ATE 23587 20,6 + WK Ceramic
			➔	+PR 1LJ	13.0460-7226.2	607226	ATE 23587 20,8 + WK
			➔		13.0470-7226.2	LD7226	ATE 23587 20,8 + WK Ceramic
			➔	+PR 1ZM,1ZN,1ZS	13.0460-7285.2	607285	ATE 23587 20,6 - WE / - WK
			➔		13.0470-7285.2	LD7285	ATE 23587 20,6 - WE / - WK Ceramic
			➔	+PR 1KT	13.0460-2787.2	602787	TRW 23554 17,3 - WK / - WE
			➔		13.0460-2860.2	602860	TRW 23554 16,4 - WK / + WE
➔		13.0470-2860.2	LD2860	TRW 23554 16,4 - WK / + WE Ceramic			
➔	+PR 1KF,1KX	13.0460-2790.2	602790	TRW 25110 17,5 - WE / - WK			
➔		13.0470-2790.2	LD2790	TRW 25110 17,5 - WE / - WK Ceramic			

↓

	kw			 	! #		
<b>AUDI - A1 (8X1, 8XK) 05/10→10/18</b>							
<b> Bremsbelagsatz, Scheibenbremse</b>							
1.2 TFSI 1.4 TFSI 1.4 TFSI 1.4 TFSI 1.6 TDI 1.6 TDI 2.0 TDI 2.0 TDI	63 90 103 136 66 77 100 105	05/10→04/15 05/10→04/15 04/12→04/15 01/11→04/15 03/11→04/15 05/10→04/15 05/12→04/15 09/11→04/15	➡	+PR 1KS		13.0460-3858.2 603858 13.0470-3858.2 LD3858	BOS 24563 17,7 - WE / - WK + Zub BOS 24563 17,7 - WE / - WK + Zub Ceramic
1.4 TDI 1.4 TFSI 1.4 TSI 1.6 TDI	66 92 110 85	11/14→10/18 11/14→10/18 11/14→10/18 11/14→10/18	⬅	+PR 1ZG		13.0460-7111.2 607111 13.0470-7111.2 LD7111	VW 23130 19,6 - WE / - WK VW 23130 19,6 - WE / - WK Ceramic
			⬅	+PR 1ZC		13.0460-7184.2 607184 13.0470-7184.2 LD7184	ATE 23587 20,6 + WK ATE 23587 20,6 + WK Ceramic
			⬅	+PR 1ZM,1ZN,1ZS		13.0460-7285.2 607285 13.0470-7285.2 LD7285	ATE 23587 20,6 - WE / - WK ATE 23587 20,6 - WE / - WK Ceramic
			➡	+PR 1KT		13.0460-2787.2 602787 13.0460-2860.2 602860 13.0470-2860.2 LD2860	TRW 23554 17,3 - WK / - WE TRW 23554 16,4 - WK / + WE TRW 23554 16,4 - WK / + WE Ceramic
			➡	+PR 1KF,1KX		13.0460-2790.2 602790 13.0470-2790.2 LD2790	TRW 25110 17,5 - WE / - WK TRW 25110 17,5 - WE / - WK Ceramic
			➡	+PR 1KS		13.0460-3858.2 603858 13.0470-3858.2 LD3858	BOS 24563 17,7 - WE / - WK + Zub BOS 24563 17,7 - WE / - WK + Zub Ceramic
2.0 TFSI quattro	188	03/12→11/12	⬅	10/12→; +PR 1ZG		13.0460-7111.2 607111 13.0470-7111.2 LD7111	VW 23130 19,6 - WE / - WK VW 23130 19,6 - WE / - WK Ceramic
			⬅	10/12→; +PR 1ZC		13.0460-7184.2 607184 13.0470-7184.2 LD7184	ATE 23587 20,6 + WK ATE 23587 20,6 + WK Ceramic
			⬅	10/12→; +PR 1LJ		13.0460-7226.2 607226 13.0470-7226.2 LD7226	ATE 23587 20,8 + WK ATE 23587 20,8 + WK Ceramic
			⬅	10/12→; +PR 1ZM,1ZN,1ZS		13.0460-7285.2 607285 13.0470-7285.2 LD7285	ATE 23587 20,6 - WE / - WK ATE 23587 20,6 - WE / - WK Ceramic
			➡	10/12→; +PR 1KT		13.0460-2787.2 602787 13.0460-2860.2 602860 13.0470-2860.2 LD2860	TRW 23554 17,3 - WK / - WE TRW 23554 16,4 - WK / + WE TRW 23554 16,4 - WK / + WE Ceramic
			➡	10/12→; +PR 1KF,1KX		13.0460-2790.2 602790 13.0470-2790.2 LD2790	TRW 25110 17,5 - WE / - WK TRW 25110 17,5 - WE / - WK Ceramic
			➡	10/12→; +PR 1KS		13.0460-3858.2 603858 13.0470-3858.2 LD3858	BOS 24563 17,7 - WE / - WK + Zub BOS 24563 17,7 - WE / - WK + Zub Ceramic
S1 quattro	170	03/14→10/18	⬅	+PR 1ZC		13.0460-7184.2 607184 13.0470-7184.2 LD7184	ATE 23587 20,6 + WK ATE 23587 20,6 + WK Ceramic
			⬅	+PR 1ZM,1ZN,1ZS		13.0460-7285.2 607285 13.0470-7285.2 LD7285	ATE 23587 20,6 - WE / - WK ATE 23587 20,6 - WE / - WK Ceramic
			➡	+PR 1KF,1KX		13.0460-2790.2 602790 13.0470-2790.2 LD2790	TRW 25110 17,5 - WE / - WK TRW 25110 17,5 - WE / - WK Ceramic
<b> Bremsscheibe</b>							
1.0 TFSI 1.0 TFSI 1.8 TFSI	60 70 141	01/16→10/18 03/15→10/18 02/15→10/18	⬅	+PR 1ZG		24.0122-0151.1 422151 24.0322-0151.1 522151	Ø 256 22 19 V + S Ø 256 22 19 V + S
			⬅	+PR 1ZC		24.0125-0113.1 425113 24.0325-0113.1 525113	Ø 288 25 22 V + S Ø 288 25 22 V + S
			⬅	+PR 1ZM,1ZN,1ZS		24.0125-0123.1 425123 24.0325-0123.1 525123	Ø 310 25 22 V + S Ø 310 25 22 V + S
			➡	+PR 1KT		24.0109-0123.1 409123 24.0309-0123.1 509123	Ø 230 9 7 + S Ø 230 9 7 + S
1.2 TFSI 1.4 TFSI ↓	63 90	05/10→04/15 05/10→04/15	⬅	+PR 1ZG		24.0122-0151.1 422151	Ø 256 22 19 V + S

**AUDI - A1 (8X1, 8XK) 05/10→10/18**

**Bremsscheibe**







1.4 TFSI	103	04/12→04/15	←	+PR 1ZG		24.0322-0151.1	522151	Ø 256 22 19 V + S
1.4 TFSI	136	01/11→04/15	←	+PR 1ZC		24.0125-0113.1	425113	Ø 288 25 22 V + S
1.6 TDI	66	03/11→04/15	←	+PR 1ZC		24.0325-0113.1	525113	Ø 288 25 22 V + S
1.6 TDI	77	05/10→04/15	←	+PR 1ZM,1ZN,1ZS		24.0125-0123.1	425123	Ø 310 25 22 V + S
2.0 TDI	100	05/12→04/15	←	+PR 1ZM,1ZN,1ZS		24.0325-0123.1	525123	Ø 310 25 22 V + S
2.0 TDI	105	09/11→04/15	←	+PR 1LJ		24.0125-0158.1	425158	Ø 312 25 22 V + S
			→	+PR 1KT		24.0109-0123.1	409123	Ø 230 9 7 + S
			→	+PR 1KS		24.0309-0123.1	509123	Ø 230 9 7 + S
			→	+PR 1KS		24.0110-0356.1	410356	Ø 272 9,7 8 + S
			→	+PR 1KS		24.0310-0356.1	510356	Ø 272 9,7 8 + S
1.4 TDI	66	11/14→10/18	←	+PR 1ZG		24.0122-0151.1	422151	Ø 256 22 19 V + S
1.4 TFSI	92	11/14→10/18	←	+PR 1ZC		24.0322-0151.1	522151	Ø 256 22 19 V + S
1.6 TDI	85	11/14→10/18	←	+PR 1ZC		24.0125-0113.1	425113	Ø 288 25 22 V + S
			←	+PR 1ZM,1ZN,1ZS		24.0325-0113.1	525113	Ø 288 25 22 V + S
			←	+PR 1ZM,1ZN,1ZS		24.0125-0123.1	425123	Ø 310 25 22 V + S
			←	+PR 1ZM,1ZN,1ZS		24.0325-0123.1	525123	Ø 310 25 22 V + S
			→	+PR 1KT		24.0109-0123.1	409123	Ø 230 9 7 + S
			→	+PR 1KT		24.0309-0123.1	509123	Ø 230 9 7 + S
			→	+PR 1KS		24.0110-0356.1	410356	Ø 272 9,7 8 + S
			→	+PR 1KS		24.0310-0356.1	510356	Ø 272 9,7 8 + S
1.4 TSI	110	11/14→10/18	←	+PR 1ZG		24.0122-0151.1	422151	Ø 256 22 19 V + S
			←	+PR 1ZM,1ZN,1ZS		24.0322-0151.1	522151	Ø 256 22 19 V + S
			←	+PR 1ZM,1ZN,1ZS		24.0125-0123.1	425123	Ø 310 25 22 V + S
			←	+PR 1ZM,1ZN,1ZS		24.0325-0123.1	525123	Ø 310 25 22 V + S
			→	+PR 1KT		24.0109-0123.1	409123	Ø 230 9 7 + S
			→	+PR 1KT		24.0309-0123.1	509123	Ø 230 9 7 + S
			→	+PR 1KS		24.0110-0356.1	410356	Ø 272 9,7 8 + S
			→	+PR 1KS		24.0310-0356.1	510356	Ø 272 9,7 8 + S
2.0 TFSI quattro	188	03/12→11/12	←	10/12→; +PR 1ZG		24.0122-0151.1	422151	Ø 256 22 19 V + S
			←	10/12→; +PR 1ZG		24.0322-0151.1	522151	Ø 256 22 19 V + S
			←	10/12→; +PR 1ZC		24.0125-0113.1	425113	Ø 288 25 22 V + S
			←	10/12→; +PR 1ZC		24.0325-0113.1	525113	Ø 288 25 22 V + S
			←	10/12→; +PR 1ZM,1ZN,1ZS		24.0125-0123.1	425123	Ø 310 25 22 V + S
			←	10/12→; +PR 1ZM,1ZN,1ZS		24.0325-0123.1	525123	Ø 310 25 22 V + S
			←	10/12→; +PR 1LJ		24.0125-0158.1	425158	Ø 312 25 22 V + S
			←	10/12→; +PR 1LJ		24.0325-0158.1	525158	Ø 312 25 22 V + S
			→	10/12→; +PR 1KT		24.0109-0123.1	409123	Ø 230 9 7 + S
			→	10/12→; +PR 1KT		24.0309-0123.1	509123	Ø 230 9 7 + S
			→	10/12→; +PR 1KS		24.0110-0356.1	410356	Ø 272 9,7 8 + S
			→	10/12→; +PR 1KS		24.0310-0356.1	510356	Ø 272 9,7 8 + S
S1 quattro	170	03/14→10/18	←	+PR 1ZC		24.0125-0113.1	425113	Ø 288 25 22 V + S
			←	+PR 1ZC		24.0325-0113.1	525113	Ø 288 25 22 V + S

**AUDI - A1 Sportback (8XA, 8XF) 09/11→10/18**







**Bremsbelagsatz, Scheibenbremse**









1.0 TFSI	60	01/16→10/18	←	+PR 1ZG		13.0460-7111.2	607111	VW 23130 19,6 - WE / - WK
1.0 TFSI	70	03/15→10/18	←	+PR 1ZG		13.0470-7111.2	LD7111	VW 23130 19,6 - WE / - WK
1.8 TFSI	141	02/15→10/18	←	+PR 1ZC		13.0460-7184.2	607184	ATE 23587 20,6 + WK
			←	+PR 1ZC		13.0470-7184.2	LD7184	ATE 23587 20,6 + WK Ceramic
			←	+PR 1ZM,1ZN,1ZS		13.0460-7285.2	607285	ATE 23587 20,6 - WE / - WK
			←	+PR 1ZM,1ZN,1ZS		13.0470-7285.2	LD7285	ATE 23587 20,6 - WE / - WK Ceramic
			→	+PR 1KT		13.0460-2787.2	602787	TRW 23554 17,3 - WK / - WE
			→	+PR 1KT		13.0460-2860.2	602860	TRW 23554 16,4 - WK / + WE
			→	+PR 1KT		13.0470-2860.2	LD2860	TRW 23554 16,4 - WK / + WE Ceramic
			→	+PR 1KF,1KX		13.0460-2790.2	602790	TRW 25110 17,5 - WE / - WK
			→	+PR 1KF,1KX		13.0470-2790.2	LD2790	TRW 25110 17,5 - WE / - WK Ceramic
1.2 TFSI	63	01/12→04/15	←	+PR 1ZG		13.0460-7111.2	607111	VW 23130 19,6 - WE / - WK
1.4 TFSI	90	11/11→04/15	←	+PR 1ZG				









	kw			 	! #		
<b>AUDI - A1 Sportback (8XA, 8XF) 09/11→10/18</b>							
<b>Bremsbelagsatz, Scheibenbremse</b>							
1.4 TFSI 1.4 TFSI 1.6 TDI 1.6 TDI 2.0 TDI 2.0 TDI	103 136 66 77 100 105	04/12→04/15 11/11→04/15 11/11→04/15 11/11→04/15 05/12→04/15 09/11→04/15	← ← ← ← ← → → →	+PR 1ZG +PR 1ZC +PR 1LJ +PR 1ZM,1ZN,1ZS +PR 1KT +PR 1KF,1KX +PR 1KS		13.0470-7111.2 LD7111 13.0460-7184.2 607184 13.0470-7184.2 LD7184 13.0460-7226.2 607226 13.0470-7226.2 LD7226 13.0460-7285.2 607285 13.0470-7285.2 LD7285 13.0460-2787.2 602787 13.0460-2860.2 602860 13.0470-2860.2 LD2860 13.0460-2790.2 602790 13.0470-2790.2 LD2790 13.0460-3858.2 603858 13.0470-3858.2 LD3858	VW 23130 19,6 - WE / - WK Ceramic ATE 23587 20,6 + WK ATE 23587 20,6 + WK Ceramic ATE 23587 20,8 + WK ATE 23587 20,8 + WK Ceramic ATE 23587 20,6 - WE / - WK ATE 23587 20,6 - WE / - WK Ceramic TRW 23554 17,3 - WK / - WE TRW 23554 16,4 - WK / + WE TRW 23554 16,4 - WK / + WE Ceramic TRW 25110 17,5 - WE / - WK TRW 25110 17,5 - WE / - WK Ceramic BOS 24563 17,7 - WE / - WK + Zub BOS 24563 17,7 - WE / - WK + Zub Ceramic
1.4 TDI 1.4 TFSI 1.4 TSI 1.6 TDI	66 92 110 85	11/14→10/18 11/14→10/18 11/14→10/18 11/14→10/18	← ← ← → → →	+PR 1ZG +PR 1ZC +PR 1ZM,1ZN,1ZS +PR 1KT +PR 1KF,1KX +PR 1KS		13.0460-7111.2 607111 13.0470-7111.2 LD7111 13.0460-7184.2 607184 13.0470-7184.2 LD7184 13.0460-7285.2 607285 13.0470-7285.2 LD7285 13.0460-2787.2 602787 13.0460-2860.2 602860 13.0470-2860.2 LD2860 13.0460-2790.2 602790 13.0470-2790.2 LD2790 13.0460-3858.2 603858 13.0470-3858.2 LD3858	VW 23130 19,6 - WE / - WK VW 23130 19,6 - WE / - WK Ceramic ATE 23587 20,6 + WK ATE 23587 20,6 + WK Ceramic ATE 23587 20,6 - WE / - WK ATE 23587 20,6 - WE / - WK Ceramic TRW 23554 17,3 - WK / - WE TRW 23554 16,4 - WK / + WE TRW 23554 16,4 - WK / + WE Ceramic TRW 25110 17,5 - WE / - WK TRW 25110 17,5 - WE / - WK Ceramic BOS 24563 17,7 - WE / - WK + Zub BOS 24563 17,7 - WE / - WK + Zub Ceramic
S1 quattro	170	03/14→10/18	← ← →	+PR 1ZC +PR 1ZM,1ZN,1ZS +PR 1KF,1KX		13.0460-7184.2 607184 13.0470-7184.2 LD7184 13.0460-7285.2 607285 13.0470-7285.2 LD7285 13.0460-2790.2 602790 13.0470-2790.2 LD2790	ATE 23587 20,6 + WK ATE 23587 20,6 + WK Ceramic ATE 23587 20,6 - WE / - WK ATE 23587 20,6 - WE / - WK Ceramic TRW 25110 17,5 - WE / - WK TRW 25110 17,5 - WE / - WK Ceramic
<b>Bremsscheibe</b>							
1.0 TFSI 1.0 TFSI 1.8 TFSI	60 70 141	01/16→10/18 03/15→10/18 02/15→10/18	← ← ← ← → →	+PR 1ZG +PR 1ZC +PR 1ZM,1ZN,1ZS +PR 1KT		24.0122-0151.1 422151 24.0322-0151.1 522151 24.0125-0113.1 425113 24.0325-0113.1 525113 24.0125-0123.1 425123 24.0325-0123.1 525123 24.0109-0123.1 409123 24.0309-0123.1 509123	Ø 256 22 19 V + S Ø 256 22 19 V + S Ø 288 25 22 V + S Ø 288 25 22 V + S Ø 310 25 22 V + S Ø 310 25 22 V + S Ø 230 9 7 + S Ø 230 9 7 + S
1.2 TFSI 1.4 TFSI 1.4 TFSI 1.4 TFSI 1.6 TDI 1.6 TDI 2.0 TDI 2.0 TDI	63 90 103 136 66 77 100 105	01/12→04/15 11/11→04/15 04/12→04/15 11/11→04/15 11/11→04/15 11/11→04/15 05/12→04/15 09/11→04/15	← ← ← ← ← ←	+PR 1ZG +PR 1ZC +PR 1ZM,1ZN,1ZS +PR 1LJ		24.0122-0151.1 422151 24.0322-0151.1 522151 24.0125-0113.1 425113 24.0325-0113.1 525113 24.0125-0123.1 425123 24.0325-0123.1 525123 24.0125-0158.1 425158 24.0325-0158.1 525158	Ø 256 22 19 V + S Ø 256 22 19 V + S Ø 288 25 22 V + S Ø 288 25 22 V + S Ø 310 25 22 V + S Ø 310 25 22 V + S Ø 312 25 22 V + S Ø 312 25 22 V + S



















	kw			 	! #		
<b>AUDI - A1 Sportback (8XA, 8XF) 09/11→10/18</b>							
<b>Bremsscheibe</b>							
1.2 TFSI	63	01/12→04/15	➔	+PR 1KT		24.0109-0123.1 409123	Ø 230 9 7 + S
1.4 TFSI	90	11/11→04/15				24.0309-0123.1 509123	Ø 230 9 7 + S
1.4 TFSI	103	04/12→04/15					
1.4 TFSI	136	11/11→04/15	➔	+PR 1KS		24.0110-0356.1 410356	Ø 272 9,7 8 + S
1.6 TDI	66	11/11→04/15				24.0310-0356.1 510356	Ø 272 9,7 8 + S
1.6 TDI	77	11/11→04/15					
2.0 TDI	100	05/12→04/15					
2.0 TDI	105	09/11→04/15					
1.4 TDI	66	11/14→10/18	➔	+PR 1ZG		24.0122-0151.1 422151	Ø 256 22 19 V + S
1.4 TFSI	92	11/14→10/18				24.0322-0151.1 522151	Ø 256 22 19 V + S
1.6 TDI	85	11/14→10/18	➔	+PR 1ZC		24.0125-0113.1 425113	Ø 288 25 22 V + S
						24.0325-0113.1 525113	Ø 288 25 22 V + S
			➔	+PR 1ZM,1ZN,1ZS		24.0125-0123.1 425123	Ø 310 25 22 V + S
						24.0325-0123.1 525123	Ø 310 25 22 V + S
			➔	+PR 1KT		24.0109-0123.1 409123	Ø 230 9 7 + S
						24.0309-0123.1 509123	Ø 230 9 7 + S
			➔	+PR 1KS		24.0110-0356.1 410356	Ø 272 9,7 8 + S
						24.0310-0356.1 510356	Ø 272 9,7 8 + S
1.4 TSI	110	11/14→10/18	➔	+PR 1ZG		24.0122-0151.1 422151	Ø 256 22 19 V + S
						24.0322-0151.1 522151	Ø 256 22 19 V + S
			➔	+PR 1ZM,1ZN,1ZS		24.0125-0123.1 425123	Ø 310 25 22 V + S
						24.0325-0123.1 525123	Ø 310 25 22 V + S
			➔	+PR 1KT		24.0109-0123.1 409123	Ø 230 9 7 + S
						24.0309-0123.1 509123	Ø 230 9 7 + S
			➔	+PR 1KS		24.0110-0356.1 410356	Ø 272 9,7 8 + S
						24.0310-0356.1 510356	Ø 272 9,7 8 + S
S1 quattro	170	03/14→10/18	➔	+PR 1ZC		24.0125-0113.1 425113	Ø 288 25 22 V + S
						24.0325-0113.1 525113	Ø 288 25 22 V + S
<b>AUDI - A2 (8Z0) 02/00→08/05</b>							
<b>Bremsbelagsatz, Scheibenbremse</b>							
1.2 TDI	45	03/01→08/05	➔	→ 07/05		13.0460-7178.2 607178	VW 23394 13,7 + WK
1.4	55	02/00→08/05	➔	06/00→ 07/05		13.0460-7117.2 607117	VW 23130 19,6 + WK
1.4 TDI	55	02/00→08/05				13.0470-7117.2 LD7117	VW 23130 19,6 + WK Ceramic
1.4 TDI	66	11/03→08/05	➔	→ 07/05		13.0460-7117.2 607117	VW 23130 19,6 + WK
1.6 FSI	81	05/02→08/05				13.0470-7117.2 LD7117	VW 23130 19,6 + WK Ceramic
			➔	→ 07/05		13.0460-2864.2 602864	TRW 20961 17,2 - WK
						13.0460-2894.2 602894	TRW 20961 17,2 - WK + Zub
						13.0470-2894.2 LD2894	TRW 20961 17,2 - WK + Zub Ceramic
<b>Zubehörsatz, Scheibenbremsbelag</b>							
1.4 TDI	66	11/03→08/05	➔	→ 07/05		13.0460-0072.2 610072	TRW
1.6 FSI	81	05/02→08/05					
<b>Bremsscheibe</b>							
1.2 TDI	45	03/01→08/05	➔	→ 07/05		24.0115-0109.1 415109	Ø 239 15 13 V
1.4	55	02/00→08/05	➔	06/00→ 07/05		24.0122-0151.1 422151	Ø 256 22 19 V + S
1.4 TDI	55	02/00→08/05				24.0322-0151.1 522151	Ø 256 22 19 V + S
1.4 TDI	66	11/03→08/05	➔	→ 07/05		24.0122-0151.1 422151	Ø 256 22 19 V + S
1.6 FSI	81	05/02→08/05				24.0322-0151.1 522151	Ø 256 22 19 V + S
			➔	→ 07/05		24.0109-0123.1 409123	Ø 230 9 7 + S
						24.0309-0123.1 509123	Ø 230 9 7 + S
<b>AUDI - A3 (8L1) 09/96→09/06</b>							
<b>Bremsbelagsatz, Scheibenbremse</b>							
1.6	74	09/96→05/03	➔	→ 8L-X-150000; +PR 1LE,1LN,1ZD		13.0460-7081.2 607081	ATE 20676 19,8 - WE / - WK
1.6	75	08/00→05/03				13.0470-7081.2 LD7081	ATE 20676 19,8 - WE / - WK Ceramic
1.8	92	09/96→05/03					
1.8 T	110	12/96→05/03	➔	→ 8L-X-200000; +PR 1LQ,1LR,1LS		13.0460-7111.2 607111	VW 23130 19,6 - WE / - WK
1.8 T	132	12/98→05/03				13.0470-7111.2 LD7111	VW 23130 19,6 - WE / - WK Ceramic
1.8 T quattro	132	10/98→05/03	➔	8L-Y-000001→; +PR 1LQ,1LS		13.0460-7117.2 607117	VW 23130 19,6 + WK
						13.0470-7117.2 LD7117	VW 23130 19,6 + WK Ceramic
			➔	+PR 1ZP		13.0460-7117.2 607117	VW 23130 19,6 + WK

	kw			 	! #		
<b>AUDI - A3 (8L1) 09/96→09/06</b>							
<b> Bremsbelagsatz, Scheibenbremse</b>							
1.6	74	09/96→05/03	←	+PR 1ZP		13.0470-7117.2 LD7117	VW 23130 19,6 + WK Ceramic
1.6	75	08/00→05/03	←	8L-Y-000001→; +PR 1LE,1LN,1ZD		13.0460-7122.2 607122	ATE 20676 19,8 + WK
1.8	92	09/96→05/03	←			13.0470-7122.2 LD7122	ATE 20676 19,8 + WK Ceramic
1.8 T	110	12/96→05/03					
1.8 T	132	12/98→05/03	→	+PR 1KK,1KV,1KE		13.0460-2894.2 602894	TRW 20961 17,2 - WK + Zub
1.8 T quattro	132	10/98→05/03				13.0470-2894.2 LD2894	TRW 20961 17,2 - WK + Zub Ceramic
1.8 T quattro	110	12/96→05/03	←	08/98→; → 8L-X-150000; +PR 1LE,1LN,1ZD		13.0460-7081.2 607081	ATE 20676 19,8 - WE / - WK
					13.0470-7081.2 LD7081	ATE 20676 19,8 - WE / - WK Ceramic	
			←	08/98→; → 8L-X-200000; +PR 1LQ,1LR,1LS		13.0460-7111.2 607111	VW 23130 19,6 - WE / - WK
					13.0470-7111.2 LD7111	VW 23130 19,6 - WE / - WK Ceramic	
			←	08/98→; +PR 1ZP		13.0460-7117.2 607117	VW 23130 19,6 + WK
					13.0470-7117.2 LD7117	VW 23130 19,6 + WK Ceramic	
			←	8L-Y-000001→; +PR 1LQ,1LS		13.0460-7117.2 607117	VW 23130 19,6 + WK
		13.0470-7117.2 LD7117	VW 23130 19,6 + WK Ceramic				
			←	8L-Y-000001→; +PR 1LE,1LN,1ZD		13.0460-7122.2 607122	ATE 20676 19,8 + WK
						13.0470-7122.2 LD7122	ATE 20676 19,8 + WK Ceramic
			→	08/98→; +PR 1KK,1KV,1KE		13.0460-2894.2 602894	TRW 20961 17,2 - WK + Zub
						13.0470-2894.2 LD2894	TRW 20961 17,2 - WK + Zub Ceramic
1.9 TDI 1.9 TDI	66 81	09/96→07/01 08/97→07/01	←	→ 8L-X-150000; +PR 1LE,1LN,1ZD		13.0460-7081.2 607081	ATE 20676 19,8 - WE / - WK
					13.0470-7081.2 LD7081	ATE 20676 19,8 - WE / - WK Ceramic	
			←	→ 8L-X-200000; +PR 1LQ,1LR,1LS		13.0460-7111.2 607111	VW 23130 19,6 - WE / - WK
					13.0470-7111.2 LD7111	VW 23130 19,6 - WE / - WK Ceramic	
			←	8L-Y-000001→; → 06/01; +PR 1LQ,1LS		13.0460-7117.2 607117	VW 23130 19,6 + WK
					13.0470-7117.2 LD7117	VW 23130 19,6 + WK Ceramic	
			←	→ 06/01; +PR 1ZP		13.0460-7117.2 607117	VW 23130 19,6 + WK
						13.0470-7117.2 LD7117	VW 23130 19,6 + WK Ceramic
			←	8L-Y-000001→; → 06/01; +PR 1LE,1LN,1ZD		13.0460-7122.2 607122	ATE 20676 19,8 + WK
						13.0470-7122.2 LD7122	ATE 20676 19,8 + WK Ceramic
			→	→ 06/01; +PR 1KK,1KV,1KE		13.0460-2894.2 602894	TRW 20961 17,2 - WK + Zub
						13.0470-2894.2 LD2894	TRW 20961 17,2 - WK + Zub Ceramic
1.9 TDI	74	10/00→05/03	←	+PR 1LQ,1LS		13.0460-7117.2 607117	VW 23130 19,6 + WK
					13.0470-7117.2 LD7117	VW 23130 19,6 + WK Ceramic	
			←	+PR 1ZP		13.0460-7117.2 607117	VW 23130 19,6 + WK
					13.0470-7117.2 LD7117	VW 23130 19,6 + WK Ceramic	
			←	+PR 1LE,1LN,1ZD		13.0460-7122.2 607122	ATE 20676 19,8 + WK
						13.0470-7122.2 LD7122	ATE 20676 19,8 + WK Ceramic
			→	+PR 1KK,1KV,1KE		13.0460-2894.2 602894	TRW 20961 17,2 - WK + Zub
						13.0470-2894.2 LD2894	TRW 20961 17,2 - WK + Zub Ceramic
1.9 TDI 1.9 TDI quattro	96 96	08/00→05/03 08/00→05/03	←	09/00→; +PR 1ZP		13.0460-7117.2 607117	VW 23130 19,6 + WK
					13.0470-7117.2 LD7117	VW 23130 19,6 + WK Ceramic	
			←	09/00→; +PR 1LQ,1LS		13.0460-7117.2 607117	VW 23130 19,6 + WK
					13.0470-7117.2 LD7117	VW 23130 19,6 + WK Ceramic	
			←	09/00→; +PR 1LE,1LN,1ZD		13.0460-7122.2 607122	ATE 20676 19,8 + WK
						13.0470-7122.2 LD7122	ATE 20676 19,8 + WK Ceramic
			→	09/00→; +PR 1KK,1KV,1KE		13.0460-2894.2 602894	TRW 20961 17,2 - WK + Zub
						13.0470-2894.2 LD2894	TRW 20961 17,2 - WK + Zub Ceramic
S3 quattro S3 quattro	154 165	03/99→04/02 10/01→05/03	←	→ 8L-X-200000; +PR 1LT		13.0460-7081.2 607081	ATE 20676 19,8 - WE / - WK
					13.0470-7081.2 LD7081	ATE 20676 19,8 - WE / - WK Ceramic	
			←	8L-Y-000001→; +PR 1LT		13.0460-7122.2 607122	ATE 20676 19,8 + WK
					13.0470-7122.2 LD7122	ATE 20676 19,8 + WK Ceramic	
			→	+PR 1KF		13.0460-2787.2 602787	TRW 23554 17,3 - WK / - WE
						13.0460-2820.2 602820	TRW 20961 17,2 - WK
						13.0470-2820.2 LD2820	TRW 20961 17,2 - WK Ceramic









	kw			 	! #		
<b>AUDI - A3 (8L1) 09/96→09/06</b>							
<b>Bremsscheibe</b>							
1.6	74	09/96→05/03	←	+PR 1LR,1LS,1ZP		24.0122-0150.1 422150	Ø 280 22 19 V + S
1.6	75	08/00→05/03				24.0322-0150.1 522150	Ø 280 22 19 V + S
1.8	92	09/96→05/03					
1.8 T	110	12/96→05/03	←	+PR 1LQ		24.0122-0151.1 422151	Ø 256 22 19 V + S
1.8 T	132	12/98→05/03				24.0322-0151.1 522151	Ø 256 22 19 V + S
1.9 TDI	74	10/00→05/03	←	+PR 1LE,1LN,1ZD		24.0125-0113.1 425113	Ø 288 25 22 V + S
						24.0325-0113.1 525113	Ø 288 25 22 V + S
			→	+PR 1KK,1KV		24.0109-0123.1 409123	Ø 230 9 7 + S
						24.0309-0123.1 509123	Ø 230 9 7 + S
1.8 T quattro	110	12/96→05/03	←	08/98→; +PR 1LR,1LS,1ZP		24.0122-0150.1 422150	Ø 280 22 19 V + S
						24.0322-0150.1 522150	Ø 280 22 19 V + S
			←	08/98→; +PR 1LQ		24.0122-0151.1 422151	Ø 256 22 19 V + S
						24.0322-0151.1 522151	Ø 256 22 19 V + S
			←	08/98→; +PR 1LE,1LN,1ZD		24.0125-0113.1 425113	Ø 288 25 22 V + S
						24.0325-0113.1 525113	Ø 288 25 22 V + S
			→	08/98→; +PR 1KE		24.0109-0133.1 409133	Ø 239 8,9 7 + S
						24.0309-0133.1 509133	Ø 239 8,9 7 + S
1.8 T quattro	132	10/98→05/03	←	+PR 1LR,1LS,1ZP		24.0122-0150.1 422150	Ø 280 22 19 V + S
						24.0322-0150.1 522150	Ø 280 22 19 V + S
			←	+PR 1LQ		24.0122-0151.1 422151	Ø 256 22 19 V + S
						24.0322-0151.1 522151	Ø 256 22 19 V + S
			←	+PR 1LE,1LN,1ZD		24.0125-0113.1 425113	Ø 288 25 22 V + S
						24.0325-0113.1 525113	Ø 288 25 22 V + S
			→	+PR 1KE		24.0109-0133.1 409133	Ø 239 8,9 7 + S
						24.0309-0133.1 509133	Ø 239 8,9 7 + S
1.9 TDI	66	09/96→07/01	←	→ 06/01; +PR 1LR,1LS,1ZP		24.0122-0150.1 422150	Ø 280 22 19 V + S
1.9 TDI	81	08/97→07/01				24.0322-0150.1 522150	Ø 280 22 19 V + S
			←	→ 06/01; +PR 1LQ		24.0122-0151.1 422151	Ø 256 22 19 V + S
						24.0322-0151.1 522151	Ø 256 22 19 V + S
			←	→ 06/01; +PR 1LE,1LN,1ZD		24.0125-0113.1 425113	Ø 288 25 22 V + S
						24.0325-0113.1 525113	Ø 288 25 22 V + S
			→	→ 06/01; +PR 1KK,1KV		24.0109-0123.1 409123	Ø 230 9 7 + S
						24.0309-0123.1 509123	Ø 230 9 7 + S
1.9 TDI	96	08/00→05/03	←	09/00→; +PR 1LR,1LS,1ZP		24.0122-0150.1 422150	Ø 280 22 19 V + S
						24.0322-0150.1 522150	Ø 280 22 19 V + S
			←	09/00→; +PR 1LQ		24.0122-0151.1 422151	Ø 256 22 19 V + S
						24.0322-0151.1 522151	Ø 256 22 19 V + S
			←	09/00→; +PR 1LE,1LN,1ZD		24.0125-0113.1 425113	Ø 288 25 22 V + S
						24.0325-0113.1 525113	Ø 288 25 22 V + S
			→	09/00→; +PR 1KK,1KV		24.0109-0123.1 409123	Ø 230 9 7 + S
						24.0309-0123.1 509123	Ø 230 9 7 + S
1.9 TDI quattro	96	08/00→05/03	←	09/00→; +PR 1LR,1LS,1ZP		24.0122-0150.1 422150	Ø 280 22 19 V + S
						24.0322-0150.1 522150	Ø 280 22 19 V + S
			←	09/00→; +PR 1LQ		24.0122-0151.1 422151	Ø 256 22 19 V + S
						24.0322-0151.1 522151	Ø 256 22 19 V + S
			←	09/00→; +PR 1LE,1LN,1ZD		24.0125-0113.1 425113	Ø 288 25 22 V + S
						24.0325-0113.1 525113	Ø 288 25 22 V + S
			→	09/00→; +PR 1KE		24.0109-0133.1 409133	Ø 239 8,9 7 + S
						24.0309-0133.1 509133	Ø 239 8,9 7 + S
S3 quattro	154	03/99→04/02	←	+PR 1LT		24.0125-0123.1 425123	Ø 310 25 22 V + S
S3 quattro	165	10/01→05/03				24.0325-0123.1 525123	Ø 310 25 22 V + S
			→	+PR 1KF		24.0122-0163.1 422163	Ø 256 22 20 V
						24.0322-0163.1 522163	Ø 256 22 20 V
<b>AUDI - A3 (8P1) 05/03→12/13</b>							
<b>Bremsbelagsatz, Scheibenbremse</b>							
1.2 TSI	77	04/10→08/12	←	+PR 1ZF,1ZM		13.0460-7117.2 607117	VW 23130 19,6 + WK
1.6 TDI	66	05/09→08/12				13.0470-7117.2 LD7117	VW 23130 19,6 + WK Ceramic
1.6 TDI	77	05/09→08/12	←	+PR 1ZE,1ZP,1ZD,1LJ / 1ZA		13.0460-7184.2 607184	ATE 23587 20,6 + WK
						13.0470-7184.2 LD7184	ATE 23587 20,6 + WK Ceramic
			←	+PR 1LK		13.0460-7200.2 607200	ATE 23801 20,3 + WK
						13.0470-7200.2 LD7200	ATE 23801 20,3 + WK Ceramic
↓							











	kw			 	! #			
<b>AUDI - A3 (8P1) 05/03→12/13</b>								
<b> Bremsbelagsatz, Scheibenbremse</b>								
1.2 TSI 1.6 TDI 1.6 TDI	77	04/10→08/12	➡	+PR 1KE,1KZ		13.0460-2749.2 602749	TRW 24483 16,9 - WE / - WK + Zub	
	66	05/09→08/12				13.0460-2880.2 602880	TRW 23914 17,1 + WE / - WK + Zub	
	77	05/09→08/12				13.0470-2749.2 LD2749	TRW 24483 16,9 - WE / - WK + Zub Ceramic	
						13.0470-2880.2 LD2880	TRW 23914 17,1 + WE / - WK + Zub Ceramic	
				➡	+PR 1KQ,1KD		13.0460-2787.2 602787	TRW 23554 17,3 - WK / - WE
							13.0460-2860.2 602860	TRW 23554 16,4 - WK / + WE
							13.0470-2860.2 LD2860	TRW 23554 16,4 - WK / + WE Ceramic
				➡	+PR 1KS		13.0460-3858.2 603858	BOS 24563 17,7 - WE / - WK + Zub
							13.0470-3858.2 LD3858	BOS 24563 17,7 - WE / - WK + Zub Ceramic
1.4 TFSI 2.0 TDI	92	09/07→08/12	⬅	+PR 1ZF;1ZM		13.0460-7117.2 607117	VW 23130 19,6 + WK	
	125	03/06→08/12				13.0470-7117.2 LD7117	VW 23130 19,6 + WK Ceramic	
			⬅	+PR 1ZE;1ZP;1ZD;1LJ / 1ZA		13.0460-7184.2 607184	ATE 23587 20,6 + WK	
						13.0470-7184.2 LD7184	ATE 23587 20,6 + WK Ceramic	
			⬅	+PR 1LK		13.0460-7200.2 607200	ATE 23801 20,3 + WK	
						13.0470-7200.2 LD7200	ATE 23801 20,3 + WK Ceramic	
				➡	+PR 1KE;1KZ		13.0460-2749.2 602749	TRW 24483 16,9 - WE / - WK + Zub
							13.0460-2880.2 602880	TRW 23914 17,1 + WE / - WK + Zub
							13.0470-2749.2 LD2749	TRW 24483 16,9 - WE / - WK + Zub Ceramic
						13.0470-2880.2 LD2880	TRW 23914 17,1 + WE / - WK + Zub Ceramic	
			➡	+PR 1KQ;1KD		13.0460-2787.2 602787	TRW 23554 17,3 - WK / - WE	
						13.0460-2860.2 602860	TRW 23554 16,4 - WK / + WE	
						13.0470-2860.2 LD2860	TRW 23554 16,4 - WK / + WE Ceramic	
			➡	+PR 1KS		13.0460-3858.2 603858	BOS 24563 17,7 - WE / - WK + Zub	
						13.0470-3858.2 LD3858	BOS 24563 17,7 - WE / - WK + Zub Ceramic	
1.6 1.6 E-Power 1.6 FSI 2.0 FSI 2.0 TDI 2.0 TDI 2.0 TDI 16V 2.0 TFSI	75	05/03→08/12	⬅	+PR 1ZF;1ZM		13.0460-7117.2 607117	VW 23130 19,6 + WK	
	75	01/11→08/12				13.0470-7117.2 LD7117	VW 23130 19,6 + WK Ceramic	
	85	08/03→09/07	⬅	+PR 1ZE;1ZP;1ZD;1LJ / 1ZA		13.0460-7184.2 607184	ATE 23587 20,6 + WK	
	110	05/03→06/08				13.0470-7184.2 LD7184	ATE 23587 20,6 + WK Ceramic	
	100	05/03→08/12	⬅	+PR 1LK		13.0460-7200.2 607200	ATE 23801 20,3 + WK	
	103	06/05→06/08				13.0470-7200.2 LD7200	ATE 23801 20,3 + WK Ceramic	
	103	05/03→08/12	⬅	+PR 1LK		13.0460-7200.2 607200	ATE 23801 20,3 + WK	
	103	05/03→08/12				13.0470-7200.2 LD7200	ATE 23801 20,3 + WK Ceramic	
	147	09/04→08/12	➡	+PR 1KE;1KZ		13.0460-2749.2 602749	TRW 24483 16,9 - WE / - WK + Zub	
						13.0460-2880.2 602880	TRW 23914 17,1 + WE / - WK + Zub	
						13.0470-2749.2 LD2749	TRW 24483 16,9 - WE / - WK + Zub Ceramic	
						13.0470-2880.2 LD2880	TRW 23914 17,1 + WE / - WK + Zub Ceramic	
			➡	+PR 1KQ;1KD		13.0460-2787.2 602787	TRW 23554 17,3 - WK / - WE	
						13.0460-2860.2 602860	TRW 23554 16,4 - WK / + WE	
						13.0470-2860.2 LD2860	TRW 23554 16,4 - WK / + WE Ceramic	
			➡	+PR 1KS		13.0460-3858.2 603858	BOS 24563 17,7 - WE / - WK + Zub	
						13.0470-3858.2 LD3858	BOS 24563 17,7 - WE / - WK + Zub Ceramic	
1.8 T 1.8 TFSI	110	08/06→08/12	⬅	01/07→; +PR 1ZF;1ZM		13.0460-7117.2 607117	VW 23130 19,6 + WK	
	118	11/06→08/12				13.0470-7117.2 LD7117	VW 23130 19,6 + WK Ceramic	
			⬅	01/07→; +PR 1ZE;1ZP;1ZD;1LJ / 1ZA		13.0460-7184.2 607184	ATE 23587 20,6 + WK	
						13.0470-7184.2 LD7184	ATE 23587 20,6 + WK Ceramic	
			⬅	01/07→; +PR 1LK		13.0460-7200.2 607200	ATE 23801 20,3 + WK	
						13.0470-7200.2 LD7200	ATE 23801 20,3 + WK Ceramic	
↓								







	kw			 	! #		
<b>AUDI - A3 (8P1) 05/03→12/13</b>							
<b> Bremsbelagsatz, Scheibenbremse</b>							
1.8 T 1.8 TFSI	110 118	08/06→08/12 11/06→08/12	➔	01/07→; +PR 1KE;1KZ	13.0460-2749.2	602749	TRW 24483 16,9 - WE / - WK + Zub
					13.0460-2880.2	602880	TRW 23914 17,1 + WE / - WK + Zub
					13.0470-2749.2	LD2749	TRW 24483 16,9 - WE / - WK + Zub Ceramic
					13.0470-2880.2	LD2880	TRW 23914 17,1 + WE / - WK + Zub Ceramic
			➔	01/07→; +PR 1KQ;1KD	13.0460-2787.2	602787	TRW 23554 17,3 - WK / - WE
					13.0460-2860.2	602860	TRW 23554 16,4 - WK / + WE
		13.0470-2860.2	LD2860	TRW 23554 16,4 - WK / + WE Ceramic			
		➔	01/07→; +PR 1KS	13.0460-3858.2	603858	BOS 24563 17,7 - WE / - WK + Zub	
				13.0470-3858.2	LD3858	BOS 24563 17,7 - WE / - WK + Zub Ceramic	
1.8 TFSI quattro	118	07/08→08/12	←	+PR 1ZF;1ZM	13.0460-7117.2	607117	VW 23130 19,6 + WK
					13.0470-7117.2	LD7117	VW 23130 19,6 + WK Ceramic
			←	+PR 1ZE;1ZP;1ZD;1LJ / 1ZA	13.0460-7184.2	607184	ATE 23587 20,6 + WK
					13.0470-7184.2	LD7184	ATE 23587 20,6 + WK Ceramic
			←	+PR 1LK	13.0460-7200.2	607200	ATE 23801 20,3 + WK
					13.0470-7200.2	LD7200	ATE 23801 20,3 + WK Ceramic
		➔	+PR 1KF,1KJ,1KU	13.0460-2749.2	602749	TRW 24483 16,9 - WE / - WK + Zub	
				13.0460-2880.2	602880	TRW 23914 17,1 + WE / - WK + Zub	
				13.0470-2749.2	LD2749	TRW 24483 16,9 - WE / - WK + Zub Ceramic	
				13.0470-2880.2	LD2880	TRW 23914 17,1 + WE / - WK + Zub Ceramic	
			➔	+PR 1KS	13.0460-3858.2	603858	BOS 24563 17,7 - WE / - WK + Zub
				13.0470-3858.2	LD3858	BOS 24563 17,7 - WE / - WK + Zub Ceramic	
1.9 TDI	77	05/03→05/10	←	06/03→; +PR 1ZF,1ZM	13.0460-7117.2	607117	VW 23130 19,6 + WK
					13.0470-7117.2	LD7117	VW 23130 19,6 + WK Ceramic
			←	06/03→; +PR 1ZE;1ZP;1ZD;1LJ / 1ZA	13.0460-7184.2	607184	ATE 23587 20,6 + WK
					13.0470-7184.2	LD7184	ATE 23587 20,6 + WK Ceramic
			←	+PR 1LK	13.0460-7200.2	607200	ATE 23801 20,3 + WK
					13.0470-7200.2	LD7200	ATE 23801 20,3 + WK Ceramic
		➔	06/03→; +PR 1KE;1KZ	13.0460-2749.2	602749	TRW 24483 16,9 - WE / - WK + Zub	
				13.0460-2880.2	602880	TRW 23914 17,1 + WE / - WK + Zub	
				13.0470-2749.2	LD2749	TRW 24483 16,9 - WE / - WK + Zub Ceramic	
				13.0470-2880.2	LD2880	TRW 23914 17,1 + WE / - WK + Zub Ceramic	
			➔	06/03→; +PR 1KQ;1KD	13.0460-2787.2	602787	TRW 23554 17,3 - WK / - WE
				13.0460-2860.2	602860	TRW 23554 16,4 - WK / + WE	
				13.0470-2860.2	LD2860	TRW 23554 16,4 - WK / + WE Ceramic	
			➔	06/03→; +PR 1KS	13.0460-3858.2	603858	BOS 24563 17,7 - WE / - WK + Zub
				13.0470-3858.2	LD3858	BOS 24563 17,7 - WE / - WK + Zub Ceramic	
2.0 TDI	120	06/06→06/08	←	+PR 1ZF; 1ZM	13.0460-7117.2	607117	VW 23130 19,6 + WK
					13.0470-7117.2	LD7117	VW 23130 19,6 + WK Ceramic
			←	+PR 1ZE;1ZP;1ZD;1LJ / 1ZA	13.0460-7184.2	607184	ATE 23587 20,6 + WK
					13.0470-7184.2	LD7184	ATE 23587 20,6 + WK Ceramic
			←	+PR 1LK	13.0460-7200.2	607200	ATE 23801 20,3 + WK
		13.0470-7200.2	LD7200	ATE 23801 20,3 + WK Ceramic			
		➔	+PR 1KE; 1KZ	13.0460-2749.2	602749	TRW 24483 16,9 - WE / - WK + Zub	
				13.0460-2880.2	602880	TRW 23914 17,1 + WE / - WK + Zub	
				13.0470-2749.2	LD2749	TRW 24483 16,9 - WE / - WK + Zub Ceramic	









	kw			 	! #		
<b>AUDI - A3 (8P1) 05/03→12/13</b>							
<b> Bremsbelagsatz, Scheibenbremse</b>							
2.0 TDI	120	06/06→06/08	➡	+PR 1KE; 1KZ	13.0470-2880.2	LD2880	TRW 23914 17,1 + WE / - WK + Zub Ceramic
			➡	+PR 1KQ; 1KD	13.0460-2787.2	602787	TRW 23554 17,3 - WK / - WE
					13.0460-2860.2	602860	TRW 23554 16,4 - WK / + WE
					13.0470-2860.2	LD2860	TRW 23554 16,4 - WK / + WE Ceramic
		➡	+PR 1KS	13.0460-3858.2	603858	BOS 24563 17,7 - WE / - WK + Zub	
				13.0470-3858.2	LD3858	BOS 24563 17,7 - WE / - WK + Zub Ceramic	
2.0 TDI 16V quattro 2.0 TDI quattro 2.0 TDI quattro 2.0 TFSI quattro	103 100 103 147	08/04→08/12 05/03→06/08	←	+PR 1ZF;1ZM	13.0460-7117.2	607117	VW 23130 19,6 + WK
					13.0470-7117.2	LD7117	VW 23130 19,6 + WK Ceramic
		01/06→06/08	←	+PR 1ZE;1ZP;1ZD;1LJ / 1ZA	13.0460-7184.2	607184	ATE 23587 20,6 + WK
					13.0470-7184.2	LD7184	ATE 23587 20,6 + WK Ceramic
		09/04→08/12	←	+PR 1LK	13.0460-7200.2	607200	ATE 23801 20,3 + WK
					13.0470-7200.2	LD7200	ATE 23801 20,3 + WK Ceramic
			➡	+PR 1KF;1KJ;1KU	13.0460-2749.2	602749	TRW 24483 16,9 - WE / - WK + Zub
				13.0460-2880.2	602880	TRW 23914 17,1 + WE / - WK + Zub	
				13.0470-2749.2	LD2749	TRW 24483 16,9 - WE / - WK + Zub Ceramic	
				13.0470-2880.2	LD2880	TRW 23914 17,1 + WE / - WK + Zub Ceramic	
		➡	+PR 1KS	13.0460-3858.2	603858	BOS 24563 17,7 - WE / - WK + Zub	
				13.0470-3858.2	LD3858	BOS 24563 17,7 - WE / - WK + Zub Ceramic	
2.0 TDI quattro	125	03/06→08/12	←	+PR 1ZF;1ZM	13.0460-7117.2	607117	VW 23130 19,6 + WK
					13.0470-7117.2	LD7117	VW 23130 19,6 + WK Ceramic
			←	+PR 1ZE;1ZP;1ZD;1LJ / 1ZA	13.0460-7184.2	607184	ATE 23587 20,6 + WK
					13.0470-7184.2	LD7184	ATE 23587 20,6 + WK Ceramic
			←	+PR 1LK	13.0460-7200.2	607200	ATE 23801 20,3 + WK
					13.0470-7200.2	LD7200	ATE 23801 20,3 + WK Ceramic
			➡	+PR 1KF;1KJ;1KU	13.0460-2749.2	602749	TRW 24483 16,9 - WE / - WK + Zub
				13.0460-2880.2	602880	TRW 23914 17,1 + WE / - WK + Zub	
				13.0470-2749.2	LD2749	TRW 24483 16,9 - WE / - WK + Zub Ceramic	
				13.0470-2880.2	LD2880	TRW 23914 17,1 + WE / - WK + Zub Ceramic	
		➡	+PR 1KS	13.0460-3858.2	603858	BOS 24563 17,7 - WE / - WK + Zub	
				13.0470-3858.2	LD3858	BOS 24563 17,7 - WE / - WK + Zub Ceramic	
3.2 V6 quattro	184	07/03→05/09	←	03/06→; +PR 1ZF;1ZM	13.0460-7117.2	607117	VW 23130 19,6 + WK
					13.0470-7117.2	LD7117	VW 23130 19,6 + WK Ceramic
			←	03/06→; +PR 1ZE;1ZP;1ZD;1LJ / 1ZA	13.0460-7184.2	607184	ATE 23587 20,6 + WK
					13.0470-7184.2	LD7184	ATE 23587 20,6 + WK Ceramic
			←	03/06→; +PR 1LK	13.0460-7200.2	607200	ATE 23801 20,3 + WK
					13.0470-7200.2	LD7200	ATE 23801 20,3 + WK Ceramic
			➡	+PR 1KF;1KJ;1KU	13.0460-2749.2	602749	TRW 24483 16,9 - WE / - WK + Zub
				13.0460-2880.2	602880	TRW 23914 17,1 + WE / - WK + Zub	
				13.0470-2749.2	LD2749	TRW 24483 16,9 - WE / - WK + Zub Ceramic	
				13.0470-2880.2	LD2880	TRW 23914 17,1 + WE / - WK + Zub Ceramic	
		➡	+PR 2EA	13.0460-2749.2	602749	TRW 24483 16,9 - WE / - WK + Zub	
				13.0460-2880.2	602880	TRW 23914 17,1 + WE / - WK + Zub	
				13.0470-2749.2	LD2749	TRW 24483 16,9 - WE / - WK + Zub Ceramic	
				13.0470-2880.2	LD2880	TRW 23914 17,1 + WE / - WK + Zub Ceramic	







	kw			 	! #				
<b>AUDI - A3 (8P1) 05/03→12/13</b>									
<b> Bremsbelagsatz, Scheibenbremse</b>									
3.2 V6 quattro	184	07/03→05/09	➡	+PR 1KS		13.0460-3858.2 603858 13.0470-3858.2 LD3858	BOS 24563 17,7 - WE / - WK + Zub BOS 24563 17,7 - WE / - WK + Zub Ceramic		
S3 quattro	188	02/07→08/12	←	07/08→; +PR 1ZK		13.0460-7227.2 607227 13.0470-7227.2 LD7227	ATE 23801 20,3 + WK ATE 23801 20,4 + WK Ceramic		
			➡	07/08→; +PR 1KW		13.0460-2749.2 602749 13.0460-2880.2 602880 13.0470-2749.2 LD2749 13.0470-2880.2 LD2880	TRW 24483 16,9 - WE / - WK + Zub TRW 23914 17,1 + WE / - WK + Zub TRW 24483 16,9 - WE / - WK + Zub Ceramic TRW 23914 17,1 + WE / - WK + Zub Ceramic		
			←	+PR 1ZK		13.0460-7227.2 607227 13.0470-7227.2 LD7227	ATE 23801 20,3 + WK ATE 23801 20,4 + WK Ceramic		
			➡	+PR 1KW		13.0460-2749.2 602749 13.0460-2880.2 602880 13.0470-2749.2 LD2749 13.0470-2880.2 LD2880	TRW 24483 16,9 - WE / - WK + Zub TRW 23914 17,1 + WE / - WK + Zub TRW 24483 16,9 - WE / - WK + Zub Ceramic TRW 23914 17,1 + WE / - WK + Zub Ceramic		
S3 quattro	195	11/06→08/12	←	+PR 1ZK		13.0460-7227.2 607227 13.0470-7227.2 LD7227	ATE 23801 20,3 + WK ATE 23801 20,4 + WK Ceramic		
			➡	+PR 1KW		13.0460-2749.2 602749 13.0460-2880.2 602880 13.0470-2749.2 LD2749 13.0470-2880.2 LD2880	TRW 24483 16,9 - WE / - WK + Zub TRW 23914 17,1 + WE / - WK + Zub TRW 24483 16,9 - WE / - WK + Zub Ceramic TRW 23914 17,1 + WE / - WK + Zub Ceramic		
<b>Zubehörsatz, Scheibenbremsbelag</b>									
1.2 TSI 1.6 TDI 1.6 TDI	77 66 77	04/10→08/12 05/09→08/12 05/09→08/12	➡	+PR 1KE,1KZ		13.0460-0259.2 610259			
1.4 TFSI 1.6 1.6 E-Power 1.6 FSI 2.0 FSI 2.0 TDI 2.0 TDI 2.0 TDI 2.0 TDI 16V 2.0 TFSI	92 75 75 85 110 100 103 125 103 147	09/07→08/12 05/03→08/12 01/11→08/12 08/03→09/07 05/03→06/08 05/03→08/12 06/05→06/08 03/06→08/12 05/03→08/12 09/04→08/12	➡	+PR 1KE;1KZ		13.0460-0259.2 610259			
1.8 T 1.8 TFSI	110 118	08/06→08/12 11/06→08/12	➡	01/07→; +PR 1KE;1KZ		13.0460-0259.2 610259			
1.8 TFSI quattro	118	07/08→08/12	➡	+PR 1KF,1KJ,1KU		13.0460-0259.2 610259			
1.9 TDI	77	05/03→05/10	➡	06/03→; +PR 1KE;1KZ		13.0460-0259.2 610259			
2.0 TDI	120	06/06→06/08	➡	+PR 1KE; 1KZ		13.0460-0259.2 610259			
2.0 TDI 16V quattro 2.0 TDI quattro 2.0 TDI quattro 2.0 TDI quattro 2.0 TFSI quattro	103 100 103 125 147	08/04→08/12 05/03→06/08 01/06→06/08 03/06→08/12 09/04→08/12	➡	+PR 1KF;1KJ;1KU		13.0460-0259.2 610259			
3.2 V6 quattro	184	07/03→05/09	➡	+PR 2EA		13.0460-0035.2 610035			
			➡	+PR 1KF,1KJ,1KU		13.0460-0259.2 610259			
S3 quattro	188	02/07→08/12	➡	07/08→; +PR 1KW		13.0460-0035.2 610035			
S3 quattro	195	11/06→08/12	➡	+PR 1KW		13.0460-0035.2 610035			
<b> Bremsscheibe</b>									
1.2 TSI 1.6 TDI 1.6 TDI	77 66 77	04/10→08/12 05/09→08/12 05/09→08/12	←	+PR 1ZF,1ZM		24.0122-0210.1 422210 24.0322-0210.1 522210	Ø 280 22 19 V + S Ø 280 22 19 V + S		
			←	+PR 1ZE,1ZP		24.0125-0145.1 425145 24.0325-0145.1 525145	Ø 288 25 22 V + S Ø 288 25 22 V + S		
			←	+PR 1ZD,1LJ,1ZA		24.0125-0158.1 425158 24.0325-0158.1 525158	Ø 312 25 22 V + S Ø 312 25 22 V + S		
			←	+PR 1LK		24.0130-0115.1 430115 24.0330-0115.1 530115	Ø 345 30 27 V Ø 345 30 27 V		
			➡	+PR 1KQ,1KD		24.0110-0277.1 410277 24.0310-0277.1 510277	Ø 253 10 8 + S Ø 253 10 8 + S		
			➡	+PR 1KS		24.0110-0356.1 410356 24.0310-0356.1 510356	Ø 272 9,7 8 + S Ø 272 9,7 8 + S		
			➡	+PR 1KE		24.0112-0158.1 412158	Ø 256 12 10 + S		
			↓						









	kW			 	! #		
<b>AUDI - A3 (8P1) 05/03→12/13</b>							
<b>Bremsscheibe</b>							
1.2 TSI	77	04/10→08/12	➡	+PR 1KE		24.0312-0158.1 512158	Ø 256 12 10
1.6 TDI	66	05/09→08/12	➡	+PR 1KZ		24.0112-0169.1 412169	Ø 282 12 10 + S
1.6 TDI	77	05/09→08/12	➡			24.0312-0169.1 512169	Ø 282 12 10 + S
1.4 TFSI	92	09/07→08/12	⬅	+PR 1ZF;1ZM		24.0122-0210.1 422210	Ø 280 22 19 V + S
1.6	75	05/03→08/12				24.0322-0210.1 522210	Ø 280 22 19 V + S
1.6 E-Power	75	01/11→08/12					
1.6 FSI	85	08/03→09/07	⬅	+PR 1ZE;1ZP		24.0125-0145.1 425145	Ø 288 25 22 V + S
2.0 FSI	110	05/03→06/08				24.0325-0145.1 525145	Ø 288 25 22 V + S
2.0 TDI	100	05/03→08/12					
2.0 TDI	103	06/05→06/08	⬅	+PR 1ZD,1LJ,1ZA		24.0125-0158.1 425158	Ø 312 25 22 V + S
2.0 TDI 16V	103	05/03→08/12				24.0325-0158.1 525158	Ø 312 25 22 V + S
2.0 TFSI	147	09/04→08/12	⬅	+PR 1LK		24.0130-0115.1 430115	Ø 345 30 27 V
						24.0330-0115.1 530115	Ø 345 30 27 V
			➡	+PR 1KQ;1KD		24.0110-0277.1 410277	Ø 253 10 8 + S
						24.0310-0277.1 510277	Ø 253 10 8 + S
			➡	+PR 1KS		24.0110-0356.1 410356	Ø 272 9,7 8 + S
						24.0310-0356.1 510356	Ø 272 9,7 8 + S
			➡	+PR 1KE		24.0112-0158.1 412158	Ø 256 12 10 + S
						24.0312-0158.1 512158	Ø 256 12 10
			➡	+PR 1KZ		24.0112-0169.1 412169	Ø 282 12 10 + S
						24.0312-0169.1 512169	Ø 282 12 10 + S
1.8 T	110	08/06→08/12	⬅	01/07→; +PR 1ZF;1ZM		24.0122-0210.1 422210	Ø 280 22 19 V + S
1.8 TFSI	118	11/06→08/12				24.0322-0210.1 522210	Ø 280 22 19 V + S
			⬅	01/07→; +PR 1ZE;1ZP		24.0125-0145.1 425145	Ø 288 25 22 V + S
						24.0325-0145.1 525145	Ø 288 25 22 V + S
			⬅	01/07→; +PR 1ZD,1LJ,1ZA		24.0125-0158.1 425158	Ø 312 25 22 V + S
						24.0325-0158.1 525158	Ø 312 25 22 V + S
			⬅	01/07→; +PR 1LK		24.0130-0115.1 430115	Ø 345 30 27 V
						24.0330-0115.1 530115	Ø 345 30 27 V
			➡	01/07→; +PR 1KQ;1KD		24.0110-0277.1 410277	Ø 253 10 8 + S
						24.0310-0277.1 510277	Ø 253 10 8 + S
			➡	01/07→; +PR 1KS		24.0110-0356.1 410356	Ø 272 9,7 8 + S
						24.0310-0356.1 510356	Ø 272 9,7 8 + S
			➡	01/07→; +PR 1KE		24.0112-0158.1 412158	Ø 256 12 10 + S
						24.0312-0158.1 512158	Ø 256 12 10
			➡	01/07→; +PR 1KZ		24.0112-0169.1 412169	Ø 282 12 10 + S
						24.0312-0169.1 512169	Ø 282 12 10 + S
1.8 TFSI quattro	118	07/08→08/12	⬅	+PR 1ZF;1ZM		24.0122-0210.1 422210	Ø 280 22 19 V + S
						24.0322-0210.1 522210	Ø 280 22 19 V + S
			⬅	+PR 1ZE;1ZP		24.0125-0145.1 425145	Ø 288 25 22 V + S
						24.0325-0145.1 525145	Ø 288 25 22 V + S
			⬅	+PR 1ZD,1LJ,1ZA		24.0125-0158.1 425158	Ø 312 25 22 V + S
						24.0325-0158.1 525158	Ø 312 25 22 V + S
			⬅	+PR 1LK		24.0130-0115.1 430115	Ø 345 30 27 V
						24.0330-0115.1 530115	Ø 345 30 27 V
			➡	+PR 1KS		24.0110-0356.1 410356	Ø 272 9,7 8 + S
						24.0310-0356.1 510356	Ø 272 9,7 8 + S
			➡	+PR 1KJ		24.0112-0169.1 412169	Ø 282 12 10 + S
						24.0312-0169.1 512169	Ø 282 12 10 + S
1.9 TDI	77	05/03→05/10	⬅	06/03→; +PR 1ZF;1ZM		24.0122-0210.1 422210	Ø 280 22 19 V + S
						24.0322-0210.1 522210	Ø 280 22 19 V + S
			⬅	06/03→; +PR 1ZE;1ZP		24.0125-0145.1 425145	Ø 288 25 22 V + S
						24.0325-0145.1 525145	Ø 288 25 22 V + S
			⬅	06/03→; +PR 1ZD,1LJ,1ZA		24.0125-0158.1 425158	Ø 312 25 22 V + S
						24.0325-0158.1 525158	Ø 312 25 22 V + S
			⬅	06/03→; +PR 1LK		24.0130-0115.1 430115	Ø 345 30 27 V
						24.0330-0115.1 530115	Ø 345 30 27 V
			➡	06/03→; +PR 1KQ;1KD		24.0110-0277.1 410277	Ø 253 10 8 + S
						24.0310-0277.1 510277	Ø 253 10 8 + S
			➡	06/03→; +PR 1KS		24.0110-0356.1 410356	Ø 272 9,7 8 + S
						24.0310-0356.1 510356	Ø 272 9,7 8 + S
			➡	06/03→; +PR 1KE		24.0112-0158.1 412158	Ø 256 12 10 + S
						24.0312-0158.1 512158	Ø 256 12 10

	kw			 	! #					
<b>AUDI - A3 (8P1) 05/03→12/13</b>										
<b>Bremsscheibe</b>										
1.9 TDI	77	05/03→05/10	➔	06/03→; +PR 1KZ		24.0112-0169.1 412169 24.0312-0169.1 512169	Ø 282 12 10 + S Ø 282 12 10 + S			
2.0 TDI	120	06/06→06/08	➔	+PR 1ZF; 1ZM		24.0122-0210.1 422210 24.0322-0210.1 522210	Ø 280 22 19 V + S Ø 280 22 19 V + S			
			➔	+PR 1ZE; 1ZP		24.0125-0145.1 425145 24.0325-0145.1 525145	Ø 288 25 22 V + S Ø 288 25 22 V + S			
			➔	+PR 1ZD,1LJ,1ZA		24.0125-0158.1 425158 24.0325-0158.1 525158	Ø 312 25 22 V + S Ø 312 25 22 V + S			
			➔	+PR 1LK		24.0130-0115.1 430115 24.0330-0115.1 530115	Ø 345 30 27 V Ø 345 30 27 V			
			➔	+PR 1KQ, 1KD		24.0110-0277.1 410277 24.0310-0277.1 510277	Ø 253 10 8 + S Ø 253 10 8 + S			
			➔	+PR 1KS		24.0110-0356.1 410356 24.0310-0356.1 510356	Ø 272 9,7 8 + S Ø 272 9,7 8 + S			
			➔	+PR 1KE		24.0112-0158.1 412158 24.0312-0158.1 512158	Ø 256 12 10 + S Ø 256 12 10			
			➔	+PR 1KZ		24.0112-0169.1 412169 24.0312-0169.1 512169	Ø 282 12 10 + S Ø 282 12 10 + S			
			2.0 TDI	125	03/06→08/12	➔	+PR 1ZF;1ZM		24.0122-0210.1 422210 24.0322-0210.1 522210	Ø 280 22 19 V + S Ø 280 22 19 V + S
						➔	+PR 1ZE;1ZP		24.0125-0145.1 425145 24.0325-0145.1 525145	Ø 288 25 22 V + S Ø 288 25 22 V + S
➔	+PR 1ZD,1LJ,1ZA					24.0125-0158.1 425158 24.0325-0158.1 525158	Ø 312 25 22 V + S Ø 312 25 22 V + S			
➔	+PR 1ZD;1LJ					24.0130-0115.1 430115 24.0330-0115.1 530115	Ø 345 30 27 V Ø 345 30 27 V			
➔	+PR 1KQ;1KD					24.0110-0277.1 410277 24.0310-0277.1 510277	Ø 253 10 8 + S Ø 253 10 8 + S			
➔	+PR 1KS					24.0110-0356.1 410356 24.0310-0356.1 510356	Ø 272 9,7 8 + S Ø 272 9,7 8 + S			
➔	+PR 1KE					24.0112-0158.1 412158 24.0312-0158.1 512158	Ø 256 12 10 + S Ø 256 12 10			
➔	+PR 1KZ					24.0112-0169.1 412169 24.0312-0169.1 512169	Ø 282 12 10 + S Ø 282 12 10 + S			
2.0 TDI 16V quattro 2.0 TDI quattro 2.0 TDI quattro 2.0 TFSI quattro	103 100 103 147	08/04→08/12 05/03→06/08 01/06→06/08 09/04→08/12				➔	+PR 1ZF;1ZM		24.0122-0210.1 422210 24.0322-0210.1 522210	Ø 280 22 19 V + S Ø 280 22 19 V + S
	➔	+PR 1ZE;1ZP					24.0125-0145.1 425145 24.0325-0145.1 525145	Ø 288 25 22 V + S Ø 288 25 22 V + S		
	➔	+PR 1ZD,1LJ,1ZA		24.0125-0158.1 425158 24.0325-0158.1 525158	Ø 312 25 22 V + S Ø 312 25 22 V + S					
	➔	+PR 1LK		24.0130-0115.1 430115 24.0330-0115.1 530115	Ø 345 30 27 V Ø 345 30 27 V					
	➔	+PR 1KS		24.0110-0356.1 410356 24.0310-0356.1 510356	Ø 272 9,7 8 + S Ø 272 9,7 8 + S					
	➔	+PR 1KF		24.0112-0158.1 412158 24.0312-0158.1 512158	Ø 256 12 10 + S Ø 256 12 10					
	➔	+PR 1KJ;1KU		24.0112-0169.1 412169 24.0312-0169.1 512169	Ø 282 12 10 + S Ø 282 12 10 + S					
	2.0 TDI quattro	125	03/06→08/12	➔	+PR 1ZF;1ZM		24.0122-0210.1 422210 24.0322-0210.1 522210	Ø 280 22 19 V + S Ø 280 22 19 V + S		
				➔	+PR 1ZE;1ZP		24.0125-0145.1 425145 24.0325-0145.1 525145	Ø 288 25 22 V + S Ø 288 25 22 V + S		
				➔	+PR 1ZD,1LJ,1ZA		24.0125-0158.1 425158 24.0325-0158.1 525158	Ø 312 25 22 V + S Ø 312 25 22 V + S		
➔				+PR 1ZD;1LJ		24.0130-0115.1 430115 24.0330-0115.1 530115	Ø 345 30 27 V Ø 345 30 27 V			
➔				+PR 1KS		24.0110-0356.1 410356 24.0310-0356.1 510356	Ø 272 9,7 8 + S Ø 272 9,7 8 + S			
➔				+PR 1KF		24.0112-0158.1 412158 24.0312-0158.1 512158	Ø 256 12 10 + S Ø 256 12 10			
➔	+PR 1KJ;1KU		24.0112-0169.1 412169	Ø 282 12 10 + S						













	kw			 	! #		
<b>AUDI - A3 (8P1) 05/03→12/13</b>							
<b>Bremsscheibe</b>							
2.0 TDI quattro	125	03/06→08/12	➡	+PR 1KJ;1KU		24.0312-0169.1 512169	Ø 282 12 10 + S
3.2 V6 quattro	184	07/03→05/09	←	03/06→; +PR 1ZF;1ZM		24.0122-0210.1 422210	Ø 280 22 19 V + S
						24.0322-0210.1 522210	Ø 280 22 19 V + S
			➡	+PR 1ZE;1ZP		24.0125-0145.1 425145	Ø 288 25 22 V + S
						24.0325-0145.1 525145	Ø 288 25 22 V + S
			←	+PR 1ZD,1LJ,1ZA		24.0125-0158.1 425158	Ø 312 25 22 V + S
						24.0325-0158.1 525158	Ø 312 25 22 V + S
			←	+PR 1LK		24.0130-0115.1 430115	Ø 345 30 27 V
						24.0330-0115.1 530115	Ø 345 30 27 V
S3 quattro	188	02/07→08/12	➡	+PR 1KS		24.0110-0356.1 410356	Ø 272 9,7 8 + S
						24.0310-0356.1 510356	Ø 272 9,7 8 + S
S3 quattro	195	11/06→08/12	➡	+PR 1KJ		24.0112-0169.1 412169	Ø 282 12 10 + S
						24.0312-0169.1 512169	Ø 282 12 10 + S
S3 quattro	188	02/07→08/12	➡	+PR 2EA		24.0122-0219.1 422219	Ø 310 22 20 V
S3 quattro	188	02/07→08/12	←	07/08→; +PR 1ZK		24.0130-0115.1 430115	Ø 345 30 27 V
						24.0330-0115.1 530115	Ø 345 30 27 V
S3 quattro	195	11/06→08/12	➡	07/08→; +PR 1KW		24.0122-0219.1 422219	Ø 310 22 20 V
S3 quattro	195	11/06→08/12	←	+PR 1ZK		24.0130-0115.1 430115	Ø 345 30 27 V
						24.0330-0115.1 530115	Ø 345 30 27 V
S3 quattro	195	11/06→08/12	➡	+PR 1KW		24.0122-0219.1 422219	Ø 310 22 20 V
<b>AUDI - A3 (8V1, 8VK) 04/12→</b>							
<b>Bremselagsatz, Scheibenbremse</b>							
1.0 TFSI 1.5 TFSI 2.0 TFSI 2.0 TFSI quattro	85 110 140 140	07/16→ 05/17→ 05/16→ 05/16→	←	+PR 1ZA,1ZD,1ZE,1ZP		13.0460-2785.2 602785	TRW 25683 20,4 + WE / + WK
						13.0470-2785.2 LD2785	TRW 25683 20,4 + WE / + WK Ceramic
			➡	+PR 1KE; + eFSB		13.0460-7293.2 607293	ATE 25008 16,3 - WE / - WK
1.2 TFSI 1.2 TFSI 1.4 TFSI 1.4 TFSI 1.4 TSI 1.6 TDI 1.6 TDI 1.6 TDI 1.6 TDI 1.8 TFSI quattro 2.0 TDI 2.0 TDI 2.0 TDI 2.0 TDI 2.0 TDI quattro 2.0 TDI quattro	77 81 92 103 110 77 81 85 132 81 100 105 135 110 135	02/13→ 05/14→ 05/14→ 03/13→ 05/14→ 10/12→ 09/13→ 02/17→ 08/12→ 01/13→ 05/13→ 09/12→ 05/13→ 10/12→ 12/12→	➡	+PR 1KE; + eFSB		13.0460-7293.2 607293	ATE 25008 16,3 - WE / - WK Ceramic
						13.0470-7293.2 LD7293	ATE 25008 16,3 - WE / - WK Ceramic
			➡	+PR 1KJ,1KY,2ED; + eFSB		13.0460-7294.2 607294	ATE 25009 16,4 - WE / - WK
1.2 TFSI 1.2 TFSI 1.4 TFSI 1.4 TFSI 1.4 TSI 1.6 TDI 1.6 TDI 1.6 TDI 1.6 TDI 1.8 TFSI quattro 2.0 TDI 2.0 TDI 2.0 TDI 2.0 TDI 2.0 TDI quattro 2.0 TDI quattro	77 81 92 103 110 77 81 85 132 81 100 105 135 110 135	02/13→ 05/14→ 05/14→ 03/13→ 05/14→ 10/12→ 09/13→ 02/17→ 08/12→ 01/13→ 05/13→ 09/12→ 05/13→ 10/12→ 12/12→	←	+PR 1ZA,1ZD,1ZE,1ZP		13.0460-2785.2 602785	TRW 25683 20,4 + WE / + WK
						13.0470-2785.2 LD2785	TRW 25683 20,4 + WE / + WK Ceramic
			←	+PR 1ZF		13.0460-7303.2 607303	ATE 22035 17,5 + WK
1.4 TFSI 1.8 TFSI 2.0 TDI	90 132 110	04/12→ 04/12→ 04/12→	←	08/12→; +PR 1KE; + eFSB		13.0460-7293.2 607293	ATE 25008 16,3 - WE / - WK
						13.0470-7293.2 LD7293	ATE 25008 16,3 - WE / - WK Ceramic
			➡	+PR 1KJ,1KY,2ED; + eFSB		13.0460-7294.2 607294	ATE 25009 16,4 - WE / - WK
1.4 TFSI 1.8 TFSI 2.0 TDI	90 132 110	04/12→ 04/12→ 04/12→	←	08/12→; +PR 1ZA,1ZD,1ZE,1ZP		13.0460-2785.2 602785	TRW 25683 20,4 + WE / + WK
						13.0470-2785.2 LD2785	TRW 25683 20,4 + WE / + WK Ceramic
			←	08/12→; +PR 1ZF		13.0460-7303.2 607303	ATE 22035 17,5 + WK
S3 quattro S3 quattro S3 quattro S3 quattro S3 quattro	206 210 213 221 228	02/13→ 05/14→ 07/16→ 11/12→ 06/16→	➡	+PR 1KE; + eFSB		13.0460-7293.2 607293	ATE 25008 16,3 - WE / - WK
						13.0470-7293.2 LD7293	ATE 25008 16,3 - WE / - WK Ceramic
			➡	+PR 1KJ,1KY,2ED; + eFSB		13.0460-7294.2 607294	ATE 25009 16,4 - WE / - WK
S3 quattro S3 quattro S3 quattro S3 quattro S3 quattro	206 210 213 221 228	02/13→ 05/14→ 07/16→ 11/12→ 06/16→	➡	+PR 1KJ,1KY,2ED; + eFSB		13.0460-7294.2 607294	ATE 25009 16,4 - WE / - WK
						13.0470-7294.2 LD7294	ATE 25009 16,4 - WE / - WK Ceramic
			➡	+PR 1KJ,1KY,2ED; + eFSB		13.0460-7294.2 607294	ATE 25009 16,4 - WE / - WK
S3 quattro S3 quattro S3 quattro S3 quattro S3 quattro	206 210 213 221 228	02/13→ 05/14→ 07/16→ 11/12→ 06/16→	➡	+PR 1KE; + eFSB		13.0460-7293.2 607293	ATE 25008 16,3 - WE / - WK
						13.0470-7293.2 LD7293	ATE 25008 16,3 - WE / - WK Ceramic
			➡	+PR 1KJ,1KY,2ED; + eFSB		13.0460-7294.2 607294	ATE 25009 16,4 - WE / - WK
S3 quattro S3 quattro S3 quattro S3 quattro S3 quattro	206 210 213 221 228	02/13→ 05/14→ 07/16→ 11/12→ 06/16→	➡	+PR 1KJ,1KY,2ED; + eFSB		13.0460-7294.2 607294	ATE 25009 16,4 - WE / - WK
						13.0470-7294.2 LD7294	ATE 25009 16,4 - WE / - WK Ceramic
			➡	+PR 1KJ,1KY,2ED; + eFSB		13.0460-7294.2 607294	ATE 25009 16,4 - WE / - WK
<b>Warnkontakt, Bremsbelagverschleiß</b>							
1.0 TFSI ↓	85	07/16→	←	+PR 1ZA,1ZD,1ZE,1ZP	1	24.8190-0065.2 620065	L= 172



	kw			 	! #		
<b>AUDI - A3 (8V1, 8VK) 04/12→</b>							
<b>Warnkontakt, Bremsbelagverschleiß</b>							
1.2 TFSI 1.2 TFSI 1.4 TFSI 1.4 TFSI 1.4 TSI 1.5 TFSI 1.6 TDI 1.6 TDI 1.6 TDI 1.8 TFSI quattro 2.0 TDI 2.0 TDI 2.0 TDI 2.0 TDI 2.0 TDI quattro 2.0 TDI quattro 2.0 TFSI 2.0 TFSI quattro	77 81 92 103 110 110 77 81 85 132 81 100 105 135 110 135 140 140	02/13→ 05/14→ 05/14→ 03/13→ 05/14→ 05/17→ 10/12→ 09/13→ 02/17→ 08/12→ 01/13→ 05/13→ 09/12→ 05/13→ 10/12→ 12/12→ 05/16→ 05/16→	←	+PR 1ZA,1ZD,1ZE,1ZP	1	24.8190-0065.2 620065	L= 172
1.4 TFSI 1.8 TFSI 2.0 TDI	90 132 110	04/12→ 04/12→ 04/12→	←	08/12→; +PR 1ZA,1ZD,1ZE,1ZP	1	24.8190-0065.2 620065	L= 172
S3 quattro S3 quattro S3 quattro S3 quattro	206 210 213 221 228	02/13→ 05/14→ 07/16→ 11/12→ 06/16→	←	+PR 1LC,1LJ	1	24.8190-0065.2 620065	L= 172
<b>Bremsscheibe</b>							
1.0 TFSI 1.5 TFSI 2.0 TFSI	85 110 140	07/16→ 05/17→ 05/16→	←	+PR 1ZE,1ZP		24.0125-0145.1 425145	Ø 288 25 22 V + S
			←	+PR 1ZA,1ZD		24.0325-0145.1 525145	Ø 288 25 22 V + S
			←	+PR 1ZE,1ZD		24.0125-0158.1 425158	Ø 312 25 22 V + S
			←	+PR 1ZE,1ZD		24.0325-0158.1 525158	Ø 312 25 22 V + S
			→	+PR 1KE		24.0110-0356.1 410356	Ø 272 9,7 8 + S
			→	+PR 1KE		24.0310-0356.1 510356	Ø 272 9,7 8 + S
			→	+PR 2ED; + eFSB		24.0112-0210.1 412210	Ø 300 12 10 + S
			→	+PR 1KJ,1KY; + eFSB		24.0122-0219.1 422219	Ø 310 22 20 V
1.2 TFSI 1.2 TFSI 1.4 TFSI 1.4 TFSI 1.4 TSI 1.6 TDI 1.6 TDI 1.6 TDI 1.8 TFSI quattro 2.0 TDI 2.0 TDI 2.0 TDI 2.0 TDI 2.0 TDI quattro 2.0 TDI quattro	77 81 92 103 110 77 81 85 132 81 100 105 135 110 135	02/13→ 05/14→ 05/14→ 03/13→ 05/14→ 10/12→ 09/13→ 02/17→ 08/12→ 01/13→ 05/13→ 09/12→ 05/13→ 10/12→ 12/12→	←	+PR 1ZF		24.0124-0258.1 424258	Ø 276 24 21 V + S
			←	+PR 1ZE,1ZP		24.0125-0145.1 425145	Ø 288 25 22 V + S
			←	+PR 1ZE,1ZP		24.0325-0145.1 525145	Ø 288 25 22 V + S
			←	+PR 1ZA,1ZD		24.0125-0158.1 425158	Ø 312 25 22 V + S
			←	+PR 1ZA,1ZD		24.0325-0158.1 525158	Ø 312 25 22 V + S
			→	+PR 1KE		24.0110-0356.1 410356	Ø 272 9,7 8 + S
			→	+PR 1KE		24.0310-0356.1 510356	Ø 272 9,7 8 + S
			→	+PR 2ED; + eFSB		24.0112-0210.1 412210	Ø 300 12 10 + S
			→	+PR 1KJ,1KY; + eFSB		24.0122-0219.1 422219	Ø 310 22 20 V
1.4 TFSI 1.8 TFSI 2.0 TDI	90 132 110	04/12→ 04/12→ 04/12→	←	08/12→; +PR 1ZF		24.0124-0258.1 424258	Ø 276 24 21 V + S
			←	08/12→; +PR 1ZE,1ZP		24.0125-0145.1 425145	Ø 288 25 22 V + S
			←	08/12→; +PR 1ZE,1ZP		24.0325-0145.1 525145	Ø 288 25 22 V + S
			←	08/12→; +PR 1ZA,1ZD		24.0125-0158.1 425158	Ø 312 25 22 V + S
			←	08/12→; +PR 1ZA,1ZD		24.0325-0158.1 525158	Ø 312 25 22 V + S
			→	08/12→; +PR 1KE		24.0110-0356.1 410356	Ø 272 9,7 8 + S
			→	08/12→; +PR 1KE		24.0310-0356.1 510356	Ø 272 9,7 8 + S
			→	08/12→; +PR 2ED; + eFSB		24.0112-0210.1 412210	Ø 300 12 10 + S
			→	08/12→; +PR 1KJ,1KY; + eFSB		24.0122-0219.1 422219	Ø 310 22 20 V
2.0 TFSI quattro	140	05/16→	←	+PR 1ZE,1ZP		24.0125-0145.1 425145	Ø 288 25 22 V + S
			←	+PR 1ZE,1ZP		24.0325-0145.1 525145	Ø 288 25 22 V + S
			←	+PR 1ZA,1ZD		24.0125-0158.1 425158	Ø 312 25 22 V + S
			←	+PR 1ZA,1ZD		24.0325-0158.1 525158	Ø 312 25 22 V + S
			→	+PR 1KE		24.0110-0356.1 410356	Ø 272 9,7 8 + S
			→	+PR 1KE		24.0310-0356.1 510356	Ø 272 9,7 8 + S
			→	+PR 1KJ,1KY; + eFSB		24.0122-0219.1 422219	Ø 310 22 20 V
S3 quattro S3 quattro S3 quattro S3 quattro S3 quattro	206 210 213 221 228	02/13→ 05/14→ 07/16→ 11/12→ 06/16→	←	+PR 1LC,1LJ		24.0130-0225.1 430225	Ø 340 30 27 V + S
			→	+PR 1KE		24.0110-0356.1 410356	Ø 272 9,7 8 + S
			→	+PR 1KE		24.0310-0356.1 510356	Ø 272 9,7 8 + S
			→	+PR 2ED; + eFSB		24.0112-0210.1 412210	Ø 300 12 10 + S



	kW			 	! #		
<b>AUDI - A3 (8V1, 8VK) 04/12→</b>							
 <b>Bremsscheibe</b>							
S3 quattro S3 quattro S3 quattro S3 quattro S3 quattro	206 210 213 221 228	02/13→ 05/14→ 07/16→ 11/12→ 06/16→	➔	+PR 1KJ,1KY; + eFSB		24.0122-0219.1 422219	Ø 310 22 20 V
<b>AUDI - A3 Cabriolet (8P7) 04/08→05/13</b>							
 <b>Bremsbelagsatz, Scheibenbremse</b>							
1.2 TFSI 1.4 TFSI 1.6 1.6 TDI 1.8 TFSI 1.9 TDI 2.0 TDI 2.0 TFSI	77 92 75 77 118 77 100 103 147	03/10→05/13 02/11→05/13 09/08→05/10 05/09→05/13 04/08→05/13 04/08→10/09 04/08→05/13 04/08→05/13 04/08→05/13	← ← ← ➔ ➔ ➔ ➔ ➔	+PR 1ZF  +PR 1LJ,1ZE  +PR 1KZ  +PR 1KD  +PR 1KS		13.0460-7117.2 607117 13.0470-7117.2 LD7117 13.0460-7184.2 607184 13.0470-7184.2 LD7184 13.0460-2749.2 602749 13.0460-2880.2 602880 13.0470-2749.2 LD2749 13.0470-2880.2 LD2880 13.0460-2787.2 602787 13.0460-2860.2 602860 13.0470-2860.2 LD2860 13.0460-3858.2 603858 13.0470-3858.2 LD3858	VW 23130 19,6 + WK VW 23130 19,6 + WK Ceramic ATE 23587 20,6 + WK ATE 23587 20,6 + WK Ceramic TRW 24483 16,9 - WE / - WK + Zub TRW 23914 17,1 + WE / - WK + Zub TRW 24483 16,9 - WE / - WK + Zub Ceramic TRW 23914 17,1 + WE / - WK + Zub Ceramic TRW 23554 17,3 - WK / - WE TRW 23554 16,4 - WK / + WE TRW 23554 16,4 - WK / + WE Ceramic BOS 24563 17,7 - WE / - WK + Zub BOS 24563 17,7 - WE / - WK + Zub Ceramic
<b>Zubehörsatz, Scheibenbremsbelag</b>							
1.2 TFSI 1.4 TFSI 1.6 1.6 TDI 1.8 TFSI 1.9 TDI 2.0 TDI 2.0 TFSI	77 92 75 77 118 77 100 103 147	03/10→05/13 02/11→05/13 09/08→05/10 05/09→05/13 04/08→05/13 04/08→10/09 04/08→05/13 04/08→05/13 04/08→05/13	➔	+PR 1KZ		13.0460-0259.2 610259	
 <b>Bremsscheibe</b>							
1.2 TFSI 1.4 TFSI 1.6 1.6 TDI 1.8 TFSI 1.9 TDI 2.0 TDI 2.0 TFSI	77 92 75 77 118 77 100 103 147	03/10→05/13 02/11→05/13 09/08→05/10 05/09→05/13 04/08→05/13 04/08→10/09 04/08→05/13 04/08→05/13 04/08→05/13	← ← ← ← ← ← ➔ ➔ ➔ ➔	+PR 1ZF  +PR 1ZE  +PR 1LJ  +PR 1KD  +PR 1KS  +PR 1KZ		24.0122-0210.1 422210 24.0322-0210.1 522210 24.0125-0145.1 425145 24.0325-0145.1 525145 24.0125-0158.1 425158 24.0325-0158.1 525158 24.0110-0277.1 410277 24.0310-0277.1 510277 24.0110-0356.1 410356 24.0310-0356.1 510356 24.0112-0169.1 412169 24.0312-0169.1 512169	Ø 280 22 19 V + S Ø 280 22 19 V + S Ø 288 25 22 V + S Ø 288 25 22 V + S Ø 312 25 22 V + S Ø 312 25 22 V + S Ø 253 10 8 + S Ø 253 10 8 + S Ø 272 9,7 8 + S Ø 272 9,7 8 + S Ø 282 12 10 + S Ø 282 12 10 + S
<b>AUDI - A3 Cabriolet (8V7, 8VE) 10/13→</b>							
 <b>Bremsbelagsatz, Scheibenbremse</b>							
1.4 TFSI 1.4 TFSI 1.4 TFSI 1.4 TFSI 1.5 TFSI 1.6 TDI 1.6 TDI 1.8 TFSI 1.8 TFSI 1.8 TFSI quattro 2.0 TDI 2.0 TDI 2.0 TDI 2.0 TDI quattro 2.0 TDI quattro ↓	85 92 103 110 110 81 85 125 132 132 100 110 135 110 135	02/16→ 02/14→ 10/13→ 05/14→ 05/17→ 02/14→ 04/17→ 05/14→ 10/13→ 03/14→ 10/13→ 10/13→ 05/14→ 03/14→ 05/14→	← ← ← ← ← ➔ ➔ ➔ ➔ ➔ ➔ ➔ ➔ ➔ ➔	+PR 1ZA,1ZD,1ZE,1ZP   +PR 1ZF  +PR 1KE; + eFSB  +PR 1KJ,1KY; + eFSB		13.0460-2785.2 602785 13.0470-2785.2 LD2785 13.0460-7303.2 607303 13.0470-7303.2 LD7303 13.0460-7293.2 607293 13.0470-7293.2 LD7293 13.0460-7294.2 607294 13.0470-7294.2 LD7294	TRW 25683 20,4 + WE / + WK TRW 25683 20,4 + WE / + WK Ceramic ATE 22035 17,5 + WK ATE 22035 17,5 + WK Ceramic ATE 25008 16,3 - WE / - WK ATE 25008 16,3 - WE / - WK Ceramic ATE 25009 16,4 - WE / - WK ATE 25009 16,4 - WE / - WK Ceramic

**AUDI - A3 Cabriolet (8V7, 8VE) 10/13→**

**Bremsbelagsatz, Scheibenbremse**

2.0 TFSI 2.0 TFSI quattro 2.0 TFSI quattro	140 140 162	05/16→ 05/16→ 05/14→	←	+PR 1ZA,1ZD,1ZE,1ZP	13.0460-2785.2	602785	TRW 25683 20,4 + WE / + WK
			←	+PR 1ZF	13.0470-2785.2	LD2785	TRW 25683 20,4 + WE / + WK Ceramic
			→	+PR 1KE; + eFSB	13.0460-7303.2	607303	ATE 22035 17,5 + WK
			→	+PR 1KE; + eFSB	13.0470-7303.2	LD7303	ATE 22035 17,5 + WK Ceramic
S3 quattro	210	03/14→	→	04/14→; +PR 1KE; + eFSB	13.0460-7293.2	607293	ATE 25008 16,3 - WE / - WK
			→	04/14→; +PR 1KE; + eFSB	13.0470-7293.2	LD7293	ATE 25008 16,3 - WE / - WK Ceramic
S3 quattro S3 quattro	221 228	04/14→ 07/16→	→	+PR 1KE; + eFSB	13.0460-7293.2	607293	ATE 25008 16,3 - WE / - WK
			→	+PR 1KE; + eFSB	13.0470-7293.2	LD7293	ATE 25008 16,3 - WE / - WK Ceramic
S3 quattro S3 quattro	221 228	04/14→ 07/16→	→	+PR 1KJ,1KY; + eFSB	13.0460-7294.2	607294	ATE 25009 16,4 - WE / - WK
			→	+PR 1KJ,1KY; + eFSB	13.0470-7294.2	LD7294	ATE 25009 16,4 - WE / - WK Ceramic







**Bremsscheibe**







1.4 TFSI 1.4 TFSI	85 92	02/16→ 02/14→	←	+PR 1ZF	24.0124-0258.1	424258	∅ 276 24 21 V + S
			←	+PR 1ZE,1ZP	24.0125-0145.1	425145	∅ 288 25 22 V + S
1.4 TFSI 1.4 TSI	103 110	10/13→ 05/14→	←	+PR 1ZA,1ZD	24.0325-0145.1	525145	∅ 288 25 22 V + S
1.5 TFSI 1.6 TDI 1.6 TDI	110 81 85	05/17→ 02/14→ 04/17→	←	+PR 1KE	24.0125-0158.1	425158	∅ 312 25 22 V + S
1.8 TFSI 1.8 TFSI	125 132	05/14→ 10/13→	→	+PR 1KE	24.0325-0158.1	525158	∅ 312 25 22 V + S
1.8 TFSI quattro 2.0 TDI 2.0 TDI	132 100 110	03/14→ 10/13→ 10/13→	→	+PR 1KJ,1KY	24.0110-0356.1	410356	∅ 272 9,7 8 + S
2.0 TDI quattro 2.0 TDI quattro 2.0 TFSI 2.0 TFSI quattro 2.0 TFSI quattro	135 110 135 140 140 162	05/14→ 03/14→ 05/14→ 05/16→ 05/16→ 05/14→	→	+PR 1KJ,1KY	24.0310-0356.1	510356	∅ 272 9,7 8 + S
S3 quattro	210	03/14→	←	04/14→; +PR 1LC,1LJ	24.0122-0219.1	422219	∅ 310 22 20 V
			→	04/14→; +PR 1KE	24.0130-0225.1	430225	∅ 340 30 27 V + S
			→	04/14→; +PR 1KE	24.0110-0356.1	410356	∅ 272 9,7 8 + S
S3 quattro S3 quattro	221 228	04/14→ 07/16→	→	04/14→; +PR 1KJ,1KY	24.0310-0356.1	510356	∅ 272 9,7 8 + S
			←	+PR 1LC,1LJ	24.0122-0219.1	422219	∅ 310 22 20 V
			→	+PR 1KE	24.0130-0225.1	430225	∅ 340 30 27 V + S
S3 quattro S3 quattro	221 228	04/14→ 07/16→	→	+PR 1KE	24.0110-0356.1	410356	∅ 272 9,7 8 + S
			→	+PR 1KE	24.0310-0356.1	510356	∅ 272 9,7 8 + S
			→	+PR 1KJ,1KY	24.0122-0219.1	422219	∅ 310 22 20 V

**AUDI - A3 Limousine (8VS, 8VM) 05/13→**









**Bremsbelagsatz, Scheibenbremse**









1.0 TFSI 2.0 TFSI 2.0 TFSI quattro	85 140 140	07/16→ 05/16→ 05/16→	←	+PR 1ZA,1ZD,1ZE,1ZP	13.0460-2785.2	602785	TRW 25683 20,4 + WE / + WK
			→	+PR 1KE; + eFSB	13.0470-2785.2	LD2785	TRW 25683 20,4 + WE / + WK Ceramic
			→	+PR 1KE; + eFSB	13.0460-7293.2	607293	ATE 25008 16,3 - WE / - WK
1.2 TFSI 1.2 TFSI 1.4 TFSI 1.4 TFSI 1.4 TFSI 1.4 TSI 1.5 TFSI ↓	77 81 90 92 103 110 110	10/13→ 05/14→ 09/13→ 09/13→ 05/13→ 05/14→ 05/17→	→	+PR 1KE; + eFSB	13.0470-7293.2	LD7293	ATE 25008 16,3 - WE / - WK Ceramic
			→	+PR 1KJ,1KY,2ED; + eFSB	13.0460-7294.2	607294	ATE 25009 16,4 - WE / - WK
			→	+PR 1KJ,1KY,2ED; + eFSB	13.0470-7294.2	LD7294	ATE 25009 16,4 - WE / - WK Ceramic
1.2 TFSI 1.2 TFSI 1.4 TFSI 1.4 TFSI 1.4 TFSI 1.4 TSI 1.5 TFSI ↓	77 81 90 92 103 110 110	10/13→ 05/14→ 09/13→ 09/13→ 05/13→ 05/14→ 05/17→	←	+PR 1ZA,1ZD,1ZE,1ZP	13.0460-2785.2	602785	TRW 25683 20,4 + WE / + WK
			←	+PR 1ZF	13.0470-2785.2	LD2785	TRW 25683 20,4 + WE / + WK Ceramic
1.4 TFSI 1.4 TFSI 1.4 TFSI 1.4 TSI 1.5 TFSI ↓	90 92 103 110 110	09/13→ 09/13→ 05/13→ 05/14→ 05/17→	←	+PR 1ZF	13.0460-7303.2	607303	ATE 22035 17,5 + WK
			←	+PR 1ZF	13.0470-7303.2	LD7303	ATE 22035 17,5 + WK Ceramic







	kw			 	! #		
<b>AUDI - A3 Limousine (8VS, 8VM) 05/13→</b>							
<b>Bremsbelagsatz, Scheibenbremse</b>							
1.6 TDI	77	09/13→	➔	+PR 1KE; + eFSB		13.0460-7293.2 607293	ATE 25008 16,3 - WE / - WK
1.6 TDI	81	05/14→				13.0470-7293.2 LD7293	ATE 25008 16,3 - WE / - WK
1.6 TDI	85	03/17→					Ceramic
1.6 TDI quattro	81	05/15→					
1.8 TFSI	125	11/13→	➔	+PR 1KJ,1KY,2ED; + eFSB		13.0460-7294.2 607294	ATE 25009 16,4 - WE / - WK
1.8 TFSI	132	05/13→				13.0470-7294.2 LD7294	ATE 25009 16,4 - WE / - WK
1.8 TFSI quattro	132	11/13→					Ceramic
2.0 TDI	81	05/13→					
2.0 TDI	100	09/13→					
2.0 TDI	105	10/13→					
2.0 TDI	110	05/13→					
2.0 TDI	135	05/14→					
2.0 TDI quattro	110	10/13→					
2.0 TDI quattro	135	05/14→					
S3 quattro	206	10/13→	➔	+PR 1KE; + eFSB		13.0460-7293.2 607293	ATE 25008 16,3 - WE / - WK
S3 quattro	210	05/14→				13.0470-7293.2 LD7293	ATE 25008 16,3 - WE / - WK
S3 quattro	213	08/16→					Ceramic
S3 quattro	221	10/13→					
S3 quattro	228	06/16→	➔	+PR 1KJ,1KY,2ED; + eFSB		13.0460-7294.2 607294	ATE 25009 16,4 - WE / - WK
						13.0470-7294.2 LD7294	ATE 25009 16,4 - WE / - WK
							Ceramic
<b>Warnkontakt, Bremsbelagverschleiß</b>							
1.0 TFSI	85	07/16→	←	+PR 1ZA,1ZD,1ZE,1ZP	1	24.8190-0065.2 620065	L= 172
1.2 TFSI	77	10/13→					
1.2 TFSI	81	05/14→					
1.4 TFSI	90	09/13→					
1.4 TFSI	92	09/13→					
1.4 TFSI	103	05/13→					
1.4 TSI	110	05/14→					
1.5 TFSI	110	05/17→					
1.6 TDI	77	09/13→					
1.6 TDI	81	05/14→					
1.6 TDI	85	03/17→					
1.6 TDI quattro	81	05/15→					
1.8 TFSI	125	11/13→					
1.8 TFSI	132	05/13→					
1.8 TFSI quattro	132	11/13→					
2.0 TDI	81	05/13→					
2.0 TDI	100	09/13→					
2.0 TDI	105	10/13→					
2.0 TDI	110	05/13→					
2.0 TDI	135	05/14→					
2.0 TDI quattro	110	10/13→					
2.0 TDI quattro	135	05/14→					
2.0 TFSI	140	05/16→					
2.0 TFSI quattro	140	05/16→					
S3 quattro	206	10/13→	←	+PR 1LC,1LJ	1	24.8190-0065.2 620065	L= 172
S3 quattro	210	05/14→					
S3 quattro	213	08/16→					
S3 quattro	221	10/13→					
S3 quattro	228	06/16→					
<b>Bremsscheibe</b>							
1.0 TFSI	85	07/16→	←	+PR 1ZE,1ZP		24.0125-0145.1 425145	Ø 288 25 22 V + S
2.0 TFSI	140	05/16→				24.0325-0145.1 525145	Ø 288 25 22 V + S
			←	+PR 1ZA,1ZD		24.0125-0158.1 425158	Ø 312 25 22 V + S
						24.0325-0158.1 525158	Ø 312 25 22 V + S
			➔	+PR 1KE		24.0110-0356.1 410356	Ø 272 9,7 8 + S
						24.0310-0356.1 510356	Ø 272 9,7 8 + S
			➔	+PR 2ED; + eFSB		24.0112-0210.1 412210	Ø 300 12 10 + S
			➔	+PR 1KJ,1KY; + eFSB		24.0122-0219.1 422219	Ø 310 22 20 V
1.2 TFSI	77	10/13→	←	+PR 1ZF		24.0124-0258.1 424258	Ø 276 24 21 V + S
1.2 TFSI	81	05/14→					
1.4 TFSI	90	09/13→	←	+PR 1ZE,1ZP		24.0125-0145.1 425145	Ø 288 25 22 V + S
1.4 TFSI	92	09/13→				24.0325-0145.1 525145	Ø 288 25 22 V + S
1.4 TFSI	103	05/13→	←	+PR 1ZA,1ZD		24.0125-0158.1 425158	Ø 312 25 22 V + S
1.4 TSI	110	05/14→				24.0325-0158.1 525158	Ø 312 25 22 V + S
1.5 TFSI	110	05/17→					
1.6 TDI	77	09/13→	➔	+PR 1KE		24.0110-0356.1 410356	Ø 272 9,7 8 + S
1.6 TDI	81	05/14→				24.0310-0356.1 510356	Ø 272 9,7 8 + S
1.6 TDI	85	03/17→					
1.6 TDI quattro	81	05/15→	➔	+PR 2ED; + eFSB		24.0112-0210.1 412210	Ø 300 12 10 + S
1.8 TFSI	125	11/13→	➔	+PR 1KJ,1KY; + eFSB		24.0122-0219.1 422219	Ø 310 22 20 V
1.8 TFSI	132	05/13→					
1.8 TFSI quattro	132	11/13→					
2.0 TDI	81	05/13→					
2.0 TDI	100	09/13→					
2.0 TDI	105	10/13→					







	kw			 	! #		
<b>AUDI - A3 Limousine (8VS, 8VM) 05/13→</b>							
<b>Bremsscheibe</b>							
2.0 TDI	110	05/13→	←	+PR 1ZF	24.0124-0258.1	424258	Ø 276 24 21 V + S
2.0 TDI	135	05/14→	←	+PR 1ZE,1ZP	24.0125-0145.1	425145	Ø 288 25 22 V + S
2.0 TDI quattro	110	10/13→	←	+PR 1ZE,1ZP	24.0325-0145.1	525145	Ø 288 25 22 V + S
2.0 TDI quattro	135	05/14→	←	+PR 1ZA,1ZD	24.0125-0158.1	425158	Ø 312 25 22 V + S
			←	+PR 1ZA,1ZD	24.0325-0158.1	525158	Ø 312 25 22 V + S
			→	+PR 1KE	24.0110-0356.1	410356	Ø 272 9,7 8 + S
			→	+PR 1KE	24.0310-0356.1	510356	Ø 272 9,7 8 + S
			→	+PR 2ED; + eFSB	24.0112-0210.1	412210	Ø 300 12 10 + S
			→	+PR 1KJ,1KY; + eFSB	24.0122-0219.1	422219	Ø 310 22 20 V
2.0 TFSI quattro	140	05/16→	←	+PR 1ZE,1ZP	24.0125-0145.1	425145	Ø 288 25 22 V + S
			←	+PR 1ZE,1ZP	24.0325-0145.1	525145	Ø 288 25 22 V + S
			←	+PR 1ZA,1ZD	24.0125-0158.1	425158	Ø 312 25 22 V + S
			←	+PR 1ZA,1ZD	24.0325-0158.1	525158	Ø 312 25 22 V + S
			→	+PR 1KE	24.0110-0356.1	410356	Ø 272 9,7 8 + S
			→	+PR 1KE	24.0310-0356.1	510356	Ø 272 9,7 8 + S
			→	+PR 1KJ,1KY; + eFSB	24.0122-0219.1	422219	Ø 310 22 20 V
RS3 quattro	294	04/17→	→	+PR 1KX,2EE	24.0122-0219.1	422219	Ø 310 22 20 V
S3 quattro	206	10/13→	←	+PR 1LC,1LJ	24.0130-0225.1	430225	Ø 340 30 27 V + S
S3 quattro	210	05/14→	→	+PR 1KE	24.0110-0356.1	410356	Ø 272 9,7 8 + S
S3 quattro	213	08/16→	→	+PR 1KE	24.0310-0356.1	510356	Ø 272 9,7 8 + S
S3 quattro	221	10/13→	→	+PR 1KE	24.0310-0356.1	510356	Ø 272 9,7 8 + S
S3 quattro	228	06/16→	→	+PR 2ED; + eFSB	24.0112-0210.1	412210	Ø 300 12 10 + S
			→	+PR 1KJ,1KY; + eFSB	24.0122-0219.1	422219	Ø 310 22 20 V
<b>AUDI - A3 Sportback (8PA) 09/04→12/15</b>							
<b>Bremsbelagsatz, Scheibenbremse</b>							
1.2 TSI	77	04/10→03/13	←	+PR 1ZF,1ZM	13.0460-7117.2	607117	VW 23130 19,6 + WK
1.6 TDI	66	05/09→03/13	←	+PR 1ZF,1ZM	13.0470-7117.2	LD7117	VW 23130 19,6 + WK Ceramic
1.6 TDI	77	05/09→03/13	←	+PR 1ZE,1ZP,1ZD,1LJ / 1ZA	13.0460-7184.2	607184	ATE 23587 20,6 + WK
			←	+PR 1ZE,1ZP,1ZD,1LJ / 1ZA	13.0470-7184.2	LD7184	ATE 23587 20,6 + WK Ceramic
			←	+PR 1LK	13.0460-7200.2	607200	ATE 23801 20,3 + WK
			←	+PR 1LK	13.0470-7200.2	LD7200	ATE 23801 20,3 + WK Ceramic
			→	+PR 1KE,1KZ	13.0460-2749.2	602749	TRW 24483 16,9 - WE / - WK + Zub
			→	+PR 1KE,1KZ	13.0460-2880.2	602880	TRW 23914 17,1 + WE / - WK + Zub
			→	+PR 1KE,1KZ	13.0470-2749.2	LD2749	TRW 24483 16,9 - WE / - WK + Zub Ceramic
			→	+PR 1KE,1KZ	13.0470-2880.2	LD2880	TRW 23914 17,1 + WE / - WK + Zub Ceramic
			→	+PR 1KQ,1KD	13.0460-2787.2	602787	TRW 23554 17,3 - WK / - WE
			→	+PR 1KQ,1KD	13.0460-2860.2	602860	TRW 23554 16,4 - WK / + WE
			→	+PR 1KQ,1KD	13.0470-2860.2	LD2860	TRW 23554 16,4 - WK / + WE Ceramic
			→	+PR 1KS	13.0460-3858.2	603858	BOS 24563 17,7 - WE / - WK + Zub
			→	+PR 1KS	13.0470-3858.2	LD3858	BOS 24563 17,7 - WE / - WK + Zub Ceramic
1.4 TFSI	92	09/07→03/13	←	+PR 1ZF,1ZM	13.0460-7117.2	607117	VW 23130 19,6 + WK
2.0 TDI	125	03/06→03/13	←	+PR 1ZF,1ZM	13.0470-7117.2	LD7117	VW 23130 19,6 + WK Ceramic
			←	+PR 1ZE,1ZP,1ZD,1LJ / 1ZA	13.0460-7184.2	607184	ATE 23587 20,6 + WK
			←	+PR 1ZE,1ZP,1ZD,1LJ / 1ZA	13.0470-7184.2	LD7184	ATE 23587 20,6 + WK Ceramic
			←	+PR 1LK	13.0460-7200.2	607200	ATE 23801 20,3 + WK
			←	+PR 1LK	13.0470-7200.2	LD7200	ATE 23801 20,3 + WK Ceramic
			→	+PR 1KE,1KZ	13.0460-2749.2	602749	TRW 24483 16,9 - WE / - WK + Zub
			→	+PR 1KE,1KZ	13.0460-2880.2	602880	TRW 23914 17,1 + WE / - WK + Zub
			→	+PR 1KE,1KZ	13.0470-2749.2	LD2749	TRW 24483 16,9 - WE / - WK + Zub Ceramic
			→	+PR 1KE,1KZ	13.0470-2880.2	LD2880	TRW 23914 17,1 + WE / - WK + Zub Ceramic
			→	+PR 1KQ,1KD	13.0460-2787.2	602787	TRW 23554 17,3 - WK / - WE
			→	+PR 1KQ,1KD	13.0460-2860.2	602860	TRW 23554 16,4 - WK / + WE









	kw			 	! #			
<b>AUDI - A3 Sportback (8PA) 09/04→12/15</b>								
<b> Bremsbelagsatz, Scheibenbremse</b>								
1.4 TFSI 2.0 TDI	92	09/07→03/13	➔	+PR 1KQ;1KD		<b>13.0470-2860.2</b>	<b>LD2860</b>	TRW 23554 16,4 - WK / + WE Ceramic
	125	03/06→03/13	➔	+PR 1KS		<b>13.0460-3858.2</b>	<b>603858</b>	BOS 24563 17,7 - WE / - WK + Zub
						<b>13.0470-3858.2</b>	<b>LD3858</b>	BOS 24563 17,7 - WE / - WK + Zub Ceramic
1.6 1.6 E-Power 1.6 FSI 1.9 TDI 2.0 FSI 2.0 TDI 2.0 TDI 2.0 TDI 16V 2.0 TFSI	75	09/04→03/13	➔	+PR 1ZF;1ZM		<b>13.0460-7117.2</b>	<b>607117</b>	VW 23130 19,6 + WK
	75	01/11→03/13	➔			<b>13.0470-7117.2</b>	<b>LD7117</b>	VW 23130 19,6 + WK Ceramic
	85	09/04→09/07	➔					
	77	09/04→05/10	➔	+PR 1ZE;1ZP;1ZD;1LJ / 1ZA		<b>13.0460-7184.2</b>	<b>607184</b>	ATE 23587 20,6 + WK
	110	09/04→06/08	➔			<b>13.0470-7184.2</b>	<b>LD7184</b>	ATE 23587 20,6 + WK Ceramic
	100	09/04→03/13	➔	+PR 1LK		<b>13.0460-7200.2</b>	<b>607200</b>	ATE 23801 20,3 + WK
	103	06/05→06/08	➔			<b>13.0470-7200.2</b>	<b>LD7200</b>	ATE 23801 20,3 + WK Ceramic
	103	09/04→03/13	➔					
	147	09/04→03/13	➔	+PR 1KE;1KZ		<b>13.0460-2749.2</b>	<b>602749</b>	TRW 24483 16,9 - WE / - WK + Zub
						<b>13.0460-2880.2</b>	<b>602880</b>	TRW 23914 17,1 + WE / - WK + Zub
						<b>13.0470-2749.2</b>	<b>LD2749</b>	TRW 24483 16,9 - WE / - WK + Zub Ceramic
						<b>13.0470-2880.2</b>	<b>LD2880</b>	TRW 23914 17,1 + WE / - WK + Zub Ceramic
			➔	+PR 1KQ;1KD		<b>13.0460-2787.2</b>	<b>602787</b>	TRW 23554 17,3 - WK / - WE
					<b>13.0460-2860.2</b>	<b>602860</b>	TRW 23554 16,4 - WK / + WE	
					<b>13.0470-2860.2</b>	<b>LD2860</b>	TRW 23554 16,4 - WK / + WE Ceramic	
			➔	+PR 1KS		<b>13.0460-3858.2</b>	<b>603858</b>	BOS 24563 17,7 - WE / - WK + Zub
					<b>13.0470-3858.2</b>	<b>LD3858</b>	BOS 24563 17,7 - WE / - WK + Zub Ceramic	
1.8 TFSI	118	11/06→03/13	➔	01/07→; +PR 1ZF;1ZM		<b>13.0460-7117.2</b>	<b>607117</b>	VW 23130 19,6 + WK
			➔			<b>13.0470-7117.2</b>	<b>LD7117</b>	VW 23130 19,6 + WK Ceramic
			➔	01/07→; +PR 1ZE;1ZP;1ZD;1LJ / 1ZA		<b>13.0460-7184.2</b>	<b>607184</b>	ATE 23587 20,6 + WK
			➔			<b>13.0470-7184.2</b>	<b>LD7184</b>	ATE 23587 20,6 + WK Ceramic
			➔	01/07→; +PR 1LK		<b>13.0460-7200.2</b>	<b>607200</b>	ATE 23801 20,3 + WK
			➔			<b>13.0470-7200.2</b>	<b>LD7200</b>	ATE 23801 20,3 + WK Ceramic
			➔	01/07→; +PR 1KE;1KZ		<b>13.0460-2749.2</b>	<b>602749</b>	TRW 24483 16,9 - WE / - WK + Zub
						<b>13.0460-2880.2</b>	<b>602880</b>	TRW 23914 17,1 + WE / - WK + Zub
					<b>13.0470-2749.2</b>	<b>LD2749</b>	TRW 24483 16,9 - WE / - WK + Zub Ceramic	
					<b>13.0470-2880.2</b>	<b>LD2880</b>	TRW 23914 17,1 + WE / - WK + Zub Ceramic	
			➔	01/07→; +PR 1KQ;1KD		<b>13.0460-2787.2</b>	<b>602787</b>	TRW 23554 17,3 - WK / - WE
					<b>13.0460-2860.2</b>	<b>602860</b>	TRW 23554 16,4 - WK / + WE	
					<b>13.0470-2860.2</b>	<b>LD2860</b>	TRW 23554 16,4 - WK / + WE Ceramic	
			➔	01/07→; +PR 1KS		<b>13.0460-3858.2</b>	<b>603858</b>	BOS 24563 17,7 - WE / - WK + Zub
					<b>13.0470-3858.2</b>	<b>LD3858</b>	BOS 24563 17,7 - WE / - WK + Zub Ceramic	
1.8 TFSI quattro	118	07/08→03/13	➔	+PR 1ZF;1ZM		<b>13.0460-7117.2</b>	<b>607117</b>	VW 23130 19,6 + WK
			➔			<b>13.0470-7117.2</b>	<b>LD7117</b>	VW 23130 19,6 + WK Ceramic
			➔	+PR 1ZE;1ZP;1ZD;1LJ / 1ZA		<b>13.0460-7184.2</b>	<b>607184</b>	ATE 23587 20,6 + WK
			➔			<b>13.0470-7184.2</b>	<b>LD7184</b>	ATE 23587 20,6 + WK Ceramic
			➔	+PR 1LK		<b>13.0460-7200.2</b>	<b>607200</b>	ATE 23801 20,3 + WK
			➔			<b>13.0470-7200.2</b>	<b>LD7200</b>	ATE 23801 20,3 + WK Ceramic
			➔	+PR 1KF;1KJ;1KU		<b>13.0460-2749.2</b>	<b>602749</b>	TRW 24483 16,9 - WE / - WK + Zub
					<b>13.0460-2880.2</b>	<b>602880</b>	TRW 23914 17,1 + WE / - WK + Zub	
					<b>13.0470-2749.2</b>	<b>LD2749</b>	TRW 24483 16,9 - WE / - WK + Zub Ceramic	
					<b>13.0470-2880.2</b>	<b>LD2880</b>	TRW 23914 17,1 + WE / - WK + Zub Ceramic	
			➔	+PR 1KS		<b>13.0460-3858.2</b>	<b>603858</b>	BOS 24563 17,7 - WE / - WK + Zub







	kw			 	! #		
<b>AUDI - A3 Sportback (8PA) 09/04→12/15</b>							
<b> Bremsbelagsatz, Scheibenbremse</b>							
1.8 TFSI quattro	118	07/08→03/13	➡	+PR 1KS		13.0470-3858.2 LD3858	BOS 24563 17,7 - WE / - WK + Zub Ceramic
2.0 TDI	120	06/06→06/08	←	+PR 1ZF; 1ZM		13.0460-7117.2 607117	VW 23130 19,6 + WK
						13.0470-7117.2 LD7117	VW 23130 19,6 + WK Ceramic
			←	+PR 1ZE;1ZP;1ZD;1LJ / 1ZA		13.0460-7184.2 607184	ATE 23587 20,6 + WK
					13.0470-7184.2 LD7184	ATE 23587 20,6 + WK Ceramic	
			←	+PR 1LK		13.0460-7200.2 607200	ATE 23801 20,3 + WK
					13.0470-7200.2 LD7200	ATE 23801 20,3 + WK Ceramic	
			➡	+PR 1KE; 1KZ		13.0460-2749.2 602749	TRW 24483 16,9 - WE / - WK + Zub
					13.0460-2880.2 602880	TRW 23914 17,1 + WE / - WK + Zub	
		13.0470-2749.2 LD2749	TRW 24483 16,9 - WE / - WK + Zub Ceramic				
		13.0470-2880.2 LD2880	TRW 23914 17,1 + WE / - WK + Zub Ceramic				
			➡	+PR 1KQ; 1KD		13.0460-2787.2 602787	TRW 23554 17,3 - WK / - WE
						13.0460-2860.2 602860	TRW 23554 16,4 - WK / + WE
						13.0470-2860.2 LD2860	TRW 23554 16,4 - WK / + WE Ceramic
			➡	+PR 1KS		13.0460-3858.2 603858	BOS 24563 17,7 - WE / - WK + Zub
						13.0470-3858.2 LD3858	BOS 24563 17,7 - WE / - WK + Zub Ceramic
2.0 TDI 16V quattro 2.0 TDI quattro 2.0 TFSI quattro	103 103 147	11/05→03/13 01/06→06/08 09/04→03/13	←	+PR 1ZF;1ZM		13.0460-7117.2 607117	VW 23130 19,6 + WK
						13.0470-7117.2 LD7117	VW 23130 19,6 + WK Ceramic
			←	+PR 1ZE;1ZP;1ZD;1LJ / 1ZA		13.0460-7184.2 607184	ATE 23587 20,6 + WK
					13.0470-7184.2 LD7184	ATE 23587 20,6 + WK Ceramic	
			←	+PR 1LK		13.0460-7200.2 607200	ATE 23801 20,3 + WK
					13.0470-7200.2 LD7200	ATE 23801 20,3 + WK Ceramic	
			➡	+PR 1KF;1KJ;1KU		13.0460-2749.2 602749	TRW 24483 16,9 - WE / - WK + Zub
						13.0460-2880.2 602880	TRW 23914 17,1 + WE / - WK + Zub
						13.0470-2749.2 LD2749	TRW 24483 16,9 - WE / - WK + Zub Ceramic
						13.0470-2880.2 LD2880	TRW 23914 17,1 + WE / - WK + Zub Ceramic
			➡	+PR 1KS		13.0460-3858.2 603858	BOS 24563 17,7 - WE / - WK + Zub
						13.0470-3858.2 LD3858	BOS 24563 17,7 - WE / - WK + Zub Ceramic
2.0 TDI quattro	125	03/06→03/13	←	+PR 1ZF;1ZM		13.0460-7117.2 607117	VW 23130 19,6 + WK
						13.0470-7117.2 LD7117	VW 23130 19,6 + WK Ceramic
			←	+PR 1ZE;1ZP;1ZD;1LJ / 1ZA		13.0460-7184.2 607184	ATE 23587 20,6 + WK
					13.0470-7184.2 LD7184	ATE 23587 20,6 + WK Ceramic	
			←	+PR 1LK		13.0460-7200.2 607200	ATE 23801 20,3 + WK
					13.0470-7200.2 LD7200	ATE 23801 20,3 + WK Ceramic	
			➡	+PR 1KF;1KJ;1KU		13.0460-2749.2 602749	TRW 24483 16,9 - WE / - WK + Zub
						13.0460-2880.2 602880	TRW 23914 17,1 + WE / - WK + Zub
						13.0470-2749.2 LD2749	TRW 24483 16,9 - WE / - WK + Zub Ceramic
						13.0470-2880.2 LD2880	TRW 23914 17,1 + WE / - WK + Zub Ceramic
			➡	+PR 1KS		13.0460-3858.2 603858	BOS 24563 17,7 - WE / - WK + Zub
						13.0470-3858.2 LD3858	BOS 24563 17,7 - WE / - WK + Zub Ceramic
3.2 V6 quattro	184	09/04→05/09	←	03/06→; +PR 1ZF;1ZM		13.0460-7117.2 607117	VW 23130 19,6 + WK
						13.0470-7117.2 LD7117	VW 23130 19,6 + WK Ceramic
			←	03/06→; +PR 1ZE;1ZP;1ZD;1LJ / 1ZA		13.0460-7184.2 607184	ATE 23587 20,6 + WK
					13.0470-7184.2 LD7184	ATE 23587 20,6 + WK Ceramic	
			←	03/06→; +PR 1LK		13.0460-7200.2 607200	ATE 23801 20,3 + WK
						13.0470-7200.2 LD7200	ATE 23801 20,3 + WK Ceramic
↓							







	kw			 	! #					
<b>AUDI - A3 Sportback (8PA) 09/04→12/15</b>										
<b>Bremsbelagsatz, Scheibenbremse</b>										
3.2 V6 quattro	184	09/04→05/09	➡	+PR 1KF,1KJ,1KU		13.0460-2749.2 602749	TRW 24483 16,9 - WE / - WK + Zub			
						13.0460-2880.2 602880	TRW 23914 17,1 + WE / - WK + Zub			
						13.0470-2749.2 LD2749	TRW 24483 16,9 - WE / - WK + Zub Ceramic			
						13.0470-2880.2 LD2880	TRW 23914 17,1 + WE / - WK + Zub Ceramic			
			➡	+PR 2EA		13.0460-2749.2 602749	TRW 24483 16,9 - WE / - WK + Zub			
						13.0460-2880.2 602880	TRW 23914 17,1 + WE / - WK + Zub			
						13.0470-2749.2 LD2749	TRW 24483 16,9 - WE / - WK + Zub Ceramic			
						13.0470-2880.2 LD2880	TRW 23914 17,1 + WE / - WK + Zub Ceramic			
			➡	+PR 1KS		13.0460-3858.2 603858	BOS 24563 17,7 - WE / - WK + Zub			
						13.0470-3858.2 LD3858	BOS 24563 17,7 - WE / - WK + Zub Ceramic			
			RS3 quattro	250	01/11→12/12	⬅	04/11→; +PR 1LG		13.0460-4833.2 604833	BRE 24098 17,1 + WE / - WK
						➡	04/11→		13.0460-2749.2 602749	TRW 24483 16,9 - WE / - WK + Zub
						13.0460-2880.2 602880	TRW 23914 17,1 + WE / - WK + Zub			
						13.0470-2749.2 LD2749	TRW 24483 16,9 - WE / - WK + Zub Ceramic			
			13.0470-2880.2 LD2880	TRW 23914 17,1 + WE / - WK + Zub Ceramic						
S3 quattro S3 quattro	188 195	07/08→03/13 06/08→03/13	⬅	+PR 1ZK		13.0460-7227.2 607227	ATE 23801 20,3 + WK			
						13.0470-7227.2 LD7227	ATE 23801 20,4 + WK Ceramic			
			➡	+PR 1KW		13.0460-2749.2 602749	TRW 24483 16,9 - WE / - WK + Zub			
						13.0460-2880.2 602880	TRW 23914 17,1 + WE / - WK + Zub			
			13.0470-2749.2 LD2749	TRW 24483 16,9 - WE / - WK + Zub Ceramic						
			13.0470-2880.2 LD2880	TRW 23914 17,1 + WE / - WK + Zub Ceramic						
<b>Warnkontakt, Bremsbelagverschleiß</b>										
RS3 quattro	250	01/11→12/12	⬅	04/11→; +PR 1LG	1	24.8190-0302.2 620302	L= 367,4			
<b>Zubehörsatz, Scheibenbremsbelag</b>										
1.2 TSI	77	04/10→03/13	➡	+PR 1KE,1KZ		13.0460-0259.2 610259				
1.6 TDI	66	05/09→03/13								
1.6 TDI	77	05/09→03/13								
1.4 TFSI	92	09/07→03/13	➡	+PR 1KE;1KZ		13.0460-0259.2 610259				
1.6	75	09/04→03/13								
1.6 E-Power	75	01/11→03/13								
1.6 FSI	85	09/04→09/07								
1.9 TDI	77	09/04→05/10								
2.0 FSI	110	09/04→06/08								
2.0 TDI	100	09/04→03/13								
2.0 TDI	103	06/05→06/08								
2.0 TDI	125	03/06→03/13								
2.0 TDI 16V	103	09/04→03/13								
2.0 TFSI	147	09/04→03/13								
1.8 TFSI	118	11/06→03/13	➡	01/07→; +PR 1KE;1KZ		13.0460-0259.2 610259				
1.8 TFSI quattro	118	07/08→03/13	➡	+PR 1KF,1KJ,1KU		13.0460-0259.2 610259				
2.0 TDI	120	06/06→06/08	➡	+PR 1KE; 1KZ		13.0460-0259.2 610259				
2.0 TDI 16V quattro	103	11/05→03/13	➡	+PR 1KF;1KJ;1KU		13.0460-0259.2 610259				
2.0 TDI quattro	103	01/06→06/08								
2.0 TDI quattro	125	03/06→03/13								
2.0 TFSI quattro	147	09/04→03/13								
3.2 V6 quattro	184	09/04→05/09	➡	+PR 2EA		13.0460-0035.2 610035				
			➡	+PR 1KF,1KJ,1KU		13.0460-0259.2 610259				
RS3 quattro	250	01/11→12/12	➡	04/11→		13.0460-0035.2 610035				
S3 quattro S3 quattro ↓	188 195	07/08→03/13 06/08→03/13	➡	+PR 1KW		13.0460-0035.2 610035				







	kw			 	! #		
<b>AUDI - A3 Sportback (8PA) 09/04→12/15</b>							
<b>Bremsscheibe</b>							
1.2 TSI	77	04/10→03/13	←	+PR 1ZF,1ZM		24.0122-0210.1 422210	Ø 280 22 19 V + S
1.6 TDI	66	05/09→03/13				24.0322-0210.1 522210	Ø 280 22 19 V + S
1.6 TDI	77	05/09→03/13	←	+PR 1ZE,1ZP		24.0125-0145.1 425145	Ø 288 25 22 V + S
						24.0325-0145.1 525145	Ø 288 25 22 V + S
			←	+PR 1ZD,1LJ,1ZA		24.0125-0158.1 425158	Ø 312 25 22 V + S
						24.0325-0158.1 525158	Ø 312 25 22 V + S
			←	+PR 1LK		24.0130-0115.1 430115	Ø 345 30 27 V
						24.0330-0115.1 530115	Ø 345 30 27 V
			→	+PR 1KQ,1KD		24.0110-0277.1 410277	Ø 253 10 8 + S
						24.0310-0277.1 510277	Ø 253 10 8 + S
			→	+PR 1KS		24.0110-0356.1 410356	Ø 272 9,7 8 + S
						24.0310-0356.1 510356	Ø 272 9,7 8 + S
			→	+PR 1KE		24.0112-0158.1 412158	Ø 256 12 10 + S
						24.0312-0158.1 512158	Ø 256 12 10
			→	+PR 1KZ		24.0112-0169.1 412169	Ø 282 12 10 + S
						24.0312-0169.1 512169	Ø 282 12 10 + S
1.4 TFSI	92	09/07→03/13	←	+PR 1ZF,1ZM		24.0122-0210.1 422210	Ø 280 22 19 V + S
1.6	75	09/04→03/13				24.0322-0210.1 522210	Ø 280 22 19 V + S
1.6 E-Power	75	01/11→03/13					
1.6 FSI	85	09/04→09/07	←	+PR 1ZE,1ZP		24.0125-0145.1 425145	Ø 288 25 22 V + S
1.9 TDI	77	09/04→05/10				24.0325-0145.1 525145	Ø 288 25 22 V + S
2.0 FSI	110	09/04→06/08	←	+PR 1ZD,1LJ,1ZA		24.0125-0158.1 425158	Ø 312 25 22 V + S
2.0 TDI	100	09/04→03/13				24.0325-0158.1 525158	Ø 312 25 22 V + S
2.0 TDI	103	06/05→06/08					
2.0 TDI 16V	103	09/04→03/13	←	+PR 1LK		24.0130-0115.1 430115	Ø 345 30 27 V
2.0 TFSI	147	09/04→03/13				24.0330-0115.1 530115	Ø 345 30 27 V
			→	+PR 1KQ,1KD		24.0110-0277.1 410277	Ø 253 10 8 + S
						24.0310-0277.1 510277	Ø 253 10 8 + S
			→	+PR 1KS		24.0110-0356.1 410356	Ø 272 9,7 8 + S
						24.0310-0356.1 510356	Ø 272 9,7 8 + S
			→	+PR 1KE		24.0112-0158.1 412158	Ø 256 12 10 + S
						24.0312-0158.1 512158	Ø 256 12 10
			→	+PR 1KZ		24.0112-0169.1 412169	Ø 282 12 10 + S
						24.0312-0169.1 512169	Ø 282 12 10 + S
1.8 TFSI	118	11/06→03/13	←	01/07→; +PR 1ZF,1ZM		24.0122-0210.1 422210	Ø 280 22 19 V + S
						24.0322-0210.1 522210	Ø 280 22 19 V + S
			←	01/07→; +PR 1ZE,1ZP		24.0125-0145.1 425145	Ø 288 25 22 V + S
						24.0325-0145.1 525145	Ø 288 25 22 V + S
			←	01/07→; +PR 1ZD,1LJ,1ZA		24.0125-0158.1 425158	Ø 312 25 22 V + S
						24.0325-0158.1 525158	Ø 312 25 22 V + S
			←	01/07→; +PR 1LK		24.0130-0115.1 430115	Ø 345 30 27 V
						24.0330-0115.1 530115	Ø 345 30 27 V
			→	01/07→; +PR 1KQ,1KD		24.0110-0277.1 410277	Ø 253 10 8 + S
						24.0310-0277.1 510277	Ø 253 10 8 + S
			→	01/07→; +PR 1KS		24.0110-0356.1 410356	Ø 272 9,7 8 + S
						24.0310-0356.1 510356	Ø 272 9,7 8 + S
			→	01/07→; +PR 1KE		24.0112-0158.1 412158	Ø 256 12 10 + S
						24.0312-0158.1 512158	Ø 256 12 10
			→	01/07→; +PR 1KZ		24.0112-0169.1 412169	Ø 282 12 10 + S
						24.0312-0169.1 512169	Ø 282 12 10 + S
1.8 TFSI quattro	118	07/08→03/13	←	+PR 1ZF,1ZM		24.0122-0210.1 422210	Ø 280 22 19 V + S
						24.0322-0210.1 522210	Ø 280 22 19 V + S
			←	+PR 1ZE,1ZP		24.0125-0145.1 425145	Ø 288 25 22 V + S
						24.0325-0145.1 525145	Ø 288 25 22 V + S
			←	+PR 1ZD,1LJ,1ZA		24.0125-0158.1 425158	Ø 312 25 22 V + S
						24.0325-0158.1 525158	Ø 312 25 22 V + S
			←	+PR 1LK		24.0130-0115.1 430115	Ø 345 30 27 V
						24.0330-0115.1 530115	Ø 345 30 27 V
			→	+PR 1KS		24.0110-0356.1 410356	Ø 272 9,7 8 + S
						24.0310-0356.1 510356	Ø 272 9,7 8 + S
			→	+PR 1KJ		24.0112-0169.1 412169	Ø 282 12 10 + S
						24.0312-0169.1 512169	Ø 282 12 10 + S
2.0 TDI	120	06/06→06/08	←	+PR 1ZF, 1ZM		24.0122-0210.1 422210	Ø 280 22 19 V + S
↓							











	kw			 	! #		
<b>AUDI - A3 Sportback (8PA) 09/04→12/15</b>							
<b>Bremsscheibe</b>							
2.0 TDI	120	06/06→06/08	←	+PR 1ZF; 1ZM	24.0322-0210.1	522210	Ø 280 22 19 V + S
			←	+PR 1ZE; 1ZP	24.0125-0145.1	425145	Ø 288 25 22 V + S
					24.0325-0145.1	525145	Ø 288 25 22 V + S
			←	+PR 1ZD, 1LJ, 1ZA	24.0125-0158.1	425158	Ø 312 25 22 V + S
					24.0325-0158.1	525158	Ø 312 25 22 V + S
			←	+PR 1LK	24.0130-0115.1	430115	Ø 345 30 27 V
					24.0330-0115.1	530115	Ø 345 30 27 V
			→	+PR 1KQ, 1KD	24.0110-0277.1	410277	Ø 253 10 8 + S
					24.0310-0277.1	510277	Ø 253 10 8 + S
				24.0110-0356.1	410356	Ø 272 9,7 8 + S	
				24.0310-0356.1	510356	Ø 272 9,7 8 + S	
				24.0112-0158.1	412158	Ø 256 12 10 + S	
				24.0312-0158.1	512158	Ø 256 12 10	
				24.0112-0169.1	412169	Ø 282 12 10 + S	
				24.0312-0169.1	512169	Ø 282 12 10 + S	
2.0 TDI	125	03/06→03/13	←	+PR 1ZF; 1ZM	24.0122-0210.1	422210	Ø 280 22 19 V + S
					24.0322-0210.1	522210	Ø 280 22 19 V + S
			←	+PR 1ZE; 1ZP	24.0125-0145.1	425145	Ø 288 25 22 V + S
					24.0325-0145.1	525145	Ø 288 25 22 V + S
			←	+PR 1ZD, 1LJ, 1ZA	24.0125-0158.1	425158	Ø 312 25 22 V + S
					24.0325-0158.1	525158	Ø 312 25 22 V + S
			←	+PR 1ZD; 1LJ	24.0130-0115.1	430115	Ø 345 30 27 V
					24.0330-0115.1	530115	Ø 345 30 27 V
			→	+PR 1KQ; 1KD	24.0110-0277.1	410277	Ø 253 10 8 + S
		24.0310-0277.1	510277	Ø 253 10 8 + S			
				24.0110-0356.1	410356	Ø 272 9,7 8 + S	
				24.0310-0356.1	510356	Ø 272 9,7 8 + S	
				24.0112-0158.1	412158	Ø 256 12 10 + S	
				24.0312-0158.1	512158	Ø 256 12 10	
				24.0112-0169.1	412169	Ø 282 12 10 + S	
				24.0312-0169.1	512169	Ø 282 12 10 + S	
2.0 TDI 16V quattro 2.0 TDI quattro 2.0 TFSI quattro	103 103 147	11/05→03/13 01/06→06/08 09/04→03/13	←	+PR 1ZF; 1ZM	24.0122-0210.1	422210	Ø 280 22 19 V + S
					24.0322-0210.1	522210	Ø 280 22 19 V + S
			←	+PR 1ZE; 1ZP	24.0125-0145.1	425145	Ø 288 25 22 V + S
					24.0325-0145.1	525145	Ø 288 25 22 V + S
			←	+PR 1ZD, 1LJ, 1ZA	24.0125-0158.1	425158	Ø 312 25 22 V + S
					24.0325-0158.1	525158	Ø 312 25 22 V + S
			←	+PR 1LK	24.0130-0115.1	430115	Ø 345 30 27 V
					24.0330-0115.1	530115	Ø 345 30 27 V
			→	+PR 1KS	24.0110-0356.1	410356	Ø 272 9,7 8 + S
		24.0310-0356.1	510356	Ø 272 9,7 8 + S			
				24.0112-0158.1	412158	Ø 256 12 10 + S	
				24.0312-0158.1	512158	Ø 256 12 10	
				24.0112-0169.1	412169	Ø 282 12 10 + S	
				24.0312-0169.1	512169	Ø 282 12 10 + S	
2.0 TDI quattro	125	03/06→03/13	←	+PR 1ZF; 1ZM	24.0122-0210.1	422210	Ø 280 22 19 V + S
					24.0322-0210.1	522210	Ø 280 22 19 V + S
			←	+PR 1ZE; 1ZP	24.0125-0145.1	425145	Ø 288 25 22 V + S
					24.0325-0145.1	525145	Ø 288 25 22 V + S
			←	+PR 1ZD, 1LJ, 1ZA	24.0125-0158.1	425158	Ø 312 25 22 V + S
					24.0325-0158.1	525158	Ø 312 25 22 V + S
			←	+PR 1ZD; 1LJ	24.0130-0115.1	430115	Ø 345 30 27 V
					24.0330-0115.1	530115	Ø 345 30 27 V
			→	+PR 1KS	24.0110-0356.1	410356	Ø 272 9,7 8 + S
		24.0310-0356.1	510356	Ø 272 9,7 8 + S			
				24.0112-0158.1	412158	Ø 256 12 10 + S	
				24.0312-0158.1	512158	Ø 256 12 10	
				24.0112-0169.1	412169	Ø 282 12 10 + S	
				24.0312-0169.1	512169	Ø 282 12 10 + S	
3.2 V6 quattro	184	09/04→05/09	←	03/06→; +PR 1ZF; 1ZM	24.0122-0210.1	422210	Ø 280 22 19 V + S
					24.0322-0210.1	522210	Ø 280 22 19 V + S









	kw			 	! #		
<b>AUDI - A3 Sportback (8PA) 09/04→12/15</b>							
<b>Bremsscheibe</b>							
3.2 V6 quattro	184	09/04→05/09	←	+PR 1ZE;1ZP	24.0125-0145.1 425145	∅ 288 25 22 V + S	
			←	+PR 1ZD,1LJ,1ZA	24.0125-0158.1 425158	∅ 312 25 22 V + S	
			←	+PR 1LK	24.0130-0115.1 430115	∅ 345 30 27 V	
			→	+PR 1KS	24.0110-0356.1 410356	∅ 272 9,7 8 + S	
			→	+PR 1KJ	24.0112-0169.1 412169	∅ 282 12 10 + S	
			→	+PR 2EA	24.0122-0219.1 422219	∅ 310 22 20 V	
			→		24.0325-0145.1 525145	∅ 288 25 22 V + S	
→		24.0325-0158.1 525158	∅ 312 25 22 V + S				
RS3 quattro	250	01/11→12/12	→	04/11→	24.0122-0219.1 422219	∅ 310 22 20 V	
S3 quattro	188	07/08→03/13	←	+PR 1ZK	24.0130-0115.1 430115	∅ 345 30 27 V	
S3 quattro	195	06/08→03/13	←		24.0330-0115.1 530115	∅ 345 30 27 V	
			→	+PR 1KW	24.0122-0219.1 422219	∅ 310 22 20 V	
<b>AUDI - A3 Sportback (8VA, 8VF) 09/12→</b>							
<b>Bremsbelagsatz, Scheibenbremse</b>							
1.0 TFSI 2.0 TFSI 2.0 TFSI quattro	85 140 140	07/16→ 05/16→ 05/16→	←	+PR 1ZA,1ZD,1ZE,1ZP	13.0460-2785.2 602785	TRW 25683 20,4 + WE / + WK	
			→	+PR 1KE; + eFSB	13.0460-7293.2 607293	ATE 25008 16,3 - WE / - WK	
			→	+PR 1KJ,1KY,2ED; + eFSB	13.0460-7294.2 607294	ATE 25009 16,4 - WE / - WK	
1.2 TFSI 1.2 TFSI 1.4 TFSI 1.4 TFSI 1.4 TFSI 1.4 TFSI e-tron 1.4 TFSI 1.5 TFSI 1.6 TDI 1.6 TDI 1.6 TDI 1.6 TDI quattro 1.8 TFSI 1.8 TFSI quattro 2.0 TDI 2.0 TDI 2.0 TDI 2.0 TDI 2.0 TDI quattro 2.0 TDI quattro	77 81 90 92 103 110 110 110 77 81 85 81 132 132 81 100 105 110 135 110 135	05/13→ 05/14→ 09/12→ 05/14→ 03/13→ 05/14→ 05/14→ 05/17→ 10/12→ 09/13→ 02/17→ 05/15→ 09/12→ 05/13→ 05/13→ 03/13→ 09/12→ 05/13→ 02/13→ 05/13→	←	+PR 1ZA,1ZD,1ZE,1ZP	13.0460-2785.2 602785	TRW 25683 20,4 + WE / + WK	
			←	+PR 1ZF	13.0460-7303.2 607303	ATE 22035 17,5 + WK	
			→	+PR 1KE; + eFSB	13.0460-7293.2 607293	ATE 25008 16,3 - WE / - WK	
			→	+PR 1KJ,1KY,2ED; + eFSB	13.0460-7294.2 607294	ATE 25009 16,4 - WE / - WK	
			←		13.0470-2785.2 LD2785	TRW 25683 20,4 + WE / + WK Ceramic	
			←		13.0470-7303.2 LD7303	ATE 22035 17,5 + WK Ceramic	
			→		13.0460-7293.2 607293	ATE 25008 16,3 - WE / - WK Ceramic	
			→		13.0470-7293.2 LD7293	ATE 25008 16,3 - WE / - WK Ceramic	
			→		13.0460-7294.2 607294	ATE 25009 16,4 - WE / - WK Ceramic	
			→		13.0470-7294.2 LD7294	ATE 25009 16,4 - WE / - WK Ceramic	
			←		13.0460-2785.2 602785	TRW 25683 20,4 + WE / + WK Ceramic	
			←		13.0470-2785.2 LD2785	TRW 25683 20,4 + WE / + WK Ceramic	
			→		13.0460-7303.2 607303	ATE 22035 17,5 + WK Ceramic	
			→		13.0470-7303.2 LD7303	ATE 22035 17,5 + WK Ceramic	
			→		13.0460-7293.2 607293	ATE 25008 16,3 - WE / - WK Ceramic	
			→		13.0470-7293.2 LD7293	ATE 25008 16,3 - WE / - WK Ceramic	
			→		13.0460-7294.2 607294	ATE 25009 16,4 - WE / - WK Ceramic	
→		13.0470-7294.2 LD7294	ATE 25009 16,4 - WE / - WK Ceramic				
RS3 quattro	270	03/15→	→	+PR 1KX,2EE; + eFSB	13.0460-7307.2 607307	ATE 22601 16,4 + WK	
S3 quattro S3 quattro S3 quattro S3 quattro S3 quattro	206 210 213 221 228	05/13→ 05/14→ 07/16→ 11/12→ 06/16→	→	+PR 1KE; + eFSB	13.0460-7293.2 607293	ATE 25008 16,3 - WE / - WK	
			→		13.0470-7293.2 LD7293	ATE 25008 16,3 - WE / - WK Ceramic	
			→	+PR 1KJ,1KY,2ED; + eFSB	13.0460-7294.2 607294	ATE 25009 16,4 - WE / - WK	
			→		13.0470-7294.2 LD7294	ATE 25009 16,4 - WE / - WK Ceramic	







	kw			 	! #		
<b>AUDI - A3 Sportback (8VA, 8VF) 09/12→</b>							
<b>Warnkontakt, Bremsbelagverschleiß</b>							
1.0 TFSI	85	07/16→	←	+PR 1ZA,1ZD,1ZE,1ZP	1	24.8190-0065.2 620065	L= 172
1.2 TFSI	77	05/13→					
1.2 TFSI	81	05/14→					
1.4 TFSI	90	09/12→					
1.4 TFSI	92	05/14→					
1.4 TFSI	103	03/13→					
1.4 TFSI e-tron	110	05/14→					
1.4 TFSI	110	05/14→					
1.5 TFSI	110	05/17→					
1.6 TDI	77	10/12→					
1.6 TDI	81	09/13→					
1.6 TDI	85	02/17→					
1.6 TDI quattro	81	05/15→					
1.8 TFSI	132	09/12→					
1.8 TFSI quattro	132	05/13→					
2.0 TDI	81	05/13→					
2.0 TDI	100	05/13→					
2.0 TDI	105	03/13→					
2.0 TDI	110	09/12→					
2.0 TDI	135	05/13→					
2.0 TDI quattro	110	02/13→					
2.0 TDI quattro	135	05/13→					
2.0 TFSI	140	05/16→					
2.0 TFSI quattro	140	05/16→					
1.4 TFSI g-tron	81	11/13→	←	02/14→; +PR 1ZA,1ZD,1ZE,1ZP	1	24.8190-0065.2 620065	L= 172
S3 quattro	206	05/13→	←	+PR 1LC,1LJ	1	24.8190-0065.2 620065	L= 172
S3 quattro	210	05/14→					
S3 quattro	213	07/16→					
S3 quattro	221	11/12→					
S3 quattro	228	06/16→					
<b>Bremsscheibe</b>							
1.0 TFSI	85	07/16→	←	+PR 1ZE,1ZP		24.0125-0145.1 425145	Ø 288 25 22 V + S
2.0 TFSI	140	05/16→				24.0325-0145.1 525145	Ø 288 25 22 V + S
			←	+PR 1ZA,1ZD		24.0125-0158.1 425158	Ø 312 25 22 V + S
						24.0325-0158.1 525158	Ø 312 25 22 V + S
			→	+PR 1KE		24.0110-0356.1 410356	Ø 272 9,7 8 + S
						24.0310-0356.1 510356	Ø 272 9,7 8 + S
			→	+PR 2ED; + eFSB		24.0112-0210.1 412210	Ø 300 12 10 + S
			→	+PR 1KJ,1KY; + eFSB		24.0122-0219.1 422219	Ø 310 22 20 V
1.2 TFSI	77	05/13→	←	+PR 1ZF		24.0124-0258.1 424258	Ø 276 24 21 V + S
1.2 TFSI	81	05/14→					
1.4 TFSI	90	09/12→	←	+PR 1ZE,1ZP		24.0125-0145.1 425145	Ø 288 25 22 V + S
1.4 TFSI	92	05/14→				24.0325-0145.1 525145	Ø 288 25 22 V + S
1.4 TFSI	103	03/13→					
1.4 TFSI e-tron	110	05/14→	←	+PR 1ZA,1ZD		24.0125-0158.1 425158	Ø 312 25 22 V + S
1.4 TFSI	110	05/14→				24.0325-0158.1 525158	Ø 312 25 22 V + S
1.5 TFSI	110	05/17→	→	+PR 1KE		24.0110-0356.1 410356	Ø 272 9,7 8 + S
1.6 TDI	77	10/12→				24.0310-0356.1 510356	Ø 272 9,7 8 + S
1.6 TDI	81	09/13→					
1.6 TDI	85	02/17→	→	+PR 2ED; + eFSB		24.0112-0210.1 412210	Ø 300 12 10 + S
1.6 TDI quattro	81	05/15→	→	+PR 1KJ,1KY; + eFSB		24.0122-0219.1 422219	Ø 310 22 20 V
1.8 TFSI	132	09/12→					
1.8 TFSI quattro	132	05/13→					
2.0 TDI	81	05/13→					
2.0 TDI	100	05/13→					
2.0 TDI	105	03/13→					
2.0 TDI	110	09/12→					
2.0 TDI	135	05/13→					
2.0 TDI quattro	110	02/13→					
2.0 TDI quattro	135	05/13→					
1.4 TFSI g-tron	81	11/13→	←	02/14→; +PR 1ZF		24.0124-0258.1 424258	Ø 276 24 21 V + S
			←	02/14→; +PR 1ZE,1ZP		24.0125-0145.1 425145	Ø 288 25 22 V + S
						24.0325-0145.1 525145	Ø 288 25 22 V + S
			←	02/14→; +PR 1ZA,1ZD		24.0125-0158.1 425158	Ø 312 25 22 V + S
						24.0325-0158.1 525158	Ø 312 25 22 V + S
			→	02/14→; +PR 1KE		24.0110-0356.1 410356	Ø 272 9,7 8 + S
						24.0310-0356.1 510356	Ø 272 9,7 8 + S
			→	02/14→; +PR 2ED; + eFSB		24.0112-0210.1 412210	Ø 300 12 10 + S
			→	02/14→; +PR 1KJ,1KY; + eFSB		24.0122-0219.1 422219	Ø 310 22 20 V
2.0 TFSI quattro	140	05/16→	←	+PR 1ZE,1ZP		24.0125-0145.1 425145	Ø 288 25 22 V + S
						24.0325-0145.1 525145	Ø 288 25 22 V + S
			←	+PR 1ZA,1ZD		24.0125-0158.1 425158	Ø 312 25 22 V + S
						24.0325-0158.1 525158	Ø 312 25 22 V + S







	kW			 	! #		
<b>AUDI - A3 Sportback (8VA, 8VF) 09/12→</b>							
<b>Bremsscheibe</b>							
2.0 TFSI quattro	140	05/16→	➔	+PR 1KE		24.0110-0356.1 410356 24.0310-0356.1 510356	Ø 272 9,7 8 + S Ø 272 9,7 8 + S
			➔	+PR 1KJ,1KY; + eFSB		24.0122-0219.1 422219	Ø 310 22 20 V
RS3 quattro	270	03/15→	➔	+PR 1KX,2EE; + eFSB		24.0122-0219.1 422219	Ø 310 22 20 V
RS3 quattro	294	04/17→	➔	+PR 1KX,2EE		24.0122-0219.1 422219	Ø 310 22 20 V
S3 quattro	206	05/13→	➔	+PR 1LC,1LJ		24.0130-0225.1 430225	Ø 340 30 27 V + S
S3 quattro	210	05/14→	➔	+PR 1KE		24.0110-0356.1 410356	Ø 272 9,7 8 + S
S3 quattro	213	07/16→	➔	+PR 1KE		24.0310-0356.1 510356	Ø 272 9,7 8 + S
S3 quattro	221	11/12→	➔	+PR 2ED; + eFSB		24.0112-0210.1 412210	Ø 300 12 10 + S
S3 quattro	228	06/16→	➔	+PR 1KJ,1KY; + eFSB		24.0122-0219.1 422219	Ø 310 22 20 V
<b>AUDI - A4 (8D2, B5) 11/94→12/01</b>							
<b>Bremsbelagsatz, Scheibenbremse</b>							
1.6	74	11/94→10/00	➔	8D-V-169696→		13.0460-2822.2 602822	TRW 21945 19,6 - WK
1.6	75	07/00→11/00	➔	→ 8D-V-169695		13.0460-2837.2 602837	TRW 21945 19,6 + WK
1.9 TDI	66	01/95→11/00	➔	8D-V-054062→		13.0470-2837.2 LD2837	TRW 21945 19,6 + WK Ceramic
			➔	→ 8D-V-054061		13.0460-2822.2 602822	TRW 21945 19,6 - WK
			➔	8D-V-160001→		13.0460-2934.2 602934	TRW 20669 19,0 - WK
			➔	→ 8D-V-160000		13.0460-2822.2 602822	TRW 21945 19,6 - WK
			➔	8D-V-054062→		13.0460-2837.2 602837	TRW 21945 19,6 + WK
			➔	→ 8D-V-054061		13.0470-2837.2 LD2837	TRW 21945 19,6 + WK Ceramic
			➔	8D-V-160001→		13.0460-7077.2 607077	ATE 20676 19,8 - WE / - WK
			➔	→ 8D-V-160000		13.0460-2787.2 602787	TRW 23554 17,3 - WK / - WE
			➔	8D-V-160001→		13.0460-2820.2 602820	TRW 20961 17,2 - WK
			➔	→ 8D-V-160000		13.0470-2820.2 LD2820	TRW 20961 17,2 - WK Ceramic
			➔	8D-V-160000		13.0460-3602.2 603602	TRW 21144 15,8 - WK
1.8	85	04/95→11/00	➔	8D-V-054062→		13.0460-2822.2 602822	TRW 21945 19,6 - WK
			➔	07/95→; → 8D-V-054061		13.0460-2837.2 602837	TRW 21945 19,6 + WK
			➔	8D-V-054062→		13.0470-2837.2 LD2837	TRW 21945 19,6 + WK Ceramic
			➔	→ 8D-V-054061		13.0460-7077.2 607077	ATE 20676 19,8 - WE / - WK
			➔	8D-V-160001→		13.0460-7110.2 607110	ATE 20676 19,8 + WK
			➔	→ 8D-V-160000		13.0470-7110.2 LD7110	ATE 20676 19,8 + WK Ceramic
			➔	8D-V-160001→		13.0460-2787.2 602787	TRW 23554 17,3 - WK / - WE
			➔	8D-V-160001→		13.0460-2820.2 602820	TRW 20961 17,2 - WK
			➔	→ 8D-V-160000		13.0470-2820.2 LD2820	TRW 20961 17,2 - WK Ceramic
			➔	8D-V-160000		13.0460-3602.2 603602	TRW 21144 15,8 - WK
1.8	92	11/94→11/00	➔	8D-V-054062→		13.0460-2822.2 602822	TRW 21945 19,6 - WK
			➔	→ 8D-V-054061		13.0460-2837.2 602837	TRW 21945 19,6 + WK
			➔	8D-V-054062→		13.0470-2837.2 LD2837	TRW 21945 19,6 + WK Ceramic
			➔	→ 8D-V-054061		13.0460-7077.2 607077	ATE 20676 19,8 - WE / - WK
			➔	8D-V-160001→		13.0460-7110.2 607110	ATE 20676 19,8 + WK
			➔	→ 8D-V-160000		13.0470-7110.2 LD7110	ATE 20676 19,8 + WK Ceramic
			➔	8D-V-160001→		13.0460-2787.2 602787	TRW 23554 17,3 - WK / - WE
			➔	8D-V-160001→		13.0460-2820.2 602820	TRW 20961 17,2 - WK
			➔	→ 8D-V-160000		13.0470-2820.2 LD2820	TRW 20961 17,2 - WK Ceramic
			➔	8D-V-160000		13.0460-3602.2 603602	TRW 21144 15,8 - WK
1.8 quattro	85	07/95→11/00	➔	8D-V-054062→		13.0460-2822.2 602822	TRW 21945 19,6 - WK
			➔	→ 8D-V-054061		13.0460-2837.2 602837	TRW 21945 19,6 + WK
			➔	8D-V-054062→		13.0470-2837.2 LD2837	TRW 21945 19,6 + WK Ceramic
			➔	→ 8D-V-054061		13.0460-7077.2 607077	ATE 20676 19,8 - WE / - WK
			➔	8D-V-160001→		13.0460-3602.2 603602	TRW 21144 15,8 - WK
1.8 quattro	92	01/95→11/00	➔	8D-V-054062→		13.0460-2822.2 602822	TRW 21945 19,6 - WK
			➔	02/95→; → 8D-V-054061		13.0460-2837.2 602837	TRW 21945 19,6 + WK
			➔	8D-V-054062→		13.0470-2837.2 LD2837	TRW 21945 19,6 + WK Ceramic
			➔	→ 8D-V-054061		13.0460-7077.2 607077	ATE 20676 19,8 - WE / - WK
			➔	8D-V-160001→		13.0460-3602.2 603602	TRW 21144 15,8 - WK
1.8 T	110	01/95→11/00	➔	05/95→		13.0460-7077.2 607077	ATE 20676 19,8 - WE / - WK
			➔			13.0460-7110.2 607110	ATE 20676 19,8 + WK
			➔			13.0470-7110.2 LD7110	ATE 20676 19,8 + WK Ceramic









	kw			 	! #		
<b>AUDI - A4 (8D2, B5) 11/94→12/01</b>							
<b> Bremsbelagsatz, Scheibenbremse</b>							
1.8 T	110	01/95→11/00	➔	8D-V-160001→		<b>13.0460-2787.2 602787</b> <b>13.0460-2820.2 602820</b> <b>13.0470-2820.2 LD2820</b>	TRW 23554 17,3 - WK / - WE TRW 20961 17,2 - WK TRW 20961 17,2 - WK Ceramic
			➔	05/95→; → 8D-V-160000		<b>13.0460-3602.2 603602</b>	TRW 21144 15,8 - WK
1.8 T	125	05/00→09/00	➔			<b>13.0460-7077.2 607077</b>	ATE 20676 19,8 - WE / - WK
1.8 T	132	12/97→11/00	➔			<b>13.0460-7110.2 607110</b>	ATE 20676 19,8 + WK
2.6	110	01/95→11/00	➔			<b>13.0470-7110.2 LD7110</b>	ATE 20676 19,8 + WK Ceramic
2.8	128	09/95→07/97	➔				
2.8	140	09/99→10/00	➔	8D-V-160001→		<b>13.0460-2787.2 602787</b>	TRW 23554 17,3 - WK / - WE
2.8	142	10/96→07/99	➔			<b>13.0460-2820.2 602820</b>	TRW 20961 17,2 - WK
2.8	142	10/96→11/00	➔			<b>13.0470-2820.2 LD2820</b>	TRW 20961 17,2 - WK Ceramic
			➔	→ 8D-V-160000		<b>13.0460-3602.2 603602</b>	TRW 21144 15,8 - WK
1.8 T quattro	110	01/95→11/00	➔	02/95→ 01/99		<b>13.0460-7077.2 607077</b>	ATE 20676 19,8 - WE / - WK
			➔	02/99→		<b>13.0460-7110.2 607110</b>	ATE 20676 19,8 + WK
			➔			<b>13.0470-7110.2 LD7110</b>	ATE 20676 19,8 + WK Ceramic
			➔	02/95→		<b>13.0460-3602.2 603602</b>	TRW 21144 15,8 - WK
1.8 T quattro	132	12/97→11/00	➔	→ 01/99		<b>13.0460-7077.2 607077</b>	ATE 20676 19,8 - WE / - WK
1.9 TDI quattro	81	09/96→11/00	➔	02/99→		<b>13.0460-7110.2 607110</b>	ATE 20676 19,8 + WK
2.4 quattro	120	08/97→11/00	➔			<b>13.0470-7110.2 LD7110</b>	ATE 20676 19,8 + WK Ceramic
2.6 quattro	110	01/95→11/00	➔			<b>13.0460-3602.2 603602</b>	TRW 21144 15,8 - WK
1.9 TDI	55	12/95→11/00	➔	8D-V-054062→		<b>13.0460-2822.2 602822</b> <b>13.0460-2837.2 602837</b> <b>13.0470-2837.2 LD2837</b>	TRW 21945 19,6 - WK TRW 21945 19,6 + WK TRW 21945 19,6 + WK Ceramic
			➔	03/96→; → 8D-V-169695		<b>13.0460-2822.2 602822</b> <b>13.0460-2934.2 602934</b>	TRW 21945 19,6 - WK TRW 20669 19,0 - WK
			➔	8D-V-169696→		<b>13.0460-2822.2 602822</b> <b>13.0460-2837.2 602837</b> <b>13.0470-2837.2 LD2837</b>	TRW 21945 19,6 - WK TRW 21945 19,6 + WK TRW 21945 19,6 + WK Ceramic
			➔	03/96→; → 8D-V-054061		<b>13.0460-7077.2 607077</b>	ATE 20676 19,8 - WE / - WK
			➔	8D-V-160001→		<b>13.0460-2787.2 602787</b> <b>13.0460-2820.2 602820</b> <b>13.0470-2820.2 LD2820</b>	TRW 23554 17,3 - WK / - WE TRW 20961 17,2 - WK TRW 20961 17,2 - WK Ceramic
			➔	03/96→; → 8D-V-160000		<b>13.0460-3602.2 603602</b>	TRW 21144 15,8 - WK
1.9 TDI	81	10/95→11/00	➔	02/96→		<b>13.0460-7077.2 607077</b> <b>13.0460-7110.2 607110</b> <b>13.0470-7110.2 LD7110</b>	ATE 20676 19,8 - WE / - WK ATE 20676 19,8 + WK ATE 20676 19,8 + WK Ceramic
			➔	8D-V-160001→		<b>13.0460-2787.2 602787</b> <b>13.0460-2820.2 602820</b> <b>13.0470-2820.2 LD2820</b>	TRW 23554 17,3 - WK / - WE TRW 20961 17,2 - WK TRW 20961 17,2 - WK Ceramic
			➔	02/96→; → 8D-V-160000		<b>13.0460-3602.2 603602</b>	TRW 21144 15,8 - WK
1.9 TDI	85	03/00→11/00	➔			<b>13.0460-7077.2 607077</b>	ATE 20676 19,8 - WE / - WK
2.4	120	08/97→11/00	➔			<b>13.0460-7110.2 607110</b>	ATE 20676 19,8 + WK
2.5 TDI	110	09/97→11/00	➔			<b>13.0470-7110.2 LD7110</b>	ATE 20676 19,8 + WK Ceramic
			➔			<b>13.0460-2787.2 602787</b> <b>13.0460-2820.2 602820</b> <b>13.0470-2820.2 LD2820</b>	TRW 23554 17,3 - WK / - WE TRW 20961 17,2 - WK TRW 20961 17,2 - WK Ceramic
			➔	→ 8D-V-160000		<b>13.0460-3602.2 603602</b>	TRW 21144 15,8 - WK
1.9 TDI quattro	85	03/00→11/00	➔			<b>13.0460-7110.2 607110</b>	ATE 20676 19,8 + WK
2.8 quattro	140	09/99→10/00	➔			<b>13.0470-7110.2 LD7110</b>	ATE 20676 19,8 + WK Ceramic
			➔			<b>13.0460-3602.2 603602</b>	TRW 21144 15,8 - WK
2.4	121	03/97→11/00	➔	→ 07/97		<b>13.0460-7077.2 607077</b> <b>13.0460-7110.2 607110</b> <b>13.0470-7110.2 LD7110</b>	ATE 20676 19,8 - WE / - WK ATE 20676 19,8 + WK ATE 20676 19,8 + WK Ceramic
			➔	08/97→		<b>13.0460-7077.2 607077</b> <b>13.0460-7110.2 607110</b> <b>13.0470-7110.2 LD7110</b>	ATE 20676 19,8 - WE / - WK ATE 20676 19,8 + WK ATE 20676 19,8 + WK Ceramic
			➔	08/97→		<b>13.0460-2787.2 602787</b> <b>13.0460-2820.2 602820</b> <b>13.0470-2820.2 LD2820</b>	TRW 23554 17,3 - WK / - WE TRW 20961 17,2 - WK TRW 20961 17,2 - WK Ceramic
			➔	8D-V-160001→; → 07/97; Thailand		<b>13.0460-2787.2 602787</b>	TRW 23554 17,3 - WK / - WE
↓							









	kw			 	! #		
<b>AUDI - A4 (8D2, B5) 11/94→12/01</b>							
<b> Bremsbelagsatz, Scheibenbremse</b>							
2.4	121	03/97→11/00	➔	8D-V-160001→; → 07/97		<b>13.0460-2820.2 602820</b>	TRW 20961 17,2 - WK
			➔	→ 8D-V-160000		<b>13.0470-2820.2 LD2820</b>	TRW 20961 17,2 - WK Ceramic
			➔	→ 8D-V-160000		<b>13.0460-3602.2 603602</b>	TRW 21144 15,8 - WK
2.4 quattro	121	03/97→11/00	➔	08/97→ 01/99		<b>13.0460-7077.2 607077</b>	ATE 20676 19,8 - WE / - WK
			➔	02/99→		<b>13.0460-7110.2 607110</b>	ATE 20676 19,8 + WK
			➔	08/97→		<b>13.0470-7110.2 LD7110</b>	ATE 20676 19,8 + WK Ceramic
			➔	08/97→		<b>13.0460-3602.2 603602</b>	TRW 21144 15,8 - WK
2.5 TDI quattro	110	09/97→11/00	➔	11/97→ 01/99		<b>13.0460-7077.2 607077</b>	ATE 20676 19,8 - WE / - WK
			➔	02/99→		<b>13.0460-7110.2 607110</b>	ATE 20676 19,8 + WK
			➔	11/97→		<b>13.0470-7110.2 LD7110</b>	ATE 20676 19,8 + WK Ceramic
			➔	11/97→		<b>13.0460-3602.2 603602</b>	TRW 21144 15,8 - WK
2.8 quattro	128	01/95→07/97	➔	→ 07/96		<b>13.0460-7077.2 607077</b>	ATE 20676 19,8 - WE / - WK
			➔	→ 07/96		<b>13.0460-3602.2 603602</b>	TRW 21144 15,8 - WK
2.8 quattro	142	10/96→08/01	➔	→ 01/99		<b>13.0460-7077.2 607077</b>	ATE 20676 19,8 - WE / - WK
			➔	02/99→ 04/01		<b>13.0460-7110.2 607110</b>	ATE 20676 19,8 + WK
			➔	→ 04/01		<b>13.0470-7110.2 LD7110</b>	ATE 20676 19,8 + WK Ceramic
			➔	→ 04/01		<b>13.0460-3602.2 603602</b>	TRW 21144 15,8 - WK
S4 quattro	195	09/97→09/01	➔	10/97→; → 8D-X-199 999		<b>13.0460-2705.2 602705</b>	TRW 21452 18,5 - WK
			➔	8D-X-200 001→; → 04/01		<b>13.0460-2875.2 602875</b>	TRW 23119 17,5 + WK
			➔	10/97→ 04/01		<b>13.0460-2787.2 602787</b>	TRW 23554 17,3 - WK / - WE
			➔			<b>13.0460-2820.2 602820</b>	TRW 20961 17,2 - WK
			➔			<b>13.0470-2820.2 LD2820</b>	TRW 20961 17,2 - WK Ceramic
<b>Zubehörsatz, Scheibenbremsbelag</b>							
1.6	74	11/94→10/00	➔	8D-V-160001→		<b>13.0460-0072.2 610072</b>	TRW
1.6	75	07/00→11/00					
1.8	85	04/95→11/00					
1.8	92	11/94→11/00					
1.8 T	110	01/95→11/00					
1.8 T	125	05/00→09/00					
1.8 T	132	12/97→11/00					
1.9 TDI	55	12/95→11/00					
1.9 TDI	66	01/95→11/00					
1.9 TDI	81	10/95→11/00					
2.6	110	01/95→11/00					
2.8	128	09/95→07/97					
2.8	140	09/99→10/00					
2.8	142	10/96→07/99					
2.8	142	10/96→11/00					
1.9 TDI	85	03/00→11/00	➔			<b>13.0460-0072.2 610072</b>	TRW
2.4	120	08/97→11/00					
2.5 TDI	110	09/97→11/00					
2.4	121	03/97→11/00	➔	8D-V-160001→; → 07/97		<b>13.0460-0072.2 610072</b>	TRW
			➔	08/97→		<b>13.0460-0072.2 610072</b>	TRW
S4 quattro	195	09/97→09/01	➔	10/97→ 04/01		<b>13.0460-0072.2 610072</b>	TRW
<b> Bremsscheibe</b>							
1.6	74	11/94→10/00	➔	→ 8D-V-169695		<b>24.0113-0181.1 413181</b>	Ø 280 13 11
1.6	75	07/00→11/00				<b>24.0313-0181.1 513181</b>	Ø 280 13 11
			➔	→ 8D-V-054061		<b>24.0115-0105.1 415105</b>	Ø 288 15 13
			➔			<b>24.0315-0105.1 515105</b>	Ø 288 15 13
			➔	8D-V-054062→		<b>24.0122-0152.1 422152</b>	Ø 280 22 20 V + S
			➔			<b>24.0322-0152.1 522152</b>	Ø 280 22 20 V + S
			➔	8D-V-169696→		<b>24.0122-0152.1 422152</b>	Ø 280 22 20 V + S
			➔			<b>24.0322-0152.1 522152</b>	Ø 280 22 20 V + S
			➔			<b>24.0110-0210.1 410210</b>	Ø 245 10 8 - LG / - ABS Ring
1.8	85	04/95→11/00	➔	07/95→; → 8D-V-054061; für China/GUS		<b>24.0115-0105.1 415105</b>	Ø 288 15 13
			➔			<b>24.0315-0105.1 515105</b>	Ø 288 15 13
			➔	8D-V-054062→; für China/GUS		<b>24.0122-0152.1 422152</b>	Ø 280 22 20 V + S
			➔			<b>24.0322-0152.1 522152</b>	Ø 280 22 20 V + S
			➔			<b>24.0110-0210.1 410210</b>	Ø 245 10 8 - LG / - ABS Ring
1.8	92	11/94→11/00	➔	→ 8D-V-054061		<b>24.0115-0105.1 415105</b>	Ø 288 15 13
			➔			<b>24.0315-0105.1 515105</b>	Ø 288 15 13
			➔	8D-V-054062→		<b>24.0122-0152.1 422152</b>	Ø 280 22 20 V + S
↓							









	kw			 	! #		
<b>AUDI - A4 (8D2, B5) 11/94→12/01</b>							
<b>Bremsscheibe</b>							
1.8	92	11/94→11/00	← 8D-V-054062→		24.0322-0152.1	522152	Ø 280 22 20 V + S
			→		24.0110-0210.1	410210	Ø 245 10 8 - LG / - ABS Ring
1.8 quattro	85	07/95→11/00	← → 8D-V-054061; für GUS		24.0115-0105.1	415105	Ø 288 15 13
			→		24.0315-0105.1	515105	Ø 288 15 13
			← 8D-V-054062→; für GUS		24.0122-0152.1	422152	Ø 280 22 20 V + S
			→		24.0322-0152.1	522152	Ø 280 22 20 V + S
			→		24.0110-0224.1	410224	Ø 245 10 8
			→		24.0310-0224.1	510224	Ø 245 10 8
1.8 quattro	92	01/95→11/00	← → 8D-V-054061		24.0115-0105.1	415105	Ø 288 15 13
			→		24.0315-0105.1	515105	Ø 288 15 13
			← 8D-V-054062→		24.0122-0152.1	422152	Ø 280 22 20 V + S
			→		24.0322-0152.1	522152	Ø 280 22 20 V + S
			→		24.0110-0224.1	410224	Ø 245 10 8
			→		24.0310-0224.1	510224	Ø 245 10 8
1.8 T	110	01/95→11/00	← 05/95→		24.0125-0105.1	425105	Ø 288 25 23 V + S
			→		24.0325-0105.1	525105	Ø 288 25 23 V
			→		24.0110-0210.1	410210	Ø 245 10 8 - LG / - ABS Ring
1.8 T	125	05/00→09/00	←		24.0125-0105.1	425105	Ø 288 25 23 V + S
1.8 T	132	12/97→11/00	←		24.0325-0105.1	525105	Ø 288 25 23 V
1.9 TDI	85	03/00→11/00	→		24.0110-0210.1	410210	Ø 245 10 8 - LG / - ABS Ring
2.4	120	08/97→11/00	→				
2.5 TDI	110	09/97→11/00	→				
2.6	110	01/95→11/00	→				
2.8	128	09/95→07/97	→				
2.8	140	09/99→10/00	→				
2.8	142	10/96→07/99	→				
2.8	142	10/96→11/00	→				
1.8 T quattro	110	01/95→11/00	← 02/95→		24.0125-0105.1	425105	Ø 288 25 23 V + S
			→		24.0325-0105.1	525105	Ø 288 25 23 V
			→		24.0110-0224.1	410224	Ø 245 10 8
			→		24.0310-0224.1	510224	Ø 245 10 8
1.8 T quattro	132	12/97→11/00	←		24.0125-0105.1	425105	Ø 288 25 23 V + S
1.9 TDI quattro	81	09/96→11/00	←		24.0325-0105.1	525105	Ø 288 25 23 V
1.9 TDI quattro	85	03/00→11/00	→		24.0110-0224.1	410224	Ø 245 10 8
2.4 quattro	120	08/97→11/00	→		24.0310-0224.1	510224	Ø 245 10 8
2.6 quattro	110	01/95→11/00	→				
2.8 quattro	140	09/99→10/00	→				
1.9 TDI	55	12/95→11/00	← 03/96→; → 8D-V-169695		24.0113-0181.1	413181	Ø 280 13 11
			→		24.0313-0181.1	513181	Ø 280 13 11
			← 8D-V-169696→		24.0122-0152.1	422152	Ø 280 22 20 V + S
			→		24.0322-0152.1	522152	Ø 280 22 20 V + S
			← 8D-V-054062→		24.0122-0152.1	422152	Ø 280 22 20 V + S
			→		24.0322-0152.1	522152	Ø 280 22 20 V + S
			→		24.0110-0210.1	410210	Ø 245 10 8 - LG / - ABS Ring
1.9 TDI	66	01/95→11/00	← → 8D-V-169695		24.0113-0181.1	413181	Ø 280 13 11
			→		24.0313-0181.1	513181	Ø 280 13 11
			← 8D-V-054062→		24.0122-0152.1	422152	Ø 280 22 20 V + S
			→		24.0322-0152.1	522152	Ø 280 22 20 V + S
			← 8D-V-169696→		24.0122-0152.1	422152	Ø 280 22 20 V + S
			→		24.0322-0152.1	522152	Ø 280 22 20 V + S
			→		24.0110-0210.1	410210	Ø 245 10 8 - LG / - ABS Ring
1.9 TDI	81	10/95→11/00	← 02/96→		24.0125-0105.1	425105	Ø 288 25 23 V + S
			→		24.0325-0105.1	525105	Ø 288 25 23 V
			→		24.0110-0210.1	410210	Ø 245 10 8 - LG / - ABS Ring
2.4	121	03/97→11/00	← 08/97→		24.0125-0105.1	425105	Ø 288 25 23 V + S
			→		24.0325-0105.1	525105	Ø 288 25 23 V
			← → 07/97; für Thailand		24.0125-0105.1	425105	Ø 288 25 23 V + S
			→		24.0325-0105.1	525105	Ø 288 25 23 V
			→		24.0110-0210.1	410210	Ø 245 10 8 - LG / - ABS Ring
			→		24.0110-0210.1	410210	Ø 245 10 8 - LG / - ABS Ring
2.4 quattro	121	03/97→11/00	← 08/97→		24.0125-0105.1	425105	Ø 288 25 23 V + S
			→		24.0325-0105.1	525105	Ø 288 25 23 V
			→		24.0110-0224.1	410224	Ø 245 10 8
			→		24.0310-0224.1	510224	Ø 245 10 8
↓							









	kw			 	! #		
<b>AUDI - A4 (8D2, B5) 11/94→12/01</b>							
<b>Bremsscheibe</b>							
2.5 TDI quattro	110	09/97→11/00	←	11/97→		24.0125-0105.1 425105	Ø 288 25 23 V + S
			→	11/97→		24.0325-0105.1 525105	Ø 288 25 23 V
2.8 quattro	128	01/95→07/97	←	→ 07/96		24.0125-0105.1 425105	Ø 288 25 23 V + S
			→	→ 07/96		24.0325-0105.1 525105	Ø 288 25 23 V
			→	→ 07/96		24.0110-0224.1 410224	Ø 245 10 8
2.8 quattro	142	10/96→08/01	←	→ 04/01		24.0310-0224.1 510224	Ø 245 10 8
			→	→ 04/01		24.0125-0105.1 425105	Ø 288 25 23 V + S
			→	→ 04/01		24.0325-0105.1 525105	Ø 288 25 23 V
S4 quattro	195	09/97→09/01	←	10/97→ 04/01		24.0110-0224.1 410224	Ø 245 10 8
			→	→ 04/01		24.0310-0224.1 510224	Ø 245 10 8
			→	10/97→ 04/01		24.0125-0105.1 425105	Ø 288 25 23 V + S
						24.0330-0113.1 530113	Ø 320 30 28 V
						24.0122-0221.1 422221	Ø 256 22 20 V
<b>AUDI - A4 (8E2, B6) 11/00→12/05</b>							
<b>Bremsbelagsatz, Scheibenbremse</b>							
1.6	75	11/00→12/04	←	12/00→; +PR 1LZ		13.0460-2837.2 602837	TRW 21945 19,6 + WK
1.8 T	110	11/00→07/02				13.0470-2837.2 LD2837	TRW 21945 19,6 + WK Ceramic
1.8 T quattro	110	11/00→07/02					
1.9 TDI	96	11/00→12/04	←	12/00→; +PR 1LB;1LE;1LF;1LT		13.0460-7110.2 607110	ATE 20676 19,8 + WK
2.0	96	11/00→12/04				13.0470-7110.2 LD7110	ATE 20676 19,8 + WK Ceramic
2.5 TDI quattro	132	11/00→12/04	←	12/00→; +PR 1LA;1LC		13.0460-7201.2 607201	ATE 23763 20,3 + WK
			→	8E-5-400001→; +PR 1KW		13.0470-7201.2 LD7201	ATE 23763 20,3 + WK Ceramic
			→	8E-5-400001→; +PR 1KW		13.0460-2749.2 602749	TRW 24483 16,9 - WE / - WK + Zub
						13.0460-2880.2 602880	TRW 23914 17,1 + WE / - WK + Zub
						13.0470-2749.2 LD2749	TRW 24483 16,9 - WE / - WK + Zub Ceramic
						13.0470-2880.2 LD2880	TRW 23914 17,1 + WE / - WK + Zub Ceramic
			→	12/00→; → 8E-4-180000; +PR 1KD		13.0460-2787.2 602787	TRW 23554 17,3 - WK / - WE
			→	12/00→; → 8E-4-180000; +PR 1KP		13.0460-2860.2 602860	TRW 23554 16,4 - WK / + WE
						13.0470-2860.2 LD2860	TRW 23554 16,4 - WK / + WE Ceramic
			→	8E-4-180001→; +PR 1KD;1KP		13.0460-2886.2 602886	TRW 20961 16,0 - WK
						13.0460-2937.2 602937	TRW 20961 15,2 - WK + Zub
						13.0470-2886.2 LD2886	TRW 20961 16,0 - WK Ceramic
1.8 T	120	07/02→12/04	←	+PR 1LZ		13.0460-2837.2 602837	TRW 21945 19,6 + WK
1.8 T	125	07/01→12/04				13.0470-2837.2 LD2837	TRW 21945 19,6 + WK Ceramic
1.8 T	140	11/02→12/04					
1.8 T quattro	120	07/02→12/04	←	+PR 1LB;1LE;1LF;1LT		13.0460-7110.2 607110	ATE 20676 19,8 + WK
1.8 T quattro	125	07/01→12/04				13.0470-7110.2 LD7110	ATE 20676 19,8 + WK Ceramic
1.8 T quattro	140	11/02→12/04					
1.9 TDI	74	05/01→12/04	←	+PR 1LA;1LC		13.0460-7201.2 607201	ATE 23763 20,3 + WK
1.9 TDI quattro	96	11/01→12/04				13.0470-7201.2 LD7201	ATE 23763 20,3 + WK Ceramic
2.0 FSI	110	07/02→12/04	→	8E-5-400001→; +PR 1KW		13.0460-2749.2 602749	TRW 24483 16,9 - WE / - WK + Zub
2.4	120	09/01→12/04					
2.4	125	09/01→12/04					
2.5 TDI	114	08/01→07/02				13.0460-2880.2 602880	TRW 23914 17,1 + WE / - WK + Zub
2.5 TDI	120	07/02→12/04				13.0470-2749.2 LD2749	TRW 24483 16,9 - WE / - WK + Zub Ceramic
						13.0470-2880.2 LD2880	TRW 23914 17,1 + WE / - WK + Zub Ceramic
			→	→ 8E-4-180000; +PR 1KD		13.0460-2787.2 602787	TRW 23554 17,3 - WK / - WE
			→	→ 8E-4-180000; +PR 1KP		13.0460-2860.2 602860	TRW 23554 16,4 - WK / + WE
						13.0470-2860.2 LD2860	TRW 23554 16,4 - WK / + WE Ceramic
			→	8E-4-180001→; +PR 1KD;1KP		13.0460-2886.2 602886	TRW 20961 16,0 - WK
						13.0460-2937.2 602937	TRW 20961 15,2 - WK + Zub
						13.0470-2886.2 LD2886	TRW 20961 16,0 - WK Ceramic
1.9 TDI	85	06/04→12/04	←	+PR 1LZ		13.0460-2837.2 602837	TRW 21945 19,6 + WK
						13.0470-2837.2 LD2837	TRW 21945 19,6 + WK Ceramic
			←	+PR 1LB;1LE;1LF;1LT		13.0460-7110.2 607110	ATE 20676 19,8 + WK











	kw			 	! #		
<b>AUDI - A4 (8E2, B6) 11/00→12/05</b>							
<b>Bremsbelagsatz, Scheibenbremse</b>							
1.9 TDI	85	06/04→12/04	←	+PR 1LB;1LE;1LF;1LT	13.0470-7110.2	LD7110	ATE 20676 19,8 + WK Ceramic
			←	+PR 1LA;1LC	13.0460-7201.2	607201	ATE 23763 20,3 + WK
					13.0470-7201.2	LD7201	ATE 23763 20,3 + WK Ceramic
			→	8E-5-400001→; +PR 1KW	13.0460-2749.2	602749	TRW 24483 16,9 - WE / - WK + Zub
					13.0460-2880.2	602880	TRW 23914 17,1 + WE / - WK + Zub
				13.0470-2749.2	LD2749	TRW 24483 16,9 - WE / - WK + Zub Ceramic	
				13.0470-2880.2	LD2880	TRW 23914 17,1 + WE / - WK + Zub Ceramic	
			→	+PR 1KD;1KP	13.0460-2886.2	602886	TRW 20961 16,0 - WK
					13.0460-2937.2	602937	TRW 20961 15,2 - WK + Zub
					13.0470-2886.2	LD2886	TRW 20961 16,0 - WK Ceramic
3.0 3.0 quattro	160 160	04/01→12/04 04/01→12/04	←	+PR 1LZ	13.0460-2837.2	602837	TRW 21945 19,6 + WK
					13.0470-2837.2	LD2837	TRW 21945 19,6 + WK Ceramic
			←	+PR 1LB;1LE;1LF;1LT	13.0460-7110.2	607110	ATE 20676 19,8 + WK
					13.0470-7110.2	LD7110	ATE 20676 19,8 + WK Ceramic
			←	+PR 1LA;1LC	13.0460-7201.2	607201	ATE 23763 20,3 + WK
		13.0470-7201.2	LD7201	ATE 23763 20,3 + WK Ceramic			
			→	8E-5-400001→; +PR 1KW	13.0460-2749.2	602749	TRW 24483 16,9 - WE / - WK + Zub
					13.0460-2880.2	602880	TRW 23914 17,1 + WE / - WK + Zub
					13.0470-2749.2	LD2749	TRW 24483 16,9 - WE / - WK + Zub Ceramic
					13.0470-2880.2	LD2880	TRW 23914 17,1 + WE / - WK + Zub Ceramic
			→	→ 8E-7-300000; +PR 1KD;1KP	13.0460-2886.2	602886	TRW 20961 16,0 - WK
					13.0460-2937.2	602937	TRW 20961 15,2 - WK + Zub
					13.0470-2886.2	LD2886	TRW 20961 16,0 - WK Ceramic
3.0 3.0 quattro	162 162	11/00→12/04 11/00→12/04	←	12/00→; +PR 1LZ	13.0460-2837.2	602837	TRW 21945 19,6 + WK
					13.0470-2837.2	LD2837	TRW 21945 19,6 + WK Ceramic
			←	12/00→; +PR 1LB;1LE;1LF;1LT	13.0460-7110.2	607110	ATE 20676 19,8 + WK
					13.0470-7110.2	LD7110	ATE 20676 19,8 + WK Ceramic
			←	12/00→; +PR 1LA;1LC	13.0460-7201.2	607201	ATE 23763 20,3 + WK
		13.0470-7201.2	LD7201	ATE 23763 20,3 + WK Ceramic			
			→	8E-5-400001→; +PR 1KW	13.0460-2749.2	602749	TRW 24483 16,9 - WE / - WK + Zub
					13.0460-2880.2	602880	TRW 23914 17,1 + WE / - WK + Zub
					13.0470-2749.2	LD2749	TRW 24483 16,9 - WE / - WK + Zub Ceramic
					13.0470-2880.2	LD2880	TRW 23914 17,1 + WE / - WK + Zub Ceramic
			→	12/00→; → 8E-7-300000; +PR 1KD;1KP	13.0460-2886.2	602886	TRW 20961 16,0 - WK
					13.0460-2937.2	602937	TRW 20961 15,2 - WK + Zub
					13.0470-2886.2	LD2886	TRW 20961 16,0 - WK Ceramic
S4 quattro	253	03/03→12/04	←	+PR 1LJ	13.0460-7201.2	607201	ATE 23763 20,3 + WK
			→		13.0460-2888.2	602888	TRW 23326 17,4 + WE / - WK
					13.0470-2888.2	LD2888	TRW 23326 17,4 + WE / - WK Ceramic
<b>Zubehörsatz, Scheibenbremsbelag</b>							
1.6	75	11/00→12/04	→	12/00→; → 8E-4-180000; +PR 1KP	13.0460-0072.2	610072	TRW
1.8 T	110	11/00→07/02					
1.8 T quattro	110	11/00→07/02	→	12/00→; → 8E-4-180000; +PR 1KD	13.0460-0072.2	610072	TRW
1.9 TDI	96	11/00→12/04	→	8E-5-400001→; +PR 1KW	13.0460-0259.2	610259	
2.0	96	11/00→12/04					
2.5 TDI quattro	132	11/00→12/04					
1.8 T	120	07/02→12/04	→	→ 8E-4-180000; +PR 1KP	13.0460-0072.2	610072	TRW
1.8 T	125	07/01→12/04					
1.8 T	140	11/02→12/04	→	→ 8E-4-180000; +PR 1KD	13.0460-0072.2	610072	TRW
1.8 T quattro	120	07/02→12/04	→	8E-5-400001→; +PR 1KW	13.0460-0259.2	610259	
1.8 T quattro	125	07/01→12/04					
1.8 T quattro	140	11/02→12/04					
1.9 TDI	74	05/01→12/04					
1.9 TDI quattro	96	11/01→12/04					
2.0 FSI	110	07/02→12/04					
↓							







	kw			 	! #		
<b>AUDI - A4 (8E2, B6) 11/00→12/05</b>							
<b>Zubehörsatz, Scheibenbremsbelag</b>							
2.4	120	09/01→12/04	➔	→ 8E-4-180000; +PR 1KP		13.0460-0072.2 610072	TRW
2.4	125	09/01→12/04	➔	→ 8E-4-180000; +PR 1KD		13.0460-0072.2 610072	TRW
2.5 TDI	114	08/01→07/02	➔	→ 8E-4-180000; +PR 1KD		13.0460-0072.2 610072	TRW
2.5 TDI	120	07/02→12/04	➔	8E-5-400001→; +PR 1KW		13.0460-0259.2 610259	
1.9 TDI	85	06/04→12/04	➔	8E-5-400001→; +PR 1KW		13.0460-0259.2 610259	
3.0	160	04/01→12/04					
3.0	162	11/00→12/04					
3.0 quattro	160	04/01→12/04					
3.0 quattro	162	11/00→12/04					
<b> Bremsscheibe</b>							
1.6	75	11/00→12/04	←	12/00→; +PR 1LZ		24.0122-0152.1 422152	Ø 280 22 20 V + S
1.8 T	110	11/00→07/02				24.0322-0152.1 522152	Ø 280 22 20 V + S
1.8 T quattro	110	11/00→07/02				24.0322-0152.1 522152	Ø 280 22 20 V + S
1.9 TDI	96	11/00→12/04	←	12/00→; +PR 1LB;1LE		24.0125-0105.1 425105	Ø 288 25 23 V + S
2.0	96	11/00→12/04				24.0325-0105.1 525105	Ø 288 25 23 V
2.5 TDI quattro	132	11/00→12/04	←	12/00→; +PR 1LF;1LT		24.0125-0137.1 425137	Ø 312 25 23 V + S
						24.0325-0137.1 525137	Ø 312 25 23 V
			←	12/00→; +PR 1LA		24.0130-0113.1 430113	Ø 320 30 28 V + S
						24.0330-0113.1 530113	Ø 320 30 28 V
			←	12/00→; +PR 1LC		24.0130-0185.1 430185	Ø 320 30 28 V•
			➔	12/00→; +PR 1KD		24.0110-0261.1 410261	Ø 245 10 8 + S
						24.0310-0261.1 510261	Ø 245 10 8
			➔	12/00→; +PR 1KP		24.0112-0148.1 412148	Ø 255 12 10
						24.0312-0148.1 512148	Ø 255 12 10
			➔	8E-5-400001→; +PR 1KW		24.0112-0166.1 412166	Ø 288 12 10
						24.0312-0166.1 512166	Ø 288 12 10
1.8 T	120	07/02→12/04	←	+PR 1LZ		24.0122-0152.1 422152	Ø 280 22 20 V + S
1.8 T	125	07/01→12/04				24.0322-0152.1 522152	Ø 280 22 20 V + S
1.8 T	140	11/02→12/04				24.0322-0152.1 522152	Ø 280 22 20 V + S
1.8 T quattro	120	07/02→12/04	←	+PR 1LB;1LE		24.0125-0105.1 425105	Ø 288 25 23 V + S
1.8 T quattro	125	07/01→12/04				24.0325-0105.1 525105	Ø 288 25 23 V
1.8 T quattro	140	11/02→12/04				24.0325-0105.1 525105	Ø 288 25 23 V
1.9 TDI	74	05/01→12/04	←	+PR 1LF;1LT		24.0125-0137.1 425137	Ø 312 25 23 V + S
1.9 TDI	85	06/04→12/04				24.0325-0137.1 525137	Ø 312 25 23 V
1.9 TDI quattro	96	11/01→12/04	←	+PR 1LA		24.0130-0113.1 430113	Ø 320 30 28 V + S
2.0 FSI	110	07/02→12/04				24.0330-0113.1 530113	Ø 320 30 28 V
2.4	120	09/01→12/04	←	+PR 1LC		24.0130-0185.1 430185	Ø 320 30 28 V•
2.4	125	09/01→12/04	←	+PR 1LC		24.0130-0185.1 430185	Ø 320 30 28 V•
2.5 TDI	114	08/01→07/02	➔	+PR 1KD		24.0110-0261.1 410261	Ø 245 10 8 + S
2.5 TDI	120	07/02→12/04	➔	+PR 1KP		24.0310-0261.1 510261	Ø 245 10 8
			➔	+PR 1KP		24.0112-0148.1 412148	Ø 255 12 10
						24.0312-0148.1 512148	Ø 255 12 10
			➔	8E-5-400001→; +PR 1KW		24.0112-0166.1 412166	Ø 288 12 10
						24.0312-0166.1 512166	Ø 288 12 10
3.0	160	04/01→12/04	←	+PR 1LZ		24.0122-0152.1 422152	Ø 280 22 20 V + S
3.0 quattro	160	04/01→12/04	←	+PR 1LB;1LE		24.0322-0152.1 522152	Ø 280 22 20 V + S
			←	+PR 1LB;1LE		24.0125-0105.1 425105	Ø 288 25 23 V + S
			←	+PR 1LF;1LT		24.0125-0137.1 425137	Ø 312 25 23 V + S
						24.0325-0137.1 525137	Ø 312 25 23 V
			←	+PR 1LA		24.0130-0113.1 430113	Ø 320 30 28 V + S
						24.0330-0113.1 530113	Ø 320 30 28 V
			←	+PR 1LC		24.0130-0185.1 430185	Ø 320 30 28 V•
			➔	+PR 1KD,1KP		24.0112-0148.1 412148	Ø 255 12 10
						24.0312-0148.1 512148	Ø 255 12 10
			➔	8E-5-400001→; +PR 1KW		24.0112-0166.1 412166	Ø 288 12 10
						24.0312-0166.1 512166	Ø 288 12 10
3.0	162	11/00→12/04	←	12/00→; +PR 1LZ		24.0122-0152.1 422152	Ø 280 22 20 V + S
3.0 quattro	162	11/00→12/04	←	12/00→; +PR 1LB;1LE		24.0322-0152.1 522152	Ø 280 22 20 V + S
			←	12/00→; +PR 1LB;1LE		24.0125-0105.1 425105	Ø 288 25 23 V + S
			←	12/00→; +PR 1LF;1LT		24.0125-0137.1 425137	Ø 312 25 23 V + S
						24.0325-0137.1 525137	Ø 312 25 23 V
			←	12/00→; +PR 1LA		24.0130-0113.1 430113	Ø 320 30 28 V + S
						24.0330-0113.1 530113	Ø 320 30 28 V
			←	12/00→; +PR 1LC		24.0130-0185.1 430185	Ø 320 30 28 V•
			➔	12/00→; +PR 1KD,1KP		24.0112-0148.1 412148	Ø 255 12 10







	kw			 	! #		
<b>AUDI - A4 (8E2, B6) 11/00→12/05</b>							
 <b>Bremsscheibe</b>							
3.0 3.0 quattro	162 162	11/00→12/04 11/00→12/04	➡	12/00→; +PR 1KD,1KP		24.0312-0148.1 512148	Ø 255 12 10
			➡	8E-5-400001→; +PR 1KW		24.0112-0166.1 412166	Ø 288 12 10
						24.0312-0166.1 512166	Ø 288 12 10
S4 quattro	253	03/03→12/04	←	+PR 1LJ		24.0130-0119.1 430119	Ø 345 30 28 V
			➡			24.0122-0220.1 422220	Ø 300 22 20 V
<b>AUDI - A4 (8EC, B7) 11/04→06/08</b>							
 <b>Bremsbelagsatz, Scheibenbremse</b>							
1.6 1.8 T 1.8 T quattro 2.0 2.5 TDI	75 120 120 96 120	11/04→06/08 11/04→06/08 11/04→06/08 11/04→05/06	←	+PR 1LZ		13.0460-2837.2 602837	TRW 21945 19,6 + WK
						13.0470-2837.2 LD2837	TRW 21945 19,6 + WK Ceramic
			←	+PR 1LB;1LE;1LF;1LT		13.0460-7110.2 607110	ATE 20676 19,8 + WK
						13.0470-7110.2 LD7110	ATE 20676 19,8 + WK Ceramic
			←	+PR 1LA;1LC		13.0460-7201.2 607201	ATE 23763 20,3 + WK
						13.0470-7201.2 LD7201	ATE 23763 20,3 + WK Ceramic
			➡	8E-5-400001→; +PR 1KW		13.0460-2749.2 602749	TRW 24483 16,9 - WE / - WK + Zub
						13.0460-2880.2 602880	TRW 23914 17,1 + WE / - WK + Zub
						13.0470-2749.2 LD2749	TRW 24483 16,9 - WE / - WK + Zub Ceramic
						13.0470-2880.2 LD2880	TRW 23914 17,1 + WE / - WK + Zub Ceramic
			➡	→ 8E-4-180000; +PR 1KD		13.0460-2787.2 602787	TRW 23554 17,3 - WK / - WE
			➡	→ 8E-4-180000; +PR 1KP		13.0460-2860.2 602860	TRW 23554 16,4 - WK / + WE
						13.0470-2860.2 LD2860	TRW 23554 16,4 - WK / + WE Ceramic
			➡	8E-4-180001→; +PR 1KD;1KP		13.0460-2886.2 602886	TRW 20961 16,0 - WK
						13.0460-2937.2 602937	TRW 20961 15,2 - WK + Zub
						13.0470-2886.2 LD2886	TRW 20961 16,0 - WK Ceramic
1.9 TDI 2.0 TDI 2.0 TDI 16V	85 103 103	11/04→06/08 11/04→06/08 11/04→06/08	←	+PR 1LZ		13.0460-2837.2 602837	TRW 21945 19,6 + WK
						13.0470-2837.2 LD2837	TRW 21945 19,6 + WK Ceramic
			←	+PR 1LB;1LE;1LF;1LT		13.0460-7110.2 607110	ATE 20676 19,8 + WK
						13.0470-7110.2 LD7110	ATE 20676 19,8 + WK Ceramic
			←	+PR 1LA;1LC		13.0460-7201.2 607201	ATE 23763 20,3 + WK
						13.0470-7201.2 LD7201	ATE 23763 20,3 + WK Ceramic
			➡	8E-5-400001→; +PR 1KW		13.0460-2749.2 602749	TRW 24483 16,9 - WE / - WK + Zub
						13.0460-2880.2 602880	TRW 23914 17,1 + WE / - WK + Zub
						13.0470-2749.2 LD2749	TRW 24483 16,9 - WE / - WK + Zub Ceramic
						13.0470-2880.2 LD2880	TRW 23914 17,1 + WE / - WK + Zub Ceramic
			➡	+PR 1KD;1KP		13.0460-2886.2 602886	TRW 20961 16,0 - WK
						13.0460-2937.2 602937	TRW 20961 15,2 - WK + Zub
						13.0470-2886.2 LD2886	TRW 20961 16,0 - WK Ceramic
2.0 TDI 2.0 TDI 3.0 TDI quattro 3.2 FSI 3.2 FSI quattro	89 100 150 188 188	09/05→09/06 11/04→06/08 11/04→06/08 01/05→06/08 01/05→06/08	←	+PR 1LZ		13.0460-2837.2 602837	TRW 21945 19,6 + WK
						13.0470-2837.2 LD2837	TRW 21945 19,6 + WK Ceramic
			←	+PR 1LB;1LE;1LF;1LT		13.0460-7110.2 607110	ATE 20676 19,8 + WK
						13.0470-7110.2 LD7110	ATE 20676 19,8 + WK Ceramic
			←	+PR 1LA;1LC		13.0460-7201.2 607201	ATE 23763 20,3 + WK
						13.0470-7201.2 LD7201	ATE 23763 20,3 + WK Ceramic
			➡	8E-5-400001→; +PR 1KW		13.0460-2749.2 602749	TRW 24483 16,9 - WE / - WK + Zub
						13.0460-2880.2 602880	TRW 23914 17,1 + WE / - WK + Zub
						13.0470-2749.2 LD2749	TRW 24483 16,9 - WE / - WK + Zub Ceramic
						13.0470-2880.2 LD2880	TRW 23914 17,1 + WE / - WK + Zub Ceramic
2.0 TDI	93	11/05→11/06	←	06/06→; +PR 1LZ		13.0460-2837.2 602837	TRW 21945 19,6 + WK
						13.0470-2837.2 LD2837	TRW 21945 19,6 + WK Ceramic
			←	06/06→; +PR 1LB;1LE;1LF;1LT		13.0460-7110.2 607110	ATE 20676 19,8 + WK
						13.0470-7110.2 LD7110	ATE 20676 19,8 + WK Ceramic
↓							

	kw			 	! #		
<b>AUDI - A4 (8EC, B7) 11/04→06/08</b>							
<b> Bremsbelagsatz, Scheibenbremse</b>							
2.0 TDI	93	11/05→11/06	←	06/06→; +PR 1LA;1LC	13.0460-7201.2 607201	ATE 23763 20,3 + WK	
					13.0470-7201.2 LD7201	ATE 23763 20,3 + WK Ceramic	
			→	06/06→; +PR 1KW	13.0460-2749.2 602749	TRW 24483 16,9 - WE / - WK + Zub	
					13.0460-2880.2 602880	TRW 23914 17,1 + WE / - WK + Zub	
				13.0470-2749.2 LD2749	TRW 24483 16,9 - WE / - WK + Zub Ceramic		
				13.0470-2880.2 LD2880	TRW 23914 17,1 + WE / - WK + Zub Ceramic		
			→	06/06→; +PR 1KD;1KP	13.0460-2886.2 602886	TRW 20961 16,0 - WK	
					13.0460-2937.2 602937	TRW 20961 15,2 - WK + Zub	
					13.0470-2886.2 LD2886	TRW 20961 16,0 - WK Ceramic	
2.0 TDI 2.0 TDI 2.0 TDI quattro 2.0 TDI quattro 2.0 TDI quattro	120 125 103 120 125	06/06→06/08 06/06→06/08 01/06→06/08 06/06→06/08 06/06→06/08	←	+PR 1LZ	13.0460-2837.2 602837	TRW 21945 19,6 + WK	
					13.0470-2837.2 LD2837	TRW 21945 19,6 + WK Ceramic	
			←	+PR 1LB;1LE;1LF;1LT	13.0460-7110.2 607110	ATE 20676 19,8 + WK	
					13.0470-7110.2 LD7110	ATE 20676 19,8 + WK Ceramic	
			←	+PR 1LA;1LC	13.0460-7201.2 607201	ATE 23763 20,3 + WK	
					13.0470-7201.2 LD7201	ATE 23763 20,3 + WK Ceramic	
			→	+PR 1KW	13.0460-2749.2 602749	TRW 24483 16,9 - WE / - WK + Zub	
				13.0460-2880.2 602880	TRW 23914 17,1 + WE / - WK + Zub		
				13.0470-2749.2 LD2749	TRW 24483 16,9 - WE / - WK + Zub Ceramic		
				13.0470-2880.2 LD2880	TRW 23914 17,1 + WE / - WK + Zub Ceramic		
			→	+PR 1KD;1KP	13.0460-2886.2 602886	TRW 20961 16,0 - WK	
					13.0460-2937.2 602937	TRW 20961 15,2 - WK + Zub	
					13.0470-2886.2 LD2886	TRW 20961 16,0 - WK Ceramic	
2.0 TFSI 2.0 TFSI 2.0 TFSI 2.0 TFSI quattro 2.0 TFSI quattro	125 147 162 147 162	10/06→06/08 11/04→06/08 06/05→06/08 11/04→06/08 06/05→06/08	←	+PR 1LZ	13.0460-2837.2 602837	TRW 21945 19,6 + WK	
					13.0470-2837.2 LD2837	TRW 21945 19,6 + WK Ceramic	
			←	+PR 1LB;1LE;1LF;1LT	13.0460-7110.2 607110	ATE 20676 19,8 + WK	
					13.0470-7110.2 LD7110	ATE 20676 19,8 + WK Ceramic	
			←	+PR 1LA;1LC	13.0460-7201.2 607201	ATE 23763 20,3 + WK	
					13.0470-7201.2 LD7201	ATE 23763 20,3 + WK Ceramic	
			→	8E-5-400001→; +PR 1KW	13.0460-2749.2 602749	TRW 24483 16,9 - WE / - WK + Zub	
				13.0460-2880.2 602880	TRW 23914 17,1 + WE / - WK + Zub		
				13.0470-2749.2 LD2749	TRW 24483 16,9 - WE / - WK + Zub Ceramic		
				13.0470-2880.2 LD2880	TRW 23914 17,1 + WE / - WK + Zub Ceramic		
			→	+PR 1KD;1KP	13.0460-2886.2 602886	TRW 20961 16,0 - WK	
					13.0460-2937.2 602937	TRW 20961 15,2 - WK + Zub	
					13.0470-2886.2 LD2886	TRW 20961 16,0 - WK Ceramic	
2.7 TDI 2.7 TDI 3.0 TDI quattro	120 132 171	11/05→06/08 01/06→06/08 01/06→06/08	←	+PR 1LZ	13.0460-2837.2 602837	TRW 21945 19,6 + WK	
					13.0470-2837.2 LD2837	TRW 21945 19,6 + WK Ceramic	
			←	+PR 1LB;1LE;1LF;1LT	13.0460-7110.2 607110	ATE 20676 19,8 + WK	
					13.0470-7110.2 LD7110	ATE 20676 19,8 + WK Ceramic	
			←	+PR 1LA;1LC	13.0460-7201.2 607201	ATE 23763 20,3 + WK	
			13.0470-7201.2 LD7201	ATE 23763 20,3 + WK Ceramic			
			→	+PR 1KW	13.0460-2749.2 602749	TRW 24483 16,9 - WE / - WK + Zub	
					13.0460-2880.2 602880	TRW 23914 17,1 + WE / - WK + Zub	
					13.0470-2749.2 LD2749	TRW 24483 16,9 - WE / - WK + Zub Ceramic	
					13.0470-2880.2 LD2880	TRW 23914 17,1 + WE / - WK + Zub Ceramic	
3.0 3.0 quattro	160 160	11/04→05/06 11/04→07/06	←	+PR 1LZ	13.0460-2837.2 602837	TRW 21945 19,6 + WK	
					13.0470-2837.2 LD2837	TRW 21945 19,6 + WK Ceramic	
			←	+PR 1LB;1LE;1LF;1LT	13.0460-7110.2 607110	ATE 20676 19,8 + WK	
				13.0470-7110.2 LD7110	ATE 20676 19,8 + WK Ceramic		
↓							











	kw			 	! #		
<b>AUDI - A4 (8EC, B7) 11/04→06/08</b>							
<b> Bremsbelagsatz, Scheibenbremse</b>							
3.0 3.0 quattro	160	11/04→05/06	←	+PR 1LA;1LC		<b>13.0460-7201.2 607201</b>	ATE 23763 20,3 + WK
	160	11/04→07/06				<b>13.0470-7201.2 LD7201</b>	ATE 23763 20,3 + WK Ceramic
			→	8E-5-400001→; +PR 1KW		<b>13.0460-2749.2 602749</b>	TRW 24483 16,9 - WE / - WK + Zub
						<b>13.0460-2880.2 602880</b>	TRW 23914 17,1 + WE / - WK + Zub
						<b>13.0470-2749.2 LD2749</b>	TRW 24483 16,9 - WE / - WK + Zub Ceramic
			→	→ 8E-7-300000; +PR 1KD;1KP		<b>13.0470-2880.2 LD2880</b>	TRW 23914 17,1 + WE / - WK + Zub Ceramic
			→			<b>13.0460-2886.2 602886</b>	TRW 20961 16,0 - WK
						<b>13.0460-2937.2 602937</b>	TRW 20961 15,2 - WK + Zub
						<b>13.0470-2886.2 LD2886</b>	TRW 20961 16,0 - WK Ceramic
S4 quattro	253	11/04→06/08	←	+PR 1LJ		<b>13.0460-7201.2 607201</b>	ATE 23763 20,3 + WK
			→			<b>13.0460-2888.2 602888</b>	TRW 23326 17,4 + WE / - WK
						<b>13.0470-2888.2 LD2888</b>	TRW 23326 17,4 + WE / - WK Ceramic
			→	01/05→		<b>13.0460-2889.2 602889</b>	TRW 23326 17,4 + WE / - WK
<b>Zubehörsatz, Scheibenbremsbelag</b>							
1.6	75	11/04→06/08	→	→ 8E-4-180000; +PR 1KP		<b>13.0460-0072.2 610072</b>	TRW
1.8 T	120	11/04→06/08					
1.8 T quattro	120	11/04→06/08	→	→ 8E-4-180000; +PR 1KD		<b>13.0460-0072.2 610072</b>	TRW
2.0	96	11/04→06/08					
2.5 TDI	120	11/04→05/06	→	8E-5-400001→; +PR 1KW		<b>13.0460-0259.2 610259</b>	
1.9 TDI	85	11/04→06/08	→	8E-5-400001→; +PR 1KW		<b>13.0460-0259.2 610259</b>	
2.0 TDI	89	09/05→09/06					
2.0 TDI	100	11/04→06/08					
2.0 TDI	103	11/04→06/08					
2.0 TDI 16V	103	11/04→06/08					
2.0 TFSI	125	10/06→06/08					
2.0 TFSI	147	11/04→06/08					
2.0 TFSI	162	06/05→06/08					
2.0 TFSI quattro	147	11/04→06/08					
2.0 TFSI quattro	162	06/05→06/08					
3.0	160	11/04→05/06					
3.0 quattro	160	11/04→07/06					
3.0 TDI quattro	150	11/04→06/08					
3.2 FSI	188	01/05→06/08					
3.2 FSI quattro	188	01/05→06/08					
2.0 TDI	93	11/05→11/06	→	06/06→; +PR 1KW		<b>13.0460-0259.2 610259</b>	
2.0 TDI	120	06/06→06/08	→	+PR 1KW		<b>13.0460-0259.2 610259</b>	
2.0 TDI	125	06/06→06/08					
2.0 TDI quattro	103	01/06→06/08					
2.0 TDI quattro	120	06/06→06/08					
2.0 TDI quattro	125	06/06→06/08					
2.7 TDI	120	11/05→06/08					
2.7 TDI	132	01/06→06/08					
3.0 TDI quattro	171	01/06→06/08					
RS4 quattro	309	09/05→06/08	→	11/05→		<b>13.0460-0023.2 610023</b>	
S4 quattro	253	11/04→06/08	→	01/05→		<b>13.0460-0023.2 610023</b>	
<b> Bremsscheibe</b>							
1.6	75	11/04→06/08	←	+PR 1LZ		<b>24.0122-0152.1 422152</b>	Ø 280 22 20 V + S
1.8 T	120	11/04→06/08				<b>24.0322-0152.1 522152</b>	Ø 280 22 20 V + S
1.8 T quattro	120	11/04→06/08					
1.9 TDI	85	11/04→06/08	←	+PR 1LB;1LE		<b>24.0125-0105.1 425105</b>	Ø 288 25 23 V + S
2.0	96	11/04→06/08				<b>24.0325-0105.1 525105</b>	Ø 288 25 23 V
2.0 TDI	89	09/05→09/06					
2.0 TDI	100	11/04→06/08	←	+PR 1LF;1LT		<b>24.0125-0137.1 425137</b>	Ø 312 25 23 V + S
2.0 TDI	103	11/04→06/08				<b>24.0325-0137.1 525137</b>	Ø 312 25 23 V
2.0 TDI 16V	103	11/04→06/08	←	+PR 1LA		<b>24.0130-0113.1 430113</b>	Ø 320 30 28 V + S
2.0 TFSI	125	10/06→06/08				<b>24.0330-0113.1 530113</b>	Ø 320 30 28 V
2.0 TFSI	147	11/04→06/08					
2.0 TFSI quattro	147	11/04→06/08	←	+PR 1LC		<b>24.0130-0185.1 430185</b>	Ø 320 30 28 V*
2.5 TDI	120	11/04→05/06	→	+PR 1KD		<b>24.0110-0261.1 410261</b>	Ø 245 10 8 + S
			→			<b>24.0310-0261.1 510261</b>	Ø 245 10 8
			→	+PR 1KP		<b>24.0112-0148.1 412148</b>	Ø 255 12 10
						<b>24.0312-0148.1 512148</b>	Ø 255 12 10
			→	8E-5-400001→; +PR 1KW		<b>24.0112-0166.1 412166</b>	Ø 288 12 10
						<b>24.0312-0166.1 512166</b>	Ø 288 12 10
2.0 TDI	93	11/05→11/06	←	06/06→; +PR 1LZ		<b>24.0122-0152.1 422152</b>	Ø 280 22 20 V + S
↓							













	kw			 	! #		
<b>AUDI - A4 (8EC, B7) 11/04→06/08</b>							
<b>Bremsscheibe</b>							
2.0 TDI	93	11/05→11/06	←	06/06→; +PR 1LZ	24.0322-0152.1	522152	Ø 280 22 20 V + S
			←	06/06→; +PR 1LB;1LE	24.0125-0105.1	425105	Ø 288 25 23 V + S
					24.0325-0105.1	525105	Ø 288 25 23 V
			←	06/06→; +PR 1LF;1LT	24.0125-0137.1	425137	Ø 312 25 23 V + S
					24.0325-0137.1	525137	Ø 312 25 23 V
			←	06/06→; +PR 1LA	24.0130-0113.1	430113	Ø 320 30 28 V + S
					24.0330-0113.1	530113	Ø 320 30 28 V
			←	06/06→; +PR 1LC	24.0130-0185.1	430185	Ø 320 30 28 V*
2.0 TDI 2.0 TDI 2.0 TDI quattro 2.0 TDI quattro 2.0 TDI quattro	120 125 103 120 125	06/06→06/08 06/06→06/08 01/06→06/08 06/06→06/08 06/06→06/08	←	+PR 1LZ	24.0122-0152.1	422152	Ø 280 22 20 V + S
					24.0322-0152.1	522152	Ø 280 22 20 V + S
			←	+PR 1LB;1LE	24.0125-0105.1	425105	Ø 288 25 23 V + S
					24.0325-0105.1	525105	Ø 288 25 23 V
			←	+PR 1LF;1LT	24.0125-0137.1	425137	Ø 312 25 23 V + S
					24.0325-0137.1	525137	Ø 312 25 23 V
			←	+PR 1LA	24.0130-0113.1	430113	Ø 320 30 28 V + S
					24.0330-0113.1	530113	Ø 320 30 28 V
2.0 TFSI 2.0 TFSI quattro 3.0 TDI quattro 3.2 FSI 3.2 FSI quattro	162 162 150 188 188	06/05→06/08 06/05→06/08 11/04→06/08 01/05→06/08 01/05→06/08	←	+PR 1LZ	24.0122-0152.1	422152	Ø 280 22 20 V + S
					24.0322-0152.1	522152	Ø 280 22 20 V + S
			←	+PR 1LB;1LE	24.0125-0105.1	425105	Ø 288 25 23 V + S
					24.0325-0105.1	525105	Ø 288 25 23 V
			←	+PR 1LF;1LT	24.0125-0137.1	425137	Ø 312 25 23 V + S
					24.0325-0137.1	525137	Ø 312 25 23 V
			←	+PR 1LA	24.0130-0113.1	430113	Ø 320 30 28 V + S
					24.0330-0113.1	530113	Ø 320 30 28 V
2.7 TDI 2.7 TDI	120 132	11/05→06/08 01/06→06/08	←	+PR 1LZ	24.0122-0152.1	422152	Ø 280 22 20 V + S
					24.0322-0152.1	522152	Ø 280 22 20 V + S
			←	+PR 1LB;1LE	24.0125-0105.1	425105	Ø 288 25 23 V + S
					24.0325-0105.1	525105	Ø 288 25 23 V
			←	+PR 1LF;1LT	24.0125-0137.1	425137	Ø 312 25 23 V + S
					24.0325-0137.1	525137	Ø 312 25 23 V
			←	+PR 1LA	24.0130-0113.1	430113	Ø 320 30 28 V + S
					24.0330-0113.1	530113	Ø 320 30 28 V
3.0 3.0 quattro	160 160	11/04→05/06 11/04→07/06	←	+PR 1LZ	24.0122-0152.1	422152	Ø 280 22 20 V + S
					24.0322-0152.1	522152	Ø 280 22 20 V + S
			←	+PR 1LB;1LE	24.0125-0105.1	425105	Ø 288 25 23 V + S
					24.0325-0105.1	525105	Ø 288 25 23 V
			←	+PR 1LF;1LT	24.0125-0137.1	425137	Ø 312 25 23 V + S
					24.0325-0137.1	525137	Ø 312 25 23 V
			←	+PR 1LA	24.0130-0113.1	430113	Ø 320 30 28 V + S
					24.0330-0113.1	530113	Ø 320 30 28 V







	kw			 	! #		
<b>AUDI - A4 (8EC, B7) 11/04→06/08</b>							
<b>Bremsscheibe</b>							
3.0	160	11/04→05/06	←	+PR 1LA		24.0330-0113.1 530113	Ø 320 30 28 V
3.0 quattro	160	11/04→07/06	←	+PR 1LC		24.0130-0185.1 430185	Ø 320 30 28 V*
			→	+PR 1KD,1KP		24.0112-0148.1 412148	Ø 255 12 10
			→	8E-5-400001→; +PR 1KW		24.0312-0148.1 512148	Ø 255 12 10
			→			24.0112-0166.1 412166	Ø 288 12 10
			→			24.0312-0166.1 512166	Ø 288 12 10
3.0 TDI quattro	171	01/06→06/08	←	+PR 1LZ		24.0122-0152.1 422152	Ø 280 22 20 V + S
			←	+PR 1LB;1LE		24.0322-0152.1 522152	Ø 280 22 20 V + S
			←	+PR 1LF;1LT		24.0125-0105.1 425105	Ø 288 25 23 V + S
			←			24.0125-0137.1 425137	Ø 312 25 23 V + S
			←			24.0325-0137.1 525137	Ø 312 25 23 V
			←	+PR 1LA		24.0130-0113.1 430113	Ø 320 30 28 V + S
			←			24.0330-0113.1 530113	Ø 320 30 28 V
			←	+PR 1LC		24.0130-0185.1 430185	Ø 320 30 28 V*
			→	+PR 1KW		24.0112-0166.1 412166	Ø 288 12 10
			→			24.0312-0166.1 512166	Ø 288 12 10
S4 quattro	253	11/04→06/08	←	+PR 1LJ		24.0130-0119.1 430119	Ø 345 30 28 V
			→			24.0122-0220.1 422220	Ø 300 22 20 V
<b>AUDI - A4 (8K2, B8) 08/07→12/15</b>							
<b>Bremsbelagsatz, Scheibenbremse</b>							
1.8 TFSI	88	01/08→12/15	←	+PR 1LA,1LB,1LD		13.0460-2746.2 602746	TRW 24408 19,2 + WK
1.8 TFSI	118	11/07→03/12				13.0460-2765.2 602765	TRW 24409 19,2 + WK + Zub
1.8 TFSI quattro	118	09/08→03/12				13.0470-2746.2 LD2746	TRW 24408 19,2 + WK + Zub Ceramic
2.0 TDI	88	06/08→12/15				13.0470-2765.2 LD2765	TRW 24409 19,2 + WK + Zub Ceramic
2.0 TDI	100	11/07→12/15					
2.0 TDI	105	11/07→12/15					
2.0 TDI	110	05/13→12/15					
2.0 TDI	120	08/08→12/15	←	+PR 1LT,1LY		13.0460-7256.2 607256	ATE 24705 19,8 + WK
2.0 TDI	125	01/08→03/12				13.0470-7256.2 LD7256	ATE 24705 19,8 + WK Ceramic
2.0 TDI	130	11/11→12/15					
2.0 TDI	140	09/13→12/15	→	+PR 1KW,2EH; + eFSB		13.0460-2747.2 602747	TRW 24606 17,4 - WE / - WK + Zub
2.0 TDI 16V	103	07/08→					
2.0 TDI quattro	105	11/08→12/15				13.0470-2747.2 LD2747	TRW 24606 17,4 - WE / - WK + Zub Ceramic
2.0 TDI quattro	110	05/13→12/15					
2.0 TDI quattro	125	01/08→03/12					
2.0 TDI quattro	130	11/11→12/15	→	+PR 1KP; + eFSB		13.0460-2748.2 602748	TRW 24606 17,4 - WE / - WK + Zub
2.0 TDI quattro	140	09/13→12/15					
2.0 TFSI	132	06/08→12/15				13.0470-2748.2 LD2748	TRW 24606 17,4 - WE / - WK + Zub Ceramic
2.0 TFSI	155	06/08→05/13					
2.0 TFSI	165	05/13→12/15					
2.0 TFSI flexible fuel	132	11/09→12/15					
2.0 TFSI flexible fuel quattro	132	11/09→12/15					
2.0 TFSI quattro	155	06/08→12/15					
2.0 TFSI quattro	162	05/13→12/15					
2.0 TFSI quattro	165	05/13→12/15					
2.7 TDI	120	11/07→03/12					
2.7 TDI	140	11/07→03/12					
3.0 TDI	150	11/11→12/15					
3.0 TDI quattro	155	06/08→05/10					
3.0 TDI quattro	176	11/07→03/12					
3.0 TDI quattro	180	11/11→12/15					
3.0 TFSI quattro	200	02/12→12/15					
3.2 FSI	195	09/08→03/12					
3.2 FSI quattro	195	11/07→03/12					
1.8 TFSI	125	11/11→12/15	←	01/12→; +PR 1LA,1LB,1LD		13.0460-2746.2 602746	TRW 24408 19,2 + WK
1.8 TFSI quattro	125	11/11→12/15				13.0460-2765.2 602765	TRW 24409 19,2 + WK + Zub
						13.0470-2746.2 LD2746	TRW 24408 19,2 + WK + Zub Ceramic
						13.0470-2765.2 LD2765	TRW 24409 19,2 + WK + Zub Ceramic
			←	01/12→; +PR 1LT,1LY		13.0460-7256.2 607256	ATE 24705 19,8 + WK
						13.0470-7256.2 LD7256	ATE 24705 19,8 + WK Ceramic
			→	01/12→; +PR 1KW,2EH; + eFSB		13.0460-2747.2 602747	TRW 24606 17,4 - WE / - WK + Zub
						13.0470-2747.2 LD2747	TRW 24606 17,4 - WE / - WK + Zub Ceramic
			→	01/12→; +PR 1KP; + eFSB		13.0460-2748.2 602748	TRW 24606 17,4 - WE / - WK + Zub



















	kw			 	! #					
<b>AUDI - A4 (8K2, B8) 08/07→12/15</b>										
<b> Bremsbelagsatz, Scheibenbremse</b>										
1.8 TFSI 1.8 TFSI quattro	125 125	11/11→12/15 11/11→12/15	➡	01/12→; +PR 1KP; + eFSB		13.0470-2748.2 LD2748	TRW 24606 17,4 - WE / - WK + Zub Ceramic			
S4 quattro	245	11/08→12/15	←	07/11→; +PR 1LJ,1ZT		13.0460-2746.2 602746	TRW 24408 19,2 + WK			
						13.0460-2765.2 602765	TRW 24409 19,2 + WK + Zub			
			➡	+PR 1KE; + eFSB		13.0460-2748.2 602748	TRW 24606 17,4 - WE / - WK + Zub			
						13.0470-2748.2 LD2748	TRW 24606 17,4 - WE / - WK + Zub Ceramic			
<b> Bremsscheibe</b>										
1.8 TFSI 1.8 TFSI 1.8 TFSI quattro	88 118 118	01/08→12/15 11/07→03/12 09/08→03/12	←	+PR 1LT,1LY		24.0125-0184.1 425184	Ø 314 25 23 V + S			
2.0 TDI 2.0 TDI	88 100	06/08→12/15 11/07→12/15	←	→ 06/11; +PR 1LA		24.0130-0193.1 430193	Ø 320 30 28 V + S			
2.0 TDI 2.0 TDI	105 120	11/07→12/15 08/08→12/15	←	07/11→; +PR 1LA,1LB		24.0330-0193.1 530193	Ø 320 30 28 V + S			
2.0 TDI 2.0 TDI 16V	125 103	01/08→03/12 07/08→	←	+PR 1LD		24.0130-0222.1 430222	Ø 345 30 28 V + S			
2.0 TDI quattro 2.0 TDI quattro	105 125	11/08→12/15 01/08→03/12	➡	+PR 1KW,2EH		24.0112-0178.1 412178	Ø 300 12 10 + S			
2.0 TFSI 2.0 TFSI	132 155	06/08→12/15 06/08→05/13	➡	+PR 1KP; + eFSB		24.0312-0178.1 512178	Ø 300 12 10 + S			
2.0 TFSI flexible fuel 2.0 TFSI quattro	132 155	11/09→12/15 06/08→12/15				24.0122-0272.1 422272	Ø 330 21,9 20 V + S			
2.7 TDI 2.7 TDI	120 140	11/07→03/12 11/07→03/12								
3.0 TDI quattro 3.2 FSI	176 195	11/07→03/12 09/08→03/12								
3.2 FSI quattro	195	11/07→03/12								
1.8 TFSI 1.8 TFSI quattro	125 125	11/11→12/15 11/11→12/15	←	01/12→; +PR 1LT,1LY		24.0125-0184.1 425184	Ø 314 25 23 V + S			
						24.0325-0184.1 525184	Ø 314 25 23 V + S			
			←	01/12→; +PR 1LA,1LB		24.0130-0221.1 430221	Ø 320 30 28 V + S			
			←	01/12→; +PR 1LD		24.0130-0222.1 430222	Ø 345 30 28 V + S			
			➡	01/12→; +PR 1KW,2EH		24.0112-0178.1 412178	Ø 300 12 10 + S			
			➡	01/12→; +PR 1KP; + eFSB		24.0312-0178.1 512178	Ø 300 12 10 + S			
2.0 TDI 2.0 TDI 2.0 TDI 2.0 TDI quattro 2.0 TDI quattro 2.0 TDI quattro 2.0 TFSI 2.0 TFSI quattro 2.0 TFSI quattro 2.0 TFSI quattro 3.0 TDI 3.0 TDI quattro 3.0 TFSI quattro	110 130 140 110 130 140 165 162 165 150 180 200	05/13→12/15 11/11→12/15 09/13→12/15 05/13→12/15 11/11→12/15 09/13→12/15 05/13→12/15 05/13→12/15 05/13→12/15 11/11→12/15 11/11→12/15 02/12→12/15	←	+PR 1LT,1LY		24.0125-0184.1 425184	Ø 314 25 23 V + S			
						24.0325-0184.1 525184	Ø 314 25 23 V + S			
			←	+PR 1LA,1LB		24.0130-0221.1 430221	Ø 320 30 28 V + S			
			←	+PR 1LD		24.0130-0222.1 430222	Ø 345 30 28 V + S			
			➡	+PR 1KW,2EH		24.0112-0178.1 412178	Ø 300 12 10 + S			
			➡	+PR 1KP; + eFSB		24.0312-0178.1 512178	Ø 300 12 10 + S			
			➡	+PR 1KP; + eFSB		24.0122-0272.1 422272	Ø 330 21,9 20 V + S			
			2.0 TFSI flexible fuel quattro	132	11/09→12/15	←	+PR 1LT,1LY		24.0125-0184.1 425184	Ø 314 25 23 V + S
									24.0325-0184.1 525184	Ø 314 25 23 V + S
						←	→ 06/11; +PR 1LA		24.0130-0193.1 430193	Ø 320 30 28 V + S
									24.0330-0193.1 530193	Ø 320 30 28 V + S
						←	+PR 1LA,1LB		24.0130-0221.1 430221	Ø 320 30 28 V + S
←	+PR 1LD					24.0130-0222.1 430222	Ø 345 30 28 V + S			
3.0 TDI quattro	155	06/08→05/10	←	+PR 1KW,2EH		24.0112-0178.1 412178	Ø 300 12 10 + S			
						24.0312-0178.1 512178	Ø 300 12 10 + S			
			➡	+PR 1KP; + eFSB		24.0122-0272.1 422272	Ø 330 21,9 20 V + S			
			3.0 TDI quattro	180 200	11/11→12/15 02/12→12/15	←	+PR 1LT,1LY		24.0125-0184.1 425184	Ø 314 25 23 V + S
									24.0325-0184.1 525184	Ø 314 25 23 V + S
						←	+PR 1LA		24.0130-0193.1 430193	Ø 320 30 28 V + S
			24.0330-0193.1 530193	Ø 320 30 28 V + S						
←	+PR 1LD		24.0130-0222.1 430222	Ø 345 30 28 V + S						
➡	+PR 1KW,2EH		24.0112-0178.1 412178	Ø 300 12 10 + S						
➡	+PR 1KP; + eFSB		24.0312-0178.1 512178	Ø 300 12 10 + S						
S4 quattro	245	11/08→12/15	←	→ 06/11; +PR 1LJ		24.0129-0102.1 429102	Ø 345 29,5 28 V + S			
			←	07/11→; +PR 1LJ,1ZT		24.0130-0222.1 430222	Ø 345 30 28 V + S			
			➡	→ 10/10; +PR 1KE; + eFSB		24.0122-0272.1 422272	Ø 330 21,9 20 V + S			









	kW					! #		
<b>AUDI - A4 (8K2, B8) 08/07→12/15</b>								
 <b>Bremsscheibe</b>								
S4 quattro	245	11/08→12/15	➡	11/10→; +PR 1KE; + eFSB		24.0122-0272.1	422272	Ø 330 21,9 20 V + S
<b>AUDI - A4 (8W2, B9) 05/15→</b>								
 <b>Bremsbelagsatz, Scheibenbremse</b>								
1.4 TFSI	110	08/15→	←	+PR 1LA,1LB		13.0460-7314.2	607314	ATE 22383 17,3 + WK
2.0 TDI	90	05/16→				13.0470-7314.2	LD7314	ATE 22383 17,3 + WK Ceramic
2.0 TDI	100	05/15→						
2.0 TDI	110	05/15→	➡	+PR 1KI		13.0460-2796.2	602796	TRW 22308 17,7 + WE / - WK
2.0 TDI	140	05/15→						
2.0 TDI quattro	110	09/16→	➡	+PR 1KD,1KE,1KF,1KK / 1KJ,2EJ		13.0460-2796.2	602796	TRW 22308 17,7 + WE / - WK
2.0 TDI quattro	120	09/16→						
2.0 TDI quattro	140	09/15→						
2.0 TFSI	140	05/15→						
2.0 TFSI	183	11/15→						
2.0 TFSI	185	05/15→						
2.0 TFSI quattro	183	11/15→						
2.0 TFSI quattro	185	05/15→						
3.0 TDI	160	09/15→						
3.0 TDI quattro	160	09/15→						
3.0 TDI quattro	200	05/15→						
S4 quattro	260	05/16→	←	+PR 1LA,1LB		13.0460-7314.2	607314	ATE 22383 17,3 + WK
			➡	+PR 1KI		13.0460-2796.2	602796	TRW 22308 17,7 + WE / - WK
			➡	+PR 1KD,1KE,1KF,1KK / 1KJ,2EJ		13.0460-2796.2	602796	TRW 22308 17,7 + WE / - WK
 <b>Bremsscheibe</b>								
1.4 TFSI	110	08/15→	←	+PR 1LA,1LB		24.0125-0184.1	425184	Ø 314 25 23 V + S
2.0 TDI	90	05/16→				24.0325-0184.1	525184	Ø 314 25 23 V + S
2.0 TDI	100	05/15→						
2.0 TDI	110	05/15→	←	+PR 1LC,1LD		24.0130-0244.1	430244	Ø 318 30 28 V + S
2.0 TDI	140	05/15→	←	+PR 1LL,1ZA,1ZC,1ZK		24.0134-0110.1	434110	Ø 349 34 32 V + S
2.0 TDI quattro	110	09/16→						
2.0 TDI quattro	120	09/16→	➡	+PR 1KD,1KE,1KI		24.0112-0218.1	412218	Ø 300 12 10 + S
2.0 TDI quattro	140	09/15→						
2.0 TFSI	140	05/15→	➡	+PR 1KF,1KJ,1KK,2EJ		24.0122-0272.1	422272	Ø 330 21,9 20 V + S
2.0 TFSI	183	11/15→						
2.0 TFSI	185	05/15→						
2.0 TFSI quattro	183	11/15→						
2.0 TFSI quattro	185	05/15→						
3.0 TDI	160	09/15→						
3.0 TDI quattro	160	09/15→						
3.0 TDI quattro	200	05/15→						
S4 quattro	260	05/16→						
<b>AUDI - A4 Allroad (8KH, B8) 04/09→05/16</b>								
 <b>Bremsbelagsatz, Scheibenbremse</b>								
2.0 TDI quattro	100	09/09→05/16	←	+PR 1LA		13.0460-2746.2	602746	TRW 24408 19,2 + WK
2.0 TDI quattro	105	09/09→05/16				13.0460-2765.2	602765	TRW 24409 19,2 + WK + Zub
2.0 TDI quattro	110	05/13→05/16				13.0470-2746.2	LD2746	TRW 24408 19,2 + WK + Zub Ceramic
2.0 TDI quattro	120	04/09→05/16						
2.0 TDI quattro	125	04/09→05/16						
2.0 TDI quattro	140	09/13→05/16				13.0470-2765.2	LD2765	TRW 24409 19,2 + WK + Zub Ceramic
2.0 TFSI quattro	155	04/09→05/16						
2.0 TFSI quattro	162	05/13→05/16	←	+PR 1LT		13.0460-7256.2	607256	ATE 24705 19,8 + WK
2.0 TFSI quattro	165	05/13→05/16				13.0470-7256.2	LD7256	ATE 24705 19,8 + WK Ceramic
3.0 TDI quattro	176	04/09→01/12						
3.0 TDI quattro	180	01/12→05/16	➡	+PR 1KW,GP0,GP1,GP2		13.0460-2747.2	602747	TRW 24606 17,4 - WE / - WK + Zub
						13.0470-2747.2	LD2747	TRW 24606 17,4 - WE / - WK + Zub Ceramic
2.0 TDI quattro	130	11/11→05/16	←	01/12→; +PR 1LA		13.0460-2746.2	602746	TRW 24408 19,2 + WK
						13.0460-2765.2	602765	TRW 24409 19,2 + WK + Zub
						13.0470-2746.2	LD2746	TRW 24408 19,2 + WK + Zub Ceramic
						13.0470-2765.2	LD2765	TRW 24409 19,2 + WK + Zub Ceramic
			←	01/12→; +PR 1LT		13.0460-7256.2	607256	ATE 24705 19,8 + WK
						13.0470-7256.2	LD7256	ATE 24705 19,8 + WK Ceramic
			➡	01/12→; +PR 1KW,GP0,GP1,GP2		13.0460-2747.2	602747	TRW 24606 17,4 - WE / - WK + Zub
						13.0470-2747.2	LD2747	TRW 24606 17,4 - WE / - WK + Zub Ceramic
 <b>Bremsscheibe</b>								
2.0 TDI quattro	100	09/09→05/16	←	+PR 1LT		24.0125-0184.1	425184	Ø 314 25 23 V + S

	kw			 	! #		
<b>AUDI - A4 Allroad (8KH, B8) 04/09→05/16</b>							
<b>Bremsscheibe</b>							
2.0 TDI quattro	105	09/09→05/16	←	+PR 1LT		24.0325-0184.1 525184	Ø 314 25 23 V + S
2.0 TDI quattro	120	04/09→05/16	←	→ 06/11; +PR 1LA		24.0130-0193.1 430193	Ø 320 30 28 V + S
2.0 TDI quattro	125	04/09→05/16	←			24.0330-0193.1 530193	Ø 320 30 28 V + S
2.0 TFSI quattro	155	04/09→05/16	←			24.0330-0193.1 530193	Ø 320 30 28 V + S
3.0 TDI quattro	176	04/09→01/12	←	07/11→; +PR 1LA		24.0130-0221.1 430221	Ø 320 30 28 V + S
			→	+PR 1KW,GP0,GP1,GP2		24.0112-0178.1 412178	Ø 300 12 10 + S
			→	+PR 1KW,GP0,GP1,GP2		24.0312-0178.1 512178	Ø 300 12 10 + S
2.0 TDI quattro	110	05/13→05/16	←	+PR 1LT		24.0125-0184.1 425184	Ø 314 25 23 V + S
2.0 TDI quattro	140	09/13→05/16	←			24.0325-0184.1 525184	Ø 314 25 23 V + S
2.0 TFSI quattro	162	05/13→05/16	←			24.0325-0184.1 525184	Ø 314 25 23 V + S
2.0 TFSI quattro	165	05/13→05/16	←	+PR 1LA		24.0130-0221.1 430221	Ø 320 30 28 V + S
3.0 TDI quattro	180	01/12→05/16	→	+PR 1KW,GP0,GP1,GP2		24.0112-0178.1 412178	Ø 300 12 10 + S
			→	+PR 1KW,GP0,GP1,GP2		24.0312-0178.1 512178	Ø 300 12 10 + S
2.0 TDI quattro	130	11/11→05/16	←	01/12→; +PR 1LT		24.0125-0184.1 425184	Ø 314 25 23 V + S
			←	01/12→; +PR 1LA		24.0325-0184.1 525184	Ø 314 25 23 V + S
			←	01/12→; +PR 1LA		24.0130-0221.1 430221	Ø 320 30 28 V + S
			→	01/12→; +PR 1KW,GP0,GP1,GP2		24.0112-0178.1 412178	Ø 300 12 10 + S
			→	01/12→; +PR 1KW,GP0,GP1,GP2		24.0312-0178.1 512178	Ø 300 12 10 + S
<b>AUDI - A4 Allroad (8WH, B9) 01/16→</b>							
<b>Bremsbelagsatz, Scheibenbremse</b>							
2.0 TDI quattro	100	11/16→	←	+PR 1LA,1LB		13.0460-7314.2 607314	ATE 22383 17,3 + WK
2.0 TDI quattro	110	11/16→	←			13.0470-7314.2 LD7314	ATE 22383 17,3 + WK Ceramic
2.0 TDI quattro	120	05/16→	→	+PR 1KD,1KE,1KJ,1KF / 1KK,2EJ		13.0460-2796.2 602796	TRW 22308 17,7 + WE / - WK
2.0 TDI quattro	140	01/16→	→				
2.0 TFSI quattro	183	05/16→					
2.0 TFSI quattro	185	01/16→					
3.0 TDI quattro	160	01/16→					
3.0 TDI quattro	200	01/16→					
<b>Bremsscheibe</b>							
2.0 TDI quattro	100	11/16→	←	+PR 1LC,1LD		24.0130-0244.1 430244	Ø 318 30 28 V + S
2.0 TDI quattro	110	11/16→	←	+PR 1LL,1ZA,1ZC,1ZK		24.0134-0110.1 434110	Ø 349 34 32 V + S
			→	+PR 1KD,1KE,1KI		24.0112-0218.1 412218	Ø 300 12 10 + S
			→	+PR 1KF,1KJ,1KK,2EJ; + eFSB		24.0122-0272.1 422272	Ø 330 21,9 20 V + S
2.0 TDI quattro	120	05/16→	←	+PR 1LA,1LB		24.0125-0184.1 425184	Ø 314 25 23 V + S
2.0 TDI quattro	140	01/16→	←			24.0325-0184.1 525184	Ø 314 25 23 V + S
2.0 TFSI quattro	183	05/16→	←			24.0325-0184.1 525184	Ø 314 25 23 V + S
2.0 TFSI quattro	185	01/16→	←	+PR 1LC,1LD		24.0130-0244.1 430244	Ø 318 30 28 V + S
3.0 TDI quattro	160	01/16→	←	+PR 1LL,1ZA,1ZC,1ZK		24.0134-0110.1 434110	Ø 349 34 32 V + S
3.0 TDI quattro	200	01/16→	→	+PR 1KD,1KE,1KI		24.0112-0218.1 412218	Ø 300 12 10 + S
			→	+PR 1KF,1KJ,1KK,2EJ; + eFSB		24.0122-0272.1 422272	Ø 330 21,9 20 V + S
<b>AUDI - A4 Avant (8D5, B5) 11/94→09/01</b>							
<b>Bremsbelagsatz, Scheibenbremse</b>							
1.6	74	11/94→09/01	←	→ 8D-V-169695		13.0460-2822.2 602822	TRW 21945 19,6 - WK
1.6	75	07/00→09/01				13.0460-2934.2 602934	TRW 20669 19,0 - WK
1.9 DUO	66	03/98→09/01					
1.9 TDI	55	03/96→09/01	←	8D-V-169696→; → 04/01		13.0460-2822.2 602822	TRW 21945 19,6 - WK
1.9 TDI	66	02/96→09/01				13.0460-2837.2 602837	TRW 21945 19,6 + WK
						13.0470-2837.2 LD2837	TRW 21945 19,6 + WK Ceramic
			←	8D-V-054062→; → 04/01		13.0460-2822.2 602822	TRW 21945 19,6 - WK
						13.0460-2837.2 602837	TRW 21945 19,6 + WK
						13.0470-2837.2 LD2837	TRW 21945 19,6 + WK Ceramic
			←	→ 8D-V-054061		13.0460-7077.2 607077	ATE 20676 19,8 - WE / - WK
			→	8D-V-160001→; → 04/01		13.0460-2787.2 602787	TRW 23554 17,3 - WK / - WE
						13.0460-2820.2 602820	TRW 20961 17,2 - WK
						13.0470-2820.2 LD2820	TRW 20961 17,2 - WK Ceramic
			→	→ 8D-V-160000		13.0460-3602.2 603602	TRW 21144 15,8 - WK
1.8	85	07/95→09/01	←	8D-V-054062→; → 04/01		13.0460-2822.2 602822	TRW 21945 19,6 - WK
1.8	92	02/96→09/01				13.0460-2837.2 602837	TRW 21945 19,6 + WK
						13.0470-2837.2 LD2837	TRW 21945 19,6 + WK Ceramic
			←	→ 8D-V-054061		13.0460-7077.2 607077	ATE 20676 19,8 - WE / - WK
						13.0460-7110.2 607110	ATE 20676 19,8 + WK
						13.0470-7110.2 LD7110	ATE 20676 19,8 + WK Ceramic







	kW			 	! #		
<b>AUDI - A4 Avant (8D5, B5) 11/94→09/01</b>							
<b> Bremsbelagsatz, Scheibenbremse</b>							
1.8 1.8	85 92	07/95→09/01 02/96→09/01	➡	8D-V-160001→; → 04/01		<b>13.0460-2787.2 602787</b> <b>13.0460-2820.2 602820</b> <b>13.0470-2820.2 LD2820</b>	TRW 23554 17,3 - WK / - WE TRW 20961 17,2 - WK TRW 20961 17,2 - WK Ceramic
			➡	→ 8D-V-160000		<b>13.0460-3602.2 603602</b>	TRW 21144 15,8 - WK
1.8 quattro 1.8 quattro	85 92	07/95→09/01 01/96→09/01	⬅	8D-V-054062→; → 04/01		<b>13.0460-2822.2 602822</b> <b>13.0460-2837.2 602837</b> <b>13.0470-2837.2 LD2837</b>	TRW 21945 19,6 - WK TRW 21945 19,6 + WK TRW 21945 19,6 + WK Ceramic
			⬅	→ 8D-V-054061		<b>13.0460-7077.2 607077</b>	ATE 20676 19,8 - WE / - WK
			➡	→ 04/01		<b>13.0460-3602.2 603602</b>	TRW 21144 15,8 - WK
1.8 T 1.8 T 1.9 TDI 2.6 2.8	110 132 81 110 142	03/96→09/01 12/97→09/01 02/96→09/01 02/96→09/01 10/96→09/01	⬅	→ 04/01		<b>13.0460-7077.2 607077</b> <b>13.0460-7110.2 607110</b> <b>13.0470-7110.2 LD7110</b>	ATE 20676 19,8 - WE / - WK ATE 20676 19,8 + WK ATE 20676 19,8 + WK Ceramic
			➡	8D-V-160001→; → 04/01		<b>13.0460-2787.2 602787</b> <b>13.0460-2820.2 602820</b> <b>13.0470-2820.2 LD2820</b>	TRW 23554 17,3 - WK / - WE TRW 20961 17,2 - WK TRW 20961 17,2 - WK Ceramic
			➡	→ 8D-V-160000		<b>13.0460-3602.2 603602</b>	TRW 21144 15,8 - WK
1.8 T quattro 1.8 T quattro 1.9 TDI quattro 2.4 quattro 2.6 quattro 2.8 quattro	110 132 81 120 110 142	01/96→09/01 12/97→09/01 09/96→09/01 08/97→09/01 01/96→09/01 10/96→09/01	⬅	→ 01/99		<b>13.0460-7077.2 607077</b>	ATE 20676 19,8 - WE / - WK
			⬅	02/99→ 04/01		<b>13.0460-7110.2 607110</b> <b>13.0470-7110.2 LD7110</b>	ATE 20676 19,8 + WK ATE 20676 19,8 + WK Ceramic
			➡	→ 04/01		<b>13.0460-3602.2 603602</b>	TRW 21144 15,8 - WK
1.9 TDI 2.5 TDI	85 110	03/00→09/01 09/97→09/01	⬅	→ 04/01		<b>13.0460-7077.2 607077</b> <b>13.0460-7110.2 607110</b> <b>13.0470-7110.2 LD7110</b>	ATE 20676 19,8 - WE / - WK ATE 20676 19,8 + WK ATE 20676 19,8 + WK Ceramic
			➡	→ 04/01		<b>13.0460-2787.2 602787</b> <b>13.0460-2820.2 602820</b> <b>13.0470-2820.2 LD2820</b>	TRW 23554 17,3 - WK / - WE TRW 20961 17,2 - WK TRW 20961 17,2 - WK Ceramic
			➡	→ 8D-V-160000		<b>13.0460-3602.2 603602</b>	TRW 21144 15,8 - WK
1.9 TDI quattro	85	03/00→09/01	⬅	→ 04/01		<b>13.0460-7110.2 607110</b> <b>13.0470-7110.2 LD7110</b>	ATE 20676 19,8 + WK ATE 20676 19,8 + WK Ceramic
			➡	→ 04/01		<b>13.0460-3602.2 603602</b>	TRW 21144 15,8 - WK
2.4	120	08/97→09/01	⬅	→ 04/01		<b>13.0460-7077.2 607077</b> <b>13.0460-7110.2 607110</b> <b>13.0470-7110.2 LD7110</b>	ATE 20676 19,8 - WE / - WK ATE 20676 19,8 + WK ATE 20676 19,8 + WK Ceramic
			➡	→ 04/01		<b>13.0460-2787.2 602787</b> <b>13.0460-2820.2 602820</b> <b>13.0470-2820.2 LD2820</b>	TRW 23554 17,3 - WK / - WE TRW 20961 17,2 - WK TRW 20961 17,2 - WK Ceramic
2.4	121	03/97→09/01	⬅	08/97→ 04/01		<b>13.0460-7077.2 607077</b> <b>13.0460-7110.2 607110</b> <b>13.0470-7110.2 LD7110</b>	ATE 20676 19,8 - WE / - WK ATE 20676 19,8 + WK ATE 20676 19,8 + WK Ceramic
			➡	08/97→ 04/01		<b>13.0460-2787.2 602787</b> <b>13.0460-2820.2 602820</b> <b>13.0470-2820.2 LD2820</b>	TRW 23554 17,3 - WK / - WE TRW 20961 17,2 - WK TRW 20961 17,2 - WK Ceramic
2.4 quattro	121	03/97→09/01	⬅	08/97→ 01/99		<b>13.0460-7077.2 607077</b>	ATE 20676 19,8 - WE / - WK
			⬅	02/99→ 04/01		<b>13.0460-7110.2 607110</b> <b>13.0470-7110.2 LD7110</b>	ATE 20676 19,8 + WK ATE 20676 19,8 + WK Ceramic
			➡	08/97→ 04/01		<b>13.0460-3602.2 603602</b>	TRW 21144 15,8 - WK
2.5 TDI quattro	110	09/97→09/01	⬅	11/97→ 01/99		<b>13.0460-7077.2 607077</b>	ATE 20676 19,8 - WE / - WK
			⬅	02/99→ 04/01		<b>13.0460-7110.2 607110</b> <b>13.0470-7110.2 LD7110</b>	ATE 20676 19,8 + WK ATE 20676 19,8 + WK Ceramic
			➡	11/97→ 04/01		<b>13.0460-3602.2 603602</b>	TRW 21144 15,8 - WK
2.8 2.8	128 140	03/96→09/96 03/99→09/00	⬅			<b>13.0460-7077.2 607077</b> <b>13.0460-7110.2 607110</b> <b>13.0470-7110.2 LD7110</b>	ATE 20676 19,8 - WE / - WK ATE 20676 19,8 + WK ATE 20676 19,8 + WK Ceramic
			➡	8D-V-160001→		<b>13.0460-2787.2 602787</b> <b>13.0460-2820.2 602820</b> <b>13.0470-2820.2 LD2820</b>	TRW 23554 17,3 - WK / - WE TRW 20961 17,2 - WK TRW 20961 17,2 - WK Ceramic
			➡	→ 8D-V-160000		<b>13.0460-3602.2 603602</b>	TRW 21144 15,8 - WK
2.8 quattro	128	01/96→09/96	⬅	→ 07/96		<b>13.0460-7077.2 607077</b>	ATE 20676 19,8 - WE / - WK
			➡	→ 07/96		<b>13.0460-3602.2 603602</b>	TRW 21144 15,8 - WK
↓							

	kw			 	! #		
<b>AUDI - A4 Avant (8D5, B5) 11/94→09/01</b>							
<b> Bremsbelagsatz, Scheibenbremse</b>							
2.8 quattro	140	03/99→09/00	←			<b>13.0460-7110.2 607110</b>	ATE 20676 19,8 + WK
			→			<b>13.0470-7110.2 LD7110</b>	ATE 20676 19,8 + WK Ceramic
			←			<b>13.0460-3602.2 603602</b>	TRW 21144 15,8 - WK
RS4 quattro	280	05/00→09/01	←	06/00→ 04/01		<b>13.0460-7183.2 607183</b>	ATE 21484 20,5 + WE / - WK
S4 quattro	195	09/97→09/01	←	10/97→; → 8D-X-199 999		<b>13.0460-2705.2 602705</b>	TRW 21452 18,5 - WK
			←	8D-X-200 001→; → 04/01		<b>13.0460-2875.2 602875</b>	TRW 23119 17,5 + WK
			→	10/97→ 04/01		<b>13.0460-2787.2 602787</b>	TRW 23554 17,3 - WK / - WE
						<b>13.0460-2820.2 602820</b>	TRW 20961 17,2 - WK
						<b>13.0470-2820.2 LD2820</b>	TRW 20961 17,2 - WK Ceramic
<b>Zubehörsatz, Scheibenbremsbelag</b>							
1.6	74	11/94→09/01	→	8D-V-160001→; → 04/01		<b>13.0460-0072.2 610072</b>	TRW
1.6	75	07/00→09/01					
1.8	85	07/95→09/01					
1.8	92	02/96→09/01					
1.8 T	110	03/96→09/01					
1.8 T	132	12/97→09/01					
1.9 DUO	66	03/98→09/01					
1.9 TDI	55	03/96→09/01					
1.9 TDI	66	02/96→09/01					
1.9 TDI	81	02/96→09/01					
2.6	110	02/96→09/01					
2.8	142	10/96→09/01					
1.9 TDI	85	03/00→09/01	→	→ 04/01		<b>13.0460-0072.2 610072</b>	TRW
2.4	120	08/97→09/01					
2.5 TDI	110	09/97→09/01					
2.4	121	03/97→09/01	→	08/97→ 04/01		<b>13.0460-0072.2 610072</b>	TRW
2.8	128	03/96→09/96	→	8D-V-160001→		<b>13.0460-0072.2 610072</b>	TRW
2.8	140	03/99→09/00					
S4 quattro	195	09/97→09/01	→	10/97→ 04/01		<b>13.0460-0072.2 610072</b>	TRW
<b> Bremsscheibe</b>							
1.6	74	11/94→09/01	←	→ 8D-V-169695		<b>24.0113-0181.1 413181</b>	Ø 280 13 11
1.6	75	07/00→09/01				<b>24.0313-0181.1 513181</b>	Ø 280 13 11
			←	→ 8D-V-054061		<b>24.0115-0105.1 415105</b>	Ø 288 15 13
						<b>24.0315-0105.1 515105</b>	Ø 288 15 13
			←	8D-V-054062→; → 04/01		<b>24.0122-0152.1 422152</b>	Ø 280 22 20 V + S
						<b>24.0322-0152.1 522152</b>	Ø 280 22 20 V + S
			←	8D-V-169696→; → 04/01		<b>24.0122-0152.1 422152</b>	Ø 280 22 20 V + S
						<b>24.0322-0152.1 522152</b>	Ø 280 22 20 V + S
			→	→ 04/01		<b>24.0110-0210.1 410210</b>	Ø 245 10 8 - LG / - ABS Ring
1.8	85	07/95→09/01	←	→ 8D-V-054061; für China/GUS		<b>24.0115-0105.1 415105</b>	Ø 288 15 13
						<b>24.0315-0105.1 515105</b>	Ø 288 15 13
			←	8D-V-054062→; → 04/01; für China/GUS		<b>24.0122-0152.1 422152</b>	Ø 280 22 20 V + S
						<b>24.0322-0152.1 522152</b>	Ø 280 22 20 V + S
			→	→ 04/01		<b>24.0110-0210.1 410210</b>	Ø 245 10 8 - LG / - ABS Ring
1.8	92	02/96→09/01	←	→ 8D-V-054061		<b>24.0115-0105.1 415105</b>	Ø 288 15 13
						<b>24.0315-0105.1 515105</b>	Ø 288 15 13
			←	8D-V-054062→; → 04/01		<b>24.0122-0152.1 422152</b>	Ø 280 22 20 V + S
						<b>24.0322-0152.1 522152</b>	Ø 280 22 20 V + S
			→	→ 04/01		<b>24.0110-0210.1 410210</b>	Ø 245 10 8 - LG / - ABS Ring
1.8 quattro	85	07/95→09/01	←	→ 8D-V-054061; für GUS		<b>24.0115-0105.1 415105</b>	Ø 288 15 13
						<b>24.0315-0105.1 515105</b>	Ø 288 15 13
			←	8D-V-054062→; → 04/01; für GUS		<b>24.0122-0152.1 422152</b>	Ø 280 22 20 V + S
						<b>24.0322-0152.1 522152</b>	Ø 280 22 20 V + S
			→	→ 04/01		<b>24.0110-0224.1 410224</b>	Ø 245 10 8
						<b>24.0310-0224.1 510224</b>	Ø 245 10 8
1.8 quattro	92	01/96→09/01	←	→ 8D-V-054061		<b>24.0115-0105.1 415105</b>	Ø 288 15 13
						<b>24.0315-0105.1 515105</b>	Ø 288 15 13
			←	8D-V-054062→; → 04/01		<b>24.0122-0152.1 422152</b>	Ø 280 22 20 V + S
						<b>24.0322-0152.1 522152</b>	Ø 280 22 20 V + S
			→	→ 04/01		<b>24.0110-0224.1 410224</b>	Ø 245 10 8
						<b>24.0310-0224.1 510224</b>	Ø 245 10 8
1.8 T	110	03/96→09/01	←	→ 04/01		<b>24.0125-0105.1 425105</b>	Ø 288 25 23 V + S
1.8 T	132	12/97→09/01					
↓							



	kw			 	! #		
<b>AUDI - A4 Avant (8D5, B5) 11/94→09/01</b>							
<b>Bremsscheibe</b>							
1.9 TDI	81	02/96→09/01	←	→ 04/01		24.0325-0105.1 525105	Ø 288 25 23 V
1.9 TDI	85	03/00→09/01	→	→ 04/01		24.0110-0210.1 410210	Ø 245 10 8 - LG / - ABS Ring
2.4	120	08/97→09/01					
2.5 TDI	110	09/97→09/01					
2.6	110	02/96→09/01					
2.8	142	10/96→09/01					
1.8 T quattro	110	01/96→09/01	←	→ 04/01		24.0125-0105.1 425105	Ø 288 25 23 V + S
1.8 T quattro	132	12/97→09/01				24.0325-0105.1 525105	Ø 288 25 23 V
1.9 TDI quattro	81	09/96→09/01					
1.9 TDI quattro	85	03/00→09/01	→	→ 04/01		24.0110-0224.1 410224	Ø 245 10 8
2.4 quattro	120	08/97→09/01				24.0310-0224.1 510224	Ø 245 10 8
2.6 quattro	110	01/96→09/01					
2.8 quattro	142	10/96→09/01					
1.9 DUO	66	03/98→09/01	←	→ 8D-V-169695		24.0113-0181.1 413181	Ø 280 13 11
1.9 TDI	55	03/96→09/01				24.0313-0181.1 513181	Ø 280 13 11
1.9 TDI	66	02/96→09/01	←	8D-V-054062→; → 04/01		24.0122-0152.1 422152	Ø 280 22 20 V + S
			←	8D-V-169696→; → 04/01		24.0322-0152.1 522152	Ø 280 22 20 V + S
			←	8D-V-169696→; → 04/01		24.0122-0152.1 422152	Ø 280 22 20 V + S
			←	8D-V-169696→; → 04/01		24.0322-0152.1 522152	Ø 280 22 20 V + S
			→	→ 04/01		24.0110-0210.1 410210	Ø 245 10 8 - LG / - ABS Ring
2.4	121	03/97→09/01	←	08/97→ 04/01		24.0125-0105.1 425105	Ø 288 25 23 V + S
			→	08/97→ 04/01		24.0325-0105.1 525105	Ø 288 25 23 V
			→	08/97→ 04/01		24.0110-0210.1 410210	Ø 245 10 8 - LG / - ABS Ring
2.4 quattro	121	03/97→09/01	←	08/97→ 04/01		24.0125-0105.1 425105	Ø 288 25 23 V + S
			→	08/97→ 04/01		24.0325-0105.1 525105	Ø 288 25 23 V
			→	08/97→ 04/01		24.0110-0224.1 410224	Ø 245 10 8
			→	08/97→ 04/01		24.0310-0224.1 510224	Ø 245 10 8
2.5 TDI quattro	110	09/97→09/01	←	11/97→ 04/01		24.0125-0105.1 425105	Ø 288 25 23 V + S
			→	11/97→ 04/01		24.0325-0105.1 525105	Ø 288 25 23 V
			→	11/97→ 04/01		24.0110-0224.1 410224	Ø 245 10 8
			→	11/97→ 04/01		24.0310-0224.1 510224	Ø 245 10 8
2.8	128	03/96→09/96	←			24.0125-0105.1 425105	Ø 288 25 23 V + S
2.8	140	03/99→09/00				24.0325-0105.1 525105	Ø 288 25 23 V
			→			24.0110-0210.1 410210	Ø 245 10 8 - LG / - ABS Ring
2.8 quattro	128	01/96→09/96	←	→ 07/96		24.0125-0105.1 425105	Ø 288 25 23 V + S
			→	→ 07/96		24.0325-0105.1 525105	Ø 288 25 23 V
			→	→ 07/96		24.0110-0224.1 410224	Ø 245 10 8
			→	→ 07/96		24.0310-0224.1 510224	Ø 245 10 8
2.8 quattro	140	03/99→09/00	←			24.0125-0105.1 425105	Ø 288 25 23 V + S
			→			24.0325-0105.1 525105	Ø 288 25 23 V
			→			24.0110-0224.1 410224	Ø 245 10 8
			→			24.0310-0224.1 510224	Ø 245 10 8
S4 quattro	195	09/97→09/01	←	10/97→ 04/01		24.0130-0113.1 430113	Ø 320 30 28 V + S
			→	10/97→ 04/01		24.0330-0113.1 530113	Ø 320 30 28 V
			→	10/97→ 04/01		24.0122-0221.1 422221	Ø 256 22 20 V
<b>AUDI - A4 Avant (8E5, B6) 02/00→12/05</b>							
<b>Bremsbelagsatz, Scheibenbremse</b>							
1.6	75	09/01→12/04	←	+PR 1LZ		13.0460-2837.2 602837	TRW 21945 19,6 + WK
1.8 T	110	09/01→07/02				13.0470-2837.2 LD2837	TRW 21945 19,6 + WK Ceramic
1.8 T	120	07/02→12/04					
1.8 T	140	11/02→12/04	←	+PR 1LB;1LE;1LF;1LT		13.0460-7110.2 607110	ATE 20676 19,8 + WK
1.8 T quattro	110	09/01→07/02				13.0470-7110.2 LD7110	ATE 20676 19,8 + WK Ceramic
1.8 T quattro	120	07/02→12/04					
1.8 T quattro	125	09/01→12/04	←	+PR 1LA;1LC		13.0460-7201.2 607201	ATE 23763 20,3 + WK
1.8 T quattro	140	11/02→12/04				13.0470-7201.2 LD7201	ATE 23763 20,3 + WK Ceramic
1.9 TDI	74	11/01→12/04	→	8E-5-400001→; +PR 1KW		13.0460-2749.2 602749	TRW 24483 16,9 - WE / - WK + Zub
1.9 TDI	96	09/01→12/04					
1.9 TDI quattro	96	11/01→12/04					
2.0	96	09/01→12/04				13.0460-2880.2 602880	TRW 23914 17,1 + WE / - WK + Zub
2.0 FSI	110	07/02→12/04					
2.4	120	09/01→12/04				13.0470-2749.2 LD2749	TRW 24483 16,9 - WE / - WK + Zub Ceramic
2.4	125	09/01→12/04					
2.5 TDI	114	09/01→07/02				13.0470-2880.2 LD2880	TRW 23914 17,1 + WE / - WK + Zub Ceramic
2.5 TDI	120	07/02→12/04					
2.5 TDI quattro	132	09/01→12/04	→	→ 8E-4-180000; +PR 1KD		13.0460-2787.2 602787	TRW 23554 17,3 - WK / - WE
			→	→ 8E-4-180000; +PR 1KP		13.0460-2860.2 602860	TRW 23554 16,4 - WK / + WE
↓							



	kW			 	! #		
<b>AUDI - A4 Avant (8E5, B6) 02/00→12/05</b>							
<b>Bremsbelagsatz, Scheibenbremse</b>							
1.6	75	09/01→12/04	➡	→ 8E-4-180000; +PR 1KP		<b>13.0470-2860.2</b> <b>LD2860</b>	TRW 23554 16,4 - WK / + WE Ceramic
1.8 T	110	09/01→07/02					
1.8 T	120	07/02→12/04					
1.8 T	140	11/02→12/04	➡	8E-4-180001→; +PR 1KD;1KP		<b>13.0460-2886.2</b> <b>602886</b>	TRW 20961 16,0 - WK
1.8 T quattro	110	09/01→07/02				<b>13.0460-2937.2</b> <b>602937</b>	TRW 20961 15,2 - WK + Zub
1.8 T quattro	120	07/02→12/04				<b>13.0470-2886.2</b> <b>LD2886</b>	TRW 20961 16,0 - WK Ceramic
1.8 T quattro	125	09/01→12/04					
1.8 T quattro	140	11/02→12/04					
1.9 TDI	74	11/01→12/04					
1.9 TDI	96	09/01→12/04					
1.9 TDI quattro	96	11/01→12/04					
2.0	96	09/01→12/04					
2.0 FSI	110	07/02→12/04					
2.4	120	09/01→12/04					
2.4	125	09/01→12/04					
2.5 TDI	114	09/01→07/02					
2.5 TDI	120	07/02→12/04					
2.5 TDI quattro	132	09/01→12/04					
1.9 TDI	85	06/04→12/04	⬅	+PR 1LZ		<b>13.0460-2837.2</b> <b>602837</b>	TRW 21945 19,6 + WK
						<b>13.0470-2837.2</b> <b>LD2837</b>	TRW 21945 19,6 + WK Ceramic
			⬅	+PR 1LB;1LE;1LF;1LT		<b>13.0460-7110.2</b> <b>607110</b>	ATE 20676 19,8 + WK
						<b>13.0470-7110.2</b> <b>LD7110</b>	ATE 20676 19,8 + WK Ceramic
			⬅	+PR 1LA;1LC		<b>13.0460-7201.2</b> <b>607201</b>	ATE 23763 20,3 + WK
						<b>13.0470-7201.2</b> <b>LD7201</b>	ATE 23763 20,3 + WK Ceramic
			➡	8E-5-400001→; +PR 1KW		<b>13.0460-2749.2</b> <b>602749</b>	TRW 24483 16,9 - WE / - WK + Zub
						<b>13.0460-2880.2</b> <b>602880</b>	TRW 23914 17,1 + WE / - WK + Zub
						<b>13.0470-2749.2</b> <b>LD2749</b>	TRW 24483 16,9 - WE / - WK + Zub Ceramic
						<b>13.0470-2880.2</b> <b>LD2880</b>	TRW 23914 17,1 + WE / - WK + Zub Ceramic
			➡	+PR 1KD;1KP		<b>13.0460-2886.2</b> <b>602886</b>	TRW 20961 16,0 - WK
						<b>13.0460-2937.2</b> <b>602937</b>	TRW 20961 15,2 - WK + Zub
						<b>13.0470-2886.2</b> <b>LD2886</b>	TRW 20961 16,0 - WK Ceramic
3.0	160	04/01→12/04	⬅	+PR 1LZ		<b>13.0460-2837.2</b> <b>602837</b>	TRW 21945 19,6 + WK
3.0	162	09/01→12/04				<b>13.0470-2837.2</b> <b>LD2837</b>	TRW 21945 19,6 + WK Ceramic
3.0 quattro	160	04/01→12/04					
3.0 quattro	162	09/01→12/04	⬅	+PR 1LB;1LE;1LF;1LT		<b>13.0460-7110.2</b> <b>607110</b>	ATE 20676 19,8 + WK
						<b>13.0470-7110.2</b> <b>LD7110</b>	ATE 20676 19,8 + WK Ceramic
			⬅	+PR 1LA;1LC		<b>13.0460-7201.2</b> <b>607201</b>	ATE 23763 20,3 + WK
						<b>13.0470-7201.2</b> <b>LD7201</b>	ATE 23763 20,3 + WK Ceramic
			➡	8E-5-400001→; +PR 1KW		<b>13.0460-2749.2</b> <b>602749</b>	TRW 24483 16,9 - WE / - WK + Zub
						<b>13.0460-2880.2</b> <b>602880</b>	TRW 23914 17,1 + WE / - WK + Zub
						<b>13.0470-2749.2</b> <b>LD2749</b>	TRW 24483 16,9 - WE / - WK + Zub Ceramic
						<b>13.0470-2880.2</b> <b>LD2880</b>	TRW 23914 17,1 + WE / - WK + Zub Ceramic
			➡	→ 8E-7-300000; +PR 1KD;1KP		<b>13.0460-2886.2</b> <b>602886</b>	TRW 20961 16,0 - WK
						<b>13.0460-2937.2</b> <b>602937</b>	TRW 20961 15,2 - WK + Zub
						<b>13.0470-2886.2</b> <b>LD2886</b>	TRW 20961 16,0 - WK Ceramic
S4 quattro	253	03/03→12/04	⬅	+PR 1LJ		<b>13.0460-7201.2</b> <b>607201</b>	ATE 23763 20,3 + WK
			➡			<b>13.0460-2888.2</b> <b>602888</b>	TRW 23326 17,4 + WE / - WK
						<b>13.0470-2888.2</b> <b>LD2888</b>	TRW 23326 17,4 + WE / - WK Ceramic
<b>Zubehörsatz, Scheibenbremsbelag</b>							
1.6	75	09/01→12/04	➡	→ 8E-4-180000; +PR 1KP		<b>13.0460-0072.2</b> <b>610072</b>	TRW
1.8 T	110	09/01→07/02					
1.8 T	120	07/02→12/04	➡	→ 8E-4-180000; +PR 1KD		<b>13.0460-0072.2</b> <b>610072</b>	TRW
1.8 T	140	11/02→12/04					
1.8 T quattro	110	09/01→07/02	➡	8E-5-400001→; +PR 1KW		<b>13.0460-0259.2</b> <b>610259</b>	
1.8 T quattro	120	07/02→12/04					
1.8 T quattro	125	09/01→12/04					
1.8 T quattro	140	11/02→12/04					
1.9 TDI	74	11/01→12/04					
1.9 TDI	96	09/01→12/04					
1.9 TDI quattro	96	11/01→12/04					
2.0	96	09/01→12/04					
2.0 FSI	110	07/02→12/04					
2.4	120	09/01→12/04					
2.4	125	09/01→12/04					
↓							

### AUDI - A4 Avant (8E5, B6) 02/00→12/05

#### Zubehörsatz, Scheibenbremsbelag

2.5 TDI	114	09/01→07/02	➔	→ 8E-4-180000; +PR 1KP	13.0460-0072.2	610072	TRW
2.5 TDI	120	07/02→12/04	➔	→ 8E-4-180000; +PR 1KD	13.0460-0072.2	610072	TRW
2.5 TDI quattro	132	09/01→12/04	➔	8E-5-400001→; +PR 1KW	13.0460-0259.2	610259	
1.9 TDI	85	06/04→12/04	➔	8E-5-400001→; +PR 1KW	13.0460-0259.2	610259	
3.0	160	04/01→12/04					
3.0	162	09/01→12/04					
3.0 quattro	160	04/01→12/04					
3.0 quattro	162	09/01→12/04					









#### Bremsscheibe

1.6	75	09/01→12/04	←	+PR 1LZ	24.0122-0152.1	422152	∅ 280 22 20 V + S
1.8 T	110	09/01→07/02			24.0322-0152.1	522152	∅ 280 22 20 V + S
1.8 T	120	07/02→12/04					
1.8 T	140	11/02→12/04	←	+PR 1LB;1LE	24.0125-0105.1	425105	∅ 288 25 23 V + S
1.8 T quattro	110	09/01→07/02			24.0325-0105.1	525105	∅ 288 25 23 V
1.8 T quattro	120	07/02→12/04					
1.8 T quattro	125	09/01→12/04	←	+PR 1LF;1LT	24.0125-0137.1	425137	∅ 312 25 23 V + S
1.8 T quattro	140	11/02→12/04			24.0325-0137.1	525137	∅ 312 25 23 V
1.9 TDI	74	11/01→12/04	←	+PR 1LA	24.0130-0113.1	430113	∅ 320 30 28 V + S
1.9 TDI	85	06/04→12/04			24.0330-0113.1	530113	∅ 320 30 28 V
1.9 TDI	96	09/01→12/04					
1.9 TDI quattro	96	11/01→12/04	←	+PR 1LC	24.0130-0185.1	430185	∅ 320 30 28 V•
2.0	96	09/01→12/04					
2.0 FSI	110	07/02→12/04	➔	+PR 1KD	24.0110-0261.1	410261	∅ 245 10 8 + S
2.4	120	09/01→12/04			24.0310-0261.1	510261	∅ 245 10 8
2.4	125	09/01→12/04	➔	+PR 1KP	24.0112-0148.1	412148	∅ 255 12 10
2.5 TDI	114	09/01→07/02			24.0312-0148.1	512148	∅ 255 12 10
2.5 TDI	120	07/02→12/04					
2.5 TDI quattro	132	09/01→12/04	➔	8E-5-400001→; +PR 1KW	24.0112-0166.1	412166	∅ 288 12 10
					24.0312-0166.1	512166	∅ 288 12 10
3.0	160	04/01→12/04	←	+PR 1LZ	24.0122-0152.1	422152	∅ 280 22 20 V + S
3.0	162	09/01→12/04			24.0322-0152.1	522152	∅ 280 22 20 V + S
3.0 quattro	160	04/01→12/04					
3.0 quattro	162	09/01→12/04	←	+PR 1LB;1LE	24.0125-0105.1	425105	∅ 288 25 23 V + S
			←	+PR 1LF;1LT	24.0125-0137.1	425137	∅ 312 25 23 V + S
					24.0325-0137.1	525137	∅ 312 25 23 V
			←	+PR 1LA	24.0130-0113.1	430113	∅ 320 30 28 V + S
					24.0330-0113.1	530113	∅ 320 30 28 V
			←	+PR 1LC	24.0130-0185.1	430185	∅ 320 30 28 V•
			➔	+PR 1KD,1KP	24.0112-0148.1	412148	∅ 255 12 10
					24.0312-0148.1	512148	∅ 255 12 10
			➔	8E-5-400001→; +PR 1KW	24.0112-0166.1	412166	∅ 288 12 10
					24.0312-0166.1	512166	∅ 288 12 10
S4 quattro	253	03/03→12/04	←	+PR 1LJ	24.0130-0119.1	430119	∅ 345 30 28 V
			➔		24.0122-0220.1	422220	∅ 300 22 20 V







### AUDI - A4 Avant (8ED, B7) 11/04→06/08









#### Bremsbelagsatz, Scheibenbremse









1.6	75	11/04→06/08	←	+PR 1LZ	13.0460-2837.2	602837	TRW 21945 19,6 + WK
1.8 T	120	11/04→06/08			13.0470-2837.2	LD2837	TRW 21945 19,6 + WK Ceramic
1.8 T quattro	120	11/04→06/08					
2.0	96	11/04→06/08	←	+PR 1LB;1LE;1LF;1LT	13.0460-7110.2	607110	ATE 20676 19,8 + WK
2.5 TDI	120	11/04→05/06			13.0470-7110.2	LD7110	ATE 20676 19,8 + WK Ceramic
			←	+PR 1LA;1LC	13.0460-7201.2	607201	ATE 23763 20,3 + WK
					13.0470-7201.2	LD7201	ATE 23763 20,3 + WK Ceramic
			➔	8E-5-400001→; +PR 1KW	13.0460-2749.2	602749	TRW 24483 16,9 - WE / - WK + Zub
					13.0460-2880.2	602880	TRW 23914 17,1 + WE / - WK + Zub
					13.0470-2749.2	LD2749	TRW 24483 16,9 - WE / - WK + Zub Ceramic
					13.0470-2880.2	LD2880	TRW 23914 17,1 + WE / - WK + Zub Ceramic
			➔	→ 8E-4-180000; +PR 1KD	13.0460-2787.2	602787	TRW 23554 17,3 - WK / - WE
			➔	→ 8E-4-180000; +PR 1KP	13.0460-2860.2	602860	TRW 23554 16,4 - WK / + WE
					13.0470-2860.2	LD2860	TRW 23554 16,4 - WK / + WE Ceramic
			➔	8E-4-180001→; +PR 1KD;1KP	13.0460-2886.2	602886	TRW 20961 16,0 - WK
					13.0460-2937.2	602937	TRW 20961 15,2 - WK + Zub
					13.0470-2886.2	LD2886	TRW 20961 16,0 - WK Ceramic

	kw			 	! #		
<b>AUDI - A4 Avant (8ED, B7) 11/04→06/08</b>							
<b> Bremsbelagsatz, Scheibenbremse</b>							
1.9 TDI 2.0 TDI 2.0 TDI 16V	85 103 103	11/04→06/08 11/04→06/08 11/04→06/08	←	+PR 1LZ	13.0460-2837.2	602837	TRW 21945 19,6 + WK
			←	+PR 1LB;1LE;1LF;1LT	13.0470-2837.2	LD2837	TRW 21945 19,6 + WK Ceramic
			←	+PR 1LA;1LC	13.0460-7110.2	607110	ATE 20676 19,8 + WK
			←	+PR 1LA;1LC	13.0470-7110.2	LD7110	ATE 20676 19,8 + WK Ceramic
			→	8E-5-400001→; +PR 1KW	13.0460-7201.2	607201	ATE 23763 20,3 + WK
			→	8E-5-400001→; +PR 1KW	13.0470-7201.2	LD7201	ATE 23763 20,3 + WK Ceramic
2.0 TDI 2.0 TDI 3.0 TDI quattro 3.2 FSI 3.2 FSI quattro	89 100 150 188 188	09/05→09/06 11/04→06/08 11/04→06/08 01/05→06/08 01/05→06/08	←	+PR 1LZ	13.0460-2837.2	602837	TRW 21945 19,6 + WK
			←	+PR 1LB;1LE;1LF;1LT	13.0470-2837.2	LD2837	TRW 21945 19,6 + WK Ceramic
			←	+PR 1LB;1LE;1LF;1LT	13.0460-7110.2	607110	ATE 20676 19,8 + WK
			←	+PR 1LA;1LC	13.0470-7110.2	LD7110	ATE 20676 19,8 + WK Ceramic
			←	+PR 1LA;1LC	13.0460-7201.2	607201	ATE 23763 20,3 + WK
			←	+PR 1LA;1LC	13.0470-7201.2	LD7201	ATE 23763 20,3 + WK Ceramic
2.0 TDI	93	11/05→11/06	→	8E-5-400001→; +PR 1KW	13.0460-2749.2	602749	TRW 24483 16,9 - WE / - WK + Zub
			→	8E-5-400001→; +PR 1KW	13.0460-2880.2	602880	TRW 23914 17,1 + WE / - WK + Zub
			→	8E-5-400001→; +PR 1KW	13.0470-2749.2	LD2749	TRW 24483 16,9 - WE / - WK + Zub Ceramic
			→	8E-5-400001→; +PR 1KW	13.0470-2749.2	LD2749	TRW 24483 16,9 - WE / - WK + Zub Ceramic
			→	8E-5-400001→; +PR 1KW	13.0470-2880.2	LD2880	TRW 23914 17,1 + WE / - WK + Zub Ceramic
			→	8E-5-400001→; +PR 1KW	13.0470-2880.2	LD2880	TRW 23914 17,1 + WE / - WK + Zub Ceramic
2.0 TDI	93	11/05→11/06	←	06/06→; +PR 1LZ	13.0460-2837.2	602837	TRW 21945 19,6 + WK
			←	06/06→; +PR 1LZ	13.0470-2837.2	LD2837	TRW 21945 19,6 + WK Ceramic
			←	06/06→; +PR 1LB;1LE;1LF;1LT	13.0460-7110.2	607110	ATE 20676 19,8 + WK
			←	06/06→; +PR 1LB;1LE;1LF;1LT	13.0470-7110.2	LD7110	ATE 20676 19,8 + WK Ceramic
			←	06/06→; +PR 1LA;1LC	13.0460-7201.2	607201	ATE 23763 20,3 + WK
			←	06/06→; +PR 1LA;1LC	13.0470-7201.2	LD7201	ATE 23763 20,3 + WK Ceramic
2.0 TDI 2.0 TDI 2.0 TDI quattro 2.0 TDI quattro 2.0 TDI quattro	120 125 103 120 125	06/06→06/08 06/06→06/08 01/06→06/08 06/06→06/08 06/06→06/08	→	06/06→; +PR 1KW	13.0460-2749.2	602749	TRW 24483 16,9 - WE / - WK + Zub
			→	06/06→; +PR 1KW	13.0460-2880.2	602880	TRW 23914 17,1 + WE / - WK + Zub
			→	06/06→; +PR 1KW	13.0470-2749.2	LD2749	TRW 24483 16,9 - WE / - WK + Zub Ceramic
			→	06/06→; +PR 1KW	13.0470-2749.2	LD2749	TRW 24483 16,9 - WE / - WK + Zub Ceramic
			→	06/06→; +PR 1KW	13.0470-2880.2	LD2880	TRW 23914 17,1 + WE / - WK + Zub Ceramic
			→	06/06→; +PR 1KW	13.0470-2880.2	LD2880	TRW 23914 17,1 + WE / - WK + Zub Ceramic
2.0 TDI 2.0 TDI 2.0 TDI quattro 2.0 TDI quattro 2.0 TDI quattro	120 125 103 120 125	06/06→06/08 06/06→06/08 01/06→06/08 06/06→06/08 06/06→06/08	→	06/06→; +PR 1KD;1KP	13.0460-2886.2	602886	TRW 20961 16,0 - WK
			→	06/06→; +PR 1KD;1KP	13.0460-2937.2	602937	TRW 20961 15,2 - WK + Zub
			→	06/06→; +PR 1KD;1KP	13.0470-2886.2	LD2886	TRW 20961 16,0 - WK Ceramic
			→	06/06→; +PR 1KD;1KP	13.0460-2886.2	602886	TRW 20961 16,0 - WK
			→	06/06→; +PR 1KD;1KP	13.0460-2937.2	602937	TRW 20961 15,2 - WK + Zub
			→	06/06→; +PR 1KD;1KP	13.0470-2886.2	LD2886	TRW 20961 16,0 - WK Ceramic
2.0 TDI 2.0 TDI 2.0 TDI quattro 2.0 TDI quattro 2.0 TDI quattro	120 125 103 120 125	06/06→06/08 06/06→06/08 01/06→06/08 06/06→06/08 06/06→06/08	←	+PR 1LZ	13.0460-2837.2	602837	TRW 21945 19,6 + WK
			←	+PR 1LZ	13.0470-2837.2	LD2837	TRW 21945 19,6 + WK Ceramic
			←	+PR 1LB;1LE;1LF;1LT	13.0460-7110.2	607110	ATE 20676 19,8 + WK
			←	+PR 1LB;1LE;1LF;1LT	13.0470-7110.2	LD7110	ATE 20676 19,8 + WK Ceramic
			←	+PR 1LA;1LC	13.0460-7201.2	607201	ATE 23763 20,3 + WK
			←	+PR 1LA;1LC	13.0470-7201.2	LD7201	ATE 23763 20,3 + WK Ceramic
2.0 TFSI ↓	125	10/06→06/08	→	+PR 1KW	13.0460-2749.2	602749	TRW 24483 16,9 - WE / - WK + Zub
			→	+PR 1KW	13.0460-2880.2	602880	TRW 23914 17,1 + WE / - WK + Zub
			→	+PR 1KW	13.0470-2749.2	LD2749	TRW 24483 16,9 - WE / - WK + Zub Ceramic
			→	+PR 1KW	13.0470-2749.2	LD2749	TRW 24483 16,9 - WE / - WK + Zub Ceramic
			→	+PR 1KW	13.0470-2880.2	LD2880	TRW 23914 17,1 + WE / - WK + Zub Ceramic
			→	+PR 1KW	13.0470-2880.2	LD2880	TRW 23914 17,1 + WE / - WK + Zub Ceramic
2.0 TFSI ↓	125	10/06→06/08	→	+PR 1KD;1KP	13.0460-2886.2	602886	TRW 20961 16,0 - WK
			→	+PR 1KD;1KP	13.0460-2937.2	602937	TRW 20961 15,2 - WK + Zub
			→	+PR 1KD;1KP	13.0470-2886.2	LD2886	TRW 20961 16,0 - WK Ceramic
			→	+PR 1KD;1KP	13.0460-2886.2	602886	TRW 20961 16,0 - WK
			→	+PR 1KD;1KP	13.0460-2937.2	602937	TRW 20961 15,2 - WK + Zub
			→	+PR 1KD;1KP	13.0470-2886.2	LD2886	TRW 20961 16,0 - WK Ceramic
2.0 TFSI ↓	125	10/06→06/08	←	+PR 1LZ	13.0460-2837.2	602837	TRW 21945 19,6 + WK
			←	+PR 1LZ	13.0460-2837.2	602837	TRW 21945 19,6 + WK











	kw			 	! #		
<b>AUDI - A4 Avant (8ED, B7) 11/04→06/08</b>							
<b>Bremsbelagsatz, Scheibenbremse</b>							
2.0 TFSI	147	11/04→06/08	←	+PR 1LZ		13.0470-2837.2 LD2837	TRW 21945 19,6 + WK Ceramic
2.0 TFSI	162	06/05→06/08	←	+PR 1LB;1LE;1LF;1LT		13.0460-7110.2 607110	ATE 20676 19,8 + WK
2.0 TFSI quattro	147	11/04→06/08	←	+PR 1LB;1LE;1LF;1LT		13.0470-7110.2 LD7110	ATE 20676 19,8 + WK Ceramic
2.0 TFSI quattro	162	06/05→06/08	←	+PR 1LA;1LC		13.0460-7201.2 607201	ATE 23763 20,3 + WK
			←	+PR 1LA;1LC		13.0470-7201.2 LD7201	ATE 23763 20,3 + WK Ceramic
			→	8E-5-400001→; +PR 1KW		13.0460-2749.2 602749	TRW 24483 16,9 - WE / - WK + Zub
						13.0460-2880.2 602880	TRW 23914 17,1 + WE / - WK + Zub
						13.0470-2749.2 LD2749	TRW 24483 16,9 - WE / - WK + Zub Ceramic
						13.0470-2880.2 LD2880	TRW 23914 17,1 + WE / - WK + Zub Ceramic
			→	+PR 1KD,1KP		13.0460-2886.2 602886	TRW 20961 16,0 - WK
						13.0460-2937.2 602937	TRW 20961 15,2 - WK + Zub
						13.0470-2886.2 LD2886	TRW 20961 16,0 - WK Ceramic
2.7 TDi	120	11/05→03/08	←	+PR 1LZ		13.0460-2837.2 602837	TRW 21945 19,6 + WK
2.7 TDi	132	01/06→06/08	←	+PR 1LZ		13.0470-2837.2 LD2837	TRW 21945 19,6 + WK Ceramic
3.0 TDi quattro	171	01/06→06/08	←	+PR 1LB;1LE;1LF;1LT		13.0460-7110.2 607110	ATE 20676 19,8 + WK
			←	+PR 1LB;1LE;1LF;1LT		13.0470-7110.2 LD7110	ATE 20676 19,8 + WK Ceramic
			←	+PR 1LA;1LC		13.0460-7201.2 607201	ATE 23763 20,3 + WK
			←	+PR 1LA;1LC		13.0470-7201.2 LD7201	ATE 23763 20,3 + WK Ceramic
			→	+PR 1KW		13.0460-2749.2 602749	TRW 24483 16,9 - WE / - WK + Zub
						13.0460-2880.2 602880	TRW 23914 17,1 + WE / - WK + Zub
						13.0470-2749.2 LD2749	TRW 24483 16,9 - WE / - WK + Zub Ceramic
						13.0470-2880.2 LD2880	TRW 23914 17,1 + WE / - WK + Zub Ceramic
3.0	160	11/04→05/06	←	+PR 1LZ		13.0460-2837.2 602837	TRW 21945 19,6 + WK
3.0 quattro	160	11/04→07/06	←	+PR 1LZ		13.0470-2837.2 LD2837	TRW 21945 19,6 + WK Ceramic
			←	+PR 1LB;1LE;1LF;1LT		13.0460-7110.2 607110	ATE 20676 19,8 + WK
			←	+PR 1LB;1LE;1LF;1LT		13.0470-7110.2 LD7110	ATE 20676 19,8 + WK Ceramic
			←	+PR 1LA;1LC		13.0460-7201.2 607201	ATE 23763 20,3 + WK
			←	+PR 1LA;1LC		13.0470-7201.2 LD7201	ATE 23763 20,3 + WK Ceramic
			→	8E-5-400001→; +PR 1KW		13.0460-2749.2 602749	TRW 24483 16,9 - WE / - WK + Zub
						13.0460-2880.2 602880	TRW 23914 17,1 + WE / - WK + Zub
						13.0470-2749.2 LD2749	TRW 24483 16,9 - WE / - WK + Zub Ceramic
						13.0470-2880.2 LD2880	TRW 23914 17,1 + WE / - WK + Zub Ceramic
			→	→ 8E-7-300000; +PR 1KD;1KP		13.0460-2886.2 602886	TRW 20961 16,0 - WK
						13.0460-2937.2 602937	TRW 20961 15,2 - WK + Zub
						13.0470-2886.2 LD2886	TRW 20961 16,0 - WK Ceramic
S4 quattro	253	11/04→06/08	←	+PR 1LJ		13.0460-7201.2 607201	ATE 23763 20,3 + WK
			→			13.0460-2888.2 602888	TRW 23326 17,4 + WE / - WK
						13.0470-2888.2 LD2888	TRW 23326 17,4 + WE / - WK Ceramic
			→	01/05→		13.0460-2889.2 602889	TRW 23326 17,4 + WE / - WK
<b>Zubehörsatz, Scheibenbremsbelag</b>							
1.6	75	11/04→06/08	→	→ 8E-4-180000; +PR 1KP		13.0460-0072.2 610072	TRW
1.8 T	120	11/04→06/08	→	→ 8E-4-180000; +PR 1KD		13.0460-0072.2 610072	TRW
1.8 T quattro	120	11/04→06/08	→	→ 8E-4-180000; +PR 1KD		13.0460-0072.2 610072	TRW
2.0	96	11/04→06/08	→	8E-5-400001→; +PR 1KW		13.0460-0259.2 610259	
2.5 TDI	120	11/04→05/06	→	8E-5-400001→; +PR 1KW		13.0460-0259.2 610259	
1.9 TDI	85	11/04→06/08	→	8E-5-400001→; +PR 1KW		13.0460-0259.2 610259	
2.0 TDI	89	09/05→09/06					
2.0 TDI	100	11/04→06/08					
2.0 TDI	103	11/04→06/08					
2.0 TDI 16V	103	11/04→06/08					
2.0 TFSI	125	10/06→06/08					
2.0 TFSI	147	11/04→06/08					
2.0 TFSI	162	06/05→06/08					
2.0 TFSI quattro	147	11/04→06/08					
2.0 TFSI quattro	162	06/05→06/08					









	kW			 	! #			
<b>AUDI - A4 Avant (8ED, B7) 11/04→06/08</b>								
<b>Zubehörsatz, Scheibenbremsbelag</b>								
3.0	160	11/04→05/06	➡	8E-5-400001→; +PR 1KW		13.0460-0259.2	610259	
3.0 quattro	160	11/04→07/06						
3.0 TDI quattro	150	11/04→06/08						
3.2 FSI	188	01/05→06/08						
3.2 FSI quattro	188	01/05→06/08						
2.0 TDI	93	11/05→11/06	➡	06/06→; +PR 1KW		13.0460-0259.2	610259	
2.0 TDI	120	06/06→06/08	➡	+PR 1KW		13.0460-0259.2	610259	
2.0 TDI	125	06/06→06/08						
2.0 TDI quattro	103	01/06→06/08						
2.0 TDI quattro	120	06/06→06/08						
2.0 TDI quattro	125	06/06→06/08						
2.7 TDi	120	11/05→03/08						
2.7 TDI	132	01/06→06/08						
3.0 TDI quattro	171	01/06→06/08						
RS4 quattro	309	09/05→06/08	➡	11/05→		13.0460-0023.2	610023	
S4 quattro	253	11/04→06/08	➡	01/05→		13.0460-0023.2	610023	
<b> Bremsscheibe</b>								
1.6	75	11/04→06/08	←	+PR 1LZ		24.0122-0152.1	422152	Ø 280 22 20 V + S
1.8 T	120	11/04→06/08				24.0322-0152.1	522152	Ø 280 22 20 V + S
1.8 T quattro	120	11/04→06/08						
1.9 TDI	85	11/04→06/08	←	+PR 1LB;1LE		24.0125-0105.1	425105	Ø 288 25 23 V + S
2.0	96	11/04→06/08				24.0325-0105.1	525105	Ø 288 25 23 V
2.0 TDI	89	09/05→09/06	←	+PR 1LF;1LT		24.0125-0137.1	425137	Ø 312 25 23 V + S
2.0 TDI	100	11/04→06/08				24.0325-0137.1	525137	Ø 312 25 23 V
2.0 TDI	103	11/04→06/08						
2.0 TDI 16V	103	11/04→06/08	←	+PR 1LA		24.0130-0113.1	430113	Ø 320 30 28 V + S
2.0 TFSI	125	10/06→06/08				24.0330-0113.1	530113	Ø 320 30 28 V
2.0 TFSI	147	11/04→06/08						
2.0 TFSI quattro	147	11/04→06/08	←	+PR 1LC		24.0130-0185.1	430185	Ø 320 30 28 V•
2.5 TDI	120	11/04→05/06	➡	+PR 1KD		24.0110-0261.1	410261	Ø 245 10 8 + S
			➡	+PR 1KP		24.0310-0261.1	510261	Ø 245 10 8
			➡	+PR 1KW		24.0112-0148.1	412148	Ø 255 12 10
			➡	8E-5-400001→; +PR 1KW		24.0312-0148.1	512148	Ø 255 12 10
						24.0112-0166.1	412166	Ø 288 12 10
						24.0312-0166.1	512166	Ø 288 12 10
2.0 TDI	93	11/05→11/06	←	06/06→; +PR 1LZ		24.0122-0152.1	422152	Ø 280 22 20 V + S
			←	06/06→; +PR 1LB;1LE		24.0322-0152.1	522152	Ø 280 22 20 V + S
			←	06/06→; +PR 1LF;1LT		24.0125-0105.1	425105	Ø 288 25 23 V + S
			←	06/06→; +PR 1LA		24.0325-0105.1	525105	Ø 288 25 23 V
			←	06/06→; +PR 1LC		24.0125-0137.1	425137	Ø 312 25 23 V + S
			←	06/06→; +PR 1KD		24.0325-0137.1	525137	Ø 312 25 23 V
			←	06/06→; +PR 1KP		24.0130-0113.1	430113	Ø 320 30 28 V + S
			←	06/06→; +PR 1KW		24.0330-0113.1	530113	Ø 320 30 28 V
			➡	06/06→; +PR 1LC		24.0130-0185.1	430185	Ø 320 30 28 V•
			➡	06/06→; +PR 1KD		24.0110-0261.1	410261	Ø 245 10 8 + S
			➡	06/06→; +PR 1KP		24.0310-0261.1	510261	Ø 245 10 8
			➡	06/06→; +PR 1KW		24.0112-0148.1	412148	Ø 255 12 10
			➡	06/06→; +PR 1KW		24.0312-0148.1	512148	Ø 255 12 10
						24.0112-0166.1	412166	Ø 288 12 10
						24.0312-0166.1	512166	Ø 288 12 10
2.0 TDI	120	06/06→06/08	←	+PR 1LZ		24.0122-0152.1	422152	Ø 280 22 20 V + S
2.0 TDI	125	06/06→06/08				24.0322-0152.1	522152	Ø 280 22 20 V + S
2.0 TDI quattro	103	01/06→06/08						
2.0 TDI quattro	120	06/06→06/08	←	+PR 1LB;1LE		24.0125-0105.1	425105	Ø 288 25 23 V + S
2.0 TDI quattro	125	06/06→06/08				24.0325-0105.1	525105	Ø 288 25 23 V
			←	+PR 1LF;1LT		24.0125-0137.1	425137	Ø 312 25 23 V + S
			←	+PR 1LA		24.0325-0137.1	525137	Ø 312 25 23 V
			←	+PR 1LC		24.0130-0113.1	430113	Ø 320 30 28 V + S
			←	+PR 1KD		24.0330-0113.1	530113	Ø 320 30 28 V
			➡	+PR 1KP		24.0130-0185.1	430185	Ø 320 30 28 V•
			➡	+PR 1KW		24.0110-0261.1	410261	Ø 245 10 8 + S
			➡	+PR 1KW		24.0310-0261.1	510261	Ø 245 10 8
			➡	+PR 1KW		24.0112-0148.1	412148	Ø 255 12 10
			➡	+PR 1KW		24.0312-0148.1	512148	Ø 255 12 10
						24.0112-0166.1	412166	Ø 288 12 10
						24.0312-0166.1	512166	Ø 288 12 10
2.0 TFSI	162	06/05→06/08	←	+PR 1LZ		24.0122-0152.1	422152	Ø 280 22 20 V + S
↓								

	kw			 	! #		
<b>AUDI - A4 Avant (8ED, B7) 11/04→06/08</b>							
 <b>Bremsscheibe</b>							
2.0 TFSI quattro	162	06/05→06/08	←	+PR 1LZ		24.0322-0152.1 522152	Ø 280 22 20 V + S
3.0 TDI quattro	150	11/04→06/08	←	+PR 1LB;1LE		24.0125-0105.1 425105	Ø 288 25 23 V + S
3.2 FSI	188	01/05→06/08	←	+PR 1LF;1LT		24.0125-0137.1 425137	Ø 312 25 23 V + S
3.2 FSI quattro	188	01/05→06/08	←	+PR 1LA		24.0130-0113.1 430113	Ø 320 30 28 V + S
			←	+PR 1LC		24.0330-0113.1 530113	Ø 320 30 28 V
			←	+PR 1LC		24.0130-0185.1 430185	Ø 320 30 28 V*
			→	+PR 1KD		24.0110-0261.1 410261	Ø 245 10 8 + S
			→	+PR 1KP		24.0310-0261.1 510261	Ø 245 10 8
			→	+PR 1KP		24.0112-0148.1 412148	Ø 255 12 10
			→	+PR 1KP		24.0312-0148.1 512148	Ø 255 12 10
			→	8E-5-400001→; +PR 1KW		24.0112-0166.1 412166	Ø 288 12 10
			→	8E-5-400001→; +PR 1KW		24.0312-0166.1 512166	Ø 288 12 10
2.7 TDi	120	11/05→03/08	←	+PR 1LZ		24.0122-0152.1 422152	Ø 280 22 20 V + S
2.7 TDI	132	01/06→06/08	←	+PR 1LB;1LE		24.0322-0152.1 522152	Ø 280 22 20 V + S
			←	+PR 1LB;1LE		24.0125-0105.1 425105	Ø 288 25 23 V + S
			←	+PR 1LB;1LE		24.0325-0105.1 525105	Ø 288 25 23 V
			←	+PR 1LF;1LT		24.0125-0137.1 425137	Ø 312 25 23 V + S
			←	+PR 1LF;1LT		24.0325-0137.1 525137	Ø 312 25 23 V
			←	+PR 1LA		24.0130-0113.1 430113	Ø 320 30 28 V + S
			←	+PR 1LA		24.0330-0113.1 530113	Ø 320 30 28 V
			←	+PR 1LC		24.0130-0185.1 430185	Ø 320 30 28 V*
			→	+PR 1KW		24.0112-0166.1 412166	Ø 288 12 10
			→	+PR 1KW		24.0312-0166.1 512166	Ø 288 12 10
3.0	160	11/04→05/06	←	+PR 1LZ		24.0122-0152.1 422152	Ø 280 22 20 V + S
3.0 quattro	160	11/04→07/06	←	+PR 1LZ		24.0322-0152.1 522152	Ø 280 22 20 V + S
			←	+PR 1LB;1LE		24.0125-0105.1 425105	Ø 288 25 23 V + S
			←	+PR 1LB;1LE		24.0325-0105.1 525105	Ø 288 25 23 V
			←	+PR 1LF;1LT		24.0125-0137.1 425137	Ø 312 25 23 V + S
			←	+PR 1LF;1LT		24.0325-0137.1 525137	Ø 312 25 23 V
			←	+PR 1LA		24.0130-0113.1 430113	Ø 320 30 28 V + S
			←	+PR 1LA		24.0330-0113.1 530113	Ø 320 30 28 V
			←	+PR 1LC		24.0130-0185.1 430185	Ø 320 30 28 V*
			→	+PR 1KD,1KP		24.0112-0148.1 412148	Ø 255 12 10
			→	+PR 1KD,1KP		24.0312-0148.1 512148	Ø 255 12 10
			→	8E-5-400001→; +PR 1KW		24.0112-0166.1 412166	Ø 288 12 10
			→	8E-5-400001→; +PR 1KW		24.0312-0166.1 512166	Ø 288 12 10
3.0 TDI quattro	171	01/06→06/08	←	+PR 1LZ		24.0122-0152.1 422152	Ø 280 22 20 V + S
			←	+PR 1LZ		24.0322-0152.1 522152	Ø 280 22 20 V + S
			←	+PR 1LB;1LE		24.0125-0105.1 425105	Ø 288 25 23 V + S
			←	+PR 1LB;1LE		24.0325-0105.1 525105	Ø 288 25 23 V
			←	+PR 1LF;1LT		24.0125-0137.1 425137	Ø 312 25 23 V + S
			←	+PR 1LF;1LT		24.0325-0137.1 525137	Ø 312 25 23 V
			←	+PR 1LA		24.0130-0113.1 430113	Ø 320 30 28 V + S
			←	+PR 1LA		24.0330-0113.1 530113	Ø 320 30 28 V
			←	+PR 1LC		24.0130-0185.1 430185	Ø 320 30 28 V*
			→	+PR 1KW		24.0112-0166.1 412166	Ø 288 12 10
			→	+PR 1KW		24.0312-0166.1 512166	Ø 288 12 10
S4 quattro	253	11/04→06/08	←	+PR 1LJ		24.0130-0119.1 430119	Ø 345 30 28 V
			→			24.0122-0220.1 422220	Ø 300 22 20 V
<b>AUDI - A4 Avant (8K5, B8) 11/07→12/15</b>							
 <b>Bremsbelagsatz, Scheibenbremse</b>							
1.8 TFSI	88	04/08→12/15	←	+PR 1LA,1LB,1LD		13.0460-2746.2 602746	TRW 24408 19,2 + WK
1.8 TFSI quattro	118	09/08→03/12	←	+PR 1LA,1LB,1LD		13.0460-2765.2 602765	TRW 24409 19,2 + WK + Zub
2.0 TDI	88	06/08→12/15	←	+PR 1LA,1LB,1LD		13.0470-2746.2 LD2746	TRW 24408 19,2 + WK + Zub
2.0 TDI	100	04/08→12/15	←	+PR 1LA,1LB,1LD		13.0470-2746.2 LD2746	Ceramic
2.0 TDI	105	04/08→12/15	←	+PR 1LA,1LB,1LD		13.0470-2765.2 LD2765	TRW 24409 19,2 + WK + Zub
2.0 TDI	110	05/13→12/15	←	+PR 1LA,1LB,1LD		13.0470-2765.2 LD2765	Ceramic
2.0 TDI	120	08/08→12/15	←	+PR 1LA,1LB,1LD		13.0460-7256.2 607256	ATE 24705 19,8 + WK
2.0 TDI	125	04/08→03/12	←	+PR 1LT,1LY		13.0470-7256.2 LD7256	ATE 24705 19,8 + WK Ceramic
2.0 TDI	130	11/11→12/15	←	+PR 1LT,1LY		13.0460-7256.2 607256	ATE 24705 19,8 + WK Ceramic
2.0 TDI	140	09/13→12/15	←	+PR 1LT,1LY		13.0470-7256.2 LD7256	ATE 24705 19,8 + WK Ceramic
2.0 TDI 16V	103	07/08→	→	+PR 1KW,2EH; + eFSB		13.0460-2747.2 602747	TRW 24606 17,4 - WE / - WK + Zub
2.0 TDI quattro	105	04/08→12/15	→	+PR 1KW,2EH; + eFSB		13.0460-2747.2 602747	TRW 24606 17,4 - WE / - WK + Zub

















	kw			 	! #		
<b>AUDI - A4 Avant (8K5, B8) 11/07→12/15</b>							
<b> Bremsbelagsatz, Scheibenbremse</b>							
2.0 TDI quattro	110	05/13→12/15	➡	+PR 1KW,2EH; + eFSB		<b>13.0470-2747.2</b> <b>LD2747</b>	TRW 24606 17,4 - WE / - WK + Zub Ceramic
2.0 TDI quattro	125	08/08→03/12					
2.0 TDI quattro	130	11/11→12/15					
2.0 TDI quattro	140	09/13→12/15	➡	+PR 1KP; + eFSB		<b>13.0460-2748.2</b> <b>602748</b>	TRW 24606 17,4 - WE / - WK + Zub
2.0 TFSI	132	06/08→12/15					
2.0 TFSI	155	06/08→05/13				<b>13.0470-2748.2</b> <b>LD2748</b>	TRW 24606 17,4 - WE / - WK + Zub Ceramic
2.0 TFSI	165	05/13→12/15					
2.0 TFSI flexible fuel	132	11/09→12/15					
2.0 TFSI flexible fuel quattro	132	11/09→12/15					
2.0 TFSI quattro	155	06/08→12/15					
2.7 TDI	120	06/08→03/12					
3.0 TDI	150	11/11→12/15					
3.0 TDI quattro	155	06/08→05/10					
3.0 TDI quattro	176	04/08→03/12					
3.0 TDI quattro	180	11/11→12/15					
3.0 TFSI quattro	200	02/12→12/15					
3.2 FSI	195	09/08→03/12					
3.2 FSI quattro	195	04/08→03/12					
1.8 TFSI	118	11/07→03/12	⬅	04/08→; +PR 1LA,1LB,1LD		<b>13.0460-2746.2</b> <b>602746</b>	TRW 24408 19,2 + WK
						<b>13.0460-2765.2</b> <b>602765</b>	TRW 24409 19,2 + WK + Zub
						<b>13.0470-2746.2</b> <b>LD2746</b>	TRW 24408 19,2 + WK + Zub Ceramic
						<b>13.0470-2765.2</b> <b>LD2765</b>	TRW 24409 19,2 + WK + Zub Ceramic
			⬅	04/08→; +PR 1LT,1LY		<b>13.0460-7256.2</b> <b>607256</b>	ATE 24705 19,8 + WK
						<b>13.0470-7256.2</b> <b>LD7256</b>	ATE 24705 19,8 + WK Ceramic
			➡	04/08→; +PR 1KW,2EH; + eFSB		<b>13.0460-2747.2</b> <b>602747</b>	TRW 24606 17,4 - WE / - WK + Zub
						<b>13.0470-2747.2</b> <b>LD2747</b>	TRW 24606 17,4 - WE / - WK + Zub Ceramic
			➡	04/08→; +PR 1KP; + eFSB		<b>13.0460-2748.2</b> <b>602748</b>	TRW 24606 17,4 - WE / - WK + Zub
						<b>13.0470-2748.2</b> <b>LD2748</b>	TRW 24606 17,4 - WE / - WK + Zub Ceramic
1.8 TFSI	125	11/11→12/15	⬅	01/12→; +PR 1LA,1LB,1LD		<b>13.0460-2746.2</b> <b>602746</b>	TRW 24408 19,2 + WK
1.8 TFSI quattro	125	11/11→12/15				<b>13.0460-2765.2</b> <b>602765</b>	TRW 24409 19,2 + WK + Zub
						<b>13.0470-2746.2</b> <b>LD2746</b>	TRW 24408 19,2 + WK + Zub Ceramic
						<b>13.0470-2765.2</b> <b>LD2765</b>	TRW 24409 19,2 + WK + Zub Ceramic
			⬅	01/12→; +PR 1LT,1LY		<b>13.0460-7256.2</b> <b>607256</b>	ATE 24705 19,8 + WK
						<b>13.0470-7256.2</b> <b>LD7256</b>	ATE 24705 19,8 + WK Ceramic
			➡	01/12→; +PR 1KW,2EH; + eFSB		<b>13.0460-2747.2</b> <b>602747</b>	TRW 24606 17,4 - WE / - WK + Zub
						<b>13.0470-2747.2</b> <b>LD2747</b>	TRW 24606 17,4 - WE / - WK + Zub Ceramic
			➡	01/12→; +PR 1KP; + eFSB		<b>13.0460-2748.2</b> <b>602748</b>	TRW 24606 17,4 - WE / - WK + Zub
						<b>13.0470-2748.2</b> <b>LD2748</b>	TRW 24606 17,4 - WE / - WK + Zub Ceramic
2.0 TFSI quattro	165	05/13→12/15	⬅	+PR 1LA,1LB,1LD		<b>13.0460-2746.2</b> <b>602746</b>	TRW 24408 19,2 + WK
						<b>13.0460-2765.2</b> <b>602765</b>	TRW 24409 19,2 + WK + Zub
						<b>13.0470-2746.2</b> <b>LD2746</b>	TRW 24408 19,2 + WK + Zub Ceramic
						<b>13.0470-2765.2</b> <b>LD2765</b>	TRW 24409 19,2 + WK + Zub Ceramic
			⬅	+PR 1LT,1LY		<b>13.0460-7256.2</b> <b>607256</b>	ATE 24705 19,8 + WK
						<b>13.0470-7256.2</b> <b>LD7256</b>	ATE 24705 19,8 + WK Ceramic
			➡	+PR 1KW,2EH; + eFSB		<b>13.0460-2747.2</b> <b>602747</b>	TRW 24606 17,4 - WE / - WK + Zub
						<b>13.0470-2747.2</b> <b>LD2747</b>	TRW 24606 17,4 - WE / - WK + Zub Ceramic
2.7 TDI	140	04/08→03/12	⬅	06/08→; +PR 1LA,1LB,1LD		<b>13.0460-2746.2</b> <b>602746</b>	TRW 24408 19,2 + WK
						<b>13.0460-2765.2</b> <b>602765</b>	TRW 24409 19,2 + WK + Zub
						<b>13.0470-2746.2</b> <b>LD2746</b>	TRW 24408 19,2 + WK + Zub Ceramic
						<b>13.0470-2765.2</b> <b>LD2765</b>	TRW 24409 19,2 + WK + Zub Ceramic
			⬅	06/08→; +PR 1LT,1LY		<b>13.0460-7256.2</b> <b>607256</b>	ATE 24705 19,8 + WK
						<b>13.0470-7256.2</b> <b>LD7256</b>	ATE 24705 19,8 + WK Ceramic
↓							



















	kw			 	! #		
<b>AUDI - A4 Avant (8K5, B8) 11/07→12/15</b>							
<b> Bremsbelagsatz, Scheibenbremse</b>							
2.7 TDI	140	04/08→03/12	➡	06/08→; +PR 1KW,2EH; + eFSB		13.0460-2747.2 602747 13.0470-2747.2 LD2747	TRW 24606 17,4 - WE / - WK + Zub TRW 24606 17,4 - WE / - WK + Zub Ceramic
			➡	06/08→; +PR 1KP; + eFSB		13.0460-2748.2 602748 13.0470-2748.2 LD2748	TRW 24606 17,4 - WE / - WK + Zub TRW 24606 17,4 - WE / - WK + Zub Ceramic
RS4 quattro	331	05/12→08/15	➡	+ eFSB		13.0460-2770.2 602770 13.0470-2770.2 LD2770	TRW 24606 17,4 + WK + Zub TRW 24606 17,4 + WK + Zub Ceramic
S4 quattro	245	11/08→12/15	⬅	07/11→; +PR 1LJ,1ZT		13.0460-2746.2 602746 13.0460-2765.2 602765	TRW 24408 19,2 + WK TRW 24409 19,2 + WK + Zub
			➡	+PR 1KE; + eFSB		13.0460-2748.2 602748 13.0470-2748.2 LD2748	TRW 24606 17,4 - WE / - WK + Zub TRW 24606 17,4 - WE / - WK + Zub Ceramic
<b>Warnkontakt, Bremsbelagverschleiß</b>							
RS4 quattro	331	05/12→08/15	⬅	☐; +PR 1LW	1	24.8190-0017.2 620017	L= 388,3
<b> Bremsscheibe</b>							
1.8 TFSI	88	04/08→12/15	⬅	+PR 1LT,1LY		24.0125-0184.1 425184	Ø 314 25 23 V + S
1.8 TFSI quattro	118	09/08→03/12				24.0325-0184.1 525184	Ø 314 25 23 V + S
2.0 TDI	88	06/08→12/15					
2.0 TDI	100	04/08→12/15	⬅	→ 06/11; +PR 1LA		24.0130-0193.1 430193	Ø 320 30 28 V + S
2.0 TDI	105	04/08→12/15				24.0330-0193.1 530193	Ø 320 30 28 V + S
2.0 TDI	120	08/08→12/15					
2.0 TDI	125	04/08→03/12	⬅	07/11→; +PR 1LA,1LB		24.0130-0221.1 430221	Ø 320 30 28 V + S
2.0 TDI 16V	103	07/08→	⬅	+PR 1LD		24.0130-0222.1 430222	Ø 345 30 28 V + S
2.0 TDI quattro	105	04/08→12/15					
2.0 TDI quattro	125	08/08→03/12	➡	+PR 1KW,2EH		24.0112-0178.1 412178	Ø 300 12 10 + S
2.0 TFSI	132	06/08→12/15				24.0312-0178.1 512178	Ø 300 12 10 + S
2.0 TFSI	155	06/08→05/13					
2.0 TFSI flexible fuel	132	11/09→12/15	➡	+PR 1KP; + eFSB		24.0122-0272.1 422272	Ø 330 21,9 20 V + S
2.0 TFSI flexible fuel quattro	132	11/09→12/15					
2.0 TFSI quattro	155	06/08→12/15					
2.7 TDI	120	06/08→03/12					
3.0 TDI quattro	176	04/08→03/12					
3.2 FSI	195	09/08→03/12					
3.2 FSI quattro	195	04/08→03/12					
1.8 TFSI	118	11/07→03/12	⬅	04/08→; +PR 1LT,1LY		24.0125-0184.1 425184	Ø 314 25 23 V + S
			⬅	04/08→ 06/11; +PR 1LA		24.0325-0184.1 525184	Ø 314 25 23 V + S
			⬅	07/11→; +PR 1LA,1LB		24.0130-0193.1 430193	Ø 320 30 28 V + S
			⬅	04/08→; +PR 1LD		24.0330-0193.1 530193	Ø 320 30 28 V + S
			⬅	04/08→; +PR 1LD		24.0130-0221.1 430221	Ø 320 30 28 V + S
			➡	04/08→; +PR 1KW,2EH		24.0130-0222.1 430222	Ø 345 30 28 V + S
			➡	04/08→; +PR 1KP; + eFSB		24.0112-0178.1 412178	Ø 300 12 10 + S
			➡	04/08→; +PR 1KP; + eFSB		24.0312-0178.1 512178	Ø 300 12 10 + S
			➡	04/08→; +PR 1KP; + eFSB		24.0122-0272.1 422272	Ø 330 21,9 20 V + S
1.8 TFSI	125	11/11→12/15	⬅	01/12→; +PR 1LT,1LY		24.0125-0184.1 425184	Ø 314 25 23 V + S
1.8 TFSI quattro	125	11/11→12/15	⬅	01/12→; +PR 1LA,1LB		24.0325-0184.1 525184	Ø 314 25 23 V + S
			⬅	01/12→; +PR 1LD		24.0130-0221.1 430221	Ø 320 30 28 V + S
			⬅	01/12→; +PR 1LD		24.0130-0222.1 430222	Ø 345 30 28 V + S
			➡	01/12→; +PR 1KW,2EH		24.0112-0178.1 412178	Ø 300 12 10 + S
			➡	01/12→; +PR 1KW,2EH		24.0312-0178.1 512178	Ø 300 12 10 + S
			➡	01/12→; +PR 1KP; + eFSB		24.0122-0272.1 422272	Ø 330 21,9 20 V + S
2.0 TDI	110	05/13→12/15	⬅	+PR 1LT,1LY		24.0125-0184.1 425184	Ø 314 25 23 V + S
2.0 TDI	130	11/11→12/15				24.0325-0184.1 525184	Ø 314 25 23 V + S
2.0 TDI	140	09/13→12/15					
2.0 TDI quattro	110	05/13→12/15	⬅	+PR 1LA,1LB		24.0130-0221.1 430221	Ø 320 30 28 V + S
2.0 TDI quattro	130	11/11→12/15	⬅	+PR 1LD		24.0130-0222.1 430222	Ø 345 30 28 V + S
2.0 TDI quattro	140	09/13→12/15					
2.0 TFSI	165	05/13→12/15	➡	+PR 1KW,2EH		24.0112-0178.1 412178	Ø 300 12 10 + S
2.0 TFSI quattro	165	05/13→12/15				24.0312-0178.1 512178	Ø 300 12 10 + S
3.0 TDI	150	11/11→12/15					
3.0 TDI quattro	180	11/11→12/15	➡	+PR 1KP; + eFSB		24.0122-0272.1 422272	Ø 330 21,9 20 V + S
3.0 TFSI quattro	200	02/12→12/15					
2.7 TDI	140	04/08→03/12	⬅	06/08→; +PR 1LT,1LY		24.0125-0184.1 425184	Ø 314 25 23 V + S
						24.0325-0184.1 525184	Ø 314 25 23 V + S









	kw			 	! #		
<b>AUDI - A4 Avant (8K5, B8) 11/07→12/15</b>							
<b>Bremsscheibe</b>							
2.7 TDI	140	04/08→03/12	←	06/08→ 06/11; +PR 1LA	24.0130-0193.1	430193	∅ 320 30 28 V + S
					24.0330-0193.1	530193	∅ 320 30 28 V + S
			←	07/11→; +PR 1LA,1LB	24.0130-0221.1	430221	∅ 320 30 28 V + S
			←	06/08→; +PR 1LD	24.0130-0222.1	430222	∅ 345 30 28 V + S
			→	06/08→; +PR 1KW,2EH	24.0112-0178.1	412178	∅ 300 12 10 + S
				24.0312-0178.1	512178	∅ 300 12 10 + S	
			→	06/08→; +PR 1KP; + eFSB	24.0122-0272.1	422272	∅ 330 21,9 20 V + S
3.0 TDI quattro	155	06/08→05/10	←	+PR 1LT,1LY	24.0125-0184.1	425184	∅ 314 25 23 V + S
					24.0325-0184.1	525184	∅ 314 25 23 V + S
			←	+PR 1LA	24.0130-0193.1	430193	∅ 320 30 28 V + S
					24.0330-0193.1	530193	∅ 320 30 28 V + S
			←	+PR 1LD	24.0130-0222.1	430222	∅ 345 30 28 V + S
			→	+PR 1KW,2EH	24.0112-0178.1	412178	∅ 300 12 10 + S
				24.0312-0178.1	512178	∅ 300 12 10 + S	
			→	+PR 1KP; + eFSB	24.0122-0272.1	422272	∅ 330 21,9 20 V + S
S4 quattro	245	11/08→12/15	←	→ 06/11; +PR 1LJ	24.0129-0102.1	429102	∅ 345 29,5 28 V + S
			←	+PR 1ZT	24.0130-0222.1	430222	∅ 345 30 28 V + S
			←	07/11→; +PR 1LJ	24.0130-0222.1	430222	∅ 345 30 28 V + S
			→	+PR 1KE; + eFSB	24.0122-0272.1	422272	∅ 330 21,9 20 V + S
<b>AUDI - A4 Avant (8W5, B9) 08/15→</b>							
<b>Bremsbelagsatz, Scheibenbremse</b>							
1.4 TFSI	110	02/16→	←	+PR 1LA,1LB	13.0460-7314.2	607314	ATE 22383 17,3 + WK
2.0 TDI	90	04/16→			13.0470-7314.2	LD7314	ATE 22383 17,3 + WK Ceramic
2.0 TDI	100	08/15→					
2.0 TDI	110	08/15→	→	+PR 1KI	13.0460-2796.2	602796	TRW 22308 17,7 + WE / - WK
2.0 TDI	140	08/15→					
2.0 TDI quattro	110	09/16→	→	+PR 1KD,1KE,1KF,1KK / 1KJ,2EJ	13.0460-2796.2	602796	TRW 22308 17,7 + WE / - WK
2.0 TDI quattro	120	09/16→					
2.0 TDI quattro	140	10/15→					
2.0 TFSI	140	08/15→					
2.0 TFSI	183	05/16→					
2.0 TFSI	185	05/16→					
2.0 TFSI g-tron	125	11/16→					
2.0 TFSI quattro	183	11/15→					
2.0 TFSI quattro	185	08/15→					
3.0 TDI	160	10/15→					
3.0 TDI quattro	160	11/15→					
3.0 TDI quattro	200	08/15→					
S4 quattro	260	05/16→	←	+PR 1LA,1LB	13.0460-7314.2	607314	ATE 22383 17,3 + WK
			→	+PR 1KI	13.0460-2796.2	602796	TRW 22308 17,7 + WE / - WK
			→	+PR 1KD,1KE,1KF,1KK / 1KJ,2EJ	13.0460-2796.2	602796	TRW 22308 17,7 + WE / - WK
<b>Bremsscheibe</b>							
1.4 TFSI	110	02/16→	←	+PR 1LA,1LB	24.0125-0184.1	425184	∅ 314 25 23 V + S
2.0 TDI	90	04/16→			24.0325-0184.1	525184	∅ 314 25 23 V + S
2.0 TDI	100	08/15→	←	+PR 1LC,1LD	24.0130-0244.1	430244	∅ 318 30 28 V + S
2.0 TDI	110	08/15→					
2.0 TDI	140	08/15→	←	+PR 1LL,1ZA,1ZC,1ZK	24.0134-0110.1	434110	∅ 349 34 32 V + S
2.0 TDI quattro	110	09/16→					
2.0 TDI quattro	120	09/16→	→	+PR 1KD,1KE,1KI	24.0112-0218.1	412218	∅ 300 12 10 + S
2.0 TDI quattro	140	10/15→					
2.0 TFSI	140	08/15→	→	+PR 1KF,1KJ,1KK,2EJ	24.0122-0272.1	422272	∅ 330 21,9 20 V + S
2.0 TFSI	183	05/16→					
2.0 TFSI	185	05/16→					
2.0 TFSI quattro	183	11/15→					
2.0 TFSI quattro	185	08/15→					
3.0 TDI	160	10/15→					
3.0 TDI quattro	160	11/15→					
3.0 TDI quattro	200	08/15→					
S4 quattro	260	05/16→					
2.0 TFSI g-tron	125	11/16→	←	+PR 1LC,1LD	24.0130-0244.1	430244	∅ 318 30 28 V + S
			←	+PR 1LL,1ZA,1ZC,1ZK	24.0134-0110.1	434110	∅ 349 34 32 V + S
			→	+PR 1KD,1KE,1KI	24.0112-0218.1	412218	∅ 300 12 10 + S
			→	+PR 1KF,1KJ,1KK,2EJ	24.0122-0272.1	422272	∅ 330 21,9 20 V + S









	kw			 	! #		
<b>AUDI - A4 Cabriolet (8H7, B6, 8HE, B7) 01/02→12/09</b>							
<b> Bremsbelagsatz, Scheibenbremse</b>							
1.8 T 1.8 T quattro	120 120	07/02→03/09 05/03→03/09	←	→ 11/08; +PR 1LB;1LE;1LF;1LT	13.0460-7110.2	607110	ATE 20676 19,8 + WK
					13.0470-7110.2	LD7110	ATE 20676 19,8 + WK Ceramic
			←	+PR 1LA; → 11/08	13.0460-7201.2	607201	ATE 23763 20,3 + WK
					13.0470-7201.2	LD7201	ATE 23763 20,3 + WK Ceramic
			→	8E-5-400001→; → 11/08; +PR 1KW	13.0460-2749.2	602749	TRW 24483 16,9 - WE / - WK + Zub
					13.0460-2880.2	602880	TRW 23914 17,1 + WE / - WK + Zub
					13.0470-2749.2	LD2749	TRW 24483 16,9 - WE / - WK + Zub Ceramic
		13.0470-2880.2	LD2880	TRW 23914 17,1 + WE / - WK + Zub Ceramic			
		→	→ 11/08; +PR 1KD;1KP / 1KD,1KP	13.0460-2886.2	602886	TRW 20961 16,0 - WK	
		→	→ 11/08; +PR 1KD;1KP	13.0460-2937.2	602937	TRW 20961 15,2 - WK + Zub	
				13.0470-2886.2	LD2886	TRW 20961 16,0 - WK Ceramic	
1.8 T 2.0	125 96	10/02→10/05 09/04→12/05	←	+PR 1LB;1LE;1LF;1LT	13.0460-7110.2	607110	ATE 20676 19,8 + WK
					13.0470-7110.2	LD7110	ATE 20676 19,8 + WK Ceramic
			←	+PR 1LA	13.0460-7201.2	607201	ATE 23763 20,3 + WK
					13.0470-7201.2	LD7201	ATE 23763 20,3 + WK Ceramic
			→	8E-5-400001→; +PR 1KW	13.0460-2749.2	602749	TRW 24483 16,9 - WE / - WK + Zub
					13.0460-2880.2	602880	TRW 23914 17,1 + WE / - WK + Zub
					13.0470-2749.2	LD2749	TRW 24483 16,9 - WE / - WK + Zub Ceramic
		13.0470-2880.2	LD2880	TRW 23914 17,1 + WE / - WK + Zub Ceramic			
		→	+PR 1KD;1KP / 1KD,1KP	13.0460-2886.2	602886	TRW 20961 16,0 - WK	
		→	+PR 1KD;1KP	13.0460-2937.2	602937	TRW 20961 15,2 - WK + Zub	
				13.0470-2886.2	LD2886	TRW 20961 16,0 - WK Ceramic	
2.0 TDI 2.0 TDI 2.0 TFSI 16V	100 103 147	01/06→03/09 01/06→03/09 01/06→03/09	←	→ 11/08; +PR 1LB;1LE;1LF;1LT	13.0460-7110.2	607110	ATE 20676 19,8 + WK
					13.0470-7110.2	LD7110	ATE 20676 19,8 + WK Ceramic
			←	+PR 1LA; → 11/08	13.0460-7201.2	607201	ATE 23763 20,3 + WK
					13.0470-7201.2	LD7201	ATE 23763 20,3 + WK Ceramic
			→	8E-5-400001→; → 11/08; +PR 1KW	13.0460-2749.2	602749	TRW 24483 16,9 - WE / - WK + Zub
					13.0460-2880.2	602880	TRW 23914 17,1 + WE / - WK + Zub
					13.0470-2749.2	LD2749	TRW 24483 16,9 - WE / - WK + Zub Ceramic
		13.0470-2880.2	LD2880	TRW 23914 17,1 + WE / - WK + Zub Ceramic			
		→	→ 11/08; +PR 1KD,1KP	13.0460-2886.2	602886	TRW 20961 16,0 - WK	
		→	→ 11/08	13.0460-2937.2	602937	TRW 20961 15,2 - WK + Zub	
				13.0470-2886.2	LD2886	TRW 20961 16,0 - WK Ceramic	
2.4 2.4 2.5 TDI 3.0 3.0 quattro	120 125 120 162 162	04/02→12/05 04/02→12/05 08/02→12/05 04/02→12/05 05/03→12/05	←	+PR 1LB;1LE;1LF;1LT	13.0460-7110.2	607110	ATE 20676 19,8 + WK
					13.0470-7110.2	LD7110	ATE 20676 19,8 + WK Ceramic
			←	+PR 1LA	13.0460-7201.2	607201	ATE 23763 20,3 + WK
					13.0470-7201.2	LD7201	ATE 23763 20,3 + WK Ceramic
			→	8E-5-400001→; +PR 1KW	13.0460-2749.2	602749	TRW 24483 16,9 - WE / - WK + Zub
					13.0460-2880.2	602880	TRW 23914 17,1 + WE / - WK + Zub
					13.0470-2749.2	LD2749	TRW 24483 16,9 - WE / - WK + Zub Ceramic
		13.0470-2880.2	LD2880	TRW 23914 17,1 + WE / - WK + Zub Ceramic			
		→	+PR 1KD,1KP	13.0460-2886.2	602886	TRW 20961 16,0 - WK	
		→		13.0460-2937.2	602937	TRW 20961 15,2 - WK + Zub	
				13.0470-2886.2	LD2886	TRW 20961 16,0 - WK Ceramic	
2.7 TDI 3.0 TDI quattro 3.2 FSI 3.2 FSI quattro	132 171 188 188	06/06→03/09 01/06→03/09 01/06→03/09 01/06→03/09	←	→ 11/08; +PR 1LB;1LE;1LF;1LT	13.0460-7110.2	607110	ATE 20676 19,8 + WK
					13.0470-7110.2	LD7110	ATE 20676 19,8 + WK Ceramic
			←	+PR 1LA; → 11/08	13.0460-7201.2	607201	ATE 23763 20,3 + WK
					13.0470-7201.2	LD7201	ATE 23763 20,3 + WK Ceramic
↓							









	kw			 	! #		
<b>AUDI - A4 Cabriolet (8H7, B6, 8HE, B7) 01/02→12/09</b>							
<b> Bremsbelagsatz, Scheibenbremse</b>							
2.7 TDI 3.0 TDI quattro 3.2 FSI 3.2 FSI quattro	132 171 188 188	06/06→03/09 01/06→03/09 01/06→03/09 01/06→03/09	➔	8E-5-400001→; → 11/08; +PR 1KW		13.0460-2749.2 602749 13.0460-2880.2 602880 13.0470-2749.2 LD2749 13.0470-2880.2 LD2880	TRW 24483 16,9 - WE / - WK + Zub TRW 23914 17,1 + WE / - WK + Zub TRW 24483 16,9 - WE / - WK + Zub Ceramic TRW 23914 17,1 + WE / - WK + Zub Ceramic
3.0	160	04/02→12/05	←	+PR 1LZ		13.0460-2837.2 602837 13.0470-2837.2 LD2837	TRW 21945 19,6 + WK TRW 21945 19,6 + WK Ceramic
			←	+PR 1LB;1LE;1LF;1LT		13.0460-7110.2 607110 13.0470-7110.2 LD7110	ATE 20676 19,8 + WK ATE 20676 19,8 + WK Ceramic
			←	+PR 1LA;1LC		13.0460-7201.2 607201 13.0470-7201.2 LD7201	ATE 23763 20,3 + WK ATE 23763 20,3 + WK Ceramic
			➔	8E-5-400001→; +PR 1KW		13.0460-2749.2 602749 13.0460-2880.2 602880 13.0470-2749.2 LD2749 13.0470-2880.2 LD2880	TRW 24483 16,9 - WE / - WK + Zub TRW 23914 17,1 + WE / - WK + Zub TRW 24483 16,9 - WE / - WK + Zub Ceramic TRW 23914 17,1 + WE / - WK + Zub Ceramic
			➔	→ 8E-7-300000; +PR 1KD;1KP		13.0460-2886.2 602886 13.0460-2937.2 602937 13.0470-2886.2 LD2886	TRW 20961 16,0 - WK TRW 20961 15,2 - WK + Zub TRW 20961 16,0 - WK Ceramic
3.0 TDI quattro	150	01/06→03/09	←	→ 11/08; +PR 1LB;1LE;1LF;1LT		13.0460-7110.2 607110 13.0470-7110.2 LD7110	ATE 20676 19,8 + WK ATE 20676 19,8 + WK Ceramic
			←	+PR 1LA; → 11/08		13.0460-7201.2 607201 13.0470-7201.2 LD7201	ATE 23763 20,3 + WK ATE 23763 20,3 + WK Ceramic
			➔	→ 11/08; +PR 1KW		13.0460-2749.2 602749 13.0460-2880.2 602880 13.0470-2749.2 LD2749 13.0470-2880.2 LD2880	TRW 24483 16,9 - WE / - WK + Zub TRW 23914 17,1 + WE / - WK + Zub TRW 24483 16,9 - WE / - WK + Zub Ceramic TRW 23914 17,1 + WE / - WK + Zub Ceramic
S4 quattro	253	03/04→03/09	←	→ 11/08		13.0460-7201.2 607201	ATE 23763 20,3 + WK
			➔	→ 11/08		13.0460-2888.2 602888 13.0470-2888.2 LD2888	TRW 23326 17,4 + WE / - WK TRW 23326 17,4 + WE / - WK Ceramic
<b>Warnkontakt, Bremsbelagverschleiß</b>							
RS4 quattro	309	06/06→03/09	←	→ 11/08; +PR 1LU	2	24.8190-0017.2 620017	L= 388,3
<b>Zubehörsatz, Scheibenbremsbelag</b>							
1.8 T 1.8 T quattro 2.0 TDI 2.0 TDI 2.0 TFSI 16V 2.7 TDI 3.0 TDI quattro 3.2 FSI 3.2 FSI quattro	120 120 100 103 147 132 171 188 188	07/02→03/09 05/03→03/09 01/06→03/09 01/06→03/09 01/06→03/09 06/06→03/09 01/06→03/09 01/06→03/09 01/06→03/09	➔	8E-5-400001→; → 11/08; +PR 1KW		13.0460-0259.2 610259	
1.8 T 2.0 2.4 2.4 2.5 TDI 3.0 3.0 3.0 quattro	125 96 120 125 120 160 162 162	10/02→10/05 09/04→12/05 04/02→12/05 04/02→12/05 08/02→12/05 04/02→12/05 04/02→12/05 05/03→12/05	➔	8E-5-400001→; +PR 1KW		13.0460-0259.2 610259	
3.0 TDI quattro	150	01/06→03/09	➔	→ 11/08; +PR 1KW		13.0460-0259.2 610259	
RS4 quattro S4 quattro	309 253	06/06→03/09 03/04→03/09	➔	→ 11/08		13.0460-0023.2 610023	
<b> Bremsscheibe</b>							
1.8 T 1.8 T quattro 2.0 TDI ↓	120 120 100	07/02→03/09 05/03→03/09 01/06→03/09	←	→ 11/08; +PR 1LB;1LE		24.0125-0105.1 425105 24.0325-0105.1 525105	∅ 288 25 23 V + S ∅ 288 25 23 V







	kw			 	! #		
<b>AUDI - A4 Cabriolet (8H7, B6, 8HE, B7) 01/02→12/09</b>							
<b>Bremsscheibe</b>							
2.0 TDI	103	01/06→03/09	←	→ 11/08; +PR 1LF;1LT	24.0125-0137.1	425137	∅ 312 25 23 V + S
			←	+PR 1LA; → 11/08	24.0130-0113.1	430113	∅ 320 30 28 V + S
			→	→ 11/08; +PR 1KD	24.0110-0261.1	410261	∅ 245 10 8 + S
			→	→ 11/08; +PR 1KP	24.0112-0148.1	412148	∅ 255 12 10
			→	8E-5-400001→; → 11/08; +PR 1KW	24.0112-0166.1	412166	∅ 288 12 10
			→		24.0312-0148.1	512148	∅ 255 12 10
1.8 T 2.0	125 96	10/02→10/05 09/04→12/05	←	+PR 1LB;1LE	24.0125-0105.1	425105	∅ 288 25 23 V + S
			←	+PR 1LF;1LT	24.0125-0137.1	425137	∅ 288 25 23 V
			←	+PR 1LA	24.0130-0113.1	430113	∅ 320 30 28 V + S
			→	+PR 1KD	24.0330-0113.1	530113	∅ 320 30 28 V
			→	+PR 1KP	24.0110-0261.1	410261	∅ 245 10 8 + S
			→		24.0310-0261.1	510261	∅ 245 10 8
			→	8E-5-400001→; +PR 1KW	24.0112-0148.1	412148	∅ 255 12 10
2.0 TFSI 16V	147	01/06→03/09	←	→ 11/08; +PR 1LB;1LE	24.0125-0105.1	425105	∅ 288 25 23 V + S
			←	→ 11/08; +PR 1LF;1LT	24.0125-0137.1	425137	∅ 312 25 23 V + S
			←	+PR 1LA; → 11/08	24.0325-0137.1	525137	∅ 312 25 23 V
			→	+PR 1KD	24.0130-0113.1	430113	∅ 320 30 28 V + S
			→	→ 11/08; +PR 1KP	24.0330-0113.1	530113	∅ 320 30 28 V
			→		24.0110-0261.1	410261	∅ 245 10 8 + S
			→	8E-5-400001→; → 11/08; +PR 1KW	24.0310-0261.1	510261	∅ 245 10 8
2.4 2.4 2.5 TDI	120 125 120	04/02→12/05 04/02→12/05 08/02→12/05	←	+PR 1LB;1LE	24.0112-0148.1	412148	∅ 255 12 10
			←	+PR 1LF;1LT	24.0125-0105.1	425105	∅ 288 12 10
			←	+PR 1LA	24.0125-0137.1	425137	∅ 288 25 23 V + S
			→		24.0325-0137.1	525137	∅ 288 25 23 V
			→	8E-5-400001→; +PR 1KW	24.0130-0113.1	430113	∅ 320 30 28 V + S
			→		24.0330-0113.1	530113	∅ 320 30 28 V
			→		24.0112-0148.1	412148	∅ 255 12 10
2.7 TDI 3.0 TDI quattro 3.2 FSI 3.2 FSI quattro	132 171 188 188	06/06→03/09 01/06→03/09 01/06→03/09 01/06→03/09	←	→ 11/08; +PR 1LB;1LE	24.0312-0148.1	512148	∅ 255 12 10
			←	→ 11/08; +PR 1LF;1LT	24.0125-0105.1	425105	∅ 288 12 10
			←	+PR 1LA; → 11/08	24.0125-0137.1	425137	∅ 288 25 23 V + S
			→	8E-5-400001→; → 11/08; +PR 1KW	24.0325-0137.1	525137	∅ 312 25 23 V
			→		24.0110-0261.1	410261	∅ 245 10 8 + S
			→		24.0312-0148.1	512148	∅ 255 12 10
3.0	160	04/02→12/05	←	+PR 1LZ	24.0112-0166.1	412166	∅ 288 12 10
			←	+PR 1LB;1LE	24.0122-0152.1	422152	∅ 280 22 20 V + S
			←	+PR 1LF;1LT	24.0322-0152.1	522152	∅ 280 22 20 V + S
			←	+PR 1LA	24.0125-0105.1	425105	∅ 288 25 23 V + S
			←	+PR 1LC	24.0125-0137.1	425137	∅ 312 25 23 V + S
			→	+PR 1KD,1KP	24.0325-0137.1	525137	∅ 312 25 23 V
			→		24.0130-0113.1	430113	∅ 320 30 28 V + S
↓		24.0330-0113.1	530113	∅ 320 30 28 V			
				24.0130-0185.1	430185	∅ 320 30 28 V*	
				24.0112-0148.1	412148	∅ 255 12 10	
				24.0312-0148.1	512148	∅ 255 12 10	













	kw				! #					
<b>AUDI - A4 Cabriolet (8H7, B6, 8HE, B7) 01/02→12/09</b>										
<b>Bremsscheibe</b>										
3.0	160	04/02→12/05	➔	8E-5-400001→; +PR 1KW		24.0112-0166.1 412166 24.0312-0166.1 512166	Ø 288 12 10 Ø 288 12 10			
3.0 3.0 quattro	162 162	04/02→12/05 05/03→12/05	➔	+PR 1LB;1LE		24.0125-0105.1 425105	Ø 288 25 23 V + S			
			➔	+PR 1LF;1LT		24.0125-0137.1 425137 24.0325-0137.1 525137	Ø 312 25 23 V + S Ø 312 25 23 V			
			➔	+PR 1LA		24.0130-0113.1 430113 24.0330-0113.1 530113	Ø 320 30 28 V + S Ø 320 30 28 V			
			➔			24.0112-0148.1 412148 24.0312-0148.1 512148	Ø 255 12 10 Ø 255 12 10			
			➔	8E-5-400001→; +PR 1KW		24.0112-0166.1 412166 24.0312-0166.1 512166	Ø 288 12 10 Ø 288 12 10			
			➔							
3.0 TDI quattro	150	01/06→03/09	➔	→ 11/08; +PR 1LB;1LE		24.0125-0105.1 425105	Ø 288 25 23 V + S			
			➔	→ 11/08; +PR 1LF;1LT		24.0125-0137.1 425137 24.0325-0137.1 525137	Ø 312 25 23 V + S Ø 312 25 23 V			
			➔	+PR 1LA; → 11/08		24.0130-0113.1 430113 24.0330-0113.1 530113	Ø 320 30 28 V + S Ø 320 30 28 V			
			➔	→ 11/08; +PR 1KW		24.0112-0166.1 412166 24.0312-0166.1 512166	Ø 288 12 10 Ø 288 12 10			
			➔							
S4 quattro	253	03/04→03/09	➔	→ 11/08		24.0130-0119.1 430119	Ø 345 30 28 V			
			➔	→ 11/08		24.0122-0220.1 422220	Ø 300 22 20 V			
<b>AUDI - A5 (8T3) 06/07→01/17</b>										
<b>Bremsbelagsatz, Scheibenbremse</b>										
1.8 TFSI 1.8 TFSI 1.8 TFSI 2.0 TDI 2.0 TDI 2.0 TDI 2.0 TDI quattro 2.0 TDI quattro 2.0 TDI quattro 2.0 TFSI 2.0 TFSI 2.0 TFSI 2.0 TFSI quattro 2.0 TFSI quattro 2.0 TFSI quattro 2.7 TDI 3.0 TDI 3.0 TDI quattro 3.0 TDI quattro 3.0 TFSI quattro 3.2 FSI 3.2 FSI quattro	118 125 130 125 130 140 125 130 140 130 140 132 155 165 169 155 165 169 155 165 169 120 150 155 160 180 200 195 195	05/09→09/11 10/07→01/17 05/15→01/17 08/08→03/12 10/11→01/17 09/13→01/17 08/08→03/12 12/11→01/17 09/13→01/17 11/08→03/12 06/08→11/13 05/13→05/16 08/15→01/17 06/08→01/17 05/13→05/16 08/15→01/17 09/07→03/12 10/11→01/17 03/08→05/10 05/15→01/17 10/11→01/17 12/11→01/17 06/07→03/12 06/07→03/12	➔	+PR 1LD		13.0460-2746.2 602746 13.0460-2765.2 602765 13.0470-2746.2 LD2746 13.0470-2765.2 LD2765	TRW 24408 19,2 + WK TRW 24409 19,2 + WK + Zub TRW 24408 19,2 + WK + Zub Ceramic TRW 24409 19,2 + WK + Zub Ceramic			
			➔	+PR 1LA		13.0460-2746.2 602746 13.0460-2765.2 602765 13.0470-2746.2 LD2746 13.0470-2765.2 LD2765	TRW 24408 19,2 + WK TRW 24409 19,2 + WK + Zub TRW 24408 19,2 + WK + Zub Ceramic TRW 24409 19,2 + WK + Zub Ceramic			
			➔	+PR 1LT		13.0460-7256.2 607256 13.0470-7256.2 LD7256	ATE 24705 19,8 + WK ATE 24705 19,8 + WK Ceramic			
			➔	+PR 1KW,2EH		13.0460-2747.2 602747 13.0470-2747.2 LD2747	TRW 24606 17,4 - WE / - WK + Zub TRW 24606 17,4 - WE / - WK + Zub Ceramic			
			➔	+PR 1KE		13.0460-2748.2 602748 13.0470-2748.2 LD2748	TRW 24606 17,4 - WE / - WK + Zub TRW 24606 17,4 - WE / - WK + Zub Ceramic			
			➔	+PR 1KP		13.0460-2748.2 602748 13.0470-2748.2 LD2748	TRW 24606 17,4 - WE / - WK + Zub TRW 24606 17,4 - WE / - WK + Zub Ceramic			
			2.0 TDI	120	08/08→01/17	➔	10/08→; +PR 1LA		13.0460-2746.2 602746 13.0460-2765.2 602765 13.0470-2746.2 LD2746 13.0470-2765.2 LD2765	TRW 24408 19,2 + WK TRW 24409 19,2 + WK + Zub TRW 24408 19,2 + WK + Zub Ceramic TRW 24409 19,2 + WK + Zub Ceramic
						➔	10/08→; +PR 1LD		13.0460-2746.2 602746 13.0460-2765.2 602765 13.0470-2746.2 LD2746 13.0470-2765.2 LD2765	TRW 24408 19,2 + WK TRW 24409 19,2 + WK + Zub TRW 24408 19,2 + WK + Zub Ceramic TRW 24409 19,2 + WK + Zub Ceramic
						➔	10/08→; +PR 1LT		13.0460-7256.2 607256 13.0470-7256.2 LD7256	ATE 24705 19,8 + WK ATE 24705 19,8 + WK Ceramic
						➔	10/08→; +PR 1KW,2EH		13.0460-2747.2 602747	TRW 24606 17,4 - WE / - WK + Zub
						➔				

	kw			 	! #		
<b>AUDI - A5 (8T3) 06/07→01/17</b>							
<b> Bremsbelagsatz, Scheibenbremse</b>							
2.0 TDI	120	08/08→01/17	➡	10/08→; +PR 1KW,2EH	13.0470-2747.2	LD2747	TRW 24606 17,4 - WE / - WK + Zub Ceramic
			➡	10/08→; +PR 1KE	13.0460-2748.2	602748	TRW 24606 17,4 - WE / - WK + Zub
			➡	10/08→; +PR 1KP	13.0470-2748.2	LD2748	TRW 24606 17,4 - WE / - WK + Zub Ceramic
2.0 TFSI quattro	162	03/12→01/17	➡	05/13→; +PR 1LD	13.0460-2746.2	602746	TRW 24408 19,2 + WK
			➡		13.0460-2765.2	602765	TRW 24409 19,2 + WK + Zub
			➡		13.0470-2746.2	LD2746	TRW 24408 19,2 + WK + Zub Ceramic
			➡		13.0470-2765.2	LD2765	TRW 24409 19,2 + WK + Zub Ceramic
			➡	05/13→; +PR 1LA	13.0460-2746.2	602746	TRW 24408 19,2 + WK
			➡		13.0460-2765.2	602765	TRW 24409 19,2 + WK + Zub
			➡		13.0470-2746.2	LD2746	TRW 24408 19,2 + WK + Zub Ceramic
			➡		13.0470-2765.2	LD2765	TRW 24409 19,2 + WK + Zub Ceramic
2.7 TDI 3.0 TDI quattro	140 176	06/07→03/12 06/07→03/12	➡	+PR 1LD	13.0460-2746.2	602746	TRW 24408 19,2 + WK
			➡		13.0460-2765.2	602765	TRW 24409 19,2 + WK + Zub
			➡		13.0470-2746.2	LD2746	TRW 24408 19,2 + WK + Zub Ceramic
			➡		13.0470-2765.2	LD2765	TRW 24409 19,2 + WK + Zub Ceramic
			➡	07/07→; +PR 1LA	13.0460-2746.2	602746	TRW 24408 19,2 + WK
			➡		13.0460-2765.2	602765	TRW 24409 19,2 + WK + Zub
			➡		13.0470-2746.2	LD2746	TRW 24408 19,2 + WK + Zub Ceramic
			➡		13.0470-2765.2	LD2765	TRW 24409 19,2 + WK + Zub Ceramic
RS5 quattro	331	03/10→08/15	➡	+PR GP1	13.0460-2748.2	602748	TRW 24606 17,4 - WE / - WK + Zub
			➡		13.0470-2748.2	LD2748	TRW 24606 17,4 - WE / - WK + Zub Ceramic
			➡	+PR 1KP	13.0460-2748.2	602748	TRW 24606 17,4 - WE / - WK + Zub
			➡		13.0470-2748.2	LD2748	TRW 24606 17,4 - WE / - WK + Zub Ceramic
			➡		13.0460-2748.2	602748	TRW 24606 17,4 - WE / - WK + Zub
			➡		13.0470-2748.2	LD2748	TRW 24606 17,4 - WE / - WK + Zub Ceramic









	kw			 	! #		
<b>AUDI - A5 (8T3) 06/07→01/17</b>							
<b> Bremsbelagsatz, Scheibenbremse</b>							
RS5 quattro	331	03/10→08/15	➡	+PR 1KP		13.0470-2748.2 LD2748	TRW 24606 17,4 - WE / - WK + Zub Ceramic
S5 quattro	245	10/11→01/17	←	+PR 1LJ		13.0460-2746.2 602746	TRW 24408 19,2 + WK
			←	+PR 1ZT,1LD		13.0460-2765.2 602765	TRW 24409 19,2 + WK + Zub
			➡	+PR 1KE,1KP		13.0460-2748.2 602748	TRW 24606 17,4 - WE / - WK + Zub
						13.0470-2748.2 LD2748	TRW 24606 17,4 - WE / - WK + Zub Ceramic
S5 quattro	260	06/07→03/12	←	07/11→; +PR 1LJ		13.0460-2746.2 602746	TRW 24408 19,2 + WK
			←	+PR 1ZT,1LD		13.0460-2765.2 602765	TRW 24409 19,2 + WK + Zub
			➡	→ 10/10; +PR 1KE		13.0460-2748.2 602748	TRW 24606 17,4 - WE / - WK + Zub
			➡	11/10→; +PR 1KE,1KP		13.0460-2748.2 602748	TRW 24606 17,4 - WE / - WK + Zub
						13.0470-2748.2 LD2748	TRW 24606 17,4 - WE / - WK + Zub Ceramic
<b>Zubehörsatz, Scheibenbremsbelag</b>							
1.8 TFSI	118	05/09→09/11		+PR 1KE		13.0460-0023.2 610023	
1.8 TFSI	125	10/07→01/17					
1.8 TFSI	130	05/15→01/17					
2.0 TDI	125	08/08→03/12					
2.0 TDI	130	10/11→01/17					
2.0 TDI	140	09/13→01/17					
2.0 TDI quattro	125	08/08→03/12					
2.0 TDI quattro	130	12/11→01/17					
2.0 TDI quattro	140	09/13→01/17					
2.0 TFSI	132	11/08→03/12					
2.0 TFSI	155	06/08→11/13					
2.0 TFSI	165	05/13→05/16					
2.0 TFSI	169	08/15→01/17					
2.0 TFSI quattro	155	06/08→01/17					
2.0 TFSI quattro	165	05/13→05/16					
2.0 TFSI quattro	169	08/15→01/17					
2.7 TDI	120	09/07→03/12					
2.7 TDI	140	06/07→03/12					
3.0 TDI	150	10/11→01/17					
3.0 TDI quattro	155	03/08→05/10					
3.0 TDI quattro	160	05/15→01/17					
3.0 TDI quattro	176	06/07→03/12					
3.0 TDI quattro	180	10/11→01/17					
3.0 TFSI quattro	200	12/11→01/17					
3.2 FSI	195	06/07→03/12					
3.2 FSI quattro	195	06/07→03/12					
2.0 TDI	120	08/08→01/17		10/08→; +PR 1KE		13.0460-0023.2 610023	
2.0 TFSI quattro	162	03/12→01/17		05/13→; +PR 1KE		13.0460-0023.2 610023	
RS5 quattro	331	03/10→08/15		+PR GP1		13.0460-0023.2 610023	
S5 quattro	260	06/07→03/12		→ 10/10; +PR 1KE		13.0460-0023.2 610023	
<b> Bremsscheibe</b>							
1.8 TFSI	118	05/09→09/11	←	+PR 1LT		24.0125-0184.1 425184	Ø 314 25 23 V + S
1.8 TFSI	125	10/07→01/17				24.0325-0184.1 525184	Ø 314 25 23 V + S
2.0 TDI	125	08/08→03/12					
2.0 TDI quattro	125	08/08→03/12	←	+PR 1LJ		24.0129-0102.1 429102	Ø 345 29,5 28 V + S
2.0 TFSI	132	11/08→03/12					
2.0 TFSI	155	06/08→11/13	←	→ 06/11; +PR 1LA		24.0130-0193.1 430193	Ø 320 30 28 V + S
2.0 TFSI quattro	155	06/08→01/17				24.0330-0193.1 530193	Ø 320 30 28 V + S
2.7 TDI	120	09/07→03/12	←	07/11→; +PR 1LA		24.0130-0221.1 430221	Ø 320 30 28 V + S
3.2 FSI	195	06/07→03/12					
3.2 FSI quattro	195	06/07→03/12	←	+PR 1LD		24.0130-0222.1 430222	Ø 345 30 28 V + S
			➡	+PR 1KW,2EH		24.0112-0178.1 412178	Ø 300 12 10 + S
						24.0312-0178.1 512178	Ø 300 12 10 + S
			➡	+PR 1KE; + eFSB		24.0122-0272.1 422272	Ø 330 21,9 20 V + S
			➡	+PR 1KP		24.0122-0272.1 422272	Ø 330 21,9 20 V + S
1.8 TFSI	130	05/15→01/17	←	+PR 1LT		24.0125-0184.1 425184	Ø 314 25 23 V + S
2.0 TDI	130	10/11→01/17					
2.0 TDI	140	09/13→01/17				24.0325-0184.1 525184	Ø 314 25 23 V + S
2.0 TDI quattro	130	12/11→01/17					







	kw				! #		
<b>AUDI - A5 (8T3) 06/07→01/17</b>							
<b>Bremsscheibe</b>							
2.0 TDI quattro	140	09/13→01/17	←	+PR 1LJ		24.0129-0102.1 429102	Ø 345 29,5 28 V + S
2.0 TFSI	165	05/13→05/16	←	+PR 1LA		24.0130-0221.1 430221	Ø 320 30 28 V + S
2.0 TFSI	169	08/15→01/17	←	+PR 1LA		24.0130-0221.1 430221	Ø 320 30 28 V + S
2.0 TFSI quattro	165	05/13→05/16	←	+PR 1LD		24.0130-0222.1 430222	Ø 345 30 28 V + S
2.0 TFSI quattro	169	08/15→01/17	←	+PR 1LD		24.0130-0222.1 430222	Ø 345 30 28 V + S
3.0 TDI	150	10/11→01/17	→	+PR 1KW,2EH		24.0112-0178.1 412178	Ø 300 12 10 + S
3.0 TDI quattro	160	05/15→01/17	→	+PR 1KW,2EH		24.0312-0178.1 512178	Ø 300 12 10 + S
3.0 TDI quattro	180	10/11→01/17	→	+PR 1KE; + eFSB		24.0122-0272.1 422272	Ø 330 21,9 20 V + S
			→	+PR 1KP		24.0122-0272.1 422272	Ø 330 21,9 20 V + S
2.0 TDI	120	08/08→01/17	←	10/08→; +PR 1LT		24.0125-0184.1 425184	Ø 314 25 23 V + S
			←	10/08→; +PR 1LA		24.0325-0184.1 525184	Ø 314 25 23 V + S
			←	10/08→; +PR 1LJ		24.0129-0102.1 429102	Ø 345 29,5 28 V + S
			←	10/08→; +PR 1LA; → 06/11		24.0130-0193.1 430193	Ø 320 30 28 V + S
			←	07/11→; +PR 1LA		24.0330-0193.1 530193	Ø 320 30 28 V + S
			←	10/08→; +PR 1LD		24.0130-0221.1 430221	Ø 320 30 28 V + S
			→	10/08→; +PR 1LD		24.0130-0222.1 430222	Ø 345 30 28 V + S
			→	10/08→; +PR 1KW,2EH		24.0112-0178.1 412178	Ø 300 12 10 + S
			→	10/08→; +PR 1KW,2EH		24.0312-0178.1 512178	Ø 300 12 10 + S
			→	10/08→; +PR 1KP		24.0122-0272.1 422272	Ø 330 21,9 20 V + S
			→	10/08→; +PR 1KP		24.0122-0272.1 422272	Ø 330 21,9 20 V + S
			→	10/08→; +PR 1KE; + eFSB		24.0122-0272.1 422272	Ø 330 21,9 20 V + S
			→	10/08→; +PR 1KE; + eFSB		24.0122-0272.1 422272	Ø 330 21,9 20 V + S
2.0 TFSI quattro	162	03/12→01/17	←	05/13→; +PR 1LT		24.0125-0184.1 425184	Ø 314 25 23 V + S
			←	05/13→; +PR 1LA		24.0325-0184.1 525184	Ø 314 25 23 V + S
			←	05/13→; +PR 1LJ		24.0129-0102.1 429102	Ø 345 29,5 28 V + S
			←	05/13→; +PR 1LA		24.0130-0221.1 430221	Ø 320 30 28 V + S
			←	05/13→; +PR 1LD		24.0130-0222.1 430222	Ø 345 30 28 V + S
			→	05/13→; +PR 1KW,2EH		24.0112-0178.1 412178	Ø 300 12 10 + S
			→	05/13→; +PR 1KW,2EH		24.0312-0178.1 512178	Ø 300 12 10 + S
			→	05/13→; +PR 1KE; + eFSB		24.0122-0272.1 422272	Ø 330 21,9 20 V + S
			→	05/13→; +PR 1KE; + eFSB		24.0122-0272.1 422272	Ø 330 21,9 20 V + S
			→	05/13→; +PR 1KP		24.0122-0272.1 422272	Ø 330 21,9 20 V + S
			→	05/13→; +PR 1KP		24.0122-0272.1 422272	Ø 330 21,9 20 V + S
2.7 TDI	140	06/07→03/12	←	+PR 1LT		24.0125-0184.1 425184	Ø 314 25 23 V + S
3.0 TDI quattro	176	06/07→03/12	←	+PR 1LA		24.0325-0184.1 525184	Ø 314 25 23 V + S
			←	+PR 1LJ		24.0129-0102.1 429102	Ø 345 29,5 28 V + S
			←	07/07→ 06/11; +PR 1LA		24.0130-0193.1 430193	Ø 320 30 28 V + S
			←	07/11→; +PR 1LA		24.0330-0193.1 530193	Ø 320 30 28 V + S
			←	+PR 1LA		24.0130-0221.1 430221	Ø 320 30 28 V + S
			←	+PR 1LD		24.0130-0222.1 430222	Ø 345 30 28 V + S
			→	+PR 1KW,2EH		24.0112-0178.1 412178	Ø 300 12 10 + S
			→	+PR 1KW,2EH		24.0312-0178.1 512178	Ø 300 12 10 + S
			→	+PR 1KP		24.0122-0272.1 422272	Ø 330 21,9 20 V + S
			→	+PR 1KP		24.0122-0272.1 422272	Ø 330 21,9 20 V + S
			→	+PR 1KE; + eFSB		24.0122-0272.1 422272	Ø 330 21,9 20 V + S
			→	+PR 1KE; + eFSB		24.0122-0272.1 422272	Ø 330 21,9 20 V + S
3.0 TDI quattro	155	03/08→05/10	←	+PR 1LT		24.0125-0184.1 425184	Ø 314 25 23 V + S
			←	+PR 1LA		24.0325-0184.1 525184	Ø 314 25 23 V + S
			←	+PR 1LJ		24.0129-0102.1 429102	Ø 345 29,5 28 V + S
			←	+PR 1LA		24.0130-0193.1 430193	Ø 320 30 28 V + S
			←	+PR 1LA		24.0330-0193.1 530193	Ø 320 30 28 V + S
			←	+PR 1LD		24.0130-0221.1 430221	Ø 320 30 28 V + S
			←	+PR 1LD		24.0130-0222.1 430222	Ø 345 30 28 V + S
			→	+PR 1KW,2EH		24.0112-0178.1 412178	Ø 300 12 10 + S
			→	+PR 1KW,2EH		24.0312-0178.1 512178	Ø 300 12 10 + S
			→	+PR 1KE; + eFSB		24.0122-0272.1 422272	Ø 330 21,9 20 V + S
			→	+PR 1KE; + eFSB		24.0122-0272.1 422272	Ø 330 21,9 20 V + S
			→	+PR 1KP		24.0122-0272.1 422272	Ø 330 21,9 20 V + S
			→	+PR 1KP		24.0122-0272.1 422272	Ø 330 21,9 20 V + S
3.0 TFSI quattro	200	12/11→01/17	←	+PR 1LT		24.0125-0184.1 425184	Ø 314 25 23 V + S
			←	+PR 1LA		24.0325-0184.1 525184	Ø 314 25 23 V + S
			←	+PR 1LJ		24.0129-0102.1 429102	Ø 345 29,5 28 V + S
			←	+PR 1LA		24.0130-0221.1 430221	Ø 320 30 28 V + S
			←	+PR 1LD		24.0130-0222.1 430222	Ø 345 30 28 V + S
			→	+PR 1KW,2EH		24.0112-0178.1 412178	Ø 300 12 10 + S
			→	+PR 1KW,2EH		24.0312-0178.1 512178	Ø 300 12 10 + S
S5 quattro	245	10/11→01/17	←	+PR 1ZT		24.0130-0222.1 430222	Ø 345 30 28 V + S
↓							



















	kW			 	! #		
<b>AUDI - A5 (8T3) 06/07→01/17</b>							
 <b>Bremsscheibe</b>							
S5 quattro	245	10/11→01/17	←	+PR 1LJ	24.0130-0222.1	430222	∅ 345 30 28 V + S
			←	+PR 1ZT,1LD	24.0130-0222.1	430222	∅ 345 30 28 V + S
			→	+PR 1KE,1KP	24.0122-0272.1	422272	∅ 330 21,9 20 V + S
S5 quattro	260	06/07→03/12	←	+PR 1LJ; → 06/11	24.0129-0102.1	429102	∅ 345 29,5 28 V + S
			←	+PR 1ZT	24.0130-0222.1	430222	∅ 345 30 28 V + S
			←	+PR 1ZT,1LD	24.0130-0222.1	430222	∅ 345 30 28 V + S
			←	07/11→; +PR 1LJ	24.0130-0222.1	430222	∅ 345 30 28 V + S
			→	→ 10/10; +PR 1KE; + eFSB	24.0122-0272.1	422272	∅ 330 21,9 20 V + S
			→	11/10→; +PR 1KE,1KP	24.0122-0272.1	422272	∅ 330 21,9 20 V + S
<b>AUDI - A5 (F53) 06/16→</b>							
 <b>Bremsbelagsatz, Scheibenbremse</b>							
1.4 TFSI	110	11/16→	←	+PR 1LA,1LB	13.0460-7314.2	607314	ATE 22383 17,3 + WK
2.0 TDI	110	05/17→			13.0470-7314.2	LD7314	ATE 22383 17,3 + WK Ceramic
2.0 TDI	140	07/16→					
2.0 TDI quattro	140	10/16→	→	+PR 1KD,1KE,1KJ,1KF / 1KK,2EJ	13.0460-2796.2	602796	TRW 22308 17,7 + WE / - WK
2.0 TFSI	140	09/16→					
2.0 TFSI	185	11/16→					
3.0 TDI	160	11/16→					
3.0 TDI quattro	160	07/16→					
3.0 TDI quattro	200	02/17→					
3.0 TDI quattro	210	01/17→					
2.0 TFSI quattro	183	06/16→	←	07/16→; +PR 1LA,1LB	13.0460-7314.2	607314	ATE 22383 17,3 + WK
2.0 TFSI quattro	185	06/16→			13.0470-7314.2	LD7314	ATE 22383 17,3 + WK Ceramic
			→	07/16→; +PR 1KD,1KE,1KJ,1KF / 1KK,2EJ	13.0460-2796.2	602796	TRW 22308 17,7 + WE / - WK
S5 quattro	260	07/16→	←	+PR 1LA,1LB	13.0460-7314.2	607314	ATE 22383 17,3 + WK
			→	+PR 1KD,1KE,1KJ,1KF / 1KK,2EJ	13.0460-2796.2	602796	TRW 22308 17,7 + WE / - WK
 <b>Bremsscheibe</b>							
1.4 TFSI	110	11/16→	←	+PR 1LC,1LD	24.0130-0244.1	430244	∅ 318 30 28 V + S
2.0 TFSI	185	11/16→	←	+PR 1LL,1ZA,1ZC,1ZK	24.0134-0110.1	434110	∅ 349 34 32 V + S
3.0 TDI	160	11/16→	→	+PR 1KD,1KE	24.0112-0218.1	412218	∅ 300 12 10 + S
			→	+PR 1KF,1KJ,1KK,2EJ	24.0122-0272.1	422272	∅ 330 21,9 20 V + S
2.0 TDI	110	05/17→	←	+PR 1LA,1LB	24.0125-0184.1	425184	∅ 314 25 23 V + S
2.0 TDI	140	07/16→			24.0325-0184.1	525184	∅ 314 25 23 V + S
2.0 TDI quattro	140	10/16→					
2.0 TFSI	140	09/16→	←	+PR 1LC,1LD	24.0130-0244.1	430244	∅ 318 30 28 V + S
3.0 TDI quattro	160	07/16→	←	+PR 1LL,1ZA,1ZC,1ZK	24.0134-0110.1	434110	∅ 349 34 32 V + S
3.0 TDI quattro	200	02/17→	→	+PR 1KD,1KE	24.0112-0218.1	412218	∅ 300 12 10 + S
3.0 TDI quattro	210	01/17→	→	+PR 1KD,1KE	24.0112-0218.1	412218	∅ 300 12 10 + S
S5 quattro	260	07/16→	→	+PR 1KF,1KJ,1KK,2EJ	24.0122-0272.1	422272	∅ 330 21,9 20 V + S
2.0 TFSI quattro	183	06/16→	←	07/16→; +PR 1LA,1LB	24.0125-0184.1	425184	∅ 314 25 23 V + S
2.0 TFSI quattro	185	06/16→			24.0325-0184.1	525184	∅ 314 25 23 V + S
			←	07/16→; +PR 1LC,1LD	24.0130-0244.1	430244	∅ 318 30 28 V + S
			←	07/16→; +PR 1LL,1ZA,1ZC,1ZK	24.0134-0110.1	434110	∅ 349 34 32 V + S
			→	07/16→; +PR 1KD,1KE	24.0112-0218.1	412218	∅ 300 12 10 + S
			→	07/16→; +PR 1KF,1KJ,1KK,2EJ	24.0122-0272.1	422272	∅ 330 21,9 20 V + S
<b>AUDI - A5 Cabriolet (8F7) 02/09→01/17</b>							
 <b>Bremsbelagsatz, Scheibenbremse</b>							
1.8 TFSI	118	09/09→03/12	←	+PR 1LA,1LB,1LD	13.0460-2746.2	602746	TRW 24408 19,2 + WK
1.8 TFSI	125	10/11→03/16			13.0460-2765.2	602765	TRW 24409 19,2 + WK + Zub
2.0 TDI	110	05/13→01/17			13.0470-2746.2	LD2746	TRW 24408 19,2 + WK + Zub Ceramic
2.0 TDI	120	05/09→06/14					
2.0 TDI	125	05/09→03/12					
2.0 TDI	130	10/11→01/17			13.0470-2765.2	LD2765	TRW 24409 19,2 + WK + Zub Ceramic
2.0 TDI	140	09/13→01/17					
2.0 TFSI	132	03/09→03/12	←	+PR 1LT	13.0460-7256.2	607256	ATE 24705 19,8 + WK
2.0 TFSI	155	03/09→06/14			13.0470-7256.2	LD7256	ATE 24705 19,8 + WK Ceramic
2.0 TFSI	162	05/13→12/14					
2.0 TFSI	165	05/13→05/16	→	+PR 1KW,2EH; + eFSB	13.0460-2747.2	602747	TRW 24606 17,4 - WE / - WK + Zub
2.0 TFSI	169	08/15→01/17					
2.0 TFSI quattro	155	03/09→01/17			13.0470-2747.2	LD2747	TRW 24606 17,4 - WE / - WK + Zub Ceramic
2.0 TFSI quattro	165	05/13→05/16					
2.0 TFSI quattro	169	08/15→01/17					
2.7 TDI	120	05/09→03/12					













	kw			 	! #		
<b>AUDI - A5 Cabriolet (8F7) 02/09→01/17</b>							
<b> Bremsbelagsatz, Scheibenbremse</b>							
2.7 TDI	140	03/09→03/12	➔	+PR 1KE,1KP; + eFSB		13.0460-2748.2 602748	TRW 24606 17,4 - WE / - WK + Zub
3.0 TDI	150	10/11→01/17					
3.0 TDI quattro	176	03/09→03/12				13.0470-2748.2 LD2748	TRW 24606 17,4 - WE / - WK + Zub Ceramic
3.0 TDI quattro	180	10/11→01/17					
3.2 FSI	195	03/09→03/12					
3.2 FSI quattro	195	03/09→03/12					
1.8 TFSI	130	05/15→01/17	➔	+PR 1LA,1LB,1LD,1LJ		13.0460-2746.2 602746	TRW 24408 19,2 + WK
2.0 TDI quattro	130	01/12→05/15				13.0460-2765.2 602765	TRW 24409 19,2 + WK + Zub
2.0 TDI quattro	140	09/13→01/17				13.0470-2746.2 LD2746	TRW 24408 19,2 + WK + Zub Ceramic
3.0 TDI quattro	160	05/15→01/17				13.0470-2765.2 LD2765	TRW 24409 19,2 + WK + Zub Ceramic
3.0 TFSI quattro	200	11/11→01/17					
			➔	+PR 1LT		13.0460-7256.2 607256	ATE 24705 19,8 + WK
						13.0470-7256.2 LD7256	ATE 24705 19,8 + WK Ceramic
			➔	+PR 1KW,2EH; + eFSB		13.0460-2747.2 602747	TRW 24606 17,4 - WE / - WK + Zub
						13.0470-2747.2 LD2747	TRW 24606 17,4 - WE / - WK + Zub Ceramic
			➔	+PR 1KE,1KP; + eFSB		13.0460-2748.2 602748	TRW 24606 17,4 - WE / - WK + Zub
						13.0470-2748.2 LD2748	TRW 24606 17,4 - WE / - WK + Zub Ceramic
2.0 TDI	105	10/11→05/15	➔	11/11→; +PR 1LA,1LB,1LD,1LJ		13.0460-2746.2 602746	TRW 24408 19,2 + WK
						13.0460-2765.2 602765	TRW 24409 19,2 + WK + Zub
						13.0470-2746.2 LD2746	TRW 24408 19,2 + WK + Zub Ceramic
						13.0470-2765.2 LD2765	TRW 24409 19,2 + WK + Zub Ceramic
			➔	11/11→; +PR 1LT		13.0460-7256.2 607256	ATE 24705 19,8 + WK
						13.0470-7256.2 LD7256	ATE 24705 19,8 + WK Ceramic
			➔	11/11→; +PR 1KW,2EH; + eFSB		13.0460-2747.2 602747	TRW 24606 17,4 - WE / - WK + Zub
						13.0470-2747.2 LD2747	TRW 24606 17,4 - WE / - WK + Zub Ceramic
			➔	11/11→; +PR 1KE,1KP; + eFSB		13.0460-2748.2 602748	TRW 24606 17,4 - WE / - WK + Zub
						13.0470-2748.2 LD2748	TRW 24606 17,4 - WE / - WK + Zub Ceramic
2.0 TFSI quattro	162	03/12→01/17	➔	05/13→; +PR 1LA,1LB,1LD		13.0460-2746.2 602746	TRW 24408 19,2 + WK
						13.0460-2765.2 602765	TRW 24409 19,2 + WK + Zub
						13.0470-2746.2 LD2746	TRW 24408 19,2 + WK + Zub Ceramic
						13.0470-2765.2 LD2765	TRW 24409 19,2 + WK + Zub Ceramic
			➔	05/13→; +PR 1LT		13.0460-7256.2 607256	ATE 24705 19,8 + WK
						13.0470-7256.2 LD7256	ATE 24705 19,8 + WK Ceramic
			➔	05/13→; +PR 1KW,2EH; + eFSB		13.0460-2747.2 602747	TRW 24606 17,4 - WE / - WK + Zub
						13.0470-2747.2 LD2747	TRW 24606 17,4 - WE / - WK + Zub Ceramic
			➔	05/13→; +PR 1KE,1KP; + eFSB		13.0460-2748.2 602748	TRW 24606 17,4 - WE / - WK + Zub
						13.0470-2748.2 LD2748	TRW 24606 17,4 - WE / - WK + Zub Ceramic
RS5 quattro	331	11/12→08/15	➔	02/13→; +PR 1KZ,2ED; + eFSB		13.0460-2770.2 602770	TRW 24606 17,4 + WK + Zub
						13.0470-2770.2 LD2770	TRW 24606 17,4 + WK + Zub Ceramic
S5 quattro	245	06/09→01/17	➔	07/11→; +PR 1LJ		13.0460-2746.2 602746	TRW 24408 19,2 + WK
						13.0460-2765.2 602765	TRW 24409 19,2 + WK + Zub
			➔	+PR 1ZT,1LD		13.0460-2746.2 602746	TRW 24408 19,2 + WK
						13.0460-2765.2 602765	TRW 24409 19,2 + WK + Zub
			➔	+PR 1KE,1KP; + eFSB		13.0460-2748.2 602748	TRW 24606 17,4 - WE / - WK + Zub
						13.0470-2748.2 LD2748	TRW 24606 17,4 - WE / - WK + Zub Ceramic
<b>Warnkontakt, Bremsbelagverschleiß</b>							
RS5 quattro	331	11/12→08/15	➔	☐; 02/13→; +PR 1LW	1	24.8190-0017.2 620017	L= 388,3
↓							

	kw			 	! #		
<b>AUDI - A5 Cabriolet (8F7) 02/09→01/17</b>							
<b>Bremsscheibe</b>							
1.8 TFSI	118	09/09→03/12	←	+PR 1LT		24.0125-0184.1 425184	Ø 314 25 23 V + S
2.0 TDI	120	05/09→06/14				24.0325-0184.1 525184	Ø 314 25 23 V + S
2.0 TDI	125	05/09→03/12					
2.0 TFSI	132	03/09→03/12	←	+PR 1LJ		24.0129-0102.1 429102	Ø 345 29,5 28 V + S
2.0 TFSI	155	03/09→06/14	←	→ 06/11; +PR 1LA,1LB		24.0130-0193.1 430193	Ø 320 30 28 V + S
2.7 TDI	120	05/09→03/12	←			24.0330-0193.1 530193	Ø 320 30 28 V + S
2.7 TDI	140	03/09→03/12	←				
3.0 TDI quattro	176	03/09→03/12	←	07/11→; +PR 1LA,1LB		24.0130-0221.1 430221	Ø 320 30 28 V + S
3.2 FSI	195	03/09→03/12	←	+PR 1LD		24.0130-0222.1 430222	Ø 345 30 28 V + S
3.2 FSI quattro	195	03/09→03/12	→	+PR 1KW,2EH		24.0112-0178.1 412178	Ø 300 12 10 + S
			→	+PR 1KE,1KP; + eFSB		24.0312-0178.1 512178	Ø 300 12 10 + S
			→	11/10→; +PR 1KE,1KP; + eFSB		24.0122-0272.1 422272	Ø 330 21,9 20 V + S
			→	→ 10/10; +PR 1KE; + eFSB		24.0122-0272.1 422272	Ø 330 21,9 20 V + S
1.8 TFSI	125	10/11→03/16	←	+PR 1LT		24.0125-0184.1 425184	Ø 314 25 23 V + S
1.8 TFSI	130	05/15→01/17				24.0325-0184.1 525184	Ø 314 25 23 V + S
2.0 TDI	110	05/13→01/17					
2.0 TDI	130	10/11→01/17	←	+PR 1LJ		24.0129-0102.1 429102	Ø 345 29,5 28 V + S
2.0 TDI	140	09/13→01/17	←	+PR 1LA,1LB		24.0130-0221.1 430221	Ø 320 30 28 V + S
2.0 TDI quattro	140	09/13→01/17	←				
2.0 TFSI	162	05/13→12/14	←	+PR 1LD		24.0130-0222.1 430222	Ø 345 30 28 V + S
2.0 TFSI	165	05/13→05/16					
2.0 TFSI	169	08/15→01/17	→	+PR 1KW,2EH		24.0112-0178.1 412178	Ø 300 12 10 + S
2.0 TFSI quattro	165	05/13→05/16				24.0312-0178.1 512178	Ø 300 12 10 + S
2.0 TFSI quattro	169	08/15→01/17	→	+PR 1KE,1KP; + eFSB		24.0122-0272.1 422272	Ø 330 21,9 20 V + S
3.0 TDI	150	10/11→01/17					
3.0 TDI quattro	160	05/15→01/17					
3.0 TDI quattro	180	10/11→01/17					
2.0 TDI	105	10/11→05/15	←	11/11→; +PR 1LT		24.0125-0184.1 425184	Ø 314 25 23 V + S
			←	11/11→; +PR 1LA,1LB		24.0325-0184.1 525184	Ø 314 25 23 V + S
			←	11/11→; +PR 1LD,1LJ		24.0130-0221.1 430221	Ø 320 30 28 V + S
			→	11/11→; +PR 1KW,2EH		24.0112-0178.1 412178	Ø 300 12 10 + S
			→	11/11→; +PR 1KE,1KP; + eFSB		24.0312-0178.1 512178	Ø 300 12 10 + S
			→	11/11→; +PR 1KE,1KP; + eFSB		24.0122-0272.1 422272	Ø 330 21,9 20 V + S
2.0 TDI quattro	130	01/12→05/15	←	+PR 1LT		24.0125-0184.1 425184	Ø 314 25 23 V + S
3.0 TFSI quattro	200	11/11→01/17	←	+PR 1LA,1LB		24.0325-0184.1 525184	Ø 314 25 23 V + S
			←	+PR 1LD,1LJ		24.0130-0221.1 430221	Ø 320 30 28 V + S
			→	+PR 1KW,2EH		24.0130-0222.1 430222	Ø 345 30 28 V + S
			→	+PR 1KE,1KP; + eFSB		24.0112-0178.1 412178	Ø 300 12 10 + S
			→	+PR 1KE,1KP; + eFSB		24.0312-0178.1 512178	Ø 300 12 10 + S
			→	+PR 1KE,1KP; + eFSB		24.0122-0272.1 422272	Ø 330 21,9 20 V + S
2.0 TFSI quattro	155	03/09→01/17	←	+PR 1LT		24.0125-0184.1 425184	Ø 314 25 23 V + S
			←	+PR 1LJ		24.0325-0184.1 525184	Ø 314 25 23 V + S
			←	→ 06/11; +PR 1LA,1LB		24.0129-0102.1 429102	Ø 345 29,5 28 V + S
			←	→ 06/11; +PR 1LA,1LB		24.0130-0193.1 430193	Ø 320 30 28 V + S
			←	07/11→; +PR 1LA,1LB		24.0330-0193.1 530193	Ø 320 30 28 V + S
			←	07/11→; +PR 1LA,1LB		24.0130-0221.1 430221	Ø 320 30 28 V + S
			←	+PR 1LD		24.0130-0222.1 430222	Ø 345 30 28 V + S
			→	+PR 1KW,2EH		24.0112-0178.1 412178	Ø 300 12 10 + S
			→	+PR 1KW,2EH		24.0312-0178.1 512178	Ø 300 12 10 + S
			→	11/10→; +PR 1KE,1KP; + eFSB		24.0122-0272.1 422272	Ø 330 21,9 20 V + S
2.0 TFSI quattro	162	03/12→01/17	←	05/13→; +PR 1LT		24.0125-0184.1 425184	Ø 314 25 23 V + S
			←	05/13→; +PR 1LJ		24.0325-0184.1 525184	Ø 314 25 23 V + S
			←	05/13→; +PR 1LA,1LB		24.0129-0102.1 429102	Ø 345 29,5 28 V + S
			←	05/13→; +PR 1LA,1LB		24.0130-0221.1 430221	Ø 320 30 28 V + S
			←	05/13→; +PR 1LD		24.0130-0222.1 430222	Ø 345 30 28 V + S
			→	05/13→; +PR 1KW,2EH		24.0112-0178.1 412178	Ø 300 12 10 + S
			→	05/13→; +PR 1KW,2EH		24.0312-0178.1 512178	Ø 300 12 10 + S
			→	05/13→; +PR 1KE,1KP; + eFSB		24.0122-0272.1 422272	Ø 330 21,9 20 V + S
S5 quattro	245	06/09→01/17	←	+PR 1LJ; → 06/11		24.0129-0102.1 429102	Ø 345 29,5 28 V + S
			←	07/11→; +PR 1ZT,1LD,1LJ		24.0130-0221.1 430221	Ø 345 30 28 V + S
			→	→ 10/10; +PR 1KE; + eFSB		24.0122-0272.1 422272	Ø 330 21,9 20 V + S
			→	11/10→; +PR 1KE,1KP; + eFSB		24.0122-0272.1 422272	Ø 330 21,9 20 V + S











	kw			 	! #		
<b>AUDI - A5 Cabriolet (F57) 11/16→</b>							
 <b>Bremsbelagsatz, Scheibenbremse</b>							
2.0 TDI 2.0 TFSI quattro 3.0 TDI quattro	140 185 160	11/16→ 11/16→ 12/16→	←	03/17→; +PR 1LB		13.0460-7314.2 607314 13.0470-7314.2 LD7314	ATE 22383 17,3 + WK ATE 22383 17,3 + WK Ceramic
			→	03/17→; +PR 1KD,1KE,1KJ,1KF / 1KK,2EJ		13.0460-2796.2 602796	TRW 22308 17,7 + WE / - WK
2.0 TDI quattro 2.0 TFSI 2.0 TFSI 3.0 TDI 3.0 TDI quattro	140 140 185 160 210	03/17→ 03/17→ 03/17→ 03/17→ 11/16→	←	+PR 1LB		13.0460-7314.2 607314 13.0470-7314.2 LD7314	ATE 22383 17,3 + WK ATE 22383 17,3 + WK Ceramic
			→	+PR 1KD,1KE,1KJ,1KF / 1KK,2EJ		13.0460-2796.2 602796	TRW 22308 17,7 + WE / - WK
S5 quattro	260	03/17→	←	+PR 1LB		13.0460-7314.2 607314	ATE 22383 17,3 + WK
			→	+PR 1KD,1KE,1KJ,1KF / 1KK,2EJ		13.0460-2796.2 602796	TRW 22308 17,7 + WE / - WK
 <b>Bremsscheibe</b>							
2.0 TDI	110	08/17→	←	+PR 1LC		24.0130-0244.1 430244	Ø 318 30 28 V + S
2.0 TDI 2.0 TFSI quattro 3.0 TDI quattro	140 185 160	11/16→ 11/16→ 12/16→	←	03/17→; +PR 1LA,1LB		24.0125-0184.1 425184	Ø 314 25 23 V + S
			←	+PR 1LC		24.0130-0244.1 430244	Ø 318 30 28 V + S
			→	+PR 1KD,1KE		24.0112-0218.1 412218	Ø 300 12 10 + S
			→	03/17→; +PR 1KF,1KJ,1KK,2EJ		24.0122-0272.1 422272	Ø 330 21,9 20 V + S
2.0 TDI quattro 2.0 TFSI 3.0 TDI S5 quattro	140 140 160 260	03/17→ 03/17→ 03/17→ 03/17→	←	+PR 1LA,1LB		24.0125-0184.1 425184	Ø 314 25 23 V + S
			←	+PR 1LC		24.0130-0244.1 430244	Ø 318 30 28 V + S
			→	+PR 1KD,1KE		24.0112-0218.1 412218	Ø 300 12 10 + S
			→	+PR 1KF,1KJ,1KK,2EJ		24.0122-0272.1 422272	Ø 330 21,9 20 V + S
2.0 TFSI	185	03/17→	←	+PR 1LA,1LB		24.0125-0184.1 425184	Ø 314 25 23 V + S
			←	+PR 1LC		24.0130-0244.1 430244	Ø 318 30 28 V + S
			→	+PR 1KD,1KE		24.0112-0218.1 412218	Ø 300 12 10 + S
			→	+PR 1KF,1KJ,1KK,2EJ		24.0122-0272.1 422272	Ø 330 21,9 20 V + S
3.0 TDI quattro	210	11/16→	←	+PR 1LC		24.0130-0244.1 430244	Ø 318 30 28 V + S
			→	+PR 1KD,1KE		24.0112-0218.1 412218	Ø 300 12 10 + S
			→			24.0122-0272.1 422272	Ø 330 21,9 20 V + S
<b>AUDI - A5 Sportback (8TA) 09/09→01/17</b>							
 <b>Bremsbelagsatz, Scheibenbremse</b>							
1.8 TFSI 1.8 TFSI 1.8 TFSI 1.8 TFSI 2.0 TDI 2.0 TDI 2.0 TDI 2.0 TDI 2.0 TDI 2.0 TDI quattro 2.0 TDI quattro 2.0 TDI quattro 2.0 TFSI 2.0 TFSI 2.0 TFSI 2.0 TFSI quattro 2.0 TFSI quattro 2.0 TFSI quattro 2.7 TDI 2.7 TDI 3.0 TDI 3.0 TDI quattro 3.0 TDI quattro 3.0 TDI quattro 3.0 TFSI quattro 3.2 FSI quattro	106 118 125 130 100 105 110 120 125 130 140 125 130 140 125 132 155 165 169 155 165 169 120 140 150 160 176 180 200 195	09/14→01/17 11/09→09/11 08/11→01/17 05/15→01/17 09/09→01/17 09/09→01/17 05/13→01/17 09/09→01/17 09/09→03/12 10/11→01/17 09/13→01/17 09/09→03/12 12/11→01/17 09/13→01/17 09/09→06/14 09/09→11/13 05/13→05/16 08/15→01/17 09/09→01/17 05/13→05/16 08/15→01/17 09/09→01/17 09/09→03/12 10/11→01/17 05/15→01/17 09/09→03/12 10/11→01/17 12/11→01/17 09/09→03/12	←	+PR 1LD		13.0460-2746.2 602746 13.0460-2765.2 602765 13.0470-2746.2 LD2746 13.0470-2765.2 LD2765	TRW 24408 19,2 + WK TRW 24409 19,2 + WK + Zub TRW 24408 19,2 + WK + Zub Ceramic TRW 24409 19,2 + WK + Zub Ceramic
			←	+PR 1LA		13.0460-2746.2 602746 13.0460-2765.2 602765 13.0470-2746.2 LD2746	TRW 24408 19,2 + WK TRW 24409 19,2 + WK + Zub TRW 24408 19,2 + WK + Zub Ceramic
			←	+PR 1LT		13.0460-7256.2 607256 13.0470-7256.2 LD7256	ATE 24705 19,8 + WK ATE 24705 19,8 + WK Ceramic
			→	+PR 1KW,2EH		13.0460-2747.2 602747 13.0470-2747.2 LD2747	TRW 24606 17,4 - WE / - WK + Zub TRW 24606 17,4 - WE / - WK + Zub Ceramic
			→	+PR 1KE		13.0460-2748.2 602748 13.0470-2748.2 LD2748	TRW 24606 17,4 - WE / - WK + Zub TRW 24606 17,4 - WE / - WK + Zub Ceramic
			→	+PR 1KP		13.0460-2748.2 602748 13.0470-2748.2 LD2748	TRW 24606 17,4 - WE / - WK + Zub TRW 24606 17,4 - WE / - WK + Zub Ceramic
S5 quattro	245	01/10→01/17	←	07/11→; +PR 1LJ		13.0460-2746.2 602746 13.0460-2765.2 602765	TRW 24408 19,2 + WK TRW 24409 19,2 + WK + Zub
			←	+PR 1ZT,1LD		13.0460-2746.2 602746 13.0460-2765.2 602765	TRW 24408 19,2 + WK TRW 24409 19,2 + WK + Zub
↓							









	kw			 	! #		
<b>AUDI - A5 Sportback (8TA) 09/09→01/17</b>							
<b>Bremsbelagsatz, Scheibenbremse</b>							
S5 quattro	245	01/10→01/17	➔	→ 10/10; +PR 1KE	13.0460-2748.2	602748	TRW 24606 17,4 - WE / - WK + Zub
				13.0470-2748.2	LD2748	TRW 24606 17,4 - WE / - WK + Zub Ceramic	
			➔	11/10→; +PR 1KE,1KP	13.0460-2748.2	602748	TRW 24606 17,4 - WE / - WK + Zub
					13.0470-2748.2	LD2748	TRW 24606 17,4 - WE / - WK + Zub Ceramic
<b>Zubehörsatz, Scheibenbremsbelag</b>							
1.8 TFSI	106	09/14→01/17		+PR 1KE	13.0460-0023.2	610023	
1.8 TFSI	118	11/09→09/11					
1.8 TFSI	125	08/11→01/17					
1.8 TFSI	130	05/15→01/17					
2.0 TDI	100	09/09→01/17					
2.0 TDI	105	09/09→01/17					
2.0 TDI	110	05/13→01/17					
2.0 TDI	120	09/09→01/17					
2.0 TDI	125	09/09→03/12					
2.0 TDI	130	10/11→01/17					
2.0 TDI	140	09/13→01/17					
2.0 TDI quattro	125	09/09→03/12					
2.0 TDI quattro	130	12/11→01/17					
2.0 TDI quattro	140	09/13→01/17					
2.0 TFSI	132	09/09→06/14					
2.0 TFSI	155	09/09→11/13					
2.0 TFSI	165	05/13→05/16					
2.0 TFSI	169	08/15→01/17					
2.0 TFSI quattro	155	09/09→01/17					
2.0 TFSI quattro	165	05/13→05/16					
2.0 TFSI quattro	169	08/15→01/17					
2.7 TDI	120	09/09→01/17					
2.7 TDI	140	09/09→03/12					
3.0 TDI	150	10/11→01/17					
3.0 TDI quattro	160	05/15→01/17					
3.0 TDI quattro	176	09/09→03/12					
3.0 TDI quattro	180	10/11→01/17					
3.0 TFSI quattro	200	12/11→01/17					
3.2 FSI quattro	195	09/09→03/12					
S5 quattro	245	01/10→01/17		→ 10/10; +PR 1KE	13.0460-0023.2	610023	
<b>Bremsscheibe</b>							
1.8 TFSI	106	09/14→01/17	←	+PR 1LT	24.0125-0184.1	425184	Ø 314 25 23 V + S
1.8 TFSI	125	08/11→01/17			24.0325-0184.1	525184	Ø 314 25 23 V + S
1.8 TFSI	130	05/15→01/17					
2.0 TDI	110	05/13→01/17	←	+PR 1LJ	24.0129-0102.1	429102	Ø 345 29,5 28 V + S
2.0 TDI	130	10/11→01/17	←	+PR 1LA	24.0130-0221.1	430221	Ø 320 30 28 V + S
2.0 TDI	140	09/13→01/17					
2.0 TDI quattro	130	12/11→01/17	←	+PR 1LD	24.0130-0222.1	430222	Ø 345 30 28 V + S
2.0 TDI quattro	140	09/13→01/17					
2.0 TFSI	165	05/13→05/16	➔	+PR 1KW,2EH	24.0112-0178.1	412178	Ø 300 12 10 + S
2.0 TFSI	169	08/15→01/17			24.0312-0178.1	512178	Ø 300 12 10 + S
2.0 TFSI quattro	165	05/13→05/16	➔	+PR 1KE; + eFSB	24.0122-0272.1	422272	Ø 330 21,9 20 V + S
2.0 TFSI quattro	169	08/15→01/17					
3.0 TDI	150	10/11→01/17	➔	+PR 1KP	24.0122-0272.1	422272	Ø 330 21,9 20 V + S
3.0 TDI quattro	160	05/15→01/17					
3.0 TDI quattro	180	10/11→01/17					
1.8 TFSI	118	11/09→09/11	←	+PR 1LT	24.0125-0184.1	425184	Ø 314 25 23 V + S
2.0 TDI	100	09/09→01/17			24.0325-0184.1	525184	Ø 314 25 23 V + S
2.0 TDI	105	09/09→01/17					
2.0 TDI	120	09/09→01/17	←	+PR 1LJ	24.0129-0102.1	429102	Ø 345 29,5 28 V + S
2.0 TDI	125	09/09→03/12	←	→ 06/11; +PR 1LA	24.0130-0193.1	430193	Ø 320 30 28 V + S
2.0 TDI quattro	125	09/09→03/12			24.0330-0193.1	530193	Ø 320 30 28 V + S
2.0 TFSI	132	09/09→06/14					
2.0 TFSI	155	09/09→11/13	←	07/11→; +PR 1LA	24.0130-0221.1	430221	Ø 320 30 28 V + S
2.0 TFSI quattro	155	09/09→01/17					
2.7 TDI	120	09/09→01/17	←	+PR 1LD	24.0130-0222.1	430222	Ø 345 30 28 V + S
2.7 TDI	140	09/09→03/12	➔	+PR 1KW,2EH	24.0112-0178.1	412178	Ø 300 12 10 + S
3.0 TDI quattro	176	09/09→03/12			24.0312-0178.1	512178	Ø 300 12 10 + S
3.2 FSI quattro	195	09/09→03/12	➔	+PR 1KE; + eFSB	24.0122-0272.1	422272	Ø 330 21,9 20 V + S
			➔	+PR 1KP	24.0122-0272.1	422272	Ø 330 21,9 20 V + S
3.0 TFSI quattro	200	12/11→01/17	←	+PR 1LT	24.0125-0184.1	425184	Ø 314 25 23 V + S
					24.0325-0184.1	525184	Ø 314 25 23 V + S
			←	+PR 1LJ	24.0129-0102.1	429102	Ø 345 29,5 28 V + S
			←	+PR 1LA	24.0130-0221.1	430221	Ø 320 30 28 V + S
			←	+PR 1LD	24.0130-0222.1	430222	Ø 345 30 28 V + S









	kw			 	! #		
<b>AUDI - A5 Sportback (8TA) 09/09→01/17</b>							
 <b>Bremsscheibe</b>							
3.0 TFSI quattro	200	12/11→01/17	➔	+PR 1KW,2EH		24.0112-0178.1 412178 24.0312-0178.1 512178	Ø 300 12 10 + S Ø 300 12 10 + S
S5 quattro	245	01/10→01/17	➔	+PR 1LJ; → 06/11		24.0129-0102.1 429102	Ø 345 29,5 28 V + S
			➔	+PR 1ZT		24.0130-0222.1 430222	Ø 345 30 28 V + S
			➔	+PR 1ZT,1LD		24.0130-0222.1 430222	Ø 345 30 28 V + S
			➔	07/11→; +PR 1LJ		24.0130-0222.1 430222	Ø 345 30 28 V + S
			➔	+PR 1KE; → 10/10; + eFSB		24.0122-0272.1 422272	Ø 330 21,9 20 V + S
			➔	11/10→; +PR 1KE,1KP		24.0122-0272.1 422272	Ø 330 21,9 20 V + S
<b>AUDI - A5 Sportback (F5A) 08/16→</b>							
 <b>Bremsbelagsatz, Scheibenbremse</b>							
1.4 TFSI	110	01/17→	➔	+PR 1LA,1LB		13.0460-7314.2 607314	ATE 22383 17,3 + WK
2.0 TDI	100	05/17→	➔			13.0470-7314.2 LD7314	ATE 22383 17,3 + WK Ceramic
2.0 TDI	110	01/17→					
2.0 TDI	140	09/16→					
2.0 TDI quattro	110	05/17→					
2.0 TDI quattro	140	10/16→					
2.0 TFSI	140	01/17→					
2.0 TFSI	185	11/16→					
2.0 TFSI g-tron	125	02/17→					
2.0 TFSI quattro	183	09/16→					
2.0 TFSI quattro	185	09/16→					
3.0 TDI	160	03/17→					
3.0 TDI quattro	160	09/16→					
3.0 TDI quattro	200	02/17→					
3.0 TDI quattro	210	01/17→					
S5 quattro	260	09/16→	➔	+PR 1LA,1LB		13.0460-7314.2 607314	ATE 22383 17,3 + WK
			➔	+PR 1KD,1KE,1KJ,1KF / 1KK,2EJ		13.0460-2796.2 602796	TRW 22308 17,7 + WE / - WK
 <b>Bremsscheibe</b>							
1.4 TFSI	110	01/17→	➔	+PR 1LC,1LD		24.0130-0244.1 430244	Ø 318 30 28 V + S
2.0 TFSI	185	11/16→	➔			24.0134-0110.1 434110	Ø 349 34 32 V + S
3.0 TDI	160	03/17→					
			➔	+PR 1KD,1KE		24.0112-0218.1 412218	Ø 300 12 10 + S
			➔	+PR 1KF,1KJ,1KK,2EJ		24.0122-0272.1 422272	Ø 330 21,9 20 V + S
2.0 TDI	100	05/17→	➔	+PR 1LA,1LB		24.0125-0184.1 425184	Ø 314 25 23 V + S
2.0 TDI	110	01/17→	➔			24.0325-0184.1 525184	Ø 314 25 23 V + S
2.0 TDI	140	09/16→					
2.0 TDI quattro	110	05/17→					
2.0 TDI quattro	140	10/16→					
2.0 TFSI	140	01/17→					
2.0 TFSI g-tron	125	02/17→					
2.0 TFSI quattro	183	09/16→					
2.0 TFSI quattro	185	09/16→					
3.0 TDI quattro	160	09/16→					
3.0 TDI quattro	200	02/17→					
3.0 TDI quattro	210	01/17→					
S5 quattro	260	09/16→					
			➔	+PR 1KF,1KJ,1KK,2EJ		24.0122-0272.1 422272	Ø 330 21,9 20 V + S
<b>AUDI - A6 (4A2, C4) 06/94→10/97</b>							
 <b>Bremsbelagsatz, Scheibenbremse</b>							
1.8	92	12/95→10/97	➔			13.0460-7050.2 607050	ATE 20676 19,5 + WK
1.8 quattro	92	12/95→10/97	➔			13.0460-3602.2 603602	TRW 21144 15,8 - WK
1.9 TDI	66	06/94→10/97					
2.0	74	06/94→10/97					
2.0	85	06/94→10/97					
2.0 16V	103	06/94→10/97					
2.0 16V quattro	103	06/94→10/97					
2.4	110	07/95→06/96					
2.5 TDI	84	01/95→10/97					
2.5 TDI	85	06/94→10/97					
2.5 TDI	103	08/94→10/97					
2.5 TDI quattro	103	10/95→10/97					
2.6	102	06/94→10/97					
2.6	110	06/94→10/97					
2.6 quattro	110	06/94→10/97					
2.8	120	08/95→07/96					
2.8	128	06/94→10/97					
2.8	142	12/95→10/97					
2.8 quattro	128	06/94→10/97					
2.8 quattro	142	12/95→10/97					
S6 4.2 quattro	213	06/94→10/97					
			➔	09/94→		13.0460-3602.2 603602	TRW 21144 15,8 - WK
↓							



















	kW			 	! #		
<b>AUDI - A6 (4A2, C4) 06/94→10/97</b>							
 <b>Bremsbelagsatz, Scheibenbremse</b>							
S6 Plus quattro	240	04/96→10/97	←	06/96→		13.0460-2717.2 602717	TRW 21452 18,5 + WK
			→	06/96→		13.0460-3602.2 603602	TRW 21144 15,8 - WK
S6 Turbo quattro	169	06/94→10/97	←			13.0460-2717.2 602717	TRW 21452 18,5 + WK
			→			13.0460-3602.2 603602	TRW 21144 15,8 - WK
 <b>Bremsscheibe</b>							
1.8	92	12/95→10/97	←			24.0115-0105.1 415105	Ø 288 15 13
1.8 quattro	92	12/95→10/97				24.0315-0105.1 515105	Ø 288 15 13
1.9 TDI	66	06/94→10/97	→			24.0110-0201.1 410201	Ø 245 10 8
2.0	74	06/94→10/97				24.0310-0201.1 510201	Ø 245 10 8
2.0	85	06/94→10/97					
2.0 16V	103	06/94→10/97					
2.0 16V quattro	103	06/94→10/97					
2.4	110	07/95→06/96					
2.5 TDI	84	01/95→10/97					
2.5 TDI	85	06/94→10/97					
2.5 TDI	103	08/94→10/97	←	10/94→		24.0125-0105.1 425105	Ø 288 25 23 V + S
			→			24.0325-0105.1 525105	Ø 288 25 23 V
						24.0110-0201.1 410201	Ø 245 10 8
						24.0310-0201.1 510201	Ø 245 10 8
2.5 TDI quattro	103	10/95→10/97	←			24.0125-0105.1 425105	Ø 288 25 23 V + S
2.6	102	06/94→10/97				24.0325-0105.1 525105	Ø 288 25 23 V
2.6	110	06/94→10/97	→			24.0110-0201.1 410201	Ø 245 10 8
2.6 quattro	110	06/94→10/97				24.0310-0201.1 510201	Ø 245 10 8
2.8	120	08/95→07/96					
2.8	128	06/94→10/97					
2.8	142	12/95→10/97					
2.8 quattro	128	06/94→10/97					
2.8 quattro	142	12/95→10/97					
S6 4.2 quattro	213	06/94→10/97	←	09/94→		24.0130-0104.1 430104	Ø 314 30 28 V
			→	09/94→		24.0120-0172.1 420172	Ø 269 19,9 18 V
S6 Plus quattro	240	04/96→10/97	←	06/96→		24.0130-0183.1 430183	Ø 323 30 28 V
			→	06/96→		24.0120-0172.1 420172	Ø 269 19,9 18 V
S6 Turbo quattro	169	06/94→10/97	←			24.0130-0104.1 430104	Ø 314 30 28 V
			→			24.0120-0172.1 420172	Ø 269 19,9 18 V
<b>AUDI - A6 (4B2, C5) 01/97→08/05</b>							
 <b>Bremsbelagsatz, Scheibenbremse</b>							
1.8	85	05/97→01/05	←			13.0460-7110.2 607110	ATE 20676 19,8 + WK
1.8	92	07/97→01/05				13.0470-7110.2 LD7110	ATE 20676 19,8 + WK Ceramic
1.8 T	132	12/97→01/05	→	→ 05/01		13.0460-2787.2 602787	TRW 23554 17,3 - WK / - WE
1.9 TDI	85	07/00→01/05				13.0460-2820.2 602820	TRW 20961 17,2 - WK
2.4	100	07/98→01/05				13.0470-2820.2 LD2820	TRW 20961 17,2 - WK Ceramic
2.5 TDI	110	07/97→01/05					
2.8	140	07/99→01/05	→	06/01→		13.0460-2886.2 602886	TRW 20961 16,0 - WK
						13.0460-2937.2 602937	TRW 20961 15,2 - WK + Zub
						13.0470-2886.2 LD2886	TRW 20961 16,0 - WK Ceramic
1.8 T	110	01/97→01/05	←	04/97→		13.0460-7110.2 607110	ATE 20676 19,8 + WK
2.4	115	02/97→01/05				13.0470-7110.2 LD7110	ATE 20676 19,8 + WK Ceramic
2.4	120	02/97→01/05	→	04/97→ 05/01		13.0460-2787.2 602787	TRW 23554 17,3 - WK / - WE
2.4	121	02/97→01/05				13.0460-2820.2 602820	TRW 20961 17,2 - WK
2.8	142	02/97→01/05	→	06/01→		13.0470-2820.2 LD2820	TRW 20961 17,2 - WK Ceramic
						13.0460-2886.2 602886	TRW 20961 16,0 - WK
						13.0460-2937.2 602937	TRW 20961 15,2 - WK + Zub
						13.0470-2886.2 LD2886	TRW 20961 16,0 - WK Ceramic
1.8 T quattro	110	02/97→01/05	←	04/97→; +PR 1LB;1LE;1LF;1LT		13.0460-7110.2 607110	ATE 20676 19,8 + WK
2.4 quattro	120	02/97→01/05				13.0470-7110.2 LD7110	ATE 20676 19,8 + WK Ceramic
2.4 quattro	121	02/97→01/05	←	06/01→; +PR 1LG,1LA		13.0460-7166.2 607166	ATE 23762 20,4 + WK
						13.0470-7166.2 LD7166	ATE 23762 20,4 + WK Ceramic
			→	04/97→ 05/01		13.0460-2787.2 602787	TRW 23554 17,3 - WK / - WE
						13.0460-2820.2 602820	TRW 20961 17,2 - WK
						13.0470-2820.2 LD2820	TRW 20961 17,2 - WK Ceramic
			→	06/01→		13.0460-2886.2 602886	TRW 20961 16,0 - WK
						13.0460-2937.2 602937	TRW 20961 15,2 - WK + Zub
						13.0470-2886.2 LD2886	TRW 20961 16,0 - WK Ceramic
1.8 T quattro	132	12/97→01/05	←	+PR 1LB;1LE;1LF;1LT		13.0460-7110.2 607110	ATE 20676 19,8 + WK









	kw			 	! #		
<b>AUDI - A6 (4B2, C5) 01/97→08/05</b>							
<b> Bremsbelagsatz, Scheibenbremse</b>							
2.5 TDI quattro 2.5 TDI quattro	110 132	07/97→01/05 02/00→01/05	← +PR 1LB;1LE;1LF;1LT			<b>13.0470-7110.2 LD7110</b>	ATE 20676 19,8 + WK Ceramic
			← 06/01→; +PR 1LG,1LA			<b>13.0460-7166.2 607166</b> <b>13.0470-7166.2 LD7166</b>	ATE 23762 20,4 + WK ATE 23762 20,4 + WK Ceramic
			→ 05/01			<b>13.0460-2787.2 602787</b> <b>13.0460-2820.2 602820</b> <b>13.0470-2820.2 LD2820</b>	TRW 23554 17,3 - WK / - WE TRW 20961 17,2 - WK TRW 20961 17,2 - WK Ceramic
			→ 06/01→			<b>13.0460-2886.2 602886</b> <b>13.0460-2937.2 602937</b> <b>13.0470-2886.2 LD2886</b>	TRW 20961 16,0 - WK TRW 20961 15,2 - WK + Zub TRW 20961 16,0 - WK Ceramic
1.9 TDI 2.8	81 132	04/97→10/00 10/97→05/00	←			<b>13.0460-7110.2 607110</b> <b>13.0470-7110.2 LD7110</b>	ATE 20676 19,8 + WK ATE 20676 19,8 + WK Ceramic
			→			<b>13.0460-2787.2 602787</b> <b>13.0460-2820.2 602820</b> <b>13.0470-2820.2 LD2820</b>	TRW 23554 17,3 - WK / - WE TRW 20961 17,2 - WK TRW 20961 17,2 - WK Ceramic
1.9 TDI 2.0 2.4 2.5 TDI	96 96 125 114	08/01→01/05 08/01→01/05 08/01→01/05 08/01→01/05	←			<b>13.0460-7110.2 607110</b> <b>13.0470-7110.2 LD7110</b>	ATE 20676 19,8 + WK ATE 20676 19,8 + WK Ceramic
			→			<b>13.0460-2886.2 602886</b> <b>13.0460-2937.2 602937</b> <b>13.0470-2886.2 LD2886</b>	TRW 20961 16,0 - WK TRW 20961 15,2 - WK + Zub TRW 20961 16,0 - WK Ceramic
2.4 quattro 2.8 quattro 2.8 quattro	115 132 140	08/98→07/99 01/98→04/00 07/99→05/01	← +PR 1LB;1LE;1LF;1LT			<b>13.0460-7110.2 607110</b> <b>13.0470-7110.2 LD7110</b>	ATE 20676 19,8 + WK ATE 20676 19,8 + WK Ceramic
			→			<b>13.0460-2787.2 602787</b> <b>13.0460-2820.2 602820</b> <b>13.0470-2820.2 LD2820</b>	TRW 23554 17,3 - WK / - WE TRW 20961 17,2 - WK TRW 20961 17,2 - WK Ceramic
2.4 quattro 2.5 TDI	125 120	08/01→01/05 07/02→01/05	← +PR 1LB;1LE;1LF;1LT			<b>13.0460-7110.2 607110</b> <b>13.0470-7110.2 LD7110</b>	ATE 20676 19,8 + WK ATE 20676 19,8 + WK Ceramic
			← +PR 1LG,1LA			<b>13.0460-7166.2 607166</b> <b>13.0470-7166.2 LD7166</b>	ATE 23762 20,4 + WK ATE 23762 20,4 + WK Ceramic
			→			<b>13.0460-2886.2 602886</b> <b>13.0460-2937.2 602937</b> <b>13.0470-2886.2 LD2886</b>	TRW 20961 16,0 - WK TRW 20961 15,2 - WK + Zub TRW 20961 16,0 - WK Ceramic
2.5 TDI	132	02/00→01/05	← +PR 1LB;1LE;1LF;1LT			<b>13.0460-7110.2 607110</b> <b>13.0470-7110.2 LD7110</b>	ATE 20676 19,8 + WK ATE 20676 19,8 + WK Ceramic
			← +PR 1LG,1LA			<b>13.0460-7166.2 607166</b> <b>13.0470-7166.2 LD7166</b>	ATE 23762 20,4 + WK ATE 23762 20,4 + WK Ceramic
			→ 05/01			<b>13.0460-2787.2 602787</b> <b>13.0460-2820.2 602820</b> <b>13.0470-2820.2 LD2820</b>	TRW 23554 17,3 - WK / - WE TRW 20961 17,2 - WK TRW 20961 17,2 - WK Ceramic
			→ 06/01→			<b>13.0460-2886.2 602886</b> <b>13.0460-2937.2 602937</b> <b>13.0470-2886.2 LD2886</b>	TRW 20961 16,0 - WK TRW 20961 15,2 - WK + Zub TRW 20961 16,0 - WK Ceramic
2.7 quattro 2.7 T 2.7 T quattro	187 169 169	05/01→07/04 02/99→01/05 12/97→01/05	← → 4B-X-060000			<b>13.0460-2701.2 602701</b>	TRW 21452 18,5 + WK
			← 4B-X-060001→; → 05/01			<b>13.0460-2875.2 602875</b>	TRW 23119 17,5 + WK
			← 06/01→; +PR 1LG,1LA			<b>13.0460-7166.2 607166</b> <b>13.0470-7166.2 LD7166</b>	ATE 23762 20,4 + WK ATE 23762 20,4 + WK Ceramic
			→ 05/01			<b>13.0460-2787.2 602787</b> <b>13.0460-2820.2 602820</b> <b>13.0470-2820.2 LD2820</b>	TRW 23554 17,3 - WK / - WE TRW 20961 17,2 - WK TRW 20961 17,2 - WK Ceramic
			→ 06/01→			<b>13.0460-2886.2 602886</b> <b>13.0460-2937.2 602937</b> <b>13.0470-2886.2 LD2886</b>	TRW 20961 16,0 - WK TRW 20961 15,2 - WK + Zub TRW 20961 16,0 - WK Ceramic
2.7 T quattro	184	08/01→01/05	← → 4B-X-060000			<b>13.0460-2701.2 602701</b>	TRW 21452 18,5 + WK
			← +PR 1LG,1LA			<b>13.0460-7166.2 607166</b> <b>13.0470-7166.2 LD7166</b>	ATE 23762 20,4 + WK ATE 23762 20,4 + WK Ceramic
			→			<b>13.0460-2886.2 602886</b> <b>13.0460-2937.2 602937</b> <b>13.0470-2886.2 LD2886</b>	TRW 20961 16,0 - WK TRW 20961 15,2 - WK + Zub TRW 20961 16,0 - WK Ceramic
2.8 quattro	142	02/97→01/05	← 04/97→; +PR 1LB;1LE;1LF;1LT			<b>13.0460-7110.2 607110</b> <b>13.0470-7110.2 LD7110</b>	ATE 20676 19,8 + WK ATE 20676 19,8 + WK Ceramic
			→ 04/97→ 05/01			<b>13.0460-2787.2 602787</b> <b>13.0460-2820.2 602820</b>	TRW 23554 17,3 - WK / - WE TRW 20961 17,2 - WK







	kw			 	! #		
<b>AUDI - A6 (4B2, C5) 01/97→08/05</b>							
<b> Bremsbelagsatz, Scheibenbremse</b>							
2.8 quattro	142	02/97→01/05	➡	04/97→ 05/01		<b>13.0470-2820.2 LD2820</b>	TRW 20961 17,2 - WK Ceramic
			➡	06/01→		<b>13.0460-2886.2 602886</b>	TRW 20961 16,0 - WK
						<b>13.0460-2937.2 602937</b>	TRW 20961 15,2 - WK + Zub
						<b>13.0470-2886.2 LD2886</b>	TRW 20961 16,0 - WK Ceramic
3.0	160	06/01→01/05	←	+PR 1LG,1LA		<b>13.0460-7166.2 607166</b>	ATE 23762 20,4 + WK
3.0 quattro	160	06/01→07/04				<b>13.0470-7166.2 LD7166</b>	ATE 23762 20,4 + WK Ceramic
3.0 quattro	162	08/01→01/05	➡			<b>13.0460-2886.2 602886</b>	TRW 20961 16,0 - WK
3.7	191	03/99→01/05				<b>13.0460-2937.2 602937</b>	TRW 20961 15,2 - WK + Zub
3.7 quattro	191	03/99→01/05				<b>13.0470-2886.2 LD2886</b>	TRW 20961 16,0 - WK Ceramic
4.2 quattro	220	11/98→01/05	←			<b>13.0460-2875.2 602875</b>	TRW 23119 17,5 + WK
S6 quattro	250	09/99→01/05	➡	→ 05/01		<b>13.0460-2787.2 602787</b>	TRW 23554 17,3 - WK / - WE
						<b>13.0460-2820.2 602820</b>	TRW 20961 17,2 - WK
						<b>13.0470-2820.2 LD2820</b>	TRW 20961 17,2 - WK Ceramic
			➡	06/01→		<b>13.0460-2886.2 602886</b>	TRW 20961 16,0 - WK
						<b>13.0460-2937.2 602937</b>	TRW 20961 15,2 - WK + Zub
						<b>13.0470-2886.2 LD2886</b>	TRW 20961 16,0 - WK Ceramic
RS6 quattro	331	07/02→01/05	➡			<b>13.0460-2889.2 602889</b>	TRW 23326 17,4 + WE / - WK
<b>Zubehörsatz, Scheibenbremsbelag</b>							
1.8	85	05/97→01/05	➡	→ 05/01		<b>13.0460-0072.2 610072</b>	TRW
1.8	92	07/97→01/05					
1.8 T	132	12/97→01/05					
1.8 T quattro	132	12/97→01/05					
1.9 TDI	85	07/00→01/05					
2.4	100	07/98→01/05					
2.5 TDI	110	07/97→01/05					
2.5 TDI	132	02/00→01/05					
2.5 TDI quattro	110	07/97→01/05					
2.5 TDI quattro	132	02/00→01/05					
2.7 quattro	187	05/01→07/04					
2.7 T	169	02/99→01/05					
2.7 T quattro	169	12/97→01/05					
2.8	140	07/99→01/05					
4.2 quattro	220	11/98→01/05					
S6 quattro	250	09/99→01/05					
1.8 T	110	01/97→01/05	➡	04/97→ 05/01		<b>13.0460-0072.2 610072</b>	TRW
1.8 T quattro	110	02/97→01/05					
2.4	115	02/97→01/05					
2.4	120	02/97→01/05					
2.4	121	02/97→01/05					
2.4 quattro	120	02/97→01/05					
2.4 quattro	121	02/97→01/05					
2.8	142	02/97→01/05					
2.8 quattro	142	02/97→01/05					
1.9 TDI	81	04/97→10/00	➡			<b>13.0460-0072.2 610072</b>	TRW
2.4 quattro	115	08/98→07/99					
2.8	132	10/97→05/00					
2.8 quattro	132	01/98→04/00					
2.8 quattro	140	07/99→05/01					
<b> Bremsscheibe</b>							
1.8	85	05/97→01/05	←	+PR 1LB;1LE		<b>24.0125-0105.1 425105</b>	Ø 288 25 23 V + S
1.8	92	07/97→01/05				<b>24.0325-0105.1 525105</b>	Ø 288 25 23 V
1.8 T	132	12/97→01/05					
1.9 TDI	81	04/97→10/00	←	+PR 1LF;1LT		<b>24.0125-0137.1 425137</b>	Ø 312 25 23 V + S
1.9 TDI	85	07/00→01/05				<b>24.0325-0137.1 525137</b>	Ø 312 25 23 V
1.9 TDI	96	08/01→01/05	➡			<b>24.0110-0201.1 410201</b>	Ø 245 10 8
2.0	96	08/01→01/05				<b>24.0310-0201.1 510201</b>	Ø 245 10 8
2.4	100	07/98→01/05					
2.4	125	08/01→01/05					
1.8 T	110	01/97→01/05	←	04/97→; +PR 1LB;1LE		<b>24.0125-0105.1 425105</b>	Ø 288 25 23 V + S
						<b>24.0325-0105.1 525105</b>	Ø 288 25 23 V
			←	04/97→; +PR 1LF;1LT		<b>24.0125-0137.1 425137</b>	Ø 312 25 23 V + S
						<b>24.0325-0137.1 525137</b>	Ø 312 25 23 V
			←	04/97→; +PR 1LG;1LA		<b>24.0130-0113.1 430113</b>	Ø 320 30 28 V + S
						<b>24.0330-0113.1 530113</b>	Ø 320 30 28 V
			➡	04/97→		<b>24.0110-0201.1 410201</b>	Ø 245 10 8
						<b>24.0310-0201.1 510201</b>	Ø 245 10 8
1.8 T quattro	110	02/97→01/05	←	04/97→; +PR 1LB;1LE		<b>24.0125-0105.1 425105</b>	Ø 288 25 23 V + S
2.4 quattro	120	02/97→01/05				<b>24.0325-0105.1 525105</b>	Ø 288 25 23 V
2.4 quattro	121	02/97→01/05	←	04/97→; +PR 1LF;1LT		<b>24.0125-0137.1 425137</b>	Ø 312 25 23 V + S
↓							

	kw			 	! #		
<b>AUDI - A6 (4B2, C5) 01/97→08/05</b>							
<b>Bremsscheibe</b>							
1.8 T quattro	110	02/97→01/05	←	04/97→; +PR 1LF;1LT		24.0325-0137.1 525137	Ø 312 25 23 V
2.4 quattro	120	02/97→01/05	←	06/01→; +PR 1LG;1LA		24.0130-0113.1 430113	Ø 320 30 28 V + S
2.4 quattro	121	02/97→01/05	←			24.0330-0113.1 530113	Ø 320 30 28 V
			→	4B-Y-000001→; +PR 0N1		24.0110-0258.1 410258	Ø 245 10 8
			→	04/97→; → 4B-X-200000		24.0110-0258.1 410258	Ø 245 10 8
			→	04/97→; → 4B-X-200000; + Avant; Kombi		24.0110-0259.1 410259	Ø 255 10 8
			→	4B-Y-000001→; +PR 0N5; - Avant; Geschlossen		24.0110-0259.1 410259	Ø 255 10 8
			→	04/97→; +PR 0N6		24.0110-0260.1 410260	Ø 255 10 8
						24.0310-0260.1 510260	Ø 255 10 8
1.8 T quattro	132	12/97→01/05	←	+PR 1LB;1LE		24.0125-0105.1 425105	Ø 288 25 23 V + S
2.5 TDI quattro	110	07/97→01/05				24.0325-0105.1 525105	Ø 288 25 23 V
2.5 TDI quattro	132	02/00→01/05	←	+PR 1LF;1LT		24.0125-0137.1 425137	Ø 312 25 23 V + S
						24.0325-0137.1 525137	Ø 312 25 23 V
			←	06/01→; +PR 1LG;1LA		24.0130-0113.1 430113	Ø 320 30 28 V + S
						24.0330-0113.1 530113	Ø 320 30 28 V
			→	4B-Y-000001→; +PR 0N1		24.0110-0258.1 410258	Ø 245 10 8
			→	→ 4B-X-200000		24.0110-0258.1 410258	Ø 245 10 8
			→	4B-Y-000001→; +PR 0N5; - Avant; Geschlossen		24.0110-0259.1 410259	Ø 255 10 8
			→	→ 4B-X-200000; + Avant; Kombi		24.0110-0259.1 410259	Ø 255 10 8
			→	+PR 0N6		24.0110-0260.1 410260	Ø 255 10 8
						24.0310-0260.1 510260	Ø 255 10 8
2.4	115	02/97→01/05	←	04/97→; +PR 1LB;1LE		24.0125-0105.1 425105	Ø 288 25 23 V + S
2.4	120	02/97→01/05				24.0325-0105.1 525105	Ø 288 25 23 V
2.4	121	02/97→01/05	←	04/97→; +PR 1LF;1LT		24.0125-0137.1 425137	Ø 312 25 23 V + S
						24.0325-0137.1 525137	Ø 312 25 23 V
			→	04/97→		24.0110-0201.1 410201	Ø 245 10 8
						24.0310-0201.1 510201	Ø 245 10 8
2.4 quattro	115	08/98→07/99	←	+PR 1LB;1LE		24.0125-0105.1 425105	Ø 288 25 23 V + S
			←	+PR 1LF;1LT		24.0325-0105.1 525105	Ø 288 25 23 V
						24.0125-0137.1 425137	Ø 312 25 23 V + S
						24.0325-0137.1 525137	Ø 312 25 23 V
			→	→ 4B-X-200000		24.0110-0258.1 410258	Ø 245 10 8
			→	4B-Y-000001→; +PR 0N1		24.0110-0258.1 410258	Ø 245 10 8
			→	4B-Y-000001→; +PR 0N5; - Avant; Geschlossen		24.0110-0259.1 410259	Ø 255 10 8
			→	→ 4B-X-200000; + Avant; Kombi		24.0110-0259.1 410259	Ø 255 10 8
			→	+PR 0N6		24.0110-0260.1 410260	Ø 255 10 8
						24.0310-0260.1 510260	Ø 255 10 8
2.4 quattro	125	08/01→01/05	←	+PR 1LB;1LE		24.0125-0105.1 425105	Ø 288 25 23 V + S
						24.0325-0105.1 525105	Ø 288 25 23 V
			←	+PR 1LF;1LT		24.0125-0137.1 425137	Ø 312 25 23 V + S
						24.0325-0137.1 525137	Ø 312 25 23 V
			←	+PR 1LG;1LA		24.0130-0113.1 430113	Ø 320 30 28 V + S
						24.0330-0113.1 530113	Ø 320 30 28 V
			→	→ 4B-X-200000		24.0110-0258.1 410258	Ø 245 10 8
			→	4B-Y-000001→; +PR 0N1		24.0110-0258.1 410258	Ø 245 10 8
			→	4B-Y-000001→; +PR 0N5; - Avant; Geschlossen		24.0110-0259.1 410259	Ø 255 10 8
			→	→ 4B-X-200000; + Avant; Kombi		24.0110-0259.1 410259	Ø 255 10 8
			→	+PR 0N6		24.0110-0260.1 410260	Ø 255 10 8
						24.0310-0260.1 510260	Ø 255 10 8
2.5 TDI	110	07/97→01/05	←	+PR 1LB;1LE		24.0125-0105.1 425105	Ø 288 25 23 V + S
2.5 TDI	114	08/01→01/05				24.0325-0105.1 525105	Ø 288 25 23 V
2.5 TDI	120	07/02→01/05	←	+PR 1LF;1LT		24.0125-0137.1 425137	Ø 312 25 23 V + S
2.5 TDI	132	02/00→01/05				24.0325-0137.1 525137	Ø 312 25 23 V
			←	+PR 1LG;1LA		24.0130-0113.1 430113	Ø 320 30 28 V + S
						24.0330-0113.1 530113	Ø 320 30 28 V
			→			24.0110-0201.1 410201	Ø 245 10 8







	kW			 	! #		
<b>AUDI - A6 (4B2, C5) 01/97→08/05</b>							
<b>Bremsscheibe</b>							
2.5 TDI	110	07/97→01/05	➔			24.0310-0201.1 510201	Ø 245 10 8
2.5 TDI	114	08/01→01/05					
2.5 TDI	120	07/02→01/05					
2.5 TDI	132	02/00→01/05					
2.7 quattro	187	05/01→07/04	➔			24.0130-0113.1 430113	Ø 320 30 28 V + S
2.7 T quattro	169	12/97→01/05				24.0330-0113.1 530113	Ø 320 30 28 V
2.7 T quattro	184	08/01→01/05					
3.0 quattro	160	06/01→07/04	➔	4B-Y-000001→; +PR 0N1		24.0110-0258.1 410258	Ø 245 10 8
3.0 quattro	162	08/01→01/05	➔	→ 4B-X-200000		24.0110-0258.1 410258	Ø 245 10 8
3.7 quattro	191	03/99→01/05	➔	4B-Y-000001→; +PR 0N5; - Avant; Geschlossen		24.0110-0259.1 410259	Ø 255 10 8
			➔	→ 4B-X-200000; + Avant; Kombi		24.0110-0259.1 410259	Ø 255 10 8
			➔	+PR 0N6		24.0110-0260.1 410260	Ø 255 10 8
2.7 T	169	02/99→01/05	➔			24.0130-0113.1 430113	Ø 320 30 28 V + S
3.0	160	06/01→01/05				24.0330-0113.1 530113	Ø 320 30 28 V
3.0	162	08/01→01/05					
3.7	191	03/99→01/05	➔			24.0110-0201.1 410201	Ø 245 10 8
						24.0310-0201.1 510201	Ø 245 10 8
2.8	132	10/97→05/00	➔	+PR 1LB;1LE		24.0125-0105.1 425105	Ø 288 25 23 V + S
2.8	140	07/99→01/05	➔			24.0325-0105.1 525105	Ø 288 25 23 V
			➔	+PR 1LF,1LT		24.0125-0137.1 425137	Ø 312 25 23 V + S
			➔			24.0325-0137.1 525137	Ø 312 25 23 V
			➔			24.0110-0201.1 410201	Ø 245 10 8
			➔			24.0310-0201.1 510201	Ø 245 10 8
2.8	142	02/97→01/05	➔	04/97→; +PR 1LB;1LE		24.0125-0105.1 425105	Ø 288 25 23 V + S
			➔			24.0325-0105.1 525105	Ø 288 25 23 V
			➔	04/97→; +PR 1LF,1LT		24.0125-0137.1 425137	Ø 312 25 23 V + S
			➔			24.0325-0137.1 525137	Ø 312 25 23 V
			➔	04/97→		24.0110-0201.1 410201	Ø 245 10 8
			➔			24.0310-0201.1 510201	Ø 245 10 8
2.8 quattro	132	01/98→04/00	➔	+PR 1LB;1LE		24.0125-0105.1 425105	Ø 288 25 23 V + S
2.8 quattro	140	07/99→05/01	➔			24.0325-0105.1 525105	Ø 288 25 23 V
			➔	+PR 1LF,1LT		24.0125-0137.1 425137	Ø 312 25 23 V + S
			➔			24.0325-0137.1 525137	Ø 312 25 23 V
			➔	4B-Y-000001→; +PR 0N1		24.0110-0258.1 410258	Ø 245 10 8
			➔	4B-Y-000001→; +PR 0N5; - Avant; Geschlossen		24.0110-0259.1 410259	Ø 255 10 8
			➔	→ 4B-X-200000; + Avant; Kombi		24.0110-0259.1 410259	Ø 255 10 8
			➔	+PR 0N6		24.0110-0260.1 410260	Ø 255 10 8
2.8 quattro	142	02/97→01/05	➔	04/97→; +PR 1LB;1LE		24.0125-0105.1 425105	Ø 288 25 23 V + S
			➔			24.0325-0105.1 525105	Ø 288 25 23 V
			➔	04/97→; +PR 1LF,1LT		24.0125-0137.1 425137	Ø 312 25 23 V + S
			➔			24.0325-0137.1 525137	Ø 312 25 23 V
			➔	04/97→; → 4B-X-200000		24.0110-0258.1 410258	Ø 245 10 8
			➔	4B-Y-000001→; +PR 0N1		24.0110-0258.1 410258	Ø 245 10 8
			➔	04/97→; → 4B-X-200000; + Avant; Kombi		24.0110-0259.1 410259	Ø 255 10 8
			➔	4B-Y-000001→; +PR 0N5; - Avant; Geschlossen		24.0110-0259.1 410259	Ø 255 10 8
			➔	04/97→; +PR 0N6		24.0110-0260.1 410260	Ø 255 10 8
4.2 quattro	220	11/98→01/05	➔			24.0130-0174.1 430174	Ø 321 30 28 V
S6 quattro	250	09/99→01/05	➔			24.0122-0222.1 422222	Ø 269 22 20 V
<b>AUDI - A6 (4F2, C6) 04/04→06/11</b>							
<b>Bremsbelagsatz, Scheibenbremse</b>							
2.0 TDI	89	09/05→06/06	➔	+PR 1LT		13.0460-7110.2 607110	ATE 20676 19,8 + WK
2.0 TFSI	125	06/05→03/11				13.0470-7110.2 LD7110	ATE 20676 19,8 + WK Ceramic
2.4	130	05/04→10/08					
2.4 quattro	130	01/05→10/08	➔	+PR 1LG;1LD;1ZL;1LH		13.0460-7201.2 607201	ATE 23763 20,3 + WK
2.7 TDI	120	11/04→03/11				13.0470-7201.2 LD7201	ATE 23763 20,3 + WK Ceramic
2.7 TDI	132	11/04→10/08					
2.7 TDI quattro	120	06/05→03/11	➔	+PR 1KQ		13.0460-2749.2 602749	TRW 24483 16,9 - WE / - WK + Zub
2.7 TDI quattro	132	11/04→10/08					
2.8 FSI quattro	154	06/07→10/08				13.0460-2880.2 602880	TRW 23914 17,1 + WE / - WK + Zub
3.0 quattro	160	05/04→05/06					
3.0 TDI quattro	155	05/04→03/11					
3.0 TDI quattro	165	05/04→05/06					

















	kw			 	! #		
<b>AUDI - A6 (4F2, C6) 04/04→06/11</b>							
<b> Bremsbelagsatz, Scheibenbremse</b>							
3.0 TDI quattro	171	06/06→10/08	➡	+PR 1KQ		<b>13.0470-2749.2</b> <b>LD2749</b>	TRW 24483 16,9 - WE / - WK + Zub Ceramic
3.2 FSI	188	05/04→05/09					
3.2 FSI	195	05/09→03/11				<b>13.0470-2880.2</b> <b>LD2880</b>	TRW 23914 17,1 + WE / - WK + Zub Ceramic
3.2 FSI quattro	183	09/06→10/08					
3.2 FSI quattro	188	05/04→10/08	➡	+PR 1KD;2ED		<b>13.0460-2749.2</b> <b>602749</b>	TRW 24483 16,9 - WE / - WK + Zub
						<b>13.0460-2880.2</b> <b>602880</b>	TRW 23914 17,1 + WE / - WK + Zub
						<b>13.0470-2749.2</b> <b>LD2749</b>	TRW 24483 16,9 - WE / - WK + Zub Ceramic
						<b>13.0470-2880.2</b> <b>LD2880</b>	TRW 23914 17,1 + WE / - WK + Zub Ceramic
			➡	+PR 1KW;2EE; + eFSB		<b>13.0460-2888.2</b> <b>602888</b>	TRW 23326 17,4 + WE / - WK
						<b>13.0470-2888.2</b> <b>LD2888</b>	TRW 23326 17,4 + WE / - WK Ceramic
2.0 TDI	100	07/04→03/11	⬅	06/05→; +PR 1LT		<b>13.0460-7110.2</b> <b>607110</b>	ATE 20676 19,8 + WK
						<b>13.0470-7110.2</b> <b>LD7110</b>	ATE 20676 19,8 + WK Ceramic
			⬅	06/05→; +PR 1LG;1LD;1ZL;1LH		<b>13.0460-7201.2</b> <b>607201</b>	ATE 23763 20,3 + WK
						<b>13.0470-7201.2</b> <b>LD7201</b>	ATE 23763 20,3 + WK Ceramic
			➡	06/05→; +PR 1KD;2ED		<b>13.0460-2749.2</b> <b>602749</b>	TRW 24483 16,9 - WE / - WK + Zub
						<b>13.0460-2880.2</b> <b>602880</b>	TRW 23914 17,1 + WE / - WK + Zub
						<b>13.0470-2749.2</b> <b>LD2749</b>	TRW 24483 16,9 - WE / - WK + Zub Ceramic
						<b>13.0470-2880.2</b> <b>LD2880</b>	TRW 23914 17,1 + WE / - WK + Zub Ceramic
			➡	06/05→; +PR 1KQ		<b>13.0460-2749.2</b> <b>602749</b>	TRW 24483 16,9 - WE / - WK + Zub
						<b>13.0460-2880.2</b> <b>602880</b>	TRW 23914 17,1 + WE / - WK + Zub
						<b>13.0470-2749.2</b> <b>LD2749</b>	TRW 24483 16,9 - WE / - WK + Zub Ceramic
						<b>13.0470-2880.2</b> <b>LD2880</b>	TRW 23914 17,1 + WE / - WK + Zub Ceramic
			➡	06/05→; +PR 1KW;2EE; + eFSB		<b>13.0460-2888.2</b> <b>602888</b>	TRW 23326 17,4 + WE / - WK
						<b>13.0470-2888.2</b> <b>LD2888</b>	TRW 23326 17,4 + WE / - WK Ceramic
2.0 TDI	103	07/04→10/08	⬅	10/08→; +PR 1LT		<b>13.0460-7110.2</b> <b>607110</b>	ATE 20676 19,8 + WK
						<b>13.0470-7110.2</b> <b>LD7110</b>	ATE 20676 19,8 + WK Ceramic
			⬅	+PR 1LT		<b>13.0460-7110.2</b> <b>607110</b>	ATE 20676 19,8 + WK
						<b>13.0470-7110.2</b> <b>LD7110</b>	ATE 20676 19,8 + WK Ceramic
			⬅	+PR 1LG;1LD;1ZL;1LH		<b>13.0460-7201.2</b> <b>607201</b>	ATE 23763 20,3 + WK
						<b>13.0470-7201.2</b> <b>LD7201</b>	ATE 23763 20,3 + WK Ceramic
			➡	+PR 1KQ		<b>13.0460-2749.2</b> <b>602749</b>	TRW 24483 16,9 - WE / - WK + Zub
						<b>13.0460-2880.2</b> <b>602880</b>	TRW 23914 17,1 + WE / - WK + Zub
						<b>13.0470-2749.2</b> <b>LD2749</b>	TRW 24483 16,9 - WE / - WK + Zub Ceramic
						<b>13.0470-2880.2</b> <b>LD2880</b>	TRW 23914 17,1 + WE / - WK + Zub Ceramic
			➡	+PR 1KD;2ED		<b>13.0460-2749.2</b> <b>602749</b>	TRW 24483 16,9 - WE / - WK + Zub
						<b>13.0460-2880.2</b> <b>602880</b>	TRW 23914 17,1 + WE / - WK + Zub
						<b>13.0470-2749.2</b> <b>LD2749</b>	TRW 24483 16,9 - WE / - WK + Zub Ceramic
						<b>13.0470-2880.2</b> <b>LD2880</b>	TRW 23914 17,1 + WE / - WK + Zub Ceramic
			➡	+PR 1KW;2EE; + eFSB		<b>13.0460-2888.2</b> <b>602888</b>	TRW 23326 17,4 + WE / - WK
						<b>13.0470-2888.2</b> <b>LD2888</b>	TRW 23326 17,4 + WE / - WK Ceramic
2.0 TDI	120	04/09→03/11	⬅	+PR 1LT		<b>13.0460-7110.2</b> <b>607110</b>	ATE 20676 19,8 + WK
2.0 TDI	125	11/08→03/11				<b>13.0470-7110.2</b> <b>LD7110</b>	ATE 20676 19,8 + WK Ceramic
2.7 TDI quattro	140	10/08→03/11	⬅	+PR 1LG;1ZL		<b>13.0460-7201.2</b> <b>607201</b>	ATE 23763 20,3 + WK
2.8 FSI	140	10/08→03/11				<b>13.0470-7201.2</b> <b>LD7201</b>	ATE 23763 20,3 + WK Ceramic
2.8 FSI	162	10/08→03/11					
2.8 FSI quattro	140	10/08→03/11					
2.8 FSI quattro	162	10/08→03/11					
↓							

	kw				! #		
<b>AUDI - A6 (4F2, C6) 04/04→06/11</b>							
<b> Bremsbelagsatz, Scheibenbremse</b>							
2.0 TDI	120	04/09→03/11	➡	+PR 1KD		<b>13.0460-2749.2 602749</b>	TRW 24483 16,9 - WE / - WK + Zub
2.0 TDI	125	11/08→03/11					
2.7 TDI quattro	140	10/08→03/11				<b>13.0460-2880.2 602880</b>	TRW 23914 17,1 + WE / - WK + Zub
2.8 FSI	140	10/08→03/11					
2.8 FSI	162	10/08→03/11				<b>13.0470-2749.2 LD2749</b>	TRW 24483 16,9 - WE / - WK + Zub Ceramic
2.8 FSI quattro	140	10/08→03/11				<b>13.0470-2880.2 LD2880</b>	TRW 23914 17,1 + WE / - WK + Zub Ceramic
2.8 FSI quattro	162	10/08→03/11					
			➡	+PR 1KQ		<b>13.0460-2749.2 602749</b>	TRW 24483 16,9 - WE / - WK + Zub
						<b>13.0460-2880.2 602880</b>	TRW 23914 17,1 + WE / - WK + Zub
						<b>13.0470-2749.2 LD2749</b>	TRW 24483 16,9 - WE / - WK + Zub Ceramic
						<b>13.0470-2880.2 LD2880</b>	TRW 23914 17,1 + WE / - WK + Zub Ceramic
			➡	+PR 1KW; + eFSB		<b>13.0460-2888.2 602888</b>	TRW 23326 17,4 + WE / - WK Ceramic
						<b>13.0470-2888.2 LD2888</b>	TRW 23326 17,4 + WE / - WK Ceramic
2.7 TDI	140	10/08→03/11	⬅	+PR 1LG;1ZL		<b>13.0460-7201.2 607201</b>	ATE 23763 20,3 + WK
						<b>13.0470-7201.2 LD7201</b>	ATE 23763 20,3 + WK Ceramic
			➡	+PR 1KD		<b>13.0460-2749.2 602749</b>	TRW 24483 16,9 - WE / - WK + Zub
						<b>13.0460-2880.2 602880</b>	TRW 23914 17,1 + WE / - WK + Zub
						<b>13.0470-2749.2 LD2749</b>	TRW 24483 16,9 - WE / - WK + Zub Ceramic
						<b>13.0470-2880.2 LD2880</b>	TRW 23914 17,1 + WE / - WK + Zub Ceramic
			➡	+PR 1KQ		<b>13.0460-2749.2 602749</b>	TRW 24483 16,9 - WE / - WK + Zub
						<b>13.0460-2880.2 602880</b>	TRW 23914 17,1 + WE / - WK + Zub
						<b>13.0470-2749.2 LD2749</b>	TRW 24483 16,9 - WE / - WK + Zub Ceramic
						<b>13.0470-2880.2 LD2880</b>	TRW 23914 17,1 + WE / - WK + Zub Ceramic
			➡	+PR 1KW; + eFSB		<b>13.0460-2888.2 602888</b>	TRW 23326 17,4 + WE / - WK Ceramic
						<b>13.0470-2888.2 LD2888</b>	TRW 23326 17,4 + WE / - WK Ceramic
2.8 FSI	154	11/06→10/08	⬅	+PR 1LT		<b>13.0460-7110.2 607110</b>	ATE 20676 19,8 + WK
						<b>13.0470-7110.2 LD7110</b>	ATE 20676 19,8 + WK Ceramic
			⬅	+PR 1LG;1LD;1ZL;1LH		<b>13.0460-7201.2 607201</b>	ATE 23763 20,3 + WK
						<b>13.0470-7201.2 LD7201</b>	ATE 23763 20,3 + WK Ceramic
			➡	+PR 1KD;2ED		<b>13.0460-2749.2 602749</b>	TRW 24483 16,9 - WE / - WK + Zub
						<b>13.0460-2880.2 602880</b>	TRW 23914 17,1 + WE / - WK + Zub
						<b>13.0470-2749.2 LD2749</b>	TRW 24483 16,9 - WE / - WK + Zub Ceramic
						<b>13.0470-2880.2 LD2880</b>	TRW 23914 17,1 + WE / - WK + Zub Ceramic
			➡	+PR 1KQ		<b>13.0460-2749.2 602749</b>	TRW 24483 16,9 - WE / - WK + Zub
						<b>13.0460-2880.2 602880</b>	TRW 23914 17,1 + WE / - WK + Zub
						<b>13.0470-2749.2 LD2749</b>	TRW 24483 16,9 - WE / - WK + Zub Ceramic
						<b>13.0470-2880.2 LD2880</b>	TRW 23914 17,1 + WE / - WK + Zub Ceramic
			➡	+PR 1KW,2EE; + eFSB		<b>13.0460-2888.2 602888</b>	TRW 23326 17,4 + WE / - WK Ceramic
						<b>13.0470-2888.2 LD2888</b>	TRW 23326 17,4 + WE / - WK Ceramic
3.0	160	08/04→05/06	⬅	+PR 1LT		<b>13.0460-7110.2 607110</b>	ATE 20676 19,8 + WK
						<b>13.0470-7110.2 LD7110</b>	ATE 20676 19,8 + WK Ceramic
			⬅	+PR 1LG,1LD,1ZL,1LH		<b>13.0460-7201.2 607201</b>	ATE 23763 20,3 + WK
						<b>13.0470-7201.2 LD7201</b>	ATE 23763 20,3 + WK Ceramic
			➡	+PR 1KQ		<b>13.0460-2749.2 602749</b>	TRW 24483 16,9 - WE / - WK + Zub

↓









	kw			 	! #		
<b>AUDI - A6 (4F2, C6) 04/04→06/11</b>							
<b>Bremsbelagsatz, Scheibenbremse</b>							
3.0	160	08/04→05/06	➡	+PR 1KQ		13.0460-2880.2 602880 13.0470-2749.2 LD2749 13.0470-2880.2 LD2880	TRW 23914 17,1 + WE / - WK + Zub TRW 24483 16,9 - WE / - WK + Zub Ceramic TRW 23914 17,1 + WE / - WK + Zub Ceramic
			➡	+PR 1KD;2ED		13.0460-2749.2 602749 13.0460-2880.2 602880 13.0470-2749.2 LD2749 13.0470-2880.2 LD2880	TRW 24483 16,9 - WE / - WK + Zub TRW 23914 17,1 + WE / - WK + Zub TRW 24483 16,9 - WE / - WK + Zub Ceramic TRW 23914 17,1 + WE / - WK + Zub Ceramic
			➡	+PR 1KW;2EE; + eFSB		13.0460-2888.2 602888 13.0470-2888.2 LD2888	TRW 23326 17,4 + WE / - WK Ceramic TRW 23326 17,4 + WE / - WK Ceramic
3.0 TDI quattro 3.0 TFSI quattro 3.0 TFSI quattro	176 213 220	10/08→03/11 10/08→03/11 10/08→03/11	⬅	+PR 1LG,1ZL		13.0460-7201.2 607201 13.0470-7201.2 LD7201	ATE 23763 20,3 + WK ATE 23763 20,3 + WK Ceramic
			➡	+PR 1KD		13.0460-2749.2 602749 13.0460-2880.2 602880 13.0470-2749.2 LD2749 13.0470-2880.2 LD2880	TRW 24483 16,9 - WE / - WK + Zub TRW 23914 17,1 + WE / - WK + Zub TRW 24483 16,9 - WE / - WK + Zub Ceramic TRW 23914 17,1 + WE / - WK + Zub Ceramic
			➡	+PR 1KQ		13.0460-2749.2 602749 13.0460-2880.2 602880 13.0470-2749.2 LD2749 13.0470-2880.2 LD2880	TRW 24483 16,9 - WE / - WK + Zub TRW 23914 17,1 + WE / - WK + Zub TRW 24483 16,9 - WE / - WK + Zub Ceramic TRW 23914 17,1 + WE / - WK + Zub Ceramic
			➡	+PR 1KW; + eFSB		13.0460-2888.2 602888 13.0470-2888.2 LD2888	TRW 23326 17,4 + WE / - WK Ceramic TRW 23326 17,4 + WE / - WK Ceramic
4.2 FSI quattro 4.2 quattro	257 246	06/06→03/11 05/04→05/06	⬅	+PR 1LT		13.0460-7110.2 607110	ATE 20676 19,8 + WK
			⬅	+PR 1LG;1LD;1ZL;1LH		13.0460-7201.2 607201	ATE 23763 20,3 + WK
			➡	+PR 1KQ		13.0460-2749.2 602749 13.0460-2880.2 602880 13.0470-2749.2 LD2749 13.0470-2880.2 LD2880	TRW 24483 16,9 - WE / - WK + Zub TRW 23914 17,1 + WE / - WK + Zub TRW 24483 16,9 - WE / - WK + Zub Ceramic TRW 23914 17,1 + WE / - WK + Zub Ceramic
			➡	+PR 1KD;2ED		13.0460-2749.2 602749 13.0460-2880.2 602880 13.0470-2749.2 LD2749 13.0470-2880.2 LD2880	TRW 24483 16,9 - WE / - WK + Zub TRW 23914 17,1 + WE / - WK + Zub TRW 24483 16,9 - WE / - WK + Zub Ceramic TRW 23914 17,1 + WE / - WK + Zub Ceramic
			➡	+PR 1KW;2EE; + eFSB		13.0460-2888.2 602888 13.0470-2888.2 LD2888	TRW 23326 17,4 + WE / - WK Ceramic TRW 23326 17,4 + WE / - WK Ceramic
RS6 quattro	426	09/08→08/10	⬅	+PR 1LM		13.0460-4864.2 604864	BRE 24455 16,8 + WE / + WK
			➡	+ eFSB		13.0460-2888.2 602888	TRW 23326 17,4 + WE / - WK
S6 quattro	320	03/06→03/11	⬅			13.0460-7182.2 607182	ATE 23896 20,6 + WK
			➡	+PR 1KW;2EE; + eFSB		13.0460-2888.2 602888	TRW 23326 17,4 + WE / - WK
<b>Zubehörsatz, Scheibenbremsbelag</b>							
2.0 TDI 2.0 TDI 2.0 TFSI 2.4 ↓	89 103 125 130	09/05→06/06 07/04→10/08 06/05→03/11 05/04→10/08	➡	+PR 1KW;2EE		13.0460-0023.2 610023	
			➡	+PR 1KD;2ED		13.0460-0259.2 610259	

	kW			 	! #		
<b>AUDI - A6 (4F2, C6) 04/04→06/11</b>							
<b>Zubehörsatz, Scheibenbremsbelag</b>							
2.4 quattro	130	01/05→10/08	➡	+PR 1KQ		13.0460-0259.2	610259
2.7 TDI	120	11/04→03/11					
2.7 TDI	132	11/04→10/08					
2.7 TDI quattro	120	06/05→03/11					
2.7 TDI quattro	132	11/04→10/08					
2.8 FSI quattro	154	06/07→10/08					
3.0	160	08/04→05/06					
3.0 quattro	160	05/04→05/06					
3.0 TDI quattro	155	05/04→03/11					
3.0 TDI quattro	165	05/04→05/06					
3.0 TDI quattro	171	06/06→10/08					
3.2 FSI	188	05/04→05/09					
3.2 FSI	195	05/09→03/11					
3.2 FSI quattro	183	09/06→10/08					
3.2 FSI quattro	188	05/04→10/08					
4.2 FSI quattro	257	06/06→03/11					
4.2 quattro	246	05/04→05/06					
2.0 TDI	100	07/04→03/11	➡	06/05→; +PR 1KW;2EE		13.0460-0023.2	610023
			➡	06/05→; +PR 1KD;2ED		13.0460-0259.2	610259
			➡	06/05→; +PR 1KQ		13.0460-0259.2	610259
2.0 TDI	120	04/09→03/11	➡	+PR 1KW		13.0460-0023.2	610023
2.0 TDI	125	11/08→03/11					
2.7 TDI	140	10/08→03/11	➡	+PR 1KD		13.0460-0259.2	610259
2.7 TDI quattro	140	10/08→03/11	➡	+PR 1KQ		13.0460-0259.2	610259
2.8 FSI	140	10/08→03/11					
2.8 FSI	162	10/08→03/11					
2.8 FSI quattro	140	10/08→03/11					
2.8 FSI quattro	162	10/08→03/11					
3.0 TDI quattro	176	10/08→03/11					
3.0 TFSI quattro	213	10/08→03/11					
3.0 TFSI quattro	220	10/08→03/11					
2.8 FSI	154	11/06→10/08	➡	+PR 1KW;2EE		13.0460-0023.2	610023
			➡	+PR 1KD;2ED		13.0460-0259.2	610259
			➡	+PR 1KQ		13.0460-0259.2	610259
RS6 quattro	426	09/08→08/10				13.0460-0023.2	610023
S6 quattro	320	03/06→03/11		+PR 1KW;2EE		13.0460-0023.2	610023
<b>Bremsscheibe</b>							
2.0 TDI	89	09/05→06/06	←	+PR 1LT		24.0125-0149.1	425149 Ø 314 25 23 V
2.0 TDI	103	07/04→10/08				24.0325-0149.1	525149 Ø 314 25 23 V
2.0 TFSI	125	06/05→03/11					
2.4	130	05/04→10/08	←	+PR 1LG;1LD		24.0130-0175.1	430175 Ø 321 30 28 V + S
2.4 quattro	130	01/05→10/08				24.0330-0175.1	530175 Ø 321 30 28 V + S
2.7 TDI	120	11/04→03/11	←	+PR 1ZL;1LH		24.0130-0176.1	430176 Ø 347 30 28 V + S
2.7 TDI	132	11/04→10/08				24.0330-0176.1	530176 Ø 347 30 28 V + S
2.7 TDI quattro	120	06/05→03/11					
2.7 TDI quattro	132	11/04→10/08	➡	+PR 1KD,2ED,1KQ; + eFSB		24.0112-0159.1	412159 Ø 302 12 10 + S
2.8 FSI	154	11/06→10/08				24.0312-0159.1	512159 Ø 302 12 10 + S
2.8 FSI quattro	154	06/07→10/08					
3.0 quattro	160	05/04→05/06	➡	+PR 1KW;2EE		24.0122-0223.1	422223 Ø 330 22 20 V
3.0 TDI quattro	155	05/04→03/11				24.0322-0223.1	522223 Ø 330 22 20 V
3.0 TDI quattro	165	05/04→05/06					
3.0 TDI quattro	171	06/06→10/08					
3.2 FSI	188	05/04→05/09					
3.2 FSI	195	05/09→03/11					
3.2 FSI quattro	183	09/06→10/08					
3.2 FSI quattro	188	05/04→10/08					
4.2 FSI quattro	257	06/06→03/11					
4.2 quattro	246	05/04→05/06					
2.0 TDI	100	07/04→03/11	←	06/05→; +PR 1LT		24.0125-0149.1	425149 Ø 314 25 23 V
			←	06/05→; +PR 1LG;1LD		24.0130-0175.1	430175 Ø 321 30 28 V + S
			←	06/05→; +PR 1ZL;1LH		24.0130-0176.1	430176 Ø 347 30 28 V + S
			➡	06/05→; +PR 1KD,2ED,1KQ; + eFSB		24.0112-0159.1	412159 Ø 302 12 10 + S
			➡	06/05→; +PR 1KW;2EE		24.0122-0223.1	422223 Ø 330 22 20 V
2.0 TDI	120	04/09→03/11	←	+PR 1LT		24.0125-0149.1	425149 Ø 314 25 23 V
2.0 TDI	125	11/08→03/11				24.0325-0149.1	525149 Ø 314 25 23 V
2.7 TDI	140	10/08→03/11	←	+PR 1LG		24.0130-0175.1	430175 Ø 321 30 28 V + S
2.7 TDI quattro	140	10/08→03/11				24.0330-0175.1	530175 Ø 321 30 28 V + S
2.8 FSI	140	10/08→03/11					
2.8 FSI	162	10/08→03/11					
↓							









	kw			 	! #		
<b>AUDI - A6 (4F2, C6) 04/04→06/11</b>							
<b>Bremsscheibe</b>							
2.8 FSI quattro	140	10/08→03/11	←	+PR 1ZL		24.0130-0176.1 430176	Ø 347 30 28 V + S
2.8 FSI quattro	162	10/08→03/11				24.0330-0176.1 530176	Ø 347 30 28 V + S
3.0 TDI quattro	176	10/08→03/11					
3.0 TFSI quattro	213	10/08→03/11	→	+PR 1KD,1KQ; + eFSB		24.0112-0159.1 412159	Ø 302 12 10 + S
3.0 TFSI quattro	220	10/08→03/11				24.0312-0159.1 512159	Ø 302 12 10 + S
			→	+PR 1KW		24.0122-0223.1 422223	Ø 330 22 20 V
						24.0322-0223.1 522223	Ø 330 22 20 V
3.0	160	08/04→05/06	←	+PR 1LT		24.0125-0149.1 425149	Ø 314 25 23 V
						24.0325-0149.1 525149	Ø 314 25 23 V
			←	+PR 1LG;1LD		24.0130-0175.1 430175	Ø 321 30 28 V + S
						24.0330-0175.1 530175	Ø 321 30 28 V + S
			←	+PR 1ZL;1LH		24.0130-0176.1 430176	Ø 347 30 28 V + S
						24.0330-0176.1 530176	Ø 347 30 28 V + S
			→	+PR 1KW;2EE		24.0122-0223.1 422223	Ø 330 22 20 V
						24.0322-0223.1 522223	Ø 330 22 20 V
S6 quattro	320	03/06→03/11	←			24.0136-0107.1 436107	Ø 385 36 33,5 V
			→	+PR 1KW;2EE; + eFSB		24.0122-0243.1 422243	Ø 330 22 20 V
<b>AUDI - A6 (4G2, 4GC, C7) 11/10→</b>							
<b>Bremsbelagsatz, Scheibenbremse</b>							
1.8 TFSI	140	09/14→	←	+PR 1LA,1LJ		13.0460-2765.2 602765	TRW 24409 19,2 + WK + Zub
2.0 TDI	100	01/12→				13.0470-2765.2 LD2765	TRW 24409 19,2 + WK + Zub Ceramic
2.0 TDI	110	09/14→					
2.0 TDI	140	11/13→					
2.0 TDI quattro	140	04/15→	←	+PR 1LU		13.0460-4873.2 604873	BRE 24847 17,0 + WE / - WK
2.0 TFSI	162	05/13→	←	+PR 1LP		13.0460-4879.2 604879	BRE 25643 16,8 + WE / - WK
2.0 TFSI	185	09/14→				13.0470-4879.2 LD4879	BRE 25643 17,0 + WE / - WK Ceramic
2.0 TFSI hybrid	155	11/11→					
2.0 TFSI quattro	155	05/12→05/13					
2.0 TFSI quattro	162	05/13→	←	+PR 1LL,1ZK		13.0460-7280.2 607280	ATE 25158 20,3 + WK
2.0 TFSI quattro	183	05/15→				13.0470-7280.2 LD7280	ATE 25158 20,3 + WK Ceramic
2.0 TFSI quattro	185	05/14→					
2.8 FSI quattro	162	09/14→	←	+PR 1LF		13.0460-7280.2 607280	ATE 25158 20,3 + WK
3.0 TDI	155	09/14→				13.0470-7280.2 LD7280	ATE 25158 20,3 + WK Ceramic
3.0 TDI	160	09/14→					
3.0 TDI quattro	155	09/14→	→	+PR 1KW		13.0460-2769.2 602769	TRW 24606 17,4 + WK + Zub
3.0 TDI quattro	160	09/14→				13.0470-2769.2 LD2769	TRW 24606 17,4 + WK + Zub Ceramic
3.0 TDI quattro	200	09/14→	→	+PR 1KY,2EA,2EE,2EJ		13.0460-2770.2 602770	TRW 24606 17,4 + WK + Zub
						13.0470-2770.2 LD2770	TRW 24606 17,4 + WK + Zub Ceramic
2.0 TDI	120	03/11→	←	04/11→; +PR 1LA,1LJ		13.0460-2765.2 602765	TRW 24409 19,2 + WK + Zub
2.0 TDI	130	03/11→				13.0470-2765.2 LD2765	TRW 24409 19,2 + WK + Zub Ceramic
2.0 TFSI	155	03/11→05/13					
2.8 FSI	150	11/10→04/15					
2.8 FSI quattro	150	11/10→04/15	←	04/11→; +PR 1LU		13.0460-4873.2 604873	BRE 24847 17,0 + WE / - WK
3.0 TDI	150	11/10→	←	04/11→; +PR 1LP		13.0460-4879.2 604879	BRE 25643 16,8 + WE / - WK
3.0 TDI quattro	150	03/11→				13.0470-4879.2 LD4879	BRE 25643 17,0 + WE / - WK Ceramic
3.0 TDI quattro	180	03/11→					
3.0 TFSI quattro	220	11/10→05/12	←	04/11→; +PR 1LL,1ZK		13.0460-7280.2 607280	ATE 25158 20,3 + WK
						13.0470-7280.2 LD7280	ATE 25158 20,3 + WK Ceramic
			←	07/11→; +PR 1LF		13.0460-7280.2 607280	ATE 25158 20,3 + WK
						13.0470-7280.2 LD7280	ATE 25158 20,3 + WK Ceramic
			→	04/11→; +PR 1KW		13.0460-2769.2 602769	TRW 24606 17,4 + WK + Zub
						13.0470-2769.2 LD2769	TRW 24606 17,4 + WK + Zub Ceramic
			→	04/11→; +PR 1KY,2EA,2EE,2EJ		13.0460-2770.2 602770	TRW 24606 17,4 + WK + Zub
						13.0470-2770.2 LD2770	TRW 24606 17,4 + WK + Zub Ceramic
2.0 TFSI	132	05/11→	←	+PR 1LA,1LJ		13.0460-2765.2 602765	TRW 24409 19,2 + WK + Zub
						13.0470-2765.2 LD2765	TRW 24409 19,2 + WK + Zub Ceramic
			←	+PR 1LU		13.0460-4873.2 604873	BRE 24847 17,0 + WE / - WK
			←	+PR 1LP		13.0460-4879.2 604879	BRE 25643 16,8 + WE / - WK
						13.0470-4879.2 LD4879	BRE 25643 17,0 + WE / - WK Ceramic
			←	+PR 1LL,1ZK		13.0460-7280.2 607280	ATE 25158 20,3 + WK
						13.0470-7280.2 LD7280	ATE 25158 20,3 + WK Ceramic
			←	07/11→; +PR 1LF		13.0460-7280.2 607280	ATE 25158 20,3 + WK

































	kw			 	! #		
<b>AUDI - A6 (4G2, 4GC, C7) 11/10→</b>							
<b> Bremsbelagsatz, Scheibenbremse</b>							
2.0 TFSI	132	05/11→	←	07/11→; +PR 1LF	13.0470-7280.2	LD7280	ATE 25158 20,3 + WK Ceramic
			→	+PR 1KW	13.0460-2769.2	602769	TRW 24606 17,4 + WK + Zub
			→	+PR 1KY,2EA,2EE,2EJ	13.0460-2769.2	LD2769	TRW 24606 17,4 + WK + Zub Ceramic
3.0 TDI quattro	230	11/11→	←	12/11→; +PR 1LA,1LJ	13.0460-2765.2	602765	TRW 24409 19,2 + WK + Zub
			←	12/11→; +PR 1LU	13.0460-4873.2	604873	BRE 24847 17,0 + WE / - WK
			←	12/11→; +PR 1LP	13.0460-4879.2	604879	BRE 25643 16,8 + WE / - WK
			←	12/11→; +PR 1LF	13.0460-7280.2	607280	ATE 25158 20,3 + WK
			←	12/11→; +PR 1LL,1ZK	13.0460-7280.2	607280	ATE 25158 20,3 + WK
			→	12/11→; +PR 1KW	13.0460-2769.2	602769	TRW 24606 17,4 + WK + Zub
			→	12/11→; +PR 1KY,2EA,2EE,2EJ	13.0460-2769.2	LD2769	TRW 24606 17,4 + WK + Zub Ceramic
3.0 TDI quattro 3.0 TDI quattro 3.0 TFSI quattro	235 240 245	09/14→ 09/14→ 09/14→	←	+PR 1LA,1LJ	13.0460-2765.2	602765	TRW 24409 19,2 + WK + Zub
			←	+PR 1LU	13.0460-4873.2	604873	BRE 24847 17,0 + WE / - WK
			←	+PR 1LP	13.0460-4879.2	604879	BRE 25643 16,8 + WE / - WK
			←	+PR 1LL,1ZK	13.0460-7280.2	607280	ATE 25158 20,3 + WK
			←	+PR 1LF	13.0460-7280.2	607280	ATE 25158 20,3 + WK
			→	+PR 1KW	13.0460-2769.2	602769	TRW 24606 17,4 + WK + Zub
			→	+PR 1KY,2EA,2EE,2EJ	13.0460-2769.2	LD2769	TRW 24606 17,4 + WK + Zub Ceramic
			→	+PR 1KY,2EA,2EE,2EJ	13.0460-2770.2	602770	TRW 24606 17,4 + WK + Zub
3.0 TFSI quattro	228	03/11→	←	04/11→; +PR 1LA,1LJ	13.0460-2765.2	602765	TRW 24409 19,2 + WK + Zub
			←	04/11→; +PR 1LU	13.0460-4873.2	604873	BRE 24847 17,0 + WE / - WK
			←	04/11→; +PR 1LP	13.0460-4879.2	604879	BRE 25643 16,8 + WE / - WK
			←	04/11→; +PR 1LL,1ZK	13.0460-7280.2	607280	ATE 25158 20,3 + WK
			←	07/11→; +PR 1LF	13.0460-7280.2	607280	ATE 25158 20,3 + WK
			→	04/11→; +PR 1KW	13.0460-2769.2	602769	TRW 24606 17,4 + WK + Zub
			→	04/11→; +PR 1KY,2EA,2EE,2EJ	13.0460-2769.2	LD2769	TRW 24606 17,4 + WK + Zub Ceramic
			→	04/11→; +PR 1KY,2EA,2EE,2EJ	13.0460-2770.2	602770	TRW 24606 17,4 + WK + Zub
S6 quattro	309	02/12→	←	04/12→; +PR 1LA,1LJ	13.0460-2765.2	602765	TRW 24409 19,2 + WK + Zub
			←	04/12→; +PR 1LU	13.0460-4873.2	604873	BRE 24847 17,0 + WE / - WK
			←	04/12→; +PR 1LP	13.0460-4879.2	604879	BRE 25643 16,8 + WE / - WK
			←	04/12→; +PR 1LF	13.0460-7280.2	607280	ATE 25158 20,3 + WK
			←	04/12→; +PR 1LL,1ZK	13.0460-7280.2	607280	ATE 25158 20,3 + WK
			→	04/12→; +PR 1KW	13.0460-2769.2	602769	TRW 24606 17,4 + WK + Zub
			→	04/12→; +PR 1KY,2EA,2EE,2EJ	13.0460-2769.2	LD2769	TRW 24606 17,4 + WK + Zub Ceramic
S6 quattro	331	10/14→	←	+PR 1LA,1LJ	13.0460-2765.2	602765	TRW 24409 19,2 + WK + Zub
			←	+PR 1LP	13.0460-4879.2	604879	BRE 25643 16,8 + WE / - WK
			←	+PR 1LL,1ZK	13.0460-7280.2	607280	ATE 25158 20,3 + WK
			←	+PR 1LF	13.0460-7280.2	607280	ATE 25158 20,3 + WK
			→	+PR 1KW	13.0460-2769.2	602769	TRW 24606 17,4 + WK + Zub
			→	+PR 1KY,2EA,2EE,2EJ	13.0460-2769.2	LD2769	TRW 24606 17,4 + WK + Zub Ceramic
			→	+PR 1KY,2EA,2EE,2EJ	13.0460-2770.2	602770	TRW 24606 17,4 + WK + Zub











	kw			 	! #		
<b>AUDI - A6 (4G2, 4GC, C7) 11/10→</b>							
<b> Bremsbelagsatz, Scheibenbremse</b>							
S6 quattro	331	10/14→	➡	+PR 1KY,2EA,2EE,2EJ		13.0470-2770.2 LD2770	TRW 24606 17,4 + WK + Zub Ceramic
<b>Warnkontakt, Bremsbelagverschleiß</b>							
1.8 TFSI	140	09/14→	←	+PR 1LU	2	24.8190-0019.2 620019	L= 254
2.0 TDI	100	01/12→	←	+PR 1LW	2	24.8190-0020.2 620020	L= 443,3
2.0 TDI	110	09/14→	←	+PR 1LL,1ZK	1	24.8190-0301.2 620301	L= 311,6
2.0 TDI	140	11/13→	←	+PR 1LL,1ZK	1	24.8190-0301.2 620301	L= 311,6
2.0 TDI quattro	140	04/15→	←	+PR 1LF	1	24.8190-0301.2 620301	L= 311,6
2.0 TFSI	162	05/13→	←	+PR 1LF	1	24.8190-0301.2 620301	L= 311,6
2.0 TFSI	185	09/14→	➡	+PR 1KY,2EA,2EE,2EJ	1	24.8190-0313.2 620313	L= 217
2.0 TFSI hybrid	155	11/11→	➡	+PR 1KY,2EA,2EE,2EJ	1	24.8190-0313.2 620313	L= 217
2.0 TFSI quattro	155	05/12→05/13	➡	+PR 1KY,2EA,2EE,2EJ	1	24.8190-0313.2 620313	L= 217
2.0 TFSI quattro	162	05/13→	➡	+PR 1KY,2EA,2EE,2EJ	1	24.8190-0313.2 620313	L= 217
2.0 TFSI quattro	183	05/15→	➡	+PR 1KY,2EA,2EE,2EJ	1	24.8190-0313.2 620313	L= 217
2.0 TFSI quattro	185	05/14→	➡	+PR 1KY,2EA,2EE,2EJ	1	24.8190-0313.2 620313	L= 217
2.8 FSI quattro	162	09/14→	➡	+PR 1KY,2EA,2EE,2EJ	1	24.8190-0313.2 620313	L= 217
3.0 TDI	155	09/14→	➡	+PR 1KY,2EA,2EE,2EJ	1	24.8190-0313.2 620313	L= 217
3.0 TDI	160	09/14→	➡	+PR 1KY,2EA,2EE,2EJ	1	24.8190-0313.2 620313	L= 217
3.0 TDI quattro	155	09/14→	➡	+PR 1KY,2EA,2EE,2EJ	1	24.8190-0313.2 620313	L= 217
3.0 TDI quattro	160	09/14→	➡	+PR 1KY,2EA,2EE,2EJ	1	24.8190-0313.2 620313	L= 217
3.0 TDI quattro	200	09/14→	➡	+PR 1KY,2EA,2EE,2EJ	1	24.8190-0313.2 620313	L= 217
3.0 TDI quattro	235	09/14→	➡	+PR 1KY,2EA,2EE,2EJ	1	24.8190-0313.2 620313	L= 217
3.0 TDI quattro	240	09/14→	➡	+PR 1KY,2EA,2EE,2EJ	1	24.8190-0313.2 620313	L= 217
3.0 TFSI quattro	245	09/14→	➡	+PR 1KY,2EA,2EE,2EJ	1	24.8190-0313.2 620313	L= 217
2.0 TDI	120	03/11→	←	04/11→; +PR 1LU	2	24.8190-0019.2 620019	L= 254
2.0 TDI	130	03/11→	←	04/11→; +PR 1LW	2	24.8190-0020.2 620020	L= 443,3
2.0 TFSI	155	03/11→05/13	←	04/11→; +PR 1LW	2	24.8190-0020.2 620020	L= 443,3
2.8 FSI	150	11/10→04/15	←	04/11→; +PR 1LL,1ZK	1	24.8190-0301.2 620301	L= 311,6
2.8 FSI quattro	150	11/10→04/15	←	04/11→; +PR 1LL,1ZK	1	24.8190-0301.2 620301	L= 311,6
3.0 TDI	150	11/10→	←	07/11→; +PR 1LF	1	24.8190-0301.2 620301	L= 311,6
3.0 TDI quattro	150	03/11→	➡	04/11→; +PR 1KY,2EA,2EE,2EJ	1	24.8190-0313.2 620313	L= 217
3.0 TDI quattro	180	03/11→	➡	04/11→; +PR 1KY,2EA,2EE,2EJ	1	24.8190-0313.2 620313	L= 217
3.0 TFSI quattro	220	11/10→05/12	➡	04/11→; +PR 1KY,2EA,2EE,2EJ	1	24.8190-0313.2 620313	L= 217
3.0 TFSI quattro	228	03/11→	➡	04/11→; +PR 1KY,2EA,2EE,2EJ	1	24.8190-0313.2 620313	L= 217
2.0 TFSI	132	05/11→	←	+PR 1LU	2	24.8190-0019.2 620019	L= 254
			←	+PR 1LW	2	24.8190-0020.2 620020	L= 443,3
			←	+PR 1LL,1ZK	1	24.8190-0301.2 620301	L= 311,6
			←	07/11→; +PR 1LF	1	24.8190-0301.2 620301	L= 311,6
			➡	+PR 1KY,2EA,2EE,2EJ	1	24.8190-0313.2 620313	L= 217
3.0 TDI quattro	230	11/11→	←	12/11→; +PR 1LU	2	24.8190-0019.2 620019	L= 254
			←	12/11→; +PR 1LW	2	24.8190-0020.2 620020	L= 443,3
			←	12/11→; +PR 1LF	1	24.8190-0301.2 620301	L= 311,6
			←	12/11→; +PR 1LL,1ZK	1	24.8190-0301.2 620301	L= 311,6
			➡	12/11→; +PR 1KY,2EA,2EE,2EJ	1	24.8190-0313.2 620313	L= 217
S6 quattro	309	02/12→	←	04/12→; +PR 1LU	2	24.8190-0019.2 620019	L= 254
			←	04/12→; +PR 1LW	2	24.8190-0020.2 620020	L= 443,3
			←	04/12→; +PR 1LF	1	24.8190-0301.2 620301	L= 311,6
			←	04/12→; +PR 1LL,1ZK	1	24.8190-0301.2 620301	L= 311,6
			➡	04/12→; +PR 1KY,2EA,2EE,2EJ	1	24.8190-0313.2 620313	L= 217
S6 quattro	331	10/14→	←	+PR 1LW	2	24.8190-0020.2 620020	L= 443,3
			←	+PR 1LL,1ZK	1	24.8190-0301.2 620301	L= 311,6
			←	+PR 1LF	1	24.8190-0301.2 620301	L= 311,6
			➡	+PR 1KY,2EA,2EE,2EJ	1	24.8190-0313.2 620313	L= 217
<b> Bremsscheibe</b>							
1.8 TFSI	140	09/14→	←	+PR 1LA		24.0130-0221.1 430221	Ø 320 30 28 V + S
2.0 TDI	100	01/12→	←	+PR 1LJ,1LP		24.0130-0222.1 430222	Ø 345 30 28 V + S
2.0 TDI	110	09/14→	←	+PR 1LJ,1LP		24.0130-0222.1 430222	Ø 345 30 28 V + S
2.0 TDI	140	11/13→	←	+PR 1LL,1LF,1ZK		24.0134-0103.1 434103	Ø 356 34 31,5 V + S
2.0 TDI quattro	140	04/15→	➡	+PR 1KW		24.0112-0178.1 412178	Ø 300 12 10 + S
2.0 TFSI	132	05/11→	➡	+PR 1KW		24.0112-0178.1 412178	Ø 300 12 10 + S
2.0 TFSI	162	05/13→	➡	+PR 1KW		24.0312-0178.1 512178	Ø 300 12 10 + S
2.0 TFSI	185	09/14→	➡	+PR 1KW		24.0312-0178.1 512178	Ø 300 12 10 + S
2.0 TFSI hybrid	155	11/11→	➡	+PR 2EA,2EE,2EJ		24.0122-0272.1 422272	Ø 330 21,9 20 V + S
2.0 TFSI quattro	155	05/12→05/13	➡	+PR 1KY		24.0122-0273.1 422273	Ø 356 22 20 V + S
2.0 TFSI quattro	162	05/13→	➡	+PR 1KY		24.0122-0273.1 422273	Ø 356 22 20 V + S
2.0 TFSI quattro	183	05/15→	➡	+PR 1KY		24.0122-0273.1 422273	Ø 356 22 20 V + S
2.0 TFSI quattro	185	05/14→	➡	+PR 1KY		24.0122-0273.1 422273	Ø 356 22 20 V + S
2.8 FSI quattro	162	09/14→	➡	+PR 1KY		24.0122-0273.1 422273	Ø 356 22 20 V + S
3.0 TDI	155	09/14→	➡	+PR 1KY		24.0122-0273.1 422273	Ø 356 22 20 V + S

	kw			 	! #		
<b>AUDI - A6 (4G2, 4GC, C7) 11/10→</b>							
<b>Bremsscheibe</b>							
3.0 TDI	160	09/14→	←	+PR 1LA		24.0130-0221.1 430221	Ø 320 30 28 V + S
3.0 TDI quattro	155	09/14→	←	+PR 1LJ,1LP		24.0130-0222.1 430222	Ø 345 30 28 V + S
3.0 TDI quattro	160	09/14→	←	+PR 1LL,1LF,1ZK		24.0134-0103.1 434103	Ø 356 34 31,5 V + S
3.0 TDI quattro	200	09/14→	←	+PR 1KW		24.0112-0178.1 412178	Ø 300 12 10 + S
3.0 TDI quattro	235	09/14→	←	+PR 1KW		24.0312-0178.1 512178	Ø 300 12 10 + S
3.0 TDI quattro	240	09/14→	→	+PR 1KW		24.0112-0178.1 412178	Ø 300 12 10 + S
3.0 TFSI quattro	245	09/14→	→	+PR 1KW		24.0312-0178.1 512178	Ø 300 12 10 + S
S6 quattro	331	10/14→	→	+PR 2EA,2EE,2EJ		24.0122-0272.1 422272	Ø 330 21,9 20 V + S
			→	+PR 1KY		24.0122-0273.1 422273	Ø 356 22 20 V + S
2.0 TDI	120	03/11→	←	04/11→; +PR 1LA		24.0130-0221.1 430221	Ø 320 30 28 V + S
2.0 TDI	130	03/11→	←	04/11→; +PR 1LA		24.0130-0221.1 430221	Ø 320 30 28 V + S
2.0 TFSI	155	03/11→05/13	←	04/11→; +PR 1LJ,1LP		24.0130-0222.1 430222	Ø 345 30 28 V + S
2.8 FSI	150	11/10→04/15	←	04/11→; +PR 1LL,1LF,1ZK		24.0134-0103.1 434103	Ø 356 34 31,5 V + S
2.8 FSI quattro	150	11/10→04/15	←	04/11→; +PR 1LL,1LF,1ZK		24.0134-0103.1 434103	Ø 356 34 31,5 V + S
3.0 TDI	150	11/10→	→	04/11→; +PR 1KW		24.0112-0178.1 412178	Ø 300 12 10 + S
3.0 TDI quattro	150	03/11→	→	04/11→; +PR 1KW		24.0112-0178.1 412178	Ø 300 12 10 + S
3.0 TDI quattro	180	03/11→	→	04/11→; +PR 1KW		24.0312-0178.1 512178	Ø 300 12 10 + S
3.0 TFSI quattro	220	11/10→05/12	→	04/11→; +PR 2EA,2EE,2EJ		24.0122-0272.1 422272	Ø 330 21,9 20 V + S
3.0 TFSI quattro	228	03/11→	→	04/11→; +PR 1KY		24.0122-0273.1 422273	Ø 356 22 20 V + S
3.0 TDI quattro	230	11/11→	←	12/11→; +PR 1LA		24.0130-0221.1 430221	Ø 320 30 28 V + S
			←	12/11→; +PR 1LJ,1LP		24.0130-0222.1 430222	Ø 345 30 28 V + S
			←	12/11→; +PR 1LL,1LF,1ZK		24.0134-0103.1 434103	Ø 356 34 31,5 V + S
			→	12/11→; +PR 1KW		24.0112-0178.1 412178	Ø 300 12 10 + S
			→	12/11→; +PR 1KW		24.0312-0178.1 512178	Ø 300 12 10 + S
			→	12/11→; +PR 2EA,2EE,2EJ		24.0122-0272.1 422272	Ø 330 21,9 20 V + S
			→	12/11→; +PR 1KY		24.0122-0273.1 422273	Ø 356 22 20 V + S
S6 quattro	309	02/12→	←	04/12→; +PR 1LA		24.0130-0221.1 430221	Ø 320 30 28 V + S
			←	04/12→; +PR 1LJ,1LP		24.0130-0222.1 430222	Ø 345 30 28 V + S
			←	04/12→; +PR 1LL,1LF,1ZK		24.0134-0103.1 434103	Ø 356 34 31,5 V + S
			→	04/12→; +PR 1KW		24.0112-0178.1 412178	Ø 300 12 10 + S
			→	04/12→; +PR 1KW		24.0312-0178.1 512178	Ø 300 12 10 + S
			→	04/12→; +PR 2EA,2EE,2EJ		24.0122-0272.1 422272	Ø 330 21,9 20 V + S
			→	04/12→; +PR 1KY		24.0122-0273.1 422273	Ø 356 22 20 V + S
<b>AUDI - A6 Allroad (4FH, C6) 05/06→08/11</b>							
<b>Bremsbelagsatz, Scheibenbremse</b>							
2.7 TDI quattro	120	05/06→08/11	←	→ 05/11; +PR 1LG,1ZL		13.0460-7201.2 607201	ATE 23763 20,3 + WK
2.7 TDI quattro	140	10/08→08/11	←	→ 05/11; +PR 1LG,1ZL		13.0470-7201.2 LD7201	ATE 23763 20,3 + WK Ceramic
3.0 TDI quattro	155	05/06→08/11	→	→ 05/11; +PR 1KD		13.0460-2749.2 602749	TRW 24483 16,9 - WE / - WK + Zub
3.0 TDI quattro	176	10/08→08/11	→	→ 05/11; +PR 1KD		13.0460-2749.2 602749	TRW 24483 16,9 - WE / - WK + Zub
3.0 TFSI quattro	213	10/08→08/11	→	→ 05/11; +PR 1KD		13.0460-2880.2 602880	TRW 23914 17,1 + WE / - WK + Zub
			→	→ 05/11; +PR 1KW,2EE; + eFSB		13.0470-2749.2 LD2749	TRW 24483 16,9 - WE / - WK + Zub Ceramic
			→	→ 05/11; +PR 1KW,2EE; + eFSB		13.0470-2880.2 LD2880	TRW 23914 17,1 + WE / - WK + Zub Ceramic
			→	→ 05/11; +PR 1KW,2EE; + eFSB		13.0460-2888.2 602888	TRW 23326 17,4 + WE / - WK
			→	→ 05/11; +PR 1KW,2EE; + eFSB		13.0470-2888.2 LD2888	TRW 23326 17,4 + WE / - WK Ceramic
2.7 TDI quattro	132	05/06→10/08	←	+PR 1LG,1ZL		13.0460-7201.2 607201	ATE 23763 20,3 + WK
3.0 TDI quattro	171	05/06→10/08	←	+PR 1LG,1ZL		13.0470-7201.2 LD7201	ATE 23763 20,3 + WK Ceramic
3.2 FSI quattro	188	05/06→10/08	→	+PR 1KD		13.0460-2749.2 602749	TRW 24483 16,9 - WE / - WK + Zub
			→	+PR 1KD		13.0460-2880.2 602880	TRW 23914 17,1 + WE / - WK + Zub
			→	+PR 1KD		13.0470-2749.2 LD2749	TRW 24483 16,9 - WE / - WK + Zub Ceramic
			→	+PR 1KD		13.0470-2880.2 LD2880	TRW 23914 17,1 + WE / - WK + Zub Ceramic
			→	+PR 1KW,2EE; + eFSB		13.0460-2888.2 602888	TRW 23326 17,4 + WE / - WK
			→	+PR 1KW,2EE; + eFSB		13.0470-2888.2 LD2888	TRW 23326 17,4 + WE / - WK Ceramic
4.2 FSI quattro	257	05/06→12/10	←	+PR 1LG,1ZL		13.0460-7201.2 607201	ATE 23763 20,3 + WK
			→	+PR 1KD		13.0460-2749.2 602749	TRW 24483 16,9 - WE / - WK + Zub
↓							









	kw					! #		
<b>AUDI - A6 Allroad (4FH, C6) 05/06→08/11</b>								
 <b>Bremsbelagsatz, Scheibenbremse</b>								
4.2 FSI quattro	257	05/06→12/10	➡	+PR 1KD			13.0460-2880.2 602880	TRW 23914 17,1 + WE / - WK + Zub
							13.0470-2749.2 LD2749	TRW 24483 16,9 - WE / - WK + Zub Ceramic
							13.0470-2880.2 LD2880	TRW 23914 17,1 + WE / - WK + Zub Ceramic
			➡	+PR 1KW;2EE; + eFSB			13.0460-2888.2 602888	TRW 23326 17,4 + WE / - WK
							13.0470-2888.2 LD2888	TRW 23326 17,4 + WE / - WK Ceramic
<b>Zubehörsatz, Scheibenbremsbelag</b>								
2.7 TDI quattro	120	05/06→08/11	➡	→ 05/11; +PR 1KW;2EE			13.0460-0023.2 610023	
2.7 TDI quattro	140	10/08→08/11						
3.0 TDI quattro	155	05/06→08/11	➡	→ 05/11; +PR 1KD			13.0460-0259.2 610259	
3.0 TDI quattro	176	10/08→08/11						
3.0 TFSI quattro	213	10/08→08/11						
2.7 TDI quattro	132	05/06→10/08	➡	+PR 1KW;2EE			13.0460-0023.2 610023	
3.0 TDI quattro	171	05/06→10/08						
3.2 FSI quattro	188	05/06→10/08	➡	+PR 1KD			13.0460-0259.2 610259	
4.2 FSI quattro	257	05/06→12/10						
 <b>Bremsscheibe</b>								
2.7 TDI quattro	120	05/06→08/11	←	→ 05/11; +PR 1LG			24.0130-0175.1 430175	Ø 321 30 28 V + S
2.7 TDI quattro	140	10/08→08/11					24.0330-0175.1 530175	Ø 321 30 28 V + S
3.0 TDI quattro	155	05/06→08/11						
3.0 TDI quattro	176	10/08→08/11	←	→ 05/11; +PR 1ZL			24.0130-0176.1 430176	Ø 347 30 28 V + S
3.0 TFSI quattro	213	10/08→08/11					24.0330-0176.1 530176	Ø 347 30 28 V + S
			➡	→ 05/11; +PR 1KD; + eFSB			24.0112-0176.1 412176	Ø 302 12 10
			➡	→ 05/11; +PR 1KW;2EE; + eFSB			24.0122-0243.1 422243	Ø 330 22 20 V
2.7 TDI quattro	132	05/06→10/08	←	+PR 1LG			24.0130-0175.1 430175	Ø 321 30 28 V + S
3.0 TDI quattro	171	05/06→10/08					24.0330-0175.1 530175	Ø 321 30 28 V + S
3.2 FSI quattro	188	05/06→10/08						
4.2 FSI quattro	257	05/06→12/10	←	+PR 1ZL			24.0130-0176.1 430176	Ø 347 30 28 V + S
							24.0330-0176.1 530176	Ø 347 30 28 V + S
			➡	+PR 1KD; + eFSB			24.0112-0176.1 412176	Ø 302 12 10
			➡	+PR 1KW;2EE; + eFSB			24.0122-0243.1 422243	Ø 330 22 20 V
<b>AUDI - A6 Allroad (4GH, 4GJ) 01/12→09/18</b>								
 <b>Bremsbelagsatz, Scheibenbremse</b>								
3.0 TDI quattro	140	11/15→09/18	←	+PR 1LJ			13.0460-2765.2 602765	TRW 24409 19,2 + WK + Zub
3.0 TDI quattro	150	01/12→12/14					13.0470-2765.2 LD2765	TRW 24409 19,2 + WK + Zub Ceramic
3.0 TDI quattro	155	09/14→09/18						
3.0 TDI quattro	160	09/14→09/18						
3.0 TDI quattro	180	01/12→06/16	←	+PR 1LL,1ZK			13.0460-7280.2 607280	ATE 25158 20,3 + WK
3.0 TDI quattro	200	09/14→09/18					13.0470-7280.2 LD7280	ATE 25158 20,3 + WK Ceramic
			➡	+PR 2EA,2EJ; + eFSB			13.0460-2770.2 602770	TRW 24606 17,4 + WK + Zub
							13.0470-2770.2 LD2770	TRW 24606 17,4 + WK + Zub Ceramic
3.0 TDI quattro	230	01/12→12/14	←	+PR 1LJ			13.0460-2765.2 602765	TRW 24409 19,2 + WK + Zub
3.0 TDI quattro	235	01/12→12/14						
3.0 TFSI quattro	228	01/12→12/14	←	+PR 1LL,1ZK			13.0460-7280.2 607280	ATE 25158 20,3 + WK
3.0 TFSI quattro	245	09/14→09/18	➡	+PR 2EA,2EJ; + eFSB			13.0460-2770.2 602770	TRW 24606 17,4 + WK + Zub
							13.0470-2770.2 LD2770	TRW 24606 17,4 + WK + Zub Ceramic
<b>Warnkontakt, Bremsbelagverschleiß</b>								
3.0 TDI quattro	140	11/15→09/18	←	+PR 1LL,1ZK	1	24.8190-0301.2 620301		L= 311,6
3.0 TDI quattro	150	01/12→12/14	←	+PR 1LJ	1	24.8190-0311.2 620311		L= 300
3.0 TDI quattro	155	09/14→09/18						
3.0 TDI quattro	160	09/14→09/18	➡	+PR 2EA,2EJ	1	24.8190-0313.2 620313		L= 217
3.0 TDI quattro	180	01/12→06/16						
3.0 TDI quattro	200	09/14→09/18						
3.0 TDI quattro	230	01/12→12/14						
3.0 TDI quattro	235	01/12→12/14						
3.0 TFSI quattro	228	01/12→12/14						
3.0 TFSI quattro	245	09/14→09/18						
 <b>Bremsscheibe</b>								
3.0 TDI quattro	140	11/15→09/18	←	+PR 1LJ			24.0130-0236.1 430236	Ø 345 30 28 V + S
3.0 TDI quattro	150	01/12→12/14						
3.0 TDI quattro	155	09/14→09/18	←	+PR 1ZK			24.0134-0103.1 434103	Ø 356 34 31,5 V + S
3.0 TDI quattro	160	09/14→09/18	←	+PR 1LL			24.0134-0107.1 434107	Ø 356 34 31,5 V + S
3.0 TDI quattro	180	01/12→06/16						







	kw				! #		
<b>AUDI - A6 Allroad (4GH, 4GJ) 01/12→09/18</b>							
 <b>Bremsscheibe</b>							
3.0 TDI quattro	230	01/12→12/14	➔	+PR 2EA,2EJ; + eFSB		24.0122-0272.1 422272	Ø 330 21,9 20 V + S
3.0 TDI quattro	235	01/12→12/14					
3.0 TFSI quattro	228	01/12→12/14					
3.0 TFSI quattro	245	09/14→09/18					
3.0 TDI quattro	200	09/14→09/18	➔	+PR 1LJ		24.0130-0236.1 430236	Ø 345 30 28 V + S
			➔	+PR 2EA,2EJ; + eFSB		24.0122-0272.1 422272	Ø 330 21,9 20 V + S
<b>AUDI - A6 Avant (4A5, C4) 06/94→12/97</b>							
 <b>Bremsbelagsatz, Scheibenbremse</b>							
1.8	92	12/95→12/97	➔			13.0460-7050.2 607050	ATE 20676 19,5 + WK
1.8 quattro	92	12/95→12/97	➔				
1.9 TDI	66	06/94→12/97	➔			13.0460-3602.2 603602	TRW 21144 15,8 - WK
2.0	74	06/94→12/97					
2.0	85	06/94→12/97					
2.0 16V	103	06/94→12/97					
2.0 16V quattro	103	06/94→12/97					
2.5 TDI	84	01/95→12/97					
2.5 TDI	85	06/94→12/97					
2.5 TDI	103	08/94→12/97					
2.5 TDI quattro	103	07/95→12/97					
2.6	102	06/94→02/97					
2.6	110	06/94→12/97					
2.6 quattro	110	06/94→12/97					
2.8	128	06/94→12/97					
2.8	142	12/95→12/97					
2.8 quattro	128	06/94→12/97					
2.8 quattro	142	12/95→12/97					
S6 4.2 quattro	213	06/94→12/97	➔	09/94→		13.0460-2717.2 602717	TRW 21452 18,5 + WK
			➔	09/94→		13.0460-3602.2 603602	TRW 21144 15,8 - WK
S6 Plus quattro	240	04/96→12/97	➔	06/96→		13.0460-2717.2 602717	TRW 21452 18,5 + WK
			➔	06/96→		13.0460-3602.2 603602	TRW 21144 15,8 - WK
S6 Turbo quattro	169	06/94→12/97	➔			13.0460-2717.2 602717	TRW 21452 18,5 + WK
			➔			13.0460-3602.2 603602	TRW 21144 15,8 - WK
 <b>Bremsscheibe</b>							
1.8	92	12/95→12/97	➔			24.0115-0105.1 415105	Ø 288 15 13
1.8 quattro	92	12/95→12/97	➔			24.0315-0105.1 515105	Ø 288 15 13
1.9 TDI	66	06/94→12/97	➔				
2.0	74	06/94→12/97	➔			24.0110-0201.1 410201	Ø 245 10 8
2.0	85	06/94→12/97	➔			24.0310-0201.1 510201	Ø 245 10 8
2.0 16V	103	06/94→12/97					
2.0 16V quattro	103	06/94→12/97					
2.5 TDI	84	01/95→12/97					
2.5 TDI	85	06/94→12/97					
2.5 TDI	103	08/94→12/97	➔	10/94→		24.0125-0105.1 425105	Ø 288 25 23 V + S
			➔			24.0325-0105.1 525105	Ø 288 25 23 V
			➔			24.0110-0201.1 410201	Ø 245 10 8
			➔			24.0310-0201.1 510201	Ø 245 10 8
2.5 TDI quattro	103	07/95→12/97	➔			24.0125-0105.1 425105	Ø 288 25 23 V + S
2.6	102	06/94→02/97				24.0325-0105.1 525105	Ø 288 25 23 V
2.6	110	06/94→12/97					
2.6 quattro	110	06/94→12/97	➔			24.0110-0201.1 410201	Ø 245 10 8
2.8	128	06/94→12/97				24.0310-0201.1 510201	Ø 245 10 8
2.8	142	12/95→12/97					
2.8 quattro	128	06/94→12/97					
2.8 quattro	142	12/95→12/97					
S6 4.2 quattro	213	06/94→12/97	➔	09/94→		24.0130-0104.1 430104	Ø 314 30 28 V
			➔	09/94→		24.0120-0172.1 420172	Ø 269 19,9 18 V
S6 Plus quattro	240	04/96→12/97	➔	06/96→		24.0130-0183.1 430183	Ø 323 30 28 V
			➔	06/96→		24.0120-0172.1 420172	Ø 269 19,9 18 V
S6 Turbo quattro	169	06/94→12/97	➔			24.0130-0104.1 430104	Ø 314 30 28 V
			➔			24.0120-0172.1 420172	Ø 269 19,9 18 V
<b>AUDI - A6 Avant (4B5, C5) 11/97→01/05</b>							
 <b>Bremsbelagsatz, Scheibenbremse</b>							
1.8	85	02/98→01/05	➔			13.0460-7110.2 607110	ATE 20676 19,8 + WK
1.8	92	12/97→01/05				13.0470-7110.2 LD7110	ATE 20676 19,8 + WK Ceramic
1.8 T	110	12/97→01/05					
1.8 T	132	04/99→01/05	➔	→ 05/01		13.0460-2787.2 602787	TRW 23554 17,3 - WK / - WE
1.9 TDI	85	07/00→01/05				13.0460-2820.2 602820	TRW 20961 17,2 - WK
2.4	100	07/98→01/05					



















	kw			 	! #		
<b>AUDI - A6 Avant (4B5, C5) 11/97→01/05</b>							
<b> Bremsbelagsatz, Scheibenbremse</b>							
2.4	115	12/97→01/05	→	→ 05/01		<b>13.0470-2820.2 LD2820</b>	TRW 20961 17,2 - WK Ceramic
2.4	120	12/97→01/05	→	06/01→		<b>13.0460-2886.2 602886</b>	TRW 20961 16,0 - WK
2.4	121	12/97→01/05	→			<b>13.0460-2937.2 602937</b>	TRW 20961 15,2 - WK + Zub
2.5 TDI	110	12/97→01/05	→			<b>13.0470-2886.2 LD2886</b>	TRW 20961 16,0 - WK Ceramic
2.8	140	07/99→01/05	→				
2.8	142	12/97→01/05	→				
1.8 T quattro	110	12/97→01/05	←	+PR 1LB;1LE;1LF;1LT		<b>13.0460-7110.2 607110</b>	ATE 20676 19,8 + WK
1.8 T quattro	132	12/97→01/05	←			<b>13.0470-7110.2 LD7110</b>	ATE 20676 19,8 + WK Ceramic
2.4 quattro	120	12/97→01/05	←	06/01→; +PR 1LG,1LA		<b>13.0460-7166.2 607166</b>	ATE 23762 20,4 + WK
2.4 quattro	121	12/97→01/05	←			<b>13.0470-7166.2 LD7166</b>	ATE 23762 20,4 + WK Ceramic
2.5 TDI quattro	110	12/97→01/05	→	→ 05/01		<b>13.0460-2787.2 602787</b>	TRW 23554 17,3 - WK / - WE
2.5 TDI quattro	132	02/00→01/05	→			<b>13.0460-2820.2 602820</b>	TRW 20961 17,2 - WK
			→			<b>13.0470-2820.2 LD2820</b>	TRW 20961 17,2 - WK Ceramic
			→	06/01→		<b>13.0460-2886.2 602886</b>	TRW 20961 16,0 - WK
			→			<b>13.0460-2937.2 602937</b>	TRW 20961 15,2 - WK + Zub
			→			<b>13.0470-2886.2 LD2886</b>	TRW 20961 16,0 - WK Ceramic
1.9 TDI	81	02/98→04/01	←			<b>13.0460-7110.2 607110</b>	ATE 20676 19,8 + WK
2.8	132	12/97→05/00	←			<b>13.0470-7110.2 LD7110</b>	ATE 20676 19,8 + WK Ceramic
			→			<b>13.0460-2787.2 602787</b>	TRW 23554 17,3 - WK / - WE
			→			<b>13.0460-2820.2 602820</b>	TRW 20961 17,2 - WK
			→			<b>13.0470-2820.2 LD2820</b>	TRW 20961 17,2 - WK Ceramic
1.9 TDI	96	08/01→01/05	←			<b>13.0460-7110.2 607110</b>	ATE 20676 19,8 + WK
2.0	96	08/01→01/05	←			<b>13.0470-7110.2 LD7110</b>	ATE 20676 19,8 + WK Ceramic
2.4	125	08/01→01/05	→			<b>13.0460-2886.2 602886</b>	TRW 20961 16,0 - WK
2.5 TDI	114	08/01→01/05	→			<b>13.0460-2937.2 602937</b>	TRW 20961 15,2 - WK + Zub
			→			<b>13.0470-2886.2 LD2886</b>	TRW 20961 16,0 - WK Ceramic
2.4 quattro	115	08/98→05/01	←	+PR 1LB;1LE;1LF;1LT		<b>13.0460-7110.2 607110</b>	ATE 20676 19,8 + WK
			→			<b>13.0470-7110.2 LD7110</b>	ATE 20676 19,8 + WK Ceramic
			→			<b>13.0460-2787.2 602787</b>	TRW 23554 17,3 - WK / - WE
			→			<b>13.0460-2820.2 602820</b>	TRW 20961 17,2 - WK
			→			<b>13.0470-2820.2 LD2820</b>	TRW 20961 17,2 - WK Ceramic
2.4 quattro	125	08/01→01/05	←	+PR 1LB;1LE;1LF;1LT		<b>13.0460-7110.2 607110</b>	ATE 20676 19,8 + WK
2.5 TDI	120	07/02→01/05	←	+PR 1LG,1LA		<b>13.0470-7110.2 LD7110</b>	ATE 20676 19,8 + WK Ceramic
			←			<b>13.0460-7166.2 607166</b>	ATE 23762 20,4 + WK
			←			<b>13.0470-7166.2 LD7166</b>	ATE 23762 20,4 + WK Ceramic
			→			<b>13.0460-2886.2 602886</b>	TRW 20961 16,0 - WK
			→			<b>13.0460-2937.2 602937</b>	TRW 20961 15,2 - WK + Zub
			→			<b>13.0470-2886.2 LD2886</b>	TRW 20961 16,0 - WK Ceramic
2.5 TDI	132	02/00→01/05	←	+PR 1LB;1LE;1LF;1LT		<b>13.0460-7110.2 607110</b>	ATE 20676 19,8 + WK
			←	+PR 1LG,1LA		<b>13.0470-7110.2 LD7110</b>	ATE 20676 19,8 + WK Ceramic
			←			<b>13.0460-7166.2 607166</b>	ATE 23762 20,4 + WK
			←			<b>13.0470-7166.2 LD7166</b>	ATE 23762 20,4 + WK Ceramic
			→	→ 05/01		<b>13.0460-2787.2 602787</b>	TRW 23554 17,3 - WK / - WE
			→			<b>13.0460-2820.2 602820</b>	TRW 20961 17,2 - WK
			→			<b>13.0470-2820.2 LD2820</b>	TRW 20961 17,2 - WK Ceramic
			→	06/01→		<b>13.0460-2886.2 602886</b>	TRW 20961 16,0 - WK
			→			<b>13.0460-2937.2 602937</b>	TRW 20961 15,2 - WK + Zub
			→			<b>13.0470-2886.2 LD2886</b>	TRW 20961 16,0 - WK Ceramic
2.7 T	169	02/99→01/05	←	→ 4B-X-060000		<b>13.0460-2701.2 602701</b>	TRW 21452 18,5 + WK
2.7 T quattro	169	12/97→01/05	←	4B-X-060001→; → 05/01		<b>13.0460-2875.2 602875</b>	TRW 23119 17,5 + WK
			←	06/01→; +PR 1LG,1LA		<b>13.0460-7166.2 607166</b>	ATE 23762 20,4 + WK
			←			<b>13.0470-7166.2 LD7166</b>	ATE 23762 20,4 + WK Ceramic
			→	→ 05/01		<b>13.0460-2787.2 602787</b>	TRW 23554 17,3 - WK / - WE
			→			<b>13.0460-2820.2 602820</b>	TRW 20961 17,2 - WK
			→			<b>13.0470-2820.2 LD2820</b>	TRW 20961 17,2 - WK Ceramic
			→	06/01→		<b>13.0460-2886.2 602886</b>	TRW 20961 16,0 - WK
			→			<b>13.0460-2937.2 602937</b>	TRW 20961 15,2 - WK + Zub
			→			<b>13.0470-2886.2 LD2886</b>	TRW 20961 16,0 - WK Ceramic
2.7 T quattro	184	08/01→01/05	←	→ 4B-X-060000		<b>13.0460-2701.2 602701</b>	TRW 21452 18,5 + WK
			←	+PR 1LG,1LA		<b>13.0460-7166.2 607166</b>	ATE 23762 20,4 + WK
			←			<b>13.0470-7166.2 LD7166</b>	ATE 23762 20,4 + WK Ceramic
			→			<b>13.0460-2886.2 602886</b>	TRW 20961 16,0 - WK









	kW			 	! #		
<b>AUDI - A6 Avant (4B5, C5) 11/97→01/05</b>							
<b> Bremsbelagsatz, Scheibenbremse</b>							
2.7 T quattro	184	08/01→01/05	➡			<b>13.0460-2937.2 602937</b> <b>13.0470-2886.2 LD2886</b>	TRW 20961 15,2 - WK + Zub TRW 20961 16,0 - WK Ceramic
2.8 quattro	142	12/97→01/05	⬅	+PR 1LB;1LE;1LF;1LT		<b>13.0460-7110.2 607110</b> <b>13.0470-7110.2 LD7110</b>	ATE 20676 19,8 + WK ATE 20676 19,8 + WK Ceramic
			➡	→ 05/01		<b>13.0460-2787.2 602787</b> <b>13.0460-2820.2 602820</b> <b>13.0470-2820.2 LD2820</b>	TRW 23554 17,3 - WK / - WE TRW 20961 17,2 - WK TRW 20961 17,2 - WK Ceramic
			➡	06/01→		<b>13.0460-2886.2 602886</b> <b>13.0460-2937.2 602937</b> <b>13.0470-2886.2 LD2886</b>	TRW 20961 16,0 - WK TRW 20961 15,2 - WK + Zub TRW 20961 16,0 - WK Ceramic
			⬅	+PR 1LG,1LA		<b>13.0460-7166.2 607166</b> <b>13.0470-7166.2 LD7166</b>	ATE 23762 20,4 + WK ATE 23762 20,4 + WK Ceramic
3.0	160	06/01→01/05	⬅	+PR 1LG,1LA		<b>13.0460-2886.2 602886</b>	TRW 20961 16,0 - WK
3.0	162	08/01→01/05				<b>13.0460-2937.2 602937</b> <b>13.0470-2886.2 LD2886</b>	TRW 20961 15,2 - WK + Zub TRW 20961 16,0 - WK Ceramic
3.0 quattro	160	06/01→01/05	➡			<b>13.0460-2886.2 602886</b>	TRW 20961 16,0 - WK
3.0 quattro	162	08/01→01/05				<b>13.0460-2937.2 602937</b> <b>13.0470-2886.2 LD2886</b>	TRW 20961 15,2 - WK + Zub TRW 20961 16,0 - WK Ceramic
3.7 quattro	191	03/99→01/05				<b>13.0460-2886.2 602886</b> <b>13.0460-2937.2 602937</b> <b>13.0470-2886.2 LD2886</b>	TRW 20961 16,0 - WK TRW 20961 15,2 - WK + Zub TRW 20961 16,0 - WK Ceramic
4.2 quattro S6 quattro	220 250	11/98→01/05 09/99→01/05	⬅			<b>13.0460-2875.2 602875</b>	TRW 23119 17,5 + WK
			➡	→ 05/01		<b>13.0460-2787.2 602787</b> <b>13.0460-2820.2 602820</b> <b>13.0470-2820.2 LD2820</b>	TRW 23554 17,3 - WK / - WE TRW 20961 17,2 - WK TRW 20961 17,2 - WK Ceramic
			➡	06/01→		<b>13.0460-2886.2 602886</b> <b>13.0460-2937.2 602937</b> <b>13.0470-2886.2 LD2886</b>	TRW 20961 16,0 - WK TRW 20961 15,2 - WK + Zub TRW 20961 16,0 - WK Ceramic
RS6 plus quattro	353	04/04→01/05	➡			<b>13.0460-2889.2 602889</b>	TRW 23326 17,4 + WE / - WK
RS6 quattro	331	07/02→01/05					
<b>Zubehörsatz, Scheibenbremsbelag</b>							
1.8	85	02/98→01/05	➡	→ 05/01		<b>13.0460-0072.2 610072</b>	TRW
1.8	92	12/97→01/05					
1.8 T	110	12/97→01/05					
1.8 T	132	04/99→01/05					
1.8 T quattro	110	12/97→01/05					
1.8 T quattro	132	12/97→01/05					
1.9 TDI	85	07/00→01/05					
2.4	100	07/98→01/05					
2.4	115	12/97→01/05					
2.4	120	12/97→01/05					
2.4	121	12/97→01/05					
2.4 quattro	120	12/97→01/05					
2.4 quattro	121	12/97→01/05					
2.5 TDI	110	12/97→01/05					
2.5 TDI	132	02/00→01/05					
2.5 TDI quattro	110	12/97→01/05					
2.5 TDI quattro	132	02/00→01/05					
2.7 T	169	02/99→01/05					
2.7 T quattro	169	12/97→01/05					
2.8	140	07/99→01/05					
2.8	142	12/97→01/05					
2.8 quattro	142	12/97→01/05					
4.2 quattro	220	11/98→01/05					
S6 quattro	250	09/99→01/05					
1.9 TDI	81	02/98→04/01	➡			<b>13.0460-0072.2 610072</b>	TRW
2.4 quattro	115	08/98→05/01					
2.8	132	12/97→05/00					
<b> Bremsscheibe</b>							
1.8	85	02/98→01/05	⬅	+PR 1LB;1LE		<b>24.0125-0105.1 425105</b>	Ø 288 25 23 V + S
1.8	92	12/97→01/05				<b>24.0325-0105.1 525105</b>	Ø 288 25 23 V
1.8 T	132	04/99→01/05					
1.9 TDI	81	02/98→04/01	⬅	+PR 1LF;1LT		<b>24.0125-0137.1 425137</b>	Ø 312 25 23 V + S
1.9 TDI	85	07/00→01/05				<b>24.0325-0137.1 525137</b>	Ø 312 25 23 V
1.9 TDI	96	08/01→01/05	➡			<b>24.0110-0201.1 410201</b>	Ø 245 10 8
2.0	96	08/01→01/05				<b>24.0310-0201.1 510201</b>	Ø 245 10 8
2.4	100	07/98→01/05					
2.4	115	12/97→01/05					
2.4	120	12/97→01/05					
2.4	121	12/97→01/05					
2.4	125	08/01→01/05					
1.8 T	110	12/97→01/05	⬅	+PR 1LB;1LE		<b>24.0125-0105.1 425105</b>	Ø 288 25 23 V + S
2.5 TDI	110	12/97→01/05				<b>24.0325-0105.1 525105</b>	Ø 288 25 23 V
2.5 TDI	114	08/01→01/05					
2.5 TDI	120	07/02→01/05	⬅	+PR 1LF;1LT		<b>24.0125-0137.1 425137</b>	Ø 312 25 23 V + S
2.5 TDI	132	02/00→01/05				<b>24.0325-0137.1 525137</b>	Ø 312 25 23 V
↓			⬅	+PR 1LG;1LA		<b>24.0130-0113.1 430113</b>	Ø 320 30 28 V + S







	kw			 	! #		
<b>AUDI - A6 Avant (4B5, C5) 11/97→01/05</b>							
<b>Bremsscheibe</b>							
1.8 T	110	12/97→01/05	←	+PR 1LG;1LA		24.0330-0113.1 530113	Ø 320 30 28 V
2.5 TDI	110	12/97→01/05	→			24.0110-0201.1 410201	Ø 245 10 8
2.5 TDI	114	08/01→01/05				24.0310-0201.1 510201	Ø 245 10 8
2.5 TDI	120	07/02→01/05					
2.5 TDI	132	02/00→01/05					
1.8 T quattro	110	12/97→01/05	←	+PR 1LB;1LE		24.0125-0105.1 425105	Ø 288 25 23 V + S
1.8 T quattro	132	12/97→01/05				24.0325-0105.1 525105	Ø 288 25 23 V
2.4 quattro	120	12/97→01/05	←	+PR 1LF;1LT		24.0125-0137.1 425137	Ø 312 25 23 V + S
2.4 quattro	121	12/97→01/05				24.0325-0137.1 525137	Ø 312 25 23 V
2.5 TDI quattro	110	12/97→01/05	←	06/01→; +PR 1LG;1LA		24.0130-0113.1 430113	Ø 320 30 28 V + S
2.5 TDI quattro	132	02/00→01/05				24.0330-0113.1 530113	Ø 320 30 28 V
			→	4B-Y-000001→; +PR 0N1		24.0110-0258.1 410258	Ø 245 10 8
			→	4B-Y-000001→; +PR 0N5; - Avant; Geschlossen		24.0110-0259.1 410259	Ø 255 10 8
			→	→ 4B-X-200000; + Avant; Kombi		24.0110-0259.1 410259	Ø 255 10 8
			→	+PR 0N6		24.0110-0260.1 410260	Ø 255 10 8
						24.0310-0260.1 510260	Ø 255 10 8
2.4 quattro	115	08/98→05/01	←	+PR 1LB;1LE		24.0125-0105.1 425105	Ø 288 25 23 V + S
			←	+PR 1LF;1LT		24.0325-0105.1 525105	Ø 288 25 23 V
			←	+PR 1LF;1LT		24.0125-0137.1 425137	Ø 312 25 23 V + S
						24.0325-0137.1 525137	Ø 312 25 23 V
			→	4B-Y-000001→; +PR 0N1		24.0110-0258.1 410258	Ø 245 10 8
			→	4B-Y-000001→; +PR 0N5; - Avant; Geschlossen		24.0110-0259.1 410259	Ø 255 10 8
			→	→ 4B-X-200000; + Avant; Kombi		24.0110-0259.1 410259	Ø 255 10 8
			→	+PR 0N6		24.0110-0260.1 410260	Ø 255 10 8
						24.0310-0260.1 510260	Ø 255 10 8
2.4 quattro	125	08/01→01/05	←	+PR 1LB;1LE		24.0125-0105.1 425105	Ø 288 25 23 V + S
			←	+PR 1LF;1LT		24.0325-0105.1 525105	Ø 288 25 23 V
			←	+PR 1LF;1LT		24.0125-0137.1 425137	Ø 312 25 23 V + S
						24.0325-0137.1 525137	Ø 312 25 23 V
			←	+PR 1LG;1LA		24.0130-0113.1 430113	Ø 320 30 28 V + S
						24.0330-0113.1 530113	Ø 320 30 28 V
			→	4B-Y-000001→; +PR 0N1		24.0110-0258.1 410258	Ø 245 10 8
			→	4B-Y-000001→; +PR 0N5; - Avant; Geschlossen		24.0110-0259.1 410259	Ø 255 10 8
			→	→ 4B-X-200000; + Avant; Kombi		24.0110-0259.1 410259	Ø 255 10 8
			→	+PR 0N6		24.0110-0260.1 410260	Ø 255 10 8
						24.0310-0260.1 510260	Ø 255 10 8
2.7 T	169	02/99→01/05	←			24.0130-0113.1 430113	Ø 320 30 28 V + S
3.0	160	06/01→01/05				24.0330-0113.1 530113	Ø 320 30 28 V
3.0	162	08/01→01/05	→			24.0110-0201.1 410201	Ø 245 10 8
						24.0310-0201.1 510201	Ø 245 10 8
2.7 T quattro	169	12/97→01/05	←			24.0130-0113.1 430113	Ø 320 30 28 V + S
2.7 T quattro	184	08/01→01/05				24.0330-0113.1 530113	Ø 320 30 28 V
3.0 quattro	160	06/01→01/05	→	4B-Y-000001→; +PR 0N1		24.0110-0258.1 410258	Ø 245 10 8
3.0 quattro	162	08/01→01/05	→	4B-Y-000001→; +PR 0N5; - Avant; Geschlossen		24.0110-0259.1 410259	Ø 255 10 8
3.7 quattro	191	03/99→01/05	→	→ 4B-X-200000; + Avant; Kombi		24.0110-0259.1 410259	Ø 255 10 8
			→	+PR 0N6		24.0110-0260.1 410260	Ø 255 10 8
						24.0310-0260.1 510260	Ø 255 10 8
2.8	132	12/97→05/00	←	+PR 1LB;1LE		24.0125-0105.1 425105	Ø 288 25 23 V + S
2.8	140	07/99→01/05				24.0325-0105.1 525105	Ø 288 25 23 V
2.8	142	12/97→01/05	←	+PR 1LF;1LT		24.0125-0137.1 425137	Ø 312 25 23 V + S
						24.0325-0137.1 525137	Ø 312 25 23 V
			→			24.0110-0201.1 410201	Ø 245 10 8
						24.0310-0201.1 510201	Ø 245 10 8
2.8 quattro	142	12/97→01/05	←	+PR 1LB;1LE		24.0125-0105.1 425105	Ø 288 25 23 V + S
			←	+PR 1LF;1LT		24.0325-0105.1 525105	Ø 288 25 23 V
			←	+PR 1LF;1LT		24.0125-0137.1 425137	Ø 312 25 23 V + S
						24.0325-0137.1 525137	Ø 312 25 23 V
			→	4B-Y-000001→; +PR 0N1		24.0110-0258.1 410258	Ø 245 10 8
			→	4B-Y-000001→; +PR 0N5; - Avant; Geschlossen		24.0110-0259.1 410259	Ø 255 10 8







	kw			 	! #		
<b>AUDI - A6 Avant (4B5, C5) 11/97→01/05</b>							
<b>Bremsscheibe</b>							
2.8 quattro	142	12/97→01/05	→	→ 4B-X-200000; + Avant; Kombi		24.0110-0259.1 410259	Ø 255 10 8
			→	+PR 0N6		24.0110-0260.1 410260	Ø 255 10 8
4.2 quattro	220	11/98→01/05	←			24.0130-0174.1 430174	Ø 321 30 28 V
S6 quattro	250	09/99→01/05	→			24.0122-0222.1 422222	Ø 269 22 20 V
<b>AUDI - A6 Avant (4F5, C6) 03/05→08/11</b>							
<b>Bremsbelagsatz, Scheibenbremse</b>							
2.0 TDI	89	09/05→06/06	←	+PR 1LT		13.0460-7110.2 607110	ATE 20676 19,8 + WK
2.0 TDI	100	06/05→08/11				13.0470-7110.2 LD7110	ATE 20676 19,8 + WK Ceramic
2.0 TDI	103	06/05→10/08					
2.0 TFSI	125	06/05→08/11	←	+PR 1LG;1LD;1ZL;1LH		13.0460-7201.2 607201	ATE 23763 20,3 + WK
2.4	130	03/05→10/08				13.0470-7201.2 LD7201	ATE 23763 20,3 + WK Ceramic
2.4 quattro	130	03/05→10/08	→	+PR 1KQ		13.0460-2749.2 602749	TRW 24483 16,9 - WE / - WK + Zub
2.7 TDI	120	03/05→08/11				13.0460-2880.2 602880	TRW 23914 17,1 + WE / - WK + Zub
2.7 TDI	132	03/05→10/08					
2.7 TDI quattro	120	06/05→08/11				13.0460-2880.2 602880	TRW 23914 17,1 + WE / - WK + Zub
2.7 TDI quattro	132	03/05→10/08					
2.8 FSI	154	11/06→10/08				13.0470-2749.2 LD2749	TRW 24483 16,9 - WE / - WK + Zub Ceramic
2.8 FSI quattro	154	06/07→10/08					
3.0	160	03/05→05/06				13.0470-2880.2 LD2880	TRW 23914 17,1 + WE / - WK + Zub Ceramic
3.0 quattro	160	03/05→05/06					
3.0 TDI quattro	155	03/05→08/11					
3.0 TDI quattro	165	03/05→05/06	→	+PR 1KD;2ED		13.0460-2749.2 602749	TRW 24483 16,9 - WE / - WK + Zub
3.0 TDI quattro	171	06/06→10/08				13.0460-2880.2 602880	TRW 23914 17,1 + WE / - WK + Zub
3.2 FSI	188	03/05→10/08				13.0470-2749.2 LD2749	TRW 24483 16,9 - WE / - WK + Zub Ceramic
3.2 FSI quattro	188	03/05→10/08				13.0470-2880.2 LD2880	TRW 23914 17,1 + WE / - WK + Zub Ceramic
			→	+PR 1KW;2EE; + eFSB		13.0460-2888.2 602888	TRW 23326 17,4 + WE / - WK Ceramic
						13.0470-2888.2 LD2888	TRW 23326 17,4 + WE / - WK Ceramic
2.0 TDI	120	04/09→08/11	←	+PR 1LT		13.0460-7110.2 607110	ATE 20676 19,8 + WK
2.0 TDI	125	10/08→08/11				13.0470-7110.2 LD7110	ATE 20676 19,8 + WK Ceramic
2.7 TDI	140	10/08→08/11					
2.7 TDI quattro	140	10/08→08/11	←	+PR 1LG;1ZL		13.0460-7201.2 607201	ATE 23763 20,3 + WK
2.8 FSI	140	10/08→08/11				13.0470-7201.2 LD7201	ATE 23763 20,3 + WK Ceramic
2.8 FSI	162	10/08→08/11					
2.8 FSI quattro	140	10/08→08/11	→	+PR 1KD		13.0460-2749.2 602749	TRW 24483 16,9 - WE / - WK + Zub
2.8 FSI quattro	162	10/08→08/11				13.0460-2880.2 602880	TRW 23914 17,1 + WE / - WK + Zub
						13.0470-2749.2 LD2749	TRW 24483 16,9 - WE / - WK + Zub Ceramic
						13.0470-2880.2 LD2880	TRW 23914 17,1 + WE / - WK + Zub Ceramic
			→	+PR 1KQ		13.0460-2749.2 602749	TRW 24483 16,9 - WE / - WK + Zub
						13.0460-2880.2 602880	TRW 23914 17,1 + WE / - WK + Zub
						13.0470-2749.2 LD2749	TRW 24483 16,9 - WE / - WK + Zub Ceramic
						13.0470-2880.2 LD2880	TRW 23914 17,1 + WE / - WK + Zub Ceramic
			→	+PR 1KW; + eFSB		13.0460-2888.2 602888	TRW 23326 17,4 + WE / - WK Ceramic
						13.0470-2888.2 LD2888	TRW 23326 17,4 + WE / - WK Ceramic
3.0 TDI quattro	176	10/08→08/11	←	+PR 1LT		13.0460-7110.2 607110	ATE 20676 19,8 + WK
3.0 TFSI quattro	213	10/08→08/11				13.0470-7110.2 LD7110	ATE 20676 19,8 + WK Ceramic
3.0 TFSI quattro	220	10/08→08/11	←	+PR 1LG;1ZL		13.0460-7201.2 607201	ATE 23763 20,3 + WK
						13.0470-7201.2 LD7201	ATE 23763 20,3 + WK Ceramic
			→	+PR 1KD		13.0460-2749.2 602749	TRW 24483 16,9 - WE / - WK + Zub
						13.0460-2880.2 602880	TRW 23914 17,1 + WE / - WK + Zub
						13.0470-2749.2 LD2749	TRW 24483 16,9 - WE / - WK + Zub Ceramic
						13.0470-2880.2 LD2880	TRW 23914 17,1 + WE / - WK + Zub Ceramic
			→	+PR 1KQ		13.0460-2749.2 602749	TRW 24483 16,9 - WE / - WK + Zub









	kw			 	! #		
<b>AUDI - A6 Avant (4F5, C6) 03/05→08/11</b>							
<b> Bremsbelagsatz, Scheibenbremse</b>							
3.0 TDI quattro 3.0 TFSI quattro 3.0 TFSI quattro	176 213 220	10/08→08/11 10/08→08/11 10/08→08/11	➡	+PR 1KQ		13.0460-2880.2 602880 13.0470-2749.2 LD2749 13.0470-2880.2 LD2880	TRW 23914 17,1 + WE / - WK + Zub TRW 24483 16,9 - WE / - WK + Zub Ceramic TRW 23914 17,1 + WE / - WK + Zub Ceramic
			➡	+PR 1KW; + eFSB		13.0460-2888.2 602888 13.0470-2888.2 LD2888	TRW 23326 17,4 + WE / - WK Ceramic TRW 23326 17,4 + WE / - WK Ceramic
4.2 FSI quattro 4.2 quattro	257 246	06/06→08/11 03/05→05/06	⬅	+PR 1LT		13.0460-7110.2 607110	ATE 20676 19,8 + WK
			⬅	+PR 1LG;1LD;1ZL;1LH		13.0460-7201.2 607201	ATE 23763 20,3 + WK
			➡	+PR 1KQ		13.0460-2749.2 602749 13.0460-2880.2 602880 13.0470-2749.2 LD2749 13.0470-2880.2 LD2880	TRW 24483 16,9 - WE / - WK + Zub TRW 23914 17,1 + WE / - WK + Zub TRW 24483 16,9 - WE / - WK + Zub Ceramic TRW 23914 17,1 + WE / - WK + Zub Ceramic
			➡	+PR 1KD;2ED		13.0460-2749.2 602749 13.0460-2880.2 602880 13.0470-2749.2 LD2749 13.0470-2880.2 LD2880	TRW 24483 16,9 - WE / - WK + Zub TRW 23914 17,1 + WE / - WK + Zub TRW 24483 16,9 - WE / - WK + Zub Ceramic TRW 23914 17,1 + WE / - WK + Zub Ceramic
			➡	+PR 1KW;2EE; + eFSB		13.0460-2888.2 602888 13.0470-2888.2 LD2888	TRW 23326 17,4 + WE / - WK Ceramic TRW 23326 17,4 + WE / - WK Ceramic
RS6 quattro	426	04/08→08/10	⬅	+PR 1LM		13.0460-4864.2 604864	BRE 24455 16,8 + WE / + WK
			➡	+ eFSB		13.0460-2888.2 602888	TRW 23326 17,4 + WE / - WK
S6 quattro	320	03/06→08/11	⬅			13.0460-7182.2 607182	ATE 23896 20,6 + WK
			➡	+PR 1KW;2EE; + eFSB		13.0460-2888.2 602888	TRW 23326 17,4 + WE / - WK
<b>Zubehörsatz, Scheibenbremsbelag</b>							
2.0 TDI 2.0 TDI 2.0 TDI 2.0 TFSI 2.4 2.4 quattro 2.7 TDI 2.7 TDI 2.7 TDI quattro 2.7 TDI quattro 2.8 FSI 2.8 FSI quattro 3.0 3.0 quattro 3.0 TDI quattro 3.0 TDI quattro 3.0 TDI quattro 3.2 FSI 3.2 FSI quattro 4.2 FSI quattro 4.2 quattro	89 100 103 125 130 130 120 132 120 132 154 154 160 160 155 165 171 188 188 257 246	09/05→06/06 06/05→08/11 06/05→10/08 06/05→08/11 03/05→10/08 03/05→10/08 03/05→08/11 03/05→10/08 06/05→08/11 03/05→10/08 11/06→10/08 06/07→10/08 03/05→05/06 03/05→05/06 03/05→08/11 03/05→05/06 06/06→10/08 03/05→10/08 03/05→10/08 06/06→08/11 03/05→05/06	➡ ➡ ➡	+PR 1KW;2EE +PR 1KD;2ED +PR 1KQ		13.0460-0023.2 610023 13.0460-0259.2 610259 13.0460-0259.2 610259	
2.0 TDI 2.0 TDI 2.7 TDI 2.7 TDI quattro 2.8 FSI 2.8 FSI 2.8 FSI quattro 2.8 FSI quattro 3.0 TDI quattro 3.0 TFSI quattro 3.0 TFSI quattro	120 125 140 140 140 162 140 162 176 213 220	04/09→08/11 10/08→08/11 10/08→08/11 10/08→08/11 10/08→08/11 10/08→08/11 10/08→08/11 10/08→08/11 10/08→08/11 10/08→08/11 10/08→08/11	➡ ➡ ➡	+PR 1KW +PR 1KD +PR 1KQ		13.0460-0023.2 610023 13.0460-0259.2 610259 13.0460-0259.2 610259	
RS6 quattro	426	04/08→08/10				13.0460-0023.2 610023	
S6 quattro	320	03/06→08/11		+PR 1KW;2EE		13.0460-0023.2 610023	
<b> Bremsscheibe</b>							
2.0 TDI ↓	89	09/05→06/06	⬅	+PR 1LT		24.0125-0149.1 425149	Ø 314 25 23 V









	kw			 	! #		
<b>AUDI - A6 Avant (4F5, C6) 03/05→08/11</b>							
<b>Bremsscheibe</b>							
2.0 TDI	100	06/05→08/11	←	+PR 1LT		24.0325-0149.1 525149	Ø 314 25 23 V
2.0 TDI	103	06/05→10/08	←	+PR 1LG;1LD		24.0130-0175.1 430175	Ø 321 30 28 V + S
2.0 TFSI	125	06/05→08/11	←			24.0330-0175.1 530175	Ø 321 30 28 V + S
2.4	130	03/05→10/08	←				
2.4 quattro	130	03/05→10/08	←	+PR 1ZL;1LH		24.0130-0176.1 430176	Ø 347 30 28 V + S
2.7 TDI	120	03/05→08/11	←			24.0330-0176.1 530176	Ø 347 30 28 V + S
2.7 TDI	132	03/05→10/08	←				
2.7 TDI quattro	120	06/05→08/11	→	+PR 1KD,2ED,1KQ; + eFSB		24.0112-0159.1 412159	Ø 302 12 10 + S
2.7 TDI quattro	132	03/05→10/08	←			24.0312-0159.1 512159	Ø 302 12 10 + S
2.8 FSI	154	11/06→10/08	←				
2.8 FSI quattro	154	06/07→10/08	→	+PR 1KW;2EE		24.0122-0223.1 422223	Ø 330 22 20 V
3.0	160	03/05→05/06	←			24.0322-0223.1 522223	Ø 330 22 20 V
3.0 quattro	160	03/05→05/06	←				
3.0 TDI quattro	155	03/05→08/11	←				
3.0 TDI quattro	165	03/05→05/06	←				
3.0 TDI quattro	171	06/06→10/08	←				
3.2 FSI	188	03/05→10/08	←				
3.2 FSI quattro	188	03/05→10/08	←				
4.2 FSI quattro	257	06/06→08/11	←				
4.2 quattro	246	03/05→05/06	←				
2.0 TDI	120	04/09→08/11	←	+PR 1LT		24.0125-0149.1 425149	Ø 314 25 23 V
2.0 TDI	125	10/08→08/11	←			24.0325-0149.1 525149	Ø 314 25 23 V
2.7 TDI	140	10/08→08/11	←	+PR 1LG		24.0130-0175.1 430175	Ø 321 30 28 V + S
2.7 TDI quattro	140	10/08→08/11	←			24.0330-0175.1 530175	Ø 321 30 28 V + S
2.8 FSI	140	10/08→08/11	←				
2.8 FSI	162	10/08→08/11	←	+PR 1ZL		24.0130-0176.1 430176	Ø 347 30 28 V + S
2.8 FSI quattro	140	10/08→08/11	←			24.0330-0176.1 530176	Ø 347 30 28 V + S
2.8 FSI quattro	162	10/08→08/11	←				
3.0 TDI quattro	176	10/08→08/11	→	+PR 1KD,1KQ; + eFSB		24.0112-0159.1 412159	Ø 302 12 10 + S
3.0 TFSI quattro	213	10/08→08/11	→			24.0312-0159.1 512159	Ø 302 12 10 + S
3.0 TFSI quattro	220	10/08→08/11	→	+PR 1KW		24.0122-0223.1 422223	Ø 330 22 20 V
			→			24.0322-0223.1 522223	Ø 330 22 20 V
S6 quattro	320	03/06→08/11	←			24.0136-0107.1 436107	Ø 385 36 33,5 V
			→	+PR 1KW;2EE; + eFSB		24.0122-0243.1 422243	Ø 330 22 20 V
<b>AUDI - A6 Avant (4G5, 4GD, C7) 05/11→</b>							
<b>Bremsbelagsatz, Scheibenbremse</b>							
1.8 TFSI	140	09/14→	←	+PR 1LA,1LJ		13.0460-2765.2 602765	TRW 24409 19,2 + WK + Zub
2.0 TDI	100	01/12→	←			13.0470-2765.2 LD2765	TRW 24409 19,2 + WK + Zub Ceramic
2.0 TDI	110	09/14→	←				
2.0 TDI	140	11/13→	←	+PR 1LU		13.0460-4873.2 604873	BRE 24847 17,0 + WE / - WK
2.0 TDI quattro	140	04/15→	←				
2.0 TFSI	132	06/11→	←	+PR 1LP		13.0460-4879.2 604879	BRE 25643 16,8 + WE / - WK
2.0 TFSI	185	09/14→	←			13.0470-4879.2 LD4879	BRE 25643 17,0 + WE / - WK Ceramic
2.0 TFSI quattro	183	05/15→	←				
2.0 TFSI quattro	185	05/15→	←				
2.8 FSI quattro	162	09/14→	←	+PR 1LL,1ZK		13.0460-7280.2 607280	ATE 25158 20,3 + WK
3.0 TDI	155	09/14→	←			13.0470-7280.2 LD7280	ATE 25158 20,3 + WK Ceramic
3.0 TDI	160	09/14→	←				
3.0 TDI quattro	155	09/14→	←	+PR 1LF		13.0460-7280.2 607280	ATE 25158 20,3 + WK
3.0 TDI quattro	160	09/14→	←			13.0470-7280.2 LD7280	ATE 25158 20,3 + WK Ceramic
3.0 TDI quattro	200	09/14→	→	+PR 1KW		13.0460-2769.2 602769	TRW 24606 17,4 + WK + Zub
			→			13.0470-2769.2 LD2769	TRW 24606 17,4 + WK + Zub Ceramic
			→	+PR 1KY,2EA,2EE,2EJ		13.0460-2770.2 602770	TRW 24606 17,4 + WK + Zub
			→			13.0470-2770.2 LD2770	TRW 24606 17,4 + WK + Zub Ceramic
2.0 TDI	120	05/11→	←	09/11→; +PR 1LA,1LJ		13.0460-2765.2 602765	TRW 24409 19,2 + WK + Zub
2.0 TDI	130	05/11→	←			13.0470-2765.2 LD2765	TRW 24409 19,2 + WK + Zub Ceramic
2.8 FSI	150	05/11→04/15	←				
2.8 FSI quattro	150	05/11→04/15	←				
3.0 TDI	150	05/11→	←	09/11→; +PR 1LU		13.0460-4873.2 604873	BRE 24847 17,0 + WE / - WK
3.0 TDI quattro	150	05/11→	←			13.0460-4879.2 604879	BRE 25643 16,8 + WE / - WK
3.0 TDI quattro	180	05/11→	←	09/11→; +PR 1LP		13.0470-4879.2 LD4879	BRE 25643 17,0 + WE / - WK Ceramic
3.0 TFSI quattro	220	05/11→05/12	←				
			←	09/11→; +PR 1LF		13.0460-7280.2 607280	ATE 25158 20,3 + WK
			←			13.0470-7280.2 LD7280	ATE 25158 20,3 + WK Ceramic
			←	09/11→; +PR 1LL,1ZK		13.0460-7280.2 607280	ATE 25158 20,3 + WK
			←			13.0470-7280.2 LD7280	ATE 25158 20,3 + WK Ceramic
			→	09/11→; +PR 1KW		13.0460-2769.2 602769	TRW 24606 17,4 + WK + Zub
			→			13.0470-2769.2 LD2769	TRW 24606 17,4 + WK + Zub Ceramic
			→	09/11→; +PR 1KY,2EA,2EE,2EJ		13.0460-2770.2 602770	TRW 24606 17,4 + WK + Zub

	kw			 	! #		
<b>AUDI - A6 Avant (4G5, 4GD, C7) 05/11→</b>							
<b>Bremsbelagsatz, Scheibenbremse</b>							
2.0 TDI 2.0 TDI 2.8 FSI 2.8 FSI quattro 3.0 TDI 3.0 TDI quattro 3.0 TDI quattro 3.0 TFSI quattro	120 130 150 150 150 150 180 220	05/11→ 05/11→ 05/11→04/15 05/11→04/15 05/11→ 05/11→ 05/11→ 05/11→05/12	➡	09/11→; +PR 1KY,2EA,2EE,2EJ		13.0470-2770.2 LD2770	TRW 24606 17,4 + WK + Zub Ceramic
3.0 TDI quattro	230	11/11→	⬅	12/11→; +PR 1LA,1LJ		13.0460-2765.2 602765	TRW 24409 19,2 + WK + Zub
			⬅	12/11→; +PR 1LU		13.0460-4873.2 604873	BRE 24847 17,0 + WE / - WK
			⬅	12/11→; +PR 1LP		13.0460-4879.2 604879	BRE 25643 16,8 + WE / - WK
			⬅	12/11→; +PR 1LF		13.0460-7280.2 607280	ATE 25158 20,3 + WK
			⬅	12/11→; +PR 1LL,1ZK		13.0460-7280.2 607280	ATE 25158 20,3 + WK
			➡	12/11→; +PR 1KW		13.0460-2769.2 602769	TRW 24606 17,4 + WK + Zub
						13.0470-2769.2 LD2769	TRW 24606 17,4 + WK + Zub Ceramic
			➡	12/11→; +PR 1KY,2EA,2EE,2EJ		13.0460-2770.2 602770	TRW 24606 17,4 + WK + Zub
						13.0470-2770.2 LD2770	TRW 24606 17,4 + WK + Zub Ceramic
3.0 TDI quattro 3.0 TDI quattro 3.0 TFSI quattro 3.0 TFSI quattro S6 quattro	235 240 228 245 331	09/14→09/18 09/14→ 11/11→ 09/14→09/18 10/14→	⬅	+PR 1LA,1LJ		13.0460-2765.2 602765	TRW 24409 19,2 + WK + Zub
			⬅	+PR 1LU		13.0460-4873.2 604873	BRE 24847 17,0 + WE / - WK
			⬅	+PR 1LP		13.0460-4879.2 604879	BRE 25643 16,8 + WE / - WK
			⬅	+PR 1LL,1ZK		13.0460-7280.2 607280	ATE 25158 20,3 + WK
			⬅	+PR 1LF		13.0460-7280.2 607280	ATE 25158 20,3 + WK
			➡	+PR 1KW		13.0460-2769.2 602769	TRW 24606 17,4 + WK + Zub
						13.0470-2769.2 LD2769	TRW 24606 17,4 + WK + Zub Ceramic
			➡	+PR 1KY,2EA,2EE,2EJ		13.0460-2770.2 602770	TRW 24606 17,4 + WK + Zub
						13.0470-2770.2 LD2770	TRW 24606 17,4 + WK + Zub Ceramic
RS6 performance quattro	445	11/15→	➡	+PR 1KJ,1KQ		13.0460-2770.2 602770	TRW 24606 17,4 + WK + Zub
						13.0470-2770.2 LD2770	TRW 24606 17,4 + WK + Zub Ceramic
RS6 quattro	412	01/13→	⬅	03/13→; +PR 1LU		13.0460-4873.2 604873	BRE 24847 17,0 + WE / - WK
			➡	03/13→; +PR 1KJ,1KQ		13.0460-2770.2 602770	TRW 24606 17,4 + WK + Zub
						13.0470-2770.2 LD2770	TRW 24606 17,4 + WK + Zub Ceramic
S6 quattro	309	02/12→	⬅	04/12→; +PR 1LA,1LJ		13.0460-2765.2 602765	TRW 24409 19,2 + WK + Zub
			⬅	04/12→; +PR 1LU		13.0460-4873.2 604873	BRE 24847 17,0 + WE / - WK
			⬅	04/12→; +PR 1LP		13.0460-4879.2 604879	BRE 25643 16,8 + WE / - WK
			⬅	04/12→; +PR 1LF		13.0460-7280.2 607280	ATE 25158 20,3 + WK
			⬅	04/12→; +PR 1LL,1ZK		13.0460-7280.2 607280	ATE 25158 20,3 + WK
			➡	04/12→; +PR 1KW		13.0460-2769.2 602769	TRW 24606 17,4 + WK + Zub
						13.0470-2769.2 LD2769	TRW 24606 17,4 + WK + Zub Ceramic
			➡	04/12→; +PR 1KY,2EA,2EE,2EJ		13.0460-2770.2 602770	TRW 24606 17,4 + WK + Zub
						13.0470-2770.2 LD2770	TRW 24606 17,4 + WK + Zub Ceramic
<b>Warnkontakt, Bremsbelagsverschleiß</b>							
1.8 TFSI 2.0 TDI 2.0 TDI 2.0 TDI 2.0 TDI quattro 2.0 TFSI 2.0 TFSI 2.0 TFSI quattro 2.0 TFSI quattro 2.8 FSI quattro 3.0 TDI 3.0 TDI 3.0 TDI quattro 3.0 TDI quattro 3.0 TDI quattro 3.0 TDI quattro 3.0 TDI quattro 3.0 TDI quattro 3.0 TFSI quattro	140 100 110 140 140 132 185 183 185 162 155 160 155 160 200 235 240 228	09/14→ 01/12→ 09/14→ 11/13→ 04/15→ 06/11→ 09/14→ 05/15→ 05/15→ 09/14→ 09/14→ 09/14→ 09/14→ 09/14→ 09/14→ 09/14→ 09/14→ 09/14→ 09/14→ 09/14→ 09/14→ 09/14→ 09/14→ 09/14→ 09/14→ 09/14→ 11/11→	⬅	+PR 1LU	2	24.8190-0019.2 620019	L= 254
			⬅	+PR 1LW	2	24.8190-0020.2 620020	L= 443,3
			⬅	+PR 1LL,1ZK	1	24.8190-0301.2 620301	L= 311,6
			⬅	+PR 1LF	1	24.8190-0301.2 620301	L= 311,6
			⬅	+PR 1LA,1LJ	1	24.8190-0311.2 620311	L= 300
			➡	+PR 1KY,2EA,2EE,2EJ	1	24.8190-0313.2 620313	L= 217







	kw			 	! #		
<b>AUDI - A6 Avant (4G5, 4GD, C7) 05/11→</b>							
<b>Warnkontakt, Bremsbelagverschleiß</b>							
3.0 TFSI quattro S6 quattro	245 331	09/14→09/18 10/14→	← +PR 1LU	2	24.8190-0019.2	620019	L= 254
			← +PR 1LW	2	24.8190-0020.2	620020	L= 443,3
			← +PR 1LL,1ZK	1	24.8190-0301.2	620301	L= 311,6
			← +PR 1LF	1	24.8190-0301.2	620301	L= 311,6
			← +PR 1LA,1LJ	1	24.8190-0311.2	620311	L= 300
			→ +PR 1KY,2EA,2EE,2EJ	1	24.8190-0313.2	620313	L= 217
2.0 TDI 2.0 TDI 2.8 FSI 2.8 FSI quattro 3.0 TDI 3.0 TDI quattro 3.0 TDI quattro 3.0 TFSI quattro	120 130 150 150 150 180 220	05/11→ 05/11→ 05/11→04/15 05/11→04/15 05/11→ 05/11→ 05/11→ 05/11→05/12	← 09/11→; +PR 1LU	2	24.8190-0019.2	620019	L= 254
			← 09/11→; +PR 1LW	2	24.8190-0020.2	620020	L= 443,3
			← 09/11→; +PR 1LL,1ZK	1	24.8190-0301.2	620301	L= 311,6
			← 09/11→; +PR 1LF	1	24.8190-0301.2	620301	L= 311,6
			← 09/11→; +PR 1LA,1LJ	1	24.8190-0311.2	620311	L= 300
			→ 09/11→; +PR 1KY,2EA,2EE,2EJ	1	24.8190-0313.2	620313	L= 217
			← 09/11→; +PR 1LU	2	24.8190-0019.2	620019	L= 254
3.0 TDI quattro	230	11/11→	← 12/11→; +PR 1LW	2	24.8190-0020.2	620020	L= 443,3
			← 12/11→; +PR 1LF	1	24.8190-0301.2	620301	L= 311,6
			← 12/11→; +PR 1LL,1ZK	1	24.8190-0301.2	620301	L= 311,6
			← 12/11→; +PR 1LA,1LJ	1	24.8190-0311.2	620311	L= 300
			→ 12/11→; +PR 1KY,2EA,2EE,2EJ	1	24.8190-0313.2	620313	L= 217
			← 12/11→; +PR 1LU	2	24.8190-0019.2	620019	L= 254
RS6 performance quattro	445	11/15→	→ +PR 1KJ,1KQ	1	24.8190-0313.2	620313	L= 217
RS6 quattro	412	01/13→	← 03/13→; +PR 1LU	2	24.8190-0019.2	620019	L= 254
			← 03/13→; +PR 1LW	2	24.8190-0020.2	620020	L= 443,3
			→ 03/13→; +PR 1KJ,1KQ	1	24.8190-0313.2	620313	L= 217
S6 quattro	309	02/12→	← 04/12→; +PR 1LU	2	24.8190-0019.2	620019	L= 254
			← 04/12→; +PR 1LW	2	24.8190-0020.2	620020	L= 443,3
			← 04/12→; +PR 1LF	1	24.8190-0301.2	620301	L= 311,6
			← 04/12→; +PR 1LL,1ZK	1	24.8190-0301.2	620301	L= 311,6
			← 04/12→; +PR 1LA,1LJ	1	24.8190-0311.2	620311	L= 300
			→ 04/12→; +PR 1KY,2EA,2EE,2EJ	1	24.8190-0313.2	620313	L= 217
<b>Bremsscheibe</b>							
1.8 TFSI 2.0 TDI 2.0 TDI 2.0 TDI 2.0 TDI quattro 2.0 TFSI 2.0 TFSI 2.0 TFSI quattro 2.0 TFSI quattro 2.8 FSI quattro 3.0 TDI 3.0 TDI 3.0 TDI quattro 3.0 TDI quattro 3.0 TDI quattro 3.0 TDI quattro 3.0 TFSI quattro 3.0 TFSI quattro S6 quattro	140 100 110 140 140 132 185 183 185 162 155 160 155 160 200 235 240 228 245 331	09/14→ 01/12→ 09/14→ 11/13→ 04/15→ 06/11→ 09/14→ 05/15→ 05/15→ 09/14→ 09/14→ 09/14→ 09/14→ 09/14→ 09/14→ 09/14→ 11/11→ 09/14→09/18 10/14→	← +PR 1LA		24.0130-0221.1	430221	Ø 320 30 28 V + S
			← +PR 1LJ,1LP		24.0130-0222.1	430222	Ø 345 30 28 V + S
			← +PR 1LL,1LF,1ZK		24.0134-0103.1	434103	Ø 356 34 31,5 V + S
			→ +PR 1KW		24.0112-0178.1	412178	Ø 300 12 10 + S
			→ +PR 2EA,2EE,2EJ		24.0312-0178.1	512178	Ø 300 12 10 + S
			→ +PR 1KY		24.0122-0272.1	422272	Ø 330 21,9 20 V + S
			→ +PR 1KY		24.0122-0273.1	422273	Ø 356 22 20 V + S
			← 09/11→; +PR 1LA		24.0130-0221.1	430221	Ø 320 30 28 V + S
			← 09/11→; +PR 1LJ,1LP		24.0130-0222.1	430222	Ø 345 30 28 V + S
			← 09/11→; +PR 1LL,1LF,1ZK		24.0134-0103.1	434103	Ø 356 34 31,5 V + S
			→ 09/11→; +PR 1KW		24.0112-0178.1	412178	Ø 300 12 10 + S
			→ 09/11→; +PR 1KW		24.0312-0178.1	512178	Ø 300 12 10 + S
			→ 09/11→; +PR 2EA,2EE,2EJ		24.0122-0272.1	422272	Ø 330 21,9 20 V + S
			→ 09/11→; +PR 1KY		24.0122-0273.1	422273	Ø 356 22 20 V + S
			← 09/11→; +PR 1LA		24.0130-0221.1	430221	Ø 320 30 28 V + S
			← 09/11→; +PR 1LJ,1LP		24.0130-0222.1	430222	Ø 345 30 28 V + S
			← 09/11→; +PR 1LJ		24.0134-0103.1	434103	Ø 356 34 31,5 V + S
			↓				

	kw			 	! #		
<b>AUDI - A6 Avant (4G5, 4GD, C7) 05/11→</b>							
 <b>Bremsscheibe</b>							
2.0 TDI	130	05/11→	➔	09/11→; +PR 1KW		24.0112-0178.1 412178 24.0312-0178.1 512178	Ø 300 12 10 + S Ø 300 12 10 + S
			➔	09/11→; +PR 2EA,2EE,2EJ		24.0122-0272.1 422272	Ø 330 21,9 20 V + S
			➔	09/11→; +PR 1KY		24.0122-0273.1 422273	Ø 356 22 20 V + S
3.0 TDI quattro	230	11/11→	➔	12/11→; +PR 1LA		24.0130-0221.1 430221	Ø 320 30 28 V + S
			➔	12/11→; +PR 1LJ,1LP		24.0130-0222.1 430222	Ø 345 30 28 V + S
			➔	12/11→; +PR 1LL,1LF,1ZK		24.0134-0103.1 434103	Ø 356 34 31,5 V + S
			➔	12/11→; +PR 1KW		24.0112-0178.1 412178 24.0312-0178.1 512178	Ø 300 12 10 + S Ø 300 12 10 + S
			➔	12/11→; +PR 2EA,2EE,2EJ		24.0122-0272.1 422272	Ø 330 21,9 20 V + S
			➔	12/11→; +PR 1KY		24.0122-0273.1 422273	Ø 356 22 20 V + S
S6 quattro	309	02/12→	➔	04/12→; +PR 1LA		24.0130-0221.1 430221	Ø 320 30 28 V + S
			➔	04/12→; +PR 1LJ,1LP		24.0130-0222.1 430222	Ø 345 30 28 V + S
			➔	04/12→; +PR 1LL,1LF,1ZK		24.0134-0103.1 434103	Ø 356 34 31,5 V + S
			➔	04/12→; +PR 1KW		24.0112-0178.1 412178 24.0312-0178.1 512178	Ø 300 12 10 + S Ø 300 12 10 + S
			➔	04/12→; +PR 2EA,2EE,2EJ		24.0122-0272.1 422272	Ø 330 21,9 20 V + S
			➔	04/12→; +PR 1KY		24.0122-0273.1 422273	Ø 356 22 20 V + S
<b>AUDI - A7 Sportback (4GA, 4GF) 10/10→05/18</b>							
 <b>Bremsbelagsatz, Scheibenbremse</b>							
1.8 TFSI	140	04/15→05/18	➔	+PR 1LA,1LJ		13.0460-2765.2 602765	TRW 24409 19,2 + WK + Zub
2.0 TFSI	185	09/14→05/18	➔			13.0470-2765.2 LD2765	TRW 24409 19,2 + WK + Zub Ceramic
2.0 TFSI quattro	183	05/15→05/18	➔				
2.0 TFSI quattro	185	05/15→05/18	➔				
2.8 FSI quattro	162	09/14→05/18	➔	+PR 1LU		13.0460-4873.2 604873	BRE 24847 17,0 + WE / - WK
3.0 TDI	140	11/15→05/18	➔	+PR 1LP		13.0460-4879.2 604879	BRE 25643 16,8 + WE / - WK
3.0 TDI	155	11/15→05/18	➔			13.0470-4879.2 LD4879	BRE 25643 17,0 + WE / - WK Ceramic
3.0 TDI	160	07/14→05/18	➔				
3.0 TDI quattro	140	11/15→05/18	➔				
3.0 TDI quattro	155	07/14→05/18	➔	+PR 1LL,1LF,1ZK		13.0460-7280.2 607280	ATE 25158 20,3 + WK
3.0 TDI quattro	160	07/14→05/18	➔			13.0470-7280.2 LD7280	ATE 25158 20,3 + WK Ceramic
3.0 TDI quattro	200	05/14→05/18	➔	+PR 1KW; + eFSB		13.0460-2769.2 602769	TRW 24606 17,4 + WK + Zub
			➔			13.0470-2769.2 LD2769	TRW 24606 17,4 + WK + Zub Ceramic
			➔	+PR 1KY,2EA,2EE,2EJ; + eFSB		13.0460-2770.2 602770	TRW 24606 17,4 + WK + Zub
			➔			13.0470-2770.2 LD2770	TRW 24606 17,4 + WK + Zub Ceramic
2.8 FSI	150	02/11→03/15	➔	05/11→; +PR 1LA,1LJ		13.0460-2765.2 602765	TRW 24409 19,2 + WK + Zub
			➔			13.0470-2765.2 LD2765	TRW 24409 19,2 + WK + Zub Ceramic
			➔	05/11→; +PR 1LU		13.0460-4873.2 604873	BRE 24847 17,0 + WE / - WK
			➔	05/14→; +PR 1LP		13.0460-4879.2 604879	BRE 25643 16,8 + WE / - WK
			➔			13.0470-4879.2 LD4879	BRE 25643 17,0 + WE / - WK Ceramic
			➔	05/11→; +PR 1LL,1LF,1ZK		13.0460-7280.2 607280	ATE 25158 20,3 + WK
			➔			13.0470-7280.2 LD7280	ATE 25158 20,3 + WK Ceramic
			➔	05/11→; +PR 1KW; + eFSB		13.0460-2769.2 602769	TRW 24606 17,4 + WK + Zub
			➔			13.0470-2769.2 LD2769	TRW 24606 17,4 + WK + Zub Ceramic
			➔	05/11→; +PR 1KY,2EA,2EE,2EJ; + eFSB		13.0460-2770.2 602770	TRW 24606 17,4 + WK + Zub
			➔			13.0470-2770.2 LD2770	TRW 24606 17,4 + WK + Zub Ceramic
2.8 FSI quattro	150	10/10→03/15	➔	+PR 1LA,1LJ		13.0460-2765.2 602765	TRW 24409 19,2 + WK + Zub
3.0 TDI	150	11/10→03/15	➔			13.0470-2765.2 LD2765	TRW 24409 19,2 + WK + Zub Ceramic
3.0 TDI quattro	150	12/10→03/15	➔				
3.0 TDI quattro	176	05/13→06/17	➔	+PR 1LU		13.0460-4873.2 604873	BRE 24847 17,0 + WE / - WK
3.0 TDI quattro	180	10/10→06/16	➔	05/14→; +PR 1LP		13.0460-4879.2 604879	BRE 25643 16,8 + WE / - WK
			➔			13.0470-4879.2 LD4879	BRE 25643 17,0 + WE / - WK Ceramic
			➔	+PR 1LL,1LF,1ZK		13.0460-7280.2 607280	ATE 25158 20,3 + WK
			➔			13.0470-7280.2 LD7280	ATE 25158 20,3 + WK Ceramic
			➔	+PR 1KW; + eFSB		13.0460-2769.2 602769	TRW 24606 17,4 + WK + Zub





















	kw			 	! #		
<b>AUDI - A7 Sportback (4GA, 4GF) 10/10→05/18</b>							
<b>Bremsbelagsatz, Scheibenbremse</b>							
2.8 FSI quattro	150	10/10→03/15	➡	+PR 1KW; + eFSB		13.0470-2769.2 LD2769	TRW 24606 17,4 + WK + Zub Ceramic
3.0 TDI	150	11/10→03/15					
3.0 TDI quattro	150	12/10→03/15					
3.0 TDI quattro	176	05/13→06/17	➡	+PR 1KY,2EA,2EE,2EJ; + eFSB		13.0460-2770.2 602770	TRW 24606 17,4 + WK + Zub
3.0 TDI quattro	180	10/10→06/16				13.0470-2770.2 LD2770	TRW 24606 17,4 + WK + Zub Ceramic
3.0 TDI quattro	230	11/11→03/15	⬅	+PR 1LA,1LJ		13.0460-2765.2 602765	TRW 24409 19,2 + WK + Zub
3.0 TFSI quattro	228	01/11→03/15	⬅	+PR 1LU		13.0460-4873.2 604873	BRE 24847 17,0 + WE / - WK
S7 quattro	309	02/12→03/15	⬅	05/14→; +PR 1LP		13.0460-4879.2 604879	BRE 25643 16,8 + WE / - WK
			⬅	+PR 1LL,1LF,1ZK		13.0460-7280.2 607280	ATE 25158 20,3 + WK
			➡	+PR 1KW; + eFSB		13.0460-2769.2 602769	TRW 24606 17,4 + WK + Zub
						13.0470-2769.2 LD2769	TRW 24606 17,4 + WK + Zub Ceramic
			➡	+PR 1KY,2EA,2EE,2EJ; + eFSB		13.0460-2770.2 602770	TRW 24606 17,4 + WK + Zub
						13.0470-2770.2 LD2770	TRW 24606 17,4 + WK + Zub Ceramic
3.0 TDI quattro	235	05/14→05/18	⬅	+PR 1LA,1LJ		13.0460-2765.2 602765	TRW 24409 19,2 + WK + Zub
3.0 TDI quattro	240	09/14→05/18	⬅	+PR 1LU		13.0460-4873.2 604873	BRE 24847 17,0 + WE / - WK
3.0 TFSI quattro	245	05/14→05/18	⬅	+PR 1LP		13.0460-4879.2 604879	BRE 25643 16,8 + WE / - WK
S7 quattro	331	07/14→05/18	⬅	+PR 1LL,1LF,1ZK		13.0460-7280.2 607280	ATE 25158 20,3 + WK
			➡	+PR 1KW; + eFSB		13.0460-2769.2 602769	TRW 24606 17,4 + WK + Zub
						13.0470-2769.2 LD2769	TRW 24606 17,4 + WK + Zub Ceramic
			➡	+PR 1KY,2EA,2EE,2EJ; + eFSB		13.0460-2770.2 602770	TRW 24606 17,4 + WK + Zub
						13.0470-2770.2 LD2770	TRW 24606 17,4 + WK + Zub Ceramic
3.0 TFSI quattro	220	10/10→05/12	⬅	+PR 1LA,1LJ		13.0460-2765.2 602765	TRW 24409 19,2 + WK + Zub
			⬅	+PR 1LU		13.0460-4873.2 604873	BRE 24847 17,0 + WE / - WK
			⬅	+PR 1LL,1LF,1ZK		13.0460-7280.2 607280	ATE 25158 20,3 + WK
						13.0470-7280.2 LD7280	ATE 25158 20,3 + WK Ceramic
			➡	+PR 1KW; + eFSB		13.0460-2769.2 602769	TRW 24606 17,4 + WK + Zub
						13.0470-2769.2 LD2769	TRW 24606 17,4 + WK + Zub Ceramic
			➡	+PR 1KY,2EA,2EE,2EJ; + eFSB		13.0460-2770.2 602770	TRW 24606 17,4 + WK + Zub
						13.0470-2770.2 LD2770	TRW 24606 17,4 + WK + Zub Ceramic
RS7 performance quattro	445	11/15→04/18	➡	+PR 1KJ; + eFSB		13.0460-2770.2 602770	TRW 24606 17,4 + WK + Zub
RS7 quattro	412	10/13→04/18				13.0470-2770.2 LD2770	TRW 24606 17,4 + WK + Zub Ceramic
<b>Warnkontakt, Bremsbelagverschleiß</b>							
1.8 TFSI	140	04/15→05/18	⬅	+PR 1LU	2	24.8190-0019.2 620019	L= 254
2.0 TFSI	185	09/14→05/18					
2.0 TFSI quattro	183	05/15→05/18	⬅	+PR 1LW	2	24.8190-0020.2 620020	L= 443,3
2.0 TFSI quattro	185	05/15→05/18	⬅	☐; +PR 1LP	1	24.8190-0068.2 620068	L= 332
2.8 FSI quattro	162	09/14→05/18	⬅	+PR 1LL,1LF,1ZK	2	24.8190-0301.2 620301	L= 311,6
3.0 TDI	140	11/15→05/18	⬅	+PR 1LA,1LJ	2	24.8190-0311.2 620311	L= 300
3.0 TDI	155	11/15→05/18	⬅	+PR 1LA,1LJ	2	24.8190-0311.2 620311	L= 300
3.0 TDI	160	07/14→05/18	⬅	+PR 1LA,1LJ	2	24.8190-0311.2 620311	L= 300
3.0 TDI quattro	140	11/15→05/18	➡	+PR 1KW	1	24.8190-0313.2 620313	L= 217
3.0 TDI quattro	155	07/14→05/18	➡	+PR 1KY,2EA,2EE,2EJ	1	24.8190-0313.2 620313	L= 217
3.0 TDI quattro	160	07/14→05/18					
3.0 TDI quattro	200	05/14→05/18					
2.8 FSI	150	02/11→03/15	⬅	05/11→; +PR 1LU	2	24.8190-0019.2 620019	L= 254
			⬅	05/11→; +PR 1LW	2	24.8190-0020.2 620020	L= 443,3
			⬅	☐; 05/14→; +PR 1LP	1	24.8190-0068.2 620068	L= 332
			⬅	05/11→; +PR 1LL,1LF,1ZK	2	24.8190-0301.2 620301	L= 311,6
			⬅	05/11→; +PR 1LA,1LJ	2	24.8190-0311.2 620311	L= 300
			➡	05/11→; +PR 1KW	1	24.8190-0313.2 620313	L= 217
			➡	05/11→; +PR 1KY,2EA,2EE,2EJ	1	24.8190-0313.2 620313	L= 217
2.8 FSI quattro	150	10/10→03/15	⬅	+PR 1LU	2	24.8190-0019.2 620019	L= 254
3.0 TDI	150	11/10→03/15					
3.0 TDI quattro	150	12/10→03/15	⬅	+PR 1LW	2	24.8190-0020.2 620020	L= 443,3
3.0 TDI quattro	176	05/13→06/17	⬅	☐; 05/14→; +PR 1LP	1	24.8190-0068.2 620068	L= 332
3.0 TDI quattro	180	10/10→06/16					

















	kw			 	! #		
<b>AUDI - A7 Sportback (4GA, 4GF) 10/10→05/18</b>							
<b>Warnkontakt, Bremsbelagverschleiß</b>							
3.0 TFSI quattro	228	01/11→03/15	←	+PR 1LL,1LF,1ZK	2	24.8190-0301.2 620301	L= 311,6
			←	+PR 1LA,1LJ	2	24.8190-0311.2 620311	L= 300
			→	+PR 1KW	1	24.8190-0313.2 620313	L= 217
			→	+PR 1KY,2EA,2EE,2EJ	1	24.8190-0313.2 620313	L= 217
3.0 TDI quattro S7 quattro	230 309	11/11→03/15 02/12→03/15	←	+PR 1LU	2	24.8190-0019.2 620019	L= 254
			←	+PR 1LW	2	24.8190-0020.2 620020	L= 443,3
			←	☐; 05/14→; +PR 1LP	1	24.8190-0068.2 620068	L= 332
			←	+PR 1LL,1LF	2	24.8190-0301.2 620301	L= 311,6
			←	+PR 1LA,1LJ	2	24.8190-0311.2 620311	L= 300
			→	+PR 1KW	1	24.8190-0313.2 620313	L= 217
			→	+PR 1KY,2EA,2EE,2EJ	1	24.8190-0313.2 620313	L= 217
3.0 TDI quattro 3.0 TDI quattro 3.0 TFSI quattro S7 quattro	235 240 245 331	05/14→05/18 09/14→05/18 05/14→05/18 07/14→05/18	←	+PR 1LU	2	24.8190-0019.2 620019	L= 254
			←	+PR 1LW	2	24.8190-0020.2 620020	L= 443,3
			←	☐; +PR 1LP	1	24.8190-0068.2 620068	L= 332
			←	+PR 1LL,1LF	2	24.8190-0301.2 620301	L= 311,6
			←	+PR 1LA,1LJ	2	24.8190-0311.2 620311	L= 300
			→	+PR 1KW	1	24.8190-0313.2 620313	L= 217
			→	+PR 1KY,2EA,2EE,2EJ	1	24.8190-0313.2 620313	L= 217
3.0 TFSI quattro	220	10/10→05/12	←	+PR 1LU	2	24.8190-0019.2 620019	L= 254
			←	+PR 1LW	2	24.8190-0020.2 620020	L= 443,3
			←	+PR 1LL,1LF,1ZK	2	24.8190-0301.2 620301	L= 311,6
			←	+PR 1LA,1LJ	2	24.8190-0311.2 620311	L= 300
			→	+PR 1KW	1	24.8190-0313.2 620313	L= 217
			→	+PR 1KY,2EA,2EE,2EJ	1	24.8190-0313.2 620313	L= 217
			RS7 performance quattro	445	11/15→04/18	→	+PR 1KJ
RS7 quattro	412	10/13→04/18					
<b>Bremsscheibe</b>							
1.8 TFSI	140	04/15→05/18	←	+PR 1LA		24.0130-0221.1 430221	Ø 320 30 28 V + S
2.0 TFSI	185	09/14→05/18					
2.0 TFSI quattro	183	05/15→05/18	←	+PR 1LJ,1LP		24.0130-0222.1 430222	Ø 345 30 28 V + S
2.0 TFSI quattro	185	05/15→05/18	←	+PR 1LL,1LF,1ZK		24.0134-0103.1 434103	Ø 356 34 31,5 V + S
2.8 FSI quattro	150	10/10→03/15					
2.8 FSI quattro	162	09/14→05/18	→	+PR 1KW		24.0112-0178.1 412178	Ø 300 12 10 + S
3.0 TDI	140	11/15→05/18				24.0312-0178.1 512178	Ø 300 12 10 + S
3.0 TDI	150	11/10→03/15					
3.0 TDI	155	11/15→05/18	→	+PR 2EA,2EE,2EJ; + eFSB		24.0122-0272.1 422272	Ø 330 21,9 20 V + S
3.0 TDI	160	07/14→05/18	→	+PR 1KY; + eFSB		24.0122-0273.1 422273	Ø 356 22 20 V + S
3.0 TDI quattro	140	11/15→05/18					
3.0 TDI quattro	150	12/10→03/15					
3.0 TDI quattro	155	07/14→05/18					
3.0 TDI quattro	160	07/14→05/18					
3.0 TDI quattro	176	05/13→06/17					
3.0 TDI quattro	180	10/10→06/16					
3.0 TDI quattro	200	05/14→05/18					
3.0 TDI quattro	230	11/11→03/15					
3.0 TDI quattro	235	05/14→05/18					
3.0 TDI quattro	240	09/14→05/18					
3.0 TFSI quattro	220	10/10→05/12					
3.0 TFSI quattro	228	01/11→03/15					
3.0 TFSI quattro	245	05/14→05/18					
S7 quattro	309	02/12→03/15					
S7 quattro	331	07/14→05/18					
2.8 FSI	150	02/11→03/15	←	05/11→; +PR 1LA		24.0130-0221.1 430221	Ø 320 30 28 V + S
			←	05/11→; +PR 1LJ,1LP		24.0130-0222.1 430222	Ø 345 30 28 V + S
			←	05/11→; +PR 1LL,1LF,1ZK		24.0134-0103.1 434103	Ø 356 34 31,5 V + S
			→	05/11→; +PR 1KW		24.0112-0178.1 412178	Ø 300 12 10 + S
			→	05/11→; +PR 1KY; + eFSB		24.0312-0178.1 512178	Ø 300 12 10 + S
			→	05/11→; +PR 2EA,2EE,2EJ; + eFSB		24.0122-0272.1 422272	Ø 330 21,9 20 V + S
→	05/11→; +PR 1KY; + eFSB		24.0122-0273.1 422273	Ø 356 22 20 V + S			











	kw			 	! #		
<b>AUDI - A7 Sportback (4KA) 10/17→</b>							
 <b>Bremsbelagsatz, Scheibenbremse</b>							
50 TDI Mild Hybrid quattro	210	10/17→	←	+PR 1LA		13.0460-2765.2 602765	TRW 24409 19,2 + WK + Zub
						13.0470-2765.2 LD2765	TRW 24409 19,2 + WK + Zub Ceramic
			←	+PR 1LP		13.0460-4879.2 604879	BRE 25643 16,8 + WE / - WK
						13.0470-4879.2 LD4879	BRE 25643 17,0 + WE / - WK Ceramic
			←	+PR 1LL,1ZK		13.0460-7280.2 607280	ATE 25158 20,3 + WK
						13.0470-7280.2 LD7280	ATE 25158 20,3 + WK Ceramic
55 TFSI Mild Hybrid quattro	250	10/17→	→	+PR 1KW		13.0460-2769.2 602769	TRW 24606 17,4 + WK + Zub
						13.0470-2769.2 LD2769	TRW 24606 17,4 + WK + Zub Ceramic
			→	+PR 1KD,2EA,2EE,2EJ		13.0460-2770.2 602770	TRW 24606 17,4 + WK + Zub
						13.0470-2770.2 LD2770	TRW 24606 17,4 + WK + Zub Ceramic
			→	+PR 1KD,2EA,2EE,2EJ		13.0460-2770.2 602770	TRW 24606 17,4 + WK + Zub
						13.0470-2770.2 LD2770	TRW 24606 17,4 + WK + Zub Ceramic
<b>Warnkontakt, Bremsbelagverschleiß</b>							
50 TDI Mild Hybrid quattro	210	10/17→	←	+PR 1LW	2	24.8190-0020.2 620020	L= 443,3
55 TFSI Mild Hybrid quattro	250	10/17→	←	+PR 1LA	1	24.8190-0311.2 620311	L= 300
			→	+PR 1KD,1KW,2EA,2EE / 1KY,1KZ	1	24.8190-0313.2 620313	L= 217
			→	+PR 1KU	2	24.8190-0967.2 620967	L= 313
 <b>Bremsscheibe</b>							
50 TDI Mild Hybrid quattro	210	10/17→	←	+PR 1LP		24.0130-0222.1 430222	Ø 345 30 28 V + S
55 TFSI Mild Hybrid quattro	250	10/17→	←	+PR 1LL,1LF,1LG,1ZK		24.0134-0103.1 434103	Ø 356 34 31,5 V + S
			→	+PR 1KW		24.0112-0178.1 412178	Ø 300 12 10 + S
						24.0312-0178.1 512178	Ø 300 12 10 + S
<b>AUDI - A8 (4D2, 4D8) 03/94→12/05</b>							
 <b>Bremsbelagsatz, Scheibenbremse</b>							
2.5 TDI	110	01/97→04/00	←	06/97→ 09/98		13.0460-2700.2 602700	TRW 21452 18,5 + WK
			←	10/98→		13.0460-2876.2 602876	TRW 23119 17,5 + WK
			→	10/98→		13.0460-2787.2 602787	TRW 23554 17,3 - WK / - WE
						13.0460-2820.2 602820	TRW 20961 17,2 - WK
						13.0470-2820.2 LD2820	TRW 20961 17,2 - WK Ceramic
			→	06/97→ 09/98		13.0460-3602.2 603602	TRW 21144 15,8 - WK
2.5 TDI 3.7	132 191	09/00→09/02 11/98→09/02	←			13.0460-2876.2 602876	TRW 23119 17,5 + WK
			→			13.0460-2787.2 602787	TRW 23554 17,3 - WK / - WE
						13.0460-2820.2 602820	TRW 20961 17,2 - WK
						13.0470-2820.2 LD2820	TRW 20961 17,2 - WK Ceramic
2.5 TDI quattro 4.2 quattro	110 224	07/97→04/00 09/96→12/99	←	→ 09/98; nicht für Sonderfahrzeuge		13.0460-2700.2 602700	TRW 21452 18,5 + WK
			←	10/98→		13.0460-2876.2 602876	TRW 23119 17,5 + WK
			→	10/98→; nicht für Sonderfahrzeuge		13.0460-2787.2 602787	TRW 23554 17,3 - WK / - WE
						13.0460-2820.2 602820	TRW 20961 17,2 - WK
						13.0470-2820.2 LD2820	TRW 20961 17,2 - WK Ceramic
			→	→ 09/98		13.0460-3602.2 603602	TRW 21144 15,8 - WK
2.5 TDI quattro 3.3 TDI quattro 3.7 quattro 4.2 quattro 4.2 quattro	132 165 191 175 228	09/00→09/02 06/00→09/02 11/98→09/02 02/99→04/00 11/98→09/02	←			13.0460-2876.2 602876	TRW 23119 17,5 + WK
			→	nicht für Sonderfahrzeuge		13.0460-2787.2 602787	TRW 23554 17,3 - WK / - WE
						13.0460-2820.2 602820	TRW 20961 17,2 - WK
						13.0470-2820.2 LD2820	TRW 20961 17,2 - WK Ceramic
2.8	120	07/95→03/96	←			13.0460-2700.2 602700	TRW 21452 18,5 + WK
			→			13.0460-3602.2 603602	TRW 21144 15,8 - WK
↓							









	kw			 	! #		
<b>AUDI - A8 (4D2, 4D8) 03/94→12/05</b>							
<b> Bremsbelagsatz, Scheibenbremse</b>							
2.8	128	03/94→03/96	← 06/94→ → 06/94→			13.0460-2700.2 602700	TRW 21452 18,5 + WK
						13.0460-3602.2 603602	TRW 21144 15,8 - WK
2.8	142	04/96→09/02	← → 09/98 ← 10/98→ → 10/98→; nicht für Sonderfahrzeuge → 09/98			13.0460-2700.2 602700 13.0460-2876.2 602876 13.0460-2787.2 602787 13.0460-2820.2 602820 13.0470-2820.2 LD2820 13.0460-3602.2 603602	TRW 21452 18,5 + WK TRW 23119 17,5 + WK TRW 23554 17,3 - WK / - WE TRW 20961 17,2 - WK TRW 20961 17,2 - WK Ceramic TRW 21144 15,8 - WK
2.8 quattro	120	07/95→03/96	← nicht für Sonderfahrzeuge →			13.0460-2700.2 602700 13.0460-3602.2 603602	TRW 21452 18,5 + WK TRW 21144 15,8 - WK
2.8 quattro 4.2 quattro	128 180	03/94→03/96 03/94→07/96	← 06/94→; nicht für Sonderfahrzeuge → 06/94→			13.0460-2700.2 602700 13.0460-3602.2 603602	TRW 21452 18,5 + WK TRW 21144 15,8 - WK
2.8 quattro	142	04/96→09/02	← → 09/98; nicht für Sonderfahrzeuge ← 10/98→ → 10/98→ → 09/98			13.0460-2700.2 602700 13.0460-2876.2 602876 13.0460-2787.2 602787 13.0460-2820.2 602820 13.0470-2820.2 LD2820 13.0460-3602.2 603602	TRW 21452 18,5 + WK TRW 23119 17,5 + WK TRW 23554 17,3 - WK / - WE TRW 20961 17,2 - WK TRW 20961 17,2 - WK Ceramic TRW 21144 15,8 - WK
3.7	169	07/95→12/98	← → 09/98 ← 10/98→ → 10/98→ → 09/98			13.0460-2700.2 602700 13.0460-2876.2 602876 13.0460-2787.2 602787 13.0460-2820.2 602820 13.0470-2820.2 LD2820 13.0460-3602.2 603602	TRW 21452 18,5 + WK TRW 23119 17,5 + WK TRW 23554 17,3 - WK / - WE TRW 20961 17,2 - WK TRW 20961 17,2 - WK Ceramic TRW 21144 15,8 - WK
3.7 quattro	169	07/95→11/98	← 10/95→ 09/98; nicht für Sonderfahrzeuge ← 10/98→ → 10/98→; nicht für Sonderfahrzeuge → 10/95→ 09/98			13.0460-2700.2 602700 13.0460-2876.2 602876 13.0460-2787.2 602787 13.0460-2820.2 602820 13.0470-2820.2 LD2820 13.0460-3602.2 603602	TRW 21452 18,5 + WK TRW 23119 17,5 + WK TRW 23554 17,3 - WK / - WE TRW 20961 17,2 - WK TRW 20961 17,2 - WK Ceramic TRW 21144 15,8 - WK
4.2 quattro	220	03/94→11/98	← 06/94→ 09/98; nicht für Sonderfahrzeuge ← 10/98→ → 10/98→; nicht für Sonderfahrzeuge → 06/94→ 09/98			13.0460-2700.2 602700 13.0460-2876.2 602876 13.0460-2787.2 602787 13.0460-2820.2 602820 13.0470-2820.2 LD2820 13.0460-3602.2 603602	TRW 21452 18,5 + WK TRW 23119 17,5 + WK TRW 23554 17,3 - WK / - WE TRW 20961 17,2 - WK TRW 20961 17,2 - WK Ceramic TRW 21144 15,8 - WK
6.0 W12 quattro	309	01/01→09/02	← → nicht für Sonderfahrzeuge			13.0460-7183.2 607183 13.0460-2787.2 602787 13.0460-2820.2 602820 13.0470-2820.2 LD2820	ATE 21484 20,5 + WE / - WK TRW 23554 17,3 - WK / - WE TRW 20961 17,2 - WK TRW 20961 17,2 - WK Ceramic
S8 quattro	250	07/96→06/99	← → 04/99; nicht für Sonderfahrzeuge ← 05/99→; nicht für Sonderfahrzeuge → 10/98→; nicht für Sonderfahrzeuge → 09/98			13.0460-2717.2 602717 13.0460-4802.2 604802 13.0460-2787.2 602787 13.0460-2820.2 602820 13.0470-2820.2 LD2820 13.0460-3602.2 603602	TRW 21452 18,5 + WK BRE 23773 17,5 + WK TRW 23554 17,3 - WK / - WE TRW 20961 17,2 - WK TRW 20961 17,2 - WK Ceramic TRW 21144 15,8 - WK
S 8 quattro	265	06/99→09/02	← nicht für Sonderfahrzeuge → nicht für Sonderfahrzeuge			13.0460-4802.2 604802 13.0460-2787.2 602787 13.0460-2820.2 602820 13.0470-2820.2 LD2820	BRE 23773 17,5 + WK TRW 23554 17,3 - WK / - WE TRW 20961 17,2 - WK TRW 20961 17,2 - WK Ceramic
<b>Zubehörsatz, Scheibenbremsbelag</b>							
2.5 TDI 2.8 quattro 3.7	110 142 169	01/97→04/00 04/96→09/02 07/95→12/98	→ 10/98→			13.0460-0072.2 610072	TRW
2.5 TDI 3.7	132 191	09/00→09/02 11/98→09/02	→			13.0460-0072.2 610072	TRW
2.5 TDI quattro 2.8 ↓	110 142	07/97→04/00 04/96→09/02	→ 10/98→; nicht für Sonderfahrzeuge			13.0460-0072.2 610072	TRW

	kW			 	! #		
<b>AUDI - A8 (4D2, 4D8) 03/94→12/05</b>							
<b>Zubehörsatz, Scheibenbremsbelag</b>							
3.7 quattro 4.2 quattro 4.2 quattro S8 quattro	169 220 224 250	07/95→11/98 03/94→11/98 09/96→12/99 07/96→06/99	➡	10/98→; nicht für Sonderfahrzeuge		13.0460-0072.2 610072	TRW
2.5 TDI quattro 3.3 TDI quattro 3.7 quattro 4.2 quattro 4.2 quattro 6.0 W12 quattro S 8 quattro	132 165 191 175 228 309 265	09/00→09/02 06/00→09/02 11/98→09/02 02/99→04/00 11/98→09/02 01/01→09/02 06/99→09/02	➡	nicht für Sonderfahrzeuge		13.0460-0072.2 610072	TRW
<b> Bremsscheibe</b>							
2.5 TDI	110	01/97→04/00	←	06/97→ 09/98		24.0130-0104.1 430104	Ø 314 30 28 V
			←	10/98→		24.0130-0183.1 430183	Ø 323 30 28 V
			➡	06/97→ 09/98		24.0110-0116.1 410116	Ø 245 10 8
			➡	10/98→		24.0122-0198.1 422198	Ø 269 21,9 20 V
2.5 TDI	132	09/00→09/02	←			24.0130-0183.1 430183	Ø 323 30 28 V
			➡			24.0122-0198.1 422198	Ø 269 21,9 20 V
2.5 TDI quattro	110	07/97→04/00	←	→ 09/98		24.0130-0104.1 430104	Ø 314 30 28 V
			←	10/98→		24.0130-0183.1 430183	Ø 323 30 28 V
			➡	→ 09/98; nicht für Sonderfahrzeuge		24.0110-0116.1 410116	Ø 245 10 8
			➡	10/98→; nicht für Sonderfahrzeuge		24.0122-0198.1 422198	Ø 269 21,9 20 V
2.5 TDI quattro 3.3 TDI quattro 3.7 quattro 4.2 quattro 4.2 quattro	132 165 191 175 228	09/00→09/02 06/00→09/02 11/98→09/02 02/99→04/00 11/98→09/02	←			24.0130-0183.1 430183	Ø 323 30 28 V
			➡	nicht für Sonderfahrzeuge		24.0122-0198.1 422198	Ø 269 21,9 20 V
2.8	120	07/95→03/96	←			24.0130-0104.1 430104	Ø 314 30 28 V
			➡			24.0110-0116.1 410116	Ø 245 10 8
2.8	128	03/94→03/96	←	06/94→		24.0130-0104.1 430104	Ø 314 30 28 V
			➡	06/94→		24.0110-0116.1 410116	Ø 245 10 8
2.8 3.7	142 169	04/96→09/02 07/95→12/98	←	→ 09/98		24.0130-0104.1 430104	Ø 314 30 28 V
			←	10/98→		24.0130-0183.1 430183	Ø 323 30 28 V
			➡	10/98→		24.0120-0137.1 420137	Ø 269 19,9 18 V
						24.0122-0198.1 422198	Ø 269 21,9 20 V
2.8 quattro	120	07/95→03/96	←			24.0130-0104.1 430104	Ø 314 30 28 V
			➡	nicht für Sonderfahrzeuge		24.0110-0116.1 410116	Ø 245 10 8
2.8 quattro	128	03/94→03/96	←	06/94→		24.0130-0104.1 430104	Ø 314 30 28 V
			➡	06/94→; nicht für Sonderfahrzeuge		24.0110-0116.1 410116	Ø 245 10 8
2.8 quattro 4.2 quattro	142 224	04/96→09/02 09/96→12/99	←	→ 09/98		24.0130-0104.1 430104	Ø 314 30 28 V
			←	10/98→		24.0130-0183.1 430183	Ø 323 30 28 V
			➡	→ 09/98; nicht für Sonderfahrzeuge		24.0120-0137.1 420137	Ø 269 19,9 18 V
			➡	10/98→; nicht für Sonderfahrzeuge		24.0122-0198.1 422198	Ø 269 21,9 20 V
3.7	191	11/98→09/02	←			24.0130-0183.1 430183	Ø 323 30 28 V
			➡			24.0120-0137.1 420137	Ø 269 19,9 18 V
						24.0122-0198.1 422198	Ø 269 21,9 20 V
3.7 quattro	169	07/95→11/98	←	10/95→ 09/98		24.0130-0104.1 430104	Ø 314 30 28 V
			←	10/98→		24.0130-0183.1 430183	Ø 323 30 28 V
			➡	10/95→ 09/98; nicht für Sonderfahrzeuge		24.0120-0137.1 420137	Ø 269 19,9 18 V
			➡	10/98→; nicht für Sonderfahrzeuge		24.0122-0198.1 422198	Ø 269 21,9 20 V
4.2 quattro	180	03/94→07/96	←	06/94→		24.0130-0104.1 430104	Ø 314 30 28 V
			➡	06/94→; nicht für Sonderfahrzeuge		24.0120-0137.1 420137	Ø 269 19,9 18 V
4.2 quattro	220	03/94→11/98	←	06/94→ 09/98		24.0130-0104.1 430104	Ø 314 30 28 V
			←	10/98→		24.0130-0183.1 430183	Ø 323 30 28 V
			➡	06/94→ 09/98; nicht für Sonderfahrzeuge		24.0120-0137.1 420137	Ø 269 19,9 18 V
			➡	10/98→; nicht für Sonderfahrzeuge		24.0122-0198.1 422198	Ø 269 21,9 20 V
6.0 W12 quattro	309	01/01→09/02	➡	nicht für Sonderfahrzeuge		24.0122-0152.1 422152	Ø 280 22 20 V + S
S8 quattro ↓	250	07/96→06/99	←	05/99→		24.0130-0177.1 430177	Ø 345 30 28 V







	kW			 	! #		
<b>AUDI - A8 (4D2, 4D8) 03/94→12/05</b>							
<b>Bremsscheibe</b>							
S8 quattro	250	07/96→06/99	←	→ 04/99		24.0130-0183.1 430183	∅ 323 30 28 V
			→	→ 09/98; nicht für Sonderfahrzeuge		24.0120-0137.1 420137	∅ 269 19,9 18 V
			→	10/98→		24.0122-0152.1 422152	∅ 280 22 20 V + S
S 8 quattro	265	06/99→09/02	←			24.0130-0177.1 430177	∅ 345 30 28 V
			→			24.0122-0152.1 422152	∅ 280 22 20 V + S
<b>AUDI - A8 (4E2, 4E8) 10/02→12/10</b>							
<b>Bremsbelagsatz, Scheibenbremse</b>							
2.8 FSI	154	08/07→07/10	←	→ 10/09; +PR 1LJ;1LL;1LM		13.0460-7182.2 607182	ATE 23896 20,6 + WK
3.0 TDI quattro	155	11/03→07/10	←	→ 10/09; +PR 1LG		13.0460-7201.2 607201	ATE 23763 20,3 + WK
3.2 FSI	191	06/05→07/10	←	→ 10/09; +PR 1LG		13.0470-7201.2 LD7201	ATE 23763 20,3 + WK Ceramic
3.2 FSI quattro	191	06/05→07/10	→	→ 10/09; +PR 1KE;1KW;1KY;1KZ; + eFSB		13.0460-2889.2 602889	TRW 23326 17,4 + WE / - WK
3.0	160	07/03→05/06	←	+PR 1LJ;1LL;1LM		13.0460-7182.2 607182	ATE 23896 20,6 + WK
3.0	162	07/03→05/05	←	+PR 1LG		13.0460-7201.2 607201	ATE 23763 20,3 + WK
			→	+PR 1KE;1KW;1KY;1KZ; + eFSB		13.0460-2889.2 602889	TRW 23326 17,4 + WE / - WK
3.0 quattro	160	11/03→05/04	←	+PR 1LJ,1LL,1LM		13.0460-7182.2 607182	ATE 23896 20,6 + WK
			←	+PR 1LG		13.0460-7201.2 607201	ATE 23763 20,3 + WK
			→	+PR 1KE,1KW,1KY,1KZ; + eFSB		13.0470-7201.2 LD7201	ATE 23763 20,3 + WK Ceramic
			→	+PR 1KE,1KW,1KY,1KZ; + eFSB		13.0460-2889.2 602889	TRW 23326 17,4 + WE / - WK
3.0 TDI quattro	171	08/03→07/10	←	11/03→ 10/09; +PR 1LJ;1LL;1LM		13.0460-7182.2 607182	ATE 23896 20,6 + WK
			←	11/03→ 10/09; +PR 1LG		13.0460-7201.2 607201	ATE 23763 20,3 + WK
			→	11/03→ 10/09; +PR 1KE;1KW;1KY;1KZ; + eFSB		13.0470-7201.2 LD7201	ATE 23763 20,3 + WK Ceramic
			→	11/03→ 10/09; +PR 1KE;1KW;1KY;1KZ; + eFSB		13.0460-2889.2 602889	TRW 23326 17,4 + WE / - WK
3.7 quattro	206	10/02→05/06	←	11/02→; +PR 1LJ;1LL;1LM		13.0460-7182.2 607182	ATE 23896 20,6 + WK
			←	11/02→; +PR 1LG		13.0460-7201.2 607201	ATE 23763 20,3 + WK
			→	11/02→; +PR 1KE;1KW;1KY;1KZ; + eFSB		13.0470-7201.2 LD7201	ATE 23763 20,3 + WK Ceramic
			→	11/02→; +PR 1KE;1KW;1KY;1KZ; + eFSB		13.0460-2889.2 602889	TRW 23326 17,4 + WE / - WK
4.0 TDI quattro	202	05/03→07/05	←	+PR 1LJ;1LL;1LM		13.0460-7182.2 607182	ATE 23896 20,6 + WK
			←	+PR 1LG		13.0460-7201.2 607201	ATE 23763 20,3 + WK
			→	+PR 1KE;1KW;1KY;1KZ; + eFSB		13.0460-2889.2 602889	TRW 23326 17,4 + WE / - WK
4.2 FSI quattro	257	06/06→07/10	←	→ 10/09; +PR 1LJ;1LL;1LM		13.0460-7182.2 607182	ATE 23896 20,6 + WK
4.2 TDI quattro	240	07/05→07/10	←	→ 10/09; +PR 1LG		13.0460-7201.2 607201	ATE 23763 20,3 + WK
			→	→ 10/09; +PR 1KE;1KW;1KY;1KZ; + eFSB		13.0460-2889.2 602889	TRW 23326 17,4 + WE / - WK
4.2 quattro	246	10/02→07/10	←	11/02→ 10/09; +PR 1LJ;1LL;1LM		13.0460-7182.2 607182	ATE 23896 20,6 + WK
			←	11/02→ 10/09; +PR 1LG		13.0460-7201.2 607201	ATE 23763 20,3 + WK
			→	11/02→ 10/09; +PR 1KE;1KW;1KY;1KZ; + eFSB		13.0460-2889.2 602889	TRW 23326 17,4 + WE / - WK
6.0 W12 quattro	331	12/03→07/10	←	02/04→ 10/09; +PR 1LJ;1LL;1LM		13.0460-7182.2 607182	ATE 23896 20,6 + WK
			←	02/04→ 10/09; +PR 1LG		13.0460-7201.2 607201	ATE 23763 20,3 + WK
			→	02/04→ 10/09; +PR 1KE;1KW;1KY;1KZ; + eFSB		13.0460-2889.2 602889	TRW 23326 17,4 + WE / - WK
S8 quattro	324	09/06→07/10	←	→ 10/09		13.0460-7182.2 607182	ATE 23896 20,6 + WK
S8 quattro	331	06/06→07/10	→	→ 10/09; +PR 1KE;1KW;1KY;1KZ; + eFSB		13.0460-2889.2 602889	TRW 23326 17,4 + WE / - WK
<b>Zubehörsatz, Scheibenbremsbelag</b>							
2.8 FSI	154	08/07→07/10	→	→ 10/09; +PR 1KE;1KW;1KY;1KZ; + eFSB		13.0460-0023.2 610023	
3.0 TDI quattro	155	11/03→07/10	→	→ 10/09; +PR 1KE;1KW;1KY;1KZ; + eFSB		13.0460-0023.2 610023	
3.2 FSI	191	06/05→07/10	→	→ 10/09; +PR 1KE;1KW;1KY;1KZ; + eFSB		13.0460-0023.2 610023	
3.2 FSI quattro	191	06/05→07/10	→	→ 10/09; +PR 1KE;1KW;1KY;1KZ; + eFSB		13.0460-0023.2 610023	
4.2 FSI quattro	257	06/06→07/10	→	→ 10/09; +PR 1KE;1KW;1KY;1KZ; + eFSB		13.0460-0023.2 610023	
4.2 TDI quattro	240	07/05→07/10	→	→ 10/09; +PR 1KE;1KW;1KY;1KZ; + eFSB		13.0460-0023.2 610023	
S8 quattro	324	09/06→07/10	→	→ 10/09; +PR 1KE;1KW;1KY;1KZ; + eFSB		13.0460-0023.2 610023	
S8 quattro	331	06/06→07/10	→	→ 10/09; +PR 1KE;1KW;1KY;1KZ; + eFSB		13.0460-0023.2 610023	
3.0	160	07/03→05/06	→	+PR 1KE;1KW;1KY;1KZ; + eFSB		13.0460-0023.2 610023	
3.0	162	07/03→05/05	→	+PR 1KE;1KW;1KY;1KZ; + eFSB		13.0460-0023.2 610023	
4.0 TDI quattro	202	05/03→07/05	→	+PR 1KE;1KW;1KY;1KZ; + eFSB		13.0460-0023.2 610023	
4.0 quattro	160	11/03→05/04	→	+PR 1KE,1KW,1KY,1KZ; + eFSB		13.0460-0023.2 610023	
↓							













	kw			 	! #		
<b>AUDI - A8 (4E2, 4E8) 10/02→12/10</b>							
<b>Zubehörsatz, Scheibenbremsbelag</b>							
3.0 TDI quattro	171	08/03→07/10	➡	11/03→ 10/09; +PR 1KE;1KW;1KY;1KZ; + eFSB		13.0460-0023.2 610023	
3.7 quattro	206	10/02→05/06	➡	11/02→; +PR 1KE;1KW;1KY;1KZ; + eFSB		13.0460-0023.2 610023	
4.2 quattro	246	10/02→07/10	➡	11/02→ 10/09; +PR 1KE;1KW;1KY;1KZ; + eFSB		13.0460-0023.2 610023	
6.0 W12 quattro	331	12/03→07/10	➡	02/04→ 10/09; +PR 1KE;1KW;1KY;1KZ; + eFSB		13.0460-0023.2 610023	
<b> Bremsscheibe</b>							
2.8 FSI	154	08/07→07/10	←	→ 10/09; +PR 1LG		24.0130-0175.1 430175	Ø 321 30 28 V + S
						24.0330-0175.1 530175	Ø 321 30 28 V + S
			←	→ 10/09; +PR 1LL;1LM		24.0134-0100.1 434100	Ø 360 34 31 V
			←	→ 10/09; +PR 1LJ		24.0136-0103.1 436103	Ø 385 36 33,5 V
			➡	→ 10/09; +PR 1KE; + eFSB		24.0122-0202.1 422202	Ø 280 22 20 V
			➡	→ 10/09; +PR 1KW; + eFSB		24.0122-0212.1 422212	Ø 310 22 20 V
3.0 3.0 4.0 TDI quattro	160 162 202	07/03→05/06 07/03→05/05 05/03→07/05	←	4E-5-003251→; +PR 1LG		24.0130-0175.1 430175	Ø 321 30 28 V + S
						24.0330-0175.1 530175	Ø 321 30 28 V + S
			←	+PR 1LG; → 4E-5-003250		24.0130-0183.1 430183	Ø 323 30 28 V
			←	+PR 1LL;1LM		24.0134-0100.1 434100	Ø 360 34 31 V
			←	+PR 1LJ		24.0136-0103.1 436103	Ø 385 36 33,5 V
			➡	+PR 1KE; + eFSB		24.0122-0202.1 422202	Ø 280 22 20 V
3.0 quattro	160	11/03→05/04	←	4E-5-003251→; +PR 1LG		24.0130-0175.1 430175	Ø 321 30 28 V + S
						24.0330-0175.1 530175	Ø 321 30 28 V + S
			←	+PR 1LG; → 4E-5-003250		24.0130-0183.1 430183	Ø 323 30 28 V
			←	+PR 1LL,1LM		24.0134-0100.1 434100	Ø 360 34 31 V
			←	+PR 1LJ		24.0136-0103.1 436103	Ø 385 36 33,5 V
			➡	+PR 1KE; + eFSB		24.0122-0202.1 422202	Ø 280 22 20 V
3.0 TDI quattro 3.2 FSI 3.2 FSI quattro 4.2 FSI quattro 4.2 TDI quattro	155 191 191 257 240	11/03→07/10 06/05→07/10 06/05→07/10 06/06→07/10 07/05→07/10	←	4E-5-003251→; → 10/09; +PR 1LG		24.0130-0175.1 430175	Ø 321 30 28 V + S
						24.0330-0175.1 530175	Ø 321 30 28 V + S
			←	+PR 1LG; → 4E-5-003250		24.0130-0183.1 430183	Ø 323 30 28 V
			←	→ 10/09; +PR 1LL;1LM		24.0134-0100.1 434100	Ø 360 34 31 V
			←	→ 10/09; +PR 1LJ		24.0136-0103.1 436103	Ø 385 36 33,5 V
			➡	→ 10/09; +PR 1KE; + eFSB		24.0122-0202.1 422202	Ø 280 22 20 V
3.0 TDI quattro	171	08/03→07/10	←	4E-5-003251→; → 10/09; +PR 1LG		24.0130-0175.1 430175	Ø 321 30 28 V + S
						24.0330-0175.1 530175	Ø 321 30 28 V + S
			←	11/03→; +PR 1LG; → 4E-5-003250		24.0130-0183.1 430183	Ø 323 30 28 V
			←	11/03→ 10/09; +PR 1LL;1LM		24.0134-0100.1 434100	Ø 360 34 31 V
			←	11/03→ 10/09; +PR 1LJ		24.0136-0103.1 436103	Ø 385 36 33,5 V
			➡	11/03→; +PR 1KE; → 10/09; + eFSB		24.0122-0202.1 422202	Ø 280 22 20 V
3.7 quattro	206	10/02→05/06	←	4E-5-003251→; +PR 1LG		24.0130-0175.1 430175	Ø 321 30 28 V + S
						24.0330-0175.1 530175	Ø 321 30 28 V + S
			←	11/02→; +PR 1LG; → 4E-5-003250		24.0130-0183.1 430183	Ø 323 30 28 V
			←	11/02→; +PR 1LL;1LM		24.0134-0100.1 434100	Ø 360 34 31 V
			←	11/02→; +PR 1LJ		24.0136-0103.1 436103	Ø 385 36 33,5 V
			➡	11/02→; +PR 1KE; + eFSB		24.0122-0202.1 422202	Ø 280 22 20 V
			24.0122-0212.1 422212	Ø 310 22 20 V			
			24.0122-0214.1 422214	Ø 335 22 20 V			













	kw			 	! #		
<b>AUDI - A8 (4E2, 4E8) 10/02→12/10</b>							
<b> Bremsscheibe</b>							
4.2 quattro	246	10/02→07/10	←	4E-5-003251→; → 10/09; +PR 1LG	24.0130-0175.1	430175	Ø 321 30 28 V + S
			←	11/02→; +PR 1LG; → 4E-5-003250	24.0330-0175.1	530175	Ø 321 30 28 V + S
			←	11/02→ 10/09; +PR 1LL;1LM	24.0130-0183.1	430183	Ø 323 30 28 V
			←	11/02→ 10/09; +PR 1LJ	24.0134-0100.1	434100	Ø 360 34 31 V
			→	11/02→; +PR 1KE; → 10/09; + eFSB	24.0136-0103.1	436103	Ø 385 36 33,5 V
			→	11/02→; +PR 1KW; → 10/09; + eFSB	24.0122-0202.1	422202	Ø 280 22 20 V
			→	11/02→; +PR 1KY;1KZ; → 10/09; + eFSB	24.0122-0212.1	422212	Ø 310 22 20 V
4.2 TDI quattro	235	01/05→06/05	←	4E-5-003251→; +PR 1LG	24.0122-0214.1	422214	Ø 335 22 20 V
			←	4E-5-003251→; → 10/09; +PR 1LG	24.0130-0175.1	430175	Ø 321 30 28 V + S
			←	02/04→; +PR 1LG; → 4E-5-003250	24.0330-0175.1	530175	Ø 321 30 28 V + S
			←	02/04→ 10/09; +PR 1LL;1LM	24.0130-0183.1	430183	Ø 323 30 28 V
			←	02/04→ 10/09; +PR 1LJ	24.0134-0100.1	434100	Ø 360 34 31 V
			→	02/04→; +PR 1KE; → 10/09; + eFSB	24.0136-0103.1	436103	Ø 385 36 33,5 V
			→	02/04→; +PR 1KW; → 10/09; + eFSB	24.0122-0202.1	422202	Ø 280 22 20 V
6.0 W12 quattro	331	12/03→07/10	←	02/04→; +PR 1KY;1KZ; → 10/09; + eFSB	24.0122-0212.1	422212	Ø 310 22 20 V
			←	4E-5-003251→; → 10/09; +PR 1LG	24.0122-0214.1	422214	Ø 335 22 20 V
			←	02/04→; +PR 1LG; → 4E-5-003250	24.0130-0175.1	430175	Ø 321 30 28 V + S
			←	02/04→ 10/09; +PR 1LL;1LM	24.0330-0175.1	530175	Ø 321 30 28 V + S
			←	02/04→ 10/09; +PR 1LJ	24.0130-0183.1	430183	Ø 323 30 28 V
			→	02/04→; +PR 1KE; → 10/09; + eFSB	24.0134-0100.1	434100	Ø 360 34 31 V
			→	02/04→; +PR 1KW; → 10/09; + eFSB	24.0136-0103.1	436103	Ø 385 36 33,5 V
S8 quattro S8 quattro	324 331	09/06→07/10 06/06→07/10	←	→ 10/09	24.0122-0212.1	422212	Ø 310 22 20 V
			→	→ 10/09; +PR 1KE; + eFSB	24.0136-0103.1	436103	Ø 385 36 33,5 V
			→	→ 10/09; +PR 1KW; + eFSB	24.0122-0202.1	422202	Ø 280 22 20 V
			→	→ 10/09; +PR 1KY;1KZ; + eFSB	24.0122-0214.1	422214	Ø 335 22 20 V
<b>AUDI - A8 (4H2, 4H8, 4HC, 4HL) 11/09→</b>							
<b> Bremsbelagsatz, Scheibenbremse</b>							
2.0 TFSI hybrid	155	02/12→	←	05/12→; +PR 1LX,1LN	13.0460-4873.2	604873	BRE 24847 17,0 + WE / - WK
			←	05/12→; +PR 1LL	13.0460-7280.2	607280	ATE 25158 20,3 + WK
			←	05/12→; +PR 1LJ	13.0470-7280.2	LD7280	ATE 25158 20,3 + WK Ceramic
			→	05/12→; +PR 1KW,1KY,1KZ; + eFSB	13.0460-7281.2	607281	ATE 25160 20,3 + WK
			→	05/12→; +PR 1KW,1KY,1KZ; + eFSB	13.0470-7281.2	LD7281	ATE 25160 20,3 + WK Ceramic
2.0 TFSI quattro	185	09/16→	←	+PR 1LX,1LN	13.0460-4873.2	604873	BRE 24847 17,0 + WE / - WK
			←	+PR 1LL	13.0460-7280.2	607280	ATE 25158 20,3 + WK
			←	+PR 1LJ	13.0470-7280.2	LD7280	ATE 25158 20,3 + WK Ceramic
			→	+PR 1KE,1KW,1KY,1KZ; + eFSB	13.0460-7281.2	607281	ATE 25160 20,3 + WK
			→	+PR 1KE,1KW,1KY,1KZ; + eFSB	13.0470-7281.2	LD7281	ATE 25160 20,3 + WK Ceramic
2.5 TFSI 3.0 TDI 3.0 TDI quattro 3.0 TDI quattro 3.0 TDI quattro 3.0 TDI quattro 3.0 TDI quattro	150 150 155 176 184 190 193	07/12→ 09/11→ 08/10→ 11/12→ 07/10→ 10/13→ 05/15→	←	+PR 1KE,1KW,1KY,1KZ; + eFSB	13.0460-2773.2	602773	TRW 24606 17,4 + WK + Zub
			←	+PR 1LX,1LN	13.0470-2773.2	LD2773	TRW 24606 17,4 + WK + Zub Ceramic
			←	+PR 1LX,1LN	13.0460-4873.2	604873	BRE 24847 17,0 + WE / - WK
			←	+PR 1LL	13.0460-7280.2	607280	ATE 25158 20,3 + WK
			←	+PR 1LJ	13.0470-7280.2	LD7280	ATE 25158 20,3 + WK Ceramic
			→	+PR 1KW,1KY,1KZ; + eFSB	13.0460-7281.2	607281	ATE 25160 20,3 + WK
3.0 TFSI quattro	213	07/10→	←	+PR 1KW,1KY,1KZ; + eFSB	13.0470-7281.2	LD7281	ATE 25160 20,3 + WK Ceramic
			←	+PR 1LX,1LN	13.0460-4873.2	604873	BRE 24847 17,0 + WE / - WK
			←	+PR 1LL	13.0460-7280.2	607280	ATE 25158 20,3 + WK
			←	+PR 1LJ	13.0470-7280.2	LD7280	ATE 25158 20,3 + WK Ceramic
			→	+PR 1KW,1KY,1KZ; + eFSB	13.0460-7281.2	607281	ATE 25160 20,3 + WK
3.0 TFSI quattro 4.0 TFSI quattro 4.0 TFSI quattro ↓	228 309 320	11/11→ 03/12→ 10/13→	←	+PR 1KW,1KY,1KZ; + eFSB	13.0460-2773.2	602773	TRW 24606 17,4 + WK + Zub
			←	+PR 1LX,1LN	13.0470-2773.2	LD2773	TRW 24606 17,4 + WK + Zub Ceramic
			←	+PR 1LX,1LN	13.0460-4873.2	604873	BRE 24847 17,0 + WE / - WK
			←	+PR 1LX,1LN	13.0460-4873.2	604873	BRE 24847 17,0 + WE / - WK









	kw			 	! #		
<b>AUDI - A8 (4H2, 4H8, 4HC, 4HL) 11/09→</b>							
<b>Bremsbelagsatz, Scheibenbremse</b>							
4.2 TDI quattro 6.3 W12 quattro S8 plus quattro S8 quattro	283 368 445 382	10/13→ 01/11→ 11/15→ 04/12→	← ← →	+PR 1LL +PR 1LJ +PR 1KW,1KY,1KZ; + eFSB		13.0460-7280.2 607280 13.0460-7281.2 607281 13.0460-2773.2 602773 13.0470-2773.2 LD2773	ATE 25158 20,3 + WK ATE 25160 20,3 + WK TRW 24606 17,4 + WK + Zub TRW 24606 17,4 + WK + Zub Ceramic
3.0 TFSI quattro	245	06/10→	← ← ← →	07/10→; +PR 1LX,1LN 07/10→; +PR 1LL 07/10→; +PR 1LJ 07/10→; +PR 1KW,1KY,1KZ; + eFSB		13.0460-4873.2 604873 13.0460-7280.2 607280 13.0460-7281.2 607281 13.0460-2773.2 602773 13.0470-2773.2 LD2773	BRE 24847 17,0 + WE / - WK ATE 25158 20,3 + WK ATE 25160 20,3 + WK TRW 24606 17,4 + WK + Zub TRW 24606 17,4 + WK + Zub Ceramic
4.2 FSI quattro 4.2 TDI quattro	273 258	11/09→ 11/09→	← ← ← ← ← →	+PR 1LX,1LN → 06/10; +PR 1LL 07/10→; +PR 1LL 07/10→; +PR 1LJ → 06/10; +PR 1LJ +PR 1KW,1KY,1KZ; + eFSB		13.0460-4873.2 604873 13.0460-7280.2 607280 13.0460-7280.2 607280 13.0460-7281.2 607281 13.0460-7281.2 607281 13.0460-2773.2 602773 13.0470-2773.2 LD2773	BRE 24847 17,0 + WE / - WK ATE 25158 20,3 + WK ATE 25158 20,3 + WK ATE 25160 20,3 + WK ATE 25160 20,3 + WK TRW 24606 17,4 + WK + Zub TRW 24606 17,4 + WK + Zub Ceramic
<b>Warnkontakt, Bremsbelagverschleiß</b>							
2.0 TFSI hybrid	155	02/12→	← ← ← ← → → →	05/12→; +PR 1LX,1LN 05/12→; +PR 1LW 05/12→; +PR 1LL 05/12→; +PR 1LJ 05/12→; +PR 1KW,1KY,1KZ 05/12→; +PR 2EM 05/12→; +PR 1KU	2	24.8190-0019.2 620019 24.8190-0020.2 620020 24.8190-0301.2 620301 24.8190-0301.2 620301 24.8190-0963.2 620963 24.8190-0963.2 620963 24.8190-0968.2 620968	L= 254 L= 443,3 L= 311,6 L= 311,6 L= 247 L= 247 L= 343
2.0 TFSI quattro	185	09/16→	← ← ← ← → → →	+PR 1LX,1LN +PR 1LW +PR 1LJ +PR 1LL +PR 2EM +PR 1KE,1KW,1KY,1KZ +PR 1KU	2	24.8190-0019.2 620019 24.8190-0020.2 620020 24.8190-0301.2 620301 24.8190-0301.2 620301 24.8190-0963.2 620963 24.8190-0963.2 620963 24.8190-0968.2 620968	L= 254 L= 443,3 L= 311,6 L= 311,6 L= 247 L= 247 L= 343
2.5 TFSI 3.0 TDI 3.0 TDI quattro 3.0 TDI quattro 3.0 TDI quattro 3.0 TDI quattro 3.0 TDI quattro 3.0 TFSI quattro 3.0 TFSI quattro 4.0 TFSI quattro 4.0 TFSI quattro 4.2 TDI quattro 6.3 W12 quattro S8 plus quattro S8 quattro	150 150 155 176 184 190 193 213 228 309 320 283 368 445 382	07/12→ 09/11→ 08/10→ 11/12→ 07/10→ 10/13→ 05/15→ 07/10→ 11/11→ 03/12→ 10/13→ 10/13→ 01/11→ 11/15→ 04/12→	← ← ← ← → → → → → → →	+PR 1LX,1LN +PR 1LW +PR 1LL +PR 1LJ +PR 1KW,1KY,1KZ +PR 2EM +PR 1KU	2	24.8190-0019.2 620019 24.8190-0020.2 620020 24.8190-0301.2 620301 24.8190-0301.2 620301 24.8190-0963.2 620963 24.8190-0963.2 620963 24.8190-0968.2 620968	L= 254 L= 443,3 L= 311,6 L= 311,6 L= 247 L= 247 L= 343
3.0 TFSI quattro	245	06/10→	← ← ← ← → → →	07/10→; +PR 1LX,1LN 07/10→; +PR 1LW 07/10→; +PR 1LJ 07/10→; +PR 1LL 07/10→; +PR 1KW,1KY,1KZ 07/10→; +PR 2EM 07/10→; +PR 1KU	2	24.8190-0019.2 620019 24.8190-0020.2 620020 24.8190-0301.2 620301 24.8190-0301.2 620301 24.8190-0963.2 620963 24.8190-0963.2 620963 24.8190-0968.2 620968	L= 254 L= 443,3 L= 311,6 L= 311,6 L= 247 L= 247 L= 343
4.2 FSI quattro 4.2 TDI quattro	273 258	11/09→ 11/09→	← ← ←	+PR 1LX,1LN +PR 1LW 07/10→; +PR 1LJ	2	24.8190-0019.2 620019 24.8190-0020.2 620020 24.8190-0301.2 620301	L= 254 L= 443,3 L= 311,6
↓							











	kw			 	! #		
<b>AUDI - A8 (4H2, 4H8, 4HC, 4HL) 11/09→</b>							
<b>Warnkontakt, Bremsbelagverschleiß</b>							
4.2 FSI quattro 4.2 TDI quattro	273 258	11/09→ 11/09→	←	07/10→; +PR 1LL	2	24.8190-0301.2 620301	L= 311,6
			←	→ 06/10; +PR 1LL	2	24.8190-0303.2 620303	L= 296,6
			←	→ 06/10; +PR 1LJ	2	24.8190-0303.2 620303	L= 296,6
			→	+PR 1KW,1KY,1KZ	2	24.8190-0963.2 620963	L= 247
			→	+PR 2EM	2	24.8190-0963.2 620963	L= 247
			→	+PR 1KU	2	24.8190-0968.2 620968	L= 343
<b> Bremsscheibe</b>							
2.0 TFSI hybrid	155	02/12→	←	05/12→; +PR 1LL		24.0134-0103.1 434103	Ø 356 34 31,5 V + S
			→	05/12→; +PR 1KW; + eFSB		24.0122-0272.1 422272	Ø 330 21,9 20 V + S
			→	05/12→; +PR 1KY,1KZ; + eFSB		24.0122-0273.1 422273	Ø 356 22 20 V + S
2.0 TFSI quattro	185	09/16→	←	+PR 1LL		24.0134-0103.1 434103	Ø 356 34 31,5 V + S
			→	+PR 1KW; + eFSB		24.0122-0272.1 422272	Ø 330 21,9 20 V + S
			→	+PR 1KE,1KY,1KZ; + eFSB		24.0122-0273.1 422273	Ø 356 22 20 V + S
2.5 TFSI	150	07/12→	←	+PR 1LL		24.0134-0103.1 434103	Ø 356 34 31,5 V + S
3.0 TDI	150	09/11→	→	+PR 1KW; + eFSB		24.0122-0272.1 422272	Ø 330 21,9 20 V + S
3.0 TDI quattro	155	08/10→	→	+PR 1KY,1KZ; + eFSB		24.0122-0273.1 422273	Ø 356 22 20 V + S
3.0 TDI quattro	176	11/12→	→	+PR 1KY,1KZ; + eFSB		24.0122-0273.1 422273	Ø 356 22 20 V + S
3.0 TDI quattro	184	07/10→					
3.0 TDI quattro	190	10/13→					
3.0 TDI quattro	193	05/15→					
3.0 TFSI quattro	213	07/10→					
3.0 TFSI quattro	228	11/11→					
4.0 TFSI quattro	309	03/12→					
4.0 TFSI quattro	320	10/13→					
4.2 FSI quattro	273	11/09→					
4.2 TDI quattro	258	11/09→					
4.2 TDI quattro	283	10/13→					
6.3 W12 quattro	368	01/11→					
S8 plus quattro	445	11/15→					
S8 quattro	382	04/12→					
3.0 TFSI quattro	245	06/10→	←	07/10→; +PR 1LL		24.0134-0103.1 434103	Ø 356 34 31,5 V + S
			→	07/10→; +PR 1KW; + eFSB		24.0122-0272.1 422272	Ø 330 21,9 20 V + S
			→	07/10→; +PR 1KY,1KZ; + eFSB		24.0122-0273.1 422273	Ø 356 22 20 V + S
<b>AUDI - A8 (4N2, 4N8) 06/17→</b>							
<b>Warnkontakt, Bremsbelagverschleiß</b>							
50 TDI Mild Hybrid quattro	210	06/17→	←	+PR 1LT	2	24.8190-0977.2 620977	L= 431
			→		2	24.8190-0964.2 620964	L= 379
55 TFSI Mild Hybrid quattro	250	06/17→	←	+PR 1LT; für Fahrzeuge mit Keramikbremse	2	24.8190-0977.2 620977	L= 431
			→		2	24.8190-0964.2 620964	L= 379
<b> Bremsscheibe</b>							
50 TDI Mild Hybrid quattro 55 TFSI Mild Hybrid quattro	210 250	06/17→ 06/17→	→	+PR 1KF,1KJ,2ED,2EE		24.0122-0272.1 422272	Ø 330 21,9 20 V + S
<b>AUDI - ALLROAD (4BH, C5) 05/00→08/05</b>							
<b> Bremsbelagsatz, Scheibenbremse</b>							
2.5 TDI quattro 2.5 TDI quattro 2.7 quattro 2.7 T quattro	120 132 187 184	05/03→08/05 05/00→08/05 09/00→08/05 05/00→08/05	←	+PR 1LX; → 07/05		13.0460-2875.2 602875	TRW 23119 17,5 + WK
			←	+PR 1LA; → 07/05		13.0460-7166.2 607166	ATE 23762 20,4 + WK
						13.0470-7166.2 LD7166	ATE 23762 20,4 + WK Ceramic
			→	→ 07/05		13.0460-2886.2 602886	TRW 20961 16,0 - WK
						13.0460-2937.2 602937	TRW 20961 15,2 - WK + Zub
						13.0470-2886.2 LD2886	TRW 20961 16,0 - WK Ceramic
4.2 V8 quattro	220	07/02→08/05	←	+PR 1LX; → 07/05		13.0460-2875.2 602875	TRW 23119 17,5 + WK
			←	+PR 1LA; → 07/05		13.0460-7166.2 607166	ATE 23762 20,4 + WK
			→	→ 07/05		13.0460-2886.2 602886	TRW 20961 16,0 - WK
						13.0460-2937.2 602937	TRW 20961 15,2 - WK + Zub
						13.0470-2886.2 LD2886	TRW 20961 16,0 - WK Ceramic

















	kW			 	! #		
<b>AUDI - ALLROAD (4BH, C5) 05/00→08/05</b>							
 <b>Bremsscheibe</b>							
2.5 TDI quattro 2.5 TDI quattro	120 132	05/03→08/05 05/00→08/05	← →	→ 07/05 → 07/05		24.0130-0113.1 430113 24.0330-0113.1 530113	Ø 320 30 28 V + S Ø 320 30 28 V
			→	→ 07/05		24.0110-0260.1 410260 24.0310-0260.1 510260	Ø 255 10 8 Ø 255 10 8
2.7 quattro 2.7 T quattro	187 184	09/00→08/05 05/00→08/05	← →	→ 07/05 → 07/05		24.0130-0113.1 430113 24.0330-0113.1 530113	Ø 320 30 28 V + S Ø 320 30 28 V
			→	→ 07/05		24.0110-0260.1 410260	Ø 255 10 8
4.2 V8 quattro	220	07/02→08/05	← →	→ 07/05 → 07/05		24.0130-0113.1 430113 24.0330-0113.1 530113	Ø 320 30 28 V + S Ø 320 30 28 V
			→	→ 07/05		24.0122-0203.1 422203	Ø 269 22 20 V
<b>AUDI - CABRIOLET (8G7, B4) 05/91→08/00</b>							
 <b>Bremsbelagsatz, Scheibenbremse</b>							
1.8	92	01/97→08/00	← →	04/97→ 04/97→		13.0460-2934.2 602934 13.0460-3602.2 603602	TRW 20669 19,0 - WK TRW 21144 15,8 - WK
1.9 TDI	66	06/95→08/00	← →	07/95→ 07/95→		13.0460-2934.2 602934 13.0460-3602.2 603602	TRW 20669 19,0 - WK TRW 21144 15,8 - WK
2.0 16V 2.0 E	103 85	06/95→07/96 01/93→07/98	← →			13.0460-2934.2 602934 13.0460-3602.2 603602	TRW 20669 19,0 - WK TRW 21144 15,8 - WK
2.6	110	06/93→08/00	← →	01/94→ 01/94→		13.0460-2934.2 602934 13.0460-3602.2 603602	TRW 20669 19,0 - WK TRW 21144 15,8 - WK
2.8	128	11/92→08/00	← →			13.0460-2963.2 602963 13.0460-3602.2 603602	TRW 21138 18,8 + WK TRW 21144 15,8 - WK
 <b>Bremsscheibe</b>							
1.8	92	01/97→08/00	← →	04/97→ 04/97→		24.0122-0139.1 422139 24.0110-0178.1 410178	Ø 280 22 20 V Ø 245 10 8
1.9 TDI	66	06/95→08/00	← →	07/95→ 07/95→		24.0122-0139.1 422139 24.0110-0178.1 410178	Ø 280 22 20 V Ø 245 10 8
2.0 16V	103	06/95→07/96	← →	für Italien für Italien		24.0122-0139.1 422139 24.0110-0178.1 410178	Ø 280 22 20 V Ø 245 10 8
2.0 E	85	01/93→07/98	← →			24.0122-0139.1 422139 24.0110-0178.1 410178	Ø 280 22 20 V Ø 245 10 8
2.6	110	06/93→08/00	← →	01/94→ 01/94→		24.0122-0139.1 422139 24.0110-0178.1 410178	Ø 280 22 20 V Ø 245 10 8
2.8	128	11/92→08/00	← →			24.0125-0106.1 425106 24.0110-0178.1 410178	Ø 276 25 23 V Ø 245 10 8
<b>AUDI - COUPE (89, 8B) 10/88→12/96</b>							
 <b>Bremsbelagsatz, Scheibenbremse</b>							
2.0 2.0 16 V	85 103	05/89→12/96 08/92→12/96	← →			13.0460-2934.2 602934 13.0460-3602.2 603602	TRW 20669 19,0 - WK TRW 21144 15,8 - WK
2.3 2.3 quattro	98 98	03/90→12/96 05/90→12/96	→				
2.6 2.6 quattro	110 110	08/92→12/96 08/92→12/96	→				
2.3 20V quattro 2.8	123 128	05/90→12/96 09/91→12/96	← →			13.0460-2963.2 602963 13.0460-3602.2 603602	TRW 21138 18,8 + WK TRW 21144 15,8 - WK
2.8 quattro S2 quattro	128 169	08/91→12/96 10/92→12/96	→				
 <b>Bremsscheibe</b>							
2.0	85	05/89→12/96	← ← →	→ 07/92 08/92→		24.0122-0108.1 422108 24.0122-0139.1 422139 24.0110-0178.1 410178	Ø 256 22 20 V Ø 280 22 20 V Ø 245 10 8
2.0 16 V 2.6	103 110	08/92→12/96 08/92→12/96	← →			24.0122-0139.1 422139 24.0110-0178.1 410178	Ø 280 22 20 V Ø 245 10 8
2.3	98	03/90→12/96	← ←	→ 07/92 08/92→		24.0122-0108.1 422108 24.0122-0139.1 422139	Ø 256 22 20 V Ø 280 22 20 V
↓							













	kW			 	! #							
<b>AUDI - COUPE (89, 8B) 10/88→12/96</b>												
<b>Bremsscheibe</b>												
2.3	98	03/90→12/96	→	→ 07/94		24.0110-0178.1 410178	Ø 245 10 8					
2.3 20V quattro	123	05/90→12/96	←			24.0125-0106.1 425106	Ø 276 25 23 V					
			→			24.0110-0182.1 410182	Ø 245 10 8					
2.3 quattro	98	05/90→12/96	←	→ 8B-N-015000		24.0122-0108.1 422108	Ø 256 22 20 V					
			←	8B-P-000001→		24.0122-0139.1 422139	Ø 280 22 20 V					
			→			24.0110-0182.1 410182	Ø 245 10 8					
2.6 quattro	110	08/92→12/96	←	passend für Felgengröße [Zoll]: 15		24.0122-0139.1 422139	Ø 280 22 20 V					
			←	passend für Felgengröße [Zoll]: 16		24.0125-0139.1 425139	Ø 276 24,9 23 V					
			→	passend für Felgengröße [Zoll]: 15		24.0110-0182.1 410182	Ø 245 10 8					
			→	passend für Felgengröße [Zoll]: 16		24.0110-0261.1 410261 24.0310-0261.1 510261	Ø 245 10 8 + S Ø 245 10 8					
2.8	128	09/91→12/96	←			24.0125-0106.1 425106	Ø 276 25 23 V					
			→			24.0110-0178.1 410178	Ø 245 10 8					
2.8 quattro	128	08/91→12/96	←	passend für Felgengröße [Zoll]: 15		24.0125-0106.1 425106	Ø 276 25 23 V					
			←	passend für Felgengröße [Zoll]: 16		24.0125-0139.1 425139	Ø 276 24,9 23 V					
			→	passend für Felgengröße [Zoll]: 15		24.0110-0182.1 410182	Ø 245 10 8					
			→	passend für Felgengröße [Zoll]: 16		24.0110-0261.1 410261 24.0310-0261.1 510261	Ø 245 10 8 + S Ø 245 10 8					
S2 quattro	169	10/92→12/96	←			24.0125-0139.1 425139	Ø 276 24,9 23 V					
			→	passend für Felgengröße [Zoll]: 15		24.0110-0182.1 410182	Ø 245 10 8					
			→	passend für Felgengröße [Zoll]: 16		24.0110-0261.1 410261 24.0310-0261.1 510261	Ø 245 10 8 + S Ø 245 10 8					
<b>AUDI - Q2 (GAB) 06/16→</b>												
<b>Bremsbelagsatz, Scheibenbremse</b>												
1.0 TFSI	85	10/16→	←	+PR 1ZA,1ZB,1ZD		13.0460-2785.2 602785	TRW 25683 20,4 + WE / + WK					
1.4 TSI	110	06/16→	←			13.0470-2785.2 LD2785	TRW 25683 20,4 + WE / + WK Ceramic					
1.6 TDI	85	06/16→										
2.0 TDI	110	09/16→	→	+PR 1KE,2EC; + eFSB		13.0460-7293.2 607293	ATE 25008 16,3 - WE / - WK					
2.0 TDI quattro	110	09/16→										
2.0 TDI quattro	140	07/16→										
2.0 TFSI quattro	140	05/17→										
<b>Warnkontakt, Bremsbelagverschleiß</b>												
1.0 TFSI	85	10/16→	←	+PR 1ZA,1ZB,1ZD	1	24.8190-0065.2 620065	L= 172					
1.4 TSI	110	06/16→	←									
2.0 TDI	110	09/16→										
2.0 TDI quattro	110	09/16→										
2.0 TFSI quattro	140	05/17→										
1.6 TDI	85	06/16→	←	09/16→; +PR 1ZA,1ZB,1ZD	1	24.8190-0065.2 620065	L= 172					
2.0 TDI quattro	140	07/16→	←									
<b>Bremsscheibe</b>												
1.0 TFSI	85	10/16→	←	+PR 1ZA,1ZB,1ZD		24.0125-0158.1 425158	Ø 312 25 22 V + S					
2.0 TDI	110	09/16→	←	+PR 1ZA,1ZD		24.0325-0158.1 525158	Ø 312 25 22 V + S					
2.0 TDI quattro	110	09/16→										
2.0 TFSI quattro	140	05/17→	→	+PR 1KE,1KR / 0N4		24.0110-0356.1 410356	Ø 272 9,7 8 + S					
			→	+PR 1KJ,1KY		24.0122-0219.1 422219	Ø 310 22 20 V					
			→	+PR 1KE,2EC / 0N4		24.0310-0356.1 510356	Ø 272 9,7 8 + S					
1.4 TSI	110	06/16→	←	09/16→; +PR 1ZA,1ZB,1ZD		24.0125-0158.1 425158	Ø 312 25 22 V + S					
1.6 TDI	85	06/16→	←	09/16→; +PR 1ZA,1ZD		24.0325-0158.1 525158	Ø 312 25 22 V + S					
2.0 TDI quattro	140	07/16→										
								→	+PR 1KE,1KR / 0N4		24.0110-0356.1 410356	Ø 272 9,7 8 + S
								→	+PR 1KJ,1KY		24.0122-0219.1 422219	Ø 310 22 20 V
			→	+PR 1KE,2EC / 0N4		24.0310-0356.1 510356	Ø 272 9,7 8 + S					
<b>AUDI - Q3 (8UB, 8UG) 06/11→</b>												
<b>Bremsbelagsatz, Scheibenbremse</b>												
1.4 TFSI	92	07/16→	←	+PR 1LJ,1ZD		13.0460-7242.2 607242	ATE 24332 19,8 + WK					
2.0 TDI	88	03/15→	←			13.0470-7242.2 LD7242	ATE 24332 19,8 + WK Ceramic					
2.0 TDI	110	11/14→										
2.0 TDI	135	05/15→	→	+PR 1KU; + eFSB		13.0460-2790.2 602790	TRW 25110 17,5 - WE / - WK					
2.0 TDI quattro	110	11/14→	→			13.0470-2790.2 LD2790	TRW 25110 17,5 - WE / - WK Ceramic					
2.0 TDI quattro	135	11/14→										

	kw			 	! #		
<b>AUDI - Q3 (8UB, 8UG) 06/11→</b>							
 <b>Bremsbelagsatz, Scheibenbremse</b>							
2.0 TFSI 2.0 TFSI quattro 2.0 TFSI quattro	132 132 162	05/15→ 11/14→ 11/14→	← →	+PR 1LJ,1ZD +PR 1KU; + eFSB		13.0460-7242.2 607242 13.0470-7242.2 LD7242 13.0460-2790.2 602790 13.0470-2790.2 LD2790	ATE 24332 19,8 + WK ATE 24332 19,8 + WK Ceramic TRW 25110 17,5 - WE / - WK TRW 25110 17,5 - WE / - WK Ceramic
1.4 TSI 2.0 TDI 2.0 TDI 2.0 TDI 2.0 TDI quattro 2.0 TDI quattro 2.0 TDI quattro 2.0 TFSI quattro 2.0 TFSI quattro	110 100 103 130 103 120 130 125 155	10/13→ 09/11→ 09/11→ 05/13→ 01/12→ 06/11→ 06/11→ 06/11→ 06/11→	← →	+PR 1LJ,1ZD +PR 1KU		13.0460-7242.2 607242 13.0470-7242.2 LD7242 13.0460-2749.2 602749 13.0460-2880.2 602880 13.0470-2749.2 LD2749 13.0470-2880.2 LD2880	ATE 24332 19,8 + WK ATE 24332 19,8 + WK Ceramic TRW 24483 16,9 - WE / - WK + Zub TRW 23914 17,1 + WE / - WK + Zub TRW 24483 16,9 - WE / - WK + Zub Ceramic TRW 23914 17,1 + WE / - WK + Zub Ceramic
 <b>Bremsscheibe</b>							
1.4 TFSI 2.0 TDI 2.0 TDI 2.0 TDI 2.0 TDI quattro 2.0 TDI quattro 2.0 TFSI 2.0 TFSI quattro 2.0 TFSI quattro	92 88 110 135 110 135 132 132 162	07/16→ 03/15→ 11/14→ 05/15→ 11/14→ 11/14→ 05/15→ 11/14→ 11/14→	← →	+PR 1LJ,1ZD +PR 1KU; + eFSB		24.0125-0158.1 425158 24.0325-0158.1 525158 24.0112-0210.1 412210	Ø 312 25 22 V + S Ø 312 25 22 V + S Ø 300 12 10 + S
1.4 TSI 2.0 TDI 2.0 TDI 2.0 TDI 2.0 TDI quattro 2.0 TDI quattro 2.0 TDI quattro 2.0 TFSI quattro 2.0 TFSI quattro	110 100 103 130 103 120 130 125 155	10/13→ 09/11→ 09/11→ 05/13→ 01/12→ 06/11→ 06/11→ 06/11→ 06/11→	← →	+PR 1LJ,1ZD +PR 1KU		24.0125-0158.1 425158 24.0325-0158.1 525158 24.0112-0169.1 412169 24.0312-0169.1 512169	Ø 312 25 22 V + S Ø 312 25 22 V + S Ø 282 12 10 + S Ø 282 12 10 + S
RS 2.5 quattro RS performance 2.5 quattro	228 270	10/13→ 01/15→	→	+PR 2EA,2EJ; + eFSB		24.0122-0219.1 422219	Ø 310 22 20 V
RS 2.5 quattro	250	05/13→	→	03/15→; +PR 2EA,2EJ; + eFSB		24.0122-0219.1 422219	Ø 310 22 20 V
<b>AUDI - Q5 (8RB) 11/08→</b>							
 <b>Bremsbelagsatz, Scheibenbremse</b>							
2.0 TDI 2.0 TDI 2.0 TDI 2.0 TDI quattro 2.0 TDI quattro 2.0 TDI quattro 2.0 TDI quattro 2.0 TFSI hybrid quattro 2.0 TFSI quattro 2.0 TFSI quattro 3.0 TDI quattro	100 105 110 100 105 110 140 155 132 162 169 190	11/10→ 11/10→ 05/13→ 08/09→ 08/09→ 05/13→ 11/13→ 06/11→ 08/09→ 05/13→ 08/15→ 11/13→	← ← ← → →	+PR 1LJ +PR 1LA,1ZB,1ZT +PR 1LB,1LC,1LE,1LP +PR 1KW,2EK; + eFSB +PR 1KE,2EL; + eFSB		13.0460-2765.2 602765 13.0470-2765.2 LD2765 13.0460-2765.2 602765 13.0470-2765.2 LD2765 13.0460-4879.2 604879 13.0470-4879.2 LD4879 13.0460-2747.2 602747 13.0470-2747.2 LD2747 13.0460-2748.2 602748 13.0470-2748.2 LD2748	TRW 24409 19,2 + WK + Zub TRW 24409 19,2 + WK + Zub Ceramic TRW 24409 19,2 + WK + Zub TRW 24409 19,2 + WK + Zub Ceramic BRE 25643 16,8 + WE / - WK BRE 25643 17,0 + WE / - WK Ceramic TRW 24606 17,4 - WE / - WK + Zub TRW 24606 17,4 - WE / - WK + Zub Ceramic TRW 24606 17,4 - WE / - WK + Zub TRW 24606 17,4 - WE / - WK + Zub Ceramic
2.0 TDI	140	09/15→	← ← ← →	+PR 1LJ +PR 1LA,1ZB,1ZT +PR 1LB,1LC,1LE,1LP +PR 1KW,2EK; + eFSB		13.0460-2765.2 602765 13.0470-2765.2 LD2765 13.0460-2765.2 602765 13.0470-2765.2 LD2765 13.0460-4879.2 604879 13.0470-4879.2 LD4879 13.0460-2747.2 602747	TRW 24409 19,2 + WK + Zub TRW 24409 19,2 + WK + Zub Ceramic TRW 24409 19,2 + WK + Zub TRW 24409 19,2 + WK + Zub Ceramic BRE 25643 16,8 + WE / - WK BRE 25643 17,0 + WE / - WK Ceramic TRW 24606 17,4 - WE / - WK + Zub
↓							

	kw			 	! #		
<b>AUDI - Q5 (8RB) 11/08→</b>							
<b> Bremsbelagsatz, Scheibenbremse</b>							
2.0 TDI	140	09/15→	➡	+PR 1KW,2EK; + eFSB		<b>13.0470-2747.2 LD2747</b>	TRW 24606 17,4 - WE / - WK + Zub Ceramic
			➡	+PR 1KF,2EJ; + eFSB		<b>13.0460-2748.2 602748</b>	TRW 24606 17,4 - WE / - WK + Zub
						<b>13.0470-2748.2 LD2748</b>	TRW 24606 17,4 - WE / - WK + Zub Ceramic
2.0 TDI quattro	120	11/08→	⬅	03/09→; +PR 1LA,1ZB,1ZT		<b>13.0460-2765.2 602765</b>	TRW 24409 19,2 + WK + Zub
2.0 TDI quattro	125	11/08→				<b>13.0470-2765.2 LD2765</b>	TRW 24409 19,2 + WK + Zub Ceramic
2.0 TFSI quattro	155	11/08→					
3.0 TDI quattro	155	11/08→	⬅	+PR 1LJ		<b>13.0460-2765.2 602765</b>	TRW 24409 19,2 + WK + Zub
3.0 TDI quattro	176	11/08→				<b>13.0470-2765.2 LD2765</b>	TRW 24409 19,2 + WK + Zub Ceramic
3.2 FSI quattro	199	11/08→	⬅	03/09→; +PR 1LB,1LC,1LE,1LP		<b>13.0460-4879.2 604879</b>	BRE 25643 16,8 + WE / - WK
						<b>13.0470-4879.2 LD4879</b>	BRE 25643 17,0 + WE / - WK Ceramic
			➡	03/09→; +PR 1KW,2EK; + eFSB		<b>13.0460-2747.2 602747</b>	TRW 24606 17,4 - WE / - WK + Zub
						<b>13.0470-2747.2 LD2747</b>	TRW 24606 17,4 - WE / - WK + Zub Ceramic
			➡	03/09→; +PR 1KE,2EL; + eFSB		<b>13.0460-2748.2 602748</b>	TRW 24606 17,4 - WE / - WK + Zub
						<b>13.0470-2748.2 LD2748</b>	TRW 24606 17,4 - WE / - WK + Zub Ceramic
2.0 TDI quattro	130	06/12→	⬅	09/12→; +PR 1LA,1ZB,1ZT		<b>13.0460-2765.2 602765</b>	TRW 24409 19,2 + WK + Zub
2.0 TFSI quattro	165	06/12→				<b>13.0470-2765.2 LD2765</b>	TRW 24409 19,2 + WK + Zub Ceramic
3.0 TDI quattro	180	06/12→					
3.0 TDI quattro	184	06/12→	⬅	09/12→; +PR 1LJ		<b>13.0460-2765.2 602765</b>	TRW 24409 19,2 + WK + Zub
3.0 TFSI quattro	200	06/12→				<b>13.0470-2765.2 LD2765</b>	TRW 24409 19,2 + WK + Zub Ceramic
			⬅	09/12→; +PR 1LB,1LC,1LE,1LP		<b>13.0460-4879.2 604879</b>	BRE 25643 16,8 + WE / - WK
						<b>13.0470-4879.2 LD4879</b>	BRE 25643 17,0 + WE / - WK Ceramic
			➡	09/12→; +PR 1KW,2EK; + eFSB		<b>13.0460-2747.2 602747</b>	TRW 24606 17,4 - WE / - WK + Zub
						<b>13.0470-2747.2 LD2747</b>	TRW 24606 17,4 - WE / - WK + Zub Ceramic
			➡	09/12→; +PR 1KE,2EL; + eFSB		<b>13.0460-2748.2 602748</b>	TRW 24606 17,4 - WE / - WK + Zub
						<b>13.0470-2748.2 LD2748</b>	TRW 24606 17,4 - WE / - WK + Zub Ceramic
SQ5 TDI quattro	230	12/12→	⬅	+PR 1LV,1ZK		<b>13.0460-7281.2 607281</b>	ATE 25160 20,3 + WK
SQ5 TDI quattro	240	04/15→	➡	+PR 1KF,2EJ; + eFSB		<b>13.0460-2748.2 602748</b>	TRW 24606 17,4 - WE / - WK + Zub
SQ5 TDI quattro	250	11/15→					
SQ5 TFSI quattro	260	05/13→				<b>13.0470-2748.2 LD2748</b>	TRW 24606 17,4 - WE / - WK + Zub Ceramic
<b>Warnkontakt, Bremsbelagverschleiß</b>							
2.0 TDI	100	11/10→	⬅	☐; +PR 1LB,1LC,1LE,1LP	1	<b>24.8190-0068.2 620068</b>	L= 332
2.0 TDI	105	11/10→					
2.0 TDI	110	05/13→	⬅	☐; +PR 1LA,1ZB,1ZT	1	<b>24.8190-0311.2 620311</b>	L= 300
2.0 TDI	140	09/15→					
2.0 TDI quattro	100	08/09→					
2.0 TDI quattro	105	08/09→					
2.0 TDI quattro	110	05/13→					
2.0 TDI quattro	140	11/13→					
2.0 TFSI hybrid quattro	155	06/11→					
2.0 TFSI quattro	132	08/09→					
2.0 TFSI quattro	162	05/13→					
2.0 TFSI quattro	169	08/15→					
3.0 TDI quattro	190	11/13→					
2.0 TDI quattro	120	11/08→	⬅	☐; 03/09→; +PR 1LB,1LC,1LE,1LP	1	<b>24.8190-0068.2 620068</b>	L= 332
2.0 TDI quattro	125	11/08→					
2.0 TFSI quattro	155	11/08→	⬅	☐; 03/09→; +PR 1LA,1ZB,1ZT	1	<b>24.8190-0311.2 620311</b>	L= 300
3.0 TDI quattro	155	11/08→					
3.0 TDI quattro	176	11/08→					
3.2 FSI quattro	199	11/08→					
2.0 TDI quattro	130	06/12→	⬅	☐; 09/12→; +PR 1LB,1LC,1LE,1LP	1	<b>24.8190-0068.2 620068</b>	L= 332
2.0 TFSI quattro	165	06/12→					
3.0 TDI quattro	180	06/12→	⬅	☐; 09/12→; +PR 1LA,1ZB,1ZT	1	<b>24.8190-0311.2 620311</b>	L= 300
3.0 TDI quattro	184	06/12→					
3.0 TFSI quattro	200	06/12→					
SQ5 TDI quattro	230	12/12→	⬅	☐; +PR 1LV,1ZK	1	<b>24.8190-0301.2 620301</b>	L= 311,6
SQ5 TDI quattro	240	04/15→					

	kw			 	! #		
<b>AUDI - Q5 (8RB) 11/08→</b>							
<b>Warnkontakt, Bremsbelagverschleiß</b>							
SQ5 TDI quattro SQ5 TFSI quattro	250 260	11/15→ 05/13→	←	☐; +PR 1LV,1ZK	1	24.8190-0301.2 620301	L= 311,6
<b>Bremsscheibe</b>							
2.0 TDI 2.0 TDI 2.0 TFSI hybrid quattro	100 105 155	11/10→ 11/10→ 06/11→	←	→ 06/11; +PR 1LJ		24.0129-0102.1 429102	Ø 345 29,5 28 V + S
			←	→ 06/11; +PR 1LA		24.0130-0193.1 430193	Ø 320 30 28 V + S
						24.0330-0193.1 530193	Ø 320 30 28 V + S
			←	07/11→; +PR 1LA		24.0130-0221.1 430221	Ø 320 30 28 V + S
			←	+PR 1ZB		24.0130-0221.1 430221	Ø 320 30 28 V + S
			←	+PR 1LE,1LP,1ZT		24.0130-0222.1 430222	Ø 345 30 28 V + S
			←	07/11→; +PR 1LJ		24.0130-0222.1 430222	Ø 345 30 28 V + S
			←	+PR 1LB,1LC		24.0130-0235.1 430235	Ø 320 30 28 V + S
			→	+PR 1KW,2EK		24.0112-0178.1 412178	Ø 300 12 10 + S
						24.0312-0178.1 512178	Ø 300 12 10 + S
			→	+PR 1KE,2EL; + eFSB		24.0122-0272.1 422272	Ø 330 21,9 20 V + S
2.0 TDI 2.0 TDI quattro 2.0 TDI quattro 2.0 TFSI quattro 2.0 TFSI quattro 3.0 TDI quattro	110 110 140 162 169 190	05/13→ 05/13→ 11/13→ 05/13→ 08/15→ 11/13→	←	+PR 1LA		24.0130-0221.1 430221	Ø 320 30 28 V + S
			←	+PR 1ZB		24.0130-0221.1 430221	Ø 320 30 28 V + S
			←	+PR 1LE,1LP,1ZT		24.0130-0222.1 430222	Ø 345 30 28 V + S
			←	+PR 1LJ		24.0130-0222.1 430222	Ø 345 30 28 V + S
			←	+PR 1LB,1LC		24.0130-0235.1 430235	Ø 320 30 28 V + S
			→	+PR 1KW,2EK		24.0112-0178.1 412178	Ø 300 12 10 + S
						24.0312-0178.1 512178	Ø 300 12 10 + S
			→	+PR 1KE,2EL; + eFSB		24.0122-0272.1 422272	Ø 330 21,9 20 V + S
2.0 TDI	140	09/15→	←	+PR 1LA		24.0130-0221.1 430221	Ø 320 30 28 V + S
			←	+PR 1ZB		24.0130-0221.1 430221	Ø 320 30 28 V + S
			←	+PR 1LE,1LP,1ZT		24.0130-0222.1 430222	Ø 345 30 28 V + S
			←	+PR 1LJ		24.0130-0222.1 430222	Ø 345 30 28 V + S
			←	+PR 1LB,1LC		24.0130-0235.1 430235	Ø 320 30 28 V + S
			→	+PR 11KW,2EK		24.0112-0178.1 412178	Ø 300 12 10 + S
						24.0312-0178.1 512178	Ø 300 12 10 + S
			→	+PR 1KE,2EL; + eFSB		24.0122-0272.1 422272	Ø 330 21,9 20 V + S
2.0 TDI quattro 2.0 TDI quattro	100 105	08/09→ 08/09→	←	→ 06/11; +PR 1LJ		24.0129-0102.1 429102	Ø 345 29,5 28 V + S
			←	→ 06/11; +PR 1LA		24.0130-0193.1 430193	Ø 320 30 28 V + S
						24.0330-0193.1 530193	Ø 320 30 28 V + S
			←	+PR 1ZB		24.0130-0221.1 430221	Ø 320 30 28 V + S
			←	07/11→; +PR 1LA		24.0130-0221.1 430221	Ø 320 30 28 V + S
			←	+PR 1LE,1LP,1ZT		24.0130-0222.1 430222	Ø 345 30 28 V + S
			←	+PR 1LJ		24.0130-0222.1 430222	Ø 345 30 28 V + S
			←	+PR 1LB,1LC		24.0130-0235.1 430235	Ø 320 30 28 V + S
			→	+PR 1KW,2EK		24.0112-0178.1 412178	Ø 300 12 10 + S
						24.0312-0178.1 512178	Ø 300 12 10 + S
			→	→ 10/10; +PR 1KE; + eFSB		24.0122-0272.1 422272	Ø 330 21,9 20 V + S
			→	11/10→; +PR 1KE,2EL; + eFSB		24.0122-0272.1 422272	Ø 330 21,9 20 V + S
2.0 TDI quattro 2.0 TDI quattro 2.0 TFSI quattro 3.0 TDI quattro 3.0 TDI quattro 3.2 FSI quattro	120 125 155 155 176 199	11/08→ 11/08→ 11/08→ 11/08→ 11/08→ 11/08→	←	03/09→ 06/11; +PR 1LJ		24.0129-0102.1 429102	Ø 345 29,5 28 V + S
			←	03/09→ 06/11; +PR 1LA		24.0130-0193.1 430193	Ø 320 30 28 V + S
						24.0330-0193.1 530193	Ø 320 30 28 V + S
			←	03/09→; +PR 1ZB		24.0130-0221.1 430221	Ø 320 30 28 V + S
			←	07/11→; +PR 1LA		24.0130-0221.1 430221	Ø 320 30 28 V + S
			←	03/09→; +PR 1LE,1LP,1ZT		24.0130-0222.1 430222	Ø 345 30 28 V + S
			←	07/11→; +PR 1LJ		24.0130-0222.1 430222	Ø 345 30 28 V + S
			←	03/09→; +PR 1LB,1LC		24.0130-0235.1 430235	Ø 320 30 28 V + S
			→	03/09→; +PR 1KW,2EK		24.0112-0178.1 412178	Ø 300 12 10 + S
						24.0312-0178.1 512178	Ø 300 12 10 + S
			→	03/09→ 10/10; +PR 1KE; + eFSB		24.0122-0272.1 422272	Ø 330 21,9 20 V + S
			→	11/10→; +PR 1KE,2EL; + eFSB		24.0122-0272.1 422272	Ø 330 21,9 20 V + S
2.0 TDI quattro 2.0 TFSI quattro ↓	130 165	06/12→ 06/12→	←	09/12→; +PR 1ZB		24.0130-0221.1 430221	Ø 320 30 28 V + S

	kw					! #		
<b>AUDI - Q5 (8RB) 11/08→</b>								
 <b>Bremsscheibe</b>								
3.0 TDI quattro	180	06/12→	←	09/12→; +PR 1LA		24.0130-0221.1	430221	Ø 320 30 28 V + S
3.0 TDI quattro	184	06/12→	←	09/12→; +PR 1LE,1LP,1ZT		24.0130-0222.1	430222	Ø 345 30 28 V + S
3.0 TFSI quattro	200	06/12→	←	09/12→; +PR 1LJ		24.0130-0222.1	430222	Ø 345 30 28 V + S
			←	09/12→; +PR 1LB,1LC		24.0130-0235.1	430235	Ø 320 30 28 V + S
			→	09/12→; +PR 1KW,2EK		24.0112-0178.1	412178	Ø 300 12 10 + S
						24.0312-0178.1	512178	Ø 300 12 10 + S
			→	09/12→; +PR 1KE,2EL; + eFSB		24.0122-0272.1	422272	Ø 330 21,9 20 V + S
2.0 TFSI quattro	132	08/09→	←	→ 06/11; +PR 1LJ		24.0129-0102.1	429102	Ø 345 29,5 28 V + S
			←	→ 06/11; +PR 1LA		24.0130-0193.1	430193	Ø 320 30 28 V + S
						24.0330-0193.1	530193	Ø 320 30 28 V + S
			←	+PR 1ZB		24.0130-0221.1	430221	Ø 320 30 28 V + S
			←	07/11→; +PR 1LA		24.0130-0221.1	430221	Ø 320 30 28 V + S
			←	+PR 1LE,1LP,1ZT		24.0130-0222.1	430222	Ø 345 30 28 V + S
			←	07/11→; +PR 1LJ		24.0130-0222.1	430222	Ø 345 30 28 V + S
			←	+PR 1LB,1LC		24.0130-0235.1	430235	Ø 320 30 28 V + S
			→	+PR 1KW,2EK		24.0112-0178.1	412178	Ø 300 12 10 + S
						24.0312-0178.1	512178	Ø 300 12 10 + S
			→	→ 10/10; +PR 1KE; + eFSB		24.0122-0272.1	422272	Ø 330 21,9 20 V + S
			→	11/10→; +PR 1KE,2EL; + eFSB		24.0122-0272.1	422272	Ø 330 21,9 20 V + S
SQ5 TDI quattro	230	12/12→	→	+PR 1KF,2EJ; + eFSB		24.0122-0272.1	422272	Ø 330 21,9 20 V + S
SQ5 TDI quattro	240	04/15→						
SQ5 TDI quattro	250	11/15→						
SQ5 TFSI quattro	260	05/13→						
<b>AUDI - Q5 (FYB) 05/16→</b>								
 <b>Brembelagsatz, Scheibenbremse</b>								
2.0 TDI	100	01/17→	→	+PR 1KF,1KJ,1KK,2EJ		13.0460-2796.2	602796	TRW 22308 17,7 + WE / - WK
2.0 TDI	110	01/17→						
2.0 TFSI quattro	183	01/17→						
3.0 TDI quattro	210	07/17→						
SQ5 TFSI quattro	260	11/16→						
2.0 TDI quattro	120	06/16→	→	01/17→; +PR 1KF,1KJ,1KK,2EJ		13.0460-2796.2	602796	TRW 22308 17,7 + WE / - WK
2.0 TDI quattro	140	06/16→						
2.0 TFSI quattro	185	06/16→						
 <b>Bremsscheibe</b>								
2.0 TDI	100	01/17→	←	+PR 1LC		24.0130-0244.1	430244	Ø 318 30 28 V + S
2.0 TDI	110	01/17→						
2.0 TFSI quattro	183	01/17→	→	+PR 1LC		24.0112-0218.1	412218	Ø 300 12 10 + S
3.0 TDI quattro	210	07/17→	→	+PR 1KF,1KJ,1KK,2EJ		24.0122-0272.1	422272	Ø 330 21,9 20 V + S
SQ5 TFSI quattro	260	11/16→						
2.0 TDI quattro	120	06/16→	←	01/17→; +PR 1LC		24.0130-0244.1	430244	Ø 318 30 28 V + S
2.0 TDI quattro	140	06/16→	→	+PR 1LC		24.0112-0218.1	412218	Ø 300 12 10 + S
2.0 TFSI quattro	185	06/16→	→	+PR 1KF,1KJ,1KK,2EJ		24.0122-0272.1	422272	Ø 330 21,9 20 V + S
<b>AUDI - Q7 (4LB) 03/06→01/16</b>								
 <b>Brembelagsatz, Scheibenbremse</b>								
3.0 TDI quattro	150	05/10→08/15	←	+PR 1LF		13.0460-4993.2	604993	BRE 23693 16,6 + WE / - WK
3.0 TDI quattro	155	03/06→05/10				13.0470-4993.2	LD4993	BRE 23693 16,6 + WE / - WK
3.0 TDI quattro	165	06/09→05/12						Ceramic
3.0 TDI quattro	171	03/06→05/08						
3.0 TDI quattro	176	11/07→08/15	→	+PR 1KD		13.0460-4850.2	604850	BRE 24296 15,5 + WE / - WK
3.0 TDI quattro	180	05/11→08/15				13.0470-4850.2	LD4850	BRE 24296 15,5 + WE / - WK
3.0 TFSI quattro	200	05/10→08/15						Ceramic
3.0 TFSI quattro	206	05/11→08/15						
3.6 FSI quattro	206	08/06→05/10	→	+PR 1KF,2EA		13.0460-4976.2	604976	BRE 23694 16,7 + WE / - WK
						13.0470-4976.2	LD4976	BRE 23694 16,4 + WE / - WK
								Ceramic
3.0 TFSI quattro	245	05/10→08/15	←	+PR 1LF		13.0460-4993.2	604993	BRE 23693 16,6 + WE / - WK
4.2 FSI quattro	257	03/06→05/10						
4.2 TDI quattro	240	03/07→06/09	→	+PR 1KD		13.0460-4850.2	604850	BRE 24296 15,5 + WE / - WK
4.2 TDI quattro	250	05/09→08/15				13.0470-4850.2	LD4850	BRE 24296 15,5 + WE / - WK
6.0 TDI quattro	368	09/08→05/14						Ceramic
			→	+PR 1KF,2EA		13.0460-4976.2	604976	BRE 23694 16,7 + WE / - WK
						13.0470-4976.2	LD4976	BRE 23694 16,4 + WE / - WK
								Ceramic



### AUDI - Q7 (4LB) 03/06→01/16

#### Warnkontakt, Bremsbelagverschleiß

3.0 TDI quattro	150	05/10→08/15	←	+PR 1LW	2	24.8190-0011.2	620011	L= 362,5
3.0 TDI quattro	155	03/06→05/10	←	+PR 1LF	2	24.8190-0929.2	620929	L= 417,4
3.0 TDI quattro	165	06/09→05/12	←	+PR 1LF	2	24.8190-0929.2	620929	L= 417,4
3.0 TDI quattro	171	03/06→05/08	→	+PR 2EF	2	24.8190-0012.2	620012	L= 272,4
3.0 TDI quattro	176	11/07→08/15	→	+PR 1KF,2EA	2	24.8190-0930.2	620930	L= 252,4
3.0 TFSI quattro	180	05/11→08/15	→	+PR 1KD	2	24.8190-0937.2	620937	L= 247,4
3.0 TFSI quattro	200	05/10→08/15	→	+PR 1KD	2	24.8190-0937.2	620937	L= 247,4
3.0 TFSI quattro	206	05/11→08/15	→	+PR 1KD	2	24.8190-0937.2	620937	L= 247,4
3.0 TFSI quattro	245	05/10→08/15	→	+PR 1KD	2	24.8190-0937.2	620937	L= 247,4
3.6 FSI quattro	206	08/06→05/10	→	+PR 1KD	2	24.8190-0937.2	620937	L= 247,4
4.2 FSI quattro	257	03/06→05/10	→	+PR 1KD	2	24.8190-0937.2	620937	L= 247,4
4.2 TDI quattro	240	03/07→06/09	→	+PR 1KD	2	24.8190-0937.2	620937	L= 247,4
4.2 TDI quattro	250	05/09→08/15	→	+PR 1KD	2	24.8190-0937.2	620937	L= 247,4
6.0 TDI quattro	368	09/08→05/14	→	+PR 1KD	2	24.8190-0937.2	620937	L= 247,4

#### Bremsscheibe

3.0 TDI quattro	150	05/10→08/15	←	☐; +PR 1LF		24.0134-0123.1	434123	∅ 350 34 32 V
3.0 TDI quattro	155	03/06→05/10	←	☐; +PR 1LF		24.0134-0124.1	434124	∅ 350 34 32 V
3.0 TDI quattro	165	06/09→05/12	←	☐; +PR 1LF		24.0134-0124.1	434124	∅ 350 34 32 V
3.0 TDI quattro	171	03/06→05/08	→	+PR 1KF		24.0128-0149.1	428149	∅ 330 28 26 V + S
3.0 TDI quattro	176	11/07→08/15	→	+PR 1KF		24.0128-0149.1	428149	∅ 330 28 26 V + S
3.0 TDI quattro	180	05/11→08/15	→	+PR 1KD,2EA		24.0128-0169.1	428169	∅ 358 28 26 V
3.0 TFSI quattro	200	05/10→08/15	→	+PR 1KD,2EA		24.0128-0169.1	428169	∅ 358 28 26 V
3.0 TFSI quattro	206	05/11→08/15	→	+PR 1KD,2EA		24.0128-0169.1	428169	∅ 358 28 26 V
3.0 TFSI quattro	245	05/10→08/15	→	+PR 1KD,2EA		24.0128-0169.1	428169	∅ 358 28 26 V
3.6 FSI quattro	206	08/06→05/10	→	+PR 1KD,2EA		24.0128-0169.1	428169	∅ 358 28 26 V
4.2 FSI quattro	257	03/06→05/10	→	+PR 1KD,2EA		24.0128-0169.1	428169	∅ 358 28 26 V
4.2 TDI quattro	240	03/07→06/09	→	+PR 1KD,2EA		24.0128-0169.1	428169	∅ 358 28 26 V
4.2 TDI quattro	250	05/09→08/15	→	+PR 1KD,2EA		24.0128-0169.1	428169	∅ 358 28 26 V
6.0 TDI quattro	368	09/08→05/14	→	+PR 1KD,2EA		24.0128-0169.1	428169	∅ 358 28 26 V

### AUDI - Q7 (4MB) 01/15→

#### Bremsbelagsatz, Scheibenbremse

2.0 TFSI quattro	185	08/15→	→	+PR 2ED,2EE		13.0460-2796.2	602796	TRW 22308 17,7 + WE / - WK
3.0 TDI e-tron quattro	190	08/15→	→	+PR 2ED,2EE		13.0460-2796.2	602796	TRW 22308 17,7 + WE / - WK
3.0 TDI quattro	155	08/15→	→	+PR 2ED,2EE		13.0460-2796.2	602796	TRW 22308 17,7 + WE / - WK
3.0 TDI quattro	160	05/15→	→	+PR 2ED,2EE		13.0460-2796.2	602796	TRW 22308 17,7 + WE / - WK
3.0 TDI quattro	183	06/15→	→	+PR 2ED,2EE		13.0460-2796.2	602796	TRW 22308 17,7 + WE / - WK
3.0 TDI quattro	190	08/15→	→	+PR 2ED,2EE		13.0460-2796.2	602796	TRW 22308 17,7 + WE / - WK
3.0 TDI quattro	200	06/15→	→	+PR 2ED,2EE		13.0460-2796.2	602796	TRW 22308 17,7 + WE / - WK
SQ7 TDI quattro	320	04/16→	→	+PR 2ED,2EE		13.0460-2796.2	602796	TRW 22308 17,7 + WE / - WK
3.0 TFSI quattro	245	01/15→	→	06/15→; +PR 2ED,2EE		13.0460-2796.2	602796	TRW 22308 17,7 + WE / - WK

#### Warnkontakt, Bremsbelagverschleiß

2.0 TFSI quattro	185	08/15→	←	+PR 1LV,1LW,1LD	2	24.8190-0976.2	620976	L= 422
3.0 TDI e-tron quattro	190	08/15→	←	+PR 1LT	2	24.8190-0977.2	620977	L= 431
3.0 TDI quattro	155	08/15→	←	+PR 1LT	2	24.8190-0977.2	620977	L= 431
3.0 TDI quattro	160	05/15→	→	+PR 2ED,2EE	2	24.8190-0964.2	620964	L= 379
3.0 TDI quattro	183	06/15→	→	+PR 2ED,2EE	2	24.8190-0964.2	620964	L= 379
3.0 TDI quattro	190	08/15→	→	+PR 1KD,1KQ,1KW	2	24.8190-0964.2	620964	L= 379
3.0 TDI quattro	200	06/15→	→	+PR 1KD,1KQ,1KW	2	24.8190-0964.2	620964	L= 379
SQ7 TDI quattro	320	04/16→	→	+PR 1KU	2	24.8190-0964.2	620964	L= 379
3.0 TFSI quattro	245	01/15→	←	06/15→; +PR 1LV,1LW,1LD	2	24.8190-0976.2	620976	L= 422
3.0 TFSI quattro	245	01/15→	←	06/15→; +PR 1LT	2	24.8190-0977.2	620977	L= 431
3.0 TFSI quattro	245	01/15→	→	06/15→; +PR 2ED,2EE	2	24.8190-0964.2	620964	L= 379
3.0 TFSI quattro	245	01/15→	→	06/15→; +PR 1KD,1KQ,1KW	2	24.8190-0964.2	620964	L= 379
3.0 TFSI quattro	245	01/15→	→	06/15→; +PR 1KU	2	24.8190-0964.2	620964	L= 379









#### Bremsscheibe









2.0 TFSI quattro	185	08/15→	←	+PR 1ZA,1ZK		24.0134-0110.1	434110	∅ 349 34 32 V + S
3.0 TDI e-tron quattro	190	08/15→	→	+PR 2ED,2EE; + eFSB		24.0122-0272.1	422272	∅ 330 21,9 20 V + S
3.0 TDI quattro	155	08/15→	→	+PR 2ED,2EE; + eFSB		24.0122-0272.1	422272	∅ 330 21,9 20 V + S
3.0 TDI quattro	160	05/15→	→	+PR 1KD,1KQ,1KU,1KW		24.0128-0296.1	428296	∅ 350 28 26 V + S
3.0 TDI quattro	183	06/15→	→	+PR 1KD,1KQ,1KU,1KW		24.0128-0296.1	428296	∅ 350 28 26 V + S
3.0 TDI quattro	190	08/15→	→	+PR 1KD,1KQ,1KU,1KW		24.0128-0296.1	428296	∅ 350 28 26 V + S
3.0 TDI quattro	200	06/15→	→	+PR 1KD,1KQ,1KU,1KW		24.0128-0296.1	428296	∅ 350 28 26 V + S
SQ7 TDI quattro	320	04/16→	→	+PR 1KD,1KQ,1KU,1KW		24.0128-0296.1	428296	∅ 350 28 26 V + S
3.0 TFSI quattro	245	01/15→	←	06/15→; +PR 1ZA,1ZK		24.0134-0110.1	434110	∅ 349 34 32 V + S
3.0 TFSI quattro	245	01/15→	→	06/15→; +PR 2ED,2EE; + eFSB		24.0122-0272.1	422272	∅ 330 21,9 20 V + S
3.0 TFSI quattro	245	01/15→	→	06/15→; +PR 1KD,1KQ,1KU,1KW		24.0128-0296.1	428296	∅ 350 28 26 V + S











### AUDI - R8 (4S3) 07/15→













#### Warnkontakt, Bremsbelagverschleiß

5.2 FSI quattro	397	07/15→	→	+PR 1KY,2ED	1	24.8190-0971.2	620971	L= 223
5.2 FSI quattro	449	07/15→	→	+PR 1KY,2ED	1	24.8190-0971.2	620971	L= 223
5.2 FSI RWS	397	09/17→	→	+PR 1KY,2ED	1	24.8190-0971.2	620971	L= 223









	kw			 	! #		
<b>AUDI - R8 (422, 423) 04/07→07/15</b>							
<b>Warnkontakt, Bremsbelagverschleiß</b>							
4.2 FSI quattro	309	04/07→09/10	←	+PR 1LE,1LW	1	24.8190-0017.2 620017	L= 388,3
4.2 FSI quattro	316	07/10→07/15	→	+PR 2ED	1	24.8190-0971.2 620971	L= 223
5.2 FSI quattro	386	04/09→07/15	→	+PR 1KU,2EJ	1	24.8190-0971.2 620971	L= 223
5.2 FSI quattro	404	05/12→07/15	→				
5.2 FSI quattro	412	11/10→07/15					
5.2 FSI quattro	419	07/14→07/15					
<b>AUDI - R8 Spyder (4S9) 05/16→</b>							
<b>Warnkontakt, Bremsbelagverschleiß</b>							
5.2 FSI quattro	397	05/16→	→	+PR 1KY,2ED	1	24.8190-0971.2 620971	L= 223
5.2 FSI quattro	449	05/17→					
5.2 FSI RWS	397	09/17→					
<b>AUDI - R8 Spyder (427, 429) 02/10→07/15</b>							
<b>Warnkontakt, Bremsbelagverschleiß</b>							
4.2 FSI quattro	316	09/10→07/15	←	+PR 1LE,1LW	1	24.8190-0017.2 620017	L= 388,3
5.2 FSI quattro	386	02/10→07/15	→	+PR 2ED	1	24.8190-0971.2 620971	L= 223
5.2 FSI quattro	412	11/11→07/15	→	+PR 1KU,2EJ	1	24.8190-0971.2 620971	L= 223
<b>AUDI - TT (8J3) 07/06→06/14</b>							
	<b>Bremsbelagsatz, Scheibenbremse</b>						
1.8 TFSI	118	06/08→06/14	←	+PR 1LJ,1LL		13.0460-7226.2 607226	ATE 23587 20,8 + WK
2.0 TFSI	147	08/06→06/10	←	+PR 1LK,1LM,1LN		13.0470-7226.2 LD7226	ATE 23587 20,8 + WK Ceramic
			←	+PR 1LK,1LM,1LN		13.0460-7227.2 607227	ATE 23801 20,3 + WK
			←	+PR 1LK,1LM,1LN		13.0470-7227.2 LD7227	ATE 23801 20,4 + WK Ceramic
			→	+PR 1KZ,2ED		13.0460-2749.2 602749	TRW 24483 16,9 - WE / - WK + Zub
						13.0460-2880.2 602880	TRW 23914 17,1 + WE / - WK + Zub
						13.0470-2749.2 LD2749	TRW 24483 16,9 - WE / - WK + Zub Ceramic
						13.0470-2880.2 LD2880	TRW 23914 17,1 + WE / - WK + Zub Ceramic
2.0 TDI quattro	125	06/08→06/14	←	+PR 1LJ,1LL		13.0460-7226.2 607226	ATE 23587 20,8 + WK
2.0 TFSI quattro	147	06/08→06/10	←	+PR 1LK,1LM,1LN		13.0470-7226.2 LD7226	ATE 23587 20,8 + WK Ceramic
2.0 TTS quattro	195	05/08→06/14	←	+PR 1LK,1LM,1LN		13.0460-7227.2 607227	ATE 23801 20,3 + WK
			←	+PR 1LK,1LM,1LN		13.0470-7227.2 LD7227	ATE 23801 20,4 + WK Ceramic
			→	+PR 1KJ,2EE		13.0460-2749.2 602749	TRW 24483 16,9 - WE / - WK + Zub
						13.0460-2880.2 602880	TRW 23914 17,1 + WE / - WK + Zub
						13.0470-2749.2 LD2749	TRW 24483 16,9 - WE / - WK + Zub Ceramic
						13.0470-2880.2 LD2880	TRW 23914 17,1 + WE / - WK + Zub Ceramic
2.0 TFSI	155	05/10→06/14	←	+PR 1LJ,1LL		13.0460-7226.2 607226	ATE 23587 20,8 + WK
			←	+PR 1LK,1LM,1LN		13.0470-7226.2 LD7226	ATE 23587 20,8 + WK Ceramic
			←	+PR 1LK,1LM,1LN		13.0460-7227.2 607227	ATE 23801 20,3 + WK
			←	+PR 1LK,1LM,1LN		13.0470-7227.2 LD7227	ATE 23801 20,4 + WK Ceramic
			→	+PR 1KZ,2ED		13.0460-2749.2 602749	TRW 24483 16,9 - WE / - WK + Zub
						13.0460-2880.2 602880	TRW 23914 17,1 + WE / - WK + Zub
						13.0470-2749.2 LD2749	TRW 24483 16,9 - WE / - WK + Zub Ceramic
						13.0470-2880.2 LD2880	TRW 23914 17,1 + WE / - WK + Zub Ceramic
2.0 TFSI quattro	155	05/10→06/14	←	+PR 1LJ,1LL		13.0460-7226.2 607226	ATE 23587 20,8 + WK
			←	+PR 1LK,1LM,1LN		13.0470-7226.2 LD7226	ATE 23587 20,8 + WK Ceramic
			←	+PR 1LK,1LM,1LN		13.0460-7227.2 607227	ATE 23801 20,3 + WK
			←	+PR 1LK,1LM,1LN		13.0470-7227.2 LD7227	ATE 23801 20,4 + WK Ceramic
			→	+PR 1KJ,2EE		13.0460-2749.2 602749	TRW 24483 16,9 - WE / - WK + Zub
						13.0460-2880.2 602880	TRW 23914 17,1 + WE / - WK + Zub
						13.0470-2749.2 LD2749	TRW 24483 16,9 - WE / - WK + Zub Ceramic

	kw			 	! #		
<b>AUDI - TT (8J3) 07/06→06/14</b>							
<b> Bremsbelagsatz, Scheibenbremse</b>							
2.0 TFSI quattro	155	05/10→06/14	➡	+PR 1KJ,2EE		13.0470-2880.2 LD2880	TRW 23914 17,1 + WE / - WK + Zub Ceramic
2.0 TTS quattro	200	05/08→06/14	←	+PR 1LN		13.0460-7227.2 607227	ATE 23801 20,3 + WK
						13.0470-7227.2 LD7227	ATE 23801 20,4 + WK Ceramic
			➡	+PR 2ED,2EG		13.0460-2887.2 602887	TRW 23914 17,1 + WE / - WK + Zub
						13.0470-2887.2 LD2887	TRW 23914 17,1 + WE / - WK + Zub Ceramic
2.5 RS quattro	250	07/09→06/14	←	+PR 1LA		13.0460-4833.2 604833	BRE 24098 17,1 + WE / - WK
2.5 RS quattro	265	05/11→06/14	➡			13.0460-2887.2 602887	TRW 23914 17,1 + WE / - WK + Zub
3.2 V6 quattro	184	08/06→06/10	←	+PR 1LJ,1LL		13.0460-7226.2 607226	ATE 23587 20,8 + WK
						13.0470-7226.2 LD7226	ATE 23587 20,8 + WK Ceramic
			←	+PR 1LK,1LM,1LN		13.0460-7227.2 607227	ATE 23801 20,3 + WK
						13.0470-7227.2 LD7227	ATE 23801 20,4 + WK Ceramic
			➡	+PR 1KJ;2EE		13.0460-2749.2 602749	TRW 24483 16,9 - WE / - WK + Zub
						13.0460-2880.2 602880	TRW 23914 17,1 + WE / - WK + Zub
						13.0470-2749.2 LD2749	TRW 24483 16,9 - WE / - WK + Zub Ceramic
						13.0470-2880.2 LD2880	TRW 23914 17,1 + WE / - WK + Zub Ceramic
			➡	+PR 2EA,2EF		13.0460-2887.2 602887	TRW 23914 17,1 + WE / - WK + Zub
						13.0470-2887.2 LD2887	TRW 23914 17,1 + WE / - WK + Zub Ceramic
<b>Warnkontakt, Bremsbelagsverschleiß</b>							
2.5 RS quattro	250	07/09→06/14	←	+PR 1LA	1	24.8190-0302.2 620302	L= 367,4
2.5 RS quattro	265	05/11→06/14					
<b>Zubehörsatz, Scheibenbremsbelag</b>							
1.8 TFSI	118	06/08→06/14	➡	+PR 1KZ;2ED		13.0460-0259.2 610259	
2.0 TFSI	147	08/06→06/10					
2.0 TDI quattro	125	06/08→06/14	➡	+PR 1KJ;2EE		13.0460-0259.2 610259	
2.0 TFSI quattro	147	06/08→06/10					
2.0 TTS quattro	195	05/08→06/14					
3.2 V6 quattro	184	08/06→06/10					
2.0 TFSI	155	05/10→06/14	➡	+PR 1KZ;2ED		13.0460-0259.2 610259	
2.0 TFSI quattro	155	05/10→06/14	➡	+PR 1KJ;2EE		13.0460-0259.2 610259	
<b> Bremsscheibe</b>							
1.8 TFSI	118	06/08→06/14	←	+PR 1LJ;1LL		24.0125-0158.1 425158	Ø 312 25 22 V + S
2.0 TFSI	147	08/06→06/10				24.0325-0158.1 525158	Ø 312 25 22 V + S
			←	+PR 1LK;1LM		24.0130-0219.1 430219	Ø 340 30 28 V + S
			➡	+PR 1KZ;2ED		24.0112-0175.1 412175	Ø 286 12 10 + S
2.0 TDI quattro	125	06/08→06/14	←	+PR 1LJ;1LL		24.0125-0158.1 425158	Ø 312 25 22 V + S
2.0 TFSI quattro	147	06/08→06/10				24.0325-0158.1 525158	Ø 312 25 22 V + S
2.0 TTS quattro	195	05/08→06/14	←	+PR 1LK;1LM		24.0130-0219.1 430219	Ø 340 30 28 V + S
			➡	+PR 1KJ;2EE		24.0112-0175.1 412175	Ø 286 12 10 + S
2.0 TFSI	155	05/10→06/14	←	+PR 1LJ,1LL		24.0125-0158.1 425158	Ø 312 25 22 V + S
						24.0325-0158.1 525158	Ø 312 25 22 V + S
			←	+PR 1LK,1LM		24.0130-0219.1 430219	Ø 340 30 28 V + S
			➡	+PR 1KZ,2ED		24.0112-0175.1 412175	Ø 286 12 10 + S
2.0 TFSI quattro	155	05/10→06/14	←	+PR 1LJ,1LL		24.0125-0158.1 425158	Ø 312 25 22 V + S
						24.0325-0158.1 525158	Ø 312 25 22 V + S
			←	+PR 1LK,1LM		24.0130-0219.1 430219	Ø 340 30 28 V + S
			➡	+PR 1KJ,2EE		24.0112-0175.1 412175	Ø 286 12 10 + S
2.0 TTS quattro	200	05/08→06/14	←	+PR 1LK,1LM		24.0130-0219.1 430219	Ø 340 30 28 V + S
						24.0130-0219.1 430219	Ø 340 30 28 V + S
			➡	+PR 1LN		24.0122-0242.1 422242	Ø 310 22 20 V + S
			➡	+PR 2ED,2EG		24.0122-0242.1 422242	Ø 310 22 20 V + S
2.5 RS quattro	250	07/09→06/14	➡			24.0122-0242.1 422242	Ø 310 22 20 V + S
2.5 RS quattro	265	05/11→06/14					
3.2 V6 quattro	184	08/06→06/10	←	+PR 1LJ;1LL		24.0125-0158.1 425158	Ø 312 25 22 V + S
↓							

	kw			 	! #				
<b>AUDI - TT (8J3) 07/06→06/14</b>									
 <b>Bremsscheibe</b>									
3.2 V6 quattro	184	08/06→06/10	←	+PR 1LJ;1LL	24.0325-0158.1	525158	∅ 312 25 22 V + S		
			←	+PR 1LK;1LM	24.0130-0219.1	430219	∅ 340 30 28 V + S		
			→	+PR 1KJ;2EE	24.0112-0175.1	412175	∅ 286 12 10 + S		
			→	+PR 2EA,2EF	24.0122-0242.1	422242	∅ 310 22 20 V + S		
<b>AUDI - TT (8N3) 10/98→06/06</b>									
 <b>Bremsbelagsatz, Scheibenbremse</b>									
1.8 T	110	09/02→06/06	←	+PR 1LD,1LT,1LV	13.0460-7081.2	607081	ATE 20676 19,8 - WE / - WK		
	120	09/05→06/06			13.0460-7122.2	607122	ATE 20676 19,8 + WK		
	132	10/98→06/06			13.0470-7081.2	LD7081	ATE 20676 19,8 - WE / - WK Ceramic		
	140	09/05→06/06			13.0470-7122.2	LD7122	ATE 20676 19,8 + WK Ceramic		
			←	+PR 1LV	13.0460-7122.2	607122	ATE 20676 19,8 + WK		
					13.0470-7122.2	LD7122	ATE 20676 19,8 + WK Ceramic		
			→	+PR 1KE,1KK,2EK	13.0460-2894.2	602894	TRW 20961 17,2 - WK + Zub		
					13.0470-2894.2	LD2894	TRW 20961 17,2 - WK + Zub Ceramic		
1.8 T quattro	132	10/98→06/06	←	+PR 1LD,1LT,1LV	13.0460-7081.2	607081	ATE 20676 19,8 - WE / - WK		
	140	09/05→06/06			13.0460-7122.2	607122	ATE 20676 19,8 + WK		
	165	10/98→06/06			13.0470-7081.2	LD7081	ATE 20676 19,8 - WE / - WK Ceramic		
	176	03/05→06/06			13.0470-7122.2	LD7122	ATE 20676 19,8 + WK Ceramic		
			←	+PR 1LV	13.0460-7122.2	607122	ATE 20676 19,8 + WK		
					13.0470-7122.2	LD7122	ATE 20676 19,8 + WK Ceramic		
			→	+PR 1KF,2EH	13.0460-2787.2	602787	TRW 23554 17,3 - WK / - WE		
					13.0460-2820.2	602820	TRW 20961 17,2 - WK		
					13.0470-2820.2	LD2820	TRW 20961 17,2 - WK Ceramic		
			→	+PR 1KE,1KK	13.0460-2894.2	602894	TRW 20961 17,2 - WK + Zub		
					13.0470-2894.2	LD2894	TRW 20961 17,2 - WK + Zub Ceramic		
3.2 VR6 quattro	184	07/03→06/06	←		13.0460-7183.2	607183	ATE 21484 20,5 + WE / - WK		
			→	+PR 1KF,2EH	13.0460-2787.2	602787	TRW 23554 17,3 - WK / - WE		
					13.0460-2820.2	602820	TRW 20961 17,2 - WK		
					13.0470-2820.2	LD2820	TRW 20961 17,2 - WK Ceramic		
			→	+PR 1KE,1KK	13.0460-2894.2	602894	TRW 20961 17,2 - WK + Zub		
					13.0470-2894.2	LD2894	TRW 20961 17,2 - WK + Zub Ceramic		
<b>Warnkontakt, Bremsbelagverschleiß</b>									
3.2 VR6 quattro	184	07/03→06/06	←		1	24.8190-0106.2	620106	L= 270	
<b>Zubehörsatz, Scheibenbremsbelag</b>									
1.8 T	110	09/02→06/06	→	+PR 1KE,1KK,2EK	13.0460-0072.2	610072	TRW		
	120	09/05→06/06							
	132	10/98→06/06							
	140	09/05→06/06							
1.8 T quattro	132	10/98→06/06	→	+PR 1KE,1KK	13.0460-0072.2	610072	TRW		
	140	09/05→06/06							
	165	10/98→06/06							
	176	03/05→06/06							
3.2 VR6 quattro	184	07/03→06/06							
 <b>Bremsscheibe</b>									
1.8 T	110	09/02→06/06	←	+PR 1LD,1LT,1LV	24.0125-0123.1	425123	∅ 310 25 22 V + S		
	120	09/05→06/06			24.0325-0123.1	525123	∅ 310 25 22 V + S		
	132	10/98→06/06			→	+PR 1KK,2EK	24.0109-0123.1	409123	∅ 230 9 7 + S
	140	09/05→06/06					24.0309-0123.1	509123	∅ 230 9 7 + S
1.8 T quattro	132	10/98→06/06	←	+PR 1LD,1LT,1LV	24.0125-0123.1	425123	∅ 310 25 22 V + S		
	165	10/98→06/06			24.0325-0123.1	525123	∅ 310 25 22 V + S		
	176	03/05→06/06			→	+PR 1KE	24.0109-0133.1	409133	∅ 239 8,9 7 + S
							24.0309-0133.1	509133	∅ 239 8,9 7 + S
			→	+PR 1KF,2EH	24.0122-0163.1	422163	∅ 256 22 20 V		
					24.0322-0163.1	522163	∅ 256 22 20 V		
1.8 T quattro	140	09/05→06/06	←	+PR 1LD,1LT,1LV	24.0125-0123.1	425123	∅ 310 25 22 V + S		
					24.0325-0123.1	525123	∅ 310 25 22 V + S		
↓									

	kW			 	! #				
<b>AUDI - TT (8N3) 10/98→06/06</b>									
 <b>Bremsscheibe</b>									
1.8 T quattro	140	09/05→06/06	➔	+PR 1KE		24.0109-0133.1 409133	Ø 239 8,9 7 + S		
						24.0309-0133.1 509133	Ø 239 8,9 7 + S		
			➔	+PR 1KF,2EH		24.0122-0163.1 422163	Ø 256 22 20 V		
						24.0322-0163.1 522163	Ø 256 22 20 V		
3.2 VR6 quattro	184	07/03→06/06	←			24.0132-0165.2 432165	Ø 334 32 30 V Bremsscheibe zweiteilig		
			←			24.0132-0166.2 432166	Ø 334 32 30 V Bremsscheibe zweiteilig		
			➔	+PR 1KE		24.0109-0133.1 409133	Ø 239 8,9 7 + S		
						24.0309-0133.1 509133	Ø 239 8,9 7 + S		
			➔	+PR 1KF,2EH		24.0122-0163.1 422163	Ø 256 22 20 V		
						24.0322-0163.1 522163	Ø 256 22 20 V		
<b>AUDI - TT (FV3) 07/14→</b>									
 <b>Bremsbelagsatz, Scheibenbremse</b>									
1.8 TFSI 2.0 TDI 2.0 TDI quattro 2.0 TFSI 2.0 TFSI quattro 2.0 TFSI quattro 2.0 TTS quattro	132 135 135 169 162 169 210	08/15→ 07/14→ 01/17→ 07/14→ 04/15→ 07/14→ 02/15→	←	+PR 1LJ,1ZD		13.0460-2785.2 602785	TRW 25683 20,4 + WE / + WK		
						13.0470-2785.2 LD2785	TRW 25683 20,4 + WE / + WK Ceramic		
			➔	+PR 1KZ; + eFSB		13.0460-7293.2 607293	ATE 25008 16,3 - WE / - WK		
						13.0470-7293.2 LD7293	ATE 25008 16,3 - WE / - WK Ceramic		
			➔	+PR 2ED,2EG,2EK; + eFSB		13.0460-7294.2 607294	ATE 25009 16,4 - WE / - WK		
						13.0470-7294.2 LD7294	ATE 25009 16,4 - WE / - WK Ceramic		
2.0 TTS quattro	228	11/14→	←	+PR 1LJ,1ZD		13.0460-2785.2 602785	TRW 25683 20,4 + WE / + WK		
			➔	+PR 1KZ; + eFSB		13.0460-7293.2 607293	ATE 25008 16,3 - WE / - WK		
						13.0470-7293.2 LD7293	ATE 25008 16,3 - WE / - WK Ceramic		
			➔	+PR 2ED,2EG,2EK; + eFSB		13.0460-7294.2 607294	ATE 25009 16,4 - WE / - WK		
						13.0470-7294.2 LD7294	ATE 25009 16,4 - WE / - WK Ceramic		
2.5 RS quattro	294	10/16→	➔	+PR 2EE; + eFSB		13.0460-7294.2 607294	ATE 25009 16,4 - WE / - WK		
						13.0470-7294.2 LD7294	ATE 25009 16,4 - WE / - WK Ceramic		
<b>Warnkontakt, Bremsbelagverschleiß</b>									
1.8 TFSI 2.0 TDI 2.0 TDI quattro 2.0 TFSI 2.0 TFSI quattro 2.0 TFSI quattro 2.0 TTS quattro 2.0 TTS quattro	132 135 135 169 162 169 210 228	08/15→ 07/14→ 01/17→ 07/14→ 04/15→ 07/14→ 02/15→ 11/14→	←	+PR 1LJ,1ZD	1	24.8190-0065.2 620065	L= 172		
 <b>Bremsscheibe</b>									
1.8 TFSI 2.0 TDI 2.0 TDI quattro 2.0 TFSI 2.0 TFSI quattro 2.0 TFSI quattro 2.0 TTS quattro 2.0 TTS quattro	132 135 135 169 162 169 210 228	08/15→ 07/14→ 01/17→ 07/14→ 04/15→ 07/14→ 02/15→ 11/14→	←	+PR 1LJ,1ZD		24.0125-0158.1 425158	Ø 312 25 22 V + S		
						24.0325-0158.1 525158	Ø 312 25 22 V + S		
			←	+PR 1LK,1LH		24.0130-0225.1 430225	Ø 340 30 27 V + S		
			➔	+PR 1KZ		24.0110-0356.1 410356	Ø 272 9,7 8 + S		
						24.0310-0356.1 510356	Ø 272 9,7 8 + S		
			➔	+PR 2ED; + eFSB		24.0112-0210.1 412210	Ø 300 12 10 + S		
						24.0122-0219.1 422219	Ø 310 22 20 V		
						➔	+PR 2EG,2EK		24.0122-0219.1 422219
2.5 RS quattro	294	10/16→	➔	+PR 1KX,2EE		24.0122-0219.1 422219	Ø 310 22 20 V		
<b>AUDI - TT Roadster (8J9) 03/07→06/14</b>									
 <b>Bremsbelagsatz, Scheibenbremse</b>									
1.8 TFSI 2.0 TFSI	118 147	06/08→06/14 03/07→06/10	←	+PR 1LJ;1LL		13.0460-7226.2 607226	ATE 23587 20,8 + WK		
						13.0470-7226.2 LD7226	ATE 23587 20,8 + WK Ceramic		
			←	+PR 1LK,1LM,1LN		13.0460-7227.2 607227	ATE 23801 20,3 + WK		
						13.0470-7227.2 LD7227	ATE 23801 20,4 + WK Ceramic		
			➔	+PR 1KZ,2ED		13.0460-2749.2 602749	TRW 24483 16,9 - WE / - WK + Zub		
						13.0460-2880.2 602880	TRW 23914 17,1 + WE / - WK + Zub		
↓									



	kw			 	! #		
<b>AUDI - TT Roadster (8J9) 03/07→06/14</b>							
<b> Bremsbelagsatz, Scheibenbremse</b>							
1.8 TFSI 2.0 TFSI	118 147	06/08→06/14 03/07→06/10	➡	+PR 1KZ,2ED		13.0470-2749.2 LD2749 13.0470-2880.2 LD2880	TRW 24483 16,9 - WE / - WK + Zub Ceramic TRW 23914 17,1 + WE / - WK + Zub Ceramic
2.0 TDI quattro 2.0 TFSI quattro 2.0 TTS quattro	125 147 195	06/08→06/14 06/08→06/10 05/08→06/14	←	+PR 1LJ;1LL		13.0460-7226.2 607226 13.0470-7226.2 LD7226	ATE 23587 20,8 + WK ATE 23587 20,8 + WK Ceramic
			←	+PR 1LK,1LM,1LN		13.0460-7227.2 607227 13.0470-7227.2 LD7227	ATE 23801 20,3 + WK ATE 23801 20,4 + WK Ceramic
			➡	+PR 1KJ,2EE		13.0460-2749.2 602749 13.0460-2880.2 602880 13.0470-2749.2 LD2749 13.0470-2880.2 LD2880	TRW 24483 16,9 - WE / - WK + Zub TRW 23914 17,1 + WE / - WK + Zub TRW 24483 16,9 - WE / - WK + Zub Ceramic TRW 23914 17,1 + WE / - WK + Zub Ceramic
			←	+PR 1LJ,1LL		13.0460-7226.2 607226 13.0470-7226.2 LD7226	ATE 23587 20,8 + WK ATE 23587 20,8 + WK Ceramic
2.0 TFSI	155	05/10→06/14	←	+PR 1LK,1LM,1LN		13.0460-7227.2 607227 13.0470-7227.2 LD7227	ATE 23801 20,3 + WK ATE 23801 20,4 + WK Ceramic
			➡	+PR 1KZ,2ED		13.0460-2749.2 602749 13.0460-2880.2 602880 13.0470-2749.2 LD2749 13.0470-2880.2 LD2880	TRW 24483 16,9 - WE / - WK + Zub TRW 23914 17,1 + WE / - WK + Zub TRW 24483 16,9 - WE / - WK + Zub Ceramic TRW 23914 17,1 + WE / - WK + Zub Ceramic
			←	+PR 1LJ,1LL		13.0460-7226.2 607226 13.0470-7226.2 LD7226	ATE 23587 20,8 + WK ATE 23587 20,8 + WK Ceramic
2.0 TFSI quattro	155	05/10→06/14	←	+PR 1LK,1LM,1LN		13.0460-7227.2 607227 13.0470-7227.2 LD7227	ATE 23801 20,3 + WK ATE 23801 20,4 + WK Ceramic
			➡	+PR 1KJ,2EE		13.0460-2749.2 602749 13.0460-2880.2 602880 13.0470-2749.2 LD2749 13.0470-2880.2 LD2880	TRW 24483 16,9 - WE / - WK + Zub TRW 23914 17,1 + WE / - WK + Zub TRW 24483 16,9 - WE / - WK + Zub Ceramic TRW 23914 17,1 + WE / - WK + Zub Ceramic
			←	+PR 1LJ,1LL		13.0460-7226.2 607226 13.0470-7226.2 LD7226	ATE 23587 20,8 + WK ATE 23587 20,8 + WK Ceramic
2.0 TTS quattro	200	05/08→06/14	←	+PR 1LN		13.0460-7227.2 607227 13.0470-7227.2 LD7227	ATE 23801 20,3 + WK ATE 23801 20,4 + WK Ceramic
			➡	+PR 2ED,2EG		13.0460-2887.2 602887 13.0470-2887.2 LD2887	TRW 23914 17,1 + WE / - WK + Zub TRW 23914 17,1 + WE / - WK + Zub Ceramic
2.5 RS quattro 2.5 RS quattro	250 265	07/09→06/14 03/12→06/14	←	+PR 1LA		13.0460-4833.2 604833 13.0460-2887.2 602887	BRE 24098 17,1 + WE / - WK TRW 23914 17,1 + WE / - WK + Zub
3.2 V6 quattro	184	03/07→06/10	←	+PR 1LJ;1LL		13.0460-7226.2 607226 13.0470-7226.2 LD7226	ATE 23587 20,8 + WK ATE 23587 20,8 + WK Ceramic
			←	+PR 1LK,1LM,1LN		13.0460-7227.2 607227 13.0470-7227.2 LD7227	ATE 23801 20,3 + WK ATE 23801 20,4 + WK Ceramic
			➡	+PR 1KJ,2EE		13.0460-2749.2 602749 13.0460-2880.2 602880 13.0470-2749.2 LD2749 13.0470-2880.2 LD2880	TRW 24483 16,9 - WE / - WK + Zub TRW 23914 17,1 + WE / - WK + Zub TRW 24483 16,9 - WE / - WK + Zub Ceramic TRW 23914 17,1 + WE / - WK + Zub Ceramic
			➡	+PR 2EA,2EF		13.0460-2887.2 602887 13.0470-2887.2 LD2887	TRW 23914 17,1 + WE / - WK + Zub TRW 23914 17,1 + WE / - WK + Zub Ceramic
			←	+PR 1LA		13.0460-4833.2 604833	BRE 24098 17,1 + WE / - WK
<b>Warnkontakt, Bremsbelagsverschleiß</b>							
2.5 RS quattro ↓	250	07/09→06/14	←	+PR 1LA	1	24.8190-0302.2 620302	L= 367,4

### AUDI - TT Roadster (8J9) 03/07→06/14

#### Warnkontakt, Bremsbelagverschleiß

2.5 RS quattro	265	03/12→06/14	←	+PR 1LA	1	24.8190-0302.2	620302	L= 367,4
----------------	-----	-------------	---	---------	---	----------------	--------	----------

#### Zubehörsatz, Scheibenbremsbelag

1.8 TFSI	118	06/08→06/14	→	+PR 1KZ,2ED		13.0460-0259.2	610259	
2.0 TFSI	147	03/07→06/10						
2.0 TFSI	155	05/10→06/14						
2.0 TDI quattro	125	06/08→06/14	→	+PR 1KJ,2EE		13.0460-0259.2	610259	
2.0 TFSI quattro	147	06/08→06/10						
2.0 TFSI quattro	155	05/10→06/14						
2.0 TTS quattro	195	05/08→06/14						
3.2 V6 quattro	184	03/07→06/10						









#### **Bremsscheibe**















1.8 TFSI	118	06/08→06/14	←	+PR 1LJ;1LL		24.0125-0158.1	425158	Ø 312 25 22 V + S
2.0 TFSI	147	03/07→06/10				24.0325-0158.1	525158	Ø 312 25 22 V + S
			←	+PR 1LK;1LM		24.0130-0219.1	430219	Ø 340 30 28 V + S
			→	+PR 1KZ;2ED		24.0112-0175.1	412175	Ø 286 12 10 + S
2.0 TDI quattro	125	06/08→06/14	←	+PR 1LJ;1LL		24.0125-0158.1	425158	Ø 312 25 22 V + S
						24.0325-0158.1	525158	Ø 312 25 22 V + S
			←	+PR 1LK;1LM		24.0130-0219.1	430219	Ø 340 30 28 V + S
			→	+PR 1KJ, 2EE		24.0112-0175.1	412175	Ø 286 12 10 + S
2.0 TFSI	155	05/10→06/14	←	+PR 1LJ,1LL		24.0125-0158.1	425158	Ø 312 25 22 V + S
						24.0325-0158.1	525158	Ø 312 25 22 V + S
			←	+PR 1LK,1LM		24.0130-0219.1	430219	Ø 340 30 28 V + S
			→	+PR 1KZ,2ED		24.0112-0175.1	412175	Ø 286 12 10 + S
2.0 TFSI quattro	147	06/08→06/10	←	+PR 1LJ;1LL		24.0125-0158.1	425158	Ø 312 25 22 V + S
2.0 TTS quattro	195	05/08→06/14				24.0325-0158.1	525158	Ø 312 25 22 V + S
			←	+PR 1LK;1LM		24.0130-0219.1	430219	Ø 340 30 28 V + S
			→	+PR 1KJ;2EE		24.0112-0175.1	412175	Ø 286 12 10 + S
2.0 TFSI quattro	155	05/10→06/14	←	+PR 1LJ,1LL		24.0125-0158.1	425158	Ø 312 25 22 V + S
						24.0325-0158.1	525158	Ø 312 25 22 V + S
			←	+PR 1LK,1LM		24.0130-0219.1	430219	Ø 340 30 28 V + S
			→	+PR 1KJ,2EE		24.0112-0175.1	412175	Ø 286 12 10 + S
2.0 TTS quattro	200	05/08→06/14	←	+PR 1LK,1LM		24.0130-0219.1	430219	Ø 340 30 28 V + S
						24.0130-0219.1	430219	Ø 340 30 28 V + S
			→	+PR 2ED,2EG		24.0122-0242.1	422242	Ø 310 22 20 V + S
2.5 RS quattro	250	07/09→06/14	→			24.0122-0242.1	422242	Ø 310 22 20 V + S
2.5 RS quattro	265	03/12→06/14						
3.2 V6 quattro	184	03/07→06/10	←	+PR 1LJ;1LL		24.0125-0158.1	425158	Ø 312 25 22 V + S
						24.0325-0158.1	525158	Ø 312 25 22 V + S
			←	+PR 1LK;1LM		24.0130-0219.1	430219	Ø 340 30 28 V + S
			→	+PR 1KJ;2EE		24.0112-0175.1	412175	Ø 286 12 10 + S
			→	+PR 2EA,2EF		24.0122-0242.1	422242	Ø 310 22 20 V + S









### AUDI - TT Roadster (8N9) 10/99→06/06

#### **Bremsbelagsatz, Scheibenbremse**









1.8 T	110	01/01→06/06	←	+PR 1LD,1LT,1LV		13.0460-7081.2	607081	ATE 20676 19,8 - WE / - WK
1.8 T	120	09/05→06/06				13.0460-7122.2	607122	ATE 20676 19,8 + WK
1.8 T	132	10/99→06/06				13.0470-7081.2	LD7081	ATE 20676 19,8 - WE / - WK Ceramic
1.8 T	140	09/05→06/06				13.0470-7122.2	LD7122	ATE 20676 19,8 + WK Ceramic
			←	+PR 1LV		13.0460-7183.2	607183	ATE 21484 20,5 + WE / - WK
			→	8N5-011 001→; +PR 1KE,1KF,1KK,2EH		13.0460-2886.2	602886	TRW 20961 16,0 - WK
						13.0460-2937.2	602937	TRW 20961 15,2 - WK + Zub
						13.0470-2886.2	LD2886	TRW 20961 16,0 - WK Ceramic
			→	+PR 2EK		13.0460-2894.2	602894	TRW 20961 17,2 - WK + Zub
						13.0470-2894.2	LD2894	TRW 20961 17,2 - WK + Zub Ceramic
			→	→ 8N5-011 000; +PR 1KE,1KF,1KK,2EH		13.0460-2894.2	602894	TRW 20961 17,2 - WK + Zub
						13.0470-2894.2	LD2894	TRW 20961 17,2 - WK + Zub Ceramic
1.8 T quattro	132	02/00→06/06	←	+PR 1LD,1LT,1LV		13.0460-7081.2	607081	ATE 20676 19,8 - WE / - WK
1.8 T quattro	140	09/05→06/06						









	kw			 	! #		
<b>AUDI - TT Roadster (8N9) 10/99→06/06</b>							
 <b>Bremsbelagsatz, Scheibenbremse</b>							
1.8 T quattro	165	10/99→06/06	←	+PR 1LD,1LT,1LV	13.0460-7122.2	607122	ATE 20676 19,8 + WK
					13.0470-7081.2	LD7081	ATE 20676 19,8 - WE / - WK Ceramic
					13.0470-7122.2	LD7122	ATE 20676 19,8 + WK Ceramic
			←	+PR 1LV	13.0460-7183.2	607183	ATE 21484 20,5 + WE / - WK
			→	8N5-011 001→; +PR 1KE,1KF,1KK,2EH	13.0460-2886.2	602886	TRW 20961 16,0 - WK
					13.0460-2937.2	602937	TRW 20961 15,2 - WK + Zub
					13.0470-2886.2	LD2886	TRW 20961 16,0 - WK Ceramic
			→	→ 8N5-011 000; +PR 1KE,1KF,1KK,2EH	13.0460-2894.2	602894	TRW 20961 17,2 - WK + Zub
				13.0470-2894.2	LD2894	TRW 20961 17,2 - WK + Zub Ceramic	
<b>Warnkontakt, Bremsbelagverschleiß</b>							
3.2 VR6 quattro	184	07/03→06/06	←		1	24.8190-0106.2	620106 L= 270
<b>Zubehörsatz, Scheibenbremsbelag</b>							
1.8 T	110	01/01→06/06	→	→ 8N5-011 000; +PR 1KE,1KF,1KK,2EH	13.0460-0072.2	610072	TRW
1.8 T	120	09/05→06/06					
1.8 T	132	10/99→06/06	→	8N5-011 001→; +PR 1KE,1KF,1KK,2EH	13.0460-0072.2	610072	TRW
1.8 T	140	09/05→06/06					
1.8 T quattro	132	02/00→06/06					
1.8 T quattro	140	09/05→06/06					
1.8 T quattro	165	10/99→06/06					
3.2 VR6 quattro	184	07/03→06/06					
<b>Bremsscheibe</b>							
1.8 T	110	01/01→06/06	←	+PR 1LD,1LT,1LV	24.0125-0123.1	425123	Ø 310 25 22 V + S
1.8 T	120	09/05→06/06			24.0325-0123.1	525123	Ø 310 25 22 V + S
1.8 T	132	10/99→06/06					
1.8 T	140	09/05→06/06	→	+PR 1KK,2EK	24.0109-0123.1	409123	Ø 230 9 7 + S
					24.0309-0123.1	509123	Ø 230 9 7 + S
1.8 T quattro	132	02/00→06/06	←	+PR 1LD,1LT,1LV	24.0125-0123.1	425123	Ø 310 25 22 V + S
1.8 T quattro	140	09/05→06/06			24.0325-0123.1	525123	Ø 310 25 22 V + S
1.8 T quattro	165	10/99→06/06					
			→	+PR 1KE	24.0109-0133.1	409133	Ø 239 8,9 7 + S
					24.0309-0133.1	509133	Ø 239 8,9 7 + S
			→	+PR 1KF;2EH	24.0122-0163.1	422163	Ø 256 22 20 V
					24.0322-0163.1	522163	Ø 256 22 20 V
3.2 VR6 quattro	184	07/03→06/06	←	☐	24.0132-0165.2	432165	Ø 334 32 30 V Bremsscheibe zweiteilig
			←	☐	24.0132-0166.2	432166	Ø 334 32 30 V Bremsscheibe zweiteilig
			→	+PR 1KE	24.0109-0133.1	409133	Ø 239 8,9 7 + S
					24.0309-0133.1	509133	Ø 239 8,9 7 + S
			→	+PR 1KF;2EH	24.0122-0163.1	422163	Ø 256 22 20 V
					24.0322-0163.1	522163	Ø 256 22 20 V
<b>AUDI - TT Roadster (FV9) 11/14→</b>							
 <b>Bremsbelagsatz, Scheibenbremse</b>							
1.8 TFSI	132	08/15→	←	+PR 1LJ,1ZD	13.0460-2785.2	602785	TRW 25683 20,4 + WE / + WK
2.0 TDI	135	11/14→			13.0470-2785.2	LD2785	TRW 25683 20,4 + WE / + WK Ceramic
2.0 TDI quattro	135	01/17→					
2.0 TFSI	169	11/14→					
2.0 TFSI quattro	162	04/15→	→	+PR 1KZ; + eFSB	13.0460-7293.2	607293	ATE 25008 16,3 - WE / - WK
2.0 TFSI quattro	169	11/14→			13.0470-7293.2	LD7293	ATE 25008 16,3 - WE / - WK Ceramic
2.0 TTS quattro	210	02/15→					
			→	+PR 2ED,2EG,2EK; + eFSB	13.0460-7294.2	607294	ATE 25009 16,4 - WE / - WK
					13.0470-7294.2	LD7294	ATE 25009 16,4 - WE / - WK Ceramic
2.0 TTS quattro	228	11/14→	←	+PR 1LJ,1ZD	13.0460-2785.2	602785	TRW 25683 20,4 + WE / + WK
↓			→	+PR 1KZ; + eFSB	13.0460-7293.2	607293	ATE 25008 16,3 - WE / - WK









	kw			 	! #		
<b>AUDI - TT Roadster (FV9) 11/14→</b>							
 <b>Bremsbelagsatz, Scheibenbremse</b>							
2.0 TTS quattro	228	11/14→	➡	+PR 1KZ; + eFSB		13.0470-7293.2 LD7293	ATE 25008 16,3 - WE / - WK Ceramic
			➡	+PR 2ED,2EG,2EK; + eFSB		13.0460-7294.2 607294	ATE 25009 16,4 - WE / - WK
						13.0470-7294.2 LD7294	ATE 25009 16,4 - WE / - WK Ceramic
2.5 RS quattro	294	10/16→	➡	+PR 2EE; + eFSB		13.0460-7294.2 607294	ATE 25009 16,4 - WE / - WK
						13.0470-7294.2 LD7294	ATE 25009 16,4 - WE / - WK Ceramic
<b>Warnkontakt, Bremsbelagverschleiß</b>							
1.8 TFSI	132	08/15→	←	+PR 1LJ,1ZD	1	24.8190-0065.2 620065	L= 172
2.0 TDI	135	11/14→					
2.0 TDI quattro	135	01/17→					
2.0 TFSI	169	11/14→					
2.0 TFSI quattro	162	04/15→					
2.0 TFSI quattro	169	11/14→					
2.0 TTS quattro	210	02/15→					
2.0 TTS quattro	228	11/14→					
 <b>Bremsscheibe</b>							
1.8 TFSI	132	08/15→	←	+PR 1LJ,1ZD		24.0125-0158.1 425158	Ø 312 25 22 V + S
2.0 TDI	135	11/14→				24.0325-0158.1 525158	Ø 312 25 22 V + S
2.0 TDI quattro	135	01/17→					
2.0 TFSI	169	11/14→	←	+PR 1LK,1LH		24.0130-0225.1 430225	Ø 340 30 27 V + S
2.0 TFSI quattro	162	04/15→	➡	+PR 1KZ		24.0110-0356.1 410356	Ø 272 9,7 8 + S
2.0 TFSI quattro	169	11/14→				24.0310-0356.1 510356	Ø 272 9,7 8 + S
2.0 TTS quattro	210	02/15→					
2.0 TTS quattro	228	11/14→	➡	+PR 2ED; + eFSB		24.0112-0210.1 412210	Ø 300 12 10 + S
			➡	+PR 2EG,2EK		24.0122-0219.1 422219	Ø 310 22 20 V
2.5 RS quattro	294	10/16→	➡	+PR 1KX,2EE		24.0122-0219.1 422219	Ø 310 22 20 V
<b>BENTLEY - ARNAGE (RBS_) 03/98→12/13</b>							
 <b>Bremsbelagsatz, Scheibenbremse</b>							
4.4 V8	260	03/98→12/13	←			13.0460-7183.2 607183	ATE 21484 20,5 + WE / - WK
6.7 V8	298	09/99→08/03					
<b>BENTLEY - AZURE 09/95→06/06</b>							
 <b>Bremsbelagsatz, Scheibenbremse</b>							
6.75 V8	300	08/99→06/06	←			13.0460-7183.2 607183	ATE 21484 20,5 + WE / - WK
<b>BENTLEY - CONTINENTAL 10/91→12/02</b>							
 <b>Bremsbelagsatz, Scheibenbremse</b>							
6.75 V8 R	300	08/99→10/02	←			13.0460-7183.2 607183	ATE 21484 20,5 + WE / - WK
			➡			13.0460-2888.2 602888	TRW 23326 17,4 + WE / - WK
<b>BENTLEY - CONTINENTAL Coupe (3W_) 06/03→</b>							
 <b>Bremsbelagsatz, Scheibenbremse</b>							
6.0	412	06/03→12/11	←			13.0460-7183.2 607183	ATE 21484 20,5 + WE / - WK
			➡			13.0460-2888.2 602888	TRW 23326 17,4 + WE / - WK
<b>BMW - 1 (E81) 09/06→09/12</b>							
 <b>Bremsbelagsatz, Scheibenbremse</b>							
116 d	66	01/11→12/11	←	- Performance Parts		13.0460-2710.2 602710	TRW 23915 17,6 + WE / - WK + Zub
						13.0470-2710.2 LD2710	TRW 23915 17,6 + WE / - WK + Zub Ceramic
			←	+ Performance Parts		13.0460-4848.2 604848	BRE 24316 16,9 + WE / - WK
			➡	- Performance Parts		13.0460-2713.2 602713	TRW 23623 17,4 + WE / - WK + Zub
						13.0470-2713.2 LD2713	TRW 23623 17,4 + WE / - WK + Zub Ceramic
116 d	85	11/08→12/11	←	03/10→ 05/11; - Performance Parts		13.0460-2710.2 602710	TRW 23915 17,6 + WE / - WK + Zub
						13.0470-2710.2 LD2710	TRW 23915 17,6 + WE / - WK + Zub Ceramic
			←	03/09→ 02/10; - Performance Parts		13.0460-2710.2 602710	TRW 23915 17,6 + WE / - WK + Zub









	kw			 	! #		
<b>BMW - 1 (E81) 09/06→09/12</b>							
<b> Bremsbelagsatz, Scheibenbremse</b>							
116 d	85	11/08→12/11	←	03/09→ 02/10; - Performance Parts	13.0470-2710.2	LD2710	TRW 23915 17,6 + WE / - WK + Zub Ceramic
			←	03/09→ 05/11; + Performance Parts	13.0460-4848.2	604848	BRE 24316 16,9 + WE / - WK
			→	03/10→ 05/11; - Performance Parts	13.0460-2713.2	602713	TRW 23623 17,4 + WE / - WK + Zub
			→	03/09→ 02/10; - Performance Parts	13.0470-2713.2	LD2713	TRW 23623 17,4 + WE / - WK + Zub Ceramic
116 i	85	04/07→12/11	←	→ 08/07; - Performance Parts	13.0460-2710.2	602710	TRW 23915 17,6 + WE / - WK + Zub
			←	→ 08/07; + Performance Parts	13.0460-4848.2	604848	BRE 24316 16,9 + WE / - WK
			→	→ 08/07; - Performance Parts	13.0460-2713.2	602713	TRW 23623 17,4 + WE / - WK + Zub
			→	→ 08/07; - Performance Parts	13.0470-2713.2	LD2713	TRW 23623 17,4 + WE / - WK + Zub Ceramic
116 i 116 i	89 90	08/07→11/11 03/07→11/11	←	09/07→ 12/08; - Performance Parts	13.0460-2710.2	602710	TRW 23915 17,6 + WE / - WK + Zub
			←	09/07→ 12/08; + Performance Parts	13.0460-4848.2	604848	BRE 24316 16,9 + WE / - WK
			→	09/07→ 12/08; - Performance Parts	13.0460-2713.2	602713	TRW 23623 17,4 + WE / - WK + Zub
116 i	90	11/08→12/11	←	03/10→ 05/11; - Performance Parts	13.0460-2710.2	602710	TRW 23915 17,6 + WE / - WK + Zub
			←	01/09→ 02/10; - Performance Parts	13.0470-2710.2	LD2710	TRW 23915 17,6 + WE / - WK + Zub Ceramic
			←	01/09→ 05/11; + Performance Parts	13.0460-4848.2	604848	BRE 24316 16,9 + WE / - WK
			→	01/09→ 02/10; - Performance Parts	13.0460-2713.2	602713	TRW 23623 17,4 + WE / - WK + Zub
			→	03/10→ 05/11; - Performance Parts	13.0470-2713.2	LD2713	TRW 23623 17,4 + WE / - WK + Zub Ceramic
			→	03/10→ 05/11; - Performance Parts	13.0460-2713.2	602713	TRW 23623 17,4 + WE / - WK + Zub
118 d 118 d	100 105	09/06→12/11 09/06→12/11	←	04/07→ 02/10; - Performance Parts	13.0460-2710.2	602710	TRW 23915 17,6 + WE / - WK + Zub
			←	03/10→ 05/11; - Performance Parts	13.0470-2710.2	LD2710	TRW 23915 17,6 + WE / - WK + Zub Ceramic
			←	03/10→ 05/11; - Performance Parts	13.0460-2710.2	602710	TRW 23915 17,6 + WE / - WK + Zub
			←	04/07→ 05/11; + Performance Parts	13.0470-2710.2	LD2710	TRW 23915 17,6 + WE / - WK + Zub Ceramic
			→	04/07→ 02/10; - Performance Parts	13.0460-4848.2	604848	BRE 24316 16,9 + WE / - WK
			→	04/07→ 02/10; - Performance Parts	13.0460-7217.2	607217	ATE 23926 17,3 + WE / - WK
118 i 118 i	100 105	09/06→12/11 09/06→12/11	←	04/07→ 02/10; - Performance Parts	13.0470-7217.2	LD7217	ATE 23926 17,3 + WE / - WK Ceramic
			←	03/10→ 05/11; - Performance Parts	13.0460-7217.2	607217	ATE 23926 17,3 + WE / - WK
			←	04/07→ 02/10; - Performance Parts	13.0470-7217.2	LD7217	ATE 23926 17,3 + WE / - WK Ceramic
			←	03/10→ 05/11; - Performance Parts	13.0460-7217.2	607217	ATE 23926 17,3 + WE / - WK Ceramic
↓			←	04/07→ 02/10; - Performance Parts	13.0460-2710.2	602710	TRW 23915 17,6 + WE / - WK + Zub
			←	03/10→ 05/11; - Performance Parts	13.0470-2710.2	LD2710	TRW 23915 17,6 + WE / - WK + Zub Ceramic
			←	03/10→ 05/11; - Performance Parts	13.0460-2710.2	602710	TRW 23915 17,6 + WE / - WK + Zub
					13.0470-2710.2	LD2710	TRW 23915 17,6 + WE / - WK + Zub Ceramic











	kw			 	! #		
<b>BMW - 1 (E81) 09/06→09/12</b>							
<b> Bremsbelagsatz, Scheibenbremse</b>							
118 i 118 i	100 105	09/06→12/11 09/06→12/11	← 04/07→ 05/11; + Performance Parts			<b>13.0460-4848.2 604848</b>	BRE 24316 16,9 + WE / - WK
			→ 04/07→ 02/10; - Performance Parts			<b>13.0460-2713.2 602713</b>	TRW 23623 17,4 + WE / - WK + Zub
						<b>13.0470-2713.2 LD2713</b>	TRW 23623 17,4 + WE / - WK + Zub Ceramic
			→ 03/10→ 05/11; - Performance Parts			<b>13.0460-2713.2 602713</b>	TRW 23623 17,4 + WE / - WK + Zub
						<b>13.0470-2713.2 LD2713</b>	TRW 23623 17,4 + WE / - WK + Zub Ceramic
120 d	120	03/07→12/11	← + Performance Parts			<b>13.0460-4848.2 604848</b>	BRE 24316 16,9 + WE / - WK
			← Türenanzahl: 5; - Performance Parts			<b>13.0460-7215.2 607215</b>	ATE 23935 17,8 + WE / - WK
						<b>13.0470-7215.2 LD7215</b>	ATE 23935 17,8 + WE / - WK Ceramic
			← Türenanzahl: 3; - Performance Parts			<b>13.0460-7216.2 607216</b>	ATE 23794 20,3 + WE / - WK
						<b>13.0470-7216.2 LD7216</b>	ATE 23794 20,3 + WE / - WK Ceramic
			→ - Performance Parts			<b>13.0460-7217.2 607217</b>	ATE 23926 17,3 + WE / - WK
						<b>13.0470-7217.2 LD7217</b>	ATE 23926 17,3 + WE / - WK Ceramic
120 d 120 d	130 145	03/07→12/11 03/07→12/11	← → 05/11; + Performance Parts			<b>13.0460-4848.2 604848</b>	BRE 24316 16,9 + WE / - WK
			← 03/10→ 05/11; - Performance Parts			<b>13.0460-7216.2 607216</b>	ATE 23794 20,3 + WE / - WK
						<b>13.0470-7216.2 LD7216</b>	ATE 23794 20,3 + WE / - WK Ceramic
			← → 02/10; - Performance Parts			<b>13.0460-7216.2 607216</b>	ATE 23794 20,3 + WE / - WK
						<b>13.0470-7216.2 LD7216</b>	ATE 23794 20,3 + WE / - WK Ceramic
			→ 02/10; - Performance Parts			<b>13.0460-7217.2 607217</b>	ATE 23926 17,3 + WE / - WK
						<b>13.0470-7217.2 LD7217</b>	ATE 23926 17,3 + WE / - WK Ceramic
			→ 03/10→ 05/11; - Performance Parts			<b>13.0460-7217.2 607217</b>	ATE 23926 17,3 + WE / - WK
						<b>13.0470-7217.2 LD7217</b>	ATE 23926 17,3 + WE / - WK Ceramic
120 i	115	09/06→10/11	← → 03/07; Türenanzahl: 5; - Performance Parts			<b>13.0460-2710.2 602710</b>	TRW 23915 17,6 + WE / - WK + Zub
						<b>13.0470-2710.2 LD2710</b>	TRW 23915 17,6 + WE / - WK + Zub Ceramic
			← → 03/07; + Performance Parts			<b>13.0460-4848.2 604848</b>	BRE 24316 16,9 + WE / - WK
			← → 03/07; Türenanzahl: 3; - Performance Parts			<b>13.0460-7216.2 607216</b>	ATE 23794 20,3 + WE / - WK
						<b>13.0470-7216.2 LD7216</b>	ATE 23794 20,3 + WE / - WK Ceramic
			→ 03/07; - Performance Parts			<b>13.0460-2713.2 602713</b>	TRW 23623 17,4 + WE / - WK + Zub
						<b>13.0470-2713.2 LD2713</b>	TRW 23623 17,4 + WE / - WK + Zub Ceramic
120 i 120 i	120 125	09/06→12/11 01/07→09/12	← 04/07→ 05/11; + Performance Parts			<b>13.0460-4848.2 604848</b>	BRE 24316 16,9 + WE / - WK
			← 04/07→ 02/10; - Performance Parts			<b>13.0460-7216.2 607216</b>	ATE 23794 20,3 + WE / - WK
						<b>13.0470-7216.2 LD7216</b>	ATE 23794 20,3 + WE / - WK Ceramic
			← 03/10→ 05/11; - Performance Parts			<b>13.0460-7216.2 607216</b>	ATE 23794 20,3 + WE / - WK
						<b>13.0470-7216.2 LD7216</b>	ATE 23794 20,3 + WE / - WK Ceramic
			→ 04/07→ 02/10; - Performance Parts			<b>13.0460-2713.2 602713</b>	TRW 23623 17,4 + WE / - WK + Zub
						<b>13.0470-2713.2 LD2713</b>	TRW 23623 17,4 + WE / - WK + Zub Ceramic
			→ 03/10→ 05/11; - Performance Parts			<b>13.0460-2713.2 602713</b>	TRW 23623 17,4 + WE / - WK + Zub
						<b>13.0470-2713.2 LD2713</b>	TRW 23623 17,4 + WE / - WK + Zub Ceramic
123 d	150	03/07→12/11	← 10/07→ 05/11; + Performance Parts			<b>13.0460-4848.2 604848</b>	BRE 24316 16,9 + WE / - WK
			← 10/07→ 02/10; - Performance Parts			<b>13.0460-7223.2 607223</b>	ATE 23794 20,3 + WE / - WK
						<b>13.0470-7223.2 LD7223</b>	ATE 23794 20,3 + WE / - WK Ceramic
			← 03/10→ 05/11; - Performance Parts			<b>13.0460-7223.2 607223</b>	ATE 23794 20,3 + WE / - WK
						<b>13.0470-7223.2 LD7223</b>	ATE 23794 20,3 + WE / - WK Ceramic
↓							

	kw			 	! #		
<b>BMW - 1 (E81) 09/06→09/12</b>							
<b> Bremsbelagsatz, Scheibenbremse</b>							
123 d	150	03/07→12/11	➡	10/07→ 02/10; - Performance Parts		<b>13.0460-7217.2 607217</b> <b>13.0470-7217.2 LD7217</b>	ATE 23926 17,3 + WE / - WK ATE 23926 17,3 + WE / - WK Ceramic
			➡	03/10→ 05/11; - Performance Parts		<b>13.0460-7217.2 607217</b> <b>13.0470-7217.2 LD7217</b>	ATE 23926 17,3 + WE / - WK ATE 23926 17,3 + WE / - WK Ceramic
130 i 130 i	190 195	09/06→12/11 09/06→12/11	➡	→ 05/11; + Performance Parts		<b>13.0460-4848.2 604848</b>	BRE 24316 16,9 + WE / - WK
			➡	→ 02/10; - Performance Parts		<b>13.0460-7223.2 607223</b> <b>13.0470-7223.2 LD7223</b>	ATE 23794 20,3 + WE / - WK ATE 23794 20,3 + WE / - WK Ceramic
			➡	03/10→ 05/11; - Performance Parts		<b>13.0460-7223.2 607223</b> <b>13.0470-7223.2 LD7223</b>	ATE 23794 20,3 + WE / - WK ATE 23794 20,3 + WE / - WK Ceramic
			➡	→ 02/10; - Performance Parts		<b>13.0460-7217.2 607217</b> <b>13.0470-7217.2 LD7217</b>	ATE 23926 17,3 + WE / - WK ATE 23926 17,3 + WE / - WK Ceramic
			➡	03/10→ 05/11; - Performance Parts		<b>13.0460-7217.2 607217</b> <b>13.0470-7217.2 LD7217</b>	ATE 23926 17,3 + WE / - WK ATE 23926 17,3 + WE / - WK Ceramic
<b>Warnkontakt, Bremsbelagverschleiß</b>							
116 d	66	01/11→12/11	➡	+ Performance Parts	1	<b>24.8190-0267.2 620267</b>	L= 679
			➡		1	<b>24.8190-0284.2 620284</b>	L= 650
			➡		1	<b>24.8190-0285.2 620285</b>	L= 1.107
116 d	85	11/08→12/11	➡	03/09→ 02/10	1	<b>24.8190-0264.2 620264</b>	L= 630
			➡	03/09→ 05/11; + Performance Parts	1	<b>24.8190-0267.2 620267</b>	L= 679
			➡	03/10→ 05/11	1	<b>24.8190-0284.2 620284</b>	L= 650
			➡	03/09→ 02/10	1	<b>24.8190-0265.2 620265</b>	L= 1.086
			➡	03/10→ 05/11	1	<b>24.8190-0285.2 620285</b>	L= 1.107
116 i	85	04/07→12/11	➡	→ 08/07	1	<b>24.8190-0264.2 620264</b>	L= 630
			➡	→ 08/07; + Performance Parts	1	<b>24.8190-0267.2 620267</b>	L= 679
			➡	→ 08/07	1	<b>24.8190-0265.2 620265</b>	L= 1.086
116 i 116 i	89 90	08/07→11/11 03/07→11/11	➡	09/07→ 12/08	1	<b>24.8190-0264.2 620264</b>	L= 630
			➡	09/07→ 12/08; + Performance Parts	1	<b>24.8190-0267.2 620267</b>	L= 679
			➡	09/07→ 12/08	1	<b>24.8190-0265.2 620265</b>	L= 1.086
116 i	90	11/08→12/11	➡	01/09→ 02/10	1	<b>24.8190-0264.2 620264</b>	L= 630
			➡	01/09→ 05/11; + Performance Parts	1	<b>24.8190-0267.2 620267</b>	L= 679
			➡	03/10→ 05/11	1	<b>24.8190-0284.2 620284</b>	L= 650
			➡	01/09→ 02/10	1	<b>24.8190-0265.2 620265</b>	L= 1.086
			➡	03/10→ 05/11	1	<b>24.8190-0285.2 620285</b>	L= 1.107
118 d 118 d 118 i 118 i 120 i 120 i	100 105 100 105 120 125	09/06→12/11 09/06→12/11 09/06→12/11 09/06→12/11 09/06→12/11 01/07→09/12	➡	04/07→ 02/10	1	<b>24.8190-0264.2 620264</b>	L= 630
			➡	04/07→ 05/11; + Performance Parts	1	<b>24.8190-0267.2 620267</b>	L= 679
			➡	03/10→ 05/11	1	<b>24.8190-0284.2 620284</b>	L= 650
			➡	04/07→ 02/10	1	<b>24.8190-0265.2 620265</b>	L= 1.086
			➡	03/10→ 05/11	1	<b>24.8190-0285.2 620285</b>	L= 1.107
120 d	120	03/07→12/11	➡	Türenanzahl: 5	1	<b>24.8190-0264.2 620264</b>	L= 630
			➡	Türenanzahl: 3	1	<b>24.8190-0264.2 620264</b>	L= 630
			➡	+ Performance Parts	1	<b>24.8190-0267.2 620267</b>	L= 679
			➡		1	<b>24.8190-0265.2 620265</b>	L= 1.086
120 d 120 d	130 145	03/07→12/11 03/07→12/11	➡	→ 02/10	1	<b>24.8190-0264.2 620264</b>	L= 630
			➡	→ 05/11; + Performance Parts	1	<b>24.8190-0267.2 620267</b>	L= 679
			➡	03/10→ 05/11	1	<b>24.8190-0284.2 620284</b>	L= 650
			➡	→ 02/10	1	<b>24.8190-0265.2 620265</b>	L= 1.086
			➡	03/10→ 05/11	1	<b>24.8190-0285.2 620285</b>	L= 1.107
120 i	115	09/06→10/11	➡	→ 03/07; Türenanzahl: 5	1	<b>24.8190-0264.2 620264</b>	L= 630
			➡	→ 03/07; Türenanzahl: 3	1	<b>24.8190-0264.2 620264</b>	L= 630
			➡	→ 03/07; + Performance Parts	1	<b>24.8190-0267.2 620267</b>	L= 679
↓							









	kW			 	! #		
<b>BMW - 1 (E81) 09/06→09/12</b>							
<b>Warnkontakt, Bremsbelagverschleiß</b>							
120 i	115	09/06→10/11	➡	→ 03/07	1	24.8190-0265.2 620265	L= 1.086
123 d	150	03/07→12/11	⬅	10/07→ 02/10	1	24.8190-0267.2 620267	L= 679
			⬅	10/07→ 05/11; + Performance Parts	1	24.8190-0267.2 620267	L= 679
			⬅	03/10→ 05/11	1	24.8190-0287.2 620287	L= 723
			➡	10/07→ 02/10	1	24.8190-0265.2 620265	L= 1.086
			➡	03/10→ 05/11	1	24.8190-0285.2 620285	L= 1.107
130 i 130 i	190 195	09/06→12/11 09/06→12/11	⬅	→ 05/11; + Performance Parts	1	24.8190-0267.2 620267	L= 679
			⬅	→ 02/10	1	24.8190-0267.2 620267	L= 679
			⬅	03/10→ 05/11	1	24.8190-0287.2 620287	L= 723
			➡	→ 02/10	1	24.8190-0265.2 620265	L= 1.086
			➡	03/10→ 05/11	1	24.8190-0285.2 620285	L= 1.107
<b> Bremsscheibe</b>							
116 d	66	01/11→12/11	⬅	- Performance Parts		24.0122-0239.1 422239	Ø 284 22 20,4 V + S
						24.0322-0239.1 522239	Ø 284 22 19,6 V + S
			➡	- Performance Parts		24.0110-0314.1 410314	Ø 280 10 8,4 + S
116 d	85	11/08→12/11	⬅	03/09→ 05/11; - Performance Parts		24.0122-0239.1 422239	Ø 284 22 20,4 V + S
						24.0322-0239.1 522239	Ø 284 22 19,6 V + S
			➡	03/09→ 05/11; - Performance Parts		24.0110-0314.1 410314	Ø 280 10 8,4 + S
116 i	85	04/07→12/11	⬅	→ 08/07; - Performance Parts		24.0122-0239.1 422239	Ø 284 22 20,4 V + S
						24.0322-0239.1 522239	Ø 284 22 19,6 V + S
			➡	→ 08/07; - Performance Parts		24.0110-0314.1 410314	Ø 280 10 8,4 + S
116 i 116 i	89 90	08/07→11/11 03/07→11/11	⬅	09/07→ 12/08; - Performance Parts		24.0122-0239.1 422239	Ø 284 22 20,4 V + S
						24.0322-0239.1 522239	Ø 284 22 19,6 V + S
			➡	09/07→ 12/08; - Performance Parts		24.0110-0314.1 410314	Ø 280 10 8,4 + S
116 i	90	11/08→12/11	⬅	01/09→ 05/11; - Performance Parts		24.0122-0239.1 422239	Ø 284 22 20,4 V + S
						24.0322-0239.1 522239	Ø 284 22 19,6 V + S
			➡	01/09→ 05/11; - Performance Parts		24.0110-0314.1 410314	Ø 280 10 8,4 + S
118 d 118 d	100 105	09/06→12/11 09/06→12/11	⬅	04/07→ 05/11; - Performance Parts		24.0122-0238.1 422238	Ø 292 22 20,4 V + S
						24.0322-0238.1 522238	Ø 292 22 19,6 V + S
			➡	04/07→ 05/11; - Performance Parts		24.0120-0195.1 420195	Ø 300 20 18,4 V + S
118 i 118 i	100 105	09/06→12/11 09/06→12/11	⬅	04/07→ 05/11; - Performance Parts		24.0122-0238.1 422238	Ø 292 22 20,4 V + S
						24.0322-0238.1 522238	Ø 292 22 19,6 V + S
			➡	04/07→ 05/11; - Performance Parts		24.0110-0315.1 410315	Ø 296 10,4 8,9 + S
120 d	120	03/07→12/11	⬅	Türenanzahl: 5; - Performance Parts		24.0122-0238.1 422238	Ø 292 22 20,4 V + S
						24.0322-0238.1 522238	Ø 292 22 19,6 V + S
			⬅	Türenanzahl: 3; - Performance Parts		24.0124-0197.1 424197	Ø 300 24 22,4 V + S
120 d 120 d	130 145	03/07→12/11 03/07→12/11	⬅	→ 05/11; - Performance Parts		24.0324-0197.1 524197	Ø 300 24 21,6 V + S
						24.0120-0195.1 420195	Ø 300 20 18,4 V + S
			➡	→ 05/11; - Performance Parts		24.0320-0195.1 520195	Ø 300 20 17,6 V + S
120 i	115	09/06→10/11	⬅	→ 03/07; Türenanzahl: 5; - Performance Parts		24.0122-0238.1 422238	Ø 292 22 20,4 V + S
						24.0322-0238.1 522238	Ø 292 22 19,6 V + S
			⬅	→ 03/07; Türenanzahl: 3; - Performance Parts		24.0124-0197.1 424197	Ø 300 24 22,4 V + S
120 i 120 i	120 125	09/06→12/11 01/07→09/12	⬅	→ 03/07; - Performance Parts		24.0324-0197.1 524197	Ø 300 24 21,6 V + S
						24.0110-0315.1 410315	Ø 296 10,4 8,9 + S
			➡	→ 03/07; - Performance Parts		24.0310-0315.1 510315	Ø 296 10,4 8,1 + S
120 i 120 i	120 125	09/06→12/11 01/07→09/12	⬅	04/07→ 05/11; - Performance Parts		24.0124-0197.1 424197	Ø 300 24 22,4 V + S
						24.0324-0197.1 524197	Ø 300 24 21,6 V + S
			➡	04/07→ 05/11; - Performance Parts		24.0110-0315.1 410315	Ø 296 10,4 8,9 + S







	kW			 	! #		
<b>BMW - 1 (E81) 09/06→09/12</b>							
 <b>Bremsscheibe</b>							
120 i 120 i	120 125	09/06→12/11 01/07→09/12	➡	04/07→ 05/11; - Performance Parts		<b>24.0310-0315.1 510315</b>	Ø 296 10,4 8,1 + S
123 d	150	03/07→12/11	⬅	10/07→ 05/11; - Performance Parts		<b>24.0124-0200.1 424200</b>	Ø 330 24 22,4 V + S
						<b>24.0324-0200.1 524200</b>	Ø 330 24 21,6 V + S
			➡	04/07→ 05/11; - Performance Parts		<b>24.0120-0204.1 420204</b>	Ø 300 20 18,4 V + S
						<b>24.0320-0204.1 520204</b>	Ø 300 20 17,6 V + S
130 i 130 i	190 195	09/06→12/11 09/06→12/11	⬅	→ 05/11; - Performance Parts		<b>24.0124-0200.1 424200</b>	Ø 330 24 22,4 V + S
						<b>24.0324-0200.1 524200</b>	Ø 330 24 21,6 V + S
			➡	→ 05/11; - Performance Parts		<b>24.0120-0204.1 420204</b>	Ø 300 20 18,4 V + S
						<b>24.0320-0204.1 520204</b>	Ø 300 20 17,6 V + S
<b>BMW - 1 (E87) 02/03→01/13</b>							
 <b>Bremsbelagsatz, Scheibenbremse</b>							
116 d	66	01/11→12/11	⬅	- Performance Parts		<b>13.0460-2710.2 602710</b>	TRW 23915 17,6 + WE / - WK + Zub
						<b>13.0470-2710.2 LD2710</b>	TRW 23915 17,6 + WE / - WK + Zub Ceramic
			⬅	+ Performance Parts		<b>13.0460-4848.2 604848</b>	BRE 24316 16,9 + WE / - WK
			➡	- Performance Parts		<b>13.0460-2713.2 602713</b>	TRW 23623 17,4 + WE / - WK + Zub
						<b>13.0470-2713.2 LD2713</b>	TRW 23623 17,4 + WE / - WK + Zub Ceramic
116 d	85	12/08→09/12	⬅	03/10→ 05/11; - Performance Parts		<b>13.0460-2710.2 602710</b>	TRW 23915 17,6 + WE / - WK + Zub
						<b>13.0470-2710.2 LD2710</b>	TRW 23915 17,6 + WE / - WK + Zub Ceramic
			⬅	03/09→ 02/10; - Performance Parts		<b>13.0460-2710.2 602710</b>	TRW 23915 17,6 + WE / - WK + Zub
						<b>13.0470-2710.2 LD2710</b>	TRW 23915 17,6 + WE / - WK + Zub Ceramic
			⬅	03/09→ 05/11; + Performance Parts		<b>13.0460-4848.2 604848</b>	BRE 24316 16,9 + WE / - WK
			➡	03/10→ 05/11; - Performance Parts		<b>13.0460-2713.2 602713</b>	TRW 23623 17,4 + WE / - WK + Zub
						<b>13.0470-2713.2 LD2713</b>	TRW 23623 17,4 + WE / - WK + Zub Ceramic
			➡	03/09→ 02/10; - Performance Parts		<b>13.0460-2713.2 602713</b>	TRW 23623 17,4 + WE / - WK + Zub
						<b>13.0470-2713.2 LD2713</b>	TRW 23623 17,4 + WE / - WK + Zub Ceramic
116 i	85	11/03→06/11	⬅	09/04→ 08/07; - Performance Parts		<b>13.0460-2710.2 602710</b>	TRW 23915 17,6 + WE / - WK + Zub
						<b>13.0470-2710.2 LD2710</b>	TRW 23915 17,6 + WE / - WK + Zub Ceramic
			⬅	09/04→ 08/07; + Performance Parts		<b>13.0460-4848.2 604848</b>	BRE 24316 16,9 + WE / - WK
			➡	09/04→ 08/07; - Performance Parts		<b>13.0460-2713.2 602713</b>	TRW 23623 17,4 + WE / - WK + Zub
						<b>13.0470-2713.2 LD2713</b>	TRW 23623 17,4 + WE / - WK + Zub Ceramic
116 i 116 i	89 90	03/07→06/11 03/07→06/11	⬅	09/07→ 12/08; - Performance Parts		<b>13.0460-2710.2 602710</b>	TRW 23915 17,6 + WE / - WK + Zub
						<b>13.0470-2710.2 LD2710</b>	TRW 23915 17,6 + WE / - WK + Zub Ceramic
			⬅	09/07→ 12/08; + Performance Parts		<b>13.0460-4848.2 604848</b>	BRE 24316 16,9 + WE / - WK
			➡	09/07→ 12/08; - Performance Parts		<b>13.0460-2713.2 602713</b>	TRW 23623 17,4 + WE / - WK + Zub
						<b>13.0470-2713.2 LD2713</b>	TRW 23623 17,4 + WE / - WK + Zub Ceramic
116 i	90	01/09→06/11	⬅	03/10→ 05/11; - Performance Parts		<b>13.0460-2710.2 602710</b>	TRW 23915 17,6 + WE / - WK + Zub
						<b>13.0470-2710.2 LD2710</b>	TRW 23915 17,6 + WE / - WK + Zub Ceramic
			⬅	→ 02/10; - Performance Parts		<b>13.0460-2710.2 602710</b>	TRW 23915 17,6 + WE / - WK + Zub
						<b>13.0470-2710.2 LD2710</b>	TRW 23915 17,6 + WE / - WK + Zub Ceramic
			⬅	→ 05/11; + Performance Parts		<b>13.0460-4848.2 604848</b>	BRE 24316 16,9 + WE / - WK
↓							







	kw			 	! #		
<b>BMW - 1 (E87) 02/03→01/13</b>							
<b> Bremsbelagsatz, Scheibenbremse</b>							
116 i	90	01/09→06/11	➔	→ 02/10; - Performance Parts		<b>13.0460-2713.2 602713</b>	TRW 23623 17,4 + WE / - WK + Zub
					<b>13.0470-2713.2 LD2713</b>	TRW 23623 17,4 + WE / - WK + Zub Ceramic	
			➔	03/10→ 05/11; - Performance Parts		<b>13.0460-2713.2 602713</b>	TRW 23623 17,4 + WE / - WK + Zub
					<b>13.0470-2713.2 LD2713</b>	TRW 23623 17,4 + WE / - WK + Zub Ceramic	
118 d	90	11/03→02/07	➔	09/04→; - Performance Parts		<b>13.0460-2710.2 602710</b>	TRW 23915 17,6 + WE / - WK + Zub
					<b>13.0470-2710.2 LD2710</b>	TRW 23915 17,6 + WE / - WK + Zub Ceramic	
			➔	09/04→; + Performance Parts		<b>13.0460-4848.2 604848</b>	BRE 24316 16,9 + WE / - WK
			➔	09/04→; Türenanzahl: 5; - Performance Parts		<b>13.0460-2713.2 602713</b>	TRW 23623 17,4 + WE / - WK + Zub
					<b>13.0470-2713.2 LD2713</b>	TRW 23623 17,4 + WE / - WK + Zub Ceramic	
			➔	09/04→; Türenanzahl: 3; - Performance Parts		<b>13.0460-7217.2 607217</b>	ATE 23926 17,3 + WE / - WK
					<b>13.0470-7217.2 LD7217</b>	ATE 23926 17,3 + WE / - WK Ceramic	
118 d 118 d	100 105	09/06→06/11 09/06→06/11	➔	03/10→ 05/11; - Performance Parts		<b>13.0460-2710.2 602710</b>	TRW 23915 17,6 + WE / - WK + Zub
					<b>13.0470-2710.2 LD2710</b>	TRW 23915 17,6 + WE / - WK + Zub Ceramic	
			➔	04/07→ 02/10; - Performance Parts		<b>13.0460-2710.2 602710</b>	TRW 23915 17,6 + WE / - WK + Zub
					<b>13.0470-2710.2 LD2710</b>	TRW 23915 17,6 + WE / - WK + Zub Ceramic	
			➔	04/07→ 05/11; + Performance Parts		<b>13.0460-4848.2 604848</b>	BRE 24316 16,9 + WE / - WK
			➔	04/07→ 02/10; - Performance Parts		<b>13.0460-7217.2 607217</b>	ATE 23926 17,3 + WE / - WK
				<b>13.0470-7217.2 LD7217</b>	ATE 23926 17,3 + WE / - WK Ceramic		
			➔	03/10→ 05/11; - Performance Parts		<b>13.0460-7217.2 607217</b>	ATE 23926 17,3 + WE / - WK
					<b>13.0470-7217.2 LD7217</b>	ATE 23926 17,3 + WE / - WK Ceramic	
118 i	95	07/04→02/07	➔	09/04→; - Performance Parts		<b>13.0460-2710.2 602710</b>	TRW 23915 17,6 + WE / - WK + Zub
					<b>13.0470-2710.2 LD2710</b>	TRW 23915 17,6 + WE / - WK + Zub Ceramic	
			➔	09/04→; + Performance Parts		<b>13.0460-4848.2 604848</b>	BRE 24316 16,9 + WE / - WK
			➔	09/04→; - Performance Parts		<b>13.0460-2713.2 602713</b>	TRW 23623 17,4 + WE / - WK + Zub
					<b>13.0470-2713.2 LD2713</b>	TRW 23623 17,4 + WE / - WK + Zub Ceramic	
118 i	100	10/06→06/11	➔	→ 03/07; - Performance Parts		<b>13.0460-2710.2 602710</b>	TRW 23915 17,6 + WE / - WK + Zub
					<b>13.0470-2710.2 LD2710</b>	TRW 23915 17,6 + WE / - WK + Zub Ceramic	
			➔	→ 03/07; + Performance Parts		<b>13.0460-4848.2 604848</b>	BRE 24316 16,9 + WE / - WK
			➔	→ 03/07; - Performance Parts		<b>13.0460-2713.2 602713</b>	TRW 23623 17,4 + WE / - WK + Zub
					<b>13.0470-2713.2 LD2713</b>	TRW 23623 17,4 + WE / - WK + Zub Ceramic	
118 i	105	09/06→06/11	➔	03/10→ 05/11; - Performance Parts		<b>13.0460-2710.2 602710</b>	TRW 23915 17,6 + WE / - WK + Zub
					<b>13.0470-2710.2 LD2710</b>	TRW 23915 17,6 + WE / - WK + Zub Ceramic	
			➔	04/07→ 02/10; - Performance Parts		<b>13.0460-2710.2 602710</b>	TRW 23915 17,6 + WE / - WK + Zub
					<b>13.0470-2710.2 LD2710</b>	TRW 23915 17,6 + WE / - WK + Zub Ceramic	
			➔	04/07→ 05/11; + Performance Parts		<b>13.0460-4848.2 604848</b>	BRE 24316 16,9 + WE / - WK
			➔	04/07→ 02/10; - Performance Parts		<b>13.0460-2713.2 602713</b>	TRW 23623 17,4 + WE / - WK + Zub
					<b>13.0470-2713.2 LD2713</b>	TRW 23623 17,4 + WE / - WK + Zub Ceramic	
			➔	03/10→ 05/11; - Performance Parts		<b>13.0460-2713.2 602713</b>	TRW 23623 17,4 + WE / - WK + Zub









↓









	kw			 	! #		
<b>BMW - 1 (E87) 02/03→01/13</b>							
<b> Bremsbelagsatz, Scheibenbremse</b>							
118 i	105	09/06→06/11	➡	03/10→ 05/11; - Performance Parts		<b>13.0470-2713.2 LD2713</b>	TRW 23623 17,4 + WE / - WK + Zub Ceramic
118 i	125	03/07→12/07	←	04/07→; - Performance Parts		<b>13.0460-2710.2 602710</b>	TRW 23915 17,6 + WE / - WK + Zub
						<b>13.0470-2710.2 LD2710</b>	TRW 23915 17,6 + WE / - WK + Zub Ceramic
			←	04/07→; + Performance Parts		<b>13.0460-4848.2 604848</b>	BRE 24316 16,9 + WE / - WK
			➡	04/07→; - Performance Parts		<b>13.0460-2713.2 602713</b>	TRW 23623 17,4 + WE / - WK + Zub
						<b>13.0470-2713.2 LD2713</b>	TRW 23623 17,4 + WE / - WK + Zub Ceramic
120 d	110	03/03→02/07	←	09/04→; + Performance Parts		<b>13.0460-4848.2 604848</b>	BRE 24316 16,9 + WE / - WK
			←	09/04→; Türenanzahl: 5; - Performance Parts		<b>13.0460-7215.2 607215</b>	ATE 23935 17,8 + WE / - WK
						<b>13.0470-7215.2 LD7215</b>	ATE 23935 17,8 + WE / - WK Ceramic
			←	09/04→; Türenanzahl: 3; - Performance Parts		<b>13.0460-7216.2 607216</b>	ATE 23794 20,3 + WE / - WK
						<b>13.0470-7216.2 LD7216</b>	ATE 23794 20,3 + WE / - WK Ceramic
			➡	09/04→; - Performance Parts		<b>13.0460-7217.2 607217</b>	ATE 23926 17,3 + WE / - WK
						<b>13.0470-7217.2 LD7217</b>	ATE 23926 17,3 + WE / - WK Ceramic
120 d	120	03/03→06/11	←	09/04→ 02/07; + Performance Parts		<b>13.0460-4848.2 604848</b>	BRE 24316 16,9 + WE / - WK
			←	09/04→ 02/07; Türenanzahl: 5; - Performance Parts		<b>13.0460-7215.2 607215</b>	ATE 23935 17,8 + WE / - WK
						<b>13.0470-7215.2 LD7215</b>	ATE 23935 17,8 + WE / - WK Ceramic
			←	09/04→ 02/07; Türenanzahl: 3; - Performance Parts		<b>13.0460-7216.2 607216</b>	ATE 23794 20,3 + WE / - WK
						<b>13.0470-7216.2 LD7216</b>	ATE 23794 20,3 + WE / - WK Ceramic
			➡	09/04→ 02/07; - Performance Parts		<b>13.0460-7217.2 607217</b>	ATE 23926 17,3 + WE / - WK
						<b>13.0470-7217.2 LD7217</b>	ATE 23926 17,3 + WE / - WK Ceramic
120 d	130	09/06→06/11	←	03/07→ 05/11; + Performance Parts		<b>13.0460-4848.2 604848</b>	BRE 24316 16,9 + WE / - WK
			←	03/10→ 05/11; - Performance Parts		<b>13.0460-7216.2 607216</b>	ATE 23794 20,3 + WE / - WK
						<b>13.0470-7216.2 LD7216</b>	ATE 23794 20,3 + WE / - WK Ceramic
			←	03/07→ 02/10; - Performance Parts		<b>13.0460-7216.2 607216</b>	ATE 23794 20,3 + WE / - WK
						<b>13.0470-7216.2 LD7216</b>	ATE 23794 20,3 + WE / - WK Ceramic
			➡	03/10→ 05/11; - Performance Parts		<b>13.0460-7217.2 607217</b>	ATE 23926 17,3 + WE / - WK
						<b>13.0470-7217.2 LD7217</b>	ATE 23926 17,3 + WE / - WK Ceramic
120 i 120 i	110	11/03→06/11	←	01/06→ 03/07; Türenanzahl: 5; - Performance Parts		<b>13.0460-2710.2 602710</b>	TRW 23915 17,6 + WE / - WK + Zub
	115	11/03→06/11				<b>13.0470-2710.2 LD2710</b>	TRW 23915 17,6 + WE / - WK + Zub Ceramic
			←	09/04→ 03/07; + Performance Parts		<b>13.0460-4848.2 604848</b>	BRE 24316 16,9 + WE / - WK
			←	09/04→ 12/05; Türenanzahl: 5; - Performance Parts		<b>13.0460-7215.2 607215</b>	ATE 23935 17,8 + WE / - WK
						<b>13.0470-7215.2 LD7215</b>	ATE 23935 17,8 + WE / - WK Ceramic
			←	09/04→ 03/07; Türenanzahl: 3; - Performance Parts		<b>13.0460-7216.2 607216</b>	ATE 23794 20,3 + WE / - WK
						<b>13.0470-7216.2 LD7216</b>	ATE 23794 20,3 + WE / - WK Ceramic
			➡	09/04→ 03/07; - Performance Parts		<b>13.0460-2713.2 602713</b>	TRW 23623 17,4 + WE / - WK + Zub
						<b>13.0470-2713.2 LD2713</b>	TRW 23623 17,4 + WE / - WK + Zub Ceramic
120 i 120 i	120	09/06→06/11	←	04/07→ 05/11; + Performance Parts		<b>13.0460-4848.2 604848</b>	BRE 24316 16,9 + WE / - WK
	125	09/06→06/11	←	04/07→ 02/10; - Performance Parts		<b>13.0460-7216.2 607216</b>	ATE 23794 20,3 + WE / - WK
						<b>13.0470-7216.2 LD7216</b>	ATE 23794 20,3 + WE / - WK Ceramic
			←	03/10→ 05/11; - Performance Parts		<b>13.0460-7216.2 607216</b>	ATE 23794 20,3 + WE / - WK
						<b>13.0470-7216.2 LD7216</b>	ATE 23794 20,3 + WE / - WK Ceramic
↓							

	kw			 	! #		
<b>BMW - 1 (E87) 02/03→01/13</b>							
<b>Bremsbelagsatz, Scheibenbremse</b>							
120 i 120 i	120 125	09/06→06/11 09/06→06/11	➡	04/07→ 02/10; - Performance Parts		<b>13.0460-2713.2 602713</b> <b>13.0470-2713.2 LD2713</b>	TRW 23623 17,4 + WE / - WK + Zub TRW 23623 17,4 + WE / - WK + Zub Ceramic
			➡	03/10→ 05/11; - Performance Parts		<b>13.0460-2713.2 602713</b> <b>13.0470-2713.2 LD2713</b>	TRW 23623 17,4 + WE / - WK + Zub TRW 23623 17,4 + WE / - WK + Zub Ceramic
123 d	150	03/07→09/12	⬅	10/07→ 05/11; + Performance Parts		<b>13.0460-4848.2 604848</b>	BRE 24316 16,9 + WE / - WK
			⬅	10/07→ 02/10; - Performance Parts		<b>13.0460-7223.2 607223</b> <b>13.0470-7223.2 LD7223</b>	ATE 23794 20,3 + WE / - WK ATE 23794 20,3 + WE / - WK Ceramic
			⬅	03/10→ 05/11; - Performance Parts		<b>13.0460-7223.2 607223</b> <b>13.0470-7223.2 LD7223</b>	ATE 23794 20,3 + WE / - WK ATE 23794 20,3 + WE / - WK Ceramic
			➡	10/07→ 02/10; - Performance Parts		<b>13.0460-7217.2 607217</b> <b>13.0470-7217.2 LD7217</b>	ATE 23926 17,3 + WE / - WK ATE 23926 17,3 + WE / - WK Ceramic
			➡	03/10→ 05/11; - Performance Parts		<b>13.0460-7217.2 607217</b> <b>13.0470-7217.2 LD7217</b>	ATE 23926 17,3 + WE / - WK ATE 23926 17,3 + WE / - WK Ceramic
130 i	190	03/05→09/12	⬅	→ 05/11; + Performance Parts		<b>13.0460-4848.2 604848</b>	BRE 24316 16,9 + WE / - WK
			⬅	→ 02/10; - Performance Parts		<b>13.0460-7223.2 607223</b> <b>13.0470-7223.2 LD7223</b>	ATE 23794 20,3 + WE / - WK ATE 23794 20,3 + WE / - WK Ceramic
			⬅	03/10→ 05/11; - Performance Parts		<b>13.0460-7223.2 607223</b> <b>13.0470-7223.2 LD7223</b>	ATE 23794 20,3 + WE / - WK ATE 23794 20,3 + WE / - WK Ceramic
			➡	→ 02/10; - Performance Parts		<b>13.0460-7217.2 607217</b> <b>13.0470-7217.2 LD7217</b>	ATE 23926 17,3 + WE / - WK ATE 23926 17,3 + WE / - WK Ceramic
			➡	03/10→ 05/11; - Performance Parts		<b>13.0460-7217.2 607217</b> <b>13.0470-7217.2 LD7217</b>	ATE 23926 17,3 + WE / - WK ATE 23926 17,3 + WE / - WK Ceramic
130 i	195	03/05→09/12	⬅	09/05→ 05/11; + Performance Parts		<b>13.0460-4848.2 604848</b>	BRE 24316 16,9 + WE / - WK
			⬅	03/10→ 05/11; - Performance Parts		<b>13.0460-7223.2 607223</b> <b>13.0470-7223.2 LD7223</b>	ATE 23794 20,3 + WE / - WK ATE 23794 20,3 + WE / - WK Ceramic
			⬅	09/05→ 02/10; - Performance Parts		<b>13.0460-7223.2 607223</b> <b>13.0470-7223.2 LD7223</b>	ATE 23794 20,3 + WE / - WK ATE 23794 20,3 + WE / - WK Ceramic
			➡	03/10→ 05/11; - Performance Parts		<b>13.0460-7217.2 607217</b> <b>13.0470-7217.2 LD7217</b>	ATE 23926 17,3 + WE / - WK ATE 23926 17,3 + WE / - WK Ceramic
			➡	09/05→ 02/10; - Performance Parts		<b>13.0460-7217.2 607217</b> <b>13.0470-7217.2 LD7217</b>	ATE 23926 17,3 + WE / - WK ATE 23926 17,3 + WE / - WK Ceramic
<b>Warnkontakt, Bremsbelagverschleiß</b>							
116 d	66	01/11→12/11	⬅	+ Performance Parts	1	<b>24.8190-0267.2 620267</b>	L= 679
			⬅		1	<b>24.8190-0284.2 620284</b>	L= 650
			➡		1	<b>24.8190-0285.2 620285</b>	L= 1.107
116 d	85	12/08→09/12	⬅	03/09→ 02/10	1	<b>24.8190-0264.2 620264</b>	L= 630
			⬅	03/09→ 05/11; + Performance Parts	1	<b>24.8190-0267.2 620267</b>	L= 679
			⬅	03/10→ 05/11	1	<b>24.8190-0284.2 620284</b>	L= 650
			➡	03/09→ 02/10	1	<b>24.8190-0265.2 620265</b>	L= 1.086
			➡	03/10→ 05/11	1	<b>24.8190-0285.2 620285</b>	L= 1.107
116 i	85	11/03→06/11	⬅	09/04→ 08/07	1	<b>24.8190-0264.2 620264</b>	L= 630
			⬅	09/04→ 08/07; + Performance Parts	1	<b>24.8190-0267.2 620267</b>	L= 679
			➡	09/04→ 08/07	1	<b>24.8190-0265.2 620265</b>	L= 1.086
116 i 116 i	89 90	03/07→06/11 03/07→06/11	⬅	09/07→ 12/08	1	<b>24.8190-0264.2 620264</b>	L= 630
			⬅	09/07→ 12/08; + Performance Parts	1	<b>24.8190-0267.2 620267</b>	L= 679
			➡	09/07→ 12/08	1	<b>24.8190-0265.2 620265</b>	L= 1.086
↓							









	kw			 	! #			
<b>BMW - 1 (E87) 02/03→01/13</b>								
<b>Warnkontakt, Bremsbelagverschleiß</b>								
116 i	90	01/09→06/11	←	→ 02/10	1	24.8190-0264.2	620264	L= 630
			←	→ 05/11; + Performance Parts	1	24.8190-0267.2	620267	L= 679
			←	03/10→ 05/11	1	24.8190-0284.2	620284	L= 650
			→	→ 02/10	1	24.8190-0265.2	620265	L= 1.086
			→	03/10→ 05/11	1	24.8190-0285.2	620285	L= 1.107
118 d	90	11/03→02/07	←	09/04→	1	24.8190-0264.2	620264	L= 630
			←	09/04→; + Performance Parts	1	24.8190-0267.2	620267	L= 679
			→	09/04→; Türenanzahl: 5	1	24.8190-0265.2	620265	L= 1.086
			→	09/04→; Türenanzahl: 3	1	24.8190-0265.2	620265	L= 1.086
118 d 118 d 118 i 120 i 120 i	100 105 105 120 125	09/06→06/11 09/06→06/11 09/06→06/11 09/06→06/11 09/06→06/11	←	04/07→ 02/10	1	24.8190-0264.2	620264	L= 630
			←	04/07→ 05/11; + Performance Parts	1	24.8190-0267.2	620267	L= 679
			←	03/10→ 05/11	1	24.8190-0284.2	620284	L= 650
			→	04/07→ 02/10	1	24.8190-0265.2	620265	L= 1.086
			→	03/10→ 05/11	1	24.8190-0285.2	620285	L= 1.107
118 i	95	07/04→02/07	←	09/04→	1	24.8190-0264.2	620264	L= 630
			←	09/04→; + Performance Parts	1	24.8190-0267.2	620267	L= 679
			→	09/04→	1	24.8190-0265.2	620265	L= 1.086
118 i	100	10/06→06/11	←	→ 03/07	1	24.8190-0264.2	620264	L= 630
			←	→ 03/07; + Performance Parts	1	24.8190-0267.2	620267	L= 679
			→	→ 03/07	1	24.8190-0265.2	620265	L= 1.086
118 i	125	03/07→12/07	←	04/07→	1	24.8190-0264.2	620264	L= 630
			←	04/07→; + Performance Parts	1	24.8190-0267.2	620267	L= 679
			→	04/07→	1	24.8190-0265.2	620265	L= 1.086
120 d	110	03/03→02/07	←	09/04→; Türenanzahl: 3	1	24.8190-0264.2	620264	L= 630
			←	09/04→; Türenanzahl: 5	1	24.8190-0264.2	620264	L= 630
			←	09/04→; + Performance Parts	1	24.8190-0267.2	620267	L= 679
			→	09/04→	1	24.8190-0265.2	620265	L= 1.086
120 d	120	03/03→06/11	←	09/04→ 02/07; Türenanzahl: 3	1	24.8190-0264.2	620264	L= 630
			←	09/04→ 02/07; Türenanzahl: 5	1	24.8190-0264.2	620264	L= 630
			←	09/04→ 02/07; + Performance Parts	1	24.8190-0267.2	620267	L= 679
			→	09/04→ 02/07	1	24.8190-0265.2	620265	L= 1.086
120 d	130	09/06→06/11	←	03/07→ 02/10	1	24.8190-0264.2	620264	L= 630
			←	03/07→ 05/11; + Performance Parts	1	24.8190-0267.2	620267	L= 679
			←	03/10→ 05/11	1	24.8190-0284.2	620284	L= 650
			→	03/07→ 02/10	1	24.8190-0265.2	620265	L= 1.086
			→	03/10→ 05/11	1	24.8190-0285.2	620285	L= 1.107
120 i 120 i	110 115	11/03→06/11 11/03→06/11	←	09/04→ 03/07; Türenanzahl: 3	1	24.8190-0264.2	620264	L= 630
			←	01/06→ 03/07; Türenanzahl: 5	1	24.8190-0264.2	620264	L= 630
			←	09/04→ 12/05; Türenanzahl: 5	1	24.8190-0264.2	620264	L= 630
			←	09/04→ 03/07; + Performance Parts	1	24.8190-0267.2	620267	L= 679
			→	09/04→ 03/07	1	24.8190-0265.2	620265	L= 1.086
123 d	150	03/07→09/12	←	10/07→ 02/10	1	24.8190-0267.2	620267	L= 679
			←	10/07→ 05/11; + Performance Parts	1	24.8190-0267.2	620267	L= 679
			←	03/10→ 05/11	1	24.8190-0287.2	620287	L= 723
			→	10/07→ 02/10	1	24.8190-0265.2	620265	L= 1.086
			→	03/10→ 05/11	1	24.8190-0285.2	620285	L= 1.107
130 i	190	03/05→09/12	←	→ 05/11; + Performance Parts	1	24.8190-0267.2	620267	L= 679
			←	→ 02/10	1	24.8190-0267.2	620267	L= 679
			←	03/10→ 05/11	1	24.8190-0287.2	620287	L= 723
			→	→ 02/10	1	24.8190-0265.2	620265	L= 1.086
			→	03/10→ 05/11	1	24.8190-0285.2	620285	L= 1.107
130 i	195	03/05→09/12	←	09/05→ 02/10	1	24.8190-0267.2	620267	L= 679
			←	09/05→ 05/11; + Performance Parts	1	24.8190-0267.2	620267	L= 679
↓								













	kw			 	! #		
<b>BMW - 1 (E87) 02/03→01/13</b>							
<b>Warnkontakt, Bremsbelagverschleiß</b>							
130 i	195	03/05→09/12	←	03/10→ 05/11	1	24.8190-0287.2 620287	L= 723
			→	09/05→ 02/10	1	24.8190-0265.2 620265	L= 1.086
			→	03/10→ 05/11	1	24.8190-0285.2 620285	L= 1.107
<b> Bremsscheibe</b>							
116 d	66	01/11→12/11	←	- Performance Parts		24.0122-0239.1 422239	Ø 284 22 20,4 V + S
						24.0322-0239.1 522239	Ø 284 22 19,6 V + S
			→	- Performance Parts		24.0110-0314.1 410314	Ø 280 10 8,4 + S
						24.0310-0314.1 510314	Ø 280 10 7,6 + S
116 d	85	12/08→09/12	←	03/09→ 05/11; - Performance Parts		24.0122-0239.1 422239	Ø 284 22 20,4 V + S
						24.0322-0239.1 522239	Ø 284 22 19,6 V + S
			→	03/09→ 05/11; - Performance Parts		24.0110-0314.1 410314	Ø 280 10 8,4 + S
						24.0310-0314.1 510314	Ø 280 10 7,6 + S
116 i	85	11/03→06/11	←	09/04→ 08/07; - Performance Parts		24.0122-0239.1 422239	Ø 284 22 20,4 V + S
						24.0322-0239.1 522239	Ø 284 22 19,6 V + S
			→	09/04→ 08/07; - Performance Parts		24.0110-0314.1 410314	Ø 280 10 8,4 + S
						24.0310-0314.1 510314	Ø 280 10 7,6 + S
116 i 116 i	89 90	03/07→06/11 03/07→06/11	←	09/07→ 12/08; - Performance Parts		24.0122-0239.1 422239	Ø 284 22 20,4 V + S
						24.0322-0239.1 522239	Ø 284 22 19,6 V + S
			→	09/07→ 12/08; - Performance Parts		24.0110-0314.1 410314	Ø 280 10 8,4 + S
						24.0310-0314.1 510314	Ø 280 10 7,6 + S
116 i	90	01/09→06/11	←	→ 05/11; - Performance Parts		24.0122-0239.1 422239	Ø 284 22 20,4 V + S
						24.0322-0239.1 522239	Ø 284 22 19,6 V + S
			→	→ 05/11; - Performance Parts		24.0110-0314.1 410314	Ø 280 10 8,4 + S
						24.0310-0314.1 510314	Ø 280 10 7,6 + S
118 d	90	11/03→02/07	←	09/04→; TÜrenanzahl: 3; - Performance Parts		24.0122-0238.1 422238	Ø 292 22 20,4 V + S
						24.0322-0238.1 522238	Ø 292 22 19,6 V + S
			←	09/04→; TÜrenanzahl: 5; - Performance Parts		24.0122-0239.1 422239	Ø 284 22 20,4 V + S
						24.0322-0239.1 522239	Ø 284 22 19,6 V + S
			→	09/04→; TÜrenanzahl: 5; - Performance Parts		24.0110-0314.1 410314	Ø 280 10 8,4 + S
						24.0310-0314.1 510314	Ø 280 10 7,6 + S
			→	09/04→; TÜrenanzahl: 3; - Performance Parts		24.0120-0195.1 420195	Ø 300 20 18,4 V + S
						24.0320-0195.1 520195	Ø 300 20 17,6 V + S
118 d 118 d	100 105	09/06→06/11 09/06→06/11	←	04/07→ 05/11; - Performance Parts		24.0122-0238.1 422238	Ø 292 22 20,4 V + S
						24.0322-0238.1 522238	Ø 292 22 19,6 V + S
			→	04/07→ 05/11; - Performance Parts		24.0120-0195.1 420195	Ø 300 20 18,4 V + S
						24.0320-0195.1 520195	Ø 300 20 17,6 V + S
118 i	95	07/04→02/07	←	09/04→; TÜrenanzahl: 3; - Performance Parts		24.0122-0238.1 422238	Ø 292 22 20,4 V + S
						24.0322-0238.1 522238	Ø 292 22 19,6 V + S
			←	09/04→; TÜrenanzahl: 5; - Performance Parts		24.0122-0239.1 422239	Ø 284 22 20,4 V + S
						24.0322-0239.1 522239	Ø 284 22 19,6 V + S
			→	09/04→; TÜrenanzahl: 5; - Performance Parts		24.0110-0314.1 410314	Ø 280 10 8,4 + S
						24.0310-0314.1 510314	Ø 280 10 7,6 + S
			→	09/04→; TÜrenanzahl: 3; - Performance Parts		24.0110-0315.1 410315	Ø 296 10,4 8,9 + S
						24.0310-0315.1 510315	Ø 296 10,4 8,1 + S
118 i	100	10/06→06/11	←	→ 03/07; TÜrenanzahl: 3; - Performance Parts		24.0122-0238.1 422238	Ø 292 22 20,4 V + S
						24.0322-0238.1 522238	Ø 292 22 19,6 V + S
			←	→ 03/07; TÜrenanzahl: 5; - Performance Parts		24.0122-0239.1 422239	Ø 284 22 20,4 V + S
						24.0322-0239.1 522239	Ø 284 22 19,6 V + S
			→	→ 03/07; TÜrenanzahl: 5; - Performance Parts		24.0110-0314.1 410314	Ø 280 10 8,4 + S
						24.0310-0314.1 510314	Ø 280 10 7,6 + S
			→	→ 03/07; TÜrenanzahl: 3; - Performance Parts		24.0110-0315.1 410315	Ø 296 10,4 8,9 + S
						24.0310-0315.1 510315	Ø 296 10,4 8,1 + S
118 i	105	09/06→06/11	←	04/07→ 05/11; - Performance Parts		24.0122-0238.1 422238	Ø 292 22 20,4 V + S
						24.0322-0238.1 522238	Ø 292 22 19,6 V + S
			→	04/07→ 05/11; - Performance Parts		24.0110-0315.1 410315	Ø 296 10,4 8,9 + S
						24.0310-0315.1 510315	Ø 296 10,4 8,1 + S
118 i	125	03/07→12/07	←	04/07→; - Performance Parts		24.0122-0238.1 422238	Ø 292 22 20,4 V + S
						24.0322-0238.1 522238	Ø 292 22 19,6 V + S
			→	04/07→; - Performance Parts		24.0110-0315.1 410315	Ø 296 10,4 8,9 + S
						24.0310-0315.1 510315	Ø 296 10,4 8,1 + S
↓							







	kw			 	! #		
<b>BMW - 1 (E87) 02/03→01/13</b>							
<b>Bremsscheibe</b>							
120 d	110	03/03→02/07	←	09/04→; TÜrenanzahl: 5; - Performance Parts	24.0122-0238.1 422238	Ø 292 22 20,4 V + S	
			←	09/04→; TÜrenanzahl: 3; - Performance Parts	24.0322-0238.1 522238	Ø 292 22 19,6 V + S	
			→	09/04→; - Performance Parts	24.0124-0197.1 424197 24.0324-0197.1 524197	Ø 300 24 22,4 V + S Ø 300 24 21,6 V + S	
120 d	120	03/03→06/11	←	09/04→ 02/07; TÜrenanzahl: 5; - Performance Parts	24.0122-0238.1 422238	Ø 292 22 20,4 V + S	
			←	09/04→ 02/07; TÜrenanzahl: 3; - Performance Parts	24.0322-0238.1 522238	Ø 292 22 19,6 V + S	
			→	09/04→ 02/07; - Performance Parts	24.0124-0197.1 424197 24.0324-0197.1 524197	Ø 300 24 22,4 V + S Ø 300 24 21,6 V + S	
120 d	130	09/06→06/11	←	09/04→ 02/07; - Performance Parts	24.0120-0195.1 420195	Ø 300 20 18,4 V + S	
			←	03/07→ 05/11; - Performance Parts	24.0320-0195.1 520195	Ø 300 20 17,6 V + S	
			→	03/07→ 05/11; - Performance Parts	24.0120-0195.1 420195 24.0320-0195.1 520195	Ø 300 20 18,4 V + S Ø 300 20 17,6 V + S	
120 i 120 i	110 115	11/03→06/11 11/03→06/11	←	09/04→ 03/07; TÜrenanzahl: 5; - Performance Parts	24.0122-0238.1 422238	Ø 292 22 20,4 V + S	
			←	09/04→ 03/07; TÜrenanzahl: 3; - Performance Parts	24.0322-0238.1 522238	Ø 292 22 19,6 V + S	
			→	09/04→ 03/07; - Performance Parts	24.0124-0197.1 424197 24.0324-0197.1 524197	Ø 300 24 22,4 V + S Ø 300 24 21,6 V + S	
120 i 120 i	120 125	09/06→06/11 09/06→06/11	←	09/04→ 03/07; - Performance Parts	24.0110-0315.1 410315	Ø 296 10,4 8,9 + S	
			←	04/07→ 05/11; - Performance Parts	24.0310-0315.1 510315	Ø 296 10,4 8,1 + S	
			→	04/07→ 05/11; - Performance Parts	24.0124-0197.1 424197 24.0324-0197.1 524197	Ø 300 24 22,4 V + S Ø 300 24 21,6 V + S	
123 d	150	03/07→09/12	←	04/07→ 05/11; - Performance Parts	24.0110-0315.1 410315	Ø 296 10,4 8,9 + S	
			←	10/07→ 05/11; - Performance Parts	24.0310-0315.1 510315	Ø 296 10,4 8,1 + S	
			→	04/07→ 05/11; - Performance Parts	24.0124-0200.1 424200 24.0324-0200.1 524200	Ø 330 24 22,4 V + S Ø 330 24 21,6 V + S	
130 i	190	03/05→09/12	←	10/07→ 05/11; - Performance Parts	24.0120-0204.1 420204	Ø 300 20 18,4 V + S	
			←	→ 05/11; - Performance Parts	24.0320-0204.1 520204	Ø 300 20 17,6 V + S	
			→	→ 05/11; - Performance Parts	24.0124-0200.1 424200 24.0324-0200.1 524200	Ø 330 24 22,4 V + S Ø 330 24 21,6 V + S	
130 i	195	03/05→09/12	←	09/05→ 05/11; - Performance Parts	24.0120-0204.1 420204	Ø 300 20 18,4 V + S	
			←	09/05→ 05/11; - Performance Parts	24.0320-0204.1 520204	Ø 300 20 17,6 V + S	
			→	09/05→ 05/11; - Performance Parts	24.0124-0200.1 424200 24.0324-0200.1 524200	Ø 330 24 22,4 V + S Ø 330 24 21,6 V + S	
<b>BMW - 1 (F20) 11/10→</b>							
<b>Brembelagsatz, Scheibenbremse</b>							
114 d 114 d 116 d 116 i 118 d 118 d xDrive 118 i	70 70 85 80 110 110 100	06/15→ 10/12→ 03/15→ 03/15→ 03/15→ 03/15→ 03/15→	←	- Performance Parts	13.0460-3865.2 603865	BOS 25014 18,2 + WE / - WK	
			←	+ Performance Parts	13.0470-3865.2 LD3865	BOS 25014 18,2 + WE / - WK Ceramic	
			→	- Performance Parts	13.0460-4875.2 604875	BRE 25028 18,0 + WE / - WK	
			→	+ Performance Parts	13.0470-4875.2 LD4875	BRE 25028 18,0 + WE / - WK Ceramic	
			→	- Performance Parts	13.0460-3859.2 603859	BOS 25307 17,5 + WE / - WK	
			→	+ Performance Parts	13.0470-3859.2 LD3859	BOS 25307 17,5 + WE / - WK Ceramic	
114 i	75	11/11→	←	09/12→; - Performance Parts	13.0460-4874.2 604874	BRE 25029 16,7 + WE / - WK	
			←	09/12→; - Performance Parts	13.0460-3865.2 603865	BOS 25014 18,2 + WE / - WK	
			←	09/12→; + Performance Parts	13.0470-3865.2 LD3865	BOS 25014 18,2 + WE / - WK Ceramic	
			→	09/12→; + Performance Parts	13.0460-4875.2 604875 13.0470-4875.2 LD4875	BRE 25028 18,0 + WE / - WK BRE 25028 18,0 + WE / - WK Ceramic	
116 d ↓	85	11/12→	←	09/12→; - Performance Parts	13.0460-3859.2 603859	BOS 25307 17,5 + WE / - WK	
			←	- Performance Parts	13.0470-3859.2 LD3859	BOS 25307 17,5 + WE / - WK Ceramic	
116 d ↓	85	11/12→	←	09/12→; + Performance Parts	13.0460-4874.2 604874	BRE 25029 16,7 + WE / - WK	
			←	- Performance Parts	13.0460-3865.2 603865	BOS 25014 18,2 + WE / - WK	





















	kW			 	! #			
<b>BMW - 1 (F20) 11/10→</b>								
<b> Bremsbelagsatz, Scheibenbremse</b>								
116 d	85	11/12→	←	- Performance Parts		<b>13.0470-3865.2</b>	<b>LD3865</b>	BOS 25014 18,2 + WE / - WK Ceramic
			←	+ Performance Parts		<b>13.0460-4875.2</b>	<b>604875</b>	BRE 25028 18,0 + WE / - WK Ceramic
			→			<b>13.0470-4875.2</b>	<b>LD4875</b>	BRE 25028 18,0 + WE / - WK Ceramic
116 d 116 i 118 d 118 d	85 100 100 105	12/10→ 12/10→ 12/10→ 12/10→	←	06/11→; - Performance Parts		<b>13.0460-3865.2</b>	<b>603865</b>	BOS 25014 18,2 + WE / - WK Ceramic
			←	06/11→; + Performance Parts		<b>13.0470-3865.2</b>	<b>LD3865</b>	BOS 25014 18,2 + WE / - WK Ceramic
			→	06/11→		<b>13.0460-4875.2</b>	<b>604875</b>	BRE 25028 18,0 + WE / - WK Ceramic
118 d xDrive 120 d 120 d xDrive 120 i 120 i	105 140 140 130 135	07/13→ 03/15→ 03/15→ 03/15→ 09/15→	←	- Performance Parts		<b>13.0460-3866.2</b>	<b>603866</b>	BOS 25506 18,2 + WE / - WK Ceramic
			←	+ Performance Parts		<b>13.0470-3866.2</b>	<b>LD3866</b>	BOS 25506 18,2 + WE / - WK Ceramic
			→	- Performance Parts		<b>13.0460-4875.2</b>	<b>604875</b>	BRE 25028 18,0 + WE / - WK Ceramic
118 i 120 d 120 d 120 d	125 120 135 147	11/10→ 12/10→ 12/10→ 01/11→	←	06/11→		<b>13.0470-4875.2</b>	<b>LD4875</b>	BRE 25028 18,0 + WE / - WK Ceramic
			→	06/11→		<b>13.0460-3859.2</b>	<b>603859</b>	BOS 25307 17,5 + WE / - WK Ceramic
			→	06/11→		<b>13.0470-3859.2</b>	<b>LD3859</b>	BOS 25307 17,5 + WE / - WK Ceramic
120 d xDrive 120 d xDrive	135 147	02/12→ 01/11→	←	07/12→; - Performance Parts		<b>13.0460-3866.2</b>	<b>603866</b>	BOS 25506 18,2 + WE / - WK Ceramic
			←	07/12→; + Performance Parts		<b>13.0470-3866.2</b>	<b>LD3866</b>	BOS 25506 18,2 + WE / - WK Ceramic
			→	07/12→; - Performance Parts		<b>13.0460-4875.2</b>	<b>604875</b>	BRE 25028 18,0 + WE / - WK Ceramic
			→	07/12→; + Performance Parts		<b>13.0470-4875.2</b>	<b>LD4875</b>	BRE 25028 18,0 + WE / - WK Ceramic
125 d 125 d 125 i	155 160 160	08/11→ 08/11→ 08/11→	←	03/12→; - Performance Parts		<b>13.0460-3859.2</b>	<b>603859</b>	BOS 25307 17,5 + WE / - WK Ceramic
			←	03/12→; + Performance Parts		<b>13.0470-3857.2</b>	<b>LD3857</b>	BOS 25199 19,6 + WE / - WK Ceramic
			→	03/12→; - Performance Parts		<b>13.0460-4875.2</b>	<b>604875</b>	BRE 25028 18,0 + WE / - WK Ceramic
			→	03/12→; + Performance Parts		<b>13.0470-4875.2</b>	<b>LD4875</b>	BRE 25028 18,0 + WE / - WK Ceramic
125 d 125 i 125 i	165 165 175	03/15→ 09/15→ 03/13→	←	- Performance Parts		<b>13.0460-3859.2</b>	<b>603859</b>	BOS 25307 17,5 + WE / - WK Ceramic
			←	+ Performance Parts		<b>13.0470-3857.2</b>	<b>LD3857</b>	BOS 25199 19,6 + WE / - WK Ceramic
			→	- Performance Parts		<b>13.0460-4875.2</b>	<b>604875</b>	BRE 25028 18,0 + WE / - WK Ceramic
			→	+ Performance Parts		<b>13.0470-4875.2</b>	<b>LD4875</b>	BRE 25028 18,0 + WE / - WK Ceramic
M 135 i	235	11/11→	←	09/12→		<b>13.0460-3859.2</b>	<b>603859</b>	BOS 25307 17,5 + WE / - WK Ceramic
			→	09/12→		<b>13.0470-3859.2</b>	<b>LD3859</b>	BOS 25307 17,5 + WE / - WK Ceramic
↓								







	kW			 	! #		
<b>BMW - 1 (F20) 11/10→</b>							
<b> Bremsbelagsatz, Scheibenbremse</b>							
M 135 i	240	03/15→	←			13.0460-4875.2 604875	BRE 25028 18,0 + WE / - WK
M 135 i xDrive	240	03/15→	→			13.0460-4874.2 604874	BRE 25029 16,7 + WE / - WK
M 140 i	250	09/15→					
M 140 i xDrive	250	09/15→					
M 135 i xDrive	235	02/12→	←	07/12→		13.0460-4875.2 604875	BRE 25028 18,0 + WE / - WK
			→	07/12→		13.0460-4874.2 604874	BRE 25029 16,7 + WE / - WK
<b>Warnkontakt, Bremsbelagverschleiß</b>							
114 d	70	06/15→	←		1	24.8190-0006.2 620006	L= 675
114 d	70	10/12→	→		1	24.8190-0007.2 620007	L= 1.045
116 d	85	03/15→					
116 d	85	11/12→					
116 i	80	03/15→					
118 d	110	03/15→					
118 d xDrive	110	03/15→					
118 i	100	03/15→					
M 135 i	240	03/15→					
M 135 i xDrive	240	03/15→					
M 140 i	250	09/15→					
M 140 i xDrive	250	09/15→					
114 i	75	11/11→	←	09/12→	1	24.8190-0006.2 620006	L= 675
M 135 i	235	11/11→	→	09/12→	1	24.8190-0007.2 620007	L= 1.045
116 d	85	12/10→	←	06/11→	1	24.8190-0006.2 620006	L= 675
116 i	100	12/10→	→	06/11→	1	24.8190-0007.2 620007	L= 1.045
118 d	100	12/10→					
118 d	105	12/10→					
118 d xDrive	105	07/13→	←		1	24.8190-0006.2 620006	L= 675
120 d	140	03/15→	→		1	24.8190-0007.2 620007	L= 1.045
120 d xDrive	140	03/15→					
120 i	130	03/15→					
120 i	135	09/15→					
125 d	165	03/15→					
125 i	165	09/15→					
125 i	175	03/13→					
118 i	125	11/10→	←	 ; 06/11→	1	24.8190-0006.2 620006	L= 675
120 d	120	12/10→	→	06/11→	1	24.8190-0007.2 620007	L= 1.045
120 d	135	12/10→					
120 d	147	01/11→					
120 d xDrive	135	02/12→	←	 ; 07/12→	1	24.8190-0006.2 620006	L= 675
120 d xDrive	147	01/11→	→	07/12→	1	24.8190-0007.2 620007	L= 1.045
125 d	155	08/11→	←	 ; 03/12→	1	24.8190-0006.2 620006	L= 675
125 d	160	08/11→	→	03/12→	1	24.8190-0007.2 620007	L= 1.045
125 i	160	08/11→					
M 135 i xDrive	235	02/12→	←	07/12→	1	24.8190-0006.2 620006	L= 675
			→	07/12→	1	24.8190-0007.2 620007	L= 1.045
<b> Bremsscheibe</b>							
114 d	70	06/15→	←	- Performance Parts		24.0122-0239.1 422239	Ø 284 22 20,4 V + S
114 d	70	10/12→	←	+ Performance Parts		24.0130-0233.2 430233	Ø 340 30 28,4 V Bremsscheibe zweiteilig / + S
116 d	85	03/15→				24.0322-0239.1 522239	Ø 284 22 19,6 V + S
116 i	80	03/15→					
118 d	110	03/15→	→	- Performance Parts		24.0111-0175.1 411175	Ø 290 11 9,4 + S
118 d xDrive	110	03/15→	→	+ Performance Parts		24.0124-0250.2 424250	Ø 345 24 22,4 V Bremsscheibe zweiteilig / + S
118 i	100	03/15→					
114 i	75	11/11→	←	09/12→; - Performance Parts		24.0122-0239.1 422239	Ø 284 22 20,4 V + S
			←	09/12→; + Performance Parts		24.0130-0233.2 430233	Ø 340 30 28,4 V Bremsscheibe zweiteilig / + S
						24.0322-0239.1 522239	Ø 284 22 19,6 V + S
			→	09/12→; - Performance Parts		24.0111-0175.1 411175	Ø 290 11 9,4 + S
			→	09/12→; + Performance Parts		24.0124-0250.2 424250	Ø 345 24 22,4 V Bremsscheibe zweiteilig / + S
116 d	85	11/12→	←	- Performance Parts		24.0122-0239.1 422239	Ø 284 22 20,4 V + S
			←	+ Performance Parts		24.0130-0233.2 430233	Ø 340 30 28,4 V Bremsscheibe zweiteilig / + S
						24.0322-0239.1 522239	Ø 284 22 19,6 V + S
			→			24.0111-0175.1 411175	Ø 290 11 9,4 + S
116 d	85	12/10→	←	06/11→; - Performance Parts		24.0122-0239.1 422239	Ø 284 22 20,4 V + S
116 i	100	12/10→	←	06/11→; + Performance Parts		24.0130-0233.2 430233	Ø 340 30 28,4 V Bremsscheibe zweiteilig / + S
118 d	100	12/10→					
118 d	105	12/10→				24.0322-0239.1 522239	Ø 284 22 19,6 V + S
↓							









	kW			 	! #		
<b>BMW - 1 (F20) 11/10→</b>							
<b>Bremsscheibe</b>							
116 d 116 i 118 d 118 d	85 100 100 105	12/10→ 12/10→ 12/10→ 12/10→	➡	06/11→		24.0111-0175.1 411175	Ø 290 11 9,4 + S
118 d xDrive 120 i 120 i	105 130 135	07/13→ 03/15→ 09/15→	⬅	- Performance Parts		24.0122-0278.1 422278	Ø 300 22 20,4 V + S
			⬅	+ Performance Parts		24.0130-0233.2 430233	Ø 340 30 28,4 V Bremsscheibe zweiteilig / + S
			➡	- Performance Parts		24.0111-0175.1 411175	Ø 290 11 9,4 + S
			➡	+ Performance Parts		24.0124-0250.2 424250	Ø 345 24 22,4 V Bremsscheibe zweiteilig / + S
118 i	125	11/10→	⬅	06/11→		24.0122-0278.1 422278	Ø 300 22 20,4 V + S
			➡	06/11→		24.0111-0175.1 411175	Ø 290 11 9,4 + S
120 d 120 d 120 d	120 135 147	12/10→ 12/10→ 01/11→	⬅	06/11→		24.0122-0278.1 422278	Ø 300 22 20,4 V + S
			➡	06/11→		24.0120-0237.1 420237	Ø 300 20 18,4 V + S
120 d 120 d xDrive	140 140	03/15→ 03/15→	⬅	- Performance Parts		24.0122-0278.1 422278	Ø 300 22 20,4 V + S
			⬅	+ Performance Parts		24.0130-0233.2 430233	Ø 340 30 28,4 V Bremsscheibe zweiteilig / + S
			➡	- Performance Parts		24.0120-0237.1 420237	Ø 300 20 18,4 V + S
			➡	+ Performance Parts		24.0124-0250.2 424250	Ø 345 24 22,4 V Bremsscheibe zweiteilig / + S
120 d xDrive 120 d xDrive	135 147	02/12→ 01/11→	⬅	07/12→; - Performance Parts		24.0122-0278.1 422278	Ø 300 22 20,4 V + S
			⬅	07/12→; + Performance Parts		24.0130-0233.2 430233	Ø 340 30 28,4 V Bremsscheibe zweiteilig / + S
			➡	07/12→; - Performance Parts		24.0120-0237.1 420237	Ø 300 20 18,4 V + S
			➡	07/12→; + Performance Parts		24.0124-0250.2 424250	Ø 345 24 22,4 V Bremsscheibe zweiteilig / + S
125 d 125 d 125 i	155 160 160	08/11→ 08/11→ 08/11→	⬅	03/12→; - Performance Parts		24.0124-0203.1 424203	Ø 312 23,9 22,4 V + S
			⬅	03/12→; + Performance Parts		24.0324-0203.1 524203	Ø 312 23,9 21,6 V + S
			⬅	03/12→; - Performance Parts		24.0130-0233.2 430233	Ø 340 30 28,4 V Bremsscheibe zweiteilig / + S
			➡	03/12→; - Performance Parts		24.0120-0237.1 420237	Ø 300 20 18,4 V + S
125 d 125 i 125 i	165 165 175	03/15→ 09/15→ 03/13→	⬅	- Performance Parts		24.0124-0203.1 424203	Ø 312 23,9 22,4 V + S
			⬅	+ Performance Parts		24.0324-0203.1 524203	Ø 312 23,9 21,6 V + S
			⬅	+ Performance Parts		24.0130-0233.2 430233	Ø 340 30 28,4 V Bremsscheibe zweiteilig / + S
			➡	- Performance Parts		24.0120-0237.1 420237	Ø 300 20 18,4 V + S
M 135 i	235	11/11→	⬅	09/12→		24.0130-0233.2 430233	Ø 340 30 28,4 V Bremsscheibe zweiteilig / + S
			➡	09/12→		24.0124-0250.2 424250	Ø 345 24 22,4 V Bremsscheibe zweiteilig / + S
M 135 i M 135 i xDrive M 140 i M 140 i xDrive	240 240 250 250	03/15→ 03/15→ 09/15→ 09/15→	⬅			24.0130-0233.2 430233	Ø 340 30 28,4 V Bremsscheibe zweiteilig / + S
			➡			24.0124-0250.2 424250	Ø 345 24 22,4 V Bremsscheibe zweiteilig / + S
M 135 i xDrive	235	02/12→	⬅	07/12→		24.0130-0233.2 430233	Ø 340 30 28,4 V Bremsscheibe zweiteilig / + S
			➡	07/12→		24.0124-0250.2 424250	Ø 345 24 22,4 V Bremsscheibe zweiteilig / + S
<b>BMW - 1 (F21) 12/11→</b>							
<b>Bremsbelagsatz, Scheibenbremse</b>							
114 d 116 d 116 i 118 d 118 d xDrive 118 i	70 85 80 110 110 100	06/15→ 03/15→ 03/15→ 03/15→ 03/15→ 03/15→	⬅	- Performance Parts		13.0460-3865.2 603865	BOS 25014 18,2 + WE / - WK
			⬅	- Performance Parts		13.0470-3865.2 LD3865	BOS 25014 18,2 + WE / - WK Ceramic
			⬅	+ Performance Parts		13.0460-4875.2 604875	BRE 25028 18,0 + WE / - WK
			⬅	+ Performance Parts		13.0470-4875.2 LD4875	BRE 25028 18,0 + WE / - WK Ceramic
			➡	- Performance Parts		13.0460-3859.2 603859	BOS 25307 17,5 + WE / - WK
			➡	- Performance Parts		13.0470-3859.2 LD3859	BOS 25307 17,5 + WE / - WK Ceramic
			➡	+ Performance Parts		13.0460-4874.2 604874	BRE 25029 16,7 + WE / - WK
114 d	70	07/12→	⬅	10/12→; - Performance Parts		13.0460-3865.2 603865	BOS 25014 18,2 + WE / - WK
			⬅	10/12→; - Performance Parts		13.0470-3865.2 LD3865	BOS 25014 18,2 + WE / - WK Ceramic
↓							











	kW			 	! #		
<b>BMW - 1 (F21) 12/11→</b>							
<b> Bremsbelagsatz, Scheibenbremse</b>							
114 d	70	07/12→	←	10/12→; + Performance Parts	13.0460-4875.2	604875	BRE 25028 18,0 + WE / - WK
			→	10/12→; - Performance Parts	13.0470-4875.2	LD4875	BRE 25028 18,0 + WE / - WK Ceramic
			→	10/12→; + Performance Parts	13.0460-3859.2	603859	BOS 25307 17,5 + WE / - WK
114 i	75	12/11→	←	09/12→; - Performance Parts	13.0470-3859.2	LD3859	BOS 25307 17,5 + WE / - WK Ceramic
			←	09/12→; + Performance Parts	13.0460-4875.2	604875	BRE 25028 18,0 + WE / - WK
			→	09/12→; - Performance Parts	13.0470-4875.2	LD4875	BRE 25028 18,0 + WE / - WK Ceramic
116 d 116 d 116 i 118 d 118 d	85 85 100 100 105	12/11→ 01/12→ 12/11→ 12/11→ 12/11→	←	- Performance Parts	13.0460-3859.2	603859	BOS 25307 17,5 + WE / - WK
			←	+ Performance Parts	13.0470-3859.2	LD3859	BOS 25307 17,5 + WE / - WK Ceramic
			→		13.0460-4875.2	604875	BRE 25028 18,0 + WE / - WK
118 d xDrive 120 d 120 d xDrive 120 i 120 i	105 140 140 130 135	05/13→ 03/15→ 03/15→ 03/15→ 10/15→	←	- Performance Parts	13.0470-4875.2	LD4875	BRE 25028 18,0 + WE / - WK
			←	+ Performance Parts	13.0460-4875.2	604875	BRE 25028 18,0 + WE / - WK Ceramic
			→	- Performance Parts	13.0470-4875.2	LD4875	BRE 25028 18,0 + WE / - WK Ceramic
118 i 120 d 120 d 120 d	125 120 135 147	07/12→ 07/12→ 07/12→ 01/12→	←		13.0460-3859.2	603859	BOS 25307 17,5 + WE / - WK
			→		13.0470-3859.2	LD3859	BOS 25307 17,5 + WE / - WK Ceramic
			←	07/12→; - Performance Parts	13.0460-3866.2	603866	BOS 25506 18,2 + WE / - WK
120 d xDrive 120 d xDrive	135 147	02/12→ 01/12→	←	07/12→; - Performance Parts	13.0470-3866.2	LD3866	BOS 25506 18,2 + WE / - WK Ceramic
			←	07/12→; + Performance Parts	13.0460-4875.2	604875	BRE 25028 18,0 + WE / - WK
			→	07/12→; - Performance Parts	13.0470-4875.2	LD4875	BRE 25028 18,0 + WE / - WK Ceramic
125 d 125 d 125 i	155 160 160	12/11→ 12/11→ 12/11→	←	03/12→; - Performance Parts	13.0460-3859.2	603859	BOS 25307 17,5 + WE / - WK
			←	03/12→; + Performance Parts	13.0470-3859.2	LD3859	BOS 25307 17,5 + WE / - WK Ceramic
			→	03/12→; - Performance Parts	13.0460-4874.2	604874	BRE 25029 16,7 + WE / - WK
125 d 125 i 125 i	165 165 175	03/15→ 10/15→ 03/13→	←	- Performance Parts	13.0460-4874.2	604874	BRE 25029 16,7 + WE / - WK
			←	+ Performance Parts	13.0460-3857.2	603857	BOS 25199 19,6 + WE / - WK
			←		13.0470-3857.2	LD3857	BOS 25199 19,6 + WE / - WK Ceramic
↓			←		13.0460-4875.2	604875	BRE 25028 18,0 + WE / - WK









	kW			 	! #			
<b>BMW - 1 (F21) 12/11→</b>								
<b> Bremsbelagsatz, Scheibenbremse</b>								
125 d 125 i 125 i	165 165 175	03/15→ 10/15→ 03/13→	← → →	+ Performance Parts - Performance Parts + Performance Parts		13.0470-4875.2 13.0460-3859.2 13.0470-3859.2 13.0460-4874.2	LD4875 603859 LD3859 604874	BRE 25028 18,0 + WE / - WK Ceramic BOS 25307 17,5 + WE / - WK BOS 25307 17,5 + WE / - WK Ceramic BRE 25029 16,7 + WE / - WK
M 135 i	235	12/11→	← →	09/12→ 09/12→		13.0460-4875.2 13.0460-4874.2	604875 604874	BRE 25028 18,0 + WE / - WK BRE 25029 16,7 + WE / - WK
M 135 i M 135 i xDrive M 140 i M 140 i xDrive	240 240 250 250	03/15→ 03/15→ 10/15→ 09/15→	← → → →			13.0460-4875.2 13.0460-4874.2	604875 604874	BRE 25028 18,0 + WE / - WK BRE 25029 16,7 + WE / - WK
M 135 i xDrive	235	02/12→	← →	07/12→ 07/12→		13.0460-4875.2 13.0460-4874.2	604875 604874	BRE 25028 18,0 + WE / - WK BRE 25029 16,7 + WE / - WK
<b>Warnkontakt, Bremsbelagverschleiß</b>								
114 d 116 d 116 d 116 d 116 i 116 i 118 d 118 d 118 d 118 d xDrive 118 i M 135 i M 135 i xDrive M 140 i M 140 i xDrive	70 85 85 85 80 100 100 105 110 110 100 240 240 250 250	06/15→ 03/15→ 12/11→ 01/12→ 03/15→ 12/11→ 12/11→ 03/15→ 03/15→ 03/15→ 03/15→ 03/15→ 10/15→ 09/15→	← → → → → → → → → → → → → → →		1 1	24.8190-0006.2 24.8190-0007.2	620006 620007	L= 675 L= 1.045
114 d	70	07/12→	← →	10/12→ 10/12→	1	24.8190-0006.2 24.8190-0007.2	620006 620007	L= 675 L= 1.045
114 i M 135 i	75 235	12/11→ 12/11→	← →	09/12→ 09/12→	1	24.8190-0006.2 24.8190-0007.2	620006 620007	L= 675 L= 1.045
118 d xDrive 118 i 120 d 120 d 120 d 120 d xDrive 120 i 120 i 125 d 125 i 125 i	105 125 120 135 140 140 140 130 135 165 165 175	05/13→ 07/12→ 07/12→ 07/12→ 03/15→ 01/12→ 03/15→ 03/15→ 10/15→ 03/15→ 10/15→ 03/13→	← → → → → → → → → → → →		1 1	24.8190-0006.2 24.8190-0007.2	620006 620007	L= 675 L= 1.045
120 d xDrive 120 d xDrive	135 147	02/12→ 01/12→	← →	☐; 07/12→ 07/12→	1	24.8190-0006.2 24.8190-0007.2	620006 620007	L= 675 L= 1.045
125 d 125 d 125 i	155 160 160	12/11→ 12/11→ 12/11→	← → →	☐; 03/12→ 03/12→	1	24.8190-0006.2 24.8190-0007.2	620006 620007	L= 675 L= 1.045
M 135 i xDrive	235	02/12→	← →	07/12→ 07/12→	1	24.8190-0006.2 24.8190-0007.2	620006 620007	L= 675 L= 1.045
<b> Bremsscheibe</b>								
114 d 116 d 116 i 118 d 118 d xDrive 118 i	70 85 80 110 110 100	06/15→ 03/15→ 03/15→ 03/15→ 03/15→ 03/15→	← ← → → → →	- Performance Parts + Performance Parts - Performance Parts + Performance Parts		24.0122-0239.1 24.0130-0233.2 24.0322-0239.1 24.0111-0175.1 24.0124-0250.2	422239 430233 522239 411175 424250	Ø 284 22 20,4 V + S Ø 340 30 28,4 V Bremsscheibe zweiteilig / + S Ø 284 22 19,6 V + S Ø 290 11 9,4 + S Ø 345 24 22,4 V Bremsscheibe zweiteilig / + S
114 d	70	07/12→	← ← →	10/12→; - Performance Parts 10/12→; + Performance Parts 10/12→; - Performance Parts		24.0122-0239.1 24.0130-0233.2 24.0322-0239.1 24.0111-0175.1	422239 430233 522239 411175	Ø 284 22 20,4 V + S Ø 340 30 28,4 V Bremsscheibe zweiteilig / + S Ø 284 22 19,6 V + S Ø 290 11 9,4 + S
↓								











	kW			 	! #		
<b>BMW - 1 (F21) 12/11→</b>							
<b>Bremsscheibe</b>							
114 d	70	07/12→	➡	10/12→; + Performance Parts		24.0124-0250.2 424250	Ø 345 24 22,4 V Bremsscheibe zweiteilig / + S
114 i	75	12/11→	⬅	09/12→; - Performance Parts		24.0122-0239.1 422239	Ø 284 22 20,4 V + S
			⬅	09/12→; + Performance Parts		24.0130-0233.2 430233	Ø 340 30 28,4 V Bremsscheibe zweiteilig / + S
						24.0322-0239.1 522239	Ø 284 22 19,6 V + S
			➡	09/12→; - Performance Parts		24.0111-0175.1 411175	Ø 290 11 9,4 + S
			➡	09/12→; + Performance Parts		24.0124-0250.2 424250	Ø 345 24 22,4 V Bremsscheibe zweiteilig / + S
116 d	85	12/11→	⬅	- Performance Parts		24.0122-0239.1 422239	Ø 284 22 20,4 V + S
116 d	85	01/12→	⬅	+ Performance Parts		24.0130-0233.2 430233	Ø 340 30 28,4 V Bremsscheibe zweiteilig / + S
116 i	100	12/11→				24.0322-0239.1 522239	Ø 284 22 19,6 V + S
118 d	100	12/11→				24.0111-0175.1 411175	Ø 290 11 9,4 + S
118 d	105	12/11→	➡			24.0111-0175.1 411175	Ø 290 11 9,4 + S
118 d xDrive	105	05/13→	⬅	- Performance Parts		24.0122-0278.1 422278	Ø 300 22 20,4 V + S
			⬅	+ Performance Parts		24.0130-0233.2 430233	Ø 340 30 28,4 V Bremsscheibe zweiteilig / + S
			➡	- Performance Parts		24.0111-0175.1 411175	Ø 290 11 9,4 + S
			➡	+ Performance Parts		24.0124-0250.2 424250	Ø 345 24 22,4 V Bremsscheibe zweiteilig / + S
120 i	130	03/15→	⬅			24.0130-0233.2 430233	Ø 340 30 28,4 V Bremsscheibe zweiteilig / + S
120 i	135	10/15→	⬅			24.0111-0175.1 411175	Ø 290 11 9,4 + S
118 i	125	07/12→	⬅			24.0122-0278.1 422278	Ø 300 22 20,4 V + S
			➡			24.0111-0175.1 411175	Ø 290 11 9,4 + S
			⬅			24.0122-0278.1 422278	Ø 300 22 20,4 V + S
			➡			24.0120-0237.1 420237	Ø 300 20 18,4 V + S
120 d	120	07/12→	⬅			24.0120-0237.1 420237	Ø 300 20 18,4 V + S
120 d	135	07/12→	⬅			24.0122-0278.1 422278	Ø 300 22 20,4 V + S
120 d	147	01/12→	➡			24.0120-0237.1 420237	Ø 300 20 18,4 V + S
120 d	140	03/15→	⬅	- Performance Parts		24.0122-0278.1 422278	Ø 300 22 20,4 V + S
			⬅	+ Performance Parts		24.0130-0233.2 430233	Ø 340 30 28,4 V Bremsscheibe zweiteilig / + S
			➡	- Performance Parts		24.0120-0237.1 420237	Ø 300 20 18,4 V + S
			➡	+ Performance Parts		24.0124-0250.2 424250	Ø 345 24 22,4 V Bremsscheibe zweiteilig / + S
120 d xDrive	140	03/15→	⬅			24.0122-0278.1 422278	Ø 300 22 20,4 V + S
120 d xDrive	140	03/15→	⬅	- Performance Parts		24.0122-0278.1 422278	Ø 300 22 20,4 V + S
			⬅	+ Performance Parts		24.0130-0233.2 430233	Ø 340 30 28,4 V Bremsscheibe zweiteilig / + S
			➡	- Performance Parts		24.0120-0237.1 420237	Ø 300 20 18,4 V + S
			➡	+ Performance Parts		24.0124-0250.2 424250	Ø 345 24 22,4 V Bremsscheibe zweiteilig / + S
120 d xDrive	135	02/12→	⬅	07/12→; - Performance Parts		24.0122-0278.1 422278	Ø 300 22 20,4 V + S
			⬅	07/12→; + Performance Parts		24.0130-0233.2 430233	Ø 340 30 28,4 V Bremsscheibe zweiteilig / + S
			➡	07/12→; - Performance Parts		24.0120-0237.1 420237	Ø 300 20 18,4 V + S
			➡	07/12→; + Performance Parts		24.0124-0250.2 424250	Ø 345 24 22,4 V Bremsscheibe zweiteilig / + S
120 d xDrive	147	01/12→	⬅			24.0122-0278.1 422278	Ø 300 22 20,4 V + S
			⬅			24.0130-0233.2 430233	Ø 340 30 28,4 V Bremsscheibe zweiteilig / + S
			➡			24.0120-0237.1 420237	Ø 300 20 18,4 V + S
			➡			24.0124-0250.2 424250	Ø 345 24 22,4 V Bremsscheibe zweiteilig / + S
125 d	155	12/11→	⬅	03/12→; - Performance Parts		24.0124-0203.1 424203	Ø 312 23,9 22,4 V + S
			⬅	03/12→; + Performance Parts		24.0324-0203.1 524203	Ø 312 23,9 21,6 V + S
			⬅	03/12→; - Performance Parts		24.0130-0233.2 430233	Ø 340 30 28,4 V Bremsscheibe zweiteilig / + S
			➡	03/12→; - Performance Parts		24.0120-0237.1 420237	Ø 300 20 18,4 V + S
125 d	160	12/11→	⬅			24.0124-0203.1 424203	Ø 312 23,9 22,4 V + S
			⬅			24.0324-0203.1 524203	Ø 312 23,9 21,6 V + S
			⬅			24.0130-0233.2 430233	Ø 340 30 28,4 V Bremsscheibe zweiteilig / + S
			➡			24.0120-0237.1 420237	Ø 300 20 18,4 V + S
125 i	160	12/11→	⬅			24.0124-0203.1 424203	Ø 312 23,9 22,4 V + S
			⬅			24.0324-0203.1 524203	Ø 312 23,9 21,6 V + S
			⬅			24.0130-0233.2 430233	Ø 340 30 28,4 V Bremsscheibe zweiteilig / + S
			➡			24.0120-0237.1 420237	Ø 300 20 18,4 V + S
125 d	165	03/15→	⬅	- Performance Parts		24.0124-0203.1 424203	Ø 312 23,9 22,4 V + S
			⬅			24.0324-0203.1 524203	Ø 312 23,9 21,6 V + S
			⬅			24.0130-0233.2 430233	Ø 340 30 28,4 V Bremsscheibe zweiteilig / + S
			➡			24.0120-0237.1 420237	Ø 300 20 18,4 V + S
125 i	165	10/15→	⬅			24.0124-0203.1 424203	Ø 312 23,9 22,4 V + S
			⬅			24.0324-0203.1 524203	Ø 312 23,9 21,6 V + S
			⬅			24.0130-0233.2 430233	Ø 340 30 28,4 V Bremsscheibe zweiteilig / + S
			➡			24.0120-0237.1 420237	Ø 300 20 18,4 V + S
125 i	175	03/13→	⬅			24.0124-0203.1 424203	Ø 312 23,9 22,4 V + S
			⬅			24.0324-0203.1 524203	Ø 312 23,9 21,6 V + S
			⬅			24.0130-0233.2 430233	Ø 340 30 28,4 V Bremsscheibe zweiteilig / + S
			➡			24.0120-0237.1 420237	Ø 300 20 18,4 V + S
M 135 i	235	12/11→	⬅	09/12→		24.0130-0233.2 430233	Ø 340 30 28,4 V Bremsscheibe zweiteilig / + S
			➡	09/12→		24.0124-0250.2 424250	Ø 345 24 22,4 V Bremsscheibe zweiteilig / + S
M 135 i	240	03/15→	⬅			24.0130-0233.2 430233	Ø 340 30 28,4 V Bremsscheibe zweiteilig / + S
M 135 i xDrive	240	03/15→	⬅			24.0130-0233.2 430233	Ø 340 30 28,4 V Bremsscheibe zweiteilig / + S
M 140 i	250	10/15→	➡			24.0124-0250.2 424250	Ø 345 24 22,4 V Bremsscheibe zweiteilig / + S
M 140 i xDrive	250	09/15→	➡			24.0124-0250.2 424250	Ø 345 24 22,4 V Bremsscheibe zweiteilig / + S
M 135 i xDrive	235	02/12→	⬅	07/12→		24.0130-0233.2 430233	Ø 340 30 28,4 V Bremsscheibe zweiteilig / + S
			➡	07/12→		24.0124-0250.2 424250	Ø 345 24 22,4 V Bremsscheibe zweiteilig / + S
<b>BMW - 1 Cabriolet (E88) 03/08→12/13</b>							
<b>Bremsbelagsatz, Scheibenbremse</b>							
118 d	100	09/08→12/13	⬅	03/10→ 10/13; - Performance Parts		13.0460-2710.2 602710	TRW 23915 17,6 + WE / - WK + Zub
118 d	105	09/08→12/13					
118 i	100	09/08→12/13					
↓							







	kw			 	! #		
<b>BMW - 1 Cabriolet (E88) 03/08→12/13</b>							
<b> Bremsbelagsatz, Scheibenbremse</b>							
118 i	105	03/08→12/13	←	03/10→ 10/13; - Performance Parts	13.0470-2710.2	LD2710	TRW 23915 17,6 + WE / - WK + Zub Ceramic
			←	→ 02/10; - Performance Parts	13.0460-2710.2	602710	TRW 23915 17,6 + WE / - WK + Zub
			←		13.0470-2710.2	LD2710	TRW 23915 17,6 + WE / - WK + Zub Ceramic
			←	→ 10/13; + Performance Parts	13.0460-4848.2	604848	BRE 24316 16,9 + WE / - WK
			→	03/10→ 10/13; - Performance Parts	13.0460-7217.2	607217	ATE 23926 17,3 + WE / - WK
			→	02/10; - Performance Parts	13.0470-7217.2	LD7217	ATE 23926 17,3 + WE / - WK Ceramic
			→	02/10; - Performance Parts	13.0460-7217.2	607217	ATE 23926 17,3 + WE / - WK
			→	02/10; - Performance Parts	13.0470-7217.2	LD7217	ATE 23926 17,3 + WE / - WK Ceramic
120 d 120 d 120 i 120 i 125 i 125 i	120 130 115 120 125 160	03/08→12/13	←	→ 10/13; + Performance Parts	13.0460-4848.2	604848	BRE 24316 16,9 + WE / - WK
			←	03/10→ 10/13; - Performance Parts	13.0460-7216.2	607216	ATE 23794 20,3 + WE / - WK
					13.0470-7216.2	LD7216	ATE 23794 20,3 + WE / - WK Ceramic
			←	→ 02/10; - Performance Parts	13.0460-7216.2	607216	ATE 23794 20,3 + WE / - WK
					13.0470-7216.2	LD7216	ATE 23794 20,3 + WE / - WK Ceramic
			→	03/10→ 10/13; - Performance Parts	13.0460-7217.2	607217	ATE 23926 17,3 + WE / - WK
					13.0470-7217.2	LD7217	ATE 23926 17,3 + WE / - WK Ceramic
			→	02/10; - Performance Parts	13.0460-7217.2	607217	ATE 23926 17,3 + WE / - WK
			→	02/10; - Performance Parts	13.0470-7217.2	LD7217	ATE 23926 17,3 + WE / - WK Ceramic
120 d	145	03/08→12/13	←	→ 10/13; + Performance Parts	13.0460-4848.2	604848	BRE 24316 16,9 + WE / - WK
			←	03/10→ 10/13; - Performance Parts	13.0460-7216.2	607216	ATE 23794 20,3 + WE / - WK
					13.0470-7216.2	LD7216	ATE 23794 20,3 + WE / - WK Ceramic
			←	→ 02/10; - Performance Parts	13.0460-7216.2	607216	ATE 23794 20,3 + WE / - WK
					13.0470-7216.2	LD7216	ATE 23794 20,3 + WE / - WK Ceramic
			→	→ 10/13; - Performance Parts	13.0460-7217.2	607217	ATE 23926 17,3 + WE / - WK
			→	02/10; - Performance Parts	13.0470-7217.2	LD7217	ATE 23926 17,3 + WE / - WK Ceramic
123 d	150	09/08→12/13	←	→ 10/13; + Performance Parts	13.0460-4848.2	604848	BRE 24316 16,9 + WE / - WK
			←	03/10→ 10/13; - Performance Parts	13.0460-7223.2	607223	ATE 23794 20,3 + WE / - WK
					13.0470-7223.2	LD7223	ATE 23794 20,3 + WE / - WK Ceramic
			←	→ 02/10; - Performance Parts	13.0460-7223.2	607223	ATE 23794 20,3 + WE / - WK
					13.0470-7223.2	LD7223	ATE 23794 20,3 + WE / - WK Ceramic
			→	03/10→ 10/13; - Performance Parts	13.0460-7217.2	607217	ATE 23926 17,3 + WE / - WK
			→	02/10; - Performance Parts	13.0470-7217.2	LD7217	ATE 23926 17,3 + WE / - WK Ceramic
128 i	171	03/08→12/13	←	03/10→ 10/13; - Performance Parts	13.0460-7216.2	607216	ATE 23794 20,3 + WE / - WK
					13.0470-7216.2	LD7216	ATE 23794 20,3 + WE / - WK Ceramic
			←	→ 02/10; - Performance Parts	13.0460-7216.2	607216	ATE 23794 20,3 + WE / - WK
					13.0470-7216.2	LD7216	ATE 23794 20,3 + WE / - WK Ceramic
			→	03/10→ 10/13; - Performance Parts	13.0460-7217.2	607217	ATE 23926 17,3 + WE / - WK
			→	02/10; - Performance Parts	13.0470-7217.2	LD7217	ATE 23926 17,3 + WE / - WK Ceramic
135 i 135 i	225 240	03/08→12/13	←	→ 02/10	13.0460-4848.2	604848	BRE 24316 16,9 + WE / - WK
			←	03/10→ 10/13	13.0460-4848.2	604848	BRE 24316 16,9 + WE / - WK
↓							

	kW					! #		
<b>BMW - 1 Cabriolet (E88) 03/08→12/13</b>								
 <b>Bremsbelagsatz, Scheibenbremse</b>								
135 i	225	03/08→12/13	➡	→ 02/10			<b>13.0460-4849.2 604849</b>	BRE 24315 16,2 + WE / - WK
135 i	240	03/08→12/13	➡	03/10→ 10/13			<b>13.0460-4849.2 604849</b>	BRE 24315 16,2 + WE / - WK
<b>Warnkontakt, Bremsbelagverschleiß</b>								
118 d	100	09/08→12/13	⬅	→ 02/10	1	<b>24.8190-0264.2 620264</b>	L= 630	
118 d	105	09/08→12/13	⬅	→ 10/13; + Performance Parts	1	<b>24.8190-0267.2 620267</b>	L= 679	
118 i	100	09/08→12/13	⬅	→ 10/13; + Performance Parts	1	<b>24.8190-0267.2 620267</b>	L= 679	
118 i	105	03/08→12/13	⬅	03/10→ 10/13	1	<b>24.8190-0284.2 620284</b>	L= 650	
120 d	120	03/08→12/13	➡	→ 02/10	1	<b>24.8190-0265.2 620265</b>	L= 1.086	
120 d	130	03/08→12/13	➡	→ 02/10	1	<b>24.8190-0265.2 620265</b>	L= 1.086	
120 i	115	03/08→12/13	➡	03/10→ 10/13	1	<b>24.8190-0285.2 620285</b>	L= 1.107	
120 i	120	03/08→12/13	➡	→ 02/10	1	<b>24.8190-0265.2 620265</b>	L= 1.086	
120 i	125	03/08→12/13	➡	→ 02/10	1	<b>24.8190-0265.2 620265</b>	L= 1.086	
125 i	160	03/08→12/13	➡	03/10→ 10/13	1	<b>24.8190-0285.2 620285</b>	L= 1.107	
120 d	145	03/08→12/13	⬅	→ 02/10	1	<b>24.8190-0264.2 620264</b>	L= 630	
			⬅	→ 10/13; + Performance Parts	1	<b>24.8190-0267.2 620267</b>	L= 679	
			⬅	03/10→ 10/13	1	<b>24.8190-0284.2 620284</b>	L= 650	
			➡	→ 02/10	1	<b>24.8190-0265.2 620265</b>	L= 1.086	
			➡	→ 10/13	1	<b>24.8190-0285.2 620285</b>	L= 1.107	
123 d	150	09/08→12/13	⬅	→ 10/13; + Performance Parts	1	<b>24.8190-0267.2 620267</b>	L= 679	
			⬅	→ 02/10	1	<b>24.8190-0267.2 620267</b>	L= 679	
			⬅	03/10→ 10/13	1	<b>24.8190-0287.2 620287</b>	L= 723	
			➡	→ 02/10	1	<b>24.8190-0265.2 620265</b>	L= 1.086	
			➡	03/10→ 10/13	1	<b>24.8190-0285.2 620285</b>	L= 1.107	
128 i	171	03/08→12/13	⬅	→ 02/10	1	<b>24.8190-0264.2 620264</b>	L= 630	
			⬅	03/10→ 10/13	1	<b>24.8190-0284.2 620284</b>	L= 650	
			➡	→ 02/10	1	<b>24.8190-0265.2 620265</b>	L= 1.086	
			➡	03/10→ 10/13	1	<b>24.8190-0285.2 620285</b>	L= 1.107	
135 i	225	03/08→12/13	⬅	→ 02/10	1	<b>24.8190-0267.2 620267</b>	L= 679	
135 i	240	03/08→12/13	⬅	03/10→ 10/13	1	<b>24.8190-0288.2 620288</b>	L= 698	
			➡	→ 02/10	1	<b>24.8190-0265.2 620265</b>	L= 1.086	
			➡	03/10→ 10/13	1	<b>24.8190-0285.2 620285</b>	L= 1.107	
<b>Zubehörsatz, Scheibenbremsbelag</b>								
135 i	225	03/08→12/13	⬅	→ 02/10			<b>13.0460-0238.2 610238</b>	BRE
135 i	240	03/08→12/13	⬅	03/10→ 10/13			<b>13.0460-0238.2 610238</b>	BRE
 <b>Bremsscheibe</b>								
118 d	100	09/08→12/13	⬅	→ 10/13; - Performance Parts		<b>24.0122-0238.1 422238</b>	Ø 292 22 20,4 V + S	
118 d	105	09/08→12/13	⬅	→ 10/13; - Performance Parts		<b>24.0322-0238.1 522238</b>	Ø 292 22 19,6 V + S	
118 i	100	09/08→12/13	⬅	→ 10/13; - Performance Parts		<b>24.0120-0214.1 420214</b>	Ø 300 20 18,4 V + S	
118 i	105	03/08→12/13	➡	→ 10/13; - Performance Parts		<b>24.0120-0214.1 420214</b>	Ø 300 20 18,4 V + S	
120 d	120	03/08→12/13	⬅	→ 10/13; - Performance Parts		<b>24.0124-0197.1 424197</b>	Ø 300 24 22,4 V + S	
120 d	130	03/08→12/13	⬅	→ 10/13; - Performance Parts		<b>24.0324-0197.1 524197</b>	Ø 300 24 21,6 V + S	
120 d	145	03/08→12/13	⬅	→ 10/13; - Performance Parts		<b>24.0324-0197.1 524197</b>	Ø 300 24 21,6 V + S	
120 i	115	03/08→12/13	➡	→ 10/13; - Performance Parts		<b>24.0120-0214.1 420214</b>	Ø 300 20 18,4 V + S	
120 i	120	03/08→12/13	➡	→ 10/13; - Performance Parts		<b>24.0120-0214.1 420214</b>	Ø 300 20 18,4 V + S	
120 i	125	03/08→12/13	➡	→ 10/13; - Performance Parts		<b>24.0120-0214.1 420214</b>	Ø 300 20 18,4 V + S	
125 i	160	03/08→12/13	➡	→ 10/13; - Performance Parts		<b>24.0120-0214.1 420214</b>	Ø 300 20 18,4 V + S	
128 i	171	03/08→12/13	➡	→ 10/13; - Performance Parts		<b>24.0120-0214.1 420214</b>	Ø 300 20 18,4 V + S	
123 d	150	09/08→12/13	⬅	→ 10/13; - Performance Parts		<b>24.0124-0200.1 424200</b>	Ø 330 24 22,4 V + S	
			⬅	→ 10/13; - Performance Parts		<b>24.0324-0200.1 524200</b>	Ø 330 24 21,6 V + S	
			➡	→ 10/13; - Performance Parts		<b>24.0120-0215.1 420215</b>	Ø 300 20 18,4 V + S	
135 i	225	03/08→12/13	⬅	→ 10/13		<b>24.0126-0152.2 426152</b>	Ø 338 25,9 24,4 V Bremsscheibe zweiteilig / + S	
135 i	240	03/08→12/13	⬅	→ 10/13		<b>24.0122-0257.1 422257</b>	Ø 324 22 20,4 V + S	
			➡	→ 10/13		<b>24.0122-0257.1 422257</b>	Ø 324 22 20,4 V + S	
<b>BMW - 1 Coupe (E82) 10/06→10/13</b>								
 <b>Bremsbelagsatz, Scheibenbremse</b>								
118 d	100	09/09→10/13	⬅	03/10→; - Performance Parts		<b>13.0460-2710.2 602710</b>	TRW 23915 17,6 + WE / - WK + Zub	
118 d	105	09/09→10/13	⬅	→ 02/10; - Performance Parts		<b>13.0470-2710.2 LD2710</b>	TRW 23915 17,6 + WE / - WK + Zub Ceramic	
			⬅	→ 02/10; - Performance Parts		<b>13.0460-2710.2 602710</b>	TRW 23915 17,6 + WE / - WK + Zub	

	kw			 	! #		
<b>BMW - 1 Coupe (E82) 10/06→10/13</b>							
<b> Bremsbelagsatz, Scheibenbremse</b>							
118 d 118 d	100 105	09/09→10/13 09/09→10/13	←	→ 02/10; - Performance Parts	13.0470-2710.2	LD2710	TRW 23915 17,6 + WE / - WK + Zub Ceramic
			←	+ Performance Parts	13.0460-4848.2	604848	BRE 24316 16,9 + WE / - WK
			→	→ 02/10; - Performance Parts	13.0460-7217.2	607217	ATE 23926 17,3 + WE / - WK
			→	→ 02/10; - Performance Parts	13.0470-7217.2	LD7217	ATE 23926 17,3 + WE / - WK Ceramic
			→	03/10→; - Performance Parts	13.0460-7217.2	607217	ATE 23926 17,3 + WE / - WK
			→	03/10→; - Performance Parts	13.0470-7217.2	LD7217	ATE 23926 17,3 + WE / - WK Ceramic
			←	+ Performance Parts	13.0460-4848.2	604848	BRE 24316 16,9 + WE / - WK
			←	03/10→; - Performance Parts	13.0460-7216.2	607216	ATE 23794 20,3 + WE / - WK
120 d 120 d 120 i	120 130 115	09/07→10/13 09/07→10/13 09/09→10/13	←	→ 02/10; - Performance Parts	13.0460-7216.2	607216	ATE 23794 20,3 + WE / - WK
			←	→ 02/10; - Performance Parts	13.0470-7216.2	LD7216	ATE 23794 20,3 + WE / - WK Ceramic
			→	03/10→; - Performance Parts	13.0460-7217.2	607217	ATE 23926 17,3 + WE / - WK
			→	03/10→; - Performance Parts	13.0470-7217.2	LD7217	ATE 23926 17,3 + WE / - WK Ceramic
			→	→ 02/10; - Performance Parts	13.0460-7217.2	607217	ATE 23926 17,3 + WE / - WK
			→	→ 02/10; - Performance Parts	13.0470-7217.2	LD7217	ATE 23926 17,3 + WE / - WK Ceramic
			←	10/07→; + Performance Parts	13.0460-4848.2	604848	BRE 24316 16,9 + WE / - WK
			←	10/07→ 02/10; - Performance Parts	13.0460-7216.2	607216	ATE 23794 20,3 + WE / - WK
120 d	145	09/07→10/13	←	10/07→ 02/10; - Performance Parts	13.0470-7216.2	LD7216	ATE 23794 20,3 + WE / - WK Ceramic
			←	03/10→; - Performance Parts	13.0460-7216.2	607216	ATE 23794 20,3 + WE / - WK
			←	03/10→; - Performance Parts	13.0470-7216.2	LD7216	ATE 23794 20,3 + WE / - WK Ceramic
			→	03/10→; - Performance Parts	13.0460-7217.2	607217	ATE 23926 17,3 + WE / - WK
			→	03/10→; - Performance Parts	13.0470-7217.2	LD7217	ATE 23926 17,3 + WE / - WK Ceramic
			→	10/07→ 02/10; - Performance Parts	13.0460-7217.2	607217	ATE 23926 17,3 + WE / - WK
			→	10/07→ 02/10; - Performance Parts	13.0470-7217.2	LD7217	ATE 23926 17,3 + WE / - WK Ceramic
			←	09/09→; + Performance Parts	13.0460-4848.2	604848	BRE 24316 16,9 + WE / - WK
120 i	125	10/07→10/13	←	09/09→ 02/10; - Performance Parts	13.0460-7216.2	607216	ATE 23794 20,3 + WE / - WK
			←	09/09→ 02/10; - Performance Parts	13.0470-7216.2	LD7216	ATE 23794 20,3 + WE / - WK Ceramic
			←	03/10→; - Performance Parts	13.0460-7216.2	607216	ATE 23794 20,3 + WE / - WK
			←	03/10→; - Performance Parts	13.0470-7216.2	LD7216	ATE 23794 20,3 + WE / - WK Ceramic
			→	03/10→; - Performance Parts	13.0460-7217.2	607217	ATE 23926 17,3 + WE / - WK
			→	03/10→; - Performance Parts	13.0470-7217.2	LD7217	ATE 23926 17,3 + WE / - WK Ceramic
			→	09/09→ 02/10; - Performance Parts	13.0460-7217.2	607217	ATE 23926 17,3 + WE / - WK
			→	09/09→ 02/10; - Performance Parts	13.0470-7217.2	LD7217	ATE 23926 17,3 + WE / - WK Ceramic
123 d	150	10/07→10/13	←	+ Performance Parts	13.0460-4848.2	604848	BRE 24316 16,9 + WE / - WK
			←	03/10→; - Performance Parts	13.0460-7223.2	607223	ATE 23794 20,3 + WE / - WK
			←	03/10→; - Performance Parts	13.0470-7223.2	LD7223	ATE 23794 20,3 + WE / - WK Ceramic
			←	→ 02/10; - Performance Parts	13.0460-7223.2	607223	ATE 23794 20,3 + WE / - WK
			←	→ 02/10; - Performance Parts	13.0470-7223.2	LD7223	ATE 23794 20,3 + WE / - WK Ceramic
			→	→ 02/10; - Performance Parts	13.0460-7217.2	607217	ATE 23926 17,3 + WE / - WK
			→	→ 02/10; - Performance Parts	13.0470-7217.2	LD7217	ATE 23926 17,3 + WE / - WK Ceramic
			→	03/10→; - Performance Parts	13.0460-7217.2	607217	ATE 23926 17,3 + WE / - WK
125 i	160	10/07→10/13	←	03/08→; + Performance Parts	13.0460-4848.2	604848	BRE 24316 16,9 + WE / - WK
			←	03/08→ 02/10; - Performance Parts	13.0460-7216.2	607216	ATE 23794 20,3 + WE / - WK
			←	03/08→ 02/10; - Performance Parts	13.0470-7216.2	LD7216	ATE 23794 20,3 + WE / - WK Ceramic
			←				

	kw			 	! #		
<b>BMW - 1 Coupe (E82) 10/06→10/13</b>							
<b> Bremsbelagsatz, Scheibenbremse</b>							
125 i	160	10/07→10/13	←	03/10→; - Performance Parts		13.0460-7216.2 607216 13.0470-7216.2 LD7216	ATE 23794 20,3 + WE / - WK ATE 23794 20,3 + WE / - WK Ceramic
			→	03/10→; - Performance Parts		13.0460-7217.2 607217 13.0470-7217.2 LD7217	ATE 23926 17,3 + WE / - WK ATE 23926 17,3 + WE / - WK Ceramic
			→	03/08→ 02/10; - Performance Parts		13.0460-7217.2 607217 13.0470-7217.2 LD7217	ATE 23926 17,3 + WE / - WK ATE 23926 17,3 + WE / - WK Ceramic
135 i	225	10/07→10/13	←	03/10→		13.0460-4848.2 604848	BRE 24316 16,9 + WE / - WK
135 i	240	10/07→10/13	←	→ 02/10		13.0460-4848.2 604848	BRE 24316 16,9 + WE / - WK
			→	03/10→		13.0460-4849.2 604849	BRE 24315 16,2 + WE / - WK
			→	→ 02/10		13.0460-4849.2 604849	BRE 24315 16,2 + WE / - WK
M	250	04/11→06/12	←	05/11→		13.0460-7167.2 607167	ATE 23312 20,3 + WE / - WK
			→	05/11→		13.0460-7169.2 607169 13.0470-7169.2 LD7169	ATE 23309 17,3 + WE / - WK ATE 23309 17,3 + WE / - WK Ceramic
<b>Warnkontakt, Bremsbelagverschleiß</b>							
118 d	100	09/09→10/13	←	→ 02/10	1	24.8190-0264.2 620264	L= 630
118 d	105	09/09→10/13	←	+ Performance Parts	1	24.8190-0267.2 620267	L= 679
120 d	120	09/07→10/13	←	03/10→	1	24.8190-0284.2 620284	L= 650
120 d	130	09/07→10/13	←	03/10→	1	24.8190-0284.2 620284	L= 650
120 i	115	09/09→10/13	→	→ 02/10	1	24.8190-0265.2 620265	L= 1.086
123 d	150	10/07→10/13	→	03/10→	1	24.8190-0285.2 620285	L= 1.107
120 d	145	09/07→10/13	←	10/07→ 02/10	1	24.8190-0264.2 620264	L= 630
			←	10/07→; + Performance Parts	1	24.8190-0267.2 620267	L= 679
			←	03/10→	1	24.8190-0284.2 620284	L= 650
			→	10/07→ 02/10	1	24.8190-0265.2 620265	L= 1.086
			→	03/10→	1	24.8190-0285.2 620285	L= 1.107
120 i	125	10/07→10/13	←	09/09→ 02/10	1	24.8190-0264.2 620264	L= 630
			←	09/09→; + Performance Parts	1	24.8190-0267.2 620267	L= 679
			←	03/10→	1	24.8190-0284.2 620284	L= 650
			→	09/09→ 02/10	1	24.8190-0265.2 620265	L= 1.086
			→	03/10→	1	24.8190-0285.2 620285	L= 1.107
125 i	160	10/07→10/13	←	03/08→ 02/10	1	24.8190-0264.2 620264	L= 630
			←	03/08→; + Performance Parts	1	24.8190-0267.2 620267	L= 679
			←	03/10→	1	24.8190-0284.2 620284	L= 650
			→	03/08→ 02/10	1	24.8190-0265.2 620265	L= 1.086
			→	03/10→	1	24.8190-0285.2 620285	L= 1.107
135 i	225	10/07→10/13	←	→ 02/10	1	24.8190-0267.2 620267	L= 679
135 i	240	10/07→10/13	←	03/10→	1	24.8190-0287.2 620287	L= 723
			→	→ 02/10	1	24.8190-0265.2 620265	L= 1.086
			→	03/10→	1	24.8190-0285.2 620285	L= 1.107
M	250	04/11→06/12	←	☐; 05/11→	1	24.8190-0271.2 620271	L= 659
			→	05/11→	1	24.8190-0265.2 620265	L= 1.086
<b>Zubehörsatz, Scheibenbremsbelag</b>							
135 i	225	10/07→10/13	←	→ 02/10		13.0460-0238.2 610238	BRE
135 i	240	10/07→10/13	←	03/10→		13.0460-0238.2 610238	BRE
<b> Bremsscheibe</b>							
118 d	100	09/09→10/13	←	- Performance Parts		24.0122-0238.1 422238	Ø 292 22 20,4 V + S
118 d	105	09/09→10/13	→	- Performance Parts		24.0322-0238.1 522238	Ø 292 22 19,6 V + S
			→	- Performance Parts		24.0120-0214.1 420214	Ø 300 20 18,4 V + S
120 d	120	09/07→10/13	←	- Performance Parts		24.0124-0197.1 424197	Ø 300 24 22,4 V + S
120 d	130	09/07→10/13	←	- Performance Parts		24.0324-0197.1 524197	Ø 300 24 21,6 V + S
120 i	115	09/09→10/13	→	- Performance Parts		24.0120-0214.1 420214	Ø 300 20 18,4 V + S
↓							



	kw			 	! #		
<b>BMW - 1 Coupe (E82) 10/06→10/13</b>							
<b>Bremsscheibe</b>							
120 d	145	09/07→10/13	←	10/07→; - Performance Parts		24.0124-0197.1 424197 24.0324-0197.1 524197	Ø 300 24 22,4 V + S Ø 300 24 21,6 V + S
			→	10/07→; - Performance Parts		24.0120-0214.1 420214	Ø 300 20 18,4 V + S
120 i	125	10/07→10/13	←	09/09→; - Performance Parts		24.0124-0197.1 424197 24.0324-0197.1 524197	Ø 300 24 22,4 V + S Ø 300 24 21,6 V + S
			→	09/09→; - Performance Parts		24.0120-0214.1 420214	Ø 300 20 18,4 V + S
123 d	150	10/07→10/13	←	- Performance Parts		24.0124-0200.1 424200 24.0324-0200.1 524200	Ø 330 24 22,4 V + S Ø 330 24 21,6 V + S
			→	- Performance Parts		24.0120-0215.1 420215	Ø 300 20 18,4 V + S
125 i	160	10/07→10/13	←	03/08→; - Performance Parts		24.0124-0197.1 424197 24.0324-0197.1 524197	Ø 300 24 22,4 V + S Ø 300 24 21,6 V + S
			→	03/08→; - Performance Parts		24.0120-0214.1 420214	Ø 300 20 18,4 V + S
135 i 135 i	225 240	10/07→10/13 10/07→10/13	←			24.0126-0152.2 426152	Ø 338 25,9 24,4 V Bremsscheibe zweiteilig / + S
			→			24.0122-0257.1 422257	Ø 324 22 20,4 V + S
M	250	04/11→06/12	←	☐; 05/11→		24.0130-0213.2 430213	Ø 360 30 28,4 V* Bremsscheibe zweiteilig / + S
			←	☐; 05/11→		24.0130-0214.2 430214	Ø 360 30 28,4 V* Bremsscheibe zweiteilig / + S
			→	☐; 05/11→		24.0124-0231.2 424231	Ø 350 24 22,4 V* Bremsscheibe zweiteilig / + S
			→	☐; 05/11→		24.0124-0232.2 424232	Ø 350 24 22,4 V* Bremsscheibe zweiteilig / + S
<b>BMW - 2 Active Tourer (F45) 11/13→</b>							
<b>Bremsbelagsatz, Scheibenbremse</b>							
214 d	70	07/14→02/18	←	03/15→		13.0460-2795.2 602795 13.0470-2795.2 LD2795	TRW 23915 17,6 + WE / - WK + Zub TRW 23915 17,6 + WE / - WK + Zub Ceramic
			→	03/15→; + eFSB		13.0460-7315.2 607315 13.0470-7315.2 LD7315	ATE 25331 16,2 + WE / - WK ATE 25331 16,2 + WE / - WK Ceramic
216 d 218 d 218 i	85 110 100	03/14→ 11/13→ 11/13→02/18	←	10/14→		13.0460-2613.2 602613 13.0470-2613.2 LD2613	TRW 22187 18,6 + WE / - WK Ceramic
			→	10/14→; + eFSB		13.0460-7315.2 607315 13.0470-7315.2 LD7315	ATE 25331 16,2 + WE / - WK ATE 25331 16,2 + WE / - WK Ceramic
216 i	75	02/15→02/18	←	11/15→		13.0460-2795.2 602795 13.0470-2795.2 LD2795	TRW 23915 17,6 + WE / - WK + Zub TRW 23915 17,6 + WE / - WK + Zub Ceramic
			→	11/15→; + eFSB		13.0460-7315.2 607315 13.0470-7315.2 LD7315	ATE 25331 16,2 + WE / - WK ATE 25331 16,2 + WE / - WK Ceramic
216 i	80	03/18→	→			13.0460-7315.2 607315 13.0470-7315.2 LD7315	ATE 25331 16,2 + WE / - WK ATE 25331 16,2 + WE / - WK Ceramic
218 d	100	11/13→	←	09/14→		13.0460-2613.2 602613 13.0470-2613.2 LD2613	TRW 22187 18,6 + WE / - WK Ceramic
			→	09/14→; + eFSB		13.0460-7315.2 607315 13.0470-7315.2 LD7315	ATE 25331 16,2 + WE / - WK ATE 25331 16,2 + WE / - WK Ceramic
218 d xDrive 218 d xDrive	100 110	12/14→ 12/14→	←	11/15→		13.0460-2613.2 602613 13.0470-2613.2 LD2613	TRW 22187 18,6 + WE / - WK Ceramic
			→	11/15→; + eFSB		13.0460-7315.2 607315 13.0470-7315.2 LD7315	ATE 25331 16,2 + WE / - WK ATE 25331 16,2 + WE / - WK Ceramic
218 i	103	03/18→	←			13.0460-2613.2 602613 13.0470-2613.2 LD2613	TRW 22187 18,6 + WE / - WK Ceramic
			→	+ eFSB		13.0460-7315.2 607315	ATE 25331 16,2 + WE / - WK
↓							

**BMW - 2 Active Tourer (F45) 11/13→**

**Bremsbelagsatz, Scheibenbremse**

218 i	103	03/18→	➡	+ eFSB		13.0470-7315.2	LD7315	ATE 25331 16,2 + WE / - WK Ceramic
220 d 220 d xDrive 220 i	120	03/14→	⬅	11/14→		13.0460-2601.2	602601	TRW 25617 18,5 + WE / - WK
	120	03/14→		11/14→; + eFSB		13.0460-7315.2	607315	ATE 25331 16,2 + WE / - WK Ceramic
	120	03/14→	➡				13.0470-7315.2	LD7315
220 d 220 d xDrive 220 i 225 i 225 i xDrive	140	03/14→	⬅	10/14→		13.0460-2601.2	602601	TRW 25617 18,5 + WE / - WK
	140	03/14→		10/14→; + eFSB		13.0460-7315.2	607315	ATE 25331 16,2 + WE / - WK
	141	03/14→	➡				13.0470-7315.2	LD7315
	170	11/13→						
225 xe 225 xe	100	11/14→	⬅	03/16→		13.0460-2601.2	602601	TRW 25617 18,5 + WE / - WK
	165	11/14→	➡	03/16→; + eFSB		13.0460-7315.2	607315	ATE 25331 16,2 + WE / - WK Ceramic
						13.0470-7315.2	LD7315	ATE 25331 16,2 + WE / - WK Ceramic

**Warnkontakt, Bremsbelagverschleiß**

214 d	70	07/14→02/18	➡	03/15→	1	24.8190-0942.2	620942	L= 641
216 d 218 d 218 i 220 d 220 d xDrive 220 i 225 i 225 i xDrive	85	03/14→	➡	10/14→	1	24.8190-0942.2	620942	L= 641
	110	11/13→						
	100	11/13→02/18						
	140	03/14→						
	140	03/14→						
	141	03/14→						
	170	11/13→						
216 i 218 d xDrive 218 d xDrive	75	02/15→02/18	➡	11/15→	1	24.8190-0942.2	620942	L= 641
	100	12/14→						
	110	12/14→						
216 i 218 i	80	03/18→	➡		1	24.8190-0942.2	620942	L= 641
	103	03/18→						
218 d	100	11/13→	➡	09/14→	1	24.8190-0942.2	620942	L= 641
220 d 220 d xDrive 220 i	120	03/14→	➡	11/14→	1	24.8190-0942.2	620942	L= 641
	120	03/14→						
	120	03/14→						
225 xe 225 xe	100	11/14→	➡	03/16→	1	24.8190-0942.2	620942	L= 641
	165	11/14→						









**Bremsscheibe**









214 d	70	07/14→02/18	⬅	03/15→		24.0122-0292.1	422292	Ø 280 22 20,4 V + S
			➡	03/15→		24.0110-0401.1	410401	Ø 280 10 8,4 + S
216 d 218 d 218 i	85	03/14→ 11/13→ 11/13→02/18	➡	10/14→		24.0110-0401.1	410401	Ø 280 10 8,4 + S
216 i	75	02/15→02/18	⬅	11/15→		24.0122-0292.1	422292	Ø 280 22 20,4 V + S
			➡	11/15→		24.0110-0401.1	410401	Ø 280 10 8,4 + S
216 i	80	03/18→	⬅			24.0122-0292.1	422292	Ø 280 22 20,4 V + S
			➡			24.0110-0401.1	410401	Ø 280 10 8,4 + S
218 d	100	11/13→	➡	09/14→		24.0110-0401.1	410401	Ø 280 10 8,4 + S
218 d xDrive 218 d xDrive	100	12/14→	➡	11/15→		24.0110-0401.1	410401	Ø 280 10 8,4 + S
	110	12/14→						
218 i	103	03/18→	➡			24.0110-0401.1	410401	Ø 280 10 8,4 + S
220 d 220 d xDrive 220 i	120	03/14→ 03/14→ 03/14→	⬅	11/14→		24.0124-0260.1	424260	Ø 307 24 22,4 V + S
			➡	11/14→		24.0110-0401.1	410401	Ø 280 10 8,4 + S
220 d 220 d xDrive 220 i	140	03/14→ 03/14→ 03/14→	⬅	10/14→		24.0124-0260.1	424260	Ø 307 24 22,4 V + S
			➡	10/14→		24.0110-0401.1	410401	Ø 280 10 8,4 + S
225 i 225 i xDrive	170	11/13→ 03/14→	⬅	10/14→		24.0124-0259.1	424259	Ø 330 24 22,4 V + S
			➡	10/14→		24.0120-0244.1	420244	Ø 300 20 18,4 V + S
225 xe 225 xe	100	11/14→ 11/14→	⬅	03/16→		24.0124-0259.1	424259	Ø 330 24 22,4 V + S
			➡	03/16→		24.0120-0244.1	420244	Ø 300 20 18,4 V + S













**BMW - 2 Cabriolet (F23) 03/14→**

**Bremsbelagsatz, Scheibenbremse**







218 d 218 d 218 i ↓	100 110 100	07/15→ 07/15→ 03/15→	⬅	- Performance Parts		13.0460-3865.2	603865	BOS 25014 18,2 + WE / - WK
						13.0470-3865.2	LD3865	BOS 25014 18,2 + WE / - WK Ceramic











	kw			 	! #		
<b>BMW - 2 Cabriolet (F23) 03/14→</b>							
<b> Bremsbelagsatz, Scheibenbremse</b>							
218 d 218 d 218 i	100 110 100	07/15→ 07/15→ 03/15→	←	+ Performance Parts		13.0460-4875.2 604875 13.0470-4875.2 LD4875	BRE 25028 18,0 + WE / - WK BRE 25028 18,0 + WE / - WK Ceramic
			→	- Performance Parts		13.0460-3859.2 603859 13.0470-3859.2 LD3859	BOS 25307 17,5 + WE / - WK BOS 25307 17,5 + WE / - WK Ceramic
			→	+ Performance Parts		13.0460-4874.2 604874	BRE 25029 16,7 + WE / - WK
220 d	120	03/14→	←	11/14→; - Performance Parts		13.0460-3857.2 603857 13.0470-3857.2 LD3857	BOS 25199 19,6 + WE / - WK BOS 25199 19,6 + WE / - WK Ceramic
			←	11/14→; + Performance Parts		13.0460-4875.2 604875 13.0470-4875.2 LD4875	BRE 25028 18,0 + WE / - WK BRE 25028 18,0 + WE / - WK Ceramic
			→	07/15→; - Performance Parts		13.0460-3859.2 603859 13.0470-3859.2 LD3859	BOS 25307 17,5 + WE / - WK BOS 25307 17,5 + WE / - WK Ceramic
			→	07/15→; + Performance Parts		13.0460-4874.2 604874	BRE 25029 16,7 + WE / - WK
220 d 220 i	140 135	03/14→ 04/14→07/16	←	11/14→; - Performance Parts		13.0460-3857.2 603857 13.0470-3857.2 LD3857	BOS 25199 19,6 + WE / - WK BOS 25199 19,6 + WE / - WK Ceramic
			←	11/14→; + Performance Parts		13.0460-4875.2 604875 13.0470-4875.2 LD4875	BRE 25028 18,0 + WE / - WK BRE 25028 18,0 + WE / - WK Ceramic
			→	11/14→; - Performance Parts		13.0460-3859.2 603859 13.0470-3859.2 LD3859	BOS 25307 17,5 + WE / - WK BOS 25307 17,5 + WE / - WK Ceramic
			→	11/14→; + Performance Parts		13.0460-4874.2 604874	BRE 25029 16,7 + WE / - WK
220 i 225 d 228 i 230 i	135 165 180 185	09/15→ 07/15→ 11/14→ 09/15→	←	- Performance Parts		13.0460-3857.2 603857 13.0470-3857.2 LD3857	BOS 25199 19,6 + WE / - WK BOS 25199 19,6 + WE / - WK Ceramic
			←	+ Performance Parts		13.0460-4875.2 604875 13.0470-4875.2 LD4875	BRE 25028 18,0 + WE / - WK BRE 25028 18,0 + WE / - WK Ceramic
			→	- Performance Parts		13.0460-3859.2 603859 13.0470-3859.2 LD3859	BOS 25307 17,5 + WE / - WK BOS 25307 17,5 + WE / - WK Ceramic
			→	+ Performance Parts		13.0460-4874.2 604874	BRE 25029 16,7 + WE / - WK
M 235 i M 235 i xDrive M 240 i M 240 i xDrive	240 240 250 250	11/14→ 07/15→ 09/15→ 09/15→	←			13.0460-4875.2 604875	BRE 25028 18,0 + WE / - WK
			→			13.0460-4874.2 604874	BRE 25029 16,7 + WE / - WK
<b>Warnkontakt, Bremsbelagverschleiß</b>							
218 d 218 d 218 i 220 i 225 d 228 i 230 i M 235 i M 235 i xDrive M 240 i M 240 i xDrive	100 110 100 135 165 180 185 240 240 250 250	07/15→ 07/15→ 03/15→ 09/15→ 07/15→ 11/14→ 09/15→ 11/14→ 07/15→ 09/15→ 09/15→	←		1	24.8190-0006.2 620006	L= 675
			→		1	24.8190-0007.2 620007	L= 1.045
220 d	120	03/14→	←	☐; 11/14→	1	24.8190-0006.2 620006	L= 675
			→	07/15→	1	24.8190-0007.2 620007	L= 1.045
220 d 220 i	140 135	03/14→ 04/14→07/16	←	☐; 11/14→	1	24.8190-0006.2 620006	L= 675
			→	11/14→	1	24.8190-0007.2 620007	L= 1.045
<b> Bremsscheibe</b>							
218 d 218 d 218 i	100 110 100	07/15→ 07/15→ 03/15→	←	- Performance Parts		24.0122-0239.1 422239 24.0322-0239.1 522239	Ø 284 22 20,4 V + S Ø 284 22 19,6 V + S
			←	+ Performance Parts		24.0130-0233.2 430233	Ø 340 30 28,4 V Bremsscheibe zweiteilig / + S
			→	- Performance Parts		24.0111-0175.1 411175	Ø 290 11 9,4 + S
			→	+ Performance Parts		24.0124-0250.2 424250	Ø 345 24 22,4 V Bremsscheibe zweiteilig / + S
↓							









	kW			 	! #		
<b>BMW - 2 Cabriolet (F23) 03/14→</b>							
<b> Bremsscheibe</b>							
220 d 220 d 220 i	120 140 135	03/14→ 03/14→ 04/14→07/16	← ← → →	11/14→; - Performance Parts 11/14→; + Performance Parts 11/14→; - Performance Parts 11/14→; + Performance Parts		24.0124-0203.1 424203 24.0324-0203.1 524203 24.0130-0233.2 430233 24.0120-0237.1 420237 24.0124-0250.2 424250	Ø 312 23,9 22,4 V + S Ø 312 23,9 21,6 V + S Ø 340 30 28,4 V Bremsscheibe zweiteilig / + S Ø 300 20 18,4 V + S Ø 345 24 22,4 V Bremsscheibe zweiteilig / + S
220 i 225 d	135 165	09/15→ 07/15→	← ← → →	- Performance Parts + Performance Parts - Performance Parts + Performance Parts		24.0124-0203.1 424203 24.0324-0203.1 524203 24.0130-0233.2 430233 24.0120-0237.1 420237 24.0124-0250.2 424250	Ø 312 23,9 22,4 V + S Ø 312 23,9 21,6 V + S Ø 340 30 28,4 V Bremsscheibe zweiteilig / + S Ø 300 20 18,4 V + S Ø 345 24 22,4 V Bremsscheibe zweiteilig / + S
228 i 230 i	180 185	11/14→ 09/15→	← ← → →	- Performance Parts + Performance Parts - Performance Parts + Performance Parts		24.0124-0248.1 424248 24.0130-0233.2 430233 24.0120-0237.1 420237 24.0124-0250.2 424250	Ø 330 24 22,4 V + S Ø 340 30 28,4 V Bremsscheibe zweiteilig / + S Ø 300 20 18,4 V + S Ø 345 24 22,4 V Bremsscheibe zweiteilig / + S
M 235 i M 235 i xDrive M 240 i M 240 i xDrive	240 240 250 250	11/14→ 07/15→ 09/15→ 09/15→	← →			24.0130-0233.2 430233 24.0124-0250.2 424250	Ø 340 30 28,4 V Bremsscheibe zweiteilig / + S Ø 345 24 22,4 V Bremsscheibe zweiteilig / + S
<b>BMW - 2 Coupe (F22, F87) 10/12→</b>							
<b> Bremsbelagsatz, Scheibenbremse</b>							
218 d 218 d 218 d 218 i	100 105 110 100	07/15→ 01/14→ 07/15→ 03/15→	← ← → →	- Performance Parts + Performance Parts - Performance Parts + Performance Parts		13.0460-3865.2 603865 13.0470-3865.2 LD3865 13.0460-4875.2 604875 13.0470-4875.2 LD4875 13.0460-3859.2 603859 13.0470-3859.2 LD3859 13.0460-4874.2 604874	BOS 25014 18,2 + WE / - WK BOS 25014 18,2 + WE / - WK Ceramic BRE 25028 18,0 + WE / - WK BRE 25028 18,0 + WE / - WK Ceramic BOS 25307 17,5 + WE / - WK BOS 25307 17,5 + WE / - WK Ceramic BRE 25029 16,7 + WE / - WK
220 d 220 d xDrive 220 i 220 i 225 d 225 d 228 i 230 i	120 120 135 135 160 165 180 185	11/14→ 03/15→ 10/13→ 09/15→ 01/14→ 07/15→ 07/14→ 09/15→	← ← → →	- Performance Parts + Performance Parts - Performance Parts + Performance Parts		13.0460-3857.2 603857 13.0470-3857.2 LD3857 13.0460-4875.2 604875 13.0470-4875.2 LD4875 13.0460-3859.2 603859 13.0470-3859.2 LD3859 13.0460-4874.2 604874	BOS 25199 19,6 + WE / - WK BOS 25199 19,6 + WE / - WK Ceramic BRE 25028 18,0 + WE / - WK BRE 25028 18,0 + WE / - WK Ceramic BOS 25307 17,5 + WE / - WK BOS 25307 17,5 + WE / - WK Ceramic BRE 25029 16,7 + WE / - WK
220 d 220 d	135 147	10/12→11/14 10/12→11/14	← ← → →	10/13→; - Performance Parts 10/13→; + Performance Parts 10/13→; - Performance Parts 10/13→; + Performance Parts		13.0460-3857.2 603857 13.0470-3857.2 LD3857 13.0460-4875.2 604875 13.0470-4875.2 LD4875 13.0460-3859.2 603859 13.0470-3859.2 LD3859 13.0460-4874.2 604874	BOS 25199 19,6 + WE / - WK BOS 25199 19,6 + WE / - WK Ceramic BRE 25028 18,0 + WE / - WK BRE 25028 18,0 + WE / - WK Ceramic BOS 25307 17,5 + WE / - WK BOS 25307 17,5 + WE / - WK Ceramic BRE 25029 16,7 + WE / - WK
220 d	140	03/14→	← ← →	11/14→; - Performance Parts 11/14→; + Performance Parts 11/14→; - Performance Parts		13.0460-3857.2 603857 13.0470-3857.2 LD3857 13.0460-4875.2 604875 13.0470-4875.2 LD4875 13.0460-3859.2 603859	BOS 25199 19,6 + WE / - WK BOS 25199 19,6 + WE / - WK Ceramic BRE 25028 18,0 + WE / - WK BRE 25028 18,0 + WE / - WK Ceramic BOS 25307 17,5 + WE / - WK
↓							









	kW			 	! #		
<b>BMW - 2 Coupe (F22, F87) 10/12→</b>							
<b> Bremsbelagsatz, Scheibenbremse</b>							
220 d	140	03/14→	➡	11/14→; - Performance Parts		13.0470-3859.2 LD3859	BOS 25307 17,5 + WE / - WK Ceramic
			➡	11/14→; + Performance Parts		13.0460-4874.2 604874	BRE 25029 16,7 + WE / - WK
220 d xDrive	140	06/14→	⬅	03/15→; - Performance Parts		13.0460-3857.2 603857	BOS 25199 19,6 + WE / - WK Ceramic
			⬅	03/15→; + Performance Parts		13.0470-3857.2 LD3857	BOS 25199 19,6 + WE / - WK Ceramic
			⬅	03/15→; - Performance Parts		13.0460-4875.2 604875	BRE 25028 18,0 + WE / - WK Ceramic
			⬅	03/15→; + Performance Parts		13.0470-4875.2 LD4875	BRE 25028 18,0 + WE / - WK Ceramic
			➡	03/15→; - Performance Parts		13.0460-3859.2 603859	BOS 25307 17,5 + WE / - WK Ceramic
			➡	03/15→; + Performance Parts		13.0470-3859.2 LD3859	BOS 25307 17,5 + WE / - WK Ceramic
M 235 i	240	10/13→	⬅			13.0460-4875.2 604875	BRE 25028 18,0 + WE / - WK
M 235 i xDrive	240	07/14→					
M 240 i	250	09/15→	➡			13.0460-4874.2 604874	BRE 25029 16,7 + WE / - WK
M 240 i xDrive	250	09/15→					
<b>Warnkontakt, Bremsbelagverschleiß</b>							
218 d	100	07/15→	⬅		1	24.8190-0006.2 620006	L= 675
218 d	105	01/14→					
218 d	110	07/15→	➡		1	24.8190-0007.2 620007	L= 1.045
218 i	100	03/15→					
220 d	120	11/14→					
220 d xDrive	120	03/15→					
220 i	135	10/13→					
220 i	135	09/15→					
225 d	160	01/14→					
225 d	165	07/15→					
M2	272	11/15→06/18					
M 235 i	240	10/13→					
M 235 i xDrive	240	07/14→					
M 240 i	250	09/15→					
M 240 i xDrive	250	09/15→					
M2 Competition	302	06/18→					
220 d	135	10/12→11/14	⬅	 ; 10/13→	1	24.8190-0006.2 620006	L= 675
220 d	147	10/12→11/14	➡	10/13→	1	24.8190-0007.2 620007	L= 1.045
220 d	140	03/14→	⬅	 ; 11/14→	1	24.8190-0006.2 620006	L= 675
			➡	11/14→	1	24.8190-0007.2 620007	L= 1.045
220 d xDrive	140	06/14→	⬅	 ; 03/15→	1	24.8190-0006.2 620006	L= 675
			➡	03/15→	1	24.8190-0007.2 620007	L= 1.045
228 i	180	07/14→	⬅		1	24.8190-0006.2 620006	L= 675
230 i	185	09/15→	➡		1	24.8190-0007.2 620007	L= 1.045
<b> Bremsscheibe</b>							
218 d	100	07/15→	⬅	- Performance Parts		24.0122-0239.1 422239	Ø 284 22 20,4 V + S
218 d	105	01/14→				24.0322-0239.1 522239	Ø 284 22 19,6 V + S
218 d	110	07/15→					
218 i	100	03/15→	⬅	+ Performance Parts		24.0130-0233.2 430233	Ø 340 30 28,4 V Bremsscheibe zweiteilig / + S
			➡	- Performance Parts		24.0111-0175.1 411175	Ø 290 11 9,4 + S
			➡	+ Performance Parts		24.0124-0250.2 424250	Ø 345 24 22,4 V Bremsscheibe zweiteilig / + S
220 d	120	11/14→	⬅	- Performance Parts		24.0124-0203.1 424203	Ø 312 23,9 22,4 V + S
220 d xDrive	120	03/15→				24.0324-0203.1 524203	Ø 312 23,9 21,6 V + S
220 i	135	10/13→					
220 i	135	09/15→	⬅	+ Performance Parts		24.0130-0233.2 430233	Ø 340 30 28,4 V Bremsscheibe zweiteilig / + S
225 d	160	01/14→					
225 d	165	07/15→	➡	- Performance Parts		24.0120-0237.1 420237	Ø 300 20 18,4 V + S
			➡	+ Performance Parts		24.0124-0250.2 424250	Ø 345 24 22,4 V Bremsscheibe zweiteilig / + S
220 d	135	10/12→11/14	⬅	10/13→; - Performance Parts		24.0124-0203.1 424203	Ø 312 23,9 22,4 V + S
220 d	147	10/12→11/14	⬅	10/13→; + Performance Parts		24.0324-0203.1 524203	Ø 312 23,9 21,6 V + S
			➡	10/13→; - Performance Parts		24.0120-0237.1 420237	Ø 300 20 18,4 V + S
			➡	10/13→; + Performance Parts		24.0124-0250.2 424250	Ø 345 24 22,4 V Bremsscheibe zweiteilig / + S
220 d	140	03/14→	⬅	11/14→; - Performance Parts		24.0124-0203.1 424203	Ø 312 23,9 22,4 V + S
↓							









	kw			 	! #		
<b>BMW - 2 Coupe (F22, F87) 10/12→</b>							
<b>Bremsscheibe</b>							
220 d	140	03/14→	←	11/14→; - Performance Parts	24.0324-0203.1	524203	Ø 312 23,9 21,6 V + S
			←	11/14→; + Performance Parts	24.0130-0233.2	430233	Ø 340 30 28,4 V Bremsscheibe zweiteilig / + S
			→	11/14→; - Performance Parts	24.0120-0237.1	420237	Ø 300 20 18,4 V + S
			→	11/14→; + Performance Parts	24.0124-0250.2	424250	Ø 345 24 22,4 V Bremsscheibe zweiteilig / + S
220 d xDrive	140	06/14→	←	03/15→; - Performance Parts	24.0124-0203.1	424203	Ø 312 23,9 22,4 V + S
			←	03/15→; + Performance Parts	24.0324-0203.1	524203	Ø 312 23,9 21,6 V + S
			→	03/15→; - Performance Parts	24.0120-0237.1	420237	Ø 300 20 18,4 V + S
			→	03/15→; + Performance Parts	24.0124-0250.2	424250	Ø 345 24 22,4 V Bremsscheibe zweiteilig / + S
228 i 230 i	180 185	07/14→ 09/15→	←	- Performance Parts	24.0124-0248.1	424248	Ø 330 24 22,4 V + S
			←	+ Performance Parts	24.0130-0233.2	430233	Ø 340 30 28,4 V Bremsscheibe zweiteilig / + S
			→	- Performance Parts	24.0120-0237.1	420237	Ø 300 20 18,4 V + S
			→	+ Performance Parts	24.0124-0250.2	424250	Ø 345 24 22,4 V Bremsscheibe zweiteilig / + S
M 235 i M 235 i xDrive M 240 i M 240 i xDrive	240 240 250 250	10/13→ 07/14→ 09/15→ 09/15→	←		24.0130-0233.2	430233	Ø 340 30 28,4 V Bremsscheibe zweiteilig / + S
			→		24.0124-0250.2	424250	Ø 345 24 22,4 V Bremsscheibe zweiteilig / + S
			←		24.0130-0233.2	430233	Ø 340 30 28,4 V Bremsscheibe zweiteilig / + S
			→		24.0124-0250.2	424250	Ø 345 24 22,4 V Bremsscheibe zweiteilig / + S
<b>BMW - 2 Gran Tourer (F46) 07/14→</b>							
<b>Bremsbelagsatz, Scheibenbremse</b>							
214 d	70	07/15→02/18	←		13.0460-2613.2	602613	TRW 22187 18,6 + WE / - WK
			→	+ eFSB	13.0460-7315.2	607315	ATE 25331 16,2 + WE / - WK
216 d	85	08/14→	←	03/15→	13.0460-2613.2	602613	TRW 22187 18,6 + WE / - WK
			→	03/15→; + eFSB	13.0460-7315.2	607315	ATE 25331 16,2 + WE / - WK
216 i	75	09/14→02/18	←	07/15→	13.0460-2613.2	602613	TRW 22187 18,6 + WE / - WK
			→	07/15→; + eFSB	13.0460-7315.2	607315	ATE 25331 16,2 + WE / - WK
216 i	80	03/18→	←		13.0460-2613.2	602613	TRW 22187 18,6 + WE / - WK
			→		13.0460-7315.2	607315	ATE 25331 16,2 + WE / - WK
218 d 218 d 218 i	100 110 100	07/14→ 07/14→ 07/14→	←	03/15→	13.0460-2601.2	602601	TRW 25617 18,5 + WE / - WK
			→	03/15→; + eFSB	13.0460-7315.2	607315	ATE 25331 16,2 + WE / - WK
218 d xDrive 218 d xDrive 220 d xDrive 220 d xDrive 220 i 220 i	100 110 120 140 120 141	03/15→ 03/15→ 07/14→ 07/14→ 07/14→ 07/14→	←		13.0460-2601.2	602601	TRW 25617 18,5 + WE / - WK
			→	+ eFSB	13.0460-7315.2	607315	ATE 25331 16,2 + WE / - WK
218 i	103	04/17→	←		13.0460-2601.2	602601	TRW 25617 18,5 + WE / - WK
			→		13.0460-7315.2	607315	ATE 25331 16,2 + WE / - WK
220 d 220 d	120 140	09/14→ 09/14→	←	07/15→	13.0460-2601.2	602601	TRW 25617 18,5 + WE / - WK
			→	07/15→; + eFSB	13.0460-7315.2	607315	ATE 25331 16,2 + WE / - WK
↓							

	kw			 	! #			
<b>BMW - 2 Gran Tourer (F46) 07/14→</b>								
<b> Bremsbelagsatz, Scheibenbremse</b>								
220 d	120	09/14→	➡	07/15→; + eFSB		13.0470-7315.2	LD7315	ATE 25331 16,2 + WE / - WK Ceramic
220 d	140	09/14→						
<b>Warnkontakt, Bremsbelagverschleiß</b>								
214 d	70	07/15→02/18	➡		1	24.8190-0942.2	620942	L= 641
218 d xDrive	100	03/15→						
218 d xDrive	110	03/15→						
218 i	103	04/17→						
220 d xDrive	120	07/14→						
220 d xDrive	140	07/14→						
220 i	120	07/14→						
220 i	141	07/14→						
216 d	85	08/14→	➡	03/15→	1	24.8190-0942.2	620942	L= 641
218 d	100	07/14→						
218 d	110	07/14→						
218 i	100	07/14→						
216 i	75	09/14→02/18	➡	07/15→	1	24.8190-0942.2	620942	L= 641
220 d	120	09/14→						
220 d	140	09/14→						
<b> Bremsscheibe</b>								
214 d	70	07/15→02/18	➡			24.0110-0401.1	410401	Ø 280 10 8,4 + S
216 i	80	03/18→						
216 d	85	08/14→	➡	03/15→		24.0110-0401.1	410401	Ø 280 10 8,4 + S
216 i	75	09/14→02/18	➡	07/15→		24.0110-0401.1	410401	Ø 280 10 8,4 + S
218 d	100	07/14→	⬅	03/15→		24.0124-0260.1	424260	Ø 307 24 22,4 V + S
218 d	110	07/14→						
218 i	100	07/14→	➡	03/15→		24.0110-0401.1	410401	Ø 280 10 8,4 + S
218 d xDrive	100	03/15→	⬅			24.0124-0260.1	424260	Ø 307 24 22,4 V + S
218 d xDrive	110	03/15→	➡			24.0110-0401.1	410401	Ø 280 10 8,4 + S
218 i	103	04/17→	⬅	für Fahrzeuge mit verstärkter Bremse		24.0124-0259.1	424259	Ø 330 24 22,4 V + S
			⬅	nicht für Fahrzeuge mit verstärkter Bremse		24.0124-0260.1	424260	Ø 307 24 22,4 V + S
			➡	nicht für Fahrzeuge mit verstärkter Bremse		24.0110-0401.1	410401	Ø 280 10 8,4 + S
			➡	für Fahrzeuge mit verstärkter Bremse		24.0120-0244.1	420244	Ø 300 20 18,4 V + S
220 d	120	09/14→	⬅	07/15→		24.0124-0259.1	424259	Ø 330 24 22,4 V + S
220 d	140	09/14→	➡	07/15→		24.0110-0401.1	410401	Ø 280 10 8,4 + S
220 d xDrive	120	07/14→	⬅			24.0124-0259.1	424259	Ø 330 24 22,4 V + S
220 d xDrive	140	07/14→						
220 i	120	07/14→	➡			24.0110-0401.1	410401	Ø 280 10 8,4 + S
220 i	141	07/14→						
<b>BMW - 3 (E36) 09/90→12/98</b>								
<b> Bremsbelagsatz, Scheibenbremse</b>								
316 i	75	07/93→02/98	⬅	Artikelnummer des empfohlenen Zubehörs: WK 24.8190-0207.2		13.0460-5405.2	605405	ATE 21643 17,8 + WE / - WK
318 i	85	10/93→02/98						
318 tds	66	01/95→02/98	⬅			13.0470-5405.2	LD5405	ATE 21643 17,8 + WE / - WK Ceramic
			➡	+ ABS		13.0460-3605.2	603605	ATE 20180 17,3 + WE / - WK
						13.0470-3605.2	LD3605	ATE 20180 17,3 + WE / - WK Ceramic
318 is	103	03/93→02/98	⬅	Artikelnummer des empfohlenen Zubehörs: WK 24.8190-0207.2		13.0460-5405.2	605405	ATE 21643 17,8 + WE / - WK
318 is	103	09/95→02/98						
320 i	110	09/90→02/98	⬅			13.0470-5405.2	LD5405	ATE 21643 17,8 + WE / - WK Ceramic
323 i 2.5	125	03/95→02/98						
325 td	85	09/91→02/98						
325 tds	105	05/93→02/98	➡			13.0460-3605.2	603605	ATE 20180 17,3 + WE / - WK
328 i	142	08/94→12/98				13.0470-3605.2	LD3605	ATE 20180 17,3 + WE / - WK Ceramic
M3 3.2	236	09/95→02/98	⬅			13.0460-7185.2	607185	ATE 20968 20,3 + WE / - WK
			➡			13.0460-3803.2	603803	ATE 20995 17,3 + WE / - WK
<b>Warnkontakt, Bremsbelagverschleiß</b>								
316 i	75	07/93→02/98	⬅		1	24.8190-0207.2	620207	L= 786
318 i	85	10/93→02/98						
318 tds	66	01/95→02/98	➡	+ ABS	1	24.8190-0206.2	620206	L= 790
318 is	103	03/93→02/98	⬅		1	24.8190-0207.2	620207	L= 786
318 is	103	09/95→02/98						
320 i	110	09/90→02/98	➡		1	24.8190-0206.2	620206	L= 790
323 i 2.5	125	03/95→02/98						
325 td	85	09/91→02/98						









	kw			 	! #		
<b>BMW - 3 (E36) 09/90→12/98</b>							
<b>Warnkontakt, Bremsbelagverschleiß</b>							
325 tds	105	05/93→02/98	←		1	24.8190-0207.2 620207	L= 786
328 i	142	08/94→12/98	→		1	24.8190-0206.2 620206	L= 790
M3 3.2	236	09/95→02/98	←		1	24.8190-0210.2 620210	L= 810
			→		1	24.8190-0206.2 620206	L= 790
<b> Bremsscheibe</b>							
316 i	75	07/93→02/98	←			24.0112-0126.1 412126	Ø 286 12 10,4 + S
			→	+ ABS		24.0312-0126.1 512126	Ø 286 12 9,6 + S
			←	nicht für erhöhte Nutzlast		24.0110-0202.1 410202	Ø 280 10 8,4 + S
			→			24.0310-0202.1 510202	Ø 280 10 7,6 + S
318 i	85	10/93→02/98	←	nicht für erhöhte Nutzlast		24.0112-0126.1 412126	Ø 286 12 10,4 + S
318 tds	66	01/95→02/98	←	für erhöhte Nutzlast		24.0312-0126.1 512126	Ø 286 12 9,6 + S
			←	für erhöhte Nutzlast		24.0122-0115.1 422115	Ø 286 22 20,4 V + S
			→	+ ABS		24.0322-0115.1 522115	Ø 286 22 19,6 V + S
			→			24.0110-0202.1 410202	Ø 280 10 8,4 + S
			→			24.0310-0202.1 510202	Ø 280 10 7,6 + S
318 is	103	03/93→02/98	←			24.0122-0115.1 422115	Ø 286 22 20,4 V + S
318 is	103	09/95→02/98	←			24.0322-0115.1 522115	Ø 286 22 19,6 V + S
320 i	110	09/90→02/98	→			24.0110-0202.1 410202	Ø 280 10 8,4 + S
325 td	85	09/91→02/98	→			24.0310-0202.1 510202	Ø 280 10 7,6 + S
325 tds	105	05/93→02/98	→				
323 i 2.5	125	03/95→02/98	←			24.0122-0115.1 422115	Ø 286 22 20,4 V + S
328 i	142	08/94→12/98	←			24.0322-0115.1 522115	Ø 286 22 19,6 V + S
			→			24.0119-0107.1 419107	Ø 276 19 17,4 V + S
			→			24.0319-0107.1 519107	Ø 276 19 16,6 V + S
M3 3.2	236	09/95→02/98	←	☐		24.0128-0204.2 428204	Ø 315 28 26,4 V Brems Scheibe zweiteilig / + S
			←	☐		24.0128-0205.2 428205	Ø 315 28 26,4 V Brems Scheibe zweiteilig / + S
			→	☐		24.0120-0189.1 420189	Ø 312 20 18,4 V + S
			→	☐		24.0120-0190.1 420190	Ø 312 20 18,4 V + S
<b>BMW - 3 (E46) 02/98→04/05</b>							
<b> Bremsbelagsatz, Scheibenbremse</b>							
316 i	77	04/00→02/05	←			13.0460-5405.2 605405	ATE 21643 17,8 + WE / - WK
316 i	85	06/02→02/05	←			13.0470-5405.2 LD5405	ATE 21643 17,8 + WE / - WK Ceramic
316 i	85	02/02→02/05	←				
316 i	77	09/98→02/05	→			13.0460-3605.2 603605	ATE 20180 17,3 + WE / - WK
318 d	85	09/01→03/03	→			13.0470-3605.2 LD3605	ATE 20180 17,3 + WE / - WK Ceramic
318 d	85	03/03→02/05	→				
318 i	87	02/98→09/01	→				
318 i	100	09/01→02/05	→				
318 i	105	09/01→02/05	→				
320 d	95	02/98→08/01	→				
320 d	100	04/98→09/01	→				
320 d	110	09/01→02/05	→				
320 i	110	03/98→09/00	→				
320 i	120	09/00→02/05	→				
320 i	125	09/00→02/05	→				
323 i	120	03/98→09/00	→				
323 i	125	03/98→09/00	→				
328 i	142	02/98→06/00	→				
325 i	141	09/00→02/05	←	nicht für erhöhte Nutzlast		13.0460-5405.2 605405	ATE 21643 17,8 + WE / - WK
325 xi	141	09/00→02/05	←	für erhöhte Nutzlast		13.0470-5405.2 LD5405	ATE 21643 17,8 + WE / - WK Ceramic
			←	für erhöhte Nutzlast		13.0460-7155.2 607155	ATE 21676 20,3 + WE / - WK
			→	nicht für erhöhte Nutzlast		13.0470-7155.2 LD7155	ATE 21676 20,3 + WE / - WK Ceramic
			→	nicht für erhöhte Nutzlast		13.0460-3605.2 603605	ATE 20180 17,3 + WE / - WK
			→	für erhöhte Nutzlast		13.0470-3605.2 LD3605	ATE 20180 17,3 + WE / - WK Ceramic
			→	für erhöhte Nutzlast		13.0460-7079.2 607079	ATE 21282 17,3 + WE / - WK
			→			13.0470-7079.2 LD7079	ATE 21282 17,3 + WE / - WK Ceramic
330 d	135	10/99→02/05	←			13.0460-7155.2 607155	ATE 21676 20,3 + WE / - WK
330 d	150	03/03→02/05	←			13.0470-7155.2 LD7155	ATE 21676 20,3 + WE / - WK Ceramic
330 i	170	06/00→02/05	→				
330 xi	170	06/00→02/05	→			13.0460-7079.2 607079	ATE 21282 17,3 + WE / - WK









	kw			 	! #		
<b>BMW - 3 (E46) 02/98→04/05</b>							
<b> Bremsbelagsatz, Scheibenbremse</b>							
330 d	135	10/99→02/05	➡			13.0470-7079.2 LD7079	ATE 21282 17,3 + WE / - WK Ceramic
330 d	150	03/03→02/05					
330 i	170	06/00→02/05					
330 xi	170	06/00→02/05					
330 i	168	01/01→04/05	⬅	→ 02/05		13.0460-7155.2 607155	ATE 21676 20,3 + WE / - WK Ceramic
			➡	→ 02/05		13.0470-7155.2 LD7155	ATE 21676 20,3 + WE / - WK Ceramic
			➡	→ 02/05		13.0460-7079.2 607079	ATE 21282 17,3 + WE / - WK Ceramic
			➡	→ 02/05		13.0470-7079.2 LD7079	ATE 21282 17,3 + WE / - WK Ceramic
330 xd	135	01/00→02/03	⬅	06/00→		13.0460-7155.2 607155	ATE 21676 20,3 + WE / - WK Ceramic
			➡	06/00→		13.0470-7155.2 LD7155	ATE 21676 20,3 + WE / - WK Ceramic
			➡	06/00→		13.0460-7079.2 607079	ATE 21282 17,3 + WE / - WK Ceramic
			➡	06/00→		13.0470-7079.2 LD7079	ATE 21282 17,3 + WE / - WK Ceramic
330 xd	150	09/02→12/04	⬅	03/03→		13.0460-7155.2 607155	ATE 21676 20,3 + WE / - WK Ceramic
			➡	03/03→		13.0470-7155.2 LD7155	ATE 21676 20,3 + WE / - WK Ceramic
			➡	03/03→		13.0460-7079.2 607079	ATE 21282 17,3 + WE / - WK Ceramic
			➡	03/03→		13.0470-7079.2 LD7079	ATE 21282 17,3 + WE / - WK Ceramic
<b>Warnkontakt, Bremsbelagverschleiß</b>							
316 i	77	04/00→02/05	⬅		1	24.8190-0220.2 620220	L= 601
316 i	85	06/02→02/05					
316 i	85	02/02→02/05	➡		1	24.8190-0221.2 620221	L= 1.338
316 i	77	09/98→02/05					
318 d	85	09/01→03/03					
318 d	85	03/03→02/05					
318 i	87	02/98→09/01					
318 i	100	09/01→02/05					
318 i	105	09/01→02/05					
320 d	95	02/98→08/01					
320 d	100	04/98→09/01					
320 d	110	09/01→02/05					
320 i	110	03/98→09/00					
320 i	120	09/00→02/05					
320 i	125	09/00→02/05					
323 i	120	03/98→09/00					
323 i	125	03/98→09/00					
325 i	141	09/00→02/05					
328 i	142	02/98→06/00					
325 xi	141	09/00→02/05	⬅		1	24.8190-0227.2 620227	L= 651
330 d	135	10/99→02/05					
330 d	150	03/03→02/05	➡		1	24.8190-0221.2 620221	L= 1.338
330 i	170	06/00→02/05					
330 xi	170	06/00→02/05					
330 i	168	01/01→04/05	⬅	→ 02/05	1	24.8190-0227.2 620227	L= 651
			➡	→ 02/05	1	24.8190-0221.2 620221	L= 1.338
330 xd	135	01/00→02/03	⬅	06/00→	1	24.8190-0227.2 620227	L= 651
			➡	06/00→	1	24.8190-0221.2 620221	L= 1.338
330 xd	150	09/02→12/04	⬅	03/03→	1	24.8190-0227.2 620227	L= 651
			➡	03/03→	1	24.8190-0221.2 620221	L= 1.338
<b> Bremsscheibe</b>							
316 i	77	04/00→02/05	⬅			24.0122-0115.1 422115	Ø 286 22 20,4 V + S
			➡			24.0322-0115.1 522115	Ø 286 22 19,6 V + S
			➡			24.0110-0202.1 410202	Ø 280 10 8,4 + S
			➡			24.0310-0202.1 510202	Ø 280 10 7,6 + S
316 i	85	06/02→02/05	⬅			24.0122-0115.1 422115	Ø 286 22 20,4 V + S
316 i	85	02/02→02/05				24.0322-0115.1 522115	Ø 286 22 19,6 V + S
316 i	77	09/98→02/05					
318 i	87	02/98→09/01	➡	nicht für erhöhte Nutzlast		24.0110-0202.1 410202	Ø 280 10 8,4 + S
			➡	für erhöhte Nutzlast		24.0310-0202.1 510202	Ø 280 10 7,6 + S
			➡	für erhöhte Nutzlast		24.0119-0107.1 419107	Ø 276 19 17,4 V + S
			➡	für erhöhte Nutzlast		24.0319-0107.1 519107	Ø 276 19 16,6 V + S
318 d	85	09/01→03/03	⬅			24.0122-0115.1 422115	Ø 286 22 20,4 V + S
318 d	85	03/03→02/05				24.0322-0115.1 522115	Ø 286 22 19,6 V + S
320 d	95	02/98→08/01					
320 d	100	04/98→09/01	➡			24.0119-0107.1 419107	Ø 276 19 17,4 V + S
			➡			24.0319-0107.1 519107	Ø 276 19 16,6 V + S
↓							









	kw			 	! #		
<b>BMW - 3 (E46) 02/98→04/05</b>							
<b>Bremsscheibe</b>							
318 i	100	09/01→02/05	←	nicht für erhöhte Nutzlast		24.0122-0115.1 422115	Ø 286 22 20,4 V + S
318 i	105	09/01→02/05				24.0322-0115.1 522115	Ø 286 22 19,6 V + S
320 i	110	03/98→09/00					
320 i	120	09/00→02/05	←	für erhöhte Nutzlast		24.0122-0160.1 422160	Ø 300 22 20,4 V + S
320 i	125	09/00→02/05				24.0322-0160.1 522160	Ø 300 22 19,6 V + S
323 i	120	03/98→09/00	→	nicht für erhöhte Nutzlast		24.0119-0107.1 419107	Ø 276 19 17,4 V + S
323 i	125	03/98→09/00				24.0319-0107.1 519107	Ø 276 19 16,6 V + S
			→	für erhöhte Nutzlast		24.0119-0108.1 419108	Ø 294 18,9 17,4 V + S
						24.0319-0108.1 519108	Ø 294 18,9 16,6 V + S
320 d	110	09/01→02/05	←			24.0122-0160.1 422160	Ø 300 22 20,4 V + S
328 i	142	02/98→06/00				24.0322-0160.1 522160	Ø 300 22 19,6 V + S
			→			24.0119-0108.1 419108	Ø 294 18,9 17,4 V + S
						24.0319-0108.1 519108	Ø 294 18,9 16,6 V + S
325 i	141	09/00→02/05	←	nicht für erhöhte Nutzlast		24.0122-0160.1 422160	Ø 300 22 20,4 V + S
						24.0322-0160.1 522160	Ø 300 22 19,6 V + S
			←	für erhöhte Nutzlast		24.0125-0138.1 425138	Ø 325 24,9 23,4 V + S
						24.0325-0138.1 525138	Ø 325 24,9 22,6 V + S
			→	nicht für erhöhte Nutzlast		24.0119-0108.1 419108	Ø 294 18,9 17,4 V + S
						24.0319-0108.1 519108	Ø 294 18,9 16,6 V + S
325 xi	141	09/00→02/05	←	nicht für erhöhte Nutzlast		24.0122-0160.1 422160	Ø 300 22 20,4 V + S
						24.0322-0160.1 522160	Ø 300 22 19,6 V + S
			←	für erhöhte Nutzlast		24.0125-0138.1 425138	Ø 325 24,9 23,4 V + S
						24.0325-0138.1 525138	Ø 325 24,9 22,6 V + S
			→	nicht für erhöhte Nutzlast		24.0119-0113.1 419113	Ø 294 19 17,4 V + S
			→	für erhöhte Nutzlast		24.0122-0209.1 422209	Ø 320 22 20,4 V + S
						24.0322-0209.1 522209	Ø 320 22 19,6 V + S
330 d	135	10/99→02/05	←			24.0125-0138.1 425138	Ø 325 24,9 23,4 V + S
330 d	150	03/03→02/05				24.0325-0138.1 525138	Ø 325 24,9 22,6 V + S
330 i	170	06/00→02/05	→			24.0122-0209.1 422209	Ø 320 22 20,4 V + S
330 xi	170	06/00→02/05				24.0322-0209.1 522209	Ø 320 22 19,6 V + S
330 i	168	01/01→04/05	←	→ 02/05		24.0125-0138.1 425138	Ø 325 24,9 23,4 V + S
						24.0325-0138.1 525138	Ø 325 24,9 22,6 V + S
			→	→ 02/05		24.0122-0209.1 422209	Ø 320 22 20,4 V + S
						24.0322-0209.1 522209	Ø 320 22 19,6 V + S
330 xd	135	01/00→02/03	←	06/00→		24.0125-0138.1 425138	Ø 325 24,9 23,4 V + S
						24.0325-0138.1 525138	Ø 325 24,9 22,6 V + S
			→	06/00→		24.0122-0209.1 422209	Ø 320 22 20,4 V + S
						24.0322-0209.1 522209	Ø 320 22 19,6 V + S
330 xd	150	09/02→12/04	←	03/03→		24.0125-0138.1 425138	Ø 325 24,9 23,4 V + S
						24.0325-0138.1 525138	Ø 325 24,9 22,6 V + S
			→	03/03→		24.0122-0209.1 422209	Ø 320 22 20,4 V + S
						24.0322-0209.1 522209	Ø 320 22 19,6 V + S
<b>BMW - 3 (E90) 02/04→12/11</b>							
<b>Bremsbelagsatz, Scheibenbremse</b>							
316 d	85	07/09→12/11	←	+ Performance Parts		13.0460-4848.2 604848	BRE 24316 16,9 + WE / - WK
316 i	90	09/07→10/11	←			13.0460-7216.2 607216	ATE 23794 20,3 + WE / - WK
						13.0470-7216.2 LD7216	ATE 23794 20,3 + WE / - WK Ceramic
			→			13.0460-2713.2 602713	TRW 23623 17,4 + WE / - WK + Zub
						13.0470-2713.2 LD2713	TRW 23623 17,4 + WE / - WK + Zub Ceramic
316 i	85	09/05→10/11	←	→ 08/07; + Performance Parts		13.0460-4848.2 604848	BRE 24316 16,9 + WE / - WK
			←	→ 08/07		13.0460-7215.2 607215	ATE 23935 17,8 + WE / - WK
						13.0470-7215.2 LD7215	ATE 23935 17,8 + WE / - WK Ceramic
			←	09/07→		13.0460-7216.2 607216	ATE 23794 20,3 + WE / - WK
						13.0470-7216.2 LD7216	ATE 23794 20,3 + WE / - WK Ceramic
			→	→ 08/07		13.0460-2713.2 602713	TRW 23623 17,4 + WE / - WK + Zub
						13.0470-2713.2 LD2713	TRW 23623 17,4 + WE / - WK + Zub Ceramic
↓							













	kw			 	! #		
<b>BMW - 3 (E90) 02/04→12/11</b>							
<b> Bremsbelagsatz, Scheibenbremse</b>							
318 d	90	03/05→08/07	←	09/05→; + Performance Parts	13.0460-4848.2	604848	BRE 24316 16,9 + WE / - WK
			←	09/05→; nicht für erhöhte Nutzlast	13.0460-7215.2	607215	ATE 23935 17,8 + WE / - WK
					13.0470-7215.2	LD7215	ATE 23935 17,8 + WE / - WK Ceramic
			←	09/05→; für erhöhte Nutzlast	13.0460-7216.2	607216	ATE 23794 20,3 + WE / - WK
					13.0470-7216.2	LD7216	ATE 23794 20,3 + WE / - WK Ceramic
		→	09/05→; nicht für erhöhte Nutzlast	13.0460-2713.2	602713	TRW 23623 17,4 + WE / - WK + Zub	
				13.0470-2713.2	LD2713	TRW 23623 17,4 + WE / - WK + Zub Ceramic	
			→	09/05→; für erhöhte Nutzlast	13.0460-7217.2	607217	ATE 23926 17,3 + WE / - WK
				13.0470-7217.2	LD7217	ATE 23926 17,3 + WE / - WK Ceramic	
318 d	100	02/07→03/10	←	09/07→; + Performance Parts	13.0460-4848.2	604848	BRE 24316 16,9 + WE / - WK
			←	09/07→ 02/10	13.0460-7216.2	607216	ATE 23794 20,3 + WE / - WK
					13.0470-7216.2	LD7216	ATE 23794 20,3 + WE / - WK Ceramic
			→	09/07→ 02/10	13.0460-7217.2	607217	ATE 23926 17,3 + WE / - WK
				13.0470-7217.2	LD7217	ATE 23926 17,3 + WE / - WK Ceramic	
318 d 318 i 320 si	105 100 127	02/07→10/11 03/07→10/11 09/05→08/06	←	+ Performance Parts	13.0460-4848.2	604848	BRE 24316 16,9 + WE / - WK
			←		13.0460-7216.2	607216	ATE 23794 20,3 + WE / - WK
					13.0470-7216.2	LD7216	ATE 23794 20,3 + WE / - WK Ceramic
			→		13.0460-7217.2	607217	ATE 23926 17,3 + WE / - WK
					13.0470-7217.2	LD7217	ATE 23926 17,3 + WE / - WK Ceramic
318 i	95	03/05→08/07	←	09/05→; + Performance Parts	13.0460-4848.2	604848	BRE 24316 16,9 + WE / - WK
			←	09/05→; nicht für erhöhte Nutzlast; Motorcode: N46	13.0460-7215.2	607215	ATE 23935 17,8 + WE / - WK
					13.0470-7215.2	LD7215	ATE 23935 17,8 + WE / - WK Ceramic
			←	09/05→; für erhöhte Nutzlast; Motorcode: N46	13.0460-7216.2	607216	ATE 23794 20,3 + WE / - WK
					13.0470-7216.2	LD7216	ATE 23794 20,3 + WE / - WK Ceramic
			←	03/07→; Motorcode: N46N; nicht für erhöhte Nutzlast	13.0460-7216.2	607216	ATE 23794 20,3 + WE / - WK
					13.0470-7216.2	LD7216	ATE 23794 20,3 + WE / - WK Ceramic
			←	03/07→; Motorcode: N46N; für erhöhte Nutzlast	13.0460-7238.2	607238	ATE 23313 20,3 + WE / - WK
					13.0470-7238.2	LD7238	ATE 23313 20,3 + WE / - WK Ceramic
		→	09/05→; nicht für erhöhte Nutzlast; Motorcode: N46	13.0460-2713.2	602713	TRW 23623 17,4 + WE / - WK + Zub	
				13.0470-2713.2	LD2713	TRW 23623 17,4 + WE / - WK + Zub Ceramic	
			→	09/05→; für erhöhte Nutzlast; Motorcode: N46	13.0460-7217.2	607217	ATE 23926 17,3 + WE / - WK
				13.0470-7217.2	LD7217	ATE 23926 17,3 + WE / - WK Ceramic	
			→	03/07→; Motorcode: N46N	13.0460-7217.2	607217	ATE 23926 17,3 + WE / - WK
				13.0470-7217.2	LD7217	ATE 23926 17,3 + WE / - WK Ceramic	
318 i	105	02/07→10/11	←		13.0460-4848.2	604848	BRE 24316 16,9 + WE / - WK
					13.0460-7216.2	607216	ATE 23794 20,3 + WE / - WK
				13.0470-7216.2	LD7216	ATE 23794 20,3 + WE / - WK Ceramic	
			→		13.0460-7217.2	607217	ATE 23926 17,3 + WE / - WK
					13.0470-7217.2	LD7217	ATE 23926 17,3 + WE / - WK Ceramic
320 d 320 d 320 d 320 d xDrive 320 d xDrive 320 d xDrive	110 130 135 120 130 135	12/04→09/07 09/07→03/10 03/10→12/11 09/08→10/11 09/08→02/10 03/10→10/11	←	+ Performance Parts	13.0460-4848.2	604848	BRE 24316 16,9 + WE / - WK
			←	für Behördenfahrzeuge	13.0460-7216.2	607216	ATE 23794 20,3 + WE / - WK
					13.0470-7216.2	LD7216	ATE 23794 20,3 + WE / - WK Ceramic
			←	nicht für Behördenfahrzeuge	13.0460-7238.2	607238	ATE 23313 20,3 + WE / - WK
					13.0470-7238.2	LD7238	ATE 23313 20,3 + WE / - WK Ceramic
			→	nicht für Behördenfahrzeuge	13.0460-7217.2	607217	ATE 23926 17,3 + WE / - WK









	kw			 	! #		
<b>BMW - 3 (E90) 02/04→12/11</b>							
<b> Bremsbelagsatz, Scheibenbremse</b>							
320 d	110	12/04→09/07	➡	nicht für Behördenfahrzeuge		13.0470-7217.2 LD7217	ATE 23926 17,3 + WE / - WK Ceramic
320 d	130	09/07→03/10					
320 d	135	03/10→12/11					
320 d xDrive	120	09/08→10/11	➡	für Behördenfahrzeuge		13.0460-7225.2 607225	ATE 23550 17,3 + WE / - WK
320 d xDrive	130	09/08→02/10				13.0470-7225.2 LD7225	ATE 23550 17,3 + WE / - WK Ceramic
320 d xDrive	135	03/10→10/11					
320 d	120	12/04→12/11	⬅	+ Performance Parts		13.0460-4848.2 604848	BRE 24316 16,9 + WE / - WK
			⬅	für Behördenfahrzeuge		13.0460-7216.2 607216	ATE 23794 20,3 + WE / - WK
						13.0470-7216.2 LD7216	ATE 23794 20,3 + WE / - WK Ceramic
			⬅	03/10→; nicht für Behördenfahrzeuge		13.0460-7238.2 607238	ATE 23313 20,3 + WE / - WK
						13.0470-7238.2 LD7238	ATE 23313 20,3 + WE / - WK Ceramic
			⬅	→ 02/10; nicht für Behördenfahrzeuge		13.0460-7238.2 607238	ATE 23313 20,3 + WE / - WK
						13.0470-7238.2 LD7238	ATE 23313 20,3 + WE / - WK Ceramic
			➡			13.0460-7217.2 607217	ATE 23926 17,3 + WE / - WK
						13.0470-7217.2 LD7217	ATE 23926 17,3 + WE / - WK Ceramic
320 i	110	06/04→09/07	⬅	12/04→ 08/07; + Performance Parts		13.0460-4848.2 604848	BRE 24316 16,9 + WE / - WK
			⬅	12/04→ 08/07; nicht für erhöhte Nutzlast; Motorcode: N46		13.0460-7215.2 607215	ATE 23935 17,8 + WE / - WK
						13.0470-7215.2 LD7215	ATE 23935 17,8 + WE / - WK Ceramic
			⬅	12/04→ 08/07; für erhöhte Nutzlast; Motorcode: N46		13.0460-7216.2 607216	ATE 23794 20,3 + WE / - WK
						13.0470-7216.2 LD7216	ATE 23794 20,3 + WE / - WK Ceramic
			➡	12/04→ 08/07; nicht für erhöhte Nutzlast; Motorcode: N46		13.0460-2713.2 602713	TRW 23623 17,4 + WE / - WK + Zub
						13.0470-2713.2 LD2713	TRW 23623 17,4 + WE / - WK + Zub Ceramic
			➡	12/04→ 08/07; für erhöhte Nutzlast; Motorcode: N46		13.0460-7217.2 607217	ATE 23926 17,3 + WE / - WK
						13.0470-7217.2 LD7217	ATE 23926 17,3 + WE / - WK Ceramic
320 i	115	02/07→12/11	⬅	→ 08/07; + Performance Parts		13.0460-4848.2 604848	BRE 24316 16,9 + WE / - WK
			⬅	→ 08/07; nicht für erhöhte Nutzlast; Motorcode: N46		13.0460-7215.2 607215	ATE 23935 17,8 + WE / - WK
						13.0470-7215.2 LD7215	ATE 23935 17,8 + WE / - WK Ceramic
			⬅	→ 08/07; für erhöhte Nutzlast; Motorcode: N46		13.0460-7216.2 607216	ATE 23794 20,3 + WE / - WK
						13.0470-7216.2 LD7216	ATE 23794 20,3 + WE / - WK Ceramic
			⬅	03/07→ 08/07; Motorcode: N46N; nicht für erhöhte Nutzlast		13.0460-7216.2 607216	ATE 23794 20,3 + WE / - WK
						13.0470-7216.2 LD7216	ATE 23794 20,3 + WE / - WK Ceramic
			⬅	03/07→ 08/07; für erhöhte Nutzlast; Motorcode: N46N		13.0460-7238.2 607238	ATE 23313 20,3 + WE / - WK
						13.0470-7238.2 LD7238	ATE 23313 20,3 + WE / - WK Ceramic
			➡	→ 08/07; nicht für erhöhte Nutzlast; Motorcode: N46		13.0460-2713.2 602713	TRW 23623 17,4 + WE / - WK + Zub
						13.0470-2713.2 LD2713	TRW 23623 17,4 + WE / - WK + Zub Ceramic
			➡	→ 08/07; für erhöhte Nutzlast; Motorcode: N46		13.0460-7217.2 607217	ATE 23926 17,3 + WE / - WK
						13.0470-7217.2 LD7217	ATE 23926 17,3 + WE / - WK Ceramic
			➡	03/07→ 08/07; Motorcode: N46N		13.0460-7217.2 607217	ATE 23926 17,3 + WE / - WK
						13.0470-7217.2 LD7217	ATE 23926 17,3 + WE / - WK Ceramic
320 i	120	03/07→12/11	⬅	+ Performance Parts		13.0460-4848.2 604848	BRE 24316 16,9 + WE / - WK
320 i	125	03/07→12/11	⬅	nicht für erhöhte Nutzlast		13.0460-7216.2 607216	ATE 23794 20,3 + WE / - WK
						13.0470-7216.2 LD7216	ATE 23794 20,3 + WE / - WK Ceramic
			⬅	für erhöhte Nutzlast		13.0460-7238.2 607238	ATE 23313 20,3 + WE / - WK
						13.0470-7238.2 LD7238	ATE 23313 20,3 + WE / - WK Ceramic
			➡			13.0460-7217.2 607217	ATE 23926 17,3 + WE / - WK
						13.0470-7217.2 LD7217	ATE 23926 17,3 + WE / - WK Ceramic
323 i	130	09/05→02/07	⬅	+ Performance Parts		13.0460-4848.2 604848	BRE 24316 16,9 + WE / - WK
↓							

	kw			 	! #		
<b>BMW - 3 (E90) 02/04→12/11</b>							
<b> Bremsbelagsatz, Scheibenbremse</b>							
323 i	130	09/05→02/07	←	nicht für erhöhte Nutzlast; Motorcode: N52	13.0460-7216.2	607216	ATE 23794 20,3 + WE / - WK Ceramic
			←	für erhöhte Nutzlast	13.0460-7216.2	607216	ATE 23794 20,3 + WE / - WK Ceramic
			←	nicht für erhöhte Nutzlast	13.0460-7238.2	607238	ATE 23313 20,3 + WE / - WK Ceramic
			→	nicht für erhöhte Nutzlast	13.0460-7217.2	607217	ATE 23926 17,3 + WE / - WK Ceramic
			→	für erhöhte Nutzlast	13.0460-7225.2	607225	ATE 23550 17,3 + WE / - WK Ceramic
323 i 325 i 325 i 328 i	140 155 155 172	03/07→12/11 01/06→12/11 03/07→12/11 03/07→12/11	←	+ Performance Parts	13.0460-4848.2	604848	BRE 24316 16,9 + WE / - WK
			←	→ 08/07; nicht für erhöhte Nutzlast; Motorcode: N52	13.0460-7216.2	607216	ATE 23794 20,3 + WE / - WK Ceramic
			←	für erhöhte Nutzlast	13.0460-7216.2	607216	ATE 23794 20,3 + WE / - WK Ceramic
			←	nicht für erhöhte Nutzlast	13.0460-7238.2	607238	ATE 23313 20,3 + WE / - WK Ceramic
			→	nicht für erhöhte Nutzlast	13.0460-7217.2	607217	ATE 23926 17,3 + WE / - WK Ceramic
325 d 325 d	145 150	09/06→02/10 03/10→10/11	←	+ Performance Parts	13.0460-4848.2	604848	BRE 24316 16,9 + WE / - WK
			←	nicht für Behördenfahrzeuge	13.0460-7216.2	607216	ATE 23794 20,3 + WE / - WK Ceramic
			←	für Behördenfahrzeuge	13.0460-7237.2	607237	ATE 23347 20,3 + WE / - WK Ceramic
			←		13.0460-7238.2	607238	ATE 23313 20,3 + WE / - WK Ceramic
			→		13.0460-7225.2	607225	ATE 23550 17,3 + WE / - WK Ceramic
325 i	160	01/05→10/11	←	+ Performance Parts	13.0460-4848.2	604848	BRE 24316 16,9 + WE / - WK
			←	→ 08/07; nicht für erhöhte Nutzlast; Motorcode: N52	13.0460-7216.2	607216	ATE 23794 20,3 + WE / - WK Ceramic
			←	→ 02/10; für erhöhte Nutzlast	13.0460-7216.2	607216	ATE 23794 20,3 + WE / - WK Ceramic
			←	03/10→; für erhöhte Nutzlast	13.0460-7216.2	607216	ATE 23794 20,3 + WE / - WK Ceramic
			←	09/07→ 02/10; nicht für erhöhte Nutzlast; Motorcode: N53	13.0460-7238.2	607238	ATE 23313 20,3 + WE / - WK Ceramic
			←	03/10→; nicht für erhöhte Nutzlast; Motorcode: N53	13.0460-7238.2	607238	ATE 23313 20,3 + WE / - WK Ceramic
			←	→ 08/07; nicht für erhöhte Nutzlast; Motorcode: N52N	13.0460-7238.2	607238	ATE 23313 20,3 + WE / - WK Ceramic
			→	03/10→; nicht für erhöhte Nutzlast	13.0460-7217.2	607217	ATE 23926 17,3 + WE / - WK Ceramic

















	kw			 	! #		
<b>BMW - 3 (E90) 02/04→12/11</b>							
<b> Bremsbelagsatz, Scheibenbremse</b>							
325 i	160	01/05→10/11	➡	→ 02/10; nicht für erhöhte Nutzlast	13.0460-7217.2	607217	ATE 23926 17,3 + WE / - WK
					13.0470-7217.2	LD7217	ATE 23926 17,3 + WE / - WK Ceramic
			➡	→ 02/10; für erhöhte Nutzlast	13.0460-7225.2	607225	ATE 23550 17,3 + WE / - WK
				13.0470-7225.2	LD7225	ATE 23550 17,3 + WE / - WK Ceramic	
			➡	03/10→; für erhöhte Nutzlast	13.0460-7225.2	607225	ATE 23550 17,3 + WE / - WK
					13.0470-7225.2	LD7225	ATE 23550 17,3 + WE / - WK Ceramic
325 i	160	03/07→12/11	⬅	+ Performance Parts	13.0460-4848.2	604848	BRE 24316 16,9 + WE / - WK
			⬅	nicht für erhöhte Nutzlast; Motorcode: N52	13.0460-7216.2	607216	ATE 23794 20,3 + WE / - WK
					13.0470-7216.2	LD7216	ATE 23794 20,3 + WE / - WK Ceramic
			⬅	für erhöhte Nutzlast; Motorcode: N53	13.0460-7216.2	607216	ATE 23794 20,3 + WE / - WK
			⬅	nicht für erhöhte Nutzlast; Motorcode: N53	13.0460-7238.2	607238	ATE 23313 20,3 + WE / - WK
					13.0470-7238.2	LD7238	ATE 23313 20,3 + WE / - WK Ceramic
			⬅	nicht für erhöhte Nutzlast; Motorcode: N52N	13.0460-7238.2	607238	ATE 23313 20,3 + WE / - WK
					13.0470-7238.2	LD7238	ATE 23313 20,3 + WE / - WK Ceramic
⬅	für erhöhte Nutzlast	13.0470-7216.2	LD7216	ATE 23794 20,3 + WE / - WK Ceramic			
➡	nicht für erhöhte Nutzlast	13.0460-7217.2	607217	ATE 23926 17,3 + WE / - WK			
		13.0470-7217.2	LD7217	ATE 23926 17,3 + WE / - WK Ceramic			
			➡	für erhöhte Nutzlast	13.0460-7225.2	607225	ATE 23550 17,3 + WE / - WK
					13.0470-7225.2	LD7225	ATE 23550 17,3 + WE / - WK Ceramic
325 i xDrive 325 xi	160	06/08→10/11	⬅	+ Performance Parts	13.0460-4848.2	604848	BRE 24316 16,9 + WE / - WK
	160	03/07→06/08	⬅	für erhöhte Nutzlast	13.0460-7216.2	607216	ATE 23794 20,3 + WE / - WK
					13.0470-7216.2	LD7216	ATE 23794 20,3 + WE / - WK Ceramic
			⬅	nicht für erhöhte Nutzlast	13.0460-7238.2	607238	ATE 23313 20,3 + WE / - WK
					13.0470-7238.2	LD7238	ATE 23313 20,3 + WE / - WK Ceramic
			➡	nicht für erhöhte Nutzlast	13.0460-7217.2	607217	ATE 23926 17,3 + WE / - WK
					13.0470-7217.2	LD7217	ATE 23926 17,3 + WE / - WK Ceramic
			➡	für erhöhte Nutzlast	13.0460-7225.2	607225	ATE 23550 17,3 + WE / - WK
					13.0470-7225.2	LD7225	ATE 23550 17,3 + WE / - WK Ceramic
325 xi	160	03/05→10/11	⬅	+ Performance Parts	13.0460-4848.2	604848	BRE 24316 16,9 + WE / - WK
			⬅	Motorcode: N52N / N53; für erhöhte Nutzlast	13.0460-7216.2	607216	ATE 23794 20,3 + WE / - WK
					13.0470-7216.2	LD7216	ATE 23794 20,3 + WE / - WK Ceramic
			⬅	→ 08/07; Motorcode: N52	13.0460-7216.2	607216	ATE 23794 20,3 + WE / - WK
					13.0470-7216.2	LD7216	ATE 23794 20,3 + WE / - WK Ceramic
			⬅	Motorcode: N52N / N53; nicht für erhöhte Nutzlast	13.0460-7238.2	607238	ATE 23313 20,3 + WE / - WK
			⬅	Motorcode: N53 / N52N; nicht für erhöhte Nutzlast	13.0470-7238.2	LD7238	ATE 23313 20,3 + WE / - WK Ceramic
➡	nicht für erhöhte Nutzlast	13.0460-7217.2	607217	ATE 23926 17,3 + WE / - WK			
		13.0470-7217.2	LD7217	ATE 23926 17,3 + WE / - WK Ceramic			
			➡	für erhöhte Nutzlast	13.0460-7225.2	607225	ATE 23550 17,3 + WE / - WK
					13.0470-7225.2	LD7225	ATE 23550 17,3 + WE / - WK Ceramic
330 d	155	09/05→12/11	⬅	+ Performance Parts	13.0460-4848.2	604848	BRE 24316 16,9 + WE / - WK
			⬅	nicht für erhöhte Nutzlast	13.0460-7216.2	607216	ATE 23794 20,3 + WE / - WK
					13.0470-7216.2	LD7216	ATE 23794 20,3 + WE / - WK Ceramic
			⬅	für erhöhte Nutzlast	13.0460-7237.2	607237	ATE 23347 20,3 + WE / - WK
					13.0460-7238.2	607238	ATE 23313 20,3 + WE / - WK
					13.0470-7237.2	LD7237	ATE 23347 20,3 + WE / - WK Ceramic















	kw			 	! #			
<b>BMW - 3 (E90) 02/04→12/11</b>								
<b> Bremsbelagsatz, Scheibenbremse</b>								
330 d	155	09/05→12/11	←	→ 02/10; für erhöhte Nutzlast		<b>13.0470-7238.2</b>	<b>LD7238</b>	ATE 23313 20,3 + WE / - WK Ceramic
			→			<b>13.0460-7225.2</b>	<b>607225</b>	ATE 23550 17,3 + WE / - WK
						<b>13.0470-7225.2</b>	<b>LD7225</b>	ATE 23550 17,3 + WE / - WK Ceramic
330 d 330 d 330 d xDrive 330 i xDrive 330 xi	170	09/05→09/08	←	+ Performance Parts		<b>13.0460-4848.2</b>	<b>604848</b>	BRE 24316 16,9 + WE / - WK
	180	09/08→12/11	←	nicht für erhöhte Nutzlast		<b>13.0460-7216.2</b>	<b>607216</b>	ATE 23794 20,3 + WE / - WK
	180	09/08→10/11	←			<b>13.0470-7216.2</b>	<b>LD7216</b>	ATE 23794 20,3 + WE / - WK Ceramic
	200	09/08→10/11	←			<b>13.0460-7237.2</b>	<b>607237</b>	ATE 23347 20,3 + WE / - WK
	200	09/07→08/08	←	für erhöhte Nutzlast		<b>13.0460-7238.2</b>	<b>607238</b>	ATE 23313 20,3 + WE / - WK
				→			<b>13.0470-7237.2</b>	<b>LD7237</b>
			→			<b>13.0460-7225.2</b>	<b>607225</b>	ATE 23550 17,3 + WE / - WK
						<b>13.0470-7225.2</b>	<b>LD7225</b>	ATE 23550 17,3 + WE / - WK Ceramic
330 i	190	12/04→08/07	←	+ Performance Parts		<b>13.0460-4848.2</b>	<b>604848</b>	BRE 24316 16,9 + WE / - WK
			←	Motorcode: N52N		<b>13.0460-7216.2</b>	<b>607216</b>	ATE 23794 20,3 + WE / - WK
						<b>13.0470-7216.2</b>	<b>LD7216</b>	ATE 23794 20,3 + WE / - WK Ceramic
			←	Motorcode: N52		<b>13.0460-7216.2</b>	<b>607216</b>	ATE 23794 20,3 + WE / - WK
						<b>13.0470-7216.2</b>	<b>LD7216</b>	ATE 23794 20,3 + WE / - WK Ceramic
			→			<b>13.0460-7225.2</b>	<b>607225</b>	ATE 23550 17,3 + WE / - WK
						<b>13.0470-7225.2</b>	<b>LD7225</b>	ATE 23550 17,3 + WE / - WK Ceramic
330 i	200	09/07→10/11	←	+ Performance Parts		<b>13.0460-4848.2</b>	<b>604848</b>	BRE 24316 16,9 + WE / - WK
			←	für Bremsscheibendurchmesser [mm]: 330		<b>13.0460-7216.2</b>	<b>607216</b>	ATE 23794 20,3 + WE / - WK
						<b>13.0470-7216.2</b>	<b>LD7216</b>	ATE 23794 20,3 + WE / - WK Ceramic
			←	für Bremsscheibendurchmesser [mm]: 348		<b>13.0460-7237.2</b>	<b>607237</b>	ATE 23347 20,3 + WE / - WK
						<b>13.0460-7238.2</b>	<b>607238</b>	ATE 23313 20,3 + WE / - WK
						<b>13.0470-7237.2</b>	<b>LD7237</b>	ATE 23347 20,3 + WE / - WK Ceramic
						<b>13.0470-7238.2</b>	<b>LD7238</b>	ATE 23313 20,3 + WE / - WK Ceramic
			→			<b>13.0460-7225.2</b>	<b>607225</b>	ATE 23550 17,3 + WE / - WK
						<b>13.0470-7225.2</b>	<b>LD7225</b>	ATE 23550 17,3 + WE / - WK Ceramic
330 i	200	09/07→12/11	←	+ Performance Parts		<b>13.0460-4848.2</b>	<b>604848</b>	BRE 24316 16,9 + WE / - WK
			←			<b>13.0460-7237.2</b>	<b>607237</b>	ATE 23347 20,3 + WE / - WK
						<b>13.0460-7238.2</b>	<b>607238</b>	ATE 23313 20,3 + WE / - WK
						<b>13.0470-7237.2</b>	<b>LD7237</b>	ATE 23347 20,3 + WE / - WK Ceramic
						<b>13.0470-7238.2</b>	<b>LD7238</b>	ATE 23313 20,3 + WE / - WK Ceramic
			→			<b>13.0460-7225.2</b>	<b>607225</b>	ATE 23550 17,3 + WE / - WK
						<b>13.0470-7225.2</b>	<b>LD7225</b>	ATE 23550 17,3 + WE / - WK Ceramic
330 xd	170	09/05→08/08	←	+ Performance Parts		<b>13.0460-4848.2</b>	<b>604848</b>	BRE 24316 16,9 + WE / - WK
			←	→ 08/07; für Bremsscheibendurchmesser [mm]: 330		<b>13.0460-7216.2</b>	<b>607216</b>	ATE 23794 20,3 + WE / - WK
						<b>13.0470-7216.2</b>	<b>LD7216</b>	ATE 23794 20,3 + WE / - WK Ceramic
			←	09/07→; für Bremsscheibendurchmesser [mm]: 348		<b>13.0460-7237.2</b>	<b>607237</b>	ATE 23347 20,3 + WE / - WK
						<b>13.0460-7238.2</b>	<b>607238</b>	ATE 23313 20,3 + WE / - WK
						<b>13.0470-7237.2</b>	<b>LD7237</b>	ATE 23347 20,3 + WE / - WK Ceramic
			→			<b>13.0460-7225.2</b>	<b>607225</b>	ATE 23550 17,3 + WE / - WK
						<b>13.0470-7225.2</b>	<b>LD7225</b>	ATE 23550 17,3 + WE / - WK Ceramic
330 xi	190	09/05→08/07	←	+ Performance Parts		<b>13.0460-4848.2</b>	<b>604848</b>	BRE 24316 16,9 + WE / - WK
			←	für erhöhte Nutzlast		<b>13.0460-7216.2</b>	<b>607216</b>	ATE 23794 20,3 + WE / - WK
						<b>13.0460-7238.2</b>	<b>607238</b>	ATE 23313 20,3 + WE / - WK









	kw			 	! #			
<b>BMW - 3 (E90) 02/04→12/11</b>								
<b>Bremsbelagsatz, Scheibenbremse</b>								
330 xi	190	09/05→08/07	←	für erhöhte Nutzlast		13.0470-7238.2	LD7238	ATE 23313 20,3 + WE / - WK Ceramic
			←	nicht für erhöhte Nutzlast		13.0470-7216.2	LD7216	ATE 23794 20,3 + WE / - WK Ceramic
			→			13.0460-7225.2	607225	ATE 23550 17,3 + WE / - WK Ceramic
						13.0470-7225.2	LD7225	ATE 23550 17,3 + WE / - WK Ceramic
335 d 335 i xDrive 335 xi 335 xi	210 225 224 225	09/06→12/11 05/08→10/11 09/06→06/08 09/06→06/08	←			13.0460-7237.2	607237	ATE 23347 20,3 + WE / - WK Ceramic
			←			13.0460-7238.2	607238	ATE 23313 20,3 + WE / - WK Ceramic
			←			13.0470-7237.2	LD7237	ATE 23347 20,3 + WE / - WK Ceramic
			←			13.0470-7238.2	LD7238	ATE 23313 20,3 + WE / - WK Ceramic
			→			13.0460-7225.2	607225	ATE 23550 17,3 + WE / - WK Ceramic
			→			13.0470-7225.2	LD7225	ATE 23550 17,3 + WE / - WK Ceramic
335 i	220	03/06→12/11	←	09/06→		13.0460-7237.2	607237	ATE 23347 20,3 + WE / - WK Ceramic
			←			13.0460-7238.2	607238	ATE 23313 20,3 + WE / - WK Ceramic
			←			13.0470-7237.2	LD7237	ATE 23347 20,3 + WE / - WK Ceramic
			←			13.0470-7238.2	LD7238	ATE 23313 20,3 + WE / - WK Ceramic
			→	09/06→		13.0460-7225.2	607225	ATE 23550 17,3 + WE / - WK Ceramic
			→			13.0470-7225.2	LD7225	ATE 23550 17,3 + WE / - WK Ceramic
335 i	224	03/06→12/11	←	09/06→		13.0460-7237.2	607237	ATE 23347 20,3 + WE / - WK Ceramic
			←			13.0460-7238.2	607238	ATE 23313 20,3 + WE / - WK Ceramic
			←			13.0470-7237.2	LD7237	ATE 23347 20,3 + WE / - WK Ceramic
			←			13.0470-7238.2	LD7238	ATE 23313 20,3 + WE / - WK Ceramic
			→			13.0460-7225.2	607225	ATE 23550 17,3 + WE / - WK Ceramic
			→			13.0470-7225.2	LD7225	ATE 23550 17,3 + WE / - WK Ceramic
335 i	225	03/06→12/11	←	09/06→		13.0460-7237.2	607237	ATE 23347 20,3 + WE / - WK Ceramic
			←			13.0460-7238.2	607238	ATE 23313 20,3 + WE / - WK Ceramic
			←			13.0470-7237.2	LD7237	ATE 23347 20,3 + WE / - WK Ceramic
			←			13.0470-7238.2	LD7238	ATE 23313 20,3 + WE / - WK Ceramic
			→			13.0460-7225.2	607225	ATE 23550 17,3 + WE / - WK Ceramic
			→			13.0470-7225.2	LD7225	ATE 23550 17,3 + WE / - WK Ceramic
			→	09/06→ 02/10		13.0460-7225.2	607225	ATE 23550 17,3 + WE / - WK Ceramic
			→			13.0470-7225.2	LD7225	ATE 23550 17,3 + WE / - WK Ceramic
335 i 335 i xDrive 335 xi	240 240 240	03/06→12/11 05/08→10/11 09/06→06/08	←			13.0460-7237.2	607237	ATE 23347 20,3 + WE / - WK Ceramic
			←			13.0460-7238.2	607238	ATE 23313 20,3 + WE / - WK Ceramic
			←			13.0470-7237.2	LD7237	ATE 23347 20,3 + WE / - WK Ceramic
			→			13.0460-7225.2	607225	ATE 23550 17,3 + WE / - WK Ceramic
			→			13.0470-7225.2	LD7225	ATE 23550 17,3 + WE / - WK Ceramic
M3 M3 CRT	309 331	03/07→12/11 03/11→12/11	←			13.0460-7167.2	607167	ATE 23312 20,3 + WE / - WK Ceramic
			←			13.0460-7169.2	607169	ATE 23309 17,3 + WE / - WK Ceramic
			→			13.0470-7169.2	LD7169	ATE 23309 17,3 + WE / - WK Ceramic
<b>Warnkontakt, Bremsbelagverschleiß</b>								
316 d 316 i	85 90	07/09→12/11 09/07→10/11	←	→ 02/10	1	24.8190-0264.2	620264	L= 630
			←	+ Performance Parts	1	24.8190-0267.2	620267	L= 679
			←	03/10→	1	24.8190-0284.2	620284	L= 650
			→	→ 02/10	1	24.8190-0265.2	620265	L= 1.086
			→	03/10→	1	24.8190-0285.2	620285	L= 1.107
316 i	85	09/05→10/11	←	→ 08/07	1	24.8190-0264.2	620264	L= 630
			←	→ 08/07; + Performance Parts	1	24.8190-0267.2	620267	L= 679
			→	→ 08/07	1	24.8190-0265.2	620265	L= 1.086
↓								







	kw			 	! #		
<b>BMW - 3 (E90) 02/04→12/11</b>							
<b>Warnkontakt, Bremsbelagverschleiß</b>							
318 d	90	03/05→08/07	←	09/05→	1	24.8190-0264.2 620264	L= 630
			←	09/05→; + Performance Parts	1	24.8190-0267.2 620267	L= 679
			→	09/05→	1	24.8190-0265.2 620265	L= 1.086
318 d	100	02/07→03/10	←	09/07→ 02/10	1	24.8190-0264.2 620264	L= 630
			←	09/07→; + Performance Parts	1	24.8190-0267.2 620267	L= 679
			→	09/07→ 02/10	1	24.8190-0265.2 620265	L= 1.086
318 d 318 i 318 i	105 100 105	02/07→10/11 03/07→10/11 02/07→10/11	←	09/07→ 02/10	1	24.8190-0264.2 620264	L= 630
			←	09/07→; + Performance Parts	1	24.8190-0267.2 620267	L= 679
			←	03/10→	1	24.8190-0284.2 620284	L= 650
			→	09/07→ 02/10	1	24.8190-0265.2 620265	L= 1.086
			→	03/10→	1	24.8190-0285.2 620285	L= 1.107
318 i	95	03/05→08/07	←	09/05→; Motorcode: N46	1	24.8190-0264.2 620264	L= 630
			←	03/07→; Motorcode: N46N	1	24.8190-0264.2 620264	L= 630
			←	09/05→; + Performance Parts	1	24.8190-0267.2 620267	L= 679
			←	03/07→; Motorcode: N46N; für erhöhte Nutzlast	1	24.8190-0284.2 620284	L= 650
			→	09/05→; Motorcode: N46	1	24.8190-0265.2 620265	L= 1.086
			→	03/07→; Motorcode: N46N	1	24.8190-0265.2 620265	L= 1.086
320 d 320 d xDrive	110 130	12/04→09/07 09/08→02/10	←	+ Performance Parts	1	24.8190-0267.2 620267	L= 679
			←		1	24.8190-0267.2 620267	L= 679
			→		1	24.8190-0265.2 620265	L= 1.086
320 d	120	12/04→12/11	←	+ Performance Parts	1	24.8190-0267.2 620267	L= 679
			←	für Behördenfahrzeuge	1	24.8190-0267.2 620267	L= 679
			←	→ 02/10; nicht für Behördenfahrzeuge	1	24.8190-0267.2 620267	L= 679
			←	03/10→; nicht für Behördenfahrzeuge	1	24.8190-0287.2 620287	L= 723
			→		1	24.8190-0265.2 620265	L= 1.086
320 d 320 d xDrive 330 i 330 i	130 120 200 200	09/07→03/10 09/08→10/11 09/07→10/11 09/07→12/11	←	→ 02/10	1	24.8190-0267.2 620267	L= 679
			←	+ Performance Parts	1	24.8190-0267.2 620267	L= 679
			←	03/10→	1	24.8190-0287.2 620287	L= 723
			→	→ 02/10	1	24.8190-0265.2 620265	L= 1.086
			→	03/10→	1	24.8190-0285.2 620285	L= 1.107
320 d 320 d xDrive	135 135	03/10→12/11 03/10→10/11	←	+ Performance Parts	1	24.8190-0267.2 620267	L= 679
			←		1	24.8190-0287.2 620287	L= 723
			→		1	24.8190-0285.2 620285	L= 1.107
320 i	110	06/04→09/07	←	12/04→ 08/07; Motorcode: N46	1	24.8190-0264.2 620264	L= 630
			←	03/07→ 08/07; Motorcode: N46N; nicht für erhöhte Nutzlast	1	24.8190-0264.2 620264	L= 630
			←	03/07→ 08/07; für erhöhte Nutzlast; Motorcode: N46N	1	24.8190-0267.2 620267	L= 679
			←	12/04→ 08/07; + Performance Parts	1	24.8190-0267.2 620267	L= 679
			→	12/04→ 08/07; Motorcode: N46	1	24.8190-0265.2 620265	L= 1.086
			→	03/07→ 08/07; Motorcode: N46N	1	24.8190-0265.2 620265	L= 1.086
320 i	115	02/07→12/11	←	03/07→ 08/07; Motorcode: N46N; nicht für erhöhte Nutzlast	1	24.8190-0264.2 620264	L= 630
			←	→ 08/07; Motorcode: N46	1	24.8190-0264.2 620264	L= 630
			←	→ 08/07; + Performance Parts	1	24.8190-0267.2 620267	L= 679
			←	03/07→ 08/07; für erhöhte Nutzlast; Motorcode: N46N	1	24.8190-0267.2 620267	L= 679
			→	03/07→ 08/07; Motorcode: N46N	1	24.8190-0265.2 620265	L= 1.086
			→	→ 08/07; Motorcode: N46	1	24.8190-0265.2 620265	L= 1.086
320 i 320 i	120 125	03/07→12/11 03/07→12/11	←	09/07→ 02/10; nicht für erhöhte Nutzlast	1	24.8190-0264.2 620264	L= 630
			←	09/07→ 02/10; für erhöhte Nutzlast	1	24.8190-0267.2 620267	L= 679
			←	09/07→; + Performance Parts	1	24.8190-0267.2 620267	L= 679
			←	03/10→; nicht für erhöhte Nutzlast	1	24.8190-0284.2 620284	L= 650
			←	03/10→; für erhöhte Nutzlast	1	24.8190-0287.2 620287	L= 723
			→	09/07→ 02/10	1	24.8190-0265.2 620265	L= 1.086







	kw			 	! #		
<b>BMW - 3 (E90) 02/04→12/11</b>							
<b>Warnkontakt, Bremsbelagverschleiß</b>							
320 i	120	03/07→12/11	➡	03/10→	1	24.8190-0285.2 620285	L= 1.107
320 i	125	03/07→12/11					
320 si	127	09/05→08/06	⬅		1	24.8190-0264.2 620264	L= 630
			⬅	+ Performance Parts	1	24.8190-0267.2 620267	L= 679
			➡		1	24.8190-0265.2 620265	L= 1.086
323 i	130	09/05→02/07	⬅	nicht für erhöhte Nutzlast; Motorcode: N52	1	24.8190-0264.2 620264	L= 630
			⬅	für erhöhte Nutzlast	1	24.8190-0267.2 620267	L= 679
			⬅	nicht für erhöhte Nutzlast; Motorcode: N53	1	24.8190-0267.2 620267	L= 679
			⬅	+ Performance Parts	1	24.8190-0267.2 620267	L= 679
			⬅	nicht für erhöhte Nutzlast; Motorcode: N52N	1	24.8190-0267.2 620267	L= 679
			➡		1	24.8190-0265.2 620265	L= 1.086
323 i	140	03/07→12/11	⬅	→ 08/07; nicht für erhöhte Nutzlast; Motorcode: N52	1	24.8190-0264.2 620264	L= 630
325 i	155	01/06→12/11					
325 i	160	01/05→10/11	⬅	+ Performance Parts	1	24.8190-0267.2 620267	L= 679
325 i	155	03/07→12/11					
325 i	160	03/07→12/11	⬅	→ 08/07; nicht für erhöhte Nutzlast; Motorcode: N52N	1	24.8190-0267.2 620267	L= 679
328 i	172	03/07→12/11	⬅	→ 02/10; für erhöhte Nutzlast	1	24.8190-0267.2 620267	L= 679
			⬅	09/07→ 02/10; nicht für erhöhte Nutzlast; Motorcode: N53	1	24.8190-0267.2 620267	L= 679
			⬅	03/10→; nicht für erhöhte Nutzlast; Motorcode: N53	1	24.8190-0287.2 620287	L= 723
			⬅	03/10→; für erhöhte Nutzlast	1	24.8190-0287.2 620287	L= 723
			➡	→ 02/10	1	24.8190-0265.2 620265	L= 1.086
			➡	03/10→	1	24.8190-0285.2 620285	L= 1.107
325 d	145	09/06→02/10	⬅	nicht für Behördenfahrzeuge	1	24.8190-0264.2 620264	L= 630
			⬅	für Behördenfahrzeuge	1	24.8190-0267.2 620267	L= 679
			⬅	+ Performance Parts	1	24.8190-0267.2 620267	L= 679
			➡		1	24.8190-0265.2 620265	L= 1.086
325 d	150	03/10→10/11	⬅	+ Performance Parts	1	24.8190-0267.2 620267	L= 679
			⬅	nicht für Behördenfahrzeuge	1	24.8190-0284.2 620284	L= 650
			⬅	für Behördenfahrzeuge	1	24.8190-0287.2 620287	L= 723
			➡		1	24.8190-0285.2 620285	L= 1.107
325 i xDrive	160	06/08→10/11	⬅	→ 02/10; Motorcode: N53	1	24.8190-0266.2 620266	L= 840
			⬅	+ Performance Parts	1	24.8190-0267.2 620267	L= 679
			⬅	03/10→; Motorcode: N53	1	24.8190-0286.2 620286	L= 867
			➡	→ 02/10	1	24.8190-0265.2 620265	L= 1.086
			➡	03/10→	1	24.8190-0285.2 620285	L= 1.107
325 xi	160	03/05→10/11	⬅	09/07→ 02/10; Motorcode: N53	1	24.8190-0266.2 620266	L= 840
			⬅	Motorcode: N52N / N52	1	24.8190-0266.2 620266	L= 840
			⬅	+ Performance Parts	1	24.8190-0267.2 620267	L= 679
			⬅	03/10→; Motorcode: N53	1	24.8190-0286.2 620286	L= 867
			➡	→ 02/10	1	24.8190-0265.2 620265	L= 1.086
			➡	03/10→	1	24.8190-0285.2 620285	L= 1.107
325 xi	160	03/07→06/08	⬅	→ 08/07; Motorcode: N52	1	24.8190-0266.2 620266	L= 840
			⬅	09/07→; Motorcode: N53	1	24.8190-0266.2 620266	L= 840
			⬅	→ 08/07; Motorcode: N52N	1	24.8190-0266.2 620266	L= 840
			⬅	+ Performance Parts	1	24.8190-0267.2 620267	L= 679
			➡		1	24.8190-0265.2 620265	L= 1.086
330 d	155	09/05→12/11	⬅	nicht für erhöhte Nutzlast	1	24.8190-0267.2 620267	L= 679
330 d	180	09/08→12/11				24.8190-0287.2 620287	L= 723
			⬅	+ Performance Parts	1	24.8190-0267.2 620267	L= 679
			⬅	→ 02/10; für erhöhte Nutzlast	1	24.8190-0267.2 620267	L= 679
			⬅	03/10→; für erhöhte Nutzlast	1	24.8190-0287.2 620287	L= 723
			➡	→ 02/10	1	24.8190-0265.2 620265	L= 1.086
			➡	03/10→	1	24.8190-0285.2 620285	L= 1.107
↓							







	kW				! #		
<b>BMW - 3 (E90) 02/04→12/11</b>							
<b>Warnkontakt, Bremsbelagverschleiß</b>							
330 d	170	09/05→09/08	←	nicht für erhöhte Nutzlast	1	24.8190-0267.2 620267	L= 679
						24.8190-0287.2 620287	L= 723
			←	für erhöhte Nutzlast	1	24.8190-0267.2 620267	L= 679
			←	+ Performance Parts	1	24.8190-0267.2 620267	L= 679
			→		1	24.8190-0265.2 620265	L= 1.086
330 d xDrive 330 i xDrive	180 200	09/08→10/11 09/08→10/11	←	→ 02/10	1	24.8190-0266.2 620266	L= 840
			←	+ Performance Parts	1	24.8190-0267.2 620267	L= 679
			←	03/10→	1	24.8190-0286.2 620286	L= 867
			→	→ 02/10	1	24.8190-0265.2 620265	L= 1.086
			→	03/10→	1	24.8190-0285.2 620285	L= 1.107
330 i	190	12/04→08/07	←	nicht für erhöhte Nutzlast; Motorcode: N52	1	24.8190-0264.2 620264	L= 630
						24.8190-0284.2 620284	L= 650
			←	Motorcode: N52N	1	24.8190-0264.2 620264	L= 630
						24.8190-0284.2 620284	L= 650
			←	+ Performance Parts	1	24.8190-0267.2 620267	L= 679
			←	für erhöhte Nutzlast; Motorcode: N52	1	24.8190-0267.2 620267	L= 679
			→		1	24.8190-0287.2 620287	L= 723
			→		1	24.8190-0265.2 620265	L= 1.086
330 xd	170	09/05→08/08	←	→ 08/07	1	24.8190-0266.2 620266	L= 840
			←	09/07→	1	24.8190-0266.2 620266	L= 840
			←	+ Performance Parts	1	24.8190-0267.2 620267	L= 679
			→		1	24.8190-0265.2 620265	L= 1.086
330 xi 330 xi	190 200	09/05→08/07 09/07→08/08	←		1	24.8190-0266.2 620266	L= 840
			←	+ Performance Parts	1	24.8190-0267.2 620267	L= 679
			→		1	24.8190-0265.2 620265	L= 1.086
335 d	210	09/06→12/11	←		1	24.8190-0267.2 620267	L= 679
			→	→ 02/10	1	24.8190-0265.2 620265	L= 1.086
			→	03/10→	1	24.8190-0285.2 620285	L= 1.107
335 i 335 i 335 i	220 224 225	03/06→12/11 03/06→12/11 03/06→12/11	←	09/06→	1	24.8190-0267.2 620267	L= 679
			→	09/06→ 02/10	1	24.8190-0265.2 620265	L= 1.086
			→	03/10→	1	24.8190-0285.2 620285	L= 1.107
			→		1	24.8190-0265.2 620265	L= 1.086
335 i	240	03/06→12/11	←		1	24.8190-0267.2 620267	L= 679
			→	09/06→ 02/10	1	24.8190-0265.2 620265	L= 1.086
			→	03/10→	1	24.8190-0285.2 620285	L= 1.107
335 i xDrive 335 i xDrive	225 240	05/08→10/11 05/08→10/11	←	→ 02/10	1	24.8190-0266.2 620266	L= 840
			←	03/10→	1	24.8190-0286.2 620286	L= 867
			→	→ 02/10	1	24.8190-0265.2 620265	L= 1.086
			→	03/10→	1	24.8190-0285.2 620285	L= 1.107
335 xi 335 xi	224 240	09/06→06/08 09/06→06/08	←	03/07→	1	24.8190-0266.2 620266	L= 840
			→	03/07→	1	24.8190-0265.2 620265	L= 1.086
335 xi	225	09/06→06/08	←		1	24.8190-0266.2 620266	L= 840
			→		1	24.8190-0265.2 620265	L= 1.086
M3	309	03/07→12/11	←	☐; 12/07→	1	24.8190-0271.2 620271	L= 659
			←	☐; 12/07→	1	24.8190-0272.2 620272	L= 672
			→	12/07→ 02/10	1	24.8190-0265.2 620265	L= 1.086
			→	03/10→	1	24.8190-0285.2 620285	L= 1.107
M3 CRT	331	03/11→12/11	←	☐	1	24.8190-0271.2 620271	L= 659
			←	☐	1	24.8190-0272.2 620272	L= 672
			→		1	24.8190-0285.2 620285	L= 1.107
<b>Bremsscheibe</b>							
316 d 316 i	85 90	07/09→12/11 09/07→10/11	←			24.0124-0197.1 424197	Ø 300 24 22,4 V + S
						24.0324-0197.1 524197	Ø 300 24 21,6 V + S
			→			24.0110-0315.1 410315	Ø 296 10,4 8,9 + S
						24.0310-0315.1 510315	Ø 296 10,4 8,1 + S
↓							









	kw			 	! #		
<b>BMW - 3 (E90) 02/04→12/11</b>							
<b>Bremsscheibe</b>							
316 i	85	09/05→10/11	←	→ 08/07		24.0122-0238.1 422238	Ø 292 22 20,4 V + S
						24.0322-0238.1 522238	Ø 292 22 19,6 V + S
			←	09/07→		24.0124-0197.1 424197	Ø 300 24 22,4 V + S
						24.0324-0197.1 524197	Ø 300 24 21,6 V + S
318 d	90	03/05→08/07	←	09/05→; nicht für erhöhte Nutzlast		24.0122-0238.1 422238	Ø 292 22 20,4 V + S
						24.0322-0238.1 522238	Ø 292 22 19,6 V + S
			←	09/05→; für erhöhte Nutzlast		24.0124-0197.1 424197	Ø 300 24 22,4 V + S
						24.0324-0197.1 524197	Ø 300 24 21,6 V + S
318 d	100	02/07→03/10	←	09/07→		24.0124-0197.1 424197	Ø 300 24 22,4 V + S
						24.0324-0197.1 524197	Ø 300 24 21,6 V + S
			→	09/07→		24.0120-0195.1 420195	Ø 300 20 18,4 V + S
						24.0320-0195.1 520195	Ø 300 20 17,6 V + S
318 d 318 i 318 i	105 100 105	02/07→10/11 03/07→10/11 02/07→10/11	←			24.0124-0197.1 424197	Ø 300 24 22,4 V + S
						24.0324-0197.1 524197	Ø 300 24 21,6 V + S
			→			24.0120-0195.1 420195	Ø 300 20 18,4 V + S
						24.0320-0195.1 520195	Ø 300 20 17,6 V + S
318 i	95	03/05→08/07	←	09/05→; nicht für erhöhte Nutzlast; Motorcode: N46		24.0122-0238.1 422238	Ø 292 22 20,4 V + S
						24.0322-0238.1 522238	Ø 292 22 19,6 V + S
			←	03/07→; Motorcode: N46N; nicht für erhöhte Nutzlast		24.0124-0197.1 424197	Ø 300 24 22,4 V + S
						24.0324-0197.1 524197	Ø 300 24 21,6 V + S
			←	09/05→; für erhöhte Nutzlast; Motorcode: N46		24.0124-0197.1 424197	Ø 300 24 22,4 V + S
						24.0324-0197.1 524197	Ø 300 24 21,6 V + S
			←	03/07→; Motorcode: N46N; für erhöhte Nutzlast		24.0124-0203.1 424203	Ø 312 23,9 22,4 V + S
						24.0324-0203.1 524203	Ø 312 23,9 21,6 V + S
320 d	110	12/04→09/07	←	nicht für Behördenfahrzeuge		24.0124-0197.1 424197	Ø 300 24 22,4 V + S
						24.0324-0197.1 524197	Ø 300 24 21,6 V + S
			←	für Behördenfahrzeuge		24.0124-0200.1 424200	Ø 330 24 22,4 V + S
						24.0324-0200.1 524200	Ø 330 24 21,6 V + S
			→	nicht für Behördenfahrzeuge		24.0120-0195.1 420195	Ø 300 20 18,4 V + S
						24.0320-0195.1 520195	Ø 300 20 17,6 V + S
			→	für Behördenfahrzeuge		24.0122-0236.1 422236	Ø 336 22 20,4 V + S
						24.0322-0236.1 522236	Ø 336 22 19,6 V + S
320 d	120	12/04→12/11	←	nicht für Behördenfahrzeuge		24.0124-0197.1 424197	Ø 300 24 22,4 V + S
						24.0324-0197.1 524197	Ø 300 24 21,6 V + S
			←	für Behördenfahrzeuge		24.0124-0200.1 424200	Ø 330 24 22,4 V + S
						24.0324-0200.1 524200	Ø 330 24 21,6 V + S
			←	09/07→; nicht für Behördenfahrzeuge		24.0124-0203.1 424203	Ø 312 23,9 22,4 V + S
320 d 320 d	130 135	09/07→03/10 03/10→12/11	←	für Behördenfahrzeuge		24.0124-0200.1 424200	Ø 330 24 22,4 V + S
						24.0324-0200.1 524200	Ø 330 24 21,6 V + S
			←	nicht für Behördenfahrzeuge		24.0124-0203.1 424203	Ø 312 23,9 22,4 V + S
						24.0324-0203.1 524203	Ø 312 23,9 21,6 V + S
320 d xDrive 320 d xDrive ↓	120 130	09/08→10/11 09/08→02/10	←	für Behördenfahrzeuge		24.0120-0195.1 420195	Ø 300 20 18,4 V + S
						24.0320-0195.1 520195	Ø 300 20 17,6 V + S
			→	nicht für Behördenfahrzeuge		24.0122-0236.1 422236	Ø 336 22 20,4 V + S
						24.0322-0236.1 522236	Ø 336 22 19,6 V + S
320 d xDrive 320 d xDrive	120 130	09/08→10/11 09/08→02/10	←	für Behördenfahrzeuge		24.0124-0200.1 424200	Ø 330 24 22,4 V + S











	kw			 	! #		
<b>BMW - 3 (E90) 02/04→12/11</b>							
<b>Bremsscheibe</b>							
320 d xDrive	135	03/10→10/11	←	für Behördenfahrzeuge	24.0324-0200.1	524200	Ø 330 24 21,6 V + S
			←	nicht für Behördenfahrzeuge	24.0124-0203.1	424203	Ø 312 23,9 22,4 V + S
					24.0324-0203.1	524203	Ø 312 23,9 21,6 V + S
			→	nicht für Behördenfahrzeuge	24.0120-0204.1	420204	Ø 300 20 18,4 V + S
					24.0320-0204.1	520204	Ø 300 20 17,6 V + S
320 i	110	06/04→09/07	←	12/04→ 08/07; nicht für erhöhte Nutzlast; Motorcode: N46	24.0122-0238.1	422238	Ø 292 22 20,4 V + S
					24.0322-0238.1	522238	Ø 292 22 19,6 V + S
			←	03/07→ 08/07; Motorcode: N46N; nicht für erhöhte Nutzlast	24.0124-0197.1	424197	Ø 300 24 22,4 V + S
					24.0324-0197.1	524197	Ø 300 24 21,6 V + S
			←	12/04→ 08/07; für erhöhte Nutzlast; Motorcode: N46	24.0124-0197.1	424197	Ø 300 24 22,4 V + S
		24.0324-0197.1	524197	Ø 300 24 21,6 V + S			
320 i	115	02/07→12/11	←	→ 08/07; nicht für erhöhte Nutzlast; Motorcode: N46	24.0122-0238.1	422238	Ø 292 22 20,4 V + S
					24.0322-0238.1	522238	Ø 292 22 19,6 V + S
			←	→ 08/07; für erhöhte Nutzlast; Motorcode: N46	24.0124-0197.1	424197	Ø 300 24 22,4 V + S
					24.0324-0197.1	524197	Ø 300 24 21,6 V + S
			←	03/07→ 08/07; Motorcode: N46N; nicht für erhöhte Nutzlast	24.0124-0197.1	424197	Ø 300 24 22,4 V + S
		24.0324-0197.1	524197	Ø 300 24 21,6 V + S			
320 i	120	03/07→12/11	←	03/07→ 08/07; Motorcode: N46N; für erhöhte Nutzlast	24.0124-0203.1	424203	Ø 312 23,9 22,4 V + S
					24.0324-0203.1	524203	Ø 312 23,9 21,6 V + S
			→	→ 08/07; nicht für erhöhte Nutzlast; Motorcode: N46	24.0110-0315.1	410315	Ø 296 10,4 8,9 + S
					24.0310-0315.1	510315	Ø 296 10,4 8,1 + S
			→	03/07→ 08/07; Motorcode: N46N	24.0120-0195.1	420195	Ø 300 20 18,4 V + S
		24.0320-0195.1	520195	Ø 300 20 17,6 V + S			
320 i 320 i	125	03/07→12/11	←	nicht für erhöhte Nutzlast	24.0124-0197.1	424197	Ø 300 24 22,4 V + S
					24.0324-0197.1	524197	Ø 300 24 21,6 V + S
			←	für erhöhte Nutzlast	24.0124-0203.1	424203	Ø 312 23,9 22,4 V + S
					24.0324-0203.1	524203	Ø 312 23,9 21,6 V + S
			→		24.0120-0195.1	420195	Ø 300 20 18,4 V + S
		24.0320-0195.1	520195	Ø 300 20 17,6 V + S			
320 si	127	09/05→08/06	←		24.0124-0197.1	424197	Ø 300 24 22,4 V + S
					24.0324-0197.1	524197	Ø 300 24 21,6 V + S
			→		24.0120-0204.1	420204	Ø 300 20 18,4 V + S
		24.0320-0204.1	520204	Ø 300 20 17,6 V + S			
323 i	130	09/05→02/07	←	Motorcode: N52; nicht für erhöhte Nutzlast	24.0124-0197.1	424197	Ø 300 24 22,4 V + S
					24.0324-0197.1	524197	Ø 300 24 21,6 V + S
			←	für erhöhte Nutzlast	24.0124-0200.1	424200	Ø 330 24 22,4 V + S
					24.0324-0200.1	524200	Ø 330 24 21,6 V + S
			←	nicht für erhöhte Nutzlast	24.0124-0203.1	424203	Ø 312 23,9 22,4 V + S
					24.0324-0203.1	524203	Ø 312 23,9 21,6 V + S
			←	nicht für erhöhte Nutzlast; Motorcode: N52N	24.0324-0203.1	524203	Ø 312 23,9 21,6 V + S
→	nicht für erhöhte Nutzlast	24.0120-0195.1	420195	Ø 300 20 18,4 V + S			
		24.0320-0195.1	520195	Ø 300 20 17,6 V + S			
323 i 325 i 160 328 i	140 155 160 172	03/07→12/11 01/06→12/11 01/05→10/11 03/07→12/11	←	→ 08/07; Motorcode: N52; nicht für erhöhte Nutzlast	24.0124-0197.1	424197	Ø 300 24 22,4 V + S
					24.0324-0197.1	524197	Ø 300 24 21,6 V + S
			←	für erhöhte Nutzlast	24.0124-0200.1	424200	Ø 330 24 22,4 V + S
		24.0324-0200.1	524200	Ø 330 24 21,6 V + S			









	kw			 	! #		
<b>BMW - 3 (E90) 02/04→12/11</b>							
<b>Bremsscheibe</b>							
323 i 325 i 325 i 328 i	140 155 160 172	03/07→12/11 01/06→12/11 01/05→10/11 03/07→12/11	←	→ 08/07; nicht für erhöhte Nutzlast; Motorcode: N52N		24.0124-0203.1 424203 24.0324-0203.1 524203	Ø 312 23,9 22,4 V + S Ø 312 23,9 21,6 V + S
			←	09/07→; Motorcode: N53; nicht für erhöhte Nutzlast		24.0124-0203.1 424203 24.0324-0203.1 524203	Ø 312 23,9 22,4 V + S Ø 312 23,9 21,6 V + S
			→	nicht für erhöhte Nutzlast		24.0120-0195.1 420195 24.0320-0195.1 520195	Ø 300 20 18,4 V + S Ø 300 20 17,6 V + S
			→	für erhöhte Nutzlast		24.0122-0236.1 422236 24.0322-0236.1 522236	Ø 336 22 20,4 V + S Ø 336 22 19,6 V + S
325 d 325 d	145 150	09/06→02/10 03/10→10/11	←	nicht für Behördenfahrzeuge		24.0124-0200.1 424200 24.0324-0200.1 524200	Ø 330 24 22,4 V + S Ø 330 24 21,6 V + S
			←	für Behördenfahrzeuge		24.0130-0192.1 430192	Ø 348 30 28,4 V + S
			→			24.0122-0236.1 422236 24.0322-0236.1 522236	Ø 336 22 20,4 V + S Ø 336 22 19,6 V + S
325 i	155	03/07→12/11	←	→ 08/07; Motorcode: N52; nicht für erhöhte Nutzlast		24.0124-0197.1 424197 24.0324-0197.1 524197	Ø 300 24 22,4 V + S Ø 300 24 21,6 V + S
			←	für erhöhte Nutzlast		24.0124-0200.1 424200 24.0324-0200.1 524200	Ø 330 24 22,4 V + S Ø 330 24 21,6 V + S
			←	nicht für erhöhte Nutzlast		24.0124-0203.1 424203	Ø 312 23,9 22,4 V + S
			←	→ 08/07; nicht für erhöhte Nutzlast; Motorcode: N52N		24.0324-0203.1 524203	Ø 312 23,9 21,6 V + S
			←	09/07→; Motorcode: N53; nicht für erhöhte Nutzlast		24.0324-0203.1 524203	Ø 312 23,9 21,6 V + S
			→	nicht für erhöhte Nutzlast		24.0120-0195.1 420195 24.0320-0195.1 520195	Ø 300 20 18,4 V + S Ø 300 20 17,6 V + S
			→	für erhöhte Nutzlast		24.0122-0236.1 422236 24.0322-0236.1 522236	Ø 336 22 20,4 V + S Ø 336 22 19,6 V + S
325 i	160	03/07→12/11	←	Motorcode: N52; nicht für erhöhte Nutzlast		24.0124-0197.1 424197 24.0324-0197.1 524197	Ø 300 24 22,4 V + S Ø 300 24 21,6 V + S
			←	für erhöhte Nutzlast		24.0124-0200.1 424200 24.0324-0200.1 524200	Ø 330 24 22,4 V + S Ø 330 24 21,6 V + S
			←	→ 08/07; nicht für erhöhte Nutzlast; Motorcode: N52N		24.0124-0203.1 424203 24.0324-0203.1 524203	Ø 312 23,9 22,4 V + S Ø 312 23,9 21,6 V + S
			←	09/07→; Motorcode: N53; nicht für erhöhte Nutzlast		24.0124-0203.1 424203 24.0324-0203.1 524203	Ø 312 23,9 22,4 V + S Ø 312 23,9 21,6 V + S
			→	nicht für erhöhte Nutzlast		24.0120-0195.1 420195 24.0320-0195.1 520195	Ø 300 20 18,4 V + S Ø 300 20 17,6 V + S
			→	für erhöhte Nutzlast		24.0122-0236.1 422236 24.0322-0236.1 522236	Ø 336 22 20,4 V + S Ø 336 22 19,6 V + S
325 i xDrive	160	06/08→10/11	←	nicht für erhöhte Nutzlast		24.0124-0197.1 424197 24.0324-0197.1 524197	Ø 300 24 22,4 V + S Ø 300 24 21,6 V + S
			←	für erhöhte Nutzlast		24.0124-0200.1 424200 24.0324-0200.1 524200	Ø 330 24 22,4 V + S Ø 330 24 21,6 V + S
			←	nicht für erhöhte Nutzlast; Motorcode: N52N		24.0124-0203.1 424203 24.0324-0203.1 524203	Ø 312 23,9 22,4 V + S Ø 312 23,9 21,6 V + S
			→	nicht für erhöhte Nutzlast		24.0120-0204.1 420204 24.0320-0204.1 520204	Ø 300 20 18,4 V + S Ø 300 20 17,6 V + S
			→	für erhöhte Nutzlast		24.0122-0236.1 422236 24.0322-0236.1 522236	Ø 336 22 20,4 V + S Ø 336 22 19,6 V + S
325 xi	160	03/05→10/11	←	→ 08/07; Motorcode: N52; nicht für erhöhte Nutzlast		24.0124-0197.1 424197 24.0324-0197.1 524197	Ø 300 24 22,4 V + S Ø 300 24 21,6 V + S
			←	für erhöhte Nutzlast		24.0124-0200.1 424200 24.0324-0200.1 524200	Ø 330 24 22,4 V + S Ø 330 24 21,6 V + S
			←	Motorcode: N53 / N52N; nicht für erhöhte Nutzlast		24.0124-0203.1 424203 24.0324-0203.1 524203	Ø 312 23,9 22,4 V + S Ø 312 23,9 21,6 V + S
			→	nicht für erhöhte Nutzlast		24.0120-0204.1 420204 24.0320-0204.1 520204	Ø 300 20 18,4 V + S Ø 300 20 17,6 V + S
			→	für erhöhte Nutzlast		24.0122-0236.1 422236 24.0322-0236.1 522236	Ø 336 22 20,4 V + S Ø 336 22 19,6 V + S
325 xi	160	03/07→06/08	←	→ 08/07; Motorcode: N52; nicht für erhöhte Nutzlast		24.0124-0197.1 424197 24.0324-0197.1 524197	Ø 300 24 22,4 V + S Ø 300 24 21,6 V + S
			←	für erhöhte Nutzlast		24.0124-0200.1 424200 24.0324-0200.1 524200	Ø 330 24 22,4 V + S Ø 330 24 21,6 V + S







	kw			 	! #		
<b>BMW - 3 (E90) 02/04→12/11</b>							
<b>Bremsscheibe</b>							
325 xi	160	03/07→06/08	←	→ 08/07; nicht für erhöhte Nutzlast; Motorcode: N52N	24.0124-0203.1	424203	Ø 312 23,9 22,4 V + S
			←	09/07→; Motorcode: N53; nicht für erhöhte Nutzlast	24.0124-0203.1	424203	Ø 312 23,9 21,6 V + S
			→	nicht für erhöhte Nutzlast	24.0120-0204.1	420204	Ø 300 20 18,4 V + S
			→	für erhöhte Nutzlast	24.0122-0236.1	422236	Ø 336 22 20,4 V + S
330 d	155	09/05→12/11	←	10/09→; nicht für erhöhte Nutzlast	24.0124-0200.1	424200	Ø 330 24 22,4 V + S
			←	09/07→ 09/09; nicht für erhöhte Nutzlast	24.0324-0200.1	524200	Ø 330 24 21,6 V + S
			←	für erhöhte Nutzlast	24.0130-0192.1	430192	Ø 348 30 28,4 V + S
			→		24.0122-0236.1	422236	Ø 336 22 20,4 V + S
330 d	170	09/05→09/08	←	09/07→; nicht für erhöhte Nutzlast	24.0322-0236.1	522236	Ø 336 22 19,6 V + S
			←	für erhöhte Nutzlast	24.0130-0192.1	430192	Ø 348 30 28,4 V + S
			→		24.0122-0236.1	422236	Ø 336 22 20,4 V + S
			→		24.0322-0236.1	522236	Ø 336 22 19,6 V + S
330 d	180	09/08→12/11	←	10/09→; nicht für erhöhte Nutzlast	24.0124-0200.1	424200	Ø 330 24 22,4 V + S
			←	→ 09/09; nicht für erhöhte Nutzlast	24.0324-0200.1	524200	Ø 330 24 21,6 V + S
			←	für erhöhte Nutzlast	24.0130-0192.1	430192	Ø 348 30 28,4 V + S
			→		24.0122-0236.1	422236	Ø 336 22 20,4 V + S
330 d xDrive 330 i xDrive 330 xi 330 xi	180 200 190 200	09/08→10/11 09/08→10/11 09/05→08/07 09/07→08/08	←	nicht für erhöhte Nutzlast	24.0322-0236.1	522236	Ø 336 22 19,6 V + S
			←		24.0124-0200.1	424200	Ø 330 24 22,4 V + S
			←	für erhöhte Nutzlast	24.0324-0200.1	524200	Ø 330 24 21,6 V + S
			→		24.0130-0192.1	430192	Ø 348 30 28,4 V + S
330 i	190	12/04→08/07	←		24.0122-0236.1	422236	Ø 336 22 20,4 V + S
			←		24.0324-0200.1	524200	Ø 330 24 21,6 V + S
			→		24.0122-0236.1	422236	Ø 336 22 20,4 V + S
			→		24.0322-0236.1	522236	Ø 336 22 19,6 V + S
330 i	200	09/07→10/11	←		24.0124-0200.1	424200	Ø 330 24 22,4 V + S
			←		24.0130-0192.1	430192	Ø 348 30 28,4 V + S
			←		24.0324-0200.1	524200	Ø 330 24 21,6 V + S
			→		24.0122-0236.1	422236	Ø 336 22 20,4 V + S
330 i 335 d 335 i 335 i xDrive 335 i xDrive 335 xi 335 xi 335 xi	200 210 240 225 240 224 225 240	09/07→12/11 09/06→12/11 03/06→12/11 05/08→10/11 05/08→10/11 09/06→06/08 09/06→06/08 09/06→06/08	←		24.0322-0236.1	522236	Ø 336 22 19,6 V + S
			→		24.0122-0236.1	422236	Ø 336 22 20,4 V + S
			→		24.0322-0236.1	522236	Ø 336 22 19,6 V + S
			→		24.0130-0192.1	430192	Ø 348 30 28,4 V + S
330 xd	170	09/05→08/08	←	→ 08/07	24.0124-0200.1	424200	Ø 330 24 22,4 V + S
			←		24.0324-0200.1	524200	Ø 330 24 21,6 V + S
			←	09/07→	24.0130-0192.1	430192	Ø 348 30 28,4 V + S
			→		24.0122-0236.1	422236	Ø 336 22 20,4 V + S
335 i 335 i 335 i	220 224 225	03/06→12/11 03/06→12/11 03/06→12/11	←	09/06→	24.0322-0236.1	522236	Ø 336 22 19,6 V + S
			←		24.0130-0192.1	430192	Ø 348 30 28,4 V + S
			→	09/06→	24.0122-0236.1	422236	Ø 336 22 20,4 V + S
			→		24.0322-0236.1	522236	Ø 336 22 19,6 V + S
M3	309	03/07→12/11	←	☐; 12/07→	24.0124-0231.2	424231	Ø 350 24 22,4 V• Bremsscheibe zweiteilig / + S
			←	☐; 12/07→	24.0130-0213.2	430213	Ø 360 30 28,4 V• Bremsscheibe zweiteilig / + S
			→	☐; 12/07→	24.0130-0214.2	430214	Ø 360 30 28,4 V• Bremsscheibe zweiteilig / + S
			→	☐; 12/07→	24.0124-0232.2	424232	Ø 350 24 22,4 V• Bremsscheibe zweiteilig / + S
↓							







	kw			 	! #		
<b>BMW - 3 (E90) 02/04→12/11</b>							
 <b>Bremsscheibe</b>							
M3 CRT	331	03/11→12/11	←	☐		24.0130-0213.2 430213	Ø 360 30 28,4 V• Bremsscheibe zweiteilig / + S
			←	☐		24.0130-0214.2 430214	Ø 360 30 28,4 V• Bremsscheibe zweiteilig / + S
			→	☐		24.0124-0231.2 424231	Ø 350 24 22,4 V• Bremsscheibe zweiteilig / + S
			→	☐		24.0124-0232.2 424232	Ø 350 24 22,4 V• Bremsscheibe zweiteilig / + S
<b>BMW - 3 (F30, F80) 03/11→</b>							
 <b>Bremsbelagsatz, Scheibenbremse</b>							
316 d 318 d 320 d 320 i 320 i xDrive	85 105 120 135 135	05/11→ 05/11→06/15 04/11→ 04/11→ 05/11→06/15	←		02/12→; - Performance Parts	13.0460-3866.2 603866 13.0470-3866.2 LD3866	BOS 25506 18,2 + WE / - WK BOS 25506 18,2 + WE / - WK Ceramic
			←		02/12→; + Performance Parts	13.0460-4875.2 604875 13.0470-4875.2 LD4875	BRE 25028 18,0 + WE / - WK BRE 25028 18,0 + WE / - WK Ceramic
			→		02/12→; - Performance Parts	13.0460-3859.2 603859 13.0470-3859.2 LD3859	BOS 25307 17,5 + WE / - WK BOS 25307 17,5 + WE / - WK Ceramic
			→		02/12→; + Performance Parts	13.0460-4874.2 604874	BRE 25029 16,7 + WE / - WK
316 i	100	10/12→08/16	←		11/12→; - Performance Parts	13.0460-3866.2 603866 13.0470-3866.2 LD3866	BOS 25506 18,2 + WE / - WK BOS 25506 18,2 + WE / - WK Ceramic
			←		11/12→; + Performance Parts	13.0460-4875.2 604875 13.0470-4875.2 LD4875	BRE 25028 18,0 + WE / - WK BRE 25028 18,0 + WE / - WK Ceramic
			→		11/12→; - Performance Parts	13.0460-3859.2 603859 13.0470-3859.2 LD3859	BOS 25307 17,5 + WE / - WK BOS 25307 17,5 + WE / - WK Ceramic
			→		11/12→; + Performance Parts	13.0460-4874.2 604874	BRE 25029 16,7 + WE / - WK
318 d 320 d 320 d 320 d xDrive 320 d xDrive 328 i 328 i xDrive	100 135 147 120 135 147 180 180	05/11→ 03/11→03/16 03/11→03/16 05/11→ 10/11→07/15 05/11→06/15 04/11→07/16 05/11→07/16	←		02/12→; - Performance Parts	13.0460-3857.2 603857 13.0470-3857.2 LD3857	BOS 25199 19,6 + WE / - WK BOS 25199 19,6 + WE / - WK Ceramic
			←		02/12→; + Performance Parts	13.0460-4875.2 604875 13.0470-4875.2 LD4875	BRE 25028 18,0 + WE / - WK BRE 25028 18,0 + WE / - WK Ceramic
			→		02/12→; - Performance Parts	13.0460-3859.2 603859 13.0470-3859.2 LD3859	BOS 25307 17,5 + WE / - WK BOS 25307 17,5 + WE / - WK Ceramic
			→		02/12→; + Performance Parts	13.0460-4874.2 604874	BRE 25029 16,7 + WE / - WK
318 d 318 d xDrive 318 i 320 d 320 d xDrive	110 110 100 140 140	10/14→ 11/14→ 03/15→ 10/14→ 10/14→	←		07/15→; - Performance Parts	13.0460-3866.2 603866 13.0470-3866.2 LD3866	BOS 25506 18,2 + WE / - WK BOS 25506 18,2 + WE / - WK Ceramic
			←		07/15→; + Performance Parts	13.0460-4875.2 604875 13.0470-4875.2 LD4875	BRE 25028 18,0 + WE / - WK BRE 25028 18,0 + WE / - WK Ceramic
			→		07/15→; - Performance Parts	13.0460-3859.2 603859 13.0470-3859.2 LD3859	BOS 25307 17,5 + WE / - WK BOS 25307 17,5 + WE / - WK Ceramic
			→		07/15→; + Performance Parts	13.0460-4874.2 604874	BRE 25029 16,7 + WE / - WK
318 d xDrive	105	11/12→05/15	←		05/13→; - Performance Parts	13.0460-3866.2 603866 13.0470-3866.2 LD3866	BOS 25506 18,2 + WE / - WK BOS 25506 18,2 + WE / - WK Ceramic
			←		05/13→; + Performance Parts	13.0460-4875.2 604875 13.0470-4875.2 LD4875	BRE 25028 18,0 + WE / - WK BRE 25028 18,0 + WE / - WK Ceramic
			→		05/13→; - Performance Parts	13.0460-3859.2 603859 13.0470-3859.2 LD3859	BOS 25307 17,5 + WE / - WK BOS 25307 17,5 + WE / - WK Ceramic
			→		05/13→; + Performance Parts	13.0460-4874.2 604874	BRE 25029 16,7 + WE / - WK
320 i	125	04/12→06/16	←		11/12→	13.0460-3866.2 603866 13.0470-3866.2 LD3866	BOS 25506 18,2 + WE / - WK BOS 25506 18,2 + WE / - WK Ceramic
			→		11/12→	13.0460-3859.2 603859	BOS 25307 17,5 + WE / - WK
↓							











	kW			 	! #		
<b>BMW - 3 (F30, F80) 03/11→</b>							
<b> Bremsbelagsatz, Scheibenbremse</b>							
320 i	125	04/12→06/16	➡	11/12→		<b>13.0470-3859.2 LD3859</b>	BOS 25307 17,5 + WE / - WK Ceramic
320 i 320 i xDrive	135 135	09/14→ 09/14→	←	- Performance Parts		<b>13.0460-3866.2 603866</b>	BOS 25506 18,2 + WE / - WK
						<b>13.0470-3866.2 LD3866</b>	BOS 25506 18,2 + WE / - WK Ceramic
			←	+ Performance Parts		<b>13.0460-4875.2 604875</b>	BRE 25028 18,0 + WE / - WK
						<b>13.0470-4875.2 LD4875</b>	BRE 25028 18,0 + WE / - WK Ceramic
			➡	- Performance Parts		<b>13.0460-3859.2 603859</b>	BOS 25307 17,5 + WE / - WK
					<b>13.0470-3859.2 LD3859</b>	BOS 25307 17,5 + WE / - WK Ceramic	
			➡	+ Performance Parts		<b>13.0460-4874.2 604874</b>	BRE 25029 16,7 + WE / - WK
325 d 325 d	155 160	07/12→02/16 07/12→02/16	←	04/13→; - Performance Parts		<b>13.0460-3857.2 603857</b>	BOS 25199 19,6 + WE / - WK
						<b>13.0470-3857.2 LD3857</b>	BOS 25199 19,6 + WE / - WK Ceramic
			←	04/13→; + Performance Parts		<b>13.0460-4875.2 604875</b>	BRE 25028 18,0 + WE / - WK
						<b>13.0470-4875.2 LD4875</b>	BRE 25028 18,0 + WE / - WK Ceramic
			➡	04/13→; - Performance Parts		<b>13.0460-3859.2 603859</b>	BOS 25307 17,5 + WE / - WK
						<b>13.0470-3859.2 LD3859</b>	BOS 25307 17,5 + WE / - WK Ceramic
			➡	04/13→; + Performance Parts		<b>13.0460-4874.2 604874</b>	BRE 25029 16,7 + WE / - WK
325 d	165	04/15→	←	03/16→; - Performance Parts		<b>13.0460-3857.2 603857</b>	BOS 25199 19,6 + WE / - WK
						<b>13.0470-3857.2 LD3857</b>	BOS 25199 19,6 + WE / - WK Ceramic
			←	03/16→; + Performance Parts		<b>13.0460-4875.2 604875</b>	BRE 25028 18,0 + WE / - WK
						<b>13.0470-4875.2 LD4875</b>	BRE 25028 18,0 + WE / - WK Ceramic
			➡	03/16→; - Performance Parts		<b>13.0460-3859.2 603859</b>	BOS 25307 17,5 + WE / - WK
						<b>13.0470-3859.2 LD3859</b>	BOS 25307 17,5 + WE / - WK Ceramic
			➡	03/16→; + Performance Parts		<b>13.0460-4874.2 604874</b>	BRE 25029 16,7 + WE / - WK
330 d	190	01/12→	←	07/12→; - Performance Parts		<b>13.0460-3857.2 603857</b>	BOS 25199 19,6 + WE / - WK
						<b>13.0470-3857.2 LD3857</b>	BOS 25199 19,6 + WE / - WK Ceramic
			←	07/12→; + Performance Parts		<b>13.0460-4875.2 604875</b>	BRE 25028 18,0 + WE / - WK
						<b>13.0470-4875.2 LD4875</b>	BRE 25028 18,0 + WE / - WK Ceramic
			➡	07/12→; + Performance Parts		<b>13.0460-4874.2 604874</b>	BRE 25029 16,7 + WE / - WK
330 d 330 d xDrive	210 210	01/12→ 01/12→	←	09/15→; - Performance Parts		<b>13.0460-3857.2 603857</b>	BOS 25199 19,6 + WE / - WK
						<b>13.0470-3857.2 LD3857</b>	BOS 25199 19,6 + WE / - WK Ceramic
			←	09/15→; + Performance Parts		<b>13.0460-4875.2 604875</b>	BRE 25028 18,0 + WE / - WK
						<b>13.0470-4875.2 LD4875</b>	BRE 25028 18,0 + WE / - WK Ceramic
			➡	09/15→; + Performance Parts		<b>13.0460-4874.2 604874</b>	BRE 25029 16,7 + WE / - WK
330 d xDrive	190	01/12→	←	03/13→; - Performance Parts		<b>13.0460-3857.2 603857</b>	BOS 25199 19,6 + WE / - WK
						<b>13.0470-3857.2 LD3857</b>	BOS 25199 19,6 + WE / - WK Ceramic
			←	03/13→; + Performance Parts		<b>13.0460-4875.2 604875</b>	BRE 25028 18,0 + WE / - WK
						<b>13.0470-4875.2 LD4875</b>	BRE 25028 18,0 + WE / - WK Ceramic
			➡	03/13→; + Performance Parts		<b>13.0460-4874.2 604874</b>	BRE 25029 16,7 + WE / - WK
330 e 330 e	135 185	02/15→ 02/15→	←	01/16→; - Performance Parts		<b>13.0460-3857.2 603857</b>	BOS 25199 19,6 + WE / - WK
						<b>13.0470-3857.2 LD3857</b>	BOS 25199 19,6 + WE / - WK Ceramic
			←	01/16→; + Performance Parts		<b>13.0460-4875.2 604875</b>	BRE 25028 18,0 + WE / - WK
						<b>13.0470-4875.2 LD4875</b>	BRE 25028 18,0 + WE / - WK Ceramic
			➡	01/16→; - Performance Parts		<b>13.0460-3859.2 603859</b>	BOS 25307 17,5 + WE / - WK
						<b>13.0470-3859.2 LD3859</b>	BOS 25307 17,5 + WE / - WK Ceramic
			➡	01/16→; + Performance Parts		<b>13.0460-4874.2 604874</b>	BRE 25029 16,7 + WE / - WK
330 i 330 i xDrive ↓	185 185	09/14→ 10/14→	←	07/15→; - Performance Parts		<b>13.0460-3857.2 603857</b>	BOS 25199 19,6 + WE / - WK









	kw			 	! #		
<b>BMW - 3 (F30, F80) 03/11→</b>							
<b> Bremsbelagsatz, Scheibenbremse</b>							
330 i 330 i xDrive	185 185	09/14→ 10/14→	←	07/15→; - Performance Parts		13.0470-3857.2 LD3857	BOS 25199 19,6 + WE / - WK Ceramic
			←	07/15→; + Performance Parts		13.0460-4875.2 604875 13.0470-4875.2 LD4875	BRE 25028 18,0 + WE / - WK BRE 25028 18,0 + WE / - WK Ceramic
			→	07/15→; - Performance Parts		13.0460-3859.2 603859 13.0470-3859.2 LD3859	BOS 25307 17,5 + WE / - WK BOS 25307 17,5 + WE / - WK Ceramic
			→	07/15→; + Performance Parts		13.0460-4874.2 604874	BRE 25029 16,7 + WE / - WK
335 d xDrive	230	11/12→	←	07/13→		13.0460-4875.2 604875	BRE 25028 18,0 + WE / - WK
			→	07/13→; + Performance Parts		13.0460-4874.2 604874	BRE 25029 16,7 + WE / - WK
335 i 335 i 335 i xDrive 335 i xDrive	225 240 225 240	04/11→07/15 04/11→07/13 05/11→07/15 04/11→07/13	←	02/12→		13.0460-4875.2 604875	BRE 25028 18,0 + WE / - WK
			→	02/12→; + Performance Parts		13.0460-4874.2 604874	BRE 25029 16,7 + WE / - WK
335 i 335 i xDrive	250 250	07/13→ 07/13→	←			13.0460-4875.2 604875	BRE 25028 18,0 + WE / - WK
			→	+ Performance Parts		13.0460-4874.2 604874	BRE 25029 16,7 + WE / - WK
340 i 340 i 340 i xDrive 340 i xDrive	240 265 240 265	10/14→ 10/14→ 10/14→ 10/14→	←	07/15→		13.0460-4875.2 604875	BRE 25028 18,0 + WE / - WK
			→	07/15→; + Performance Parts		13.0460-4874.2 604874	BRE 25029 16,7 + WE / - WK
ActiveHybrid ActiveHybrid	225 250	11/11→05/15 11/11→05/15	←	07/12→		13.0460-4875.2 604875	BRE 25028 18,0 + WE / - WK
			→	07/12→; + Performance Parts		13.0460-4874.2 604874	BRE 25029 16,7 + WE / - WK
<b>Warnkontakt, Bremsbelagverschleiß</b>							
316 d 318 d 318 d 320 d 320 d 320 d 320 d xDrive 320 d xDrive 320 d xDrive 320 i 320 i xDrive 328 i 328 i xDrive 335 i 335 i 335 i xDrive 335 i xDrive	85 100 105 120 135 147 120 135 147 135 135 180 180 225 240 225 240	05/11→ 05/11→ 05/11→06/15 04/11→ 03/11→03/16 03/11→03/16 05/11→ 10/11→07/15 05/11→06/15 04/11→ 05/11→06/15 04/11→07/16 05/11→07/16 04/11→07/15 04/11→07/13 05/11→07/15 04/11→07/13	← →	☐; 02/12→ 02/12→	1 1	24.8190-0006.2 620006 24.8190-0007.2 620007	L= 675 L= 1.045
316 i 320 i	100 125	10/12→08/16 04/12→06/16	← →	☐; 11/12→ 11/12→	1 1	24.8190-0006.2 620006 24.8190-0007.2 620007	L= 675 L= 1.045
318 d 318 d xDrive 318 i 320 d 320 d xDrive 330 i 330 i xDrive 340 i 340 i 340 i xDrive 340 i xDrive	110 110 100 140 140 185 185 240 265 240 265	10/14→ 11/14→ 03/15→ 10/14→ 10/14→ 09/14→ 10/14→ 10/14→ 10/14→ 10/14→ 10/14→	← →	☐; 07/15→ 07/15→	1 1	24.8190-0006.2 620006 24.8190-0007.2 620007	L= 675 L= 1.045
318 d xDrive	105	11/12→05/15	← →	☐; 05/13→ 05/13→	1 1	24.8190-0006.2 620006 24.8190-0007.2 620007	L= 675 L= 1.045
320 i 320 i xDrive 335 i 335 i xDrive M3 Competition M3 CS	135 135 250 250 331 338	09/14→ 09/14→ 07/13→ 07/13→ 03/16→ 01/18→	← →	☐ 	1 1	24.8190-0006.2 620006 24.8190-0007.2 620007	L= 675 L= 1.045
325 d 325 d	155 160	07/12→02/16 07/12→02/16	← →	☐; 04/13→ 04/13→	1 1	24.8190-0006.2 620006 24.8190-0007.2 620007	L= 675 L= 1.045
325 d	165	04/15→	← →	☐; 03/16→ 03/16→	1 1	24.8190-0006.2 620006 24.8190-0007.2 620007	L= 675 L= 1.045
330 d ActiveHybrid ActiveHybrid	190 225 250	01/12→ 11/11→05/15 11/11→05/15	← →	☐; 07/12→ 07/12→	1 1	24.8190-0006.2 620006 24.8190-0007.2 620007	L= 675 L= 1.045
330 d 330 d xDrive ↓	210 210	01/12→ 01/12→	←	☐; 09/15→	1	24.8190-0006.2 620006	L= 675

	kW			 	! #		
<b>BMW - 3 (F30, F80) 03/11→</b>							
<b>Warnkontakt, Bremsbelagverschleiß</b>							
330 d 330 d xDrive	210 210	01/12→	➡	09/15→	1	24.8190-0007.2 620007	L= 1.045
330 d xDrive	190	01/12→	←	☐; 03/13→	1	24.8190-0006.2 620006	L= 675
			➡	03/13→	1	24.8190-0007.2 620007	L= 1.045
330 e 330 e	135 185	02/15→ 02/15→	←	☐; 01/16→	1	24.8190-0006.2 620006	L= 675
			➡	01/16→	1	24.8190-0007.2 620007	L= 1.045
335 d xDrive	230	11/12→	←	☐; 07/13→	1	24.8190-0006.2 620006	L= 675
			➡	07/13→	1	24.8190-0007.2 620007	L= 1.045
M3	317	04/12→	←	☐; 01/14→	1	24.8190-0006.2 620006	L= 675
			➡	01/14→	1	24.8190-0007.2 620007	L= 1.045
<b>Bremsscheibe</b>							
316 d 318 d 320 d 320 i	85 105 120 135	05/11→ 05/11→06/15 04/11→ 04/11→	←	02/12→; - Performance Parts		24.0122-0278.1 422278	Ø 300 22 20,4 V + S
			←	02/12→; + Performance Parts		24.0130-0233.2 430233	Ø 340 30 28,4 V Brems Scheibe zweiteilig / + S
			➡	02/12→; - Performance Parts		24.0120-0237.1 420237	Ø 300 20 18,4 V + S
			➡	02/12→; + Performance Parts		24.0124-0250.2 424250	Ø 345 24 22,4 V Brems Scheibe zweiteilig / + S
316 i	100	10/12→08/16	←	11/12→; - Performance Parts		24.0122-0278.1 422278	Ø 300 22 20,4 V + S
			←	11/12→; + Performance Parts		24.0130-0233.2 430233	Ø 340 30 28,4 V Brems Scheibe zweiteilig / + S
			➡	11/12→; - Performance Parts		24.0120-0237.1 420237	Ø 300 20 18,4 V + S
			➡	11/12→; + Performance Parts		24.0124-0250.2 424250	Ø 345 24 22,4 V Brems Scheibe zweiteilig / + S
318 d 320 d 320 d	100 135 147	05/11→ 03/11→03/16 03/11→03/16	←	02/12→; - Performance Parts		24.0124-0203.1 424203	Ø 312 23,9 22,4 V + S
			←	02/12→; + Performance Parts		24.0324-0203.1 524203	Ø 312 23,9 21,6 V + S
			➡	02/12→; - Performance Parts		24.0130-0233.2 430233	Ø 340 30 28,4 V Brems Scheibe zweiteilig / + S
			➡	02/12→; + Performance Parts		24.0120-0237.1 420237	Ø 300 20 18,4 V + S
318 d 318 i 320 d	110 100 140	10/14→ 03/15→ 10/14→	←	07/15→; - Performance Parts		24.0122-0278.1 422278	Ø 300 22 20,4 V + S
			←	07/15→; + Performance Parts		24.0130-0233.2 430233	Ø 340 30 28,4 V Brems Scheibe zweiteilig / + S
			➡	07/15→; - Performance Parts		24.0120-0237.1 420237	Ø 300 20 18,4 V + S
			➡	07/15→; + Performance Parts		24.0124-0250.2 424250	Ø 345 24 22,4 V Brems Scheibe zweiteilig / + S
318 d xDrive	105	11/12→05/15	←	05/13→; - Performance Parts		24.0122-0278.1 422278	Ø 300 22 20,4 V + S
			←	05/13→; + Performance Parts		24.0130-0233.2 430233	Ø 340 30 28,4 V Brems Scheibe zweiteilig / + S
			➡	05/13→; - Performance Parts		24.0120-0240.1 420240	Ø 300 20 18,4 V + S
			➡	05/13→; + Performance Parts		24.0124-0251.2 424251	Ø 345 24 22,4 V Brems Scheibe zweiteilig / + S
318 d xDrive 320 d xDrive	110 140	11/14→ 10/14→	←	07/15→; - Performance Parts		24.0122-0278.1 422278	Ø 300 22 20,4 V + S
			←	07/15→; + Performance Parts		24.0130-0233.2 430233	Ø 340 30 28,4 V Brems Scheibe zweiteilig / + S
			➡	07/15→; - Performance Parts		24.0120-0240.1 420240	Ø 300 20 18,4 V + S
			➡	07/15→; + Performance Parts		24.0124-0251.2 424251	Ø 345 24 22,4 V Brems Scheibe zweiteilig / + S
320 d xDrive 320 d xDrive 320 d xDrive	120 135 147	05/11→ 10/11→07/15 05/11→06/15	←	02/12→; - Performance Parts		24.0124-0203.1 424203	Ø 312 23,9 22,4 V + S
			←	02/12→; + Performance Parts		24.0324-0203.1 524203	Ø 312 23,9 21,6 V + S
			➡	02/12→; - Performance Parts		24.0130-0233.2 430233	Ø 340 30 28,4 V Brems Scheibe zweiteilig / + S
			➡	02/12→; + Performance Parts		24.0120-0240.1 420240	Ø 300 20 18,4 V + S
320 i	125	04/12→06/16	←	11/12→		24.0122-0278.1 422278	Ø 300 22 20,4 V + S
			➡	11/12→		24.0120-0237.1 420237	Ø 300 20 18,4 V + S
			←	- Performance Parts		24.0122-0278.1 422278	Ø 300 22 20,4 V + S
			←	+ Performance Parts		24.0130-0233.2 430233	Ø 340 30 28,4 V Brems Scheibe zweiteilig / + S
320 i	135	09/14→	➡	- Performance Parts		24.0120-0237.1 420237	Ø 300 20 18,4 V + S
			➡	- Performance Parts		24.0120-0237.1 420237	Ø 300 20 18,4 V + S







	kw			 	! #		
<b>BMW - 3 (F30, F80) 03/11→</b>							
<b>Bremsscheibe</b>							
320 i	135	09/14→	➡	+ Performance Parts		24.0124-0250.2 424250	Ø 345 24 22,4 V Bremsscheibe zweiteilig / + S
320 i xDrive	135	05/11→06/15	⬅	02/12→; - Performance Parts		24.0122-0278.1 422278	Ø 300 22 20,4 V + S
			⬅	02/12→; + Performance Parts		24.0130-0233.2 430233	Ø 340 30 28,4 V Bremsscheibe zweiteilig / + S
			➡	02/12→; - Performance Parts		24.0120-0240.1 420240	Ø 300 20 18,4 V + S
			➡	02/12→; + Performance Parts		24.0124-0251.2 424251	Ø 345 24 22,4 V Bremsscheibe zweiteilig / + S
320 i xDrive	135	09/14→	⬅	- Performance Parts		24.0122-0278.1 422278	Ø 300 22 20,4 V + S
			⬅	+ Performance Parts		24.0130-0233.2 430233	Ø 340 30 28,4 V Bremsscheibe zweiteilig / + S
			➡	- Performance Parts		24.0120-0240.1 420240	Ø 300 20 18,4 V + S
			➡	+ Performance Parts		24.0124-0251.2 424251	Ø 345 24 22,4 V Bremsscheibe zweiteilig / + S
325 d 325 d	155 160	07/12→02/16 07/12→02/16	⬅	04/13→; - Performance Parts		24.0124-0248.1 424248	Ø 330 24 22,4 V + S
			⬅	04/13→; + Performance Parts		24.0130-0234.2 430234	Ø 370 30 28,4 V Bremsscheibe zweiteilig / + S
			➡	04/13→; - Performance Parts		24.0120-0237.1 420237	Ø 300 20 18,4 V + S
			➡	04/13→; + Performance Parts		24.0124-0250.2 424250	Ø 345 24 22,4 V Bremsscheibe zweiteilig / + S
325 d	165	04/15→	⬅	03/16→; - Performance Parts		24.0124-0248.1 424248	Ø 330 24 22,4 V + S
			⬅	03/16→; + Performance Parts		24.0130-0234.2 430234	Ø 370 30 28,4 V Bremsscheibe zweiteilig / + S
			➡	03/16→; - Performance Parts		24.0120-0237.1 420237	Ø 300 20 18,4 V + S
			➡	03/16→; + Performance Parts		24.0124-0250.2 424250	Ø 345 24 22,4 V Bremsscheibe zweiteilig / + S
328 i 328 i xDrive	180 180	04/11→07/16 05/11→07/16	⬅	02/12→; - Performance Parts		24.0124-0248.1 424248	Ø 330 24 22,4 V + S
			⬅	02/12→; + Performance Parts		24.0130-0234.2 430234	Ø 370 30 28,4 V Bremsscheibe zweiteilig / + S
			➡	02/12→; - Performance Parts		24.0120-0240.1 420240	Ø 300 20 18,4 V + S
			➡	02/12→; + Performance Parts		24.0124-0251.2 424251	Ø 345 24 22,4 V Bremsscheibe zweiteilig / + S
330 d	190	01/12→	⬅	07/12→; - Performance Parts		24.0124-0248.1 424248	Ø 330 24 22,4 V + S
			⬅	07/12→; + Performance Parts		24.0130-0234.2 430234	Ø 370 30 28,4 V Bremsscheibe zweiteilig / + S
			➡	07/12→; - Performance Parts		24.0120-0243.1 420243	Ø 330 20 18,4 V + S
			➡	07/12→; + Performance Parts		24.0124-0251.2 424251	Ø 345 24 22,4 V Bremsscheibe zweiteilig / + S
330 d 330 d xDrive	210 210	01/12→ 01/12→	⬅	09/15→; - Performance Parts		24.0124-0248.1 424248	Ø 330 24 22,4 V + S
			⬅	09/15→; + Performance Parts		24.0130-0234.2 430234	Ø 370 30 28,4 V Bremsscheibe zweiteilig / + S
			➡	09/15→; - Performance Parts		24.0120-0243.1 420243	Ø 330 20 18,4 V + S
			➡	09/15→; + Performance Parts		24.0124-0251.2 424251	Ø 345 24 22,4 V Bremsscheibe zweiteilig / + S
330 d xDrive	190	01/12→	⬅	03/13→; - Performance Parts		24.0124-0248.1 424248	Ø 330 24 22,4 V + S
			⬅	03/13→; + Performance Parts		24.0130-0234.2 430234	Ø 370 30 28,4 V Bremsscheibe zweiteilig / + S
			➡	03/13→; - Performance Parts		24.0120-0243.1 420243	Ø 330 20 18,4 V + S
			➡	03/13→; + Performance Parts		24.0124-0251.2 424251	Ø 345 24 22,4 V Bremsscheibe zweiteilig / + S
330 e 330 e	135 185	02/15→ 02/15→	⬅	01/16→; - Performance Parts		24.0124-0203.1 424203	Ø 312 23,9 22,4 V + S
			⬅	01/16→; + Performance Parts		24.0324-0203.1 524203	Ø 312 23,9 21,6 V + S
			⬅	01/16→; + Performance Parts		24.0130-0233.2 430233	Ø 340 30 28,4 V Bremsscheibe zweiteilig / + S
			➡	01/16→; - Performance Parts		24.0120-0240.1 420240	Ø 300 20 18,4 V + S
330 i 330 i xDrive	185 185	09/14→ 10/14→	⬅	07/15→; - Performance Parts		24.0124-0248.1 424248	Ø 330 24 22,4 V + S
			⬅	07/15→; + Performance Parts		24.0130-0234.2 430234	Ø 370 30 28,4 V Bremsscheibe zweiteilig / + S
			➡	07/15→; - Performance Parts		24.0120-0240.1 420240	Ø 300 20 18,4 V + S
			➡	07/15→; + Performance Parts		24.0124-0251.2 424251	Ø 345 24 22,4 V Bremsscheibe zweiteilig / + S
↓							









	kw			 	! #		
<b>BMW - 3 (F30, F80) 03/11→</b>							
<b> Bremsscheibe</b>							
335 d xDrive	230	11/12→	←	07/13→; - Performance Parts		24.0130-0233.2 430233	Ø 340 30 28,4 V Bremsscheibe zweiteilig / + S
			←	07/13→; + Performance Parts		24.0130-0234.2 430234	Ø 370 30 28,4 V Bremsscheibe zweiteilig / + S
			→	07/13→; - Performance Parts		24.0120-0243.1 420243	Ø 330 20 18,4 V + S
			→	07/13→; + Performance Parts		24.0124-0251.2 424251	Ø 345 24 22,4 V Bremsscheibe zweiteilig / + S
335 i 335 i 335 i xDrive 335 i xDrive	225 240 225 240	04/11→07/15 04/11→07/13 05/11→07/15 04/11→07/13	←	02/12→; - Performance Parts		24.0130-0233.2 430233	Ø 340 30 28,4 V Bremsscheibe zweiteilig / + S
			←	02/12→; + Performance Parts		24.0130-0234.2 430234	Ø 370 30 28,4 V Bremsscheibe zweiteilig / + S
			→	02/12→; - Performance Parts		24.0120-0243.1 420243	Ø 330 20 18,4 V + S
			→	02/12→; + Performance Parts		24.0124-0251.2 424251	Ø 345 24 22,4 V Bremsscheibe zweiteilig / + S
335 i 335 i xDrive	250 250	07/13→ 07/13→	←	- Performance Parts		24.0130-0233.2 430233	Ø 340 30 28,4 V Bremsscheibe zweiteilig / + S
			←	+ Performance Parts		24.0130-0234.2 430234	Ø 370 30 28,4 V Bremsscheibe zweiteilig / + S
			→	- Performance Parts		24.0120-0243.1 420243	Ø 330 20 18,4 V + S
			→	+ Performance Parts		24.0124-0251.2 424251	Ø 345 24 22,4 V Bremsscheibe zweiteilig / + S
340 i 340 i 340 i xDrive 340 i xDrive	240 265 240 265	10/14→ 10/14→ 10/14→ 10/14→	←	07/15→; - Performance Parts		24.0130-0233.2 430233	Ø 340 30 28,4 V Bremsscheibe zweiteilig / + S
			←	07/15→; + Performance Parts		24.0130-0234.2 430234	Ø 370 30 28,4 V Bremsscheibe zweiteilig / + S
			→	07/15→; - Performance Parts		24.0120-0243.1 420243	Ø 330 20 18,4 V + S
			→	07/15→; + Performance Parts		24.0124-0251.2 424251	Ø 345 24 22,4 V Bremsscheibe zweiteilig / + S
ActiveHybrid ActiveHybrid	225 250	11/11→05/15 11/11→05/15	←	07/12→; - Performance Parts		24.0130-0233.2 430233	Ø 340 30 28,4 V Bremsscheibe zweiteilig / + S
			←	07/12→; + Performance Parts		24.0130-0234.2 430234	Ø 370 30 28,4 V Bremsscheibe zweiteilig / + S
			→	07/12→; - Performance Parts		24.0120-0243.1 420243	Ø 330 20 18,4 V + S
			→	07/12→; + Performance Parts		24.0124-0251.2 424251	Ø 345 24 22,4 V Bremsscheibe zweiteilig / + S
<b>BMW - 3 Cabriolet (E36) 03/93→04/99</b>							
<b> Bremsbelagsatz, Scheibenbremse</b>							
318 i 320 i 323 i 328 i	85 110 125 142	01/94→04/99 12/93→04/99 06/95→04/99 03/95→04/99	←			13.0460-5405.2 605405	ATE 21643 17,8 + WE / - WK
			←			13.0470-5405.2 LD5405	ATE 21643 17,8 + WE / - WK Ceramic
			→			13.0460-3605.2 603605	ATE 20180 17,3 + WE / - WK
			→			13.0470-3605.2 LD3605	ATE 20180 17,3 + WE / - WK Ceramic
M3 3.2	236	10/95→04/99	←			13.0460-7185.2 607185	ATE 20968 20,3 + WE / - WK
			→			13.0460-3803.2 603803	ATE 20995 17,3 + WE / - WK
<b>Warnkontakt, Bremsbelagverschleiß</b>							
318 i 320 i 323 i 328 i	85 110 125 142	01/94→04/99 12/93→04/99 06/95→04/99 03/95→04/99	←		1	24.8190-0207.2 620207	L= 786
			→		1	24.8190-0206.2 620206	L= 790
			←		1	24.8190-0210.2 620210	L= 810
			→		1	24.8190-0206.2 620206	L= 790
<b> Bremsscheibe</b>							
318 i	85	01/94→04/99	←			24.0112-0126.1 412126	Ø 286 12 10,4 + S
			←			24.0312-0126.1 512126	Ø 286 12 9,6 + S
			→			24.0110-0202.1 410202	Ø 280 10 8,4 + S
			→			24.0310-0202.1 510202	Ø 280 10 7,6 + S
320 i	110	12/93→04/99	←	Motorcode: M50		24.0112-0126.1 412126	Ø 286 12 10,4 + S
			←	Motorcode: M52		24.0312-0126.1 512126	Ø 286 12 9,6 + S
			←			24.0122-0115.1 422115	Ø 286 22 20,4 V + S
			←			24.0322-0115.1 522115	Ø 286 22 19,6 V + S
↓			→			24.0110-0202.1 410202	Ø 280 10 8,4 + S









	kW			 	! #		
<b>BMW - 3 Cabriolet (E36) 03/93→04/99</b>							
<b>Bremsscheibe</b>							
320 i	110	12/93→04/99	➔			24.0310-0202.1 510202	Ø 280 10 7,6 + S
323 i 328 i	125 142	06/95→04/99 03/95→04/99	➔			24.0122-0115.1 422115	Ø 286 22 20,4 V + S
			➔			24.0322-0115.1 522115	Ø 286 22 19,6 V + S
			➔			24.0119-0107.1 419107	Ø 276 19 17,4 V + S
			➔			24.0319-0107.1 519107	Ø 276 19 16,6 V + S
M3 3.2	236	10/95→04/99	➔	☐		24.0128-0204.2 428204	Ø 315 28 26,4 V Bremsscheibe zweiteilig / + S
			➔	☐		24.0128-0205.2 428205	Ø 315 28 26,4 V Bremsscheibe zweiteilig / + S
			➔	☐		24.0120-0189.1 420189	Ø 312 20 18,4 V + S
			➔	☐		24.0120-0190.1 420190	Ø 312 20 18,4 V + S
<b>BMW - 3 Cabriolet (E46) 04/00→12/07</b>							
<b>Brembelagsatz, Scheibenbremse</b>							
318 Ci	100	12/00→08/06	➔	09/01→		13.0460-5405.2 605405	ATE 21643 17,8 + WE / - WK
			➔	09/01→		13.0470-5405.2 LD5405	ATE 21643 17,8 + WE / - WK Ceramic
318 Ci 318 Ci 320 Cd 320 Ci 320 Ci 325 Ci	105 110 110 120 125 141	09/01→12/07 02/05→12/07 02/05→12/07 01/06→12/07 09/00→12/07 09/00→12/07	➔	→ 09/06		13.0460-5405.2 605405	ATE 21643 17,8 + WE / - WK
			➔	→ 09/06		13.0470-5405.2 LD5405	ATE 21643 17,8 + WE / - WK Ceramic
318 Ci 318 Ci 320 Cd 320 Ci 320 Ci 325 Ci	105 110 110 120 125 141	09/01→12/07 02/05→12/07 02/05→12/07 01/06→12/07 09/00→12/07 09/00→12/07	➔	→ 09/06		13.0460-3605.2 603605	ATE 20180 17,3 + WE / - WK
			➔	→ 09/06		13.0470-3605.2 LD3605	ATE 20180 17,3 + WE / - WK Ceramic
323 Ci 323 Ci	120 125	04/00→09/00 04/00→09/00	➔			13.0460-5405.2 605405	ATE 21643 17,8 + WE / - WK
			➔			13.0470-5405.2 LD5405	ATE 21643 17,8 + WE / - WK Ceramic
323 Ci 323 Ci	120 125	04/00→09/00 04/00→09/00	➔			13.0460-3605.2 603605	ATE 20180 17,3 + WE / - WK
			➔			13.0470-3605.2 LD3605	ATE 20180 17,3 + WE / - WK Ceramic
330 Cd 330 Ci	150 170	08/05→12/07 06/00→12/07	➔	→ 09/06		13.0460-7155.2 607155	ATE 21676 20,3 + WE / - WK
			➔	→ 09/06		13.0470-7155.2 LD7155	ATE 21676 20,3 + WE / - WK Ceramic
M3 3.2	252	04/01→12/07	➔	→ 09/06		13.0460-7079.2 607079	ATE 21282 17,3 + WE / - WK
			➔	→ 09/06		13.0470-7079.2 LD7079	ATE 21282 17,3 + WE / - WK Ceramic
M3 3.2	252	04/01→12/07	➔	→ 09/06		13.0460-7185.2 607185	ATE 20968 20,3 + WE / - WK
			➔	→ 09/06		13.0460-7079.2 607079	ATE 21282 17,3 + WE / - WK
M3 3.2	252	04/01→12/07	➔	→ 09/06		13.0470-7079.2 LD7079	ATE 21282 17,3 + WE / - WK Ceramic
			➔	→ 09/06		13.0470-7079.2 LD7079	ATE 21282 17,3 + WE / - WK Ceramic
<b>Warnkontakt, Bremsbelagverschleiß</b>							
318 Ci	100	12/00→08/06	➔	09/01→	1	24.8190-0220.2 620220	L= 601
			➔	09/01→	1	24.8190-0221.2 620221	L= 1.338
318 Ci 318 Ci 320 Cd 320 Ci 320 Ci 325 Ci	105 110 110 120 125 141	09/01→12/07 02/05→12/07 02/05→12/07 01/06→12/07 09/00→12/07 09/00→12/07	➔	→ 09/06	1	24.8190-0220.2 620220	L= 601
			➔	→ 09/06	1	24.8190-0221.2 620221	L= 1.338
323 Ci 323 Ci	120 125	04/00→09/00 04/00→09/00	➔		1	24.8190-0220.2 620220	L= 601
			➔		1	24.8190-0221.2 620221	L= 1.338
330 Cd 330 Ci	150 170	08/05→12/07 06/00→12/07	➔	→ 09/06	1	24.8190-0227.2 620227	L= 651
			➔	→ 09/06	1	24.8190-0221.2 620221	L= 1.338
M3 3.2	252	04/01→12/07	➔	→ 09/06	1	24.8190-0227.2 620227	L= 651
			➔	→ 09/06	1	24.8190-0228.2 620228	L= 1.353
<b>Bremsscheibe</b>							
318 Ci	100	12/00→08/06	➔	09/01→		24.0122-0115.1 422115	Ø 286 22 20,4 V + S
			➔	09/01→		24.0322-0115.1 522115	Ø 286 22 19,6 V + S
			➔	09/01→		24.0119-0107.1 419107	Ø 276 19 17,4 V + S
			➔	09/01→		24.0319-0107.1 519107	Ø 276 19 16,6 V + S
↓							

























	kw			 	! #		
<b>BMW - 3 Cabriolet (E46) 04/00→12/07</b>							
<b>Bremsscheibe</b>							
318 Ci 318 Ci	105 110	09/01→12/07 02/05→12/07	← →	→ 09/06 → 09/06		24.0122-0115.1 422115 24.0322-0115.1 522115 24.0119-0107.1 419107 24.0319-0107.1 519107	Ø 286 22 20,4 V + S Ø 286 22 19,6 V + S Ø 276 19 17,4 V + S Ø 276 19 16,6 V + S
320 Cd 320 Ci 320 Ci 325 Ci	110 120 125 141	02/05→12/07 01/06→12/07 09/00→12/07 09/00→12/07	← →	→ 09/06 → 09/06		24.0122-0160.1 422160 24.0322-0160.1 522160 24.0119-0108.1 419108 24.0319-0108.1 519108	Ø 300 22 20,4 V + S Ø 300 22 19,6 V + S Ø 294 18,9 17,4 V + S Ø 294 18,9 16,6 V + S
323 Ci 323 Ci	120 125	04/00→09/00 04/00→09/00	← →			24.0122-0160.1 422160 24.0322-0160.1 522160 24.0119-0108.1 419108 24.0319-0108.1 519108	Ø 300 22 20,4 V + S Ø 300 22 19,6 V + S Ø 294 18,9 17,4 V + S Ø 294 18,9 16,6 V + S
330 Cd 330 Ci	150 170	08/05→12/07 06/00→12/07	← →	→ 09/06 → 09/06		24.0125-0138.1 425138 24.0325-0138.1 525138 24.0122-0209.1 422209 24.0322-0209.1 522209	Ø 325 24,9 23,4 V + S Ø 325 24,9 22,6 V + S Ø 320 22 20,4 V + S Ø 320 22 19,6 V + S
M3 3.2	252	04/01→12/07	← ← → →	☐; → 09/06 ☐; → 09/06 ☐; → 09/06 ☐; → 09/06		24.0128-0206.2 428206 24.0128-0207.2 428207 24.0120-0221.2 420221 24.0120-0222.2 420222	Ø 325 28 26,4 V* Bremsscheibe zweiteilig / + S Ø 325 28 26,4 V* Bremsscheibe zweiteilig / + S Ø 328 20 18,4 V* Bremsscheibe zweiteilig / + S Ø 328 20 18,4 V* Bremsscheibe zweiteilig / + S
<b>BMW - 3 Cabriolet (E93) 05/06→12/13</b>							
<b>Bremsbelagsatz, Scheibenbremse</b>							
318 i	105	03/10→12/13	← ← →	+ Performance Parts		13.0460-4848.2 604848 13.0460-7216.2 607216 13.0470-7216.2 LD7216 13.0460-7217.2 607217 13.0470-7217.2 LD7217	BRE 24316 16,9 + WE / - WK ATE 23794 20,3 + WE / - WK ATE 23794 20,3 + WE / - WK Ceramic ATE 23926 17,3 + WE / - WK ATE 23926 17,3 + WE / - WK Ceramic
320 d 320 d 320 d 320 d 320 d 323 i	120 130 135 145 147 140	01/08→12/13 09/07→02/10 03/10→10/13 09/07→02/10 03/10→10/13 03/07→09/11	← ← →	+ Performance Parts		13.0460-4848.2 604848 13.0460-7238.2 607238 13.0470-7238.2 LD7238 13.0460-7217.2 607217 13.0470-7217.2 LD7217	BRE 24316 16,9 + WE / - WK ATE 23313 20,3 + WE / - WK ATE 23313 20,3 + WE / - WK Ceramic ATE 23926 17,3 + WE / - WK ATE 23926 17,3 + WE / - WK Ceramic
320 i 320 i 320 i	115 120 125	01/07→08/13 09/06→10/13 09/06→10/13	← ← ←	+ Performance Parts 03/08→ → 02/08		13.0460-4848.2 604848 13.0460-7216.2 607216 13.0470-7216.2 LD7216 13.0460-7238.2 607238 13.0470-7238.2 LD7238 13.0460-7217.2 607217 13.0470-7217.2 LD7217	BRE 24316 16,9 + WE / - WK ATE 23794 20,3 + WE / - WK ATE 23794 20,3 + WE / - WK Ceramic ATE 23313 20,3 + WE / - WK ATE 23313 20,3 + WE / - WK Ceramic ATE 23926 17,3 + WE / - WK ATE 23926 17,3 + WE / - WK Ceramic
325 d 325 d 325 d	145 150 155	03/07→12/10 09/09→09/13 03/07→12/10	← ← →	+ Performance Parts		13.0460-4848.2 604848 13.0460-7216.2 607216 13.0470-7216.2 LD7216 13.0460-7225.2 607225 13.0470-7225.2 LD7225	BRE 24316 16,9 + WE / - WK ATE 23794 20,3 + WE / - WK ATE 23794 20,3 + WE / - WK Ceramic ATE 23550 17,3 + WE / - WK ATE 23550 17,3 + WE / - WK Ceramic
325 i 325 i 325 i	150 155 160	03/10→09/13 10/06→12/13 03/07→12/13	← ← ←	+ Performance Parts Motorcode: N53 Motorcode: N52N		13.0460-4848.2 604848 13.0460-7216.2 607216 13.0470-7216.2 LD7216 13.0460-7238.2 607238	BRE 24316 16,9 + WE / - WK ATE 23794 20,3 + WE / - WK ATE 23794 20,3 + WE / - WK Ceramic ATE 23313 20,3 + WE / - WK
↓							











	kw			 	! #			
<b>BMW - 3 Cabriolet (E93) 05/06→12/13</b>								
<b> Bremsbelagsatz, Scheibenbremse</b>								
325 i 325 i 325 i	150	03/10→09/13	←	Motorcode: N52N		13.0470-7238.2	LD7238	ATE 23313 20,3 + WE / - WK Ceramic
	155	10/06→12/13				13.0460-7217.2	607217	ATE 23926 17,3 + WE / - WK
	160	03/07→12/13	→			13.0470-7217.2	LD7217	ATE 23926 17,3 + WE / - WK Ceramic
330 d 330 d	170	03/07→12/13	←	+ Performance Parts		13.0460-4848.2	604848	BRE 24316 16,9 + WE / - WK
	180	01/09→12/13	←	09/09→		13.0460-7216.2	607216	ATE 23794 20,3 + WE / - WK
			←	→ 08/09		13.0460-7216.2	LD7216	ATE 23794 20,3 + WE / - WK Ceramic
			←			13.0460-7237.2	607237	ATE 23347 20,3 + WE / - WK
			→			13.0460-7238.2	607238	ATE 23313 20,3 + WE / - WK
330 i	190	03/07→12/13	←	+ Performance Parts		13.0460-4848.2	604848	BRE 24316 16,9 + WE / - WK
			←	09/09→; Motorcode: N53		13.0460-7216.2	607216	ATE 23794 20,3 + WE / - WK
			←	Motorcode: N52N		13.0470-7216.2	LD7216	ATE 23794 20,3 + WE / - WK Ceramic
			←	→ 08/09; Motorcode: N53		13.0460-7216.2	LD7216	ATE 23794 20,3 + WE / - WK Ceramic
			←			13.0460-7237.2	607237	ATE 23347 20,3 + WE / - WK
			→			13.0460-7238.2	607238	ATE 23313 20,3 + WE / - WK
330 i	200	03/07→12/13	←	+ Performance Parts		13.0460-4848.2	604848	BRE 24316 16,9 + WE / - WK
			←	09/09→; Motorcode: N53		13.0460-7216.2	607216	ATE 23794 20,3 + WE / - WK
			←	Motorcode: N52N		13.0470-7216.2	LD7216	ATE 23794 20,3 + WE / - WK Ceramic
			←	09/09→		13.0460-7216.2	607216	ATE 23794 20,3 + WE / - WK
			←	→ 08/09		13.0470-7216.2	LD7216	ATE 23794 20,3 + WE / - WK Ceramic
			←			13.0460-7237.2	607237	ATE 23347 20,3 + WE / - WK
			←	→ 08/09; Motorcode: N53		13.0460-7238.2	607238	ATE 23313 20,3 + WE / - WK
			→			13.0470-7237.2	LD7237	ATE 23347 20,3 + WE / - WK Ceramic
335 i	225	05/06→10/13	←			13.0460-7238.2	607238	ATE 23313 20,3 + WE / - WK
			←			13.0470-7237.2	LD7237	ATE 23347 20,3 + WE / - WK Ceramic
			←			13.0470-7238.2	LD7238	ATE 23313 20,3 + WE / - WK Ceramic
			←			13.0460-7237.2	607237	ATE 23347 20,3 + WE / - WK
			→			13.0460-7225.2	607225	ATE 23550 17,3 + WE / - WK Ceramic









	kW			 	! #		
<b>BMW - 3 Cabriolet (E93) 05/06→12/13</b>							
<b> Bremsbelagsatz, Scheibenbremse</b>							
335 i	225	05/06→10/13	→			13.0470-7225.2 LD7225	ATE 23550 17,3 + WE / - WK Ceramic
335 i	240	05/06→10/13	←			13.0460-7237.2 607237	ATE 23347 20,3 + WE / - WK
						13.0460-7238.2 607238	ATE 23313 20,3 + WE / - WK
			→			13.0460-7225.2 607225	ATE 23550 17,3 + WE / - WK
						13.0470-7225.2 LD7225	ATE 23550 17,3 + WE / - WK Ceramic
M3	309	03/07→10/13	←			13.0460-7167.2 607167	ATE 23312 20,3 + WE / - WK
<b>Warnkontakt, Bremsbelagsverschleiß</b>							
318 i	105	03/10→12/13	←	+ Performance Parts	1	24.8190-0267.2 620267	L= 679
			←		1	24.8190-0284.2 620284	L= 650
			→		1	24.8190-0285.2 620285	L= 1.107
320 d 330 d	120 170	01/08→12/13 03/07→12/13	←	→ 02/10	1	24.8190-0267.2 620267	L= 679
			←	+ Performance Parts	1	24.8190-0267.2 620267	L= 679
			←	03/10→	1	24.8190-0287.2 620287	L= 723
			→	→ 02/10	1	24.8190-0265.2 620265	L= 1.086
			→	03/10→	1	24.8190-0285.2 620285	L= 1.107
320 d 320 d	130 145	09/07→02/10 09/07→02/10	←	+ Performance Parts	1	24.8190-0267.2 620267	L= 679
			←		1	24.8190-0267.2 620267	L= 679
			→		1	24.8190-0265.2 620265	L= 1.086
320 d 320 d	135 147	03/10→10/13 03/10→10/13	←	+ Performance Parts	1	24.8190-0267.2 620267	L= 679
			←		1	24.8190-0287.2 620287	L= 723
			→		1	24.8190-0285.2 620285	L= 1.107
320 i 320 i 320 i	115 120 125	01/07→08/13 09/06→10/13 09/06→10/13	←	03/08→ 02/10	1	24.8190-0264.2 620264	L= 630
			←	+ Performance Parts	1	24.8190-0267.2 620267	L= 679
			←	→ 02/08	1	24.8190-0267.2 620267	L= 679
			←	03/10→	1	24.8190-0284.2 620284	L= 650
			→	→ 02/10	1	24.8190-0265.2 620265	L= 1.086
			→	03/10→	1	24.8190-0285.2 620285	L= 1.107
323 i	140	03/07→09/11	←	→ 02/10	1	24.8190-0267.2 620267	L= 679
			←	+ Performance Parts	1	24.8190-0267.2 620267	L= 679
			←	03/10→	1	24.8190-0285.2 620285 24.8190-0287.2 620287	L= 1.107 L= 723
			→	→ 02/10	1	24.8190-0265.2 620265	L= 1.086
325 d 325 d 325 d	145 150 155	03/07→12/10 09/09→09/13 03/07→12/10	←	→ 02/10	1	24.8190-0264.2 620264	L= 630
			←	+ Performance Parts	1	24.8190-0267.2 620267	L= 679
			←	03/10→	1	24.8190-0284.2 620284	L= 650
			→	→ 02/10	1	24.8190-0265.2 620265	L= 1.086
			→	03/10→	1	24.8190-0285.2 620285	L= 1.107
325 i	150	03/10→09/13	←	+ Performance Parts	1	24.8190-0267.2 620267	L= 679
			←	Motorcode: N53	1	24.8190-0284.2 620284	L= 650
			←	Motorcode: N52N	1	24.8190-0287.2 620287	L= 723
			→		1	24.8190-0285.2 620285	L= 1.107
325 i 325 i	155 160	10/06→12/13 03/07→12/13	←	→ 02/10; Motorcode: N53	1	24.8190-0264.2 620264	L= 630
			←	→ 02/10; Motorcode: N52N	1	24.8190-0267.2 620267	L= 679
			←	+ Performance Parts	1	24.8190-0267.2 620267	L= 679
			←	03/10→; Motorcode: N53	1	24.8190-0284.2 620284	L= 650
			←	03/10→; Motorcode: N52N	1	24.8190-0287.2 620287	L= 723
			→	→ 02/10	1	24.8190-0265.2 620265	L= 1.086
			→	03/10→	1	24.8190-0285.2 620285	L= 1.107
330 d	180	01/09→12/13	←	09/09→ 02/10	1	24.8190-0264.2 620264	L= 630
			←	→ 08/09	1	24.8190-0267.2 620267	L= 679
			←	+ Performance Parts	1	24.8190-0267.2 620267	L= 679
			←	03/10→	1	24.8190-0287.2 620287	L= 723







	kw			 	! #		
<b>BMW - 3 Cabriolet (E93) 05/06→12/13</b>							
<b>Warnkontakt, Bremsbelagverschleiß</b>							
330 d	180	01/09→12/13	➡	→ 02/10	1	24.8190-0265.2 620265	L= 1.086
			➡	03/10→	1	24.8190-0285.2 620285	L= 1.107
330 i	190	03/07→12/13	⬅	Motorcode: N53; 09/09→ 02/10	1	24.8190-0264.2 620264	L= 630
			⬅	→ 02/10; Motorcode: N52N	1	24.8190-0264.2 620264	L= 630
			⬅	→ 08/09; Motorcode: N53	1	24.8190-0267.2 620267	L= 679
			⬅	+ Performance Parts	1	24.8190-0267.2 620267	L= 679
			⬅	03/10→; Motorcode: N53/N52N	1	24.8190-0287.2 620287	L= 723
			➡	→ 02/10	1	24.8190-0265.2 620265	L= 1.086
			➡	03/10→	1	24.8190-0285.2 620285	L= 1.107
330 i	200	03/07→12/13	⬅	→ 02/10; Motorcode: N52N	1	24.8190-0264.2 620264	L= 630
			⬅	09/09→ 02/10	1	24.8190-0264.2 620264	L= 630
			⬅	Motorcode: N53; 09/09→ 02/10	1	24.8190-0264.2 620264	L= 630
			⬅	→ 08/09	1	24.8190-0267.2 620267	L= 679
			⬅	→ 08/09; Motorcode: N53	1	24.8190-0267.2 620267	L= 679
			⬅	+ Performance Parts	1	24.8190-0267.2 620267	L= 679
			⬅	03/10→; Motorcode: N52N/N53	1	24.8190-0284.2 620284	L= 650
			⬅	03/10→	1	24.8190-0287.2 620287	L= 723
			➡	→ 02/10	1	24.8190-0265.2 620265	L= 1.086
			➡	03/10→	1	24.8190-0285.2 620285	L= 1.107
335 i 335 i	225 240	05/06→10/13 05/06→10/13	⬅	→ 02/10	1	24.8190-0267.2 620267	L= 679
			⬅	03/10→	1	24.8190-0287.2 620287	L= 723
			➡	→ 02/10	1	24.8190-0265.2 620265	L= 1.086
			➡	03/10→	1	24.8190-0285.2 620285	L= 1.107
M3	309	03/07→10/13	⬅		1	24.8190-0271.2 620271	L= 659
			⬅		1	24.8190-0272.2 620272	L= 672
			➡	→ 02/10	1	24.8190-0265.2 620265	L= 1.086
			➡	03/10→	1	24.8190-0285.2 620285	L= 1.107
<b> Bremsscheibe</b>							
318 i	105	03/10→12/13	⬅			24.0124-0197.1 424197	Ø 300 24 22,4 V + S
			➡			24.0324-0197.1 524197	Ø 300 24 21,6 V + S
320 d 320 d 320 d 320 d 320 d 323 i	120 130 135 145 147 140	01/08→12/13 09/07→02/10 03/10→10/13 09/07→02/10 03/10→10/13 03/07→09/11	⬅			24.0124-0203.1 424203	Ø 312 23,9 22,4 V + S
			➡			24.0324-0203.1 524203	Ø 312 23,9 21,6 V + S
320 i 320 i 320 i	115 120 125	01/07→08/13 09/06→10/13 09/06→10/13	⬅	03/08→		24.0124-0197.1 424197	Ø 300 24 22,4 V + S
			⬅	→ 02/08		24.0124-0203.1 424203	Ø 312 23,9 22,4 V + S
325 d 325 d 325 d	145 150 155	03/07→12/10 09/09→09/13 03/07→12/10	⬅			24.0124-0200.1 424200	Ø 330 24 22,4 V + S
			➡			24.0324-0200.1 524200	Ø 330 24 21,6 V + S
325 i 325 i 325 i	150 155 160	03/10→09/13 10/06→12/13 03/07→12/13	⬅	Motorcode: N53		24.0124-0200.1 424200	Ø 330 24 22,4 V + S
			⬅	Motorcode: N52N		24.0324-0200.1 524200	Ø 330 24 21,6 V + S
330 d 330 d	170 180	03/07→12/13 01/09→12/13	⬅	09/09→		24.0124-0200.1 424200	Ø 330 24 22,4 V + S
			➡			24.0324-0200.1 524200	Ø 330 24 21,6 V + S









	kw			 	! #		
<b>BMW - 3 Cabriolet (E93) 05/06→12/13</b>							
<b>Bremsscheibe</b>							
330 d 330 d	170 180	03/07→12/13 01/09→12/13	← →	→ 08/09		24.0130-0192.1 430192 24.0122-0236.1 422236 24.0322-0236.1 522236	Ø 348 30 28,4 V + S Ø 336 22 20,4 V + S Ø 336 22 19,6 V + S
330 i	190	03/07→12/13	← ← ← →	09/09→; Motorcode: N53 Motorcode: N52N → 08/09; Motorcode: N53		24.0124-0200.1 424200 24.0324-0200.1 524200 24.0124-0200.1 424200 24.0324-0200.1 524200 24.0130-0192.1 430192 24.0122-0236.1 422236 24.0322-0236.1 522236	Ø 330 24 22,4 V + S Ø 330 24 21,6 V + S Ø 330 24 22,4 V + S Ø 330 24 21,6 V + S Ø 348 30 28,4 V + S Ø 336 22 20,4 V + S Ø 336 22 19,6 V + S
330 i	200	03/07→12/13	← ← ← ← ← →	09/09→; Motorcode: N53 Motorcode: N52N 09/09→ → 08/09 → 08/09; Motorcode: N53		24.0124-0200.1 424200 24.0324-0200.1 524200 24.0124-0200.1 424200 24.0324-0200.1 524200 24.0124-0200.1 424200 24.0324-0200.1 524200 24.0130-0192.1 430192 24.0122-0236.1 422236 24.0322-0236.1 522236	Ø 330 24 22,4 V + S Ø 330 24 21,6 V + S Ø 330 24 22,4 V + S Ø 330 24 21,6 V + S Ø 348 30 28,4 V + S Ø 348 30 28,4 V + S Ø 336 22 20,4 V + S Ø 336 22 19,6 V + S
335 i 335 i	225 240	05/06→10/13 05/06→10/13	← →			24.0130-0192.1 430192 24.0122-0236.1 422236 24.0322-0236.1 522236	Ø 348 30 28,4 V + S Ø 336 22 20,4 V + S Ø 336 22 19,6 V + S
M3	309	03/07→10/13	← ← → →	   		24.0130-0213.2 430213 24.0130-0214.2 430214 24.0124-0231.2 424231 24.0124-0232.2 424232	Ø 360 30 28,4 V• Bremsscheibe zweiteilig / + S Ø 360 30 28,4 V• Bremsscheibe zweiteilig / + S Ø 350 24 22,4 V• Bremsscheibe zweiteilig / + S Ø 350 24 22,4 V• Bremsscheibe zweiteilig / + S
<b>BMW - 3 Compact (E36) 03/94→05/01</b>							
<b>Bremsbelagsatz, Scheibenbremse</b>							
316 g 316 i 316 i 318 tds 318 ti 323 ti 323 ti	75 75 77 66 103 120 125	03/94→08/00 03/94→08/00 12/98→08/00 03/94→05/01 07/95→08/00 01/99→08/00 08/97→08/00	← →			13.0460-5405.2 605405 13.0470-5405.2 LD5405 13.0460-3605.2 603605 13.0470-3605.2 LD3605	ATE 21643 17,8 + WE / - WK ATE 21643 17,8 + WE / - WK Ceramic ATE 20180 17,3 + WE / - WK ATE 20180 17,3 + WE / - WK Ceramic
<b>Warnkontakt, Bremsbelagverschleiß</b>							
316 g 316 i 316 i 318 tds 318 ti 323 ti 323 ti	75 75 77 66 103 120 125	03/94→08/00 03/94→08/00 12/98→08/00 03/94→05/01 07/95→08/00 01/99→08/00 08/97→08/00	← →		1 1	24.8190-0207.2 620207 24.8190-0211.2 620211	L= 786 L= 840
<b>Bremsscheibe</b>							
316 g 316 i 316 i 318 tds	75 75 77 66	03/94→08/00 03/94→08/00 12/98→08/00 03/94→05/01	← →			24.0112-0126.1 412126 24.0312-0126.1 512126 24.0110-0211.1 410211	Ø 286 12 10,4 + S Ø 286 12 9,6 + S Ø 272 10 8,4 + S
318 ti	103	07/95→08/00	← ← →	→ 04/98; Motorcode: M44 05/98→; Motorcode: M44		24.0112-0126.1 412126 24.0312-0126.1 512126 24.0122-0115.1 422115 24.0322-0115.1 522115 24.0110-0211.1 410211	Ø 286 12 10,4 + S Ø 286 12 9,6 + S Ø 286 22 20,4 V + S Ø 286 22 19,6 V + S Ø 272 10 8,4 + S
323 ti 323 ti	120 125	01/99→08/00 08/97→08/00	← →			24.0122-0115.1 422115 24.0322-0115.1 522115 24.0110-0211.1 410211	Ø 286 22 20,4 V + S Ø 286 22 19,6 V + S Ø 272 10 8,4 + S











	kW			 	! #		
<b>BMW - 3 Compact (E46) 03/01→02/05</b>							
 <b>Bremsbelagsatz, Scheibenbremse</b>							
316 ti	77	06/02→02/05	←			13.0460-5405.2 605405	ATE 21643 17,8 + WE / - WK
316 ti	85	06/02→02/05				13.0470-5405.2 LD5405	ATE 21643 17,8 + WE / - WK
316 ti	85	06/01→02/05					Ceramic
318 td	85	03/03→02/05					
320 td	110	09/01→02/05	→			13.0460-3605.2 603605	ATE 20180 17,3 + WE / - WK
325 ti	141	06/01→02/05				13.0470-3605.2 LD3605	ATE 20180 17,3 + WE / - WK
							Ceramic
318 ti	100	03/01→12/04	←	09/01→		13.0460-5405.2 605405	ATE 21643 17,8 + WE / - WK
318 ti	105	03/01→12/04				13.0470-5405.2 LD5405	ATE 21643 17,8 + WE / - WK
							Ceramic
			→	09/01→		13.0460-3605.2 603605	ATE 20180 17,3 + WE / - WK
						13.0470-3605.2 LD3605	ATE 20180 17,3 + WE / - WK
							Ceramic
<b>Warnkontakt, Bremsbelagverschleiß</b>							
316 ti	77	06/02→02/05	←		1	24.8190-0220.2 620220	L= 601
316 ti	85	06/02→02/05					
316 ti	85	06/01→02/05	→		1	24.8190-0221.2 620221	L= 1.338
318 td	85	03/03→02/05					
320 td	110	09/01→02/05					
325 ti	141	06/01→02/05					
318 ti	100	03/01→12/04	←	09/01→	1	24.8190-0220.2 620220	L= 601
318 ti	105	03/01→12/04					
			→	09/01→	1	24.8190-0221.2 620221	L= 1.338
 <b>Bremsscheibe</b>							
316 ti	77	06/02→02/05	←			24.0122-0115.1 422115	Ø 286 22 20,4 V + S
						24.0322-0115.1 522115	Ø 286 22 19,6 V + S
			→			24.0110-0202.1 410202	Ø 280 10 8,4 + S
						24.0310-0202.1 510202	Ø 280 10 7,6 + S
316 ti	85	06/02→02/05	←			24.0122-0115.1 422115	Ø 286 22 20,4 V + S
316 ti	85	06/01→02/05				24.0322-0115.1 522115	Ø 286 22 19,6 V + S
			→	nicht für erhöhte Nutzlast		24.0110-0202.1 410202	Ø 280 10 8,4 + S
			→	für erhöhte Nutzlast		24.0310-0202.1 510202	Ø 280 10 7,6 + S
			→			24.0119-0107.1 419107	Ø 276 19 17,4 V + S
			→			24.0319-0107.1 519107	Ø 276 19 16,6 V + S
318 td	85	03/03→02/05	←			24.0122-0115.1 422115	Ø 286 22 20,4 V + S
						24.0322-0115.1 522115	Ø 286 22 19,6 V + S
			→			24.0119-0107.1 419107	Ø 276 19 17,4 V + S
			→			24.0319-0107.1 519107	Ø 276 19 16,6 V + S
318 ti	100	03/01→12/04	←	09/01→		24.0122-0115.1 422115	Ø 286 22 20,4 V + S
318 ti	105	03/01→12/04				24.0322-0115.1 522115	Ø 286 22 19,6 V + S
			→	09/01→		24.0119-0107.1 419107	Ø 276 19 17,4 V + S
			→			24.0319-0107.1 519107	Ø 276 19 16,6 V + S
320 td	110	09/01→02/05	←			24.0122-0160.1 422160	Ø 300 22 20,4 V + S
325 ti	141	06/01→02/05				24.0322-0160.1 522160	Ø 300 22 19,6 V + S
			→			24.0119-0108.1 419108	Ø 294 18,9 17,4 V + S
			→			24.0319-0108.1 519108	Ø 294 18,9 16,6 V + S
<b>BMW - 3 Coupe (E36) 09/91→04/99</b>							
 <b>Bremsbelagsatz, Scheibenbremse</b>							
316 i	75	09/93→04/99	←			13.0460-5405.2 605405	ATE 21643 17,8 + WE / - WK
318 is	103	09/95→04/99				13.0470-5405.2 LD5405	ATE 21643 17,8 + WE / - WK
320 i	110	03/92→04/99					Ceramic
323 i	125	03/95→04/99					
325 i	141	09/91→04/99	→			13.0460-3605.2 603605	ATE 20180 17,3 + WE / - WK
328 i	142	01/95→04/99				13.0470-3605.2 LD3605	ATE 20180 17,3 + WE / - WK
							Ceramic
M3 3.2	236	10/95→04/99	←			13.0460-7185.2 607185	ATE 20968 20,3 + WE / - WK
			→			13.0460-3803.2 603803	ATE 20995 17,3 + WE / - WK
<b>Warnkontakt, Bremsbelagverschleiß</b>							
316 i	75	09/93→04/99	←		1	24.8190-0207.2 620207	L= 786
318 is	103	09/95→04/99					
320 i	110	03/92→04/99	→		1	24.8190-0206.2 620206	L= 790
323 i	125	03/95→04/99					
325 i	141	09/91→04/99					
328 i	142	01/95→04/99					
M3 3.2	236	10/95→04/99	←		1	24.8190-0210.2 620210	L= 810
↓							









	kw			 	! #		
<b>BMW - 3 Coupe (E36) 09/91→04/99</b>							
<b>Warnkontakt, Bremsbelagverschleiß</b>							
M3 3.2	236	10/95→04/99	➡		1	24.8190-0206.2 620206	L= 790
<b> Brems Scheibe</b>							
316 i	75	09/93→04/99	←			24.0112-0126.1 412126 24.0312-0126.1 512126	Ø 286 12 10,4 + S Ø 286 12 9,6 + S
			➡			24.0110-0202.1 410202 24.0310-0202.1 510202	Ø 280 10 8,4 + S Ø 280 10 7,6 + S
318 is 320 i 325 i	103 110 141	09/95→04/99 03/92→04/99 09/91→04/99	←			24.0122-0115.1 422115 24.0322-0115.1 522115	Ø 286 22 20,4 V + S Ø 286 22 19,6 V + S
			➡			24.0110-0202.1 410202 24.0310-0202.1 510202	Ø 280 10 8,4 + S Ø 280 10 7,6 + S
323 i 328 i	125 142	03/95→04/99 01/95→04/99	←			24.0122-0115.1 422115 24.0322-0115.1 522115	Ø 286 22 20,4 V + S Ø 286 22 19,6 V + S
			➡			24.0119-0107.1 419107 24.0319-0107.1 519107	Ø 276 19 17,4 V + S Ø 276 19 16,6 V + S
M3 3.2	236	10/95→04/99	←	☐		24.0128-0204.2 428204	Ø 315 28 26,4 V Brems Scheibe zweiteilig / + S
			←	☐		24.0128-0205.2 428205	Ø 315 28 26,4 V Brems Scheibe zweiteilig / + S
			➡	☐		24.0120-0189.1 420189	Ø 312 20 18,4 V + S
			➡	☐		24.0120-0190.1 420190	Ø 312 20 18,4 V + S
<b>BMW - 3 Coupe (E46) 02/99→12/06</b>							
<b> Bremsbelagsatz, Scheibenbremse</b>							
316 Ci 316 Ci	77 85	04/00→07/06 06/02→07/06	←			13.0460-5405.2 605405 13.0470-5405.2 LD5405	ATE 21643 17,8 + WE / - WK ATE 21643 17,8 + WE / - WK Ceramic
			➡			13.0460-3605.2 603605 13.0470-3605.2 LD3605	ATE 20180 17,3 + WE / - WK ATE 20180 17,3 + WE / - WK Ceramic
318 Ci 318 Ci	85 87	11/99→09/01 11/99→09/01	←			13.0460-5405.2 605405 13.0470-5405.2 LD5405	ATE 21643 17,8 + WE / - WK ATE 21643 17,8 + WE / - WK Ceramic
			➡			13.0460-3605.2 603605 13.0470-3605.2 LD3605	ATE 20180 17,3 + WE / - WK ATE 20180 17,3 + WE / - WK Ceramic
320 Cd 323 Ci 323 Ci 325 Ci 328 Ci	110 120 125 141 142	03/05→07/06 11/03→07/06 04/99→09/00 04/99→09/00 09/00→07/06 04/99→06/00	←			13.0460-5405.2 605405 13.0470-5405.2 LD5405	ATE 21643 17,8 + WE / - WK ATE 21643 17,8 + WE / - WK Ceramic
			➡			13.0460-3605.2 603605 13.0470-3605.2 LD3605	ATE 20180 17,3 + WE / - WK ATE 20180 17,3 + WE / - WK Ceramic
318 Ci 318 Ci	100 105	12/00→05/06 12/00→05/06	←	09/01→		13.0460-5405.2 605405 13.0470-5405.2 LD5405	ATE 21643 17,8 + WE / - WK ATE 21643 17,8 + WE / - WK Ceramic
			➡	09/01→		13.0460-3605.2 603605 13.0470-3605.2 LD3605	ATE 20180 17,3 + WE / - WK ATE 20180 17,3 + WE / - WK Ceramic
320 Ci	110	02/99→08/01	←	08/99→ 09/00		13.0460-5405.2 605405 13.0470-5405.2 LD5405	ATE 21643 17,8 + WE / - WK ATE 21643 17,8 + WE / - WK Ceramic
			➡	08/99→ 09/00		13.0460-3605.2 603605 13.0470-3605.2 LD3605	ATE 20180 17,3 + WE / - WK ATE 20180 17,3 + WE / - WK Ceramic
320 Ci 320 Ci	120 125	01/00→05/06 01/00→05/06	←	09/00→		13.0460-5405.2 605405 13.0470-5405.2 LD5405	ATE 21643 17,8 + WE / - WK ATE 21643 17,8 + WE / - WK Ceramic
			➡	09/00→		13.0460-3605.2 603605 13.0470-3605.2 LD3605	ATE 20180 17,3 + WE / - WK ATE 20180 17,3 + WE / - WK Ceramic
330 Cd 330 Ci 330 xi	150 170 170	03/03→07/06 06/00→07/06 06/00→07/06	←			13.0460-7155.2 607155 13.0470-7155.2 LD7155	ATE 21676 20,3 + WE / - WK ATE 21676 20,3 + WE / - WK Ceramic
			➡			13.0460-7079.2 607079 13.0470-7079.2 LD7079	ATE 21282 17,3 + WE / - WK ATE 21282 17,3 + WE / - WK Ceramic
M3 M3	252 265	06/00→07/06 06/03→07/06	←			13.0460-7185.2 607185	ATE 20968 20,3 + WE / - WK
			➡			13.0460-7079.2 607079 13.0470-7079.2 LD7079	ATE 21282 17,3 + WE / - WK ATE 21282 17,3 + WE / - WK Ceramic
<b>Warnkontakt, Bremsbelagverschleiß</b>							
316 Ci 316 Ci	77 85	04/00→07/06 06/02→07/06	←		1	24.8190-0220.2 620220	L= 601
318 Ci 318 Ci	85 87	11/99→09/01 11/99→09/01	➡		1	24.8190-0221.2 620221	L= 1.338
↓							









	kw			 	! #		
<b>BMW - 3 Coupe (E46) 02/99→12/06</b>							
<b>Warnkontakt, Bremsbelagverschleiß</b>							
318 Ci	110	03/05→07/06	←		1	24.8190-0220.2 620220	L= 601
320 Cd	110	11/03→07/06	→		1	24.8190-0221.2 620221	L= 1.338
323 Ci	120	04/99→09/00					
323 Ci	125	04/99→09/00					
325 Ci	141	09/00→07/06					
328 Ci	142	04/99→06/00					
318 Ci	100	12/00→05/06	←	09/01→	1	24.8190-0220.2 620220	L= 601
318 Ci	105	12/00→05/06	→	09/01→	1	24.8190-0221.2 620221	L= 1.338
320 Ci	110	02/99→08/01	←	08/99→ 09/00	1	24.8190-0220.2 620220	L= 601
			→	08/99→ 09/00	1	24.8190-0221.2 620221	L= 1.338
320 Ci	120	01/00→05/06	←	09/00→	1	24.8190-0220.2 620220	L= 601
320 Ci	125	01/00→05/06	→	09/00→	1	24.8190-0221.2 620221	L= 1.338
330 Cd	150	03/03→07/06	←		1	24.8190-0227.2 620227	L= 651
330 Ci	170	06/00→07/06	→		1	24.8190-0221.2 620221	L= 1.338
330 xi	170	06/00→07/06	→		1	24.8190-0221.2 620221	L= 1.338
M3	252	06/00→07/06	←		1	24.8190-0227.2 620227	L= 651
M3	265	06/03→07/06	→		1	24.8190-0228.2 620228	L= 1.353
<b>Bremsscheibe</b>							
316 Ci	77	04/00→07/06	←			24.0122-0115.1 422115	Ø 286 22 20,4 V + S
316 Ci	85	06/02→07/06				24.0322-0115.1 522115	Ø 286 22 19,6 V + S
318 Ci	85	11/99→09/01					
318 Ci	87	11/99→09/01	→			24.0110-0202.1 410202	Ø 280 10 8,4 + S
						24.0310-0202.1 510202	Ø 280 10 7,6 + S
318 Ci	100	12/00→05/06	←	09/01→		24.0122-0115.1 422115	Ø 286 22 20,4 V + S
318 Ci	105	12/00→05/06	→	09/01→		24.0322-0115.1 522115	Ø 286 22 19,6 V + S
						24.0119-0107.1 419107	Ø 276 19 17,4 V + S
						24.0319-0107.1 519107	Ø 276 19 16,6 V + S
318 Ci	110	03/05→07/06	←			24.0122-0115.1 422115	Ø 286 22 20,4 V + S
323 Ci	120	04/99→09/00				24.0322-0115.1 522115	Ø 286 22 19,6 V + S
323 Ci	125	04/99→09/00	→			24.0119-0107.1 419107	Ø 276 19 17,4 V + S
						24.0319-0107.1 519107	Ø 276 19 16,6 V + S
320 Cd	110	11/03→07/06	←			24.0122-0160.1 422160	Ø 300 22 20,4 V + S
325 Ci	141	09/00→07/06				24.0322-0160.1 522160	Ø 300 22 19,6 V + S
328 Ci	142	04/99→06/00	→			24.0119-0108.1 419108	Ø 294 18,9 17,4 V + S
						24.0319-0108.1 519108	Ø 294 18,9 16,6 V + S
320 Ci	110	02/99→08/01	←	08/99→ 09/00		24.0122-0115.1 422115	Ø 286 22 20,4 V + S
			→	08/99→ 09/00		24.0322-0115.1 522115	Ø 286 22 19,6 V + S
						24.0119-0107.1 419107	Ø 276 19 17,4 V + S
						24.0319-0107.1 519107	Ø 276 19 16,6 V + S
320 Ci	120	01/00→05/06	←	09/00→		24.0122-0115.1 422115	Ø 286 22 20,4 V + S
320 Ci	125	01/00→05/06	→	09/00→		24.0322-0115.1 522115	Ø 286 22 19,6 V + S
						24.0119-0107.1 419107	Ø 276 19 17,4 V + S
						24.0319-0107.1 519107	Ø 276 19 16,6 V + S
330 Cd	150	03/03→07/06	←			24.0125-0138.1 425138	Ø 325 24,9 23,4 V + S
330 Ci	170	06/00→07/06				24.0325-0138.1 525138	Ø 325 24,9 22,6 V + S
330 xi	170	06/00→07/06	→			24.0122-0209.1 422209	Ø 320 22 20,4 V + S
						24.0322-0209.1 522209	Ø 320 22 19,6 V + S
M3	252	06/00→07/06	←	☐; - Competition Paket		24.0128-0206.2 428206	Ø 325 28 26,4 V• Bremsscheibe zweiteilig / + S
			←	☐; - Competition Paket		24.0128-0207.2 428207	Ø 325 28 26,4 V• Bremsscheibe zweiteilig / + S
			←	☐; + Competition Paket		24.0128-0208.2 428208	Ø 345 28 26,4 V• Bremsscheibe zweiteilig / + S
			←	☐; + Competition Paket		24.0128-0209.2 428209	Ø 345 28 26,4 V• Bremsscheibe zweiteilig / + S
			→	☐		24.0120-0221.2 420221	Ø 328 20 18,4 V• Bremsscheibe zweiteilig / + S
			→	☐		24.0120-0222.2 420222	Ø 328 20 18,4 V• Bremsscheibe zweiteilig / + S
M3	265	06/03→07/06	←	☐		24.0128-0208.2 428208	Ø 345 28 26,4 V• Bremsscheibe zweiteilig / + S
			←	☐		24.0128-0209.2 428209	Ø 345 28 26,4 V• Bremsscheibe zweiteilig / + S
			→	☐		24.0120-0221.2 420221	Ø 328 20 18,4 V• Bremsscheibe zweiteilig / + S

	kW			 	! #		
<b>BMW - 3 Coupe (E46) 02/99→12/06</b>							
<b> Bremsscheibe</b>							
M3	265	06/03→07/06	➔	<input type="checkbox"/>		24.0120-0222.2 420222	Ø 328 20 18,4 V• Bremsscheibe zweiteilig / + S
<b>BMW - 3 Coupe (E92) 01/05→12/13</b>							
<b> Bremsbelagsatz, Scheibenbremse</b>							
316 i	90	09/07→12/13	➔	→ 06/13; + Performance Parts		13.0460-4848.2 604848	BRE 24316 16,9 + WE / - WK
			➔			13.0460-7216.2 607216	ATE 23794 20,3 + WE / - WK
			➔			13.0470-7216.2 LD7216	ATE 23794 20,3 + WE / - WK Ceramic
			➔			13.0460-2713.2 602713	TRW 23623 17,4 + WE / - WK + Zub
			➔			13.0470-2713.2 LD2713	TRW 23623 17,4 + WE / - WK + Zub Ceramic
318 i	105	03/10→12/13	➔	+ Performance Parts		13.0460-4848.2 604848	BRE 24316 16,9 + WE / - WK
320 i	115	06/07→12/13	➔			13.0460-7216.2 607216	ATE 23794 20,3 + WE / - WK
320 i	120	01/07→12/13	➔			13.0470-7216.2 LD7216	ATE 23794 20,3 + WE / - WK Ceramic
320 i	125	03/07→12/13	➔			13.0460-7217.2 607217	ATE 23926 17,3 + WE / - WK
			➔			13.0470-7217.2 LD7217	ATE 23926 17,3 + WE / - WK Ceramic
320 d	120	03/07→06/13	➔	+ Performance Parts		13.0460-4848.2 604848	BRE 24316 16,9 + WE / - WK
320 d	135	03/10→06/13	➔			13.0460-7238.2 607238	ATE 23313 20,3 + WE / - WK
320 d	145	09/06→02/10	➔			13.0470-7238.2 LD7238	ATE 23313 20,3 + WE / - WK Ceramic
320 d	147	03/10→06/13	➔			13.0460-7217.2 607217	ATE 23926 17,3 + WE / - WK
320 d xDrive	120	03/10→06/13	➔			13.0470-7217.2 LD7217	ATE 23926 17,3 + WE / - WK Ceramic
320 d xDrive	130	09/09→02/10	➔				
320 d xDrive	135	03/10→06/13	➔			13.0460-7217.2 607217	ATE 23926 17,3 + WE / - WK
320 d xDrive	145	09/09→02/10	➔			13.0470-7217.2 LD7217	ATE 23926 17,3 + WE / - WK Ceramic
320 d xDrive	147	03/10→06/13	➔				
320 xd	120	03/08→02/10	➔				
320 xd	130	03/08→02/10	➔				
320 xd	145	03/08→02/10	➔				
325 i xDrive	150	03/10→04/13	➔				
320 d	130	09/06→02/10	➔	03/07→; + Performance Parts		13.0460-4848.2 604848	BRE 24316 16,9 + WE / - WK
			➔	03/07→		13.0460-7238.2 607238	ATE 23313 20,3 + WE / - WK
			➔			13.0470-7238.2 LD7238	ATE 23313 20,3 + WE / - WK Ceramic
			➔	03/07→		13.0460-7217.2 607217	ATE 23926 17,3 + WE / - WK
			➔			13.0470-7217.2 LD7217	ATE 23926 17,3 + WE / - WK Ceramic
323 i	140	04/06→02/12	➔	+ Performance Parts		13.0460-4848.2 604848	BRE 24316 16,9 + WE / - WK
325 i	160	11/05→02/10	➔	→ 08/07		13.0460-7216.2 607216	ATE 23794 20,3 + WE / - WK
325 xi	160	09/06→02/10	➔			13.0470-7216.2 LD7216	ATE 23794 20,3 + WE / - WK Ceramic
			➔	09/07→		13.0460-7238.2 607238	ATE 23313 20,3 + WE / - WK
			➔			13.0470-7238.2 LD7238	ATE 23313 20,3 + WE / - WK Ceramic
			➔			13.0460-7217.2 607217	ATE 23926 17,3 + WE / - WK
			➔			13.0470-7217.2 LD7217	ATE 23926 17,3 + WE / - WK Ceramic
325 d	145	02/07→02/10	➔	03/07→; + Performance Parts		13.0460-4848.2 604848	BRE 24316 16,9 + WE / - WK
			➔	03/07→		13.0460-7216.2 607216	ATE 23794 20,3 + WE / - WK
			➔			13.0470-7216.2 LD7216	ATE 23794 20,3 + WE / - WK Ceramic
			➔	03/07→		13.0460-7225.2 607225	ATE 23550 17,3 + WE / - WK
			➔			13.0470-7225.2 LD7225	ATE 23550 17,3 + WE / - WK Ceramic
325 d	150	09/09→12/13	➔	+ Performance Parts		13.0460-4848.2 604848	BRE 24316 16,9 + WE / - WK
325 d	155	02/07→02/10	➔			13.0460-7216.2 607216	ATE 23794 20,3 + WE / - WK
330 i xDrive	200	03/10→06/13	➔			13.0470-7216.2 LD7216	ATE 23794 20,3 + WE / - WK Ceramic
330 xi	200	09/06→08/07	➔				
330 xi	200	03/07→02/10	➔			13.0460-7225.2 607225	ATE 23550 17,3 + WE / - WK
			➔			13.0470-7225.2 LD7225	ATE 23550 17,3 + WE / - WK Ceramic
325 i	155	03/10→06/13	➔	+ Performance Parts		13.0460-4848.2 604848	BRE 24316 16,9 + WE / - WK
			➔	Motorcode: N53		13.0460-7216.2 607216	ATE 23794 20,3 + WE / - WK
			➔			13.0470-7216.2 LD7216	ATE 23794 20,3 + WE / - WK Ceramic
↓							







	kw			 	! #		
<b>BMW - 3 Coupe (E92) 01/05→12/13</b>							
<b> Bremsbelagsatz, Scheibenbremse</b>							
325 i	155	03/10→06/13	←	Motorcode: N52N		<b>13.0460-7238.2 607238</b> <b>13.0470-7238.2 LD7238</b>	ATE 23313 20,3 + WE / - WK ATE 23313 20,3 + WE / - WK Ceramic
			→			<b>13.0460-7217.2 607217</b> <b>13.0470-7217.2 LD7217</b>	ATE 23926 17,3 + WE / - WK ATE 23926 17,3 + WE / - WK Ceramic
325 i 325 i xDrive 325 xi	160 160 160	03/07→06/13 09/08→12/13 09/07→02/10	←	+ Performance Parts		<b>13.0460-4848.2 604848</b>	BRE 24316 16,9 + WE / - WK
			←	Motorcode: N53		<b>13.0460-7216.2 607216</b> <b>13.0470-7216.2 LD7216</b>	ATE 23794 20,3 + WE / - WK ATE 23794 20,3 + WE / - WK Ceramic
			←			<b>13.0460-7238.2 607238</b> <b>13.0470-7238.2 LD7238</b>	ATE 23313 20,3 + WE / - WK ATE 23313 20,3 + WE / - WK Ceramic
			→			<b>13.0460-7217.2 607217</b> <b>13.0470-7217.2 LD7217</b>	ATE 23926 17,3 + WE / - WK ATE 23926 17,3 + WE / - WK Ceramic
325 i xDrive	155	03/10→04/13	←			<b>13.0460-7238.2 607238</b> <b>13.0470-7238.2 LD7238</b>	ATE 23313 20,3 + WE / - WK ATE 23313 20,3 + WE / - WK Ceramic
			→			<b>13.0460-7217.2 607217</b> <b>13.0470-7217.2 LD7217</b>	ATE 23926 17,3 + WE / - WK ATE 23926 17,3 + WE / - WK Ceramic
328 i	172	06/07→12/13	←	→ 06/13		<b>13.0460-7216.2 607216</b> <b>13.0470-7216.2 LD7216</b>	ATE 23794 20,3 + WE / - WK ATE 23794 20,3 + WE / - WK Ceramic
			→	→ 02/10		<b>13.0460-7217.2 607217</b> <b>13.0470-7217.2 LD7217</b>	ATE 23926 17,3 + WE / - WK ATE 23926 17,3 + WE / - WK Ceramic
			→	03/10→ 06/13		<b>13.0460-7217.2 607217</b> <b>13.0470-7217.2 LD7217</b>	ATE 23926 17,3 + WE / - WK ATE 23926 17,3 + WE / - WK Ceramic
328 i xDrive	172	09/09→06/13	←			<b>13.0460-7216.2 607216</b> <b>13.0470-7216.2 LD7216</b>	ATE 23794 20,3 + WE / - WK ATE 23794 20,3 + WE / - WK Ceramic
			→	→ 02/10		<b>13.0460-7217.2 607217</b> <b>13.0470-7217.2 LD7217</b>	ATE 23926 17,3 + WE / - WK ATE 23926 17,3 + WE / - WK Ceramic
			→	03/10→		<b>13.0460-7217.2 607217</b> <b>13.0470-7217.2 LD7217</b>	ATE 23926 17,3 + WE / - WK ATE 23926 17,3 + WE / - WK Ceramic
330 d	170	03/06→08/08	←	+ Performance Parts		<b>13.0460-4848.2 604848</b>	BRE 24316 16,9 + WE / - WK
			←			<b>13.0460-7216.2 607216</b> <b>13.0470-7216.2 LD7216</b>	ATE 23794 20,3 + WE / - WK ATE 23794 20,3 + WE / - WK Ceramic
			←	Motorcode: M57		<b>13.0460-7237.2 607237</b> <b>13.0460-7238.2 607238</b> <b>13.0470-7237.2 LD7237</b> <b>13.0470-7238.2 LD7238</b>	ATE 23347 20,3 + WE / - WK ATE 23313 20,3 + WE / - WK ATE 23347 20,3 + WE / - WK Ceramic ATE 23313 20,3 + WE / - WK Ceramic
			→			<b>13.0460-7225.2 607225</b> <b>13.0470-7225.2 LD7225</b>	ATE 23550 17,3 + WE / - WK ATE 23550 17,3 + WE / - WK Ceramic
330 d	180	01/09→12/13	←	→ 06/13; + Performance Parts		<b>13.0460-4848.2 604848</b>	BRE 24316 16,9 + WE / - WK
			←	09/09→		<b>13.0460-7216.2 607216</b> <b>13.0470-7216.2 LD7216</b>	ATE 23794 20,3 + WE / - WK ATE 23794 20,3 + WE / - WK Ceramic
			←	→ 08/09		<b>13.0460-7237.2 607237</b> <b>13.0460-7238.2 607238</b> <b>13.0470-7237.2 LD7237</b> <b>13.0470-7238.2 LD7238</b>	ATE 23347 20,3 + WE / - WK ATE 23313 20,3 + WE / - WK ATE 23347 20,3 + WE / - WK Ceramic ATE 23313 20,3 + WE / - WK Ceramic
			→			<b>13.0460-7225.2 607225</b> <b>13.0470-7225.2 LD7225</b>	ATE 23550 17,3 + WE / - WK ATE 23550 17,3 + WE / - WK Ceramic
↓							















	kw			 	! #		
<b>BMW - 3 Coupe (E92) 01/05→12/13</b>							
<b> Bremsbelagsatz, Scheibenbremse</b>							
330 d xDrive	180	02/10→06/13	← + Performance Parts	13.0460-4848.2	604848	BRE 24316 16,9 + WE / - WK	
			← nicht für erhöhte Nutzlast	13.0460-7216.2	607216	ATE 23794 20,3 + WE / - WK	
				13.0470-7216.2	LD7216	ATE 23794 20,3 + WE / - WK Ceramic	
			← für erhöhte Nutzlast	13.0460-7237.2	607237	ATE 23347 20,3 + WE / - WK	
				13.0460-7238.2	607238	ATE 23313 20,3 + WE / - WK	
			13.0470-7237.2	LD7237	ATE 23347 20,3 + WE / - WK Ceramic		
			13.0470-7238.2	LD7238	ATE 23313 20,3 + WE / - WK Ceramic		
			→	13.0460-7225.2	607225	ATE 23550 17,3 + WE / - WK	
				13.0470-7225.2	LD7225	ATE 23550 17,3 + WE / - WK Ceramic	
330 i	190	09/06→02/10	← + Performance Parts	13.0460-4848.2	604848	BRE 24316 16,9 + WE / - WK	
			← Motorcode: N52N	13.0460-7216.2	607216	ATE 23794 20,3 + WE / - WK	
				13.0470-7216.2	LD7216	ATE 23794 20,3 + WE / - WK Ceramic	
			← Motorcode: N53	13.0460-7237.2	607237	ATE 23347 20,3 + WE / - WK	
				13.0460-7238.2	607238	ATE 23313 20,3 + WE / - WK	
			13.0470-7237.2	LD7237	ATE 23347 20,3 + WE / - WK Ceramic		
			13.0470-7238.2	LD7238	ATE 23313 20,3 + WE / - WK Ceramic		
			→	13.0460-7225.2	607225	ATE 23550 17,3 + WE / - WK	
				13.0470-7225.2	LD7225	ATE 23550 17,3 + WE / - WK Ceramic	
330 i 330 i	200 200	09/06→08/12 03/07→06/13	← + Performance Parts	13.0460-4848.2	604848	BRE 24316 16,9 + WE / - WK	
			← Motorcode: N53; 03/10→	13.0460-7216.2	607216	ATE 23794 20,3 + WE / - WK	
				13.0470-7216.2	LD7216	ATE 23794 20,3 + WE / - WK Ceramic	
			← Motorcode: N52N	13.0460-7216.2	607216	ATE 23794 20,3 + WE / - WK	
				13.0470-7216.2	LD7216	ATE 23794 20,3 + WE / - WK Ceramic	
			← Motorcode: N53; → 02/10	13.0460-7237.2	607237	ATE 23347 20,3 + WE / - WK	
	13.0460-7238.2	607238	ATE 23313 20,3 + WE / - WK				
			13.0470-7237.2	LD7237	ATE 23347 20,3 + WE / - WK Ceramic		
			13.0470-7238.2	LD7238	ATE 23313 20,3 + WE / - WK Ceramic		
			→	13.0460-7225.2	607225	ATE 23550 17,3 + WE / - WK	
				13.0470-7225.2	LD7225	ATE 23550 17,3 + WE / - WK Ceramic	
330 xd	170	03/06→08/08	← 09/06→; + Performance Parts	13.0460-4848.2	604848	BRE 24316 16,9 + WE / - WK	
			←	13.0460-7237.2	607237	ATE 23347 20,3 + WE / - WK	
				13.0460-7238.2	607238	ATE 23313 20,3 + WE / - WK	
				13.0470-7237.2	LD7237	ATE 23347 20,3 + WE / - WK Ceramic	
				13.0470-7238.2	LD7238	ATE 23313 20,3 + WE / - WK Ceramic	
			→	13.0460-7225.2	607225	ATE 23550 17,3 + WE / - WK	
				13.0470-7225.2	LD7225	ATE 23550 17,3 + WE / - WK Ceramic	
330 xd	180	03/08→02/10	← + Performance Parts	13.0460-4848.2	604848	BRE 24316 16,9 + WE / - WK	
			← 09/09→	13.0460-7216.2	607216	ATE 23794 20,3 + WE / - WK	
				13.0470-7216.2	LD7216	ATE 23794 20,3 + WE / - WK Ceramic	
			← → 08/09	13.0460-7237.2	607237	ATE 23347 20,3 + WE / - WK	
				13.0460-7238.2	607238	ATE 23313 20,3 + WE / - WK	
			13.0470-7237.2	LD7237	ATE 23347 20,3 + WE / - WK Ceramic		
			13.0470-7238.2	LD7238	ATE 23313 20,3 + WE / - WK Ceramic		
			→	13.0460-7225.2	607225	ATE 23550 17,3 + WE / - WK	
				13.0470-7225.2	LD7225	ATE 23550 17,3 + WE / - WK Ceramic	
335 d ↓	210	03/06→03/13	←	13.0460-7237.2	607237	ATE 23347 20,3 + WE / - WK	







	kw			 	! #		
<b>BMW - 3 Coupe (E92) 01/05→12/13</b>							
<b> Bremsbelagsatz, Scheibenbremse</b>							
335 i 335 i xDrive 335 i xDrive 335 xi	225 224 225 225	11/05→06/13 01/09→06/13 11/08→12/13 03/07→02/10	←  →			13.0460-7238.2 607238 13.0470-7237.2 LD7237 13.0470-7238.2 LD7238	ATE 23313 20,3 + WE / - WK ATE 23347 20,3 + WE / - WK Ceramic ATE 23313 20,3 + WE / - WK Ceramic
335 i 335 i xDrive 335 xi	240 240 240	11/05→06/13 11/08→06/13 03/07→02/10	←  →			13.0460-7237.2 607237 13.0460-7238.2 607238 13.0460-7225.2 607225 13.0470-7225.2 LD7225	ATE 23347 20,3 + WE / - WK ATE 23313 20,3 + WE / - WK ATE 23550 17,3 + WE / - WK ATE 23550 17,3 + WE / - WK Ceramic
M	309	03/07→12/13	← →			13.0460-7167.2 607167 13.0460-7169.2 607169 13.0470-7169.2 LD7169	ATE 23312 20,3 + WE / - WK ATE 23309 17,3 + WE / - WK ATE 23309 17,3 + WE / - WK Ceramic
M GTS	331	03/07→12/13	← → 06/13 → 02/10 → 03/10→ 06/13			13.0460-7167.2 607167 13.0460-7169.2 607169 13.0470-7169.2 LD7169 13.0460-7169.2 607169 13.0470-7169.2 LD7169	ATE 23312 20,3 + WE / - WK ATE 23309 17,3 + WE / - WK ATE 23309 17,3 + WE / - WK Ceramic ATE 23309 17,3 + WE / - WK ATE 23309 17,3 + WE / - WK Ceramic
<b>Warnkontakt, Bremsbelagsverschleiß</b>							
316 i	90	09/07→12/13	← → 02/10 ← → 06/13; + Performance Parts ← 03/10→ 06/13 → → 02/10 → 03/10→ 06/13		1	24.8190-0264.2 620264 24.8190-0267.2 620267 24.8190-0284.2 620284 24.8190-0265.2 620265 24.8190-0285.2 620285	L= 630 L= 679 L= 650 L= 1.086 L= 1.107
318 i	105	03/10→12/13	← + Performance Parts ← →		1	24.8190-0267.2 620267 24.8190-0284.2 620284 24.8190-0285.2 620285	L= 679 L= 650 L= 1.107
320 d	120	03/07→06/13	← → 02/10 ← + Performance Parts ← 03/10→ → → 02/10 → 03/10→		1	24.8190-0267.2 620267 24.8190-0267.2 620267 24.8190-0287.2 620287 24.8190-0265.2 620265 24.8190-0285.2 620285	L= 679 L= 679 L= 723 L= 1.086 L= 1.107
320 d	130	09/06→02/10	← 03/07→ ← 03/07→; + Performance Parts → 03/07→		1	24.8190-0267.2 620267 24.8190-0267.2 620267 24.8190-0265.2 620265	L= 679 L= 679 L= 1.086
320 d 320 d	135 147	03/10→06/13 03/10→06/13	← + Performance Parts ← →		1	24.8190-0267.2 620267 24.8190-0287.2 620287 24.8190-0285.2 620285	L= 679 L= 723 L= 1.107
320 d 330 d	145 170	09/06→02/10 03/06→08/08	← + Performance Parts ← →		1	24.8190-0267.2 620267 24.8190-0267.2 620267 24.8190-0265.2 620265	L= 679 L= 679 L= 1.086
320 d xDrive 320 d xDrive 320 d xDrive 325 i xDrive 330 i xDrive	120 135 147 150 200	03/10→06/13 03/10→06/13 03/10→06/13 03/10→04/13 03/10→06/13	← + Performance Parts ← ← → →		1	24.8190-0267.2 620267 24.8190-0286.2 620286 24.8190-0285.2 620285	L= 679 L= 867 L= 1.107
320 d xDrive 320 d xDrive 320 xd 320 xd 320 xd 325 xi 325 xi 330 xd 330 xd 330 xi 330 xi	130 145 120 130 145 160 160 170 180 200 200	09/09→02/10 09/09→02/10 03/08→02/10 03/08→02/10 03/08→02/10 09/06→02/10 09/07→02/10 03/06→08/08 03/08→02/10 09/06→08/07 03/07→02/10	← ← + Performance Parts ← → → → → → → → →		1	24.8190-0266.2 620266 24.8190-0267.2 620267 24.8190-0265.2 620265	L= 840 L= 679 L= 1.086
↓							









	kw			 	! #			
<b>BMW - 3 Coupe (E92) 01/05→12/13</b>								
<b>Warnkontakt, Bremsbelagverschleiß</b>								
320 i	115	06/07→12/13	←	→ 02/10	1	24.8190-0264.2	620264	L= 630
			←	→ 06/13; + Performance Parts	1	24.8190-0267.2	620267	L= 679
			←	03/10→	1	24.8190-0284.2	620284	L= 650
			→	→ 02/10	1	24.8190-0265.2	620265	L= 1.086
			→	03/10→	1	24.8190-0285.2	620285	L= 1.107
320 i 320 i 325 d	120 125 150	01/07→12/13 03/07→12/13 09/09→12/13	←	→ 02/10	1	24.8190-0264.2	620264	L= 630
			←	+ Performance Parts	1	24.8190-0267.2	620267	L= 679
			←	03/10→	1	24.8190-0284.2	620284	L= 650
			→	→ 02/10	1	24.8190-0265.2	620265	L= 1.086
			→	03/10→	1	24.8190-0285.2	620285	L= 1.107
			←	→ 08/07		24.8190-0264.2	620264	L= 630
			←	09/07→ 02/10	1	24.8190-0267.2	620267	L= 679
			←	+ Performance Parts	1	24.8190-0267.2	620267	L= 679
323 i	140	04/06→02/12	←	03/10→	1	24.8190-0287.2	620287	L= 723
			→	→ 02/10	1	24.8190-0265.2	620265	L= 1.086
			→	03/10→	1	24.8190-0285.2	620285	L= 1.107
			←	→ 08/07		24.8190-0264.2	620264	L= 630
325 d	145	02/07→02/10	←	03/07→	1	24.8190-0264.2	620264	L= 630
			←	03/07→; + Performance Parts	1	24.8190-0267.2	620267	L= 679
			→	03/07→	1	24.8190-0265.2	620265	L= 1.086
325 d	155	02/07→02/10	←		1	24.8190-0264.2	620264	L= 630
			←	+ Performance Parts	1	24.8190-0267.2	620267	L= 679
			→		1	24.8190-0265.2	620265	L= 1.086
325 i	160	11/05→02/10	←	→ 08/07	1	24.8190-0264.2	620264	L= 630
			←	09/07→	1	24.8190-0267.2	620267	L= 679
			→		1	24.8190-0265.2	620265	L= 1.086
325 i	155	03/10→06/13	←	+ Performance Parts	1	24.8190-0267.2	620267	L= 679
			←	Motorcode: N53; → 03/10	1	24.8190-0284.2	620284	L= 650
			←		1	24.8190-0287.2	620287	L= 723
			→		1	24.8190-0285.2	620285	L= 1.107
325 i	160	03/07→06/13	←	Motorcode: N53; → 02/10	1	24.8190-0264.2	620264	L= 630
			←	09/07→ 02/10; Motorcode: N52N	1	24.8190-0267.2	620267	L= 679
			←	+ Performance Parts	1	24.8190-0267.2	620267	L= 679
			←	03/10→; Motorcode: N53	1	24.8190-0284.2	620284	L= 650
			←	03/10→; Motorcode: N52N	1	24.8190-0287.2	620287	L= 723
			→	→ 02/10	1	24.8190-0265.2	620265	L= 1.086
325 i xDrive	155	03/10→04/13	←		1	24.8190-0286.2	620286	L= 867
			→		1	24.8190-0285.2	620285	L= 1.107
325 i xDrive 330 d xDrive	160 180	09/08→12/13 02/10→06/13	←	→ 02/10	1	24.8190-0266.2	620266	L= 840
			←	+ Performance Parts	1	24.8190-0267.2	620267	L= 679
			←	03/10→	1	24.8190-0286.2	620286	L= 867
			→	→ 02/10	1	24.8190-0265.2	620265	L= 1.086
328 i	172	06/07→12/13	→	03/10→	1	24.8190-0285.2	620285	L= 1.107
			←	→ 06/13	1	24.8190-0266.2	620266	L= 840
			→	→ 02/10	1	24.8190-0265.2	620265	L= 1.086
328 i xDrive	172	09/09→06/13	→	03/10→ 06/13	1	24.8190-0285.2	620285	L= 1.107
			←		1	24.8190-0266.2	620266	L= 840
			→	→ 02/10	1	24.8190-0265.2	620265	L= 1.086
330 d 335 d 335 i 335 i	180 210 225 240	01/09→12/13 03/06→03/13 11/05→06/13 11/05→06/13	→	03/10→	1	24.8190-0287.2	620287	L= 723
			←	→ 02/10	1	24.8190-0265.2	620265	L= 1.086
			→	03/10→	1	24.8190-0285.2	620285	L= 1.107
			←	→ 02/10	1	24.8190-0267.2	620267	L= 679
↓								

	kW			 	! #		
<b>BMW - 3 Coupe (E92) 01/05→12/13</b>							
<b>Warnkontakt, Bremsbelagverschleiß</b>							
330 i	190	09/06→02/10	←	Motorcode: N52N	1	24.8190-0264.2 620264	L= 630
			←	Motorcode: N53	1	24.8190-0267.2 620267	L= 679
			←	+ Performance Parts	1	24.8190-0267.2 620267	L= 679
			→		1	24.8190-0265.2 620265	L= 1.086
330 i	200	09/06→08/12	←	→ 02/10; Motorcode: N25N	1	24.8190-0264.2 620264	L= 630
			←	→ 02/10; Motorcode: N53	1	24.8190-0267.2 620267	L= 679
			←	+ Performance Parts	1	24.8190-0267.2 620267	L= 679
			←	03/10→	1	24.8190-0287.2 620287	L= 723
			→	→ 02/10	1	24.8190-0265.2 620265	L= 1.086
			→	03/10→	1	24.8190-0285.2 620285	L= 1.107
330 i	200	03/07→06/13	←	→ 02/10; Motorcode: N52N	1	24.8190-0264.2 620264	L= 630
			←	+ Performance Parts	1	24.8190-0267.2 620267	L= 679
			←	→ 02/10; Motorcode: N53	1	24.8190-0267.2 620267	L= 679
			←	03/10→; Motorcode: N52N	1	24.8190-0284.2 620284	L= 650
			←	03/10→; Motorcode: N53	1	24.8190-0287.2 620287	L= 723
			→	→ 02/10	1	24.8190-0265.2 620265	L= 1.086
			→	03/10→	1	24.8190-0285.2 620285	L= 1.107
335 i xDrive 335 i xDrive 335 i xDrive	224 225 240	01/09→06/13 11/08→12/13 11/08→06/13	←	→ 02/10	1	24.8190-0266.2 620266	L= 840
			←	03/10→	1	24.8190-0286.2 620286	L= 867
			→	→ 02/10	1	24.8190-0265.2 620265	L= 1.086
			→	03/10→	1	24.8190-0285.2 620285	L= 1.107
335 xi 335 xi	225 240	03/07→02/10 03/07→02/10	←		1	24.8190-0266.2 620266	L= 840
			→		1	24.8190-0265.2 620265	L= 1.086
M	309	03/07→12/13	←			24.8190-0271.2 620271	L= 659
			←			24.8190-0272.2 620272	L= 672
			→		1	24.8190-0265.2 620265 24.8190-0285.2 620285	L= 1.086 L= 1.107
M GTS	331	03/07→12/13	←	 ; → 06/13		24.8190-0271.2 620271	L= 659
			←	 ; → 06/13		24.8190-0272.2 620272	L= 672
			→	→ 02/10	1	24.8190-0265.2 620265	L= 1.086
			→	03/10→ 06/13	1	24.8190-0285.2 620285	L= 1.107
<b> Bremsscheibe</b>							
316 i	90	09/07→12/13	←			24.0124-0197.1 424197	Ø 300 24 22,4 V + S
						24.0324-0197.1 524197	Ø 300 24 21,6 V + S
			→			24.0110-0315.1 410315	Ø 296 10,4 8,9 + S
						24.0310-0315.1 510315	Ø 296 10,4 8,1 + S
318 i 320 i 320 i 320 i	105 115 120 125	03/10→12/13 06/07→12/13 01/07→12/13 03/07→12/13	←			24.0124-0197.1 424197	Ø 300 24 22,4 V + S
						24.0324-0197.1 524197	Ø 300 24 21,6 V + S
			→			24.0120-0195.1 420195	Ø 300 20 18,4 V + S
						24.0320-0195.1 520195	Ø 300 20 17,6 V + S
320 d 320 d 320 d 320 d	120 135 145 147	03/07→06/13 03/10→06/13 09/06→02/10 03/10→06/13	←			24.0124-0203.1 424203	Ø 312 23,9 22,4 V + S
						24.0324-0203.1 524203	Ø 312 23,9 21,6 V + S
			→			24.0120-0195.1 420195	Ø 300 20 18,4 V + S
						24.0320-0195.1 520195	Ø 300 20 17,6 V + S
320 d	130	09/06→02/10	←	03/07→		24.0124-0203.1 424203	Ø 312 23,9 22,4 V + S
						24.0324-0203.1 524203	Ø 312 23,9 21,6 V + S
			→	03/07→		24.0120-0195.1 420195	Ø 300 20 18,4 V + S
						24.0320-0195.1 520195	Ø 300 20 17,6 V + S
320 d xDrive 320 d xDrive 320 d xDrive 320 d xDrive 320 xd 320 xd 320 xd	120 135 145 147 120 130 145	03/10→06/13 03/10→06/13 09/09→02/10 03/10→06/13 03/08→02/10 03/08→02/10 03/08→02/10	←			24.0124-0203.1 424203	Ø 312 23,9 22,4 V + S
						24.0324-0203.1 524203	Ø 312 23,9 21,6 V + S
			→	nicht für Behördenfahrzeuge		24.0120-0204.1 420204	Ø 300 20 18,4 V + S
						24.0320-0204.1 520204	Ø 300 20 17,6 V + S
			→	für Behördenfahrzeuge		24.0122-0236.1 422236	Ø 336 22 20,4 V + S
						24.0322-0236.1 522236	Ø 336 22 19,6 V + S
320 d xDrive 325 i xDrive	130 155	09/09→02/10 03/10→04/13	←			24.0124-0203.1 424203	Ø 312 23,9 22,4 V + S
						24.0324-0203.1 524203	Ø 312 23,9 21,6 V + S
↓							



















	kw			 	! #		
<b>BMW - 3 Coupe (E92) 01/05→12/13</b>							
<b>Bremsscheibe</b>							
328 i xDrive	172	09/09→06/13	➔			24.0120-0204.1 420204 24.0320-0204.1 520204	Ø 300 20 18,4 V + S Ø 300 20 17,6 V + S
323 i	140	04/06→02/12	➔	→ 08/07		24.0124-0197.1 424197 24.0324-0197.1 524197	Ø 300 24 22,4 V + S Ø 300 24 21,6 V + S
			➔	09/07→		24.0124-0203.1 424203 24.0324-0203.1 524203	Ø 312 23,9 22,4 V + S Ø 312 23,9 21,6 V + S
			➔			24.0120-0195.1 420195 24.0320-0195.1 520195	Ø 300 20 18,4 V + S Ø 300 20 17,6 V + S
			➔			24.0124-0200.1 424200 24.0324-0200.1 524200	Ø 330 24 22,4 V + S Ø 330 24 21,6 V + S
325 d	145	02/07→02/10	➔	03/07→		24.0122-0236.1 422236 24.0322-0236.1 522236	Ø 336 22 20,4 V + S Ø 336 22 19,6 V + S
			➔	03/07→		24.0124-0200.1 424200 24.0324-0200.1 524200	Ø 330 24 22,4 V + S Ø 330 24 21,6 V + S
325 d 325 d 330 i xDrive 330 xi 330 xi	150 155 200 200 200	09/09→12/13 02/07→02/10 03/10→06/13 09/06→08/07 03/07→02/10	➔			24.0124-0200.1 424200 24.0324-0200.1 524200	Ø 330 24 22,4 V + S Ø 330 24 21,6 V + S
			➔			24.0122-0236.1 422236 24.0322-0236.1 522236	Ø 336 22 20,4 V + S Ø 336 22 19,6 V + S
			➔			24.0124-0200.1 424200 24.0324-0200.1 524200	Ø 330 24 22,4 V + S Ø 330 24 21,6 V + S
			➔			24.0120-0195.1 420195 24.0320-0195.1 520195	Ø 300 20 18,4 V + S Ø 300 20 17,6 V + S
325 i	160	11/05→02/10	➔	→ 08/07		24.0124-0200.1 424200 24.0324-0200.1 524200	Ø 330 24 22,4 V + S Ø 330 24 21,6 V + S
			➔	09/07→		24.0124-0203.1 424203 24.0324-0203.1 524203	Ø 312 23,9 22,4 V + S Ø 312 23,9 21,6 V + S
			➔			24.0120-0195.1 420195 24.0320-0195.1 520195	Ø 300 20 18,4 V + S Ø 300 20 17,6 V + S
			➔			24.0124-0200.1 424200 24.0324-0200.1 524200	Ø 330 24 22,4 V + S Ø 330 24 21,6 V + S
325 i	155	03/10→06/13	➔	Motorcode: N53		24.0124-0200.1 424200 24.0324-0200.1 524200	Ø 330 24 22,4 V + S Ø 330 24 21,6 V + S
			➔	Motorcode: N52N		24.0124-0203.1 424203 24.0324-0203.1 524203	Ø 312 23,9 22,4 V + S Ø 312 23,9 21,6 V + S
			➔			24.0120-0195.1 420195 24.0320-0195.1 520195	Ø 300 20 18,4 V + S Ø 300 20 17,6 V + S
			➔			24.0124-0200.1 424200 24.0324-0200.1 524200	Ø 330 24 22,4 V + S Ø 330 24 21,6 V + S
325 i	160	03/07→06/13	➔	Motorcode: N53		24.0124-0200.1 424200 24.0324-0200.1 524200	Ø 330 24 22,4 V + S Ø 330 24 21,6 V + S
			➔	09/07→; Motorcode: N52N		24.0124-0203.1 424203 24.0324-0203.1 524203	Ø 312 23,9 22,4 V + S Ø 312 23,9 21,6 V + S
			➔			24.0120-0195.1 420195 24.0320-0195.1 520195	Ø 300 20 18,4 V + S Ø 300 20 17,6 V + S
			➔			24.0124-0200.1 424200 24.0324-0200.1 524200	Ø 330 24 22,4 V + S Ø 330 24 21,6 V + S
325 i xDrive	150	03/10→04/13	➔	Motorcode: N53		24.0124-0200.1 424200 24.0324-0200.1 524200	Ø 330 24 22,4 V + S Ø 330 24 21,6 V + S
			➔	Motorcode: N52N		24.0124-0203.1 424203 24.0324-0203.1 524203	Ø 312 23,9 22,4 V + S Ø 312 23,9 21,6 V + S
			➔			24.0120-0204.1 420204 24.0320-0204.1 520204	Ø 300 20 18,4 V + S Ø 300 20 17,6 V + S
			➔			24.0124-0200.1 424200 24.0324-0200.1 524200	Ø 330 24 22,4 V + S Ø 330 24 21,6 V + S
325 i xDrive 325 xi	160 160	09/08→12/13 09/07→02/10	➔			24.0124-0200.1 424200 24.0324-0200.1 524200	Ø 330 24 22,4 V + S Ø 330 24 21,6 V + S
			➔			24.0120-0204.1 420204 24.0320-0204.1 520204	Ø 300 20 18,4 V + S Ø 300 20 17,6 V + S
			➔			24.0124-0200.1 424200 24.0324-0200.1 524200	Ø 330 24 22,4 V + S Ø 330 24 21,6 V + S
325 xi	160	09/06→02/10	➔	→ 08/07		24.0124-0200.1 424200 24.0324-0200.1 524200	Ø 330 24 22,4 V + S Ø 330 24 21,6 V + S
			➔	09/07→		24.0124-0203.1 424203 24.0324-0203.1 524203	Ø 312 23,9 22,4 V + S Ø 312 23,9 21,6 V + S
			➔			24.0120-0204.1 420204 24.0320-0204.1 520204	Ø 300 20 18,4 V + S Ø 300 20 17,6 V + S
			➔			24.0124-0203.1 424203 24.0324-0203.1 524203	Ø 312 23,9 22,4 V + S Ø 312 23,9 21,6 V + S
328 i	172	06/07→12/13	➔	→ 06/13		24.0124-0203.1 424203 24.0324-0203.1 524203	Ø 312 23,9 22,4 V + S Ø 312 23,9 21,6 V + S
			➔	→ 06/13		24.0120-0204.1 420204 24.0320-0204.1 520204	Ø 300 20 18,4 V + S Ø 300 20 17,6 V + S
			➔			24.0124-0200.1 424200 24.0324-0200.1 524200	Ø 330 24 22,4 V + S Ø 330 24 21,6 V + S
330 d	170	03/06→08/08	➔			24.0124-0200.1 424200 24.0324-0200.1 524200	Ø 330 24 22,4 V + S Ø 330 24 21,6 V + S
			➔	Motorcode: M57		24.0130-0192.1 430192	Ø 348 30 28,4 V + S
			➔			24.0122-0236.1 422236 24.0322-0236.1 522236	Ø 336 22 20,4 V + S Ø 336 22 19,6 V + S
330 d	180	01/09→12/13	➔	09/09→		24.0124-0200.1 424200 24.0324-0200.1 524200	Ø 330 24 22,4 V + S Ø 330 24 21,6 V + S
↓							



















	kW			 	! #		
<b>BMW - 3 Coupe (E92) 01/05→12/13</b>							
<b>Bremsscheibe</b>							
330 d	180	01/09→12/13	←	→ 08/09	24.0130-0192.1	430192	Ø 348 30 28,4 V + S
			→		24.0122-0236.1	422236	Ø 336 22 20,4 V + S
					24.0322-0236.1	522236	Ø 336 22 19,6 V + S
330 d xDrive	180	02/10→06/13	←	nicht für erhöhte Nutzlast	24.0124-0200.1	424200	Ø 330 24 22,4 V + S
					24.0324-0200.1	524200	Ø 330 24 21,6 V + S
			←	für erhöhte Nutzlast	24.0130-0192.1	430192	Ø 348 30 28,4 V + S
			→		24.0122-0236.1	422236	Ø 336 22 20,4 V + S
330 i	190	09/06→02/10	←	Motorcode: N52N	24.0124-0200.1	424200	Ø 330 24 22,4 V + S
					24.0324-0200.1	524200	Ø 330 24 21,6 V + S
			←	Motorcode: N53	24.0130-0192.1	430192	Ø 348 30 28,4 V + S
			→		24.0122-0236.1	422236	Ø 336 22 20,4 V + S
330 i	200	09/06→08/12	←	Motorcode: N53; 03/10→	24.0124-0200.1	424200	Ø 330 24 22,4 V + S
					24.0324-0200.1	524200	Ø 330 24 21,6 V + S
			←	Motorcode: N25N	24.0124-0200.1	424200	Ø 330 24 22,4 V + S
					24.0324-0200.1	524200	Ø 330 24 21,6 V + S
330 i	200	03/07→06/13	←	Motorcode: N53; 03/10→	24.0124-0200.1	424200	Ø 330 24 22,4 V + S
					24.0324-0200.1	524200	Ø 330 24 21,6 V + S
			←	Motorcode: N52N	24.0124-0200.1	424200	Ø 330 24 22,4 V + S
					24.0324-0200.1	524200	Ø 330 24 21,6 V + S
330 i	200	03/07→06/13	←	Motorcode: N53; → 02/10	24.0130-0192.1	430192	Ø 348 30 28,4 V + S
			→		24.0122-0236.1	422236	Ø 336 22 20,4 V + S
					24.0322-0236.1	522236	Ø 336 22 19,6 V + S
			←	Motorcode: N53; 03/10→	24.0124-0200.1	424200	Ø 330 24 22,4 V + S
330 i	200	03/07→06/13	←	Motorcode: N52N	24.0124-0200.1	424200	Ø 330 24 22,4 V + S
					24.0324-0200.1	524200	Ø 330 24 21,6 V + S
			←	Motorcode: N53; → 02/10	24.0130-0192.1	430192	Ø 348 30 28,4 V + S
			→		24.0122-0236.1	422236	Ø 336 22 20,4 V + S
330 i	200	03/07→06/13	←	Motorcode: N53; → 02/10	24.0130-0192.1	430192	Ø 348 30 28,4 V + S
			→		24.0122-0236.1	422236	Ø 336 22 20,4 V + S
					24.0322-0236.1	522236	Ø 336 22 19,6 V + S
			←	Motorcode: N53; 03/10→	24.0124-0200.1	424200	Ø 330 24 22,4 V + S
330 xd	170	03/06→08/08	←		24.0124-0200.1	424200	Ø 330 24 22,4 V + S
					24.0130-0192.1	430192	Ø 348 30 28,4 V + S
					24.0324-0200.1	524200	Ø 330 24 21,6 V + S
			→		24.0122-0236.1	422236	Ø 336 22 20,4 V + S
330 xd	180	03/08→02/10	←	09/09→	24.0124-0200.1	424200	Ø 330 24 22,4 V + S
					24.0130-0192.1	430192	Ø 348 30 28,4 V + S
					24.0324-0200.1	524200	Ø 330 24 21,6 V + S
			→		24.0122-0236.1	422236	Ø 336 22 20,4 V + S
330 xd	180	03/08→02/10	←	09/09→	24.0124-0200.1	424200	Ø 330 24 22,4 V + S
					24.0130-0192.1	430192	Ø 348 30 28,4 V + S
					24.0324-0200.1	524200	Ø 330 24 21,6 V + S
			→		24.0122-0236.1	422236	Ø 336 22 20,4 V + S
335 d	210	03/06→03/13	←	09/06→	24.0130-0192.1	430192	Ø 348 30 28,4 V + S
			→	09/06→	24.0122-0236.1	422236	Ø 336 22 20,4 V + S
					24.0322-0236.1	522236	Ø 336 22 19,6 V + S
			←		24.0130-0192.1	430192	Ø 348 30 28,4 V + S
335 i 335 i 335 i xDrive 335 i xDrive 335 i xDrive 335 xi 335 xi	225 240 224 225 240 225 240	11/05→06/13 11/05→06/13 01/09→06/13 11/08→12/13 11/08→06/13 03/07→02/10 03/07→02/10	←		24.0130-0192.1	430192	Ø 348 30 28,4 V + S
			→		24.0122-0236.1	422236	Ø 336 22 20,4 V + S
					24.0322-0236.1	522236	Ø 336 22 19,6 V + S
			←		24.0130-0192.1	430192	Ø 348 30 28,4 V + S
			→		24.0122-0236.1	422236	Ø 336 22 20,4 V + S
					24.0322-0236.1	522236	Ø 336 22 19,6 V + S
M	309	03/07→12/13	←	☐	24.0130-0213.2	430213	Ø 360 30 28,4 V• Bremsscheibe zweiteilig / + S
			←	☐	24.0130-0214.2	430214	Ø 360 30 28,4 V• Bremsscheibe zweiteilig / + S
			→	☐	24.0124-0231.2	424231	Ø 350 24 22,4 V• Bremsscheibe zweiteilig / + S
			→	☐	24.0124-0232.2	424232	Ø 350 24 22,4 V• Bremsscheibe zweiteilig / + S
M GTS	331	03/07→12/13	←	☐; → 06/13	24.0130-0213.2	430213	Ø 360 30 28,4 V• Bremsscheibe zweiteilig / + S
			←	☐; → 06/13	24.0130-0214.2	430214	Ø 360 30 28,4 V• Bremsscheibe zweiteilig / + S
			→	☐; → 06/13	24.0124-0231.2	424231	Ø 350 24 22,4 V• Bremsscheibe zweiteilig / + S
			→	☐; → 06/13	24.0124-0232.2	424232	Ø 350 24 22,4 V• Bremsscheibe zweiteilig / + S



	kW			 	! #		
<b>BMW - 3 Gran Turismo (F34) 07/12→</b>							
<b> Bremsbelagsatz, Scheibenbremse</b>							
318 d	100	03/13→	←	- Performance Parts		13.0460-3866.2 603866	BOS 25506 18,2 + WE / - WK
318 d	105	03/13→				13.0470-3866.2 LD3866	BOS 25506 18,2 + WE / - WK
318 d	110	07/15→					Ceramic
320 i	135	09/15→					
320 i xDrive	135	10/15→	←	+ Performance Parts		13.0460-4875.2 604875	BRE 25028 18,0 + WE / - WK
						13.0470-4875.2 LD4875	BRE 25028 18,0 + WE / - WK
							Ceramic
			→	- Performance Parts		13.0460-3859.2 603859	BOS 25307 17,5 + WE / - WK
						13.0470-3859.2 LD3859	BOS 25307 17,5 + WE / - WK
							Ceramic
			→	+ Performance Parts		13.0460-4874.2 604874	BRE 25029 16,7 + WE / - WK
320 d	120	03/13→	←	- Performance Parts		13.0460-3857.2 603857	BOS 25199 19,6 + WE / - WK
320 d	135	03/13→07/15				13.0470-3857.2 LD3857	BOS 25199 19,6 + WE / - WK
320 d	140	07/15→					Ceramic
320 d	147	05/13→07/15					
320 d xDrive	135	03/13→07/15	←	+ Performance Parts		13.0460-4875.2 604875	BRE 25028 18,0 + WE / - WK
320 d xDrive	140	07/15→				13.0470-4875.2 LD4875	BRE 25028 18,0 + WE / - WK
320 d xDrive	147	05/13→07/15					Ceramic
325 d	155	07/13→					
325 d	160	03/13→	→	- Performance Parts		13.0460-3859.2 603859	BOS 25307 17,5 + WE / - WK
325 d	165	07/16→				13.0470-3859.2 LD3859	BOS 25307 17,5 + WE / - WK
325 d	165						Ceramic
328 i xDrive	180	03/13→07/16	→	+ Performance Parts		13.0460-4874.2 604874	BRE 25029 16,7 + WE / - WK
320 d xDrive	120	03/13→	←	- Performance Parts		13.0460-3857.2 603857	BOS 25199 19,6 + WE / - WK
						13.0470-3857.2 LD3857	BOS 25199 19,6 + WE / - WK
							Ceramic
			←	10/15→; - Performance Parts		13.0460-3857.2 603857	BOS 25199 19,6 + WE / - WK
						13.0470-3857.2 LD3857	BOS 25199 19,6 + WE / - WK
							Ceramic
			←	10/15→; + Performance Parts		13.0460-4875.2 604875	BRE 25028 18,0 + WE / - WK
						13.0470-4875.2 LD4875	BRE 25028 18,0 + WE / - WK
							Ceramic
			←	+ Performance Parts		13.0460-4875.2 604875	BRE 25028 18,0 + WE / - WK
						13.0470-4875.2 LD4875	BRE 25028 18,0 + WE / - WK
							Ceramic
			→	- Performance Parts		13.0460-3859.2 603859	BOS 25307 17,5 + WE / - WK
						13.0470-3859.2 LD3859	BOS 25307 17,5 + WE / - WK
							Ceramic
			→	+ Performance Parts		13.0460-4874.2 604874	BRE 25029 16,7 + WE / - WK
320 i	120	07/12→06/16	←	03/13→; - Performance Parts		13.0460-3866.2 603866	BOS 25506 18,2 + WE / - WK
320 i	135	07/12→06/16				13.0470-3866.2 LD3866	BOS 25506 18,2 + WE / - WK
320 i xDrive	120	11/12→06/16					Ceramic
320 i xDrive	135	11/12→06/16	←	03/13→; + Performance Parts		13.0460-4875.2 604875	BRE 25028 18,0 + WE / - WK
						13.0470-4875.2 LD4875	BRE 25028 18,0 + WE / - WK
							Ceramic
			→	03/13→; - Performance Parts		13.0460-3859.2 603859	BOS 25307 17,5 + WE / - WK
						13.0470-3859.2 LD3859	BOS 25307 17,5 + WE / - WK
							Ceramic
			→	03/13→; + Performance Parts		13.0460-4874.2 604874	BRE 25029 16,7 + WE / - WK
328 i	180	08/12→02/15	←	03/13→; - Performance Parts		13.0460-3857.2 603857	BOS 25199 19,6 + WE / - WK
						13.0470-3857.2 LD3857	BOS 25199 19,6 + WE / - WK
							Ceramic
			←	03/13→; + Performance Parts		13.0460-4875.2 604875	BRE 25028 18,0 + WE / - WK
						13.0470-4875.2 LD4875	BRE 25028 18,0 + WE / - WK
							Ceramic
			→	03/13→; - Performance Parts		13.0460-3859.2 603859	BOS 25307 17,5 + WE / - WK
						13.0470-3859.2 LD3859	BOS 25307 17,5 + WE / - WK
							Ceramic
			→	03/13→; + Performance Parts		13.0460-4874.2 604874	BRE 25029 16,7 + WE / - WK
330 d	190	01/14→	←	03/14→; - Performance Parts		13.0460-3857.2 603857	BOS 25199 19,6 + WE / - WK
330 d xDrive	190	01/14→				13.0470-3857.2 LD3857	BOS 25199 19,6 + WE / - WK
							Ceramic
			←	03/14→; + Performance Parts		13.0460-4875.2 604875	BRE 25028 18,0 + WE / - WK
						13.0470-4875.2 LD4875	BRE 25028 18,0 + WE / - WK
							Ceramic
			→	03/14→; + Performance Parts		13.0460-4874.2 604874	BRE 25029 16,7 + WE / - WK
330 d	210	01/14→	←	09/15→; - Performance Parts		13.0460-3857.2 603857	BOS 25199 19,6 + WE / - WK
330 d xDrive	210	01/14→					
↓							









	kw			 	! #		
<b>BMW - 3 Gran Turismo (F34) 07/12→</b>							
<b> Bremsbelagsatz, Scheibenbremse</b>							
330 d 330 d xDrive	210 210	01/14→ 01/14→	←	09/15→; - Performance Parts		13.0470-3857.2 LD3857	BOS 25199 19,6 + WE / - WK Ceramic
			←	09/15→; + Performance Parts		13.0460-4875.2 604875 13.0470-4875.2 LD4875	BRE 25028 18,0 + WE / - WK Ceramic BRE 25028 18,0 + WE / - WK Ceramic
			→	09/15→; + Performance Parts		13.0460-4874.2 604874	BRE 25029 16,7 + WE / - WK
330 i	185	10/15→	←	- Performance Parts		13.0460-3857.2 603857 13.0470-3857.2 LD3857	BOS 25199 19,6 + WE / - WK Ceramic BOS 25199 19,6 + WE / - WK Ceramic
			←	+ Performance Parts		13.0460-4875.2 604875 13.0470-4875.2 LD4875	BRE 25028 18,0 + WE / - WK Ceramic BRE 25028 18,0 + WE / - WK Ceramic
335 d xDrive	230	01/14→	←	03/14→		13.0460-4875.2 604875	BRE 25028 18,0 + WE / - WK
			→	03/14→; + Performance Parts		13.0460-4874.2 604874	BRE 25029 16,7 + WE / - WK
335 i 335 i 335 i 335 i xDrive 335 i xDrive 335 i xDrive 340 i 340 i xDrive	225 240 250 225 240 250 240 240	03/13→ 03/13→03/14 07/13→ 03/13→ 03/13→03/14 03/14→ 10/15→ 10/15→	←	+ Performance Parts		13.0460-4875.2 604875 13.0460-4874.2 604874	BRE 25028 18,0 + WE / - WK BRE 25029 16,7 + WE / - WK
340 i 340 i xDrive	265 265	09/15→ 09/15→	←	10/15→		13.0460-4875.2 604875	BRE 25028 18,0 + WE / - WK
			→	10/15→; + Performance Parts		13.0460-4874.2 604874	BRE 25029 16,7 + WE / - WK
<b>Warnkontakt, Bremsbelagsverschleiß</b>							
318 d 318 d 318 d 320 d 320 d 320 d 320 d 320 d xDrive 320 d xDrive 320 d xDrive 320 i 320 i xDrive 325 d 325 d 325 d 328 i xDrive 335 i 335 i 335 i 335 i xDrive 335 i xDrive 335 i xDrive 340 i 340 i xDrive	100 105 110 120 135 140 147 135 140 147 135 140 147 135 135 155 160 165 180 225 240 250 225 240 250 240 240 240	03/13→ 03/13→ 07/15→ 03/13→ 03/13→07/15 07/15→ 05/13→07/15 03/13→07/15 07/15→ 05/13→07/15 09/15→ 10/15→ 07/13→ 03/13→ 07/16→ 03/13→07/16 03/13→ 03/13→03/14 07/13→ 03/13→ 03/13→03/14 03/14→ 10/15→ 10/15→	← →		1 1	24.8190-0006.2 620006 24.8190-0007.2 620007	L= 675 L= 1.045
320 d xDrive	120	03/13→	←	☐; 10/15→	1	24.8190-0006.2 620006	L= 675
			←	☐	1	24.8190-0006.2 620006	L= 675
			→		1	24.8190-0007.2 620007	L= 1.045
320 i 320 i 320 i xDrive 320 i xDrive 328 i	120 135 120 135 180	07/12→06/16 07/12→06/16 11/12→06/16 11/12→06/16 08/12→02/15	←	☐; 03/13→	1	24.8190-0006.2 620006	L= 675
			→	03/13→	1	24.8190-0007.2 620007	L= 1.045
330 d 330 d xDrive 335 d xDrive	190 190 230	01/14→ 01/14→ 01/14→	←	☐; 03/14→	1	24.8190-0006.2 620006	L= 675
			→	03/14→	1	24.8190-0007.2 620007	L= 1.045
330 d 330 d xDrive	210 210	01/14→ 01/14→	←	☐; 09/15→	1	24.8190-0006.2 620006	L= 675
			→	09/15→	1	24.8190-0007.2 620007	L= 1.045
330 i	185	10/15→	←	☐	1	24.8190-0006.2 620006	L= 675
340 i 340 i xDrive	265 265	09/15→ 09/15→	←	☐; 10/15→	1	24.8190-0006.2 620006	L= 675
			→	10/15→	1	24.8190-0007.2 620007	L= 1.045
<b> Bremsscheibe</b>							
318 d 318 d 318 d 320 i ↓	100 105 110 135	03/13→ 03/13→ 07/15→ 09/15→	←	- Performance Parts		24.0122-0278.1 422278	Ø 300 22 20,4 V + S
			←	+ Performance Parts		24.0130-0233.2 430233	Ø 340 30 28,4 V Bremsscheibe zweiteilig / + S









	kw			 	! #		
<b>BMW - 3 Gran Turismo (F34) 07/12→</b>							
<b>Bremsscheibe</b>							
320 i xDrive	135	10/15→	➡	- Performance Parts		24.0120-0240.1 420240	Ø 300 20 18,4 V + S
			➡	+ Performance Parts		24.0124-0251.2 424251	Ø 345 24 22,4 V Bremsscheibe zweiteilig / + S
320 d	120	03/13→	⬅	- Performance Parts		24.0124-0203.1 424203	Ø 312 23,9 22,4 V + S
320 d	135	03/13→07/15					
320 d	140	07/15→				24.0324-0203.1 524203	Ø 312 23,9 21,6 V + S
320 d	147	05/13→07/15	⬅	+ Performance Parts		24.0130-0233.2 430233	Ø 340 30 28,4 V Bremsscheibe zweiteilig / + S
320 d xDrive	120	03/13→					
320 d xDrive	135	03/13→07/15	➡	- Performance Parts		24.0120-0240.1 420240	Ø 300 20 18,4 V + S
320 d xDrive	140	07/15→					
320 d xDrive	147	05/13→07/15	➡	+ Performance Parts		24.0124-0251.2 424251	Ø 345 24 22,4 V Bremsscheibe zweiteilig / + S
320 i	120	07/12→06/16	⬅	03/13→; - Performance Parts		24.0122-0278.1 422278	Ø 300 22 20,4 V + S
320 i	135	07/12→06/16					
320 i xDrive	120	11/12→06/16	⬅	03/13→; + Performance Parts		24.0130-0233.2 430233	Ø 340 30 28,4 V Bremsscheibe zweiteilig / + S
320 i xDrive	135	11/12→06/16					
			➡	03/13→; - Performance Parts		24.0120-0240.1 420240	Ø 300 20 18,4 V + S
			➡	03/13→; + Performance Parts		24.0124-0251.2 424251	Ø 345 24 22,4 V Bremsscheibe zweiteilig / + S
325 d	155	07/13→	⬅	- Performance Parts		24.0124-0248.1 424248	Ø 330 24 22,4 V + S
325 d	160	03/13→	⬅	+ Performance Parts		24.0130-0234.2 430234	Ø 370 30 28,4 V Bremsscheibe zweiteilig / + S
			➡	- Performance Parts		24.0120-0237.1 420237	Ø 300 20 18,4 V + S
			➡	für Fahrzeuge mit verstärkter Bremse; + M Sportbremse		24.0120-0243.1 420243	Ø 330 20 18,4 V + S
			➡	+ Performance Parts		24.0124-0250.2 424250	Ø 345 24 22,4 V Bremsscheibe zweiteilig / + S
325 d	165	07/16→	⬅	- Performance Parts		24.0124-0248.1 424248	Ø 330 24 22,4 V + S
328 i xDrive	180	03/13→07/16					
330 i	185	10/15→	⬅	+ Performance Parts		24.0130-0234.2 430234	Ø 370 30 28,4 V Bremsscheibe zweiteilig / + S
330 i xDrive	185	10/15→					
			➡	- Performance Parts		24.0120-0240.1 420240	Ø 300 20 18,4 V + S
			➡	+ Performance Parts		24.0124-0251.2 424251	Ø 345 24 22,4 V Bremsscheibe zweiteilig / + S
328 i	180	08/12→02/15	⬅	03/13→; - Performance Parts		24.0124-0248.1 424248	Ø 330 24 22,4 V + S
			⬅	03/13→; + Performance Parts		24.0130-0234.2 430234	Ø 370 30 28,4 V Bremsscheibe zweiteilig / + S
			➡	03/13→; - Performance Parts		24.0120-0240.1 420240	Ø 300 20 18,4 V + S
			➡	03/13→; + Performance Parts		24.0124-0251.2 424251	Ø 345 24 22,4 V Bremsscheibe zweiteilig / + S
330 d	190	01/14→	⬅	03/14→; - Performance Parts		24.0124-0248.1 424248	Ø 330 24 22,4 V + S
330 d xDrive	190	01/14→					
335 d xDrive	230	01/14→	⬅	03/14→; + Performance Parts		24.0130-0234.2 430234	Ø 370 30 28,4 V Bremsscheibe zweiteilig / + S
			➡	03/14→; - Performance Parts		24.0120-0243.1 420243	Ø 330 20 18,4 V + S
			➡	03/14→; + Performance Parts		24.0124-0251.2 424251	Ø 345 24 22,4 V Bremsscheibe zweiteilig / + S
330 d	210	01/14→	⬅	09/15→; - Performance Parts		24.0124-0248.1 424248	Ø 330 24 22,4 V + S
330 d xDrive	210	01/14→					
			⬅	09/15→; + Performance Parts		24.0130-0234.2 430234	Ø 370 30 28,4 V Bremsscheibe zweiteilig / + S
			➡	09/15→; - Performance Parts		24.0120-0243.1 420243	Ø 330 20 18,4 V + S
			➡	09/15→; + Performance Parts		24.0124-0251.2 424251	Ø 345 24 22,4 V Bremsscheibe zweiteilig / + S
335 i	225	03/13→	⬅	- Performance Parts		24.0130-0233.2 430233	Ø 340 30 28,4 V Bremsscheibe zweiteilig / + S
335 i	240	03/13→03/14					
335 i	250	07/13→	⬅	+ Performance Parts		24.0130-0234.2 430234	Ø 370 30 28,4 V Bremsscheibe zweiteilig / + S
335 i xDrive	225	03/13→					
335 i xDrive	240	03/13→03/14					
335 i xDrive	250	03/14→	➡	- Performance Parts		24.0120-0243.1 420243	Ø 330 20 18,4 V + S
340 i	240	10/15→					
340 i xDrive	240	10/15→	➡	+ Performance Parts		24.0124-0251.2 424251	Ø 345 24 22,4 V Bremsscheibe zweiteilig / + S
340 i	265	09/15→	⬅	10/15→; - Performance Parts		24.0130-0233.2 430233	Ø 340 30 28,4 V Bremsscheibe zweiteilig / + S
340 i xDrive	265	09/15→					
			⬅	10/15→; + Performance Parts		24.0130-0234.2 430234	Ø 370 30 28,4 V Bremsscheibe zweiteilig / + S
			➡	10/15→; - Performance Parts		24.0120-0243.1 420243	Ø 330 20 18,4 V + S
			➡	10/15→; + Performance Parts		24.0124-0251.2 424251	Ø 345 24 22,4 V Bremsscheibe zweiteilig / + S









	kW			 	! #		
<b>BMW - 3 Touring (E36) 08/94→12/99</b>							
 <b>Bremsbelagsatz, Scheibenbremse</b>							
316 i	75	01/96→10/99	←			<b>13.0460-5405.2 605405</b>	ATE 21643 17,8 + WE / - WK
318 i	85	07/95→10/99				<b>13.0470-5405.2 LD5405</b>	ATE 21643 17,8 + WE / - WK
318 tds	66	01/95→10/99					Ceramic
320 i	110	01/95→10/99					
323 i	125	09/95→10/99	→			<b>13.0460-3605.2 603605</b>	ATE 20180 17,3 + WE / - WK
325 tds	105	01/95→10/99				<b>13.0470-3605.2 LD3605</b>	ATE 20180 17,3 + WE / - WK
328 i	142	08/94→12/99					Ceramic
<b>Warnkontakt, Bremsbelagverschleiß</b>							
316 i	75	01/96→10/99	←		1	<b>24.8190-0207.2 620207</b>	L= 786
318 i	85	07/95→10/99					
318 tds	66	01/95→10/99	→		1	<b>24.8190-0206.2 620206</b>	L= 790
320 i	110	01/95→10/99					
323 i	125	09/95→10/99					
325 tds	105	01/95→10/99					
328 i	142	08/94→12/99					
 <b>Bremsscheibe</b>							
316 i	75	01/96→10/99	←	nicht für erhöhte Nutzlast		<b>24.0112-0126.1 412126</b>	Ø 286 12 10,4 + S
318 i	85	07/95→10/99				<b>24.0312-0126.1 512126</b>	Ø 286 12 9,6 + S
318 tds	66	01/95→10/99	←	für erhöhte Nutzlast		<b>24.0122-0115.1 422115</b>	Ø 286 22 20,4 V + S
						<b>24.0322-0115.1 522115</b>	Ø 286 22 19,6 V + S
			→			<b>24.0110-0202.1 410202</b>	Ø 280 10 8,4 + S
						<b>24.0310-0202.1 510202</b>	Ø 280 10 7,6 + S
320 i	110	01/95→10/99	←			<b>24.0122-0115.1 422115</b>	Ø 286 22 20,4 V + S
325 tds	105	01/95→10/99				<b>24.0322-0115.1 522115</b>	Ø 286 22 19,6 V + S
			→			<b>24.0110-0202.1 410202</b>	Ø 280 10 8,4 + S
						<b>24.0310-0202.1 510202</b>	Ø 280 10 7,6 + S
323 i	125	09/95→10/99	←			<b>24.0122-0115.1 422115</b>	Ø 286 22 20,4 V + S
328 i	142	08/94→12/99				<b>24.0322-0115.1 522115</b>	Ø 286 22 19,6 V + S
			→			<b>24.0119-0107.1 419107</b>	Ø 276 19 17,4 V + S
						<b>24.0319-0107.1 519107</b>	Ø 276 19 16,6 V + S
<b>BMW - 3 Touring (E46) 10/99→05/05</b>							
 <b>Bremsbelagsatz, Scheibenbremse</b>							
316 i	85	06/02→02/05	←			<b>13.0460-5405.2 605405</b>	ATE 21643 17,8 + WE / - WK
316 i	85	03/02→02/05				<b>13.0470-5405.2 LD5405</b>	ATE 21643 17,8 + WE / - WK
318 d	85	10/02→03/03					Ceramic
318 d	85	03/03→02/05					
318 i	85	10/99→09/01	→			<b>13.0460-3605.2 603605</b>	ATE 20180 17,3 + WE / - WK
318 i	87	10/99→09/01				<b>13.0470-3605.2 LD3605</b>	ATE 20180 17,3 + WE / - WK
318 i	105	09/01→02/05					Ceramic
320 d	100	03/00→09/01					
320 d	110	09/01→02/05					
320 i	110	10/99→09/00					
320 i	120	09/00→02/05					
320 i	125	09/00→02/05					
325 i	141	09/00→02/05					
325 xi	141	09/00→02/05					
328 i	142	10/99→06/00					
330 d	135	10/99→02/05	←			<b>13.0460-7155.2 607155</b>	ATE 21676 20,3 + WE / - WK
330 d	150	03/03→02/05				<b>13.0470-7155.2 LD7155</b>	ATE 21676 20,3 + WE / - WK
330 i	170	06/00→02/05					Ceramic
330 xi	170	06/00→02/05	→			<b>13.0460-7079.2 607079</b>	ATE 21282 17,3 + WE / - WK
						<b>13.0470-7079.2 LD7079</b>	ATE 21282 17,3 + WE / - WK
							Ceramic
330 xd	135	01/00→03/03	←	06/00→		<b>13.0460-7155.2 607155</b>	ATE 21676 20,3 + WE / - WK
						<b>13.0470-7155.2 LD7155</b>	ATE 21676 20,3 + WE / - WK
			→	06/00→		<b>13.0460-7079.2 607079</b>	ATE 21282 17,3 + WE / - WK
						<b>13.0470-7079.2 LD7079</b>	ATE 21282 17,3 + WE / - WK
							Ceramic
330 xd	150	08/02→05/05	←	03/03→ 02/05		<b>13.0460-7155.2 607155</b>	ATE 21676 20,3 + WE / - WK
						<b>13.0470-7155.2 LD7155</b>	ATE 21676 20,3 + WE / - WK
			→	03/03→ 02/05		<b>13.0460-7079.2 607079</b>	ATE 21282 17,3 + WE / - WK
						<b>13.0470-7079.2 LD7079</b>	ATE 21282 17,3 + WE / - WK
							Ceramic
<b>Warnkontakt, Bremsbelagverschleiß</b>							
316 i	85	06/02→02/05	←		1	<b>24.8190-0220.2 620220</b>	L= 601
↓							





















	kW			 	! #		
<b>BMW - 3 Touring (E46) 10/99→05/05</b>							
<b>Warnkontakt, Bremsbelagverschleiß</b>							
316 i	85	03/02→02/05	➔		1	24.8190-0221.2 620221	L= 1.338
318 d	85	10/02→03/03					
318 d	85	03/03→02/05					
318 i	85	10/99→09/01					
318 i	87	10/99→09/01					
318 i	105	09/01→02/05					
320 d	100	03/00→09/01					
320 d	110	09/01→02/05					
320 i	110	10/99→09/00					
320 i	120	09/00→02/05					
320 i	125	09/00→02/05					
325 i	141	09/00→02/05					
328 i	142	10/99→06/00					
325 xi	141	09/00→02/05	➔		1	24.8190-0227.2 620227	L= 651
330 d	135	10/99→02/05					
330 d	150	03/03→02/05	➔		1	24.8190-0221.2 620221	L= 1.338
330 i	170	06/00→02/05					
330 xi	170	06/00→02/05					
330 xd	135	01/00→03/03	➔	06/00→	1	24.8190-0227.2 620227	L= 651
			➔	06/00→	1	24.8190-0221.2 620221	L= 1.338
330 xd	150	08/02→05/05	➔	03/03→ 02/05	1	24.8190-0227.2 620227	L= 651
			➔	03/03→ 02/05	1	24.8190-0221.2 620221	L= 1.338
<b> Bremsscheibe</b>							
316 i	85	06/02→02/05	➔			24.0122-0115.1 422115	Ø 286 22 20,4 V + S
316 i	85	03/02→02/05				24.0322-0115.1 522115	Ø 286 22 19,6 V + S
318 i	85	10/99→09/01					
318 i	87	10/99→09/01	➔			24.0119-0107.1 419107	Ø 276 19 17,4 V + S
318 i	105	09/01→02/05				24.0319-0107.1 519107	Ø 276 19 16,6 V + S
320 d	100	03/00→09/01					
320 i	110	10/99→09/00					
318 d	85	10/02→03/03	➔	nicht für erhöhte Nutzlast		24.0122-0115.1 422115	Ø 286 22 20,4 V + S
318 d	85	03/03→02/05				24.0322-0115.1 522115	Ø 286 22 19,6 V + S
			➔	für erhöhte Nutzlast		24.0122-0160.1 422160	Ø 300 22 20,4 V + S
						24.0322-0160.1 522160	Ø 300 22 19,6 V + S
			➔	nicht für erhöhte Nutzlast		24.0119-0107.1 419107	Ø 276 19 17,4 V + S
						24.0319-0107.1 519107	Ø 276 19 16,6 V + S
			➔	für erhöhte Nutzlast		24.0119-0108.1 419108	Ø 294 18,9 17,4 V + S
						24.0319-0108.1 519108	Ø 294 18,9 16,6 V + S
320 d	110	09/01→02/05	➔			24.0122-0160.1 422160	Ø 300 22 20,4 V + S
320 i	120	09/00→02/05				24.0322-0160.1 522160	Ø 300 22 19,6 V + S
320 i	125	09/00→02/05					
325 i	141	09/00→02/05	➔			24.0119-0108.1 419108	Ø 294 18,9 17,4 V + S
328 i	142	10/99→06/00				24.0319-0108.1 519108	Ø 294 18,9 16,6 V + S
325 xi	141	09/00→02/05	➔			24.0122-0160.1 422160	Ø 300 22 20,4 V + S
						24.0322-0160.1 522160	Ø 300 22 19,6 V + S
			➔			24.0119-0113.1 419113	Ø 294 19 17,4 V + S
330 d	135	10/99→02/05	➔			24.0125-0138.1 425138	Ø 325 24,9 23,4 V + S
330 d	150	03/03→02/05				24.0325-0138.1 525138	Ø 325 24,9 22,6 V + S
330 i	170	06/00→02/05					
330 xi	170	06/00→02/05	➔			24.0122-0209.1 422209	Ø 320 22 20,4 V + S
						24.0322-0209.1 522209	Ø 320 22 19,6 V + S
330 xd	135	01/00→03/03	➔	06/00→		24.0125-0138.1 425138	Ø 325 24,9 23,4 V + S
						24.0325-0138.1 525138	Ø 325 24,9 22,6 V + S
			➔	06/00→		24.0122-0209.1 422209	Ø 320 22 20,4 V + S
						24.0322-0209.1 522209	Ø 320 22 19,6 V + S
330 xd	150	08/02→05/05	➔	03/03→ 02/05		24.0125-0138.1 425138	Ø 325 24,9 23,4 V + S
						24.0325-0138.1 525138	Ø 325 24,9 22,6 V + S
			➔	03/03→ 02/05		24.0122-0209.1 422209	Ø 320 22 20,4 V + S
						24.0322-0209.1 522209	Ø 320 22 19,6 V + S
<b>BMW - 3 Touring (E91) 12/04→12/12</b>							
<b> Bremsbelagsatz, Scheibenbremse</b>							
316 d	85	09/09→06/12	➔	+ Performance Parts		13.0460-4848.2 604848	BRE 24316 16,9 + WE / - WK
316 i	90	05/08→05/12	➔			13.0460-7216.2 607216	ATE 23794 20,3 + WE / - WK
318 d	90	09/05→08/07	➔			13.0470-7216.2 LD7216	ATE 23794 20,3 + WE / - WK Ceramic
			➔			13.0460-7217.2 607217	ATE 23926 17,3 + WE / - WK
						13.0470-7217.2 LD7217	ATE 23926 17,3 + WE / - WK Ceramic
↓							

	kw			 	! #		
<b>BMW - 3 Touring (E91) 12/04→12/12</b>							
<b> Bremsbelagsatz, Scheibenbremse</b>							
318 d	100	07/07→06/12	←	+ Performance Parts		13.0460-4848.2 604848	BRE 24316 16,9 + WE / - WK
318 d	105	09/07→06/12	←			13.0460-7238.2 607238	ATE 23313 20,3 + WE / - WK
320 i	120	02/07→05/12	←			13.0470-7238.2 LD7238	ATE 23313 20,3 + WE / - WK
320 i	125	02/07→12/12	→			13.0460-7217.2 607217	ATE 23926 17,3 + WE / - WK
			→			13.0470-7217.2 LD7217	ATE 23926 17,3 + WE / - WK
			→			13.0460-7217.2 607217	ATE 23926 17,3 + WE / - WK
			→			13.0470-7217.2 LD7217	ATE 23926 17,3 + WE / - WK
318 i	95	01/06→08/07	←	+ Performance Parts		13.0460-4848.2 604848	BRE 24316 16,9 + WE / - WK
			←			13.0460-7216.2 607216	ATE 23794 20,3 + WE / - WK
			←			13.0470-7216.2 LD7216	ATE 23794 20,3 + WE / - WK
			←	Motorcode: N46N		13.0460-7238.2 607238	ATE 23313 20,3 + WE / - WK
			←			13.0470-7238.2 LD7238	ATE 23313 20,3 + WE / - WK
			→			13.0460-7217.2 607217	ATE 23926 17,3 + WE / - WK
			→			13.0470-7217.2 LD7217	ATE 23926 17,3 + WE / - WK
318 i	100	09/07→03/12	←	+ Performance Parts		13.0460-4848.2 604848	BRE 24316 16,9 + WE / - WK
			←	nicht für erhöhte Nutzlast		13.0460-7216.2 607216	ATE 23794 20,3 + WE / - WK
			←			13.0470-7216.2 LD7216	ATE 23794 20,3 + WE / - WK
			←	für erhöhte Nutzlast		13.0460-7238.2 607238	ATE 23313 20,3 + WE / - WK
			←			13.0470-7238.2 LD7238	ATE 23313 20,3 + WE / - WK
			←	→ 07/08; nicht für erhöhte Nutzlast; Motorcode: N46N		13.0460-7238.2 607238	ATE 23313 20,3 + WE / - WK
			←			13.0470-7238.2 LD7238	ATE 23313 20,3 + WE / - WK
			→			13.0460-7217.2 607217	ATE 23926 17,3 + WE / - WK
			→			13.0470-7217.2 LD7217	ATE 23926 17,3 + WE / - WK
318 i	105	05/07→05/12	←	+ Performance Parts		13.0460-4848.2 604848	BRE 24316 16,9 + WE / - WK
			←	03/08→; nicht für erhöhte Nutzlast		13.0460-7216.2 607216	ATE 23794 20,3 + WE / - WK
			←			13.0470-7216.2 LD7216	ATE 23794 20,3 + WE / - WK
			←	für erhöhte Nutzlast		13.0460-7238.2 607238	ATE 23313 20,3 + WE / - WK
			←			13.0470-7238.2 LD7238	ATE 23313 20,3 + WE / - WK
			←	→ 02/08; nicht für erhöhte Nutzlast		13.0460-7238.2 607238	ATE 23313 20,3 + WE / - WK
			←			13.0470-7238.2 LD7238	ATE 23313 20,3 + WE / - WK
			→			13.0460-7217.2 607217	ATE 23926 17,3 + WE / - WK
			→			13.0470-7217.2 LD7217	ATE 23926 17,3 + WE / - WK
320 d	110	12/04→08/07	←	06/05→; + Performance Parts		13.0460-4848.2 604848	BRE 24316 16,9 + WE / - WK
			←			13.0460-7216.2 607216	ATE 23794 20,3 + WE / - WK
			←			13.0470-7216.2 LD7216	ATE 23794 20,3 + WE / - WK
			→	nicht für Behördenfahrzeuge		13.0460-7217.2 607217	ATE 23926 17,3 + WE / - WK
			→			13.0470-7217.2 LD7217	ATE 23926 17,3 + WE / - WK
			→	für Behördenfahrzeuge		13.0460-7225.2 607225	ATE 23550 17,3 + WE / - WK
			→			13.0470-7225.2 LD7225	ATE 23550 17,3 + WE / - WK
320 d	120	12/04→06/12	←	+ Performance Parts		13.0460-4848.2 604848	BRE 24316 16,9 + WE / - WK
			←	für Behördenfahrzeuge		13.0460-7216.2 607216	ATE 23794 20,3 + WE / - WK
			←			13.0470-7216.2 LD7216	ATE 23794 20,3 + WE / - WK
			←	Motorcode: M47N2; nicht für Behördenfahrzeuge		13.0460-7216.2 607216	ATE 23794 20,3 + WE / - WK
			←			13.0470-7216.2 LD7216	ATE 23794 20,3 + WE / - WK
			←	nicht für Behördenfahrzeuge		13.0460-7238.2 607238	ATE 23313 20,3 + WE / - WK
			←			13.0470-7238.2 LD7238	ATE 23313 20,3 + WE / - WK
			→	nicht für Behördenfahrzeuge		13.0460-7217.2 607217	ATE 23926 17,3 + WE / - WK
			→			13.0470-7217.2 LD7217	ATE 23926 17,3 + WE / - WK









	kW			 	! #		
<b>BMW - 3 Touring (E91) 12/04→12/12</b>							
<b> Bremsbelagsatz, Scheibenbremse</b>							
320 d	120	12/04→06/12	➡	für Behördenfahrzeuge		<b>13.0460-7225.2 607225</b> <b>13.0470-7225.2 LD7225</b>	ATE 23550 17,3 + WE / - WK ATE 23550 17,3 + WE / - WK Ceramic
320 d	130	02/07→12/10	←	+ Performance Parts		<b>13.0460-4848.2 604848</b>	BRE 24316 16,9 + WE / - WK
320 d	135	03/10→05/12	←	für Behördenfahrzeuge		<b>13.0460-7216.2 607216</b> <b>13.0470-7216.2 LD7216</b>	ATE 23794 20,3 + WE / - WK ATE 23794 20,3 + WE / - WK Ceramic
320 d	145	02/07→02/10	←				
320 d	147	03/10→05/12	←				
320 d xDrive	120	07/09→06/12	←	nicht für Behördenfahrzeuge		<b>13.0460-7238.2 607238</b> <b>13.0470-7238.2 LD7238</b>	ATE 23313 20,3 + WE / - WK ATE 23313 20,3 + WE / - WK Ceramic
320 d xDrive	130	02/08→02/10	←				
320 d xDrive	135	03/10→05/12	←				
320 d xDrive	145	02/08→02/10	←				
320 d xDrive	147	03/10→05/12	➡	nicht für Behördenfahrzeuge		<b>13.0460-7217.2 607217</b> <b>13.0470-7217.2 LD7217</b>	ATE 23926 17,3 + WE / - WK ATE 23926 17,3 + WE / - WK Ceramic
			➡	für Behördenfahrzeuge		<b>13.0460-7225.2 607225</b> <b>13.0470-7225.2 LD7225</b>	ATE 23550 17,3 + WE / - WK ATE 23550 17,3 + WE / - WK Ceramic
320 i	110	09/05→06/12	←	+ Performance Parts		<b>13.0460-4848.2 604848</b>	BRE 24316 16,9 + WE / - WK
			←	→ 07/08; Motorcode: N46		<b>13.0460-7216.2 607216</b> <b>13.0470-7216.2 LD7216</b>	ATE 23794 20,3 + WE / - WK ATE 23794 20,3 + WE / - WK Ceramic
			←	Motorcode: N46N		<b>13.0460-7238.2 607238</b> <b>13.0470-7238.2 LD7238</b>	ATE 23313 20,3 + WE / - WK ATE 23313 20,3 + WE / - WK Ceramic
			➡			<b>13.0460-7217.2 607217</b> <b>13.0470-7217.2 LD7217</b>	ATE 23926 17,3 + WE / - WK ATE 23926 17,3 + WE / - WK Ceramic
323 i	130	04/06→06/07	←	09/06→		<b>13.0460-7238.2 607238</b> <b>13.0470-7238.2 LD7238</b>	ATE 23313 20,3 + WE / - WK ATE 23313 20,3 + WE / - WK Ceramic
			➡	09/06→		<b>13.0460-7217.2 607217</b> <b>13.0470-7217.2 LD7217</b>	ATE 23926 17,3 + WE / - WK ATE 23926 17,3 + WE / - WK Ceramic
323 i	140	09/06→07/08	←			<b>13.0460-7238.2 607238</b> <b>13.0470-7238.2 LD7238</b>	ATE 23313 20,3 + WE / - WK ATE 23313 20,3 + WE / - WK Ceramic
			➡			<b>13.0460-7217.2 607217</b> <b>13.0470-7217.2 LD7217</b>	ATE 23926 17,3 + WE / - WK ATE 23926 17,3 + WE / - WK Ceramic
325 d	145	09/06→06/12	←	+ Performance Parts		<b>13.0460-4848.2 604848</b>	BRE 24316 16,9 + WE / - WK
325 d	150	02/10→06/12	←	nicht für Behördenfahrzeuge		<b>13.0460-7216.2 607216</b> <b>13.0470-7216.2 LD7216</b>	ATE 23794 20,3 + WE / - WK ATE 23794 20,3 + WE / - WK Ceramic
			←	für Behördenfahrzeuge		<b>13.0460-7237.2 607237</b> <b>13.0460-7238.2 607238</b> <b>13.0470-7237.2 LD7237</b> <b>13.0470-7238.2 LD7238</b>	ATE 23347 20,3 + WE / - WK ATE 23313 20,3 + WE / - WK ATE 23347 20,3 + WE / - WK ATE 23313 20,3 + WE / - WK Ceramic
			➡			<b>13.0460-7225.2 607225</b> <b>13.0470-7225.2 LD7225</b>	ATE 23550 17,3 + WE / - WK ATE 23550 17,3 + WE / - WK Ceramic
325 i	155	12/04→12/10	←	06/05→; + Performance Parts		<b>13.0460-4848.2 604848</b>	BRE 24316 16,9 + WE / - WK
			←	Motorcode: N53/N52N; für erhöhte Nutzlast		<b>13.0460-7216.2 607216</b> <b>13.0470-7216.2 LD7216</b>	ATE 23794 20,3 + WE / - WK ATE 23794 20,3 + WE / - WK Ceramic
			←	Motorcode: N52		<b>13.0460-7216.2 607216</b> <b>13.0470-7216.2 LD7216</b>	ATE 23794 20,3 + WE / - WK ATE 23794 20,3 + WE / - WK Ceramic
			←	Motorcode: N52N/N53; nicht für erhöhte Nutzlast		<b>13.0460-7238.2 607238</b> <b>13.0470-7238.2 LD7238</b>	ATE 23313 20,3 + WE / - WK ATE 23313 20,3 + WE / - WK Ceramic
			➡	nicht für erhöhte Nutzlast		<b>13.0460-7217.2 607217</b> <b>13.0470-7217.2 LD7217</b>	ATE 23926 17,3 + WE / - WK ATE 23926 17,3 + WE / - WK Ceramic
			➡	für erhöhte Nutzlast		<b>13.0460-7225.2 607225</b>	ATE 23550 17,3 + WE / - WK







	kw			 	! #		
<b>BMW - 3 Touring (E91) 12/04→12/12</b>							
<b> Bremsbelagsatz, Scheibenbremse</b>							
325 i	155	12/04→12/10	➡	für erhöhte Nutzlast		<b>13.0470-7225.2 LD7225</b>	ATE 23550 17,3 + WE / - WK Ceramic
325 i	160	12/04→12/12	←	+ Performance Parts		<b>13.0460-4848.2 604848</b>	BRE 24316 16,9 + WE / - WK
			←	Motorcode: N52N; für erhöhte Nutzlast		<b>13.0460-7216.2 607216</b>	ATE 23794 20,3 + WE / - WK
						<b>13.0470-7216.2 LD7216</b>	ATE 23794 20,3 + WE / - WK Ceramic
			←	Motorcode: N53; für erhöhte Nutzlast		<b>13.0460-7216.2 607216</b>	ATE 23794 20,3 + WE / - WK
						<b>13.0470-7216.2 LD7216</b>	ATE 23794 20,3 + WE / - WK Ceramic
			←	Motorcode: N52		<b>13.0460-7216.2 607216</b>	ATE 23794 20,3 + WE / - WK
						<b>13.0470-7216.2 LD7216</b>	ATE 23794 20,3 + WE / - WK Ceramic
			←	Motorcode: N52N/N53; nicht für erhöhte Nutzlast		<b>13.0460-7238.2 607238</b>	ATE 23313 20,3 + WE / - WK
			<b>13.0470-7238.2 LD7238</b>	ATE 23313 20,3 + WE / - WK Ceramic			
➡	nicht für erhöhte Nutzlast		<b>13.0460-7217.2 607217</b>	ATE 23926 17,3 + WE / - WK			
			<b>13.0470-7217.2 LD7217</b>	ATE 23926 17,3 + WE / - WK Ceramic			
➡	für erhöhte Nutzlast		<b>13.0460-7225.2 607225</b>	ATE 23550 17,3 + WE / - WK			
			<b>13.0470-7225.2 LD7225</b>	ATE 23550 17,3 + WE / - WK Ceramic			
325 i	155	09/07→06/12	←	+ Performance Parts		<b>13.0460-4848.2 604848</b>	BRE 24316 16,9 + WE / - WK
			←	für erhöhte Nutzlast		<b>13.0460-7216.2 607216</b>	ATE 23794 20,3 + WE / - WK
						<b>13.0470-7216.2 LD7216</b>	ATE 23794 20,3 + WE / - WK Ceramic
			←	nicht für erhöhte Nutzlast		<b>13.0460-7238.2 607238</b>	ATE 23313 20,3 + WE / - WK
						<b>13.0470-7238.2 LD7238</b>	ATE 23313 20,3 + WE / - WK Ceramic
			➡	nicht für erhöhte Nutzlast		<b>13.0460-7217.2 607217</b>	ATE 23926 17,3 + WE / - WK
			<b>13.0470-7217.2 LD7217</b>	ATE 23926 17,3 + WE / - WK Ceramic			
➡	für erhöhte Nutzlast		<b>13.0460-7225.2 607225</b>	ATE 23550 17,3 + WE / - WK			
			<b>13.0470-7225.2 LD7225</b>	ATE 23550 17,3 + WE / - WK Ceramic			
325 i	160	09/07→06/12	←	+ Performance Parts		<b>13.0460-4848.2 604848</b>	BRE 24316 16,9 + WE / - WK
			←	Motorcode: N53/N52N; für erhöhte Nutzlast		<b>13.0460-7216.2 607216</b>	ATE 23794 20,3 + WE / - WK
						<b>13.0470-7216.2 LD7216</b>	ATE 23794 20,3 + WE / - WK Ceramic
			←	Motorcode: N52		<b>13.0460-7216.2 607216</b>	ATE 23794 20,3 + WE / - WK
						<b>13.0470-7216.2 LD7216</b>	ATE 23794 20,3 + WE / - WK Ceramic
			←	Motorcode: N52N/N53; nicht für erhöhte Nutzlast		<b>13.0460-7238.2 607238</b>	ATE 23313 20,3 + WE / - WK
						<b>13.0470-7238.2 LD7238</b>	ATE 23313 20,3 + WE / - WK Ceramic
➡	nicht für erhöhte Nutzlast		<b>13.0460-7217.2 607217</b>	ATE 23926 17,3 + WE / - WK			
			<b>13.0470-7217.2 LD7217</b>	ATE 23926 17,3 + WE / - WK Ceramic			
➡	für erhöhte Nutzlast		<b>13.0460-7225.2 607225</b>	ATE 23550 17,3 + WE / - WK			
			<b>13.0470-7225.2 LD7225</b>	ATE 23550 17,3 + WE / - WK Ceramic			
325 i xDrive 325 xi	160 160	09/07→06/12 09/07→06/12	←	+ Performance Parts		<b>13.0460-4848.2 604848</b>	BRE 24316 16,9 + WE / - WK
			←	Motorcode: N52N; für erhöhte Nutzlast		<b>13.0460-7216.2 607216</b>	ATE 23794 20,3 + WE / - WK
						<b>13.0470-7216.2 LD7216</b>	ATE 23794 20,3 + WE / - WK Ceramic
			←	Motorcode: N52/N53		<b>13.0460-7216.2 607216</b>	ATE 23794 20,3 + WE / - WK
						<b>13.0470-7216.2 LD7216</b>	ATE 23794 20,3 + WE / - WK Ceramic
			←	Motorcode: N52N; nicht für erhöhte Nutzlast		<b>13.0460-7238.2 607238</b>	ATE 23313 20,3 + WE / - WK
						<b>13.0470-7238.2 LD7238</b>	ATE 23313 20,3 + WE / - WK Ceramic
➡	Motorcode: N52N; nicht für erhöhte Nutzlast		<b>13.0460-7217.2 607217</b>	ATE 23926 17,3 + WE / - WK			
			<b>13.0470-7217.2 LD7217</b>	ATE 23926 17,3 + WE / - WK Ceramic			
➡	Motorcode: N52/N53		<b>13.0460-7225.2 607225</b>	ATE 23550 17,3 + WE / - WK			
			<b>13.0470-7225.2 LD7225</b>	ATE 23550 17,3 + WE / - WK Ceramic			









	kw			 	! #		
<b>BMW - 3 Touring (E91) 12/04→12/12</b>							
<b> Bremsbelagsatz, Scheibenbremse</b>							
325 i xDrive 325 xi	160 160	09/07→06/12 09/07→06/12	➔	Motorcode: N52N; für erhöhte Nutzlast		<b>13.0460-7225.2 607225</b> <b>13.0470-7225.2 LD7225</b>	ATE 23550 17,3 + WE / - WK ATE 23550 17,3 + WE / - WK Ceramic
325 xi	160	08/05→08/11	←	+ Performance Parts		<b>13.0460-4848.2 604848</b>	BRE 24316 16,9 + WE / - WK
			←	Motorcode: N52N; für erhöhte Nutzlast		<b>13.0460-7216.2 607216</b> <b>13.0470-7216.2 LD7216</b>	ATE 23794 20,3 + WE / - WK ATE 23794 20,3 + WE / - WK Ceramic
			←	Motorcode: N52/N53		<b>13.0460-7216.2 607216</b> <b>13.0470-7216.2 LD7216</b>	ATE 23794 20,3 + WE / - WK ATE 23794 20,3 + WE / - WK Ceramic
			←	Motorcode: N52N; nicht für erhöhte Nutzlast		<b>13.0460-7238.2 607238</b> <b>13.0470-7238.2 LD7238</b>	ATE 23313 20,3 + WE / - WK ATE 23313 20,3 + WE / - WK Ceramic
			➔	Motorcode: N52N; nicht für erhöhte Nutzlast		<b>13.0460-7217.2 607217</b>	ATE 23926 17,3 + WE / - WK
			➔	Motorcode: N52/N53		<b>13.0460-7225.2 607225</b> <b>13.0470-7225.2 LD7225</b>	ATE 23550 17,3 + WE / - WK ATE 23550 17,3 + WE / - WK Ceramic
			➔	Motorcode: N52N; für erhöhte Nutzlast		<b>13.0460-7225.2 607225</b> <b>13.0470-7225.2 LD7225</b>	ATE 23550 17,3 + WE / - WK ATE 23550 17,3 + WE / - WK Ceramic
			➔	→ 08/07; Motorcode: N52N; nicht für erhöhte Nutzlast		<b>13.0470-7217.2 LD7217</b>	ATE 23926 17,3 + WE / - WK Ceramic
330 d	155	12/04→05/12	←	+ Performance Parts		<b>13.0460-4848.2 604848</b>	BRE 24316 16,9 + WE / - WK
			←	→ 08/07		<b>13.0460-7216.2 607216</b> <b>13.0470-7216.2 LD7216</b>	ATE 23794 20,3 + WE / - WK ATE 23794 20,3 + WE / - WK Ceramic
			←	10/09→		<b>13.0460-7216.2 607216</b> <b>13.0470-7216.2 LD7216</b>	ATE 23794 20,3 + WE / - WK ATE 23794 20,3 + WE / - WK Ceramic
			←	09/07→ 09/09		<b>13.0460-7237.2 607237</b> <b>13.0460-7238.2 607238</b> <b>13.0470-7237.2 LD7237</b> <b>13.0470-7238.2 LD7238</b>	ATE 23347 20,3 + WE / - WK ATE 23313 20,3 + WE / - WK ATE 23347 20,3 + WE / - WK Ceramic ATE 23313 20,3 + WE / - WK Ceramic
			➔			<b>13.0460-7225.2 607225</b> <b>13.0470-7225.2 LD7225</b>	ATE 23550 17,3 + WE / - WK ATE 23550 17,3 + WE / - WK Ceramic
			➔			<b>13.0460-7225.2 607225</b> <b>13.0470-7225.2 LD7225</b>	ATE 23550 17,3 + WE / - WK ATE 23550 17,3 + WE / - WK Ceramic
330 d	170	12/04→08/08	←	+ Performance Parts		<b>13.0460-4848.2 604848</b>	BRE 24316 16,9 + WE / - WK
			←	→ 08/07		<b>13.0460-7216.2 607216</b> <b>13.0470-7216.2 LD7216</b>	ATE 23794 20,3 + WE / - WK ATE 23794 20,3 + WE / - WK Ceramic
			←	09/07→		<b>13.0460-7237.2 607237</b> <b>13.0460-7238.2 607238</b> <b>13.0470-7237.2 LD7237</b> <b>13.0470-7238.2 LD7238</b>	ATE 23347 20,3 + WE / - WK ATE 23313 20,3 + WE / - WK ATE 23347 20,3 + WE / - WK Ceramic ATE 23313 20,3 + WE / - WK Ceramic
			➔			<b>13.0460-7225.2 607225</b> <b>13.0470-7225.2 LD7225</b>	ATE 23550 17,3 + WE / - WK ATE 23550 17,3 + WE / - WK Ceramic
			➔			<b>13.0460-7225.2 607225</b> <b>13.0470-7225.2 LD7225</b>	ATE 23550 17,3 + WE / - WK ATE 23550 17,3 + WE / - WK Ceramic
330 d 330 d xDrive	180 180	02/08→05/12 01/09→06/12	←	+ Performance Parts		<b>13.0460-4848.2 604848</b>	BRE 24316 16,9 + WE / - WK
			←	10/09→; nicht für erhöhte Nutzlast		<b>13.0460-7216.2 607216</b> <b>13.0470-7216.2 LD7216</b>	ATE 23794 20,3 + WE / - WK ATE 23794 20,3 + WE / - WK Ceramic
			←	→ 09/09; nicht für erhöhte Nutzlast		<b>13.0460-7237.2 607237</b> <b>13.0460-7238.2 607238</b> <b>13.0470-7237.2 LD7237</b> <b>13.0470-7238.2 LD7238</b>	ATE 23347 20,3 + WE / - WK ATE 23313 20,3 + WE / - WK ATE 23347 20,3 + WE / - WK Ceramic ATE 23313 20,3 + WE / - WK Ceramic
			←	für erhöhte Nutzlast		<b>13.0460-7237.2 607237</b> <b>13.0460-7238.2 607238</b> <b>13.0470-7237.2 LD7237</b>	ATE 23347 20,3 + WE / - WK ATE 23313 20,3 + WE / - WK ATE 23347 20,3 + WE / - WK Ceramic
			↓				

















	kw			 	! #			
<b>BMW - 3 Touring (E91) 12/04→12/12</b>								
<b> Bremsbelagsatz, Scheibenbremse</b>								
330 d 330 d xDrive	180 180	02/08→05/12 01/09→06/12	←	für erhöhte Nutzlast		13.0470-7238.2	LD7238	ATE 23313 20,3 + WE / - WK Ceramic
			→			13.0460-7225.2	607225	ATE 23550 17,3 + WE / - WK
						13.0470-7225.2	LD7225	ATE 23550 17,3 + WE / - WK Ceramic
330 i 330 xi	190 190	08/05→08/07 09/05→08/07	←	+ Performance Parts		13.0460-4848.2	604848	BRE 24316 16,9 + WE / - WK
			←			13.0460-7216.2	607216	ATE 23794 20,3 + WE / - WK
			→			13.0470-7216.2	LD7216	ATE 23794 20,3 + WE / - WK Ceramic
			→			13.0460-7225.2	607225	ATE 23550 17,3 + WE / - WK
						13.0470-7225.2	LD7225	ATE 23550 17,3 + WE / - WK Ceramic
330 i 330 i xDrive 330 xi	200 200 200	09/07→06/12 09/07→06/12 09/07→06/12	←	+ Performance Parts		13.0460-4848.2	604848	BRE 24316 16,9 + WE / - WK
			←	10/09→		13.0460-7216.2	607216	ATE 23794 20,3 + WE / - WK
						13.0470-7216.2	LD7216	ATE 23794 20,3 + WE / - WK Ceramic
			←	→ 09/09		13.0460-7237.2	607237	ATE 23347 20,3 + WE / - WK
						13.0460-7238.2	607238	ATE 23313 20,3 + WE / - WK
					13.0470-7237.2	LD7237	ATE 23347 20,3 + WE / - WK Ceramic	
					13.0470-7238.2	LD7238	ATE 23313 20,3 + WE / - WK Ceramic	
			→			13.0460-7225.2	607225	ATE 23550 17,3 + WE / - WK
						13.0470-7225.2	LD7225	ATE 23550 17,3 + WE / - WK Ceramic
330 xd	170	09/05→06/12	←	+ Performance Parts		13.0460-4848.2	604848	BRE 24316 16,9 + WE / - WK
			←			13.0460-7216.2	607216	ATE 23794 20,3 + WE / - WK
						13.0460-7237.2	607237	ATE 23347 20,3 + WE / - WK
						13.0460-7238.2	607238	ATE 23313 20,3 + WE / - WK
						13.0470-7216.2	LD7216	ATE 23794 20,3 + WE / - WK Ceramic
						13.0470-7237.2	LD7237	ATE 23347 20,3 + WE / - WK Ceramic
					13.0470-7238.2	LD7238	ATE 23313 20,3 + WE / - WK Ceramic	
			→			13.0460-7225.2	607225	ATE 23550 17,3 + WE / - WK
						13.0470-7225.2	LD7225	ATE 23550 17,3 + WE / - WK Ceramic
335 d 335 i 335 i xDrive 335 xi	210 225 225 225	09/06→06/12 09/06→06/12 09/08→06/12 03/07→08/08	←			13.0460-7237.2	607237	ATE 23347 20,3 + WE / - WK
						13.0460-7238.2	607238	ATE 23313 20,3 + WE / - WK
						13.0470-7237.2	LD7237	ATE 23347 20,3 + WE / - WK Ceramic
						13.0470-7238.2	LD7238	ATE 23313 20,3 + WE / - WK Ceramic
			→			13.0460-7225.2	607225	ATE 23550 17,3 + WE / - WK
						13.0470-7225.2	LD7225	ATE 23550 17,3 + WE / - WK Ceramic
335 i 335 i xDrive 335 xi	240 240 240	09/06→06/12 09/08→06/12 03/07→08/08	←			13.0460-7237.2	607237	ATE 23347 20,3 + WE / - WK
						13.0460-7238.2	607238	ATE 23313 20,3 + WE / - WK
			→			13.0460-7225.2	607225	ATE 23550 17,3 + WE / - WK
						13.0470-7225.2	LD7225	ATE 23550 17,3 + WE / - WK Ceramic
<b>Warnkontakt, Bremsbelagverschleiß</b>								
316 d	85	09/09→06/12	←	→ 02/10	1	24.8190-0264.2	620264	L= 630
			←	→ 05/12; + Performance Parts	1	24.8190-0267.2	620267	L= 679
			←	03/10→	1	24.8190-0284.2	620284	L= 650
			→	→ 02/10	1	24.8190-0265.2	620265	L= 1.086
			→	03/10→	1	24.8190-0285.2	620285	L= 1.107
316 i	90	05/08→05/12	←	→ 02/10	1	24.8190-0264.2	620264	L= 630
			←	+ Performance Parts	1	24.8190-0267.2	620267	L= 679
			←	03/10→	1	24.8190-0284.2	620284	L= 650
			→	→ 02/10	1	24.8190-0265.2	620265	L= 1.086
			→	03/10→	1	24.8190-0285.2	620285	L= 1.107
↓								

	kW			 	! #		
<b>BMW - 3 Touring (E91) 12/04→12/12</b>							
<b>Warnkontakt, Bremsbelagverschleiß</b>							
318 d	90	09/05→08/07	←		1	24.8190-0264.2 620264	L= 630
320 d	110	12/04→08/07	←	+ Performance Parts	1	24.8190-0267.2 620267	L= 679
			→		1	24.8190-0265.2 620265	L= 1.086
318 d	100	07/07→06/12	←	→ 02/10	1	24.8190-0267.2 620267	L= 679
320 i	120	02/07→05/12	←	+ Performance Parts	1	24.8190-0267.2 620267	L= 679
320 i	125	02/07→12/12	←				
330 d	155	12/04→05/12	←	03/10→	1	24.8190-0287.2 620287	L= 723
330 d	180	02/08→05/12	←				
330 i	200	09/07→06/12	→	→ 02/10	1	24.8190-0265.2 620265	L= 1.086
			→	03/10→	1	24.8190-0285.2 620285	L= 1.107
318 d	105	09/07→06/12	←	→ 02/10	1	24.8190-0267.2 620267	L= 679
			←	→ 05/12; + Performance Parts	1	24.8190-0267.2 620267	L= 679
			←	03/10→ 05/12	1	24.8190-0287.2 620287	L= 723
			→	→ 02/10	1	24.8190-0265.2 620265	L= 1.086
			→	03/10→ 05/12	1	24.8190-0285.2 620285	L= 1.107
318 i	95	01/06→08/07	←	Motorcode: N46	1	24.8190-0264.2 620264	L= 630
			←	Motorcode: N46N	1	24.8190-0267.2 620267	L= 679
			←	+ Performance Parts	1	24.8190-0267.2 620267	L= 679
			→		1	24.8190-0265.2 620265	L= 1.086
318 i	100	09/07→03/12	←	→ 02/10; nicht für erhöhte Nutzlast	1	24.8190-0264.2 620264	L= 630
			←	+ Performance Parts	1	24.8190-0267.2 620267	L= 679
			←	→ 07/08; nicht für erhöhte Nutzlast; Motorcode: N46N	1	24.8190-0267.2 620267	L= 679
			←	→ 02/10; für erhöhte Nutzlast	1	24.8190-0267.2 620267	L= 679
			←	03/10→; nicht für erhöhte Nutzlast	1	24.8190-0284.2 620284	L= 650
			←	03/10→; für erhöhte Nutzlast	1	24.8190-0287.2 620287	L= 723
			→	→ 02/10	1	24.8190-0265.2 620265	L= 1.086
			→	03/10→	1	24.8190-0285.2 620285	L= 1.107
318 i	105	05/07→05/12	←	03/08→ 02/10; nicht für erhöhte Nutzlast	1	24.8190-0264.2 620264	L= 630
			←	+ Performance Parts	1	24.8190-0267.2 620267	L= 679
			←	→ 02/10; für erhöhte Nutzlast	1	24.8190-0267.2 620267	L= 679
			←	→ 02/08; nicht für erhöhte Nutzlast	1	24.8190-0267.2 620267	L= 679
			←	03/10→; nicht für erhöhte Nutzlast	1	24.8190-0284.2 620284	L= 650
			←	03/10→; für erhöhte Nutzlast	1	24.8190-0287.2 620287	L= 723
			→	→ 02/10	1	24.8190-0265.2 620265	L= 1.086
			→	03/10→	1	24.8190-0285.2 620285	L= 1.107
320 d	120	12/04→06/12	←	Motorcode: M47N2	1	24.8190-0264.2 620264	L= 630
			←	→ 02/10	1	24.8190-0267.2 620267	L= 679
			←	06/05→; + Performance Parts	1	24.8190-0267.2 620267	L= 679
			←	03/10→	1	24.8190-0287.2 620287	L= 723
			→	→ 02/10	1	24.8190-0265.2 620265	L= 1.086
			→	03/10→	1	24.8190-0285.2 620285	L= 1.107
320 d	130	02/07→12/10	←	für Behördenfahrzeuge	1	24.8190-0264.2 620264	L= 630
			←	+ Performance Parts	1	24.8190-0267.2 620267	L= 679
			←		1	24.8190-0267.2 620267	L= 679
			→		1	24.8190-0265.2 620265	L= 1.086
320 d	135	03/10→05/12	←	+ Performance Parts	1	24.8190-0267.2 620267	L= 679
320 d	147	03/10→05/12	←	für Behördenfahrzeuge	1	24.8190-0284.2 620284	L= 650
			←		1	24.8190-0287.2 620287	L= 723
			→		1	24.8190-0285.2 620285	L= 1.107
320 d	145	02/07→02/10	←	für Behördenfahrzeuge	1	24.8190-0264.2 620264	L= 630
			←	nicht für Behördenfahrzeuge	1	24.8190-0267.2 620267	L= 679
			←	+ Performance Parts	1	24.8190-0267.2 620267	L= 679
			→		1	24.8190-0265.2 620265	L= 1.086
320 d xDrive	120	07/09→06/12	←	→ 02/10	1	24.8190-0266.2 620266	L= 840
325 i xDrive	160	09/07→06/12					
↓							







	kW			 	! #		
<b>BMW - 3 Touring (E91) 12/04→12/12</b>							
<b>Warnkontakt, Bremsbelagverschleiß</b>							
330 d xDrive	180	01/09→06/12	←	+ Performance Parts	1	24.8190-0267.2 620267	L= 679
330 i xDrive	200	09/07→06/12	←	03/10→	1	24.8190-0286.2 620286	L= 867
330 xd	170	09/05→06/12	→	→ 02/10	1	24.8190-0265.2 620265	L= 1.086
330 xi	200	09/07→06/12	→	03/10→	1	24.8190-0285.2 620285	L= 1.107
320 d xDrive	130	02/08→02/10	←		1	24.8190-0266.2 620266	L= 840
320 d xDrive	145	02/08→02/10	→		1	24.8190-0265.2 620265	L= 1.086
320 d xDrive	135	03/10→05/12	←	+ Performance Parts	1	24.8190-0267.2 620267	L= 679
320 d xDrive	147	03/10→05/12	←		1	24.8190-0286.2 620286	L= 867
			→		1	24.8190-0285.2 620285	L= 1.107
320 i	110	09/05→06/12	←	→ 07/08; Motorcode: N46	1	24.8190-0264.2 620264	L= 630
			←	→ 07/08; + Performance Parts	1	24.8190-0267.2 620267	L= 679
			←	→ 02/10; Motorcode: N46N	1	24.8190-0267.2 620267	L= 679
			←	Motorcode: N46N; 03/10→	1	24.8190-0287.2 620287	L= 723
			→	→ 02/10	1	24.8190-0265.2 620265	L= 1.086
			→	03/10→	1	24.8190-0285.2 620285	L= 1.107
323 i	130	04/06→06/07	←	09/06→	1	24.8190-0267.2 620267	L= 679
			→	09/06→	1	24.8190-0265.2 620265	L= 1.086
323 i	140	09/06→07/08	←		1	24.8190-0267.2 620267	L= 679
335 xi	225	03/07→08/08	→		1	24.8190-0265.2 620265	L= 1.086
335 xi	240	03/07→08/08	→		1	24.8190-0265.2 620265	L= 1.086
325 d	145	09/06→06/12	←	→ 02/10; nicht für Behördenfahrzeuge	1	24.8190-0264.2 620264	L= 630
			←	→ 02/10; für Behördenfahrzeuge	1	24.8190-0267.2 620267	L= 679
			←	→ 05/12; + Performance Parts	1	24.8190-0267.2 620267	L= 679
			←	03/10→; nicht für Behördenfahrzeuge	1	24.8190-0284.2 620284	L= 650
			←	03/10→; für Behördenfahrzeuge	1	24.8190-0287.2 620287	L= 723
			→	→ 02/10	1	24.8190-0265.2 620265	L= 1.086
			→	03/10→ 05/12	1	24.8190-0285.2 620285	L= 1.107
325 d	150	02/10→06/12	←	→ 02/10; nicht für Behördenfahrzeuge	1	24.8190-0264.2 620264	L= 630
			←	→ 02/10; für Behördenfahrzeuge	1	24.8190-0267.2 620267	L= 679
			←	+ Performance Parts	1	24.8190-0267.2 620267	L= 679
			←	03/10→; nicht für Behördenfahrzeuge	1	24.8190-0284.2 620284	L= 650
			←	03/10→; für Behördenfahrzeuge	1	24.8190-0287.2 620287	L= 723
			→	→ 02/10	1	24.8190-0265.2 620265	L= 1.086
			→	03/10→	1	24.8190-0285.2 620285	L= 1.107
325 i	155	12/04→12/10	←	Motorcode: N53/N52N; → 02/10; für erhöhte Nutzlast	1	24.8190-0264.2 620264	L= 630
			←	Motorcode: N52	1	24.8190-0264.2 620264	L= 630
			←	+ Performance Parts	1	24.8190-0267.2 620267	L= 679
			←	→ 02/10; Motorcode: N52N/N53; nicht für erhöhte Nutzlast	1	24.8190-0267.2 620267	L= 679
			←	Motorcode: N52N/N53; für erhöhte Nutzlast; 03/10→	1	24.8190-0284.2 620284	L= 650
			←	03/10→; Motorcode: N52N/N53; nicht für erhöhte Nutzlast	1	24.8190-0287.2 620287	L= 723
			→	→ 02/10	1	24.8190-0265.2 620265	L= 1.086
			→	03/10→	1	24.8190-0285.2 620285	L= 1.107
325 i	160	12/04→12/12	←	→ 08/07; Motorcode: N52	1	24.8190-0264.2 620264	L= 630
			←	→ 08/07; Motorcode: N52N; für erhöhte Nutzlast	1	24.8190-0266.2 620266	L= 840
			←	06/05→; + Performance Parts	1	24.8190-0267.2 620267	L= 679
			←	→ 02/10; Motorcode: N52N/N53; nicht für erhöhte Nutzlast	1	24.8190-0267.2 620267	L= 679
			←	09/07→ 02/10; Motorcode: N53; für erhöhte Nutzlast	1	24.8190-0267.2 620267	L= 679
			←	03/10→; Motorcode: N53; für erhöhte Nutzlast	1	24.8190-0287.2 620287	L= 723
			←	03/10→; Motorcode: N52N/N53; nicht für erhöhte Nutzlast	1	24.8190-0287.2 620287	L= 723
			→	→ 02/10	1	24.8190-0265.2 620265	L= 1.086
↓							

















	kw			 	! #		
<b>BMW - 3 Touring (E91) 12/04→12/12</b>							
<b>Warnkontakt, Bremsbelagverschleiß</b>							
325 i	160	12/04→12/12	➡	03/10→	1	24.8190-0285.2 620285	L= 1.107
325 i	155	09/07→06/12	←	→ 02/10; für erhöhte Nutzlast	1	24.8190-0264.2 620264	L= 630
			←	→ 02/10; nicht für erhöhte Nutzlast	1	24.8190-0267.2 620267	L= 679
			←	03/10→; für erhöhte Nutzlast	1	24.8190-0284.2 620284	L= 650
			←	nicht für erhöhte Nutzlast; 03/10→	1	24.8190-0287.2 620287	L= 723
			➡	→ 02/10	1	24.8190-0265.2 620265	L= 1.086
			➡	03/10→	1	24.8190-0285.2 620285	L= 1.107
325 i	160	09/07→06/12	←	Motorcode: N52	1	24.8190-0264.2 620264	L= 630
			←	+ Performance Parts	1	24.8190-0267.2 620267	L= 679
			←	→ 02/10; Motorcode: N53; für erhöhte Nutzlast	1	24.8190-0267.2 620267	L= 679
			←	→ 02/10; Motorcode: N52N/N53; nicht für erhöhte Nutzlast	1	24.8190-0267.2 620267	L= 679
			←	03/10→ 05/12; Motorcode: N52N/N53; nicht für erhöhte Nutzlast	1	24.8190-0287.2 620287	L= 723
			←	03/10→ 05/12; Motorcode: N53; für erhöhte Nutzlast	1	24.8190-0287.2 620287	L= 723
			➡	→ 02/10	1	24.8190-0265.2 620265	L= 1.086
			➡	03/10→	1	24.8190-0285.2 620285	L= 1.107
325 xi	160	08/05→08/11	←	→ 02/10; Motorcode: N52/N53	1	24.8190-0266.2 620266	L= 840
			←	→ 02/10; für erhöhte Nutzlast; Motorcode: N52N	1	24.8190-0266.2 620266	L= 840
			←	→ 02/10; Motorcode: N52N; nicht für erhöhte Nutzlast	1	24.8190-0266.2 620266	L= 840
			←	+ Performance Parts	1	24.8190-0267.2 620267	L= 679
			←	03/10→; Motorcode: N52N; nicht für erhöhte Nutzlast	1	24.8190-0286.2 620286	L= 867
			←	02/10→; Motorcode: N25N; für erhöhte Nutzlast	1	24.8190-0286.2 620286	L= 867
			←	03/10→; Motorcode: N52/N53	1	24.8190-0286.2 620286	L= 867
			➡	→ 02/10; Motorcode: N52/N53	1	24.8190-0265.2 620265	L= 1.086
			➡	→ 02/10; Motorcode: N52N	1	24.8190-0265.2 620265	L= 1.086
			➡	03/10→; Motorcode: N52/N53/N25N	1	24.8190-0285.2 620285	L= 1.107
325 xi	160	09/07→06/12	←	Motorcode: N52/N53/N52N	1	24.8190-0266.2 620266	L= 840
			←	+ Performance Parts	1	24.8190-0267.2 620267	L= 679
			➡	Motorcode: N52/N53/N52N	1	24.8190-0265.2 620265	L= 1.086
330 d	170	12/04→08/08	←		1	24.8190-0264.2 620264	L= 630
						24.8190-0267.2 620267	L= 679
						24.8190-0284.2 620284	L= 650
			←	+ Performance Parts	1	24.8190-0267.2 620267	L= 679
			➡		1	24.8190-0265.2 620265	L= 1.086
330 i	190	08/05→08/07	←		1	24.8190-0264.2 620264	L= 630
						24.8190-0284.2 620284	L= 650
			←	+ Performance Parts	1	24.8190-0267.2 620267	L= 679
			➡		1	24.8190-0265.2 620265	L= 1.086
330 xi	190	09/05→08/07	←		1	24.8190-0266.2 620266	L= 840
			←	+ Performance Parts	1	24.8190-0267.2 620267	L= 679
			➡		1	24.8190-0265.2 620265	L= 1.086
335 d 335 i 335 i xDrive	210 240 240	09/06→06/12	←	→ 02/10	1	24.8190-0267.2 620267	L= 679
			←	03/10→	1	24.8190-0287.2 620287	L= 723
			➡	→ 02/10	1	24.8190-0265.2 620265	L= 1.086
			➡	03/10→	1	24.8190-0285.2 620285	L= 1.107
335 i	225	09/06→06/12	←	→ 02/10	1	24.8190-0267.2 620267	L= 679
			←	03/10→		24.8190-0287.2 620287	L= 723
			➡	→ 02/10	1	24.8190-0265.2 620265	L= 1.086
			➡	03/10→	1	24.8190-0285.2 620285	L= 1.107
335 i xDrive	225	09/08→06/12	←	→ 02/10	1	24.8190-0266.2 620266	L= 840
			←	03/10→	1	24.8190-0286.2 620286	L= 867
↓							









	kw			 	! #		
<b>BMW - 3 Touring (E91) 12/04→12/12</b>							
<b>Warnkontakt, Bremsbelagverschleiß</b>							
335 i xDrive	225	09/08→06/12	➡	→ 02/10	1	24.8190-0265.2 620265	L= 1.086
			➡	03/10→	1	24.8190-0285.2 620285	L= 1.107
<b> Bremsscheibe</b>							
316 d	85	09/09→06/12	←			24.0124-0197.1 424197	Ø 300 24 22,4 V + S
						24.0324-0197.1 524197	Ø 300 24 21,6 V + S
			➡			24.0120-0195.1 420195	Ø 300 20 18,4 V + S
			➡	für erhöhte Nutzlast		24.0320-0195.1 520195	Ø 300 20 17,6 V + S
316 i	90	05/08→05/12	←			24.0124-0197.1 424197	Ø 300 24 22,4 V + S
						24.0324-0197.1 524197	Ø 300 24 21,6 V + S
			➡	10/09→		24.0120-0195.1 420195	Ø 300 20 18,4 V + S
			➡	→ 09/09		24.0320-0195.1 520195	Ø 300 20 17,6 V + S
318 d	90	09/05→08/07	←			24.0124-0197.1 424197	Ø 300 24 22,4 V + S
						24.0324-0197.1 524197	Ø 300 24 21,6 V + S
			➡			24.0120-0204.1 420204	Ø 300 20 18,4 V + S
			➡			24.0320-0204.1 520204	Ø 300 20 17,6 V + S
318 d	100	07/07→06/12	←			24.0124-0203.1 424203	Ø 312 23,9 22,4 V + S
						24.0324-0203.1 524203	Ø 312 23,9 21,6 V + S
			➡	10/09→		24.0120-0195.1 420195	Ø 300 20 18,4 V + S
			➡	→ 09/09		24.0320-0195.1 520195	Ø 300 20 17,6 V + S
318 d	105	09/07→06/12	←			24.0124-0203.1 424203	Ø 312 23,9 22,4 V + S
						24.0324-0203.1 524203	Ø 312 23,9 21,6 V + S
			➡	10/09→		24.0120-0195.1 420195	Ø 300 20 18,4 V + S
			➡	→ 09/09		24.0320-0195.1 520195	Ø 300 20 17,6 V + S
318 i	95	01/06→08/07	←			24.0124-0197.1 424197	Ø 300 24 22,4 V + S
						24.0324-0197.1 524197	Ø 300 24 21,6 V + S
			←	Motorcode: N46N		24.0124-0203.1 424203	Ø 312 23,9 22,4 V + S
						24.0324-0203.1 524203	Ø 312 23,9 21,6 V + S
318 i	100	09/07→03/12	←	nicht für erhöhte Nutzlast		24.0120-0204.1 420204	Ø 300 20 18,4 V + S
						24.0320-0204.1 520204	Ø 300 20 17,6 V + S
			←	für erhöhte Nutzlast		24.0124-0203.1 424203	Ø 312 23,9 22,4 V + S
						24.0324-0203.1 524203	Ø 312 23,9 21,6 V + S
318 i	105	05/07→05/12	←	→ 07/08; nicht für erhöhte Nutzlast; Motorcode: N46N		24.0124-0203.1 424203	Ø 312 23,9 22,4 V + S
						24.0324-0203.1 524203	Ø 312 23,9 21,6 V + S
			➡	10/09→		24.0120-0195.1 420195	Ø 300 20 18,4 V + S
			➡	→ 09/09		24.0320-0195.1 520195	Ø 300 20 17,6 V + S
318 i	105	05/07→05/12	←	03/08→; nicht für erhöhte Nutzlast		24.0124-0197.1 424197	Ø 300 24 22,4 V + S
						24.0324-0197.1 524197	Ø 300 24 21,6 V + S
			←	→ 02/08; nicht für erhöhte Nutzlast		24.0124-0203.1 424203	Ø 312 23,9 22,4 V + S
						24.0324-0203.1 524203	Ø 312 23,9 21,6 V + S
320 d	110	12/04→08/07	←	nicht für Behördenfahrzeuge		24.0124-0203.1 424203	Ø 312 23,9 22,4 V + S
						24.0324-0203.1 524203	Ø 312 23,9 21,6 V + S
			➡	10/09→		24.0120-0195.1 420195	Ø 300 20 18,4 V + S
			➡	→ 09/09		24.0320-0195.1 520195	Ø 300 20 17,6 V + S
↓			←			24.0120-0204.1 420204	Ø 300 20 18,4 V + S
						24.0320-0204.1 520204	Ø 300 20 17,6 V + S











	kw			 	! #					
<b>BMW - 3 Touring (E91) 12/04→12/12</b>										
<b>Bremsscheibe</b>										
320 d	110	12/04→08/07	←	nicht für Behördenfahrzeuge	24.0324-0197.1	524197	Ø 300 24 21,6 V + S			
			←	für Behördenfahrzeuge	24.0124-0200.1	424200	Ø 330 24 22,4 V + S			
					24.0324-0200.1	524200	Ø 330 24 21,6 V + S			
			→	nicht für Behördenfahrzeuge	24.0120-0204.1	420204	Ø 300 20 18,4 V + S			
			→	für Behördenfahrzeuge	24.0320-0204.1	520204	Ø 300 20 17,6 V + S			
320 d	120	12/04→06/12	←	nicht für Behördenfahrzeuge; Motorcode: M47N2	24.0124-0197.1	424197	Ø 300 24 22,4 V + S			
			←	für Behördenfahrzeuge	24.0124-0200.1	424200	Ø 330 24 22,4 V + S			
					24.0324-0200.1	524200	Ø 330 24 21,6 V + S			
			←	nicht für Behördenfahrzeuge	24.0124-0203.1	424203	Ø 312 23,9 22,4 V + S			
					24.0324-0197.1	524197	Ø 300 24 21,6 V + S			
		24.0324-0203.1	524203	Ø 312 23,9 21,6 V + S						
320 d	130	02/07→12/10	←	für Behördenfahrzeuge	24.0124-0200.1	424200	Ø 330 24 22,4 V + S			
			320 d	145	02/07→02/10	←	nicht für Behördenfahrzeuge	24.0124-0203.1	424203	Ø 312 23,9 22,4 V + S
								24.0324-0203.1	524203	Ø 312 23,9 21,6 V + S
			→	10/09→; nicht für Behördenfahrzeuge	24.0120-0195.1	420195	Ø 300 20 18,4 V + S			
					24.0320-0195.1	520195	Ø 300 20 17,6 V + S			
→	→ 09/09; nicht für Behördenfahrzeuge	24.0120-0204.1	420204	Ø 300 20 18,4 V + S						
		24.0320-0204.1	520204	Ø 300 20 17,6 V + S						
→	für Behördenfahrzeuge	24.0122-0236.1	422236	Ø 336 22 20,4 V + S						
		24.0322-0236.1	522236	Ø 336 22 19,6 V + S						
320 d	135	03/10→05/12	←	für Behördenfahrzeuge	24.0124-0200.1	424200	Ø 330 24 22,4 V + S			
			←	nicht für Behördenfahrzeuge	24.0124-0203.1	424203	Ø 312 23,9 22,4 V + S			
					24.0324-0203.1	524203	Ø 312 23,9 21,6 V + S			
			→	nicht für Behördenfahrzeuge	24.0120-0195.1	420195	Ø 300 20 18,4 V + S			
					24.0320-0195.1	520195	Ø 300 20 17,6 V + S			
→	für Behördenfahrzeuge	24.0122-0236.1	422236	Ø 336 22 20,4 V + S						
		24.0322-0236.1	522236	Ø 336 22 19,6 V + S						
320 d	147	03/10→05/12	←	für Behördenfahrzeuge	24.0124-0200.1	424200	Ø 330 24 22,4 V + S			
			←	nicht für Behördenfahrzeuge	24.0124-0203.1	424203	Ø 312 23,9 22,4 V + S			
					24.0324-0203.1	524203	Ø 312 23,9 21,6 V + S			
			→	nicht für Behördenfahrzeuge	24.0120-0195.1	420195	Ø 300 20 18,4 V + S			
					24.0320-0195.1	520195	Ø 300 20 17,6 V + S			
→	für erhöhte Nutzlast	24.0120-0204.1	420204	Ø 300 20 18,4 V + S						
		24.0320-0204.1	520204	Ø 300 20 17,6 V + S						
→	für Behördenfahrzeuge	24.0122-0236.1	422236	Ø 336 22 20,4 V + S						
		24.0322-0236.1	522236	Ø 336 22 19,6 V + S						
320 d xDrive 320 d xDrive 320 d xDrive 320 d xDrive 320 d xDrive	120	07/09→06/12	←	für Behördenfahrzeuge	24.0124-0200.1	424200	Ø 330 24 22,4 V + S			
	130	02/08→02/10			24.0324-0200.1	524200	Ø 330 24 21,6 V + S			
	135	03/10→05/12	←	nicht für Behördenfahrzeuge	24.0124-0203.1	424203	Ø 312 23,9 22,4 V + S			
	145	02/08→02/10	←	nicht für Behördenfahrzeuge	24.0324-0203.1	524203	Ø 312 23,9 21,6 V + S			
	147	03/10→05/12	→	nicht für Behördenfahrzeuge	24.0120-0204.1	420204	Ø 300 20 18,4 V + S			
				24.0320-0204.1	520204	Ø 300 20 17,6 V + S				
→	für Behördenfahrzeuge	24.0122-0236.1	422236	Ø 336 22 20,4 V + S						
		24.0322-0236.1	522236	Ø 336 22 19,6 V + S						
320 i	110	09/05→06/12	←	→ 07/08; Motorcode: N46	24.0124-0197.1	424197	Ø 300 24 22,4 V + S			
					24.0324-0197.1	524197	Ø 300 24 21,6 V + S			
			←	Motorcode: N46N	24.0124-0203.1	424203	Ø 312 23,9 22,4 V + S			
		24.0324-0203.1	524203	Ø 312 23,9 21,6 V + S						
→		24.0120-0204.1	420204	Ø 300 20 18,4 V + S						
		24.0320-0204.1	520204	Ø 300 20 17,6 V + S						
323 i ↓	130	04/06→06/07	←	09/06→	24.0124-0203.1	424203	Ø 312 23,9 22,4 V + S			









	kw			 	! #		
<b>BMW - 3 Touring (E91) 12/04→12/12</b>							
<b>Bremsscheibe</b>							
323 i	130	04/06→06/07	←	09/06→		24.0324-0203.1 524203	Ø 312 23,9 21,6 V + S
			→	09/06→		24.0120-0204.1 420204	Ø 300 20 18,4 V + S
						24.0320-0204.1 520204	Ø 300 20 17,6 V + S
323 i	140	09/06→07/08	←			24.0124-0203.1 424203	Ø 312 23,9 22,4 V + S
			→			24.0324-0203.1 524203	Ø 312 23,9 21,6 V + S
						24.0120-0204.1 420204	Ø 300 20 18,4 V + S
					24.0320-0204.1 520204	Ø 300 20 17,6 V + S	
325 d 325 d	145 150	09/06→06/12 02/10→06/12	←	nicht für Behördenfahrzeuge		24.0124-0200.1 424200	Ø 330 24 22,4 V + S
			→			24.0324-0200.1 524200	Ø 330 24 21,6 V + S
			←	für Behördenfahrzeuge		24.0130-0192.1 430192	Ø 348 30 28,4 V + S
			→			24.0122-0236.1 422236	Ø 336 22 20,4 V + S
					24.0322-0236.1 522236	Ø 336 22 19,6 V + S	
325 i 325 i	155 160	12/04→12/10 12/04→12/12	←	nicht für erhöhte Nutzlast; Motorcode: N52		24.0124-0197.1 424197	Ø 300 24 22,4 V + S
			→			24.0324-0197.1 524197	Ø 300 24 21,6 V + S
			←	für erhöhte Nutzlast		24.0124-0200.1 424200	Ø 330 24 22,4 V + S
			→			24.0324-0200.1 524200	Ø 330 24 21,6 V + S
			←	Motorcode: N52N/N53; nicht für erhöhte Nutzlast		24.0124-0203.1 424203	Ø 312 23,9 22,4 V + S
			→			24.0324-0203.1 524203	Ø 312 23,9 21,6 V + S
			→			24.0120-0195.1 420195	Ø 300 20 18,4 V + S
			→	nicht für erhöhte Nutzlast		24.0320-0195.1 520195	Ø 300 20 17,6 V + S
					24.0120-0204.1 420204	Ø 300 20 18,4 V + S	
					24.0320-0204.1 520204	Ø 300 20 17,6 V + S	
					24.0122-0236.1 422236	Ø 336 22 20,4 V + S	
					24.0322-0236.1 522236	Ø 336 22 19,6 V + S	
325 i	155	09/07→06/12	←	für erhöhte Nutzlast		24.0124-0200.1 424200	Ø 330 24 22,4 V + S
			→			24.0324-0200.1 524200	Ø 330 24 21,6 V + S
			←	nicht für erhöhte Nutzlast		24.0124-0203.1 424203	Ø 312 23,9 22,4 V + S
			→			24.0324-0203.1 524203	Ø 312 23,9 21,6 V + S
			→	nicht für erhöhte Nutzlast		24.0120-0204.1 420204	Ø 300 20 18,4 V + S
					24.0320-0204.1 520204	Ø 300 20 17,6 V + S	
					24.0122-0236.1 422236	Ø 336 22 20,4 V + S	
					24.0322-0236.1 522236	Ø 336 22 19,6 V + S	
325 i	160	09/07→06/12	←	nicht für erhöhte Nutzlast; Motorcode: N52		24.0124-0197.1 424197	Ø 300 24 22,4 V + S
			→			24.0324-0197.1 524197	Ø 300 24 21,6 V + S
			←	für erhöhte Nutzlast		24.0124-0200.1 424200	Ø 330 24 22,4 V + S
			→			24.0324-0200.1 524200	Ø 330 24 21,6 V + S
			←	Motorcode: N52N/N53; nicht für erhöhte Nutzlast		24.0124-0203.1 424203	Ø 312 23,9 22,4 V + S
			→			24.0324-0203.1 524203	Ø 312 23,9 21,6 V + S
					24.0120-0204.1 420204	Ø 300 20 18,4 V + S	
					24.0320-0204.1 520204	Ø 300 20 17,6 V + S	
					24.0122-0236.1 422236	Ø 336 22 20,4 V + S	
					24.0322-0236.1 522236	Ø 336 22 19,6 V + S	
325 i xDrive 325 xi 325 xi	160 160 160	09/07→06/12 08/05→08/11 09/07→06/12	←	Motorcode: N52N; für erhöhte Nutzlast		24.0124-0200.1 424200	Ø 330 24 22,4 V + S
			→			24.0324-0200.1 524200	Ø 330 24 21,6 V + S
			←	Motorcode: N52/N53		24.0124-0200.1 424200	Ø 330 24 22,4 V + S
			→			24.0324-0200.1 524200	Ø 330 24 21,6 V + S
			←	Motorcode: N52N; nicht für erhöhte Nutzlast		24.0124-0203.1 424203	Ø 312 23,9 22,4 V + S
			→			24.0324-0203.1 524203	Ø 312 23,9 21,6 V + S
			→	Motorcode: N52N; nicht für erhöhte Nutzlast		24.0120-0204.1 420204	Ø 300 20 18,4 V + S
			→	Motorcode: N52N; für erhöhte Nutzlast		24.0320-0204.1 520204	Ø 300 20 17,6 V + S
					24.0122-0236.1 422236	Ø 336 22 20,4 V + S	
					24.0322-0236.1 522236	Ø 336 22 19,6 V + S	
					24.0122-0236.1 422236	Ø 336 22 20,4 V + S	
					24.0322-0236.1 522236	Ø 336 22 19,6 V + S	
330 d	155	12/04→05/12	←	→ 08/07		24.0124-0200.1 424200	Ø 330 24 22,4 V + S
			→			24.0324-0200.1 524200	Ø 330 24 21,6 V + S
			←	10/09→		24.0124-0200.1 424200	Ø 330 24 22,4 V + S
			→			24.0324-0200.1 524200	Ø 330 24 21,6 V + S
			←	09/07→ 09/09		24.0130-0192.1 430192	Ø 348 30 28,4 V + S
					24.0122-0236.1 422236	Ø 336 22 20,4 V + S	
					24.0322-0236.1 522236	Ø 336 22 19,6 V + S	







	kW			 	! #		
<b>BMW - 3 Touring (E91) 12/04→12/12</b>							
<b>Bremsscheibe</b>							
330 d	170	12/04→08/08	←	→ 08/07		24.0124-0200.1 424200	Ø 330 24 22,4 V + S
						24.0324-0200.1 524200	Ø 330 24 21,6 V + S
			←	09/07→		24.0130-0192.1 430192	Ø 348 30 28,4 V + S
			→			24.0122-0236.1 422236	Ø 336 22 20,4 V + S
						24.0322-0236.1 522236	Ø 336 22 19,6 V + S
330 d 330 d xDrive	180 180	02/08→05/12 01/09→06/12	←	10/09→; nicht für erhöhte Nutzlast		24.0124-0200.1 424200	Ø 330 24 22,4 V + S
						24.0324-0200.1 524200	Ø 330 24 21,6 V + S
			←	→ 09/09; nicht für erhöhte Nutzlast		24.0130-0192.1 430192	Ø 348 30 28,4 V + S
			←	für erhöhte Nutzlast		24.0130-0192.1 430192	Ø 348 30 28,4 V + S
			→			24.0122-0236.1 422236	Ø 336 22 20,4 V + S
						24.0322-0236.1 522236	Ø 336 22 19,6 V + S
330 i 330 xi	190 190	08/05→08/07 09/05→08/07	←			24.0124-0200.1 424200	Ø 330 24 22,4 V + S
						24.0324-0200.1 524200	Ø 330 24 21,6 V + S
			→			24.0122-0236.1 422236	Ø 336 22 20,4 V + S
						24.0322-0236.1 522236	Ø 336 22 19,6 V + S
330 i 330 i xDrive 330 xi	200 200 200	09/07→06/12 09/07→06/12 09/07→06/12	←	10/09→		24.0124-0200.1 424200	Ø 330 24 22,4 V + S
						24.0324-0200.1 524200	Ø 330 24 21,6 V + S
			←	→ 09/09		24.0130-0192.1 430192	Ø 348 30 28,4 V + S
			→			24.0122-0236.1 422236	Ø 336 22 20,4 V + S
						24.0322-0236.1 522236	Ø 336 22 19,6 V + S
330 xd	170	09/05→06/12	←			24.0124-0200.1 424200	Ø 330 24 22,4 V + S
						24.0130-0192.1 430192	Ø 348 30 28,4 V + S
						24.0324-0200.1 524200	Ø 330 24 21,6 V + S
			→			24.0122-0236.1 422236	Ø 336 22 20,4 V + S
						24.0322-0236.1 522236	Ø 336 22 19,6 V + S
335 d 335 i 335 i 335 i xDrive 335 i xDrive 335 xi 335 xi	210 225 240 225 240 225 240	09/06→06/12 09/06→06/12 09/06→06/12 09/08→06/12 09/08→06/12 03/07→08/08 03/07→08/08	←			24.0130-0192.1 430192	Ø 348 30 28,4 V + S
			→			24.0122-0236.1 422236	Ø 336 22 20,4 V + S
						24.0322-0236.1 522236	Ø 336 22 19,6 V + S
<b>BMW - 3 Touring (F31) 07/11→</b>							
<b>Bremsbelagsatz, Scheibenbremse</b>							
316 d 318 d 318 d	85 100 105	02/12→ 07/11→ 07/11→06/15	←	05/12→; - Performance Parts		13.0460-3866.2 603866	BOS 25506 18,2 + WE / - WK
						13.0470-3866.2 LD3866	BOS 25506 18,2 + WE / - WK Ceramic
			←	05/12→; + Performance Parts		13.0460-4875.2 604875	BRE 25028 18,0 + WE / - WK
						13.0470-4875.2 LD4875	BRE 25028 18,0 + WE / - WK Ceramic
			→	05/12→; - Performance Parts		13.0460-3859.2 603859	BOS 25307 17,5 + WE / - WK
						13.0470-3859.2 LD3859	BOS 25307 17,5 + WE / - WK Ceramic
			→	05/12→; + Performance Parts		13.0460-4874.2 604874	BRE 25029 16,7 + WE / - WK
316 i	100	03/12→08/16	←	03/13→; - Performance Parts		13.0460-3866.2 603866	BOS 25506 18,2 + WE / - WK
						13.0470-3866.2 LD3866	BOS 25506 18,2 + WE / - WK Ceramic
			←	03/13→; + Performance Parts		13.0460-4875.2 604875	BRE 25028 18,0 + WE / - WK
						13.0470-4875.2 LD4875	BRE 25028 18,0 + WE / - WK Ceramic
			→	03/13→; - Performance Parts		13.0460-3859.2 603859	BOS 25307 17,5 + WE / - WK
						13.0470-3859.2 LD3859	BOS 25307 17,5 + WE / - WK Ceramic
			→	03/13→; + Performance Parts		13.0460-4874.2 604874	BRE 25029 16,7 + WE / - WK
318 d 318 d xDrive 318 i	110 110 100	09/14→ 03/15→ 01/15→	←	07/15→; - Performance Parts		13.0460-3866.2 603866	BOS 25506 18,2 + WE / - WK
						13.0470-3866.2 LD3866	BOS 25506 18,2 + WE / - WK Ceramic
			←	07/15→; + Performance Parts		13.0460-4875.2 604875	BRE 25028 18,0 + WE / - WK
						13.0470-4875.2 LD4875	BRE 25028 18,0 + WE / - WK Ceramic
			→	07/15→; - Performance Parts		13.0460-3859.2 603859	BOS 25307 17,5 + WE / - WK
						13.0470-3859.2 LD3859	BOS 25307 17,5 + WE / - WK Ceramic
↓							







	kw			 	! #		
<b>BMW - 3 Touring (F31) 07/11→</b>							
<b> Bremsbelagsatz, Scheibenbremse</b>							
318 d 318 d xDrive 318 i	110 110 100	09/14→ 03/15→ 01/15→	➡	07/15→; + Performance Parts		13.0460-4874.2 604874	BRE 25029 16,7 + WE / - WK
318 d xDrive	105	01/13→05/15	←	05/13→; - Performance Parts		13.0460-3866.2 603866 13.0470-3866.2 LD3866	BOS 25506 18,2 + WE / - WK BOS 25506 18,2 + WE / - WK Ceramic
			←	05/13→; + Performance Parts		13.0460-4875.2 604875 13.0470-4875.2 LD4875	BRE 25028 18,0 + WE / - WK BRE 25028 18,0 + WE / - WK Ceramic
			➡	05/13→; - Performance Parts		13.0460-3859.2 603859 13.0470-3859.2 LD3859	BOS 25307 17,5 + WE / - WK BOS 25307 17,5 + WE / - WK Ceramic
			➡	05/13→; + Performance Parts		13.0460-4874.2 604874	BRE 25029 16,7 + WE / - WK
320 d	120	07/11→	←	05/12→; - Performance Parts		13.0460-3857.2 603857 13.0470-3857.2 LD3857	BOS 25199 19,6 + WE / - WK BOS 25199 19,6 + WE / - WK Ceramic
			←	+ Performance Parts		13.0460-4875.2 604875 13.0470-4875.2 LD4875	BRE 25028 18,0 + WE / - WK BRE 25028 18,0 + WE / - WK Ceramic
			➡	05/12→; - Performance Parts		13.0460-3859.2 603859 13.0470-3859.2 LD3859	BOS 25307 17,5 + WE / - WK BOS 25307 17,5 + WE / - WK Ceramic
			➡	+ Performance Parts		13.0460-4874.2 604874	BRE 25029 16,7 + WE / - WK
320 d 320 d	135 147	07/11→02/16 07/11→02/16	←	05/12→; - Performance Parts		13.0460-3857.2 603857 13.0470-3857.2 LD3857	BOS 25199 19,6 + WE / - WK BOS 25199 19,6 + WE / - WK Ceramic
			←	05/12→; + Performance Parts		13.0460-4875.2 604875 13.0470-4875.2 LD4875	BRE 25028 18,0 + WE / - WK BRE 25028 18,0 + WE / - WK Ceramic
			←	05/12→; für Fahrzeuge mit verstärkter Bremse		13.0460-4875.2 604875 13.0470-4875.2 LD4875	BRE 25028 18,0 + WE / - WK BRE 25028 18,0 + WE / - WK Ceramic
			➡	05/12→; - Performance Parts		13.0460-3859.2 603859 13.0470-3859.2 LD3859	BOS 25307 17,5 + WE / - WK BOS 25307 17,5 + WE / - WK Ceramic
			➡	05/12→; + Performance Parts		13.0460-4874.2 604874	BRE 25029 16,7 + WE / - WK
320 d	140	09/14→	←	07/15→; - Performance Parts		13.0460-3857.2 603857 13.0470-3857.2 LD3857	BOS 25199 19,6 + WE / - WK BOS 25199 19,6 + WE / - WK Ceramic
			←	07/15→; + Performance Parts		13.0460-4875.2 604875 13.0470-4875.2 LD4875	BRE 25028 18,0 + WE / - WK BRE 25028 18,0 + WE / - WK Ceramic
			←	07/15→; für Fahrzeuge mit verstärkter Bremse		13.0460-4875.2 604875 13.0470-4875.2 LD4875	BRE 25028 18,0 + WE / - WK BRE 25028 18,0 + WE / - WK Ceramic
			➡	07/15→; - Performance Parts		13.0460-3859.2 603859 13.0470-3859.2 LD3859	BOS 25307 17,5 + WE / - WK BOS 25307 17,5 + WE / - WK Ceramic
			➡	07/15→; + Performance Parts		13.0460-4874.2 604874	BRE 25029 16,7 + WE / - WK
320 d xDrive 320 d xDrive 320 d xDrive	120 135 147	01/12→ 01/12→06/15 01/12→06/15	←	03/13→; - Performance Parts		13.0460-3857.2 603857 13.0470-3857.2 LD3857	BOS 25199 19,6 + WE / - WK BOS 25199 19,6 + WE / - WK Ceramic
			←	03/13→; + Performance Parts		13.0460-4875.2 604875 13.0470-4875.2 LD4875	BRE 25028 18,0 + WE / - WK BRE 25028 18,0 + WE / - WK Ceramic
			←	03/13→; für Fahrzeuge mit verstärkter Bremse		13.0460-4875.2 604875 13.0470-4875.2 LD4875	BRE 25028 18,0 + WE / - WK BRE 25028 18,0 + WE / - WK Ceramic
			➡	03/13→; - Performance Parts		13.0460-3859.2 603859 13.0470-3859.2 LD3859	BOS 25307 17,5 + WE / - WK BOS 25307 17,5 + WE / - WK Ceramic
			➡	03/13→; + Performance Parts		13.0460-4874.2 604874	BRE 25029 16,7 + WE / - WK
320 d xDrive	140	07/15→	←	- Performance Parts		13.0460-3857.2 603857 13.0470-3857.2 LD3857	BOS 25199 19,6 + WE / - WK BOS 25199 19,6 + WE / - WK Ceramic
			←	für Fahrzeuge mit verstärkter Bremse		13.0460-4875.2 604875	BRE 25028 18,0 + WE / - WK







	kw			 	! #			
<b>BMW - 3 Touring (F31) 07/11→</b>								
<b> Bremsbelagsatz, Scheibenbremse</b>								
320 d xDrive	140	07/15→	←	für Fahrzeuge mit verstärkter Bremse		<b>13.0470-4875.2</b>	<b>LD4875</b>	BRE 25028 18,0 + WE / - WK Ceramic
			←	+ Performance Parts		<b>13.0460-4875.2</b>	<b>604875</b>	BRE 25028 18,0 + WE / - WK
			→	- Performance Parts		<b>13.0460-3859.2</b>	<b>603859</b>	BOS 25307 17,5 + WE / - WK
			→	+ Performance Parts		<b>13.0470-3859.2</b>	<b>LD3859</b>	BOS 25307 17,5 + WE / - WK Ceramic
320 i 320 i 320 i 320 i xDrive 320 i xDrive 320 i xDrive	120 135 135 120 135 135	02/12→06/15 02/12→06/15 10/14→ 01/12→06/15 01/12→06/15 09/14→	←	- Performance Parts		<b>13.0460-3866.2</b>	<b>603866</b>	BOS 25506 18,2 + WE / - WK
			←	+ Performance Parts		<b>13.0470-3866.2</b>	<b>LD3866</b>	BOS 25506 18,2 + WE / - WK Ceramic
			→	- Performance Parts		<b>13.0460-3859.2</b>	<b>603859</b>	BOS 25307 17,5 + WE / - WK
			→	+ Performance Parts		<b>13.0470-3859.2</b>	<b>LD3859</b>	BOS 25307 17,5 + WE / - WK Ceramic
325 d 325 d	155 160	09/12→02/16 09/12→02/16	←	04/13→; - Performance Parts		<b>13.0460-3857.2</b>	<b>603857</b>	BOS 25199 19,6 + WE / - WK
			←	04/13→; + Performance Parts		<b>13.0470-3857.2</b>	<b>LD3857</b>	BOS 25199 19,6 + WE / - WK Ceramic
			←	04/13→; für Fahrzeuge mit verstärkter Bremse		<b>13.0460-4875.2</b>	<b>604875</b>	BRE 25028 18,0 + WE / - WK
			→	04/13→; - Performance Parts		<b>13.0470-4875.2</b>	<b>LD4875</b>	BRE 25028 18,0 + WE / - WK Ceramic
325 d	165	04/15→	→	04/13→; + Performance Parts		<b>13.0460-3859.2</b>	<b>603859</b>	BOS 25307 17,5 + WE / - WK
			→	04/13→; - Performance Parts		<b>13.0470-3859.2</b>	<b>LD3859</b>	BOS 25307 17,5 + WE / - WK Ceramic
			→	04/13→; + Performance Parts		<b>13.0460-4874.2</b>	<b>604874</b>	BRE 25029 16,7 + WE / - WK
			→	04/13→; - Performance Parts		<b>13.0470-3857.2</b>	<b>LD3857</b>	BOS 25199 19,6 + WE / - WK
325 d	165	04/15→	←	03/16→; - Performance Parts		<b>13.0460-3857.2</b>	<b>603857</b>	BOS 25199 19,6 + WE / - WK
			←	03/16→; + Performance Parts		<b>13.0470-3857.2</b>	<b>LD3857</b>	BOS 25199 19,6 + WE / - WK Ceramic
			←	03/16→; für Fahrzeuge mit verstärkter Bremse		<b>13.0460-4875.2</b>	<b>604875</b>	BRE 25028 18,0 + WE / - WK
			→	03/16→; - Performance Parts		<b>13.0470-4875.2</b>	<b>LD4875</b>	BRE 25028 18,0 + WE / - WK Ceramic
328 i	180	01/12→06/15	→	03/16→; + Performance Parts		<b>13.0460-3859.2</b>	<b>603859</b>	BOS 25307 17,5 + WE / - WK
			→	03/16→; - Performance Parts		<b>13.0470-3859.2</b>	<b>LD3859</b>	BOS 25307 17,5 + WE / - WK Ceramic
			→	03/16→; + Performance Parts		<b>13.0460-4874.2</b>	<b>604874</b>	BRE 25029 16,7 + WE / - WK
			→	03/16→; - Performance Parts		<b>13.0470-3857.2</b>	<b>LD3857</b>	BOS 25199 19,6 + WE / - WK
328 i	180	01/12→06/15	←	05/12→; - Performance Parts		<b>13.0460-3857.2</b>	<b>603857</b>	BOS 25199 19,6 + WE / - WK
			←	05/12→; + Performance Parts		<b>13.0470-3857.2</b>	<b>LD3857</b>	BOS 25199 19,6 + WE / - WK Ceramic
			→	05/12→; - Performance Parts		<b>13.0460-4875.2</b>	<b>604875</b>	BRE 25028 18,0 + WE / - WK
			→	05/12→; + Performance Parts		<b>13.0470-4875.2</b>	<b>LD4875</b>	BRE 25028 18,0 + WE / - WK Ceramic
328 i xDrive	180	06/12→06/16	→	05/12→; - Performance Parts		<b>13.0460-3859.2</b>	<b>603859</b>	BOS 25307 17,5 + WE / - WK
			→	05/12→; + Performance Parts		<b>13.0470-3859.2</b>	<b>LD3859</b>	BOS 25307 17,5 + WE / - WK Ceramic
			→	05/12→; - Performance Parts		<b>13.0460-4874.2</b>	<b>604874</b>	BRE 25029 16,7 + WE / - WK
			→	05/12→; + Performance Parts		<b>13.0470-3857.2</b>	<b>LD3857</b>	BOS 25199 19,6 + WE / - WK
328 i xDrive	180	06/12→06/16	←	03/13→; - Performance Parts		<b>13.0460-3857.2</b>	<b>603857</b>	BOS 25199 19,6 + WE / - WK
			←	03/13→; + Performance Parts		<b>13.0470-3857.2</b>	<b>LD3857</b>	BOS 25199 19,6 + WE / - WK Ceramic
			→	03/13→; - Performance Parts		<b>13.0460-4875.2</b>	<b>604875</b>	BRE 25028 18,0 + WE / - WK
			→	03/13→; + Performance Parts		<b>13.0470-4875.2</b>	<b>LD4875</b>	BRE 25028 18,0 + WE / - WK Ceramic
328 i xDrive	180	06/12→06/16	→	03/13→; - Performance Parts		<b>13.0460-3859.2</b>	<b>603859</b>	BOS 25307 17,5 + WE / - WK
			→	03/13→; + Performance Parts		<b>13.0470-3859.2</b>	<b>LD3859</b>	BOS 25307 17,5 + WE / - WK Ceramic
			→	03/13→; - Performance Parts		<b>13.0460-4874.2</b>	<b>604874</b>	BRE 25029 16,7 + WE / - WK
			→	03/13→; + Performance Parts		<b>13.0470-3857.2</b>	<b>LD3857</b>	BOS 25199 19,6 + WE / - WK
↓								











	kW			 	! #		
<b>BMW - 3 Touring (F31) 07/11→</b>							
<b> Bremsbelagsatz, Scheibenbremse</b>							
330 d	190	01/12→	←	05/12→; - Performance Parts		<b>13.0460-3857.2 603857</b> <b>13.0470-3857.2 LD3857</b>	BOS 25199 19,6 + WE / - WK BOS 25199 19,6 + WE / - WK Ceramic
			←	05/12→; + Performance Parts		<b>13.0460-4875.2 604875</b> <b>13.0470-4875.2 LD4875</b>	BRE 25028 18,0 + WE / - WK BRE 25028 18,0 + WE / - WK Ceramic
			→	05/12→; + Performance Parts		<b>13.0460-4874.2 604874</b>	BRE 25029 16,7 + WE / - WK
330 d 330 d xDrive	210 210	01/12→ 06/12→	←	09/15→; - Performance Parts		<b>13.0460-3857.2 603857</b> <b>13.0470-3857.2 LD3857</b>	BOS 25199 19,6 + WE / - WK BOS 25199 19,6 + WE / - WK Ceramic
			←	09/15→; + Performance Parts		<b>13.0460-4875.2 604875</b> <b>13.0470-4875.2 LD4875</b>	BRE 25028 18,0 + WE / - WK BRE 25028 18,0 + WE / - WK Ceramic
			→	09/15→; + Performance Parts		<b>13.0460-4874.2 604874</b>	BRE 25029 16,7 + WE / - WK
330 d xDrive	190	06/12→	←	03/13→; - Performance Parts		<b>13.0460-3857.2 603857</b> <b>13.0470-3857.2 LD3857</b>	BOS 25199 19,6 + WE / - WK BOS 25199 19,6 + WE / - WK Ceramic
			←	03/13→; + Performance Parts		<b>13.0460-4875.2 604875</b> <b>13.0470-4875.2 LD4875</b>	BRE 25028 18,0 + WE / - WK BRE 25028 18,0 + WE / - WK Ceramic
			→	03/13→; + Performance Parts		<b>13.0460-4874.2 604874</b>	BRE 25029 16,7 + WE / - WK
330 i 330 i xDrive	185 185	09/14→ 10/14→	←	07/15→; - Performance Parts		<b>13.0460-3857.2 603857</b> <b>13.0470-3857.2 LD3857</b>	BOS 25199 19,6 + WE / - WK BOS 25199 19,6 + WE / - WK Ceramic
			←	07/15→; + Performance Parts		<b>13.0460-4875.2 604875</b> <b>13.0470-4875.2 LD4875</b>	BRE 25028 18,0 + WE / - WK BRE 25028 18,0 + WE / - WK Ceramic
			→	07/15→; - Performance Parts		<b>13.0460-3859.2 603859</b> <b>13.0470-3859.2 LD3859</b>	BOS 25307 17,5 + WE / - WK BOS 25307 17,5 + WE / - WK Ceramic
			→	07/15→; + Performance Parts		<b>13.0460-4874.2 604874</b>	BRE 25029 16,7 + WE / - WK
335 d xDrive	230	04/13→	←	11/13→		<b>13.0460-4875.2 604875</b>	BRE 25028 18,0 + WE / - WK
			→	11/13→; + Performance Parts		<b>13.0460-4874.2 604874</b>	BRE 25029 16,7 + WE / - WK
335 i 335 i 335 i xDrive 335 i xDrive	225 240 225 240	07/12→06/15 07/12→07/13 07/12→06/15 07/12→07/13	←	03/13→		<b>13.0460-4875.2 604875</b>	BRE 25028 18,0 + WE / - WK
			→	03/13→; + Performance Parts		<b>13.0460-4874.2 604874</b>	BRE 25029 16,7 + WE / - WK
335 i 335 i xDrive	250 250	07/13→06/15 07/13→06/15	←			<b>13.0460-4875.2 604875</b>	BRE 25028 18,0 + WE / - WK
			→	+ Performance Parts		<b>13.0460-4874.2 604874</b>	BRE 25029 16,7 + WE / - WK
340 i 340 i 340 i xDrive 340 i xDrive	240 265 240 265	10/14→ 10/14→ 10/14→ 10/14→	←	07/15→; - Performance Parts		<b>13.0460-4875.2 604875</b>	BRE 25028 18,0 + WE / - WK
			→	07/15→; + Performance Parts		<b>13.0460-4874.2 604874</b>	BRE 25029 16,7 + WE / - WK
<b>Warnkontakt, Bremsbelagsverschleiß</b>							
316 d 318 d 318 d 320 d 328 i 330 d	85 100 105 120 180 190	02/12→ 07/11→ 07/11→06/15 07/11→ 01/12→06/15 01/12→	←	☐; 05/12→	1	<b>24.8190-0006.2 620006</b>	L= 675
			→	05/12→	1	<b>24.8190-0007.2 620007</b>	L= 1.045
316 i 328 i xDrive 330 d xDrive	100 180 190	03/12→08/16 06/12→06/16 06/12→	←	☐; 03/13→	1	<b>24.8190-0006.2 620006</b>	L= 675
			→	03/13→	1	<b>24.8190-0007.2 620007</b>	L= 1.045
318 d 318 d xDrive 318 i 330 i 330 i xDrive 340 i 340 i 340 i xDrive 340 i xDrive	110 110 100 185 185 240 265 240 265	09/14→ 03/15→ 01/15→ 09/14→ 10/14→ 10/14→ 10/14→ 10/14→	←	☐; 07/15→	1	<b>24.8190-0006.2 620006</b>	L= 675
			→	07/15→	1	<b>24.8190-0007.2 620007</b>	L= 1.045
318 d xDrive	105	01/13→05/15	←	☐; 05/13→	1	<b>24.8190-0006.2 620006</b>	L= 675
			→	05/13→	1	<b>24.8190-0007.2 620007</b>	L= 1.045
320 d 320 d	135 147	07/11→02/16 07/11→02/16	←	☐; 05/12→	1	<b>24.8190-0006.2 620006</b>	L= 675
			←	☐; 05/12→; für Fahrzeuge mit verstärkter Bremse	1	<b>24.8190-0006.2 620006</b>	L= 675
			→	05/12→	1	<b>24.8190-0007.2 620007</b>	L= 1.045
↓							

	kw			 	! #		
<b>BMW - 3 Touring (F31) 07/11→</b>							
<b>Warnkontakt, Bremsbelagverschleiß</b>							
320 d	140	09/14→	←	☐; 07/15→; für Fahrzeuge mit verstärkter Bremse	1	24.8190-0006.2 620006	L= 675
			←	☐; 07/15→	1	24.8190-0006.2 620006	L= 675
			→	07/15→	1	24.8190-0007.2 620007	L= 1.045
320 d xDrive 320 d xDrive 320 d xDrive	120 135 147	01/12→ 01/12→06/15 01/12→06/15	←	☐; 03/13→; für Fahrzeuge mit verstärkter Bremse	1	24.8190-0006.2 620006	L= 675
			←	☐; 03/13→	1	24.8190-0006.2 620006	L= 675
			→	03/13→	1	24.8190-0007.2 620007	L= 1.045
320 d xDrive	140	07/15→	←	☐; für Fahrzeuge mit verstärkter Bremse	1	24.8190-0006.2 620006	L= 675
			←	☐	1	24.8190-0006.2 620006	L= 675
			→		1	24.8190-0007.2 620007	L= 1.045
320 i 320 i 320 i 320 i xDrive 320 i xDrive 320 i xDrive	120 135 135 120 135 135	02/12→06/15 02/12→06/15 10/14→ 01/12→06/15 01/12→06/15 09/14→	←	☐	1	24.8190-0006.2 620006	L= 675
			→		1	24.8190-0007.2 620007	L= 1.045
325 d 325 d	155 160	09/12→02/16 09/12→02/16	←	☐; 04/13→; für Fahrzeuge mit verstärkter Bremse	1	24.8190-0006.2 620006	L= 675
			←	☐; 04/13→	1	24.8190-0006.2 620006	L= 675
			→	04/13→	1	24.8190-0007.2 620007	L= 1.045
325 d	165	04/15→	←	☐; 03/16→; für Fahrzeuge mit verstärkter Bremse	1	24.8190-0006.2 620006	L= 675
			←	☐; 03/16→	1	24.8190-0006.2 620006	L= 675
			→	03/16→	1	24.8190-0007.2 620007	L= 1.045
330 d 330 d xDrive	210 210	01/12→ 06/12→	←	☐; 09/15→	1	24.8190-0006.2 620006	L= 675
			→	09/15→	1	24.8190-0007.2 620007	L= 1.045
335 d xDrive	230	04/13→	←	☐; 11/13→; für Fahrzeuge mit verstärkter Bremse	1	24.8190-0006.2 620006	L= 675
			→	11/13→	1	24.8190-0007.2 620007	L= 1.045
335 i 335 i 335 i xDrive 335 i xDrive	225 240 225 240	07/12→06/15 07/12→07/13 07/12→06/15 07/12→07/13	←	☐; 03/13→; für Fahrzeuge mit verstärkter Bremse	1	24.8190-0006.2 620006	L= 675
			→	03/13→	1	24.8190-0007.2 620007	L= 1.045
335 i 335 i xDrive	250 250	07/13→06/15 07/13→06/15	←	☐; für Fahrzeuge mit verstärkter Bremse	1	24.8190-0006.2 620006	L= 675
			→		1	24.8190-0007.2 620007	L= 1.045
<b>Bremsscheibe</b>							
316 d 318 d	85 100	02/12→ 07/11→	←	05/12→; - Performance Parts		24.0122-0278.1 422278	Ø 300 22 20,4 V + S
			←	05/12→; + Performance Parts		24.0130-0233.2 430233	Ø 340 30 28,4 V Bremsscheibe zweiteilig / + S
			→	05/12→; - Performance Parts		24.0120-0237.1 420237	Ø 300 20 18,4 V + S
			→	05/12→; + Performance Parts		24.0124-0250.2 424250	Ø 345 24 22,4 V Bremsscheibe zweiteilig / + S
316 i	100	03/12→08/16	←	03/13→; - Performance Parts		24.0122-0278.1 422278	Ø 300 22 20,4 V + S
			←	03/13→; + Performance Parts		24.0130-0233.2 430233	Ø 340 30 28,4 V Bremsscheibe zweiteilig / + S
			→	03/13→; - Performance Parts		24.0120-0237.1 420237	Ø 300 20 18,4 V + S
			→	03/13→; + Performance Parts		24.0124-0250.2 424250	Ø 345 24 22,4 V Bremsscheibe zweiteilig / + S
318 d	105	07/11→06/15	←	05/12→; - Performance Parts		24.0122-0278.1 422278	Ø 300 22 20,4 V + S
			←	05/12→; + Performance Parts		24.0130-0233.2 430233	Ø 340 30 28,4 V Bremsscheibe zweiteilig / + S
			→	- Performance Parts; → 01/14		24.0120-0237.1 420237	Ø 300 20 18,4 V + S
			→	02/14→; - Performance Parts		24.0120-0240.1 420240	Ø 300 20 18,4 V + S
			→	05/12→; + Performance Parts		24.0124-0250.2 424250	Ø 345 24 22,4 V Bremsscheibe zweiteilig / + S
318 d 318 d xDrive	110 110	09/14→ 03/15→	←	07/15→; - Performance Parts		24.0122-0278.1 422278	Ø 300 22 20,4 V + S
			←	07/15→; + Performance Parts		24.0130-0233.2 430233	Ø 340 30 28,4 V Bremsscheibe zweiteilig / + S
			→	07/15→; + Performance Parts		24.0124-0251.2 424251	Ø 345 24 22,4 V Bremsscheibe zweiteilig / + S
318 d xDrive	105	01/13→05/15	←	05/13→; - Performance Parts		24.0122-0278.1 422278	Ø 300 22 20,4 V + S
↓							







	kw			 	! #		
<b>BMW - 3 Touring (F31) 07/11→</b>							
<b>Bremsscheibe</b>							
318 d xDrive	105	01/13→05/15	←	05/13→; + Performance Parts	24.0130-0233.2	430233	Ø 340 30 28,4 V Bremsscheibe zweiteilig / + S
			→	05/13→; - Performance Parts	24.0120-0240.1	420240	Ø 300 20 18,4 V + S
			→	05/13→; + Performance Parts	24.0124-0251.2	424251	Ø 345 24 22,4 V Bremsscheibe zweiteilig / + S
318 i	100	01/15→	←	07/15→; - Performance Parts	24.0122-0278.1	422278	Ø 300 22 20,4 V + S
			←	07/15→; + Performance Parts	24.0130-0233.2	430233	Ø 340 30 28,4 V Bremsscheibe zweiteilig / + S
			→	07/15→; - Performance Parts	24.0120-0240.1	420240	Ø 300 20 18,4 V + S
			→	07/15→; + Performance Parts	24.0124-0251.2	424251	Ø 345 24 22,4 V Bremsscheibe zweiteilig / + S
320 d	120	07/11→	←	05/12→; - Performance Parts	24.0124-0203.1	424203	Ø 312 23,9 22,4 V + S
					24.0324-0203.1	524203	Ø 312 23,9 21,6 V + S
			←	05/12→; + Performance Parts / für Fahrzeuge mit verstärkter Bremse	24.0130-0233.2	430233	Ø 340 30 28,4 V Bremsscheibe zweiteilig / + S
			→	05/12→; - Performance Parts	24.0120-0240.1	420240	Ø 300 20 18,4 V + S
			→	für Fahrzeuge mit verstärkter Bremse	24.0120-0243.1	420243	Ø 330 20 18,4 V + S
320 d 320 d	135 147	07/11→02/16 07/11→02/16	←	05/12→; - Performance Parts	24.0124-0203.1	424203	Ø 312 23,9 22,4 V + S
					24.0324-0203.1	524203	Ø 312 23,9 21,6 V + S
			←	05/12→; + Performance Parts	24.0130-0233.2	430233	Ø 340 30 28,4 V Bremsscheibe zweiteilig / + S
			←	05/12→; für Fahrzeuge mit verstärkter Bremse	24.0130-0233.2	430233	Ø 340 30 28,4 V Bremsscheibe zweiteilig / + S
			→	05/12→; - Performance Parts	24.0120-0240.1	420240	Ø 300 20 18,4 V + S
320 d	140	09/14→	←	07/15→; - Performance Parts	24.0124-0203.1	424203	Ø 312 23,9 22,4 V + S
					24.0324-0203.1	524203	Ø 312 23,9 21,6 V + S
			←	07/15→; + Performance Parts	24.0130-0233.2	430233	Ø 340 30 28,4 V Bremsscheibe zweiteilig / + S
			←	07/15→; für Fahrzeuge mit verstärkter Bremse	24.0130-0233.2	430233	Ø 340 30 28,4 V Bremsscheibe zweiteilig / + S
			→	07/15→; - Performance Parts	24.0120-0240.1	420240	Ø 300 20 18,4 V + S
320 d xDrive 320 d xDrive 320 d xDrive	120 135 147	01/12→ 01/12→06/15 01/12→06/15	←	03/13→; - Performance Parts	24.0124-0203.1	424203	Ø 312 23,9 22,4 V + S
					24.0324-0203.1	524203	Ø 312 23,9 21,6 V + S
			←	03/13→; + Performance Parts	24.0130-0233.2	430233	Ø 340 30 28,4 V Bremsscheibe zweiteilig / + S
			←	03/13→; für Fahrzeuge mit verstärkter Bremse	24.0130-0233.2	430233	Ø 340 30 28,4 V Bremsscheibe zweiteilig / + S
			→	03/13→; - Performance Parts	24.0120-0240.1	420240	Ø 300 20 18,4 V + S
320 d xDrive	140	07/15→	←	- Performance Parts	24.0124-0203.1	424203	Ø 312 23,9 22,4 V + S
					24.0324-0203.1	524203	Ø 312 23,9 21,6 V + S
			←	+ Performance Parts	24.0130-0233.2	430233	Ø 340 30 28,4 V Bremsscheibe zweiteilig / + S
			←	für Fahrzeuge mit verstärkter Bremse	24.0130-0233.2	430233	Ø 340 30 28,4 V Bremsscheibe zweiteilig / + S
			→	- Performance Parts	24.0120-0240.1	420240	Ø 300 20 18,4 V + S
320 i 320 i 320 i	120 135 135	02/12→06/15 02/12→06/15 10/14→	←	- Performance Parts	24.0122-0278.1	422278	Ø 300 22 20,4 V + S
			←	+ Performance Parts	24.0130-0233.2	430233	Ø 340 30 28,4 V Bremsscheibe zweiteilig / + S







	kw			 	! #		
<b>BMW - 3 Touring (F31) 07/11→</b>							
<b>Bremsscheibe</b>							
320 i	120	02/12→06/15	➡	- Performance Parts		24.0120-0237.1 420237	Ø 300 20 18,4 V + S
320 i	135	02/12→06/15	➡	+ Performance Parts		24.0124-0250.2 424250	Ø 345 24 22,4 V
320 i	135	10/14→	➡				Bremsscheibe zweiteilig / + S
320 i xDrive	120	01/12→06/15	⬅	- Performance Parts		24.0122-0278.1 422278	Ø 300 22 20,4 V + S
320 i xDrive	135	01/12→06/15	⬅	+ Performance Parts		24.0130-0233.2 430233	Ø 340 30 28,4 V
320 i xDrive	135	09/14→	➡				Bremsscheibe zweiteilig / + S
			➡	- Performance Parts		24.0120-0240.1 420240	Ø 300 20 18,4 V + S
			➡	+ Performance Parts		24.0124-0251.2 424251	Ø 345 24 22,4 V
							Bremsscheibe zweiteilig / + S
325 d	155	09/12→02/16	⬅	04/13→; - Performance Parts		24.0124-0248.1 424248	Ø 330 24 22,4 V + S
325 d	160	09/12→02/16	⬅	04/13→; für Fahrzeuge mit verstärkter Bremse		24.0130-0233.2 430233	Ø 340 30 28,4 V
			⬅	04/13→; + Performance Parts		24.0130-0234.2 430234	Ø 370 30 28,4 V
							Bremsscheibe zweiteilig / + S
			➡	04/13→; - Performance Parts		24.0120-0243.1 420243	Ø 330 20 18,4 V + S
			➡	04/13→; für Fahrzeuge mit verstärkter Bremse		24.0120-0243.1 420243	Ø 330 20 18,4 V + S
			➡	04/13→; + Performance Parts		24.0124-0250.2 424250	Ø 345 24 22,4 V
							Bremsscheibe zweiteilig / + S
325 d	165	04/15→	⬅	03/16→; - Performance Parts		24.0124-0248.1 424248	Ø 330 24 22,4 V + S
			⬅	03/16→; für Fahrzeuge mit verstärkter Bremse		24.0130-0233.2 430233	Ø 340 30 28,4 V
			⬅	03/16→; + Performance Parts		24.0130-0234.2 430234	Ø 370 30 28,4 V
							Bremsscheibe zweiteilig / + S
			➡	03/16→; für Fahrzeuge mit verstärkter Bremse		24.0120-0243.1 420243	Ø 330 20 18,4 V + S
			➡	03/16→; - Performance Parts		24.0120-0243.1 420243	Ø 330 20 18,4 V + S
			➡	03/16→; + Performance Parts		24.0124-0250.2 424250	Ø 345 24 22,4 V
							Bremsscheibe zweiteilig / + S
328 i	180	01/12→06/15	⬅	05/12→; - Performance Parts		24.0124-0248.1 424248	Ø 330 24 22,4 V + S
			⬅	05/12→; für Fahrzeuge mit verstärkter Bremse		24.0130-0233.2 430233	Ø 340 30 28,4 V
			⬅	05/12→; + Performance Parts		24.0130-0234.2 430234	Ø 370 30 28,4 V
							Bremsscheibe zweiteilig / + S
			➡	05/12→; - Performance Parts		24.0120-0240.1 420240	Ø 300 20 18,4 V + S
			➡	05/12→; + Performance Parts		24.0124-0251.2 424251	Ø 345 24 22,4 V
							Bremsscheibe zweiteilig / + S
328 i xDrive	180	06/12→06/16	⬅	03/13→; - Performance Parts		24.0124-0248.1 424248	Ø 330 24 22,4 V + S
			⬅	03/13→; + Performance Parts		24.0130-0233.2 430233	Ø 340 30 28,4 V
						24.0130-0234.2 430234	Ø 370 30 28,4 V
							Bremsscheibe zweiteilig / + S
			⬅	03/13→; für Fahrzeuge mit verstärkter Bremse		24.0130-0233.2 430233	Ø 340 30 28,4 V
							Bremsscheibe zweiteilig / + S
			➡	03/13→; - Performance Parts		24.0120-0240.1 420240	Ø 300 20 18,4 V + S
			➡	03/13→; + Performance Parts		24.0124-0251.2 424251	Ø 345 24 22,4 V
							Bremsscheibe zweiteilig / + S
330 d	190	01/12→	⬅	05/12→; - Performance Parts		24.0124-0248.1 424248	Ø 330 24 22,4 V + S
			⬅	05/12→; für Fahrzeuge mit verstärkter Bremse		24.0130-0233.2 430233	Ø 340 30 28,4 V
			⬅	05/12→; + Performance Parts		24.0130-0234.2 430234	Ø 370 30 28,4 V
							Bremsscheibe zweiteilig / + S
			➡	05/12→; - Performance Parts		24.0120-0243.1 420243	Ø 330 20 18,4 V + S
			➡	05/12→; + Performance Parts		24.0124-0251.2 424251	Ø 345 24 22,4 V
							Bremsscheibe zweiteilig / + S
330 d	210	01/12→	⬅	09/15→; - Performance Parts		24.0124-0248.1 424248	Ø 330 24 22,4 V + S
330 d xDrive	210	06/12→	⬅	09/15→; für Fahrzeuge mit verstärkter Bremse		24.0130-0233.2 430233	Ø 340 30 28,4 V
			⬅	09/15→; + Performance Parts		24.0130-0234.2 430234	Ø 370 30 28,4 V
							Bremsscheibe zweiteilig / + S
			➡	09/15→; - Performance Parts		24.0120-0243.1 420243	Ø 330 20 18,4 V + S
			➡	09/15→; + Performance Parts		24.0124-0251.2 424251	Ø 345 24 22,4 V
							Bremsscheibe zweiteilig / + S
330 d xDrive	190	06/12→	⬅	03/13→; - Performance Parts		24.0124-0248.1 424248	Ø 330 24 22,4 V + S
↓							









	kW			 	! #		
<b>BMW - 3 Touring (F31) 07/11→</b>							
<b> Bremsscheibe</b>							
330 d xDrive	190	06/12→	←	03/13→; für Fahrzeuge mit verstärkter Bremse	24.0130-0233.2	430233	Ø 340 30 28,4 V Bremsscheibe zweiteilig / + S
			←	03/13→; + Performance Parts	24.0130-0234.2	430234	Ø 370 30 28,4 V Bremsscheibe zweiteilig / + S
			→	03/13→; - Performance Parts	24.0120-0243.1	420243	Ø 330 20 18,4 V + S
			→	03/13→; + Performance Parts	24.0124-0251.2	424251	Ø 345 24 22,4 V Bremsscheibe zweiteilig / + S
330 i 330 i xDrive	185 185	09/14→ 10/14→	←	07/15→; - Performance Parts	24.0124-0248.1	424248	Ø 330 24 22,4 V + S
			←	07/15→; + Performance Parts	24.0130-0234.2	430234	Ø 370 30 28,4 V Bremsscheibe zweiteilig / + S
			→	07/15→; - Performance Parts	24.0120-0240.1	420240	Ø 300 20 18,4 V + S
			→	07/15→; + Performance Parts	24.0124-0251.2	424251	Ø 345 24 22,4 V Bremsscheibe zweiteilig / + S
335 d xDrive	230	04/13→	←	11/13→; - Performance Parts	24.0130-0233.2	430233	Ø 340 30 28,4 V Bremsscheibe zweiteilig / + S
			←	11/13→; + Performance Parts	24.0130-0234.2	430234	Ø 370 30 28,4 V Bremsscheibe zweiteilig / + S
			→	11/13→; - Performance Parts	24.0120-0243.1	420243	Ø 330 20 18,4 V + S
			→	11/13→; + Performance Parts	24.0124-0251.2	424251	Ø 345 24 22,4 V Bremsscheibe zweiteilig / + S
335 i 335 i	225 240	07/12→06/15 07/12→07/13	←	03/13→; - Performance Parts	24.0130-0233.2	430233	Ø 340 30 28,4 V Bremsscheibe zweiteilig / + S
			←	+ Performance Parts	24.0130-0234.2	430234	Ø 370 30 28,4 V Bremsscheibe zweiteilig / + S
			→	03/13→; - Performance Parts	24.0120-0243.1	420243	Ø 330 20 18,4 V + S
			→	03/13→; + Performance Parts	24.0124-0251.2	424251	Ø 345 24 22,4 V Bremsscheibe zweiteilig / + S
335 i 335 i xDrive	250 250	07/13→06/15 07/13→06/15	←	- Performance Parts	24.0130-0233.2	430233	Ø 340 30 28,4 V Bremsscheibe zweiteilig / + S
			←	+ Performance Parts	24.0130-0234.2	430234	Ø 370 30 28,4 V Bremsscheibe zweiteilig / + S
			→	- Performance Parts	24.0120-0243.1	420243	Ø 330 20 18,4 V + S
			→	+ Performance Parts	24.0124-0251.2	424251	Ø 345 24 22,4 V Bremsscheibe zweiteilig / + S
335 i xDrive 335 i xDrive	225 240	07/12→06/15 07/12→07/13	←	03/13→; - Performance Parts	24.0130-0233.2	430233	Ø 340 30 28,4 V Bremsscheibe zweiteilig / + S
			←	03/13→; + Performance Parts	24.0130-0234.2	430234	Ø 370 30 28,4 V Bremsscheibe zweiteilig / + S
			→	03/13→; - Performance Parts	24.0120-0243.1	420243	Ø 330 20 18,4 V + S
			→	03/13→; + Performance Parts	24.0124-0251.2	424251	Ø 345 24 22,4 V Bremsscheibe zweiteilig / + S
340 i 340 i 340 i xDrive 340 i xDrive	240 265 240 265	10/14→ 10/14→ 10/14→ 10/14→	←	07/15→; - Performance Parts	24.0130-0233.2	430233	Ø 340 30 28,4 V Bremsscheibe zweiteilig / + S
			←	07/15→; + Performance Parts	24.0130-0234.2	430234	Ø 370 30 28,4 V Bremsscheibe zweiteilig / + S
			→	07/15→; - Performance Parts	24.0120-0243.1	420243	Ø 330 20 18,4 V + S
			→	07/15→; + Performance Parts	24.0124-0251.2	424251	Ø 345 24 22,4 V Bremsscheibe zweiteilig / + S
<b>BMW - 4 Cabriolet (F33, F83) 10/13→</b>							
<b> Bremsbelagsatz, Scheibenbremse</b>							
420 d 420 d 420 d 420 d	120 135 140 147	10/13→ 10/13→07/15 07/15→ 10/13→07/15	←	- Performance Parts	13.0460-3857.2	603857	BOS 25199 19,6 + WE / - WK
					13.0470-3857.2	LD3857	BOS 25199 19,6 + WE / - WK Ceramic
			←	+ Performance Parts	13.0460-4875.2	604875	BRE 25028 18,0 + WE / - WK
					13.0470-4875.2	LD4875	BRE 25028 18,0 + WE / - WK Ceramic
425 d 425 d 425 d 428 i 428 i xDrive 430 i 430 i xDrive	155 160 165 180 180 185 185	07/14→ 07/14→ 03/16→ 10/13→ 01/14→ 03/16→ 03/16→	←	- Performance Parts	13.0460-3859.2	603859	BOS 25307 17,5 + WE / - WK
					13.0470-3859.2	LD3859	BOS 25307 17,5 + WE / - WK Ceramic
			→	+ Performance Parts	13.0460-4874.2	604874	BRE 25029 16,7 + WE / - WK
420 i 420 i 420 i 420 i	120 120 135 135	07/14→ 02/16→ 07/14→ 02/16→	←	- Performance Parts	13.0460-3866.2	603866	BOS 25506 18,2 + WE / - WK
					13.0470-3866.2	LD3866	BOS 25506 18,2 + WE / - WK Ceramic
			←	+ Performance Parts	13.0460-4875.2	604875	BRE 25028 18,0 + WE / - WK
↓							





















	kW			 	! #		
<b>BMW - 4 Cabriolet (F33, F83) 10/13→</b>							
<b>Bremsbelagsatz, Scheibenbremse</b>							
420 i	120	07/14→	←	+ Performance Parts		13.0470-4875.2 LD4875	BRE 25028 18,0 + WE / - WK Ceramic
420 i	120	02/16→					
420 i	135	07/14→	→	- Performance Parts		13.0460-3859.2 603859	BOS 25307 17,5 + WE / - WK Ceramic
420 i	135	02/16→				13.0470-3859.2 LD3859	BOS 25307 17,5 + WE / - WK Ceramic
			→	+ Performance Parts		13.0460-4874.2 604874	BRE 25029 16,7 + WE / - WK
430 d	190	07/14→	←	- Performance Parts		13.0460-3857.2 603857	BOS 25199 19,6 + WE / - WK Ceramic
						13.0470-3857.2 LD3857	BOS 25199 19,6 + WE / - WK Ceramic
			←	+ Performance Parts		13.0460-4875.2 604875	BRE 25028 18,0 + WE / - WK Ceramic
						13.0470-4875.2 LD4875	BRE 25028 18,0 + WE / - WK Ceramic
			→	+ Performance Parts		13.0460-4874.2 604874	BRE 25029 16,7 + WE / - WK
430 d	210	10/13→	←	07/14→; - Performance Parts		13.0460-3857.2 603857	BOS 25199 19,6 + WE / - WK Ceramic
						13.0470-3857.2 LD3857	BOS 25199 19,6 + WE / - WK Ceramic
			←	07/14→; + Performance Parts		13.0460-4875.2 604875	BRE 25028 18,0 + WE / - WK Ceramic
						13.0470-4875.2 LD4875	BRE 25028 18,0 + WE / - WK Ceramic
			→	07/14→; + Performance Parts		13.0460-4874.2 604874	BRE 25029 16,7 + WE / - WK
435 d xDrive	230	07/14→	←			13.0460-4875.2 604875	BRE 25028 18,0 + WE / - WK
435 i	225	10/13→					
435 i	250	10/13→	→	+ Performance Parts		13.0460-4874.2 604874	BRE 25029 16,7 + WE / - WK
435 i xDrive	225	07/14→					
435 i xDrive	250	07/14→					
440 i	240	03/16→					
440 i	265	03/16→					
440 i xDrive	240	03/16→					
440 i xDrive	265	03/16→					
<b>Warnkontakt, Bremsbelagverschleiß</b>							
420 d	120	10/13→	←	<input type="checkbox"/>	1	24.8190-0006.2 620006	L= 675
420 d	135	10/13→07/15					
420 d	140	07/15→	→		1	24.8190-0007.2 620007	L= 1.045
420 d	147	10/13→07/15					
420 i	120	07/14→					
420 i	120	02/16→					
420 i	135	07/14→					
420 i	135	02/16→					
425 d	155	07/14→					
425 d	160	07/14→					
428 i	180	10/13→					
428 i xDrive	180	01/14→					
430 d	190	07/14→					
435 d xDrive	230	07/14→					
435 i	225	10/13→					
435 i	250	10/13→					
435 i xDrive	225	07/14→					
435 i xDrive	250	07/14→					
M4	317	07/14→					
M4 Competition	331	03/16→					
425 d	165	03/16→	←	<input type="checkbox"/>	1	24.8190-0006.2 620006	L= 675
430 i	185	03/16→					
430 i xDrive	185	03/16→	←		1	24.8190-0006.2 620006	L= 675
440 i	240	03/16→					
440 i	265	03/16→	→		1	24.8190-0007.2 620007	L= 1.045
440 i xDrive	240	03/16→					
440 i xDrive	265	03/16→					
430 d	210	10/13→	←	<input type="checkbox"/> ; 07/14→	1	24.8190-0006.2 620006	L= 675
			→	07/14→	1	24.8190-0007.2 620007	L= 1.045
<b>Bremsscheibe</b>							
420 d	120	10/13→	←	- Performance Parts		24.0124-0203.1 424203	Ø 312 23,9 22,4 V + S
420 d	135	10/13→07/15				24.0324-0203.1 524203	Ø 312 23,9 21,6 V + S
420 d	140	07/15→					
420 d	147	10/13→07/15	←	+ Performance Parts		24.0130-0233.2 430233	Ø 340 30 28,4 V Bremsscheibe zweiteilig / + S
			→	- Performance Parts		24.0120-0240.1 420240	Ø 300 20 18,4 V + S
			→	+ Performance Parts		24.0124-0251.2 424251	Ø 345 24 22,4 V Bremsscheibe zweiteilig / + S
420 i	120	07/14→	←	- Performance Parts		24.0122-0278.1 422278	Ø 300 22 20,4 V + S
420 i	120	02/16→					
420 i	135	07/14→	←	+ Performance Parts		24.0130-0233.2 430233	Ø 340 30 28,4 V Bremsscheibe zweiteilig / + S
420 i	135	02/16→					
↓							

	kW			 	! #		
<b>BMW - 4 Cabriolet (F33, F83) 10/13→</b>							
<b>Bremsscheibe</b>							
420 i	120	07/14→	➡	- Performance Parts		24.0120-0240.1 420240	Ø 300 20 18,4 V + S
420 i	120	02/16→	➡	+ Performance Parts		24.0124-0251.2 424251	Ø 345 24 22,4 V Bremsscheibe zweiteilig / + S
420 i	135	07/14→					
420 i	135	02/16→					
425 d	155	07/14→	⬅	- Performance Parts		24.0124-0248.1 424248	Ø 330 24 22,4 V + S
425 d	160	07/14→	⬅	+ Performance Parts		24.0130-0234.2 430234	Ø 370 30 28,4 V Bremsscheibe zweiteilig / + S
425 d	165	03/16→					
428 i	180	10/13→					
428 i xDrive	180	01/14→	➡	- Performance Parts		24.0120-0240.1 420240	Ø 300 20 18,4 V + S
430 i	185	03/16→	➡	+ Performance Parts		24.0124-0251.2 424251	Ø 345 24 22,4 V Bremsscheibe zweiteilig / + S
430 i xDrive	185	03/16→					
430 d	190	07/14→	⬅	- Performance Parts		24.0124-0248.1 424248	Ø 330 24 22,4 V + S
			⬅	+ Performance Parts		24.0130-0234.2 430234	Ø 370 30 28,4 V Bremsscheibe zweiteilig / + S
			➡	- Performance Parts		24.0120-0243.1 420243	Ø 330 20 18,4 V + S
			➡	+ Performance Parts		24.0124-0251.2 424251	Ø 345 24 22,4 V Bremsscheibe zweiteilig / + S
430 d	210	10/13→	⬅	07/14→; - Performance Parts		24.0124-0248.1 424248	Ø 330 24 22,4 V + S
			⬅	07/14→; + Performance Parts		24.0130-0234.2 430234	Ø 370 30 28,4 V Bremsscheibe zweiteilig / + S
			➡	07/14→; - Performance Parts		24.0120-0243.1 420243	Ø 330 20 18,4 V + S
			➡	07/14→; + Performance Parts		24.0124-0251.2 424251	Ø 345 24 22,4 V Bremsscheibe zweiteilig / + S
435 d xDrive	230	07/14→	⬅	- Performance Parts		24.0130-0233.2 430233	Ø 340 30 28,4 V Bremsscheibe zweiteilig / + S
435 i	225	10/13→					
435 i	250	10/13→	⬅	+ Performance Parts		24.0130-0234.2 430234	Ø 370 30 28,4 V Bremsscheibe zweiteilig / + S
435 i xDrive	225	07/14→					
435 i xDrive	250	07/14→					
440 i	240	03/16→	➡	- Performance Parts		24.0120-0243.1 420243	Ø 330 20 18,4 V + S
440 i	265	03/16→					
440 i xDrive	240	03/16→	➡	+ Performance Parts		24.0124-0251.2 424251	Ø 345 24 22,4 V Bremsscheibe zweiteilig / + S
440 i xDrive	265	03/16→					
<b>BMW - 4 Coupe (F32, F82) 07/13→</b>							
<b>Bremsbelagsatz, Scheibenbremse</b>							
418 d	100	03/15→	⬅	- Performance Parts		13.0460-3866.2 603866	BOS 25506 18,2 + WE / - WK
418 d	110	03/15→				13.0470-3866.2 LD3866	BOS 25506 18,2 + WE / - WK Ceramic
420 i	120	11/13→					
420 i	120	02/16→	⬅	+ Performance Parts		13.0460-4875.2 604875	BRE 25028 18,0 + WE / - WK Ceramic
420 i	135	11/13→				13.0470-4875.2 LD4875	BRE 25028 18,0 + WE / - WK Ceramic
420 i	135	02/16→					
420 i xDrive	120	11/13→					
420 i xDrive	120	02/16→	➡	- Performance Parts		13.0460-3859.2 603859	BOS 25307 17,5 + WE / - WK
420 i xDrive	135	11/13→				13.0470-3859.2 LD3859	BOS 25307 17,5 + WE / - WK Ceramic
420 i xDrive	135	02/16→					
			➡	+ Performance Parts		13.0460-4874.2 604874	BRE 25029 16,7 + WE / - WK
418 i	100	02/16→	⬅	- Performance Parts		13.0460-3866.2 603866	BOS 25506 18,2 + WE / - WK
						13.0470-3866.2 LD3866	BOS 25506 18,2 + WE / - WK Ceramic
			⬅	+ Performance Parts		13.0460-4875.2 604875	BRE 25028 18,0 + WE / - WK
			➡	- Performance Parts		13.0460-3859.2 603859	BOS 25307 17,5 + WE / - WK
						13.0470-3859.2 LD3859	BOS 25307 17,5 + WE / - WK Ceramic
			➡	+ Performance Parts		13.0460-4874.2 604874	BRE 25029 16,7 + WE / - WK
420 d	120	07/13→	⬅	- Performance Parts		13.0460-3857.2 603857	BOS 25199 19,6 + WE / - WK
420 d	135	07/13→03/15				13.0470-3857.2 LD3857	BOS 25199 19,6 + WE / - WK Ceramic
420 d	140	03/15→					
420 d	147	07/13→03/15					
420 d xDrive	120	11/13→	⬅	+ Performance Parts		13.0460-4875.2 604875	BRE 25028 18,0 + WE / - WK
420 d xDrive	135	11/13→03/15				13.0470-4875.2 LD4875	BRE 25028 18,0 + WE / - WK Ceramic
420 d xDrive	140	03/15→					
420 d xDrive	147	11/13→03/15					
425 d	165	03/16→	➡	- Performance Parts		13.0460-3859.2 603859	BOS 25307 17,5 + WE / - WK
428 i	180	07/13→				13.0470-3859.2 LD3859	BOS 25307 17,5 + WE / - WK Ceramic
428 i xDrive	180	07/13→					
430 i	185	03/16→	➡	+ Performance Parts		13.0460-4874.2 604874	BRE 25029 16,7 + WE / - WK
430 i xDrive	185	03/16→					
425 d	155	01/14→	⬅	03/14→; - Performance Parts		13.0460-3857.2 603857	BOS 25199 19,6 + WE / - WK
425 d	160	01/14→				13.0470-3857.2 LD3857	BOS 25199 19,6 + WE / - WK Ceramic
			⬅	03/14→; + Performance Parts		13.0460-4875.2 604875	BRE 25028 18,0 + WE / - WK
↓							









	kW			 	! #		
<b>BMW - 4 Coupe (F32, F82) 07/13→</b>							
<b> Bremsbelagsatz, Scheibenbremse</b>							
425 d 425 d	155 160	01/14→ 01/14→	←	03/14→; + Performance Parts		13.0470-4875.2 LD4875	BRE 25028 18,0 + WE / - WK Ceramic
			→	03/14→; - Performance Parts		13.0460-3859.2 603859	BOS 25307 17,5 + WE / - WK
			→	03/14→; - Performance Parts		13.0470-3859.2 LD3859	BOS 25307 17,5 + WE / - WK Ceramic
			→	03/14→; + Performance Parts		13.0460-4874.2 604874	BRE 25029 16,7 + WE / - WK
430 d 430 d	190 210	11/13→ 11/13→	←	- Performance Parts		13.0460-3857.2 603857	BOS 25199 19,6 + WE / - WK
			←	- Performance Parts		13.0470-3857.2 LD3857	BOS 25199 19,6 + WE / - WK Ceramic
			←	+ Performance Parts		13.0460-4875.2 604875	BRE 25028 18,0 + WE / - WK
			←	+ Performance Parts		13.0470-4875.2 LD4875	BRE 25028 18,0 + WE / - WK Ceramic
			→	+ Performance Parts		13.0460-4874.2 604874	BRE 25029 16,7 + WE / - WK
430 d xDrive 430 d xDrive	190 210	01/14→ 11/13→	←	03/14→; - Performance Parts		13.0460-3857.2 603857	BOS 25199 19,6 + WE / - WK
			←	03/14→; - Performance Parts		13.0470-3857.2 LD3857	BOS 25199 19,6 + WE / - WK Ceramic
			←	03/14→; + Performance Parts		13.0460-4875.2 604875	BRE 25028 18,0 + WE / - WK
			←	03/14→; + Performance Parts		13.0470-4875.2 LD4875	BRE 25028 18,0 + WE / - WK Ceramic
			→	03/14→; + Performance Parts		13.0460-4874.2 604874	BRE 25029 16,7 + WE / - WK
435 d xDrive 435 i 435 i 435 i xDrive 435 i xDrive 440 i 440 i 440 i xDrive 440 i xDrive	230 225 250 225 250 240 265 240 265	11/13→ 07/13→ 07/13→ 07/13→ 07/13→ 03/16→ 03/16→ 03/16→ 03/16→	←			13.0460-4875.2 604875	BRE 25028 18,0 + WE / - WK
			→	+ Performance Parts		13.0460-4874.2 604874	BRE 25029 16,7 + WE / - WK
<b>Warnkontakt, Bremsbelagverschleiß</b>							
418 d 418 d 418 i 420 d 420 d 420 d 420 d 420 d xDrive 420 d xDrive 420 d xDrive 420 d xDrive 420 i 420 i 420 i 420 i 420 i xDrive 420 i xDrive 420 i xDrive 420 i xDrive 425 d 430 i 430 i xDrive M4 Competition M4 CS M4 GTS	100 110 100 120 135 140 147 120 135 140 147 120 120 135 120 120 135 120 120 135 135 165 185 185 331 338 368	03/15→ 03/15→ 02/16→ 07/13→ 07/13→03/15 03/15→ 07/13→03/15 11/13→ 11/13→03/15 03/15→ 11/13→03/15 11/13→ 02/16→ 11/13→ 02/16→ 11/13→ 02/16→ 11/13→ 02/16→ 03/16→ 03/16→ 03/16→ 09/16→ 03/16→02/17	←	☐	1	24.8190-0006.2 620006	L= 675
			→		1	24.8190-0007.2 620007	L= 1.045
425 d 425 d 430 d xDrive 430 d xDrive	155 160 190 210	01/14→ 01/14→ 01/14→ 11/13→	←	☐; 03/14→; - Performance Parts	1	24.8190-0006.2 620006	L= 675
			←	☐; 03/14→; + Performance Parts	1	24.8190-0006.2 620006	L= 675
			→	03/14→	1	24.8190-0007.2 620007	L= 1.045
428 i 428 i xDrive 430 d 430 d	180 180 190 210	07/13→ 07/13→ 11/13→ 11/13→	←	☐; - Performance Parts	1	24.8190-0006.2 620006	L= 675
			←	☐; + Performance Parts	1	24.8190-0006.2 620006	L= 675
			→		1	24.8190-0007.2 620007	L= 1.045
435 d xDrive 435 i 435 i 435 i xDrive 435 i xDrive	230 225 250 225 250	11/13→ 07/13→ 07/13→ 07/13→ 07/13→	←		1	24.8190-0006.2 620006	L= 675
			→		1	24.8190-0007.2 620007	L= 1.045
440 i 440 i 440 i xDrive 440 i xDrive	240 265 240 265	03/16→ 03/16→ 03/16→ 03/16→	←	☐; - Performance Parts	1	24.8190-0006.2 620006	L= 675
			←	+ Performance Parts	1	24.8190-0006.2 620006	L= 675
			→		1	24.8190-0007.2 620007	L= 1.045
M4 ↓	317	01/14→	←	☐; 03/14→	1	24.8190-0006.2 620006	L= 675







	kw			 	! #		
<b>BMW - 4 Coupe (F32, F82) 07/13→</b>							
<b>Warnkontakt, Bremsbelagverschleiß</b>							
M4	317	01/14→	➡	03/14→	1	24.8190-0007.2 620007	L= 1.045
<b>Bremsscheibe</b>							
418 d	100	03/15→	←	- Performance Parts		24.0122-0278.1 422278	Ø 300 22 20,4 V + S
418 d	110	03/15→	←	+ Performance Parts		24.0130-0233.2 430233	Ø 340 30 28,4 V Brems Scheibe zweiteilig / + S
420 i	120	11/13→	➡	- Performance Parts		24.0120-0237.1 420237	Ø 300 20 18,4 V + S
420 i	135	11/13→	➡	+ Performance Parts		24.0124-0250.2 424250	Ø 345 24 22,4 V Brems Scheibe zweiteilig / + S
418 i	100	02/16→	←	- Performance Parts		24.0122-0278.1 422278	Ø 300 22 20,4 V + S
420 i	120	02/16→	←	+ Performance Parts		24.0130-0233.2 430233	Ø 340 30 28,4 V Brems Scheibe zweiteilig / + S
420 i	135	02/16→	➡	- Performance Parts		24.0120-0240.1 420240	Ø 300 20 18,4 V + S
420 i xDrive	120	11/13→	➡	+ Performance Parts		24.0124-0251.2 424251	Ø 345 24 22,4 V Brems Scheibe zweiteilig / + S
420 i xDrive	120	02/16→	←	- Performance Parts		24.0122-0278.1 422278	Ø 300 22 20,4 V + S
420 i xDrive	135	11/13→	←	+ Performance Parts		24.0130-0233.2 430233	Ø 340 30 28,4 V Brems Scheibe zweiteilig / + S
420 i xDrive	135	02/16→	➡	- Performance Parts		24.0120-0240.1 420240	Ø 300 20 18,4 V + S
420 i xDrive	135	02/16→	➡	+ Performance Parts		24.0124-0251.2 424251	Ø 345 24 22,4 V Brems Scheibe zweiteilig / + S
420 d	120	07/13→	←	- Performance Parts		24.0124-0203.1 424203	Ø 312 23,9 22,4 V + S
420 d	135	07/13→03/15	←	+ Performance Parts		24.0324-0203.1 524203	Ø 312 23,9 21,6 V + S
420 d	147	07/13→03/15	➡	- Performance Parts		24.0120-0237.1 420237	Ø 300 20 18,4 V + S
420 d	147	07/13→03/15	➡	+ Performance Parts		24.0124-0250.2 424250	Ø 345 24 22,4 V Brems Scheibe zweiteilig / + S
420 d	140	03/15→	←	- Performance Parts		24.0124-0203.1 424203	Ø 312 23,9 22,4 V + S
420 d	140	03/15→	←	+ Performance Parts		24.0324-0203.1 524203	Ø 312 23,9 21,6 V + S
420 d	140	03/15→	➡	+ Performance Parts		24.0130-0233.2 430233	Ø 340 30 28,4 V Brems Scheibe zweiteilig / + S
420 d	140	03/15→	➡	+ Performance Parts		24.0124-0250.2 424250	Ø 345 24 22,4 V Brems Scheibe zweiteilig / + S
420 d xDrive	120	11/13→	←	- Performance Parts		24.0124-0203.1 424203	Ø 312 23,9 22,4 V + S
420 d xDrive	135	11/13→03/15	←	+ Performance Parts		24.0324-0203.1 524203	Ø 312 23,9 21,6 V + S
420 d xDrive	140	03/15→	➡	- Performance Parts		24.0120-0240.1 420240	Ø 300 20 18,4 V + S
420 d xDrive	147	11/13→03/15	➡	+ Performance Parts		24.0124-0251.2 424251	Ø 345 24 22,4 V Brems Scheibe zweiteilig / + S
425 d	155	01/14→	←	03/14→; - Performance Parts		24.0124-0248.1 424248	Ø 330 24 22,4 V + S
425 d	160	01/14→	←	03/14→; + Performance Parts		24.0130-0234.2 430234	Ø 370 30 28,4 V Brems Scheibe zweiteilig / + S
425 d	160	01/14→	➡	03/14→; - Performance Parts		24.0120-0237.1 420237	Ø 300 20 18,4 V + S
425 d	160	01/14→	➡	03/14→; + Performance Parts		24.0124-0250.2 424250	Ø 345 24 22,4 V Brems Scheibe zweiteilig / + S
425 d	165	03/16→	←	- Performance Parts		24.0124-0248.1 424248	Ø 330 24 22,4 V + S
428 i	180	07/13→	←	+ Performance Parts		24.0130-0234.2 430234	Ø 370 30 28,4 V Brems Scheibe zweiteilig / + S
428 i xDrive	180	07/13→	➡	- Performance Parts		24.0120-0240.1 420240	Ø 300 20 18,4 V + S
430 i	185	03/16→	➡	+ Performance Parts		24.0124-0251.2 424251	Ø 345 24 22,4 V Brems Scheibe zweiteilig / + S
430 i xDrive	185	03/16→	➡	+ Performance Parts		24.0124-0251.2 424251	Ø 345 24 22,4 V Brems Scheibe zweiteilig / + S
430 d	190	11/13→	←	- Performance Parts		24.0124-0248.1 424248	Ø 330 24 22,4 V + S
430 d	210	11/13→	←	+ Performance Parts		24.0130-0234.2 430234	Ø 370 30 28,4 V Brems Scheibe zweiteilig / + S
430 d	210	11/13→	➡	- Performance Parts		24.0120-0243.1 420243	Ø 330 20 18,4 V + S
430 d	210	11/13→	➡	+ Performance Parts		24.0124-0251.2 424251	Ø 345 24 22,4 V Brems Scheibe zweiteilig / + S
430 d xDrive	190	01/14→	←	03/14→; - Performance Parts		24.0124-0248.1 424248	Ø 330 24 22,4 V + S
430 d xDrive	210	11/13→	←	03/14→; + Performance Parts		24.0130-0234.2 430234	Ø 370 30 28,4 V Brems Scheibe zweiteilig / + S
430 d xDrive	210	11/13→	➡	03/14→; - Performance Parts		24.0120-0243.1 420243	Ø 330 20 18,4 V + S
430 d xDrive	210	11/13→	➡	03/14→; + Performance Parts		24.0124-0251.2 424251	Ø 345 24 22,4 V Brems Scheibe zweiteilig / + S
435 d xDrive	230	11/13→	←	- Performance Parts		24.0130-0233.2 430233	Ø 340 30 28,4 V Brems Scheibe zweiteilig / + S
435 i	225	07/13→	←	+ Performance Parts		24.0130-0234.2 430234	Ø 370 30 28,4 V Brems Scheibe zweiteilig / + S
435 i	250	07/13→	➡	- Performance Parts		24.0120-0243.1 420243	Ø 330 20 18,4 V + S
435 i xDrive	225	07/13→	➡	+ Performance Parts		24.0124-0251.2 424251	Ø 345 24 22,4 V Brems Scheibe zweiteilig / + S
435 i xDrive	250	07/13→	➡	+ Performance Parts		24.0124-0251.2 424251	Ø 345 24 22,4 V Brems Scheibe zweiteilig / + S
440 i	240	03/16→	➡	- Performance Parts		24.0120-0243.1 420243	Ø 330 20 18,4 V + S

















	kW			 	! #		
<b>BMW - 4 Coupe (F32, F82) 07/13→</b>							
 <b>Bremsscheibe</b>							
440 i 440 i xDrive 440 i xDrive	265 240 265	03/16→ 03/16→ 03/16→	➡	+ Performance Parts		24.0124-0251.2 424251	Ø 345 24 22,4 V Bremsscheibe zweiteilig / + S
<b>BMW - 4 Gran Coupe (F36) 03/14→</b>							
 <b>Bremsbelagsatz, Scheibenbremse</b>							
418 d 418 d 418 d 418 i 420 i xDrive	100 105 110 100 135	03/14→ 03/14→ 07/15→ 07/15→ 07/14→	←	- Performance Parts		13.0460-3866.2 603866 13.0470-3866.2 LD3866	BOS 25506 18,2 + WE / - WK BOS 25506 18,2 + WE / - WK Ceramic
			←	+ Performance Parts		13.0460-4875.2 604875 13.0470-4875.2 LD4875	BRE 25028 18,0 + WE / - WK BRE 25028 18,0 + WE / - WK Ceramic
			➡	- Performance Parts		13.0460-3859.2 603859 13.0470-3859.2 LD3859	BOS 25307 17,5 + WE / - WK BOS 25307 17,5 + WE / - WK Ceramic
			➡	+ Performance Parts		13.0460-4874.2 604874	BRE 25029 16,7 + WE / - WK
420 d 420 d 420 d 420 d 420 d xDrive 420 d xDrive 420 d xDrive 420 d xDrive 420 i 420 i 425 d 425 d 428 i 428 i xDrive 430 i 430 i xDrive	120 135 140 147 120 135 140 147 120 135 155 165 180 180 185 185	03/14→ 03/14→03/15 03/15→ 03/14→03/15 03/14→ 03/14→03/15 03/15→ 03/14→03/15 03/14→ 03/14→ 03/16→ 03/16→ 03/14→ 03/14→ 03/16→ 03/16→	←	- Performance Parts		13.0460-3857.2 603857 13.0470-3857.2 LD3857	BOS 25199 19,6 + WE / - WK BOS 25199 19,6 + WE / - WK Ceramic
			←	+ Performance Parts		13.0460-4875.2 604875 13.0470-4875.2 LD4875	BRE 25028 18,0 + WE / - WK BRE 25028 18,0 + WE / - WK Ceramic
			➡	- Performance Parts		13.0460-3859.2 603859 13.0470-3859.2 LD3859	BOS 25307 17,5 + WE / - WK BOS 25307 17,5 + WE / - WK Ceramic
			➡	+ Performance Parts		13.0460-4874.2 604874	BRE 25029 16,7 + WE / - WK
420 i 420 i	120 135	02/16→ 02/16→	←	- Performance Parts; Motorcode: B48		13.0460-3866.2 603866 13.0470-3866.2 LD3866	BOS 25506 18,2 + WE / - WK BOS 25506 18,2 + WE / - WK Ceramic
			←	+ Performance Parts; Motorcode: B48		13.0460-4875.2 604875 13.0470-4875.2 LD4875	BRE 25028 18,0 + WE / - WK BRE 25028 18,0 + WE / - WK Ceramic
			➡	- Performance Parts		13.0460-3859.2 603859 13.0470-3859.2 LD3859	BOS 25307 17,5 + WE / - WK BOS 25307 17,5 + WE / - WK Ceramic
			➡	+ Performance Parts; Motorcode: B48		13.0460-4874.2 604874	BRE 25029 16,7 + WE / - WK
420 i xDrive	120	03/14→	←	07/14→; - Performance Parts		13.0460-3866.2 603866 13.0470-3866.2 LD3866	BOS 25506 18,2 + WE / - WK BOS 25506 18,2 + WE / - WK Ceramic
			←	07/14→; + Performance Parts		13.0460-4875.2 604875 13.0470-4875.2 LD4875	BRE 25028 18,0 + WE / - WK BRE 25028 18,0 + WE / - WK Ceramic
			➡	07/14→; - Performance Parts		13.0460-3859.2 603859 13.0470-3859.2 LD3859	BOS 25307 17,5 + WE / - WK BOS 25307 17,5 + WE / - WK Ceramic
			➡	07/14→; + Performance Parts		13.0460-4874.2 604874	BRE 25029 16,7 + WE / - WK
420 i xDrive 420 i xDrive	120 135	02/16→ 02/16→	←	- Performance Parts		13.0460-3866.2 603866 13.0470-3866.2 LD3866	BOS 25506 18,2 + WE / - WK BOS 25506 18,2 + WE / - WK Ceramic
			←	+ Performance Parts; Motorcode: B48		13.0460-4875.2 604875 13.0470-4875.2 LD4875	BRE 25028 18,0 + WE / - WK BRE 25028 18,0 + WE / - WK Ceramic
			➡	- Performance Parts		13.0460-3859.2 603859 13.0470-3859.2 LD3859	BOS 25307 17,5 + WE / - WK BOS 25307 17,5 + WE / - WK Ceramic
			➡	+ Performance Parts; Motorcode: B48		13.0460-4874.2 604874	BRE 25029 16,7 + WE / - WK
430 d 430 d 430 d xDrive 430 d xDrive	190 210 190 210	07/14→ 07/14→ 07/14→ 07/14→	←	- Performance Parts		13.0460-3857.2 603857 13.0470-3857.2 LD3857	BOS 25199 19,6 + WE / - WK BOS 25199 19,6 + WE / - WK Ceramic
			←	+ Performance Parts		13.0460-4875.2 604875 13.0470-4875.2 LD4875	BRE 25028 18,0 + WE / - WK BRE 25028 18,0 + WE / - WK Ceramic
			➡	+ Performance Parts		13.0460-4874.2 604874	BRE 25029 16,7 + WE / - WK
↓							









	kW			 	! #		
<b>BMW - 4 Gran Coupe (F36) 03/14→</b>							
<b> Bremsbelagsatz, Scheibenbremse</b>							
435 d xDrive	230	07/14→	←			13.0460-4875.2 604875	BRE 25028 18,0 + WE / - WK
435 i	225	03/14→	→	+ Performance Parts		13.0460-4874.2 604874	BRE 25029 16,7 + WE / - WK
435 i	250	03/14→					
435 i xDrive	225	07/14→					
435 i xDrive	250	07/14→					
440 i	240	03/16→					
440 i	265	03/16→					
440 i xDrive	240	03/16→					
440 i xDrive	265	03/16→					
<b>Warnkontakt, Bremsbelagverschleiß</b>							
418 d	100	03/14→	←	<input type="checkbox"/>	1	24.8190-0006.2 620006	L= 675
418 d	105	03/14→	→				
418 d	110	07/15→	→		1	24.8190-0007.2 620007	L= 1.045
418 i	100	07/15→					
420 d	120	03/14→					
420 d	135	03/14→03/15					
420 d	140	03/15→					
420 d	147	03/14→03/15					
420 d xDrive	120	03/14→					
420 d xDrive	135	03/14→03/15					
420 d xDrive	140	03/15→					
420 d xDrive	147	03/14→03/15					
420 i	120	03/14→					
420 i	135	03/14→					
420 i xDrive	135	07/14→					
425 d	155	03/16→					
425 d	165	03/16→					
428 i	180	03/14→					
428 i xDrive	180	03/14→					
430 d	190	07/14→					
430 d	210	07/14→					
430 d xDrive	190	07/14→					
430 d xDrive	210	07/14→					
430 i	185	03/16→					
430 i xDrive	185	03/16→					
420 i	120	02/16→	←	<input type="checkbox"/> ; Motorcode: B48	1	24.8190-0006.2 620006	L= 675
420 i	135	02/16→	→	- Performance Parts	1	24.8190-0007.2 620007	L= 1.045
			→	+ Performance Parts; Motorcode: B48	1	24.8190-0007.2 620007	L= 1.045
420 i xDrive	120	03/14→	←	<input type="checkbox"/> ; 07/14→	1	24.8190-0006.2 620006	L= 675
			→	07/14→	1	24.8190-0007.2 620007	L= 1.045
420 i xDrive	120	02/16→	←	<input type="checkbox"/> ; + Performance Parts; Motorcode: B48	1	24.8190-0006.2 620006	L= 675
420 i xDrive	135	02/16→	←	<input type="checkbox"/> ; - Performance Parts	1	24.8190-0006.2 620006	L= 675
			→	+ Performance Parts; Motorcode: B48	1	24.8190-0007.2 620007	L= 1.045
			→	- Performance Parts	1	24.8190-0007.2 620007	L= 1.045
435 d xDrive	230	07/14→	←		1	24.8190-0006.2 620006	L= 675
435 i	225	03/14→	→				
435 i	250	03/14→	→		1	24.8190-0007.2 620007	L= 1.045
435 i xDrive	225	07/14→					
435 i xDrive	250	07/14→					
440 i	240	03/16→					
440 i	265	03/16→					
440 i xDrive	240	03/16→					
440 i xDrive	265	03/16→					
<b> Bremsscheibe</b>							
418 d	100	03/14→	←	- Performance Parts		24.0122-0278.1 422278	Ø 300 22 20,4 V + S
418 d	105	03/14→	←	+ Performance Parts		24.0130-0233.2 430233	Ø 340 30 28,4 V Bremsscheibe zweiteilig / + S
			→	- Performance Parts		24.0120-0237.1 420237	Ø 300 20 18,4 V + S
			→	+ Performance Parts		24.0124-0250.2 424250	Ø 345 24 22,4 V Bremsscheibe zweiteilig / + S
418 d	110	07/15→	←	- Performance Parts		24.0122-0278.1 422278	Ø 300 22 20,4 V + S
418 i	100	07/15→	←	+ Performance Parts		24.0130-0233.2 430233	Ø 340 30 28,4 V Bremsscheibe zweiteilig / + S
420 d	120	03/14→	←				
420 d	135	03/14→03/15	←				
420 d	147	03/14→03/15	→	- Performance Parts		24.0120-0240.1 420240	Ø 300 20 18,4 V + S
420 i	120	03/14→	→	+ Performance Parts		24.0124-0251.2 424251	Ø 345 24 22,4 V Bremsscheibe zweiteilig / + S
420 i	120	02/16→	→				
420 i	135	03/14→					
420 i	135	02/16→					
420 i xDrive	120	02/16→					
420 i xDrive	135	07/14→					
420 i xDrive	135	02/16→					
↓							







	kw			 	! #		
<b>BMW - 4 Gran Coupe (F36) 03/14→</b>							
<b>Bremsscheibe</b>							
420 d	140	03/15→	←	- Performance Parts		24.0124-0203.1 424203	Ø 312 23,9 22,4 V + S
420 d xDrive	120	03/14→				24.0324-0203.1 524203	Ø 312 23,9 21,6 V + S
420 d xDrive	135	03/14→03/15	←	+ Performance Parts		24.0130-0233.2 430233	Ø 340 30 28,4 V
420 d xDrive	140	03/15→					Bremsscheibe zweiteilig / + S
420 d xDrive	147	03/14→03/15	→	- Performance Parts		24.0120-0240.1 420240	Ø 300 20 18,4 V + S
			→	+ Performance Parts		24.0124-0251.2 424251	Ø 345 24 22,4 V Bremsscheibe zweiteilig / + S
420 i xDrive	120	03/14→	←	07/14→; - Performance Parts		24.0122-0278.1 422278	Ø 300 22 20,4 V + S
			←	07/14→; + Performance Parts		24.0130-0233.2 430233	Ø 340 30 28,4 V Bremsscheibe zweiteilig / + S
			→	07/14→; - Performance Parts		24.0120-0240.1 420240	Ø 300 20 18,4 V + S
			→	07/14→; + Performance Parts		24.0124-0251.2 424251	Ø 345 24 22,4 V Bremsscheibe zweiteilig / + S
425 d	155	03/16→	←	- Performance Parts		24.0124-0248.1 424248	Ø 330 24 22,4 V + S
425 d	165	03/16→					
428 i	180	03/14→	←	+ Performance Parts		24.0130-0234.2 430234	Ø 370 30 28,4 V Bremsscheibe zweiteilig / + S
428 i xDrive	180	03/14→					
430 i	185	03/16→	→	- Performance Parts		24.0120-0240.1 420240	Ø 300 20 18,4 V + S
430 i xDrive	185	03/16→	→	+ Performance Parts		24.0124-0251.2 424251	Ø 345 24 22,4 V Bremsscheibe zweiteilig / + S
430 d	190	07/14→	←	- Performance Parts		24.0124-0248.1 424248	Ø 330 24 22,4 V + S
430 d	210	07/14→					
430 d xDrive	190	07/14→	←	+ Performance Parts		24.0130-0234.2 430234	Ø 370 30 28,4 V Bremsscheibe zweiteilig / + S
430 d xDrive	210	07/14→					
			→	- Performance Parts		24.0120-0243.1 420243	Ø 330 20 18,4 V + S
			→	+ Performance Parts		24.0124-0251.2 424251	Ø 345 24 22,4 V Bremsscheibe zweiteilig / + S
435 d xDrive	230	07/14→	←	- Performance Parts		24.0130-0233.2 430233	Ø 340 30 28,4 V Bremsscheibe zweiteilig / + S
435 i	225	03/14→					
435 i	250	03/14→	←	+ Performance Parts		24.0130-0234.2 430234	Ø 370 30 28,4 V Bremsscheibe zweiteilig / + S
435 i xDrive	225	07/14→					
435 i xDrive	250	07/14→					
440 i	240	03/16→	→	- Performance Parts		24.0120-0243.1 420243	Ø 330 20 18,4 V + S
440 i	265	03/16→					
440 i xDrive	240	03/16→	→	+ Performance Parts		24.0124-0251.2 424251	Ø 345 24 22,4 V Bremsscheibe zweiteilig / + S
440 i xDrive	265	03/16→					
<b>BMW - 5 (E39) 09/95→07/03</b>							
<b>Bremsbelagsatz, Scheibenbremse</b>							
520 d	100	02/00→06/03	←	04/00→; für Behördenfahrzeuge		13.0460-7078.2 607078	ATE 21486 19,5 + WE / - WK
525 d	120	02/00→06/03				13.0470-7078.2 LD7078	ATE 21486 19,5 + WE / - WK Ceramic
			←	04/00→; nicht für Behördenfahrzeuge		13.0460-7089.2 607089	ATE 21676 20,3 + WE / - WK
						13.0470-7089.2 LD7089	ATE 21676 20,3 + WE / - WK Ceramic
			→	04/00→		13.0460-7090.2 607090	ATE 21691 17,3 + WE / - WK
						13.0470-7090.2 LD7090	ATE 21691 17,3 + WE / - WK Ceramic
520 i	100	04/99→06/03	←	für Behördenfahrzeuge		13.0460-7078.2 607078	ATE 21486 19,5 + WE / - WK
520 i	120	09/00→06/03				13.0470-7078.2 LD7078	ATE 21486 19,5 + WE / - WK Ceramic
520 i	125	09/00→06/03	←	nicht für Behördenfahrzeuge		13.0460-7089.2 607089	ATE 21676 20,3 + WE / - WK
						13.0470-7089.2 LD7089	ATE 21676 20,3 + WE / - WK Ceramic
			→			13.0460-7090.2 607090	ATE 21691 17,3 + WE / - WK
						13.0470-7090.2 LD7090	ATE 21691 17,3 + WE / - WK Ceramic
520 i	110	01/96→06/03	←	03/96→; für Behördenfahrzeuge		13.0460-7078.2 607078	ATE 21486 19,5 + WE / - WK
						13.0470-7078.2 LD7078	ATE 21486 19,5 + WE / - WK Ceramic
			←	03/96→; nicht für Behördenfahrzeuge		13.0460-7089.2 607089	ATE 21676 20,3 + WE / - WK
						13.0470-7089.2 LD7089	ATE 21676 20,3 + WE / - WK Ceramic
			→	03/96→		13.0460-7090.2 607090	ATE 21691 17,3 + WE / - WK
						13.0470-7090.2 LD7090	ATE 21691 17,3 + WE / - WK Ceramic
523 i	125	11/95→09/00	←	12/95→		13.0460-7089.2 607089	ATE 21676 20,3 + WE / - WK
528 i	142	11/95→09/00				13.0470-7089.2 LD7089	ATE 21676 20,3 + WE / - WK Ceramic
↓							









	kW			 	! #		
<b>BMW - 5 (E39) 09/95→07/03</b>							
<b>Bremsbelagsatz, Scheibenbremse</b>							
523 i 528 i	125 142	11/95→09/00 11/95→09/00	➡	12/95→		13.0460-7090.2 607090 13.0470-7090.2 LD7090	ATE 21691 17,3 + WE / - WK ATE 21691 17,3 + WE / - WK Ceramic
525 i	141	09/00→06/03	←	10/00→; für Behördenfahrzeuge		13.0460-7078.2 607078 13.0470-7078.2 LD7078	ATE 21486 19,5 + WE / - WK ATE 21486 19,5 + WE / - WK Ceramic
			←	10/00→; nicht für Behördenfahrzeuge		13.0460-7089.2 607089 13.0470-7089.2 LD7089	ATE 21676 20,3 + WE / - WK ATE 21676 20,3 + WE / - WK Ceramic
			➡	10/00→		13.0460-7090.2 607090 13.0470-7090.2 LD7090	ATE 21691 17,3 + WE / - WK ATE 21691 17,3 + WE / - WK Ceramic
525 td	85	01/97→06/03	←	→ 09/00		13.0460-7089.2 607089 13.0470-7089.2 LD7089	ATE 21676 20,3 + WE / - WK ATE 21676 20,3 + WE / - WK Ceramic
			➡	→ 09/00		13.0460-7090.2 607090 13.0470-7090.2 LD7090	ATE 21691 17,3 + WE / - WK ATE 21691 17,3 + WE / - WK Ceramic
525 tds	105	01/96→06/03	←	02/96→ 09/00		13.0460-7089.2 607089 13.0470-7089.2 LD7089	ATE 21676 20,3 + WE / - WK ATE 21676 20,3 + WE / - WK Ceramic
			➡	02/96→ 09/00		13.0460-7090.2 607090 13.0470-7090.2 LD7090	ATE 21691 17,3 + WE / - WK ATE 21691 17,3 + WE / - WK Ceramic
530 d	135	08/98→09/00	←	09/98→		13.0460-7089.2 607089 13.0470-7089.2 LD7089	ATE 21676 20,3 + WE / - WK ATE 21676 20,3 + WE / - WK Ceramic
			➡	09/98→		13.0460-7090.2 607090 13.0470-7090.2 LD7090	ATE 21691 17,3 + WE / - WK ATE 21691 17,3 + WE / - WK Ceramic
530 d	142	09/98→06/03	←	10/00→		13.0460-7078.2 607078 13.0470-7078.2 LD7078	ATE 21486 19,5 + WE / - WK ATE 21486 19,5 + WE / - WK Ceramic
			←	→ 09/00		13.0460-7089.2 607089 13.0470-7089.2 LD7089	ATE 21676 20,3 + WE / - WK ATE 21676 20,3 + WE / - WK Ceramic
			➡			13.0460-7090.2 607090 13.0470-7090.2 LD7090	ATE 21691 17,3 + WE / - WK ATE 21691 17,3 + WE / - WK Ceramic
530 i	170	09/00→06/03	←	10/00→		13.0460-7078.2 607078 13.0470-7078.2 LD7078	ATE 21486 19,5 + WE / - WK ATE 21486 19,5 + WE / - WK Ceramic
			➡	10/00→		13.0460-7090.2 607090 13.0470-7090.2 LD7090	ATE 21691 17,3 + WE / - WK ATE 21691 17,3 + WE / - WK Ceramic
535 i	173	04/96→03/99	←	09/97→		13.0460-7078.2 607078	ATE 21486 19,5 + WE / - WK
			←	05/96→ 08/97		13.0460-7089.2 607089	ATE 21676 20,3 + WE / - WK
			➡	05/96→		13.0460-7090.2 607090 13.0470-7090.2 LD7090	ATE 21691 17,3 + WE / - WK ATE 21691 17,3 + WE / - WK Ceramic
535 i	180	04/99→06/03	←			13.0460-7078.2 607078	ATE 21486 19,5 + WE / - WK
			➡			13.0460-7090.2 607090 13.0470-7090.2 LD7090	ATE 21691 17,3 + WE / - WK ATE 21691 17,3 + WE / - WK Ceramic
540 i	210	04/96→06/03	←	05/96→		13.0460-7078.2 607078 13.0470-7078.2 LD7078	ATE 21486 19,5 + WE / - WK ATE 21486 19,5 + WE / - WK Ceramic
			➡	05/96→		13.0460-7090.2 607090 13.0470-7090.2 LD7090	ATE 21691 17,3 + WE / - WK ATE 21691 17,3 + WE / - WK Ceramic
M5	294	10/98→06/03	←			13.0460-7078.2 607078	ATE 21486 19,5 + WE / - WK
			➡			13.0460-7079.2 607079	ATE 21282 17,3 + WE / - WK
<b>Warnkontakt, Bremsbelagsverschleiß</b>							
520 d 525 d ↓	100 120	02/00→06/03 02/00→06/03	←	04/00→	1	24.8190-0219.2 620219	L= 764









	kw			 	! #		
<b>BMW - 5 (E39) 09/95→07/03</b>							
<b>Warnkontakt, Bremsbelagverschleiß</b>							
520 d	100	02/00→06/03	➡	04/00→	1	24.8190-0218.2 620218	L= 545
525 d	120	02/00→06/03					
520 i	100	04/99→06/03	⬅		1	24.8190-0219.2 620219	L= 764
520 i	120	09/00→06/03					
520 i	125	09/00→06/03	➡		1	24.8190-0218.2 620218	L= 545
535 i	180	04/99→06/03					
520 i	110	01/96→06/03	⬅	03/96→	1	24.8190-0219.2 620219	L= 764
			➡	03/96→	1	24.8190-0218.2 620218	L= 545
523 i	125	11/95→09/00	⬅	12/95→	1	24.8190-0219.2 620219	L= 764
528 i	142	11/95→09/00	➡	12/95→	1	24.8190-0218.2 620218	L= 545
525 i	141	09/00→06/03	⬅	10/00→	1	24.8190-0219.2 620219	L= 764
530 i	170	09/00→06/03	➡	10/00→	1	24.8190-0218.2 620218	L= 545
525 td	85	01/97→06/03	⬅	→ 09/00	1	24.8190-0219.2 620219	L= 764
			➡	→ 09/00	1	24.8190-0218.2 620218	L= 545
525 tds	105	01/96→06/03	⬅	02/96→ 09/00	1	24.8190-0219.2 620219	L= 764
			➡	02/96→ 09/00	1	24.8190-0218.2 620218	L= 545
530 d	135	08/98→09/00	⬅	09/98→	1	24.8190-0219.2 620219	L= 764
			➡	09/98→	1	24.8190-0218.2 620218	L= 545
530 d	142	09/98→06/03	⬅	10/00→	1	24.8190-0219.2 620219	L= 764
			⬅	→ 09/00	1	24.8190-0219.2 620219	L= 764
			➡		1	24.8190-0218.2 620218	L= 545
535 i	173	04/96→03/99	⬅	05/96→ 08/97	1	24.8190-0219.2 620219	L= 764
			⬅	09/97→	1	24.8190-0219.2 620219	L= 764
			➡	05/96→	1	24.8190-0218.2 620218	L= 545
540 i	210	04/96→06/03	⬅	05/96→	1	24.8190-0219.2 620219	L= 764
			➡	05/96→	1	24.8190-0218.2 620218	L= 545
M5	294	10/98→06/03	⬅		1	24.8190-0219.2 620219	L= 764
<b>Bremsscheibe</b>							
520 d	100	02/00→06/03	⬅	04/00→; nicht für Behördenfahrzeuge		24.0122-0159.1 422159 24.0322-0159.1 522159	Ø 296 22 20,4 V + S Ø 296 22 19,6 V + S
			⬅	04/00→; für Behördenfahrzeuge		24.0130-0107.1 430107 24.0330-0107.1 530107	Ø 324 29,9 28,4 V + S Ø 324 29,9 27,6 V + S
			➡	04/00→; nicht für Behördenfahrzeuge		24.0110-0227.1 410227 24.0310-0227.1 510227	Ø 298 10 8,4 + S Ø 298 10 7,6 + S
			➡	04/00→; für Behördenfahrzeuge		24.0120-0154.1 420154 24.0320-0154.1 520154	Ø 298 20 18,4 V + S Ø 298 20 17,6 V + S
520 i	100	04/99→06/03	⬅	nicht für Behördenfahrzeuge		24.0122-0159.1 422159 24.0322-0159.1 522159	Ø 296 22 20,4 V + S Ø 296 22 19,6 V + S
520 i	120	09/00→06/03					
520 i	125	09/00→06/03	⬅	für Behördenfahrzeuge		24.0130-0107.1 430107 24.0330-0107.1 530107	Ø 324 29,9 28,4 V + S Ø 324 29,9 27,6 V + S
			➡	nicht für Behördenfahrzeuge		24.0110-0227.1 410227 24.0310-0227.1 510227	Ø 298 10 8,4 + S Ø 298 10 7,6 + S
			➡	für Behördenfahrzeuge		24.0120-0154.1 420154 24.0320-0154.1 520154	Ø 298 20 18,4 V + S Ø 298 20 17,6 V + S
520 i	110	01/96→06/03	⬅	03/96→; nicht für Behördenfahrzeuge		24.0122-0159.1 422159 24.0322-0159.1 522159	Ø 296 22 20,4 V + S Ø 296 22 19,6 V + S
			⬅	03/96→; für Behördenfahrzeuge		24.0130-0107.1 430107 24.0330-0107.1 530107	Ø 324 29,9 28,4 V + S Ø 324 29,9 27,6 V + S
			➡	03/96→; nicht für Behördenfahrzeuge		24.0110-0227.1 410227 24.0310-0227.1 510227	Ø 298 10 8,4 + S Ø 298 10 7,6 + S
			➡	03/96→; für Behördenfahrzeuge		24.0120-0154.1 420154 24.0320-0154.1 520154	Ø 298 20 18,4 V + S Ø 298 20 17,6 V + S
523 i	125	11/95→09/00	⬅	12/95→		24.0122-0159.1 422159 24.0322-0159.1 522159	Ø 296 22 20,4 V + S Ø 296 22 19,6 V + S
			➡	12/95→ 08/98; nicht für Behördenfahrzeuge		24.0110-0227.1 410227 24.0310-0227.1 510227	Ø 298 10 8,4 + S Ø 298 10 7,6 + S
			➡	09/98→		24.0120-0154.1 420154 24.0320-0154.1 520154	Ø 298 20 18,4 V + S Ø 298 20 17,6 V + S
↓							









	kw			 	! #		
<b>BMW - 5 (E39) 09/95→07/03</b>							
<b>Bremsscheibe</b>							
523 i	125	11/95→09/00	➔	12/95→ 08/98; für Behördenfahrzeuge		24.0120-0154.1 420154 24.0320-0154.1 520154	Ø 298 20 18,4 V + S Ø 298 20 17,6 V + S
525 d	120	02/00→06/03	➔	04/00→; nicht für Behördenfahrzeuge		24.0122-0159.1 422159 24.0322-0159.1 522159	Ø 296 22 20,4 V + S Ø 296 22 19,6 V + S
			➔	04/00→; für Behördenfahrzeuge		24.0130-0107.1 430107 24.0330-0107.1 530107	Ø 324 29,9 28,4 V + S Ø 324 29,9 27,6 V + S
			➔	04/00→		24.0120-0154.1 420154 24.0320-0154.1 520154	Ø 298 20 18,4 V + S Ø 298 20 17,6 V + S
525 i	141	09/00→06/03	➔	10/00→; nicht für Behördenfahrzeuge		24.0122-0159.1 422159 24.0322-0159.1 522159	Ø 296 22 20,4 V + S Ø 296 22 19,6 V + S
			➔	10/00→; für Behördenfahrzeuge		24.0130-0107.1 430107 24.0330-0107.1 530107	Ø 324 29,9 28,4 V + S Ø 324 29,9 27,6 V + S
			➔	10/00→		24.0120-0154.1 420154 24.0320-0154.1 520154	Ø 298 20 18,4 V + S Ø 298 20 17,6 V + S
525 td	85	01/97→06/03	➔	→ 09/00		24.0122-0159.1 422159 24.0322-0159.1 522159	Ø 296 22 20,4 V + S Ø 296 22 19,6 V + S
			➔	→ 09/00; nicht für Behördenfahrzeuge		24.0110-0227.1 410227 24.0310-0227.1 510227	Ø 298 10 8,4 + S Ø 298 10 7,6 + S
			➔	→ 09/00; für Behördenfahrzeuge		24.0120-0154.1 420154 24.0320-0154.1 520154	Ø 298 20 18,4 V + S Ø 298 20 17,6 V + S
525 tds	105	01/96→06/03	➔	02/96→ 09/00		24.0122-0159.1 422159 24.0322-0159.1 522159	Ø 296 22 20,4 V + S Ø 296 22 19,6 V + S
			➔	02/96→ 09/00; nicht für Behördenfahrzeuge		24.0110-0227.1 410227 24.0310-0227.1 510227	Ø 298 10 8,4 + S Ø 298 10 7,6 + S
			➔	02/96→ 09/00; für Behördenfahrzeuge		24.0120-0154.1 420154 24.0320-0154.1 520154	Ø 298 20 18,4 V + S Ø 298 20 17,6 V + S
528 i	142	11/95→09/00	➔	12/95→		24.0122-0159.1 422159 24.0322-0159.1 522159	Ø 296 22 20,4 V + S Ø 296 22 19,6 V + S
			➔	12/95→		24.0120-0154.1 420154 24.0320-0154.1 520154	Ø 298 20 18,4 V + S Ø 298 20 17,6 V + S
530 d	135	08/98→09/00	➔	09/98→		24.0122-0159.1 422159 24.0322-0159.1 522159	Ø 296 22 20,4 V + S Ø 296 22 19,6 V + S
			➔	09/98→		24.0120-0154.1 420154 24.0320-0154.1 520154	Ø 298 20 18,4 V + S Ø 298 20 17,6 V + S
530 d	142	09/98→06/03	➔	→ 09/00		24.0122-0159.1 422159 24.0322-0159.1 522159	Ø 296 22 20,4 V + S Ø 296 22 19,6 V + S
			➔	10/00→		24.0130-0107.1 430107 24.0330-0107.1 530107	Ø 324 29,9 28,4 V + S Ø 324 29,9 27,6 V + S
			➔			24.0120-0154.1 420154 24.0320-0154.1 520154	Ø 298 20 18,4 V + S Ø 298 20 17,6 V + S
530 i	170	09/00→06/03	➔	10/00→		24.0130-0107.1 430107 24.0330-0107.1 530107	Ø 324 29,9 28,4 V + S Ø 324 29,9 27,6 V + S
			➔	10/00→		24.0120-0154.1 420154 24.0320-0154.1 520154	Ø 298 20 18,4 V + S Ø 298 20 17,6 V + S
			➔				
535 i	173	04/96→03/99	➔	05/96→ 08/97		24.0122-0159.1 422159 24.0322-0159.1 522159	Ø 296 22 20,4 V + S Ø 296 22 19,6 V + S
			➔	09/97→		24.0130-0101.1 430101	Ø 324 30 28,4 V + S
			➔	05/96→		24.0120-0154.1 420154 24.0320-0154.1 520154	Ø 298 20 18,4 V + S Ø 298 20 17,6 V + S
535 i	180	04/99→06/03	➔	→ 02/00		24.0130-0101.1 430101	Ø 324 30 28,4 V + S
			➔	03/00→		24.0130-0107.1 430107 24.0330-0107.1 530107	Ø 324 29,9 28,4 V + S Ø 324 29,9 27,6 V + S
			➔			24.0120-0154.1 420154 24.0320-0154.1 520154	Ø 298 20 18,4 V + S Ø 298 20 17,6 V + S
540 i	210	04/96→06/03	➔	05/96→ 02/00		24.0130-0101.1 430101	Ø 324 30 28,4 V + S
			➔	03/00→		24.0130-0107.1 430107 24.0330-0107.1 530107	Ø 324 29,9 28,4 V + S Ø 324 29,9 27,6 V + S
			➔	05/96→		24.0120-0154.1 420154 24.0320-0154.1 520154	Ø 298 20 18,4 V + S Ø 298 20 17,6 V + S
M5	294	10/98→06/03	➔	☐		24.0132-0161.2 432161	Ø 345 32 30,4 V Bremsscheibe zweiteilig / + S
↓							



	kw			 	! #		
<b>BMW - 5 (E39) 09/95→07/03</b>							
<b>Bremsscheibe</b>							
M5	294	10/98→06/03	←	<input type="checkbox"/>		24.0132-0162.2 432162	Ø 345 32 30,4 V Bremsscheibe zweiteilig / + S
<b>BMW - 5 (E60) 12/01→03/10</b>							
<b>Bremsbelagsatz, Scheibenbremse</b>							
520 d 520 d 523 i	110 120 130	02/05→02/08 02/05→02/08 10/04→02/07	←	07/05→; für Behördenfahrzeuge	13.0460-7167.2 607167	ATE 23312 20,3 + WE / - WK	
					13.0460-7296.2 607296	ATE 23212 20,3 + WE / - WK	
					13.0470-7167.2 LD7167	ATE 23312 20,3 + WE / - WK Ceramic	
			←	07/05→; nicht für Behördenfahrzeuge	13.0460-7176.2 607176	ATE 23793 20,3 + WE / - WK	
					13.0470-7176.2 LD7176	ATE 23793 20,3 + WE / - WK Ceramic	
			→	07/05→	13.0460-7174.2 607174	ATE 23732 17,3 + WE / - WK	
					13.0470-7174.2 LD7174	ATE 23732 17,3 + WE / - WK Ceramic	
520 d	130	04/06→12/09	←	09/07→	13.0460-7167.2 607167	ATE 23312 20,3 + WE / - WK	
					13.0460-7296.2 607296	ATE 23212 20,3 + WE / - WK	
					13.0470-7167.2 LD7167	ATE 23312 20,3 + WE / - WK Ceramic	
					13.0470-7296.2 LD7296	ATE 23212 20,3 + WE / - WK Ceramic	
			→	09/07→	13.0460-7174.2 607174	ATE 23732 17,3 + WE / - WK	
					13.0470-7174.2 LD7174	ATE 23732 17,3 + WE / - WK Ceramic	
520 i	125	07/03→03/10	←	→ 03/05; Vollautomatik	13.0460-7167.2 607167	ATE 23312 20,3 + WE / - WK	
					13.0460-7296.2 607296	ATE 23212 20,3 + WE / - WK	
					13.0470-7167.2 LD7167	ATE 23312 20,3 + WE / - WK Ceramic	
			←	→ 03/05; Schaltgetriebe	13.0460-7176.2 607176	ATE 23793 20,3 + WE / - WK	
					13.0470-7176.2 LD7176	ATE 23793 20,3 + WE / - WK Ceramic	
			→	→ 03/05	13.0460-7174.2 607174	ATE 23732 17,3 + WE / - WK	
					13.0470-7174.2 LD7174	ATE 23732 17,3 + WE / - WK Ceramic	
523 i	140	01/07→03/10	←	03/07→ 02/10; für Behördenfahrzeuge; Motorcode: N52N	13.0460-7167.2 607167	ATE 23312 20,3 + WE / - WK	
					13.0460-7296.2 607296	ATE 23212 20,3 + WE / - WK	
					13.0470-7167.2 LD7167	ATE 23312 20,3 + WE / - WK Ceramic	
					13.0470-7296.2 LD7296	ATE 23212 20,3 + WE / - WK Ceramic	
			←	03/07→ 02/10; Motorcode: N53	13.0460-7167.2 607167	ATE 23312 20,3 + WE / - WK	
		13.0460-7296.2 607296	ATE 23212 20,3 + WE / - WK				
				13.0470-7167.2 LD7167	ATE 23312 20,3 + WE / - WK Ceramic		
					13.0470-7296.2 LD7296	ATE 23212 20,3 + WE / - WK Ceramic	
			←	03/07→ 02/10; nicht für Behördenfahrzeuge; Motorcode: N52N	13.0460-7176.2 607176	ATE 23793 20,3 + WE / - WK	
					13.0470-7176.2 LD7176	ATE 23793 20,3 + WE / - WK Ceramic	
			→	03/07→ 02/10	13.0460-7174.2 607174	ATE 23732 17,3 + WE / - WK	
					13.0470-7174.2 LD7174	ATE 23732 17,3 + WE / - WK Ceramic	
525 d 525 d	120 130	12/04→03/10 06/04→03/10	←	für Behördenfahrzeuge; → 03/07	13.0460-7167.2 607167	ATE 23312 20,3 + WE / - WK	
					13.0460-7296.2 607296	ATE 23212 20,3 + WE / - WK	
					13.0470-7167.2 LD7167	ATE 23312 20,3 + WE / - WK Ceramic	
					13.0470-7296.2 LD7296	ATE 23212 20,3 + WE / - WK Ceramic	
			←	nicht für Behördenfahrzeuge; → 03/07	13.0460-7176.2 607176	ATE 23793 20,3 + WE / - WK	
					13.0470-7176.2 LD7176	ATE 23793 20,3 + WE / - WK Ceramic	
			→	→ 03/07	13.0460-7174.2 607174	ATE 23732 17,3 + WE / - WK	









	kW			 	! #		
<b>BMW - 5 (E60) 12/01→03/10</b>							
<b> Bremsbelagsatz, Scheibenbremse</b>							
525 d	120	12/04→03/10	➡	→ 03/07		13.0470-7174.2 LD7174	ATE 23732 17,3 + WE / - WK Ceramic
525 d	130	06/04→03/10					
525 d	145	01/07→03/10	←	03/07→ 02/10		13.0460-7167.2 607167 13.0460-7296.2 607296 13.0470-7167.2 LD7167 13.0470-7296.2 LD7296	ATE 23312 20,3 + WE / - WK ATE 23212 20,3 + WE / - WK ATE 23312 20,3 + WE / - WK Ceramic ATE 23212 20,3 + WE / - WK Ceramic
				➡ 03/07→ 02/10; für Behördenfahrzeuge		13.0460-7169.2 607169 13.0470-7169.2 LD7169	ATE 23309 17,3 + WE / - WK ATE 23309 17,3 + WE / - WK Ceramic
				➡ 03/07→ 02/10; nicht für Behördenfahrzeuge		13.0460-7174.2 607174 13.0470-7174.2 LD7174	ATE 23732 17,3 + WE / - WK ATE 23732 17,3 + WE / - WK Ceramic
525 d xDrive 530 d xDrive 530 i xDrive 530 xd 530 xi	145 173 200 173 200	09/07→12/09 09/07→12/09 09/08→12/09 03/07→08/07 03/07→10/09	←			13.0460-7167.2 607167 13.0460-7296.2 607296 13.0470-7167.2 LD7167 13.0470-7296.2 LD7296	ATE 23312 20,3 + WE / - WK ATE 23212 20,3 + WE / - WK ATE 23312 20,3 + WE / - WK Ceramic ATE 23212 20,3 + WE / - WK Ceramic
				➡		13.0460-7174.2 607174 13.0470-7174.2 LD7174	ATE 23732 17,3 + WE / - WK ATE 23732 17,3 + WE / - WK Ceramic
525 i	141	09/03→03/10	←	für Behördenfahrzeuge; → 06/05		13.0460-7167.2 607167 13.0460-7296.2 607296 13.0470-7167.2 LD7167 13.0470-7296.2 LD7296	ATE 23312 20,3 + WE / - WK ATE 23212 20,3 + WE / - WK ATE 23312 20,3 + WE / - WK Ceramic ATE 23212 20,3 + WE / - WK Ceramic
				← nicht für Behördenfahrzeuge; → 06/05		13.0460-7176.2 607176 13.0470-7176.2 LD7176	ATE 23793 20,3 + WE / - WK ATE 23793 20,3 + WE / - WK Ceramic
				➡ → 06/05		13.0460-7174.2 607174 13.0470-7174.2 LD7174	ATE 23732 17,3 + WE / - WK ATE 23732 17,3 + WE / - WK Ceramic
525 i 525 i 525 i	155 155 160	07/05→03/10 01/07→03/10 01/07→03/10	←	03/07→ 02/10; für Behördenfahrzeuge; Motorcode: N52N		13.0460-7167.2 607167 13.0460-7296.2 607296 13.0470-7167.2 LD7167 13.0470-7296.2 LD7296	ATE 23312 20,3 + WE / - WK ATE 23212 20,3 + WE / - WK ATE 23312 20,3 + WE / - WK Ceramic ATE 23212 20,3 + WE / - WK Ceramic
				← 03/07→ 02/10; Motorcode: N53		13.0460-7167.2 607167 13.0460-7296.2 607296 13.0470-7167.2 LD7167 13.0470-7296.2 LD7296	ATE 23312 20,3 + WE / - WK ATE 23212 20,3 + WE / - WK ATE 23312 20,3 + WE / - WK Ceramic ATE 23212 20,3 + WE / - WK Ceramic
				← → 03/07		13.0460-7167.2 607167 13.0460-7296.2 607296 13.0470-7167.2 LD7167 13.0470-7296.2 LD7296	ATE 23312 20,3 + WE / - WK ATE 23212 20,3 + WE / - WK ATE 23312 20,3 + WE / - WK Ceramic ATE 23212 20,3 + WE / - WK Ceramic
				← 03/07→ 02/10; nicht für Behördenfahrzeuge; Motorcode: N52N		13.0460-7176.2 607176 13.0470-7176.2 LD7176	ATE 23793 20,3 + WE / - WK ATE 23793 20,3 + WE / - WK Ceramic
				➡ 03/07→ 02/10; Motorcode: N53; für Behördenfahrzeuge		13.0460-7169.2 607169 13.0470-7169.2 LD7169	ATE 23309 17,3 + WE / - WK ATE 23309 17,3 + WE / - WK Ceramic
				➡ 03/07→ 02/10; Motorcode: N53; nicht für Behördenfahrzeuge		13.0460-7174.2 607174 13.0470-7174.2 LD7174	ATE 23732 17,3 + WE / - WK ATE 23732 17,3 + WE / - WK Ceramic
				➡ → 03/07		13.0460-7174.2 607174 13.0470-7174.2 LD7174	ATE 23732 17,3 + WE / - WK ATE 23732 17,3 + WE / - WK Ceramic
				➡ 03/07→ 02/10; Motorcode: N52N		13.0460-7174.2 607174 13.0470-7174.2 LD7174	ATE 23732 17,3 + WE / - WK ATE 23732 17,3 + WE / - WK Ceramic

	kw			 	! #					
<b>BMW - 5 (E60) 12/01→03/10</b>										
<b> Bremsbelagsatz, Scheibenbremse</b>										
525 i	160	10/04→12/09	←	07/05→ 03/07	13.0460-7167.2	607167	ATE 23312 20,3 + WE / - WK			
					13.0460-7296.2	607296	ATE 23212 20,3 + WE / - WK			
					13.0470-7167.2	LD7167	ATE 23312 20,3 + WE / - WK Ceramic			
					13.0470-7296.2	LD7296	ATE 23212 20,3 + WE / - WK Ceramic			
			←	03/07→; für Behördenfahrzeuge; Motorcode: N52N	13.0460-7167.2	607167	ATE 23312 20,3 + WE / - WK			
					13.0460-7296.2	607296	ATE 23212 20,3 + WE / - WK			
					13.0470-7167.2	LD7167	ATE 23312 20,3 + WE / - WK Ceramic			
					13.0470-7296.2	LD7296	ATE 23212 20,3 + WE / - WK Ceramic			
525 i xDrive 525 xi 525 xi	160 160 160	09/08→03/10 07/05→03/10 01/07→03/10	←	→ 02/10	13.0460-7167.2	607167	ATE 23312 20,3 + WE / - WK			
					13.0460-7296.2	607296	ATE 23212 20,3 + WE / - WK			
					13.0470-7167.2	LD7167	ATE 23312 20,3 + WE / - WK Ceramic			
					13.0470-7296.2	LD7296	ATE 23212 20,3 + WE / - WK Ceramic			
			→	→ 02/10	13.0460-7174.2	607174	ATE 23732 17,3 + WE / - WK			
					13.0470-7174.2	LD7174	ATE 23732 17,3 + WE / - WK Ceramic			
			525 xd 530 xi	145 200	11/06→08/07 02/07→08/08	←	03/07→	13.0460-7167.2	607167	ATE 23312 20,3 + WE / - WK
								13.0460-7296.2	607296	ATE 23212 20,3 + WE / - WK
		13.0470-7167.2				LD7167	ATE 23312 20,3 + WE / - WK Ceramic			
		13.0470-7296.2				LD7296	ATE 23212 20,3 + WE / - WK Ceramic			
→	03/07→	13.0460-7174.2				607174	ATE 23732 17,3 + WE / - WK			
		13.0470-7174.2				LD7174	ATE 23732 17,3 + WE / - WK Ceramic			
530 d 530 d	155 160	09/02→12/09 09/02→09/05				←	07/03→ 08/05	13.0460-7167.2	607167	ATE 23312 20,3 + WE / - WK
								13.0460-7296.2	607296	ATE 23212 20,3 + WE / - WK
					13.0470-7167.2	LD7167	ATE 23312 20,3 + WE / - WK Ceramic			
			→	07/03→; für Behördenfahrzeuge; → 08/05	13.0460-7169.2	607169	ATE 23309 17,3 + WE / - WK			
			→	07/03→; nicht für Behördenfahrzeuge; → 08/05	13.0460-7174.2	607174	ATE 23732 17,3 + WE / - WK			
					13.0470-7174.2	LD7174	ATE 23732 17,3 + WE / - WK Ceramic			
530 d	170	04/05→02/07	←		13.0460-7167.2	607167	ATE 23312 20,3 + WE / - WK			
					13.0460-7296.2	607296	ATE 23212 20,3 + WE / - WK			
					13.0470-7167.2	LD7167	ATE 23312 20,3 + WE / - WK Ceramic			









	kw			 	! #			
<b>BMW - 5 (E60) 12/01→03/10</b>								
<b> Bremsbelagsatz, Scheibenbremse</b>								
530 d	170	04/05→02/07	←			<b>13.0470-7296.2</b>	<b>LD7296</b>	ATE 23212 20,3 + WE / - WK Ceramic
			→	für Behördenfahrzeuge		<b>13.0460-7169.2</b>	<b>607169</b>	ATE 23309 17,3 + WE / - WK
						<b>13.0470-7169.2</b>	<b>LD7169</b>	ATE 23309 17,3 + WE / - WK Ceramic
			→	nicht für Behördenfahrzeuge		<b>13.0460-7174.2</b>	<b>607174</b>	ATE 23732 17,3 + WE / - WK
						<b>13.0470-7174.2</b>	<b>LD7174</b>	ATE 23732 17,3 + WE / - WK Ceramic
530 d	173	02/07→12/09	←	03/07→		<b>13.0460-7167.2</b>	<b>607167</b>	ATE 23312 20,3 + WE / - WK
						<b>13.0460-7296.2</b>	<b>607296</b>	ATE 23212 20,3 + WE / - WK
						<b>13.0470-7167.2</b>	<b>LD7167</b>	ATE 23312 20,3 + WE / - WK Ceramic
						<b>13.0470-7296.2</b>	<b>LD7296</b>	ATE 23212 20,3 + WE / - WK Ceramic
			→	03/07→; für Behördenfahrzeuge		<b>13.0460-7169.2</b>	<b>607169</b>	ATE 23309 17,3 + WE / - WK
						<b>13.0470-7169.2</b>	<b>LD7169</b>	ATE 23309 17,3 + WE / - WK Ceramic
			→	03/07→; nicht für Behördenfahrzeuge		<b>13.0460-7174.2</b>	<b>607174</b>	ATE 23732 17,3 + WE / - WK
						<b>13.0470-7174.2</b>	<b>LD7174</b>	ATE 23732 17,3 + WE / - WK Ceramic
530 i	170	12/01→02/05	←	07/03→		<b>13.0460-7167.2</b>	<b>607167</b>	ATE 23312 20,3 + WE / - WK
						<b>13.0460-7296.2</b>	<b>607296</b>	ATE 23212 20,3 + WE / - WK
						<b>13.0470-7167.2</b>	<b>LD7167</b>	ATE 23312 20,3 + WE / - WK Ceramic
						<b>13.0470-7296.2</b>	<b>LD7296</b>	ATE 23212 20,3 + WE / - WK Ceramic
			→	07/03→		<b>13.0460-7174.2</b>	<b>607174</b>	ATE 23732 17,3 + WE / - WK
						<b>13.0470-7174.2</b>	<b>LD7174</b>	ATE 23732 17,3 + WE / - WK Ceramic
530 i	187	03/05→03/10	←	07/05→ 03/07		<b>13.0460-7167.2</b>	<b>607167</b>	ATE 23312 20,3 + WE / - WK
						<b>13.0460-7296.2</b>	<b>607296</b>	ATE 23212 20,3 + WE / - WK
						<b>13.0470-7167.2</b>	<b>LD7167</b>	ATE 23312 20,3 + WE / - WK Ceramic
						<b>13.0470-7296.2</b>	<b>LD7296</b>	ATE 23212 20,3 + WE / - WK Ceramic
			→	07/05→ 03/07; für Behördenfahrzeuge		<b>13.0460-7169.2</b>	<b>607169</b>	ATE 23309 17,3 + WE / - WK
						<b>13.0470-7169.2</b>	<b>LD7169</b>	ATE 23309 17,3 + WE / - WK Ceramic
			→	07/05→ 03/07; nicht für Behördenfahrzeuge		<b>13.0460-7174.2</b>	<b>607174</b>	ATE 23732 17,3 + WE / - WK
						<b>13.0470-7174.2</b>	<b>LD7174</b>	ATE 23732 17,3 + WE / - WK Ceramic
530 i	190	09/04→02/07	←	07/05→		<b>13.0460-7167.2</b>	<b>607167</b>	ATE 23312 20,3 + WE / - WK
						<b>13.0460-7296.2</b>	<b>607296</b>	ATE 23212 20,3 + WE / - WK
						<b>13.0470-7167.2</b>	<b>LD7167</b>	ATE 23312 20,3 + WE / - WK Ceramic
						<b>13.0470-7296.2</b>	<b>LD7296</b>	ATE 23212 20,3 + WE / - WK Ceramic
			→	07/05→; für Behördenfahrzeuge		<b>13.0460-7169.2</b>	<b>607169</b>	ATE 23309 17,3 + WE / - WK
						<b>13.0470-7169.2</b>	<b>LD7169</b>	ATE 23309 17,3 + WE / - WK Ceramic
			→	07/05→; nicht für Behördenfahrzeuge		<b>13.0460-7174.2</b>	<b>607174</b>	ATE 23732 17,3 + WE / - WK
						<b>13.0470-7174.2</b>	<b>LD7174</b>	ATE 23732 17,3 + WE / - WK Ceramic
530 i	200	09/06→12/09	←	01/07→		<b>13.0460-7167.2</b>	<b>607167</b>	ATE 23312 20,3 + WE / - WK
						<b>13.0460-7296.2</b>	<b>607296</b>	ATE 23212 20,3 + WE / - WK
						<b>13.0470-7167.2</b>	<b>LD7167</b>	ATE 23312 20,3 + WE / - WK Ceramic
						<b>13.0470-7296.2</b>	<b>LD7296</b>	ATE 23212 20,3 + WE / - WK Ceramic
			→	01/07→; für Behördenfahrzeuge; Motorcode: N52N		<b>13.0460-7169.2</b>	<b>607169</b>	ATE 23309 17,3 + WE / - WK
						<b>13.0470-7169.2</b>	<b>LD7169</b>	ATE 23309 17,3 + WE / - WK Ceramic
			→	01/07→; Motorcode: N53		<b>13.0460-7169.2</b>	<b>607169</b>	ATE 23309 17,3 + WE / - WK
						<b>13.0470-7169.2</b>	<b>LD7169</b>	ATE 23309 17,3 + WE / - WK Ceramic
			→	01/07→; nicht für Behördenfahrzeuge; Motorcode: N52N		<b>13.0460-7174.2</b>	<b>607174</b>	ATE 23732 17,3 + WE / - WK









↓

















	kw			 	! #		
<b>BMW - 5 (E60) 12/01→03/10</b>							
<b> Bremsbelagsatz, Scheibenbremse</b>							
530 i	200	09/06→12/09	➡	01/07→; nicht für Behördenfahrzeuge; Motorcode: N52N		13.0470-7174.2 LD7174	ATE 23732 17,3 + WE / - WK Ceramic
530 xd 530 xi	170 190	02/05→02/07 09/04→02/07	←	07/05→		13.0460-7167.2 607167	ATE 23312 20,3 + WE / - WK
						13.0460-7296.2 607296	ATE 23212 20,3 + WE / - WK
						13.0470-7167.2 LD7167	ATE 23312 20,3 + WE / - WK Ceramic
						13.0470-7296.2 LD7296	ATE 23212 20,3 + WE / - WK Ceramic
			➡	07/05→		13.0460-7174.2 607174	ATE 23732 17,3 + WE / - WK
						13.0470-7174.2 LD7174	ATE 23732 17,3 + WE / - WK Ceramic
535 d	200	09/04→03/10	←	→ 03/07		13.0460-7210.2 607210	ATE 23791 20,8 + WE / - WK
						13.0470-7210.2 LD7210	ATE 23791 20,8 + WE / - WK Ceramic
			➡	→ 03/07		13.0460-7169.2 607169	ATE 23309 17,3 + WE / - WK
						13.0470-7169.2 LD7169	ATE 23309 17,3 + WE / - WK Ceramic
535 d	210	01/07→03/10	←	03/07→ 02/10		13.0460-7210.2 607210	ATE 23791 20,8 + WE / - WK
						13.0470-7210.2 LD7210	ATE 23791 20,8 + WE / - WK Ceramic
			➡	03/07→ 02/10		13.0460-7169.2 607169	ATE 23309 17,3 + WE / - WK
						13.0470-7169.2 LD7169	ATE 23309 17,3 + WE / - WK Ceramic
535 i 540 i	225 225	04/06→12/09 09/05→02/10	←	03/07→; nicht für erhöhte Nutzlast		13.0460-7167.2 607167	ATE 23312 20,3 + WE / - WK
						13.0460-7296.2 607296	ATE 23212 20,3 + WE / - WK
						13.0470-7167.2 LD7167	ATE 23312 20,3 + WE / - WK Ceramic
						13.0470-7296.2 LD7296	ATE 23212 20,3 + WE / - WK Ceramic
			←	→ 03/07		13.0460-7167.2 607167	ATE 23312 20,3 + WE / - WK
						13.0460-7296.2 607296	ATE 23212 20,3 + WE / - WK
						13.0470-7167.2 LD7167	ATE 23312 20,3 + WE / - WK Ceramic
						13.0470-7296.2 LD7296	ATE 23212 20,3 + WE / - WK Ceramic
			←	03/07→; für erhöhte Nutzlast		13.0460-7210.2 607210	ATE 23791 20,8 + WE / - WK
						13.0470-7210.2 LD7210	ATE 23791 20,8 + WE / - WK Ceramic
			➡			13.0460-7169.2 607169	ATE 23309 17,3 + WE / - WK
						13.0470-7169.2 LD7169	ATE 23309 17,3 + WE / - WK Ceramic
540 i	225	07/05→03/10	←	03/07→ 02/10; nicht für erhöhte Nutzlast		13.0460-7167.2 607167	ATE 23312 20,3 + WE / - WK
						13.0460-7296.2 607296	ATE 23212 20,3 + WE / - WK
						13.0470-7167.2 LD7167	ATE 23312 20,3 + WE / - WK Ceramic
						13.0470-7296.2 LD7296	ATE 23212 20,3 + WE / - WK Ceramic
			←	→ 03/07		13.0460-7167.2 607167	ATE 23312 20,3 + WE / - WK
						13.0460-7296.2 607296	ATE 23212 20,3 + WE / - WK
						13.0470-7167.2 LD7167	ATE 23312 20,3 + WE / - WK Ceramic
						13.0470-7296.2 LD7296	ATE 23212 20,3 + WE / - WK Ceramic
			←	03/07→ 02/10; für erhöhte Nutzlast		13.0460-7210.2 607210	ATE 23791 20,8 + WE / - WK
						13.0470-7210.2 LD7210	ATE 23791 20,8 + WE / - WK Ceramic
			➡	→ 02/10		13.0460-7169.2 607169	ATE 23309 17,3 + WE / - WK
						13.0470-7169.2 LD7169	ATE 23309 17,3 + WE / - WK Ceramic
545 i	245	09/03→03/10	←	→ 08/05		13.0460-7167.2 607167	ATE 23312 20,3 + WE / - WK
						13.0460-7296.2 607296	ATE 23212 20,3 + WE / - WK
			➡	→ 08/05		13.0460-7169.2 607169	ATE 23309 17,3 + WE / - WK
						13.0470-7169.2 LD7169	ATE 23309 17,3 + WE / - WK Ceramic
550 i	270	07/05→03/10	←	03/07→ 02/10		13.0460-7167.2 607167	ATE 23312 20,3 + WE / - WK
						13.0460-7210.2 607210	ATE 23791 20,8 + WE / - WK
						13.0460-7296.2 607296	ATE 23212 20,3 + WE / - WK
↓							









	kw			 	! #		
<b>BMW - 5 (E60) 12/01→03/10</b>							
<b> Bremsbelagsatz, Scheibenbremse</b>							
550 i	270	07/05→03/10	← → 03/07 → → 02/10			13.0460-7210.2 607210 13.0460-7169.2 607169 13.0470-7169.2 LD7169	ATE 23791 20,8 + WE / - WK ATE 23309 17,3 + WE / - WK ATE 23309 17,3 + WE / - WK Ceramic
M5	373	09/04→03/10	← → 02/10 → → 02/10			13.0460-7210.2 607210 13.0460-7169.2 607169 13.0470-7169.2 LD7169	ATE 23791 20,8 + WE / - WK ATE 23309 17,3 + WE / - WK ATE 23309 17,3 + WE / - WK Ceramic
<b>Warnkontakt, Bremsbelagverschleiß</b>							
520 d	110	02/05→02/08	← ☐; 07/05→	1	24.8190-0273.2 620273	L= 662	
520 d	120	02/05→02/08	→ 07/05→	1	24.8190-0274.2 620274	L= 664	
523 i	130	10/04→02/07					
530 i	190	09/04→02/07					
530 xd	170	02/05→02/07					
530 xi	190	09/04→02/07					
520 d	130	04/06→12/09	← ☐; 09/07→ → 09/07→	1	24.8190-0273.2 620273 24.8190-0274.2 620274	L= 662 L= 664	
520 i	125	07/03→03/10	← ☐; → 03/05; Schaltgetriebe ← ☐; → 03/05; Vollautomatik → → 03/05	1	24.8190-0273.2 620273 24.8190-0273.2 620273 24.8190-0274.2 620274	L= 662 L= 662 L= 664	
523 i	140	01/07→03/10	← ☐; 03/07→ 02/10; Motorcode: N53 ← ☐; 03/07→ 02/10; Motorcode: N52N → 03/07→ 02/10	1	24.8190-0273.2 620273 24.8190-0273.2 620273 24.8190-0274.2 620274	L= 662 L= 662 L= 664	
525 d	120	12/04→03/10	← ☐; → 03/07	1	24.8190-0273.2 620273	L= 662	
525 d	130	06/04→03/10	→ → 03/07	1	24.8190-0274.2 620274	L= 664	
535 d	200	09/04→03/10					
525 d	145	01/07→03/10	← ☐; 03/07→ 02/10	1	24.8190-0273.2 620273	L= 662	
535 d	210	01/07→03/10	→ 03/07→ 02/10	1	24.8190-0274.2 620274	L= 664	
525 d xDrive	145	09/07→12/09	← ☐	1	24.8190-0273.2 620273	L= 662	
530 d	170	04/05→02/07					
530 d xDrive	173	09/07→12/09	→	1	24.8190-0274.2 620274	L= 664	
530 i xDrive	200	09/08→12/09					
530 xd	173	03/07→08/07					
530 xi	200	03/07→10/09					
525 i	141	09/03→03/10	← ☐; → 06/05 → → 06/05	1	24.8190-0273.2 620273 24.8190-0274.2 620274	L= 662 L= 664	
525 i	155	07/05→03/10	← ☐; → 03/07	1	24.8190-0273.2 620273	L= 662	
525 i	155	01/07→03/10	← ☐; 03/07→ 02/10; Motorcode: N53	1	24.8190-0273.2 620273	L= 662	
525 i	160	01/07→03/10	← ☐; 03/07→ 02/10; Motorcode: N52N → 03/07→ 02/10; Motorcode: N53 → 03/07→ 02/10; Motorcode: N52N → → 03/07	1	24.8190-0273.2 620273 24.8190-0274.2 620274 24.8190-0274.2 620274 24.8190-0274.2 620274	L= 662 L= 664 L= 664 L= 664	
525 i	160	10/04→12/09	← ☐; 03/07→; Motorcode: N52N ← ☐; 07/05→ 03/07 ← ☐; 03/07→; Motorcode: N53 → 03/07→; Motorcode: N52N → 07/05→ 03/07 → 03/07→; Motorcode: N53	1	24.8190-0273.2 620273 24.8190-0273.2 620273 24.8190-0273.2 620273 24.8190-0274.2 620274 24.8190-0274.2 620274 24.8190-0274.2 620274	L= 662 L= 662 L= 662 L= 664 L= 664 L= 664	
525 i xDrive	160	09/08→03/10	← ☐; → 02/10	1	24.8190-0273.2 620273	L= 662	
525 xi	160	07/05→03/10					
525 xi	160	01/07→03/10	→ → 02/10	1	24.8190-0274.2 620274	L= 664	
M5	373	09/04→03/10					
525 xd	145	11/06→08/07	← ☐; 03/07→	1	24.8190-0273.2 620273	L= 662	
530 d	173	02/07→12/09					
530 xi	200	02/07→08/08	→ 03/07→	1	24.8190-0274.2 620274	L= 664	
530 d	155	09/02→12/09	← ☐; 07/03→ 08/05	1	24.8190-0273.2 620273	L= 662	
530 d	160	09/02→09/05	→ 07/03→ 08/05	1	24.8190-0274.2 620274	L= 664	
530 i	170	12/01→02/05	← ☐; 07/03→ → 07/03→	1	24.8190-0273.2 620273 24.8190-0274.2 620274	L= 662 L= 664	
530 i	187	03/05→03/10	← ☐; 07/05→ 03/07 → 07/05→ 03/07	1	24.8190-0273.2 620273 24.8190-0274.2 620274	L= 662 L= 664	
↓							









	kw			 	! #		
<b>BMW - 5 (E60) 12/01→03/10</b>							
<b>Warnkontakt, Bremsbelagverschleiß</b>							
530 i	200	09/06→12/09	←	☐; 01/07→	1	24.8190-0273.2 620273	L= 662
			→	01/07→; Motorcode: N52N	1	24.8190-0274.2 620274	L= 664
			→	01/07→; Motorcode: N53	1	24.8190-0274.2 620274	L= 664
535 i 540 i	225 225	04/06→12/09 09/05→02/10	←	☐; 03/07→	1	24.8190-0273.2 620273	L= 662
			←	☐; → 03/07	1	24.8190-0273.2 620273	L= 662
			→		1	24.8190-0274.2 620274	L= 664
540 i	225	07/05→03/10	←	☐; 03/07→ 02/10	1	24.8190-0273.2 620273	L= 662
			←	☐; → 03/07	1	24.8190-0273.2 620273	L= 662
			→	→ 02/10	1	24.8190-0274.2 620274	L= 664
545 i	245	09/03→03/10	←	→ 08/05	1	24.8190-0273.2 620273	L= 662
			→	→ 08/05	1	24.8190-0274.2 620274	L= 664
550 i	270	07/05→03/10	←	☐; 03/07→ 02/10	1	24.8190-0273.2 620273	L= 662
			←	03/07→ 02/10	1	24.8190-0273.2 620273	L= 662
			←	☐; → 03/07	1	24.8190-0273.2 620273	L= 662
			→	→ 02/10	1	24.8190-0274.2 620274	L= 664
<b> Bremsscheibe</b>							
520 d 520 d 523 i	110 120 130	02/05→02/08 02/05→02/08 10/04→02/07	←	07/05→; nicht für Behördenfahrzeuge		24.0124-0181.1 424181	∅ 310 24 22,4 V + S
						24.0324-0181.1 524181	∅ 310 24 21,6 V + S
			←	07/05→; für Behördenfahrzeuge		24.0130-0173.1 430173	∅ 324 30 28,4 V + S
						24.0330-0173.1 530173	∅ 324 30 27,6 V + S
520 d	130	04/06→12/09	←	07/05→		24.0120-0183.1 420183	∅ 320 20 18,4 V + S
						24.0320-0183.1 520183	∅ 320 20 17,6 V + S
			←	09/07→		24.0130-0173.1 430173	∅ 324 30 28,4 V + S
						24.0330-0173.1 530173	∅ 324 30 27,6 V + S
520 d	130	04/06→12/09	→	09/07→		24.0120-0183.1 420183	∅ 320 20 18,4 V + S
						24.0320-0183.1 520183	∅ 320 20 17,6 V + S
			←	09/07→		24.0130-0173.1 430173	∅ 324 30 28,4 V + S
						24.0330-0173.1 530173	∅ 324 30 27,6 V + S
520 i	125	07/03→03/10	←	Schaltgetriebe; → 03/05		24.0124-0181.1 424181	∅ 310 24 22,4 V + S
						24.0324-0181.1 524181	∅ 310 24 21,6 V + S
			←	Vollautomatik; → 03/05		24.0130-0173.1 430173	∅ 324 30 28,4 V + S
						24.0330-0173.1 530173	∅ 324 30 27,6 V + S
520 i	140	01/07→03/10	→	→ 03/05		24.0120-0183.1 420183	∅ 320 20 18,4 V + S
						24.0320-0183.1 520183	∅ 320 20 17,6 V + S
			←	03/07→ 02/10; nicht für Behördenfahrzeuge; Motorcode: N52N		24.0124-0181.1 424181	∅ 310 24 22,4 V + S
						24.0324-0181.1 524181	∅ 310 24 21,6 V + S
523 i	140	01/07→03/10	←	03/07→ 02/10; Motorcode: N53		24.0130-0173.1 430173	∅ 324 30 28,4 V + S
						24.0330-0173.1 530173	∅ 324 30 27,6 V + S
			←	03/07→ 02/10; für Behördenfahrzeuge; Motorcode: N52N		24.0130-0173.1 430173	∅ 324 30 28,4 V + S
						24.0330-0173.1 530173	∅ 324 30 27,6 V + S
525 d 525 d	120 130	12/04→03/10 06/04→03/10	→	03/07→ 02/10		24.0120-0183.1 420183	∅ 320 20 18,4 V + S
						24.0320-0183.1 520183	∅ 320 20 17,6 V + S
			←	nicht für Behördenfahrzeuge; → 03/07		24.0124-0181.1 424181	∅ 310 24 22,4 V + S
						24.0324-0181.1 524181	∅ 310 24 21,6 V + S
525 d	145	01/07→03/10	←	für Behördenfahrzeuge; → 03/07		24.0130-0173.1 430173	∅ 324 30 28,4 V + S
						24.0330-0173.1 530173	∅ 324 30 27,6 V + S
			→	→ 03/07		24.0120-0183.1 420183	∅ 320 20 18,4 V + S
						24.0320-0183.1 520183	∅ 320 20 17,6 V + S
525 d	145	01/07→03/10	←	03/07→ 02/10; nicht für Behördenfahrzeuge		24.0130-0173.1 430173	∅ 324 30 28,4 V + S
						24.0330-0173.1 530173	∅ 324 30 27,6 V + S
			←	03/07→ 02/10; für Behördenfahrzeuge		24.0130-0186.2 430186	∅ 348 30 28,4 V Bremsscheibe zweiteilig / + S
						24.0120-0183.1 420183	∅ 320 20 18,4 V + S
525 d xDrive 530 d xDrive 530 i xDrive 530 xd 530 xi	145 173 200 173 200	09/07→12/09 09/07→12/09 09/08→12/09 03/07→08/07 03/07→10/09	→	03/07→ 02/10; nicht für Behördenfahrzeuge		24.0120-0183.1 420183	∅ 320 20 18,4 V + S
						24.0320-0183.1 520183	∅ 320 20 17,6 V + S
			←	03/07→ 02/10; für Behördenfahrzeuge		24.0124-0201.2 424201	∅ 345 24 22,4 V Bremsscheibe zweiteilig / + S
						24.0130-0173.1 430173	∅ 324 30 28,4 V + S
↓						24.0330-0173.1 530173	∅ 324 30 27,6 V + S
						24.0120-0213.1 420213	∅ 320 20 18,4 V + S
						24.0320-0213.1 520213	∅ 320 20 17,6 V + S









	kw			 	! #		
<b>BMW - 5 (E60) 12/01→03/10</b>							
<b>Bremsscheibe</b>							
525 i	141	09/03→03/10	←	nicht für Behördenfahrzeuge; → 06/05	24.0124-0181.1 424181	Ø 310 24 22,4 V + S	
			←	für Behördenfahrzeuge; → 06/05	24.0324-0181.1 524181	Ø 310 24 21,6 V + S	
			→	→ 06/05	24.0130-0173.1 430173	Ø 324 30 28,4 V + S	
525 i 525 i 525 i	155 155 160	07/05→03/10 01/07→03/10 01/07→03/10	←	03/07→ 02/10; nicht für Behördenfahrzeuge; Motorcode: N52N	24.0124-0181.1 424181	Ø 310 24 22,4 V + S	
			←	03/07→ 02/10; nicht für Behördenfahrzeuge; Motorcode: N53	24.0324-0181.1 524181	Ø 310 24 21,6 V + S	
			←	→ 03/07	24.0130-0173.1 430173	Ø 324 30 28,4 V + S	
			←	→ 03/07	24.0330-0173.1 530173	Ø 324 30 27,6 V + S	
			←	03/07→ 02/10; für Behördenfahrzeuge; Motorcode: N52N	24.0130-0173.1 430173	Ø 324 30 28,4 V + S	
			←	03/07→; für Behördenfahrzeuge; Motorcode: N53; → 02/10	24.0330-0173.1 530173	Ø 324 30 27,6 V + S	
			→	→ 03/07	24.0130-0173.1 430173	Ø 324 30 28,4 V + S	
			→	→ 03/07	24.0330-0173.1 530173	Ø 324 30 27,6 V + S	
			→	03/07→ 02/10; Motorcode: N52N	24.0120-0183.1 420183	Ø 320 20 18,4 V + S	
			→	03/07→ 02/10; Motorcode: N53; nicht für Behördenfahrzeuge	24.0320-0183.1 520183	Ø 320 20 17,6 V + S	
525 i	160	10/04→12/09	←	03/07→; nicht für Behördenfahrzeuge; Motorcode: N52N	24.0124-0181.1 424181	Ø 310 24 22,4 V + S	
			←	03/07→; für Behördenfahrzeuge; Motorcode: N52N	24.0324-0181.1 524181	Ø 310 24 21,6 V + S	
			←	03/07→; nicht für Behördenfahrzeuge; Motorcode: N53	24.0130-0173.1 430173	Ø 324 30 28,4 V + S	
			←	07/05→ 03/07	24.0330-0173.1 530173	Ø 324 30 27,6 V + S	
			←	03/07→; für Behördenfahrzeuge; Motorcode: N53	24.0130-0173.1 430173	Ø 324 30 28,4 V + S	
			→	03/07→; Motorcode: N52N	24.0330-0173.1 530173	Ø 324 30 27,6 V + S	
			→	07/05→ 03/07	24.0120-0183.1 420183	Ø 320 20 18,4 V + S	
			→	07/05→ 03/07	24.0320-0183.1 520183	Ø 320 20 17,6 V + S	
			→	03/07→; Motorcode: N53; nicht für Behördenfahrzeuge	24.0120-0183.1 420183	Ø 320 20 18,4 V + S	
			→	03/07→; Motorcode: N53; für Behördenfahrzeuge	24.0320-0183.1 520183	Ø 320 20 17,6 V + S	
525 i xDrive 525 xi 525 xi	160 160 160	09/08→03/10 07/05→03/10 01/07→03/10	←	→ 02/10	24.0124-0181.1 424181	Ø 310 24 22,4 V + S	
			←	→ 02/10	24.0130-0173.1 430173	Ø 324 30 28,4 V + S	
			→	→ 02/10	24.0330-0173.1 530173	Ø 324 30 27,6 V + S	
525 xd 530 xi	145 200	11/06→08/07 02/07→08/08	←	03/07→	24.0120-0213.1 420213	Ø 320 20 18,4 V + S	
			←	03/07→	24.0320-0213.1 520213	Ø 320 20 17,6 V + S	
			→	→ 02/10	24.0120-0213.1 420213	Ø 320 20 18,4 V + S	
530 d 530 d	155 160	09/02→12/09 09/02→09/05	←	07/03→; nicht für Behördenfahrzeuge; → 08/05	24.0120-0213.1 420213	Ø 320 20 17,6 V + S	
			←	07/03→; für Behördenfahrzeuge; → 08/05	24.0320-0213.1 520213	Ø 320 20 17,6 V + S	
			→	07/03→; nicht für Behördenfahrzeuge; → 08/05	24.0130-0173.1 430173	Ø 324 30 28,4 V + S	
			→	07/03→; für Behördenfahrzeuge; → 08/05	24.0330-0173.1 530173	Ø 324 30 27,6 V + S	
530 d	170	04/05→02/07	←	nicht für Behördenfahrzeuge	24.0130-0173.1 430173	Ø 324 30 28,4 V + S	
			←	für Behördenfahrzeuge	24.0330-0173.1 530173	Ø 324 30 27,6 V + S	
↓					24.0124-0201.2 424201	Ø 345 24 22,4 V Bremsscheibe zweiteilig / + S	









	kw			 	! #		
<b>BMW - 5 (E60) 12/01→03/10</b>							
<b>Bremsscheibe</b>							
530 d	170	04/05→02/07	➔	nicht für Behördenfahrzeuge	24.0120-0183.1 420183	Ø 320 20 18,4 V + S	
			➔	für Behördenfahrzeuge	24.0320-0183.1 520183	Ø 320 20 17,6 V + S	
530 d	173	02/07→12/09	➔	03/07→; nicht für Behördenfahrzeuge	24.0130-0173.1 430173	Ø 324 30 28,4 V + S	
			➔	03/07→; für Behördenfahrzeuge	24.0330-0173.1 530173	Ø 324 30 27,6 V + S	
			➔	03/07→; nicht für Behördenfahrzeuge	24.0120-0183.1 420183	Ø 320 20 18,4 V + S	
			➔	03/07→; für Behördenfahrzeuge	24.0320-0183.1 520183	Ø 320 20 17,6 V + S	
530 i	170	12/01→02/05	➔	07/03→	24.0124-0201.2 424201	Ø 345 24 22,4 V Bremsscheibe zweiteilig / + S	
			➔	07/03→	24.0130-0173.1 430173	Ø 324 30 28,4 V + S	
530 i	187	03/05→03/10	➔	07/05→ 03/07; nicht für Behördenfahrzeuge	24.0330-0173.1 530173	Ø 324 30 27,6 V + S	
			➔	07/05→ 03/07; für Behördenfahrzeuge	24.0130-0173.1 430173	Ø 324 30 28,4 V + S	
			➔	07/05→ 03/07; nicht für Behördenfahrzeuge	24.0130-0186.2 430186	Ø 348 30 28,4 V Bremsscheibe zweiteilig / + S	
			➔	07/05→ 03/07; für Behördenfahrzeuge	24.0120-0183.1 420183	Ø 320 20 18,4 V + S	
530 i	190	09/04→02/07	➔	07/05→; nicht für Behördenfahrzeuge	24.0320-0183.1 520183	Ø 320 20 17,6 V + S	
			➔	07/05→; für Behördenfahrzeuge	24.0124-0201.2 424201	Ø 345 24 22,4 V Bremsscheibe zweiteilig / + S	
			➔	07/05→; nicht für Behördenfahrzeuge	24.0130-0173.1 430173	Ø 324 30 28,4 V + S	
			➔	07/05→; für Behördenfahrzeuge	24.0330-0173.1 530173	Ø 324 30 27,6 V + S	
530 i	200	09/06→12/09	➔	01/07→; nicht für Behördenfahrzeuge; Motorcode: N52N	24.0120-0183.1 420183	Ø 320 20 18,4 V + S	
			➔	01/07→; Motorcode: N53	24.0320-0183.1 520183	Ø 320 20 17,6 V + S	
			➔	01/07→; für Behördenfahrzeuge; Motorcode: N52N	24.0130-0173.1 430173	Ø 324 30 28,4 V + S	
			➔	01/07→; nicht für Behördenfahrzeuge; Motorcode: N52N	24.0130-0186.2 430186	Ø 348 30 28,4 V Bremsscheibe zweiteilig / + S	
			➔	01/07→; für Behördenfahrzeuge; Motorcode: N52N	24.0120-0183.1 420183	Ø 320 20 18,4 V + S	
			➔	01/07→; Motorcode: N53	24.0320-0183.1 520183	Ø 320 20 17,6 V + S	
530 xd 530 xi	170 190	02/05→02/07 09/04→02/07	➔	07/05→	24.0124-0201.2 424201	Ø 345 24 22,4 V Bremsscheibe zweiteilig / + S	
			➔	07/05→	24.0130-0173.1 430173	Ø 324 30 28,4 V + S	
535 d	200	09/04→03/10	➔	→ 03/07	24.0330-0173.1 530173	Ø 324 30 27,6 V + S	
			➔	→ 03/07	24.0120-0213.1 420213	Ø 320 20 18,4 V + S	
535 d	210	01/07→03/10	➔	03/07→ 02/10	24.0320-0213.1 520213	Ø 320 20 17,6 V + S	
			➔	03/07→ 02/10	24.0136-0106.2 436106	Ø 348 36 34,4 V Bremsscheibe zweiteilig / + S	
535 i 540 i	225 225	04/06→12/09 09/05→02/10	➔	03/07→; nicht für erhöhte Nutzlast	24.0124-0201.2 424201	Ø 345 24 22,4 V Bremsscheibe zweiteilig / + S	
			➔	→ 03/07	24.0136-0106.2 436106	Ø 348 36 34,4 V Bremsscheibe zweiteilig / + S	
			➔	03/07→; für erhöhte Nutzlast	24.0130-0186.2 430186	Ø 324 30 28,4 V Bremsscheibe zweiteilig / + S	
			➔		24.0124-0201.2 424201	Ø 345 24 22,4 V Bremsscheibe zweiteilig / + S	
540 i	225	07/05→03/10	➔	03/07→ 02/10; nicht für erhöhte Nutzlast	24.0130-0186.2 430186	Ø 348 30 28,4 V Bremsscheibe zweiteilig / + S	







	kw			 	! #		
<b>BMW - 5 (E60) 12/01→03/10</b>							
<b>Bremsscheibe</b>							
540 i	225	07/05→03/10	←	→ 03/07		24.0130-0186.2 430186	Ø 348 30 28,4 V Bremsscheibe zweiteilig / + S
			←	03/07→; für erhöhte Nutzlast; → 02/10		24.0136-0106.2 436106	Ø 348 36 34,4 V Bremsscheibe zweiteilig / + S
			→	→ 02/10		24.0124-0201.2 424201	Ø 345 24 22,4 V Bremsscheibe zweiteilig / + S
545 i	245	09/03→03/10	←	→ 08/05		24.0130-0186.2 430186	Ø 348 30 28,4 V Bremsscheibe zweiteilig / + S
			→	→ 08/05		24.0124-0201.2 424201	Ø 345 24 22,4 V Bremsscheibe zweiteilig / + S
550 i	270	07/05→03/10	←	03/07→; für USA; → 02/10		24.0130-0186.2 430186	Ø 348 30 28,4 V Bremsscheibe zweiteilig / + S
			←	03/07→; nicht für USA; → 02/10		24.0136-0106.2 436106	Ø 348 36 34,4 V Bremsscheibe zweiteilig / + S
			←	→ 03/07		24.0136-0106.2 436106	Ø 348 36 34,4 V Bremsscheibe zweiteilig / + S
			→	→ 02/10		24.0124-0201.2 424201	Ø 345 24 22,4 V Bremsscheibe zweiteilig / + S
M5	373	09/04→03/10	←	☐; → 02/10		24.0136-0116.2 436116	Ø 374 36 34,4 V* Bremsscheibe zweiteilig / + S
			←	☐; → 02/10		24.0136-0117.2 436117	Ø 374 36 34,4 V* Bremsscheibe zweiteilig / + S
			→	☐; → 02/10		24.0124-0234.2 424234	Ø 370 24 22,4 V* Bremsscheibe zweiteilig / + S
			→	☐; → 02/10		24.0124-0235.2 424235	Ø 370 24 22,4 V* Bremsscheibe zweiteilig / + S
<b>BMW - 5 (F10) 01/09→10/16</b>							
<b>Bremsbelagsatz, Scheibenbremse</b>							
518 d	100	02/13→06/14	←			13.0460-7268.2 607268	ATE 23794 20,3 + WE / - WK
518 d	105	02/13→06/14				13.0470-7268.2 LD7268	ATE 23794 20,3 + WE / - WK Ceramic
520 d	100	01/13→06/14					
520 d	135	03/10→06/14					
520 d	147	01/13→06/14	→			13.0460-2760.2 602760	TRW 24561 17,7 + WE / - WK + Zub
520 d	151	07/14→10/16					
520 d xDrive	100	01/13→06/14				13.0470-2760.2 LD2760	TRW 24561 17,7 + WE / - WK + Zub Ceramic
520 d xDrive	120	10/13→10/16					
520 d xDrive	151	07/14→10/16					
520 i	125	07/13→10/16					
518 d	110	10/13→10/16	←	07/14→		13.0460-7268.2 607268	ATE 23794 20,3 + WE / - WK
518 d	120	10/13→10/16				13.0470-7268.2 LD7268	ATE 23794 20,3 + WE / - WK Ceramic
520 d	140	10/13→10/16					
520 d	155	10/13→10/16					
520 d xDrive	140	10/13→10/16	→	07/14→		13.0460-2760.2 602760	TRW 24561 17,7 + WE / - WK + Zub
520 d xDrive	155	10/13→10/16				13.0470-2760.2 LD2760	TRW 24561 17,7 + WE / - WK + Zub Ceramic
520 d	120	01/09→10/16	←	03/10→		13.0460-7268.2 607268	ATE 23794 20,3 + WE / - WK
523 i	150	01/09→08/11				13.0470-7268.2 LD7268	ATE 23794 20,3 + WE / - WK Ceramic
523 i	150	06/09→08/11					
523 i	155	06/09→08/11					
523 i	160	06/09→08/11	→	03/10→		13.0460-2760.2 602760	TRW 24561 17,7 + WE / - WK + Zub
						13.0470-2760.2 LD2760	TRW 24561 17,7 + WE / - WK + Zub Ceramic
520 d xDrive	135	01/13→06/14	←	02/13→		13.0460-7268.2 607268	ATE 23794 20,3 + WE / - WK
520 d xDrive	147	01/13→06/14				13.0470-7268.2 LD7268	ATE 23794 20,3 + WE / - WK Ceramic
			→	02/13→		13.0460-2760.2 602760	TRW 24561 17,7 + WE / - WK + Zub
						13.0470-2760.2 LD2760	TRW 24561 17,7 + WE / - WK + Zub Ceramic
520 i	120	10/10→10/16	←	09/11→		13.0460-7268.2 607268	ATE 23794 20,3 + WE / - WK
520 i	135	10/10→10/16				13.0470-7268.2 LD7268	ATE 23794 20,3 + WE / - WK Ceramic
			→	09/11→		13.0460-2760.2 602760	TRW 24561 17,7 + WE / - WK + Zub
						13.0470-2760.2 LD2760	TRW 24561 17,7 + WE / - WK + Zub Ceramic
525 d	155	01/11→10/16	←	09/11→;		13.0460-7267.2 607267	ATE 25045 19,5 + WE / - WK
525 d	160	01/11→10/16		für Fahrzeuge mit verstärkter Bremse		13.0470-7267.2 LD7267	ATE 25045 19,5 + WE / - WK Ceramic
525 d xDrive	155	01/11→10/16					
525 d xDrive	160	01/11→10/16					









	kW			 	! #		
<b>BMW - 5 (F10) 01/09→10/16</b>							
<b> Bremsbelagsatz, Scheibenbremse</b>							
528 i 528 i xDrive 530 i 530 i	180 180 190 200	10/10→10/16 10/10→10/16 06/09→06/13 05/11→06/13	←	09/11→; nicht für Fahrzeuge mit verstärkter Bremsen	13.0460-7275.2	607275	ATE 23313 20,2 + WE / - WK Ceramic
			→	09/11→	13.0460-2760.2	602760	TRW 24561 17,7 + WE / - WK + Zub
525 d	150	03/10→08/11	←	für Fahrzeuge mit verstärkter Bremse	13.0460-7267.2	607267	ATE 25045 19,5 + WE / - WK Ceramic
			←	nicht für Fahrzeuge mit verstärkter Bremsen	13.0460-7275.2	607275	ATE 23313 20,2 + WE / - WK Ceramic
			→		13.0460-2716.2	602716	TRW 24703 17,8 + WE / - WK + Zub
528 i	190	01/09→08/11	←	03/10→; für Fahrzeuge mit verstärkter Bremse	13.0460-7267.2	607267	ATE 25045 19,5 + WE / - WK Ceramic
			←	03/10→; nicht für Fahrzeuge mit verstärkter Bremsen	13.0460-7275.2	607275	ATE 23313 20,2 + WE / - WK Ceramic
			→	03/10→	13.0460-2760.2	602760	TRW 24561 17,7 + WE / - WK + Zub
530 d	180	01/09→08/11	←	03/10→; für Fahrzeuge mit verstärkter Bremse	13.0460-7267.2	607267	ATE 25045 19,5 + WE / - WK Ceramic
			←	03/10→; nicht für Fahrzeuge mit verstärkter Bremsen	13.0460-7275.2	607275	ATE 23313 20,2 + WE / - WK Ceramic
			→	03/10→; für Bremsscheibendurchmesser [mm]: 345	13.0460-2716.2	602716	TRW 24703 17,8 + WE / - WK + Zub
			→	03/10→; für Bremsscheibendurchmesser [mm]: 330	13.0460-2760.2	602760	TRW 24561 17,7 + WE / - WK + Zub
530 d	190	01/11→10/16	←	09/11→; für Fahrzeuge mit verstärkter Bremse	13.0460-7267.2	607267	ATE 25045 19,5 + WE / - WK Ceramic
			←	09/11→; nicht für Fahrzeuge mit verstärkter Bremsen	13.0460-7275.2	607275	ATE 23313 20,2 + WE / - WK Ceramic
			→	09/11→; für Bremsscheibendurchmesser [mm]: 345	13.0460-2716.2	602716	TRW 24703 17,8 + WE / - WK + Zub
			→	09/11→; für Bremsscheibendurchmesser [mm]: 330	13.0460-2760.2	602760	TRW 24561 17,7 + WE / - WK + Zub
530 d 530 d xDrive	210 210	09/10→10/16 09/10→10/16	←	10/15→; für Fahrzeuge mit verstärkter Bremse	13.0460-7267.2	607267	ATE 25045 19,5 + WE / - WK Ceramic
			←	10/15→; nicht für Fahrzeuge mit verstärkter Bremsen	13.0460-7275.2	607275	ATE 23313 20,2 + WE / - WK Ceramic
			→	10/15→	13.0460-2716.2	602716	TRW 24703 17,8 + WE / - WK + Zub
↓							









	kW			 	! #		
<b>BMW - 5 (F10) 01/09→10/16</b>							
<b> Bremsbelagsatz, Scheibenbremse</b>							
530 d xDrive	190	03/11→10/16	←	für Fahrzeuge mit verstärkter Bremse		<b>13.0460-7267.2 607267</b> <b>13.0470-7267.2 LD7267</b>	ATE 25045 19,5 + WE / - WK ATE 25045 19,5 + WE / - WK Ceramic
			←	nicht für Fahrzeuge mit verstärkter Bremse		<b>13.0460-7275.2 607275</b> <b>13.0470-7275.2 LD7275</b>	ATE 23313 20,2 + WE / - WK ATE 23313 20,2 + WE / - WK Ceramic
			→	für Bremsscheibendurchmesser [mm]: 345		<b>13.0460-2716.2 602716</b> <b>13.0470-2716.2 LD2716</b>	TRW 24703 17,8 + WE / - WK + Zub TRW 24703 17,8 + WE / - WK + Zub Ceramic
			→	für Bremsscheibendurchmesser [mm]: 330		<b>13.0460-2760.2 602760</b> <b>13.0470-2760.2 LD2760</b>	TRW 24561 17,7 + WE / - WK + Zub TRW 24561 17,7 + WE / - WK + Zub Ceramic
535 d	220	03/10→08/11	←			<b>13.0460-7267.2 607267</b> <b>13.0470-7267.2 LD7267</b>	ATE 25045 19,5 + WE / - WK ATE 25045 19,5 + WE / - WK Ceramic
			→			<b>13.0460-2716.2 602716</b> <b>13.0470-2716.2 LD2716</b>	TRW 24703 17,8 + WE / - WK + Zub TRW 24703 17,8 + WE / - WK + Zub Ceramic
535 d 535 d xDrive 535 i 535 i xDrive	230 230 240 240	01/11→10/16 02/11→10/16 07/13→10/16 07/13→10/16	←			<b>13.0460-7267.2 607267</b>	ATE 25045 19,5 + WE / - WK
			→			<b>13.0460-2716.2 602716</b>	TRW 24703 17,8 + WE / - WK + Zub
			←			<b>13.0470-2716.2 LD2716</b>	TRW 24703 17,8 + WE / - WK + Zub Ceramic
			→			<b>13.0470-2716.2 LD2716</b>	TRW 24703 17,8 + WE / - WK + Zub Ceramic
535 i	225	01/09→10/16	←	03/10→		<b>13.0460-7267.2 607267</b> <b>13.0470-7267.2 LD7267</b>	ATE 25045 19,5 + WE / - WK ATE 25045 19,5 + WE / - WK Ceramic
			→	03/10→		<b>13.0460-2716.2 602716</b> <b>13.0470-2716.2 LD2716</b>	TRW 24703 17,8 + WE / - WK + Zub TRW 24703 17,8 + WE / - WK + Zub Ceramic
535 i xDrive	225	03/10→10/16	←	03/11→		<b>13.0460-7267.2 607267</b> <b>13.0470-7267.2 LD7267</b>	ATE 25045 19,5 + WE / - WK ATE 25045 19,5 + WE / - WK Ceramic
			→	03/11→		<b>13.0460-2716.2 602716</b> <b>13.0470-2716.2 LD2716</b>	TRW 24703 17,8 + WE / - WK + Zub TRW 24703 17,8 + WE / - WK + Zub Ceramic
550 i	300	01/09→06/13	←	03/10→		<b>13.0460-7267.2 607267</b>	ATE 25045 19,5 + WE / - WK
			→	03/10→		<b>13.0460-2716.2 602716</b> <b>13.0470-2716.2 LD2716</b>	TRW 24703 17,8 + WE / - WK + Zub TRW 24703 17,8 + WE / - WK + Zub Ceramic
550 i 550 i xDrive	330 330	08/12→10/16 01/13→10/16	←	05/13→		<b>13.0460-7267.2 607267</b>	ATE 25045 19,5 + WE / - WK
			→	05/13→		<b>13.0460-2716.2 602716</b> <b>13.0470-2716.2 LD2716</b>	TRW 24703 17,8 + WE / - WK + Zub TRW 24703 17,8 + WE / - WK + Zub Ceramic
550 i xDrive	300	08/10→06/13	←	09/10→		<b>13.0460-7267.2 607267</b>	ATE 25045 19,5 + WE / - WK
			→	09/10→		<b>13.0460-2716.2 602716</b> <b>13.0470-2716.2 LD2716</b>	TRW 24703 17,8 + WE / - WK + Zub TRW 24703 17,8 + WE / - WK + Zub Ceramic
ActiveHybrid ActiveHybrid	225 250	09/10→08/16 09/10→08/16	←	09/11→		<b>13.0460-7267.2 607267</b>	ATE 25045 19,5 + WE / - WK
			→	09/11→		<b>13.0460-2716.2 602716</b> <b>13.0470-2716.2 LD2716</b>	TRW 24703 17,8 + WE / - WK + Zub TRW 24703 17,8 + WE / - WK + Zub Ceramic
M5	412	10/10→10/16	→	09/11→		<b>13.0460-2716.2 602716</b> <b>13.0470-2716.2 LD2716</b>	TRW 24703 17,8 + WE / - WK + Zub TRW 24703 17,8 + WE / - WK + Zub Ceramic
M 550 d xDrive  ↓	280	07/11→10/16	←	03/12→		<b>13.0460-7267.2 607267</b>	ATE 25045 19,5 + WE / - WK
			→	03/12→		<b>13.0460-2716.2 602716</b>	TRW 24703 17,8 + WE / - WK + Zub











	kW			 	! #		
<b>BMW - 5 (F10) 01/09→10/16</b>							
<b> Bremsbelagsatz, Scheibenbremse</b>							
M 550 d xDrive	280	07/11→10/16	➡	03/12→		<b>13.0470-2716.2 LD2716</b>	TRW 24703 17,8 + WE / - WK + Zub Ceramic
M5 Competition	423	02/13→10/16	➡	01/14→		<b>13.0460-2716.2 602716</b> <b>13.0470-2716.2 LD2716</b>	TRW 24703 17,8 + WE / - WK + Zub TRW 24703 17,8 + WE / - WK + Zub Ceramic
M5 Edition 30	441	07/14→10/16	➡			<b>13.0460-2716.2 602716</b> <b>13.0470-2716.2 LD2716</b>	TRW 24703 17,8 + WE / - WK + Zub TRW 24703 17,8 + WE / - WK + Zub Ceramic
<b>Warnkontakt, Bremsbelagsverschleiß</b>							
518 d	100	02/13→06/14	←	☐	1	<b>24.8190-0298.2 620298</b>	L= 1.087
518 d	105	02/13→06/14	➡		1	<b>24.8190-0312.2 620312</b>	L= 915
520 d	100	01/13→06/14					
520 d	135	03/10→06/14					
520 d	147	01/13→06/14					
520 d	151	07/14→10/16					
520 d xDrive	100	01/13→06/14					
520 d xDrive	120	10/13→10/16					
520 d xDrive	151	07/14→10/16					
520 i	125	07/13→10/16					
525 d	150	03/10→08/11					
535 d	220	03/10→08/11					
535 d	230	01/11→10/16					
535 d xDrive	230	02/11→10/16					
535 i	240	07/13→10/16					
535 i xDrive	240	07/13→10/16					
518 d	110	10/13→10/16	←	☐; 07/14→	1	<b>24.8190-0298.2 620298</b>	L= 1.087
518 d	120	10/13→10/16	➡	07/14→	1	<b>24.8190-0312.2 620312</b>	L= 915
520 d	140	10/13→10/16					
520 d	155	10/13→10/16					
520 d xDrive	140	10/13→10/16					
520 d xDrive	155	10/13→10/16					
520 d	120	01/09→10/16	←	☐; 03/10→	1	<b>24.8190-0298.2 620298</b>	L= 1.087
523 i	150	01/09→08/11	➡	03/10→	1	<b>24.8190-0312.2 620312</b>	L= 915
523 i	150	06/09→08/11					
523 i	155	06/09→08/11					
523 i	160	06/09→08/11					
528 i	190	01/09→08/11					
535 i	225	01/09→10/16					
550 i	300	01/09→06/13					
520 d xDrive	135	01/13→06/14	←	☐; 02/13→	1	<b>24.8190-0298.2 620298</b>	L= 1.087
520 d xDrive	147	01/13→06/14	➡	02/13→	1	<b>24.8190-0312.2 620312</b>	L= 915
520 i	120	10/10→10/16	←	☐; 09/11→	1	<b>24.8190-0298.2 620298</b>	L= 1.087
520 i	135	10/10→10/16	➡	09/11→	1	<b>24.8190-0312.2 620312</b>	L= 915
525 d	155	01/11→10/16					
525 d	160	01/11→10/16					
525 d xDrive	155	01/11→10/16					
525 d xDrive	160	01/11→10/16					
528 i	180	10/10→10/16					
528 i xDrive	180	10/10→10/16					
530 i	190	06/09→06/13					
530 i	200	05/11→06/13					
ActiveHybrid	225	09/10→08/16					
ActiveHybrid	250	09/10→08/16					
530 d	180	01/09→08/11	←	☐; 03/10→	1	<b>24.8190-0298.2 620298</b>	L= 1.087
			➡	03/10→; für Bremsscheibendurchmesser [mm]: 330	1	<b>24.8190-0312.2 620312</b>	L= 915
			➡	03/10→; für Bremsscheibendurchmesser [mm]: 345	1	<b>24.8190-0312.2 620312</b>	L= 915
530 d	190	01/11→10/16	←	☐; 09/11→	1	<b>24.8190-0298.2 620298</b>	L= 1.087
			➡	09/11→; für Bremsscheibendurchmesser [mm]: 345	1	<b>24.8190-0312.2 620312</b>	L= 915
			➡	09/11→; für Bremsscheibendurchmesser [mm]: 330	1	<b>24.8190-0312.2 620312</b>	L= 915
530 d	210	09/10→10/16	←	☐; 10/15→	1	<b>24.8190-0298.2 620298</b>	L= 1.087
530 d xDrive	210	09/10→10/16	➡	10/15→	1	<b>24.8190-0312.2 620312</b>	L= 915
530 d xDrive	190	03/11→10/16	←	☐	1	<b>24.8190-0298.2 620298</b>	L= 1.087
			➡	für Bremsscheibendurchmesser [mm]: 345	1	<b>24.8190-0312.2 620312</b>	L= 915
↓							









	kW			 	! #		
<b>BMW - 5 (F10) 01/09→10/16</b>							
<b>Warnkontakt, Bremsbelagverschleiß</b>							
530 d xDrive	190	03/11→10/16	➡	für Bremsscheibendurchmesser [mm]: 330	1	24.8190-0312.2 620312	L= 915
535 i xDrive	225	03/10→10/16	⬅	☐; 03/11→	1	24.8190-0298.2 620298	L= 1.087
			➡	03/11→	1	24.8190-0312.2 620312	L= 915
550 i 550 i xDrive	330 330	08/12→10/16 01/13→10/16	⬅	☐; 05/13→	1	24.8190-0298.2 620298	L= 1.087
			➡	05/13→	1	24.8190-0312.2 620312	L= 915
550 i xDrive	300	08/10→06/13	⬅	☐; 09/10→	1	24.8190-0298.2 620298	L= 1.087
			➡	09/10→	1	24.8190-0312.2 620312	L= 915
M5	412	10/10→10/16	⬅	☐; 09/11→	1	24.8190-0298.2 620298	L= 1.087
			➡	09/11→	1	24.8190-0008.2 620008	L= 1.000
M 550 d xDrive	280	07/11→10/16	⬅	☐; 03/12→	1	24.8190-0298.2 620298	L= 1.087
			➡	03/12→	1	24.8190-0312.2 620312	L= 915
M5 Competition	423	02/13→10/16	⬅	☐; 01/14→	1	24.8190-0298.2 620298	L= 1.087
			➡	01/14→	1	24.8190-0008.2 620008	L= 1.000
M5 Edition 30	441	07/14→10/16	⬅	☐	1	24.8190-0298.2 620298	L= 1.087
			➡		1	24.8190-0008.2 620008	L= 1.000
<b>Bremsscheibe</b>							
518 d	100	02/13→06/14	⬅			24.0124-0239.2 424239	Ø 330 24 22,4 V Bremsscheibe zweiteilig / + S
518 d	105	02/13→06/14					
520 d	100	01/13→06/14	➡			24.0120-0229.2 420229	Ø 330 20 18,4 V Bremsscheibe zweiteilig / + S
520 d	135	03/10→06/14					
520 d	147	01/13→06/14					
520 d	151	07/14→10/16					
520 d xDrive	100	01/13→06/14					
520 d xDrive	120	10/13→10/16					
520 d xDrive	151	07/14→10/16					
520 i	125	07/13→10/16					
518 d	110	10/13→10/16	⬅	07/14→		24.0124-0239.2 424239	Ø 330 24 22,4 V Bremsscheibe zweiteilig / + S
518 d	120	10/13→10/16					
520 d	140	10/13→10/16	➡	07/14→		24.0120-0229.2 420229	Ø 330 20 18,4 V Bremsscheibe zweiteilig / + S
520 d	155	10/13→10/16					
520 d xDrive	140	10/13→10/16					
520 d xDrive	155	10/13→10/16					
520 d	120	01/09→10/16	⬅	03/10→		24.0124-0239.2 424239	Ø 330 24 22,4 V Bremsscheibe zweiteilig / + S
523 i	150	01/09→08/11					
523 i	150	06/09→08/11	➡	03/10→		24.0120-0229.2 420229	Ø 330 20 18,4 V Bremsscheibe zweiteilig / + S
523 i	155	06/09→08/11					
523 i	160	06/09→08/11					
520 d xDrive	135	01/13→06/14	⬅	02/13→		24.0124-0239.2 424239	Ø 330 24 22,4 V Bremsscheibe zweiteilig / + S
520 d xDrive	147	01/13→06/14	➡	02/13→		24.0120-0229.2 420229	Ø 330 20 18,4 V Bremsscheibe zweiteilig / + S
520 i	120	10/10→10/16	⬅	09/11→		24.0124-0239.2 424239	Ø 330 24 22,4 V Bremsscheibe zweiteilig / + S
520 i	135	10/10→10/16	➡	09/11→		24.0120-0229.2 420229	Ø 330 20 18,4 V Bremsscheibe zweiteilig / + S
525 d	155	01/11→10/16	⬅	09/11→; nicht für Fahrzeuge mit verstärkter Bremse		24.0130-0218.2 430218	Ø 348 30 28,4 V Bremsscheibe zweiteilig / + S
525 d	160	01/11→10/16					
525 d xDrive	155	01/11→10/16					
525 d xDrive	160	01/11→10/16	⬅	☐; 09/11→; für Fahrzeuge mit verstärkter Bremse		24.0136-0114.2 436114	Ø 348 36 34,4 V Bremsscheibe zweiteilig / + S
528 i	180	10/10→10/16	⬅	☐; 09/11→; für Fahrzeuge mit verstärkter Bremse		24.0136-0115.2 436115	Ø 348 36 34,4 V Bremsscheibe zweiteilig / + S
528 i xDrive	180	10/10→10/16	➡	09/11→		24.0120-0229.2 420229	Ø 330 20 18,4 V Bremsscheibe zweiteilig / + S
525 d	150	03/10→08/11	⬅	nicht für Fahrzeuge mit verstärkter Bremse		24.0130-0218.2 430218	Ø 348 30 28,4 V Bremsscheibe zweiteilig / + S
			⬅	☐; für Fahrzeuge mit verstärkter Bremse		24.0136-0114.2 436114	Ø 348 36 34,4 V Bremsscheibe zweiteilig / + S
			⬅	☐; für Fahrzeuge mit verstärkter Bremse		24.0136-0115.2 436115	Ø 348 36 34,4 V Bremsscheibe zweiteilig / + S
			➡			24.0120-0229.2 420229	Ø 330 20 18,4 V Bremsscheibe zweiteilig / + S
528 i	190	01/09→08/11	⬅	03/10→; nicht für Fahrzeuge mit verstärkter Bremse		24.0130-0218.2 430218	Ø 348 30 28,4 V Bremsscheibe zweiteilig / + S
			⬅	☐; 03/10→; für Fahrzeuge mit verstärkter Bremse		24.0136-0114.2 436114	Ø 348 36 34,4 V Bremsscheibe zweiteilig / + S
↓							







	kw			 	! #		
<b>BMW - 5 (F10) 01/09→10/16</b>							
<b>Bremsscheibe</b>							
528 i	190	01/09→08/11	←	☐; 03/10→; für Fahrzeuge mit verstärkter Bremse	24.0136-0115.2	436115	Ø 348 36 34,4 V Bremsscheibe zweiteilig / + S
			→	03/10→	24.0120-0229.2	420229	Ø 330 20 18,4 V Bremsscheibe zweiteilig / + S
530 d	180	01/09→08/11	←	03/10→; nicht für Fahrzeuge mit verstärkter Bremse	24.0130-0218.2	430218	Ø 348 30 28,4 V Bremsscheibe zweiteilig / + S
			←	☐; 03/10→; für Fahrzeuge mit verstärkter Bremse	24.0136-0114.2	436114	Ø 348 36 34,4 V Bremsscheibe zweiteilig / + S
			←	☐; 03/10→; für Fahrzeuge mit verstärkter Bremse	24.0136-0115.2	436115	Ø 348 36 34,4 V Bremsscheibe zweiteilig / + S
			→	03/10→; für Bremsscheibendurchmesser [mm]: 330	24.0120-0229.2	420229	Ø 330 20 18,4 V Bremsscheibe zweiteilig / + S
			→	03/10→; für Bremsscheibendurchmesser [mm]: 345	24.0124-0233.2	424233	Ø 345 24 22,4 V Bremsscheibe zweiteilig / + S
530 d	190	01/11→10/16	←	09/11→; nicht für Fahrzeuge mit verstärkter Bremse	24.0130-0218.2	430218	Ø 348 30 28,4 V Bremsscheibe zweiteilig / + S
			←	☐; 09/11→; für Fahrzeuge mit verstärkter Bremse	24.0136-0114.2	436114	Ø 348 36 34,4 V Bremsscheibe zweiteilig / + S
			←	☐; 09/11→; für Fahrzeuge mit verstärkter Bremse	24.0136-0115.2	436115	Ø 348 36 34,4 V Bremsscheibe zweiteilig / + S
			→	09/11→; für Bremsscheibendurchmesser [mm]: 330	24.0120-0229.2	420229	Ø 330 20 18,4 V Bremsscheibe zweiteilig / + S
			→	09/11→; für Bremsscheibendurchmesser [mm]: 345	24.0124-0233.2	424233	Ø 345 24 22,4 V Bremsscheibe zweiteilig / + S
530 d 530 d xDrive	210 210	09/10→10/16 09/10→10/16	←	10/15→; nicht für Fahrzeuge mit verstärkter Bremse	24.0130-0218.2	430218	Ø 348 30 28,4 V Bremsscheibe zweiteilig / + S
			←	☐; 10/15→; für Fahrzeuge mit verstärkter Bremse	24.0136-0114.2	436114	Ø 348 36 34,4 V Bremsscheibe zweiteilig / + S
			←	☐; 10/15→; für Fahrzeuge mit verstärkter Bremse	24.0136-0115.2	436115	Ø 348 36 34,4 V Bremsscheibe zweiteilig / + S
			→	10/15→	24.0124-0233.2	424233	Ø 345 24 22,4 V Bremsscheibe zweiteilig / + S
530 d xDrive	190	03/11→10/16	←	nicht für Fahrzeuge mit verstärkter Bremse	24.0130-0218.2	430218	Ø 348 30 28,4 V Bremsscheibe zweiteilig / + S
			←	☐; für Fahrzeuge mit verstärkter Bremse	24.0136-0114.2	436114	Ø 348 36 34,4 V Bremsscheibe zweiteilig / + S
			←	☐; für Fahrzeuge mit verstärkter Bremse	24.0136-0115.2	436115	Ø 348 36 34,4 V Bremsscheibe zweiteilig / + S
			→	für Bremsscheibendurchmesser [mm]: 330	24.0120-0229.2	420229	Ø 330 20 18,4 V Bremsscheibe zweiteilig / + S
			→	für Bremsscheibendurchmesser [mm]: 345	24.0124-0233.2	424233	Ø 345 24 22,4 V Bremsscheibe zweiteilig / + S
530 i 530 i	190 200	06/09→06/13 05/11→06/13	←	09/11→	24.0124-0239.2	424239	Ø 330 24 22,4 V Bremsscheibe zweiteilig / + S
			←	09/11→; nicht für Fahrzeuge mit verstärkter Bremse	24.0130-0218.2	430218	Ø 348 30 28,4 V Bremsscheibe zweiteilig / + S
			←	☐; 09/11→; für Fahrzeuge mit verstärkter Bremse	24.0136-0114.2	436114	Ø 348 36 34,4 V Bremsscheibe zweiteilig / + S
			←	☐; 09/11→; für Fahrzeuge mit verstärkter Bremse	24.0136-0115.2	436115	Ø 348 36 34,4 V Bremsscheibe zweiteilig / + S
			→	09/11→	24.0120-0229.2	420229	Ø 330 20 18,4 V Bremsscheibe zweiteilig / + S
535 d 535 d 535 d xDrive 535 i 535 i xDrive	220 230 230 240 240	03/10→08/11 01/11→10/16 02/11→10/16 07/13→10/16 07/13→10/16	←	☐	24.0136-0114.2	436114	Ø 348 36 34,4 V Bremsscheibe zweiteilig / + S
			←	☐	24.0136-0115.2	436115	Ø 348 36 34,4 V Bremsscheibe zweiteilig / + S
			→		24.0124-0233.2	424233	Ø 345 24 22,4 V Bremsscheibe zweiteilig / + S
535 i	225	01/09→10/16	←	☐; 03/10→	24.0136-0114.2	436114	Ø 348 36 34,4 V Bremsscheibe zweiteilig / + S
			←	☐; 03/10→	24.0136-0115.2	436115	Ø 348 36 34,4 V Bremsscheibe zweiteilig / + S
			→	03/10→	24.0124-0233.2	424233	Ø 345 24 22,4 V Bremsscheibe zweiteilig / + S
↓							











	kw			 	! #			
<b>BMW - 5 (F10) 01/09→10/16</b>								
 <b>Bremsscheibe</b>								
535 i xDrive	225	03/10→10/16	←	☐; 03/11→		24.0136-0114.2	436114	Ø 348 36 34,4 V Bremsscheibe zweiteilig / + S
			←	☐; 03/11→		24.0136-0115.2	436115	Ø 348 36 34,4 V Bremsscheibe zweiteilig / + S
			→	03/11→		24.0124-0233.2	424233	Ø 345 24 22,4 V Bremsscheibe zweiteilig / + S
550 i	300	01/09→06/13	←	☐; 03/10→		24.0136-0118.2	436118	Ø 374 36 34,4 V Bremsscheibe zweiteilig / + S
			←	☐; 03/10→		24.0136-0119.2	436119	Ø 374 36 34,4 V Bremsscheibe zweiteilig / + S
			→	03/10→		24.0124-0233.2	424233	Ø 345 24 22,4 V Bremsscheibe zweiteilig / + S
550 i 550 i xDrive	330 330	08/12→10/16 01/13→10/16	←	☐; 05/13→		24.0136-0118.2	436118	Ø 374 36 34,4 V Bremsscheibe zweiteilig / + S
			←	☐; 05/13→		24.0136-0119.2	436119	Ø 374 36 34,4 V Bremsscheibe zweiteilig / + S
			→	05/13→		24.0124-0233.2	424233	Ø 345 24 22,4 V Bremsscheibe zweiteilig / + S
550 i xDrive	300	08/10→06/13	←	☐; 09/10→		24.0136-0118.2	436118	Ø 374 36 34,4 V Bremsscheibe zweiteilig / + S
			←	☐; 09/10→		24.0136-0119.2	436119	Ø 374 36 34,4 V Bremsscheibe zweiteilig / + S
			→	09/10→		24.0124-0233.2	424233	Ø 345 24 22,4 V Bremsscheibe zweiteilig / + S
ActiveHybrid ActiveHybrid	225 250	09/10→08/16 09/10→08/16	←	☐; 09/11→		24.0136-0114.2	436114	Ø 348 36 34,4 V Bremsscheibe zweiteilig / + S
			←	☐; 09/11→		24.0136-0115.2	436115	Ø 348 36 34,4 V Bremsscheibe zweiteilig / + S
			→	09/11→		24.0124-0233.2	424233	Ø 345 24 22,4 V Bremsscheibe zweiteilig / + S
M5	412	10/10→10/16	←	☐; 09/11→		24.0136-0125.2	436125	Ø 400 36 34,4 V• Bremsscheibe zweiteilig / + S
			←	☐; 09/11→		24.0136-0126.2	436126	Ø 400 36 34,4 V• Bremsscheibe zweiteilig / + S
M 550 d xDrive	280	07/11→10/16	←	☐; 03/12→		24.0136-0118.2	436118	Ø 374 36 34,4 V Bremsscheibe zweiteilig / + S
			←	☐; 03/12→		24.0136-0119.2	436119	Ø 374 36 34,4 V Bremsscheibe zweiteilig / + S
			→	03/12→		24.0124-0233.2	424233	Ø 345 24 22,4 V Bremsscheibe zweiteilig / + S
M5 Competition	423	02/13→10/16	←	☐; 01/14→		24.0136-0125.2	436125	Ø 400 36 34,4 V• Bremsscheibe zweiteilig / + S
			←	☐; 01/14→		24.0136-0126.2	436126	Ø 400 36 34,4 V• Bremsscheibe zweiteilig / + S
M5 Edition 30	441	07/14→10/16	←	☐		24.0136-0125.2	436125	Ø 400 36 34,4 V• Bremsscheibe zweiteilig / + S
			←	☐		24.0136-0126.2	436126	Ø 400 36 34,4 V• Bremsscheibe zweiteilig / + S
<b>BMW - 5 (G30, F90) 09/16→</b>								
 <b>Brembelagsatz, Scheibenbremse</b>								
525 d 525 d	155 170	07/17→ 07/17→	→	für Fahrzeuge mit Sportpaket		13.0460-2716.2	602716	TRW 24703 17,8 + WE / - WK + Zub
						13.0470-2716.2	LD2716	TRW 24703 17,8 + WE / - WK + Zub Ceramic
530 d 530 d xDrive 530 d xDrive 530 i 530 i xDrive 540 i 540 i 540 i xDrive 540 i xDrive M 550 i xDrive M5 Competition M xDrive M5 M xDrive	195 183 195 185 185 250 265 250 265 340 460 441	09/16→ 09/16→ 09/16→ 09/16→ 09/16→ 09/16→ 09/16→ 09/16→ 09/16→ 03/17→ 07/18→ 09/17→	→	+ eFSB		13.0460-2716.2	602716	TRW 24703 17,8 + WE / - WK + Zub
						13.0470-2716.2	LD2716	TRW 24703 17,8 + WE / - WK + Zub Ceramic
			→	für Fahrzeuge mit Sportpaket / + eFSB		13.0460-2716.2	602716	TRW 24703 17,8 + WE / - WK + Zub
						13.0470-2716.2	LD2716	TRW 24703 17,8 + WE / - WK + Zub Ceramic









	kW			 	! #		
<b>BMW - 5 (G30, F90) 09/16→</b>							
 <b>Bremsbelagsatz, Scheibenbremse</b>							
540 d xDrive M 550 d xDrive	235 294	07/17→ 06/17→	→			13.0460-2716.2 602716 13.0470-2716.2 LD2716	TRW 24703 17,8 + WE / - WK + Zub TRW 24703 17,8 + WE / - WK + Zub Ceramic
 <b>Bremsscheibe</b>							
525 d 525 d 530 e iPerformance 530 e iPerformance	155 170 135 185	07/17→ 07/17→ 03/17→ 03/17→	← ← →	<input type="checkbox"/> ; für Fahrzeuge mit Sportpaket <input type="checkbox"/> ; für Fahrzeuge mit Sportpaket für Fahrzeuge mit Sportpaket		24.0136-0132.2 436132 24.0136-0133.2 436133 24.0124-0262.2 424262	Ø 348 36 34,4 V Bremsscheibe zweiteilig / + S Ø 348 36 34,4 V Bremsscheibe zweiteilig / + S Ø 345 24 22,4 V Bremsscheibe zweiteilig / + S
530 d 530 d xDrive 530 d xDrive 530 i 530 i xDrive	195 183 195 185 185	09/16→ 09/16→ 09/16→ 09/16→ 09/16→	← ← →	<input type="checkbox"/> ; für Fahrzeuge mit Sportpaket <input type="checkbox"/> ; für Fahrzeuge mit Sportpaket		24.0136-0132.2 436132 24.0136-0133.2 436133 24.0124-0262.2 424262	Ø 348 36 34,4 V Bremsscheibe zweiteilig / + S Ø 348 36 34,4 V Bremsscheibe zweiteilig / + S Ø 345 24 22,4 V Bremsscheibe zweiteilig / + S
540 d xDrive 540 i 540 i 540 i xDrive M 550 d xDrive	235 250 265 250 294	07/17→ 09/16→ 09/16→ 09/16→ 06/17→	← ← →	<input type="checkbox"/> ; für Fahrzeuge ohne Sportpaket <input type="checkbox"/> ; für Fahrzeuge ohne Sportpaket		24.0136-0132.2 436132 24.0136-0133.2 436133 24.0124-0262.2 424262	Ø 348 36 34,4 V Bremsscheibe zweiteilig / + S Ø 348 36 34,4 V Bremsscheibe zweiteilig / + S Ø 345 24 22,4 V Bremsscheibe zweiteilig / + S
540 i xDrive	265	09/16→	← ←	<input type="checkbox"/> ; für Fahrzeuge ohne Sportpaket <input type="checkbox"/> ; für Fahrzeuge ohne Sportpaket		24.0136-0132.2 436132 24.0136-0133.2 436133	Ø 348 36 34,4 V Bremsscheibe zweiteilig / + S Ø 348 36 34,4 V Bremsscheibe zweiteilig / + S
M 550 i xDrive M5 Competition M xDrive M5 M xDrive	340 460 441	03/17→ 07/18→ 09/17→	→			24.0124-0262.2 424262	Ø 345 24 22,4 V Bremsscheibe zweiteilig / + S
<b>BMW - 5 Gran Turismo (F07) 01/09→02/17</b>							
 <b>Bremsbelagsatz, Scheibenbremse</b>							
520 d 520 d 530 d 530 d 530 d xDrive 535 d	100 120 155 190 190 220	10/12→02/17 04/11→02/17 09/10→06/12 07/12→02/17 07/12→02/17 03/10→06/12	← ← →			13.0460-7267.2 607267 13.0470-7267.2 LD7267 13.0460-7274.2 607274	ATE 25045 19,5 + WE / - WK ATE 25045 19,5 + WE / - WK ATE 25045 19,5 + WE / - WK Ceramic ATE 23731 17,3 + WE / - WK
520 d	135	04/11→02/17	← →	10/11→ 10/11→		13.0460-7267.2 607267 13.0470-7267.2 LD7267 13.0460-7274.2 607274	ATE 25045 19,5 + WE / - WK ATE 25045 19,5 + WE / - WK Ceramic ATE 23731 17,3 + WE / - WK
528 i	180	07/13→02/17	← →	08/13→ 08/13→		13.0460-7267.2 607267 13.0470-7267.2 LD7267 13.0460-7274.2 607274	ATE 25045 19,5 + WE / - WK ATE 25045 19,5 + WE / - WK Ceramic ATE 23731 17,3 + WE / - WK
530 d 535 i	180 225	08/09→06/12 01/09→02/17	← →	10/09→ 10/09→		13.0460-7267.2 607267 13.0470-7267.2 LD7267 13.0460-7274.2 607274	ATE 25045 19,5 + WE / - WK ATE 25045 19,5 + WE / - WK Ceramic ATE 23731 17,3 + WE / - WK
530 d xDrive 535 d xDrive 535 i xDrive	180 220 225	06/10→06/12 03/10→06/12 01/10→02/17	← →	09/10→ 09/10→		13.0460-7267.2 607267 13.0470-7267.2 LD7267 13.0460-7274.2 607274	ATE 25045 19,5 + WE / - WK ATE 25045 19,5 + WE / - WK Ceramic ATE 23731 17,3 + WE / - WK
535 d 535 d xDrive	230 230	07/12→02/17 07/12→02/17	← →			13.0460-7267.2 607267 13.0460-7274.2 607274	ATE 25045 19,5 + WE / - WK ATE 23731 17,3 + WE / - WK
550 i	298	10/09→06/12	← ← →	03/10→ → 02/10		13.0460-7261.2 607261 13.0460-7261.2 607261 13.0460-7274.2 607274	ATE 24436 19,7 + WE / - WK ATE 24436 19,7 + WE / - WK ATE 23731 17,3 + WE / - WK
550 i	300	08/09→06/12	← ← →	03/10→ 10/09→ 02/10 10/09→		13.0460-7261.2 607261 13.0460-7261.2 607261 13.0460-7274.2 607274	ATE 24436 19,7 + WE / - WK ATE 24436 19,7 + WE / - WK ATE 23731 17,3 + WE / - WK
550 i 550 i xDrive ↓	330 330	07/12→02/17 07/12→06/13	←			13.0460-7261.2 607261	ATE 24436 19,7 + WE / - WK









	kW			 	! #		
<b>BMW - 5 Gran Turismo (F07) 01/09→02/17</b>							
<b> Bremsbelagsatz, Scheibenbremse</b>							
550 i	330	07/12→02/17	➔			13.0460-7274.2 607274	ATE 23731 17,3 + WE / - WK
550 i xDrive	330	07/12→06/13					
550 i xDrive	300	06/10→06/12	➔	09/10→		13.0460-7261.2 607261	ATE 24436 19,7 + WE / - WK
			➔	09/10→		13.0460-7274.2 607274	ATE 23731 17,3 + WE / - WK
<b>Warnkontakt, Bremsbelagverschleiß</b>							
520 d	100	10/12→02/17	➔		1	24.8190-0298.2 620298	L= 1.087
520 d	120	04/11→02/17					
530 d	155	09/10→06/12	➔		1	24.8190-0300.2 620300	L= 1.054
530 d	190	07/12→02/17					
530 d xDrive	190	07/12→02/17					
535 d	220	03/10→06/12					
550 i	330	07/12→02/17					
550 i xDrive	330	07/12→06/13					
520 d	135	04/11→02/17	➔	10/11→	1	24.8190-0298.2 620298	L= 1.087
			➔	10/11→	1	24.8190-0300.2 620300	L= 1.054
528 i	180	07/13→02/17	➔	08/13→	1	24.8190-0298.2 620298	L= 1.087
			➔	08/13→	1	24.8190-0300.2 620300	L= 1.054
530 d	180	08/09→06/12	➔	10/09→	1	24.8190-0298.2 620298	L= 1.087
535 i	225	01/09→02/17	➔	10/09→	1	24.8190-0300.2 620300	L= 1.054
530 d xDrive	180	06/10→06/12	➔	09/10→	1	24.8190-0298.2 620298	L= 1.087
535 d xDrive	220	03/10→06/12					
535 i xDrive	225	01/10→02/17	➔	09/10→	1	24.8190-0300.2 620300	L= 1.054
550 i xDrive	300	06/10→06/12					
535 d	230	07/12→02/17	➔		1	24.8190-0298.2 620298	L= 1.087
535 d xDrive	230	07/12→02/17	➔		1	24.8190-0300.2 620300	L= 1.054
550 i	298	10/09→06/12	➔	03/10→	1	24.8190-0260.2 620260	L= 1.060
			➔	03/10→	1	24.8190-0298.2 620298	L= 1.087
			➔		1	24.8190-0300.2 620300	L= 1.054
550 i	300	08/09→06/12	➔	10/09→ 02/10	1	24.8190-0260.2 620260	L= 1.060
			➔	03/10→	1	24.8190-0298.2 620298	L= 1.087
			➔	10/09→	1	24.8190-0300.2 620300	L= 1.054
<b> Bremsscheibe</b>							
520 d	100	10/12→02/17	➔			24.0136-0114.2 436114	Ø 348 36 34,4 V Bremsscheibe zweiteilig / + S
520 d	120	04/11→02/17					
530 d	155	09/10→06/12	➔			24.0136-0115.2 436115	Ø 348 36 34,4 V Bremsscheibe zweiteilig / + S
530 d	190	07/12→02/17					
530 d xDrive	190	07/12→02/17					
535 d	220	03/10→06/12	➔			24.0124-0233.2 424233	Ø 345 24 22,4 V Bremsscheibe zweiteilig / + S
535 d	230	07/12→02/17					
535 d xDrive	230	07/12→02/17					
520 d	135	04/11→02/17	➔	10/11→		24.0136-0114.2 436114	Ø 348 36 34,4 V Bremsscheibe zweiteilig / + S
			➔	10/11→		24.0136-0115.2 436115	Ø 348 36 34,4 V Bremsscheibe zweiteilig / + S
			➔	10/11→		24.0124-0233.2 424233	Ø 345 24 22,4 V Bremsscheibe zweiteilig / + S
528 i	180	07/13→02/17	➔	08/13→		24.0136-0114.2 436114	Ø 348 36 34,4 V Bremsscheibe zweiteilig / + S
			➔	08/13→		24.0136-0115.2 436115	Ø 348 36 34,4 V Bremsscheibe zweiteilig / + S
			➔	08/13→		24.0124-0233.2 424233	Ø 345 24 22,4 V Bremsscheibe zweiteilig / + S
530 d	180	08/09→06/12	➔	10/09→		24.0136-0114.2 436114	Ø 348 36 34,4 V Bremsscheibe zweiteilig / + S
535 i	225	01/09→02/17	➔	10/09→		24.0136-0115.2 436115	Ø 348 36 34,4 V Bremsscheibe zweiteilig / + S
			➔	10/09→		24.0124-0233.2 424233	Ø 345 24 22,4 V Bremsscheibe zweiteilig / + S
530 d xDrive	180	06/10→06/12	➔	09/10→		24.0136-0114.2 436114	Ø 348 36 34,4 V Bremsscheibe zweiteilig / + S
535 d xDrive	220	03/10→06/12					
535 i xDrive	225	01/10→02/17	➔	09/10→		24.0136-0115.2 436115	Ø 348 36 34,4 V Bremsscheibe zweiteilig / + S
			➔	09/10→		24.0124-0233.2 424233	Ø 345 24 22,4 V Bremsscheibe zweiteilig / + S
550 i	298	10/09→06/12	➔			24.0136-0120.2 436120	Ø 374 36 34,4 V Bremsscheibe zweiteilig / + S
550 i	330	07/12→02/17					
↓							









	kW			 	! #		
<b>BMW - 5 Gran Turismo (F07) 01/09→02/17</b>							
<b>Bremsscheibe</b>							
550 i	298	10/09→06/12	←	☐		24.0136-0121.2 436121	Ø 374 36 34,4 V Bremsscheibe zweiteilig / + S
550 i	330	07/12→02/17	→			24.0124-0241.1 424241	Ø 370 23,9 22,4 V + S
550 i	300	08/09→06/12	←	☐; 10/09→		24.0136-0120.2 436120	Ø 374 36 34,4 V Bremsscheibe zweiteilig / + S
			←	☐; 10/09→		24.0136-0121.2 436121	Ø 374 36 34,4 V Bremsscheibe zweiteilig / + S
			→	10/09→		24.0124-0241.1 424241	Ø 370 23,9 22,4 V + S
550 i xDrive	300	06/10→06/12	←	☐; 09/10→; nicht für Fahrzeuge mit verstärkter Bremsen		24.0136-0118.2 436118	Ø 374 36 34,4 V Bremsscheibe zweiteilig / + S
			←	☐; 09/10→; nicht für Fahrzeuge mit verstärkter Bremsen		24.0136-0119.2 436119	Ø 374 36 34,4 V Bremsscheibe zweiteilig / + S
			←	☐; 09/10→; für Fahrzeuge mit verstärkter Bremsen		24.0136-0120.2 436120	Ø 374 36 34,4 V Bremsscheibe zweiteilig / + S
			←	☐; 09/10→; für Fahrzeuge mit verstärkter Bremsen		24.0136-0121.2 436121	Ø 374 36 34,4 V Bremsscheibe zweiteilig / + S
			→	09/10→		24.0124-0241.1 424241	Ø 370 23,9 22,4 V + S
550 i xDrive	330	07/12→06/13	←	☐; nicht für Fahrzeuge mit verstärkter Bremsen		24.0136-0118.2 436118	Ø 374 36 34,4 V Bremsscheibe zweiteilig / + S
			←	☐; nicht für Fahrzeuge mit verstärkter Bremsen		24.0136-0119.2 436119	Ø 374 36 34,4 V Bremsscheibe zweiteilig / + S
			←	☐; für Fahrzeuge mit verstärkter Bremsen		24.0136-0120.2 436120	Ø 374 36 34,4 V Bremsscheibe zweiteilig / + S
			←	☐; für Fahrzeuge mit verstärkter Bremsen		24.0136-0121.2 436121	Ø 374 36 34,4 V Bremsscheibe zweiteilig / + S
			→			24.0124-0241.1 424241	Ø 370 23,9 22,4 V + S
<b>BMW - 5 Touring (E34) 11/91→01/97</b>							
<b>Brembelagsatz, Scheibenbremse</b>							
518 g	85	11/95→06/96	←			13.0460-6033.2 606033	ATE 20968 20,3 + WE / - WK
			→			13.0460-3803.2 603803	ATE 20995 17,3 + WE / - WK
518 i	85	09/94→01/97	←	→ 11/96		13.0460-6033.2 606033	ATE 20968 20,3 + WE / - WK
520 i	110	11/91→01/97	→	→ 11/96		13.0460-3803.2 603803	ATE 20995 17,3 + WE / - WK
525 i	141	11/91→01/97	→	→ 11/96		13.0460-3803.2 603803	ATE 20995 17,3 + WE / - WK
525 ix	141	02/92→01/97					
525 td	85	03/93→01/97					
525 tds	105	12/91→01/97					
530 i V8	160	09/92→01/97					
540 i	210	09/93→01/97					
M5	250	09/94→01/97	←	→ 11/96		13.0460-9037.2 609037	ATE 20309 17,9 + WE / - WK
<b>Warnkontakt, Bremsbelagverschleiß</b>							
518 g	85	11/95→06/96	←		1	24.8190-0214.2 620214	L= 235
			→		1	24.8190-0214.2 620214	L= 235
518 i	85	09/94→01/97	←	→ 11/96	1	24.8190-0214.2 620214	L= 235
520 i	110	11/91→01/97	→	→ 11/96	1	24.8190-0214.2 620214	L= 235
525 i	141	11/91→01/97	→	→ 11/96	1	24.8190-0214.2 620214	L= 235
525 td	85	03/93→01/97					
525 tds	105	12/91→01/97					
530 i V8	160	09/92→01/97					
540 i	210	09/93→01/97					
M5	250	09/94→01/97					
525 ix	141	02/92→01/97	←	→ 11/96	1	24.8190-0224.2 620224	L= 311
			→	→ 11/96	1	24.8190-0214.2 620214	L= 235
<b>Bremsscheibe</b>							
518 g	85	11/95→06/96	←			24.0112-0124.1 412124	Ø 302 12 10,4 + S
			→			24.0110-0117.1 410117	Ø 300 10 8,4 + S
						24.0310-0117.1 510117	Ø 300 10 7,6 + S
518 i	85	09/94→01/97	←	→ 11/96		24.0112-0124.1 412124	Ø 302 12 10,4 + S
			→	→ 11/96		24.0110-0117.1 410117	Ø 300 10 8,4 + S
						24.0310-0117.1 510117	Ø 300 10 7,6 + S
520 i	110	11/91→01/97	←	→ 11/96		24.0122-0103.1 422103	Ø 302 22 20,4 V + S
525 i	141	11/91→01/97				24.0322-0103.1 522103	Ø 302 22 19,6 V + S
↓							









	kW			 	! #		
<b>BMW - 5 Touring (E34) 11/91→01/97</b>							
<b> Bremsscheibe</b>							
525 td	85	03/93→01/97	➔	→ 11/96		24.0110-0117.1 410117	Ø 300 10 8,4 + S
525 tds	105	12/91→01/97				24.0310-0117.1 510117	Ø 300 10 7,6 + S
530 i V8	160	09/92→01/97					
525 ix	141	02/92→01/97	➔	→ 11/96		24.0128-0122.1 428122	Ø 296 28 26,4 V
			➔	→ 11/96		24.0110-0262.1 410262	Ø 300 10 8,4
540 i	210	09/93→01/97	➔	→ 11/96		24.0128-0101.1 428101	Ø 302 28 26,4 V
			➔	→ 11/96		24.0120-0181.1 420181	Ø 300 20 18,4 V
<b>BMW - 5 Touring (E39) 09/96→05/04</b>							
<b> Bremsbelagsatz, Scheibenbremse</b>							
520 d	100	02/00→09/03	➔	04/00→ 07/03; für Behördenfahrzeuge		13.0460-7078.2 607078	ATE 21486 19,5 + WE / - WK
525 d	120	02/00→05/04				13.0470-7078.2 LD7078	ATE 21486 19,5 + WE / - WK Ceramic
			➔	04/00→ 07/03; nicht für Behördenfahrzeuge		13.0460-7089.2 607089	ATE 21676 20,3 + WE / - WK
						13.0470-7089.2 LD7089	ATE 21676 20,3 + WE / - WK Ceramic
			➔	04/00→ 07/03		13.0460-7090.2 607090	ATE 21691 17,3 + WE / - WK
						13.0470-7090.2 LD7090	ATE 21691 17,3 + WE / - WK Ceramic
520 i	100	04/99→05/04	➔	→ 07/03; für Behördenfahrzeuge		13.0460-7078.2 607078	ATE 21486 19,5 + WE / - WK
520 i	120	09/00→05/04				13.0470-7078.2 LD7078	ATE 21486 19,5 + WE / - WK Ceramic
520 i	125	09/00→05/04	➔	→ 07/03; nicht für Behördenfahrzeuge		13.0460-7089.2 607089	ATE 21676 20,3 + WE / - WK
						13.0470-7089.2 LD7089	ATE 21676 20,3 + WE / - WK Ceramic
			➔	→ 07/03		13.0460-7090.2 607090	ATE 21691 17,3 + WE / - WK
						13.0470-7090.2 LD7090	ATE 21691 17,3 + WE / - WK Ceramic
520 i	110	01/97→09/00	➔	05/97→; für Behördenfahrzeuge		13.0460-7078.2 607078	ATE 21486 19,5 + WE / - WK
						13.0470-7078.2 LD7078	ATE 21486 19,5 + WE / - WK Ceramic
			➔	05/97→; nicht für Behördenfahrzeuge		13.0460-7089.2 607089	ATE 21676 20,3 + WE / - WK
						13.0470-7089.2 LD7089	ATE 21676 20,3 + WE / - WK Ceramic
			➔	05/97→		13.0460-7090.2 607090	ATE 21691 17,3 + WE / - WK
						13.0470-7090.2 LD7090	ATE 21691 17,3 + WE / - WK Ceramic
523 i	120	09/98→08/00	➔			13.0460-7089.2 607089	ATE 21676 20,3 + WE / - WK
						13.0470-7089.2 LD7089	ATE 21676 20,3 + WE / - WK Ceramic
			➔			13.0460-7090.2 607090	ATE 21691 17,3 + WE / - WK
						13.0470-7090.2 LD7090	ATE 21691 17,3 + WE / - WK Ceramic
523 i	125	09/96→08/00	➔	05/97→		13.0460-7089.2 607089	ATE 21676 20,3 + WE / - WK
528 i	142	01/97→09/00				13.0470-7089.2 LD7089	ATE 21676 20,3 + WE / - WK Ceramic
			➔	05/97→		13.0460-7090.2 607090	ATE 21691 17,3 + WE / - WK
						13.0470-7090.2 LD7090	ATE 21691 17,3 + WE / - WK Ceramic
525 i	141	09/00→05/04	➔	10/00→ 07/03; für Behördenfahrzeuge		13.0460-7078.2 607078	ATE 21486 19,5 + WE / - WK
						13.0470-7078.2 LD7078	ATE 21486 19,5 + WE / - WK Ceramic
			➔	10/00→ 07/03; nicht für Behördenfahrzeuge		13.0460-7089.2 607089	ATE 21676 20,3 + WE / - WK
						13.0470-7089.2 LD7089	ATE 21676 20,3 + WE / - WK Ceramic
			➔	10/00→ 07/03		13.0460-7090.2 607090	ATE 21691 17,3 + WE / - WK
						13.0470-7090.2 LD7090	ATE 21691 17,3 + WE / - WK Ceramic
525 tds	105	03/97→05/04	➔	06/98→ 09/00		13.0460-7089.2 607089	ATE 21676 20,3 + WE / - WK
						13.0470-7089.2 LD7089	ATE 21676 20,3 + WE / - WK Ceramic
			➔	06/98→ 09/00		13.0460-7090.2 607090	ATE 21691 17,3 + WE / - WK
						13.0470-7090.2 LD7090	ATE 21691 17,3 + WE / - WK Ceramic
530 d	135	08/98→09/00	➔	09/98→		13.0460-7089.2 607089	ATE 21676 20,3 + WE / - WK
↓							











	kw			 	! #			
<b>BMW - 5 Touring (E39) 09/96→05/04</b>								
<b> Bremsbelagsatz, Scheibenbremse</b>								
530 d	135	08/98→09/00	←	09/98→		<b>13.0470-7089.2</b>	<b>LD7089</b>	ATE 21676 20,3 + WE / - WK Ceramic
			→	09/98→		<b>13.0460-7090.2</b>	<b>607090</b>	ATE 21691 17,3 + WE / - WK Ceramic
530 d	142	09/00→05/04	←	10/00→ 07/03		<b>13.0460-7078.2</b>	<b>607078</b>	ATE 21486 19,5 + WE / - WK Ceramic
			←	→ 09/00		<b>13.0470-7078.2</b>	<b>LD7078</b>	ATE 21486 19,5 + WE / - WK Ceramic
			→	→ 07/03		<b>13.0460-7089.2</b>	<b>607089</b>	ATE 21676 20,3 + WE / - WK Ceramic
530 d	142	09/00→05/04	←	10/00→ 07/03		<b>13.0460-7089.2</b>	<b>LD7089</b>	ATE 21676 20,3 + WE / - WK Ceramic
			→	→ 07/03		<b>13.0470-7090.2</b>	<b>LD7090</b>	ATE 21691 17,3 + WE / - WK Ceramic
530 i	170	09/00→05/04	←	10/00→ 07/03		<b>13.0460-7078.2</b>	<b>607078</b>	ATE 21486 19,5 + WE / - WK Ceramic
			→	10/00→ 07/03		<b>13.0470-7078.2</b>	<b>LD7078</b>	ATE 21486 19,5 + WE / - WK Ceramic
540 i	210	01/97→05/04	←	10/00→ 07/03		<b>13.0460-7090.2</b>	<b>607090</b>	ATE 21691 17,3 + WE / - WK Ceramic
			→	→ 07/03		<b>13.0470-7090.2</b>	<b>LD7090</b>	ATE 21691 17,3 + WE / - WK Ceramic
540 i	210	01/97→05/04	←	05/97→ 07/03		<b>13.0460-7078.2</b>	<b>607078</b>	ATE 21486 19,5 + WE / - WK Ceramic
			→	05/97→ 07/03		<b>13.0470-7078.2</b>	<b>LD7078</b>	ATE 21486 19,5 + WE / - WK Ceramic
540 i	210	01/97→05/04	←	05/97→ 07/03		<b>13.0460-7090.2</b>	<b>607090</b>	ATE 21691 17,3 + WE / - WK Ceramic
			→	05/97→ 07/03		<b>13.0470-7090.2</b>	<b>LD7090</b>	ATE 21691 17,3 + WE / - WK Ceramic
<b>Warnkontakt, Bremsbelagverschleiß</b>								
520 d	100	02/00→09/03	←	04/00→ 07/03	1	<b>24.8190-0219.2</b>	<b>620219</b>	L= 764
525 d	120	02/00→05/04	→	04/00→ 07/03	1	<b>24.8190-0222.2</b>	<b>620222</b>	L= 1.090
520 i	100	04/99→05/04	←	→ 07/03	1	<b>24.8190-0219.2</b>	<b>620219</b>	L= 764
520 i	120	09/00→05/04	←	→ 07/03	1	<b>24.8190-0222.2</b>	<b>620222</b>	L= 1.090
520 i	125	09/00→05/04	→	→ 07/03	1	<b>24.8190-0222.2</b>	<b>620222</b>	L= 1.090
520 i	110	01/97→09/00	←	05/97→	1	<b>24.8190-0219.2</b>	<b>620219</b>	L= 764
523 i	125	09/96→08/00	←	05/97→	1	<b>24.8190-0219.2</b>	<b>620219</b>	L= 764
528 i	142	01/97→09/00	→	05/97→	1	<b>24.8190-0222.2</b>	<b>620222</b>	L= 1.090
523 i	120	09/98→08/00	←		1	<b>24.8190-0219.2</b>	<b>620219</b>	L= 764
523 i	120	09/98→08/00	→		1	<b>24.8190-0222.2</b>	<b>620222</b>	L= 1.090
525 i	141	09/00→05/04	←	10/00→ 07/03	1	<b>24.8190-0219.2</b>	<b>620219</b>	L= 764
530 i	170	09/00→05/04	→	10/00→ 07/03	1	<b>24.8190-0222.2</b>	<b>620222</b>	L= 1.090
525 tds	105	03/97→05/04	←	06/98→ 09/00	1	<b>24.8190-0219.2</b>	<b>620219</b>	L= 764
525 tds	105	03/97→05/04	→	06/98→ 09/00	1	<b>24.8190-0222.2</b>	<b>620222</b>	L= 1.090
530 d	135	08/98→09/00	←	09/98→	1	<b>24.8190-0219.2</b>	<b>620219</b>	L= 764
			→	09/98→	1	<b>24.8190-0222.2</b>	<b>620222</b>	L= 1.090
530 d	142	09/00→05/04	←	→ 09/00	1	<b>24.8190-0219.2</b>	<b>620219</b>	L= 764
			←	10/00→ 07/03	1	<b>24.8190-0219.2</b>	<b>620219</b>	L= 764
			→	→ 07/03	1	<b>24.8190-0222.2</b>	<b>620222</b>	L= 1.090
540 i	210	01/97→05/04	←	05/97→ 07/03	1	<b>24.8190-0219.2</b>	<b>620219</b>	L= 764
			→	05/97→ 07/03	1	<b>24.8190-0222.2</b>	<b>620222</b>	L= 1.090
<b> Bremsscheibe</b>								
520 d	100	02/00→09/03	←	04/00→ 07/03; nicht für Behördenfahrzeuge		<b>24.0122-0159.1</b>	<b>422159</b>	Ø 296 22 20,4 V + S
			←	04/00→ 07/03; für Behördenfahrzeuge		<b>24.0322-0159.1</b>	<b>522159</b>	Ø 296 22 19,6 V + S
			←	04/00→ 07/03; für Behördenfahrzeuge		<b>24.0130-0107.1</b>	<b>430107</b>	Ø 324 29,9 28,4 V + S
			←	04/00→ 07/03; für Behördenfahrzeuge		<b>24.0330-0107.1</b>	<b>530107</b>	Ø 324 29,9 27,6 V + S
520 d	120	02/00→05/04	→	04/00→ 07/03		<b>24.0120-0154.1</b>	<b>420154</b>	Ø 298 20 18,4 V + S
			→	04/00→ 07/03		<b>24.0320-0154.1</b>	<b>520154</b>	Ø 298 20 17,6 V + S
520 i	100	04/99→05/04	←	→ 07/03; nicht für Behördenfahrzeuge		<b>24.0122-0159.1</b>	<b>422159</b>	Ø 296 22 20,4 V + S
			←	→ 07/03; nicht für Behördenfahrzeuge		<b>24.0322-0159.1</b>	<b>522159</b>	Ø 296 22 19,6 V + S
			←	→ 07/03; für Behördenfahrzeuge		<b>24.0130-0107.1</b>	<b>430107</b>	Ø 324 29,9 28,4 V + S
520 i	120	09/00→05/04	←	→ 07/03; für Behördenfahrzeuge		<b>24.0330-0107.1</b>	<b>530107</b>	Ø 324 29,9 27,6 V + S
			←	→ 07/03		<b>24.0120-0154.1</b>	<b>420154</b>	Ø 298 20 18,4 V + S
520 i	125	09/00→05/04	←	→ 07/03		<b>24.0320-0154.1</b>	<b>520154</b>	Ø 298 20 17,6 V + S
			←	→ 07/03		<b>24.0330-0107.1</b>	<b>530107</b>	Ø 324 29,9 27,6 V + S
↓								

	kw			 	! #		
<b>BMW - 5 Touring (E39) 09/96→05/04</b>							
<b> Bremsscheibe</b>							
520 i	110	01/97→09/00	←	05/97→; nicht für Behördenfahrzeuge	24.0122-0159.1 422159	Ø 296 22 20,4 V + S	
			←	05/97→; für Behördenfahrzeuge	24.0130-0107.1 430107	Ø 324 29,9 28,4 V + S	
			→	05/97→	24.0120-0154.1 420154	Ø 298 20 18,4 V + S	
523 i	120	09/98→08/00	←		24.0122-0159.1 422159	Ø 296 22 20,4 V + S	
			←		24.0322-0159.1 522159	Ø 296 22 19,6 V + S	
			→		24.0120-0154.1 420154	Ø 298 20 18,4 V + S	
523 i 528 i	125 142	09/96→08/00 01/97→09/00	←	05/97→	24.0122-0159.1 422159	Ø 296 22 20,4 V + S	
			←		24.0322-0159.1 522159	Ø 296 22 19,6 V + S	
			→	05/97→	24.0120-0154.1 420154	Ø 298 20 18,4 V + S	
525 i	141	09/00→05/04	←	10/00→ 07/03; nicht für Behördenfahrzeuge	24.0122-0159.1 422159	Ø 296 22 20,4 V + S	
			←	10/00→ 07/03; für Behördenfahrzeuge	24.0130-0107.1 430107	Ø 324 29,9 28,4 V + S	
			→	10/00→ 07/03	24.0120-0154.1 420154	Ø 298 20 18,4 V + S	
525 tds	105	03/97→05/04	←	06/98→ 09/00	24.0122-0159.1 422159	Ø 296 22 20,4 V + S	
			←		24.0322-0159.1 522159	Ø 296 22 19,6 V + S	
			→	06/98→ 09/00	24.0120-0154.1 420154	Ø 298 20 18,4 V + S	
530 d	135	08/98→09/00	←	09/98→	24.0122-0159.1 422159	Ø 296 22 20,4 V + S	
			←		24.0322-0159.1 522159	Ø 296 22 19,6 V + S	
			→	09/98→	24.0120-0154.1 420154	Ø 298 20 18,4 V + S	
530 d	142	09/00→05/04	←	→ 09/00	24.0122-0159.1 422159	Ø 296 22 20,4 V + S	
			←	10/00→ 07/03	24.0130-0107.1 430107	Ø 324 29,9 28,4 V + S	
			→	→ 07/03	24.0120-0154.1 420154	Ø 298 20 18,4 V + S	
530 i	170	09/00→05/04	←	10/00→ 07/03	24.0130-0107.1 430107	Ø 324 29,9 28,4 V + S	
			←		24.0330-0107.1 530107	Ø 324 29,9 27,6 V + S	
			→	10/00→ 07/03	24.0120-0154.1 420154	Ø 298 20 18,4 V + S	
540 i	210	01/97→05/04	←	05/97→ 02/00	24.0130-0101.1 430101	Ø 324 30 28,4 V + S	
			←	03/00→ 07/03	24.0130-0107.1 430107	Ø 324 29,9 28,4 V + S	
			→	05/97→ 07/03	24.0120-0154.1 420154	Ø 298 20 18,4 V + S	
			←		24.0320-0154.1 520154	Ø 298 20 17,6 V + S	
			←				
			→				
<b>BMW - 5 Touring (E61) 03/04→12/10</b>							
<b> Bremsbelagsatz, Scheibenbremse</b>							
520 d	110	04/05→02/08	←	09/05→; für Behördenfahrzeuge	13.0460-7167.2 607167	ATE 23312 20,3 + WE / - WK	
			←		13.0460-7296.2 607296	ATE 23212 20,3 + WE / - WK	
			←		13.0470-7167.2 LD7167	ATE 23312 20,3 + WE / - WK Ceramic	
520 d 523 i	120 130	04/05→02/08 10/04→02/07	←	07/05→; für Behördenfahrzeuge	13.0460-7167.2 607167	ATE 23312 20,3 + WE / - WK	
			←		13.0460-7296.2 607296	ATE 23212 20,3 + WE / - WK	
			←		13.0470-7167.2 LD7167	ATE 23312 20,3 + WE / - WK Ceramic	
↓							









	kw			 	! #		
<b>BMW - 5 Touring (E61) 03/04→12/10</b>							
<b> Bremsbelagsatz, Scheibenbremse</b>							
520 d 523 i	120 130	04/05→02/08 10/04→02/07	←	07/05→; für Behördenfahrzeuge	13.0470-7296.2	LD7296	ATE 23212 20,3 + WE / - WK Ceramic
			←	07/05→; nicht für Behördenfahrzeuge	13.0460-7176.2 13.0470-7176.2	607176 LD7176	ATE 23793 20,3 + WE / - WK ATE 23793 20,3 + WE / - WK Ceramic
			→	07/05→	13.0460-7174.2 13.0470-7174.2	607174 LD7174	ATE 23732 17,3 + WE / - WK ATE 23732 17,3 + WE / - WK Ceramic
520 d	130	03/07→05/10	←	09/07→	13.0460-7167.2 13.0460-7296.2 13.0470-7167.2	607167 607296 LD7167	ATE 23312 20,3 + WE / - WK ATE 23212 20,3 + WE / - WK ATE 23312 20,3 + WE / - WK Ceramic
			→	09/07→	13.0460-7174.2 13.0470-7174.2	607174 LD7174	ATE 23732 17,3 + WE / - WK ATE 23732 17,3 + WE / - WK Ceramic
520 i 520 i	120 125	07/07→08/10 09/07→12/10	←	→ 05/10; für Behördenfahrzeuge	13.0460-7167.2 13.0460-7296.2 13.0470-7167.2	607167 607296 LD7167	ATE 23312 20,3 + WE / - WK ATE 23212 20,3 + WE / - WK ATE 23312 20,3 + WE / - WK Ceramic
			←	→ 05/10; nicht für Behördenfahrzeuge	13.0460-7176.2 13.0470-7176.2	607176 LD7176	ATE 23793 20,3 + WE / - WK ATE 23793 20,3 + WE / - WK Ceramic
			→	→ 05/10	13.0460-7174.2 13.0470-7174.2	607174 LD7174	ATE 23732 17,3 + WE / - WK ATE 23732 17,3 + WE / - WK Ceramic
523 i	140	01/07→12/10	←	03/07→ 05/10; Motorcode: N53	13.0460-7167.2 13.0460-7296.2 13.0470-7167.2	607167 607296 LD7167	ATE 23312 20,3 + WE / - WK ATE 23212 20,3 + WE / - WK ATE 23312 20,3 + WE / - WK Ceramic
			←	03/07→ 05/10; für Behördenfahrzeuge; Motorcode: N52N	13.0460-7167.2 13.0460-7296.2 13.0470-7167.2	607167 607296 LD7167	ATE 23312 20,3 + WE / - WK ATE 23212 20,3 + WE / - WK ATE 23312 20,3 + WE / - WK Ceramic
			←	03/07→ 05/10; nicht für Behördenfahrzeuge; Motorcode: N52N	13.0460-7176.2 13.0470-7176.2	607176 LD7176	ATE 23793 20,3 + WE / - WK ATE 23793 20,3 + WE / - WK Ceramic
			→	03/07→ 05/10	13.0460-7174.2 13.0470-7174.2	607174 LD7174	ATE 23732 17,3 + WE / - WK ATE 23732 17,3 + WE / - WK Ceramic
523 i	140	03/07→01/10	←	für Behördenfahrzeuge; Motorcode: N52N	13.0460-7167.2 13.0460-7296.2 13.0470-7167.2	607167 607296 LD7167	ATE 23312 20,3 + WE / - WK ATE 23212 20,3 + WE / - WK ATE 23312 20,3 + WE / - WK Ceramic
			←	Motorcode: N53	13.0460-7167.2 13.0460-7296.2 13.0470-7167.2	607167 607296 LD7167	ATE 23312 20,3 + WE / - WK ATE 23212 20,3 + WE / - WK ATE 23312 20,3 + WE / - WK Ceramic
			←	nicht für Behördenfahrzeuge; Motorcode: N52N	13.0460-7176.2 13.0470-7176.2	607176 LD7176	ATE 23793 20,3 + WE / - WK ATE 23793 20,3 + WE / - WK Ceramic
			→		13.0460-7174.2 13.0470-7174.2	607174 LD7174	ATE 23732 17,3 + WE / - WK ATE 23732 17,3 + WE / - WK Ceramic
525 d ↓	120	03/04→03/07	←	12/04→	13.0460-7167.2 13.0460-7176.2	607167 607176	ATE 23312 20,3 + WE / - WK ATE 23793 20,3 + WE / - WK









	kw			 	! #		
<b>BMW - 5 Touring (E61) 03/04→12/10</b>							
<b> Bremsbelagsatz, Scheibenbremse</b>							
525 d	120	03/04→03/07	←	12/04→		13.0460-7296.2 607296	ATE 23212 20,3 + WE / - WK
						13.0470-7167.2 LD7167	ATE 23312 20,3 + WE / - WK Ceramic
						13.0470-7176.2 LD7176	ATE 23793 20,3 + WE / - WK Ceramic
						13.0470-7296.2 LD7296	ATE 23212 20,3 + WE / - WK Ceramic
			→	12/04→		13.0460-7174.2 607174	ATE 23732 17,3 + WE / - WK
						13.0470-7174.2 LD7174	ATE 23732 17,3 + WE / - WK Ceramic
525 d	130	03/04→03/07	←	05/04→; für Behördenfahrzeuge		13.0460-7167.2 607167	ATE 23312 20,3 + WE / - WK
						13.0460-7296.2 607296	ATE 23212 20,3 + WE / - WK
						13.0470-7167.2 LD7167	ATE 23312 20,3 + WE / - WK Ceramic
						13.0470-7296.2 LD7296	ATE 23212 20,3 + WE / - WK Ceramic
			←	05/04→; nicht für Behördenfahrzeuge		13.0460-7176.2 607176	ATE 23793 20,3 + WE / - WK
						13.0470-7176.2 LD7176	ATE 23793 20,3 + WE / - WK Ceramic
			→	05/04→		13.0460-7174.2 607174	ATE 23732 17,3 + WE / - WK
						13.0470-7174.2 LD7174	ATE 23732 17,3 + WE / - WK Ceramic
525 d	145	03/07→05/10	←	für Behördenfahrzeuge		13.0460-7167.2 607167	ATE 23312 20,3 + WE / - WK
						13.0460-7296.2 607296	ATE 23212 20,3 + WE / - WK
						13.0470-7167.2 LD7167	ATE 23312 20,3 + WE / - WK Ceramic
						13.0470-7296.2 LD7296	ATE 23212 20,3 + WE / - WK Ceramic
			←	nicht für Behördenfahrzeuge		13.0460-7176.2 607176	ATE 23793 20,3 + WE / - WK
						13.0470-7176.2 LD7176	ATE 23793 20,3 + WE / - WK Ceramic
			→	für Behördenfahrzeuge		13.0460-7169.2 607169	ATE 23309 17,3 + WE / - WK
						13.0470-7169.2 LD7169	ATE 23309 17,3 + WE / - WK Ceramic
			→	nicht für Behördenfahrzeuge		13.0460-7174.2 607174	ATE 23732 17,3 + WE / - WK
						13.0470-7174.2 LD7174	ATE 23732 17,3 + WE / - WK Ceramic
525 d xDrive 525 xd 530 d xDrive 530 i xDrive 530 xi 530 xi	145 145 173 200 200 200	09/08→05/10 09/07→09/08 09/07→05/10 09/08→05/10 09/06→09/08 03/07→05/10	←			13.0460-7167.2 607167	ATE 23312 20,3 + WE / - WK
						13.0460-7296.2 607296	ATE 23212 20,3 + WE / - WK
						13.0470-7167.2 LD7167	ATE 23312 20,3 + WE / - WK Ceramic
						13.0470-7296.2 LD7296	ATE 23212 20,3 + WE / - WK Ceramic
			→			13.0460-7174.2 607174	ATE 23732 17,3 + WE / - WK
						13.0470-7174.2 LD7174	ATE 23732 17,3 + WE / - WK Ceramic
525 i	141	06/04→12/10	←	für Behördenfahrzeuge; → 03/05		13.0460-7167.2 607167	ATE 23312 20,3 + WE / - WK
						13.0460-7296.2 607296	ATE 23212 20,3 + WE / - WK
						13.0470-7167.2 LD7167	ATE 23312 20,3 + WE / - WK Ceramic
						13.0470-7296.2 LD7296	ATE 23212 20,3 + WE / - WK Ceramic
			←	nicht für Behördenfahrzeuge; → 03/05		13.0460-7176.2 607176	ATE 23793 20,3 + WE / - WK
						13.0470-7176.2 LD7176	ATE 23793 20,3 + WE / - WK Ceramic
			→	→ 03/05		13.0460-7174.2 607174	ATE 23732 17,3 + WE / - WK
						13.0470-7174.2 LD7174	ATE 23732 17,3 + WE / - WK Ceramic
525 i	155	07/05→12/10	←	03/07→; für Behördenfahrzeuge; Motorcode: N52N		13.0460-7167.2 607167	ATE 23312 20,3 + WE / - WK
						13.0460-7296.2 607296	ATE 23212 20,3 + WE / - WK
						13.0470-7167.2 LD7167	ATE 23312 20,3 + WE / - WK Ceramic
						13.0470-7296.2 LD7296	ATE 23212 20,3 + WE / - WK Ceramic
			←	→ 03/07		13.0460-7167.2 607167	ATE 23312 20,3 + WE / - WK
						13.0460-7296.2 607296	ATE 23212 20,3 + WE / - WK
						13.0470-7167.2 LD7167	ATE 23312 20,3 + WE / - WK Ceramic









	kw			 	! #			
<b>BMW - 5 Touring (E61) 03/04→12/10</b>								
<b> Bremsbelagsatz, Scheibenbremse</b>								
525 i	155	07/05→12/10	←	→ 03/07		<b>13.0470-7296.2</b>	<b>LD7296</b>	ATE 23212 20,3 + WE / - WK Ceramic
			←	03/07→; Motorcode: N53		<b>13.0460-7167.2</b>	<b>607167</b>	ATE 23312 20,3 + WE / - WK
						<b>13.0460-7296.2</b>	<b>607296</b>	ATE 23212 20,3 + WE / - WK
						<b>13.0470-7167.2</b>	<b>LD7167</b>	ATE 23312 20,3 + WE / - WK Ceramic
						<b>13.0470-7296.2</b>	<b>LD7296</b>	ATE 23212 20,3 + WE / - WK Ceramic
			←	03/07→; nicht für Behördenfahrzeuge; Motorcode: N52N		<b>13.0460-7176.2</b>	<b>607176</b>	ATE 23793 20,3 + WE / - WK
						<b>13.0470-7176.2</b>	<b>LD7176</b>	ATE 23793 20,3 + WE / - WK Ceramic
			→	03/07→; für Behördenfahrzeuge; Motorcode: N53		<b>13.0460-7169.2</b>	<b>607169</b>	ATE 23309 17,3 + WE / - WK
						<b>13.0470-7169.2</b>	<b>LD7169</b>	ATE 23309 17,3 + WE / - WK Ceramic
			→	03/07		<b>13.0460-7174.2</b>	<b>607174</b>	ATE 23732 17,3 + WE / - WK
						<b>13.0470-7174.2</b>	<b>LD7174</b>	ATE 23732 17,3 + WE / - WK Ceramic
			→	03/07→; Motorcode: N53; nicht für Behördenfahrzeuge		<b>13.0460-7174.2</b>	<b>607174</b>	ATE 23732 17,3 + WE / - WK
						<b>13.0470-7174.2</b>	<b>LD7174</b>	ATE 23732 17,3 + WE / - WK Ceramic
			→	03/07→; Motorcode: N52N		<b>13.0460-7174.2</b>	<b>607174</b>	ATE 23732 17,3 + WE / - WK
						<b>13.0470-7174.2</b>	<b>LD7174</b>	ATE 23732 17,3 + WE / - WK Ceramic
525 i	160	10/04→03/10	←	07/05→ 03/07		<b>13.0460-7167.2</b>	<b>607167</b>	ATE 23312 20,3 + WE / - WK
						<b>13.0460-7296.2</b>	<b>607296</b>	ATE 23212 20,3 + WE / - WK
						<b>13.0470-7167.2</b>	<b>LD7167</b>	ATE 23312 20,3 + WE / - WK Ceramic
						<b>13.0470-7296.2</b>	<b>LD7296</b>	ATE 23212 20,3 + WE / - WK Ceramic
			←	03/07→; für Behördenfahrzeuge; Motorcode: N52N		<b>13.0460-7167.2</b>	<b>607167</b>	ATE 23312 20,3 + WE / - WK
						<b>13.0460-7296.2</b>	<b>607296</b>	ATE 23212 20,3 + WE / - WK
						<b>13.0470-7167.2</b>	<b>LD7167</b>	ATE 23312 20,3 + WE / - WK Ceramic
						<b>13.0470-7296.2</b>	<b>LD7296</b>	ATE 23212 20,3 + WE / - WK Ceramic
←	03/07→; Motorcode: N53		<b>13.0460-7167.2</b>	<b>607167</b>	ATE 23312 20,3 + WE / - WK			
			<b>13.0460-7296.2</b>	<b>607296</b>	ATE 23212 20,3 + WE / - WK			
			<b>13.0470-7167.2</b>	<b>LD7167</b>	ATE 23312 20,3 + WE / - WK Ceramic			
			<b>13.0470-7296.2</b>	<b>LD7296</b>	ATE 23212 20,3 + WE / - WK Ceramic			
←	03/07→; nicht für Behördenfahrzeuge; Motorcode: N52N		<b>13.0460-7176.2</b>	<b>607176</b>	ATE 23793 20,3 + WE / - WK			
			<b>13.0470-7176.2</b>	<b>LD7176</b>	ATE 23793 20,3 + WE / - WK Ceramic			
→	03/07→; für Behördenfahrzeuge; Motorcode: N53		<b>13.0460-7169.2</b>	<b>607169</b>	ATE 23309 17,3 + WE / - WK			
			<b>13.0470-7169.2</b>	<b>LD7169</b>	ATE 23309 17,3 + WE / - WK Ceramic			
→	07/05→ 03/07		<b>13.0460-7174.2</b>	<b>607174</b>	ATE 23732 17,3 + WE / - WK			
			<b>13.0470-7174.2</b>	<b>LD7174</b>	ATE 23732 17,3 + WE / - WK Ceramic			
→	03/07→; Motorcode: N53; nicht für Behördenfahrzeuge		<b>13.0460-7174.2</b>	<b>607174</b>	ATE 23732 17,3 + WE / - WK			
			<b>13.0470-7174.2</b>	<b>LD7174</b>	ATE 23732 17,3 + WE / - WK Ceramic			
→	03/07→; Motorcode: N52N		<b>13.0460-7174.2</b>	<b>607174</b>	ATE 23732 17,3 + WE / - WK			
			<b>13.0470-7174.2</b>	<b>LD7174</b>	ATE 23732 17,3 + WE / - WK Ceramic			
525 i 525 i	155 160	01/07→12/10 01/07→12/10	←	03/07→ 05/10; Motorcode: N53		<b>13.0460-7167.2</b>	<b>607167</b>	ATE 23312 20,3 + WE / - WK
						<b>13.0460-7296.2</b>	<b>607296</b>	ATE 23212 20,3 + WE / - WK
						<b>13.0470-7167.2</b>	<b>LD7167</b>	ATE 23312 20,3 + WE / - WK Ceramic
						<b>13.0470-7296.2</b>	<b>LD7296</b>	ATE 23212 20,3 + WE / - WK Ceramic
			←	→ 03/07		<b>13.0460-7167.2</b>	<b>607167</b>	ATE 23312 20,3 + WE / - WK
						<b>13.0460-7296.2</b>	<b>607296</b>	ATE 23212 20,3 + WE / - WK
						<b>13.0470-7167.2</b>	<b>LD7167</b>	ATE 23312 20,3 + WE / - WK Ceramic
						<b>13.0470-7296.2</b>	<b>LD7296</b>	ATE 23212 20,3 + WE / - WK Ceramic



















	kw			 	! #		
<b>BMW - 5 Touring (E61) 03/04→12/10</b>							
<b> Bremsbelagsatz, Scheibenbremse</b>							
525 i 525 i	155 160	01/07→12/10 01/07→12/10	←	03/07→ 05/10; für Behördenfahrzeuge; Motorcode: N52N	13.0460-7167.2 607167	ATE 23312 20,3 + WE / - WK	
					13.0460-7296.2 607296	ATE 23212 20,3 + WE / - WK	
					13.0470-7167.2 LD7167	ATE 23312 20,3 + WE / - WK Ceramic	
					13.0470-7296.2 LD7296	ATE 23212 20,3 + WE / - WK Ceramic	
			←	03/07→ 05/10; nicht für Behördenfahrzeuge; Motorcode: N52N	13.0460-7176.2 607176	ATE 23793 20,3 + WE / - WK	
					13.0470-7176.2 LD7176	ATE 23793 20,3 + WE / - WK Ceramic	
525 i xDrive 525 xi 525 xi	160 160 160	09/08→12/10 07/05→12/10 01/07→12/10	←	→ 05/10	13.0460-7167.2 607167	ATE 23312 20,3 + WE / - WK	
					13.0460-7296.2 607296	ATE 23212 20,3 + WE / - WK	
					13.0470-7167.2 LD7167	ATE 23312 20,3 + WE / - WK Ceramic	
					13.0470-7296.2 LD7296	ATE 23212 20,3 + WE / - WK Ceramic	
			→	→ 05/10	13.0460-7174.2 607174	ATE 23732 17,3 + WE / - WK	
					13.0470-7174.2 LD7174	ATE 23732 17,3 + WE / - WK Ceramic	
530 d 530 d	155 160	03/04→05/10 03/04→09/05	←	05/04→	13.0460-7167.2 607167	ATE 23312 20,3 + WE / - WK	
					13.0460-7296.2 607296	ATE 23212 20,3 + WE / - WK	
					13.0470-7167.2 LD7167	ATE 23312 20,3 + WE / - WK Ceramic	
		13.0470-7296.2 LD7296	ATE 23212 20,3 + WE / - WK Ceramic				
→	05/04→; für Behördenfahrzeuge	13.0460-7169.2 607169	ATE 23309 17,3 + WE / - WK				
		13.0470-7169.2 LD7169	ATE 23309 17,3 + WE / - WK Ceramic				
→	05/04→; nicht für Behördenfahrzeuge	13.0460-7174.2 607174	ATE 23732 17,3 + WE / - WK				
		13.0470-7174.2 LD7174	ATE 23732 17,3 + WE / - WK Ceramic				
530 d	170	02/05→02/07	←	07/05→	13.0460-7167.2 607167	ATE 23312 20,3 + WE / - WK	
					13.0460-7296.2 607296	ATE 23212 20,3 + WE / - WK	
					13.0470-7167.2 LD7167	ATE 23312 20,3 + WE / - WK Ceramic	
		13.0470-7296.2 LD7296	ATE 23212 20,3 + WE / - WK Ceramic				
→	07/05→; für Behördenfahrzeuge	13.0460-7169.2 607169	ATE 23309 17,3 + WE / - WK				
		13.0470-7169.2 LD7169	ATE 23309 17,3 + WE / - WK Ceramic				
→	07/05→; nicht für Behördenfahrzeuge	13.0460-7174.2 607174	ATE 23732 17,3 + WE / - WK				
		13.0470-7174.2 LD7174	ATE 23732 17,3 + WE / - WK Ceramic				
530 d	173	02/07→05/10	←	03/07→	13.0460-7167.2 607167	ATE 23312 20,3 + WE / - WK	
					13.0460-7296.2 607296	ATE 23212 20,3 + WE / - WK	
					13.0470-7167.2 LD7167	ATE 23312 20,3 + WE / - WK Ceramic	
		13.0470-7296.2 LD7296	ATE 23212 20,3 + WE / - WK Ceramic				
→	03/07→; für Behördenfahrzeuge	13.0460-7169.2 607169	ATE 23309 17,3 + WE / - WK				
		13.0470-7169.2 LD7169	ATE 23309 17,3 + WE / - WK Ceramic				
→	03/07→; nicht für Behördenfahrzeuge	13.0460-7174.2 607174	ATE 23732 17,3 + WE / - WK				
		13.0470-7174.2 LD7174	ATE 23732 17,3 + WE / - WK Ceramic				
530 i 530 xd ↓	190 170	09/04→02/07 02/05→02/07	←	07/05→	13.0460-7167.2 607167	ATE 23312 20,3 + WE / - WK	







	kw			 	! #		
<b>BMW - 5 Touring (E61) 03/04→12/10</b>							
<b> Bremsbelagsatz, Scheibenbremse</b>							
530 xi	190	04/05→02/07	←	07/05→		13.0460-7296.2 607296	ATE 23212 20,3 + WE / - WK
						13.0470-7167.2 LD7167	ATE 23312 20,3 + WE / - WK Ceramic
			→	07/05→		13.0470-7296.2 LD7296	ATE 23212 20,3 + WE / - WK Ceramic
			→	07/05→		13.0460-7174.2 607174	ATE 23732 17,3 + WE / - WK
						13.0470-7174.2 LD7174	ATE 23732 17,3 + WE / - WK Ceramic
530 i	200	09/06→03/10	←	03/07→		13.0460-7167.2 607167	ATE 23312 20,3 + WE / - WK
						13.0460-7296.2 607296	ATE 23212 20,3 + WE / - WK
						13.0470-7167.2 LD7167	ATE 23312 20,3 + WE / - WK Ceramic
						13.0470-7296.2 LD7296	ATE 23212 20,3 + WE / - WK Ceramic
			→	03/07→; Motorcode: N53		13.0460-7169.2 607169	ATE 23309 17,3 + WE / - WK
						13.0470-7169.2 LD7169	ATE 23309 17,3 + WE / - WK Ceramic
			→	03/07→; für Behördenfahrzeuge; Motorcode: N52N		13.0460-7169.2 607169	ATE 23309 17,3 + WE / - WK
						13.0470-7169.2 LD7169	ATE 23309 17,3 + WE / - WK Ceramic
			→	03/07→; nicht für Behördenfahrzeuge; Motorcode: N52N		13.0460-7174.2 607174	ATE 23732 17,3 + WE / - WK
						13.0470-7174.2 LD7174	ATE 23732 17,3 + WE / - WK Ceramic
530 i	200	01/07→12/10	←	03/07→ 05/10		13.0460-7167.2 607167	ATE 23312 20,3 + WE / - WK
						13.0460-7296.2 607296	ATE 23212 20,3 + WE / - WK
						13.0470-7167.2 LD7167	ATE 23312 20,3 + WE / - WK Ceramic
						13.0470-7296.2 LD7296	ATE 23212 20,3 + WE / - WK Ceramic
			→	03/07→ 05/10; Motorcode: N53		13.0460-7169.2 607169	ATE 23309 17,3 + WE / - WK
						13.0470-7169.2 LD7169	ATE 23309 17,3 + WE / - WK Ceramic
			→	03/07→ 05/10; für Behördenfahrzeuge; Motorcode: N52N		13.0460-7169.2 607169	ATE 23309 17,3 + WE / - WK
						13.0470-7169.2 LD7169	ATE 23309 17,3 + WE / - WK Ceramic
			→	03/07→ 05/10; nicht für Behördenfahrzeuge; Motorcode: N52N		13.0460-7174.2 607174	ATE 23732 17,3 + WE / - WK
						13.0470-7174.2 LD7174	ATE 23732 17,3 + WE / - WK Ceramic
530 xd	173	01/07→08/07	←	03/07→		13.0460-7167.2 607167	ATE 23312 20,3 + WE / - WK
						13.0460-7296.2 607296	ATE 23212 20,3 + WE / - WK
						13.0470-7167.2 LD7167	ATE 23312 20,3 + WE / - WK Ceramic
						13.0470-7296.2 LD7296	ATE 23212 20,3 + WE / - WK Ceramic
			→	03/07→		13.0460-7174.2 607174	ATE 23732 17,3 + WE / - WK
						13.0470-7174.2 LD7174	ATE 23732 17,3 + WE / - WK Ceramic
535 d	200	09/04→12/10	←	→ 03/07		13.0460-7210.2 607210	ATE 23791 20,8 + WE / - WK
						13.0470-7210.2 LD7210	ATE 23791 20,8 + WE / - WK Ceramic
			→	→ 03/07		13.0460-7169.2 607169	ATE 23309 17,3 + WE / - WK
						13.0470-7169.2 LD7169	ATE 23309 17,3 + WE / - WK Ceramic
535 d	210	01/07→12/10	←	03/07→ 05/10		13.0460-7210.2 607210	ATE 23791 20,8 + WE / - WK
						13.0470-7210.2 LD7210	ATE 23791 20,8 + WE / - WK Ceramic
			→	03/07→ 05/10		13.0460-7169.2 607169	ATE 23309 17,3 + WE / - WK
						13.0470-7169.2 LD7169	ATE 23309 17,3 + WE / - WK Ceramic
545 i	245	06/04→12/10	←	→ 08/05		13.0460-7167.2 607167	ATE 23312 20,3 + WE / - WK
						13.0460-7296.2 607296	ATE 23212 20,3 + WE / - WK
			→	→ 08/05		13.0460-7169.2 607169	ATE 23309 17,3 + WE / - WK
						13.0470-7169.2 LD7169	ATE 23309 17,3 + WE / - WK Ceramic
550 i	270	07/05→12/10	←	03/07→ 05/10		13.0460-7167.2 607167	ATE 23312 20,3 + WE / - WK
						13.0460-7210.2 607210	ATE 23791 20,8 + WE / - WK
						13.0460-7296.2 607296	ATE 23212 20,3 + WE / - WK
↓							







	kW			 	! #		
<b>BMW - 5 Touring (E61) 03/04→12/10</b>							
<b> Bremsbelagsatz, Scheibenbremse</b>							
550 i	270	07/05→12/10	←	→ 03/07		13.0460-7210.2 607210	ATE 23791 20,8 + WE / - WK
			→	→ 05/10		13.0460-7169.2 607169	ATE 23309 17,3 + WE / - WK
						13.0470-7169.2 LD7169	ATE 23309 17,3 + WE / - WK Ceramic
M5	373	02/07→12/10	←	→ 05/10		13.0460-7210.2 607210	ATE 23791 20,8 + WE / - WK
			→	→ 05/10		13.0460-7169.2 607169	ATE 23309 17,3 + WE / - WK
						13.0470-7169.2 LD7169	ATE 23309 17,3 + WE / - WK Ceramic
<b>Warnkontakt, Bremsbelagverschleiß</b>							
520 d	110	04/05→02/08	←	☐; 09/05→	1	24.8190-0273.2 620273	L= 662
			→	09/05→	1	24.8190-0275.2 620275	L= 872
520 d	120	04/05→02/08	←	☐; 07/05→	1	24.8190-0273.2 620273	L= 662
523 i	130	10/04→02/07	→	07/05→	1	24.8190-0275.2 620275	L= 872
530 d	170	02/05→02/07					
530 i	190	09/04→02/07					
530 xd	170	02/05→02/07					
530 xi	190	04/05→02/07					
520 d	130	03/07→05/10	←	☐; 09/07→	1	24.8190-0273.2 620273	L= 662
			→	09/07→	1	24.8190-0275.2 620275	L= 872
520 i	120	07/07→08/10	←	☐; → 05/10	1	24.8190-0273.2 620273	L= 662
520 i	125	09/07→12/10	→	→ 05/10	1	24.8190-0275.2 620275	L= 872
525 i xDrive	160	09/08→12/10					
525 xi	160	07/05→12/10					
525 xi	160	01/07→12/10					
523 i	140	01/07→12/10	←	☐; 03/07→ 05/10; Motorcode: N52N	1	24.8190-0273.2 620273	L= 662
			←	☐; 03/07→ 05/10; Motorcode: N53	1	24.8190-0273.2 620273	L= 662
			→	03/07→ 05/10	1	24.8190-0275.2 620275	L= 872
523 i	140	03/07→01/10	←	☐; Motorcode: N52N	1	24.8190-0273.2 620273	L= 662
			←	☐; Motorcode: N53	1	24.8190-0273.2 620273	L= 662
			→		1	24.8190-0275.2 620275	L= 872
525 d	120	03/04→03/07	←	☐; 12/04→	1	24.8190-0273.2 620273	L= 662
			→	12/04→	1	24.8190-0275.2 620275	L= 872
525 d	130	03/04→03/07	←	☐; 05/04→	1	24.8190-0273.2 620273	L= 662
530 d	155	03/04→05/10	→	05/04→	1	24.8190-0275.2 620275	L= 872
530 d	160	03/04→09/05					
525 d	145	03/07→05/10	←	☐	1	24.8190-0273.2 620273	L= 662
525 d xDrive	145	09/08→05/10	→		1	24.8190-0275.2 620275	L= 872
525 xd	145	09/07→09/08					
530 d xDrive	173	09/07→05/10					
530 i xDrive	200	09/08→05/10					
530 xi	200	09/06→09/08					
530 xi	200	03/07→05/10					
525 i	141	06/04→12/10	←	☐; → 03/05	1	24.8190-0273.2 620273	L= 662
			→	→ 03/05	1	24.8190-0275.2 620275	L= 872
525 i	155	07/05→12/10	←	☐; → 03/07	1	24.8190-0273.2 620273	L= 662
			←	☐; 03/07→; Motorcode: N52N	1	24.8190-0273.2 620273	L= 662
			←	☐; 03/07→; Motorcode: N53	1	24.8190-0273.2 620273	L= 662
			→	→ 03/07	1	24.8190-0275.2 620275	L= 872
			→	03/07→; Motorcode: N52N	1	24.8190-0275.2 620275	L= 872
			→	03/07→; Motorcode: N53	1	24.8190-0275.2 620275	L= 872
525 i	160	10/04→03/10	←	☐; 03/07→; Motorcode: N53	1	24.8190-0273.2 620273	L= 662
			←	☐; 07/05→ 03/07	1	24.8190-0273.2 620273	L= 662
			←	☐; 03/07→; Motorcode: N52N	1	24.8190-0273.2 620273	L= 662
			→	03/07→; Motorcode: N52N	1	24.8190-0275.2 620275	L= 872
			→	07/05→ 03/07	1	24.8190-0275.2 620275	L= 872
			→	03/07→; Motorcode: N53	1	24.8190-0275.2 620275	L= 872
525 i	155	01/07→12/10	←	☐; 03/07→ 05/10; Motorcode: N52N	1	24.8190-0273.2 620273	L= 662
525 i	160	01/07→12/10	←	☐; 03/07→ 05/10; Motorcode: N53	1	24.8190-0273.2 620273	L= 662
			←	☐; → 03/07	1	24.8190-0273.2 620273	L= 662
			→	03/07→ 05/10; Motorcode: N53	1	24.8190-0275.2 620275	L= 872
			→	03/07→ 05/10; Motorcode: N52N	1	24.8190-0275.2 620275	L= 872









	kw			 	! #		
<b>BMW - 5 Touring (E61) 03/04→12/10</b>							
<b>Warnkontakt, Bremsbelagverschleiß</b>							
525 i	155	01/07→12/10	➡	→ 03/07	1	24.8190-0275.2 620275	L= 872
525 i	160	01/07→12/10					
530 d	173	02/07→05/10	⬅	☐; 03/07→	1	24.8190-0273.2 620273	L= 662
530 d	173	01/07→08/07	➡	03/07→	1	24.8190-0275.2 620275	L= 872
530 i	200	09/06→03/10	⬅	☐; 03/07→	1	24.8190-0273.2 620273	L= 662
			➡	03/07→; Motorcode: N52N	1	24.8190-0275.2 620275	L= 872
			➡	03/07→; Motorcode: N53	1	24.8190-0275.2 620275	L= 872
530 i	200	01/07→12/10	⬅	☐; 03/07→ 05/10	1	24.8190-0273.2 620273	L= 662
			➡	03/07→ 05/10; Motorcode: N53	1	24.8190-0275.2 620275	L= 872
			➡	03/07→ 05/10; Motorcode: N52N	1	24.8190-0275.2 620275	L= 872
535 d	200	09/04→12/10	⬅	☐; → 03/07	1	24.8190-0273.2 620273	L= 662
			➡	→ 03/07	1	24.8190-0275.2 620275	L= 872
535 d	210	01/07→12/10	⬅	☐; 03/07→ 05/10	1	24.8190-0273.2 620273	L= 662
			➡	03/07→ 05/10	1	24.8190-0275.2 620275	L= 872
545 i	245	06/04→12/10	⬅	→ 08/05	1	24.8190-0273.2 620273	L= 662
			➡	→ 08/05	1	24.8190-0275.2 620275	L= 872
550 i	270	07/05→12/10	⬅	03/07→ 05/10	1	24.8190-0273.2 620273	L= 662
			⬅	→ 03/07	1	24.8190-0273.2 620273	L= 662
			➡	→ 05/10	1	24.8190-0275.2 620275	L= 872
M5	373	02/07→12/10	⬅	☐; → 05/10	1	24.8190-0273.2 620273	L= 662
			⬅	☐; → 05/10	1	24.8190-0276.2 620276	L= 674
			➡	→ 05/10	1	24.8190-0279.2 620279	L= 992
<b> Bremsscheibe</b>							
520 d	110	04/05→02/08	⬅	09/05→; nicht für Behördenfahrzeuge		24.0124-0181.1 424181 24.0324-0181.1 524181	Ø 310 24 22,4 V + S Ø 310 24 21,6 V + S
			➡	09/05→		24.0120-0183.1 420183 24.0320-0183.1 520183	Ø 320 20 18,4 V + S Ø 320 20 17,6 V + S
520 d	120	04/05→02/08	⬅	07/05→; nicht für Behördenfahrzeuge		24.0124-0181.1 424181 24.0324-0181.1 524181	Ø 310 24 22,4 V + S Ø 310 24 21,6 V + S
523 i	130	10/04→02/07	⬅	07/05→; für Behördenfahrzeuge		24.0130-0173.1 430173 24.0330-0173.1 530173	Ø 324 30 28,4 V + S Ø 324 30 27,6 V + S
			➡	07/05→		24.0120-0183.1 420183 24.0320-0183.1 520183	Ø 320 20 18,4 V + S Ø 320 20 17,6 V + S
520 d	130	03/07→05/10	⬅	09/07→		24.0130-0173.1 430173 24.0330-0173.1 530173	Ø 324 30 28,4 V + S Ø 324 30 27,6 V + S
			➡	09/07→		24.0120-0183.1 420183 24.0320-0183.1 520183	Ø 320 20 18,4 V + S Ø 320 20 17,6 V + S
520 i	120	07/07→08/10	⬅	→ 05/10; nicht für Behördenfahrzeuge		24.0124-0181.1 424181 24.0324-0181.1 524181	Ø 310 24 22,4 V + S Ø 310 24 21,6 V + S
520 i	125	09/07→12/10	⬅	→ 05/10; für Behördenfahrzeuge		24.0130-0173.1 430173 24.0330-0173.1 530173	Ø 324 30 28,4 V + S Ø 324 30 27,6 V + S
			➡	→ 05/10		24.0120-0183.1 420183 24.0320-0183.1 520183	Ø 320 20 18,4 V + S Ø 320 20 17,6 V + S
523 i	140	01/07→12/10	⬅	03/07→ 05/10; nicht für Behördenfahrzeuge; Motorcode: N52N		24.0124-0181.1 424181 24.0324-0181.1 524181	Ø 310 24 22,4 V + S Ø 310 24 21,6 V + S
			⬅	03/07→ 05/10; Motorcode: N53		24.0130-0173.1 430173 24.0330-0173.1 530173	Ø 324 30 28,4 V + S Ø 324 30 27,6 V + S
			⬅	03/07→ 05/10; für Behördenfahrzeuge; Motorcode: N52N		24.0130-0173.1 430173 24.0330-0173.1 530173	Ø 324 30 28,4 V + S Ø 324 30 27,6 V + S
			➡	03/07→ 05/10		24.0120-0183.1 420183 24.0320-0183.1 520183	Ø 320 20 18,4 V + S Ø 320 20 17,6 V + S
523 i	140	03/07→01/10	⬅	nicht für Behördenfahrzeuge; Motorcode: N52N		24.0124-0181.1 424181 24.0324-0181.1 524181	Ø 310 24 22,4 V + S Ø 310 24 21,6 V + S
			⬅	Motorcode: N53		24.0130-0173.1 430173 24.0330-0173.1 530173	Ø 324 30 28,4 V + S Ø 324 30 27,6 V + S
			⬅	für Behördenfahrzeuge; Motorcode: N52N		24.0130-0173.1 430173 24.0330-0173.1 530173	Ø 324 30 28,4 V + S Ø 324 30 27,6 V + S
↓							









	kw			 	! #			
<b>BMW - 5 Touring (E61) 03/04→12/10</b>								
<b>Bremsscheibe</b>								
523 i	140	03/07→01/10	➔			24.0120-0183.1 420183 24.0320-0183.1 520183	Ø 320 20 18,4 V + S Ø 320 20 17,6 V + S	
525 d	120	03/04→03/07	➔	12/04→		24.0124-0181.1 424181 24.0130-0173.1 430173 24.0324-0181.1 524181 24.0330-0173.1 530173	Ø 310 24 22,4 V + S Ø 324 30 28,4 V + S Ø 310 24 21,6 V + S Ø 324 30 27,6 V + S	
			➔	12/04→		24.0120-0183.1 420183 24.0320-0183.1 520183	Ø 320 20 18,4 V + S Ø 320 20 17,6 V + S	
525 d	130	03/04→03/07	➔	05/04→; nicht für Behördenfahrzeuge		24.0124-0181.1 424181 24.0324-0181.1 524181	Ø 310 24 22,4 V + S Ø 310 24 21,6 V + S	
			➔	05/04→; für Behördenfahrzeuge		24.0130-0173.1 430173 24.0330-0173.1 530173	Ø 324 30 28,4 V + S Ø 324 30 27,6 V + S	
			➔	05/04→		24.0120-0183.1 420183 24.0320-0183.1 520183	Ø 320 20 18,4 V + S Ø 320 20 17,6 V + S	
525 d	145	03/07→05/10	➔	nicht für Behördenfahrzeuge		24.0130-0173.1 430173 24.0330-0173.1 530173	Ø 324 30 28,4 V + S Ø 324 30 27,6 V + S	
			➔	für Behördenfahrzeuge		24.0130-0186.2 430186	Ø 348 30 28,4 V Bremsscheibe zweiteilig / + S	
			➔	nicht für Behördenfahrzeuge		24.0120-0183.1 420183 24.0320-0183.1 520183	Ø 320 20 18,4 V + S Ø 320 20 17,6 V + S	
			➔	für Behördenfahrzeuge		24.0124-0201.2 424201	Ø 345 24 22,4 V Bremsscheibe zweiteilig / + S	
525 d xDrive 525 xd 530 d xDrive 530 i xDrive 530 xi 530 xi	145 145 173 200 200 200	09/08→05/10 09/07→09/08 09/07→05/10 09/08→05/10 09/06→09/08 03/07→05/10	➔			24.0130-0173.1 430173 24.0330-0173.1 530173 24.0120-0213.1 420213 24.0320-0213.1 520213	Ø 324 30 28,4 V + S Ø 324 30 27,6 V + S Ø 320 20 18,4 V + S Ø 320 20 17,6 V + S	
	525 i	141	06/04→12/10	➔	nicht für Behördenfahrzeuge; → 03/05		24.0124-0181.1 424181 24.0324-0181.1 524181	Ø 310 24 22,4 V + S Ø 310 24 21,6 V + S
				➔	für Behördenfahrzeuge; → 03/05		24.0130-0173.1 430173 24.0330-0173.1 530173	Ø 324 30 28,4 V + S Ø 324 30 27,6 V + S
				➔	→ 03/05		24.0120-0183.1 420183 24.0320-0183.1 520183	Ø 320 20 18,4 V + S Ø 320 20 17,6 V + S
525 i	155	07/05→12/10	➔	03/07→; nicht für Behördenfahrzeuge; Motorcode: N52N		24.0124-0181.1 424181 24.0324-0181.1 524181	Ø 310 24 22,4 V + S Ø 310 24 21,6 V + S	
			➔	03/07→; für Behördenfahrzeuge; Motorcode: N52N		24.0130-0173.1 430173 24.0330-0173.1 530173	Ø 324 30 28,4 V + S Ø 324 30 27,6 V + S	
			➔	03/07→; nicht für Behördenfahrzeuge; Motorcode: N53		24.0130-0173.1 430173 24.0330-0173.1 530173	Ø 324 30 28,4 V + S Ø 324 30 27,6 V + S	
			➔	→ 03/07		24.0130-0173.1 430173 24.0330-0173.1 530173	Ø 324 30 28,4 V + S Ø 324 30 27,6 V + S	
			➔	03/07→; für Behördenfahrzeuge; Motorcode: N53		24.0130-0186.2 430186	Ø 348 30 28,4 V Bremsscheibe zweiteilig / + S	
			➔	03/07→; Motorcode: N52N		24.0120-0183.1 420183 24.0320-0183.1 520183	Ø 320 20 18,4 V + S Ø 320 20 17,6 V + S	
			➔	→ 03/07		24.0120-0183.1 420183 24.0320-0183.1 520183	Ø 320 20 18,4 V + S Ø 320 20 17,6 V + S	
			➔	03/07→; Motorcode: N53; nicht für Behördenfahrzeuge		24.0120-0183.1 420183 24.0320-0183.1 520183	Ø 320 20 18,4 V + S Ø 320 20 17,6 V + S	
			➔	03/07→; für Behördenfahrzeuge; Motorcode: N53		24.0124-0201.2 424201	Ø 345 24 22,4 V Bremsscheibe zweiteilig / + S	
525 i	160	10/04→03/10	➔	03/07→; nicht für Behördenfahrzeuge; Motorcode: N52N		24.0124-0181.1 424181 24.0324-0181.1 524181	Ø 310 24 22,4 V + S Ø 310 24 21,6 V + S	
			➔	03/07→; für Behördenfahrzeuge; Motorcode: N52N		24.0130-0173.1 430173 24.0330-0173.1 530173	Ø 324 30 28,4 V + S Ø 324 30 27,6 V + S	
			➔	03/07→; nicht für Behördenfahrzeuge; Motorcode: N53		24.0130-0173.1 430173 24.0330-0173.1 530173	Ø 324 30 28,4 V + S Ø 324 30 27,6 V + S	
			➔	07/05→ 03/07		24.0130-0173.1 430173 24.0330-0173.1 530173	Ø 324 30 28,4 V + S Ø 324 30 27,6 V + S	
			➔	03/07→; für Behördenfahrzeuge; Motorcode: N53		24.0130-0186.2 430186	Ø 348 30 28,4 V Bremsscheibe zweiteilig / + S	
			➔	03/07→; Motorcode: N52N		24.0120-0183.1 420183 24.0320-0183.1 520183	Ø 320 20 18,4 V + S Ø 320 20 17,6 V + S	











	kw			 	! #		
<b>BMW - 5 Touring (E61) 03/04→12/10</b>							
<b>Bremsscheibe</b>							
525 i	160	10/04→03/10	➔	07/05→ 03/07	24.0120-0183.1 420183	Ø 320 20 18,4 V + S	
			➔	03/07→; Motorcode: N53; nicht für Behördenfahrzeuge	24.0320-0183.1 520183	Ø 320 20 17,6 V + S	
			➔	03/07→; für Behördenfahrzeuge; Motorcode: N53	24.0124-0201.2 424201	Ø 345 24 22,4 V Bremsscheibe zweiteilig / + S	
525 i 525 i	155 160	01/07→12/10 01/07→12/10	←	03/07→ 05/10; nicht für Behördenfahrzeuge; Motorcode: N52N	24.0124-0181.1 424181	Ø 310 24 22,4 V + S	
			←	→ 03/07	24.0324-0181.1 524181	Ø 310 24 21,6 V + S	
			←	→ 03/07	24.0130-0173.1 430173	Ø 324 30 28,4 V + S	
			←	03/07→ 05/10; für Behördenfahrzeuge; Motorcode: N52N	24.0330-0173.1 530173	Ø 324 30 27,6 V + S	
			←	03/07→ 05/10; für Behördenfahrzeuge; Motorcode: N52N	24.0130-0173.1 430173	Ø 324 30 28,4 V + S	
			←	03/07→ 05/10; für Behördenfahrzeuge; Motorcode: N52N	24.0330-0173.1 530173	Ø 324 30 27,6 V + S	
			←	03/07→ 05/10; nicht für Behördenfahrzeuge; Motorcode: N53	24.0130-0173.1 430173	Ø 324 30 28,4 V + S	
			←	03/07→ 05/10; für Behördenfahrzeuge; Motorcode: N53	24.0330-0173.1 530173	Ø 324 30 27,6 V + S	
			➔	03/07→ 05/10; Motorcode: N53; nicht für Behördenfahrzeuge	24.0120-0183.1 420183	Ø 320 20 18,4 V + S	
			➔	03/07→ 05/10; Motorcode: N52N	24.0320-0183.1 520183	Ø 320 20 17,6 V + S	
525 i xDrive 525 xi 525 xi	160 160 160	09/08→12/10 07/05→12/10 01/07→12/10	←	→ 05/10	24.0120-0183.1 420183	Ø 320 20 18,4 V + S	
			←	→ 05/10	24.0320-0183.1 520183	Ø 320 20 17,6 V + S	
			➔	→ 05/10	24.0120-0213.1 420213	Ø 320 20 18,4 V + S	
			➔	→ 05/10	24.0320-0213.1 520213	Ø 320 20 17,6 V + S	
530 d 530 d	155 160	03/04→05/10 03/04→09/05	←	05/04→; nicht für Behördenfahrzeuge	24.0130-0173.1 430173	Ø 324 30 28,4 V + S	
			←	05/04→; für Behördenfahrzeuge	24.0330-0173.1 530173	Ø 324 30 27,6 V + S	
			➔	05/04→; nicht für Behördenfahrzeuge	24.0120-0183.1 420183	Ø 320 20 18,4 V + S	
			➔	05/04→; für Behördenfahrzeuge	24.0320-0183.1 520183	Ø 320 20 17,6 V + S	
530 d	170	02/05→02/07	←	05/04→; für Behördenfahrzeuge	24.0124-0201.2 424201	Ø 345 24 22,4 V Bremsscheibe zweiteilig / + S	
			←	07/05→; nicht für Behördenfahrzeuge	24.0130-0173.1 430173	Ø 324 30 28,4 V + S	
			←	07/05→; für Behördenfahrzeuge	24.0330-0173.1 530173	Ø 324 30 27,6 V + S	
			➔	07/05→; nicht für Behördenfahrzeuge	24.0130-0186.2 430186	Ø 348 30 28,4 V Bremsscheibe zweiteilig / + S	
530 d	173	02/07→05/10	➔	07/05→; nicht für Behördenfahrzeuge	24.0120-0183.1 420183	Ø 320 20 18,4 V + S	
			➔	07/05→; für Behördenfahrzeuge	24.0320-0183.1 520183	Ø 320 20 17,6 V + S	
			➔	07/05→; nicht für Behördenfahrzeuge	24.0124-0201.2 424201	Ø 345 24 22,4 V Bremsscheibe zweiteilig / + S	
			➔	07/05→; für Behördenfahrzeuge	24.0130-0186.2 430186	Ø 348 30 28,4 V Bremsscheibe zweiteilig / + S	
530 i	190	09/04→02/07	←	03/07→; nicht für Behördenfahrzeuge	24.0130-0173.1 430173	Ø 324 30 28,4 V + S	
			←	03/07→; für Behördenfahrzeuge	24.0330-0173.1 530173	Ø 324 30 27,6 V + S	
			➔	03/07→; nicht für Behördenfahrzeuge	24.0120-0183.1 420183	Ø 320 20 18,4 V + S	
			➔	03/07→; für Behördenfahrzeuge	24.0320-0183.1 520183	Ø 320 20 17,6 V + S	
530 i	200	09/06→03/10	←	03/07→; für Behördenfahrzeuge	24.0124-0201.2 424201	Ø 345 24 22,4 V Bremsscheibe zweiteilig / + S	
			←	03/07→; nicht für Behördenfahrzeuge; Motorcode: N52N	24.0130-0173.1 430173	Ø 324 30 28,4 V + S	
			←	03/07→; für Behördenfahrzeuge; Motorcode: N52N	24.0330-0173.1 530173	Ø 324 30 27,6 V + S	
			←	03/07→; Motorcode: N53	24.0130-0186.2 430186	Ø 348 30 28,4 V Bremsscheibe zweiteilig / + S	
↓							









	kw			 	! #		
<b>BMW - 5 Touring (E61) 03/04→12/10</b>							
<b>Bremsscheibe</b>							
530 i	200	09/06→03/10	➔	03/07→; nicht für Behördenfahrzeuge; Motorcode: N52N	24.0120-0183.1 420183	420183	Ø 320 20 18,4 V + S
			➔	03/07→; für Behördenfahrzeuge; Motorcode: N52N	24.0320-0183.1 520183	520183	Ø 320 20 17,6 V + S
			➔	03/07→; Motorcode: N53	24.0124-0201.2 424201	424201	Ø 345 24 22,4 V Bremsscheibe zweiteilig / + S
530 i	200	01/07→12/10	←	03/07→ 05/10; nicht für Behördenfahrzeuge; Motorcode: N52N	24.0130-0173.1 430173	430173	Ø 324 30 28,4 V + S
			←	03/07→ 05/10; für Behördenfahrzeuge; Motorcode: N52N	24.0330-0173.1 530173	530173	Ø 324 30 27,6 V + S
			←	03/07→ 05/10; Motorcode: N53	24.0130-0186.2 430186	430186	Ø 348 30 28,4 V Bremsscheibe zweiteilig / + S
			➔	03/07→ 05/10; nicht für Behördenfahrzeuge; Motorcode: N52N	24.0130-0186.2 430186	430186	Ø 348 30 28,4 V Bremsscheibe zweiteilig / + S
			➔	03/07→ 05/10; Motorcode: N53	24.0120-0183.1 420183	420183	Ø 320 20 18,4 V + S
			➔	03/07→ 05/10; für Behördenfahrzeuge; Motorcode: N52N	24.0320-0183.1 520183	520183	Ø 320 20 17,6 V + S
530 xd 530 xi	170 190	02/05→02/07 04/05→02/07	←	07/05→	24.0130-0173.1 430173	430173	Ø 324 30 28,4 V + S
			➔	07/05→	24.0330-0173.1 530173	530173	Ø 324 30 27,6 V + S
530 xd	173	01/07→08/07	←	03/07→	24.0120-0213.1 420213	420213	Ø 320 20 18,4 V + S
			➔	03/07→	24.0320-0213.1 520213	520213	Ø 320 20 17,6 V + S
			←	03/07→	24.0130-0173.1 430173	430173	Ø 324 30 28,4 V + S
535 d	200	09/04→12/10	←	→ 03/07	24.0330-0173.1 530173	530173	Ø 324 30 27,6 V + S
			➔	→ 03/07	24.0120-0213.1 420213	420213	Ø 320 20 18,4 V + S
535 d	210	01/07→12/10	←	03/07→ 05/10	24.0320-0213.1 520213	520213	Ø 320 20 17,6 V + S
			➔	03/07→ 05/10	24.0136-0106.2 436106	436106	Ø 348 36 34,4 V Bremsscheibe zweiteilig / + S
545 i	245	06/04→12/10	←	→ 08/05	24.0124-0201.2 424201	424201	Ø 345 24 22,4 V Bremsscheibe zweiteilig / + S
			➔	→ 08/05	24.0130-0186.2 430186	430186	Ø 348 30 28,4 V Bremsscheibe zweiteilig / + S
550 i	270	07/05→12/10	←	03/07→; für USA; → 05/10	24.0124-0201.2 424201	424201	Ø 345 24 22,4 V Bremsscheibe zweiteilig / + S
			←	03/07→; nicht für USA; → 05/10	24.0136-0106.2 436106	436106	Ø 348 36 34,4 V Bremsscheibe zweiteilig / + S
			←	→ 03/07	24.0136-0106.2 436106	436106	Ø 348 36 34,4 V Bremsscheibe zweiteilig / + S
			➔	→ 05/10	24.0124-0201.2 424201	424201	Ø 345 24 22,4 V Bremsscheibe zweiteilig / + S
M5	373	02/07→12/10	←	☐; → 05/10	24.0124-0234.2 424234	424234	Ø 370 24 22,4 V* Bremsscheibe zweiteilig / + S
			←	☐; → 05/10	24.0136-0117.2 436117	436117	Ø 374 36 34,4 V* Bremsscheibe zweiteilig / + S
			➔	☐; → 05/10	24.0136-0116.2 436116	436116	Ø 374 36 34,4 V* Bremsscheibe zweiteilig / + S
			➔	☐; → 05/10	24.0124-0235.2 424235	424235	Ø 370 24 22,4 V* Bremsscheibe zweiteilig / + S
<b>BMW - 5 Touring (F11) 11/09→</b>							
<b>Brembelagsatz, Scheibenbremse</b>							
518 d 518 d	100 105	10/12→ 10/12→07/14	←	01/13→; nicht für Fahrzeuge mit verstärkter Bremse	13.0460-7268.2 607268	607268	ATE 23794 20,3 + WE / - WK
			←	01/13→; für Fahrzeuge mit verstärkter Bremse	13.0470-7268.2 LD7268	LD7268	ATE 23794 20,3 + WE / - WK Ceramic
			➔	01/13→; für Fahrzeuge mit verstärkter Bremse	13.0460-7275.2 607275	607275	ATE 23313 20,2 + WE / - WK
↓					13.0470-7275.2 LD7275	LD7275	ATE 23313 20,2 + WE / - WK Ceramic
					13.0460-2716.2 602716	602716	TRW 24703 17,8 + WE / - WK + Zub







	kw			 	! #		
<b>BMW - 5 Touring (F11) 11/09→</b>							
<b> Bremsbelagsatz, Scheibenbremse</b>							
518 d 518 d	100 105	10/12→ 10/12→07/14	➡	01/13→; für Fahrzeuge mit verstärkter Bremse		13.0470-2716.2 LD2716	TRW 24703 17,8 + WE / - WK + Zub Ceramic
			➡	01/13→; nicht für Fahrzeuge mit verstärkter Bremse		13.0460-2760.2 602760 13.0470-2760.2 LD2760	TRW 24561 17,7 + WE / - WK + Zub TRW 24561 17,7 + WE / - WK + Zub Ceramic
518 d	110	01/14→	⬅	05/14→; nicht für Fahrzeuge mit verstärkter Bremse		13.0460-7268.2 607268 13.0470-7268.2 LD7268	ATE 23794 20,3 + WE / - WK ATE 23794 20,3 + WE / - WK Ceramic
			⬅	05/14→; für Fahrzeuge mit verstärkter Bremse		13.0460-7275.2 607275 13.0470-7275.2 LD7275	ATE 23313 20,2 + WE / - WK ATE 23313 20,2 + WE / - WK Ceramic
			➡	05/14→; für Fahrzeuge mit verstärkter Bremse		13.0460-2716.2 602716 13.0470-2716.2 LD2716	TRW 24703 17,8 + WE / - WK + Zub TRW 24703 17,8 + WE / - WK + Zub Ceramic
			➡	05/14→; nicht für Fahrzeuge mit verstärkter Bremse		13.0460-2760.2 602760 13.0470-2760.2 LD2760	TRW 24561 17,7 + WE / - WK + Zub TRW 24561 17,7 + WE / - WK + Zub Ceramic
518 d 520 d xDrive 520 d xDrive 520 d xDrive 520 d xDrive	120 100 120 135 147	05/14→ 07/13→07/14 10/13→06/13 02/13→07/14 02/13→07/14	⬅	nicht für Fahrzeuge mit verstärkter Bremse		13.0460-7268.2 607268 13.0470-7268.2 LD7268	ATE 23794 20,3 + WE / - WK ATE 23794 20,3 + WE / - WK Ceramic
			⬅	für Fahrzeuge mit verstärkter Bremse		13.0460-7275.2 607275 13.0470-7275.2 LD7275	ATE 23313 20,2 + WE / - WK ATE 23313 20,2 + WE / - WK Ceramic
			➡	für Fahrzeuge mit verstärkter Bremse		13.0460-2716.2 602716 13.0470-2716.2 LD2716	TRW 24703 17,8 + WE / - WK + Zub TRW 24703 17,8 + WE / - WK + Zub Ceramic
			➡	nicht für Fahrzeuge mit verstärkter Bremse		13.0460-2760.2 602760 13.0470-2760.2 LD2760	TRW 24561 17,7 + WE / - WK + Zub TRW 24561 17,7 + WE / - WK + Zub Ceramic
520 d 520 d 520 d 520 d	100 120 135 147	11/09→10/16 11/09→06/13 11/09→10/16 11/09→10/16	⬅	09/10→; nicht für Fahrzeuge mit verstärkter Bremse		13.0460-7268.2 607268 13.0470-7268.2 LD7268	ATE 23794 20,3 + WE / - WK ATE 23794 20,3 + WE / - WK Ceramic
			⬅	09/10→; für Fahrzeuge mit verstärkter Bremse		13.0460-7275.2 607275 13.0470-7275.2 LD7275	ATE 23313 20,2 + WE / - WK ATE 23313 20,2 + WE / - WK Ceramic
			➡	09/10→; für Fahrzeuge mit verstärkter Bremse		13.0460-2716.2 602716 13.0470-2716.2 LD2716	TRW 24703 17,8 + WE / - WK + Zub TRW 24703 17,8 + WE / - WK + Zub Ceramic
			➡	09/10→; nicht für Fahrzeuge mit verstärkter Bremse		13.0460-2760.2 602760 13.0470-2760.2 LD2760	TRW 24561 17,7 + WE / - WK + Zub TRW 24561 17,7 + WE / - WK + Zub Ceramic
520 d 520 d 520 d xDrive 520 d xDrive	140 155 140 155	10/13→ 10/13→ 10/13→ 10/13→	⬅	05/14→; für Fahrzeuge mit verstärkter Bremse		13.0460-7267.2 607267 13.0470-7267.2 LD7267	ATE 25045 19,5 + WE / - WK ATE 25045 19,5 + WE / - WK Ceramic
			⬅	05/14→; nicht für Fahrzeuge mit verstärkter Bremse		13.0460-7268.2 607268 13.0470-7268.2 LD7268	ATE 23794 20,3 + WE / - WK ATE 23794 20,3 + WE / - WK Ceramic
			➡	05/14→; für Fahrzeuge mit verstärkter Bremse		13.0460-2716.2 602716 13.0470-2716.2 LD2716	TRW 24703 17,8 + WE / - WK + Zub TRW 24703 17,8 + WE / - WK + Zub Ceramic
			➡	05/14→; nicht für Fahrzeuge mit verstärkter Bremse		13.0460-2760.2 602760 13.0470-2760.2 LD2760	TRW 24561 17,7 + WE / - WK + Zub TRW 24561 17,7 + WE / - WK + Zub Ceramic
520 d 520 d xDrive	151 151	07/14→10/16 07/14→10/16	⬅	für Fahrzeuge mit verstärkter Bremse		13.0460-7267.2 607267 13.0470-7267.2 LD7267	ATE 25045 19,5 + WE / - WK ATE 25045 19,5 + WE / - WK Ceramic
			⬅	nicht für Fahrzeuge mit verstärkter Bremse		13.0460-7268.2 607268 13.0470-7268.2 LD7268	ATE 23794 20,3 + WE / - WK ATE 23794 20,3 + WE / - WK Ceramic
↓							







	kW			 	! #		
<b>BMW - 5 Touring (F11) 11/09→</b>							
<b> Bremsbelagsatz, Scheibenbremse</b>							
520 d 520 d xDrive	151 151	07/14→10/16 07/14→10/16	➡	für Fahrzeuge mit verstärkter Bremse		<b>13.0460-2716.2</b> <b>602716</b>	TRW 24703 17,8 + WE / - WK + Zub
						<b>13.0470-2716.2</b> <b>LD2716</b>	TRW 24703 17,8 + WE / - WK + Zub Ceramic
			➡	nicht für Fahrzeuge mit verstärkter Bremse		<b>13.0460-2760.2</b> <b>602760</b>	TRW 24561 17,7 + WE / - WK + Zub
						<b>13.0470-2760.2</b> <b>LD2760</b>	TRW 24561 17,7 + WE / - WK + Zub Ceramic
520 i	120	09/11→02/17	←			<b>13.0460-7268.2</b> <b>607268</b>	ATE 23794 20,3 + WE / - WK
						<b>13.0470-7268.2</b> <b>LD7268</b>	ATE 23794 20,3 + WE / - WK Ceramic
			➡			<b>13.0460-2760.2</b> <b>602760</b>	TRW 24561 17,7 + WE / - WK + Zub
						<b>13.0470-2760.2</b> <b>LD2760</b>	TRW 24561 17,7 + WE / - WK + Zub Ceramic
520 i	135	10/10→	←	09/11→		<b>13.0460-7268.2</b> <b>607268</b>	ATE 23794 20,3 + WE / - WK
						<b>13.0470-7268.2</b> <b>LD7268</b>	ATE 23794 20,3 + WE / - WK Ceramic
			➡	09/11→		<b>13.0460-2760.2</b> <b>602760</b>	TRW 24561 17,7 + WE / - WK + Zub
						<b>13.0470-2760.2</b> <b>LD2760</b>	TRW 24561 17,7 + WE / - WK + Zub Ceramic
523 i	150	11/09→08/11	←	09/10→		<b>13.0460-7268.2</b> <b>607268</b>	ATE 23794 20,3 + WE / - WK
						<b>13.0470-7268.2</b> <b>LD7268</b>	ATE 23794 20,3 + WE / - WK Ceramic
			➡	09/10→		<b>13.0460-2760.2</b> <b>602760</b>	TRW 24561 17,7 + WE / - WK + Zub
						<b>13.0470-2760.2</b> <b>LD2760</b>	TRW 24561 17,7 + WE / - WK + Zub Ceramic
525 d 525 d 525 d xDrive 525 d xDrive 530 d	155 160 155 160 190	03/11→ 03/11→ 02/11→ 02/11→ 02/11→	←	09/11→; für Fahrzeuge mit verstärkter Bremse		<b>13.0460-7267.2</b> <b>607267</b>	ATE 25045 19,5 + WE / - WK
						<b>13.0470-7267.2</b> <b>LD7267</b>	ATE 25045 19,5 + WE / - WK Ceramic
			←	09/11→; nicht für Fahrzeuge mit verstärkter Bremse		<b>13.0460-7275.2</b> <b>607275</b>	ATE 23313 20,2 + WE / - WK
						<b>13.0470-7275.2</b> <b>LD7275</b>	ATE 23313 20,2 + WE / - WK Ceramic
			➡	09/11→; für Fahrzeuge mit verstärkter Bremse		<b>13.0460-2716.2</b> <b>602716</b>	TRW 24703 17,8 + WE / - WK + Zub
						<b>13.0470-2716.2</b> <b>LD2716</b>	TRW 24703 17,8 + WE / - WK + Zub Ceramic
			➡	09/11→; nicht für Fahrzeuge mit verstärkter Bremse		<b>13.0460-2760.2</b> <b>602760</b>	TRW 24561 17,7 + WE / - WK + Zub
						<b>13.0470-2760.2</b> <b>LD2760</b>	TRW 24561 17,7 + WE / - WK + Zub Ceramic
525 d 528 i	150 190	11/09→08/11 11/09→08/11	←	09/10→		<b>13.0460-7275.2</b> <b>607275</b>	ATE 23313 20,2 + WE / - WK
						<b>13.0470-7275.2</b> <b>LD7275</b>	ATE 23313 20,2 + WE / - WK Ceramic
			➡	09/10→		<b>13.0460-2760.2</b> <b>602760</b>	TRW 24561 17,7 + WE / - WK + Zub
						<b>13.0470-2760.2</b> <b>LD2760</b>	TRW 24561 17,7 + WE / - WK + Zub Ceramic
528 i 528 i xDrive 530 i 530 i	180 180 190 200	10/10→ 03/11→ 03/10→05/13 07/11→06/13	←	09/11→		<b>13.0460-7275.2</b> <b>607275</b>	ATE 23313 20,2 + WE / - WK
						<b>13.0470-7275.2</b> <b>LD7275</b>	ATE 23313 20,2 + WE / - WK Ceramic
			➡	09/11→		<b>13.0460-2760.2</b> <b>602760</b>	TRW 24561 17,7 + WE / - WK + Zub
						<b>13.0470-2760.2</b> <b>LD2760</b>	TRW 24561 17,7 + WE / - WK + Zub Ceramic
530 d	180	11/09→08/11	←	09/10→		<b>13.0460-7275.2</b> <b>607275</b>	ATE 23313 20,2 + WE / - WK
						<b>13.0470-7275.2</b> <b>LD7275</b>	ATE 23313 20,2 + WE / - WK Ceramic
			➡	09/10→; für Fahrzeuge mit verstärkter Bremse		<b>13.0460-2716.2</b> <b>602716</b>	TRW 24703 17,8 + WE / - WK + Zub
						<b>13.0470-2716.2</b> <b>LD2716</b>	TRW 24703 17,8 + WE / - WK + Zub Ceramic
			➡	09/10→; nicht für Fahrzeuge mit verstärkter Bremse		<b>13.0460-2760.2</b> <b>602760</b>	TRW 24561 17,7 + WE / - WK + Zub
						<b>13.0470-2760.2</b> <b>LD2760</b>	TRW 24561 17,7 + WE / - WK + Zub Ceramic
530 d ↓	210	09/11→	←	10/15→; für Fahrzeuge mit verstärkter Bremse		<b>13.0460-7267.2</b> <b>607267</b>	ATE 25045 19,5 + WE / - WK

















	kW			 	! #		
<b>BMW - 5 Touring (F11) 11/09→</b>							
<b> Bremsbelagsatz, Scheibenbremse</b>							
530 d	210	09/11→	←	10/15→; für Fahrzeuge mit verstärkter Bremse	13.0470-7267.2	LD7267	ATE 25045 19,5 + WE / - WK Ceramic
			←	10/15→; nicht für Fahrzeuge mit verstärkter Bremse	13.0460-7275.2	607275	ATE 23313 20,2 + WE / - WK
			→	10/15→; für Fahrzeuge mit verstärkter Bremse	13.0460-2716.2	602716	TRW 24703 17,8 + WE / - WK + Zub
			→	10/15→; nicht für Fahrzeuge mit verstärkter Bremse	13.0460-2760.2	602760	TRW 24561 17,7 + WE / - WK + Zub
					13.0470-2760.2	LD2760	TRW 24561 17,7 + WE / - WK + Zub Ceramic
530 d xDrive	190	07/10→	←	03/11→; für Fahrzeuge mit verstärkter Bremse	13.0460-7267.2	607267	ATE 25045 19,5 + WE / - WK
			←	03/11→; nicht für Fahrzeuge mit verstärkter Bremse	13.0460-7275.2	607275	ATE 23313 20,2 + WE / - WK
			→	03/11→; für Fahrzeuge mit verstärkter Bremse	13.0460-2716.2	602716	TRW 24703 17,8 + WE / - WK + Zub
			→	03/11→; nicht für Fahrzeuge mit verstärkter Bremse	13.0460-2760.2	602760	TRW 24561 17,7 + WE / - WK + Zub
					13.0470-2760.2	LD2760	TRW 24561 17,7 + WE / - WK + Zub Ceramic
530 d xDrive	210	09/11→	←	10/15→; für Fahrzeuge mit verstärkter Bremse	13.0460-7267.2	607267	ATE 25045 19,5 + WE / - WK
			←	10/15→; nicht für Fahrzeuge mit verstärkter Bremse	13.0460-7275.2	607275	ATE 23313 20,2 + WE / - WK
			→	10/15→	13.0460-2716.2	602716	TRW 24703 17,8 + WE / - WK + Zub
					13.0470-2716.2	LD2716	TRW 24703 17,8 + WE / - WK + Zub Ceramic
535 d 535 i	220 225	03/10→08/11 11/09→	←	09/10→	13.0460-7267.2	607267	ATE 25045 19,5 + WE / - WK
			→	09/10→	13.0460-2716.2	602716	TRW 24703 17,8 + WE / - WK + Zub
					13.0470-2716.2	LD2716	TRW 24703 17,8 + WE / - WK + Zub Ceramic
535 d 535 d xDrive 550 i	230 230 300	03/11→ 01/11→ 09/10→06/13	←	09/11→	13.0460-7267.2	607267	ATE 25045 19,5 + WE / - WK
			→	09/11→	13.0460-2716.2	602716	TRW 24703 17,8 + WE / - WK + Zub
					13.0470-2716.2	LD2716	TRW 24703 17,8 + WE / - WK + Zub Ceramic
535 i 535 i xDrive	240 240	01/13→ 07/13→	←	10/15→	13.0460-7267.2	607267	ATE 25045 19,5 + WE / - WK
			→	10/15→	13.0460-2716.2	602716	TRW 24703 17,8 + WE / - WK + Zub
					13.0470-2716.2	LD2716	TRW 24703 17,8 + WE / - WK + Zub Ceramic
535 i xDrive	225	07/10→	←	09/11→	13.0460-7267.2	607267	ATE 25045 19,5 + WE / - WK
			→	09/11→	13.0460-2716.2	602716	TRW 24703 17,8 + WE / - WK + Zub
					13.0470-2716.2	LD2716	TRW 24703 17,8 + WE / - WK + Zub Ceramic
550 i	330	08/12→	←	05/13→	13.0460-7267.2	607267	ATE 25045 19,5 + WE / - WK
			→	05/13→	13.0460-2716.2	602716	TRW 24703 17,8 + WE / - WK + Zub
					13.0470-2716.2	LD2716	TRW 24703 17,8 + WE / - WK + Zub Ceramic
M 550 d xDrive ↓	280	10/10→	←	03/12→	13.0460-7267.2	607267	ATE 25045 19,5 + WE / - WK













	kW			 	! #		
<b>BMW - 5 Touring (F11) 11/09→</b>							
<b> Bremsbelagsatz, Scheibenbremse</b>							
M 550 d xDrive	280	10/10→	➡	03/12→		<b>13.0460-2716.2 602716</b>	TRW 24703 17,8 + WE / - WK + Zub
						<b>13.0470-2716.2 LD2716</b>	TRW 24703 17,8 + WE / - WK + Zub Ceramic
<b>Warnkontakt, Bremsbelagsverschleiß</b>							
518 d	100	10/12→	←	☐; 01/13→	1	<b>24.8190-0298.2 620298</b>	L= 1.087
518 d	105	10/12→07/14	➡	01/13→	1	<b>24.8190-0308.2 620308</b>	L= 1.110
518 d	110	01/14→	←	☐; 05/14→	1	<b>24.8190-0298.2 620298</b>	L= 1.087
520 d	140	10/13→					
520 d	155	10/13→	➡	05/14→	1	<b>24.8190-0308.2 620308</b>	L= 1.110
520 d xDrive	140	10/13→					
520 d xDrive	155	10/13→					
518 d	120	05/14→	←	☐	1	<b>24.8190-0298.2 620298</b>	L= 1.087
520 d	151	07/14→10/16					
520 d xDrive	100	07/13→07/14	➡		1	<b>24.8190-0308.2 620308</b>	L= 1.110
520 d xDrive	120	10/13→06/13					
520 d xDrive	135	02/13→07/14					
520 d xDrive	147	02/13→07/14					
520 d xDrive	151	07/14→10/16					
520 i	120	09/11→02/17					
520 d	100	11/09→10/16	←	☐; 09/10→	1	<b>24.8190-0298.2 620298</b>	L= 1.087
520 d	120	11/09→06/13					
520 d	135	11/09→10/16	➡	09/10→	1	<b>24.8190-0308.2 620308</b>	L= 1.110
520 d	147	11/09→10/16					
523 i	150	11/09→08/11					
525 d	150	11/09→08/11					
528 i	190	11/09→08/11					
530 d	180	11/09→08/11					
535 d	220	03/10→08/11					
535 i	225	11/09→					
520 i	135	10/10→	←	☐; 09/11→	1	<b>24.8190-0298.2 620298</b>	L= 1.087
525 d	155	03/11→					
525 d	160	03/11→	➡	09/11→	1	<b>24.8190-0308.2 620308</b>	L= 1.110
525 d xDrive	155	02/11→					
525 d xDrive	160	02/11→					
528 i	180	10/10→					
528 i xDrive	180	03/11→					
530 d	190	02/11→					
530 i	190	03/10→05/13					
530 i	200	07/11→06/13					
535 d	230	03/11→					
535 d xDrive	230	01/11→					
535 i xDrive	225	07/10→					
550 i	300	09/10→06/13					
530 d	210	09/11→	←	☐; 10/15→	1	<b>24.8190-0298.2 620298</b>	L= 1.087
530 d xDrive	210	09/11→					
535 i	240	01/13→	➡	10/15→	1	<b>24.8190-0308.2 620308</b>	L= 1.110
535 i xDrive	240	07/13→					
530 d xDrive	190	07/10→	←	☐; 03/11→	1	<b>24.8190-0298.2 620298</b>	L= 1.087
			➡	03/11→	1	<b>24.8190-0308.2 620308</b>	L= 1.110
550 i	330	08/12→	←	☐; 05/13→	1	<b>24.8190-0298.2 620298</b>	L= 1.087
			➡	05/13→	1	<b>24.8190-0308.2 620308</b>	L= 1.110
M 550 d xDrive	280	10/10→	←	☐; 03/12→	1	<b>24.8190-0298.2 620298</b>	L= 1.087
			➡	03/12→	1	<b>24.8190-0308.2 620308</b>	L= 1.110
<b> Bremsscheibe</b>							
518 d	100	10/12→	←	01/13→;		<b>24.0124-0239.2 424239</b>	Ø 330 24 22,4 V
518 d	105	10/12→07/14		nicht für Fahrzeuge mit verstärkter Bremse			Bremsscheibe zweiteilig / + S
			←	01/13→;		<b>24.0130-0218.2 430218</b>	Ø 348 30 28,4 V
				für Fahrzeuge mit verstärkter Bremse			Bremsscheibe zweiteilig / + S
			➡	01/13→;		<b>24.0120-0229.2 420229</b>	Ø 330 20 18,4 V
				nicht für Fahrzeuge mit verstärkter Bremse			Bremsscheibe zweiteilig / + S
			➡	01/13→;		<b>24.0124-0233.2 424233</b>	Ø 345 24 22,4 V
				für Fahrzeuge mit verstärkter Bremse			Bremsscheibe zweiteilig / + S
518 d	110	01/14→	←	05/14→;		<b>24.0124-0239.2 424239</b>	Ø 330 24 22,4 V
				nicht für Fahrzeuge mit verstärkter Bremse			Bremsscheibe zweiteilig / + S
			←	05/14→;		<b>24.0130-0218.2 430218</b>	Ø 348 30 28,4 V
				für Fahrzeuge mit verstärkter Bremse			Bremsscheibe zweiteilig / + S
			➡	05/14→;		<b>24.0120-0229.2 420229</b>	Ø 330 20 18,4 V
				nicht für Fahrzeuge mit verstärkter Bremse			Bremsscheibe zweiteilig / + S
↓							



















	kW			 	! #		
<b>BMW - 5 Touring (F11) 11/09→</b>							
<b>Bremsscheibe</b>							
518 d	110	01/14→	➔	05/14→; für Fahrzeuge mit verstärkter Bremse	24.0124-0233.2	424233	Ø 345 24 22,4 V Bremsscheibe zweiteilig / + S
518 d	120	05/14→	➔	nicht für Fahrzeuge mit verstärkter Bremse	24.0124-0239.2	424239	Ø 330 24 22,4 V Bremsscheibe zweiteilig / + S
520 d xDrive	100	07/13→07/14	➔	für Fahrzeuge mit verstärkter Bremse	24.0130-0218.2	430218	Ø 348 30 28,4 V Bremsscheibe zweiteilig / + S
520 d xDrive	120	10/13→06/13	➔	für Fahrzeuge mit verstärkter Bremse	24.0120-0229.2	420229	Ø 330 20 18,4 V Bremsscheibe zweiteilig / + S
520 d xDrive	135	02/13→07/14	➔	für Fahrzeuge mit verstärkter Bremse	24.0124-0233.2	424233	Ø 345 24 22,4 V Bremsscheibe zweiteilig / + S
520 d xDrive	147	02/13→07/14	➔	nicht für Fahrzeuge mit verstärkter Bremse	24.0124-0239.2	424239	Ø 330 24 22,4 V Bremsscheibe zweiteilig / + S
520 d	100	11/09→10/16	➔	09/10→; nicht für Fahrzeuge mit verstärkter Bremse	24.0130-0218.2	430218	Ø 348 30 28,4 V Bremsscheibe zweiteilig / + S
520 d	120	11/09→06/13	➔	09/10→; nicht für Fahrzeuge mit verstärkter Bremse	24.0120-0229.2	420229	Ø 330 20 18,4 V Bremsscheibe zweiteilig / + S
520 d	135	11/09→10/16	➔	09/10→; für Fahrzeuge mit verstärkter Bremse	24.0124-0233.2	424233	Ø 345 24 22,4 V Bremsscheibe zweiteilig / + S
520 d	147	11/09→10/16	➔	09/10→; für Fahrzeuge mit verstärkter Bremse	24.0124-0239.2	424239	Ø 330 24 22,4 V Bremsscheibe zweiteilig / + S
520 d	140	10/13→	➔	05/14→; nicht für Fahrzeuge mit verstärkter Bremse	24.0136-0114.2	436114	Ø 348 36 34,4 V Bremsscheibe zweiteilig / + S
520 d	155	10/13→	➔	05/14→; für Fahrzeuge mit verstärkter Bremse	24.0136-0115.2	436115	Ø 348 36 34,4 V Bremsscheibe zweiteilig / + S
520 d xDrive	140	10/13→	➔	05/14→; nicht für Fahrzeuge mit verstärkter Bremse	24.0120-0229.2	420229	Ø 330 20 18,4 V Bremsscheibe zweiteilig / + S
520 d xDrive	155	10/13→	➔	05/14→; für Fahrzeuge mit verstärkter Bremse	24.0124-0233.2	424233	Ø 345 24 22,4 V Bremsscheibe zweiteilig / + S
520 d	151	07/14→10/16	➔	nicht für Fahrzeuge mit verstärkter Bremse	24.0136-0114.2	436114	Ø 348 36 34,4 V Bremsscheibe zweiteilig / + S
520 d xDrive	151	07/14→10/16	➔	05/14→; für Fahrzeuge mit verstärkter Bremse	24.0136-0115.2	436115	Ø 348 36 34,4 V Bremsscheibe zweiteilig / + S
			➔	nicht für Fahrzeuge mit verstärkter Bremse	24.0120-0229.2	420229	Ø 330 20 18,4 V Bremsscheibe zweiteilig / + S
			➔	für Fahrzeuge mit verstärkter Bremse	24.0124-0233.2	424233	Ø 345 24 22,4 V Bremsscheibe zweiteilig / + S
520 i	120	09/11→02/17	➔		24.0124-0239.2	424239	Ø 330 24 22,4 V Bremsscheibe zweiteilig / + S
			➔		24.0120-0229.2	420229	Ø 330 20 18,4 V Bremsscheibe zweiteilig / + S
520 i	135	10/10→	➔	09/11→	24.0124-0239.2	424239	Ø 330 24 22,4 V Bremsscheibe zweiteilig / + S
			➔	09/11→	24.0120-0229.2	420229	Ø 330 20 18,4 V Bremsscheibe zweiteilig / + S
523 i	150	11/09→08/11	➔	09/10→	24.0124-0239.2	424239	Ø 330 24 22,4 V Bremsscheibe zweiteilig / + S
			➔	09/10→	24.0120-0229.2	420229	Ø 330 20 18,4 V Bremsscheibe zweiteilig / + S
525 d	155	03/11→	➔	09/11→; nicht für Fahrzeuge mit verstärkter Bremse	24.0136-0114.2	436114	Ø 348 36 34,4 V Bremsscheibe zweiteilig / + S
525 d	160	03/11→	➔	09/11→; für Fahrzeuge mit verstärkter Bremse	24.0136-0115.2	436115	Ø 348 36 34,4 V Bremsscheibe zweiteilig / + S
525 d xDrive	155	02/11→	➔	09/11→; nicht für Fahrzeuge mit verstärkter Bremse	24.0120-0229.2	420229	Ø 330 20 18,4 V Bremsscheibe zweiteilig / + S
525 d xDrive	160	02/11→	➔	09/11→; für Fahrzeuge mit verstärkter Bremse	24.0124-0233.2	424233	Ø 345 24 22,4 V Bremsscheibe zweiteilig / + S
530 d	190	02/11→	➔	09/11→; für Fahrzeuge mit verstärkter Bremse	24.0130-0218.2	430218	Ø 348 30 28,4 V Bremsscheibe zweiteilig / + S
525 d	150	11/09→08/11	➔	09/10→	24.0120-0229.2	420229	Ø 330 20 18,4 V Bremsscheibe zweiteilig / + S
528 i	190	11/09→08/11	➔	09/10→	24.0124-0233.2	424233	Ø 345 24 22,4 V Bremsscheibe zweiteilig / + S
530 d	180	11/09→08/11	➔	09/10→	24.0130-0218.2	430218	Ø 348 30 28,4 V Bremsscheibe zweiteilig / + S
528 i	180	10/10→	➔	09/11→	24.0130-0218.2	430218	Ø 348 30 28,4 V Bremsscheibe zweiteilig / + S
528 i xDrive	180	03/11→	➔				























	kw			 	! #		
<b>BMW - 5 Touring (F11) 11/09→</b>							
<b>Bremsscheibe</b>							
530 i 530 i	190 200	03/10→05/13 07/11→06/13	➔	09/11→		24.0120-0229.2 420229	Ø 330 20 18,4 V Bremsscheibe zweiteilig / + S
530 d	210	09/11→	➔	10/15→; nicht für Fahrzeuge mit verstärkter Bremse		24.0130-0218.2 430218	Ø 348 30 28,4 V Bremsscheibe zweiteilig / + S
			➔	☐; 10/15→; für Fahrzeuge mit verstärkter Bremse		24.0136-0114.2 436114	Ø 348 36 34,4 V Bremsscheibe zweiteilig / + S
			➔	☐; 10/15→; für Fahrzeuge mit verstärkter Bremse		24.0136-0115.2 436115	Ø 348 36 34,4 V Bremsscheibe zweiteilig / + S
			➔	10/15→; nicht für Fahrzeuge mit verstärkter Bremse		24.0120-0229.2 420229	Ø 330 20 18,4 V Bremsscheibe zweiteilig / + S
			➔	10/15→; für Fahrzeuge mit verstärkter Bremse		24.0124-0233.2 424233	Ø 345 24 22,4 V Bremsscheibe zweiteilig / + S
530 d xDrive	190	07/10→	➔	03/11→; nicht für Fahrzeuge mit verstärkter Bremse		24.0130-0218.2 430218	Ø 348 30 28,4 V Bremsscheibe zweiteilig / + S
			➔	☐; 03/11→; für Fahrzeuge mit verstärkter Bremse		24.0136-0114.2 436114	Ø 348 36 34,4 V Bremsscheibe zweiteilig / + S
			➔	☐; 03/11→; für Fahrzeuge mit verstärkter Bremse		24.0136-0115.2 436115	Ø 348 36 34,4 V Bremsscheibe zweiteilig / + S
			➔	03/11→		24.0124-0233.2 424233	Ø 345 24 22,4 V Bremsscheibe zweiteilig / + S
530 d xDrive	210	09/11→	➔	10/15→; nicht für Fahrzeuge mit verstärkter Bremse		24.0130-0218.2 430218	Ø 348 30 28,4 V Bremsscheibe zweiteilig / + S
			➔	☐; 10/15→; für Fahrzeuge mit verstärkter Bremse		24.0136-0114.2 436114	Ø 348 36 34,4 V Bremsscheibe zweiteilig / + S
			➔	☐; 10/15→; für Fahrzeuge mit verstärkter Bremse		24.0136-0115.2 436115	Ø 348 36 34,4 V Bremsscheibe zweiteilig / + S
			➔	10/15→		24.0124-0233.2 424233	Ø 345 24 22,4 V Bremsscheibe zweiteilig / + S
535 d 535 i	220 225	03/10→08/11 11/09→	➔	☐; 09/10→		24.0136-0114.2 436114	Ø 348 36 34,4 V Bremsscheibe zweiteilig / + S
			➔	☐; 09/10→		24.0136-0115.2 436115	Ø 348 36 34,4 V Bremsscheibe zweiteilig / + S
			➔	09/10→		24.0124-0233.2 424233	Ø 345 24 22,4 V Bremsscheibe zweiteilig / + S
535 d 535 d xDrive 535 i xDrive	230 230 225	03/11→ 01/11→ 07/10→	➔	☐; 09/11→		24.0136-0114.2 436114	Ø 348 36 34,4 V Bremsscheibe zweiteilig / + S
			➔	☐; 09/11→		24.0136-0115.2 436115	Ø 348 36 34,4 V Bremsscheibe zweiteilig / + S
			➔	09/11→		24.0124-0233.2 424233	Ø 345 24 22,4 V Bremsscheibe zweiteilig / + S
535 i 535 i xDrive	240 240	01/13→ 07/13→	➔	☐; 10/15→		24.0136-0114.2 436114	Ø 348 36 34,4 V Bremsscheibe zweiteilig / + S
			➔	☐; 10/15→		24.0136-0115.2 436115	Ø 348 36 34,4 V Bremsscheibe zweiteilig / + S
			➔	10/15→		24.0124-0233.2 424233	Ø 345 24 22,4 V Bremsscheibe zweiteilig / + S
550 i	300	09/10→06/13	➔	☐; 09/11→		24.0136-0118.2 436118	Ø 374 36 34,4 V Bremsscheibe zweiteilig / + S
			➔	☐; 09/11→		24.0136-0119.2 436119	Ø 374 36 34,4 V Bremsscheibe zweiteilig / + S
			➔	09/11→		24.0124-0233.2 424233	Ø 345 24 22,4 V Bremsscheibe zweiteilig / + S
550 i	330	08/12→	➔	☐; 05/13→		24.0136-0118.2 436118	Ø 374 36 34,4 V Bremsscheibe zweiteilig / + S
			➔	☐; 05/13→		24.0136-0119.2 436119	Ø 374 36 34,4 V Bremsscheibe zweiteilig / + S
			➔	05/13→		24.0124-0233.2 424233	Ø 345 24 22,4 V Bremsscheibe zweiteilig / + S
M 550 d xDrive	280	10/10→	➔	☐; 03/12→		24.0136-0118.2 436118	Ø 374 36 34,4 V Bremsscheibe zweiteilig / + S
			➔	☐; 03/12→		24.0136-0119.2 436119	Ø 374 36 34,4 V Bremsscheibe zweiteilig / + S
			➔	03/12→		24.0124-0233.2 424233	Ø 345 24 22,4 V Bremsscheibe zweiteilig / + S











	kW			 	! #		
<b>BMW - 5 Touring (G31) 03/17→</b>							
 <b>Bremsbelagsatz, Scheibenbremse</b>							
520 d xDrive 520 d xDrive	120 140	07/17→ 07/17→	➔	für Fahrzeuge mit verstärkter Bremse		<b>13.0460-2716.2 602716</b> <b>13.0470-2716.2 LD2716</b>	TRW 24703 17,8 + WE / - WK + Zub TRW 24703 17,8 + WE / - WK + Zub Ceramic
525 d 525 d 530 d 530 d xDrive 530 i 530 i xDrive	155 170 195 195 185 185	07/17→ 07/17→ 03/17→ 03/17→ 03/17→ 07/17→	➔	für Fahrzeuge mit Sportpaket		<b>13.0460-2716.2 602716</b> <b>13.0470-2716.2 LD2716</b>	TRW 24703 17,8 + WE / - WK + Zub TRW 24703 17,8 + WE / - WK + Zub Ceramic
540 d xDrive 540 i xDrive 540 i xDrive M 550 d xDrive	235 250 265 294	07/17→ 03/17→ 03/17→ 07/17→	➔			<b>13.0460-2716.2 602716</b> <b>13.0470-2716.2 LD2716</b>	TRW 24703 17,8 + WE / - WK + Zub TRW 24703 17,8 + WE / - WK + Zub Ceramic
 <b>Bremsscheibe</b>							
520 d xDrive 520 d xDrive	120 140	07/17→ 07/17→	←	 ; für Fahrzeuge mit verstärkter Bremse		<b>24.0136-0132.2 436132</b>	Ø 348 36 34,4 V Bremsscheibe zweiteilig / + S
			←	 ; für Fahrzeuge mit verstärkter Bremse		<b>24.0136-0133.2 436133</b>	Ø 348 36 34,4 V Bremsscheibe zweiteilig / + S
			➔	für Fahrzeuge mit verstärkter Bremse		<b>24.0124-0262.2 424262</b>	Ø 345 24 22,4 V Bremsscheibe zweiteilig / + S
525 d 525 d 530 d 530 d xDrive 530 i 530 i xDrive	155 170 195 195 185 185	07/17→ 07/17→ 03/17→ 03/17→ 03/17→ 07/17→	←	 ; für Fahrzeuge mit Sportpaket		<b>24.0136-0132.2 436132</b>	Ø 348 36 34,4 V Bremsscheibe zweiteilig / + S
			←	 ; für Fahrzeuge mit Sportpaket		<b>24.0136-0133.2 436133</b>	Ø 348 36 34,4 V Bremsscheibe zweiteilig / + S
			➔	für Fahrzeuge mit Sportpaket		<b>24.0124-0262.2 424262</b>	Ø 345 24 22,4 V Bremsscheibe zweiteilig / + S
540 d xDrive 540 i xDrive 540 i xDrive M 550 d xDrive	235 250 265 294	07/17→ 03/17→ 03/17→ 07/17→	←	 ; für Fahrzeuge ohne Sportpaket		<b>24.0136-0132.2 436132</b>	Ø 348 36 34,4 V Bremsscheibe zweiteilig / + S
			←	 ; für Fahrzeuge ohne Sportpaket		<b>24.0136-0133.2 436133</b>	Ø 348 36 34,4 V Bremsscheibe zweiteilig / + S
			➔			<b>24.0124-0262.2 424262</b>	Ø 345 24 22,4 V Bremsscheibe zweiteilig / + S
<b>BMW - 6 (E63) 01/04→12/10</b>							
 <b>Bremsbelagsatz, Scheibenbremse</b>							
630 i	190	02/04→07/07	←	07/04→		<b>13.0460-7167.2 607167</b> <b>13.0460-7296.2 607296</b> <b>13.0470-7167.2 LD7167</b> <b>13.0470-7296.2 LD7296</b>	ATE 23312 20,3 + WE / - WK ATE 23212 20,3 + WE / - WK ATE 23312 20,3 + WE / - WK Ceramic ATE 23212 20,3 + WE / - WK Ceramic
			➔	07/04→		<b>13.0460-7174.2 607174</b> <b>13.0470-7174.2 LD7174</b>	ATE 23732 17,3 + WE / - WK ATE 23732 17,3 + WE / - WK Ceramic
630 i	200	07/07→07/10	←	09/07→		<b>13.0460-7167.2 607167</b> <b>13.0460-7296.2 607296</b> <b>13.0470-7167.2 LD7167</b> <b>13.0470-7296.2 LD7296</b>	ATE 23312 20,3 + WE / - WK ATE 23212 20,3 + WE / - WK ATE 23312 20,3 + WE / - WK Ceramic ATE 23212 20,3 + WE / - WK Ceramic
			➔	09/07→		<b>13.0460-7169.2 607169</b> <b>13.0470-7169.2 LD7169</b>	ATE 23309 17,3 + WE / - WK ATE 23309 17,3 + WE / - WK Ceramic
635 d	210	07/07→07/10	←	09/07→		<b>13.0460-7210.2 607210</b> <b>13.0470-7210.2 LD7210</b>	ATE 23791 20,8 + WE / - WK ATE 23791 20,8 + WE / - WK Ceramic
			➔	09/07→		<b>13.0460-7169.2 607169</b> <b>13.0470-7169.2 LD7169</b>	ATE 23309 17,3 + WE / - WK ATE 23309 17,3 + WE / - WK Ceramic
645 Ci	245	01/04→08/05	←			<b>13.0460-7167.2 607167</b>	ATE 23312 20,3 + WE / - WK
			➔			<b>13.0460-7169.2 607169</b> <b>13.0470-7169.2 LD7169</b>	ATE 23309 17,3 + WE / - WK ATE 23309 17,3 + WE / - WK Ceramic
650 i	270	07/05→07/10	←			<b>13.0460-7210.2 607210</b>	ATE 23791 20,8 + WE / - WK
			➔			<b>13.0460-7169.2 607169</b> <b>13.0470-7169.2 LD7169</b>	ATE 23309 17,3 + WE / - WK ATE 23309 17,3 + WE / - WK Ceramic
↓							











	kW			 	! #		
<b>BMW - 6 (E63) 01/04→12/10</b>							
 <b>Bremsbelagsatz, Scheibenbremse</b>							
M	373	09/05→07/10	←			<b>13.0460-7210.2 607210</b>	ATE 23791 20,8 + WE / - WK
<b>Warnkontakt, Bremsbelagverschleiß</b>							
630 i	190	02/04→07/07	←	07/04→	1	<b>24.8190-0273.2 620273</b>	L= 662
			→	07/04→	1	<b>24.8190-0274.2 620274</b>	L= 664
630 i 635 d	200 210	07/07→07/10 07/07→07/10	←	09/07→	1	<b>24.8190-0273.2 620273</b>	L= 662
			→	09/07→	1	<b>24.8190-0274.2 620274</b>	L= 664
645 Ci 650 i	245 270	01/04→08/05 07/05→07/10	←		1	<b>24.8190-0273.2 620273</b>	L= 662
			→		1	<b>24.8190-0274.2 620274</b>	L= 664
M	373	09/05→07/10	←	☐	1	<b>24.8190-0273.2 620273</b>	L= 662
			←	☐	1	<b>24.8190-0276.2 620276</b>	L= 674
			→		1	<b>24.8190-0274.2 620274</b>	L= 664
 <b>Bremsscheibe</b>							
630 i	190	02/04→07/07	←	07/04→		<b>24.0130-0173.1 430173</b>	Ø 324 30 28,4 V + S
			→	07/04→		<b>24.0330-0173.1 530173</b>	Ø 324 30 27,6 V + S
			→	07/04→		<b>24.0120-0183.1 420183</b>	Ø 320 20 18,4 V + S
			→	07/04→		<b>24.0320-0183.1 520183</b>	Ø 320 20 17,6 V + S
630 i	200	07/07→07/10	←	09/07→		<b>24.0130-0186.2 430186</b>	Ø 348 30 28,4 V Bremsscheibe zweiteilig / + S
			→	09/07→		<b>24.0124-0201.2 424201</b>	Ø 345 24 22,4 V Bremsscheibe zweiteilig / + S
635 d	210	07/07→07/10	←	09/07→		<b>24.0136-0106.2 436106</b>	Ø 348 36 34,4 V Bremsscheibe zweiteilig / + S
			→	09/07→		<b>24.0124-0201.2 424201</b>	Ø 345 24 22,4 V Bremsscheibe zweiteilig / + S
645 Ci	245	01/04→08/05	←			<b>24.0130-0186.2 430186</b>	Ø 348 30 28,4 V Bremsscheibe zweiteilig / + S
			→			<b>24.0124-0201.2 424201</b>	Ø 345 24 22,4 V Bremsscheibe zweiteilig / + S
650 i	270	07/05→07/10	←			<b>24.0136-0106.2 436106</b>	Ø 348 36 34,4 V Bremsscheibe zweiteilig / + S
			→			<b>24.0124-0201.2 424201</b>	Ø 345 24 22,4 V Bremsscheibe zweiteilig / + S
M	373	09/05→07/10	←	☐		<b>24.0136-0116.2 436116</b>	Ø 374 36 34,4 V• Bremsscheibe zweiteilig / + S
			←	☐		<b>24.0136-0117.2 436117</b>	Ø 374 36 34,4 V• Bremsscheibe zweiteilig / + S
			→	☐		<b>24.0124-0234.2 424234</b>	Ø 370 24 22,4 V• Bremsscheibe zweiteilig / + S
			→	☐		<b>24.0124-0235.2 424235</b>	Ø 370 24 22,4 V• Bremsscheibe zweiteilig / + S
<b>BMW - 6 Cabriolet (E64) 03/04→12/10</b>							
 <b>Bremsbelagsatz, Scheibenbremse</b>							
630 i	190	03/04→07/07	←	07/04→		<b>13.0460-7167.2 607167</b>	ATE 23312 20,3 + WE / - WK
						<b>13.0460-7296.2 607296</b>	ATE 23212 20,3 + WE / - WK
						<b>13.0470-7167.2 LD7167</b>	ATE 23312 20,3 + WE / - WK Ceramic
						<b>13.0470-7296.2 LD7296</b>	ATE 23212 20,3 + WE / - WK Ceramic
			→	07/04→		<b>13.0460-7174.2 607174</b>	ATE 23732 17,3 + WE / - WK
						<b>13.0470-7174.2 LD7174</b>	ATE 23732 17,3 + WE / - WK Ceramic
630 i	200	07/07→07/10	←	09/07→		<b>13.0460-7167.2 607167</b>	ATE 23312 20,3 + WE / - WK
						<b>13.0460-7296.2 607296</b>	ATE 23212 20,3 + WE / - WK
						<b>13.0470-7167.2 LD7167</b>	ATE 23312 20,3 + WE / - WK Ceramic
						<b>13.0470-7296.2 LD7296</b>	ATE 23212 20,3 + WE / - WK Ceramic
			→	09/07→		<b>13.0460-7169.2 607169</b>	ATE 23309 17,3 + WE / - WK
						<b>13.0470-7169.2 LD7169</b>	ATE 23309 17,3 + WE / - WK Ceramic
635 d ↓	210	07/07→07/10	←	09/07→		<b>13.0460-7210.2 607210</b>	ATE 23791 20,8 + WE / - WK













	kW			 	! #		
<b>BMW - 6 Cabriolet (E64) 03/04→12/10</b>							
 <b>Bremsbelagsatz, Scheibenbremse</b>							
635 d	210	07/07→07/10	←	09/07→		13.0470-7210.2 LD7210	ATE 23791 20,8 + WE / - WK Ceramic
			→	09/07→		13.0460-7169.2 607169	ATE 23309 17,3 + WE / - WK Ceramic
						13.0470-7169.2 LD7169	ATE 23309 17,3 + WE / - WK Ceramic
645 Ci	245	04/04→08/05	←			13.0460-7167.2 607167	ATE 23312 20,3 + WE / - WK
			→			13.0460-7169.2 607169	ATE 23309 17,3 + WE / - WK
						13.0470-7169.2 LD7169	ATE 23309 17,3 + WE / - WK Ceramic
650 i	270	07/05→07/10	←			13.0460-7210.2 607210	ATE 23791 20,8 + WE / - WK
			→			13.0460-7169.2 607169	ATE 23309 17,3 + WE / - WK
						13.0470-7169.2 LD7169	ATE 23309 17,3 + WE / - WK Ceramic
M	373	07/06→07/10	←			13.0460-7210.2 607210	ATE 23791 20,8 + WE / - WK
<b>Warnkontakt, Bremsbelagverschleiß</b>							
630 i	190	03/04→07/07	←	 ; 07/04→	1	24.8190-0273.2 620273	L= 662
			→	07/04→	1	24.8190-0274.2 620274	L= 664
630 i	200	07/07→07/10	←	 ; 09/07→	1	24.8190-0273.2 620273	L= 662
635 d	210	07/07→07/10	→	09/07→	1	24.8190-0274.2 620274	L= 664
645 Ci	245	04/04→08/05	←		1	24.8190-0273.2 620273	L= 662
			→		1	24.8190-0274.2 620274	L= 664
650 i	270	07/05→07/10	←		1	24.8190-0273.2 620273	L= 662
			→		1	24.8190-0274.2 620274	L= 664
M	373	07/06→07/10	←		1	24.8190-0273.2 620273	L= 662
			←		1	24.8190-0276.2 620276	L= 674
			→		1	24.8190-0274.2 620274	L= 664
 <b>Bremsscheibe</b>							
630 i	190	03/04→07/07	←	07/04→		24.0130-0173.1 430173	Ø 324 30 28,4 V + S
			→	07/04→		24.0330-0173.1 530173	Ø 324 30 27,6 V + S
						24.0120-0183.1 420183	Ø 320 20 18,4 V + S
						24.0320-0183.1 520183	Ø 320 20 17,6 V + S
630 i	200	07/07→07/10	←	09/07→		24.0130-0186.2 430186	Ø 348 30 28,4 V Bremsscheibe zweiteilig / + S
			→	09/07→		24.0124-0201.2 424201	Ø 345 24 22,4 V Bremsscheibe zweiteilig / + S
635 d	210	07/07→07/10	←	09/07→		24.0136-0106.2 436106	Ø 348 36 34,4 V Bremsscheibe zweiteilig / + S
			→	09/07→		24.0124-0201.2 424201	Ø 345 24 22,4 V Bremsscheibe zweiteilig / + S
645 Ci	245	04/04→08/05	←			24.0130-0186.2 430186	Ø 348 30 28,4 V Bremsscheibe zweiteilig / + S
			→			24.0124-0201.2 424201	Ø 345 24 22,4 V Bremsscheibe zweiteilig / + S
650 i	270	07/05→07/10	←			24.0136-0106.2 436106	Ø 348 36 34,4 V Bremsscheibe zweiteilig / + S
			→			24.0124-0201.2 424201	Ø 345 24 22,4 V Bremsscheibe zweiteilig / + S
M	373	07/06→07/10	←			24.0136-0116.2 436116	Ø 374 36 34,4 V* Bremsscheibe zweiteilig / + S
			←			24.0136-0117.2 436117	Ø 374 36 34,4 V* Bremsscheibe zweiteilig / + S
			→			24.0124-0234.2 424234	Ø 370 24 22,4 V* Bremsscheibe zweiteilig / + S
			→			24.0124-0235.2 424235	Ø 370 24 22,4 V* Bremsscheibe zweiteilig / + S
<b>BMW - 6 Cabriolet (F12) 03/11→</b>							
 <b>Bremsbelagsatz, Scheibenbremse</b>							
640 d	230	09/11→	←			13.0460-7267.2 607267	ATE 25045 19,5 + WE / - WK
640 i	235	03/11→	→			13.0460-2716.2 602716	TRW 24703 17,8 + WE / - WK + Zub
640 i xDrive	235	01/13→					
650 i	298	09/11→12/12					
650 i	300	03/11→					
↓							









	kW			 	! #		
<b>BMW - 6 Cabriolet (F12) 03/11→</b>							
<b> Bremsbelagsatz, Scheibenbremse</b>							
650 i 650 i xDrive	330 300	10/11→ 06/11→	→			13.0470-2716.2 LD2716	TRW 24703 17,8 + WE / - WK + Zub Ceramic
640 d xDrive	230	09/11→	←	03/12→		13.0460-7267.2 607267	ATE 25045 19,5 + WE / - WK
			→	03/12→		13.0460-2716.2 602716	TRW 24703 17,8 + WE / - WK + Zub
650 i xDrive	330	11/11→	←	09/12→		13.0460-2716.2 607267	ATE 25045 19,5 + WE / - WK
			→	09/12→		13.0460-2716.2 LD2716	TRW 24703 17,8 + WE / - WK + Zub Ceramic
M6	412	01/12→	→	06/12→; für Fahrzeuge ohne Keramikbremse		13.0460-2716.2 602716	TRW 24703 17,8 + WE / - WK + Zub
			→			13.0470-2716.2 LD2716	TRW 24703 17,8 + WE / - WK + Zub Ceramic
M6 M6	423 441	02/14→ 07/15→	→	für Fahrzeuge ohne Keramikbremse		13.0460-2716.2 602716	TRW 24703 17,8 + WE / - WK + Zub
			→			13.0470-2716.2 LD2716	TRW 24703 17,8 + WE / - WK + Zub Ceramic
<b>Warnkontakt, Bremsbelagverschleiß</b>							
640 d 640 i 640 i xDrive	230 235 235	09/11→ 03/11→ 01/13→	←		1	24.8190-0298.2 620298	L= 1.087
			→		1	24.8190-0312.2 620312	L= 915
650 i 650 i 650 i xDrive	298 300 300	09/11→12/12 03/11→ 10/11→	←	09/11→12/12			
			→				
650 i xDrive	300	06/11→	←	06/11→			
			→				
640 d xDrive	230	09/11→	←	 ; 03/12→	1	24.8190-0298.2 620298	L= 1.087
			→	03/12→	1	24.8190-0312.2 620312	L= 915
650 i xDrive	330	11/11→	←	 ; 09/12→	1	24.8190-0298.2 620298	L= 1.087
			→	09/12→	1	24.8190-0312.2 620312	L= 915
M6	412	01/12→	←	 ; 06/12→	1	24.8190-0298.2 620298	L= 1.087
			→	06/12→	1	24.8190-0008.2 620008	L= 1.000
M6 M6	423 441	02/14→ 07/15→	←		1	24.8190-0298.2 620298	L= 1.087
			→		1	24.8190-0008.2 620008	L= 1.000
<b> Bremsscheibe</b>							
640 d 640 i 640 i xDrive	230 235 235	09/11→ 03/11→ 01/13→	←			24.0136-0114.2 436114	Ø 348 36 34,4 V Bremsscheibe zweiteilig / + S
			→			24.0124-0233.2 424233	Ø 345 24 22,4 V Bremsscheibe zweiteilig / + S
640 d xDrive	230	09/11→	←	 ; 03/12→		24.0136-0114.2 436114	Ø 348 36 34,4 V Bremsscheibe zweiteilig / + S
			←	 ; 03/12→		24.0136-0115.2 436115	Ø 348 36 34,4 V Bremsscheibe zweiteilig / + S
			→	03/12→		24.0124-0233.2 424233	Ø 345 24 22,4 V Bremsscheibe zweiteilig / + S
650 i 650 i 650 i xDrive	298 300 300	09/11→12/12 03/11→ 10/11→	←			24.0136-0118.2 436118	Ø 374 36 34,4 V Bremsscheibe zweiteilig / + S
			←			24.0136-0119.2 436119	Ø 374 36 34,4 V Bremsscheibe zweiteilig / + S
			→			24.0124-0233.2 424233	Ø 345 24 22,4 V Bremsscheibe zweiteilig / + S
650 i xDrive	330	11/11→	←	 ; 09/12→		24.0136-0118.2 436118	Ø 374 36 34,4 V Bremsscheibe zweiteilig / + S
			←	 ; 09/12→		24.0136-0119.2 436119	Ø 374 36 34,4 V Bremsscheibe zweiteilig / + S
			→	09/12→		24.0124-0233.2 424233	Ø 345 24 22,4 V Bremsscheibe zweiteilig / + S
M6	412	01/12→	←	 ; 06/12→; für Fahrzeuge ohne Keramikbremse		24.0136-0125.2 436125	Ø 400 36 34,4 V* Bremsscheibe zweiteilig / + S
			←	 ; 06/12→; für Fahrzeuge ohne Keramikbremse		24.0136-0126.2 436126	Ø 400 36 34,4 V* Bremsscheibe zweiteilig / + S
↓							









	kw			 	! #		
<b>BMW - 6 Cabriolet (F12) 03/11→</b>							
 <b>Bremsscheibe</b>							
M6 M6	423 441	02/14→ 07/15→	← ←	☐; für Fahrzeuge ohne Keramikbremse ☐; für Fahrzeuge ohne Keramikbremse		24.0136-0125.2 436125 24.0136-0126.2 436126	Ø 400 36 34,4 V• Bremsscheibe zweiteilig / + S Ø 400 36 34,4 V• Bremsscheibe zweiteilig / + S
<b>BMW - 6 Coupe (F13) 11/10→</b>							
 <b>Bremsbelagsatz, Scheibenbremse</b>							
640 d 640 i 650 i	230 235 300	11/10→ 11/10→ 11/10→	← →	06/11→ 06/11→		13.0460-7267.2 607267 13.0460-2716.2 602716 13.0470-2716.2 LD2716	ATE 25045 19,5 + WE / - WK TRW 24703 17,8 + WE / - WK + Zub TRW 24703 17,8 + WE / - WK + Zub Ceramic
640 d xDrive	230	09/11→	← →	03/12→ 03/12→		13.0460-7267.2 607267 13.0460-2716.2 602716 13.0470-2716.2 LD2716	ATE 25045 19,5 + WE / - WK TRW 24703 17,8 + WE / - WK + Zub TRW 24703 17,8 + WE / - WK + Zub Ceramic
640 i xDrive 650 i 650 i xDrive	235 298 300	01/13→ 09/11→12/12 06/11→	← →			13.0460-7267.2 607267 13.0460-2716.2 602716 13.0470-2716.2 LD2716	ATE 25045 19,5 + WE / - WK TRW 24703 17,8 + WE / - WK + Zub TRW 24703 17,8 + WE / - WK + Zub Ceramic
650 i 650 i xDrive	330 330	10/11→ 11/11→	← →	09/12→ 09/12→		13.0460-7267.2 607267 13.0460-2716.2 602716 13.0470-2716.2 LD2716	ATE 25045 19,5 + WE / - WK TRW 24703 17,8 + WE / - WK + Zub TRW 24703 17,8 + WE / - WK + Zub Ceramic
M6	412	01/12→	→	06/12→; für Fahrzeuge ohne Keramikbremse		13.0460-2716.2 602716 13.0470-2716.2 LD2716	TRW 24703 17,8 + WE / - WK + Zub TRW 24703 17,8 + WE / - WK + Zub Ceramic
M6 M6	423 441	02/14→ 07/15→	→	für Fahrzeuge ohne Keramikbremse		13.0460-2716.2 602716 13.0470-2716.2 LD2716	TRW 24703 17,8 + WE / - WK + Zub TRW 24703 17,8 + WE / - WK + Zub Ceramic
<b>Warnkontakt, Bremsbelagverschleiß</b>							
640 d 640 i 650 i	230 235 300	11/10→ 11/10→ 11/10→	← →	☐; 06/11→ 06/11→	1	24.8190-0298.2 620298 24.8190-0312.2 620312	L= 1.087 L= 915
640 d xDrive	230	09/11→	← →	☐; 03/12→ 03/12→	1	24.8190-0298.2 620298 24.8190-0312.2 620312	L= 1.087 L= 915
640 i xDrive 650 i 650 i xDrive	235 298 300	01/13→ 09/11→12/12 06/11→	← →	☐ ☐	1	24.8190-0298.2 620298 24.8190-0312.2 620312	L= 1.087 L= 915
650 i 650 i xDrive	330 330	10/11→ 11/11→	← →	☐; 09/12→ 09/12→	1	24.8190-0298.2 620298 24.8190-0312.2 620312	L= 1.087 L= 915
M6	412	01/12→	← →	☐; 06/12→ 06/12→	1	24.8190-0298.2 620298 24.8190-0008.2 620008	L= 1.087 L= 1.000
M6 M6	423 441	02/14→ 07/15→	← →	☐ ☐	1	24.8190-0298.2 620298 24.8190-0008.2 620008	L= 1.087 L= 1.000
 <b>Bremsscheibe</b>							
640 d 640 i	230 235	11/10→ 11/10→	← ← →	☐; 06/11→ ☐; 06/11→ 06/11→		24.0136-0114.2 436114 24.0136-0115.2 436115 24.0124-0233.2 424233	Ø 348 36 34,4 V Bremsscheibe zweiteilig / + S Ø 348 36 34,4 V Bremsscheibe zweiteilig / + S Ø 345 24 22,4 V Bremsscheibe zweiteilig / + S
640 d xDrive	230	09/11→	← ← →	☐; 03/12→ ☐; 03/12→ 03/12→		24.0136-0114.2 436114 24.0136-0115.2 436115 24.0124-0233.2 424233	Ø 348 36 34,4 V Bremsscheibe zweiteilig / + S Ø 348 36 34,4 V Bremsscheibe zweiteilig / + S Ø 345 24 22,4 V Bremsscheibe zweiteilig / + S
640 i xDrive	235	01/13→	←	☐		24.0136-0114.2 436114	Ø 348 36 34,4 V Bremsscheibe zweiteilig / + S
↓							











	kw			 	! #		
<b>BMW - 6 Coupe (F13) 11/10→</b>							
 <b>Bremsscheibe</b>							
640 i xDrive	235	01/13→	←	☐		24.0136-0115.2 436115	Ø 348 36 34,4 V Bremsscheibe zweiteilig / + S
			→			24.0124-0233.2 424233	Ø 345 24 22,4 V Bremsscheibe zweiteilig / + S
650 i 650 i xDrive	298 300	09/11→12/12 06/11→	←	☐		24.0136-0118.2 436118	Ø 374 36 34,4 V Bremsscheibe zweiteilig / + S
			←	☐		24.0136-0119.2 436119	Ø 374 36 34,4 V Bremsscheibe zweiteilig / + S
			→			24.0124-0233.2 424233	Ø 345 24 22,4 V Bremsscheibe zweiteilig / + S
650 i	300	11/10→	←	☐; 06/11→		24.0136-0118.2 436118	Ø 374 36 34,4 V Bremsscheibe zweiteilig / + S
			←	☐; 06/11→		24.0136-0119.2 436119	Ø 374 36 34,4 V Bremsscheibe zweiteilig / + S
			→	06/11→		24.0124-0233.2 424233	Ø 345 24 22,4 V Bremsscheibe zweiteilig / + S
650 i 650 i xDrive	330 330	10/11→ 11/11→	←	☐; 09/12→		24.0136-0118.2 436118	Ø 374 36 34,4 V Bremsscheibe zweiteilig / + S
			←	☐; 09/12→		24.0136-0119.2 436119	Ø 374 36 34,4 V Bremsscheibe zweiteilig / + S
			→	09/12→		24.0124-0233.2 424233	Ø 345 24 22,4 V Bremsscheibe zweiteilig / + S
M6	412	01/12→	←	☐; 06/12→; für Fahrzeuge ohne Keramikbremse		24.0136-0125.2 436125	Ø 400 36 34,4 V* Bremsscheibe zweiteilig / + S
			←	☐; 06/12→; für Fahrzeuge ohne Keramikbremse		24.0136-0126.2 436126	Ø 400 36 34,4 V* Bremsscheibe zweiteilig / + S
M6 M6	423 441	02/14→ 07/15→	←	☐; für Fahrzeuge ohne Keramikbremse		24.0136-0125.2 436125	Ø 400 36 34,4 V* Bremsscheibe zweiteilig / + S
			←	☐; für Fahrzeuge ohne Keramikbremse		24.0136-0126.2 436126	Ø 400 36 34,4 V* Bremsscheibe zweiteilig / + S
<b>BMW - 6 Gran Coupe (F06) 09/11→</b>							
 <b>Bremsbelagsatz, Scheibenbremse</b>							
640 d 640 d xDrive 640 i xDrive 650 i 650 i xDrive	230 230 235 330 330	09/11→ 01/13→ 01/13→ 11/11→ 11/11→	←			13.0460-7267.2 607267	ATE 25045 19,5 + WE / - WK
			→			13.0460-2716.2 602716	TRW 24703 17,8 + WE / - WK + Zub
						13.0470-2716.2 LD2716	TRW 24703 17,8 + WE / - WK + Zub Ceramic
640 i	235	09/11→	←	03/12→		13.0460-7267.2 607267	ATE 25045 19,5 + WE / - WK
			→	03/12→		13.0460-2716.2 602716	TRW 24703 17,8 + WE / - WK + Zub
						13.0470-2716.2 LD2716	TRW 24703 17,8 + WE / - WK + Zub Ceramic
M6 M6 M6	412 423 441	12/12→ 02/14→ 07/15→	→	für Fahrzeuge ohne Keramikbremse		13.0460-2716.2 602716	TRW 24703 17,8 + WE / - WK + Zub
						13.0470-2716.2 LD2716	TRW 24703 17,8 + WE / - WK + Zub Ceramic
<b>Warnkontakt, Bremsbelagsverschleiß</b>							
640 d 640 d xDrive 640 i xDrive 650 i 650 i xDrive	230 230 235 330 330	09/11→ 01/13→ 01/13→ 11/11→ 11/11→	←	☐	1	24.8190-0298.2 620298	L= 1.087
			→		1	24.8190-0312.2 620312	L= 915
640 i	235	09/11→	←	☐; 03/12→	1	24.8190-0298.2 620298	L= 1.087
			→	03/12→	1	24.8190-0312.2 620312	L= 915
M6 M6 M6	412 423 441	12/12→ 02/14→ 07/15→	←	☐	1	24.8190-0298.2 620298	L= 1.087
			→		1	24.8190-0008.2 620008	L= 1.000
 <b>Bremsscheibe</b>							
640 d 640 d xDrive 640 i xDrive	230 230 235	09/11→ 01/13→ 01/13→	←	☐		24.0136-0114.2 436114	Ø 348 36 34,4 V Bremsscheibe zweiteilig / + S
			←	☐		24.0136-0115.2 436115	Ø 348 36 34,4 V Bremsscheibe zweiteilig / + S
			→			24.0124-0233.2 424233	Ø 345 24 22,4 V Bremsscheibe zweiteilig / + S
640 i	235	09/11→	←	☐; 03/12→		24.0136-0114.2 436114	Ø 348 36 34,4 V Bremsscheibe zweiteilig / + S
↓							









	kW			 	! #		
<b>BMW - 6 Gran Coupe (F06) 09/11→</b>							
 <b>Bremsscheibe</b>							
640 i	235	09/11→	←	☐; 03/12→	24.0136-0115.2	436115	Ø 348 36 34,4 V Bremsscheibe zweiteilig / + S
			→	03/12→	24.0124-0233.2	424233	Ø 345 24 22,4 V Bremsscheibe zweiteilig / + S
650 i 650 i xDrive	330 330	11/11→ 11/11→	←	☐	24.0136-0118.2	436118	Ø 374 36 34,4 V Bremsscheibe zweiteilig / + S
			←	☐	24.0136-0119.2	436119	Ø 374 36 34,4 V Bremsscheibe zweiteilig / + S
			→		24.0124-0233.2	424233	Ø 345 24 22,4 V Bremsscheibe zweiteilig / + S
M6 M6 M6	412 423 441	12/12→ 02/14→ 07/15→	←	☐; für Fahrzeuge ohne Keramikbremse	24.0136-0125.2	436125	Ø 400 36 34,4 V* Bremsscheibe zweiteilig / + S
			←	☐; für Fahrzeuge ohne Keramikbremse	24.0136-0126.2	436126	Ø 400 36 34,4 V* Bremsscheibe zweiteilig / + S
<b>BMW - 6 Gran Turismo (G32) 06/17→</b>							
 <b>Bremsbelagsatz, Scheibenbremse</b>							
630 d	155	06/17→	→		13.0460-2716.2	602716	TRW 24703 17,8 + WE / - WK + Zub
630 d	195	06/17→			13.0470-2716.2	LD2716	TRW 24703 17,8 + WE / - WK + Zub Ceramic
630 d xDrive	155	06/17→					
630 d xDrive	183	06/17→					
630 d xDrive	195	06/17→					
630 i	190	06/17→					
640 d xDrive	235	11/17→					
640 i	250	06/17→					
640 i	265	06/17→					
640 i xDrive	250	06/17→					
640 i xDrive	265	06/17→					
 <b>Bremsscheibe</b>							
630 d	155	06/17→	←	☐; für Fahrzeuge ohne Sportpaket	24.0136-0132.2	436132	Ø 348 36 34,4 V Bremsscheibe zweiteilig / + S
630 d	195	06/17→			24.0136-0133.2	436133	Ø 348 36 34,4 V Bremsscheibe zweiteilig / + S
630 d xDrive	155	06/17→	←	☐; für Fahrzeuge ohne Sportpaket			
630 d xDrive	183	06/17→					
630 d xDrive	195	06/17→					
630 i	190	06/17→	→		24.0124-0262.2	424262	Ø 345 24 22,4 V Bremsscheibe zweiteilig / + S
640 d xDrive	235	11/17→					
640 i	250	06/17→					
640 i	265	06/17→					
640 i xDrive	250	06/17→					
640 i xDrive	265	06/17→					
<b>BMW - 7 (E38) 09/94→11/01</b>							
 <b>Bremsbelagsatz, Scheibenbremse</b>							
725 tds	105	04/96→11/01	←	05/96→	13.0460-4965.2	604965	BRE 21471 18,0 + WE / - WK
			→	05/96→	13.0460-7079.2	607079	ATE 21282 17,3 + WE / - WK
					13.0470-7079.2	LD7079	ATE 21282 17,3 + WE / - WK Ceramic
728 i, iL	142	08/95→11/01	←		13.0460-4965.2	604965	BRE 21471 18,0 + WE / - WK
			←	01/96→	13.0460-4965.2	604965	BRE 21471 18,0 + WE / - WK
			→	01/96→	13.0460-7079.2	607079	ATE 21282 17,3 + WE / - WK
					13.0460-7079.2	607079	ATE 21282 17,3 + WE / - WK
					13.0470-7079.2	LD7079	ATE 21282 17,3 + WE / - WK Ceramic
728i X	142	11/95→09/01	←		13.0460-4965.2	604965	BRE 21471 18,0 + WE / - WK
730 d	142	04/00→11/01			13.0460-7079.2	607079	ATE 21282 17,3 + WE / - WK
730 i, iL	155	10/94→11/01	→				
730 i, iL	160	10/94→11/01			13.0470-7079.2	LD7079	ATE 21282 17,3 + WE / - WK Ceramic
735 i, iL	173	01/96→12/98					
735 i, iL	175	09/98→07/01					
730 d	135	08/98→04/00	←	09/98→	13.0460-4965.2	604965	BRE 21471 18,0 + WE / - WK
			→	09/98→	13.0460-7079.2	607079	ATE 21282 17,3 + WE / - WK
					13.0470-7079.2	LD7079	ATE 21282 17,3 + WE / - WK Ceramic
740 d	180	05/99→11/01	←		13.0460-7183.2	607183	ATE 21484 20,5 + WE / - WK
			→		13.0460-7079.2	607079	ATE 21282 17,3 + WE / - WK
					13.0470-7079.2	LD7079	ATE 21282 17,3 + WE / - WK Ceramic
740 i, iL	210	10/94→11/01	←		13.0460-7078.2	607078	ATE 21486 19,5 + WE / - WK











	kW			 	! #			
<b>BMW - 7 (E38) 09/94→11/01</b>								
<b> Bremsbelagsatz, Scheibenbremse</b>								
740 i, iL	210	01/96→11/01	←			<b>13.0470-7078.2</b>	<b>LD7078</b>	ATE 21486 19,5 + WE / - WK Ceramic
			→			<b>13.0460-7079.2</b>	<b>607079</b>	ATE 21282 17,3 + WE / - WK
						<b>13.0470-7079.2</b>	<b>LD7079</b>	ATE 21282 17,3 + WE / - WK Ceramic
750 i, iL	240	09/94→11/01	←	→ 08/98		<b>13.0460-7183.2</b>	<b>607183</b>	ATE 21484 20,5 + WE / - WK
			←	09/98→		<b>13.0460-7183.2</b>	<b>607183</b>	ATE 21484 20,5 + WE / - WK
			→			<b>13.0460-7079.2</b>	<b>607079</b>	ATE 21282 17,3 + WE / - WK
						<b>13.0470-7079.2</b>	<b>LD7079</b>	ATE 21282 17,3 + WE / - WK Ceramic
<b>Warnkontakt, Bremsbelagverschleiß</b>								
725 tds	105	04/96→11/01	←	05/96→	1	<b>24.8190-0208.2</b>	<b>620208</b>	L= 569
			→	05/96→	1	<b>24.8190-0209.2</b>	<b>620209</b>	L= 620
728 i, iL	142	08/95→11/01	←		1	<b>24.8190-0208.2</b>	<b>620208</b>	L= 569
			←	01/96→	1	<b>24.8190-0208.2</b>	<b>620208</b>	L= 569
			→		1	<b>24.8190-0209.2</b>	<b>620209</b>	L= 620
			→	01/96→	1	<b>24.8190-0209.2</b>	<b>620209</b>	L= 620
728i X	142	11/95→09/01	←		1	<b>24.8190-0208.2</b>	<b>620208</b>	L= 569
730 d	142	04/00→11/01	→		1	<b>24.8190-0209.2</b>	<b>620209</b>	L= 620
730 i, iL	155	10/94→11/01						
730 i, iL	160	10/94→11/01						
735 i, iL	173	01/96→12/98						
735 i, iL	175	09/98→07/01						
740 i, iL	210	10/94→11/01						
740 i, iL	210	01/96→11/01						
730 d	135	08/98→04/00	←	09/98→	1	<b>24.8190-0208.2</b>	<b>620208</b>	L= 569
			→	09/98→	1	<b>24.8190-0209.2</b>	<b>620209</b>	L= 620
740 d	180	05/99→11/01	←		1	<b>24.8190-0234.2</b>	<b>620234</b>	L= 585
			→		1	<b>24.8190-0209.2</b>	<b>620209</b>	L= 620
750 i, iL	240	09/94→11/01	←	→ 08/98	1	<b>24.8190-0232.2</b>	<b>620232</b>	L= 578
			←	09/98→	1	<b>24.8190-0234.2</b>	<b>620234</b>	L= 585
			→		1	<b>24.8190-0209.2</b>	<b>620209</b>	L= 620
<b>Zubehörsatz, Scheibenbremsbelag</b>								
725 tds	105	04/96→11/01	←	05/96→		<b>13.0460-0267.2</b>	<b>610267</b>	
728 i, iL	142	08/95→11/01	←			<b>13.0460-0267.2</b>	<b>610267</b>	
			←	01/96→		<b>13.0460-0267.2</b>	<b>610267</b>	
728i X	142	11/95→09/01	←			<b>13.0460-0267.2</b>	<b>610267</b>	
730 d	142	04/00→11/01						
730 i, iL	155	10/94→11/01						
730 i, iL	160	10/94→11/01						
735 i, iL	173	01/96→12/98						
735 i, iL	175	09/98→07/01						
730 d	135	08/98→04/00	←	09/98→		<b>13.0460-0267.2</b>	<b>610267</b>	
<b> Bremsscheibe</b>								
725 tds	105	04/96→11/01	←	05/96→		<b>24.0128-0105.1</b>	<b>428105</b>	Ø 316 28 26,4 V + S
			→	05/96→		<b>24.0112-0132.1</b>	<b>412132</b>	Ø 324 12 10,4 + S
728 i, iL	142	08/95→11/01	←			<b>24.0128-0105.1</b>	<b>428105</b>	Ø 316 28 26,4 V + S
			←	01/96→		<b>24.0128-0105.1</b>	<b>428105</b>	Ø 316 28 26,4 V + S
			→			<b>24.0112-0132.1</b>	<b>412132</b>	Ø 324 12 10,4 + S
			→	01/96→		<b>24.0112-0132.1</b>	<b>412132</b>	Ø 324 12 10,4 + S
728i X	142	11/95→09/01	←			<b>24.0128-0105.1</b>	<b>428105</b>	Ø 316 28 26,4 V + S
730 d	142	04/00→11/01	→			<b>24.0112-0132.1</b>	<b>412132</b>	Ø 324 12 10,4 + S
730 i, iL	155	10/94→11/01						
730 i, iL	160	10/94→11/01						
735 i, iL	173	01/96→12/98						
735 i, iL	175	09/98→07/01						
730 d	135	08/98→04/00	←	09/98→		<b>24.0128-0105.1</b>	<b>428105</b>	Ø 316 28 26,4 V + S
			→	09/98→		<b>24.0112-0132.1</b>	<b>412132</b>	Ø 324 12 10,4 + S
740 d	180	05/99→11/01	←			<b>24.0132-0113.1</b>	<b>432113</b>	Ø 334 31,9 30,4 V + S
750 i, iL	240	09/94→11/01	→			<b>24.0120-0182.1</b>	<b>420182</b>	Ø 328 20 18,4 V + S
↓								









	kW			 	! #		
<b>BMW - 7 (E38) 09/94→11/01</b>							
 <b>Bremsscheibe</b>							
740 i, iL 740 i, iL	210 210	10/94→11/01 01/96→11/01	← →			24.0130-0101.1 430101 24.0112-0132.1 412132	∅ 324 30 28,4 V + S ∅ 324 12 10,4 + S
<b>BMW - 7 (E65, E66, E67) 11/01→12/09</b>							
 <b>Bremsbelagsatz, Scheibenbremse</b>							
730 d 730 d	150 155	10/02→07/08 10/02→07/08	← →			13.0460-7167.2 607167 13.0460-7306.2 607306 13.0470-7167.2 LD7167	ATE 23312 20,3 + WE / - WK ATE 23312 20,3 + WE / - WK ATE 23312 20,3 + WE / - WK Ceramic
				→ 02/05		13.0460-7168.2 607168 13.0470-7168.2 LD7168	ATE 21282 17,3 + WE / - WK ATE 21282 17,3 + WE / - WK Ceramic
730 d	160	06/02→02/05	←	09/02→		13.0460-7167.2 607167 13.0460-7306.2 607306 13.0470-7167.2 LD7167	ATE 23312 20,3 + WE / - WK ATE 23312 20,3 + WE / - WK ATE 23312 20,3 + WE / - WK Ceramic
			→	09/02→		13.0460-7168.2 607168 13.0470-7168.2 LD7168	ATE 21282 17,3 + WE / - WK ATE 21282 17,3 + WE / - WK Ceramic
730 i, Li	170	03/03→07/08	←			13.0460-7167.2 607167 13.0460-7306.2 607306 13.0470-7167.2 LD7167	ATE 23312 20,3 + WE / - WK ATE 23312 20,3 + WE / - WK ATE 23312 20,3 + WE / - WK Ceramic
			→			13.0460-7168.2 607168 13.0470-7168.2 LD7168	ATE 21282 17,3 + WE / - WK ATE 21282 17,3 + WE / - WK Ceramic
730 i, Li	190	03/05→07/08	←	07/05→		13.0460-7167.2 607167 13.0460-7306.2 607306 13.0470-7167.2 LD7167	ATE 23312 20,3 + WE / - WK ATE 23312 20,3 + WE / - WK ATE 23312 20,3 + WE / - WK Ceramic
			→	07/05→		13.0460-7168.2 607168 13.0470-7168.2 LD7168	ATE 21282 17,3 + WE / - WK ATE 21282 17,3 + WE / - WK Ceramic
730 Ld	170	07/05→08/08	←			13.0460-7167.2 607167 13.0460-7306.2 607306 13.0470-7167.2 LD7167	ATE 23312 20,3 + WE / - WK ATE 23312 20,3 + WE / - WK ATE 23312 20,3 + WE / - WK Ceramic
			→			13.0460-7169.2 607169 13.0470-7169.2 LD7169	ATE 23309 17,3 + WE / - WK ATE 23309 17,3 + WE / - WK Ceramic
735 i, Li	200	11/01→02/05	←			13.0460-7167.2 607167 13.0460-7306.2 607306	ATE 23312 20,3 + WE / - WK ATE 23312 20,3 + WE / - WK
			→			13.0460-7168.2 607168 13.0470-7168.2 LD7168	ATE 21282 17,3 + WE / - WK ATE 21282 17,3 + WE / - WK Ceramic
740 d 740 i, Li 745 i, Li	190 225 245	10/02→02/05 07/05→07/08 11/01→07/08	←			13.0460-7167.2 607167 13.0460-7306.2 607306	ATE 23312 20,3 + WE / - WK ATE 23312 20,3 + WE / - WK
			→			13.0460-7169.2 607169 13.0470-7169.2 LD7169	ATE 23309 17,3 + WE / - WK ATE 23309 17,3 + WE / - WK Ceramic
745 d 745 d	220 242	03/05→08/05 07/05→07/08	←			13.0460-7210.2 607210	ATE 23791 20,8 + WE / - WK
			→			13.0460-7169.2 607169 13.0470-7169.2 LD7169	ATE 23309 17,3 + WE / - WK ATE 23309 17,3 + WE / - WK Ceramic
750 i, Li	270	07/05→07/08	←			13.0460-7167.2 607167 13.0460-7210.2 607210 13.0460-7306.2 607306	ATE 23312 20,3 + WE / - WK ATE 23791 20,8 + WE / - WK ATE 23312 20,3 + WE / - WK
			→			13.0460-7169.2 607169 13.0470-7169.2 LD7169	ATE 23309 17,3 + WE / - WK ATE 23309 17,3 + WE / - WK Ceramic
760 i, Li	327	01/03→07/08	←	03/03→		13.0460-7167.2 607167 13.0460-7210.2 607210 13.0460-7306.2 607306	ATE 23312 20,3 + WE / - WK ATE 23791 20,8 + WE / - WK ATE 23312 20,3 + WE / - WK
			→	03/03→		13.0460-7169.2 607169	ATE 23309 17,3 + WE / - WK
↓							















	kW			 	! #		
<b>BMW - 7 (E65, E66, E67) 11/01→12/09</b>							
<b> Bremsbelagsatz, Scheibenbremse</b>							
760 i, Li	327	01/03→07/08	➡	03/03→		<b>13.0470-7169.2 LD7169</b>	ATE 23309 17,3 + WE / - WK Ceramic
760 i, LI	326	11/01→12/09	⬅	03/03→ 08/08		<b>13.0460-7167.2 607167</b>	ATE 23312 20,3 + WE / - WK
			➡	03/03→ 08/08		<b>13.0460-7210.2 607210</b>	ATE 23791 20,8 + WE / - WK
						<b>13.0460-7306.2 607306</b>	ATE 23312 20,3 + WE / - WK
						<b>13.0460-7169.2 607169</b>	ATE 23309 17,3 + WE / - WK
						<b>13.0470-7169.2 LD7169</b>	ATE 23309 17,3 + WE / - WK Ceramic
<b> Warnkontakt, Bremsbelagverschleiß</b>							
730 d	150	10/02→07/08	⬅		1	<b>24.8190-0230.2 620230</b>	L= 814
730 d	155	10/02→07/08	➡	→ 02/05	1	<b>24.8190-0231.2 620231</b>	L= 830
730 d	160	06/02→02/05	⬅	09/02→	1	<b>24.8190-0230.2 620230</b>	L= 814
			➡	09/02→	1	<b>24.8190-0231.2 620231</b>	L= 830
730 i, Li	170	03/03→07/08	⬅		1	<b>24.8190-0230.2 620230</b>	L= 814
730 Ld	170	07/05→08/08	➡		1	<b>24.8190-0231.2 620231</b>	L= 830
735 i, Li	200	11/01→02/05	➡				
740 d	190	10/02→02/05	➡				
740 i, Li	225	07/05→07/08	➡				
745 d	220	03/05→08/05	➡				
745 d	242	07/05→07/08	➡				
745 i, Li	245	11/01→07/08	➡				
750 i, Li	270	07/05→07/08	➡				
730 i, Li	190	03/05→07/08	⬅	07/05→	1	<b>24.8190-0230.2 620230</b>	L= 814
			➡	07/05→	1	<b>24.8190-0231.2 620231</b>	L= 830
760 i, Li	327	01/03→07/08	⬅	03/03→	1	<b>24.8190-0230.2 620230</b>	L= 814
			➡	03/03→	1	<b>24.8190-0231.2 620231</b>	L= 830
760 i, LI	326	11/01→12/09	⬅	03/03→ 08/08	1	<b>24.8190-0230.2 620230</b>	L= 814
			➡	03/03→ 08/08	1	<b>24.8190-0231.2 620231</b>	L= 830
<b> Bremsscheibe</b>							
730 d	150	10/02→07/08	⬅	→ 02/05		<b>24.0130-0117.1 430117</b>	Ø 324 30 28,4 V
730 d	155	10/02→07/08	➡	→ 02/05		<b>24.0120-0178.1 420178</b>	Ø 324 20 18,4 V
730 d	160	06/02→02/05	⬅	09/02→		<b>24.0130-0117.1 430117</b>	Ø 324 30 28,4 V
			➡	09/02→		<b>24.0120-0178.1 420178</b>	Ø 324 20 18,4 V
730 i, Li	170	03/03→07/08	⬅			<b>24.0130-0117.1 430117</b>	Ø 324 30 28,4 V
735 i, Li	200	11/01→02/05	➡			<b>24.0120-0178.1 420178</b>	Ø 324 20 18,4 V
730 i, Li	190	03/05→07/08	⬅	07/05→		<b>24.0130-0117.1 430117</b>	Ø 324 30 28,4 V
			➡	07/05→		<b>24.0120-0217.1 420217</b>	Ø 324 20 18,4 V
730 Ld	170	07/05→08/08	⬅			<b>24.0130-0118.1 430118</b>	Ø 348 30 28,4 V
740 i, Li	225	07/05→07/08	➡			<b>24.0124-0213.1 424213</b>	Ø 345 24 22,4 V
740 d	190	10/02→02/05	⬅			<b>24.0130-0118.1 430118</b>	Ø 348 30 28,4 V
745 i, Li	245	11/01→07/08	➡			<b>24.0124-0177.1 424177</b>	Ø 345 24 22,4 V
745 d	220	03/05→08/05	⬅			<b>24.0136-0101.1 436101</b>	Ø 374 36 34,4 V
745 d	242	07/05→07/08	➡			<b>24.0124-0214.1 424214</b>	Ø 370 24 22,4 V
750 i, Li	270	07/05→07/08	⬅			<b>24.0130-0118.1 430118</b>	Ø 348 30 28,4 V
			➡			<b>24.0136-0110.1 436110</b>	Ø 348 35,9 34,4 V
			➡			<b>24.0124-0213.1 424213</b>	Ø 345 24 22,4 V
760 i, Li	327	01/03→07/08	⬅	03/03→		<b>24.0130-0118.1 430118</b>	Ø 348 30 28,4 V
			➡	03/03→ 03/05		<b>24.0136-0101.1 436101</b>	Ø 374 36 34,4 V
			➡	03/03→ 03/05		<b>24.0124-0177.1 424177</b>	Ø 345 24 22,4 V
			➡	04/05→		<b>24.0124-0186.1 424186</b>	Ø 370 24 22,4 V
						<b>24.0124-0213.1 424213</b>	Ø 345 24 22,4 V
						<b>24.0124-0214.1 424214</b>	Ø 370 24 22,4 V
760 i, LI	326	11/01→12/09	⬅	03/03→ 08/08		<b>24.0130-0118.1 430118</b>	Ø 348 30 28,4 V
			➡	03/03→ 03/05		<b>24.0136-0101.1 436101</b>	Ø 374 36 34,4 V
			➡	03/03→ 03/05		<b>24.0124-0177.1 424177</b>	Ø 345 24 22,4 V
			➡	04/05→ 08/08		<b>24.0124-0186.1 424186</b>	Ø 370 24 22,4 V
						<b>24.0124-0213.1 424213</b>	Ø 345 24 22,4 V
						<b>24.0124-0214.1 424214</b>	Ø 370 24 22,4 V









	kw			 	! #		
<b>BMW - 7 (F01, F02, F03, F04) 02/08→12/15</b>							
<b> Bremsbelagsatz, Scheibenbremse</b>							
730 d 730 d 730 i, Li	155 180 190	02/08→05/15 02/08→07/12 06/08→12/15	←	03/10→		13.0460-7267.2 607267	ATE 25045 19,5 + WE / - WK
					13.0470-7267.2 LD7267	ATE 25045 19,5 + WE / - WK Ceramic	
			←	09/08→ 02/10		13.0460-7267.2 607267	ATE 25045 19,5 + WE / - WK
					13.0470-7267.2 LD7267	ATE 25045 19,5 + WE / - WK Ceramic	
			→	09/08→ 02/10		13.0460-7274.2 607274	ATE 23731 17,3 + WE / - WK
			→	03/10→		13.0460-7274.2 607274	ATE 23731 17,3 + WE / - WK
730 d	190	07/12→05/15	←			13.0460-7267.2 607267	ATE 25045 19,5 + WE / - WK
					13.0470-7267.2 LD7267	ATE 25045 19,5 + WE / - WK Ceramic	
			→			13.0460-7274.2 607274	ATE 23731 17,3 + WE / - WK
730 d xDrive 730 d xDrive	155 190	11/11→05/15 11/11→05/15	←	06/12→		13.0460-7267.2 607267	ATE 25045 19,5 + WE / - WK
					13.0470-7267.2 LD7267	ATE 25045 19,5 + WE / - WK Ceramic	
			→	06/12→		13.0460-7274.2 607274	ATE 23731 17,3 + WE / - WK
740 d	225	09/09→12/15	←	03/10→		13.0460-7267.2 607267	ATE 25045 19,5 + WE / - WK
					13.0470-7267.2 LD7267	ATE 25045 19,5 + WE / - WK Ceramic	
			←	→ 02/10		13.0460-7267.2 607267	ATE 25045 19,5 + WE / - WK
					13.0470-7267.2 LD7267	ATE 25045 19,5 + WE / - WK Ceramic	
			→	→ 02/10		13.0460-7274.2 607274	ATE 23731 17,3 + WE / - WK
			→	03/10→		13.0460-7274.2 607274	ATE 23731 17,3 + WE / - WK
740 d 740 d xDrive 740 i, Li 740 i, Li xDrive	230 230 235 235	07/12→12/15 07/12→12/15 07/12→12/15 07/12→12/15	←			13.0460-7267.2 607267	ATE 25045 19,5 + WE / - WK
			→			13.0460-7274.2 607274	ATE 23731 17,3 + WE / - WK
740 d xDrive	225	09/09→12/15	←	09/10→		13.0460-7267.2 607267	ATE 25045 19,5 + WE / - WK
					13.0470-7267.2 LD7267	ATE 25045 19,5 + WE / - WK Ceramic	
			→	09/10→		13.0460-7274.2 607274	ATE 23731 17,3 + WE / - WK
740 i	240	10/08→12/15	←	→ 02/10		13.0460-7267.2 607267	ATE 25045 19,5 + WE / - WK
			←	03/10→		13.0460-7267.2 607267	ATE 25045 19,5 + WE / - WK
			→	→ 02/10		13.0460-7274.2 607274	ATE 23731 17,3 + WE / - WK
			→	03/10→		13.0460-7274.2 607274	ATE 23731 17,3 + WE / - WK
750 d xDrive	280	07/12→12/15	←			13.0460-7261.2 607261	ATE 24436 19,7 + WE / - WK
			→			13.0460-7274.2 607274	ATE 23731 17,3 + WE / - WK
750 i 750 i xDrive	300 300	10/08→12/15 09/09→12/15	←	für Fahrzeuge mit verstärkter Bremse		13.0460-7261.2 607261	ATE 24436 19,7 + WE / - WK
			←	→ 02/10; nicht für Fahrzeuge mit verstärkter Bremse		13.0460-7267.2 607267	ATE 25045 19,5 + WE / - WK
			←	03/10→; nicht für Fahrzeuge mit verstärkter Bremse		13.0460-7267.2 607267	ATE 25045 19,5 + WE / - WK
			→	03/10→		13.0460-7274.2 607274	ATE 23731 17,3 + WE / - WK
			→	→ 02/10		13.0460-7274.2 607274	ATE 23731 17,3 + WE / - WK
750 i 750 i xDrive	330 330	10/12→12/15 10/12→12/15	←	für Fahrzeuge mit verstärkter Bremse		13.0460-7261.2 607261	ATE 24436 19,7 + WE / - WK
			←	nicht für Fahrzeuge mit verstärkter Bremse		13.0460-7267.2 607267	ATE 25045 19,5 + WE / - WK
			→			13.0460-7274.2 607274	ATE 23731 17,3 + WE / - WK
760 i	400	09/09→12/15	←			13.0460-7261.2 607261	ATE 24436 19,7 + WE / - WK
			→	03/10→		13.0460-7274.2 607274	ATE 23731 17,3 + WE / - WK
			→	→ 02/10		13.0460-7274.2 607274	ATE 23731 17,3 + WE / - WK
ActiveHybrid ActiveHybrid	235 260	05/11→05/15 05/11→05/15	←	06/12→		13.0460-7267.2 607267	ATE 25045 19,5 + WE / - WK
			→	06/12→		13.0460-7274.2 607274	ATE 23731 17,3 + WE / - WK
ActiveHybrid ActiveHybrid	330 342	09/09→06/12 09/09→06/12	←	03/10→; für Fahrzeuge mit verstärkter Bremse		13.0460-7261.2 607261	ATE 24436 19,7 + WE / - WK
			←	03/10→; nicht für Fahrzeuge mit verstärkter Bremse		13.0460-7267.2 607267	ATE 25045 19,5 + WE / - WK
			→	03/10→		13.0460-7274.2 607274	ATE 23731 17,3 + WE / - WK
↓							









	kW			 	! #			
<b>BMW - 7 (F01, F02, F03, F04) 02/08→12/15</b>								
<b>Warnkontakt, Bremsbelagverschleiß</b>								
730 d 730 d 730 i, Li	155 180 190	02/08→05/15 02/08→07/12 06/08→12/15	← ← →	☐; 09/08→ 02/10 ☐; 03/10→ 09/08→ 02/10	1 1 1	24.8190-0260.2 24.8190-0298.2 24.8190-0261.2	620260 620298 620261	L= 1.060 L= 1.087 L= 1.045
730 d 740 d 740 d xDrive 740 i, Li 740 i, Li xDrive 750 d xDrive	190 230 230 235 235 280	07/12→05/15 07/12→12/15 07/12→12/15 07/12→12/15 07/12→12/15 07/12→12/15	← →	☐ ☐	1 1	24.8190-0298.2 24.8190-0299.2	620298 620299	L= 1.087 L= 1.065
730 d xDrive 730 d xDrive ActiveHybrid ActiveHybrid	155 190 235 260	11/11→05/15 11/11→05/15 05/11→05/15 05/11→05/15	← →	☐; 06/12→ 06/12→	1 1	24.8190-0298.2 24.8190-0299.2	620298 620299	L= 1.087 L= 1.065
740 d 740 i	225 240	09/09→12/15 10/08→12/15	← ← → →	☐; → 02/10 ☐; 03/10→ → 02/10 03/10→	1 1 1 1	24.8190-0260.2 24.8190-0298.2 24.8190-0261.2 24.8190-0299.2	620260 620298 620261 620299	L= 1.060 L= 1.087 L= 1.045 L= 1.065
740 d xDrive	225	09/09→12/15	← →	☐; 09/10→ 09/10→	1 1	24.8190-0298.2 24.8190-0299.2	620298 620299	L= 1.087 L= 1.065
750 i 750 i xDrive	300 300	10/08→12/15 09/09→12/15	← ← ← → →	☐; → 02/10; nicht für Fahrzeuge mit verstärkter Bremsen ☐; für Fahrzeuge mit verstärkter Bremsen ☐; 03/10→; nicht für Fahrzeuge mit verstärkter Bremsen → 02/10 03/10→	1 1 1 1 1	24.8190-0260.2 24.8190-0298.2 24.8190-0298.2 24.8190-0261.2 24.8190-0299.2	620260 620298 620298 620261 620299	L= 1.060 L= 1.087 L= 1.087 L= 1.045 L= 1.065
750 i 750 i xDrive	330 330	10/12→12/15 10/12→12/15	← ← →	☐; für Fahrzeuge mit verstärkter Bremsen ☐; nicht für Fahrzeuge mit verstärkter Bremsen	1 1 1	24.8190-0298.2 24.8190-0298.2	620298 620298	L= 1.087 L= 1.087 L= 1.065
760 i	400	09/09→12/15	← → →	☐ → 02/10 03/10→	1 1 1	24.8190-0298.2 24.8190-0261.2 24.8190-0299.2	620298 620261 620299	L= 1.087 L= 1.045 L= 1.065
ActiveHybrid ActiveHybrid	330 342	09/09→06/12 09/09→06/12	← ← →	☐; 03/10→; für Fahrzeuge mit verstärkter Bremsen ☐; 03/10→; nicht für Fahrzeuge mit verstärkter Bremsen 03/10→	1 1 1	24.8190-0298.2 24.8190-0298.2	620298 620298	L= 1.087 L= 1.087 L= 1.065
<b> Brems Scheibe</b>								
730 d 730 d 730 i, Li	155 180 190	02/08→05/15 02/08→07/12 06/08→12/15	← ← →	☐; 09/08→ ☐; 09/08→ 09/08→		24.0136-0114.2 24.0136-0115.2 24.0124-0233.2	436114 436115 424233	Ø 348 36 34,4 V Brems Scheibe zweiteilig / + S Ø 348 36 34,4 V Brems Scheibe zweiteilig / + S Ø 345 24 22,4 V Brems Scheibe zweiteilig / + S
730 d 740 d 740 d 740 d xDrive 740 i, Li 740 i, Li xDrive	190 225 230 230 235 235	07/12→05/15 09/09→12/15 07/12→12/15 07/12→12/15 07/12→12/15 07/12→12/15	← ← →	☐ ☐ ☐		24.0136-0114.2 24.0136-0115.2 24.0124-0233.2	436114 436115 424233	Ø 348 36 34,4 V Brems Scheibe zweiteilig / + S Ø 348 36 34,4 V Brems Scheibe zweiteilig / + S Ø 345 24 22,4 V Brems Scheibe zweiteilig / + S
730 d xDrive 730 d xDrive ActiveHybrid ActiveHybrid	155 190 235 260	11/11→05/15 11/11→05/15 05/11→05/15 05/11→05/15	← ← →	☐; 06/12→ ☐; 06/12→ 06/12→		24.0136-0114.2 24.0136-0115.2 24.0124-0233.2	436114 436115 424233	Ø 348 36 34,4 V Brems Scheibe zweiteilig / + S Ø 348 36 34,4 V Brems Scheibe zweiteilig / + S Ø 345 24 22,4 V Brems Scheibe zweiteilig / + S
740 d xDrive	225	09/09→12/15	←	☐; 09/10→		24.0136-0114.2	436114	Ø 348 36 34,4 V Brems Scheibe zweiteilig / + S
↓								



	kw			 	! #		
<b>BMW - 7 (F01, F02, F03, F04) 02/08→12/15</b>							
<b> Bremsscheibe</b>							
740 d xDrive	225	09/09→12/15	←	☐; 09/10→		24.0136-0115.2 436115	Ø 348 36 34,4 V Bremsscheibe zweiteilig / + S
			→	09/10→		24.0124-0233.2 424233	Ø 345 24 22,4 V Bremsscheibe zweiteilig / + S
740 i	240	10/08→12/15	←	☐		24.0136-0118.2 436118	Ø 374 36 34,4 V Bremsscheibe zweiteilig / + S
			←	☐		24.0136-0119.2 436119	Ø 374 36 34,4 V Bremsscheibe zweiteilig / + S
			→			24.0124-0233.2 424233	Ø 345 24 22,4 V Bremsscheibe zweiteilig / + S
750 d xDrive 760 i	280 400	07/12→12/15 09/09→12/15	←	☐		24.0136-0120.2 436120	Ø 374 36 34,4 V Bremsscheibe zweiteilig / + S
			←	☐		24.0136-0121.2 436121	Ø 374 36 34,4 V Bremsscheibe zweiteilig / + S
			→			24.0124-0241.1 424241	Ø 370 23,9 22,4 V + S
750 i 750 i 750 i xDrive 750 i xDrive	300 330 300 330	10/08→12/15 10/12→12/15 09/09→12/15 10/12→12/15	←	☐; nicht für Fahrzeuge mit verstärkter Bremse		24.0136-0118.2 436118	Ø 374 36 34,4 V Bremsscheibe zweiteilig / + S
			←	☐; nicht für Fahrzeuge mit verstärkter Bremse		24.0136-0119.2 436119	Ø 374 36 34,4 V Bremsscheibe zweiteilig / + S
			←	☐; für Fahrzeuge mit verstärkter Bremse		24.0136-0120.2 436120	Ø 374 36 34,4 V Bremsscheibe zweiteilig / + S
			←	☐; für Fahrzeuge mit verstärkter Bremse		24.0136-0121.2 436121	Ø 374 36 34,4 V Bremsscheibe zweiteilig / + S
			→			24.0124-0241.1 424241	Ø 370 23,9 22,4 V + S
			←	☐; 03/10→; nicht für Fahrzeuge mit verstärkter Bremse		24.0136-0118.2 436118	Ø 374 36 34,4 V Bremsscheibe zweiteilig / + S
			←	☐; 03/10→; nicht für Fahrzeuge mit verstärkter Bremse		24.0136-0119.2 436119	Ø 374 36 34,4 V Bremsscheibe zweiteilig / + S
ActiveHybrid ActiveHybrid	330 342	09/09→06/12 09/09→06/12	←	☐; 03/10→; für Fahrzeuge mit verstärkter Bremse		24.0136-0120.2 436120	Ø 374 36 34,4 V Bremsscheibe zweiteilig / + S
			←	☐; 03/10→; für Fahrzeuge mit verstärkter Bremse		24.0136-0121.2 436121	Ø 374 36 34,4 V Bremsscheibe zweiteilig / + S
			←	☐; 03/10→; für Fahrzeuge mit verstärkter Bremse		24.0136-0118.2 436118	Ø 374 36 34,4 V Bremsscheibe zweiteilig / + S
			→	03/10→		24.0124-0241.1 424241	Ø 370 23,9 22,4 V + S
<b>BMW - 7 (G11, G12) 10/14→</b>							
<b> Bremsbelagsatz, Scheibenbremse</b>							
725 d, Ld 725 d, Ld 730 i, Li	155 170 190	07/17→ 09/15→ 02/16→	→	+ Performance Parts; + eFSB		13.0460-2716.2 602716	TRW 24703 17,8 + WE / - WK + Zub
						13.0470-2716.2 LD2716	TRW 24703 17,8 + WE / - WK + Zub Ceramic
730 d 730 d 730 d, Ld xDrive 730 d xDrive 740 d, Ld xDrive 740 e, Le 740 e, Le 740 e, Le xDrive 740 e, Le xDrive 740 i, Li 740 i, Li xDrive 750 d, Ld xDrive 750 i, Li 750 i, Li xDrive	155 195 195 155 235 190 240 190 240 240 240 294 330 330	09/15→ 09/15→ 09/15→ 09/15→ 11/15→ 04/16→ 04/16→ 04/16→ 04/16→ 09/15→ 03/16→ 07/16→ 11/15→ 09/15→	→	+ eFSB		13.0460-2716.2 602716	TRW 24703 17,8 + WE / - WK + Zub
						13.0470-2716.2 LD2716	TRW 24703 17,8 + WE / - WK + Zub Ceramic
			←	☐		24.0136-0132.2 436132	Ø 348 36 34,4 V Bremsscheibe zweiteilig / + S
			←	☐		24.0136-0133.2 436133	Ø 348 36 34,4 V Bremsscheibe zweiteilig / + S
			→			24.0124-0262.2 424262	Ø 345 24 22,4 V Bremsscheibe zweiteilig / + S
			←	☐; - Performance Parts		24.0136-0132.2 436132	Ø 348 36 34,4 V Bremsscheibe zweiteilig / + S
			←	☐; - Performance Parts		24.0136-0133.2 436133	Ø 348 36 34,4 V Bremsscheibe zweiteilig / + S
			→	- Performance Parts		24.0124-0262.2 424262	Ø 345 24 22,4 V Bremsscheibe zweiteilig / + S

	kw			 	! #		
<b>BMW - 8 (E31) 04/90→12/99</b>							
 <b>Bremsbelagsatz, Scheibenbremse</b>							
840 i	210	02/93→02/96	←	→ 02/94		13.0460-7147.2 607147	ATE 21284 19,1 + WE / - WK
850 CSi	280	11/92→12/96	←	→ 10/96		13.0460-9037.2 609037	ATE 20309 17,9 + WE / - WK
<b>Warnkontakt, Bremsbelagverschleiß</b>							
840 Ci	210	01/96→12/99	←	→ 08/99	1	24.8190-0223.2 620223	L= 261
840 i	210	02/93→02/96	←	03/94→	1	24.8190-0223.2 620223	L= 261
			←	→ 02/94	1	24.8190-0223.2 620223	L= 261
850 Ci	240	09/94→12/99	←		1	24.8190-0223.2 620223	L= 261
850 CSi	280	11/92→12/96	←	→ 10/96	1	24.8190-0223.2 620223	L= 261
<b>Zubehörsatz, Scheibenbremsbelag</b>							
840 Ci	210	01/96→12/99	←	→ 08/99		13.0460-0267.2 610267	
840 i	210	02/93→02/96	←	03/94→		13.0460-0267.2 610267	
850 Ci	240	09/94→12/99	←			13.0460-0267.2 610267	
 <b>Bremsscheibe</b>							
840 Ci	210	01/96→12/99	→	→ 08/99		24.0112-0132.1 412132	Ø 324 12 10,4 + S
840 i	210	02/93→02/96	←	→ 02/94		24.0130-0101.1 430101	Ø 324 30 28,4 V + S
			→			24.0112-0132.1 412132	Ø 324 12 10,4 + S
850 Ci	240	09/94→12/99	→			24.0112-0132.1 412132	Ø 324 12 10,4 + S
850 CSi	280	11/92→12/96	→	→ 10/96		24.0120-0182.1 420182	Ø 328 20 18,4 V + S
<b>BMW - i3 (I01) 08/13→</b>							
 <b>Bremsbelagsatz, Scheibenbremse</b>							
Electric	75	08/13→	→			13.0460-7315.2 607315	ATE 25331 16,2 + WE / - WK
Electric	125	09/14→	→			13.0470-7315.2 LD7315	ATE 25331 16,2 + WE / - WK
Range Extender	75	08/13→	→				Ceramic
Range Extender	125	09/14→	→				
s Electric	75	11/17→	→				
s Electric	135	11/17→	→				
s Range Extender	75	11/17→	→				
s Range Extender	135	11/17→	→				
 <b>Bremsscheibe</b>							
Electric	75	08/13→	→			24.0110-0401.1 410401	Ø 280 10 8,4 + S
Electric	125	09/14→	→				
Range Extender	75	08/13→	→				
Range Extender	125	09/14→	→				
s Electric	75	11/17→	→				
s Electric	135	11/17→	→				
s Range Extender	75	11/17→	→				
s Range Extender	135	11/17→	→				
<b>BMW - i8 (I12) 03/14→</b>							
 <b>Bremsbelagsatz, Scheibenbremse</b>							
hybrid	170	03/14→	→			13.0460-2760.2 602760	TRW 24561 17,7 + WE / - WK
hybrid	266	03/14→02/18	→				+ Zub
hybrid	275	03/18→	→			13.0470-2760.2 LD2760	TRW 24561 17,7 + WE / - WK
							+ Zub Ceramic
<b>BMW - i8 Roadster (I15) 03/18→</b>							
 <b>Bremsbelagsatz, Scheibenbremse</b>							
hybrid	170	03/18→	→			13.0460-2760.2 602760	TRW 24561 17,7 + WE / - WK
hybrid	275	03/18→	→			13.0470-2760.2 LD2760	TRW 24561 17,7 + WE / - WK
							+ Zub Ceramic
<b>BMW - X1 (E84) 03/09→06/15</b>							
 <b>Bremsbelagsatz, Scheibenbremse</b>							
sDrive 16 d	85	04/12→06/15	←	07/12→		13.0460-7238.2 607238	ATE 23313 20,3 + WE / - WK
xDrive 25 d	160	10/09→06/15	←			13.0470-7238.2 LD7238	ATE 23313 20,3 + WE / - WK
			→	07/12→		13.0460-7217.2 607217	ATE 23926 17,3 + WE / - WK
						13.0470-7217.2 LD7217	ATE 23926 17,3 + WE / - WK
							Ceramic
↓							

	kw			 	! #		
<b>BMW - X1 (E84) 03/09→06/15</b>							
<b> Bremsbelagsatz, Scheibenbremse</b>							
sDrive 16 i	105	03/13→06/15	←			13.0460-7238.2 607238	ATE 23313 20,3 + WE / - WK
sDrive 20 d	120	03/10→06/15				13.0470-7238.2 LD7238	ATE 23313 20,3 + WE / - WK
sDrive 20 d	135	07/12→06/15					Ceramic
sDrive 20 i	135	09/11→06/15					
xDrive 20 d	120	03/10→06/15	→			13.0460-7217.2 607217	ATE 23926 17,3 + WE / - WK
xDrive 20 d	135	07/12→06/15				13.0470-7217.2 LD7217	ATE 23926 17,3 + WE / - WK
xDrive 20 i	135	09/11→06/15					Ceramic
sDrive 18 d	100	03/09→06/15	←	10/09→ 02/10		13.0460-7238.2 607238	ATE 23313 20,3 + WE / - WK
xDrive 18 d	100	03/09→06/15				13.0470-7238.2 LD7238	ATE 23313 20,3 + WE / - WK
			←	03/10→		13.0460-7238.2 607238	ATE 23313 20,3 + WE / - WK
						13.0470-7238.2 LD7238	ATE 23313 20,3 + WE / - WK
			→	03/10→		13.0460-7217.2 607217	ATE 23926 17,3 + WE / - WK
						13.0470-7217.2 LD7217	ATE 23926 17,3 + WE / - WK
			→	10/09→ 02/10		13.0460-7217.2 607217	ATE 23926 17,3 + WE / - WK
						13.0470-7217.2 LD7217	ATE 23926 17,3 + WE / - WK
							Ceramic
sDrive 18 d	105	10/09→06/15	←	→ 02/10		13.0460-7238.2 607238	ATE 23313 20,3 + WE / - WK
sDrive 20 d	130	10/09→06/15				13.0470-7238.2 LD7238	ATE 23313 20,3 + WE / - WK
xDrive 18 d	105	10/09→06/15					Ceramic
xDrive 20 d	130	10/09→06/15	←	03/10→		13.0460-7238.2 607238	ATE 23313 20,3 + WE / - WK
						13.0470-7238.2 LD7238	ATE 23313 20,3 + WE / - WK
			→	→ 02/10		13.0460-7217.2 607217	ATE 23926 17,3 + WE / - WK
						13.0470-7217.2 LD7217	ATE 23926 17,3 + WE / - WK
			→	03/10→		13.0460-7217.2 607217	ATE 23926 17,3 + WE / - WK
						13.0470-7217.2 LD7217	ATE 23926 17,3 + WE / - WK
							Ceramic
sDrive 18 i	100	03/09→06/15	←	03/10→		13.0460-7238.2 607238	ATE 23313 20,3 + WE / - WK
sDrive 18 i	110	01/10→06/15				13.0470-7238.2 LD7238	ATE 23313 20,3 + WE / - WK
			→	03/10→		13.0460-7217.2 607217	ATE 23926 17,3 + WE / - WK
						13.0470-7217.2 LD7217	ATE 23926 17,3 + WE / - WK
							Ceramic
xDrive 23 d	150	10/09→06/15	←	→ 02/10		13.0460-7216.2 607216	ATE 23794 20,3 + WE / - WK
						13.0470-7216.2 LD7216	ATE 23794 20,3 + WE / - WK
			←	03/10→ 02/12		13.0460-7216.2 607216	ATE 23794 20,3 + WE / - WK
						13.0470-7216.2 LD7216	ATE 23794 20,3 + WE / - WK
			←	03/12→		13.0460-7238.2 607238	ATE 23313 20,3 + WE / - WK
						13.0470-7238.2 LD7238	ATE 23313 20,3 + WE / - WK
			→	→ 02/10		13.0460-7217.2 607217	ATE 23926 17,3 + WE / - WK
						13.0470-7217.2 LD7217	ATE 23926 17,3 + WE / - WK
			→	03/10→		13.0460-7217.2 607217	ATE 23926 17,3 + WE / - WK
						13.0470-7217.2 LD7217	ATE 23926 17,3 + WE / - WK
							Ceramic
xDrive 25 i	160	01/10→06/15	←	03/10→ 02/12		13.0460-7216.2 607216	ATE 23794 20,3 + WE / - WK
						13.0470-7216.2 LD7216	ATE 23794 20,3 + WE / - WK
			←	03/12→		13.0460-7238.2 607238	ATE 23313 20,3 + WE / - WK
						13.0470-7238.2 LD7238	ATE 23313 20,3 + WE / - WK
			→	03/10→		13.0460-7217.2 607217	ATE 23926 17,3 + WE / - WK
						13.0470-7217.2 LD7217	ATE 23926 17,3 + WE / - WK
							Ceramic
xDrive 28 i	180	04/11→06/15	←	→ 02/12		13.0460-7216.2 607216	ATE 23794 20,3 + WE / - WK
xDrive 28 i Flex	180	04/11→06/15				13.0470-7216.2 LD7216	ATE 23794 20,3 + WE / - WK
			←	03/12→		13.0460-7238.2 607238	ATE 23313 20,3 + WE / - WK
						13.0470-7238.2 LD7238	ATE 23313 20,3 + WE / - WK
			→			13.0460-7217.2 607217	ATE 23926 17,3 + WE / - WK
							Ceramic

	kw			 	! #		
<b>BMW - X1 (E84) 03/09→06/15</b>							
<b> Bremsbelagsatz, Scheibenbremse</b>							
xDrive 28 i	180	04/11→06/15	→			13.0470-7217.2 LD7217	ATE 23926 17,3 + WE / - WK Ceramic
xDrive 28 i Flex	180	04/11→06/15					
xDrive 28 i	190	10/09→06/15	←	03/10→		13.0460-7237.2 607237	ATE 23347 20,3 + WE / - WK
						13.0460-7238.2 607238	ATE 23313 20,3 + WE / - WK
						13.0470-7237.2 LD7237	ATE 23347 20,3 + WE / - WK Ceramic
						13.0470-7238.2 LD7238	ATE 23313 20,3 + WE / - WK Ceramic
			←	→ 02/10		13.0460-7237.2 607237	ATE 23347 20,3 + WE / - WK
						13.0460-7238.2 607238	ATE 23313 20,3 + WE / - WK
						13.0470-7237.2 LD7237	ATE 23347 20,3 + WE / - WK Ceramic
						13.0470-7238.2 LD7238	ATE 23313 20,3 + WE / - WK Ceramic
			→	03/10→		13.0460-7225.2 607225	ATE 23550 17,3 + WE / - WK
						13.0470-7225.2 LD7225	ATE 23550 17,3 + WE / - WK Ceramic
			→	→ 02/10		13.0460-7225.2 607225	ATE 23550 17,3 + WE / - WK
						13.0470-7225.2 LD7225	ATE 23550 17,3 + WE / - WK Ceramic
<b>Warnkontakt, Bremsbelagverschleiß</b>							
sDrive 16 d	85	04/12→06/15	←	07/12→	1	24.8190-0297.2 620297	L= 676
			→	07/12→	1	24.8190-0296.2 620296	L= 1.141
sDrive 16 i	105	03/13→06/15	←		1	24.8190-0297.2 620297	L= 676
sDrive 20 d	120	03/10→06/15					
sDrive 20 d	135	07/12→06/15	→		1	24.8190-0296.2 620296	L= 1.141
sDrive 20 i	135	09/11→06/15					
sDrive 18 d	100	03/09→06/15	←	10/09→ 02/10	1	24.8190-0283.2 620283	L= 632
			←	03/10→	1	24.8190-0297.2 620297	L= 676
			→	10/09→ 02/10	1	24.8190-0282.2 620282	L= 1.120
			→	03/10→	1	24.8190-0296.2 620296	L= 1.141
sDrive 18 d	105	10/09→06/15	←	→ 02/10	1	24.8190-0283.2 620283	L= 632
sDrive 20 d	130	10/09→06/15	←	03/10→	1	24.8190-0297.2 620297	L= 676
			→	→ 02/10	1	24.8190-0282.2 620282	L= 1.120
			→	03/10→	1	24.8190-0296.2 620296	L= 1.141
sDrive 18 i	100	03/09→06/15	←	03/10→	1	24.8190-0297.2 620297	L= 676
sDrive 18 i	110	01/10→06/15	→	03/10→	1	24.8190-0296.2 620296	L= 1.141
xDrive 18 d	100	03/09→06/15	←	10/09→ 02/10	1	24.8190-0266.2 620266	L= 840
			←	03/10→	1	24.8190-0286.2 620286	L= 867
			→	10/09→ 02/10	1	24.8190-0282.2 620282	L= 1.120
			→	03/10→	1	24.8190-0296.2 620296	L= 1.141
xDrive 18 d	105	10/09→06/15	←	→ 02/10	1	24.8190-0266.2 620266	L= 840
xDrive 20 d	130	10/09→06/15	←	03/10→	1	24.8190-0286.2 620286	L= 867
xDrive 28 i	190	10/09→06/15	←	03/10→	1	24.8190-0286.2 620286	L= 867
			→	→ 02/10	1	24.8190-0282.2 620282	L= 1.120
			→	03/10→	1	24.8190-0296.2 620296	L= 1.141
xDrive 20 d	120	03/10→06/15	←		1	24.8190-0286.2 620286	L= 867
xDrive 20 d	135	07/12→06/15	→		1	24.8190-0296.2 620296	L= 1.141
xDrive 20 i	135	09/11→06/15					
xDrive 23 d	150	10/09→06/15	←	→ 02/10	1	24.8190-0266.2 620266	L= 840
			←	03/12→	1	24.8190-0286.2 620286	L= 867
			←	03/10→ 02/12	1	24.8190-0286.2 620286	L= 867
			→	→ 02/10	1	24.8190-0282.2 620282	L= 1.120
			→	03/10→	1	24.8190-0296.2 620296	L= 1.141
xDrive 25 d	160	10/09→06/15	←	07/12→	1	24.8190-0286.2 620286	L= 867
			→	07/12→	1	24.8190-0296.2 620296	L= 1.141
xDrive 25 i	160	01/10→06/15	←	03/12→	1	24.8190-0286.2 620286	L= 867
			←	03/10→ 02/12	1	24.8190-0286.2 620286	L= 867
			→	03/10→	1	24.8190-0296.2 620296	L= 1.141
xDrive 28 i	180	04/11→06/15	←	03/12→	1	24.8190-0286.2 620286	L= 867
xDrive 28 i Flex	180	04/11→06/15					

### BMW - X1 (E84) 03/09→06/15

#### Warnkontakt, Bremsbelagverschleiß

xDrive 28 i	180	04/11→06/15	←	→ 02/12	1	24.8190-0286.2	620286	L= 867
xDrive 28 i Flex	180	04/11→06/15	→		1	24.8190-0296.2	620296	L= 1.141

#### Brems Scheibe











sDrive 16 d xDrive 25 d	85 160	04/12→06/15 10/09→06/15	←	07/12→		24.0124-0203.1	424203	Ø 312 23,9 22,4 V + S
			→	07/12→		24.0324-0203.1	524203	Ø 312 23,9 21,6 V + S
			→			24.0120-0204.1	420204	Ø 300 20 18,4 V + S
			→			24.0320-0204.1	520204	Ø 300 20 17,6 V + S
sDrive 16 i sDrive 18 d sDrive 20 d sDrive 20 d sDrive 20 d sDrive 20 i xDrive 18 d xDrive 20 d xDrive 20 d xDrive 20 d xDrive 20 i	105	03/13→06/15	←			24.0124-0203.1	424203	Ø 312 23,9 22,4 V + S
	105	10/09→06/15	←			24.0324-0203.1	524203	Ø 312 23,9 21,6 V + S
	120	03/10→06/15	→			24.0120-0204.1	420204	Ø 300 20 18,4 V + S
	130	10/09→06/15	→			24.0320-0204.1	520204	Ø 300 20 17,6 V + S
	135	07/12→06/15	→			24.0120-0204.1	420204	Ø 300 20 18,4 V + S
	135	09/11→06/15	→			24.0320-0204.1	520204	Ø 300 20 17,6 V + S
	105	10/09→06/15	→			24.0120-0204.1	420204	Ø 300 20 18,4 V + S
	120	03/10→06/15	→			24.0320-0204.1	520204	Ø 300 20 17,6 V + S
	130	10/09→06/15	→			24.0120-0204.1	420204	Ø 300 20 18,4 V + S
	135	07/12→06/15	→			24.0320-0204.1	520204	Ø 300 20 17,6 V + S
sDrive 18 d xDrive 18 d	100	03/09→06/15	←	10/09→		24.0124-0203.1	424203	Ø 312 23,9 22,4 V + S
	100	03/09→06/15	→	10/09→		24.0324-0203.1	524203	Ø 312 23,9 21,6 V + S
			→	10/09→		24.0120-0204.1	420204	Ø 300 20 18,4 V + S
sDrive 18 i	100	03/09→06/15	←	10/09→		24.0320-0204.1	520204	Ø 300 20 17,6 V + S
			→	10/09→		24.0124-0203.1	424203	Ø 312 23,9 22,4 V + S
			→	03/10→		24.0324-0203.1	524203	Ø 312 23,9 21,6 V + S
sDrive 18 i	110	01/10→06/15	→	03/10→		24.0120-0204.1	420204	Ø 300 20 18,4 V + S
			→	03/10→		24.0320-0204.1	520204	Ø 300 20 17,6 V + S
			→	03/10→		24.0124-0203.1	424203	Ø 312 23,9 22,4 V + S
xDrive 23 d xDrive 28 i xDrive 28 i Flex	150	10/09→06/15	←	→ 02/12		24.0324-0203.1	524203	Ø 312 23,9 21,6 V + S
	180	04/11→06/15	←	→ 02/12		24.0124-0200.1	424200	Ø 330 24 22,4 V + S
	180	04/11→06/15	←	→ 02/12		24.0324-0200.1	524200	Ø 330 24 21,6 V + S
			←	03/12→		24.0124-0203.1	424203	Ø 312 23,9 22,4 V + S
			→			24.0324-0203.1	524203	Ø 312 23,9 21,6 V + S
			→			24.0120-0204.1	420204	Ø 300 20 18,4 V + S
xDrive 25 i	160	01/10→06/15	←	03/10→ 02/12		24.0320-0204.1	520204	Ø 300 20 17,6 V + S
			←	03/10→ 02/12		24.0124-0200.1	424200	Ø 330 24 22,4 V + S
			←	03/12→		24.0324-0200.1	524200	Ø 330 24 21,6 V + S
			→	03/10→		24.0124-0203.1	424203	Ø 312 23,9 22,4 V + S
xDrive 28 i	190	10/09→06/15	→			24.0120-0204.1	420204	Ø 300 20 18,4 V + S
			→			24.0320-0204.1	520204	Ø 300 20 17,6 V + S
			←			24.0130-0192.1	430192	Ø 348 30 28,4 V + S
			←			24.0122-0236.1	422236	Ø 336 22 20,4 V + S
			→			24.0322-0236.1	522236	Ø 336 22 19,6 V + S
			→			24.0120-0204.1	420204	Ø 300 20 18,4 V + S

### BMW - X1 (F48) 11/14→

#### Bremsbelagsatz, Scheibenbremse

sDrive 16 d sDrive 18 d sDrive 18 d sDrive 18 i sDrive 20 i xDrive 18 d xDrive 18 d xDrive 20 d xDrive 20 i xDrive 25 d xDrive 25 i	85 100 110 100 141 100 110 140 141 170 170	11/14→ 11/14→ 11/14→ 11/14→05/17 11/14→ 11/14→ 11/14→ 11/14→ 11/14→ 11/14→ 11/14→	←	09/15→		13.0460-2601.2	602601	TRW 25617 18,5 + WE / - WK			
			→	09/15→; + eFSB		13.0460-7315.2	607315	ATE 25331 16,2 + WE / - WK			
			→	09/15→; + eFSB		13.0470-7315.2	LD7315	ATE 25331 16,2 + WE / - WK Ceramic			
			←			13.0460-2601.2	602601	TRW 25617 18,5 + WE / - WK			
			→	+ eFSB		13.0460-7315.2	607315	ATE 25331 16,2 + WE / - WK			
			→	+ eFSB		13.0470-7315.2	LD7315	ATE 25331 16,2 + WE / - WK Ceramic			
			sDrive 20 d sDrive 20 d xDrive 20 d	120	01/15→	←	11/15→		13.0460-2601.2	602601	TRW 25617 18,5 + WE / - WK
				140	01/15→	←	11/15→		13.0460-7315.2	607315	ATE 25331 16,2 + WE / - WK
				120	11/14→	→	11/15→; + eFSB		13.0460-7315.2	607315	ATE 25331 16,2 + WE / - WK



	kW				! #		
<b>BMW - X1 (F48) 11/14→</b>							
 <b>Bremsbelagsatz, Scheibenbremse</b>							
sDrive 20 d	120	01/15→	➔	11/15→; + eFSB		13.0470-7315.2 LD7315	ATE 25331 16,2 + WE / - WK Ceramic
sDrive 20 d	140	01/15→					
xDrive 20 d	120	11/14→					
<b>Warnkontakt, Bremsbelagverschleiß</b>							
sDrive 16 d	85	11/14→	➔	09/15→	1	24.8190-0942.2 620942	L= 641
sDrive 18 d	100	11/14→					
sDrive 18 d	110	11/14→					
sDrive 18 i	100	11/14→05/17					
sDrive 20 i	141	11/14→					
xDrive 18 d	100	11/14→					
xDrive 18 d	110	11/14→					
xDrive 20 d	140	11/14→					
xDrive 20 i	141	11/14→					
xDrive 25 d	170	11/14→					
xDrive 25 i	170	11/14→					
sDrive 18 i	103	06/17→	➔		1	24.8190-0942.2 620942	L= 641
sDrive 20 d	120	01/15→	➔	11/15→	1	24.8190-0942.2 620942	L= 641
sDrive 20 d	140	01/15→					
xDrive 20 d	120	11/14→					
<b> Brems Scheibe</b>							
sDrive 16 d	85	11/14→	➔	09/15→		24.0124-0260.1 424260	Ø 307 24 22,4 V + S
sDrive 18 d	100	11/14→					
sDrive 18 d	110	11/14→	➔	09/15→		24.0110-0401.1 410401	Ø 280 10 8,4 + S
sDrive 18 i	100	11/14→05/17					
xDrive 18 d	100	11/14→					
xDrive 18 d	110	11/14→					
sDrive 18 i	103	06/17→	➔			24.0124-0260.1 424260	Ø 307 24 22,4 V + S
			➔			24.0110-0401.1 410401	Ø 280 10 8,4 + S
sDrive 20 d	120	01/15→	➔	11/15→		24.0124-0259.1 424259	Ø 330 24 22,4 V + S
sDrive 20 d	140	01/15→					
xDrive 20 d	120	11/14→	➔	11/15→		24.0120-0244.1 420244	Ø 300 20 18,4 V + S
sDrive 20 i	141	11/14→	➔	09/15→		24.0124-0259.1 424259	Ø 330 24 22,4 V + S
xDrive 20 d	140	11/14→					
xDrive 20 i	141	11/14→	➔	09/15→		24.0120-0244.1 420244	Ø 300 20 18,4 V + S
xDrive 25 d	170	11/14→					
xDrive 25 i	170	11/14→					
<b>BMW - X2 (F39) 11/17→</b>							
 <b>Bremsbelagsatz, Scheibenbremse</b>							
sDrive 18 d	110	03/18→	➔			13.0460-2601.2 602601	TRW 25617 18,5 + WE / - WK
sDrive 18 i	100	03/18→					
sDrive 18 i	103	03/18→	➔			13.0460-7315.2 607315	ATE 25331 16,2 + WE / - WK
sDrive 20 i	141	11/17→				13.0470-7315.2 LD7315	ATE 25331 16,2 + WE / - WK Ceramic
xDrive 18 d	110	03/18→					
xDrive 20 d	120	11/17→					
xDrive 20 d	140	11/17→					
xDrive 20 i	141	03/18→					
xDrive 25 d	170	11/17→					
<b>Warnkontakt, Bremsbelagverschleiß</b>							
sDrive 18 d	110	03/18→	➔		1	24.8190-0942.2 620942	L= 641
sDrive 18 i	100	03/18→					
sDrive 18 i	103	03/18→					
sDrive 20 i	141	11/17→					
xDrive 18 d	110	03/18→					
xDrive 20 d	120	11/17→					
xDrive 20 d	140	11/17→					
xDrive 20 i	141	03/18→					
xDrive 25 d	170	11/17→					
<b> Brems Scheibe</b>							
sDrive 18 d	110	03/18→	➔			24.0124-0260.1 424260	Ø 307 24 22,4 V + S
sDrive 18 i	100	03/18→					
sDrive 18 i	103	03/18→	➔			24.0110-0401.1 410401	Ø 280 10 8,4 + S
xDrive 18 d	110	03/18→					
sDrive 20 i	141	11/17→	➔			24.0124-0259.1 424259	Ø 330 24 22,4 V + S
xDrive 20 d	120	11/17→					
xDrive 20 d	140	11/17→	➔			24.0120-0244.1 420244	Ø 300 20 18,4 V + S
xDrive 20 i	141	03/18→					
xDrive 25 d	170	11/17→					
<b>BMW - X3 (E83) 01/03→12/11</b>							
 <b>Bremsbelagsatz, Scheibenbremse</b>							
2.0 d ↓	110	11/03→08/07	➔	08/04→		13.0460-7155.2 607155	ATE 21676 20,3 + WE / - WK









**BMW - X3 (E83) 01/03→12/11**











**Bremsbelagsatz, Scheibenbremse**













2.0 d	110	11/03→08/07	←	08/04→	13.0470-7155.2	LD7155	ATE 21676 20,3 + WE / - WK Ceramic
			→	08/04→	13.0460-7079.2	607079	ATE 21282 17,3 + WE / - WK Ceramic
2.0 d	130	03/07→03/09	←		13.0460-7155.2	607155	ATE 21676 20,3 + WE / - WK Ceramic
			→		13.0470-7155.2	LD7155	ATE 21676 20,3 + WE / - WK Ceramic
2.0 i	110	07/05→08/08	←		13.0460-7155.2	607155	ATE 21676 20,3 + WE / - WK Ceramic
			→		13.0470-7155.2	LD7155	ATE 21676 20,3 + WE / - WK Ceramic
2.5 si	160	09/06→08/08	←		13.0460-7155.2	607155	ATE 21676 20,3 + WE / - WK Ceramic
			→		13.0470-7155.2	LD7155	ATE 21676 20,3 + WE / - WK Ceramic
2.5 si xDrive	155	07/06→12/08	←		13.0460-7155.2	607155	ATE 21676 20,3 + WE / - WK Ceramic
			→		13.0470-7155.2	LD7155	ATE 21676 20,3 + WE / - WK Ceramic
3.0 d	150	01/04→08/05	←		13.0460-7079.2	607079	ATE 21282 17,3 + WE / - WK Ceramic
			→		13.0470-7079.2	LD7079	ATE 21282 17,3 + WE / - WK Ceramic
3.0 d	155	09/05→08/08	←		13.0460-7079.2	607079	ATE 21282 17,3 + WE / - WK Ceramic
			→		13.0470-7079.2	LD7079	ATE 21282 17,3 + WE / - WK Ceramic
3.0 d	160	09/05→08/08	←		13.0460-7079.2	607079	ATE 21282 17,3 + WE / - WK Ceramic
			→		13.0470-7079.2	LD7079	ATE 21282 17,3 + WE / - WK Ceramic
3.0 i xDrive	170	01/04→08/06	←		13.0460-7079.2	607079	ATE 21282 17,3 + WE / - WK Ceramic
			→		13.0470-7079.2	LD7079	ATE 21282 17,3 + WE / - WK Ceramic
3.0 si	200	09/06→08/08	←		13.0460-7079.2	607079	ATE 21282 17,3 + WE / - WK Ceramic
			→		13.0470-7079.2	LD7079	ATE 21282 17,3 + WE / - WK Ceramic
xDrive 25 i	160	09/08→12/11	←		13.0460-7079.2	607079	ATE 21282 17,3 + WE / - WK Ceramic
			→		13.0470-7079.2	LD7079	ATE 21282 17,3 + WE / - WK Ceramic
xDrive 30 d	155	09/08→08/10	←		13.0460-7079.2	607079	ATE 21282 17,3 + WE / - WK Ceramic
			→		13.0470-7079.2	LD7079	ATE 21282 17,3 + WE / - WK Ceramic
xDrive 30 d	160	09/08→08/10	←		13.0460-7079.2	607079	ATE 21282 17,3 + WE / - WK Ceramic
			→		13.0470-7079.2	LD7079	ATE 21282 17,3 + WE / - WK Ceramic
2.5 i	141	01/04→08/06	←	03/04→	13.0460-7155.2	607155	ATE 21676 20,3 + WE / - WK Ceramic
			→	03/04→	13.0470-7155.2	LD7155	ATE 21676 20,3 + WE / - WK Ceramic
3.0 sd	210	09/06→08/08	←		13.0460-7078.2	607078	ATE 21486 19,5 + WE / - WK Ceramic
			→		13.0460-7079.2	607079	ATE 21282 17,3 + WE / - WK Ceramic
xDrive 18 d	100	04/09→12/11	←	→ 08/10	13.0460-7155.2	607155	ATE 21676 20,3 + WE / - WK Ceramic
			→	→ 08/10	13.0470-7155.2	LD7155	ATE 21676 20,3 + WE / - WK Ceramic
xDrive 18 d	105	09/08→12/11	←	→ 08/10	13.0460-7079.2	607079	ATE 21282 17,3 + WE / - WK Ceramic
			→	→ 08/10	13.0470-7079.2	LD7079	ATE 21282 17,3 + WE / - WK Ceramic
xDrive 20 i	110	09/08→08/11	←	→ 08/10	13.0460-7155.2	607155	ATE 21676 20,3 + WE / - WK Ceramic
			→	→ 08/10	13.0470-7155.2	LD7155	ATE 21676 20,3 + WE / - WK Ceramic
xDrive 30 i	200	09/08→12/11	←	→ 08/10	13.0460-7079.2	607079	ATE 21282 17,3 + WE / - WK Ceramic
			→	→ 08/10	13.0470-7079.2	LD7079	ATE 21282 17,3 + WE / - WK Ceramic
xDrive 20 d	120	09/07→08/10	←	09/08→	13.0460-7155.2	607155	ATE 21676 20,3 + WE / - WK Ceramic
			→	09/08→	13.0470-7155.2	LD7155	ATE 21676 20,3 + WE / - WK Ceramic
xDrive 20 d	130	09/07→08/10	←	09/08→	13.0460-7079.2	607079	ATE 21282 17,3 + WE / - WK Ceramic
			→	09/08→	13.0470-7079.2	LD7079	ATE 21282 17,3 + WE / - WK Ceramic
xDrive 35 d	210	09/08→08/11	←	→ 08/10	13.0460-7078.2	607078	ATE 21486 19,5 + WE / - WK Ceramic
			→	→ 08/10	13.0460-7079.2	607079	ATE 21282 17,3 + WE / - WK Ceramic
xDrive 35 d	210	09/08→08/11	←	→ 08/10	13.0460-7079.2	607079	ATE 21282 17,3 + WE / - WK Ceramic
			→	→ 08/10	13.0470-7079.2	LD7079	ATE 21282 17,3 + WE / - WK Ceramic

**Warnkontakt, Bremsbelagverschleiß**













2.0 d	110	11/03→08/07	←	08/04→	1	24.8190-0240.2	620240	L= 735
			→	08/04→	1	24.8190-0241.2	620241	L= 1.055
2.0 d	130	03/07→03/09	←		1	24.8190-0240.2	620240	L= 735
			→		1	24.8190-0241.2	620241	L= 1.055
2.0 i	110	07/05→08/08	←		1	24.8190-0240.2	620240	L= 735
			→		1	24.8190-0241.2	620241	L= 1.055
2.5 si	160	09/06→08/08	←		1	24.8190-0240.2	620240	L= 735
			→		1	24.8190-0241.2	620241	L= 1.055
2.5 si xDrive	155	07/06→12/08	←		1	24.8190-0240.2	620240	L= 735
			→		1	24.8190-0241.2	620241	L= 1.055
3.0 d	150	01/04→08/05	←		1	24.8190-0240.2	620240	L= 735
			→		1	24.8190-0241.2	620241	L= 1.055
3.0 d	155	09/05→08/08	←		1	24.8190-0240.2	620240	L= 735
			→		1	24.8190-0241.2	620241	L= 1.055
3.0 d	160	09/05→08/08	←		1	24.8190-0240.2	620240	L= 735
			→		1	24.8190-0241.2	620241	L= 1.055
3.0 i xDrive	170	01/04→08/06	←		1	24.8190-0240.2	620240	L= 735
			→		1	24.8190-0241.2	620241	L= 1.055
3.0 si	200	09/06→08/08	←		1	24.8190-0240.2	620240	L= 735
			→		1	24.8190-0241.2	620241	L= 1.055
xDrive 25 i	160	09/08→12/11	←		1	24.8190-0240.2	620240	L= 735
			→		1	24.8190-0241.2	620241	L= 1.055
xDrive 30 d	155	09/08→08/10	←		1	24.8190-0240.2	620240	L= 735
			→		1	24.8190-0241.2	620241	L= 1.055
xDrive 30 d	160	09/08→08/10	←		1	24.8190-0240.2	620240	L= 735
			→		1	24.8190-0241.2	620241	L= 1.055
2.5 i	141	01/04→08/06	←	03/04→	1	24.8190-0240.2	620240	L= 735
			→	03/04→	1	24.8190-0241.2	620241	L= 1.055
3.0 sd	210	09/06→08/08	←		1	24.8190-0254.2	620254	L= 745
			→		1	24.8190-0241.2	620241	L= 1.055
xDrive 18 d	100	04/09→12/11	←	→ 08/10	1	24.8190-0240.2	620240	L= 735
			→	→ 08/10	1	24.8190-0241.2	620241	L= 1.055
xDrive 18 d	105	09/08→12/11	←	→ 08/10	1	24.8190-0240.2	620240	L= 735
			→	→ 08/10	1	24.8190-0241.2	620241	L= 1.055
xDrive 20 i	110	09/08→08/11	←	→ 08/10	1	24.8190-0240.2	620240	L= 735
			→	→ 08/10	1	24.8190-0241.2	620241	L= 1.055
xDrive 30 i	200	09/08→12/11	←	→ 08/10	1	24.8190-0240.2	620240	L= 735
			→	→ 08/10	1	24.8190-0241.2	620241	L= 1.055
xDrive 20 d	120	09/07→08/10	←	09/08→	1	24.8190-0240.2	620240	L= 735
			→	09/08→	1	24.8190-0241.2	620241	L= 1.055
xDrive 20 d	130	09/07→08/10	←	09/08→	1	24.8190-0240.2	620240	L= 735
			→	09/08→	1	24.8190-0241.2	620241	L= 1.055
xDrive 35 d	210	09/08→08/11	←	→ 08/10	1	24.8190-0254.2	620254	L= 745
			→	→ 08/10	1	24.8190-0241.2	620241	L= 1.055









	kW			 	! #		
<b>BMW - X3 (E83) 01/03→12/11</b>							
<b>Warnkontakt, Bremsbelagverschleiß</b>							
xDrive 35 d	210	09/08→08/11	➡	→ 08/10	1	24.8190-0241.2 620241	L= 1.055
<b> Brems Scheibe</b>							
2.0 d	110	11/03→08/07	←	08/04→		24.0125-0160.1 425160	Ø 325 25 23,4 V + S
			➡	08/04→		24.0325-0160.1 525160	Ø 325 25 22,6 V + S
			➡	08/04→		24.0122-0224.1 422224	Ø 320 22 20,4 V + S
						24.0322-0224.1 522224	Ø 320 22 19,6 V + S
2.0 d	130	03/07→03/09	←			24.0125-0160.1 425160	Ø 325 25 23,4 V + S
2.0 i	110	07/05→08/08	←			24.0325-0160.1 525160	Ø 325 25 22,6 V + S
2.5 si	160	09/06→08/08	←			24.0122-0224.1 422224	Ø 320 22 20,4 V + S
2.5 si xDrive	155	07/06→12/08	➡			24.0322-0224.1 522224	Ø 320 22 19,6 V + S
3.0 d	150	01/04→08/05	➡			24.0122-0224.1 422224	Ø 320 22 20,4 V + S
3.0 d	155	09/05→08/08	➡			24.0322-0224.1 522224	Ø 320 22 19,6 V + S
3.0 d	160	09/05→08/08	➡				
3.0 i xDrive	170	01/04→08/06	➡				
3.0 si	200	09/06→08/08	➡				
xDrive 25 i	160	09/08→12/11	➡				
xDrive 30 d	155	09/08→08/10	➡				
xDrive 30 d	160	09/08→08/10	➡				
2.5 i	141	01/04→08/06	←	03/04→		24.0125-0160.1 425160	Ø 325 25 23,4 V + S
			➡	03/04→		24.0325-0160.1 525160	Ø 325 25 22,6 V + S
			➡	03/04→		24.0122-0224.1 422224	Ø 320 22 20,4 V + S
						24.0322-0224.1 522224	Ø 320 22 19,6 V + S
3.0 sd	210	09/06→08/08	←			24.0130-0109.1 430109	Ø 332 29,9 28,4 V + S
			➡			24.0330-0109.1 530109	Ø 332 29,9 27,6 V + S
			➡			24.0122-0224.1 422224	Ø 320 22 20,4 V + S
						24.0322-0224.1 522224	Ø 320 22 19,6 V + S
xDrive 18 d	100	04/09→12/11	←	→ 08/10		24.0125-0160.1 425160	Ø 325 25 23,4 V + S
xDrive 18 d	105	09/08→12/11	←	→ 08/10		24.0325-0160.1 525160	Ø 325 25 22,6 V + S
xDrive 20 i	110	09/08→08/11	➡	→ 08/10		24.0122-0224.1 422224	Ø 320 22 20,4 V + S
xDrive 30 i	200	09/08→12/11	➡	→ 08/10		24.0322-0224.1 522224	Ø 320 22 19,6 V + S
xDrive 20 d	120	09/07→08/10	←	09/08→		24.0125-0160.1 425160	Ø 325 25 23,4 V + S
			➡	09/08→		24.0325-0160.1 525160	Ø 325 25 22,6 V + S
xDrive 20 d	130	09/07→08/10	➡	09/08→		24.0122-0224.1 422224	Ø 320 22 20,4 V + S
						24.0322-0224.1 522224	Ø 320 22 19,6 V + S
xDrive 35 d	210	09/08→08/11	←	→ 08/10		24.0130-0109.1 430109	Ø 332 29,9 28,4 V + S
			➡	→ 08/10		24.0330-0109.1 530109	Ø 332 29,9 27,6 V + S
			➡	→ 08/10		24.0122-0224.1 422224	Ø 320 22 20,4 V + S
						24.0322-0224.1 522224	Ø 320 22 19,6 V + S
<b>BMW - X3 (F25) 09/10→</b>							
<b> Bremsbelagsatz, Scheibenbremse</b>							
sDrive 18 d	100	08/11→	←			13.0460-3857.2 603857	BOS 25199 19,6 + WE / - WK
sDrive 18 d	105	08/11→	←			13.0470-3857.2 LD3857	BOS 25199 19,6 + WE / - WK
sDrive 18 d	110	02/14→	←				Ceramic
sDrive 20 i	125	04/14→08/17	➡			13.0460-2760.2 602760	TRW 24561 17,7 + WE / - WK
sDrive 20 i	135	02/14→	➡				+ Zub
xDrive 20 d	120	09/10→	➡			13.0470-2760.2 LD2760	TRW 24561 17,7 + WE / - WK
xDrive 20 d	135	09/10→	➡				+ Zub Ceramic
xDrive 20 d	140	02/14→	➡				
xDrive 20 i	135	09/11→	➡				
xDrive 28 i	190	04/11→	➡				
xDrive 30 d	155	05/11→	➡				
xDrive 30 d	183	04/15→	➡				
xDrive 30 d	190	05/11→	➡				
xDrive 30 d	204	06/16→	➡				
xDrive 30 d	210	04/14→	➡				
xDrive 35 i	225	09/10→	➡				
xDrive 28 i	180	08/11→	←	03/12→		13.0460-3857.2 603857	BOS 25199 19,6 + WE / - WK
			➡	03/12→		13.0470-3857.2 LD3857	BOS 25199 19,6 + WE / - WK
			➡	03/12→		13.0460-2760.2 602760	TRW 24561 17,7 + WE / - WK
						13.0470-2760.2 LD2760	TRW 24561 17,7 + WE / - WK
			➡				+ Zub Ceramic
xDrive 35 d	230	09/11→	←			13.0460-3857.2 603857	BOS 25199 19,6 + WE / - WK
			➡			13.0460-2760.2 602760	TRW 24561 17,7 + WE / - WK
			➡			13.0470-2760.2 LD2760	TRW 24561 17,7 + WE / - WK
							+ Zub Ceramic









	kW			 	! #		
<b>BMW - X3 (F25) 09/10→</b>							
<b>Warnkontakt, Bremsbelagverschleiß</b>							
sDrive 18 d	100	08/11→	←	<input type="checkbox"/>	1	24.8190-0309.2 620309	L= 954
sDrive 18 d	105	08/11→	→		1	24.8190-0310.2 620310	L= 1.243
sDrive 18 d	110	02/14→					
sDrive 20 i	125	04/14→08/17					
sDrive 20 i	135	02/14→					
xDrive 20 d	120	09/10→					
xDrive 20 d	135	09/10→					
xDrive 20 d	140	02/14→					
xDrive 20 i	135	09/11→					
xDrive 28 i	190	04/11→					
xDrive 30 d	155	05/11→					
xDrive 30 d	183	04/15→					
xDrive 30 d	190	05/11→					
xDrive 30 d	204	06/16→					
xDrive 30 d	210	04/14→					
xDrive 35 d	230	09/11→					
xDrive 35 i	225	09/10→					
xDrive 28 i	180	08/11→	←	<input type="checkbox"/> ; 03/12→	1	24.8190-0309.2 620309	L= 954
			→	03/12→	1	24.8190-0310.2 620310	L= 1.243
<b> Bremsscheibe</b>							
sDrive 18 d	100	08/11→	←			24.0128-0254.1 428254	Ø 328 28 26,4 V + S
sDrive 18 d	105	08/11→				24.0328-0254.1 528254	Ø 328 28 25,6 V + S
sDrive 18 d	110	02/14→					
sDrive 20 i	125	04/14→08/17	→	+ eFSB		24.0120-0234.1 420234	Ø 330 20 18,4 V + S
sDrive 20 i	135	02/14→				24.0320-0234.1 520234	Ø 330 20 17,6 V + S
xDrive 20 d	120	09/10→					
xDrive 20 d	135	09/10→					
xDrive 20 d	140	02/14→					
xDrive 20 i	135	09/11→					
xDrive 28 i	190	04/11→					
xDrive 30 d	155	05/11→					
xDrive 30 d	183	04/15→					
xDrive 30 d	190	05/11→					
xDrive 30 d	204	06/16→					
xDrive 30 d	210	04/14→					
xDrive 35 d	230	09/11→					
xDrive 35 i	225	09/10→					
xDrive 28 i	180	08/11→	←	03/12→		24.0128-0254.1 428254	Ø 328 28 26,4 V + S
						24.0328-0254.1 528254	Ø 328 28 25,6 V + S
			→	03/12→; + eFSB		24.0120-0234.1 420234	Ø 330 20 18,4 V + S
						24.0320-0234.1 520234	Ø 330 20 17,6 V + S
<b>BMW - X3 (G01) 07/17→</b>							
<b> Bremsbelagsatz, Scheibenbremse</b>							
sDrive 20 i	135	12/17→	→	für Fahrzeuge mit Sportpaket		13.0460-2716.2 602716	TRW 24703 17,8 + WE / - WK + Zub
sDrive 20 i 1.6	125	12/17→				13.0470-2716.2 LD2716	TRW 24703 17,8 + WE / - WK + Zub Ceramic
xDrive 20 d	120	10/17→					
xDrive 20 d	140	10/17→					
xDrive 20 i	135	03/18→					
xDrive 25 d	170	04/18→					
xDrive 30d	195	07/17→					
xDrive 30 i	185	12/17→					
xDrive M40 d	240	08/18→	→			13.0460-2716.2 602716	TRW 24703 17,8 + WE / - WK + Zub
xDrive M40 i	265	10/17→				13.0470-2716.2 LD2716	TRW 24703 17,8 + WE / - WK + Zub Ceramic
<b> Bremsscheibe</b>							
sDrive 20 i	135	12/17→	←	<input type="checkbox"/> ; für Fahrzeuge mit Sportpaket		24.0136-0132.2 436132	Ø 348 36 34,4 V Bremsscheibe zweiteilig / + S
sDrive 20 i 1.6	125	12/17→				24.0136-0133.2 436133	Ø 348 36 34,4 V Bremsscheibe zweiteilig / + S
xDrive 20 d	120	10/17→	←	<input type="checkbox"/> ; für Fahrzeuge mit Sportpaket			
xDrive 20 d	140	10/17→					
xDrive 20 i	135	03/18→					
xDrive 25 d	170	04/18→	→	für Fahrzeuge mit Sportpaket		24.0124-0262.2 424262	Ø 345 24 22,4 V Bremsscheibe zweiteilig / + S
xDrive 30 i	185	12/17→					
xDrive 30d	195	07/17→	←	<input type="checkbox"/> ; 10/17→; für Fahrzeuge mit Sportpaket		24.0136-0132.2 436132	Ø 348 36 34,4 V Bremsscheibe zweiteilig / + S
			←	<input type="checkbox"/> ; 10/17→; für Fahrzeuge mit Sportpaket		24.0136-0133.2 436133	Ø 348 36 34,4 V Bremsscheibe zweiteilig / + S
			→	10/17→; für Fahrzeuge mit Sportpaket		24.0124-0262.2 424262	Ø 345 24 22,4 V Bremsscheibe zweiteilig / + S
xDrive M40 d	240	08/18→	←	<input type="checkbox"/>		24.0136-0132.2 436132	Ø 348 36 34,4 V Bremsscheibe zweiteilig / + S
			←	<input type="checkbox"/>		24.0136-0133.2 436133	Ø 348 36 34,4 V Bremsscheibe zweiteilig / + S
↓							







	kW			 	! #		
<b>BMW - X3 (G01) 07/17→</b>							
 <b>Bremsscheibe</b>							
xDrive M40 d	240	08/18→	→			24.0124-0262.2 424262	Ø 345 24 22,4 V Bremsscheibe zweiteilig / + S
xDrive M40 i	265	10/17→	←			24.0136-0132.2 436132	Ø 348 36 34,4 V Bremsscheibe zweiteilig / + S
			→			24.0136-0133.2 436133	Ø 348 36 34,4 V Bremsscheibe zweiteilig / + S
			→			24.0124-0262.2 424262	Ø 345 24 22,4 V Bremsscheibe zweiteilig / + S
<b>BMW - X4 (F26) 05/13→03/18</b>							
 <b>Bremsbelagsatz, Scheibenbremse</b>							
xDrive 20 d	120	04/14→03/18	←			13.0460-3857.2 603857	BOS 25199 19,6 + WE / - WK
xDrive 20 d	140	04/14→03/18				13.0470-3857.2 LD3857	BOS 25199 19,6 + WE / - WK Ceramic
xDrive 20 i	135	04/14→03/18					
xDrive 28 i	180	04/14→03/18					
xDrive 30 d	155	04/14→03/18	→			13.0460-2760.2 602760	TRW 24561 17,7 + WE / - WK + Zub
xDrive 30 d	183	04/15→03/18					
xDrive 30 d	190	04/14→03/18				13.0470-2760.2 LD2760	TRW 24561 17,7 + WE / - WK + Zub Ceramic
xDrive 30 d	204	04/14→03/18					
xDrive 30 d	210	04/14→03/18					
xDrive 35 i	225	04/14→03/18					
xDrive 35 d	230	04/14→03/18	←			13.0460-3857.2 603857	BOS 25199 19,6 + WE / - WK
			→			13.0460-2760.2 602760	TRW 24561 17,7 + WE / - WK + Zub
						13.0470-2760.2 LD2760	TRW 24561 17,7 + WE / - WK + Zub Ceramic
<b>Warnkontakt, Bremsbelagverschleiß</b>							
M 40 i	265	12/15→03/18	←	<input checked="" type="checkbox"/>	1	24.8190-0309.2 620309	L= 954
xDrive 20 d	120	04/14→03/18					
xDrive 20 d	140	04/14→03/18	→		1	24.8190-0310.2 620310	L= 1.243
xDrive 20 i	135	04/14→03/18					
xDrive 28 i	180	04/14→03/18					
xDrive 30 d	155	04/14→03/18					
xDrive 30 d	183	04/15→03/18					
xDrive 30 d	190	04/14→03/18					
xDrive 30 d	204	04/14→03/18					
xDrive 30 d	210	04/14→03/18					
xDrive 35 d	230	04/14→03/18					
xDrive 35 i	225	04/14→03/18					
 <b>Bremsscheibe</b>							
M 40 i	265	12/15→03/18	→			24.0120-0234.1 420234	Ø 330 20 18,4 V + S
						24.0320-0234.1 520234	Ø 330 20 17,6 V + S
xDrive 20 d	120	04/14→03/18	←			24.0128-0254.1 428254	Ø 328 28 26,4 V + S
xDrive 20 d	140	04/14→03/18				24.0328-0254.1 528254	Ø 328 28 25,6 V + S
xDrive 20 i	135	04/14→03/18					
xDrive 28 i	180	04/14→03/18	→			24.0120-0234.1 420234	Ø 330 20 18,4 V + S
xDrive 30 d	155	04/14→03/18				24.0320-0234.1 520234	Ø 330 20 17,6 V + S
xDrive 30 d	183	04/15→03/18					
xDrive 30 d	190	04/14→03/18					
xDrive 30 d	204	04/14→03/18					
xDrive 30 d	210	04/14→03/18					
xDrive 35 d	230	04/14→03/18					
xDrive 35 i	225	04/14→03/18					
<b>BMW - X4 (G02) 04/18→</b>							
 <b>Bremsbelagsatz, Scheibenbremse</b>							
M40 d xDrive	240	04/18→	→			13.0460-2716.2 602716	TRW 24703 17,8 + WE / - WK + Zub
M40 i xDrive	260	04/18→				13.0470-2716.2 LD2716	TRW 24703 17,8 + WE / - WK + Zub Ceramic
xDrive 20 d	140	04/18→	→			13.0460-2716.2 602716	TRW 24703 17,8 + WE / - WK + Zub
xDrive 20 i	135	04/18→					
xDrive 25 d	170	04/18→					
xDrive 30 d	195	04/18→				13.0470-2716.2 LD2716	TRW 24703 17,8 + WE / - WK + Zub Ceramic
xDrive 30 i	185	04/18→					
 <b>Bremsscheibe</b>							
M40 d xDrive	240	04/18→	←	<input checked="" type="checkbox"/>		24.0136-0132.2 436132	Ø 348 36 34,4 V Bremsscheibe zweiteilig / + S
			←	<input checked="" type="checkbox"/>		24.0136-0133.2 436133	Ø 348 36 34,4 V Bremsscheibe zweiteilig / + S
M40 i xDrive	260	04/18→					
↓							

















	kW			 	! #		
<b>BMW - X4 (G02) 04/18→</b>							
<b>Bremsscheibe</b>							
M40 d xDrive M40 i xDrive	240 260	04/18→ 04/18→	→			24.0124-0262.2 424262	Ø 345 24 22,4 V Bremsscheibe zweiteilig / + S
xDrive 20 d xDrive 25 d	140 170	04/18→ 04/18→	←	 ; für Fahrzeuge mit Sportpaket		24.0136-0132.2 436132	Ø 348 36 34,4 V Bremsscheibe zweiteilig / + S
			←	 ; für Fahrzeuge mit Sportpaket		24.0136-0133.2 436133	Ø 348 36 34,4 V Bremsscheibe zweiteilig / + S
			→	für Fahrzeuge mit Sportpaket		24.0124-0262.2 424262	Ø 345 24 22,4 V Bremsscheibe zweiteilig / + S
xDrive 20 i xDrive 30 i	135 185	04/18→ 04/18→	←	 ; für Fahrzeuge mit Sportpaket		24.0136-0132.2 436132	Ø 348 36 34,4 V Bremsscheibe zweiteilig / + S
			←	 ; für Fahrzeuge mit Sportpaket		24.0136-0133.2 436133	Ø 348 36 34,4 V Bremsscheibe zweiteilig / + S
xDrive 30 d	195	04/18→	←	 ; für Fahrzeuge mit Sportpaket		24.0136-0132.2 436132	Ø 348 36 34,4 V Bremsscheibe zweiteilig / + S
			←	 ; für Fahrzeuge mit Sportpaket		24.0136-0133.2 436133	Ø 348 36 34,4 V Bremsscheibe zweiteilig / + S
			→	für Fahrzeuge mit Sportpaket		24.0124-0262.2 424262	Ø 345 24 22,4 V Bremsscheibe zweiteilig / + S
<b>BMW - X5 (E53) 05/00→02/07</b>							
<b>Bremsbelagsatz, Scheibenbremse</b>							
3.0 d	135	05/01→12/03	←	→ 09/03		13.0460-7078.2 607078	ATE 21486 19,5 + WE / - WK
			→	→ 09/03		13.0470-7078.2 LD7078	ATE 21486 19,5 + WE / - WK Ceramic
3.0 d	155	09/03→12/06	←	10/03→		13.0460-7078.2 607078	ATE 21486 19,5 + WE / - WK
			→	10/03→		13.0470-7078.2 LD7078	ATE 21486 19,5 + WE / - WK Ceramic
3.0 d	160	12/03→12/06	←			13.0460-7078.2 607078	ATE 21486 19,5 + WE / - WK
			→			13.0470-7078.2 LD7078	ATE 21486 19,5 + WE / - WK Ceramic
3.0 i	170	05/00→12/06	←			13.0460-7078.2 607078	ATE 21486 19,5 + WE / - WK
			→			13.0470-7078.2 LD7078	ATE 21486 19,5 + WE / - WK Ceramic
4.4 i	210	05/00→12/03	←	→ 09/03		13.0460-7078.2 607078	ATE 21486 19,5 + WE / - WK
			→	→ 09/03		13.0470-7078.2 LD7078	ATE 21486 19,5 + WE / - WK Ceramic
4.4 i	235	12/03→09/06	←	nicht für Sonderfahrzeuge		13.0460-7078.2 607078	ATE 21486 19,5 + WE / - WK
			←	für Sonderfahrzeuge		13.0460-7170.2 607170	ATE 23448 20,8 + WE / - WK
			→			13.0470-7078.2 LD7078	ATE 21486 19,5 + WE / - WK Ceramic
4.6 is	255	02/02→12/03	←	→ 09/03		13.0460-7170.2 607170	ATE 23448 20,8 + WE / - WK
			→	→ 09/03		13.0470-7078.2 LD7078	ATE 21486 19,5 + WE / - WK Ceramic
4.8 is	265	04/04→09/06	←			13.0460-7170.2 607170	ATE 23448 20,8 + WE / - WK
			→			13.0470-7078.2 LD7078	ATE 21486 19,5 + WE / - WK Ceramic
<b>Warnkontakt, Bremsbelagverschleiß</b>							
3.0 d	135	05/01→12/03	←	→ 09/03	1	24.8190-0225.2 620225	L= 794
4.4 i	210	05/00→12/03	→	→ 09/03	1	24.8190-0226.2 620226	L= 712
4.6 is	255	02/02→12/03	→	→ 09/03	1	24.8190-0226.2 620226	L= 712
3.0 d	155	09/03→12/06	←	10/03→	1	24.8190-0225.2 620225	L= 794
			→	10/03→	1	24.8190-0226.2 620226	L= 712
3.0 d	160	12/03→12/06	←		1	24.8190-0225.2 620225	L= 794
3.0 i	170	05/00→12/06	→		1	24.8190-0226.2 620226	L= 712
4.4 i	235	12/03→09/06	→		1	24.8190-0226.2 620226	L= 712
4.8 is	265	04/04→09/06	→		1	24.8190-0226.2 620226	L= 712
↓							

















	kW			 	! #		
<b>BMW - X5 (E53) 05/00→02/07</b>							
 <b>Bremsscheibe</b>							
3.0 d 4.4 i	135 210	05/01→12/03 05/00→12/03	←	→ 09/03		24.0130-0109.1 430109	Ø 332 29,9 28,4 V + S
			→	→ 09/03		24.0330-0109.1 530109	Ø 332 29,9 27,6 V + S
3.0 d	155	09/03→12/06	←	10/03→		24.0130-0109.1 430109	Ø 332 29,9 28,4 V + S
			→	10/03→		24.0330-0109.1 530109	Ø 332 29,9 27,6 V + S
			←			24.0112-0152.1 412152	Ø 324 12 10,4
			→			24.0312-0152.1 512152	Ø 324 12 9,6
3.0 d 3.0 i	160 170	12/03→12/06 05/00→12/06	←			24.0130-0109.1 430109	Ø 332 29,9 28,4 V + S
			→			24.0330-0109.1 530109	Ø 332 29,9 27,6 V + S
			←			24.0112-0152.1 412152	Ø 324 12 10,4
			→			24.0312-0152.1 512152	Ø 324 12 9,6
4.4 i	235	12/03→09/06	←	nicht für Sonderfahrzeuge		24.0130-0109.1 430109	Ø 332 29,9 28,4 V + S
			→			24.0330-0109.1 530109	Ø 332 29,9 27,6 V + S
			←	für Sonderfahrzeuge		24.0136-0104.1 436104	Ø 356 36 34,4 V
			→			24.0120-0191.1 420191	Ø 324 20 18,4 V
4.6 is	255	02/02→12/03	←	→ 09/03		24.0136-0104.1 436104	Ø 356 36 34,4 V
			→	→ 09/03		24.0120-0191.1 420191	Ø 324 20 18,4 V
4.8 is	265	04/04→09/06	←			24.0136-0104.1 436104	Ø 356 36 34,4 V
			→			24.0120-0191.1 420191	Ø 324 20 18,4 V
<b>BMW - X5 (E70) 02/06→07/13</b>							
 <b>Bremsbelagsatz, Scheibenbremse</b>							
3.0 d 3.0 d xDrive 35 i xDrive 40 d xDrive 40 i	155 173 225 225 225	02/07→09/08 02/07→09/08 09/10→06/13 09/10→06/13 01/12→06/13	←			13.0460-7231.2 607231	ATE 24170 20,2 + WE / - WK
			→			13.0470-7231.2 LD7231	ATE 24170 20,2 + WE / - WK Ceramic
			←			13.0460-7232.2 607232	ATE 21282 17,3 + WE / - WK
			→			13.0470-7232.2 LD7232	ATE 21282 17,3 + WE / - WK Ceramic
3.0 sd	210	10/07→03/10	←	10/08→		13.0460-7231.2 607231	ATE 24170 20,2 + WE / - WK
			←	→ 09/08		13.0470-7231.2 LD7231	ATE 24170 20,2 + WE / - WK Ceramic
			→	→ 09/09		13.0460-7169.2 607169	ATE 24172 19,0 + WE / - WK
			→	03/10→		13.0470-7169.2 LD7169	ATE 24172 19,0 + WE / - WK Ceramic
			→	10/09→ 02/10		13.0460-7232.2 607232	ATE 23309 17,3 + WE / - WK
			→			13.0470-7232.2 LD7232	ATE 23309 17,3 + WE / - WK Ceramic
3.0 si	200	02/06→09/08	←	01/07→		13.0460-7231.2 607231	ATE 24170 20,2 + WE / - WK
			→	01/07→		13.0470-7231.2 LD7231	ATE 24170 20,2 + WE / - WK Ceramic
			←			13.0460-7232.2 607232	ATE 21282 17,3 + WE / - WK
			→			13.0470-7232.2 LD7232	ATE 21282 17,3 + WE / - WK Ceramic
4.8 i xDrive	261	02/07→09/08	←			13.0460-7231.2 607231	ATE 24170 20,2 + WE / - WK
			→			13.0460-7239.2 607239	ATE 24172 19,0 + WE / - WK
			←			13.0460-7169.2 607169	ATE 23309 17,3 + WE / - WK
			→			13.0470-7169.2 LD7169	ATE 23309 17,3 + WE / - WK Ceramic
M 50 d	280	08/11→06/13	←	06/12→		13.0460-7261.2 607261	ATE 24436 19,7 + WE / - WK
			→	06/12→		13.0460-7169.2 607169	ATE 23309 17,3 + WE / - WK
			→			13.0470-7169.2 LD7169	ATE 23309 17,3 + WE / - WK Ceramic
xDrive 30 d xDrive 30 d xDrive 35 d	155 173 210	10/08→07/13 10/08→03/10 09/08→06/13	←			13.0460-7231.2 607231	ATE 24170 20,2 + WE / - WK
			→			13.0470-7231.2 LD7231	ATE 24170 20,2 + WE / - WK Ceramic
			→	03/10→		13.0460-7232.2 607232	ATE 21282 17,3 + WE / - WK
↓							









	kW			 	! #		
<b>BMW - X5 (E70) 02/06→07/13</b>							
<b> Bremsbelagsatz, Scheibenbremse</b>							
xDrive 30 d xDrive 30 d xDrive 35 d	155 173 210	10/08→07/13 10/08→03/10 09/08→06/13	➡	03/10→		13.0470-7232.2 LD7232	ATE 21282 17,3 + WE / - WK Ceramic
			➡	→ 02/10		13.0460-7232.2 607232 13.0470-7232.2 LD7232	ATE 21282 17,3 + WE / - WK ATE 21282 17,3 + WE / - WK Ceramic
xDrive 30 d	180	04/10→07/13	⬅	09/10→		13.0460-7231.2 607231 13.0470-7231.2 LD7231	ATE 24170 20,2 + WE / - WK ATE 24170 20,2 + WE / - WK Ceramic
			➡	09/10→		13.0460-7232.2 607232 13.0470-7232.2 LD7232	ATE 21282 17,3 + WE / - WK ATE 21282 17,3 + WE / - WK Ceramic
xDrive 30 i xDrive 30 i	171 200	09/08→12/10 09/08→03/10	⬅			13.0460-7231.2 607231 13.0470-7231.2 LD7231	ATE 24170 20,2 + WE / - WK ATE 24170 20,2 + WE / - WK Ceramic
			⬅	03/10→		13.0460-7231.2 607231 13.0470-7231.2 LD7231	ATE 24170 20,2 + WE / - WK ATE 24170 20,2 + WE / - WK Ceramic
			➡	→ 02/10		13.0460-7232.2 607232 13.0470-7232.2 LD7232	ATE 21282 17,3 + WE / - WK ATE 21282 17,3 + WE / - WK Ceramic
			➡	03/10→		13.0460-7232.2 607232 13.0470-7232.2 LD7232	ATE 21282 17,3 + WE / - WK ATE 21282 17,3 + WE / - WK Ceramic
xDrive 35 i	235	02/12→06/13	⬅			13.0460-7231.2 607231	ATE 24170 20,2 + WE / - WK
			➡			13.0460-7232.2 607232 13.0470-7232.2 LD7232	ATE 21282 17,3 + WE / - WK ATE 21282 17,3 + WE / - WK Ceramic
xDrive 48 i	261	09/08→06/13	⬅	03/10→		13.0460-7231.2 607231 13.0460-7239.2 607239	ATE 24170 20,2 + WE / - WK ATE 24172 19,0 + WE / - WK
			⬅	→ 02/10		13.0460-7231.2 607231 13.0460-7239.2 607239	ATE 24170 20,2 + WE / - WK ATE 24172 19,0 + WE / - WK
			➡	03/10→		13.0460-7169.2 607169 13.0470-7169.2 LD7169	ATE 23309 17,3 + WE / - WK ATE 23309 17,3 + WE / - WK Ceramic
			➡	→ 02/10		13.0460-7169.2 607169 13.0470-7169.2 LD7169	ATE 23309 17,3 + WE / - WK ATE 23309 17,3 + WE / - WK Ceramic
xDrive 50 i	300	07/09→06/13	⬅	03/10→; nicht für gepanzerte Fahrzeuge		13.0460-7261.2 607261	ATE 24436 19,7 + WE / - WK
			➡	03/10→		13.0460-7169.2 607169 13.0470-7169.2 LD7169	ATE 23309 17,3 + WE / - WK ATE 23309 17,3 + WE / - WK Ceramic
<b>Warnkontakt, Bremsbelagsverschleiß</b>							
3.0 d 3.0 d	155 173	02/07→09/08 02/07→09/08	⬅	<input type="checkbox"/>	1	24.8190-0268.2 620268	L= 905
			➡		1	24.8190-0269.2 620269	L= 965
3.0 sd	210	10/07→03/10	⬅	<input type="checkbox"/> ; 10/08→	1	24.8190-0268.2 620268	L= 905
			⬅	<input type="checkbox"/> ; → 09/08	1	24.8190-0270.2 620270	L= 898
			➡	03/10→	1	24.8190-0028.2 620028 24.8190-0290.2 620290	L= 977 L= 1.002
			➡	→ 09/09	1	24.8190-0269.2 620269	L= 965
			➡	10/09→ 02/10	1	24.8190-0269.2 620269	L= 965
3.0 si	200	02/06→09/08	⬅	<input type="checkbox"/> ; 01/07→	1	24.8190-0268.2 620268	L= 905
			➡	01/07→	1	24.8190-0269.2 620269	L= 965
4.8 i xDrive	261	02/07→09/08	⬅	<input type="checkbox"/>	1	24.8190-0268.2 620268 24.8190-0270.2 620270	L= 905 L= 898
			➡		1	24.8190-0269.2 620269	L= 965
M	408	09/09→06/13	⬅	<input type="checkbox"/> ; → 02/10	1	24.8190-0281.2 620281	L= 962
			⬅	<input type="checkbox"/> ; 03/10→	1	24.8190-0291.2 620291	L= 974
			➡	03/10→	1	24.8190-0028.2 620028 24.8190-0290.2 620290	L= 977 L= 1.002
			➡	→ 02/10	1	24.8190-0269.2 620269	L= 965
M 50 d ↓	280	08/11→06/13	⬅	<input type="checkbox"/> ; 06/12→	1	24.8190-0071.2 620071	L= 945









	kW			 	! #		
<b>BMW - X5 (E70) 02/06→07/13</b>							
<b>Warnkontakt, Bremsbelagverschleiß</b>							
M 50 d	280	08/11→06/13	➡	06/12→	1	24.8190-0028.2 620028 24.8190-0290.2 620290	L= 977 L= 1.002
xDrive 30 d xDrive 30 d	155 173	10/08→07/13 10/08→03/10	⬅ ➡	☐ 03/10→	1	24.8190-0289.2 620289 24.8190-0028.2 620028 24.8190-0290.2 620290	L= 938 L= 977 L= 1.002
			➡	→ 02/10	1	24.8190-0269.2 620269	L= 965
xDrive 30 d	180	04/10→07/13	⬅	☐; 09/10→	1	24.8190-0289.2 620289	L= 938
			➡	09/10→	1	24.8190-0028.2 620028 24.8190-0290.2 620290	L= 977 L= 1.002
xDrive 30 i xDrive 30 i	171 200	09/08→12/10 09/08→03/10	⬅	☐	1	24.8190-0268.2 620268	L= 905
			⬅	☐; 03/10→	1	24.8190-0289.2 620289	L= 938
			➡	03/10→	1	24.8190-0028.2 620028 24.8190-0290.2 620290	L= 977 L= 1.002
			➡	→ 02/10	1	24.8190-0269.2 620269	L= 965
xDrive 35 d	210	09/08→06/13	⬅	☐	1	24.8190-0268.2 620268	L= 905
			➡	03/10→	1	24.8190-0028.2 620028 24.8190-0290.2 620290	L= 977 L= 1.002
			➡	→ 02/10	1	24.8190-0269.2 620269	L= 965
xDrive 35 i xDrive 35 i xDrive 40 d xDrive 40 i	225 235 225 225	09/10→06/13 02/12→06/13 09/10→06/13 01/12→06/13	⬅ ➡	☐	1	24.8190-0289.2 620289 24.8190-0028.2 620028 24.8190-0290.2 620290	L= 938 L= 977 L= 1.002
xDrive 48 i	261	09/08→06/13	⬅	☐; → 02/10	1	24.8190-0268.2 620268 24.8190-0270.2 620270	L= 905 L= 898
			⬅	☐; 03/10→	1	24.8190-0289.2 620289 24.8190-0291.2 620291	L= 938 L= 974
			➡	03/10→	1	24.8190-0028.2 620028 24.8190-0290.2 620290	L= 977 L= 1.002
			➡	→ 02/10	1	24.8190-0269.2 620269	L= 965
xDrive 50 i	300	07/09→06/13	⬅	☐; 03/10→; nicht für gepanzerte Fahrzeuge	1	24.8190-0071.2 620071	L= 945
			⬅	☐; 03/10→; für gepanzerte Fahrzeuge	1	24.8190-0291.2 620291	L= 974
			➡	03/10→	1	24.8190-0028.2 620028 24.8190-0290.2 620290	L= 977 L= 1.002
<b>Bremsscheibe</b>							
3.0 d 3.0 d xDrive 35 d xDrive 35 i xDrive 35 i xDrive 40 d xDrive 40 i	155 173 210 225 235 225 225	02/07→09/08 02/07→09/08 09/08→06/13 09/10→06/13 02/12→06/13 09/10→06/13 01/12→06/13	⬅ ➡			24.0130-0199.1 430199 24.0120-0206.1 420206	∅ 348 29,9 28,4 V + S ∅ 320 19,9 18,4 V + S
3.0 sd	210	10/07→03/10	⬅	10/08→		24.0130-0199.1 430199	∅ 348 29,9 28,4 V + S
			⬅	→ 09/08		24.0136-0109.1 436109	∅ 365 36 34,4 V + S
			➡	10/09→		24.0120-0206.1 420206	∅ 320 19,9 18,4 V + S
			➡	→ 09/09		24.0124-0216.1 424216	∅ 345 24 22,4 V + S
3.0 si	200	02/06→09/08	⬅	01/07→		24.0130-0200.1 430200	∅ 332 29,9 28,4 V + S
			➡	01/07→		24.0120-0206.1 420206	∅ 320 19,9 18,4 V + S
4.8 i xDrive xDrive 48 i	261 261	02/07→09/08 09/08→06/13	⬅	für USA		24.0130-0199.1 430199	∅ 348 29,9 28,4 V + S
			⬅	nicht für USA		24.0136-0109.1 436109	∅ 365 36 34,4 V + S
			➡			24.0124-0216.1 424216	∅ 345 24 22,4 V + S
M 50 d	280	08/11→06/13	⬅	☐; 06/12→		24.0136-0112.2 436112	∅ 385 36 34,4 V Bremsscheibe zweiteilig / + S
			⬅	☐; 06/12→		24.0136-0113.2 436113	∅ 385 36 34,4 V Bremsscheibe zweiteilig / + S
			➡	06/12→		24.0124-0216.1 424216	∅ 345 24 22,4 V + S
xDrive 30 d xDrive 30 d xDrive 30 i xDrive 30 i xDrive 30 d	155 173 171 200 180	10/08→07/13 10/08→03/10 09/08→12/10 09/08→03/10 04/10→07/13	⬅ ➡ ⬅			24.0130-0200.1 430200 24.0120-0206.1 420206	∅ 332 29,9 28,4 V + S ∅ 320 19,9 18,4 V + S
			⬅	09/10→		24.0130-0200.1 430200	∅ 332 29,9 28,4 V + S
↓							







	kw			 	! #		
<b>BMW - X5 (E70) 02/06→07/13</b>							
 <b>Bremsscheibe</b>							
xDrive 30 d	180	04/10→07/13	→	09/10→		24.0120-0206.1 420206	Ø 320 19,9 18,4 V + S
xDrive 50 i	300	07/09→06/13	←	03/10→; für gepanzerte Fahrzeuge		24.0136-0109.1 436109	Ø 365 36 34,4 V + S
			←	 ; 03/10→; nicht für gepanzerte Fahrzeuge		24.0136-0112.2 436112	Ø 385 36 34,4 V Bremsscheibe zweiteilig / + S
			←	 ; 03/10→; nicht für gepanzerte Fahrzeuge		24.0136-0113.2 436113	Ø 385 36 34,4 V Bremsscheibe zweiteilig / + S
			→	03/10→		24.0124-0216.1 424216	Ø 345 24 22,4 V + S
<b>BMW - X5 (F15, F85) 06/12→10/18</b>							
 <b>Bremsbelagsatz, Scheibenbremse</b>							
M	423	12/14→	→			13.0460-7260.2 607260	ATE 24458 17,3 + WE / - WK
M 50 d	280	07/13→	←	08/13→		13.0460-7261.2 607261	ATE 24436 19,7 + WE / - WK
			→	08/13→		13.0460-7169.2 607169 13.0470-7169.2 LD7169	ATE 23309 17,3 + WE / - WK ATE 23309 17,3 + WE / - WK Ceramic
sDrive 25 d	155	11/13→	←			13.0460-7231.2 607231	ATE 24170 20,2 + WE / - WK
sDrive 25 d	160	11/13→				13.0470-7231.2 LD7231	ATE 24170 20,2 + WE / - WK Ceramic
sDrive 25 d	170	07/15→	→			13.0460-7232.2 607232	ATE 21282 17,3 + WE / - WK
xDrive 25 d	155	11/13→				13.0470-7232.2 LD7232	ATE 21282 17,3 + WE / - WK Ceramic
xDrive 25 d	160	11/13→	→			13.0460-7232.2 607232	ATE 21282 17,3 + WE / - WK
xDrive 25 d	170	07/15→				13.0470-7232.2 LD7232	ATE 21282 17,3 + WE / - WK Ceramic
xDrive 25 d	160	04/14→	→			13.0460-7232.2 607232	ATE 21282 17,3 + WE / - WK
xDrive 30 d	183	04/15→				13.0470-7232.2 LD7232	ATE 21282 17,3 + WE / - WK Ceramic
xDrive 30 d	204	11/13→	→			13.0460-7232.2 607232	ATE 21282 17,3 + WE / - WK
xDrive 30 d	210	07/13→				13.0470-7232.2 LD7231	ATE 24170 20,2 + WE / - WK Ceramic
xDrive 30 d	190	07/13→	←	08/13→		13.0460-7231.2 607231	ATE 24170 20,2 + WE / - WK
xDrive 30 d	210	07/13→	→	08/13→		13.0460-7232.2 607232 13.0470-7232.2 LD7232	ATE 21282 17,3 + WE / - WK ATE 21282 17,3 + WE / - WK Ceramic
xDrive 35 i	225	11/13→	←			13.0460-7231.2 607231	ATE 24170 20,2 + WE / - WK
			→			13.0470-7231.2 LD7231	ATE 24170 20,2 + WE / - WK Ceramic
xDrive 35 i	225	11/13→	←			13.0460-7169.2 607169	ATE 23309 17,3 + WE / - WK
			→			13.0470-7169.2 LD7169	ATE 23309 17,3 + WE / - WK Ceramic
xDrive 35 i	240	11/13→	←			13.0460-7231.2 607231	ATE 24170 20,2 + WE / - WK
			→			13.0460-7169.2 607169 13.0470-7169.2 LD7169	ATE 23309 17,3 + WE / - WK ATE 23309 17,3 + WE / - WK Ceramic
xDrive 40 d	230	12/13→	←			13.0460-7231.2 607231	ATE 24170 20,2 + WE / - WK
			→			13.0460-7169.2 607169 13.0470-7169.2 LD7169	ATE 23309 17,3 + WE / - WK ATE 23309 17,3 + WE / - WK Ceramic
xDrive 40e	155	09/15→	←			13.0460-7231.2 607231	ATE 24170 20,2 + WE / - WK
xDrive 40e	180	09/15→	→			13.0460-7232.2 607232	ATE 21282 17,3 + WE / - WK
xDrive 40e	205	09/15→				13.0470-7232.2 LD7232	ATE 21282 17,3 + WE / - WK Ceramic
xDrive 40e	230	09/15→	→			13.0460-7232.2 607232	ATE 21282 17,3 + WE / - WK
xDrive 50 i	330	07/13→	←	08/13→		13.0460-7261.2 607261	ATE 24436 19,7 + WE / - WK
			→	08/13→		13.0460-7169.2 607169	ATE 23309 17,3 + WE / - WK
<b>Warnkontakt, Bremsbelagverschleiß</b>							
M	423	12/14→	←		1	24.8190-0291.2 620291	L= 974
			→		1	24.8190-0290.2 620290	L= 1.002
M 50 d	280	07/13→	←	 ; 08/13→	1	24.8190-0071.2 620071	L= 945
			xDrive 50 i	330	07/13→	→	08/13→
sDrive 25 d	155	11/13→	←		1	24.8190-0289.2 620289	L= 938
sDrive 25 d	160	11/13→	→			24.8190-0028.2 620028	L= 977
sDrive 25 d	170	07/15→					
xDrive 25 d	155	11/13→	→			24.8190-0028.2 620028	L= 977
xDrive 25 d	160	11/13→					
xDrive 25 d	160	11/13→	→			24.8190-0028.2 620028	L= 977
xDrive 25 d	170	07/15→					
xDrive 25 d	170	07/15→	→			24.8190-0028.2 620028	L= 977
xDrive 25 d	160	04/14→					
xDrive 30 d	183	04/15→	→			24.8190-0028.2 620028	L= 977
xDrive 30 d	204	11/13→					
xDrive 30 d	204	11/13→	→			24.8190-0028.2 620028	L= 977
xDrive 35 i	225	11/13→					
xDrive 35 i	240	11/13→	→			24.8190-0028.2 620028	L= 977
xDrive 40 d	230	12/13→					
xDrive 40e	155	09/15→	→			24.8190-0028.2 620028	L= 977
xDrive 40e	180	09/15→					
xDrive 40e	205	09/15→	→			24.8190-0028.2 620028	L= 977
xDrive 40e	230	09/15→					
↓							













	kW					! #		
<b>BMW - X5 (F15, F85) 06/12→10/18</b>								
<b>Warnkontakt, Bremsbelagverschleiß</b>								
xDrive 30 d	190	07/13→	←	 ; 08/13→		1	24.8190-0289.2 620289	L= 938
xDrive 30 d	210	07/13→	→	08/13→		1	24.8190-0028.2 620028	L= 977
<b> Brems Scheibe</b>								
M 50 d	280	07/13→	←	 ; 08/13→			24.0136-0112.2 436112	Ø 385 36 34,4 V Brems Scheibe zweiteilig / + S
xDrive 50 i	330	07/13→	←	 ; 08/13→			24.0136-0113.2 436113	Ø 385 36 34,4 V Brems Scheibe zweiteilig / + S
			→	08/13→			24.0124-0216.1 424216	Ø 345 24 22,4 V + S
sDrive 25 d	155	11/13→	←				24.0130-0200.1 430200	Ø 332 29,9 28,4 V + S
sDrive 25 d	160	11/13→	→				24.0120-0206.1 420206	Ø 320 19,9 18,4 V + S
sDrive 25 d	170	07/15→						
xDrive 25 d	155	11/13→						
xDrive 25 d	160	11/13→						
xDrive 25 d	170	07/15→						
xDrive 25 d	160	04/14→						
xDrive 30 d	183	04/15→						
xDrive 30 d	204	11/13→						
xDrive 30 d	190	07/13→	←	08/13→			24.0130-0200.1 430200	Ø 332 29,9 28,4 V + S
xDrive 30 d	210	07/13→	→	08/13→			24.0120-0206.1 420206	Ø 320 19,9 18,4 V + S
xDrive 35 i	225	11/13→	←				24.0130-0199.1 430199	Ø 348 29,9 28,4 V + S
xDrive 35 i	240	11/13→	→				24.0124-0216.1 424216	Ø 345 24 22,4 V + S
xDrive 40 d	230	12/13→						
xDrive 40e	155	09/15→	←				24.0130-0199.1 430199	Ø 348 29,9 28,4 V + S
xDrive 40e	180	09/15→	→				24.0120-0206.1 420206	Ø 320 19,9 18,4 V + S
xDrive 40e	205	09/15→						
xDrive 40e	230	09/15→						
<b>BMW - X5 (G05) 11/18→</b>								
<b> Bremsbelagsatz, Scheibenbremse</b>								
xDrive 30 d	195	11/18→	→				13.0460-2716.2 602716	TRW 24703 17,8 + WE / - WK + Zub
xDrive 40 i	250	11/18→					13.0470-2716.2 LD2716	TRW 24703 17,8 + WE / - WK + Zub Ceramic
xDrive M 50 d	294	11/18→						
<b> Brems Scheibe</b>								
xDrive 30 d	195	11/18→	←	 ; für Fahrzeuge ohne Sportpaket			24.0136-0132.2 436132	Ø 348 36 34,4 V Brems Scheibe zweiteilig / + S
xDrive 40 i	250	11/18→	←	 ; für Fahrzeuge ohne Sportpaket			24.0136-0133.2 436133	Ø 348 36 34,4 V Brems Scheibe zweiteilig / + S
<b>BMW - X6 (E71, E72) 06/07→06/14</b>								
<b> Bremsbelagsatz, Scheibenbremse</b>								
ActiveHybrid	357	01/09→10/11	←	10/10→			13.0460-7261.2 607261	ATE 24436 19,7 + WE / - WK
ActiveHybrid xDrive	300	01/09→10/11	→	10/10→			13.0460-7169.2 607169	ATE 23309 17,3 + WE / - WK
							13.0470-7169.2 LD7169	ATE 23309 17,3 + WE / - WK Ceramic
M 50 d	280	08/11→06/14	←	06/12→			13.0460-7261.2 607261	ATE 24436 19,7 + WE / - WK
			→	06/12→			13.0460-7169.2 607169	ATE 23309 17,3 + WE / - WK
							13.0470-7169.2 LD7169	ATE 23309 17,3 + WE / - WK Ceramic
xDrive 30 d	155	07/09→06/14	←				13.0460-7231.2 607231	ATE 24170 20,2 + WE / - WK
			→				13.0470-7231.2 LD7231	ATE 24170 20,2 + WE / - WK Ceramic
							13.0460-7232.2 607232	ATE 21282 17,3 + WE / - WK
							13.0470-7232.2 LD7232	ATE 21282 17,3 + WE / - WK Ceramic
xDrive 30 d	173	09/07→06/14	←	11/08→ 02/10			13.0460-7231.2 607231	ATE 24170 20,2 + WE / - WK
			←	03/10→			13.0470-7231.2 LD7231	ATE 24170 20,2 + WE / - WK Ceramic
			←	09/08→ 10/08			13.0460-7239.2 607239	ATE 24172 19,0 + WE / - WK
			→	09/08→ 02/10			13.0470-7239.2 LD7239	ATE 24172 19,0 + WE / - WK Ceramic
							13.0460-7232.2 607232	ATE 21282 17,3 + WE / - WK







	kW			 	! #			
<b>BMW - X6 (E71, E72) 06/07→06/14</b>								
<b> Bremsbelagsatz, Scheibenbremse</b>								
xDrive 30 d	173	09/07→06/14	➡	09/08→ 02/10		<b>13.0470-7232.2</b>	<b>LD7232</b>	ATE 21282 17,3 + WE / - WK Ceramic
			➡	03/10→		<b>13.0460-7232.2</b>	<b>607232</b>	ATE 21282 17,3 + WE / - WK
xDrive 30 d	180	04/09→06/14	⬅	09/10→		<b>13.0460-7231.2</b>	<b>607231</b>	ATE 24170 20,2 + WE / - WK
			➡	09/10→		<b>13.0470-7231.2</b>	<b>LD7231</b>	ATE 24170 20,2 + WE / - WK Ceramic
xDrive 35 d xDrive 35 i xDrive 35 i	210 224 225	06/07→03/10 01/08→06/14 06/07→06/14	⬅	11/08→ 02/10		<b>13.0460-7231.2</b>	<b>607231</b>	ATE 24170 20,2 + WE / - WK
						<b>13.0470-7231.2</b>	<b>LD7231</b>	ATE 24170 20,2 + WE / - WK Ceramic
			⬅	03/10→		<b>13.0460-7231.2</b>	<b>607231</b>	ATE 24170 20,2 + WE / - WK
						<b>13.0470-7231.2</b>	<b>LD7231</b>	ATE 24170 20,2 + WE / - WK Ceramic
			⬅	09/08→ 10/08		<b>13.0460-7239.2</b>	<b>607239</b>	ATE 24172 19,0 + WE / - WK
						<b>13.0470-7239.2</b>	<b>LD7239</b>	ATE 24172 19,0 + WE / - WK Ceramic
			➡	09/08→ 09/09		<b>13.0460-7169.2</b>	<b>607169</b>	ATE 23309 17,3 + WE / - WK
			<b>13.0470-7169.2</b>	<b>LD7169</b>	ATE 23309 17,3 + WE / - WK Ceramic			
xDrive 35 i	235	07/09→06/14	➡	03/10→		<b>13.0460-7232.2</b>	<b>607232</b>	ATE 21282 17,3 + WE / - WK
						<b>13.0470-7232.2</b>	<b>LD7232</b>	ATE 21282 17,3 + WE / - WK Ceramic
			⬅	→ 02/10		<b>13.0460-7231.2</b>	<b>607231</b>	ATE 24170 20,2 + WE / - WK
			⬅	03/10→		<b>13.0460-7231.2</b>	<b>607231</b>	ATE 24170 20,2 + WE / - WK
			➡	→ 09/09		<b>13.0460-7169.2</b>	<b>607169</b>	ATE 23309 17,3 + WE / - WK
						<b>13.0470-7169.2</b>	<b>LD7169</b>	ATE 23309 17,3 + WE / - WK Ceramic
xDrive 35 i	240	06/07→03/10	➡	03/10→		<b>13.0460-7232.2</b>	<b>607232</b>	ATE 21282 17,3 + WE / - WK
						<b>13.0470-7232.2</b>	<b>LD7232</b>	ATE 21282 17,3 + WE / - WK Ceramic
			⬅	11/08→ 02/10		<b>13.0460-7231.2</b>	<b>607231</b>	ATE 24170 20,2 + WE / - WK
			⬅	03/10→		<b>13.0460-7231.2</b>	<b>607231</b>	ATE 24170 20,2 + WE / - WK
			⬅	09/08→ 10/08		<b>13.0460-7239.2</b>	<b>607239</b>	ATE 24172 19,0 + WE / - WK
			➡	09/08→ 09/09		<b>13.0460-7169.2</b>	<b>607169</b>	ATE 23309 17,3 + WE / - WK
			<b>13.0470-7169.2</b>	<b>LD7169</b>	ATE 23309 17,3 + WE / - WK Ceramic			
xDrive 35 i	240	06/07→03/10	➡	03/10→		<b>13.0460-7232.2</b>	<b>607232</b>	ATE 21282 17,3 + WE / - WK
						<b>13.0470-7232.2</b>	<b>LD7232</b>	ATE 21282 17,3 + WE / - WK Ceramic
			⬅	11/08→ 02/10		<b>13.0460-7231.2</b>	<b>607231</b>	ATE 24170 20,2 + WE / - WK
			⬅	03/10→		<b>13.0460-7231.2</b>	<b>607231</b>	ATE 24170 20,2 + WE / - WK
			⬅	09/08→ 10/08		<b>13.0460-7239.2</b>	<b>607239</b>	ATE 24172 19,0 + WE / - WK
			➡	09/08→ 09/09		<b>13.0460-7169.2</b>	<b>607169</b>	ATE 23309 17,3 + WE / - WK
			<b>13.0470-7169.2</b>	<b>LD7169</b>	ATE 23309 17,3 + WE / - WK Ceramic			
xDrive 35 i	240	06/07→03/10	➡	03/10→		<b>13.0460-7232.2</b>	<b>607232</b>	ATE 21282 17,3 + WE / - WK
						<b>13.0470-7232.2</b>	<b>LD7232</b>	ATE 21282 17,3 + WE / - WK Ceramic
			⬅	11/08→ 02/10		<b>13.0460-7231.2</b>	<b>607231</b>	ATE 24170 20,2 + WE / - WK
			⬅	03/10→		<b>13.0460-7231.2</b>	<b>607231</b>	ATE 24170 20,2 + WE / - WK
			⬅	09/08→ 10/08		<b>13.0460-7239.2</b>	<b>607239</b>	ATE 24172 19,0 + WE / - WK
			➡	09/08→ 09/09		<b>13.0460-7169.2</b>	<b>607169</b>	ATE 23309 17,3 + WE / - WK
			<b>13.0470-7169.2</b>	<b>LD7169</b>	ATE 23309 17,3 + WE / - WK Ceramic			
xDrive 35 i	240	06/07→03/10	➡	03/10→		<b>13.0460-7232.2</b>	<b>607232</b>	ATE 21282 17,3 + WE / - WK
						<b>13.0470-7232.2</b>	<b>LD7232</b>	ATE 21282 17,3 + WE / - WK Ceramic
			⬅	11/08→ 02/10		<b>13.0460-7231.2</b>	<b>607231</b>	ATE 24170 20,2 + WE / - WK
			⬅	03/10→		<b>13.0460-7231.2</b>	<b>607231</b>	ATE 24170 20,2 + WE / - WK
			⬅	09/08→ 10/08		<b>13.0460-7239.2</b>	<b>607239</b>	ATE 24172 19,0 + WE / - WK
			➡	09/08→ 09/09		<b>13.0460-7169.2</b>	<b>607169</b>	ATE 23309 17,3 + WE / - WK
			<b>13.0470-7169.2</b>	<b>LD7169</b>	ATE 23309 17,3 + WE / - WK Ceramic			
xDrive 40 d	225	07/09→06/14	⬅	10/10→		<b>13.0460-7231.2</b>	<b>607231</b>	ATE 24170 20,2 + WE / - WK
						<b>13.0470-7231.2</b>	<b>LD7231</b>	ATE 24170 20,2 + WE / - WK Ceramic
xDrive 40 d	225	07/09→06/14	➡	10/10→		<b>13.0460-7232.2</b>	<b>607232</b>	ATE 21282 17,3 + WE / - WK
						<b>13.0470-7232.2</b>	<b>LD7232</b>	ATE 21282 17,3 + WE / - WK Ceramic
xDrive 50 i xDrive 50 i	300 330	10/07→06/14 10/07→06/14	⬅	09/08→ 02/10		<b>13.0460-7261.2</b>	<b>607261</b>	ATE 24436 19,7 + WE / - WK
			⬅	03/10→		<b>13.0460-7261.2</b>	<b>607261</b>	ATE 24436 19,7 + WE / - WK
			➡	10/09→ 02/10		<b>13.0460-7169.2</b>	<b>607169</b>	ATE 23309 17,3 + WE / - WK
						<b>13.0470-7169.2</b>	<b>LD7169</b>	ATE 23309 17,3 + WE / - WK Ceramic
➡	03/10→		<b>13.0460-7169.2</b>	<b>607169</b>	ATE 23309 17,3 + WE / - WK			
					<b>13.0470-7169.2</b>	<b>LD7169</b>	ATE 23309 17,3 + WE / - WK Ceramic	









	kw			 	! #		
<b>BMW - X6 (E71, E72) 06/07→06/14</b>							
<b> Bremsbelagsatz, Scheibenbremse</b>							
xDrive 50 i xDrive 50 i	300 330	10/07→06/14 10/07→06/14	➡	03/10→		13.0470-7169.2 LD7169	ATE 23309 17,3 + WE / - WK Ceramic
			➡	09/08→ 09/09		13.0460-7260.2 607260	ATE 24458 17,3 + WE / - WK
<b>Warnkontakt, Bremsbelagverschleiß</b>							
ActiveHybrid ActiveHybrid xDrive	357 300	01/09→10/11 01/09→10/11	⬅	☐; 10/10→	1	24.8190-0071.2 620071	L= 945
			➡	10/10→	1	24.8190-0028.2 620028 24.8190-0290.2 620290	L= 977 L= 1.002
M	408	07/08→06/14	⬅	☐; 09/09→ 02/10	1	24.8190-0281.2 620281	L= 962
			⬅	03/10→	1	24.8190-0291.2 620291	L= 974
			➡	03/10→	1	24.8190-0028.2 620028 24.8190-0290.2 620290	L= 977 L= 1.002
			➡	09/09→ 02/10	1	24.8190-0269.2 620269	L= 965
M 50 d	280	08/11→06/14	⬅	☐; 06/12→	1	24.8190-0071.2 620071	L= 945
			➡	06/12→	1	24.8190-0028.2 620028 24.8190-0290.2 620290	L= 977 L= 1.002
xDrive 30 d	155	07/09→06/14	⬅		1	24.8190-0289.2 620289	L= 938
			➡		1	24.8190-0028.2 620028 24.8190-0290.2 620290	L= 977 L= 1.002
xDrive 30 d	173	09/07→06/14	⬅	☐; 11/08→ 02/10	1	24.8190-0268.2 620268	L= 905
			⬅	☐; 09/08→ 10/08	1	24.8190-0270.2 620270	L= 898
			⬅	03/10→	1	24.8190-0289.2 620289	L= 938
			➡	03/10→	1	24.8190-0028.2 620028 24.8190-0290.2 620290	L= 977 L= 1.002
			➡	09/08→ 02/10	1	24.8190-0269.2 620269	L= 965
xDrive 30 d	180	04/09→06/14	⬅	09/10→	1	24.8190-0289.2 620289	L= 938
			➡	09/10→	1	24.8190-0028.2 620028 24.8190-0290.2 620290	L= 977 L= 1.002
xDrive 35 d xDrive 35 i xDrive 35 i xDrive 35 i	210 224 225 240	06/07→03/10 01/08→06/14 06/07→06/14 06/07→03/10	⬅	☐; 11/08→ 02/10	1	24.8190-0268.2 620268	L= 905
			⬅	☐; 09/08→ 10/08	1	24.8190-0270.2 620270	L= 898
			⬅	03/10→	1	24.8190-0289.2 620289	L= 938
			➡	03/10→	1	24.8190-0028.2 620028 24.8190-0290.2 620290	L= 977 L= 1.002
			➡	10/09→ 02/10	1	24.8190-0269.2 620269	L= 965
			➡	09/08→ 09/09	1	24.8190-0269.2 620269	L= 965
xDrive 35 i	235	07/09→06/14	⬅	☐; → 02/10	1	24.8190-0268.2 620268	L= 905
			⬅	03/10→	1	24.8190-0289.2 620289	L= 938
			➡	03/10→	1	24.8190-0028.2 620028 24.8190-0290.2 620290	L= 977 L= 1.002
			➡	10/09→ 02/10	1	24.8190-0269.2 620269	L= 965
			➡	→ 09/09	1	24.8190-0269.2 620269	L= 965
xDrive 40 d	225	07/09→06/14	⬅	10/10→	1	24.8190-0289.2 620289	L= 938
			➡	10/10→	1	24.8190-0028.2 620028 24.8190-0290.2 620290	L= 977 L= 1.002
xDrive 50 i xDrive 50 i	300 330	10/07→06/14 10/07→06/14	⬅	☐; 03/10→	1	24.8190-0071.2 620071	L= 945
			⬅	☐; 09/08→ 02/10	1	24.8190-0280.2 620280	L= 930
			➡	03/10→	1	24.8190-0028.2 620028 24.8190-0290.2 620290	L= 977 L= 1.002
			➡	10/09→ 02/10	1	24.8190-0269.2 620269	L= 965
			➡	09/08→ 09/09	1	24.8190-0269.2 620269	L= 965
<b> Bremsscheibe</b>							
ActiveHybrid ActiveHybrid xDrive	357 300	01/09→10/11 01/09→10/11	⬅	☐; 10/10→		24.0136-0112.2 436112	Ø 385 36 34,4 V Bremsscheibe zweiteilig / + S
			⬅	☐; 10/10→		24.0136-0113.2 436113	Ø 385 36 34,4 V Bremsscheibe zweiteilig / + S
			➡	10/10→		24.0124-0216.1 424216	Ø 345 24 22,4 V + S
↓							











	kw			 	! #		
<b>BMW - X6 (E71, E72) 06/07→06/14</b>							
<b>Bremsscheibe</b>							
M 50 d	280	08/11→06/14	←	☐; 06/12→		24.0136-0112.2 436112	Ø 385 36 34,4 V Bremsscheibe zweiteilig / + S
			←	☐; 06/12→		24.0136-0113.2 436113	Ø 385 36 34,4 V Bremsscheibe zweiteilig / + S
			→	06/12→		24.0124-0216.1 424216	Ø 345 24 22,4 V + S
xDrive 30 d	155	07/09→06/14	←			24.0130-0199.1 430199	Ø 348 29,9 28,4 V + S
			→			24.0120-0206.1 420206	Ø 320 19,9 18,4 V + S
xDrive 30 d	173	09/07→06/14	←	09/08→		24.0130-0199.1 430199	Ø 348 29,9 28,4 V + S
			→	09/08→		24.0120-0206.1 420206	Ø 320 19,9 18,4 V + S
xDrive 30 d	180	04/09→06/14	←	09/10→; Motorcode: M57		24.0130-0199.1 430199	Ø 348 29,9 28,4 V + S
			←	09/10→; Motorcode: N57		24.0130-0200.1 430200	Ø 332 29,9 28,4 V + S
			→	09/10→		24.0120-0206.1 420206	Ø 320 19,9 18,4 V + S
xDrive 35 d	210	06/07→03/10	←	11/08→		24.0130-0199.1 430199	Ø 348 29,9 28,4 V + S
			←	09/08→ 10/08		24.0136-0109.1 436109	Ø 365 36 34,4 V + S
			→	10/09→		24.0120-0206.1 420206	Ø 320 19,9 18,4 V + S
			→	09/08→ 09/09		24.0124-0216.1 424216	Ø 345 24 22,4 V + S
xDrive 35 i	224	01/08→06/14	←	11/08→		24.0130-0199.1 430199	Ø 348 29,9 28,4 V + S
xDrive 35 i	225	06/07→06/14	←	09/08→ 10/08		24.0136-0109.1 436109	Ø 365 36 34,4 V + S
xDrive 35 i	240	06/07→03/10	→	10/09→		24.0120-0206.1 420206	Ø 320 19,9 18,4 V + S
			→	11/08→ 09/09		24.0124-0216.1 424216	Ø 345 24 22,4 V + S
xDrive 35 i	235	07/09→06/14	←			24.0130-0199.1 430199	Ø 348 29,9 28,4 V + S
			→	10/09→		24.0120-0206.1 420206	Ø 320 19,9 18,4 V + S
			→	→ 09/09		24.0124-0216.1 424216	Ø 345 24 22,4 V + S
xDrive 40 d	225	07/09→06/14	←	10/10→		24.0130-0199.1 430199	Ø 348 29,9 28,4 V + S
			→	10/10→		24.0120-0206.1 420206	Ø 320 19,9 18,4 V + S
xDrive 50 i	300	10/07→06/14	←	☐; 09/08→		24.0136-0112.2 436112	Ø 385 36 34,4 V Bremsscheibe zweiteilig / + S
xDrive 50 i	330	10/07→06/14	←	☐; 09/08→		24.0136-0113.2 436113	Ø 385 36 34,4 V Bremsscheibe zweiteilig / + S
			→	10/09→		24.0124-0216.1 424216	Ø 345 24 22,4 V + S
			→	11/08→ 09/09		24.0124-0219.2 424219	Ø 385 24 22,4 V Bremsscheibe zweiteilig / + S
<b>BMW - X6 (F16, F86) 08/14→</b>							
<b>Bremsbelagsatz, Scheibenbremse</b>							
M	423	12/14→	→			13.0460-7260.2 607260	ATE 24458 17,3 + WE / - WK
M 50 d	280	08/14→	←			13.0460-7261.2 607261	ATE 24436 19,7 + WE / - WK
xDrive 50 i	330	08/14→	→			13.0460-7169.2 607169	ATE 23309 17,3 + WE / - WK
						13.0470-7169.2 LD7169	ATE 23309 17,3 + WE / - WK Ceramic
xDrive 30 d	155	08/14→	←			13.0460-7231.2 607231	ATE 24170 20,2 + WE / - WK
xDrive 30 d	183	12/15→				13.0470-7231.2 LD7231	ATE 24170 20,2 + WE / - WK Ceramic
xDrive 30 d	190	08/14→					
xDrive 30 d	204	02/15→	→			13.0460-7232.2 607232	ATE 21282 17,3 + WE / - WK
						13.0470-7232.2 LD7232	ATE 21282 17,3 + WE / - WK Ceramic
xDrive 35 i	225	12/14→	←			13.0460-7231.2 607231	ATE 24170 20,2 + WE / - WK
						13.0470-7231.2 LD7231	ATE 24170 20,2 + WE / - WK Ceramic
			→			13.0460-7169.2 607169	ATE 23309 17,3 + WE / - WK
						13.0470-7169.2 LD7169	ATE 23309 17,3 + WE / - WK Ceramic
xDrive 35 i	240	02/15→	←			13.0460-7231.2 607231	ATE 24170 20,2 + WE / - WK
xDrive 40 d	230	12/14→	→			13.0460-7169.2 607169	ATE 23309 17,3 + WE / - WK
						13.0470-7169.2 LD7169	ATE 23309 17,3 + WE / - WK Ceramic
<b>Warnkontakt, Bremsbelagverschleiß</b>							
M	423	12/14→	←	☐	1	24.8190-0291.2 620291	L= 974
			→		1	24.8190-0290.2 620290	L= 1.002
↓							







	kW			 	! #			
<b>BMW - X6 (F16, F86) 08/14→</b>								
<b>Warnkontakt, Bremsbelagverschleiß</b>								
M 50 d xDrive 50 i	280 330	08/14→ 08/14→	← →	<input type="checkbox"/> <input type="checkbox"/>	1 1	24.8190-0071.2 24.8190-0028.2	620071 620028	L= 945 L= 977
xDrive 30 d xDrive 30 d xDrive 30 d xDrive 30 d xDrive 35 i xDrive 35 i xDrive 40 d	155 183 190 204 225 240 230	08/14→ 12/15→ 08/14→ 02/15→ 12/14→ 02/15→ 12/14→	← →	<input type="checkbox"/> <input type="checkbox"/>	1	24.8190-0289.2 24.8190-0028.2	620289 620028	L= 938 L= 977
<b> Brems Scheibe</b>								
M 50 d xDrive 50 i	280 330	08/14→ 08/14→	← ← →	<input type="checkbox"/> <input type="checkbox"/> <input type="checkbox"/>		24.0136-0112.2 24.0136-0113.2 24.0124-0216.1	436112 436113 424216	∅ 385 36 34,4 V Brems Scheibe zweiteilig / + S ∅ 385 36 34,4 V Brems Scheibe zweiteilig / + S ∅ 345 24 22,4 V + S
xDrive 30 d xDrive 30 d xDrive 30 d xDrive 30 d	155 183 190 204	08/14→ 12/15→ 08/14→ 02/15→	← →	<input type="checkbox"/> <input type="checkbox"/>		24.0130-0200.1 24.0120-0206.1	430200 420206	∅ 332 29,9 28,4 V + S ∅ 320 19,9 18,4 V + S
xDrive 35 i xDrive 35 i xDrive 40 d	225 240 230	12/14→ 02/15→ 12/14→	← →	<input type="checkbox"/> <input type="checkbox"/>		24.0130-0199.1 24.0124-0216.1	430199 424216	∅ 348 29,9 28,4 V + S ∅ 345 24 22,4 V + S
<b>BMW - Z3 Coupe (E36) 04/97→06/03</b>								
<b> Bremsbelagsatz, Scheibenbremse</b>								
2.8 i	142	07/97→06/00	← →	<input type="checkbox"/> <input type="checkbox"/>		13.0460-5405.2 13.0470-5405.2	605405 LD5405	ATE 21643 17,8 + WE / - WK ATE 21643 17,8 + WE / - WK Ceramic
			→			13.0460-3605.2 13.0470-3605.2	603605 LD3605	ATE 20180 17,3 + WE / - WK ATE 20180 17,3 + WE / - WK Ceramic
3.0 i	170	06/00→06/03	← →	→ 12/02 → 12/02		13.0460-5405.2 13.0470-5405.2	605405 LD5405	ATE 21643 17,8 + WE / - WK ATE 21643 17,8 + WE / - WK Ceramic
			→			13.0460-3605.2 13.0470-3605.2	603605 LD3605	ATE 20180 17,3 + WE / - WK ATE 20180 17,3 + WE / - WK Ceramic
M M 3.2	236 176	02/98→06/01 02/98→06/00	← →	<input type="checkbox"/> <input type="checkbox"/>		13.0460-6033.2 13.0460-3803.2	606033 603803	ATE 20968 20,3 + WE / - WK ATE 20995 17,3 + WE / - WK
M	239	06/01→06/03	← →	→ 12/02 → 12/02		13.0460-6033.2 13.0460-3803.2	606033 603803	ATE 20968 20,3 + WE / - WK ATE 20995 17,3 + WE / - WK
<b>Warnkontakt, Bremsbelagverschleiß</b>								
2.8 i	142	07/97→06/00	← →	<input type="checkbox"/> <input type="checkbox"/>	1 1	24.8190-0207.2 24.8190-0211.2	620207 620211	L= 786 L= 840
3.0 i	170	06/00→06/03	← →	→ 12/02 → 12/02	1 1	24.8190-0207.2 24.8190-0211.2	620207 620211	L= 786 L= 840
M M 3.2	236 176	02/98→06/01 02/98→06/00	← →	<input type="checkbox"/> <input type="checkbox"/>	1 1	24.8190-0210.2 24.8190-0211.2	620210 620211	L= 810 L= 840
M	239	06/01→06/03	← →	→ 12/02 → 12/02	1 1	24.8190-0210.2 24.8190-0211.2	620210 620211	L= 810 L= 840
<b> Brems Scheibe</b>								
2.8 i	142	07/97→06/00	← →	<input type="checkbox"/> <input type="checkbox"/>		24.0122-0115.1 24.0322-0115.1	422115 522115	∅ 286 22 20,4 V + S ∅ 286 22 19,6 V + S
			→			24.0110-0273.1	410273	∅ 272 10 8,4 + S
3.0 i	170	06/00→06/03	← →	→ 12/02 → 12/02		24.0122-0160.1 24.0322-0160.1	422160 522160	∅ 300 22 20,4 V + S ∅ 300 22 19,6 V + S
			→			24.0110-0273.1	410273	∅ 272 10 8,4 + S
M M 3.2	236 176	02/98→06/01 02/98→06/00	← ← →	<input type="checkbox"/> <input type="checkbox"/> <input type="checkbox"/>		24.0128-0204.2 24.0128-0205.2	428204 428205	∅ 315 28 26,4 V Brems Scheibe zweiteilig / + S ∅ 315 28 26,4 V Brems Scheibe zweiteilig / + S
			→			24.0120-0189.1	420189	∅ 312 20 18,4 V + S
↓								















	kW			 	! #		
<b>BMW - Z3 Coupe (E36) 04/97→06/03</b>							
<b>Bremsscheibe</b>							
M M 3.2	236 176	02/98→06/01 02/98→06/00	→	☐		24.0120-0190.1 420190	Ø 312 20 18,4 V + S
M	239	06/01→06/03	←	☐; → 12/02		24.0128-0204.2 428204	Ø 315 28 26,4 V Bremsscheibe zweiteilig / + S
			←	☐; → 12/02		24.0128-0205.2 428205	Ø 315 28 26,4 V Bremsscheibe zweiteilig / + S
			→	☐; → 12/02		24.0120-0189.1 420189	Ø 312 20 18,4 V + S
			→	☐; → 12/02		24.0120-0190.1 420190	Ø 312 20 18,4 V + S
<b>BMW - Z3 Roadster (E36) 10/95→01/03</b>							
<b>Bremsbelagsatz, Scheibenbremse</b>							
1.8 i 1.9 i	85 103	10/95→10/98 10/95→03/99	←			13.0460-5405.2 605405 13.0470-5405.2 LD5405	ATE 21643 17,8 + WE / - WK ATE 21643 17,8 + WE / - WK Ceramic
			→			13.0460-3605.2 603605 13.0470-3605.2 LD3605	ATE 20180 17,3 + WE / - WK ATE 20180 17,3 + WE / - WK Ceramic
1.9 i 1.9 i 3.0 i	85 87 170	01/99→01/03 07/98→01/03 06/00→01/03	←	→ 12/02		13.0460-5405.2 605405 13.0470-5405.2 LD5405	ATE 21643 17,8 + WE / - WK ATE 21643 17,8 + WE / - WK Ceramic
			→	→ 12/02		13.0460-3605.2 603605 13.0470-3605.2 LD3605	ATE 20180 17,3 + WE / - WK ATE 20180 17,3 + WE / - WK Ceramic
2.0 i	110	04/99→01/03	←	→ 08/00		13.0460-5405.2 605405 13.0470-5405.2 LD5405	ATE 21643 17,8 + WE / - WK ATE 21643 17,8 + WE / - WK Ceramic
			→	→ 08/00		13.0460-3605.2 603605 13.0470-3605.2 LD3605	ATE 20180 17,3 + WE / - WK ATE 20180 17,3 + WE / - WK Ceramic
2.2 i 2.2 i	120 125	08/00→01/03 08/00→01/03	←	10/00→ 12/02		13.0460-5405.2 605405 13.0470-5405.2 LD5405	ATE 21643 17,8 + WE / - WK ATE 21643 17,8 + WE / - WK Ceramic
			→	10/00→ 12/02		13.0460-3605.2 603605 13.0470-3605.2 LD3605	ATE 20180 17,3 + WE / - WK ATE 20180 17,3 + WE / - WK Ceramic
2.8 i	142	04/97→06/00	←	05/97→		13.0460-5405.2 605405 13.0470-5405.2 LD5405	ATE 21643 17,8 + WE / - WK ATE 21643 17,8 + WE / - WK Ceramic
			→	05/97→		13.0460-3605.2 603605 13.0470-3605.2 LD3605	ATE 20180 17,3 + WE / - WK ATE 20180 17,3 + WE / - WK Ceramic
2.8 i	143	01/96→07/00	←	05/97→ 06/00		13.0460-5405.2 605405 13.0470-5405.2 LD5405	ATE 21643 17,8 + WE / - WK ATE 21643 17,8 + WE / - WK Ceramic
			→	05/97→ 06/00		13.0460-3605.2 603605 13.0470-3605.2 LD3605	ATE 20180 17,3 + WE / - WK ATE 20180 17,3 + WE / - WK Ceramic
M 3.2 M 3.2	179 236	02/98→06/00 03/97→06/01	←			13.0460-6033.2 606033 13.0460-3803.2 603803	ATE 20968 20,3 + WE / - WK ATE 20995 17,3 + WE / - WK
M 3.2	239	06/01→01/03	←	→ 12/02		13.0460-6033.2 606033	ATE 20968 20,3 + WE / - WK
			→	→ 12/02		13.0460-3803.2 603803	ATE 20995 17,3 + WE / - WK
<b>Warnkontakt, Bremsbelagverschleiß</b>							
1.8 i 1.9 i	85 103	10/95→10/98 10/95→03/99	←		1	24.8190-0207.2 620207	L= 786
			→		1	24.8190-0211.2 620211	L= 840
1.9 i 1.9 i 3.0 i	85 87 170	01/99→01/03 07/98→01/03 06/00→01/03	←	→ 12/02	1	24.8190-0207.2 620207	L= 786
			→	→ 12/02	1	24.8190-0211.2 620211	L= 840
2.0 i	110	04/99→01/03	←	→ 08/00	1	24.8190-0207.2 620207	L= 786
			→	→ 08/00	1	24.8190-0211.2 620211	L= 840
2.2 i 2.2 i	120 125	08/00→01/03 08/00→01/03	←	10/00→ 12/02	1	24.8190-0207.2 620207	L= 786
			→	10/00→ 12/02	1	24.8190-0211.2 620211	L= 840
2.8 i	142	04/97→06/00	←	05/97→	1	24.8190-0207.2 620207	L= 786
			→	05/97→	1	24.8190-0211.2 620211	L= 840
↓							

	kw			 	! #		
<b>BMW - Z3 Roadster (E36) 10/95→01/03</b>							
<b>Warnkontakt, Bremsbelagverschleiß</b>							
2.8 i	143	01/96→07/00	←	05/97→ 06/00	1	24.8190-0207.2 620207	L= 786
			→	05/97→ 06/00	1	24.8190-0211.2 620211	L= 840
M 3.2	179	02/98→06/00	←		1	24.8190-0210.2 620210	L= 810
M 3.2	236	03/97→06/01	→		1	24.8190-0211.2 620211	L= 840
M 3.2	239	06/01→01/03	←	→ 12/02	1	24.8190-0210.2 620210	L= 810
			→	→ 12/02	1	24.8190-0211.2 620211	L= 840
<b> Brems Scheibe</b>							
1.8 i	85	10/95→10/98	←			24.0112-0126.1 412126	Ø 286 12 10,4 + S
1.9 i	103	10/95→03/99	→			24.0312-0126.1 512126	Ø 286 12 9,6 + S
			→			24.0110-0273.1 410273	Ø 272 10 8,4 + S
1.9 i	85	01/99→01/03	←	→ 12/02		24.0112-0126.1 412126	Ø 286 12 10,4 + S
1.9 i	87	07/98→01/03	→	→ 12/02		24.0312-0126.1 512126	Ø 286 12 9,6 + S
			→	→ 12/02		24.0110-0273.1 410273	Ø 272 10 8,4 + S
2.0 i	110	04/99→01/03	←	→ 08/00		24.0122-0115.1 422115	Ø 286 22 20,4 V + S
			→	→ 08/00		24.0322-0115.1 522115	Ø 286 22 19,6 V + S
			→	→ 08/00		24.0110-0273.1 410273	Ø 272 10 8,4 + S
2.2 i	120	08/00→01/03	←	10/00→ 12/02		24.0122-0115.1 422115	Ø 286 22 20,4 V + S
2.2 i	125	08/00→01/03	→	10/00→ 12/02		24.0322-0115.1 522115	Ø 286 22 19,6 V + S
			→	10/00→ 12/02		24.0110-0273.1 410273	Ø 272 10 8,4 + S
2.8 i	142	04/97→06/00	←	05/97→		24.0122-0115.1 422115	Ø 286 22 20,4 V + S
			→	05/97→		24.0322-0115.1 522115	Ø 286 22 19,6 V + S
			→	05/97→		24.0110-0273.1 410273	Ø 272 10 8,4 + S
2.8 i	143	01/96→07/00	←	05/97→ 06/00		24.0122-0115.1 422115	Ø 286 22 20,4 V + S
			→	05/97→ 06/00		24.0322-0115.1 522115	Ø 286 22 19,6 V + S
			→	05/97→ 06/00		24.0110-0273.1 410273	Ø 272 10 8,4 + S
3.0 i	170	06/00→01/03	←	→ 12/02		24.0122-0160.1 422160	Ø 300 22 20,4 V + S
			→	→ 12/02		24.0322-0160.1 522160	Ø 300 22 19,6 V + S
			→	→ 12/02		24.0110-0273.1 410273	Ø 272 10 8,4 + S
M 3.2	179	02/98→06/00	←	☐		24.0128-0204.2 428204	Ø 315 28 26,4 V Brems Scheibe zweiteilig / + S
M 3.2	236	03/97→06/01	←	☐		24.0128-0205.2 428205	Ø 315 28 26,4 V Brems Scheibe zweiteilig / + S
			→	☐		24.0120-0189.1 420189	Ø 312 20 18,4 V + S
			→	☐		24.0120-0190.1 420190	Ø 312 20 18,4 V + S
M 3.2	239	06/01→01/03	←	☐; → 12/02		24.0128-0204.2 428204	Ø 315 28 26,4 V Brems Scheibe zweiteilig / + S
			←	☐; → 12/02		24.0128-0205.2 428205	Ø 315 28 26,4 V Brems Scheibe zweiteilig / + S
			→	☐; → 12/02		24.0120-0189.1 420189	Ø 312 20 18,4 V + S
			→	☐; → 12/02		24.0120-0190.1 420190	Ø 312 20 18,4 V + S
<b>BMW - Z4 Coupe (E86) 03/06→01/09</b>							
<b> Bremsbelagsatz, Scheibenbremse</b>							
3.0 si	195	03/06→01/09	←	→ 09/08		13.0460-7155.2 607155	ATE 21676 20,3 + WE / - WK
			→	→ 09/08		13.0470-7155.2 LD7155	ATE 21676 20,3 + WE / - WK Ceramic
			→	→ 09/08		13.0460-3605.2 603605	ATE 20180 17,3 + WE / - WK
			→	→ 09/08		13.0470-3605.2 LD3605	ATE 20180 17,3 + WE / - WK Ceramic
M	252	03/06→01/09	←	→ 09/08		13.0460-7185.2 607185	ATE 20968 20,3 + WE / - WK
			→	→ 09/08		13.0460-7079.2 607079	ATE 21282 17,3 + WE / - WK
			→	→ 09/08		13.0470-7079.2 LD7079	ATE 21282 17,3 + WE / - WK Ceramic
<b>Warnkontakt, Bremsbelagverschleiß</b>							
3.0 si	195	03/06→01/09	←	→ 09/08	1	24.8190-0244.2 620244	L= 611
			→	→ 09/08	1	24.8190-0229.2 620229	L= 1.143
M	252	03/06→01/09	←	→ 09/08	1	24.8190-0244.2 620244	L= 611
			→	→ 09/08	1	24.8190-0245.2 620245	L= 1.163
↓							

















	kw			 	! #		
<b>BMW - Z4 Coupe (E86) 03/06→01/09</b>							
 <b>Bremsscheibe</b>							
3.0 si	195	03/06→01/09	←	→ 09/08		24.0125-0138.1 425138	Ø 325 24,9 23,4 V + S
			→	→ 09/08		24.0325-0138.1 525138	Ø 325 24,9 22,6 V + S
M	252	03/06→01/09	←	☐; → 09/08		24.0128-0208.2 428208	Ø 345 28 26,4 V• Bremsscheibe zweiteilig / + S
			←	☐; → 09/08		24.0128-0209.2 428209	Ø 345 28 26,4 V• Bremsscheibe zweiteilig / + S
			→	☐; → 09/08		24.0120-0221.2 420221	Ø 328 20 18,4 V• Bremsscheibe zweiteilig / + S
			→	☐; → 09/08		24.0120-0222.2 420222	Ø 328 20 18,4 V• Bremsscheibe zweiteilig / + S
<b>BMW - Z4 Roadster (E85) 02/03→12/09</b>							
 <b>Bremsbelagsatz, Scheibenbremse</b>							
2.0 i	110	03/05→02/09	←	04/05→ 12/08		13.0460-5405.2 605405	ATE 21643 17,8 + WE / - WK
			→	04/05→ 12/08		13.0470-5405.2 LD5405	ATE 21643 17,8 + WE / - WK Ceramic
2.2 i 2.5 i 3.0 i	125 141 170	10/03→10/05 02/03→12/05 02/03→10/05	←			13.0460-5405.2 605405	ATE 21643 17,8 + WE / - WK
			→			13.0470-5405.2 LD5405	ATE 21643 17,8 + WE / - WK Ceramic
2.5 i 2.5 si 2.5 si	130 155 160	09/05→02/09 09/05→02/09 09/05→02/09	←	01/06→ 12/08		13.0460-5405.2 605405	ATE 21643 17,8 + WE / - WK
			→	01/06→ 12/08		13.0470-5405.2 LD5405	ATE 21643 17,8 + WE / - WK Ceramic
3.0 si	195	01/06→12/08	←			13.0460-7155.2 607155	ATE 21676 20,3 + WE / - WK
			→			13.0470-7155.2 LD7155	ATE 21676 20,3 + WE / - WK Ceramic
M	252	03/06→02/09	←	→ 12/08		13.0460-3605.2 603605	ATE 20180 17,3 + WE / - WK
			→	→ 12/08		13.0470-3605.2 LD3605	ATE 20180 17,3 + WE / - WK Ceramic
<b>Warnkontakt, Bremsbelagverschleiß</b>							
2.0 i	110	03/05→02/09	←	04/05→ 12/08	1	24.8190-0220.2 620220	L= 601
			→	04/05→ 12/08	1	24.8190-0229.2 620229	L= 1.143
2.2 i 2.5 i 3.0 i	125 141 170	10/03→10/05 02/03→12/05 02/03→10/05	←		1	24.8190-0220.2 620220	L= 601
			→		1	24.8190-0229.2 620229	L= 1.143
2.5 i 2.5 si 2.5 si	130 155 160	09/05→02/09 09/05→02/09 09/05→02/09	←	01/06→ 12/08	1	24.8190-0220.2 620220	L= 601
			→	01/06→ 12/08	1	24.8190-0229.2 620229	L= 1.143
3.0 si	195	01/06→12/08	←		1	24.8190-0244.2 620244	L= 611
			→		1	24.8190-0229.2 620229	L= 1.143
M	252	03/06→02/09	←	→ 12/08	1	24.8190-0244.2 620244	L= 611
			→	→ 12/08	1	24.8190-0245.2 620245	L= 1.163
 <b>Bremsscheibe</b>							
2.0 i	110	03/05→02/09	←	04/05→ 12/08		24.0122-0115.1 422115	Ø 286 22 20,4 V + S
			→	04/05→ 12/08		24.0322-0115.1 522115	Ø 286 22 19,6 V + S
2.2 i 2.5 i	125 141	10/03→10/05 02/03→12/05	←			24.0110-0287.1 410287	Ø 280 10 8,4 + S
			→			24.0122-0115.1 422115	Ø 286 22 20,4 V + S
2.5 i	130	09/05→02/09	←	01/06→ 12/08		24.0322-0115.1 522115	Ø 286 22 19,6 V + S
			→			24.0110-0287.1 410287	Ø 280 10 8,4 + S
2.5 i ↓	130	09/05→02/09	←	01/06→ 12/08		24.0122-0115.1 422115	Ø 286 22 20,4 V + S















	kW			 	! #		
<b>BMW - Z4 Roadster (E85) 02/03→12/09</b>							
<b>Bremsscheibe</b>							
2.5 i	130	09/05→02/09	←	01/06→12/08		24.0322-0115.1 522115	Ø 286 22 19,6 V + S
			→	01/06→12/08		24.0110-0287.1 410287	Ø 280 10 8,4 + S
2.5 si	155	09/05→02/09	←	01/06→12/08		24.0122-0160.1 422160	Ø 300 22 20,4 V + S
2.5 si	160	09/05→02/09	→	01/06→12/08		24.0322-0160.1 522160	Ø 300 22 19,6 V + S
			→	01/06→12/08		24.0119-0112.1 419112	Ø 294 19 17,4 V + S
3.0 i	170	02/03→10/05	←			24.0122-0160.1 422160	Ø 300 22 20,4 V + S
			→			24.0322-0160.1 522160	Ø 300 22 19,6 V + S
			→			24.0119-0112.1 419112	Ø 294 19 17,4 V + S
3.0 si	195	01/06→12/08	←			24.0125-0138.1 425138	Ø 325 24,9 23,4 V + S
			→			24.0325-0138.1 525138	Ø 325 24,9 22,6 V + S
			→			24.0119-0112.1 419112	Ø 294 19 17,4 V + S
M	252	03/06→02/09	←	☐; → 12/08		24.0128-0208.2 428208	Ø 345 28 26,4 V• Bremsscheibe zweiteilig / + S
			←	☐; → 12/08		24.0128-0209.2 428209	Ø 345 28 26,4 V• Bremsscheibe zweiteilig / + S
			→	☐; → 12/08		24.0120-0221.2 420221	Ø 328 20 18,4 V• Bremsscheibe zweiteilig / + S
			→	☐; → 12/08		24.0120-0222.2 420222	Ø 328 20 18,4 V• Bremsscheibe zweiteilig / + S
<b>BMW - Z4 Roadster (E89) 05/09→</b>							
<b>Bremsbelagsatz, Scheibenbremse</b>							
sDrive 18 i	115	04/13→	←			13.0460-7216.2 607216	ATE 23794 20,3 + WE / - WK
sDrive 20 i	120	09/11→				13.0470-7216.2 LD7216	ATE 23794 20,3 + WE / - WK
sDrive 20 i	135	09/11→					Ceramic
sDrive 28 i	180	09/11→	→			13.0460-2759.2 602759	TRW 24559 17,8 + WE / - WK + Zub
sDrive 23 i	150	05/09→	←	→ 02/10		13.0460-7216.2 607216	ATE 23794 20,3 + WE / - WK
sDrive 30 i	190	05/09→				13.0470-7216.2 LD7216	ATE 23794 20,3 + WE / - WK
			←	03/10→		13.0460-7216.2 607216	ATE 23794 20,3 + WE / - WK
						13.0470-7216.2 LD7216	ATE 23794 20,3 + WE / - WK
			→	03/10→		13.0460-2759.2 602759	TRW 24559 17,8 + WE / - WK + Zub
			→	→ 02/10		13.0460-2759.2 602759	TRW 24559 17,8 + WE / - WK + Zub
sDrive 35 i	225	05/09→	←	→ 02/10		13.0460-7237.2 607237	ATE 23347 20,3 + WE / - WK
						13.0460-7238.2 607238	ATE 23313 20,3 + WE / - WK
						13.0470-7238.2 LD7238	ATE 23313 20,3 + WE / - WK
			←	03/10→		13.0460-7237.2 607237	ATE 23347 20,3 + WE / - WK
						13.0460-7238.2 607238	ATE 23313 20,3 + WE / - WK
			→	→ 02/10		13.0460-2760.2 602760	TRW 24561 17,7 + WE / - WK + Zub
						13.0470-2760.2 LD2760	TRW 24561 17,7 + WE / - WK + Zub Ceramic
			→	03/10→		13.0460-2760.2 602760	TRW 24561 17,7 + WE / - WK + Zub
						13.0470-2760.2 LD2760	TRW 24561 17,7 + WE / - WK + Zub Ceramic
sDrive 35 is	250	09/10→	←			13.0460-7237.2 607237	ATE 23347 20,3 + WE / - WK
						13.0460-7238.2 607238	ATE 23313 20,3 + WE / - WK
			→			13.0460-2760.2 602760	TRW 24561 17,7 + WE / - WK + Zub
						13.0470-2760.2 LD2760	TRW 24561 17,7 + WE / - WK + Zub Ceramic
<b>Warnkontakt, Bremsbelagverschleiß</b>							
sDrive 18 i	115	04/13→	←		1	24.8190-0295.2 620295	L= 1.013
sDrive 20 i	120	09/11→					
sDrive 20 i	135	09/11→	→		1	24.8190-0294.2 620294	L= 1.361
sDrive 28 i	180	09/11→					
sDrive 35 is	250	09/10→					
sDrive 23 i	150	05/09→	←	→ 02/10	1	24.8190-0263.2 620263	L= 969
sDrive 30 i	190	05/09→					
sDrive 35 i	225	05/09→	←	03/10→	1	24.8190-0295.2 620295	L= 1.013
↓							

























	kw				! #		
<b>BMW - Z4 Roadster (E89) 05/09→</b>							
<b>Warnkontakt, Bremsbelagverschleiß</b>							
sDrive 23 i	150	05/09→	➡	→ 02/10	1	24.8190-0262.2 620262	L= 1.338
sDrive 30 i	190	05/09→	➡	03/10→	1	24.8190-0294.2 620294	L= 1.361
sDrive 35 i	225	05/09→					
<b> Bremsscheibe</b>							
sDrive 18 i	115	04/13→	←			24.0124-0197.1 424197	Ø 300 24 22,4 V + S
sDrive 20 i	120	09/11→				24.0324-0197.1 524197	Ø 300 24 21,6 V + S
sDrive 20 i	135	09/11→	➡			24.0120-0226.1 420226	Ø 300 20 18,4 V + S
sDrive 23 i	150	05/09→					
sDrive 28 i	180	09/11→	←			24.0124-0242.2 424242	Ø 330 24 22,4 V Bremsscheibe zweiteilig / + S
sDrive 30 i	190	05/09→					
sDrive 35 i	225	05/09→	←			24.0130-0216.2 430216	Ø 348 30 28,4 V Bremsscheibe zweiteilig / + S
	sDrive 35 is	250					
			➡			24.0120-0228.1 420228	Ø 324 20 18,4 V + S
<b>BMW - Z8 Roadster (E52) 06/00→06/03</b>							
<b> Bremsbelagsatz, Scheibenbremse</b>							
4.9	294	06/00→06/03	←			13.0460-7183.2 607183	ATE 21484 20,5 + WE / - WK
			➡			13.0460-7079.2 607079	ATE 21282 17,3 + WE / - WK
<b>Warnkontakt, Bremsbelagverschleiß</b>							
4.9	294	06/00→06/03	←		1	24.8190-0233.2 620233	L= 758
			➡			1	24.8190-0218.2 620218
<b> Bremsscheibe</b>							
4.9	294	06/00→06/03	←			24.0132-0160.1 432160	Ø 334 31,9 30,4 V + S
			➡			24.0120-0182.1 420182	Ø 328 20 18,4 V + S
<b>CHEVROLET - ASTRA Schrägheck 09/98→12/11</b>							
<b> Bremsbelagsatz, Scheibenbremse</b>							
2.0	82	03/99→07/02	←	554447→		13.0460-5859.2 605859	AKE 23234 16,9 + WK
			←	10/99→; → 554446		13.0460-5994.2 605994	AKE 23234 16,8 - WE / - WK
			➡	10/99→; → 560318		13.0460-5993.2 605993	TRW 23237 14,5 - WE / - WK
			➡	10/99→		13.0460-5993.2 605993	TRW 23237 14,5 - WE / - WK
2.0 DTi	74	08/02→12/11	←	→ 07/05		13.0460-7116.2 607116	ATE 23057 20,2 - WK / + WK
						13.0470-7116.2 LD7116	ATE 23057 20,2 - WK / + WK Ceramic
			➡	→ 07/05		13.0460-2868.2 602868	TRW 23417 15,3 + WK + Zub
						13.0470-2868.2 LD2868	TRW 23417 15,3 + WK + Zub Ceramic
<b> Bremsscheibe</b>							
2.0	82	03/99→07/02	←	10/99→		24.0124-0163.1 424163	Ø 256 24 22 V + S
			➡	10/99→		24.0110-0714.1 410714	Ø 258 10,3 8
2.0 DTi	74	08/02→12/11	←	→ 07/05		24.0125-0131.1 425131	Ø 280 24,8 22 V + S
			➡	→ 07/05		24.0110-0250.1 410250	Ø 264 9,8 8 + S
						24.0310-0250.1 510250	Ø 264 9,8 8 + S
<b>CHEVROLET - ASTRA Stufenheck 10/98→12/11</b>							
<b> Bremsbelagsatz, Scheibenbremse</b>							
2.0 DTi GLS	74	08/02→12/11	←	→ 07/05		13.0460-7116.2 607116	ATE 23057 20,2 - WK / + WK
						13.0470-7116.2 LD7116	ATE 23057 20,2 - WK / + WK Ceramic
			➡	→ 07/05		13.0460-2868.2 602868	TRW 23417 15,3 + WK + Zub
						13.0470-2868.2 LD2868	TRW 23417 15,3 + WK + Zub Ceramic
2.0 GL	82	10/98→07/02	←	554447→		13.0460-5859.2 605859	AKE 23234 16,9 + WK
			←	10/99→; → 554446		13.0460-5994.2 605994	AKE 23234 16,8 - WE / - WK
			➡	10/99→; → 560318		13.0460-5993.2 605993	TRW 23237 14,5 - WE / - WK
			➡	10/99→		13.0460-5993.2 605993	TRW 23237 14,5 - WE / - WK
2.0 GL	85	08/02→12/11	←	→ 554446		13.0460-5994.2 605994	AKE 23234 16,8 - WE / - WK
↓							



















	kw					! #		
<b>CHEVROLET - ASTRA Stufenheck 10/98→12/11</b>								
 <b>Bremsbelagsatz, Scheibenbremse</b>								
2.0 GL	85	08/02→12/11	➡	→ 07/05		13.0460-5993.2	605993	TRW 23237 14,5 - WE / - WK
			➡	→ 560318		13.0460-5993.2	605993	TRW 23237 14,5 - WE / - WK
 <b>Bremsscheibe</b>								
2.0 DTi GLS	74	08/02→12/11	⬅	→ 07/05		24.0125-0131.1	425131	Ø 280 24,8 22 V + S
			➡	→ 07/05		24.0110-0250.1	410250	Ø 264 9,8 8 + S
						24.0310-0250.1	510250	Ø 264 9,8 8 + S
2.0 GL	82	10/98→07/02	⬅	10/99→		24.0124-0163.1	424163	Ø 256 24 22 V + S
			➡	10/99→		24.0110-0714.1	410714	Ø 258 10,3 8
2.0 GL	85	08/02→12/11	⬅	→ 07/05		24.0124-0163.1	424163	Ø 256 24 22 V + S
			➡	→ 07/05		24.0110-0714.1	410714	Ø 258 10,3 8
<b>CHEVROLET - AVEO / KALOS Schrägheck (T200) 02/03→05/08</b>								
 <b>Bremsbelagsatz, Scheibenbremse</b>								
1.2	53	01/04→05/08	⬅			13.0460-5899.2	605899	AKE 23974 17,6 - WE / - WK
1.4	61	03/05→05/08						
1.4 16V	69	03/05→05/08						
1.5	62	01/05→05/08	⬅	05/05→		13.0460-5899.2	605899	AKE 23974 17,6 - WE / - WK
 <b>Bremsscheibe</b>								
1.2	53	01/04→05/08	⬅	Nabendurchmesser [mm]: 60		24.0120-0115.1	420115	Ø 236 20 17 V + S
			⬅	Nabendurchmesser [mm]: 59		24.0120-0227.1	420227	Ø 236 20 18 V + S
1.4	61	03/05→05/08	⬅	Nabendurchmesser [mm]: 60		24.0120-0115.1	420115	Ø 236 20 17 V + S
1.4 16V	69	03/05→05/08				24.0320-0115.1	520115	Ø 236 20 17 V + S
			⬅	Nabendurchmesser [mm]: 59		24.0120-0227.1	420227	Ø 236 20 18 V + S
1.5	62	01/05→05/08	⬅	05/05→; Nabendurchmesser [mm]: 60		24.0120-0115.1	420115	Ø 236 20 17 V + S
			⬅	05/05→; Nabendurchmesser [mm]: 59		24.0120-0227.1	420227	Ø 236 20 18 V + S
<b>CHEVROLET - AVEO / KALOS Stufenheck (T200) 01/03→12/08</b>								
 <b>Bremsbelagsatz, Scheibenbremse</b>								
1.4	69	05/03→01/07	⬅	03/06→		13.0460-5899.2	605899	AKE 23974 17,6 - WE / - WK
1.5	63	10/04→05/06	⬅			13.0460-5899.2	605899	AKE 23974 17,6 - WE / - WK
 <b>Bremsscheibe</b>								
1.4	69	05/03→01/07	⬅	03/06→; Nabendurchmesser [mm]: 60		24.0120-0115.1	420115	Ø 236 20 17 V + S
			⬅	03/06→; Nabendurchmesser [mm]: 59		24.0120-0227.1	420227	Ø 236 20 18 V + S
1.5	63	10/04→05/06	⬅			24.0120-0227.1	420227	Ø 236 20 18 V + S
<b>CHEVROLET - AVEO Schrägheck (T250, T255) 06/06→</b>								
 <b>Bremsbelagsatz, Scheibenbremse</b>								
1.2	53	06/06→	⬅	→ 07/11		13.0460-5899.2	605899	AKE 23974 17,6 - WE / - WK
1.2	55	04/08→						
1.2	56	01/07→						
1.2	62	04/08→						
1.2 LPG	60	06/08→						
1.2 LPG	62	04/08→						
1.4	74	04/08→						
1.4 16V	69	06/06→05/08	⬅			13.0460-5899.2	605899	AKE 23974 17,6 - WE / - WK
 <b>Bremsscheibe</b>								
1.2	53	06/06→	⬅	→ 07/11; Nabendurchmesser [mm]: 60		24.0120-0115.1	420115	Ø 236 20 17 V + S
1.2	55	04/08→						
1.2	56	01/07→	⬅	→ 07/11; Nabendurchmesser [mm]: 59		24.0120-0227.1	420227	Ø 236 20 18 V + S
1.2	62	04/08→						
1.2 LPG	60	06/08→						
1.2 LPG	62	04/08→						
1.4	74	04/08→						
1.4 16V	69	06/06→05/08	⬅			24.0120-0227.1	420227	Ø 236 20 18 V + S
<b>CHEVROLET - AVEO Schrägheck (T300) 03/11→</b>								
 <b>Bremsbelagsatz, Scheibenbremse</b>								
1.2	51	03/11→	⬅	passend für Felgengröße [Zoll]: 15		13.0460-7262.2	607262	25031 19,1 + WK + Zub
1.2	63	03/11→				13.0470-7262.2	LD7262	25031 19,1 + WK + Zub Ceramic
1.2 LPG	63	11/12→						

















	kw			 	! #		
<b>CHEVROLET - AVEO Schrägheck (T300) 03/11→</b>							
 <b>Bremsbelagsatz, Scheibenbremse</b>							
1.3 D	55	07/11→	←	passend für Felgengröße [Zoll]: 15		<b>13.0460-7262.2 607262</b>	25031 19,1 + WK + Zub
1.3 D	70	07/11→				<b>13.0470-7262.2 LD7262</b>	25031 19,1 + WK + Zub Ceramic
1.4	74	03/11→					
1.6	85	03/11→					
1.4 Turbo	103	08/13→	←			<b>13.0460-7262.2 607262</b>	25031 19,1 + WK + Zub
						<b>13.0470-7262.2 LD7262</b>	25031 19,1 + WK + Zub Ceramic
			→			<b>13.0460-7264.2 607264</b>	ATE 25096 17,0 + WK + Zub
						<b>13.0470-7264.2 LD7264</b>	ATE 25096 17,0 + WK + Zub Ceramic
 <b>Bremsscheibe</b>							
1.2	51	03/11→	←	passend für Felgengröße [Zoll]: 14		<b>24.0124-0252.1 424252</b>	Ø 256 24 21 V
1.2	63	03/11→					
1.2 LPG	63	11/12→	←	passend für Felgengröße [Zoll]: 15		<b>24.0126-0165.1 426165</b>	Ø 276 26 23 V + S
1.3 D	55	07/11→				<b>24.0326-0165.1 526165</b>	Ø 276 26 23 V + S
1.3 D	70	07/11→					
1.4	74	03/11→					
1.6	85	03/11→					
1.4 Turbo	103	08/13→	←			<b>24.0126-0165.1 426165</b>	Ø 276 26 23 V + S
						<b>24.0326-0165.1 526165</b>	Ø 276 26 23 V + S
			→			<b>24.0112-0188.1 412188</b>	Ø 268 12 10 + S
						<b>24.0312-0188.1 512188</b>	Ø 268 12 10 + S
<b>CHEVROLET - AVEO Stufenheck (T250, T255) 03/05→</b>							
 <b>Bremsbelagsatz, Scheibenbremse</b>							
1.2	53	03/05→12/07	←			<b>13.0460-5899.2 605899</b>	AKE 23974 17,6 - WE / - WK
1.4	69	03/05→12/07					
1.2	55	01/08→	←	→ 07/11		<b>13.0460-5899.2 605899</b>	AKE 23974 17,6 - WE / - WK
1.2	62	01/08→					
1.2 LPG	60	12/08→					
1.2 LPG	62	01/09→					
1.4	74	09/08→					
1.5	62	05/05→					
1.4	61	03/05→	←	→ 05/08		<b>13.0460-5899.2 605899</b>	AKE 23974 17,6 - WE / - WK
 <b>Bremsscheibe</b>							
1.2	53	03/05→12/07	←	Nabendurchmesser [mm]: 60		<b>24.0120-0115.1 420115</b>	Ø 236 20 17 V + S
1.4	69	03/05→12/07	←	Nabendurchmesser [mm]: 59		<b>24.0120-0227.1 420227</b>	Ø 236 20 18 V + S
1.2	55	01/08→	←	→ 07/11; Nabendurchmesser [mm]: 60		<b>24.0120-0115.1 420115</b>	Ø 236 20 17 V + S
1.2	62	01/08→					
1.2 LPG	60	12/08→	←	→ 07/11; Nabendurchmesser [mm]: 59		<b>24.0120-0227.1 420227</b>	Ø 236 20 18 V + S
1.2 LPG	62	01/09→					
1.4	74	09/08→					
1.5	62	05/05→					
1.4	61	03/05→	←	→ 05/08; Nabendurchmesser [mm]: 60		<b>24.0120-0115.1 420115</b>	Ø 236 20 17 V + S
						<b>24.0320-0115.1 520115</b>	Ø 236 20 17 V + S
			←	→ 05/08; Nabendurchmesser [mm]: 59		<b>24.0120-0227.1 420227</b>	Ø 236 20 18 V + S
<b>CHEVROLET - AVEO Stufenheck (T300) 03/11→</b>							
 <b>Bremsbelagsatz, Scheibenbremse</b>							
1.2	51	03/11→	←	passend für Felgengröße [Zoll]: 15		<b>13.0460-7262.2 607262</b>	25031 19,1 + WK + Zub
1.2	63	03/11→				<b>13.0470-7262.2 LD7262</b>	25031 19,1 + WK + Zub Ceramic
1.2 LPG	63	11/12→					
1.3 D	55	07/11→					
1.3 D	70	07/11→					
1.4	74	07/11→					
1.6	85	03/11→					
 <b>Bremsscheibe</b>							
1.2	51	03/11→	←	passend für Felgengröße [Zoll]: 14		<b>24.0124-0252.1 424252</b>	Ø 256 24 21 V
1.2	63	03/11→					
1.2 LPG	63	11/12→	←	passend für Felgengröße [Zoll]: 15		<b>24.0126-0165.1 426165</b>	Ø 276 26 23 V + S
1.3 D	55	07/11→				<b>24.0326-0165.1 526165</b>	Ø 276 26 23 V + S
1.3 D	70	07/11→					
1.4	74	07/11→					
1.6	85	03/11→					
<b>CHEVROLET - CAMARO 02/09→12/15</b>							
 <b>Bremsscheibe</b>							
3.6	224	09/09→12/10	←	für Linkslenker		<b>24.0130-0209.1 430209</b>	Ø 321 30 27 V + S
						<b>24.0330-0209.1 530209</b>	Ø 321 30 27 V + S
↓							















	kw			 	! #		
<b>CHEVROLET - CAMARO 02/09→12/15</b>							
 <b>Bremsscheibe</b>							
3.6	241	09/11→12/15	←	12/12→		24.0130-0209.1 430209 24.0330-0209.1 530209	Ø 321 30 27 V + S Ø 321 30 27 V + S
<b>CHEVROLET - CAPTIVA (C100, C140) 06/06→</b>							
 <b>Bremsbelagsatz, Scheibenbremse</b>							
2.0 D	93	10/06→	←			13.0460-5785.2 605785	24510 17,0 + WK
2.0 D	110	09/07→	→			13.0460-5788.2 605788	24498 14,7 + WK
2.0 D 4WD	93	10/06→					
2.0 D 4WD	110	10/06→					
2.2 D	120	03/11→					
2.2 D 4WD	120	03/11→					
2.2 D 4WD	135	03/11→					
2.4	100	06/06→					
2.4	123	03/11→					
2.4 4WD	100	06/06→					
2.4 4WD	123	03/11→					
2.4 LPG	100	01/07→					
2.4 LPG 4WD	100	01/07→					
3.0 4WD	186	01/12→					
3.0 4WD	190	01/10→					
3.0 Flexfuel	197	01/11→					
3.0 Flexfuel 4WD	197	01/11→					
3.2 4WD	169	06/06→					
2.0 D	120	01/11→	→			13.0460-5788.2 605788	24498 14,7 + WK
2.0 D 4WD	120	01/11→					
2.2 D	135	07/14→					
<b>Zubehörsatz, Scheibenbremsbelag</b>							
2.0 D	93	10/06→	→			13.0460-0135.2 610135	
2.0 D	110	09/07→					
2.0 D	120	01/11→					
2.0 D 4WD	93	10/06→					
2.0 D 4WD	110	10/06→					
2.0 D 4WD	120	01/11→					
2.2 D	120	03/11→					
2.2 D	135	07/14→					
2.2 D 4WD	120	03/11→					
2.2 D 4WD	135	03/11→					
2.4	100	06/06→					
2.4	123	03/11→					
2.4 4WD	100	06/06→					
2.4 4WD	123	03/11→					
2.4 LPG	100	01/07→					
2.4 LPG 4WD	100	01/07→					
3.0 4WD	190	01/10→					
3.0 Flexfuel	197	01/11→					
3.0 Flexfuel 4WD	197	01/11→					
3.2 4WD	169	06/06→					
 <b>Bremsscheibe</b>							
2.0 D	93	10/06→	←			24.0129-0101.1 429101	Ø 296 29 27,5 V
2.0 D	110	09/07→	→			24.0120-0209.1 420209	Ø 303 20 18,4 V
2.0 D	120	01/11→					
2.0 D 4WD	93	10/06→					
2.0 D 4WD	110	10/06→					
2.0 D 4WD	120	01/11→					
2.2 D	120	03/11→					
2.2 D	135	07/14→					
2.2 D 4WD	120	03/11→					
2.2 D 4WD	135	03/11→					
2.4	100	06/06→					
2.4	123	03/11→					
2.4 4WD	100	06/06→					
2.4 4WD	123	03/11→					
2.4 LPG	100	01/07→					
2.4 LPG 4WD	100	01/07→					
3.0 4WD	186	01/12→					
3.0 4WD	190	01/10→					
3.0 Flexfuel	197	01/11→					
3.0 Flexfuel 4WD	197	01/11→					
3.2 4WD	169	06/06→					
<b>CHEVROLET - COBALT 01/11→</b>							
 <b>Bremsscheibe</b>							
1.5	77	01/14→	←			24.0124-0252.1 424252	Ø 256 24 21 V















	kw			 	! #		
<b>CHEVROLET - CRUZE (J300) 05/09→</b>							
 <b>Bremsbelagsatz, Scheibenbremse</b>							
1.4	74	07/13→	←	für Bremsscheibendurchmesser [mm]: 276	13.0460-7262.2	607262	25031 19,1 + WK + Zub
1.4	103	09/10→			13.0470-7262.2	LD7262	25031 19,1 + WK + Zub Ceramic
1.6	80	05/09→	←	für Bremsscheibendurchmesser [mm]: 300	13.0460-7263.2	607263	24034 19,1 + WK + Zub
1.6	83	05/09→			13.0470-7263.2	LD7263	24034 19,1 + WK + Zub Ceramic
1.6	86	12/12→	→		13.0460-7264.2	607264	ATE 25096 17,0 + WK + Zub
1.6	91	05/09→			13.0470-7264.2	LD7264	ATE 25096 17,0 + WK + Zub Ceramic
1.7 D	96	01/12→	→		13.0460-7264.2	607264	ATE 25096 17,0 + WK + Zub
1.7 TD	81	11/13→			13.0470-7264.2	LD7264	ATE 25096 17,0 + WK + Zub Ceramic
1.8	103	11/09→12/13	→		13.0460-7264.2	607264	ATE 25096 17,0 + WK + Zub
1.8	104	05/09→			13.0470-7264.2	LD7264	ATE 25096 17,0 + WK + Zub Ceramic
1.8 LPG	104	06/11→	→		13.0460-7264.2	607264	ATE 25096 17,0 + WK + Zub
2.0 CDI	90	05/09→			13.0470-7264.2	LD7264	ATE 25096 17,0 + WK + Zub Ceramic
2.0 CDI	92	05/09→05/11	→		13.0460-7264.2	607264	ATE 25096 17,0 + WK + Zub
2.0 CDI	110	05/09→			13.0470-7264.2	LD7264	ATE 25096 17,0 + WK + Zub Ceramic
2.0 CDI	120	08/10→	→		13.0460-7264.2	607264	ATE 25096 17,0 + WK + Zub
					13.0470-7264.2	LD7264	ATE 25096 17,0 + WK + Zub Ceramic
 <b>Bremsscheibe</b>							
1.4	74	07/13→	←		24.0126-0165.1	426165	Ø 276 26 23 V + S
1.4	103	09/10→			24.0126-0166.1	426166	Ø 300 26 23 V + S
1.6	80	05/09→	←		24.0326-0165.1	526165	Ø 276 26 23 V + S
1.6	83	05/09→			24.0326-0166.1	526166	Ø 300 26 23 V + S
1.6	86	12/12→	→		24.0112-0188.1	412188	Ø 268 12 10 + S
1.6	91	05/09→			24.0112-0189.1	412189	Ø 292 12 10 + S
1.7 D	96	01/12→	→		24.0112-0188.1	412188	Ø 268 12 10 + S
1.7 TD	81	11/13→			24.0112-0189.1	412189	Ø 292 12 10 + S
1.8	103	11/09→12/13	→		24.0312-0188.1	512188	Ø 268 12 10 + S
1.8	104	05/09→			24.0312-0189.1	512189	Ø 292 12 10 + S
1.8 LPG	104	06/11→	→		24.0312-0188.1	512188	Ø 268 12 10 + S
2.0 CDI	90	05/09→			24.0312-0189.1	512189	Ø 292 12 10 + S
2.0 CDI	92	05/09→05/11	→		24.0312-0188.1	512188	Ø 268 12 10 + S
2.0 CDI	110	05/09→			24.0312-0189.1	512189	Ø 292 12 10 + S
2.0 CDI	120	08/10→	→		24.0312-0188.1	512188	Ø 268 12 10 + S
					24.0312-0189.1	512189	Ø 292 12 10 + S
<b>CHEVROLET - CRUZE Schrägheck (J305) 12/10→</b>							
 <b>Bremsbelagsatz, Scheibenbremse</b>							
1.4	74	07/13→	←	für Bremsscheibendurchmesser [mm]: 276	13.0460-7262.2	607262	25031 19,1 + WK + Zub
1.6	80	01/12→			13.0470-7262.2	LD7262	25031 19,1 + WK + Zub Ceramic
1.6	86	12/12→	←	für Bremsscheibendurchmesser [mm]: 300	13.0460-7263.2	607263	24034 19,1 + WK + Zub
1.6	91	06/11→			13.0470-7263.2	LD7263	24034 19,1 + WK + Zub Ceramic
1.7 D	96	01/12→	→		13.0460-7264.2	607264	ATE 25096 17,0 + WK + Zub
1.7 TD	81	08/13→			13.0470-7264.2	LD7264	ATE 25096 17,0 + WK + Zub Ceramic
1.8	103	10/11→	→		13.0460-7264.2	607264	ATE 25096 17,0 + WK + Zub
1.8	104	06/11→			13.0470-7264.2	LD7264	ATE 25096 17,0 + WK + Zub Ceramic
1.8 LPG	104	06/11→	→		13.0460-7264.2	607264	ATE 25096 17,0 + WK + Zub
2.0 CDI	120	06/11→			13.0470-7264.2	LD7264	ATE 25096 17,0 + WK + Zub Ceramic
1.4	103	06/12→	←	08/12→; für Bremsscheibendurchmesser [mm]: 276	13.0460-7262.2	607262	25031 19,1 + WK + Zub
					13.0470-7262.2	LD7262	25031 19,1 + WK + Zub Ceramic
			←	08/12→; für Bremsscheibendurchmesser [mm]: 300	13.0460-7263.2	607263	24034 19,1 + WK + Zub
					13.0470-7263.2	LD7263	24034 19,1 + WK + Zub Ceramic
			→	08/12→	13.0460-7264.2	607264	ATE 25096 17,0 + WK + Zub
					13.0470-7264.2	LD7264	ATE 25096 17,0 + WK + Zub Ceramic
 <b>Bremsscheibe</b>							
1.4	74	07/13→	←		24.0126-0165.1	426165	Ø 276 26 23 V + S
1.6	80	01/12→			24.0126-0166.1	426166	Ø 300 26 23 V + S
1.6	86	12/12→	←		24.0326-0165.1	526165	Ø 276 26 23 V + S
1.6	91	06/11→			24.0326-0166.1	526166	Ø 300 26 23 V + S
1.7 D	96	01/12→	→		24.0112-0188.1	412188	Ø 268 12 10 + S
1.7 TD	81	08/13→			24.0112-0189.1	412189	Ø 292 12 10 + S
1.8	103	10/11→	→		24.0312-0188.1	512188	Ø 268 12 10 + S
1.8	104	06/11→			24.0312-0189.1	512189	Ø 292 12 10 + S
1.8 LPG	104	06/11→	→		24.0312-0188.1	512188	Ø 268 12 10 + S
2.0 CDI	120	06/11→			24.0312-0189.1	512189	Ø 292 12 10 + S
1.4	103	06/12→	←	08/12→	24.0126-0165.1	426165	Ø 276 26 23 V + S
					24.0126-0166.1	426166	Ø 300 26 23 V + S
			←		24.0326-0165.1	526165	Ø 276 26 23 V + S
					24.0326-0166.1	526166	Ø 300 26 23 V + S
			→	08/12→	24.0112-0188.1	412188	Ø 268 12 10 + S
					24.0112-0189.1	412189	Ø 292 12 10 + S
			→		24.0312-0188.1	512188	Ø 268 12 10 + S
					24.0312-0189.1	512189	Ø 292 12 10 + S

















	kw			 	! #		
<b>CHEVROLET - CRUZE Station Wagon (J308) 08/12→</b>							
 <b>Bremsbelagsatz, Scheibenbremse</b>							
1.4	74	07/13→	←	für Bremsscheibendurchmesser [mm]:	13.0460-7262.2	607262	25031 19,1 + WK + Zub
1.4	103	08/12→		276	13.0470-7262.2	LD7262	25031 19,1 + WK + Zub Ceramic
1.6	86	12/12→					
1.6	91	08/12→	←	für Bremsscheibendurchmesser [mm]:	13.0460-7263.2	607263	24034 19,1 + WK + Zub
1.7 TD	81	11/13→		300	13.0470-7263.2	LD7263	24034 19,1 + WK + Zub Ceramic
1.7 TD	96	08/12→					
1.8	104	08/12→	→		13.0460-7264.2	607264	ATE 25096 17,0 + WK + Zub
2.0 TD	120	08/12→			13.0470-7264.2	LD7264	ATE 25096 17,0 + WK + Zub Ceramic
 <b>Bremsscheibe</b>							
1.4	74	07/13→	←		24.0126-0165.1	426165	Ø 276 26 23 V + S
1.4	103	08/12→			24.0126-0166.1	426166	Ø 300 26 23 V + S
1.6	86	12/12→					
1.6	91	08/12→			24.0326-0165.1	526165	Ø 276 26 23 V + S
1.7 TD	81	11/13→			24.0326-0166.1	526166	Ø 300 26 23 V + S
1.7 TD	96	08/12→					
1.8	104	08/12→	→		24.0112-0188.1	412188	Ø 268 12 10 + S
2.0 TD	120	08/12→			24.0112-0189.1	412189	Ø 292 12 10 + S
					24.0312-0188.1	512188	Ø 268 12 10 + S
					24.0312-0189.1	512189	Ø 292 12 10 + S
<b>CHEVROLET - EPICA (KL1_) 01/05→</b>							
 <b>Bremsbelagsatz, Scheibenbremse</b>							
2.0	94	01/05→12/06	←		13.0460-5859.2	605859	AKE 23234 16,9 + WK
2.0	98	01/05→12/06					
<b>Zubehörsatz, Scheibenbremsbelag</b>							
2.0	94	01/05→12/06	←		13.0460-0140.2	610140	AKE
2.0	98	01/05→12/06					
 <b>Bremsscheibe</b>							
2.0	94	01/05→12/06	←		24.0124-0237.1	424237	Ø 278 24 22 V
2.0	98	01/05→12/06					
2.0	105	06/06→	←	→ 12/10	24.0124-0237.1	424237	Ø 278 24 22 V
2.0 D	110	01/07→					
2.5	115	06/06→					
<b>CHEVROLET - EVANDA 03/05→</b>							
 <b>Bremsbelagsatz, Scheibenbremse</b>							
2.0	96	03/05→	←	→ 12/06	13.0460-5859.2	605859	AKE 23234 16,9 + WK
<b>Zubehörsatz, Scheibenbremsbelag</b>							
2.0	96	03/05→	←	→ 12/06	13.0460-0140.2	610140	AKE
 <b>Bremsscheibe</b>							
2.0	96	03/05→	←	→ 12/06	24.0124-0199.1	424199	Ø 256 24 21 V + S
<b>CHEVROLET - IMPALA Stufenheck 01/99→12/05</b>							
 <b>Bremsbelagsatz, Scheibenbremse</b>							
3.4 V6	134	01/99→12/05	←	→ 05/05	13.0460-8002.2	608002	23358 18,0 + WK
3.8 V6	149	01/99→12/05					
<b>CHEVROLET - LACETTI (J200) 03/03→</b>							
 <b>Bremsbelagsatz, Scheibenbremse</b>							
1.4 16V	70	03/05→	←	→ 12/10	13.0460-5863.2	605863	AKE 23234 16,8 + WK
1.6	80	03/05→					
1.8	89	08/05→	→	01/07→ 12/10	13.0460-5663.2	605663	SUM 25232 14,5 - WE / - WK
1.8	90	03/05→	→	→ 12/06	13.0460-5739.2	605739	SUM 24071 14,6 - WE / - WK
1.8	67	03/05→12/09	←	08/05→	13.0460-5863.2	605863	AKE 23234 16,8 + WK
			→	01/07→	13.0460-5663.2	605663	SUM 25232 14,5 - WE / - WK
			→	08/05→ 12/06	13.0460-5739.2	605739	SUM 24071 14,6 - WE / - WK
2.0 D	89	01/07→	←	→ 12/10	13.0460-5863.2	605863	AKE 23234 16,8 + WK
			→	→ 12/10	13.0460-5663.2	605663	SUM 25232 14,5 - WE / - WK
 <b>Bremsscheibe</b>							
1.4 16V	70	03/05→	←	→ 12/10	24.0124-0199.1	424199	Ø 256 24 21 V + S
1.6	80	03/05→					
1.8	89	08/05→	→	→ 12/10	24.0110-0340.1	410340	Ø 258 10,5 8 + S
1.8	90	03/05→					



















	kw					! #		
<b>CHEVROLET - LACETTI (J200) 03/03→</b>								
 <b>Bremsscheibe</b>								
2.0 D	89	01/07→	←	→ 12/10		24.0124-0199.1	424199	Ø 256 24 21 V + S
			→	→ 12/10		24.0110-0340.1	410340	Ø 258 10,5 8 + S
1.8	67	03/05→12/09	←	08/05→		24.0124-0199.1	424199	Ø 256 24 21 V + S
			→	08/05→		24.0110-0340.1	410340	Ø 258 10,5 8 + S
<b>CHEVROLET - LACETTI Kombi (J200) 03/05→</b>								
 <b>Bremsbelagsatz, Scheibenbremse</b>								
1.6	80	03/05→	←	→ 12/10		13.0460-5863.2	605863	AKE 23234 16,8 + WK
1.8	89	08/05→	→	01/07→ 12/10		13.0460-5663.2	605663	SUM 25232 14,5 - WE / - WK
			→	→ 12/06		13.0460-5739.2	605739	SUM 24071 14,6 - WE / - WK
1.6 LPG	80	06/09→12/11	←	→ 12/10		13.0460-5863.2	605863	AKE 23234 16,8 + WK
2.0 D	89	01/07→	→	→ 12/10		13.0460-5663.2	605663	SUM 25232 14,5 - WE / - WK
 <b>Bremsscheibe</b>								
1.6	80	03/05→	←	→ 12/10		24.0124-0199.1	424199	Ø 256 24 21 V + S
1.6 LPG	80	06/09→12/11	→	→ 12/10		24.0110-0340.1	410340	Ø 258 10,5 8 + S
1.8	89	08/05→	→	→ 12/10		24.0110-0340.1	410340	Ø 258 10,5 8 + S
2.0 D	89	01/07→	→	→ 12/10		24.0110-0340.1	410340	Ø 258 10,5 8 + S
<b>CHEVROLET - LACETTI Stufenheck (J200) 03/03→03/13</b>								
 <b>Bremsbelagsatz, Scheibenbremse</b>								
1.4	69	03/05→03/13	←	→ 12/10		13.0460-5863.2	605863	AKE 23234 16,8 + WK
1.6	80	03/05→03/13	→	01/07→ 12/10		13.0460-5663.2	605663	SUM 25232 14,5 - WE / - WK
1.8	90	05/03→03/13	→	→ 12/06		13.0460-5739.2	605739	SUM 24071 14,6 - WE / - WK
1.8	66	08/03→12/09	←			13.0460-5863.2	605863	AKE 23234 16,8 + WK
			→	01/07→		13.0460-5663.2	605663	SUM 25232 14,5 - WE / - WK
			→	→ 12/06		13.0460-5739.2	605739	SUM 24071 14,6 - WE / - WK
 <b>Bremsscheibe</b>								
1.4	69	03/05→03/13	←	→ 12/10		24.0124-0199.1	424199	Ø 256 24 21 V + S
1.6	80	03/05→03/13	→	→ 12/10		24.0110-0340.1	410340	Ø 258 10,5 8 + S
1.8	90	05/03→03/13	→	→ 12/10		24.0110-0340.1	410340	Ø 258 10,5 8 + S
1.8	66	08/03→12/09	←			24.0124-0199.1	424199	Ø 256 24 21 V + S
			→			24.0110-0340.1	410340	Ø 258 10,5 8 + S
<b>CHEVROLET - LANOS Stufenheck 11/05→</b>								
 <b>Bremsbelagsatz, Scheibenbremse</b>								
1.4	55	11/05→	←	→ 12/10		13.0460-7051.2	607051	ATE 20547 16,5 + WE / - WK
1.5	64	11/05→	←	→ 12/10		13.0460-7052.2	607052	ATE 21190 17,5 + WE / - WK
1.6 16V	78	11/05→	←	→ 12/10		13.0460-7052.2	607052	ATE 21190 17,5 + WE / - WK
 <b>Bremsscheibe</b>								
1.4	55	11/05→	←	→ 12/10		24.0120-0115.1	420115	Ø 236 20 17 V + S
1.5	64	11/05→	←	→ 12/10		24.0120-0115.1	420115	Ø 236 20 17 V + S
1.6 16V	78	11/05→	←	→ 12/10		24.0124-0115.1	424115	Ø 256 24 21 V + S
<b>CHEVROLET - MALIBU (V300) 01/12→</b>								
 <b>Bremsbelagsatz, Scheibenbremse</b>								
2.0 D	118	04/12→	←	16"		13.0460-5611.2	605611	MAN 24415 19,1 + WK + Zub
2.4	123	01/12→	←	16"		13.0470-5611.2	LD5611	MAN 24415 19,1 + WK + Zub
2.4	125	01/12→	←	17"		13.0460-5612.2	605612	MAN 24412 19,0 + WK + Zub
			←	17"		13.0470-5612.2	LD5612	MAN 24412 19,0 + WK + Zub
			←	16"		13.0470-5612.2	LD5612	MAN 24412 19,0 + WK + Zub
			←	17"		13.0470-5612.2	LD5612	MAN 24412 19,0 + WK + Zub
			←	16"		13.0470-5612.2	LD5612	MAN 24412 19,0 + WK + Zub
			←	17"		13.0470-5612.2	LD5612	MAN 24412 19,0 + WK + Zub
 <b>Bremsscheibe</b>								
2.0 D	118	04/12→	←	16"		24.0130-0207.1	430207	Ø 296 30 27 V + S
2.4	123	01/12→	←	16"		24.0330-0207.1	530207	Ø 296 30 27 V + S
2.4	125	01/12→	←	17"		24.0130-0209.1	430209	Ø 321 30 27 V + S
			←	17"		24.0330-0209.1	530209	Ø 321 30 27 V + S
			→	16"		24.0112-0202.1	412202	Ø 292 12 10,5
			→	17"		24.0123-0114.1	423114	Ø 315 22,9 21,5 V + S

















	kW			 	! #		
<b>CHEVROLET - MALIBU (V300) 01/12→</b>							
 <b>Bremsscheibe</b>							
2.0 D 2.4 2.4	118 123 125	04/12→ 01/12→ 01/12→	→	17"		24.0323-0114.1 523114	∅ 315 22,9 21,5 V + S
<b>CHEVROLET - MATIZ (M200, M250) 03/05→</b>							
 <b>Bremsbelagsatz, Scheibenbremse</b>							
0.8 0.8 LPG 1.0 1.0 1.0 LPG	38 38 47 49 49	03/05→ 03/05→ 03/05→ 03/05→ 03/05→	←	→ 12/10		13.0460-5996.2 605996	23241 16,1 - WE / - WK
<b>Zubehörsatz, Scheibenbremsbelag</b>							
0.8 0.8 LPG 1.0 1.0 1.0 LPG	38 38 47 49 49	03/05→ 03/05→ 03/05→ 03/05→ 03/05→	←	→ 12/10		13.0460-0252.2 610252	
 <b>Bremsscheibe</b>							
0.8 0.8 LPG 1.0 1.0 1.0 LPG	38 38 47 49 49	03/05→ 03/05→ 03/05→ 03/05→ 03/05→	←	→ 12/10		24.0113-0195.1 413195	∅ 236 12,6 9,7
<b>CHEVROLET - MONTE CARLO Coupe 09/99→12/07</b>							
 <b>Bremsbelagsatz, Scheibenbremse</b>							
3.8	149	09/99→12/05	←	→ 05/05		13.0460-8002.2 608002	23358 18,0 + WK
<b>CHEVROLET - NUBIRA Kombi 01/05→12/11</b>							
 <b>Bremsbelagsatz, Scheibenbremse</b>							
1.6 1.8	80 89	03/05→12/11 08/05→12/11	←	→ 695960		13.0460-5859.2 605859	AKE 23234 16,9 + WK
			←	695961→; → 12/10		13.0460-5863.2 605863	AKE 23234 16,8 + WK
			→	01/07→ 12/10		13.0460-5663.2 605663	SUM 25232 14,5 - WE / - WK
			→	→ 12/06		13.0460-5739.2 605739	SUM 24071 14,6 - WE / - WK
1.6 LPG 1.8	80 90	03/05→12/10 03/05→12/09	←	→ 695960		13.0460-5859.2 605859	AKE 23234 16,9 + WK
			←	695961→		13.0460-5863.2 605863	AKE 23234 16,8 + WK
			→	01/07→		13.0460-5663.2 605663	SUM 25232 14,5 - WE / - WK
			→	→ 12/06		13.0460-5739.2 605739	SUM 24071 14,6 - WE / - WK
2.0 D	89	01/07→12/11	←	→ 695960		13.0460-5859.2 605859	AKE 23234 16,9 + WK
			←	695961→; → 12/10		13.0460-5863.2 605863	AKE 23234 16,8 + WK
			→	→ 12/10		13.0460-5663.2 605663	SUM 25232 14,5 - WE / - WK
<b>Zubehörsatz, Scheibenbremsbelag</b>							
1.6 1.6 LPG 1.8 1.8 2.0 D	80 80 89 90 89	03/05→12/11 03/05→12/10 08/05→12/11 03/05→12/09 01/07→12/11	←	→ 695960		13.0460-0140.2 610140	AKE
 <b>Bremsscheibe</b>							
1.6 1.8 2.0 D	80 89 89	03/05→12/11 08/05→12/11 01/07→12/11	←	→ 12/10		24.0124-0199.1 424199	∅ 256 24 21 V + S
			→	→ 12/10		24.0110-0340.1 410340	∅ 258 10,5 8 + S
1.6 LPG 1.8	80 90	03/05→12/10 03/05→12/09	←			24.0124-0199.1 424199	∅ 256 24 21 V + S
			→			24.0110-0340.1 410340	∅ 258 10,5 8 + S
<b>CHEVROLET - NUBIRA Stufenheck 01/05→12/11</b>							
 <b>Bremsbelagsatz, Scheibenbremse</b>							
1.4 1.4 1.8 1.8	69 70 89 90	01/05→12/07 01/06→12/08 01/06→09/07 03/05→12/09	←	→ 695960		13.0460-5859.2 605859	AKE 23234 16,9 + WK
			←	695961→		13.0460-5863.2 605863	AKE 23234 16,8 + WK
			→	01/07→		13.0460-5663.2 605663	SUM 25232 14,5 - WE / - WK
			→	→ 12/06		13.0460-5739.2 605739	SUM 24071 14,6 - WE / - WK
1.6 2.0 D ↓	80 89	03/05→12/11 01/05→12/11	←	→ 695960		13.0460-5859.2 605859	AKE 23234 16,9 + WK

















	kw			 	! #		
<b>CHEVROLET - NUBIRA Stufenheck 01/05→12/11</b>							
 <b>Bremsbelagsatz, Scheibenbremse</b>							
1.6 2.0 D	80 89	03/05→12/11 01/05→12/11	← → →	695961→; → 12/10 01/07→ 12/10 → 12/06		13.0460-5863.2 605863 13.0460-5663.2 605663 13.0460-5739.2 605739	AKE 23234 16,8 + WK SUM 25232 14,5 - WE / - WK SUM 24071 14,6 - WE / - WK
<b>Zubehörsatz, Scheibenbremsbelag</b>							
1.4 1.4 1.6 1.8 1.8 2.0 D	69 70 80 89 90 89	01/05→12/07 01/06→12/08 03/05→12/11 01/06→09/07 03/05→12/09 01/05→12/11	←	→ 695960		13.0460-0140.2 610140	AKE
 <b>Bremsscheibe</b>							
1.4 1.4 1.8 1.8	69 70 89 90	01/05→12/07 01/06→12/08 01/06→09/07 03/05→12/09	← →			24.0124-0199.1 424199 24.0110-0340.1 410340	Ø 256 24 21 V + S Ø 258 10,5 8 + S
1.6 2.0 D	80 89	03/05→12/11 01/05→12/11	← →	→ 12/10 → 12/10		24.0124-0199.1 424199 24.0110-0340.1 410340	Ø 256 24 21 V + S Ø 258 10,5 8 + S
<b>CHEVROLET - ORLANDO (J309) 12/10→</b>							
 <b>Bremsbelagsatz, Scheibenbremse</b>							
1.4 1.8 1.8 LPG 2.0 D 2.0 D 2.0 LPG	103 104 104 96 120 103	06/12→ 02/11→ 06/11→ 02/11→ 02/11→ 02/12→	← →			13.0460-7263.2 607263 13.0470-7263.2 LD7263 13.0460-7264.2 607264 13.0470-7264.2 LD7264	24034 19,1 + WK + Zub 24034 19,1 + WK + Zub Ceramic ATE 25096 17,0 + WK + Zub ATE 25096 17,0 + WK + Zub Ceramic
 <b>Bremsscheibe</b>							
1.4 1.8 1.8 LPG 2.0 D 2.0 D 2.0 LPG	103 104 104 96 120 103	06/12→ 02/11→ 06/11→ 02/11→ 02/11→ 02/12→	← →			24.0126-0166.1 426166 24.0326-0166.1 526166 24.0112-0189.1 412189 24.0312-0189.1 512189	Ø 300 26 23 V + S Ø 300 26 23 V + S Ø 292 12 10 + S Ø 292 12 10 + S
<b>CHEVROLET - REZZO Großraumlimousine (U100) 03/05→</b>							
 <b>Bremsbelagsatz, Scheibenbremse</b>							
1.6 1.6 2.0 2.0	77 79 89 90	03/05→ 08/05→ 03/05→ 08/05→	←	826909→; → 05/09		13.0460-5859.2 605859	AKE 23234 16,9 + WK
<b>Zubehörsatz, Scheibenbremsbelag</b>							
1.6 1.6 2.0 2.0	77 79 89 90	03/05→ 08/05→ 03/05→ 08/05→	←	826909→; → 05/09		13.0460-0140.2 610140	AKE
 <b>Bremsscheibe</b>							
1.6	66	03/05→03/09	←			24.0124-0199.1 424199	Ø 256 24 21 V + S
1.6 1.6 2.0 2.0	77 79 89 90	03/05→ 08/05→ 03/05→ 08/05→	←	→ 05/09		24.0124-0199.1 424199	Ø 256 24 21 V + S
<b>CHEVROLET - SPARK 05/05→</b>							
 <b>Bremsbelagsatz, Scheibenbremse</b>							
0.8 1.0 SX 1.0 SX 1.0 SX	37 44 46 49	05/05→ 06/09→ 05/05→ 05/05→	←	→ 02/10		13.0460-5996.2 605996	23241 16,1 - WE / - WK
 <b>Bremsscheibe</b>							
0.8 1.0 SX 1.0 SX 1.0 SX	37 44 46 49	05/05→ 06/09→ 05/05→ 05/05→	←	→ 02/10		24.0113-0195.1 413195	Ø 236 12,6 9,7















	kW			 	! #		
<b>CHEVROLET - SPARK (M300) 12/09→</b>							
 <b>Bremsbelagsatz, Scheibenbremse</b>							
1.0	48	07/10→	←			13.0460-5642.2 605642	AKE 25268 17,8 + WK
1.0	50	03/10→					
1.0 LPG	48	07/10→					
1.0 LPG	50	03/10→					
1.2	60	03/10→					
1.2 LPG	60	03/10→					
 <b>Bremsscheibe</b>							
1.0	48	07/10→	←			24.0120-0227.1 420227	Ø 236 20 18 V + S
1.0	50	03/10→					
1.0 LPG	48	07/10→					
1.0 LPG	50	03/10→					
1.2	60	03/10→					
1.2 LPG	60	03/10→					
<b>CHEVROLET - TIGRA 08/97→09/01</b>							
 <b>Bremsbelagsatz, Scheibenbremse</b>							
1.6	73	09/98→12/99	←			13.0460-7051.2 607051	ATE 20547 16,5 + WE / - WK
 <b>Bremsscheibe</b>							
1.6	73	09/98→12/99	←			24.0120-0140.1 420140	Ø 256 20 17 V + S
<b>CHEVROLET - TRANS SPORT 08/96→09/05</b>							
 <b>Bremsbelagsatz, Scheibenbremse</b>							
3.4	137	08/96→09/05	←	11/96→		13.0460-8002.2 608002	23358 18,0 + WK
3.4 V6	138	10/00→09/05	←			13.0460-8002.2 608002	23358 18,0 + WK
3.4 V6 AWD	138	10/01→09/05					
 <b>Bremsscheibe</b>							
3.4	137	08/96→09/05	←	11/96→		24.0132-0110.1 432110	Ø 278 32,2 30,7 V
			→	11/96→		24.0111-0133.1 411133	Ø 278 11 9
3.4 V6	138	10/00→09/05	←			24.0132-0110.1 432110	Ø 278 32,2 30,7 V
3.4 V6 AWD	138	10/01→09/05	→			24.0111-0133.1 411133	Ø 278 11 9
<b>CHEVROLET - TRAX 12/12→</b>							
 <b>Bremsbelagsatz, Scheibenbremse</b>							
1.4	103	12/12→	←			13.0460-7263.2 607263	24034 19,1 + WK + Zub
1.4 AWD	103	12/12→				13.0470-7263.2 LD7263	24034 19,1 + WK + Zub Ceramic
1.4 LPG	103	04/13→					
1.6	85	12/12→	→			13.0460-7264.2 607264	ATE 25096 17,0 + WK + Zub
1.6 D	100	11/14→12/15				13.0470-7264.2 LD7264	ATE 25096 17,0 + WK + Zub Ceramic
1.6 D AWD	100	11/14→12/15					
1.7 TD	96	12/12→					
1.7 TD AWD	96	12/12→					
1.8	103	03/13→					
1.8 AWD	103	03/13→					
 <b>Bremsscheibe</b>							
1.4	103	12/12→	←			24.0126-0182.1 426182	Ø 300 26 23 V + S
1.4 AWD	103	12/12→					
1.4 LPG	103	04/13→	→			24.0112-0188.1 412188	Ø 268 12 10 + S
1.6	85	12/12→				24.0312-0188.1 512188	Ø 268 12 10 + S
1.6 D	100	11/14→12/15					
1.6 D AWD	100	11/14→12/15					
1.7 TD	96	12/12→					
1.7 TD AWD	96	12/12→					
1.8	103	03/13→					
1.8 AWD	103	03/13→					
<b>CHEVROLET - VECTRA 03/96→11/06</b>							
 <b>Bremsbelagsatz, Scheibenbremse</b>							
2.0	81	03/96→12/05	←	→ 07/98		13.0460-7052.2 607052	ATE 21190 17,5 + WE / - WK
			←	08/98→		13.0460-7091.2 607091	ATE 21829 20,3 + WE / - WK
			→			13.0460-4040.2 604040	ATE 21050 15,8 - WE / - WK
2.0	100	03/96→04/98	←	554447→		13.0460-5859.2 605859	AKE 23234 16,9 + WK
			←	→ 554446		13.0460-5994.2 605994	AKE 23234 16,8 - WE / - WK
			→			13.0460-5993.2 605993	TRW 23237 14,5 - WE / - WK
2.2	91	05/98→07/04	←			13.0460-7091.2 607091	ATE 21829 20,3 + WE / - WK
2.2 ↓	102	05/98→12/05					

















	kw					! #		
<b>CHEVROLET - VECTRA 03/96→11/06</b>								
 <b>Bremsbelagsatz, Scheibenbremse</b>								
2.2 2.2	91 102	05/98→07/04 05/98→12/05	→				13.0460-4040.2 604040	ATE 21050 15,8 - WE / - WK
 <b>Bremsscheibe</b>								
2.0	81	03/96→12/05	←				24.0124-0115.1 424115	Ø 256 24 21 V + S
			←	08/98→			24.0324-0115.1 524115	Ø 256 24 21 V + S
			←		08/98→		24.0125-0119.1 425119	Ø 288 25 22 V + S
			←				24.0325-0119.1 525119	Ø 288 25 22 V + S
			→	Felge Lochzahl: 4			24.0110-0225.1 410225	Ø 270 10 8 + S
			→				24.0310-0225.1 510225	Ø 270 10 8 + S
			→	Felge Lochzahl: 5			24.0110-0226.1 410226	Ø 286 10 8 + S
			→				24.0310-0226.1 510226	Ø 286 10 8 + S
2.0	100	03/96→04/98	←				24.0124-0163.1 424163	Ø 256 24 22 V + S
			→				24.0110-0714.1 410714	Ø 258 10,3 8
2.2 2.2	91 102	05/98→07/04 05/98→12/05	←				24.0125-0119.1 425119	Ø 288 25 22 V + S
			←				24.0325-0119.1 525119	Ø 288 25 22 V + S
			→				24.0110-0226.1 410226	Ø 286 10 8 + S
			→				24.0310-0226.1 510226	Ø 286 10 8 + S
<b>CHEVROLET - VOLT 04/11→</b>								
 <b>Bremsbelagsatz, Scheibenbremse</b>								
EV 150	111	11/11→	←				13.0460-7263.2 607263	24034 19,1 + WK + Zub
			←				13.0470-7263.2 LD7263	24034 19,1 + WK + Zub Ceramic
			→	+ eFSB			13.0460-7264.2 607264	ATE 25096 17,0 + WK + Zub
			→				13.0470-7264.2 LD7264	ATE 25096 17,0 + WK + Zub Ceramic
 <b>Bremsscheibe</b>								
EV 150	111	11/11→	←				24.0126-0166.1 426166	Ø 300 26 23 V + S
			←				24.0326-0166.1 526166	Ø 300 26 23 V + S
			→	+ eFSB			24.0112-0189.1 412189	Ø 292 12 10 + S
			→				24.0312-0189.1 512189	Ø 292 12 10 + S
<b>CHRYSLER - 300C 09/10→</b>								
 <b>Bremsscheibe</b>								
3.0 CRD	176	09/11→	←	→ 11/12; für Fahrzeuge ohne Sportpaket			24.0128-0266.1 428266	Ø 320 28 26,5 V
<b>CHRYSLER - 300 C (LX, LE) 09/04→</b>								
 <b>Bremsscheibe</b>								
2.7 2.7 3.0 CRD 3.0 V6 CRD 3.5 5.7 6.1 SRT8	130 142 160 155 183 250 317	01/07→11/12 09/04→11/12 09/05→11/12 11/10→11/12 09/04→11/12 09/04→12/08 06/05→11/12	←	für Fahrzeuge ohne Sportpaket			24.0128-0266.1 428266	Ø 320 28 26,5 V
<b>CHRYSLER - 300 C Touring (LX, LE) 09/04→12/10</b>								
 <b>Bremsscheibe</b>								
2.7 2.7 3.0 CRD 3.5 3.5 AWD 5.7 5.7 AWD 6.1 SRT8	130 142 160 183 183 250 250 317	01/07→12/10 09/04→12/10 09/05→12/10 09/04→12/10 09/04→12/10 09/04→12/10 04/05→12/10 06/05→12/10	←	für Fahrzeuge ohne Sportpaket			24.0128-0266.1 428266	Ø 320 28 26,5 V
<b>CHRYSLER - 300 M (LR) 07/98→09/04</b>								
 <b>Bremsbelagsatz, Scheibenbremse</b>								
2.7 V6 24V 2.7 V6 24V 3.5 V6 24V 3.5 V6 24V	149 150 185 187	11/98→08/00 08/00→09/04 08/00→09/04 07/98→08/00	← →				13.0460-8003.2 608003	23043 16,0 - WE / - WK
			→				13.0460-8010.2 608010	23561 18,1 - WE / - WK
 <b>Bremsscheibe</b>								
2.7 V6 24V ↓	149	11/98→08/00	←	passend für Felgengröße [Zoll]: 16			24.0126-0179.1 426179	Ø 297 26 24,4 V















	kw			 	! #		
<b>CHRYSLER - 300 M (LR) 07/98→09/04</b>							
 <b>Bremsscheibe</b>							
2.7 V6 24V 3.5 V6 24V 3.5 V6 24V	150 185 187	08/00→09/04 08/00→09/04 07/98→08/00	←	passend für Felgenreöße [Zoll]: 16		24.0126-0179.1 426179	Ø 297 26 24,4 V
<b>CHRYSLER - CONCORDE 09/92→09/97</b>							
 <b>Bremsbelagsatz, Scheibenbremse</b>							
3.3 LX	120	10/92→09/97	←	01/95→		13.0460-8003.2 608003	23043 16,0 - WE / - WK
<b>CHRYSLER - CONCORDE 10/97→09/03</b>							
 <b>Bremsbelagsatz, Scheibenbremse</b>							
2.7 LX 3.5 LX 3.5 LX Supercharged	149 174 186	10/97→09/03 10/97→09/03 10/97→09/03	← →			13.0460-8003.2 608003 13.0460-8010.2 608010	23043 16,0 - WE / - WK 23561 18,1 - WE / - WK
 <b>Bremsscheibe</b>							
2.7 LX 3.5 LX 3.5 LX Supercharged	149 174 186	10/97→09/03 10/97→09/03 10/97→09/03	←			24.0126-0179.1 426179	Ø 297 26 24,4 V
<b>CHRYSLER - CROSSFIRE 07/03→12/08</b>							
 <b>Bremsbelagsatz, Scheibenbremse</b>							
3.2	160	07/03→12/08	←	→ 01/08		13.0460-7087.2 607087 13.0470-7087.2 LD7087	ATE 21670 19,3 + WE / - WK ATE 21670 19,3 + WE / - WK Ceramic
			→	→ 01/08		13.0460-4064.2 604064 13.0470-4064.2 LD4064	ATE 21919 15,3 - WE / - WK + Zub ATE 21919 15,3 - WE / - WK + Zub Ceramic
SRT-6	246	09/04→12/07	←	→ 08/06		13.0460-7183.2 607183	ATE 21484 20,5 + WE / - WK
			→	→ 08/06		13.0460-4047.2 604047 13.0470-4047.2 LD4047	ATE 21305 15,7 + WE / - WK ATE 21305 15,7 + WE / - WK Ceramic
 <b>Bremsscheibe</b>							
3.2	160	07/03→12/08	←	→ 01/08		24.0128-0106.1 428106	Ø 300 28 25,4 V + S
			→	→ 01/08		24.0109-0114.1 409114	Ø 278 9 7,3 + S
SRT-6	246	09/04→12/07	←	→ 08/06		24.0132-0159.1 432159	Ø 330 32 29,4 V
			→	→ 08/06		24.0122-0228.1 422228	Ø 300 22 19,4 V
<b>CHRYSLER - CROSSFIRE Roadster 05/04→12/08</b>							
 <b>Bremsbelagsatz, Scheibenbremse</b>							
3.2	160	05/04→12/08	←	→ 01/08		13.0460-7087.2 607087 13.0470-7087.2 LD7087	ATE 21670 19,3 + WE / - WK ATE 21670 19,3 + WE / - WK Ceramic
			→	→ 01/08		13.0460-4064.2 604064 13.0470-4064.2 LD4064	ATE 21919 15,3 - WE / - WK + Zub ATE 21919 15,3 - WE / - WK + Zub Ceramic
SRT-6	246	09/04→12/06	←	→ 08/06		13.0460-7183.2 607183	ATE 21484 20,5 + WE / - WK
			→	→ 08/06		13.0460-4047.2 604047 13.0470-4047.2 LD4047	ATE 21305 15,7 + WE / - WK ATE 21305 15,7 + WE / - WK Ceramic
 <b>Bremsscheibe</b>							
3.2	160	05/04→12/08	←	→ 01/08		24.0128-0106.1 428106	Ø 300 28 25,4 V + S
			→	→ 01/08		24.0109-0114.1 409114	Ø 278 9 7,3 + S
SRT-6	246	09/04→12/06	←	→ 08/06		24.0132-0159.1 432159	Ø 330 32 29,4 V
			→	→ 08/06		24.0122-0228.1 422228	Ø 300 22 19,4 V
<b>CHRYSLER - DELTA 08/11→</b>							
 <b>Bremsbelagsatz, Scheibenbremse</b>							
1.4 1.4 16V 1.6 D Multijet	88 103 88	08/11→ 08/11→ 08/11→	←			13.0460-3984.2 603984 13.0470-3984.2 LD3984	BOS 23711 19,4 + WK BOS 23711 19,4 + WK Ceramic
↓			→			13.0460-3861.2 603861	BOS 23714 17,6 + WK + Zub

	kw			 	! #		
<b>CHRYSLER - DELTA 08/11→</b>							
 <b>Bremsbelagsatz, Scheibenbremse</b>							
1.4	88	08/11→	→			13.0460-3991.2 603991	BOS 23714 16,6 - WE / - WK
1.4 16V	103	08/11→				13.0470-3861.2 LD3861	BOS + WK + Zub Ceramic
1.6 D Multijet	88	08/11→					
2.0 D Multijet	121	08/11→	←			13.0460-7265.2 607265	ATE 24727 20,7 + WK
			→			13.0460-3861.2 603861	BOS 23714 17,6 + WK + Zub
						13.0460-3991.2 603991	BOS 23714 16,6 - WE / - WK
						13.0470-3861.2 LD3861	BOS + WK + Zub Ceramic
 <b>Bremsscheibe</b>							
1.4	88	08/11→	←	für Leichtmetallfelgen		24.0126-0125.1 426125	Ø 281 26 24,2 V
1.4 16V	103	08/11→					
1.6 D Multijet	88	08/11→	→			24.0110-0190.1 410190	Ø 251,5 10 9
2.0 D Multijet	121	08/11→	←			24.0128-0243.1 428243	Ø 305 28 26 V
			→			24.0110-0190.1 410190	Ø 251,5 10 9
<b>CHRYSLER - GRAND VOYAGER V (RT) 10/07→</b>							
 <b>Bremsbelagsatz, Scheibenbremse</b>							
2.8 CRD	120	10/07→	←	+ ABS		13.0460-2766.2 602766	BOS 24604 18,7 + WK + Zub
3.3	125	01/08→					
3.8	142	10/07→	→			13.0460-2771.2 602771	TRW 24822 15,7 + WK + Zub
 <b>Bremsscheibe</b>							
2.8 CRD	120	10/07→	←	+ ABS		24.0128-0263.1 428263	Ø 302 28 26,4 V
3.3	125	01/08→					
3.8	142	10/07→					
<b>CHRYSLER - NEON (PL) 05/94→09/00</b>							
 <b>Bremsbelagsatz, Scheibenbremse</b>							
1.8 16V	85	09/97→08/99	←	Felge Lochzahl: 5		13.0460-8003.2 608003	23043 16,0 - WE / - WK
2.0 16V	107	06/94→08/99					
2.0 16V	109	04/96→08/99	→	Felge Lochzahl: 5		13.0460-8010.2 608010	23561 18,1 - WE / - WK
2.0 16V	98	05/94→08/99	←	01/95→; Felge Lochzahl: 5		13.0460-8003.2 608003	23043 16,0 - WE / - WK
			→	01/95→; Felge Lochzahl: 5		13.0460-8010.2 608010	23561 18,1 - WE / - WK
 <b>Bremsscheibe</b>							
1.8 16V	85	09/97→08/99	→	Felge Lochzahl: 5		24.0109-0146.1 409146	Ø 270 9 7,3
2.0 16V	107	06/94→08/99					
2.0 16V	109	04/96→08/99					
2.0 16V	98	05/94→08/99	→	01/95→; Felge Lochzahl: 5		24.0109-0146.1 409146	Ø 270 9 7,3
<b>CHRYSLER - NEON II 08/99→12/06</b>							
 <b>Bremsbelagsatz, Scheibenbremse</b>							
1.6	85	11/01→12/06	←			13.0460-8003.2 608003	23043 16,0 - WE / - WK
			→	+ ABS		13.0460-8010.2 608010	23561 18,1 - WE / - WK
1.8	91	01/00→12/01	←			13.0460-8003.2 608003	23043 16,0 - WE / - WK
2.0 16V	97	10/02→12/06					
2.0 16V	98	08/99→12/06	→			13.0460-8010.2 608010	23561 18,1 - WE / - WK
2.0 16V R/T	110	10/01→12/06					
 <b>Bremsscheibe</b>							
1.6	85	11/01→12/06	→	+ ABS		24.0109-0146.1 409146	Ø 270 9 7,3
1.8	91	01/00→12/01	→			24.0109-0146.1 409146	Ø 270 9 7,3
2.0 16V	97	10/02→12/06					
2.0 16V	98	08/99→12/06					
2.0 16V R/T	110	10/01→12/06					
<b>CHRYSLER - NEW YORKER 01/92→09/98</b>							
 <b>Bremsbelagsatz, Scheibenbremse</b>							
3.5	160	03/95→09/98	←			13.0460-8003.2 608003	23043 16,0 - WE / - WK
3.5 i 24V	155	04/93→09/98	←	01/95→		13.0460-8003.2 608003	23043 16,0 - WE / - WK
<b>CHRYSLER - PT CRUISER (PT_) 06/00→12/10</b>							
 <b>Bremsbelagsatz, Scheibenbremse</b>							
1.6	85	11/01→12/10	←	→ 09/10		13.0460-2959.2 602959	TRW 23532 20,1 + WK
			→	→ 09/10; + ABS		13.0460-8010.2 608010	23561 18,1 - WE / - WK
2.0	100	10/04→12/10	←	→ 09/10		13.0460-2959.2 602959	TRW 23532 20,1 + WK
↓							

	kW			 	! #		
<b>CHRYSLER - PT CRUISER (PT_) 06/00→12/10</b>							
 <b>Bremsbelagsatz, Scheibenbremse</b>							
2.2 CRD	89	03/02→12/10	➡	→ 09/10		13.0460-8010.2 608010	23561 18,1 - WE / - WK
2.2 CRD	110	08/05→12/10					
2.4	105	08/05→12/10					
2.4	110	06/00→12/10					
2.4	169	09/04→12/10					
GT 2.4	164	08/03→12/10					
2.0	104	06/00→09/04	⬅			13.0460-2959.2 602959	TRW 23532 20,1 + WK
			➡			13.0460-8010.2 608010	23561 18,1 - WE / - WK
<b>Zubehörsatz, Scheibenbremsbelag</b>							
1.6	85	11/01→12/10	⬅	→ 09/10		13.0460-0134.2 610134	TRW
2.0	100	10/04→12/10					
2.2 CRD	89	03/02→12/10					
2.2 CRD	110	08/05→12/10					
2.4	105	08/05→12/10					
2.4	110	06/00→12/10					
2.4	169	09/04→12/10					
GT 2.4	164	08/03→12/10					
2.0	104	06/00→09/04	⬅			13.0460-0134.2 610134	TRW
 <b>Bremsscheibe</b>							
1.6	85	11/01→12/10	⬅	→ 09/10		24.0123-0107.1 423107	Ø 280 23 21,4 V
			➡	→ 09/10; + ABS		24.0109-0146.1 409146	Ø 270 9 7,3
2.0	100	10/04→12/10	⬅	→ 09/10		24.0123-0107.1 423107	Ø 280 23 21,4 V
2.2 CRD	89	03/02→12/10					
2.2 CRD	110	08/05→12/10	➡	→ 09/10		24.0109-0146.1 409146	Ø 270 9 7,3
2.4	105	08/05→12/10					
2.4	110	06/00→12/10					
2.4	169	09/04→12/10					
GT 2.4	164	08/03→12/10					
2.0	104	06/00→09/04	⬅			24.0123-0107.1 423107	Ø 280 23 21,4 V
			➡			24.0109-0146.1 409146	Ø 270 9 7,3
<b>CHRYSLER - PT CRUISER Cabriolet 06/00→12/10</b>							
 <b>Bremsbelagsatz, Scheibenbremse</b>							
2.4	105	03/04→03/08	⬅			13.0460-2959.2 602959	TRW 23532 20,1 + WK
2.4 GT	164	03/04→03/08	➡			13.0460-8010.2 608010	23561 18,1 - WE / - WK
<b>Zubehörsatz, Scheibenbremsbelag</b>							
2.4	105	03/04→03/08	⬅			13.0460-0134.2 610134	TRW
2.4 GT	164	03/04→03/08					
 <b>Bremsscheibe</b>							
2.4	105	03/04→03/08	⬅			24.0123-0107.1 423107	Ø 280 23 21,4 V
2.4 GT	164	03/04→03/08	➡			24.0109-0146.1 409146	Ø 270 9 7,3
<b>CHRYSLER - SEBRING (JR) 09/00→06/07</b>							
 <b>Bremsbelagsatz, Scheibenbremse</b>							
2.0	104	04/01→06/07	➡			13.0460-5980.2 605980	21706 15,5 + WK
2.4	105	04/01→06/07	➡			13.0460-8010.2 608010	23561 18,1 - WE / - WK
2.4	112	04/01→06/07					
2.7 V6 24V	149	04/01→06/07					
 <b>Bremsscheibe</b>							
2.0	104	04/01→06/07	⬅			24.0123-0120.1 423120	Ø 282,5 23 21,4 V + S
2.4	105	04/01→06/07					
2.4	112	04/01→06/07					
2.7 V6 24V	149	04/01→06/07					
<b>CHRYSLER - SEBRING (JS) 09/06→12/10</b>							
 <b>Bremsbelagsatz, Scheibenbremse</b>							
2.0 CRD	103	07/07→12/10	⬅			13.0460-5760.2 605760	AKE 23584 16,4 + WK
2.0 VVT	115	07/07→12/10					
2.4 VVT	125	07/07→12/10	➡	+ ABS		13.0460-5735.2 605735	AKE 24014 16,0 + WK
2.7	138	07/07→12/10					
2.7 VVT	137	07/07→09/10					
2.7 VVT	141	09/06→12/10	⬅	07/07→		13.0460-5760.2 605760	AKE 23584 16,4 + WK
			➡	07/07→; + ABS		13.0460-5735.2 605735	AKE 24014 16,0 + WK
↓							

	kw			 	! #		
<b>CHRYSLER - SEBRING (JS) 09/06→12/10</b>							
 <b>Bremsscheibe</b>							
2.0 CRD	103	07/07→12/10	←			24.0126-0170.1 426170	Ø 294 26 24,4 V
2.0 VVT	115	07/07→12/10	→	+ ABS		24.0110-0363.1 410363	Ø 262 10 8,4
2.4 VVT	125	07/07→12/10					
2.7	138	07/07→12/10					
2.7 VVT	137	07/07→09/10					
2.7 VVT	141	09/06→12/10	←	07/07→		24.0126-0170.1 426170	Ø 294 26 24,4 V
			→	07/07→; + ABS		24.0110-0363.1 410363	Ø 262 10 8,4
<b>CHRYSLER - SEBRING Cabriolet (JR) 04/01→06/07</b>							
 <b>Bremsbelagsatz, Scheibenbremse</b>							
2.0	104	04/01→06/07	→			13.0460-8010.2 608010	23561 18,1 - WE / - WK
2.4	112	04/01→06/07					
2.4 Turbo	164	09/01→06/07					
2.7 V6 24V	149	04/01→06/07					
 <b>Bremsscheibe</b>							
2.0	104	04/01→06/07	←			24.0123-0120.1 423120	Ø 282,5 23 21,4 V + S
2.4	112	04/01→06/07					
2.4 Turbo	164	09/01→06/07					
2.7 V6 24V	149	04/01→06/07					
<b>CHRYSLER - SEBRING Cabriolet (JS) 05/07→12/10</b>							
 <b>Bremsbelagsatz, Scheibenbremse</b>							
2.0 CRD	103	07/07→12/10	←			13.0460-5760.2 605760	AKE 23584 16,4 + WK
2.4 VVT	125	07/07→12/10	→	+ ABS		13.0460-5855.2 605855	23582 16,0 - WK
2.7	137	07/07→12/10					
2.7 VVT	141	07/07→12/10					
 <b>Bremsscheibe</b>							
2.0 CRD	103	07/07→12/10	←			24.0126-0170.1 426170	Ø 294 26 24,4 V
2.4 VVT	125	07/07→12/10	→	+ ABS		24.0110-0372.1 410372	Ø 302 10 8,4
2.7	137	07/07→12/10					
2.7 VVT	141	07/07→12/10					
<b>CHRYSLER - STRATUS (JA) 09/94→04/01</b>							
 <b>Bremsbelagsatz, Scheibenbremse</b>							
2.5 LX V6	120	12/95→04/01	→			13.0460-8010.2 608010	23561 18,1 - WE / - WK
2.5 V6	125	12/95→04/01					
<b>CHRYSLER - STRATUS Cabriolet (JX) 04/96→04/01</b>							
 <b>Bremsbelagsatz, Scheibenbremse</b>							
2.5 LX	120	04/96→04/01	→			13.0460-8010.2 608010	23561 18,1 - WE / - WK
<b>CHRYSLER - VISION 09/93→12/97</b>							
 <b>Bremsbelagsatz, Scheibenbremse</b>							
3.5 Tsi	155	09/93→12/97	←	01/95→		13.0460-8003.2 608003	23043 16,0 - WE / - WK
<b>CHRYSLER - VOYAGER / GRAND VOYAGER III (GS) 01/95→03/01</b>							
 <b>Bremsbelagsatz, Scheibenbremse</b>							
2.0 i	98	01/95→03/01	←			13.0460-8003.2 608003	23043 16,0 - WE / - WK
2.4 i	111	01/95→03/01	→	→ 09/96; + ABS		13.0460-8010.2 608010	23561 18,1 - WE / - WK
2.5 TD	85	01/95→03/01					
3.0	112	01/95→03/01					
3.3 i	116	01/95→03/01					
2.4 AWD	111	02/97→03/01	←			13.0460-7207.2 607207	ATE 23807 18,6 - WE / - WK
						13.0460-8003.2 608003	23043 16,0 - WE / - WK
2.5 TDic AWD	85	10/95→03/01	←			13.0460-7207.2 607207	ATE 23807 18,6 - WE / - WK
						13.0460-8003.2 608003	23043 16,0 - WE / - WK
3.8 i AWD	131	01/95→03/01	→	→ 09/96; + ABS		13.0460-8010.2 608010	23561 18,1 - WE / - WK
3.8 i AWD	122	01/95→03/01	←			13.0460-7207.2 607207	ATE 23807 18,6 - WE / - WK
			←	Allrad		13.0460-8003.2 608003	23043 16,0 - WE / - WK
			→	→ 09/96; + ABS		13.0460-8010.2 608010	23561 18,1 - WE / - WK
 <b>Bremsscheibe</b>							
2.0 i	98	01/95→03/01	←	passend für Felgenreöße [Zoll]: 15		24.0124-0178.1 424178	Ø 282,5 24 22,4 V
2.4 i	111	01/95→03/01	→	+ ABS		24.0113-0196.1 413196	Ø 290 12,5 11,3
2.5 TD	85	01/95→03/01					
3.0	112	01/95→03/01					
↓							

	kW			 	! #		
<b>CHRYSLER - VOYAGER / GRAND VOYAGER III (GS) 01/95→03/01</b>							
 <b>Bremsscheibe</b>							
3.3 i	116	01/95→03/01	←	passend für Felgengröße [Zoll]: 15		24.0124-0178.1 424178	Ø 282,5 24 22,4 V
			→	+ ABS		24.0113-0196.1 413196	Ø 290 12,5 11,3
2.4 AWD	111	02/97→03/01	←	passend für Felgengröße [Zoll]: 15		24.0124-0178.1 424178	Ø 282,5 24 22,4 V
2.5 TDiC AWD	85	10/95→03/01	←			24.0128-0147.1 428147	Ø 302 28 26,5 V
3.8 i AWD	131	01/95→03/01	←			24.0113-0196.1 413196	Ø 290 12,5 11,3
			→	+ ABS		24.0113-0196.1 413196	Ø 290 12,5 11,3
3.8 i AWD	122	01/95→03/01	←	Allrad; passend für Felgengröße [Zoll]: 15		24.0124-0178.1 424178	Ø 282,5 24 22,4 V
			←			24.0128-0147.1 428147	Ø 302 28 26,5 V
			→	+ ABS		24.0113-0196.1 413196	Ø 290 12,5 11,3
<b>CHRYSLER - VOYAGER IV (RG, RS) 09/99→12/08</b>							
 <b>Bremsbelagsatz, Scheibenbremse</b>							
2.4	108	02/00→12/08	←	passend für Felgengröße [Zoll]: 15		13.0460-2899.2 602899	TRW 23638 17,5 + WK
2.5 CRD	88	08/05→12/08	←			13.0460-7207.2 607207	ATE 23807 18,6 - WE / - WK
2.5 CRD	105	02/00→12/08	←	passend für Felgengröße [Zoll]: 16		13.0460-7207.2 607207	ATE 23807 18,6 - WE / - WK
2.8 CRD	110	06/04→12/08	←			13.0460-8008.2 608008	24036 16,7 + WK
3.3	128	02/00→12/08	→				
3.3 AWD	128	02/00→12/08	→				
3.3 Flex-Fuel	128	02/00→12/08	→				
3.8	160	02/00→12/08	→				
3.8 AWD	160	02/00→12/08	→				
 <b>Bremsscheibe</b>							
2.4	108	02/00→12/08	←	passend für Felgengröße [Zoll]: 16		24.0128-0147.1 428147	Ø 302 28 26,5 V
2.5 CRD	88	08/05→12/08	←			24.0128-0148.1 428148	Ø 281 28 25,3 V
2.5 CRD	105	02/00→12/08	←	passend für Felgengröße [Zoll]: 15		24.0128-0148.1 428148	Ø 281 28 25,3 V
2.8 CRD	110	06/04→12/08	←			24.0113-0196.1 413196	Ø 290 12,5 11,3
3.3	128	02/00→12/08	→				
3.3 AWD	128	02/00→12/08	→				
3.3 Flex-Fuel	128	02/00→12/08	→				
3.8	160	02/00→12/08	→				
3.8 AWD	160	02/00→12/08	→				
<b>CHRYSLER - YPSILON 05/11→</b>							
 <b>Bremsbelagsatz, Scheibenbremse</b>							
0.9 Twinair	63	05/11→	←			13.0460-7289.2 607289	ATE 25323 17,3 + WK
1.2	51	05/11→	←				
1.3 Multijet	70	05/11→	←				
 <b>Bremsscheibe</b>							
0.9 Twinair	63	05/11→	←			24.0122-0197.1 422197	Ø 257,5 22 20,2 V
1.3 Multijet	70	05/11→	←			24.0322-0197.1 522197	Ø 257,5 22 20,2 V
1.2	51	05/11→	←			24.0112-0127.1 412127	Ø 257,5 12 10,2
<b>CITROËN - AX (ZA-_) 07/86→12/98</b>							
 <b>Bremsbelagsatz, Scheibenbremse</b>							
1.4 GTi	66	08/91→12/96	←			13.0460-2825.2 602825	TRW 21614 17,7 + WK
1.4 GTi	69	06/91→12/96	←				
10	33	07/86→12/98	←	→Orga 05089		13.0460-4041.2 604041	ATE 21179 16,8 + WK
			←	Orga 05090→		13.0460-4042.2 604042	ATE 21191 16,8 + WK
10	37	02/87→12/98	←	07/92→		13.0460-4042.2 604042	ATE 21191 16,8 + WK
11	44	09/86→12/97	←	10/89→; →Orga 05089		13.0460-4041.2 604041	ATE 21179 16,8 + WK
			←	Orga 05090→		13.0460-4042.2 604042	ATE 21191 16,8 + WK
14 (ZA)	55	04/87→04/97	←	Orga 05278→; → 12/96		13.0460-3952.2 603952	BDX 20905 18,0 + WK
			←	03/89→; →Orga 05089		13.0460-4041.2 604041	ATE 21179 16,8 + WK
			←	Orga 05090→ Orga 05277		13.0460-4042.2 604042	ATE 21191 16,8 + WK
14 4x4	55	08/91→12/96	←			13.0460-3952.2 603952	BDX 20905 18,0 + WK
15 D	40	08/94→12/97	←				
15 D	43	08/94→12/97	←				
14 D	37	08/91→12/97	←	Orga 05278→		13.0460-3952.2 603952	BDX 20905 18,0 + WK
			←	→Orga 05089		13.0460-4041.2 604041	ATE 21179 16,8 + WK
			←	Orga 05090→ Orga 05277		13.0460-4042.2 604042	ATE 21191 16,8 + WK
Electric	25	04/93→10/96	←			13.0460-4066.2 604066	ATE 21857 17,7 - WE / - WK
Electric	28	11/96→04/97	←				
↓							





**CITROËN - AX (ZA-) 07/86→12/98**

**Zubehörsatz, Scheibenbremsbelag**

1.4 GTi	66	08/91→12/96	←			13.0460-0060.2	610060	TRW
1.4 GTi	69	06/91→12/96	←					
10	33	07/86→12/98	←	→Orga 05089		13.0460-0424.2	610424	ATE
			←	Orga 05090→		13.0460-0424.2	610424	ATE
10	37	02/87→12/98	←	07/92→		13.0460-0424.2	610424	ATE
11	44	09/86→12/97	←	Orga 05090→		13.0460-0424.2	610424	ATE
			←	10/89→; →Orga 05089		13.0460-0424.2	610424	ATE
14 (ZA)	55	04/87→04/97	←	Orga 05278→; → 12/96		13.0460-0403.2	610403	BDX
			←	Orga 05090→ Orga 05277		13.0460-0424.2	610424	ATE
			←	03/89→; →Orga 05089		13.0460-0424.2	610424	ATE
14 4x4	55	08/91→12/96	←			13.0460-0403.2	610403	BDX
15 D	40	08/94→12/97	←					
15 D	43	08/94→12/97	←					
14 D	37	08/91→12/97	←	Orga 05278→		13.0460-0403.2	610403	BDX
			←	Orga 05090→ Orga 05277		13.0460-0424.2	610424	ATE
			←	→Orga 05089		13.0460-0424.2	610424	ATE









**Bremsscheibe**

1.4 GTi	66	08/91→12/96	←			24.0120-0132.1	420132	Ø 247 20,4 18,5 V + S
1.4 GTi	69	06/91→12/96	←			24.0320-0132.1	520132	Ø 247 20,4 18,5 V + S
10	33	07/86→12/98	←			24.0108-0107.1	408107	Ø 238 8 6 + S
Electric	25	04/93→10/96	←					
Electric	28	11/96→04/97	←					
10	37	02/87→12/98	←	07/92→		24.0108-0107.1	408107	Ø 238 8 6 + S
11	44	09/86→12/97	←	10/89→		24.0108-0107.1	408107	Ø 238 8 6 + S
14 (ZA)	55	04/87→04/97	←	03/89→; →Orga 05277		24.0108-0107.1	408107	Ø 238 8 6 + S
14 D	37	08/91→12/97	←	→Orga 05277		24.0108-0107.1	408107	Ø 238 8 6 + S











**CITROËN - BERLINGO / BERLINGO FIRST Großraumlimousine (MF, GJK, GFK) 07/96→12/11**

**Bremsbelagsatz, Scheibenbremse**

1.1 i (MFHDZ, MFHFX)	44	07/96→05/08	←	→Orga 09127		13.0460-2829.2	602829	TRW 23124 19,0 + WK
1.4 i (MFKFX, MFKFW, GJKFWB, GJKFWC, GFKFWC)	55	07/96→12/11	←	→Orga 09428		13.0460-2829.2	602829	TRW 23124 19,0 + WK
			←	Orga 09429→; → 03/08		13.0460-3994.2	603994	BOS 23599 19,0 - WE / - WK + Zub
			←			13.0470-3994.2	LD3994	BOS 23599 19,0 - WE / - WK + Zub Ceramic
			←	Orga 09128→; → 03/08		13.0460-3994.2	603994	BOS 23599 19,0 - WE / - WK + Zub
			←			13.0470-3994.2	LD3994	BOS 23599 19,0 - WE / - WK + Zub Ceramic
1.4	53	11/02→10/05	←			13.0460-3994.2	603994	BOS 23599 19,0 - WE / - WK + Zub
			←			13.0470-3994.2	LD3994	BOS 23599 19,0 - WE / - WK + Zub Ceramic
1.4 bivalent	48	11/02→12/11	←	→ 03/08		13.0460-3994.2	603994	BOS 23599 19,0 - WE / - WK + Zub
1.4 i bivalent (MFKFW)	55	04/03→10/08	←					
1.6 HDI 75 (MF9HW, GJ9HWC, GF9HWC, GN9HWC)	55	07/05→12/11	←			13.0470-3994.2	LD3994	BOS 23599 19,0 - WE / - WK + Zub Ceramic
1.6 16V (MFNFU)	80	10/00→12/11	←	→Orga 09127		13.0460-2829.2	602829	TRW 23124 19,0 + WK
1.6 16V (MFNFU)	81	11/02→10/08	←	Orga 09128→; → 03/08; + ESP		13.0460-3811.2	603811	BOS 23708 19,2 - WE / - WK
			←	Orga 09128→; → 03/08; - ESP		13.0460-3994.2	603994	BOS 23599 19,0 - WE / - WK + Zub
			←			13.0470-3994.2	LD3994	BOS 23599 19,0 - WE / - WK + Zub Ceramic
			→	→ 03/08; + ESP		13.0460-2820.2	602820	TRW 20961 17,2 - WK
			→			13.0470-2820.2	LD2820	TRW 20961 17,2 - WK Ceramic
1.6 HDI 90 (MF9HX)	66	07/05→05/08	←	→ 03/08; + ESP		13.0460-3811.2	603811	BOS 23708 19,2 - WE / - WK
			←	→ 03/08; - ESP		13.0460-3994.2	603994	BOS 23599 19,0 - WE / - WK + Zub
			←			13.0470-3994.2	LD3994	BOS 23599 19,0 - WE / - WK + Zub Ceramic
↓			←	04/08→		13.0460-7229.2	607229	ATE 24538 18,5 - WE / - WK

	kw			 	! #		
<b>CITROËN - BERLINGO / BERLINGO FIRST Großraumlimousine (MF, GJK, GFK) 07/96→12/11</b>							
<b> Bremsbelagsatz, Scheibenbremse</b>							
1.6 HDI 90 (MF9HX)	66	07/05→05/08	←	04/08→		13.0470-7229.2 LD7229	ATE 24538 18,5 - WE / - WK Ceramic
			→	→ 03/08; + ESP		13.0460-2820.2 602820 13.0470-2820.2 LD2820	TRW 20961 17,2 - WK TRW 20961 17,2 - WK Ceramic
1.8 D (MFA9A)	43	07/98→10/02	←	→Orga 09127		13.0460-2829.2 602829	TRW 23124 19,0 + WK
1.8 i (MFLFX)	66	05/97→10/02	←				
1.9 D (MFDJY)	50	07/96→12/03	←	Orga 09128→		13.0460-3994.2 603994	BOS 23599 19,0 - WE / - WK + Zub
1.9 D (MFWJZ)	51	07/98→10/05	←			13.0470-3994.2 LD3994	BOS 23599 19,0 - WE / - WK + Zub Ceramic
1.9 D 4WD (MFWJZ)	51	07/98→10/05	←				
1.8 i 4WD (MFLFX)	66	04/97→10/01	←	05/97→; →Orga 09127		13.0460-2829.2 602829	TRW 23124 19,0 + WK
			←	Orga 09128→		13.0460-3994.2 603994 13.0470-3994.2 LD3994	BOS 23599 19,0 - WE / - WK + Zub BOS 23599 19,0 - WE / - WK + Zub Ceramic
2.0 HDi 4x4 (MFRHY)	66	11/02→10/05	←	→Orga 09127		13.0460-2829.2 602829	TRW 23124 19,0 + WK
2.0 HDI 90 (MFRHY)	66	12/99→10/05	←	Orga 09128→; + ESP		13.0460-3811.2 603811	BOS 23708 19,2 - WE / - WK
			←	Orga 09128→; - ESP		13.0460-3994.2 603994 13.0470-3994.2 LD3994	BOS 23599 19,0 - WE / - WK + Zub BOS 23599 19,0 - WE / - WK + Zub Ceramic
			→	+ ESP		13.0460-2820.2 602820 13.0470-2820.2 LD2820	TRW 20961 17,2 - WK TRW 20961 17,2 - WK Ceramic
Electric	28	01/98→12/05	←	11/02→		13.0460-2829.2 602829	TRW 23124 19,0 + WK
electrique	16	01/00→10/02	←			13.0460-2829.2 602829	TRW 23124 19,0 + WK
<b> Bremsscheibe</b>							
1.1 i (MFHDZ, MFHFX)	44	07/96→05/08	←	→Orga 09428		24.0113-0184.1 413184	Ø 266 13 11 + S
1.4 i (MFKFX, MFKFW, GJKFWB, GJKFWC, GFKFWC)	55	07/96→12/11	←	→Orga 09127		24.0313-0184.1 513184	Ø 266 13 11 + S
			←	→Orga 09127		24.0120-0133.1 420133 24.0320-0133.1 520133	Ø 266 20,5 18,5 V + S Ø 266 20,5 18,5 V + S
			←	Orga 09429→; → 03/08		24.0122-0194.1 422194	Ø 266 22 20 V + S
			←	Orga 09128→; → 03/08		24.0122-0194.1 422194	Ø 266 22 20 V + S
1.4	53	11/02→10/05	←			24.0122-0194.1 422194	Ø 266 22 20 V + S
1.4 bivalent	48	11/02→12/11	←	→ 03/08		24.0122-0194.1 422194	Ø 266 22 20 V + S
1.4 i bivalent (MFKFW)	55	04/03→10/08	←				
1.6 HDI 75 (MF9HW, GJ9HWC, GF9HWC, GN9HWC)	55	07/05→12/11	←				
1.6 16V (MFNFU)	80	10/00→12/11	←	→Orga 09127		24.0120-0133.1 420133 24.0320-0133.1 520133	Ø 266 20,5 18,5 V + S Ø 266 20,5 18,5 V + S
1.6 16V (MFNFU)	81	11/02→10/08	←	Orga 09128→; → 03/08; - ESP		24.0122-0194.1 422194	Ø 266 22 20 V + S
			←	Orga 09128→; → 03/08; + ESP		24.0126-0120.1 426120 24.0326-0120.1 526120	Ø 283 26 24 V + S Ø 283 26 24 V + S
			→	→ 03/08; + ESP		24.0109-0137.1 409137	Ø 247 9 8 + S
1.6 HDI 90 (MF9HX)	66	07/05→05/08	←	→ 03/08; - ESP		24.0122-0194.1 422194	Ø 266 22 20 V + S
			←	→ 03/08; + ESP		24.0126-0120.1 426120 24.0326-0120.1 526120	Ø 283 26 24 V + S Ø 283 26 24 V + S
			→	→ 03/08; + ESP		24.0109-0137.1 409137	Ø 247 9 8 + S
1.8 D (MFA9A)	43	07/98→10/02	←	→Orga 09127		24.0120-0133.1 420133 24.0320-0133.1 520133	Ø 266 20,5 18,5 V + S Ø 266 20,5 18,5 V + S
1.8 i (MFLFX)	66	05/97→10/02	←				
1.9 D (MFDJY)	50	07/96→12/03	←	Orga 09128→		24.0122-0194.1 422194	Ø 266 22 20 V + S
1.9 D (MFWJZ)	51	07/98→10/05	←				
1.9 D 4WD (MFWJZ)	51	07/98→10/05	←				
1.8 i 4WD (MFLFX)	66	04/97→10/01	←	05/97→; →Orga 09127		24.0120-0133.1 420133 24.0320-0133.1 520133	Ø 266 20,5 18,5 V + S Ø 266 20,5 18,5 V + S
			←	Orga 09128→		24.0122-0194.1 422194	Ø 266 22 20 V + S
2.0 HDi 4x4 (MFRHY)	66	11/02→10/05	←	→Orga 09127		24.0120-0133.1 420133 24.0320-0133.1 520133	Ø 266 20,5 18,5 V + S Ø 266 20,5 18,5 V + S
2.0 HDI 90 (MFRHY)	66	12/99→10/05	←	Orga 09128→; - ESP		24.0122-0194.1 422194	Ø 266 22 20 V + S
			←	Orga 09128→; + ESP		24.0126-0120.1 426120 24.0326-0120.1 526120	Ø 283 26 24 V + S Ø 283 26 24 V + S
			→	+ ESP		24.0109-0137.1 409137	Ø 247 9 8 + S
Electric	28	01/98→12/05	←	11/02→		24.0113-0184.1 413184	Ø 266 13 11 + S



	kw			 	! #		
<b>CITROËN - BERLINGO / BERLINGO FIRST Großraumlimousine (MF, GJK, GFK) 07/96→12/11</b>							
 <b>Bremsscheibe</b>							
Electric	28	01/98→12/05	←	11/02→		24.0313-0184.1 513184	Ø 266 13 11 + S
electrique	16	01/00→10/02	←			24.0113-0184.1 413184	Ø 266 13 11 + S
						24.0313-0184.1 513184	Ø 266 13 11 + S
<b>CITROËN - BERLINGO / BERLINGO FIRST Kasten (M_) 07/96→12/11</b>							
 <b>Bremsbelagsatz, Scheibenbremse</b>							
1.1 i (MAHDZ, MBHDZ, MBHFX)	44	07/96→03/08	←	→Orga 09127		13.0460-2829.2 602829	TRW 23124 19,0 + WK
			←	→Orga 09428		13.0460-2829.2 602829	TRW 23124 19,0 + WK
			←	Orga 09429→		13.0460-3994.2 603994	BOS 23599 19,0 - WE / - WK + Zub
			←	Orga 09128→		13.0460-3994.2 603994	BOS 23599 19,0 - WE / - WK + Zub
						13.0470-3994.2 LD3994	BOS 23599 19,0 - WE / - WK + Zub Ceramic
						13.0460-3994.2 603994	BOS 23599 19,0 - WE / - WK + Zub
						13.0470-3994.2 LD3994	BOS 23599 19,0 - WE / - WK + Zub Ceramic
1.4 bivalent 1.6 HDI 75 (MB9HW) 1.6 HDI 90 (MB9HX, MC9HX)	48 55 66	11/02→12/11 07/05→12/11 07/05→12/11	←	→ 03/08		13.0460-3994.2 603994	BOS 23599 19,0 - WE / - WK + Zub
						13.0470-3994.2 LD3994	BOS 23599 19,0 - WE / - WK + Zub Ceramic
1.4 i (MBKFX, MBKFW)	55	07/96→12/11	←	→Orga 09127		13.0460-2829.2 602829	TRW 23124 19,0 + WK
			←	→Orga 09428		13.0460-2829.2 602829	TRW 23124 19,0 + WK
			←	Orga 09429→; → 03/08		13.0460-3994.2 603994	BOS 23599 19,0 - WE / - WK + Zub
			←	Orga 09128→; → 03/08		13.0460-3994.2 603994	BOS 23599 19,0 - WE / - WK + Zub
						13.0470-3994.2 LD3994	BOS 23599 19,0 - WE / - WK + Zub Ceramic
						13.0470-3994.2 LD3994	BOS 23599 19,0 - WE / - WK + Zub Ceramic
1.4 i bivalent (MBKFW)	55	04/03→10/05	←			13.0460-3994.2 603994	BOS 23599 19,0 - WE / - WK + Zub
						13.0470-3994.2 LD3994	BOS 23599 19,0 - WE / - WK + Zub Ceramic
1.6 16V 1.6 16V (MBNFU) 1.8 D (MBA9A, MCA9A) 1.8 i 1.9 D (MBDJY) 1.9 D 70 4WD (MBWJZ, MCWJZ)	81 80 43 66 51 51	08/05→12/07 10/00→03/08 07/96→10/02 08/99→10/02 07/96→12/03 07/98→03/06	←	→Orga 09127		13.0460-2829.2 602829	TRW 23124 19,0 + WK
			←	Orga 09128→		13.0460-3994.2 603994	BOS 23599 19,0 - WE / - WK + Zub
						13.0470-3994.2 LD3994	BOS 23599 19,0 - WE / - WK + Zub Ceramic
			←	→Orga 09127		13.0460-2829.2 602829	TRW 23124 19,0 + WK
			←	Orga 09128→; → 03/08		13.0460-3994.2 603994	BOS 23599 19,0 - WE / - WK + Zub
						13.0470-3994.2 LD3994	BOS 23599 19,0 - WE / - WK + Zub Ceramic
1.9 D 70 (MBWJZ, MCWJZ)	51	04/99→12/11	←	→Orga 09127		13.0460-2829.2 602829	TRW 23124 19,0 + WK
			←	Orga 09128→; → 03/08		13.0460-3994.2 603994	BOS 23599 19,0 - WE / - WK + Zub
						13.0470-3994.2 LD3994	BOS 23599 19,0 - WE / - WK + Zub Ceramic
2.0 HDI 90 (MBRHY, MCRHY)	66	12/99→12/11	←	→Orga 09127		13.0460-2829.2 602829	TRW 23124 19,0 + WK
			←	Orga 09128→; → 03/08		13.0460-3994.2 603994	BOS 23599 19,0 - WE / - WK + Zub
						13.0470-3994.2 LD3994	BOS 23599 19,0 - WE / - WK + Zub Ceramic
			→	→ 03/08; + ESP		13.0460-2820.2 602820	TRW 20961 17,2 - WK
						13.0470-2820.2 LD2820	TRW 20961 17,2 - WK Ceramic
2.0 HDI 90 4WD (MBRHY, MCRHY)	66	11/00→10/05	←	→Orga 09127		13.0460-2829.2 602829	TRW 23124 19,0 + WK
			←	Orga 09128→		13.0460-3994.2 603994	BOS 23599 19,0 - WE / - WK + Zub
						13.0470-3994.2 LD3994	BOS 23599 19,0 - WE / - WK + Zub Ceramic
			→	+ ESP		13.0460-2820.2 602820	TRW 20961 17,2 - WK
						13.0470-2820.2 LD2820	TRW 20961 17,2 - WK Ceramic
Electric	27	07/03→12/05	←	11/04→		13.0460-2829.2 602829	TRW 23124 19,0 + WK
 <b>Bremsscheibe</b>							
1.1 i (MAHDZ, MBHDZ, MBHFX)	44	07/96→03/08	←	→Orga 09428		24.0113-0184.1 413184	Ø 266 13 11 + S
						24.0313-0184.1 513184	Ø 266 13 11 + S
			←	→Orga 09127		24.0120-0133.1 420133	Ø 266 20,5 18,5 V + S
						24.0320-0133.1 520133	Ø 266 20,5 18,5 V + S
↓							

**CITROËN - BERLINGO / BERLINGO FIRST Kasten (M\_) 07/96→12/11**

 **Bremsscheibe**

1.1 i (MAHDZ, MBHDZ, MBHFX)	44	07/96→03/08	←	Orga 09128→	24.0122-0194.1	422194	Ø 266 22 20 V + S
			←	Orga 09429→	24.0122-0194.1	422194	Ø 266 22 20 V + S
1.4 bivalent 1.6 HDI 75 (MB9HW) 1.6 HDI 90 (MB9HX, MC9HX)	48 55 66	11/02→12/11 07/05→12/11 07/05→12/11	←	→ 03/08	24.0122-0194.1	422194	Ø 266 22 20 V + S
1.4 i (MBKFX, MBKFW)	55	07/96→12/11	←	→Orga 09428	24.0113-0184.1	413184	Ø 266 13 11 + S
					24.0313-0184.1	513184	Ø 266 13 11 + S
			←	→Orga 09127	24.0120-0133.1	420133	Ø 266 20,5 18,5 V + S
					24.0320-0133.1	520133	Ø 266 20,5 18,5 V + S
			←	Orga 09429→; → 03/08	24.0122-0194.1	422194	Ø 266 22 20 V + S
			←	Orga 09128→; → 03/08	24.0122-0194.1	422194	Ø 266 22 20 V + S
1.4 i bivalent (MBKFW)	55	04/03→10/05	←		24.0122-0194.1	422194	Ø 266 22 20 V + S
1.6 16V 1.6 16V (MBNFU)	81 80	08/05→12/07 10/00→03/08	←	→Orga 09127	24.0120-0133.1	420133	Ø 266 20,5 18,5 V + S
					24.0320-0133.1	520133	Ø 266 20,5 18,5 V + S
1.8 D (MBA9A, MCA9A) 1.8 i 1.9 D (MBDJY) 1.9 D 70 4WD (MBWJZ, MCWJZ)	43 66 51 51	07/96→10/02 08/99→10/02 07/96→12/03 07/98→03/06	←	Orga 09128→	24.0122-0194.1	422194	Ø 266 22 20 V + S
1.9 D 70 (MBWJZ, MCWJZ)	51	04/99→12/11	←	→Orga 09127	24.0120-0133.1	420133	Ø 266 20,5 18,5 V + S
					24.0320-0133.1	520133	Ø 266 20,5 18,5 V + S
			←	Orga 09128→; → 03/08	24.0122-0194.1	422194	Ø 266 22 20 V + S
2.0 HDI 90 (MBRHY, MCRHY)	66	12/99→12/11	←	→Orga 09127	24.0120-0133.1	420133	Ø 266 20,5 18,5 V + S
					24.0320-0133.1	520133	Ø 266 20,5 18,5 V + S
			←	Orga 09128→; → 03/08	24.0122-0194.1	422194	Ø 266 22 20 V + S
			→	→ 03/08; + ESP	24.0109-0137.1	409137	Ø 247 9 8 + S
2.0 HDI 90 4WD (MBRHY, MCRHY)	66	11/00→10/05	←	→Orga 09127	24.0120-0133.1	420133	Ø 266 20,5 18,5 V + S
					24.0320-0133.1	520133	Ø 266 20,5 18,5 V + S
			←	Orga 09128→	24.0122-0194.1	422194	Ø 266 22 20 V + S
			→	+ ESP	24.0109-0137.1	409137	Ø 247 9 8 + S
Electric	27	07/03→12/05	←	11/04→	24.0113-0184.1	413184	Ø 266 13 11 + S
					24.0313-0184.1	513184	Ø 266 13 11 + S











**CITROËN - BERLINGO (B9) 04/08→**

 **Bremsbelagsatz, Scheibenbremse**













1.2 PureTech 110 1.6 1.6 1.6 BlueHdi 100 1.6 BlueHdi 120 1.6 HDi 110 1.6 HDi 110 1.6 HDi 115 1.6 HDi 115 4x4 1.6 HDi 75 16V 1.6 HDi 90 1.6 HDi 90 1.6 HDi 90 4x4 1.6 VTi 120 1.6 VTi 95	81 66 80 73 88 80 82 84 84 55 66 68 66 88 72	02/16→ 04/08→ 04/08→ 12/14→ 12/14→ 04/08→ 07/10→ 07/10→ 02/12→ 04/08→ 04/08→ 07/10→ 02/12→12/14 11/09→ 07/10→	←		13.0460-7229.2	607229	ATE 24538 18,5 - WE / - WK
					13.0470-7229.2	LD7229	ATE 24538 18,5 - WE / - WK Ceramic
			→		13.0460-2745.2	602745	TRW 24765 16,5 - WE / - WK + Zub
1.6 HDi 75 / BlueHdi 75	55	04/08→	←	04/15→	13.0460-7229.2	607229	ATE 24538 18,5 - WE / - WK
					13.0470-7229.2	LD7229	ATE 24538 18,5 - WE / - WK Ceramic
			→	04/15→	13.0460-2745.2	602745	TRW 24765 16,5 - WE / - WK + Zub











 **Bremsscheibe**









1.2 PureTech 110 1.6 1.6 1.6 BlueHdi 100 1.6 BlueHdi 120 1.6 HDi 110 1.6 HDi 110 1.6 HDi 115 1.6 HDi 115 4x4 1.6 HDi 75 16V 1.6 HDi 90 1.6 HDi 90	81 66 80 73 88 80 82 84 84 55 66 68	02/16→ 04/08→ 04/08→ 12/14→ 12/14→ 04/08→ 07/10→ 07/10→ 02/12→ 04/08→ 04/08→ 07/10→	←		24.0126-0120.1	426120	Ø 283 26 24 V + S
					24.0326-0120.1	526120	Ø 283 26 24 V + S
			→		24.0112-0194.2	412194	Ø 268 12 10 + LG / + ABS Ring











	kw			 	! #		
<b>CITROËN - BERLINGO (B9) 04/08→</b>							
 <b>Bremsscheibe</b>							
1.6 HDi 90 4x4	66	02/12→12/14	←			<b>24.0126-0120.1 426120</b>	Ø 283 26 24 V + S
1.6 VTi 120	88	11/09→				<b>24.0326-0120.1 526120</b>	Ø 283 26 24 V + S
1.6 VTi 95	72	07/10→					
			→			<b>24.0112-0194.2 412194</b>	Ø 268 12 10 + LG / + ABS Ring
1.6 HDi 75 / BlueHDi 75	55	04/08→	←	04/15→		<b>24.0126-0120.1 426120</b>	Ø 283 26 24 V + S
						<b>24.0326-0120.1 526120</b>	Ø 283 26 24 V + S
			→	04/15→		<b>24.0112-0194.2 412194</b>	Ø 268 12 10 + LG / + ABS Ring
<b>CITROËN - BERLINGO Kasten (B9) 04/08→</b>							
 <b>Bremsbelagsatz, Scheibenbremse</b>							
1.6	66	04/08→	←			<b>13.0460-7229.2 607229</b>	ATE 24538 18,5 - WE / - WK
1.6	80	04/08→				<b>13.0470-7229.2 LD7229</b>	ATE 24538 18,5 - WE / - WK Ceramic
1.6 BlueHDi 100	73	12/14→					
1.6 BlueHDi 100 4x4	73	12/14→	→			<b>13.0460-2745.2 602745</b>	TRW 24765 16,5 - WE / - WK + Zub
1.6 BlueHDi 120	88	12/14→					
1.6 HDi 110	80	04/08→					
1.6 HDi 110	82	07/10→					
1.6 HDi 115	84	07/10→					
1.6 HDi 115 4x4	84	02/12→					
1.6 HDi 75	55	04/08→					
1.6 HDi 75 4x4	55	02/12→					
1.6 HDi 90	66	07/10→					
1.6 HDi 90	68	07/10→					
1.6 HDi 90 16V	66	04/08→					
1.6 HDi 90 4x4	66	02/12→					
1.6 VTi 120	88	11/09→					
1.6 VTi 95	72	07/10→					
Electric	49	03/14→					
1.6 HDi / BlueHDi 75	55	07/10→	←	04/15→		<b>13.0460-7229.2 607229</b>	ATE 24538 18,5 - WE / - WK
						<b>13.0470-7229.2 LD7229</b>	ATE 24538 18,5 - WE / - WK Ceramic
			→	04/15→		<b>13.0460-2745.2 602745</b>	TRW 24765 16,5 - WE / - WK + Zub
Electric	35	01/13→	←	02/13→		<b>13.0460-7229.2 607229</b>	ATE 24538 18,5 - WE / - WK
Electric	42	09/11→				<b>13.0470-7229.2 LD7229</b>	ATE 24538 18,5 - WE / - WK Ceramic
			→	02/13→		<b>13.0460-2745.2 602745</b>	TRW 24765 16,5 - WE / - WK + Zub
 <b>Bremsscheibe</b>							
1.6	66	04/08→	←			<b>24.0126-0120.1 426120</b>	Ø 283 26 24 V + S
1.6	80	04/08→				<b>24.0326-0120.1 526120</b>	Ø 283 26 24 V + S
1.6 BlueHDi 100	73	12/14→					
1.6 BlueHDi 100 4x4	73	12/14→	→			<b>24.0112-0194.2 412194</b>	Ø 268 12 10 + LG / + ABS Ring
1.6 BlueHDi 120	88	12/14→					
1.6 HDi 110	80	04/08→					
1.6 HDi 110	82	07/10→					
1.6 HDi 115	84	07/10→					
1.6 HDi 115 4x4	84	02/12→					
1.6 HDi 75	55	04/08→					
1.6 HDi 75 4x4	55	02/12→					
1.6 HDi 90	66	07/10→					
1.6 HDi 90	68	07/10→					
1.6 HDi 90 16V	66	04/08→					
1.6 HDi 90 4x4	66	02/12→					
1.6 VTi 120	88	11/09→					
1.6 VTi 95	72	07/10→					
Electric	49	03/14→					
1.6 HDi / BlueHDi 75	55	07/10→	←	04/15→		<b>24.0126-0120.1 426120</b>	Ø 283 26 24 V + S
						<b>24.0326-0120.1 526120</b>	Ø 283 26 24 V + S
			→	04/15→		<b>24.0112-0194.2 412194</b>	Ø 268 12 10 + LG / + ABS Ring
Electric	35	01/13→	←	02/13→		<b>24.0126-0120.1 426120</b>	Ø 283 26 24 V + S
Electric	42	09/11→				<b>24.0326-0120.1 526120</b>	Ø 283 26 24 V + S
			→	02/13→		<b>24.0112-0194.2 412194</b>	Ø 268 12 10 + LG / + ABS Ring
<b>CITROËN - BERLINGO Pritsche/Fahrgestell (B9) 04/08→</b>							
 <b>Bremsbelagsatz, Scheibenbremse</b>							
1.6 BlueHDi 100	73	12/14→	←			<b>13.0460-7229.2 607229</b>	ATE 24538 18,5 - WE / - WK
1.6 HDi 90 16V	66	04/08→				<b>13.0470-7229.2 LD7229</b>	ATE 24538 18,5 - WE / - WK Ceramic
1.6 HDi 92	68	07/10→					
			→			<b>13.0460-2745.2 602745</b>	TRW 24765 16,5 - WE / - WK + Zub
↓							















	kW					! #		
<b>CITROËN - BERLINGO Pritsche/Fahrgestell (B9) 04/08→</b>								
 <b>Bremsscheibe</b>								
1.6 BlueHDi 100	73	12/14→	←			24.0126-0120.1	426120	Ø 283 26 24 V + S
1.6 HDi 90 16V	66	04/08→				24.0326-0120.1	526120	Ø 283 26 24 V + S
1.6 HDi 92	68	07/10→	→			24.0112-0194.2	412194	Ø 268 12 10 + LG / + ABS Ring
<b>CITROËN - C1 (PM_, PN_) 06/05→09/14</b>								
 <b>Bremsbelagsatz, Scheibenbremse</b>								
1.0	50	06/05→09/14	←	→ 04/14		13.0460-3829.2	603829	BOS 23959 17,0 - WE / - WK + Zub
1.4 HDi	40	06/05→09/14	←	→ 12/08		13.0460-3829.2	603829	BOS 23959 17,0 - WE / - WK + Zub
 <b>Bremsscheibe</b>								
1.0	50	06/05→09/14	←	→ 04/14		24.0120-0180.1	420180	Ø 247 20 18 V + S
1.4 HDi	40	06/05→09/14	←	→ 12/08		24.0120-0180.1	420180	Ø 247 20 18 V + S
<b>CITROËN - C1 II (PA_, PS_) 04/14→</b>								
 <b>Bremsbelagsatz, Scheibenbremse</b>								
1.0 VTi 68	51	04/14→	←			13.0460-3829.2	603829	BOS 23959 17,0 - WE / - WK + Zub
1.2 VTi 82	60	04/14→						
 <b>Bremsscheibe</b>								
1.0 VTi 68	51	04/14→	←			24.0120-0180.1	420180	Ø 247 20 18 V + S
1.2 VTi 82	60	04/14→						
<b>CITROËN - C2 (JM_) 09/03→</b>								
 <b>Bremsbelagsatz, Scheibenbremse</b>								
1.1	44	09/03→	←	→ 12/09		13.0460-2871.2	602871	TRW 23407 19,0 - WK
1.4	54	09/03→	←	→ 12/09		13.0460-2871.2	602871	TRW 23407 19,0 - WK
1.4	55	10/06→	←	→ 12/09; V		13.0460-2881.2	602881	TRW 23409 19,3 - WK
1.4 16V	65	06/06→	→	→ 12/09		13.0460-2820.2	602820	TRW 20961 17,2 - WK
						13.0470-2820.2	LD2820	TRW 20961 17,2 - WK Ceramic
1.4 HDi	50	09/03→	←	→ 12/09		13.0460-2871.2	602871	TRW 23407 19,0 - WK
			←	→ Orga 10800; V; passend für Felgengröße [Zoll]: 16		13.0460-2881.2	602881	TRW 23409 19,3 - WK
			←	→ 12/09; V; nicht für Felgengröße [Zoll]: 16		13.0460-2881.2	602881	TRW 23409 19,3 - WK
			←	Orga 10801→; → 12/09; V; passend für Felgengröße [Zoll]: 16		13.0460-3994.2	603994	BOS 23599 19,0 - WE / - WK + Zub
						13.0470-3994.2	LD3994	BOS 23599 19,0 - WE / - WK + Zub Ceramic
			→	→ 12/09		13.0460-2820.2	602820	TRW 20961 17,2 - WK
						13.0470-2820.2	LD2820	TRW 20961 17,2 - WK Ceramic
1.6	80	09/03→	←	→ 12/09; nicht für Felgengröße [Zoll]: 16		13.0460-2881.2	602881	TRW 23409 19,3 - WK
			←	→ Orga 10800; passend für Felgengröße [Zoll]: 16		13.0460-2881.2	602881	TRW 23409 19,3 - WK
			←	Orga 10801→; → 12/09; passend für Felgengröße [Zoll]: 16		13.0460-3994.2	603994	BOS 23599 19,0 - WE / - WK + Zub
						13.0470-3994.2	LD3994	BOS 23599 19,0 - WE / - WK + Zub Ceramic
			→	→ 12/09		13.0460-2820.2	602820	TRW 20961 17,2 - WK
						13.0470-2820.2	LD2820	TRW 20961 17,2 - WK Ceramic
1.6 HDi	80	09/05→	←	→ 12/09		13.0460-3994.2	603994	BOS 23599 19,0 - WE / - WK + Zub
1.6 VTS	90	01/05→				13.0470-3994.2	LD3994	BOS 23599 19,0 - WE / - WK + Zub Ceramic
			→	→ 12/09		13.0460-2820.2	602820	TRW 20961 17,2 - WK
						13.0470-2820.2	LD2820	TRW 20961 17,2 - WK Ceramic
<b>Zubehörsatz, Scheibenbremsbelag</b>								
1.1	44	09/03→	←	→ 12/09		13.0460-0146.2	610146	TRW
1.4	54	09/03→	←	→ 12/09		13.0460-0146.2	610146	TRW
1.4	55	10/06→						
1.4 16V	65	06/06→	→	→ 12/09		13.0460-0072.2	610072	TRW
1.4 HDi	50	09/03→						
1.6	80	09/03→	→	→ 12/09		13.0460-0072.2	610072	TRW
1.6 HDi	80	09/05→						









	kW			 	! #		
<b>CITROËN - C2 (JM_) 09/03→</b>							
<b>Zubehörsatz, Scheibenbremsbelag</b>							
1.6 VTS	90	01/05→	➡	→ 12/09		13.0460-0072.2 610072	TRW
<b> Bremsscheibe</b>							
1.1	44	09/03→	←	→ 12/09		24.0113-0184.1 413184 24.0313-0184.1 513184	Ø 266 13 11 + S Ø 266 13 11 + S
1.4	54	09/03→	←	→ 12/09		24.0113-0184.1 413184	Ø 266 13 11 + S
1.4	55	10/06→				24.0122-0194.1 422194	Ø 266 22 20 V + S
1.4 HDi	50	09/03→	➡	→ 12/09		24.0313-0184.1 513184 24.0109-0137.1 409137	Ø 266 13 11 + S Ø 247 9 8 + S
1.4 16V	65	06/06→	←	→ 12/09		24.0122-0194.1 422194	Ø 266 22 20 V + S
1.6	80	09/03→				24.0109-0137.1 409137	Ø 247 9 8 + S
1.6 HDi	80	09/05→	➡	→ 12/09			
1.6 VTS	90	01/05→					
<b>CITROËN - C2 ENTERPRISE (JG_) 04/09→</b>							
<b> Bremsbelagsatz, Scheibenbremse</b>							
1.4 HDi	50	04/09→	←	→ 12/09		13.0460-2871.2 602871	TRW 23407 19,0 - WK
			←	→ Orga 10800; V; passend für Felgenreöße [Zoll]: 16		13.0460-2881.2 602881	TRW 23409 19,3 - WK
			←	→ 12/09; V; nicht für Felgenreöße [Zoll]: 16		13.0460-2881.2 602881	TRW 23409 19,3 - WK
			←	Orga 10801→; → 12/09; V; passend für Felgenreöße [Zoll]: 16		13.0460-3994.2 603994 13.0470-3994.2 LD3994	BOS 23599 19,0 - WE / - WK + Zub BOS 23599 19,0 - WE / - WK + Zub Ceramic
			➡	→ 12/09		13.0460-2820.2 602820 13.0470-2820.2 LD2820	TRW 20961 17,2 - WK TRW 20961 17,2 - WK Ceramic
<b>Zubehörsatz, Scheibenbremsbelag</b>							
1.4 HDi	50	04/09→	←	→ 12/09		13.0460-0146.2 610146	TRW
			➡	→ 12/09		13.0460-0072.2 610072	TRW
<b> Bremsscheibe</b>							
1.4 HDi	50	04/09→	←	→ 12/09		24.0113-0184.1 413184 24.0122-0194.1 422194 24.0313-0184.1 513184	Ø 266 13 11 + S Ø 266 22 20 V + S Ø 266 13 11 + S
			➡	→ 12/09		24.0109-0137.1 409137	Ø 247 9 8 + S
<b>CITROËN - C3 I (FC_, FN_) 02/02→</b>							
<b> Bremsbelagsatz, Scheibenbremse</b>							
1.1 i	44	02/02→	←	→ 08/09		13.0460-2871.2 602871	TRW 23407 19,0 - WK
1.4 HDi	50	02/02→					
1.4 HDi	52	07/03→02/11					
1.4 HDi	55	05/05→					
1.4 i	54	02/02→					
1.4 16V	65	12/03→	←	→ 08/09; nicht für Felgenreöße [Zoll]: 16		13.0460-2881.2 602881	TRW 23409 19,3 - WK
			←	→ 08/09		13.0460-3994.2 603994 13.0470-3994.2 LD3994	BOS 23599 19,0 - WE / - WK + Zub BOS 23599 19,0 - WE / - WK + Zub Ceramic
1.4 16V HDi	66	02/02→	←	→ 08/09; nicht für Felgenreöße [Zoll]: 16		13.0460-2881.2 602881	TRW 23409 19,3 - WK
			➡	→ 08/09		13.0460-2820.2 602820 13.0470-2820.2 LD2820	TRW 20961 17,2 - WK TRW 20961 17,2 - WK Ceramic
1.4 i Bivalent	54	02/02→	←	09/05→ 08/09		13.0460-2871.2 602871	TRW 23407 19,0 - WK
1.6 16V	80	02/02→	←	→ 08/09; Schaltgetriebe; nicht für Felgenreöße [Zoll]: 16		13.0460-2881.2 602881	TRW 23409 19,3 - WK
			←	→ Orga 10800; Automatikgetriebe		13.0460-3811.2 603811 13.0460-3966.2 603966 13.0470-3966.2 LD3966	BOS 23708 19,2 - WE / - WK BOS 23600 19,4 - WE / - WK + Zub BOS 23600 19,4 - WE / - WK + Zub Ceramic
			←	→ 08/09; Schaltgetriebe		13.0460-3994.2 603994 13.0470-3994.2 LD3994	BOS 23599 19,0 - WE / - WK + Zub BOS 23599 19,0 - WE / - WK + Zub Ceramic
			➡	→ 08/09		13.0460-2820.2 602820	TRW 20961 17,2 - WK

	kw			 	! #		
<b>CITROËN - C3 I (FC_, FN_) 02/02→</b>							
<b> Bremsbelagsatz, Scheibenbremse</b>							
1.6 16V	80	02/02→	➡	→ 08/09		<b>13.0470-2820.2 LD2820</b>	TRW 20961 17,2 - WK Ceramic
1.6 16V	81	05/03→09/05	⬅	Schaltgetriebe; nicht für Felgengröße [Zoll]: 16		<b>13.0460-2881.2 602881</b>	TRW 23409 19,3 - WK
			⬅	→Orga 10800; Automatikgetriebe		<b>13.0460-3811.2 603811</b> <b>13.0460-3966.2 603966</b>	BOS 23708 19,2 - WE / - WK BOS 23600 19,4 - WE / - WK + Zub
						<b>13.0470-3966.2 LD3966</b>	BOS 23600 19,4 - WE / - WK + Zub Ceramic
			⬅	Schaltgetriebe		<b>13.0460-3994.2 603994</b> <b>13.0470-3994.2 LD3994</b>	BOS 23599 19,0 - WE / - WK + Zub BOS 23599 19,0 - WE / - WK + Zub Ceramic
			➡			<b>13.0460-2820.2 602820</b> <b>13.0470-2820.2 LD2820</b>	TRW 20961 17,2 - WK TRW 20961 17,2 - WK Ceramic
1.6 16V HDi	66	10/05→	⬅	→ 08/09; nicht für Felgengröße [Zoll]: 16		<b>13.0460-2881.2 602881</b>	TRW 23409 19,3 - WK
			⬅	→ 08/09		<b>13.0460-3994.2 603994</b> <b>13.0470-3994.2 LD3994</b>	BOS 23599 19,0 - WE / - WK + Zub BOS 23599 19,0 - WE / - WK + Zub Ceramic
			➡	→ 08/09		<b>13.0460-2820.2 602820</b> <b>13.0470-2820.2 LD2820</b>	TRW 20961 17,2 - WK TRW 20961 17,2 - WK Ceramic
1.6 16V HDi	80	09/05→	⬅	→ 08/09; nicht für Felgengröße [Zoll]: 16		<b>13.0460-2881.2 602881</b>	TRW 23409 19,3 - WK
			⬅	→Orga 10800		<b>13.0460-3811.2 603811</b>	BOS 23708 19,2 - WE / - WK
			⬅	Orga 10801→; → 08/09		<b>13.0460-3966.2 603966</b> <b>13.0470-3966.2 LD3966</b>	BOS 23600 19,4 - WE / - WK + Zub BOS 23600 19,4 - WE / - WK + Zub Ceramic
			⬅	→ 08/09		<b>13.0460-3994.2 603994</b> <b>13.0470-3994.2 LD3994</b>	BOS 23599 19,0 - WE / - WK + Zub BOS 23599 19,0 - WE / - WK + Zub Ceramic
			➡	→ 08/09		<b>13.0460-2820.2 602820</b> <b>13.0470-2820.2 LD2820</b>	TRW 20961 17,2 - WK TRW 20961 17,2 - WK Ceramic
<b>Zubehörsatz, Scheibenbremsbelag</b>							
1.1 i	44	02/02→	⬅	→ 08/09		<b>13.0460-0146.2 610146</b>	TRW
1.4 HDi	50	02/02→					
1.4 HDi	52	07/03→02/11					
1.4 HDi	55	05/05→					
1.4 i	54	02/02→					
1.4 16V HDi	66	02/02→	➡	→ 08/09		<b>13.0460-0072.2 610072</b>	TRW
1.6 16V	80	02/02→					
1.6 16V HDi	66	10/05→					
1.6 16V HDi	80	09/05→					
1.4 i Bivalent	54	02/02→	⬅	09/05→ 08/09		<b>13.0460-0146.2 610146</b>	TRW
1.6 16V	81	05/03→09/05	➡			<b>13.0460-0072.2 610072</b>	TRW
<b> Bremsscheibe</b>							
1.1 i	44	02/02→	⬅	→ 08/09		<b>24.0113-0184.1 413184</b>	Ø 266 13 11 + S
1.4 HDi	50	02/02→				<b>24.0313-0184.1 513184</b>	Ø 266 13 11 + S
1.4 HDi	52	07/03→02/11					
1.4 HDi	55	05/05→					
1.4 i	54	02/02→					
1.4 16V	65	12/03→	⬅	→ 08/09		<b>24.0122-0194.1 422194</b>	Ø 266 22 20 V + S
1.4 16V HDi	66	02/02→	⬅	→ 08/09		<b>24.0122-0194.1 422194</b>	Ø 266 22 20 V + S
1.6 16V HDi	66	10/05→	➡	→ 08/09		<b>24.0109-0137.1 409137</b>	Ø 247 9 8 + S
1.4 i Bivalent	54	02/02→	⬅	09/05→ 08/09		<b>24.0113-0184.1 413184</b> <b>24.0313-0184.1 513184</b>	Ø 266 13 11 + S Ø 266 13 11 + S
1.6 16V	80	02/02→	⬅	→ 08/09; Schaltgetriebe		<b>24.0122-0194.1 422194</b>	Ø 266 22 20 V + S
			⬅	→ 08/09; Automatikgetriebe		<b>24.0126-0120.1 426120</b>	Ø 283 26 24 V + S
			➡	→ 08/09		<b>24.0109-0137.1 409137</b>	Ø 247 9 8 + S
1.6 16V	81	05/03→09/05	⬅	Schaltgetriebe		<b>24.0122-0194.1 422194</b>	Ø 266 22 20 V + S
			⬅	Automatikgetriebe		<b>24.0126-0120.1 426120</b>	Ø 283 26 24 V + S
			➡			<b>24.0109-0137.1 409137</b>	Ø 247 9 8 + S
1.6 16V HDi	80	09/05→	⬅	→ 08/09		<b>24.0122-0194.1 422194</b> <b>24.0126-0120.1 426120</b>	Ø 266 22 20 V + S Ø 283 26 24 V + S
↓							









	kW				! #		
<b>CITROËN - C3 I (FC_, FN_) 02/02→</b>							
 <b>Bremsscheibe</b>							
1.6 16V HDi	80	09/05→	←	→ 08/09		24.0326-0120.1 526120	Ø 283 26 24 V + S
			→	→ 08/09		24.0109-0137.1 409137	Ø 247 9 8 + S
<b>CITROËN - C3 II (SC_) 11/09→</b>							
 <b>Bremsbelagsatz, Scheibenbremse</b>							
1.0 VTi 68 1.2 VTi 82	50 60	08/12→ 06/12→	←	10/12→		13.0460-3994.2 603994 13.0470-3994.2 LD3994	BOS 23599 19,0 - WE / - WK + Zub BOS 23599 19,0 - WE / - WK + Zub Ceramic
1.1 1.1 BiFuel 1.4 1.4 HDi 70 1.4 LPG 1.4 VTi 1.4 VTi 95 1.6 HDi 1.6 HDi 90	44 44 54 50 54 72 70 68 66	11/09→ 11/10→ 11/09→ 11/09→ 07/10→ 11/09→ 11/09→ 11/09→ 11/09→	←			13.0460-3994.2 603994 13.0470-3994.2 LD3994	BOS 23599 19,0 - WE / - WK + Zub BOS 23599 19,0 - WE / - WK + Zub Ceramic
1.2 THP 110 1.4 LPG 1.6 BlueHDi 100 1.6 BlueHDi 75 1.6 VTi 120	81 70 73 55 88	10/14→ 06/13→ 07/14→ 04/15→ 11/09→	←	für Bremsscheibendurchmesser [mm]: 283		13.0460-3855.2 603855 13.0470-3855.2 LD3855	BOS 24883 18,0 - WE / - WK + Zub BOS 24883 18,0 - WE / - WK + Zub Ceramic
			←	für Bremsscheibendurchmesser [mm]: 266		13.0460-3994.2 603994 13.0470-3994.2 LD3994	BOS 23599 19,0 - WE / - WK + Zub BOS 23599 19,0 - WE / - WK + Zub Ceramic
			→			13.0460-2740.2 602740 13.0470-2740.2 LD2740	TRW 23554 17,0 - WE / - WK + Zub TRW 23554 17,0 - WE / - WK + Zub Ceramic
1.6 HDi 110 1.6 HDi 115	82 84	11/09→ 09/12→	←			13.0460-3855.2 603855 13.0470-3855.2 LD3855	BOS 24883 18,0 - WE / - WK + Zub BOS 24883 18,0 - WE / - WK + Zub Ceramic
			→			13.0460-2740.2 602740 13.0470-2740.2 LD2740	TRW 23554 17,0 - WE / - WK + Zub TRW 23554 17,0 - WE / - WK + Zub Ceramic
 <b>Bremsscheibe</b>							
1.0 VTi 68 1.2 VTi 82	50 60	08/12→ 06/12→	←	10/12→		24.0122-0194.1 422194	Ø 266 22 20 V + S
1.1 1.1 BiFuel 1.4 1.4 HDi 70 1.4 LPG 1.4 VTi 1.4 VTi 95 1.6 HDi 1.6 HDi 90	44 44 54 50 54 72 70 68 66	11/09→ 11/10→ 11/09→ 11/09→ 07/10→ 11/09→ 11/09→ 11/09→ 11/09→	←			24.0122-0194.1 422194	Ø 266 22 20 V + S
1.2 THP 110 1.4 LPG 1.6 BlueHDi 100 1.6 BlueHDi 75 1.6 VTi 120	81 70 73 55 88	10/14→ 06/13→ 07/14→ 04/15→ 11/09→	←			24.0122-0194.1 422194 24.0126-0120.1 426120 24.0326-0120.1 526120	Ø 266 22 20 V + S Ø 283 26 24 V + S Ø 283 26 24 V + S
			→			24.0109-0100.2 409100	Ø 249 9 7 + LG / + ABS Ring
1.6 HDi 110 1.6 HDi 115	82 84	11/09→ 09/12→	←			24.0126-0120.1 426120 24.0326-0120.1 526120	Ø 283 26 24 V + S Ø 283 26 24 V + S
			→			24.0109-0100.2 409100	Ø 249 9 7 + LG / + ABS Ring
<b>CITROËN - C3 III (SX) 07/16→</b>							
 <b>Bremsbelagsatz, Scheibenbremse</b>							
1.2 THP 110 1.2 VTi 68 1.2 VTi 82 1.6 BlueHDi 100 1.6 BlueHDi 75	81 50 60 73 55	07/16→ 07/16→ 07/16→ 07/16→ 07/16→	←			13.0460-3994.2 603994 13.0470-3994.2 LD3994	BOS 23599 19,0 - WE / - WK + Zub BOS 23599 19,0 - WE / - WK + Zub Ceramic
 <b>Bremsscheibe</b>							
1.2 THP 110 1.2 VTi 68 1.2 VTi 82 1.6 BlueHDi 100 1.6 BlueHDi 75	81 50 60 73 55	07/16→ 07/16→ 07/16→ 07/16→ 07/16→	←			24.0122-0194.1 422194	Ø 266 22 20 V + S
			→			24.0109-0100.2 409100	Ø 249 9 7 + LG / + ABS Ring









	kW			 	! #			
<b>CITROËN - C3 AIRCROSS II 06/17→</b>								
 <b>Bremsbelagsatz, Scheibenbremse</b>								
1.2 Puretech 110	81	06/17→	←	für Bremsscheibendurchmesser [mm]:		<b>13.0460-3994.2</b>	<b>603994</b>	BOS 23599 19,0 - WE / - WK + Zub
1.2 Puretech 130	96	07/17→		266				
1.2 Puretech 82	60	06/17→				<b>13.0470-3994.2</b>	<b>LD3994</b>	BOS 23599 19,0 - WE / - WK + Zub Ceramic
1.6 BlueHDi 100	73	07/17→						
1.6 BlueHDi 115	85	06/17→						
1.6 BlueHDi 120	88	07/17→						
 <b>Bremsscheibe</b>								
1.2 Puretech 110	81	06/17→	←			<b>24.0126-0120.1</b>	<b>426120</b>	Ø 283 26 24 V + S
1.2 Puretech 130	96	07/17→						
1.2 Puretech 82	60	06/17→	→	→Orga 15000		<b>24.0109-0100.2</b>	<b>409100</b>	Ø 249 9 7 + LG / + ABS Ring
1.6 BlueHDi 100	73	07/17→						
1.6 BlueHDi 115	85	06/17→						
1.6 BlueHDi 120	88	07/17→						
<b>CITROËN - C3 Picasso 02/09→</b>								
 <b>Bremsbelagsatz, Scheibenbremse</b>								
1.2 THP 110	81	01/15→	←	für Bremsscheibendurchmesser [mm]:		<b>13.0460-3855.2</b>	<b>603855</b>	BOS 24883 18,0 - WE / - WK + Zub
1.4 VTi 95	70	02/09→		283				
1.4 VTi 95 LPG	70	01/12→				<b>13.0470-3855.2</b>	<b>LD3855</b>	BOS 24883 18,0 - WE / - WK + Zub Ceramic
1.6 BlueHDi 100	73	01/15→						
1.6 HDi	66	02/09→						
1.6 HDi	80	02/09→	←	für Bremsscheibendurchmesser [mm]:		<b>13.0460-3994.2</b>	<b>603994</b>	BOS 23599 19,0 - WE / - WK + Zub
1.6 HDi 110	82	05/10→		266				
1.6 HDi 115	84	01/13→				<b>13.0470-3994.2</b>	<b>LD3994</b>	BOS 23599 19,0 - WE / - WK + Zub Ceramic
1.6 HDi 90	68	07/10→						
1.6 VTi 120	88	02/09→	→			<b>13.0460-2740.2</b>	<b>602740</b>	TRW 23554 17,0 - WE / - WK + Zub
						<b>13.0470-2740.2</b>	<b>LD2740</b>	TRW 23554 17,0 - WE / - WK + Zub Ceramic
1.6 VTi	84	07/09→	←	10/16→;		<b>13.0460-3855.2</b>	<b>603855</b>	BOS 24883 18,0 - WE / - WK + Zub
				für Bremsscheibendurchmesser [mm]:		<b>13.0470-3855.2</b>	<b>LD3855</b>	BOS 24883 18,0 - WE / - WK + Zub Ceramic
			←	10/16→;		<b>13.0460-3994.2</b>	<b>603994</b>	BOS 23599 19,0 - WE / - WK + Zub
				für Bremsscheibendurchmesser [mm]:		<b>13.0470-3994.2</b>	<b>LD3994</b>	BOS 23599 19,0 - WE / - WK + Zub Ceramic
			→	10/16→		<b>13.0460-2740.2</b>	<b>602740</b>	TRW 23554 17,0 - WE / - WK + Zub
						<b>13.0470-2740.2</b>	<b>LD2740</b>	TRW 23554 17,0 - WE / - WK + Zub Ceramic
 <b>Bremsscheibe</b>								
1.2 THP 110	81	01/15→	←			<b>24.0122-0194.1</b>	<b>422194</b>	Ø 266 22 20 V + S
1.4 VTi 95	70	02/09→				<b>24.0126-0120.1</b>	<b>426120</b>	Ø 283 26 24 V + S
1.4 VTi 95 LPG	70	01/12→				<b>24.0326-0120.1</b>	<b>526120</b>	Ø 283 26 24 V + S
1.6 BlueHDi 100	73	01/15→						
1.6 HDi	66	02/09→	→			<b>24.0109-0100.2</b>	<b>409100</b>	Ø 249 9 7 + LG / + ABS Ring
1.6 HDi	80	02/09→						
1.6 HDi 110	82	05/10→						
1.6 HDi 115	84	01/13→						
1.6 HDi 90	68	07/10→						
1.6 VTi 120	88	02/09→						
1.6 VTi	84	07/09→	←	10/16→		<b>24.0122-0194.1</b>	<b>422194</b>	Ø 266 22 20 V + S
						<b>24.0126-0120.1</b>	<b>426120</b>	Ø 283 26 24 V + S
						<b>24.0326-0120.1</b>	<b>526120</b>	Ø 283 26 24 V + S
			→	10/16→		<b>24.0109-0100.2</b>	<b>409100</b>	Ø 249 9 7 + LG / + ABS Ring
<b>CITROËN - C3 Pluriel (HB_) 05/03→</b>								
 <b>Bremsbelagsatz, Scheibenbremse</b>								
1.4	54	05/03→	←	→ 07/10		<b>13.0460-2881.2</b>	<b>602881</b>	TRW 23409 19,3 - WK
1.4	55	07/03→						
1.4 HDi	50	04/04→						
1.6	80	05/03→	←	→ 07/10		<b>13.0460-2881.2</b>	<b>602881</b>	TRW 23409 19,3 - WK
			→	→ 07/10		<b>13.0460-2820.2</b>	<b>602820</b>	TRW 20961 17,2 - WK
						<b>13.0470-2820.2</b>	<b>LD2820</b>	TRW 20961 17,2 - WK Ceramic
<b>Zubehörsatz, Scheibenbremsbelag</b>								
1.6	80	05/03→	→	→ 07/10		<b>13.0460-0072.2</b>	<b>610072</b>	TRW
↓								

























	kW			 	! #		
<b>CITROËN - C3 Pluriel (HB_) 05/03→</b>							
 <b>Bremsscheibe</b>							
1.4	54	05/03→	←	→ 07/10		24.0122-0194.1 422194	Ø 266 22 20 V + S
1.4	55	07/03→					
1.4 HDi	50	04/04→					
1.6	80	05/03→	←	→ 07/10		24.0122-0194.1 422194	Ø 266 22 20 V + S
			→	→ 07/10		24.0109-0137.1 409137	Ø 247 9 8 + S
<b>CITROËN - C4 I (LC_) 11/04→12/13</b>							
 <b>Bremsbelagsatz, Scheibenbremse</b>							
1.4 16V	65	11/04→07/11	←	→Orga 10550; + ESP		13.0460-3966.2 603966	BOS 23600 19,4 - WE / - WK + Zub
1.6 HDi	66	11/04→07/11				13.0470-3966.2 LD3966	BOS 23600 19,4 - WE / - WK + Zub Ceramic
			←	Orga 10551→; + ESP		13.0460-3994.2 603994	BOS 23599 19,0 - WE / - WK + Zub
						13.0470-3994.2 LD3994	BOS 23599 19,0 - WE / - WK + Zub Ceramic
			←	- ESP		13.0460-3994.2 603994	BOS 23599 19,0 - WE / - WK + Zub
						13.0470-3994.2 LD3994	BOS 23599 19,0 - WE / - WK + Zub Ceramic
			→	Orga 11431→ Orga 12333		13.0460-2740.2 602740	TRW 23554 17,0 - WE / - WK + Zub
						13.0470-2740.2 LD2740	TRW 23554 17,0 - WE / - WK + Zub Ceramic
			→	Orga 12334→		13.0460-2820.2 602820	TRW 20961 17,2 - WK
						13.0470-2820.2 LD2820	TRW 20961 17,2 - WK Ceramic
			→	→Orga 11584		13.0460-2820.2 602820	TRW 20961 17,2 - WK
						13.0470-2820.2 LD2820	TRW 20961 17,2 - WK Ceramic
			→	→Orga 12056		13.0460-3813.2 603813	BOS 24150 17,6 - WE / - WK + Zub
						13.0470-3813.2 LD3813	BOS 24150 17,6 - WE / - WK + Zub Ceramic
1.6 16V	80	11/04→07/11	←	Automatikgetriebe		13.0460-3966.2 603966	BOS 23600 19,4 - WE / - WK + Zub
						13.0470-3966.2 LD3966	BOS 23600 19,4 - WE / - WK + Zub Ceramic
			←	→Orga 10550; + ESP; Schaltgetriebe		13.0460-3966.2 603966	BOS 23600 19,4 - WE / - WK + Zub
						13.0470-3966.2 LD3966	BOS 23600 19,4 - WE / - WK + Zub Ceramic
			←	- ESP; Schaltgetriebe		13.0460-3994.2 603994	BOS 23599 19,0 - WE / - WK + Zub
						13.0470-3994.2 LD3994	BOS 23599 19,0 - WE / - WK + Zub Ceramic
			←	Orga 10551→; + ESP; Schaltgetriebe		13.0460-3994.2 603994	BOS 23599 19,0 - WE / - WK + Zub
						13.0470-3994.2 LD3994	BOS 23599 19,0 - WE / - WK + Zub Ceramic
			→	Orga 11431→ Orga 12333		13.0460-2740.2 602740	TRW 23554 17,0 - WE / - WK + Zub
						13.0470-2740.2 LD2740	TRW 23554 17,0 - WE / - WK + Zub Ceramic
			→	Orga 12334→		13.0460-2820.2 602820	TRW 20961 17,2 - WK
						13.0470-2820.2 LD2820	TRW 20961 17,2 - WK Ceramic
			→	→Orga 11584		13.0460-2820.2 602820	TRW 20961 17,2 - WK
						13.0470-2820.2 LD2820	TRW 20961 17,2 - WK Ceramic
			→	→Orga 12056		13.0460-3813.2 603813	BOS 24150 17,6 - WE / - WK + Zub
						13.0470-3813.2 LD3813	BOS 24150 17,6 - WE / - WK + Zub Ceramic
1.6 16V Bio-Flex	80	09/07→07/08	←	→Orga 10550; + ESP; Schaltgetriebe		13.0460-3966.2 603966	BOS 23600 19,4 - WE / - WK + Zub
						13.0470-3966.2 LD3966	BOS 23600 19,4 - WE / - WK + Zub Ceramic
			←	- ESP; Schaltgetriebe		13.0460-3994.2 603994	BOS 23599 19,0 - WE / - WK + Zub
						13.0470-3994.2 LD3994	BOS 23599 19,0 - WE / - WK + Zub Ceramic









	kw			 	! #		
<b>CITROËN - C4 I (LC_) 11/04→12/13</b>							
<b> Bremsbelagsatz, Scheibenbremse</b>							
1.6 16V Bio-Flex	80	09/07→07/08	←	Orga 10551→; + ESP; Schaltgetriebe	<b>13.0460-3994.2</b>	<b>603994</b>	BOS 23599 19,0 - WE / - WK + Zub
					<b>13.0470-3994.2</b>	<b>LD3994</b>	BOS 23599 19,0 - WE / - WK + Zub Ceramic
			→	Orga 11431→ Orga 12333	<b>13.0460-2740.2</b>	<b>602740</b>	TRW 23554 17,0 - WE / - WK + Zub
					<b>13.0470-2740.2</b>	<b>LD2740</b>	TRW 23554 17,0 - WE / - WK + Zub Ceramic
			→	Orga 12334→	<b>13.0460-2820.2</b>	<b>602820</b>	TRW 20961 17,2 - WK
		<b>13.0470-2820.2</b>	<b>LD2820</b>	TRW 20961 17,2 - WK Ceramic			
		→	Orga 11584	<b>13.0460-2820.2</b>	<b>602820</b>	TRW 20961 17,2 - WK	
				<b>13.0470-2820.2</b>	<b>LD2820</b>	TRW 20961 17,2 - WK Ceramic	
		→	Orga 12056	<b>13.0460-3813.2</b>	<b>603813</b>	BOS 24150 17,6 - WE / - WK + Zub	
				<b>13.0470-3813.2</b>	<b>LD3813</b>	BOS 24150 17,6 - WE / - WK + Zub Ceramic	
1.6 HDi	80	11/04→07/11	←	+ ESP	<b>13.0460-3966.2</b>	<b>603966</b>	BOS 23600 19,4 - WE / - WK + Zub
					<b>13.0470-3966.2</b>	<b>LD3966</b>	BOS 23600 19,4 - WE / - WK + Zub Ceramic
			→	Orga 11431→ Orga 12333	<b>13.0460-2740.2</b>	<b>602740</b>	TRW 23554 17,0 - WE / - WK + Zub
					<b>13.0470-2740.2</b>	<b>LD2740</b>	TRW 23554 17,0 - WE / - WK + Zub Ceramic
			→	Orga 12334→	<b>13.0460-2820.2</b>	<b>602820</b>	TRW 20961 17,2 - WK
		<b>13.0470-2820.2</b>	<b>LD2820</b>	TRW 20961 17,2 - WK Ceramic			
		→	Orga 11584	<b>13.0460-2820.2</b>	<b>602820</b>	TRW 20961 17,2 - WK	
				<b>13.0470-2820.2</b>	<b>LD2820</b>	TRW 20961 17,2 - WK Ceramic	
		→	Orga 12056	<b>13.0460-3813.2</b>	<b>603813</b>	BOS 24150 17,6 - WE / - WK + Zub	
				<b>13.0470-3813.2</b>	<b>LD3813</b>	BOS 24150 17,6 - WE / - WK + Zub Ceramic	
1.6 THP 140 1.6 THP 150 2.0 16V 2.0 16V 2.0 16V	103 110 100 103 105	07/08→07/11 07/08→07/11 11/04→07/07 11/04→07/11 09/06→07/09	←		<b>13.0460-3966.2</b>	<b>603966</b>	BOS 23600 19,4 - WE / - WK + Zub
					<b>13.0470-3966.2</b>	<b>LD3966</b>	BOS 23600 19,4 - WE / - WK + Zub Ceramic
			→	Orga 11431→ Orga 12333	<b>13.0460-2740.2</b>	<b>602740</b>	TRW 23554 17,0 - WE / - WK + Zub
					<b>13.0470-2740.2</b>	<b>LD2740</b>	TRW 23554 17,0 - WE / - WK + Zub Ceramic
			→	Orga 12334→	<b>13.0460-2820.2</b>	<b>602820</b>	TRW 20961 17,2 - WK
		<b>13.0470-2820.2</b>	<b>LD2820</b>	TRW 20961 17,2 - WK Ceramic			
		→	Orga 11584	<b>13.0460-2820.2</b>	<b>602820</b>	TRW 20961 17,2 - WK	
				<b>13.0470-2820.2</b>	<b>LD2820</b>	TRW 20961 17,2 - WK Ceramic	
		→	Orga 12056	<b>13.0460-3813.2</b>	<b>603813</b>	BOS 24150 17,6 - WE / - WK + Zub	
				<b>13.0470-3813.2</b>	<b>LD3813</b>	BOS 24150 17,6 - WE / - WK + Zub Ceramic	
1.6 VTi 120	88	07/08→07/11	←	Vollautomatik	<b>13.0460-3966.2</b>	<b>603966</b>	BOS 23600 19,4 - WE / - WK + Zub
					<b>13.0470-3966.2</b>	<b>LD3966</b>	BOS 23600 19,4 - WE / - WK + Zub Ceramic
			←	Schaltgetriebe	<b>13.0460-3994.2</b>	<b>603994</b>	BOS 23599 19,0 - WE / - WK + Zub
					<b>13.0470-3994.2</b>	<b>LD3994</b>	BOS 23599 19,0 - WE / - WK + Zub Ceramic
			→	Orga 11431→ Orga 12333	<b>13.0460-2740.2</b>	<b>602740</b>	TRW 23554 17,0 - WE / - WK + Zub
		<b>13.0470-2740.2</b>	<b>LD2740</b>	TRW 23554 17,0 - WE / - WK + Zub Ceramic			
→	Orga 12334→	<b>13.0460-2820.2</b>	<b>602820</b>	TRW 20961 17,2 - WK			
		<b>13.0470-2820.2</b>	<b>LD2820</b>	TRW 20961 17,2 - WK Ceramic			
		→	Orga 11584	<b>13.0460-2820.2</b>	<b>602820</b>	TRW 20961 17,2 - WK	
				<b>13.0470-2820.2</b>	<b>LD2820</b>	TRW 20961 17,2 - WK Ceramic	
		→	Orga 12056	<b>13.0460-3813.2</b>	<b>603813</b>	BOS 24150 17,6 - WE / - WK + Zub	
				<b>13.0470-3813.2</b>	<b>LD3813</b>	BOS 24150 17,6 - WE / - WK + Zub Ceramic	
↓							

	kw			 	! #		
<b>CITROËN - C4 I (LC_) 11/04→12/13</b>							
<b> Bremsbelagsatz, Scheibenbremse</b>							
2.0 16V 2.0 HDi 2.0 HDi	130 100 103	11/04→07/08 11/04→07/11 07/08→07/11	←			<b>13.0460-7230.2 607230</b> <b>13.0470-7202.2 LD7202</b> <b>13.0470-7230.2 LD7230</b>	ATE 24557 19,4 - WE / - WK ATE 23589 19,1 - WE / - WK Ceramic ATE 24557 19,4 - WE / - WK Ceramic
			→	Orga 11431→ Orga 12333		<b>13.0460-2740.2 602740</b> <b>13.0470-2740.2 LD2740</b>	TRW 23554 17,0 - WE / - WK + Zub TRW 23554 17,0 - WE / - WK + Zub Ceramic
			→	Orga 12334→		<b>13.0460-2820.2 602820</b> <b>13.0470-2820.2 LD2820</b>	TRW 20961 17,2 - WK TRW 20961 17,2 - WK Ceramic
			→	→Orga 11584		<b>13.0460-2820.2 602820</b> <b>13.0470-2820.2 LD2820</b>	TRW 20961 17,2 - WK TRW 20961 17,2 - WK Ceramic
			→	→Orga 12056		<b>13.0460-3813.2 603813</b> <b>13.0470-3813.2 LD3813</b>	BOS 24150 17,6 - WE / - WK + Zub BOS 24150 17,6 - WE / - WK + Zub Ceramic
2.0 HDi	81	04/07→07/08	←			<b>13.0460-3966.2 603966</b> <b>13.0470-3966.2 LD3966</b>	BOS 23600 19,4 - WE / - WK + Zub BOS 23600 19,4 - WE / - WK + Zub Ceramic
			→			<b>13.0460-2820.2 602820</b> <b>13.0470-2820.2 LD2820</b>	TRW 20961 17,2 - WK TRW 20961 17,2 - WK Ceramic
<b>Zubehörsatz, Scheibenbremsbelag</b>							
1.4 16V 1.6 16V 1.6 16V Bio-Flex 1.6 HDi 1.6 HDi 1.6 THP 140 1.6 THP 150 1.6 VTi 120 2.0 16V 2.0 16V 2.0 16V 2.0 16V 2.0 HDi 2.0 HDi 2.0 HDi	65 80 80 66 80 103 110 88 100 103 105 130 100 103	11/04→07/11 11/04→07/11 09/07→07/08 11/04→07/11 11/04→07/11 07/08→07/11 07/08→07/11 07/08→07/11 11/04→07/07 11/04→07/11 09/06→07/09 11/04→07/08 11/04→07/11 07/08→07/11	→	Orga 12334→		<b>13.0460-0072.2 610072</b>	TRW
			→	→Orga 11584		<b>13.0460-0072.2 610072</b>	TRW
2.0 HDi	81	04/07→07/08	→			<b>13.0460-0072.2 610072</b>	TRW
<b> Bremsscheibe</b>							
1.4 16V 1.6 HDi	65 66	11/04→07/11 11/04→07/11	←	- ESP		<b>24.0122-0194.1 422194</b>	Ø 266 22 20 V + S
			←	Orga 10551→; + ESP		<b>24.0122-0194.1 422194</b>	Ø 266 22 20 V + S
			←	→Orga 10550; + ESP		<b>24.0126-0120.1 426120</b> <b>24.0326-0120.1 526120</b>	Ø 283 26 24 V + S Ø 283 26 24 V + S
			→	Achszapfendurchmesser [mm]: 30		<b>24.0109-0100.2 409100</b> <b>24.0109-0137.1 409137</b>	Ø 249 9 7 + LG / + ABS Ring Ø 247 9 8 + S
			→	Achszapfendurchmesser [mm]: 25		<b>24.0109-0150.2 409150</b>	Ø 249 9 8 + LG / + ABS Ring
1.6 16V	80	11/04→07/11	←	Orga 10551→; + ESP; Schaltgetriebe		<b>24.0122-0194.1 422194</b>	Ø 266 22 20 V + S
			←	- ESP		<b>24.0122-0194.1 422194</b>	Ø 266 22 20 V + S
			←	Automatikgetriebe		<b>24.0126-0120.1 426120</b> <b>24.0326-0120.1 526120</b>	Ø 283 26 24 V + S Ø 283 26 24 V + S
			←	→Orga 10550; + ESP; Schaltgetriebe		<b>24.0126-0120.1 426120</b> <b>24.0326-0120.1 526120</b>	Ø 283 26 24 V + S Ø 283 26 24 V + S
			→	Achszapfendurchmesser [mm]: 30		<b>24.0109-0100.2 409100</b> <b>24.0109-0137.1 409137</b>	Ø 249 9 7 + LG / + ABS Ring Ø 247 9 8 + S
			→	Achszapfendurchmesser [mm]: 25		<b>24.0109-0150.2 409150</b>	Ø 249 9 8 + LG / + ABS Ring
1.6 16V Bio-Flex	80	09/07→07/08	←	Orga 10551→; + ESP; Schaltgetriebe		<b>24.0122-0194.1 422194</b>	Ø 266 22 20 V + S
			←	- ESP		<b>24.0122-0194.1 422194</b>	Ø 266 22 20 V + S
			←	→Orga 10550; + ESP; Schaltgetriebe		<b>24.0126-0120.1 426120</b> <b>24.0326-0120.1 526120</b>	Ø 283 26 24 V + S Ø 283 26 24 V + S
			→	Achszapfendurchmesser [mm]: 30		<b>24.0109-0100.2 409100</b> <b>24.0109-0137.1 409137</b>	Ø 249 9 7 + LG / + ABS Ring Ø 247 9 8 + S
			→	Achszapfendurchmesser [mm]: 25		<b>24.0109-0150.2 409150</b>	Ø 249 9 8 + LG / + ABS Ring
↓							

	kw			 	! #		
<b>CITROËN - C4 I (LC_) 11/04→12/13</b>							
 <b>Bremsscheibe</b>							
1.6 HDi 1.6 THP 140 1.6 THP 150	80 103 110	11/04→07/11 07/08→07/11 07/08→07/11	←	+ ESP	24.0126-0120.1	426120	Ø 283 26 24 V + S
			→	Achszapfendurchmesser [mm]: 30	24.0326-0120.1	526120	Ø 283 26 24 V + S
			→		24.0109-0100.2	409100	Ø 249 9 7 + LG / + ABS Ring
			→		24.0109-0137.1	409137	Ø 247 9 8 + S
			→	Achszapfendurchmesser [mm]: 25	24.0109-0150.2	409150	Ø 249 9 8 + LG / + ABS Ring
1.6 VTi 120	88	07/08→07/11	←	Schaltgetriebe	24.0122-0194.1	422194	Ø 266 22 20 V + S
			←	Vollautomatik	24.0126-0120.1	426120	Ø 283 26 24 V + S
			→	Achszapfendurchmesser [mm]: 30	24.0326-0120.1	526120	Ø 283 26 24 V + S
			→		24.0109-0100.2	409100	Ø 249 9 7 + LG / + ABS Ring
			→		24.0109-0137.1	409137	Ø 247 9 8 + S
2.0 16V 2.0 16V 2.0 16V	100 103 105	11/04→07/07 11/04→07/11 09/06→07/09	←		24.0126-0120.1	426120	Ø 283 26 24 V + S
			→	Achszapfendurchmesser [mm]: 30	24.0326-0120.1	526120	Ø 283 26 24 V + S
			→		24.0109-0100.2	409100	Ø 249 9 7 + LG / + ABS Ring
			→		24.0109-0137.1	409137	Ø 247 9 8 + S
			→	Achszapfendurchmesser [mm]: 25	24.0109-0150.2	409150	Ø 249 9 8 + LG / + ABS Ring
2.0 16V 2.0 HDi 2.0 HDi	130 100 103	11/04→07/08 11/04→07/11 07/08→07/11	←	→Orga 11500	24.0126-0140.1	426140	Ø 302 26 24 außenbelüftet + S
			←	Orga 11501→	24.0126-0159.1	426159	Ø 302 26 24 V + S
			→	Achszapfendurchmesser [mm]: 30	24.0109-0100.2	409100	Ø 249 9 7 + LG / + ABS Ring
			→		24.0109-0137.1	409137	Ø 247 9 8 + S
			→	Achszapfendurchmesser [mm]: 25	24.0109-0150.2	409150	Ø 249 9 8 + LG / + ABS Ring
2.0 HDi	81	04/07→07/08	←		24.0126-0120.1	426120	Ø 283 26 24 V + S
			→		24.0109-0137.1	409137	Ø 247 9 8 + S
<b>CITROËN - C4 II (B7) 02/09→</b>							
 <b>Bremsbelagsatz, Scheibenbremse</b>							
1.2 THP 110 1.4 VTi 95	81 70	02/15→ 11/09→	←		13.0460-2603.2	602603	TRW 25220 18,6 + WK
			→	+ eFSB	13.0460-2761.2	602761	TRW 24922 16,5 - WK + Zub
			→	- eFSB	13.0460-2775.2	602775	TRW 23554 16,4 - WE / - WK + Zub
1.2 THP 130 1.6 BlueHDi 100 1.6 BlueHDi 120 1.6 HDi 110 1.6 HDi 115 1.6 VTi 120 1.6 VTi 120 LPG	96 73 88 82 84 88 88	04/14→ 07/14→ 02/15→ 11/09→ 07/12→ 11/09→ 09/11→	←		13.0460-7229.2	607229	ATE 24538 18,5 - WE / - WK
			→	+ eFSB	13.0470-7229.2	LD7229	ATE 24538 18,5 - WE / - WK Ceramic
			→		13.0460-2761.2	602761	TRW 24922 16,5 - WK + Zub
			→	- eFSB	13.0460-2775.2	602775	TRW 23554 16,4 - WE / - WK + Zub
			→		13.0460-2775.2	602775	TRW 23554 16,4 - WE / - WK + Zub
1.6 BlueHDi 115	85	08/14→	←		13.0460-7229.2	607229	ATE 24538 18,5 - WE / - WK
			←		13.0470-7229.2	LD7229	ATE 24538 18,5 - WE / - WK Ceramic
			→		13.0460-2761.2	602761	TRW 24922 16,5 - WK + Zub
1.6 HDi 90	68	11/09→	←	- eFSB	13.0460-2603.2	602603	TRW 25220 18,6 + WK
			←	+ eFSB	13.0460-7229.2	607229	ATE 24538 18,5 - WE / - WK
			→		13.0470-7229.2	LD7229	ATE 24538 18,5 - WE / - WK Ceramic
			→	+ eFSB	13.0460-2761.2	602761	TRW 24922 16,5 - WK + Zub
			→	- eFSB	13.0460-2775.2	602775	TRW 23554 16,4 - WE / - WK + Zub
1.6 THP 155 2.0 HDi / BlueHDi 150	115 110	11/09→ 11/09→	←		13.0460-7230.2	607230	ATE 24557 19,4 - WE / - WK
			→		13.0470-7230.2	LD7230	ATE 24557 19,4 - WE / - WK Ceramic
			→		13.0460-2761.2	602761	TRW 24922 16,5 - WK + Zub
 <b>Bremsscheibe</b>							
1.2 THP 110 1.4 VTi 95	81 70	02/15→ 11/09→	←		24.0122-0194.1	422194	Ø 266 22 20 V + S
			→	- eFSB	24.0109-0171.2	409171	Ø 249 9 8 + LG / + ABS Ring
			→	+ eFSB; nicht für Felgenreöße [Zoll]: 19	24.0112-0194.2	412194	Ø 268 12 10 + LG / + ABS Ring
			→	+ eFSB; passend für Felgenreöße [Zoll]: 19	24.0112-0198.1	412198	Ø 290 12 10 + S
1.2 THP 130 1.6 BlueHDi 100	96 73	04/14→ 07/14→	←		24.0126-0120.1	426120	Ø 283 26 24 V + S









	kw			 	! #		
<b>CITROËN - C4 II (B7) 02/09→</b>							
 <b>Bremsscheibe</b>							
1.6 BlueHDi 120	88	02/15→	←			24.0326-0120.1 526120	Ø 283 26 24 V + S
1.6 HDi 110	82	11/09→	→	- eFSB		24.0109-0171.2 409171	Ø 249 9 8 + LG / + ABS Ring
1.6 HDi 115	84	07/12→	→	+ eFSB; nicht für Felgengröße [Zoll]: 19		24.0112-0194.2 412194	Ø 268 12 10 + LG / + ABS Ring
1.6 VTi 120	88	11/09→	→	+ eFSB;		24.0112-0198.1 412198	Ø 290 12 10 + S
1.6 VTi 120 LPG	88	09/11→	→	passend für Felgengröße [Zoll]: 19			
1.6 BlueHDi 115	85	08/14→	←			24.0126-0120.1 426120	Ø 283 26 24 V + S
			→	nicht für Felgengröße [Zoll]: 19		24.0326-0120.1 526120	Ø 283 26 24 V + S
			→	passend für Felgengröße [Zoll]: 19		24.0112-0194.2 412194	Ø 268 12 10 + LG / + ABS Ring
			→	passend für Felgengröße [Zoll]: 19		24.0112-0198.1 412198	Ø 290 12 10 + S
1.6 HDi 90	68	11/09→	←	- eFSB		24.0122-0194.1 422194	Ø 266 22 20 V + S
			←	+ eFSB		24.0126-0120.1 426120	Ø 283 26 24 V + S
			→	- eFSB		24.0326-0120.1 526120	Ø 283 26 24 V + S
			→	- eFSB		24.0109-0171.2 409171	Ø 249 9 8 + LG / + ABS Ring
			→	+ eFSB; nicht für Felgengröße [Zoll]: 19		24.0112-0194.2 412194	Ø 268 12 10 + LG / + ABS Ring
			→	+ eFSB;		24.0112-0198.1 412198	Ø 290 12 10 + S
			→	passend für Felgengröße [Zoll]: 19			
1.6 THP 155	115	11/09→	←			24.0126-0159.1 426159	Ø 302 26 24 V + S
2.0 HDi / BlueHDi 150	110	11/09→	→	nicht für Felgengröße [Zoll]: 19		24.0112-0194.2 412194	Ø 268 12 10 + LG / + ABS Ring
			→	passend für Felgengröße [Zoll]: 19		24.0112-0198.1 412198	Ø 290 12 10 + S
<b>CITROËN - C4 AIRCROSS 08/10→</b>							
 <b>Bremsbelagsatz, Scheibenbremse</b>							
1.6	86	04/12→	←			13.0460-5760.2 605760	AKE 23584 16,4 + WK
1.6 HDi 115	84	04/12→	→	10/12→		13.0460-5654.2 605654	MAN 25688 14,4 + WK
1.6 HDi 115 AWC	84	05/12→	→				
1.8 HDi 150	110	04/12→	→	→ 09/12		13.0460-5855.2 605855	23582 16,0 - WK
1.8 HDi 150 AWC	110	04/12→	→				
 <b>Bremsscheibe</b>							
1.6	86	04/12→	←			24.0126-0170.1 426170	Ø 294 26 24,4 V
1.6 HDi 115	84	04/12→	→	→ 09/12		24.0110-0360.1 410360	Ø 302 10 8,4
1.6 HDi 115 AWC	84	05/12→	→				
1.8 HDi 150	110	04/12→	→	10/12→		24.0110-0395.1 410395	Ø 302 10 8,4
1.8 HDi 150 AWC	110	04/12→	→				
<b>CITROËN - C4 CACTUS 09/14→</b>							
 <b>Bremsbelagsatz, Scheibenbremse</b>							
1.2 THP 110	81	09/14→	←			13.0460-3867.2 603867	MAN 25250 18,9 - WE / - WK + Zub
1.2 VTi 75	55	09/14→	←	V		13.0460-3994.2 603994	BOS 23599 19,0 - WE / - WK + Zub
1.2 VTi 82	60	09/14→	←				
1.6 BlueHDi 100	73	09/14→	←			13.0470-3994.2 LD3994	BOS 23599 19,0 - WE / - WK + Zub Ceramic
1.6 HDi 90	68	09/14→	→			13.0460-2740.2 602740	TRW 23554 17,0 - WE / - WK + Zub
			→			13.0470-2740.2 LD2740	TRW 23554 17,0 - WE / - WK + Zub Ceramic
 <b>Bremsscheibe</b>							
1.2 THP 110	81	09/14→	←			24.0113-0184.1 413184	Ø 266 13 11 + S
1.2 VTi 75	55	09/14→	→			24.0122-0194.1 422194	Ø 266 22 20 V + S
1.2 VTi 82	60	09/14→	→			24.0313-0184.1 513184	Ø 266 13 11 + S
1.6 BlueHDi 100	73	09/14→	→			24.0109-0100.2 409100	Ø 249 9 7 + LG / + ABS Ring
1.6 HDi 90	68	09/14→	→				
<b>CITROËN - C4 Coupe (LA_) 11/04→12/13</b>							
 <b>Bremsbelagsatz, Scheibenbremse</b>							
1.4 16V	65	11/04→07/11	←	→Orga 10550; + ESP		13.0460-3966.2 603966	BOS 23600 19,4 - WE / - WK + Zub
1.6 HDi	66	11/04→07/11	←			13.0470-3966.2 LD3966	BOS 23600 19,4 - WE / - WK + Zub Ceramic
			←	→ 07/10; - ESP		13.0460-3994.2 603994	BOS 23599 19,0 - WE / - WK + Zub
			←			13.0470-3994.2 LD3994	BOS 23599 19,0 - WE / - WK + Zub Ceramic
			←	Orga 10551→; → 07/10; + ESP		13.0460-3994.2 603994	BOS 23599 19,0 - WE / - WK + Zub



	kw			 	! #		
<b>CITROËN - C4 Coupe (LA_) 11/04→12/13</b>							
<b>Bremsbelagsatz, Scheibenbremse</b>							
1.4 16V 1.6 HDi	65 66	11/04→07/11 11/04→07/11	←	Orga 10551→; → 07/10; + ESP	13.0470-3994.2	LD3994	BOS 23599 19,0 - WE / - WK + Zub Ceramic
			→	Orga 11431→ Orga 12333	13.0460-2740.2	602740	TRW 23554 17,0 - WE / - WK + Zub
			→	→Orga 11584	13.0460-2820.2	602820	TRW 20961 17,2 - WK
			→	Orga 12334→; → 07/10	13.0460-2820.2	602820	TRW 20961 17,2 - WK Ceramic
			→	→Orga 12056	13.0460-3813.2	603813	BOS 24150 17,6 - WE / - WK + Zub
					13.0470-3813.2	LD3813	BOS 24150 17,6 - WE / - WK + Zub Ceramic
1.6 16V	80	11/04→07/11	←	→Orga 10550; + ESP; Schaltgetriebe	13.0460-3966.2	603966	BOS 23600 19,4 - WE / - WK + Zub
					13.0470-3966.2	LD3966	BOS 23600 19,4 - WE / - WK + Zub Ceramic
			←	→ 07/10; Automatikgetriebe	13.0460-3966.2	603966	BOS 23600 19,4 - WE / - WK + Zub
					13.0470-3966.2	LD3966	BOS 23600 19,4 - WE / - WK + Zub Ceramic
			←	Orga 10551→; → 07/10; + ESP; Schaltgetriebe	13.0460-3994.2	603994	BOS 23599 19,0 - WE / - WK + Zub
					13.0470-3994.2	LD3994	BOS 23599 19,0 - WE / - WK + Zub Ceramic
			←	→ 07/10; - ESP; Schaltgetriebe	13.0460-3994.2	603994	BOS 23599 19,0 - WE / - WK + Zub
					13.0470-3994.2	LD3994	BOS 23599 19,0 - WE / - WK + Zub Ceramic
			→	Orga 11431→ Orga 12333	13.0460-2740.2	602740	TRW 23554 17,0 - WE / - WK + Zub
		13.0470-2740.2	LD2740	TRW 23554 17,0 - WE / - WK + Zub Ceramic			
→	→Orga 11584	13.0460-2820.2	602820	TRW 20961 17,2 - WK			
		13.0470-2820.2	LD2820	TRW 20961 17,2 - WK Ceramic			
→	Orga 12334→; → 07/10	13.0460-2820.2	602820	TRW 20961 17,2 - WK			
		13.0470-2820.2	LD2820	TRW 20961 17,2 - WK Ceramic			
→	→Orga 12056	13.0460-3813.2	603813	BOS 24150 17,6 - WE / - WK + Zub			
				13.0470-3813.2	LD3813	BOS 24150 17,6 - WE / - WK + Zub Ceramic	
1.6 HDi 1.6 THP 150	80 110	11/04→07/11 07/08→07/11	←	+ ESP; → 07/10	13.0460-3966.2	603966	BOS 23600 19,4 - WE / - WK + Zub
					13.0470-3966.2	LD3966	BOS 23600 19,4 - WE / - WK + Zub Ceramic
			→	Orga 11431→ Orga 12333	13.0460-2740.2	602740	TRW 23554 17,0 - WE / - WK + Zub
					13.0470-2740.2	LD2740	TRW 23554 17,0 - WE / - WK + Zub Ceramic
			→	Orga 12334→; → 07/10	13.0460-2820.2	602820	TRW 20961 17,2 - WK
		13.0470-2820.2	LD2820	TRW 20961 17,2 - WK Ceramic			
→	→Orga 11584	13.0460-2820.2	602820	TRW 20961 17,2 - WK			
		13.0470-2820.2	LD2820	TRW 20961 17,2 - WK Ceramic			
→	→Orga 12056	13.0460-3813.2	603813	BOS 24150 17,6 - WE / - WK + Zub			
				13.0470-3813.2	LD3813	BOS 24150 17,6 - WE / - WK + Zub Ceramic	
1.6 VTi 120	88	07/08→07/11	←	→ 07/10; Vollautomatik	13.0460-3966.2	603966	BOS 23600 19,4 - WE / - WK + Zub
					13.0470-3966.2	LD3966	BOS 23600 19,4 - WE / - WK + Zub Ceramic
			←	→ 07/10; Schaltgetriebe	13.0460-3994.2	603994	BOS 23599 19,0 - WE / - WK + Zub
		13.0470-3994.2	LD3994	BOS 23599 19,0 - WE / - WK + Zub Ceramic			
→	Orga 11431→ Orga 12333	13.0460-2740.2	602740	TRW 23554 17,0 - WE / - WK + Zub			

↓



	kw			 	! #						
<b>CITROËN - C4 Coupe (LA_) 11/04→12/13</b>											
<b> Bremsbelagsatz, Scheibenbremse</b>											
1.6 VTi 120	88	07/08→07/11	➡	Orga 11431→ Orga 12333		<b>13.0470-2740.2</b>	<b>LD2740</b>	TRW 23554 17,0 - WE / - WK + Zub Ceramic			
			➡	Orga 12334→; → 07/10		<b>13.0460-2820.2</b>	<b>602820</b>	TRW 20961 17,2 - WK			
			➡	→Orga 11584		<b>13.0460-2820.2</b>	<b>602820</b>	TRW 20961 17,2 - WK Ceramic			
			➡	→Orga 12056		<b>13.0460-2820.2</b>	<b>LD2820</b>	TRW 20961 17,2 - WK Ceramic			
			➡	→Orga 12056		<b>13.0460-3813.2</b>	<b>603813</b>	BOS 24150 17,6 - WE / - WK + Zub			
						<b>13.0470-3813.2</b>	<b>LD3813</b>	BOS 24150 17,6 - WE / - WK + Zub Ceramic			
			2.0 16V 2.0 VTR	100 103	11/04→07/07 10/06→12/07	←			<b>13.0460-3966.2</b>	<b>603966</b>	BOS 23600 19,4 - WE / - WK + Zub
									<b>13.0470-3966.2</b>	<b>LD3966</b>	BOS 23600 19,4 - WE / - WK + Zub Ceramic
			➡	Orga 11431→ Orga 12333		<b>13.0460-2740.2</b>	<b>602740</b>	TRW 23554 17,0 - WE / - WK + Zub			
						<b>13.0470-2740.2</b>	<b>LD2740</b>	TRW 23554 17,0 - WE / - WK + Zub Ceramic			
			➡	Orga 12334→		<b>13.0460-2820.2</b>	<b>602820</b>	TRW 20961 17,2 - WK			
						<b>13.0470-2820.2</b>	<b>LD2820</b>	TRW 20961 17,2 - WK Ceramic			
			➡	→Orga 11584		<b>13.0460-2820.2</b>	<b>602820</b>	TRW 20961 17,2 - WK			
						<b>13.0470-2820.2</b>	<b>LD2820</b>	TRW 20961 17,2 - WK Ceramic			
			➡	→Orga 12056		<b>13.0460-3813.2</b>	<b>603813</b>	BOS 24150 17,6 - WE / - WK + Zub			
						<b>13.0470-3813.2</b>	<b>LD3813</b>	BOS 24150 17,6 - WE / - WK + Zub Ceramic			
2.0 16V 2.0 HDi 2.0 HDi	130 100 103	11/04→12/10 11/04→12/10 07/08→07/11	←	→ 07/10		<b>13.0460-7230.2</b>	<b>607230</b>	ATE 24557 19,4 - WE / - WK			
						<b>13.0470-7202.2</b>	<b>LD7202</b>	ATE 23589 19,1 - WE / - WK Ceramic			
						<b>13.0470-7230.2</b>	<b>LD7230</b>	ATE 24557 19,4 - WE / - WK Ceramic			
			➡	Orga 11431→ Orga 12333		<b>13.0460-2740.2</b>	<b>602740</b>	TRW 23554 17,0 - WE / - WK + Zub			
						<b>13.0470-2740.2</b>	<b>LD2740</b>	TRW 23554 17,0 - WE / - WK + Zub Ceramic			
			➡	Orga 12334→; → 07/10		<b>13.0460-2820.2</b>	<b>602820</b>	TRW 20961 17,2 - WK			
						<b>13.0470-2820.2</b>	<b>LD2820</b>	TRW 20961 17,2 - WK Ceramic			
			➡	→Orga 11584		<b>13.0460-2820.2</b>	<b>602820</b>	TRW 20961 17,2 - WK			
						<b>13.0470-2820.2</b>	<b>LD2820</b>	TRW 20961 17,2 - WK Ceramic			
			➡	→Orga 12056		<b>13.0460-3813.2</b>	<b>603813</b>	BOS 24150 17,6 - WE / - WK + Zub			
						<b>13.0470-3813.2</b>	<b>LD3813</b>	BOS 24150 17,6 - WE / - WK + Zub Ceramic			
			<b>Zubehörsatz, Scheibenbremsbelag</b>								
1.4 16V 1.6 16V 1.6 HDi 1.6 HDi 1.6 THP 150 1.6 VTi 120 2.0 16V 2.0 HDi 2.0 HDi	65 80 66 80 110 88 130 100 103	11/04→07/11 11/04→07/11 11/04→07/11 11/04→07/11 07/08→07/11 07/08→07/11 11/04→12/10 11/04→12/10 07/08→07/11	➡	Orga 12334→; → 07/10		<b>13.0460-0072.2</b>	<b>610072</b>	TRW			
			➡	→Orga 11584		<b>13.0460-0072.2</b>	<b>610072</b>	TRW			
			➡	→Orga 11584		<b>13.0460-0072.2</b>	<b>610072</b>	TRW			
			➡	→Orga 11584		<b>13.0460-0072.2</b>	<b>610072</b>	TRW			
2.0 16V 2.0 VTR	100 103	11/04→07/07 10/06→12/07	➡	Orga 12334→		<b>13.0460-0072.2</b>	<b>610072</b>	TRW			
			➡	→Orga 11584		<b>13.0460-0072.2</b>	<b>610072</b>	TRW			
<b> Bremsscheibe</b>											
1.4 16V 1.6 HDi	65 66	11/04→07/11 11/04→07/11	←	→ 07/10; - ESP		<b>24.0122-0194.1</b>	<b>422194</b>	Ø 266 22 20 V + S			
			←	Orga 10551→; → 07/10; + ESP		<b>24.0122-0194.1</b>	<b>422194</b>	Ø 266 22 20 V + S			
			←	→Orga 10550; + ESP		<b>24.0126-0120.1</b>	<b>426120</b>	Ø 283 26 24 V + S			
						<b>24.0326-0120.1</b>	<b>526120</b>	Ø 283 26 24 V + S			
			➡	→ 07/10; Achszapfendurchmesser [mm]: 30		<b>24.0109-0100.2</b>	<b>409100</b>	Ø 249 9 7 + LG / + ABS Ring			
			➡	→ 07/10		<b>24.0109-0137.1</b>	<b>409137</b>	Ø 247 9 8 + S			
			➡	→ 07/10; Achszapfendurchmesser [mm]: 25		<b>24.0109-0150.2</b>	<b>409150</b>	Ø 249 9 8 + LG / + ABS Ring			
↓											

**CITROËN - C4 Coupe (LA\_) 11/04→12/13**

**Bremsscheibe**

1.6 16V	80	11/04→07/11	←	Orga 10551→; → 07/10; + ESP; Schaltgetriebe	24.0122-0194.1	422194	∅ 266 22 20 V + S
			←	→ 07/10; - ESP; Schaltgetriebe	24.0122-0194.1	422194	∅ 266 22 20 V + S
			←	→ 07/10; Automatikgetriebe	24.0126-0120.1	426120	∅ 283 26 24 V + S
					24.0326-0120.1	526120	∅ 283 26 24 V + S
			←	→Orga 10550; + ESP; Schaltgetriebe	24.0126-0120.1	426120	∅ 283 26 24 V + S
					24.0326-0120.1	526120	∅ 283 26 24 V + S
			→	→ 07/10; Achszapfendurchmesser [mm]: 30	24.0109-0100.2	409100	∅ 249 9 7 + LG / + ABS Ring
		24.0109-0137.1	409137	∅ 247 9 8 + S			
		24.0109-0150.2	409150	∅ 249 9 8 + LG / + ABS Ring			
1.6 HDi 1.6 THP 150	80 110	11/04→07/11 07/08→07/11	←	→Orga 10550; + ESP	24.0126-0120.1	426120	∅ 283 26 24 V + S
					24.0326-0120.1	526120	∅ 283 26 24 V + S
			→	→ 07/10; Achszapfendurchmesser [mm]: 30	24.0109-0100.2	409100	∅ 249 9 7 + LG / + ABS Ring
			→	→ 07/10	24.0109-0137.1	409137	∅ 247 9 8 + S
		24.0109-0150.2	409150	∅ 249 9 8 + LG / + ABS Ring			
1.6 VTi 120	88	07/08→07/11	←	→ 07/10; Schaltgetriebe	24.0122-0194.1	422194	∅ 266 22 20 V + S
			←	→Orga 10550; Vollautomatik	24.0126-0120.1	426120	∅ 283 26 24 V + S
					24.0326-0120.1	526120	∅ 283 26 24 V + S
			→	→ 07/10; Achszapfendurchmesser [mm]: 30	24.0109-0100.2	409100	∅ 249 9 7 + LG / + ABS Ring
			→	→ 07/10	24.0109-0137.1	409137	∅ 247 9 8 + S
		24.0109-0150.2	409150	∅ 249 9 8 + LG / + ABS Ring			
2.0 16V 2.0 VTR	100 103	11/04→07/07 10/06→12/07	←		24.0126-0120.1	426120	∅ 283 26 24 V + S
					24.0326-0120.1	526120	∅ 283 26 24 V + S
			→	Achszapfendurchmesser [mm]: 30	24.0109-0100.2	409100	∅ 249 9 7 + LG / + ABS Ring
			→		24.0109-0137.1	409137	∅ 247 9 8 + S
		24.0109-0150.2	409150	∅ 249 9 8 + LG / + ABS Ring			
2.0 16V 2.0 HDi 2.0 HDi	130 100 103	11/04→12/10 11/04→12/10 07/08→07/11	←	→Orga 11500	24.0126-0140.1	426140	∅ 302 26 24 außenbelüftet + S
			←	Orga 11501→; → 07/10	24.0126-0159.1	426159	∅ 302 26 24 V + S
			→	→ 07/10; Achszapfendurchmesser [mm]: 30	24.0109-0100.2	409100	∅ 249 9 7 + LG / + ABS Ring
			→	→ 07/10	24.0109-0137.1	409137	∅ 247 9 8 + S
			→	→ 07/10; Achszapfendurchmesser [mm]: 25	24.0109-0150.2	409150	∅ 249 9 8 + LG / + ABS Ring











**CITROËN - C4 Grand Picasso I (UA\_) 10/06→**











**Bremsbelagsatz, Scheibenbremse**

1.6 16V 1.6 16V 2.0 HDi 138 2.0 HDi 150 2.0 i 16V 2.0 i 16V	103 110 100 110 103 105	07/08→ 10/08→ 10/06→ 07/09→ 10/06→ 01/10→	←	→ 07/13	13.0460-7230.2	607230	ATE 24557 19,4 - WE / - WK
					13.0470-7230.2	LD7230	ATE 24557 19,4 - WE / - WK Ceramic
1.6 HDi 1.6 HDi 110 1.6 VTi 120 1.8 i 16V	80 82 88 92	10/06→ 09/10→ 07/08→ 10/06→	←	→ 07/13	13.0460-7229.2	607229	ATE 24538 18,5 - WE / - WK
					13.0470-7229.2	LD7229	ATE 24538 18,5 - WE / - WK Ceramic
1.6 THP 155 2.0 HDi 165	115 120	09/10→ 09/10→	←	11/10→ 07/13	13.0460-7230.2	607230	ATE 24557 19,4 - WE / - WK
					13.0470-7230.2	LD7230	ATE 24557 19,4 - WE / - WK Ceramic
			→	11/10→ 07/13	13.0460-3836.2	603836	BOS 24540 16,3 - WE / - WK + Zub
					13.0470-3836.2	LD3836	BOS 24540 16,3 - WE / - WK + Zub Ceramic













↓

























	kw				! #		
<b>CITROËN - C4 Grand Picasso I (UA_) 10/06→</b>							
 <b>Bremsscheibe</b>							
1.6 16V	103	07/08→	←	→ 07/13		24.0126-0140.1 426140	Ø 302 26 24 außenbelüftet + S
1.6 16V	110	10/08→	→	→ 07/13		24.0112-0194.2 412194	Ø 268 12 10 + LG / + ABS Ring
2.0 HDi 138	100	10/06→					
2.0 HDi 150	110	07/09→					
2.0 i 16V	103	10/06→					
2.0 i 16V	105	01/10→					
1.6 HDi	80	10/06→	←	→ 07/13		24.0126-0120.1 426120	Ø 283 26 24 V + S
1.6 HDi 110	82	09/10→	→	→ 07/13		24.0326-0120.1 526120	Ø 283 26 24 V + S
1.6 VTi 120	88	07/08→					
1.8 i 16V	92	10/06→					
1.6 THP 155	115	09/10→					
2.0 HDi 165	120	09/10→	←	11/10→ 07/13		24.0126-0140.1 426140	Ø 302 26 24 außenbelüftet + S
			→	11/10→ 07/13		24.0112-0194.2 412194	Ø 268 12 10 + LG / + ABS Ring
<b>CITROËN - C4 Grand Picasso II 09/13→</b>							
 <b>Bremsbelagsatz, Scheibenbremse</b>							
1.2 THP 130	96	04/14→	←	für Bremsscheibendurchmesser [mm]:		13.0460-7300.2 607300	ATE 25833 17,3 + WE / - WK
1.6 BlueHDi 100	73	01/15→	←	304		13.0470-7300.2 LD7300	ATE 25833 17,3 + WE / - WK Ceramic
1.6 BlueHDi 120	88	07/14→					
1.6 HDi / BlueHDi 115	85	09/13→	←	für Bremsscheibendurchmesser [mm]:	283	13.0460-7305.2 607305	ATE 25836 17,0 + WE / - WK Ceramic
1.6 HDi 90	68	09/13→					
1.6 THP 150	110	09/14→					
1.6 THP 155	115	09/13→					
1.6 THP 165	121	07/14→	→	für Bremsscheibendurchmesser [mm]:	268	13.0460-3871.2 603871	BOS 25839 17,8 - WE / - WK + Zub
1.6 VTi 120	88	09/13→					
2.0 BlueHDi 135	100	09/13→					
2.0 BlueHDi 150	110	09/13→					
			→	für Bremsscheibendurchmesser [mm]:	290	13.0460-3872.2 603872	BOS 25827 17,7 - WE / - WK + Zub
						13.0470-3872.2 LD3872	BOS 25827 17,7 - WE / - WK + Zub Ceramic
 <b>Bremsscheibe</b>							
1.2 THP 130	96	04/14→	←			24.0126-0183.1 426183	Ø 283 26 24 V + S
1.6 BlueHDi 100	73	01/15→	←			24.0128-0269.1 428269	Ø 304 28 26 V + S
1.6 BlueHDi 120	88	07/14→					
1.6 HDi / BlueHDi 115	85	09/13→	→			24.0112-0211.1 412211	Ø 268 12 10 + S
1.6 HDi 90	68	09/13→					
1.6 THP 150	110	09/14→					
1.6 THP 155	115	09/13→					
1.6 THP 165	121	07/14→	→			24.0112-0212.1 412212	Ø 290 12 10 + S
1.6 VTi 120	88	09/13→					
2.0 BlueHDi 135	100	09/13→					
2.0 BlueHDi 150	110	09/13→					
<b>CITROËN - C4 Picasso I Großraumlimousine (UD_) 10/06→10/13</b>							
 <b>Bremsbelagsatz, Scheibenbremse</b>							
1.6 16V	110	07/08→08/13	←	→ 07/13		13.0460-7230.2 607230	ATE 24557 19,4 - WE / - WK
1.6 THP 140	103	07/08→08/13	→	→ 07/13		13.0470-7230.2 LD7230	ATE 24557 19,4 - WE / - WK Ceramic
2.0 HDi 150	110	07/09→08/13					
2.0 i 16V	103	02/07→08/13					
1.6 HDi	80	02/07→08/13	←	→ 07/13		13.0460-7229.2 607229	ATE 24538 18,5 - WE / - WK
1.6 VTi 120	88	07/08→08/13	→	→ 07/13		13.0470-7229.2 LD7229	ATE 24538 18,5 - WE / - WK Ceramic
						13.0460-3836.2 603836	BOS 24540 16,3 - WE / - WK + Zub
						13.0470-3836.2 LD3836	BOS 24540 16,3 - WE / - WK + Zub Ceramic
1.6 HDi 110	82	09/10→08/13	←	11/10→ 07/13		13.0460-7229.2 607229	ATE 24538 18,5 - WE / - WK
			→	11/10→ 07/13		13.0470-7229.2 LD7229	ATE 24538 18,5 - WE / - WK Ceramic
						13.0460-3836.2 603836	BOS 24540 16,3 - WE / - WK + Zub
						13.0470-3836.2 LD3836	BOS 24540 16,3 - WE / - WK + Zub Ceramic
1.6 THP 155	115	09/10→08/13	←	11/10→ 07/13		13.0460-7230.2 607230	ATE 24557 19,4 - WE / - WK
2.0 HDi 165	120	09/10→08/13	→	11/10→ 07/13		13.0470-7230.2 LD7230	ATE 24557 19,4 - WE / - WK Ceramic
						13.0460-3836.2 603836	BOS 24540 16,3 - WE / - WK + Zub











	kw			 	! #		
<b>CITROËN - C4 Picasso I Großraumlimousine (UD_) 10/06→10/13</b>							
 <b>Bremsbelagsatz, Scheibenbremse</b>							
1.6 THP 155 2.0 HDi 165	115 120	09/10→08/13 09/10→08/13	➡	11/10→ 07/13		<b>13.0470-3836.2 LD3836</b>	BOS 24540 16,3 - WE / - WK + Zub Ceramic
1.8 Bifuel 1.8 i 16V	92 92	01/09→10/12 02/07→12/11	←			<b>13.0460-7229.2 607229</b>	ATE 24538 18,5 - WE / - WK
						<b>13.0470-7229.2 LD7229</b>	ATE 24538 18,5 - WE / - WK Ceramic
			➡			<b>13.0460-3836.2 603836</b>	BOS 24540 16,3 - WE / - WK + Zub
2.0 HDi 138	100	10/06→08/13	←	02/07→ 07/13		<b>13.0460-7230.2 607230</b>	ATE 24557 19,4 - WE / - WK
						<b>13.0470-7230.2 LD7230</b>	ATE 24557 19,4 - WE / - WK Ceramic
			➡	02/07→ 07/13		<b>13.0460-3836.2 603836</b>	BOS 24540 16,3 - WE / - WK + Zub
						<b>13.0470-3836.2 LD3836</b>	BOS 24540 16,3 - WE / - WK + Zub Ceramic
2.0 i 16V	105	05/08→05/13	←			<b>13.0460-7230.2 607230</b>	ATE 24557 19,4 - WE / - WK
						<b>13.0470-7230.2 LD7230</b>	ATE 24557 19,4 - WE / - WK Ceramic
			➡			<b>13.0460-3836.2 603836</b>	BOS 24540 16,3 - WE / - WK + Zub
						<b>13.0470-3836.2 LD3836</b>	BOS 24540 16,3 - WE / - WK + Zub Ceramic
 <b>Bremsscheibe</b>							
1.6 16V 1.6 THP 140	110 103	07/08→08/13 07/08→08/13	←	→ 07/13		<b>24.0126-0140.1 426140</b>	Ø 302 26 24 außenbelüftet + S
			➡	→ 07/13		<b>24.0112-0194.2 412194</b>	Ø 268 12 10 + LG / + ABS Ring
2.0 HDi 150 2.0 i 16V	110 103	07/09→08/13 02/07→08/13	←	→ 07/13		<b>24.0126-0120.1 426120</b>	Ø 283 26 24 V + S
			➡	→ 07/13		<b>24.0326-0120.1 526120</b>	Ø 283 26 24 V + S
1.6 HDi 1.6 VTi 120	80 88	02/07→08/13 07/08→08/13	←	→ 07/13		<b>24.0112-0194.2 412194</b>	Ø 268 12 10 + LG / + ABS Ring
			➡	→ 07/13		<b>24.0112-0194.2 412194</b>	Ø 268 12 10 + LG / + ABS Ring
1.6 HDi 110	82	09/10→08/13	←	11/10→ 07/13		<b>24.0126-0120.1 426120</b>	Ø 283 26 24 V + S
						<b>24.0326-0120.1 526120</b>	Ø 283 26 24 V + S
			➡	11/10→ 07/13		<b>24.0112-0194.2 412194</b>	Ø 268 12 10 + LG / + ABS Ring
						<b>24.0126-0140.1 426140</b>	Ø 302 26 24 außenbelüftet + S
1.6 THP 155 2.0 HDi 165	115 120	09/10→08/13 09/10→08/13	←	11/10→ 07/13		<b>24.0112-0194.2 412194</b>	Ø 268 12 10 + LG / + ABS Ring
			➡	11/10→ 07/13		<b>24.0112-0194.2 412194</b>	Ø 268 12 10 + LG / + ABS Ring
1.8 Bifuel 1.8 i 16V	92 92	01/09→10/12 02/07→12/11	←			<b>24.0126-0120.1 426120</b>	Ø 283 26 24 V + S
						<b>24.0326-0120.1 526120</b>	Ø 283 26 24 V + S
			➡			<b>24.0112-0194.2 412194</b>	Ø 268 12 10 + LG / + ABS Ring
						<b>24.0126-0140.1 426140</b>	Ø 302 26 24 außenbelüftet + S
2.0 HDi 138	100	10/06→08/13	←	02/07→ 07/13		<b>24.0112-0194.2 412194</b>	Ø 268 12 10 + LG / + ABS Ring
			➡	02/07→ 07/13		<b>24.0112-0194.2 412194</b>	Ø 268 12 10 + LG / + ABS Ring
2.0 i 16V	105	05/08→05/13	←			<b>24.0126-0140.1 426140</b>	Ø 302 26 24 außenbelüftet + S
			➡			<b>24.0112-0194.2 412194</b>	Ø 268 12 10 + LG / + ABS Ring
<b>CITROËN - C4 Picasso II 02/13→</b>							
 <b>Bremsbelagsatz, Scheibenbremse</b>							
1.2 THP 110	81	04/16→	←	für Bremsscheibendurchmesser [mm]: 304		<b>13.0460-7300.2 607300</b>	ATE 25833 17,3 + WE / - WK
						<b>13.0470-7300.2 LD7300</b>	ATE 25833 17,3 + WE / - WK Ceramic
			←	für Bremsscheibendurchmesser [mm]: 283		<b>13.0460-7305.2 607305</b>	ATE 25836 17,0 + WE / - WK
						<b>13.0470-7305.2 LD7305</b>	ATE 25836 17,0 + WE / - WK Ceramic
			➡	für Bremsscheibendurchmesser [mm]: 268		<b>13.0460-3871.2 603871</b>	BOS 25839 17,8 - WE / - WK + Zub
						<b>13.0470-3871.2 LD3871</b>	BOS 25839 17,8 - WE / - WK + Zub Ceramic
			➡			<b>13.0460-3872.2 603872</b>	BOS 25827 17,7 - WE / - WK + Zub
						<b>13.0470-3872.2 LD3872</b>	BOS 25827 17,7 - WE / - WK + Zub Ceramic
1.2 THP 130 1.6 BlueHDi 100 1.6 BlueHDi 120	96 73 88	04/14→ 12/14→ 07/14→	←	für Bremsscheibendurchmesser [mm]: 304		<b>13.0460-7300.2 607300</b>	ATE 25833 17,3 + WE / - WK
						<b>13.0470-7300.2 LD7300</b>	ATE 25833 17,3 + WE / - WK Ceramic
1.6 THP 150 1.6 THP 165 2.0 BlueHDi 135	110 121 100	09/14→ 07/14→ 09/13→	←	für Bremsscheibendurchmesser [mm]: 283		<b>13.0460-7305.2 607305</b>	ATE 25836 17,0 + WE / - WK













	kw			 	! #		
<b>CITROËN - C4 Picasso II 02/13→</b>							
 <b>Bremsbelagsatz, Scheibenbremse</b>							
2.0 BlueHDi 150	110	09/13→	←	für Bremsscheibendurchmesser [mm]: 283	13.0470-7305.2	LD7305	ATE 25836 17,0 + WE / - WK Ceramic
			→	für Bremsscheibendurchmesser [mm]: 268	13.0460-3871.2	603871	BOS 25839 17,8 - WE / - WK + Zub
			→	für Bremsscheibendurchmesser [mm]: 290	13.0460-3872.2	603872	BOS 25827 17,7 - WE / - WK + Zub
1.6 HDi / BlueHDi 115 1.6 HDi 90 1.6 THP 155 1.6 VTi 120	85 68 115 88	02/13→ 02/13→ 02/13→ 02/13→	←	06/13→; für Bremsscheibendurchmesser [mm]: 304	13.0460-7300.2	607300	ATE 25833 17,3 + WE / - WK Ceramic
			←	06/13→; für Bremsscheibendurchmesser [mm]: 283	13.0460-7305.2	607305	ATE 25836 17,0 + WE / - WK Ceramic
			→	06/13→; für Bremsscheibendurchmesser [mm]: 268	13.0460-3871.2	603871	BOS 25839 17,8 - WE / - WK + Zub
			→	06/13→; für Bremsscheibendurchmesser [mm]: 290	13.0460-3872.2	603872	BOS 25827 17,7 - WE / - WK + Zub
 <b>Bremsscheibe</b>							
1.2 THP 110 1.2 THP 130 1.6 BlueHDi 100 1.6 BlueHDi 120 1.6 THP 150 1.6 THP 165 2.0 BlueHDi 135 2.0 BlueHDi 150	81 96 73 88 110 121 100 110	04/16→ 04/14→ 12/14→ 07/14→ 09/14→ 07/14→ 09/13→ 09/13→	←		24.0126-0183.1	426183	∅ 283 26 24 V + S
			←		24.0128-0269.1	428269	∅ 304 28 26 V + S
			→		24.0112-0211.1	412211	∅ 268 12 10 + S
			→		24.0112-0212.1	412212	∅ 290 12 10 + S
1.6 HDi / BlueHDi 115 1.6 HDi 90 1.6 THP 155 1.6 VTi 120	85 68 115 88	02/13→ 02/13→ 02/13→ 02/13→	←	06/13→	24.0126-0183.1	426183	∅ 283 26 24 V + S
			←		24.0128-0269.1	428269	∅ 304 28 26 V + S
			→	06/13→	24.0112-0211.1	412211	∅ 268 12 10 + S
			→		24.0112-0212.1	412212	∅ 290 12 10 + S
<b>CITROËN - C4 SPACETOURER 04/18→</b>							
 <b>Bremsbelagsatz, Scheibenbremse</b>							
1.2 PureTech 110 1.2 PureTech 130 1.5 BlueHDi 130 1.6 BlueHDi 100 1.6 BlueHDi 120 1.6 THP 165 2.0 BlueHDi 150 2.0 BlueHDi 160	81 96 96 73 88 121 110 120	04/18→ 04/18→ 05/18→ 04/18→ 04/18→ 04/18→ 04/18→ 04/18→	←	für Bremsscheibendurchmesser [mm]: 304	13.0460-7300.2	607300	ATE 25833 17,3 + WE / - WK Ceramic
			←	für Bremsscheibendurchmesser [mm]: 283	13.0460-7305.2	607305	ATE 25836 17,0 + WE / - WK Ceramic
			→	für Bremsscheibendurchmesser [mm]: 268	13.0460-3871.2	603871	BOS 25839 17,8 - WE / - WK + Zub
			→	für Bremsscheibendurchmesser [mm]: 290	13.0460-3872.2	603872	BOS 25827 17,7 - WE / - WK + Zub
 <b>Bremsscheibe</b>							
1.2 PureTech 110 1.2 PureTech 130 1.5 BlueHDi 130 1.6 BlueHDi 100 1.6 BlueHDi 120 1.6 THP 165 2.0 BlueHDi 150 2.0 BlueHDi 160	81 96 96 73 88 121 110 120	04/18→ 04/18→ 05/18→ 04/18→ 04/18→ 04/18→ 04/18→ 04/18→	←		24.0126-0183.1	426183	∅ 283 26 24 V + S
			←		24.0128-0269.1	428269	∅ 304 28 26 V + S
			→		24.0112-0211.1	412211	∅ 268 12 10 + S
			→		24.0112-0212.1	412212	∅ 290 12 10 + S
<b>CITROËN - C4 Stufenheck 07/06→</b>							
 <b>Bremsbelagsatz, Scheibenbremse</b>							
1.6 16V 1.6 HDi ↓	80 80	07/06→07/11 07/06→07/11	←		13.0460-3966.2	603966	BOS 23600 19,4 - WE / - WK + Zub













	kw			 	! #			
<b>CITROËN - C4 Stufenheck 07/06→</b>								
 <b>Bremsbelagsatz, Scheibenbremse</b>								
1.6 16V 1.6 HDi	80 80	07/06→07/11 07/06→07/11	←			<b>13.0470-3966.2</b>	<b>LD3966</b>	BOS 23600 19,4 - WE / - WK + Zub Ceramic
			→	Orga 11431→ Orga 12333		<b>13.0460-2740.2</b>	<b>602740</b>	TRW 23554 17,0 - WE / - WK + Zub
			→	Orga 12334→		<b>13.0470-2740.2</b>	<b>LD2740</b>	TRW 23554 17,0 - WE / - WK + Zub Ceramic
			→	→Orga 11584		<b>13.0460-2820.2</b>	<b>602820</b>	TRW 20961 17,2 - WK
			→	→Orga 12056		<b>13.0470-2820.2</b>	<b>LD2820</b>	TRW 20961 17,2 - WK Ceramic
2.0 16V	103	07/06→	←	→ 07/11		<b>13.0460-3966.2</b>	<b>603966</b>	BOS 23600 19,4 - WE / - WK + Zub
			→	Orga 11431→ Orga 12333		<b>13.0470-3966.2</b>	<b>LD3966</b>	BOS 23600 19,4 - WE / - WK + Zub Ceramic
			→	→Orga 11584		<b>13.0460-2740.2</b>	<b>602740</b>	TRW 23554 17,0 - WE / - WK + Zub
			→	→Orga 11584		<b>13.0470-2740.2</b>	<b>LD2740</b>	TRW 23554 17,0 - WE / - WK + Zub Ceramic
			→	Orga 12334→; → 07/11		<b>13.0460-2820.2</b>	<b>602820</b>	TRW 20961 17,2 - WK
<b>Zubehörsatz, Scheibenbremsbelag</b>								
1.6 16V 1.6 HDi	80 80	07/06→07/11 07/06→07/11	→	Orga 12334→		<b>13.0460-0072.2</b>	<b>610072</b>	TRW
			→	→Orga 11584		<b>13.0460-0072.2</b>	<b>610072</b>	TRW
2.0 16V	103	07/06→	→	Orga 12334→; → 07/11		<b>13.0460-0072.2</b>	<b>610072</b>	TRW
			→	→Orga 11584		<b>13.0460-0072.2</b>	<b>610072</b>	TRW
 <b>Bremsscheibe</b>								
1.6 16V 1.6 HDi	80 80	07/06→07/11 07/06→07/11	←			<b>24.0126-0120.1</b>	<b>426120</b>	Ø 283 26 24 V + S
			→	Achszapfendurchmesser [mm]: 30		<b>24.0326-0120.1</b>	<b>526120</b>	Ø 283 26 24 V + S
			→			<b>24.0109-0100.2</b>	<b>409100</b>	Ø 249 9 7 + LG / + ABS Ring
			→	Achszapfendurchmesser [mm]: 25		<b>24.0109-0137.1</b>	<b>409137</b>	Ø 247 9 8 + S
2.0 16V	103	07/06→	←	→ 07/11		<b>24.0109-0150.2</b>	<b>409150</b>	Ø 249 9 8 + LG / + ABS Ring
			→	→ 07/11		<b>24.0126-0120.1</b>	<b>426120</b>	Ø 283 26 24 V + S
			→	→ 07/11; Achszapfendurchmesser [mm]: 30		<b>24.0326-0120.1</b>	<b>526120</b>	Ø 283 26 24 V + S
			→	→ 07/11		<b>24.0109-0100.2</b>	<b>409100</b>	Ø 249 9 7 + LG / + ABS Ring
→	→ 07/11; Achszapfendurchmesser [mm]: 25		<b>24.0109-0137.1</b>	<b>409137</b>	Ø 247 9 8 + S			
→	→ 07/11; Achszapfendurchmesser [mm]: 25		<b>24.0109-0150.2</b>	<b>409150</b>	Ø 249 9 8 + LG / + ABS Ring			
<b>CITROËN - C5 I (DC_) 03/01→03/05</b>								
 <b>Bremsbelagsatz, Scheibenbremse</b>								
1.8 16V (DC6FZB, DC6FZE)	85	03/01→08/04	←			<b>13.0460-3996.2</b>	<b>603996</b>	BOS 23276 17,2 + WK
			→			<b>13.0460-4921.2</b>	<b>604921</b>	CIT 23305 15,2 - WE / - WK
2.0 16V (DCRFNC, DCRFNF) 2.0 16V HPi (DCRLZB) 2.0 HDi 2.0 HDi (DCRHYP) 2.0 HDi (DCRHZB, DCRHZE)	100	03/01→08/04	←			<b>13.0460-3997.2</b>	<b>603997</b>	BOS 23277 17,7 + WK
	103	03/01→08/04	→			<b>13.0460-4921.2</b>	<b>604921</b>	CIT 23305 15,2 - WE / - WK
	79	03/01→08/04						
	66	03/01→08/04						
2.2 HDi (DC4HXB, DC4HXE) 3.0 V6 (DCXFXC, DCXFXF) ↓	98	03/01→08/04	←			<b>13.0460-3998.2</b>	<b>603998</b>	BOS 23273 17,8 + WK
	152	03/01→08/04	→			<b>13.0460-4921.2</b>	<b>604921</b>	CIT 23305 15,2 - WE / - WK













	kw			 	! #		
<b>CITROËN - C5 I (DC_) 03/01→03/05</b>							
 <b>Bremsscheibe</b>							
1.8 16V (DC6FZB, DC6FZE)	85	03/01→08/04	←			24.0122-0194.1 422194	Ø 266 22 20 V + S
			→			24.0114-0112.1 414112	Ø 276 14 12 + S
2.0 16V (DCRFNC, DCRFNF)	100	03/01→08/04	←			24.0126-0120.1 426120	Ø 283 26 24 V + S
2.0 16V HPI (DCRLZB)	103	03/01→08/04				24.0326-0120.1 526120	Ø 283 26 24 V + S
2.0 HDi	79	03/01→08/04	→			24.0114-0112.1 414112	Ø 276 14 12 + S
2.0 HDi (DCRHYP)	66	03/01→08/04					
2.0 HDi (DCRHZB, DCRHZE)	80	03/01→08/04					
2.2 HDi (DC4HXB, DC4HXE)	98	03/01→08/04	←			24.0128-0128.1 428128	Ø 288 28 26 V + S
3.0 V6 (DCXFXC, DCXFXF)	152	03/01→08/04	→			24.0114-0112.1 414112	Ø 276 14 12 + S
<b>CITROËN - C5 I Break (DE_) 06/01→03/04</b>							
 <b>Bremsbelagsatz, Scheibenbremse</b>							
1.8 16V (DE6FZB, DE6FZE)	85	06/01→08/04	←			13.0460-3997.2 603997	BOS 23277 17,7 + WK
2.0 16V (DERFNF, DERFNC, RERFNC)	100	06/01→08/04	→			13.0460-4921.2 604921	CIT 23305 15,2 - WE / - WK
2.0 16V HPI (DERLZB)	103	06/01→08/04					
2.0 HDi	80	06/01→08/04					
2.0 HDi (DERHSB, DERHSE)	79	06/01→08/04					
2.0 HDi (DERHYB)	66	06/01→08/04					
2.2 HDi (DE4HXB, DE4HXE)	98	06/01→08/04	←			13.0460-3998.2 603998	BOS 23273 17,8 + WK
3.0 Carlsson	173	09/03→08/04	→			13.0460-4921.2 604921	CIT 23305 15,2 - WE / - WK
3.0 V6 (DEXFXC, DEXFXF)	152	06/01→08/04					
 <b>Bremsscheibe</b>							
1.8 16V (DE6FZB, DE6FZE)	85	06/01→08/04	←			24.0126-0120.1 426120	Ø 283 26 24 V + S
2.0 16V (DERFNF, DERFNC, RERFNC)	100	06/01→08/04	→			24.0326-0120.1 526120	Ø 283 26 24 V + S
2.0 16V HPI (DERLZB)	103	06/01→08/04				24.0114-0112.1 414112	Ø 276 14 12 + S
2.0 HDi	80	06/01→08/04					
2.0 HDi (DERHSB, DERHSE)	79	06/01→08/04					
2.0 HDi (DERHYB)	66	06/01→08/04					
2.2 HDi (DE4HXB, DE4HXE)	98	06/01→08/04	←			24.0128-0128.1 428128	Ø 288 28 26 V + S
3.0 Carlsson	173	09/03→08/04	→			24.0114-0112.1 414112	Ø 276 14 12 + S
3.0 V6 (DEXFXC, DEXFXF)	152	06/01→08/04					
<b>CITROËN - C5 II (RC_) 08/04→</b>							
 <b>Bremsbelagsatz, Scheibenbremse</b>							
1.6 HDi (RC8HZB)	80	09/04→	←	→ 01/08		13.0460-3997.2 603997	BOS 23277 17,7 + WK
2.0 16V (RCRFJB, RCRFJC)	103	09/04→	→	→ 01/08		13.0460-4921.2 604921	CIT 23305 15,2 - WE / - WK
1.8 16V	92	09/05→	←	→ 01/08		13.0460-3996.2 603996	BOS 23276 17,2 + WK
1.8 16V (RC6FZB)	85	09/04→	→	→ 01/08		13.0460-4921.2 604921	CIT 23305 15,2 - WE / - WK
2.0 HDi (RCRHRH)	100	09/04→	←	→ 01/08		13.0460-3998.2 603998	BOS 23273 17,8 + WK
2.2 HDi	120	05/06→					
2.2 HDi	125	04/06→	→	→ 01/08		13.0460-4921.2 604921	CIT 23305 15,2 - WE / - WK
2.2 HDi (RC4HXE)	98	09/04→					
3.0 V6 (RCXFUF)	152	09/04→					
3.0 V6	155	10/04→04/07	←			13.0460-3998.2 603998	BOS 23273 17,8 + WK
			→			13.0460-4921.2 604921	CIT 23305 15,2 - WE / - WK
 <b>Bremsscheibe</b>							
1.6 HDi (RC8HZB)	80	09/04→	←	→ 01/08		24.0126-0120.1 426120	Ø 283 26 24 V + S
2.0 16V (RCRFJB, RCRFJC)	103	09/04→	→	→ 01/08		24.0326-0120.1 526120	Ø 283 26 24 V + S
						24.0114-0112.1 414112	Ø 276 14 12 + S
1.8 16V	92	09/05→	←	→ 01/08		24.0122-0194.1 422194	Ø 266 22 20 V + S
1.8 16V (RC6FZB)	85	09/04→	→	→ 01/08		24.0114-0112.1 414112	Ø 276 14 12 + S
2.0 HDi (RCRHRH)	100	09/04→	←	→ 01/08		24.0128-0128.1 428128	Ø 288 28 26 V + S
2.2 HDi	120	05/06→					
2.2 HDi	125	04/06→	→	→ 01/08		24.0114-0112.1 414112	Ø 276 14 12 + S
2.2 HDi (RC4HXE)	98	09/04→					
3.0 V6 (RCXFUF)	152	09/04→					
↓							















	kW			 	! #		
<b>CITROËN - C5 II (RC_) 08/04→</b>							
 <b>Bremsscheibe</b>							
3.0 V6	155	10/04→04/07	←			24.0128-0128.1 428128	Ø 288 28 26 V + S
			→			24.0114-0112.1 414112	Ø 276 14 12 + S
<b>CITROËN - C5 II Break (RE_) 09/04→</b>							
 <b>Bremsbelagsatz, Scheibenbremse</b>							
1.6 HDi (RE8HZB)	80	09/04→	←	→ 01/08		13.0460-3997.2 603997	BOS 23277 17,7 + WK
1.8 16V	92	09/05→	→	→ 01/08		13.0460-4921.2 604921	CIT 23305 15,2 - WE / - WK
1.8 16V (RE6FZB)	85	09/04→					
2.0 16V (RERFJB, RERFJC)	103	09/04→					
2.0 HDi (RERHRH)	100	09/04→	←	→ 01/08		13.0460-3998.2 603998	BOS 23273 17,8 + WK
2.2 HDi	120	05/06→	→	→ 01/08		13.0460-4921.2 604921	CIT 23305 15,2 - WE / - WK
2.2 HDi	125	04/06→					
2.2 HDi (RE4HXE)	98	09/04→					
3.0	173	09/04→					
3.0 V6 (REXFUF)	152	09/04→					
3.0 V6	155	10/04→04/07	←			13.0460-3998.2 603998	BOS 23273 17,8 + WK
			→			13.0460-4921.2 604921	CIT 23305 15,2 - WE / - WK
 <b>Bremsscheibe</b>							
1.6 HDi (RE8HZB)	80	09/04→	←	→ 01/08		24.0126-0120.1 426120	Ø 283 26 24 V + S
1.8 16V	92	09/05→				24.0326-0120.1 526120	Ø 283 26 24 V + S
1.8 16V (RE6FZB)	85	09/04→					
2.0 16V (RERFJB, RERFJC)	103	09/04→	→	→ 01/08		24.0114-0112.1 414112	Ø 276 14 12 + S
2.0 HDi (RERHRH)	100	09/04→	←	→ 01/08		24.0128-0128.1 428128	Ø 288 28 26 V + S
2.2 HDi	120	05/06→	→	→ 01/08		24.0114-0112.1 414112	Ø 276 14 12 + S
2.2 HDi	125	04/06→					
2.2 HDi (RE4HXE)	98	09/04→					
3.0	173	09/04→					
3.0 V6 (REXFUF)	152	09/04→					
3.0 V6	155	10/04→04/07	←			24.0128-0128.1 428128	Ø 288 28 26 V + S
			→			24.0114-0112.1 414112	Ø 276 14 12 + S
<b>CITROËN - C5 III (RD_) 02/08→</b>							
 <b>Bremsbelagsatz, Scheibenbremse</b>							
1.6 HDi 110	80	02/08→	←			13.0460-7252.2 607252	ATE 24084 19,3 + WK
1.6 HDi 115	84	01/12→				13.0470-7252.2 LD7252	ATE 24084 19,3 + WK Ceramic
1.8 16V	92	02/08→					
2.0 16V	103	02/08→	→	- eFSB		13.0460-2893.2 602893	TRW 24135 17,7 - WK
2.0 16V BioFlex	103	02/08→	→	+ eFSB		13.0470-2893.2 LD2893	TRW 24135 17,7 - WK Ceramic
			→			13.0460-7253.2 607253	ATE 23482 15,8 - WE / - WK
1.6 HDi 110	82	07/10→	←	→Orga 12774		13.0460-7252.2 607252	ATE 24084 19,3 + WK
1.6 THP 150	110	07/10→				13.0470-7252.2 LD7252	ATE 24084 19,3 + WK Ceramic
1.6 THP 155	115	04/09→					
1.6 VTi 120	88	07/10→	←	Orga 12775→		13.0460-7252.2 607252	ATE 24084 19,3 + WK
2.0 HDi	100	02/08→				13.0470-7252.2 LD7252	ATE 24084 19,3 + WK Ceramic
2.0 HDi 140	103	04/09→	→	- eFSB		13.0460-2893.2 602893	TRW 24135 17,7 - WK
2.0 HDi 165	120	04/09→	→	+ eFSB		13.0470-2893.2 LD2893	TRW 24135 17,7 - WK Ceramic
			→			13.0460-7253.2 607253	ATE 23482 15,8 - WE / - WK
2.0 HDi 150 / BlueHDi 150	110	04/09→	←	05/15→		13.0460-7252.2 607252	ATE 24084 19,3 + WK
			→	05/15→; - eFSB		13.0470-7252.2 LD7252	ATE 24084 19,3 + WK Ceramic
			→	05/15→; - eFSB		13.0460-2893.2 602893	TRW 24135 17,7 - WK
			→	05/15→; + eFSB		13.0470-2893.2 LD2893	TRW 24135 17,7 - WK Ceramic
			→			13.0460-7253.2 607253	ATE 23482 15,8 - WE / - WK
2.0 HDi 180	133	03/15→	←			13.0460-7279.2 607279	ATE 25069 17,3 + WK
2.2 HDi 200	150	07/10→				13.0470-7279.2 LD7279	ATE 25069 17,3 + WK Ceramic
3.0 HDi 240	177	04/09→	→	- eFSB		13.0460-2893.2 602893	TRW 24135 17,7 - WK
			→	+ eFSB		13.0470-2893.2 LD2893	TRW 24135 17,7 - WK Ceramic
			→			13.0460-7253.2 607253	ATE 23482 15,8 - WE / - WK
2.2 HDi	125	02/08→	←			13.0460-2892.2 602892	TRW 24133 18,6 + WK + Zub
2.7 HDi	150	02/08→				13.0470-2892.2 LD2892	TRW 24133 18,6 + WK + Zub Ceramic
3.0 V6	155	02/08→	→	- eFSB		13.0460-2893.2 602893	TRW 24135 17,7 - WK
			→	+ eFSB		13.0470-2893.2 LD2893	TRW 24135 17,7 - WK Ceramic
			→			13.0460-7253.2 607253	ATE 23482 15,8 - WE / - WK
↓							









	kw			 	! #		
<b>CITROËN - C5 III (RD_) 02/08→</b>							
 <b>Bremsscheibe</b>							
1.6 HDi 110	80	02/08→	←			24.0128-0216.1 428216	Ø 304 28 26 V + S
1.6 HDi 110	82	07/10→	→				
1.6 HDi 115	84	01/12→				24.0112-0162.1 412162	Ø 290 12 10 + S
1.6 THP 150	110	07/10→					
1.6 THP 155	115	04/09→					
1.6 VTi 120	88	07/10→					
1.8 16V	92	02/08→					
2.0 16V	103	02/08→					
2.0 16V BioFlex	103	02/08→					
2.0 HDi 140	103	04/09→					
2.0 HDi 165	120	04/09→					
2.0 HDi	100	02/08→	←			24.0128-0216.1 428216	Ø 304 28 26 V + S
			→			24.0130-0206.1 430206	Ø 330 30 28 V + S
			→			24.0112-0162.1 412162	Ø 290 12 10 + S
2.0 HDi 150 / BlueHDi 150	110	04/09→	←	05/15→		24.0128-0216.1 428216	Ø 304 28 26 V + S
			→	05/15→		24.0112-0162.1 412162	Ø 290 12 10 + S
2.0 HDi 180	133	03/15→	←			24.0130-0227.1 430227	Ø 340 30 28 V + S
2.2 HDi 200	150	07/10→	→				
3.0 HDi 240	177	04/09→				24.0112-0162.1 412162	Ø 290 12 10 + S
2.2 HDi	125	02/08→	←			24.0130-0206.1 430206	Ø 330 30 28 V + S
2.7 HDi	150	02/08→	→			24.0112-0162.1 412162	Ø 290 12 10 + S
3.0 V6	155	02/08→					
<b>CITROËN - C5 III Break (RW_) 02/08→</b>							
 <b>Bremsbelagsatz, Scheibenbremse</b>							
1.6 HDi 110	80	02/08→	←			13.0460-7252.2 607252	ATE 24084 19,3 + WK
1.8 16V	92	02/08→				13.0470-7252.2 LD7252	ATE 24084 19,3 + WK Ceramic
2.0 16V	103	02/08→	→	- eFSB		13.0460-2893.2 602893	TRW 24135 17,7 - WK
2.0 16V BioFlex	103	02/08→	→	+ eFSB		13.0470-2893.2 LD2893	TRW 24135 17,7 - WK Ceramic
			→	+ eFSB		13.0460-7253.2 607253	ATE 23482 15,8 - WE / - WK
1.6 HDi 110	82	07/10→	←	Orga 12775→		13.0460-7252.2 607252	ATE 24084 19,3 + WK
1.6 HDi 115	84	01/12→				13.0470-7252.2 LD7252	ATE 24084 19,3 + WK Ceramic
1.6 THP 150	110	04/09→	←	→Orga 12774		13.0460-7252.2 607252	ATE 24084 19,3 + WK
1.6 THP 155	115	04/09→				13.0470-7252.2 LD7252	ATE 24084 19,3 + WK Ceramic
1.6 VTi 120	88	07/10→					
2.0 HDi	100	02/08→	→	- eFSB		13.0460-2893.2 602893	TRW 24135 17,7 - WK
2.0 HDi 140	103	04/09→				13.0470-2893.2 LD2893	TRW 24135 17,7 - WK Ceramic
2.0 HDi 150 / BlueHDi 150	110	04/09→	→	+ eFSB		13.0460-7253.2 607253	ATE 23482 15,8 - WE / - WK
2.0 HDi 165	120	04/09→					
2.0 HDi 180	133	03/15→	←			13.0460-7279.2 607279	ATE 25069 17,3 + WK
2.2 HDi 200	150	07/10→				13.0470-7279.2 LD7279	ATE 25069 17,3 + WK Ceramic
3.0 HDi 240	177	04/09→	→	- eFSB		13.0460-2893.2 602893	TRW 24135 17,7 - WK
			→	+ eFSB		13.0470-2893.2 LD2893	TRW 24135 17,7 - WK Ceramic
			→	+ eFSB		13.0460-7253.2 607253	ATE 23482 15,8 - WE / - WK
2.2 HDi	125	02/08→	←			13.0460-2892.2 602892	TRW 24133 18,6 + WK + Zub
2.2 HDi 165	120	02/08→				13.0470-2892.2 LD2892	TRW 24133 18,6 + WK + Zub Ceramic
2.7 HDi	150	02/08→					
3.0 V6	155	02/08→	→	- eFSB		13.0460-2893.2 602893	TRW 24135 17,7 - WK
			→	+ eFSB		13.0470-2893.2 LD2893	TRW 24135 17,7 - WK Ceramic
			→	+ eFSB		13.0460-7253.2 607253	ATE 23482 15,8 - WE / - WK
 <b>Bremsscheibe</b>							
1.6 HDi 110	80	02/08→	←			24.0128-0216.1 428216	Ø 304 28 26 V + S
1.6 HDi 110	82	07/10→	→				
1.6 HDi 115	84	01/12→				24.0112-0162.1 412162	Ø 290 12 10 + S
1.6 THP 150	110	04/09→					
1.6 THP 155	115	04/09→					
1.6 VTi 120	88	07/10→					
1.8 16V	92	02/08→					
2.0 16V	103	02/08→					
2.0 16V BioFlex	103	02/08→					
2.0 HDi	100	02/08→					
2.0 HDi 140	103	04/09→					
2.0 HDi 150 / BlueHDi 150	110	04/09→					
2.0 HDi 165	120	04/09→	←			24.0128-0269.1 428269	Ø 304 28 26 V + S
			→			24.0112-0162.1 412162	Ø 290 12 10 + S
2.0 HDi 180	133	03/15→	←			24.0130-0227.1 430227	Ø 340 30 28 V + S
2.2 HDi 200	150	07/10→	→				
3.0 HDi 240	177	04/09→				24.0112-0162.1 412162	Ø 290 12 10 + S
↓							













	kw			 	! #		
<b>CITROËN - C5 III Break (RW_) 02/08→</b>							
 <b>Bremsscheibe</b>							
2.2 HDi	125	02/08→	←		24.0130-0206.1	430206	Ø 330 30 28 V + S
2.2 HDi 165	120	02/08→	→				
2.7 HDi	150	02/08→			24.0112-0162.1	412162	Ø 290 12 10 + S
3.0 V6	155	02/08→					
<b>CITROËN - C6 (TD_) 09/05→</b>							
 <b>Bremsbelagsatz, Scheibenbremse</b>							
2.2 HDi	120	06/06→	←	→ 12/12	13.0460-2892.2	602892	TRW 24133 18,6 + WK + Zub
2.2 HDi	125	06/06→					
2.7 HDi	150	09/05→			13.0470-2892.2	LD2892	TRW 24133 18,6 + WK + Zub Ceramic
3.0 V6	155	09/05→	→	→ 12/12			
					13.0460-2706.2	602706	TRW 24462 16,7 - WK
3.0 HDi	177	04/09→	←	07/09→ 12/12	13.0460-7279.2	607279	ATE 25069 17,3 + WK
					13.0470-7279.2	LD7279	ATE 25069 17,3 + WK Ceramic
			→	07/09→ 12/12	13.0460-2706.2	602706	TRW 24462 16,7 - WK
 <b>Bremsscheibe</b>							
2.2 HDi	120	06/06→	←	→ Orga 11193	24.0130-0181.1	430181	Ø 330 30 28 V + S
2.2 HDi	125	06/06→					
2.7 HDi	150	09/05→	←	Orga 11194→; → 12/12	24.0130-0206.1	430206	Ø 330 30 28 V + S
3.0 V6	155	09/05→	→	→ 12/12	24.0122-0255.1	422255	Ø 302 22 20 V
3.0 HDi	177	04/09→	←	07/09→ 12/12	24.0130-0227.1	430227	Ø 340 30 28 V + S
			→	07/09→ 12/12	24.0122-0255.1	422255	Ø 302 22 20 V
<b>CITROËN - C8 (EA_, EB_) 07/02→</b>							
 <b>Bremsbelagsatz, Scheibenbremse</b>							
2.0	100	07/02→	←	→ 07/14	13.0460-2863.2	602863	TRW 20261 19,0 + WK + Zub
2.0 16V	103	09/05→					
2.0 16V	104	09/05→	→	→ 07/14	13.0460-2819.2	602819	TRW 20961 17,2 - WK
2.0 HDi	79	07/02→					
2.0 HDi	80	07/02→					
2.0 HDi	81	07/02→					
2.0 HDi 135	100	03/06→					
2.2	116	07/02→					
2.2 HDi	94	07/02→					
2.0 HDi	88	07/06→	←	02/07→ 07/14	13.0460-2863.2	602863	TRW 20261 19,0 + WK + Zub
			→	02/07→ 07/14	13.0460-2819.2	602819	TRW 20961 17,2 - WK
2.0 HDi 165	120	03/06→	←	→ 07/14	13.0460-2752.2	602752	TRW 24839 19,4 + WK + Zub
2.2 HDi	120	06/07→					
2.2 HDi	125	06/06→	→	→ 07/14	13.0460-2819.2	602819	TRW 20961 17,2 - WK
3.0 V6	150	07/02→	←	→ 07/14	13.0460-4995.2	604995	BRE 23575 15,6 + WK
			→	→ 07/14	13.0460-2819.2	602819	TRW 20961 17,2 - WK
<b>Zubehörsatz, Scheibenbremsbelag</b>							
2.0	100	07/02→	→	→ 07/14	13.0460-0072.2	610072	TRW
2.0 16V	103	09/05→					
2.0 16V	104	09/05→					
2.0 HDi	79	07/02→					
2.0 HDi	80	07/02→					
2.0 HDi	81	07/02→					
2.0 HDi 135	100	03/06→					
2.0 HDi 165	120	03/06→					
2.2	116	07/02→					
2.2 HDi	94	07/02→					
2.2 HDi	120	06/07→					
2.2 HDi	125	06/06→					
3.0 V6	150	07/02→					
2.0 HDi	88	07/06→	→	02/07→ 07/14	13.0460-0072.2	610072	TRW
 <b>Bremsscheibe</b>							
2.0	100	07/02→	←	→ 07/14	24.0128-0136.1	428136	Ø 285 28 26 V
2.0 16V	103	09/05→			24.0328-0136.1	528136	Ø 285 28 26 V
2.0 16V	104	09/05→					
2.0 HDi	79	07/02→	→	→ 07/14	24.0112-0156.1	412156	Ø 272 12 10
2.0 HDi	80	07/02→					
2.0 HDi	81	07/02→					
2.0 HDi 135	100	03/06→					
2.2	116	07/02→					
2.2 HDi	94	07/02→					
2.0 HDi	88	07/06→	←	02/07→ 07/14	24.0128-0136.1	428136	Ø 285 28 26 V
					24.0328-0136.1	528136	Ø 285 28 26 V
			→	02/07→ 07/14	24.0112-0156.1	412156	Ø 272 12 10
↓							









	kW			 	! #		
<b>CITROËN - C8 (EA_, EB_) 07/02→</b>							
 <b>Bremsscheibe</b>							
2.0 HDi 165	120	03/06→	←	→ 07/14		24.0132-0126.1 432126	Ø 310 32 30 V
2.2 HDi	120	06/07→					
2.2 HDi	125	06/06→	→	→ 07/14		24.0112-0156.1 412156	Ø 272 12 10
3.0 V6	150	07/02→					
<b>CITROËN - C15 (VD_) 10/84→10/06</b>							
 <b>Bremsbelagsatz, Scheibenbremse</b>							
1.0	33	10/84→12/97	←	Orga 04196→		13.0460-2825.2 602825	TRW 21614 17,7 + WK
1.0 E	37	11/92→07/96					
1.1	35	10/84→12/96					
1.1	40	11/88→07/96					
1.1 i	44	07/88→12/96					
1.4	49	07/87→12/96	←	07/96→		13.0460-2825.2 602825	TRW 21614 17,7 + WK
1.4 E	40	07/87→12/96					
1.4 E	44	05/87→12/96					
1.4 i	55	05/91→12/96					
1.8 D	44	07/86→12/00	←			13.0460-2825.2 602825	TRW 21614 17,7 + WK
1.9 D	44	12/00→12/05	←			13.0460-3952.2 603952	BDX 20905 18,0 + WK
1.9 D	51	10/00→10/02	←				
<b>Zubehörsatz, Scheibenbremsbelag</b>							
1.0	33	10/84→12/97	←	Orga 04196→		13.0460-0060.2 610060	TRW
1.0 E	37	11/92→07/96					
1.1	35	10/84→12/96					
1.1	40	11/88→07/96					
1.1 i	44	07/88→12/96					
1.4	49	07/87→12/96	←	07/96→		13.0460-0060.2 610060	TRW
1.4 E	40	07/87→12/96					
1.4 E	44	05/87→12/96					
1.4 i	55	05/91→12/96					
1.8 D	44	07/86→12/00	←			13.0460-0060.2 610060	TRW
1.9 D	44	12/00→12/05	←			13.0460-0403.2 610403	BDX
1.9 D	51	10/00→10/02	←				
 <b>Bremsscheibe</b>							
1.0	33	10/84→12/97	←	→Orga 04195		24.0109-0108.1 409108	Ø 244,5 9 7
1.0 E	37	11/92→07/96					
1.1	35	10/84→12/96	←	Orga 04196→		24.0110-0187.1 410187	Ø 247 10 9 + S
1.1	40	11/88→07/96					
1.1 i	44	07/88→12/96					
1.4	49	07/87→12/96					
1.4 E	40	07/87→12/96					
1.4 E	44	05/87→12/96					
1.4 i	55	05/91→12/96					
1.8 D	44	07/86→12/00	←			24.0110-0187.1 410187	Ø 247 10 9 + S
1.9 D	44	12/00→12/05					
1.9 D	51	10/00→10/02					
<b>CITROËN - C15 Kombi 04/87→08/00</b>							
 <b>Bremsbelagsatz, Scheibenbremse</b>							
1.1	44	08/88→07/96	←			13.0460-2825.2 602825	TRW 21614 17,7 + WK
1.4	55	05/91→07/96					
1.8 D	44	04/87→08/00					
<b>Zubehörsatz, Scheibenbremsbelag</b>							
1.1	44	08/88→07/96	←			13.0460-0060.2 610060	TRW
1.4	55	05/91→07/96					
1.8 D	44	04/87→08/00					
 <b>Bremsscheibe</b>							
1.1	44	08/88→07/96	←			24.0110-0187.1 410187	Ø 247 10 9 + S
1.8 D	44	04/87→08/00					
1.4	55	05/91→07/96	←	→Orga 04195		24.0109-0108.1 409108	Ø 244,5 9 7
			←	Orga 04196→		24.0110-0187.1 410187	Ø 247 10 9 + S
<b>CITROËN - C-CROSSER (EP_) 02/07→</b>							
 <b>Bremsbelagsatz, Scheibenbremse</b>							
2.0	108	11/10→	←	→ 01/13		13.0460-5958.2 605958	AKE 21363 15,8 + WK
2.0 Allrad	108	11/10→					
2.2 HDi	115	02/07→	→	→ 01/13		13.0460-5855.2 605855	23582 16,0 - WK
2.4 16V	125	08/08→					
<b>Zubehörsatz, Scheibenbremsbelag</b>							
2.0	108	11/10→	←	→ 01/13		13.0460-0235.2 610235	
2.0 Allrad	108	11/10→					
↓							









	kw					! #		
<b>CITROËN - C-CROSSER (EP_) 02/07→</b>								
<b>Zubehörsatz, Scheibenbremsbelag</b>								
2.2 HDi 2.4 16V	115 125	02/07→ 08/08→	→	→ 01/13		13.0460-0137.2	610137	
 <b>Bremsscheibe</b>								
2.0 2.0 Allrad	108 108	11/10→ 11/10→	←	→ 01/13		24.0124-0215.1	424215	Ø 294 24 22,4 V
			→	→ 01/13		24.0110-0360.1	410360	Ø 302 10 8,4
2.2 HDi 2.4 16V	115 125	02/07→ 08/08→	←	→ 01/13		24.0124-0215.1	424215	Ø 294 24 22,4 V
			→	→ 01/13		24.0110-0330.1	410330	Ø 302 10 8
<b>CITROËN - C-CROSSER ENTERPRISE 01/09→</b>								
 <b>Bremselagsatz, Scheibenbremse</b>								
2.2 HDi 2.4 16V	115 125	01/09→ 01/09→	←	→ 01/13		13.0460-5958.2	605958	AKE 21363 15,8 + WK
			→	→ 01/13		13.0460-5855.2	605855	23582 16,0 - WK
<b>Zubehörsatz, Scheibenbremsbelag</b>								
2.2 HDi 2.4 16V	115 125	01/09→ 01/09→	←	→ 01/13		13.0460-0235.2	610235	
			→	→ 01/13		13.0460-0137.2	610137	
 <b>Bremsscheibe</b>								
2.2 HDi 2.4 16V	115 125	01/09→ 01/09→	←	→ 01/13		24.0124-0215.1	424215	Ø 294 24 22,4 V
			→	→ 01/13		24.0110-0330.1	410330	Ø 302 10 8
<b>CITROËN - C-ELYSEE 11/12→</b>								
 <b>Bremselagsatz, Scheibenbremse</b>								
1.2 VTi 72 1.2 VTi 82 1.6 BlueHDi 100 1.6 HDi 92 1.6 VTi 115	53 60 73 68 85	11/12→ 12/14→ 11/14→ 11/12→ 11/12→	←			13.0460-3867.2	603867	MAN 25250 18,9 - WE / - WK + Zub
			←	V		13.0460-3994.2	603994	BOS 23599 19,0 - WE / - WK + Zub
						13.0470-3994.2	LD3994	BOS 23599 19,0 - WE / - WK + Zub Ceramic
 <b>Bremsscheibe</b>								
1.2 VTi 72 1.2 VTi 82 1.6 BlueHDi 100 1.6 HDi 92 1.6 VTi 115	53 60 73 68 85	11/12→ 12/14→ 11/14→ 11/12→ 11/12→	←			24.0113-0184.1	413184	Ø 266 13 11 + S
						24.0122-0194.1	422194	Ø 266 22 20 V + S
						24.0313-0184.1	513184	Ø 266 13 11 + S
<b>CITROËN - C-ZERO 10/10→</b>								
 <b>Bremselagsatz, Scheibenbremse</b>								
C-Zero C-Zero C-Zero	35 47 49	10/10→ 10/10→ 10/14→	←			13.0460-5621.2	605621	24423 14,6 + WK
 <b>Bremsscheibe</b>								
C-Zero C-Zero C-Zero	35 47 49	10/10→ 10/10→ 10/14→	←			24.0117-0110.1	417110	Ø 257 17 15 V
<b>CITROËN - DS3 11/09→07/15</b>								
 <b>Bremselagsatz, Scheibenbremse</b>								
1.2 THP 110 1.6 BlueHDi 100 1.6 BlueHDi 75 1.6 HDi 110 1.6 THP 165 1.6 VTi 120	81 73 55 82 121 88	10/14→03/15 07/14→07/15 03/15→07/15 11/09→07/15 10/14→06/15 04/10→07/15	←	für Bremsscheibendurchmesser [mm]: 283		13.0460-3855.2	603855	BOS 24883 18,0 - WE / - WK + Zub
						13.0470-3855.2	LD3855	BOS 24883 18,0 - WE / - WK + Zub Ceramic
			←	für Bremsscheibendurchmesser [mm]: 266		13.0460-3994.2	603994	BOS 23599 19,0 - WE / - WK + Zub
						13.0470-3994.2	LD3994	BOS 23599 19,0 - WE / - WK + Zub Ceramic
			→			13.0460-2740.2	602740	TRW 23554 17,0 - WE / - WK + Zub
						13.0470-2740.2	LD2740	TRW 23554 17,0 - WE / - WK + Zub Ceramic
1.2 VTi 82 1.4 HDi 70 1.4 VTi 95 1.4 VTi 95 LPG	60 50 70 70	01/13→03/15 04/10→07/15 04/10→07/15 08/12→07/15	←			13.0460-3994.2	603994	BOS 23599 19,0 - WE / - WK + Zub
						13.0470-3994.2	LD3994	BOS 23599 19,0 - WE / - WK + Zub Ceramic
↓								

	kw			 	! #		
<b>CITROËN - DS3 11/09→07/15</b>							
<b> Bremsbelagsatz, Scheibenbremse</b>							
1.4 VTi 98	72	11/09→07/15	←	04/10→		<b>13.0460-3994.2 603994</b> <b>13.0470-3994.2 LD3994</b>	BOS 23599 19,0 - WE / - WK + Zub BOS 23599 19,0 - WE / - WK + Zub Ceramic
1.6	120	01/12→07/15	←	10/14→; für Bremsscheibendurchmesser [mm]: 283		<b>13.0460-3855.2 603855</b> <b>13.0470-3855.2 LD3855</b>	BOS 24883 18,0 - WE / - WK + Zub BOS 24883 18,0 - WE / - WK + Zub Ceramic
			←	10/14→; für Bremsscheibendurchmesser [mm]: 266		<b>13.0460-3994.2 603994</b> <b>13.0470-3994.2 LD3994</b>	BOS 23599 19,0 - WE / - WK + Zub BOS 23599 19,0 - WE / - WK + Zub Ceramic
			→	10/14→		<b>13.0460-2740.2 602740</b> <b>13.0470-2740.2 LD2740</b>	TRW 23554 17,0 - WE / - WK + Zub TRW 23554 17,0 - WE / - WK + Zub Ceramic
1.6 BlueHDi 120 1.6 HDi 115 1.6 HDi 115 1.6 THP 155	88 84 85 115	10/13→07/15 08/12→07/15 10/13→07/15 04/10→07/15	←			<b>13.0460-3855.2 603855</b> <b>13.0470-3855.2 LD3855</b>	BOS 24883 18,0 - WE / - WK + Zub BOS 24883 18,0 - WE / - WK + Zub Ceramic
			→			<b>13.0460-2740.2 602740</b> <b>13.0470-2740.2 LD2740</b>	TRW 23554 17,0 - WE / - WK + Zub TRW 23554 17,0 - WE / - WK + Zub Ceramic
1.6 HDi 90	68	11/09→07/15	←			<b>13.0460-3855.2 603855</b> <b>13.0460-3994.2 603994</b> <b>13.0470-3855.2 LD3855</b> <b>13.0470-3994.2 LD3994</b>	BOS 24883 18,0 - WE / - WK + Zub BOS 23599 19,0 - WE / - WK + Zub BOS 24883 18,0 - WE / - WK + Zub Ceramic BOS 23599 19,0 - WE / - WK + Zub Ceramic
1.6 Racing 1.6 Racing	149 152	02/11→07/15 02/11→07/15	→			<b>13.0460-2740.2 602740</b> <b>13.0470-2740.2 LD2740</b>	TRW 23554 17,0 - WE / - WK + Zub TRW 23554 17,0 - WE / - WK + Zub Ceramic
1.6 THP 150	110	01/10→07/15	←	04/10→		<b>13.0460-3855.2 603855</b> <b>13.0470-3855.2 LD3855</b>	BOS 24883 18,0 - WE / - WK + Zub BOS 24883 18,0 - WE / - WK + Zub Ceramic
			→	04/10→		<b>13.0460-2740.2 602740</b> <b>13.0470-2740.2 LD2740</b>	TRW 23554 17,0 - WE / - WK + Zub TRW 23554 17,0 - WE / - WK + Zub Ceramic
<b> Bremsscheibe</b>							
1.2 THP 110 1.6 BlueHDi 100 1.6 BlueHDi 75 1.6 HDi 110 1.6 THP 165 1.6 VTi 120	81 73 55 82 121 88	10/14→03/15 07/14→07/15 03/15→07/15 11/09→07/15 10/14→06/15 04/10→07/15	←			<b>24.0122-0194.1 422194</b> <b>24.0126-0120.1 426120</b> <b>24.0326-0120.1 526120</b>	∅ 266 22 20 V + S ∅ 283 26 24 V + S ∅ 283 26 24 V + S
			→			<b>24.0109-0100.2 409100</b>	∅ 249 9 7 + LG / + ABS Ring
1.2 VTi 82 1.4 HDi 70 1.4 VTi 95 1.4 VTi 95 LPG	60 50 70 70	01/13→03/15 04/10→07/15 04/10→07/15 08/12→07/15	←			<b>24.0122-0194.1 422194</b>	∅ 266 22 20 V + S
1.4 VTi 98	72	11/09→07/15	←	04/10→		<b>24.0122-0194.1 422194</b>	∅ 266 22 20 V + S
1.6	120	01/12→07/15	←	10/14→		<b>24.0122-0194.1 422194</b> <b>24.0126-0120.1 426120</b> <b>24.0326-0120.1 526120</b>	∅ 266 22 20 V + S ∅ 283 26 24 V + S ∅ 283 26 24 V + S
			→	10/14→		<b>24.0109-0100.2 409100</b>	∅ 249 9 7 + LG / + ABS Ring
1.6 BlueHDi 120 1.6 HDi 115 1.6 HDi 115 1.6 THP 155	88 84 85 115	10/13→07/15 08/12→07/15 10/13→07/15 04/10→07/15	←			<b>24.0126-0120.1 426120</b> <b>24.0326-0120.1 526120</b>	∅ 283 26 24 V + S ∅ 283 26 24 V + S
			→			<b>24.0109-0100.2 409100</b>	∅ 249 9 7 + LG / + ABS Ring
1.6 HDi 90	68	11/09→07/15	←			<b>24.0122-0194.1 422194</b> <b>24.0126-0120.1 426120</b> <b>24.0326-0120.1 526120</b>	∅ 266 22 20 V + S ∅ 283 26 24 V + S ∅ 283 26 24 V + S
1.6 Racing 1.6 Racing	149 152	02/11→07/15 02/11→07/15	→			<b>24.0109-0100.2 409100</b>	∅ 249 9 7 + LG / + ABS Ring
1.6 THP 150 ↓	110	01/10→07/15	←	04/10→		<b>24.0126-0120.1 426120</b>	∅ 283 26 24 V + S

	kw			 	! #			
<b>CITROËN - DS3 11/09→07/15</b>								
 <b>Bremsscheibe</b>								
1.6 THP 150	110	01/10→07/15	←	04/10→		<b>24.0326-0120.1</b>	<b>526120</b>	Ø 283 26 24 V + S
			→	04/10→		<b>24.0109-0100.2</b>	<b>409100</b>	Ø 249 9 7 + LG / + ABS Ring
<b>CITROËN - DS3 Cabriolet 01/13→07/15</b>								
 <b>Bremsbelagsatz, Scheibenbremse</b>								
1.2 THP 110 1.6 BlueHDi 100 1.6 BlueHDi 115 1.6 THP 165	81 73 85 121	10/14→07/15 07/14→07/15 10/13→07/15 10/14→07/15	←	für Bremsscheibendurchmesser [mm]: 283		<b>13.0460-3855.2</b>	<b>603855</b>	BOS 24883 18,0 - WE / - WK + Zub
						<b>13.0470-3855.2</b>	<b>LD3855</b>	BOS 24883 18,0 - WE / - WK + Zub Ceramic
			←	für Bremsscheibendurchmesser [mm]: 266		<b>13.0460-3994.2</b>	<b>603994</b>	BOS 23599 19,0 - WE / - WK + Zub
						<b>13.0470-3994.2</b>	<b>LD3994</b>	BOS 23599 19,0 - WE / - WK + Zub Ceramic
			→			<b>13.0460-2740.2</b>	<b>602740</b>	TRW 23554 17,0 - WE / - WK + Zub
						<b>13.0470-2740.2</b>	<b>LD2740</b>	TRW 23554 17,0 - WE / - WK + Zub Ceramic
1.2 VTi 82 1.6 HDi 90	60 69	01/13→07/15 01/13→07/15	←	03/13→		<b>13.0460-3994.2</b>	<b>603994</b>	BOS 23599 19,0 - WE / - WK + Zub
						<b>13.0470-3994.2</b>	<b>LD3994</b>	BOS 23599 19,0 - WE / - WK + Zub Ceramic
1.6 BlueHDi 120	88	07/14→07/15	←			<b>13.0460-3855.2</b>	<b>603855</b>	BOS 24883 18,0 - WE / - WK + Zub
						<b>13.0470-3855.2</b>	<b>LD3855</b>	BOS 24883 18,0 - WE / - WK + Zub Ceramic
			→			<b>13.0460-2740.2</b>	<b>602740</b>	TRW 23554 17,0 - WE / - WK + Zub
					<b>13.0470-2740.2</b>	<b>LD2740</b>	TRW 23554 17,0 - WE / - WK + Zub Ceramic	
1.6 Racing	152	03/14→07/15	→			<b>13.0460-2740.2</b>	<b>602740</b>	TRW 23554 17,0 - WE / - WK + Zub
						<b>13.0470-2740.2</b>	<b>LD2740</b>	TRW 23554 17,0 - WE / - WK + Zub Ceramic
1.6 THP 150 1.6 THP 155 1.6 VTi 120	110 115 88	01/13→07/15 01/13→07/15 01/13→07/15	←	03/13→		<b>13.0460-3855.2</b>	<b>603855</b>	BOS 24883 18,0 - WE / - WK + Zub
						<b>13.0470-3855.2</b>	<b>LD3855</b>	BOS 24883 18,0 - WE / - WK + Zub Ceramic
			→	03/13→		<b>13.0460-2740.2</b>	<b>602740</b>	TRW 23554 17,0 - WE / - WK + Zub
						<b>13.0470-2740.2</b>	<b>LD2740</b>	TRW 23554 17,0 - WE / - WK + Zub Ceramic
 <b>Bremsscheibe</b>								
1.2 THP 110 1.6 BlueHDi 100 1.6 BlueHDi 115 1.6 THP 165	81 73 85 121	10/14→07/15 07/14→07/15 10/13→07/15 10/14→07/15	←			<b>24.0122-0194.1</b>	<b>422194</b>	Ø 266 22 20 V + S
						<b>24.0126-0120.1</b>	<b>426120</b>	Ø 283 26 24 V + S
						<b>24.0326-0120.1</b>	<b>526120</b>	Ø 283 26 24 V + S
			→			<b>24.0109-0100.2</b>	<b>409100</b>	Ø 249 9 7 + LG / + ABS Ring
1.2 VTi 82 1.6 HDi 90	60 69	01/13→07/15 01/13→07/15	←	03/13→		<b>24.0122-0194.1</b>	<b>422194</b>	Ø 266 22 20 V + S
1.6 BlueHDi 120	88	07/14→07/15	←			<b>24.0126-0120.1</b>	<b>426120</b>	Ø 283 26 24 V + S
						<b>24.0326-0120.1</b>	<b>526120</b>	Ø 283 26 24 V + S
			→			<b>24.0109-0100.2</b>	<b>409100</b>	Ø 249 9 7 + LG / + ABS Ring
1.6 Racing	152	03/14→07/15	→			<b>24.0109-0100.2</b>	<b>409100</b>	Ø 249 9 7 + LG / + ABS Ring
1.6 THP 150 1.6 THP 155 1.6 VTi 120	110 115 88	01/13→07/15 01/13→07/15 01/13→07/15	←	03/13→		<b>24.0126-0120.1</b>	<b>426120</b>	Ø 283 26 24 V + S
						<b>24.0326-0120.1</b>	<b>526120</b>	Ø 283 26 24 V + S
			→	03/13→		<b>24.0109-0100.2</b>	<b>409100</b>	Ø 249 9 7 + LG / + ABS Ring
<b>CITROËN - DS4 04/11→07/15</b>								
 <b>Bremsbelagsatz, Scheibenbremse</b>								
1.2 THP 130 1.6 BlueHDi 120	96 88	07/14→07/15 07/14→07/15	←			<b>13.0460-7229.2</b>	<b>607229</b>	ATE 24538 18,5 - WE / - WK Ceramic
			→			<b>13.0460-2761.2</b>	<b>602761</b>	TRW 24922 16,5 - WK + Zub
1.6 BlueHDi 115	85	07/14→07/15	←	08/14→		<b>13.0460-7229.2</b>	<b>607229</b>	ATE 24538 18,5 - WE / - WK Ceramic
						<b>13.0470-7229.2</b>	<b>LD7229</b>	ATE 24538 18,5 - WE / - WK Ceramic
↓								



	kw			 	! #		
<b>CITROËN - DS4 04/11→07/15</b>							
<b> Bremsbelagsatz, Scheibenbremse</b>							
1.6 BlueHDi 115	85	07/14→07/15	➡	08/14→		<b>13.0460-2761.2 602761</b>	TRW 24922 16,5 - WK + Zub
1.6 HDi 110	82	04/11→07/15	⬅			<b>13.0460-7229.2 607229</b>	ATE 24538 18,5 - WE / - WK
1.6 HDi 115	84	08/12→07/15	⬅			<b>13.0470-7229.2 LD7229</b>	ATE 24538 18,5 - WE / - WK Ceramic
1.6 HDi 90	68	05/11→07/15	⬅				
1.6 THP 155	115	04/11→07/15	➡	+ eFSB		<b>13.0460-2761.2 602761</b>	TRW 24922 16,5 - WK + Zub
1.6 VTi 120	88	04/11→07/15	➡	- eFSB		<b>13.0460-2775.2 602775</b>	TRW 23554 16,4 - WE / - WK + Zub
1.6 THP 160	120	04/12→07/15	⬅			<b>13.0460-7230.2 607230</b>	ATE 24557 19,4 - WE / - WK
			⬅			<b>13.0470-7230.2 LD7230</b>	ATE 24557 19,4 - WE / - WK Ceramic
			➡	+ eFSB		<b>13.0460-2761.2 602761</b>	TRW 24922 16,5 - WK + Zub
			➡	- eFSB		<b>13.0460-2775.2 602775</b>	TRW 23554 16,4 - WE / - WK + Zub
1.6 THP 165	121	01/12→07/15	⬅	04/12→		<b>13.0460-7230.2 607230</b>	ATE 24557 19,4 - WE / - WK
			⬅			<b>13.0470-7230.2 LD7230</b>	ATE 24557 19,4 - WE / - WK Ceramic
			➡	04/12→; + eFSB		<b>13.0460-2761.2 602761</b>	TRW 24922 16,5 - WK + Zub
			➡	04/12→; - eFSB		<b>13.0460-2775.2 602775</b>	TRW 23554 16,4 - WE / - WK + Zub
1.6 THP 200	147	04/11→07/15	⬅			<b>13.0460-7279.2 607279</b>	ATE 25069 17,3 + WK
			⬅			<b>13.0470-7279.2 LD7279</b>	ATE 25069 17,3 + WK Ceramic
			➡	+ eFSB		<b>13.0460-2761.2 602761</b>	TRW 24922 16,5 - WK + Zub
			➡			<b>13.0460-2775.2 602775</b>	TRW 23554 16,4 - WE / - WK + Zub
2.0 BlueHDi 150	110	07/14→07/15	⬅			<b>13.0460-7230.2 607230</b>	ATE 24557 19,4 - WE / - WK
			⬅			<b>13.0470-7230.2 LD7230</b>	ATE 24557 19,4 - WE / - WK Ceramic
			➡			<b>13.0460-2761.2 602761</b>	TRW 24922 16,5 - WK + Zub
2.0 BlueHDi 180	133	07/14→07/15	⬅	nicht für Felgenreöße [Zoll]: 19		<b>13.0460-7230.2 607230</b>	ATE 24557 19,4 - WE / - WK
2.0 HDi / BlueHDi 135	100	09/11→07/15	⬅			<b>13.0470-7230.2 LD7230</b>	ATE 24557 19,4 - WE / - WK Ceramic
			⬅	passend für Felgenreöße [Zoll]: 19		<b>13.0460-7279.2 607279</b>	ATE 25069 17,3 + WK
			⬅			<b>13.0470-7279.2 LD7279</b>	ATE 25069 17,3 + WK Ceramic
			➡	+ eFSB		<b>13.0460-2761.2 602761</b>	TRW 24922 16,5 - WK + Zub
			➡	- eFSB		<b>13.0460-2775.2 602775</b>	TRW 23554 16,4 - WE / - WK + Zub
2.0 HDi 165	120	04/11→07/15	⬅			<b>13.0460-7229.2 607229</b>	ATE 24538 18,5 - WE / - WK
			⬅			<b>13.0470-7229.2 LD7229</b>	ATE 24538 18,5 - WE / - WK Ceramic
			⬅	nicht für Felgenreöße [Zoll]: 19		<b>13.0460-7230.2 607230</b>	ATE 24557 19,4 - WE / - WK
			⬅			<b>13.0470-7230.2 LD7230</b>	ATE 24557 19,4 - WE / - WK Ceramic
			⬅	passend für Felgenreöße [Zoll]: 19		<b>13.0460-7279.2 607279</b>	ATE 25069 17,3 + WK
			⬅			<b>13.0470-7279.2 LD7279</b>	ATE 25069 17,3 + WK Ceramic
			➡	+ eFSB		<b>13.0460-2761.2 602761</b>	TRW 24922 16,5 - WK + Zub
			➡	- eFSB		<b>13.0460-2775.2 602775</b>	TRW 23554 16,4 - WE / - WK + Zub
<b> Bremsscheibe</b>							
1.2 THP 130	96	07/14→07/15	⬅			<b>24.0126-0120.1 426120</b>	Ø 283 26 24 V + S
1.6 BlueHDi 120	88	07/14→07/15	⬅			<b>24.0326-0120.1 526120</b>	Ø 283 26 24 V + S
			➡	nicht für Felgenreöße [Zoll]: 19		<b>24.0112-0194.2 412194</b>	Ø 268 12 10 + LG / + ABS Ring
			➡	passend für Felgenreöße [Zoll]: 19		<b>24.0112-0198.1 412198</b>	Ø 290 12 10 + S
1.6 BlueHDi 115	85	07/14→07/15	⬅	08/14→		<b>24.0126-0120.1 426120</b>	Ø 283 26 24 V + S
			⬅			<b>24.0326-0120.1 526120</b>	Ø 283 26 24 V + S
			➡	08/14→; nicht für Felgenreöße [Zoll]: 19		<b>24.0112-0194.2 412194</b>	Ø 268 12 10 + LG / + ABS Ring
			➡	08/14→; passend für Felgenreöße [Zoll]: 19		<b>24.0112-0198.1 412198</b>	Ø 290 12 10 + S
1.6 HDi 110	82	04/11→07/15	⬅			<b>24.0126-0120.1 426120</b>	Ø 283 26 24 V + S
1.6 HDi 115	84	08/12→07/15	⬅			<b>24.0326-0120.1 526120</b>	Ø 283 26 24 V + S
1.6 HDi 90	68	05/11→07/15	⬅				
1.6 VTi 120	88	04/11→07/15	➡	- eFSB		<b>24.0109-0171.2 409171</b>	Ø 249 9 8 + LG / + ABS Ring
			➡	+ eFSB; nicht für Felgenreöße [Zoll]: 19		<b>24.0112-0194.2 412194</b>	Ø 268 12 10 + LG / + ABS Ring
↓							

	kw			 	! #		
<b>CITROËN - DS4 04/11→07/15</b>							
 <b>Bremsscheibe</b>							
1.6 HDi 110 1.6 HDi 115 1.6 HDi 90 1.6 VTi 120	82 84 68 88	04/11→07/15 08/12→07/15 05/11→07/15 04/11→07/15	➔	+ eFSB; passend für Felgengröße [Zoll]: 19		24.0112-0198.1 412198	Ø 290 12 10 + S
1.6 THP 155	115	04/11→07/15	➔	+ eFSB; nicht für Felgengröße [Zoll]: 19		24.0112-0194.2 412194	Ø 268 12 10 + LG / + ABS Ring
			➔	+ eFSB; passend für Felgengröße [Zoll]: 19		24.0112-0198.1 412198	Ø 290 12 10 + S
1.6 THP 160	120	04/12→07/15	➔	- eFSB		24.0109-0171.2 409171	Ø 249 9 8 + LG / + ABS Ring
			➔	+ eFSB; nicht für Felgengröße [Zoll]: 19		24.0112-0194.2 412194	Ø 268 12 10 + LG / + ABS Ring
			➔	+ eFSB; passend für Felgengröße [Zoll]: 19		24.0112-0198.1 412198	Ø 290 12 10 + S
1.6 THP 165	121	01/12→07/15	➔	04/12→; - eFSB		24.0109-0171.2 409171	Ø 249 9 8 + LG / + ABS Ring
			➔	04/12→; + eFSB; nicht für Felgengröße [Zoll]: 19		24.0112-0194.2 412194	Ø 268 12 10 + LG / + ABS Ring
			➔	04/12→; + eFSB; passend für Felgengröße [Zoll]: 19		24.0112-0198.1 412198	Ø 290 12 10 + S
1.6 THP 200	147	04/11→07/15	➔	- eFSB		24.0109-0171.2 409171	Ø 249 9 8 + LG / + ABS Ring
			➔	+ eFSB; nicht für Felgengröße [Zoll]: 19		24.0112-0194.2 412194	Ø 268 12 10 + LG / + ABS Ring
			➔	+ eFSB; passend für Felgengröße [Zoll]: 19		24.0112-0198.1 412198	Ø 290 12 10 + S
2.0 BlueHDi 150	110	07/14→07/15	➔	nicht für Felgengröße [Zoll]: 19		24.0112-0194.2 412194	Ø 268 12 10 + LG / + ABS Ring
			➔	passend für Felgengröße [Zoll]: 19		24.0112-0198.1 412198	Ø 290 12 10 + S
2.0 BlueHDi 180	133	07/14→07/15	➔	nicht für Felgengröße [Zoll]: 19		24.0112-0194.2 412194	Ø 268 12 10 + LG / + ABS Ring
			➔	passend für Felgengröße [Zoll]: 19		24.0112-0198.1 412198	Ø 290 12 10 + S
			➔	- eFSB		24.0109-0171.2 409171	Ø 249 9 8 + LG / + ABS Ring
			➔	nicht für Felgengröße [Zoll]: 19		24.0112-0194.2 412194	Ø 268 12 10 + LG / + ABS Ring
			➔	passend für Felgengröße [Zoll]: 19		24.0112-0198.1 412198	Ø 290 12 10 + S
2.0 HDi / BlueHDi 135	100	09/11→07/15	➔	nicht für Felgengröße [Zoll]: 19		24.0112-0194.2 412194	Ø 268 12 10 + LG / + ABS Ring
			➔	passend für Felgengröße [Zoll]: 19		24.0112-0198.1 412198	Ø 290 12 10 + S
			➔	- eFSB		24.0109-0171.2 409171	Ø 249 9 8 + LG / + ABS Ring
			➔	+ eFSB; nicht für Felgengröße [Zoll]: 19		24.0112-0194.2 412194	Ø 268 12 10 + LG / + ABS Ring
			➔	+ eFSB; passend für Felgengröße [Zoll]: 19		24.0112-0198.1 412198	Ø 290 12 10 + S
2.0 HDi 165	120	04/11→07/15	➔	nicht für Felgengröße [Zoll]: 19		24.0112-0194.2 412194	Ø 268 12 10 + LG / + ABS Ring
			➔	passend für Felgengröße [Zoll]: 19		24.0112-0198.1 412198	Ø 290 12 10 + S
			➔	+ eFSB; nicht für Felgengröße [Zoll]: 19		24.0112-0194.2 412194	Ø 268 12 10 + LG / + ABS Ring
			➔	+ eFSB; passend für Felgengröße [Zoll]: 19		24.0112-0198.1 412198	Ø 290 12 10 + S
<b>CITROËN - DS5 11/11→07/15</b>							
 <b>Bremsbelagsatz, Scheibenbremse</b>							
1.6 BlueHDi 120 1.6 HDi	88 85	07/14→07/15 11/13→07/15	➔	Nabendurchmesser [mm]: 82		13.0460-7229.2 607229	ATE 24538 18,5 - WE / - WK
			➔	Nabendurchmesser [mm]: 82		13.0470-7229.2 LD7229	ATE 24538 18,5 - WE / - WK Ceramic
1.6 HDi 110	82	11/11→07/15	➔	Orga 13343→; Nabendurchmesser [mm]: 82		13.0460-7229.2 607229	ATE 24538 18,5 - WE / - WK
			➔	→Orga 13342; Nabendurchmesser [mm]: 82		13.0470-7230.2 LD7230	ATE 24557 19,4 - WE / - WK Ceramic
			➔	Nabendurchmesser [mm]: 83		13.0460-7279.2 607279	ATE 25069 17,3 + WK
			➔			13.0470-7279.2 LD7279	ATE 25069 17,3 + WK Ceramic

**CITROËN - DS5 11/11→07/15**

**Bremsbelagsatz, Scheibenbremse**

1.6 HDi 110	82	11/11→07/15	➔	Nabendurchmesser [mm]: 82	13.0460-2761.2 602761	TRW 24922 16,5 - WK + Zub
1.6 HDi 115	84	06/12→07/15	➔	Orga 13343→; Nabendurchmesser [mm]: 82	13.0460-7229.2 607229	ATE 24538 18,5 - WE / - WK
			➔	08/12→; →Orga 13342; Nabendurchmesser [mm]: 82	13.0460-7230.2 607230	ATE 24538 18,5 - WE / - WK Ceramic
			➔	08/12→; Nabendurchmesser [mm]: 83	13.0460-7279.2 607279	ATE 24557 19,4 - WE / - WK
			➔	08/12→; Nabendurchmesser [mm]: 82	13.0470-7279.2 LD7279	ATE 24557 19,4 - WE / - WK Ceramic
1.6 THP 150	110	11/11→07/15	➔	Nabendurchmesser [mm]: 82	13.0460-7230.2 607230	ATE 25069 17,3 + WK
1.6 THP 155	115	11/11→07/15	➔	Nabendurchmesser [mm]: 82	13.0470-7230.2 LD7230	ATE 25069 17,3 + WK Ceramic
1.6 THP 165	121	01/12→07/15	➔	Nabendurchmesser [mm]: 83	13.0460-7279.2 607279	ATE 25069 17,3 + WK
1.6 THP 165 Hybrid	121	06/12→07/15	➔	Nabendurchmesser [mm]: 83	13.0470-7279.2 LD7279	ATE 25069 17,3 + WK Ceramic
1.6 THP 200	147	11/11→07/15	➔	Nabendurchmesser [mm]: 82	13.0460-2761.2 602761	TRW 24922 16,5 - WK + Zub
2.0 BlueHDi 150	110	07/14→07/15	➔	Nabendurchmesser [mm]: 82	13.0460-2761.2 602761	TRW 24922 16,5 - WK + Zub
2.0 BlueHDi 180	133	08/13→07/15	➔	Nabendurchmesser [mm]: 82	13.0460-2761.2 602761	TRW 24922 16,5 - WK + Zub
2.0 HDi 135	100	11/11→07/15	➔	Nabendurchmesser [mm]: 82	13.0460-2761.2 602761	TRW 24922 16,5 - WK + Zub
2.0 HDi 150 Hybrid	110	11/11→07/15	➔	Nabendurchmesser [mm]: 82	13.0460-2761.2 602761	TRW 24922 16,5 - WK + Zub
2.0 HDi 165	120	11/11→07/15	➔	Nabendurchmesser [mm]: 82	13.0460-2761.2 602761	TRW 24922 16,5 - WK + Zub
2.0 HDi 165 Hybrid4 4x4	120	12/11→07/15	➔	Nabendurchmesser [mm]: 82	13.0460-2761.2 602761	TRW 24922 16,5 - WK + Zub
2.0 HDi 200 Hybrid4	147	12/11→07/15	➔	Nabendurchmesser [mm]: 82	13.0460-2761.2 602761	TRW 24922 16,5 - WK + Zub













**Bremsscheibe**

1.6 BlueHDi 120	88	07/14→07/15	➔		24.0126-0120.1 426120	Ø 283 26 24 V + S
1.6 HDi	85	11/13→07/15	➔		24.0112-0194.2 412194	Ø 268 12 10 + LG / + ABS Ring
1.6 HDi 110	82	11/11→07/15	➔	Orga 13343→	24.0126-0120.1 426120	Ø 283 26 24 V + S
			➔	→Orga 13342; Nabendurchmesser [mm]: 82	24.0126-0159.1 426159	Ø 302 26 24 V + S
			➔	Nabendurchmesser [mm]: 83	24.0130-0230.1 430230	Ø 340 30 28 V + S
			➔		24.0112-0194.2 412194	Ø 268 12 10 + LG / + ABS Ring
1.6 HDi 115	84	06/12→07/15	➔	Orga 13343→	24.0126-0120.1 426120	Ø 283 26 24 V + S
			➔	08/12→; →Orga 13342; Nabendurchmesser [mm]: 82	24.0126-0159.1 426159	Ø 302 26 24 V + S
			➔	08/12→; Nabendurchmesser [mm]: 83	24.0130-0230.1 430230	Ø 340 30 28 V + S
			➔	08/12→	24.0112-0194.2 412194	Ø 268 12 10 + LG / + ABS Ring
1.6 THP 150	110	11/11→07/15	➔	Nabendurchmesser [mm]: 82	24.0126-0159.1 426159	Ø 302 26 24 V + S
1.6 THP 155	115	11/11→07/15	➔	Nabendurchmesser [mm]: 82	24.0126-0159.1 426159	Ø 302 26 24 V + S
1.6 THP 165	121	01/12→07/15	➔	Nabendurchmesser [mm]: 83	24.0130-0230.1 430230	Ø 340 30 28 V + S
1.6 THP 165 Hybrid	121	06/12→07/15	➔	Nabendurchmesser [mm]: 83	24.0130-0230.1 430230	Ø 340 30 28 V + S
2.0 BlueHDi 150	110	07/14→07/15	➔		24.0112-0194.2 412194	Ø 268 12 10 + LG / + ABS Ring
2.0 HDi 135	100	11/11→07/15	➔		24.0112-0194.2 412194	Ø 268 12 10 + LG / + ABS Ring
2.0 HDi 150 Hybrid	110	11/11→07/15	➔		24.0112-0194.2 412194	Ø 268 12 10 + LG / + ABS Ring
2.0 HDi 165	120	11/11→07/15	➔		24.0112-0194.2 412194	Ø 268 12 10 + LG / + ABS Ring
1.6 THP 200	147	11/11→07/15	➔	Nabendurchmesser [mm]: 82	24.0126-0159.1 426159	Ø 302 26 24 V + S
2.0 HDi 200 Hybrid4	147	12/11→07/15	➔	Nabendurchmesser [mm]: 83	24.0130-0230.1 430230	Ø 340 30 28 V + S
			➔		24.0112-0198.1 412198	Ø 290 12 10 + S
2.0 BlueHDi 180	133	08/13→07/15	➔	Nabendurchmesser [mm]: 82	24.0126-0159.1 426159	Ø 302 26 24 V + S
			➔	Nabendurchmesser [mm]: 83	24.0130-0230.1 430230	Ø 340 30 28 V + S
			➔		24.0112-0194.2 412194	Ø 268 12 10 + LG / + ABS Ring
			➔		24.0112-0198.1 412198	Ø 290 12 10 + S
2.0 HDi 165 Hybrid4 4x4	120	12/11→07/15	➔	Nabendurchmesser [mm]: 82	24.0126-0159.1 426159	Ø 302 26 24 V + S
			➔		24.0112-0198.1 412198	Ø 290 12 10 + S

**CITROËN - EVASION Großraumlimousine (22, U6) 03/94→07/02**

**Bremsbelagsatz, Scheibenbremse**

1.8	73	05/97→07/02	➔		13.0460-3957.2 603957	BDX 23042 19,0 + WK + Zub
			➔	+ ABS	13.0460-7061.2 607061	ATE 21275 17,0 + WK
1.8	76	02/96→12/96	➔	V	13.0460-3957.2 603957	BDX 23042 19,0 + WK + Zub
			➔	+ ABS	13.0460-7061.2 607061	ATE 21275 17,0 + WK
1.9 TD	66	11/94→07/02	➔	02/95→	13.0460-2978.2 602978	TRW 21801 19,0 + WK
			➔	02/95→; + ABS	13.0460-7061.2 607061	ATE 21275 17,0 + WK
1.9 TD	68	10/95→12/98	➔		13.0460-2978.2 602978	TRW 21801 19,0 + WK
2.0	89	06/94→07/02	➔		13.0460-2978.2 602978	TRW 21801 19,0 + WK
2.0 HDI	80	08/99→07/02	➔	+ ABS	13.0460-7061.2 607061	ATE 21275 17,0 + WK

	kW					! #		
<b>CITROËN - EVASION Großraumlimousine (22, U6) 03/94→07/02</b>								
 <b>Bremsbelagsatz, Scheibenbremse</b>								
2.0 HDI 16V	80	09/99→07/02	←				<b>13.0460-2978.2 602978</b>	TRW 21801 19,0 + WK
			→	+ ABS			<b>13.0460-7061.2 607061</b>	ATE 21275 17,0 + WK
2.0 16V	97	05/98→04/00	←	12/98→			<b>13.0460-2978.2 602978</b>	TRW 21801 19,0 + WK
			→	12/98→			<b>13.0460-7061.2 607061</b>	ATE 21275 17,0 + WK
2.0 16V	100	05/00→07/02	←				<b>13.0460-2978.2 602978</b>	TRW 21801 19,0 + WK
2.0 Turbo C.T.	108	06/94→07/02	←				<b>13.0460-2978.2 602978</b>	TRW 21801 19,0 + WK
2.1 TD	80	05/96→07/02	→				<b>13.0460-7061.2 607061</b>	ATE 21275 17,0 + WK
 <b>Bremsscheibe</b>								
1.8	73	05/97→07/02	←				<b>24.0120-0155.1 420155</b>	Ø 257,5 20 18,2 V
1.8	76	02/96→12/96	→	+ ABS			<b>24.0110-0218.1 410218</b>	Ø 295 10 8
1.9 TD	66	11/94→07/02	←	02/95→			<b>24.0126-0104.1 426104</b>	Ø 281 26 24,2 V
			→	02/95→; + ABS			<b>24.0110-0218.1 410218</b>	Ø 295 10 8
1.9 TD	68	10/95→12/98	←				<b>24.0126-0104.1 426104</b>	Ø 281 26 24,2 V
2.0	89	06/94→07/02	←				<b>24.0126-0104.1 426104</b>	Ø 281 26 24,2 V
2.0 HDI	80	08/99→07/02	→	+ ABS			<b>24.0110-0218.1 410218</b>	Ø 295 10 8
2.0 HDI 16V	80	09/99→07/02	→				<b>24.0110-0218.1 410218</b>	Ø 295 10 8
2.0 16V	97	05/98→04/00	←	12/98→			<b>24.0126-0104.1 426104</b>	Ø 281 26 24,2 V
			→	12/98→			<b>24.0110-0218.1 410218</b>	Ø 295 10 8
2.0 16V	100	05/00→07/02	←				<b>24.0126-0104.1 426104</b>	Ø 281 26 24,2 V
2.0 Turbo C.T.	108	06/94→07/02	←				<b>24.0126-0104.1 426104</b>	Ø 281 26 24,2 V
2.1 TD	80	05/96→07/02	→				<b>24.0110-0218.1 410218</b>	Ø 295 10 8
<b>CITROËN - GRAND C4 SPACETOURER 04/18→</b>								
 <b>Bremsbelagsatz, Scheibenbremse</b>								
1.2 PureTech 130	96	04/18→	←	für Bremsscheibendurchmesser [mm]: 304			<b>13.0460-7300.2 607300</b>	ATE 25833 17,3 + WE / - WK
1.5 BlueHDI 130	96	05/18→	←				<b>13.0470-7300.2 LD7300</b>	ATE 25833 17,3 + WE / - WK Ceramic
1.6 BlueHDI 100	73	04/18→	←	für Bremsscheibendurchmesser [mm]: 283			<b>13.0460-7305.2 607305</b>	ATE 25836 17,0 + WE / - WK
1.6 BlueHDI 120	88	04/18→	←				<b>13.0470-7305.2 LD7305</b>	ATE 25836 17,0 + WE / - WK Ceramic
1.6 THP 165	121	04/18→	←	für Bremsscheibendurchmesser [mm]: 268			<b>13.0460-3871.2 603871</b>	BOS 25839 17,8 - WE / - WK + Zub
2.0 BlueHDI 150	110	04/18→	←				<b>13.0470-3871.2 LD3871</b>	BOS 25839 17,8 - WE / - WK + Zub Ceramic
2.0 BlueHDI 160	120	04/18→	←	für Bremsscheibendurchmesser [mm]: 290			<b>13.0460-3872.2 603872</b>	BOS 25827 17,7 - WE / - WK + Zub
			→				<b>13.0470-3872.2 LD3872</b>	BOS 25827 17,7 - WE / - WK + Zub Ceramic
 <b>Bremsscheibe</b>								
1.2 PureTech 130	96	04/18→	←				<b>24.0126-0183.1 426183</b>	Ø 283 26 24 V + S
1.5 BlueHDI 130	96	05/18→	←				<b>24.0128-0269.1 428269</b>	Ø 304 28 26 V + S
1.6 BlueHDI 100	73	04/18→	←				<b>24.0112-0211.1 412211</b>	Ø 268 12 10 + S
1.6 BlueHDI 120	88	04/18→	→				<b>24.0112-0212.1 412212</b>	Ø 290 12 10 + S
1.6 THP 165	121	04/18→	→				<b>24.0112-0212.1 412212</b>	Ø 290 12 10 + S
2.0 BlueHDI 150	110	04/18→	→				<b>24.0112-0212.1 412212</b>	Ø 290 12 10 + S
2.0 BlueHDI 160	120	04/18→	→				<b>24.0112-0212.1 412212</b>	Ø 290 12 10 + S
<b>CITROËN - JUMPER Bus 04/06→</b>								
 <b>Bremsbelagsatz, Scheibenbremse</b>								
2.0 BlueHDI 110	81	07/15→	←	Nutzlast 12Q/14Q; Nutzlast ab [kg] 1.200 Nutzlast bis [kg] 1.400			<b>13.0460-4807.2 604807</b>	BRE 24468 19,1 + WK + Zub
2.0 BlueHDI 130	96	07/15→	←	Nutzlast leicht 16Q; Nutzlast [kg]: 1.600; nicht für erhöhte Nutzlast			<b>13.0460-4809.2 604809</b>	BRE 24468 19,1 + WK + Zub
2.0 BlueHDI 160	120	07/15→	←	Nutzlast s. 16Q+ 20Q; Nutzlast ab [kg] 1.600 Nutzlast bis [kg] 2.000; für erhöhte Nutzlast			<b>13.0460-4811.2 604811</b>	BRE 24466 19,1 + WK + Zub
			→	Nutzlast 12Q/14Q/16Q; Nutzlast ab [kg] 1.200 Nutzlast bis [kg] 1.600			<b>13.0460-4889.2 604889</b>	BOS 22041 19,2 + WK + Zub
			→	Nutzlast 20Q; Nutzlast [kg]: 2.000			<b>13.0460-4890.2 604890</b>	BRE + WK + Zub
2.2 HDi 100	74	04/06→	←	Nutzlast 12Q/14Q; Nutzlast ab [kg] 1.200 Nutzlast bis [kg] 1.400			<b>13.0460-4807.2 604807</b>	BRE 24468 19,1 + WK + Zub
2.2 HDi 110	81	07/11→	←	Nutzlast leicht 16Q; Nutzlast [kg]: 1.600; nicht für erhöhte Nutzlast			<b>13.0460-4809.2 604809</b>	BRE 24468 19,1 + WK + Zub
2.2 HDi 130	96	07/11→	←	Nutzlast schwer 16Q; Nutzlast [kg]: 1.600; für erhöhte Nutzlast			<b>13.0460-4810.2 604810</b>	BRE 24466 19,1 + WK + Zub
3.0 HDi 180	130	07/11→	←	Nutzlast 20Q; Nutzlast [kg]: 2.000			<b>13.0460-4811.2 604811</b>	BRE 24466 19,1 + WK + Zub
↓								



**CITROËN - JUMPER Bus 04/06→**

**Bremsbelagsatz, Scheibenbremse**

2.2 HDi 100 2.2 HDi 110 2.2 HDi 130 3.0 HDi 180	74 81 96 130	04/06→ 07/11→ 07/11→ 07/11→	➔					BOS 24465 19,2 - WE / - WK + Zub
2.2 HDi 120 3.0 HDi 155 3.0 HDi 160	88 115 116	04/06→ 07/10→ 09/06→	←	Nutzlast 12Q/14Q; Nutzlast ab [kg] 1.200 Nutzlast bis [kg] 1.400	13.0460-4807.2	604807		BRE 24468 19,1 + WK + Zub
			←	Nutzlast leicht 16Q; Nutzlast [kg]: 1.600; nicht für erhöhte Nutzlast	13.0460-4809.2	604809		BRE 24468 19,1 + WK + Zub
			←	Nutzlast schwer 16Q; Nutzlast [kg]: 1.600; für erhöhte Nutzlast	13.0460-4810.2	604810		BRE 24466 19,1 + WK + Zub
			←	Nutzlast 20Q; Nutzlast [kg]: 2.000	13.0460-4811.2	604811		BRE 24466 19,1 + WK + Zub
			➔	Nutzlast ab [kg] 1.200 Nutzlast bis [kg] 2.000; light/heavy	13.0460-4812.2	604812		BOS 24465 19,2 - WE / - WK + Zub
2.2 HDi 150	110	07/11→	←	Nutzlast 12Q/14Q; Nutzlast ab [kg] 1.200 Nutzlast bis [kg] 1.400	13.0460-4807.2	604807		BRE 24468 19,1 + WK + Zub
			←	Nutzlast leicht 16Q; Nutzlast [kg]: 1.600; nicht für erhöhte Nutzlast	13.0460-4809.2	604809		BRE 24468 19,1 + WK + Zub
			←	Nutzlast schwer 16Q; Nutzlast [kg]: 1.600; für erhöhte Nutzlast	13.0460-4810.2	604810		BRE 24466 19,1 + WK + Zub
			←	Nutzlast 20Q; Nutzlast [kg]: 2.000	13.0460-4811.2	604811		BRE 24466 19,1 + WK + Zub
			➔	→ 12/13	13.0460-4812.2	604812		BOS 24465 19,2 - WE / - WK + Zub
			➔	01/14→; Nutzlast 12Q/14Q/16Q; Nutzlast ab [kg] 1.200 Nutzlast bis [kg] 1.600	13.0460-4889.2	604889		BOS 22041 19,2 + WK + Zub
			➔	01/14→; Nutzlast 20Q; Nutzlast [kg]: 2.000	13.0460-4890.2	604890		BRE + WK + Zub

**Bremsscheibe**









2.0 BlueHDi 110 2.0 BlueHDi 130 2.0 BlueHDi 160	81 96 120	07/15→ 07/15→ 07/15→	←	Nutzlast leicht 12Q; Nutzlast [kg]: 1.200; nicht für erhöhte Nutzlast	24.0124-0127.1	424127		Ø 280 24 21,9 V
			➔	Nutzlast 12Q/14Q + / leicht 16Q; Nutzlast ab [kg] 1.200 Nutzlast bis [kg] 1.600; nicht für erhöhte Nutzlast	24.0116-0124.1	416124		Ø 280 16 14,2
			➔	Nutzlast schwer 16Q; Nutzlast [kg]: 1.600; für erhöhte Nutzlast	24.0116-0125.1	416125		Ø 280 16 14,2
2.2 HDi 100 2.2 HDi 110 2.2 HDi 120 2.2 HDi 130 2.2 HDi 150 3.0 HDi 155 3.0 HDi 160 3.0 HDi 180	74 81 88 96 110 115 116 130	04/06→ 07/11→ 04/06→ 07/11→ 07/11→ 07/10→ 09/06→ 07/11→	←	Nutzlast 12Q/14Q; Nutzlast ab [kg] 1.200 Nutzlast bis [kg] 1.400	24.0124-0127.1	424127		Ø 280 24 21,9 V
			←	Nutzlast schwer 16Q; Nutzlast [kg]: 1.600; für erhöhte Nutzlast	24.0124-0138.1	424138		Ø 300 24 21,9 V
			←	Nutzlast leicht 16Q; Nutzlast [kg]: 1.600; nicht für erhöhte Nutzlast	24.0128-0213.1	428213		Ø 280 28 25,9 V
			←	Nutzlast 20Q; Nutzlast [kg]: 2.000	24.0132-0131.1	432131		Ø 300 32 29,9 V
			➔	Nutzlast 20Q; Nutzlast [kg]: 2.000	24.0116-0123.1	416123		Ø 300 16 14,2
			➔	Nutzlast 12Q/14Q + / leicht 16Q; Nutzlast ab [kg] 1.200 Nutzlast bis [kg] 1.600; nicht für erhöhte Nutzlast	24.0116-0124.1	416124		Ø 280 16 14,2
			➔	Nutzlast schwer 16Q; Nutzlast [kg]: 1.600; für erhöhte Nutzlast	24.0116-0125.1	416125		Ø 280 16 14,2

**CITROËN - JUMPER Bus (230P) 02/94→04/02**







**Bremsbelagsatz, Scheibenbremse**











1.9 D	51	01/99→04/02	←	01/00→ 10/01; Nutzlast [kg]: 1.000	13.0460-2850.2	602850		TRW 21797 19,7 + WK
			←	→ 12/99; Nutzlast [kg]: 1.000	13.0460-2976.2	602976		TRW 21797 19,7 + WK
			←	11/01→ 03/02; Nutzlast [kg]: 1.000	13.0460-4978.2	604978		BRE 23917 19,3 + WK + Zub
			➔	11/01→ 03/02; Nutzlast [kg]: 1.000	13.0460-4980.2	604980		BRE 23921 20,3 - WE / - WK + Zub
			←	01/00→ 10/01; Nutzlast ab [kg] 1.000 Nutzlast bis [kg] 1.400	13.0460-2850.2	602850		TRW 21797 19,7 + WK
1.9 TD 1.9 TD 1.9 TD 4x4	66 68 68	08/94→04/02 02/94→04/02 08/96→04/02	←	→ 12/99; Nutzlast ab [kg] 1.000 Nutzlast bis [kg] 1.400	13.0460-2976.2	602976		TRW 21797 19,7 + WK
			←	11/01→ 03/02; Nutzlast ab [kg] 1.000 Nutzlast bis [kg] 1.400	13.0460-4978.2	604978		BRE 23917 19,3 + WK + Zub
			➔	11/01→ 03/02; Nutzlast ab [kg] 1.000 Nutzlast bis [kg] 1.400	13.0460-4980.2	604980		BRE 23921 20,3 - WE / - WK + Zub
			←	01/00→ 10/01; Nutzlast ab [kg] 1.000 Nutzlast bis [kg] 1.400	13.0460-2850.2	602850		TRW 21797 19,7 + WK
2.0	80	02/94→04/02	←	01/00→ 10/01; Nutzlast [kg]: 1.800	13.0460-2852.2	602852		TRW 21799 19,7 + WK
			←	→ 12/99; Nutzlast ab [kg] 1.000 Nutzlast bis [kg] 1.400	13.0460-2976.2	602976		TRW 21797 19,7 + WK
			←	→ 12/99; Nutzlast [kg]: 1.800	13.0460-2977.2	602977		TRW 21799 19,7 + WK



	kw			 	! #		
<b>CITROËN - JUMPER Bus (230P) 02/94→04/02</b>							
<b> Bremsbelagsatz, Scheibenbremse</b>							
2.0	80	02/94→04/02	←	11/01→ 03/02; Nutzlast ab [kg] 1.000 Nutzlast bis [kg] 1.400		13.0460-4978.2 604978	BRE 23917 19,3 + WK + Zub
			←	11/01→ 03/02; Nutzlast [kg]: 1.800		13.0460-4979.2 604979	BRE 23919 19,3 + WK + Zub
			→	11/01→ 03/02; Nutzlast ab [kg] 1.000 Nutzlast bis [kg] 1.800		13.0460-4980.2 604980	BRE 23921 20,3 - WE / - WK + Zub
2.0 4x4	80	08/96→04/02	←	01/00→ 10/01; Nutzlast ab [kg] 1.000 Nutzlast bis [kg] 1.400		13.0460-2850.2 602850	TRW 21797 19,7 + WK
			←	→ 12/99; Nutzlast ab [kg] 1.000 Nutzlast bis [kg] 1.400		13.0460-2976.2 602976	TRW 21797 19,7 + WK
			←	11/01→ 03/02; Nutzlast ab [kg] 1.000 Nutzlast bis [kg] 1.400		13.0460-4978.2 604978	BRE 23917 19,3 + WK + Zub
			→	11/01→ 03/02; Nutzlast ab [kg] 1.000 Nutzlast bis [kg] 1.800		13.0460-4980.2 604980	BRE 23921 20,3 - WE / - WK + Zub
2.5 D 2.5 TD	63 76	08/94→04/02 08/94→04/02	←	01/00→ 10/01; Nutzlast [kg]: 1.400		13.0460-2850.2 602850	TRW 21797 19,7 + WK
			←	01/00→ 10/01; Nutzlast [kg]: 1.800		13.0460-2852.2 602852	TRW 21799 19,7 + WK
			←	→ 12/99; Nutzlast [kg]: 1.400		13.0460-2976.2 602976	TRW 21797 19,7 + WK
			←	→ 12/99; Nutzlast [kg]: 1.800		13.0460-2977.2 602977	TRW 21799 19,7 + WK
			←	11/01→ 03/02; Nutzlast [kg]: 1.400		13.0460-4978.2 604978	BRE 23917 19,3 + WK + Zub
			←	11/01→ 03/02; Nutzlast [kg]: 1.800		13.0460-4979.2 604979	BRE 23919 19,3 + WK + Zub
			→	11/01→ 03/02; Nutzlast ab [kg] 1.400 Nutzlast bis [kg] 1.800		13.0460-4980.2 604980	BRE 23921 20,3 - WE / - WK + Zub
2.5 D 4x4 2.5 TD 4x4 2.8 HDi 4x4	63 76 94	08/96→04/02 08/96→04/02 09/00→04/02	→	11/01→ 03/02; Nutzlast ab [kg] 1.400 Nutzlast bis [kg] 1.800		13.0460-4980.2 604980	BRE 23921 20,3 - WE / - WK + Zub
2.5 TDi	79	12/96→11/00	←	01/00→; Nutzlast [kg]: 1.400		13.0460-2850.2 602850	TRW 21797 19,7 + WK
			←	01/00→; Nutzlast [kg]: 1.800		13.0460-2852.2 602852	TRW 21799 19,7 + WK
			←	→ 12/99; Nutzlast [kg]: 1.400		13.0460-2976.2 602976	TRW 21797 19,7 + WK
			←	→ 12/99; Nutzlast [kg]: 1.800		13.0460-2977.2 602977	TRW 21799 19,7 + WK
2.8 D	64	01/99→02/02	←	→ S 16206253; Nutzlast [kg]: 1.400		13.0460-2850.2 602850 13.0460-2976.2 602976	TRW 21797 19,7 + WK TRW 21797 19,7 + WK
			←	→ S 16205352; Nutzlast [kg]: 1.800		13.0460-2852.2 602852 13.0460-2977.2 602977	TRW 21799 19,7 + WK TRW 21799 19,7 + WK
			←	S 16204256→; Nutzlast [kg]: 1.400		13.0460-4978.2 604978	BRE 23917 19,3 + WK + Zub
			←	S 16194400→; Nutzlast [kg]: 1.800		13.0460-4979.2 604979	BRE 23919 19,3 + WK + Zub
			→	S 16194400→; Nutzlast ab [kg] 1.400 Nutzlast bis [kg] 1.800		13.0460-4980.2 604980	BRE 23921 20,3 - WE / - WK + Zub
2.8 HDi	94	09/00→04/02	←	→ 10/01; Nutzlast [kg]: 1.400		13.0460-2850.2 602850	TRW 21797 19,7 + WK
			←	→ 10/01; Nutzlast [kg]: 1.800		13.0460-2852.2 602852	TRW 21799 19,7 + WK
			←	11/01→ 03/02; Nutzlast [kg]: 1.400		13.0460-4978.2 604978	BRE 23917 19,3 + WK + Zub
			←	11/01→ 03/02; Nutzlast [kg]: 1.800		13.0460-4979.2 604979	BRE 23919 19,3 + WK + Zub
			→	11/01→ 03/02; Nutzlast ab [kg] 1.400 Nutzlast bis [kg] 1.800		13.0460-4980.2 604980	BRE 23921 20,3 - WE / - WK + Zub
<b> Bremsscheibe</b>							
1.9 D	51	01/99→04/02	←	→ 10/01; Nutzlast [kg]: 1.000		24.0118-0108.1 418108	Ø 280 18 15,9
			←	11/01→ 03/02; Nutzlast [kg]: 1.000		24.0124-0127.1 424127	Ø 280 24 21,9 V
			→	11/01→ 03/02; Nutzlast [kg]: 1.000		24.0116-0124.1 416124	Ø 280 16 14,2
1.9 TD 1.9 TD 1.9 TD 4x4 2.0 4x4	66 68 68 80	08/94→04/02 02/94→04/02 08/96→04/02 08/96→04/02	←	→ 10/01; Nutzlast ab [kg] 1.000 Nutzlast bis [kg] 1.400		24.0118-0108.1 418108	Ø 280 18 15,9
			←	11/01→ 03/02; Nutzlast ab [kg] 1.000 Nutzlast bis [kg] 1.400		24.0124-0127.1 424127	Ø 280 24 21,9 V
			→	11/01→ 03/02; Nutzlast ab [kg] 1.000 Nutzlast bis [kg] 1.400		24.0116-0124.1 416124	Ø 280 16 14,2
2.0	80	02/94→04/02	←	→ 10/01; Nutzlast ab [kg] 1.000 Nutzlast bis [kg] 1.400		24.0118-0108.1 418108	Ø 280 18 15,9
			←	11/01→ 03/02; Nutzlast ab [kg] 1.000 Nutzlast bis [kg] 1.400		24.0124-0127.1 424127	Ø 280 24 21,9 V
			←	→ 03/02; Nutzlast [kg]: 1.800		24.0124-0138.1 424138	Ø 300 24 21,9 V
			→	11/01→ 03/02; Nutzlast ab [kg] 1.000 Nutzlast bis [kg] 1.400		24.0116-0124.1 416124	Ø 280 16 14,2
			→	11/01→ 03/02; Nutzlast [kg]: 1.800		24.0116-0125.1 416125	Ø 280 16 14,2
2.5 D	63	08/94→04/02	←	→ 10/01; Nutzlast [kg]: 1.400		24.0118-0108.1 418108	Ø 280 18 15,9
			←	11/01→ 03/02; Nutzlast [kg]: 1.400		24.0124-0127.1 424127	Ø 280 24 21,9 V
↓							













	kW			 	! #		
<b>CITROËN - JUMPER Bus (230P) 02/94→04/02</b>							
 <b>Bremsscheibe</b>							
2.5 D	63	08/94→04/02	←	→ 03/02; Nutzlast [kg]: 1.800	24.0124-0138.1	424138	Ø 300 24 21,9 V
			→	11/01→ 03/02; Nutzlast [kg]: 1.400	24.0116-0124.1	416124	Ø 280 16 14,2
			→	11/01→ 03/02; Nutzlast [kg]: 1.800	24.0116-0125.1	416125	Ø 280 16 14,2
2.5 TD 2.8 HDi	76 94	08/94→04/02 09/00→04/02	←	→ 03/02; Nutzlast [kg]: 1.400	24.0124-0127.1	424127	Ø 280 24 21,9 V
			←	→ 03/02; Nutzlast [kg]: 1.800	24.0124-0138.1	424138	Ø 300 24 21,9 V
			→	11/01→ 03/02; Nutzlast [kg]: 1.400	24.0116-0124.1	416124	Ø 280 16 14,2
			→	11/01→ 03/02; Nutzlast [kg]: 1.800	24.0116-0125.1	416125	Ø 280 16 14,2
2.5 TDi	79	12/96→11/00	←	Nutzlast [kg]: 1.400	24.0124-0127.1	424127	Ø 280 24 21,9 V
			←	Nutzlast [kg]: 1.800	24.0124-0138.1	424138	Ø 300 24 21,9 V
2.8 D	64	01/99→02/02	←	→ S 16206253; Nutzlast [kg]: 1.400	24.0118-0108.1	418108	Ø 280 18 15,9
			←	Nutzlast [kg]: 1.400	24.0124-0127.1	424127	Ø 280 24 21,9 V
			←	Nutzlast [kg]: 1.800	24.0124-0138.1	424138	Ø 300 24 21,9 V
			→	S 16194400→; Nutzlast [kg]: 1.400	24.0116-0124.1	416124	Ø 280 16 14,2
			→	S 16194400→; Nutzlast [kg]: 1.800	24.0116-0125.1	416125	Ø 280 16 14,2
<b>CITROËN - JUMPER Bus (244, Z_) 04/02→</b>							
 <b>Bremsbelagsatz, Scheibenbremse</b>							
2.0 2.0 HDi 2.2 HDi 2.8 HDi	81 62 74 94	04/02→ 04/02→ 04/02→ 04/02→	←	→ 03/06; Nutzlast ab [kg] 1.000 Nutzlast bis [kg] 1.400	13.0460-4978.2	604978	BRE 23917 19,3 + WK + Zub
			←	→ 03/06; Nutzlast [kg]: 1.800	13.0460-4979.2	604979	BRE 23919 19,3 + WK + Zub
			→	→ 03/06; Nutzlast ab [kg] 1.000 Nutzlast bis [kg] 1.800	13.0460-4980.2	604980	BRE 23921 20,3 - WE / - WK + Zub
2.8 HDi Allrad	94	04/02→	←	→ 03/06; Nutzlast ab [kg] 1.000 Nutzlast bis [kg] 1.400	13.0460-4978.2	604978	BRE 23917 19,3 + WK + Zub
			←	→ 03/06; Nutzlast [kg]: 1.800	13.0460-4979.2	604979	BRE 23919 19,3 + WK + Zub
			→	→ 03/06	13.0460-4980.2	604980	BRE 23921 20,3 - WE / - WK + Zub
 <b>Bremsscheibe</b>							
2.0 2.0 HDi 2.2 HDi 2.8 HDi 2.8 HDi Allrad	81 62 74 94 94	04/02→ 04/02→ 04/02→ 04/02→ 04/02→	←	→ 03/06; Nutzlast ab [kg] 1.000 Nutzlast bis [kg] 1.400	24.0124-0127.1	424127	Ø 280 24 21,9 V
			←	→ 03/06; Nutzlast [kg]: 1.800	24.0124-0138.1	424138	Ø 300 24 21,9 V
			→	→ 03/06; Nutzlast ab [kg] 1.000 Nutzlast bis [kg] 1.400	24.0116-0124.1	416124	Ø 280 16 14,2
			→	→ 03/06; Nutzlast [kg]: 1.800	24.0116-0125.1	416125	Ø 280 16 14,2
<b>CITROËN - JUMPER Kasten 04/06→</b>							
 <b>Bremsbelagsatz, Scheibenbremse</b>							
2.0 BlueHDi 110 2.0 BlueHDi 130 2.0 BlueHDi 160 2.0 BlueHDi 160 4x4	81 96 120 120	04/16→ 04/16→ 04/16→ 04/16→	←	Nutzlast 12Q/14Q; Nutzlast ab [kg] 1.200 Nutzlast bis [kg] 1.400	13.0460-4807.2	604807	BRE 24468 19,1 + WK + Zub
			←	Nutzlast leicht 16Q; Nutzlast [kg]: 1.600; nicht für erhöhte Nutzlast	13.0460-4809.2	604809	BRE 24468 19,1 + WK + Zub
			←	Nutzlast s. 16Q+ 20Q; Nutzlast ab [kg] 1.600 Nutzlast bis [kg] 2.000; für erhöhte Nutzlast	13.0460-4811.2	604811	BRE 24466 19,1 + WK + Zub
			→	Nutzlast 12Q/14Q/16Q; Nutzlast ab [kg] 1.200 Nutzlast bis [kg] 1.600	13.0460-4889.2	604889	BOS 22041 19,2 + WK + Zub
			→	Nutzlast 20Q; Nutzlast [kg]: 2.000	13.0460-4890.2	604890	BRE + WK + Zub
2.2 HDi 100 2.2 HDi 110 2.2 HDi 130 3.0 HDi 180	74 81 96 130	04/06→ 07/11→ 07/11→ 07/11→	←	Nutzlast 12Q/14Q; Nutzlast ab [kg] 1.200 Nutzlast bis [kg] 1.400	13.0460-4807.2	604807	BRE 24468 19,1 + WK + Zub
			←	Nutzlast leicht 16Q; Nutzlast [kg]: 1.600; nicht für erhöhte Nutzlast	13.0460-4809.2	604809	BRE 24468 19,1 + WK + Zub
			←	Nutzlast schwer 16Q; Nutzlast [kg]: 1.600; für erhöhte Nutzlast	13.0460-4810.2	604810	BRE 24466 19,1 + WK + Zub
			←	Nutzlast 20Q; Nutzlast [kg]: 2.000	13.0460-4811.2	604811	BRE 24466 19,1 + WK + Zub
			→		13.0460-4812.2	604812	BOS 24465 19,2 - WE / - WK + Zub
2.2 HDi 120 3.0 HDi 145 3.0 HDi 155 3.0 HDi 160	88 107 115 116	04/06→ 07/10→ 07/10→ 09/06→	←	Nutzlast 12Q/14Q; Nutzlast ab [kg] 1.200 Nutzlast bis [kg] 1.400	13.0460-4807.2	604807	BRE 24468 19,1 + WK + Zub
			←	Nutzlast leicht 16Q; Nutzlast [kg]: 1.600; nicht für erhöhte Nutzlast	13.0460-4809.2	604809	BRE 24468 19,1 + WK + Zub
			←	Nutzlast schwer 16Q; Nutzlast [kg]: 1.600; für erhöhte Nutzlast	13.0460-4810.2	604810	BRE 24466 19,1 + WK + Zub
			←	Nutzlast 20Q; Nutzlast [kg]: 2.000	13.0460-4811.2	604811	BRE 24466 19,1 + WK + Zub











	kw			 	! #		
<b>CITROËN - JUMPER Kasten 04/06→</b>							
 <b>Bremsbelagsatz, Scheibenbremse</b>							
2.2 HDi 120 3.0 HDi 145 3.0 HDi 155 3.0 HDi 160	88 107 115 116	04/06→ 07/10→ 07/10→ 09/06→	➡	Nutzlast ab [kg] 1.200 Nutzlast bis [kg] 2.000; light/heavy		<b>13.0460-4812.2 604812</b>	BOS 24465 19,2 - WE / - WK + Zub
2.2 HDi 150	110	07/11→	←	Nutzlast 12Q/14Q; Nutzlast ab [kg] 1.200 Nutzlast bis [kg] 1.400		<b>13.0460-4807.2 604807</b>	BRE 24468 19,1 + WK + Zub
			←	Nutzlast leicht 16Q; Nutzlast [kg]: 1.600; nicht für erhöhte Nutzlast		<b>13.0460-4809.2 604809</b>	BRE 24468 19,1 + WK + Zub
			←	Nutzlast schwer 16Q; Nutzlast [kg]: 1.600; für erhöhte Nutzlast		<b>13.0460-4810.2 604810</b>	BRE 24466 19,1 + WK + Zub
			←	Nutzlast 20Q; Nutzlast [kg]: 2.000		<b>13.0460-4811.2 604811</b>	BRE 24466 19,1 + WK + Zub
			➡	→ 12/13		<b>13.0460-4812.2 604812</b>	BOS 24465 19,2 - WE / - WK + Zub
			➡	01/14→; Nutzlast 12Q/14Q/16Q; Nutzlast ab [kg] 1.200 Nutzlast bis [kg] 1.600		<b>13.0460-4889.2 604889</b>	BOS 22041 19,2 + WK + Zub
			➡	01/14→; Nutzlast 20Q; Nutzlast [kg]: 2.000		<b>13.0460-4890.2 604890</b>	BRE + WK + Zub
 <b>Bremsscheibe</b>							
2.0 BlueHDi 110 2.0 BlueHDi 130 2.0 BlueHDi 160 2.0 BlueHDi 160 4x4	81 96 120 120	04/16→ 04/16→ 04/16→ 04/16→	←	Nutzlast leicht 12Q; Nutzlast [kg]: 1.200; nicht für erhöhte Nutzlast		<b>24.0124-0127.1 424127</b>	Ø 280 24 21,9 V
			➡	Nutzlast 12Q/14Q + / leicht 16Q; Nutzlast ab [kg] 1.200 Nutzlast bis [kg] 1.600; nicht für erhöhte Nutzlast		<b>24.0116-0124.1 416124</b>	Ø 280 16 14,2
			➡	Nutzlast schwer 16Q; Nutzlast [kg]: 1.600; für erhöhte Nutzlast		<b>24.0116-0125.1 416125</b>	Ø 280 16 14,2
2.2 HDi 100 2.2 HDi 110 2.2 HDi 120 2.2 HDi 130 2.2 HDi 150 3.0 HDi 145 3.0 HDi 155 3.0 HDi 160 3.0 HDi 180	74 81 88 96 110 107 115 116 130	04/06→ 07/11→ 04/06→ 07/11→ 07/11→ 07/10→ 07/10→ 09/06→ 07/11→	←	Nutzlast 12Q/14Q; Nutzlast ab [kg] 1.200 Nutzlast bis [kg] 1.400		<b>24.0124-0127.1 424127</b>	Ø 280 24 21,9 V
			←	Nutzlast schwer 16Q; Nutzlast [kg]: 1.600; für erhöhte Nutzlast		<b>24.0124-0138.1 424138</b>	Ø 300 24 21,9 V
			←	Nutzlast leicht 16Q; Nutzlast [kg]: 1.600; nicht für erhöhte Nutzlast		<b>24.0128-0213.1 428213</b>	Ø 280 28 25,9 V
			←	Nutzlast 20Q; Nutzlast [kg]: 2.000		<b>24.0132-0131.1 432131</b>	Ø 300 32 29,9 V
			➡	Nutzlast 20Q; Nutzlast [kg]: 2.000		<b>24.0116-0123.1 416123</b>	Ø 300 16 14,2
			➡	Nutzlast 12Q/14Q + / leicht 16Q; Nutzlast ab [kg] 1.200 Nutzlast bis [kg] 1.600; nicht für erhöhte Nutzlast		<b>24.0116-0124.1 416124</b>	Ø 280 16 14,2
			➡	Nutzlast schwer 16Q; Nutzlast [kg]: 1.600; für erhöhte Nutzlast		<b>24.0116-0125.1 416125</b>	Ø 280 16 14,2
<b>CITROËN - JUMPER Kasten (230L) 02/94→04/02</b>							
 <b>Bremsbelagsatz, Scheibenbremse</b>							
1.9 D 1.9 D	50 51	07/99→04/02 02/94→04/02	←	01/00→ 10/01; Nutzlast [kg]: 1.000		<b>13.0460-2850.2 602850</b>	TRW 21797 19,7 + WK
			←	→ 12/99; Nutzlast [kg]: 1.000		<b>13.0460-2976.2 602976</b>	TRW 21797 19,7 + WK
			←	11/01→ 03/02; Nutzlast [kg]: 1.000		<b>13.0460-4978.2 604978</b>	BRE 23917 19,3 + WK + Zub
			➡	11/01→ 03/02; Nutzlast [kg]: 1.000		<b>13.0460-4980.2 604980</b>	BRE 23921 20,3 - WE / - WK + Zub
1.9 TD 1.9 TD	66 68	03/94→04/02 03/94→04/02	←	01/00→ 10/01; Nutzlast ab [kg] 1.000 Nutzlast bis [kg] 1.400		<b>13.0460-2850.2 602850</b>	TRW 21797 19,7 + WK
			←	→ 12/99; Nutzlast ab [kg] 1.000 Nutzlast bis [kg] 1.400		<b>13.0460-2976.2 602976</b>	TRW 21797 19,7 + WK
			←	11/01→ 03/02; Nutzlast ab [kg] 1.000 Nutzlast bis [kg] 1.400		<b>13.0460-4978.2 604978</b>	BRE 23917 19,3 + WK + Zub
			➡	11/01→ 03/02; Nutzlast ab [kg] 1.000 Nutzlast bis [kg] 1.400		<b>13.0460-4980.2 604980</b>	BRE 23921 20,3 - WE / - WK + Zub
2.0	80	03/94→04/02	←	01/00→ 10/01; Nutzlast ab [kg] 1.000 Nutzlast bis [kg] 1.400		<b>13.0460-2850.2 602850</b>	TRW 21797 19,7 + WK
			←	01/00→ 10/01; Nutzlast [kg]: 1.800		<b>13.0460-2852.2 602852</b>	TRW 21799 19,7 + WK
			←	→ 12/99; Nutzlast ab [kg] 1.000 Nutzlast bis [kg] 1.400		<b>13.0460-2976.2 602976</b>	TRW 21797 19,7 + WK
			←	→ 12/99; Nutzlast [kg]: 1.800		<b>13.0460-2977.2 602977</b>	TRW 21799 19,7 + WK
			←	11/01→ 03/02; Nutzlast ab [kg] 1.000 Nutzlast bis [kg] 1.400		<b>13.0460-4978.2 604978</b>	BRE 23917 19,3 + WK + Zub
			←	11/01→ 03/02; Nutzlast [kg]: 1.800		<b>13.0460-4979.2 604979</b>	BRE 23919 19,3 + WK + Zub
			➡	11/01→ 03/02; Nutzlast ab [kg] 1.000 Nutzlast bis [kg] 1.800		<b>13.0460-4980.2 604980</b>	BRE 23921 20,3 - WE / - WK + Zub
2.0 4x4	80	10/96→01/02	←	01/00→ 10/01; Nutzlast ab [kg] 1.000 Nutzlast bis [kg] 1.400		<b>13.0460-2850.2 602850</b>	TRW 21797 19,7 + WK
			←	01/00→ 10/01; Nutzlast [kg]: 1.800		<b>13.0460-2852.2 602852</b>	TRW 21799 19,7 + WK
↓							









	kw			 	! #		
<b>CITROËN - JUMPER Kasten (230L) 02/94→04/02</b>							
<b> Bremsbelagsatz, Scheibenbremse</b>							
2.0 4x4	80	10/96→01/02	←	→ 12/99; Nutzlast ab [kg] 1.000 Nutzlast bis [kg] 1.400	13.0460-2976.2	602976	TRW 21797 19,7 + WK
			←	→ 12/99; Nutzlast [kg]: 1.800	13.0460-2977.2	602977	TRW 21799 19,7 + WK
			←	11/01→; Nutzlast ab [kg] 1.000 Nutzlast bis [kg] 1.400	13.0460-4978.2	604978	BRE 23917 19,3 + WK + Zub
			←	11/01→; Nutzlast [kg]: 1.800	13.0460-4979.2	604979	BRE 23919 19,3 + WK + Zub
			→	11/01→; Nutzlast ab [kg] 1.000 Nutzlast bis [kg] 1.800	13.0460-4980.2	604980	BRE 23921 20,3 - WE / - WK + Zub
2.0 HDI	62	11/01→04/02	←	→ 03/02; Nutzlast ab [kg] 1.000 Nutzlast bis [kg] 1.400	13.0460-4978.2	604978	BRE 23917 19,3 + WK + Zub
			←	→ 03/02; Nutzlast [kg]: 1.800	13.0460-4979.2	604979	BRE 23919 19,3 + WK + Zub
			→	→ 03/02; Nutzlast ab [kg] 1.000 Nutzlast bis [kg] 1.800	13.0460-4980.2	604980	BRE 23921 20,3 - WE / - WK + Zub
2.5 D 2.5 TD	63 76	03/94→04/02 03/94→04/02	←	01/00→ 10/01; Nutzlast [kg]: 1.400	13.0460-2850.2	602850	TRW 21797 19,7 + WK
			←	01/00→ 10/01; Nutzlast [kg]: 1.800	13.0460-2852.2	602852	TRW 21799 19,7 + WK
			←	→ 12/99; Nutzlast [kg]: 1.400	13.0460-2976.2	602976	TRW 21797 19,7 + WK
			←	→ 12/99; Nutzlast [kg]: 1.800	13.0460-2977.2	602977	TRW 21799 19,7 + WK
			←	11/01→ 03/02; Nutzlast [kg]: 1.400	13.0460-4978.2	604978	BRE 23917 19,3 + WK + Zub
			←	11/01→ 03/02; Nutzlast [kg]: 1.800	13.0460-4979.2	604979	BRE 23919 19,3 + WK + Zub
			→	11/01→ 03/02; Nutzlast ab [kg] 1.400 Nutzlast bis [kg] 1.800	13.0460-4980.2	604980	BRE 23921 20,3 - WE / - WK + Zub
2.5 D 4x4 2.8 HDi 2.8 HDi 4x4	63 94 94	03/00→04/02 09/00→04/02 09/00→04/02	←	→ 10/01; Nutzlast [kg]: 1.400	13.0460-2850.2	602850	TRW 21797 19,7 + WK
			←	→ 10/01; Nutzlast [kg]: 1.800	13.0460-2852.2	602852	TRW 21799 19,7 + WK
			←	11/01→ 03/02; Nutzlast [kg]: 1.400	13.0460-4978.2	604978	BRE 23917 19,3 + WK + Zub
			←	11/01→ 03/02; Nutzlast [kg]: 1.800	13.0460-4979.2	604979	BRE 23919 19,3 + WK + Zub
			→	11/01→ 03/02; Nutzlast ab [kg] 1.400 Nutzlast bis [kg] 1.800	13.0460-4980.2	604980	BRE 23921 20,3 - WE / - WK + Zub
2.5 DT 4x4	76	10/96→08/97	←	Nutzlast [kg]: 1.400	13.0460-2976.2	602976	TRW 21797 19,7 + WK
2.5 TDi	79	12/96→11/00	←	01/00→; Nutzlast [kg]: 1.400	13.0460-2850.2	602850	TRW 21797 19,7 + WK
			←	01/00→; Nutzlast [kg]: 1.800	13.0460-2852.2	602852	TRW 21799 19,7 + WK
			←	→ 12/99; Nutzlast [kg]: 1.400	13.0460-2976.2	602976	TRW 21797 19,7 + WK
			←	→ 12/99; Nutzlast [kg]: 1.800	13.0460-2977.2	602977	TRW 21799 19,7 + WK
2.5 TDi 4x4	79	03/00→11/00	←	Nutzlast [kg]: 1.400	13.0460-2850.2	602850	TRW 21797 19,7 + WK
			←	Nutzlast [kg]: 1.800	13.0460-2852.2	602852	TRW 21799 19,7 + WK
<b> Bremsscheibe</b>							
1.9 D 1.9 D	50 51	07/99→04/02 02/94→04/02	←	→ 10/01; Nutzlast [kg]: 1.000	24.0118-0108.1	418108	Ø 280 18 15,9
			←	11/01→ 03/02; Nutzlast [kg]: 1.000	24.0124-0127.1	424127	Ø 280 24 21,9 V
			→	11/01→ 03/02; Nutzlast [kg]: 1.000	24.0116-0124.1	416124	Ø 280 16 14,2
1.9 TD 1.9 TD	66 68	03/94→04/02 03/94→04/02	←	→ 10/01; Nutzlast ab [kg] 1.000 Nutzlast bis [kg] 1.400	24.0118-0108.1	418108	Ø 280 18 15,9
			←	11/01→ 03/02; Nutzlast ab [kg] 1.000 Nutzlast bis [kg] 1.400	24.0124-0127.1	424127	Ø 280 24 21,9 V
			→	11/01→ 03/02; Nutzlast ab [kg] 1.000 Nutzlast bis [kg] 1.400	24.0116-0124.1	416124	Ø 280 16 14,2
2.0	80	03/94→04/02	←	→ 10/01; Nutzlast ab [kg] 1.000 Nutzlast bis [kg] 1.400	24.0118-0108.1	418108	Ø 280 18 15,9
			←	11/01→ 03/02; Nutzlast ab [kg] 1.000 Nutzlast bis [kg] 1.400	24.0124-0127.1	424127	Ø 280 24 21,9 V
			←	11/01→ 03/02; Nutzlast [kg]: 1.800	24.0124-0138.1	424138	Ø 300 24 21,9 V
			→	11/01→ 03/02; Nutzlast ab [kg] 1.000 Nutzlast bis [kg] 1.400	24.0116-0124.1	416124	Ø 280 16 14,2
			→	11/01→ 03/02; Nutzlast [kg]: 1.800	24.0116-0125.1	416125	Ø 280 16 14,2
2.0 4x4	80	10/96→01/02	←	→ 10/01; Nutzlast ab [kg] 1.000 Nutzlast bis [kg] 1.400	24.0118-0108.1	418108	Ø 280 18 15,9
			←	11/01→; Nutzlast ab [kg] 1.000 Nutzlast bis [kg] 1.400	24.0124-0127.1	424127	Ø 280 24 21,9 V
			←	11/01→; Nutzlast [kg]: 1.800	24.0124-0138.1	424138	Ø 300 24 21,9 V
			→	11/01→; Nutzlast ab [kg] 1.000 Nutzlast bis [kg] 1.400	24.0116-0124.1	416124	Ø 280 16 14,2
			→	11/01→; Nutzlast [kg]: 1.800	24.0116-0125.1	416125	Ø 280 16 14,2
2.0 HDI	62	11/01→04/02	←	→ 03/02; Nutzlast ab [kg] 1.000 Nutzlast bis [kg] 1.400	24.0124-0127.1	424127	Ø 280 24 21,9 V
↓							































	kw					! #		
<b>CITROËN - JUMPER Kasten (230L) 02/94→04/02</b>								
 <b>Bremsscheibe</b>								
2.0 HDI	62	11/01→04/02	←	→ 03/02; Nutzlast [kg]: 1.800	24.0124-0138.1	424138	Ø 300 24 21,9 V	
			→	→ 03/02; Nutzlast ab [kg] 1.000 Nutzlast bis [kg] 1.400	24.0116-0124.1	416124	Ø 280 16 14,2	
			→	→ 03/02; Nutzlast [kg]: 1.800	24.0116-0125.1	416125	Ø 280 16 14,2	
2.5 D 2.5 D 4x4	63	03/94→04/02	←	→ 10/01; Nutzlast [kg]: 1.400	24.0118-0108.1	418108	Ø 280 18 15,9	
	63	03/00→04/02	←	11/01→ 03/02; Nutzlast [kg]: 1.400	24.0124-0127.1	424127	Ø 280 24 21,9 V	
			←	11/01→ 03/02; Nutzlast [kg]: 1.800	24.0124-0138.1	424138	Ø 300 24 21,9 V	
			→	11/01→ 03/02; Nutzlast [kg]: 1.400	24.0116-0124.1	416124	Ø 280 16 14,2	
			→	11/01→ 03/02; Nutzlast [kg]: 1.800	24.0116-0125.1	416125	Ø 280 16 14,2	
2.5 DT 4x4	76	10/96→08/97	←	Nutzlast [kg]: 1.400	24.0124-0127.1	424127	Ø 280 24 21,9 V	
2.5 TD 2.8 HDi 2.8 HDi 4x4	76	03/94→04/02	←	→ 03/02; Nutzlast [kg]: 1.400	24.0124-0127.1	424127	Ø 280 24 21,9 V	
	94	09/00→04/02	←	→ 03/02; Nutzlast [kg]: 1.800	24.0124-0138.1	424138	Ø 300 24 21,9 V	
	94	09/00→04/02	→	11/01→ 03/02; Nutzlast [kg]: 1.400	24.0116-0124.1	416124	Ø 280 16 14,2	
			→	11/01→ 03/02; Nutzlast [kg]: 1.800	24.0116-0125.1	416125	Ø 280 16 14,2	
2.5 TDi 2.5 TDi 4x4	79	12/96→11/00	←	Nutzlast [kg]: 1.400	24.0124-0127.1	424127	Ø 280 24 21,9 V	
	79	03/00→11/00	←	Nutzlast [kg]: 1.800	24.0124-0138.1	424138	Ø 300 24 21,9 V	
<b>CITROËN - JUMPER Kasten (244) 04/02→</b>								
 <b>Bremsbelagsatz, Scheibenbremse</b>								
2.0 2.0 bivalent 2.0 HDi 2.2 HDi 2.8 HDi 2.8 HDi	81	04/02→	←	→ 03/06; Nutzlast ab [kg] 1.000 Nutzlast bis [kg] 1.400	13.0460-4978.2	604978	BRE 23917 19,3 + WK + Zub	
	81	02/03→	←	→ 03/06; Nutzlast [kg]: 1.800	13.0460-4979.2	604979	BRE 23919 19,3 + WK + Zub	
	62	04/02→						
	74	04/02→	→	→ 03/06; Nutzlast ab [kg] 1.000 Nutzlast bis [kg] 1.800	13.0460-4980.2	604980	BRE 23921 20,3 - WE / - WK + Zub	
	94	04/02→	→	→ 03/06	13.0460-4980.2	604980	BRE 23921 20,3 - WE / - WK + Zub	
107	05/04→							
2.8 HDi 4x4	94	04/02→	←	→ 03/06; Nutzlast ab [kg] 1.000 Nutzlast bis [kg] 1.400	13.0460-4978.2	604978	BRE 23917 19,3 + WK + Zub	
			←	→ 03/06; Nutzlast [kg]: 1.800	13.0460-4979.2	604979	BRE 23919 19,3 + WK + Zub	
			→	→ 03/06	13.0460-4980.2	604980	BRE 23921 20,3 - WE / - WK + Zub	
			→	→ 03/06; Nutzlast ab [kg] 1.000 Nutzlast bis [kg] 1.800	13.0460-4980.2	604980	BRE 23921 20,3 - WE / - WK + Zub	
 <b>Bremsscheibe</b>								
2.0 2.0 bivalent 2.0 HDi 2.2 HDi 2.8 HDi 2.8 HDi 2.8 HDi 4x4	81	04/02→	←	→ 03/06; Nutzlast ab [kg] 1.000 Nutzlast bis [kg] 1.400	24.0124-0127.1	424127	Ø 280 24 21,9 V	
	81	02/03→	←	→ 03/06; Nutzlast [kg]: 1.800	24.0124-0138.1	424138	Ø 300 24 21,9 V	
	62	04/02→						
	74	04/02→	→	→ 03/06; Nutzlast ab [kg] 1.000 Nutzlast bis [kg] 1.400	24.0116-0124.1	416124	Ø 280 16 14,2	
	94	04/02→	→	→ 03/06; Nutzlast [kg]: 1.800	24.0116-0125.1	416125	Ø 280 16 14,2	
	107	05/04→						
94	04/02→							
<b>CITROËN - JUMPER Pritsche/Fahrgestell 04/06→</b>								
 <b>Bremsbelagsatz, Scheibenbremse</b>								
2.0 BlueHdi 110 2.0 BlueHdi 130 2.0 BlueHdi 130 4x4 2.0 BlueHdi 160 2.0 BlueHdi 160 4x4	81	04/16→	←	Nutzlast 12Q/14Q; Nutzlast ab [kg] 1.200 Nutzlast bis [kg] 1.400	13.0460-4807.2	604807	BRE 24468 19,1 + WK + Zub	
	96	04/16→	←	Nutzlast leicht 16Q; Nutzlast [kg]: 1.600; nicht für erhöhte Nutzlast	13.0460-4809.2	604809	BRE 24468 19,1 + WK + Zub	
	96	04/16→						
	120	04/16→	←	Nutzlast s. 16Q+ 20Q; Nutzlast ab [kg] 1.600 Nutzlast bis [kg] 2.000; für erhöhte Nutzlast	13.0460-4811.2	604811	BRE 24466 19,1 + WK + Zub	
	2.2 HDi 100 2.2 HDi 110 2.2 HDi 130 3.0 HDi 180	74	04/06→	←	Nutzlast 12Q/14Q; Nutzlast ab [kg] 1.200 Nutzlast bis [kg] 1.400	13.0460-4807.2	604807	BRE 24468 19,1 + WK + Zub
		81	07/11→	←	Nutzlast leicht 16Q; Nutzlast [kg]: 1.600; nicht für erhöhte Nutzlast	13.0460-4809.2	604809	BRE 24468 19,1 + WK + Zub
96		07/11→						
130	07/11→	←	Nutzlast schwer 16Q; Nutzlast [kg]: 1.600; für erhöhte Nutzlast	13.0460-4810.2	604810	BRE 24466 19,1 + WK + Zub		
2.2 HDi 120 3.0 HDi 145 3.0 HDi 160	88	04/06→	←	Nutzlast 20Q; Nutzlast [kg]: 2.000	13.0460-4811.2	604811	BRE 24466 19,1 + WK + Zub	
	107	07/10→	→		13.0460-4812.2	604812	BOS 24465 19,2 - WE / - WK + Zub	
	116	09/06→						
↓								

















	kw			 	! #		
<b>CITROËN - JUMPER Pritsche/Fahrgestell 04/06→</b>							
 <b>Bremsbelagsatz, Scheibenbremse</b>							
2.2 HDi 120 3.0 HDi 145 3.0 HDi 160	88 107 116	04/06→ 07/10→ 09/06→	←	Nutzlast leicht 16Q; Nutzlast [kg]: 1.600; nicht für erhöhte Nutzlast	13.0460-4809.2	604809	BRE 24468 19,1 + WK + Zub
			←	Nutzlast schwer 16Q; Nutzlast [kg]: 1.600; für erhöhte Nutzlast	13.0460-4810.2	604810	BRE 24466 19,1 + WK + Zub
			←	Nutzlast 20Q; Nutzlast [kg]: 2.000	13.0460-4811.2	604811	BRE 24466 19,1 + WK + Zub
			→	Nutzlast ab [kg] 1.200 Nutzlast bis [kg] 2.000; light/heavy	13.0460-4812.2	604812	BOS 24465 19,2 - WE / - WK + Zub
2.2 HDi 150	110	07/11→	←	Nutzlast 12Q/14Q; Nutzlast ab [kg] 1.200 Nutzlast bis [kg] 1.400	13.0460-4807.2	604807	BRE 24468 19,1 + WK + Zub
			←	Nutzlast leicht 16Q; Nutzlast [kg]: 1.600; nicht für erhöhte Nutzlast	13.0460-4809.2	604809	BRE 24468 19,1 + WK + Zub
			←	Nutzlast schwer 16Q; Nutzlast [kg]: 1.600; für erhöhte Nutzlast	13.0460-4810.2	604810	BRE 24466 19,1 + WK + Zub
			←	Nutzlast 20Q; Nutzlast [kg]: 2.000	13.0460-4811.2	604811	BRE 24466 19,1 + WK + Zub
			→	→ 12/13	13.0460-4812.2	604812	BOS 24465 19,2 - WE / - WK + Zub
			→	01/14→; Nutzlast 12Q/14Q/16Q; Nutzlast ab [kg] 1.200 Nutzlast bis [kg] 1.600	13.0460-4889.2	604889	BOS 22041 19,2 + WK + Zub
			→	01/14→; Nutzlast 20Q; Nutzlast [kg]: 2.000	13.0460-4890.2	604890	BRE + WK + Zub
 <b>Bremsscheibe</b>							
2.0 BlueHDi 110 2.0 BlueHDi 130 2.0 BlueHDi 130 4x4 2.0 BlueHDi 160 2.0 BlueHDi 160 4x4	81 96 96 120 120	04/16→ 04/16→ 04/16→ 04/16→ 04/16→	←	Nutzlast leicht 12Q; Nutzlast [kg]: 1.200; nicht für erhöhte Nutzlast	24.0124-0127.1	424127	Ø 280 24 21,9 V
			→	Nutzlast 12Q/14Q + / leicht 16Q; Nutzlast ab [kg] 1.200 Nutzlast bis [kg] 1.600; nicht für erhöhte Nutzlast	24.0116-0124.1	416124	Ø 280 16 14,2
			→	Nutzlast schwer 16Q; Nutzlast [kg]: 1.600; für erhöhte Nutzlast	24.0116-0125.1	416125	Ø 280 16 14,2
2.2 HDi 100 2.2 HDi 110 2.2 HDi 120 2.2 HDi 130 2.2 HDi 150 3.0 HDi 145 3.0 HDi 160 3.0 HDi 180	74 81 88 96 110 107 116 130	04/06→ 07/11→ 04/06→ 07/11→ 07/11→ 07/10→ 09/06→ 07/11→	←	Nutzlast 12Q/14Q; Nutzlast ab [kg] 1.200 Nutzlast bis [kg] 1.400	24.0124-0127.1	424127	Ø 280 24 21,9 V
			←	Nutzlast schwer 16Q; Nutzlast [kg]: 1.600; für erhöhte Nutzlast	24.0124-0138.1	424138	Ø 300 24 21,9 V
			←	Nutzlast leicht 16Q; Nutzlast [kg]: 1.600; nicht für erhöhte Nutzlast	24.0128-0213.1	428213	Ø 280 28 25,9 V
			←	Nutzlast 20Q; Nutzlast [kg]: 2.000	24.0132-0131.1	432131	Ø 300 32 29,9 V
			→	Nutzlast 20Q; Nutzlast [kg]: 2.000	24.0116-0123.1	416123	Ø 300 16 14,2
			→	Nutzlast 12Q/14Q + / leicht 16Q; Nutzlast ab [kg] 1.200 Nutzlast bis [kg] 1.600; nicht für erhöhte Nutzlast	24.0116-0124.1	416124	Ø 280 16 14,2
			→	Nutzlast schwer 16Q; Nutzlast [kg]: 1.600; für erhöhte Nutzlast	24.0116-0125.1	416125	Ø 280 16 14,2
<b>CITROËN - JUMPER Pritsche/Fahrgestell (230) 03/94→04/02</b>							
 <b>Bremsbelagsatz, Scheibenbremse</b>							
1.9 TD 1.9 TD	66 68	03/94→04/02 03/94→04/02	←	01/00→ 10/01; Nutzlast ab [kg] 1.000 Nutzlast bis [kg] 1.400	13.0460-2850.2	602850	TRW 21797 19,7 + WK
			←	→ 12/99; Nutzlast ab [kg] 1.000 Nutzlast bis [kg] 1.400	13.0460-2976.2	602976	TRW 21797 19,7 + WK
			←	11/01→ 03/02; Nutzlast ab [kg] 1.000 Nutzlast bis [kg] 1.400	13.0460-4978.2	604978	BRE 23917 19,3 + WK + Zub
			→	11/01→ 03/02; Nutzlast ab [kg] 1.000 Nutzlast bis [kg] 1.400	13.0460-4980.2	604980	BRE 23921 20,3 - WE / - WK + Zub
2.0	80	03/94→04/02	←	01/00→ 10/01; Nutzlast ab [kg] 1.000 Nutzlast bis [kg] 1.400	13.0460-2850.2	602850	TRW 21797 19,7 + WK
			←	01/00→ 10/01; Nutzlast [kg]: 1.800	13.0460-2852.2	602852	TRW 21799 19,7 + WK
			←	→ 12/99; Nutzlast ab [kg] 1.000 Nutzlast bis [kg] 1.400	13.0460-2976.2	602976	TRW 21797 19,7 + WK
			←	→ 12/99; Nutzlast [kg]: 1.800	13.0460-2977.2	602977	TRW 21799 19,7 + WK
			←	11/01→ 03/02; Nutzlast ab [kg] 1.000 Nutzlast bis [kg] 1.400	13.0460-4978.2	604978	BRE 23917 19,3 + WK + Zub
			←	11/01→ 03/02; Nutzlast [kg]: 1.800	13.0460-4979.2	604979	BRE 23919 19,3 + WK + Zub
			→	11/01→ 03/02; Nutzlast ab [kg] 1.000 Nutzlast bis [kg] 1.800	13.0460-4980.2	604980	BRE 23921 20,3 - WE / - WK + Zub
2.5 D 2.5 TD 2.5 TDi	63 76 79	03/94→04/02 03/94→04/02 12/96→04/02	←	01/00→ 10/01; Nutzlast [kg]: 1.400	13.0460-2850.2	602850	TRW 21797 19,7 + WK
			←	01/00→ 10/01; Nutzlast [kg]: 1.800	13.0460-2852.2	602852	TRW 21799 19,7 + WK
			←	→ 12/99; Nutzlast [kg]: 1.400	13.0460-2976.2	602976	TRW 21797 19,7 + WK
			←	→ 12/99; Nutzlast [kg]: 1.800	13.0460-2977.2	602977	TRW 21799 19,7 + WK
			←	11/01→ 03/02; Nutzlast [kg]: 1.400	13.0460-4978.2	604978	BRE 23917 19,3 + WK + Zub













	kw				! #		
<b>CITROËN - JUMPER Pritsche/Fahrgestell (230) 03/94→04/02</b>							
<b> Bremsbelagsatz, Scheibenbremse</b>							
2.5 D	63	03/94→04/02	←	11/01→ 03/02; Nutzlast [kg]: 1.800		<b>13.0460-4979.2 604979</b>	BRE 23919 19,3 + WK + Zub
2.5 TD	76	03/94→04/02	→	11/01→ 03/02; Nutzlast ab [kg] 1.400		<b>13.0460-4980.2 604980</b>	BRE 23921 20,3 - WE / - WK + Zub
2.5 TDi	79	12/96→04/02	→	Nutzlast bis [kg] 1.800			
2.5 D 4x4 2.5 TDi 4x4 2.8 HDi	63	03/00→04/02	←	→ 10/01; Nutzlast [kg]: 1.400		<b>13.0460-2850.2 602850</b>	TRW 21797 19,7 + WK
	79	03/00→04/02	←	→ 10/01; Nutzlast [kg]: 1.800		<b>13.0460-2852.2 602852</b>	TRW 21799 19,7 + WK
	94	09/00→04/02	←	11/01→ 03/02; Nutzlast [kg]: 1.400		<b>13.0460-4978.2 604978</b>	BRE 23917 19,3 + WK + Zub
			←	11/01→ 03/02; Nutzlast [kg]: 1.800		<b>13.0460-4979.2 604979</b>	BRE 23919 19,3 + WK + Zub
			→	11/01→ 03/02; Nutzlast ab [kg] 1.400 Nutzlast bis [kg] 1.800		<b>13.0460-4980.2 604980</b>	BRE 23921 20,3 - WE / - WK + Zub
2.8 D	64	01/99→02/02	←	→ S 16205352; Nutzlast [kg]: 1.800		<b>13.0460-2852.2 602852</b>	TRW 21799 19,7 + WK
						<b>13.0460-2977.2 602977</b>	TRW 21799 19,7 + WK
			←	→ S 16206253; Nutzlast [kg]: 1.400		<b>13.0460-2976.2 602976</b>	TRW 21797 19,7 + WK
			←	S 16204256→; Nutzlast [kg]: 1.400		<b>13.0460-4978.2 604978</b>	BRE 23917 19,3 + WK + Zub
			←	S 16194400→; Nutzlast [kg]: 1.800		<b>13.0460-4979.2 604979</b>	BRE 23919 19,3 + WK + Zub
			→	S 16194400→; Nutzlast ab [kg] 1.400 Nutzlast bis [kg] 1.800		<b>13.0460-4980.2 604980</b>	BRE 23921 20,3 - WE / - WK + Zub
<b> Bremsscheibe</b>							
1.9 TD	66 68	03/94→04/02 03/94→04/02	←	→ 10/01; Nutzlast ab [kg] 1.000 Nutzlast bis [kg] 1.400		<b>24.0118-0108.1 418108</b>	Ø 280 18 15,9
			←	11/01→ 03/02; Nutzlast ab [kg] 1.000 Nutzlast bis [kg] 1.400		<b>24.0124-0127.1 424127</b>	Ø 280 24 21,9 V
			→	11/01→ 03/02; Nutzlast ab [kg] 1.000 Nutzlast bis [kg] 1.400		<b>24.0116-0124.1 416124</b>	Ø 280 16 14,2
2.0	80	03/94→04/02	←	→ 10/01; Nutzlast ab [kg] 1.000 Nutzlast bis [kg] 1.400		<b>24.0118-0108.1 418108</b>	Ø 280 18 15,9
			←	11/01→ 03/02; Nutzlast ab [kg] 1.000 Nutzlast bis [kg] 1.400		<b>24.0124-0127.1 424127</b>	Ø 280 24 21,9 V
			←	→ 03/02; Nutzlast [kg]: 1.800		<b>24.0124-0138.1 424138</b>	Ø 300 24 21,9 V
			→	11/01→ 03/02; Nutzlast ab [kg] 1.000 Nutzlast bis [kg] 1.400		<b>24.0116-0124.1 416124</b>	Ø 280 16 14,2
			→	11/01→ 03/02; Nutzlast [kg]: 1.800		<b>24.0116-0125.1 416125</b>	Ø 280 16 14,2
2.5 D 2.5 D 4x4	63 63	03/94→04/02 03/00→04/02	←	→ 10/01; Nutzlast [kg]: 1.400		<b>24.0118-0108.1 418108</b>	Ø 280 18 15,9
			←	11/01→ 03/02; Nutzlast [kg]: 1.400		<b>24.0124-0127.1 424127</b>	Ø 280 24 21,9 V
			←	→ 03/02; Nutzlast [kg]: 1.800		<b>24.0124-0138.1 424138</b>	Ø 300 24 21,9 V
			→	11/01→ 03/02; Nutzlast [kg]: 1.400		<b>24.0116-0124.1 416124</b>	Ø 280 16 14,2
			→	11/01→ 03/02; Nutzlast [kg]: 1.800		<b>24.0116-0125.1 416125</b>	Ø 280 16 14,2
2.5 TD 2.5 TDi 2.5 TDi 4x4 2.8 HDi	76 79 79 94	03/94→04/02 12/96→04/02 03/00→04/02 09/00→04/02	←	→ 03/02; Nutzlast [kg]: 1.400		<b>24.0124-0127.1 424127</b>	Ø 280 24 21,9 V
			←	→ 03/02; Nutzlast [kg]: 1.800		<b>24.0124-0138.1 424138</b>	Ø 300 24 21,9 V
			→	11/01→ 03/02; Nutzlast [kg]: 1.400		<b>24.0116-0124.1 416124</b>	Ø 280 16 14,2
			→	11/01→ 03/02; Nutzlast [kg]: 1.800		<b>24.0116-0125.1 416125</b>	Ø 280 16 14,2
			←	→ S 16206253; Nutzlast [kg]: 1.400		<b>24.0118-0108.1 418108</b>	Ø 280 18 15,9
2.8 D	64	01/99→02/02	←	S 16204256→; Nutzlast [kg]: 1.400		<b>24.0124-0127.1 424127</b>	Ø 280 24 21,9 V
			←	Nutzlast [kg]: 1.800		<b>24.0124-0138.1 424138</b>	Ø 300 24 21,9 V
			→	S 16194400→; Nutzlast [kg]: 1.400		<b>24.0116-0124.1 416124</b>	Ø 280 16 14,2
			→	S 16194400→; Nutzlast [kg]: 1.800		<b>24.0116-0125.1 416125</b>	Ø 280 16 14,2
			←	→ S 16206253; Nutzlast [kg]: 1.400		<b>24.0118-0108.1 418108</b>	Ø 280 18 15,9
<b>CITROËN - JUMPER Pritsche/Fahrgestell (244) 02/02→</b>							
<b> Bremsbelagsatz, Scheibenbremse</b>							
2.0 HDi	62	04/02→	←	→ 03/06; Nutzlast ab [kg] 1.000 Nutzlast bis [kg] 1.400		<b>13.0460-4978.2 604978</b>	BRE 23917 19,3 + WK + Zub
2.2 HDi	74	04/02→	←	→ 03/06; Nutzlast [kg]: 1.800		<b>13.0460-4979.2 604979</b>	BRE 23919 19,3 + WK + Zub
2.8 HDi	94	04/02→	→	→ 03/06; Nutzlast ab [kg] 1.000 Nutzlast bis [kg] 1.800		<b>13.0460-4980.2 604980</b>	BRE 23921 20,3 - WE / - WK + Zub
2.8 HDi	107	05/04→					
2.2 HDi	74	02/02→06/06	←	04/02→ 03/06; Nutzlast ab [kg] 1.000 Nutzlast bis [kg] 1.400		<b>13.0460-4978.2 604978</b>	BRE 23917 19,3 + WK + Zub
			←	04/02→ 03/06; Nutzlast [kg]: 1.800		<b>13.0460-4979.2 604979</b>	BRE 23919 19,3 + WK + Zub
			→	04/02→ 03/06; Nutzlast ab [kg] 1.000 Nutzlast bis [kg] 1.800		<b>13.0460-4980.2 604980</b>	BRE 23921 20,3 - WE / - WK + Zub
2.8 HDi 4x4	94	02/02→06/06	←	04/02→ 03/06; Nutzlast ab [kg] 1.000 Nutzlast bis [kg] 1.400		<b>13.0460-4978.2 604978</b>	BRE 23917 19,3 + WK + Zub
↓							











	kw					! #		
<b>CITROËN - JUMPER Pritsche/Fahrgestell (244) 02/02→</b>								
 <b>Bremsbelagsatz, Scheibenbremse</b>								
2.8 HDi 4x4	94	02/02→06/06	←	04/02→ 03/06; Nutzlast [kg]: 1.800		13.0460-4979.2	604979	BRE 23919 19,3 + WK + Zub
			→	04/02→ 03/06		13.0460-4980.2	604980	BRE 23921 20,3 - WE / - WK + Zub
 <b>Bremsscheibe</b>								
2.0 HDi	62	04/02→	←	→ 03/06; Nutzlast ab [kg] 1.000 Nutzlast bis [kg] 1.400		24.0124-0127.1	424127	Ø 280 24 21,9 V
2.2 HDi	74	04/02→						
2.8 HDi	94	04/02→	←	→ 03/06; Nutzlast [kg]: 1.800		24.0124-0138.1	424138	Ø 300 24 21,9 V
2.8 HDi	107	05/04→	→	→ 03/06; Nutzlast ab [kg] 1.000 Nutzlast bis [kg] 1.400		24.0116-0124.1	416124	Ø 280 16 14,2
			→	→ 03/06; Nutzlast [kg]: 1.800		24.0116-0125.1	416125	Ø 280 16 14,2
2.2 HDi	74	02/02→06/06	←	04/02→ 03/06; Nutzlast ab [kg] 1.000 Nutzlast bis [kg] 1.400		24.0124-0127.1	424127	Ø 280 24 21,9 V
2.8 HDi 4x4	94	02/02→06/06	←	04/02→ 03/06; Nutzlast [kg]: 1.800		24.0124-0138.1	424138	Ø 300 24 21,9 V
			→	04/02→ 03/06; Nutzlast ab [kg] 1.000 Nutzlast bis [kg] 1.400		24.0116-0124.1	416124	Ø 280 16 14,2
			→	04/02→ 03/06; Nutzlast [kg]: 1.800		24.0116-0125.1	416125	Ø 280 16 14,2
<b>CITROËN - JUMPY (U6U) 06/94→12/06</b>								
 <b>Bremsbelagsatz, Scheibenbremse</b>								
1.6	58	10/95→08/00	←	Orga 09793→		13.0460-2863.2	602863	TRW 20261 19,0 + WK + Zub
			←	→Orga 09792		13.0460-2978.2	602978	TRW 21801 19,0 + WK
			←	→Orga 09155		13.0460-3957.2	603957	BDX 23042 19,0 + WK + Zub
1.9 D	51	10/95→08/98	←	→Orga 09155		13.0460-2978.2	602978	TRW 21801 19,0 + WK
1.9 D 70	51	04/98→11/03	←	Orga 09156→		13.0460-3957.2	603957	BDX 23042 19,0 + WK + Zub
1.9 TD	66	10/95→08/00	←	Orga 09793→		13.0460-2863.2	602863	TRW 20261 19,0 + WK + Zub
2.0 HDi 110	80	03/00→10/06						
2.0 HDi 95	69	10/99→10/06	←	→Orga 09792		13.0460-2978.2	602978	TRW 21801 19,0 + WK
2.0 i 16V	102	03/00→10/06						
1.9 TD	68	04/96→11/03	←	→Orga 09792		13.0460-2978.2	602978	TRW 21801 19,0 + WK
2.0	100	04/00→12/06	←	Orga 09793→		13.0460-2863.2	602863	TRW 20261 19,0 + WK + Zub
			←	Orga 09156→ Orga 09792		13.0460-2978.2	602978	TRW 21801 19,0 + WK
			←	→Orga 09155		13.0460-3957.2	603957	BDX 23042 19,0 + WK + Zub
 <b>Bremsscheibe</b>								
1.6	58	10/95→08/00	←	→Orga 09155		24.0120-0155.1	420155	Ø 257,5 20 18,2 V
1.9 D	51	10/95→08/98						
1.9 D 70	51	04/98→11/03	←	→Orga 09792		24.0126-0104.1	426104	Ø 281 26 24,2 V
1.9 TD	66	10/95→08/00						
1.9 TD	68	04/96→11/03	←	Orga 09793→		24.0128-0136.1	428136	Ø 285 28 26 V
2.0	100	04/00→12/06				24.0328-0136.1	528136	Ø 285 28 26 V
2.0 HDi 110	80	03/00→10/06						
2.0 HDi 95	69	10/99→10/06						
2.0 i 16V	102	03/00→10/06						
<b>CITROËN - JUMPY (VA_, VE_) 04/16→</b>								
 <b>Bremsbelagsatz, Scheibenbremse</b>								
1.6 BlueHDi 115	85	04/16→	←	für Bremsscheibendurchmesser [mm]: 304		13.0460-7331.2	607331	ATE 22593 18,0 + WE / - WK
1.6 BlueHDi 95	70	04/16→						
2.0 BlueHDi 150	110	04/16→						
2.0 BlueHDi 180	130	04/16→	←			13.0460-7331.2	607331	ATE 22593 18,0 + WE / - WK
 <b>Bremsscheibe</b>								
1.6 BlueHDi 115	85	04/16→	→			24.0112-0212.1	412212	Ø 290 12 10 + S
1.6 BlueHDi 95	70	04/16→						
2.0 BlueHDi 150	110	04/16→						
2.0 BlueHDi 180	130	04/16→						
<b>CITROËN - JUMPY (VF7) 01/07→</b>								
 <b>Bremsbelagsatz, Scheibenbremse</b>								
1.6 HDi 90 16V	66	01/07→	←			13.0460-2738.2	602738	TRW 24595 18,5 + WK + Zub
1.6 HDi 90 8V	66	01/07→						
2.0 HDi 120	88	01/07→	→			13.0460-2739.2	602739	TRW 24578 16,5 - WE / - WK + Zub
2.0 HDi 125	94	07/11→						
2.0 HDi 140	100	01/07→						
2.0 HDi 165	120	07/10→						
2.0 HDi 95	72	07/11→						
2.0 i	103	01/07→	←			13.0460-2738.2	602738	TRW 24595 18,5 + WK + Zub











	kw			 	! #		
<b>CITROËN - JUMPY (VF7) 01/07→</b>							
 <b>Bremsbelagsatz, Scheibenbremse</b>							
2.0 i	103	01/07→	➔	langer Radstand		<b>13.0460-2739.2 602739</b>	TRW 24578 16,5 - WE / - WK + Zub
 <b>Bremsscheibe</b>							
1.6 HDi 90 16V 1.6 HDi 90 8V	66 66	01/07→ 01/07→	←	für Fahrzeuge mit Trommelbremse an der Hinterachse		<b>24.0128-0214.1 428214</b>	Ø 280 28 26 V + S
			←	für Fahrzeuge mit Scheibenbremse an der Hinterachse		<b>24.0128-0216.1 428216</b>	Ø 304 28 26 V + S
			➔			<b>24.0114-0116.1 414116</b>	Ø 290 14 12 + S
2.0 HDi 120 2.0 HDi 125 2.0 HDi 140 2.0 HDi 165 2.0 HDi 95	88 94 100 120 72	01/07→ 07/11→ 01/07→ 07/10→ 07/11→	←			<b>24.0128-0216.1 428216</b>	Ø 304 28 26 V + S
			➔			<b>24.0114-0116.1 414116</b>	Ø 290 14 12 + S
2.0 i	103	01/07→	←			<b>24.0128-0216.1 428216</b>	Ø 304 28 26 V + S
			➔	langer Radstand		<b>24.0114-0116.1 414116</b>	Ø 290 14 12 + S
<b>CITROËN - JUMPY Kasten 04/16→</b>							
 <b>Bremsbelagsatz, Scheibenbremse</b>							
1.6 BlueHDi 115 1.6 BlueHDi 95 2.0 BlueHDi 120 2.0 BlueHDi 150 2.0 BlueHDi 180	85 70 90 110 130	04/16→ 04/16→ 04/16→ 04/16→ 04/16→	←	für Bremsscheibendurchmesser [mm]: 304		<b>13.0460-7331.2 607331</b>	ATE 22593 18,0 + WE / - WK
			←			<b>13.0460-7331.2 607331</b>	ATE 22593 18,0 + WE / - WK
 <b>Bremsscheibe</b>							
1.6 BlueHDi 115 1.6 BlueHDi 95 2.0 BlueHDi 120 2.0 BlueHDi 150 2.0 BlueHDi 180	85 70 90 110 130	04/16→ 04/16→ 04/16→ 04/16→ 04/16→	➔			<b>24.0112-0212.1 412212</b>	Ø 290 12 10 + S
<b>CITROËN - JUMPY Kasten 01/07→</b>							
 <b>Bremsbelagsatz, Scheibenbremse</b>							
1.6 HDi 90 16V 1.6 HDi 90 8V 2.0 HDi 120 2.0 HDi 120 4x4 2.0 HDi 125 2.0 HDi 125 4x4 2.0 HDi 140 2.0 HDi 165 2.0 HDi 95	66 66 88 88 94 94 100 120 72	01/07→ 01/07→ 01/07→ 01/10→ 07/11→ 07/11→ 01/07→ 07/10→ 07/11→	←			<b>13.0460-2738.2 602738</b>	TRW 24595 18,5 + WK + Zub
			➔			<b>13.0460-2739.2 602739</b>	TRW 24578 16,5 - WE / - WK + Zub
2.0 i	103	01/07→	←			<b>13.0460-2738.2 602738</b>	TRW 24595 18,5 + WK + Zub
			➔	langer Radstand		<b>13.0460-2739.2 602739</b>	TRW 24578 16,5 - WE / - WK + Zub
 <b>Bremsscheibe</b>							
1.6 HDi 90 16V 1.6 HDi 90 8V	66 66	01/07→ 01/07→	←	für Fahrzeuge mit Trommelbremse an der Hinterachse		<b>24.0128-0214.1 428214</b>	Ø 280 28 26 V + S
			←	für Fahrzeuge mit Scheibenbremse an der Hinterachse		<b>24.0128-0216.1 428216</b>	Ø 304 28 26 V + S
			➔			<b>24.0114-0116.1 414116</b>	Ø 290 14 12 + S
2.0 HDi 120 2.0 HDi 120 4x4 2.0 HDi 125 2.0 HDi 125 4x4 2.0 HDi 140 2.0 HDi 165 2.0 HDi 95	88 88 94 94 100 120 72	01/07→ 01/10→ 07/11→ 07/11→ 01/07→ 07/10→ 07/11→	←			<b>24.0128-0216.1 428216</b>	Ø 304 28 26 V + S
			➔			<b>24.0114-0116.1 414116</b>	Ø 290 14 12 + S
2.0 i	103	01/07→	←			<b>24.0128-0216.1 428216</b>	Ø 304 28 26 V + S
			➔	langer Radstand		<b>24.0114-0116.1 414116</b>	Ø 290 14 12 + S
<b>CITROËN - JUMPY Kasten (BS_, BT_, BY_, BZ_) 06/94→10/06</b>							
 <b>Bremsbelagsatz, Scheibenbremse</b>							
1.6 i 2.0 2.0 HDi 110 2.0 HDi 95 2.0 i 16V	58 100 80 69 102	10/95→08/00 04/00→10/06 01/02→10/06 10/99→10/06 03/00→10/06	←	Orga 09793→; Nutzlast ab [kg] 800 Nutzlast bis [kg] 900		<b>13.0460-2863.2 602863</b>	TRW 20261 19,0 + WK + Zub
			←	→Orga 09792; Nutzlast ab [kg] 800 Nutzlast bis [kg] 900		<b>13.0460-2978.2 602978</b>	TRW 21801 19,0 + WK
			←	→Orga 09155; Nutzlast ab [kg] 800 Nutzlast bis [kg] 900		<b>13.0460-3957.2 603957</b>	BDX 23042 19,0 + WK + Zub
1.9 D 1.9 D 70	51 51	10/95→08/98 04/98→10/06	←	→Orga 09155; Nutzlast ab [kg] 800 Nutzlast bis [kg] 900		<b>13.0460-2978.2 602978</b>	TRW 21801 19,0 + WK

	kw					! #		
<b>CITROËN - JUMPY Kasten (BS_, BT_, BY_, BZ_) 06/94→10/06</b>								
 <b>Bremsbelagsatz, Scheibenbremse</b>								
1.9 DT 1.9 TD	65 66	10/95→08/00 10/95→08/00	←	→Orga 09155; Nutzlast ab [kg] 800 Nutzlast bis [kg] 900		13.0460-3957.2	603957	BDX 23042 19,0 + WK + Zub
			←	Orga 09156→; Nutzlast ab [kg] 800 Nutzlast bis [kg] 900		13.0460-3957.2	603957	BDX 23042 19,0 + WK + Zub
2.0 HDi 110	80	10/01→10/06	←	Orga 09793→; Nutzlast ab [kg] 800 Nutzlast bis [kg] 900		13.0460-2863.2	602863	TRW 20261 19,0 + WK + Zub
			←	01/02→; →Orga 09792; Nutzlast ab [kg] 800 Nutzlast bis [kg] 900		13.0460-2978.2	602978	TRW 21801 19,0 + WK
						13.0460-3957.2	603957	BDX 23042 19,0 + WK + Zub
 <b>Bremsscheibe</b>								
1.6 i 1.9 D 70 1.9 DT 1.9 TD 2.0 2.0 HDi 110 2.0 HDi 95 2.0 i 16V	58 51 65 66 100 80 69 102	10/95→08/00 04/98→10/06 10/95→08/00 10/95→08/00 04/00→10/06 01/02→10/06 10/99→10/06 03/00→10/06	←	→Orga 09155; Nutzlast [kg]: 800		24.0120-0155.1	420155	Ø 257,5 20 18,2 V
			←	→Orga 09792; Nutzlast [kg]: 900		24.0126-0104.1	426104	Ø 281 26 24,2 V
			←	Orga 09156→ Orga 09792; Nutzlast [kg]: 800		24.0126-0104.1	426104	Ø 281 26 24,2 V
			←	Orga 09793→; Nutzlast [kg]: 800		24.0128-0136.1	428136	Ø 285 28 26 V
			←	Orga 09793→; Nutzlast [kg]: 900		24.0128-0136.1	428136	Ø 285 28 26 V
						24.0328-0136.1	528136	Ø 285 28 26 V
2.0 HDi 110	80	10/01→10/06	←	01/02→; →Orga 09155; Nutzlast [kg]: 800		24.0120-0155.1	420155	Ø 257,5 20 18,2 V
			←	01/02→; →Orga 09792; Nutzlast [kg]: 900		24.0126-0104.1	426104	Ø 281 26 24,2 V
			←	Orga 09156→ Orga 09792; Nutzlast [kg]: 800		24.0126-0104.1	426104	Ø 281 26 24,2 V
			←	Orga 09793→; Nutzlast [kg]: 900		24.0128-0136.1	428136	Ø 285 28 26 V
						24.0328-0136.1	528136	Ø 285 28 26 V
			←	Orga 09793→; Nutzlast [kg]: 800		24.0128-0136.1	428136	Ø 285 28 26 V
						24.0328-0136.1	528136	Ø 285 28 26 V
<b>CITROËN - JUMPY Pritsche/Fahrgestell 07/11→</b>								
 <b>Bremsbelagsatz, Scheibenbremse</b>								
2.0 HDi 125	94	07/11→	←			13.0460-2738.2	602738	TRW 24595 18,5 + WK + Zub
			→			13.0460-2739.2	602739	TRW 24578 16,5 - WE / - WK + Zub
 <b>Bremsscheibe</b>								
2.0 HDi 125	94	07/11→	←			24.0128-0216.1	428216	Ø 304 28 26 V + S
			→			24.0114-0116.1	414116	Ø 290 14 12 + S
<b>CITROËN - JUMPY Pritsche/Fahrgestell 09/16→</b>								
 <b>Bremsbelagsatz, Scheibenbremse</b>								
1.6 BlueHDi 95 2.0 BlueHDi 120 2.0 BlueHDi 150	70 90 110	09/16→ 09/16→ 09/16→	←	für Bremsscheibendurchmesser [mm]: 304		13.0460-7331.2	607331	ATE 22593 18,0 + WE / - WK
 <b>Bremsscheibe</b>								
1.6 BlueHDi 95 2.0 BlueHDi 120 2.0 BlueHDi 150	70 90 110	09/16→ 09/16→ 09/16→	→			24.0112-0212.1	412212	Ø 290 12 10 + S
<b>CITROËN - JUMPY Pritsche/Fahrgestell (BU_, BV_, BW_, BX_) 10/99→10/06</b>								
 <b>Bremsbelagsatz, Scheibenbremse</b>								
1.9 TD 2.0 HDi 95	68 69	10/99→10/06 10/99→10/06	←	Orga 09793→		13.0460-2863.2	602863	TRW 20261 19,0 + WK + Zub
			←	→Orga 09792		13.0460-2978.2	602978	TRW 21801 19,0 + WK
2.0 2.0 HDi 110 2.0 HDi 110 16V	100 80 80	12/03→10/06 12/03→10/06 12/03→10/06	←			13.0460-2863.2	602863	TRW 20261 19,0 + WK + Zub
 <b>Bremsscheibe</b>								
1.9 TD 2.0 HDi 95	68 69	10/99→10/06 10/99→10/06	←	→Orga 09792		24.0126-0104.1	426104	Ø 281 26 24,2 V
			←	Orga 09793→		24.0128-0136.1	428136	Ø 285 28 26 V
						24.0328-0136.1	528136	Ø 285 28 26 V
2.0 2.0 HDi 110 2.0 HDi 110 16V	100 80 80	12/03→10/06 12/03→10/06 12/03→10/06	←			24.0128-0136.1	428136	Ø 285 28 26 V
						24.0328-0136.1	528136	Ø 285 28 26 V



	kW			 	! #		
<b>CITROËN - NEMO Kasten (AA_) 02/08→</b>							
 <b>Bremsbelagsatz, Scheibenbremse</b>							
1.3 BlueHDi 80 1.3 HDi 75	59 55	02/16→ 10/10→	←			13.0460-3863.2 603863	BOS 23706 18,0 + WK + Zub
1.4 1.4 HDi	54 50	02/08→ 02/08→	←			13.0460-3818.2 603818	BOS 23706 18,1 + WK
 <b>Bremsscheibe</b>							
1.3 BlueHDi 80 1.3 HDi 75 1.4	59 55 54	02/16→ 10/10→ 02/08→	←			24.0122-0197.1 422197 24.0322-0197.1 522197	Ø 257,5 22 20,2 V Ø 257,5 22 20,2 V
1.4 HDi	50	02/08→	←	Schaltgetriebe, automatisch betätigt		24.0122-0147.1 422147	Ø 284 22 20,2 V
			←	Schaltgetriebe		24.0122-0197.1 422197 24.0322-0197.1 522197	Ø 257,5 22 20,2 V Ø 257,5 22 20,2 V
<b>CITROËN - NEMO Kombi 04/09→</b>							
 <b>Bremsbelagsatz, Scheibenbremse</b>							
1.3 HDi 75 1.3 HDi 80	55 59	10/10→ 10/15→	←			13.0460-3863.2 603863	BOS 23706 18,0 + WK + Zub
1.4 1.4 HDi	54 50	04/09→ 04/09→	←			13.0460-3818.2 603818	BOS 23706 18,1 + WK
 <b>Bremsscheibe</b>							
1.3 HDi 75 1.3 HDi 80 1.4	55 59 54	10/10→ 10/15→ 04/09→	←			24.0122-0197.1 422197 24.0322-0197.1 522197	Ø 257,5 22 20,2 V Ø 257,5 22 20,2 V
1.4 HDi	50	04/09→	←	Schaltgetriebe, automatisch betätigt		24.0122-0147.1 422147	Ø 284 22 20,2 V
			←	Schaltgetriebe		24.0122-0197.1 422197 24.0322-0197.1 522197	Ø 257,5 22 20,2 V Ø 257,5 22 20,2 V
<b>CITROËN - SAXO (S0, S1) 02/96→04/04</b>							
 <b>Bremsbelagsatz, Scheibenbremse</b>							
1.0 X 1.0 X 1.1 BiFuel 1.1 X,SX 1.1 X,SX	33 37 44 40 44	05/96→11/98 05/98→06/03 07/00→06/03 05/96→09/03 05/96→09/03	←	Felge Lochzahl: 4 Felge Lochzahl: 3		13.0460-3962.2 603962 13.0460-4066.2 604066	BDX 20905 18,0 + WE / - WK ATE 21857 17,7 - WE / - WK
1.4 VTS	55	05/96→06/03	←			13.0460-3962.2 603962 13.0460-7088.2 607088	BDX 20905 18,0 + WE / - WK ATE 21430 17,3 - WE / - WK
1.5 D 1.5 D 1.5 D	40 42 43	09/96→09/03 09/96→06/01 07/01→04/04	←			13.0460-3962.2 603962	BDX 20905 18,0 + WE / - WK
1.6 1.6 1.6 1.6 VTL,VTR 1.6 VTS	66 74 88 65 72	02/96→06/03 02/01→04/04 02/96→04/04 05/96→06/03 09/00→09/03	←			13.0460-7088.2 607088 13.0460-3823.2 603823	ATE 21430 17,3 - WE / - WK BOS 20974 11,0 - WK
1.6 VTS	87	06/96→09/03	←	07/96→		13.0460-7088.2 607088	ATE 21430 17,3 - WE / - WK
			→	07/96→		13.0460-3823.2 603823	BOS 20974 11,0 - WK
Electric	20	11/96→06/03	←	Felge Lochzahl: 4 Felge Lochzahl: 3		13.0460-3962.2 603962 13.0460-7088.2 607088 13.0460-4066.2 604066	BDX 20905 18,0 + WE / - WK ATE 21430 17,3 - WE / - WK ATE 21857 17,7 - WE / - WK
			→			13.0460-3823.2 603823	BOS 20974 11,0 - WK
<b>Zubehörsatz, Scheibenbremsbelag</b>							
1.0 X 1.0 X 1.1 BiFuel 1.1 X,SX 1.1 X,SX	33 37 44 40 44	05/96→11/98 05/98→06/03 07/00→06/03 05/96→09/03 05/96→09/03	←			13.0460-0424.2 610424	ATE
1.6 1.6 1.6 1.6 VTL,VTR 1.6 VTS	66 74 88 65 72	02/96→06/03 02/01→04/04 02/96→04/04 05/96→06/03 09/00→09/03	→			13.0460-0435.2 610435	BDX
1.6 VTS	87	06/96→09/03	→	07/96→		13.0460-0435.2 610435	BDX
Electric	20	11/96→06/03	←			13.0460-0424.2 610424	ATE
			→			13.0460-0435.2 610435	BDX
 <b>Bremsscheibe</b>							
1.0 X 1.0 X ↓	33 37	05/96→11/98 05/98→06/03	←	Felge Lochzahl: 3		24.0108-0107.1 408107	Ø 238 8 6 + S

	kw			 	! #		
<b>CITROËN - SAXO (S0, S1) 02/96→04/04</b>							
 <b>Bremsscheibe</b>							
1.1 BiFuel 1.1 X,SX 1.1 X,SX	44 40 44	07/00→06/03 05/96→09/03 05/96→09/03	←	Felge Lochzahl: 4		24.0110-0187.1 410187	Ø 247 10 9 + S
1.4 VTS	55	05/96→06/03	←			24.0110-0187.1 410187 24.0120-0132.1 420132	Ø 247 10 9 + S Ø 247 20,4 18,5 V + S
1.5 D 1.5 D 1.5 D	40 42 43	09/96→09/03 09/96→06/01 07/01→04/04	←			24.0110-0187.1 410187	Ø 247 10 9 + S
1.6 1.6 1.6	66 74 88	02/96→06/03 02/01→04/04 02/96→04/04	←			24.0120-0132.1 420132 24.0320-0132.1 520132	Ø 247 20,4 18,5 V + S Ø 247 20,4 18,5 V + S
1.6 VTL,VTR 1.6 VTS	65 72	05/96→06/03 09/00→09/03	→			24.0108-0106.1 408106	Ø 247 8 6 + S
1.6 VTS	87	06/96→09/03	←	07/96→		24.0120-0132.1 420132 24.0320-0132.1 520132	Ø 247 20,4 18,5 V + S Ø 247 20,4 18,5 V + S
			→	07/96→		24.0108-0106.1 408106	Ø 247 8 6 + S
Electric	20	11/96→06/03	←	Felge Lochzahl: 3		24.0108-0107.1 408107	Ø 238 8 6 + S
			←	Felge Lochzahl: 4		24.0110-0187.1 410187 24.0120-0132.1 420132	Ø 247 10 9 + S Ø 247 20,4 18,5 V + S
			→			24.0108-0106.1 408106	Ø 247 8 6 + S
<b>CITROËN - SPACETOURER 04/16→</b>							
 <b>Bremsbelagsatz, Scheibenbremse</b>							
1.6 BlueHDi 115 1.6 BlueHDi 95 2.0 BlueHDi 120 2.0 BlueHDi 150 2.0 BlueHDi 180	85 70 90 110 130	04/16→ 04/16→ 04/16→ 04/16→ 04/16→	←	für Bremsscheibendurchmesser [mm]: 304		13.0460-7331.2 607331	ATE 22593 18,0 + WE / - WK
 <b>Bremsscheibe</b>							
1.6 BlueHDi 115 1.6 BlueHDi 95 2.0 BlueHDi 120 2.0 BlueHDi 150 2.0 BlueHDi 180	85 70 90 110 130	04/16→ 04/16→ 04/16→ 04/16→ 04/16→	→			24.0112-0212.1 412212	Ø 290 12 10 + S
<b>CITROËN - XANTIA (X1_, X2_) 03/93→04/03</b>							
 <b>Bremsbelagsatz, Scheibenbremse</b>							
1.6 i 1.8 i 1.8 i 1.8 i 16V 1.9 D 1.9 D 1.9 SD 1.9 Turbo D 2.0 i 2.0 i 16V 2.0 i 16V 2.0 i 16V	65 66 74 81 50 51 55 66 89 97 110 112	03/93→03/01 04/97→04/03 03/93→01/98 06/95→04/03 06/94→01/98 06/94→01/98 02/96→04/03 05/93→04/03 03/93→04/03 06/95→04/03 06/94→01/98 03/93→01/98	←	→ 12/97		13.0460-3956.2 603956	BDX 21631 17,0 + WK
			→	→ 12/97		13.0460-4956.2 604956	CIT 20162 15,4 - WE / - WK
2.0 HDi 109	80	02/99→04/03	←	→ 09/01		13.0460-3986.2 603986	BOS 23135 18,0 + WK
			→	→ 09/01		13.0460-4956.2 604956	CIT 20162 15,4 - WE / - WK
2.0 HDi 90	66	03/99→04/03	←			13.0460-3956.2 603956	BDX 21631 17,0 + WK
			→	→ 09/01		13.0460-4956.2 604956	CIT 20162 15,4 - WE / - WK
2.0 Turbo 2.1 Turbo D 12V	108 80	06/95→04/03 06/95→02/99	←	→ 12/97		13.0460-3973.2 603973	BDX 23146 17,0 + WK
			→	→ 12/97		13.0460-4956.2 604956	CIT 20162 15,4 - WE / - WK
3.0 i 24V	140	01/97→04/03	←	→ 12/97		13.0460-3986.2 603986	BOS 23135 18,0 + WK
			→	→ 12/97		13.0460-4956.2 604956	CIT 20162 15,4 - WE / - WK
<b>Zubehörsatz, Scheibenbremsbelag</b>							
1.6 i 1.8 i 1.8 i 1.8 i 16V 1.9 D 1.9 D 1.9 SD 1.9 Turbo D 2.0 i 2.0 i 16V 2.0 i 16V ↓	65 66 74 81 50 51 55 66 89 97 110	03/93→03/01 04/97→04/03 03/93→01/98 06/95→04/03 06/94→01/98 06/94→01/98 02/96→04/03 05/93→04/03 03/93→04/03 06/95→04/03 06/94→01/98	→	→ 12/97		13.0460-0437.2 610437	CIT

	kw			 	! #		
<b>CITROËN - XANTIA (X1_, X2_) 03/93→04/03</b>							
<b>Zubehörsatz, Scheibenbremsbelag</b>							
2.0 i 16V	112	03/93→01/98	➡	→ 12/97		13.0460-0437.2 610437	CIT
2.0 Turbo	108	06/95→04/03					
2.1 Turbo D 12V	80	06/95→02/99					
3.0 i 24V	140	01/97→04/03					
2.0 HDI 109	80	02/99→04/03	➡	→ 09/01		13.0460-0437.2 610437	CIT
2.0 HDI 90	66	03/99→04/03					
<b> Bremsscheibe</b>							
1.6 i	65	03/93→03/01	←	→ 12/97		24.0120-0133.1 420133	Ø 266 20,5 18,5 V + S
1.8 i	66	04/97→04/03				24.0320-0133.1 520133	Ø 266 20,5 18,5 V + S
1.8 i	74	03/93→01/98					
1.8 i 16V	81	06/95→04/03	➡	→ 12/97		24.0109-0122.1 409122	Ø 224 9 7
1.9 D	50	06/94→01/98					
1.9 D	51	06/94→01/98					
1.9 SD	55	02/96→04/03					
2.0 i	89	03/93→04/03					
1.9 Turbo D	66	05/93→04/03	←	Orga 07568→; → 12/97		24.0120-0133.1 420133	Ø 266 20,5 18,5 V + S
			←	→Orga 07567		24.0122-0142.1 422142	Ø 283 22 20 V
			➡	→ 12/97		24.0109-0122.1 409122	Ø 224 9 7
2.0 HDI 109	80	02/99→04/03	←	→ 09/01		24.0128-0128.1 428128	Ø 288 28 26 V + S
			➡	→ 09/01		24.0109-0122.1 409122	Ø 224 9 7
2.0 HDI 90	66	03/99→04/03	←			24.0120-0133.1 420133	Ø 266 20,5 18,5 V + S
			➡	→ 09/01		24.0109-0122.1 409122	Ø 224 9 7
2.0 i 16V	97	06/95→04/03	←	→ 12/97		24.0122-0142.1 422142	Ø 283 22 20 V
2.0 i 16V	110	06/94→01/98	➡	→ 12/97		24.0109-0122.1 409122	Ø 224 9 7
2.0 i 16V	112	03/93→01/98					
2.0 Turbo	108	06/95→04/03	←	→ 12/97		24.0126-0106.1 426106	Ø 283 26 24,2 V + S
2.1 Turbo D 12V	80	06/95→02/99				24.0326-0106.1 526106	Ø 283 26 24,2 V + S
			➡	→ 12/97		24.0109-0122.1 409122	Ø 224 9 7
3.0 i 24V	140	01/97→04/03	←	→ 12/97		24.0128-0128.1 428128	Ø 288 28 26 V + S
			➡	→ 12/97		24.0109-0122.1 409122	Ø 224 9 7
<b>CITROËN - XANTIA Break (X1_, X2_) 06/95→04/03</b>							
<b> Bremsbelagsatz, Scheibenbremse</b>							
1.8 i	66	04/97→04/03	←	→ 12/97		13.0460-3956.2 603956	BDX 21631 17,0 + WK
1.8 i 16V	81	06/95→04/03	➡	→ 12/97		13.0460-4911.2 604911	CIT 20389 15,4 - WE / - WK
1.8 i	74	06/95→01/98	←	Orga 07483→; → 12/97; + ABS		13.0460-3956.2 603956	BDX 21631 17,0 + WK
			←	→ 12/97; - ABS		13.0460-3956.2 603956	BDX 21631 17,0 + WK
			←	→Orga 07482; + ABS		13.0460-3972.2 603972	BDX 21632 16,0 + WK
			➡	→ 12/97		13.0460-4911.2 604911	CIT 20389 15,4 - WE / - WK
1.9 SD	55	04/97→04/03	←	→ 12/97		13.0460-3972.2 603972	BDX 21632 16,0 + WK
1.9 Turbo D	66	06/95→04/03	➡	→ 12/97		13.0460-4911.2 604911	CIT 20389 15,4 - WE / - WK
2.0 i	89	06/95→04/03					
2.0 i 16V	97	06/95→04/03					
2.0 Turbo	108	06/95→04/03					
2.1 Turbo D 12V	80	06/96→02/99					
2.0 HDI 109	80	02/99→04/03	←	→ 09/01		13.0460-3986.2 603986	BOS 23135 18,0 + WK
3.0 V6	140	01/98→04/03	➡	→ 09/01		13.0460-4911.2 604911	CIT 20389 15,4 - WE / - WK
2.0 HDI 90	66	03/99→04/03	←			13.0460-3972.2 603972	BDX 21632 16,0 + WK
			➡	→ 09/01		13.0460-4911.2 604911	CIT 20389 15,4 - WE / - WK
<b>Zubehörsatz, Scheibenbremsbelag</b>							
1.8 i	66	04/97→04/03	➡	→ 12/97		13.0460-0264.2 610264	
1.8 i	74	06/95→01/98					
1.8 i 16V	81	06/95→04/03					
1.9 SD	55	04/97→04/03					
1.9 Turbo D	66	06/95→04/03					
2.0 i	89	06/95→04/03					
2.0 i 16V	97	06/95→04/03					
2.0 Turbo	108	06/95→04/03					
2.1 Turbo D 12V	80	06/96→02/99					
2.0 HDI 109	80	02/99→04/03	➡	→ 09/01		13.0460-0264.2 610264	
2.0 HDI 90	66	03/99→04/03					
3.0 V6	140	01/98→04/03					
<b> Bremsscheibe</b>							
1.8 i	66	04/97→04/03	←	→ 12/97		24.0120-0133.1 420133	Ø 266 20,5 18,5 V + S

**CITROËN - XANTIA Break (X1\_, X2\_) 06/95→04/03**

<b>Bremsscheibe</b>							
1.8 i	66	04/97→04/03	←	→ 12/97	24.0320-0133.1	520133	Ø 266 20,5 18,5 V + S
			→	→ 12/97	24.0112-0143.1	412143	Ø 251 12 10,8
1.8 i 1.8 i 16V	74 81	06/95→01/98 06/95→04/03	←	→ 12/97; Orga 07483→; + ABS	24.0120-0133.1	420133	Ø 266 20,5 18,5 V + S
			←	→ 12/97; - ABS	24.0120-0133.1	420133	Ø 266 20,5 18,5 V + S
			←	→Orga 07482; + ABS	24.0122-0142.1	422142	Ø 283 22 20 V
			→	→ 12/97	24.0112-0143.1	412143	Ø 251 12 10,8
			←	→ 12/97	24.0122-0142.1	422142	Ø 283 22 20 V
1.9 SD 1.9 Turbo D 2.0 i 2.0 i 16V	55 66 89 97	04/97→04/03 06/95→04/03 06/95→04/03 06/95→04/03	←	→ 12/97	24.0122-0142.1	422142	Ø 283 22 20 V
			→	→ 12/97	24.0112-0143.1	412143	Ø 251 12 10,8
			←	→ 09/01	24.0128-0128.1	428128	Ø 288 28 26 V + S
2.0 HDI 109 3.0 V6	80 140	02/99→04/03 01/98→04/03	←	→ 09/01	24.0112-0143.1	412143	Ø 251 12 10,8
			→	→ 09/01	24.0112-0143.1	412143	Ø 251 12 10,8
2.0 HDI 90	66	03/99→04/03	←		24.0122-0142.1	422142	Ø 283 22 20 V
			→	→ 09/01	24.0112-0143.1	412143	Ø 251 12 10,8
2.0 Turbo 2.1 Turbo D 12V	108 80	06/95→04/03 06/96→02/99	←	→ 12/97	24.0126-0106.1	426106	Ø 283 26 24,2 V + S
			→	→ 12/97	24.0326-0106.1	526106	Ø 283 26 24,2 V + S
			→	→ 12/97	24.0112-0143.1	412143	Ø 251 12 10,8

**CITROËN - XM (Y4) 05/94→10/00**











<b>Bremsbelagsatz, Scheibenbremse</b>							
2.0 i 16V 2.0 Turbo	97 108	05/94→10/00	←		13.0460-3947.2	603947	BDX 21505 17,0 + WK
			→		13.0460-4956.2	604956	CIT 20162 15,4 - WE / - WK
2.1 D12 VSX 2.1 TD 12V 3.0 V6 3.0 V6 24V	60 80 123 147	03/96→08/96 05/94→10/00 05/94→10/00 05/94→10/00	←	→Orga 07475	13.0460-3947.2	603947	BDX 21505 17,0 + WK
			←	Orga 07476→	13.0460-3986.2	603986	BOS 23135 18,0 + WK
			→		13.0460-4956.2	604956	CIT 20162 15,4 - WE / - WK
			←		13.0460-3986.2	603986	BOS 23135 18,0 + WK
3.0 V6	140	04/97→10/00	←		13.0460-3986.2	603986	BOS 23135 18,0 + WK
			→		13.0460-4956.2	604956	CIT 20162 15,4 - WE / - WK

<b>Zubehörsatz, Scheibenbremsbelag</b>							
2.0 i 16V 2.0 Turbo 2.1 D12 VSX 2.1 TD 12V 2.5 TD 3.0 V6 3.0 V6 3.0 V6 24V	97 108 60 80 95 123 140 147	05/94→10/00 05/94→10/00 03/96→08/96 05/94→10/00 05/94→10/00 05/94→10/00 04/97→10/00 05/94→10/00	→		13.0460-0437.2	610437	CIT









<b>Bremsscheibe</b>							
2.0 i 16V 2.0 Turbo	97 108	05/94→10/00	←		24.0126-0100.1	426100	Ø 283 26 24 V
			→		24.0109-0121.2	409121	Ø 224 9 8
2.1 D12 VSX 2.1 TD 12V 3.0 V6 3.0 V6 24V	60 80 123 147	03/96→08/96 05/94→10/00 05/94→10/00 05/94→10/00	←	→Orga 07475	24.0126-0100.1	426100	Ø 283 26 24 V
			←	Orga 07476→	24.0128-0178.1	428178	Ø 288 28 26 V
			→		24.0109-0121.2	409121	Ø 224 9 8
3.0 V6	140	04/97→10/00	←		24.0128-0178.1	428178	Ø 288 28 26 V
			→		24.0109-0121.2	409121	Ø 224 9 8







**CITROËN - XM Break (Y4) 05/94→10/00**











<b>Bremsbelagsatz, Scheibenbremse</b>							
2.0 i 16V 2.0 Turbo	97 108	05/94→10/00	←		13.0460-3947.2	603947	BDX 21505 17,0 + WK
			→		13.0460-4911.2	604911	CIT 20389 15,4 - WE / - WK
2.1 D12 2.1 TD 12V 3.0 V6	60 80 123	07/94→06/96 05/94→10/00 05/94→10/00	←	→Orga 07475	13.0460-3947.2	603947	BDX 21505 17,0 + WK
			←	Orga 07476→	13.0460-3986.2	603986	BOS 23135 18,0 + WK









	kW			 	! #		
<b>CITROËN - XM Break (Y4) 05/94→10/00</b>							
 <b>Bremsbelagsatz, Scheibenbremse</b>							
2.5 TD	95	05/94→10/00	➔			<b>13.0460-4911.2 604911</b>	CIT 20389 15,4 - WE / - WK
3.0 V6	140	04/97→10/00	➔			<b>13.0460-3986.2 603986</b>	BOS 23135 18,0 + WK
			➔			<b>13.0460-4911.2 604911</b>	CIT 20389 15,4 - WE / - WK
<b>Zubehörsatz, Scheibenbremsbelag</b>							
2.0 i 16V	97	05/94→10/00	➔			<b>13.0460-0264.2 610264</b>	
2.0 Turbo	108	05/94→10/00					
2.1 D12	60	07/94→06/96					
2.1 TD 12V	80	05/94→10/00					
2.5 TD	95	05/94→10/00					
3.0 V6	123	05/94→10/00					
3.0 V6	140	04/97→10/00					
 <b>Bremsscheibe</b>							
2.0 i 16V	97	05/94→10/00	➔			<b>24.0126-0100.1 426100</b>	Ø 283 26 24 V
2.0 Turbo	108	05/94→10/00					
2.1 D12	60	07/94→06/96	➔			<b>24.0112-0136.2 412136</b>	Ø 251 12 10,8
2.1 TD 12V	80	05/94→10/00					
3.0 V6	123	05/94→10/00					
2.5 TD	95	05/94→10/00	➔	→Orga 07475		<b>24.0126-0100.1 426100</b>	Ø 283 26 24 V
			➔	Orga 07476→		<b>24.0128-0178.1 428178</b>	Ø 288 28 26 V
			➔			<b>24.0112-0136.2 412136</b>	Ø 251 12 10,8
3.0 V6	140	04/97→10/00	➔			<b>24.0128-0178.1 428178</b>	Ø 288 28 26 V
			➔			<b>24.0112-0136.2 412136</b>	Ø 251 12 10,8
<b>CITROËN - XSARA (N1) 04/97→12/05</b>							
 <b>Bremsbelagsatz, Scheibenbremse</b>							
1.4 HDi	50	01/03→03/05	➔			<b>13.0460-3994.2 603994</b>	BOS 23599 19,0 - WE / - WK + Zub
						<b>13.0470-3994.2 LD3994</b>	BOS 23599 19,0 - WE / - WK + Zub Ceramic
1.4 i	55	04/97→03/05	➔	→ 08/00; - ABS		<b>13.0460-3977.2 603977</b>	BOS 21980 18,0 + WE / - WK
			➔	09/00→		<b>13.0460-3994.2 603994</b>	BOS 23599 19,0 - WE / - WK + Zub
			➔			<b>13.0470-3994.2 LD3994</b>	BOS 23599 19,0 - WE / - WK + Zub Ceramic
			➔	→ 08/00; + ABS		<b>13.0460-7088.2 607088</b>	ATE 21430 17,3 - WE / - WK
1.4 LPG	55	05/98→08/00	➔	- ABS		<b>13.0460-3977.2 603977</b>	BOS 21980 18,0 + WE / - WK
			➔	+ ABS		<b>13.0460-7088.2 607088</b>	ATE 21430 17,3 - WE / - WK
1.5 D	42	04/97→09/00	➔	→ 08/00; - ABS		<b>13.0460-3977.2 603977</b>	BOS 21980 18,0 + WE / - WK
			➔	→ 08/00; + ABS		<b>13.0460-7088.2 607088</b>	ATE 21430 17,3 - WE / - WK
1.6 16V	80	09/00→03/05	➔			<b>13.0460-3994.2 603994</b>	BOS 23599 19,0 - WE / - WK + Zub
						<b>13.0470-3994.2 LD3994</b>	BOS 23599 19,0 - WE / - WK + Zub Ceramic
			➔			<b>13.0460-3823.2 603823</b>	BOS 20974 11,0 - WK
1.6 i	65	04/97→09/00	➔	→ 08/00		<b>13.0460-7088.2 607088</b>	ATE 21430 17,3 - WE / - WK
1.8 D	43	04/97→09/00					
1.8 i	66	04/97→09/00					
1.9 D	50	04/97→09/00					
1.9 SD	55	01/98→09/00					
1.9 TD	66	04/97→09/00					
1.8 BiFuel	82	07/97→08/00	➔			<b>13.0460-2829.2 602829</b>	TRW 23124 19,0 + WK
						<b>13.0460-3978.2 603978</b>	BOS 23332 18,0 - WK + Zub
			➔			<b>13.0460-3823.2 603823</b>	BOS 20974 11,0 - WK
1.8 i 16V	81	04/97→09/00	➔	→ 08/00		<b>13.0460-2829.2 602829</b>	TRW 23124 19,0 + WK
2.0 16V	97	07/98→09/00				<b>13.0460-3978.2 603978</b>	BOS 23332 18,0 - WK + Zub
			➔			<b>13.0460-3823.2 603823</b>	BOS 20974 11,0 - WK
1.8 i Aut.	74	04/97→09/00	➔	→ 08/00		<b>13.0460-2829.2 602829</b>	TRW 23124 19,0 + WK
						<b>13.0460-3978.2 603978</b>	BOS 23332 18,0 - WK + Zub
						<b>13.0460-7088.2 607088</b>	ATE 21430 17,3 - WE / - WK
			➔			<b>13.0460-3823.2 603823</b>	BOS 20974 11,0 - WK
1.8 VTS	85	09/00→10/04	➔	→ 09/00		<b>13.0460-3823.2 603823</b>	BOS 20974 11,0 - WK
1.9 D	51	07/98→03/05	➔	09/00→		<b>13.0460-3994.2 603994</b>	BOS 23599 19,0 - WE / - WK + Zub
↓							













	kw			 	! #		
<b>CITROËN - XSARA (N1) 04/97→12/05</b>							
<b> Bremsbelagsatz, Scheibenbremse</b>							
1.9 D	51	07/98→03/05	←	09/00→		<b>13.0470-3994.2 LD3994</b>	BOS 23599 19,0 - WE / - WK + Zub Ceramic
			←	→ 08/00		<b>13.0460-7088.2 607088</b>	ATE 21430 17,3 - WE / - WK
1.9 D	52	04/00→04/05	←	09/00→ 03/05		<b>13.0460-3994.2 603994</b>	BOS 23599 19,0 - WE / - WK + Zub
			←	→ 08/00		<b>13.0470-3994.2 LD3994</b>	BOS 23599 19,0 - WE / - WK + Zub Ceramic
			←	→ 08/00		<b>13.0460-7088.2 607088</b>	ATE 21430 17,3 - WE / - WK
2.0 16V	100	09/00→03/05	←	→Orga 09184		<b>13.0460-2817.2 602817</b>	TRW 21674 19,0 + WK
2.0 16V	120	04/97→09/00	←	Orga 09185→		<b>13.0460-3966.2 603966</b>	BOS 23600 19,4 - WE / - WK + Zub
2.0 HDi 109	80	05/01→03/05	←			<b>13.0470-3966.2 LD3966</b>	BOS 23600 19,4 - WE / - WK + Zub Ceramic
			→			<b>13.0460-3823.2 603823</b>	BOS 20974 11,0 - WK
2.0 HDi 90	66	02/99→03/05	←	→ 08/00		<b>13.0460-2829.2 602829</b>	TRW 23124 19,0 + WK
			←	09/00→		<b>13.0460-3978.2 603978</b>	BOS 23332 18,0 - WK + Zub
			←			<b>13.0460-3994.2 603994</b>	BOS 23599 19,0 - WE / - WK + Zub
			→			<b>13.0470-3994.2 LD3994</b>	BOS 23599 19,0 - WE / - WK + Zub Ceramic
			→			<b>13.0460-3823.2 603823</b>	BOS 20974 11,0 - WK
<b>Zubehörsatz, Scheibenbremsbelag</b>							
1.6 16V	80	09/00→03/05	→			<b>13.0460-0435.2 610435</b>	BDX
1.8 BiFuel	82	07/97→08/00					
1.8 i 16V	81	04/97→09/00					
1.8 i Aut.	74	04/97→09/00					
2.0 16V	97	07/98→09/00					
2.0 16V	100	09/00→03/05					
2.0 16V	120	04/97→09/00					
2.0 HDi 109	80	05/01→03/05					
2.0 HDi 90	66	02/99→03/05					
1.8 VTS	85	09/00→10/04	→	→ 09/00		<b>13.0460-0435.2 610435</b>	BDX
<b> Bremsscheibe</b>							
1.4 HDi	50	01/03→03/05	←			<b>24.0122-0194.1 422194</b>	Ø 266 22 20 V + S
1.4 i	55	04/97→03/05	←	→ 08/00; - ABS		<b>24.0113-0185.1 413185</b>	Ø 247,5 13 11 + S
			←	→ 08/00; + ABS		<b>24.0313-0185.1 513185</b>	Ø 247,5 13 11 + S
			←	→ 08/00; + ABS		<b>24.0120-0132.1 420132</b>	Ø 247 20,4 18,5 V + S
			←	09/00→		<b>24.0320-0132.1 520132</b>	Ø 247 20,4 18,5 V + S
			←			<b>24.0122-0194.1 422194</b>	Ø 266 22 20 V + S
1.4 LPG	55	05/98→08/00	←	- ABS		<b>24.0113-0185.1 413185</b>	Ø 247,5 13 11 + S
			←	+ ABS		<b>24.0313-0185.1 513185</b>	Ø 247,5 13 11 + S
			←			<b>24.0120-0132.1 420132</b>	Ø 247 20,4 18,5 V + S
			←			<b>24.0320-0132.1 520132</b>	Ø 247 20,4 18,5 V + S
1.5 D	42	04/97→09/00	←	→ 08/00; - ABS		<b>24.0113-0185.1 413185</b>	Ø 247,5 13 11 + S
			←	→ 08/00; + ABS		<b>24.0313-0185.1 513185</b>	Ø 247,5 13 11 + S
			←			<b>24.0120-0132.1 420132</b>	Ø 247 20,4 18,5 V + S
			←			<b>24.0320-0132.1 520132</b>	Ø 247 20,4 18,5 V + S
1.6 16V	80	09/00→03/05	←			<b>24.0122-0194.1 422194</b>	Ø 266 22 20 V + S
			→			<b>24.0108-0106.1 408106</b>	Ø 247 8 6 + S
1.6 i	65	04/97→09/00	←	→ 08/00		<b>24.0120-0132.1 420132</b>	Ø 247 20,4 18,5 V + S
1.8 D	43	04/97→09/00				<b>24.0320-0132.1 520132</b>	Ø 247 20,4 18,5 V + S
1.8 i	66	04/97→09/00					
1.9 D	50	04/97→09/00					
1.9 SD	55	01/98→09/00					
1.9 TD	66	04/97→09/00					
1.8 BiFuel	82	07/97→08/00	←			<b>24.0120-0133.1 420133</b>	Ø 266 20,5 18,5 V + S
			→			<b>24.0320-0133.1 520133</b>	Ø 266 20,5 18,5 V + S
			→			<b>24.0108-0106.1 408106</b>	Ø 247 8 6 + S
1.8 i 16V	81	04/97→09/00	←	→ 08/00		<b>24.0120-0133.1 420133</b>	Ø 266 20,5 18,5 V + S
2.0 16V	97	07/98→09/00	←			<b>24.0320-0133.1 520133</b>	Ø 266 20,5 18,5 V + S
			→	→ 08/00		<b>24.0108-0106.1 408106</b>	Ø 247 8 6 + S
1.8 i Aut.	74	04/97→09/00	←	→ 08/00		<b>24.0120-0132.1 420132</b>	Ø 247 20,4 18,5 V + S
			←			<b>24.0120-0133.1 420133</b>	Ø 266 20,5 18,5 V + S
↓							











	kW			 	! #		
<b>CITROËN - XSARA (N1) 04/97→12/05</b>							
<b>Bremsscheibe</b>							
1.8 i Aut.	74	04/97→09/00	←	→ 08/00		24.0320-0132.1 520132 24.0320-0133.1 520133	Ø 247 20,4 18,5 V + S Ø 266 20,5 18,5 V + S
			→	→ 08/00		24.0108-0106.1 408106	Ø 247 8 6 + S
1.9 D	51	07/98→03/05	←	→ 08/00		24.0120-0132.1 420132 24.0320-0132.1 520132	Ø 247 20,4 18,5 V + S Ø 247 20,4 18,5 V + S
			←	09/00→		24.0122-0194.1 422194	Ø 266 22 20 V + S
1.9 D	52	04/00→04/05	←	→ 08/00		24.0120-0132.1 420132 24.0320-0132.1 520132	Ø 247 20,4 18,5 V + S Ø 247 20,4 18,5 V + S
			←	09/00→ 03/05		24.0122-0194.1 422194	Ø 266 22 20 V + S
2.0 16V 2.0 HDi 109	100 80	09/00→03/05 05/01→03/05	←	→Orga 09184		24.0122-0142.1 422142	Ø 283 22 20 V
			←	Orga 09185→		24.0126-0120.1 426120 24.0326-0120.1 526120	Ø 283 26 24 V + S Ø 283 26 24 V + S
			→			24.0108-0106.1 408106	Ø 247 8 6 + S
2.0 16V	120	04/97→09/00	←	→Orga 09184		24.0122-0142.1 422142	Ø 283 22 20 V
			←	Orga 09185→		24.0126-0120.1 426120 24.0326-0120.1 526120	Ø 283 26 24 V + S Ø 283 26 24 V + S
			→	→ 08/00		24.0108-0106.1 408106	Ø 247 8 6 + S
2.0 HDi 90	66	02/99→03/05	←	→ 08/00		24.0120-0133.1 420133 24.0320-0133.1 520133	Ø 266 20,5 18,5 V + S Ø 266 20,5 18,5 V + S
			←	09/00→		24.0122-0194.1 422194	Ø 266 22 20 V + S
			→			24.0108-0106.1 408106	Ø 247 8 6 + S
<b>CITROËN - XSARA Break (N2) 10/97→03/10</b>							
<b>Bremsbelagsatz, Scheibenbremse</b>							
1.4 HDi	50	01/03→08/05	←			13.0460-3994.2 603994 13.0470-3994.2 LD3994	BOS 23599 19,0 - WE / - WK + Zub BOS 23599 19,0 - WE / - WK + Zub Ceramic
1.4 i 1.9 D	55 51	10/97→08/05 07/98→08/05	←	→ 08/00; + ABS		13.0460-2829.2 602829 13.0460-3978.2 603978	TRW 23124 19,0 + WK BOS 23332 18,0 - WK + Zub
			←	09/00→		13.0460-3994.2 603994 13.0470-3994.2 LD3994	BOS 23599 19,0 - WE / - WK + Zub BOS 23599 19,0 - WE / - WK + Zub Ceramic
			←	→ 08/00; - ABS		13.0460-7088.2 607088	ATE 21430 17,3 - WE / - WK
1.5 D 1.6 i 1.8 D 1.9 D	42 65 43 50	10/97→09/00 10/97→09/00 10/97→09/00 10/97→09/00	←	→ 08/00; + ABS		13.0460-2829.2 602829 13.0460-3978.2 603978 13.0460-7088.2 607088	TRW 23124 19,0 + WK BOS 23332 18,0 - WK + Zub ATE 21430 17,3 - WE / - WK
1.6 16V	80	09/00→08/05	←			13.0460-3994.2 603994 13.0470-3994.2 LD3994	BOS 23599 19,0 - WE / - WK + Zub BOS 23599 19,0 - WE / - WK + Zub Ceramic
			→			13.0460-3823.2 603823	BOS 20974 11,0 - WK
1.8 i 1.9 D 1.9 TD	66 55 66	10/97→09/00 01/98→09/00 10/97→09/00	←	→ 08/00		13.0460-2829.2 602829 13.0460-3978.2 603978	TRW 23124 19,0 + WK BOS 23332 18,0 - WK + Zub
1.8 i 16V 1.8 i Aut. 2.0 16V	81 74 97	10/97→09/00 10/97→09/00 07/98→09/00	←	→ 08/00		13.0460-2829.2 602829 13.0460-3978.2 603978	TRW 23124 19,0 + WK BOS 23332 18,0 - WK + Zub
			→	→ 08/00		13.0460-3823.2 603823	BOS 20974 11,0 - WK
1.8 LPG	81	05/98→08/00	←			13.0460-2829.2 602829 13.0460-3978.2 603978	TRW 23124 19,0 + WK BOS 23332 18,0 - WK + Zub
			→			13.0460-3823.2 603823	BOS 20974 11,0 - WK
2.0 16V 2.0 HDi 109	100 80	09/00→08/05 05/01→08/05	←	→Orga 09184		13.0460-2817.2 602817	TRW 21674 19,0 + WK
			←	Orga 09185→		13.0460-3966.2 603966 13.0470-3966.2 LD3966	BOS 23600 19,4 - WE / - WK + Zub BOS 23600 19,4 - WE / - WK + Zub Ceramic
			→			13.0460-3823.2 603823	BOS 20974 11,0 - WK
2.0 HDI 90	66	02/99→08/05	←	→ 08/00		13.0460-2829.2 602829 13.0460-3978.2 603978	TRW 23124 19,0 + WK BOS 23332 18,0 - WK + Zub
			←	09/00→		13.0460-3994.2 603994	BOS 23599 19,0 - WE / - WK + Zub









	kW			 	! #		
<b>CITROËN - XSARA Break (N2) 10/97→03/10</b>							
 <b>Bremsbelagsatz, Scheibenbremse</b>							
2.0 HDi 90	66	02/99→08/05	←	09/00→		<b>13.0470-3994.2 LD3994</b>	BOS 23599 19,0 - WE / - WK + Zub Ceramic
			→			<b>13.0460-3823.2 603823</b>	BOS 20974 11,0 - WK
<b>Zubehörsatz, Scheibenbremsbelag</b>							
1.6 16V	80	09/00→08/05	→			<b>13.0460-0435.2 610435</b>	BDX
1.8 LPG	81	05/98→08/00					
2.0 16V	100	09/00→08/05					
2.0 HDi 109	80	05/01→08/05					
2.0 HDi 90	66	02/99→08/05					
1.8 i 16V	81	10/97→09/00	→	→ 08/00		<b>13.0460-0435.2 610435</b>	BDX
1.8 i Aut.	74	10/97→09/00					
2.0 16V	97	07/98→09/00					
 <b>Bremsscheibe</b>							
1.4 HDi	50	01/03→08/05	←			<b>24.0122-0194.1 422194</b>	Ø 266 22 20 V + S
1.4 i	55	10/97→08/05	←	→ 08/00; - ABS		<b>24.0120-0132.1 420132</b>	Ø 247 20,4 18,5 V + S
1.9 D	51	07/98→08/05				<b>24.0124-0127.1 424127</b>	Ø 280 24 21,9 V
			←	→ 08/00; + ABS		<b>24.0320-0132.1 520132</b>	Ø 247 20,4 18,5 V + S
			←	→ 08/00; + ABS		<b>24.0120-0133.1 420133</b>	Ø 266 20,5 18,5 V + S
			←	→ 08/00; + ABS		<b>24.0320-0133.1 520133</b>	Ø 266 20,5 18,5 V + S
			←	09/00→		<b>24.0122-0194.1 422194</b>	Ø 266 22 20 V + S
1.5 D	42	10/97→09/00	←	→ 08/00; - ABS		<b>24.0120-0132.1 420132</b>	Ø 247 20,4 18,5 V + S
1.6 i	65	10/97→09/00				<b>24.0124-0127.1 424127</b>	Ø 280 24 21,9 V
1.8 D	43	10/97→09/00				<b>24.0320-0132.1 520132</b>	Ø 247 20,4 18,5 V + S
1.9 D	50	10/97→09/00	←	→ 08/00; + ABS		<b>24.0120-0133.1 420133</b>	Ø 266 20,5 18,5 V + S
			←	→ 08/00; + ABS		<b>24.0320-0133.1 520133</b>	Ø 266 20,5 18,5 V + S
1.6 16V	80	09/00→08/05	←			<b>24.0122-0194.1 422194</b>	Ø 266 22 20 V + S
			→			<b>24.0108-0106.1 408106</b>	Ø 247 8 6 + S
1.8 i	66	10/97→09/00	←	→ 08/00		<b>24.0120-0133.1 420133</b>	Ø 266 20,5 18,5 V + S
1.9 D	55	01/98→09/00				<b>24.0320-0133.1 520133</b>	Ø 266 20,5 18,5 V + S
1.9 TD	66	10/97→09/00					
1.8 i 16V	81	10/97→09/00	←	→ 08/00		<b>24.0120-0133.1 420133</b>	Ø 266 20,5 18,5 V + S
1.8 i Aut.	74	10/97→09/00				<b>24.0320-0133.1 520133</b>	Ø 266 20,5 18,5 V + S
2.0 16V	97	07/98→09/00	→	→ 08/00		<b>24.0108-0106.1 408106</b>	Ø 247 8 6 + S
1.8 LPG	81	05/98→08/00	←			<b>24.0120-0133.1 420133</b>	Ø 266 20,5 18,5 V + S
			→			<b>24.0320-0133.1 520133</b>	Ø 266 20,5 18,5 V + S
			→			<b>24.0108-0106.1 408106</b>	Ø 247 8 6 + S
2.0 16V	100	09/00→08/05	←	→Orga 09184		<b>24.0122-0142.1 422142</b>	Ø 283 22 20 V
2.0 HDi 109	80	05/01→08/05	←	Orga 09185→		<b>24.0126-0120.1 426120</b>	Ø 283 26 24 V + S
			→			<b>24.0326-0120.1 526120</b>	Ø 283 26 24 V + S
			→			<b>24.0108-0106.1 408106</b>	Ø 247 8 6 + S
2.0 HDi 90	66	02/99→08/05	←	→ 08/00		<b>24.0120-0133.1 420133</b>	Ø 266 20,5 18,5 V + S
			←	09/00→		<b>24.0320-0133.1 520133</b>	Ø 266 20,5 18,5 V + S
			→			<b>24.0122-0194.1 422194</b>	Ø 266 22 20 V + S
			→			<b>24.0108-0106.1 408106</b>	Ø 247 8 6 + S
<b>CITROËN - XSARA Coupe (N0) 01/98→04/05</b>							
 <b>Bremsbelagsatz, Scheibenbremse</b>							
1.4 HDi	50	01/03→03/05	←			<b>13.0460-3994.2 603994</b>	BOS 23599 19,0 - WE / - WK + Zub
						<b>13.0470-3994.2 LD3994</b>	BOS 23599 19,0 - WE / - WK + Zub Ceramic
1.4 i	55	03/98→03/05	←	→ 08/00; - ABS		<b>13.0460-3977.2 603977</b>	BOS 21980 18,0 + WE / - WK
			←	09/00→		<b>13.0460-3994.2 603994</b>	BOS 23599 19,0 - WE / - WK + Zub
						<b>13.0470-3994.2 LD3994</b>	BOS 23599 19,0 - WE / - WK + Zub Ceramic
			←	→ 08/00; + ABS		<b>13.0460-7088.2 607088</b>	ATE 21430 17,3 - WE / - WK
1.6 16V	80	09/00→03/05	←			<b>13.0460-3994.2 603994</b>	BOS 23599 19,0 - WE / - WK + Zub
						<b>13.0470-3994.2 LD3994</b>	BOS 23599 19,0 - WE / - WK + Zub Ceramic
			→			<b>13.0460-3823.2 603823</b>	BOS 20974 11,0 - WK
↓							

	kw			 	! #		
<b>CITROËN - XSARA Coupe (N0) 01/98→04/05</b>							
<b> Bremsbelagsatz, Scheibenbremse</b>							
1.6 i 1.8 i 1.9 D 1.9 TD	65 66 50 66	02/98→09/00	←	→ 08/00		13.0460-7088.2 607088	ATE 21430 17,3 - WE / - WK
1.8 i	74	02/98→09/00	←	→ 08/00		13.0460-2829.2 602829 13.0460-3978.2 603978 13.0460-7088.2 607088	TRW 23124 19,0 + WK BOS 23332 18,0 - WK + Zub ATE 21430 17,3 - WE / - WK
			→	→ 08/00		13.0460-3823.2 603823	BOS 20974 11,0 - WK
1.8 i 16V	81	02/98→09/00	←	→ 08/00		13.0460-2829.2 602829 13.0460-3978.2 603978	TRW 23124 19,0 + WK BOS 23332 18,0 - WK + Zub
			→	→ 08/00		13.0460-3823.2 603823	BOS 20974 11,0 - WK
1.8 LPG	82	01/98→08/00	←	02/98→		13.0460-2829.2 602829 13.0460-3978.2 603978	TRW 23124 19,0 + WK BOS 23332 18,0 - WK + Zub
			→	02/98→		13.0460-3823.2 603823	BOS 20974 11,0 - WK
1.9 D	51	02/99→03/05	←	09/00→		13.0460-3994.2 603994 13.0470-3994.2 LD3994	BOS 23599 19,0 - WE / - WK + Zub BOS 23599 19,0 - WE / - WK + Zub Ceramic
			←	→ 08/00		13.0460-7088.2 607088	ATE 21430 17,3 - WE / - WK
1.9 D	55	02/98→05/99	←			13.0460-7088.2 607088	ATE 21430 17,3 - WE / - WK
2.0 16V 2.0 HDi 109 2.0 i 16V	100 80 120	09/00→03/05 05/01→03/05 02/98→03/05	←	→Orga 09184		13.0460-2817.2 602817	TRW 21674 19,0 + WK
			←	Orga 09185→		13.0460-3966.2 603966 13.0470-3966.2 LD3966	BOS 23600 19,4 - WE / - WK + Zub BOS 23600 19,4 - WE / - WK + Zub Ceramic
			→			13.0460-3823.2 603823	BOS 20974 11,0 - WK
2.0 HDi 90	66	02/99→03/05	←	→ 08/00		13.0460-2829.2 602829 13.0460-3978.2 603978	TRW 23124 19,0 + WK BOS 23332 18,0 - WK + Zub
			←	09/00→		13.0460-3994.2 603994 13.0470-3994.2 LD3994	BOS 23599 19,0 - WE / - WK + Zub BOS 23599 19,0 - WE / - WK + Zub Ceramic
			→			13.0460-3823.2 603823	BOS 20974 11,0 - WK
<b>Zubehörsatz, Scheibenbremsbelag</b>							
1.6 16V 2.0 16V 2.0 HDi 109 2.0 HDi 90 2.0 i 16V	80 100 80 66 120	09/00→03/05 09/00→03/05 05/01→03/05 02/99→03/05 02/98→03/05	→			13.0460-0435.2 610435	BDX
1.8 i 1.8 i 16V	74 81	02/98→09/00 02/98→09/00	→	→ 08/00		13.0460-0435.2 610435	BDX
1.8 LPG	82	01/98→08/00	→	02/98→		13.0460-0435.2 610435	BDX
<b> Bremsscheibe</b>							
1.4 HDi	50	01/03→03/05	←			24.0122-0194.1 422194	Ø 266 22 20 V + S
1.4 i	55	03/98→03/05	←	→ 08/00; - ABS		24.0113-0185.1 413185 24.0313-0185.1 513185	Ø 247,5 13 11 + S Ø 247,5 13 11 + S
			←	→ 08/00; + ABS		24.0120-0132.1 420132 24.0320-0132.1 520132	Ø 247 20,4 18,5 V + S Ø 247 20,4 18,5 V + S
			←	09/00→		24.0122-0194.1 422194	Ø 266 22 20 V + S
1.6 16V	80	09/00→03/05	←			24.0122-0194.1 422194 24.0108-0106.1 408106	Ø 266 22 20 V + S Ø 247 8 6 + S
1.6 i 1.8 i 1.9 D 1.9 TD	65 66 50 66	02/98→09/00 02/98→09/00 02/98→09/00 02/98→09/00	←	→ 08/00		24.0120-0132.1 420132 24.0320-0132.1 520132	Ø 247 20,4 18,5 V + S Ø 247 20,4 18,5 V + S
1.8 i	74	02/98→09/00	←	→ 08/00		24.0120-0132.1 420132 24.0120-0133.1 420133 24.0320-0132.1 520132 24.0320-0133.1 520133	Ø 247 20,4 18,5 V + S Ø 266 20,5 18,5 V + S Ø 247 20,4 18,5 V + S Ø 266 20,5 18,5 V + S
			→	→ 08/00		24.0108-0106.1 408106	Ø 247 8 6 + S
1.8 i 16V	81	02/98→09/00	←	→ 08/00		24.0120-0133.1 420133 24.0320-0133.1 520133	Ø 266 20,5 18,5 V + S Ø 266 20,5 18,5 V + S
			→	→ 08/00		24.0108-0106.1 408106	Ø 247 8 6 + S
↓							









	kw					! #		
<b>CITROËN - XSARA Coupe (N0) 01/98→04/05</b>								
 <b>Bremsscheibe</b>								
1.8 LPG	82	01/98→08/00	←	02/98→			24.0120-0133.1 420133 24.0320-0133.1 520133	Ø 266 20,5 18,5 V + S Ø 266 20,5 18,5 V + S
			→	02/98→			24.0108-0106.1 408106	Ø 247 8 6 + S
1.9 D	51	02/99→03/05	←	→ 08/00			24.0120-0132.1 420132 24.0320-0132.1 520132	Ø 247 20,4 18,5 V + S Ø 247 20,4 18,5 V + S
			←	09/00→			24.0122-0194.1 422194	Ø 266 22 20 V + S
1.9 D	55	02/98→05/99	←				24.0120-0132.1 420132 24.0320-0132.1 520132	Ø 247 20,4 18,5 V + S Ø 247 20,4 18,5 V + S
2.0 16V 2.0 HDi 109 2.0 i 16V	100 80 120	09/00→03/05 05/01→03/05 02/98→03/05	←	→Orga 09184			24.0122-0142.1 422142	Ø 283 22 20 V
			←	Orga 09185→			24.0126-0120.1 426120 24.0326-0120.1 526120	Ø 283 26 24 V + S Ø 283 26 24 V + S
			→				24.0108-0106.1 408106	Ø 247 8 6 + S
2.0 HDi 90	66	02/99→03/05	←	→ 08/00			24.0120-0133.1 420133 24.0320-0133.1 520133	Ø 266 20,5 18,5 V + S Ø 266 20,5 18,5 V + S
			←	09/00→			24.0122-0194.1 422194	Ø 266 22 20 V + S
			→				24.0108-0106.1 408106	Ø 247 8 6 + S
<b>CITROËN - XSARA Kasten/Kombi 05/98→08/05</b>								
 <b>Bremsbelagsatz, Scheibenbremse</b>								
1.4	55	09/00→03/05	←				13.0460-3994.2 603994 13.0470-3994.2 LD3994	BOS 23599 19,0 - WE / - WK + Zub BOS 23599 19,0 - WE / - WK + Zub Ceramic
1.8 D	43	05/98→05/99	←	+ ABS			13.0460-2829.2 602829 13.0460-3978.2 603978	TRW 23124 19,0 + WK BOS 23332 18,0 - WK + Zub
			←	- ABS			13.0460-7088.2 607088	ATE 21430 17,3 - WE / - WK
1.9 D	51	06/99→08/05	←	→ 08/00; + ABS			13.0460-2829.2 602829 13.0460-3978.2 603978	TRW 23124 19,0 + WK BOS 23332 18,0 - WK + Zub
			←	09/00→			13.0460-3994.2 603994 13.0470-3994.2 LD3994	BOS 23599 19,0 - WE / - WK + Zub BOS 23599 19,0 - WE / - WK + Zub Ceramic
			←	→ 08/00; - ABS			13.0460-7088.2 607088	ATE 21430 17,3 - WE / - WK
2.0 HDi	66	09/00→03/05	←				13.0460-3994.2 603994 13.0470-3994.2 LD3994	BOS 23599 19,0 - WE / - WK + Zub BOS 23599 19,0 - WE / - WK + Zub Ceramic
			→				13.0460-3823.2 603823	BOS 20974 11,0 - WK
<b>Zubehörsatz, Scheibenbremsbelag</b>								
2.0 HDi	66	09/00→03/05	→				13.0460-0435.2 610435	BDX
 <b>Bremsscheibe</b>								
1.4	55	09/00→03/05	←				24.0122-0194.1 422194	Ø 266 22 20 V + S
1.8 D	43	05/98→05/99	←	- ABS			24.0120-0132.1 420132 24.0124-0127.1 424127 24.0320-0132.1 520132	Ø 247 20,4 18,5 V + S Ø 280 24 21,9 V Ø 247 20,4 18,5 V + S
			←	+ ABS			24.0120-0133.1 420133 24.0320-0133.1 520133	Ø 266 20,5 18,5 V + S Ø 266 20,5 18,5 V + S
1.9 D	51	06/99→08/05	←	→ 08/00; - ABS			24.0120-0132.1 420132 24.0124-0127.1 424127 24.0320-0132.1 520132	Ø 247 20,4 18,5 V + S Ø 280 24 21,9 V Ø 247 20,4 18,5 V + S
			←	→ 08/00; + ABS			24.0120-0133.1 420133 24.0320-0133.1 520133	Ø 266 20,5 18,5 V + S Ø 266 20,5 18,5 V + S
			←	09/00→			24.0122-0194.1 422194	Ø 266 22 20 V + S
2.0 HDi	66	09/00→03/05	←				24.0122-0194.1 422194	Ø 266 22 20 V + S
			→				24.0108-0106.1 408106	Ø 247 8 6 + S
<b>CITROËN - XSARA Kasten/Schrägheck (N3_) 05/98→03/05</b>								
 <b>Bremsbelagsatz, Scheibenbremse</b>								
1.4 ↓	55	05/98→10/04	←	→ 08/00; - ABS			13.0460-3977.2 603977	BOS 21980 18,0 + WE / - WK























	kw			 	! #		
<b>CITROËN - XSARA Kasten/Schrägheck (N3_) 05/98→03/05</b>							
<b> Bremsbelagsatz, Scheibenbremse</b>							
1.4	55	05/98→10/04	←	09/00→		<b>13.0460-3994.2 603994</b> <b>13.0470-3994.2 LD3994</b>	BOS 23599 19,0 - WE / - WK + Zub BOS 23599 19,0 - WE / - WK + Zub Ceramic
			←	→ 08/00; + ABS		<b>13.0460-7088.2 607088</b>	ATE 21430 17,3 - WE / - WK
1.4 LPG	55	06/99→08/00	←	- ABS		<b>13.0460-3977.2 603977</b>	BOS 21980 18,0 + WE / - WK
			←	+ ABS		<b>13.0460-7088.2 607088</b>	ATE 21430 17,3 - WE / - WK
1.8 D 1.9 D	43 65	05/98→05/99 05/98→08/00	←			<b>13.0460-7088.2 607088</b>	ATE 21430 17,3 - WE / - WK
1.9 D	51	06/99→03/05	←	09/00→		<b>13.0460-3994.2 603994</b> <b>13.0470-3994.2 LD3994</b>	BOS 23599 19,0 - WE / - WK + Zub BOS 23599 19,0 - WE / - WK + Zub Ceramic
			←	→ 08/00		<b>13.0460-7088.2 607088</b>	ATE 21430 17,3 - WE / - WK
2.0 HDi	66	09/00→03/05	←			<b>13.0460-3994.2 603994</b> <b>13.0470-3994.2 LD3994</b>	BOS 23599 19,0 - WE / - WK + Zub BOS 23599 19,0 - WE / - WK + Zub Ceramic
			→			<b>13.0460-3823.2 603823</b>	BOS 20974 11,0 - WK
<b>Zubehörsatz, Scheibenbremsbelag</b>							
2.0 HDi	66	09/00→03/05	→			<b>13.0460-0435.2 610435</b>	BDX
<b> Bremsscheibe</b>							
1.4	55	05/98→10/04	←	→ 08/00; - ABS		<b>24.0113-0185.1 413185</b> <b>24.0313-0185.1 513185</b>	Ø 247,5 13 11 + S Ø 247,5 13 11 + S
			←	→ 08/00; + ABS		<b>24.0120-0132.1 420132</b> <b>24.0320-0132.1 520132</b>	Ø 247 20,4 18,5 V + S Ø 247 20,4 18,5 V + S
			←	09/00→		<b>24.0122-0194.1 422194</b>	Ø 266 22 20 V + S
1.4 LPG	55	06/99→08/00	←	- ABS		<b>24.0113-0185.1 413185</b> <b>24.0313-0185.1 513185</b>	Ø 247,5 13 11 + S Ø 247,5 13 11 + S
			←	+ ABS		<b>24.0120-0132.1 420132</b> <b>24.0320-0132.1 520132</b>	Ø 247 20,4 18,5 V + S Ø 247 20,4 18,5 V + S
1.8 D 1.9 D	43 65	05/98→05/99 05/98→08/00	←			<b>24.0120-0132.1 420132</b> <b>24.0320-0132.1 520132</b>	Ø 247 20,4 18,5 V + S Ø 247 20,4 18,5 V + S
1.9 D	51	06/99→03/05	←	→ 08/00		<b>24.0120-0132.1 420132</b> <b>24.0320-0132.1 520132</b>	Ø 247 20,4 18,5 V + S Ø 247 20,4 18,5 V + S
			←	09/00→		<b>24.0122-0194.1 422194</b>	Ø 266 22 20 V + S
2.0 HDi	66	09/00→03/05	←			<b>24.0122-0194.1 422194</b> <b>24.0108-0106.1 408106</b>	Ø 266 22 20 V + S Ø 247 8 6 + S
<b>CITROËN - XSARA PICASSO (N68) 12/99→</b>							
<b> Bremsbelagsatz, Scheibenbremse</b>							
1.6	65	12/99→	←	06/00→ 03/10		<b>13.0460-2862.2 602862</b>	TRW 23346 19,0 - WK
			←	06/00→ 03/10; + ESP		<b>13.0460-3811.2 603811</b>	BOS 23708 19,2 - WE / - WK
			←	06/00→ 03/10; - ESP		<b>13.0460-3994.2 603994</b> <b>13.0470-3994.2 LD3994</b>	BOS 23599 19,0 - WE / - WK + Zub BOS 23599 19,0 - WE / - WK + Zub Ceramic
1.6	67	06/02→	←	→ 03/10		<b>13.0460-2862.2 602862</b>	TRW 23346 19,0 - WK
			←	→ 03/10; + ESP		<b>13.0460-3811.2 603811</b>	BOS 23708 19,2 - WE / - WK
			←	→ 03/10; - ESP		<b>13.0460-3994.2 603994</b> <b>13.0470-3994.2 LD3994</b>	BOS 23599 19,0 - WE / - WK + Zub BOS 23599 19,0 - WE / - WK + Zub Ceramic
1.6	70	12/99→	←	09/00→ 03/10		<b>13.0460-2862.2 602862</b>	TRW 23346 19,0 - WK
			←	09/00→ 03/10; + ESP		<b>13.0460-3811.2 603811</b>	BOS 23708 19,2 - WE / - WK
			←	09/00→ 03/10; - ESP		<b>13.0460-3994.2 603994</b> <b>13.0470-3994.2 LD3994</b>	BOS 23599 19,0 - WE / - WK + Zub BOS 23599 19,0 - WE / - WK + Zub Ceramic
1.6 16V 1.6 HDi ↓	80 80	09/05→ 05/04→	←	→ 03/10		<b>13.0460-2862.2 602862</b>	TRW 23346 19,0 - WK

	kw			 	! #			
<b>CITROËN - XSARA PICASSO (N68) 12/99→</b>								
<b> Bremsbelagsatz, Scheibenbremse</b>								
1.6 16V 1.6 HDi	80 80	09/05→ 05/04→	←	→ 03/10; + ESP		<b>13.0460-3811.2</b>	<b>603811</b>	BOS 23708 19,2 - WE / - WK
			←	→ 03/10; - ESP		<b>13.0460-3994.2</b>	<b>603994</b>	BOS 23599 19,0 - WE / - WK + Zub
						<b>13.0470-3994.2</b>	<b>LD3994</b>	BOS 23599 19,0 - WE / - WK + Zub Ceramic
			→	→ 03/10		<b>13.0460-2820.2</b>	<b>602820</b>	TRW 20961 17,2 - WK
					<b>13.0470-2820.2</b>	<b>LD2820</b>	TRW 20961 17,2 - WK Ceramic	
1.6 16V	81	06/05→09/06	←	09/05→		<b>13.0460-2862.2</b>	<b>602862</b>	TRW 23346 19,0 - WK
			←	09/05→; + ESP		<b>13.0460-3811.2</b>	<b>603811</b>	BOS 23708 19,2 - WE / - WK
			←	09/05→; - ESP		<b>13.0460-3994.2</b>	<b>603994</b>	BOS 23599 19,0 - WE / - WK + Zub
						<b>13.0470-3994.2</b>	<b>LD3994</b>	BOS 23599 19,0 - WE / - WK + Zub Ceramic
			→	09/05→		<b>13.0460-2820.2</b>	<b>602820</b>	TRW 20961 17,2 - WK
					<b>13.0470-2820.2</b>	<b>LD2820</b>	TRW 20961 17,2 - WK Ceramic	
1.6 Chrono	74	04/01→10/04	←			<b>13.0460-2862.2</b>	<b>602862</b>	TRW 23346 19,0 - WK
			←	+ ESP		<b>13.0460-3811.2</b>	<b>603811</b>	BOS 23708 19,2 - WE / - WK
			←	- ESP		<b>13.0460-3994.2</b>	<b>603994</b>	BOS 23599 19,0 - WE / - WK + Zub
					<b>13.0470-3994.2</b>	<b>LD3994</b>	BOS 23599 19,0 - WE / - WK + Zub Ceramic	
1.6 HDi	66	09/05→	←	→ 03/10		<b>13.0460-2862.2</b>	<b>602862</b>	TRW 23346 19,0 - WK
			←	→ 03/10; - ESP		<b>13.0460-3811.2</b>	<b>603811</b>	BOS 23708 19,2 - WE / - WK
						<b>13.0460-3994.2</b>	<b>603994</b>	BOS 23599 19,0 - WE / - WK + Zub
						<b>13.0470-3994.2</b>	<b>LD3994</b>	BOS 23599 19,0 - WE / - WK + Zub Ceramic
			→	→ 03/10		<b>13.0460-2820.2</b>	<b>602820</b>	TRW 20961 17,2 - WK
					<b>13.0470-2820.2</b>	<b>LD2820</b>	TRW 20961 17,2 - WK Ceramic	
1.8 16V	85	02/00→	←	→ 03/10		<b>13.0460-2862.2</b>	<b>602862</b>	TRW 23346 19,0 - WK
			←	→ 03/10; + ESP		<b>13.0460-3811.2</b>	<b>603811</b>	BOS 23708 19,2 - WE / - WK
			←	→ 03/10; - ESP		<b>13.0460-3994.2</b>	<b>603994</b>	BOS 23599 19,0 - WE / - WK + Zub
						<b>13.0470-3994.2</b>	<b>LD3994</b>	BOS 23599 19,0 - WE / - WK + Zub Ceramic
			→	→ 03/10; + ESP		<b>13.0460-2820.2</b>	<b>602820</b>	TRW 20961 17,2 - WK
					<b>13.0470-2820.2</b>	<b>LD2820</b>	TRW 20961 17,2 - WK Ceramic	
2.0 16V	100	01/03→	←	→ 03/10		<b>13.0460-2862.2</b>	<b>602862</b>	TRW 23346 19,0 - WK
			←	→ 03/10; Automatikgetriebe		<b>13.0460-3811.2</b>	<b>603811</b>	BOS 23708 19,2 - WE / - WK
			←	→ 03/10; + ESP; Schaltgetriebe		<b>13.0460-3811.2</b>	<b>603811</b>	BOS 23708 19,2 - WE / - WK
			←	→ 03/10; - ESP; Schaltgetriebe		<b>13.0460-3994.2</b>	<b>603994</b>	BOS 23599 19,0 - WE / - WK + Zub
						<b>13.0470-3994.2</b>	<b>LD3994</b>	BOS 23599 19,0 - WE / - WK + Zub Ceramic
			→	→ 03/10		<b>13.0460-2820.2</b>	<b>602820</b>	TRW 20961 17,2 - WK
					<b>13.0470-2820.2</b>	<b>LD2820</b>	TRW 20961 17,2 - WK Ceramic	
2.0 16V	101	12/99→11/11	←	01/03→ 03/10		<b>13.0460-2862.2</b>	<b>602862</b>	TRW 23346 19,0 - WK
			←	01/03→ 03/10; Automatikgetriebe		<b>13.0460-3811.2</b>	<b>603811</b>	BOS 23708 19,2 - WE / - WK
			←	01/03→ 03/10; + ESP; Schaltgetriebe		<b>13.0460-3811.2</b>	<b>603811</b>	BOS 23708 19,2 - WE / - WK
			←	01/03→ 03/10; - ESP; Schaltgetriebe		<b>13.0460-3994.2</b>	<b>603994</b>	BOS 23599 19,0 - WE / - WK + Zub
						<b>13.0470-3994.2</b>	<b>LD3994</b>	BOS 23599 19,0 - WE / - WK + Zub Ceramic
			→	01/03→ 03/10		<b>13.0460-2820.2</b>	<b>602820</b>	TRW 20961 17,2 - WK
					<b>13.0470-2820.2</b>	<b>LD2820</b>	TRW 20961 17,2 - WK Ceramic	
2.0 HDi	66	12/99→	←	06/00→ 03/10		<b>13.0460-2862.2</b>	<b>602862</b>	TRW 23346 19,0 - WK
			←	06/00→ 03/10; + ESP		<b>13.0460-3811.2</b>	<b>603811</b>	BOS 23708 19,2 - WE / - WK
			←	06/00→ 03/10; - ESP		<b>13.0460-3994.2</b>	<b>603994</b>	BOS 23599 19,0 - WE / - WK + Zub
						<b>13.0470-3994.2</b>	<b>LD3994</b>	BOS 23599 19,0 - WE / - WK + Zub Ceramic
			→	06/00→ 03/10		<b>13.0460-2820.2</b>	<b>602820</b>	TRW 20961 17,2 - WK
					<b>13.0470-2820.2</b>	<b>LD2820</b>	TRW 20961 17,2 - WK Ceramic	

























	kw			 	! #		
<b>CITROËN - XSARA PICASSO (N68) 12/99→</b>							
 <b>Bremsscheibe</b>							
1.6	65	12/99→	←	06/00→ 03/10; Herstellereinschränkung TRW	24.0120-0133.1 420133	Ø 266 20,5 18,5 V + S	
			←	06/00→ 03/10; - ESP	24.0320-0133.1 520133	Ø 266 20,5 18,5 V + S	
			←	06/00→ 03/10; + ESP	24.0122-0194.1 422194	Ø 266 22 20 V + S	
1.6	67	06/02→	←	06/00→ 03/10; + ESP	24.0126-0120.1 426120	Ø 283 26 24 V + S	
			←	06/00→ 03/10; - ESP	24.0326-0120.1 526120	Ø 283 26 24 V + S	
			←	06/00→ 03/10; Herstellereinschränkung TRW	24.0120-0133.1 420133	Ø 266 20,5 18,5 V + S	
1.6	70	12/99→	←	06/00→ 03/10; - ESP	24.0320-0133.1 520133	Ø 266 20,5 18,5 V + S	
			←	06/00→ 03/10; + ESP	24.0122-0194.1 422194	Ø 266 22 20 V + S	
			←	06/00→ 03/10; Herstellereinschränkung TRW	24.0126-0120.1 426120	Ø 283 26 24 V + S	
1.6 16V 1.6 HDi 1.6 HDi 1.8 16V	80 66 80 85	09/05→ 09/05→ 05/04→ 02/00→	←	09/00→ 03/10; Herstellereinschränkung TRW	24.0326-0120.1 526120	Ø 283 26 24 V + S	
			←	09/00→ 03/10; - ESP	24.0120-0133.1 420133	Ø 266 20,5 18,5 V + S	
			←	09/00→ 03/10; + ESP	24.0320-0133.1 520133	Ø 266 20,5 18,5 V + S	
1.6 16V	81	06/05→09/06	←	09/05→; Herstellereinschränkung TRW	24.0122-0194.1 422194	Ø 266 22 20 V + S	
			←	09/05→; - ESP	24.0126-0120.1 426120	Ø 283 26 24 V + S	
			←	09/05→; + ESP	24.0326-0120.1 526120	Ø 283 26 24 V + S	
1.6 Chrono	74	04/01→10/04	←	09/05→	24.0109-0137.1 409137	Ø 247 9 8 + S	
			←	09/05→	24.0120-0133.1 420133	Ø 266 20,5 18,5 V + S	
			←	09/05→	24.0320-0133.1 520133	Ø 266 20,5 18,5 V + S	
2.0 16V	100	01/03→	←	09/05→	24.0126-0120.1 426120	Ø 283 26 24 V + S	
			←	09/05→	24.0326-0120.1 526120	Ø 283 26 24 V + S	
			←	09/05→	24.0126-0120.1 426120	Ø 283 26 24 V + S	
2.0 16V	101	12/99→11/11	←	09/05→	24.0326-0120.1 526120	Ø 283 26 24 V + S	
			←	09/05→	24.0126-0120.1 426120	Ø 283 26 24 V + S	
			←	09/05→	24.0326-0120.1 526120	Ø 283 26 24 V + S	
2.0 HDi	66	12/99→	←	09/05→	24.0109-0137.1 409137	Ø 247 9 8 + S	
			←	09/05→	24.0120-0133.1 420133	Ø 266 20,5 18,5 V + S	
			←	09/05→	24.0320-0133.1 520133	Ø 266 20,5 18,5 V + S	
<b>CITROËN - ZX (N2) 03/91→07/99</b>							
 <b>Bremsbelagsatz, Scheibenbremse</b>							
1.1 1.4 1.4 i	44 55 55	03/91→06/97 03/91→06/97 03/91→06/97	←		13.0460-3952.2 603952	BDX 20905 18,0 + WK	
1.4 D	37	07/94→10/97	←	→ 06/97	13.0460-3952.2 603952	BDX 20905 18,0 + WK	
1.6 1.9 DT	66 65	07/94→10/97 07/94→10/97	←	→ 06/97	13.0460-2981.2 602981	TRW 21460 18,0 + WK	
↓					13.0460-3952.2 603952	BDX 20905 18,0 + WK	













	kw			 	! #		
<b>CITROËN - ZX (N2) 03/91→07/99</b>							
<b> Bremsbelagsatz, Scheibenbremse</b>							
1.6 1.9 DT	66 65	07/94→10/97 07/94→10/97	➔	→ 06/97		13.0460-3823.2 603823	BOS 20974 11,0 - WK
1.6 i 1.9 TD	65 66	03/91→06/97 07/92→06/97	➔			13.0460-2981.2 602981 13.0460-3952.2 603952	TRW 21460 18,0 + WK BDX 20905 18,0 + WK
			➔			13.0460-3823.2 603823	BOS 20974 11,0 - WK
1.8 1.8 2.0	76 82 90	07/94→10/97 04/96→10/97 07/94→10/97	➔	→ 06/97		13.0460-2981.2 602981	TRW 21460 18,0 + WK
			➔	→ 06/97		13.0460-3823.2 603823	BOS 20974 11,0 - WK
1.8 D 1.9 D	44 47	06/93→06/97 03/91→06/97	➔	→Orga 06049		13.0460-2825.2 602825	TRW 21614 17,7 + WK
			➔			13.0460-3952.2 603952	BDX 20905 18,0 + WK
			➔			13.0460-3823.2 603823	BOS 20974 11,0 - WK
1.8 i 1.8 i 16V 1.9 1.9 i 2.0 i	74 81 93 88 89	07/92→06/97 01/96→06/97 03/91→06/97 03/91→06/97 07/92→06/97	➔			13.0460-2981.2 602981	TRW 21460 18,0 + WK
			➔			13.0460-3823.2 603823	BOS 20974 11,0 - WK
1.9 D	50	07/93→06/97	➔	06/94→		13.0460-3952.2 603952	BDX 20905 18,0 + WK
			➔	06/94→		13.0460-3823.2 603823	BOS 20974 11,0 - WK
2.0 2.0 i 16V	122 120	09/96→10/97 05/96→06/97	➔			13.0460-2817.2 602817	TRW 21674 19,0 + WK
			➔			13.0460-3954.2 603954	BDX 20973 11,0 - WK
2.0 i 16V 2.0 i 16V	110 114	06/94→06/97 07/92→10/97	➔			13.0460-3954.2 603954	BDX 20973 11,0 - WK
<b>Zubehörsatz, Scheibenbremsbelag</b>							
1.1 1.4 1.4 i	44 55 55	03/91→06/97 03/91→06/97 03/91→06/97	➔			13.0460-0403.2 610403	BDX
1.4 D	37	07/94→10/97	➔	→ 06/97		13.0460-0403.2 610403	BDX
1.6 1.9 DT	66 65	07/94→10/97 07/94→10/97	➔	→ 06/97		13.0460-0403.2 610403	BDX
			➔	→ 06/97		13.0460-0435.2 610435	BDX
1.6 i 1.9 TD	65 66	03/91→06/97 07/92→06/97	➔			13.0460-0403.2 610403	BDX
			➔			13.0460-0435.2 610435	BDX
1.8 1.8 2.0	76 82 90	07/94→10/97 04/96→10/97 07/94→10/97	➔	→ 06/97		13.0460-0435.2 610435	BDX
1.8 D 1.9 D	44 47	06/93→06/97 03/91→06/97	➔	→Orga 06049		13.0460-0060.2 610060	TRW
			➔			13.0460-0435.2 610435	BDX
1.8 i 1.8 i 16V 1.9 1.9 i 2.0 2.0 i 2.0 i 16V 2.0 i 16V 2.0 i 16V	74 81 93 88 122 89 110 114 120	07/92→06/97 01/96→06/97 03/91→06/97 03/91→06/97 09/96→10/97 07/92→06/97 06/94→06/97 07/92→10/97 05/96→06/97	➔			13.0460-0435.2 610435	BDX
1.9 D	50	07/93→06/97	➔	06/94→		13.0460-0435.2 610435	BDX
<b> Bremsscheibe</b>							
1.1 1.4 1.4 i	44 55 55	03/91→06/97 03/91→06/97 03/91→06/97	➔			24.0110-0187.1 410187	Ø 247 10 9 + S
1.4 D	37	07/94→10/97	➔	→ 06/97		24.0110-0187.1 410187	Ø 247 10 9 + S
1.6 1.8 1.8 2.0	66 76 82 90	07/94→10/97 07/94→10/97 04/96→10/97 07/94→10/97	➔	→ 06/97		24.0120-0132.1 420132 24.0320-0132.1 520132	Ø 247 20,4 18,5 V + S Ø 247 20,4 18,5 V + S
			➔	→ 06/97		24.0108-0106.1 408106	Ø 247 8 6 + S
1.6 i 1.8 i 1.8 i 16V 1.9 1.9 i 2.0 i	65 74 81 93 88 89	03/91→06/97 07/92→06/97 01/96→06/97 03/91→06/97 03/91→06/97 07/92→06/97	➔			24.0120-0132.1 420132 24.0320-0132.1 520132	Ø 247 20,4 18,5 V + S Ø 247 20,4 18,5 V + S
			➔			24.0108-0106.1 408106	Ø 247 8 6 + S
1.8 D 1.9 D	44 47	06/93→06/97 03/91→06/97	➔			24.0110-0187.1 410187	Ø 247 10 9 + S
			➔			24.0108-0106.1 408106	Ø 247 8 6 + S
1.9 D	50	07/93→06/97	➔	06/94→		24.0110-0187.1 410187	Ø 247 10 9 + S
			➔	06/94→		24.0108-0106.1 408106	Ø 247 8 6 + S
1.9 DT ↓	65	07/94→10/97	➔	→ 06/97		24.0110-0187.1 410187	Ø 247 10 9 + S













	kw			 	! #		
<b>CITROËN - ZX (N2) 03/91→07/99</b>							
 <b>Bremsscheibe</b>							
1.9 DT	65	07/94→10/97	←	→ 06/97		24.0120-0132.1 420132 24.0320-0132.1 520132	Ø 247 20,4 18,5 V + S Ø 247 20,4 18,5 V + S
			→	→ 06/97		24.0108-0106.1 408106	Ø 247 8 6 + S
1.9 TD	66	07/92→06/97	←			24.0110-0187.1 410187 24.0120-0132.1 420132 24.0320-0132.1 520132	Ø 247 10 9 + S Ø 247 20,4 18,5 V + S Ø 247 20,4 18,5 V + S
			→			24.0108-0106.1 408106	Ø 247 8 6 + S
2.0	122	09/96→10/97	←			24.0120-0133.1 420133 24.0122-0142.1 422142 24.0320-0133.1 520133	Ø 266 20,5 18,5 V + S Ø 283 22 20 V Ø 266 20,5 18,5 V + S
			→			24.0108-0106.1 408106	Ø 247 8 6 + S
2.0 i 16V 2.0 i 16V	110 114	06/94→06/97 07/92→10/97	←			24.0120-0133.1 420133 24.0320-0133.1 520133	Ø 266 20,5 18,5 V + S Ø 266 20,5 18,5 V + S
			→			24.0108-0106.1 408106	Ø 247 8 6 + S
2.0 i 16V	120	05/96→06/97	←			24.0122-0142.1 422142	Ø 283 22 20 V
			→			24.0108-0106.1 408106	Ø 247 8 6 + S
<b>CITROËN - ZX Break (N2) 10/93→07/99</b>							
 <b>Bremsbelagsatz, Scheibenbremse</b>							
1.4 i 1.5 D	55 42	10/93→10/97 06/96→02/98	←			13.0460-3952.2 603952	BDX 20905 18,0 + WK
1.6 i	65	10/93→10/97	←			13.0460-2981.2 602981 13.0460-3952.2 603952	TRW 21460 18,0 + WK BDX 20905 18,0 + WK
			→			13.0460-3823.2 603823	BOS 20974 11,0 - WK
1.8 D 1.8 i 1.8 i 16V 1.9 D 1.9 D 1.9 TD	44 74 81 47 50 66	10/93→10/97 10/93→10/97 01/96→02/98 10/93→10/97 06/94→10/97 10/93→10/97	←			13.0460-2981.2 602981 13.0460-3823.2 603823	TRW 21460 18,0 + WK BOS 20974 11,0 - WK
			→				
<b>Zubehörsatz, Scheibenbremsbelag</b>							
1.4 i 1.5 D	55 42	10/93→10/97 06/96→02/98	←			13.0460-0403.2 610403	BDX
1.6 i	65	10/93→10/97	←			13.0460-0403.2 610403	BDX
			→			13.0460-0435.2 610435	BDX
1.8 D 1.8 i 1.8 i 16V 1.9 D 1.9 D 1.9 TD	44 74 81 47 50 66	10/93→10/97 10/93→10/97 01/96→02/98 10/93→10/97 06/94→10/97 10/93→10/97	→			13.0460-0435.2 610435	BDX
 <b>Bremsscheibe</b>							
1.4 i 1.5 D	55 42	10/93→10/97 06/96→02/98	←			24.0110-0187.1 410187	Ø 247 10 9 + S
1.6 i 1.8 D 1.8 i 1.8 i 16V	65 44 74 81	10/93→10/97 10/93→10/97 10/93→10/97 01/96→02/98	←			24.0120-0132.1 420132 24.0320-0132.1 520132	Ø 247 20,4 18,5 V + S Ø 247 20,4 18,5 V + S
1.9 D 1.9 D 1.9 TD	47 50 66	10/93→10/97 06/94→10/97 10/93→10/97	→			24.0108-0106.1 408106	Ø 247 8 6 + S
<b>DACIA - DOKKER 11/12→</b>							
 <b>Bremsbelagsatz, Scheibenbremse</b>							
1.2 TCe	85	11/12→	←			13.0460-7266.2 607266 13.0470-7266.2 LD7266	ATE 24538 17,9 - WE / - WK ATE 24538 17,9 - WE / - WK Ceramic
1.5 dCi 1.5 dCi 1.6 1.6 1.6 LPG 1.6 LPG	55 66 61 75 61 75	11/12→ 11/12→ 11/12→ 04/15→ 11/13→ 04/15→	←	- ESP		13.0460-2709.2 602709 13.0470-2709.2 LD2709	TRW 23973 17,1 - WE / - WK + Zub TRW 23973 17,1 - WE / - WK + Zub Ceramic
			←	+ ESP		13.0460-7266.2 607266 13.0470-7266.2 LD7266	ATE 24538 17,9 - WE / - WK ATE 24538 17,9 - WE / - WK Ceramic
↓							













	kw			 	! #		
<b>DACIA - DOKKER 11/12→</b>							
 <b>Bremsscheibe</b>							
1.2 TCe	85	11/12→	←			24.0124-0253.1 424253	Ø 280 24 21,8 V + S
1.5 dCi	55	11/12→	←	- ESP; nicht für erhöhte Nutzlast		24.0122-0270.1 422270	Ø 258 22 19,8 V + S
1.5 dCi	66	11/12→	←	- ESP; für erhöhte Nutzlast		24.0124-0253.1 424253	Ø 280 24 21,8 V + S
1.6	61	11/12→	←				
1.6	75	04/15→	←	+ ESP		24.0124-0253.1 424253	Ø 280 24 21,8 V + S
1.6 LPG	61	11/13→					
1.6 LPG	75	04/15→					
<b>DACIA - DOKKER Express 12/12→</b>							
 <b>Bremsbelagsatz, Scheibenbremse</b>							
1.2 TCe 115	84	12/12→	←			13.0460-7266.2 607266	ATE 24538 17,9 - WE / - WK
1.2 TCe 115	85	07/15→				13.0470-7266.2 LD7266	ATE 24538 17,9 - WE / - WK Ceramic
1.5 dCi	55	12/12→	←	- ESP; nicht für erhöhte Nutzlast		13.0460-2709.2 602709	TRW 23973 17,1 - WE / - WK + Zub
1.5 dCi	66	12/12→					
1.6	61	12/12→					
1.6	75	04/15→				13.0470-2709.2 LD2709	TRW 23973 17,1 - WE / - WK + Zub Ceramic
1.6 LPG	61	11/13→					
1.6 LPG	75	04/15→	←	- ESP; für erhöhte Nutzlast		13.0460-7266.2 607266	ATE 24538 17,9 - WE / - WK
						13.0470-7266.2 LD7266	ATE 24538 17,9 - WE / - WK Ceramic
			←	+ ESP		13.0460-7266.2 607266	ATE 24538 17,9 - WE / - WK
						13.0470-7266.2 LD7266	ATE 24538 17,9 - WE / - WK Ceramic
 <b>Bremsscheibe</b>							
1.2 TCe 115	84	12/12→	←			24.0124-0253.1 424253	Ø 280 24 21,8 V + S
1.2 TCe 115	85	07/15→					
1.5 dCi	55	12/12→	←	- ESP; nicht für erhöhte Nutzlast		24.0122-0270.1 422270	Ø 258 22 19,8 V + S
1.5 dCi	66	12/12→					
1.6	61	12/12→	←	- ESP; für erhöhte Nutzlast		24.0124-0253.1 424253	Ø 280 24 21,8 V + S
1.6	75	04/15→	←	+ ESP		24.0124-0253.1 424253	Ø 280 24 21,8 V + S
1.6 LPG	61	11/13→					
1.6 LPG	75	04/15→					
<b>DACIA - DUSTER 04/10→</b>							
 <b>Bremsbelagsatz, Scheibenbremse</b>							
1.2 TCe 125	92	10/13→	←			13.0460-7266.2 607266	ATE 24538 17,9 - WE / - WK
1.2 TCe 125 4x4	92	06/15→				13.0470-7266.2 LD7266	ATE 24538 17,9 - WE / - WK Ceramic
1.5 dCi 4x4	66	10/10→					
1.5 dCi	63	04/10→	←	- ABS		13.0460-2709.2 602709	TRW 23973 17,1 - WE / - WK + Zub
1.5 dCi	66	10/10→					
1.5 dCi	79	06/10→				13.0470-2709.2 LD2709	TRW 23973 17,1 - WE / - WK + Zub Ceramic
1.5 dCi 4x4	79	06/10→					
1.5 dCi 4x4	80	08/13→					
1.5 dCi 4x4	81	10/10→	←	+ ABS		13.0460-7266.2 607266	ATE 24538 17,9 - WE / - WK
						13.0470-7266.2 LD7266	ATE 24538 17,9 - WE / - WK Ceramic
1.5 dCi	80	08/13→	←	09/13→; - ABS		13.0460-2709.2 602709	TRW 23973 17,1 - WE / - WK + Zub
1.5 dCi	81	08/13→				13.0470-2709.2 LD2709	TRW 23973 17,1 - WE / - WK + Zub Ceramic
			←	09/13→; + ABS		13.0460-7266.2 607266	ATE 24538 17,9 - WE / - WK
						13.0470-7266.2 LD7266	ATE 24538 17,9 - WE / - WK Ceramic
1.6 16V	77	04/10→	←	- ESP		13.0460-2709.2 602709	TRW 23973 17,1 - WE / - WK + Zub
1.6 16V 4x4	77	06/10→					
1.6 16V LPG	77	04/11→				13.0470-2709.2 LD2709	TRW 23973 17,1 - WE / - WK + Zub Ceramic
1.6 SCe 115	84	06/15→					
1.6 SCe 115 4x4	84	06/15→					
1.6 SCe 115 LPG	84	06/15→	←	+ ESP		13.0460-7266.2 607266	ATE 24538 17,9 - WE / - WK
						13.0470-7266.2 LD7266	ATE 24538 17,9 - WE / - WK Ceramic
1.6 16V Hi-Flex	77	08/10→	←	04/11→; - ESP		13.0460-2709.2 602709	TRW 23973 17,1 - WE / - WK + Zub
						13.0470-2709.2 LD2709	TRW 23973 17,1 - WE / - WK + Zub Ceramic
			←	04/11→; + ESP		13.0460-7266.2 607266	ATE 24538 17,9 - WE / - WK
						13.0470-7266.2 LD7266	ATE 24538 17,9 - WE / - WK Ceramic
 <b>Bremsscheibe</b>							
1.2 TCe 125	92	10/13→	←			24.0124-0221.1 424221	Ø 280 24 21,8 V + S











	kw			 	! #		
<b>DACIA - DUSTER 04/10→</b>							
 <b>Bremsscheibe</b>							
1.2 TCe 125 4x4 1.5 dCi 4x4	92 66	06/15→ 10/10→	←			24.0124-0221.1 424221	Ø 280 24 21,8 V + S
1.5 dCi 1.5 dCi 1.5 dCi 1.5 dCi 4x4 1.5 dCi 4x4 1.5 dCi 4x4	63 66 79 79 80 81	04/10→ 10/10→ 06/10→ 06/10→ 08/13→ 10/10→	←	- ABS + ABS		24.0123-0119.1 423119 24.0124-0221.1 424221	Ø 269 22,5 19,8 V + S Ø 280 24 21,8 V + S
1.5 dCi 1.5 dCi	80 81	08/13→ 08/13→	←	09/13→; - ABS 09/13→; + ABS		24.0123-0119.1 423119 24.0124-0221.1 424221	Ø 269 22,5 19,8 V + S Ø 280 24 21,8 V + S
1.6 16V 1.6 16V 4x4 1.6 16V LPG 1.6 SCe 115 1.6 SCe 115 4x4 1.6 SCe 115 LPG	77 77 77 84 84 84	04/10→ 06/10→ 04/11→ 06/15→ 06/15→ 06/15→	←	- ESP + ESP		24.0123-0119.1 423119 24.0124-0221.1 424221	Ø 269 22,5 19,8 V + S Ø 280 24 21,8 V + S
1.6 16V Hi-Flex	77	08/10→	←	04/11→; - ESP 04/11→; + ESP		24.0123-0119.1 423119 24.0124-0221.1 424221	Ø 269 22,5 19,8 V + S Ø 280 24 21,8 V + S
<b>DACIA - DUSTER Kasten 04/11→</b>							
 <b>Bremsbelagsatz, Scheibenbremse</b>							
1.2 TCe 125 4x4	92	10/13→	←	06/15→		13.0460-7266.2 607266 13.0470-7266.2 LD7266	ATE 24538 17,9 - WE / - WK ATE 24538 17,9 - WE / - WK Ceramic
1.5 dCi	66	04/11→	←	- ABS + ABS		13.0460-2709.2 602709 13.0470-2709.2 LD2709 13.0460-7266.2 607266 13.0470-7266.2 LD7266	TRW 23973 17,1 - WE / - WK + Zub TRW 23973 17,1 - WE / - WK + Zub Ceramic ATE 24538 17,9 - WE / - WK ATE 24538 17,9 - WE / - WK Ceramic
1.5 dCi	80	04/13→	←	09/13→; - ABS 09/13→; + ABS		13.0460-2709.2 602709 13.0470-2709.2 LD2709 13.0460-7266.2 607266 13.0470-7266.2 LD7266	TRW 23973 17,1 - WE / - WK + Zub TRW 23973 17,1 - WE / - WK + Zub Ceramic ATE 24538 17,9 - WE / - WK ATE 24538 17,9 - WE / - WK Ceramic
1.5 dCi 4x4	66	04/11→	←			13.0460-7266.2 607266 13.0470-7266.2 LD7266	ATE 24538 17,9 - WE / - WK ATE 24538 17,9 - WE / - WK Ceramic
1.5 dCi 4x4	80	04/13→	←	08/13→; - ABS 08/13→; + ABS		13.0460-2709.2 602709 13.0470-2709.2 LD2709 13.0460-7266.2 607266 13.0470-7266.2 LD7266	TRW 23973 17,1 - WE / - WK + Zub TRW 23973 17,1 - WE / - WK + Zub Ceramic ATE 24538 17,9 - WE / - WK ATE 24538 17,9 - WE / - WK Ceramic
1.6 16V 4x4 1.6 16V Hi-Flex 1.6 SCe 115 1.6 SCe 115 4x4	77 77 84 84	04/11→ 04/11→ 06/15→ 06/15→	←	- ESP + ESP		13.0460-2709.2 602709 13.0470-2709.2 LD2709 13.0460-7266.2 607266 13.0470-7266.2 LD7266	TRW 23973 17,1 - WE / - WK + Zub TRW 23973 17,1 - WE / - WK + Zub Ceramic ATE 24538 17,9 - WE / - WK ATE 24538 17,9 - WE / - WK Ceramic
 <b>Bremsscheibe</b>							
1.2 TCe 125 4x4	92	10/13→	←	06/15→		24.0124-0221.1 424221	Ø 280 24 21,8 V + S
1.5 dCi	66	04/11→	←	- ABS + ABS		24.0123-0119.1 423119 24.0124-0221.1 424221	Ø 269 22,5 19,8 V + S Ø 280 24 21,8 V + S
1.5 dCi	80	04/13→	←	09/13→; - ABS 09/13→; + ABS		24.0123-0119.1 423119 24.0124-0221.1 424221	Ø 269 22,5 19,8 V + S Ø 280 24 21,8 V + S
1.5 dCi 4x4	66	04/11→	←			24.0124-0221.1 424221	Ø 280 24 21,8 V + S
1.5 dCi 4x4	80	04/13→	←	08/13→; - ABS 08/13→; + ABS		24.0123-0119.1 423119 24.0124-0221.1 424221	Ø 269 22,5 19,8 V + S Ø 280 24 21,8 V + S
1.6 16V 4x4 1.6 16V Hi-Flex ↓	77 77	04/11→ 04/11→	←	- ESP		24.0123-0119.1 423119	Ø 269 22,5 19,8 V + S

	kw			 	! #		
<b>DACIA - DUSTER Kasten 04/11→</b>							
 <b>Bremsscheibe</b>							
1.6 S Ce 115 1.6 S Ce 115 4x4	84 84	06/15→ 06/15→	←	+ ESP		24.0124-0221.1 424221	Ø 280 24 21,8 V + S
<b>DACIA - LODGY 03/12→</b>							
 <b>Bremsbelagsatz, Scheibenbremse</b>							
1.2 TCe 1.5 dCi 1.5 dCi 1.5 dCi	85 79 80 81	03/12→ 01/13→ 06/15→ 03/12→	←			13.0460-7266.2 607266 13.0470-7266.2 LD7266	ATE 24538 17,9 - WE / - WK ATE 24538 17,9 - WE / - WK Ceramic
1.5 dCi 1.6 1.6 LPG	66 61 61	03/12→ 03/12→ 11/13→	←	- ESP		13.0460-2709.2 602709 13.0470-2709.2 LD2709	TRW 23973 17,1 - WE / - WK + Zub TRW 23973 17,1 - WE / - WK + Zub Ceramic
			←	+ ESP		13.0460-7266.2 607266 13.0470-7266.2 LD7266	ATE 24538 17,9 - WE / - WK ATE 24538 17,9 - WE / - WK Ceramic
1.6 LPG 1.6 S Ce 115	75 75	04/15→ 06/15→	←			13.0460-2709.2 602709 13.0470-2709.2 LD2709	TRW 23973 17,1 - WE / - WK + Zub TRW 23973 17,1 - WE / - WK + Zub Ceramic
 <b>Bremsscheibe</b>							
1.2 TCe 1.6 S Ce 115	85 75	03/12→ 06/15→	←			24.0122-0270.1 422270 24.0124-0253.1 424253	Ø 258 22 19,8 V + S Ø 280 24 21,8 V + S
1.5 dCi 1.5 dCi 1.5 dCi 1.5 dCi 1.6 1.6 LPG	66 79 80 81 61 61	03/12→ 01/13→ 06/15→ 03/12→ 03/12→ 11/13→	←	- ESP		24.0122-0270.1 422270	Ø 258 22 19,8 V + S
			←	+ ESP		24.0124-0253.1 424253	Ø 280 24 21,8 V + S
1.6 LPG	75	04/15→	←			24.0124-0253.1 424253	Ø 280 24 21,8 V + S
<b>DACIA - LOGAN (LS_) 09/04→</b>							
 <b>Bremsbelagsatz, Scheibenbremse</b>							
1.0 Hi-Flex (LS0R, LS1G)	56	01/11→10/12	←			13.0460-2834.2 602834	TRW 21463 18,0 + WK
1.2 16V 1.2 16V LPG 1.4 (LSOA, LSOC, LSOE, LSOG) 1.4 MPI LPG (LSOC) 1.5 dCi (LS04) 1.5 dCi (LS04) 1.5 dCi (LS0J, LS0Y) 1.5 dCi (LS0K) 1.5 dCi (LS0W) 1.6 (LSOB, LSOD, LSOF, LSOH) 1.6 16V (LS09, LS0L, LS0M, LS0P, LS0V, LS18, LS1S, LS1V,... 1.6 Bifuel 1.6 MPI 85	55 55 55 55 55 65 48 50 63 64 77 62 62	02/06→ 02/06→ 09/04→ 02/06→ 05/10→ 05/10→ 09/05→ 01/06→ 09/07→ 09/04→ 02/06→ 05/10→ 05/10→	←	→ 04/13		13.0460-2834.2 602834	TRW 21463 18,0 + WK
1.6 16V Flexifuel	77	07/10→	←	01/11→ 04/13		13.0460-2834.2 602834	TRW 21463 18,0 + WK
 <b>Bremsscheibe</b>							
1.0 Hi-Flex (LS0R, LS1G)	56	01/11→10/12	←	- ABS		24.0112-0116.1 412116	Ø 238 12 10,5 + S
			←	+ ABS		24.0112-0171.1 412171	Ø 259 12 10,6 + S
			←			24.0121-0106.1 421106	Ø 259 20,7 17,7 V + S
1.2 16V 1.2 16V LPG 1.4 (LSOA, LSOC, LSOE, LSOG) 1.4 MPI LPG (LSOC) 1.5 dCi (LS04) 1.5 dCi (LS04) 1.5 dCi (LS0J, LS0Y) 1.5 dCi (LS0K) 1.5 dCi (LS0W) 1.6 (LSOB, LSOD, LSOF, LSOH) 1.6 16V (LS09, LS0L, LS0M, LS0P, LS0V, LS18, LS1S, LS1V,... ↓	55 55 55 55 55 65 48 50 63 64 77	02/06→ 02/06→ 09/04→ 02/06→ 05/10→ 05/10→ 09/05→ 01/06→ 09/07→ 09/04→ 02/06→	←	- ABS; → 04/13		24.0112-0116.1 412116 24.0112-0171.1 412171	Ø 238 12 10,5 + S Ø 259 12 10,6 + S
			←	+ ABS; → 04/13		24.0112-0171.1 412171	Ø 259 12 10,6 + S
			←	→ 04/13		24.0121-0106.1 421106	Ø 259 20,7 17,7 V + S



















	kw			 	! #		
<b>DACIA - LOGAN (LS_) 09/04→</b>							
 <b>Bremsscheibe</b>							
1.6 Bifuel 1.6 MPI 85	62 62	05/10→ 05/10→	←	- ABS; → 04/13		24.0112-0116.1 412116	Ø 238 12 10,5 + S
			←	+ ABS; → 04/13		24.0112-0171.1 412171	Ø 259 12 10,6 + S
			←	→ 04/13		24.0121-0106.1 421106	Ø 259 20,7 17,7 V + S
1.6 16V Flexifuel	77	07/10→	←	01/11→; - ABS; → 04/13		24.0112-0116.1 412116	Ø 238 12 10,5 + S
			←	01/11→; + ABS; → 04/13		24.0112-0171.1 412171	Ø 259 12 10,6 + S
			←	01/11→ 04/13		24.0121-0106.1 421106	Ø 259 20,7 17,7 V + S
<b>DACIA - LOGAN II 10/12→</b>							
 <b>Bremsbelagsatz, Scheibenbremse</b>							
1.2	54	05/15→	←	SAN713		13.0460-7298.2 607298	ATE 25702 18,2 - WE / - WK
						13.0470-7298.2 LD7298	ATE 25702 18,2 - WE / - WK Ceramic
1.2 1.5 dCi	55 63	10/12→ 01/13→	←			13.0460-7298.2 607298	ATE 25702 18,2 - WE / - WK
						13.0470-7298.2 LD7298	ATE 25702 18,2 - WE / - WK Ceramic
1.2 LPG 1.5 dCi 1.5 dCi TCe 90	55 55 66 66	10/12→ 10/12→ 10/12→ 10/12→	←	11/12→		13.0460-7298.2 607298	ATE 25702 18,2 - WE / - WK
						13.0470-7298.2 LD7298	ATE 25702 18,2 - WE / - WK Ceramic
1.6 16V	77	01/13→	←	→ 03/15		13.0460-7298.2 607298	ATE 25702 18,2 - WE / - WK
						13.0470-7298.2 LD7298	ATE 25702 18,2 - WE / - WK Ceramic
 <b>Bremsscheibe</b>							
1.0 SCe 75 1.5 dCi 1.6 16V TCe 90 LPG	54 63 77 66	01/17→ 01/13→ 01/13→ 09/15→	←			24.0122-0289.1 422289	Ø 258 22 19,8 V + S
1.2	54	05/15→	←			24.0112-0171.1 412171	Ø 259 12 10,6 + S
1.2 1.2 LPG	55 55	10/12→ 10/12→	←	11/12→		24.0112-0171.1 412171	Ø 259 12 10,6 + S
1.5 dCi 1.5 dCi TCe 90	55 66 66	10/12→ 10/12→ 10/12→	←	11/12→		24.0122-0289.1 422289	Ø 258 22 19,8 V + S
<b>DACIA - LOGAN EXPRESS (FS_) 03/09→</b>							
 <b>Bremsbelagsatz, Scheibenbremse</b>							
1.4 1.5 dCi 1.5 dCi 1.5 dCi (FS0K) 1.5 dCi (FS0W) 1.6 1.6 MPI 85	55 55 65 50 63 64 62	03/09→ 05/10→ 05/10→ 03/09→ 03/09→ 03/09→ 05/10→	←	→ 06/13		13.0460-2709.2 602709	TRW 23973 17,1 - WE / - WK + Zub
						13.0470-2709.2 LD2709	TRW 23973 17,1 - WE / - WK + Zub Ceramic
 <b>Bremsscheibe</b>							
1.4 1.5 dCi 1.5 dCi 1.5 dCi (FS0K) 1.5 dCi (FS0W) 1.6 1.6 MPI 85	55 55 65 50 63 64 62	03/09→ 05/10→ 05/10→ 03/09→ 03/09→ 03/09→ 05/10→	←	→ 06/13		24.0122-0216.1 422216	Ø 260 22 19,8 V + S
<b>DACIA - LOGAN MCV (KS_) 02/07→</b>							
 <b>Bremsbelagsatz, Scheibenbremse</b>							
1.4	55	02/07→	←	für Bremsscheibendurchmesser [mm]: 260; → 04/13		13.0460-2709.2 602709	TRW 23973 17,1 - WE / - WK + Zub
						13.0460-7270.2 607270	ATE 24673 18,0 - WE / - WK
			←	für Bremsscheibendurchmesser [mm]: 259; → 04/13		13.0470-2709.2 LD2709	TRW 23973 17,1 - WE / - WK + Zub Ceramic
			←	für Bremsscheibendurchmesser [mm]: 259; → 04/13		13.0460-2834.2 602834	TRW 21463 18,0 + WK
1.5 dCi (KS04) 1.5 dCi (KS04)	55 65	05/10→ 05/10→	←	für Bremsscheibendurchmesser [mm]: 260; → 04/13		13.0460-2709.2 602709	TRW 23973 17,1 - WE / - WK + Zub
						13.0470-2709.2 LD2709	TRW 23973 17,1 - WE / - WK + Zub Ceramic
			←	für Bremsscheibendurchmesser [mm]: 259; → 04/13		13.0460-2834.2 602834	TRW 21463 18,0 + WK
↓							



















	kW				! #		
<b>DACIA - LOGAN MCV (KS_) 02/07→</b>							
 <b>Bremsbelagsatz, Scheibenbremse</b>							
1.5 dCi (KS0K) 1.5 dCi (KS0W) 1.6	50 63 64	02/07→ 09/07→ 02/07→	←	12/08→; für Bremsscheibendurchmesser [mm]: 260; → 04/13		13.0460-2709.2 602709 13.0470-2709.2 LD2709	TRW 23973 17,1 - WE / - WK + Zub TRW 23973 17,1 - WE / - WK + Zub Ceramic
			←	für Bremsscheibendurchmesser [mm]: 259; → 04/13		13.0460-2834.2 602834	TRW 21463 18,0 + WK
			←	für Bremsscheibendurchmesser [mm]: 260; → 11/08		13.0460-7270.2 607270	ATE 24673 18,0 - WE / - WK
1.6 16V (KS0L, KS0M, KS0P, KS1S) 1.6 16V Hi-Flex 1.6 Bifuel 1.6 Bifuel	77 77 62 64	02/07→ 11/09→ 05/10→ 11/08→	←	für Bremsscheibendurchmesser [mm]: 260; → 04/13		13.0460-2709.2 602709 13.0460-7270.2 607270 13.0470-2709.2 LD2709	TRW 23973 17,1 - WE / - WK + Zub ATE 24673 18,0 - WE / - WK TRW 23973 17,1 - WE / - WK + Zub Ceramic
1.6 MPI 85	62	05/10→	←	für Bremsscheibendurchmesser [mm]: 260; → 04/13		13.0460-7270.2 607270	ATE 24673 18,0 - WE / - WK
 <b>Bremsscheibe</b>							
1.4 1.5 dCi (KS04) 1.5 dCi (KS04) 1.5 dCi (KS0K) 1.5 dCi (KS0W) 1.6 1.6 Bifuel 1.6 Bifuel 1.6 MPI 85	55 55 65 50 63 64 62 64 62	02/07→ 05/10→ 05/10→ 02/07→ 09/07→ 02/07→ 05/10→ 11/08→ 05/10→	←	→ 04/13		24.0121-0106.1 421106 24.0122-0216.1 422216	Ø 259 20,7 17,7 V + S Ø 260 22 19,8 V + S
1.6 16V (KS0L, KS0M, KS0P, KS1S) 1.6 16V Hi-Flex	77 77	02/07→ 11/09→	←	→ 04/13		24.0122-0216.1 422216	Ø 260 22 19,8 V + S
<b>DACIA - LOGAN MCV II 02/13→</b>							
 <b>Bremsbelagsatz, Scheibenbremse</b>							
1.2 1.2 LPG 1.5 dCi 1.5 dCi 1.5 dCi TCe 90	55 55 55 63 66 66	02/13→ 02/13→ 02/13→ 02/13→ 02/13→ 02/13→	←	→ 03/15		13.0460-7298.2 607298 13.0470-7298.2 LD7298	ATE 25702 18,2 - WE / - WK ATE 25702 18,2 - WE / - WK Ceramic
1.6	62	06/13→	←			13.0460-7298.2 607298 13.0470-7298.2 LD7298	ATE 25702 18,2 - WE / - WK ATE 25702 18,2 - WE / - WK Ceramic
 <b>Bremsscheibe</b>							
1.0 SCe 75 1.2 1.2 1.2 LPG 1.5 dCi 1.5 dCi 1.6 TCe 90 LPG	54 54 55 55 63 62 66	12/16→ 05/15→ 02/13→ 02/13→ 02/13→ 06/13→ 09/15→	←			24.0122-0289.1 422289	Ø 258 22 19,8 V + S
1.5 dCi TCe 90	66 66	02/13→ 02/13→	←	→ 12/15		24.0122-0289.1 422289	Ø 258 22 19,8 V + S
<b>DACIA - LOGAN Pick-up (US_) 03/08→</b>							
 <b>Bremsbelagsatz, Scheibenbremse</b>							
1.4 1.5 dCi 1.5 dCi 1.6 Bifuel 1.6 MPI 85	55 55 65 62 62	01/09→ 05/10→ 05/10→ 05/10→ 05/10→	←	→ 06/13		13.0460-2709.2 602709 13.0470-2709.2 LD2709	TRW 23973 17,1 - WE / - WK + Zub TRW 23973 17,1 - WE / - WK + Zub Ceramic
1.5 dCi (US00, US0J, US0Y)	48	04/08→12/12	←	12/08→		13.0460-2709.2 602709 13.0470-2709.2 LD2709	TRW 23973 17,1 - WE / - WK + Zub TRW 23973 17,1 - WE / - WK + Zub Ceramic
			←	→ 11/08		13.0460-7270.2 607270	ATE 24673 18,0 - WE / - WK
1.5 dCi (US0K) 1.5 dCi (US0W) 1.6	50 63 64	03/08→ 03/08→ 03/08→	←	12/08→ 06/13		13.0460-2709.2 602709 13.0470-2709.2 LD2709	TRW 23973 17,1 - WE / - WK + Zub TRW 23973 17,1 - WE / - WK + Zub Ceramic
			←	→ 11/08		13.0460-7270.2 607270	ATE 24673 18,0 - WE / - WK
1.6 16V (US1Y)	77	01/10→08/13	←			13.0460-2709.2 602709	TRW 23973 17,1 - WE / - WK + Zub

































	kw				! #		
<b>DACIA - LOGAN Pick-up (US_) 03/08→</b>							
 <b>Bremsbelagsatz, Scheibenbremse</b>							
1.6 16V (US1Y)	77	01/10→08/13	←			13.0470-2709.2 LD2709	TRW 23973 17,1 - WE / - WK + Zub Ceramic
 <b>Bremsscheibe</b>							
1.4	55	01/09→	←	→ 06/13		24.0122-0216.1 422216	Ø 260 22 19,8 V + S
1.5 dCi	55	05/10→					
1.5 dCi	65	05/10→					
1.5 dCi (US0K)	50	03/08→					
1.5 dCi (US0W)	63	03/08→					
1.6	64	03/08→					
1.6 Bifuel	62	05/10→					
1.6 MPI 85	62	05/10→					
1.5 dCi (US00, US0J, US0Y)	48	04/08→12/12	←			24.0122-0216.1 422216	Ø 260 22 19,8 V + S
1.6 16V (US1Y)	77	01/10→08/13					
<b>DACIA - SANDERO 06/08→</b>							
 <b>Bremsbelagsatz, Scheibenbremse</b>							
1.0 Hi-Flex	56	01/11→12/12	←			13.0460-2834.2 602834	TRW 21463 18,0 + WK
1.5 dCi	63	11/08→					
1.6 Hi-Flex (BS1H)	64	06/08→12/12					
1.6 LPG	62	05/10→10/12					
1.2 16V	55	11/08→	←	→ 02/13		13.0460-2834.2 602834	TRW 21463 18,0 + WK
1.2 16V LPG	55	11/08→					
1.4	55	06/08→					
1.4 MPI LPG	53	01/09→					
1.5 dCi	48	11/08→					
1.5 dCi	50	11/08→					
1.5 dCi	55	05/10→					
1.5 dCi	65	05/10→					
1.6	64	06/08→					
1.6 16V	77	07/11→					
1.6 16V Bifuel	77	01/11→					
1.6 MPI 85	62	05/10→					
1.6 LPG (BS03)	60	01/11→12/12	←	→ 10/12		13.0460-2834.2 602834	TRW 21463 18,0 + WK
 <b>Bremsscheibe</b>							
1.0 Hi-Flex	56	01/11→12/12	←			24.0112-0116.1 412116	Ø 238 12 10,5 + S
1.5 dCi	63	11/08→				24.0112-0171.1 412171	Ø 259 12 10,6 + S
1.6 LPG	62	05/10→10/12				24.0121-0106.1 421106	Ø 259 20,7 17,7 V + S
1.2 16V	55	11/08→	←	→ 02/13		24.0112-0116.1 412116	Ø 238 12 10,5 + S
						24.0112-0171.1 412171	Ø 259 12 10,6 + S
			←	02/09→ 02/13		24.0121-0106.1 421106	Ø 259 20,7 17,7 V + S
1.2 16V LPG	55	11/08→	←	→ 02/13		24.0112-0116.1 412116	Ø 238 12 10,5 + S
1.4	55	06/08→				24.0112-0171.1 412171	Ø 259 12 10,6 + S
1.4 MPI LPG	53	01/09→				24.0121-0106.1 421106	Ø 259 20,7 17,7 V + S
1.5 dCi	50	11/08→					
1.5 dCi	55	05/10→					
1.5 dCi	65	05/10→					
1.6	64	06/08→					
1.6 16V	77	07/11→					
1.6 16V Bifuel	77	01/11→					
1.6 MPI 85	62	05/10→					
1.5 dCi	48	11/08→	←	→ 02/13		24.0112-0116.1 412116	Ø 238 12 10,5 + S
						24.0112-0171.1 412171	Ø 259 12 10,6 + S
1.6 Hi-Flex (BS1H)	64	06/08→12/12	←			24.0112-0116.1 412116	Ø 238 12 10,5 + S
						24.0112-0171.1 412171	Ø 259 12 10,6 + S
1.6 LPG (BS03)	60	01/11→12/12	←	→ 10/12		24.0112-0116.1 412116	Ø 238 12 10,5 + S
						24.0112-0171.1 412171	Ø 259 12 10,6 + S
						24.0121-0106.1 421106	Ø 259 20,7 17,7 V + S
<b>DACIA - SANDERO II 10/12→</b>							
 <b>Bremsbelagsatz, Scheibenbremse</b>							
1.0 SCe 75	54	12/16→	←			13.0460-7298.2 607298	ATE 25702 18,2 - WE / - WK
1.6	61	11/12→				13.0470-7298.2 LD7298	ATE 25702 18,2 - WE / - WK Ceramic
1.2	54	05/15→	←	SAN713		13.0460-7298.2 607298	ATE 25702 18,2 - WE / - WK
						13.0470-7298.2 LD7298	ATE 25702 18,2 - WE / - WK Ceramic
1.2	55	10/12→	←	11/12→		13.0460-7298.2 607298	ATE 25702 18,2 - WE / - WK
1.2 LPG	55	10/12→				13.0470-7298.2 LD7298	ATE 25702 18,2 - WE / - WK Ceramic
TCe 90	66	10/12→					
↓							

















	kw			 	! #		
<b>DACIA - SANDERO II 10/12→</b>							
 <b>Bremsbelagsatz, Scheibenbremse</b>							
1.5 dCi 1.5 dCi	55 66	10/12→ 10/12→	←	→ 03/15		13.0460-7298.2 607298 13.0470-7298.2 LD7298	ATE 25702 18,2 - WE / - WK ATE 25702 18,2 - WE / - WK Ceramic
			←	STEPWAY		13.0460-7298.2 607298 13.0470-7298.2 LD7298	ATE 25702 18,2 - WE / - WK ATE 25702 18,2 - WE / - WK Ceramic
1.5 dCi	63	01/13→	←	→ 03/15		13.0460-7298.2 607298 13.0470-7298.2 LD7298	ATE 25702 18,2 - WE / - WK ATE 25702 18,2 - WE / - WK Ceramic
TCe 90 LPG	66	09/15→	←	STEPWAY		13.0460-7298.2 607298 13.0470-7298.2 LD7298	ATE 25702 18,2 - WE / - WK ATE 25702 18,2 - WE / - WK Ceramic
 <b>Bremsscheibe</b>							
1.2	54	05/15→	←			24.0112-0171.1 412171	Ø 259 12 10,6 + S
1.2 1.2 LPG	55 55	10/12→ 10/12→	←	11/12→		24.0112-0171.1 412171	Ø 259 12 10,6 + S
1.5 dCi 1.5 dCi TCe 90	55 66 66	10/12→ 10/12→ 10/12→	←	11/12→		24.0122-0289.1 422289	Ø 258 22 19,8 V + S
1.5 dCi 1.6 TCe 90 LPG	63 61 66	01/13→ 11/12→ 09/15→	←			24.0122-0289.1 422289	Ø 258 22 19,8 V + S
<b>DAEWOO - ARANOS 01/95→11/97</b>							
 <b>Bremsbelagsatz, Scheibenbremse</b>							
1.8	70	01/95→11/97	←			13.0460-7052.2 607052	ATE 21190 17,5 + WE / - WK
 <b>Bremsscheibe</b>							
1.8	70	01/95→11/97	←			24.0124-0115.1 424115	Ø 256 24 21 V + S
<b>DAEWOO - CIELO 06/94→12/07</b>							
 <b>Bremsbelagsatz, Scheibenbremse</b>							
1.5	66	06/94→07/98	←			13.0460-7052.2 607052	ATE 21190 17,5 + WE / - WK
 <b>Bremsscheibe</b>							
1.5	66	06/94→07/98	←			24.0124-0115.1 424115	Ø 256 24 21 V + S
<b>DAEWOO - ESPERO (KLEJ) 10/91→09/99</b>							
 <b>Bremsbelagsatz, Scheibenbremse</b>							
1.5 1.8	55 66	10/97→08/99 02/95→09/99	←	→ 06/99		13.0460-7052.2 607052	ATE 21190 17,5 + WE / - WK
1.5 16V 1.8 2.0	66 70 77	02/95→06/99 02/95→06/99 02/95→06/99	←			13.0460-7052.2 607052	ATE 21190 17,5 + WE / - WK
 <b>Bremsscheibe</b>							
1.5 1.8	55 66	10/97→08/99 02/95→09/99	←	→ 06/99		24.0124-0115.1 424115 24.0324-0115.1 524115	Ø 256 24 21 V + S Ø 256 24 21 V + S
1.5 16V 1.8 2.0	66 70 77	02/95→06/99 02/95→06/99 02/95→06/99	←			24.0124-0115.1 424115 24.0324-0115.1 524115	Ø 256 24 21 V + S Ø 256 24 21 V + S
<b>DAEWOO - EVANDA (KLAL) 08/02→</b>							
 <b>Bremsbelagsatz, Scheibenbremse</b>							
2.0	96	08/02→	←	→ 02/05		13.0460-5859.2 605859	AKE 23234 16,9 + WK
<b>Zubehörsatz, Scheibenbremsbelag</b>							
2.0	96	08/02→	←	→ 02/05		13.0460-0140.2 610140	AKE
 <b>Bremsscheibe</b>							
2.0	96	08/02→	←	→ 02/05		24.0124-0199.1 424199	Ø 256 24 21 V + S
<b>DAEWOO - GENTRA Stufenheck 06/13→</b>							
 <b>Bremsbelagsatz, Scheibenbremse</b>							
1.5 ↓	79	06/13→	←			13.0460-5859.2 605859	AKE 23234 16,9 + WK















	kw					! #		
<b>DAEWOO - GENTRA Stufenheck 06/13→</b>								
 <b>Bremsbelagsatz, Scheibenbremse</b>								
1.5	79	06/13→	←			13.0460-5863.2	605863	AKE 23234 16,8 + WK
			→			13.0460-5663.2	605663	SUM 25232 14,5 - WE / - WK
 <b>Bremsscheibe</b>								
1.5	79	06/13→	→			24.0110-0340.1	410340	Ø 258 10,5 8 + S
<b>DAEWOO - KALOS (KLAS) 09/02→</b>								
 <b>Bremsbelagsatz, Scheibenbremse</b>								
1.2	53	04/03→	←	→ 02/05		13.0460-5899.2	605899	AKE 23974 17,6 - WE / - WK
1.4	61	09/02→						
1.4 16V	69	04/03→						
1.5	62	11/02→12/04	←			13.0460-5899.2	605899	AKE 23974 17,6 - WE / - WK
1.6	78	02/03→						
 <b>Bremsscheibe</b>								
1.2	53	04/03→	←	→ 02/05		24.0120-0115.1	420115	Ø 236 20 17 V + S
1.4	61	09/02→				24.0320-0115.1	520115	Ø 236 20 17 V + S
1.4 16V	69	04/03→						
1.5	62	11/02→12/04	←			24.0120-0115.1	420115	Ø 236 20 17 V + S
						24.0320-0115.1	520115	Ø 236 20 17 V + S
1.6	78	02/03→	←			24.0120-0227.1	420227	Ø 236 20 18 V + S
<b>DAEWOO - KALOS Stufenheck (KLAS) 11/02→12/04</b>								
 <b>Bremsbelagsatz, Scheibenbremse</b>								
1.4	61	11/02→12/04	←			13.0460-5899.2	605899	AKE 23974 17,6 - WE / - WK
1.4	69	05/03→12/04						
1.5	62	11/02→12/04						
 <b>Bremsscheibe</b>								
1.4	61	11/02→12/04	←			24.0120-0115.1	420115	Ø 236 20 17 V + S
1.4	69	05/03→12/04				24.0320-0115.1	520115	Ø 236 20 17 V + S
1.5	62	11/02→12/04						
<b>DAEWOO - KORANDO (KJ) 11/98→</b>								
 <b>Bremsscheibe</b>								
2.3	103	01/99→02/01	→			24.0110-0352.1	410352	Ø 299 10,4 8,5
2.3	105	01/99→	→	→ 11/05		24.0110-0352.1	410352	Ø 299 10,4 8,5
2.9 D	72	01/99→						
2.9 TD	88	01/99→						
3.2 4x4	156	01/99→						
<b>DAEWOO - KORANDO Cabrio (KJ) 02/99→</b>								
 <b>Bremsscheibe</b>								
2.0 16V	94	02/99→	→	→ 11/05		24.0110-0352.1	410352	Ø 299 10,4 8,5
2.3	105	02/99→						
2.9 D	72	02/99→						
2.9 TD	88	02/99→						
2.3	103	02/99→02/01	→			24.0110-0352.1	410352	Ø 299 10,4 8,5
<b>DAEWOO - LACETTI Schrägheck (KLAN) 02/02→</b>								
 <b>Bremsbelagsatz, Scheibenbremse</b>								
1.4	69	06/02→12/04	←			13.0460-5863.2	605863	AKE 23234 16,8 + WK
			→			13.0460-5739.2	605739	SUM 24071 14,6 - WE / - WK
1.4	70	02/04→	←	→ 02/05		13.0460-5863.2	605863	AKE 23234 16,8 + WK
1.6	80	02/04→	→	→ 02/05		13.0460-5739.2	605739	SUM 24071 14,6 - WE / - WK
1.8	90	02/04→	→	→ 02/05				
 <b>Bremsscheibe</b>								
1.4	69	06/02→12/04	←			24.0124-0199.1	424199	Ø 256 24 21 V + S
			→			24.0110-0340.1	410340	Ø 258 10,5 8 + S
1.4	70	02/04→	←	→ 02/05		24.0124-0199.1	424199	Ø 256 24 21 V + S
1.6	80	02/04→	→	→ 02/05		24.0110-0340.1	410340	Ø 258 10,5 8 + S
1.8	90	02/04→	→	→ 02/05				
<b>DAEWOO - LACETTI Stufenheck 06/99→07/03</b>								
 <b>Bremsbelagsatz, Scheibenbremse</b>								
1.6	78	06/99→07/03	←	06/02→		13.0460-5863.2	605863	AKE 23234 16,8 + WK
↓								

	kw			 	! #		
<b>DAEWOO - LACETTI Stufenheck 06/99→07/03</b>							
 <b>Bremsbelagsatz, Scheibenbremse</b>							
1.6	78	06/99→07/03	➡	06/02→		13.0460-5739.2 605739	SUM 24071 14,6 - WE / - WK
 <b>Bremsscheibe</b>							
1.6	78	06/99→07/03	←	06/02→		24.0124-0199.1 424199	Ø 256 24 21 V + S
			➡	06/02→		24.0110-0340.1 410340	Ø 258 10,5 8 + S
<b>DAEWOO - LANOS (KLAT) 04/97→</b>							
 <b>Bremsbelagsatz, Scheibenbremse</b>							
1.3 1.5	55 63	05/97→ 05/97→	←	447434→; → 12/02		13.0460-5996.2 605996	23241 16,1 - WE / - WK
			←	→ 447433		13.0460-7051.2 607051	ATE 20547 16,5 + WE / - WK
1.5	73	10/97→06/99	←	447434→		13.0460-5996.2 605996	23241 16,1 - WE / - WK
			←	→ 447433		13.0460-7051.2 607051	ATE 20547 16,5 + WE / - WK
1.6 16V	78	05/97→	←	447434→; → 12/02		13.0460-5994.2 605994	AKE 23234 16,8 - WE / - WK
			←	→ 447433		13.0460-7052.2 607052	ATE 21190 17,5 + WE / - WK
<b>Zubehörsatz, Scheibenbremsbelag</b>							
1.6 16V	78	05/97→	←	447434→; → 12/02		13.0460-0140.2 610140	AKE
 <b>Bremsscheibe</b>							
1.3 1.5	55 63	05/97→ 05/97→	←	→ 12/02		24.0120-0115.1 420115	Ø 236 20 17 V + S
						24.0320-0115.1 520115	Ø 236 20 17 V + S
1.5	73	10/97→06/99	←			24.0120-0115.1 420115	Ø 236 20 17 V + S
						24.0320-0115.1 520115	Ø 236 20 17 V + S
1.6 16V	78	05/97→	←	→ 12/02		24.0124-0115.1 424115	Ø 256 24 21 V + S
						24.0324-0115.1 524115	Ø 256 24 21 V + S
<b>DAEWOO - LANOS Stufenheck (KLAT) 02/97→</b>							
 <b>Bremsbelagsatz, Scheibenbremse</b>							
1.3 1.5	55 63	05/97→ 05/97→	←	447434→; → 12/02		13.0460-5996.2 605996	23241 16,1 - WE / - WK
			←	→ 447433		13.0460-7051.2 607051	ATE 20547 16,5 + WE / - WK
1.5	73	10/97→06/99	←	447434→		13.0460-5996.2 605996	23241 16,1 - WE / - WK
			←	→ 447433		13.0460-7051.2 607051	ATE 20547 16,5 + WE / - WK
1.6 16V	78	02/97→	←	447434→; → 12/02		13.0460-5994.2 605994	AKE 23234 16,8 - WE / - WK
			←	05/97→; → 447433		13.0460-7052.2 607052	ATE 21190 17,5 + WE / - WK
<b>Zubehörsatz, Scheibenbremsbelag</b>							
1.6 16V	78	02/97→	←	447434→; → 12/02		13.0460-0140.2 610140	AKE
 <b>Bremsscheibe</b>							
1.3 1.5	55 63	05/97→ 05/97→	←	→ 12/02		24.0120-0115.1 420115	Ø 236 20 17 V + S
						24.0320-0115.1 520115	Ø 236 20 17 V + S
1.5	73	10/97→06/99	←			24.0120-0115.1 420115	Ø 236 20 17 V + S
						24.0320-0115.1 520115	Ø 236 20 17 V + S
1.6 16V	78	02/97→	←	05/97→ 12/02		24.0124-0115.1 424115	Ø 256 24 21 V + S
						24.0324-0115.1 524115	Ø 256 24 21 V + S
<b>DAEWOO - LEGANZA (KLAV) 03/97→04/04</b>							
 <b>Bremsbelagsatz, Scheibenbremse</b>							
2.0 2.0	85 133	06/97→12/02 01/01→12/02	←			13.0460-5859.2 605859	AKE 23234 16,9 + WK
			➡			13.0460-5993.2 605993	TRW 23237 14,5 - WE / - WK
2.2 16V 2.0 16V	100 93	04/99→12/02 07/00→04/04	➡			13.0460-5859.2 605859	AKE 23234 16,9 + WK
			←	→ 12/02		13.0460-5993.2 605993	TRW 23237 14,5 - WE / - WK
2.0 16V	98	06/97→12/02	←			13.0460-5859.2 605859	AKE 23234 16,9 + WK
			←	07/00→		13.0460-5859.2 605859	AKE 23234 16,9 + WK
			➡	07/00→		13.0460-5993.2 605993	TRW 23237 14,5 - WE / - WK
			➡			13.0460-5993.2 605993	TRW 23237 14,5 - WE / - WK
<b>Zubehörsatz, Scheibenbremsbelag</b>							
2.0	85	06/97→12/02	←			13.0460-0140.2 610140	AKE













	kw			 	! #		
<b>DAEWOO - LEGANZA (KLAV) 03/97→04/04</b>							
<b>Zubehörsatz, Scheibenbremsbelag</b>							
2.0	133	01/01→12/02	←			13.0460-0140.2	610140 AKE
2.2 16V	100	04/99→12/02					
2.0 16V	93	07/00→04/04	←	→ 12/02		13.0460-0140.2	610140 AKE
2.0 16V	98	06/97→12/02	←	07/00→		13.0460-0140.2	610140 AKE
			←			13.0460-0140.2	610140 AKE
<b> Bremsscheibe</b>							
2.0	85	06/97→12/02	←			24.0124-0723.1	424723 Ø 256 24 21 V
2.0	133	01/01→12/02					
2.2 16V	100	04/99→12/02	→			24.0110-0282.1	410282 Ø 258 10,3 8
2.0 16V	93	07/00→04/04	←	→ 12/02		24.0124-0723.1	424723 Ø 256 24 21 V
			→	→ 12/02		24.0110-0282.1	410282 Ø 258 10,3 8
2.0 16V	98	06/97→12/02	←			24.0124-0723.1	424723 Ø 256 24 21 V
			←	07/00→		24.0124-0723.1	424723 Ø 256 24 21 V
			→			24.0110-0282.1	410282 Ø 258 10,3 8
			→	07/00→		24.0110-0282.1	410282 Ø 258 10,3 8
<b>DAEWOO - MAGNUS 07/99→</b>							
<b> Bremsbelagsatz, Scheibenbremse</b>							
2.0	96	07/99→	←	→ 12/04		13.0460-5859.2	605859 AKE 23234 16,9 + WK
<b>Zubehörsatz, Scheibenbremsbelag</b>							
2.0	96	07/99→	←	→ 12/04		13.0460-0140.2	610140 AKE
<b> Bremsscheibe</b>							
2.0	96	07/99→	←	→ 12/04		24.0124-0199.1	424199 Ø 256 24 21 V + S
<b>DAEWOO - MATIZ (M100, M150) 09/98→</b>							
<b> Bremsbelagsatz, Scheibenbremse</b>							
0.8	38	09/98→	←	→ 02/05		13.0460-5996.2	605996 23241 16,1 - WE / - WK
1.0	47	01/03→					
1.0	46	04/03→12/04	←			13.0460-5996.2	605996 23241 16,1 - WE / - WK
<b>Zubehörsatz, Scheibenbremsbelag</b>							
0.8	38	09/98→	←	→ 02/05		13.0460-0252.2	610252
1.0	47	01/03→					
1.0	46	04/03→12/04	←			13.0460-0252.2	610252
<b> Bremsscheibe</b>							
0.8	38	09/98→	←	→ 02/05		24.0113-0195.1	413195 Ø 236 12,6 9,7
1.0	47	01/03→					
1.0	46	04/03→12/04	←			24.0113-0195.1	413195 Ø 236 12,6 9,7
<b>DAEWOO - MATIZ (M200, M250) 01/05→06/10</b>							
<b> Bremsbelagsatz, Scheibenbremse</b>							
0.8	38	01/05→06/10	←			13.0460-5996.2	605996 23241 16,1 - WE / - WK
<b> Bremsscheibe</b>							
0.8	38	01/05→06/10	←			24.0113-0195.1	413195 Ø 236 12,6 9,7
<b>DAEWOO - MATIZ Kasten (KLA4) 08/98→08/02</b>							
<b> Bremsbelagsatz, Scheibenbremse</b>							
0.8	38	08/98→08/02	←			13.0460-5996.2	605996 23241 16,1 - WE / - WK
<b>Zubehörsatz, Scheibenbremsbelag</b>							
0.8	38	08/98→08/02	←			13.0460-0252.2	610252
<b> Bremsscheibe</b>							
0.8	38	08/98→08/02	←			24.0113-0195.1	413195 Ø 236 12,6 9,7





































	kw			 	! #			
<b>DAEWOO - MUSSO (FJ) 07/98→</b>								
 <b>Bremsscheibe</b>								
2.2 TD 2.3 2.9 TD 4x4 3.2 4x4 2.9 D 4x4	74 103 88 162 73	09/99→ 01/99→ 01/99→ 01/99→ 01/99→09/99	→ → → → →	→ 11/05		24.0110-0352.1    24.0110-0352.1	410352    410352	Ø 299 10,4 8,5    Ø 299 10,4 8,5
<b>DAEWOO - NEXIA 02/95→08/97</b>								
 <b>Bremsbelagsatz, Scheibenbremse</b>								
1.5 (08, 68) 1.5 (08, 68) 1.5 (08, 68) 1.5 16V (08, 68)	44 52 55 66	08/96→08/97 02/95→08/97 02/95→08/97 02/95→08/97	← ← ← ←			13.0460-7051.2   13.0460-7052.2	607051   607052	ATE 20547 16,5 + WE / - WK   ATE 21190 17,5 + WE / - WK
 <b>Bremsscheibe</b>								
1.5 (08, 68) 1.5 (08, 68) 1.5 (08, 68) 1.5 16V (08, 68)	44 52 55 66	08/96→08/97 02/95→08/97 02/95→08/97 02/95→08/97	← ← ← ←			24.0120-0115.1 24.0320-0115.1 24.0124-0115.1 24.0324-0115.1	420115 520115 424115 524115	Ø 236 20 17 V + S Ø 236 20 17 V + S Ø 256 24 21 V + S Ø 256 24 21 V + S
<b>DAEWOO - NEXIA Stufenheck 02/95→06/08</b>								
 <b>Bremsbelagsatz, Scheibenbremse</b>								
1.5 (19) 1.5 (19) 1.5 (19) 1.5 16V (19) 1.8 (19)	44 52 55 66 74	08/96→08/97 02/95→08/97 02/95→08/97 02/95→08/97 02/95→06/08	← ← ← ← ←		10/95→	13.0460-7051.2   13.0460-7052.2 13.0460-7052.2	607051   607052 607052	ATE 20547 16,5 + WE / - WK   ATE 21190 17,5 + WE / - WK ATE 21190 17,5 + WE / - WK
 <b>Bremsscheibe</b>								
1.5 (19) 1.5 (19) 1.5 (19) 1.5 16V (19) 1.8 (19)	44 52 55 66 74	08/96→08/97 02/95→08/97 02/95→08/97 02/95→08/97 02/95→06/08	← ← ← ← ←		10/95→	24.0120-0115.1 24.0320-0115.1 24.0124-0115.1 24.0324-0115.1 24.0124-0115.1 24.0324-0115.1	420115 520115 424115 524115 424115 524115	Ø 236 20 17 V + S Ø 236 20 17 V + S Ø 256 24 21 V + S Ø 256 24 21 V + S Ø 256 24 21 V + S Ø 256 24 21 V + S
<b>DAEWOO - NUBIRA (J100) 04/97→</b>								
 <b>Bremsbelagsatz, Scheibenbremse</b>								
1.6 16V 2.0 16V 2.0 CDX	78 98 93	05/97→07/02 05/97→ 08/02→07/03	← ← ←	06/97→ 05/99 06/97→ 05/99 01/03→		13.0460-5994.2 13.0460-5994.2 13.0460-5993.2 13.0460-5863.2 13.0460-5994.2 13.0460-5739.2 13.0460-5993.2	605994 605994 605993 605863 605994 605739 605993	AKE 23234 16,8 - WE / - WK AKE 23234 16,8 - WE / - WK TRW 23237 14,5 - WE / - WK AKE 23234 16,8 + WK AKE 23234 16,8 - WE / - WK SUM 24071 14,6 - WE / - WK TRW 23237 14,5 - WE / - WK
<b>Zubehörsatz, Scheibenbremsbelag</b>								
1.6 16V 2.0 16V	78 98	05/97→07/02 05/97→	← ←	06/97→ 05/99		13.0460-0140.2	610140	AKE
 <b>Bremsscheibe</b>								
1.6 16V 2.0 16V 2.0 CDX	78 98 93	05/97→07/02 05/97→ 08/02→07/03	← ← ←	06/97→ 05/99 06/97→ 05/99 06/97→ 05/99 → 12/02 01/03→ 01/03→ → 12/02; Brems-/Fahrdyn. Artikelbezug: + ABS		24.0124-0163.1 24.0124-0163.1 24.0110-0714.1 24.0124-0163.1 24.0124-0199.1 24.0110-0340.1 24.0110-0714.1	424163 424163 410714 424163 424199 410340 410714	Ø 256 24 22 V + S Ø 256 24 22 V + S Ø 258 10,3 8 Ø 256 24 22 V + S Ø 256 24 21 V + S Ø 258 10,5 8 + S Ø 258 10,3 8
<b>DAEWOO - NUBIRA (J150) 06/99→07/03</b>								
 <b>Bremsbelagsatz, Scheibenbremse</b>								
1.6 16V ↓	78	06/99→07/02	←			13.0460-5994.2	605994	AKE 23234 16,8 - WE / - WK

	kw			 	! #		
<b>DAEWOO - NUBIRA (J150) 06/99→07/03</b>							
 <b>Bremsbelagsatz, Scheibenbremse</b>							
1.6 16V	78	06/99→07/02	➡	+ ABS		13.0460-5993.2 605993	TRW 23237 14,5 - WE / - WK
2.0 16V	98	06/99→07/02	⬅	554447→		13.0460-5859.2 605859	AKE 23234 16,9 + WK
			⬅	→ 554446		13.0460-5994.2 605994	AKE 23234 16,8 - WE / - WK
			➡			13.0460-5993.2 605993	TRW 23237 14,5 - WE / - WK
 <b>Bremsscheibe</b>							
1.6 16V	78	06/99→07/02	⬅			24.0124-0163.1 424163	Ø 256 24 22 V + S
			➡	+ ABS		24.0110-0714.1 410714	Ø 258 10,3 8
2.0 16V	98	06/99→07/02	⬅			24.0124-0163.1 424163	Ø 256 24 22 V + S
			➡			24.0110-0714.1 410714	Ø 258 10,3 8
<b>DAEWOO - NUBIRA Kombi (J150) 06/99→12/02</b>							
 <b>Bremsbelagsatz, Scheibenbremse</b>							
1.6 16V	78	06/99→12/02	⬅	554447→		13.0460-5859.2 605859	AKE 23234 16,9 + WK
2.0 16V	98	06/99→07/02	⬅	→ 554446		13.0460-5994.2 605994	AKE 23234 16,8 - WE / - WK
			➡			13.0460-5993.2 605993	TRW 23237 14,5 - WE / - WK
 <b>Bremsscheibe</b>							
1.6 16V	78	06/99→12/02	⬅			24.0124-0163.1 424163	Ø 256 24 22 V + S
2.0 16V	98	06/99→07/02	➡			24.0110-0714.1 410714	Ø 258 10,3 8
<b>DAEWOO - NUBIRA Stufenheck (J100) 04/97→</b>							
 <b>Bremsbelagsatz, Scheibenbremse</b>							
1.6 16V	76	07/00→	⬅	→ 02/05		13.0460-5859.2 605859	AKE 23234 16,9 + WK
			➡	→ 02/05; + ABS		13.0460-5993.2 605993	TRW 23237 14,5 - WE / - WK
1.6 16V	78	05/97→	⬅	06/97→ 05/99		13.0460-5994.2 605994	AKE 23234 16,8 - WE / - WK
2.0	81	06/99→07/03	⬅	→ 695960		13.0460-5859.2 605859	AKE 23234 16,9 + WK
			⬅	695961→		13.0460-5863.2 605863	AKE 23234 16,8 + WK
			➡			13.0460-5993.2 605993	TRW 23237 14,5 - WE / - WK
2.0 16V	93	12/00→	⬅	→ 695960		13.0460-5859.2 605859	AKE 23234 16,9 + WK
			⬅	695961→; → 02/05		13.0460-5863.2 605863	AKE 23234 16,8 + WK
			➡	→ 02/05		13.0460-5993.2 605993	TRW 23237 14,5 - WE / - WK
2.0 16V	98	05/97→	⬅	06/97→ 05/99		13.0460-5994.2 605994	AKE 23234 16,8 - WE / - WK
			➡	06/97→ 05/99		13.0460-5993.2 605993	TRW 23237 14,5 - WE / - WK
<b>Zubehörsatz, Scheibenbremsbelag</b>							
1.6 16V	76	07/00→	⬅	→ 02/05		13.0460-0140.2 610140	AKE
1.6 16V	78	05/97→	⬅	06/97→ 05/99		13.0460-0140.2 610140	AKE
2.0 16V	98	05/97→					
2.0	81	06/99→07/03	⬅	→ 695960		13.0460-0140.2 610140	AKE
2.0 16V	93	12/00→					
 <b>Bremsscheibe</b>							
1.6 16V	76	07/00→	⬅	→ 02/05		24.0124-0163.1 424163	Ø 256 24 22 V + S
			➡	→ 02/05; + ABS		24.0110-0714.1 410714	Ø 258 10,3 8
1.6 16V	78	05/97→	⬅	06/97→ 05/99		24.0124-0163.1 424163	Ø 256 24 22 V + S
2.0	81	06/99→07/03	⬅			24.0124-0163.1 424163	Ø 256 24 22 V + S
			➡			24.0110-0714.1 410714	Ø 258 10,3 8
2.0 16V	93	12/00→	⬅	→ 02/05		24.0124-0163.1 424163	Ø 256 24 22 V + S
			➡	→ 02/05		24.0110-0714.1 410714	Ø 258 10,3 8
2.0 16V	98	05/97→	⬅	06/97→ 05/99		24.0124-0163.1 424163	Ø 256 24 22 V + S
			➡	06/97→ 05/99		24.0110-0714.1 410714	Ø 258 10,3 8
<b>DAEWOO - NUBIRA Stufenheck (J150) 06/99→07/02</b>							
 <b>Bremsbelagsatz, Scheibenbremse</b>							
1.6 16V	78	06/99→07/02	⬅	554447→		13.0460-5859.2 605859	AKE 23234 16,9 + WK
2.0 16V	98	06/99→07/02	⬅	→ 554446		13.0460-5994.2 605994	AKE 23234 16,8 - WE / - WK
↓							









































	kw					! #		
<b>DAEWOO - NUBIRA Stufenheck (J150) 06/99→07/02</b>								
 <b>Bremsbelagsatz, Scheibenbremse</b>								
1.6 16V 2.0 16V	78 98	06/99→07/02 06/99→07/02	→				13.0460-5993.2 605993	TRW 23237 14,5 - WE / - WK
 <b>Bremsscheibe</b>								
1.6 16V 2.0 16V	78 98	06/99→07/02 06/99→07/02	←				24.0124-0163.1 424163	Ø 256 24 22 V + S
			→				24.0110-0714.1 410714	Ø 258 10,3 8
<b>DAEWOO - NUBIRA Stufenheck (J200) 07/03→</b>								
 <b>Bremsbelagsatz, Scheibenbremse</b>								
1.4	69	10/03→12/04	←	→ 695960			13.0460-5859.2 605859	AKE 23234 16,9 + WK
			←	695961→			13.0460-5863.2 605863	AKE 23234 16,8 + WK
			→				13.0460-5739.2 605739	SUM 24071 14,6 - WE / - WK
1.6 1.8	80 90	07/03→ 07/03→	←	08/03→; → 695960			13.0460-5859.2 605859	AKE 23234 16,9 + WK
			←	695961→; → 02/05			13.0460-5863.2 605863	AKE 23234 16,8 + WK
			→	08/03→ 02/05			13.0460-5739.2 605739	SUM 24071 14,6 - WE / - WK
<b>Zubehörsatz, Scheibenbremsbelag</b>								
1.4	69	10/03→12/04	←	→ 695960			13.0460-0140.2 610140	AKE
1.6 1.8	80 90	07/03→ 07/03→	←	08/03→; → 695960			13.0460-0140.2 610140	AKE
 <b>Bremsscheibe</b>								
1.4	69	10/03→12/04	←				24.0124-0199.1 424199	Ø 256 24 21 V + S
			→				24.0110-0340.1 410340	Ø 258 10,5 8 + S
1.6 1.8	80 90	07/03→ 07/03→	←	08/03→ 02/05			24.0124-0199.1 424199	Ø 256 24 21 V + S
			→	08/03→ 02/05			24.0110-0340.1 410340	Ø 258 10,5 8 + S
<b>DAEWOO - NUBIRA Wagon (J100) 04/97→</b>								
 <b>Bremsbelagsatz, Scheibenbremse</b>								
1.6 16V	66	06/97→	←	→ 05/99			13.0460-5994.2 605994	AKE 23234 16,8 - WE / - WK
1.6 16V	76	12/00→	←	→ 02/05			13.0460-5859.2 605859	AKE 23234 16,9 + WK
			→	→ 02/05; + ABS			13.0460-5993.2 605993	TRW 23237 14,5 - WE / - WK
1.6 16V	78	05/97→	←	06/97→ 05/99			13.0460-5994.2 605994	AKE 23234 16,8 - WE / - WK
2.0 16V	93	12/00→	←	→ 695960			13.0460-5859.2 605859	AKE 23234 16,9 + WK
			←	695961→; → 02/05			13.0460-5863.2 605863	AKE 23234 16,8 + WK
			→	→ 02/05			13.0460-5993.2 605993	TRW 23237 14,5 - WE / - WK
2.0 16V	98	05/97→	←	06/97→ 05/99			13.0460-5994.2 605994	AKE 23234 16,8 - WE / - WK
			→	06/97→ 05/99			13.0460-5993.2 605993	TRW 23237 14,5 - WE / - WK
<b>Zubehörsatz, Scheibenbremsbelag</b>								
1.6 16V	66	06/97→	←	→ 05/99			13.0460-0140.2 610140	AKE
1.6 16V	76	12/00→	←	→ 02/05			13.0460-0140.2 610140	AKE
1.6 16V 2.0 16V	78 98	05/97→ 05/97→	←	06/97→ 05/99			13.0460-0140.2 610140	AKE
2.0 16V	93	12/00→	←	→ 695960			13.0460-0140.2 610140	AKE
 <b>Bremsscheibe</b>								
1.6 16V	66	06/97→	←	→ 05/99			24.0124-0163.1 424163	Ø 256 24 22 V + S
1.6 16V	76	12/00→	←	→ 02/05			24.0124-0163.1 424163	Ø 256 24 22 V + S
			→	→ 02/05; + ABS			24.0110-0714.1 410714	Ø 258 10,3 8
1.6 16V	78	05/97→	←	06/97→ 05/99			24.0124-0163.1 424163	Ø 256 24 22 V + S
2.0 16V	93	12/00→	←	→ 02/05			24.0124-0163.1 424163	Ø 256 24 22 V + S
			→	→ 02/05			24.0110-0714.1 410714	Ø 258 10,3 8
2.0 16V	98	05/97→	←	06/97→ 05/99			24.0124-0163.1 424163	Ø 256 24 22 V + S
			→	06/97→ 05/99			24.0110-0714.1 410714	Ø 258 10,3 8

















	kw			 	! #		
<b>DAEWOO - NUBIRA Wagon (J200) 07/03→</b>							
 <b>Bremsbelagsatz, Scheibenbremse</b>							
1.6 1.8	80 90	07/03→ 07/03→	←	08/03→; → 695960		<b>13.0460-5859.2 605859</b>	AKE 23234 16,9 + WK
			←	695961→; → 02/05		<b>13.0460-5863.2 605863</b>	AKE 23234 16,8 + WK
			→	08/03→ 02/05		<b>13.0460-5739.2 605739</b>	SUM 24071 14,6 - WE / - WK
<b>Zubehörsatz, Scheibenbremsbelag</b>							
1.6 1.8	80 90	07/03→ 07/03→	←	08/03→; → 695960		<b>13.0460-0140.2 610140</b>	AKE
 <b>Bremsscheibe</b>							
1.6 1.8	80 90	07/03→ 07/03→	←	08/03→ 02/05		<b>24.0124-0199.1 424199</b>	Ø 256 24 21 V + S
			→	08/03→ 02/05		<b>24.0110-0340.1 410340</b>	Ø 258 10,5 8 + S
<b>DAEWOO - RACER Schrägheck 01/86→12/97</b>							
 <b>Bremsbelagsatz, Scheibenbremse</b>							
1.5	52	03/95→12/97	←	→ 08/97		<b>13.0460-7051.2 607051</b>	ATE 20547 16,5 + WE / - WK
 <b>Bremsscheibe</b>							
1.5	52	03/95→12/97	←	→ 08/97		<b>24.0120-0115.1 420115</b>	Ø 236 20 17 V + S
						<b>24.0320-0115.1 520115</b>	Ø 236 20 17 V + S
<b>DAEWOO - REXTON (GAB_) 04/02→</b>							
 <b>Bremsbelagsatz, Scheibenbremse</b>							
2.3 RX230 4x4	110	05/02→	→	→ 12/04		<b>13.0460-5623.2 605623</b>	MAN 23673 15,9 + WK
2.9 TD 3.2 V6	88 162	04/02→ 04/02→	→	→ 05/04; für Linkslenker		<b>13.0460-5623.2 605623</b>	MAN 23673 15,9 + WK
 <b>Bremsscheibe</b>							
2.3 RX230 4x4	110	05/02→	→	→ 12/04		<b>24.0110-0352.1 410352</b>	Ø 299 10,4 8,5
2.9 TD 3.2 V6	88 162	04/02→ 04/02→	→	→ 05/04; für Linkslenker		<b>24.0110-0352.1 410352</b>	Ø 299 10,4 8,5
<b>DAEWOO - REZZO (U100) 06/00→</b>							
 <b>Bremsbelagsatz, Scheibenbremse</b>							
1.6 1.8 1.8 1.8 2.0	77 67 72 74 94	09/00→ 09/00→ 09/00→ 09/00→ 09/00→	←	826909→; → 08/05		<b>13.0460-5859.2 605859</b>	AKE 23234 16,9 + WK
1.6 SX 2.0	66 89	08/01→12/04 09/01→12/04	←	826909→		<b>13.0460-5859.2 605859</b>	AKE 23234 16,9 + WK
<b>Zubehörsatz, Scheibenbremsbelag</b>							
1.6 1.8 1.8 1.8 2.0	77 67 72 74 94	09/00→ 09/00→ 09/00→ 09/00→ 09/00→	←	826909→; → 08/05		<b>13.0460-0140.2 610140</b>	AKE
1.6 SX 2.0	66 89	08/01→12/04 09/01→12/04	←	826909→		<b>13.0460-0140.2 610140</b>	AKE
 <b>Bremsscheibe</b>							
1.6 1.8 1.8 1.8 2.0	77 67 72 74 94	09/00→ 09/00→ 09/00→ 09/00→ 09/00→	←	→ 08/05		<b>24.0124-0199.1 424199</b>	Ø 256 24 21 V + S
1.6 SX 2.0	66 89	08/01→12/04 09/01→12/04	←			<b>24.0124-0199.1 424199</b>	Ø 256 24 21 V + S
<b>DAEWOO - TOSCA 02/06→</b>							
 <b>Bremsscheibe</b>							
2.0 XT 2.5 Executive	105 115	02/06→ 02/06→	←	→ 12/10		<b>24.0124-0237.1 424237</b>	Ø 278 24 22 V
<b>DAIHATSU - APPLAUSE I Schrägheck (A101, A111) 06/89→07/97</b>							
 <b>Bremsbelagsatz, Scheibenbremse</b>							
1.6 16V (A101) 1.6 16V (A101) ↓	66 77	06/89→07/97 06/89→07/97	→	+ ABS		<b>13.0460-5972.2 605972</b>	21559 11,5 - WE / - WK

	kw					! #		
<b>DAIHATSU - APPLAUSE I Schrägheck (A101, A111) 06/89→07/97</b>								
 <b>Bremsscheibe</b>								
1.6 16V (A101)	66	06/89→07/97	←			24.0118-0126.1	418126	Ø 234,5 18 17 V
1.6 16V (A101)	77	06/89→07/97						
1.6 16V 4WD (A111)	77	06/89→07/97						
<b>DAIHATSU - APPLAUSE II Schrägheck (A101) 07/97→05/00</b>								
 <b>Bremsscheibe</b>								
1.6 16V (A101)	73	07/97→05/00	←			24.0118-0126.1	418126	Ø 234,5 18 17 V
<b>DAIHATSU - CHARADE 05/11→</b>								
 <b>Bremsbelagsatz, Scheibenbremse</b>								
1.33 16V	73	05/11→	←	→ 01/13		13.0460-7213.2	607213	ATE 23202 17,8 + WK
			→	→ 01/13		13.0460-7214.2	607214	ATE 24574 15,0 + WK
 <b>Bremsscheibe</b>								
1.33 16V	73	05/11→	←	→ 01/13		24.0122-0240.1	422240	Ø 258 22 20 V
			→	→ 01/13		24.0109-0142.1	409142	Ø 278 9 7
<b>DAIHATSU - CHARADE IV (G200, G202) 01/93→09/00</b>								
 <b>Bremsbelagsatz, Scheibenbremse</b>								
1.3	44	09/96→11/99	←			13.0460-5898.2	605898	21952 15,0 + WK
1.3 16V	55	05/96→11/99						
1.3 i 16V	62	01/93→09/00	→	+ ABS		13.0460-5824.2	605824	AKE 20008 13,0 - WE / - WK
1.5 i 16V	66	01/97→11/99						
1.6 GTi	77	03/93→11/99	←	→ 03/96		13.0460-5898.2	605898	21952 15,0 + WK
			→	→ 03/96; + ABS		13.0460-5824.2	605824	AKE 20008 13,0 - WE / - WK
 <b>Bremsscheibe</b>								
1.3	44	09/96→11/99	←			24.0111-0139.1	411139	Ø 234 11 10
1.3 16V	55	05/96→11/99						
1.3 i 16V	62	01/93→09/00						
1.5 i 16V	66	01/97→11/99	←			24.0118-0126.1	418126	Ø 234,5 18 17 V
1.6 GTi	77	03/93→11/99	←	→ 03/96		24.0118-0126.1	418126	Ø 234,5 18 17 V
<b>DAIHATSU - CHARADE IV Stufenheck (G203) 03/93→01/01</b>								
 <b>Bremsbelagsatz, Scheibenbremse</b>								
1.5 16V	55	10/94→01/01	←	→ 11/99		13.0460-5898.2	605898	21952 15,0 + WK
			→	→ 11/99; + ABS		13.0460-5824.2	605824	AKE 20008 13,0 - WE / - WK
1.5 i 16V	66	06/94→11/99	←	08/94→		13.0460-5898.2	605898	21952 15,0 + WK
			→	08/94→; + ABS		13.0460-5824.2	605824	AKE 20008 13,0 - WE / - WK
 <b>Bremsscheibe</b>								
1.5 16V	55	10/94→01/01	←	→ 11/99		24.0118-0126.1	418126	Ø 234,5 18 17 V
1.5 i 16V	66	06/94→11/99	←	08/94→		24.0118-0126.1	418126	Ø 234,5 18 17 V
<b>DAIHATSU - COPEN (L880_, L881_) 03/02→09/12</b>								
 <b>Bremsbelagsatz, Scheibenbremse</b>								
0.7	47	09/03→09/12	←	01/06→ 07/12		13.0460-5887.2	605887	SUM 23507 15,2 + WK
0.7 (L880)	50	09/03→12/07	←	01/06→		13.0460-5887.2	605887	SUM 23507 15,2 + WK
1.3	64	03/06→09/12	←	→ 07/12		13.0460-5887.2	605887	SUM 23507 15,2 + WK
 <b>Bremsscheibe</b>								
0.7	47	09/03→09/12	←	→ 07/12		24.0117-0107.1	417107	Ø 246 17 16 V
1.3	64	03/06→09/12						
0.7 (L880)	50	09/03→12/07	←			24.0117-0107.1	417107	Ø 246 17 16 V
<b>DAIHATSU - CUORE IV (L501) 08/94→12/99</b>								
 <b>Bremsscheibe</b>								
0.7 4WD	48	10/97→05/99	←			24.0110-0235.1	410235	Ø 211 10 9
0.8	31	11/96→10/98						
0.8	32	01/95→08/98	←	→ 10/96		24.0110-0235.1	410235	Ø 211 10 9

























	kw					! #		
<b>DAIHATSU - CUORE V (L7_) 10/98→05/03</b>								
 <b>Bremsscheibe</b>								
1.0 1.0 i (L701)	40 41	11/98→09/00 10/98→05/03	←			24.0111-0159.1	411159	Ø 211 11 10
1.0 DVVT	43	10/00→02/03	←	→ 12/02		24.0111-0159.1	411159	Ø 211 11 10
<b>DAIHATSU - CUORE VI (L251, L250_, L260_) 03/03→</b>								
 <b>Bremsbelagsatz, Scheibenbremse</b>								
1.0	43	03/03→	←	12/04→ 08/07; V		13.0460-5613.2	605613	25262 15,0 + WK + Zub
			←	05/03→ 08/07		13.0460-5709.2	605709	AKE 24229 14,8 + WK + Zub
1.0	43	05/03→	←	12/04→ 08/07; V		13.0460-5613.2	605613	25262 15,0 + WK + Zub
			←	→ 08/07		13.0460-5709.2	605709	AKE 24229 14,8 + WK + Zub
 <b>Bremsscheibe</b>								
1.0	43	03/03→	←	05/03→ 08/07		24.0111-0159.1	411159	Ø 211 11 10
			←	12/04→ 08/07		24.0116-0130.1	416130	Ø 234 16 15 V
1.0	43	05/03→	←	→ 08/07		24.0111-0159.1	411159	Ø 211 11 10
			←	12/04→ 08/07		24.0116-0130.1	416130	Ø 234 16 15 V
<b>DAIHATSU - CUORE VII (L275_, L285_, L276_) 12/06→</b>								
 <b>Bremsbelagsatz, Scheibenbremse</b>								
1.0	51	04/07→	←	09/07→ 01/13; passend für Felgengröße [Zoll]: 13		13.0460-5613.2	605613	25262 15,0 + WK + Zub
			←	09/07→ 01/13; passend für Felgengröße [Zoll]: 14		13.0460-5709.2	605709	AKE 24229 14,8 + WK + Zub
			←	09/07→ 01/13; passend für Felgengröße [Zoll]: 13; V		13.0460-5887.2	605887	SUM 23507 15,2 + WK
 <b>Bremsscheibe</b>								
1.0	51	04/07→	←	09/07→ 01/13; passend für Felgengröße [Zoll]: 13		24.0111-0159.1	411159	Ø 211 11 10
			←	09/07→ 01/13; passend für Felgengröße [Zoll]: 14		24.0116-0130.1	416130	Ø 234 16 15 V
			←	09/07→ 01/13; passend für Felgengröße [Zoll]: 14		24.0117-0107.1	417107	Ø 246 17 16 V
<b>DAIHATSU - FERENZA Hard Top (F300) 10/88→12/99</b>								
 <b>Bremsbelagsatz, Scheibenbremse</b>								
1.6 16V 4WD 1.6 i 16V 4x4	63 70	10/88→12/99 10/88→12/99	←	→ 12/95; V		13.0460-5816.2	605816	21243 14,0 - WE / - WK
 <b>Bremsscheibe</b>								
1.6 16V 4WD 1.6 i 16V 4x4	63 70	10/88→12/99 10/88→12/99	←	→ 12/95		24.0118-0121.1	418121	Ø 277 18 17 V
<b>DAIHATSU - FERENZA Soft Top (F300) 10/88→12/99</b>								
 <b>Bremsbelagsatz, Scheibenbremse</b>								
1.6 16V 1.6 i 16V	63 70	10/88→12/99 10/88→12/99	←	→ 12/95; V		13.0460-5816.2	605816	21243 14,0 - WE / - WK
 <b>Bremsscheibe</b>								
1.6 16V 1.6 i 16V	63 70	10/88→12/99 10/88→12/99	←	→ 12/95		24.0118-0121.1	418121	Ø 277 18 17 V
<b>DAIHATSU - GRAN MOVE (G3) 10/96→</b>								
 <b>Bremsbelagsatz, Scheibenbremse</b>								
1.5 16V (G303) 1.5 GLX 1.5 GX 1.6 GX	66 71 55 67	10/96→07/98 10/96→08/98 10/96→08/98 06/98→07/02	←			13.0460-5898.2	605898	21952 15,0 + WK
			→	+ ABS		13.0460-5824.2	605824	AKE 20008 13,0 - WE / - WK
1.6 16V (G301)	67	05/98→	←	06/98→ 07/02		13.0460-5898.2	605898	21952 15,0 + WK
			→	06/98→ 07/02; + ABS		13.0460-5824.2	605824	AKE 20008 13,0 - WE / - WK
 <b>Bremsscheibe</b>								
1.5 16V (G303) 1.5 GLX 1.5 GX	66 71 55	10/96→07/98 10/96→08/98 10/96→08/98	←			24.0118-0126.1	418126	Ø 234,5 18 17 V

	kw			 	! #		
<b>DAIHATSU - MATERIA (M4_) 10/06→</b>							
 <b>Bremsbelagsatz, Scheibenbremse</b>							
1.3 1.5 1.5 ECO 4WD	67 76 76	10/06→ 10/06→ 10/06→	←	→ 07/12		13.0460-5794.2 605794	TRW 24283 15,5 + WK + Zub
 <b>Bremsscheibe</b>							
1.3 1.5 1.5 ECO 4WD	67 76 76	10/06→ 10/06→ 10/06→	←	→ 07/12		24.0122-0263.1 422263	Ø 254 22 20 V
<b>DAIHATSU - MOVE (L6_) 06/94→11/99</b>							
 <b>Bremsbelagsatz, Scheibenbremse</b>							
0.8 (L601)	31	01/97→11/99	←	→ 09/98		13.0460-5710.2 605710	AKE 23783 14,0 - WE / - WK
 <b>Bremsscheibe</b>							
0.8 (L601)	31	01/97→11/99	←	→ 09/98		24.0116-0118.1 416118	Ø 234 16 14 V
<b>DAIHATSU - MOVE (L9_) 04/97→09/02</b>							
 <b>Bremsbelagsatz, Scheibenbremse</b>							
1.0 i	41	10/98→09/02	←	→ 11/00		13.0460-5852.2 605852	23497 15,0 + WK + Zub
 <b>Bremsscheibe</b>							
1.0 i	41	10/98→09/02	←	→ 11/00		24.0116-0130.1 416130	Ø 234 16 15 V
<b>DAIHATSU - ROCKY Hard Top (F7, F8) 06/84→12/98</b>							
 <b>Bremsbelagsatz, Scheibenbremse</b>							
2.8 D (F70, F75, F80, F85)	54	02/85→12/98	←	→ 09/89		13.0460-5816.2 605816	21243 14,0 - WE / - WK
 <b>Bremsscheibe</b>							
2.8 TD 2.8 TD (F70, F75, F80, F85)	72 75	05/93→12/98 09/91→12/98	←			24.0118-0121.1 418121	Ø 277 18 17 V
<b>DAIHATSU - ROCKY Soft Top (F7, F8) 02/85→12/98</b>							
 <b>Bremsbelagsatz, Scheibenbremse</b>							
2.8 D (F70, F75, F80, F85)	54	02/85→12/98	←	→ 09/89		13.0460-5816.2 605816	21243 14,0 - WE / - WK
 <b>Bremsscheibe</b>							
2.8 TD	75	09/91→12/98	←			24.0118-0121.1 418121	Ø 277 18 17 V
<b>DAIHATSU - SIRION (M1) 04/98→04/05</b>							
 <b>Bremsbelagsatz, Scheibenbremse</b>							
1.0 1.0 i (M100) 1.0 i 4WD	40 41 41	04/98→10/00 04/98→09/00 04/99→09/00	←	→ 08/00		13.0460-5852.2 605852	23497 15,0 + WK + Zub
1.0 i (M101) 1.0 i 4WD 1.3 Rally 1.3 Rally 4WD 1.3 Sport 1.3 Sport 4WD	43 43 81 81 75 75	09/00→01/05 09/00→01/05 06/02→03/05 06/02→03/05 08/00→01/05 08/00→03/05	←	→ 12/04		13.0460-5852.2 605852	23497 15,0 + WK + Zub
 <b>Bremsscheibe</b>							
1.0 1.0 i (M100) 1.0 i 4WD	40 41 41	04/98→10/00 04/98→09/00 04/99→09/00	←	→ 08/00		24.0116-0130.1 416130	Ø 234 16 15 V
1.0 i (M101) 1.0 i 4WD 1.3 Rally 1.3 Rally 4WD 1.3 Sport 1.3 Sport 4WD	43 43 81 81 75 75	09/00→01/05 09/00→01/05 06/02→03/05 06/02→03/05 08/00→01/05 08/00→03/05	←	→ 12/04		24.0116-0130.1 416130	Ø 234 16 15 V
<b>DAIHATSU - SIRION (M3_) 01/05→</b>							
 <b>Bremsbelagsatz, Scheibenbremse</b>							
1.0	51	01/05→	←	→ 01/13; passend für Felgenreöße [Zoll]: 13		13.0460-5613.2 605613	25262 15,0 + WK + Zub
↓			←	07/07→ 01/13; passend für Felgenreöße [Zoll]: 14		13.0460-5794.2 605794	TRW 24283 15,5 + WK + Zub

	kw			 	! #		
<b>DAIHATSU - SIRION (M3_) 01/05→</b>							
 <b>Bremsbelagsatz, Scheibenbremse</b>							
1.0	51	01/05→	←	07/07→ 01/13; passend für Felgengröße [Zoll]: 14		13.0460-5887.2 605887	SUM 23507 15,2 + WK
1.3	67	03/08→	←	→ 01/13		13.0460-5794.2 605794	TRW 24283 15,5 + WK + Zub
1.3 4WD	64	04/05→				13.0460-5887.2 605887	SUM 23507 15,2 + WK
1.3 4WD	67	03/08→					
1.5	76	03/08→					
1.3 (M301)	64	01/05→	←	07/07→ 01/13		13.0460-5794.2 605794	TRW 24283 15,5 + WK + Zub
						13.0460-5887.2 605887	SUM 23507 15,2 + WK
 <b>Bremsscheibe</b>							
1.0	51	01/05→	←	→ 01/13; passend für Felgengröße [Zoll]: 13		24.0116-0130.1 416130	Ø 234 16 15 V
			←	→ 01/13; passend für Felgengröße [Zoll]: 14		24.0117-0107.1 417107	Ø 246 17 16 V
						24.0122-0263.1 422263	Ø 254 22 20 V
1.3	67	03/08→	←	→ 01/13		24.0117-0107.1 417107	Ø 246 17 16 V
1.3 (M301)	64	01/05→					
1.3 4WD	67	03/08→				24.0122-0263.1 422263	Ø 254 22 20 V
1.5	76	03/08→					
1.3 4WD	64	04/05→	←	→ 12/06		24.0116-0130.1 416130	Ø 234 16 15 V
			←	01/07→ 01/13		24.0117-0107.1 417107	Ø 246 17 16 V
						24.0122-0263.1 422263	Ø 254 22 20 V
<b>DAIHATSU - TERIOS (J1_) 05/97→10/06</b>							
 <b>Bremsbelagsatz, Scheibenbremse</b>							
1.3	63	09/01→10/05	←			13.0460-5713.2 605713	SUM 21650 15,5 + WK + Zub
1.3 4WD (J102)	63	10/00→10/05					
1.3 VVT-i Turbo 4WD	103	10/02→10/05					
1.3 4WD (J100)	61	10/97→10/00	←	→ 09/00		13.0460-5713.2 605713	SUM 21650 15,5 + WK + Zub
 <b>Bremsscheibe</b>							
1.3	63	09/01→10/05	←			24.0116-0117.1 416117	Ø 273 16 15
1.3 4WD (J102)	63	10/00→10/05					
1.3 VVT-i Turbo 4WD	103	10/02→10/05					
1.3 4WD (J100)	61	10/97→10/00	←	→ 09/00		24.0116-0117.1 416117	Ø 273 16 15
<b>DAIHATSU - TERIOS (J2_) 11/05→</b>							
 <b>Bremsbelagsatz, Scheibenbremse</b>							
1.3 VVT-i 4x4	63	11/05→	←	→ 01/13		13.0460-5713.2 605713	SUM 21650 15,5 + WK + Zub
1.5 4x4	77	05/06→					
1.5 VVT-i 4x4	75	09/10→					
1.5 VVT-i RWD	75	09/10→					
1.5 VVT-i RWD	77	11/05→					
 <b>Bremsscheibe</b>							
1.3 VVT-i 4x4	63	11/05→	←	→ 01/13		24.0116-0117.1 416117	Ø 273 16 15
1.5 4x4	77	05/06→					
1.5 VVT-i 4x4	75	09/10→					
1.5 VVT-i RWD	75	09/10→					
1.5 VVT-i RWD	77	11/05→					
<b>DAIHATSU - TREVIS 06/06→</b>							
 <b>Bremsbelagsatz, Scheibenbremse</b>							
1.0	43	06/06→	←	→ 09/09; passend für Felgengröße [Zoll]: 13		13.0460-5613.2 605613	25262 15,0 + WK + Zub
			←	→ 09/09; passend für Felgengröße [Zoll]: 14		13.0460-5709.2 605709	AKE 24229 14,8 + WK + Zub
 <b>Bremsscheibe</b>							
1.0	43	06/06→	←	→ 09/09; passend für Felgengröße [Zoll]: 14		24.0111-0159.1 411159	Ø 211 11 10
			←	→ 09/09; passend für Felgengröße [Zoll]: 13		24.0116-0130.1 416130	Ø 234 16 15 V
<b>DAIHATSU - YRV (M2) 02/01→</b>							
 <b>Bremsbelagsatz, Scheibenbremse</b>							
1.0	43	02/01→	←	→ 08/06		13.0460-5852.2 605852	23497 15,0 + WK + Zub
1.3 (M201)	64	02/01→					
1.3 4WD	64	02/01→					
↓							

























	kw				! #		
<b>DAIHATSU - YRV (M2) 02/01→</b>							
 <b>Bremsscheibe</b>							
1.0	43	02/01→	←	→ 08/06		24.0116-0130.1 416130	Ø 234 16 15 V
1.3 (M201)	64	02/01→					
1.3 4WD	64	02/01→					
1.3 GTi	95	07/02→	←	→ 08/06		24.0117-0107.1 417107	Ø 246 17 16 V
<b>DS - DS5 04/15→</b>							
 <b>Bremsbelagsatz, Scheibenbremse</b>							
1.6 BlueHDi 120	88	06/15→	←	Nabendurchmesser [mm]: 82		13.0460-7229.2 607229	ATE 24538 18,5 - WE / - WK
			→	Nabendurchmesser [mm]: 82		13.0470-7229.2 LD7229	ATE 24538 18,5 - WE / - WK Ceramic
1.6 THP 165	121	07/15→	←	Nabendurchmesser [mm]: 82		13.0460-7230.2 607230	ATE 24557 19,4 - WE / - WK
			→	Nabendurchmesser [mm]: 82		13.0470-7230.2 LD7230	ATE 24557 19,4 - WE / - WK Ceramic
1.6 THP 210	155	04/15→					
2.0 BlueHDi 150	110	04/15→					
2.0 BlueHDi 180	133	04/15→					
2.0 HDi 165 Hybrid4 4x4	120	04/15→	←	Nabendurchmesser [mm]: 83		13.0460-7279.2 607279	ATE 25069 17,3 + WK
			→	Nabendurchmesser [mm]: 82		13.0470-7279.2 LD7279	ATE 25069 17,3 + WK Ceramic
			→	Nabendurchmesser [mm]: 82		13.0460-2761.2 602761	TRW 24922 16,5 - WK + Zub
 <b>Bremsscheibe</b>							
1.6 BlueHDi 120	88	06/15→	←			24.0126-0120.1 426120	Ø 283 26 24 V + S
			→			24.0112-0194.2 412194	Ø 268 12 10 + LG / + ABS Ring
1.6 THP 165	121	07/15→	←	Nabendurchmesser [mm]: 82		24.0126-0159.1 426159	Ø 302 26 24 V + S
			→	Nabendurchmesser [mm]: 82			
2.0 BlueHDi 150	110	04/15→	←	Nabendurchmesser [mm]: 83		24.0130-0230.1 430230	Ø 340 30 28 V + S
			→			24.0112-0194.2 412194	Ø 268 12 10 + LG / + ABS Ring
1.6 THP 210	155	04/15→	←			24.0126-0120.1 426120	Ø 283 26 24 V + S
			←	Nabendurchmesser [mm]: 83		24.0130-0230.1 430230	Ø 340 30 28 V + S
			→			24.0112-0198.1 412198	Ø 290 12 10 + S
2.0 BlueHDi 180	133	04/15→	←	Nabendurchmesser [mm]: 82		24.0126-0159.1 426159	Ø 302 26 24 V + S
			←	Nabendurchmesser [mm]: 83		24.0130-0230.1 430230	Ø 340 30 28 V + S
			→			24.0112-0194.2 412194	Ø 268 12 10 + LG / + ABS Ring
			→			24.0112-0198.1 412198	Ø 290 12 10 + S
2.0 HDi 165 Hybrid4 4x4	120	04/15→	←	Nabendurchmesser [mm]: 82		24.0126-0159.1 426159	Ø 302 26 24 V + S
			→			24.0112-0198.1 412198	Ø 290 12 10 + S
<b>DS - DS 3 04/15→</b>							
 <b>Bremsbelagsatz, Scheibenbremse</b>							
1.2 THP 110	81	04/15→	←	für Bremsscheibendurchmesser [mm]: 283		13.0460-3855.2 603855	BOS 24883 18,0 - WE / - WK + Zub
						13.0470-3855.2 LD3855	BOS 24883 18,0 - WE / - WK + Zub Ceramic
1.2 THP 130	96	09/15→					
1.6 BlueHDi 100	73	04/15→					
1.6 BlueHDi 75	55	07/15→					
1.6 THP 165	121	07/15→					
1.6 THP 208	153	09/15→	←	für Bremsscheibendurchmesser [mm]: 266		13.0460-3994.2 603994	BOS 23599 19,0 - WE / - WK + Zub
			→			13.0470-3994.2 LD3994	BOS 23599 19,0 - WE / - WK + Zub Ceramic
			→			13.0460-2740.2 602740	TRW 23554 17,0 - WE / - WK + Zub
						13.0470-2740.2 LD2740	TRW 23554 17,0 - WE / - WK + Zub Ceramic
1.2 VTi 82	60	04/15→	←			13.0460-3994.2 603994	BOS 23599 19,0 - WE / - WK + Zub
			→			13.0470-3994.2 LD3994	BOS 23599 19,0 - WE / - WK + Zub Ceramic
1.6 BlueHDi 120	88	07/15→	←			13.0460-3855.2 603855	BOS 24883 18,0 - WE / - WK + Zub
			→			13.0470-3855.2 LD3855	BOS 24883 18,0 - WE / - WK + Zub Ceramic
			→			13.0460-2740.2 602740	TRW 23554 17,0 - WE / - WK + Zub
						13.0470-2740.2 LD2740	TRW 23554 17,0 - WE / - WK + Zub Ceramic
 <b>Bremsscheibe</b>							
1.2 THP 110	81	04/15→	←			24.0122-0194.1 422194	Ø 266 22 20 V + S
1.2 THP 130	96	09/15→				24.0126-0120.1 426120	Ø 283 26 24 V + S













	kW			 	! #		
<b>DS - DS 3 04/15→</b>							
 <b>Bremsscheibe</b>							
1.6 BlueHDi 100	73	04/15→	←		24.0326-0120.1	526120	Ø 283 26 24 V + S
1.6 BlueHDi 75	55	07/15→	→		24.0109-0100.2	409100	Ø 249 9 7 + LG / + ABS Ring
1.6 THP 165	121	07/15→					
1.6 THP 208	153	09/15→					
1.2 VTi 82	60	04/15→	←		24.0122-0194.1	422194	Ø 266 22 20 V + S
1.6 BlueHDi 120	88	07/15→	←		24.0126-0120.1	426120	Ø 283 26 24 V + S
			→		24.0326-0120.1	526120	Ø 283 26 24 V + S
			→		24.0109-0100.2	409100	Ø 249 9 7 + LG / + ABS Ring
<b>DS - DS 3 Cabriolet 07/15→</b>							
 <b>Bremsbelagsatz, Scheibenbremse</b>							
1.2 THP 110	81	07/15→	←	für Bremsscheibendurchmesser [mm]: 283	13.0460-3855.2	603855	BOS 24883 18,0 - WE / - WK + Zub
1.2 THP 130	96	09/15→			13.0470-3855.2	LD3855	BOS 24883 18,0 - WE / - WK + Zub Ceramic
1.6 BlueHDi 100	73	07/15→					
1.6 THP 165	121	07/15→					
1.6 THP 208	153	09/15→					
			←	für Bremsscheibendurchmesser [mm]: 266	13.0460-3994.2	603994	BOS 23599 19,0 - WE / - WK + Zub
					13.0470-3994.2	LD3994	BOS 23599 19,0 - WE / - WK + Zub Ceramic
			→		13.0460-2740.2	602740	TRW 23554 17,0 - WE / - WK + Zub
					13.0470-2740.2	LD2740	TRW 23554 17,0 - WE / - WK + Zub Ceramic
1.2 VTi 82	60	07/15→	←		13.0460-3994.2	603994	BOS 23599 19,0 - WE / - WK + Zub
					13.0470-3994.2	LD3994	BOS 23599 19,0 - WE / - WK + Zub Ceramic
1.6 BlueHDi 120	88	07/15→	←		13.0460-3855.2	603855	BOS 24883 18,0 - WE / - WK + Zub
			→		13.0470-3855.2	LD3855	BOS 24883 18,0 - WE / - WK + Zub Ceramic
			→		13.0460-2740.2	602740	TRW 23554 17,0 - WE / - WK + Zub
					13.0470-2740.2	LD2740	TRW 23554 17,0 - WE / - WK + Zub Ceramic
 <b>Bremsscheibe</b>							
1.2 THP 110	81	07/15→	←		24.0122-0194.1	422194	Ø 266 22 20 V + S
1.2 THP 130	96	09/15→			24.0126-0120.1	426120	Ø 283 26 24 V + S
1.6 BlueHDi 100	73	07/15→			24.0326-0120.1	526120	Ø 283 26 24 V + S
1.6 THP 165	121	07/15→					
1.6 THP 208	153	09/15→			24.0109-0100.2	409100	Ø 249 9 7 + LG / + ABS Ring
1.2 VTi 82	60	07/15→	←		24.0122-0194.1	422194	Ø 266 22 20 V + S
1.6 BlueHDi 120	88	07/15→	←		24.0126-0120.1	426120	Ø 283 26 24 V + S
			→		24.0326-0120.1	526120	Ø 283 26 24 V + S
			→		24.0109-0100.2	409100	Ø 249 9 7 + LG / + ABS Ring
<b>DS - DS 4 / DS 4 CROSSBACK 07/15→</b>							
 <b>Bremsbelagsatz, Scheibenbremse</b>							
1.2 THP 130	96	07/15→	←		13.0460-7229.2	607229	ATE 24538 18,5 - WE / - WK
1.6 BlueHDi 120	88	07/15→			13.0470-7229.2	LD7229	ATE 24538 18,5 - WE / - WK Ceramic
			→		13.0460-2761.2	602761	TRW 24922 16,5 - WK + Zub
1.6 BlueHDi 100	73	04/16→	→	+ eFSB	13.0460-2761.2	602761	TRW 24922 16,5 - WK + Zub
			→	- eFSB	13.0460-2775.2	602775	TRW 23554 16,4 - WE / - WK + Zub
1.6 THP 165	121	07/15→	←		13.0460-7230.2	607230	ATE 24557 19,4 - WE / - WK
					13.0470-7230.2	LD7230	ATE 24557 19,4 - WE / - WK Ceramic
			→	+ eFSB	13.0460-2761.2	602761	TRW 24922 16,5 - WK + Zub
			→	- eFSB	13.0460-2775.2	602775	TRW 23554 16,4 - WE / - WK + Zub
1.6 THP 210	155	07/15→	←		13.0460-7279.2	607279	ATE 25069 17,3 + WK
					13.0470-7279.2	LD7279	ATE 25069 17,3 + WK Ceramic
			→	+ eFSB	13.0460-2761.2	602761	TRW 24922 16,5 - WK + Zub

























	kw			 	! #		
<b>DS - DS 4 / DS 4 CROSSBACK 07/15→</b>							
 <b>Bremsbelagsatz, Scheibenbremse</b>							
1.6 THP 210	155	07/15→	➔	- eFSB		13.0460-2775.2 602775	TRW 23554 16,4 - WE / - WK + Zub
2.0 BlueHDi 150	110	07/15→	➔			13.0460-7230.2 607230	ATE 24557 19,4 - WE / - WK
			➔			13.0470-7230.2 LD7230	ATE 24557 19,4 - WE / - WK Ceramic
2.0 BlueHDi 180	133	07/15→	➔	nicht für Felgenreöße [Zoll]: 19		13.0460-2761.2 602761	TRW 24922 16,5 - WK + Zub
			➔			13.0460-7230.2 607230	ATE 24557 19,4 - WE / - WK
			➔			13.0470-7230.2 LD7230	ATE 24557 19,4 - WE / - WK Ceramic
			➔	passend für Felgenreöße [Zoll]: 19		13.0460-7279.2 607279	ATE 25069 17,3 + WK
			➔			13.0470-7279.2 LD7279	ATE 25069 17,3 + WK Ceramic
			➔	+ eFSB		13.0460-2761.2 602761	TRW 24922 16,5 - WK + Zub
			➔	- eFSB		13.0460-2775.2 602775	TRW 23554 16,4 - WE / - WK + Zub
 <b>Bremsscheibe</b>							
1.2 THP 130	96	07/15→	➔			24.0126-0120.1 426120	Ø 283 26 24 V + S
1.6 BlueHDi 120	88	07/15→	➔			24.0326-0120.1 526120	Ø 283 26 24 V + S
			➔	nicht für Felgenreöße [Zoll]: 19		24.0112-0194.2 412194	Ø 268 12 10 + LG / + ABS Ring
			➔	passend für Felgenreöße [Zoll]: 19		24.0112-0198.1 412198	Ø 290 12 10 + S
1.6 BlueHDi 100	73	04/16→	➔	- eFSB		24.0109-0171.2 409171	Ø 249 9 8 + LG / + ABS Ring
			➔	+ eFSB; nicht für Felgenreöße [Zoll]: 19		24.0112-0194.2 412194	Ø 268 12 10 + LG / + ABS Ring
			➔	+ eFSB; passend für Felgenreöße [Zoll]: 19		24.0112-0198.1 412198	Ø 290 12 10 + S
1.6 THP 165	121	07/15→	➔			24.0126-0159.1 426159	Ø 302 26 24 V + S
			➔	- eFSB		24.0109-0171.2 409171	Ø 249 9 8 + LG / + ABS Ring
			➔	+ eFSB; nicht für Felgenreöße [Zoll]: 19		24.0112-0194.2 412194	Ø 268 12 10 + LG / + ABS Ring
			➔	+ eFSB; passend für Felgenreöße [Zoll]: 19		24.0112-0198.1 412198	Ø 290 12 10 + S
1.6 THP 210	155	07/15→	➔			24.0130-0230.1 430230	Ø 340 30 28 V + S
			➔	- eFSB		24.0109-0171.2 409171	Ø 249 9 8 + LG / + ABS Ring
			➔	+ eFSB; nicht für Felgenreöße [Zoll]: 19		24.0112-0194.2 412194	Ø 268 12 10 + LG / + ABS Ring
			➔	+ eFSB; passend für Felgenreöße [Zoll]: 19		24.0112-0198.1 412198	Ø 290 12 10 + S
2.0 BlueHDi 150	110	07/15→	➔			24.0126-0159.1 426159	Ø 302 26 24 V + S
			➔	nicht für Felgenreöße [Zoll]: 19		24.0112-0194.2 412194	Ø 268 12 10 + LG / + ABS Ring
			➔	passend für Felgenreöße [Zoll]: 19		24.0112-0198.1 412198	Ø 290 12 10 + S
2.0 BlueHDi 180	133	07/15→	➔	nicht für Felgenreöße [Zoll]: 19		24.0126-0159.1 426159	Ø 302 26 24 V + S
			➔	passend für Felgenreöße [Zoll]: 19		24.0130-0230.1 430230	Ø 340 30 28 V + S
			➔	- eFSB		24.0109-0171.2 409171	Ø 249 9 8 + LG / + ABS Ring
			➔	nicht für Felgenreöße [Zoll]: 19		24.0112-0194.2 412194	Ø 268 12 10 + LG / + ABS Ring
			➔	passend für Felgenreöße [Zoll]: 19		24.0112-0198.1 412198	Ø 290 12 10 + S
<b>FIAT - 124 Spider (348_) 03/16→</b>							
 <b>Bremsbelagsatz, Scheibenbremse</b>							
1.4	103	03/16→	➔			13.0460-5762.2 605762	AKE 24298 14,0 + WK + Zub
<b>FIAT - 500 (312_) 07/07→</b>							
 <b>Bremsbelagsatz, Scheibenbremse</b>							
0.9	44	12/13→	➔			13.0460-7288.2 607288	ATE 25429 17,5 + WK
0.9	48	09/12→	➔			13.0470-7288.2 LD7288	ATE 25429 17,5 + WK Ceramic
0.9	59	12/13→	➔				
0.9	63	07/10→	➔				
0.9 ELECTRIC	77	10/13→	➔	12/13→		13.0460-3826.2 603826	BOS 23706 18,0 + WK + Zub
						13.0460-3863.2 603863	BOS 23706 18,0 + WK + Zub
83	09/12→	➔	12/13→		13.0470-3826.2 LD3826	BOS 23706 18,0 + WK + Zub Ceramic	
					13.0460-2879.2 602879	TRW 23601 13,7 - WE / - WK	
					13.0470-2879.2 LD2879	TRW 23601 13,7 - WE / - WK Ceramic	
1.2	51	10/07→	➔	→ 03/15		13.0460-3838.2 603838	BOS 21436 17,0 + WK + Zub
1.2 LPG	51	12/10→	➔				













	kw			 	! #		
<b>FIAT - 500 (312_) 07/07→</b>							
 <b>Bremsbelagsatz, Scheibenbremse</b>							
1.2 1.2 LPG	51 51	10/07→ 12/10→	←	→ 03/15		13.0470-3838.2 LD3838	BOS 21436 17,0 + WK + Zub Ceramic
			←	04/15→		13.0460-3846.2 603846 13.0470-3846.2 LD3846	BOS 24072 17,9 + WK + Zub Ceramic
1.3 D Multijet	55	10/07→	←			13.0460-3846.2 603846 13.0470-3846.2 LD3846	BOS 24072 17,9 + WK + Zub Ceramic
1.3 D Multijet	57	06/16→	←			13.0460-3826.2 603826 13.0460-3863.2 603863 13.0470-3826.2 LD3826	BOS 23706 18,0 + WK + Zub Ceramic
1.3 D Multijet	70	12/09→	←			13.0460-3818.2 603818	BOS 23706 18,1 + WK
1.4 1.4	74 75	10/07→ 09/08→	←			13.0460-3826.2 603826 13.0460-3863.2 603863 13.0470-3826.2 LD3826	BOS 23706 18,0 + WK + Zub Ceramic
			←	für Fahrzeuge mit Sportpaket		13.0460-3850.2 603850	BOS 23707 18,0 - WE / - WK + Zub
			→			13.0460-2879.2 602879 13.0470-2879.2 LD2879	TRW 23601 13,7 - WE / - WK Ceramic
 <b>Bremsscheibe</b>							
0.9 0.9 0.9 0.9	44 48 59 63	12/13→ 09/12→ 12/13→ 07/10→	←			24.0112-0127.1 412127	Ø 257,5 12 10,2
0.9 ELECTRIC	77 83	10/13→ 09/12→	←	12/13→		24.0122-0197.1 422197 24.0322-0197.1 522197	Ø 257,5 22 20,2 V Ø 257,5 22 20,2 V
			→	12/13→		24.0111-0119.1 411119	Ø 240,5 11 9,2
1.2 1.2 LPG	51 51	10/07→ 12/10→	←	→ 03/15		24.0111-0119.1 411119	Ø 240,5 11 9,2
			←	04/15→		24.0112-0127.1 412127	Ø 257,5 12 10,2
1.3 D Multijet 1.3 D Multijet	55 57	10/07→ 06/16→	←			24.0120-0184.1 420184	Ø 240,5 20 18,2 V
1.3 D Multijet	70	12/09→	←			24.0122-0197.1 422197 24.0322-0197.1 522197	Ø 257,5 22 20,2 V Ø 257,5 22 20,2 V
1.4 1.4	74 75	10/07→ 09/08→	←			24.0122-0197.1 422197 24.0322-0197.1 522197	Ø 257,5 22 20,2 V Ø 257,5 22 20,2 V
			→			24.0111-0119.1 411119	Ø 240,5 11 9,2
<b>FIAT - 500 C (312_) 09/09→</b>							
 <b>Bremsbelagsatz, Scheibenbremse</b>							
0.9 0.9 0.9	44 48 63	12/13→ 09/12→ 09/09→	←			13.0460-7288.2 607288 13.0470-7288.2 LD7288	ATE 25429 17,5 + WK Ceramic
0.9 0.9 1.4 1.4	59 77 74 75	12/13→ 12/13→ 09/09→ 09/11→	←			13.0460-3826.2 603826 13.0460-3863.2 603863 13.0470-3826.2 LD3826	BOS 23706 18,0 + WK + Zub Ceramic
1.2	51	09/09→	←	→ 04/13		13.0460-3846.2 603846 13.0470-3846.2 LD3846	BOS 24072 17,9 + WK + Zub Ceramic
			←	05/13→		13.0460-7288.2 607288 13.0470-7288.2 LD7288	ATE 25429 17,5 + WK Ceramic
1.3 D Multijet	55	09/09→	←			13.0460-3846.2 603846 13.0470-3846.2 LD3846	BOS 24072 17,9 + WK + Zub Ceramic
1.3 D Multijet	70	09/09→	←			13.0460-3818.2 603818	BOS 23706 18,1 + WK
 <b>Bremsscheibe</b>							
0.9 0.9 0.9	44 48 63	12/13→ 09/12→ 09/09→	←			24.0112-0127.1 412127	Ø 257,5 12 10,2
0.9 0.9 1.4 ↓	59 77 74	12/13→ 12/13→ 09/09→	←			24.0122-0197.1 422197 24.0322-0197.1 522197	Ø 257,5 22 20,2 V Ø 257,5 22 20,2 V

	kw			 	! #		
<b>FIAT - 500 C (312_) 09/09→</b>							
 <b>Bremsscheibe</b>							
1.4	75	09/11→	→			24.0111-0119.1 411119	Ø 240,5 11 9,2
1.2	51	09/09→	←	04/15→		24.0111-0119.1 411119	Ø 240,5 11 9,2
			←	→ 03/15		24.0120-0184.1 420184	Ø 240,5 20 18,2 V
1.3 D Multijet	55	09/09→	←			24.0120-0184.1 420184	Ø 240,5 20 18,2 V
1.3 D Multijet	70	09/09→	←			24.0122-0197.1 422197	Ø 257,5 22 20,2 V
			←			24.0322-0197.1 522197	Ø 257,5 22 20,2 V
<b>FIAT - 500L (351_, 352_) 09/12→</b>							
 <b>Bremsbelagsatz, Scheibenbremse</b>							
0.9	77	09/12→	←			13.0460-3840.2 603840	BOS 23981 19,6 + WK + Zub
0.9 Natural Power	59	04/17→				13.0470-3840.2 LD3840	BOS 23981 19,6 + WK + Zub
0.9 Natural Power	63	03/13→					Ceramic
1.3 D Multijet	62	09/12→					
1.3 D Multijet	70	06/14→	→			13.0460-2789.2 602789	TRW 25652 17,1 + WK + Zub
1.4	70	09/12→				13.0470-2789.2 LD2789	TRW 25652 17,1 + WK + Zub
1.6 D Multijet	77	09/12→					Ceramic
1.4	88	10/13→	←	01/14→		13.0460-7302.2 607302	ATE 24727 20,7 + WK
			→	01/14→		13.0460-2793.2 602793	TRW 25973 17,2 + WK + Zub
1.4 LPG	88	02/14→	←			13.0460-7302.2 607302	ATE 24727 20,7 + WK
1.6 D Multijet	88	09/13→	→			13.0460-2793.2 602793	TRW 25973 17,2 + WK + Zub
 <b>Bremsscheibe</b>							
0.9	77	09/12→	←			24.0122-0286.1 422286	Ø 284 22 20 V
0.9 Natural Power	59	04/17→					
0.9 Natural Power	63	03/13→	→			24.0110-0378.1 410378	Ø 251 10 9
1.3 D Multijet	62	09/12→					
1.3 D Multijet	70	06/14→					
1.4	70	09/12→					
1.6 D Multijet	77	09/12→					
1.4	88	10/13→	←	01/14→		24.0128-0253.1 428253	Ø 305 28 26 V
			→	01/14→		24.0110-0393.1 410393	Ø 264 10 8
1.4 LPG	88	02/14→	←			24.0128-0253.1 428253	Ø 305 28 26 V
1.6 D Multijet	88	09/13→	→			24.0110-0393.1 410393	Ø 264 10 8
<b>FIAT - 500X (334_) 09/14→</b>							
 <b>Bremsbelagsatz, Scheibenbremse</b>							
1.3 D Multijet	70	06/15→	←			13.0460-7311.2 607311	ATE 22240 19,2 + WK
1.4	100	09/14→	→				
1.4 (334AXC1B, 334AXC11)	103	09/14→				13.0460-2602.2 602602	TRW 22304 17,3 + WK + Zub
1.4 LPG	88	03/17→					
1.6 D Multijet	84	09/14→					
1.6 D Multijet	88	09/14→					
1.4 4x4	120	02/15→	←			13.0460-5662.2 605662	MAN 22165 20,7 + WK
1.4 4x4	125	02/15→					
1.6	81	11/14→	→			13.0460-2602.2 602602	TRW 22304 17,3 + WK + Zub
2.0 D Multijet 4x4	100	09/14→					
2.0 D Multijet 4x4	103	09/14→					
 <b>Bremsscheibe</b>							
1.3 D Multijet	70	06/15→	←			24.0126-0168.1 426168	Ø 281 26,2 24,2 V + S
1.4	100	09/14→					
1.4 (334AXC1B, 334AXC11)	103	09/14→	→			24.0112-0170.1 412170	Ø 278 12 10 + S
1.4 LPG	88	03/17→					
1.6 D Multijet	84	09/14→					
1.6 D Multijet	88	09/14→					
1.4 4x4	120	02/15→	←			24.0128-0292.1 428292	Ø 305 28 26 V + S
1.4 4x4	125	02/15→					
1.6	81	11/14→	→			24.0112-0170.1 412170	Ø 278 12 10 + S
2.0 D Multijet 4x4	100	09/14→					
2.0 D Multijet 4x4	103	09/14→					
<b>FIAT - BARCHETTA (183_) 03/95→05/05</b>							
 <b>Bremsbelagsatz, Scheibenbremse</b>							
1.8 16V	96	04/95→05/05	←	→ 05/95		13.0460-2949.2 602949	TRW 20833 17,0 + WK
			←	06/95→ 10/04		13.0460-7065.2 607065	ATE 21927 17,9 + WK
			→	→ 10/04; ALU		13.0460-2826.2 602826	TRW 23177 14,2 - WK
↓							











	kw			 	! #		
<b>FIAT - BARCHETTA (183_) 03/95→05/05</b>							
 <b>Bremsbelagsatz, Scheibenbremse</b>							
1.8 16V	96	04/95→05/05	➡	→ 10/04; GG		13.0460-2951.2 602951	TRW 21103 14,2 - WK
<b>Zubehörsatz, Scheibenbremsbelag</b>							
1.8 16V	96	04/95→05/05	➡	→ 10/04; GG		13.0460-0072.2 610072	TRW
 <b>Bremsscheibe</b>							
1.8 16V	96	04/95→05/05	⬅	→ 10/04		24.0120-0142.1 420142	Ø 257,5 20 18,2 V
						24.0320-0142.1 520142	Ø 257,5 20 18,2 V
			➡	→ 10/04		24.0111-0119.1 411119	Ø 240,5 11 9,2
<b>FIAT - BRAVA (182_) 10/95→06/03</b>							
 <b>Bremsbelagsatz, Scheibenbremse</b>							
1.2 16V	64	12/98→12/02	⬅	→ 10/01; Schaltgetriebe		13.0460-7064.2 607064	ATE 21930 17,9 + WK
1.2 16V 80	60	12/98→12/02	⬅	→ 10/01; Automatikgetriebe		13.0460-7065.2 607065	ATE 21927 17,9 + WK
1.2 16V 80	59	10/00→10/01	⬅	Schaltgetriebe		13.0460-7064.2 607064	ATE 21930 17,9 + WK
1.4 (182.BG)	55	10/95→10/01	⬅				
1.4 12 V (182.BA)	59	10/95→08/98	⬅	Automatikgetriebe		13.0460-7065.2 607065	ATE 21927 17,9 + WK
1.6 16V (182.BB)	76	02/96→10/01					
1.6 16V (182.BH)	66	10/95→10/01					
1.6 16V (182.BU)	76	01/99→12/02					
1.9 D	48	10/95→10/01					
1.8 GT 16V (182.BC)	83	10/95→08/01	⬅			13.0460-7065.2 607065	ATE 21927 17,9 + WK
1.9 JTD	74	09/00→10/01					
1.9 JTD 105	77	12/98→10/01					
2.0	113	09/98→08/00					
1.9 JTD	79	01/01→12/02	⬅	→ 10/01		13.0460-7065.2 607065	ATE 21927 17,9 + WK
1.9 TD 100 S (182.BF)	74	03/96→10/01	⬅	06/96→		13.0460-7065.2 607065	ATE 21927 17,9 + WK
1.9 TD 75 S (182.BF)	55	03/96→10/01	⬅	06/96→; Schaltgetriebe		13.0460-7064.2 607064	ATE 21930 17,9 + WK
			⬅	06/96→; Automatikgetriebe		13.0460-7065.2 607065	ATE 21927 17,9 + WK
 <b>Bremsscheibe</b>							
1.2 16V	64	12/98→12/02	⬅	→ 10/01; Schaltgetriebe		24.0112-0127.1 412127	Ø 257,5 12 10,2
1.2 16V 80	60	12/98→12/02	⬅	→ 10/01; Automatikgetriebe		24.0120-0142.1 420142	Ø 257,5 20 18,2 V
						24.0320-0142.1 520142	Ø 257,5 20 18,2 V
			⬅	Schaltgetriebe		24.0112-0127.1 412127	Ø 257,5 12 10,2
1.4 (182.BG)	55	10/95→10/01	⬅				
1.4 12 V (182.BA)	59	10/95→08/98	⬅	Automatikgetriebe		24.0120-0142.1 420142	Ø 257,5 20 18,2 V
1.6 16V (182.BB)	76	02/96→10/01				24.0320-0142.1 520142	Ø 257,5 20 18,2 V
1.6 16V (182.BH)	66	10/95→10/01					
1.6 16V (182.BU)	76	01/99→12/02					
1.9 D	48	10/95→10/01					
1.8 GT 16V (182.BC)	83	10/95→08/01	⬅			24.0120-0142.1 420142	Ø 257,5 20 18,2 V
1.9 JTD	74	09/00→10/01				24.0320-0142.1 520142	Ø 257,5 20 18,2 V
1.9 JTD 105	77	12/98→10/01					
2.0	113	09/98→08/00					
1.9 JTD	79	01/01→12/02	⬅	→ 10/01		24.0120-0142.1 420142	Ø 257,5 20 18,2 V
						24.0320-0142.1 520142	Ø 257,5 20 18,2 V
1.9 TD 100 S (182.BF)	74	03/96→10/01	⬅	06/96→		24.0120-0142.1 420142	Ø 257,5 20 18,2 V
						24.0320-0142.1 520142	Ø 257,5 20 18,2 V
1.9 TD 75 S (182.BF)	55	03/96→10/01	⬅	06/96→; Schaltgetriebe		24.0112-0127.1 412127	Ø 257,5 12 10,2
			⬅	06/96→; Automatikgetriebe		24.0120-0142.1 420142	Ø 257,5 20 18,2 V
						24.0320-0142.1 520142	Ø 257,5 20 18,2 V
<b>FIAT - BRAVO I (182_) 10/95→10/01</b>							
 <b>Bremsbelagsatz, Scheibenbremse</b>							
1.2 16V 80	59	10/00→10/01	⬅			13.0460-7064.2 607064	ATE 21930 17,9 + WK
1.2 16V 80	60	12/98→10/00					
1.2 16V 80	64	12/98→10/01					
1.4 (182.AA)	59	10/95→10/01					
1.4 (182.AG)	55	10/95→10/01					
1.6	76	09/00→10/01					
1.6 16V (182.AB)	76	03/96→10/01					
1.6 16V (182.AH)	66	10/95→10/01					
1.9 D	48	10/95→10/01					
1.8 GT (182.AC)	83	10/95→10/01	⬅			13.0460-7065.2 607065	ATE 21927 17,9 + WK
1.9 JTD	74	09/00→10/01					
1.9 JTD 105	77	12/98→10/01					
1.9 TD 100 S (182.AF)	74	03/96→10/01	⬅	06/96→		13.0460-7065.2 607065	ATE 21927 17,9 + WK
↓							









	kw				! #		
<b>FIAT - BRAVO I (182_) 10/95→10/01</b>							
 <b>Bremsbelagsatz, Scheibenbremse</b>							
1.9 TD 75 S (182.AF)	55	03/96→10/01	←	06/96→		<b>13.0460-7064.2 607064</b>	ATE 21930 17,9 + WK
2.0 HGT 20V (182.AD)	108	10/95→07/98	←			<b>13.0460-7069.2 607069</b>	ATE 21636 19,3 + WK
			→	ALU		<b>13.0460-2826.2 602826</b>	TRW 23177 14,2 - WK
			→	GG		<b>13.0460-2951.2 602951</b>	TRW 21103 14,2 - WK
2.0 HGT 20V (182AQ)	113	07/98→10/01	←	→ 04/99		<b>13.0460-7069.2 607069</b>	ATE 21636 19,3 + WK
			←	05/99→		<b>13.0460-7140.2 607140</b>	ATE 21637 19,3 + WK
						<b>13.0470-7140.2 LD7140</b>	ATE 21637 19,3 + WK Ceramic
			→	ALU		<b>13.0460-2826.2 602826</b>	TRW 23177 14,2 - WK
			→	GG		<b>13.0460-2951.2 602951</b>	TRW 21103 14,2 - WK
<b>Zubehörsatz, Scheibenbremsbelag</b>							
2.0 HGT 20V (182.AD)	108	10/95→07/98	→	GG		<b>13.0460-0072.2 610072</b>	TRW
2.0 HGT 20V (182AQ)	113	07/98→10/01					
 <b>Bremsscheibe</b>							
1.2 16V 80	59	10/00→10/01	←			<b>24.0112-0127.1 412127</b>	Ø 257,5 12 10,2
1.2 16V 80	60	12/98→10/00					
1.2 16V 80	64	12/98→10/01					
1.4 (182.AA)	59	10/95→10/01					
1.4 (182.AG)	55	10/95→10/01					
1.6	76	09/00→10/01					
1.6 16V (182.AB)	76	03/96→10/01					
1.6 16V (182.AH)	66	10/95→10/01					
1.9 D	48	10/95→10/01					
1.8 GT (182.AC)	83	10/95→10/01	←			<b>24.0120-0142.1 420142</b>	Ø 257,5 20 18,2 V
1.9 JTD	74	09/00→10/01				<b>24.0320-0142.1 520142</b>	Ø 257,5 20 18,2 V
1.9 JTD 105	77	12/98→10/01					
1.9 TD 100 S (182.AF)	74	03/96→10/01	←	06/96→		<b>24.0120-0142.1 420142</b>	Ø 257,5 20 18,2 V
						<b>24.0320-0142.1 520142</b>	Ø 257,5 20 18,2 V
1.9 TD 75 S (182.AF)	55	03/96→10/01	←	06/96→		<b>24.0112-0127.1 412127</b>	Ø 257,5 12 10,2
2.0 HGT 20V (182.AD)	108	10/95→07/98	←			<b>24.0122-0147.1 422147</b>	Ø 284 22 20,2 V
			→			<b>24.0111-0119.1 411119</b>	Ø 240,5 11 9,2
2.0 HGT 20V (182AQ)	113	07/98→10/01					
<b>FIAT - BRAVO II (198_) 11/06→</b>							
 <b>Bremsbelagsatz, Scheibenbremse</b>							
1.4 (198AXA1B)	66	04/07→12/14	←			<b>13.0460-3982.2 603982</b>	BOS 23705 18,1 + WK
						<b>13.0470-3982.2 LD3982</b>	BOS 23705 18,1 + WK Ceramic
			→			<b>13.0460-3861.2 603861</b>	BOS 23714 17,6 + WK + Zub
						<b>13.0460-3991.2 603991</b>	BOS 23714 16,6 - WE / - WK
1.4 16V	103	03/08→	←	04/08→		<b>13.0460-3984.2 603984</b>	BOS 23711 19,4 + WK
						<b>13.0470-3984.2 LD3984</b>	BOS 23711 19,4 + WK Ceramic
			→	04/08→		<b>13.0460-3861.2 603861</b>	BOS 23714 17,6 + WK + Zub
1.4 LPG	66	12/08→12/14	←	11/09→		<b>13.0460-3982.2 603982</b>	BOS 23705 18,1 + WK
						<b>13.0470-3982.2 LD3982</b>	BOS 23705 18,1 + WK Ceramic
			→	11/09→		<b>13.0460-3861.2 603861</b>	BOS 23714 17,6 + WK + Zub
1.4 T-Jet	88	09/07→	←			<b>13.0460-3983.2 603983</b>	BOS 23708 19,4 + WK
						<b>13.0470-3983.2 LD3983</b>	BOS 23708 19,4 + WK Ceramic
			→			<b>13.0460-3861.2 603861</b>	BOS 23714 17,6 + WK + Zub
1.6 D Multijet	66	03/08→					
1.6 D Multijet	85	11/08→					
1.6 D Multijet	88	03/08→	→			<b>13.0460-3991.2 603991</b>	BOS 23714 16,6 - WE / - WK
1.9 D Multijet	66	04/07→12/08				<b>13.0470-3861.2 LD3861</b>	BOS + WK + Zub Ceramic
1.9 D Multijet	88	04/07→					
1.4 T-Jet (198AXF1B)	110	09/07→12/14	←			<b>13.0460-3984.2 603984</b>	BOS 23711 19,4 + WK
						<b>13.0470-3984.2 LD3984</b>	BOS 23711 19,4 + WK Ceramic
			→			<b>13.0460-3861.2 603861</b>	BOS 23714 17,6 + WK + Zub
						<b>13.0460-3991.2 603991</b>	BOS 23714 16,6 - WE / - WK
1.9 D Multijet	110	04/07→					
2.0 D Multijet	120	09/08→					
2.0 D Multijet	121	09/08→	→			<b>13.0470-3861.2 LD3861</b>	BOS + WK + Zub Ceramic
1.6 D Multijet	77	09/07→	←	03/08→		<b>13.0460-3983.2 603983</b>	BOS 23708 19,4 + WK
						<b>13.0470-3983.2 LD3983</b>	BOS 23708 19,4 + WK Ceramic
			→	03/08→		<b>13.0460-3861.2 603861</b>	BOS 23714 17,6 + WK + Zub
					<b>13.0460-3991.2 603991</b>	BOS 23714 16,6 - WE / - WK	

























	kw			 	! #		
<b>FIAT - BRAVO II (198_) 11/06→</b>							
 <b>Bremsbelagsatz, Scheibenbremse</b>							
1.6 D Multijet	77	09/07→	➡	03/08→		<b>13.0470-3861.2 LD3861</b>	BOS + WK + Zub Ceramic
1.9 D Multijet	85	11/06→	←	04/07→		<b>13.0460-3983.2 603983</b>	BOS 23708 19,4 + WK
						<b>13.0470-3983.2 LD3983</b>	BOS 23708 19,4 + WK Ceramic
			➡	04/07→		<b>13.0460-3861.2 603861</b>	BOS 23714 17,6 + WK + Zub
						<b>13.0460-3991.2 603991</b>	BOS 23714 16,6 - WE / - WK
						<b>13.0470-3861.2 LD3861</b>	BOS + WK + Zub Ceramic
 <b>Bremsscheibe</b>							
1.4 (198AXA1B)	66	04/07→12/14	←			<b>24.0122-0197.1 422197</b>	Ø 257,5 22 20,2 V
						<b>24.0322-0197.1 522197</b>	Ø 257,5 22 20,2 V
			➡			<b>24.0110-0190.1 410190</b>	Ø 251,5 10 9
1.4 16V	103	03/08→	←	04/08→		<b>24.0126-0125.1 426125</b>	Ø 281 26 24,2 V
			➡	04/08→		<b>24.0110-0190.1 410190</b>	Ø 251,5 10 9
1.4 LPG	66	12/08→12/14	←	11/09→		<b>24.0122-0197.1 422197</b>	Ø 257,5 22 20,2 V
						<b>24.0322-0197.1 522197</b>	Ø 257,5 22 20,2 V
			➡	11/09→		<b>24.0110-0190.1 410190</b>	Ø 251,5 10 9
1.4 T-Jet	88	09/07→	←			<b>24.0122-0147.1 422147</b>	Ø 284 22 20,2 V
1.6 D Multijet	66	03/08→	➡				
1.6 D Multijet	85	11/08→	➡			<b>24.0110-0190.1 410190</b>	Ø 251,5 10 9
1.6 D Multijet	88	03/08→					
1.9 D Multijet	66	04/07→12/08					
1.9 D Multijet	88	04/07→					
1.4 T-Jet (198AXF1B)	110	09/07→12/14	←			<b>24.0126-0125.1 426125</b>	Ø 281 26 24,2 V
1.9 D Multijet	110	04/07→	➡			<b>24.0110-0190.1 410190</b>	Ø 251,5 10 9
2.0 D Multijet	120	09/08→					
2.0 D Multijet	121	09/08→					
1.6 D Multijet	77	09/07→	←	03/08→		<b>24.0122-0147.1 422147</b>	Ø 284 22 20,2 V
			➡	03/08→		<b>24.0110-0190.1 410190</b>	Ø 251,5 10 9
1.9 D Multijet	85	11/06→	←	04/07→		<b>24.0122-0147.1 422147</b>	Ø 284 22 20,2 V
			➡	04/07→		<b>24.0110-0190.1 410190</b>	Ø 251,5 10 9
<b>FIAT - CINQUECENTO (170_) 07/91→07/99</b>							
 <b>Bremsbelagsatz, Scheibenbremse</b>							
0.7 (170AA)	23	12/91→01/96	←	02/92→		<b>13.0460-3949.2 603949</b>	BDX 21365 17,0 - WE / - WK
0.7 i (170AD)	22	07/94→01/98	←			<b>13.0460-3949.2 603949</b>	BDX 21365 17,0 - WE / - WK
0.9 i.e. S (170AF, 170CF)	29	07/91→07/99	←	02/92→ 05/98		<b>13.0460-3949.2 603949</b>	BDX 21365 17,0 - WE / - WK
1.1 Sporting (170AH)	40	10/94→01/98	←	11/94→		<b>13.0460-3949.2 603949</b>	BDX 21365 17,0 - WE / - WK
<b>Zubehörsatz, Scheibenbremsbelag</b>							
0.7 (170AA)	23	12/91→01/96	←	02/92→		<b>13.0460-0434.2 610434</b>	BDX
0.7 i (170AD)	22	07/94→01/98	←			<b>13.0460-0434.2 610434</b>	BDX
0.9 i.e. S (170AF, 170CF)	29	07/91→07/99	←	02/92→ 05/98		<b>13.0460-0434.2 610434</b>	BDX
1.1 Sporting (170AH)	40	10/94→01/98	←	11/94→		<b>13.0460-0434.2 610434</b>	BDX
 <b>Bremsscheibe</b>							
0.7 (170AA)	23	12/91→01/96	←	02/92→		<b>24.0111-0119.1 411119</b>	Ø 240,5 11 9,2
0.7 i (170AD)	22	07/94→01/98	←			<b>24.0111-0119.1 411119</b>	Ø 240,5 11 9,2
0.9 i.e. S (170AF, 170CF)	29	07/91→07/99	←	02/92→ 05/98		<b>24.0111-0119.1 411119</b>	Ø 240,5 11 9,2
1.1 Sporting (170AH)	40	10/94→01/98	←	11/94→		<b>24.0111-0119.1 411119</b>	Ø 240,5 11 9,2
<b>FIAT - COUPE (175_) 11/93→08/00</b>							
 <b>Bremsbelagsatz, Scheibenbremse</b>							
1.8 16V	96	03/96→08/00	←	07/96→		<b>13.0460-7069.2 607069</b>	ATE 21636 19,3 + WK
			➡	47168→; ALU		<b>13.0460-2826.2 602826</b>	TRW 23177 14,2 - WK
			➡	07/96→; → 47167; GG		<b>13.0460-2951.2 602951</b>	TRW 21103 14,2 - WK
2.0 16V 2.0 16V Turbo	102 140	11/93→08/96 11/93→08/96	←	12/93→ 06/96		<b>13.0460-2979.2 602979</b>	TRW 21147 19,0 + WK
			➡	12/93→ 06/96; GG		<b>13.0460-7069.2 607069</b>	ATE 21636 19,3 + WK
2.0 20V	113	04/98→08/00	←			<b>13.0460-7069.2 607069</b>	ATE 21636 19,3 + WK
↓							



	kw			 	! #		
<b>FIAT - COUPE (175_) 11/93→08/00</b>							
 <b>Bremsbelagsatz, Scheibenbremse</b>							
2.0 20V	113	04/98→08/00	➡	47168→; ALU		13.0460-2826.2 602826	TRW 23177 14,2 - WK
			➡	→ 47167; GG		13.0460-2951.2 602951	TRW 21103 14,2 - WK
2.0 20V (175AXC1A)	108	08/96→09/98	⬅	01/97→		13.0460-7069.2 607069	ATE 21636 19,3 + WK
			➡	47168→; ALU		13.0460-2826.2 602826	TRW 23177 14,2 - WK
			➡	01/97→; → 47167; GG		13.0460-2951.2 602951	TRW 21103 14,2 - WK
2.0 20V Turbo	162	08/96→08/00	⬅	01/97→		13.0460-4968.2 604968	BRE 21381 18,0 + WK
			➡	47168→; ALU		13.0460-2826.2 602826	TRW 23177 14,2 - WK
			➡	01/97→; → 47167; GG		13.0460-2951.2 602951	TRW 21103 14,2 - WK
<b>Zubehörsatz, Scheibenbremsbelag</b>							
1.8 16V	96	03/96→08/00	➡	07/96→; → 47167; GG		13.0460-0072.2 610072	TRW
2.0 16V	102	11/93→08/96	➡	12/93→ 06/96; GG		13.0460-0072.2 610072	TRW
2.0 16V Turbo	140	11/93→08/96					
2.0 20V	113	04/98→08/00	➡	→ 47167; GG		13.0460-0072.2 610072	TRW
2.0 20V (175AXC1A)	108	08/96→09/98	➡	01/97→; → 47167; GG		13.0460-0072.2 610072	TRW
2.0 20V Turbo	162	08/96→08/00					
 <b>Bremsscheibe</b>							
1.8 16V	96	03/96→08/00	⬅	07/96→		24.0122-0107.1 422107	Ø 284 22 20,2 V
			➡	07/96→		24.0111-0119.1 411119	Ø 240,5 11 9,2
2.0 16V	102	11/93→08/96	⬅	12/93→ 06/96		24.0122-0107.1 422107	Ø 284 22 20,2 V
			➡	12/93→ 06/96		24.0111-0119.1 411119	Ø 240,5 11 9,2
2.0 16V Turbo	140	11/93→08/96	⬅	12/93→ 06/96		24.0122-0147.1 422147	Ø 284 22 20,2 V
			➡	12/93→ 06/96		24.0111-0119.1 411119	Ø 240,5 11 9,2
2.0 20V	113	04/98→08/00	⬅			24.0122-0107.1 422107	Ø 284 22 20,2 V
			➡			24.0111-0119.1 411119	Ø 240,5 11 9,2
2.0 20V (175AXC1A)	108	08/96→09/98	⬅	01/97→		24.0122-0107.1 422107	Ø 284 22 20,2 V
			➡	01/97→		24.0111-0119.1 411119	Ø 240,5 11 9,2
2.0 20V Turbo	162	08/96→08/00	⬅	01/97→		24.0128-0120.1 428120	Ø 305 28 26 V
			➡	01/97→		24.0111-0119.1 411119	Ø 240,5 11 9,2
<b>FIAT - CROMA (154_) 12/85→12/96</b>							
 <b>Bremsbelagsatz, Scheibenbremse</b>							
1900 Turbo D i.d.	69	11/92→12/96	⬅	→ 10/96		13.0460-2952.2 602952	TRW 21182 19,4 + WK
			➡	→ 10/96; - ABS		13.0460-3904.2 603904	BDX 21107 12,0 - WK
2000 16V	101	08/92→08/96	⬅	12/92→; nicht für gepanzerte Fahrzeuge		13.0460-2952.2 602952	TRW 21182 19,4 + WK
			➡	12/92→; - ABS; nicht für gepanzerte Fahrzeuge		13.0460-3904.2 603904	BDX 21107 12,0 - WK
2000 i.e. (154.AM, 154.LM)	85	10/87→08/96	⬅	11/90→; nicht für gepanzerte Fahrzeuge		13.0460-2952.2 602952	TRW 21182 19,4 + WK
			⬅	11/90→; für gepanzerte Fahrzeuge		13.0460-2979.2 602979	TRW 21147 19,0 + WK
			➡	11/90→; - ABS; nicht für gepanzerte Fahrzeuge		13.0460-3904.2 603904	BDX 21107 12,0 - WK
2000 i.e. Turbo (154.AM, 154.LM)	110	06/87→08/96	⬅	11/90→; nicht für gepanzerte Fahrzeuge		13.0460-2952.2 602952	TRW 21182 19,4 + WK
			⬅	11/90→; für gepanzerte Fahrzeuge		13.0460-2979.2 602979	TRW 21147 19,0 + WK
			⬅	01/93→		13.0460-2979.2 602979	TRW 21147 19,0 + WK
			➡	11/90→; - ABS; nicht für gepanzerte Fahrzeuge		13.0460-3904.2 603904	BDX 21107 12,0 - WK
2500 TD (154.LL, 154.PL)	85	05/89→08/96	⬅	11/90→		13.0460-2952.2 602952	TRW 21182 19,4 + WK
			➡	11/90→; - ABS		13.0460-3904.2 603904	BDX 21107 12,0 - WK
2500 TDE	77	12/91→08/96	⬅			13.0460-2952.2 602952	TRW 21182 19,4 + WK
			➡	- ABS		13.0460-3904.2 603904	BDX 21107 12,0 - WK
2500 V6	119	06/93→08/96	⬅			13.0460-2979.2 602979	TRW 21147 19,0 + WK
<b>Zubehörsatz, Scheibenbremsbelag</b>							
1900 Turbo D i.d.	69	11/92→12/96	➡	→ 10/96; + ABS		13.0460-0072.2 610072	TRW
2000 16V	101	08/92→08/96	➡	12/92→; + ABS; für gepanzerte Fahrzeuge		13.0460-0072.2 610072	TRW
2000 i.e. (154.AM, 154.LM) ↓	85	10/87→08/96	➡	11/90→; + ABS; für gepanzerte Fahrzeuge		13.0460-0072.2 610072	TRW













	kw			 	! #		
<b>FIAT - CROMA (154_) 12/85→12/96</b>							
<b>Zubehörsatz, Scheibenbremsbelag</b>							
2000 i.e. Turbo (154.AM, 154.LM)	110	06/87→08/96	➡	11/90→; + ABS; für gepanzerte Fahrzeuge		13.0460-0072.2 610072	TRW
2500 TD (154.LL, 154.PL)	85	05/89→08/96	➡	11/90→; + ABS		13.0460-0072.2 610072	TRW
2500 TDE	77	12/91→08/96	➡	+ ABS		13.0460-0072.2 610072	TRW
2500 V6	119	06/93→08/96	➡			13.0460-0072.2 610072	TRW
<b> Bremsscheibe</b>							
1900 Turbo D i.d.	69	11/92→12/96	←	→ 10/96; + ABS		24.0122-0130.1 422130	Ø 257,2 22 20,2 V
			➡	→ 10/96		24.0110-0190.1 410190	Ø 251,5 10 9
2000 16V	101	08/92→08/96	←	12/92→; nicht für gepanzerte Fahrzeuge		24.0122-0130.1 422130	Ø 257,2 22 20,2 V
			➡	12/92→; nicht für gepanzerte Fahrzeuge		24.0110-0190.1 410190	Ø 251,5 10 9
2000 i.e. (154.AM, 154.LM)	85	10/87→08/96	←	11/90→; + ABS; nicht für gepanzerte Fahrzeuge		24.0122-0130.1 422130	Ø 257,2 22 20,2 V
			←	11/90→; für gepanzerte Fahrzeuge		24.0122-0145.1 422145	Ø 284 22 20,2 V
			➡	11/90→; nicht für gepanzerte Fahrzeuge		24.0110-0190.1 410190	Ø 251,5 10 9
			➡	11/90→; für gepanzerte Fahrzeuge		24.0110-0209.1 410209	Ø 251,4 10 9
2000 i.e. Turbo (154.AM, 154.LM)	110	06/87→08/96	←	11/90→; nicht für gepanzerte Fahrzeuge		24.0122-0130.1 422130	Ø 257,2 22 20,2 V
			←	11/90→; für gepanzerte Fahrzeuge		24.0122-0145.1 422145	Ø 284 22 20,2 V
			➡	11/90→; nicht für gepanzerte Fahrzeuge		24.0110-0190.1 410190	Ø 251,5 10 9
			➡	11/90→; für gepanzerte Fahrzeuge		24.0110-0209.1 410209	Ø 251,4 10 9
2500 TD (154.LL, 154.PL)	85	05/89→08/96	←	11/90→		24.0122-0130.1 422130	Ø 257,2 22 20,2 V
			➡	11/90→		24.0110-0190.1 410190	Ø 251,5 10 9
2500 TDE	77	12/91→08/96	←			24.0122-0130.1 422130	Ø 257,2 22 20,2 V
			➡			24.0110-0190.1 410190	Ø 251,5 10 9
2500 V6	119	06/93→08/96	←			24.0122-0147.1 422147	Ø 284 22 20,2 V
			➡			24.0110-0190.1 410190	Ø 251,5 10 9
<b>FIAT - CROMA (194_) 06/05→</b>							
<b> Bremsbelagsatz, Scheibenbremse</b>							
1.8 16V	103	12/05→	←	01/06→ 11/10; für Bremssattel mit Kunststoffkolben		13.0460-7172.2 607172	ATE 23378 20,1 + WE / - WK
			←	01/06→ 11/10; für Bremssattel mit Stahlkolben		13.0470-7172.2 LD7172	ATE 23378 20,1 + WE / - WK Ceramic
			➡	01/06→ 11/10		13.0460-3825.2 603825	TRW 24348 17,1 - WE / - WK
1.9 D Multijet 1.9 D Multijet (194AXB1B) 2.2 16V	85	06/05→	←	→ 11/10; für Bremssattel mit Kunststoffkolben		13.0460-7172.2 607172	ATE 23378 20,1 + WE / - WK
	88	06/05→12/11				13.0470-7172.2 LD7172	ATE 23378 20,1 + WE / - WK Ceramic
	108	06/05→			←	→ 11/10; für Bremssattel mit Stahlkolben	
1.9 D Multijet 1.9 D Multijet (194AXC1B, 194AXC12)	100 110	12/05→ 06/05→12/11	←	→ 2060168		13.0460-3824.2 603824	TRW 20261 19,0 + WK
			←	2060169→; → 11/10; für Bremssattel mit Kunststoffkolben		13.0460-7172.2 607172	ATE 23378 20,1 + WE / - WK
			←	2060169→; → 11/10; für Bremssattel mit Stahlkolben		13.0460-7212.2 607212	ATE 23738 20,1 + WE / - WK
			➡	→ 11/10		13.0460-3825.2 603825	TRW 24348 17,1 - WE / - WK
2.4 D Multijet	147	06/05→	←	→ 11/10		13.0460-3824.2 603824	TRW 20261 19,0 + WK
			➡	→ 11/10		13.0460-3825.2 603825	TRW 24348 17,1 - WE / - WK
<b>Warnkontakt, Bremsbelagverschleiß</b>							
1.8 16V	103	12/05→	←	01/06→ 11/10	1	24.8190-0719.2 620719	L= 685,5
1.9 D Multijet 1.9 D Multijet (194AXB1B) 2.2 16V	85	06/05→	←	→ 11/10	1	24.8190-0719.2 620719	L= 685,5
	88	06/05→12/11					
1.9 D Multijet 1.9 D Multijet (194AXC1B, 194AXC12)	100 110	12/05→ 06/05→12/11	←	2060169→; → 11/10	1	24.8190-0719.2 620719	L= 685,5



	kw			 	! #		
<b>FIAT - CROMA (194_) 06/05→</b>							
 <b>Bremsscheibe</b>							
1.8 16V	103	12/05→	←	01/06→ 11/10		24.0125-0141.1 425141 24.0325-0141.1 525141	Ø 285 24,9 22 V + S Ø 285 24,9 22 V + S
			→	01/06→ 11/10		24.0112-0157.1 412157 24.0312-0157.1 512157	Ø 278 11,9 10 + S Ø 278 11,9 10 + S
1.9 D Multijet	85	06/05→	←	→ 11/10		24.0125-0141.1 425141	Ø 285 24,9 22 V + S
1.9 D Multijet (194AXB1B)	88	06/05→12/11				24.0325-0141.1 525141	Ø 285 24,9 22 V + S
2.2 16V	108	06/05→	→	→ 11/10		24.0112-0157.1 412157 24.0312-0157.1 512157	Ø 278 11,9 10 + S Ø 278 11,9 10 + S
1.9 D Multijet	100	12/05→	←	2060169→; → 11/10		24.0125-0141.1 425141	Ø 285 24,9 22 V + S
1.9 D Multijet (194AXC1B, 194AXC12)	110	06/05→12/11				24.0325-0141.1 525141	Ø 285 24,9 22 V + S
			←	→ 2060168		24.0128-0185.1 428185	Ø 305 28 26 V
			→	→ 11/10		24.0120-0173.1 420173 24.0320-0173.1 520173	Ø 292 19,9 18 V + S Ø 292 19,9 18 V + S
2.4 D Multijet	147	06/05→	←	→ 11/10		24.0128-0185.1 428185	Ø 305 28 26 V
			→	→ 11/10		24.0120-0173.1 420173 24.0320-0173.1 520173	Ø 292 19,9 18 V + S Ø 292 19,9 18 V + S
<b>FIAT - DOBLO Cargo (223_) 11/00→</b>							
 <b>Bremsbelagsatz, Scheibenbremse</b>							
1.2 (223ZX1A)	48	03/01→	←	→ 09/05		13.0460-7141.2 607141	ATE 20907 18,1 - WE / - WK
1.3 JTD 16V	51	05/04→12/06					
1.9 D (223ZXB1A)	46	03/01→					
1.3 D Multijet	55	10/05→01/10	←	für Bremsscheibendurchmesser [mm]: 284		13.0460-3811.2 603811	BOS 23708 19,2 - WE / - WK
			←	für Bremsscheibendurchmesser [mm]: 258		13.0460-3850.2 603850	BOS 23707 18,0 - WE / - WK + Zub
1.3 JTD 16V Multijet	62	08/06→	←	→ 01/10;		13.0460-3811.2 603811	BOS 23708 19,2 - WE / - WK
1.4	57	10/05→		für Bremsscheibendurchmesser [mm]: 284			
1.9 JTD Multijet	88	12/06→	←	→ 01/10;		13.0460-3850.2 603850	BOS 23707 18,0 - WE / - WK + Zub
				für Bremsscheibendurchmesser [mm]: 258			
1.6 16V (223ZXD1A)	76	10/01→	←	10/05→ 01/10;		13.0460-3811.2 603811	BOS 23708 19,2 - WE / - WK
1.6 Natural Power	76	09/02→		für Bremsscheibendurchmesser [mm]: 284			
1.9 JTD	77	07/03→					
1.9 JTD (223ZXE1A)	74	10/01→	←	10/05→ 01/10;		13.0460-3850.2 603850	BOS 23707 18,0 - WE / - WK + Zub
				für Bremsscheibendurchmesser [mm]: 258			
			←	→ 09/05		13.0460-7141.2 607141	ATE 20907 18,1 - WE / - WK
 <b>Bremsscheibe</b>							
1.2 (223ZX1A)	48	03/01→	←	→ 09/05		24.0120-0142.1 420142	Ø 257,5 20 18,2 V
1.3 JTD 16V	51	05/04→12/06				24.0320-0142.1 520142	Ø 257,5 20 18,2 V
1.9 D (223ZXB1A)	46	03/01→					
1.3 D Multijet	55	10/05→01/10	←			24.0122-0147.1 422147 24.0122-0197.1 422197 24.0322-0197.1 522197	Ø 284 22 20,2 V Ø 257,5 22 20,2 V Ø 257,5 22 20,2 V
1.3 JTD 16V Multijet	62	08/06→	←	→ 01/10		24.0122-0147.1 422147	Ø 284 22 20,2 V
1.4	57	10/05→				24.0122-0197.1 422197	Ø 257,5 22 20,2 V
1.9 JTD Multijet	88	12/06→				24.0322-0197.1 522197	Ø 257,5 22 20,2 V
1.6 16V (223ZXD1A)	76	10/01→	←	→ 09/05		24.0120-0142.1 420142	Ø 257,5 20 18,2 V
1.6 Natural Power	76	09/02→				24.0320-0142.1 520142	Ø 257,5 20 18,2 V
1.9 JTD	77	07/03→					
1.9 JTD (223ZXE1A)	74	10/01→	←	10/05→ 01/10		24.0122-0147.1 422147 24.0122-0197.1 422197 24.0322-0197.1 522197	Ø 284 22 20,2 V Ø 257,5 22 20,2 V Ø 257,5 22 20,2 V
<b>FIAT - DOBLO Großraumlimousine (119_, 223_) 03/01→</b>							
 <b>Bremsbelagsatz, Scheibenbremse</b>							
1.2 (223AX1A)	48	03/01→	←	→ 09/05		13.0460-7141.2 607141	ATE 20907 18,1 - WE / - WK
1.9 D (223AXB1A)	46	03/01→					
1.3 D Multijet	62	10/05→	←	→ 01/10;		13.0460-3811.2 603811	BOS 23708 19,2 - WE / - WK
1.4	57	10/05→		für Bremsscheibendurchmesser [mm]: 284			
1.9 D Multijet	88	10/05→	←	→ 01/10;		13.0460-3850.2 603850	BOS 23707 18,0 - WE / - WK + Zub
				für Bremsscheibendurchmesser [mm]: 258			
↓							







	kw			 	! #		
<b>FIAT - DOBLO Großraumlimousine (119_, 223_) 03/01→</b>							
 <b>Bremsbelagsatz, Scheibenbremse</b>							
1.3 JTD	55	05/05→	←	10/05→ 01/10; für Bremsscheibendurchmesser [mm]: 284		<b>13.0460-3811.2 603811</b>	BOS 23708 19,2 - WE / - WK
			←	10/05→ 01/10; für Bremsscheibendurchmesser [mm]: 258		<b>13.0460-3850.2 603850</b>	BOS 23707 18,0 - WE / - WK + Zub
1.3 JTD 16V	51	12/04→05/05	←			<b>13.0460-7141.2 607141</b>	ATE 20907 18,1 - WE / - WK
1.6 16V (223AXD1A)	76	10/01→	←	10/05→ 01/10; für Bremsscheibendurchmesser [mm]: 284		<b>13.0460-3811.2 603811</b>	BOS 23708 19,2 - WE / - WK
1.6 Natural Power	76	09/02→					
1.9 JTD	77	07/03→					
1.9 JTD (223AXE1A)	74	10/01→	←	10/05→ 01/10; für Bremsscheibendurchmesser [mm]: 258		<b>13.0460-3850.2 603850</b>	BOS 23707 18,0 - WE / - WK + Zub
			←	→ 09/05		<b>13.0460-7141.2 607141</b>	ATE 20907 18,1 - WE / - WK
 <b>Bremsscheibe</b>							
1.2 (223AXA1A)	48	03/01→	←	→ 09/05		<b>24.0120-0142.1 420142</b>	Ø 257,5 20 18,2 V
1.9 D (223AXB1A)	46	03/01→				<b>24.0320-0142.1 520142</b>	Ø 257,5 20 18,2 V
1.3 D Multijet	62	10/05→	←	→ 01/10		<b>24.0122-0147.1 422147</b>	Ø 284 22 20,2 V
1.4	57	10/05→				<b>24.0122-0197.1 422197</b>	Ø 257,5 22 20,2 V
1.9 D Multijet	88	10/05→				<b>24.0322-0197.1 522197</b>	Ø 257,5 22 20,2 V
1.3 JTD	55	05/05→	←	10/05→ 01/10		<b>24.0122-0147.1 422147</b>	Ø 284 22 20,2 V
						<b>24.0122-0197.1 422197</b>	Ø 257,5 22 20,2 V
						<b>24.0322-0197.1 522197</b>	Ø 257,5 22 20,2 V
1.3 JTD 16V	51	12/04→05/05	←			<b>24.0120-0142.1 420142</b>	Ø 257,5 20 18,2 V
						<b>24.0320-0142.1 520142</b>	Ø 257,5 20 18,2 V
1.6 16V (223AXD1A)	76	10/01→	←	→ 09/05		<b>24.0120-0142.1 420142</b>	Ø 257,5 20 18,2 V
1.9 JTD	77	07/03→				<b>24.0320-0142.1 520142</b>	Ø 257,5 20 18,2 V
1.9 JTD (223AXE1A)	74	10/01→	←	10/05→ 01/10		<b>24.0122-0147.1 422147</b>	Ø 284 22 20,2 V
						<b>24.0122-0197.1 422197</b>	Ø 257,5 22 20,2 V
						<b>24.0322-0197.1 522197</b>	Ø 257,5 22 20,2 V
1.6 Natural Power	76	09/02→	←	→ 09/05		<b>24.0120-0142.1 420142</b>	Ø 257,5 20 18,2 V
			←	→ 01/10		<b>24.0122-0147.1 422147</b>	Ø 284 22 20,2 V
						<b>24.0122-0197.1 422197</b>	Ø 257,5 22 20,2 V
			←	10/05→ 01/10		<b>24.0322-0197.1 522197</b>	Ø 257,5 22 20,2 V
						<b>24.0122-0197.1 422197</b>	Ø 257,5 22 20,2 V
						<b>24.0322-0197.1 522197</b>	Ø 257,5 22 20,2 V
<b>FIAT - DOBLO Kasten/Kombi (263_) 02/10→</b>							
 <b>Bremsbelagsatz, Scheibenbremse</b>							
1.3 D Multijet	55	11/13→	←	für Bremsscheibendurchmesser [mm]: 284		<b>13.0460-3827.2 603827</b>	BOS 23709 19,6 + WK + Zub
1.3 D Multijet	59	03/16→				<b>13.0470-3827.2 LD3827</b>	BOS 23709 19,6 + WK + Zub Ceramic
1.3 D Multijet	66	02/10→					
1.3 D Multijet	70	03/16→	←	für Bremsscheibendurchmesser [mm]: 305		<b>13.0460-7265.2 607265</b>	ATE 24727 20,7 + WK
1.4	70	02/10→					
1.4	88	10/11→					
1.4 Natural Power	88	06/10→					
1.6 D Multijet	66	02/10→					
1.6 D Multijet	74	02/10→					
1.6 D Multijet	77	02/10→					
1.6 D Multijet	88	02/16→					
2.0 D Multijet	99	02/10→	←			<b>13.0460-3827.2 603827</b>	BOS 23709 19,6 + WK + Zub
						<b>13.0470-3827.2 LD3827</b>	BOS 23709 19,6 + WK + Zub Ceramic
			←	für Bremsscheibendurchmesser [mm]: 305		<b>13.0460-7265.2 607265</b>	ATE 24727 20,7 + WK
 <b>Bremsscheibe</b>							
1.3 D Multijet	55	11/13→	←			<b>24.0122-0145.1 422145</b>	Ø 284 22 20,2 V
1.3 D Multijet	59	03/16→				<b>24.0128-0253.1 428253</b>	Ø 305 28 26 V
1.3 D Multijet	66	02/10→					
1.3 D Multijet	70	03/16→					
1.4	70	02/10→					
1.4	88	10/11→					
1.4 Natural Power	88	06/10→					
1.6 D Multijet	66	02/10→					
1.6 D Multijet	74	02/10→					
1.6 D Multijet	77	02/10→					





	kw					! #		
<b>FIAT - DOBLO Kasten/Kombi (263_) 02/10→</b>								
 <b>Bremsscheibe</b>								
1.6 D Multijet	88	02/16→	←			24.0122-0145.1	422145	Ø 284 22 20,2 V
2.0 D Multijet	99	02/10→				24.0128-0253.1	428253	Ø 305 28 26 V
<b>FIAT - DOBLO Kombi (263_) 11/09→</b>								
 <b>Bremsbelagsatz, Scheibenbremse</b>								
1.3 D Multijet	66	02/10→	←	für Bremsscheibendurchmesser [mm]:		13.0460-3827.2	603827	BOS 23709 19,6 + WK + Zub
1.3 D Multijet	70	03/16→		284		13.0470-3827.2	LD3827	BOS 23709 19,6 + WK + Zub
1.4	88	10/11→						Ceramic
1.4 (263AXA1A)	70	02/10→						
1.4 Natural Power	88	02/10→	←	für Bremsscheibendurchmesser [mm]:		13.0460-7265.2	607265	ATE 24727 20,7 + WK
1.6 D Multijet	66	02/10→		305				
1.6 D Multijet	70	03/15→						
1.6 D Multijet	74	03/16→						
1.6 D Multijet	77	02/10→						
1.6 D Multijet	88	03/15→						
2.0 D Multijet (263AXF1B)	99	01/10→	←			13.0460-3827.2	603827	BOS 23709 19,6 + WK + Zub
						13.0470-3827.2	LD3827	BOS 23709 19,6 + WK + Zub
								Ceramic
			←	für Bremsscheibendurchmesser [mm]:		13.0460-7265.2	607265	ATE 24727 20,7 + WK
				305				
 <b>Bremsscheibe</b>								
1.3 D Multijet	66	02/10→	←			24.0122-0145.1	422145	Ø 284 22 20,2 V
1.3 D Multijet	70	03/16→				24.0128-0253.1	428253	Ø 305 28 26 V
1.4	88	10/11→						
1.4 (263AXA1A)	70	02/10→						
1.4 Natural Power	88	02/10→						
1.6 D Multijet	66	02/10→						
1.6 D Multijet	70	03/15→						
1.6 D Multijet	74	03/16→						
1.6 D Multijet	77	02/10→						
1.6 D Multijet	88	03/15→						
2.0 D Multijet (263AXF1B)	99	01/10→						
<b>FIAT - DOBLO Pritsche/Fahrgestell (263_) 02/10→</b>								
 <b>Bremsbelagsatz, Scheibenbremse</b>								
1.3 D Multijet	55	11/13→	←	für Bremsscheibendurchmesser [mm]:		13.0460-3827.2	603827	BOS 23709 19,6 + WK + Zub
1.3 D Multijet	59	03/16→		284		13.0470-3827.2	LD3827	BOS 23709 19,6 + WK + Zub
1.3 D Multijet	66	02/10→						Ceramic
1.3 D Multijet	70	03/16→						
1.4	70	04/10→	←	für Bremsscheibendurchmesser [mm]:		13.0460-7265.2	607265	ATE 24727 20,7 + WK
1.4	88	10/11→		305				
1.4 Natural Power	88	06/10→						
1.6 D Multijet	66	02/10→						
1.6 D Multijet	74	02/11→						
1.6 D Multijet	77	02/10→						
1.6 D Multijet	88	02/16→						
2.0 D Multijet	99	02/10→	←			13.0460-3827.2	603827	BOS 23709 19,6 + WK + Zub
						13.0470-3827.2	LD3827	BOS 23709 19,6 + WK + Zub
								Ceramic
			←	für Bremsscheibendurchmesser [mm]:		13.0460-7265.2	607265	ATE 24727 20,7 + WK
				305				
 <b>Bremsscheibe</b>								
1.3 D Multijet	55	11/13→	←			24.0122-0145.1	422145	Ø 284 22 20,2 V
1.3 D Multijet	59	03/16→				24.0128-0253.1	428253	Ø 305 28 26 V
1.3 D Multijet	66	02/10→						
1.3 D Multijet	70	03/16→						
1.4	70	04/10→						
1.4	88	10/11→						
1.4 Natural Power	88	06/10→						
1.6 D Multijet	66	02/10→						
1.6 D Multijet	74	02/11→						
1.6 D Multijet	77	02/10→						
1.6 D Multijet	88	02/16→						
2.0 D Multijet	99	02/10→						
<b>FIAT - DUCATO Bus (230_) 03/94→04/02</b>								
 <b>Bremsbelagsatz, Scheibenbremse</b>								
1.9 D	50	04/98→04/02	←	01/00→ 10/01; Nutzlast [kg]: 1.000		13.0460-2850.2	602850	TRW 21797 19,7 + WK
1.9 D Combinato	51	06/95→04/02	←	→ 12/99; Nutzlast [kg]: 1.000		13.0460-2976.2	602976	TRW 21797 19,7 + WK
1.9 TD	66	04/98→04/02	←					
1.9 TD Combinato	59	08/94→04/02	←	11/01→ 03/02; Nutzlast [kg]: 1.000		13.0460-4978.2	604978	BRE 23917 19,3 + WK + Zub
1.9 TD Panorama/Combinato	60	03/94→04/02						
↓								

	kw			 	! #		
<b>FIAT - DUCATO Bus (230_) 03/94→04/02</b>							
<b>Bremsbelagsatz, Scheibenbremse</b>							
1.9 D 1.9 D Combinato 1.9 TD 1.9 TD Combinato 1.9 TD Panorama/ Combinato	50 51 66 59 60	04/98→04/02 06/95→04/02 04/98→04/02 08/94→04/02 03/94→04/02	➡	11/01→ 03/02; Nutzlast [kg]: 1.000		<b>13.0460-4980.2 604980</b>	BRE 23921 20,3 - WE / - WK + Zub
1.9 D	59	05/98→11/01	⬅	01/00→ 10/01; Nutzlast [kg]: 1.000		<b>13.0460-2850.2 602850</b>	TRW 21797 19,7 + WK
			⬅	→ 12/99; Nutzlast [kg]: 1.000		<b>13.0460-2976.2 602976</b>	TRW 21797 19,7 + WK
			⬅	11/01→; Nutzlast [kg]: 1.000		<b>13.0460-4978.2 604978</b>	BRE 23917 19,3 + WK + Zub
			➡	11/01→; Nutzlast [kg]: 1.000		<b>13.0460-4980.2 604980</b>	BRE 23921 20,3 - WE / - WK + Zub
2.0 4x4	80	11/94→11/01	⬅	01/00→ 10/01; Nutzlast ab [kg] 1.000 Nutzlast bis [kg] 1.400		<b>13.0460-2850.2 602850</b>	TRW 21797 19,7 + WK
			⬅	01/00→ 10/01; Nutzlast [kg]: 1.800		<b>13.0460-2852.2 602852</b>	TRW 21799 19,7 + WK
			⬅	→ 12/99; Nutzlast ab [kg] 1.000 Nutzlast bis [kg] 1.400		<b>13.0460-2976.2 602976</b>	TRW 21797 19,7 + WK
			⬅	→ 12/99; Nutzlast [kg]: 1.800		<b>13.0460-2977.2 602977</b>	TRW 21799 19,7 + WK
			⬅	11/01→; Nutzlast ab [kg] 1.000 Nutzlast bis [kg] 1.400		<b>13.0460-4978.2 604978</b>	BRE 23917 19,3 + WK + Zub
			⬅	11/01→; Nutzlast [kg]: 1.800		<b>13.0460-4979.2 604979</b>	BRE 23919 19,3 + WK + Zub
			➡	11/01→; Nutzlast ab [kg] 1.000 Nutzlast bis [kg] 1.800		<b>13.0460-4980.2 604980</b>	BRE 23921 20,3 - WE / - WK + Zub
2.0 JTD	62	10/01→04/02	⬅	→ 03/02; Nutzlast [kg]: 1.400		<b>13.0460-4978.2 604978</b>	BRE 23917 19,3 + WK + Zub
			⬅	→ 03/02; Nutzlast [kg]: 1.800		<b>13.0460-4979.2 604979</b>	BRE 23919 19,3 + WK + Zub
			➡	→ 03/02; Nutzlast ab [kg] 1.400 Nutzlast bis [kg] 1.800		<b>13.0460-4980.2 604980</b>	BRE 23921 20,3 - WE / - WK + Zub
2.0 Panorama/Combinato	80	03/94→04/02	⬅	01/00→ 10/01; Nutzlast ab [kg] 1.000 Nutzlast bis [kg] 1.400		<b>13.0460-2850.2 602850</b>	TRW 21797 19,7 + WK
			⬅	01/00→ 10/01; Nutzlast [kg]: 1.800		<b>13.0460-2852.2 602852</b>	TRW 21799 19,7 + WK
			⬅	→ 12/99; Nutzlast ab [kg] 1.000 Nutzlast bis [kg] 1.400		<b>13.0460-2976.2 602976</b>	TRW 21797 19,7 + WK
			⬅	→ 12/99; Nutzlast [kg]: 1.800		<b>13.0460-2977.2 602977</b>	TRW 21799 19,7 + WK
			⬅	11/01→ 03/02; Nutzlast ab [kg] 1.000 Nutzlast bis [kg] 1.400		<b>13.0460-4978.2 604978</b>	BRE 23917 19,3 + WK + Zub
			⬅	11/01→ 03/02; Nutzlast [kg]: 1.800		<b>13.0460-4979.2 604979</b>	BRE 23919 19,3 + WK + Zub
2.5 D Combinato 2.5 TD 2.5 TDI Panorama/ Combinato 2.5 TDI Panorama/ Combinato 2.8 D 2.8 TDI 2.8 TDI 4x4	62 70 80 85 64 90 90	08/94→04/02 03/94→04/02 07/94→04/02 03/94→04/02 02/98→04/02 10/97→04/02 07/99→04/02	⬅	01/00→ 10/01; Nutzlast [kg]: 1.400		<b>13.0460-2850.2 602850</b>	TRW 21797 19,7 + WK
	⬅	01/00→ 10/01; Nutzlast [kg]: 1.800		<b>13.0460-2852.2 602852</b>	TRW 21799 19,7 + WK		
	⬅	→ 12/99; Nutzlast [kg]: 1.400		<b>13.0460-2976.2 602976</b>	TRW 21797 19,7 + WK		
	⬅	→ 12/99; Nutzlast [kg]: 1.800		<b>13.0460-2977.2 602977</b>	TRW 21799 19,7 + WK		
	⬅	11/01→ 03/02; Nutzlast [kg]: 1.400		<b>13.0460-4978.2 604978</b>	BRE 23917 19,3 + WK + Zub		
	⬅	11/01→ 03/02; Nutzlast [kg]: 1.800		<b>13.0460-4979.2 604979</b>	BRE 23919 19,3 + WK + Zub		
	➡	11/01→ 03/02; Nutzlast ab [kg] 1.400 Nutzlast bis [kg] 1.800		<b>13.0460-4980.2 604980</b>	BRE 23921 20,3 - WE / - WK + Zub		
2.5 TD	85	06/94→09/01	⬅	01/00→; Nutzlast [kg]: 1.400		<b>13.0460-2850.2 602850</b>	TRW 21797 19,7 + WK
			⬅	01/00→; Nutzlast [kg]: 1.800		<b>13.0460-2852.2 602852</b>	TRW 21799 19,7 + WK
			⬅	→ 12/99; Nutzlast [kg]: 1.400		<b>13.0460-2976.2 602976</b>	TRW 21797 19,7 + WK
			⬅	→ 12/99; Nutzlast [kg]: 1.800		<b>13.0460-2977.2 602977</b>	TRW 21799 19,7 + WK
2.5 TD 4x4	80	11/94→04/98	⬅	Nutzlast [kg]: 1.400		<b>13.0460-2976.2 602976</b>	TRW 21797 19,7 + WK
			⬅	Nutzlast [kg]: 1.800		<b>13.0460-2977.2 602977</b>	TRW 21799 19,7 + WK
2.5 TDI 4x4	85	04/97→04/02	⬅	01/00→ 10/01; Nutzlast [kg]: 1.400		<b>13.0460-2850.2 602850</b>	TRW 21797 19,7 + WK
			⬅	→ 12/99; Nutzlast [kg]: 1.400		<b>13.0460-2976.2 602976</b>	TRW 21797 19,7 + WK
			⬅	11/01→ 03/02; Nutzlast [kg]: 1.400		<b>13.0460-4978.2 604978</b>	BRE 23917 19,3 + WK + Zub
			➡	11/01→ 03/02; Nutzlast ab [kg] 1.400 Nutzlast bis [kg] 1.800		<b>13.0460-4980.2 604980</b>	BRE 23921 20,3 - WE / - WK + Zub
2.8 JTD 2.8 JTD 4x4	94 94	11/00→04/02 11/00→04/02	⬅	→ 10/01; Nutzlast [kg]: 1.400		<b>13.0460-2850.2 602850</b>	TRW 21797 19,7 + WK
	⬅	→ 10/01; Nutzlast [kg]: 1.800		<b>13.0460-2852.2 602852</b>	TRW 21799 19,7 + WK		
	⬅	11/01→ 03/02; Nutzlast [kg]: 1.400		<b>13.0460-4978.2 604978</b>	BRE 23917 19,3 + WK + Zub		
	⬅	11/01→ 03/02; Nutzlast [kg]: 1.800		<b>13.0460-4979.2 604979</b>	BRE 23919 19,3 + WK + Zub		
	➡	11/01→ 03/02; Nutzlast ab [kg] 1.400 Nutzlast bis [kg] 1.800		<b>13.0460-4980.2 604980</b>	BRE 23921 20,3 - WE / - WK + Zub		

	kw			 	! #		
<b>FIAT - DUCATO Bus (230_) 03/94→04/02</b>							
<b>Bremsscheibe</b>							
1.9 D	50	04/98→04/02	←	→ 10/01; Nutzlast [kg]: 1.000		24.0118-0108.1 418108	Ø 280 18 15,9
1.9 D Combinato	51	06/95→04/02	←	11/01→ 03/02; Nutzlast [kg]: 1.000		24.0124-0127.1 424127	Ø 280 24 21,9 V
1.9 TD	66	04/98→04/02	←	11/01→ 03/02; Nutzlast [kg]: 1.000		24.0116-0124.1 416124	Ø 280 16 14,2
1.9 TD Combinato	59	08/94→04/02	→	11/01→ 03/02; Nutzlast [kg]: 1.000			
1.9 TD Panorama/ Combinato	60	03/94→04/02	→	11/01→ 03/02; Nutzlast [kg]: 1.000			
1.9 D	59	05/98→11/01	←	→ 10/01; Nutzlast [kg]: 1.000		24.0118-0108.1 418108	Ø 280 18 15,9
			←	11/01→; Nutzlast [kg]: 1.000		24.0124-0127.1 424127	Ø 280 24 21,9 V
			→	11/01→; Nutzlast [kg]: 1.000		24.0116-0124.1 416124	Ø 280 16 14,2
2.0 4x4	80	11/94→11/01	←	→ 10/01; Nutzlast ab [kg] 1.000 Nutzlast bis [kg] 1.400		24.0118-0108.1 418108	Ø 280 18 15,9
			←	11/01→; Nutzlast ab [kg] 1.000 Nutzlast bis [kg] 1.400		24.0124-0127.1 424127	Ø 280 24 21,9 V
			←	→ 10/01; Nutzlast [kg]: 1.800		24.0124-0138.1 424138	Ø 300 24 21,9 V
			←	11/01→; Nutzlast [kg]: 1.800		24.0124-0138.1 424138	Ø 300 24 21,9 V
			→	11/01→; Nutzlast ab [kg] 1.000 Nutzlast bis [kg] 1.400		24.0116-0124.1 416124	Ø 280 16 14,2
			→	11/01→; Nutzlast [kg]: 1.800		24.0116-0125.1 416125	Ø 280 16 14,2
2.0 JTD	62	10/01→04/02	←	→ 03/02; Nutzlast [kg]: 1.400		24.0124-0127.1 424127	Ø 280 24 21,9 V
			←	→ 03/02; Nutzlast [kg]: 1.800		24.0124-0138.1 424138	Ø 300 24 21,9 V
			→	→ 03/02; Nutzlast [kg]: 1.400		24.0116-0124.1 416124	Ø 280 16 14,2
			→	→ 03/02; Nutzlast [kg]: 1.800		24.0116-0125.1 416125	Ø 280 16 14,2
2.0 Panorama/Combi- nato	80	03/94→04/02	←	→ 10/01; Nutzlast ab [kg] 1.000 Nutzlast bis [kg] 1.400		24.0118-0108.1 418108	Ø 280 18 15,9
			←	11/01→ 03/02; Nutzlast ab [kg] 1.000 Nutzlast bis [kg] 1.400		24.0124-0127.1 424127	Ø 280 24 21,9 V
			←	11/01→ 03/02; Nutzlast [kg]: 1.800		24.0124-0138.1 424138	Ø 300 24 21,9 V
			←	→ 10/01; Nutzlast [kg]: 1.800		24.0124-0138.1 424138	Ø 300 24 21,9 V
			→	11/01→ 03/02; Nutzlast ab [kg] 1.000 Nutzlast bis [kg] 1.400		24.0116-0124.1 416124	Ø 280 16 14,2
			→	11/01→ 03/02; Nutzlast [kg]: 1.800		24.0116-0125.1 416125	Ø 280 16 14,2
2.5 D Combinato	62	08/94→04/02	←	→ 10/01; Nutzlast [kg]: 1.400		24.0118-0108.1 418108	Ø 280 18 15,9
2.8 D	64	02/98→04/02	←	11/01→ 03/02; Nutzlast [kg]: 1.400		24.0124-0127.1 424127	Ø 280 24 21,9 V
			←	11/01→ 03/02; Nutzlast [kg]: 1.800		24.0124-0138.1 424138	Ø 300 24 21,9 V
			←	→ 10/01; Nutzlast [kg]: 1.800		24.0124-0138.1 424138	Ø 300 24 21,9 V
			→	11/01→ 03/02; Nutzlast [kg]: 1.400		24.0116-0124.1 416124	Ø 280 16 14,2
			→	11/01→ 03/02; Nutzlast [kg]: 1.800		24.0116-0125.1 416125	Ø 280 16 14,2
2.5 TD	70	03/94→04/02	←	11/01→ 03/02; Nutzlast [kg]: 1.400		24.0124-0127.1 424127	Ø 280 24 21,9 V
2.5 TDI Panorama/ Combinato	80	07/94→04/02	←	→ 10/01; Nutzlast [kg]: 1.400		24.0124-0127.1 424127	Ø 280 24 21,9 V
2.5 TDI Panorama/ Combinato	85	03/94→04/02	←	11/01→ 03/02; Nutzlast [kg]: 1.800		24.0124-0138.1 424138	Ø 300 24 21,9 V
2.8 JTD	94	11/00→04/02	←	→ 10/01; Nutzlast [kg]: 1.800		24.0124-0138.1 424138	Ø 300 24 21,9 V
2.8 JTD 4x4	94	11/00→04/02	→	11/01→ 03/02; Nutzlast [kg]: 1.400		24.0116-0124.1 416124	Ø 280 16 14,2
2.8 TDI	90	10/97→04/02	→	11/01→ 03/02; Nutzlast [kg]: 1.800		24.0116-0125.1 416125	Ø 280 16 14,2
2.8 TDI 4x4	90	07/99→04/02	→	11/01→ 03/02; Nutzlast [kg]: 1.800		24.0116-0125.1 416125	Ø 280 16 14,2
2.5 TD	85	06/94→09/01	←	Nutzlast [kg]: 1.400		24.0124-0127.1 424127	Ø 280 24 21,9 V
2.5 TD 4x4	80	11/94→04/98	←	Nutzlast [kg]: 1.800		24.0124-0138.1 424138	Ø 300 24 21,9 V
2.5 TDI 4x4	85	04/97→04/02	←	11/01→ 03/02; Nutzlast [kg]: 1.400		24.0124-0127.1 424127	Ø 280 24 21,9 V
			←	→ 10/01; Nutzlast [kg]: 1.400		24.0124-0127.1 424127	Ø 280 24 21,9 V
			→	11/01→ 03/02; Nutzlast [kg]: 1.400		24.0116-0124.1 416124	Ø 280 16 14,2
<b>FIAT - DUCATO Bus (244_) 04/02→</b>							
<b>Bremsbelagsatz, Scheibenbremse</b>							
2.0	81	04/02→	←	→ 07/06; Nutzlast ab [kg] 1.100 Nutzlast bis [kg] 1.500		13.0460-4978.2 604978	BRE 23917 19,3 + WK + Zub
2.0 Bipower	81	11/02→	←	→ 07/06; Nutzlast bis [kg] 1.800		13.0460-4979.2 604979	BRE 23919 19,3 + WK + Zub
2.0 JTD	62	04/02→	←	→ 07/06; Nutzlast bis [kg] 1.800		13.0460-4979.2 604979	BRE 23919 19,3 + WK + Zub
2.3 JTD	81	04/02→	←	→ 07/06; Nutzlast bis [kg] 1.800		13.0460-4979.2 604979	BRE 23919 19,3 + WK + Zub
2.8 JTD	94	04/02→	→	→ 07/06; Nutzlast ab [kg] 1.100 Nutzlast bis [kg] 1.800		13.0460-4980.2 604980	BRE 23921 20,3 - WE / - WK + Zub
2.8 JTD 4x4	94	07/02→	→	→ 07/06; Nutzlast ab [kg] 1.100 Nutzlast bis [kg] 1.800		13.0460-4980.2 604980	BRE 23921 20,3 - WE / - WK + Zub
2.0 4x4	81	05/02→07/06	←	Nutzlast ab [kg] 1.100 Nutzlast bis [kg] 1.500		13.0460-4978.2 604978	BRE 23917 19,3 + WK + Zub
2.8 JTD	107	04/04→07/06	←	Nutzlast bis [kg] 1.800		13.0460-4979.2 604979	BRE 23919 19,3 + WK + Zub
2.8 TD	90	11/03→07/06	←	Nutzlast bis [kg] 1.800		13.0460-4979.2 604979	BRE 23919 19,3 + WK + Zub
2.8 TD 4x4	90	11/03→07/06	→	Nutzlast ab [kg] 1.100 Nutzlast bis [kg] 1.800		13.0460-4980.2 604980	BRE 23921 20,3 - WE / - WK + Zub
↓							

**FIAT - DUCATO Bus (244\_) 04/02→**

**Bremsscheibe**

2.0 2.0 Bipower 2.0 JTD 2.3 JTD 2.8 JTD 2.8 JTD 4x4	81	04/02→	←	→ 07/06; Nutzlast ab [kg] 1.100 Nutzlast bis [kg] 1.500	24.0124-0127.1	424127	Ø 280 24 21,9 V
	81	11/02→					
	62	04/02→	←	→ 07/06; Nutzlast [kg]: 1.800	24.0124-0138.1	424138	Ø 300 24 21,9 V
	81	04/02→					
2.0 4x4 2.8 JTD 2.8 TD 2.8 TD 4x4	94	04/02→	→	→ 07/06; Nutzlast ab [kg] 1.100 Nutzlast bis [kg] 1.500	24.0116-0124.1	416124	Ø 280 16 14,2
	94	07/02→					
			→	→ 07/06; Nutzlast [kg]: 1.800	24.0116-0125.1	416125	Ø 280 16 14,2
2.0 4x4 2.8 JTD 2.8 TD 2.8 TD 4x4	81	05/02→07/06	←	Nutzlast ab [kg] 1.100 Nutzlast bis [kg] 1.500	24.0124-0127.1	424127	Ø 280 24 21,9 V
	107	04/04→07/06					
	90	11/03→07/06	←	Nutzlast [kg]: 1.800	24.0124-0138.1	424138	Ø 300 24 21,9 V
	90	11/03→07/06					
			→	Nutzlast ab [kg] 1.100 Nutzlast bis [kg] 1.500	24.0116-0124.1	416124	Ø 280 16 14,2
			→	Nutzlast [kg]: 1.800	24.0116-0125.1	416125	Ø 280 16 14,2

**FIAT - DUCATO Bus (250\_, 290\_) 07/06→**

**Bremsbelagsatz, Scheibenbremse**







100 Multijet 2,2 D 110 Multijet 2,3 D 110 Multijet 2,3 D 115 Multijet 2,0 D 120 Multijet 2,2 D 120 Multijet 2,3 D 130 Multijet 2,3 D 130 Multijet 2,3 D 130 Multijet 2,3 D 130 Multijet 2,3 D 4x4 140 Multijet 3,0 D 140 Natural Power 150 Multijet 2,3 D 150 Multijet 3,0 D 160 Multijet 3,0 D 160 Multijet 3,0 D 160 Multijet 3,0 D 4x4 180 Multijet 3,0 D	74	07/06→05/11	←	Nutzlast 11Q/15Q; Nutzlast ab [kg] 1.100 Nutzlast bis [kg] 1.500	13.0460-4807.2	604807	BRE 24468 19,1 + WK + Zub
	82	05/14→					
	83	10/11→	←	Nutzlast leicht 17Q; Nutzlast [kg]: 1.700; nicht für erhöhte Nutzlast	13.0460-4809.2	604809	BRE 24468 19,1 + WK + Zub
	85	06/11→					
	88	07/06→07/14	←	Nutzlast schwer 17Q; für erhöhte Nutzlast; Nutzlast [kg]: 1.700	13.0460-4810.2	604810	BRE 24466 19,1 + WK + Zub
	88	07/06→					
	93	01/10→	←	Nutzlast 20Q; Nutzlast [kg]: 2.000	13.0460-4811.2	604811	BRE 24466 19,1 + WK + Zub
	96	06/11→					
	96	06/11→	→	Nutzlast 11Q/15Q/17Q; Nutzlast ab [kg] 1.100 Nutzlast bis [kg] 1.700; Baumuster: 30/33/35	13.0460-4812.2	604812	BOS 24465 19,2 - WE / - WK + Zub
	103	07/06→07/14					
	100	04/09→	→	Nutzlast 20Q; Nutzlast [kg]: 2.000; für erhöhte Nutzlast; Baumuster: 40	13.0460-4890.2	604890	BRE + WK + Zub
	109	06/11→					
	107	04/10→					
	115	10/06→					
	116	07/06→					
	116	07/06→					
130	06/11→						
150 Multijet 2,3 D 150 Multijet 2,3 D 4x4	110	04/15→	←	12/15→; Nutzlast 11Q/15Q; Nutzlast ab [kg] 1.100 Nutzlast bis [kg] 1.500	13.0460-4807.2	604807	BRE 24468 19,1 + WK + Zub
	110	04/15→	←	12/15→; Nutzlast leicht 17Q; Nutzlast [kg]: 1.700; nicht für erhöhte Nutzlast	13.0460-4809.2	604809	BRE 24468 19,1 + WK + Zub
			←	12/15→; Nutzlast schwer 17Q; Nutzlast [kg]: 1.700; für erhöhte Nutzlast	13.0460-4810.2	604810	BRE 24466 19,1 + WK + Zub
			←	12/15→; Nutzlast [kg]: 2.000; Nutzlast 20Q	13.0460-4811.2	604811	BRE 24466 19,1 + WK + Zub
			→	12/15→; Nutzlast 11Q/15Q/17Q; Nutzlast ab [kg] 1.100 Nutzlast bis [kg] 1.700; Baumuster: 30/33/35	13.0460-4812.2	604812	BOS 24465 19,2 - WE / - WK + Zub
			→	12/15→; Nutzlast 20Q; Nutzlast [kg]: 2.000; für erhöhte Nutzlast; Baumuster: 40	13.0460-4890.2	604890	BRE + WK + Zub

**Bremsscheibe**











100 Multijet 2,2 D 110 Multijet 2,3 D 110 Multijet 2,3 D 115 Multijet 2,0 D 120 Multijet 2,2 D 120 Multijet 2,3 D 130 Multijet 2,3 D 130 Multijet 2,3 D 130 Multijet 2,3 D 4x4 140 Multijet 3,0 D 140 Natural Power 150 Multijet 2,3 D 150 Multijet 3,0 D 160 Multijet 3,0 D 160 Multijet 3,0 D 160 Multijet 3,0 D 4x4 180 Multijet 3,0 D	74	07/06→05/11	←	Nutzlast 11Q/15Q; Nutzlast ab [kg] 1.100 Nutzlast bis [kg] 1.500	24.0124-0127.1	424127	Ø 280 24 21,9 V
	82	05/14→					
	83	10/11→	←	Nutzlast schwer 17Q; Nutzlast [kg]: 1.700; für erhöhte Nutzlast	24.0124-0138.1	424138	Ø 300 24 21,9 V
	85	06/11→					
	88	07/06→07/14	←	Nutzlast leicht 17Q; Nutzlast [kg]: 1.700; nicht für erhöhte Nutzlast	24.0128-0213.1	428213	Ø 280 28 25,9 V
	88	07/06→					
	93	01/10→	←	Nutzlast 20Q; Nutzlast [kg]: 2.000	24.0132-0131.1	432131	Ø 300 32 29,9 V
	96	06/11→					
	96	06/11→	→	Nutzlast 20Q; Nutzlast [kg]: 2.000	24.0116-0123.1	416123	Ø 300 16 14,2
	103	07/06→07/14					
	100	04/09→	→	Nutzlast 11Q/15Q / leicht 17Q; Nutzlast ab [kg] 1.100 Nutzlast bis [kg] 1.700; nicht für erhöhte Nutzlast	24.0116-0124.1	416124	Ø 280 16 14,2
	109	06/11→					
	107	04/10→					
	115	10/06→	→	Nutzlast schwer 17Q; Nutzlast [kg]: 1.700; für erhöhte Nutzlast	24.0116-0125.1	416125	Ø 280 16 14,2
	116	07/06→					
	116	07/06→					
130	06/11→						
150 Multijet 2,3 D 150 Multijet 2,3 D 4x4	110	04/15→	←	12/15→; Nutzlast 11Q/15Q; Nutzlast ab [kg] 1.100 Nutzlast bis [kg] 1.500	24.0124-0127.1	424127	Ø 280 24 21,9 V
	110	04/15→	←	12/15→; Nutzlast schwer 17Q; Nutzlast [kg]: 1.700; für erhöhte Nutzlast	24.0124-0138.1	424138	Ø 300 24 21,9 V
			←	12/15→; Nutzlast leicht 17Q; Nutzlast [kg]: 1.700; nicht für erhöhte Nutzlast	24.0128-0213.1	428213	Ø 280 28 25,9 V
			←	12/15→; Nutzlast [kg]: 2.000; Nutzlast 20Q	24.0132-0131.1	432131	Ø 300 32 29,9 V

↓



















	kw			 	! #		
<b>FIAT - DUCATO Bus (250_, 290_) 07/06→</b>							
 <b>Bremsscheibe</b>							
150 Multijet 2,3 D 150 Multijet 2,3 D 4x4	110 110	04/15→ 04/15→	➡	12/15→; Nutzlast 20Q; Nutzlast [kg]: 2.000		24.0116-0123.1 416123	Ø 300 16 14,2
			➡	12/15→; Nutzlast 11Q/15Q / leicht 17Q; Nutzlast ab [kg] 1.100 Nutzlast bis [kg] 1.700; nicht für erhöhte Nutzlast		24.0116-0124.1 416124	Ø 280 16 14,2
			➡	12/15→; Nutzlast schwer 17Q; Nutzlast [kg]: 1.700; für erhöhte Nutzlast		24.0116-0125.1 416125	Ø 280 16 14,2
<b>FIAT - DUCATO Kasten (230_) 03/94→05/05</b>							
 <b>Bremsbelagsatz, Scheibenbremse</b>							
1.9 D 1.9 D 1.9 TD 1.9 TD 1.9 TD CAT	50 51 60 66 59	04/98→04/02 03/94→04/02 03/94→04/02 04/98→04/02 08/94→04/02	←	01/00→ 10/01; Nutzlast [kg]: 1.000		13.0460-2850.2 602850	TRW 21797 19,7 + WK
			←	→ 12/99; Nutzlast [kg]: 1.000		13.0460-2976.2 602976	TRW 21797 19,7 + WK
			←	11/01→ 03/02; Nutzlast [kg]: 1.000		13.0460-4978.2 604978	BRE 23917 19,3 + WK + Zub
			➡	11/01→ 03/02; Nutzlast [kg]: 1.000		13.0460-4980.2 604980	BRE 23921 20,3 - WE / - WK + Zub
1.9 TD	59	05/98→11/01	←	01/00→ 10/01; Nutzlast [kg]: 1.000		13.0460-2850.2 602850	TRW 21797 19,7 + WK
			←	→ 12/99; Nutzlast [kg]: 1.000		13.0460-2976.2 602976	TRW 21797 19,7 + WK
			←	11/01→; Nutzlast [kg]: 1.000		13.0460-4978.2 604978	BRE 23917 19,3 + WK + Zub
			➡	11/01→; Nutzlast [kg]: 1.000		13.0460-4980.2 604980	BRE 23921 20,3 - WE / - WK + Zub
2.0 2.0 4x4	80 80	03/94→04/02 11/94→04/02	←	01/00→ 10/01; Nutzlast ab [kg] 1.000 Nutzlast bis [kg] 1.400		13.0460-2850.2 602850	TRW 21797 19,7 + WK
			←	01/00→ 10/01; Nutzlast [kg]: 1.800		13.0460-2852.2 602852	TRW 21799 19,7 + WK
			←	→ 12/99; Nutzlast ab [kg] 1.000 Nutzlast bis [kg] 1.400		13.0460-2976.2 602976	TRW 21797 19,7 + WK
			←	→ 12/99; Nutzlast [kg]: 1.800		13.0460-2977.2 602977	TRW 21799 19,7 + WK
			←	11/01→ 03/02; Nutzlast ab [kg] 1.000 Nutzlast bis [kg] 1.400		13.0460-4978.2 604978	BRE 23917 19,3 + WK + Zub
			←	11/01→ 03/02; Nutzlast [kg]: 1.800		13.0460-4979.2 604979	BRE 23919 19,3 + WK + Zub
			➡	11/01→ 03/02; Nutzlast ab [kg] 1.000 Nutzlast bis [kg] 1.800		13.0460-4980.2 604980	BRE 23921 20,3 - WE / - WK + Zub
2.0 JTD	62	10/01→04/02	←	→ 03/02; Nutzlast [kg]: 1.400		13.0460-4978.2 604978	BRE 23917 19,3 + WK + Zub
			←	→ 03/02; Nutzlast [kg]: 1.800		13.0460-4979.2 604979	BRE 23919 19,3 + WK + Zub
			➡	→ 03/02; Nutzlast ab [kg] 1.400 Nutzlast bis [kg] 1.800		13.0460-4980.2 604980	BRE 23921 20,3 - WE / - WK + Zub
2.5 D 2.5 D 4x4 2.5 TDI 2.5 TDI 2.5 TDI 4x4 2.8 D 2.8 D 4x4 2.8 TDI 2.8 TDI 4x4	62 62 80 85 85 64 64 90 90	03/94→04/02 03/94→04/02 03/94→04/02 03/94→04/02 05/98→04/02 05/98→04/02 08/98→04/02 10/97→04/02 06/99→04/02	←	01/00→ 10/01; Nutzlast [kg]: 1.400		13.0460-2850.2 602850	TRW 21797 19,7 + WK
			←	01/00→ 10/01; Nutzlast [kg]: 1.800		13.0460-2852.2 602852	TRW 21799 19,7 + WK
			←	→ 12/99; Nutzlast [kg]: 1.400		13.0460-2976.2 602976	TRW 21797 19,7 + WK
			←	→ 12/99; Nutzlast [kg]: 1.800		13.0460-2977.2 602977	TRW 21799 19,7 + WK
			←	11/01→ 03/02; Nutzlast [kg]: 1.400		13.0460-4978.2 604978	BRE 23917 19,3 + WK + Zub
			←	11/01→ 03/02; Nutzlast [kg]: 1.800		13.0460-4979.2 604979	BRE 23919 19,3 + WK + Zub
			➡	11/01→ 03/02; Nutzlast ab [kg] 1.400 Nutzlast bis [kg] 1.800		13.0460-4980.2 604980	BRE 23921 20,3 - WE / - WK + Zub
2.5 TD 2.5 TD 4x4 2.5 TD 4x4	80 80 85	06/94→08/98 11/94→04/98 11/94→04/98	←	Nutzlast [kg]: 1.400		13.0460-2976.2 602976	TRW 21797 19,7 + WK
			←	Nutzlast [kg]: 1.800		13.0460-2977.2 602977	TRW 21799 19,7 + WK
2.8 JTD 2.8 JTD 4x4	94 94	11/00→04/02 11/00→04/02	←	→ 10/01; Nutzlast [kg]: 1.400		13.0460-2850.2 602850	TRW 21797 19,7 + WK
			←	→ 10/01; Nutzlast [kg]: 1.800		13.0460-2852.2 602852	TRW 21799 19,7 + WK
			←	11/01→ 03/02; Nutzlast [kg]: 1.400		13.0460-4978.2 604978	BRE 23917 19,3 + WK + Zub
			←	11/01→ 03/02; Nutzlast [kg]: 1.800		13.0460-4979.2 604979	BRE 23919 19,3 + WK + Zub
			➡	11/01→ 03/02; Nutzlast ab [kg] 1.400 Nutzlast bis [kg] 1.800		13.0460-4980.2 604980	BRE 23921 20,3 - WE / - WK + Zub
2.8 TD 4x4	90	05/98→09/01	←	01/00→; Nutzlast [kg]: 1.400		13.0460-2850.2 602850	TRW 21797 19,7 + WK
			←	01/00→; Nutzlast [kg]: 1.800		13.0460-2852.2 602852	TRW 21799 19,7 + WK
			←	→ 12/99; Nutzlast [kg]: 1.400		13.0460-2976.2 602976	TRW 21797 19,7 + WK
			←	→ 12/99; Nutzlast [kg]: 1.800		13.0460-2977.2 602977	TRW 21799 19,7 + WK
 <b>Bremsscheibe</b>							
1.9 D 1.9 D 1.9 TD 1.9 TD 1.9 TD CAT	50 51 60 66 59	04/98→04/02 03/94→04/02 03/94→04/02 04/98→04/02 08/94→04/02	←	→ 10/01; Nutzlast [kg]: 1.000		24.0118-0108.1 418108	Ø 280 18 15,9
			←	11/01→ 03/02; Nutzlast [kg]: 1.000		24.0124-0127.1 424127	Ø 280 24 21,9 V
			➡	11/01→ 03/02; Nutzlast [kg]: 1.000		24.0116-0124.1 416124	Ø 280 16 14,2
↓							









	kw			 	! #		
<b>FIAT - DUCATO Kasten (230_) 03/94→05/05</b>							
 <b>Bremsscheibe</b>							
1.9 TD	59	05/98→11/01	←	→ 10/01; Nutzlast [kg]: 1.000		24.0118-0108.1 418108	Ø 280 18 15,9
			←	11/01→; Nutzlast [kg]: 1.000		24.0124-0127.1 424127	Ø 280 24 21,9 V
			→	11/01→; Nutzlast [kg]: 1.000		24.0116-0124.1 416124	Ø 280 16 14,2
2.0	80	03/94→04/02	←	→ 10/01; Nutzlast ab [kg] 1.000 Nutzlast bis [kg] 1.400		24.0118-0108.1 418108	Ø 280 18 15,9
2.0 4x4	80	11/94→04/02	←	11/01→ 03/02; Nutzlast ab [kg] 1.000 Nutzlast bis [kg] 1.400		24.0124-0127.1 424127	Ø 280 24 21,9 V
			←	11/01→ 03/02; Nutzlast [kg]: 1.800		24.0124-0138.1 424138	Ø 300 24 21,9 V
			←	→ 10/01; Nutzlast [kg]: 1.800		24.0124-0138.1 424138	Ø 300 24 21,9 V
			→	11/01→ 03/02; Nutzlast ab [kg] 1.000 Nutzlast bis [kg] 1.400		24.0116-0124.1 416124	Ø 280 16 14,2
			→	11/01→ 03/02; Nutzlast [kg]: 1.800		24.0116-0125.1 416125	Ø 280 16 14,2
2.0 JTD	62	10/01→04/02	←	→ 03/02; Nutzlast [kg]: 1.400		24.0124-0127.1 424127	Ø 280 24 21,9 V
			←	→ 03/02; Nutzlast [kg]: 1.800		24.0124-0138.1 424138	Ø 300 24 21,9 V
			→	→ 03/02; Nutzlast [kg]: 1.400		24.0116-0124.1 416124	Ø 280 16 14,2
			→	→ 03/02; Nutzlast [kg]: 1.800		24.0116-0125.1 416125	Ø 280 16 14,2
2.5 D	62	03/94→04/02	←	→ 10/01; Nutzlast [kg]: 1.400		24.0118-0108.1 418108	Ø 280 18 15,9
2.5 D 4x4	62	03/94→04/02	←	11/01→ 03/02; Nutzlast [kg]: 1.400		24.0124-0127.1 424127	Ø 280 24 21,9 V
2.8 D	64	05/98→04/02	←	11/01→ 03/02; Nutzlast [kg]: 1.800		24.0124-0138.1 424138	Ø 300 24 21,9 V
2.8 D 4x4	64	08/98→04/02	←	→ 10/01; Nutzlast [kg]: 1.800		24.0124-0138.1 424138	Ø 300 24 21,9 V
			→	11/01→ 03/02; Nutzlast [kg]: 1.400		24.0116-0124.1 416124	Ø 280 16 14,2
			→	11/01→ 03/02; Nutzlast [kg]: 1.800		24.0116-0125.1 416125	Ø 280 16 14,2
2.5 TD	80	06/94→08/98	←	Nutzlast [kg]: 1.400		24.0124-0127.1 424127	Ø 280 24 21,9 V
2.5 TD 4x4	80	11/94→04/98	←	Nutzlast [kg]: 1.800		24.0124-0138.1 424138	Ø 300 24 21,9 V
2.5 TD 4x4	85	11/94→04/98	←	Nutzlast [kg]: 1.800		24.0124-0138.1 424138	Ø 300 24 21,9 V
2.8 TD 4x4	90	05/98→09/01	←	Nutzlast [kg]: 1.800		24.0124-0138.1 424138	Ø 300 24 21,9 V
2.5 TDI	80	03/94→04/02	←	11/01→ 03/02; Nutzlast [kg]: 1.400		24.0124-0127.1 424127	Ø 280 24 21,9 V
2.5 TDI	85	03/94→04/02	←	→ 10/01; Nutzlast [kg]: 1.400		24.0124-0127.1 424127	Ø 280 24 21,9 V
2.5 TDI 4x4	85	05/98→04/02	←	→ 10/01; Nutzlast [kg]: 1.400		24.0124-0127.1 424127	Ø 280 24 21,9 V
2.8 JTD	94	11/00→04/02	←	11/01→ 03/02; Nutzlast [kg]: 1.800		24.0124-0138.1 424138	Ø 300 24 21,9 V
2.8 JTD 4x4	94	11/00→04/02	←	→ 10/01; Nutzlast [kg]: 1.800		24.0124-0138.1 424138	Ø 300 24 21,9 V
2.8 TDI	90	10/97→04/02	←	→ 10/01; Nutzlast [kg]: 1.800		24.0124-0138.1 424138	Ø 300 24 21,9 V
2.8 TDI 4x4	90	06/99→04/02	→	11/01→ 03/02; Nutzlast [kg]: 1.400		24.0116-0124.1 416124	Ø 280 16 14,2
			→	11/01→ 03/02; Nutzlast [kg]: 1.800		24.0116-0125.1 416125	Ø 280 16 14,2
<b>FIAT - DUCATO Kasten (244_) 04/02→</b>							
 <b>Bremsbelagsatz, Scheibenbremse</b>							
2.0	81	04/02→	←	→ 07/06; Nutzlast ab [kg] 1.100 Nutzlast bis [kg] 1.500		13.0460-4978.2 604978	BRE 23917 19,3 + WK + Zub
2.0 Bipower	81	11/02→	←	→ 07/06; Nutzlast bis [kg] 1.800		13.0460-4979.2 604979	BRE 23919 19,3 + WK + Zub
2.0 JTD	62	04/02→	←	→ 07/06; Nutzlast bis [kg] 1.800		13.0460-4979.2 604979	BRE 23919 19,3 + WK + Zub
2.3 JTD	81	04/02→	→	→ 07/06; Nutzlast ab [kg] 1.100 Nutzlast bis [kg] 1.800		13.0460-4980.2 604980	BRE 23921 20,3 - WE / - WK + Zub
2.8 JTD	94	04/02→	→	→ 07/06; Nutzlast ab [kg] 1.100 Nutzlast bis [kg] 1.800		13.0460-4980.2 604980	BRE 23921 20,3 - WE / - WK + Zub
2.8 JTD 4x4	94	07/02→	→	→ 07/06; Nutzlast ab [kg] 1.100 Nutzlast bis [kg] 1.800		13.0460-4980.2 604980	BRE 23921 20,3 - WE / - WK + Zub
2.8 JTD Power	107	05/04→	→	→ 07/06; Nutzlast [kg]: 1.800		24.0116-0125.1 416125	Ø 280 16 14,2
2.0 4x4	81	05/02→07/06	←	Nutzlast ab [kg] 1.100 Nutzlast bis [kg] 1.500		13.0460-4978.2 604978	BRE 23917 19,3 + WK + Zub
2.8 TD	90	04/02→07/06	←	Nutzlast ab [kg] 1.100 Nutzlast bis [kg] 1.500		13.0460-4978.2 604978	BRE 23917 19,3 + WK + Zub
			←	Nutzlast bis [kg] 1.800		13.0460-4979.2 604979	BRE 23919 19,3 + WK + Zub
			→	Nutzlast ab [kg] 1.100 Nutzlast bis [kg] 1.800		13.0460-4980.2 604980	BRE 23921 20,3 - WE / - WK + Zub
 <b>Bremsscheibe</b>							
2.0	81	04/02→	←	→ 07/06; Nutzlast ab [kg] 1.100 Nutzlast bis [kg] 1.500		24.0124-0127.1 424127	Ø 280 24 21,9 V
2.0 Bipower	81	11/02→	←	→ 07/06; Nutzlast [kg]: 1.800		24.0124-0138.1 424138	Ø 300 24 21,9 V
2.0 JTD	62	04/02→	←	→ 07/06; Nutzlast [kg]: 1.800		24.0124-0138.1 424138	Ø 300 24 21,9 V
2.3 JTD	81	04/02→	→	→ 07/06; Nutzlast ab [kg] 1.100 Nutzlast bis [kg] 1.500		24.0116-0124.1 416124	Ø 280 16 14,2
2.8 JTD	94	04/02→	→	→ 07/06; Nutzlast ab [kg] 1.100 Nutzlast bis [kg] 1.500		24.0116-0124.1 416124	Ø 280 16 14,2
2.8 JTD 4x4	94	07/02→	→	→ 07/06; Nutzlast [kg]: 1.800		24.0116-0125.1 416125	Ø 280 16 14,2
2.8 JTD Power	107	05/04→	→	→ 07/06; Nutzlast [kg]: 1.800		24.0116-0125.1 416125	Ø 280 16 14,2
2.0 4x4	81	05/02→07/06	←	Nutzlast ab [kg] 1.100 Nutzlast bis [kg] 1.500		24.0124-0127.1 424127	Ø 280 24 21,9 V
			→	Nutzlast ab [kg] 1.100 Nutzlast bis [kg] 1.500		24.0116-0124.1 416124	Ø 280 16 14,2
2.8 TD	90	04/02→07/06	←	Nutzlast ab [kg] 1.100 Nutzlast bis [kg] 1.500		24.0124-0127.1 424127	Ø 280 24 21,9 V
			←	Nutzlast [kg]: 1.800		24.0124-0138.1 424138	Ø 300 24 21,9 V
↓							













	kw					! #		
<b>FIAT - DUCATO Kasten (244_) 04/02→</b>								
 <b>Bremsscheibe</b>								
2.8 TD	90	04/02→07/06	➡	Nutzlast ab [kg] 1.100 Nutzlast bis [kg] 1.500		24.0116-0124.1	416124	Ø 280 16 14,2
			➡	Nutzlast [kg]: 1.800		24.0116-0125.1	416125	Ø 280 16 14,2
<b>FIAT - DUCATO Kasten (250_, 290_) 07/06→</b>								
 <b>Bremsbelagsatz, Scheibenbremse</b>								
100 Multijet 2,2 D	74	07/06→	←	Nutzlast 11Q/15Q; Nutzlast ab [kg] 1.100 Nutzlast bis [kg] 1.500		13.0460-4807.2	604807	BRE 24468 19,1 + WK + Zub
110 Multijet 2,3 D	83	10/11→	←	Nutzlast leicht 17Q; Nutzlast [kg]: 1.700; nicht für erhöhte Nutzlast		13.0460-4809.2	604809	BRE 24468 19,1 + WK + Zub
115 Multijet 2,0 D	85	06/11→	←	Nutzlast schwer 17Q; für erhöhte Nutzlast; Nutzlast [kg]: 1.700		13.0460-4810.2	604810	BRE 24466 19,1 + WK + Zub
120 Multijet 2,3 D	88	07/06→	←	Nutzlast 20Q; Nutzlast [kg]: 2.000		13.0460-4811.2	604811	BRE 24466 19,1 + WK + Zub
120 Multijet 2,3 D 4x4	88	03/10→	➡	Nutzlast 11Q/15Q/17Q; Nutzlast ab [kg] 1.100 Nutzlast bis [kg] 1.700; Baumuster: 30/33/35		13.0460-4812.2	604812	BOS 24465 19,2 - WE / - WK + Zub
130 Multijet 2,3 D	96	06/11→	➡	12/15→; Nutzlast 20Q; Nutzlast [kg]: 2.000; Baumuster: 40; für erhöhte Nutzlast		13.0460-4890.2	604890	BRE + WK + Zub
130 Multijet 2,3 D 4x4	96	06/11→	➡					
140 Natural Power	100	04/09→	➡					
150 Multijet 2,3 D	109	06/11→	➡					
150 Multijet 2,3 D	110	12/15→	➡					
150 Multijet 3,0 D	107	04/10→	➡					
160 Multijet 3,0 D	115	07/06→12/11	➡					
160 Multijet 3,0 D	116	07/06→	➡					
160 Multijet 3,0 D 4x4	116	07/06→	➡					
180 Multijet 2,3 D	130	12/15→	➡					
180 Multijet 3,0 D	130	06/11→	➡					
110 Multijet 2,3 D	82	05/14→	←	Nutzlast 11Q/15Q; Nutzlast ab [kg] 1.100 Nutzlast bis [kg] 1.500		13.0460-4807.2	604807	BRE 24468 19,1 + WK + Zub
150 Multijet 2,3 D 4x4	110	04/15→	←	Nutzlast leicht 17Q; Nutzlast [kg]: 1.700; nicht für erhöhte Nutzlast		13.0460-4809.2	604809	BRE 24468 19,1 + WK + Zub
			←	Nutzlast schwer 17Q; für erhöhte Nutzlast; Nutzlast [kg]: 1.700		13.0460-4810.2	604810	BRE 24466 19,1 + WK + Zub
			←	Nutzlast 20Q; Nutzlast [kg]: 2.000		13.0460-4811.2	604811	BRE 24466 19,1 + WK + Zub
			➡	Nutzlast 11Q/15Q/17Q; Nutzlast ab [kg] 1.100 Nutzlast bis [kg] 1.700; Baumuster: 30/33/35		13.0460-4812.2	604812	BOS 24465 19,2 - WE / - WK + Zub
			➡	12/15→; Nutzlast 20Q; Nutzlast [kg]: 2.000; Baumuster: 40; für erhöhte Nutzlast		13.0460-4890.2	604890	BRE + WK + Zub
130 Multijet 2,3 D	93	08/06→	←	01/07→; Nutzlast 11Q/15Q; Nutzlast ab [kg] 1.100 Nutzlast bis [kg] 1.500		13.0460-4807.2	604807	BRE 24468 19,1 + WK + Zub
			←	01/07→; Nutzlast leicht 17Q; Nutzlast [kg]: 1.700; nicht für erhöhte Nutzlast		13.0460-4809.2	604809	BRE 24468 19,1 + WK + Zub
			←	01/07→; Nutzlast schwer 17Q; Nutzlast [kg]: 1.700; für erhöhte Nutzlast		13.0460-4810.2	604810	BRE 24466 19,1 + WK + Zub
			←	01/07→; Nutzlast 20Q; Nutzlast [kg]: 2.000		13.0460-4811.2	604811	BRE 24466 19,1 + WK + Zub
			➡	01/07→; Nutzlast 11Q/15Q/17Q; Nutzlast ab [kg] 1.100 Nutzlast bis [kg] 1.700; Baumuster: 30/33/35		13.0460-4812.2	604812	BOS 24465 19,2 - WE / - WK + Zub
			➡	01/07→; Nutzlast 20Q; Nutzlast [kg]: 2.000; Baumuster: 40; für erhöhte Nutzlast		13.0460-4890.2	604890	BRE + WK + Zub
140 Multijet 3,0 D	103	07/06→07/14	←	Nutzlast 11Q/15Q; Nutzlast ab [kg] 1.100 Nutzlast bis [kg] 1.500		13.0460-4807.2	604807	BRE 24468 19,1 + WK + Zub
			←	Nutzlast leicht 17Q; Nutzlast [kg]: 1.700; nicht für erhöhte Nutzlast		13.0460-4809.2	604809	BRE 24468 19,1 + WK + Zub
			←	Nutzlast schwer 17Q; für erhöhte Nutzlast; Nutzlast [kg]: 1.700		13.0460-4810.2	604810	BRE 24466 19,1 + WK + Zub
			←	Nutzlast 20Q; Nutzlast [kg]: 2.000		13.0460-4811.2	604811	BRE 24466 19,1 + WK + Zub
			➡	Nutzlast 11Q/15Q/17Q; Nutzlast ab [kg] 1.100 Nutzlast bis [kg] 1.700; Baumuster: 30/33/35		13.0460-4812.2	604812	BOS 24465 19,2 - WE / - WK + Zub
			➡	04/10→; Nutzlast 20Q; Nutzlast [kg]: 2.000; Baumuster: 40; für erhöhte Nutzlast		13.0460-4890.2	604890	BRE + WK + Zub
 <b>Bremsscheibe</b>								
100 Multijet 2,2 D	74	07/06→	←	Nutzlast 11Q/15Q; Nutzlast ab [kg] 1.100 Nutzlast bis [kg] 1.500		24.0124-0127.1	424127	Ø 280 24 21,9 V
110 Multijet 2,3 D	82	05/14→	←	Nutzlast schwer 17Q; Nutzlast [kg]: 1.700; für erhöhte Nutzlast		24.0124-0138.1	424138	Ø 300 24 21,9 V
110 Multijet 2,3 D	83	10/11→	←	Nutzlast leicht 17Q; Nutzlast [kg]: 1.700; nicht für erhöhte Nutzlast		24.0128-0213.1	428213	Ø 280 28 25,9 V
115 Multijet 2,0 D	85	06/11→	←	Nutzlast 20Q; Nutzlast [kg]: 2.000		24.0132-0131.1	432131	Ø 300 32 29,9 V
120 Multijet 2,3 D	88	07/06→	➡	Nutzlast 20Q; Nutzlast [kg]: 2.000		24.0116-0123.1	416123	Ø 300 16 14,2
120 Multijet 2,3 D 4x4	88	03/10→	➡					
130 Multijet 2,3 D	96	06/11→	➡					
130 Multijet 2,3 D 4x4	96	06/11→	➡					
140 Multijet 3,0 D	103	07/06→07/14	➡					
140 Natural Power	100	04/09→	➡					











	kw			 	! #		
<b>FIAT - DUCATO Kasten (250_, 290_) 07/06→</b>							
<b>Bremsscheibe</b>							
150 Multijet 2,3 D	109	06/11→	➔	Nutzlast 11Q/15Q / leicht 17Q; Nutzlast ab [kg] 1.100 Nutzlast bis [kg] 1.700; nicht für erhöhte Nutzlast	24.0116-0124.1	416124	Ø 280 16 14,2
150 Multijet 2,3 D	110	12/15→					
150 Multijet 2,3 D 4x4	110	04/15→					
150 Multijet 3,0 D	107	04/10→	➔	Nutzlast schwer 17Q; Nutzlast [kg]: 1.700; für erhöhte Nutzlast	24.0116-0125.1	416125	Ø 280 16 14,2
160 Multijet 3,0 D	115	07/06→12/11					
160 Multijet 3,0 D	116	07/06→					
160 Multijet 3,0 D 4x4	116	07/06→					
180 Multijet 3,0 D	130	06/11→					
130 Multijet 2,3 D	93	08/06→	➔	01/07→; Nutzlast 11Q/15Q; Nutzlast ab [kg] 1.100 Nutzlast bis [kg] 1.500	24.0124-0127.1	424127	Ø 280 24 21,9 V
			➔	01/07→; Nutzlast schwer 17Q; Nutzlast [kg]: 1.700; für erhöhte Nutzlast	24.0124-0138.1	424138	Ø 300 24 21,9 V
			➔	01/07→; Nutzlast leicht 17Q; Nutzlast [kg]: 1.700; nicht für erhöhte Nutzlast	24.0128-0213.1	428213	Ø 280 28 25,9 V
			➔	01/07→; Nutzlast 20Q; Nutzlast [kg]: 2.000	24.0132-0131.1	432131	Ø 300 32 29,9 V
			➔	01/07→; Nutzlast 20Q; Nutzlast [kg]: 2.000	24.0116-0123.1	416123	Ø 300 16 14,2
			➔	01/07→; Nutzlast 11Q/15Q / leicht 17Q; Nutzlast ab [kg] 1.100 Nutzlast bis [kg] 1.700; nicht für erhöhte Nutzlast	24.0116-0124.1	416124	Ø 280 16 14,2
			➔	01/07→; Nutzlast schwer 17Q; Nutzlast [kg]: 1.700; für erhöhte Nutzlast	24.0116-0125.1	416125	Ø 280 16 14,2
180 Multijet 2,3 D	130	12/15→	➔	Nutzlast 11Q/15Q; Nutzlast ab [kg] 1.100 Nutzlast bis [kg] 1.500	24.0124-0127.1	424127	Ø 280 24 21,9 V
			➔	Nutzlast schwer 17Q; Nutzlast [kg]: 1.700; für erhöhte Nutzlast	24.0124-0138.1	424138	Ø 300 24 21,9 V
			➔	Nutzlast leicht 17Q; Nutzlast [kg]: 1.700; nicht für erhöhte Nutzlast	24.0128-0213.1	428213	Ø 280 28 25,9 V
			➔	Nutzlast 20Q; Nutzlast [kg]: 2.000	24.0132-0131.1	432131	Ø 300 32 29,9 V
			➔	Nutzlast 20Q; Nutzlast [kg]: 2.000	24.0116-0123.1	416123	Ø 300 16 14,2
			➔	Nutzlast schwer 17Q; Nutzlast [kg]: 1.700; für erhöhte Nutzlast	24.0116-0125.1	416125	Ø 280 16 14,2
<b>FIAT - DUCATO Pritsche/Fahrgestell (230_) 03/94→04/02</b>							
<b>Brembelagsatz, Scheibenbremse</b>							
1.9 D	50	04/98→04/02	➔	01/00→ 10/01; Nutzlast [kg]: 1.000	13.0460-2850.2	602850	TRW 21797 19,7 + WK
1.9 D	51	03/94→04/02	➔	→ 12/99; Nutzlast [kg]: 1.000	13.0460-2976.2	602976	TRW 21797 19,7 + WK
1.9 TD	60	03/94→04/02	➔				
1.9 TD	66	04/98→04/02	➔	11/01→ 03/02; Nutzlast [kg]: 1.000	13.0460-4978.2	604978	BRE 23917 19,3 + WK + Zub
1.9 TD CAT	59	08/94→04/02	➔	11/01→ 03/02; Nutzlast [kg]: 1.000	13.0460-4980.2	604980	BRE 23921 20,3 - WE / - WK + Zub
1.9 TD	59	05/98→11/01	➔	01/00→ 10/01; Nutzlast [kg]: 1.000	13.0460-2850.2	602850	TRW 21797 19,7 + WK
			➔	→ 12/99; Nutzlast [kg]: 1.000	13.0460-2976.2	602976	TRW 21797 19,7 + WK
			➔	11/01→; Nutzlast [kg]: 1.000	13.0460-4978.2	604978	BRE 23917 19,3 + WK + Zub
			➔	11/01→; Nutzlast [kg]: 1.000	13.0460-4980.2	604980	BRE 23921 20,3 - WE / - WK + Zub
2.0	80	03/94→04/02	➔	01/00→ 10/01; Nutzlast ab [kg] 1.000 Nutzlast bis [kg] 1.400	13.0460-2850.2	602850	TRW 21797 19,7 + WK
			➔	01/00→ 10/01; Nutzlast [kg]: 1.800	13.0460-2852.2	602852	TRW 21799 19,7 + WK
			➔	→ 12/99; Nutzlast ab [kg] 1.000 Nutzlast bis [kg] 1.400	13.0460-2976.2	602976	TRW 21797 19,7 + WK
			➔	→ 12/99; Nutzlast [kg]: 1.800	13.0460-2977.2	602977	TRW 21799 19,7 + WK
			➔	11/01→ 03/02; Nutzlast ab [kg] 1.000 Nutzlast bis [kg] 1.400	13.0460-4978.2	604978	BRE 23917 19,3 + WK + Zub
			➔	11/01→ 03/02; Nutzlast [kg]: 1.800	13.0460-4979.2	604979	BRE 23919 19,3 + WK + Zub
			➔	11/01→ 03/02; Nutzlast ab [kg] 1.000 Nutzlast bis [kg] 1.800	13.0460-4980.2	604980	BRE 23921 20,3 - WE / - WK + Zub
2.0 JTD	62	07/01→04/02	➔	10/01→ 03/02; Nutzlast [kg]: 1.400	13.0460-4978.2	604978	BRE 23917 19,3 + WK + Zub
			➔	10/01→ 03/02; Nutzlast [kg]: 1.800	13.0460-4979.2	604979	BRE 23919 19,3 + WK + Zub
			➔	10/01→ 03/02; Nutzlast ab [kg] 1.400 Nutzlast bis [kg] 1.800	13.0460-4980.2	604980	BRE 23921 20,3 - WE / - WK + Zub
2.5 D	62	03/94→04/02	➔	01/00→ 10/01; Nutzlast [kg]: 1.400	13.0460-2850.2	602850	TRW 21797 19,7 + WK
			➔	01/00→ 10/01; Nutzlast [kg]: 1.800	13.0460-2852.2	602852	TRW 21799 19,7 + WK
			➔	→ 12/99; Nutzlast [kg]: 1.400	13.0460-2976.2	602976	TRW 21797 19,7 + WK
			➔	→ 12/99; Nutzlast [kg]: 1.800	13.0460-2977.2	602977	TRW 21799 19,7 + WK
			➔	11/01→ 03/02; Nutzlast [kg]: 1.400	13.0460-4978.2	604978	BRE 23917 19,3 + WK + Zub
			➔	11/01→ 03/02; Nutzlast [kg]: 1.800	13.0460-4979.2	604979	BRE 23919 19,3 + WK + Zub
			➔	11/01→ 03/02; Nutzlast ab [kg] 1.400 Nutzlast bis [kg] 1.800	13.0460-4980.2	604980	BRE 23921 20,3 - WE / - WK + Zub
2.5 D 4x4	80	03/94→04/02	➔	01/00→ 10/01; Nutzlast [kg]: 1.800	13.0460-2852.2	602852	TRW 21799 19,7 + WK
2.5 TDI	85	03/94→04/02	➔	→ 12/99; Nutzlast [kg]: 1.400	13.0460-2976.2	602976	TRW 21797 19,7 + WK
2.5 TDI 4x4	85	06/98→04/02	➔	→ 12/99; Nutzlast [kg]: 1.800	13.0460-2977.2	602977	TRW 21799 19,7 + WK
2.8 D	64	02/98→04/02	➔				
2.8 TDI	90	12/98→04/02	➔	11/01→ 03/02; Nutzlast [kg]: 1.400	13.0460-4978.2	604978	BRE 23917 19,3 + WK + Zub
↓							















	kw			 	! #						
<b>FIAT - DUCATO Pritsche/Fahrgestell (230_) 03/94→04/02</b>											
<b>Bremsbelagsatz, Scheibenbremse</b>											
2.5 D	62	03/94→04/02	←	11/01→ 03/02; Nutzlast [kg]: 1.800		<b>13.0460-4979.2 604979</b>	BRE 23919 19,3 + WK + Zub				
2.5 D 4x4	62	03/94→04/02	→	11/01→ 03/02; Nutzlast ab [kg] 1.400 Nutzlast bis [kg] 1.800		<b>13.0460-4980.2 604980</b>	BRE 23921 20,3 - WE / - WK + Zub				
2.5 TDI	80	03/94→04/02									
2.5 TDI	85	03/94→04/02									
2.5 TDI 4x4	85	06/98→04/02									
2.8 D	64	02/98→04/02									
2.8 TDI	90	12/98→04/02									
2.5 TD	80	06/94→08/98	←	Nutzlast [kg]: 1.400		<b>13.0460-2976.2 602976</b>	TRW 21797 19,7 + WK				
2.5 TD	85	06/94→04/98	←	Nutzlast [kg]: 1.800		<b>13.0460-2977.2 602977</b>	TRW 21799 19,7 + WK				
2.5 TD 4x4	85	11/94→04/98	←								
2.8 iDTD 4x4	90	05/98→09/01	←	01/00→; Nutzlast [kg]: 1.400		<b>13.0460-2850.2 602850</b>	TRW 21797 19,7 + WK				
			←	01/00→; Nutzlast [kg]: 1.800		<b>13.0460-2852.2 602852</b>	TRW 21799 19,7 + WK				
			←	→ 12/99; Nutzlast [kg]: 1.400		<b>13.0460-2976.2 602976</b>	TRW 21797 19,7 + WK				
			←	→ 12/99; Nutzlast [kg]: 1.800		<b>13.0460-2977.2 602977</b>	TRW 21799 19,7 + WK				
2.8 JTD	94	11/00→04/02	←	→ 10/01; Nutzlast [kg]: 1.400		<b>13.0460-2850.2 602850</b>	TRW 21797 19,7 + WK				
2.8 JTD	94	03/01→04/02	←	→ 10/01; Nutzlast [kg]: 1.800		<b>13.0460-2852.2 602852</b>	TRW 21799 19,7 + WK				
2.8 JTD 4x4	94	10/01→04/02	←								
			←					11/01→ 03/02; Nutzlast [kg]: 1.400		<b>13.0460-4978.2 604978</b>	BRE 23917 19,3 + WK + Zub
			←					11/01→ 03/02; Nutzlast [kg]: 1.800		<b>13.0460-4979.2 604979</b>	BRE 23919 19,3 + WK + Zub
			→					11/01→ 03/02; Nutzlast ab [kg] 1.400 Nutzlast bis [kg] 1.800		<b>13.0460-4980.2 604980</b>	BRE 23921 20,3 - WE / - WK + Zub
2.8 TD 4x4	64	05/98→11/01	←	01/00→ 09/01; Nutzlast [kg]: 1.400		<b>13.0460-2850.2 602850</b>	TRW 21797 19,7 + WK				
			←	01/00→ 10/01; Nutzlast [kg]: 1.800		<b>13.0460-2852.2 602852</b>	TRW 21799 19,7 + WK				
			←	→ 12/99; Nutzlast [kg]: 1.400		<b>13.0460-2976.2 602976</b>	TRW 21797 19,7 + WK				
			←	→ 12/99; Nutzlast [kg]: 1.800		<b>13.0460-2977.2 602977</b>	TRW 21799 19,7 + WK				
<b>Bremsscheibe</b>											
1.9 D	50	04/98→04/02	←	→ 10/01; Nutzlast [kg]: 1.000		<b>24.0118-0108.1 418108</b>	Ø 280 18 15,9				
1.9 D	51	03/94→04/02	←	11/01→ 03/02; Nutzlast [kg]: 1.000		<b>24.0124-0127.1 424127</b>	Ø 280 24 21,9 V				
1.9 TD	60	03/94→04/02	←								
1.9 TD	66	04/98→04/02	→								
1.9 TD CAT	59	08/94→04/02	→								
1.9 TD	59	05/98→11/01	←	→ 10/01; Nutzlast [kg]: 1.000		<b>24.0118-0108.1 418108</b>	Ø 280 18 15,9				
			←	11/01→; Nutzlast [kg]: 1.000		<b>24.0124-0127.1 424127</b>	Ø 280 24 21,9 V				
			→	11/01→; Nutzlast [kg]: 1.000		<b>24.0116-0124.1 416124</b>	Ø 280 16 14,2				
2.0	80	03/94→04/02	←	→ 10/01; Nutzlast ab [kg] 1.000 Nutzlast bis [kg] 1.400		<b>24.0118-0108.1 418108</b>	Ø 280 18 15,9				
			←	11/01→ 03/02; Nutzlast ab [kg] 1.000 Nutzlast bis [kg] 1.400		<b>24.0124-0127.1 424127</b>	Ø 280 24 21,9 V				
			←	11/01→ 03/02; Nutzlast [kg]: 1.800		<b>24.0124-0138.1 424138</b>	Ø 300 24 21,9 V				
			←	→ 10/01; Nutzlast [kg]: 1.800		<b>24.0124-0138.1 424138</b>	Ø 300 24 21,9 V				
			→	11/01→ 03/02; Nutzlast ab [kg] 1.000 Nutzlast bis [kg] 1.400		<b>24.0116-0124.1 416124</b>	Ø 280 16 14,2				
			→	11/01→ 03/02; Nutzlast [kg]: 1.800		<b>24.0116-0125.1 416125</b>	Ø 280 16 14,2				
2.0 JTD	62	07/01→04/02	←	10/01→ 03/02; Nutzlast [kg]: 1.400		<b>24.0124-0127.1 424127</b>	Ø 280 24 21,9 V				
			←	10/01→ 03/02; Nutzlast [kg]: 1.800		<b>24.0124-0138.1 424138</b>	Ø 300 24 21,9 V				
			→	10/01→ 03/02; Nutzlast [kg]: 1.400		<b>24.0116-0124.1 416124</b>	Ø 280 16 14,2				
			→	10/01→ 03/02; Nutzlast [kg]: 1.800		<b>24.0116-0125.1 416125</b>	Ø 280 16 14,2				
2.5 D	62	03/94→04/02	←	→ 10/01; Nutzlast [kg]: 1.400		<b>24.0118-0108.1 418108</b>	Ø 280 18 15,9				
			←	11/01→ 03/02; Nutzlast [kg]: 1.400		<b>24.0124-0127.1 424127</b>	Ø 280 24 21,9 V				
			←	11/01→ 03/02; Nutzlast [kg]: 1.800		<b>24.0124-0138.1 424138</b>	Ø 300 24 21,9 V				
			←	→ 10/01; Nutzlast [kg]: 1.800		<b>24.0124-0138.1 424138</b>	Ø 300 24 21,9 V				
			→	11/01→ 03/02; Nutzlast [kg]: 1.400		<b>24.0116-0124.1 416124</b>	Ø 280 16 14,2				
			→	11/01→ 03/02; Nutzlast [kg]: 1.800		<b>24.0116-0125.1 416125</b>	Ø 280 16 14,2				
2.5 TD	80	06/94→08/98	←	Nutzlast [kg]: 1.400		<b>24.0124-0127.1 424127</b>	Ø 280 24 21,9 V				
			←	Nutzlast [kg]: 1.800		<b>24.0124-0138.1 424138</b>	Ø 300 24 21,9 V				
2.5 TD 4x4	85	11/94→04/98	←								
2.8 iDTD 4x4	90	05/98→09/01	←								
2.5 TDI	80	03/94→04/02	←	11/01→ 03/02; Nutzlast [kg]: 1.400		<b>24.0124-0127.1 424127</b>	Ø 280 24 21,9 V				
2.5 TDI	85	03/94→04/02	←	→ 10/01; Nutzlast [kg]: 1.400		<b>24.0124-0127.1 424127</b>	Ø 280 24 21,9 V				
2.5 TDI 4x4	85	06/98→04/02	←								
2.8 JTD	94	11/00→04/02	←	11/01→ 03/02; Nutzlast [kg]: 1.800		<b>24.0124-0138.1 424138</b>	Ø 300 24 21,9 V				
2.8 JTD	94	03/01→04/02	←	→ 10/01; Nutzlast [kg]: 1.800		<b>24.0124-0138.1 424138</b>	Ø 300 24 21,9 V				
2.8 JTD 4x4	94	10/01→04/02	←								
2.8 TDI	90	12/98→04/02	→					11/01→ 03/02; Nutzlast [kg]: 1.400		<b>24.0116-0124.1 416124</b>	Ø 280 16 14,2
↓											













	kw				! #		
<b>FIAT - DUCATO Pritsche/Fahrgestell (230_) 03/94→04/02</b>							
 <b>Bremsscheibe</b>							
2.5 TDI	80	03/94→04/02	➔	11/01→ 03/02; Nutzlast [kg]: 1.800		24.0116-0125.1 416125	Ø 280 16 14,2
2.5 TDI	85	03/94→04/02					
2.5 TDI 4x4	85	06/98→04/02					
2.8 JTD	94	11/00→04/02					
2.8 JTD	94	03/01→04/02					
2.8 JTD 4x4	94	10/01→04/02					
2.8 TDI	90	12/98→04/02					
2.8 TD 4x4	64	05/98→11/01	➔	→ 09/01; Nutzlast [kg]: 1.400		24.0124-0127.1 424127	Ø 280 24 21,9 V
			➔	→ 09/01; Nutzlast [kg]: 1.800		24.0124-0138.1 424138	Ø 300 24 21,9 V
<b>FIAT - DUCATO Pritsche/Fahrgestell (244_) 04/02→</b>							
 <b>Bremsbelagsatz, Scheibenbremse</b>							
2.0	81	04/02→07/06	➔	Nutzlast ab [kg] 1.100 Nutzlast bis [kg] 1.500		13.0460-4978.2 604978	BRE 23917 19,3 + WK + Zub
2.0 JTD	62	04/02→07/06					
2.3 JTD	81	04/02→07/06	➔	Nutzlast bis [kg] 1.800		13.0460-4979.2 604979	BRE 23919 19,3 + WK + Zub
2.8 JTD	90	11/03→07/06					
2.8 JTD	94	04/02→07/06	➔	Nutzlast ab [kg] 1.100 Nutzlast bis [kg] 1.800		13.0460-4980.2 604980	BRE 23921 20,3 - WE / - WK + Zub
2.8 JTD 4x4	94	10/02→07/06					
2.8 JTD Power	107	05/04→07/06					
 <b>Bremsscheibe</b>							
2.0	81	04/02→07/06	➔	Nutzlast ab [kg] 1.100 Nutzlast bis [kg] 1.500		24.0124-0127.1 424127	Ø 280 24 21,9 V
2.0 JTD	62	04/02→07/06					
2.3 JTD	81	04/02→07/06	➔	Nutzlast [kg]: 1.800		24.0124-0138.1 424138	Ø 300 24 21,9 V
2.8 JTD	90	11/03→07/06					
2.8 JTD	94	04/02→07/06	➔	Nutzlast ab [kg] 1.100 Nutzlast bis [kg] 1.500		24.0116-0124.1 416124	Ø 280 16 14,2
2.8 JTD 4x4	94	10/02→07/06					
2.8 JTD Power	107	05/04→07/06	➔	Nutzlast [kg]: 1.800		24.0116-0125.1 416125	Ø 280 16 14,2
<b>FIAT - DUCATO Pritsche/Fahrgestell (250_, 290_) 07/06→</b>							
 <b>Bremsbelagsatz, Scheibenbremse</b>							
100 Multijet 2,2 D	74	07/06→	➔	Nutzlast 11Q/15Q; Nutzlast ab [kg] 1.100 Nutzlast bis [kg] 1.500		13.0460-4807.2 604807	BRE 24468 19,1 + WK + Zub
110 Multijet 2,3 D	83	10/11→					
115 Multijet 2,0 D	85	06/11→	➔	Nutzlast leicht 17Q; Nutzlast [kg]: 1.700; nicht für erhöhte Nutzlast		13.0460-4809.2 604809	BRE 24468 19,1 + WK + Zub
120 Multijet 2,3 D	88	07/06→					
120 Multijet 2,3 D 4x4	88	03/10→	➔	Nutzlast schwer 17Q; für erhöhte Nutzlast; Nutzlast [kg]: 1.700		13.0460-4810.2 604810	BRE 24466 19,1 + WK + Zub
140 Multijet 3,0 D	103	07/06→07/14					
140 Natural Power	100	04/09→					
150 Multijet 2,3 D	109	06/11→	➔	Nutzlast 20Q; Nutzlast [kg]: 2.000		13.0460-4811.2 604811	BRE 24466 19,1 + WK + Zub
150 Multijet 2,3 D	110	12/15→	➔	Nutzlast 11Q/15Q/17Q; Nutzlast ab [kg] 1.100 Nutzlast bis [kg] 1.700; Baumuster: 30/33/35		13.0460-4812.2 604812	BOS 24465 19,2 - WE / - WK + Zub
150 Multijet 3,0 D	107	04/10→					
160 Multijet 3,0 D	115	07/06→12/11					
160 Multijet 3,0 D	116	07/06→	➔	Nutzlast 20Q; Nutzlast [kg]: 2.000; für erhöhte Nutzlast; Baumuster: 40		13.0460-4890.2 604890	BRE + WK + Zub
180 Multijet 2,3 D	130	12/15→					
180 Multijet 3,0 D	130	06/11→					
110 Multijet 2,3 D	82	08/06→	➔	Nutzlast 11Q/15Q; Nutzlast ab [kg] 1.100 Nutzlast bis [kg] 1.500		13.0460-4807.2 604807	BRE 24468 19,1 + WK + Zub
			➔	Nutzlast leicht 17Q; Nutzlast [kg]: 1.700; nicht für erhöhte Nutzlast		13.0460-4809.2 604809	BRE 24468 19,1 + WK + Zub
			➔	Nutzlast schwer 17Q; für erhöhte Nutzlast; Nutzlast [kg]: 1.700		13.0460-4810.2 604810	BRE 24466 19,1 + WK + Zub
			➔	Nutzlast 20Q; Nutzlast [kg]: 2.000		13.0460-4811.2 604811	BRE 24466 19,1 + WK + Zub
			➔	Nutzlast 11Q/15Q/17Q; Nutzlast ab [kg] 1.100 Nutzlast bis [kg] 1.700; Baumuster: 30/33/35		13.0460-4812.2 604812	BOS 24465 19,2 - WE / - WK + Zub
			➔	06/11→; Nutzlast 20Q; Nutzlast [kg]: 2.000; Baumuster: 40; für erhöhte Nutzlast		13.0460-4890.2 604890	BRE + WK + Zub
130 Multijet 2,3 D	93	08/06→	➔	01/07→; Nutzlast 11Q/15Q; Nutzlast ab [kg] 1.100 Nutzlast bis [kg] 1.500		13.0460-4807.2 604807	BRE 24468 19,1 + WK + Zub
130 Multijet 2,3 D	96	07/06→	➔	01/07→; Nutzlast leicht 17Q; Nutzlast [kg]: 1.700; nicht für erhöhte Nutzlast		13.0460-4809.2 604809	BRE 24468 19,1 + WK + Zub
			➔	01/07→; Nutzlast schwer 17Q; Nutzlast [kg]: 1.700; für erhöhte Nutzlast		13.0460-4810.2 604810	BRE 24466 19,1 + WK + Zub
			➔	01/07→; Nutzlast 20Q; Nutzlast [kg]: 2.000		13.0460-4811.2 604811	BRE 24466 19,1 + WK + Zub
			➔	01/07→; Nutzlast 11Q/15Q/17Q; Nutzlast ab [kg] 1.100 Nutzlast bis [kg] 1.700; Baumuster: 30/33/35		13.0460-4812.2 604812	BOS 24465 19,2 - WE / - WK + Zub
			➔	01/07→; Nutzlast 20Q; Nutzlast [kg]: 2.000; für erhöhte Nutzlast; Baumuster: 40		13.0460-4890.2 604890	BRE + WK + Zub













	kw			 	! #		
<b>FIAT - DUCATO Pritsche/Fahrgestell (250_, 290_) 07/06→</b>							
 <b>Bremsscheibe</b>							
100 Multijet 2,2 D	74	07/06→	←	Nutzlast 11Q/15Q; Nutzlast ab [kg] 1.100		24.0124-0127.1 424127	Ø 280 24 21,9 V
110 Multijet 2,3 D	82	08/06→		Nutzlast bis [kg] 1.500			
110 Multijet 2,3 D	83	10/11→	←	Nutzlast schwer 17Q;		24.0124-0138.1 424138	Ø 300 24 21,9 V
115 Multijet 2,0 D	85	06/11→		Nutzlast [kg]: 1.700; für erhöhte Nutzlast			
120 Multijet 2,3 D	88	07/06→	←	Nutzlast leicht 17Q; Nutzlast [kg]: 1.700;		24.0128-0213.1 428213	Ø 280 28 25,9 V
120 Multijet 2,3 D 4x4	88	03/10→		nicht für erhöhte Nutzlast			
140 Multijet 3,0 D	103	07/06→07/14					
140 Natural Power	100	04/09→	←	Nutzlast 20Q; Nutzlast [kg]: 2.000		24.0132-0131.1 432131	Ø 300 32 29,9 V
150 Multijet 2,3 D	109	06/11→	→	Nutzlast 20Q; Nutzlast [kg]: 2.000		24.0116-0123.1 416123	Ø 300 16 14,2
150 Multijet 2,3 D	110	12/15→					
150 Multijet 3,0 D	107	04/10→	→	Nutzlast 11Q/15Q / leicht 17Q; Nutzlast		24.0116-0124.1 416124	Ø 280 16 14,2
160 Multijet 3,0 D	115	07/06→12/11		ab [kg] 1.100 Nutzlast bis [kg] 1.700;			
160 Multijet 3,0 D	116	07/06→		nicht für erhöhte Nutzlast			
180 Multijet 3,0 D	130	06/11→	→	Nutzlast schwer 17Q;		24.0116-0125.1 416125	Ø 280 16 14,2
				Nutzlast [kg]: 1.700; für erhöhte Nutzlast			
130 Multijet 2,3 D	93	08/06→	←	01/07→; Nutzlast 11Q/15Q; Nutzlast ab		24.0124-0127.1 424127	Ø 280 24 21,9 V
130 Multijet 2,3 D	96	07/06→		[kg] 1.100 Nutzlast bis [kg] 1.500			
			←	01/07→; Nutzlast schwer 17Q;		24.0124-0138.1 424138	Ø 300 24 21,9 V
				Nutzlast [kg]: 1.700; für erhöhte Nutzlast			
			←	01/07→; Nutzlast leicht 17Q;		24.0128-0213.1 428213	Ø 280 28 25,9 V
				Nutzlast [kg]: 1.700;			
				nicht für erhöhte Nutzlast			
			←	01/07→; Nutzlast 20Q;		24.0132-0131.1 432131	Ø 300 32 29,9 V
				Nutzlast [kg]: 2.000			
			→	01/07→; Nutzlast 20Q;		24.0116-0123.1 416123	Ø 300 16 14,2
				Nutzlast [kg]: 2.000			
			→	01/07→; Nutzlast 11Q/15Q / leicht 17Q;		24.0116-0124.1 416124	Ø 280 16 14,2
				Nutzlast ab [kg] 1.100 Nutzlast bis [kg]			
				1.700; nicht für erhöhte Nutzlast			
			→	01/07→; Nutzlast schwer 17Q;		24.0116-0125.1 416125	Ø 280 16 14,2
				Nutzlast [kg]: 1.700; für erhöhte Nutzlast			
180 Multijet 2,3 D	130	12/15→	←	Nutzlast 11Q/15Q; Nutzlast ab [kg] 1.100		24.0124-0127.1 424127	Ø 280 24 21,9 V
				Nutzlast bis [kg] 1.500			
			←	Nutzlast schwer 17Q;		24.0124-0138.1 424138	Ø 300 24 21,9 V
				Nutzlast [kg]: 1.700; für erhöhte Nutzlast			
			←	Nutzlast leicht 17Q; Nutzlast [kg]: 1.700;		24.0128-0213.1 428213	Ø 280 28 25,9 V
				nicht für erhöhte Nutzlast			
			←	Nutzlast 20Q; Nutzlast [kg]: 2.000		24.0132-0131.1 432131	Ø 300 32 29,9 V
			→	Nutzlast 20Q; Nutzlast [kg]: 2.000		24.0116-0123.1 416123	Ø 300 16 14,2
			→	Nutzlast schwer 17Q;		24.0116-0125.1 416125	Ø 280 16 14,2
				Nutzlast [kg]: 1.700; für erhöhte Nutzlast			
<b>FIAT - ELBA (146_) 10/85→12/97</b>							
 <b>Bremsbelagsatz, Scheibenbremse</b>							
1.5	49	01/92→12/96	←			13.0460-5409.2 605409	ATE 21193 18,0 - WE / - WK
1.5	55	01/92→12/96				13.0460-5410.2 605410	ATE 21193 18,0 + WK
1.6	69	01/94→12/96					
 <b>Bremsscheibe</b>							
1.5	49	01/92→12/96	←			24.0112-0122.1 412122	Ø 240 12 10,8
1.5	55	01/92→12/96					
1.6	69	01/94→12/96					
<b>FIAT - FIORINO Kasten/Kombi (225_) 01/07→</b>							
 <b>Bremsbelagsatz, Scheibenbremse</b>							
1.3 D Multijet	55	11/07→	←	09/08→; Schaltgetriebe		13.0460-3826.2 603826	BOS 23706 18,0 + WK + Zub
						13.0470-3826.2 LD3826	BOS 23706 18,0 + WK + Zub
							Ceramic
			←	09/08→; Halbautomatik		13.0460-3863.2 603863	BOS 23706 18,0 + WK + Zub
1.3 D Multijet	59	03/15→	←	Schaltgetriebe		13.0460-3826.2 603826	BOS 23706 18,0 + WK + Zub
						13.0470-3826.2 LD3826	BOS 23706 18,0 + WK + Zub
							Ceramic
			←	Halbautomatik		13.0460-3863.2 603863	BOS 23706 18,0 + WK + Zub
1.3 D Multijet	70	07/09→	←	07/10→		13.0460-3827.2 603827	BOS 23709 19,6 + WK + Zub
						13.0470-3827.2 LD3827	BOS 23709 19,6 + WK + Zub
							Ceramic
1.4	54	11/07→	←	09/08→; → 6446		13.0460-3826.2 603826	BOS 23706 18,0 + WK + Zub
						13.0470-3826.2 LD3826	BOS 23706 18,0 + WK + Zub
							Ceramic
			←	6447→		13.0460-3863.2 603863	BOS 23706 18,0 + WK + Zub
1.4	57	10/09→	←	→ 6446		13.0460-3826.2 603826	BOS 23706 18,0 + WK + Zub
↓							













	kw			 	! #		
<b>FIAT - FIORINO Kasten/Kombi (225_) 01/07→</b>							
 <b>Bremsbelagsatz, Scheibenbremse</b>							
1.4	57	10/09→	←	→ 6446		13.0470-3826.2 LD3826	BOS 23706 18,0 + WK + Zub Ceramic
			←	6447→		13.0460-3863.2 603863	BOS 23706 18,0 + WK + Zub
1.4 Natural Power	51	06/08→	←	10/09→; → 6446		13.0460-3826.2 603826	BOS 23706 18,0 + WK + Zub
1.4 Natural Power	57	06/08→				13.0470-3826.2 LD3826	BOS 23706 18,0 + WK + Zub Ceramic
			←	6447→		13.0460-3863.2 603863	BOS 23706 18,0 + WK + Zub
 <b>Bremsscheibe</b>							
1.3 D Multijet	55	11/07→	←	09/08→		24.0122-0197.1 422197	Ø 257,5 22 20,2 V
1.4	54	11/07→				24.0322-0197.1 522197	Ø 257,5 22 20,2 V
1.3 D Multijet	59	03/15→	←			24.0122-0197.1 422197	Ø 257,5 22 20,2 V
1.4	57	10/09→				24.0322-0197.1 522197	Ø 257,5 22 20,2 V
1.3 D Multijet	70	07/09→	←	07/10→		24.0122-0147.1 422147	Ø 284 22 20,2 V
1.4 Natural Power	51	06/08→	←	10/09→		24.0122-0197.1 422197	Ø 257,5 22 20,2 V
1.4 Natural Power	57	06/08→				24.0322-0197.1 522197	Ø 257,5 22 20,2 V
<b>FIAT - FIORINO Kasten (146_) 01/88→</b>							
 <b>Bremsbelagsatz, Scheibenbremse</b>							
1.4	52	11/92→10/96	←	09/93→		13.0460-7063.2 607063	ATE 21193 18,0 - WE / - WK
1.7 TD	46	11/96→05/00	←			13.0460-7063.2 607063	ATE 21193 18,0 - WE / - WK
60 1.7 D	42	05/88→10/96	←	09/88→ 08/93		13.0460-5409.2 605409	ATE 21193 18,0 - WE / - WK
60 1.7 D	44	05/88→05/00	←	09/93→		13.0460-7063.2 607063	ATE 21193 18,0 - WE / - WK
65 1.7 TD	46	01/97→05/01	←	→ 03/01		13.0460-7063.2 607063	ATE 21193 18,0 - WE / - WK
70 i.e. 1.4	49	05/94→05/01					
75 i.e. 1.6	55	10/93→05/01					
 <b>Bremsscheibe</b>							
1.4	52	11/92→10/96	←	09/93→		24.0112-0122.1 412122	Ø 240 12 10,8
1.7 TD	46	11/96→05/00	←			24.0112-0122.1 412122	Ø 240 12 10,8
60 1.7 D	42	05/88→10/96	←	09/93→		24.0112-0122.1 412122	Ø 240 12 10,8
60 1.7 D	44	05/88→05/00	←	09/88→ 08/93		24.0112-0122.1 412122	Ø 240 12 10,8
65 1.7 TD	46	01/97→05/01	←	→ 03/01		24.0112-0122.1 412122	Ø 240 12 10,8
70 i.e. 1.4	49	05/94→05/01					
75 i.e. 1.6	55	10/93→05/01					
<b>FIAT - FIORINO Pick up (146_) 01/88→05/01</b>							
 <b>Bremsbelagsatz, Scheibenbremse</b>							
1.4	49	05/94→05/01	←	→ 03/01		13.0460-7063.2 607063	ATE 21193 18,0 - WE / - WK
1.6	55	01/94→05/01					
1.7 TD	46	01/97→05/01					
1.4	52	10/93→10/96	←			13.0460-7063.2 607063	ATE 21193 18,0 - WE / - WK
1.7 D	42	10/93→10/99					
1.7 D	44	05/88→10/99	←	09/93→		13.0460-7063.2 607063	ATE 21193 18,0 - WE / - WK
 <b>Bremsscheibe</b>							
1.4	49	05/94→05/01	←	→ 03/01		24.0112-0122.1 412122	Ø 240 12 10,8
1.6	55	01/94→05/01					
1.7 TD	46	01/97→05/01					
1.4	52	10/93→10/96	←			24.0112-0122.1 412122	Ø 240 12 10,8
1.7 D	42	10/93→10/99					
1.7 D	44	05/88→10/99	←	09/93→		24.0112-0122.1 412122	Ø 240 12 10,8
<b>FIAT - FREEMONT (345_) 08/11→</b>							
 <b>Bremsbelagsatz, Scheibenbremse</b>							
2.0 JTD	100	08/11→	←	BRE		13.0460-2766.2 602766	BOS 24604 18,7 + WK + Zub
2.0 JTD	103	08/11→	→	BRF		13.0460-2771.2 602771	TRW 24822 15,7 + WK + Zub
2.0 JTD	120	08/11→					
2.0 JTD	125	08/11→					
2.0 JTD 4x4	120	08/11→					
2.0 JTD 4x4	125	08/11→					
2.4	125	08/11→					
3.6	206	08/11→					
3.6 4x4	206	08/11→					
↓							



	kw			 	! #		
<b>FIAT - FREEMONT (345_) 08/11→</b>							
 <b>Bremsscheibe</b>							
2.0 JTD	100	08/11→	←	BRF		24.0128-0263.1 428263	Ø 302 28 26,4 V
2.0 JTD	103	08/11→				24.0128-0290.1 428290	Ø 302 28 26,4 V
2.0 JTD	120	08/11→					
2.0 JTD	125	08/11→	→	BRF		24.0112-0199.1 412199	Ø 305 12 10,4
2.0 JTD 4x4	120	08/11→					
2.0 JTD 4x4	125	08/11→					
2.4	125	08/11→					
3.6	206	08/11→					
3.6 4x4	206	08/11→					
<b>FIAT - GRANDE PUNTO (199_) 06/05→</b>							
 <b>Bremsbelagsatz, Scheibenbremse</b>							
1.2	48	10/05→	←	→ 08/10		13.0460-3826.2 603826	BOS 23706 18,0 + WK + Zub
1.3 D Multijet	51	07/08→				13.0470-3826.2 LD3826	BOS 23706 18,0 + WK + Zub Ceramic
1.4 (199.AXB11, 199.AXB1A)	57	06/05→12/15					
			←	09/10→ 01/11		13.0460-3863.2 603863	BOS 23706 18,0 + WK + Zub
1.2	51	09/10→	←	→ 01/11		13.0460-3863.2 603863	BOS 23706 18,0 + WK + Zub
1.2 LPG	51	07/08→	←	09/10→ 01/11		13.0460-3863.2 603863	BOS 23706 18,0 + WK + Zub
1.3 D Multijet	55	10/05→					
1.3 D Multijet	56	06/09→	←	10/09→ 04/10		13.0460-3863.2 603863	BOS 23706 18,0 + WK + Zub
			←	09/10→ 01/11		13.0460-3863.2 603863	BOS 23706 18,0 + WK + Zub
			←	05/10→		13.0460-7288.2 607288	ATE 25429 17,5 + WK
						13.0470-7288.2 LD7288	ATE 25429 17,5 + WK Ceramic
			→	09/09→		13.0460-3862.2 603862	BOS 24349 17,6 + WK + Zub
1.3 D Multijet	62	04/10→	←	→ 01/11		13.0460-3864.2 603864	BOS 23709 19,6 + WK + Zub
1.3 D Multijet	66	10/05→	←	→ 01/11		13.0460-3827.2 603827	BOS 23709 19,6 + WK + Zub
						13.0470-3827.2 LD3827	BOS 23709 19,6 + WK + Zub Ceramic
1.4 (199AXB1A)	55	10/05→07/07	←			13.0460-3826.2 603826	BOS 23706 18,0 + WK + Zub
						13.0470-3826.2 LD3826	BOS 23706 18,0 + WK + Zub Ceramic
1.4 16V	70	10/05→	←	→ 01/11		13.0460-3826.2 603826	BOS 23706 18,0 + WK + Zub
1.4 16V	112	09/07→07/12				13.0470-3826.2 LD3826	BOS 23706 18,0 + WK + Zub Ceramic
1.4 LPG	57	12/08→					
1.4 Natural Power	57	07/08→					
1.4 T-Jet	88	09/07→	←	→ 01/11		13.0460-3827.2 603827	BOS 23709 19,6 + WK + Zub
1.6 D Multijet	88	07/08→				13.0470-3827.2 LD3827	BOS 23709 19,6 + WK + Zub Ceramic
1.9 D Multijet	88	10/05→					
			→	→ 01/11		13.0460-3828.2 603828	BOS 24349 17,5 - WE / - WK
						13.0470-3828.2 LD3828	BOS 24349 17,5 - WE / - WK Ceramic
1.9 D Multijet	85	06/06→12/09	←			13.0460-3827.2 603827	BOS 23709 19,6 + WK + Zub
						13.0470-3827.2 LD3827	BOS 23709 19,6 + WK + Zub Ceramic
			→			13.0460-3828.2 603828	BOS 24349 17,5 - WE / - WK
						13.0470-3828.2 LD3828	BOS 24349 17,5 - WE / - WK Ceramic
1.9 D Multijet	96	10/05→	←	02/06→ 01/11		13.0460-3827.2 603827	BOS 23709 19,6 + WK + Zub
						13.0470-3827.2 LD3827	BOS 23709 19,6 + WK + Zub Ceramic
			→	02/06→ 01/11		13.0460-3828.2 603828	BOS 24349 17,5 - WE / - WK
						13.0470-3828.2 LD3828	BOS 24349 17,5 - WE / - WK Ceramic
 <b>Bremsscheibe</b>							
1.2	48	10/05→	←	→ 01/11		24.0112-0184.1 412184	Ø 257 12 10 + S
						24.0122-0231.1 422231	Ø 257 22 20 V + S
						24.0322-0231.1 522231	Ø 257 22 20 V + S
1.2	51	09/10→	←	→ 01/11		24.0122-0231.1 422231	Ø 257 22 20 V + S
1.3 D Multijet	51	07/08→				24.0322-0231.1 522231	Ø 257 22 20 V + S
1.4 (199.AXB11, 199.AXB1A)	57	06/05→12/15					
1.4 16V	70	10/05→					
1.4 16V	112	09/07→07/12					
1.4 LPG	57	12/08→					
1.4 Natural Power	57	07/08→					
1.2 LPG	51	07/08→	←	09/10→ 01/11		24.0122-0231.1 422231	Ø 257 22 20 V + S
						24.0322-0231.1 522231	Ø 257 22 20 V + S
1.3 D Multijet	55	10/05→	←	04/08→ 01/11		24.0122-0231.1 422231	Ø 257 22 20 V + S

	kw			 	! #		
<b>FIAT - GRANDE PUNTO (199_) 06/05→</b>							
 <b>Bremsscheibe</b>							
1.3 D Multijet	55	10/05→	←	04/08→ 01/11		24.0322-0231.1 522231	Ø 257 22 20 V + S
1.3 D Multijet	56	06/09→	←	10/09→		24.0122-0231.1 422231	Ø 257 22 20 V + S
				→ 01/11		24.0322-0231.1 522231	Ø 257 22 20 V + S
						24.0122-0231.1 422231	Ø 257 22 20 V + S
						24.0322-0231.1 522231	Ø 257 22 20 V + S
		09/09→	→			24.0110-0323.1 410323	Ø 264 10 8
1.3 D Multijet	62	04/10→	←	→ 01/11		24.0122-0241.1 422241	Ø 284 22 20 V + S
1.3 D Multijet	66	10/05→					
1.4 (199AXB1A)	55	10/05→07/07	←			24.0122-0231.1 422231	Ø 257 22 20 V + S
						24.0322-0231.1 522231	Ø 257 22 20 V + S
1.4 T-Jet	88	09/07→	←	→ 01/11		24.0122-0241.1 422241	Ø 284 22 20 V + S
1.6 D Multijet	88	07/08→					
1.9 D Multijet	88	10/05→	→	→ 01/11		24.0110-0323.1 410323	Ø 264 10 8
1.9 D Multijet	85	06/06→12/09	←			24.0122-0241.1 422241	Ø 284 22 20 V + S
						24.0110-0323.1 410323	Ø 264 10 8
1.9 D Multijet	96	10/05→	←	02/06→ 01/11		24.0122-0241.1 422241	Ø 284 22 20 V + S
				02/06→ 01/11		24.0110-0323.1 410323	Ø 264 10 8
<b>FIAT - GRANDE PUNTO Van (199_) 10/05→06/13</b>							
 <b>Bremsbelagsatz, Scheibenbremse</b>							
1.3 JTD Multijet	55	02/06→06/13	←	→ 01/11		13.0460-3827.2 603827	BOS 23709 19,6 + WK + Zub
						13.0470-3827.2 LD3827	BOS 23709 19,6 + WK + Zub Ceramic
 <b>Bremsscheibe</b>							
1.3 JTD Multijet	55	02/06→06/13	←	→ 01/11		24.0122-0241.1 422241	Ø 284 22 20 V + S
<b>FIAT - IDEA (350_) 12/03→</b>							
 <b>Bremsbelagsatz, Scheibenbremse</b>							
1.2 16V	59	01/04→	←	→ 02/08		13.0460-3810.2 603810	BOS 23705 18,1 - WE / - WK
1.4 16V	70	01/04→				13.0460-3818.2 603818	BOS 23706 18,1 + WK
1.3 D Multijet	51	01/04→	←	→ 07/12		13.0460-3810.2 603810	BOS 23705 18,1 - WE / - WK
1.3 D Multijet	66	10/05→	←	11/05→ 02/08		13.0460-3811.2 603811	BOS 23708 19,2 - WE / - WK
						13.0460-3827.2 603827	BOS 23709 19,6 + WK + Zub
						13.0470-3827.2 LD3827	BOS 23709 19,6 + WK + Zub Ceramic
1.3 D Multijet	70	05/08→12/12	←	→ 07/12		13.0460-3811.2 603811	BOS 23708 19,2 - WE / - WK
						13.0460-3827.2 603827	BOS 23709 19,6 + WK + Zub
						13.0470-3827.2 LD3827	BOS 23709 19,6 + WK + Zub Ceramic
1.4	57	10/05→	←	11/05→ 02/08		13.0460-3810.2 603810	BOS 23705 18,1 - WE / - WK
						13.0460-3818.2 603818	BOS 23706 18,1 + WK
1.4	66	12/03→	←	01/04→ 02/08		13.0460-3810.2 603810	BOS 23705 18,1 - WE / - WK
						13.0460-3818.2 603818	BOS 23706 18,1 + WK
1.6 D Multijet	85	11/08→12/10	←			13.0460-3811.2 603811	BOS 23708 19,2 - WE / - WK
						13.0460-3827.2 603827	BOS 23709 19,6 + WK + Zub
						13.0470-3827.2 LD3827	BOS 23709 19,6 + WK + Zub Ceramic
			→			13.0460-2879.2 602879	TRW 23601 13,7 - WE / - WK
						13.0470-2879.2 LD2879	TRW 23601 13,7 - WE / - WK Ceramic
1.6 D Multijet	88	05/08→	←	→ 07/12		13.0460-3811.2 603811	BOS 23708 19,2 - WE / - WK
						13.0460-3827.2 603827	BOS 23709 19,6 + WK + Zub
						13.0470-3827.2 LD3827	BOS 23709 19,6 + WK + Zub Ceramic
			→	→ 07/12		13.0460-2879.2 602879	TRW 23601 13,7 - WE / - WK
						13.0470-2879.2 LD2879	TRW 23601 13,7 - WE / - WK Ceramic
1.8	81	01/08→07/10	←			13.0460-3810.2 603810	BOS 23705 18,1 - WE / - WK
						13.0460-3818.2 603818	BOS 23706 18,1 + WK
			→			13.0460-2879.2 602879	TRW 23601 13,7 - WE / - WK
						13.0470-2879.2 LD2879	TRW 23601 13,7 - WE / - WK Ceramic
↓							



	kw			 	! #		
<b>FIAT - IDEA (350_) 12/03→</b>							
 <b>Bremsbelagsatz, Scheibenbremse</b>							
1.9 JTD	74	01/04→	←	→ 02/08		13.0460-3811.2 603811 13.0460-3827.2 603827 13.0470-3827.2 LD3827	BOS 23708 19,2 - WE / - WK BOS 23709 19,6 + WK + Zub BOS 23709 19,6 + WK + Zub Ceramic
 <b>Bremsscheibe</b>							
1.2 16V 1.4 16V	59 70	01/04→ 01/04→	←	→ 02/08		24.0122-0197.1 422197 24.0322-0197.1 522197	Ø 257,5 22 20,2 V Ø 257,5 22 20,2 V
1.3 D Multijet 1.4 LPG	51 57	01/04→ 03/09→	←	→ 07/12		24.0122-0197.1 422197 24.0322-0197.1 522197	Ø 257,5 22 20,2 V Ø 257,5 22 20,2 V
1.3 D Multijet	66	10/05→	←	11/05→ 02/08		24.0122-0147.1 422147	Ø 284 22 20,2 V
1.3 D Multijet	70	05/08→12/12	←	→ 07/12		24.0122-0147.1 422147	Ø 284 22 20,2 V
1.4	57	10/05→	←	11/05→ 02/08		24.0122-0197.1 422197 24.0322-0197.1 522197	Ø 257,5 22 20,2 V Ø 257,5 22 20,2 V
1.4	66	12/03→	←	01/04→ 02/08		24.0122-0197.1 422197 24.0322-0197.1 522197	Ø 257,5 22 20,2 V Ø 257,5 22 20,2 V
1.6 D Multijet	85	11/08→12/10	←			24.0122-0147.1 422147 24.0111-0119.1 411119	Ø 284 22 20,2 V Ø 240,5 11 9,2
1.6 D Multijet	88	05/08→	←	→ 07/12		24.0122-0147.1 422147	Ø 284 22 20,2 V
			→	→ 07/12		24.0111-0119.1 411119	Ø 240,5 11 9,2
1.8	81	01/08→07/10	←			24.0122-0197.1 422197 24.0322-0197.1 522197	Ø 257,5 22 20,2 V Ø 257,5 22 20,2 V
			→			24.0111-0119.1 411119	Ø 240,5 11 9,2
1.9 JTD	74	01/04→	←	→ 02/08		24.0122-0147.1 422147	Ø 284 22 20,2 V
<b>FIAT - LINEA (323_, 110_) 06/07→</b>							
 <b>Bremsbelagsatz, Scheibenbremse</b>							
1.3 D Multijet 1.4	66 57	06/07→ 06/07→	←	07/07→ 05/11		13.0460-3818.2 603818 13.0460-3826.2 603826 13.0460-3863.2 603863 13.0470-3826.2 LD3826	BOS 23706 18,1 + WK BOS 23706 18,0 + WK + Zub BOS 23706 18,0 + WK + Zub BOS 23706 18,0 + WK + Zub Ceramic
1.3 D Multijet	70	09/09→	←	→ 05/11		13.0460-3818.2 603818 13.0460-3826.2 603826 13.0460-3863.2 603863 13.0470-3826.2 LD3826	BOS 23706 18,1 + WK BOS 23706 18,0 + WK + Zub BOS 23706 18,0 + WK + Zub BOS 23706 18,0 + WK + Zub Ceramic
1.4 T-Jet 1.6 (323.AXD1A) 1.6 D Multijet 1.9 16V	88 80 77 94	09/07→ 07/08→ 06/09→ 07/08→	←	→ 05/11		13.0460-3827.2 603827 13.0470-3827.2 LD3827	BOS 23709 19,6 + WK + Zub BOS 23709 19,6 + WK + Zub Ceramic
			→	→ 05/11		13.0460-2867.2 602867 13.0470-2867.2 LD2867	TRW 23517 16,6 - WE / - WK TRW 23517 16,6 - WE / - WK Ceramic
 <b>Bremsscheibe</b>							
1.3 D Multijet 1.4	66 57	06/07→ 06/07→	←	07/07→ 05/11		24.0122-0197.1 422197 24.0322-0197.1 522197	Ø 257,5 22 20,2 V Ø 257,5 22 20,2 V
1.3 D Multijet	70	09/09→	←	→ 05/11		24.0122-0197.1 422197 24.0322-0197.1 522197	Ø 257,5 22 20,2 V Ø 257,5 22 20,2 V
1.4 T-Jet 1.6 (323.AXD1A) 1.6 D Multijet 1.9 16V	88 80 77 94	09/07→ 07/08→ 06/09→ 07/08→	←	→ 05/11		24.0122-0147.1 422147	Ø 284 22 20,2 V
			→	→ 05/11		24.0110-0190.1 410190	Ø 251,5 10 9
<b>FIAT - MAREA (185_) 05/96→12/07</b>							
 <b>Bremsbelagsatz, Scheibenbremse</b>							
1.2 16V	60	10/98→05/02	←	04/99→		13.0460-7064.2 607064	ATE 21930 17,9 + WK
1.4 80 12V 1.6 1.6 1.6 100 16V 1.6 100 16V Bipower 1.6 16V 1.6 SX 1.9 TD 75	59 68 76 76 76 75 72 55	09/96→05/02 03/99→08/00 09/00→08/02 09/96→05/02 04/99→05/02 04/97→02/99 09/00→08/02 09/96→05/02	←			13.0460-7064.2 607064	ATE 21930 17,9 + WK



**FIAT - MAREA (185\_) 05/96→12/07**

**Bremsbelagsatz, Scheibenbremse**

1.8 115 16V 1.9 JTD 105 (185AXN1A) 1.9 JTD 110 (185AXT1A) 1.9 TD 100 (185AX_)	83 77 81 74	09/96→05/02 12/98→12/02 09/00→08/02 05/96→12/02	←			13.0460-7065.2	607065	ATE 21927 17,9 + WK
1.9 JTD	79	01/01→12/07	←	→ 12/02		13.0460-7065.2	607065	ATE 21927 17,9 + WK
2.0 150 20V 2.4 TD 125	108 91	09/96→04/99 09/96→04/99	←			13.0460-7069.2	607069	ATE 21636 19,3 + WK
			→	ALU		13.0460-2826.2	602826	TRW 23177 14,2 - WK
			→	GG		13.0460-2951.2	602951	TRW 21103 14,2 - WK
2.0 150 20V 2.4 JTD 130	110 96	01/01→05/02 04/99→05/02	←			13.0460-7140.2	607140	ATE 21637 19,3 + WK
			→	ALU		13.0470-7140.2	LD7140	ATE 21637 19,3 + WK Ceramic
			→	GG		13.0460-2826.2	602826	TRW 23177 14,2 - WK
2.0 155 20V	113	04/99→01/01	←	→ 04/99		13.0460-7069.2	607069	ATE 21636 19,3 + WK
			←	05/99→		13.0460-7140.2	607140	ATE 21637 19,3 + WK
			→			13.0470-7140.2	LD7140	ATE 21637 19,3 + WK Ceramic
			→	ALU		13.0460-2826.2	602826	TRW 23177 14,2 - WK
			→	GG		13.0460-2951.2	602951	TRW 21103 14,2 - WK

**Zubehörsatz, Scheibenbremsbelag**

2.0 150 20V 2.0 150 20V 2.0 155 20V 2.4 JTD 130 2.4 TD 125	108 110 113 96 91	09/96→04/99 01/01→05/02 04/99→01/01 04/99→05/02 09/96→04/99	→	GG		13.0460-0072.2	610072	TRW
--	-------------------------------	---	---	----	--	----------------	--------	-----











**Bremsscheibe**

1.2 16V	60	10/98→05/02	←	04/99→		24.0112-0127.1	412127	Ø 257,5 12 10,2
1.4 80 12V 1.6 1.6 1.6 100 16V 1.6 100 16V Bipower 1.6 16V 1.6 SX 1.9 TD 75	59	09/96→05/02	←			24.0112-0127.1	412127	Ø 257,5 12 10,2
	68	03/99→08/00						
	76	09/00→08/02						
	76	09/96→05/02						
	76	04/99→05/02						
	75	04/97→02/99						
	72	09/00→08/02						
	55	09/96→05/02						
1.8 115 16V 1.9 JTD 105 (185AXN1A) 1.9 JTD 110 (185AXT1A) 1.9 TD 100 (185AX_)	83	09/96→05/02	←			24.0120-0142.1	420142	Ø 257,5 20 18,2 V
	77	12/98→12/02				24.0320-0142.1	520142	Ø 257,5 20 18,2 V
	81	09/00→08/02						
	74	05/96→12/02						
1.9 JTD	79	01/01→12/07	←	→ 12/02		24.0120-0142.1	420142	Ø 257,5 20 18,2 V
						24.0320-0142.1	520142	Ø 257,5 20 18,2 V
2.0 150 20V 2.0 150 20V 2.0 155 20V 2.4 JTD 130 2.4 TD 125	108	09/96→04/99	←			24.0122-0147.1	422147	Ø 284 22 20,2 V
	110	01/01→05/02						
	113	04/99→01/01	→			24.0111-0119.1	411119	Ø 240,5 11 9,2
	96	04/99→05/02						
	91	09/96→04/99						

**FIAT - MAREA Weekend (185\_) 09/96→12/07**

**Bremsbelagsatz, Scheibenbremse**

1.2 16V	60	10/98→05/02	←	04/99→		13.0460-7065.2	607065	ATE 21927 17,9 + WK
1.4 80 12V 1.9 TD 75	59	09/96→05/02	←			13.0460-7064.2	607064	ATE 21930 17,9 + WK
	55	09/96→05/02						
1.6 1.6 100 16V 1.8 115 16V 1.9 JTD 105 (185BXN1A) 1.9 JTD 110 (185BXT1A) 1.9 TD 100 (185BX_)	76	09/00→08/02	←			13.0460-7065.2	607065	ATE 21927 17,9 + WK
	76	09/96→05/02						
	83	09/96→05/02						
	77	12/98→12/02						
	81	09/00→08/02						
	74	09/96→06/03						
1.9 JTD	79	01/01→12/07	←	→ 12/02		13.0460-7065.2	607065	ATE 21927 17,9 + WK
2.0 150 20V 2.4 TD 125	108 91	09/96→04/99 09/96→04/99	←			13.0460-7069.2	607069	ATE 21636 19,3 + WK
			→	ALU		13.0460-2826.2	602826	TRW 23177 14,2 - WK
			→	GG		13.0460-2951.2	602951	TRW 21103 14,2 - WK
2.0 150 20V 2.4 JTD 130	110 96	01/01→05/02 04/99→05/02	←			13.0460-7140.2	607140	ATE 21637 19,3 + WK

	kW			 	! #		
<b>FIAT - MAREA Weekend (185_) 09/96→12/07</b>							
 <b>Bremsbelagsatz, Scheibenbremse</b>							
2.0 150 20V 2.4 JTD 130	110 96	01/01→05/02 04/99→05/02	←			<b>13.0470-7140.2 LD7140</b>	ATE 21637 19,3 + WK Ceramic
			→	ALU		<b>13.0460-2826.2 602826</b>	TRW 23177 14,2 - WK
			→	GG		<b>13.0460-2951.2 602951</b>	TRW 21103 14,2 - WK
2.0 155 20V	113	04/99→02/03	←	→ 04/99		<b>13.0460-7069.2 607069</b>	ATE 21636 19,3 + WK
			←	05/99→ 12/02		<b>13.0460-7140.2 607140</b>	ATE 21637 19,3 + WK
						<b>13.0470-7140.2 LD7140</b>	ATE 21637 19,3 + WK Ceramic
			→	→ 12/02; ALU		<b>13.0460-2826.2 602826</b>	TRW 23177 14,2 - WK
			→	→ 12/02; GG		<b>13.0460-2951.2 602951</b>	TRW 21103 14,2 - WK
<b>Zubehörsatz, Scheibenbremsbelag</b>							
2.0 150 20V 2.0 150 20V 2.4 JTD 130 2.4 TD 125	108 110 96 91	09/96→04/99 01/01→05/02 04/99→05/02 09/96→04/99	→	GG		<b>13.0460-0072.2 610072</b>	TRW
2.0 155 20V	113	04/99→02/03	→	→ 12/02; GG		<b>13.0460-0072.2 610072</b>	TRW
 <b>Bremsscheibe</b>							
1.2 16V	60	10/98→05/02	←	04/99→		<b>24.0120-0142.1 420142</b>	Ø 257,5 20 18,2 V
						<b>24.0320-0142.1 520142</b>	Ø 257,5 20 18,2 V
1.4 80 12V 1.9 TD 75	59 55	09/96→05/02 09/96→05/02	←			<b>24.0112-0127.1 412127</b>	Ø 257,5 12 10,2
1.6 1.6 100 16V 1.8 115 16V 1.9 JTD 105 (185BXN1A) 1.9 JTD 110 (185BXT1A) 1.9 TD 100 (185BX_)	76 76 83 77 81 74	09/00→08/02 09/96→05/02 09/96→05/02 12/98→12/02 09/00→08/02 09/96→06/03	←			<b>24.0120-0142.1 420142</b>	Ø 257,5 20 18,2 V
						<b>24.0320-0142.1 520142</b>	Ø 257,5 20 18,2 V
1.9 JTD	79	01/01→12/07	←	→ 12/02		<b>24.0120-0142.1 420142</b>	Ø 257,5 20 18,2 V
						<b>24.0320-0142.1 520142</b>	Ø 257,5 20 18,2 V
2.0 150 20V 2.0 150 20V 2.4 JTD 130 2.4 TD 125	108 110 96 91	09/96→04/99 01/01→05/02 04/99→05/02 09/96→04/99	←			<b>24.0122-0147.1 422147</b>	Ø 284 22 20,2 V
			→			<b>24.0111-0119.1 411119</b>	Ø 240,5 11 9,2
2.0 155 20V	113	04/99→02/03	←	→ 12/02		<b>24.0122-0147.1 422147</b>	Ø 284 22 20,2 V
			→	→ 12/02		<b>24.0111-0119.1 411119</b>	Ø 240,5 11 9,2
<b>FIAT - MULTIPLA (186_) 04/99→06/10</b>							
 <b>Bremsbelagsatz, Scheibenbremse</b>							
1.6 1.6 1.6	68 74 76	05/04→08/05 03/01→08/05 09/00→06/10	←			<b>13.0460-7069.2 607069</b>	ATE 21636 19,3 + WK
						<b>13.0460-7140.2 607140</b>	ATE 21637 19,3 + WK
						<b>13.0470-7140.2 LD7140</b>	ATE 21637 19,3 + WK Ceramic
			→			<b>13.0460-3991.2 603991</b>	BOS 23714 16,6 - WE / - WK
1.6 100 16V (186AXA1A) 1.6 16V GPL 1.9 JTD 105 (186AXB1A)	76 76 77	04/99→06/10 10/01→06/10 04/99→06/10	←	10/04→		<b>13.0460-3827.2 603827</b>	BOS 23709 19,6 + WK + Zub
						<b>13.0470-3827.2 LD3827</b>	BOS 23709 19,6 + WK + Zub Ceramic
			←	→ 09/04		<b>13.0460-7069.2 607069</b>	ATE 21636 19,3 + WK
						<b>13.0460-7140.2 607140</b>	ATE 21637 19,3 + WK
						<b>13.0470-7140.2 LD7140</b>	ATE 21637 19,3 + WK Ceramic
			→	12/05→		<b>13.0460-3861.2 603861</b>	BOS 23714 17,6 + WK + Zub
						<b>13.0460-3991.2 603991</b>	BOS 23714 16,6 - WE / - WK
						<b>13.0470-3861.2 LD3861</b>	BOS + WK + Zub Ceramic
			→	04/02→ 11/05		<b>13.0460-3991.2 603991</b>	BOS 23714 16,6 - WE / - WK
1.6 16V (186AGB1A) 1.6 16V Blupower (186AMA1A)	70 70	04/02→06/10 04/99→06/10	←			<b>13.0460-3827.2 603827</b>	BOS 23709 19,6 + WK + Zub
						<b>13.0470-3827.2 LD3827</b>	BOS 23709 19,6 + WK + Zub Ceramic
			→			<b>13.0460-3861.2 603861</b>	BOS 23714 17,6 + WK + Zub
						<b>13.0460-3991.2 603991</b>	BOS 23714 16,6 - WE / - WK
						<b>13.0470-3861.2 LD3861</b>	BOS + WK + Zub Ceramic
1.6 16V Bipower (186AMB1A) 1.6 16V Bipower (186AXC1A)	76 76	04/99→06/10 10/01→06/10	←	2232224→		<b>13.0460-3827.2 603827</b>	BOS 23709 19,6 + WK + Zub
						<b>13.0470-3827.2 LD3827</b>	BOS 23709 19,6 + WK + Zub Ceramic
			←	→ 2232223		<b>13.0460-7069.2 607069</b>	ATE 21636 19,3 + WK
						<b>13.0460-7140.2 607140</b>	ATE 21637 19,3 + WK

### FIAT - MULTIPLA (186\_) 04/99→06/10

#### Bremsbelagsatz, Scheibenbremse

1.6 16V Bipower (186AMB1A) 1.6 16V Bipower (186AXC1A)	76	04/99→06/10	←	→ 2232223		<b>13.0470-7140.2</b>	<b>LD7140</b>	ATE 21637 19,3 + WK Ceramic
	76	10/01→06/10	→			<b>13.0460-3861.2</b>	<b>603861</b>	BOS 23714 17,6 + WK + Zub
						<b>13.0460-3991.2</b>	<b>603991</b>	BOS 23714 16,6 - WE / - WK
						<b>13.0470-3861.2</b>	<b>LD3861</b>	BOS + WK + Zub Ceramic
1.9 JTD (186AXE1A) 1.9 JTD 115	88	04/02→06/10	←	10/04→		<b>13.0460-3827.2</b>	<b>603827</b>	BOS 23709 19,6 + WK + Zub
	85	07/02→06/10				<b>13.0470-3827.2</b>	<b>LD3827</b>	BOS 23709 19,6 + WK + Zub Ceramic
			←	→ 09/04		<b>13.0460-7069.2</b>	<b>607069</b>	ATE 21636 19,3 + WK
						<b>13.0460-7140.2</b>	<b>607140</b>	ATE 21637 19,3 + WK
						<b>13.0470-7140.2</b>	<b>LD7140</b>	ATE 21637 19,3 + WK Ceramic
			→	12/05→		<b>13.0460-3861.2</b>	<b>603861</b>	BOS 23714 17,6 + WK + Zub
						<b>13.0460-3991.2</b>	<b>603991</b>	BOS 23714 16,6 - WE / - WK
			→	11/05		<b>13.0460-3991.2</b>	<b>603991</b>	BOS 23714 16,6 - WE / - WK
1.9 JTD 110	81	03/01→07/02	←			<b>13.0460-7069.2</b>	<b>607069</b>	ATE 21636 19,3 + WK
						<b>13.0460-7140.2</b>	<b>607140</b>	ATE 21637 19,3 + WK
						<b>13.0470-7140.2</b>	<b>LD7140</b>	ATE 21637 19,3 + WK Ceramic
			→	04/02→		<b>13.0460-3991.2</b>	<b>603991</b>	BOS 23714 16,6 - WE / - WK

#### Zubehörsatz, Scheibenbremsbelag

1.6	68	05/04→08/05	→			<b>13.0460-0256.2</b>	<b>610256</b>	BOS
	74	03/01→08/05						
	76	09/00→06/10						
1.6 100 16V (186AXA1A)	76	04/99→06/10	→	04/02→ 11/05		<b>13.0460-0256.2</b>	<b>610256</b>	BOS
	76	10/01→06/10						
1.6 16V GPL	77	04/99→06/10						
1.9 JTD 105 (186AXB1A)								
1.9 JTD (186AXE1A)	88	04/02→06/10	→	→ 11/05		<b>13.0460-0256.2</b>	<b>610256</b>	BOS
	85	07/02→06/10						
1.9 JTD 110	81	03/01→07/02	→	04/02→		<b>13.0460-0256.2</b>	<b>610256</b>	BOS











#### Bremsscheibe











1.6	68	05/04→08/05	←			<b>24.0122-0107.1</b>	<b>422107</b>	Ø 284 22 20,2 V
	74	03/01→08/05						
	76	09/00→06/10	→			<b>24.0110-0190.1</b>	<b>410190</b>	Ø 251,5 10 9
1.6 16V (186AGB1A)	70	04/02→06/10						
	76	04/99→06/10						
1.6 16V Bipower (186AMB1A)	76	10/01→06/10						
	76	04/99→06/10						
1.6 16V Blupower (186AMA1A)	70	04/99→06/10						
1.9 JTD (186AXE1A)	88	04/02→06/10						
	85	07/02→06/10						
1.6 100 16V (186AXA1A)	76	04/99→06/10	←			<b>24.0122-0107.1</b>	<b>422107</b>	Ø 284 22 20,2 V
	76	10/01→06/10	→	04/02→		<b>24.0110-0190.1</b>	<b>410190</b>	Ø 251,5 10 9
1.6 16V GPL (186AXB1A)	77	04/99→06/10						
1.9 JTD 110	81	03/01→07/02						

### FIAT - PALIO (178\_) 04/96→

#### Bremsbelagsatz, Scheibenbremse











1.0	45	04/96→10/03	←	→ 02/98		<b>13.0460-7113.2</b>	<b>607113</b>	ATE 23218 18,0 + WK
	56	04/96→10/03						
	40	07/97→10/03	←	12/98→		<b>13.0460-7126.2</b>	<b>607126</b>	ATE 20907 18,1 - WE / - WK
						<b>13.0460-7128.2</b>	<b>607128</b>	ATE 23218 18,0 + WK
1.2	44	07/97→08/02	←	10/97→ 02/98		<b>13.0460-7113.2</b>	<b>607113</b>	ATE 23218 18,0 + WK
	42	04/96→09/02	←	12/98→		<b>13.0460-7126.2</b>	<b>607126</b>	ATE 20907 18,1 - WE / - WK
			←	03/98→ 11/98		<b>13.0460-7128.2</b>	<b>607128</b>	ATE 23218 18,0 + WK
1.2	50	06/99→10/00	←			<b>13.0460-7126.2</b>	<b>607126</b>	ATE 20907 18,1 - WE / - WK
1.2	54	06/98→	←	12/98→ 12/06		<b>13.0460-7126.2</b>	<b>607126</b>	ATE 20907 18,1 - WE / - WK
			←	→ 11/98		<b>13.0460-7128.2</b>	<b>607128</b>	ATE 23218 18,0 + WK
1.2	59	09/01→	←	→ 12/06		<b>13.0460-7126.2</b>	<b>607126</b>	ATE 20907 18,1 - WE / - WK
	62	06/04→						
	51	10/02→01/12						
1.7 TD	53	09/01→						
1.3 JTD Multijet	51	06/03→	←	09/03→ 12/06		<b>13.0460-7126.2</b>	<b>607126</b>	ATE 20907 18,1 - WE / - WK













	kw				! #		
<b>FIAT - PALIO (178_) 04/96→</b>							
 <b>Bremsbelagsatz, Scheibenbremse</b>							
1.4	51	04/96→10/02	←	04/98→		<b>13.0460-7128.2 607128</b>	ATE 23218 18,0 + WK
1.4 Cat	51	04/96→08/01				<b>13.0460-7132.2 607132</b>	ATE 23218 18,0 - WE / - WK
1.6 16V	74	04/96→10/02					
 <b>Bremsscheibe</b>							
1.0	45	04/96→10/03	←	12/98→		<b>24.0120-0142.1 420142</b>	Ø 257,5 20 18,2 V
1.0	56	04/96→10/03				<b>24.0320-0142.1 520142</b>	Ø 257,5 20 18,2 V
1.1	40	07/97→10/03	←	→ 11/98		<b>24.0120-0193.1 420193</b>	Ø 240 20 18,2 V
1.2	44	07/97→08/02	←	12/98→		<b>24.0120-0142.1 420142</b>	Ø 257,5 20 18,2 V
1.7 D	42	04/96→09/02	←	10/97→ 11/98		<b>24.0320-0142.1 520142</b>	Ø 257,5 20 18,2 V
			←			<b>24.0120-0193.1 420193</b>	Ø 240 20 18,2 V
1.2	50	06/99→10/00	←			<b>24.0120-0142.1 420142</b>	Ø 257,5 20 18,2 V
			←			<b>24.0320-0142.1 520142</b>	Ø 257,5 20 18,2 V
1.2	54	06/98→	←	12/98→ 12/06		<b>24.0120-0142.1 420142</b>	Ø 257,5 20 18,2 V
			←	→ 11/98		<b>24.0320-0142.1 520142</b>	Ø 257,5 20 18,2 V
			←			<b>24.0120-0193.1 420193</b>	Ø 240 20 18,2 V
1.2	59	09/01→	←	→ 12/06		<b>24.0120-0142.1 420142</b>	Ø 257,5 20 18,2 V
1.5	62	06/04→				<b>24.0320-0142.1 520142</b>	Ø 257,5 20 18,2 V
1.7 TD	51	10/02→01/12					
1.7 TD	53	09/01→					
1.3 JTD Multijet	51	06/03→	←	09/03→ 12/06		<b>24.0120-0142.1 420142</b>	Ø 257,5 20 18,2 V
			←			<b>24.0320-0142.1 520142</b>	Ø 257,5 20 18,2 V
1.4	51	04/96→10/02	←	02/98→ 03/98		<b>24.0112-0122.1 412122</b>	Ø 240 12 10,8
1.4 Cat	51	04/96→08/01	←	04/98→		<b>24.0120-0193.1 420193</b>	Ø 240 20 18,2 V
1.6 16V	74	04/96→10/02	←	02/98→		<b>24.0120-0193.1 420193</b>	Ø 240 20 18,2 V
<b>FIAT - PALIO Weekend (178_) 04/96→</b>							
 <b>Bremsbelagsatz, Scheibenbremse</b>							
1.2	44	07/97→10/04	←	10/97→ 02/98		<b>13.0460-7113.2 607113</b>	ATE 23218 18,0 + WK
1.2	54	04/96→02/01	←	12/98→		<b>13.0460-7126.2 607126</b>	ATE 20907 18,1 - WE / - WK
1.7 TD	51	04/96→03/01	←	03/98→ 11/98		<b>13.0460-7128.2 607128</b>	ATE 23218 18,0 + WK
1.2	50	06/99→10/02	←			<b>13.0460-7126.2 607126</b>	ATE 20907 18,1 - WE / - WK
1.2	59	09/01→	←	→ 12/06		<b>13.0460-7126.2 607126</b>	ATE 20907 18,1 - WE / - WK
1.5	62	02/02→					
1.6	78	02/01→					
1.6 16V	76	02/01→					
1.9 D	46	03/01→					
1.9 JTD	59	09/01→					
1.4	51	07/97→08/01	←	→ 02/98		<b>13.0460-7113.2 607113</b>	ATE 23218 18,0 + WK
			←	12/98→		<b>13.0460-7126.2 607126</b>	ATE 20907 18,1 - WE / - WK
			←	03/98→ 11/98		<b>13.0460-7128.2 607128</b>	ATE 23218 18,0 + WK
1.6 16V	74	04/96→02/01	←	10/97→ 09/00		<b>13.0460-7108.2 607108</b>	ATE 20907 18,1 + WK
			←	10/00→		<b>13.0460-7126.2 607126</b>	ATE 20907 18,1 - WE / - WK
 <b>Bremsscheibe</b>							
1.2	44	07/97→10/04	←	12/98→		<b>24.0120-0142.1 420142</b>	Ø 257,5 20 18,2 V
1.2	54	04/96→02/01				<b>24.0320-0142.1 520142</b>	Ø 257,5 20 18,2 V
1.7 TD	51	04/96→03/01	←	10/97→ 11/98		<b>24.0120-0193.1 420193</b>	Ø 240 20 18,2 V
1.2	50	06/99→10/02	←			<b>24.0120-0142.1 420142</b>	Ø 257,5 20 18,2 V
			←			<b>24.0320-0142.1 520142</b>	Ø 257,5 20 18,2 V
1.2	59	09/01→	←	→ 12/06		<b>24.0120-0142.1 420142</b>	Ø 257,5 20 18,2 V
1.5	62	02/02→				<b>24.0320-0142.1 520142</b>	Ø 257,5 20 18,2 V
1.6	78	02/01→					
1.6 16V	76	02/01→					
1.9 D	46	03/01→					
1.9 JTD	59	09/01→					
1.4	51	07/97→08/01	←	12/98→		<b>24.0120-0142.1 420142</b>	Ø 257,5 20 18,2 V
			←	→ 11/98		<b>24.0320-0142.1 520142</b>	Ø 257,5 20 18,2 V
			←			<b>24.0120-0193.1 420193</b>	Ø 240 20 18,2 V
1.6 16V	74	04/96→02/01	←	10/97→		<b>24.0120-0142.1 420142</b>	Ø 257,5 20 18,2 V
			←			<b>24.0320-0142.1 520142</b>	Ø 257,5 20 18,2 V

	kW			 	! #		
<b>FIAT - PANDA (141_) 03/80→07/04</b>							
 <b>Bremsbelagsatz, Scheibenbremse</b>							
1000 i.e. Cat	33	10/87→08/98	←			<b>13.0460-3939.2 603939</b>	BDX 20775 18,0 + WE / - WK
			←	→ 12/92		<b>13.0460-3939.2 603939</b>	BDX 20775 18,0 + WE / - WK
1100	37	05/91→12/99	←	Vollautomatik		<b>13.0460-2941.2 602941</b>	TRW 20838 17,0 + WK
			←	Schaltgetriebe		<b>13.0460-3939.2 603939</b>	BDX 20775 18,0 + WE / - WK
1100	40	02/95→09/03	←	→ 12/02; Vollautomatik		<b>13.0460-2941.2 602941</b>	TRW 20838 17,0 + WK
			←	→ 12/02; Schaltgetriebe		<b>13.0460-3939.2 603939</b>	BDX 20775 18,0 + WE / - WK
1100 4x4 1100 Trekking 4x4	40 37	02/95→07/04 10/91→07/04	←	→ 12/02		<b>13.0460-3939.2 603939</b>	BDX 20775 18,0 + WE / - WK
650	22	01/82→07/04	←	→ 08/82		<b>13.0460-3936.2 603936</b>	BDX 20073 17,3 - WE / - WK
			←	09/82→ 12/85		<b>13.0460-3939.2 603939</b>	BDX 20775 18,0 + WE / - WK
750	25	01/86→10/03	←	→ 12/97		<b>13.0460-3939.2 603939</b>	BDX 20775 18,0 + WE / - WK
900	29	04/92→12/96	←			<b>13.0460-3939.2 603939</b>	BDX 20775 18,0 + WE / - WK
<b>Zubehörsatz, Scheibenbremsbelag</b>							
1000 i.e. Cat	33	10/87→08/98	←			<b>13.0460-0410.2 610410</b>	BDX
			←	→ 12/92		<b>13.0460-0410.2 610410</b>	BDX
1100	37	05/91→12/99	←	Schaltgetriebe		<b>13.0460-0410.2 610410</b>	BDX
1100	40	02/95→09/03	←	→ 12/02; Schaltgetriebe		<b>13.0460-0410.2 610410</b>	BDX
1100 4x4 1100 Trekking 4x4	40 37	02/95→07/04 10/91→07/04	←	→ 12/02		<b>13.0460-0410.2 610410</b>	BDX
650	22	01/82→07/04	←	09/82→ 12/85		<b>13.0460-0410.2 610410</b>	BDX
750	25	01/86→10/03	←	→ 12/97		<b>13.0460-0410.2 610410</b>	BDX
900	29	04/92→12/96	←			<b>13.0460-0410.2 610410</b>	BDX
 <b>Bremsscheibe</b>							
1000 i.e. Cat	33	10/87→08/98	←			<b>24.0111-0130.1 411130</b>	Ø 227 10,8 9
			←	→ 12/92		<b>24.0111-0130.1 411130</b>	Ø 227 10,8 9
1100	37	05/91→12/99	←	Schaltgetriebe		<b>24.0111-0130.1 411130</b>	Ø 227 10,8 9
			←	Vollautomatik		<b>24.0112-0122.1 412122</b>	Ø 240 12 10,8
1100	40	02/95→09/03	←	→ 12/02; Schaltgetriebe		<b>24.0111-0130.1 411130</b>	Ø 227 10,8 9
			←	→ 12/02; Vollautomatik		<b>24.0112-0122.1 412122</b>	Ø 240 12 10,8
1100 4x4 1100 Trekking 4x4	40 37	02/95→07/04 10/91→07/04	←	→ 12/02		<b>24.0111-0130.1 411130</b>	Ø 227 10,8 9
650	22	01/82→07/04	←	→ 12/85		<b>24.0111-0130.1 411130</b>	Ø 227 10,8 9
750	25	01/86→10/03	←	→ 12/97		<b>24.0111-0130.1 411130</b>	Ø 227 10,8 9
900	29	04/92→12/96	←			<b>24.0111-0130.1 411130</b>	Ø 227 10,8 9
<b>FIAT - PANDA (169_) 09/03→</b>							
 <b>Bremsbelagsatz, Scheibenbremse</b>							
1.1 1.2 1.2	40 44 51	09/03→ 09/03→ 03/10→	←	→ 06/13		<b>13.0460-3807.2 603807</b> <b>13.0460-3950.2 603950</b>	BDX 21436 17,0 - WK + Zub BDX 21436 17,0 - WK
1.2 4x4	44	10/04→	←	→ 06/13		<b>13.0460-3809.2 603809</b>	BOS 24072 17,9 - WE / - WK + Zub
			→	→ 06/13		<b>13.0460-2879.2 602879</b> <b>13.0470-2879.2 LD2879</b>	TRW 23601 13,7 - WE / - WK TRW 23601 13,7 - WE / - WK Ceramic
1.2 4x4	51	11/09→	←	10/10→ 06/13		<b>13.0460-3809.2 603809</b>	BOS 24072 17,9 - WE / - WK + Zub
			→	10/10→ 06/13		<b>13.0460-2879.2 602879</b> <b>13.0470-2879.2 LD2879</b>	TRW 23601 13,7 - WE / - WK TRW 23601 13,7 - WE / - WK Ceramic
1.2 LPG 1.2 LPG 1.3 D Multijet 1.3 D Multijet 1.4 Natural Power	44 51 51 55 57	04/09→ 11/10→ 09/03→ 06/06→ 09/10→	←	→ 06/13		<b>13.0460-3809.2 603809</b>	BOS 24072 17,9 - WE / - WK + Zub
1.2 Natural Power 1.4 Natural Power	44 51	01/07→12/11 01/10→	←			<b>13.0460-3809.2 603809</b>	BOS 24072 17,9 - WE / - WK + Zub
1.3 D Multijet 4x4	51	10/04→	←	04/06→ 08/11		<b>13.0460-3826.2 603826</b> <b>13.0460-3850.2 603850</b>	BOS 23706 18,0 + WK + Zub BOS 23707 18,0 - WE / - WK + Zub
↓							





	kw			 	! #			
<b>FIAT - PANDA (169_) 09/03→</b>								
 <b>Bremsbelagsatz, Scheibenbremse</b>								
1.3 D Multijet 4x4	51	10/04→	←	04/06→ 08/11		<b>13.0470-3826.2</b>	<b>LD3826</b>	BOS 23706 18,0 + WK + Zub Ceramic
			←	→ 06/13		<b>13.0460-3826.2</b>	<b>603826</b>	BOS 23706 18,0 + WK + Zub
						<b>13.0460-3850.2</b>	<b>603850</b>	BOS 23707 18,0 - WE / - WK + Zub
			→	→ 06/13		<b>13.0470-3826.2</b>	<b>LD3826</b>	BOS 23706 18,0 + WK + Zub Ceramic
			→	→ 06/13		<b>13.0460-2879.2</b>	<b>602879</b>	TRW 23601 13,7 - WE / - WK
						<b>13.0470-2879.2</b>	<b>LD2879</b>	TRW 23601 13,7 - WE / - WK Ceramic
			→	04/06→ 08/11		<b>13.0460-2879.2</b>	<b>602879</b>	TRW 23601 13,7 - WE / - WK
						<b>13.0470-2879.2</b>	<b>LD2879</b>	TRW 23601 13,7 - WE / - WK Ceramic
1.3 D Multijet 4x4	55	09/10→	←	→ 06/13		<b>13.0460-3826.2</b>	<b>603826</b>	BOS 23706 18,0 + WK + Zub
						<b>13.0460-3850.2</b>	<b>603850</b>	BOS 23707 18,0 - WE / - WK + Zub
			→	→ 06/13		<b>13.0470-3826.2</b>	<b>LD3826</b>	BOS 23706 18,0 + WK + Zub Ceramic
			→	→ 06/13		<b>13.0460-2879.2</b>	<b>602879</b>	TRW 23601 13,7 - WE / - WK
						<b>13.0470-2879.2</b>	<b>LD2879</b>	TRW 23601 13,7 - WE / - WK Ceramic
1.4 (169AXE1B)	74	10/06→	←	11/06→ 06/13		<b>13.0460-3826.2</b>	<b>603826</b>	BOS 23706 18,0 + WK + Zub
						<b>13.0460-3850.2</b>	<b>603850</b>	BOS 23707 18,0 - WE / - WK + Zub
			→	11/06→ 06/13		<b>13.0470-3826.2</b>	<b>LD3826</b>	BOS 23706 18,0 + WK + Zub Ceramic
			→	11/06→ 06/13		<b>13.0460-2879.2</b>	<b>602879</b>	TRW 23601 13,7 - WE / - WK
						<b>13.0470-2879.2</b>	<b>LD2879</b>	TRW 23601 13,7 - WE / - WK Ceramic
 <b>Bremsscheibe</b>								
1.1	40	09/03→	←	→ 06/13		<b>24.0111-0119.1</b>	<b>411119</b>	Ø 240,5 11 9,2
1.2	44	09/03→						
1.2	51	03/10→						
1.2 4x4	44	10/04→	←	→ 06/13		<b>24.0120-0184.1</b>	<b>420184</b>	Ø 240,5 20 18,2 V
			→	→ 06/13		<b>24.0111-0119.1</b>	<b>411119</b>	Ø 240,5 11 9,2
1.2 4x4	51	11/09→	←	10/10→ 06/13		<b>24.0120-0184.1</b>	<b>420184</b>	Ø 240,5 20 18,2 V
			→	10/10→ 06/13		<b>24.0111-0119.1</b>	<b>411119</b>	Ø 240,5 11 9,2
1.2 LPG	44	04/09→	←	→ 06/13		<b>24.0120-0184.1</b>	<b>420184</b>	Ø 240,5 20 18,2 V
1.2 LPG	51	11/10→						
1.3 D Multijet	51	09/03→						
1.3 D Multijet	55	06/06→						
1.4 Natural Power	57	09/10→						
1.2 Natural Power	44	01/07→12/11	←			<b>24.0120-0184.1</b>	<b>420184</b>	Ø 240,5 20 18,2 V
1.4 Natural Power	51	01/10→						
1.3 D Multijet 4x4	51	10/04→	←	04/06→ 08/11		<b>24.0122-0197.1</b>	<b>422197</b>	Ø 257,5 22 20,2 V
						<b>24.0322-0197.1</b>	<b>522197</b>	Ø 257,5 22 20,2 V
			←	→ 06/13		<b>24.0122-0197.1</b>	<b>422197</b>	Ø 257,5 22 20,2 V
						<b>24.0322-0197.1</b>	<b>522197</b>	Ø 257,5 22 20,2 V
			→	→ 06/13		<b>24.0111-0119.1</b>	<b>411119</b>	Ø 240,5 11 9,2
			→	04/06→ 08/11		<b>24.0111-0119.1</b>	<b>411119</b>	Ø 240,5 11 9,2
1.3 D Multijet 4x4	55	09/10→	←	→ 06/13		<b>24.0122-0197.1</b>	<b>422197</b>	Ø 257,5 22 20,2 V
						<b>24.0322-0197.1</b>	<b>522197</b>	Ø 257,5 22 20,2 V
			→	→ 06/13		<b>24.0111-0119.1</b>	<b>411119</b>	Ø 240,5 11 9,2
1.4 (169AXE1B)	74	10/06→	←	11/06→ 06/13		<b>24.0122-0197.1</b>	<b>422197</b>	Ø 257,5 22 20,2 V
						<b>24.0322-0197.1</b>	<b>522197</b>	Ø 257,5 22 20,2 V
			→	11/06→ 06/13		<b>24.0111-0119.1</b>	<b>411119</b>	Ø 240,5 11 9,2
<b>FIAT - PANDA (312_, 319_) 02/12→</b>								
 <b>Bremsbelagsatz, Scheibenbremse</b>								
0.9	44	12/13→	←			<b>13.0460-7289.2</b>	<b>607289</b>	ATE 25323 17,3 + WK
0.9	48	02/12→						
0.9	57	02/12→						
0.9	59	12/13→						
0.9	63	02/12→						
0.9 Natural Power	59	01/15→						
0.9 Natural Power	63	07/12→						
↓								

	kw			 	! #		
<b>FIAT - PANDA (312_, 319_) 02/12→</b>							
 <b>Bremsbelagsatz, Scheibenbremse</b>							
1.2	51	02/12→	←			13.0460-7289.2 607289	ATE 25323 17,3 + WK
1.2 LPG	51	06/12→					
1.3 D Multijet	55	02/12→					
1.3 D Multijet	70	04/15→					
0.9 4x4	63	09/12→	←			13.0460-7289.2 607289	ATE 25323 17,3 + WK
0.9 4x4	66	06/14→					
1.3 D Multijet 4x4	55	06/12→	→			13.0460-2783.2 602783	TRW 25410 14,4 + WK + Zub
1.3 D Multijet 4x4	59	06/14→					
1.3 D Multijet 4x4	70	04/15→					
 <b>Bremsscheibe</b>							
0.9	44	12/13→	←			24.0112-0127.1 412127	Ø 257,5 12 10,2
0.9	48	02/12→					
1.2	51	02/12→					
1.2 LPG	51	06/12→					
0.9	57	02/12→	←	für Leichtmetallfelgen; Serie 3		24.0112-0127.1 412127	Ø 257,5 12 10,2
0.9	59	12/13→					
0.9	63	02/12→	←	für Leichtmetallfelgen; Serie 2		24.0122-0197.1 422197	Ø 257,5 22 20,2 V
0.9 Natural Power	59	01/15→				24.0322-0197.1 522197	Ø 257,5 22 20,2 V
0.9 Natural Power	63	07/12→					
1.3 D Multijet	55	02/12→					
1.3 D Multijet	70	04/15→					
0.9 4x4	63	09/12→	←	für Leichtmetallfelgen; Serie 3		24.0112-0127.1 412127	Ø 257,5 12 10,2
0.9 4x4	66	06/14→					
1.3 D Multijet 4x4	55	06/12→	←	für Leichtmetallfelgen; Serie 2		24.0122-0197.1 422197	Ø 257,5 22 20,2 V
1.3 D Multijet 4x4	59	06/14→				24.0322-0197.1 522197	Ø 257,5 22 20,2 V
1.3 D Multijet 4x4	70	04/15→	→	nicht für Leichtmetallfelgen		24.0111-0119.1 411119	Ø 240,5 11 9,2
			→	für Leichtmetallfelgen		24.0112-0127.1 412127	Ø 257,5 12 10,2
<b>FIAT - PANDA Van (141_) 01/86→02/04</b>							
 <b>Bremsbelagsatz, Scheibenbremse</b>							
1.1	40	09/00→02/04	←	→ 12/02; Vollautomatik		13.0460-2941.2 602941	TRW 20838 17,0 + WK
			←	→ 12/02; Schaltgetriebe		13.0460-3939.2 603939	BDX 20775 18,0 + WE / - WK
1.1 4x4	40	09/00→02/04	←	→ 12/02		13.0460-3939.2 603939	BDX 20775 18,0 + WE / - WK
1000 i.e	33	08/92→02/04					
<b>Zubehörsatz, Scheibenbremsbelag</b>							
1.1	40	09/00→02/04	←	→ 12/02; Schaltgetriebe		13.0460-0410.2 610410	BDX
1.1 4x4	40	09/00→02/04	←	→ 12/02		13.0460-0410.2 610410	BDX
1000 i.e	33	08/92→02/04					
 <b>Bremsscheibe</b>							
1.1	40	09/00→02/04	←	→ 12/02; Schaltgetriebe		24.0111-0130.1 411130	Ø 227 10,8 9
			←	→ 12/02; Vollautomatik		24.0112-0122.1 412122	Ø 240 12 10,8
1.1 4x4	40	09/00→02/04	←	→ 12/02		24.0111-0130.1 411130	Ø 227 10,8 9
1000 i.e	33	08/92→02/04					
<b>FIAT - PANDA Van (169_) 03/04→</b>							
 <b>Bremsbelagsatz, Scheibenbremse</b>							
1.1 (169CXA1A)	40	09/04→	←	→ 06/13		13.0460-3807.2 603807	BDX 21436 17,0 - WK + Zub
1.2	44	09/04→				13.0460-3950.2 603950	BDX 21436 17,0 - WK
1.2	51	09/10→					
1.2 4x4	44	09/04→	←	10/04→ 06/13		13.0460-3809.2 603809	BOS 24072 17,9 - WE / - WK + Zub
			→	10/04→ 06/13		13.0460-2879.2 602879	TRW 23601 13,7 - WE / - WK
						13.0470-2879.2 LD2879	TRW 23601 13,7 - WE / - WK Ceramic
1.2 4x4	51	09/10→	←	10/10→ 06/13		13.0460-3809.2 603809	BOS 24072 17,9 - WE / - WK + Zub
			→	10/10→ 06/13		13.0460-2879.2 602879	TRW 23601 13,7 - WE / - WK
						13.0470-2879.2 LD2879	TRW 23601 13,7 - WE / - WK Ceramic
1.2 LPG	44	04/09→	←	→ 06/13		13.0460-3809.2 603809	BOS 24072 17,9 - WE / - WK + Zub
1.3 D Multijet	51	03/04→					
1.4 Natural Power	57	10/09→					
1.2 LPG	51	09/10→	←	11/10→ 06/13		13.0460-3809.2 603809	BOS 24072 17,9 - WE / - WK + Zub
1.2 Natural Power	44	01/07→11/09	←			13.0460-3809.2 603809	BOS 24072 17,9 - WE / - WK + Zub
1.3 D Multijet	55	01/06→	←	06/06→ 06/13		13.0460-3809.2 603809	BOS 24072 17,9 - WE / - WK + Zub
↓							

**FIAT - PANDA Van (169\_) 03/04→**

**Bremsbelagsatz, Scheibenbremse**

1.3 D Multijet 4x4	51	10/04→12/06	←		13.0460-3826.2 603826	BOS 23706 18,0 + WK + Zub
			→		13.0460-3850.2 603850	BOS 23707 18,0 - WE / - WK + Zub
1.3 D Multijet 4x4	55	01/06→	←	→ 06/13	13.0460-3826.2 603826	BOS 23706 18,0 + WK + Zub
			→	→ 06/13	13.0460-2879.2 602879	TRW 23601 13,7 - WE / - WK Ceramic
1.3 D Multijet 4x4	55	01/06→	←	→ 06/13	13.0460-3826.2 603826	BOS 23706 18,0 + WK + Zub
			→	→ 06/13	13.0460-2879.2 602879	TRW 23601 13,7 - WE / - WK Ceramic

**Bremsscheibe**

1.1 (169CXA1A)	40	09/04→	←	→ 06/13	24.0111-0119.1 411119	Ø 240,5 11 9,2
1.2	44	09/04→				
1.2	51	09/10→				
1.2 4x4	44	09/04→	←	10/04→ 06/13	24.0120-0184.1 420184	Ø 240,5 20 18,2 V
			→	10/04→ 06/13	24.0111-0119.1 411119	Ø 240,5 11 9,2
1.2 4x4	51	09/10→	←	10/10→ 06/13	24.0120-0184.1 420184	Ø 240,5 20 18,2 V
			→	10/10→ 06/13	24.0111-0119.1 411119	Ø 240,5 11 9,2
1.2 LPG	44	04/09→	←	→ 06/13	24.0120-0184.1 420184	Ø 240,5 20 18,2 V
1.3 D Multijet	51	03/04→				
1.4 Natural Power	57	10/09→				
1.2 LPG	51	09/10→	←	11/10→ 06/13	24.0120-0184.1 420184	Ø 240,5 20 18,2 V
1.2 Natural Power	44	01/07→11/09	←		24.0120-0184.1 420184	Ø 240,5 20 18,2 V
1.3 D Multijet	55	01/06→	←	06/06→ 06/13	24.0120-0184.1 420184	Ø 240,5 20 18,2 V
1.3 D Multijet 4x4	51	10/04→12/06	←		24.0122-0197.1 422197	Ø 257,5 22 20,2 V
			→		24.0322-0197.1 522197	Ø 257,5 22 20,2 V
1.3 D Multijet 4x4	55	01/06→	←	→ 06/13	24.0111-0119.1 411119	Ø 240,5 11 9,2
			→	→ 06/13	24.0122-0197.1 422197	Ø 257,5 22 20,2 V
1.3 D Multijet 4x4	55	01/06→	←	→ 06/13	24.0322-0197.1 522197	Ø 257,5 22 20,2 V
			→	→ 06/13	24.0111-0119.1 411119	Ø 240,5 11 9,2













**FIAT - PANDA VAN (312\_, 519\_) 02/12→**









**Bremsbelagsatz, Scheibenbremse**

0.9	48	02/12→	←		13.0460-7289.2 607289	ATE 25323 17,3 + WK
0.9	59	12/13→				
0.9	63	02/12→				
0.9 Natural Power	59	01/15→				
0.9 Natural Power	63	07/12→				
1.2	51	02/12→				
1.2 LPG	51	06/12→				
1.3 D Multijet	55	02/12→				
1.3 D Multijet	59	12/15→				
0.9 4x4	63	09/12→	←		13.0460-7289.2 607289	ATE 25323 17,3 + WK
1.3 D Multijet 4x4	55	06/12→				
1.3 D Multijet 4x4	59	06/14→	→		13.0460-2783.2 602783	TRW 25410 14,4 + WK + Zub













**Bremsscheibe**













0.9	48	02/12→	←		24.0112-0127.1 412127	Ø 257,5 12 10,2
1.2	51	02/12→				
1.2 LPG	51	06/12→				
0.9	59	12/13→	←	für Leichtmetallfelgen; Serie 3	24.0112-0127.1 412127	Ø 257,5 12 10,2
0.9	63	02/12→	←	für Leichtmetallfelgen; Serie 2	24.0122-0197.1 422197	Ø 257,5 22 20,2 V
0.9 Natural Power	59	01/15→			24.0322-0197.1 522197	Ø 257,5 22 20,2 V
0.9 Natural Power	63	07/12→				
1.3 D Multijet	55	02/12→				
1.3 D Multijet	59	12/15→				
0.9 4x4	63	09/12→	←	für Leichtmetallfelgen; Serie 3	24.0112-0127.1 412127	Ø 257,5 12 10,2
1.3 D Multijet 4x4	55	06/12→	←	für Leichtmetallfelgen; Serie 2	24.0122-0197.1 422197	Ø 257,5 22 20,2 V
1.3 D Multijet 4x4	59	06/14→	→	nicht für Leichtmetallfelgen	24.0322-0197.1 522197	Ø 257,5 22 20,2 V
			→	für Leichtmetallfelgen	24.0111-0119.1 411119	Ø 240,5 11 9,2
			→	für Leichtmetallfelgen	24.0112-0127.1 412127	Ø 257,5 12 10,2













	kw			 	! #		
<b>FIAT - PREMIO 03/85→12/96</b>							
 <b>Bremsbelagsatz, Scheibenbremse</b>							
1.5 i.e.	55	06/92→12/96	←			<b>13.0460-5409.2 605409</b> ATE 21193 18,0 - WE / - WK <b>13.0460-5410.2 605410</b> ATE 21193 18,0 + WK	
1.6 i.e.	60	08/93→12/96	←	01/94→		<b>13.0460-5409.2 605409</b> ATE 21193 18,0 - WE / - WK <b>13.0460-5410.2 605410</b> ATE 21193 18,0 + WK	
 <b>Bremsscheibe</b>							
1.5 i.e.	55	06/92→12/96	←			<b>24.0112-0122.1 412122</b> Ø 240 12 10,8	
1.6 i.e.	60	08/93→12/96	←	01/94→		<b>24.0112-0122.1 412122</b> Ø 240 12 10,8	
<b>FIAT - PUNTO (176_) 09/93→09/99</b>							
 <b>Bremsbelagsatz, Scheibenbremse</b>							
1.2 16V	63	04/97→09/99	←	06/97→		<b>13.0460-7114.2 607114</b> ATE 21930 17,9 - WE / - WK	
1.4 GT Turbo (176AD_)	98	10/93→03/97	←			<b>13.0460-2949.2 602949</b> TRW 20833 17,0 + WK	
			→	GG		<b>13.0460-2951.2 602951</b> TRW 21103 14,2 - WK	
1.4 GT Turbo (176AS_)	96	09/96→07/99	←	→ 05/97		<b>13.0460-2949.2 602949</b> TRW 20833 17,0 + WK	
			←	06/97→		<b>13.0460-7065.2 607065</b> ATE 21927 17,9 + WK	
			→	06/97→; ALU		<b>13.0460-2826.2 602826</b> TRW 23177 14,2 - WK	
			→	→ 05/97; GG		<b>13.0460-2951.2 602951</b> TRW 21103 14,2 - WK	
1.6	65	01/94→04/97	←	03/94→		<b>13.0460-2949.2 602949</b> TRW 20833 17,0 + WK	
1.7 D	42	04/94→09/97	←	01/95→ 05/97		<b>13.0460-3950.2 603950</b> BDX 21436 17,0 - WK <b>13.0460-3951.2 603951</b> BDX 21436 16,2 + WK	
1.7 TD	51	01/94→09/99	←	→ 05/97		<b>13.0460-2949.2 602949</b> TRW 20833 17,0 + WK	
1.7 TD	52	01/94→09/99	←				
1.7 TD (176AT)	46	09/96→09/99	←	06/97→		<b>13.0460-7114.2 607114</b> ATE 21930 17,9 - WE / - WK	
55 1.1	40	09/93→09/99	←	11/93→		<b>13.0460-3950.2 603950</b> BDX 21436 17,0 - WK <b>13.0460-3951.2 603951</b> BDX 21436 16,2 + WK	
60 1.2	43	01/94→09/99	←			<b>13.0460-2949.2 602949</b> TRW 20833 17,0 + WK <b>13.0460-3950.2 603950</b> BDX 21436 17,0 - WK <b>13.0460-3951.2 603951</b> BDX 21436 16,2 + WK	
60 1.2 (176AP, 176AR, 176AQ, 176BB)	44	09/93→09/99	←	11/93→		<b>13.0460-2949.2 602949</b> TRW 20833 17,0 + WK <b>13.0460-3950.2 603950</b> BDX 21436 17,0 - WK	
75 1.2	54	10/93→09/99				<b>13.0460-3951.2 603951</b> BDX 21436 16,2 + WK	
<b>Zubehörsatz, Scheibenbremsbelag</b>							
1.4 GT Turbo (176AD_)	98	10/93→03/97	→	GG		<b>13.0460-0072.2 610072</b> TRW	
1.4 GT Turbo (176AS_)	96	09/96→07/99	→	→ 05/97; GG		<b>13.0460-0072.2 610072</b> TRW	
 <b>Bremsscheibe</b>							
1.2 16V	63	04/97→09/99	←	06/97→; + ABS		<b>24.0112-0127.1 412127</b> Ø 257,5 12 10,2	
1.4 GT Turbo (176AD_)	98	10/93→03/97	←			<b>24.0120-0142.1 420142</b> Ø 257,5 20 18,2 V	
			→			<b>24.0320-0142.1 520142</b> Ø 257,5 20 18,2 V	
1.4 GT Turbo (176AS_)	96	09/96→07/99	→			<b>24.0111-0119.1 411119</b> Ø 240,5 11 9,2	
1.6	65	01/94→04/97	←	03/94→; + ABS		<b>24.0112-0127.1 412127</b> Ø 257,5 12 10,2	
1.7 D	42	04/94→09/97	←	01/95→ 05/97		<b>24.0111-0119.1 411119</b> Ø 240,5 11 9,2	
1.7 TD	51	01/94→09/99	←	+ ABS		<b>24.0112-0127.1 412127</b> Ø 257,5 12 10,2	
1.7 TD	52	01/94→09/99	←				
1.7 TD (176AT)	46	09/96→09/99	←				
55 1.1	40	09/93→09/99	←	11/93→		<b>24.0111-0119.1 411119</b> Ø 240,5 11 9,2	
60 1.2	43	01/94→09/99	←	→ 05/97		<b>24.0111-0119.1 411119</b> Ø 240,5 11 9,2	
			←	06/97→		<b>24.0111-0119.1 411119</b> Ø 240,5 11 9,2	
			←	→ 05/97; + ABS		<b>24.0112-0127.1 412127</b> Ø 257,5 12 10,2	
60 1.2 (176AP, 176AR, 176AQ, 176BB)	44	09/93→09/99	←	11/93→ 05/97		<b>24.0111-0119.1 411119</b> Ø 240,5 11 9,2	
75 1.2	54	10/93→09/99	←	06/97→		<b>24.0111-0119.1 411119</b> Ø 240,5 11 9,2	
			←	11/93→ 05/97; + ABS		<b>24.0112-0127.1 412127</b> Ø 257,5 12 10,2	
<b>FIAT - PUNTO (188_) 09/99→07/12</b>							
 <b>Bremsbelagsatz, Scheibenbremse</b>							
1.2 16V 80 (188.233, .235, .253, .255, .333, .353, .639,... ↓	59	09/99→12/06	←	07/03→ 11/05		<b>13.0460-7114.2 607114</b> ATE 21930 17,9 - WE / - WK	
			←	10/99→ 06/03; Schaltgetriebe		<b>13.0460-7114.2 607114</b> ATE 21930 17,9 - WE / - WK	

	kw			 	! #		
<b>FIAT - PUNTO (188_) 09/99→07/12</b>							
<b> Bremsbelagsatz, Scheibenbremse</b>							
1.2 16V 80 (188.233, .235, .253, .255, .333, .353, .639,...)	59	09/99→12/06	←	10/99→ 06/03; Vollautomatik		13.0460-7125.2 607125	ATE 21930 17,9 - WE / - WK
1.2 60 (188.030, .050, .130, .150, .230, .250)	44	09/99→12/10	←	10/99→ 06/03		13.0460-3950.2 603950 13.0460-3951.2 603951	BDX 21436 17,0 - WK BDX 21436 16,2 + WK
			←	07/03→ 11/05		13.0460-3950.2 603950	BDX 21436 17,0 - WK
1.2 Bifuel	44	08/07→03/12	←	10/09→ 04/10		13.0460-3863.2 603863	BOS 23706 18,0 + WK + Zub
			←	05/10→		13.0460-7288.2 607288 13.0470-7288.2 LD7288	ATE 25429 17,5 + WK ATE 25429 17,5 + WK Ceramic
			→	10/09→		13.0460-3862.2 603862	BOS 24349 17,6 + WK + Zub
1.2 Natural Power	44	09/03→03/12	←	→ 11/05		13.0460-3950.2 603950	BDX 21436 17,0 - WK
1.3 JTD 16V	51	06/03→03/12	←	07/03→ 11/05		13.0460-7133.2 607133	ATE 21927 17,9 - WE / - WK
1.4 1.4	70 71	09/03→03/12 11/05→03/12	←	→ 11/05		13.0460-7133.2 607133	ATE 21927 17,9 - WE / - WK
1.8 130 HGT (188.738, .718)	96	09/99→03/12	←	10/99→ 06/03		13.0460-7126.2 607126	ATE 20907 18,1 - WE / - WK
			←	07/03→ 11/05		13.0460-7140.2 607140 13.0470-7140.2 LD7140	ATE 21637 19,3 + WK ATE 21637 19,3 + WK Ceramic
			→	07/03→ 11/05		13.0460-2879.2 602879 13.0470-2879.2 LD2879	TRW 23601 13,7 - WE / - WK TRW 23601 13,7 - WE / - WK Ceramic
			→	10/99→ 06/03		13.0460-2879.2 602879 13.0470-2879.2 LD2879	TRW 23601 13,7 - WE / - WK TRW 23601 13,7 - WE / - WK Ceramic
1.9 DS 60 (188.031, .051, .231, .251)	44	09/99→03/12	←	10/99→ 06/03		13.0460-7125.2 607125	ATE 21930 17,9 - WE / - WK
1.9 JTD	63	10/01→03/12	←	07/03→ 11/05		13.0460-7133.2 607133	ATE 21927 17,9 - WE / - WK
			←	→ 06/03		13.0460-7133.2 607133	ATE 21927 17,9 - WE / - WK
1.9 JTD	74	06/03→03/12	←	07/03→ 11/05		13.0460-7140.2 607140 13.0470-7140.2 LD7140	ATE 21637 19,3 + WK ATE 21637 19,3 + WK Ceramic
			→	07/03→ 11/05		13.0460-2879.2 602879 13.0470-2879.2 LD2879	TRW 23601 13,7 - WE / - WK TRW 23601 13,7 - WE / - WK Ceramic
1.9 JTD 80 (188.237, .257, .337, .357)	59	09/99→03/12	←	10/99→ 06/03		13.0460-7133.2 607133	ATE 21927 17,9 - WE / - WK
<b> Bremsscheibe</b>							
1.2 16V 80 (188.233, .235, .253, .255, .333, .353, .639,...)	59	09/99→12/06	←	07/03→ 11/05		24.0112-0127.1 412127	Ø 257,5 12 10,2
			←	10/99→ 06/03		24.0112-0127.1 412127	Ø 257,5 12 10,2
1.2 60 (188.030, .050, .130, .150, .230, .250)	44	09/99→12/10	←	10/99→ 06/03		24.0111-0119.1 411119	Ø 240,5 11 9,2
			←	07/03→ 11/05		24.0112-0127.1 412127	Ø 257,5 12 10,2
1.2 Bifuel	44	08/07→03/12	←	10/09→		24.0122-0231.1 422231 24.0322-0231.1 522231	Ø 257 22 20 V + S Ø 257 22 20 V + S
			→	10/09→		24.0110-0323.1 410323	Ø 264 10 8
1.2 Natural Power	44	09/03→03/12	←	→ 11/05		24.0112-0127.1 412127	Ø 257,5 12 10,2
1.3 JTD 16V	51	06/03→03/12	←	07/03→ 11/05		24.0120-0142.1 420142 24.0320-0142.1 520142	Ø 257,5 20 18,2 V Ø 257,5 20 18,2 V
1.4 1.4	70 71	09/03→03/12 11/05→03/12	←	→ 11/05		24.0120-0142.1 420142 24.0320-0142.1 520142	Ø 257,5 20 18,2 V Ø 257,5 20 18,2 V
1.8 130 HGT (188.738, .718)	96	09/99→03/12	←	07/03→ 11/05		24.0122-0107.1 422107	Ø 284 22 20,2 V
			←	10/99→ 06/03		24.0122-0197.1 422197 24.0322-0197.1 522197	Ø 257,5 22 20,2 V Ø 257,5 22 20,2 V
			→	07/03→ 11/05		24.0111-0119.1 411119	Ø 240,5 11 9,2
			→	10/99→ 06/03		24.0111-0119.1 411119	Ø 240,5 11 9,2
1.9 DS 60 (188.031, .051, .231, .251)	44	09/99→03/12	←	10/99→ 06/03		24.0112-0127.1 412127	Ø 257,5 12 10,2
1.9 JTD	63	10/01→03/12	←	07/03→ 11/05		24.0120-0142.1 420142 24.0320-0142.1 520142	Ø 257,5 20 18,2 V Ø 257,5 20 18,2 V
			←	→ 06/03		24.0120-0142.1 420142 24.0320-0142.1 520142	Ø 257,5 20 18,2 V Ø 257,5 20 18,2 V
			↓				



























	kw			 	! #		
<b>FIAT - PUNTO (188_) 09/99→07/12</b>							
 <b>Bremsscheibe</b>							
1.9 JTD	74	06/03→03/12	←	07/03→ 11/05		24.0122-0107.1 422107	Ø 284 22 20,2 V
			→	07/03→ 11/05		24.0111-0119.1 411119	Ø 240,5 11 9,2
1.9 JTD 80 (188.237, .257, .337, .357)	59	09/99→03/12	←	10/99→ 06/03		24.0120-0142.1 420142 24.0320-0142.1 520142	Ø 257,5 20 18,2 V Ø 257,5 20 18,2 V
<b>FIAT - PUNTO (199_) 03/12→</b>							
 <b>Bremsbelagsatz, Scheibenbremse</b>							
0.9	74	12/13→	←			13.0460-7288.2 607288	ATE 25429 17,5 + WK
0.9	77	07/13→				13.0470-7288.2 LD7288	ATE 25429 17,5 + WK Ceramic
0.9 Bifuel	63	03/12→					
0.9 Twinair Turbo	63	03/12→	→			13.0460-3862.2 603862	BOS 24349 17,6 + WK + Zub
1.2	49	02/14→					
1.2	51	03/12→					
1.3 D Multijet	55	03/12→					
1.3 D Multijet	59	12/13→					
1.3 D Multijet	62	03/12→					
1.4	55	03/12→					
1.4	57	03/12→					
1.4 Bifuel	57	03/12→					
1.4 Multi Air	77	03/12→					
1.4 Natural Power	57	03/12→					
1.4 Turbo Multi Air	99	03/12→					
1.3 D Multijet	70	03/12→	←			13.0460-3864.2 603864	BOS 23709 19,6 + WK + Zub
1.3 JTD Multijet (199.AYR1A, 199.BYR1A)	66	05/18→	→			13.0460-3862.2 603862	BOS 24349 17,6 + WK + Zub
 <b>Bremsscheibe</b>							
0.9	74	12/13→	←			24.0122-0231.1 422231	Ø 257 22 20 V + S
0.9	77	07/13→				24.0322-0231.1 522231	Ø 257 22 20 V + S
0.9 Bifuel	63	03/12→					
0.9 Twinair Turbo	63	03/12→	→			24.0110-0323.1 410323	Ø 264 10 8
1.2	49	02/14→					
1.2	51	03/12→					
1.3 D Multijet	55	03/12→					
1.3 D Multijet	59	12/13→					
1.3 D Multijet	62	03/12→					
1.4	55	03/12→					
1.4	57	03/12→					
1.4 Bifuel	57	03/12→					
1.4 Multi Air	77	03/12→					
1.4 Natural Power	57	03/12→					
1.3 D Multijet	70	03/12→	←			24.0122-0241.1 422241	Ø 284 22 20 V + S
1.3 JTD Multijet (199.AYR1A, 199.BYR1A)	66	05/18→	→			24.0110-0323.1 410323	Ø 264 10 8
1.4 Turbo Multi Air	99	03/12→					
<b>FIAT - PUNTO Cabriolet (176_) 04/94→06/00</b>							
 <b>Bremsbelagsatz, Scheibenbremse</b>							
60 1.2	43	04/94→06/00	←			13.0460-2949.2 602949	TRW 20833 17,0 + WK
60 1.2 (176AR_, 176BR_)	44	05/95→06/00				13.0460-3950.2 603950	BDX 21436 17,0 - WK
						13.0460-3951.2 603951	BDX 21436 16,2 + WK
85 16V 1.2	63	04/97→06/00	←	06/97→		13.0460-7114.2 607114	ATE 21930 17,9 - WE / - WK
90 1.6	65	04/94→04/97	←			13.0460-2949.2 602949	TRW 20833 17,0 + WK
 <b>Bremsscheibe</b>							
60 1.2	43	04/94→06/00	←	06/97→		24.0111-0119.1 411119	Ø 240,5 11 9,2
60 1.2 (176AR_, 176BR_)	44	05/95→06/00	←	→ 05/97		24.0111-0119.1 411119	Ø 240,5 11 9,2
			←	→ 05/97; + ABS		24.0112-0127.1 412127	Ø 257,5 12 10,2
85 16V 1.2	63	04/97→06/00	←	06/97→; + ABS		24.0112-0127.1 412127	Ø 257,5 12 10,2
90 1.6	65	04/94→04/97	←	+ ABS		24.0112-0127.1 412127	Ø 257,5 12 10,2
<b>FIAT - PUNTO EVO (199_) 07/08→</b>							
 <b>Bremsbelagsatz, Scheibenbremse</b>							
1.2	48	10/09→02/12	←	→ 04/10		13.0460-3863.2 603863	BOS 23706 18,0 + WK + Zub
1.2	51	10/09→02/12					
1.3 D Multijet	55	10/09→02/12	←	05/10→		13.0460-7288.2 607288	ATE 25429 17,5 + WK
1.3 D Multijet	62	10/09→02/12				13.0470-7288.2 LD7288	ATE 25429 17,5 + WK Ceramic
1.4	57	10/09→02/12					
1.4 16V	77	10/09→02/12	→			13.0460-3862.2 603862	BOS 24349 17,6 + WK + Zub
↓							

	kw			 	! #		
<b>FIAT - PUNTO EVO (199_) 07/08→</b>							
 <b>Bremsbelagsatz, Scheibenbremse</b>							
1.4 LPG 1.4 Natural Power	57 57	06/09→02/12 10/09→02/12	←	→ 04/10		13.0460-3863.2 603863	BOS 23706 18,0 + WK + Zub
			←	05/10→		13.0460-7288.2 607288 13.0470-7288.2 LD7288	ATE 25429 17,5 + WK ATE 25429 17,5 + WK Ceramic
			→			13.0460-3862.2 603862	BOS 24349 17,6 + WK + Zub
1.3 D Multijet	51	07/08→02/12	←	10/09→		13.0460-3864.2 603864	BOS 23709 19,6 + WK + Zub
			→			13.0460-3862.2 603862	BOS 24349 17,6 + WK + Zub
1.3 D Multijet 1.3 D Multijet 1.4 16V (199AXW1A) 1.6 D Multijet	66 70 99 88	10/09→02/12 10/09→02/12 10/09→02/12 10/09→02/12	←			13.0460-3864.2 603864	BOS 23709 19,6 + WK + Zub
			→			13.0460-3862.2 603862	BOS 24349 17,6 + WK + Zub
1.3 D Multijet (199BXC1A)	56	09/10→02/12	←			13.0460-7288.2 607288 13.0470-7288.2 LD7288	ATE 25429 17,5 + WK ATE 25429 17,5 + WK Ceramic
			→			13.0460-3862.2 603862	BOS 24349 17,6 + WK + Zub
1.4	55	07/09→02/12	←	10/09→ 04/10		13.0460-3863.2 603863	BOS 23706 18,0 + WK + Zub
			←	05/10→		13.0460-7288.2 607288 13.0470-7288.2 LD7288	ATE 25429 17,5 + WK ATE 25429 17,5 + WK Ceramic
			→	10/09→		13.0460-3862.2 603862	BOS 24349 17,6 + WK + Zub
 <b>Bremsscheibe</b>							
1.2 1.2 1.3 D Multijet 1.3 D Multijet 1.3 D Multijet 1.3 D Multijet (199BXC1A) 1.4 1.4 16V 1.4 LPG 1.4 Natural Power	48 51 51 55 62 56 57 77 57 57	10/09→02/12 10/09→02/12 07/08→02/12 10/09→02/12 10/09→02/12 09/10→02/12 10/09→02/12 10/09→02/12 06/09→02/12 10/09→02/12	←			24.0122-0231.1 422231 24.0322-0231.1 522231	Ø 257 22 20 V + S Ø 257 22 20 V + S
			→			24.0110-0323.1 410323	Ø 264 10 8
1.3 D Multijet 1.3 D Multijet 1.4 16V (199AXW1A) 1.6 D Multijet	66 70 99 88	10/09→02/12 10/09→02/12 10/09→02/12 10/09→02/12	←			24.0122-0241.1 422241	Ø 284 22 20 V + S
			→			24.0110-0323.1 410323	Ø 264 10 8
1.4	55	07/09→02/12	←	10/09→		24.0122-0231.1 422231 24.0322-0231.1 522231	Ø 257 22 20 V + S Ø 257 22 20 V + S
			→	10/09→		24.0110-0323.1 410323	Ø 264 10 8
<b>FIAT - PUNTO EVO Van (199_) 03/09→02/12</b>							
 <b>Bremsbelagsatz, Scheibenbremse</b>							
1.3 D Multijet (199.AXT1A, 199.AXC1A) 1.4 (199.AXB1A)	55 57	03/09→02/12 03/09→02/12	←	→ 04/10		13.0460-3863.2 603863	BOS 23706 18,0 + WK + Zub
			←	05/10→		13.0460-7288.2 607288 13.0470-7288.2 LD7288	ATE 25429 17,5 + WK ATE 25429 17,5 + WK Ceramic
			→			13.0460-3862.2 603862	BOS 24349 17,6 + WK + Zub
1.3 D Multijet (199.AXU1A)	70	03/09→02/12	←			13.0460-3864.2 603864	BOS 23709 19,6 + WK + Zub
			→			13.0460-3862.2 603862	BOS 24349 17,6 + WK + Zub
 <b>Bremsscheibe</b>							
1.3 D Multijet (199.AXT1A, 199.AXC1A) 1.4 (199.AXB1A)	55 57	03/09→02/12 03/09→02/12	←			24.0122-0231.1 422231 24.0322-0231.1 522231	Ø 257 22 20 V + S Ø 257 22 20 V + S
			→			24.0110-0323.1 410323	Ø 264 10 8
1.3 D Multijet (199.AXU1A)	70	03/09→02/12	←			24.0122-0241.1 422241	Ø 284 22 20 V + S
			→			24.0110-0323.1 410323	Ø 264 10 8
<b>FIAT - PUNTO Van (176_) 04/96→02/00</b>							
 <b>Bremsbelagsatz, Scheibenbremse</b>							
1.1	40	04/96→02/00	←	→ 09/99		13.0460-3950.2 603950 13.0460-3951.2 603951	BDX 21436 17,0 - WK BDX 21436 16,2 + WK
1.7 D	42	04/96→02/00	←	→ 05/97		13.0460-3950.2 603950 13.0460-3951.2 603951	BDX 21436 17,0 - WK BDX 21436 16,2 + WK
1.7 TD	46	09/96→09/99	←	→ 05/97		13.0460-2949.2 602949	TRW 20833 17,0 + WK
			←	06/97→		13.0460-7114.2 607114	ATE 21930 17,9 - WE / - WK
1.7 TD ↓	52	04/96→02/00	←	→ 05/97		13.0460-2949.2 602949	TRW 20833 17,0 + WK















	kw			 	! #		
<b>FIAT - PUNTO Van (176_) 04/96→02/00</b>							
 <b>Bremsbelagsatz, Scheibenbremse</b>							
1.7 TD	52	04/96→02/00	←	06/97→ 09/99		13.0460-7114.2 607114	ATE 21930 17,9 - WE / - WK
 <b>Bremsscheibe</b>							
1.1	40	04/96→02/00	←	→ 09/99		24.0111-0119.1 411119	Ø 240,5 11 9,2
1.7 D	42	04/96→02/00	←	→ 05/97		24.0111-0119.1 411119	Ø 240,5 11 9,2
1.7 TD	46	09/96→09/99	←	+ ABS		24.0112-0127.1 412127	Ø 257,5 12 10,2
1.7 TD	52	04/96→02/00	←	→ 09/99; + ABS		24.0112-0127.1 412127	Ø 257,5 12 10,2
<b>FIAT - PUNTO Van (188_) 02/00→10/09</b>							
 <b>Bremsbelagsatz, Scheibenbremse</b>							
1.2 60	44	02/00→10/09	←	→ 06/03		13.0460-3950.2 603950	BDX 21436 17,0 - WK
						13.0460-3951.2 603951	BDX 21436 16,2 + WK
1.3 D Multijet	55	02/05→10/09	←	→ 11/05		13.0460-7133.2 607133	ATE 21927 17,9 - WE / - WK
1.3 JTD	51	06/03→10/05	←	07/03→		13.0460-7133.2 607133	ATE 21927 17,9 - WE / - WK
1.9 D 60	44	02/00→10/09	←	→ 06/03		13.0460-7125.2 607125	ATE 21930 17,9 - WE / - WK
1.9 JTD	63	02/00→10/09	←	→ 06/03		13.0460-7133.2 607133	ATE 21927 17,9 - WE / - WK
 <b>Bremsscheibe</b>							
1.2 60	44	02/00→10/09	←	→ 06/03		24.0111-0119.1 411119	Ø 240,5 11 9,2
1.3 D Multijet	55	02/05→10/09	←	→ 11/05		24.0120-0142.1 420142	Ø 257,5 20 18,2 V
						24.0320-0142.1 520142	Ø 257,5 20 18,2 V
1.3 JTD	51	06/03→10/05	←	07/03→		24.0120-0142.1 420142	Ø 257,5 20 18,2 V
						24.0320-0142.1 520142	Ø 257,5 20 18,2 V
1.9 D 60	44	02/00→10/09	←	→ 06/03		24.0112-0127.1 412127	Ø 257,5 12 10,2
1.9 JTD	63	02/00→10/09	←	→ 06/03		24.0120-0142.1 420142	Ø 257,5 20 18,2 V
						24.0320-0142.1 520142	Ø 257,5 20 18,2 V
<b>FIAT - PUNTO Van (199_) 02/06→</b>							
 <b>Bremsbelagsatz, Scheibenbremse</b>							
0.9 Twinair Turbo	63	03/12→	←			13.0460-7288.2 607288	ATE 25429 17,5 + WK
1.3 D Multijet	62	03/12→	←			13.0470-7288.2 LD7288	ATE 25429 17,5 + WK Ceramic
			→			13.0460-3862.2 603862	BOS 24349 17,6 + WK + Zub
1.3 D Multijet	55	04/08→	←	09/10→ 01/11		13.0460-3863.2 603863	BOS 23706 18,0 + WK + Zub
1.3 D Multijet	66	01/10→02/12	←			13.0460-3864.2 603864	BOS 23709 19,6 + WK + Zub
			→			13.0460-3862.2 603862	BOS 24349 17,6 + WK + Zub
1.3 D Multijet	70	03/09→	←	10/09→		13.0460-3864.2 603864	BOS 23709 19,6 + WK + Zub
			→	10/09→		13.0460-3862.2 603862	BOS 24349 17,6 + WK + Zub
1.4 (199.BXB1A)	57	02/06→06/13	←	10/09→ 04/10		13.0460-3863.2 603863	BOS 23706 18,0 + WK + Zub
1.4 Natural Power	57	03/09→	←	05/10→		13.0460-7288.2 607288	ATE 25429 17,5 + WK
			→	10/09→		13.0470-7288.2 LD7288	ATE 25429 17,5 + WK Ceramic
			→	10/09→		13.0460-3862.2 603862	BOS 24349 17,6 + WK + Zub
1.4 LPG (199AXB1A)	57	03/09→	←	06/09→ 04/10		13.0460-3863.2 603863	BOS 23706 18,0 + WK + Zub
			←	05/10→		13.0460-7288.2 607288	ATE 25429 17,5 + WK
			→	06/09→		13.0470-7288.2 LD7288	ATE 25429 17,5 + WK Ceramic
			→	06/09→		13.0460-3862.2 603862	BOS 24349 17,6 + WK + Zub
 <b>Bremsscheibe</b>							
0.9 Twinair Turbo	63	03/12→	←			24.0122-0231.1 422231	Ø 257 22 20 V + S
1.3 D Multijet	62	03/12→	←			24.0322-0231.1 522231	Ø 257 22 20 V + S
			→			24.0110-0323.1 410323	Ø 264 10 8
1.3 D Multijet	55	04/08→	←	→ 01/11		24.0122-0231.1 422231	Ø 257 22 20 V + S
			→			24.0322-0231.1 522231	Ø 257 22 20 V + S
1.3 D Multijet	66	01/10→02/12	←			24.0122-0241.1 422241	Ø 284 22 20 V + S
			→			24.0110-0323.1 410323	Ø 264 10 8
1.3 D Multijet	70	03/09→	←	10/09→		24.0122-0241.1 422241	Ø 284 22 20 V + S
			→	10/09→		24.0110-0323.1 410323	Ø 264 10 8
1.4 (199.BXB1A)	57	02/06→06/13	←	10/09→		24.0122-0231.1 422231	Ø 257 22 20 V + S
1.4 Natural Power	57	03/09→	←				

















	kW					! #		
<b>FIAT - PUNTO Van (199_) 02/06→</b>								
 <b>Bremsscheibe</b>								
1.4 (199.BXB1A)	57	02/06→06/13	←	10/09→		24.0322-0231.1	522231	Ø 257 22 20 V + S
1.4 Natural Power	57	03/09→	→	10/09→		24.0110-0323.1	410323	Ø 264 10 8
1.4 LPG (199AXB1A)	57	03/09→	←	06/09→		24.0122-0231.1	422231	Ø 257 22 20 V + S
			→	06/09→		24.0322-0231.1	522231	Ø 257 22 20 V + S
						24.0110-0323.1	410323	Ø 264 10 8
<b>FIAT - QUBO (225_) 02/08→</b>								
 <b>Bremsbelagsatz, Scheibenbremse</b>								
1.3 D Multijet	55	02/08→	←	09/08→; Schaltgetriebe		13.0460-3826.2	603826	BOS 23706 18,0 + WK + Zub
			→			13.0470-3826.2	LD3826	BOS 23706 18,0 + WK + Zub Ceramic
			←	09/08→; Halbautomatik		13.0460-3863.2	603863	BOS 23706 18,0 + WK + Zub
1.3 D Multijet	59	03/15→	←	Schaltgetriebe		13.0460-3826.2	603826	BOS 23706 18,0 + WK + Zub
			→			13.0470-3826.2	LD3826	BOS 23706 18,0 + WK + Zub Ceramic
			←	Halbautomatik		13.0460-3863.2	603863	BOS 23706 18,0 + WK + Zub
1.3 D Multijet	70	07/10→	←			13.0460-3827.2	603827	BOS 23709 19,6 + WK + Zub
			→			13.0470-3827.2	LD3827	BOS 23709 19,6 + WK + Zub Ceramic
1.4	54	02/08→	←	09/08→; → 6446		13.0460-3826.2	603826	BOS 23706 18,0 + WK + Zub
			→			13.0470-3826.2	LD3826	BOS 23706 18,0 + WK + Zub Ceramic
			←	6447→		13.0460-3863.2	603863	BOS 23706 18,0 + WK + Zub
1.4	57	10/09→	←	→ 6446		13.0460-3826.2	603826	BOS 23706 18,0 + WK + Zub
			→			13.0470-3826.2	LD3826	BOS 23706 18,0 + WK + Zub Ceramic
			←	6447→		13.0460-3863.2	603863	BOS 23706 18,0 + WK + Zub
 <b>Bremsscheibe</b>								
1.3 D Multijet	55	02/08→	←	09/08→		24.0122-0197.1	422197	Ø 257,5 22 20,2 V
1.4	54	02/08→	←			24.0322-0197.1	522197	Ø 257,5 22 20,2 V
1.3 D Multijet	59	03/15→	←			24.0122-0197.1	422197	Ø 257,5 22 20,2 V
1.4	57	10/09→	←			24.0322-0197.1	522197	Ø 257,5 22 20,2 V
1.4 Natural Power	57	10/09→	←			24.0322-0197.1	522197	Ø 257,5 22 20,2 V
1.3 D Multijet	70	07/10→	←			24.0122-0147.1	422147	Ø 284 22 20,2 V
<b>FIAT - SCUDO (270_, 272_) 01/07→</b>								
 <b>Bremsbelagsatz, Scheibenbremse</b>								
1.6 D Multijet	66	01/07→	←			13.0460-2738.2	602738	TRW 24595 18,5 + WK + Zub
1.6 D Multijet	66	02/11→	→			13.0460-2739.2	602739	TRW 24578 16,5 - WE / - WK + Zub
2.0 D Multijet	88	01/07→	→					
2.0 D Multijet	94	04/11→	→					
2.0 D Multijet	100	01/07→	→					
2.0 D Multijet	120	07/10→	→					
2.0 D Multijet 4x4	94	04/11→	→					
2.0 D Multijet 4x4	88	01/07→	←	04/11→		13.0460-2738.2	602738	TRW 24595 18,5 + WK + Zub
2.0 D Multijet 4x4	100	01/07→	→	04/11→		13.0460-2739.2	602739	TRW 24578 16,5 - WE / - WK + Zub
 <b>Bremsscheibe</b>								
1.6 D Multijet	66	01/07→	←	für Fahrzeuge mit Trommelbremse an der Hinterachse		24.0128-0214.1	428214	Ø 280 28 26 V + S
1.6 D Multijet	66	02/11→	←	für Fahrzeuge mit Scheibenbremse an der Hinterachse		24.0128-0216.1	428216	Ø 304 28 26 V + S
			→			24.0114-0116.1	414116	Ø 290 14 12 + S
2.0 D Multijet	88	01/07→	←			24.0128-0216.1	428216	Ø 304 28 26 V + S
2.0 D Multijet	94	04/11→	→			24.0114-0116.1	414116	Ø 290 14 12 + S
2.0 D Multijet	100	01/07→	→			24.0114-0116.1	414116	Ø 290 14 12 + S
2.0 D Multijet	120	07/10→	→					
2.0 D Multijet 4x4	94	04/11→	→					
2.0 D Multijet 4x4	88	01/07→	←	04/11→		24.0128-0216.1	428216	Ø 304 28 26 V + S
2.0 D Multijet 4x4	100	01/07→	→	04/11→		24.0114-0116.1	414116	Ø 290 14 12 + S
<b>FIAT - SCUDO Combinato (220_) 02/96→12/06</b>								
 <b>Bremsbelagsatz, Scheibenbremse</b>								
1.6	58	02/96→12/06	←	10/03→		13.0460-2863.2	602863	TRW 20261 19,0 + WK + Zub
↓								











	kw					! #		
<b>FIAT - SCUDO Combinato (220_) 02/96→12/06</b>								
 <b>Bremsbelagsatz, Scheibenbremse</b>								
1.9 D	51	04/98→12/06	←	→ 09/03		13.0460-2978.2	602978	TRW 21801 19,0 + WK
1.9 TD	68	02/96→12/06	←			13.0460-3957.2	603957	BDX 23042 19,0 + WK + Zub
1.9 TD Eco	66	02/96→12/06	←					
2.0 16V	100	06/00→12/06	←					
2.0 JTD	80	12/99→12/06	←					
1.9 D	51	02/96→04/98	←			13.0460-2978.2	602978	TRW 21801 19,0 + WK
						13.0460-3957.2	603957	BDX 23042 19,0 + WK + Zub
2.0 JTD	69	01/04→12/06	←			13.0460-2863.2	602863	TRW 20261 19,0 + WK + Zub
						13.0460-3957.2	603957	BDX 23042 19,0 + WK + Zub
2.0 JTD 16V	80	05/99→12/06	←	10/03→		13.0460-2863.2	602863	TRW 20261 19,0 + WK + Zub
			←	12/99→ 09/03		13.0460-2978.2	602978	TRW 21801 19,0 + WK
			←	12/99→		13.0460-3957.2	603957	BDX 23042 19,0 + WK + Zub
 <b>Bremsscheibe</b>								
1.6	58	02/96→12/06	←			24.0120-0155.1	420155	Ø 257,5 20 18,2 V
1.9 D	51	04/98→12/06	←	→ 09/03		24.0126-0104.1	426104	Ø 281 26 24,2 V
1.9 TD	68	02/96→12/06	←					
1.9 TD Eco	66	02/96→12/06	←	10/03→		24.0128-0136.1	428136	Ø 285 28 26 V
2.0 16V	100	06/00→12/06	←			24.0328-0136.1	528136	Ø 285 28 26 V
2.0 JTD	80	12/99→12/06	←					
1.9 D	51	02/96→04/98	←			24.0120-0155.1	420155	Ø 257,5 20 18,2 V
						24.0126-0104.1	426104	Ø 281 26 24,2 V
2.0 JTD	69	01/04→12/06	←			24.0120-0155.1	420155	Ø 257,5 20 18,2 V
						24.0128-0136.1	428136	Ø 285 28 26 V
						24.0328-0136.1	528136	Ø 285 28 26 V
2.0 JTD 16V	80	05/99→12/06	←	12/99→		24.0120-0155.1	420155	Ø 257,5 20 18,2 V
			←	12/99→ 09/03		24.0126-0104.1	426104	Ø 281 26 24,2 V
			←	10/03→		24.0128-0136.1	428136	Ø 285 28 26 V
						24.0328-0136.1	528136	Ø 285 28 26 V
<b>FIAT - SCUDO Kasten (220_) 02/96→12/06</b>								
 <b>Bremsbelagsatz, Scheibenbremse</b>								
1.6	58	02/96→12/06	←	10/03→		13.0460-2863.2	602863	TRW 20261 19,0 + WK + Zub
1.9 D	51	02/96→12/06	←	→ 09/03		13.0460-2978.2	602978	TRW 21801 19,0 + WK
1.9 D	51	04/98→12/06	←					
1.9 TD	66	02/96→12/06	←			13.0460-3957.2	603957	BDX 23042 19,0 + WK + Zub
1.9 TD	68	02/98→12/06	←					
2.0 JTD	80	12/02→12/06	←					
2.0	100	05/00→12/06	←	10/03→		13.0460-2863.2	602863	TRW 20261 19,0 + WK + Zub
			←	06/00→ 09/03		13.0460-2978.2	602978	TRW 21801 19,0 + WK
			←	06/00→		13.0460-3957.2	603957	BDX 23042 19,0 + WK + Zub
2.0 JTD	69	10/99→12/06	←	10/03→		13.0460-2863.2	602863	TRW 20261 19,0 + WK + Zub
2.0 JTD 16V	80	05/99→12/06	←	12/99→ 09/03		13.0460-2978.2	602978	TRW 21801 19,0 + WK
			←	12/99→		13.0460-3957.2	603957	BDX 23042 19,0 + WK + Zub
 <b>Bremsscheibe</b>								
1.6	58	02/96→12/06	←			24.0120-0155.1	420155	Ø 257,5 20 18,2 V
1.9 D	51	02/96→12/06	←	→ 09/03		24.0126-0104.1	426104	Ø 281 26 24,2 V
1.9 D	51	04/98→12/06	←					
1.9 TD	66	02/96→12/06	←	10/03→		24.0128-0136.1	428136	Ø 285 28 26 V
1.9 TD	68	02/98→12/06	←			24.0328-0136.1	528136	Ø 285 28 26 V
2.0 JTD	80	12/02→12/06	←					
2.0	100	05/00→12/06	←	06/00→		24.0120-0155.1	420155	Ø 257,5 20 18,2 V
			←	06/00→ 09/03		24.0126-0104.1	426104	Ø 281 26 24,2 V
			←	10/03→		24.0128-0136.1	428136	Ø 285 28 26 V
						24.0328-0136.1	528136	Ø 285 28 26 V
2.0 JTD	69	10/99→12/06	←	12/99→		24.0120-0155.1	420155	Ø 257,5 20 18,2 V
2.0 JTD 16V	80	05/99→12/06	←	12/99→ 09/03		24.0126-0104.1	426104	Ø 281 26 24,2 V
			←	10/03→		24.0128-0136.1	428136	Ø 285 28 26 V
						24.0328-0136.1	528136	Ø 285 28 26 V
<b>FIAT - SCUDO Kasten (270_, 272_) 01/07→</b>								
 <b>Bremsbelagsatz, Scheibenbremse</b>								
1.6 D Multijet	66	01/07→	←			13.0460-2738.2	602738	TRW 24595 18,5 + WK + Zub
1.6 D Multijet	66	02/11→						
2.0 D Multijet	88	01/07→						
↓								

























	kw			 	! #		
<b>FIAT - SCUDO Kasten (270_, 272_) 01/07→</b>							
 <b>Bremsbelagsatz, Scheibenbremse</b>							
2.0 D Multijet	94	05/11→	→			13.0460-2739.2 602739	TRW 24578 16,5 - WE / - WK + Zub
2.0 D Multijet	100	01/07→					
2.0 D Multijet	120	07/10→					
2.0 D Multijet 4x4	94	05/11→					
2.0 D Multijet 4x4	88	01/07→	←	04/11→		13.0460-2738.2 602738	TRW 24595 18,5 + WK + Zub
2.0 D Multijet 4x4	100	01/07→	→	04/11→		13.0460-2739.2 602739	TRW 24578 16,5 - WE / - WK + Zub
 <b>Bremsscheibe</b>							
1.6 D Multijet	66	01/07→	←	für Fahrzeuge mit Trommelbremse an der Hinterachse		24.0128-0214.1 428214	Ø 280 28 26 V + S
1.6 D Multijet	66	02/11→	←	für Fahrzeuge mit Scheibenbremse an der Hinterachse		24.0128-0216.1 428216	Ø 304 28 26 V + S
			→			24.0114-0116.1 414116	Ø 290 14 12 + S
2.0 D Multijet	88	01/07→	←			24.0128-0216.1 428216	Ø 304 28 26 V + S
2.0 D Multijet	94	05/11→					
2.0 D Multijet	100	01/07→	→			24.0114-0116.1 414116	Ø 290 14 12 + S
2.0 D Multijet	120	07/10→					
2.0 D Multijet 4x4	94	05/11→					
2.0 D Multijet 4x4	88	01/07→	←	04/11→		24.0128-0216.1 428216	Ø 304 28 26 V + S
2.0 D Multijet 4x4	100	01/07→	→	04/11→		24.0114-0116.1 414116	Ø 290 14 12 + S
<b>FIAT - SCUDO Pritsche/Fahrgestell (220_) 09/96→12/06</b>							
 <b>Bremsbelagsatz, Scheibenbremse</b>							
1.6	58	09/96→12/06	←	10/03→		13.0460-2863.2 602863	TRW 20261 19,0 + WK + Zub
1.9 D	51	04/98→12/06					
1.9 TD	68	09/96→12/06	←	→ 09/03		13.0460-2978.2 602978	TRW 21801 19,0 + WK
2.0 JTD	80	12/02→12/06	←			13.0460-3957.2 603957	BDX 23042 19,0 + WK + Zub
2.0 JTD	69	10/99→12/06	←	10/03→		13.0460-2863.2 602863	TRW 20261 19,0 + WK + Zub
2.0 JTD 16V	80	05/99→12/06	←	12/99→ 09/03		13.0460-2978.2 602978	TRW 21801 19,0 + WK
			←	12/99→		13.0460-3957.2 603957	BDX 23042 19,0 + WK + Zub
 <b>Bremsscheibe</b>							
1.6	58	09/96→12/06	←			24.0120-0155.1 420155	Ø 257,5 20 18,2 V
1.9 D	51	04/98→12/06					
1.9 TD	68	09/96→12/06	←	→ 09/03		24.0126-0104.1 426104	Ø 281 26 24,2 V
2.0 JTD	80	12/02→12/06	←	10/03→		24.0128-0136.1 428136	Ø 285 28 26 V
						24.0328-0136.1 528136	Ø 285 28 26 V
2.0 JTD	69	10/99→12/06	←	12/99→		24.0120-0155.1 420155	Ø 257,5 20 18,2 V
2.0 JTD 16V	80	05/99→12/06	←	12/99→ 09/03		24.0126-0104.1 426104	Ø 281 26 24,2 V
			←	10/03→		24.0128-0136.1 428136	Ø 285 28 26 V
						24.0328-0136.1 528136	Ø 285 28 26 V
<b>FIAT - SCUDO Pritsche/Fahrgestell (270_, 272_) 01/07→</b>							
 <b>Bremsbelagsatz, Scheibenbremse</b>							
1.6 D Multijet	66	01/07→	←			13.0460-2738.2 602738	TRW 24595 18,5 + WK + Zub
2.0 D Multijet	88	01/07→					
2.0 D Multijet	94	05/11→	→			13.0460-2739.2 602739	TRW 24578 16,5 - WE / - WK + Zub
2.0 D Multijet	100	01/07→					
2.0 D Multijet	120	07/10→					
 <b>Bremsscheibe</b>							
1.6 D Multijet	66	01/07→	←	für Fahrzeuge mit Trommelbremse an der Hinterachse		24.0128-0214.1 428214	Ø 280 28 26 V + S
			←	für Fahrzeuge mit Scheibenbremse an der Hinterachse		24.0128-0216.1 428216	Ø 304 28 26 V + S
			→			24.0114-0116.1 414116	Ø 290 14 12 + S
2.0 D Multijet	88	01/07→	←			24.0128-0216.1 428216	Ø 304 28 26 V + S
2.0 D Multijet	94	05/11→					
2.0 D Multijet	100	01/07→	→			24.0114-0116.1 414116	Ø 290 14 12 + S
2.0 D Multijet	120	07/10→					
<b>FIAT - SEDICI (FY_) 06/06→10/14</b>							
 <b>Bremsbelagsatz, Scheibenbremse</b>							
1.6 16V	79	06/06→10/14	←			13.0460-2715.2 602715	TRW 24391 16,6 + WK + Zub
1.6 16V	88	06/06→10/14					
1.6 16V 4x4	79	06/06→10/14	→			13.0460-5929.2 605929	AKE 21719 15,0 + WK
1.6 16V 4x4	88	06/06→10/14					
1.9 D Multijet	88	06/06→10/11					

	kW					! #		
<b>FIAT - SEDICI (FY_) 06/06→10/14</b>								
 <b>Bremsbelagsatz, Scheibenbremse</b>								
1.9 D Multijet 4x4	88	06/06→10/11	←			13.0460-2715.2	602715	TRW 24391 16,6 + WK + Zub
2.0 D Multijet	99	06/06→10/14						
2.0 D Multijet 4x4	99	06/06→10/14	→			13.0460-5929.2	605929	AKE 21719 15,0 + WK
 <b>Bremsscheibe</b>								
1.6 16V	79	06/06→10/14	←			24.0122-0252.1	422252	Ø 280 22 20 V
1.6 16V	88	06/06→10/14						
1.6 16V 4x4	79	06/06→10/14	→			24.0109-0167.1	409167	Ø 278 9 8
1.6 16V 4x4	88	06/06→10/14						
1.9 D Multijet	88	06/06→10/11						
1.9 D Multijet 4x4	88	06/06→10/11						
2.0 D Multijet	99	06/06→10/14						
2.0 D Multijet 4x4	99	06/06→10/14						
<b>FIAT - SEICENTO / 600 (187_) 11/97→01/10</b>								
 <b>Bremsbelagsatz, Scheibenbremse</b>								
0.9 (187AXA, 187AXA1A)	29	11/97→12/08	←	04/98→ 03/08		13.0460-3950.2	603950	BDX 21436 17,0 - WK
1.1 (187AXB, 187AXB1A, 187AXC1A02)	40	01/98→01/10						
 <b>Bremsscheibe</b>								
0.9 (187AXA, 187AXA1A)	29	11/97→12/08	←	04/98→ 03/08		24.0111-0119.1	411119	Ø 240,5 11 9,2
1.1 (187AXB, 187AXB1A, 187AXC1A02)	40	01/98→01/10						
Elektra (187AEA1A, 187BEA1A)	30	01/99→01/05	←	03/00→		24.0111-0119.1	411119	Ø 240,5 11 9,2
Elektrica	22	03/00→04/04	←			24.0111-0119.1	411119	Ø 240,5 11 9,2
<b>FIAT - SEICENTO / 600 Van (287_) 01/98→01/10</b>								
 <b>Bremsbelagsatz, Scheibenbremse</b>								
0.9 (187AXA)	29	01/98→01/10	←	04/98→ 03/08		13.0460-3950.2	603950	BDX 21436 17,0 - WK
1.1 (187CXB/C)	40	01/98→01/10						
 <b>Bremsscheibe</b>								
0.9 (187AXA)	29	01/98→01/10	←	04/98→ 03/08		24.0111-0119.1	411119	Ø 240,5 11 9,2
1.1 (187CXB/C)	40	01/98→01/10						
<b>FIAT - SIENA (178_, 172_) 04/96→10/13</b>								
 <b>Bremsbelagsatz, Scheibenbremse</b>								
1.2	44	09/01→12/12	←	03/02→		13.0460-3982.2	603982	BOS 23705 18,1 + WK
						13.0470-3982.2	LD3982	BOS 23705 18,1 + WK Ceramic
1.2	59	09/01→12/09	←	03/02→		13.0460-3982.2	603982	BOS 23705 18,1 + WK
						13.0470-3982.2	LD3982	BOS 23705 18,1 + WK Ceramic
				→ 12/06		13.0460-7126.2	607126	ATE 20907 18,1 - WE / - WK
1.3 JTD	51	09/03→12/09	←			13.0460-3982.2	603982	BOS 23705 18,1 + WK
						13.0470-3982.2	LD3982	BOS 23705 18,1 + WK Ceramic
				→ 12/06		13.0460-7126.2	607126	ATE 20907 18,1 - WE / - WK
1.4	51	04/96→12/09	←	04/98→ 12/06		13.0460-7128.2	607128	ATE 23218 18,0 + WK
1.4 Cat	51	04/96→12/09				13.0460-7132.2	607132	ATE 23218 18,0 - WE / - WK
1.4	57	01/07→12/09	←			13.0460-3982.2	603982	BOS 23705 18,1 + WK
						13.0470-3982.2	LD3982	BOS 23705 18,1 + WK Ceramic
1.5	62	06/04→12/09	←			13.0460-7128.2	607128	ATE 23218 18,0 + WK
1.7 TD	51	02/06→12/09				13.0460-7132.2	607132	ATE 23218 18,0 - WE / - WK
1.8	82	09/08→12/11						
1.6	76	11/00→12/09	←	03/02→		13.0460-3982.2	603982	BOS 23705 18,1 + WK
						13.0470-3982.2	LD3982	BOS 23705 18,1 + WK Ceramic
				→ 12/06		13.0460-7128.2	607128	ATE 23218 18,0 + WK
						13.0460-7132.2	607132	ATE 23218 18,0 - WE / - WK
1.6 16V	78	09/98→12/09	←	→ 12/06		13.0460-7128.2	607128	ATE 23218 18,0 + WK
						13.0460-7132.2	607132	ATE 23218 18,0 - WE / - WK
 <b>Bremsscheibe</b>								
1.2	59	09/01→12/09	←	→ 12/06		24.0120-0142.1	420142	Ø 257,5 20 18,2 V
1.3 JTD	51	09/03→12/09				24.0320-0142.1	520142	Ø 257,5 20 18,2 V
↓								















	kw			 	! #		
<b>FIAT - SIENA (178_, 172_) 04/96→10/13</b>							
 <b>Bremsscheibe</b>							
1.4 1.4 Cat	51 51	04/96→12/09 04/96→12/09	← ←	02/98→03/98 04/98→12/06		24.0112-0122.1 412122 24.0120-0193.1 420193	Ø 240 12 10,8 Ø 240 20 18,2 V
1.5 1.7 TD 1.8	62 51 82	06/04→12/09 02/06→12/09 09/08→12/11	←			24.0120-0193.1 420193	Ø 240 20 18,2 V
1.6 1.6 16V	76 78	11/00→12/09 09/98→12/09	←	→ 12/06		24.0120-0193.1 420193	Ø 240 20 18,2 V
<b>FIAT - STILO (192_) 10/01→11/10</b>							
 <b>Bremsbelagsatz, Scheibenbremse</b>							
1.2 16V (192_XA1B) 1.4 16V 1.4 16V 1.6 16V 1.6 16V (192_XB1A)	59 66 70 77 76	02/02→11/06 03/05→11/06 01/04→11/06 05/05→11/06 10/01→11/06	← ← ← → →			13.0460-3982.2 603982 13.0470-3982.2 LD3982 13.0460-3861.2 603861 13.0460-3991.2 603991 13.0470-3861.2 LD3861	BOS 23705 18,1 + WK BOS 23705 18,1 + WK Ceramic BOS 23714 17,6 + WK + Zub BOS 23714 16,6 - WE / - WK BOS + WK + Zub Ceramic
			→	06/05→ → 05/05		13.0460-3991.2 603991	BOS 23714 16,6 - WE / - WK
1.6 1.9 JTD 1.9 JTD 2.4 20V (192_XD1A, 192AXD12)	100 100 103 125	04/05→11/06 04/04→11/06 01/04→11/06 10/01→04/07	← ← ← →			13.0460-3984.2 603984 13.0470-3984.2 LD3984 13.0460-3861.2 603861 13.0460-3991.2 603991 13.0470-3861.2 LD3861	BOS 23711 19,4 + WK BOS 23711 19,4 + WK Ceramic BOS 23714 17,6 + WK + Zub BOS 23714 16,6 - WE / - WK BOS + WK + Zub Ceramic
			→	06/05→ → 05/05		13.0460-3991.2 603991	BOS 23714 16,6 - WE / - WK
1.8 16V (192_XC1A) 1.9 JTD 1.9 JTD (192_XE1A) 1.9 JTD (192_XF1A) 1.9 JTD (192AXS1B, 192BXS1B)	98 93 85 59 66	10/01→11/06 09/03→11/06 10/01→11/06 02/02→11/06 09/04→11/06	← ← ← ← →			13.0460-3983.2 603983 13.0470-3983.2 LD3983 13.0460-3861.2 603861 13.0460-3991.2 603991 13.0470-3861.2 LD3861	BOS 23708 19,4 + WK BOS 23708 19,4 + WK Ceramic BOS 23714 17,6 + WK + Zub BOS 23714 16,6 - WE / - WK BOS + WK + Zub Ceramic
			→	06/05→ → 05/05		13.0460-3991.2 603991	BOS 23714 16,6 - WE / - WK
1.9 D Multijet 1.9 D Multijet	74 88	09/05→11/06 09/05→11/06	← ←			13.0460-3983.2 603983 13.0470-3983.2 LD3983	BOS 23708 19,4 + WK BOS 23708 19,4 + WK Ceramic
			→			13.0460-3861.2 603861 13.0460-3991.2 603991 13.0470-3861.2 LD3861	BOS 23714 17,6 + WK + Zub BOS 23714 16,6 - WE / - WK BOS + WK + Zub Ceramic
1.9 D Multijet	110	09/05→11/06	←			13.0460-3984.2 603984 13.0470-3984.2 LD3984	BOS 23711 19,4 + WK BOS 23711 19,4 + WK Ceramic
			→			13.0460-3861.2 603861 13.0460-3991.2 603991 13.0470-3861.2 LD3861	BOS 23714 17,6 + WK + Zub BOS 23714 16,6 - WE / - WK BOS + WK + Zub Ceramic
<b>Zubehörsatz, Scheibenbremsbelag</b>							
1.2 16V (192_XA1B) 1.4 16V 1.4 16V 1.6 1.6 16V 1.6 16V (192_XB1A) 1.8 16V (192_XC1A) 1.9 JTD 1.9 JTD 1.9 JTD 1.9 JTD (192_XE1A) 1.9 JTD (192_XF1A) 1.9 JTD (192AXS1B, 192BXS1B) 2.4 20V (192_XD1A, 192AXD12)	59 66 70 100 77 76 98 93 100 103 85 59 66 125	02/02→11/06 03/05→11/06 01/04→11/06 04/05→11/06 05/05→11/06 10/01→11/06 10/01→11/06 09/03→11/06 04/04→11/06 01/04→11/06 10/01→11/06 02/02→11/06 09/04→11/06 10/01→04/07	← ← ← → → → → → → → → → → →			13.0460-0454.2 610454 13.0460-0256.2 610256	BOS BOS
1.9 D Multijet 1.9 D Multijet 1.9 D Multijet	74 88 110	09/05→11/06 09/05→11/06 09/05→11/06	← ← ←			13.0460-0454.2 610454	BOS
 <b>Bremsscheibe</b>							
1.2 16V (192_XA1B) 1.4 16V 1.4 16V 1.6 16V 1.6 16V (192_XB1A)	59 66 70 77 76	02/02→11/06 03/05→11/06 01/04→11/06 05/05→11/06 10/01→11/06	← ← ← → →			24.0122-0197.1 422197 24.0322-0197.1 522197 24.0110-0190.1 410190	Ø 257,5 22 20,2 V Ø 257,5 22 20,2 V Ø 251,5 10 9
1.6 1.9 D Multijet 1.9 JTD	100 110 100	04/05→11/06 09/05→11/06 04/04→11/06	← ← →			24.0126-0125.1 426125 24.0110-0190.1 410190	Ø 281 26 24,2 V Ø 251,5 10 9
↓							









	kw			 	! #		
<b>FIAT - STILO (192_) 10/01→11/10</b>							
<b>Bremsscheibe</b>							
1.9 JTD	103	01/04→11/06	←			24.0126-0125.1 426125	Ø 281 26 24,2 V
2.4 20V (192_XD1A, 192AXD12)	125	10/01→04/07	→			24.0110-0190.1 410190	Ø 251,5 10 9
1.8 16V (192_XC1A)	98	10/01→11/06	←			24.0122-0147.1 422147	Ø 284 22 20,2 V
1.9 D Multijet	74	09/05→11/06	→			24.0110-0190.1 410190	Ø 251,5 10 9
1.9 D Multijet	88	09/05→11/06	→				
1.9 JTD	93	09/03→11/06					
1.9 JTD (192_XE1A)	85	10/01→11/06					
1.9 JTD (192_XF1A)	59	02/02→11/06					
1.9 JTD (192AXS1B, 192BXS1B)	66	09/04→11/06					
<b>FIAT - STILO Multi Wagon (192_) 01/03→08/08</b>							
<b>Bremsbelagsatz, Scheibenbremse</b>							
1.4 16V	66	03/05→08/08	←	→ 03/08		13.0460-3982.2 603982	BOS 23705 18,1 + WK
1.4 16V	70	01/04→08/08				13.0470-3982.2 LD3982	BOS 23705 18,1 + WK Ceramic
1.6 16V	76	01/03→08/08	→	06/05→ 03/08		13.0460-3861.2 603861	BOS 23714 17,6 + WK + Zub
						13.0460-3991.2 603991	BOS 23714 16,6 - WE / - WK
			→	→ 05/05		13.0470-3861.2 LD3861	BOS + WK + Zub Ceramic
			→	→ 05/05		13.0460-3991.2 603991	BOS 23714 16,6 - WE / - WK
1.6 16V	77	03/05→12/07	←			13.0460-3982.2 603982	BOS 23705 18,1 + WK
						13.0470-3982.2 LD3982	BOS 23705 18,1 + WK Ceramic
			→	06/05→		13.0460-3861.2 603861	BOS 23714 17,6 + WK + Zub
						13.0460-3991.2 603991	BOS 23714 16,6 - WE / - WK
			→	→ 05/05		13.0470-3861.2 LD3861	BOS + WK + Zub Ceramic
			→	→ 05/05		13.0460-3991.2 603991	BOS 23714 16,6 - WE / - WK
1.8 16V	98	01/03→08/08	←	→ 03/08		13.0460-3983.2 603983	BOS 23708 19,4 + WK
1.9 D	66	09/04→08/08				13.0470-3983.2 LD3983	BOS 23708 19,4 + WK Ceramic
1.9 JTD	59	01/03→08/08	→	06/05→ 03/08		13.0460-3861.2 603861	BOS 23714 17,6 + WK + Zub
1.9 JTD	85	01/03→08/08	→	06/05→ 03/08		13.0460-3991.2 603991	BOS 23714 16,6 - WE / - WK
1.9 JTD	93	09/03→08/08				13.0470-3861.2 LD3861	BOS + WK + Zub Ceramic
			→	→ 05/05		13.0460-3991.2 603991	BOS 23714 16,6 - WE / - WK
1.9 D Multijet	74	09/05→08/08	←	→ 03/08		13.0460-3983.2 603983	BOS 23708 19,4 + WK
1.9 D Multijet	88	09/05→08/08				13.0470-3983.2 LD3983	BOS 23708 19,4 + WK Ceramic
			→	→ 03/08		13.0460-3861.2 603861	BOS 23714 17,6 + WK + Zub
						13.0460-3991.2 603991	BOS 23714 16,6 - WE / - WK
						13.0470-3861.2 LD3861	BOS + WK + Zub Ceramic
1.9 D Multijet (192DXT1B)	110	09/05→08/08	←	→ 03/08		13.0460-3984.2 603984	BOS 23711 19,4 + WK
						13.0470-3984.2 LD3984	BOS 23711 19,4 + WK Ceramic
			→	→ 03/08		13.0460-3861.2 603861	BOS 23714 17,6 + WK + Zub
						13.0460-3991.2 603991	BOS 23714 16,6 - WE / - WK
						13.0470-3861.2 LD3861	BOS + WK + Zub Ceramic
1.9 JTD	100	04/04→08/08	←	→ 03/08		13.0460-3984.2 603984	BOS 23711 19,4 + WK
1.9 JTD	103	01/04→08/08				13.0470-3984.2 LD3984	BOS 23711 19,4 + WK Ceramic
			→	06/05→ 03/08		13.0460-3861.2 603861	BOS 23714 17,6 + WK + Zub
						13.0460-3991.2 603991	BOS 23714 16,6 - WE / - WK
						13.0470-3861.2 LD3861	BOS + WK + Zub Ceramic
			→	→ 05/05		13.0460-3991.2 603991	BOS 23714 16,6 - WE / - WK
<b>Zubehörsatz, Scheibenbremsbelag</b>							
1.4 16V	66	03/05→08/08	←	→ 03/08		13.0460-0454.2 610454	BOS
1.4 16V	70	01/04→08/08				13.0460-0256.2 610256	BOS
1.6 16V	76	01/03→08/08	→	→ 05/05			
1.8 16V	98	01/03→08/08					
1.9 D	66	09/04→08/08					
1.9 JTD	59	01/03→08/08					
1.9 JTD	85	01/03→08/08					
1.9 JTD	93	09/03→08/08					
1.9 JTD	100	04/04→08/08					
1.9 JTD	103	01/04→08/08					
1.6 16V	77	03/05→12/07	←				
			→	→ 05/05		13.0460-0256.2 610256	BOS
1.9 D Multijet	74	09/05→08/08	←	→ 03/08		13.0460-0454.2 610454	BOS
1.9 D Multijet	88	09/05→08/08					
1.9 D Multijet (192DXT1B)	110	09/05→08/08					













	kw					! #		
<b>FIAT - STILO Multi Wagon (192_) 01/03→08/08</b>								
 <b>Bremsscheibe</b>								
1.4 16V	66	03/05→08/08	←	→ 03/08		24.0122-0197.1	422197	Ø 257,5 22 20,2 V
1.4 16V	70	01/04→08/08				24.0322-0197.1	522197	Ø 257,5 22 20,2 V
1.6 16V	76	01/03→08/08	→	→ 03/08		24.0110-0190.1	410190	Ø 251,5 10 9
1.6 16V	77	03/05→12/07	←			24.0122-0197.1	422197	Ø 257,5 22 20,2 V
			→			24.0322-0197.1	522197	Ø 257,5 22 20,2 V
			→			24.0110-0190.1	410190	Ø 251,5 10 9
1.8 16V	98	01/03→08/08	←	→ 03/08		24.0122-0147.1	422147	Ø 284 22 20,2 V
1.9 D	66	09/04→08/08						
1.9 D Multijet	74	09/05→08/08	→	→ 03/08		24.0110-0190.1	410190	Ø 251,5 10 9
1.9 D Multijet	88	09/05→08/08						
1.9 JTD	59	01/03→08/08						
1.9 JTD	85	01/03→08/08						
1.9 JTD	93	09/03→08/08						
1.9 D Multijet (192DXT1B)	110	09/05→08/08	←	→ 03/08		24.0126-0125.1	426125	Ø 281 26 24,2 V
1.9 JTD	100	04/04→08/08	→	→ 03/08		24.0110-0190.1	410190	Ø 251,5 10 9
1.9 JTD	103	01/04→08/08						
<b>FIAT - STRADA Pick-up (178_) 02/98→</b>								
 <b>Bremsbelagsatz, Scheibenbremse</b>								
1.2	44	04/03→	←	→ 12/11		13.0460-7126.2	607126	ATE 20907 18,1 - WE / - WK
1.2 Trekking	60	11/05→						
1.3 D Multijet	62	05/06→						
1.9 D	46	12/00→						
1.9 JTD	59	04/03→						
1.2	54	06/99→12/06	←			13.0460-7126.2	607126	ATE 20907 18,1 - WE / - WK
1.7 TD	51	06/99→12/06						
 <b>Bremsscheibe</b>								
1.2	44	04/03→	←	→ 12/11		24.0120-0142.1	420142	Ø 257,5 20 18,2 V
1.2 Trekking	60	11/05→				24.0320-0142.1	520142	Ø 257,5 20 18,2 V
1.3 D Multijet	62	05/06→						
1.9 D	46	12/00→						
1.9 JTD	59	04/03→						
1.2	54	06/99→12/06	←			24.0120-0142.1	420142	Ø 257,5 20 18,2 V
1.7 TD	51	06/99→12/06				24.0320-0142.1	520142	Ø 257,5 20 18,2 V
<b>FIAT - STRADA Pick-up (278_) 01/09→</b>								
 <b>Bremsscheibe</b>								
1.3 D Multijet (278AYR1A)	70	10/10→	←	01/11→		24.0120-0142.1	420142	Ø 257,5 20 18,2 V
<b>FIAT - TALENTO Bus (296_) 06/16→</b>								
 <b>Bremsbelagsatz, Scheibenbremse</b>								
1.6 D	70	06/16→	→			13.0460-2840.2	602840	TRW 23980 16,5 + WE / - WK
1.6 D	92	06/16→						
1.6 D	107	06/16→						
 <b>Bremsscheibe</b>								
1.6 D	70	06/16→	←			24.0128-0287.1	428287	Ø 296 28 23,4 V + S
1.6 D	92	06/16→						
1.6 D	107	06/16→						
<b>FIAT - TALENTO Kasten/Kombi (296_) 06/16→</b>								
 <b>Bremsbelagsatz, Scheibenbremse</b>								
1.6 D	70	06/16→	→			13.0460-2840.2	602840	TRW 23980 16,5 + WE / - WK
1.6 D	85	06/16→						
1.6 D	88	06/16→						
1.6 D	92	06/16→						
1.6 D	107	06/16→						
 <b>Bremsscheibe</b>								
1.6 D	70	06/16→	←			24.0128-0287.1	428287	Ø 296 28 23,4 V + S
1.6 D	85	06/16→						
1.6 D	88	06/16→						
1.6 D	92	06/16→						
1.6 D	107	06/16→						
<b>FIAT - TALENTO Kasten (296_) 06/16→</b>								
 <b>Bremsbelagsatz, Scheibenbremse</b>								
1.6 D	70	06/16→	→			13.0460-2840.2	602840	TRW 23980 16,5 + WE / - WK
1.6 D	85	06/16→						
↓								















	kw			 	! #		
<b>FIAT - TALENTO Kasten (296_) 06/16→</b>							
 <b>Bremsbelagsatz, Scheibenbremse</b>							
1.6 D	88	06/16→	→			13.0460-2840.2 602840	TRW 23980 16,5 + WE / - WK
1.6 D	92	06/16→					
1.6 D	107	06/16→					
 <b>Bremsscheibe</b>							
1.6 D	70	06/16→	←			24.0128-0287.1 428287	Ø 296 28 23,4 V + S
1.6 D	85	06/16→					
1.6 D	88	06/16→					
1.6 D	92	06/16→					
1.6 D	107	06/16→					
<b>FIAT - TALENTO Pritsche/Fahrgestell (296_) 06/16→</b>							
 <b>Bremsbelagsatz, Scheibenbremse</b>							
1.6 D	92	06/16→	→			13.0460-2840.2 602840	TRW 23980 16,5 + WE / - WK
1.6 D	107	06/16→					
 <b>Bremsscheibe</b>							
1.6 D	92	06/16→	←			24.0128-0287.1 428287	Ø 296 28 23,4 V + S
1.6 D	107	06/16→					
<b>FIAT - TEMPRA (159_) 03/90→12/98</b>							
 <b>Bremsbelagsatz, Scheibenbremse</b>							
1.4 i.e. (159.AA)	57	03/91→08/96	←	→ 04/93; Schaltgetriebe; - ABS		13.0460-2948.2 602948	TRW 21100 16,7 + WK
1.4 i.e. (159.AC, 159.AX)	51	04/90→08/96	←	→ 04/93; Vollautomatik		13.0460-2949.2 602949	TRW 20833 17,0 + WK
1.6 i.e. (159.AS, 159.AT)	55	06/92→08/96	←	→ 04/93; Schaltgetriebe; + ABS		13.0460-2949.2 602949	TRW 20833 17,0 + WK
			←	05/93→		13.0460-2949.2 602949	TRW 20833 17,0 + WK
			→	→ 04/93; + ABS		13.0460-2951.2 602951	TRW 21103 14,2 - WK
			→	05/93→; + ABS		13.0460-2951.2 602951	TRW 21103 14,2 - WK
1.6 (159AS, 159AT)	51	04/90→07/96	←	→ 04/93; Schaltgetriebe; - ABS		13.0460-2948.2 602948	TRW 21100 16,7 + WK
			←	→ 04/93; Schaltgetriebe; + ABS		13.0460-2949.2 602949	TRW 20833 17,0 + WK
			←	→ 04/93; Vollautomatik		13.0460-2949.2 602949	TRW 20833 17,0 + WK
1.6 i.e. (159.AJ)	63	06/94→08/96	←			13.0460-2949.2 602949	TRW 20833 17,0 + WK
1.6 i.e. (159.AJ)	66	06/94→08/96	→	+ ABS		13.0460-2951.2 602951	TRW 21103 14,2 - WK
1.8 i.e. (159.AV)	76	09/93→08/96	→				
1.8 i.e. (159.AZ)	66	09/93→08/96	→				
1.8 i.e. (159.BY)	74	10/94→08/96	→				
1.8 i.e. (159.AN)	77	03/92→08/96	←	→ 04/93		13.0460-2949.2 602949	TRW 20833 17,0 + WK
1.8 i.e. (159.AN)	81	03/90→08/96	←	05/93→		13.0460-2949.2 602949	TRW 20833 17,0 + WK
1.9 TD (159.AQ)	59	07/92→08/96	→	→ 04/93; + ABS		13.0460-2951.2 602951	TRW 21103 14,2 - WK
1.9 TD (159.CU, 159.AU, 159.AI, 159.BI)	66	05/90→08/96	→	05/93→; + ABS		13.0460-2951.2 602951	TRW 21103 14,2 - WK
1.9 D (159.AG)	48	07/91→08/96	←	05/93→		13.0460-2949.2 602949	TRW 20833 17,0 + WK
			→	05/93→; + ABS		13.0460-2951.2 602951	TRW 21103 14,2 - WK
2.0	81	05/94→12/98	←	→ 09/96		13.0460-2949.2 602949	TRW 20833 17,0 + WK
			→	→ 09/96		13.0460-2951.2 602951	TRW 21103 14,2 - WK
2.0 i.e. (159.AP)	83	10/90→08/96	←	05/93→		13.0460-2949.2 602949	TRW 20833 17,0 + WK
			←	→ 04/93		13.0460-2949.2 602949	TRW 20833 17,0 + WK
			→	05/93→		13.0460-2951.2 602951	TRW 21103 14,2 - WK
			→	→ 04/93		13.0460-2951.2 602951	TRW 21103 14,2 - WK
<b>Zubehörsatz, Scheibenbremsbelag</b>							
1.4 i.e. (159.AA)	57	03/91→08/96	→	05/93→; + ABS		13.0460-0072.2 610072	TRW
1.4 i.e. (159.AC, 159.AX)	51	04/90→08/96	→	→ 04/93; + ABS		13.0460-0072.2 610072	TRW
1.6 i.e. (159.AS, 159.AT)	55	06/92→08/96	→				
1.8 i.e. (159.AN)	77	03/92→08/96	→				
1.8 i.e. (159.AN)	81	03/90→08/96	→				
1.9 TD (159.AQ)	59	07/92→08/96	→				
1.9 TD (159.CU, 159.AU, 159.AI, 159.BI)	66	05/90→08/96	→				
1.6 i.e. (159.AJ)	63	06/94→08/96	→	+ ABS		13.0460-0072.2 610072	TRW
1.6 i.e. (159.AJ)	66	06/94→08/96	→				
1.8 i.e. (159.AV)	76	09/93→08/96	→				
1.8 i.e. (159.AZ)	66	09/93→08/96	→				
1.8 i.e. (159.BY)	74	10/94→08/96	→				
1.9 D (159.AG)	48	07/91→08/96	→	05/93→; + ABS		13.0460-0072.2 610072	TRW
2.0	81	05/94→12/98	→	→ 09/96		13.0460-0072.2 610072	TRW
↓							

















	kw			 	! #		
<b>FIAT - TEMPRA (159_) 03/90→12/98</b>							
<b>Zubehörsatz, Scheibenbremsbelag</b>							
2.0 i.e. (159.AP)	83	10/90→08/96	➡	05/93→		13.0460-0072.2 610072	TRW
			➡	→ 04/93		13.0460-0072.2 610072	TRW
<b> Bremsscheibe</b>							
1.4 i.e. (159.AA)	57	03/91→08/96	←	→ 04/93; Schaltgetriebe; - ABS		24.0111-0119.1 411119	Ø 240,5 11 9,2
1.4 i.e. (159.AC, 159.AX)	51	04/90→08/96	←	05/93→; - ABS		24.0111-0119.1 411119	Ø 240,5 11 9,2
			←	→ 04/93; Schaltgetriebe; + ABS		24.0112-0127.1 412127	Ø 257,5 12 10,2
			←	→ 04/93; Vollautomatik		24.0112-0127.1 412127	Ø 257,5 12 10,2
			←	05/93→; + ABS		24.0112-0127.1 412127	Ø 257,5 12 10,2
			➡	05/93→; + ABS		24.0111-0119.1 411119	Ø 240,5 11 9,2
			➡	→ 04/93; + ABS		24.0111-0119.1 411119	Ø 240,5 11 9,2
1.6 (159AS, 159AT)	51	04/90→07/96	←	→ 04/93; Schaltgetriebe; - ABS		24.0111-0119.1 411119	Ø 240,5 11 9,2
			←	→ 04/93; Schaltgetriebe; + ABS		24.0112-0127.1 412127	Ø 257,5 12 10,2
			←	→ 04/93; Vollautomatik		24.0112-0127.1 412127	Ø 257,5 12 10,2
1.6 i.e. (159.AJ)	63	06/94→08/96	←	Schaltgetriebe; - ABS		24.0111-0119.1 411119	Ø 240,5 11 9,2
1.6 i.e. (159.AJ)	66	06/94→08/96	←	Vollautomatik; + ABS		24.0112-0127.1 412127	Ø 257,5 12 10,2
			➡	+ ABS		24.0111-0119.1 411119	Ø 240,5 11 9,2
1.6 i.e. (159.AS, 159.AT)	55	06/92→08/96	←	05/93→; Schaltgetriebe; - ABS		24.0111-0119.1 411119	Ø 240,5 11 9,2
			←	→ 04/93; Schaltgetriebe; - ABS		24.0111-0119.1 411119	Ø 240,5 11 9,2
			←	→ 04/93; Schaltgetriebe; + ABS		24.0112-0127.1 412127	Ø 257,5 12 10,2
			←	→ 04/93; Vollautomatik		24.0112-0127.1 412127	Ø 257,5 12 10,2
			←	05/93→; Vollautomatik; + ABS		24.0112-0127.1 412127	Ø 257,5 12 10,2
			➡	→ 04/93; + ABS		24.0111-0119.1 411119	Ø 240,5 11 9,2
			➡	05/93→; + ABS		24.0111-0119.1 411119	Ø 240,5 11 9,2
1.8 i.e. (159.AN)	77	03/92→08/96	←	05/93→		24.0112-0127.1 412127	Ø 257,5 12 10,2
1.8 i.e. (159.AN)	81	03/90→08/96	←	→ 04/93		24.0112-0127.1 412127	Ø 257,5 12 10,2
1.9 TD (159.AQ)	59	07/92→08/96	←	→ 04/93		24.0112-0127.1 412127	Ø 257,5 12 10,2
1.9 TD (159.CU, 159.AU, 159.AI, 159.BI)	66	05/90→08/96	➡	05/93→; + ABS		24.0111-0119.1 411119	Ø 240,5 11 9,2
			➡	→ 04/93; + ABS		24.0111-0119.1 411119	Ø 240,5 11 9,2
1.8 i.e. (159.AV)	76	09/93→08/96	←			24.0112-0127.1 412127	Ø 257,5 12 10,2
1.8 i.e. (159.AZ)	66	09/93→08/96	←			24.0112-0127.1 412127	Ø 257,5 12 10,2
1.8 i.e. (159.BY)	74	10/94→08/96	➡	+ ABS		24.0111-0119.1 411119	Ø 240,5 11 9,2
1.9 D (159.AG)	48	07/91→08/96	←	05/93→; - ABS		24.0111-0119.1 411119	Ø 240,5 11 9,2
			←	05/93→; + ABS		24.0112-0127.1 412127	Ø 257,5 12 10,2
			➡	05/93→; + ABS		24.0111-0119.1 411119	Ø 240,5 11 9,2
2.0	81	05/94→12/98	←	→ 09/96		24.0120-0142.1 420142	Ø 257,5 20 18,2 V
			←			24.0320-0142.1 520142	Ø 257,5 20 18,2 V
			➡	→ 09/96		24.0111-0119.1 411119	Ø 240,5 11 9,2
2.0 i.e. (159.AP)	83	10/90→08/96	←	05/93→		24.0120-0142.1 420142	Ø 257,5 20 18,2 V
			←			24.0320-0142.1 520142	Ø 257,5 20 18,2 V
			←	→ 04/93		24.0120-0142.1 420142	Ø 257,5 20 18,2 V
			←			24.0320-0142.1 520142	Ø 257,5 20 18,2 V
			➡	→ 04/93		24.0111-0119.1 411119	Ø 240,5 11 9,2
			➡	05/93→		24.0111-0119.1 411119	Ø 240,5 11 9,2
<b>FIAT - TEMPRA S.W. (159_) 03/90→10/97</b>							
<b> Bremsbelagsatz, Scheibenbremse</b>							
1.4 i.e. (159.AC, 159.AX)	51	10/92→08/96	←	→ 04/93		13.0460-2949.2 602949	TRW 20833 17,0 + WK
1.4 i.e. (159.AC)	57	03/91→08/96	←			13.0460-2949.2 602949	TRW 20833 17,0 + WK
1.6 i.e. (159.AE)	57	10/90→08/96	←	05/93→		13.0460-2949.2 602949	TRW 20833 17,0 + WK
1.6 i.e. (159.AS, 159.AT)	55	10/92→08/96	➡	→ 04/93; + ABS		13.0460-2951.2 602951	TRW 21103 14,2 - WK
1.8 i.e. (159.AN)	81	03/90→08/96	➡			13.0460-2951.2 602951	TRW 21103 14,2 - WK
1.9 D (159.AG)	48	07/91→08/96	➡	05/93→; + ABS		13.0460-2951.2 602951	TRW 21103 14,2 - WK
1.6 i.e. (159.AJ)	66	06/94→08/96	←			13.0460-2949.2 602949	TRW 20833 17,0 + WK
1.8 i.e. (159.AV)	76	09/93→08/96	←			13.0460-2949.2 602949	TRW 20833 17,0 + WK
1.8 i.e. (159.AZ)	66	09/93→08/96	➡	+ ABS		13.0460-2951.2 602951	TRW 21103 14,2 - WK
1.8 i.e. (159.BY)	74	10/94→08/96	➡			13.0460-2951.2 602951	TRW 21103 14,2 - WK
<b>Zubehörsatz, Scheibenbremsbelag</b>							
1.4 i.e. (159.AC, 159.AX)	51	10/92→08/96	➡	→ 04/93; + ABS		13.0460-0072.2 610072	TRW
1.4 i.e. (159.AC)	57	03/91→08/96					













	kw			 	! #		
<b>FIAT - TEMPRA S.W. (159_) 03/90→10/97</b>							
<b>Zubehörsatz, Scheibenbremsbelag</b>							
1.6 i.e. (159.AE)	57	10/90→08/96	➔	05/93→; + ABS		13.0460-0072.2 610072	TRW
1.6 i.e. (159.AS, 159.AT)	55	10/92→08/96					
1.8 i.e. (159.AN)	81	03/90→08/96					
1.9 D (159.AG)	48	07/91→08/96					
1.6 i.e. (159.AJ)	66	06/94→08/96	➔	+ ABS		13.0460-0072.2 610072	TRW
1.8 i.e. (159.AV)	76	09/93→08/96					
1.8 i.e. (159.AZ)	66	09/93→08/96					
1.8 i.e. (159.BY)	74	10/94→08/96					
<b> Bremsscheibe</b>							
1.4 i.e. (159.AC, 159.AX)	51	10/92→08/96	←	→ 04/93		24.0112-0127.1 412127	Ø 257,5 12 10,2
1.4 i.e. (159.AC)	57	03/91→08/96	←	05/93→		24.0112-0127.1 412127	Ø 257,5 12 10,2
1.6 i.e. (159.AE)	57	10/90→08/96					
1.6 i.e. (159.AS, 159.AT)	55	10/92→08/96	➔	→ 04/93; + ABS		24.0111-0119.1 411119	Ø 240,5 11 9,2
1.9 D (159.AG)	48	07/91→08/96	➔	05/93→; + ABS		24.0111-0119.1 411119	Ø 240,5 11 9,2
1.6 i.e. (159.AJ)	66	06/94→08/96	←			24.0112-0127.1 412127	Ø 257,5 12 10,2
			➔	+ ABS		24.0111-0119.1 411119	Ø 240,5 11 9,2
1.8 i.e. (159.AN)	81	03/90→08/96	←	→ 04/93		24.0120-0142.1 420142	Ø 257,5 20 18,2 V
			←	05/93→		24.0320-0142.1 520142	Ø 257,5 20 18,2 V
			←			24.0120-0142.1 420142	Ø 257,5 20 18,2 V
			←			24.0320-0142.1 520142	Ø 257,5 20 18,2 V
			➔	→ 04/93; + ABS		24.0111-0119.1 411119	Ø 240,5 11 9,2
			➔	05/93→; + ABS		24.0111-0119.1 411119	Ø 240,5 11 9,2
1.8 i.e. (159.AV)	76	09/93→08/96	←			24.0120-0142.1 420142	Ø 257,5 20 18,2 V
1.8 i.e. (159.AZ)	66	09/93→08/96				24.0320-0142.1 520142	Ø 257,5 20 18,2 V
1.8 i.e. (159.BY)	74	10/94→08/96	➔	+ ABS		24.0111-0119.1 411119	Ø 240,5 11 9,2
<b>FIAT - TIPO Kombi (357_) 03/16→</b>							
<b> Bremsbelagsatz, Scheibenbremse</b>							
1.3 D	70	03/16→	←			13.0460-5679.2 605679	MAN + WK + Zub
1.4	70	03/16→					
1.4	88	03/16→					
1.6	81	07/16→					
1.6 D	84	09/16→					
1.6 D	88	03/16→					
<b> Bremsscheibe</b>							
1.3 D	70	03/16→	←			24.0122-0145.1 422145	Ø 284 22 20,2 V
1.4	70	03/16→					
1.4	88	03/16→	➔			24.0110-0378.1 410378	Ø 251 10 9
1.6	81	07/16→	←	nicht für Automatikgetriebe		24.0122-0145.1 422145	Ø 284 22 20,2 V
1.6 D	84	09/16→					
1.6 D	88	03/16→	➔			24.0110-0378.1 410378	Ø 251 10 9
<b>FIAT - TIPO Schrägheck (357_) 03/16→</b>							
<b> Bremsbelagsatz, Scheibenbremse</b>							
1.3 D	70	03/16→	←			13.0460-5679.2 605679	MAN + WK + Zub
1.4	70	03/16→					
1.4	88	03/16→					
1.6	81	07/16→					
1.6 D	84	09/16→					
1.6 D	88	03/16→					
<b> Bremsscheibe</b>							
1.3 D	70	03/16→	←			24.0122-0145.1 422145	Ø 284 22 20,2 V
1.4	70	03/16→					
1.4	88	03/16→	➔			24.0110-0378.1 410378	Ø 251 10 9
1.6	81	07/16→	←	nicht für Automatikgetriebe		24.0122-0145.1 422145	Ø 284 22 20,2 V
1.6 D	84	09/16→					
1.6 D	88	03/16→	➔			24.0110-0378.1 410378	Ø 251 10 9
<b>FIAT - TIPO Stufenheck (356_) 10/15→</b>							
<b> Bremsbelagsatz, Scheibenbremse</b>							
1.3 D	70	10/15→	←			13.0460-5679.2 605679	MAN + WK + Zub
1.4	70	10/15→					
1.6	81	10/15→					
1.6 D	84	09/16→					
1.6 D	88	10/15→					
↓							



	kw			 	! #		
<b>FIAT - TIPO Stufenheck (356_) 10/15→</b>							
 <b>Bremsscheibe</b>							
1.3 D 1.4	70 70	10/15→ 10/15→	← →			24.0122-0145.1 422145 24.0110-0378.1 410378	Ø 284 22 20,2 V Ø 251 10 9
1.6 1.6 D 1.6 D	81 84 88	10/15→ 09/16→ 10/15→	← →	nicht für Automatikgetriebe		24.0122-0145.1 422145 24.0110-0378.1 410378	Ø 284 22 20,2 V Ø 251 10 9
<b>FIAT - ULYSSE (179_) 08/02→06/11</b>							
 <b>Bremsbelagsatz, Scheibenbremse</b>							
2.0 2.0 D Multijet 2.0 D Multijet 2.2 JTD	100 88 100 120	08/02→06/11 05/06→06/11 05/06→06/11 03/08→06/11	← →	→ 01/11 → 01/11		13.0460-2863.2 602863 13.0460-2819.2 602819	TRW 20261 19,0 + WK + Zub TRW 20961 17,2 - WK
2.0 JTD 2.0 JTD 2.2 JTD	79 80 94	05/03→08/06 08/02→08/06 08/02→08/06	← →			13.0460-2863.2 602863 13.0460-2819.2 602819	TRW 20261 19,0 + WK + Zub TRW 20961 17,2 - WK
2.2 D Multijet	125	03/08→06/11	← →	→ 01/11 → 01/11		13.0460-2752.2 602752 13.0460-2819.2 602819	TRW 24839 19,4 + WK + Zub TRW 20961 17,2 - WK
3.0	150	08/02→06/11	← →	→ 01/11 → 01/11		13.0460-4995.2 604995 13.0460-2819.2 602819	BRE 23575 15,6 + WK TRW 20961 17,2 - WK
<b>Zubehörsatz, Scheibenbremsbelag</b>							
2.0 2.0 D Multijet 2.0 D Multijet 2.2 D Multijet 2.2 JTD 3.0	100 88 100 125 120 150	08/02→06/11 05/06→06/11 05/06→06/11 03/08→06/11 03/08→06/11 08/02→06/11	→	→ 01/11		13.0460-0072.2 610072	TRW
2.0 JTD 2.0 JTD 2.2 JTD	79 80 94	05/03→08/06 08/02→08/06 08/02→08/06	→			13.0460-0072.2 610072	TRW
 <b>Bremsscheibe</b>							
2.0 2.0 D Multijet 2.0 D Multijet 2.2 JTD	100 88 100 120	08/02→06/11 05/06→06/11 05/06→06/11 03/08→06/11	← →	→ 01/11 → 01/11		24.0128-0136.1 428136 24.0328-0136.1 528136 24.0112-0156.1 412156	Ø 285 28 26 V Ø 285 28 26 V Ø 272 12 10
2.0 JTD 2.0 JTD 2.2 JTD	79 80 94	05/03→08/06 08/02→08/06 08/02→08/06	← →			24.0128-0136.1 428136 24.0328-0136.1 528136 24.0112-0156.1 412156	Ø 285 28 26 V Ø 285 28 26 V Ø 272 12 10
2.2 D Multijet 3.0	125 150	03/08→06/11 08/02→06/11	← →	→ 01/11 → 01/11		24.0132-0126.1 432126 24.0112-0156.1 412156	Ø 310 32 30 V Ø 272 12 10
<b>FIAT - ULYSSE (220_) 06/94→08/02</b>							
 <b>Bremsbelagsatz, Scheibenbremse</b>							
1.8 (220.BB5)	73	05/97→08/02	← →	→ 07/02 → 07/02; + ABS		13.0460-3957.2 603957 13.0460-7061.2 607061	BDX 23042 19,0 + WK + Zub ATE 21275 17,0 + WK
1.9 TD	68	05/97→12/99	← →			13.0460-2978.2 602978 13.0460-7061.2 607061	TRW 21801 19,0 + WK ATE 21275 17,0 + WK
1.9 TD (220AH5) 2.0 (220.AC5) 2.0 JTD	66 89 80	02/95→08/02 06/94→08/02 10/99→08/02	← →	→ 07/02 → 07/02; + ABS		13.0460-2978.2 602978 13.0460-7061.2 607061	TRW 21801 19,0 + WK ATE 21275 17,0 + WK
2.0 16V	97	05/98→09/00	← →			13.0460-2978.2 602978 13.0460-7061.2 607061	TRW 21801 19,0 + WK ATE 21275 17,0 + WK
2.0 16V 2.0 Turbo (220.AD5)	100 108	09/00→08/02 06/94→08/02	← →	→ 07/02 → 07/02		13.0460-2978.2 602978 13.0460-7061.2 607061	TRW 21801 19,0 + WK ATE 21275 17,0 + WK
2.0 JTD 16V	80	05/99→08/02	← →	10/99→ 07/02 10/99→ 07/02; + ABS		13.0460-2978.2 602978 13.0460-7061.2 607061	TRW 21801 19,0 + WK ATE 21275 17,0 + WK
2.1 TD	80	03/96→10/99	← →	06/96→ 06/96→; + ABS		13.0460-2978.2 602978 13.0460-7061.2 607061	TRW 21801 19,0 + WK ATE 21275 17,0 + WK
 <b>Bremsscheibe</b>							
1.8 (220.BB5)	73	05/97→08/02	← →	→ 07/02 → 07/02; + ABS		24.0120-0155.1 420155 24.0110-0218.1 410218	Ø 257,5 20 18,2 V Ø 295 10 8
1.9 TD ↓	68	05/97→12/99	←			24.0126-0104.1 426104	Ø 281 26 24,2 V

	kw			 	! #		
<b>FIAT - ULYSSE (220_) 06/94→08/02</b>							
 <b>Bremsscheibe</b>							
1.9 TD	68	05/97→12/99	➡	+ ABS		24.0110-0218.1 410218	Ø 295 10 8
1.9 TD (220AH5)	66	02/95→08/02	←	→ 07/02		24.0126-0104.1 426104	Ø 281 26 24,2 V
2.0 (220.AC5)	89	06/94→08/02	➡	→ 07/02; + ABS		24.0110-0218.1 410218	Ø 295 10 8
2.0 JTD	80	10/99→08/02	➡			24.0110-0218.1 410218	Ø 295 10 8
2.0 16V	97	05/98→09/00	←			24.0126-0104.1 426104	Ø 281 26 24,2 V
			➡			24.0110-0218.1 410218	Ø 295 10 8
2.0 16V	100	09/00→08/02	←	→ 07/02		24.0126-0104.1 426104	Ø 281 26 24,2 V
2.0 Turbo (220.AD5)	108	06/94→08/02	➡	→ 07/02		24.0110-0218.1 410218	Ø 295 10 8
2.0 JTD 16V	80	05/99→08/02	←	10/99→ 07/02		24.0126-0104.1 426104	Ø 281 26 24,2 V
			➡	10/99→ 07/02; + ABS		24.0110-0218.1 410218	Ø 295 10 8
2.1 TD	80	03/96→10/99	←	06/96→		24.0126-0104.1 426104	Ø 281 26 24,2 V
			➡	06/96→; + ABS		24.0110-0218.1 410218	Ø 295 10 8
<b>FIAT - UNO (146_) 01/83→06/06</b>							
 <b>Bremsbelagsatz, Scheibenbremse</b>							
1.0	42	05/93→06/01	←	→ 06/95		13.0460-3939.2 603939	BDX 20775 18,0 + WE / - WK
1.7 D	43	11/94→08/00	←			13.0460-3940.2 603940	BDX 20775 18,0 + WK
1.1	41	04/86→06/06	←	10/89→ 06/95		13.0460-3939.2 603939	BDX 20775 18,0 + WE / - WK
70 i.e. 1.4	51	09/89→07/96	←			13.0460-3940.2 603940	BDX 20775 18,0 + WK
70 S 1.4	52	10/88→06/06	←			13.0460-3940.2 603940	BDX 20775 18,0 + WK
1.4 Turbo i.e.	87	12/89→12/96	←	→ 06/95		13.0460-2941.2 602941	TRW 20838 17,0 + WK
<b>Zubehörsatz, Scheibenbremsbelag</b>							
1.0	42	05/93→06/01	←	→ 06/95		13.0460-0410.2 610410	BDX
1.7 D	43	11/94→08/00	←			13.0460-0410.2 610410	BDX
1.1	41	04/86→06/06	←	10/89→ 06/95		13.0460-0410.2 610410	BDX
70 i.e. 1.4	51	09/89→07/96	←			13.0460-0410.2 610410	BDX
70 S 1.4	52	10/88→06/06	←			13.0460-0410.2 610410	BDX
 <b>Bremsscheibe</b>							
1.0	42	05/93→06/01	←	→ 06/95		24.0111-0130.1 411130	Ø 227 10,8 9
1.7 D	43	11/94→08/00	←			24.0111-0130.1 411130	Ø 227 10,8 9
1.1	41	04/86→06/06	←	10/89→ 06/95		24.0111-0130.1 411130	Ø 227 10,8 9
70 i.e. 1.4	51	09/89→07/96	←			24.0111-0130.1 411130	Ø 227 10,8 9
70 S 1.4	52	10/88→06/06	←			24.0111-0130.1 411130	Ø 227 10,8 9
1.4 Turbo i.e.	87	12/89→12/96	←	→ 06/95		24.0120-0143.1 420143	Ø 240 20 18,2 V
			➡	→ 06/95		24.0111-0130.1 411130	Ø 227 10,8 9
<b>FIAT - UNO Kasten (146_) 02/88→07/96</b>							
 <b>Bremsbelagsatz, Scheibenbremse</b>							
45 0.9	33	02/88→07/96	←	10/89→ 06/95		13.0460-3939.2 603939	BDX 20775 18,0 + WE / - WK
						13.0460-3940.2 603940	BDX 20775 18,0 + WK
<b>Zubehörsatz, Scheibenbremsbelag</b>							
45 0.9	33	02/88→07/96	←	10/89→ 06/95		13.0460-0410.2 610410	BDX
 <b>Bremsscheibe</b>							
45 0.9	33	02/88→07/96	←	10/89→ 06/95		24.0111-0130.1 411130	Ø 227 10,8 9
<b>FORD - B-MAX (JK) 10/12→</b>							
 <b>Bremsbelagsatz, Scheibenbremse</b>							
1.0 EcoBoost	74	10/12→	←			13.0460-2784.2 602784	TRW 25134 17,2 - WE / - WK + Zub
1.0 EcoBoost	88	10/12→	←			13.0470-2784.2 LD2784	TRW 25134 17,2 - WE / - WK + Zub Ceramic
1.0 EcoBoost	92	10/12→	←			13.0470-2784.2 LD2784	TRW 25134 17,2 - WE / - WK + Zub Ceramic
1.0 EcoBoost	103	02/16→	←			13.0470-2784.2 LD2784	TRW 25134 17,2 - WE / - WK + Zub Ceramic
1.4	66	10/12→	←			13.0470-2784.2 LD2784	TRW 25134 17,2 - WE / - WK + Zub Ceramic
1.4 LPG	64	08/13→	←			13.0470-2784.2 LD2784	TRW 25134 17,2 - WE / - WK + Zub Ceramic
1.4 LPG	66	08/13→	←			13.0470-2784.2 LD2784	TRW 25134 17,2 - WE / - WK + Zub Ceramic
1.5 TDCi	55	10/12→	←			13.0470-2784.2 LD2784	TRW 25134 17,2 - WE / - WK + Zub Ceramic
1.5 TDCi	70	04/15→	←			13.0470-2784.2 LD2784	TRW 25134 17,2 - WE / - WK + Zub Ceramic
1.6 TDCi	70	10/12→	←			13.0470-2784.2 LD2784	TRW 25134 17,2 - WE / - WK + Zub Ceramic
1.6 Ti	77	10/12→	←			13.0470-2784.2 LD2784	TRW 25134 17,2 - WE / - WK + Zub Ceramic
 <b>Bremsscheibe</b>							
1.0 EcoBoost	74	10/12→	←			24.0123-0122.1 423122	Ø 278 23 21 V
1.0 EcoBoost	88	10/12→	←			24.0123-0122.1 423122	Ø 278 23 21 V
1.0 EcoBoost	92	10/12→	←			24.0123-0122.1 423122	Ø 278 23 21 V
1.0 EcoBoost	103	02/16→	←			24.0123-0122.1 423122	Ø 278 23 21 V



	kW					! #		
<b>FORD - B-MAX (JK) 10/12→</b>								
 <b>Bremsscheibe</b>								
1.4	66	10/12→	←				24.0123-0122.1 423122	Ø 278 23 21 V
1.4 LPG	64	08/13→						
1.4 LPG	66	08/13→						
1.5 TDCi	55	10/12→						
1.5 TDCi	70	04/15→						
1.6 TDCi	70	10/12→						
1.6 Ti	77	10/12→						
<b>FORD - B-MAX Van 10/12→</b>								
 <b>Bremsbelagsatz, Scheibenbremse</b>								
1.0 EcoBoost	74	10/12→	←				13.0460-2784.2 602784	TRW 25134 17,2 - WE / - WK + Zub
1.0 EcoBoost	92	10/12→						
1.4	66	10/12→					13.0470-2784.2 LD2784	TRW 25134 17,2 - WE / - WK + Zub Ceramic
1.5 TDCi	55	10/12→						
1.5 TDCi	70	04/15→						
1.6 TDCi	70	10/12→						
1.6 Ti	77	10/12→						
 <b>Bremsscheibe</b>								
1.0 EcoBoost	74	10/12→	←				24.0123-0122.1 423122	Ø 278 23 21 V
1.0 EcoBoost	92	10/12→						
1.4	66	10/12→						
1.5 TDCi	55	10/12→						
1.5 TDCi	70	04/15→						
1.6 TDCi	70	10/12→						
1.6 Ti	77	10/12→						
<b>FORD - C-MAX (DM2) 02/07→09/10</b>								
 <b>Bremsbelagsatz, Scheibenbremse</b>								
1.6	74	02/07→09/10	←	03/07→			13.0460-7193.2 607193	ATE 23723 18,1 - WE / - WK
1.6 TDCi	66	02/07→09/10					13.0470-7193.2 LD7193	ATE 23723 18,1 - WE / - WK Ceramic
1.6 TDCi	74	02/07→09/10						
1.6 TDCi	80	02/07→09/10						
1.8	90	02/07→09/10	→	03/07→			13.0460-7195.2 607195	ATE 23482 16,6 - WE / - WK
1.8	92	02/07→09/10					13.0470-7195.2 LD7195	ATE 23482 16,6 - WE / - WK Ceramic
1.8 Flexifuel	92	02/07→09/10						
1.8 TDCi	85	02/07→09/10						
2.0	107	02/07→09/10						
2.0 TDCi	98	02/07→09/10						
2.0 TDCi	100	02/07→09/10						
1.6	85	04/07→09/10	←				13.0460-7193.2 607193	ATE 23723 18,1 - WE / - WK
2.0 CNG	107	04/09→09/10					13.0470-7193.2 LD7193	ATE 23723 18,1 - WE / - WK Ceramic
2.0 LPG	107	06/08→09/10						
2.0 TDCi	81	02/08→09/10	→				13.0460-7195.2 607195	ATE 23482 16,6 - WE / - WK
							13.0470-7195.2 LD7195	ATE 23482 16,6 - WE / - WK Ceramic
 <b>Bremsscheibe</b>								
1.6	74	02/07→09/10	←	03/07→			24.0125-0117.1 425117	Ø 278 25 23 V
1.6 TDCi	66	02/07→09/10					24.0325-0117.1 525117	Ø 278 25 23 V
1.6 TDCi	74	02/07→09/10						
1.6 TDCi	80	02/07→09/10	→	03/07→			24.0111-0155.1 411155	Ø 265 11 9
1.8	90	02/07→09/10					24.0311-0155.1 511155	Ø 265 11 9
1.8	92	02/07→09/10						
1.8 Flexifuel	92	02/07→09/10						
1.6	85	04/07→09/10	←				24.0125-0117.1 425117	Ø 278 25 23 V
			→				24.0325-0117.1 525117	Ø 278 25 23 V
							24.0111-0155.1 411155	Ø 265 11 9
							24.0311-0155.1 511155	Ø 265 11 9
1.8 TDCi	85	02/07→09/10	←	03/07→			24.0125-0162.1 425162	Ø 300 25 23 V
2.0	107	02/07→09/10					24.0325-0162.1 525162	Ø 300 25 23 V
2.0 TDCi	98	02/07→09/10						
2.0 TDCi	100	02/07→09/10	→	03/07→			24.0111-0158.1 411158	Ø 280 11 9 + S
							24.0311-0158.1 511158	Ø 280 11 9 + S
2.0 CNG	107	04/09→09/10	←				24.0125-0162.1 425162	Ø 300 25 23 V
2.0 LPG	107	06/08→09/10					24.0325-0162.1 525162	Ø 300 25 23 V
2.0 TDCi	81	02/08→09/10	→				24.0111-0158.1 411158	Ø 280 11 9 + S
							24.0311-0158.1 511158	Ø 280 11 9 + S
<b>FORD - C-MAX II (DXA/CB7, DXA/CEU) 04/10→</b>								
 <b>Bremsbelagsatz, Scheibenbremse</b>								
1.0 EcoBoost	74	10/12→	←				13.0460-7193.2 607193	ATE 23723 18,1 - WE / - WK
1.0 EcoBoost	92	10/12→						
1.5 EcoBoost	110	03/15→						
↓								

**FORD - C-MAX II (DXA/CB7, DXA/CEU) 04/10→**

**Bremsbelagsatz, Scheibenbremse**

1.5 EcoBoost	134	03/15→	←		13.0470-7193.2	LD7193	ATE 23723 18,1 - WE / - WK Ceramic
1.5 TDCi	70	03/15→	→		13.0460-7195.2	607195	ATE 23482 16,6 - WE / - WK
1.5 TDCi	88	03/15→					
1.5 TDCi ECONetic	77	03/15→	→		13.0470-7195.2	LD7195	ATE 23482 16,6 - WE / - WK Ceramic
1.6 CNG	86	01/13→					
1.6 EcoBoost	110	12/10→	→				
1.6 EcoBoost	134	12/10→					
1.6 Flexifuel	88	02/11→	→				
1.6 LPG	86	02/12→					
1.6 LPG	88	02/12→	→				
1.6 TDCi	70	12/10→					
1.6 TDCi	85	12/10→	→				
1.6 Ti	63	12/10→					
1.6 Ti	77	12/10→	→				
1.6 Ti	88	02/12→					
1.6 Ti	92	12/10→	→				
2.0 TDCi	85	02/11→					
2.0 TDCi	100	02/11→	→				
2.0 TDCi	103	04/10→					
2.0 TDCi	110	03/15→	→				
2.0 TDCi	120	12/10→					
2.0 TDCi	125	03/15→	→				

**Bremsscheibe**

1.0 EcoBoost	74	10/12→	←		24.0125-0199.1	425199	Ø 278 25 23 V
1.0 EcoBoost	92	10/12→	→		24.0325-0199.1	525199	Ø 278 25 23 V
1.5 EcoBoost	110	03/15→					
1.5 EcoBoost	134	03/15→	→		24.0111-0172.1	411172	Ø 280 11 9
1.6 CNG	86	01/13→					
1.6 Flexifuel	88	02/11→	→				
1.6 LPG	86	02/12→					
1.6 LPG	88	02/12→	→				
1.6 TDCi	70	12/10→					
1.6 TDCi	85	12/10→	→				
1.6 Ti	63	12/10→					
1.6 Ti	77	12/10→	→				
1.6 Ti	88	02/12→					
1.6 Ti	92	12/10→	→				
1.5 TDCi	70	03/15→					
1.5 TDCi	88	03/15→	←		24.0125-0162.1	425162	Ø 300 25 23 V
1.5 TDCi ECONetic	77	03/15→	→		24.0125-0199.1	425199	Ø 278 25 23 V
1.6 EcoBoost	110	12/10→					
1.6 EcoBoost	134	12/10→	→		24.0325-0162.1	525162	Ø 300 25 23 V
2.0 TDCi	85	02/11→					
2.0 TDCi	100	02/11→	→		24.0111-0172.1	411172	Ø 280 11 9
2.0 TDCi	103	04/10→					
2.0 TDCi	110	03/15→	→				
2.0 TDCi	120	12/10→					
2.0 TDCi	125	03/15→	→				
2.0 Energi	136	01/15→	←		24.0125-0162.1	425162	Ø 300 25 23 V
			→		24.0325-0162.1	525162	Ø 300 25 23 V
					24.0111-0172.1	411172	Ø 280 11 9















**FORD - C-MAX II Van 12/10→**













**Bremsbelagsatz, Scheibenbremse**

1.0 EcoBoost	74	10/12→	←		13.0460-7193.2	607193	ATE 23723 18,1 - WE / - WK
1.0 EcoBoost	92	10/12→	→		13.0470-7193.2	LD7193	ATE 23723 18,1 - WE / - WK Ceramic
1.5 EcoBoost	110	03/15→					
1.5 EcoBoost	134	03/15→	→		13.0460-7195.2	607195	ATE 23482 16,6 - WE / - WK
1.5 TDCi	88	03/15→					
1.5 TDCi ECONetic	77	03/15→	→		13.0470-7195.2	LD7195	ATE 23482 16,6 - WE / - WK Ceramic
1.6 EcoBoost	110	12/10→					
1.6 TDCi	70	12/10→	→				
1.6 TDCi	85	12/10→					
2.0 TDCi	85	02/11→	→				
2.0 TDCi	103	02/11→					
2.0 TDCi	110	03/15→	→				
2.0 TDCi	120	12/10→					
2.0 TDCi	125	03/15→	→				









**Bremsscheibe**

1.0 EcoBoost	74	10/12→	←		24.0125-0199.1	425199	Ø 278 25 23 V
1.0 EcoBoost	92	10/12→	→		24.0325-0199.1	525199	Ø 278 25 23 V
1.5 EcoBoost	110	03/15→					
1.5 EcoBoost	134	03/15→	→		24.0111-0172.1	411172	Ø 280 11 9
1.6 TDCi	70	12/10→					
1.6 TDCi	85	12/10→	→				
2.0 TDCi	85	02/11→					
1.5 TDCi	88	03/15→	←		24.0125-0162.1	425162	Ø 300 25 23 V
1.5 TDCi ECONetic	77	03/15→	↓				











	kW			 	! #		
<b>FORD - C-MAX II Van 12/10→</b>							
 <b>Bremsscheibe</b>							
1.6 EcoBoost	110	12/10→	←			24.0125-0199.1 425199	Ø 278 25 23 V
2.0 TDCi	103	02/11→				24.0325-0162.1 525162	Ø 300 25 23 V
2.0 TDCi	110	03/15→				24.0325-0199.1 525199	Ø 278 25 23 V
2.0 TDCi	120	12/10→				24.0111-0172.1 411172	Ø 280 11 9
2.0 TDCi	125	03/15→	→				
<b>FORD - COUGAR (EC_) 08/98→12/01</b>							
 <b>Bremsbelagsatz, Scheibenbremse</b>							
2.0 16V	96	08/98→12/01	←	09/98→		13.0460-7057.2 607057	ATE 21394 17,5 - WE / - WK
			→	09/98→		13.0460-3963.2 603963	BDX 21586 15,0 - WK
2.5 ST 200	151	01/00→12/01	←			13.0460-7056.2 607056	ATE 21396 17,5 + WK
2.5 V6 24V	125	08/98→12/01	←	09/98→		13.0460-7056.2 607056	ATE 21396 17,5 + WK
			→	08/99→		13.0460-3963.2 603963	BDX 21586 15,0 - WK
			→	09/98→ 07/99		13.0460-3964.2 603964	BDX 21586 15,0 + WK
2.5 V6 24V	125	06/00→12/01	←			13.0460-7056.2 607056	ATE 21396 17,5 + WK
			→			13.0460-3963.2 603963	BDX 21586 15,0 - WK
 <b>Bremsscheibe</b>							
2.0 16V	96	08/98→12/01	←	09/98→		24.0124-0120.1 424120	Ø 260 24 22,2 V
			→	09/98→		24.0324-0120.1 524120	Ø 260 24 22,2 V
			→	09/98→		24.0120-0146.1 420146	Ø 253 20 18 V
			→	09/98→		24.0320-0146.1 520146	Ø 253 20 18 V
2.5 ST 200	151	01/00→12/01	←			24.0124-0149.1 424149	Ø 278 24,1 22,2 V
2.5 V6 24V	125	08/98→12/01	←	09/98→		24.0124-0149.1 424149	Ø 278 24,1 22,2 V
			→	09/98→		24.0120-0146.1 420146	Ø 253 20 18 V
			→	09/98→		24.0320-0146.1 520146	Ø 253 20 18 V
2.5 V6 24V	125	06/00→12/01	←			24.0124-0149.1 424149	Ø 278 24,1 22,2 V
			→			24.0120-0146.1 420146	Ø 253 20 18 V
			→			24.0320-0146.1 520146	Ø 253 20 18 V
<b>FORD - COURIER Kasten (F3L, F5L) 04/89→02/96</b>							
 <b>Bremsbelagsatz, Scheibenbremse</b>							
1.3	44	09/91→02/96	←	V		13.0460-7071.2 607071	ATE 20640 17,5 - WE / - WK
1.8 D	44	09/91→02/96	←			13.0460-7073.2 607073	ATE 21202 16,9 - WE / - WK
 <b>Bremsscheibe</b>							
1.3	44	09/91→02/96	←	→ 10/95		24.0110-0196.1 410196	Ø 239,7 10 8
1.8 D	44	09/91→02/96				24.0120-0147.1 420147	Ø 239,5 20 18 V
						24.0320-0147.1 520147	Ø 239,5 20 18 V
			←	11/95→		24.0112-0141.1 412141	Ø 239,5 12 10
						24.0120-0147.1 420147	Ø 239,5 20 18 V
						24.0320-0147.1 520147	Ø 239,5 20 18 V
<b>FORD - COURIER Kasten (J5_, J3_) 02/96→</b>							
 <b>Bremsbelagsatz, Scheibenbremse</b>							
1.3	44	02/96→08/03	←	→ 01/00		13.0460-7071.2 607071	ATE 20640 17,5 - WE / - WK
1.8 D	44	02/96→04/02	←	02/00→ 03/02; + ABS		13.0460-7142.2 607142	ATE 23202 18,3 - WE / - WK
			←	02/00→ 03/02; - ABS		13.0460-7148.2 607148	ATE 23200 18,0 - WE / - WK
1.4 i	66	04/96→10/99	←			13.0460-7071.2 607071	ATE 20640 17,5 - WE / - WK
1.8 DI	55	09/00→08/03	←	→ 03/02; + ABS		13.0460-7142.2 607142	ATE 23202 18,3 - WE / - WK
			←	→ 03/02; - ABS		13.0460-7148.2 607148	ATE 23200 18,0 - WE / - WK
 <b>Bremsscheibe</b>							
1.3	44	02/96→08/03	←	02/00→ 03/02; - ABS		24.0120-0147.1 420147	Ø 239,5 20 18 V
1.8 D	44	02/96→04/02				24.0320-0147.1 520147	Ø 239,5 20 18 V
			←	→ 01/00		24.0120-0147.1 420147	Ø 239,5 20 18 V
						24.0320-0147.1 520147	Ø 239,5 20 18 V
			←	02/00→ 03/02; + ABS		24.0122-0172.1 422172	Ø 258 22 20 V
						24.0322-0172.1 522172	Ø 258 22 20 V
1.4 i	66	04/96→10/99	←			24.0120-0147.1 420147	Ø 239,5 20 18 V

	kW			 	! #		
<b>FORD - COURIER Kasten (J5_, J3_) 02/96→</b>							
 <b>Bremsscheibe</b>							
1.4 i	66	04/96→10/99	←			24.0320-0147.1 520147	Ø 239,5 20 18 V
1.8 DI	55	09/00→08/03	←	→ 03/02; - ABS		24.0120-0147.1 420147	Ø 239,5 20 18 V
			←	→ 03/02; + ABS		24.0320-0147.1 520147	Ø 239,5 20 18 V
			←			24.0122-0172.1 422172	Ø 258 22 20 V
						24.0322-0172.1 522172	Ø 258 22 20 V
<b>FORD - ECOSPORT 09/11→</b>							
 <b>Bremsbelagsatz, Scheibenbremse</b>							
1.0 EcoBoost	92	10/13→	←	02/14→		13.0460-7193.2 607193	ATE 23723 18,1 - WE / - WK
1.5 TDCi	66	10/13→				13.0470-7193.2 LD7193	ATE 23723 18,1 - WE / - WK
1.5 Ti	82	10/13→					Ceramic
1.0 EcoBoost	103	03/16→	←			13.0460-7193.2 607193	ATE 23723 18,1 - WE / - WK
1.5 TDCi	70	05/15→				13.0470-7193.2 LD7193	ATE 23723 18,1 - WE / - WK
1.5 TDCi	74	05/15→					Ceramic
 <b>Bremsscheibe</b>							
1.0 EcoBoost	92	10/13→	←	02/14→		24.0125-0210.1 425210	Ø 278 25 23 V
1.5 TDCi	66	10/13→					
1.5 Ti	82	10/13→					
1.0 EcoBoost	103	03/16→	←			24.0125-0210.1 425210	Ø 278 25 23 V
1.5 TDCi	70	05/15→					
1.5 TDCi	74	05/15→					
<b>FORD - ESCORT '95 Express (AVL) 01/95→06/01</b>							
 <b>Bremsbelagsatz, Scheibenbremse</b>							
1.4	54	01/95→08/00	←	02/95→ 02/99; mit Feder		13.0460-3965.2 603965	BDX 21171 18,0 - WE / - WK
1.8 D	44	01/95→08/00	←	02/95→ 07/00; mit Feder		13.0460-3965.2 603965	BDX 21171 18,0 - WE / - WK
1.8 TD	66	01/95→08/00	←	02/95→ 07/00; mit Feder		13.0460-3965.2 603965	BDX 21171 18,0 - WE / - WK
1.8 Turbo D	51	12/95→06/01	←	→ 02/99; mit Feder		13.0460-3965.2 603965	BDX 21171 18,0 - WE / - WK
			←	→ 07/00; mit Feder		13.0460-3965.2 603965	BDX 21171 18,0 - WE / - WK
<b>Zubehörsatz, Scheibenbremsbelag</b>							
1.4	54	01/95→08/00	←	02/95→ 02/99; - ABS		13.0460-0412.2 610412	BDX
			←	02/95→ 02/99; + ABS		13.0460-0413.2 610413	BDX
1.8 D	44	01/95→08/00	←	02/95→ 02/99; - ABS		13.0460-0412.2 610412	BDX
			←	02/95→ 02/99; + ABS		13.0460-0413.2 610413	BDX
			→	02/95→ 02/99; + ABS		13.0460-0436.2 610436	ATE
1.8 TD	66	01/95→08/00	←	02/95→ 07/00; - ABS		13.0460-0412.2 610412	BDX
			←	02/95→ 07/00; + ABS		13.0460-0413.2 610413	BDX
			→	02/95→ 07/00; + ABS		13.0460-0436.2 610436	ATE
1.8 Turbo D	51	12/95→06/01	←	→ 07/00; - ABS		13.0460-0412.2 610412	BDX
			←	→ 02/99; - ABS		13.0460-0412.2 610412	BDX
			←	→ 07/00; + ABS		13.0460-0413.2 610413	BDX
			←	→ 02/99; + ABS		13.0460-0413.2 610413	BDX
			→	→ 07/00; + ABS		13.0460-0436.2 610436	ATE
			→	→ 02/99; + ABS		13.0460-0436.2 610436	ATE
 <b>Bremsscheibe</b>							
1.4	54	01/95→08/00	←	02/95→ 02/99		24.0120-0147.1 420147	Ø 239,5 20 18 V
1.8 D	44	01/95→08/00	←			24.0320-0147.1 520147	Ø 239,5 20 18 V
1.8 TD	66	01/95→08/00	←	02/95→ 07/00		24.0120-0147.1 420147	Ø 239,5 20 18 V
			←			24.0320-0147.1 520147	Ø 239,5 20 18 V
1.8 Turbo D	51	12/95→06/01	←	→ 07/00		24.0120-0147.1 420147	Ø 239,5 20 18 V
			←			24.0320-0147.1 520147	Ø 239,5 20 18 V
			←	→ 02/99		24.0120-0147.1 420147	Ø 239,5 20 18 V
						24.0320-0147.1 520147	Ø 239,5 20 18 V
<b>FORD - ESCORT VII (GAL, AAL, ABL) 01/95→10/02</b>							
 <b>Bremsbelagsatz, Scheibenbremse</b>							
1.3	44	01/95→10/98	←	02/95→; mit Feder		13.0460-3965.2 603965	BDX 21171 18,0 - WE / - WK
1.4	55	01/95→10/98					
1.6 16V	66	01/95→10/98					
↓							



























	kw				! #		
<b>FORD - ESCORT VII (GAL, AAL, ABL) 01/95→10/02</b>							
<b> Bremsbelagsatz, Scheibenbremse</b>							
1.6 16V 4x4 1.8 16V 1.8 TD	66 85 66	01/95→10/98 01/95→10/98 01/95→10/98	←	02/95→; mit Feder		13.0460-3965.2 603965	BDX 21171 18,0 - WE / - WK
1.4	54	01/95→12/99	←	02/95→ 02/99; mit Feder		13.0460-3965.2 603965	BDX 21171 18,0 - WE / - WK
1.8 D	44	01/95→12/96	←	02/95→; mit Feder		13.0460-3965.2 603965	BDX 21171 18,0 - WE / - WK
			←	→ 01/95; mit Feder		13.0460-3965.2 603965	BDX 21171 18,0 - WE / - WK
1.8 Turbo D	51	12/95→10/98	←	mit Feder		13.0460-3965.2 603965	BDX 21171 18,0 - WE / - WK
RS 2000	110	02/95→02/98	←			13.0460-7040.2 607040	ATE 20907 18,0 - WE / - WK
			←	→ 12/95		13.0460-7165.2 607165	ATE 21358 19,8 - WE / - WK
RS 2000 4x4	110	02/95→10/98	←			13.0460-7040.2 607040	ATE 20907 18,0 - WE / - WK
RS Cosworth 4x4	162	02/95→10/98	←	→ 12/95		13.0460-7165.2 607165	ATE 21358 19,8 - WE / - WK
<b>Zubehörsatz, Scheibenbremsbelag</b>							
1.3 1.4	44 55	01/95→10/98 01/95→10/98	←	02/95→; - ABS		13.0460-0412.2 610412	BDX
			←	02/95→; + ABS		13.0460-0413.2 610413	BDX
1.4	54	01/95→12/99	←	02/95→ 02/99; - ABS		13.0460-0412.2 610412	BDX
			←	02/95→ 02/99; + ABS		13.0460-0413.2 610413	BDX
1.6 16V 1.6 16V 4x4 1.8 16V 1.8 TD	66 66 85 66	01/95→10/98 01/95→10/98 01/95→10/98 01/95→10/98	←	02/95→; - ABS		13.0460-0412.2 610412	BDX
			←	02/95→; + ABS		13.0460-0413.2 610413	BDX
			→	02/95→; + ABS		13.0460-0436.2 610436	ATE
			→	02/95→; + ABS		13.0460-0436.2 610436	ATE
1.8 D	44	01/95→12/96	←	→ 01/95; - ABS		13.0460-0412.2 610412	BDX
			←	02/95→; - ABS		13.0460-0412.2 610412	BDX
			←	02/95→; + ABS		13.0460-0413.2 610413	BDX
			←	→ 01/95; + ABS		13.0460-0413.2 610413	BDX
			→	02/95→; + ABS		13.0460-0436.2 610436	ATE
			→	→ 01/95; + ABS		13.0460-0436.2 610436	ATE
1.8 Turbo D	51	12/95→10/98	←	- ABS		13.0460-0412.2 610412	BDX
			←	+ ABS		13.0460-0413.2 610413	BDX
			→	+ ABS		13.0460-0436.2 610436	ATE
<b> Bremsscheibe</b>							
1.3 1.4 1.6 16V 1.6 16V 4x4 1.8 16V 1.8 TD	44 55 66 66 85 66	01/95→10/98 01/95→10/98 01/95→10/98 01/95→10/98 01/95→10/98 01/95→10/98	←	02/95→		24.0120-0147.1 420147	∅ 239,5 20 18 V
						24.0320-0147.1 520147	∅ 239,5 20 18 V
			←	02/95→ 02/99		24.0120-0147.1 420147	∅ 239,5 20 18 V
						24.0320-0147.1 520147	∅ 239,5 20 18 V
			←	02/95→		24.0120-0147.1 420147	∅ 239,5 20 18 V
1.8 D	44	01/95→12/96	←	02/95→		24.0120-0147.1 420147	∅ 239,5 20 18 V
			←	→ 01/95		24.0320-0147.1 520147	∅ 239,5 20 18 V
1.8 Turbo D	51	12/95→10/98	←			24.0120-0147.1 420147	∅ 239,5 20 18 V
			←			24.0320-0147.1 520147	∅ 239,5 20 18 V
RS 2000	110	02/95→02/98	←			24.0124-0125.1 424125	∅ 260 24,2 22,2 V
			←	→ 12/95		24.0124-0148.1 424148	∅ 278 24 22,2 V
RS 2000 4x4	110	02/95→10/98	←			24.0124-0125.1 424125	∅ 260 24,2 22,2 V
RS Cosworth 4x4	162	02/95→10/98	←	→ 12/95		24.0124-0148.1 424148	∅ 278 24 22,2 V
<b>FORD - ESCORT VII Cabriolet (ALL) 02/95→08/00</b>							
<b> Bremsbelagsatz, Scheibenbremse</b>							
1.4 1.6 16V XR3i 1.6 16V XR3i 1.8 16V XR3i 1.8 16V XR3i 1.8 TD 1.8 Turbo D	55 65 66 77 85 66 51	02/95→08/98 02/95→12/96 02/95→09/99 02/95→08/98 10/95→08/98 09/95→08/98 10/96→08/99	←	mit Feder		13.0460-3965.2 603965	BDX 21171 18,0 - WE / - WK
1.8 16V XR3i	96	02/95→08/00	←	→ 02/99		13.0460-7040.2 607040	ATE 20907 18,0 - WE / - WK
↓							















	kw			 	! #		
<b>FORD - ESCORT VII Cabriolet (ALL) 02/95→08/00</b>							
<b>Zubehörsatz, Scheibenbremsbelag</b>							
1.4	55	02/95→08/98	←	- ABS		13.0460-0412.2 610412	BDX
1.8 16V XR3i	77	02/95→08/98	←	+ ABS		13.0460-0413.2 610413	BDX
1.6 16V XR3i	65	02/95→12/96	←	- ABS		13.0460-0412.2 610412	BDX
1.6 16V XR3i	66	02/95→09/99	←	+ ABS		13.0460-0413.2 610413	BDX
1.8 16V XR3i	85	10/95→08/98	←	+ ABS		13.0460-0413.2 610413	BDX
1.8 TD	66	09/95→08/98	→	+ ABS		13.0460-0436.2 610436	ATE
1.8 Turbo D	51	10/96→08/99					
<b> Bremsscheibe</b>							
1.4	55	02/95→08/98	←			24.0120-0147.1 420147	Ø 239,5 20 18 V
1.6 16V XR3i	65	02/95→12/96					
1.6 16V XR3i	66	02/95→09/99				24.0320-0147.1 520147	Ø 239,5 20 18 V
1.8 16V XR3i	77	02/95→08/98					
1.8 16V XR3i	85	10/95→08/98					
1.8 TD	66	09/95→08/98					
1.8 Turbo D	51	10/96→08/99					
1.8 16V XR3i	96	02/95→08/00	←	→ 02/99		24.0124-0125.1 424125	Ø 260 24,2 22,2 V
<b>FORD - ESCORT VII Stufenheck (GAL, AFL) 01/95→08/02</b>							
<b> Bremsbelagsatz, Scheibenbremse</b>							
1.3	44	01/95→02/99	←	02/95→; mit Feder		13.0460-3965.2 603965	BDX 21171 18,0 - WE / - WK
1.4	54	01/95→12/96					
1.4	55	01/95→02/99					
1.6 i 16V	66	01/95→02/99					
1.8 16V	85	01/95→02/99					
1.8 TD	66	01/95→02/99					
1.8 D	44	01/95→12/96	←	→ 01/95; mit Feder		13.0460-3965.2 603965	BDX 21171 18,0 - WE / - WK
			←	02/95→; mit Feder		13.0460-3965.2 603965	BDX 21171 18,0 - WE / - WK
1.8 Turbo D	51	12/95→02/99	←	mit Feder		13.0460-3965.2 603965	BDX 21171 18,0 - WE / - WK
<b>Zubehörsatz, Scheibenbremsbelag</b>							
1.3	44	01/95→02/99	←	02/95→; - ABS		13.0460-0412.2 610412	BDX
1.4	54	01/95→12/96					
1.4	55	01/95→02/99	←	02/95→; + ABS		13.0460-0413.2 610413	BDX
1.6 i 16V	66	01/95→02/99	←	02/95→; - ABS		13.0460-0412.2 610412	BDX
1.8 16V	85	01/95→02/99	←	02/95→; + ABS		13.0460-0413.2 610413	BDX
1.8 TD	66	01/95→02/99	→	02/95→; + ABS		13.0460-0436.2 610436	ATE
1.8 D	44	01/95→12/96	←	→ 01/95; - ABS		13.0460-0412.2 610412	BDX
			←	02/95→; - ABS		13.0460-0412.2 610412	BDX
			←	02/95→; + ABS		13.0460-0413.2 610413	BDX
			←	→ 01/95; + ABS		13.0460-0413.2 610413	BDX
			→	02/95→; + ABS		13.0460-0436.2 610436	ATE
			→	→ 01/95; + ABS		13.0460-0436.2 610436	ATE
1.8 Turbo D	51	12/95→02/99	←	- ABS		13.0460-0412.2 610412	BDX
			←	+ ABS		13.0460-0413.2 610413	BDX
			→	+ ABS		13.0460-0436.2 610436	ATE
<b> Bremsscheibe</b>							
1.3	44	01/95→02/99	←	02/95→		24.0120-0147.1 420147	Ø 239,5 20 18 V
1.4	54	01/95→12/96					
1.4	55	01/95→02/99				24.0320-0147.1 520147	Ø 239,5 20 18 V
1.6 i 16V	66	01/95→02/99					
1.8 16V	85	01/95→02/99					
1.8 TD	66	01/95→02/99					
1.8 D	44	01/95→12/96	←	02/95→		24.0120-0147.1 420147	Ø 239,5 20 18 V
			←			24.0320-0147.1 520147	Ø 239,5 20 18 V
			←	→ 01/95		24.0120-0147.1 420147	Ø 239,5 20 18 V
						24.0320-0147.1 520147	Ø 239,5 20 18 V
1.8 Turbo D	51	12/95→02/99	←			24.0120-0147.1 420147	Ø 239,5 20 18 V
						24.0320-0147.1 520147	Ø 239,5 20 18 V
<b>FORD - ESCORT VII Turnier (GAL, ANL) 01/95→10/02</b>							
<b> Bremsbelagsatz, Scheibenbremse</b>							
1.3	44	01/95→01/99	←	02/95→; mit Feder		13.0460-3965.2 603965	BDX 21171 18,0 - WE / - WK
1.4	54	01/95→12/96					
1.4	55	01/95→02/99					
1.6 16V	66	01/95→02/99					
↓							











	kW				! #		
<b>FORD - ESCORT VII Turnier (GAL, ANL) 01/95→10/02</b>							
 <b>Bremsbelagsatz, Scheibenbremse</b>							
1.8 16V 1.8 D 1.8 TD	85 44 66	01/95→02/99 01/95→02/99 01/95→02/99	←	02/95→; mit Feder		13.0460-3965.2 603965	BDX 21171 18,0 - WE / - WK
1.8 Turbo D	51	12/95→02/99	←	mit Feder		13.0460-3965.2 603965	BDX 21171 18,0 - WE / - WK
<b>Zubehörsatz, Scheibenbremsbelag</b>							
1.3 1.4 1.4	44 54 55	01/95→01/99 01/95→12/96 01/95→02/99	←	02/95→; - ABS 02/95→; + ABS		13.0460-0412.2 610412 13.0460-0413.2 610413	BDX BDX
1.6 16V 1.8 16V 1.8 D 1.8 TD	66 85 44 66	01/95→02/99 01/95→02/99 01/95→02/99 01/95→02/99	←	02/95→; - ABS 02/95→; + ABS 02/95→; + ABS		13.0460-0412.2 610412 13.0460-0413.2 610413 13.0460-0436.2 610436	BDX BDX ATE
1.8 Turbo D	51	12/95→02/99	←	- ABS + ABS + ABS		13.0460-0412.2 610412 13.0460-0413.2 610413 13.0460-0436.2 610436	BDX BDX ATE
 <b>Bremsscheibe</b>							
1.3 1.4 1.4 1.6 16V 1.8 16V 1.8 D 1.8 TD	44 54 55 66 85 44 66	01/95→01/99 01/95→12/96 01/95→02/99 01/95→02/99 01/95→02/99 01/95→02/99 01/95→02/99	←	02/95→		24.0120-0147.1 420147 24.0320-0147.1 520147	Ø 239,5 20 18 V Ø 239,5 20 18 V
1.8 Turbo D	51	12/95→02/99	←			24.0120-0147.1 420147 24.0320-0147.1 520147	Ø 239,5 20 18 V Ø 239,5 20 18 V
<b>FORD - ESCORT CLASSIC (AAL, ABL) 10/98→07/00</b>							
 <b>Bremsbelagsatz, Scheibenbremse</b>							
1.6 16V 1.8 TD	66 66	10/98→07/00 10/98→07/00	←	mit Feder		13.0460-3965.2 603965	BDX 21171 18,0 - WE / - WK
<b>Zubehörsatz, Scheibenbremsbelag</b>							
1.6 16V 1.8 TD	66 66	10/98→07/00 10/98→07/00	←	- ABS + ABS + ABS		13.0460-0412.2 610412 13.0460-0413.2 610413 13.0460-0436.2 610436	BDX BDX ATE
 <b>Bremsscheibe</b>							
1.6 16V 1.8 TD	66 66	10/98→07/00 10/98→07/00	←			24.0120-0147.1 420147 24.0320-0147.1 520147	Ø 239,5 20 18 V Ø 239,5 20 18 V
<b>FORD - ESCORT CLASSIC Turnier (ANL) 02/99→07/00</b>							
 <b>Bremsbelagsatz, Scheibenbremse</b>							
1.6 16V 1.8 TD	66 66	02/99→07/00 02/99→07/00	←	mit Feder		13.0460-3965.2 603965	BDX 21171 18,0 - WE / - WK
<b>Zubehörsatz, Scheibenbremsbelag</b>							
1.6 16V 1.8 TD	66 66	02/99→07/00 02/99→07/00	←	- ABS + ABS + ABS		13.0460-0412.2 610412 13.0460-0413.2 610413 13.0460-0436.2 610436	BDX BDX ATE
 <b>Bremsscheibe</b>							
1.6 16V 1.8 TD	66 66	02/99→07/00 02/99→07/00	←			24.0120-0147.1 420147 24.0320-0147.1 520147	Ø 239,5 20 18 V Ø 239,5 20 18 V
<b>FORD - FIESTA III (GFJ) 01/89→01/97</b>							
 <b>Bremsbelagsatz, Scheibenbremse</b>							
1.3 Cat 1.4	44 55	05/91→01/97 11/92→12/96	←	→ 11/96; V → 11/96		13.0460-7071.2 607071 13.0460-7073.2 607073	ATE 20640 17,5 - WE / - WK ATE 21202 16,9 - WE / - WK
 <b>Bremsscheibe</b>							
1.3 Cat 1.4	44 55	05/91→01/97 11/92→12/96	←	→ 10/95 11/95→ 11/96		24.0110-0196.1 410196 24.0120-0147.1 420147 24.0320-0147.1 520147 24.0112-0141.1 412141	Ø 239,7 10 8 Ø 239,5 20 18 V Ø 239,5 20 18 V Ø 239,5 12 10
↓							













	kW			 	! #		
<b>FORD - FIESTA III (GFJ) 01/89→01/97</b>							
 <b>Bremsscheibe</b>							
1.3 Cat 1.4	44 55	05/91→01/97 11/92→12/96	←	11/95→11/96		24.0120-0147.1 420147 24.0320-0147.1 520147	Ø 239,5 20 18 V Ø 239,5 20 18 V
<b>FORD - FIESTA IV (JA_, JB_) 08/95→09/02</b>							
 <b>Bremsbelagsatz, Scheibenbremse</b>							
1.0 i	38	02/97→09/99	←			13.0460-7071.2 607071 13.0460-7073.2 607073	ATE 20640 17,5 - WE / - WK ATE 21202 16,9 - WE / - WK
			←	+ ABS		13.0460-7142.2 607142	ATE 23202 18,3 - WE / - WK
			←	- ABS		13.0460-7148.2 607148	ATE 23200 18,0 - WE / - WK
1.0 i	48	09/99→01/02	←	→ 01/00		13.0460-7071.2 607071 13.0460-7073.2 607073	ATE 20640 17,5 - WE / - WK ATE 21202 16,9 - WE / - WK
			←	+ ABS		13.0460-7142.2 607142	ATE 23202 18,3 - WE / - WK
			←	- ABS		13.0460-7148.2 607148	ATE 23200 18,0 - WE / - WK
1.25 i 16V	55	08/95→01/02	←	01/96→01/00; Vollautomatik		13.0460-7071.2 607071	ATE 20640 17,5 - WE / - WK
			←	01/96→01/00; Schaltgetriebe		13.0460-7073.2 607073	ATE 21202 16,9 - WE / - WK
			←	02/00→; + ABS		13.0460-7142.2 607142	ATE 23202 18,3 - WE / - WK
			←	02/00→; - ABS		13.0460-7148.2 607148	ATE 23200 18,0 - WE / - WK
1.3 1.3 i	42 44	04/96→08/99 04/96→08/99	←			13.0460-7073.2 607073	ATE 21202 16,9 - WE / - WK
1.3 i 1.3 i 1.8 D	37 44 44	08/95→01/02 08/95→01/02 08/95→04/00	←	01/96→01/00		13.0460-7073.2 607073	ATE 21202 16,9 - WE / - WK
			←	02/00→; + ABS		13.0460-7142.2 607142	ATE 23202 18,3 - WE / - WK
			←	02/00→; - ABS		13.0460-7148.2 607148	ATE 23200 18,0 - WE / - WK
1.4 i 16V	66	04/96→01/02	←	→ 01/00		13.0460-7071.2 607071	ATE 20640 17,5 - WE / - WK
			←	02/00→; + ABS		13.0460-7142.2 607142	ATE 23202 18,3 - WE / - WK
			←	02/00→; - ABS		13.0460-7148.2 607148	ATE 23200 18,0 - WE / - WK
1.6 1.6 16V Sport 1.8 DI	65 76 55	02/00→01/02 02/00→01/02 04/00→01/02	←	+ ABS		13.0460-7142.2 607142	ATE 23202 18,3 - WE / - WK
			←	- ABS		13.0460-7148.2 607148	ATE 23200 18,0 - WE / - WK
 <b>Bremsscheibe</b>							
1.0 i	38	02/97→09/99	←			24.0112-0141.1 412141 24.0120-0147.1 420147 24.0312-0141.1 512141 24.0320-0147.1 520147	Ø 239,5 12 10 Ø 239,5 20 18 V Ø 239,5 12 10 Ø 239,5 20 18 V
1.0 i	48	09/99→01/02	←	→ 01/00		24.0112-0141.1 412141 24.0120-0147.1 420147 24.0312-0141.1 512141 24.0320-0147.1 520147	Ø 239,5 12 10 Ø 239,5 20 18 V Ø 239,5 12 10 Ø 239,5 20 18 V
			←	02/00→; - ABS		24.0120-0147.1 420147 24.0320-0147.1 520147	Ø 239,5 20 18 V Ø 239,5 20 18 V
			←	02/00→; + ABS		24.0122-0172.1 422172 24.0322-0172.1 522172	Ø 258 22 20 V Ø 258 22 20 V
1.25 i 16V	55	08/95→01/02	←	01/96→01/00; Schaltgetriebe		24.0112-0141.1 412141 24.0312-0141.1 512141	Ø 239,5 12 10 Ø 239,5 12 10
			←	01/96→01/00; Vollautomatik		24.0120-0147.1 420147 24.0320-0147.1 520147	Ø 239,5 20 18 V Ø 239,5 20 18 V
			←	02/00→; - ABS		24.0120-0147.1 420147 24.0320-0147.1 520147	Ø 239,5 20 18 V Ø 239,5 20 18 V
			←	02/00→; + ABS		24.0122-0172.1 422172 24.0322-0172.1 522172	Ø 258 22 20 V Ø 258 22 20 V
1.3 1.3 i	42 44	04/96→08/99 04/96→08/99	←			24.0112-0141.1 412141 24.0312-0141.1 512141	Ø 239,5 12 10 Ø 239,5 12 10
1.3 i 1.3 i 1.8 D	37 44 44	08/95→01/02 08/95→01/02 08/95→04/00	←	01/96→01/00		24.0112-0141.1 412141 24.0312-0141.1 512141	Ø 239,5 12 10 Ø 239,5 12 10
			←	02/00→; - ABS		24.0120-0147.1 420147 24.0320-0147.1 520147	Ø 239,5 20 18 V Ø 239,5 20 18 V
			←	02/00→; + ABS		24.0122-0172.1 422172 24.0322-0172.1 522172	Ø 258 22 20 V Ø 258 22 20 V
1.4 i 16V	66	04/96→01/02	←	02/00→; - ABS		24.0120-0147.1 420147 24.0320-0147.1 520147	Ø 239,5 20 18 V Ø 239,5 20 18 V
↓							



	kW					! #		
<b>FORD - FIESTA IV (JA_, JB_) 08/95→09/02</b>								
 <b>Bremsscheibe</b>								
1.4 i 16V	66	04/96→01/02	←	→ 01/00			24.0120-0147.1 420147 24.0320-0147.1 520147	Ø 239,5 20 18 V Ø 239,5 20 18 V
			←	02/00→; + ABS			24.0122-0172.1 422172 24.0322-0172.1 522172	Ø 258 22 20 V Ø 258 22 20 V
1.6 1.6 16V Sport 1.8 DI	65 76 55	02/00→01/02 02/00→01/02 04/00→01/02	←	- ABS			24.0120-0147.1 420147 24.0320-0147.1 520147	Ø 239,5 20 18 V Ø 239,5 20 18 V
			←	+ ABS			24.0122-0172.1 422172 24.0322-0172.1 522172	Ø 258 22 20 V Ø 258 22 20 V
<b>FORD - FIESTA V (JH_, JD_) 11/01→03/10</b>								
 <b>Bremsbelagsatz, Scheibenbremse</b>								
1.25 16V 1.25 16V 1.6 TDCi	51 55 66	03/03→06/08 05/02→06/08 11/04→06/08	←				13.0460-7142.2 607142	ATE 23202 18,3 - WE / - WK
1.3 1.3 1.4 16V 1.4 TDCi 1.6 16V	44 51 59 50 74	11/01→06/08 11/01→06/08 11/01→06/08 11/01→06/08 11/01→06/08	←	04/02→			13.0460-7142.2 607142	ATE 23202 18,3 - WE / - WK
ST150	110	03/05→06/08	←				13.0460-7186.2 607186	ATE 23440 17,6 - WE / - WK
			→				13.0460-2835.2 602835	TRW 23353 14,8 + WE / - WK
 <b>Bremsscheibe</b>								
1.25 16V 1.25 16V 1.6 TDCi	51 55 66	03/03→06/08 05/02→06/08 11/04→06/08	←				24.0122-0172.1 422172 24.0322-0172.1 522172	Ø 258 22 20 V Ø 258 22 20 V
1.3 1.3 1.4 16V 1.4 TDCi 1.6 16V	44 51 59 50 74	11/01→06/08 11/01→06/08 11/01→06/08 11/01→06/08 11/01→06/08	←	04/02→			24.0122-0172.1 422172 24.0322-0172.1 522172	Ø 258 22 20 V Ø 258 22 20 V
ST150	110	03/05→06/08	→				24.0110-0115.1 410115	Ø 253 10,2 8,9
<b>FORD - FIESTA V Van 10/03→12/10</b>								
 <b>Bremsbelagsatz, Scheibenbremse</b>								
1.3	51	10/03→07/05	←				13.0460-7142.2 607142	ATE 23202 18,3 - WE / - WK
1.4 TDCi 1.6 TDCi	50 66	10/03→12/10 04/07→09/09	←	→ 08/08			13.0460-7142.2 607142	ATE 23202 18,3 - WE / - WK
 <b>Bremsscheibe</b>								
1.3	51	10/03→07/05	←				24.0122-0172.1 422172 24.0322-0172.1 522172	Ø 258 22 20 V Ø 258 22 20 V
1.4 TDCi 1.6 TDCi	50 66	10/03→12/10 04/07→09/09	←	→ 08/08			24.0122-0172.1 422172 24.0322-0172.1 522172	Ø 258 22 20 V Ø 258 22 20 V
<b>FORD - FIESTA VI (CB1, CCN) 06/08→</b>								
 <b>Bremsbelagsatz, Scheibenbremse</b>								
1.0 1.0 1.0 EcoBoost 1.0 Sport 1.4 TDCi 1.4 TDCi 1.5 TDCi 1.6 1.6 TDCi 1.6 Ti	48 59 74 103 50 51 70 62 70 99	01/13→ 10/12→ 01/13→ 05/14→ 01/09→ 07/10→ 05/15→ 03/15→ 02/10→ 12/10→	←	für Fahrzeuge mit Trommelbremse an der Hinterachse			13.0460-2605.2 602605	TRW 24283 17,3 - WE / - WK + Zub
			←	für Fahrzeuge mit Scheibenbremse an der Hinterachse			13.0460-2784.2 602784 13.0470-2784.2 LD2784	TRW 25134 17,2 - WE / - WK + Zub TRW 25134 17,2 - WE / - WK + Zub Ceramic
			→				13.0460-2835.2 602835	TRW 23353 14,8 + WE / - WK
1.0 EcoBoost 1.5 TDCi 1.6 Ti	92 55 77	09/12→ 09/12→ 09/12→	←	10/12→; für Fahrzeuge mit Trommelbremse an der Hinterachse			13.0460-2605.2 602605	TRW 24283 17,3 - WE / - WK + Zub
			←	für Fahrzeuge mit Scheibenbremse an der Hinterachse			13.0460-2784.2 602784 13.0470-2784.2 LD2784	TRW 25134 17,2 - WE / - WK + Zub TRW 25134 17,2 - WE / - WK + Zub Ceramic
			→				13.0460-2835.2 602835	TRW 23353 14,8 + WE / - WK
1.25 1.25	44 60	06/08→ 06/08→	←	09/08→			13.0460-2605.2 602605	TRW 24283 17,3 - WE / - WK + Zub
1.4 1.6 TDCi 1.6 Ti	71 55 88	06/08→ 06/08→ 06/08→	←	09/08→; für Fahrzeuge mit Trommelbremse an der Hinterachse			13.0460-2605.2 602605	TRW 24283 17,3 - WE / - WK + Zub
↓								

	kW			 	! #		
<b>FORD - FIESTA VI (CB1, CCN) 06/08→</b>							
<b> Bremsbelagsatz, Scheibenbremse</b>							
1.4 1.6 TDCi 1.6 Ti	71 55 88	06/08→ 06/08→ 06/08→	← ← ←	für Fahrzeuge mit Scheibenbremse an der Hinterachse	13.0460-2784.2 13.0470-2784.2	602784 LD2784	TRW 25134 17,2 - WE / - WK + Zub TRW 25134 17,2 - WE / - WK + Zub Ceramic
			→		13.0460-2835.2	602835	TRW 23353 14,8 + WE / - WK
1.4 LPG 1.4 LPG	68 71	01/09→ 01/09→	← ←	06/09→; für Fahrzeuge mit Trommelbremse an der Hinterachse für Fahrzeuge mit Scheibenbremse an der Hinterachse	13.0460-2605.2 13.0460-2784.2 13.0470-2784.2	602605 602784 LD2784	TRW 24283 17,3 - WE / - WK + Zub TRW 25134 17,2 - WE / - WK + Zub TRW 25134 17,2 - WE / - WK + Zub Ceramic
			→		13.0460-2835.2	602835	TRW 23353 14,8 + WE / - WK
1.6 ST 1.6 ST200	134 147	03/13→ 04/16→	← ←		13.0460-2784.2 13.0470-2784.2	602784 LD2784	TRW 25134 17,2 - WE / - WK + Zub TRW 25134 17,2 - WE / - WK + Zub Ceramic
			→		13.0460-2835.2	602835	TRW 23353 14,8 + WE / - WK
1.6 TDCi	66	06/08→	← ← ←	09/08→ für Fahrzeuge mit Scheibenbremse an der Hinterachse	13.0460-2605.2 13.0460-2784.2 13.0470-2784.2	602605 602784 LD2784	TRW 24283 17,3 - WE / - WK + Zub TRW 25134 17,2 - WE / - WK + Zub TRW 25134 17,2 - WE / - WK + Zub Ceramic
			→		13.0460-2835.2	602835	TRW 23353 14,8 + WE / - WK
<b> Bremsscheibe</b>							
1.0 1.0 1.0 EcoBoost 1.0 Sport 1.4 TDCi 1.4 TDCi 1.5 TDCi 1.6 1.6 TDCi 1.6 Ti	48 59 74 103 50 51 70 62 70 99	01/13→ 10/12→ 01/13→ 05/14→ 01/09→ 07/10→ 05/15→ 03/15→ 02/10→ 12/10→	← ← ← ← ← → → → → →	für Fahrzeuge mit Trommelbremse an der Hinterachse für Fahrzeuge mit Scheibenbremse an der Hinterachse	24.0123-0113.1 24.0323-0113.1 24.0123-0122.1	423113 523113 423122	Ø 258 23 21 V Ø 258 23 21 V Ø 278 23 21 V
			→		24.0110-0115.1 24.0310-0115.1	410115 510115	Ø 253 10,2 8,9 Ø 253 10,2 8,9
1.0 EcoBoost 1.5 TDCi 1.6 Ti	92 55 77	09/12→ 09/12→ 09/12→	← ← ←	10/12→; für Fahrzeuge mit Trommelbremse an der Hinterachse für Fahrzeuge mit Scheibenbremse an der Hinterachse	24.0123-0113.1 24.0323-0113.1 24.0123-0122.1	423113 523113 423122	Ø 258 23 21 V Ø 258 23 21 V Ø 278 23 21 V
			→		24.0110-0115.1 24.0310-0115.1	410115 510115	Ø 253 10,2 8,9 Ø 253 10,2 8,9
1.25 1.25	44 60	06/08→ 06/08→	← ←	09/08→	24.0123-0113.1 24.0323-0113.1	423113 523113	Ø 258 23 21 V Ø 258 23 21 V
1.4 1.6 TDCi 1.6 TDCi 1.6 Ti	71 55 66 88	06/08→ 06/08→ 06/08→ 06/08→	← ← ← ←	09/08→; für Fahrzeuge mit Trommelbremse an der Hinterachse für Fahrzeuge mit Scheibenbremse an der Hinterachse	24.0123-0113.1 24.0323-0113.1 24.0123-0122.1	423113 523113 423122	Ø 258 23 21 V Ø 258 23 21 V Ø 278 23 21 V
			→		24.0110-0115.1 24.0310-0115.1	410115 510115	Ø 253 10,2 8,9 Ø 253 10,2 8,9
1.4 LPG 1.4 LPG	68 71	01/09→ 01/09→	← ←	06/09→; für Fahrzeuge mit Trommelbremse an der Hinterachse für Fahrzeuge mit Scheibenbremse an der Hinterachse	24.0123-0113.1 24.0323-0113.1 24.0123-0122.1	423113 523113 423122	Ø 258 23 21 V Ø 258 23 21 V Ø 278 23 21 V
			→		24.0110-0115.1 24.0310-0115.1	410115 510115	Ø 253 10,2 8,9 Ø 253 10,2 8,9
1.6 ST	134	03/13→	← →		24.0123-0122.1	423122	Ø 278 23 21 V
			→		24.0110-0115.1 24.0310-0115.1	410115 510115	Ø 253 10,2 8,9 Ø 253 10,2 8,9
1.6 ST200	147	04/16→	← →		24.0123-0122.1	423122	Ø 278 23 21 V
			→		24.0110-0115.1	410115	Ø 253 10,2 8,9



	kw			 	! #		
<b>FORD - FIESTA VI Van 01/09→</b>							
 <b>Bremsbelagsatz, Scheibenbremse</b>							
1.0	48	01/13→	←			<b>13.0460-2605.2 602605</b>	TRW 24283 17,3 - WE / - WK + Zub
1.0	59	10/12→					
1.0 EcoBoost	74	01/13→					
1.0 EcoBoost	103	05/14→					
1.25	60	01/09→					
1.4 TDCi	50	01/09→					
1.4 TDCi	51	07/10→					
1.5 TDCi	55	10/12→					
1.5 TDCi	70	05/15→					
1.6 TDCi	66	01/09→					
1.6 TDCi	70	02/10→					
1.0 EcoBoost	92	09/12→	←	10/12→		<b>13.0460-2605.2 602605</b>	TRW 24283 17,3 - WE / - WK + Zub
1.6 ST	134	03/13→	←			<b>13.0460-2784.2 602784</b>	TRW 25134 17,2 - WE / - WK + Zub
						<b>13.0470-2784.2 LD2784</b>	TRW 25134 17,2 - WE / - WK + Zub Ceramic
			→			<b>13.0460-2835.2 602835</b>	TRW 23353 14,8 + WE / - WK
 <b>Bremsscheibe</b>							
1.0	48	01/13→	←			<b>24.0123-0113.1 423113</b>	Ø 258 23 21 V
1.0	59	10/12→				<b>24.0323-0113.1 523113</b>	Ø 258 23 21 V
1.0 EcoBoost	74	01/13→					
1.0 EcoBoost	103	05/14→					
1.25	60	01/09→					
1.4 TDCi	50	01/09→					
1.4 TDCi	51	07/10→					
1.5 TDCi	55	10/12→					
1.5 TDCi	70	05/15→					
1.6 TDCi	66	01/09→					
1.6 TDCi	70	02/10→					
1.0 EcoBoost	92	09/12→	←	10/12→		<b>24.0123-0113.1 423113</b>	Ø 258 23 21 V
						<b>24.0323-0113.1 523113</b>	Ø 258 23 21 V
1.6 ST	134	03/13→	←			<b>24.0123-0122.1 423122</b>	Ø 278 23 21 V
						<b>24.0110-0115.1 410115</b>	Ø 253 10,2 8,9
			→			<b>24.0310-0115.1 510115</b>	Ø 253 10,2 8,9
<b>FORD - FIESTA Kasten (JV_) 05/98→08/03</b>							
 <b>Bremsbelagsatz, Scheibenbremse</b>							
D 1.8	44	05/98→04/02	←	→ 01/00		<b>13.0460-7071.2 607071</b>	ATE 20640 17,5 - WE / - WK
			←	02/00→ 03/02; + ABS		<b>13.0460-7142.2 607142</b>	ATE 23202 18,3 - WE / - WK
			←	02/00→ 03/02; - ABS		<b>13.0460-7148.2 607148</b>	ATE 23200 18,0 - WE / - WK
 <b>Bremsscheibe</b>							
D 1.8	44	05/98→04/02	←	02/00→ 03/02; - ABS		<b>24.0120-0147.1 420147</b>	Ø 239,5 20 18 V
						<b>24.0320-0147.1 520147</b>	Ø 239,5 20 18 V
			←	→ 01/00		<b>24.0120-0147.1 420147</b>	Ø 239,5 20 18 V
						<b>24.0320-0147.1 520147</b>	Ø 239,5 20 18 V
			←	02/00→ 03/02; + ABS		<b>24.0122-0172.1 422172</b>	Ø 258 22 20 V
			<b>24.0322-0172.1 522172</b>	Ø 258 22 20 V			
<b>FORD - FOCUS (DAW, DBW) 09/98→12/07</b>							
 <b>Bremsbelagsatz, Scheibenbremse</b>							
1.4 16V	55	10/98→09/99	←			<b>13.0460-7121.2 607121</b>	ATE 23154 19,0 - WE / - WK
			→			<b>13.0460-2835.2 602835</b>	TRW 23353 14,8 + WE / - WK
1.4 16V	55	10/98→11/04	←	→ 09/04		<b>13.0460-7121.2 607121</b>	ATE 23154 19,0 - WE / - WK
1.6 16V	74	10/98→11/04					
1.6 16V Flexifuel	75	01/02→11/04	→	→ 09/04		<b>13.0460-2835.2 602835</b>	TRW 23353 14,8 + WE / - WK
1.8 16V	85	10/98→11/04					
1.8 DI / TDDi	55	08/99→11/04					
1.8 TDCi	74	08/02→11/04					
1.8 TDCi	85	03/01→11/04					
1.8 Turbo DI / TDDi	66	10/98→11/04					
2.0 16V	96	10/98→11/04					
RS	158	10/02→11/04	←	→ 09/04		<b>13.0460-4832.2 604832</b>	BRE 21381 18,0 - WE / - WK
			→	→ 09/04		<b>13.0460-2835.2 602835</b>	TRW 23353 14,8 + WE / - WK
ST170	127	03/02→11/04	←	→ 09/04		<b>13.0460-7186.2 607186</b>	ATE 23440 17,6 - WE / - WK
			→	→ 09/04		<b>13.0460-2835.2 602835</b>	TRW 23353 14,8 + WE / - WK
↓							

**FORD - FOCUS (DAW, DBW) 09/98→12/07**

**Bremsscheibe**

1.4 16V	55	10/98→09/99	←		24.0122-0172.1	422172	Ø 258 22 20 V
			→		24.0322-0172.1	522172	Ø 258 22 20 V
1.4 16V	55	10/98→11/04	←	→ 09/04	24.0122-0172.1	422172	Ø 258 22 20 V
			→		24.0322-0172.1	522172	Ø 258 22 20 V
1.6 16V Flexifuel	75	01/02→11/04	←		24.0110-0115.1	410115	Ø 253 10,2 8,9
1.8 16V	85	10/98→11/04	→	→ 09/04	24.0310-0115.1	510115	Ø 253 10,2 8,9
1.8 DI / TDDi	55	08/99→11/04	←		24.0110-0115.1	410115	Ø 253 10,2 8,9
1.8 TDCi	74	08/02→11/04	→		24.0310-0115.1	510115	Ø 253 10,2 8,9
1.8 TDCi	85	03/01→11/04	←				
1.8 Turbo DI / TDDi	66	10/98→11/04	→				
2.0 16V	96	10/98→11/04	←				
ST170	127	03/02→11/04	←	→ 09/04	24.0124-0198.1	424198	Ø 300 24 22 V
			→	→ 09/04	24.0110-0313.1	410313	Ø 280 10,2 8,9







**FORD - FOCUS II (DA\_, HCP, DP) 07/04→09/13**











**Bremsbelagsatz, Scheibenbremse**

1.4	59	07/04→09/12	←	10/04→ 02/11	13.0460-7193.2	607193	ATE 23723 18,1 - WE / - WK
			→		13.0470-7193.2	LD7193	ATE 23723 18,1 - WE / - WK Ceramic
1.6	74	07/04→09/12	←		13.0460-7195.2	607195	ATE 23482 16,6 - WE / - WK
1.6 TDCi	74	07/04→09/12	→	10/04→ 02/11	13.0470-7195.2	LD7195	ATE 23482 16,6 - WE / - WK Ceramic
1.6 TDCi	80	07/04→09/12	←				
1.6 Ti	85	07/04→09/12	→				
2.0	107	07/04→09/12	←				
2.0 TDCi	100	07/04→09/12	→				
1.6 LPG	85	10/09→07/11	←	→ 02/11	13.0460-7193.2	607193	ATE 23723 18,1 - WE / - WK
1.6 TDCi	66	01/05→09/12	→		13.0470-7193.2	LD7193	ATE 23723 18,1 - WE / - WK Ceramic
1.8	92	03/06→09/12	←				
1.8 Flexifuel	92	01/06→09/12	→	→ 02/11	13.0460-7195.2	607195	ATE 23482 16,6 - WE / - WK
1.8 TDCi	85	01/05→09/12	←		13.0470-7195.2	LD7195	ATE 23482 16,6 - WE / - WK Ceramic
2.0	105	04/10→09/12	→				
2.0 CNG	107	04/09→07/11	←				
2.0 LPG	107	06/08→07/11	→				
2.0 TDCi	81	02/08→07/11	←				
2.0	104	06/05→09/08	←		13.0460-7193.2	607193	ATE 23723 18,1 - WE / - WK
2.0 Flex	107	10/08→03/10	→		13.0470-7193.2	LD7193	ATE 23723 18,1 - WE / - WK Ceramic
2.0 TDCi	98	07/04→01/08	←	10/04→	13.0460-7193.2	607193	ATE 23723 18,1 - WE / - WK
			→	10/04→	13.0470-7193.2	LD7193	ATE 23723 18,1 - WE / - WK Ceramic
2.5 RS	224	01/09→07/11	←		13.0460-7195.2	607195	ATE 23482 16,6 - WE / - WK
			→		13.0470-7195.2	LD7195	ATE 23482 16,6 - WE / - WK Ceramic
2.5 RS 500	257	05/10→07/11	←	→ 02/11	13.0460-2723.2	602723	TRW 24537 16,1 - WE / - WK + Zub
2.5 ST	166	10/05→09/12	←	→ 02/11	13.0470-2723.2	LD2723	TRW 24537 16,1 - WE / - WK + Zub Ceramic
			→	→ 02/11	13.0460-7204.2	607204	ATE 23801 18,8 - WE / - WK
2.5 ST	166	10/05→09/12	←	→ 02/11	13.0470-7204.2	LD7204	ATE 23801 18,8 - WE / - WK Ceramic
			→	→ 02/11	13.0460-7195.2	607195	ATE 23482 16,6 - WE / - WK
2.5 ST	166	10/05→09/12	←	→ 02/11	13.0470-7195.2	LD7195	ATE 23482 16,6 - WE / - WK Ceramic
			→	→ 02/11			

**Bremsscheibe**

1.4	59	07/04→09/12	←	10/04→ 02/11	24.0125-0117.1	425117	Ø 278 25 23 V
			→		24.0325-0117.1	525117	Ø 278 25 23 V
1.6	74	07/04→09/12	←		24.0111-0155.1	411155	Ø 265 11 9
1.6 Ti	85	07/04→09/12	→	10/04→ 02/11	24.0311-0155.1	511155	Ø 265 11 9
1.6 LPG	85	10/09→07/11	←	→ 02/11	24.0125-0117.1	425117	Ø 278 25 23 V
1.8	92	03/06→09/12	→		24.0325-0117.1	525117	Ø 278 25 23 V
1.8 Flexifuel	92	01/06→09/12	←	→ 02/11	24.0111-0155.1	411155	Ø 265 11 9
1.6 TDCi	66	01/05→09/12	←	→ 02/11	24.0311-0155.1	511155	Ø 265 11 9
			→	→ 02/11	24.0125-0117.1	425117	Ø 278 25 23 V
↓			←	→ 02/11	24.0325-0117.1	525117	Ø 278 25 23 V
			→	→ 02/11	24.0111-0155.1	411155	Ø 265 11 9

	kw				! #		
<b>FORD - FOCUS II (DA_, HCP, DP) 07/04→09/13</b>							
<b>Bremsscheibe</b>							
1.6 TDCi	66	01/05→09/12	→	→ 02/11		24.0111-0158.1 411158 24.0311-0155.1 511155 24.0311-0158.1 511158	Ø 280 11 9 + S Ø 265 11 9 Ø 280 11 9 + S
1.6 TDCi	74	07/04→09/12	←	10/04→ 02/11		24.0125-0117.1 425117 24.0325-0117.1 525117	Ø 278 25 23 V Ø 278 25 23 V
1.6 TDCi	80	07/04→09/12	→	10/04→ 02/11		24.0111-0155.1 411155 24.0111-0158.1 411158 24.0311-0155.1 511155 24.0311-0158.1 511158	Ø 265 11 9 Ø 280 11 9 + S Ø 265 11 9 Ø 280 11 9 + S
1.8 TDCi	85	01/05→09/12	←	→ 02/11		24.0125-0162.1 425162 24.0325-0162.1 525162	Ø 300 25 23 V Ø 300 25 23 V
2.0	105	04/10→09/12	→	→ 02/11		24.0111-0158.1 411158 24.0311-0158.1 511158	Ø 280 11 9 + S Ø 280 11 9 + S
2.0 CNG	107	04/09→07/11	→	→ 02/11		24.0111-0158.1 411158 24.0311-0158.1 511158	Ø 280 11 9 + S Ø 280 11 9 + S
2.0 LPG	107	06/08→07/11	→	→ 02/11		24.0111-0158.1 411158 24.0311-0158.1 511158	Ø 280 11 9 + S Ø 280 11 9 + S
2.0 TDCi	81	02/08→07/11	→	→ 02/11		24.0111-0158.1 411158 24.0311-0158.1 511158	Ø 280 11 9 + S Ø 280 11 9 + S
2.0	104	06/05→09/08	←			24.0125-0162.1 425162 24.0325-0162.1 525162	Ø 300 25 23 V Ø 300 25 23 V
2.0 Flex	107	10/08→03/10	→			24.0111-0158.1 411158 24.0311-0158.1 511158	Ø 280 11 9 + S Ø 280 11 9 + S
2.0	107	07/04→09/12	←	10/04→ 02/11		24.0125-0162.1 425162 24.0325-0162.1 525162	Ø 300 25 23 V Ø 300 25 23 V
2.0 TDCi	100	07/04→09/12	→	10/04→ 02/11		24.0111-0158.1 411158 24.0311-0158.1 511158	Ø 280 11 9 + S Ø 280 11 9 + S
2.0 TDCi	98	07/04→01/08	←	10/04→		24.0125-0162.1 425162 24.0325-0162.1 525162	Ø 300 25 23 V Ø 300 25 23 V
2.0 TDCi	98	07/04→01/08	→	10/04→		24.0111-0158.1 411158 24.0311-0158.1 511158	Ø 280 11 9 + S Ø 280 11 9 + S
2.5 RS	224	01/09→07/11	→	→ 02/11		24.0111-0145.1 411145 24.0311-0145.1 511145	Ø 302 10,9 9 + S Ø 302 10,9 9
2.5 RS 500	257	05/10→07/11	→	→ 02/11		24.0111-0145.1 411145 24.0311-0145.1 511145	Ø 302 10,9 9 + S Ø 302 10,9 9
2.5 ST	166	10/05→09/12	←	→ 12/10		24.0125-0197.1 425197 24.0325-0197.1 525197	Ø 320 25 23 V Ø 320 25 23 V
2.5 ST	166	10/05→09/12	←	01/11→ 02/11		24.0125-0209.1 425209	Ø 320 25 23 V
2.5 ST	166	10/05→09/12	→	→ 02/11		24.0111-0158.1 411158 24.0311-0158.1 511158	Ø 280 11 9 + S Ø 280 11 9 + S
<b>FORD - FOCUS II Cabriolet 10/06→09/10</b>							
<b>Bremsbelagsatz, Scheibenbremse</b>							
1.6	74	10/06→09/10	←			13.0460-7193.2 607193 13.0470-7193.2 LD7193	ATE 23723 18,1 - WE / - WK ATE 23723 18,1 - WE / - WK Ceramic
2.0	107	10/06→09/10	→			13.0460-7195.2 607195 13.0470-7195.2 LD7195	ATE 23482 16,6 - WE / - WK ATE 23482 16,6 - WE / - WK Ceramic
2.0 TDCi	100	10/06→09/10	→			13.0460-7195.2 607195 13.0470-7195.2 LD7195	ATE 23482 16,6 - WE / - WK ATE 23482 16,6 - WE / - WK Ceramic
<b>Bremsscheibe</b>							
1.6	74	10/06→09/10	←			24.0125-0117.1 425117 24.0325-0117.1 525117	Ø 278 25 23 V Ø 278 25 23 V
1.6	74	10/06→09/10	→			24.0111-0155.1 411155 24.0311-0155.1 511155	Ø 265 11 9 Ø 265 11 9
2.0	107	10/06→09/10	←			24.0125-0162.1 425162 24.0325-0162.1 525162	Ø 300 25 23 V Ø 300 25 23 V
2.0 TDCi	100	10/06→09/10	→			24.0111-0158.1 411158 24.0311-0158.1 511158	Ø 280 11 9 + S Ø 280 11 9 + S
<b>FORD - FOCUS II Stufenheck (DB_, FCH, DH) 04/05→</b>							
<b>Bremsbelagsatz, Scheibenbremse</b>							
1.4	59	04/05→09/12	←	→ 02/11		13.0460-7193.2 607193 13.0470-7193.2 LD7193	ATE 23723 18,1 - WE / - WK ATE 23723 18,1 - WE / - WK Ceramic
1.6	74	04/05→09/12	→	→ 02/11		13.0460-7195.2 607195 13.0470-7195.2 LD7195	ATE 23482 16,6 - WE / - WK ATE 23482 16,6 - WE / - WK Ceramic
1.6 TDCi	66	04/05→09/12	→	→ 02/11		13.0460-7195.2 607195 13.0470-7195.2 LD7195	ATE 23482 16,6 - WE / - WK ATE 23482 16,6 - WE / - WK Ceramic
1.6 TDCi	74	04/05→09/12	→	→ 02/11		13.0460-7195.2 607195 13.0470-7195.2 LD7195	ATE 23482 16,6 - WE / - WK ATE 23482 16,6 - WE / - WK Ceramic
1.6 TDCi	80	04/05→09/12	→	→ 02/11		13.0460-7195.2 607195 13.0470-7195.2 LD7195	ATE 23482 16,6 - WE / - WK ATE 23482 16,6 - WE / - WK Ceramic
1.6 Ti	85	04/05→09/12	→	→ 02/11		13.0460-7195.2 607195 13.0470-7195.2 LD7195	ATE 23482 16,6 - WE / - WK ATE 23482 16,6 - WE / - WK Ceramic
1.8	92	03/06→09/12	→	→ 02/11		13.0460-7195.2 607195 13.0470-7195.2 LD7195	ATE 23482 16,6 - WE / - WK ATE 23482 16,6 - WE / - WK Ceramic
1.8 Flexifuel	92	06/06→07/11	→	→ 02/11		13.0460-7195.2 607195 13.0470-7195.2 LD7195	ATE 23482 16,6 - WE / - WK ATE 23482 16,6 - WE / - WK Ceramic
1.8 TDCi	85	04/05→09/12	→	→ 02/11		13.0460-7195.2 607195 13.0470-7195.2 LD7195	ATE 23482 16,6 - WE / - WK ATE 23482 16,6 - WE / - WK Ceramic
2.0	107	04/05→07/11	→	→ 02/11		13.0460-7195.2 607195 13.0470-7195.2 LD7195	ATE 23482 16,6 - WE / - WK ATE 23482 16,6 - WE / - WK Ceramic
2.0 TDCi	81	02/08→07/11	→	→ 02/11		13.0460-7195.2 607195 13.0470-7195.2 LD7195	ATE 23482 16,6 - WE / - WK ATE 23482 16,6 - WE / - WK Ceramic

	kw					! #		
<b>FORD - FOCUS II Stufenheck (DB_, FCH, DH) 04/05→</b>								
 <b>Bremsbelagsatz, Scheibenbremse</b>								
2.0 TDCi	100	04/05→09/12	←	→ 02/11			13.0460-7193.2 607193 13.0470-7193.2 LD7193	ATE 23723 18,1 - WE / - WK ATE 23723 18,1 - WE / - WK Ceramic
			→	→ 02/11			13.0460-7195.2 607195 13.0470-7195.2 LD7195	ATE 23482 16,6 - WE / - WK ATE 23482 16,6 - WE / - WK Ceramic
1.8 Flexifuel	96	12/05→01/08	←	01/06→			13.0460-7193.2 607193 13.0470-7193.2 LD7193	ATE 23723 18,1 - WE / - WK ATE 23723 18,1 - WE / - WK Ceramic
			→	01/06→			13.0460-7195.2 607195 13.0470-7195.2 LD7195	ATE 23482 16,6 - WE / - WK ATE 23482 16,6 - WE / - WK Ceramic
 <b>Bremsscheibe</b>								
1.4	59	04/05→09/12	←	→ 02/11			24.0125-0117.1 425117 24.0325-0117.1 525117	Ø 278 25 23 V Ø 278 25 23 V
1.6	74	04/05→09/12						
1.6 Ti	85	04/05→09/12						
1.8	92	03/06→09/12	→	→ 02/11			24.0111-0155.1 411155 24.0311-0155.1 511155	Ø 265 11 9 Ø 265 11 9
1.8 Flexifuel	92	06/06→07/11						
1.6 TDCi	66	04/05→09/12	←	→ 02/11			24.0125-0117.1 425117 24.0325-0117.1 525117	Ø 278 25 23 V Ø 278 25 23 V
1.6 TDCi	74	04/05→09/12						
1.6 TDCi	80	04/05→09/12	→	→ 02/11			24.0111-0155.1 411155 24.0111-0158.1 411158 24.0311-0155.1 511155 24.0311-0158.1 511158	Ø 265 11 9 Ø 280 11 9 + S Ø 265 11 9 Ø 280 11 9 + S
1.8 Flexifuel	96	12/05→01/08	←	01/06→			24.0125-0117.1 425117 24.0325-0117.1 525117	Ø 278 25 23 V Ø 278 25 23 V
			→	01/06→			24.0111-0155.1 411155 24.0311-0155.1 511155	Ø 265 11 9 Ø 265 11 9
1.8 TDCi	85	04/05→09/12	←	→ 02/11			24.0125-0162.1 425162 24.0325-0162.1 525162	Ø 300 25 23 V Ø 300 25 23 V
2.0	107	04/05→07/11						
2.0 TDCi	81	02/08→07/11						
2.0 TDCi	100	04/05→09/12	→	→ 02/11			24.0111-0158.1 411158 24.0311-0158.1 511158	Ø 280 11 9 + S Ø 280 11 9 + S
<b>FORD - FOCUS II Turnier (DA_, FFS, DS) 07/04→09/12</b>								
 <b>Bremsbelagsatz, Scheibenbremse</b>								
1.4	59	07/04→09/12	←	10/04→ 02/11			13.0460-7193.2 607193 13.0470-7193.2 LD7193	ATE 23723 18,1 - WE / - WK ATE 23723 18,1 - WE / - WK Ceramic
1.6	74	07/04→07/11						
1.6 TDCi	74	07/04→09/12						
1.6 TDCi	80	07/04→09/12						
1.6 Ti	85	07/04→09/12	→	10/04→ 02/11			13.0460-7195.2 607195 13.0470-7195.2 LD7195	ATE 23482 16,6 - WE / - WK ATE 23482 16,6 - WE / - WK Ceramic
2.0	107	07/04→09/12						
2.0 TDCi	100	07/04→09/12						
1.6 LPG	85	10/09→09/12	←	→ 02/11			13.0460-7193.2 607193 13.0470-7193.2 LD7193	ATE 23723 18,1 - WE / - WK ATE 23723 18,1 - WE / - WK Ceramic
1.6 TDCi	81	12/07→09/12						
1.8	92	03/06→09/12						
1.8 Flexifuel	92	01/06→09/12						
2.0 LPG	107	06/08→07/11	→	→ 02/11			13.0460-7195.2 607195 13.0470-7195.2 LD7195	ATE 23482 16,6 - WE / - WK ATE 23482 16,6 - WE / - WK Ceramic
2.0 TDCi	81	02/08→07/11						
1.6 TDCi	66	07/04→09/12	←	01/05→ 02/11			13.0460-7193.2 607193 13.0470-7193.2 LD7193	ATE 23723 18,1 - WE / - WK ATE 23723 18,1 - WE / - WK Ceramic
1.8 TDCi	85	07/04→09/12						
			→	01/05→ 02/11			13.0460-7195.2 607195 13.0470-7195.2 LD7195	ATE 23482 16,6 - WE / - WK ATE 23482 16,6 - WE / - WK Ceramic
2.0 TDCi	98	07/04→01/08	←	10/04→			13.0460-7193.2 607193 13.0470-7193.2 LD7193	ATE 23723 18,1 - WE / - WK ATE 23723 18,1 - WE / - WK Ceramic
			→	10/04→			13.0460-7195.2 607195 13.0470-7195.2 LD7195	ATE 23482 16,6 - WE / - WK ATE 23482 16,6 - WE / - WK Ceramic
 <b>Bremsscheibe</b>								
1.4	59	07/04→09/12	←	10/04→ 02/11			24.0125-0117.1 425117 24.0325-0117.1 525117	Ø 278 25 23 V Ø 278 25 23 V
1.6	74	07/04→07/11						
1.6 Ti	85	07/04→09/12	→	10/04→ 02/11			24.0111-0155.1 411155 24.0311-0155.1 511155	Ø 265 11 9 Ø 265 11 9
↓								

**FORD - FOCUS II Turnier (DA\_, FFS, DS) 07/04→09/12**

**Bremsscheibe**











1.6 LPG 1.8 1.8 Flexifuel	85	10/09→09/12	←	→ 02/11	24.0125-0117.1	425117	Ø 278 25 23 V
	92	03/06→09/12			24.0325-0117.1	525117	Ø 278 25 23 V
	92	01/06→09/12	→	→ 02/11	24.0111-0155.1	411155	Ø 265 11 9
					24.0311-0155.1	511155	Ø 265 11 9
1.6 TDCi	66	07/04→09/12	←	01/05→ 02/11	24.0125-0117.1	425117	Ø 278 25 23 V
					24.0325-0117.1	525117	Ø 278 25 23 V
			→	01/05→ 02/11	24.0111-0155.1	411155	Ø 265 11 9
					24.0111-0158.1	411158	Ø 280 11 9 + S
				24.0311-0155.1	511155	Ø 265 11 9	
				24.0311-0158.1	511158	Ø 280 11 9 + S	
1.6 TDCi 1.6 TDCi	74	07/04→09/12	←	10/04→ 02/11	24.0125-0117.1	425117	Ø 278 25 23 V
	80	07/04→09/12			24.0325-0117.1	525117	Ø 278 25 23 V
			→	10/04→ 02/11	24.0111-0155.1	411155	Ø 265 11 9
					24.0111-0158.1	411158	Ø 280 11 9 + S
					24.0311-0155.1	511155	Ø 265 11 9
					24.0311-0158.1	511158	Ø 280 11 9 + S
1.6 TDCi	81	12/07→09/12	←	→ 02/11	24.0125-0117.1	425117	Ø 278 25 23 V
					24.0325-0117.1	525117	Ø 278 25 23 V
			→	→ 02/11	24.0111-0155.1	411155	Ø 265 11 9
					24.0111-0158.1	411158	Ø 280 11 9 + S
					24.0311-0155.1	511155	Ø 265 11 9
					24.0311-0158.1	511158	Ø 280 11 9 + S
1.8 TDCi	85	07/04→09/12	←	01/05→ 02/11	24.0125-0162.1	425162	Ø 300 25 23 V
					24.0325-0162.1	525162	Ø 300 25 23 V
			→	01/05→ 02/11	24.0111-0158.1	411158	Ø 280 11 9 + S
					24.0311-0158.1	511158	Ø 280 11 9 + S
2.0 2.0 TDCi	107	07/04→09/12	←	10/04→ 02/11	24.0125-0162.1	425162	Ø 300 25 23 V
	100	07/04→09/12			24.0325-0162.1	525162	Ø 300 25 23 V
			→	10/04→ 02/11	24.0111-0158.1	411158	Ø 280 11 9 + S
					24.0311-0158.1	511158	Ø 280 11 9 + S
2.0 LPG 2.0 TDCi	107	06/08→07/11	←	→ 02/11	24.0125-0162.1	425162	Ø 300 25 23 V
	81	02/08→07/11			24.0325-0162.1	525162	Ø 300 25 23 V
			→	→ 02/11	24.0111-0158.1	411158	Ø 280 11 9 + S
					24.0311-0158.1	511158	Ø 280 11 9 + S
2.0 TDCi	98	07/04→01/08	←	10/04→	24.0125-0162.1	425162	Ø 300 25 23 V
					24.0325-0162.1	525162	Ø 300 25 23 V
			→	10/04→	24.0111-0158.1	411158	Ø 280 11 9 + S
					24.0311-0158.1	511158	Ø 280 11 9 + S











**FORD - FOCUS III 07/10→**











**Bremssattel, Scheibenbremse**











1.0 EcoBoost 1.0 EcoBoost	74	02/12→	←		13.0460-7193.2	607193	ATE 23723 18,1 - WE / - WK
	92	02/12→			13.0470-7193.2	LD7193	ATE 23723 18,1 - WE / - WK Ceramic
1.5 EcoBoost 1.5 EcoBoost	110 134	09/14→ 09/14→	→				
1.5 TDCi 1.5 TDCi	70 88	09/14→ 09/14→			13.0460-7195.2	607195	ATE 23482 16,6 - WE / - WK
1.5 TDCi ECONetic	77	09/14→			13.0470-7195.2	LD7195	ATE 23482 16,6 - WE / - WK Ceramic
1.6 Flexifuel 1.6 LPG	110 86	07/13→ 02/12→					
1.6 LPG 1.6 TDCi ECONetic	88 77	02/12→ 05/12→					
1.6 Ti 1.6 Ti	63 88	08/11→ 02/12→					
2.0 2.0 TDCi	110 110	10/13→ 11/14→					
2.0 Ti-GDi	125	08/11→					
1.0 EcoBoost 2.0 TDCi ST	103	10/17→	←		13.0460-7193.2	607193	ATE 23723 18,1 - WE / - WK
	136	11/14→			13.0470-7193.2	LD7193	ATE 23723 18,1 - WE / - WK Ceramic
			←	Bremssattelfarbe: rot	13.0470-7299.2	LD7299	ATE 25736 18,4 - WE / - WK Ceramic
			→		13.0460-7195.2	607195	ATE 23482 16,6 - WE / - WK
					13.0470-7195.2	LD7195	ATE 23482 16,6 - WE / - WK Ceramic
1.6 EcoBoost 1.6 EcoBoost	110 134	07/10→ 07/10→	←	03/11→	13.0460-7193.2	607193	ATE 23723 18,1 - WE / - WK









	kW			 	! #		
<b>FORD - FOCUS III 07/10→</b>							
 <b>Bremsbelagsatz, Scheibenbremse</b>							
1.6 Flexifuel	88	07/10→	←	03/11→		13.0470-7193.2 LD7193	ATE 23723 18,1 - WE / - WK Ceramic
1.6 TDCi	70	07/10→					
1.6 TDCi	85	07/10→	→	03/11→		13.0460-7195.2 607195	ATE 23482 16,6 - WE / - WK
1.6 Ti	77	07/10→				13.0470-7195.2 LD7195	ATE 23482 16,6 - WE / - WK Ceramic
1.6 Ti	92	07/10→					
2.0 TDCi	85	07/10→					
2.0 TDCi	100	07/10→					
2.0 TDCi	103	07/10→					
2.0 TDCi	120	07/10→					
2.0 ST	184	07/12→	←			13.0470-7299.2 LD7299	ATE 25736 18,4 - WE / - WK Ceramic
			→			13.0460-7195.2 607195	ATE 23482 16,6 - WE / - WK
						13.0470-7195.2 LD7195	ATE 23482 16,6 - WE / - WK Ceramic
2.3 RS AWD	257	07/15→	→			13.0460-7195.2 607195	ATE 23482 16,6 - WE / - WK
						13.0470-7195.2 LD7195	ATE 23482 16,6 - WE / - WK Ceramic
 <b>Bremsscheibe</b>							
1.0 EcoBoost	74	02/12→	←			24.0125-0199.1 425199	Ø 278 25 23 V
1.0 EcoBoost	92	02/12→				24.0325-0199.1 525199	Ø 278 25 23 V
1.0 EcoBoost	103	10/17→	→				
1.6 LPG	86	02/12→				24.0111-0171.1 411171	Ø 271 11 9
1.6 LPG	88	02/12→				24.0311-0171.1 511171	Ø 271 11 9
1.6 TDCi ECONetic	77	05/12→					
1.6 Ti	63	08/11→					
1.6 Ti	88	02/12→					
Electric	107	07/13→					
1.5 EcoBoost	110	09/14→	←			24.0125-0162.1 425162	Ø 300 25 23 V
1.5 EcoBoost	134	09/14→				24.0325-0162.1 525162	Ø 300 25 23 V
1.6 Flexifuel	110	07/13→	→			24.0111-0171.1 411171	Ø 271 11 9
2.0	110	10/13→				24.0311-0171.1 511171	Ø 271 11 9
2.0 TDCi	110	11/14→					
2.0 Ti-GDi	125	08/11→					
1.5 TDCi	70	09/14→	←			24.0125-0162.1 425162	Ø 300 25 23 V
1.5 TDCi	88	09/14→				24.0125-0199.1 425199	Ø 278 25 23 V
1.5 TDCi ECONetic	77	09/14→				24.0325-0162.1 525162	Ø 300 25 23 V
			→			24.0325-0199.1 525199	Ø 278 25 23 V
						24.0111-0171.1 411171	Ø 271 11 9
						24.0311-0171.1 511171	Ø 271 11 9
1.6 EcoBoost	110	07/10→	←	03/11→		24.0125-0162.1 425162	Ø 300 25 23 V
1.6 EcoBoost	134	07/10→				24.0325-0162.1 525162	Ø 300 25 23 V
2.0 TDCi	85	07/10→	→	03/11→		24.0111-0171.1 411171	Ø 271 11 9
2.0 TDCi	100	07/10→				24.0311-0171.1 511171	Ø 271 11 9
2.0 TDCi	103	07/10→					
2.0 TDCi	120	07/10→					
1.6 Flexifuel	88	07/10→	←	03/11→		24.0125-0199.1 425199	Ø 278 25 23 V
1.6 TDCi	70	07/10→				24.0325-0199.1 525199	Ø 278 25 23 V
			→	03/11→		24.0111-0171.1 411171	Ø 271 11 9
						24.0311-0171.1 511171	Ø 271 11 9
1.6 TDCi	85	07/10→	←	03/11→; für Fahrzeuge mit Active City Stop		24.0125-0162.1 425162	Ø 300 25 23 V
1.6 Ti	77	07/10→				24.0325-0162.1 525162	Ø 300 25 23 V
1.6 Ti	92	07/10→	←	03/11→; für Fahrzeuge ohne Active City Stop		24.0125-0199.1 425199	Ø 278 25 23 V
						24.0325-0199.1 525199	Ø 278 25 23 V
			→	03/11→		24.0111-0171.1 411171	Ø 271 11 9
						24.0311-0171.1 511171	Ø 271 11 9
2.0 ST	184	07/12→	←			24.0125-0209.1 425209	Ø 320 25 23 V
			→			24.0111-0171.1 411171	Ø 271 11 9
						24.0311-0171.1 511171	Ø 271 11 9
2.0 TDCi ST	136	11/14→	←			24.0125-0162.1 425162	Ø 300 25 23 V
						24.0325-0162.1 525162	Ø 300 25 23 V
			←	Bremssattelfarbe: rot; → 12/14		24.0125-0209.1 425209	Ø 320 25 23 V
			→			24.0111-0171.1 411171	Ø 271 11 9
						24.0311-0171.1 511171	Ø 271 11 9
<b>FORD - FOCUS III Kasten/Kombi 02/12→</b>							
 <b>Bremsbelagsatz, Scheibenbremse</b>							
1.0 EcoBoost	74	02/12→	←			13.0460-7193.2 607193	ATE 23723 18,1 - WE / - WK
1.0 EcoBoost	92	02/12→				13.0470-7193.2 LD7193	ATE 23723 18,1 - WE / - WK Ceramic
1.5 EcoBoost	110	09/14→					
1.5 EcoBoost	134	09/14→					













	kw			 	! #		
<b>FORD - FOCUS III Kasten/Kombi 02/12→</b>							
 <b>Bremsbelagsatz, Scheibenbremse</b>							
1.5 TDCi	70	09/14→	➔		13.0460-7195.2	607195	ATE 23482 16,6 - WE / - WK
1.5 TDCi	88	09/14→			13.0470-7195.2	LD7195	ATE 23482 16,6 - WE / - WK
1.5 TDCi ECOnetic	77	09/14→					Ceramic
2.0 TDCi	110	11/14→					
 <b>Bremsscheibe</b>							
1.0 EcoBoost	74	02/12→	➔		24.0125-0199.1	425199	Ø 278 25 23 V
1.0 EcoBoost	92	02/12→		➔		24.0325-0199.1	525199
					24.0111-0171.1	411171	Ø 271 11 9
					24.0311-0171.1	511171	Ø 271 11 9
1.5 EcoBoost	110	09/14→	➔		24.0125-0162.1	425162	Ø 300 25 23 V
1.5 EcoBoost	134	09/14→		➔		24.0325-0162.1	525162
2.0 TDCi	110	11/14→			24.0111-0171.1	411171	Ø 271 11 9
					24.0311-0171.1	511171	Ø 271 11 9
1.5 TDCi	70	09/14→	➔		24.0125-0162.1	425162	Ø 300 25 23 V
1.5 TDCi	88	09/14→		➔		24.0125-0199.1	425199
1.5 TDCi ECOnetic	77	09/14→			24.0325-0162.1	525162	Ø 300 25 23 V
					24.0325-0199.1	525199	Ø 278 25 23 V
					24.0111-0171.1	411171	Ø 271 11 9
					24.0311-0171.1	511171	Ø 271 11 9
<b>FORD - FOCUS III Kasten/Schrägheck 01/11→</b>							
 <b>Bremsbelagsatz, Scheibenbremse</b>							
1.0 EcoBoost	74	02/12→	➔		13.0460-7193.2	607193	ATE 23723 18,1 - WE / - WK
1.0 EcoBoost	92	02/12→		➔		13.0470-7193.2	LD7193
1.5 EcoBoost	110	09/14→					Ceramic
1.5 EcoBoost	134	09/14→					
1.5 TDCi	70	09/14→	➔		13.0460-7195.2	607195	ATE 23482 16,6 - WE / - WK
1.5 TDCi	88	09/14→		➔		13.0470-7195.2	LD7195
1.5 TDCi ECOnetic	77	09/14→					Ceramic
1.6 EcoBoost	110	11/11→06/14					
1.6 EcoBoost	134	11/11→06/14					
1.6 TDCi	85	02/12→					
2.0 TDCi	110	11/14→					
1.6 Ti	77	01/11→	➔	03/11→	13.0460-7193.2	607193	ATE 23723 18,1 - WE / - WK
2.0 TDCi	85	01/11→06/14		➔	03/11→	13.0470-7193.2	LD7193
2.0 TDCi	103	01/11→06/14					Ceramic
					13.0460-7195.2	607195	ATE 23482 16,6 - WE / - WK
					13.0470-7195.2	LD7195	ATE 23482 16,6 - WE / - WK
							Ceramic
 <b>Bremsscheibe</b>							
1.0 EcoBoost	74	02/12→	➔		24.0125-0199.1	425199	Ø 278 25 23 V
1.0 EcoBoost	92	02/12→		➔		24.0325-0199.1	525199
					24.0111-0171.1	411171	Ø 271 11 9
					24.0311-0171.1	511171	Ø 271 11 9
1.5 EcoBoost	110	09/14→	➔		24.0125-0162.1	425162	Ø 300 25 23 V
1.5 EcoBoost	134	09/14→		➔		24.0325-0162.1	525162
1.6 EcoBoost	110	11/11→06/14					
1.6 EcoBoost	134	11/11→06/14					
2.0 TDCi	110	11/14→			24.0111-0171.1	411171	Ø 271 11 9
					24.0311-0171.1	511171	Ø 271 11 9
1.5 TDCi	70	09/14→	➔		24.0125-0162.1	425162	Ø 300 25 23 V
1.5 TDCi	88	09/14→		➔		24.0125-0199.1	425199
1.5 TDCi ECOnetic	77	09/14→			24.0325-0162.1	525162	Ø 300 25 23 V
					24.0325-0199.1	525199	Ø 278 25 23 V
					24.0111-0171.1	411171	Ø 271 11 9
					24.0311-0171.1	511171	Ø 271 11 9
1.6 TDCi	85	02/12→	➔	für Fahrzeuge mit Active City Stop	24.0125-0162.1	425162	Ø 300 25 23 V
				➔	für Fahrzeuge ohne Active City Stop	24.0325-0162.1	525162
					24.0125-0199.1	425199	Ø 278 25 23 V
					24.0325-0199.1	525199	Ø 278 25 23 V
					24.0111-0171.1	411171	Ø 271 11 9
					24.0311-0171.1	511171	Ø 271 11 9
1.6 Ti	77	01/11→	➔	03/11→; für Fahrzeuge mit Active City Stop	24.0125-0162.1	425162	Ø 300 25 23 V
				➔	03/11→; für Fahrzeuge ohne Active City Stop	24.0325-0162.1	525162
					24.0125-0199.1	425199	Ø 278 25 23 V
					24.0325-0199.1	525199	Ø 278 25 23 V











	kw			 	! #		
<b>FORD - FOCUS III Kasten/Schrägheck 01/11→</b>							
 <b>Bremsscheibe</b>							
1.6 Ti	77	01/11→	→	03/11→		24.0111-0171.1 411171 24.0311-0171.1 511171	Ø 271 11 9 Ø 271 11 9
2.0 TDCi 2.0 TDCi	85 103	01/11→06/14 01/11→06/14	←	03/11→		24.0125-0162.1 425162 24.0325-0162.1 525162	Ø 300 25 23 V Ø 300 25 23 V
			→	03/11→		24.0111-0171.1 411171 24.0311-0171.1 511171	Ø 271 11 9 Ø 271 11 9
<b>FORD - FOCUS III Stufenheck 07/10→</b>							
 <b>Bremsbelagsatz, Scheibenbremse</b>							
1.0 EcoBoost 1.0 EcoBoost 1.5 EcoBoost 1.5 EcoBoost	74 92 110 134	02/12→ 02/12→ 11/14→ 11/14→	←			13.0460-7193.2 607193 13.0470-7193.2 LD7193	ATE 23723 18,1 - WE / - WK ATE 23723 18,1 - WE / - WK Ceramic
1.5 TDCi 1.5 TDCi 1.5 TDCi ECONetic 1.6 Flexifuel 1.6 TDCi 1.6 Ti 2.0 2.0 GDi 2.0 TDCi	70 88 77 110 77 63 110 125 110	11/14→ 11/14→ 11/14→ 07/13→ 05/12→ 08/11→ 10/13→ 08/11→ 11/14→	→			13.0460-7195.2 607195 13.0470-7195.2 LD7195	ATE 23482 16,6 - WE / - WK ATE 23482 16,6 - WE / - WK Ceramic
1.0 EcoBoost	103	10/17→	←			13.0460-7193.2 607193 13.0470-7193.2 LD7193	ATE 23723 18,1 - WE / - WK ATE 23723 18,1 - WE / - WK Ceramic
			←	Bremssattelfarbe: rot		13.0470-7299.2 LD7299	ATE 25736 18,4 - WE / - WK Ceramic
			→			13.0460-7195.2 607195 13.0470-7195.2 LD7195	ATE 23482 16,6 - WE / - WK ATE 23482 16,6 - WE / - WK Ceramic
1.6 EcoBoost 1.6 EcoBoost 1.6 Flexifuel 1.6 TDCi 1.6 TDCi 1.6 Ti 1.6 Ti 2.0 TDCi 2.0 TDCi 2.0 TDCi 2.0 TDCi	110 134 88 70 85 77 92 85 100 103 120	07/10→ 07/10→ 07/10→ 07/10→ 07/10→ 07/10→ 07/10→ 07/10→ 07/10→ 07/10→ 07/10→	←	03/11→		13.0460-7193.2 607193 13.0470-7193.2 LD7193	ATE 23723 18,1 - WE / - WK ATE 23723 18,1 - WE / - WK Ceramic
			→	03/11→		13.0460-7195.2 607195 13.0470-7195.2 LD7195	ATE 23482 16,6 - WE / - WK ATE 23482 16,6 - WE / - WK Ceramic
 <b>Bremsscheibe</b>							
1.0 EcoBoost 1.0 EcoBoost 1.0 EcoBoost 1.6 TDCi 1.6 Ti	74 92 103 77 63	02/12→ 02/12→ 10/17→ 05/12→ 08/11→	←			24.0125-0199.1 425199 24.0325-0199.1 525199	Ø 278 25 23 V Ø 278 25 23 V
			→			24.0111-0171.1 411171 24.0311-0171.1 511171	Ø 271 11 9 Ø 271 11 9
1.5 EcoBoost 1.5 EcoBoost 1.6 Flexifuel 2.0 2.0 GDi 2.0 TDCi	110 134 110 110 125 110	11/14→ 11/14→ 07/13→ 10/13→ 08/11→ 11/14→	←			24.0125-0162.1 425162 24.0325-0162.1 525162	Ø 300 25 23 V Ø 300 25 23 V
			→			24.0111-0171.1 411171 24.0311-0171.1 511171	Ø 271 11 9 Ø 271 11 9
1.5 TDCi 1.5 TDCi 1.5 TDCi ECONetic	70 88 77	11/14→ 11/14→ 11/14→	←			24.0125-0162.1 425162 24.0125-0199.1 425199 24.0325-0162.1 525162 24.0325-0199.1 525199	Ø 300 25 23 V Ø 278 25 23 V Ø 300 25 23 V Ø 278 25 23 V
			→			24.0111-0171.1 411171 24.0311-0171.1 511171	Ø 271 11 9 Ø 271 11 9
1.6 EcoBoost 1.6 EcoBoost 2.0 TDCi 2.0 TDCi 2.0 TDCi 2.0 TDCi	110 134 85 100 103 120	07/10→ 07/10→ 07/10→ 07/10→ 07/10→ 07/10→	←	03/11→		24.0125-0162.1 425162 24.0325-0162.1 525162	Ø 300 25 23 V Ø 300 25 23 V
			→	03/11→		24.0111-0171.1 411171 24.0311-0171.1 511171	Ø 271 11 9 Ø 271 11 9
1.6 Flexifuel 1.6 TDCi	88 70	07/10→ 07/10→	←	03/11→		24.0125-0199.1 425199 24.0325-0199.1 525199	Ø 278 25 23 V Ø 278 25 23 V
			→	03/11→		24.0111-0171.1 411171 24.0311-0171.1 511171	Ø 271 11 9 Ø 271 11 9
1.6 TDCi 1.6 Ti 1.6 Ti	85 77 92	07/10→ 07/10→ 07/10→	←	03/11→; für Fahrzeuge mit Active City Stop		24.0125-0162.1 425162 24.0325-0162.1 525162	Ø 300 25 23 V Ø 300 25 23 V
↓							











	kW			 	! #		
<b>FORD - FOCUS III Stufenheck 07/10→</b>							
 <b>Bremsscheibe</b>							
1.6 TDCi	85	07/10→	←	03/11→; für Fahrzeuge ohne Active City Stop		24.0125-0199.1 425199	Ø 278 25 23 V
1.6 Ti	77	07/10→					Ø 278 25 23 V
1.6 Ti	92	07/10→	→	03/11→		24.0111-0171.1 411171	Ø 271 11 9
							Ø 271 11 9
<b>FORD - FOCUS III Turnier 07/10→</b>							
 <b>Bremsbelagsatz, Scheibenbremse</b>							
1.0 EcoBoost	74	02/12→	←			13.0460-7193.2 607193	ATE 23723 18,1 - WE / - WK
1.0 EcoBoost	92	02/12→					ATE 23723 18,1 - WE / - WK
1.5 EcoBoost	110	09/14→	→			13.0470-7193.2 LD7193	Ceramic
1.5 EcoBoost	134	09/14→					ATE 23482 16,6 - WE / - WK
1.5 TDCi	70	09/14→	→			13.0460-7195.2 607195	ATE 23482 16,6 - WE / - WK
1.5 TDCi	88	09/14→					ATE 23482 16,6 - WE / - WK
1.5 TDCi ECONetic	77	09/14→	→			13.0470-7195.2 LD7195	Ceramic
1.6 Flexifuel	110	07/13→					
1.6 LPG	86	02/12→	→			13.0460-7195.2 607195	ATE 23482 16,6 - WE / - WK
1.6 LPG	88	02/12→					ATE 23482 16,6 - WE / - WK
1.6 TDCi ECONetic	77	05/12→	→			13.0470-7195.2 LD7195	Ceramic
1.6 Ti	63	08/11→					
1.6 Ti	88	02/12→	→			13.0460-7195.2 607195	ATE 23723 18,1 - WE / - WK
2.0	110	10/13→					ATE 23723 18,1 - WE / - WK
2.0 TDCi	110	11/14→	→			13.0470-7193.2 LD7193	Ceramic
1.0 EcoBoost	103	10/17→					
2.0 TDCi ST	136	11/14→	←	Bremssattelfarbe: rot		13.0470-7299.2 LD7299	ATE 25736 18,4 - WE / - WK
							Ceramic
			→			13.0460-7195.2 607195	ATE 23482 16,6 - WE / - WK
							ATE 23482 16,6 - WE / - WK
			→			13.0470-7195.2 LD7195	Ceramic
1.6 EcoBoost	110	07/10→	←	03/11→		13.0460-7193.2 607193	ATE 23723 18,1 - WE / - WK
1.6 EcoBoost	134	07/10→					ATE 23723 18,1 - WE / - WK
1.6 Flexifuel	88	07/10→	→	03/11→		13.0460-7195.2 607195	Ceramic
1.6 TDCi	70	07/10→					ATE 23482 16,6 - WE / - WK
1.6 TDCi	85	07/10→	→	03/11→		13.0470-7195.2 LD7195	ATE 23482 16,6 - WE / - WK
1.6 Ti	77	07/10→					ATE 23482 16,6 - WE / - WK
1.6 Ti	92	07/10→	→	03/11→		13.0470-7195.2 LD7195	Ceramic
2.0 TDCi	85	07/10→					
2.0 TDCi	100	07/10→	→	03/11→		13.0460-7193.2 607193	ATE 23723 18,1 - WE / - WK
2.0 TDCi	103	07/10→					ATE 23723 18,1 - WE / - WK
2.0 TDCi	120	07/10→	→	03/11→		13.0470-7195.2 LD7195	Ceramic
2.0 ST	184	07/12→	←			13.0470-7299.2 LD7299	ATE 25736 18,4 - WE / - WK
							Ceramic
			→			13.0460-7195.2 607195	ATE 23482 16,6 - WE / - WK
							ATE 23482 16,6 - WE / - WK
			→			13.0470-7195.2 LD7195	Ceramic
2.0 Ti-GDi	125	07/10→	←	08/11→		13.0460-7193.2 607193	ATE 23723 18,1 - WE / - WK
							ATE 23723 18,1 - WE / - WK
			→	08/11→		13.0460-7195.2 607195	Ceramic
							ATE 23482 16,6 - WE / - WK
			→	08/11→		13.0470-7195.2 LD7195	ATE 23482 16,6 - WE / - WK
							ATE 23482 16,6 - WE / - WK
 <b>Bremsscheibe</b>							
1.0 EcoBoost	74	02/12→	←			24.0125-0199.1 425199	Ø 278 25 23 V
1.0 EcoBoost	92	02/12→					Ø 278 25 23 V
1.0 EcoBoost	103	10/17→	→			24.0111-0171.1 411171	Ø 271 11 9
1.6 LPG	86	02/12→					Ø 271 11 9
1.6 LPG	88	02/12→	→			24.0311-0171.1 511171	Ø 271 11 9
1.6 TDCi ECONetic	77	05/12→					
1.6 Ti	63	08/11→	→			24.0111-0171.1 411171	Ø 271 11 9
1.6 Ti	88	02/12→					Ø 271 11 9
1.5 EcoBoost	110	09/14→	←			24.0125-0162.1 425162	Ø 300 25 23 V
1.5 EcoBoost	134	09/14→					Ø 300 25 23 V
1.6 Flexifuel	110	07/13→	→			24.0111-0171.1 411171	Ø 271 11 9
2.0	110	10/13→					Ø 271 11 9
2.0 TDCi	110	11/14→	→			24.0311-0171.1 511171	Ø 271 11 9
1.5 TDCi	70	09/14→	←			24.0125-0162.1 425162	Ø 300 25 23 V
1.5 TDCi	88	09/14→					Ø 278 25 23 V
1.5 TDCi ECONetic	77	09/14→	→			24.0325-0162.1 525162	Ø 300 25 23 V
							Ø 278 25 23 V
			→			24.0111-0171.1 411171	Ø 271 11 9
							Ø 271 11 9
			→			24.0311-0171.1 511171	Ø 271 11 9
							Ø 271 11 9
↓							









	kw			 	! #		
<b>FORD - FOCUS III Turnier 07/10→</b>							
<b>Bremsscheibe</b>							
1.6 EcoBoost	110	07/10→	←	03/11→		24.0125-0162.1 425162	Ø 300 25 23 V
1.6 EcoBoost	134	07/10→				24.0325-0162.1 525162	Ø 300 25 23 V
2.0 TDCi	85	07/10→					
2.0 TDCi	100	07/10→	→	03/11→		24.0111-0171.1 411171	Ø 271 11 9
2.0 TDCi	103	07/10→				24.0311-0171.1 511171	Ø 271 11 9
2.0 TDCi	120	07/10→					
1.6 Flexifuel	88	07/10→	←	03/11→		24.0125-0199.1 425199	Ø 278 25 23 V
1.6 TDCi	70	07/10→				24.0325-0199.1 525199	Ø 278 25 23 V
			→	03/11→		24.0111-0171.1 411171	Ø 271 11 9
						24.0311-0171.1 511171	Ø 271 11 9
1.6 TDCi	85	07/10→	←	03/11→; für Fahrzeuge mit Active City Stop		24.0125-0162.1 425162	Ø 300 25 23 V
1.6 Ti	77	07/10→				24.0325-0162.1 525162	Ø 300 25 23 V
1.6 Ti	92	07/10→					
			←	03/11→; für Fahrzeuge ohne Active City Stop		24.0125-0199.1 425199	Ø 278 25 23 V
						24.0325-0199.1 525199	Ø 278 25 23 V
			→	03/11→		24.0111-0171.1 411171	Ø 271 11 9
						24.0311-0171.1 511171	Ø 271 11 9
2.0 ST	184	07/12→	←			24.0125-0209.1 425209	Ø 320 25 23 V
			→			24.0111-0171.1 411171	Ø 271 11 9
						24.0311-0171.1 511171	Ø 271 11 9
2.0 TDCi ST	136	11/14→	←			24.0125-0162.1 425162	Ø 300 25 23 V
						24.0325-0162.1 525162	Ø 300 25 23 V
			←	Bremssattelfarbe: rot; → 12/14		24.0125-0209.1 425209	Ø 320 25 23 V
			→			24.0111-0171.1 411171	Ø 271 11 9
						24.0311-0171.1 511171	Ø 271 11 9
2.0 Ti-GDi	125	07/10→	←	08/11→		24.0125-0162.1 425162	Ø 300 25 23 V
						24.0325-0162.1 525162	Ø 300 25 23 V
			→	08/11→		24.0111-0171.1 411171	Ø 271 11 9
						24.0311-0171.1 511171	Ø 271 11 9
<b>FORD - FOCUS C-MAX 10/03→03/07</b>							
<b>Bremsbelagsatz, Scheibenbremse</b>							
1.6	74	10/03→03/07	←			13.0460-7193.2 607193	ATE 23723 18,1 - WE / - WK
1.6 TDCi	66	02/05→03/07				13.0470-7193.2 LD7193	ATE 23723 18,1 - WE / - WK
1.6 TDCi	80	10/03→03/07					Ceramic
1.6 Ti	85	08/04→03/07					
1.8	88	10/03→03/07	→			13.0460-7195.2 607195	ATE 23482 16,6 - WE / - WK
1.8	90	09/05→03/07				13.0470-7195.2 LD7195	ATE 23482 16,6 - WE / - WK
1.8	92	04/04→03/07					Ceramic
1.8 Flexifuel	92	01/06→03/07					
1.8 TDCi	85	01/05→03/07					
2.0 TDCi	98	10/03→03/07					
2.0 TDCi	100	10/03→03/07					
2.0	107	03/04→03/07	←	04/04→		13.0460-7193.2 607193	ATE 23723 18,1 - WE / - WK
						13.0470-7193.2 LD7193	ATE 23723 18,1 - WE / - WK
			→	04/04→		13.0460-7195.2 607195	ATE 23482 16,6 - WE / - WK
						13.0470-7195.2 LD7195	ATE 23482 16,6 - WE / - WK
							Ceramic
<b>Bremsscheibe</b>							
1.6	74	10/03→03/07	←	passend für Felgenreöße [Zoll]: 15 / 16		24.0125-0117.1 425117	Ø 278 25 23 V
1.6 Ti	85	08/04→03/07				24.0325-0117.1 525117	Ø 278 25 23 V
1.8	88	10/03→03/07					
1.8	90	09/05→03/07	←	passend für Felgenreöße [Zoll]: 17		24.0125-0162.1 425162	Ø 300 25 23 V
1.8	92	04/04→03/07				24.0325-0162.1 525162	Ø 300 25 23 V
1.8 Flexifuel	92	01/06→03/07	→			24.0111-0155.1 411155	Ø 265 11 9
						24.0311-0155.1 511155	Ø 265 11 9
1.6 TDCi	66	02/05→03/07	←	passend für Felgenreöße [Zoll]: 15 / 16		24.0125-0117.1 425117	Ø 278 25 23 V
1.6 TDCi	80	10/03→03/07				24.0325-0117.1 525117	Ø 278 25 23 V
			←	passend für Felgenreöße [Zoll]: 17		24.0125-0162.1 425162	Ø 300 25 23 V
						24.0325-0162.1 525162	Ø 300 25 23 V
			→			24.0111-0155.1 411155	Ø 265 11 9
						24.0111-0158.1 411158	Ø 280 11 9 + S
						24.0311-0155.1 511155	Ø 265 11 9
						24.0311-0158.1 511158	Ø 280 11 9 + S
1.8 TDCi	85	01/05→03/07	←	passend für Felgenreöße [Zoll]: 15 / 16		24.0125-0117.1 425117	Ø 278 25 23 V
2.0 TDCi	98	10/03→03/07				24.0325-0117.1 525117	Ø 278 25 23 V
2.0 TDCi	100	10/03→03/07					
↓							



	kw			 	! #		
<b>FORD - FOCUS C-MAX 10/03→03/07</b>							
 <b>Bremsscheibe</b>							
1.8 TDCi	85	01/05→03/07	←	passend für Felgenreöße [Zoll]: 17		24.0125-0162.1 425162	Ø 300 25 23 V
2.0 TDCi	98	10/03→03/07				24.0325-0162.1 525162	Ø 300 25 23 V
2.0 TDCi	100	10/03→03/07	→			24.0111-0158.1 411158	Ø 280 11 9 + S
						24.0311-0158.1 511158	Ø 280 11 9 + S
2.0	107	03/04→03/07	←	04/04→; passend für Felgenreöße [Zoll]: 15 / 16		24.0125-0117.1 425117	Ø 278 25 23 V
						24.0325-0117.1 525117	Ø 278 25 23 V
			←	04/04→; passend für Felgenreöße [Zoll]: 17		24.0125-0162.1 425162	Ø 300 25 23 V
						24.0325-0162.1 525162	Ø 300 25 23 V
			→	04/04→		24.0111-0158.1 411158	Ø 280 11 9 + S
						24.0311-0158.1 511158	Ø 280 11 9 + S
<b>FORD - FOCUS Stufenheck (DFW) 02/99→12/07</b>							
 <b>Bremsbelagsatz, Scheibenbremse</b>							
1.4 16V	55	02/99→11/04	←	→ 09/04		13.0460-7121.2 607121	ATE 23154 19,0 - WE / - WK
1.6 16V	74	02/99→11/04					
1.8 16V	85	02/99→11/04	→	→ 09/04		13.0460-2835.2 602835	TRW 23353 14,8 + WE / - WK
1.8 TDCi	74	08/02→11/04					
1.8 TDCi	85	03/01→11/04					
1.8 Turbo DI / TDDi	55	08/01→03/05					
1.8 Turbo DI / TDDi	66	02/99→11/04					
2.0 16V	96	02/99→11/04					
 <b>Bremsscheibe</b>							
1.4 16V	55	02/99→11/04	←	→ 09/04		24.0122-0172.1 422172	Ø 258 22 20 V
1.6 16V	74	02/99→11/04				24.0322-0172.1 522172	Ø 258 22 20 V
1.8 16V	85	02/99→11/04					
1.8 TDCi	74	08/02→11/04	→	→ 09/04		24.0110-0115.1 410115	Ø 253 10,2 8,9
1.8 TDCi	85	03/01→11/04				24.0310-0115.1 510115	Ø 253 10,2 8,9
1.8 Turbo DI / TDDi	55	08/01→03/05					
1.8 Turbo DI / TDDi	66	02/99→11/04					
2.0 16V	96	02/99→11/04					
<b>FORD - FOCUS Turnier (DNW) 02/99→12/07</b>							
 <b>Bremsbelagsatz, Scheibenbremse</b>							
1.4 16V	55	02/99→11/04	←	→ 09/04		13.0460-7121.2 607121	ATE 23154 19,0 - WE / - WK
1.6 16V	74	02/99→11/04					
1.6 16V Flexifuel	75	01/02→11/04	→	→ 09/04		13.0460-2835.2 602835	TRW 23353 14,8 + WE / - WK
1.8 16V	85	02/99→11/04					
1.8 DI / TDDi	55	08/99→11/04					
1.8 TDCi	74	08/02→11/04					
1.8 TDCi	85	03/01→11/04					
1.8 Turbo DI / TDDi	66	02/99→11/04					
2.0 16V	96	02/99→11/04					
1.8 BiFuel	82	02/03→01/05	←			13.0460-7121.2 607121	ATE 23154 19,0 - WE / - WK
			→			13.0460-2835.2 602835	TRW 23353 14,8 + WE / - WK
ST170	127	08/02→11/04	←	→ 09/04		13.0460-7186.2 607186	ATE 23440 17,6 - WE / - WK
			→	→ 09/04		13.0460-2835.2 602835	TRW 23353 14,8 + WE / - WK
 <b>Bremsscheibe</b>							
1.4 16V	55	02/99→11/04	←	→ 09/04		24.0122-0172.1 422172	Ø 258 22 20 V
1.6 16V	74	02/99→11/04				24.0322-0172.1 522172	Ø 258 22 20 V
1.6 16V Flexifuel	75	01/02→11/04					
1.8 16V	85	02/99→11/04	→	→ 09/04		24.0110-0115.1 410115	Ø 253 10,2 8,9
1.8 DI / TDDi	55	08/99→11/04				24.0310-0115.1 510115	Ø 253 10,2 8,9
1.8 TDCi	74	08/02→11/04					
1.8 TDCi	85	03/01→11/04					
1.8 Turbo DI / TDDi	66	02/99→11/04					
2.0 16V	96	02/99→11/04					
1.8 BiFuel	82	02/03→01/05	←			24.0122-0172.1 422172	Ø 258 22 20 V
			→			24.0322-0172.1 522172	Ø 258 22 20 V
						24.0110-0115.1 410115	Ø 253 10,2 8,9
						24.0310-0115.1 510115	Ø 253 10,2 8,9
ST170	127	08/02→11/04	←	→ 09/04		24.0124-0198.1 424198	Ø 300 24 22 V
			→	→ 09/04		24.0110-0313.1 410313	Ø 280 10,2 8,9
<b>FORD - FUSION (JU_) 08/02→12/12</b>							
 <b>Bremsbelagsatz, Scheibenbremse</b>							
1.25	55	08/04→12/12	←	→ 09/12		13.0460-7142.2 607142	ATE 23202 18,3 - WE / - WK
1.4	59	08/02→12/12					
1.4 LPG	59	01/10→12/12					
↓							

	kw			 	! #		
<b>FORD - FUSION (JU_) 08/02→12/12</b>							
 <b>Bremsbelagsatz, Scheibenbremse</b>							
1.4 TDCi	50	08/02→12/12	←	→ 09/12		13.0460-7142.2 607142	ATE 23202 18,3 - WE / - WK
1.6 TDCi	66	11/04→12/12					
1.6	74	08/02→11/08	←			13.0460-7142.2 607142	ATE 23202 18,3 - WE / - WK
 <b>Bremsscheibe</b>							
1.25	55	08/04→12/12	←	→ 09/12		24.0122-0172.1 422172	Ø 258 22 20 V
1.4	59	08/02→12/12				24.0322-0172.1 522172	Ø 258 22 20 V
1.4 LPG	59	01/10→12/12					
1.4 TDCi	50	08/02→12/12					
1.6 TDCi	66	11/04→12/12					
1.6	74	08/02→11/08	←			24.0122-0172.1 422172	Ø 258 22 20 V
						24.0322-0172.1 522172	Ø 258 22 20 V
<b>FORD - GALAXY 01/15→</b>							
 <b>Bremsbelagsatz, Scheibenbremse</b>							
1.5 EcoBoost	118	01/15→	←	04/15→;		13.0460-7313.2 607313	ATE 22269 19,4 + WK
2.0 EcoBoost	176	01/15→		passend für Felgenreöße [Zoll]: 16			
2.0 TDCi	88	01/15→	→	04/15→; + eFSB		13.0460-7320.2 607320	ATE 22231 16,1 + WK
2.0 TDCi	110	01/15→				13.0470-7320.2 LD7320	ATE 22231 16,1 + WK Ceramic
2.0 TDCi	132	01/15→					
2.0 TDCi Bi-Turbo	154	01/15→					
2.0 TDCi 4x4	110	05/15→	←	passend für Felgenreöße [Zoll]: 16		13.0460-7313.2 607313	ATE 22269 19,4 + WK
2.0 TDCi 4x4	132	05/15→	→	+ eFSB		13.0460-7320.2 607320	ATE 22231 16,1 + WK
						13.0470-7320.2 LD7320	ATE 22231 16,1 + WK Ceramic
<b>FORD - GALAXY (WA6) 05/06→06/15</b>							
 <b>Bremsbelagsatz, Scheibenbremse</b>							
1.6 EcoBoost	118	11/10→06/15	←	02/11→		13.0460-7228.2 607228	ATE 24123 20,3 - WE / - WK
						13.0470-7228.2 LD7228	ATE 24123 20,3 - WE / - WK Ceramic
			→	02/11→; + eFSB		13.0460-2722.2 602722	TRW 24496 17,3 - WE / - WK + Zub
						13.0470-2722.2 LD2722	TRW 24496 17,3 - WE / - WK + Zub Ceramic
			→	02/11→; - eFSB		13.0460-2723.2 602723	TRW 24537 16,1 - WE / - WK + Zub
						13.0470-2723.2 LD2723	TRW 24537 16,1 - WE / - WK + Zub Ceramic
1.6 TDCi	85	02/11→06/15	←			13.0460-7228.2 607228	ATE 24123 20,3 - WE / - WK
1.8 TDCi	74	05/06→06/15				13.0470-7228.2 LD7228	ATE 24123 20,3 - WE / - WK Ceramic
1.8 TDCi	92	05/06→06/15					
2.0	107	05/06→06/15					
2.0 Flexifuel	107	05/06→06/15	→	+ eFSB		13.0460-2722.2 602722	TRW 24496 17,3 - WE / - WK + Zub
2.0 TDCi	85	11/07→06/15				13.0470-2722.2 LD2722	TRW 24496 17,3 - WE / - WK + Zub Ceramic
2.0 TDCi	96	05/06→06/15					
2.0 TDCi	100	05/06→06/15					
2.0 TDCi	103	05/06→06/15	→	- eFSB		13.0460-2723.2 602723	TRW 24537 16,1 - WE / - WK + Zub
2.0 TDCi	120	03/10→06/15					
2.2 TDCi	147	11/10→06/15				13.0470-2723.2 LD2723	TRW 24537 16,1 - WE / - WK + Zub Ceramic
2.3	118	09/07→06/15					
2.0 EcoBoost	146	07/10→06/15	←			13.0460-7243.2 607243	ATE 24142 20,6 - WE / - WK
						13.0470-7243.2 LD7243	ATE 24142 20,6 - WE / - WK Ceramic
			→	+ eFSB		13.0460-2722.2 602722	TRW 24496 17,3 - WE / - WK + Zub
						13.0470-2722.2 LD2722	TRW 24496 17,3 - WE / - WK + Zub Ceramic
			→	- eFSB		13.0460-2723.2 602723	TRW 24537 16,1 - WE / - WK + Zub
						13.0470-2723.2 LD2723	TRW 24537 16,1 - WE / - WK + Zub Ceramic
2.0 EcoBoost	149	03/10→06/15	←	06/11→		13.0460-7228.2 607228	ATE 24123 20,3 - WE / - WK
						13.0470-7228.2 LD7228	ATE 24123 20,3 - WE / - WK Ceramic
			←	→ 05/11		13.0460-7243.2 607243	ATE 24142 20,6 - WE / - WK
						13.0470-7243.2 LD7243	ATE 24142 20,6 - WE / - WK Ceramic
			→	+ eFSB		13.0460-2722.2 602722	TRW 24496 17,3 - WE / - WK + Zub

	kw			 	! #		
<b>FORD - GALAXY (WA6) 05/06→06/15</b>							
 <b>Bremsbelagsatz, Scheibenbremse</b>							
2.0 EcoBoost	149	03/10→06/15	➡	+ eFSB		13.0470-2722.2 LD2722	TRW 24496 17,3 - WE / - WK + Zub Ceramic
			➡	- eFSB		13.0460-2723.2 602723	TRW 24537 16,1 - WE / - WK + Zub
2.2 TDCi	129	03/08→12/12	⬅	11/08→		13.0460-7228.2 607228	ATE 24123 20,3 - WE / - WK
						13.0470-7228.2 LD7228	ATE 24123 20,3 - WE / - WK Ceramic
			⬅	04/08→ 10/08		13.0460-7243.2 607243	ATE 24142 20,6 - WE / - WK
						13.0470-7243.2 LD7243	ATE 24142 20,6 - WE / - WK Ceramic
2.0 EcoBoost	149	03/10→06/15	➡	04/08→; + eFSB		13.0460-2722.2 602722	TRW 24496 17,3 - WE / - WK + Zub
						13.0470-2722.2 LD2722	TRW 24496 17,3 - WE / - WK + Zub Ceramic
			➡	04/08→; - eFSB		13.0460-2723.2 602723	TRW 24537 16,1 - WE / - WK + Zub
					13.0470-2723.2 LD2723	TRW 24537 16,1 - WE / - WK + Zub Ceramic	
 <b>Bremsscheibe</b>							
1.6 EcoBoost	118	11/10→06/15	⬅	02/11→		24.0128-0154.1 428154	Ø 300 28 26 V + S
						24.0328-0154.1 528154	Ø 300 28 26 V + S
1.6 TDCi	85	02/11→06/15	⬅			24.0128-0154.1 428154	Ø 300 28 26 V + S
						24.0328-0154.1 528154	Ø 300 28 26 V + S
1.8 TDCi	74	05/06→06/15	⬅			24.0128-0154.1 428154	Ø 300 28 26 V + S
1.8 TDCi	92	05/06→06/15	⬅			24.0128-0154.1 428154	Ø 300 28 26 V + S
2.0	107	05/06→06/15	➡			24.0111-0145.1 411145	Ø 302 10,9 9 + S
2.0 Flexifuel	107	05/06→06/15	➡			24.0311-0145.1 511145	Ø 302 10,9 9
2.0 TDCi	85	11/07→06/15	➡			24.0111-0145.1 411145	Ø 302 10,9 9 + S
2.0 TDCi	96	05/06→06/15	➡			24.0111-0145.1 411145	Ø 302 10,9 9 + S
2.0 TDCi	100	05/06→06/15	➡			24.0111-0145.1 411145	Ø 302 10,9 9 + S
2.0 TDCi	103	05/06→06/15	➡			24.0111-0145.1 411145	Ø 302 10,9 9 + S
2.0 TDCi	120	03/10→06/15	➡			24.0111-0145.1 411145	Ø 302 10,9 9 + S
2.2 TDCi	147	11/10→06/15	➡			24.0111-0145.1 411145	Ø 302 10,9 9 + S
2.3	118	09/07→06/15	➡			24.0111-0145.1 411145	Ø 302 10,9 9 + S
2.0 EcoBoost	146	07/10→06/15	⬅			24.0128-0162.1 428162	Ø 316 28 26 V + S
						24.0328-0162.1 528162	Ø 316 28 26 V + S
			➡			24.0111-0145.1 411145	Ø 302 10,9 9 + S
2.0 EcoBoost	149	03/10→06/15	⬅	06/11→		24.0128-0154.1 428154	Ø 300 28 26 V + S
						24.0328-0154.1 528154	Ø 300 28 26 V + S
			⬅	→ 05/11		24.0128-0162.1 428162	Ø 316 28 26 V + S
						24.0328-0162.1 528162	Ø 316 28 26 V + S
2.2 TDCi	129	03/08→12/12	➡			24.0111-0145.1 411145	Ø 302 10,9 9 + S
						24.0311-0145.1 511145	Ø 302 10,9 9
			⬅	11/08→		24.0128-0154.1 428154	Ø 300 28 26 V + S
					24.0328-0154.1 528154	Ø 300 28 26 V + S	
2.0 EcoBoost	146	07/10→06/15	⬅			24.0128-0162.1 428162	Ø 316 28 26 V + S
						24.0328-0162.1 528162	Ø 316 28 26 V + S
			➡			24.0111-0145.1 411145	Ø 302 10,9 9 + S
2.0 EcoBoost	149	03/10→06/15	⬅	04/08→ 10/08		24.0128-0154.1 428154	Ø 300 28 26 V + S
						24.0328-0154.1 528154	Ø 300 28 26 V + S
			➡	04/08→		24.0111-0145.1 411145	Ø 302 10,9 9 + S
					24.0311-0145.1 511145	Ø 302 10,9 9	
<b>FORD - GALAXY (WGR) 03/95→05/06</b>							
 <b>Bremsbelagsatz, Scheibenbremse</b>							
1.9 TDI	66	03/95→05/06	⬅	01/96→ 03/00		13.0460-7076.2 607076	ATE 21848 19,8 - WE / - WK
			⬅	04/00→ 04/01		13.0460-7143.2 607143	ATE 21848 19,8 + WK
			⬅	05/01→ 04/06		13.0460-7154.2 607154	ATE 23034 18,8 + WK
			➡	01/96→ 03/00		13.0460-2819.2 602819	TRW 20961 17,2 - WK
			➡	04/00→ 04/06		13.0460-2859.2 602859	TRW 20961 17,0 + WK + Zub
1.9 TDI	81	08/97→04/00	⬅	10/97→ 03/00		13.0460-7076.2 607076	ATE 21848 19,8 - WE / - WK
			➡	10/97→ 03/00		13.0460-2819.2 602819	TRW 20961 17,2 - WK
1.9 TDI	85	04/00→05/06	⬅	→ 04/01		13.0460-7143.2 607143	ATE 21848 19,8 + WK
↓							

	kw			 	! #		
<b>FORD - GALAXY (WGR) 03/95→05/06</b>							
<b> Bremsbelagsatz, Scheibenbremse</b>							
1.9 TDI	85	04/00→05/06	←	05/01→ 04/06		<b>13.0460-7154.2 607154</b>	ATE 23034 18,8 + WK
			→	→ 04/06		<b>13.0460-2859.2 602859</b>	TRW 20961 17,0 + WK + Zub
1.9 TDI	96	02/03→05/06	←	→ 04/06		<b>13.0460-7154.2 607154</b>	ATE 23034 18,8 + WK
			→	→ 04/06		<b>13.0460-2859.2 602859</b>	TRW 20961 17,0 + WK + Zub
1.9 TDI	110	05/05→05/06	←			<b>13.0460-7154.2 607154</b>	ATE 23034 18,8 + WK
			→	→ 04/06; passend für Felgengröße [Zoll]: 15		<b>13.0460-2859.2 602859</b>	TRW 20961 17,0 + WK + Zub
			→	→ 04/06; passend für Felgengröße [Zoll]: 16		<b>13.0460-2872.2 602872</b>	TRW 23224 16,5 + WK + Zub
2.0 i 2.3 16V	85 107	11/95→05/06 01/97→05/06	←	→ 04/01		<b>13.0460-7076.2 607076</b>	ATE 21848 19,8 - WE / - WK
			←	05/01→ 04/06		<b>13.0460-7156.2 607156</b>	ATE 23034 19,4 - WE / - WK
2.3 16V	103	09/01→05/06	←	→ 04/06		<b>13.0460-7156.2 607156</b>	ATE 23034 19,4 - WE / - WK
			→	→ 04/06		<b>13.0460-2819.2 602819</b>	TRW 20961 17,2 - WK
2.8 i V6 2.8 i V6 4x4	128 128	11/95→04/00 04/96→04/00	←	→ 03/00		<b>13.0460-7076.2 607076</b>	ATE 21848 19,8 - WE / - WK
			→	→ 03/00		<b>13.0460-2819.2 602819</b>	TRW 20961 17,2 - WK
2.8 V6	150	04/00→05/06	←	→ 04/06		<b>13.0460-7153.2 607153</b>	ATE 23269 19,8 + WK
			→	→ 04/06		<b>13.0460-2872.2 602872</b>	TRW 23224 16,5 + WK + Zub
<b>Zubehörsatz, Scheibenbremsbelag</b>							
1.9 TDI	66	03/95→05/06	→	01/96→ 03/00		<b>13.0460-0072.2 610072</b>	TRW
1.9 TDI	81	08/97→04/00	→	10/97→ 03/00		<b>13.0460-0072.2 610072</b>	TRW
1.9 TDI	110	05/05→05/06	→	→ 04/06; passend für Felgengröße [Zoll]: 16		<b>13.0460-0225.2 610225</b>	
2.0 i 2.3 16V	85 103	11/95→05/06 09/01→05/06	→	→ 04/06		<b>13.0460-0072.2 610072</b>	TRW
			→	→ 04/06		<b>13.0460-0072.2 610072</b>	TRW
2.8 i V6 2.8 i V6 4x4	128 128	11/95→04/00 04/96→04/00	→	→ 03/00		<b>13.0460-0072.2 610072</b>	TRW
			→	→ 04/06		<b>13.0460-0225.2 610225</b>	
2.8 V6	150	04/00→05/06	→	→ 04/06		<b>13.0460-0225.2 610225</b>	
			→	→ 04/06		<b>13.0460-0225.2 610225</b>	
<b> Bremsscheibe</b>							
1.9 TDI	66	03/95→05/06	←	01/96→ 04/01		<b>24.0125-0114.1 425114</b>	Ø 288 25,1 21 V + S
			←	05/01→ 04/06		<b>24.0325-0114.1 525114</b>	Ø 288 25,1 21 V + S
			→	01/96→ 04/06		<b>24.0110-0223.1 410223</b>	Ø 268 10 8 + S
1.9 TDI	81	08/97→04/00	←	10/97→ 03/00		<b>24.0125-0114.1 425114</b>	Ø 288 25,1 21 V + S
			←	10/97→ 03/00		<b>24.0325-0114.1 525114</b>	Ø 288 25,1 21 V + S
			→	10/97→ 03/00		<b>24.0110-0223.1 410223</b>	Ø 268 10 8 + S
1.9 TDI 2.0 i 2.3 16V	85 85 107	04/00→05/06 11/95→05/06 01/97→05/06	←	→ 04/01		<b>24.0125-0114.1 425114</b>	Ø 288 25,1 21 V + S
			←	05/01→ 04/06		<b>24.0325-0114.1 525114</b>	Ø 288 25,1 21 V + S
			→	→ 04/06		<b>24.0110-0223.1 410223</b>	Ø 268 10 8 + S
1.9 TDI 1.9 TDI 2.3 16V	96 110 103	02/03→05/06 05/05→05/06 09/01→05/06	←	→ 04/06		<b>24.0126-0115.1 426115</b>	Ø 300 26 22 V
			←	→ 04/06		<b>24.0326-0115.1 526115</b>	Ø 300 26 22 V
			→	→ 04/06		<b>24.0110-0223.1 410223</b>	Ø 268 10 8 + S
2.8 i V6 2.8 i V6 4x4	128 128	11/95→04/00 04/96→04/00	←	→ 03/00		<b>24.0110-0223.1 410223</b>	Ø 268 10 8 + S
			←	→ 03/00		<b>24.0310-0223.1 510223</b>	Ø 268 10 8 + S
			→	→ 03/00		<b>24.0110-0223.1 410223</b>	Ø 268 10 8 + S
2.8 V6	150	04/00→05/06	←	→ 04/06		<b>24.0126-0119.1 426119</b>	Ø 313 25,9 22 V
			←	→ 04/06		<b>24.0326-0119.1 526119</b>	Ø 313 25,9 22 V
			→	→ 04/06		<b>24.0113-0194.1 413194</b>	Ø 294 13,5 11,5

**FORD - GRAND C-MAX (DXA/CB7, DXA/CEU) 12/10→**

**Bremsbelagsatz, Scheibenbremse**

1.0 EcoBoost	74	10/12→	←			13.0460-7193.2	607193	ATE 23723 18,1 - WE / - WK
1.0 EcoBoost	92	10/12→						
1.5 EcoBoost	110	03/15→	→			13.0470-7193.2	LD7193	ATE 23723 18,1 - WE / - WK Ceramic
1.5 EcoBoost	134	03/15→						
1.5 TDCi	70	03/15→	→			13.0460-7195.2	607195	ATE 23482 16,6 - WE / - WK
1.5 TDCi	88	03/15→						
1.6 EcoBoost	110	12/10→	→			13.0470-7195.2	LD7195	ATE 23482 16,6 - WE / - WK Ceramic
1.6 EcoBoost	134	12/10→						
1.6 TDCi	70	12/10→	→					
1.6 TDCi	85	12/10→						
1.6 Ti	77	12/10→	→					
1.6 Ti	92	12/10→						
2.0 TDCi	85	02/11→	→					
2.0 TDCi	100	02/11→						
2.0 TDCi	103	02/11→	→					
2.0 TDCi	110	03/15→						
2.0 TDCi	120	12/10→	→					
2.0 TDCi	125	03/15→						

**Bremsscheibe**

1.0 EcoBoost	74	10/12→	←			24.0125-0162.1	425162	Ø 300 25 23 V
1.0 EcoBoost	92	10/12→						
1.5 EcoBoost	110	03/15→	→			24.0325-0162.1	525162	Ø 300 25 23 V
1.5 EcoBoost	134	03/15→						
1.5 TDCi	70	03/15→	→			24.0111-0172.1	411172	Ø 280 11 9
1.5 TDCi	88	03/15→						
1.6 EcoBoost	110	12/10→	→					
1.6 EcoBoost	134	12/10→						
1.6 TDCi	70	12/10→	→					
1.6 TDCi	85	12/10→						
1.6 Ti	77	12/10→	→					
1.6 Ti	92	12/10→						
2.0 TDCi	85	02/11→	→					
2.0 TDCi	100	02/11→						
2.0 TDCi	103	02/11→	→					
2.0 TDCi	110	03/15→						
2.0 TDCi	120	12/10→	→					
2.0 TDCi	125	03/15→						

**FORD - GRAND C-MAX Van 12/10→**

**Bremsbelagsatz, Scheibenbremse**

1.0 EcoBoost	74	10/12→	←			13.0460-7193.2	607193	ATE 23723 18,1 - WE / - WK
1.0 EcoBoost	92	10/12→						
1.5 EcoBoost	110	03/15→	→			13.0470-7193.2	LD7193	ATE 23723 18,1 - WE / - WK Ceramic
1.5 TDCi	88	03/15→						
1.6 EcoBoost	110	12/10→	→			13.0460-7195.2	607195	ATE 23482 16,6 - WE / - WK
1.6 TDCi	70	12/10→						
1.6 TDCi	85	12/10→	→			13.0470-7195.2	LD7195	ATE 23482 16,6 - WE / - WK Ceramic
2.0 TDCi	103	12/10→						
2.0 TDCi	110	03/15→	→					
2.0 TDCi	120	12/10→						
2.0 TDCi	125	03/15→	→					
2.0 TDCi	85	02/11→						

**Bremsscheibe**

















1.0 EcoBoost	74	10/12→	←			24.0125-0162.1	425162	Ø 300 25 23 V
1.0 EcoBoost	92	10/12→						
1.5 EcoBoost	110	03/15→	→			24.0325-0162.1	525162	Ø 300 25 23 V
1.5 TDCi	88	03/15→						
1.6 EcoBoost	110	12/10→	→			24.0111-0172.1	411172	Ø 280 11 9
1.6 TDCi	70	12/10→						
1.6 TDCi	85	12/10→	→					
2.0 TDCi	103	12/10→						
2.0 TDCi	110	03/15→	→					
2.0 TDCi	120	12/10→						
2.0 TDCi	125	03/15→	→					
2.0 TDCi	85	02/11→						

**FORD - KA (RB\_) 09/96→11/08**

**Bremsbelagsatz, Scheibenbremse**

1.0 i	38	07/97→09/99	←			13.0460-7073.2	607073	ATE 21202 16,9 - WE / - WK
1.0 i	48	09/99→11/08	←	→ 01/00		13.0460-7073.2	607073	ATE 21202 16,9 - WE / - WK
1.3 i	36	06/98→11/08	←	02/00→		13.0460-7148.2	607148	ATE 23200 18,0 - WE / - WK
1.3 i	37	09/96→10/02	←	11/96→ 01/00		13.0460-7073.2	607073	ATE 21202 16,9 - WE / - WK
1.3 i	44	09/96→11/08	←	02/00→		13.0460-7148.2	607148	ATE 23200 18,0 - WE / - WK
1.3 i	51	08/02→11/08	←			13.0460-7148.2	607148	ATE 23200 18,0 - WE / - WK
↓								



	kw			 	! #		
<b>FORD - KA (RB_) 09/96→11/08</b>							
 <b>Bremsbelagsatz, Scheibenbremse</b>							
1.6	68	10/06→12/07	←			13.0460-7142.2 607142	ATE 23202 18,3 - WE / - WK
1.6 i	71	11/05→09/08					
1.6 i	70	02/01→11/08	←	08/03→		13.0460-7142.2 607142	ATE 23202 18,3 - WE / - WK
 <b>Bremsscheibe</b>							
1.0 i	38	07/97→09/99	←			24.0112-0141.1 412141	Ø 239,5 12 10
						24.0312-0141.1 512141	Ø 239,5 12 10
1.0 i	48	09/99→11/08	←	→ 01/00		24.0112-0141.1 412141	Ø 239,5 12 10
1.3 i	36	06/98→11/08				24.0312-0141.1 512141	Ø 239,5 12 10
			←	02/00→		24.0120-0147.1 420147	Ø 239,5 20 18 V
						24.0320-0147.1 520147	Ø 239,5 20 18 V
1.3 i	37	09/96→10/02	←	11/96→ 01/00		24.0112-0141.1 412141	Ø 239,5 12 10
1.3 i	44	09/96→11/08				24.0312-0141.1 512141	Ø 239,5 12 10
			←	02/00→		24.0120-0147.1 420147	Ø 239,5 20 18 V
						24.0320-0147.1 520147	Ø 239,5 20 18 V
1.3 i	51	08/02→11/08	←			24.0120-0147.1 420147	Ø 239,5 20 18 V
						24.0320-0147.1 520147	Ø 239,5 20 18 V
1.6	68	10/06→12/07	←			24.0122-0172.1 422172	Ø 258 22 20 V
1.6 i	71	11/05→09/08				24.0322-0172.1 522172	Ø 258 22 20 V
1.6 i	70	02/01→11/08	←	08/03→		24.0122-0172.1 422172	Ø 258 22 20 V
						24.0322-0172.1 522172	Ø 258 22 20 V
<b>FORD - KA (RU8) 10/08→</b>							
 <b>Bremsbelagsatz, Scheibenbremse</b>							
1.2	51	10/08→	←			13.0460-3838.2 603838	BOS 21436 17,0 + WK + Zub
						13.0470-3838.2 LD3838	BOS 21436 17,0 + WK + Zub Ceramic
1.3 TDCi	55	10/08→	←			13.0460-3846.2 603846	BOS 24072 17,9 + WK + Zub
						13.0470-3846.2 LD3846	BOS 24072 17,9 + WK + Zub Ceramic
 <b>Bremsscheibe</b>							
1.2	51	10/08→	←			24.0111-0119.1 411119	Ø 240,5 11 9,2
1.3 TDCi	55	10/08→	←			24.0120-0184.1 420184	Ø 240,5 20 18,2 V
<b>FORD - KA Van (RB) 05/02→05/05</b>							
 <b>Bremsbelagsatz, Scheibenbremse</b>							
1.3	51	09/02→03/04	←			13.0460-7148.2 607148	ATE 23200 18,0 - WE / - WK
1.3 i	44	05/02→05/05					
 <b>Bremsscheibe</b>							
1.3	51	09/02→03/04	←			24.0120-0147.1 420147	Ø 239,5 20 18 V
1.3 i	44	05/02→05/05				24.0320-0147.1 520147	Ø 239,5 20 18 V
<b>FORD - KA+ 08/14→</b>							
 <b>Bremsbelagsatz, Scheibenbremse</b>							
1.2	51	06/16→	←			13.0460-2605.2 602605	TRW 24283 17,3 - WE / - WK + Zub
1.2	63	06/16→					
<b>FORD - KA+ Stufenheck 08/14→</b>							
 <b>Bremsbelagsatz, Scheibenbremse</b>							
1.2 (TK)	63	06/16→	←			13.0460-2605.2 602605	TRW 24283 17,3 - WE / - WK + Zub
<b>FORD - KUGA I 03/08→</b>							
 <b>Bremsbelagsatz, Scheibenbremse</b>							
2.0 TDCi	100	03/08→11/12	←	04/08→		13.0460-7193.2 607193	ATE 23723 18,1 - WE / - WK
2.0 TDCi 4x4	100	03/08→11/12				13.0470-7193.2 LD7193	ATE 23723 18,1 - WE / - WK Ceramic
			→	04/08→		13.0460-2723.2 602723	TRW 24537 16,1 - WE / - WK + Zub
						13.0470-2723.2 LD2723	TRW 24537 16,1 - WE / - WK + Zub Ceramic
2.0 TDCi	103	03/10→11/12	←			13.0460-7193.2 607193	ATE 23723 18,1 - WE / - WK
↓							

**FORD - KUGA I 03/08→**

**Bremsbelagsatz, Scheibenbremse**

2.0 TDCi 4x4 2.0 TDCi 4x4 2.5	103	03/10→11/12	←		13.0470-7193.2	LD7193	ATE 23723 18,1 - WE / - WK Ceramic
	120	03/10→11/12					
	147	03/09→11/12	→		13.0460-2723.2	602723	TRW 24537 16,1 - WE / - WK + Zub
					13.0470-2723.2	LD2723	TRW 24537 16,1 - WE / - WK + Zub Ceramic
2.5 4x4	147	03/09→	←	→ 12/12	13.0460-7193.2	607193	ATE 23723 18,1 - WE / - WK
					13.0470-7193.2	LD7193	ATE 23723 18,1 - WE / - WK Ceramic
			→	→ 12/12	13.0460-2723.2	602723	TRW 24537 16,1 - WE / - WK + Zub
					13.0470-2723.2	LD2723	TRW 24537 16,1 - WE / - WK + Zub Ceramic

**Bremsscheibe**

2.0 TDCi 2.0 TDCi 4x4	100	03/08→11/12	←	04/08→	24.0125-0162.1	425162	Ø 300 25 23 V
	100	03/08→11/12			24.0325-0162.1	525162	Ø 300 25 23 V
			→	04/08→	24.0111-0145.1	411145	Ø 302 10,9 9 + S
					24.0311-0145.1	511145	Ø 302 10,9 9
2.0 TDCi 2.0 TDCi 4x4 2.0 TDCi 4x4 2.5	103	03/10→11/12	←		24.0125-0162.1	425162	Ø 300 25 23 V
	103	03/10→11/12			24.0325-0162.1	525162	Ø 300 25 23 V
	120	03/10→11/12					
	147	03/09→11/12	→		24.0111-0145.1	411145	Ø 302 10,9 9 + S
					24.0311-0145.1	511145	Ø 302 10,9 9
2.5 4x4	147	03/09→	←	→ 12/12	24.0125-0162.1	425162	Ø 300 25 23 V
					24.0325-0162.1	525162	Ø 300 25 23 V
			→	→ 12/12	24.0111-0145.1	411145	Ø 302 10,9 9 + S
					24.0311-0145.1	511145	Ø 302 10,9 9















**FORD - KUGA II (DM2) 05/12→**













**Bremsbelagsatz, Scheibenbremse**











1.5 EcoBoost 1.5 EcoBoost 1.6 EcoBoost 2.5	88	01/16→	←		13.0460-7193.2	607193	ATE 23723 18,1 - WE / - WK
	110	09/14→			13.0470-7193.2	LD7193	ATE 23723 18,1 - WE / - WK Ceramic
	110	03/13→	→	- eFSB	13.0460-7195.2	607195	ATE 23482 16,6 - WE / - WK
	110	01/14→	→	+ eFSB	13.0470-7195.2	LD7195	ATE 23482 16,6 - WE / - WK Ceramic
			→		13.0460-7320.2	607320	ATE 22231 16,1 + WK
					13.0470-7320.2	LD7320	ATE 22231 16,1 + WK Ceramic
1.5 EcoBoost 4x4 1.5 TDCi	134	09/14→	←		13.0470-7299.2	LD7299	ATE 25736 18,4 - WE / - WK Ceramic
	88	07/16→					
1.6 EcoBoost 4x4 1.6 EcoBoost 4x4	110	03/13→	→	- eFSB	13.0460-7195.2	607195	ATE 23482 16,6 - WE / - WK
	132	10/12→04/15			13.0470-7195.2	LD7195	ATE 23482 16,6 - WE / - WK Ceramic
2.0 TDCi 2.0 TDCi	85	03/13→	→	+ eFSB			
	88	09/14→			13.0460-7320.2	607320	ATE 22231 16,1 + WK
2.0 TDCi 2.0 TDCi	100	03/13→			13.0470-7320.2	LD7320	ATE 22231 16,1 + WK Ceramic
	103	03/13→					
2.0 TDCi 2.0 TDCi 4x4	110	09/14→					
	100	03/13→					
2.0 TDCi 4x4 2.0 TDCi 4x4	103	03/13→					
	110	09/14→					
2.0 TDCi 4x4 2.0 TDCi 4x4	120	03/13→					
	132	09/14→					

**Bremsscheibe**











1.5 EcoBoost 1.5 EcoBoost	88	01/16→	←		24.0125-0162.1	425162	Ø 300 25 23 V
	110	09/14→			24.0325-0162.1	525162	Ø 300 25 23 V
1.6 EcoBoost 2.5	110	03/13→	→	- eFSB	24.0111-0172.1	411172	Ø 280 11 9
	110	01/14→					
1.5 EcoBoost 4x4 1.5 TDCi	134	09/14→	←		24.0125-0209.1	425209	Ø 320 25 23 V
	88	07/16→					
1.6 EcoBoost 4x4 2.0 TDCi	132	10/12→04/15	→	- eFSB	24.0111-0172.1	411172	Ø 280 11 9
	88	09/14→					
2.0 TDCi 2.0 TDCi 4x4	110	09/14→					
	110	09/14→					
2.0 TDCi 4x4 2.0 TDCi 4x4	132	09/14→					
1.6 EcoBoost 4x4 2.0 TDCi	134	03/13→	←	→ 09/14	24.0125-0209.1	425209	Ø 320 25 23 V
	85	03/13→					
2.0 TDCi 2.0 TDCi	100	03/13→	←	10/14→	24.0125-0209.1	425209	Ø 320 25 23 V
	103	03/13→					
2.0 TDCi 4x4 ↓	100	03/13→	→	- eFSB	24.0111-0172.1	411172	Ø 280 11 9











	kw			 	! #		
<b>FORD - KUGA II (DM2) 05/12→</b>							
 <b>Bremsscheibe</b>							
2.0 TDCi 4x4 2.0 TDCi 4x4	103 120	03/13→ 03/13→	←	→ 09/14		24.0125-0209.1 425209	Ø 320 25 23 V
			←	10/14→		24.0125-0209.1 425209	Ø 320 25 23 V
			→	- eFSB		24.0111-0172.1 411172	Ø 280 11 9
<b>FORD - KUGA II Van 05/12→</b>							
 <b>Bremsbelagsatz, Scheibenbremse</b>							
1.5 EcoBoost	110	09/14→	←			13.0460-7193.2 607193 13.0470-7193.2 LD7193	ATE 23723 18,1 - WE / - WK ATE 23723 18,1 - WE / - WK Ceramic
			→	- eFSB		13.0460-7195.2 607195 13.0470-7195.2 LD7195	ATE 23482 16,6 - WE / - WK ATE 23482 16,6 - WE / - WK Ceramic
			→	+ eFSB		13.0460-7320.2 607320 13.0470-7320.2 LD7320	ATE 22231 16,1 + WK ATE 22231 16,1 + WK Ceramic
1.5 EcoBoost 4x4 2.0 TDCi 2.0 TDCi 4x4 2.0 TDCi 4x4	134 110 110 132	09/14→ 09/14→ 09/14→ 09/14→	←			13.0470-7299.2 LD7299	ATE 25736 18,4 - WE / - WK Ceramic
			→	- eFSB		13.0460-7195.2 607195 13.0470-7195.2 LD7195	ATE 23482 16,6 - WE / - WK ATE 23482 16,6 - WE / - WK Ceramic
			→	+ eFSB		13.0460-7320.2 607320 13.0470-7320.2 LD7320	ATE 22231 16,1 + WK ATE 22231 16,1 + WK Ceramic
 <b>Bremsscheibe</b>							
1.5 EcoBoost	110	09/14→	←			24.0125-0162.1 425162 24.0325-0162.1 525162	Ø 300 25 23 V Ø 300 25 23 V
			→	- eFSB		24.0111-0172.1 411172	Ø 280 11 9
1.5 EcoBoost 4x4 2.0 TDCi 2.0 TDCi 4x4 2.0 TDCi 4x4	134 110 110 132	09/14→ 09/14→ 09/14→ 09/14→	←			24.0125-0209.1 425209	Ø 320 25 23 V
			→	- eFSB		24.0111-0172.1 411172	Ø 280 11 9
<b>FORD - MAVERICK 02/01→</b>							
 <b>Bremsbelagsatz, Scheibenbremse</b>							
2.0 16V 2.3 16V 3.0 V6 24V 3.0 V6 24V	91 110 145 149	02/01→ 03/04→ 02/01→ 03/04→	←	→ 06/07; für Fahrzeuge mit Trommelbremse an der Hinterachse		13.0460-7205.2 607205	ATE 23787 19,0 - WE / - WK
			←	→ 06/07; für Fahrzeuge mit Scheibenbremse an der Hinterachse		13.0460-7234.2 607234	ATE 24438 16,1 - WE / - WK
			→	→ 06/07		13.0460-7235.2 607235	ATE 24670 18,0 - WE / - WK
 <b>Bremsscheibe</b>							
2.0 16V 2.3 16V 3.0 V6 24V 3.0 V6 24V	91 110 145 149	02/01→ 03/04→ 02/01→ 03/04→	←	→ 06/07; für Fahrzeuge mit Trommelbremse an der Hinterachse		24.0124-0735.1 424735	Ø 278 24 22 V
			←	→ 06/07; für Fahrzeuge mit Scheibenbremse an der Hinterachse		24.0126-0151.1 426151	Ø 303 26 24 V
			→	→ 06/07		24.0112-0181.1 412181	Ø 302 12 11
<b>FORD - MAVERICK (UDS, UNS) 02/93→04/98</b>							
 <b>Bremsbelagsatz, Scheibenbremse</b>							
2.4 i 2.4 i (UDS) 2.7 TD	87 85 92	09/96→04/98 09/96→04/98 09/96→04/98	←	10/96→ 03/98		13.0460-5959.2 605959	TRW 21481 15,5 - WK
2.4 i 2.7 TD	91 74	02/93→08/96 02/93→08/96	←			13.0460-5959.2 605959	TRW 21481 15,5 - WK
 <b>Bremsscheibe</b>							
2.4 i 2.4 i (UDS) 2.7 TD	87 85 92	09/96→04/98 09/96→04/98 09/96→04/98	←	10/96→ 03/98		24.0126-0109.1 426109	Ø 277 26 24 V
2.4 i 2.7 TD	91 74	02/93→08/96 02/93→08/96	←			24.0126-0109.1 426109	Ø 277 26 24 V











	kW			 	! #		
<b>FORD - MAVERICK VAN 06/96→04/98</b>							
 <b>Bremsbelagsatz, Scheibenbremse</b>							
2.7 TD	74	06/96→04/98	←	10/96→03/98		13.0460-5959.2 60599	TRW 21481 15,5 - WK
2.7 TD	92	06/96→04/98					
 <b>Bremsscheibe</b>							
2.7 TD	74	06/96→04/98	←	10/96→03/98		24.0126-0109.1 426109	Ø 277 26 24 V
2.7 TD	92	06/96→04/98					
<b>FORD - MONDEO I (GBP) 02/93→08/96</b>							
 <b>Bremsbelagsatz, Scheibenbremse</b>							
1.6 i 16V	65	07/94→08/96	←			13.0460-7056.2 607056	ATE 21396 17,5 + WK
1.6 i 16V	66	02/93→08/96				13.0460-7057.2 607057	ATE 21394 17,5 - WE / - WK
1.8 i 16V	82	07/94→08/96					
1.8 i 16V	85	02/93→08/96	→	- Ghia Modelle		13.0460-3963.2 603963	BDX 21586 15,0 - WK
1.8 i 16V 4x4	85	02/93→08/96	→	+ Ghia Modelle		13.0460-3964.2 603964	BDX 21586 15,0 + WK
1.8 TD	65	06/93→08/96					
1.8 TD	66	10/95→08/96					
2.0 i 16V	97	12/94→08/96					
2.0 i 16V	100	02/93→08/96					
2.0 i 16V 4x4	97	12/94→08/96	←			13.0460-7163.2 607163	ATE 21358 19,8 + WK
2.0 i 16V 4x4	100	04/93→08/96				13.0460-7165.2 607165	ATE 21358 19,8 - WE / - WK
			→	- Ghia Modelle		13.0460-3963.2 603963	BDX 21586 15,0 - WK
			→	+ Ghia Modelle		13.0460-3964.2 603964	BDX 21586 15,0 + WK
2.5 i 24V	125	07/94→08/96	←	08/94→		13.0460-7163.2 607163	ATE 21358 19,8 + WK
						13.0460-7165.2 607165	ATE 21358 19,8 - WE / - WK
			→	08/94→; - Ghia Modelle		13.0460-3963.2 603963	BDX 21586 15,0 - WK
			→	08/94→; + Ghia Modelle		13.0460-3964.2 603964	BDX 21586 15,0 + WK
<b>Zubehörsatz, Scheibenbremsbelag</b>							
1.6 i 16V	65	07/94→08/96	→			13.0460-0428.2 610428	BDX
1.6 i 16V	66	02/93→08/96					
1.8 i 16V	82	07/94→08/96					
1.8 i 16V	85	02/93→08/96					
1.8 i 16V 4x4	85	02/93→08/96					
1.8 TD	65	06/93→08/96					
1.8 TD	66	10/95→08/96					
2.0 i 16V	97	12/94→08/96					
2.0 i 16V	100	02/93→08/96					
2.0 i 16V 4x4	97	12/94→08/96					
2.0 i 16V 4x4	100	04/93→08/96					
2.5 i 24V	125	07/94→08/96	→	08/94→		13.0460-0428.2 610428	BDX
 <b>Bremsscheibe</b>							
1.6 i 16V	65	07/94→08/96	←			24.0124-0120.1 424120	Ø 260 24 22,2 V
1.6 i 16V	66	02/93→08/96				24.0324-0120.1 524120	Ø 260 24 22,2 V
1.8 i 16V	82	07/94→08/96					
1.8 i 16V	85	02/93→08/96	→			24.0120-0146.1 420146	Ø 253 20 18 V
1.8 i 16V 4x4	85	02/93→08/96	→			24.0320-0146.1 520146	Ø 253 20 18 V
1.8 TD	65	06/93→08/96					
1.8 TD	66	10/95→08/96					
2.0 i 16V	97	12/94→08/96					
2.0 i 16V	100	02/93→08/96					
2.0 i 16V 4x4	97	12/94→08/96	←			24.0124-0149.1 424149	Ø 278 24,1 22,2 V
2.0 i 16V 4x4	100	04/93→08/96				24.0120-0146.1 420146	Ø 253 20 18 V
			→			24.0320-0146.1 520146	Ø 253 20 18 V
2.5 i 24V	125	07/94→08/96	←	08/94→		24.0124-0149.1 424149	Ø 278 24,1 22,2 V
			→	08/94→		24.0120-0146.1 420146	Ø 253 20 18 V
						24.0320-0146.1 520146	Ø 253 20 18 V
<b>FORD - MONDEO I Stufenheck (GBP) 02/93→08/96</b>							
 <b>Bremsbelagsatz, Scheibenbremse</b>							
1.6 i 16V	65	07/94→08/96	←			13.0460-7056.2 607056	ATE 21396 17,5 + WK
1.6 i 16V	66	02/93→08/96				13.0460-7057.2 607057	ATE 21394 17,5 - WE / - WK
1.8 4x4	85	02/93→08/96					
1.8 i 16V	82	01/94→08/96	→	- Ghia Modelle		13.0460-3963.2 603963	BDX 21586 15,0 - WK
1.8 i 16V	85	02/93→08/96	→	+ Ghia Modelle		13.0460-3964.2 603964	BDX 21586 15,0 + WK
1.8 TD	65	06/93→08/96					
1.8 TD	66	10/95→08/96					
2.0 i 16V	100	02/93→08/96					
2.0 i 16V 4x4	97	12/94→08/96	←			13.0460-7163.2 607163	ATE 21358 19,8 + WK
						13.0460-7165.2 607165	ATE 21358 19,8 - WE / - WK
			→	- Ghia Modelle		13.0460-3963.2 603963	BDX 21586 15,0 - WK
↓							











	kw			 	! #		
<b>FORD - MONDEO I Stufenheck (GBP) 02/93→08/96</b>							
<b> Bremsbelagsatz, Scheibenbremse</b>							
2.0 i 16V 4x4	97	12/94→08/96	➡	+ Ghia Modelle		<b>13.0460-3964.2 603964</b>	BDX 21586 15,0 + WK
2.0 i 16V 4x4	100	02/93→08/96	←	04/93→		<b>13.0460-7163.2 607163</b>	ATE 21358 19,8 + WK
			➡	04/93→; - Ghia Modelle		<b>13.0460-7165.2 607165</b>	ATE 21358 19,8 - WE / - WK
			➡	04/93→; + Ghia Modelle		<b>13.0460-3963.2 603963</b>	BDX 21586 15,0 - WK
2.5 i 24V	125	07/94→08/96	←	08/94→		<b>13.0460-3964.2 603964</b>	BDX 21586 15,0 + WK
			➡	08/94→; - Ghia Modelle		<b>13.0460-7163.2 607163</b>	ATE 21358 19,8 + WK
			➡	08/94→; + Ghia Modelle		<b>13.0460-7165.2 607165</b>	ATE 21358 19,8 - WE / - WK
<b>Zubehörsatz, Scheibenbremsbelag</b>							
1.6 i 16V	65	07/94→08/96	➡			<b>13.0460-0428.2 610428</b>	BDX
1.6 i 16V	66	02/93→08/96					
1.8 4x4	85	02/93→08/96					
1.8 i 16V	82	01/94→08/96					
1.8 i 16V	85	02/93→08/96					
1.8 TD	65	06/93→08/96					
1.8 TD	66	10/95→08/96					
2.0 i 16V	100	02/93→08/96					
2.0 i 16V 4x4	97	12/94→08/96					
2.0 i 16V 4x4	100	02/93→08/96	➡	04/93→		<b>13.0460-0428.2 610428</b>	BDX
2.5 i 24V	125	07/94→08/96	➡	08/94→		<b>13.0460-0428.2 610428</b>	BDX
<b> Bremsscheibe</b>							
1.6 i 16V	65	07/94→08/96	←			<b>24.0124-0120.1 424120</b>	Ø 260 24 22,2 V
1.6 i 16V	66	02/93→08/96				<b>24.0324-0120.1 524120</b>	Ø 260 24 22,2 V
1.8 4x4	85	02/93→08/96					
1.8 i 16V	82	01/94→08/96	➡			<b>24.0120-0146.1 420146</b>	Ø 253 20 18 V
1.8 i 16V	85	02/93→08/96				<b>24.0320-0146.1 520146</b>	Ø 253 20 18 V
1.8 TD	65	06/93→08/96					
1.8 TD	66	10/95→08/96					
2.0 i 16V	100	02/93→08/96					
2.0 i 16V 4x4	97	12/94→08/96	←			<b>24.0124-0149.1 424149</b>	Ø 278 24,1 22,2 V
			➡			<b>24.0120-0146.1 420146</b>	Ø 253 20 18 V
			➡			<b>24.0320-0146.1 520146</b>	Ø 253 20 18 V
2.0 i 16V 4x4	100	02/93→08/96	←	04/93→		<b>24.0124-0149.1 424149</b>	Ø 278 24,1 22,2 V
			➡	04/93→		<b>24.0120-0146.1 420146</b>	Ø 253 20 18 V
			➡			<b>24.0320-0146.1 520146</b>	Ø 253 20 18 V
2.5 i 24V	125	07/94→08/96	←	08/94→		<b>24.0124-0149.1 424149</b>	Ø 278 24,1 22,2 V
			➡	08/94→		<b>24.0120-0146.1 420146</b>	Ø 253 20 18 V
			➡			<b>24.0320-0146.1 520146</b>	Ø 253 20 18 V
<b>FORD - MONDEO I Turnier (BNP) 01/93→08/96</b>							
<b> Bremsbelagsatz, Scheibenbremse</b>							
1.6 i 16V	65	07/94→08/96	←			<b>13.0460-7056.2 607056</b>	ATE 21396 17,5 + WK
1.6 i 16V	66	04/93→08/96				<b>13.0460-7057.2 607057</b>	ATE 21394 17,5 - WE / - WK
1.8 i 16V	82	07/94→08/96					
1.8 i 16V	85	04/93→08/96	➡	- Ghia Modelle		<b>13.0460-3963.2 603963</b>	BDX 21586 15,0 - WK
1.8 i 16V 4x4	85	04/93→08/96	➡	+ Ghia Modelle		<b>13.0460-3964.2 603964</b>	BDX 21586 15,0 + WK
1.8 TD	65	06/93→08/96					
1.8 TD	66	11/95→08/96					
2.0 i 16V	97	01/93→08/96					
2.0 i 16V	100	04/93→08/96					
2.0 i 16V 4x4	97	12/94→08/96	←			<b>13.0460-7163.2 607163</b>	ATE 21358 19,8 + WK
			➡	- Ghia Modelle		<b>13.0460-7165.2 607165</b>	ATE 21358 19,8 - WE / - WK
			➡	+ Ghia Modelle		<b>13.0460-3963.2 603963</b>	BDX 21586 15,0 - WK
2.0 i 16V 4x4	100	04/93→08/96	←			<b>13.0460-3964.2 603964</b>	BDX 21586 15,0 + WK
			➡	- Ghia Modelle		<b>13.0460-3963.2 603963</b>	BDX 21586 15,0 - WK
			➡	+ Ghia Modelle		<b>13.0460-3964.2 603964</b>	BDX 21586 15,0 + WK
2.5 i 24V	125	07/94→08/96	←	08/94→		<b>13.0460-7163.2 607163</b>	ATE 21358 19,8 + WK
			➡	08/94→; - Ghia Modelle		<b>13.0460-7165.2 607165</b>	ATE 21358 19,8 - WE / - WK
			➡	08/94→; + Ghia Modelle		<b>13.0460-3963.2 603963</b>	BDX 21586 15,0 - WK
<b>Zubehörsatz, Scheibenbremsbelag</b>							
1.6 i 16V	65	07/94→08/96	➡			<b>13.0460-0428.2 610428</b>	BDX
1.6 i 16V	66	04/93→08/96					
1.8 i 16V	82	07/94→08/96					
1.8 i 16V	85	04/93→08/96					
1.8 i 16V 4x4	85	04/93→08/96					













	kW			 	! #		
<b>FORD - MONDEO I Turnier (BNP) 01/93→08/96</b>							
<b>Zubehörsatz, Scheibenbremsbelag</b>							
1.8 TD	65	06/93→08/96	➔			13.0460-0428.2 610428	BDX
1.8 TD	66	11/95→08/96					
2.0 i 16V	97	01/93→08/96					
2.0 i 16V	100	04/93→08/96					
2.0 i 16V 4x4	97	12/94→08/96					
2.0 i 16V 4x4	100	04/93→08/96					
2.5 i 24V	125	07/94→08/96	➔	08/94→		13.0460-0428.2 610428	BDX
<b> Bremsscheibe</b>							
1.6 i 16V	65	07/94→08/96	➔			24.0124-0120.1 424120	Ø 260 24 22,2 V
1.6 i 16V	66	04/93→08/96				24.0324-0120.1 524120	Ø 260 24 22,2 V
1.8 i 16V	82	07/94→08/96					
1.8 i 16V	85	04/93→08/96	➔			24.0120-0146.1 420146	Ø 253 20 18 V
1.8 i 16V 4x4	85	04/93→08/96				24.0320-0146.1 520146	Ø 253 20 18 V
1.8 TD	65	06/93→08/96					
1.8 TD	66	11/95→08/96					
2.0 i 16V	97	01/93→08/96					
2.0 i 16V	100	04/93→08/96					
2.0 i 16V 4x4	97	12/94→08/96	➔			24.0124-0149.1 424149	Ø 278 24,1 22,2 V
2.0 i 16V 4x4	100	04/93→08/96	➔			24.0120-0146.1 420146	Ø 253 20 18 V
						24.0320-0146.1 520146	Ø 253 20 18 V
2.5 i 24V	125	07/94→08/96	➔	08/94→		24.0124-0149.1 424149	Ø 278 24,1 22,2 V
			➔	08/94→		24.0120-0146.1 420146	Ø 253 20 18 V
						24.0320-0146.1 520146	Ø 253 20 18 V
<b>FORD - MONDEO II (BAP) 08/96→09/00</b>							
<b> Bremsbelagsatz, Scheibenbremse</b>							
1.6 i	66	08/96→09/00	➔	10/96→		13.0460-7056.2 607056	ATE 21396 17,5 + WK
1.8 i	85	08/96→09/00				13.0460-7057.2 607057	ATE 21394 17,5 - WE / - WK
1.8 TD	66	08/96→09/00					
2.0 i	96	08/96→09/00	➔	10/96→; - Ghia Modelle		13.0460-3963.2 603963	BDX 21586 15,0 - WK
			➔	10/96→; + Ghia Modelle		13.0460-3964.2 603964	BDX 21586 15,0 + WK
1.6 i 16V	70	05/98→09/00	➔			13.0460-7056.2 607056	ATE 21396 17,5 + WK
2.5 24V	125	06/00→09/00				13.0460-7057.2 607057	ATE 21394 17,5 - WE / - WK
2.5 ST 200	151	05/99→09/00	➔	- Ghia Modelle		13.0460-3963.2 603963	BDX 21586 15,0 - WK
			➔	+ Ghia Modelle		13.0460-3964.2 603964	BDX 21586 15,0 + WK
2.5 24V	125	08/96→09/00	➔	12/97→		13.0460-7056.2 607056	ATE 21396 17,5 + WK
						13.0460-7057.2 607057	ATE 21394 17,5 - WE / - WK
			➔	10/96→ 11/97		13.0460-7163.2 607163	ATE 21358 19,8 + WK
						13.0460-7165.2 607165	ATE 21358 19,8 - WE / - WK
			➔	10/96→; - Ghia Modelle		13.0460-3963.2 603963	BDX 21586 15,0 - WK
			➔	10/96→; + Ghia Modelle		13.0460-3964.2 603964	BDX 21586 15,0 + WK
<b>Zubehörsatz, Scheibenbremsbelag</b>							
1.6 i	66	08/96→09/00	➔	10/96→		13.0460-0428.2 610428	BDX
1.8 i	85	08/96→09/00					
1.8 TD	66	08/96→09/00					
2.0 i	96	08/96→09/00					
2.5 24V	125	08/96→09/00					
1.6 i 16V	70	05/98→09/00	➔			13.0460-0428.2 610428	BDX
2.5 24V	125	06/00→09/00					
2.5 ST 200	151	05/99→09/00					
<b> Bremsscheibe</b>							
1.6 i	66	08/96→09/00	➔	10/96→		24.0124-0120.1 424120	Ø 260 24 22,2 V
1.8 TD	66	08/96→09/00				24.0324-0120.1 524120	Ø 260 24 22,2 V
2.0 i	96	08/96→09/00	➔	10/96→		24.0120-0146.1 420146	Ø 253 20 18 V
						24.0320-0146.1 520146	Ø 253 20 18 V
1.6 i 16V	70	05/98→09/00	➔			24.0124-0120.1 424120	Ø 260 24 22,2 V
						24.0324-0120.1 524120	Ø 260 24 22,2 V
			➔			24.0120-0146.1 420146	Ø 253 20 18 V
						24.0320-0146.1 520146	Ø 253 20 18 V
1.8 i	85	08/96→09/00	➔	10/96→		24.0124-0120.1 424120	Ø 260 24 22,2 V
						24.0324-0120.1 524120	Ø 260 24 22,2 V
			➔	10/96→; passend für Felgengröße [Zoll]: 15		24.0124-0149.1 424149	Ø 278 24,1 22,2 V
			➔	10/96→		24.0120-0146.1 420146	Ø 253 20 18 V
						24.0320-0146.1 520146	Ø 253 20 18 V
↓							











	kw			 	! #		
<b>FORD - MONDEO II (BAP) 08/96→09/00</b>							
 <b>Bremsscheibe</b>							
2.5 24V	125	08/96→09/00	←	10/96→		24.0124-0149.1 424149	Ø 278 24,1 22,2 V
			→	10/96→		24.0120-0146.1 420146	Ø 253 20 18 V
						24.0320-0146.1 520146	Ø 253 20 18 V
2.5 24V	125	06/00→09/00	←			24.0124-0149.1 424149	Ø 278 24,1 22,2 V
2.5 ST 200	151	05/99→09/00	→			24.0120-0146.1 420146	Ø 253 20 18 V
						24.0320-0146.1 520146	Ø 253 20 18 V
<b>FORD - MONDEO II Stufenheck (BFP) 08/96→09/00</b>							
 <b>Bremsbelagsatz, Scheibenbremse</b>							
1.6 i	66	08/96→09/00	←	10/96→		13.0460-7056.2 607056	ATE 21396 17,5 + WK
1.8 i	85	08/96→09/00				13.0460-7057.2 607057	ATE 21394 17,5 - WE / - WK
1.8 TD	66	08/96→09/00					
2.0 i	96	08/96→09/00	→	10/96→; - Ghia Modelle		13.0460-3963.2 603963	BDX 21586 15,0 - WK
			→	10/96→; + Ghia Modelle		13.0460-3964.2 603964	BDX 21586 15,0 + WK
1.6 i 16V	70	05/98→09/00	←			13.0460-7056.2 607056	ATE 21396 17,5 + WK
2.5 24V	125	06/00→09/00				13.0460-7057.2 607057	ATE 21394 17,5 - WE / - WK
2.5 ST 200	151	05/99→09/00	→	- Ghia Modelle		13.0460-3963.2 603963	BDX 21586 15,0 - WK
			→	+ Ghia Modelle		13.0460-3964.2 603964	BDX 21586 15,0 + WK
2.5 24V	125	08/96→09/00	←	12/97→		13.0460-7056.2 607056	ATE 21396 17,5 + WK
						13.0460-7057.2 607057	ATE 21394 17,5 - WE / - WK
			←	10/96→ 11/97		13.0460-7163.2 607163	ATE 21358 19,8 + WK
						13.0460-7165.2 607165	ATE 21358 19,8 - WE / - WK
			→	10/96→; - Ghia Modelle		13.0460-3963.2 603963	BDX 21586 15,0 - WK
			→	10/96→; + Ghia Modelle		13.0460-3964.2 603964	BDX 21586 15,0 + WK
<b>Zubehörsatz, Scheibenbremsbelag</b>							
1.6 i	66	08/96→09/00	→	10/96→		13.0460-0428.2 610428	BDX
1.8 i	85	08/96→09/00					
1.8 TD	66	08/96→09/00					
2.0 i	96	08/96→09/00					
2.5 24V	125	08/96→09/00					
1.6 i 16V	70	05/98→09/00	→			13.0460-0428.2 610428	BDX
2.5 24V	125	06/00→09/00					
2.5 ST 200	151	05/99→09/00					
 <b>Bremsscheibe</b>							
1.6 i	66	08/96→09/00	←	10/96→		24.0124-0120.1 424120	Ø 260 24 22,2 V
1.8 TD	66	08/96→09/00				24.0324-0120.1 524120	Ø 260 24 22,2 V
2.0 i	96	08/96→09/00	→	10/96→		24.0120-0146.1 420146	Ø 253 20 18 V
						24.0320-0146.1 520146	Ø 253 20 18 V
1.6 i 16V	70	05/98→09/00	←			24.0124-0120.1 424120	Ø 260 24 22,2 V
			→			24.0120-0146.1 420146	Ø 253 20 18 V
						24.0320-0146.1 520146	Ø 253 20 18 V
1.8 i	85	08/96→09/00	←	10/96→		24.0124-0120.1 424120	Ø 260 24 22,2 V
						24.0324-0120.1 524120	Ø 260 24 22,2 V
			←	10/96→; passend für Felgenreöße [Zoll]: 15		24.0124-0149.1 424149	Ø 278 24,1 22,2 V
			→	10/96→		24.0120-0146.1 420146	Ø 253 20 18 V
						24.0320-0146.1 520146	Ø 253 20 18 V
2.5 24V	125	08/96→09/00	←	10/96→		24.0124-0149.1 424149	Ø 278 24,1 22,2 V
			→	10/96→		24.0120-0146.1 420146	Ø 253 20 18 V
						24.0320-0146.1 520146	Ø 253 20 18 V
2.5 24V	125	06/00→09/00	←			24.0124-0149.1 424149	Ø 278 24,1 22,2 V
2.5 ST 200	151	05/99→09/00	→			24.0120-0146.1 420146	Ø 253 20 18 V
						24.0320-0146.1 520146	Ø 253 20 18 V
<b>FORD - MONDEO II Turnier (BNP) 08/96→09/00</b>							
 <b>Bremsbelagsatz, Scheibenbremse</b>							
1.6 i	66	08/96→09/00	←	10/96→		13.0460-7056.2 607056	ATE 21396 17,5 + WK
1.8 i	85	08/96→09/00				13.0460-7057.2 607057	ATE 21394 17,5 - WE / - WK
1.8 TD	66	08/96→09/00					
2.0 i	96	08/96→09/00	→	10/96→; - Ghia Modelle		13.0460-3963.2 603963	BDX 21586 15,0 - WK
			→	10/96→; + Ghia Modelle		13.0460-3964.2 603964	BDX 21586 15,0 + WK
↓							

	kw			 	! #		
<b>FORD - MONDEO II Turnier (BNP) 08/96→09/00</b>							
<b> Bremsbelagsatz, Scheibenbremse</b>							
1.6 i 16V 2.5 24V 2.5 ST 200	70 125 151	05/98→09/00 10/99→09/00 05/99→09/00	←			<b>13.0460-7056.2 607056</b> <b>13.0460-7057.2 607057</b>	ATE 21396 17,5 + WK ATE 21394 17,5 - WE / - WK
			→	- Ghia Modelle		<b>13.0460-3963.2 603963</b>	BDX 21586 15,0 - WK
			→	+ Ghia Modelle		<b>13.0460-3964.2 603964</b>	BDX 21586 15,0 + WK
2.5 24V	125	08/96→09/00	←	12/97→		<b>13.0460-7056.2 607056</b> <b>13.0460-7057.2 607057</b>	ATE 21396 17,5 + WK ATE 21394 17,5 - WE / - WK
			←	10/96→ 11/97		<b>13.0460-7163.2 607163</b> <b>13.0460-7165.2 607165</b>	ATE 21358 19,8 + WK ATE 21358 19,8 - WE / - WK
			→	10/96→; - Ghia Modelle		<b>13.0460-3963.2 603963</b>	BDX 21586 15,0 - WK
			→	10/96→; + Ghia Modelle		<b>13.0460-3964.2 603964</b>	BDX 21586 15,0 + WK
<b>Zubehörsatz, Scheibenbremsbelag</b>							
1.6 i 1.8 i 1.8 TD 2.0 i 2.5 24V	66 85 66 96 125	08/96→09/00 08/96→09/00 08/96→09/00 08/96→09/00 08/96→09/00	→	10/96→		<b>13.0460-0428.2 610428</b>	BDX
1.6 i 16V 2.5 24V 2.5 ST 200	70 125 151	05/98→09/00 10/99→09/00 05/99→09/00	→			<b>13.0460-0428.2 610428</b>	BDX
<b> Bremsscheibe</b>							
1.6 i 1.8 TD 2.0 i	66 66 96	08/96→09/00 08/96→09/00 08/96→09/00	←	10/96→		<b>24.0124-0120.1 424120</b> <b>24.0324-0120.1 524120</b>	Ø 260 24 22,2 V Ø 260 24 22,2 V
			→	10/96→		<b>24.0120-0146.1 420146</b> <b>24.0320-0146.1 520146</b>	Ø 253 20 18 V Ø 253 20 18 V
1.6 i 16V	70	05/98→09/00	←			<b>24.0124-0120.1 424120</b> <b>24.0324-0120.1 524120</b>	Ø 260 24 22,2 V Ø 260 24 22,2 V
			→			<b>24.0120-0146.1 420146</b> <b>24.0320-0146.1 520146</b>	Ø 253 20 18 V Ø 253 20 18 V
1.8 i	85	08/96→09/00	←	10/96→		<b>24.0124-0120.1 424120</b> <b>24.0324-0120.1 524120</b>	Ø 260 24 22,2 V Ø 260 24 22,2 V
			←	10/96→; passend für Felgengröße [Zoll]: 15		<b>24.0124-0149.1 424149</b>	Ø 278 24,1 22,2 V
			→	10/96→		<b>24.0120-0146.1 420146</b> <b>24.0320-0146.1 520146</b>	Ø 253 20 18 V Ø 253 20 18 V
2.5 24V	125	08/96→09/00	←	10/96→		<b>24.0124-0149.1 424149</b>	Ø 278 24,1 22,2 V
			→	10/96→		<b>24.0120-0146.1 420146</b> <b>24.0320-0146.1 520146</b>	Ø 253 20 18 V Ø 253 20 18 V
2.5 24V 2.5 ST 200	125 151	10/99→09/00 05/99→09/00	←			<b>24.0124-0149.1 424149</b>	Ø 278 24,1 22,2 V
			→			<b>24.0120-0146.1 420146</b> <b>24.0320-0146.1 520146</b>	Ø 253 20 18 V Ø 253 20 18 V
<b>FORD - MONDEO III (B5Y) 10/00→03/07</b>							
<b> Bremsbelagsatz, Scheibenbremse</b>							
1.8 16V 1.8 16V 1.8 Sci 2.0 16V 2.0 16V DI / TDDi / TDCi 2.0 16V TDDi / TDCi 2.0 TDCi 2.5 V6 24V ST220	81 92 96 107 66 85 96 125 166	10/00→03/07 10/00→03/07 06/03→03/07 10/00→03/07 10/00→03/07 10/01→03/07 10/00→03/07 04/02→03/07	←			<b>13.0460-3987.2 603987</b> <b>13.0470-3987.2 LD3987</b>	BOS 23279 18,4 - WE / - WK BOS 23279 18,4 - WE / - WK Ceramic
			→	09/04→		<b>13.0460-3831.2 603831</b> <b>13.0470-3831.2 LD3831</b>	BOS 24260 17,3 - WE / - WK + Zub BOS 24260 17,3 - WE / - WK + Zub Ceramic
			→	→ 08/04		<b>13.0460-3988.2 603988</b> <b>13.0470-3988.2 LD3988</b>	BOS 23557 17,2 - WE / - WK Ceramic BOS 23557 17,2 - WE / - WK Ceramic
2.2 TDCi 2.2 TDCi 3.0 V6 24V	110 114 150	09/04→03/07 09/04→03/07 09/04→03/07	←			<b>13.0460-3987.2 603987</b> <b>13.0470-3987.2 LD3987</b>	BOS 23279 18,4 - WE / - WK Ceramic BOS 23279 18,4 - WE / - WK Ceramic
			→			<b>13.0460-3831.2 603831</b> <b>13.0470-3831.2 LD3831</b>	BOS 24260 17,3 - WE / - WK + Zub BOS 24260 17,3 - WE / - WK + Zub Ceramic
<b> Bremsscheibe</b>							
1.8 16V 1.8 16V ↓	81 92	10/00→03/07 10/00→03/07	←			<b>24.0124-0161.1 424161</b>	Ø 300 23,9 22 V

	kW			 	! #		
<b>FORD - MONDEO III (B5Y) 10/00→03/07</b>							
 <b>Bremsscheibe</b>							
1.8 SCi	96	06/03→03/07	←			24.0324-0161.1 524161	Ø 300 23,9 22 V
2.0 16V	107	10/00→03/07	→			24.0112-0154.1 412154	Ø 280 12 10
2.0 16V DI / TDDi / TDCi	66	10/00→03/07				24.0312-0154.1 512154	Ø 280 12 10
2.0 16V TDDi / TDCi	85	10/00→03/07					
2.0 TDCi	96	10/01→03/07					
2.2 TDCi	110	09/04→03/07					
2.2 TDCi	114	09/04→03/07					
2.5 V6 24V	125	10/00→03/07					
3.0 V6 24V	150	09/04→03/07					
ST220	166	04/02→03/07					
<b>FORD - MONDEO III Stufenheck (B4Y) 10/00→09/07</b>							
 <b>Bremsbelagsatz, Scheibenbremse</b>							
1.8 16V	81	10/00→03/07	←			13.0460-3987.2 603987	BOS 23279 18,4 - WE / - WK
1.8 16V	92	10/00→03/07				13.0470-3987.2 LD3987	BOS 23279 18,4 - WE / - WK Ceramic
1.8 SCi	96	06/03→03/07					
2.0 16V	107	10/00→03/07	→	09/04→		13.0460-3831.2 603831	BOS 24260 17,3 - WE / - WK + Zub
2.0 16V DI / TDDi / TDCi	66	10/00→03/07				13.0470-3831.2 LD3831	BOS 24260 17,3 - WE / - WK + Zub Ceramic
2.0 16V TDDi / TDCi	85	10/00→03/07					
2.0 TDCi	96	10/01→03/07					
2.5 V6	125	10/00→03/07					
2.5 V6 24V	125	10/00→03/07	→	→ 08/04		13.0460-3988.2 603988	BOS 23557 17,2 - WE / - WK
ST220	166	04/02→03/07				13.0470-3988.2 LD3988	BOS 23557 17,2 - WE / - WK Ceramic
2.0 DI	92	10/00→03/07	←	10/01→		13.0460-3987.2 603987	BOS 23279 18,4 - WE / - WK
						13.0470-3987.2 LD3987	BOS 23279 18,4 - WE / - WK Ceramic
			→	09/04→		13.0460-3831.2 603831	BOS 24260 17,3 - WE / - WK + Zub
						13.0470-3831.2 LD3831	BOS 24260 17,3 - WE / - WK + Zub Ceramic
			→	10/01→ 08/04		13.0460-3988.2 603988	BOS 23557 17,2 - WE / - WK
						13.0470-3988.2 LD3988	BOS 23557 17,2 - WE / - WK Ceramic
2.2 TDCi	110	09/04→03/07	←			13.0460-3987.2 603987	BOS 23279 18,4 - WE / - WK
2.2 TDCi	114	09/04→03/07				13.0470-3987.2 LD3987	BOS 23279 18,4 - WE / - WK Ceramic
3.0 V6 24V	150	09/04→03/07	→			13.0460-3831.2 603831	BOS 24260 17,3 - WE / - WK + Zub
						13.0470-3831.2 LD3831	BOS 24260 17,3 - WE / - WK + Zub Ceramic
<b>Bremsscheibe</b>							
1.8 16V	81	10/00→03/07	←			24.0124-0161.1 424161	Ø 300 23,9 22 V
1.8 16V	92	10/00→03/07				24.0324-0161.1 524161	Ø 300 23,9 22 V
1.8 SCi	96	06/03→03/07					
2.0 16V	107	10/00→03/07	→			24.0112-0154.1 412154	Ø 280 12 10
2.0 16V DI / TDDi / TDCi	66	10/00→03/07				24.0312-0154.1 512154	Ø 280 12 10
2.0 16V TDDi / TDCi	85	10/00→03/07					
2.0 TDCi	96	10/01→03/07					
2.2 TDCi	110	09/04→03/07					
2.2 TDCi	114	09/04→03/07					
2.5 V6	125	10/00→03/07					
2.5 V6 24V	125	10/00→03/07					
3.0 V6 24V	150	09/04→03/07					
ST220	166	04/02→03/07					
2.0 DI	92	10/00→03/07	←	10/01→		24.0124-0161.1 424161	Ø 300 23,9 22 V
						24.0324-0161.1 524161	Ø 300 23,9 22 V
			→	10/01→		24.0112-0154.1 412154	Ø 280 12 10
						24.0312-0154.1 512154	Ø 280 12 10
<b>FORD - MONDEO III Turnier (BWY) 10/00→03/07</b>							
 <b>Bremsbelagsatz, Scheibenbremse</b>							
1.8 16V	81	10/00→03/07	←			13.0460-3987.2 603987	BOS 23279 18,4 - WE / - WK
1.8 16V	92	10/00→03/07				13.0470-3987.2 LD3987	BOS 23279 18,4 - WE / - WK Ceramic
1.8 SCi	96	06/03→03/07					
2.0 16V	107	10/00→03/07	→	09/04→		13.0460-3831.2 603831	BOS 24260 17,3 - WE / - WK + Zub
2.0 16V DI / TDDi / TDCi	66	10/00→03/07				13.0470-3831.2 LD3831	BOS 24260 17,3 - WE / - WK + Zub Ceramic
2.0 16V TDDi / TDCi	85	10/00→03/07					
2.0 TDCi	96	10/01→03/07					
2.5 V6 24V	125	10/00→03/07					
ST220	166	04/02→03/07	→	→ 08/04		13.0460-3988.2 603988	BOS 23557 17,2 - WE / - WK
↓							

	kW			 	! #		
<b>FORD - MONDEO III Turnier (BWY) 10/00→03/07</b>							
<b> Bremsbelagsatz, Scheibenbremse</b>							
1.8 16V	81	10/00→03/07	→	→ 08/04		13.0470-3988.2 LD3988	BOS 23557 17,2 - WE / - WK Ceramic
1.8 16V	92	10/00→03/07					
1.8 Sci	96	06/03→03/07					
2.0 16V	107	10/00→03/07					
2.0 16V DI / TDDi / TDCi	66	10/00→03/07					
2.0 16V TDDi / TDCi	85	10/00→03/07					
2.0 TDCi	96	10/01→03/07					
2.5 V6 24V	125	10/00→03/07					
ST220	166	04/02→03/07					
2.2 TDCi	110	09/04→03/07	←			13.0460-3987.2 603987	BOS 23279 18,4 - WE / - WK
2.2 TDCi	114	09/04→03/07				13.0470-3987.2 LD3987	BOS 23279 18,4 - WE / - WK Ceramic
3.0 V6 24V	150	09/04→03/07					
			→			13.0460-3831.2 603831	BOS 24260 17,3 - WE / - WK + Zub
						13.0470-3831.2 LD3831	BOS 24260 17,3 - WE / - WK + Zub Ceramic
<b> Bremsscheibe</b>							
1.8 16V	81	10/00→03/07	←			24.0124-0161.1 424161	Ø 300 23,9 22 V
1.8 16V	92	10/00→03/07				24.0324-0161.1 524161	Ø 300 23,9 22 V
1.8 Sci	96	06/03→03/07					
2.0 16V	107	10/00→03/07	→			24.0112-0154.1 412154	Ø 280 12 10
2.0 16V DI / TDDi / TDCi	66	10/00→03/07				24.0312-0154.1 512154	Ø 280 12 10
2.0 16V TDDi / TDCi	85	10/00→03/07					
2.0 TDCi	96	10/01→03/07					
2.2 TDCi	110	09/04→03/07					
2.2 TDCi	114	09/04→03/07					
2.5 V6 24V	125	10/00→03/07					
3.0 V6 24V	150	09/04→03/07					
ST220	166	04/02→03/07					
<b>FORD - MONDEO IV (BA7) 03/07→01/15</b>							
<b> Bremsbelagsatz, Scheibenbremse</b>							
1.6 EcoBoost	118	02/11→01/15	←	→ 09/14		13.0460-7228.2 607228	ATE 24123 20,3 - WE / - WK
1.6 TDCi	85	02/11→01/15				13.0470-7228.2 LD7228	ATE 24123 20,3 - WE / - WK Ceramic
1.6 Ti	88	07/10→01/15					
1.8 TDCi	92	06/07→01/15					
2.0 EcoBoost	176	07/10→01/15	→	→ 09/14		13.0460-2723.2 602723	TRW 24537 16,1 - WE / - WK + Zub
2.0 Flexifuel	107	03/09→01/15					
2.0 LPG	107	07/09→01/15				13.0470-2723.2 LD2723	TRW 24537 16,1 - WE / - WK + Zub Ceramic
2.0 SCTi	149	03/10→01/15					
2.0 TDCi	85	11/07→01/15					
2.0 TDCi	100	03/07→01/15					
2.0 TDCi	120	03/10→01/15					
2.3	118	07/07→01/15					
1.6 Ti	81	03/07→01/15	←	04/07→ 09/14		13.0460-7228.2 607228	ATE 24123 20,3 - WE / - WK
1.6 Ti	92	03/07→01/15				13.0470-7228.2 LD7228	ATE 24123 20,3 - WE / - WK Ceramic
1.8 TDCi	74	03/07→01/15					
2.0	107	03/07→01/15					
2.0 TDCi	96	03/07→01/15	→	04/07→ 09/14		13.0460-2723.2 602723	TRW 24537 16,1 - WE / - WK + Zub
2.0 TDCi	103	03/07→01/15				13.0470-2723.2 LD2723	TRW 24537 16,1 - WE / - WK + Zub Ceramic
2.5	162	03/07→01/15					
2.2 TDCi	129	03/08→10/10	←	04/08→		13.0460-7228.2 607228	ATE 24123 20,3 - WE / - WK
						13.0470-7228.2 LD7228	ATE 24123 20,3 - WE / - WK Ceramic
			→	04/08→		13.0460-2723.2 602723	TRW 24537 16,1 - WE / - WK + Zub
						13.0470-2723.2 LD2723	TRW 24537 16,1 - WE / - WK + Zub Ceramic
2.2 TDCi	147	07/10→01/15	←	11/10→ 09/14		13.0460-7228.2 607228	ATE 24123 20,3 - WE / - WK
						13.0470-7228.2 LD7228	ATE 24123 20,3 - WE / - WK Ceramic
			→	11/10→ 09/14		13.0460-2723.2 602723	TRW 24537 16,1 - WE / - WK + Zub
						13.0470-2723.2 LD2723	TRW 24537 16,1 - WE / - WK + Zub Ceramic
<b> Bremsscheibe</b>							
1.6 EcoBoost	118	02/11→01/15	←	→ 09/14		24.0128-0250.1 428250	Ø 300 28 26 V
1.6 TDCi	85	02/11→01/15				24.0328-0250.1 528250	Ø 300 28 26 V
1.6 Ti	88	07/10→01/15					
1.8 TDCi	92	06/07→01/15	→	→ 09/14		24.0111-0145.1 411145	Ø 302 10,9 9 + S
2.0 EcoBoost	176	07/10→01/15				24.0311-0145.1 511145	Ø 302 10,9 9
2.0 Flexifuel	107	03/09→01/15					
2.0 LPG	107	07/09→01/15					
↓							



	kW			 	! #		
<b>FORD - MONDEO IV (BA7) 03/07→01/15</b>							
<b> Bremsscheibe</b>							
2.0 SCTi	149	03/10→01/15	←	→ 09/14		24.0128-0250.1 428250	Ø 300 28 26 V
2.0 TDCi	85	11/07→01/15				24.0328-0250.1 528250	Ø 300 28 26 V
2.0 TDCi	100	03/07→01/15					
2.0 TDCi	120	03/10→01/15	→	→ 09/14		24.0111-0145.1 411145	Ø 302 10,9 9 + S
2.3	118	07/07→01/15				24.0311-0145.1 511145	Ø 302 10,9 9
1.6 Ti	81	03/07→01/15	←	04/07→ 09/14		24.0128-0250.1 428250	Ø 300 28 26 V
1.6 Ti	92	03/07→01/15				24.0328-0250.1 528250	Ø 300 28 26 V
1.8 TDCi	74	03/07→01/15					
2.0	107	03/07→01/15	→	04/07→ 09/14		24.0111-0145.1 411145	Ø 302 10,9 9 + S
2.0 TDCi	96	03/07→01/15				24.0311-0145.1 511145	Ø 302 10,9 9
2.0 TDCi	103	03/07→01/15					
2.5	162	03/07→01/15					
2.2 TDCi	129	03/08→10/10	←	04/08→		24.0128-0250.1 428250	Ø 300 28 26 V
						24.0328-0250.1 528250	Ø 300 28 26 V
			→	04/08→		24.0111-0145.1 411145	Ø 302 10,9 9 + S
						24.0311-0145.1 511145	Ø 302 10,9 9
2.2 TDCi	147	07/10→01/15	←	11/10→ 09/14		24.0128-0250.1 428250	Ø 300 28 26 V
						24.0328-0250.1 528250	Ø 300 28 26 V
			→	11/10→ 09/14		24.0111-0145.1 411145	Ø 302 10,9 9 + S
						24.0311-0145.1 511145	Ø 302 10,9 9
<b>FORD - MONDEO IV Stufenheck (BA7) 03/07→01/15</b>							
<b> Bremsbelagsatz, Scheibenbremse</b>							
1.6 EcoBoost	118	11/10→01/15	←	02/11→ 09/14		13.0460-7228.2 607228	ATE 24123 20,3 - WE / - WK
1.6 TDCi	85	12/10→01/15				13.0470-7228.2 LD7228	ATE 24123 20,3 - WE / - WK Ceramic
			→	02/11→ 09/14		13.0460-2723.2 602723	TRW 24537 16,1 - WE / - WK + Zub
						13.0470-2723.2 LD2723	TRW 24537 16,1 - WE / - WK + Zub Ceramic
1.6 Ti	81	03/07→01/15	←	04/07→ 09/14		13.0460-7228.2 607228	ATE 24123 20,3 - WE / - WK
1.6 Ti	92	03/07→01/15				13.0470-7228.2 LD7228	ATE 24123 20,3 - WE / - WK Ceramic
1.8 TDCi	74	03/07→01/15					
2.0	107	03/07→01/15					
2.0 TDCi	96	03/07→01/15	→	04/07→ 09/14		13.0460-2723.2 602723	TRW 24537 16,1 - WE / - WK + Zub
2.0 TDCi	103	03/07→01/15				13.0470-2723.2 LD2723	TRW 24537 16,1 - WE / - WK + Zub Ceramic
2.5	162	03/07→01/15					
1.6 Ti	88	03/10→01/15	←	→ 09/14		13.0460-7228.2 607228	ATE 24123 20,3 - WE / - WK
1.8 TDCi	92	06/07→01/15				13.0470-7228.2 LD7228	ATE 24123 20,3 - WE / - WK Ceramic
2.0 Flexifuel	107	03/09→01/15					
2.0 LPG	107	07/09→01/15					
2.0 SCTi	149	03/10→01/15	→	→ 09/14		13.0460-2723.2 602723	TRW 24537 16,1 - WE / - WK + Zub
2.0 TDCi	85	11/07→01/15				13.0470-2723.2 LD2723	TRW 24537 16,1 - WE / - WK + Zub Ceramic
2.0 TDCi	120	03/10→01/15					
2.3	118	07/07→01/15					
2.0 EcoBoost	176	03/10→09/14	←			13.0460-7228.2 607228	ATE 24123 20,3 - WE / - WK
2.0 TDCi	100	08/08→01/15				13.0470-7228.2 LD7228	ATE 24123 20,3 - WE / - WK Ceramic
			→			13.0460-2723.2 602723	TRW 24537 16,1 - WE / - WK + Zub
						13.0470-2723.2 LD2723	TRW 24537 16,1 - WE / - WK + Zub Ceramic
2.2 TDCi	129	03/08→10/10	←	04/08→		13.0460-7228.2 607228	ATE 24123 20,3 - WE / - WK
						13.0470-7228.2 LD7228	ATE 24123 20,3 - WE / - WK Ceramic
			→	04/08→		13.0460-2723.2 602723	TRW 24537 16,1 - WE / - WK + Zub
						13.0470-2723.2 LD2723	TRW 24537 16,1 - WE / - WK + Zub Ceramic
2.2 TDCi	147	10/10→01/15	←	11/10→ 09/14		13.0460-7228.2 607228	ATE 24123 20,3 - WE / - WK
						13.0470-7228.2 LD7228	ATE 24123 20,3 - WE / - WK Ceramic
			→	11/10→ 09/14		13.0460-2723.2 602723	TRW 24537 16,1 - WE / - WK + Zub
						13.0470-2723.2 LD2723	TRW 24537 16,1 - WE / - WK + Zub Ceramic
<b> Bremsscheibe</b>							
1.6 EcoBoost	118	11/10→01/15	←	02/11→ 09/14		24.0128-0250.1 428250	Ø 300 28 26 V
1.6 TDCi	85	12/10→01/15				24.0328-0250.1 528250	Ø 300 28 26 V
↓							

**FORD - MONDEO IV Stufenheck (BA7) 03/07→01/15**

**Bremsscheibe**

1.6 EcoBoost 1.6 TDCi	118	11/10→01/15	➔	02/11→ 09/14	24.0111-0145.1	411145	Ø 302 10,9 9 + S
	85	12/10→01/15			24.0311-0145.1	511145	Ø 302 10,9 9
1.6 Ti 1.6 Ti 1.8 TDCi 2.0 2.0 TDCi 2.0 TDCi 2.5	81	03/07→01/15	➔	04/07→ 09/14	24.0128-0250.1	428250	Ø 300 28 26 V
	92	03/07→01/15			24.0328-0250.1	528250	Ø 300 28 26 V
	74	03/07→01/15					
	107	03/07→01/15					
	96	03/07→01/15					
1.6 Ti 1.8 TDCi 2.0 Flexifuel 2.0 LPG 2.0 SCTi 2.0 TDCi 2.0 TDCi 2.3	103	03/07→01/15	➔	→ 09/14	24.0111-0145.1	411145	Ø 302 10,9 9 + S
	162	03/07→01/15			24.0311-0145.1	511145	Ø 302 10,9 9
	88	03/10→01/15					
	92	06/07→01/15					
	107	03/09→01/15					
	107	07/09→01/15					
	149	03/10→01/15					
	85	11/07→01/15					
2.0 EcoBoost 2.0 TDCi	176	03/10→09/14	➔		24.0128-0250.1	428250	Ø 300 28 26 V
	100	08/08→01/15			24.0328-0250.1	528250	Ø 300 28 26 V
2.2 TDCi	129	03/08→10/10	➔	04/08→	24.0111-0145.1	411145	Ø 302 10,9 9 + S
					24.0311-0145.1	511145	Ø 302 10,9 9
					24.0128-0250.1	428250	Ø 300 28 26 V
2.2 TDCi	147	10/10→01/15	➔	11/10→ 09/14	24.0328-0250.1	528250	Ø 300 28 26 V
					24.0111-0145.1	411145	Ø 302 10,9 9 + S
					24.0311-0145.1	511145	Ø 302 10,9 9
					24.0128-0250.1	428250	Ø 300 28 26 V

**FORD - MONDEO IV Turnier (BA7) 03/07→01/15**

**Bremsbelagsatz, Scheibenbremse**

1.6 EcoBoost 1.6 TDCi	118	02/11→01/15	➔	→ 09/14	13.0460-7228.2	607228	ATE 24123 20,3 - WE / - WK
	85	02/11→01/15			13.0470-7228.2	LD7228	ATE 24123 20,3 - WE / - WK Ceramic
1.6 Ti 2.0 EcoBoost 2.0 Flexifuel 2.0 LPG 2.0 SCTi 2.0 TDCi 2.0 TDCi 2.0 TDCi 2.3	88	07/10→01/15	➔	→ 09/14	13.0460-2723.2	602723	TRW 24537 16,1 - WE / - WK + Zub
	176	07/10→01/15			13.0470-2723.2	LD2723	TRW 24537 16,1 - WE / - WK + Zub Ceramic
	107	03/09→01/15					
	107	07/09→01/15					
	149	03/10→01/15					
	85	11/07→01/15					
	100	03/07→01/15					
	120	03/10→01/15					
1.6 Ti 1.6 Ti 1.8 TDCi 2.0 TDCi 2.5	118	07/07→01/15	➔	04/07→	13.0460-7228.2	607228	ATE 24123 20,3 - WE / - WK
	81	03/07→12/12			13.0470-7228.2	LD7228	ATE 24123 20,3 - WE / - WK Ceramic
	92	03/07→12/10					
	74	03/07→12/12					
	96	03/07→12/12					
1.8 TDCi	92	06/07→12/12	➔	04/07→	13.0460-2723.2	602723	TRW 24537 16,1 - WE / - WK + Zub
					13.0470-2723.2	LD2723	TRW 24537 16,1 - WE / - WK + Zub Ceramic
					13.0460-7228.2	607228	ATE 24123 20,3 - WE / - WK
					13.0470-7228.2	LD7228	ATE 24123 20,3 - WE / - WK Ceramic
2.0 2.0 TDCi	107	03/07→01/15	➔	04/07→ 09/14	13.0460-2723.2	602723	TRW 24537 16,1 - WE / - WK + Zub
					13.0470-2723.2	LD2723	TRW 24537 16,1 - WE / - WK + Zub Ceramic
					13.0460-7228.2	607228	ATE 24123 20,3 - WE / - WK
					13.0470-7228.2	LD7228	ATE 24123 20,3 - WE / - WK Ceramic
2.2 TDCi	129	03/08→10/10	➔	04/08→	13.0460-2723.2	602723	TRW 24537 16,1 - WE / - WK + Zub
					13.0470-2723.2	LD2723	TRW 24537 16,1 - WE / - WK + Zub Ceramic
					13.0460-7228.2	607228	ATE 24123 20,3 - WE / - WK
					13.0470-7228.2	LD7228	ATE 24123 20,3 - WE / - WK Ceramic

**FORD - MONDEO IV Turnier (BA7) 03/07→01/15**

**Bremsbelagsatz, Scheibenbremse**

2.2 TDCi	147	07/10→01/15	←	11/10→ 09/14		13.0460-7228.2 607228	ATE 24123 20,3 - WE / - WK
			→	11/10→ 09/14		13.0470-7228.2 LD7228	ATE 24123 20,3 - WE / - WK Ceramic
			←			13.0460-2723.2 602723	TRW 24537 16,1 - WE / - WK + Zub
			→			13.0470-2723.2 LD2723	TRW 24537 16,1 - WE / - WK + Zub Ceramic

**Bremsscheibe**

1.6 EcoBoost	118	02/11→01/15	←	→ 09/14		24.0128-0250.1 428250	Ø 300 28 26 V
			→			24.0328-0250.1 528250	Ø 300 28 26 V
1.6 TDCi	85	02/11→01/15					
1.6 Ti	88	07/10→01/15					
2.0 EcoBoost	176	07/10→01/15	→	→ 09/14		24.0111-0145.1 411145	Ø 302 10,9 9 + S
2.0 Flexifuel	107	03/09→01/15				24.0311-0145.1 511145	Ø 302 10,9 9
2.0 LPG	107	07/09→01/15					
2.0 SCTi	149	03/10→01/15					
2.0 TDCi	85	11/07→01/15					
2.0 TDCi	100	03/07→01/15					
2.0 TDCi	120	03/10→01/15					
2.3	118	07/07→01/15					
1.6 Ti	81	03/07→12/12	←	04/07→		24.0128-0250.1 428250	Ø 300 28 26 V
1.6 Ti	92	03/07→12/10				24.0328-0250.1 528250	Ø 300 28 26 V
1.8 TDCi	74	03/07→12/12					
2.0 TDCi	96	03/07→12/12	→	04/07→		24.0111-0145.1 411145	Ø 302 10,9 9 + S
2.5	162	03/07→12/12				24.0311-0145.1 511145	Ø 302 10,9 9
1.8 TDCi	92	06/07→12/12	←			24.0128-0250.1 428250	Ø 300 28 26 V
			→			24.0328-0250.1 528250	Ø 300 28 26 V
						24.0111-0145.1 411145	Ø 302 10,9 9 + S
						24.0311-0145.1 511145	Ø 302 10,9 9
2.0	107	03/07→01/15	←	04/07→ 09/14		24.0128-0250.1 428250	Ø 300 28 26 V
2.0 TDCi	103	03/07→01/15				24.0328-0250.1 528250	Ø 300 28 26 V
			→	04/07→ 09/14		24.0111-0145.1 411145	Ø 302 10,9 9 + S
						24.0311-0145.1 511145	Ø 302 10,9 9
2.2 TDCi	129	03/08→10/10	←	04/08→		24.0128-0250.1 428250	Ø 300 28 26 V
			→			24.0328-0250.1 528250	Ø 300 28 26 V
						24.0111-0145.1 411145	Ø 302 10,9 9 + S
						24.0311-0145.1 511145	Ø 302 10,9 9
2.2 TDCi	147	07/10→01/15	←	11/10→ 09/14		24.0128-0250.1 428250	Ø 300 28 26 V
			→	11/10→ 09/14		24.0328-0250.1 528250	Ø 300 28 26 V
						24.0111-0145.1 411145	Ø 302 10,9 9 + S
						24.0311-0145.1 511145	Ø 302 10,9 9

**FORD - MONDEO V Schrägheck 09/14→**

**Bremsbelagsatz, Scheibenbremse**

1.0 EcoBoost	92	02/15→	→	+ eFSB		13.0460-7320.2 607320	ATE 22231 16,1 + WK		
			→			13.0470-7320.2 LD7320	ATE 22231 16,1 + WK Ceramic		
			1.5 TDCi	88	03/15→				
			2.0 TDCi 4x4	110	02/15→				
2.0 TDCi 4x4	132	02/15→							
2.0 TDCi Bi-Turbo	154	03/15→							
1.5 EcoBoost	118	09/14→	←	10/14→ 01/15		13.0460-7313.2 607313	ATE 22269 19,4 + WK		
1.6 TDCi	85	09/14→							
2.0 EcoBoost	149	09/14→	→	10/14→; + eFSB		13.0460-7320.2 607320	ATE 22231 16,1 + WK		
2.0 EcoBoost	176	09/14→				13.0470-7320.2 LD7320	ATE 22231 16,1 + WK Ceramic		
2.0 TDCi	110	09/14→							
2.0 TDCi	132	09/14→							

**Bremsscheibe**

1.0 EcoBoost	92	02/15→	←	→ 09/14		24.0128-0286.1 428286	Ø 300 28 26,5 V
			→			24.0111-0185.1 411185	Ø 302 11 9,5
1.5 TDCi	88	03/15→					
2.0 TDCi 4x4	110	02/15→	→	+ eFSB			
2.0 TDCi 4x4	132	02/15→					
2.0 TDCi Bi-Turbo	154	03/15→					
1.5 EcoBoost	118	09/14→	←	10/14→		24.0128-0286.1 428286	Ø 300 28 26,5 V
1.6 TDCi	85	09/14→					
2.0 EcoBoost	149	09/14→	→	10/14→; + eFSB		24.0111-0185.1 411185	Ø 302 11 9,5
2.0 EcoBoost	176	09/14→					
2.0 TDCi	110	09/14→					
2.0 TDCi	132	09/14→					

**FORD - MONDEO V Stufenheck 09/12→**

**Bremsbelagsatz, Scheibenbremse**

1.0 EcoBoost	92	02/15→	→	+ eFSB		13.0460-7320.2 607320	ATE 22231 16,1 + WK
--------------	----	--------	---	--------	--	-----------------------	---------------------

**FORD - MONDEO V Stufenheck 09/12→**

**Bremsbelagsatz, Scheibenbremse**

1.5 TDCi 2.0 EcoBoost 2.0 EcoBoost 2.0 EcoBoost 2.0 TDCi 2.0 TDCi 4x4 2.0 TDCi Bi-Turbo 2.5	88 146 149 176 132 132 154 110	03/15→ 05/15→ 05/15→ 05/15→ 05/15→ 05/15→ 05/15→ 05/15→	➡ ➡ ➡ ➡ ➡ ➡ ➡ ➡	+ eFSB		13.0470-7320.2 LD7320	ATE 22231 16,1 + WK Ceramic
1.5 EcoBoost 2.0 Hybrid 2.0 Hybrid 2.0 TDCi	118 130 140 110	09/14→ 09/14→ 09/14→ 09/14→	⬅ ➡ ➡ ➡	10/14→ 01/15 10/14→; + eFSB 10/14→; + eFSB 10/14→; + eFSB		13.0460-7313.2 607313 13.0460-7320.2 607320 13.0470-7320.2 LD7320	ATE 22269 19,4 + WK ATE 22231 16,1 + WK ATE 22231 16,1 + WK Ceramic
2.0 EcoBoost	179	09/12→07/16	⬅ ➡ ➡ ➡	+ eFSB		13.0460-7313.2 607313 13.0460-7320.2 607320 13.0470-7320.2 LD7320	ATE 22269 19,4 + WK ATE 22231 16,1 + WK ATE 22231 16,1 + WK Ceramic
2.0 Hybrid	103	10/14→	⬅ ➡ ➡ ➡	→ 01/15 + eFSB + eFSB + eFSB		13.0460-7313.2 607313 13.0460-7320.2 607320 13.0470-7320.2 LD7320	ATE 22269 19,4 + WK ATE 22231 16,1 + WK ATE 22231 16,1 + WK Ceramic
2.0 TDCi 4x4	110	09/14→	➡ ➡	02/15→; + eFSB		13.0460-7320.2 607320 13.0470-7320.2 LD7320	ATE 22231 16,1 + WK ATE 22231 16,1 + WK Ceramic

**Bremsscheibe**

1.0 EcoBoost 1.5 TDCi 2.0 EcoBoost 2.0 EcoBoost 2.0 EcoBoost 2.0 EcoBoost 2.0 Hybrid 2.0 TDCi 2.0 TDCi 4x4 2.0 TDCi Bi-Turbo 2.5	92 88 146 149 176 179 103 132 132 154 110	02/15→ 03/15→ 05/15→ 05/15→ 05/15→ 09/12→07/16 10/14→ 05/15→ 05/15→ 05/15→ 05/15→	⬅ ➡ ➡ ➡ ➡ ➡ ➡ ➡ ➡ ➡ ➡	+ eFSB		24.0128-0286.1 428286 24.0111-0185.1 411185	Ø 300 28 26,5 V Ø 302 11 9,5
1.5 EcoBoost 2.0 Hybrid 2.0 Hybrid 2.0 TDCi	118 130 140 110	09/14→ 09/14→ 09/14→ 09/14→	⬅ ➡ ➡ ➡	10/14→ 10/14→; + eFSB 10/14→; + eFSB 10/14→; + eFSB		24.0128-0286.1 428286 24.0111-0185.1 411185	Ø 300 28 26,5 V Ø 302 11 9,5
2.0 TDCi 4x4	110	09/14→	⬅ ➡	02/15→ 02/15→; + eFSB		24.0128-0286.1 428286 24.0111-0185.1 411185	Ø 300 28 26,5 V Ø 302 11 9,5

**FORD - MONDEO V Turnier 09/14→**

**Bremsbelagsatz, Scheibenbremse**

1.0 EcoBoost 1.5 TDCi 2.0 TDCi 4x4 2.0 TDCi 4x4 2.0 TDCi Bi-Turbo	92 88 110 132 154	02/15→ 03/15→ 02/15→ 02/15→ 03/15→	➡ ➡ ➡ ➡ ➡	+ eFSB		13.0460-7320.2 607320 13.0470-7320.2 LD7320	ATE 22231 16,1 + WK ATE 22231 16,1 + WK Ceramic
1.5 EcoBoost 1.6 TDCi 2.0 EcoBoost 2.0 EcoBoost 2.0 TDCi 2.0 TDCi	118 85 149 176 110 132	09/14→ 09/14→ 09/14→ 09/14→ 09/14→ 09/14→	⬅ ➡ ➡ ➡ ➡ ➡	10/14→ 01/15 10/14→; + eFSB 10/14→; + eFSB 10/14→; + eFSB 10/14→; + eFSB 10/14→; + eFSB		13.0460-7313.2 607313 13.0460-7320.2 607320 13.0470-7320.2 LD7320	ATE 22269 19,4 + WK ATE 22231 16,1 + WK ATE 22231 16,1 + WK Ceramic

**Bremsscheibe**















1.0 EcoBoost 1.5 TDCi 2.0 TDCi 4x4 2.0 TDCi 4x4 2.0 TDCi Bi-Turbo	92 88 110 132 154	02/15→ 03/15→ 02/15→ 02/15→ 03/15→	⬅ ➡ ➡ ➡ ➡	+ eFSB		24.0128-0286.1 428286 24.0111-0185.1 411185	Ø 300 28 26,5 V Ø 302 11 9,5
1.5 EcoBoost 1.6 TDCi 2.0 EcoBoost 2.0 EcoBoost 2.0 TDCi 2.0 TDCi	118 85 149 176 110 132	09/14→ 09/14→ 09/14→ 09/14→ 09/14→ 09/14→	⬅ ➡ ➡ ➡ ➡ ➡	10/14→ 10/14→; + eFSB 10/14→; + eFSB 10/14→; + eFSB 10/14→; + eFSB 10/14→; + eFSB		24.0128-0286.1 428286 24.0111-0185.1 411185	Ø 300 28 26,5 V Ø 302 11 9,5

**FORD - PUMA (EC\_) 03/97→06/02**













**Bremsbelagsatz, Scheibenbremse**















1.4 16V	66	11/97→10/00	⬅ ⬅	02/98→ 01/00 02/00→		13.0460-7071.2 607071 13.0460-7142.2 607142	ATE 20640 17,5 - WE / - WK ATE 23202 18,3 - WE / - WK
1.6 16V	76	08/00→06/02	⬅	→ 12/01		13.0460-7142.2 607142	ATE 23202 18,3 - WE / - WK













↓							
---	--	--	--	--	--	--	--











	kW			 	! #		
<b>FORD - PUMA (EC_) 03/97→06/02</b>							
 <b>Bremsbelagsatz, Scheibenbremse</b>							
1.7 16V	92	03/97→06/02	←	06/97→ 01/00		<b>13.0460-7071.2 607071</b>	ATE 20640 17,5 - WE / - WK
			←	02/00→ 12/01		<b>13.0460-7142.2 607142</b>	ATE 23202 18,3 - WE / - WK
Racing ST 160	114	06/99→06/02	←	→ 01/00		<b>13.0460-7071.2 607071</b>	ATE 20640 17,5 - WE / - WK
			←	02/00→ 12/01		<b>13.0460-7142.2 607142</b>	ATE 23202 18,3 - WE / - WK
 <b>Bremsscheibe</b>							
1.4 16V	66	11/97→10/00	←	02/98→ 01/00		<b>24.0120-0147.1 420147</b>	Ø 239,5 20 18 V
						<b>24.0320-0147.1 520147</b>	Ø 239,5 20 18 V
			←	02/00→		<b>24.0122-0172.1 422172</b>	Ø 258 22 20 V
						<b>24.0322-0172.1 522172</b>	Ø 258 22 20 V
1.6 16V	76	08/00→06/02	←	→ 12/01		<b>24.0122-0172.1 422172</b>	Ø 258 22 20 V
						<b>24.0322-0172.1 522172</b>	Ø 258 22 20 V
1.7 16V	92	03/97→06/02	←	06/97→ 01/00		<b>24.0120-0147.1 420147</b>	Ø 239,5 20 18 V
						<b>24.0320-0147.1 520147</b>	Ø 239,5 20 18 V
			←	02/00→ 12/01		<b>24.0122-0172.1 422172</b>	Ø 258 22 20 V
						<b>24.0322-0172.1 522172</b>	Ø 258 22 20 V
Racing ST 160	114	06/99→06/02	←	→ 01/00		<b>24.0120-0147.1 420147</b>	Ø 239,5 20 18 V
						<b>24.0320-0147.1 520147</b>	Ø 239,5 20 18 V
			←	02/00→ 12/01		<b>24.0122-0172.1 422172</b>	Ø 258 22 20 V
						<b>24.0322-0172.1 522172</b>	Ø 258 22 20 V
<b>FORD - RANGER (ER, EQ) 04/97→06/06</b>							
 <b>Bremsscheibe</b>							
2.9 D	70	06/99→02/02	←			<b>24.0124-0245.1 424245</b>	Ø 256 24 22 V
<b>FORD - RANGER (ET) 01/05→07/12</b>							
 <b>Bremsscheibe</b>							
2.5 TDCi 4x4	105	05/06→07/12	←	04/10→ 10/11		<b>24.0128-0226.1 428226</b>	Ø 289 28 26 V
3.0 TDCi 4x4	115	05/06→07/12					
2.5 TDi	105	05/06→07/12	←	04/10→; - High Rider; → 10/11		<b>24.0124-0245.1 424245</b>	Ø 256 24 22 V
3.0 TDCi	115	05/06→07/12	←	04/10→; + High Rider; → 10/11		<b>24.0128-0226.1 428226</b>	Ø 289 28 26 V
<b>FORD - RANGER (TKE) 04/11→</b>							
 <b>Bremsbelagsatz, Scheibenbremse</b>							
2.2 TDCi	88	04/11→	←	11/11→		<b>13.0460-8014.2 608014</b>	25632 15,5 + WK + Zub
2.2 TDCi	92	04/11→					
2.2 TDCi 4x4	92	04/11→					
2.2 TDCi 4x4	110	04/11→					
3.2 TDCi 4x4	147	04/11→					
2.2 TDCi	96	05/15→	←			<b>13.0460-8014.2 608014</b>	25632 15,5 + WK + Zub
2.2 TDCi	110	11/11→					
2.2 TDCi	118	05/15→					
2.2 TDCi 4x4	96	05/15→					
2.2 TDCi 4x4	118	05/15→					
2.5 i 4x4	122	11/11→					
 <b>Bremsscheibe</b>							
2.2 TDCi	88	04/11→	←	11/11→ 03/12		<b>24.0132-0176.1 432176</b>	Ø 302 32 30 V
2.2 TDCi	92	04/11→					
2.2 TDCi 4x4	92	04/11→					
2.2 TDCi 4x4	110	04/11→					
3.2 TDCi 4x4	147	04/11→					
2.2 TDCi	110	11/11→	←	→ 03/12		<b>24.0132-0176.1 432176</b>	Ø 302 32 30 V
2.5 i 4x4	122	11/11→	←			<b>24.0132-0176.1 432176</b>	Ø 302 32 30 V
<b>FORD - SCORPIO II (GFR, GGR) 10/94→08/98</b>							
 <b>Bremsbelagsatz, Scheibenbremse</b>							
2.0 i	85	10/94→08/98	←			<b>13.0460-7057.2 607057</b>	ATE 21394 17,5 - WE / - WK
2.0 i 16V	100	10/94→08/98					
2.3 i 16V	108	06/96→08/98	→			<b>13.0460-2928.2 602928</b>	TRW 20981 13,8 - WK
2.5 TD	85	10/94→08/98					
2.9 i	110	02/95→08/98					
2.9 i 24V	152	10/94→08/98	←	12/97→		<b>13.0460-7056.2 607056</b>	ATE 21396 17,5 + WK
			←	→ 11/97		<b>13.0460-7165.2 607165</b>	ATE 21358 19,8 - WE / - WK
			→			<b>13.0460-2928.2 602928</b>	TRW 20981 13,8 - WK
↓							













	kW			 	! #		
<b>FORD - SCORPIO II (GFR, GGR) 10/94→08/98</b>							
 <b>Bremsscheibe</b>							
2.0 i	85	10/94→08/98	←			24.0124-0120.1 424120	Ø 260 24 22,2 V
2.0 i 16V	100	10/94→08/98				24.0324-0120.1 524120	Ø 260 24 22,2 V
2.3 i 16V	108	06/96→08/98	→				
2.5 TD	85	10/94→08/98				24.0110-0115.1 410115	Ø 253 10,2 8,9
2.9 i	110	02/95→08/98				24.0310-0115.1 510115	Ø 253 10,2 8,9
2.5 TD	92	09/96→08/98	→			24.0110-0115.1 410115	Ø 253 10,2 8,9
						24.0310-0115.1 510115	Ø 253 10,2 8,9
2.9 i 24V	152	10/94→08/98	←			24.0124-0149.1 424149	Ø 278 24,1 22,2 V
<b>FORD - SCORPIO II Turnier (GNR, GGR) 10/94→08/98</b>							
 <b>Bremsbelagsatz, Scheibenbremse</b>							
2.0 i	85	10/94→08/98	←			13.0460-7057.2 607057	ATE 21394 17,5 - WE / - WK
2.0 i 16V	100	10/94→08/98					
2.3 i 16V	108	06/96→08/98	→			13.0460-2928.2 602928	TRW 20981 13,8 - WK
2.5 TD	85	10/94→08/98					
2.9 i	110	02/95→08/98					
2.9 i 24V	152	10/94→08/98	←	12/97→		13.0460-7056.2 607056	ATE 21396 17,5 + WK
			←	→ 11/97		13.0460-7165.2 607165	ATE 21358 19,8 - WE / - WK
			→			13.0460-2928.2 602928	TRW 20981 13,8 - WK
 <b>Bremsscheibe</b>							
2.0 i	85	10/94→08/98	←			24.0124-0120.1 424120	Ø 260 24 22,2 V
2.0 i 16V	100	10/94→08/98				24.0324-0120.1 524120	Ø 260 24 22,2 V
2.3 i 16V	108	06/96→08/98					
2.5 TD	85	10/94→08/98	→			24.0120-0146.1 420146	Ø 253 20 18 V
2.9 i	110	02/95→08/98				24.0320-0146.1 520146	Ø 253 20 18 V
2.5 TD	92	09/96→08/98	→			24.0120-0146.1 420146	Ø 253 20 18 V
						24.0320-0146.1 520146	Ø 253 20 18 V
2.9 i 24V	152	10/94→08/98	←			24.0124-0149.1 424149	Ø 278 24,1 22,2 V
<b>FORD - S-MAX 01/15→</b>							
 <b>Bremsbelagsatz, Scheibenbremse</b>							
1.5 EcoBoost	118	01/15→	←	02/15→;		13.0460-7313.2 607313	ATE 22269 19,4 + WK
2.0 EcoBoost	176	01/15→		passend für Felgenreöße [Zoll]: 16			
2.0 TDCi	88	01/15→	→	02/15→; + eFSB		13.0460-7320.2 607320	ATE 22231 16,1 + WK
2.0 TDCi	110	01/15→				13.0470-7320.2 LD7320	ATE 22231 16,1 + WK Ceramic
2.0 TDCi	132	01/15→					
2.0 TDCi 4x4	110	01/15→					
2.0 TDCi 4x4	132	01/15→					
2.0 TDCi BI-Turbo	154	01/15→					
<b>FORD - S-MAX (WA6) 05/06→12/14</b>							
 <b>Bremsbelagsatz, Scheibenbremse</b>							
1.6 EcoBoost	118	02/11→12/14	←			13.0460-7228.2 607228	ATE 24123 20,3 - WE / - WK
1.6 TDCi	85	02/11→12/14				13.0470-7228.2 LD7228	ATE 24123 20,3 - WE / - WK Ceramic
1.8 TDCi	74	01/07→12/10					
1.8 TDCi	92	05/06→12/14	→	+ eFSB		13.0460-2722.2 602722	TRW 24496 17,3 - WE / - WK + Zub
2.0	107	05/06→12/14					
2.0 Flexifuel	107	05/06→12/14				13.0470-2722.2 LD2722	TRW 24496 17,3 - WE / - WK + Zub Ceramic
2.0 TDCi	85	11/07→12/14					
2.0 TDCi	96	05/06→12/14					
2.0 TDCi	100	05/06→12/14	→	- eFSB		13.0460-2723.2 602723	TRW 24537 16,1 - WE / - WK + Zub
2.0 TDCi	103	05/06→12/14				13.0470-2723.2 LD2723	TRW 24537 16,1 - WE / - WK + Zub Ceramic
2.0 TDCi	120	03/10→12/14					
2.2 TDCi	147	07/10→12/14					
2.3	118	07/07→12/14					
2.0 EcoBoost	146	07/10→12/14	←			13.0460-7243.2 607243	ATE 24142 20,6 - WE / - WK
2.0 EcoBoost	149	03/10→12/14				13.0470-7243.2 LD7243	ATE 24142 20,6 - WE / - WK Ceramic
2.0 EcoBoost	176	07/10→12/14					
2.5 ST	162	05/06→12/14	→	+ eFSB		13.0460-2722.2 602722	TRW 24496 17,3 - WE / - WK + Zub
						13.0470-2722.2 LD2722	TRW 24496 17,3 - WE / - WK + Zub Ceramic
			→	- eFSB		13.0460-2723.2 602723	TRW 24537 16,1 - WE / - WK + Zub
						13.0470-2723.2 LD2723	TRW 24537 16,1 - WE / - WK + Zub Ceramic
2.2 TDCi	129	03/08→12/12	←	11/08→		13.0460-7228.2 607228	ATE 24123 20,3 - WE / - WK
						13.0470-7228.2 LD7228	ATE 24123 20,3 - WE / - WK Ceramic
			←	04/08→ 10/08		13.0460-7243.2 607243	ATE 24142 20,6 - WE / - WK











	kW			 	! #		
<b>FORD - S-MAX (WA6) 05/06→12/14</b>							
 <b>Bremsbelagsatz, Scheibenbremse</b>							
2.2 TDCi	129	03/08→12/12	←	04/08→ 10/08	13.0470-7243.2	LD7243	ATE 24142 20,6 - WE / - WK Ceramic
			→	04/08→; + eFSB	13.0460-2722.2	602722	TRW 24496 17,3 - WE / - WK + Zub
			→	04/08→; - eFSB	13.0470-2722.2	LD2722	TRW 24496 17,3 - WE / - WK + Zub Ceramic
					13.0460-2723.2	602723	TRW 24537 16,1 - WE / - WK + Zub
					13.0470-2723.2	LD2723	TRW 24537 16,1 - WE / - WK + Zub Ceramic
 <b>Bremsscheibe</b>							
1.6 EcoBoost	118	02/11→12/14	←		24.0128-0154.1	428154	Ø 300 28 26 V + S
1.6 TDCi	85	02/11→12/14			24.0328-0154.1	528154	Ø 300 28 26 V + S
1.8 TDCi	74	01/07→12/10					
1.8 TDCi	92	05/06→12/14	→		24.0111-0145.1	411145	Ø 302 10,9 9 + S
2.0	107	05/06→12/14			24.0311-0145.1	511145	Ø 302 10,9 9
2.0 Flexifuel	107	05/06→12/14					
2.0 TDCi	85	11/07→12/14					
2.0 TDCi	96	05/06→12/14					
2.0 TDCi	100	05/06→12/14					
2.0 TDCi	103	05/06→12/14					
2.0 TDCi	120	03/10→12/14					
2.2 TDCi	147	07/10→12/14					
2.3	118	07/07→12/14					
2.0 EcoBoost	146	07/10→12/14	←		24.0128-0162.1	428162	Ø 316 28 26 V + S
2.0 EcoBoost	176	07/10→12/14			24.0328-0162.1	528162	Ø 316 28 26 V + S
2.5 ST	162	05/06→12/14	→		24.0111-0145.1	411145	Ø 302 10,9 9 + S
					24.0311-0145.1	511145	Ø 302 10,9 9
2.0 EcoBoost	149	03/10→12/14	←	05/11→	24.0128-0154.1	428154	Ø 300 28 26 V + S
					24.0328-0154.1	528154	Ø 300 28 26 V + S
			←	→ 04/11	24.0128-0162.1	428162	Ø 316 28 26 V + S
					24.0328-0162.1	528162	Ø 316 28 26 V + S
			→		24.0111-0145.1	411145	Ø 302 10,9 9 + S
				24.0311-0145.1	511145	Ø 302 10,9 9	
2.2 TDCi	129	03/08→12/12	←	11/08→	24.0128-0154.1	428154	Ø 300 28 26 V + S
					24.0328-0154.1	528154	Ø 300 28 26 V + S
			←	04/08→ 10/08	24.0128-0162.1	428162	Ø 316 28 26 V + S
					24.0328-0162.1	528162	Ø 316 28 26 V + S
			→	04/08→	24.0111-0145.1	411145	Ø 302 10,9 9 + S
				24.0311-0145.1	511145	Ø 302 10,9 9	
<b>FORD - STREET KA (RL2) 03/03→07/05</b>							
 <b>Bremsbelagsatz, Scheibenbremse</b>							
1.6	70	05/03→07/05	←		13.0460-7142.2	607142	ATE 23202 18,3 - WE / - WK
 <b>Bremsscheibe</b>							
1.6	70	05/03→07/05	←		24.0122-0172.1	422172	Ø 258 22 20 V
					24.0322-0172.1	522172	Ø 258 22 20 V
<b>FORD - TOURNEO CONNECT 06/02→12/13</b>							
 <b>Bremsbelagsatz, Scheibenbremse</b>							
1.8 16V	85	06/02→12/13	←	→ 08/13	13.0460-7186.2	607186	ATE 23440 17,6 - WE / - WK
1.8 TDCi	66	06/02→12/13					
1.8 TDCi	81	08/06→12/13	→	→ 08/13	13.0460-7160.2	607160	ATE 23482 15,8 - WE / - WK
1.8 TDCi /TDDi /DI	55	06/02→12/13			13.0460-7194.2	607194	ATE 23482 16,6 - WE / - WK
					13.0470-7194.2	LD7194	ATE 23482 16,6 - WE / - WK Ceramic
 <b>Bremsscheibe</b>							
1.8 16V	85	06/02→12/13	←	→ 08/13	24.0124-0179.1	424179	Ø 278 24 22 V
1.8 TDCi	66	06/02→12/13					
1.8 TDCi	81	08/06→12/13	→	→ 08/13	24.0111-0154.1	411154	Ø 278 11 9
1.8 TDCi /TDDi /DI	55	06/02→12/13					
<b>FORD - TOURNEO CONNECT / GRAND TOURNEO CONNECT Kombi 09/13→</b>							
 <b>Bremsbelagsatz, Scheibenbremse</b>							
1.0 EcoBoost	74	11/13→	←	kurzer Radstand	13.0460-7193.2	607193	ATE 23723 18,1 - WE / - WK
1.5 TDCi	55	05/15→					
↓							













	kw					! #		
<b>FORD - TOURNEO CONNECT / GRAND TOURNEO CONNECT Kombi 09/13→</b>								
 <b>Bremsbelagsatz, Scheibenbremse</b>								
1.5 TDCi	74	05/15→	←	kurzer Radstand		13.0470-7193.2	LD7193	ATE 23723 18,1 - WE / - WK Ceramic
1.5 TDCi	88	05/15→						
1.6 EcoBoost	110	11/13→						
1.6 TDCi	55	09/13→	←	langer Radstand; nicht für erhöhte Nutzlast		13.0460-7193.2	607193	ATE 23723 18,1 - WE / - WK
1.6 TDCi	70	09/13→				13.0470-7193.2	LD7193	ATE 23723 18,1 - WE / - WK Ceramic
1.6 TDCi	85	09/13→	←	langer Radstand; für erhöhte Nutzlast		13.0470-7299.2	LD7299	ATE 25736 18,4 - WE / - WK Ceramic
			→			13.0460-7195.2	607195	ATE 23482 16,6 - WE / - WK
						13.0470-7195.2	LD7195	ATE 23482 16,6 - WE / - WK Ceramic
 <b>Bremsscheibe</b>								
1.0 EcoBoost	74	11/13→	←	nicht für Taxifahrzeuge; für Leichtmetallfelgen;		24.0125-0162.1	425162	Ø 300 25 23 V
1.5 TDCi	55	05/15→		nicht für erhöhte Nutzlast		24.0325-0162.1	525162	Ø 300 25 23 V
1.5 TDCi	74	05/15→						
1.5 TDCi	88	05/15→	←	nicht für Taxifahrzeuge; für Stahlfelgen; nicht für erhöhte Nutzlast		24.0125-0202.1	425202	Ø 300 25 23 V
1.6 EcoBoost	110	11/13→						
1.6 TDCi	55	09/13→	←	nicht für Taxifahrzeuge; für erhöhte Nutzlast		24.0125-0209.1	425209	Ø 320 25 23 V
1.6 TDCi	70	09/13→						
1.6 TDCi	85	09/13→	→			24.0111-0172.1	411172	Ø 280 11 9
<b>FORD - TOURNEO COURIER Kombi 02/14→</b>								
 <b>Bremsbelagsatz, Scheibenbremse</b>								
1.0 EcoBoost	74	02/14→	←			13.0460-2784.2	602784	TRW 25134 17,2 - WE / - WK + Zub
1.5 TDCi	55	02/14→						
1.5 TDCi	70	05/15→				13.0470-2784.2	LD2784	TRW 25134 17,2 - WE / - WK + Zub Ceramic
1.6 TDCi	70	02/14→						
 <b>Bremsscheibe</b>								
1.0 EcoBoost	74	02/14→	←	für Leichtmetallfelgen		24.0123-0122.1	423122	Ø 278 23 21 V
1.5 TDCi	55	02/14→						
1.5 TDCi	70	05/15→						
1.6 TDCi	70	02/14→						
<b>FORD - TOURNEO CUSTOM Bus 04/12→</b>								
<b>Warnkontakt, Bremsbelagverschleiß</b>								
2.0 TDCi	77	12/15→	←	nicht für Baumuster: 330	1	24.8190-0021.2	620021	L= 478
2.0 TDCi	96	12/15→	←	Baumuster: 330	1	24.8190-0026.2	620026	L= 312
2.0 TDCi	125	12/15→	→		2	24.8190-0021.2	620021	L= 478
2.2 TDCi	74	04/12→	←	05/12→; nicht für Baumuster: 330	1	24.8190-0021.2	620021	L= 478
2.2 TDCi	92	04/12→	←	05/12→; Baumuster: 330	1	24.8190-0026.2	620026	L= 312
2.2 TDCi	114	04/12→	→	05/12→	2	24.8190-0021.2	620021	L= 478
 <b>Bremsscheibe</b>								
2.2 TDCi	74	04/12→	←	05/12→; nicht für Baumuster: 330 / 290S Sport		24.0133-0101.1	433101	Ø 288 33 30 V + S
2.2 TDCi	92	04/12→						
2.2 TDCi	114	04/12→	←	05/12→ 04/16; Baumuster: 290S Sport		24.0133-0102.1	433102	Ø 308 33 30 V + S
			←	05/12→; Baumuster: 330		24.0133-0102.1	433102	Ø 308 33 30 V + S
<b>FORD - TRANSIT Bus 08/13→</b>								
<b>Warnkontakt, Bremsbelagverschleiß</b>								
2.0 TDCi	77	03/16→	←		2	24.8190-0026.2	620026	L= 312
2.0 TDCi	96	03/16→						
2.0 TDCi	125	03/16→						
2.2 TDCi	114	12/14→						
2.2 TDCi Allrad	114	12/14→						
2.2 TDCi	74	08/13→	←	05/14→	2	24.8190-0026.2	620026	L= 312
2.2 TDCi	92	08/13→						
2.2 TDCi 4x4	92	08/13→						
2.2 TDCi RWD	74	08/13→						
2.2 TDCi RWD	92	08/13→						
2.2 TDCi RWD	99	08/13→						
2.2 TDCi RWD	114	08/13→						
 <b>Bremsscheibe</b>								
2.0 TDCi	77	03/16→	←	für Doppelbereifung		24.0131-0100.1	431100	Ø 308 31 28 V
2.0 TDCi	96	03/16→	←	Baumuster: 10/60/70/80/90/250 / 300; für Einfachbereifung		24.0133-0101.1	433101	Ø 288 33 30 V + S
2.0 TDCi	125	03/16→						
2.2 TDCi	114	12/14→						
↓								













	kw					! #		
<b>FORD - TRANSIT Bus 08/13→</b>								
 <b>Bremsscheibe</b>								
2.2 TDCi Allrad	114	12/14→	←	Baumuster: 330/350/390/410/470; für Einfachbereifung		24.0133-0102.1	433102	Ø 308 33 30 V + S
2.2 TDCi	74	08/13→	←	05/14→; für Doppelbereifung		24.0131-0100.1	431100	Ø 308 31 28 V
2.2 TDCi	92	08/13→	←	05/14→; Baumuster: 10/60/70/80/90/250 / 300; für Einfachbereifung		24.0133-0101.1	433101	Ø 288 33 30 V + S
2.2 TDCi 4x4	92	08/13→						
2.2 TDCi RWD	74	08/13→						
2.2 TDCi RWD	92	08/13→						
2.2 TDCi RWD	99	08/13→	←	05/14→; Baumuster: 330/350/390/410/470; für Einfachbereifung		24.0133-0102.1	433102	Ø 308 33 30 V + S
2.2 TDCi RWD	114	08/13→						
<b>FORD - TRANSIT Bus (E_) 06/94→07/00</b>								
 <b>Bremsbelagsatz, Scheibenbremse</b>								
2.0 (EBL, EBS, ECL, EDS, EDL, EGL, ESS, ESL, EUS)	84	09/95→03/00	←	passend für Felgenreöße [Zoll]: 15		13.0460-3959.2	603959	BDX 21469 18,0 + WE / - WK
2.5 DI (EBL, ECL, EDS, EDL)	56	07/94→03/00	←	passend für Felgenreöße [Zoll]: 14		13.0460-3960.2	603960	BDX 21470 18,0 + WE / - WK
2.5 DI (EBL, EDL, EDS, ESL, ESS)	85	08/97→03/00						
2.5 DI (EBL, EDS, ESL, ESS, EUS)	51	08/94→03/00						
2.5 TD (EBL, EDL, EDS, EGL, ESL, ESS, EUS)	63	01/95→03/00						
2.5 TD (ECL, EDL, EDS, ESL, ESS, EUS)	74	07/94→03/00						
2.0 CNG	84	06/94→03/00	←	passend für Felgenreöße [Zoll]: 15		13.0460-3959.2	603959	BDX 21469 18,0 + WE / - WK
			←	07/94→; passend für Felgenreöße [Zoll]: 15		13.0460-3959.2	603959	BDX 21469 18,0 + WE / - WK
			←	passend für Felgenreöße [Zoll]: 14		13.0460-3960.2	603960	BDX 21470 18,0 + WE / - WK
			←	07/94→; passend für Felgenreöße [Zoll]: 14		13.0460-3960.2	603960	BDX 21470 18,0 + WE / - WK
2.5 TD (EB_, ED_, ES_)	55	08/94→06/00	←	→ 03/00; passend für Felgenreöße [Zoll]: 15		13.0460-3959.2	603959	BDX 21469 18,0 + WE / - WK
			←	→ 03/00; passend für Felgenreöße [Zoll]: 14		13.0460-3960.2	603960	BDX 21470 18,0 + WE / - WK
<b>Zubehörsatz, Scheibenbremsbelag</b>								
2.0 (EBL, EBS, ECL, EDS, EDL, EGL, ESS, ESL, EUS)	84	09/95→03/00	←	passend für Felgenreöße [Zoll]: 14		13.0460-0427.2	610427	BDX
2.5 DI (EBL, ECL, EDS, EDL)	56	07/94→03/00	←	passend für Felgenreöße [Zoll]: 15		13.0460-0427.2	610427	BDX
2.5 DI (EBL, EDL, EDS, ESL, ESS)	85	08/97→03/00						
2.5 DI (EBL, EDS, ESL, ESS, EUS)	51	08/94→03/00						
2.5 TD (EBL, EDL, EDS, EGL, ESL, ESS, EUS)	63	01/95→03/00						
2.5 TD (ECL, EDL, EDS, ESL, ESS, EUS)	74	07/94→03/00						
2.0 CNG	84	06/94→03/00	←	passend für Felgenreöße [Zoll]: 15		13.0460-0427.2	610427	BDX
			←	passend für Felgenreöße [Zoll]: 14		13.0460-0427.2	610427	BDX
			←	07/94→; passend für Felgenreöße [Zoll]: 15		13.0460-0427.2	610427	BDX
			←	07/94→; passend für Felgenreöße [Zoll]: 14		13.0460-0427.2	610427	BDX
2.5 TD (EB_, ED_, ES_)	55	08/94→06/00	←	→ 03/00; passend für Felgenreöße [Zoll]: 14		13.0460-0427.2	610427	BDX
			←	→ 03/00; passend für Felgenreöße [Zoll]: 15		13.0460-0427.2	610427	BDX
 <b>Bremsscheibe</b>								
2.0 (EBL, EBS, ECL, EDS, EDL, EGL, ESS, ESL, EUS)	84	09/95→03/00	←	passend für Felgenreöße [Zoll]: 14		24.0124-0131.1	424131	Ø 254 24,2 22,2 V
2.5 DI (EBL, ECL, EDS, EDL)	56	07/94→03/00	←	passend für Felgenreöße [Zoll]: 15		24.0124-0132.1	424132	Ø 270 24,2 22,2 V
2.5 DI (EBL, EDL, EDS, ESL, ESS)	85	08/97→03/00						
2.5 DI (EBL, EDS, ESL, ESS, EUS)	51	08/94→03/00						
2.5 TD (EBL, EDL, EDS, EGL, ESL, ESS, EUS)	63	01/95→03/00						
2.5 TD (ECL, EDL, EDS, ESL, ESS, EUS)	74	07/94→03/00						
			↓					













	kw			 	! #		
<b>FORD - TRANSIT Bus (E_) 06/94→07/00</b>							
 <b>Bremsscheibe</b>							
2.0 CNG	84	06/94→03/00	←	07/94→; passend für Felgenreöße [Zoll]: 14	24.0124-0131.1	424131	Ø 254 24,2 22,2 V
			←	passend für Felgenreöße [Zoll]: 14	24.0124-0131.1	424131	Ø 254 24,2 22,2 V
			←	07/94→; passend für Felgenreöße [Zoll]: 15	24.0124-0132.1	424132	Ø 270 24,2 22,2 V
			←	passend für Felgenreöße [Zoll]: 15	24.0124-0132.1	424132	Ø 270 24,2 22,2 V
2.5 TD (EB_, ED_, ES_)	55	08/94→06/00	←	→ 03/00; passend für Felgenreöße [Zoll]: 14	24.0124-0131.1	424131	Ø 254 24,2 22,2 V
			←	→ 03/00; passend für Felgenreöße [Zoll]: 15	24.0124-0132.1	424132	Ø 270 24,2 22,2 V
<b>FORD - TRANSIT Bus (FD_, FB_, FS_, FZ_, FC_) 04/06→</b>							
 <b>Bremsbelagsatz, Scheibenbremse</b>							
2.2 TDCi	63	04/06→08/14	←	05/06→; Baumuster: 260/280/300; → 04/14	13.0460-3833.2	603833	BOS 24485 19,0 + WK + Zub
2.2 TDCi	81	04/06→08/14	←	→ 04/14	13.0460-3834.2	603834	BOS 24484 19,0 + WK + Zub
2.2 TDCi	96	04/06→08/14	←	05/06→; Baumuster: 330/350; → 04/14	13.0460-3834.2	603834	BOS 24484 19,0 + WK + Zub
			→	05/06→ 04/14; für Einfachbereifung	13.0460-3835.2	603835	BOS 24486 17,9 + WK + Zub
2.2 TDCi	74	10/11→08/14	←	Baumuster: 260/280/300; → 04/14	13.0460-3833.2	603833	BOS 24485 19,0 + WK + Zub
2.2 TDCi	85	10/08→08/14	←	→ 04/14	13.0460-3834.2	603834	BOS 24484 19,0 + WK + Zub
2.2 TDCi	92	10/11→08/14	←	Baumuster: 330/350; → 04/14	13.0460-3834.2	603834	BOS 24484 19,0 + WK + Zub
2.2 TDCi	103	10/07→08/14	→	→ 04/14; für Einfachbereifung	13.0460-3835.2	603835	BOS 24486 17,9 + WK + Zub
2.2 TDCi RWD	74	10/11→08/14	←	→ 04/14	13.0460-3834.2	603834	BOS 24484 19,0 + WK + Zub
2.2 TDCi RWD	92	10/11→08/14	←	→ 04/14	13.0460-3834.2	603834	BOS 24484 19,0 + WK + Zub
2.4 TDCi 4x4	103	11/06→08/14	→	→ 04/14; für Einfachbereifung	13.0460-3835.2	603835	BOS 24486 17,9 + WK + Zub
3.2 TDCi	147	02/08→08/14	→	→ 04/14	13.0460-3835.2	603835	BOS 24486 17,9 + WK + Zub
2.2 TDCi RWD	100	09/11→08/14	←	10/11→ 04/14	13.0460-3834.2	603834	BOS 24484 19,0 + WK + Zub
			→	10/11→ 04/14; für Einfachbereifung	13.0460-3835.2	603835	BOS 24486 17,9 + WK + Zub
2.4 TDCi	74	04/06→08/14	←	05/06→ 04/14	13.0460-3834.2	603834	BOS 24484 19,0 + WK + Zub
2.4 TDCi	85	04/06→08/14	←	→ 04/14	13.0460-3834.2	603834	BOS 24484 19,0 + WK + Zub
2.4 TDCi	103	04/06→08/14	→	05/06→ 04/14; für Einfachbereifung	13.0460-3835.2	603835	BOS 24486 17,9 + WK + Zub
 <b>Bremsscheibe</b>							
2.2 TDCi	63	04/06→08/14	←	05/06→; Baumuster: 260/280/300; → 04/14	24.0128-0156.1	428156	Ø 280 28 25 V + S
2.2 TDCi	81	04/06→08/14	←	→ 04/14	24.0128-0157.1	428157	Ø 300 28 25 V + S
2.2 TDCi	96	04/06→08/14	←	05/06→; Baumuster: 330/350; → 04/14	24.0128-0157.1	428157	Ø 300 28 25 V + S
			→	05/06→ 04/14	24.0116-0216.1	416216	Ø 280 16 13 + ABS Ring
2.2 TDCi	74	10/11→08/14	←	Baumuster: 260/280/300; → 04/14	24.0128-0156.1	428156	Ø 280 28 25 V + S
2.2 TDCi	85	10/08→08/14	←	→ 04/14	24.0128-0157.1	428157	Ø 300 28 25 V + S
2.2 TDCi	92	10/11→08/14	←	Baumuster: 330/350; → 04/14	24.0128-0157.1	428157	Ø 300 28 25 V + S
2.2 TDCi	103	10/07→08/14	→	→ 04/14	24.0116-0216.1	416216	Ø 280 16 13 + ABS Ring
2.2 TDCi RWD	74	10/11→08/14	←	→ 04/14; mit Einfachbereifung	24.0128-0157.1	428157	Ø 300 28 25 V + S
2.2 TDCi RWD	92	10/11→08/14	←	→ 04/14	24.0128-0157.1	428157	Ø 300 28 25 V + S
2.4 TDCi 4x4	103	11/06→08/14	←	→ 04/14; mit Doppelbereifung	24.0128-0293.1	428293	Ø 300 28 24 V
3.2 TDCi	147	02/08→08/14	→	→ 04/14	24.0116-0126.1	416126	Ø 280 16 13
2.2 TDCi RWD	100	09/11→08/14	←	10/11→ 04/14; mit Einfachbereifung	24.0128-0157.1	428157	Ø 300 28 25 V + S
			←	10/11→ 04/14; mit Doppelbereifung	24.0128-0293.1	428293	Ø 300 28 24 V
			→	10/11→ 04/14	24.0116-0126.1	416126	Ø 280 16 13
2.4 TDCi	74	04/06→08/14	←	05/06→ 04/14; mit Einfachbereifung	24.0128-0157.1	428157	Ø 300 28 25 V + S
2.4 TDCi	85	04/06→08/14	←	→ 04/14	24.0128-0157.1	428157	Ø 300 28 25 V + S
2.4 TDCi	103	04/06→08/14	←	05/06→ 04/14; mit Doppelbereifung	24.0128-0293.1	428293	Ø 300 28 24 V
			→	05/06→ 04/14	24.0116-0126.1	416126	Ø 280 16 13
<b>FORD - TRANSIT Bus (FD_, FB_, FS_, FZ_, FC_) 01/00→05/06</b>							
 <b>Bremsbelagsatz, Scheibenbremse</b>							
2.0 DI (F_E_, F_F_, F_G_)	55	08/00→05/06	←	→ 04/06; Baumuster: 260/280/300	13.0460-3992.2	603992	BOS 23434 18,7 + WK
2.0 DI (F_E_, F_F_, F_G_)	63	08/00→05/06	←	→ 04/06; Baumuster: 330/350	13.0460-3993.2	603993	BOS 23577 18,7 + WK
2.0 DI (F_E_, F_F_, F_G_)	74	08/00→05/06					
2.0 TDCi (F_F_, F_E_, F_G_)	92	08/02→05/06					
2.3	107	08/00→03/06	←		13.0460-3993.2	603993	BOS 23577 18,7 + WK
2.3 16V RWD (F_B_, F_C_, F_A_)	107	08/00→05/06	←	→ 04/06	13.0460-3993.2	603993	BOS 23577 18,7 + WK
2.4 DI (F_B_, F_C_, F_A_)	66	01/00→05/06					
2.4 DI RWD (F_B_, F_C_, F_A_)	88	01/00→05/06					



	kW				! #		
<b>FORD - TRANSIT Bus (FD_, FB_, FS_, FZ_, FC_) 01/00→05/06</b>							
 <b>Bremsbelagsatz, Scheibenbremse</b>							
2.4 DI RWD (F_B_, F_C_) 2.4 TDCi 2.4 TDE	55 101 85	01/00→05/06 03/04→05/06 03/04→05/06	←	→ 04/06		13.0460-3993.2 603993	BOS 23577 18,7 + WK
2.4 TDE (F_C_, F_B_, F_A_)	92	07/01→05/06	←	11/01→ 04/06		13.0460-3993.2 603993	BOS 23577 18,7 + WK
 <b>Bremsscheibe</b>							
2.0 DI (F_E_, F_F_, F_G_) 2.0 DI (F_E_, F_F_, F_G_) 2.0 DI (F_E_, F_F_, F_G_) 2.0 TDCi (F_F_, F_E_, F_G_)	55 63 74 92	08/00→05/06 08/00→05/06 08/00→05/06 08/02→05/06	←	→ 04/06; Baumuster: 260/280/300 → 04/06; Baumuster: 330/350		24.0124-0167.1 424167 24.0124-0168.1 424168	Ø 276 24,5 22,1 V Ø 294 24,5 22,1 V
2.3	107	08/00→03/06	←			24.0124-0168.1 424168	Ø 294 24,5 22,1 V
2.3 16V RWD (F_B_, F_C_, F_A_) 2.4 DI (F_B_, F_C_, F_A_) 2.4 DI RWD (F_B_, F_C_, F_A_) 2.4 DI RWD (F_B_, F_C_) 2.4 TDCi 2.4 TDE	107 66 88 55 101 85	08/00→05/06 01/00→05/06 01/00→05/06 01/00→05/06 03/04→05/06 03/04→05/06	←	→ 04/06		24.0124-0168.1 424168	Ø 294 24,5 22,1 V
2.4 TDE (F_C_, F_B_, F_A_)	92	07/01→05/06	←	11/01→ 04/06		24.0124-0168.1 424168	Ø 294 24,5 22,1 V
<b>FORD - TRANSIT CONNECT (P65_, P70_, P80_) 06/02→</b>							
 <b>Bremsbelagsatz, Scheibenbremse</b>							
1.8 16V 1.8 16V LPG 1.8 Di 1.8 TDCi 1.8 TDCi	85 85 55 66 81	06/02→12/13 06/02→12/13 06/02→12/13 06/02→12/13 08/06→12/13	←	→ 08/13		13.0460-7186.2 607186 13.0460-7160.2 607160 13.0460-7194.2 607194 13.0470-7194.2 LD7194	ATE 23440 17,6 - WE / - WK ATE 23482 15,8 - WE / - WK ATE 23482 16,6 - WE / - WK ATE 23482 16,6 - WE / - WK Ceramic
 <b>Bremsscheibe</b>							
1.8 16V 1.8 16V LPG 1.8 Di 1.8 TDCi 1.8 TDCi	85 85 55 66 81	06/02→12/13 06/02→12/13 06/02→12/13 06/02→12/13 08/06→12/13	←	→ 08/13		24.0124-0179.1 424179 24.0111-0154.1 411154	Ø 278 24 22 V Ø 278 11 9
<b>FORD - TRANSIT CONNECT Kasten 02/13→</b>							
 <b>Bremsbelagsatz, Scheibenbremse</b>							
1.0 EcoBoost 1.6 TDCi 1.6 TDCi 1.6 TDCi	74 55 70 85	02/13→ 02/13→ 02/13→ 02/13→	←	09/13→; langer Radstand; nicht für erhöhte Nutzlast		13.0460-7193.2 607193 13.0470-7193.2 LD7193	ATE 23723 18,1 - WE / - WK ATE 23723 18,1 - WE / - WK Ceramic
			←	09/13→; kurzer Radstand		13.0460-7193.2 607193 13.0470-7193.2 LD7193	ATE 23723 18,1 - WE / - WK ATE 23723 18,1 - WE / - WK Ceramic
			←	09/13→; langer Radstand; für erhöhte Nutzlast		13.0470-7299.2 LD7299	ATE 25736 18,4 - WE / - WK Ceramic
			→	09/13→		13.0460-7195.2 607195 13.0470-7195.2 LD7195	ATE 23482 16,6 - WE / - WK ATE 23482 16,6 - WE / - WK Ceramic
1.5 TDCi 1.5 TDCi 1.5 TDCi 1.6 EcoBoost	55 74 88 110	08/15→ 05/15→ 05/15→ 11/13→	←	kurzer Radstand		13.0460-7193.2 607193 13.0470-7193.2 LD7193	ATE 23723 18,1 - WE / - WK ATE 23723 18,1 - WE / - WK Ceramic
			←	langer Radstand; nicht für erhöhte Nutzlast		13.0460-7193.2 607193 13.0470-7193.2 LD7193	ATE 23723 18,1 - WE / - WK ATE 23723 18,1 - WE / - WK Ceramic
			←	langer Radstand; für erhöhte Nutzlast		13.0470-7299.2 LD7299	ATE 25736 18,4 - WE / - WK Ceramic
			→			13.0460-7195.2 607195 13.0470-7195.2 LD7195	ATE 23482 16,6 - WE / - WK ATE 23482 16,6 - WE / - WK Ceramic
↓							

	kw			 	! #		
<b>FORD - TRANSIT CONNECT Kasten 02/13→</b>							
 <b>Bremsscheibe</b>							
1.0 EcoBoost	74	02/13→	←	09/13→; nicht für Taxifahrzeuge; für Leichtmetallfelgen; nicht für erhöhte Nutzlast	24.0125-0162.1	425162	Ø 300 25 23 V
1.6 TDCi	55	02/13→			24.0325-0162.1	525162	Ø 300 25 23 V
1.6 TDCi	70	02/13→	←	09/13→; nicht für Taxifahrzeuge; für Stahlfelgen; nicht für erhöhte Nutzlast	24.0125-0202.1	425202	Ø 300 25 23 V
1.6 TDCi	85	02/13→	←	09/13→; nicht für Taxifahrzeuge; für erhöhte Nutzlast	24.0125-0209.1	425209	Ø 320 25 23 V
			→	09/13→	24.0111-0172.1	411172	Ø 280 11 9
1.5 TDCi	55	08/15→	←	nicht für Taxifahrzeuge; für Leichtmetallfelgen; nicht für erhöhte Nutzlast	24.0125-0162.1	425162	Ø 300 25 23 V
1.5 TDCi	74	05/15→			24.0325-0162.1	525162	Ø 300 25 23 V
1.5 TDCi	88	05/15→	←	nicht für Taxifahrzeuge; für Stahlfelgen; nicht für erhöhte Nutzlast	24.0125-0202.1	425202	Ø 300 25 23 V
1.6 EcoBoost	110	11/13→	←	nicht für Taxifahrzeuge; für erhöhte Nutzlast	24.0125-0209.1	425209	Ø 320 25 23 V
			→		24.0111-0172.1	411172	Ø 280 11 9
<b>FORD - TRANSIT CONNECT Kombi 02/13→</b>							
 <b>Bremsbelagsatz, Scheibenbremse</b>							
1.5 TDCi	55	08/15→	←	kurzer Radstand	13.0460-7193.2	607193	ATE 23723 18,1 - WE / - WK
1.5 TDCi	74	05/15→			13.0470-7193.2	LD7193	ATE 23723 18,1 - WE / - WK Ceramic
1.5 TDCi	88	05/15→	←	langer Radstand; nicht für erhöhte Nutzlast	13.0460-7193.2	607193	ATE 23723 18,1 - WE / - WK
					13.0470-7193.2	LD7193	ATE 23723 18,1 - WE / - WK Ceramic
			←	langer Radstand; für erhöhte Nutzlast	13.0470-7299.2	LD7299	ATE 25736 18,4 - WE / - WK Ceramic
			→		13.0460-7195.2	607195	ATE 23482 16,6 - WE / - WK
					13.0470-7195.2	LD7195	ATE 23482 16,6 - WE / - WK Ceramic
1.6 TDCi	55	02/13→	←	09/13→; langer Radstand; nicht für erhöhte Nutzlast	13.0460-7193.2	607193	ATE 23723 18,1 - WE / - WK
1.6 TDCi	70	02/13→			13.0470-7193.2	LD7193	ATE 23723 18,1 - WE / - WK Ceramic
1.6 TDCi	85	02/13→	←	09/13→; kurzer Radstand	13.0460-7193.2	607193	ATE 23723 18,1 - WE / - WK
					13.0470-7193.2	LD7193	ATE 23723 18,1 - WE / - WK Ceramic
			←	09/13→; langer Radstand; für erhöhte Nutzlast	13.0470-7299.2	LD7299	ATE 25736 18,4 - WE / - WK Ceramic
			→	09/13→	13.0460-7195.2	607195	ATE 23482 16,6 - WE / - WK
					13.0470-7195.2	LD7195	ATE 23482 16,6 - WE / - WK Ceramic
 <b>Bremsscheibe</b>							
1.5 TDCi	55	08/15→	←	nicht für Taxifahrzeuge; für Leichtmetallfelgen; nicht für erhöhte Nutzlast	24.0125-0162.1	425162	Ø 300 25 23 V
1.5 TDCi	74	05/15→			24.0325-0162.1	525162	Ø 300 25 23 V
1.5 TDCi	88	05/15→	←	nicht für Taxifahrzeuge; für Stahlfelgen; nicht für erhöhte Nutzlast	24.0125-0202.1	425202	Ø 300 25 23 V
			←	nicht für Taxifahrzeuge; für erhöhte Nutzlast	24.0125-0209.1	425209	Ø 320 25 23 V
			→		24.0111-0172.1	411172	Ø 280 11 9
1.6 TDCi	55	02/13→	←	09/13→; nicht für Taxifahrzeuge; für Leichtmetallfelgen; nicht für erhöhte Nutzlast	24.0125-0162.1	425162	Ø 300 25 23 V
1.6 TDCi	70	02/13→			24.0325-0162.1	525162	Ø 300 25 23 V
1.6 TDCi	85	02/13→	←	09/13→; nicht für Taxifahrzeuge; für Stahlfelgen; nicht für erhöhte Nutzlast	24.0125-0202.1	425202	Ø 300 25 23 V
			←	09/13→; nicht für Taxifahrzeuge; für erhöhte Nutzlast	24.0125-0209.1	425209	Ø 320 25 23 V
			→	09/13→	24.0111-0172.1	411172	Ø 280 11 9
<b>FORD - TRANSIT COURIER Kasten 02/14→</b>							
 <b>Bremsbelagsatz, Scheibenbremse</b>							
1.0 EcoBoost	74	02/14→	←		13.0460-2784.2	602784	TRW 25134 17,2 - WE / - WK + Zub
1.5 TDCi	55	02/14→					
1.5 TDCi	70	05/15→			13.0470-2784.2	LD2784	TRW 25134 17,2 - WE / - WK + Zub Ceramic
1.6 TDCi	70	02/14→					
 <b>Bremsscheibe</b>							
1.0 EcoBoost	74	02/14→	←	für Leichtmetallfelgen	24.0123-0122.1	423122	Ø 278 23 21 V

	kw					! #			
<b>FORD - TRANSIT COURIER Kasten 02/14→</b>									
 <b>Bremsscheibe</b>									
1.5 TDCi	55	02/14→	←	für Leichtmetallfelgen		24.0123-0122.1	423122	Ø 278 23 21 V	
1.5 TDCi	70	05/15→							
1.6 TDCi	70	02/14→							
<b>FORD - TRANSIT COURIER Kombi 02/14→</b>									
 <b>Bremsbelagsatz, Scheibenbremse</b>									
1.0 EcoBoost	74	02/14→	←			13.0460-2784.2	602784	TRW 25134 17,2 - WE / - WK + Zub	
1.5 TDCi	55	02/14→							
1.5 TDCi	70	05/15→							
1.6 TDCi	70	02/14→				13.0470-2784.2	LD2784	TRW 25134 17,2 - WE / - WK + Zub Ceramic	
 <b>Bremsscheibe</b>									
1.0 EcoBoost	74	02/14→	←	für Leichtmetallfelgen		24.0123-0122.1	423122	Ø 278 23 21 V	
1.5 TDCi	55	02/14→							
1.5 TDCi	70	05/15→							
1.6 TDCi	70	02/14→							
<b>FORD - TRANSIT CUSTOM Bus 04/12→</b>									
<b>Warnkontakt, Bremsbelagverschleiß</b>									
2.0 TDCi	77	12/15→	←	nicht für Baumuster: 330		1	24.8190-0021.2	620021	L= 478
2.0 TDCi	96	12/15→	←	Baumuster: 330		1	24.8190-0026.2	620026	L= 312
2.0 TDCi	125	12/15→	→			2	24.8190-0021.2	620021	L= 478
2.2 TDCi	74	04/12→	←	05/12→; nicht für Baumuster: 330		1	24.8190-0021.2	620021	L= 478
2.2 TDCi	92	04/12→	←	05/12→; Baumuster: 330		1	24.8190-0026.2	620026	L= 312
2.2 TDCi	114	04/12→	→	05/12→		2	24.8190-0021.2	620021	L= 478
 <b>Bremsscheibe</b>									
2.2 TDCi	74	04/12→	←	05/12→; nicht für Baumuster: 330 / 290S Sport		24.0133-0101.1	433101	Ø 288 33 30 V + S	
2.2 TDCi	92	04/12→	←	05/12→ 04/16; Baumuster: 290S Sport		24.0133-0102.1	433102	Ø 308 33 30 V + S	
2.2 TDCi	114	04/12→	←	05/12→; Baumuster: 330		24.0133-0102.1	433102	Ø 308 33 30 V + S	
<b>FORD - TRANSIT CUSTOM Kasten 04/12→</b>									
<b>Warnkontakt, Bremsbelagverschleiß</b>									
2.0 TDCi	77	12/15→	←	nicht für Baumuster: 330		1	24.8190-0021.2	620021	L= 478
2.0 TDCi	96	12/15→	←	Baumuster: 330		1	24.8190-0026.2	620026	L= 312
2.0 TDCi	125	12/15→	→			2	24.8190-0021.2	620021	L= 478
2.2 TDCi	74	04/12→	←	05/12→; nicht für Baumuster: 330		1	24.8190-0021.2	620021	L= 478
2.2 TDCi	92	04/12→	←	05/12→; Baumuster: 330		1	24.8190-0026.2	620026	L= 312
2.2 TDCi	114	04/12→	→	05/12→		2	24.8190-0021.2	620021	L= 478
 <b>Bremsscheibe</b>									
2.2 TDCi	74	04/12→	←	05/12→; nicht für Baumuster: 330 / 290S Sport		24.0133-0101.1	433101	Ø 288 33 30 V + S	
2.2 TDCi	92	04/12→	←	05/12→ 04/16; Baumuster: 290S Sport		24.0133-0102.1	433102	Ø 308 33 30 V + S	
2.2 TDCi	114	04/12→	←	05/12→; Baumuster: 330		24.0133-0102.1	433102	Ø 308 33 30 V + S	
<b>FORD - TRANSIT Kasten 08/13→</b>									
<b>Warnkontakt, Bremsbelagverschleiß</b>									
2.0 TDCi	77	03/16→	←			2	24.8190-0026.2	620026	L= 312
2.0 TDCi	96	03/16→							
2.0 TDCi	125	03/16→							
2.0 TDCi 4x4	96	01/17→							
2.0 TDCi 4x4	125	01/17→							
2.0 TDCi RWD	77	03/16→							
2.0 TDCi RWD	96	03/16→							
2.0 TDCi RWD	125	03/16→							
2.2 TDCi	74	08/13→	←	05/14→		2	24.8190-0026.2	620026	L= 312
2.2 TDCi	92	08/13→							
2.2 TDCi	114	08/13→							
2.2 TDCi 4x4	92	08/13→							
2.2 TDCi 4x4	114	08/13→							
2.2 TDCi RWD	74	08/13→							
2.2 TDCi RWD	92	08/13→							
2.2 TDCi RWD	114	08/13→							

	kw					! #		
<b>FORD - TRANSIT Kasten 08/13→</b>								
 <b>Bremsscheibe</b>								
2.0 TDCi	77	03/16→	←	für Doppelbereifung		24.0131-0100.1	431100	Ø 308 31 28 V
2.0 TDCi	96	03/16→	←	Baumuster: 10/60/70/80/90/250 / 300; für Einfachbereifung		24.0133-0101.1	433101	Ø 288 33 30 V + S
2.0 TDCi	125	03/16→	←	Baumuster: 330/350/390/410/470; für Einfachbereifung		24.0133-0102.1	433102	Ø 308 33 30 V + S
2.0 TDCi 4x4	96	01/17→	←					
2.0 TDCi 4x4	125	01/17→	←					
2.0 TDCi RWD	77	03/16→	←					
2.0 TDCi RWD	96	03/16→	←					
2.0 TDCi RWD	125	03/16→	←					
2.2 TDCi	74	08/13→	←	05/14→; für Doppelbereifung		24.0131-0100.1	431100	Ø 308 31 28 V
2.2 TDCi	92	08/13→	←	05/14→;		24.0133-0101.1	433101	Ø 288 33 30 V + S
2.2 TDCi	114	08/13→	←	Baumuster: 10/60/70/80/90/250 / 300; für Einfachbereifung		24.0133-0102.1	433102	Ø 308 33 30 V + S
2.2 TDCi 4x4	92	08/13→	←					
2.2 TDCi 4x4	114	08/13→	←					
2.2 TDCi RWD	74	08/13→	←	05/14→;		24.0133-0102.1	433102	Ø 308 33 30 V + S
2.2 TDCi RWD	92	08/13→	←	Baumuster: 330/350/390/410/470; für Einfachbereifung				
2.2 TDCi RWD	114	08/13→	←					
<b>FORD - TRANSIT Kasten (E_ ) 06/94→07/00</b>								
 <b>Bremsbelagsatz, Scheibenbremse</b>								
2.0 (EAL, EAS)	84	06/94→03/00	←	passend für Felgengröße [Zoll]: 15		13.0460-3959.2	603959	BDX 21469 18,0 + WE / - WK
2.5 DI (EAL, EAS)	51	06/94→03/00	←	passend für Felgengröße [Zoll]: 14		13.0460-3960.2	603960	BDX 21470 18,0 + WE / - WK
2.5 DI (EAL, EAS)	56	06/94→03/00	←					
2.5 DI (EAL, EAS)	85	05/99→03/00	←					
2.5 TD (EAL, EAS)	63	06/94→03/00	←					
2.5 TD (EAS)	56	10/98→03/00	←					
2.5 TDI (EAL, EAS)	74	06/94→03/00	←					
<b>Zubehörsatz, Scheibenbremsbelag</b>								
2.0 (EAL, EAS)	84	06/94→03/00	←	passend für Felgengröße [Zoll]: 14		13.0460-0427.2	610427	BDX
2.5 DI (EAL, EAS)	51	06/94→03/00	←	passend für Felgengröße [Zoll]: 15		13.0460-0427.2	610427	BDX
2.5 DI (EAL, EAS)	56	06/94→03/00	←					
2.5 DI (EAL, EAS)	85	05/99→03/00	←					
2.5 TD (EAL, EAS)	63	06/94→03/00	←					
2.5 TD (EAS)	56	10/98→03/00	←					
2.5 TDI (EAL, EAS)	74	06/94→03/00	←					
 <b>Bremsscheibe</b>								
2.0 (EAL, EAS)	84	06/94→03/00	←	passend für Felgengröße [Zoll]: 14		24.0124-0131.1	424131	Ø 254 24,2 22,2 V
2.5 DI (EAL, EAS)	51	06/94→03/00	←	passend für Felgengröße [Zoll]: 15		24.0124-0132.1	424132	Ø 270 24,2 22,2 V
2.5 DI (EAL, EAS)	56	06/94→03/00	←					
2.5 DI (EAL, EAS)	85	05/99→03/00	←					
2.5 TD (EAL, EAS)	63	06/94→03/00	←					
2.5 TD (EAS)	56	10/98→03/00	←					
2.5 TDI (EAL, EAS)	74	06/94→03/00	←					
<b>FORD - TRANSIT Kasten (FA_ ) 04/06→</b>								
 <b>Bremsbelagsatz, Scheibenbremse</b>								
2.2 TDCi	63	04/06→08/14	←	05/06→; Baumuster: 260/280/300; → 04/14		13.0460-3833.2	603833	BOS 24485 19,0 + WK + Zub
2.2 TDCi	81	04/06→08/14	←	05/06→; Baumuster: 330/350; → 04/14		13.0460-3834.2	603834	BOS 24484 19,0 + WK + Zub
2.2 TDCi	96	04/06→08/14	←	05/06→ 04/14; für Einfachbereifung		13.0460-3835.2	603835	BOS 24486 17,9 + WK + Zub
2.2 TDCi	74	10/11→08/14	←	Baumuster: 260/280/300; → 04/14		13.0460-3833.2	603833	BOS 24485 19,0 + WK + Zub
2.2 TDCi	85	10/08→08/14	←	Baumuster: 330/350; → 04/14		13.0460-3834.2	603834	BOS 24484 19,0 + WK + Zub
2.2 TDCi	92	10/11→08/14	←	→ 04/14; für Einfachbereifung		13.0460-3835.2	603835	BOS 24486 17,9 + WK + Zub
2.2 TDCi	103	10/07→08/14	←					
2.2 TDCi 4x4	92	10/11→08/14	←	→ 04/14		13.0460-3834.2	603834	BOS 24484 19,0 + WK + Zub
2.2 TDCi RWD	74	10/11→08/14	←	→ 04/14; für Einfachbereifung		13.0460-3835.2	603835	BOS 24486 17,9 + WK + Zub
2.2 TDCi RWD	92	10/11→08/14	←					
2.2 TDCi RWD	100	10/11→08/14	←					
2.2 TDCi RWD	114	10/11→08/14	←					
2.4 TDCi 4x4	103	11/06→08/14	←					
3.2 TDCi RWD	147	09/07→08/14	←					
2.3 16V CNG RWD	100	04/06→08/14	←	05/06→ 04/14		13.0460-3834.2	603834	BOS 24484 19,0 + WK + Zub
2.3 16V LPG RWD	107	04/06→08/14	←	05/06→ 04/14; für Einfachbereifung		13.0460-3835.2	603835	BOS 24486 17,9 + WK + Zub
2.3 16V RWD	107	04/06→08/14	←	05/06→ 04/14; für Doppelbereifung		13.0460-4862.2	604862	BRE 29123 20,3 + WK + Zub
2.4 TDCi RWD	74	04/06→08/14	←	05/06→ 04/14		13.0460-3834.2	603834	BOS 24484 19,0 + WK + Zub
2.4 TDCi RWD	85	04/06→08/14	←	05/06→ 04/14; für Einfachbereifung		13.0460-3835.2	603835	BOS 24486 17,9 + WK + Zub
2.4 TDCi RWD	103	04/06→08/14	←					
 <b>Bremsscheibe</b>								
2.2 TDCi	63	04/06→08/14	←	05/06→; Baumuster: 260/280/300; → 04/14		24.0128-0156.1	428156	Ø 280 28 25 V + S
2.2 TDCi	81	04/06→08/14	←	05/06→; Baumuster: 330/350; → 04/14		24.0128-0157.1	428157	Ø 300 28 25 V + S
2.2 TDCi	96	04/06→08/14	←	05/06→ 04/14		24.0116-0216.1	416216	Ø 280 16 13 + ABS Ring
↓								

**FORD - TRANSIT Kasten (FA\_ ) 04/06→**

**Bremsscheibe**

2.2 TDCi	74	10/11→08/14	←	Baumuster: 260/280/300; → 04/14	24.0128-0156.1	428156	Ø 280 28 25 V + S
2.2 TDCi	85	10/08→08/14	←	Baumuster: 330/350; → 04/14	24.0128-0157.1	428157	Ø 300 28 25 V + S
2.2 TDCi	92	10/11→08/14	←	→ 04/14	24.0116-0216.1	416216	Ø 280 16 13 + ABS Ring
2.2 TDCi	103	10/07→08/14	→	→ 04/14	24.0116-0216.1	416216	Ø 280 16 13 + ABS Ring
2.2 TDCi 4x4	92	10/11→08/14	←	→ 04/14; mit Einfachbereifung	24.0128-0157.1	428157	Ø 300 28 25 V + S
2.2 TDCi RWD	74	10/11→08/14	←	→ 04/14; mit Doppelbereifung	24.0128-0293.1	428293	Ø 300 28 24 V
2.2 TDCi RWD	92	10/11→08/14	←	→ 04/14	24.0116-0126.1	416126	Ø 280 16 13
2.2 TDCi RWD	100	10/11→08/14	→	→ 04/14	24.0116-0126.1	416126	Ø 280 16 13
2.2 TDCi RWD	114	10/11→08/14	→	→ 04/14	24.0116-0126.1	416126	Ø 280 16 13
2.4 TDCi 4x4	103	11/06→08/14	→	→ 04/14	24.0116-0126.1	416126	Ø 280 16 13
3.2 TDCi RWD	147	09/07→08/14	→	→ 04/14	24.0116-0126.1	416126	Ø 280 16 13
2.3 16V CNG RWD	100	04/06→08/14	←	05/06→ 04/14	24.0128-0293.1	428293	Ø 300 28 24 V
2.3 16V LPG RWD	107	04/06→08/14	→	05/06→; mit Einfachbereifung; → 04/14	24.0116-0126.1	416126	Ø 280 16 13
2.3 16V RWD	107	04/06→08/14	→	11/07→; mit Doppelbereifung; → 04/14	24.0116-0134.1	416134	Ø 284 16 13
2.4 TDCi RWD	74	04/06→08/14	←	05/06→ 04/14; mit Einfachbereifung	24.0128-0157.1	428157	Ø 300 28 25 V + S
2.4 TDCi RWD	85	04/06→08/14	←	05/06→ 04/14; mit Doppelbereifung	24.0128-0293.1	428293	Ø 300 28 24 V
2.4 TDCi RWD	103	04/06→08/14	←	05/06→ 04/14	24.0116-0126.1	416126	Ø 280 16 13

**FORD - TRANSIT Kasten (FA\_ ) 01/00→05/06**

**Bremsbelagsatz, Scheibenbremse**

2.0 DI (FAE_, FAF_, FAG_)	55	08/00→05/06	←	→ 04/06; Baumuster: 260/280/300	13.0460-3992.2	603992	BOS 23434 18,7 + WK
2.0 DI (FAE_, FAF_, FAG_)	63	08/00→05/06	←	→ 04/06; Baumuster: 330/350	13.0460-3993.2	603993	BOS 23577 18,7 + WK
2.0 DI (FAE_, FAF_, FAG_)	74	08/00→05/06	←	→ 04/06; Baumuster: 330/350	13.0460-3993.2	603993	BOS 23577 18,7 + WK
2.0 TDCi	92	08/02→05/06	←	→ 04/06; Baumuster: 330/350	13.0460-3993.2	603993	BOS 23577 18,7 + WK
2.3	105	03/01→03/06	←	04/01→; Baumuster: 260/280/300	13.0460-3992.2	603992	BOS 23434 18,7 + WK
2.3	107	03/01→03/06	←	04/01→; Baumuster: 330/350	13.0460-3993.2	603993	BOS 23577 18,7 + WK
2.3 BiFuel	105	03/01→03/06	←	04/01→; Baumuster: 330/350	13.0460-3993.2	603993	BOS 23577 18,7 + WK
2.3 16V RWD (FAA_, FAB_, FAC_)	107	04/01→05/06	←	→ 04/06	13.0460-3993.2	603993	BOS 23577 18,7 + WK
2.4 DI (FAA_, FAB_, FAC_, FAD_)	66	01/00→05/06	←	→ 04/06	13.0460-3993.2	603993	BOS 23577 18,7 + WK
2.4 DI RWD (FAA_, FAB_, FAC_, FAD_)	55	01/00→05/06	←	→ 04/06	13.0460-3993.2	603993	BOS 23577 18,7 + WK
2.4 DI RWD (FAA_, FAB_, FAC_, FAD_)	88	01/00→05/06	←	→ 04/06	13.0460-3993.2	603993	BOS 23577 18,7 + WK
2.4 TDCi	101	03/04→05/06	←	→ 04/06; Baumuster: 260/280/300	13.0460-3992.2	603992	BOS 23434 18,7 + WK
2.4 TDE	85	03/04→05/06	←	→ 04/06	13.0460-3993.2	603993	BOS 23577 18,7 + WK
			←	→ 04/06; Baumuster: 330/350	13.0460-3993.2	603993	BOS 23577 18,7 + WK
2.4 TDE	92	07/01→05/06	←	11/01→ 04/06; Baumuster: 260/280/300	13.0460-3992.2	603992	BOS 23434 18,7 + WK
			←	11/01→ 04/06	13.0460-3993.2	603993	BOS 23577 18,7 + WK
			←	11/01→ 04/06; Baumuster: 330/350	13.0460-3993.2	603993	BOS 23577 18,7 + WK

**Bremsscheibe**

2.0 DI (FAE_, FAF_, FAG_)	55	08/00→05/06	←	→ 04/06; Baumuster: 260/280/300	24.0124-0167.1	424167	Ø 276 24,5 22,1 V
2.0 DI (FAE_, FAF_, FAG_)	63	08/00→05/06	←	→ 04/06; Baumuster: 330/350	24.0124-0168.1	424168	Ø 294 24,5 22,1 V
2.0 DI (FAE_, FAF_, FAG_)	74	08/00→05/06	←	→ 04/06; Baumuster: 330/350	24.0124-0168.1	424168	Ø 294 24,5 22,1 V
2.0 TDCi	92	08/02→05/06	←	→ 04/06; Baumuster: 330/350	24.0124-0168.1	424168	Ø 294 24,5 22,1 V
2.3	105	03/01→03/06	←	04/01→; Baumuster: 260/280/300	24.0124-0167.1	424167	Ø 276 24,5 22,1 V
2.3	107	03/01→03/06	←	04/01→; Baumuster: 330/350	24.0124-0168.1	424168	Ø 294 24,5 22,1 V
2.3 BiFuel	105	03/01→03/06	←	04/01→; Baumuster: 330/350	24.0124-0168.1	424168	Ø 294 24,5 22,1 V
2.3 16V RWD (FAA_, FAB_, FAC_)	107	04/01→05/06	←	→ 04/06	24.0124-0168.1	424168	Ø 294 24,5 22,1 V
2.4 DI (FAA_, FAB_, FAC_, FAD_)	66	01/00→05/06	←	→ 04/06	24.0124-0168.1	424168	Ø 294 24,5 22,1 V
2.4 DI RWD (FAA_, FAB_, FAC_, FAD_)	55	01/00→05/06	←	→ 04/06	24.0124-0168.1	424168	Ø 294 24,5 22,1 V
2.4 DI RWD (FAA_, FAB_, FAC_, FAD_)	88	01/00→05/06	←	→ 04/06	24.0124-0168.1	424168	Ø 294 24,5 22,1 V
2.4 TDCi	101	03/04→05/06	←	→ 04/06; Baumuster: 260/280/300	24.0124-0167.1	424167	Ø 276 24,5 22,1 V
2.4 TDE	85	03/04→05/06	←	→ 04/06	24.0124-0168.1	424168	Ø 294 24,5 22,1 V
			←	→ 04/06; Baumuster: 330/350	24.0124-0168.1	424168	Ø 294 24,5 22,1 V
2.4 TDE	92	07/01→05/06	←	11/01→ 04/06; Baumuster: 260/280/300	24.0124-0167.1	424167	Ø 276 24,5 22,1 V
			←	11/01→ 04/06	24.0124-0168.1	424168	Ø 294 24,5 22,1 V
			←	11/01→ 04/06; Baumuster: 330/350	24.0124-0168.1	424168	Ø 294 24,5 22,1 V



**FORD - TRANSIT Pritsche/Fahrgestell 08/13→**

**Warnkontakt, Bremsbelagverschleiß**

2.0 TDCi	77	03/16→	←		2	24.8190-0026.2	620026	L= 312
2.0 TDCi	96	03/16→						
2.0 TDCi	125	03/16→						
2.0 TDCi 4x4	96	01/17→						
2.0 TDCi 4x4	125	01/17→						
2.0 TDCi RWD	77	03/16→						
2.0 TDCi RWD	96	03/16→						
2.0 TDCi RWD	125	03/16→						
2.2 TDCi	74	08/13→	←	05/14→	2	24.8190-0026.2	620026	L= 312
2.2 TDCi	92	08/13→						
2.2 TDCi	114	08/13→						
2.2 TDCi 4x4	92	08/13→						
2.2 TDCi 4x4	114	08/13→						
2.2 TDCi RWD	74	08/13→						
2.2 TDCi RWD	92	08/13→						
2.2 TDCi RWD	99	08/13→						
2.2 TDCi RWD	114	08/13→						

**Bremsscheibe**

2.0 TDCi	77	03/16→	←	für Doppelbereifung		24.0131-0100.1	431100	Ø 308 31 28 V
2.0 TDCi	96	03/16→						
2.0 TDCi	125	03/16→	←	Baumuster: 10/60/70/80/90/250 / 300; für Einfachbereifung		24.0133-0101.1	433101	Ø 288 33 30 V + S
2.0 TDCi 4x4	96	01/17→						
2.0 TDCi 4x4	125	01/17→	←	Baumuster: 330/350/390/410/470; für Einfachbereifung		24.0133-0102.1	433102	Ø 308 33 30 V + S
2.0 TDCi RWD	77	03/16→						
2.0 TDCi RWD	96	03/16→						
2.0 TDCi RWD	125	03/16→						
2.2 TDCi	74	08/13→	←	05/14→; für Doppelbereifung		24.0131-0100.1	431100	Ø 308 31 28 V
2.2 TDCi	92	08/13→						
2.2 TDCi	114	08/13→	←	05/14→; Baumuster: 10/60/70/80/90/250 / 300; für Einfachbereifung		24.0133-0101.1	433101	Ø 288 33 30 V + S
2.2 TDCi 4x4	92	08/13→						
2.2 TDCi 4x4	114	08/13→						
2.2 TDCi RWD	74	08/13→	←	05/14→; Baumuster: 330/350/390/410/470; für Einfachbereifung		24.0133-0102.1	433102	Ø 308 33 30 V + S
2.2 TDCi RWD	92	08/13→						
2.2 TDCi RWD	99	08/13→						
2.2 TDCi RWD	114	08/13→						

**FORD - TRANSIT Pritsche/Fahrgestell (E\_ ) 08/94→07/00**

**Bremsbelagsatz, Scheibenbremse**











2.0 (EME/L/S, ENE/L/S)	84	08/94→03/00	←	passend für Felgengröße [Zoll]: 15		13.0460-3959.2	603959	BDX 21469 18,0 + WE / - WK
2.5 DI (EME/L/S, ENE/L/S)	56	08/94→03/00	←	passend für Felgengröße [Zoll]: 14		13.0460-3960.2	603960	BDX 21470 18,0 + WE / - WK
2.5 DI (EML, ENE/L)	85	05/99→03/00						
2.5 DI (EML/S, ENL/S)	51	08/94→03/00						
2.5 TD (EME/L/S, ENE/L/S)	63	08/94→03/00						
2.5 TD (EME/L/S, ENE/L/S)	74	08/94→03/00						
2.5 TD (EME/L/S, ENE/L/S)	55	10/98→07/00	←	→ 03/00; passend für Felgengröße [Zoll]: 15		13.0460-3959.2	603959	BDX 21469 18,0 + WE / - WK
			←	→ 03/00; passend für Felgengröße [Zoll]: 14		13.0460-3960.2	603960	BDX 21470 18,0 + WE / - WK

**Zubehörsatz, Scheibenbremsbelag**













2.0 (EME/L/S, ENE/L/S)	84	08/94→03/00	←	passend für Felgengröße [Zoll]: 14		13.0460-0427.2	610427	BDX
2.5 DI (EME/L/S, ENE/L/S)	56	08/94→03/00	←	passend für Felgengröße [Zoll]: 15		13.0460-0427.2	610427	BDX
2.5 DI (EML, ENE/L)	85	05/99→03/00						
2.5 DI (EML/S, ENL/S)	51	08/94→03/00						
2.5 TD (EME/L/S, ENE/L/S)	63	08/94→03/00						
2.5 TD (EME/L/S, ENE/L/S)	74	08/94→03/00						
2.5 TD (EME/L/S, ENE/L/S)	55	10/98→07/00	←	→ 03/00; passend für Felgengröße [Zoll]: 14		13.0460-0427.2	610427	BDX
			←	→ 03/00; passend für Felgengröße [Zoll]: 15		13.0460-0427.2	610427	BDX













**Bremsscheibe**













2.0 (EME/L/S, ENE/L/S)	84	08/94→03/00	←	passend für Felgengröße [Zoll]: 14		24.0124-0131.1	424131	Ø 254 24,2 22,2 V
2.5 DI (EME/L/S, ENE/L/S)	56	08/94→03/00	←	passend für Felgengröße [Zoll]: 15		24.0124-0132.1	424132	Ø 270 24,2 22,2 V
2.5 DI (EML, ENE/L)	85	05/99→03/00						
2.5 DI (EML/S, ENL/S)	51	08/94→03/00						
2.5 TD (EME/L/S, ENE/L/S)	63	08/94→03/00						
2.5 TD (EME/L/S, ENE/L/S)	74	08/94→03/00						
2.5 TD (EME/L/S, ENE/L/S)	55	10/98→07/00	←	→ 03/00; passend für Felgengröße [Zoll]: 14		24.0124-0131.1	424131	Ø 254 24,2 22,2 V

	kw					! #		
<b>FORD - TRANSIT Pritsche/Fahrgestell (E_ _) 08/94→07/00</b>								
 <b>Bremsscheibe</b>								
2.5 TD (EME/L/S, ENE/L/S)	55	10/98→07/00	←	→ 03/00; passend für Felgenreiße [Zoll]: 15			24.0124-0132.1 424132	Ø 270 24,2 22,2 V
<b>FORD - TRANSIT Pritsche/Fahrgestell (FM_ _, FN_ _) 04/06→08/14</b>								
 <b>Bremsbelagsatz, Scheibenbremse</b>								
2.2 TDCi	63	04/06→08/14	←	05/06→; Baumuster: 260/280/300; → 04/14			13.0460-3833.2 603833	BOS 24485 19,0 + WK + Zub
2.2 TDCi	81	04/06→08/14	←	05/06→; Baumuster: 330/350; → 04/14			13.0460-3834.2 603834	BOS 24484 19,0 + WK + Zub
2.2 TDCi	96	04/06→08/14	→	05/06→ 04/14; für Einfachbereifung			13.0460-3835.2 603835	BOS 24486 17,9 + WK + Zub
2.2 TDCi	74	10/11→08/14	←	Baumuster: 260/280/300; → 04/14			13.0460-3833.2 603833	BOS 24485 19,0 + WK + Zub
2.2 TDCi	85	10/08→08/14	←	Baumuster: 330/350; → 04/14			13.0460-3834.2 603834	BOS 24484 19,0 + WK + Zub
2.2 TDCi	92	10/11→08/14	→	→ 04/14; für Einfachbereifung			13.0460-3835.2 603835	BOS 24486 17,9 + WK + Zub
2.2 TDCi	103	10/07→09/11	←	Baumuster: 260/280/300			13.0460-3833.2 603833	BOS 24485 19,0 + WK + Zub
			←	Baumuster: 330/350			13.0460-3834.2 603834	BOS 24484 19,0 + WK + Zub
			→	für Einfachbereifung			13.0460-3835.2 603835	BOS 24486 17,9 + WK + Zub
2.2 TDCi 4x4	92	10/11→08/14	←	→ 04/14			13.0460-3834.2 603834	BOS 24484 19,0 + WK + Zub
2.2 TDCi RWD	74	10/11→08/14	→	→ 04/14; für Einfachbereifung			13.0460-3835.2 603835	BOS 24486 17,9 + WK + Zub
2.2 TDCi RWD	92	10/11→08/14	→	→ 04/14; für Einfachbereifung			13.0460-3835.2 603835	BOS 24486 17,9 + WK + Zub
2.2 TDCi RWD	114	10/11→08/14	→	→ 04/14				
2.4 TDCi 4x4	103	11/06→08/14	→	→ 04/14				
3.2 TDCi RWD	147	09/07→08/14	→	→ 04/14				
2.3 16V CNG RWD	100	04/06→08/14	←	05/06→ 04/14			13.0460-3834.2 603834	BOS 24484 19,0 + WK + Zub
2.3 16V LPG RWD	107	04/06→08/14	→	05/06→ 04/14; für Einfachbereifung			13.0460-3835.2 603835	BOS 24486 17,9 + WK + Zub
2.3 16V RWD	107	04/06→08/14	→	05/06→ 04/14; für Doppelbereifung			13.0460-4862.2 604862	BRE 29123 20,3 + WK + Zub
2.4 TDCi RWD	74	04/06→08/14	←	05/06→ 04/14			13.0460-3834.2 603834	BOS 24484 19,0 + WK + Zub
2.4 TDCi RWD	85	04/06→08/14	←	05/06→ 04/14			13.0460-3834.2 603834	BOS 24484 19,0 + WK + Zub
2.4 TDCi RWD	103	04/06→08/14	→	05/06→ 04/14; für Einfachbereifung			13.0460-3835.2 603835	BOS 24486 17,9 + WK + Zub
 <b>Bremsscheibe</b>								
2.2 TDCi	63	04/06→08/14	←	05/06→; Baumuster: 260/280/300; → 04/14			24.0128-0156.1 428156	Ø 280 28 25 V + S
2.2 TDCi	81	04/06→08/14	←	05/06→; Baumuster: 330/350; → 04/14			24.0128-0157.1 428157	Ø 300 28 25 V + S
2.2 TDCi	96	04/06→08/14	→	05/06→ 04/14			24.0116-0216.1 416216	Ø 280 16 13 + ABS Ring
2.2 TDCi	74	10/11→08/14	←	Baumuster: 260/280/300; → 04/14			24.0128-0156.1 428156	Ø 280 28 25 V + S
2.2 TDCi	85	10/08→08/14	←	Baumuster: 330/350; → 04/14			24.0128-0157.1 428157	Ø 300 28 25 V + S
2.2 TDCi	92	10/11→08/14	→	→ 04/14			24.0116-0216.1 416216	Ø 280 16 13 + ABS Ring
2.2 TDCi	103	10/07→09/11	←	Baumuster: 260/280/300			24.0128-0156.1 428156	Ø 280 28 25 V + S
			←	Baumuster: 330/350			24.0128-0157.1 428157	Ø 300 28 25 V + S
			→				24.0116-0216.1 416216	Ø 280 16 13 + ABS Ring
2.2 TDCi 4x4	92	10/11→08/14	←	→ 04/14; mit Einfachbereifung			24.0128-0157.1 428157	Ø 300 28 25 V + S
2.2 TDCi RWD	74	10/11→08/14	←	→ 04/14; mit Doppelbereifung			24.0128-0293.1 428293	Ø 300 28 24 V
2.2 TDCi RWD	92	10/11→08/14	←	→ 04/14; mit Doppelbereifung			24.0128-0293.1 428293	Ø 300 28 24 V
2.2 TDCi RWD	114	10/11→08/14	→	→ 04/14			24.0116-0126.1 416126	Ø 280 16 13
2.4 TDCi 4x4	103	11/06→08/14	→	→ 04/14			24.0116-0126.1 416126	Ø 280 16 13
3.2 TDCi RWD	147	09/07→08/14	→	→ 04/14			24.0116-0126.1 416126	Ø 280 16 13
2.3 16V CNG RWD	100	04/06→08/14	←	05/06→ 04/14			24.0128-0293.1 428293	Ø 300 28 24 V
2.3 16V LPG RWD	107	04/06→08/14	→	05/06→; mit Einfachbereifung; → 04/14			24.0116-0126.1 416126	Ø 280 16 13
2.3 16V RWD	107	04/06→08/14	→	11/07→; mit Doppelbereifung; → 04/14			24.0116-0134.1 416134	Ø 284 16 13
2.4 TDCi RWD	74	04/06→08/14	←	05/06→ 04/14; mit Einfachbereifung			24.0128-0157.1 428157	Ø 300 28 25 V + S
2.4 TDCi RWD	85	04/06→08/14	←	05/06→ 04/14; mit Doppelbereifung			24.0128-0293.1 428293	Ø 300 28 24 V
2.4 TDCi RWD	103	04/06→08/14	→	05/06→ 04/14			24.0116-0126.1 416126	Ø 280 16 13
<b>FORD - TRANSIT Pritsche/Fahrgestell (FM_ _, FN_ _) 01/00→05/06</b>								
 <b>Bremsbelagsatz, Scheibenbremse</b>								
2.0 DI (F_E_ _, F_F_ _)	55	08/00→05/06	←	→ 04/06; Baumuster: 260/280/300			13.0460-3992.2 603992	BOS 23434 18,7 + WK
2.0 DI (F_E_ _, F_F_ _)	63	08/00→05/06	←	→ 04/06; Baumuster: 330/350			13.0460-3993.2 603993	BOS 23577 18,7 + WK
2.0 DI (F_E_ _, F_F_ _)	74	08/00→05/06	←	→ 04/06; Baumuster: 330/350			13.0460-3993.2 603993	BOS 23577 18,7 + WK
2.0 TDCi (F_E_ _, F_F_ _)	92	08/02→05/06	←	→ 04/06			13.0460-3993.2 603993	BOS 23577 18,7 + WK
2.3 16V (F_A_ _, F_B_ _, F_C_ _, F_D_ _)	107	04/01→05/06	←	→ 04/06			13.0460-3993.2 603993	BOS 23577 18,7 + WK
2.4 DI (F_A_ _, F_B_ _, F_C_ _, F_D_ _)	55	01/00→05/06	←	→ 04/06			13.0460-3993.2 603993	BOS 23577 18,7 + WK
2.4 DI (F_A_ _, F_B_ _, F_C_ _, F_D_ _)	66	01/00→05/06	←	→ 04/06			13.0460-3993.2 603993	BOS 23577 18,7 + WK

































	kw			 	! #		
<b>FORD - TRANSIT Pritsche/Fahrgestell (FM_., FN_.) 01/00→05/06</b>							
 <b>Bremsbelagsatz, Scheibenbremse</b>							
2.4 DI (F_A_, F_B_, F_C_, F_D_) 2.4 TDCi 2.4 TDE	88 101 85	01/00→05/06 03/04→05/06 03/04→05/06	←	→ 04/06		13.0460-3993.2 603993	BOS 23577 18,7 + WK
2.3 BiFuel 2.4 TDE	105 92	03/01→03/06 07/01→05/06	←	11/01→ 04/06		13.0460-3993.2 603993	BOS 23577 18,7 + WK
 <b>Bremsscheibe</b>							
2.0 DI (F_E_, F_F_) 2.0 DI (F_E_, F_F_) 2.0 DI (F_E_, F_F_) 2.0 TDCi (F_E_, F_F_)	55 63 74 92	08/00→05/06 08/00→05/06 08/00→05/06 08/02→05/06	←	→ 04/06; Baumuster: 260/280/300 → 04/06; Baumuster: 330/350		24.0124-0167.1 424167 24.0124-0168.1 424168	Ø 276 24,5 22,1 V Ø 294 24,5 22,1 V
2.3 16V (F_A_, F_B_, F_C_, F_D_) 2.4 DI (F_A_, F_B_, F_C_, F_D_) 2.4 DI (F_A_, F_B_, F_C_, F_D_) 2.4 DI (F_A_, F_B_, F_C_, F_D_) 2.4 TDCi 2.4 TDE	107 55 66 88 101 85	04/01→05/06 01/00→05/06 01/00→05/06 01/00→05/06 03/04→05/06 03/04→05/06	←	→ 04/06		24.0124-0168.1 424168	Ø 294 24,5 22,1 V
2.3 BiFuel 2.4 TDE	105 92	03/01→03/06 07/01→05/06	←	11/01→ 04/06		24.0124-0168.1 424168 24.0124-0168.1 424168	Ø 294 24,5 22,1 V Ø 294 24,5 22,1 V
<b>FORD - TRANSIT TOURNEO 08/94→12/00</b>							
 <b>Bremsbelagsatz, Scheibenbremse</b>							
2.0	84	11/94→12/00	←	09/95→ 03/00; passend für Felgenreöße [Zoll]: 15		13.0460-3959.2 603959	BDX 21469 18,0 + WE / - WK
			←	09/95→ 03/00; passend für Felgenreöße [Zoll]: 14		13.0460-3960.2 603960	BDX 21470 18,0 + WE / - WK
2.4 D 2.5 DI 2.5 DI 2.5 TD	55 51 56 74	08/94→06/00 11/94→12/00 11/94→12/00 04/98→12/00	←	→ 03/00; passend für Felgenreöße [Zoll]: 15		13.0460-3959.2 603959	BDX 21469 18,0 + WE / - WK
			←	→ 03/00; passend für Felgenreöße [Zoll]: 14		13.0460-3960.2 603960	BDX 21470 18,0 + WE / - WK
2.5 TD	63	11/94→12/00	←	01/95→ 03/00; passend für Felgenreöße [Zoll]: 15		13.0460-3959.2 603959	BDX 21469 18,0 + WE / - WK
			←	01/95→ 03/00; passend für Felgenreöße [Zoll]: 14		13.0460-3960.2 603960	BDX 21470 18,0 + WE / - WK
<b>Zubehörsatz, Scheibenbremsbelag</b>							
2.0	84	11/94→12/00	←	09/95→ 03/00; passend für Felgenreöße [Zoll]: 14		13.0460-0427.2 610427	BDX
			←	09/95→ 03/00; passend für Felgenreöße [Zoll]: 15		13.0460-0427.2 610427	BDX
2.4 D 2.5 DI 2.5 DI 2.5 TD	55 51 56 74	08/94→06/00 11/94→12/00 11/94→12/00 04/98→12/00	←	→ 03/00; passend für Felgenreöße [Zoll]: 14		13.0460-0427.2 610427	BDX
			←	→ 03/00; passend für Felgenreöße [Zoll]: 15		13.0460-0427.2 610427	BDX
2.5 TD	63	11/94→12/00	←	01/95→ 03/00; passend für Felgenreöße [Zoll]: 14		13.0460-0427.2 610427	BDX
			←	01/95→ 03/00; passend für Felgenreöße [Zoll]: 15		13.0460-0427.2 610427	BDX
 <b>Bremsscheibe</b>							
2.0	84	11/94→12/00	←	09/95→ 03/00; passend für Felgenreöße [Zoll]: 14		24.0124-0131.1 424131	Ø 254 24,2 22,2 V
			←	09/95→ 03/00; passend für Felgenreöße [Zoll]: 15		24.0124-0132.1 424132	Ø 270 24,2 22,2 V
2.4 D 2.5 DI 2.5 DI 2.5 TD	55 51 56 74	08/94→06/00 11/94→12/00 11/94→12/00 04/98→12/00	←	→ 03/00; passend für Felgenreöße [Zoll]: 14		24.0124-0131.1 424131	Ø 254 24,2 22,2 V
			←	→ 03/00; passend für Felgenreöße [Zoll]: 15		24.0124-0132.1 424132	Ø 270 24,2 22,2 V
2.5 TD	63	11/94→12/00	←	01/95→ 03/00; passend für Felgenreöße [Zoll]: 14		24.0124-0131.1 424131	Ø 254 24,2 22,2 V
			←	01/95→ 03/00; passend für Felgenreöße [Zoll]: 15		24.0124-0132.1 424132	Ø 270 24,2 22,2 V
<b>FORD - TRANSIT TOURNEO 07/06→08/14</b>							
 <b>Bremsbelagsatz, Scheibenbremse</b>							
2.2 TDCi 2.2 TDCi 2.2 TDCi	81 85 96	07/06→08/14 10/08→08/14 07/06→08/14	←	Baumuster: 260/280/300; → 04/14		13.0460-3833.2 603833	BOS 24485 19,0 + WK + Zub
			←	Baumuster: 330/350; → 04/14		13.0460-3834.2 603834	BOS 24484 19,0 + WK + Zub
↓							

















	kw			 	! #		
<b>FORD - TRANSIT TOURNEO 07/06→08/14</b>							
 <b>Bremsbelagsatz, Scheibenbremse</b>							
2.2 TDCi	103	10/07→08/14	➡	→ 04/14; für Einfachbereifung		13.0460-3835.2 603835	BOS 24486 17,9 + WK + Zub
 <b>Bremsscheibe</b>							
2.2 TDCi	81	07/06→08/14	←	Baumuster: 260/280/300; → 04/14		24.0128-0156.1 428156	Ø 280 28 25 V + S
2.2 TDCi	85	10/08→08/14	←				
2.2 TDCi	96	07/06→08/14	←	Baumuster: 330/350; → 04/14		24.0128-0157.1 428157	Ø 300 28 25 V + S
2.2 TDCi	103	10/07→08/14	➡	→ 04/14		24.0116-0216.1 416216	Ø 280 16 13 + ABS Ring
<b>FORD USA - EDGE 01/14→</b>							
 <b>Bremsbelagsatz, Scheibenbremse</b>							
2.0 TDCi AWD	132	08/15→	➡	12/15→		13.0460-7320.2 607320	ATE 22231 16,1 + WK
2.0 TDCi Bi-Turbo AWD	154	08/15→	➡	12/15→; + eFSB		13.0470-7320.2 LD7320	ATE 22231 16,1 + WK Ceramic
<b>FORD USA - PROBE II (ECP) 09/92→03/98</b>							
 <b>Bremsbelagsatz, Scheibenbremse</b>							
2.0 16V	85	10/93→03/98	←	01/94→ 09/97		13.0460-5954.2 605954	SUM 23845 15,8 + WK
			➡	01/94→ 09/97		13.0460-5973.2 605973	21766 13,5 - WE / - WK
2.5 V6 24V	119	10/93→03/98	←	→ 09/97		13.0460-5954.2 605954	SUM 23845 15,8 + WK
2.5 V6 24V	120	12/94→03/98	➡	→ 09/97		13.0460-5973.2 605973	21766 13,5 - WE / - WK
<b>Zubehörsatz, Scheibenbremsbelag</b>							
2.0 16V	85	10/93→03/98	←	01/94→ 09/97		13.0460-0443.2 610443	SUM
			➡	01/94→ 09/97		13.0460-0245.2 610245	
2.5 V6 24V	119	10/93→03/98	←	→ 09/97		13.0460-0443.2 610443	SUM
2.5 V6 24V	120	12/94→03/98	➡	→ 09/97		13.0460-0245.2 610245	
 <b>Bremsscheibe</b>							
2.0 16V	85	10/93→03/98	←	01/94→ 09/97		24.0124-0129.1 424129	Ø 258 24 22 V
			➡	01/94→ 09/97		24.0110-0234.1 410234	Ø 261 10 8
2.5 V6 24V	119	10/93→03/98	←	→ 09/97		24.0124-0129.1 424129	Ø 258 24 22 V
2.5 V6 24V	120	12/94→03/98	➡	→ 09/97		24.0110-0234.1 410234	Ø 261 10 8
<b>HONDA - ACCORD V (CC, CD) 06/92→12/97</b>							
 <b>Bremsbelagsatz, Scheibenbremse</b>							
2.0 i	85	03/93→01/96	←	→ 12/95; Schaltgetriebe		13.0460-5955.2 605955	AKE 21879 18,6 + WK
			←	01/94→		13.0460-5982.2 605982	21651 17,5 + WK
			←	→ 12/95; Vollautomatik		13.0460-5982.2 605982	21651 17,5 + WK
			➡	01/94→		13.0460-5929.2 605929	AKE 21719 15,0 + WK
			➡	→ 12/95		13.0460-5929.2 605929	AKE 21719 15,0 + WK
2.0 i S	96	03/93→01/96	←	→ 12/95; Schaltgetriebe		13.0460-5955.2 605955	AKE 21879 18,6 + WK
			←	→ 12/95; Vollautomatik		13.0460-5982.2 605982	21651 17,5 + WK
			➡	→ 12/95		13.0460-5929.2 605929	AKE 21719 15,0 + WK
2.3 i SR	116	03/93→01/96	←	→ 12/95		13.0460-5982.2 605982	21651 17,5 + WK
			➡	→ 12/95		13.0460-5929.2 605929	AKE 21719 15,0 + WK
<b>Zubehörsatz, Scheibenbremsbelag</b>							
2.0 i	85	03/93→01/96	←	01/94→		13.0460-0075.2 610075	
			←	→ 12/95; Vollautomatik		13.0460-0075.2 610075	
			←	→ 12/95; Schaltgetriebe		13.0460-0453.2 610453	AKE
			➡	→ 12/95		13.0460-0287.2 610287	
			➡	01/94→		13.0460-0287.2 610287	
2.0 i S	96	03/93→01/96	←	→ 12/95; Vollautomatik		13.0460-0075.2 610075	
			←	→ 12/95; Schaltgetriebe		13.0460-0453.2 610453	AKE
			➡	→ 12/95		13.0460-0287.2 610287	
2.3 i SR	116	03/93→01/96	←	→ 12/95		13.0460-0075.2 610075	
			➡	→ 12/95		13.0460-0287.2 610287	













	kw			 	! #		
<b>HONDA - ACCORD V (CC, CD) 06/92→12/97</b>							
 <b>Bremsscheibe</b>							
2.0 i	85	03/93→01/96	←	→ 12/95; Schaltgetriebe		24.0123-0103.1 423103	Ø 260 23 21 V
			←	01/94→		24.0125-0130.1 425130	Ø 282 25 23 V
			→	→ 12/95		24.0110-0233.1 410233	Ø 260 10 8 + S
			→	01/94→		24.0110-0233.1 410233	Ø 260 10 8 + S
2.0 i S	96	03/93→01/96	←	→ 12/95; Schaltgetriebe		24.0123-0103.1 423103	Ø 260 23 21 V
			→	→ 12/95		24.0110-0233.1 410233	Ø 260 10 8 + S
2.3 i SR	116	03/93→01/96	→	→ 12/95		24.0110-0233.1 410233	Ø 260 10 8 + S
<b>HONDA - ACCORD V (CE, CF_) 09/95→10/98</b>							
 <b>Bremsbelagsatz, Scheibenbremse</b>							
1.9 i (CE7)	85	02/96→10/98	←	→ 09/98; Schaltgetriebe		13.0460-5955.2 605955	AKE 21879 18,6 + WK
2.0 i LS (CE8)	96	02/96→10/98	←	→ 09/98; Vollautomatik		13.0460-5982.2 605982	21651 17,5 + WK
			→	→ 09/98		13.0460-5929.2 605929	AKE 21719 15,0 + WK
2.0 TDi (CF1)	77	04/96→10/98	←	→ 09/98		13.0460-5955.2 605955	AKE 21879 18,6 + WK
			→	→ 09/98		13.0460-5929.2 605929	AKE 21719 15,0 + WK
2.2 i VTEC (CE9)	110	02/96→10/98	←	→ 09/98		13.0460-5982.2 605982	21651 17,5 + WK
			→	→ 09/98		13.0460-5929.2 605929	AKE 21719 15,0 + WK
<b>Zubehörsatz, Scheibenbremsbelag</b>							
1.9 i (CE7)	85	02/96→10/98	←	→ 09/98; Vollautomatik		13.0460-0075.2 610075	
2.0 i LS (CE8)	96	02/96→10/98	←	→ 09/98; Schaltgetriebe		13.0460-0453.2 610453	AKE
			→	→ 09/98		13.0460-0287.2 610287	
2.0 TDi (CF1)	77	04/96→10/98	←	→ 09/98		13.0460-0453.2 610453	AKE
			→	→ 09/98		13.0460-0287.2 610287	
2.2 i VTEC (CE9)	110	02/96→10/98	←	→ 09/98		13.0460-0075.2 610075	
			→	→ 09/98		13.0460-0287.2 610287	
 <b>Bremsscheibe</b>							
1.9 i (CE7)	85	02/96→10/98	←	→ 09/98; Schaltgetriebe		24.0123-0103.1 423103	Ø 260 23 21 V
2.0 i LS (CE8)	96	02/96→10/98	→	→ 09/98		24.0110-0233.1 410233	Ø 260 10 8 + S
2.0 TDi (CF1)	77	04/96→10/98	←	→ 09/98		24.0123-0103.1 423103	Ø 260 23 21 V
			→	→ 09/98		24.0110-0233.1 410233	Ø 260 10 8 + S
2.2 i VTEC (CE9)	110	02/96→10/98	→	→ 09/98		24.0110-0233.1 410233	Ø 260 10 8 + S
<b>HONDA - ACCORD V Aerodeck (CE) 04/93→02/98</b>							
 <b>Bremsbelagsatz, Scheibenbremse</b>							
2.0 i LS 16V (CE2)	100	09/93→02/98	←	01/94→ 01/98		13.0460-5982.2 605982	21651 17,5 + WK
2.2 i ES (CE1)	110	09/93→02/98	→	01/94→ 01/98		13.0460-5929.2 605929	AKE 21719 15,0 + WK
<b>Zubehörsatz, Scheibenbremsbelag</b>							
2.0 i LS 16V (CE2)	100	09/93→02/98	←	01/94→ 01/98		13.0460-0075.2 610075	
2.2 i ES (CE1)	110	09/93→02/98	→	01/94→ 01/98		13.0460-0287.2 610287	
 <b>Bremsscheibe</b>							
2.0 i LS 16V (CE2)	100	09/93→02/98	←	01/94→ 01/98		24.0125-0130.1 425130	Ø 282 25 23 V
2.2 i ES (CE1)	110	09/93→02/98	→	01/94→ 01/98		24.0110-0233.1 410233	Ø 260 10 8 + S
<b>HONDA - ACCORD V Coupe (CD) 04/93→12/98</b>							
 <b>Bremsbelagsatz, Scheibenbremse</b>							
2.0 (CD9)	100	09/93→12/97	←	01/94→		13.0460-5982.2 605982	21651 17,5 + WK
			→	01/94→		13.0460-5929.2 605929	AKE 21719 15,0 + WK
2.2 i ES (CD7)	110	09/93→02/98	←	01/94→ 01/98		13.0460-5982.2 605982	21651 17,5 + WK
			→	01/94→ 01/98		13.0460-5929.2 605929	AKE 21719 15,0 + WK
<b>Zubehörsatz, Scheibenbremsbelag</b>							
2.0 (CD9)	100	09/93→12/97	←	01/94→		13.0460-0075.2 610075	
↓							













	kW			 	! #		
<b>HONDA - ACCORD V Coupe (CD) 04/93→12/98</b>							
<b>Zubehörsatz, Scheibenbremsbelag</b>							
2.0 (CD9)	100	09/93→12/97	➡	01/94→		13.0460-0287.2 610287	
2.2 i ES (CD7)	110	09/93→02/98	⬅	01/94→ 01/98		13.0460-0075.2 610075	
			➡	01/94→ 01/98		13.0460-0287.2 610287	
<b> Bremsscheibe</b>							
2.0 (CD9)	100	09/93→12/97	⬅	01/94→		24.0125-0130.1 425130	Ø 282 25 23 V
			➡	01/94→		24.0110-0233.1 410233	Ø 260 10 8 + S
2.2 i ES (CD7)	110	09/93→02/98	⬅	01/94→ 01/98		24.0125-0130.1 425130	Ø 282 25 23 V
			➡	01/94→ 01/98		24.0110-0233.1 410233	Ø 260 10 8 + S
<b>HONDA - ACCORD VI (CK, CG, CH, CF8) 03/97→12/03</b>							
<b> Bremsbelagsatz, Scheibenbremse</b>							
1.6 i (CG7)	85	10/98→12/02	⬅			13.0460-5861.2 605861	23097 17,1 + WK + Zub
1.6 LS (CG7)	79	10/98→12/02					
1.8 i (CG8)	100	10/98→12/02	⬅			13.0460-5825.2 605825	TRW 23094 16,5 + WK + Zub
2.0 i (CG9)	108	10/98→01/01	➡			13.0460-5827.2 605827	TRW 23527 14,5 + WK
2.0 Turbo DI (CH2)	77	02/99→12/02	⬅	→ 10/00		13.0460-5825.2 605825	TRW 23094 16,5 + WK + Zub
			➡	→ 10/00		13.0460-5827.2 605827	TRW 23527 14,5 + WK
2.2 Type-R (CH1)	156	02/99→12/02	➡			13.0460-5827.2 605827	TRW 23527 14,5 + WK
2.3 (CL3)	113	01/01→06/03	⬅	→ 12/02		13.0460-5825.2 605825	TRW 23094 16,5 + WK + Zub
			➡	→ 12/02		13.0460-5827.2 605827	TRW 23527 14,5 + WK
<b> Bremsscheibe</b>							
1.6 i (CG7)	85	10/98→12/02	⬅	passend für Felgengröße [Zoll]: 14		24.0123-0105.1 423105	Ø 260 23 21 V
1.6 LS (CG7)	79	10/98→12/02					
1.8 i (CG8)	100	10/98→12/02	⬅	Felge Lochzahl: 4; passend für Felgengröße [Zoll]: 15		24.0125-0146.1 425146	Ø 282 25 23 V
2.0 i (CG9)	108	10/98→01/01	➡	Felge Lochzahl: 4		24.0110-0295.1 410295	Ø 260 10 8
2.0 Turbo DI (CH2)	77	02/99→12/02	⬅	→ 10/00; Felge Lochzahl: 4; passend für Felgengröße [Zoll]: 15		24.0125-0146.1 425146	Ø 282 25 23 V
			➡	→ 10/00; Felge Lochzahl: 4		24.0110-0295.1 410295	Ø 260 10 8
2.3 (CL3)	113	01/01→06/03	⬅	→ 12/02; Felge Lochzahl: 5; passend für Felgengröße [Zoll]: 15		24.0125-0183.1 425183	Ø 282 25 23 V
<b>HONDA - ACCORD VI Coupe (CG) 12/97→06/03</b>							
<b> Bremsbelagsatz, Scheibenbremse</b>							
2.0	107	11/99→10/02	⬅			13.0460-5982.2 605982	21651 17,5 + WK
2.0 i 16V	108	02/98→06/03					
3.0 V6 24V (CG2)	147	02/98→06/03	➡			13.0460-5929.2 605929	AKE 21719 15,0 + WK
<b> Bremsscheibe</b>							
2.0	107	11/99→10/02	➡			24.0109-0145.1 409145	Ø 260 9 8
2.0 i 16V	108	02/98→06/03					
3.0 V6 24V (CG2)	147	02/98→06/03	➡			24.0109-0709.1 409709	Ø 260 9 8
<b>HONDA - ACCORD VI Hatchback (CH, CL) 12/99→12/02</b>							
<b> Bremsbelagsatz, Scheibenbremse</b>							
1.6 (CH5)	85	12/99→12/02	⬅			13.0460-5861.2 605861	23097 17,1 + WK + Zub
1.8 i (CH6)	100	12/99→12/02	⬅			13.0460-5825.2 605825	TRW 23094 16,5 + WK + Zub
2.0 TDi (CH8)	77	12/99→10/00	➡			13.0460-5827.2 605827	TRW 23527 14,5 + WK
2.0 (CH7)	108	12/99→12/02	⬅	→ 01/01		13.0460-5825.2 605825	TRW 23094 16,5 + WK + Zub
			➡	→ 01/01		13.0460-5827.2 605827	TRW 23527 14,5 + WK
2.3 (CL4)	113	11/00→12/02	⬅	01/01→		13.0460-5825.2 605825	TRW 23094 16,5 + WK + Zub
			➡	01/01→		13.0460-5827.2 605827	TRW 23527 14,5 + WK
<b> Bremsscheibe</b>							
1.6 (CH5)	85	12/99→12/02	⬅	passend für Felgengröße [Zoll]: 14		24.0123-0105.1 423105	Ø 260 23 21 V
1.8 i (CH6)	100	12/99→12/02	⬅	Felge Lochzahl: 4; passend für Felgengröße [Zoll]: 15		24.0125-0146.1 425146	Ø 282 25 23 V
2.0 TDi (CH8)	77	12/99→10/00	➡	Felge Lochzahl: 4		24.0110-0295.1 410295	Ø 260 10 8
2.0 (CH7)	108	12/99→12/02	⬅	→ 01/01; Felge Lochzahl: 4; passend für Felgengröße [Zoll]: 15		24.0125-0146.1 425146	Ø 282 25 23 V
↓							









	kw					! #		
<b>HONDA - ACCORD VI Hatchback (CH, CL) 12/99→12/02</b>								
 <b>Bremsscheibe</b>								
2.0 (CH7)	108	12/99→12/02	➡	→ 01/01; Felge Lochzahl: 4			24.0110-0295.1 410295	Ø 260 10 8
2.3 (CL4)	113	11/00→12/02	⬅	01/01→; Felge Lochzahl: 5; passend für Felgengröße [Zoll]: 15			24.0125-0183.1 425183	Ø 282 25 23 V
<b>HONDA - ACCORD VII (CL, CN) 01/03→09/12</b>								
 <b>Bremsbelagsatz, Scheibenbremse</b>								
2.0 (CL7)	114	02/03→05/08	⬅				13.0460-5714.2 605714	ATE 23720 17,5 + WK
2.0 Allrad (CL8)	114	02/03→05/08	⬅					
2.2 i-CTDi (CN1)	103	01/04→05/08	➡				13.0460-5827.2 605827	TRW 23527 14,5 + WK
2.4 (CL9)	140	02/03→05/08	⬅				13.0460-5714.2 605714	ATE 23720 17,5 + WK
			➡				13.0460-5711.2 605711	23652 15,7 + WK
			➡				13.0460-5827.2 605827	TRW 23527 14,5 + WK
 <b>Bremsscheibe</b>								
2.0 (CL7)	114	02/03→05/08	⬅	16"			24.0125-0174.1 425174	Ø 300 25 23 V
2.0 Allrad (CL8)	114	02/03→05/08	⬅	15"			24.0125-0187.1 425187	Ø 280 25 23 V
2.2 i-CTDi (CN1)	103	01/04→05/08	⬅	15"			24.0125-0187.1 425187	Ø 280 25 23 V
2.4 (CL9)	140	02/03→05/08	➡				24.0110-0321.1 410321	Ø 260 10 8
<b>HONDA - ACCORD VII (CM) 09/02→05/08</b>								
 <b>Bremsbelagsatz, Scheibenbremse</b>								
2.4 Vtec E (CM5)	118	09/02→12/05	⬅	02/03→ 09/05			13.0460-5714.2 605714	ATE 23720 17,5 + WK
			➡	02/03→ 09/05			13.0460-5827.2 605827	TRW 23527 14,5 + WK
 <b>Bremsscheibe</b>								
2.4 Vtec E (CM5)	118	09/02→12/05	⬅	02/03→ 09/05; 16"			24.0125-0174.1 425174	Ø 300 25 23 V
			⬅	02/03→ 09/05; 15"			24.0125-0187.1 425187	Ø 280 25 23 V
			➡	02/03→ 09/05			24.0110-0321.1 410321	Ø 260 10 8
<b>HONDA - ACCORD VII Tourer (CM, CN) 04/03→05/08</b>								
 <b>Bremsbelagsatz, Scheibenbremse</b>								
2.0 (CM1)	114	04/03→05/08	⬅				13.0460-5714.2 605714	ATE 23720 17,5 + WK
2.2 i-CTDi (CN2)	103	01/04→05/08	➡				13.0460-5711.2 605711	23652 15,7 + WK
			⬅				13.0460-5714.2 605714	ATE 23720 17,5 + WK
2.4 (CM2)	140	04/03→05/08	⬅				13.0460-5714.2 605714	ATE 23720 17,5 + WK
2.4 Vtec T	147	09/03→05/08	➡				13.0460-5827.2 605827	TRW 23527 14,5 + WK
 <b>Bremsscheibe</b>								
2.0 (CM1)	114	04/03→05/08	⬅	16"			24.0125-0174.1 425174	Ø 300 25 23 V
2.2 i-CTDi (CN2)	103	01/04→05/08	⬅	15"			24.0125-0187.1 425187	Ø 280 25 23 V
2.4 (CM2)	140	04/03→05/08	⬅	15"			24.0125-0187.1 425187	Ø 280 25 23 V
2.4 Vtec T	147	09/03→05/08	➡				24.0109-0161.1 409161	Ø 282 9 7,5
<b>HONDA - ACCORD VIII (CU) 04/08→</b>								
 <b>Bremsbelagsatz, Scheibenbremse</b>								
2.0 i (CU1)	115	06/08→06/15	⬅	07/08→; für Bremsscheibendurchmesser [mm]: 296			13.0460-7291.2 607291	ATE 24796 17,7 + WK
			➡	07/08→; Schaltgetriebe			13.0460-5648.2 605648	NIS 24435 14,8 + WK
2.2 i-DTEC (CU3)	110	07/08→06/15	⬅	für Bremsscheibendurchmesser [mm]: 296			13.0460-7291.2 607291	ATE 24796 17,7 + WK
			➡				13.0460-5648.2 605648	NIS 24435 14,8 + WK
2.4 i (CU2)	148	07/08→06/15	⬅	für Bremsscheibendurchmesser [mm]: 296			13.0460-7291.2 607291	ATE 24796 17,7 + WK
			➡	Schaltgetriebe			13.0460-5648.2 605648	NIS 24435 14,8 + WK
 <b>Bremsscheibe</b>								
2.0 i (CU1)	115	06/08→06/15	⬅	07/08→			24.0125-0211.1 425211	Ø 296 25 23 V + S
			➡	07/08→; Schaltgetriebe			24.0132-0172.1 432172	Ø 320 32 30 V + S
2.2 i-DTEC (CU3)	110	07/08→06/15	⬅				24.0125-0211.1 425211	Ø 296 25 23 V + S
			➡				24.0109-0169.1 409169	Ø 282 9 8 + S
2.4 i (CU2)	148	07/08→06/15	⬅				24.0125-0211.1 425211	Ø 296 25 23 V + S
			➡				24.0132-0172.1 432172	Ø 320 32 30 V + S











	kw			 	! #		
<b>HONDA - ACCORD VIII (CU) 04/08→</b>							
 <b>Bremsscheibe</b>							
2.4 i (CU2)	148	07/08→06/15	➡	Schaltgetriebe		24.0109-0169.1 409169	Ø 282 9 8 + S
<b>HONDA - ACCORD VIII TOURER (CW) 07/08→</b>							
 <b>Bremsbelagsatz, Scheibenbremse</b>							
2.0 i 2.2 i-DTEC (CW3) 2.4 i (CW2)	110 132 148	07/08→ 07/08→ 07/08→	←	→ 06/15; für Bremsscheibendurchmesser [mm]: 296		13.0460-7291.2 607291	ATE 24796 17,7 + WK
			➡	→ 06/15		13.0460-5648.2 605648	NIS 24435 14,8 + WK
2.0 i (CW1) 2.2 i-DTEC (CW3)	115 110	07/08→ 07/08→	←	→ 06/15; für Bremsscheibendurchmesser [mm]: 296		13.0460-7291.2 607291	ATE 24796 17,7 + WK
			➡	→ 06/15; Schaltgetriebe		13.0460-5648.2 605648	NIS 24435 14,8 + WK
 <b>Bremsscheibe</b>							
2.0 i 2.4 i (CW2)	110 148	07/08→ 07/08→	←	→ 06/15		24.0125-0211.1 425211	Ø 296 25 23 V + S
			➡	→ 06/15		24.0109-0169.1 409169	Ø 282 9 8 + S
2.0 i (CW1)	115	07/08→	←	→ 06/15		24.0125-0211.1 425211	Ø 296 25 23 V + S
			➡	→ 06/15; Schaltgetriebe		24.0132-0172.1 432172	Ø 320 32 30 V + S
			➡	→ 06/15; Schaltgetriebe		24.0109-0169.1 409169	Ø 282 9 8 + S
2.2 i-DTEC (CW3)	110	07/08→	←	→ 06/15		24.0125-0211.1 425211	Ø 296 25 23 V + S
			➡	→ 06/15; Schaltgetriebe		24.0109-0169.1 409169	Ø 282 9 8 + S
2.2 i-DTEC (CW3)	132	07/08→	←	→ 06/15		24.0125-0211.1 425211	Ø 296 25 23 V + S
			➡	→ 06/15		24.0132-0172.1 432172	Ø 320 32 30 V + S
			➡	→ 06/15		24.0109-0169.1 409169	Ø 282 9 8 + S
<b>HONDA - ACCORD IX Stufenheck (CR) 09/12→</b>							
 <b>Bremsscheibe</b>							
2.4 2.4 2.4	129 132 141	11/13→ 07/14→ 09/12→	←			24.0132-0172.1 432172	Ø 320 32 30 V + S
<b>HONDA - CITY Stufenheck (GM2, GM3) 09/08→</b>							
 <b>Bremsbelagsatz, Scheibenbremse</b>							
1.4 i-V TEC	73	09/08→	←	→ 11/13		13.0460-5943.2 605943	SUM 21697 15,0 + WK
			➡	→ 11/13		13.0460-5731.2 605731	21738 13,5 + WK
 <b>Bremsscheibe</b>							
1.4 i-V TEC	73	09/08→	←	→ 11/13		24.0121-0105.1 421105	Ø 262 21 19 V + S
			➡	→ 11/13		24.0121-0115.1 421115	Ø 258 21 19 V + S
			➡	→ 11/13		24.0109-0168.1 409168	Ø 239 9 8 + S
<b>HONDA - CIVIC V Coupe (EJ) 08/93→03/96</b>							
 <b>Bremsbelagsatz, Scheibenbremse</b>							
1.6 i Vtec (EJ1)	92	01/94→03/96	←	→ 12/95		13.0460-5820.2 605820	SUM 21694 16,3 + WK
<b>Zubehörsatz, Scheibenbremsbelag</b>							
1.6 i Vtec (EJ1)	92	01/94→03/96	←	→ 12/95		13.0460-0073.2 610073	
 <b>Bremsscheibe</b>							
1.6 i Vtec (EJ1)	92	01/94→03/96	←	→ 12/95		24.0121-0105.1 421105	Ø 262 21 19 V + S
<b>HONDA - CIVIC VI Aerodeck (MB, MC) 04/98→02/01</b>							
 <b>Bremsbelagsatz, Scheibenbremse</b>							
1.4 16V (MB8) 1.4 16V (MB8)	55 66	04/98→02/01 04/98→02/01	←			13.0460-2803.2 602803	TRW 21515 17,5 + WK
			➡	01/99→; + ABS		13.0460-5929.2 605929	AKE 21719 15,0 + WK
			➡	→ 12/98; + ABS		13.0460-5998.2 605998	AKE 21312 12,8 + WK
1.5 16V (MB9)	84	04/98→02/01	←			13.0460-2803.2 602803	TRW 21515 17,5 + WK
			➡	+ ABS		13.0460-5929.2 605929	AKE 21719 15,0 + WK
1.6 16V (MC1) 1.6 16V (MC1)	85 92	04/98→02/01 04/98→02/01	←			13.0460-2803.2 602803	TRW 21515 17,5 + WK
			➡			13.0460-5929.2 605929	AKE 21719 15,0 + WK
↓							











	kw			 	! #		
<b>HONDA - CIVIC VI Aerodeck (MB, MC) 04/98→02/01</b>							
 <b>Bremsbelagsatz, Scheibenbremse</b>							
1.8 16V (MC2)	124	04/98→02/01	←			13.0460-5982.2 605982	21651 17,5 + WK
			→			13.0460-5929.2 605929	AKE 21719 15,0 + WK
2.0 i D (MC3)	74	04/98→02/01	←			13.0460-2803.2 602803	TRW 21515 17,5 + WK
2.0 i D (MC3)	77	04/98→02/01	→			13.0460-5998.2 605998	AKE 21312 12,8 + WK
<b>Zubehörsatz, Scheibenbremsbelag</b>							
1.4 16V (MB8)	55	04/98→02/01	←			13.0460-0142.2 610142	
1.4 16V (MB8)	66	04/98→02/01					
1.5 16V (MB9)	84	04/98→02/01					
1.6 16V (MC1)	85	04/98→02/01					
1.6 16V (MC1)	92	04/98→02/01					
2.0 i D (MC3)	74	04/98→02/01					
2.0 i D (MC3)	77	04/98→02/01					
 <b>Bremsscheibe</b>							
1.4 16V (MB8)	55	04/98→02/01	←			24.0121-0105.1 421105	Ø 262 21 19 V + S
1.4 16V (MB8)	66	04/98→02/01	→	01/99→; + ABS		24.0109-0143.1 409143	Ø 260 9 8 + S
1.5 16V (MB9)	84	04/98→02/01	→	→ 12/98; + ABS		24.0110-0212.1 410212	Ø 238,5 10 8 + S
1.6 16V (MC1)	85	04/98→02/01	←			24.0121-0105.1 421105	Ø 262 21 19 V + S
1.6 16V (MC1)	92	04/98→02/01	→			24.0109-0143.1 409143	Ø 260 9 8 + S
1.8 16V (MC2)	124	04/98→02/01	←			24.0123-0106.1 423106	Ø 282 23 21 V
			→			24.0110-0233.1 410233	Ø 260 10 8 + S
2.0 i D (MC3)	74	04/98→02/01	←			24.0121-0105.1 421105	Ø 262 21 19 V + S
2.0 i D (MC3)	77	04/98→02/01	→			24.0110-0212.1 410212	Ø 238,5 10 8 + S
<b>HONDA - CIVIC VI Coupe (EJ, EM1) 03/96→12/00</b>							
 <b>Bremsbelagsatz, Scheibenbremse</b>							
1.6	79	05/96→04/99	←	01/98→		13.0460-5820.2 605820	SUM 21694 16,3 + WK
1.6 i	77	03/96→03/00	←	→ 12/97		13.0460-5943.2 605943	SUM 21697 15,0 + WK
1.6 i Vtec	118	04/99→12/00	←			13.0460-5820.2 605820	SUM 21694 16,3 + WK
			→			13.0460-5731.2 605731	21738 13,5 + WK
1.6 i Vtec (EM1)	92	03/96→03/00	←			13.0460-5820.2 605820	SUM 21694 16,3 + WK
<b>Zubehörsatz, Scheibenbremsbelag</b>							
1.6	79	05/96→04/99	←	→ 12/97		13.0460-0073.2 610073	
1.6 i	77	03/96→03/00	←	01/98→		13.0460-0073.2 610073	
1.6 i Vtec	118	04/99→12/00	←			13.0460-0073.2 610073	
1.6 i Vtec (EM1)	92	03/96→03/00					
 <b>Bremsscheibe</b>							
1.6	79	05/96→04/99	←	→ 12/97		24.0121-0104.1 421104	SUM Ø 240 21 19 V + S
1.6 i	77	03/96→03/00	←	01/98→		24.0121-0105.1 421105	Ø 262 21 19 V + S
1.6 i Vtec	118	04/99→12/00	←			24.0121-0105.1 421105	Ø 262 21 19 V + S
			→			24.0109-0111.1 409111	Ø 239 9 8 + S
1.6 i Vtec (EM1)	92	03/96→03/00	←			24.0121-0105.1 421105	Ø 262 21 19 V + S
<b>HONDA - CIVIC VI Fastback (MA, MB) 09/94→02/01</b>							
 <b>Bremsbelagsatz, Scheibenbremse</b>							
1.4 i (MA8, MB2)	55	09/95→02/01	←	01/97→		13.0460-2803.2 602803	TRW 21515 17,5 + WK
			→	01/99→; + ABS		13.0460-5920.2 605920	AKE 21322 15,0 + WK
			→	01/97→ 12/98; + ABS		13.0460-5998.2 605998	AKE 21719 15,0 + WK
1.4 i (MA8, MB2)	66	06/95→02/01	←	→ 12/96		13.0460-2803.2 602803	TRW 21515 17,5 + WK
1.5 i Vtec-E (MA9)	66	09/94→01/97	→	→ 12/96; + ABS		13.0460-5920.2 605920	AKE 21322 15,0 + WK
			←			13.0460-5998.2 605998	AKE 21312 12,8 + WK
1.5 16V (MB3)	84	01/97→02/01	←			13.0460-2803.2 602803	TRW 21515 17,5 + WK
			→	01/99→; + ABS		13.0460-5920.2 605920	AKE 21322 15,0 + WK
			→	→ 12/98; + ABS		13.0460-5998.2 605998	AKE 21719 15,0 + WK
			→			13.0460-5998.2 605998	AKE 21312 12,8 + WK
↓							











	kw			 	! #		
<b>HONDA - CIVIC VI Fastback (MA, MB) 09/94→02/01</b>							
<b> Bremsbelagsatz, Scheibenbremse</b>							
1.6	92	11/98→10/00	←			<b>13.0460-2803.2 602803</b>	TRW 21515 17,5 + WK
			→			<b>13.0460-5929.2 605929</b>	AKE 21719 15,0 + WK
1.6 16V (MB4)	85	01/97→02/01	←			<b>13.0460-2803.2 602803</b>	TRW 21515 17,5 + WK
1.6 VTi	118	01/97→02/01	←			<b>13.0460-5920.2 605920</b>	AKE 21322 15,0 + WK
2.0 i TD (MB7)	63	01/97→02/01	←			<b>13.0460-5929.2 605929</b>	AKE 21719 15,0 + WK
2.0 TDiC (MB7)	74	11/98→10/00	→	01/99→		<b>13.0460-5929.2 605929</b>	AKE 21719 15,0 + WK
2.0 TDiC (MB7)	77	11/98→10/00	→	→ 12/98		<b>13.0460-5998.2 605998</b>	AKE 21312 12,8 + WK
1.6 i (MB1)	83	09/94→01/97	←	→ 12/96		<b>13.0460-2803.2 602803</b>	TRW 21515 17,5 + WK
1.6 i Vtec (MB1)	93	09/94→01/97	←	→ 12/96		<b>13.0460-5920.2 605920</b>	AKE 21322 15,0 + WK
			→	→ 12/96		<b>13.0460-5998.2 605998</b>	AKE 21312 12,8 + WK
1.8 16V (MB6)	124	01/97→02/01	←			<b>13.0460-5982.2 605982</b>	21651 17,5 + WK
			→			<b>13.0460-5929.2 605929</b>	AKE 21719 15,0 + WK
<b>Zubehörsatz, Scheibenbremsbelag</b>							
1.4 i (MA8, MB2)	55	09/95→02/01	←	01/97→		<b>13.0460-0142.2 610142</b>	
			→	01/97→ 12/98; + ABS		<b>13.0460-0308.2 610308</b>	AKE
			→	01/97→ 12/98; + ABS		<b>13.0460-0430.2 610430</b>	AKE
1.4 i (MA8, MB2)	66	06/95→02/01	←	→ 12/96		<b>13.0460-0142.2 610142</b>	
1.5 i Vtec-E (MA9)	66	09/94→01/97	←	→ 12/96		<b>13.0460-0308.2 610308</b>	AKE
			→	→ 12/96; + ABS		<b>13.0460-0430.2 610430</b>	AKE
1.5 16V (MB3)	84	01/97→02/01	←			<b>13.0460-0142.2 610142</b>	
			→	→ 12/98; + ABS		<b>13.0460-0308.2 610308</b>	AKE
			→	→ 12/98; + ABS		<b>13.0460-0430.2 610430</b>	AKE
1.6	92	11/98→10/00	←			<b>13.0460-0142.2 610142</b>	
1.6 16V (MB4)	85	01/97→02/01	←			<b>13.0460-0142.2 610142</b>	
1.6 VTi	118	01/97→02/01	←			<b>13.0460-0308.2 610308</b>	AKE
2.0 i TD (MB7)	63	01/97→02/01	←			<b>13.0460-0308.2 610308</b>	AKE
2.0 TDiC (MB7)	74	11/98→10/00	→	→ 12/98		<b>13.0460-0430.2 610430</b>	AKE
2.0 TDiC (MB7)	77	11/98→10/00	→	→ 12/98		<b>13.0460-0430.2 610430</b>	AKE
1.6 i (MB1)	83	09/94→01/97	←	→ 12/96		<b>13.0460-0142.2 610142</b>	
1.6 i Vtec (MB1)	93	09/94→01/97	←	→ 12/96		<b>13.0460-0308.2 610308</b>	AKE
			→	→ 12/96		<b>13.0460-0430.2 610430</b>	AKE
<b> Bremsscheibe</b>							
1.4 i (MA8, MB2)	55	09/95→02/01	←	01/97→		<b>24.0121-0105.1 421105</b>	Ø 262 21 19 V + S
			→	01/99→; + ABS		<b>24.0109-0143.1 409143</b>	Ø 260 9 8 + S
			→	01/97→ 12/98; + ABS		<b>24.0110-0212.1 410212</b>	Ø 238,5 10 8 + S
1.4 i (MA8, MB2)	66	06/95→02/01	←	→ 12/96		<b>24.0121-0105.1 421105</b>	Ø 262 21 19 V + S
1.5 i Vtec-E (MA9)	66	09/94→01/97	←	→ 12/96		<b>24.0110-0212.1 410212</b>	Ø 238,5 10 8 + S
			→	→ 12/96; + ABS		<b>24.0110-0212.1 410212</b>	Ø 238,5 10 8 + S
1.5 16V (MB3)	84	01/97→02/01	←			<b>24.0121-0105.1 421105</b>	Ø 262 21 19 V + S
			→			<b>24.0109-0143.1 409143</b>	Ø 260 9 8 + S
			→	+ ABS		<b>24.0110-0212.1 410212</b>	Ø 238,5 10 8 + S
1.6	92	11/98→10/00	←			<b>24.0121-0105.1 421105</b>	Ø 262 21 19 V + S
			→			<b>24.0109-0143.1 409143</b>	Ø 260 9 8 + S
1.6 16V (MB4)	85	01/97→02/01	←			<b>24.0121-0105.1 421105</b>	Ø 262 21 19 V + S
1.6 VTi	118	01/97→02/01	←			<b>24.0110-0212.1 410212</b>	Ø 238,5 10 8 + S
2.0 i TD (MB7)	63	01/97→02/01	←			<b>24.0110-0212.1 410212</b>	Ø 238,5 10 8 + S
2.0 TDiC (MB7)	74	11/98→10/00	→				
2.0 TDiC (MB7)	77	11/98→10/00	→				
1.6 i (MB1)	83	09/94→01/97	←	→ 12/96		<b>24.0121-0105.1 421105</b>	Ø 262 21 19 V + S
1.6 i Vtec (MB1)	93	09/94→01/97	←	→ 12/96		<b>24.0110-0212.1 410212</b>	Ø 238,5 10 8 + S
			→	→ 12/96		<b>24.0110-0212.1 410212</b>	Ø 238,5 10 8 + S
1.8 16V (MB6)	124	01/97→02/01	←			<b>24.0123-0106.1 423106</b>	Ø 282 23 21 V
			→			<b>24.0110-0233.1 410233</b>	Ø 260 10 8 + S
<b>HONDA - CIVIC VI Hatchback (EJ, EK) 10/95→02/01</b>							
<b> Bremsbelagsatz, Scheibenbremse</b>							
1.4 i (EJ9)	55	11/95→02/01	←	01/98→ 01/01		<b>13.0460-5820.2 605820</b>	SUM 21694 16,3 + WK
			←	→ 12/97		<b>13.0460-5943.2 605943</b>	SUM 21697 15,0 + WK
			→	→ 01/01; + ABS		<b>13.0460-5998.2 605998</b>	AKE 21312 12,8 + WK
1.4 i S (EJ9)	66	11/95→02/01	←	01/98→ 01/01		<b>13.0460-5820.2 605820</b>	SUM 21694 16,3 + WK
1.4 LPG	66	01/97→02/01	←				
↓							

















	kw			 	! #		
<b>HONDA - CIVIC VI Hatchback (EJ, EK) 10/95→02/01</b>							
<b> Bremsbelagsatz, Scheibenbremse</b>							
1.4 i S (EJ9) 1.4 LPG	66 66	11/95→02/01 01/97→02/01	← → 12/97			13.0460-5943.2 605943	SUM 21697 15,0 + WK
1.5	66	11/95→12/96	←			13.0460-5820.2 605820	SUM 21694 16,3 + WK
			→	Türenanzahl: 3		13.0460-5731.2 605731	21738 13,5 + WK
			→	Türenanzahl: 4		13.0460-5929.2 605929	AKE 21719 15,0 + WK
1.5 i (EK3)	84	11/95→02/01	←	→ 01/01		13.0460-5820.2 605820	SUM 21694 16,3 + WK
			→	→ 01/01; Türenanzahl: 3		13.0460-5731.2 605731	21738 13,5 + WK
			→	→ 01/01; Türenanzahl: 4		13.0460-5929.2 605929	AKE 21719 15,0 + WK
1.6	92	11/98→10/00	←			13.0460-5820.2 605820	SUM 21694 16,3 + WK
			→			13.0460-5731.2 605731	21738 13,5 + WK
1.6	93	10/95→09/00	← 01/96→			13.0460-5820.2 605820	SUM 21694 16,3 + WK
1.6 i (EK1) 1.6 VTi (EK4)	84 118	11/95→02/01 11/95→02/01	←	→ 01/01		13.0460-5820.2 605820	SUM 21694 16,3 + WK
			→	→ 01/01		13.0460-5731.2 605731	21738 13,5 + WK
2.0 TDiC	77	11/98→10/00	←			13.0460-2803.2 602803	TRW 21515 17,5 + WK
			→	01/99→		13.0460-5929.2 605929	AKE 21719 15,0 + WK
			→	→ 12/98		13.0460-5998.2 605998	AKE 21312 12,8 + WK
<b>Zubehörsatz, Scheibenbremsbelag</b>							
1.4 i (EJ9) 1.4 i S (EJ9) 1.4 LPG	55 66 66	11/95→02/01 11/95→02/01 01/97→02/01	← → 12/97			13.0460-0073.2 610073	
1.5	66	11/95→12/96	←	01/98→ 01/01		13.0460-0073.2 610073	
			→	Türenanzahl: 3		13.0460-0329.2 610329	
1.5 i (EK3)	84	11/95→02/01	←	→ 01/01		13.0460-0073.2 610073	
			→	→ 01/01; Türenanzahl: 3		13.0460-0329.2 610329	
1.6	92	11/98→10/00	←			13.0460-0073.2 610073	
			→			13.0460-0329.2 610329	
1.6	93	10/95→09/00	← 01/96→			13.0460-0073.2 610073	
1.6 i (EK1) 1.6 VTi (EK4)	84 118	11/95→02/01 11/95→02/01	←	→ 01/01		13.0460-0073.2 610073	
			→	→ 01/01		13.0460-0329.2 610329	
2.0 TDiC	77	11/98→10/00	←			13.0460-0142.2 610142	
			→	→ 12/98		13.0460-0308.2 610308	AKE
			→	→ 12/98		13.0460-0430.2 610430	AKE
<b> Bremsscheibe</b>							
1.4 i (EJ9)	55	11/95→02/01	←	→ 01/01; - ABS		24.0121-0104.1 421104	SUM Ø 240 21 19 V + S
			←	→ 01/01; + ABS		24.0121-0105.1 421105	Ø 262 21 19 V + S
			→	→ 01/01; + ABS		24.0110-0212.1 410212	Ø 238,5 10 8 + S
1.4 i S (EJ9) 1.4 LPG	66 66	11/95→02/01 01/97→02/01	←	→ 01/01		24.0121-0104.1 421104	SUM Ø 240 21 19 V + S
						24.0121-0105.1 421105	Ø 262 21 19 V + S
1.5	66	11/95→12/96	←	- ABS		24.0121-0104.1 421104	SUM Ø 240 21 19 V + S
			←	+ ABS		24.0121-0105.1 421105	Ø 262 21 19 V + S
			→	Türenanzahl: 3		24.0109-0111.1 409111	Ø 239 9 8 + S
			→	Türenanzahl: 4		24.0109-0143.1 409143	Ø 260 9 8 + S
1.5 i (EK3)	84	11/95→02/01	←	→ 01/01; - ABS		24.0121-0104.1 421104	SUM Ø 240 21 19 V + S
			←	→ 01/01; + ABS		24.0121-0105.1 421105	Ø 262 21 19 V + S
			→	→ 01/01; Türenanzahl: 3		24.0109-0111.1 409111	Ø 239 9 8 + S
			→	→ 01/01; Türenanzahl: 4		24.0109-0143.1 409143	Ø 260 9 8 + S
1.6	92	11/98→10/00	←			24.0121-0105.1 421105	Ø 262 21 19 V + S
			→			24.0109-0111.1 409111	Ø 239 9 8 + S
1.6	93	10/95→09/00	← 01/96→			24.0121-0105.1 421105	Ø 262 21 19 V + S
1.6 i (EK1) 1.6 VTi (EK4)	84 118	11/95→02/01 11/95→02/01	←	→ 01/01		24.0121-0105.1 421105	Ø 262 21 19 V + S
			→	→ 01/01		24.0109-0111.1 409111	Ø 239 9 8 + S
2.0 TDiC	77	11/98→10/00	←			24.0121-0105.1 421105	Ø 262 21 19 V + S
			→			24.0110-0212.1 410212	Ø 238,5 10 8 + S

















	kw			 	! #		
<b>HONDA - CIVIC VI Stufenheck (EJ, EK) 06/95→03/01</b>							
 <b>Bremsbelagsatz, Scheibenbremse</b>							
1.4	55	11/95→10/98	←	01/98→		<b>13.0460-5820.2 605820</b>	SUM 21694 16,3 + WK
			←	→ 12/97		<b>13.0460-5943.2 605943</b>	SUM 21697 15,0 + WK
			→	+ ABS		<b>13.0460-5998.2 605998</b>	AKE 21312 12,8 + WK
1.4 i (EJ9)	66	11/95→02/01	←	01/98→ 01/01		<b>13.0460-5820.2 605820</b>	SUM 21694 16,3 + WK
			←	→ 12/97		<b>13.0460-5943.2 605943</b>	SUM 21697 15,0 + WK
1.5 i (EK3)	84	11/95→02/01	←	→ 01/01		<b>13.0460-5820.2 605820</b>	SUM 21694 16,3 + WK
			→	→ 01/01; Türenanzahl: 3		<b>13.0460-5731.2 605731</b>	21738 13,5 + WK
			→	→ 01/01; Türenanzahl: 4		<b>13.0460-5929.2 605929</b>	AKE 21719 15,0 + WK
1.6 i Vtec	92	11/95→02/01	←	→ 01/01		<b>13.0460-5820.2 605820</b>	SUM 21694 16,3 + WK
1.6 VTi (EK4)	118	11/95→02/01	→	→ 01/01		<b>13.0460-5731.2 605731</b>	21738 13,5 + WK
<b>Zubehörsatz, Scheibenbremsbelag</b>							
1.4	55	11/95→10/98	←	→ 12/97		<b>13.0460-0073.2 610073</b>	
			←	01/98→		<b>13.0460-0073.2 610073</b>	
1.4 i (EJ9)	66	11/95→02/01	←	→ 12/97		<b>13.0460-0073.2 610073</b>	
			←	01/98→ 01/01		<b>13.0460-0073.2 610073</b>	
1.5 i (EK3)	84	11/95→02/01	←	→ 01/01		<b>13.0460-0073.2 610073</b>	
			→	→ 01/01; Türenanzahl: 3		<b>13.0460-0329.2 610329</b>	
1.6 i Vtec	92	11/95→02/01	←	→ 01/01		<b>13.0460-0073.2 610073</b>	
1.6 VTi (EK4)	118	11/95→02/01	→	→ 01/01		<b>13.0460-0329.2 610329</b>	
 <b>Bremsscheibe</b>							
1.4	55	11/95→10/98	←	- ABS		<b>24.0121-0104.1 421104</b>	SUM Ø 240 21 19 V + S
			←	+ ABS		<b>24.0121-0105.1 421105</b>	Ø 262 21 19 V + S
			→	+ ABS		<b>24.0110-0212.1 410212</b>	Ø 238,5 10 8 + S
1.4 i (EJ9)	66	11/95→02/01	←	→ 01/01		<b>24.0121-0104.1 421104</b>	SUM Ø 240 21 19 V + S
						<b>24.0121-0105.1 421105</b>	Ø 262 21 19 V + S
1.5 i (EK3)	84	11/95→02/01	←	→ 01/01; - ABS		<b>24.0121-0104.1 421104</b>	SUM Ø 240 21 19 V + S
			←	→ 01/01; + ABS		<b>24.0121-0105.1 421105</b>	Ø 262 21 19 V + S
			→	→ 01/01; Türenanzahl: 3		<b>24.0109-0111.1 409111</b>	Ø 239 9 8 + S
			→	→ 01/01; Türenanzahl: 4		<b>24.0109-0143.1 409143</b>	Ø 260 9 8 + S
1.6 i Vtec	92	11/95→02/01	←	→ 01/01		<b>24.0121-0105.1 421105</b>	Ø 262 21 19 V + S
1.6 VTi (EK4)	118	11/95→02/01	→	→ 01/01		<b>24.0109-0111.1 409111</b>	Ø 239 9 8 + S
<b>HONDA - CIVIC VII Coupe (EM2) 02/01→12/05</b>							
 <b>Bremsbelagsatz, Scheibenbremse</b>							
1.6 i	81	02/01→12/05	←			<b>13.0460-2803.2 602803</b>	TRW 21515 17,5 + WK
			←	für Fahrzeuge mit Sportfahrwerk		<b>13.0460-5755.2 605755</b>	SUM 23178 16,6 + WK
			←	→ 10/04		<b>13.0460-5820.2 605820</b>	SUM 21694 16,3 + WK
			→	→ 10/04		<b>13.0460-5929.2 605929</b>	AKE 21719 15,0 + WK
			→			<b>13.0460-5929.2 605929</b>	AKE 21719 15,0 + WK
1.7 i	88	05/01→12/05	←	→ 10/04		<b>13.0460-5820.2 605820</b>	SUM 21694 16,3 + WK
1.7 i VTEC	92	05/01→12/05	→	→ 10/04		<b>13.0460-5929.2 605929</b>	AKE 21719 15,0 + WK
<b>Zubehörsatz, Scheibenbremsbelag</b>							
1.6 i	81	02/01→12/05	←			<b>13.0460-0142.2 610142</b>	
 <b>Bremsscheibe</b>							
1.6 i	81	02/01→12/05	←			<b>24.0121-0105.1 421105</b>	Ø 262 21 19 V + S
			←	→ 10/04; für Fahrzeuge mit Sportfahrwerk		<b>24.0121-0105.1 421105</b>	Ø 262 21 19 V + S
			←	für Fahrzeuge mit Sportpaket		<b>24.0121-0702.1 421702</b>	Ø 262 21 19 V + S
			←	für Fahrzeuge mit Sportfahrwerk		<b>24.0123-0109.1 423109</b>	Ø 282 23 21 V + S
			←	→ 10/04		<b>24.0123-0109.1 423109</b>	Ø 282 23 21 V + S
			→	→ 10/04		<b>24.0109-0143.1 409143</b>	Ø 260 9 8 + S
			→			<b>24.0109-0143.1 409143</b>	Ø 260 9 8 + S
↓							













	kw			 	! #		
<b>HONDA - CIVIC VII Coupe (EM2) 02/01→12/05</b>							
 <b>Bremsscheibe</b>							
1.6 i	81	02/01→12/05	→	für Fahrzeuge mit Sportfahrwerk		24.0110-0279.1 410279	Ø 260 10 8 + S
			→	→ 10/04; für Fahrzeuge mit Sportfahrwerk		24.0110-0279.1 410279	Ø 260 10 8 + S
1.7 i	88	05/01→12/05	←	→ 10/04; für Fahrzeuge mit Sportfahrwerk		24.0121-0105.1 421105	Ø 262 21 19 V + S
1.7 i VTEC	92	05/01→12/05	←	→ 10/04		24.0123-0109.1 423109	Ø 282 23 21 V + S
			→	→ 10/04		24.0109-0143.1 409143	Ø 260 9 8 + S
			→	→ 10/04; für Fahrzeuge mit Sportfahrwerk		24.0110-0279.1 410279	Ø 260 10 8 + S
<b>HONDA - CIVIC VII Hatchback (EU, EP, EV) 03/99→02/06</b>							
 <b>Bremsbelagsatz, Scheibenbremse</b>							
1.4 i	55	02/01→09/05	←			13.0460-2803.2 602803	TRW 21515 17,5 + WK
1.6 i	81	02/01→09/05	←			13.0460-5820.2 605820	SUM 21694 16,3 + WK
			→			13.0460-5929.2 605929	AKE 21719 15,0 + WK
1.4 iS (EP1)	66	02/01→09/05	←			13.0460-2803.2 602803	TRW 21515 17,5 + WK
			←	für Fahrzeuge mit Sportfahrwerk		13.0460-5755.2 605755	SUM 23178 16,6 + WK
			→	für Linkslenker		13.0460-5929.2 605929	AKE 21719 15,0 + WK
1.7 CTDi	74	01/02→09/05	←	für Fahrzeuge mit Sportfahrwerk		13.0460-5755.2 605755	SUM 23178 16,6 + WK
			←			13.0460-5878.2 605878	23729 16,9 + WK
			→			13.0460-5861.2 605861	23097 17,1 + WK + Zub
			→			13.0460-5929.2 605929	AKE 21719 15,0 + WK
2.0 i Sport	118	09/01→09/05	←	01/04→		13.0460-5878.2 605878	23729 16,9 + WK
			→	01/04→		13.0460-5929.2 605929	AKE 21719 15,0 + WK
2.0 Type-R	147	09/01→09/05	←			13.0460-5755.2 605755	SUM 23178 16,6 + WK
			→			13.0460-5929.2 605929	AKE 21719 15,0 + WK
<b>Zubehörsatz, Scheibenbremsbelag</b>							
1.4 iS (EP1)	66	02/01→09/05	←			13.0460-0142.2 610142	
1.7 CTDi	74	01/02→09/05	←				
2.0 i Sport	118	09/01→09/05	←	01/04→		13.0460-0142.2 610142	
 <b>Bremsscheibe</b>							
1.4 i	55	02/01→09/05	←			24.0121-0105.1 421105	Ø 262 21 19 V + S
1.6 i	81	02/01→09/05	←	für Fahrzeuge mit Sportfahrwerk		24.0121-0702.1 421702	Ø 262 21 19 V + S
			→			24.0109-0143.1 409143	Ø 260 9 8 + S
			→	für Fahrzeuge mit Sportfahrwerk		24.0110-0279.1 410279	Ø 260 10 8 + S
1.4 iS (EP1)	66	02/01→09/05	←			24.0121-0105.1 421105	Ø 262 21 19 V + S
			←	für Fahrzeuge mit Sportpaket		24.0121-0702.1 421702	Ø 262 21 19 V + S
			←	für Fahrzeuge mit Sportfahrwerk		24.0123-0109.1 423109	Ø 282 23 21 V + S
			→	für Linkslenker		24.0109-0143.1 409143	Ø 260 9 8 + S
			→	für Linkslenker; für Fahrzeuge mit Sportfahrwerk		24.0110-0279.1 410279	Ø 260 10 8 + S
1.7 CTDi	74	01/02→09/05	←	für Fahrzeuge mit Sportfahrwerk		24.0123-0109.1 423109	Ø 282 23 21 V + S
			←			24.0125-0173.1 425173	Ø 300 25 23 V + S
			→			24.0123-0111.1 423111	Ø 260 23 21 V + S
			→			24.0109-0143.1 409143	Ø 260 9 8 + S
			→	für Fahrzeuge mit Sportfahrwerk		24.0110-0279.1 410279	Ø 260 10 8 + S
2.0 i Sport	118	09/01→09/05	←	01/04→		24.0123-0109.1 423109	Ø 282 23 21 V + S
			→	01/04→		24.0110-0279.1 410279	Ø 260 10 8 + S
2.0 Type-R	147	09/01→09/05	←			24.0125-0173.1 425173	Ø 300 25 23 V + S
			→			24.0110-0279.1 410279	Ø 260 10 8 + S
<b>HONDA - CIVIC VII Stufenheck (ES, ET) 10/00→04/06</b>							
 <b>Bremsbelagsatz, Scheibenbremse</b>							
1.3 IMA (ED9, ES9)	61	10/03→09/05	←	01/04→		13.0460-2803.2 602803	TRW 21515 17,5 + WK
			→	01/04→		13.0460-5820.2 605820	SUM 21694 16,3 + WK
			→	01/04→		13.0460-5929.2 605929	AKE 21719 15,0 + WK
1.4 (ES4)	66	12/00→09/05	←	02/01→		13.0460-2803.2 602803	TRW 21515 17,5 + WK

















	kw					! #		
<b>HONDA - CIVIC VII Stufenheck (ES, ET) 10/00→04/06</b>								
 <b>Bremsbelagsatz, Scheibenbremse</b>								
1.4 (ES4)	66	12/00→09/05	←	02/01→			<b>13.0460-5820.2 605820</b>	SUM 21694 16,3 + WK
			←	02/01→; für Fahrzeuge mit Sportfahrwerk			<b>13.0460-5878.2 605878</b>	23729 16,9 + WK
			→	02/01→			<b>13.0460-5929.2 605929</b>	AKE 21719 15,0 + WK
1.6	81	02/01→09/05	←				<b>13.0460-2803.2 602803</b>	TRW 21515 17,5 + WK
			←	für Fahrzeuge mit Sportfahrwerk			<b>13.0460-5820.2 605820</b>	SUM 21694 16,3 + WK
			→				<b>13.0460-5878.2 605878</b>	23729 16,9 + WK
2.0 (ET1)	118	10/03→09/05	←	01/04→			<b>13.0460-5929.2 605929</b>	AKE 21719 15,0 + WK
			←	01/04→			<b>13.0460-5878.2 605878</b>	23729 16,9 + WK
			→	01/04→			<b>13.0460-5929.2 605929</b>	AKE 21719 15,0 + WK
<b>Zubehörsatz, Scheibenbremsbelag</b>								
1.4 (ES4)	66	12/00→09/05	←	02/01→			<b>13.0460-0142.2 610142</b>	
1.6	81	02/01→09/05	←				<b>13.0460-0142.2 610142</b>	
2.0 (ET1)	118	10/03→09/05	←	01/04→			<b>13.0460-0142.2 610142</b>	
 <b>Bremsscheibe</b>								
1.3 IMA (ED9, ES9)	61	10/03→09/05	←	01/04→			<b>24.0121-0105.1 421105</b>	Ø 262 21 19 V + S
			←	01/04→; für Fahrzeuge mit Sportfahrwerk			<b>24.0121-0702.1 421702</b>	Ø 262 21 19 V + S
			→	01/04→			<b>24.0109-0143.1 409143</b>	Ø 260 9 8 + S
			→	01/04→; für Fahrzeuge mit Sportfahrwerk			<b>24.0110-0279.1 410279</b>	Ø 260 10 8 + S
1.4 (ES4)	66	12/00→09/05	←	02/01→			<b>24.0121-0105.1 421105</b>	Ø 262 21 19 V + S
			←	02/01→; für Fahrzeuge mit Sportfahrwerk			<b>24.0123-0109.1 423109</b>	Ø 282 23 21 V + S
			→	02/01→			<b>24.0109-0143.1 409143</b>	Ø 260 9 8 + S
			→	02/01→; für Fahrzeuge mit Sportfahrwerk			<b>24.0110-0279.1 410279</b>	Ø 260 10 8 + S
1.6	81	02/01→09/05	←				<b>24.0121-0105.1 421105</b>	Ø 262 21 19 V + S
			←	für Fahrzeuge mit Sportfahrwerk			<b>24.0123-0109.1 423109</b>	Ø 282 23 21 V + S
			→	für Rechtslenker			<b>24.0109-0143.1 409143</b>	Ø 260 9 8 + S
			→				<b>24.0109-0143.1 409143</b>	Ø 260 9 8 + S
			→	für Rechtslenker; für Fahrzeuge mit Sportfahrwerk			<b>24.0110-0279.1 410279</b>	Ø 260 10 8 + S
			→	für Fahrzeuge mit Sportfahrwerk			<b>24.0110-0279.1 410279</b>	Ø 260 10 8 + S
2.0 (ET1)	118	10/03→09/05	←	01/04→			<b>24.0123-0109.1 423109</b>	Ø 282 23 21 V + S
			→	01/04→			<b>24.0110-0279.1 410279</b>	Ø 260 10 8 + S
<b>HONDA - CIVIC VIII Hatchback (FN, FK) 09/05→</b>								
 <b>Bremsbelagsatz, Scheibenbremse</b>								
1.4 (FK1, FN4)	73	10/08→	←	→ 12/12			<b>13.0460-5756.2 605756</b>	24087 17,4 + WK + Zub
			→	→ 12/12			<b>13.0460-5757.2 605757</b>	24086 15,8 + WK + Zub
1.4 (FK1)	61	09/05→	←	01/06→ 01/12			<b>13.0460-5756.2 605756</b>	24087 17,4 + WK + Zub
			→	01/06→ 01/12			<b>13.0460-5757.2 605757</b>	24086 15,8 + WK + Zub
1.8 (FN1, FK2) 2.2 CTDi (FK3)	103 103	09/05→ 09/05→	←	01/06→ 12/12			<b>13.0460-5756.2 605756</b>	24087 17,4 + WK + Zub
			→	01/06→ 12/12			<b>13.0460-5757.2 605757</b>	24086 15,8 + WK + Zub
2.0 i-VTEC Type R (FN2)	177	03/10→12/10	←				<b>13.0460-5755.2 605755</b>	SUM 23178 16,6 + WK
			→				<b>13.0460-5757.2 605757</b>	24086 15,8 + WK + Zub
Type R (FN2)	148	09/06→	←	→ 12/12			<b>13.0460-5755.2 605755</b>	SUM 23178 16,6 + WK
			→	→ 12/12			<b>13.0460-5757.2 605757</b>	24086 15,8 + WK + Zub
<b>Zubehörsatz, Scheibenbremsbelag</b>								
1.4 (FK1, FN4)	73	10/08→	←	→ 12/12			<b>13.0460-0142.2 610142</b>	
1.4 (FK1)	61	09/05→	←	01/06→ 01/12			<b>13.0460-0142.2 610142</b>	
1.8 (FN1, FK2) 2.2 CTDi (FK3)	103 103	09/05→ 09/05→	←	01/06→ 12/12			<b>13.0460-0142.2 610142</b>	
 <b>Bremsscheibe</b>								
1.4 (FK1, FN4)	73	10/08→	←	→ 12/12			<b>24.0123-0110.1 423110</b>	Ø 282 23 21 V + S















	kw			 	! #		
<b>HONDA - CIVIC VIII Hatchback (FN, FK) 09/05→</b>							
 <b>Bremsscheibe</b>							
1.4 (FK1, FN4)	73	10/08→	➡	→ 12/12		24.0109-0158.1 409158	Ø 260 9 8 + S
1.4 (FK1)	61	09/05→	⬅	01/06→ 01/12		24.0123-0110.1 423110	Ø 282 23 21 V + S
			➡	01/06→ 01/12		24.0109-0158.1 409158	Ø 260 9 8 + S
1.8 (FN1, FK2) 2.2 CTDi (FK3)	103 103	09/05→ 09/05→	⬅	01/06→ 12/12		24.0123-0110.1 423110	Ø 282 23 21 V + S
			➡	01/06→ 12/12		24.0109-0158.1 409158	Ø 260 9 8 + S
2.0 i-VTEC Type R (FN2)	177	03/10→12/10	➡			24.0109-0158.1 409158	Ø 260 9 8 + S
Type R (FN2)	148	09/06→	➡	→ 12/12		24.0109-0158.1 409158	Ø 260 9 8 + S
<b>HONDA - CIVIC VIII Stufenheck (FD, FA) 09/05→</b>							
 <b>Bremsbelagsatz, Scheibenbremse</b>							
1.3 Hybrid (FA3, FD3)	70	01/06→	⬅	→ 02/12		13.0460-5820.2 605820	SUM 21694 16,3 + WK
			➡	→ 02/12		13.0460-5929.2 605929	AKE 21719 15,0 + WK
1.3 Hybrid (FD3)	85	01/10→02/12	➡			13.0460-5929.2 605929	AKE 21719 15,0 + WK
1.6 1.6 EXS Flex	84 92	09/05→ 09/05→	⬅	→ 12/12		13.0460-5878.2 605878	23729 16,9 + WK
			➡	→ 12/12		13.0460-5929.2 605929	AKE 21719 15,0 + WK
1.8 EXS Flex	103	11/06→	➡	→ 12/12		13.0460-5929.2 605929	AKE 21719 15,0 + WK
			⬅	02/12→		13.0460-7284.2 607284	ATE 25804 17,3 + WK
1.6	92	01/12→	➡	02/12→		13.0460-7290.2 607290	ATE 24574 15,0 + WK
			⬅			13.0460-5878.2 605878	23729 16,9 + WK
1.8 (FD1, FD7)	103	09/05→02/12	⬅			13.0460-5878.2 605878	23729 16,9 + WK
			➡			13.0460-5929.2 605929	AKE 21719 15,0 + WK
<b>Zubehörsatz, Scheibenbremsbelag</b>							
1.6 1.6 EXS Flex	84 92	09/05→ 09/05→	⬅	→ 12/12		13.0460-0142.2 610142	
			➡				
1.8 (FD1, FD7)	103	09/05→02/12	⬅			13.0460-0142.2 610142	
 <b>Bremsscheibe</b>							
1.3 Hybrid (FA3, FD3)	70	01/06→	⬅	→ 02/12		24.0121-0702.1 421702	Ø 262 21 19 V + S
			➡	→ 02/12		24.0109-0158.1 409158	Ø 260 9 8 + S
1.3 Hybrid (FD3)	85	01/10→02/12	⬅			24.0121-0702.1 421702	Ø 262 21 19 V + S
			➡			24.0109-0158.1 409158	Ø 260 9 8 + S
1.6 1.6 EXS Flex	84 92	09/05→ 09/05→	⬅	→ 12/12		24.0123-0110.1 423110	Ø 282 23 21 V + S
			➡	→ 12/12		24.0109-0158.1 409158	Ø 260 9 8 + S
1.8 EXS Flex	103	11/06→	➡	→ 12/12		24.0109-0158.1 409158	Ø 260 9 8 + S
			⬅	02/12→		24.0125-0201.1 425201	Ø 280 25 22,4 V
1.6	92	01/12→	➡	02/12→		24.0110-0380.1 410380	Ø 276 10 8
			⬅			24.0123-0110.1 423110	Ø 282 23 21 V + S
1.8 (FD1, FD7)	103	09/05→02/12	⬅			24.0123-0110.1 423110	Ø 282 23 21 V + S
			➡			24.0109-0158.1 409158	Ø 260 9 8 + S
<b>HONDA - CIVIC IX (FK) 02/12→</b>							
 <b>Bremsbelagsatz, Scheibenbremse</b>							
1.4 i-VTEC (FK1)	73	02/12→	⬅			13.0460-7284.2 607284	ATE 25804 17,3 + WK
1.6 i-DTEC (FK3)	88	02/13→	➡			13.0460-7290.2 607290	ATE 24574 15,0 + WK
1.8 i-VTEC (FK2)	104	02/12→	➡				
2.2 i-DTEC (FK3)	110	02/12→	➡				
 <b>Bremsscheibe</b>							
1.4 i-VTEC (FK1)	73	02/12→	⬅			24.0125-0201.1 425201	Ø 280 25 22,4 V
1.6 i-DTEC (FK3)	88	02/13→	➡			24.0110-0380.1 410380	Ø 276 10 8
2.2 i-DTEC (FK3)	110	02/12→	➡				
1.8 i-VTEC (FK2)	104	02/12→	⬅	15"		24.0125-0201.1 425201	Ø 280 25 22,4 V
			➡			24.0110-0380.1 410380	Ø 276 10 8
<b>HONDA - CIVIC IX Stufenheck (FB, FG) 09/11→</b>							
 <b>Bremsbelagsatz, Scheibenbremse</b>							
1.8 (FB2)	104	02/12→	⬅			13.0460-7284.2 607284	ATE 25804 17,3 + WK
			➡			13.0460-7290.2 607290	ATE 24574 15,0 + WK
 <b>Bremsscheibe</b>							
1.8 (FB2)	104	02/12→	⬅	15"		24.0125-0201.1 425201	Ø 280 25 22,4 V
↓							





















	kw					! #		
<b>HONDA - CIVIC IX Stufenheck (FB, FG) 09/11→</b>								
 <b>Bremsscheibe</b>								
1.8 (FB2)	104	02/12→	→			24.0110-0380.1	410380	Ø 276 10 8
<b>HONDA - CIVIC IX Tourer (FK) 01/14→</b>								
 <b>Bremsbelagsatz, Scheibenbremse</b>								
1.6 i-DTEC (FK3)	88	01/14→	←			13.0460-7284.2	607284	ATE 25804 17,3 + WK
1.8 i-VTEC (FK2)	104	01/14→	→			13.0460-7290.2	607290	ATE 24574 15,0 + WK
 <b>Bremsscheibe</b>								
1.6 i-DTEC (FK3)	88	01/14→	←			24.0125-0201.1	425201	Ø 280 25 22,4 V
			→			24.0110-0380.1	410380	Ø 276 10 8
1.8 i-VTEC (FK2)	104	01/14→	←	15"		24.0125-0201.1	425201	Ø 280 25 22,4 V
			→			24.0110-0380.1	410380	Ø 276 10 8
<b>HONDA - CIVIC X Schrägheck (FC_, FK) 09/16→</b>								
 <b>Bremsbelagsatz, Scheibenbremse</b>								
1.0 VTEC (FK6)	95	02/17→	←			13.0460-7284.2	607284	ATE 25804 17,3 + WK
1.5 VTEC (FK7)	134	02/17→						
1.6 i-DTEC (FK9)	88	01/18→						
 <b>Bremsscheibe</b>								
1.0 VTEC (FK6)	95	02/17→	←			24.0125-0201.1	425201	Ø 280 25 22,4 V
<b>HONDA - CIVIC X Stufenheck (FC_) 09/15→</b>								
 <b>Bremsbelagsatz, Scheibenbremse</b>								
1.5 VTEC	134	02/17→	←			13.0460-7284.2	607284	ATE 25804 17,3 + WK
<b>HONDA - CR-V I (RD) 10/95→02/02</b>								
 <b>Bremsbelagsatz, Scheibenbremse</b>								
2.0 (RD1)	98	04/99→02/02	←			13.0460-5982.2	605982	21651 17,5 + WK
2.0 16V 4WD (RD1, RD3)	94	10/95→12/01	←	01/97→ 04/99		13.0460-5982.2	605982	21651 17,5 + WK
2.0 16V 4WD (RD1, RD3)	108	01/99→02/02	←	04/99→		13.0460-5982.2	605982	21651 17,5 + WK
<b>Zubehörsatz, Scheibenbremsbelag</b>								
2.0 (RD1)	98	04/99→02/02	←			13.0460-0075.2	610075	
2.0 16V 4WD (RD1, RD3)	94	10/95→12/01	←	01/97→ 04/99		13.0460-0075.2	610075	
2.0 16V 4WD (RD1, RD3)	108	01/99→02/02	←	04/99→		13.0460-0075.2	610075	
 <b>Bremsscheibe</b>								
2.0 (RD1)	98	04/99→02/02	←			24.0123-0104.1	423104	Ø 282 23 21 V + S
2.0 16V 4WD (RD1, RD3)	94	10/95→12/01	←	01/97→ 04/99		24.0123-0104.1	423104	Ø 282 23 21 V + S
2.0 16V 4WD (RD1, RD3)	108	01/99→02/02	←	04/99→		24.0123-0104.1	423104	Ø 282 23 21 V + S
<b>HONDA - CR-V II (RD_) 09/01→03/07</b>								
 <b>Bremsbelagsatz, Scheibenbremse</b>								
2.0 (RD4)	110	09/01→03/07	←	07/02→ 09/06; 16"		13.0460-5753.2	605753	24638 20,0 + WK + Zub
			←	07/02→ 09/06; 15"		13.0460-5860.2	605860	23868 17,1 + WK + Zub
			→	07/02→ 12/04		13.0460-5711.2	605711	23652 15,7 + WK
			→	01/05→ 09/06		13.0460-5754.2	605754	24635 16,6 + WK + Zub
2.2 CTDi (RD9)	103	02/05→09/06	←	16"		13.0460-5753.2	605753	24638 20,0 + WK + Zub
			←	15"		13.0460-5860.2	605860	23868 17,1 + WK + Zub
			→			13.0460-5711.2	605711	23652 15,7 + WK
2.4 Vtec 4WD (RD7)	118	09/01→09/06	←	03/02→; 16"		13.0460-5753.2	605753	24638 20,0 + WK + Zub
			←	03/02→; 15"		13.0460-5860.2	605860	23868 17,1 + WK + Zub
			→	03/02→ 12/04		13.0460-5711.2	605711	23652 15,7 + WK
			→	01/05→		13.0460-5754.2	605754	24635 16,6 + WK + Zub
↓								

















	kW			 	! #		
<b>HONDA - CR-V II (RD_) 09/01→03/07</b>							
 <b>Bremsscheibe</b>							
2.0 (RD4)	110	09/01→03/07	←	07/02→ 09/06; 15"	24.0123-0109.1	423109	Ø 282 23 21 V + S
			←	07/02→ 09/06; 16"	24.0125-0182.1	425182	Ø 300 25 23 V + S
			→	07/02→ 12/04	24.0109-0144.1	409144	Ø 282 9 8 + S
			→	01/05→ 09/06	24.0109-0151.1	409151	Ø 304,5 9 7,5 + S
2.2 CTDi (RD9)	103	02/05→09/06	←	15"	24.0123-0109.1	423109	Ø 282 23 21 V + S
			←	16"	24.0125-0182.1	425182	Ø 300 25 23 V + S
			→		24.0109-0151.1	409151	Ø 304,5 9 7,5 + S
2.4 Vtec 4WD (RD7)	118	09/01→09/06	←	03/02→; 15"	24.0123-0109.1	423109	Ø 282 23 21 V + S
			←	03/02→; 16"	24.0125-0182.1	425182	Ø 300 25 23 V + S
			→	03/02→ 12/04	24.0109-0144.1	409144	Ø 282 9 8 + S
			→	01/05→	24.0109-0151.1	409151	Ø 304,5 9 7,5 + S
<b>HONDA - CR-V III (RE_) 06/06→</b>							
 <b>Bremsbelagsatz, Scheibenbremse</b>							
2.0 i	110	01/07→	←	→ 09/12	13.0460-5753.2	605753	24638 20,0 + WK + Zub
2.0 i 4WD (RE5)	110	01/07→	→	→ 09/12	13.0460-5754.2	605754	24635 16,6 + WK + Zub
2.2 i-CTDi 4WD (RE6)	103	01/07→					
2.2 i-DTEC 4WD (RE6)	110	01/07→					
2.4	125	04/07→					
2.4 i-Vtec 4WD	125	04/07→					
2.4 i-VTEC 4WD (RE7)	122	09/09→					
2.4 4WD (RE4)	124	09/06→	←	09/07→ 09/12	13.0460-5753.2	605753	24638 20,0 + WK + Zub
			→	09/07→ 09/12	13.0460-5754.2	605754	24635 16,6 + WK + Zub
2.4 i-VTEC 4WD (RE4)	118	10/06→	←	01/07→ 09/12	13.0460-5753.2	605753	24638 20,0 + WK + Zub
			→	01/07→ 09/12	13.0460-5754.2	605754	24635 16,6 + WK + Zub
 <b>Bremsscheibe</b>							
2.0 i	110	01/07→	←	→ 09/12	24.0128-0217.1	428217	Ø 293 28 26 V + S
2.0 i 4WD (RE5)	110	01/07→	→	→ 09/12	24.0110-0329.1	410329	Ø 302 10 8 + S
2.2 i-CTDi 4WD (RE6)	103	01/07→					
2.2 i-DTEC 4WD (RE6)	110	01/07→					
2.4	125	04/07→					
2.4 i-Vtec 4WD	125	04/07→					
2.4 i-VTEC 4WD (RE7)	122	09/09→					
2.4 4WD (RE4)	124	09/06→	←	09/07→ 09/12	24.0128-0217.1	428217	Ø 293 28 26 V + S
			→	09/07→ 09/12	24.0110-0329.1	410329	Ø 302 10 8 + S
2.4 i-VTEC 4WD (RE4)	118	10/06→	←	01/07→ 09/12	24.0128-0217.1	428217	Ø 293 28 26 V + S
			→	01/07→ 09/12	24.0110-0329.1	410329	Ø 302 10 8 + S
<b>HONDA - CR-V IV (RM_) 01/12→</b>							
 <b>Bremsbelagsatz, Scheibenbremse</b>							
1.6 i-DTEC (RE6)	88	10/13→	←		13.0460-5753.2	605753	24638 20,0 + WK + Zub
2.0 (RE5)	114	10/12→	→		13.0460-5754.2	605754	24635 16,6 + WK + Zub
2.0 AWD (RE5)	114	10/12→					
1.6 i-DTEC 4WD	118	02/15→	←	Bremssattel(1-Kolben)	13.0460-5753.2	605753	24638 20,0 + WK + Zub
2.2 i-DTEC AWD (RE6)	110	10/12→	→		13.0460-5754.2	605754	24635 16,6 + WK + Zub
 <b>Bremsscheibe</b>							
1.6 i-DTEC (RE6)	88	10/13→	←		24.0128-0217.1	428217	Ø 293 28 26 V + S
2.0 (RE5)	114	10/12→	→		24.0110-0329.1	410329	Ø 302 10 8 + S
2.0 AWD (RE5)	114	10/12→					
1.6 i-DTEC 4WD	118	02/15→	←	Bremssattel(1-Kolben)	24.0128-0217.1	428217	Ø 293 28 26 V + S
			→		24.0110-0329.1	410329	Ø 302 10 8 + S
2.2 i-DTEC AWD (RE6)	110	10/12→	→		24.0110-0329.1	410329	Ø 302 10 8 + S
<b>HONDA - CRX III (EH, EG) 03/92→12/98</b>							
 <b>Bremsbelagsatz, Scheibenbremse</b>							
1.6 ESi (EH6)	92	03/92→12/98	←		13.0460-5820.2	605820	SUM 21694 16,3 + WK
			→	+ ABS	13.0460-5998.2	605998	AKE 21312 12,8 + WK
1.6 i VTi (EG2)	118	03/92→12/98	←		13.0460-5820.2	605820	SUM 21694 16,3 + WK
			→		13.0460-5998.2	605998	AKE 21312 12,8 + WK
↓							















	kW			 	! #		
<b>HONDA - CRX III (EH, EG) 03/92→12/98</b>							
<b>Zubehörsatz, Scheibenbremsbelag</b>							
1.6 ESi (EH6)	92	03/92→12/98	➡	+ ABS		13.0460-0430.2 610430	AKE
1.6 i VTI (EG2)	118	03/92→12/98	➡			13.0460-0430.2 610430	AKE
<b> Bremsscheibe</b>							
1.6 ESi (EH6)	92	03/92→12/98	←			24.0121-0105.1 421105	Ø 262 21 19 V + S
			➡	+ ABS		24.0109-0111.1 409111	Ø 239 9 8 + S
1.6 i VTI (EG2)	118	03/92→12/98	←			24.0121-0105.1 421105	Ø 262 21 19 V + S
			➡			24.0109-0111.1 409111	Ø 239 9 8 + S
<b>HONDA - FR-V (BE) 08/04→</b>							
<b> Bremsbelagsatz, Scheibenbremse</b>							
1.7 (BE1)	92	08/04→	←	02/05→ 06/09		13.0460-5878.2 605878	23729 16,9 + WK
			➡	02/05→ 06/09		13.0460-5711.2 605711	23652 15,7 + WK
1.8 (BE1)	103	01/07→	←	→ 06/09		13.0460-5878.2 605878	23729 16,9 + WK
2.0 (BE3)	110	02/05→	➡	→ 12/09		13.0460-5711.2 605711	23652 15,7 + WK
2.2 i CTDi (BE5)	103	07/05→	➡				
<b> Bremsscheibe</b>							
1.7 (BE1)	92	08/04→	←	02/05→ 06/09		24.0123-0110.1 423110	Ø 282 23 21 V + S
			➡	02/05→ 06/09		24.0112-0172.1 412172	Ø 282 12 10 + S
1.8 (BE1)	103	01/07→	←	→ 06/09		24.0123-0110.1 423110	Ø 282 23 21 V + S
2.0 (BE3)	110	02/05→	➡	→ 06/09		24.0112-0172.1 412172	Ø 282 12 10 + S
2.2 i CTDi (BE5)	103	07/05→	←	→ 06/09		24.0125-0189.1 425189	Ø 281,5 25 23 V + S
			➡	→ 06/09		24.0112-0172.1 412172	Ø 282 12 10 + S
<b>HONDA - HR-V (GH) 03/99→</b>							
<b> Bremsbelagsatz, Scheibenbremse</b>							
1.6 16V (GH1, GH3)	77	03/99→	←	→ 09/05		13.0460-5982.2 605982	21651 17,5 + WK
1.6 16V 4WD (GH2, GH4)	77	03/99→					
1.6 16V 4WD (GH2, GH4)	91	10/99→					
<b> Bremsscheibe</b>							
1.6 16V (GH1, GH3)	77	03/99→	←	→ 09/05		24.0123-0104.1 423104	Ø 282 23 21 V + S
1.6 16V 4WD (GH2, GH4)	77	03/99→					
1.6 16V 4WD (GH2, GH4)	91	10/99→					
<b>HONDA - INSIGHT (ZE_) 04/09→</b>							
<b> Bremsbelagsatz, Scheibenbremse</b>							
1.3 Hybrid (ZE2)	73	04/09→	←	→ 09/13		13.0460-5620.2 605620	AKE 24979 15,9 + WK + Zub
1.3 Hybrid (ZE28, ZE2)	65	04/09→	➡	→ 09/13		13.0460-5929.2 605929	AKE 21719 15,0 + WK
<b> Bremsscheibe</b>							
1.3 Hybrid (ZE2)	73	04/09→	←	→ 09/13		24.0121-0105.1 421105	Ø 262 21 19 V + S
1.3 Hybrid (ZE28, ZE2)	65	04/09→	➡	→ 09/13		24.0109-0162.1 409162	Ø 260 9 8 + S
<b>HONDA - INSIGHT (ZE) 04/00→12/06</b>							
<b> Bremsscheibe</b>							
1.0 Hybrid (ZE1, ZE18)	56	04/00→12/06	←	08/00→		24.0117-0101.1 417101	AKE Ø 231 17 15 V
<b>HONDA - INTEGRA Coupe (DC2, DC4) 07/93→11/01</b>							
<b> Bremsbelagsatz, Scheibenbremse</b>							
1.8	107	07/93→11/01	➡	11/97→ 10/01		13.0460-5929.2 605929	AKE 21719 15,0 + WK
1.8 Type-R	140	11/97→10/01	➡			13.0460-5929.2 605929	AKE 21719 15,0 + WK
1.8 Type-R (DC2)	147	09/93→08/01	➡	11/97→		13.0460-5929.2 605929	AKE 21719 15,0 + WK
<b> Bremsscheibe</b>							
1.8	107	07/93→11/01	←	11/97→ 10/01		24.0123-0104.1 423104	Ø 282 23 21 V + S
1.8 Type-R	140	11/97→10/01	←			24.0123-0104.1 423104	Ø 282 23 21 V + S
↓							

















	kW			 	! #		
<b>HONDA - INTEGRA Coupe (DC2, DC4) 07/93→11/01</b>							
 <b>Bremsscheibe</b>							
1.8 Type-R (DC2)	147	09/93→08/01	←	11/97→		24.0123-0104.1 423104	Ø 282 23 21 V + S
<b>HONDA - JAZZ II (GD_, GE3, GE2) 06/01→12/08</b>							
 <b>Bremsbelagsatz, Scheibenbremse</b>							
1.2 i-DSI (GD5, GE2)	57	03/02→07/08	←			13.0460-5943.2 605943	SUM 21697 15,0 + WK
1.3 (GD1)	61	03/02→07/08	→	01/04→; + ABS		13.0460-5731.2 605731	21738 13,5 + WK
1.3 iDSi	63	03/02→09/07	←	10/05→		13.0460-5943.2 605943	SUM 21697 15,0 + WK
			→	10/05→		13.0460-5731.2 605731	21738 13,5 + WK
1.4	59	12/06→10/08	←			13.0460-5943.2 605943	SUM 21697 15,0 + WK
1.4 iDSI (GE3)	61	12/06→10/08	→	+ ABS		13.0460-5731.2 605731	21738 13,5 + WK
 <b>Bremsscheibe</b>							
1.2 i-DSI (GD5, GE2)	57	03/02→07/08	←	→ 12/03		24.0121-0113.1 421113	Ø 240 21 19 V + S
1.3 (GD1)	61	03/02→07/08	←	01/04→		24.0121-0115.1 421115	Ø 258 21 19 V + S
			→	01/04→; + ABS		24.0109-0111.1 409111	Ø 239 9 8 + S
1.3 iDSi	63	03/02→09/07	←	10/05→		24.0121-0115.1 421115	Ø 258 21 19 V + S
			→	10/05→		24.0109-0111.1 409111	Ø 239 9 8 + S
1.4	59	12/06→10/08	←			24.0121-0115.1 421115	Ø 258 21 19 V + S
1.4 iDSI (GE3)	61	12/06→10/08	→	+ ABS		24.0109-0111.1 409111	Ø 239 9 8 + S
<b>HONDA - JAZZ III (GE_, GG_, GP_) 10/07→</b>							
 <b>Bremsbelagsatz, Scheibenbremse</b>							
1.2	66	07/08→	←	01/09→ 12/15		13.0460-5620.2 605620	AKE 24979 15,9 + WK + Zub
1.3 i	73	07/08→	←	→ 12/08		13.0460-5943.2 605943	SUM 21697 15,0 + WK
			→	→ 12/15		13.0460-5731.2 605731	21738 13,5 + WK
1.3 HYBRID (GP1)	65	04/11→	←	→ 12/15		13.0460-5620.2 605620	AKE 24979 15,9 + WK + Zub
			→	→ 12/15		13.0460-5929.2 605929	AKE 21719 15,0 + WK
1.4	74	11/08→	←	→ 12/15		13.0460-5620.2 605620	AKE 24979 15,9 + WK + Zub
1.5 i-VTEC	88	07/08→	→	→ 12/15		13.0460-5731.2 605731	21738 13,5 + WK
 <b>Bremsscheibe</b>							
1.2	66	07/08→	←	01/09→ 12/15		24.0121-0105.1 421105	Ø 262 21 19 V + S
			←	→ 12/08		24.0121-0115.1 421115	Ø 258 21 19 V + S
			→	→ 12/08		24.0109-0111.1 409111	Ø 239 9 8 + S
1.3 HYBRID (GP1)	65	04/11→	←	→ 12/15		24.0121-0105.1 421105	Ø 262 21 19 V + S
			→	→ 12/15		24.0109-0162.1 409162	Ø 260 9 8 + S
1.3 i	73	07/08→	←	→ 12/15		24.0121-0105.1 421105	Ø 262 21 19 V + S
			→	→ 12/15		24.0109-0178.1 409178	Ø 239 9 8
1.4	74	11/08→	←	→ 12/15		24.0121-0105.1 421105	Ø 262 21 19 V + S
1.5 i-VTEC	88	07/08→	←			24.0121-0105.1 421105	Ø 262 21 19 V + S
			→	→ 12/08		24.0109-0111.1 409111	Ø 239 9 8 + S
<b>HONDA - JAZZ IV (GK_) 09/13→</b>							
 <b>Bremsbelagsatz, Scheibenbremse</b>							
1.3	75	09/15→	←			13.0460-5620.2 605620	AKE 24979 15,9 + WK + Zub
1.5	96	01/15→	→			13.0460-5731.2 605731	21738 13,5 + WK
 <b>Bremsscheibe</b>							
1.3	75	09/15→	←	→ 07/17		24.0121-0105.1 421105	Ø 262 21 19 V + S
			→	→ 07/17		24.0109-0178.1 409178	Ø 239 9 8
1.5	96	01/15→	←	→ 06/17		24.0121-0105.1 421105	Ø 262 21 19 V + S
			→	→ 07/17		24.0109-0178.1 409178	Ø 239 9 8















	kW			 	! #		
<b>HONDA - JAZZ Stufenheck (GD_) 12/02→</b>							
 <b>Bremsbelagsatz, Scheibenbremse</b>							
1.3 (GD6)	63	05/03→07/08	←			13.0460-5943.2 605943	SUM 21697 15,0 + WK
			→			13.0460-5731.2 605731	21738 13,5 + WK
 <b>Bremsscheibe</b>							
1.3 (GD6)	63	05/03→07/08	←			24.0121-0115.1 421115	Ø 258 21 19 V + S
			→			24.0109-0111.1 409111	Ø 239 9 8 + S
<b>HONDA - LEGEND II (KA) 01/91→03/96</b>							
 <b>Bremsbelagsatz, Scheibenbremse</b>							
3.2 i 24V (KA7)	151	01/91→02/96	←	→ 01/96		13.0460-5982.2 605982	21651 17,5 + WK
			→	→ 01/96		13.0460-5711.2 605711	23652 15,7 + WK
 <b>Bremsscheibe</b>							
3.2 i 24V (KA7)	151	01/91→02/96	←	→ 01/96		24.0128-0722.1 428722	Ø 282 28 26 V
			→	→ 01/96		24.0109-0132.1 409132	Ø 282 9 7,5
<b>HONDA - LEGEND II Coupe (KA) 01/91→03/96</b>							
 <b>Bremsbelagsatz, Scheibenbremse</b>							
3.2 i 24V (KA8)	151	01/91→02/96	←	→ 01/96		13.0460-5982.2 605982	21651 17,5 + WK
			→	→ 01/96		13.0460-5711.2 605711	23652 15,7 + WK
 <b>Bremsscheibe</b>							
3.2 i 24V (KA8)	151	01/91→02/96	←	→ 01/96		24.0128-0722.1 428722	Ø 282 28 26 V
			→	→ 01/96		24.0109-0132.1 409132	Ø 282 9 7,5
<b>HONDA - LEGEND III (KA) 02/96→</b>							
 <b>Bremsbelagsatz, Scheibenbremse</b>							
3.5 i 24V (KA9)	151	02/96→10/97	←			13.0460-5982.2 605982	21651 17,5 + WK
			→			13.0460-5711.2 605711	23652 15,7 + WK
3.5 i 24V (KA9)	153	11/97→09/04	←	→ 12/98		13.0460-5982.2 605982	21651 17,5 + WK
			→	01/99→		13.0460-5711.2 605711	23652 15,7 + WK
<b>Zubehörsatz, Scheibenbremsbelag</b>							
3.5 i 24V (KA9)	151	02/96→10/97	→			13.0460-0287.2 610287	
3.5 i 24V (KA9)	153	11/97→09/04	→	01/99→		13.0460-0287.2 610287	
			→	→ 12/98		13.0460-0287.2 610287	
 <b>Bremsscheibe</b>							
3.5 i 24V (KA9)	151	02/96→10/97	←			24.0123-0104.1 423104	Ø 282 23 21 V + S
			→			24.0109-0132.1 409132	Ø 282 9 7,5
3.5 i 24V (KA9)	153	11/97→09/04	←	→ 12/98		24.0123-0104.1 423104	Ø 282 23 21 V + S
			→	→ 12/98		24.0109-0132.1 409132	Ø 282 9 7,5
<b>HONDA - LOGO (GA) 03/99→03/02</b>							
 <b>Bremsbelagsatz, Scheibenbremse</b>							
1.3 (GA3)	48	03/99→03/02	←			13.0460-5943.2 605943	SUM 21697 15,0 + WK
 <b>Bremsscheibe</b>							
1.3 (GA3)	48	03/99→03/02	←			24.0121-0113.1 421113	Ø 240 21 19 V + S
<b>HONDA - NSX I Cabriolet (NA) 03/95→09/05</b>							
 <b>Bremsbelagsatz, Scheibenbremse</b>							
3.0 24V Vtec (NA1)	201	03/95→09/05	←	10/01→; Vollautomatik		13.0460-5982.2 605982	21651 17,5 + WK
3.0 24V Vtec Automatic (NA1)	188	03/95→09/05					
3.2 24V Vtec (NA2)	206	01/97→09/05	←	10/01→		13.0460-5982.2 605982	21651 17,5 + WK















	kW			 	! #		
<b>HONDA - NSX I Coupe (NA) 06/90→09/05</b>							
 <b>Bremsbelagsatz, Scheibenbremse</b>							
3.0 24V Vtec (NA1)	201	06/90→09/05	←	10/01→; Vollautomatik		13.0460-5982.2 605982	21651 17,5 + WK
3.0 24V Vtec Automatik (NA1)	188	06/90→09/05					
3.2 24V Vtec (NA2)	206	01/97→09/05	←	10/01→		13.0460-5982.2 605982	21651 17,5 + WK
<b>HONDA - ODYSSEY Großraumlimousine (RA_) 10/95→10/00</b>							
 <b>Bremsbelagsatz, Scheibenbremse</b>							
2.3	110	10/97→12/99	←	01/98→		13.0460-5982.2 605982	21651 17,5 + WK
			→	01/98→		13.0460-5711.2 605711	23652 15,7 + WK
<b>Zubehörsatz, Scheibenbremsbelag</b>							
2.3	110	10/97→12/99	←	01/98→		13.0460-0075.2 610075	
			→	01/98→		13.0460-0287.2 610287	
 <b>Bremsscheibe</b>							
2.3	110	10/97→12/99	←	01/98→		24.0123-0104.1 423104	Ø 282 23 21 V + S
			→	01/98→		24.0109-0132.1 409132	Ø 282 9 7,5
<b>HONDA - PRELUDE IV (BB_) 12/91→02/97</b>							
 <b>Bremsbelagsatz, Scheibenbremse</b>							
2.0 i 16V (BB3)	98	02/92→09/96	←	passend für Felgengröße [Zoll]: 14		13.0460-5955.2 605955	AKE 21879 18,6 + WK
			→			13.0460-5929.2 605929	AKE 21719 15,0 + WK
2.2 i 16V Vtec (BB1)	136	02/93→09/96	←	passend für Felgengröße [Zoll]: 15		13.0460-5982.2 605982	21651 17,5 + WK
2.3 i 16V (BB2)	118	02/92→09/96	→			13.0460-5929.2 605929	AKE 21719 15,0 + WK
<b>Zubehörsatz, Scheibenbremsbelag</b>							
2.0 i 16V (BB3)	98	02/92→09/96	←	passend für Felgengröße [Zoll]: 14		13.0460-0453.2 610453	AKE
 <b>Bremsscheibe</b>							
2.0 i 16V (BB3)	98	02/92→09/96	←	passend für Felgengröße [Zoll]: 14		24.0123-0105.1 423105	Ø 260 23 21 V
			→			24.0110-0267.1 410267	Ø 260 10 8
2.2 i 16V Vtec (BB1)	136	02/93→09/96	←	passend für Felgengröße [Zoll]: 15		24.0123-0106.1 423106	Ø 282 23 21 V
2.3 i 16V (BB2)	118	02/92→09/96	→			24.0110-0267.1 410267	Ø 260 10 8
<b>HONDA - PRELUDE V (BB_) 10/96→04/01</b>							
 <b>Bremsbelagsatz, Scheibenbremse</b>							
2.0 16V (BB9)	98	10/96→10/00	←			13.0460-5955.2 605955	AKE 21879 18,6 + WK
			→			13.0460-5929.2 605929	AKE 21719 15,0 + WK
2.2 16V (BB6, BB8)	136	10/96→10/00	←			13.0460-5982.2 605982	21651 17,5 + WK
2.2 16V (BB6)	147	10/96→10/00	→			13.0460-5929.2 605929	AKE 21719 15,0 + WK
<b>Zubehörsatz, Scheibenbremsbelag</b>							
2.0 16V (BB9)	98	10/96→10/00	←			13.0460-0075.2 610075	
2.2 16V (BB6, BB8)	136	10/96→10/00	→			13.0460-0287.2 610287	
2.2 16V (BB6)	147	10/96→10/00					
 <b>Bremsscheibe</b>							
2.0 16V (BB9)	98	10/96→10/00	←			24.0123-0105.1 423105	Ø 260 23 21 V
			→			24.0109-0141.1 409141	Ø 260 9 8 + S
2.2 16V (BB6, BB8)	136	10/96→10/00	←			24.0123-0104.1 423104	Ø 282 23 21 V + S
2.2 16V (BB6)	147	10/96→10/00					
<b>HONDA - S2000 (AP) 03/99→</b>							
 <b>Bremsbelagsatz, Scheibenbremse</b>							
2.0 (AP1)	177	06/99→	←	→ 09/04		13.0460-5755.2 605755	SUM 23178 16,6 + WK
2.0 Vtec (AP1)	184	10/03→	→	→ 09/04		13.0460-5929.2 605929	AKE 21719 15,0 + WK
 <b>Bremsscheibe</b>							
2.0 (AP1)	177	06/99→	←	→ 09/04		24.0125-0706.1 425706	Ø 300 25 23 V
2.0 Vtec (AP1)	184	10/03→	→	→ 09/04		24.0112-0707.1 412707	Ø 282 12 10















	kw			 	! #		
<b>HONDA - SHUTTLE (RA) 06/94→06/04</b>							
 <b>Bremsbelagsatz, Scheibenbremse</b>							
2.2 16V (RA1)	110	10/94→02/98	←	01/95→ 12/97		<b>13.0460-5982.2 605982</b>	21651 17,5 + WK
			→	01/95→ 12/97		<b>13.0460-5711.2 605711</b>	23652 15,7 + WK
2.3 16V (RA3, RA6)	110	10/97→06/04	←	01/98→ 05/01		<b>13.0460-5982.2 605982</b>	21651 17,5 + WK
3.0 (RA8)	154	10/97→06/04	→	01/98→ 05/01		<b>13.0460-5711.2 605711</b>	23652 15,7 + WK
<b>Zubehörsatz, Scheibenbremsbelag</b>							
2.2 16V (RA1)	110	10/94→02/98	←	01/95→ 12/97		<b>13.0460-0075.2 610075</b>	
			→	01/95→ 12/97		<b>13.0460-0287.2 610287</b>	
2.3 16V (RA3, RA6)	110	10/97→06/04	←	01/98→ 05/01		<b>13.0460-0075.2 610075</b>	
3.0 (RA8)	154	10/97→06/04	→	01/98→ 05/01		<b>13.0460-0287.2 610287</b>	
 <b>Bremsscheibe</b>							
2.2 16V (RA1)	110	10/94→02/98	←	01/95→ 12/97		<b>24.0123-0104.1 423104</b>	Ø 282 23 21 V + S
			→	01/95→ 12/97		<b>24.0109-0132.1 409132</b>	Ø 282 9 7,5
2.3 16V (RA3, RA6)	110	10/97→06/04	←	01/98→ 05/01		<b>24.0123-0104.1 423104</b>	Ø 282 23 21 V + S
3.0 (RA8)	154	10/97→06/04	→	01/98→ 05/01		<b>24.0109-0132.1 409132</b>	Ø 282 9 7,5
<b>HONDA - STREAM (RN) 05/01→</b>							
 <b>Bremsbelagsatz, Scheibenbremse</b>							
1.7 16V (RN1)	92	05/01→	←	→ 09/05; passend für Felgenreöße [Zoll]: 15; 15"		<b>13.0460-5878.2 605878</b>	23729 16,9 + WK
			→	→ 09/05		<b>13.0460-5711.2 605711</b>	23652 15,7 + WK
2.0 16V (RN3)	115	05/01→	←	→ 09/05; 15"		<b>13.0460-5878.2 605878</b>	23729 16,9 + WK
			→	→ 09/05		<b>13.0460-5711.2 605711</b>	23652 15,7 + WK
 <b>Bremsscheibe</b>							
1.7 16V (RN1)	92	05/01→	←	→ 09/05; passend für Felgenreöße [Zoll]: 15; 15"		<b>24.0123-0109.1 423109</b>	Ø 282 23 21 V + S
			→	→ 09/05		<b>24.0112-0172.1 412172</b>	Ø 282 12 10 + S
2.0 16V (RN3)	115	05/01→	←	→ 09/05; 15"		<b>24.0123-0109.1 423109</b>	Ø 282 23 21 V + S
			→	→ 09/05		<b>24.0112-0172.1 412172</b>	Ø 282 12 10 + S
<b>HYUNDAI - ACCENT I (X-3) 05/94→01/00</b>							
 <b>Bremsbelagsatz, Scheibenbremse</b>							
1.3	44	10/94→01/00	←	→ 12/99		<b>13.0460-5936.2 605936</b>	AKE 21012 15,0 - WE / - WK
1.3	55	10/94→01/00					
1.3 i 12V	62	10/94→01/00					
1.5 16V	76	10/94→01/00					
1.5 i 12V	65	10/94→01/00					
1.5 i 16V	73	12/95→01/00					
 <b>Bremsscheibe</b>							
1.3	44	10/94→01/00	←	→ 12/99		<b>24.0119-0109.1 419109</b>	Ø 242 19,1 17 V
1.3	55	10/94→01/00					
1.3 i 12V	62	10/94→01/00					
1.5 16V	76	10/94→01/00					
1.5 i 12V	65	10/94→01/00					
1.5 i 16V	73	12/95→01/00					
<b>HYUNDAI - ACCENT II (LC) 09/99→12/06</b>							
 <b>Bremsbelagsatz, Scheibenbremse</b>							
1.3	55	01/00→11/05	←	→ 09/05		<b>13.0460-5872.2 605872</b>	AKE 21012 15,0 + WK + Zub
1.3	61	01/00→11/05					
1.3	62	08/02→11/05					
1.3	63	01/00→11/05					
1.5	66	01/00→11/05					
1.5	75	09/00→11/05					
1.5 CRDi	60	04/02→11/05					
1.6	77	12/02→11/05					
1.5	65	09/99→10/02	←	01/00→		<b>13.0460-5872.2 605872</b>	AKE 21012 15,0 + WK + Zub
1.5	68	01/00→10/02	←			<b>13.0460-5872.2 605872</b>	AKE 21012 15,0 + WK + Zub
1.5	77	09/99→10/02	←	01/00→ 08/02		<b>13.0460-5872.2 605872</b>	AKE 21012 15,0 + WK + Zub
↓							

	kw			 	! #		
<b>HYUNDAI - ACCENT II (LC) 09/99→12/06</b>							
 <b>Bremsscheibe</b>							
1.3	55	01/00→11/05	←	→ 09/05		24.0119-0114.1 419114	Ø 241 19 17 V
1.3	61	01/00→11/05					
1.3	62	08/02→11/05					
1.3	63	01/00→11/05					
1.5	66	01/00→11/05					
1.5	75	09/00→11/05					
1.5 CRDi	60	04/02→11/05					
1.6	77	12/02→11/05					
1.5	65	09/99→10/02	←	01/00→		24.0119-0114.1 419114	Ø 241 19 17 V
1.5	68	01/00→10/02	←			24.0119-0114.1 419114	Ø 241 19 17 V
1.5	77	09/99→10/02	←	01/00→ 08/02		24.0119-0114.1 419114	Ø 241 19 17 V
<b>HYUNDAI - ACCENT II Stufenheck (LC) 09/99→12/06</b>							
 <b>Bremsbelagsatz, Scheibenbremse</b>							
1.3	55	01/00→11/05	←	→ 09/05		13.0460-5872.2 605872	AKE 21012 15,0 + WK + Zub
1.3	63	01/00→11/05					
1.5	66	01/00→11/05					
1.5	69	01/00→12/06					
1.6	77	12/02→11/05					
1.5	73	09/99→10/02	←	09/00→		13.0460-5872.2 605872	AKE 21012 15,0 + WK + Zub
1.5	75	09/99→10/02					
1.5 CRDi	60	01/02→11/05	←	04/02→ 09/05		13.0460-5872.2 605872	AKE 21012 15,0 + WK + Zub
 <b>Bremsscheibe</b>							
1.3	55	01/00→11/05	←	→ 09/05		24.0119-0114.1 419114	Ø 241 19 17 V
1.3	63	01/00→11/05					
1.5	66	01/00→11/05					
1.5	69	01/00→12/06					
1.6	77	12/02→11/05					
1.5	73	09/99→10/02	←	09/00→		24.0119-0114.1 419114	Ø 241 19 17 V
1.5	75	09/99→10/02					
1.5 CRDi	60	01/02→11/05	←	04/02→ 09/05		24.0119-0114.1 419114	Ø 241 19 17 V
<b>HYUNDAI - ACCENT III (MC) 11/05→12/10</b>							
 <b>Bremsbelagsatz, Scheibenbremse</b>							
1.4 GL	71	11/05→11/10	←			13.0460-5779.2 605779	MAN 24317 17,6 + WK + Zub
1.5 CRDi GLS	81	11/05→11/10					
1.6 GLS	82	11/05→11/10	→	+ ABS		13.0460-5780.2 605780	MAN 24320 15,3 + WK + Zub
 <b>Bremsscheibe</b>							
1.4 GL	71	11/05→11/10	←			24.0122-0260.1 422260	Ø 256 22 20 V
1.5 CRDi GLS	81	11/05→11/10					
1.6 GLS	82	11/05→11/10	→	+ ABS		24.0110-0312.1 410312	Ø 262 10 8,4
<b>HYUNDAI - ACCENT III Stufenheck (MC) 11/05→11/10</b>							
 <b>Bremsbelagsatz, Scheibenbremse</b>							
1.4 GL	71	11/05→11/10	←			13.0460-5779.2 605779	MAN 24317 17,6 + WK + Zub
1.5 CRDi GLS	81	11/05→11/10					
1.6 GLS	82	11/05→11/10	→	+ ABS		13.0460-5780.2 605780	MAN 24320 15,3 + WK + Zub
 <b>Bremsscheibe</b>							
1.4 GL	71	11/05→11/10	←			24.0122-0260.1 422260	Ø 256 22 20 V
1.5 CRDi GLS	81	11/05→11/10					
1.6 GLS	82	11/05→11/10	→	+ ABS		24.0110-0312.1 410312	Ø 262 10 8,4
<b>HYUNDAI - ACCENT IV (RB) 11/10→</b>							
 <b>Bremsbelagsatz, Scheibenbremse</b>							
1.4	79	11/10→	←			13.0460-5646.2 605646	MAN 25348 17,8 + WK + Zub
1.6	90	12/10→					
1.6	91	11/10→	→	+ ABS		13.0460-5650.2 605650	AKE 25337 15,5 + WK + Zub
 <b>Bremsscheibe</b>							
1.4	79	11/10→	→	+ ABS		24.0110-0398.1 410398	Ø 262 10 8,4
1.6	90	12/10→					
1.6	91	11/10→					
<b>HYUNDAI - ACCENT IV Stufenheck (RB) 08/10→</b>							
 <b>Bremsbelagsatz, Scheibenbremse</b>							
1.4	74	11/10→12/16	←			13.0460-5646.2 605646	MAN 25348 17,8 + WK + Zub
1.4	80	11/10→12/14					
1.6	90	11/10→	→	+ ABS		13.0460-5650.2 605650	AKE 25337 15,5 + WK + Zub
1.6	91	11/10→					















	kw			 	! #		
<b>HYUNDAI - ACCENT IV Stufenheck (RB) 08/10→</b>							
 <b>Bremsbelagsatz, Scheibenbremse</b>							
1.6 CRDI	100	04/11→	←			13.0460-5646.2 605646	MAN 25348 17,8 + WK + Zub
			→	+ ABS		13.0460-5650.2 605650	AKE 25337 15,5 + WK + Zub
1.6 CRDi	94	11/10→12/15	←	10/11→		13.0460-5646.2 605646	MAN 25348 17,8 + WK + Zub
			→	10/11→; + ABS		13.0460-5650.2 605650	AKE 25337 15,5 + WK + Zub
 <b>Bremsscheibe</b>							
1.4	74	11/10→12/16	→	+ ABS		24.0110-0398.1 410398	Ø 262 10 8,4
1.4	80	11/10→12/14					
1.6	90	11/10→					
1.6	91	11/10→					
1.6 CRDI	100	04/11→					
1.6 CRDi	94	11/10→12/15	→	10/11→; + ABS		24.0110-0398.1 410398	Ø 262 10 8,4
<b>HYUNDAI - ACCENT Stufenheck (X-3) 05/94→01/00</b>							
 <b>Bremsbelagsatz, Scheibenbremse</b>							
1.3	44	10/94→01/00	←	→ 12/99		13.0460-5936.2 605936	AKE 21012 15,0 - WE / - WK
1.3	55	10/94→01/00					
1.3 i 12V	62	10/94→01/00					
1.5 i 12V	65	10/94→01/00					
1.5 i 16V	73	10/95→01/00					
1.5	63	10/94→07/99	←			13.0460-5936.2 605936	AKE 21012 15,0 - WE / - WK
 <b>Bremsscheibe</b>							
1.3	44	10/94→01/00	←	→ 12/99		24.0119-0109.1 419109	Ø 242 19,1 17 V
1.3	55	10/94→01/00					
1.3 i 12V	62	10/94→01/00					
1.5 i 12V	65	10/94→01/00					
1.5 i 16V	73	10/95→01/00					
1.5	63	10/94→07/99	←			24.0119-0109.1 419109	Ø 242 19,1 17 V
<b>HYUNDAI - ATOS (MX) 01/97→</b>							
 <b>Bremsbelagsatz, Scheibenbremse</b>							
1.0 i	40	02/98→12/00	←			13.0460-5803.2 605803	23238 16,0 + WK
1.0 i	41	02/98→03/02	←	→ 01/01		13.0460-5803.2 605803	23238 16,0 + WK
			←	02/01→		13.0460-5829.2 605829	24277 16,0 + WK + Zub
1.0 i	43	03/01→07/03	←			13.0460-5803.2 605803	23238 16,0 + WK
			←			13.0460-5829.2 605829	24277 16,0 + WK + Zub
1.1	43	08/03→12/08	←	→ 08/08		13.0460-5829.2 605829	24277 16,0 + WK + Zub
1.1	45	06/03→12/10	←	→ 01/07		13.0460-5829.2 605829	24277 16,0 + WK + Zub
1.1	46	08/03→12/08	←	03/04→ 02/08		13.0460-5829.2 605829	24277 16,0 + WK + Zub
 <b>Bremsscheibe</b>							
1.0 i	40	02/98→12/00	←			24.0111-0125.1 411125	Ø 230 11 8,4
1.0 i	41	02/98→03/02	←	→ 01/01		24.0111-0125.1 411125	Ø 230 11 8,4
			←	02/01→		24.0118-0138.1 418138	Ø 234 18 16 V
1.0 i	43	03/01→07/03	←			24.0111-0125.1 411125	Ø 230 11 8,4
						24.0118-0138.1 418138	Ø 234 18 16 V
1.1	43	08/03→12/08	←	→ 08/08		24.0118-0138.1 418138	Ø 234 18 16 V
1.1	45	06/03→12/10	←	→ 01/07		24.0118-0138.1 418138	Ø 234 18 16 V
1.1	46	08/03→12/08	←	03/04→ 02/08		24.0118-0138.1 418138	Ø 234 18 16 V
<b>HYUNDAI - COUPE (GK) 01/01→12/12</b>							
 <b>Bremsbelagsatz, Scheibenbremse</b>							
1.6 16V	77	03/02→08/09	←			13.0460-5873.2 605873	MAN 23891 16,9 + WK
1.6 16V	79	03/02→08/09	→			13.0460-5874.2 605874	SUM 21553 14,0 + WK + Zub
2.0	100	08/01→08/09					
2.0	102	03/02→08/09					
2.0 GLS	105	02/03→08/09					
2.7 V6	123	03/02→08/09					
2.7 V6	121	01/01→08/09	←	01/07→		13.0460-5873.2 605873	MAN 23891 16,9 + WK
↓			→	01/07→		13.0460-5874.2 605874	SUM 21553 14,0 + WK + Zub











	kW					! #		
<b>HYUNDAI - COUPE (GK) 01/01→12/12</b>								
<b>Zubehörsatz, Scheibenbremsbelag</b>								
1.6 16V	77	03/02→08/09	←			13.0460-0139.2	610139	MAN
1.6 16V	79	03/02→08/09						
2.0	100	08/01→08/09						
2.0	102	03/02→08/09						
2.0 GLS	105	02/03→08/09						
2.7 V6	123	03/02→08/09						
2.7 V6	121	01/01→08/09	←	01/07→		13.0460-0139.2	610139	MAN
<b> Bremsscheibe</b>								
1.6 16V	77	03/02→08/09	←			24.0126-0128.1	426128	Ø 280 26 24,4 V
1.6 16V	79	03/02→08/09						
2.0	100	08/01→08/09	→			24.0110-0298.1	410298	Ø 258 10 8
2.0	102	03/02→08/09						
2.0 GLS	105	02/03→08/09						
2.7 V6	123	03/02→08/09						
2.7 V6	121	01/01→08/09	←	01/07→		24.0126-0128.1	426128	Ø 280 26 24,4 V
			→	01/07→		24.0110-0298.1	410298	Ø 258 10 8
<b>HYUNDAI - COUPE (RD) 06/96→04/02</b>								
<b> Bremsbelagsatz, Scheibenbremse</b>								
1.6 16V	85	03/98→04/02	←			13.0460-5933.2	605933	AKE 21725 16,8 + WK
1.6 i 16V	79	08/00→01/02						
1.6 i 16V	84	12/96→04/02	→	+ ABS		13.0460-5874.2	605874	SUM 21553 14,0 + WK + Zub
2.0	101	08/99→01/02	←			13.0460-5933.2	605933	AKE 21725 16,8 + WK
2.0 16V	99	03/01→04/02						
2.0 16V	102	08/96→04/02	→			13.0460-5874.2	605874	SUM 21553 14,0 + WK + Zub
F2 Evolution	115	01/99→12/01						
<b> Bremsscheibe</b>								
1.6 16V	85	03/98→04/02	←	→ 08/98		24.0122-0170.1	422170	Ø 257 22 20 V
1.6 i 16V	84	12/96→04/02				24.0322-0170.1	522170	Ø 257 22 20 V
			←	09/98→		24.0124-0706.1	424706	Ø 257 24 22,4 V
			→	+ ABS		24.0110-0264.1	410264	Ø 258 10 8
1.6 i 16V	79	08/00→01/02	←			24.0124-0706.1	424706	Ø 257 24 22,4 V
			→	+ ABS		24.0110-0264.1	410264	Ø 258 10 8
2.0	101	08/99→01/02	←			24.0124-0706.1	424706	Ø 257 24 22,4 V
2.0 16V	99	03/01→04/02						
F2 Evolution	115	01/99→12/01	→			24.0110-0264.1	410264	Ø 258 10 8
2.0 16V	102	08/96→04/02	←	→ 08/98		24.0122-0170.1	422170	Ø 257 22 20 V
						24.0322-0170.1	522170	Ø 257 22 20 V
			←	09/98→		24.0124-0706.1	424706	Ø 257 24 22,4 V
			→			24.0110-0264.1	410264	Ø 258 10 8
<b>HYUNDAI - CRETA 01/16→</b>								
<b> Bremsscheibe</b>								
1.6	90	01/16→	→	Made in Russia-made		24.0110-0368.1	410368	Ø 262 10 8,4
2.0	110	01/16→	→			24.0110-0368.1	410368	Ø 262 10 8,4
<b>HYUNDAI - ELANTRA (XD) 03/00→08/06</b>								
<b> Bremsbelagsatz, Scheibenbremse</b>								
1.6	66	06/00→07/06	←	06/01→ 07/03		13.0460-5875.2	605875	MAN 24031 17,7 + WK
			←	→ 05/01		13.0460-5933.2	605933	AKE 21725 16,8 + WK
			→	→ 05/06; + ABS		13.0460-5874.2	605874	SUM 21553 14,0 + WK + Zub
1.6	77	05/03→07/06	←	08/03→ 05/06		13.0460-5876.2	605876	MAN 24369 17,2 + WK
			→	08/03→ 05/06; + ABS		13.0460-5874.2	605874	SUM 21553 14,0 + WK + Zub
1.6	79	06/00→07/06	←	06/01→ 07/03		13.0460-5875.2	605875	MAN 24031 17,7 + WK
1.8	97	06/00→07/06						
2.0	102	06/00→07/06	←	08/03→ 05/06		13.0460-5876.2	605876	MAN 24369 17,2 + WK
2.0	104	06/00→07/06	←	→ 05/01		13.0460-5933.2	605933	AKE 21725 16,8 + WK
			→	→ 05/06; + ABS		13.0460-5874.2	605874	SUM 21553 14,0 + WK + Zub
2.0	105	10/03→07/06	←	→ 05/06		13.0460-5876.2	605876	MAN 24369 17,2 + WK
			→	→ 05/06; + ABS		13.0460-5874.2	605874	SUM 21553 14,0 + WK + Zub
2.0 CRDi	83	04/01→07/06	←	→ 07/03		13.0460-5875.2	605875	MAN 24031 17,7 + WK
			←	08/03→ 05/06		13.0460-5876.2	605876	MAN 24369 17,2 + WK
↓								





























	kw					! #		
<b>HYUNDAI - ELANTRA (XD) 03/00→08/06</b>								
 <b>Bremsbelagsatz, Scheibenbremse</b>								
2.0 CRDi	83	04/01→07/06	➡	→ 05/06; + ABS			13.0460-5874.2 605874	SUM 21553 14,0 + WK + Zub
 <b>Bremsscheibe</b>								
1.6	66	06/00→07/06	←	→ 07/03			24.0124-0184.1 424184	Ø 257 24 22,1 V
1.6	79	06/00→07/06	➡	→ 05/06; + ABS			24.0110-0264.1 410264	Ø 258 10 8
1.6	77	05/03→07/06	←	08/03→ 05/06; - ABS			24.0124-0184.1 424184	Ø 257 24 22,1 V
			←	08/03→ 05/06; + ABS			24.0126-0129.1 426129	Ø 280 26 24,4 V
			➡	08/03→ 05/06; + ABS			24.0110-0264.1 410264	Ø 258 10 8
1.8 2.0 2.0 2.0	97 102 104 105	06/00→07/06 06/00→07/06 06/00→07/06 10/03→07/06	←	→ 05/06			24.0124-0184.1 424184	Ø 257 24 22,1 V
			➡	→ 05/06; + ABS			24.0110-0264.1 410264	Ø 258 10 8
			←	→ 06/03			24.0124-0184.1 424184	Ø 257 24 22,1 V
2.0 CRDi	83	04/01→07/06	←	→ 05/06			24.0126-0129.1 426129	Ø 280 26 24,4 V
			➡	→ 05/06; + ABS			24.0110-0264.1 410264	Ø 258 10 8
<b>HYUNDAI - ELANTRA Stufenheck (AD) 09/15→</b>								
 <b>Bremsscheibe</b>								
1.6	94	02/16→	←				24.0123-0118.1 423118	Ø 280 23,1 21,4 V
2.0	112	10/15→	←				24.0123-0118.1 423118	Ø 280 23,1 21,4 V
			➡				24.0110-0368.1 410368	Ø 262 10 8,4
<b>HYUNDAI - ELANTRA Stufenheck (HD) 11/05→12/11</b>								
 <b>Bremsbelagsatz, Scheibenbremse</b>								
1.6 CRDi	85	11/05→12/11	←				13.0460-5873.2 605873	MAN 23891 16,9 + WK
1.6 CVVT	90	06/06→06/11						
2.0 CVVT	103	06/06→05/10	➡	+ ABS			13.0460-5833.2 605833	AKE 23543 14,4 + WK + Zub
<b>Zubehörsatz, Scheibenbremsbelag</b>								
1.6 CRDi	85	11/05→12/11	←				13.0460-0139.2 610139	MAN
1.6 CVVT	90	06/06→06/11						
2.0 CVVT	103	06/06→05/10						
 <b>Bremsscheibe</b>								
1.6 CRDi	85	11/05→12/11	←				24.0126-0157.1 426157	Ø 275 26 24 V
1.6 CVVT	90	06/06→06/11						
2.0 CVVT	103	06/06→05/10	➡	+ ABS			24.0110-0338.1 410338	Ø 262 10 8,4
<b>HYUNDAI - ELANTRA Stufenheck (MD, UD) 09/10→</b>								
 <b>Bremsbelagsatz, Scheibenbremse</b>								
1.6	94	06/11→	←	→ 08/15			13.0460-5645.2 605645	25692 17,2 + WK + Zub
1.6	96	06/11→12/15	←	→ 08/15			13.0460-5650.2 605650	AKE 25337 15,5 + WK + Zub
1.6	97	06/11→12/15	➡	→ 08/15			13.0460-5650.2 605650	AKE 25337 15,5 + WK + Zub
1.6 CRDi	94	02/11→12/15	➡				13.0460-5650.2 605650	AKE 25337 15,5 + WK + Zub
 <b>Bremsscheibe</b>								
1.6	94	06/11→	←	→ 08/15			24.0123-0118.1 423118	Ø 280 23,1 21,4 V
1.6	96	06/11→12/15	←	→ 08/15			24.0110-0368.1 410368	Ø 262 10 8,4
1.6	97	06/11→12/15	➡	→ 08/15			24.0110-0368.1 410368	Ø 262 10 8,4
1.6 CRDi	94	02/11→12/15	←				24.0123-0118.1 423118	Ø 280 23,1 21,4 V
1.6 CRDi	100	10/15→						
2.0 GDI	112	10/15→	➡				24.0110-0368.1 410368	Ø 262 10 8,4
<b>HYUNDAI - ELANTRA Stufenheck (XD) 03/00→09/06</b>								
 <b>Bremsbelagsatz, Scheibenbremse</b>								
1.5 16V	75	09/00→07/06	←	06/01→ 07/03			13.0460-5875.2 605875	MAN 24031 17,7 + WK
1.5 D	82	06/00→07/06	←	08/03→			13.0460-5876.2 605876	MAN 24369 17,2 + WK
			←	→ 05/01			13.0460-5933.2 605933	AKE 21725 16,8 + WK
			➡	+ ABS			13.0460-5874.2 605874	SUM 21553 14,0 + WK + Zub
1.6	66	06/00→07/06	←	06/01→ 07/03			13.0460-5875.2 605875	MAN 24031 17,7 + WK
			←	→ 05/01			13.0460-5933.2 605933	AKE 21725 16,8 + WK
			➡	→ 05/06; + ABS			13.0460-5874.2 605874	SUM 21553 14,0 + WK + Zub
1.6	77	05/03→05/06	←	08/03→			13.0460-5876.2 605876	MAN 24369 17,2 + WK
			➡	08/03→; + ABS			13.0460-5874.2 605874	SUM 21553 14,0 + WK + Zub



















	kw			 	! #		
<b>HYUNDAI - ELANTRA Stufenheck (XD) 03/00→09/06</b>							
 <b>Bremsbelagsatz, Scheibenbremse</b>							
1.6	79	06/00→07/06	←	06/01→ 07/03		13.0460-5875.2 605875	MAN 24031 17,7 + WK
1.8	97	06/00→07/06	←	08/03→ 05/06		13.0460-5876.2 605876	MAN 24369 17,2 + WK
2.0	102	06/00→07/06	←	→ 05/01		13.0460-5933.2 605933	AKE 21725 16,8 + WK
2.0	104	06/00→07/06	→	→ 05/06; + ABS		13.0460-5874.2 605874	SUM 21553 14,0 + WK + Zub
1.8	79	06/00→07/03	←	06/01→		13.0460-5875.2 605875	MAN 24031 17,7 + WK
			←	→ 05/01		13.0460-5933.2 605933	AKE 21725 16,8 + WK
			→	+ ABS		13.0460-5874.2 605874	SUM 21553 14,0 + WK + Zub
2.0	105	10/03→07/06	←	→ 05/06		13.0460-5876.2 605876	MAN 24369 17,2 + WK
			→	→ 05/06; + ABS		13.0460-5874.2 605874	SUM 21553 14,0 + WK + Zub
2.0 CRDi	83	04/01→07/06	←	→ 07/03		13.0460-5875.2 605875	MAN 24031 17,7 + WK
			←	08/03→ 05/06		13.0460-5876.2 605876	MAN 24369 17,2 + WK
			→	→ 05/06; + ABS		13.0460-5874.2 605874	SUM 21553 14,0 + WK + Zub
 <b>Bremsscheibe</b>							
1.5 16V	75	09/00→07/06	←			24.0124-0184.1 424184	Ø 257 24 22,1 V
1.5 D	82	06/00→07/06	→	+ ABS		24.0110-0264.1 410264	Ø 258 10 8
1.8	79	06/00→07/03	←			24.0124-0184.1 424184	Ø 257 24 22,1 V
1.6	66	06/00→07/06	←	→ 07/03		24.0124-0184.1 424184	Ø 257 24 22,1 V
1.6	79	06/00→07/06	→	→ 05/06; + ABS		24.0110-0264.1 410264	Ø 258 10 8
1.6	77	05/03→05/06	←	08/03→; - ABS		24.0124-0184.1 424184	Ø 257 24 22,1 V
			←	08/03→; + ABS		24.0126-0129.1 426129	Ø 280 26 24,4 V
			→	08/03→; + ABS		24.0110-0264.1 410264	Ø 258 10 8
1.8	97	06/00→07/06	←	→ 05/06		24.0124-0184.1 424184	Ø 257 24 22,1 V
2.0	102	06/00→07/06	→	→ 05/06; + ABS		24.0110-0264.1 410264	Ø 258 10 8
2.0	104	06/00→07/06	→	→ 05/06; + ABS		24.0110-0264.1 410264	Ø 258 10 8
2.0	105	10/03→07/06	←	→ 06/03		24.0124-0184.1 424184	Ø 257 24 22,1 V
2.0 CRDi	83	04/01→07/06	←	07/03→ 05/06		24.0126-0129.1 426129	Ø 280 26 24,4 V
			→	→ 05/06; + ABS		24.0110-0264.1 410264	Ø 258 10 8
<b>HYUNDAI - EQUUS / CENTENNIAL 03/09→</b>							
 <b>Bremsscheibe</b>							
3.8 GDi	246	03/09→	←	→ 05/13		24.0130-0231.1 430231	Ø 345 30 28 V
5.0 GDi	316	03/09→	←			24.0130-0231.1 430231	Ø 345 30 28 V
<b>HYUNDAI - EQUUS / CENTENNIAL (JS) 10/99→03/09</b>							
 <b>Bremsbelagsatz, Scheibenbremse</b>							
3.5	155	10/99→03/09	←			13.0460-5622.2 605622	MAN 23726 16,5 + WK + Zub
4.5	195	10/99→09/03	←				
<b>HYUNDAI - GALLOPER II (JK-01) 02/97→12/03</b>							
 <b>Bremsbelagsatz, Scheibenbremse</b>							
2.5 TCi D	77	08/98→12/03	←			13.0460-5885.2 605885	SUM 23518 17,0 + WK + Zub
2.5 TD	65	08/98→12/03	←				
2.5 TD intercooler	73	08/98→12/03	←				
2.6 TD Allrad	63	08/98→06/03	←				
3.0 AWD	118	05/99→09/01	←				
3.0 V6	104	08/98→12/03	←				
 <b>Bremsscheibe</b>							
2.5 TCi D	77	08/98→12/03	←	+ ABS		24.0122-0237.1 422237	Ø 277 22 20,4 V
2.5 TD	65	08/98→12/03	←				
2.5 TD intercooler	73	08/98→12/03	←				
2.6 TD Allrad	63	08/98→06/03	←				
3.0 AWD	118	05/99→09/01	←				
3.0 V6	104	08/98→12/03	←				
<b>HYUNDAI - GENESIS Coupe 01/08→</b>							
 <b>Bremsscheibe</b>							
2.0	191	01/13→12/15	←			24.0130-0231.1 430231	Ø 345 30 28 V
2.0 CVVT	184	02/13→02/14	←				
2.0 CVVT	154	06/08→02/14	←	18"		24.0130-0231.1 430231	Ø 345 30 28 V
2.0 T	157	01/08→12/12	←				
2.0 T	202	11/11→12/14	←	→ 09/13; 18"		24.0130-0231.1 430231	Ø 345 30 28 V
2.0 T	204	04/12→02/14	←				













	kw				! #		
<b>HYUNDAI - GETZ (TB) 08/02→12/10</b>							
 <b>Bremsbelagsatz, Scheibenbremse</b>							
1.1	46	09/02→09/05	←	→ 07/05		13.0460-5872.2 605872	AKE 21012 15,0 + WK + Zub
1.1	49	09/05→06/09	←	→ 02/09		13.0460-5872.2 605872	AKE 21012 15,0 + WK + Zub
1.3	61	09/04→06/09	←	→ 04/05		13.0460-5872.2 605872	AKE 21012 15,0 + WK + Zub
1.3	63	09/03→09/05					
1.3 i	60	09/02→03/04	←			13.0460-5872.2 605872	AKE 21012 15,0 + WK + Zub
1.4 i	71	08/05→12/10	←	→ 02/09		13.0460-5872.2 605872	AKE 21012 15,0 + WK + Zub
1.5 CRDi	65	08/05→06/09	→	→ 02/09; + ABS		13.0460-5833.2 605833	AKE 23543 14,4 + WK + Zub
1.5 CRDi GLS	81	08/05→06/09					
1.5 CRDi	60	03/03→09/05	←	→ 04/05		13.0460-5872.2 605872	AKE 21012 15,0 + WK + Zub
			→	→ 04/05; + ABS		13.0460-5833.2 605833	AKE 23543 14,4 + WK + Zub
1.5 CRDi GLS	75	07/04→08/05	←	→ 07/05		13.0460-5872.2 605872	AKE 21012 15,0 + WK + Zub
1.6	77	09/02→09/05	→	→ 07/05; + ABS		13.0460-5833.2 605833	AKE 23543 14,4 + WK + Zub
1.6	78	06/05→12/06	←	08/05→		13.0460-5872.2 605872	AKE 21012 15,0 + WK + Zub
			→	08/05→; + ABS		13.0460-5833.2 605833	AKE 23543 14,4 + WK + Zub
 <b>Bremsscheibe</b>							
1.1	46	09/02→09/05	←	→ 07/05; passend für Felgengröße [Zoll]: 13		24.0119-0115.1 419115	Ø 241 19 17 V
			←	→ 07/05; passend für Felgengröße [Zoll]: 14		24.0119-0116.1 419116	Ø 256 19 17 V
1.1	49	09/05→06/09	←	→ 02/09; passend für Felgengröße [Zoll]: 13		24.0119-0115.1 419115	Ø 241 19 17 V
			←	→ 02/09; passend für Felgengröße [Zoll]: 14		24.0119-0116.1 419116	Ø 256 19 17 V
1.3	61	09/04→06/09	←	→ 04/05; passend für Felgengröße [Zoll]: 13		24.0119-0115.1 419115	Ø 241 19 17 V
1.3	63	09/03→09/05	←	→ 04/05; passend für Felgengröße [Zoll]: 14		24.0119-0116.1 419116	Ø 256 19 17 V
1.3 i	60	09/02→03/04	←	passend für Felgengröße [Zoll]: 13		24.0119-0115.1 419115	Ø 241 19 17 V
			←	passend für Felgengröße [Zoll]: 14		24.0119-0116.1 419116	Ø 256 19 17 V
1.4 i	71	08/05→12/10	←	→ 02/09; passend für Felgengröße [Zoll]: 13		24.0119-0115.1 419115	Ø 241 19 17 V
1.5 CRDi GLS	81	08/05→06/09	←	→ 02/09; passend für Felgengröße [Zoll]: 14		24.0119-0116.1 419116	Ø 256 19 17 V
			→	→ 02/09; + ABS		24.0110-0312.1 410312	Ø 262 10 8,4
1.5 CRDi	60	03/03→09/05	←	→ 04/05; passend für Felgengröße [Zoll]: 13		24.0119-0115.1 419115	Ø 241 19 17 V
			←	→ 04/05; passend für Felgengröße [Zoll]: 14		24.0119-0116.1 419116	Ø 256 19 17 V
			→	→ 04/05; + ABS		24.0110-0312.1 410312	Ø 262 10 8,4
1.5 CRDi	65	08/05→06/09	←	→ 02/09; passend für Felgengröße [Zoll]: 14		24.0119-0116.1 419116	Ø 256 19 17 V
			→	→ 02/09; + ABS		24.0110-0312.1 410312	Ø 262 10 8,4
1.5 CRDi GLS	75	07/04→08/05	←	→ 07/05; passend für Felgengröße [Zoll]: 13		24.0119-0115.1 419115	Ø 241 19 17 V
1.6	77	09/02→09/05	←	→ 07/05; passend für Felgengröße [Zoll]: 14		24.0119-0116.1 419116	Ø 256 19 17 V
			→	→ 07/05; + ABS		24.0110-0312.1 410312	Ø 262 10 8,4
1.6	78	06/05→12/06	←	08/05→; passend für Felgengröße [Zoll]: 13		24.0119-0115.1 419115	Ø 241 19 17 V
			←	08/05→; passend für Felgengröße [Zoll]: 14		24.0119-0116.1 419116	Ø 256 19 17 V
			→	08/05→; + ABS		24.0110-0312.1 410312	Ø 262 10 8,4
<b>HYUNDAI - GRANDEUR (HG) 01/11→</b>							
 <b>Bremsscheibe</b>							
2.4	132	07/11→	→	- eFSB		24.0110-0388.1 410388	Ø 284 10 8,4
2.4 16V	148	01/11→					
3.0	184	07/11→	→	+ eFSB		24.0110-0400.1 410400	Ø 284 10 8,4
<b>HYUNDAI - GRANDEUR (TG) 06/03→</b>							
 <b>Bremsbelagsatz, Scheibenbremse</b>							
2.2 CRDi	110	06/06→12/11	←	→ 12/10		13.0460-5639.2 605639	24375 17,5 + WK
3.3	191	11/10→12/11	→	→ 12/10		13.0460-5833.2 605833	AKE 23543 14,4 + WK + Zub
2.2 CRDi	114	06/06→10/10	←			13.0460-5639.2 605639	24375 17,5 + WK
3.3	173	04/05→12/10					
↓							













	kw					! #		
<b>HYUNDAI - GRANDEUR (TG) 06/03→</b>								
 <b>Bremsbelagsatz, Scheibenbremse</b>								
2.2 CRDi 3.3	114 173	06/06→10/10 04/05→12/10	→				13.0460-5833.2 605833	AKE 23543 14,4 + WK + Zub
2.7	141	05/06→10/10	←	06/06→			13.0460-5639.2 605639	24375 17,5 + WK
			→	06/06→			13.0460-5833.2 605833	AKE 23543 14,4 + WK + Zub
 <b>Bremsscheibe</b>								
2.2 CRDi	110	06/06→12/11	→	→ 05/07			24.0110-0336.1 410336	Ø 284 10 8,4
			→	06/07→ 06/10			24.0110-0336.1 410336	Ø 284 10 8,4
			→	07/10→ 12/10			24.0110-0367.1 410367	Ø 284 10 8,4
2.2 CRDi 3.3	114 173	06/06→10/10 04/05→12/10	→	→ 05/07			24.0110-0336.1 410336	Ø 284 10 8,4
			→	06/07→			24.0110-0336.1 410336	Ø 284 10 8,4
2.7	141	05/06→10/10	→	06/07→			24.0110-0336.1 410336	Ø 284 10 8,4
			→	06/06→ 05/07			24.0110-0336.1 410336	Ø 284 10 8,4
3.3	191	11/10→12/11	→	→ 12/10			24.0110-0336.1 410336	Ø 284 10 8,4
<b>HYUNDAI - GRAND SANTA FÉ 01/13→</b>								
 <b>Bremsbelagsatz, Scheibenbremse</b>								
2.2 CRDi Allrad 3.3	145 183	06/13→ 01/14→	←				13.0460-5777.2 605777	24351 16,3 + WK + Zub
3.3 Allrad	199	02/14→	→				13.0460-5633.2 605633	AKE 25520 15,8 + WK + Zub
 <b>Bremsscheibe</b>								
2.2 CRDi Allrad	145	06/13→	←				24.0128-0248.1 428248	Ø 321 28 26,4 V
2.2 CRDi Allrad	147	10/15→	→				24.0111-0170.1 411170	Ø 302 11 9,4
3.3	183	01/14→	→					
3.3 Allrad	199	02/14→	→					
<b>HYUNDAI - H-1 / STAREX Großraumlimousine (A1) 06/97→12/07</b>								
 <b>Bremsbelagsatz, Scheibenbremse</b>								
2.4 2.4 2.4 4WD 2.4 4WD 2.5 CRDi 2.5 CRDi 4WD 2.5 D 2.5 TCi 2.5 TD 2.5 TD 4WD 2.5 TD 4WD 2.5 TD 4WD 2.6 TDiC	82 101 82 99 120 103 57 74 59 59 73 74 63	06/97→04/04 02/03→04/04 02/98→04/04 06/01→04/04 12/02→04/04 12/02→04/04 10/97→04/04 05/04→12/07 06/97→04/04 02/98→04/04 03/01→04/04 11/01→04/04 10/97→04/04	←				13.0460-5792.2 605792	23536 17,6 + WK + Zub
2.4	107	11/01→04/04	←	02/03→			13.0460-5792.2 605792	23536 17,6 + WK + Zub
2.5 CRDi	85	06/97→04/04	←	06/00→			13.0460-5792.2 605792	23536 17,6 + WK + Zub
2.5 CRDi	103	12/02→04/04	←	→ 04/04			13.0460-5792.2 605792	23536 17,6 + WK + Zub
2.5 TCi	73	10/97→12/07	←	06/00→ 04/04			13.0460-5792.2 605792	23536 17,6 + WK + Zub
 <b>Bremsscheibe</b>								
2.4 2.4 2.5 D 2.5 TD 2.6 TDiC	82 101 57 59 63	06/97→04/04 02/03→04/04 10/97→04/04 06/97→04/04 10/97→04/04	←				24.0124-0220.1 424220	Ø 254 24 22,4 V
2.4	107	11/01→04/04	←	02/03→			24.0124-0220.1 424220	Ø 254 24 22,4 V
2.4 4WD	99	06/01→04/04	←	07/03→			24.0126-0169.1 426169	Ø 274 26 24,4 V
2.5 CRDi	85	06/97→04/04	←	06/00→			24.0124-0220.1 424220	Ø 254 24 22,4 V
2.5 CRDi	103	12/02→04/04	←	→ 04/04			24.0124-0220.1 424220	Ø 254 24 22,4 V
			←	07/03→ 04/04			24.0126-0169.1 426169	Ø 274 26 24,4 V
2.5 CRDi	120	12/02→04/04	←				24.0124-0220.1 424220	Ø 254 24 22,4 V
			←	07/03→			24.0126-0169.1 426169	Ø 274 26 24,4 V
2.5 TCi	73	10/97→12/07	←	06/00→ 04/04			24.0124-0220.1 424220	Ø 254 24 22,4 V
2.5 TCi	74	05/04→12/07	←				24.0126-0169.1 426169	Ø 274 26 24,4 V
2.5 TD 4WD	73	03/01→04/04	←				24.0124-0243.1 424243	Ø 254,5 24 22,4 V
2.5 TD 4WD	74	11/01→04/04	←	→ 09/02			24.0124-0243.1 424243	Ø 254,5 24 22,4 V
			←	10/02→			24.0126-0169.1 426169	Ø 274 26 24,4 V















	kw			 	! #		
<b>HYUNDAI - H-1 Cargo (TQ) 02/08→</b>							
 <b>Bremsbelagsatz, Scheibenbremse</b>							
2.4	128	01/10→	←	09/10→		<b>13.0460-5799.2 605799</b>	24597 17,7 + WK + Zub
			→	09/10→		<b>13.0460-5636.2 605636</b>	MAN 24599 14,9 + WK + Zub
2.5 CRDi	81	02/08→	←			<b>13.0460-5799.2 605799</b>	24597 17,7 + WK + Zub
2.5 CRDi	85	01/09→	←				
2.5 CRDi	94	01/09→	→	+ ABS		<b>13.0460-5636.2 605636</b>	MAN 24599 14,9 + WK + Zub
2.5 CRDi	100	08/09→	←			<b>13.0460-5799.2 605799</b>	24597 17,7 + WK + Zub
2.5 CRDi	120	02/08→	←				
2.5 CRDi	125	02/08→	→			<b>13.0460-5636.2 605636</b>	MAN 24599 14,9 + WK + Zub
 <b>Bremsscheibe</b>							
2.4	128	01/10→	←	09/10→		<b>24.0130-0239.1 430239</b>	Ø 300 30 28,4 V
2.5 CRDi	81	02/08→	←			<b>24.0130-0239.1 430239</b>	Ø 300 30 28,4 V
2.5 CRDi	85	01/09→	←				
2.5 CRDi	100	08/09→	←				
2.5 CRDi	120	02/08→	←				
2.5 CRDi	125	02/08→	←				
2.5 CRDi	94	01/09→	←				
<b>HYUNDAI - H-1 Kasten (A1) 10/97→04/08</b>							
 <b>Bremsbelagsatz, Scheibenbremse</b>							
2.4	82	03/00→04/04	←			<b>13.0460-5792.2 605792</b>	23536 17,6 + WK + Zub
2.5 TD	59	03/00→09/00	←				
2.5 CRDi	81	07/01→04/04	←			<b>13.0460-5832.2 605832</b>	23569 16,5 + WK + Zub
			→	+ ABS		<b>13.0460-5637.2 605637</b>	MAN 24488 14,9 + WK + Zub
2.5 CRDi	103	08/03→12/07	←	→ 04/04		<b>13.0460-5832.2 605832</b>	23569 16,5 + WK + Zub
			→	→ 04/04; + ABS		<b>13.0460-5637.2 605637</b>	MAN 24488 14,9 + WK + Zub
2.5 TD	73	03/00→04/04	←	→ 12/01		<b>13.0460-5792.2 605792</b>	23536 17,6 + WK + Zub
			←	01/02→		<b>13.0460-5832.2 605832</b>	23569 16,5 + WK + Zub
2.5 TD	74	10/01→08/07	←	→ 12/01		<b>13.0460-5792.2 605792</b>	23536 17,6 + WK + Zub
			←	01/02→ 04/04		<b>13.0460-5832.2 605832</b>	23569 16,5 + WK + Zub
2.6 CRDi	79	10/97→12/07	←	08/05→		<b>13.0460-5832.2 605832</b>	23569 16,5 + WK + Zub
			→	08/05→; + ABS		<b>13.0460-5637.2 605637</b>	MAN 24488 14,9 + WK + Zub
 <b>Bremsscheibe</b>							
2.4	82	03/00→04/04	←			<b>24.0124-0220.1 424220</b>	Ø 254 24 22,4 V
2.5 TD	59	03/00→09/00	←				
2.5 CRDi	81	07/01→04/04	←			<b>24.0126-0169.1 426169</b>	Ø 274 26 24,4 V
			→	+ ABS		<b>24.0120-0232.1 420232</b>	Ø 303 20 18,4 V
						<b>24.0120-0235.1 420235</b>	Ø 303 20 18,4 V
2.5 CRDi	103	08/03→12/07	←	→ 04/04		<b>24.0126-0169.1 426169</b>	Ø 274 26 24,4 V
			→	→ 04/04; + ABS		<b>24.0120-0232.1 420232</b>	Ø 303 20 18,4 V
						<b>24.0120-0235.1 420235</b>	Ø 303 20 18,4 V
2.5 TD	73	03/00→04/04	←	→ 10/02		<b>24.0124-0220.1 424220</b>	Ø 254 24 22,4 V
			←	11/02→		<b>24.0124-0243.1 424243</b>	Ø 254,5 24 22,4 V
2.5 TD	74	10/01→08/07	←	→ 10/02		<b>24.0124-0220.1 424220</b>	Ø 254 24 22,4 V
			←	11/02→ 04/04		<b>24.0124-0243.1 424243</b>	Ø 254,5 24 22,4 V
2.6 CRDi	79	10/97→12/07	←	08/05→		<b>24.0126-0169.1 426169</b>	Ø 274 26 24,4 V
			→	08/05→; + ABS		<b>24.0120-0232.1 420232</b>	Ø 303 20 18,4 V
						<b>24.0120-0235.1 420235</b>	Ø 303 20 18,4 V
<b>HYUNDAI - H-1 Pritsche/Fahrgestell 06/00→10/05</b>							
 <b>Bremsbelagsatz, Scheibenbremse</b>							
2.5 CRDi	103	12/02→10/05	←			<b>13.0460-5832.2 605832</b>	23569 16,5 + WK + Zub
			→	+ ABS		<b>13.0460-5637.2 605637</b>	MAN 24488 14,9 + WK + Zub
2.5 D	73	06/00→10/05	←	09/00→ 10/02		<b>13.0460-5792.2 605792</b>	23536 17,6 + WK + Zub
			←	11/02→		<b>13.0460-5832.2 605832</b>	23569 16,5 + WK + Zub
 <b>Bremsscheibe</b>							
2.5 CRDi	103	12/02→10/05	←			<b>24.0126-0169.1 426169</b>	Ø 274 26 24,4 V
			→	+ ABS		<b>24.0120-0232.1 420232</b>	Ø 303 20 18,4 V
2.5 D	73	06/00→10/05	←	09/00→ 10/02		<b>24.0124-0220.1 424220</b>	Ø 254 24 22,4 V
			←	11/02→		<b>24.0124-0243.1 424243</b>	Ø 254,5 24 22,4 V













	kW			 	! #		
<b>HYUNDAI - H-1 Travel (TQ) 02/08→</b>							
 <b>Bremsbelagsatz, Scheibenbremse</b>							
2.4	101	02/08→	←			13.0460-5799.2 605799	24597 17,7 + WK + Zub
2.4 i	126	02/08→	→			13.0460-5636.2 605636	MAN 24599 14,9 + WK + Zub
2.4 i	129	02/08→					
2.5 CRDi	81	07/10→					
2.5 CRDi	120	05/08→					
2.5 CRDi	125	05/08→					
2.5 CRDi	94	02/08→					
2.5 CRDi	100	07/08→					
2.5 CRDi	85	08/11→	←			13.0460-5799.2 605799	24597 17,7 + WK + Zub
			→	+ ABS		13.0460-5636.2 605636	MAN 24599 14,9 + WK + Zub
 <b>Bremsscheibe</b>							
2.4	101	02/08→	←			24.0130-0239.1 430239	Ø 300 30 28,4 V
2.4 i	126	02/08→				24.0130-0239.1 430239	Ø 300 30 28,4 V
2.4 i	129	02/08→					
2.5 CRDi	81	07/10→					
2.5 CRDi	85	08/11→					
2.5 CRDi	120	05/08→					
2.5 CRDi	125	05/08→					
2.5 CRDi	94	02/08→					
2.5 CRDi	100	07/08→					
<b>HYUNDAI - H100 Bus (P) 07/93→10/04</b>							
 <b>Bremsbelagsatz, Scheibenbremse</b>							
2.4	84	01/97→03/00	←			13.0460-5718.2 605718	TRW 23081 18,0 + WK
2.4	90	07/93→03/00				13.0460-5718.2 605718	TRW 23081 18,0 + WK
2.5 D	57	12/94→03/00					
2.5 TD	59	07/93→03/00					
 <b>Bremsscheibe</b>							
2.4	84	01/97→03/00	←			24.0120-0166.1 420166	Ø 253 20 18,4 V
2.4	90	07/93→03/00				24.0120-0166.1 420166	Ø 253 20 18,4 V
2.5 D	57	12/94→03/00					
2.5 TD	59	07/93→03/00					
<b>HYUNDAI - H100 Kasten 07/93→12/04</b>							
 <b>Bremsbelagsatz, Scheibenbremse</b>							
2.4	82	10/97→12/04	←			13.0460-5792.2 605792	23536 17,6 + WK + Zub
2.4	84	08/97→10/03				13.0460-5718.2 605718	TRW 23081 18,0 + WK
2.4 TD	90	07/93→07/97	←				
2.5 D	57	12/94→03/00					
2.6 D	57	10/99→12/04					
2.5 TDiC	59	06/98→10/03	←	→ 03/00			
 <b>Bremsscheibe</b>							
2.4	82	10/97→12/04	←			24.0124-0220.1 424220	Ø 254 24 22,4 V
2.4	84	08/97→10/03				24.0120-0166.1 420166	Ø 253 20 18,4 V
2.4 TD	90	07/93→07/97	←				
2.5 D	57	12/94→03/00					
2.6 D	57	10/99→12/04					
2.5 TDiC	59	06/98→10/03	←	→ 03/00			
<b>HYUNDAI - H100 Pick-up 05/96→10/01</b>							
 <b>Bremsbelagsatz, Scheibenbremse</b>							
2.5 D	57	05/96→10/01	←	→ 03/00		13.0460-5718.2 605718	TRW 23081 18,0 + WK
 <b>Bremsscheibe</b>							
2.5 D	57	05/96→10/01	←	→ 03/00		24.0120-0166.1 420166	Ø 253 20 18,4 V
<b>HYUNDAI - H100 Pritsche/Fahrgestell 07/93→08/98</b>							
 <b>Bremsbelagsatz, Scheibenbremse</b>							
2.4	84	05/96→12/97	←			13.0460-5718.2 605718	TRW 23081 18,0 + WK
2.5 D	57	07/93→12/97				13.0460-5718.2 605718	TRW 23081 18,0 + WK
2.5 D	59	05/96→12/97					
 <b>Bremsscheibe</b>							
2.4	84	05/96→12/97	←			24.0120-0166.1 420166	Ø 253 20 18,4 V
2.5 D	57	07/93→12/97				24.0120-0166.1 420166	Ø 253 20 18,4 V
2.5 D	59	05/96→12/97					













	kw			 	! #		
<b>HYUNDAI - HIGHWAY VAN 03/00→03/04</b>							
 <b>Bremsbelagsatz, Scheibenbremse</b>							
2.0 16V	100	03/00→03/04	←			13.0460-5832.2 605832	23569 16,5 + WK + Zub
2.0 CRDi	83	03/01→03/04	→			13.0460-5833.2 605833	AKE 23543 14,4 + WK + Zub
2.0 CVVT	104	11/03→03/04					
2.7 V6 24V	125	03/00→03/04					
 <b>Bremsscheibe</b>							
2.0 16V	100	03/00→03/04	←			24.0126-0126.1 426126	Ø 276 26 24 V
2.0 CRDi	83	03/01→03/04	→			24.0110-0286.1 410286	Ø 284 10 8,4
2.0 CVVT	104	11/03→03/04					
2.7 V6 24V	125	03/00→03/04					
<b>HYUNDAI - i10 (BA, IA) 08/13→</b>							
 <b>Bremsbelagsatz, Scheibenbremse</b>							
1,0 LPG	49	02/14→	←	passend für Felgenreöße [Zoll]: 14		13.0460-5653.2 605653	MAN 25976 16,6 + WK + Zub
1.2	64	12/13→	←	passend für Felgenreöße [Zoll]: 13		13.0460-5653.2 605653	MAN 25976 16,6 + WK + Zub
			→			13.0460-5650.2 605650	AKE 25337 15,5 + WK + Zub
1,0 LPG	51	07/14→08/16	←			13.0460-5653.2 605653	MAN 25976 16,6 + WK + Zub
			→			13.0460-5650.2 605650	AKE 25337 15,5 + WK + Zub
1.0	49	08/13→	←	12/13→; passend für Felgenreöße [Zoll]: 14		13.0460-5653.2 605653	MAN 25976 16,6 + WK + Zub
			←	12/13→; passend für Felgenreöße [Zoll]: 13		13.0460-5653.2 605653	MAN 25976 16,6 + WK + Zub
			←	→ 11/13		13.0460-5776.2 605776	AKE 24275 16,5 + WK + Zub
			→	12/13→		13.0460-5650.2 605650	AKE 25337 15,5 + WK + Zub
			→	→ 11/13		13.0460-5775.2 605775	24276 14,8 + WK + Zub
 <b>Bremsscheibe</b>							
1,0 LPG	49	02/14→	←			24.0118-0144.1 418144	Ø 252 18 16 V
1,0 LPG	51	07/14→08/16	←	nicht für Leichtmetallfelgen; Made in Europa		24.0118-0145.1 418145	Ø 241 18 16 V
1.2	64	12/13→	→			24.0110-0394.1 410394	Ø 234 10 8,4
1.0	49	08/13→	←	12/13→		24.0118-0144.1 418144	Ø 252 18 16 V
			←	12/13→; nicht für Leichtmetallfelgen; Made in Europa		24.0118-0145.1 418145	Ø 241 18 16 V
			←	→ 11/13		24.0118-0145.1 418145	Ø 241 18 16 V
			→	→ 11/13		24.0110-0324.1 410324	Ø 234 10 8
			→	12/13→		24.0110-0394.1 410394	Ø 234 10 8,4
<b>HYUNDAI - i10 (PA) 10/07→02/16</b>							
 <b>Bremsbelagsatz, Scheibenbremse</b>							
1.0	51	01/11→12/17	←	→ 11/13		13.0460-5776.2 605776	AKE 24275 16,5 + WK + Zub
1.1	49	01/08→12/13	→	→ 11/13		13.0460-5775.2 605775	24276 14,8 + WK + Zub
1.1	50	11/08→12/13					
1.1	51	04/11→12/13					
1.1 LPG	51	04/11→12/13					
1.2	63	04/11→12/13					
1.1	48	12/07→12/13	←	01/08→ 11/13		13.0460-5776.2 605776	AKE 24275 16,5 + WK + Zub
			→	01/08→ 11/13		13.0460-5775.2 605775	24276 14,8 + WK + Zub
1.1 CRDi	55	01/08→12/11	←			13.0460-5776.2 605776	AKE 24275 16,5 + WK + Zub
1.2	57	11/08→12/11	→			13.0460-5775.2 605775	24276 14,8 + WK + Zub
 <b>Bremsscheibe</b>							
1.0	51	01/11→12/17	←	→ 11/13		24.0118-0145.1 418145	Ø 241 18 16 V
1.1	49	01/08→12/13	→	→ 11/13		24.0110-0324.1 410324	Ø 234 10 8
1.1	50	11/08→12/13					
1.1	51	04/11→12/13					
1.1 LPG	51	04/11→12/13					
1.2	63	04/11→12/13					
1.1	48	12/07→12/13	←	01/08→ 11/13		24.0118-0145.1 418145	Ø 241 18 16 V
			→	01/08→ 11/13		24.0110-0324.1 410324	Ø 234 10 8
1.1 CRDi	55	01/08→12/11	←			24.0118-0144.1 418144	Ø 252 18 16 V
			→			24.0110-0324.1 410324	Ø 234 10 8
1.2	57	11/08→12/11	←			24.0118-0145.1 418145	Ø 241 18 16 V
			→			24.0110-0324.1 410324	Ø 234 10 8













	kw			 	! #		
<b>HYUNDAI - i10 Stufenheck 12/13→</b>							
 <b>Bremsbelagsatz, Scheibenbremse</b>							
1.2	64	08/15→	←	passend für Felgengröße [Zoll]: 14	13.0460-5653.2	605653	MAN 25976 16,6 + WK + Zub
			←	passend für Felgengröße [Zoll]: 13	13.0460-5653.2	605653	MAN 25976 16,6 + WK + Zub
			→		13.0460-5650.2	605650	AKE 25337 15,5 + WK + Zub
 <b>Bremsscheibe</b>							
1.2	64	08/15→	←		24.0118-0144.1	418144	Ø 252 18 16 V
			←	nicht für Leichtmetallfelgen; Made in Europa	24.0118-0145.1	418145	Ø 241 18 16 V
			→		24.0110-0394.1	410394	Ø 234 10 8,4
<b>HYUNDAI - i20 (GB, IB) 11/14→</b>							
 <b>Bremsbelagsatz, Scheibenbremse</b>							
1.0 T-GDI	74	01/16→	←		13.0460-5646.2	605646	MAN 25348 17,8 + WK + Zub
1.0 T-GDI	88	01/16→	→		13.0460-5650.2	605650	AKE 25337 15,5 + WK + Zub
1.2 LPGI	61	11/14→	→		13.0460-5650.2	605650	AKE 25337 15,5 + WK + Zub
1.1 CRDi	55	11/14→	←	12/14→	13.0460-5646.2	605646	MAN 25348 17,8 + WK + Zub
1.2	55	11/14→	→	12/14→	13.0460-5650.2	605650	AKE 25337 15,5 + WK + Zub
1.2	62	11/14→	→	12/14→	13.0460-5650.2	605650	AKE 25337 15,5 + WK + Zub
1.4	74	11/14→	→	12/14→	13.0460-5650.2	605650	AKE 25337 15,5 + WK + Zub
1.4 CRDi	66	11/14→	→	12/14→	13.0460-5650.2	605650	AKE 25337 15,5 + WK + Zub
 <b>Bremsscheibe</b>							
1.0 T-GDI	74	01/16→	←	passend für Felgengröße [Zoll]: 14	24.0122-0293.1	422293	Ø 256 22 20 V
1.0 T-GDI	88	01/16→	←	passend für Felgengröße [Zoll]: 15	24.0122-0294.1	422294	Ø 280 22 19,4 V
1.2 LPGI	61	11/14→	→		24.0110-0398.1	410398	Ø 262 10 8,4
1.1 CRDi	55	11/14→	←	12/14→;	24.0122-0293.1	422293	Ø 256 22 20 V
1.2	55	11/14→	←	passend für Felgengröße [Zoll]: 14	24.0122-0293.1	422293	Ø 256 22 20 V
1.2	62	11/14→	←	12/14→;	24.0122-0294.1	422294	Ø 280 22 19,4 V
1.4	74	11/14→	←	passend für Felgengröße [Zoll]: 15	24.0122-0294.1	422294	Ø 280 22 19,4 V
1.4 CRDi	66	11/14→	→	12/14→	24.0110-0398.1	410398	Ø 262 10 8,4
<b>HYUNDAI - i20 (PB, PBT) 08/08→</b>							
 <b>Bremsbelagsatz, Scheibenbremse</b>							
1.1 CRDi	55	03/12→12/15	←	→ 12/14	13.0460-5779.2	605779	MAN 24317 17,6 + WK + Zub
1.4	74	09/08→12/15	→	→ 12/14	13.0460-5780.2	605780	MAN 24320 15,3 + WK + Zub
1.2	57	09/08→12/12	←	- ESP	13.0460-5776.2	605776	AKE 24275 16,5 + WK + Zub
			←	+ ESP	13.0460-5779.2	605779	MAN 24317 17,6 + WK + Zub
			→	+ ESP	13.0460-5780.2	605780	MAN 24320 15,3 + WK + Zub
1.2	63	03/12→12/15	←	- ESP; → 12/14	13.0460-5776.2	605776	AKE 24275 16,5 + WK + Zub
			←	+ ESP; → 12/14	13.0460-5779.2	605779	MAN 24317 17,6 + WK + Zub
			→	→ 12/14; + ESP	13.0460-5780.2	605780	MAN 24320 15,3 + WK + Zub
1.4 CRDi	55	09/08→12/12	←	08/09→	13.0460-5779.2	605779	MAN 24317 17,6 + WK + Zub
			→	08/09→	13.0460-5780.2	605780	MAN 24320 15,3 + WK + Zub
1.4 CRDi	66	08/08→12/15	←	09/08→ 12/14	13.0460-5779.2	605779	MAN 24317 17,6 + WK + Zub
			→	09/08→ 12/14	13.0460-5780.2	605780	MAN 24320 15,3 + WK + Zub
1.6	93	09/08→12/12	←		13.0460-5779.2	605779	MAN 24317 17,6 + WK + Zub
1.6 CRDi	85	09/08→12/12	→		13.0460-5780.2	605780	MAN 24320 15,3 + WK + Zub
1.6 CRDi	94	01/09→12/12	→		13.0460-5780.2	605780	MAN 24320 15,3 + WK + Zub
 <b>Bremsscheibe</b>							
1.1 CRDi	55	03/12→12/15	←	→ 12/14	24.0122-0260.1	422260	Ø 256 22 20 V
1.4	74	09/08→12/15	→	→ 12/14	24.0110-0312.1	410312	Ø 262 10 8,4
1.2	57	09/08→12/12	←	- ESP	24.0118-0151.1	418151	Ø 256 18 16 V
			←	+ ESP	24.0122-0260.1	422260	Ø 256 22 20 V
			→	+ ESP	24.0110-0312.1	410312	Ø 262 10 8,4
1.2	63	03/12→12/15	←	- ESP; → 12/14	24.0118-0151.1	418151	Ø 256 18 16 V
			←	+ ESP; → 12/14	24.0122-0260.1	422260	Ø 256 22 20 V
			→	→ 12/14; + ESP	24.0110-0312.1	410312	Ø 262 10 8,4
1.4 CRDi	55	09/08→12/12	←	08/09→	24.0122-0260.1	422260	Ø 256 22 20 V
			→	08/09→	24.0110-0312.1	410312	Ø 262 10 8,4
↓							















	kW			 	! #		
<b>HYUNDAI - i20 (PB, PBT) 08/08→</b>							
 <b>Bremsscheibe</b>							
1.4 CRDi	66	08/08→12/15	←	09/08→ 12/14		24.0122-0260.1 422260	Ø 256 22 20 V
			→	09/08→ 12/14		24.0110-0312.1 410312	Ø 262 10 8,4
1.6	93	09/08→12/12	←			24.0122-0260.1 422260	Ø 256 22 20 V
1.6 CRDi	85	09/08→12/12	←			24.0122-0260.1 422260	Ø 256 22 20 V
1.6 CRDi	94	01/09→12/12	→			24.0110-0312.1 410312	Ø 262 10 8,4
<b>HYUNDAI - i20 ACTIVE (IB, GB) 09/15→</b>							
 <b>Bremsbelagsatz, Scheibenbremse</b>							
1.0 T-GDI	74	09/15→	→			13.0460-5650.2 605650	AKE 25337 15,5 + WK + Zub
1.0 T-GDI	88	09/15→	→				
1.4	74	09/15→	→				
1.4 CRDi	66	09/15→	→				
 <b>Bremsscheibe</b>							
1.0 T-GDI	74	09/15→	←			24.0122-0294.1 422294	Ø 280 22 19,4 V
1.0 T-GDI	88	09/15→	←			24.0122-0294.1 422294	Ø 280 22 19,4 V
1.4 CRDi	66	09/15→	→			24.0110-0398.1 410398	Ø 262 10 8,4
1.4	74	09/15→	←			24.0122-0293.1 422293	Ø 256 22 20 V
			→			24.0110-0398.1 410398	Ø 262 10 8,4
<b>HYUNDAI - i20 Coupe (GB) 05/15→</b>							
 <b>Bremsbelagsatz, Scheibenbremse</b>							
1.0 T-GDI	74	01/16→	←			13.0460-5646.2 605646	MAN 25348 17,8 + WK + Zub
1.0 T-GDI	88	01/16→	←			13.0460-5646.2 605646	MAN 25348 17,8 + WK + Zub
1.1 CRDi	55	05/15→	→			13.0460-5650.2 605650	AKE 25337 15,5 + WK + Zub
1.2	62	05/15→	→				
1.4	74	05/15→	→				
1.4 CRDi	66	05/15→	→				
 <b>Bremsscheibe</b>							
1.0 T-GDI	74	01/16→	←	passend für Felgenreöße [Zoll]: 14		24.0122-0293.1 422293	Ø 256 22 20 V
1.0 T-GDI	88	01/16→	←	passend für Felgenreöße [Zoll]: 15		24.0122-0294.1 422294	Ø 280 22 19,4 V
1.1 CRDi	55	05/15→	←			24.0122-0294.1 422294	Ø 280 22 19,4 V
1.2	62	05/15→	→			24.0110-0398.1 410398	Ø 262 10 8,4
1.4	74	05/15→	→			24.0110-0398.1 410398	Ø 262 10 8,4
1.4 CRDi	66	05/15→	→				
<b>HYUNDAI - i30 (FD) 10/07→05/12</b>							
 <b>Bremsbelagsatz, Scheibenbremse</b>							
1.4	77	10/07→11/11	←	→ 10/11		13.0460-5742.2 605742	MAN 23966 17,7 + WK
1.4	80	10/07→11/11	←	→ 10/11		13.0460-5742.2 605742	MAN 23966 17,7 + WK
1.6	85	10/07→11/11	→	→ 10/11		13.0460-5780.2 605780	MAN 24320 15,3 + WK + Zub
1.6	90	10/07→11/11	→	→ 10/11		13.0460-5780.2 605780	MAN 24320 15,3 + WK + Zub
1.6	93	02/08→11/11	→	→ 10/11		13.0460-5780.2 605780	MAN 24320 15,3 + WK + Zub
1.6 CRDi	66	10/07→11/11	→	→ 10/11		13.0460-5780.2 605780	MAN 24320 15,3 + WK + Zub
1.6 CRDi	85	10/07→11/11	→	→ 10/11		13.0460-5780.2 605780	MAN 24320 15,3 + WK + Zub
1.6 CRDi	94	01/10→11/11	→	→ 10/11		13.0460-5780.2 605780	MAN 24320 15,3 + WK + Zub
2.0	105	10/07→11/11	→	→ 10/11		13.0460-5780.2 605780	MAN 24320 15,3 + WK + Zub
2.0 CRDi	103	10/07→11/11	→	→ 10/11		13.0460-5780.2 605780	MAN 24320 15,3 + WK + Zub
2.0 CRDi	100	10/07→11/11	←	02/08→ 10/11		13.0460-5742.2 605742	MAN 23966 17,7 + WK
			→	02/08→ 10/11		13.0460-5780.2 605780	MAN 24320 15,3 + WK + Zub
 <b>Bremsscheibe</b>							
1.4	77	10/07→11/11	←	→ 10/11; 15"		24.0126-0150.1 426150	Ø 280 26 24,4 V
1.4	80	10/07→11/11	←	→ 10/11; 15"		24.0126-0150.1 426150	Ø 280 26 24,4 V
1.6	85	10/07→11/11	←	→ 10/11; 16"		24.0128-0234.1 428234	Ø 300 28 26,4 V
1.6	90	10/07→11/11	←	→ 10/11; 16"		24.0128-0234.1 428234	Ø 300 28 26,4 V
1.6	93	02/08→11/11	→	→ 10/11		24.0110-0332.1 410332	Ø 262 10 8
1.6 CRDi	66	10/07→11/11	→	→ 10/11		24.0110-0332.1 410332	Ø 262 10 8
1.6 CRDi	85	10/07→11/11	→	→ 10/11		24.0110-0332.1 410332	Ø 262 10 8
1.6 CRDi	94	01/10→11/11	→	→ 10/11		24.0110-0332.1 410332	Ø 262 10 8
2.0	105	10/07→11/11	→	→ 10/11		24.0110-0332.1 410332	Ø 262 10 8
2.0 CRDi	103	10/07→11/11	→	→ 10/11		24.0110-0332.1 410332	Ø 262 10 8
2.0 CRDi	100	10/07→11/11	←	02/08→ 10/11; 15"		24.0126-0150.1 426150	Ø 280 26 24,4 V
			←	02/08→ 10/11; 16"		24.0128-0234.1 428234	Ø 300 28 26,4 V
			→	02/08→ 10/11		24.0110-0332.1 410332	Ø 262 10 8
<b>HYUNDAI - i30 (GD) 06/11→</b>							
 <b>Bremsbelagsatz, Scheibenbremse</b>							
1.4	73	12/11→12/15	←	06/13→; 15"		13.0460-5645.2 605645	25692 17,2 + WK + Zub
↓							











	kw			 	! #		
<b>HYUNDAI - i30 (GD) 06/11→</b>							
<b> Bremsbelagsatz, Scheibenbremse</b>							
1.4	73	12/11→12/15	←	→ 03/13; 15"		<b>13.0460-5645.2 605645</b>	25692 17,2 + WK + Zub
			←	16"		<b>13.0460-5651.2 605651</b>	SUM 24915 17,4 + WK
						<b>13.0470-5651.2 LD5651</b>	SUM 24915 17,4 + WK Ceramic
			→			<b>13.0460-5650.2 605650</b>	AKE 25337 15,5 + WK + Zub
1.4 1.6 T-GDI	74 137	12/14→12/16 01/15→	←	15"		<b>13.0460-5645.2 605645</b>	25692 17,2 + WK + Zub
			←	16"		<b>13.0460-5651.2 605651</b>	SUM 24915 17,4 + WK
						<b>13.0470-5651.2 LD5651</b>	SUM 24915 17,4 + WK Ceramic
			→			<b>13.0460-5650.2 605650</b>	AKE 25337 15,5 + WK + Zub
1.4 CRDi 1.6 1.6 CRDi 1.6 GDI	66 88 94 99	12/11→12/16 01/12→12/16 12/11→12/15 12/11→12/16	←	→ 05/13; 15"		<b>13.0460-5645.2 605645</b>	25692 17,2 + WK + Zub
			←	06/13→; 15"		<b>13.0460-5645.2 605645</b>	25692 17,2 + WK + Zub
			←	16"		<b>13.0460-5651.2 605651</b>	SUM 24915 17,4 + WK
						<b>13.0470-5651.2 LD5651</b>	SUM 24915 17,4 + WK Ceramic
			→			<b>13.0460-5650.2 605650</b>	AKE 25337 15,5 + WK + Zub
1.6	95	12/11→12/15	←	→ 05/13; 15"		<b>13.0460-5645.2 605645</b>	25692 17,2 + WK + Zub
			←	16"		<b>13.0460-5651.2 605651</b>	SUM 24915 17,4 + WK
						<b>13.0470-5651.2 LD5651</b>	SUM 24915 17,4 + WK Ceramic
			→			<b>13.0460-5650.2 605650</b>	AKE 25337 15,5 + WK + Zub
1.6 CRDi	81	12/11→12/16	←	06/12→ 05/13; 15"		<b>13.0460-5645.2 605645</b>	25692 17,2 + WK + Zub
			←	06/13→; 15"		<b>13.0460-5645.2 605645</b>	25692 17,2 + WK + Zub
			←	06/12→; 16"		<b>13.0460-5651.2 605651</b>	SUM 24915 17,4 + WK
						<b>13.0470-5651.2 LD5651</b>	SUM 24915 17,4 + WK Ceramic
			→	06/12→		<b>13.0460-5650.2 605650</b>	AKE 25337 15,5 + WK + Zub
1.6 CRDi	100	11/11→12/16	←	→ 05/13; 15"		<b>13.0460-5645.2 605645</b>	25692 17,2 + WK + Zub
			←	04/13→; 15"		<b>13.0460-5645.2 605645</b>	25692 17,2 + WK + Zub
			←	16"		<b>13.0460-5651.2 605651</b>	SUM 24915 17,4 + WK
						<b>13.0470-5651.2 LD5651</b>	SUM 24915 17,4 + WK Ceramic
			→			<b>13.0460-5650.2 605650</b>	AKE 25337 15,5 + WK + Zub
<b> Bremsscheibe</b>							
1.4 1.4 CRDi 1.6 1.6 1.6 CRDi 1.6 CRDi 1.6 GDI 1.6 T-GDI	73 66 88 95 94 100 99 137	12/11→12/15 12/11→12/16 01/12→12/16 12/11→12/15 12/11→12/15 11/11→12/16 12/11→12/16 01/15→	←	15"		<b>24.0123-0123.1 423123</b>	Ø 280 23,1 21 V
			←	16"		<b>24.0128-0234.1 428234</b>	Ø 300 28 26,4 V
			→	- eFSB		<b>24.0110-0379.1 410379</b>	Ø 262 10 8,4
			→	+ eFSB		<b>24.0110-0383.1 410383</b>	Ø 284 10 8,4
1.4	74	12/14→12/16	←	15"		<b>24.0123-0123.1 423123</b>	Ø 280 23,1 21 V
			←	→ 01/15; 16"		<b>24.0128-0234.1 428234</b>	Ø 300 28 26,4 V
			←	02/15→		<b>24.0128-0234.1 428234</b>	Ø 300 28 26,4 V
			→	- eFSB		<b>24.0110-0379.1 410379</b>	Ø 262 10 8,4
			→	+ eFSB		<b>24.0110-0383.1 410383</b>	Ø 284 10 8,4
1.6 CRDi	81	12/11→12/16	←	06/12→; 15"		<b>24.0123-0123.1 423123</b>	Ø 280 23,1 21 V
			←	06/12→; 16"		<b>24.0128-0234.1 428234</b>	Ø 300 28 26,4 V
			→	06/12→; - eFSB		<b>24.0110-0379.1 410379</b>	Ø 262 10 8,4
			→	06/12→; + eFSB		<b>24.0110-0383.1 410383</b>	Ø 284 10 8,4
<b>HYUNDAI - i30 (PDE, PD) 11/16→</b>							
<b> Bremsscheibe</b>							
1.0 T-GDI 1.4 T-GDI 1.6 CRDi 1.6 CRDi 1.6 CRDi	88 103 70 81 100	11/16→ 11/16→ 11/16→ 11/16→ 11/16→	←	01/17→; 16"		<b>24.0125-0213.1 425213</b>	Ø 305 25 23,4 V
			→	01/17→; + eFSB		<b>24.0110-0400.1 410400</b>	Ø 284 10 8,4
1.4 MPI 1.4 MPI	73 74	11/16→ 11/16→	←	01/17→; 15"		<b>24.0123-0123.1 423123</b>	Ø 280 23,1 21 V
			←	01/17→; 16"		<b>24.0125-0213.1 425213</b>	Ø 305 25 23,4 V
			→	01/17→; + eFSB		<b>24.0110-0400.1 410400</b>	Ø 284 10 8,4















	kw			 	! #		
<b>HYUNDAI - i30 Coupe 05/13→</b>							
 <b>Bremsbelagsatz, Scheibenbremse</b>							
1.4	73	05/13→	←	06/13→; 15"		<b>13.0460-5645.2 605645</b>	25692 17,2 + WK + Zub
			←	16"		<b>13.0460-5651.2 605651</b>	SUM 24915 17,4 + WK
						<b>13.0470-5651.2 LD5651</b>	SUM 24915 17,4 + WK Ceramic
			→			<b>13.0460-5650.2 605650</b>	AKE 25337 15,5 + WK + Zub
1.4	74	12/14→	←	15"		<b>13.0460-5645.2 605645</b>	25692 17,2 + WK + Zub
1.6 CRDi	81	11/15→	←	16"		<b>13.0460-5651.2 605651</b>	SUM 24915 17,4 + WK
1.6 CRDi	100	12/14→	←	16"		<b>13.0470-5651.2 LD5651</b>	SUM 24915 17,4 + WK Ceramic
1.6 T-GDI	137	01/15→	→			<b>13.0460-5650.2 605650</b>	AKE 25337 15,5 + WK + Zub
1.4 CRDi	66	05/13→	←	15"		<b>13.0460-5645.2 605645</b>	25692 17,2 + WK + Zub
1.6 CRDi	94	05/13→	←	→ 08/15; 16"		<b>13.0460-5651.2 605651</b>	SUM 24915 17,4 + WK
						<b>13.0470-5651.2 LD5651</b>	SUM 24915 17,4 + WK Ceramic
			←	02/15→; 16"		<b>13.0460-5659.2 605659</b>	MAN 24915 17,8 + WK + Zub
			→	+ eFSB		<b>13.0460-5650.2 605650</b>	AKE 25337 15,5 + WK + Zub
			→	für Fahrzeuge ohne Start-Stopp-Funktion		<b>13.0460-5650.2 605650</b>	AKE 25337 15,5 + WK + Zub
1.6 GDI	99	05/13→	←	06/13→; 15"		<b>13.0460-5645.2 605645</b>	25692 17,2 + WK + Zub
			←	→ 05/13; 15"		<b>13.0460-5645.2 605645</b>	25692 17,2 + WK + Zub
			←	16"		<b>13.0460-5651.2 605651</b>	SUM 24915 17,4 + WK
						<b>13.0470-5651.2 LD5651</b>	SUM 24915 17,4 + WK Ceramic
			→			<b>13.0460-5650.2 605650</b>	AKE 25337 15,5 + WK + Zub
1.6 MPI	88	11/16→	←	für Fahrzeuge mit Start-Stopp-Funktion; 16"		<b>13.0460-5659.2 605659</b>	MAN 24915 17,8 + WK + Zub
			→	für Fahrzeuge mit Start-Stopp-Funktion / + eFSB		<b>13.0460-5650.2 605650</b>	AKE 25337 15,5 + WK + Zub
 <b>Bremsscheibe</b>							
1.4	73	05/13→	←	15"		<b>24.0123-0123.1 423123</b>	Ø 280 23,1 21 V
1.4 CRDi	66	05/13→	←	16"		<b>24.0128-0234.1 428234</b>	Ø 300 28 26,4 V
1.6 CRDi	81	11/15→					
1.6 CRDi	94	05/13→	→	- eFSB		<b>24.0110-0379.1 410379</b>	Ø 262 10 8,4
1.6 CRDi	100	12/14→	→	+ eFSB		<b>24.0110-0383.1 410383</b>	Ø 284 10 8,4
1.6 GDI	99	05/13→					
1.6 MPI	88	11/16→					
1.6 T-GDI	137	01/15→					
1.4	74	12/14→	←	15"		<b>24.0123-0123.1 423123</b>	Ø 280 23,1 21 V
			←	→ 01/15; 16"		<b>24.0128-0234.1 428234</b>	Ø 300 28 26,4 V
			←	02/15→		<b>24.0128-0234.1 428234</b>	Ø 300 28 26,4 V
			→	- eFSB		<b>24.0110-0379.1 410379</b>	Ø 262 10 8,4
			→	+ eFSB		<b>24.0110-0383.1 410383</b>	Ø 284 10 8,4
<b>HYUNDAI - i30 FASTBACK (PDE) 06/17→</b>							
 <b>Bremsscheibe</b>							
1.0 T-GDI	88	06/17→	←	16"		<b>24.0125-0213.1 425213</b>	Ø 305 25 23,4 V
1.4 T-GDI	103	06/17→	→	+ eFSB		<b>24.0110-0400.1 410400</b>	Ø 284 10 8,4
<b>HYUNDAI - i30 Kombi (FD) 10/07→06/12</b>							
 <b>Bremsbelagsatz, Scheibenbremse</b>							
1.4	77	10/07→06/12	←	02/08→		<b>13.0460-5742.2 605742</b>	MAN 23966 17,7 + WK
			→	02/08→		<b>13.0460-5780.2 605780</b>	MAN 24320 15,3 + WK + Zub
1.4	80	11/09→06/12	←			<b>13.0460-5742.2 605742</b>	MAN 23966 17,7 + WK
1.6	85	02/08→06/12	→			<b>13.0460-5780.2 605780</b>	MAN 24320 15,3 + WK + Zub
1.6	90	02/08→06/12					
1.6	93	02/08→06/12					
1.6 CRDi	66	02/08→06/12					
1.6 CRDi	85	02/08→06/12					
1.6 CRDi	94	01/10→06/12					
2.0	105	02/08→06/12					
2.0 CRDi	103	02/08→06/12					
2.0 CRDi	100	10/08→06/12	←	01/10→		<b>13.0460-5742.2 605742</b>	MAN 23966 17,7 + WK
			→	01/10→		<b>13.0460-5780.2 605780</b>	MAN 24320 15,3 + WK + Zub
 <b>Bremsscheibe</b>							
1.4	77	10/07→06/12	←	02/08→; 15"		<b>24.0126-0150.1 426150</b>	Ø 280 26 24,4 V
			←	02/08→; 16"		<b>24.0128-0234.1 428234</b>	Ø 300 28 26,4 V
↓							







	kw			 	! #		
<b>HYUNDAI - i30 Kombi (FD) 10/07→06/12</b>							
 <b>Bremsscheibe</b>							
1.4	77	10/07→06/12	➔	02/08→		24.0110-0332.1 410332	Ø 262 10 8
1.4	80	11/09→06/12	➔	15"		24.0126-0150.1 426150	Ø 280 26 24,4 V
1.6	85	02/08→06/12	➔	16"		24.0128-0234.1 428234	Ø 300 28 26,4 V
1.6	90	02/08→06/12	➔			24.0110-0332.1 410332	Ø 262 10 8
1.6	93	02/08→06/12	➔				
1.6 CRDi	66	02/08→06/12	➔				
1.6 CRDi	85	02/08→06/12	➔				
1.6 CRDi	94	01/10→06/12	➔				
2.0	105	02/08→06/12	➔				
2.0 CRDi	103	02/08→06/12	➔				
2.0 CRDi	100	10/08→06/12	➔	01/10→; 15"		24.0126-0150.1 426150	Ø 280 26 24,4 V
			➔	01/10→; 16"		24.0128-0234.1 428234	Ø 300 28 26,4 V
			➔	01/10→		24.0110-0332.1 410332	Ø 262 10 8
<b>HYUNDAI - i30 Kombi (GD) 06/12→</b>							
 <b>Bremsbelagsatz, Scheibenbremse</b>							
1.4	73	06/12→12/15	➔	15"		13.0460-5645.2 605645	25692 17,2 + WK + Zub
1.4	74	01/15→	➔	16"		13.0460-5651.2 605651	SUM 24915 17,4 + WK
1.4 CRDi	66	06/12→	➔	16"		13.0470-5651.2 LD5651	SUM 24915 17,4 + WK Ceramic
1.6	95	06/12→12/15	➔			13.0460-5650.2 605650	AKE 25337 15,5 + WK + Zub
1.6 CRDi	81	06/12→	➔				
1.6 CRDi	94	06/12→12/15	➔				
1.6 CRDi	100	01/15→	➔				
1.6 GDI	99	06/12→	➔				
1.6	88	06/12→	➔	15"		13.0460-5645.2 605645	25692 17,2 + WK + Zub
			➔	16"		13.0460-5651.2 605651	SUM 24915 17,4 + WK
			➔	→ 06/12		13.0470-5651.2 LD5651	SUM 24915 17,4 + WK Ceramic
			➔			13.0460-5742.2 605742	MAN 23966 17,7 + WK
			➔			13.0460-5650.2 605650	AKE 25337 15,5 + WK + Zub
			➔	→ 06/12		13.0460-5780.2 605780	MAN 24320 15,3 + WK + Zub
 <b>Bremsscheibe</b>							
1.4	73	06/12→12/15	➔	15"		24.0123-0123.1 423123	Ø 280 23,1 21 V
1.4	74	01/15→	➔	16"		24.0128-0234.1 428234	Ø 300 28 26,4 V
1.4 CRDi	66	06/12→	➔	16"		24.0128-0234.1 428234	Ø 300 28 26,4 V
1.6	95	06/12→12/15	➔	- eFSB		24.0110-0379.1 410379	Ø 262 10 8,4
1.6 CRDi	81	06/12→	➔	+ eFSB		24.0110-0383.1 410383	Ø 284 10 8,4
1.6 CRDi	94	06/12→12/15	➔				
1.6 CRDi	100	01/15→	➔				
1.6 GDI	99	06/12→	➔				
1.6	88	06/12→	➔	15"		24.0123-0123.1 423123	Ø 280 23,1 21 V
			➔	→ 06/12; 15"		24.0126-0150.1 426150	Ø 280 26 24,4 V
			➔	16"		24.0128-0234.1 428234	Ø 300 28 26,4 V
			➔	→ 06/12; 16"		24.0128-0234.1 428234	Ø 300 28 26,4 V
			➔	→ 06/12		24.0110-0332.1 410332	Ø 262 10 8
			➔	- eFSB		24.0110-0379.1 410379	Ø 262 10 8,4
			➔	+ eFSB		24.0110-0383.1 410383	Ø 284 10 8,4
<b>HYUNDAI - i30 Kombi (PDE) 03/17→</b>							
 <b>Bremsscheibe</b>							
1.0 T-GDI	88	03/17→	➔	06/17→; 16"		24.0125-0213.1 425213	Ø 305 25 23,4 V
1.4 T-GDI	103	03/17→	➔	06/17→; + eFSB		24.0110-0400.1 410400	Ø 284 10 8,4
1.6 CRDi	81	03/17→	➔				
1.6 CRDi	100	03/17→	➔				
1.4 MPI	73	05/17→	➔	16"		24.0125-0213.1 425213	Ø 305 25 23,4 V
1.4 MPI	74	03/17→	➔	+ eFSB		24.0110-0400.1 410400	Ø 284 10 8,4
<b>HYUNDAI - i40 (VF) 03/12→</b>							
 <b>Bremsbelagsatz, Scheibenbremse</b>							
1.6 GDI	99	03/12→	➔			13.0460-5647.2 605647	MAN 24501 17,8 + WK + Zub
1.7 CRDi	85	03/12→	➔			13.0460-5650.2 605650	AKE 25337 15,5 + WK + Zub
1.7 CRDi	100	03/12→	➔				
1.7 CRDi	104	01/15→	➔				
2.0 CVVT	110	10/12→	➔				
2.0 GDi	121	12/14→	➔				
2.0 GDI	130	03/12→	➔				
2.0 GDI	131	03/12→	➔				
↓							













	kw			 	! #		
<b>HYUNDAI - i40 (VF) 03/12→</b>							
 <b>Bremsscheibe</b>							
1.6 GDI	99	03/12→	←	passend für Felgenreöße [Zoll]: 16	24.0128-0256.1	428256	Ø 300 28 26,4 V
1.7 CRDi	85	03/12→	←	passend für Felgenreöße [Zoll]: 17 / 18	24.0128-0258.1	428258	Ø 320 28,1 26,4 V
1.7 CRDi	100	03/12→	←	passend für Felgenreöße [Zoll]: 17 / 18	24.0110-0369.1	410369	Ø 300 10 8,4
1.7 CRDi	104	01/15→	→	passend für Felgenreöße [Zoll]: 17 / 18	24.0110-0369.1	410369	Ø 300 10 8,4
2.0 CVVT	110	10/12→	→	passend für Felgenreöße [Zoll]: 17 / 18	24.0110-0370.1	410370	Ø 284 10 8,4
2.0 GDi	121	12/14→	→	passend für Felgenreöße [Zoll]: 16	24.0110-0370.1	410370	Ø 284 10 8,4
2.0 GDI	130	03/12→	→	passend für Felgenreöße [Zoll]: 16	24.0110-0370.1	410370	Ø 284 10 8,4
2.0 GDI	131	03/12→	→	passend für Felgenreöße [Zoll]: 16	24.0110-0370.1	410370	Ø 284 10 8,4
<b>HYUNDAI - i40 CW (VF) 07/11→</b>							
 <b>Bremsbelagsatz, Scheibenbremse</b>							
1.6 GDI	99	07/11→	←		13.0460-5647.2	605647	MAN 24501 17,8 + WK + Zub
1.7 CRDi	85	07/11→	←		13.0460-5650.2	605650	AKE 25337 15,5 + WK + Zub
1.7 CRDi	100	07/11→	→		13.0460-5650.2	605650	AKE 25337 15,5 + WK + Zub
1.7 CRDi	104	01/15→	→		13.0460-5650.2	605650	AKE 25337 15,5 + WK + Zub
2.0 CVVT	110	10/12→	→		13.0460-5650.2	605650	AKE 25337 15,5 + WK + Zub
2.0 GDi	121	12/14→	→		13.0460-5650.2	605650	AKE 25337 15,5 + WK + Zub
2.0 GDI	130	07/11→	→		13.0460-5650.2	605650	AKE 25337 15,5 + WK + Zub
 <b>Bremsscheibe</b>							
1.6 GDI	99	07/11→	←	passend für Felgenreöße [Zoll]: 16	24.0128-0256.1	428256	Ø 300 28 26,4 V
1.7 CRDi	85	07/11→	←	passend für Felgenreöße [Zoll]: 17 / 18	24.0128-0258.1	428258	Ø 320 28,1 26,4 V
1.7 CRDi	100	07/11→	←	passend für Felgenreöße [Zoll]: 17 / 18	24.0128-0258.1	428258	Ø 320 28,1 26,4 V
1.7 CRDi	104	01/15→	→	passend für Felgenreöße [Zoll]: 17 / 18	24.0110-0369.1	410369	Ø 300 10 8,4
2.0 CVVT	110	10/12→	→	passend für Felgenreöße [Zoll]: 17 / 18	24.0110-0369.1	410369	Ø 300 10 8,4
2.0 GDi	121	12/14→	→	passend für Felgenreöße [Zoll]: 16	24.0110-0370.1	410370	Ø 284 10 8,4
2.0 GDI	130	07/11→	→	passend für Felgenreöße [Zoll]: 16	24.0110-0370.1	410370	Ø 284 10 8,4
<b>HYUNDAI - IONIQ (AE) 03/16→</b>							
 <b>Bremsscheibe</b>							
1.6 GDI Hybrid	77	03/16→	→		24.0110-0400.1	410400	Ø 284 10 8,4
1.6 GDI Hybrid	104	03/16→	→		24.0110-0400.1	410400	Ø 284 10 8,4
Electric	88	03/16→	→		24.0110-0400.1	410400	Ø 284 10 8,4
Elektro	25	03/16→	→		24.0110-0400.1	410400	Ø 284 10 8,4
<b>HYUNDAI - ix20 (JC) 11/10→</b>							
 <b>Bremsbelagsatz, Scheibenbremse</b>							
1.4	66	11/10→	←		13.0460-5641.2	605641	25187 17,8 + WK + Zub
1.4 CRDi	57	06/11→	←		13.0460-5641.2	605641	25187 17,8 + WK + Zub
1.4 CRDi	66	11/10→	→		13.0460-5781.2	605781	MAN + WK + Zub
1.6	92	11/10→	→		13.0460-5781.2	605781	MAN + WK + Zub
1.6 CRDi	85	06/11→	→		13.0460-5781.2	605781	MAN + WK + Zub
1.6 CRDi	94	06/11→	→		13.0460-5781.2	605781	MAN + WK + Zub
 <b>Bremsscheibe</b>							
1.4	66	11/10→	←		24.0126-0150.1	426150	Ø 280 26 24,4 V
1.4 CRDi	57	06/11→	←		24.0126-0150.1	426150	Ø 280 26 24,4 V
1.4 CRDi	66	11/10→	→		24.0110-0357.1	410357	Ø 258 10 8
1.6	92	11/10→	→		24.0110-0357.1	410357	Ø 258 10 8
1.6 CRDi	85	06/11→	→		24.0110-0357.1	410357	Ø 258 10 8
1.6 CRDi	94	06/11→	→		24.0110-0357.1	410357	Ø 258 10 8
<b>HYUNDAI - ix35 (LM, EL, ELH) 08/09→</b>							
 <b>Bremsbelagsatz, Scheibenbremse</b>							
1.6	99	11/10→	←	→ 04/13	13.0460-5600.2	605600	SUM 24501 16,7 + WK
1.7 CRDi	85	11/10→	←	→ 04/13	13.0460-5600.2	605600	SUM 24501 16,7 + WK
2.0 CRDi	130	01/12→	→	→ 03/13	13.0460-5780.2	605780	MAN 24320 15,3 + WK + Zub
2.0 CRDi	135	01/12→	→	→ 03/13	13.0460-5780.2	605780	MAN 24320 15,3 + WK + Zub
2.0	120	01/10→	←	04/10→ 04/13	13.0460-5600.2	605600	SUM 24501 16,7 + WK
			→	08/13→ 12/15; Made in Tschechische Republik	13.0460-5780.2	605780	MAN 24320 15,3 + WK + Zub
			→	04/10→ 03/13	13.0460-5780.2	605780	MAN 24320 15,3 + WK + Zub
2.0	122	01/10→	←	→ 04/13	13.0460-5600.2	605600	SUM 24501 16,7 + WK
			2.4 DCVVT-I 4WD	128	07/10→12/13	→	13.0460-5780.2
2.0 4WD	116	09/14→	←		13.0460-5600.2	605600	SUM 24501 16,7 + WK
			→		13.0460-5780.2	605780	MAN 24320 15,3 + WK + Zub
2.0 4WD	120	01/10→	←	04/10→ 04/13	13.0460-5600.2	605600	SUM 24501 16,7 + WK
			→	04/10→ 07/13	13.0460-5780.2	605780	MAN 24320 15,3 + WK + Zub
2.0 AWD	114	11/13→	→	+ eFSB	13.0460-5650.2	605650	AKE 25337 15,5 + WK + Zub
			→	- eFSB	13.0460-5786.2	605786	AKE 24934 15,0 + WK + Zub















	kW			 	! #		
<b>HYUNDAI - ix35 (LM, EL, ELH) 08/09 →</b>							
 <b>Bremsbelagsatz, Scheibenbremse</b>							
2.0 AWD	114	11/13 →	➡	- eFSB		13.0470-5786.2 LD5786	AKE 24934 15,0 + WK + Zub Ceramic
2.0 CRDi	100	01/10 →	⬅	04/10 → 04/13		13.0460-5600.2 605600	SUM 24501 16,7 + WK
			➡	04/10 → 03/13		13.0460-5780.2 605780	MAN 24320 15,3 + WK + Zub
2.0 CRDi 4WD 2.0 CRDi 4WD	100	01/10 →	⬅	04/10 → 12/15		13.0460-5600.2 605600	SUM 24501 16,7 + WK
	135	01/10 →	➡	04/10 → 12/15		13.0460-5780.2 605780	MAN 24320 15,3 + WK + Zub
2.0 CRDi 4WD	130	01/11 →	⬅	01/12 → 12/15		13.0460-5600.2 605600	SUM 24501 16,7 + WK
			➡	01/12 → 12/15		13.0460-5780.2 605780	MAN 24320 15,3 + WK + Zub
2.0 CVVT 2.0 CVVT AWD	110	08/09 →	⬅	→ 07/13		13.0460-5600.2 605600	SUM 24501 16,7 + WK
	110	08/09 →	➡	→ 07/13		13.0460-5780.2 605780	MAN 24320 15,3 + WK + Zub
2.0 GDi	122	08/13 →	⬅	→ 12/15; Made in Tschechische Republik		13.0460-5600.2 605600	SUM 24501 16,7 + WK
2.0 GDi 2.0 GDi 4WD	110	08/13 → 12/15	⬅	Made in Tschechische Republik		13.0460-5600.2 605600	SUM 24501 16,7 + WK
	110	08/13 → 12/15	➡	Made in Tschechische Republik		13.0460-5780.2 605780	MAN 24320 15,3 + WK + Zub
2.0 GDi 4WD	122	08/13 →	⬅	→ 12/15; Made in Tschechische Republik		13.0460-5600.2 605600	SUM 24501 16,7 + WK
			➡	→ 12/15; Made in Tschechische Republik		13.0460-5780.2 605780	MAN 24320 15,3 + WK + Zub
 <b>Bremsscheibe</b>							
1.6	99	11/10 →	⬅	→ 12/15		24.0128-0256.1 428256	Ø 300 28 26,4 V
1.7 CRDi 2.0 CRDi	85	11/10 →	➡	→ 12/15		24.0110-0332.1 410332	Ø 262 10 8
	130	01/12 →					
2.0 CRDi	135	01/12 →					
2.0 GDi	122	08/13 →					
2.0	120	01/10 →	⬅	04/10 → 07/13		24.0128-0256.1 428256	Ø 300 28 26,4 V
			➡	04/10 → 07/13		24.0110-0332.1 410332	Ø 262 10 8
2.0	122	01/10 →	⬅			24.0128-0256.1 428256	Ø 300 28 26,4 V
			➡			24.0110-0332.1 410332	Ø 262 10 8
2.0 4WD 2.4 DCVVT-I 4WD	116	09/14 →	⬅			24.0128-0256.1 428256	Ø 300 28 26,4 V
	128	07/10 → 12/13	➡			24.0110-0286.1 410286	Ø 284 10 8,4
2.0 4WD	120	01/10 →	⬅	04/10 → 07/13		24.0128-0256.1 428256	Ø 300 28 26,4 V
			➡	04/10 → 07/13		24.0110-0286.1 410286	Ø 284 10 8,4
2.0 CRDi	100	01/10 →	⬅	04/10 → 12/15		24.0128-0256.1 428256	Ø 300 28 26,4 V
			➡	04/10 → 12/15		24.0110-0332.1 410332	Ø 262 10 8
2.0 CRDi 4WD 2.0 CRDi 4WD	100	01/10 →	⬅	04/10 → 12/15		24.0128-0256.1 428256	Ø 300 28 26,4 V
	135	01/10 →	➡	04/10 → 12/15		24.0110-0286.1 410286	Ø 284 10 8,4
2.0 CRDi 4WD	130	01/11 →	⬅	01/12 → 12/15		24.0128-0256.1 428256	Ø 300 28 26,4 V
			➡	01/12 → 12/15		24.0110-0286.1 410286	Ø 284 10 8,4
2.0 CVVT 2.0 CVVT AWD	110	08/09 →	⬅	→ 07/13		24.0128-0256.1 428256	Ø 300 28 26,4 V
	110	08/09 →	➡	→ 07/13		24.0110-0332.1 410332	Ø 262 10 8
2.0 GDi 2.0 GDi 4WD	110	08/13 → 12/15 08/13 → 12/15	⬅			24.0128-0256.1 428256	Ø 300 28 26,4 V
			➡	Made in Republik Korea (Südkorea)		24.0110-0286.1 410286	Ø 284 10 8,4
			➡	Made in Tschechische Republik		24.0110-0332.1 410332	Ø 262 10 8
2.0 GDi 4WD	122	08/13 →	⬅	→ 12/15		24.0128-0256.1 428256	Ø 300 28 26,4 V
			➡	→ 12/15		24.0110-0286.1 410286	Ø 284 10 8,4
FCEV Fuel Cell	53	10/12 →	⬅			24.0128-0258.1 428258	Ø 320 28,1 26,4 V
	100	09/14 →	➡			24.0110-0388.1 410388	Ø 284 10 8,4
<b>HYUNDAI - ix55 09/06 →</b>							
 <b>Bremsbelagsatz, Scheibenbremse</b>							
3.0 V6 CRDi 4WD 3.0 V6 CRDi 4WD	176	09/08 → 12/11	⬅			13.0460-5638.2 605638	AKE 25119 16,9 + WK + Zub
	184	09/11 → 12/12	➡			13.0460-5636.2 605636	MAN 24599 14,9 + WK + Zub
3.8 V6 3.8 V6 4WD	194	01/11 → 01/11 →	⬅	→ 12/12		13.0460-5638.2 605638	AKE 25119 16,9 + WK + Zub
			➡	→ 12/12		13.0460-5636.2 605636	MAN 24599 14,9 + WK + Zub
3.8 V6 4WD	191	01/07 →	⬅	01/08 → 12/12		13.0460-5638.2 605638	AKE 25119 16,9 + WK + Zub
			➡	01/08 → 12/12		13.0460-5636.2 605636	MAN 24599 14,9 + WK + Zub
↓							











	kw					! #		
<b>HYUNDAI - ix55 09/06 →</b>								
 <b>Bremsscheibe</b>								
3.0 V6 CRDi 4WD	176	09/08 → 12/11	←			24.0132-0169.1	432169	Ø 321 32 30 V
3.0 V6 CRDi 4WD	184	09/11 → 12/12	→			24.0118-0154.1	418154	Ø 324 18 16 V
3.8 V6	194	01/11 →	←	→ 12/12		24.0132-0169.1	432169	Ø 321 32 30 V
3.8 V6 4WD	194	01/11 →	→	→ 12/12		24.0118-0154.1	418154	Ø 324 18 16 V
3.8 V6 4WD	191	01/07 →	←	01/08 → 12/12		24.0132-0169.1	432169	Ø 321 32 30 V
			→	01/08 → 12/12		24.0118-0154.1	418154	Ø 324 18 16 V
<b>HYUNDAI - KONA (OS) 06/17 →</b>								
 <b>Bremsscheibe</b>								
1.0 T-GDi	88	07/17 →	→	15"		24.0110-0368.1	410368	Ø 262 10 8,4
1.6 CRDi	85	07/17 →	←	17"		24.0128-0258.1	428258	Ø 320 28,1 26,4 V
1.6 CRDi e-VGT AWD	100	07/17 →						
1.6 T-GDi	130	07/17 →						
1.6 T-GDi 4WD	130	06/17 →						
<b>HYUNDAI - LANTRA II (J-2) 06/95 → 12/00</b>								
 <b>Bremsbelagsatz, Scheibenbremse</b>								
1.5 12V	65	12/96 → 09/00	←	→ 05/00; - ABS		13.0460-5872.2	605872	AKE 21012 15,0 + WK + Zub
			←	→ 05/00; + ABS		13.0460-5933.2	605933	AKE 21725 16,8 + WK
			→	→ 05/00; + ABS		13.0460-5874.2	605874	SUM 21553 14,0 + WK + Zub
1.5 16V	76	11/95 → 10/00	←			13.0460-5933.2	605933	AKE 21725 16,8 + WK
1.6 16V	76	11/95 → 10/00	←			13.0460-5933.2	605933	AKE 21725 16,8 + WK
1.9 D	50	03/98 → 09/00	→			13.0460-5874.2	605874	SUM 21553 14,0 + WK + Zub
2.0	100	04/97 → 05/00	→			13.0460-5874.2	605874	SUM 21553 14,0 + WK + Zub
1.6 16V	84	11/95 → 09/00	←	→ 05/00		13.0460-5933.2	605933	AKE 21725 16,8 + WK
1.6 i	66	11/95 → 09/00	←	→ 05/00		13.0460-5933.2	605933	AKE 21725 16,8 + WK
1.8 16V	94	11/95 → 09/00	→	→ 05/00		13.0460-5874.2	605874	SUM 21553 14,0 + WK + Zub
2.0 16V	102	08/96 → 09/00	→	→ 05/00		13.0460-5874.2	605874	SUM 21553 14,0 + WK + Zub
 <b>Bremsscheibe</b>								
1.5 12V	65	12/96 → 09/00	←	→ 05/00; - ABS		24.0119-0111.1	419111	Ø 242 19,2 17 V
			←	→ 05/00; + ABS		24.0122-0170.1	422170	Ø 257 22 20 V
						24.0322-0170.1	522170	Ø 257 22 20 V
			→	→ 05/00; + ABS		24.0110-0264.1	410264	Ø 258 10 8
1.5 16V	76	11/95 → 10/00	←			24.0122-0170.1	422170	Ø 257 22 20 V
1.6 16V	76	11/95 → 10/00	←			24.0122-0170.1	422170	Ø 257 22 20 V
1.9 D	50	03/98 → 09/00	→			24.0110-0264.1	410264	Ø 258 10 8
2.0	100	04/97 → 05/00	→			24.0110-0264.1	410264	Ø 258 10 8
1.6 16V	84	11/95 → 09/00	←	→ 05/00		24.0122-0170.1	422170	Ø 257 22 20 V
1.6 i	66	11/95 → 09/00	←	→ 05/00		24.0322-0170.1	522170	Ø 257 22 20 V
1.8 16V	94	11/95 → 09/00	→	→ 05/00		24.0322-0170.1	522170	Ø 257 22 20 V
2.0 16V	102	08/96 → 09/00	→	→ 05/00		24.0110-0264.1	410264	Ø 258 10 8
<b>HYUNDAI - LANTRA II Kombi (J-2) 06/95 → 10/00</b>								
 <b>Bremsbelagsatz, Scheibenbremse</b>								
1.5 12V	65	04/97 → 10/00	←	→ 05/00; - ABS		13.0460-5872.2	605872	AKE 21012 15,0 + WK + Zub
			←	→ 05/00; + ABS		13.0460-5933.2	605933	AKE 21725 16,8 + WK
			→	→ 05/00; + ABS		13.0460-5874.2	605874	SUM 21553 14,0 + WK + Zub
1.6 16V	84	02/96 → 10/00	←	→ 05/00		13.0460-5933.2	605933	AKE 21725 16,8 + WK
1.6 i	66	02/96 → 10/00	←	→ 05/00		13.0460-5933.2	605933	AKE 21725 16,8 + WK
1.8 16V	94	02/96 → 10/00	→	→ 05/00		13.0460-5874.2	605874	SUM 21553 14,0 + WK + Zub
2.0 16V	102	11/95 → 10/00	→	→ 05/00		13.0460-5874.2	605874	SUM 21553 14,0 + WK + Zub
1.9 D	50	03/98 → 10/00	←	→ 09/00		13.0460-5933.2	605933	AKE 21725 16,8 + WK
			→	→ 09/00		13.0460-5874.2	605874	SUM 21553 14,0 + WK + Zub
2.0	100	04/97 → 05/00	←			13.0460-5933.2	605933	AKE 21725 16,8 + WK
			→			13.0460-5874.2	605874	SUM 21553 14,0 + WK + Zub
 <b>Bremsscheibe</b>								
1.5 12V	65	04/97 → 10/00	←	→ 05/00; - ABS		24.0119-0111.1	419111	Ø 242 19,2 17 V
			←	→ 05/00; + ABS		24.0122-0170.1	422170	Ø 257 22 20 V
						24.0322-0170.1	522170	Ø 257 22 20 V
			→	→ 05/00; + ABS		24.0110-0264.1	410264	Ø 258 10 8
1.6 16V	84	02/96 → 10/00	←	→ 05/00		24.0122-0170.1	422170	Ø 257 22 20 V
1.6 i	66	02/96 → 10/00	←	→ 05/00		24.0322-0170.1	522170	Ø 257 22 20 V















	kw					! #		
<b>HYUNDAI - LANTRA II Kombi (J-2) 06/95→10/00</b>								
<b>Bremsscheibe</b>								
1.8 16V	94	02/96→10/00	→	→ 05/00			24.0110-0264.1 410264	Ø 258 10 8
2.0 16V	102	11/95→10/00						
1.9 D	50	03/98→10/00	←	→ 09/00			24.0122-0170.1 422170	Ø 257 22 20 V
						24.0322-0170.1 522170	Ø 257 22 20 V	
			→	→ 09/00			24.0110-0264.1 410264	Ø 258 10 8
2.0	100	04/97→05/00	←				24.0122-0170.1 422170	Ø 257 22 20 V
						24.0322-0170.1 522170	Ø 257 22 20 V	
			→			24.0110-0264.1 410264	Ø 258 10 8	
<b>HYUNDAI - MATRIX (FC) 06/01→08/10</b>								
<b>Bremsbelagsatz, Scheibenbremse</b>								
1.5	75	06/01→08/10	←	03/02→			13.0460-5875.2 605875	MAN 24031 17,7 + WK
1.5 CRDi	60	10/01→08/10						
1.6	76	06/01→08/10	←	→ 02/02			13.0460-5933.2 605933	AKE 21725 16,8 + WK
			→	+ ABS		13.0460-5833.2 605833	AKE 23543 14,4 + WK + Zub	
1.5 CRDi	75	12/04→08/10	←				13.0460-5875.2 605875	MAN 24031 17,7 + WK
1.5 CRDi VGT	81	08/05→08/10						
1.6	66	01/02→12/05	→	+ ABS			13.0460-5833.2 605833	AKE 23543 14,4 + WK + Zub
1.8	90	06/01→08/10	←	03/02→			13.0460-5875.2 605875	MAN 24031 17,7 + WK
				→ 02/02			13.0460-5933.2 605933	AKE 21725 16,8 + WK
			→			13.0460-5833.2 605833	AKE 23543 14,4 + WK + Zub	
<b>Bremsscheibe</b>								
1.5	75	06/01→08/10	←				24.0124-0184.1 424184	Ø 257 24 22,1 V
1.5 CRDi	60	10/01→08/10						
1.5 CRDi	75	12/04→08/10	→	+ ABS			24.0110-0317.1 410317	Ø 262 10 8,4
1.5 CRDi VGT	81	08/05→08/10						
1.6	66	01/02→12/05						
1.6	76	06/01→08/10						
1.8	90	06/01→08/10	←				24.0124-0184.1 424184	Ø 257 24 22,1 V
			→			24.0110-0317.1 410317	Ø 262 10 8,4	
<b>HYUNDAI - SANTA FÉ I (SM) 11/00→03/06</b>								
<b>Bremsbelagsatz, Scheibenbremse</b>								
2.0	99	08/01→03/06	←	→ 02/06			13.0460-5832.2 605832	23569 16,5 + WK + Zub
2.0 CRDi	83	08/01→03/06						
2.0 CRDi 4x4	83	04/01→03/06	→	→ 02/06; + ABS			13.0460-5833.2 605833	AKE 23543 14,4 + WK + Zub
2.0 CRDi 4x4	92	08/03→03/06						
2.4 16V	100	02/01→03/06						
2.4 16V	107	02/01→03/06						
2.4 16V 4x4	100	02/01→03/06						
2.4 16V 4x4	107	02/01→03/06						
2.7 V6 4x4	127	02/01→03/06						
2.0 CRDi Allrad	107	11/03→02/06	←				13.0460-5832.2 605832	23569 16,5 + WK + Zub
2.7 4x4	129	09/02→12/04	→	+ ABS			13.0460-5833.2 605833	AKE 23543 14,4 + WK + Zub
2.7	129	08/04→03/06	←	03/06→			13.0460-5777.2 605777	24351 16,3 + WK + Zub
			→	03/06→			13.0460-5782.2 605782	24488 14,9 + WK + Zub
2.7 4x4	132	11/00→03/06	←	02/01→ 02/06			13.0460-5832.2 605832	23569 16,5 + WK + Zub
			→	02/01→ 02/06; + ABS			13.0460-5833.2 605833	AKE 23543 14,4 + WK + Zub
<b>Bremsscheibe</b>								
2.0	99	08/01→03/06	←	→ 02/06;			24.0126-0126.1 426126	Ø 276 26 24 V
2.0 CRDi	83	08/01→03/06		passend für Felgengröße [Zoll]: 15				
2.0 CRDi 4x4	83	04/01→03/06	←	→ 02/06;			24.0126-0127.1 426127	Ø 294 26 24,4 V
2.0 CRDi 4x4	92	08/03→03/06		passend für Felgengröße [Zoll]: 16				
2.4 16V	100	02/01→03/06	→	→ 02/06; + ABS			24.0110-0286.1 410286	Ø 284 10 8,4
2.4 16V	107	02/01→03/06						
2.4 16V 4x4	100	02/01→03/06						
2.4 16V 4x4	107	02/01→03/06						
2.7 V6 4x4	127	02/01→03/06						
2.0 CRDi Allrad	107	11/03→02/06	←	passend für Felgengröße [Zoll]: 15			24.0126-0126.1 426126	Ø 276 26 24 V
			←	passend für Felgengröße [Zoll]: 16			24.0126-0127.1 426127	Ø 294 26 24,4 V
			→	+ ABS			24.0110-0286.1 410286	Ø 284 10 8,4
2.7	129	08/04→03/06	←	03/06→			24.0128-0158.1 428158	Ø 321 28 26,4 V
			→	03/06→			24.0111-0146.1 411146	Ø 302 11 9,4
2.7 4x4	132	11/00→03/06	←	02/01→ 02/06;			24.0126-0126.1 426126	Ø 276 26 24 V
				passend für Felgengröße [Zoll]: 15				
↓								







	kw			 	! #		
<b>HYUNDAI - SANTA FÉ I (SM) 11/00→03/06</b>							
 <b>Bremsscheibe</b>							
2.7 4x4	132	11/00→03/06	←	02/01→ 02/06; passend für Felgenreöße [Zoll]: 16		24.0126-0127.1 426127	Ø 294 26 24,4 V
			→	02/01→ 02/06; + ABS		24.0110-0286.1 410286	Ø 284 10 8,4
<b>HYUNDAI - SANTA FÉ II (CM) 10/05→12/12</b>							
 <b>Bremsbelagsatz, Scheibenbremse</b>							
2.0 CRDi	110	12/10→12/12	←	→ 08/12		13.0460-5777.2 605777	24351 16,3 + WK + Zub
			→	→ 08/12		13.0460-5633.2 605633	AKE 25520 15,8 + WK + Zub
2.0 CRDi 4x4	110	12/10→12/12	←			13.0460-5777.2 605777	24351 16,3 + WK + Zub
2.2 CRDi	145	01/09→12/12	→			13.0460-5633.2 605633	AKE 25520 15,8 + WK + Zub
2.2 CRDi	147	01/09→12/10					
2.2 CRDi 4x4	145	01/09→12/12					
2.2 CRDi 4x4	147	01/09→12/12					
2.4	128	11/10→12/12					
2.4 4x4	128	07/10→12/12					
2.2 CRDi	102	03/06→12/12	←	→ 08/07		13.0460-5777.2 605777	24351 16,3 + WK + Zub
2.2 CRDi 4x4	102	03/06→12/12	→	→ 08/07		13.0460-5782.2 605782	24488 14,9 + WK + Zub
2.2 CRDi	114	03/06→12/09	←			13.0460-5777.2 605777	24351 16,3 + WK + Zub
2.2 CRDi 4x4	114	03/06→12/09	→			13.0460-5782.2 605782	24488 14,9 + WK + Zub
2.2 CRDi GLS	110	03/06→12/09					
2.2 CRDi GLS 4x4	110	03/06→12/09					
2.7 V6 GLS	139	03/06→12/09					
2.7 V6 GLS 4x4	139	03/06→12/09					
2.7	125	03/06→12/12	←	→ 12/11		13.0460-5777.2 605777	24351 16,3 + WK + Zub
2.7 4x4	125	03/06→12/12	→	→ 12/11		13.0460-5782.2 605782	24488 14,9 + WK + Zub
2.7 4x4	147	01/07→12/12	←	→ 09/11		13.0460-5777.2 605777	24351 16,3 + WK + Zub
			→	→ 09/11		13.0460-5782.2 605782	24488 14,9 + WK + Zub
 <b>Bremsscheibe</b>							
2.0 CRDi	110	12/10→12/12	←	→ 08/12		24.0128-0248.1 428248	Ø 321 28 26,4 V
			→	→ 08/12		24.0111-0170.1 411170	Ø 302 11 9,4
2.0 CRDi 4x4	110	12/10→12/12	←			24.0128-0248.1 428248	Ø 321 28 26,4 V
2.2 CRDi	145	01/09→12/12	→			24.0111-0170.1 411170	Ø 302 11 9,4
2.2 CRDi	147	01/09→12/10					
2.2 CRDi 4x4	145	01/09→12/12					
2.2 CRDi 4x4	147	01/09→12/12					
2.4	128	11/10→12/12					
2.4 4x4	128	07/10→12/12					
2.2 CRDi	102	03/06→12/12	←	→ 08/07		24.0128-0158.1 428158	Ø 321 28 26,4 V
2.2 CRDi 4x4	102	03/06→12/12	→	→ 08/07		24.0111-0146.1 411146	Ø 302 11 9,4
2.2 CRDi	114	03/06→12/09	←			24.0128-0158.1 428158	Ø 321 28 26,4 V
2.2 CRDi 4x4	114	03/06→12/09	→			24.0111-0146.1 411146	Ø 302 11 9,4
2.2 CRDi GLS	110	03/06→12/09					
2.2 CRDi GLS 4x4	110	03/06→12/09					
2.7 V6 GLS	139	03/06→12/09					
2.7 V6 GLS 4x4	139	03/06→12/09					
2.7	125	03/06→12/12	←	→ 12/11		24.0128-0158.1 428158	Ø 321 28 26,4 V
2.7 4x4	125	03/06→12/12	→	→ 12/11		24.0111-0146.1 411146	Ø 302 11 9,4
2.7 4x4	147	01/07→12/12	←	→ 09/11		24.0128-0158.1 428158	Ø 321 28 26,4 V
			→	→ 09/11		24.0111-0146.1 411146	Ø 302 11 9,4
<b>HYUNDAI - SANTA FÉ III (DM) 09/12→</b>							
 <b>Bremsbelagsatz, Scheibenbremse</b>							
2.0 CRDi	110	09/12→	←			13.0460-5777.2 605777	24351 16,3 + WK + Zub
2.0 CRDi 4WD	110	09/12→	→			13.0460-5633.2 605633	AKE 25520 15,8 + WK + Zub
2.0 CRDi 4WD	136	09/12→					
2.2 CRDi	145	09/12→12/15					
2.2 CRDi 4WD	145	09/12→12/15					
2.4	141	09/12→12/15					
2.4 4WD	141	09/12→12/15					
2.4 CCVT	129	09/12→					
2.4 CCVT AWD	129	09/12→					
 <b>Bremsscheibe</b>							
2.0 CRDi	110	09/12→	←			24.0128-0248.1 428248	Ø 321 28 26,4 V
2.0 CRDi	136	05/15→	→			24.0111-0170.1 411170	Ø 302 11 9,4
2.0 CRDi 4WD	110	09/12→					
2.0 CRDi 4WD	136	09/12→					
2.2 CRDi	145	09/12→12/15					
2.2 CRDi	147	10/15→					













	kw			 	! #		
<b>HYUNDAI - SANTA FÉ III (DM) 09/12→</b>							
 <b>Bremsscheibe</b>							
2.2 CRDi 4WD	145	09/12→12/15	←			24.0128-0248.1 428248	Ø 321 28 26,4 V
2.2 CRDi 4WD	147	10/15→					
2.4	141	09/12→12/15	→			24.0111-0170.1 411170	Ø 302 11 9,4
2.4 4WD	141	09/12→12/15					
2.4 CCVT	129	09/12→					
2.4 CCVT AWD	129	09/12→					
2.4 GDI	138	05/15→					
2.4 GDI 4WD	138	05/15→					
<b>HYUNDAI - SANTAMO 10/98→12/02</b>							
 <b>Bremsscheibe</b>							
2.0	77	10/98→10/02	←	- ABS		24.0124-0136.1 424136	Ø 256 24 21,5 V
			←	+ ABS		24.0124-0146.1 424146	Ø 256 24 22,4 V
			→	+ ABS		24.0118-0141.1 418141	Ø 266 18 16,4 V
2.0 16V	102	05/99→12/02	←	→ 10/02; - ABS		24.0124-0136.1 424136	Ø 256 24 21,5 V
2.0 16V 4x4	102	05/99→12/02	←	→ 10/02; + ABS		24.0124-0146.1 424146	Ø 256 24 22,4 V
			→	→ 10/02; + ABS		24.0118-0141.1 418141	Ø 266 18 16,4 V
<b>HYUNDAI - S COUPE (SLC) 02/90→05/96</b>							
 <b>Bremsbelagsatz, Scheibenbremse</b>							
1.5 i	65	04/92→05/96	←	06/92→ 04/96		13.0460-5936.2 605936	AKE 21012 15,0 - WE / - WK
1.5 i Turbo	85	04/91→05/96	←	06/92→		13.0460-5936.2 605936	AKE 21012 15,0 - WE / - WK
<b>Zubehörsatz, Scheibenbremsbelag</b>							
1.5 i	65	04/92→05/96	←	06/92→ 04/96		13.0460-0439.2 610439	AKE
1.5 i Turbo	85	04/91→05/96	←	06/92→		13.0460-0439.2 610439	AKE
 <b>Bremsscheibe</b>							
1.5 i	62	02/90→05/96	←	03/90→ 05/92		24.0119-0109.1 419109	Ø 242 19,1 17 V
1.5 i	65	04/92→05/96	←	06/92→ 04/96		24.0119-0109.1 419109	Ø 242 19,1 17 V
1.5 i Turbo	85	04/91→05/96	←			24.0119-0109.1 419109	Ø 242 19,1 17 V
<b>HYUNDAI - SOLARIS Stufenheck 01/17→</b>							
 <b>Bremsscheibe</b>							
1.4	74	01/17→	←			24.0122-0293.1 422293	Ø 256 22 20 V
1.6	90	01/17→	→			24.0110-0398.1 410398	Ø 262 10 8,4
<b>HYUNDAI - SONATA III (Y-3) 07/92→12/98</b>							
 <b>Bremsbelagsatz, Scheibenbremse</b>							
1.8 i	72	05/93→06/98	←	07/93→ 05/98		13.0460-5933.2 605933	AKE 21725 16,8 + WK
2.0 i 16V	102	05/93→06/98					
3.0 i V6	107	05/93→06/98					
2.0 i	70	08/96→06/98	←	→ 05/98		13.0460-5933.2 605933	AKE 21725 16,8 + WK
2.0 i 16V	92	06/96→06/98					
2.0 i	77	06/94→08/96	←			13.0460-5933.2 605933	AKE 21725 16,8 + WK
<b>HYUNDAI - SONATA IV (EF) 03/98→12/05</b>							
 <b>Bremsbelagsatz, Scheibenbremse</b>							
2.0	100	04/01→11/04	←	10/01→		13.0460-5873.2 605873	MAN 23891 16,9 + WK
			→	10/01→; + ABS		13.0460-5833.2 605833	AKE 23543 14,4 + WK + Zub
2.0 16V	96	10/01→11/04	←			13.0460-5873.2 605873	MAN 23891 16,9 + WK
2.0 16V	106	10/01→11/04	→	+ ABS		13.0460-5833.2 605833	AKE 23543 14,4 + WK + Zub
2.0 16V	100	06/98→10/01	←	→ 09/01		13.0460-5933.2 605933	AKE 21725 16,8 + WK
2.4 16V	105	03/98→10/01	→	→ 09/01; + ABS		13.0460-5833.2 605833	AKE 23543 14,4 + WK + Zub
2.5 V6 24V	118	06/98→10/01					
2.7 i V6	132	10/01→05/05	←	→ 12/04		13.0460-5873.2 605873	MAN 23891 16,9 + WK
			→	→ 12/04		13.0460-5833.2 605833	AKE 23543 14,4 + WK + Zub
2.7 V6	127	10/01→11/04	←			13.0460-5873.2 605873	MAN 23891 16,9 + WK
2.7 V6	129	11/02→11/04	→			13.0460-5833.2 605833	AKE 23543 14,4 + WK + Zub
<b>Zubehörsatz, Scheibenbremsbelag</b>							
2.0	100	04/01→11/04	←	10/01→		13.0460-0139.2 610139	MAN
↓							



















	kW					! #		
<b>HYUNDAI - SONATA IV (EF) 03/98→12/05</b>								
<b>Zubehörsatz, Scheibenbremsbelag</b>								
2.0 16V	96	10/01→11/04	←			13.0460-0139.2	610139	MAN
2.0 16V	106	10/01→11/04	←					
2.7 V6	127	10/01→11/04	←					
2.7 V6	129	11/02→11/04	←					
2.7 i V6	132	10/01→05/05	←	→ 12/04		13.0460-0139.2	610139	MAN
<b> Bremsscheibe</b>								
2.0	100	04/01→11/04	←	10/01→		24.0126-0129.1	426129	Ø 280 26 24,4 V
			→	10/01→; + ABS		24.0110-0317.1	410317	Ø 262 10 8,4
2.0 16V	96	10/01→11/04	←			24.0126-0129.1	426129	Ø 280 26 24,4 V
2.0 16V	106	10/01→11/04	→	+ ABS		24.0110-0317.1	410317	Ø 262 10 8,4
2.0 16V	100	06/98→10/01	←	→ 09/01		24.0124-0706.1	424706	Ø 257 24 22,4 V
2.4 16V	105	03/98→10/01	→	→ 09/01; + ABS		24.0110-0317.1	410317	Ø 262 10 8,4
2.5 V6 24V	118	06/98→10/01	→					
2.7 i V6	132	10/01→05/05	←	→ 12/04		24.0126-0129.1	426129	Ø 280 26 24,4 V
			→	→ 12/04		24.0110-0317.1	410317	Ø 262 10 8,4
2.7 V6	127	10/01→11/04	←			24.0126-0129.1	426129	Ø 280 26 24,4 V
2.7 V6	129	11/02→11/04	→			24.0110-0317.1	410317	Ø 262 10 8,4
<b>HYUNDAI - SONATA V (NF) 12/04→11/12</b>								
<b> Bremsbelagsatz, Scheibenbremse</b>								
2.0 CRDi	100	02/06→12/10	←			13.0460-5639.2	605639	24375 17,5 + WK
2.0 CRDi	110	03/09→12/10	→			13.0460-5786.2	605786	AKE 24934 15,0 + WK + Zub
						13.0470-5786.2	LD5786	AKE 24934 15,0 + WK + Zub Ceramic
2.0 CRDi	103	02/06→12/10	←			13.0460-5639.2	605639	24375 17,5 + WK
2.0 GLSi	119	07/08→12/10	→			13.0460-5833.2	605833	AKE 23543 14,4 + WK + Zub
2.4	125	06/08→12/09	→					
2.0 VVTi GLS	106	05/05→12/10	←			13.0460-5639.2	605639	24375 17,5 + WK
2.4	119	01/05→12/10	→	02/06→		13.0460-5833.2	605833	AKE 23543 14,4 + WK + Zub
3.3	171	01/05→12/10	→					
3.3	173	06/05→12/10	→					
2.0 VVTi GLS	121	01/08→12/10	←			13.0460-5639.2	605639	24375 17,5 + WK
			→			13.0460-5780.2	605780	MAN 24320 15,3 + WK + Zub
			→	06/08→		13.0460-5833.2	605833	AKE 23543 14,4 + WK + Zub
2.4	128	06/08→12/10	←			13.0460-5639.2	605639	24375 17,5 + WK
3.3	184	01/08→12/10	→			13.0460-5780.2	605780	MAN 24320 15,3 + WK + Zub
<b> Bremsscheibe</b>								
2.0 CRDi	100	02/06→12/10	←	→ 10/07		24.0128-0256.1	428256	Ø 300 28 26,4 V
2.0 CRDi	103	02/06→12/10	←	11/07→		24.0128-0256.1	428256	Ø 300 28 26,4 V
2.0 CRDi	110	03/09→12/10	←			24.0128-0256.1	428256	Ø 300 28 26,4 V
2.0 GLSi	119	07/08→12/10	→					
2.0 VVTi GLS	121	01/08→12/10	→					
2.4	125	06/08→12/09	→					
2.0 VVTi GLS	106	05/05→12/10	←	→ 01/06		24.0126-0128.1	426128	Ø 280 26 24,4 V
			←	11/07→		24.0128-0256.1	428256	Ø 300 28 26,4 V
			←	02/06→ 10/07		24.0128-0256.1	428256	Ø 300 28 26,4 V
			→	→ 01/06		24.0110-0318.1	410318	Ø 262 10 8,4
2.4	119	01/05→12/10	←	→ 01/06		24.0126-0128.1	426128	Ø 280 26 24,4 V
3.3	171	01/05→12/10	←	11/07→		24.0128-0256.1	428256	Ø 300 28 26,4 V
3.3	173	06/05→12/10	←	02/06→ 10/07		24.0128-0256.1	428256	Ø 300 28 26,4 V
			→	→ 01/06		24.0110-0318.1	410318	Ø 262 10 8,4
			→	06/07→		24.0110-0367.1	410367	Ø 284 10 8,4
2.4	128	06/08→12/10	←			24.0128-0256.1	428256	Ø 300 28 26,4 V
3.3	184	01/08→12/10	→			24.0110-0367.1	410367	Ø 284 10 8,4
<b>HYUNDAI - SONATA VI (YF) 01/09→12/15</b>								
<b> Bremsbelagsatz, Scheibenbremse</b>								
2.0	110	01/09→06/14	←	→ 11/10		13.0460-5641.2	605641	25187 17,8 + WK + Zub
2.4	131	01/09→12/15	←	12/10→		13.0460-5641.2	605641	25187 17,8 + WK + Zub
↓								



















	kw			 	! #		
<b>HYUNDAI - SONATA VI (YF) 01/09→12/15</b>							
 <b>Bremsbelagsatz, Scheibenbremse</b>							
2.0	110	01/09→06/14	➔			13.0460-5780.2 605780	MAN 24320 15,3 + WK + Zub
2.4	131	01/09→12/15	➔				
2.0 Hybrid	110	01/11→06/14	➔			13.0460-5641.2 605641	25187 17,8 + WK + Zub
2.0 i	120	09/12→06/14	➔				
2.0 i	121	01/11→06/14	➔			13.0460-5780.2 605780	MAN 24320 15,3 + WK + Zub
2.4	128	01/09→11/10	➔				
<b>HYUNDAI - SONATA VII (LF) 06/14→</b>							
 <b>Bremsscheibe</b>							
2.0 Hybrid	153	09/14→	➔	+ eFSB; für Bremsscheibendurchmesser [Zoll]: 15		24.0110-0400.1 410400	Ø 284 10 8,4
<b>HYUNDAI - TERRACAN (HP) 06/01→03/08</b>							
 <b>Bremsbelagsatz, Scheibenbremse</b>							
2.5 TD	74	12/01→12/06	➔	11/03→		13.0460-5622.2 605622	MAN 23726 16,5 + WK + Zub
3.5 i V6 4WD	143	12/01→12/06	➔	→ 10/03		13.0460-5886.2 605886	24059 16,7 + WK + Zub
3.5 i V6 4WD	147	12/01→12/06	➔			13.0460-5788.2 605788	24498 14,7 + WK
2.9 CRDi	110	11/01→07/03	➔			13.0460-5886.2 605886	24059 16,7 + WK + Zub
2.9 CRDi 4WD	110	12/01→12/06	➔	→ 07/03		13.0460-5886.2 605886	24059 16,7 + WK + Zub
2.9 CRDi 4WD	110	12/01→12/06	➔	→ 07/03		13.0460-5788.2 605788	24498 14,7 + WK
2.9 CRDi 4WD	120	11/03→12/06	➔			13.0460-5622.2 605622	MAN 23726 16,5 + WK + Zub
2.9 CRDi 4WD	120	11/03→12/06	➔			13.0460-5788.2 605788	24498 14,7 + WK
<b>Zubehörsatz, Scheibenbremsbelag</b>							
2.5 TD	74	12/01→12/06	➔			13.0460-0135.2 610135	
2.9 CRDi	110	11/01→07/03	➔				
2.9 CRDi 4WD	120	11/03→12/06	➔				
3.5 i V6 4WD	143	12/01→12/06	➔				
3.5 i V6 4WD	147	12/01→12/06	➔				
2.9 CRDi 4WD	110	12/01→12/06	➔	→ 07/03		13.0460-0135.2 610135	
<b>Bremsscheibe</b>							
2.5 TD	74	12/01→12/06	➔	→ 10/03		24.0127-0100.1 427100	Ø 281 27 25,4 V
3.5 i V6 4WD	143	12/01→12/06	➔	11/03→		24.0128-0224.1 428224	Ø 303,5 28 26,4 V
3.5 i V6 4WD	147	12/01→12/06	➔				
2.9 CRDi	110	11/01→07/03	➔			24.0127-0100.1 427100	Ø 281 27 25,4 V
2.9 CRDi 4WD	110	12/01→12/06	➔	→ 07/03		24.0127-0100.1 427100	Ø 281 27 25,4 V
2.9 CRDi 4WD	120	11/03→12/06	➔			24.0128-0224.1 428224	Ø 303,5 28 26,4 V
<b>HYUNDAI - TIBURON Coupe 01/01→12/08</b>							
 <b>Bremsbelagsatz, Scheibenbremse</b>							
2.0 CVVT	105	10/06→12/08	➔			13.0460-5873.2 605873	MAN 23891 16,9 + WK
2.0 CVVT	105	10/06→12/08	➔			13.0460-5874.2 605874	SUM 21553 14,0 + WK + Zub
<b>Bremsscheibe</b>							
2.0 CVVT	105	10/06→12/08	➔			24.0126-0128.1 426128	Ø 280 26 24,4 V
2.0 CVVT	105	10/06→12/08	➔			24.0110-0298.1 410298	Ø 258 10 8
<b>HYUNDAI - TRAJET (FO) 03/00→07/08</b>							
 <b>Bremsbelagsatz, Scheibenbremse</b>							
2.0	100	03/00→07/08	➔	→ 10/03		13.0460-5832.2 605832	23569 16,5 + WK + Zub
2.0	100	03/00→07/08	➔	→ 10/03		13.0460-5833.2 605833	AKE 23543 14,4 + WK + Zub
2.0	103	03/01→10/03	➔			13.0460-5832.2 605832	23569 16,5 + WK + Zub
2.0	103	01/04→07/08	➔				
2.0	104	11/03→07/08	➔			13.0460-5833.2 605833	AKE 23543 14,4 + WK + Zub
2.0 CRDi	83	04/01→07/08	➔				
2.0 CRDi	92	08/05→07/08	➔				
2.7 V6	127	09/00→07/08	➔				
<b>Bremsscheibe</b>							
2.0	100	03/00→07/08	➔	→ 10/03		24.0126-0126.1 426126	Ø 276 26 24 V
2.0	100	03/00→07/08	➔	→ 10/03		24.0110-0286.1 410286	Ø 284 10 8,4
2.0	103	03/01→10/03	➔			24.0126-0126.1 426126	Ø 276 26 24 V
↓							



















	kw			 	! #		
<b>HYUNDAI - TRAJET (FO) 03/00→07/08</b>							
<b>Bremsscheibe</b>							
2.0	103	01/04→07/08	➔			24.0110-0286.1 410286	Ø 284 10 8,4
2.0	104	11/03→07/08					
2.0 CRDi	83	04/01→07/08					
2.0 CRDi	92	08/05→07/08					
2.7 V6	127	09/00→07/08					
<b>HYUNDAI - TUCSON (JM) 08/04→11/10</b>							
<b>Bremsbelagsatz, Scheibenbremse</b>							
2.0	104	08/04→03/10	←	→ 03/10		13.0460-5873.2 605873	MAN 23891 16,9 + WK
2.0	105	01/07→01/12					
2.0 Allrad	105	07/05→11/10	➔	01/08→ 03/10		13.0460-5786.2 605786	AKE 24934 15,0 + WK + Zub
2.7 Allrad	129	08/04→03/10				13.0470-5786.2 LD5786	AKE 24934 15,0 + WK + Zub Ceramic
			➔	→ 12/07		13.0460-5833.2 605833	AKE 23543 14,4 + WK + Zub
2.0 Allrad	104	08/04→03/10	←			13.0460-5873.2 605873	MAN 23891 16,9 + WK
2.0 CRDi	83	08/04→03/10					
2.0 CRDi	88	01/07→03/10	➔	01/08→		13.0460-5786.2 605786	AKE 24934 15,0 + WK + Zub
2.0 CRDi	100	01/06→03/10				13.0470-5786.2 LD5786	AKE 24934 15,0 + WK + Zub Ceramic
2.0 CRDi	103	01/06→03/10					
2.0 CRDi Allrad	83	08/04→03/10					
2.0 CRDi Allrad	88	01/07→03/10	➔	→ 12/07		13.0460-5833.2 605833	AKE 23543 14,4 + WK + Zub
2.0 CRDi Allrad	100	01/06→03/10					
2.0 CRDi Allrad	103	01/06→03/10					
2.7	129	08/04→12/09					
2.0 CRDi	110	01/09→03/10	←			13.0460-5873.2 605873	MAN 23891 16,9 + WK
2.0 CRDi Allrad	110	01/09→03/10	➔			13.0460-5786.2 605786	AKE 24934 15,0 + WK + Zub
						13.0470-5786.2 LD5786	AKE 24934 15,0 + WK + Zub Ceramic
<b>Zubehörsatz, Scheibenbremsbelag</b>							
2.0	104	08/04→03/10	←	→ 03/10		13.0460-0139.2 610139	MAN
2.0	105	01/07→01/12					
2.0 Allrad	105	07/05→11/10					
2.7 Allrad	129	08/04→03/10					
2.0 Allrad	104	08/04→03/10	←			13.0460-0139.2 610139	MAN
2.0 CRDi	83	08/04→03/10					
2.0 CRDi	88	01/07→03/10					
2.0 CRDi	100	01/06→03/10					
2.0 CRDi	103	01/06→03/10					
2.0 CRDi	110	01/09→03/10					
2.0 CRDi Allrad	83	08/04→03/10					
2.0 CRDi Allrad	88	01/07→03/10					
2.0 CRDi Allrad	100	01/06→03/10					
2.0 CRDi Allrad	103	01/06→03/10					
2.0 CRDi Allrad	110	01/09→03/10					
2.7	129	08/04→12/09					
<b>Bremsscheibe</b>							
2.0	104	08/04→03/10	←	→ 12/07		24.0126-0128.1 426128	Ø 280 26 24,4 V
2.0	105	01/07→01/12	←	01/08→ 03/10		24.0128-0256.1 428256	Ø 300 28 26,4 V
			➔	→ 03/10		24.0110-0318.1 410318	Ø 262 10 8,4
2.0 Allrad	104	08/04→03/10	←	→ 12/07		24.0126-0128.1 426128	Ø 280 26 24,4 V
2.0 CRDi Allrad	83	08/04→03/10					
2.0 CRDi Allrad	88	01/07→03/10	←	01/08→		24.0128-0256.1 428256	Ø 300 28 26,4 V
2.0 CRDi Allrad	100	01/06→03/10	➔			24.0110-0286.1 410286	Ø 284 10 8,4
2.0 CRDi Allrad	103	01/06→03/10					
2.7	129	08/04→12/09					
2.0 Allrad	105	07/05→11/10	←	→ 12/07		24.0126-0128.1 426128	Ø 280 26 24,4 V
2.7 Allrad	129	08/04→03/10	←	01/08→ 03/10		24.0128-0256.1 428256	Ø 300 28 26,4 V
			➔	→ 03/10		24.0110-0286.1 410286	Ø 284 10 8,4
2.0 CRDi	83	08/04→03/10	←	→ 12/07		24.0126-0128.1 426128	Ø 280 26 24,4 V
2.0 CRDi	88	01/07→03/10					
2.0 CRDi	100	01/06→03/10	←	01/08→		24.0128-0256.1 428256	Ø 300 28 26,4 V
2.0 CRDi	103	01/06→03/10	➔			24.0110-0318.1 410318	Ø 262 10 8,4
2.0 CRDi	110	01/09→03/10	←			24.0128-0256.1 428256	Ø 300 28 26,4 V
			➔			24.0110-0318.1 410318	Ø 262 10 8,4
2.0 CRDi Allrad	110	01/09→03/10	←			24.0128-0256.1 428256	Ø 300 28 26,4 V
			➔			24.0110-0286.1 410286	Ø 284 10 8,4









	kw			 	! #		
<b>HYUNDAI - TUCSON (TL) 05/15→</b>							
 <b>Bremsbelagsatz, Scheibenbremse</b>							
1.6 GDi	97	06/15→	←			13.0460-5600.2 605600	SUM 24501 16,7 + WK
1.6 T-GDi	130	06/15→	→	+ eFSB		13.0460-5650.2 605650	AKE 25337 15,5 + WK + Zub
1.6 T-GDi Allrad	130	06/15→	→				
1.7 CRDi	85	06/15→	→	- eFSB		13.0460-5781.2 605781	MAN + WK + Zub
1.7 CRDi	104	06/15→	→				
2.0	114	05/15→	→	06/15→; + eFSB		13.0460-5650.2 605650	AKE 25337 15,5 + WK + Zub
2.0 Allrad	114	05/15→	→	06/15→; - eFSB		13.0460-5786.2 605786	AKE 24934 15,0 + WK + Zub
						13.0470-5786.2 LD5786	AKE 24934 15,0 + WK + Zub Ceramic
2.0 CRDi	100	06/15→	←	Made in Tschechische Republik		13.0460-5600.2 605600	SUM 24501 16,7 + WK
2.0 CRDi Allrad	100	06/15→	→	Made in Republik Korea (Südkorea); + eFSB		13.0460-5650.2 605650	AKE 25337 15,5 + WK + Zub
2.0 CRDi Allrad	136	06/15→	→	Made in Tschechische Republik; + eFSB		13.0460-5650.2 605650	AKE 25337 15,5 + WK + Zub
			→	Made in Tschechische Republik; - eFSB		13.0460-5781.2 605781	MAN + WK + Zub
			→	Made in Republik Korea (Südkorea); - eFSB		13.0460-5786.2 605786	AKE 24934 15,0 + WK + Zub
						13.0470-5786.2 LD5786	AKE 24934 15,0 + WK + Zub Ceramic
2.0 CRDi	136	06/15→	→	+ eFSB		13.0460-5650.2 605650	AKE 25337 15,5 + WK + Zub
			→	- eFSB		13.0460-5786.2 605786	AKE 24934 15,0 + WK + Zub
						13.0470-5786.2 LD5786	AKE 24934 15,0 + WK + Zub Ceramic
 <b>Bremsscheibe</b>							
1.6 GDi	97	06/15→	←			24.0125-0213.1 425213	Ø 305 25 23,4 V
1.6 T-GDi	130	06/15→	←				
1.6 T-GDi Allrad	130	06/15→	←				
1.7 CRDi	85	06/15→	←				
1.7 CRDi	104	06/15→	←				
2.0 CRDi	100	06/15→	←	Made in Tschechische Republik		24.0125-0213.1 425213	Ø 305 25 23,4 V
2.0 CRDi Allrad	100	06/15→	←				
2.0 CRDi Allrad	136	06/15→	←				
<b>HYUNDAI - VELOSTER (FS) 03/11→</b>							
 <b>Bremsbelagsatz, Scheibenbremse</b>							
1.6 GDI	103	03/11→	←	→ 04/12		13.0460-5645.2 605645	25692 17,2 + WK + Zub
1.6 MPI	97	04/11→	←	05/12→		13.0460-5645.2 605645	25692 17,2 + WK + Zub
			→			13.0460-5650.2 605650	AKE 25337 15,5 + WK + Zub
1.6 T-GDI	137	10/12→	→			13.0460-5650.2 605650	AKE 25337 15,5 + WK + Zub
 <b>Bremsscheibe</b>							
1.6 GDI	103	03/11→	→			24.0110-0368.1 410368	Ø 262 10 8,4
1.6 MPI	97	04/11→	→				
1.6 T-GDI	137	10/12→	←			24.0128-0234.1 428234	Ø 300 28 26,4 V
			→			24.0110-0368.1 410368	Ø 262 10 8,4
<b>HYUNDAI - XG (XG) 12/98→12/05</b>							
 <b>Bremsbelagsatz, Scheibenbremse</b>							
250	120	12/98→12/05	→	06/99→ 05/05		13.0460-5833.2 605833	AKE 23543 14,4 + WK + Zub
			→	→ 09/05		13.0460-5833.2 605833	AKE 23543 14,4 + WK + Zub
3.0	153	10/01→05/05	→			13.0460-5833.2 605833	AKE 23543 14,4 + WK + Zub
300	145	09/99→09/03	→				
30	138	12/98→12/05	→	09/99→ 10/02		13.0460-5833.2 605833	AKE 23543 14,4 + WK + Zub
			→	→ 09/05		13.0460-5833.2 605833	AKE 23543 14,4 + WK + Zub
350	145	10/02→12/05	→	04/03→ 09/05		13.0460-5833.2 605833	AKE 23543 14,4 + WK + Zub
			→	→ 05/05		13.0460-5833.2 605833	AKE 23543 14,4 + WK + Zub
 <b>Bremsscheibe</b>							
250	120	12/98→12/05	→	06/99→ 05/05		24.0110-0318.1 410318	Ø 262 10 8,4
			→	→ 09/05		24.0110-0318.1 410318	Ø 262 10 8,4
3.0	153	10/01→05/05	→			24.0110-0318.1 410318	Ø 262 10 8,4
300	145	09/99→09/03	→				
30	138	12/98→12/05	→	09/99→ 10/02		24.0110-0318.1 410318	Ø 262 10 8,4
			→	→ 09/05		24.0110-0318.1 410318	Ø 262 10 8,4
350	145	10/02→12/05	→	04/03→ 09/05		24.0110-0318.1 410318	Ø 262 10 8,4
↓							











	kW					! #		
<b>HYUNDAI - XG (XG) 12/98→12/05</b>								
 <b>Bremsscheibe</b>								
350	145	10/02→12/05	➔	→ 05/05		24.0110-0318.1	410318	Ø 262 10 8,4
<b>HYUNDAI - XG Stufenheck 09/00→12/05</b>								
 <b>Bremsbelagsatz, Scheibenbremse</b>								
250 300	123 143	10/03→09/05 09/00→12/01	➔			13.0460-5833.2	605833	AKE 23543 14,4 + WK + Zub
 <b>Bremsscheibe</b>								
250 300	123 143	10/03→09/05 09/00→12/01	➔			24.0110-0318.1	410318	Ø 262 10 8,4
<b>INFINITI - EX 09/07→</b>								
 <b>Bremsbelagsatz, Scheibenbremse</b>								
25 30d	175 175	04/10→ 04/10→	←			13.0460-5778.2	605778	SUM 23698 16,8 + WK
25 AWD	163	09/07→	←	04/10→		13.0460-5778.2	605778	SUM 23698 16,8 + WK
37 37	228 235	10/08→ 09/10→	←			13.0460-5778.2	605778	SUM 23698 16,8 + WK
			←	02/11→; + RUS		13.0460-5778.2	605778	SUM 23698 16,8 + WK
<b>INFINITI - FX 09/02→12/08</b>								
 <b>Bremsscheibe</b>								
35 35 Allrad 45 45 Allrad	206 206 232 232	02/03→12/08 01/03→12/08 02/03→12/08 01/03→12/08	➔			24.0116-0122.1	416122	Ø 308 16 14 V
<b>INFINITI - G Cabriolet 09/10→</b>								
 <b>Bremsbelagsatz, Scheibenbremse</b>								
37 37	235 245	09/10→ 09/10→	←	+ RUS; nicht für Felgenreöße [Zoll]: 19		13.0460-5778.2	605778	SUM 23698 16,8 + WK
			←	nicht für Felgenreöße [Zoll]: 19		13.0460-5778.2	605778	SUM 23698 16,8 + WK
<b>INFINITI - G Coupe 09/07→</b>								
 <b>Bremsbelagsatz, Scheibenbremse</b>								
37 37	235 243	09/10→ 09/07→	←	für Fahrzeuge ohne Sportpaket		13.0460-5778.2	605778	SUM 23698 16,8 + WK
<b>INFINITI - G Stufenheck 01/07→</b>								
 <b>Bremsbelagsatz, Scheibenbremse</b>								
25	163	01/11→	←	für Fahrzeuge ohne Vierradlenkung		13.0460-5778.2	605778	SUM 23698 16,8 + WK
37 37 37 X	235 243 235	10/08→ 10/08→ 10/08→	←	für Fahrzeuge ohne Vierradlenkung		13.0460-5778.2	605778	SUM 23698 16,8 + WK
			←	11/09→; + RUS; für Fahrzeuge ohne Vierradlenkung		13.0460-5778.2	605778	SUM 23698 16,8 + WK
 <b>Bremsscheibe</b>								
37 37 37 X	235 243 235	10/08→ 10/08→ 10/08→	←	→ 01/10; + RUS		24.0128-0153.1	428153	Ø 320 28 26 V
<b>INFINITI - M (Y51) 03/10→</b>								
 <b>Bremsbelagsatz, Scheibenbremse</b>								
25 30d 37 56 X	163 175 235 300	07/10→ 03/10→ 03/10→ 03/10→	←	für Fahrzeuge ohne Vierradlenkung		13.0460-5778.2	605778	SUM 23698 16,8 + WK
35h	225	04/11→	←			13.0460-5778.2	605778	SUM 23698 16,8 + WK
56	300	03/10→	←	01/12→; für Fahrzeuge ohne Vierradlenkung		13.0460-5778.2	605778	SUM 23698 16,8 + WK
 <b>Bremsscheibe</b>								
25 30d 37 56 X	163 175 235 300	07/10→ 03/10→ 03/10→ 03/10→	➔	für Fahrzeuge ohne Vierradlenkung		24.0116-0122.1	416122	Ø 308 16 14 V
35h	225	04/11→	➔			24.0116-0122.1	416122	Ø 308 16 14 V
56	300	03/10→	➔	01/12→; für Fahrzeuge ohne Vierradlenkung		24.0116-0122.1	416122	Ø 308 16 14 V











	kw			 	! #		
<b>INFINITI - M35 01/05→</b>							
 <b>Bremsbelagsatz, Scheibenbremse</b>							
3.5 h	268	01/10→	←	04/11→		13.0460-5778.2 605778	SUM 23698 16,8 + WK
 <b>Bremsscheibe</b>							
3.5	226	09/08→12/10	←			24.0128-0153.1 428153	Ø 320 28 26 V
3.5 X	226	09/08→12/10					
3.5 h	268	01/10→	→	04/11→		24.0116-0122.1 416122	Ø 308 16 14 V
<b>INFINITI - M37 01/10→</b>							
 <b>Bremsbelagsatz, Scheibenbremse</b>							
3.7 Allrad	246	01/11→	←	01/12→; für Fahrzeuge ohne Vierradlenkung		13.0460-5778.2 605778	SUM 23698 16,8 + WK
 <b>Bremsscheibe</b>							
3.7 Allrad	246	01/11→	→	01/12→; für Fahrzeuge ohne Vierradlenkung		24.0116-0122.1 416122	Ø 308 16 14 V
<b>INFINITI - Q50 04/13→</b>							
 <b>Bremsscheibe</b>							
2.0 T	155	04/14→	→			24.0116-0122.1 416122	Ø 308 16 14 V
50 D	125	04/13→					
50 Hybrid	268	04/13→					
50 Hybrid AWD	268	04/13→					
<b>INFINITI - Q60 Cabriolet 10/13→</b>							
 <b>Bremsbelagsatz, Scheibenbremse</b>							
3.7	235	10/13→	←	+ RUS; nicht für Felgengröße [Zoll]: 19		13.0460-5778.2 605778	SUM 23698 16,8 + WK
			←	nicht für Felgengröße [Zoll]: 19		13.0460-5778.2 605778	SUM 23698 16,8 + WK
<b>INFINITI - Q60 Coupe 09/16→</b>							
 <b>Bremsscheibe</b>							
2.0 T	155	09/16→	→	für Fahrzeuge ohne Sportpaket		24.0116-0122.1 416122	Ø 308 16 14 V
<b>INFINITI - Q60 Coupe 10/13→</b>							
 <b>Bremsbelagsatz, Scheibenbremse</b>							
3.7	235	10/13→	←	für Fahrzeuge ohne Sportpaket		13.0460-5778.2 605778	SUM 23698 16,8 + WK
<b>INFINITI - Q70 (Y51) 03/13→</b>							
 <b>Bremsbelagsatz, Scheibenbremse</b>							
2.2 D	125	10/14→	←	Basis + GT + GT Prem		13.0460-5778.2 605778	SUM 23698 16,8 + WK
3.0	175	03/13→	←	für Fahrzeuge ohne Vierradlenkung		13.0460-5778.2 605778	SUM 23698 16,8 + WK
3.7	235	03/13→					
5.6 AWD	300	01/15→					
3.5 Hybrid	225	03/13→	←			13.0460-5778.2 605778	SUM 23698 16,8 + WK
 <b>Bremsscheibe</b>							
2.2 D	125	10/14→	→	Basis + GT + GT Prem		24.0116-0122.1 416122	Ø 308 16 14 V
3.0	175	03/13→	→	für Fahrzeuge ohne Vierradlenkung		24.0116-0122.1 416122	Ø 308 16 14 V
3.7	235	03/13→					
5.6 AWD	300	01/15→					
3.5 Hybrid	225	03/13→	→			24.0116-0122.1 416122	Ø 308 16 14 V
<b>INFINITI - QX50 08/13→</b>							
 <b>Bremsbelagsatz, Scheibenbremse</b>							
2.5 AWD	163	02/14→	←			13.0460-5778.2 605778	SUM 23698 16,8 + WK
30d AWD	175	08/13→					
37 AWD	235	08/13→	←			13.0460-5778.2 605778	SUM 23698 16,8 + WK
			←	+ RUS		13.0460-5778.2 605778	SUM 23698 16,8 + WK
<b>ISUZU - TROOPER II (UB) 08/91→04/00</b>							
 <b>Bremsbelagsatz, Scheibenbremse</b>							
3.1 TD	84	08/91→07/98	←			13.0460-5926.2 605926	AKE 21845 16,5 + WK
3.2	130	08/91→07/98	→			13.0460-5927.2 605927	AKE 21875 16,0 + WK
↓							









	kw			 	! #		
<b>ISUZU - TROOPER II (UB) 08/91→04/00</b>							
 <b>Bremsscheibe</b>							
3.1 TD	84	08/91→07/98	←			24.0126-0111.1 426111	Ø 280 26 24,6 V
3.2	130	08/91→07/98	→			24.0118-0122.1 418122	Ø 313,5 18 16,6 V
<b>ISUZU - TROOPER II Geländewagen offen (UB) 08/91→07/98</b>							
 <b>Bremsbelagsatz, Scheibenbremse</b>							
3.1 TD	84	08/91→07/98	←			13.0460-5926.2 605926	AKE 21845 16,5 + WK
3.2	130	08/91→07/98	→			13.0460-5927.2 605927	AKE 21875 16,0 + WK
 <b>Bremsscheibe</b>							
3.1 TD	84	08/91→07/98	←			24.0126-0111.1 426111	Ø 280 26 24,6 V
3.2	130	08/91→07/98	→			24.0118-0122.1 418122	Ø 313,5 18 16,6 V
<b>ISUZU - TROOPER III 05/98→08/04</b>							
 <b>Bremsbelagsatz, Scheibenbremse</b>							
3.0 DTI	117	05/98→08/04	←	08/98→		13.0460-5926.2 605926	AKE 21845 16,5 + WK
			→	08/98→		13.0460-5927.2 605927	AKE 21875 16,0 + WK
3.5 V6 24V	158	04/00→08/04	←			13.0460-5926.2 605926	AKE 21845 16,5 + WK
			→			13.0460-5927.2 605927	AKE 21875 16,0 + WK
 <b>Bremsscheibe</b>							
3.0 DTI	117	05/98→08/04	←	08/98→		24.0126-0111.1 426111	Ø 280 26 24,6 V
			→	08/98→		24.0118-0122.1 418122	Ø 313,5 18 16,6 V
3.5 V6 24V	158	04/00→08/04	←			24.0126-0111.1 426111	Ø 280 26 24,6 V
			→			24.0118-0122.1 418122	Ø 313,5 18 16,6 V
<b>ISUZU - TROOPER III Geländewagen offen 04/00→08/04</b>							
 <b>Bremsbelagsatz, Scheibenbremse</b>							
3.0 DTI	118	04/00→08/04	←			13.0460-5926.2 605926	AKE 21845 16,5 + WK
3.5 V6 24V	158	04/00→08/04	→			13.0460-5927.2 605927	AKE 21875 16,0 + WK
 <b>Bremsscheibe</b>							
3.0 DTI	118	04/00→08/04	←			24.0126-0111.1 426111	Ø 280 26 24,6 V
3.5 V6 24V	158	04/00→08/04	→			24.0118-0122.1 418122	Ø 313,5 18 16,6 V
<b>IVECO - DAILY II Bus 01/89→05/99</b>							
 <b>Bremsbelagsatz, Scheibenbremse</b>							
A 45-10 (94159111, 94159131, 94159211, 94159311,....	76	01/91→04/96	←			13.0460-7903.2 607903	PER 20465 18,0 + WK
A 45-10 (95739111, 95739131, 95739311, 95739317,....	76	05/96→05/99	←	→ 08/97		13.0460-7903.2 607903	PER 20465 18,0 + WK
<b>IVECO - DAILY II Kasten/Kombi 01/89→05/99</b>							
 <b>Bremsbelagsatz, Scheibenbremse</b>							
30-8 (12914111, 12914112, 12914117, 12914131, 12914137,....	55	01/89→08/98	←	09/97→		13.0460-4918.2 604918	BRE 21048 18,3 + WK
			←	→ 08/97		13.0460-4955.2 604955	BRE 21048 18,3 + WK
30-8 (12914111, 12914112, 12914117, 12914131, 12914137,....	60	01/89→08/98					
30-8 (14914111, 14914117, 14914211, 14914217, 14915111,....	60	01/89→08/98					
35-8 (12934104, 12934111, 12934112, 12934117, 12934124,....	55	01/91→08/98					
35-8 (12934104, 12934111, 12934112, 12934117, 12934124,....	60	01/91→08/98					
30-8 (14914111, 14914117, 14914211, 14914217, 14915111,....	62	09/98→05/99	←	→ 04/99		13.0460-4918.2 604918	BRE 21048 18,3 + WK
30-8 V (14914111, 14914117, 14914211, 14914217, 14915111,....	62	09/98→05/99					









	kw			 	! #			
<b>IVECO - DAILY II Kasten/Kombi 01/89→05/99</b>								
<b> Bremsbelagsatz, Scheibenbremse</b>								
35-8 (14934104, 14934111, 14934204, 14934205, 14934211,....	62	09/98→05/99	←	→ 04/99		<b>13.0460-4918.2 604918</b>	BRE 21048 18,3 + WK	
35-10 (12974212, 12974217, 12974417)	68	09/96→08/98	←			<b>13.0460-4966.2 604966</b>	BRE 29121 20,3 + WE / - WK	
			→			<b>13.0460-4989.2 604989</b>	BRE 29212 17,3 + WE / - WK	
			→			<b>13.0460-4966.2 604966</b>	BRE 29121 20,3 + WE / - WK	
35-10 (12974212, 12974217, 13014111, 13014131, 13014204,.... 35-10 (12974212, 12974217, 13014111, 13014131, 13014204,.... 35-12 (13114131, 13114204, 13114211, 13114212, 13114217,.... 49-12 V (13134124, 13134204, 13134211, 13134212,....	76	01/89→08/98	←	01/96→		<b>13.0460-4966.2 604966</b>	BRE 29121 20,3 + WE / - WK	
			→	01/96→		<b>13.0460-4989.2 604989</b>	BRE 29212 17,3 + WE / - WK	
	80	01/89→08/98	→				<b>13.0460-4966.2 604966</b>	BRE 29121 20,3 + WE / - WK
85	01/90→04/96							
35-10 (15034111, 15034204, 15034211, 15034215, 15034217,.... 49-12 V (15154204, 15154211, 15154215, 15154217,....	76	01/96→05/99	←	→ 04/99		<b>13.0460-4966.2 604966</b>	BRE 29121 20,3 + WE / - WK	
			→	→ 04/99		<b>13.0460-4989.2 604989</b>	BRE 29212 17,3 + WE / - WK	
45-10 V (13034204, 13034211, 13034212, 13034224,.... 49-10 V (13054204, 13054211, 13054212, 13054215,....	76	01/89→04/96	←			<b>13.0460-7903.2 607903</b>	PER 20465 18,0 + WK	
59-12 V (13154404, 13154411, 13154412, 13154417,....	85	05/91→04/96	←			<b>13.0460-7906.2 607906</b>	PER 29001 20,0 + WK	
59-12 V (15174404, 15174411, 15174415, 15174417)	90	05/96→05/99	←	→ 08/97		<b>13.0460-7906.2 607906</b>	PER 29001 20,0 + WK	
<b>Warnkontakt, Bremsbelagverschleiß</b>								
35-10 (12974212, 12974217, 12974417)	68	09/96→08/98	←		2	<b>24.8190-1304.2 621304</b>	L= 289	
			→		2	<b>24.8190-1304.2 621304</b>	L= 289	
35-10 (12974212, 12974217, 13014111, 13014131, 13014204,.... 35-10 (12974212, 12974217, 13014111, 13014131, 13014204,....	76	01/89→08/98	←	01/96→	2	<b>24.8190-1304.2 621304</b>	L= 289	
			→	01/96→	2	<b>24.8190-1304.2 621304</b>	L= 289	
35-10 (12974212, 12974217, 13014111, 13014131, 13014204,.... 35-12 (13114131, 13114204, 13114211, 13114212, 13114217,.... 49-12 V (13134124, 13134204, 13134211, 13134212,....	80	01/89→08/98						
	85	01/90→04/96						
35-10 (15034111, 15034204, 15034211, 15034215, 15034217,.... 49-12 V (15154204, 15154211, 15154215, 15154217,....	76	01/96→05/99	←	→ 04/99	2	<b>24.8190-1304.2 621304</b>	L= 289	
			→	→ 04/99	2	<b>24.8190-1304.2 621304</b>	L= 289	
<b>Zubehörsatz, Scheibenbremsbelag</b>								
30-8 (12914111, 12914112, 12914117, 12914131, 12914137,.... 30-8 (12914111, 12914112, 12914117, 12914131, 12914137,.... 30-8 (14914111, 14914117, 14914211, 14914217, 14915111,.... 35-8 (12934104, 12934111, 12934112, 12934117, 12934124,.... 35-8 (12934104, 12934111, 12934112, 12934117, 12934124,.... ↓	55	01/89→08/98	←	→ 08/97		<b>13.0460-0415.2 610415</b>	AP	
60	01/89→08/98							
60	01/89→08/98							
55	01/91→08/98							
60	01/91→08/98							











	kw			 	! #		
<b>IVECO - DAILY II Kasten/Kombi 01/89→05/99</b>							
 <b>Bremsscheibe</b>							
30-8 (12914111, 12914112, 12914117, 12914131, 12914137,...)	55	01/89→08/98	←	→ 05/96		24.0114-0110.2 414110	∅ 267 14,2 12,8 + S
30-8 (12914111, 12914112, 12914117, 12914131, 12914137,...)	60	01/89→08/98					
30-8 (14914111, 14914117, 14914211, 14914217, 14915111,...)	60	01/89→08/98					
35-8 (12934104, 12934111, 12934112, 12934117, 12934124,...)	55	01/91→08/98					
35-8 (12934104, 12934111, 12934112, 12934117, 12934124,...)	60	01/91→08/98					
<b>IVECO - DAILY II Kipper 01/89→05/99</b>							
 <b>Bremsbelagsatz, Scheibenbremse</b>							
35-10 K (15030111, 15030211, 15030311, 15031111,...)	76	01/97→05/99	←	→ 04/99		13.0460-4966.2 604966	BRE 29121 20,3 + WE / - WK
49-12 K	90	05/96→05/99	→	→ 04/99		13.0460-4966.2 604966	BRE 29121 20,3 + WE / - WK
35-12 K (15130311, 15130411, 15131111, 15131204,...)	90	09/96→08/98	←			13.0460-4966.2 604966	BRE 29121 20,3 + WE / - WK
			→			13.0460-4989.2 604989	BRE 29212 17,3 + WE / - WK
			→			13.0460-4966.2 604966	BRE 29121 20,3 + WE / - WK
35-8 K (14930304, 14931104, 14931111, 14931115, 14931204,...)	62	09/98→05/99	←	→ 04/99		13.0460-4918.2 604918	BRE 21048 18,3 + WK
45-10 (13031204, 13031211, 13031212, 13031224, 13031231,...)	76	01/92→04/96	←			13.0460-7903.2 607903	PER 20465 18,0 + WK
49-10 K (13056212, 13056224, 13056231, 13056237,...)	76	01/89→04/96					
49-10 K (15056204, 15056211, 15056304, 15056311)	76	05/96→05/99	←	→ 08/97		13.0460-7903.2 607903	PER 20465 18,0 + WK
49-12 K (13136204, 13136211, 13136212, 13136224,...)	85	06/90→04/96	←	01/96→		13.0460-4966.2 604966	BRE 29121 20,3 + WE / - WK
			→	01/96→		13.0460-4989.2 604989	BRE 29212 17,3 + WE / - WK
			→	01/96→		13.0460-4966.2 604966	BRE 29121 20,3 + WE / - WK
59-12 K (13156211, 13156212, 13156231, 13156311,...)	85	05/91→04/96	←			13.0460-7906.2 607906	PER 29001 20,0 + WK
59-12 K (15176211, 15176304, 15176311, 15176315,...)	90	05/96→05/99	←	→ 08/97		13.0460-7906.2 607906	PER 29001 20,0 + WK
<b>Warnkontakt, Bremsbelagverschleiß</b>							
35-10 K (15030111, 15030211, 15030311, 15031111,...)	76	01/97→05/99	←	→ 04/99	2	24.8190-1304.2 621304	L= 289
49-12 K	90	05/96→05/99	→	→ 04/99	2	24.8190-1304.2 621304	L= 289
35-12 K (15130311, 15130411, 15131111, 15131204,...)	90	09/96→08/98	←		2	24.8190-1304.2 621304	L= 289
			→		2	24.8190-1304.2 621304	L= 289
49-12 K (13136204, 13136211, 13136212, 13136224,...)	85	06/90→04/96	←	01/96→	2	24.8190-1304.2 621304	L= 289
			→	01/96→	2	24.8190-1304.2 621304	L= 289
<b>IVECO - DAILY II Pritsche/Fahrgestell 01/89→05/99</b>							
 <b>Bremsbelagsatz, Scheibenbremse</b>							
35-10	80	01/89→12/96	←	01/96→		13.0460-4966.2 604966	BRE 29121 20,3 + WE / - WK
35-10 (12971112, 12971212, 12971312, 12971317, 12976112,...)	68	01/89→12/96				13.0460-4989.2 604989	BRE 29212 17,3 + WE / - WK
35-10 (12971112, 12971212, 12971312, 12971317, 12976112,...)	76	01/89→12/96	→	01/96→		13.0460-4966.2 604966	BRE 29121 20,3 + WE / - WK
35-12 (13110131, 13110211, 13110231, 13110311, 13110312,...)	85	01/90→04/96					
49-12 (13130211, 13130231, 13130304, 13130311, 13130312,...)	85	06/90→04/96					
35-10 (15030111, 15030211, 15030311, 15031111, 15031117,...)	76	01/96→05/99	←	→ 04/99		13.0460-4966.2 604966	BRE 29121 20,3 + WE / - WK
						13.0460-4989.2 604989	BRE 29212 17,3 + WE / - WK

	kW					! #		
<b>IVECO - DAILY II Pritsche/Fahrgestell 01/89→05/99</b>								
<b> Bremsbelagsatz, Scheibenbremse</b>								
35-12 (15130311, 15130411, 15131111, 15131204, 15131211,...	90	05/96→05/99	➡	→ 04/99			<b>13.0460-4966.2 604966</b>	BRE 29121 20,3 + WE / - WK
49-12 (15150211, 15150311, 15150404, 15150411, 15151204,...	90	05/96→05/99						
35-8 (12931102, 12931104, 12931111, 12931112, 12931117,...	55	01/89→08/98	⬅	09/97→			<b>13.0460-4918.2 604918</b>	BRE 21048 18,3 + WK
35-8 (12931102, 12931104, 12931111, 12931112, 12931117,...	60	01/89→08/98	⬅	→ 08/97			<b>13.0460-4955.2 604955</b>	BRE 21048 18,3 + WK
35-8 (14930304, 14931104, 14931111, 14931115, 14931204,...	62	09/98→05/99	⬅	→ 04/99			<b>13.0460-4918.2 604918</b>	BRE 21048 18,3 + WK
45-10 (13031204, 13031211, 13031212, 13031224, 13031231,...	76	01/89→04/96	⬅				<b>13.0460-7903.2 607903</b>	PER 20465 18,0 + WK
49-10 (13050211, 13050231, 13050304, 13050311, 13050331,...	76	01/89→04/96						
49-10 (15050304, 15050404, 15050411, 15051204, 15051211,...	76	05/96→05/99	⬅	→ 08/97			<b>13.0460-7903.2 607903</b>	PER 20465 18,0 + WK
59-12 (13150204, 13150211, 13150231, 13150311, 13150312,...	85	05/91→04/96	⬅				<b>13.0460-7906.2 607906</b>	PER 29001 20,0 + WK
59-12 (15170211, 15170304, 15170311, 15170504, 15170511,...	90	05/96→05/99	⬅	→ 08/97			<b>13.0460-7906.2 607906</b>	PER 29001 20,0 + WK
<b>Warnkontakt, Bremsbelagverschleiß</b>								
35-10	80	01/89→12/96	⬅	01/96→	2	<b>24.8190-1304.2 621304</b>	L= 289	
35-10 (12971112, 12971212, 12971312, 12971317, 12976112,...	68	01/89→12/96	➡	01/96→	2	<b>24.8190-1304.2 621304</b>	L= 289	
35-10 (12971112, 12971212, 12971312, 12971317, 12976112,...	76	01/89→12/96						
35-12 (13110131, 13110211, 13110231, 13110311, 13110312,...	85	01/90→04/96						
49-12 (13130211, 13130231, 13130304, 13130311, 13130312,...	85	06/90→04/96						
35-10 (15030111, 15030211, 15030311, 15031111, 15031117,...	76	01/96→05/99	⬅	→ 04/99	2	<b>24.8190-1304.2 621304</b>	L= 289	
35-12 (15130311, 15130411, 15131111, 15131204, 15131211,...	90	05/96→05/99	➡	→ 04/99	2	<b>24.8190-1304.2 621304</b>	L= 289	
49-12 (15150211, 15150311, 15150404, 15150411, 15151204,...	90	05/96→05/99						
<b>Zubehörsatz, Scheibenbremsbelag</b>								
35-8 (12931102, 12931104, 12931111, 12931112, 12931117,...	55	01/89→08/98	⬅	→ 08/97			<b>13.0460-0415.2 610415</b>	AP
35-8 (12931102, 12931104, 12931111, 12931112, 12931117,...	60	01/89→08/98						
<b> Bremsscheibe</b>								
35-8 (12931102, 12931104, 12931111, 12931112, 12931117,...	55	01/89→08/98	⬅	→ 05/96			<b>24.0114-0110.2 414110</b>	Ø 267 14,2 12,8 + S
35-8 (12931102, 12931104, 12931111, 12931112, 12931117,...	60	01/89→08/98						
<b>IVECO - DAILY III Kasten/Kombi 11/97→10/09</b>								
<b> Bremsbelagsatz, Scheibenbremse</b>								
29 L 10 V (ALJA43A2, ALJA42A2, ALJA41A2)	70	09/02→07/07	⬅	→ 04/06			<b>13.0460-4966.2 604966</b>	BRE 29121 20,3 + WE / - WK
29 L 11 V	78	05/99→07/07	➡	→ 04/06			<b>13.0460-4996.2 604996</b>	BRE 29123 20,3 + WE / - WK
29 L 12 V (ALKA41A2, ALLA52A2, ALKA42A2)	85	09/02→07/07						
29 L 13	92	05/01→07/07						
29 L 9 V	62	05/99→07/07						
↓								

	kW			 	! #		
<b>IVECO - DAILY III Kasten/Kombi 11/97→10/09</b>							
<b> Bremsbelagsatz, Scheibenbremse</b>							
29 L 14 29 L 9 V	100 66	01/05→04/06 11/01→04/06	← →			13.0460-4966.2 604966 13.0460-4996.2 604996	BRE 29121 20,3 + WE / - WK BRE 29123 20,3 + WE / - WK
35 C 12 V, 35 S 12 V (AGKA43A2, AGKB43A2, AGKB46A2,...)	85	09/02→07/07	← → 04/06 → → 04/06			13.0460-4966.2 604966 13.0460-4989.2 604989 13.0460-4966.2 604966 13.0460-4996.2 604996	BRE 29121 20,3 + WE / - WK BRE 29212 17,3 + WE / - WK BRE 29121 20,3 + WE / - WK BRE 29123 20,3 + WE / - WK
35 C 14 35 C 14, 35 S 14 35 C 17, 35 S 17	100 100 122	09/04→04/06 01/05→04/06 01/05→04/06	← →			13.0460-4966.2 604966 13.0460-4989.2 604989 13.0460-4966.2 604966 13.0460-4996.2 604996	BRE 29121 20,3 + WE / - WK BRE 29212 17,3 + WE / - WK BRE 29121 20,3 + WE / - WK BRE 29123 20,3 + WE / - WK
35 S 10 (ANJA41A1, ANJA42A2, ANJA42AB, ANJA43A, ANJAV1A,... 35 S 11 V,35 C 11 V 35 S 13 V,35 C 13 V 35 S 15 V, 35 C 15 V (A6HCV3B2, A6HBV4B2, A6HC41B2,... 35 S 9 V,35 C 9 V	70 78 92 107 62	09/02→07/07 05/99→07/07 05/99→07/07 11/02→07/07 05/99→07/07	← → 04/06 → → 04/06			13.0460-4966.2 604966 13.0460-4989.2 604989 13.0460-4966.2 604966	BRE 29121 20,3 + WE / - WK BRE 29212 17,3 + WE / - WK BRE 29123 20,3 + WE / - WK
35 S 9 V	66	11/01→04/06	← →			13.0460-4966.2 604966 13.0460-4989.2 604989 13.0460-4996.2 604996	BRE 29121 20,3 + WE / - WK BRE 29212 17,3 + WE / - WK BRE 29123 20,3 + WE / - WK
50 C 11 50 C 13	78 92	05/99→07/07 05/99→07/07	← 01/01→ 04/06 → → 04/06			13.0460-4847.2 604847 13.0460-4996.2 604996	BRE 29160 20,3 + WE / - WK + Zub BRE 29123 20,3 + WE / - WK
50 C 14 50 C 15 50 C 17	100 107 122	09/04→04/06 01/01→04/06 09/04→04/06	← →			13.0460-4847.2 604847 13.0460-4996.2 604996	BRE 29160 20,3 + WE / - WK + Zub BRE 29123 20,3 + WE / - WK
65 C 14 65 C 15 65 C 17	100 107 122	09/04→04/06 11/01→04/06 09/04→04/06	← →			13.0460-4847.2 604847 13.0460-4966.2 604966	BRE 29160 20,3 + WE / - WK + Zub BRE 29121 20,3 + WE / - WK
<b>Warnkontakt, Bremsbelagsverschleiß</b>							
29 L 10 V (ALJA43A2, ALJA42A2, ALJA41A2) 29 L 11 V 29 L 12 V (ALKA41A2, ALLA52A2, ALKA42A2) 29 L 13 29 L 9 V 35 S 10 (ANJA41A1, ANJA42A2, ANJA42AB, ANJA43A, ANJAV1A,... 35 S 11 V,35 C 11 V 35 S 13 V,35 C 13 V 35 S 15 V, 35 C 15 V (A6HCV3B2, A6HBV4B2, A6HC41B2,... 35 S 9 V,35 C 9 V	70 78 85 92 62 70 78 92 107 62	09/02→07/07 05/99→07/07 09/02→07/07 05/01→07/07 05/99→07/07 09/02→07/07 05/99→07/07 05/99→07/07 11/02→07/07 05/99→07/07	← → 04/06		2	24.8190-1304.2 621304	L= 289
29 L 14 29 L 9 V 35 S 9 V	100 66 66	01/05→04/06 11/01→04/06 11/01→04/06	←		2	24.8190-1304.2 621304	L= 289
35 C 12 V, 35 S 12 V (AGKA43A2, AGKB43A2, AGKB46A2,...)	85	09/02→07/07	← → 04/06 → → 04/06		2	24.8190-1304.2 621304	L= 289
35 C 14 35 C 14, 35 S 14 35 C 17, 35 S 17	100 100 122	09/04→04/06 01/05→04/06 01/05→04/06	← →		2	24.8190-1304.2 621304	L= 289
65 C 14 65 C 15 65 C 17	100 107 122	09/04→04/06 11/01→04/06 09/04→04/06	→		2	24.8190-1304.2 621304	L= 289
<b> Bremsscheibe</b>							
29 L 10 V (ALJA43A2, ALJA42A2, ALJA41A2) 29 L 11 V 29 L 12 V (ALKA41A2, ALLA52A2, ALKA42A2) 29 L 13 29 L 9 V ↓	70 78 85 92 62	09/02→07/07 05/99→07/07 09/02→07/07 05/01→07/07 05/99→07/07	← → 04/06 → → 04/06; + ABS → → 04/06; - ABS			24.0122-0262.1 422262 24.0116-0128.1 416128 24.0116-0129.1 416129	Ø 276 22 19 Ø 276 16 13 + ABS Ring Ø 276 16 13

	kW			 	! #		
<b>IVECO - DAILY III Kasten/Kombi 11/97→10/09</b>							
<b>Bremsscheibe</b>							
35 C 12 V, 35 S 12 V (AGKA43A2, AGKB43A2, AGKB46A2,...	85	09/02→07/07	←	→ 04/06		24.0122-0262.1 422262	Ø 276 22 19
			→	→ 04/06; + ABS		24.0116-0128.1 416128	Ø 276 16 13 + ABS Ring
35 S 10 (ANJA41A1, ANJA42A2, ANJA42AB, ANJA43A, ANJAV1A,...	70	09/02→07/07	→	→ 04/06; - ABS		24.0116-0129.1 416129	Ø 276 16 13
35 S 11 V, 35 C 11 V	78	05/99→07/07					
35 S 13 V, 35 C 13 V	92	05/99→07/07					
35 S 15 V, 35 C 15 V (A6HCV3B2, A6HBV4B2, A6HC41B2,...	107	11/02→07/07					
35 S 9 V, 35 C 9 V	62	05/99→07/07					
29 L 14	100	01/05→04/06	←			24.0122-0262.1 422262	Ø 276 22 19
29 L 9 V	66	11/01→04/06					
35 C 14	100	09/04→04/06	→	+ ABS		24.0116-0128.1 416128	Ø 276 16 13 + ABS Ring
35 C 14, 35 S 14	100	01/05→04/06	→	- ABS		24.0116-0129.1 416129	Ø 276 16 13
35 C 17, 35 S 17	122	01/05→04/06					
35 S 9 V	66	11/01→04/06					
<b>IVECO - DAILY III Pritsche/Fahrgestell 03/98→10/09</b>							
<b>Bremsbelagsatz, Scheibenbremse</b>							
29 L 10 (ALJAV1A1, ALJA41AA, ALJA41A1, AHJA64A1,...	70	09/02→04/06	←			13.0460-4966.2 604966	BRE 29121 20,3 + WE / - WK
			→			13.0460-4996.2 604996	BRE 29123 20,3 + WE / - WK
29 L 11	78	05/99→04/06					
29 L 12 (ALKA41A1, AHKA64A1, ALLA51A1)	85	09/02→04/06					
29 L 13	92	11/01→04/06					
29 L 14 (AHRA11C1B1, AHRA14C1B1, AHRA64C1B1)	100	11/05→04/06					
29 L 9	62	05/99→04/06					
29 L 9	66	11/01→04/06					
35 C 10 V, 35 S 10 V (AMJA14A1, AMJA64A1, AMJA65A1,...	70	09/02→04/06	←			13.0460-4966.2 604966	BRE 29121 20,3 + WE / - WK
			→			13.0460-4989.2 604989	BRE 29121 17,3 + WE / - WK
35 C 12, 35 S 12 (AEKA14A1, AEKA14AA, AEKA64A1,...	85	09/02→04/06				13.0460-4966.2 604966	BRE 29121 20,3 + WE / - WK
						13.0460-4996.2 604996	BRE 29123 20,3 + WE / - WK
35 C 14	100	09/04→04/06					
35 C 14, 35 S 14	100	01/05→04/06					
35 C 15	107	11/01→04/06					
35 C 17, 35 S 17	122	01/05→04/06					
35 C 9, 35 S 9	66	11/01→04/06					
35 S 11, 35 C 11 (A2FC13AA, A6FBU4AB, A2NB14A1, A2ND13A1,...	78	05/99→04/06	←			13.0460-4966.2 604966	BRE 29121 20,3 + WE / - WK
			→			13.0460-4989.2 604989	BRE 29121 17,3 + WE / - WK
35 S 13, 35 C 13	92	05/99→04/06				13.0460-4996.2 604996	BRE 29123 20,3 + WE / - WK
35 S 9, 35 C 9	62	05/99→04/06					
50 C 11	78	05/99→04/06	←	01/01→		13.0460-4847.2 604847	BRE 29160 20,3 + WE / - WK
			→			13.0460-4996.2 604996	BRE 29123 20,3 + WE / - WK
50 C 13	92	05/99→04/06					
50 C 14	100	09/04→04/06	←			13.0460-4847.2 604847	BRE 29160 20,3 + WE / - WK
50 C 15	107	01/01→04/06					
50 C 17	122	09/04→04/06	→			13.0460-4996.2 604996	BRE 29123 20,3 + WE / - WK
65 C 14	100	09/04→04/06	←			13.0460-4847.2 604847	BRE 29160 20,3 + WE / - WK
65 C 15	107	11/01→04/06					
65 C 17	122	09/04→04/06	→			13.0460-4966.2 604966	BRE 29121 20,3 + WE / - WK
<b>Warnkontakt, Bremsbelagsverschleiß</b>							
29 L 10 (ALJAV1A1, ALJA41AA, ALJA41A1, AHJA64A1,...	70	09/02→04/06	←		2	24.8190-1304.2 621304	L= 289
29 L 11	78	05/99→04/06					
29 L 12 (ALKA41A1, AHKA64A1, ALLA51A1)	85	09/02→04/06					
29 L 13	92	11/01→04/06					
29 L 14 (AHRA11C1B1, AHRA14C1B1, AHRA64C1B1)	100	11/05→04/06					
29 L 9	62	05/99→04/06					
29 L 9	66	11/01→04/06					
35 S 11, 35 C 11 (A2FC13AA, ↓	78	05/99→04/06					



	kW				! #		
<b>IVECO - DAILY III Pritsche/Fahrgestell 03/98→10/09</b>							
<b>Warnkontakt, Bremsbelagverschleiß</b>							
A6FBU4AB, A2NB14A1, A2ND13A1,...	92	05/99→04/06	←		2	24.8190-1304.2 621304	L= 289
35 S 13,35 C 13	62	05/99→04/06					
35 S 9,35 C 9							
35 C 10 V , 35 S 10 V (AMJA14A1, AMJA64A1, AMJA65A1,...	70	09/02→04/06	←		2	24.8190-1304.2 621304	L= 289
35 C 12 , 35 S 12 (AEKA14A1, AEKA14AA, AEKA64A1,...	85	09/02→04/06	→		2	24.8190-1304.2 621304	L= 289
35 C 14	100	09/04→04/06					
35 C 14, 35 S 14	100	01/05→04/06					
35 C 15	107	11/01→04/06					
35 C 17, 35 S 17	122	01/05→04/06					
35 C 9, 35 S 9	66	11/01→04/06					
65 C 14	100	09/04→04/06	→		2	24.8190-1304.2 621304	L= 289
65 C 15	107	11/01→04/06					
65 C 17	122	09/04→04/06					
<b> Bremsscheibe</b>							
29 L 10 (ALJAV1A1, ALJA41AA, ALJA41A1, AHJA64A1,...	70	09/02→04/06	←			24.0122-0262.1 422262	Ø 276 22 19
			→	+ ABS		24.0116-0128.1 416128	Ø 276 16 13 + ABS Ring
29 L 11	78	05/99→04/06	→	- ABS		24.0116-0129.1 416129	Ø 276 16 13
29 L 12 (ALKA41A1, AHKA64A1, ALLA51A1)	85	09/02→04/06					
29 L 13	92	11/01→04/06					
29 L 14 (AHRA11C1B1, AHRA14C1B1, AHRA64C1B1)	100	11/05→04/06					
29 L 9	62	05/99→04/06					
29 L 9	66	11/01→04/06					
35 C 10 V , 35 S 10 V (AMJA14A1, AMJA64A1, AMJA65A1,...	70	09/02→04/06					
35 C 12 , 35 S 12 (AEKA14A1, AEKA14AA, AEKA64A1,...	85	09/02→04/06					
35 C 14	100	09/04→04/06					
35 C 14, 35 S 14	100	01/05→04/06					
35 C 15	107	11/01→04/06					
35 C 17, 35 S 17	122	01/05→04/06					
35 C 9, 35 S 9	66	11/01→04/06					
35 S 11,35 C 11 (A2FC13AA, A6FBU4AB, A2NB14A1, A2ND13A1,...	78	05/99→04/06					
35 S 13,35 C 13	92	05/99→04/06					
35 S 9,35 C 9	62	05/99→04/06					
<b>IVECO - DAILY IV Bus 05/06→08/11</b>							
<b> Bremsbelagsatz, Scheibenbremse</b>							
35S14, 35S14 /P	100	05/06→08/11	←			13.0460-4830.2 604830	BRE 29229 20,7 + WE / - WK + Zub
35S14 G	100	07/09→08/11	→			13.0460-4823.2 604823	BRE 29232 21,0 + WE / - WK + Zub
						13.0460-4996.2 604996	BRE 29123 20,3 + WE / - WK
<b> Bremsscheibe</b>							
35S14, 35S14 /P	100	05/06→08/11	←	Felge Lochzahl: 6		24.0128-0238.1 428238	Ø 300 28 25 V
35S14 G	100	07/09→08/11	←			24.0128-0239.1 428239	Ø 290 28 25 V
			→			24.0124-0228.1 424228	Ø 294 24 21 V
<b>IVECO - DAILY IV Kasten/Kombi 05/06→03/12</b>							
<b> Bremsbelagsatz, Scheibenbremse</b>							
29L10 V	70	05/06→08/11	←			13.0460-4830.2 604830	BRE 29229 20,7 + WE / - WK + Zub
29L12 V, 29L12 V/P	85	05/06→08/11					
29L14 C, 29L14 C/P, 29L14 V, 29L14 V/P	100	05/06→08/11	→			13.0460-4823.2 604823	BRE 29232 21,0 + WE / - WK + Zub
35C10, 35S10	70	05/06→08/11					
35C11 V, 35S11 V	78	07/07→08/11				13.0460-4996.2 604996	BRE 29123 20,3 + WE / - WK
35C12 V, 35C12 V/P, 35S12 V, 35S12 V/P	85	05/06→08/11					
↓							

**IVECO - DAILY IV Kasten/Kombi 05/06→03/12**

**Bremsbelagsatz, Scheibenbremse**

35C13 V, 35C13 V/P, 35S13 V, 35S13 V/P	93	07/07→08/11	←					BRE 29229 20,7 + WE / - WK + Zub
35C14 GV, 35C14 GV/P, 35S14 GV, 35S14 GV/P	100	07/07→08/11	→					BRE 29232 21,0 + WE / - WK + Zub
35C14 V, 35C14 V/P, 35S14 V, 35S14 V/P	103	07/07→08/11						BRE 29123 20,3 + WE / - WK
35C15 V, 35C15 V/P	107	05/06→08/11						
35C17 V, 35C17 V/P, 35S17 V, 35S17 V/P	125	07/07→08/11						
35C18 V, 35C18 V/P, 35S18 V, 35S18 V/P	130	05/06→08/11						
35S14 C, 35S14 C/P, 35S14 V, 35S14 V/P, 35C14 V,...	100	05/06→08/11						
65C14 V, 65C14 V/P	103	07/07→08/11	←					BRE 29122 22,1 + WE / - WK
65C15	107	05/06→08/11						
65C17 V, 65C17 V/P	125	07/07→08/11	→					BRE 29231 22,7 + WE / - WK + Zub
65C18	130	05/06→08/11						

**Bremsscheibe**

29L10 V	70	05/06→08/11	←	Felge Lochzahl: 6				Ø 300 28 25 V
29L12 V, 29L12 V/P	85	05/06→08/11						
29L14 C, 29L14 C/P, 29L14 V, 29L14 V/P	100	05/06→08/11	←					Ø 290 28 25 V
35C10, 35S10	70	05/06→08/11	→					Ø 294 24 21 V
35C11 V, 35S11 V	78	07/07→08/11						
35C12 V, 35C12 V/P, 35S12 V, 35S12 V/P	85	05/06→08/11						
35C13 V, 35C13 V/P, 35S13 V, 35S13 V/P	93	07/07→08/11						
35C14 GV, 35C14 GV/P, 35S14 GV, 35S14 GV/P	100	07/07→08/11						
35C14 V, 35C14 V/P, 35S14 V, 35S14 V/P	103	07/07→08/11						
35C15 V, 35C15 V/P	107	05/06→08/11						
35C17 V, 35C17 V/P, 35S17 V, 35S17 V/P	125	07/07→08/11						
35C18 V, 35C18 V/P, 35S18 V, 35S18 V/P	130	05/06→08/11						
35S14 C, 35S14 C/P, 35S14 V, 35S14 V/P, 35C14 V,...	100	05/06→08/11						
65C14 V, 65C14 V/P	103	07/07→08/11	←					Ø 300 28 25 V
65C15	107	05/06→08/11						
65C17 V, 65C17 V/P	125	07/07→08/11						
65C18	130	05/06→08/11						











**IVECO - DAILY IV Kipper 05/06→08/11**













**Bremsbelagsatz, Scheibenbremse**















35C10 K	70	05/06→08/11	←					BRE 29229 20,7 + WE / - WK + Zub
35C11 K, 35C11 DK, 35S11 K, 35S11 DK	78	07/07→08/11						
35C12	85	05/06→08/11	→					BRE 29232 21,0 + WE / - WK + Zub
35C13 K, 35C13 DK, 35S13 K, 35S13 DK	93	07/07→08/11						BRE 29123 20,3 + WE / - WK
35C14 K, 35C14 DK, 35S14 K, 35S14 DK	103	07/07→08/11						
35C15	107	05/06→08/11						
35C17 K, 35C17 DK, 35S17 K, 35S17 DK	125	07/07→08/11						
35C18	130	05/06→08/11						
35S14 K, 35S14 DK	100	07/07→08/11						
65C14 K, 65C14 DK	103	07/07→08/11	←					BRE 29122 22,1 + WE / - WK
65C17 K, 65C17 DK, 65C17KK	125	07/07→08/11	→					BRE 29231 22,7 + WE / - WK + Zub

**Bremsscheibe**











35C10 K	70	05/06→08/11	←	Felge Lochzahl: 6				Ø 300 28 25 V
35C11 K, 35C11 DK, 35S11 K, 35S11 DK	78	07/07→08/11						
35C12	85	05/06→08/11	←					Ø 290 28 25 V
35C13 K, 35C13 DK, 35S13 K, 35S13 DK	93	07/07→08/11	→					Ø 294 24 21 V
35C14 K, 35C14 DK, 35S14 K, 35S14 DK	103	07/07→08/11						
35C15	107	05/06→08/11						
35C17 K, 35C17 DK, 35S17 K, 35S17 DK	125	07/07→08/11						
35C18	130	05/06→08/11						
35S14 K, 35S14 DK	100	07/07→08/11						











	kw			 	! #		
<b>IVECO - DAILY IV Kipper 05/06→08/11</b>							
 <b>Bremsscheibe</b>							
65C14 K, 65C14 DK	103	07/07→08/11	←			24.0128-0238.1 428238	Ø 300 28 25 V
65C17 K, 65C17 DK, 65C17KK	125	07/07→08/11					
<b>IVECO - DAILY IV Pritsche/Fahrgestell 05/06→09/11</b>							
 <b>Bremsbelagsatz, Scheibenbremse</b>							
29L10	70	05/06→08/11	←			13.0460-4830.2 604830	BRE 29229 20,7 + WE / - WK + Zub
29L12	85	05/06→08/11					
29L14	100	05/06→08/11	→			13.0460-4823.2 604823	BRE 29232 21,0 + WE / - WK + Zub
35C10, 35S10	70	05/06→08/11					
35C11, 35S11, 35S11 D, 35S11 /P	78	07/07→08/11				13.0460-4996.2 604996	BRE 29123 20,3 + WE / - WK
35C12, 35S12	85	05/06→08/11					
35C13, 35C13 /P, 35S13 D, 35S13, 35S13 /P	93	07/07→08/11					
35C14, 35C14 /P, 35S14, 35S14 /P, 35S14 D, 35S14 D/P	103	07/07→08/11					
35C14, 35S14, 35S14 /P	100	05/06→08/11					
35C14 G, 35C14 G/P, 35S14 G, 35S14 G/P, 35C14 GD,...	100	07/07→08/11					
35C15	107	05/06→08/11					
35C17, 35C17 /P, 35S17, 35S17 /P, 35S17 D	125	07/07→08/11					
35C18, 35S18	130	05/06→08/11					
35S17 W, 35S17 WD	125	07/07→08/11					
65C14, 65C14 /P	103	07/07→08/11	←			13.0460-4828.2 604828	BRE 29122 22,1 + WE / - WK
65C14 G, 65C14 G/P, 65C14 GD, 65C14 GD/P	100	07/07→08/11	→			13.0460-4829.2 604829	BRE 29231 22,7 + WE / - WK + Zub
65C15, 65C15 /P, 65C15 D, 65C15 D/P	107	05/06→08/11					
65C17, 65C17 /P	125	07/07→08/11					
65C18	130	05/06→08/11					
 <b>Bremsscheibe</b>							
29L10	70	05/06→08/11	←	Felge Lochzahl: 6		24.0128-0238.1 428238	Ø 300 28 25 V
29L12	85	05/06→08/11					
29L14	100	05/06→08/11	←			24.0128-0239.1 428239	Ø 290 28 25 V
35C10, 35S10	70	05/06→08/11					
35C11, 35S11, 35S11 D, 35S11 /P	78	07/07→08/11	→			24.0124-0228.1 424228	Ø 294 24 21 V
35C12, 35S12	85	05/06→08/11					
35C13, 35C13 /P, 35S13 D, 35S13, 35S13 /P	93	07/07→08/11					
35C14, 35C14 /P, 35S14, 35S14 /P, 35S14 D, 35S14 D/P	103	07/07→08/11					
35C14, 35S14, 35S14 /P	100	05/06→08/11					
35C14 G, 35C14 G/P, 35S14 G, 35S14 G/P, 35C14 GD,...	100	07/07→08/11					
35C15	107	05/06→08/11					
35C17, 35C17 /P, 35S17, 35S17 /P, 35S17 D	125	07/07→08/11					
35C18, 35S18	130	05/06→08/11					
35S17 W, 35S17 WD	125	07/07→08/11					
65C14, 65C14 /P	103	07/07→08/11	←			24.0128-0238.1 428238	Ø 300 28 25 V
65C14 G, 65C14 G/P, 65C14 GD, 65C14 GD/P	100	07/07→08/11					
65C15, 65C15 /P, 65C15 D, 65C15 D/P	107	05/06→08/11					
65C17, 65C17 /P	125	07/07→08/11					
65C18	130	05/06→08/11					
<b>IVECO - DAILY V Kasten/Kombi 09/11→02/14</b>							
 <b>Bremsbelagsatz, Scheibenbremse</b>							
29L11 V, 35C11 V, 35S11 V, 40C11 V	78	09/11→02/14	←			13.0460-4830.2 604830	BRE 29229 20,7 + WE / - WK + Zub
29L13 V, 35C13 V, 35S13 V, 40C13 V, 40S13 V	93	09/11→02/14	→			13.0460-4996.2 604996	BRE 29123 20,3 + WE / - WK
29L15 V, 35C15L V, 40C15L V, 50C15L V	107	09/11→02/14					
35S, 35C Electric	60	09/11→02/14					
35C15 V, 40C15 V	107	09/11→02/14	←			13.0460-4830.2 604830	BRE 29229 20,7 + WE / - WK + Zub
↓							













	kw			 	! #		
<b>IVECO - DAILY V Kasten/Kombi 09/11→02/14</b>							
 <b>Bremsbelagsatz, Scheibenbremse</b>							
35C15 V, 40C15 V	107	09/11→02/14	➔			13.0460-4823.2 604823	BRE 29232 21,0 + WE / - WK + Zub
						13.0460-4996.2 604996	BRE 29123 20,3 + WE / - WK
35C17 V, 35S17 V, 40C17 V, 45C17 V, 50C17 V, 60C17 V	125	09/11→02/14	➔			13.0460-4830.2 604830	BRE 29229 20,7 + WE / - WK + Zub
35C21 V, 35S21 V, 40C21 V, 45C21 V, 50C21 V	150	09/11→02/14	➔			13.0460-4823.2 604823	BRE 29232 21,0 + WE / - WK + Zub
 <b>Bremsscheibe</b>							
29L11 V, 35C11 V, 35S11 V, 40C11 V	78	09/11→02/14	➔			24.0128-0238.1 428238	Ø 300 28 25 V
29L13 V, 35C13 V, 35S13 V, 40C13 V, 40S13 V	93	09/11→02/14	➔			24.0128-0239.1 428239	Ø 290 28 25 V
29L15 V, 35C15L V, 40C15L V, 50C15L V	107	09/11→02/14	➔				
35C15 V, 40C15 V	107	09/11→02/14	➔				
35C17 V, 35S17 V, 40C17 V, 45C17 V, 50C17 V, 60C17 V	125	09/11→02/14	➔			24.0128-0239.1 428239	Ø 290 28 25 V
35C21 V, 35S21 V, 40C21 V, 45C21 V, 50C21 V	150	09/11→02/14	➔			24.0124-0228.1 424228	Ø 294 24 21 V
35S, 35C Electric	60	09/11→02/14	➔			24.0128-0238.1 428238	Ø 300 28 25 V
			➔			24.0124-0228.1 424228	Ø 294 24 21 V
<b>IVECO - DAILY V Kipper 09/11→02/14</b>							
 <b>Bremsbelagsatz, Scheibenbremse</b>							
35C11K, 35S11DKP	78	09/11→02/14	➔			13.0460-4830.2 604830	BRE 29229 20,7 + WE / - WK + Zub
35C13K, 35C13DKP	93	09/11→02/14	➔				
35C15K, 35S15DKP, 50C15K, 60C15K, 65C15DK, 70C15K	107	09/11→02/14	➔			13.0460-4823.2 604823	BRE 29232 21,0 + WE / - WK + Zub
35C17K, 35S17DKP, 50C17K, 65C17DK, 70C17K	125	09/11→02/14	➔				
35S21DKP	150	09/11→02/14	➔			13.0460-4830.2 604830	BRE 29229 20,7 + WE / - WK + Zub
			➔			13.0460-4996.2 604996	BRE 29123 20,3 + WE / - WK
 <b>Bremsscheibe</b>							
35C11K, 35S11DKP	78	09/11→02/14	➔			24.0128-0239.1 428239	Ø 290 28 25 V
35C13K, 35C13DKP	93	09/11→02/14	➔				
35C15K, 35S15DKP, 50C15K, 60C15K, 65C15DK, 70C15K	107	09/11→02/14	➔			24.0124-0228.1 424228	Ø 294 24 21 V
35C17K, 35S17DKP, 50C17K, 65C17DK, 70C17K	125	09/11→02/14	➔				
35S21DKP	150	09/11→02/14	➔			24.0128-0238.1 428238	Ø 300 28 25 V
			➔			24.0124-0228.1 424228	Ø 294 24 21 V
<b>IVECO - DAILY V Pritsche/Fahrgestell 09/11→02/14</b>							
 <b>Bremsbelagsatz, Scheibenbremse</b>							
26L11, 26L11D, 35C11D, 35S11, 40C11	78	09/11→02/14	➔			13.0460-4830.2 604830	BRE 29229 20,7 + WE / - WK + Zub
29L13, 29L13D, 35C13D, 40C13	93	09/11→02/14	➔			13.0460-4996.2 604996	BRE 29123 20,3 + WE / - WK
29L15 V, 35C15L V, 40C15L V, 50C15L V	107	09/11→02/14	➔				
35C15, 35C15D, 35S15, 40C15, 45C15, 50C15, 60C15, 70C15	107	09/11→02/14	➔			13.0460-4830.2 604830	BRE 29229 20,7 + WE / - WK + Zub
			➔			13.0460-4823.2 604823	BRE 29232 21,0 + WE / - WK + Zub
			➔			13.0460-4996.2 604996	BRE 29123 20,3 + WE / - WK
35C17, 35C17D, 35S17, 40C17, 45C17, 50C17, 60C17, 70C17	125	09/11→02/14	➔			13.0460-4830.2 604830	BRE 29229 20,7 + WE / - WK + Zub
35C21, 35S21, 40C21, 45C21, 50C21, 60C21, 70C21	150	09/11→02/14	➔			13.0460-4823.2 604823	BRE 29232 21,0 + WE / - WK + Zub
↓							













	kw			 	! #		
<b>IVECO - DAILY V Pritsche/Fahrgestell 09/11→02/14</b>							
 <b>Bremsscheibe</b>							
26L11, 26L11D, 35C11D, 35S11, 40C11	78	09/11→02/14	←			24.0128-0238.1 428238	Ø 300 28 25 V
29L13, 29L13D, 35C13D, 40C13	93	09/11→02/14	→			24.0128-0239.1 428239	Ø 290 28 25 V
29L15 V, 35C15L V, 40C15L V, 50C15L V	107	09/11→02/14	→			24.0124-0228.1 424228	Ø 294 24 21 V
35C15, 35C15D, 35S15, 40C15, 45C15, 50C15, 60C15, 70C15	107	09/11→02/14	←			24.0128-0239.1 428239	Ø 290 28 25 V
35C17, 35C17D, 35S17, 40C17, 45C17, 50C17, 60C17, 70C17	125	09/11→02/14	→			24.0124-0228.1 424228	Ø 294 24 21 V
35C21, 35S21, 40C21, 45C21, 50C21, 60C21, 70C21	150	09/11→02/14	→				
<b>IVECO - MASSIF Pick-up 10/08→02/11</b>							
 <b>Bremsbelagsatz, Scheibenbremse</b>							
3.0 HPI	107	10/08→02/11	←	→ 12/10		13.0460-2750.2 602750	TRW 20741 15,0 - WE / - WK
3.0 HPT	130	10/08→02/11	→	→ 12/10		13.0460-2751.2 602751	TRW 21418 15,5 - WE / - WK
<b>IVECO - MASSIF Single Cab 10/08→02/11</b>							
 <b>Bremsbelagsatz, Scheibenbremse</b>							
3.0 HPI	107	10/08→02/11	←	→ 12/10		13.0460-2750.2 602750	TRW 20741 15,0 - WE / - WK
3.0 HPT	130	10/08→02/11	→	→ 12/10		13.0460-2751.2 602751	TRW 21418 15,5 - WE / - WK
<b>IVECO - MASSIF Station Wagon 10/08→02/11</b>							
 <b>Bremsbelagsatz, Scheibenbremse</b>							
3.0 HPI	107	10/08→02/11	←	→ 12/10		13.0460-2750.2 602750	TRW 20741 15,0 - WE / - WK
3.0 HPT	130	10/08→02/11	→	→ 12/10		13.0460-2751.2 602751	TRW 21418 15,5 - WE / - WK
<b>JAGUAR - E-PACE (X540) 09/17→</b>							
 <b>Bremsbelagsatz, Scheibenbremse</b>							
2.0 AWD	183	09/17→	→			13.0460-7326.2 607326	ATE 22141 15,5 + WE / - WK
2.0 AWD	221	09/17→					
2.0 D	110	09/17→					
2.0 D AWD	110	09/17→					
2.0 D AWD	132	09/17→					
2.0 D AWD	177	09/17→					
<b>JAGUAR - F-PACE (X761) 09/15→</b>							
 <b>Bremsbelagsatz, Scheibenbremse</b>							
2.0 AWD	184	02/17→	→			13.0460-7326.2 607326	ATE 22141 15,5 + WE / - WK
2.0 AWD	221	06/17→					
2.0 D	120	02/17→					
2.0 D	132	09/15→					
2.0 D AWD	132	09/15→					
2.0 D AWD	177	02/17→					
3.0 AWD	250	09/15→					
3.0 AWD	280	09/15→					
3.0 D AWD	221	09/15→					
<b>JAGUAR - S-TYPE (X200) 10/98→12/08</b>							
 <b>Bremsbelagsatz, Scheibenbremse</b>							
2.5 V6	147	04/02→10/07	←	→ M45254		13.0460-2729.2 602729	TRW 23423 17,8 - WE / - WK + Zub
3.0 V6	175	01/99→10/07					
4.0 V8	203	01/99→04/02	←	M45255→ N52047		13.0460-2898.2 602898	TRW 23908 18,0 + WE / - WK + Zub
4.2 V8	219	04/02→10/07	←	N52048→		13.0460-7292.2 607292	ATE 24084 19,3 + WE / - WK
			→			13.0460-2730.2 602730	TRW 23424 17,6 - WE / - WK
2.7 D	152	06/04→10/07	←	→ M45254		13.0460-2729.2 602729	TRW 23423 17,8 - WE / - WK + Zub
			←	M45255→ N52047		13.0460-2898.2 602898	TRW 23908 18,0 + WE / - WK + Zub
			←	N52048→		13.0460-7292.2 607292	ATE 24084 19,3 + WE / - WK
			→	→ N13088		13.0460-2730.2 602730	TRW 23424 17,6 - WE / - WK
			→	N52048→		13.0460-4964.2 604964	BRE 21381 15,0 - WE / - WK
						13.0460-7209.2 607209	ATE 23482 16,6 - WE / - WK
↓							















	kW			 	! #		
<b>JAGUAR - S-TYPE (X200) 10/98→12/08</b>							
 <b>Bremsbelagsatz, Scheibenbremse</b>							
4.0 V8	209	09/99→12/02	←	→ M45254		13.0460-2729.2 602729	TRW 23423 17,8 - WE / - WK + Zub
			←	M45255→ N52047		13.0460-2898.2 602898	TRW 23908 18,0 + WE / - WK + Zub
			←	N52048→		13.0460-7292.2 607292	ATE 24084 19,3 + WE / - WK
			→	→ 04/02		13.0460-2730.2 602730	TRW 23424 17,6 - WE / - WK
4.2 Supercharged	298	11/01→12/08	←	→ M45254		13.0460-2729.2 602729	TRW 23423 17,8 - WE / - WK + Zub
			←	M45255→ N52047		13.0460-4841.2 604841	BRE 23489 16,3 - WE
			→			13.0460-4964.2 604964	BRE 21381 15,0 - WE / - WK
R 4,2 V8	291	04/02→10/07	←	→ M45254		13.0460-2729.2 602729	TRW 23423 17,8 - WE / - WK + Zub
			←	M45255→ N52047		13.0460-2898.2 602898	TRW 23908 18,0 + WE / - WK + Zub
			←	N52048→		13.0460-7292.2 607292	ATE 24084 19,3 + WE / - WK
			→			13.0460-4964.2 604964	BRE 21381 15,0 - WE / - WK
			→			13.0460-7209.2 607209	ATE 23482 16,6 - WE / - WK
 <b>Bremsscheibe</b>							
2.5 V6	147	04/02→10/07	←			24.0130-0182.1 430182	Ø 320 30 28,4 V
4.2 V8	219	04/02→10/07	→			24.0120-0708.1 420708	Ø 288 20 18,5 V
2.7 D	152	06/04→10/07	←			24.0130-0182.1 430182	Ø 320 30 28,4 V
			→	N52048→		24.0120-0238.1 420238	Ø 326 20 18 V
			→	→ N52047		24.0120-0708.1 420708	Ø 288 20 18,5 V
3.0 V6	175	01/99→10/07	←	→ 01/00		24.0130-0120.1 430120	Ø 300 30 28 V
			←	02/00→		24.0130-0182.1 430182	Ø 320 30 28,4 V
			→			24.0120-0708.1 420708	Ø 288 20 18,5 V
4.0 V8	203	01/99→04/02	←			24.0130-0120.1 430120	Ø 300 30 28 V
			→			24.0120-0708.1 420708	Ø 288 20 18,5 V
4.0 V8	209	09/99→12/02	←	→ 04/02		24.0130-0120.1 430120	Ø 300 30 28 V
			→			24.0120-0708.1 420708	Ø 288 20 18,5 V
<b>JAGUAR - XE (X760) 03/15→</b>							
 <b>Bremsbelagsatz, Scheibenbremse</b>							
2.0	147	03/15→	←	passend für Felgenreöße [Zoll]: 16,5		13.0460-7228.2 607228	ATE 24123 20,3 - WE / - WK
2.0	177	03/15→				13.0470-7228.2 LD7228	ATE 24123 20,3 - WE / - WK Ceramic
2.0 D	120	03/15→					
2.0 D	132	03/15→	→	passend für Felgenreöße [Zoll]: 16		13.0460-7326.2 607326	ATE 22141 15,5 + WE / - WK
			→	passend für Felgenreöße [Zoll]: 17		13.0460-7326.2 607326	ATE 22141 15,5 + WE / - WK
2.0	184	02/17→	←	→ 942527;		13.0460-7228.2 607228	ATE 24123 20,3 - WE / - WK
2.0 AWD	184	02/17→		passend für Felgenreöße [Zoll]: 16,5		13.0470-7228.2 LD7228	ATE 24123 20,3 - WE / - WK Ceramic
2.0 AWD	221	06/17→					
2.0 D AWD	132	10/15→	→	passend für Felgenreöße [Zoll]: 16		13.0460-7326.2 607326	ATE 22141 15,5 + WE / - WK
2.0 D AWD	177	02/17→	→	passend für Felgenreöße [Zoll]: 17		13.0460-7326.2 607326	ATE 22141 15,5 + WE / - WK
3.0 S	250	03/15→	→	passend für Felgenreöße [Zoll]: 17		13.0460-7326.2 607326	ATE 22141 15,5 + WE / - WK
3.0 S	280	02/17→					
<b>JAGUAR - XF (X250) 03/08→04/15</b>							
 <b>Bremsbelagsatz, Scheibenbremse</b>							
2.0	177	06/12→04/15	←			13.0460-7292.2 607292	ATE 24084 19,3 + WE / - WK
2.2 D	120	04/11→04/15	→			13.0460-7209.2 607209	ATE 23482 16,6 - WE / - WK
2.2 D	140	05/11→04/15					
2.2 D	147	03/12→04/15					
2.7 D	152	03/08→04/15	←			13.0460-7292.2 607292	ATE 24084 19,3 + WE / - WK
3.0	175	03/08→04/15	→	→ S20572		13.0460-7209.2 607209	ATE 23482 16,6 - WE / - WK
4.2	219	03/08→04/15					
3.0	250	03/12→04/15	→			13.0460-7209.2 607209	ATE 23482 16,6 - WE / - WK
3.0 AWD	250	10/12→04/15					
3.0 D	155	03/09→04/15	←	für Bremsscheibendurchmesser [mm]: 326		13.0460-7292.2 607292	ATE 24084 19,3 + WE / - WK
3.0 D	177	03/09→04/15	→	→ S20572		13.0460-7209.2 607209	ATE 23482 16,6 - WE / - WK
3.0 D	202	03/09→04/15					
4.2 Kompressor	306	03/08→04/15	→	→ S20572		13.0460-7209.2 607209	ATE 23482 16,6 - WE / - WK
5.0	283	03/09→04/15					
↓							













	kW			 	! #		
<b>JAGUAR - XF (X250) 03/08→04/15</b>							
 <b>Bremsbelagsatz, Scheibenbremse</b>							
5.0 Kompressor	346	01/09→04/15	➔	→ B32752		<b>13.0460-7209.2 607209</b>	ATE 23482 16,6 - WE / - WK
5.0 Kompressor	375	03/09→04/15	➔	B32753→		<b>13.0460-7255.2 607255</b>	ATE 25114 15,8 - WE / - WK
5.0 XFR-S	405	10/12→04/15	➔			<b>13.0460-7255.2 607255</b>	ATE 25114 15,8 - WE / - WK
<b>Warnkontakt, Bremsbelagverschleiß</b>							
2.0	177	06/12→04/15	➔		1	<b>24.8190-0960.2 620960</b>	L= 633
2.2 D	120	04/11→04/15					
2.2 D	140	05/11→04/15					
2.2 D	147	03/12→04/15					
3.0	250	03/12→04/15					
3.0 AWD	250	10/12→04/15					
5.0 XFR-S	405	10/12→04/15					
2.7 D	152	03/08→04/15	➔	S20753→	1	<b>24.8190-0960.2 620960</b>	L= 633
3.0	175	03/08→04/15					
3.0 D	155	03/09→04/15	➔	→ S20572	1	<b>24.8190-0960.2 620960</b>	L= 633
3.0 D	177	03/09→04/15					
3.0 D	202	03/09→04/15					
4.2	219	03/08→04/15					
4.2 Kompressor	306	03/08→04/15					
5.0	283	03/09→04/15					
5.0 Kompressor	346	01/09→04/15	➔	B32753→	1	<b>24.8190-0960.2 620960</b>	L= 633
5.0 Kompressor	375	03/09→04/15	➔	→ B32752	1	<b>24.8190-0960.2 620960</b>	L= 633
 <b>Bremsscheibe</b>							
2.0	177	06/12→04/15	➔			<b>24.0130-0226.1 430226</b>	Ø 326 30 28 V
2.2 D	120	04/11→04/15					
2.2 D	140	05/11→04/15	➔	S49011→		<b>24.0120-0238.1 420238</b>	Ø 326 20 18 V
2.2 D	147	03/12→04/15	➔	→ S49010		<b>24.0120-0238.1 420238</b>	Ø 326 20 18 V
3.0 D	155	03/09→04/15					
2.7 D	152	03/08→04/15	➔			<b>24.0130-0226.1 430226</b>	Ø 326 30 28 V
3.0	175	03/08→04/15					
3.0 D	177	03/09→04/15	➔			<b>24.0120-0238.1 420238</b>	Ø 326 20 18 V
3.0 D	202	03/09→04/15					
4.2	219	03/08→04/15					
3.0	250	03/12→04/15	➔	S49011→		<b>24.0120-0238.1 420238</b>	Ø 326 20 18 V
3.0 AWD	250	10/12→04/15	➔	→ S49010		<b>24.0120-0238.1 420238</b>	Ø 326 20 18 V
4.2 Kompressor	306	03/08→04/15	➔			<b>24.0120-0238.1 420238</b>	Ø 326 20 18 V
5.0	283	03/09→04/15					
5.0 Kompressor	346	01/09→04/15	➔			<b>24.0136-0122.1 436122</b>	Ø 380 36 34 V
5.0 Kompressor	375	03/09→04/15	➔			<b>24.0126-0174.1 426174</b>	Ø 376 26 24 V
5.0 XFR-S	405	10/12→04/15	➔				
<b>JAGUAR - XF (X260) 05/15→</b>							
 <b>Bremsbelagsatz, Scheibenbremse</b>							
2.0	147	03/17→	➔			<b>13.0460-7326.2 607326</b>	ATE 22141 15,5 + WE / - WK
2.0	177	05/15→					
2.0	184	03/17→					
2.0 AWD	184	03/17→					
2.0 AWD	221	09/17→					
2.0 D	120	05/15→					
2.0 D	132	05/15→					
2.0 D	177	03/17→					
2.0 D AWD	132	03/16→					
2.0 D AWD	177	03/17→					
3.0	250	05/15→					
3.0	280	05/15→					
3.0 AWD	250	07/15→					
3.0 AWD	280	07/15→					
3.0 D	221	05/15→					
<b>JAGUAR - XF SPORTBRAKE (X250) 09/12→12/15</b>							
 <b>Bremsbelagsatz, Scheibenbremse</b>							
2.2 D	120	09/12→04/14	➔			<b>13.0460-7292.2 607292</b>	ATE 24084 19,3 + WE / - WK
2.2 D	147	09/12→04/14	➔			<b>13.0460-7209.2 607209</b>	ATE 23482 16,6 - WE / - WK
3.0 D	177	09/12→04/14	➔	für Bremsscheibendurchmesser [mm]:		<b>13.0460-7292.2 607292</b>	ATE 24084 19,3 + WE / - WK
3.0 D	202	09/12→04/14	➔	326		<b>13.0460-7209.2 607209</b>	ATE 23482 16,6 - WE / - WK
5.0 XFR-S	405	02/13→04/14	➔	02/14→		<b>13.0460-7255.2 607255</b>	ATE 25114 15,8 - WE / - WK
<b>Warnkontakt, Bremsbelagverschleiß</b>							
2.2 D	120	09/12→04/14	➔		1	<b>24.8190-0960.2 620960</b>	L= 633
2.2 D	147	09/12→04/14					
3.0 D	177	09/12→04/14					
↓							

	kw					! #		
<b>JAGUAR - XF SPORTBRAKE (X250) 09/12→12/15</b>								
<b>Warnkontakt, Bremsbelagverschleiß</b>								
3.0 D	202	09/12→04/14	➡			1	24.8190-0960.2 620960	L= 633
5.0 XFR-S	405	02/13→04/14	➡	02/14→		1	24.8190-0960.2 620960	L= 633
<b> Bremsscheibe</b>								
2.2 D	120	09/12→04/14	⬅				24.0130-0226.1 430226	Ø 326 30 28 V
2.2 D	147	09/12→04/14	➡				24.0120-0238.1 420238	Ø 326 20 18 V
3.0 D	177	09/12→04/14	➡	→ S49010			24.0120-0238.1 420238	Ø 326 20 18 V
3.0 D	202	09/12→04/14	➡	S49011→			24.0120-0238.1 420238	Ø 326 20 18 V
5.0 XFR-S	405	02/13→04/14	⬅	02/14→			24.0136-0122.1 436122	Ø 380 36 34 V
			➡	02/14→			24.0126-0174.1 426174	Ø 376 26 24 V
<b>JAGUAR - XF SPORTBRAKE (X260) 07/17→</b>								
<b> Bremsbelagsatz, Scheibenbremse</b>								
2.0	184	07/17→	➡				13.0460-7326.2 607326	ATE 22141 15,5 + WE / - WK
2.0 D	120	07/17→						
2.0 D	132	07/17→						
2.0 D AWD	132	07/17→						
2.0 D AWD	177	07/17→						
<b>JAGUAR - XJ (X300, X330) 09/94→12/98</b>								
<b> Bremsbelagsatz, Scheibenbremse</b>								
12 6.0	229	09/94→09/97	⬅	11/94→ 07/97			13.0460-7138.2 607138	ATE 20968 17,5 + WE / - WK
6 3.2	155	11/94→07/97	⬅				13.0460-7138.2 607138	ATE 20968 17,5 + WE / - WK
R Super Charged 4.0	235	11/94→07/97	➡					
6 Sovereign 4.0	177	09/94→07/97	⬅	11/94→			13.0460-7138.2 607138	ATE 20968 17,5 + WE / - WK
<b>Warnkontakt, Bremsbelagverschleiß</b>								
12 6.0	229	09/94→09/97	⬅	11/94→ 07/97		2	24.8190-1302.2 621302	L= 276
			➡	11/94→ 07/97		2	24.8190-0970.2 620970	L= 434
6 3.2	155	11/94→07/97	⬅			2	24.8190-1302.2 621302	L= 276
R Super Charged 4.0	235	11/94→07/97	➡			2	24.8190-0970.2 620970	L= 434
6 Sovereign 4.0	177	09/94→07/97	⬅	11/94→		2	24.8190-1302.2 621302	L= 276
			➡	11/94→		2	24.8190-0970.2 620970	L= 434
<b> Bremsscheibe</b>								
12 6.0	229	09/94→09/97	⬅	11/94→ 07/97			24.0128-0138.1 428138	Ø 291 28,1 26 V
			➡	11/94→ 07/97			24.0120-0188.1 420188	Ø 305 20 18,5 V
6 3.2	155	11/94→07/97	⬅				24.0128-0138.1 428138	Ø 291 28,1 26 V
R Super Charged 4.0	235	11/94→07/97	➡				24.0120-0188.1 420188	Ø 305 20 18,5 V
6 Sovereign 4.0	177	09/94→07/97	⬅	11/94→			24.0128-0138.1 428138	Ø 291 28,1 26 V
			➡	11/94→			24.0120-0188.1 420188	Ø 305 20 18,5 V
<b>JAGUAR - XJ (X308) 09/96→05/03</b>								
<b> Bremsbelagsatz, Scheibenbremse</b>								
3.2	174	07/97→05/03	⬅	für Fahrzeuge ohne Sportpaket			13.0460-7138.2 607138	ATE 20968 17,5 + WE / - WK
			➡	für Fahrzeuge ohne Sportpaket			13.0460-7246.2 607246	ATE 21275 17,0 + WE / - WK
4.0	209	07/97→05/03	⬅				13.0460-7138.2 607138	ATE 20968 17,5 + WE / - WK
			➡	08/99→			13.0460-7241.2 607241	ATE 20547 16,5 + WE / - WK
			➡	→ 07/99			13.0460-7246.2 607246	ATE 21275 17,0 + WE / - WK
4.0	216	10/97→04/03	⬅				13.0460-7138.2 607138	ATE 20968 17,5 + WE / - WK
			➡				13.0460-7246.2 607246	ATE 21275 17,0 + WE / - WK
<b> Bremsscheibe</b>								
3.2	174	07/97→05/03	⬅	für Fahrzeuge mit Sportpaket			24.0128-0229.1 428229	Ø 325 28,3 26 V
			⬅	für Fahrzeuge ohne Sportpaket			24.0129-0100.1 429100	Ø 305 28,5 26 V
			➡	für Fahrzeuge ohne Sportpaket			24.0120-0188.1 420188	Ø 305 20 18,5 V
4.0	209	07/97→05/03	⬅				24.0129-0100.1 429100	Ø 305 28,5 26 V
4.0	216	10/97→04/03	➡				24.0120-0188.1 420188	Ø 305 20 18,5 V
4.0	267	07/97→05/03	⬅				24.0129-0100.1 429100	Ø 305 28,5 26 V











	kw			 	! #			
<b>JAGUAR - XJ (X350) 03/03—03/09</b>								
 <b>Bremsbelagsatz, Scheibenbremse</b>								
3.0	175	05/03→03/09	←			13.0460-2898.2	602898	TRW 23908 18,0 + WE / - WK + Zub
3.0	179	04/04→01/07						
3.6	190	05/03→03/09	→			13.0460-2730.2	602730	TRW 23424 17,6 - WE / - WK
4.2	219	05/03→03/09						
D 2.7	152	10/05→03/09	←	H32733→		13.0460-2898.2	602898	TRW 23908 18,0 + WE / - WK + Zub
			←	→ H32732		13.0460-7292.2	607292	ATE 24084 19,3 + WE / - WK
			→	→ G27960		13.0460-2730.2	602730	TRW 23424 17,6 - WE / - WK
			→	G27961→ G30744		13.0460-2730.2	602730	TRW 23424 17,6 - WE / - WK
			→	G49701→		13.0460-7209.2	607209	ATE 23482 16,6 - WE / - WK
R 4.2	291	03/03→03/09	←	05/03→		13.0460-4841.2	604841	BRE 23489 16,3 - WE
			→	05/03→		13.0460-4964.2	604964	BRE 21381 15,0 - WE / - WK
<b>Warnkontakt, Bremsbelagverschleiß</b>								
D 2.7	152	10/05→03/09	→	G49701→	1	24.8190-0960.2	620960	L= 633
 <b>Bremsscheibe</b>								
3.0	175	05/03→03/09	←			24.0130-0182.1	430182	Ø 320 30 28,4 V
3.0	179	04/04→01/07						
3.6	190	05/03→03/09	→			24.0120-0708.1	420708	Ø 288 20 18,5 V
4.2	219	05/03→03/09						
D 2.7	152	10/05→03/09	←	H32733→		24.0130-0182.1	430182	Ø 320 30 28,4 V
			←	→ H32732		24.0130-0226.1	430226	Ø 326 30 28 V
			→	G49701→		24.0120-0238.1	420238	Ø 326 20 18 V
			→	→ G22035		24.0120-0708.1	420708	Ø 288 20 18,5 V
<b>JAGUAR - XJ (X351) 10/09→</b>								
 <b>Bremsbelagsatz, Scheibenbremse</b>								
2.0	177	05/12→	→			13.0460-7209.2	607209	ATE 23482 16,6 - WE / - WK
3.0	175	01/11→						
3.0	250	03/12→						
3.0 AWD	250	10/12→						
3.0 D	202	10/09→12/15						
5.0 V 8	283	10/09→						
3.0 D	221	04/15→	→	→ V90865		13.0460-7209.2	607209	ATE 23482 16,6 - WE / - WK
5.0 V8	346	10/09→	→			13.0460-7255.2	607255	ATE 25114 15,8 - WE / - WK
5.0 V8	375	10/09→						
5.0 V8	405	06/13→						
<b>Warnkontakt, Bremsbelagverschleiß</b>								
2.0	177	05/12→	→		1	24.8190-0960.2	620960	L= 633
3.0	175	01/11→						
3.0	250	03/12→						
3.0 AWD	250	10/12→						
3.0 D	202	10/09→12/15						
5.0 V 8	283	10/09→						
3.0 D	221	04/15→	→	→ V90865	1	24.8190-0960.2	620960	L= 633
 <b>Bremsscheibe</b>								
2.0	177	05/12→	→	→ V39426		24.0120-0238.1	420238	Ø 326 20 18 V
3.0	175	01/11→						
3.0	250	03/12→	→	V39427→		24.0120-0238.1	420238	Ø 326 20 18 V
3.0 AWD	250	10/12→						
3.0 D	202	10/09→12/15						
5.0 V 8	283	10/09→						
3.0 D	221	04/15→	→	V39427→ V90865		24.0120-0238.1	420238	Ø 326 20 18 V
			→	→ V39426		24.0120-0238.1	420238	Ø 326 20 18 V
5.0 V8	346	10/09→	←			24.0136-0122.1	436122	Ø 380 36 34 V
5.0 V8	375	10/09→						
5.0 V8	405	06/13→	→			24.0126-0174.1	426174	Ø 376 26 24 V
<b>JAGUAR - XJ Coupe 09/73→03/96</b>								
 <b>Bremsbelagsatz, Scheibenbremse</b>								
6.0	222	05/93→03/96	←			13.0460-7138.2	607138	ATE 20968 17,5 + WE / - WK
			→			13.0460-7246.2	607246	ATE 21275 17,0 + WE / - WK
<b>Warnkontakt, Bremsbelagverschleiß</b>								
6.0	222	05/93→03/96	←		2	24.8190-1302.2	621302	L= 276
↓								















	kw			 	! #		
<b>JAGUAR - XJ Coupe 09/73→03/96</b>							
<b>Warnkontakt, Bremsbelagverschleiß</b>							
6.0	222	05/93→03/96	➡		2	24.8190-0970.2 620970	L= 434
<b> Brems Scheibe</b>							
6.0	222	05/93→03/96	←			24.0124-0174.1 424174	Ø 284 24,2 22,9 V
			➡			24.0110-0319.1 410319	Ø 295 10 8,8
<b>JAGUAR - XJSC Convertible (X27) 07/85→09/97</b>							
<b> Bremsbelagsatz, Scheibenbremse</b>							
4.0	171	07/94→03/96	←			13.0460-7138.2 607138	ATE 20968 17,5 + WE / - WK
			←	→ 11/94		13.0460-7138.2 607138	ATE 20968 17,5 + WE / - WK
			➡	→ 11/94		13.0460-7246.2 607246	ATE 21275 17,0 + WE / - WK
			➡			13.0460-7246.2 607246	ATE 21275 17,0 + WE / - WK
<b>Warnkontakt, Bremsbelagverschleiß</b>							
4.0	171	07/94→03/96	←	→ 11/94	2	24.8190-1302.2 621302	L= 276
			←		2	24.8190-1302.2 621302	L= 276
			➡		2	24.8190-0970.2 620970	L= 434
			➡	→ 11/94	2	24.8190-0970.2 620970	L= 434
<b> Brems Scheibe</b>							
4.0	171	07/94→03/96	←	→ 11/94		24.0123-0108.1 423108	Ø 295 22,5 21 V
			←			24.0128-0138.1 428138	Ø 291 28,1 26 V
			←			24.0124-0174.1 424174	Ø 284 24,2 22,9 V
			➡			24.0110-0319.1 410319	Ø 295 10 8,8
			➡	→ 11/94		24.0110-0319.1 410319	Ø 295 10 8,8
<b>JAGUAR - XK 8 Convertible (X100) 03/96→12/06</b>							
<b> Bremsbelagsatz, Scheibenbremse</b>							
4.0	209	03/96→12/02	←			13.0460-7138.2 607138	ATE 20968 17,5 + WE / - WK
4.0	267	02/98→07/05	➡			13.0460-7241.2 607241	ATE 20547 16,5 + WE / - WK
4.0 XKR	276	05/98→07/05	➡				
4.0	216	05/96→07/99	←	für Fahrzeuge ohne Sportpaket		13.0460-7138.2 607138	ATE 20968 17,5 + WE / - WK
			➡	für Fahrzeuge ohne Sportpaket		13.0460-7241.2 607241	ATE 20547 16,5 + WE / - WK
4.2 R 4,2	219 291	08/02→12/06 08/02→12/06	←	→ 07/05		13.0460-7138.2 607138	ATE 20968 17,5 + WE / - WK
			➡	→ 07/05		13.0460-7241.2 607241	ATE 20547 16,5 + WE / - WK
<b>Warnkontakt, Bremsbelagverschleiß</b>							
4.0	209	03/96→12/02	←		2	24.8190-1302.2 621302	L= 276
4.0	267	02/98→07/05					
4.0 XKR	276	05/98→07/05					
4.0	216	05/96→07/99	←	für Fahrzeuge ohne Sportpaket	2	24.8190-1302.2 621302	L= 276
4.2 R 4,2	219 291	08/02→12/06 08/02→12/06	←	→ 07/05	2	24.8190-1302.2 621302	L= 276
<b> Brems Scheibe</b>							
4.0	209	03/96→12/02	←	für Bremsscheibendurchmesser [mm]: 325		24.0128-0229.1 428229	Ø 325 28,3 26 V
4.0	267	02/98→07/05	←			24.0129-0100.1 429100	Ø 305 28,5 26 V
4.0 XKR	276	05/98→07/05	➡			24.0120-0188.1 420188	Ø 305 20 18,5 V
4.0	216	05/96→07/99	←	für Fahrzeuge ohne Sportpaket; für Bremsscheibendurchmesser [mm]: 325		24.0128-0229.1 428229	Ø 325 28,3 26 V
			←	für Fahrzeuge ohne Sportpaket		24.0129-0100.1 429100	Ø 305 28,5 26 V
			➡	für Fahrzeuge ohne Sportpaket		24.0120-0188.1 420188	Ø 305 20 18,5 V
4.2 R 4,2	219 291	08/02→12/06 08/02→12/06	←	→ 07/05; für Bremsscheibendurchmesser [mm]: 325		24.0128-0229.1 428229	Ø 325 28,3 26 V
			←	→ 07/05		24.0129-0100.1 429100	Ø 305 28,5 26 V
			➡	→ 07/05		24.0120-0188.1 420188	Ø 305 20 18,5 V

















	kw			 	! #		
<b>JAGUAR - XK 8 Coupe (X100) 03/96→12/06</b>							
 <b>Bremsbelagsatz, Scheibenbremse</b>							
4.0	209	03/96→07/05	←			<b>13.0460-7138.2 607138</b>	ATE 20968 17,5 + WE / - WK
4.0	267	02/98→07/05					
4.0 XKR	276	05/98→07/05	→			<b>13.0460-7241.2 607241</b>	ATE 20547 16,5 + WE / - WK
4.2	219	08/02→07/05					
R 4,2	291	08/02→07/05					
4.0	216	05/96→07/05	←	→ 07/99; für Fahrzeuge ohne Sportpaket		<b>13.0460-7138.2 607138</b>	ATE 20968 17,5 + WE / - WK
			→	→ 07/99; für Fahrzeuge ohne Sportpaket		<b>13.0460-7241.2 607241</b>	ATE 20547 16,5 + WE / - WK
<b>Warnkontakt, Bremsbelagverschleiß</b>							
4.0	209	03/96→07/05	←		2	<b>24.8190-1302.2 621302</b>	L= 276
4.0	267	02/98→07/05					
4.0 XKR	276	05/98→07/05					
4.2	219	08/02→07/05					
R 4,2	291	08/02→07/05					
4.0	216	05/96→07/05	←	→ 07/99; für Fahrzeuge ohne Sportpaket	2	<b>24.8190-1302.2 621302</b>	L= 276
 <b>Bremsscheibe</b>							
4.0	209	03/96→07/05	←	für Bremsscheibendurchmesser [mm]: 325		<b>24.0128-0229.1 428229</b>	Ø 325 28,3 26 V
4.0	267	02/98→07/05					
4.0 XKR	276	05/98→07/05	←			<b>24.0129-0100.1 429100</b>	Ø 305 28,5 26 V
4.2	219	08/02→07/05	←			<b>24.0120-0188.1 420188</b>	Ø 305 20 18,5 V
R 4,2	291	08/02→07/05	→				
4.0	216	05/96→07/05	←	→ 07/99; für Fahrzeuge ohne Sportpaket; für Bremsscheibendurchmesser [mm]: 325		<b>24.0128-0229.1 428229</b>	Ø 325 28,3 26 V
			←	→ 07/99; für Fahrzeuge ohne Sportpaket		<b>24.0129-0100.1 429100</b>	Ø 305 28,5 26 V
			→	→ 07/99; für Fahrzeuge ohne Sportpaket		<b>24.0120-0188.1 420188</b>	Ø 305 20 18,5 V
<b>JAGUAR - XK Cabriolet (X150) 03/06→07/14</b>							
 <b>Bremsbelagsatz, Scheibenbremse</b>							
3.6	190	10/07→07/14	←	→ B00378		<b>13.0460-7292.2 607292</b>	ATE 24084 19,3 + WE / - WK
4.2	291	09/07→12/09					
4.2 XK8	219	03/06→07/14					
4.2 XKR	306	03/06→07/14					
4.2 XKR	313	08/06→07/14					
5.0 V8	283	01/09→07/14					
5.0 XKR	375	01/09→07/14	→	→ B32752		<b>13.0460-7209.2 607209</b>	ATE 23482 16,6 - WE / - WK
			→	B32753→; nicht für Ausstattungsvariante: Alcon-Bremse		<b>13.0460-7255.2 607255</b>	ATE 25114 15,8 - WE / - WK
5.0 XKR-S	405	01/11→07/14	→	nicht für Ausstattungsvariante: Alcon-Bremse		<b>13.0460-7255.2 607255</b>	ATE 25114 15,8 - WE / - WK
<b>Warnkontakt, Bremsbelagverschleiß</b>							
5.0 XKR	375	01/09→07/14	→	→ B32752	1	<b>24.8190-0960.2 620960</b>	L= 633
			→	B32753→	1	<b>24.8190-0960.2 620960</b>	L= 633
5.0 XKR-S	405	01/11→07/14	→		1	<b>24.8190-0960.2 620960</b>	L= 633
 <b>Bremsscheibe</b>							
5.0 XKR	375	01/09→07/14	←			<b>24.0136-0122.1 436122</b>	Ø 380 36 34 V
5.0 XKR-S	405	01/11→07/14	→			<b>24.0126-0174.1 426174</b>	Ø 376 26 24 V
<b>JAGUAR - XK Coupe (X150) 03/06→07/14</b>							
 <b>Bremsbelagsatz, Scheibenbremse</b>							
3.6	190	07/07→07/14	←	→ B00378		<b>13.0460-7292.2 607292</b>	ATE 24084 19,3 + WE / - WK
4.2 XK8	219	03/06→07/14					
4.2 XKR	291	03/06→07/14					
4.2 XKR	306	03/06→07/14					
4.2 XKR	313	08/06→07/14					
5.0 V8	283	01/09→07/14					
5.0 XKR	375	01/09→07/14	→	→ B32752		<b>13.0460-7209.2 607209</b>	ATE 23482 16,6 - WE / - WK
5.0 XKR	390	09/10→07/14	→	B32753→; nicht für Ausstattungsvariante: Alcon-Bremse		<b>13.0460-7255.2 607255</b>	ATE 25114 15,8 - WE / - WK
5.0 XKR-S	405	01/11→07/14	→	nicht für Ausstattungsvariante: Alcon-Bremse		<b>13.0460-7255.2 607255</b>	ATE 25114 15,8 - WE / - WK
<b>Warnkontakt, Bremsbelagverschleiß</b>							
5.0 XKR	375	01/09→07/14	→	→ B32752	1	<b>24.8190-0960.2 620960</b>	L= 633
5.0 XKR	390	09/10→07/14					















	kw			 	! #		
<b>JAGUAR - XK Coupe (X150) 03/06→07/14</b>							
<b>Warnkontakt, Bremsbelagverschleiß</b>							
5.0 XKR	375	01/09→07/14	➡	B32753→	1	24.8190-0960.2 620960	L= 633
5.0 XKR	390	09/10→07/14					
5.0 XKR-S	405	01/11→07/14	➡		1	24.8190-0960.2 620960	L= 633
<b> Brems Scheibe</b>							
5.0 XKR	375	01/09→07/14	←			24.0136-0122.1 436122	Ø 380 36 34 V
5.0 XKR	390	09/10→07/14					
5.0 XKR-S	405	01/11→07/14	➡			24.0126-0174.1 426174	Ø 376 26 24 V
<b>JAGUAR - X-TYPE (X400) 03/01→11/09</b>							
<b> Bremsbelagsatz, Scheibenbremse</b>							
2.0 D	96	07/03→11/09	←	→ J04730		13.0460-3987.2 603987	BOS 23279 18,4 - WE / - WK
2.2 D	107	01/07→11/09				13.0470-3987.2 LD3987	BOS 23279 18,4 - WE / - WK
2.2 D	110	10/05→11/09					Ceramic
2.2 D	114	10/05→11/09					
2.5 V6 Allrad	144	06/01→11/09	➡	E73994→		13.0460-3831.2 603831	BOS 24260 17,3 - WE / - WK + Zub
						13.0470-3831.2 LD3831	BOS 24260 17,3 - WE / - WK + Zub Ceramic
			➡	→ E73993		13.0460-3988.2 603988	BOS 23557 17,2 - WE / - WK
						13.0470-3988.2 LD3988	BOS 23557 17,2 - WE / - WK Ceramic
2.1 V6	115	03/02→11/09	←	→ J04730		13.0460-3987.2 603987	BOS 23279 18,4 - WE / - WK
						13.0470-3987.2 LD3987	BOS 23279 18,4 - WE / - WK Ceramic
			➡	E73994→; → 10/05		13.0460-3831.2 603831	BOS 24260 17,3 - WE / - WK + Zub
						13.0470-3831.2 LD3831	BOS 24260 17,3 - WE / - WK + Zub Ceramic
			➡	→ E73993		13.0460-3988.2 603988	BOS 23557 17,2 - WE / - WK
						13.0470-3988.2 LD3988	BOS 23557 17,2 - WE / - WK Ceramic
3.0 V6 Allrad	169	06/01→12/08	←	→ J04730		13.0460-3987.2 603987	BOS 23279 18,4 - WE / - WK
						13.0470-3987.2 LD3987	BOS 23279 18,4 - WE / - WK Ceramic
			➡	E73994→; → 11/07		13.0460-3831.2 603831	BOS 24260 17,3 - WE / - WK + Zub
						13.0470-3831.2 LD3831	BOS 24260 17,3 - WE / - WK + Zub Ceramic
			➡	→ E73993		13.0460-3988.2 603988	BOS 23557 17,2 - WE / - WK
						13.0470-3988.2 LD3988	BOS 23557 17,2 - WE / - WK Ceramic
<b> Brems Scheibe</b>							
2.0 D	96	07/03→11/09	←	J52301→		24.0124-0161.1 424161	Ø 300 23,9 22 V
2.2 D	107	01/07→11/09				24.0324-0161.1 524161	Ø 300 23,9 22 V
2.2 D	110	10/05→11/09					
2.2 D	114	10/05→11/09	←	→ J52300		24.0124-0161.1 424161	Ø 300 23,9 22 V
2.5 V6 Allrad	144	06/01→11/09				24.0324-0161.1 524161	Ø 300 23,9 22 V
			➡	→ J52300		24.0112-0154.1 412154	Ø 280 12 10
						24.0312-0154.1 512154	Ø 280 12 10
			➡	J52301→		24.0112-0154.1 412154	Ø 280 12 10
						24.0312-0154.1 512154	Ø 280 12 10
2.1 V6	115	03/02→11/09	←	J52301→; → 10/05		24.0124-0161.1 424161	Ø 300 23,9 22 V
						24.0324-0161.1 524161	Ø 300 23,9 22 V
			←	→ J52300		24.0124-0161.1 424161	Ø 300 23,9 22 V
						24.0324-0161.1 524161	Ø 300 23,9 22 V
			➡	→ J52300		24.0112-0154.1 412154	Ø 280 12 10
						24.0312-0154.1 512154	Ø 280 12 10
			➡	J52301→; → 10/05		24.0112-0154.1 412154	Ø 280 12 10
						24.0312-0154.1 512154	Ø 280 12 10
3.0 V6 Allrad	169	06/01→12/08	←	J52301→; → 11/07		24.0124-0161.1 424161	Ø 300 23,9 22 V
						24.0324-0161.1 524161	Ø 300 23,9 22 V
			←	→ J52300		24.0124-0161.1 424161	Ø 300 23,9 22 V
						24.0324-0161.1 524161	Ø 300 23,9 22 V
			➡	→ J52300		24.0112-0154.1 412154	Ø 280 12 10
						24.0312-0154.1 512154	Ø 280 12 10
			➡	J52301→; → 11/07		24.0112-0154.1 412154	Ø 280 12 10
						24.0312-0154.1 512154	Ø 280 12 10

	kw			 	! #		
<b>JAGUAR - X-TYPE Kombi (X400) 09/03→12/09</b>							
 <b>Bremsbelagsatz, Scheibenbremse</b>							
2.0 D	96	02/04→12/09	←	→ J04730		13.0460-3987.2 603987	BOS 23279 18,4 - WE / - WK
2.1 V6	115	11/03→03/09				13.0470-3987.2 LD3987	BOS 23279 18,4 - WE / - WK
2.2 D	107	01/07→12/09					Ceramic
2.2 D	110	10/05→12/09					
2.2 D	114	10/05→12/09	→	E73994→		13.0460-3831.2 603831	BOS 24260 17,3 - WE / - WK + Zub
2.5	144	02/04→12/09					
3.0	169	02/04→12/09				13.0470-3831.2 LD3831	BOS 24260 17,3 - WE / - WK + Zub Ceramic
			→	E73993		13.0460-3988.2 603988	BOS 23557 17,2 - WE / - WK
						13.0470-3988.2 LD3988	BOS 23557 17,2 - WE / - WK Ceramic
 <b>Bremsscheibe</b>							
2.0 D	96	02/04→12/09	←	J52301→		24.0124-0161.1 424161	Ø 300 23,9 22 V
2.1 V6	115	11/03→03/09				24.0324-0161.1 524161	Ø 300 23,9 22 V
2.2 D	107	01/07→12/09					
2.2 D	110	10/05→12/09	←	→ J52300		24.0124-0161.1 424161	Ø 300 23,9 22 V
2.2 D	114	10/05→12/09				24.0324-0161.1 524161	Ø 300 23,9 22 V
2.5	144	02/04→12/09	→	J52301→		24.0112-0154.1 412154	Ø 280 12 10
3.0	169	02/04→12/09				24.0312-0154.1 512154	Ø 280 12 10
			→	→ J52300		24.0112-0154.1 412154	Ø 280 12 10
						24.0312-0154.1 512154	Ø 280 12 10
<b>JEEP - CHEROKEE (KJ) 03/01→01/08</b>							
 <b>Bremsbelagsatz, Scheibenbremse</b>							
2.4 4x4	108	09/01→01/08	←			13.0460-2899.2 602899	TRW 23638 17,5 + WK
2.4 Laredo	108	10/01→09/04					
2.5 CRD 4x4	105	09/01→01/08					
2.8 CRD 4x4	110	11/02→01/08					
2.8 CRD 4x4	120	11/04→01/08					
3.7 4x4	150	08/03→01/08					
3.7 4x4	155	09/01→01/08					
3.7 Laredo	150	10/01→09/04					
3.7 4x4	157	09/01→10/07	←	10/04→		13.0460-2899.2 602899	TRW 23638 17,5 + WK
 <b>Bremsscheibe</b>							
2.4 4x4	108	09/01→01/08	←			24.0128-0708.1 428708	Ø 288 28 26 V
2.4 Laredo	108	10/01→09/04					
2.5 CRD 4x4	105	09/01→01/08					
2.8 CRD 4x4	110	11/02→01/08					
2.8 CRD 4x4	120	11/04→01/08					
3.7 4x4	150	08/03→01/08					
3.7 4x4	155	09/01→01/08					
3.7 Laredo	150	10/01→09/04					
3.7 4x4	157	09/01→10/07	←	10/04→		24.0128-0708.1 428708	Ø 288 28 26 V
<b>JEEP - CHEROKEE (KK) 01/08→</b>							
 <b>Bremsbelagsatz, Scheibenbremse</b>							
2.8 CRD 4x4	130	05/08→	←	→ 12/12; für Fahrzeuge ohne verstärktes Fahrwerk		13.0460-8013.2 608013	BOS 24604 16,5 + WK
2.8 CRD 4x4	147	01/10→					
3.7 V6	157	01/08→	→	→ 12/12		13.0460-5629.2 605629	24602 16,0 + WK
3.7 V6 4x4	151	01/08→					
3.7 V6 4x4	157	01/08→	←	für Fahrzeuge ohne verstärktes Fahrwerk		13.0460-8013.2 608013	BOS 24604 16,5 + WK
			→			13.0460-5629.2 605629	24602 16,0 + WK
 <b>Bremsscheibe</b>							
2.8 CRD 4x4	130	05/08→	←	01/10→ 12/12; für Fahrzeuge mit verstärktem Fahrwerk		24.0128-0259.1 428259	Ø 332 28 26,4 V
3.7 V6	157	01/08→					
3.7 V6 4x4	151	01/08→	←	→ 12/12; für Fahrzeuge ohne verstärktes Fahrwerk		24.0128-0270.1 428270	Ø 302 28 26,4 V
2.8 CRD 4x4	147	01/10→	←	→ 12/12; für Fahrzeuge mit verstärktem Fahrwerk		24.0128-0259.1 428259	Ø 332 28 26,4 V
			←	→ 12/12; für Fahrzeuge ohne verstärktes Fahrwerk		24.0128-0270.1 428270	Ø 302 28 26,4 V
3.7 V6 4x4	157	01/08→	←	01/10→; für Fahrzeuge mit verstärktem Fahrwerk		24.0128-0259.1 428259	Ø 332 28 26,4 V
			←	für Fahrzeuge ohne verstärktes Fahrwerk		24.0128-0270.1 428270	Ø 302 28 26,4 V
<b>JEEP - CHEROKEE (KL) 11/13→</b>							
 <b>Bremsscheibe</b>							
2.0 CRD	103	04/14→	←			24.0128-0191.1 428191	Ø 330 28 26 V + S
↓							



































	kw			 	! #		
<b>JEEP - CHEROKEE (KL) 11/13→</b>							
 <b>Bremsscheibe</b>							
2.0 CRD 4x4	103	04/14→	➔	BRF		24.0112-0214.1 412214	Ø 278 12 10,4 + S
2.0 CRD 4x4	125	04/14→	➔	BRG/BR6		24.0112-0215.1 412215	Ø 320 12 10,4 + S
2.2 CRD 4x4	136	08/15→					
2.2 CRD 4x4	147	08/15→					
3.2 V6 4x4	200	11/13→					
<b>JEEP - CHEROKEE (XJ) 09/83→09/01</b>							
 <b>Bremsscheibe</b>							
2.1 TD	64	10/84→09/01	←	01/94→ 01/99		24.0124-0702.1 424702	Ø 280 24 22,7 V
4.0 i	135	12/91→09/01	←			24.0124-0702.1 424702	Ø 280 24 22,7 V
4.0 i	136	01/88→09/01					
2.5	89	10/95→09/01	←	10/96→		24.0124-0702.1 424702	Ø 280 24 22,7 V
2.5 i 4x4	90	12/91→09/01	←	→ 12/93		24.0124-0702.1 424702	Ø 280 24 22,7 V
			←	10/96→		24.0124-0702.1 424702	Ø 280 24 22,7 V
2.5 TD 4x4	85	01/88→09/01	←	→ 12/89		24.0122-0181.1 422181	Ø 280 22,2 20,7 V
			←	01/94→ 01/99		24.0124-0702.1 424702	Ø 280 24 22,7 V
			←	01/90→ 12/93		24.0124-0702.1 424702	Ø 280 24 22,7 V
2.5 Tdi 4x4	85	10/96→09/01	←			24.0124-0702.1 424702	Ø 280 24 22,7 V
4.0 i	127	07/98→09/01	←			24.0124-0702.1 424702	Ø 280 24 22,7 V
4.0 i	135	02/99→09/01					
4.0 i 4x4	131	01/95→09/01					
4.0 i	125	10/90→09/01					
<b>JEEP - COMANCHE (MJ) 09/85→09/96</b>							
 <b>Bremsscheibe</b>							
4.0	127	10/90→09/96	←	01/94→		24.0124-0702.1 424702	Ø 280 24 22,7 V
4.0	130	10/90→09/96	←				
<b>JEEP - COMMANDER (XK, XH) 09/05→12/10</b>							
 <b>Bremsscheibe</b>							
3.0 CRD 4x4	160	04/06→12/10	←			24.0130-0223.1 430223	Ø 328 30 28,5 V
3.7 V6 4x4	157	09/05→12/10	➔			24.0114-0118.1 414118	Ø 320 14 12,5
4.7 V8 4x4	170	09/05→12/10					
5.7 V8 4x4	240	09/05→12/10					
<b>JEEP - COMPASS (MK49) 08/06→</b>							
 <b>Bremsbelagsatz, Scheibenbremse</b>							
2.0	115	05/11→	←			13.0460-5760.2 605760	AKE 23584 16,4 + WK
2.2 CRD	100	05/11→	➔	passend für Felgenreöße [Zoll]: 17		13.0460-5735.2 605735	AKE 24014 16,0 + WK
2.2 CRD 4x4	120	12/10→					
2.2 CRD 4x4	100	05/11→	➔	passend für Felgenreöße [Zoll]: 18		13.0460-5855.2 605855	23582 16,0 - WK
2.0 CRD	103	08/06→	←	passend für Felgenreöße [Zoll]: 17		13.0460-5760.2 605760	AKE 23584 16,4 + WK
2.0 CRD 4x4	103	09/06→	➔			13.0460-5735.2 605735	AKE 24014 16,0 + WK
2.4 4x4	125	09/06→					
2.4	125	08/06→	←	09/06→;		13.0460-5760.2 605760	AKE 23584 16,4 + WK
			➔	passend für Felgenreöße [Zoll]: 17		13.0460-5735.2 605735	AKE 24014 16,0 + WK
 <b>Bremsscheibe</b>							
2.0	115	05/11→	←			24.0126-0170.1 426170	Ø 294 26 24,4 V
2.2 CRD	100	05/11→	➔	passend für Felgenreöße [Zoll]: 17		24.0110-0363.1 410363	Ø 262 10 8,4
2.2 CRD 4x4	120	12/10→					
2.2 CRD 4x4	100	05/11→	➔	passend für Felgenreöße [Zoll]: 18		24.0110-0372.1 410372	Ø 302 10 8,4
2.0 CRD	103	08/06→	←			24.0126-0170.1 426170	Ø 294 26 24,4 V
2.0 CRD 4x4	103	09/06→	➔			24.0110-0363.1 410363	Ø 262 10 8,4
2.4 4x4	125	09/06→					
2.4	125	08/06→	←	09/06→		24.0126-0170.1 426170	Ø 294 26 24,4 V
			➔	09/06→		24.0110-0363.1 410363	Ø 262 10 8,4
<b>JEEP - GRAND CHEROKEE I (ZJ) 09/91→04/99</b>							
 <b>Bremsscheibe</b>							
2.5 TD 4x4 (Z)	85	10/95→04/99	←			24.0124-0702.1 424702	Ø 280 24 22,7 V
2.5 TD Laredo	85	10/96→09/98	←			24.0124-0702.1 424702	Ø 280 24 22,7 V
4.0 i 4x4 (Z)	130	10/95→04/99					
4.0 Laredo	131	10/96→09/98					
5.2	164	10/96→09/98					
5.2 4x4	164	10/96→09/98					
5.2 4x4 (Z)	156	10/95→04/99					
5.2 Limited 4x4	136	10/96→09/98					
↓							

















	kW				! #		
<b>JEEP - GRAND CHEROKEE I (ZJ) 09/91→04/99</b>							
 <b>Bremsscheibe</b>							
5.9 i 4x4	177	08/97→04/99	←			24.0124-0702.1 424702	Ø 280 24 22,7 V
4.0 i 4x4 (ZJ)	132	09/91→04/99	←	01/94→		24.0124-0702.1 424702	Ø 280 24 22,7 V
4.0 i 4x4 (ZJ)	135	09/91→04/99	←	01/93→ 12/93		24.0124-0702.1 424702	Ø 280 24 22,7 V
5.2 i 4x4 (ZJ)	155	01/92→04/99	←			24.0124-0702.1 424702	Ø 280 24 22,7 V
5.2 i 4x4 (ZJ)	158	09/92→04/99	←			24.0124-0702.1 424702	Ø 280 24 22,7 V
<b>JEEP - GRAND CHEROKEE II (WJ, WG) 09/98→09/05</b>							
 <b>Bremsbelagsatz, Scheibenbremse</b>							
2.7 CRD 4x4	120	10/01→09/05	←	→ 09/02		13.0460-7206.2 607206	ATE 23631 17,8 + WK
4.0	140	10/98→09/04	←			13.0460-7206.2 607206	ATE 23631 17,8 + WK
4.0 4x4	140	04/99→09/05	←			13.0460-7206.2 607206	ATE 23631 17,8 + WK
4.7 V8 4x4	190	10/01→09/05	←			13.0460-7206.2 607206	ATE 23631 17,8 + WK
3.1 TD 4x4	103	04/99→12/01	←			13.0460-7206.2 607206	ATE 23631 17,8 + WK
4.7 V8 4x4	162	04/99→08/00	←			13.0460-7206.2 607206	ATE 23631 17,8 + WK
4.7 V8 4x4	164	04/99→09/05	←	08/00→ 09/02		13.0460-7206.2 607206	ATE 23631 17,8 + WK
 <b>Bremsscheibe</b>							
2.7 CRD 4x4	120	10/01→09/05	←			24.0126-0130.1 426130	Ø 305 26 24,5 V
2.7 CRD 4x4	120	10/04→09/05	→			24.0110-0299.1 410299	Ø 305 10 8,5
2.7 CRD Laredo	120	10/04→09/05	→			24.0110-0299.1 410299	Ø 305 10 8,5
3.1 TD 4x4	103	04/99→12/01	→			24.0110-0299.1 410299	Ø 305 10 8,5
4.0 4x4	140	04/99→09/05	→			24.0110-0299.1 410299	Ø 305 10 8,5
4.7 V8 4x4	162	04/99→08/00	→			24.0110-0299.1 410299	Ø 305 10 8,5
4.7 V8 4x4	167	06/03→09/05	→			24.0110-0299.1 410299	Ø 305 10 8,5
4.7 V8 4x4	190	10/01→09/05	→			24.0110-0299.1 410299	Ø 305 10 8,5
4.0	140	10/98→09/04	←	04/99→		24.0126-0130.1 426130	Ø 305 26 24,5 V
			→	04/99→		24.0110-0299.1 410299	Ø 305 10 8,5
4.7 V8 4x4	164	04/99→09/05	←	08/00→		24.0126-0130.1 426130	Ø 305 26 24,5 V
			→	08/00→		24.0110-0299.1 410299	Ø 305 10 8,5
<b>JEEP - GRAND CHEROKEE III (WH, WK) 10/04→10/11</b>							
 <b>Bremsscheibe</b>							
3.0 CRD	160	06/05→12/10	←			24.0130-0223.1 430223	Ø 328 30 28,5 V
3.0 CRD 4x4	155	05/06→12/10	←			24.0130-0223.1 430223	Ø 328 30 28,5 V
3.0 CRD 4x4	160	06/05→12/10	→			24.0114-0118.1 414118	Ø 320 14 12,5
3.7 V6	157	10/04→12/10	→			24.0114-0118.1 414118	Ø 320 14 12,5
3.7 V6 4x4	148	01/08→12/10	→			24.0114-0118.1 414118	Ø 320 14 12,5
3.7 V6 4x4	157	10/04→12/10	→			24.0114-0118.1 414118	Ø 320 14 12,5
4.7 V8 4x4	164	06/05→12/10	→			24.0114-0118.1 414118	Ø 320 14 12,5
4.7 V8 4x4	170	06/05→12/10	→			24.0114-0118.1 414118	Ø 320 14 12,5
5.7 V8 4x4	240	06/05→12/10	→			24.0114-0118.1 414118	Ø 320 14 12,5
5.7 V8 4x4	259	01/09→12/10	→			24.0114-0118.1 414118	Ø 320 14 12,5
4.7 V8 4x4	223	09/07→02/10	←	→ 12/08		24.0130-0223.1 430223	Ø 328 30 28,5 V
			→	→ 12/08		24.0114-0118.1 414118	Ø 320 14 12,5
4.7 V8 FLEX	167	10/04→05/10	←	06/05→		24.0130-0223.1 430223	Ø 328 30 28,5 V
			→	06/05→		24.0114-0118.1 414118	Ø 320 14 12,5
<b>JEEP - GRAND CHEROKEE IV (WK, WK2) 06/10→</b>							
 <b>Bremsbelagsatz, Scheibenbremse</b>							
3.0 CRD V6 4x4	140	02/11→	←	für Individualausstattungs-ID: BR1/BR6 / BRY		13.0460-7282.2 607282	ATE 25190 21,3 - WK / + WK
3.0 CRD V6 4x4	177	02/11→	←	für Individualausstattungs-ID: BR1/BR6 / BRY		13.0460-7282.2 607282	ATE 25190 21,3 - WK / + WK
3.0 CRD V6 4x4	184	07/13→	←			13.0470-7282.2 LD7282	ATE 25190 21,3 - WK / + WK Ceramic
3.6 V6 4x4	210	11/10→	←			13.0470-7282.2 LD7282	ATE 25190 21,3 - WK / + WK Ceramic
5.7 V8 4x4	259	11/10→	←	für Individualausstattungs-ID: BR1/BR6 / BRY		13.0460-7282.2 607282	ATE 25190 21,3 - WK / + WK
6.4 SRT8 4x4	344	03/11→	←	für Individualausstattungs-ID: BR1/BR6 / BRY		13.0460-7282.2 607282	ATE 25190 21,3 - WK / + WK
 <b>Bremsscheibe</b>							
3.0 CRD V6 4x4	140	02/11→	←	passend für Felgenreöße [Zoll]: 17; für Individualausstattungs-ID: BRY		24.0132-0181.1 432181	Ø 330 32 30,5 V
3.0 CRD V6 4x4	177	02/11→	←	passend für Felgenreöße [Zoll]: 17		24.0114-0120.1 414120	Ø 330 14 12,5
3.0 CRD V6 4x4	184	07/13→	→			24.0114-0120.1 414120	Ø 330 14 12,5
3.6 V6 4x4	210	11/10→	→			24.0114-0120.1 414120	Ø 330 14 12,5
3.6 V6 FlexFuel 4x4	210	11/10→	→			24.0114-0120.1 414120	Ø 330 14 12,5
5.7 V8 4x4	259	11/10→	→			24.0114-0120.1 414120	Ø 330 14 12,5
6.4 SRT8 4x4	344	03/11→	→			24.0114-0120.1 414120	Ø 330 14 12,5
<b>JEEP - PATRIOT (MK74) 02/07→</b>							
 <b>Bremsbelagsatz, Scheibenbremse</b>							
2.0	115	01/11→	→	+ ABS		13.0460-5855.2 605855	23582 16,0 - WK
2.0 4x4	115	02/07→	→			13.0460-5855.2 605855	23582 16,0 - WK
2.0 CRD	103	02/07→	→			13.0460-5855.2 605855	23582 16,0 - WK
↓							













	kW			 	! #		
<b>JEEP - PATRIOT (MK74) 02/07→</b>							
 <b>Bremsbelagsatz, Scheibenbremse</b>							
2.0 CRD 4x4 2.4 2.4 4x4 2.4 Eco + 4x4	103 125 125 125	02/07→ 06/09→ 01/08→ 07/08→	→	+ ABS		13.0460-5855.2 605855	23582 16,0 - WK
2.2 CRD 4x4	100	01/11→	←			13.0460-5760.2 605760	AKE 23584 16,4 + WK
			→	+ ABS		13.0460-5735.2 605735	AKE 24014 16,0 + WK
			→	passend für Felgengröße [Zoll]: 18; + ABS		13.0460-5855.2 605855	23582 16,0 - WK
2.2 CRD 4x4	120	01/11→	→	+ ABS		13.0460-5735.2 605735	AKE 24014 16,0 + WK
			→	passend für Felgengröße [Zoll]: 18; + ABS		13.0460-5855.2 605855	23582 16,0 - WK
 <b>Bremsscheibe</b>							
2.0 2.0 CRD 2.0 CRD 4x4 2.4 2.4 4x4 2.4 Eco + 4x4	115 103 103 125 125 125	01/11→ 02/07→ 02/07→ 06/09→ 01/08→ 07/08→	←			24.0126-0170.1 426170	Ø 294 26 24,4 V
			→	+ ABS		24.0110-0372.1 410372	Ø 302 10 8,4
2.0 4x4	115	02/07→	←			24.0126-0170.1 426170	Ø 294 26 24,4 V
			→	02/17→; + ABS		24.0110-0372.1 410372	Ø 302 10 8,4
2.2 CRD 4x4 2.2 CRD 4x4	100 120	01/11→ 01/11→	←			24.0126-0170.1 426170	Ø 294 26 24,4 V
			→	passend für Felgengröße [Zoll]: 17; + ABS		24.0110-0363.1 410363	Ø 262 10 8,4
			→	passend für Felgengröße [Zoll]: 18; + ABS		24.0110-0372.1 410372	Ø 302 10 8,4
<b>JEEP - RENEGADE Geländewagen geschlossen (BU, B1) 07/14→</b>							
 <b>Bremsbelagsatz, Scheibenbremse</b>							
1.4 1.4 4x4 1.6 2.0 CRD 4x4 2.0 CRD 4x4	103 125 81 103 125	07/14→ 07/14→ 07/14→ 07/14→ 07/14→	←			13.0460-5662.2 605662	MAN 22165 20,7 + WK
			→			13.0460-2602.2 602602	TRW 22304 17,3 + WK + Zub
1.6 CRD 2.0 CRD 4x4	88 88	07/14→ 07/14→	←			13.0460-7311.2 607311	ATE 22240 19,2 + WK
			→			13.0460-2602.2 602602	TRW 22304 17,3 + WK + Zub
 <b>Bremsscheibe</b>							
1.4 1.4 4x4 1.6 2.0 CRD 4x4 2.0 CRD 4x4	103 125 81 103 125	07/14→ 07/14→ 07/14→ 07/14→ 07/14→	←			24.0128-0292.1 428292	Ø 305 28 26 V + S
			→			24.0112-0170.1 412170	Ø 278 12 10 + S
1.6 CRD 2.0 CRD 4x4	88 88	07/14→ 07/14→	←			24.0126-0168.1 426168	Ø 281 26,2 24,2 V + S
			→			24.0112-0170.1 412170	Ø 278 12 10 + S
<b>JEEP - WRANGLER I (YJ, SJ_) 08/86→08/96</b>							
 <b>Bremsscheibe</b>							
2.5 4.0	89 131	12/91→08/96 12/91→08/96	←			24.0124-0702.1 424702	Ø 280 24 22,7 V
<b>JEEP - WRANGLER II (TJ) 08/96→12/08</b>							
 <b>Bremsscheibe</b>							
2.5	87	08/96→04/07	←	→ 12/98		24.0124-0702.1 424702	Ø 280 24 22,7 V
<b>JEEP - WRANGLER III (JK) 06/06→</b>							
 <b>Bremsbelagsatz, Scheibenbremse</b>							
2.8 CRD 2.8 CRD 3.6 V6 3.8	130 147 209 146	04/07→ 11/10→ 10/11→ 04/07→	←	für Fahrzeuge ohne verstärktes Fahrwerk		13.0460-8013.2 608013	BOS 24604 16,5 + WK
			→			13.0460-5629.2 605629	24602 16,0 + WK
2.8 CRD RWD	130	04/07→02/10	←	→ 04/07; für Fahrzeuge ohne verstärktes Fahrwerk		13.0460-8013.2 608013	BOS 24604 16,5 + WK
			→	→ 04/07		13.0460-5629.2 605629	24602 16,0 + WK
 <b>Bremsscheibe</b>							
2.8 CRD 2.8 CRD 3.6 V6 ↓	130 147 209	04/07→ 11/10→ 10/11→	→			24.0112-0193.1 412193	Ø 316 12 10,4

	kW					! #		
<b>JEEP - WRANGLER III (JK) 06/06→</b>								
 <b>Bremsscheibe</b>								
3.8	146	04/07→	→			24.0112-0193.1	412193	Ø 316 12 10,4
2.8 CRD RWD	130	04/07→02/10	→	→ 04/07		24.0112-0193.1	412193	Ø 316 12 10,4
<b>KIA - BESTA Bus 07/92→12/03</b>								
 <b>Bremsbelagsatz, Scheibenbremse</b>								
2.2 D	48	07/92→12/03	←	02/96→		13.0460-5806.2	605806	20002 15,0 + WK
<b>KIA - BESTA Kasten 01/93→12/03</b>								
 <b>Bremsbelagsatz, Scheibenbremse</b>								
2.2 D	48	02/96→12/03	←			13.0460-5806.2	605806	20002 15,0 + WK
2.4 D	51	07/93→12/03	←	11/97→		13.0460-5806.2	605806	20002 15,0 + WK
<b>KIA - BONGO Pritsche/Fahrgestell 10/03→</b>								
 <b>Bremsbelagsatz, Scheibenbremse</b>								
2.4 TDi	69	10/03→	←	→ 12/10		13.0460-5806.2	605806	20002 15,0 + WK
2.9 TDiC	90	10/03→						
2.9 TDiC 4WD	90	10/03→						
2.5 CRDi	98	01/12→	←			13.0460-5806.2	605806	20002 15,0 + WK
<b>KIA - CARENS I (FC) 06/99→10/02</b>								
 <b>Bremsbelagsatz, Scheibenbremse</b>								
1.8 i	81	11/00→07/02	←	→ 06/02		13.0460-5868.2	605868	SUM 23873 15,8 + WK
			→	→ 06/02; + ABS		13.0460-5871.2	605871	SUM 23455 13,7 + WK
1.8 i 16V	81	03/00→05/02	←	11/00→		13.0460-5868.2	605868	SUM 23873 15,8 + WK
			→	11/00→; + ABS		13.0460-5871.2	605871	SUM 23455 13,7 + WK
 <b>Bremsscheibe</b>								
1.8 i	81	11/00→07/02	←	→ 06/02		24.0124-0173.1	424173	Ø 258 24 22 V
			→	→ 06/02; + ABS		24.0110-0308.1	410308	Ø 261 10 8 + S
1.8 i 16V	81	03/00→05/02	←	11/00→		24.0124-0173.1	424173	Ø 258 24 22 V
			→	11/00→; + ABS		24.0110-0308.1	410308	Ø 261 10 8 + S
<b>KIA - CARENS II Großraumlimousine (FJ) 07/02→</b>								
 <b>Bremsbelagsatz, Scheibenbremse</b>								
1.6	77	07/02→	←	→ 04/06		13.0460-5742.2	605742	MAN 23966 17,7 + WK
1.8	93	07/02→	→	→ 04/06; + ABS		13.0460-5871.2	605871	SUM 23455 13,7 + WK
2.0 CRDi	83	07/02→						
2.0 CRDi	103	11/05→						
2.0 CVVT	102	08/04→						
 <b>Bremsscheibe</b>								
1.6	77	07/02→	←	→ 04/06		24.0126-0143.1	426143	Ø 280 26 24 V + S
1.8	93	07/02→	→	→ 04/06; + ABS		24.0110-0308.1	410308	Ø 261 10 8 + S
2.0 CRDi	83	07/02→						
2.0 CRDi	103	11/05→						
2.0 CVVT	102	08/04→						
<b>KIA - CARENS III Großraumlimousine (UN) 09/06→</b>								
 <b>Bremsbelagsatz, Scheibenbremse</b>								
1.6 CRDi 110	85	10/10→	←	→ 02/13		13.0460-5600.2	605600	SUM 24501 16,7 + WK
1.6 CRDi 128	94	10/10→	→	→ 02/13		13.0460-5601.2	605601	24491 16,0 + WK
1.6 CVVT	93	10/10→						
1.6 CVVT	97	08/09→						
2.0 CRDi 115	85	05/07→						
2.0 CRDi 135	100	08/09→						
2.0 CRDi 140	103	09/06→						
2.0 CVVT	106	09/06→						
2.0 LPI	100	09/06→12/08	←			13.0460-5600.2	605600	SUM 24501 16,7 + WK
			→			13.0460-5601.2	605601	24491 16,0 + WK
 <b>Bremsscheibe</b>								
1.6 CRDi 110	85	10/10→	←	→ 02/13		24.0126-0171.1	426171	Ø 280 26 24 V
1.6 CRDi 128	94	10/10→	→	→ 02/13		24.0110-0341.1	410341	Ø 275 10 8,4
1.6 CVVT	93	10/10→						
1.6 CVVT	97	08/09→						
2.0 CRDi 115	85	05/07→						

	kw					! #		
<b>KIA - CARENS III Großraumlimousine (UN) 09/06→</b>								
 <b>Bremsscheibe</b>								
2.0 CRDi 135	100	08/09→	←	→ 02/13		24.0126-0171.1	426171	Ø 280 26 24 V
2.0 CRDi 140	103	09/06→	→	→ 02/13		24.0110-0341.1	410341	Ø 275 10 8,4
2.0 CVVT	106	09/06→						
2.0 LPI	100	09/06→12/08	←			24.0126-0171.1	426171	Ø 280 26 24 V
			→			24.0110-0341.1	410341	Ø 275 10 8,4
<b>KIA - CARENS IV 03/13→</b>								
 <b>Bremsbelagsatz, Scheibenbremse</b>								
1.6 GDi	99	03/13→	←			13.0460-5661.2	605661	MAN 25757 17,9 + WK + Zub
1.7 CRDi	85	03/13→	→			13.0460-5650.2	605650	AKE 25337 15,5 + WK + Zub
1.7 CRDi	99	03/13→						
1.7 CRDi	100	03/13→						
1.7 CRDi	104	07/15→						
2.0 GDi	122	03/13→						
2.0 GDi	130	03/13→						
2.0 MPI	112	01/14→						
 <b>Bremsscheibe</b>								
1.6 GDi	99	03/13→	←			24.0128-0256.1	428256	Ø 300 28 26,4 V
1.7 CRDi	85	03/13→	→			24.0110-0392.1	410392	Ø 284 10 8,4
1.7 CRDi	99	03/13→						
1.7 CRDi	100	03/13→						
1.7 CRDi	104	07/15→						
2.0 GDi	122	03/13→						
2.0 GDi	130	03/13→						
2.0 MPI	112	01/14→						
<b>KIA - CARNIVAL / GRAND CARNIVAL III (VQ) 09/05→</b>								
 <b>Bremsbelagsatz, Scheibenbremse</b>								
2.2 CRDi	110	01/10→	←	→ 06/15		13.0460-5799.2	605799	24597 17,7 + WK + Zub
2.2 CRDi	143	01/10→	→			13.0460-5771.2	605771	MAN 24599 14,9 + WK + Zub
2.7 V6	139	06/06→						
2.9 CRDi	136	06/06→	→	→ 06/15		13.0460-5771.2	605771	MAN 24599 14,9 + WK + Zub
2.9 CRDi LX	141	09/06→						
 <b>Bremsscheibe</b>								
2.2 CRDi	110	01/10→	←	→ 06/15		24.0128-0220.1	428220	Ø 300 28 26 V
2.2 CRDi	143	01/10→	→			24.0112-0185.1	412185	Ø 324 11,9 10,4
2.7 V6	139	06/06→						
2.9 CRDi	136	06/06→	→	→ 06/15		24.0112-0185.1	412185	Ø 324 11,9 10,4
2.9 CRDi LX	141	09/06→						
<b>KIA - CARNIVAL I (UP) 06/98→10/01</b>								
 <b>Bremsbelagsatz, Scheibenbremse</b>								
2.5 V6	121	08/99→10/01	←			13.0460-5897.2	605897	21822 17,5 + WK
2.9 TD	93	08/99→10/01	←	→ 09/01		13.0460-5897.2	605897	21822 17,5 + WK
<b>Zubehörsatz, Scheibenbremsbelag</b>								
2.5 V6	121	08/99→10/01	←			13.0460-0107.2	610107	
2.9 TD	93	08/99→10/01	←	→ 09/01		13.0460-0107.2	610107	
 <b>Bremsscheibe</b>								
2.5 V6	121	08/99→10/01	←			24.0124-0195.1	424195	Ø 274 24,1 22 V
2.9 TD	93	08/99→10/01	←	→ 09/01		24.0124-0195.1	424195	Ø 274 24,1 22 V
<b>KIA - CARNIVAL II (GQ) 01/99→09/07</b>								
 <b>Bremsbelagsatz, Scheibenbremse</b>								
2.5 V6	110	10/01→06/06	←			13.0460-5725.2	605725	23649 17,2 + WK
2.9 CRDi	106	10/01→06/06						
3.5	143	07/02→04/06						
2.9 TD	93	01/99→09/07	←	10/01→ 08/06		13.0460-5725.2	605725	23649 17,2 + WK
 <b>Bremsscheibe</b>								
2.5 V6	110	10/01→06/06	←	→ 11/03		24.0126-0135.1	426135	Ø 274 26,2 24 V
2.9 CRDi	106	10/01→06/06	←	12/03→		24.0128-0211.1	428211	Ø 274 28,3 26 V
3.5	143	07/02→04/06						
2.9 TD	93	01/99→09/07	←	10/01→ 11/03		24.0126-0135.1	426135	Ø 274 26,2 24 V
			←	12/03→ 08/06		24.0128-0211.1	428211	Ø 274 28,3 26 V

	kw			 	! #		
<b>KIA - CEE'D (JD) 05/12→</b>							
<b> Bremsbelagsatz, Scheibenbremse</b>							
1.0 T-GDI 1.0 T-GDI 1.4 MPI 1.6 CRDi 136	74 88 74 100	07/15→ 07/15→ 04/15→ 07/15→	← ← → →	15" 16" - eFSB + eFSB		13.0460-5645.2 605645 13.0460-5659.2 605659 13.0460-2794.2 602794 13.0460-5650.2 605650	25692 17,2 + WK + Zub MAN 24915 17,8 + WK + Zub TRW 25779 15,0 + WK + Zub AKE 25337 15,5 + WK + Zub
1.4 CRDi 90 1.4 CVVT 1.4 CVVT 1.6 CRDi 110 1.6 CRDi 128 1.6 CVVT 1.6 GDI	66 66 73 81 94 92 99	05/12→ 05/12→ 05/12→ 05/12→ 05/12→ 05/12→ 05/12→	← ← ← ← → →	→ 04/13; 15" 05/13→; 15" 16" 16" - eFSB + eFSB		13.0460-5645.2 605645 13.0460-5645.2 605645 13.0460-5651.2 605651 13.0470-5651.2 LD5651 13.0460-2794.2 602794 13.0460-5650.2 605650	25692 17,2 + WK + Zub 25692 17,2 + WK + Zub SUM 24915 17,4 + WK SUM 24915 17,4 + WK Ceramic TRW 25779 15,0 + WK + Zub AKE 25337 15,5 + WK + Zub
1.6 CVVT 1.6 CVVT	95 96	01/13→ 11/14→	← ← ← → →	15" 16" 06/15→; + RUS; 16" - eFSB + eFSB		13.0460-5645.2 605645 13.0460-5651.2 605651 13.0470-5651.2 LD5651 13.0460-5659.2 605659 13.0460-2794.2 602794 13.0460-5650.2 605650	25692 17,2 + WK + Zub SUM 24915 17,4 + WK SUM 24915 17,4 + WK Ceramic MAN 24915 17,8 + WK + Zub TRW 25779 15,0 + WK + Zub AKE 25337 15,5 + WK + Zub
1.6 GT	150	06/13→	← ← → →	07/13→; 15" 07/13→; 16" 07/13→; - eFSB 07/13→; + eFSB		13.0460-5645.2 605645 13.0460-5651.2 605651 13.0470-5651.2 LD5651 13.0460-2794.2 602794 13.0460-5650.2 605650	25692 17,2 + WK + Zub SUM 24915 17,4 + WK SUM 24915 17,4 + WK Ceramic TRW 25779 15,0 + WK + Zub AKE 25337 15,5 + WK + Zub
<b> Bremsscheibe</b>							
1.0 T-GDI 1.0 T-GDI 1.4 MPI 1.6 CRDi 136	74 88 74 100	07/15→ 07/15→ 04/15→ 07/15→	← ← → →	15" 16" - eFSB + eFSB		24.0123-0123.1 423123 24.0128-0234.1 428234 24.0110-0379.1 410379 24.0110-0383.1 410383	Ø 280 23,1 21 V Ø 300 28 26,4 V Ø 262 10 8,4 Ø 284 10 8,4
1.4 CRDi 90 1.4 CVVT 1.4 CVVT 1.6 CRDi 110 1.6 CRDi 128 1.6 CVVT	66 66 73 81 94 92	05/12→ 05/12→ 05/12→ 05/12→ 05/12→ 05/12→	← → →	16" - eFSB + eFSB		24.0128-0234.1 428234 24.0110-0379.1 410379 24.0110-0383.1 410383	Ø 300 28 26,4 V Ø 262 10 8,4 Ø 284 10 8,4
1.6 CVVT	95	01/13→	← ← ← ← ← → →	06/15→; + RUS; 15" 16" 06/15→; + RUS; 16" 01/14→; 17" 17" - eFSB + eFSB		24.0123-0123.1 423123 24.0128-0234.1 428234 24.0128-0234.1 428234 24.0128-0258.1 428258 24.0128-0258.1 428258 24.0110-0379.1 410379 24.0110-0383.1 410383	Ø 280 23,1 21 V Ø 300 28 26,4 V Ø 300 28 26,4 V Ø 320 28,1 26,4 V Ø 320 28,1 26,4 V Ø 262 10 8,4 Ø 284 10 8,4
1.6 CVVT	96	11/14→	← ← ← ← → →	06/15→; + RUS; 15" 16" 06/15→; + RUS; 16" 17" - eFSB + eFSB		24.0123-0123.1 423123 24.0128-0234.1 428234 24.0128-0234.1 428234 24.0128-0258.1 428258 24.0110-0379.1 410379 24.0110-0383.1 410383	Ø 280 23,1 21 V Ø 300 28 26,4 V Ø 300 28 26,4 V Ø 320 28,1 26,4 V Ø 262 10 8,4 Ø 284 10 8,4
1.6 GDI	99	05/12→	← ← → →	16" 17" - eFSB + eFSB		24.0128-0234.1 428234 24.0128-0258.1 428258 24.0110-0379.1 410379 24.0110-0383.1 410383	Ø 300 28 26,4 V Ø 320 28,1 26,4 V Ø 262 10 8,4 Ø 284 10 8,4
1.6 GT	150	06/13→	← ← → →	07/13→; 16" 07/13→; 17" 07/13→; - eFSB 07/13→; + eFSB		24.0128-0234.1 428234 24.0128-0258.1 428258 24.0110-0379.1 410379 24.0110-0383.1 410383	Ø 300 28 26,4 V Ø 320 28,1 26,4 V Ø 262 10 8,4 Ø 284 10 8,4



**KIA - CEE'D Schrägheck (ED) 12/06→12/12**

**Bremsbelagsatz, Scheibenbremse**

1.4	77	12/06→12/12	←	→ 09/12		<b>13.0460-5742.2</b>	<b>605742</b>	MAN 23966 17,7 + WK
1.4	80	12/06→12/12						
1.6	85	09/07→12/12	→	→ 09/12		<b>13.0460-5780.2</b>	<b>605780</b>	MAN 24320 15,3 + WK + Zub
1.6	90	12/06→12/12						
1.6	93	02/08→12/12						
1.6 CRDi 115	85	12/06→12/12						
1.6 CRDi 128	94	10/10→12/12						
1.6 CRDi 90	66	12/06→12/12						
1.6 CVVT	92	10/10→12/12						
2.0	105	12/06→12/12						
2.0 CRDi 140	103	09/07→12/12						
1.4 CVVT	66	08/09→12/12	←	06/10→ 09/12		<b>13.0460-5742.2</b>	<b>605742</b>	MAN 23966 17,7 + WK
			→	06/10→ 09/12		<b>13.0460-5780.2</b>	<b>605780</b>	MAN 24320 15,3 + WK + Zub
2.0 CRDi	100	06/07→12/12	←	09/07→ 09/12		<b>13.0460-5742.2</b>	<b>605742</b>	MAN 23966 17,7 + WK
			→	09/07→ 09/12		<b>13.0460-5780.2</b>	<b>605780</b>	MAN 24320 15,3 + WK + Zub

**Bremsscheibe**

1.4	77	12/06→12/12	←	→ 09/12		<b>24.0126-0150.1</b>	<b>426150</b>	Ø 280 26 24,4 V
1.4	80	12/06→12/12						
1.6	85	09/07→12/12	→	→ 09/12		<b>24.0110-0332.1</b>	<b>410332</b>	Ø 262 10 8
1.6	90	12/06→12/12						
1.6	93	02/08→12/12						
1.6 CRDi 115	85	12/06→12/12						
1.6 CRDi 128	94	10/10→12/12						
1.6 CRDi 90	66	12/06→12/12						
1.6 CVVT	92	10/10→12/12						
2.0	105	12/06→12/12						
2.0 CRDi 140	103	09/07→12/12						
1.4 CVVT	66	08/09→12/12	←	06/10→ 09/12		<b>24.0126-0150.1</b>	<b>426150</b>	Ø 280 26 24,4 V
			→	06/10→ 09/12		<b>24.0110-0332.1</b>	<b>410332</b>	Ø 262 10 8
2.0 CRDi	100	06/07→12/12	←	09/07→ 09/12		<b>24.0126-0150.1</b>	<b>426150</b>	Ø 280 26 24,4 V
			→	09/07→ 09/12		<b>24.0110-0332.1</b>	<b>410332</b>	Ø 262 10 8

**KIA - CEE'D Sportswagon (JD) 09/12→**

**Bremsbelagsatz, Scheibenbremse**













1.0 T-GDI	74	07/15→	←	15"		<b>13.0460-5645.2</b>	<b>605645</b>	25692 17,2 + WK + Zub
1.0 T-GDI	88	07/15→	←	16"		<b>13.0460-5659.2</b>	<b>605659</b>	MAN 24915 17,8 + WK + Zub
1.4 MPI	74	04/15→						
1.6 CRDi 136	100	07/15→	→	- eFSB		<b>13.0460-2794.2</b>	<b>602794</b>	TRW 25779 15,0 + WK + Zub
			→	+ eFSB		<b>13.0460-5650.2</b>	<b>605650</b>	AKE 25337 15,5 + WK + Zub
1.4 CRDi 90	66	09/12→	←	05/13→; 15"		<b>13.0460-5645.2</b>	<b>605645</b>	25692 17,2 + WK + Zub
1.4 CVVT	73	09/12→						
1.6 CRDi 110	81	03/13→	←	→ 04/13; 15"		<b>13.0460-5645.2</b>	<b>605645</b>	25692 17,2 + WK + Zub
1.6 CRDi 128	94	09/12→	←	16"		<b>13.0460-5651.2</b>	<b>605651</b>	SUM 24915 17,4 + WK
1.6 GDI	99	09/12→				<b>13.0470-5651.2</b>	<b>LD5651</b>	SUM 24915 17,4 + WK Ceramic
			→	- eFSB		<b>13.0460-2794.2</b>	<b>602794</b>	TRW 25779 15,0 + WK + Zub
			→	+ eFSB		<b>13.0460-5650.2</b>	<b>605650</b>	AKE 25337 15,5 + WK + Zub
1.6 CVVT	95	11/14→	←	15"		<b>13.0460-5645.2</b>	<b>605645</b>	25692 17,2 + WK + Zub
1.6 CVVT	96	11/14→	←	16"		<b>13.0460-5651.2</b>	<b>605651</b>	SUM 24915 17,4 + WK
						<b>13.0470-5651.2</b>	<b>LD5651</b>	SUM 24915 17,4 + WK Ceramic
			←	06/15→; + RUS; 16"		<b>13.0460-5659.2</b>	<b>605659</b>	MAN 24915 17,8 + WK + Zub
			→	- eFSB		<b>13.0460-2794.2</b>	<b>602794</b>	TRW 25779 15,0 + WK + Zub
			→	+ eFSB		<b>13.0460-5650.2</b>	<b>605650</b>	AKE 25337 15,5 + WK + Zub

















**Bremsscheibe**















1.0 T-GDI	74	07/15→	←	15"		<b>24.0123-0123.1</b>	<b>423123</b>	Ø 280 23,1 21 V
1.0 T-GDI	88	07/15→						
1.4 MPI	74	04/15→	←	16"		<b>24.0128-0234.1</b>	<b>428234</b>	Ø 300 28 26,4 V
1.6 CRDi 136	100	07/15→	→	- eFSB		<b>24.0110-0379.1</b>	<b>410379</b>	Ø 262 10 8,4
			→	+ eFSB		<b>24.0110-0383.1</b>	<b>410383</b>	Ø 284 10 8,4
1.4 CRDi 90	66	09/12→	←	16"		<b>24.0128-0234.1</b>	<b>428234</b>	Ø 300 28 26,4 V
1.4 CVVT	73	09/12→						
1.6 CRDi 110	81	03/13→	→	- eFSB		<b>24.0110-0379.1</b>	<b>410379</b>	Ø 262 10 8,4
1.6 CRDi 128	94	09/12→	→	+ eFSB		<b>24.0110-0383.1</b>	<b>410383</b>	Ø 284 10 8,4
1.6 CVVT	95	11/14→	←	06/15→; + RUS; 15"		<b>24.0123-0123.1</b>	<b>423123</b>	Ø 280 23,1 21 V
1.6 CVVT	96	11/14→	←	16"		<b>24.0128-0234.1</b>	<b>428234</b>	Ø 300 28 26,4 V































	kw			 	! #		
<b>KIA - CEE'D Sportwagon (JD) 09/12→</b>							
 <b>Bremsscheibe</b>							
1.6 CVVT 1.6 CVVT	95 96	11/14→ 11/14→	←	06/15→; + RUS; 16"		24.0128-0234.1 428234	∅ 300 28 26,4 V
			←	17"		24.0128-0258.1 428258	∅ 320 28,1 26,4 V
			→	- eFSB		24.0110-0379.1 410379	∅ 262 10 8,4
			→	+ eFSB		24.0110-0383.1 410383	∅ 284 10 8,4
1.6 GDI	99	09/12→	←	16"		24.0128-0234.1 428234	∅ 300 28 26,4 V
			←	17"		24.0128-0258.1 428258	∅ 320 28,1 26,4 V
			→	- eFSB		24.0110-0379.1 410379	∅ 262 10 8,4
			→	+ eFSB		24.0110-0383.1 410383	∅ 284 10 8,4
<b>KIA - CEE'D SW (ED) 09/07→12/12</b>							
 <b>Bremsbelagsatz, Scheibenbremse</b>							
1.4	77	10/10→12/12	←			13.0460-5742.2 605742	MAN 23966 17,7 + WK
1.4	80	09/07→12/12	→			13.0460-5780.2 605780	MAN 24320 15,3 + WK + Zub
1.6	85	09/07→11/12					
1.6	90	09/07→12/12					
1.6	93	09/07→12/12					
1.6 CRDi 115	85	09/07→12/12					
1.6 CRDi 128	94	10/10→12/12					
1.6 CRDi 90	66	09/07→12/12					
1.6 CVVT	92	06/09→12/12					
2.0	105	09/07→12/12					
2.0 CRDi 140	103	09/07→12/12					
1.4 CVVT	66	07/09→12/12	←	10/10→		13.0460-5742.2 605742	MAN 23966 17,7 + WK
			→	10/10→		13.0460-5780.2 605780	MAN 24320 15,3 + WK + Zub
1.6 LPG	91	01/08→09/12	←	→ 12/11		13.0460-5742.2 605742	MAN 23966 17,7 + WK
			→	→ 12/11		13.0460-5780.2 605780	MAN 24320 15,3 + WK + Zub
 <b>Bremsscheibe</b>							
1.4	77	10/10→12/12	←			24.0126-0150.1 426150	∅ 280 26 24,4 V
1.4	80	09/07→12/12	→			24.0110-0332.1 410332	∅ 262 10 8
1.6	85	09/07→11/12					
1.6	90	09/07→12/12					
1.6	93	09/07→12/12					
1.6 CRDi 115	85	09/07→12/12					
1.6 CRDi 128	94	10/10→12/12					
1.6 CRDi 90	66	09/07→12/12					
1.6 CVVT	92	06/09→12/12					
2.0	105	09/07→12/12					
2.0 CRDi 140	103	09/07→12/12					
1.4 CVVT	66	07/09→12/12	←	10/10→		24.0126-0150.1 426150	∅ 280 26 24,4 V
			→	10/10→		24.0110-0332.1 410332	∅ 262 10 8
1.6 LPG	91	01/08→09/12	←	→ 12/11		24.0126-0150.1 426150	∅ 280 26 24,4 V
			→	→ 12/11		24.0110-0332.1 410332	∅ 262 10 8
<b>KIA - CERATO II Stufenheck (TD) 01/09→</b>							
 <b>Bremsbelagsatz, Scheibenbremse</b>							
1.6	90	01/10→	←	→ 08/10		13.0460-5742.2 605742	MAN 23966 17,7 + WK
1.6	93	01/10→					
1.6 CVVT	91	02/09→	←	01/10→ 08/10		13.0460-5742.2 605742	MAN 23966 17,7 + WK
2.0	115	01/09→	←	03/10→ 08/10		13.0460-5742.2 605742	MAN 23966 17,7 + WK
 <b>Bremsscheibe</b>							
1.6	90	01/10→	→	+ ESP		24.0110-0362.1 410362	∅ 262 10 8,4
1.6	93	01/10→					
1.6 CVVT	91	02/09→	→	01/10→; + ESP		24.0110-0362.1 410362	∅ 262 10 8,4
2.0	115	01/09→	→	03/10→; + ESP		24.0110-0362.1 410362	∅ 262 10 8,4
<b>KIA - CERATO KOUP (TD) 01/09→</b>							
 <b>Bremsbelagsatz, Scheibenbremse</b>							
1.6 CVVT	91	10/09→	←	01/10→; - ABS		13.0460-5742.2 605742	MAN 23966 17,7 + WK
1.6 CVVT	93	01/10→06/13	←	- ABS		13.0460-5742.2 605742	MAN 23966 17,7 + WK
2.0	115	01/09→					
1.6 CVVT	150	09/13→	←	15"		13.0460-5645.2 605645	25692 17,2 + WK + Zub
			←	16"		13.0460-5659.2 605659	MAN 24915 17,8 + WK + Zub
↓							















	kw			 	! #		
<b>KIA - CERATO KOUP (TD) 01/09→</b>							
 <b>Bremsscheibe</b>							
1.6 CVVT	91	10/09→	➔	01/10→; + ABS		24.0110-0362.1 410362	Ø 262 10 8,4
1.6 CVVT 2.0	93 115	01/10→06/13 01/09→	➔	+ ABS		24.0110-0362.1 410362	Ø 262 10 8,4
1.6 CVVT	150	09/13→	➔			24.0110-0368.1 410368	Ø 262 10 8,4
<b>KIA - CERATO KOUP (YD) 12/13→</b>							
 <b>Bremsbelagsatz, Scheibenbremse</b>							
2.0 MPI	110	12/13→	➔	- ABS		13.0460-5742.2 605742	MAN 23966 17,7 + WK
 <b>Bremsscheibe</b>							
2.0 MPI	110	12/13→	➔			24.0110-0362.1 410362	Ø 262 10 8,4
<b>KIA - CERATO Schrägheck (LD) 03/04→</b>							
 <b>Bremsbelagsatz, Scheibenbremse</b>							
1.5 CRDi	66	07/05→	➔			13.0460-5791.2 605791	24218 17,5 + WK + Zub
			➔			13.0460-5874.2 605874	SUM 21553 14,0 + WK + Zub
1.5 CRDi	75	07/05→	➔	→ 06/09		13.0460-5791.2 605791	24218 17,5 + WK + Zub
1.6	77	07/04→	➔				
1.6	90	05/06→	➔	→ 06/09		13.0460-5874.2 605874	SUM 21553 14,0 + WK + Zub
1.6 CRDi	85	06/05→					
2.0	105	04/04→					
2.0 CRDi	83	04/04→					
 <b>Bremsscheibe</b>							
1.5 CRDi	66	07/05→	➔			24.0126-0155.1 426155	Ø 275 26 24 V + S
			➔			24.0110-0334.1 410334	Ø 258 10 8
1.5 CRDi	75	07/05→	➔	→ 06/09		24.0126-0155.1 426155	Ø 275 26 24 V + S
1.6	77	07/04→	➔				
1.6	90	05/06→	➔	→ 06/09		24.0110-0334.1 410334	Ø 258 10 8
1.6 CRDi	85	06/05→					
2.0	105	04/04→					
2.0 CRDi	83	04/04→					
<b>KIA - CERATO Stufenheck 09/12→</b>							
 <b>Bremsscheibe</b>							
1.6 MPI	96	06/13→	➔	+ ESP		24.0110-0362.1 410362	Ø 262 10 8,4
2.0 MPI	110	06/13→					
<b>KIA - CERATO Stufenheck 01/01→12/04</b>							
 <b>Bremsbelagsatz, Scheibenbremse</b>							
1.8	85	10/01→07/04	➔			13.0460-5868.2 605868	SUM 23873 15,8 + WK
			➔	Brems-/Fahrdyn. Artikelbezug: + ABS		13.0460-5871.2 605871	SUM 23455 13,7 + WK
 <b>Bremsscheibe</b>							
1.8	85	10/01→07/04	➔			24.0124-0185.1 424185	Ø 258 24 22 V
			➔	Brems-/Fahrdyn. Artikelbezug: + ABS		24.0110-0301.1 410301	Ø 261 10 8
<b>KIA - CERATO Stufenheck (LD) 04/04→12/09</b>							
 <b>Bremsbelagsatz, Scheibenbremse</b>							
1.5 CRDi	66	07/05→12/09	➔	→ 08/06		13.0460-5791.2 605791	24218 17,5 + WK + Zub
			➔	→ 08/06		13.0460-5874.2 605874	SUM 21553 14,0 + WK + Zub
1.5 CRDi	75	07/05→	➔	→ 06/09		13.0460-5791.2 605791	24218 17,5 + WK + Zub
1.6	77	04/04→	➔				
1.6	90	05/06→	➔	→ 06/09		13.0460-5874.2 605874	SUM 21553 14,0 + WK + Zub
1.6 CRDi	85	06/05→					
2.0	105	04/04→					
2.0 CRDi	83	04/04→					
1.6	75	04/04→12/09	➔			13.0460-5868.2 605868	SUM 23873 15,8 + WK
			➔	+ ABS		13.0460-5871.2 605871	SUM 23455 13,7 + WK
1.6	90	04/04→	➔			13.0460-5791.2 605791	24218 17,5 + WK + Zub
			➔			13.0460-5874.2 605874	SUM 21553 14,0 + WK + Zub
 <b>Bremsscheibe</b>							
1.5 CRDi	66	07/05→12/09	➔	→ 08/06		24.0126-0155.1 426155	Ø 275 26 24 V + S
↓							













	kW			 	! #		
<b>KIA - CERATO Stufenheck (LD) 04/04→12/09</b>							
 <b>Bremsscheibe</b>							
1.5 CRDi	66	07/05→12/09	➔	→ 08/06		24.0110-0334.1 410334	Ø 258 10 8
1.5 CRDi	75	07/05→	➔	→ 06/09		24.0126-0155.1 426155	Ø 275 26 24 V + S
1.6	77	04/04→	➔	→ 06/09		24.0110-0334.1 410334	Ø 258 10 8
1.6	90	05/06→					
1.6 CRDi	85	06/05→					
2.0	105	04/04→					
2.0 CRDi	83	04/04→					
1.6	75	04/04→12/09	➔			24.0124-0185.1 424185	Ø 258 24 22 V
			➔	+ ABS		24.0110-0301.1 410301	Ø 261 10 8
1.6	90	04/04→	➔			24.0126-0155.1 426155	Ø 275 26 24 V + S
			➔			24.0110-0334.1 410334	Ø 258 10 8
<b>KIA - CLARUS (K9A) 05/96→11/01</b>							
 <b>Bremsbelagsatz, Scheibenbremse</b>							
1.8 i 16V	85	07/96→08/01	➔			13.0460-5712.2 605712	ATE 23450 17,5 + WK
						13.0460-5868.2 605868	SUM 23873 15,8 + WK
2.0 i 16V	98	07/96→11/01	➔	→ 08/01		13.0460-5712.2 605712	ATE 23450 17,5 + WK
						13.0460-5868.2 605868	SUM 23873 15,8 + WK
			➔	→ 08/01; + ABS		13.0460-5871.2 605871	SUM 23455 13,7 + WK
<b>Zubehörsatz, Scheibenbremsbelag</b>							
2.0 i 16V	98	07/96→11/01	➔	→ 08/01; + ABS		13.0460-0296.2 610296	SUM
 <b>Bremsscheibe</b>							
1.8 i 16V	85	07/96→08/01	➔			24.0124-0173.1 424173	Ø 258 24 22 V
2.0 i 16V	98	07/96→11/01	➔	→ 08/01		24.0124-0173.1 424173	Ø 258 24 22 V
			➔	→ 08/01; + ABS		24.0110-0308.1 410308	Ø 261 10 8 + S
<b>KIA - CLARUS Kombi (GC) 05/98→</b>							
 <b>Bremsbelagsatz, Scheibenbremse</b>							
1.8 i 16V	85	05/98→	➔	→ 08/01		13.0460-5712.2 605712	ATE 23450 17,5 + WK
						13.0460-5868.2 605868	SUM 23873 15,8 + WK
2.0 i 16V	98	05/98→	➔	→ 08/01		13.0460-5712.2 605712	ATE 23450 17,5 + WK
						13.0460-5868.2 605868	SUM 23873 15,8 + WK
			➔	→ 08/01; + ABS		13.0460-5871.2 605871	SUM 23455 13,7 + WK
<b>Zubehörsatz, Scheibenbremsbelag</b>							
2.0 i 16V	98	05/98→	➔	→ 08/01; + ABS		13.0460-0296.2 610296	SUM
 <b>Bremsscheibe</b>							
1.8 i 16V	85	05/98→	➔	→ 08/01		24.0124-0173.1 424173	Ø 258 24 22 V
2.0 i 16V	98	05/98→	➔	→ 08/01		24.0124-0173.1 424173	Ø 258 24 22 V
			➔	→ 08/01; + ABS		24.0110-0308.1 410308	Ø 261 10 8 + S
<b>KIA - JOICE 02/00→</b>							
 <b>Bremsbelagsatz, Scheibenbremse</b>							
2.0	88	09/01→	➔	→ 08/03		13.0460-5933.2 605933	AKE 21725 16,8 + WK
2.0	102	02/00→					
 <b>Bremsscheibe</b>							
2.0	88	09/01→	➔	→ 08/03; - ABS		24.0124-0136.1 424136	Ø 256 24 21,5 V
2.0	102	02/00→	➔	→ 08/03; + ABS		24.0124-0146.1 424146	Ø 256 24 22,4 V
			➔	→ 08/03; + ABS		24.0118-0141.1 418141	Ø 266 18 16,4 V
<b>KIA - MAGENTIS (GD, MS) 05/01→</b>							
 <b>Bremsbelagsatz, Scheibenbremse</b>							
2.0	100	05/01→09/05	➔			13.0460-5873.2 605873	MAN 23891 16,9 + WK
			➔	+ ABS		13.0460-5833.2 605833	AKE 23543 14,4 + WK + Zub
2.5 V6	124	05/01→	➔	→ 10/05		13.0460-5873.2 605873	MAN 23891 16,9 + WK
			➔	→ 10/05; + ABS		13.0460-5833.2 605833	AKE 23543 14,4 + WK + Zub
↓							















	kw			 	! #				
<b>KIA - MAGENTIS (GD, MS) 05/01→</b>									
<b>Zubehörsatz, Scheibenbremsbelag</b>									
2.0	100	05/01→09/05	←			13.0460-0139.2 610139	MAN		
2.5 V6	124	05/01→	←	→ 10/05		13.0460-0139.2 610139	MAN		
<b> Bremsscheibe</b>									
2.0	100	05/01→09/05	←	→ 08/02		24.0125-0177.1 425177	Ø 257 24,5 22,4 V		
			←	09/02→		24.0126-0129.1 426129	Ø 280 26 24,4 V		
			→	+ ABS		24.0110-0317.1 410317	Ø 262 10 8,4		
2.5 V6	124	05/01→	←	→ 08/02		24.0125-0177.1 425177	Ø 257 24,5 22,4 V		
			←	09/02→ 10/05		24.0126-0129.1 426129	Ø 280 26 24,4 V		
			→	→ 10/05; + ABS		24.0110-0317.1 410317	Ø 262 10 8,4		
<b>KIA - MAGENTIS (MG) 10/05→</b>									
<b> Bremsbelagsatz, Scheibenbremse</b>									
2.0	106	11/05→	←	→ 12/10		13.0460-5873.2 605873	MAN 23891 16,9 + WK		
2.0	121	07/09→	→	→ 12/10		13.0460-5833.2 605833	AKE 23543 14,4 + WK + Zub		
2.0 CRDi	103	04/06→							
2.0 CRDi	110	04/06→							
2.7	138	11/05→							
2.7 V6	142	07/09→							
2.0 CRDi	100	11/05→12/08	←			13.0460-5873.2 605873	MAN 23891 16,9 + WK		
			→			13.0460-5833.2 605833	AKE 23543 14,4 + WK + Zub		
2.4	119	08/06→12/09	←	07/09→		13.0460-5873.2 605873	MAN 23891 16,9 + WK		
			→	07/09→		13.0460-5833.2 605833	AKE 23543 14,4 + WK + Zub		
<b>Zubehörsatz, Scheibenbremsbelag</b>									
2.0	106	11/05→	←	→ 12/10		13.0460-0139.2 610139	MAN		
2.0	121	07/09→	→	→ 12/10					
2.0 CRDi	103	04/06→							
2.0 CRDi	110	04/06→							
2.7	138	11/05→							
2.7 V6	142	07/09→							
2.0 CRDi	100	11/05→12/08	←			13.0460-0139.2 610139	MAN		
2.4	119	08/06→12/09	←	07/09→		13.0460-0139.2 610139	MAN		
<b> Bremsscheibe</b>									
2.0	106	11/05→	←	→ 12/10		24.0126-0128.1 426128	Ø 280 26 24,4 V		
			2.0	121	07/09→	→	→ 12/10	24.0110-0318.1 410318	Ø 262 10 8,4
			2.0 CRDi	103	04/06→				
2.0 CRDi	110	04/06→							
2.7	138	11/05→							
2.7 V6	142	07/09→							
2.0 CRDi	100	11/05→12/08	←			24.0126-0128.1 426128	Ø 280 26 24,4 V		
			→			24.0110-0318.1 410318	Ø 262 10 8,4		
2.4	119	08/06→12/09	←	07/09→		24.0126-0128.1 426128	Ø 280 26 24,4 V		
			→	07/09→		24.0110-0318.1 410318	Ø 262 10 8,4		
<b>KIA - NIRO 09/16→</b>									
<b> Bremsbelagsatz, Scheibenbremse</b>									
1.6 GDI Hybrid	77	09/16→	→			13.0460-5650.2 605650	AKE 25337 15,5 + WK + Zub		
1.6 GDI Hybrid	104	09/16→							
<b>KIA - OPIRUS (GH) 09/03→</b>									
<b> Bremsscheibe</b>									
3.8 V6	196	10/06→	→	→ 08/07		24.0110-0336.1 410336	Ø 284 10 8,4		
			→	09/07→ 05/10		24.0110-0336.1 410336	Ø 284 10 8,4		
<b>KIA - OPTIMA 01/10→</b>									
<b> Bremsbelagsatz, Scheibenbremse</b>									
1.7 CRDi	100	03/12→	←	→ 12/15; Leichtmetallfelge		13.0460-5659.2 605659	MAN 24915 17,8 + WK + Zub		
2.0	125	03/12→	→	→ 12/15; Stahlfelge		13.0460-5660.2 605660	MAN 25644 15,6 + WK + Zub		
2.0 CVVL	121	03/12→							
2.4	132	03/12→							
			→	→ 12/15; + eFSB		13.0460-5650.2 605650	AKE 25337 15,5 + WK + Zub		
			→	→ 12/15; - eFSB		13.0460-5786.2 605786	AKE 24934 15,0 + WK + Zub		
						13.0470-5786.2 LD5786	AKE 24934 15,0 + WK + Zub Ceramic		
↓									













	kw			 	! #		
<b>KIA - OPTIMA 01/10→</b>							
 <b>Bremsbelagsatz, Scheibenbremse</b>							
2.0 2.4	204 149	09/10→ 09/10→	←	03/12→ 12/15; Leichtmetallfelge	13.0460-5659.2	605659	MAN 24915 17,8 + WK + Zub
			←	03/12→ 12/15; Stahlfelge	13.0460-5660.2	605660	MAN 25644 15,6 + WK + Zub
			→	03/12→ 12/15; + eFSB	13.0460-5650.2	605650	AKE 25337 15,5 + WK + Zub
			→	03/12→ 12/15; - eFSB	13.0460-5786.2	605786	AKE 24934 15,0 + WK + Zub
					13.0470-5786.2	LD5786	AKE 24934 15,0 + WK + Zub Ceramic
2.0 CVVT Hybrid 2.0 CVVT Hybrid	110 140	03/12→ 12/12→	→	→ 12/15; + eFSB	13.0460-5650.2	605650	AKE 25337 15,5 + WK + Zub
			→	→ 12/15; - eFSB	13.0460-5786.2	605786	AKE 24934 15,0 + WK + Zub
					13.0470-5786.2	LD5786	AKE 24934 15,0 + WK + Zub Ceramic
2.4	129	06/10→12/15	←	Leichtmetallfelge	13.0460-5659.2	605659	MAN 24915 17,8 + WK + Zub
			←	Stahlfelge	13.0460-5660.2	605660	MAN 25644 15,6 + WK + Zub
			→	+ eFSB	13.0460-5650.2	605650	AKE 25337 15,5 + WK + Zub
			→	- eFSB	13.0460-5786.2	605786	AKE 24934 15,0 + WK + Zub
					13.0470-5786.2	LD5786	AKE 24934 15,0 + WK + Zub Ceramic
 <b>Bremsscheibe</b>							
1.7 CRDi 2.0 2.0 CVVL 2.4	100 125 121 132	03/12→ 03/12→ 03/12→ 03/12→	←	→ 12/15; Stahlfelge	24.0128-0256.1	428256	Ø 300 28 26,4 V
			←	→ 12/15; Leichtmetallfelge	24.0128-0258.1	428258	Ø 320 28,1 26,4 V
			→	→ 12/15; - eFSB	24.0110-0388.1	410388	Ø 284 10 8,4
			→	→ 12/15; + eFSB	24.0110-0400.1	410400	Ø 284 10 8,4
2.0 2.4	204 149	09/10→ 09/10→	←	03/12→ 12/15; Stahlfelge	24.0128-0256.1	428256	Ø 300 28 26,4 V
			←	03/12→ 12/15; Leichtmetallfelge	24.0128-0258.1	428258	Ø 320 28,1 26,4 V
			→	03/12→ 12/15; - eFSB	24.0110-0388.1	410388	Ø 284 10 8,4
			→	03/12→ 12/15; + eFSB	24.0110-0400.1	410400	Ø 284 10 8,4
2.0 CVVT Hybrid 2.0 CVVT Hybrid	110 140	03/12→ 12/12→	←	→ 12/15; Stahlfelge	24.0128-0256.1	428256	Ø 300 28 26,4 V
			→	→ 12/15; - eFSB	24.0110-0388.1	410388	Ø 284 10 8,4
			→	→ 12/15; + eFSB	24.0110-0400.1	410400	Ø 284 10 8,4
2.4	129	06/10→12/15	←	Stahlfelge	24.0128-0256.1	428256	Ø 300 28 26,4 V
			←	Leichtmetallfelge	24.0128-0258.1	428258	Ø 320 28,1 26,4 V
			→	- eFSB	24.0110-0388.1	410388	Ø 284 10 8,4
			→	+ eFSB	24.0110-0400.1	410400	Ø 284 10 8,4
<b>KIA - OPTIMA 09/15→</b>							
 <b>Bremsbelagsatz, Scheibenbremse</b>							
1.7 CRDi 2.0 CVVL 2.0 CVVL 2.4 GDI	104 120 124 138	11/15→ 09/15→ 09/15→ 09/15→	←		13.0460-5647.2	605647	MAN 24501 17,8 + WK + Zub
			→		13.0460-5650.2	605650	AKE 25337 15,5 + WK + Zub
2.0 GDI Hybrid 2.0 GDI Hybrid	115 151	09/16→ 09/16→	→		13.0460-5650.2	605650	AKE 25337 15,5 + WK + Zub
2.0 T-GDi	180	09/15→	→	passend für Felgengröße [Zoll]: 16 / 17	13.0460-5650.2	605650	AKE 25337 15,5 + WK + Zub
 <b>Bremsscheibe</b>							
1.7 CRDi 2.0 CVVL 2.0 CVVL 2.4 GDI	104 120 124 138	11/15→ 09/15→ 09/15→ 09/15→	←	passend für Felgengröße [Zoll]: 16 / 17	24.0128-0256.1	428256	Ø 300 28 26,4 V
			←	passend für Felgengröße [Zoll]: 18	24.0128-0258.1	428258	Ø 320 28,1 26,4 V
			→	passend für Felgengröße [Zoll]: 16 / 17	24.0110-0400.1	410400	Ø 284 10 8,4
2.0 GDI Hybrid 2.0 GDI Hybrid	115 151	09/16→ 09/16→	←	passend für Felgengröße [Zoll]: 16 / 17	24.0128-0256.1	428256	Ø 300 28 26,4 V
			→		24.0110-0400.1	410400	Ø 284 10 8,4
<b>KIA - OPTIMA Sportswagon (JF) 09/16→</b>							
 <b>Bremsbelagsatz, Scheibenbremse</b>							
1.7 CRDi 2.0 CVVL	104 120	09/16→ 09/16→	←		13.0460-5647.2	605647	MAN 24501 17,8 + WK + Zub
			→		13.0460-5650.2	605650	AKE 25337 15,5 + WK + Zub
2.0 T-GDi	180	09/16→	→	passend für Felgengröße [Zoll]: 16 / 17	13.0460-5650.2	605650	AKE 25337 15,5 + WK + Zub
 <b>Bremsscheibe</b>							
1.7 CRDi ↓	104	09/16→	←	passend für Felgengröße [Zoll]: 16 / 17	24.0128-0256.1	428256	Ø 300 28 26,4 V

















	kw					! #		
<b>KIA - OPTIMA Sportswagon (JF) 09/16→</b>								
 <b>Bremsscheibe</b>								
2.0 CVVL	120	09/16→	←	passend für Felgengröße [Zoll]: 18		24.0128-0258.1	428258	Ø 320 28,1 26,4 V
			→	passend für Felgengröße [Zoll]: 16 / 17		24.0110-0400.1	410400	Ø 284 10 8,4
2.0 GDi Hybrid	115	04/17→	←	für Individualausstattungs-ID: EV2		24.0128-0256.1	428256	Ø 300 28 26,4 V
			→	für Individualausstattungs-ID: EV1		24.0110-0400.1	410400	Ø 284 10 8,4
<b>KIA - PICANTO (JA) 03/17→</b>								
 <b>Bremsscheibe</b>								
1.0	49	03/17→	→			24.0110-0324.1	410324	Ø 234 10 8
1.0 T-GDi	74	03/17→						
1.2	62	03/17→						
<b>KIA - PICANTO (SA) 04/04→</b>								
 <b>Bremsbelagsatz, Scheibenbremse</b>								
1.0	45	04/04→	←	05/04→ 04/11		13.0460-5776.2	605776	AKE 24275 16,5 + WK + Zub
			→	05/04→ 04/11; + ABS		13.0460-5775.2	605775	24276 14,8 + WK + Zub
1.0	46	09/07→	←	11/09→ 04/11		13.0460-5776.2	605776	AKE 24275 16,5 + WK + Zub
			→	11/09→ 04/11; + ABS		13.0460-5775.2	605775	24276 14,8 + WK + Zub
1.0	53	04/04→04/11	←			13.0460-5776.2	605776	AKE 24275 16,5 + WK + Zub
			→	+ ABS		13.0460-5775.2	605775	24276 14,8 + WK + Zub
1.1	48	04/04→	←	→ 04/11		13.0460-5776.2	605776	AKE 24275 16,5 + WK + Zub
1.1 CRDi	55	11/05→	→	→ 04/11; + ABS		13.0460-5775.2	605775	24276 14,8 + WK + Zub
 <b>Bremsscheibe</b>								
1.0	45	04/04→	←	05/04→ 04/11		24.0118-0145.1	418145	Ø 241 18 16 V
			→	05/04→ 04/11; + ABS		24.0110-0324.1	410324	Ø 234 10 8
1.0	46	09/07→	←	11/09→ 04/11		24.0118-0145.1	418145	Ø 241 18 16 V
			→	11/09→ 04/11; + ABS		24.0110-0324.1	410324	Ø 234 10 8
1.0	53	04/04→04/11	←			24.0118-0145.1	418145	Ø 241 18 16 V
			→	+ ABS		24.0110-0324.1	410324	Ø 234 10 8
1.1	48	04/04→	←	→ 04/11		24.0118-0145.1	418145	Ø 241 18 16 V
			→	→ 04/11; + ABS		24.0110-0324.1	410324	Ø 234 10 8
1.1 CRDi	55	11/05→	←	→ 04/11		24.0118-0144.1	418144	Ø 252 18 16 V
			→	→ 04/11; + ABS		24.0110-0324.1	410324	Ø 234 10 8
<b>KIA - PICANTO (TA) 05/11→</b>								
 <b>Bremsbelagsatz, Scheibenbremse</b>								
1.0	49	04/15→	→			13.0460-5781.2	605781	MAN + WK + Zub
1.0	51	05/11→	←			13.0460-5649.2	605649	MAN 25365 16,0 + WK + Zub
1.0 Bi-Fuel	60	05/11→						
1.0 LPG	49	08/13→	→			13.0460-5781.2	605781	MAN + WK + Zub
1.2	63	09/11→						
1.2	64	09/11→						
 <b>Bremsscheibe</b>								
1.0	49	04/15→	←	Felgengröße [Zoll]: 14		24.0118-0144.1	418144	Ø 252 18 16 V
			←	Felgengröße [Zoll]: 13		24.0118-0145.1	418145	Ø 241 18 16 V
			→			24.0110-0324.1	410324	Ø 234 10 8
1.0	51	05/11→	←			24.0118-0145.1	418145	Ø 241 18 16 V
1.0 Bi-Fuel	60	05/11→						
1.0 LPG	49	08/13→	→			24.0110-0324.1	410324	Ø 234 10 8
1.2	63	09/11→						
1.2	64	09/11→						
<b>KIA - PREGIO Bus 08/95→09/04</b>								
 <b>Bremsbelagsatz, Scheibenbremse</b>								
2.5 D	69	08/95→09/04	←	09/02→		13.0460-5725.2	605725	23649 17,2 + WK
<b>KIA - PREGIO Kasten (TB) 10/97→</b>								
 <b>Bremsbelagsatz, Scheibenbremse</b>								
2.5 Tci D	69	09/02→	←	→ 09/04		13.0460-5725.2	605725	23649 17,2 + WK
2.7 D	60	10/97→	←	01/99→ 12/01		13.0460-5725.2	605725	23649 17,2 + WK

















	kw			 	! #		
<b>KIA - PRIDE (DA) 01/90→12/11</b>							
 <b>Bremsbelagsatz, Scheibenbremse</b>							
1.1 i	38	01/91→10/00	←	→ 04/94		13.0460-5970.2 605970	SUM 21355 13,5 + WK
1.3 16V	44	01/90→10/00					
1.3 16V	53	01/90→09/01					
1.3 i	51	01/90→05/97					
1.3 16V	47	10/96→05/01	←	→ 10/00		13.0460-5970.2 605970	SUM 21355 13,5 + WK
<b>Zubehörsatz, Scheibenbremsbelag</b>							
1.1 i	38	01/91→10/00	←	→ 04/94		13.0460-0451.2 610451	SUM
1.3 16V	44	01/90→10/00					
1.3 16V	53	01/90→09/01					
1.3 i	51	01/90→05/97					
1.3 16V	47	10/96→05/01	←	→ 10/00		13.0460-0451.2 610451	SUM
<b>KIA - PRIDE Kombi 08/98→05/01</b>							
 <b>Bremsbelagsatz, Scheibenbremse</b>							
1.3	47	08/99→05/01	←			13.0460-5970.2 605970	SUM 21355 13,5 + WK
<b>Zubehörsatz, Scheibenbremsbelag</b>							
1.3	47	08/99→05/01	←			13.0460-0451.2 610451	SUM
<b>KIA - PRIDE Van (DA) 04/92→06/99</b>							
 <b>Bremsbelagsatz, Scheibenbremse</b>							
1.3 16V	44	04/92→10/96	←	→ 04/94		13.0460-5970.2 605970	SUM 21355 13,5 + WK
1.3 16V	47	10/96→06/99	←			13.0460-5970.2 605970	SUM 21355 13,5 + WK
<b>Zubehörsatz, Scheibenbremsbelag</b>							
1.3 16V	44	04/92→10/96	←	→ 04/94		13.0460-0451.2 610451	SUM
1.3 16V	47	10/96→06/99	←			13.0460-0451.2 610451	SUM
<b>KIA - PRO CEE'D (JD) 03/13→</b>							
 <b>Bremsbelagsatz, Scheibenbremse</b>							
1.0 T-GDI	74	07/15→	←	15"		13.0460-5645.2 605645	25692 17,2 + WK + Zub
1.0 T-GDI	88	07/15→	←	16"		13.0460-5659.2 605659	MAN 24915 17,8 + WK + Zub
1.4 MPI	74	04/15→	→	- eFSB		13.0460-2794.2 602794	TRW 25779 15,0 + WK + Zub
1.6 CRDi 136	100	07/15→	→	+ eFSB		13.0460-5650.2 605650	AKE 25337 15,5 + WK + Zub
1.4 CRDi 90	66	03/13→	←	15"		13.0460-5645.2 605645	25692 17,2 + WK + Zub
1.4 CVVT	73	03/13→	←	16"		13.0460-5651.2 605651	SUM 24915 17,4 + WK
1.6 CRDi 110	81	03/13→	←	16"		13.0470-5651.2 LD5651	SUM 24915 17,4 + WK Ceramic
1.6 CRDi 128	94	03/13→	→	- eFSB		13.0460-2794.2 602794	TRW 25779 15,0 + WK + Zub
1.6 GDI	99	03/13→	→	+ eFSB		13.0460-5650.2 605650	AKE 25337 15,5 + WK + Zub
1.6 GT	150	06/13→	←	15"		13.0460-5645.2 605645	25692 17,2 + WK + Zub
1.4 MPI	73	07/13→	←	→ 05/15; 16"		13.0460-5651.2 605651	SUM 24915 17,4 + WK
			←	06/15→; 16"		13.0470-5651.2 LD5651	SUM 24915 17,4 + WK Ceramic
			→	- eFSB		13.0460-2794.2 602794	TRW 25779 15,0 + WK + Zub
			→	+ eFSB		13.0460-5650.2 605650	AKE 25337 15,5 + WK + Zub
1.6 CVVT	95	03/13→	←	15"		13.0460-5645.2 605645	25692 17,2 + WK + Zub
			←	16"		13.0460-5651.2 605651	SUM 24915 17,4 + WK
			→	07/13→; - eFSB		13.0470-5651.2 LD5651	SUM 24915 17,4 + WK Ceramic
			→	+ eFSB		13.0460-2794.2 602794	TRW 25779 15,0 + WK + Zub
			→	+ eFSB		13.0460-5650.2 605650	AKE 25337 15,5 + WK + Zub
 <b>Bremsscheibe</b>							
1.0 T-GDI	74	07/15→	←	15"		24.0123-0123.1 423123	Ø 280 23,1 21 V
1.0 T-GDI	88	07/15→	←	16"		24.0128-0234.1 428234	Ø 300 28 26,4 V
1.4 MPI	74	04/15→	→	- eFSB		24.0110-0379.1 410379	Ø 262 10 8,4
1.6 CRDi 136	100	07/15→	→	+ eFSB		24.0110-0383.1 410383	Ø 284 10 8,4
1.4 CRDi 90	66	03/13→	←	16"		24.0128-0234.1 428234	Ø 300 28 26,4 V
1.4 CVVT	73	03/13→	→	- eFSB		24.0110-0379.1 410379	Ø 262 10 8,4
1.6 CRDi 110	81	03/13→	→	+ eFSB		24.0110-0383.1 410383	Ø 284 10 8,4
1.6 CRDi 128	94	03/13→	→	+ eFSB		24.0110-0383.1 410383	Ø 284 10 8,4













	kw				! #		
<b>KIA - PRO CEE'D (JD) 03/13→</b>							
 <b>Bremsscheibe</b>							
1.6 CVVT	95	03/13→	←	16"		24.0128-0234.1 428234	Ø 300 28 26,4 V
1.6 GDI	99	03/13→	→	- eFSB		24.0110-0379.1 410379	Ø 262 10 8,4
1.6 GT	150	06/13→	→	+ eFSB		24.0110-0383.1 410383	Ø 284 10 8,4
1.4 MPI	73	07/13→	←	06/15→; 15"		24.0123-0123.1 423123	Ø 280 23,1 21 V
			←	16"		24.0128-0234.1 428234	Ø 300 28 26,4 V
			→	- eFSB		24.0110-0379.1 410379	Ø 262 10 8,4
			→	+ eFSB		24.0110-0383.1 410383	Ø 284 10 8,4
<b>KIA - PRO CEE'D (ED) 02/08→02/13</b>							
 <b>Bremsbelagsatz, Scheibenbremse</b>							
1.4	77	02/08→09/12	←			13.0460-5742.2 605742	MAN 23966 17,7 + WK
1.4	80	02/08→09/12	→			13.0460-5780.2 605780	MAN 24320 15,3 + WK + Zub
1.4 CVVT	66	06/10→09/12	→				
1.6	90	02/08→09/12					
1.6	93	02/08→09/12					
1.6 CRDi 115	85	02/08→09/12					
1.6 CRDi 128	94	10/10→09/12					
1.6 CRDi 90	66	02/08→09/12					
1.6 CVVT	92	10/10→02/13					
2.0	105	02/08→09/12					
2.0 CRDi 140	103	02/08→09/12					
2.0 LPG	105	01/09→12/09					
 <b>Bremsscheibe</b>							
1.4	77	02/08→09/12	←			24.0126-0150.1 426150	Ø 280 26 24,4 V
1.4	80	02/08→09/12	→			24.0110-0332.1 410332	Ø 262 10 8
1.4 CVVT	66	06/10→09/12	→				
1.6	90	02/08→09/12					
1.6	93	02/08→09/12					
1.6 CRDi 115	85	02/08→09/12					
1.6 CRDi 128	94	10/10→09/12					
1.6 CRDi 90	66	02/08→09/12					
1.6 CVVT	92	10/10→02/13					
2.0	105	02/08→09/12					
2.0 CRDi 140	103	02/08→09/12					
2.0 LPG	105	01/09→12/09					
<b>KIA - RETONA (CE) 06/99→</b>							
 <b>Bremsbelagsatz, Scheibenbremse</b>							
2.0 16V	94	05/00→	←	→ 08/03		13.0460-5896.2 605896	23442 15,3 + WK
2.0 TD	61	06/99→					
<b>KIA - RIO II (JB) 03/05→</b>							
 <b>Bremsbelagsatz, Scheibenbremse</b>							
1.4 16V	71	03/05→	←	→ 08/11		13.0460-5779.2 605779	MAN 24317 17,6 + WK + Zub
1.5 CRDi	65	06/08→	→	→ 08/11; + ABS		13.0460-5780.2 605780	MAN 24320 15,3 + WK + Zub
1.5 CRDi	81	03/05→					
1.6 CVVT	82	03/05→					
 <b>Bremsscheibe</b>							
1.4 16V	71	03/05→	←	→ 08/11		24.0122-0260.1 422260	Ø 256 22 20 V
1.5 CRDi	65	06/08→	→	→ 08/11; + ABS		24.0110-0312.1 410312	Ø 262 10 8,4
1.5 CRDi	81	03/05→					
1.6 CVVT	82	03/05→					
<b>KIA - RIO II Stufenheck (JB) 03/05→</b>							
 <b>Bremsbelagsatz, Scheibenbremse</b>							
1.4 16V	71	03/05→	←	→ 08/11		13.0460-5779.2 605779	MAN 24317 17,6 + WK + Zub
1.5 CRDi	65	06/08→	→	→ 08/11; + ABS		13.0460-5780.2 605780	MAN 24320 15,3 + WK + Zub
1.5 CRDi	81	03/05→					
1.6 16V	82	03/05→					
 <b>Bremsscheibe</b>							
1.4 16V	71	03/05→	←	→ 08/11		24.0122-0260.1 422260	Ø 256 22 20 V
1.5 CRDi	65	06/08→	→	→ 08/11; + ABS		24.0110-0312.1 410312	Ø 262 10 8,4
1.5 CRDi	81	03/05→					
1.6 16V	82	03/05→					
<b>KIA - RIO III (UB) 09/11→</b>							
 <b>Bremsbelagsatz, Scheibenbremse</b>							
1.1 CRDi	55	09/11→	←			13.0460-5646.2 605646	MAN 25348 17,8 + WK + Zub
1.2	51	09/11→					
↓							











	kw					! #		
<b>KIA - RIO III (UB) 09/11→</b>								
 <b>Bremsbelagsatz, Scheibenbremse</b>								
1.25 1.25 CVVT 1.25 CVVT 1.25 LPG 1.2 CVVT 1.4 CRDi 1.4 CVVT 1.4 CVVT 1.6 CVVT	64 63 65 63 62 66 79 80 90	11/14→ 09/11→ 09/11→ 09/11→ 11/14→ 09/11→ 09/11→ 09/11→ 06/12→	→				<b>13.0460-5650.2 605650</b>	AKE 25337 15,5 + WK + Zub
 <b>Bremsscheibe</b>								
1.1 CRDi 1.4 CRDi 1.4 CVVT 1.4 CVVT	55 66 79 80	09/11→ 09/11→ 09/11→ 09/11→	←	02/12→; passend für Felgenreöße [Zoll]: 15			<b>24.0122-0260.1 422260</b>	Ø 256 22 20 V
			←	→ 01/12; passend für Felgenreöße [Zoll]: 15			<b>24.0122-0294.1 422294</b>	Ø 280 22 19,4 V
			→				<b>24.0110-0398.1 410398</b>	Ø 262 10 8,4
1.2	51	09/11→	←				<b>24.0122-0260.1 422260</b>	Ø 256 22 20 V
			→				<b>24.0110-0398.1 410398</b>	Ø 262 10 8,4
1.25 1.2 CVVT	64 62	11/14→ 11/14→	←	passend für Felgenreöße [Zoll]: 15			<b>24.0122-0260.1 422260</b>	Ø 256 22 20 V
			→				<b>24.0110-0398.1 410398</b>	Ø 262 10 8,4
1.25 CVVT 1.25 CVVT 1.25 LPG 1.6 CVVT	63 65 63 90	09/11→ 09/11→ 09/11→ 06/12→	→				<b>24.0110-0398.1 410398</b>	Ø 262 10 8,4
<b>KIA - RIO III Stufenheck (UB) 09/10→</b>								
 <b>Bremsbelagsatz, Scheibenbremse</b>								
1.25 CVVT 1.2 CVVT 1.4 CVVT 1.6 CVVT	63 62 80 90	10/11→ 11/14→ 10/11→ 06/12→	←				<b>13.0460-5646.2 605646</b>	MAN 25348 17,8 + WK + Zub
			→				<b>13.0460-5650.2 605650</b>	AKE 25337 15,5 + WK + Zub
1.4 CVVT	79	06/11→	←	09/11→			<b>13.0460-5646.2 605646</b>	MAN 25348 17,8 + WK + Zub
			→	09/11→			<b>13.0460-5650.2 605650</b>	AKE 25337 15,5 + WK + Zub
 <b>Bremsscheibe</b>								
1.25 CVVT 1.6 CVVT	63 90	10/11→ 06/12→	→				<b>24.0110-0398.1 410398</b>	Ø 262 10 8,4
1.2 CVVT	62	11/14→	←	passend für Felgenreöße [Zoll]: 15			<b>24.0122-0260.1 422260</b>	Ø 256 22 20 V
			→				<b>24.0110-0398.1 410398</b>	Ø 262 10 8,4
1.4 CVVT	79	06/11→	←	02/12→; passend für Felgenreöße [Zoll]: 15			<b>24.0122-0260.1 422260</b>	Ø 256 22 20 V
			←	09/11→ 01/12; passend für Felgenreöße [Zoll]: 15			<b>24.0122-0294.1 422294</b>	Ø 280 22 19,4 V
			→	09/11→			<b>24.0110-0398.1 410398</b>	Ø 262 10 8,4
1.4 CVVT	80	10/11→	←	02/12→; passend für Felgenreöße [Zoll]: 15			<b>24.0122-0260.1 422260</b>	Ø 256 22 20 V
			←	→ 01/12; passend für Felgenreöße [Zoll]: 15			<b>24.0122-0294.1 422294</b>	Ø 280 22 19,4 V
			→				<b>24.0110-0398.1 410398</b>	Ø 262 10 8,4
<b>KIA - RIO IV (YB, SC) 01/17→</b>								
 <b>Bremsscheibe</b>								
1.0 T-GDI 100 1.0 T-GDI 120 1.4 CRDi 77 1.4 CRDi 90	74 88 57 66	01/17→ 01/17→ 01/17→ 01/17→	←				<b>24.0122-0294.1 422294</b>	Ø 280 22 19,4 V
			→				<b>24.0110-0398.1 410398</b>	Ø 262 10 8,4
1.25 1.4	62 73	01/17→ 01/17→	←	Felgenreöße [Zoll]: 14			<b>24.0122-0293.1 422293</b>	Ø 256 22 20 V
			←	Felgenreöße [Zoll]: 15			<b>24.0122-0294.1 422294</b>	Ø 280 22 19,4 V
			→				<b>24.0110-0398.1 410398</b>	Ø 262 10 8,4
<b>KIA - RIO IV Stufenheck (SC, FB) 07/17→</b>								
 <b>Bremsscheibe</b>								
1.4 1.6	74 90	07/17→ 07/17→	←				<b>24.0122-0293.1 422293</b>	Ø 256 22 20 V
			→				<b>24.0110-0398.1 410398</b>	Ø 262 10 8,4













	kw			 	! #		
<b>KIA - RIO Kombi (DC) 07/00→02/05</b>							
 <b>Bremsbelagsatz, Scheibenbremse</b>							
1.3	55	08/00→02/05	←	07/02→		13.0460-5868.2 605868	SUM 23873 15,8 + WK
1.3	60	08/00→02/05					
1.5 16V	72	08/00→02/05	←	→ 06/02		13.0460-5944.2 605944	SUM 21654 15,0 + WK
1.5 16V	71	09/02→02/05	←			13.0460-5868.2 605868	SUM 23873 15,8 + WK
<b>Zubehörsatz, Scheibenbremsbelag</b>							
1.3	55	08/00→02/05	←	→ 06/02		13.0460-0149.2 610149	SUM
1.3	60	08/00→02/05					
1.5 16V	72	08/00→02/05					
 <b>Bremsscheibe</b>							
1.3	55	08/00→02/05	←	→ 06/02		24.0122-0227.1 422227	Ø 235 22 20 V
1.3	60	08/00→02/05					
1.5 16V	72	08/00→02/05	←	07/02→		24.0124-0187.1 424187	Ø 254 24 22 V
1.5 16V	71	09/02→02/05	←			24.0124-0187.1 424187	Ø 254 24 22 V
<b>KIA - RIO Stufenheck (DC_) 07/00→02/05</b>							
 <b>Bremsbelagsatz, Scheibenbremse</b>							
1.3	55	09/00→02/05	←	07/02→		13.0460-5868.2 605868	SUM 23873 15,8 + WK
1.5 16V	72	09/00→02/05	←	→ 06/02		13.0460-5944.2 605944	SUM 21654 15,0 + WK
1.3	60	08/02→02/05	←			13.0460-5868.2 605868	SUM 23873 15,8 + WK
1.5	70	09/02→02/05					
1.5 16V	71	09/02→02/05					
<b>Zubehörsatz, Scheibenbremsbelag</b>							
1.3	55	09/00→02/05	←	→ 06/02		13.0460-0149.2 610149	SUM
1.5 16V	72	09/00→02/05					
 <b>Bremsscheibe</b>							
1.3	55	09/00→02/05	←	→ 06/02		24.0122-0227.1 422227	Ø 235 22 20 V
1.5 16V	72	09/00→02/05	←	07/02→		24.0124-0187.1 424187	Ø 254 24 22 V
1.3	60	08/02→02/05	←			24.0124-0187.1 424187	Ø 254 24 22 V
1.5	70	09/02→02/05					
1.5 16V	71	09/02→02/05					
<b>KIA - SEPHIA (FA) 01/95→10/97</b>							
 <b>Bremsbelagsatz, Scheibenbremse</b>							
1.5 i	59	02/96→10/97	→	+ ABS		13.0460-5924.2 605924	ATE 21832 14,9 - WE / - WK
1.8 i 16V	82	01/95→10/97					
1.6 i	59	01/95→10/97	→	→ 06/96; + ABS		13.0460-5924.2 605924	ATE 21832 14,9 - WE / - WK
<b>Zubehörsatz, Scheibenbremsbelag</b>							
1.5 i	59	02/96→10/97	→	+ ABS		13.0460-0436.2 610436	ATE
1.8 i 16V	82	01/95→10/97					
1.6 i	59	01/95→10/97	→	→ 06/96; + ABS		13.0460-0436.2 610436	ATE
 <b>Bremsscheibe</b>							
1.5 i	59	02/96→10/97	→	+ ABS		24.0110-0300.1 410300	Ø 270 10 8
1.8 i 16V	82	01/95→10/97					
1.6 i	59	01/95→10/97	→	→ 06/96; + ABS		24.0110-0300.1 410300	Ø 270 10 8
<b>KIA - SEPHIA Stufenheck (FA) 01/92→09/01</b>							
 <b>Bremsbelagsatz, Scheibenbremse</b>							
1.5 i	59	02/96→10/97	→	+ ABS		13.0460-5924.2 605924	ATE 21832 14,9 - WE / - WK
1.8 i 16V	82	01/95→10/97					
1.6 i	59	09/93→10/97	→	10/93→ 06/96; + ABS		13.0460-5924.2 605924	ATE 21832 14,9 - WE / - WK
<b>Zubehörsatz, Scheibenbremsbelag</b>							
1.5 i	59	02/96→10/97	→	+ ABS		13.0460-0436.2 610436	ATE
1.8 i 16V	82	01/95→10/97					
1.6 i	59	09/93→10/97	→	10/93→ 06/96; + ABS		13.0460-0436.2 610436	ATE
 <b>Bremsscheibe</b>							
1.5 i	59	02/96→10/97	→	+ ABS		24.0110-0300.1 410300	Ø 270 10 8
1.8 i 16V	82	01/95→10/97					
1.6 i	59	09/93→10/97	→	10/93→ 06/96; + ABS		24.0110-0300.1 410300	Ø 270 10 8













	kw			 	! #		
<b>KIA - SHUMA (FB) 09/96→12/01</b>							
 <b>Bremsbelagsatz, Scheibenbremse</b>							
1.5 i 16V 1.8 i 16V	65 81	10/97→03/01 10/97→03/01	➡	+ ABS		13.0460-5871.2 605871	SUM 23455 13,7 + WK
1.6	75	01/01→12/01	⬅	05/01→		13.0460-5868.2 605868	SUM 23873 15,8 + WK
			➡	05/01→; + ABS		13.0460-5871.2 605871	SUM 23455 13,7 + WK
 <b>Bremsscheibe</b>							
1.5 i 16V 1.8 i 16V	65 81	10/97→03/01 10/97→03/01	⬅			24.0120-0177.1 420177	Ø 242 20 18 V
			➡	+ ABS		24.0110-0301.1 410301	Ø 261 10 8
1.6	75	01/01→12/01	⬅	05/01→		24.0124-0185.1 424185	Ø 258 24 22 V
			➡	05/01→; + ABS		24.0110-0301.1 410301	Ø 261 10 8
<b>KIA - SHUMA II (FB) 05/01→08/04</b>							
 <b>Bremsbelagsatz, Scheibenbremse</b>							
1.6 1.8	75 84	05/01→08/04 04/03→08/04	⬅			13.0460-5868.2 605868	SUM 23873 15,8 + WK
			➡	+ ABS		13.0460-5871.2 605871	SUM 23455 13,7 + WK
1.8	81	05/01→06/04	⬅	04/03→		13.0460-5868.2 605868	SUM 23873 15,8 + WK
			➡	04/03→; + ABS		13.0460-5871.2 605871	SUM 23455 13,7 + WK
 <b>Bremsscheibe</b>							
1.6 1.8	75 84	05/01→08/04 04/03→08/04	⬅			24.0124-0185.1 424185	Ø 258 24 22 V
			➡	+ ABS		24.0110-0301.1 410301	Ø 261 10 8
1.8	81	05/01→06/04	⬅	04/03→		24.0124-0185.1 424185	Ø 258 24 22 V
			➡	04/03→; + ABS		24.0110-0301.1 410301	Ø 261 10 8
<b>KIA - SHUMA II Stufenheck (FB) 05/01→05/04</b>							
 <b>Bremsbelagsatz, Scheibenbremse</b>							
1.6	75	05/01→05/04	⬅			13.0460-5868.2 605868	SUM 23873 15,8 + WK
			➡	+ ABS		13.0460-5871.2 605871	SUM 23455 13,7 + WK
 <b>Bremsscheibe</b>							
1.6	75	05/01→05/04	⬅			24.0124-0185.1 424185	Ø 258 24 22 V
			➡	+ ABS		24.0110-0301.1 410301	Ø 261 10 8
<b>KIA - SHUMA Stufenheck (FB) 03/96→10/01</b>							
 <b>Bremsbelagsatz, Scheibenbremse</b>							
1.5	59	03/96→12/98	➡	10/97→; + ABS		13.0460-5871.2 605871	SUM 23455 13,7 + WK
1.5 i 16V	65	10/97→10/01	➡	→ 04/01; + ABS		13.0460-5871.2 605871	SUM 23455 13,7 + WK
 <b>Bremsscheibe</b>							
1.5	59	03/96→12/98	⬅	10/97→		24.0120-0177.1 420177	Ø 242 20 18 V
			➡	10/97→; + ABS		24.0110-0301.1 410301	Ø 261 10 8
1.5 i 16V	65	10/97→10/01	⬅	01/98→ 04/01		24.0120-0177.1 420177	Ø 242 20 18 V
			➡	→ 04/01; + ABS		24.0110-0301.1 410301	Ø 261 10 8
<b>KIA - SORENTO I (JC) 08/02→</b>							
 <b>Bremsbelagsatz, Scheibenbremse</b>							
2.4 2.5 CRDi	102 103	08/02→ 08/02→	⬅	→ 11/06		13.0460-5772.2 605772	24092 17,1 + WK + Zub
			➡	→ 11/06		13.0460-5773.2 605773	23993 15,5 + WK + Zub
2.5 CRDi 2.5 CRDi 3.3 V6	120 125 177	05/06→ 12/06→ 12/06→	⬅	→ 10/09		13.0460-5772.2 605772	24092 17,1 + WK + Zub
3.5 V6 4WD 3.3 V6 4WD	143 182	08/02→ 02/07→	➡	→ 10/09		13.0460-5773.2 605773	23993 15,5 + WK + Zub
			⬅	11/07→ 10/09		13.0460-5772.2 605772	24092 17,1 + WK + Zub
			➡	11/07→ 10/09		13.0460-5773.2 605773	23993 15,5 + WK + Zub
 <b>Bremsscheibe</b>							
2.4	102	08/02→	⬅	→ 11/06		24.0128-0200.1 428200	Ø 302 28 26 V
			➡	→ 11/06		24.0120-0202.1 420202	Ø 315 20 18,4 V
↓							

	kW			 	! #		
<b>KIA - SORENTO I (JC) 08/02→</b>							
 <b>Bremsscheibe</b>							
2.5 CRDi	103	08/02→	←	→ 11/06		24.0128-0200.1 428200	Ø 302 28 26 V
			→	→ 08/06		24.0120-0202.1 420202	Ø 315 20 18,4 V
			→	09/06→ 11/06		24.0120-0207.1 420207	Ø 315 20 18,4 V
2.5 CRDi	120	05/06→	←	→ 10/09		24.0128-0227.1 428227	Ø 302 28 26,4 V
2.5 CRDi	125	12/06→	→	→ 10/09		24.0120-0207.1 420207	Ø 315 20 18,4 V
3.3 V6	177	12/06→	→	→ 10/09		24.0120-0207.1 420207	Ø 315 20 18,4 V
3.3 V6 4WD	182	02/07→	←	11/07→ 10/09		24.0128-0227.1 428227	Ø 302 28 26,4 V
			→	11/07→ 10/09		24.0120-0207.1 420207	Ø 315 20 18,4 V
3.5 V6 4WD	143	08/02→	←	→ 10/09		24.0128-0200.1 428200	Ø 302 28 26 V
			→	→ 10/09		24.0120-0202.1 420202	Ø 315 20 18,4 V
<b>KIA - SORENTO II (XM) 09/09→</b>							
 <b>Bremsbelagsatz, Scheibenbremse</b>							
2.0 CRDi	110	11/10→	←	→ 12/14		13.0460-5777.2 605777	24351 16,3 + WK + Zub
2.0 CRDi 4WD	110	11/10→	→	→ 12/14		13.0460-5633.2 605633	AKE 25520 15,8 + WK + Zub
2.2 CRDi	145	11/09→					
2.2 CRDi	147	11/09→					
2.2 CRDi 4WD	145	11/09→					
2.4 CVVT	128	11/09→					
2.4 CVVT	141	10/12→					
2.4 CVVT 4WD	128	11/09→					
2.4 CVVT 4WD	141	10/12→					
2.4 GDI	141	10/12→					
2.4 GDI 4WD	141	10/12→					
3.5 4WD	204	05/13→	←			13.0460-5777.2 605777	24351 16,3 + WK + Zub
			→			13.0460-5633.2 605633	AKE 25520 15,8 + WK + Zub
 <b>Bremsscheibe</b>							
2.0 CRDi	110	11/10→	←	→ 12/14		24.0128-0248.1 428248	Ø 321 28 26,4 V
2.0 CRDi 4WD	110	11/10→	→	→ 12/14		24.0111-0170.1 411170	Ø 302 11 9,4
2.2 CRDi	145	11/09→					
2.2 CRDi	147	11/09→					
2.2 CRDi 4WD	145	11/09→					
2.4 CVVT	128	11/09→					
2.4 CVVT	141	10/12→					
2.4 CVVT 4WD	128	11/09→					
2.4 CVVT 4WD	141	10/12→					
2.4 GDI	141	10/12→					
2.4 GDI 4WD	141	10/12→					
3.5 4WD	204	05/13→	←			24.0128-0248.1 428248	Ø 321 28 26,4 V
			→			24.0111-0170.1 411170	Ø 302 11 9,4
<b>KIA - SORENTO III (UM) 01/15→</b>							
 <b>Bremsbelagsatz, Scheibenbremse</b>							
2.0 CRDi 4WD	136	07/15→	→	für Fahrzeuge ohne Sportpaket		13.0460-5636.2 605636	MAN 24599 14,9 + WK + Zub
2.4	129	01/15→					
2.4 4WD	129	01/15→					
2.4 GDI	138	01/15→					
2.4 GDI 4WD	138	01/15→					
3.3	199	04/15→					
2.2 CRDi	147	01/15→	→			13.0460-5636.2 605636	MAN 24599 14,9 + WK + Zub
2.2 CRDi 4WD	147	01/15→					
2.2 CRDi 4WD	149	01/15→					
2.2 CRDi 4WD	142	11/16→					
2.2 CRDi 4WD	145	11/16→					
 <b>Bremsscheibe</b>							
2.0 CRDi 4WD	136	07/15→	←			24.0128-0248.1 428248	Ø 321 28 26,4 V
2.2 CRDi	147	01/15→					
2.2 CRDi 4WD	147	01/15→					
2.2 CRDi 4WD	149	01/15→					
2.2 CRDi 4WD	142	11/16→					
2.2 CRDi 4WD	145	11/16→					
2.4	129	01/15→					
2.4 4WD	129	01/15→					
2.4 GDI	138	01/15→					
2.4 GDI 4WD	138	01/15→					
3.3	199	04/15→					
<b>KIA - SOUL (AM) 01/09→</b>							
 <b>Bremsbelagsatz, Scheibenbremse</b>							
1.6	91	09/09→12/14	←	→ 02/14		13.0460-5873.2 605873	MAN 23891 16,9 + WK
↓							















	kw			 	! #		
<b>KIA - SOUL (AM) 01/09→</b>							
 <b>Bremsbelagsatz, Scheibenbremse</b>							
1.6 CRDi 115	85	02/09→	➔	→ 02/14; + ABS		<b>13.0460-5786.2 605786</b>	AKE 24934 15,0 + WK + Zub
1.6 CRDi 128	94	02/09→				<b>13.0470-5786.2 LD5786</b>	AKE 24934 15,0 + WK + Zub
1.6 CVVT	77	02/09→					Ceramic
1.6 CVVT	93	02/09→					
1.6 CVVT	95	03/12→					
1.6 GDI	103	06/11→					
1.6 LPG	92	02/09→12/14	➔			<b>13.0460-5873.2 605873</b>	MAN 23891 16,9 + WK
			➔	+ ABS		<b>13.0460-5786.2 605786</b>	AKE 24934 15,0 + WK + Zub
						<b>13.0470-5786.2 LD5786</b>	AKE 24934 15,0 + WK + Zub
							Ceramic
<b>Zubehörsatz, Scheibenbremsbelag</b>							
1.6	91	09/09→12/14	➔	→ 02/14		<b>13.0460-0139.2 610139</b>	MAN
1.6 CRDi 115	85	02/09→					
1.6 CRDi 128	94	02/09→					
1.6 CVVT	77	02/09→					
1.6 CVVT	93	02/09→					
1.6 CVVT	95	03/12→					
1.6 GDI	103	06/11→					
1.6 LPG	92	02/09→12/14	➔			<b>13.0460-0139.2 610139</b>	MAN
 <b>Bremsscheibe</b>							
1.6	91	09/09→12/14	➔	→ 02/14		<b>24.0126-0150.1 426150</b>	Ø 280 26 24,4 V
1.6 CRDi 115	85	02/09→					
1.6 CRDi 128	94	02/09→	➔	→ 02/14; + ABS		<b>24.0110-0362.1 410362</b>	Ø 262 10 8,4
1.6 CVVT	77	02/09→					
1.6 CVVT	93	02/09→					
1.6 CVVT	95	03/12→					
1.6 GDI	103	06/11→					
1.6 LPG	92	02/09→12/14	➔			<b>24.0126-0150.1 426150</b>	Ø 280 26 24,4 V
			➔	+ ABS		<b>24.0110-0362.1 410362</b>	Ø 262 10 8,4
<b>KIA - SOUL II (PS) 02/14→</b>							
 <b>Bremsbelagsatz, Scheibenbremse</b>							
1.6 CRDi 128	94	02/14→	➔	15"		<b>13.0460-5641.2 605641</b>	25187 17,8 + WK + Zub
			➔	16"		<b>13.0460-5647.2 605647</b>	MAN 24501 17,8 + WK + Zub
			➔	→ 02/14		<b>13.0460-5873.2 605873</b>	MAN 23891 16,9 + WK
			➔			<b>13.0460-5650.2 605650</b>	AKE 25337 15,5 + WK + Zub
			➔	→ 02/14; + ABS		<b>13.0460-5786.2 605786</b>	AKE 24934 15,0 + WK + Zub
						<b>13.0470-5786.2 LD5786</b>	AKE 24934 15,0 + WK + Zub
							Ceramic
1.6 CRDi 136	100	04/15→	➔	15"		<b>13.0460-5641.2 605641</b>	25187 17,8 + WK + Zub
1.6 CVVT	91	02/14→					
1.6 GDI	97	02/14→	➔	16"		<b>13.0460-5647.2 605647</b>	MAN 24501 17,8 + WK + Zub
			➔			<b>13.0460-5650.2 605650</b>	AKE 25337 15,5 + WK + Zub
2.0 CVVT	113	02/14→	➔	04/14→; 15"		<b>13.0460-5641.2 605641</b>	25187 17,8 + WK + Zub
			➔	04/14→; 16"		<b>13.0460-5647.2 605647</b>	MAN 24501 17,8 + WK + Zub
			➔	04/14→		<b>13.0460-5650.2 605650</b>	AKE 25337 15,5 + WK + Zub
<b>Zubehörsatz, Scheibenbremsbelag</b>							
1.6 CRDi 128	94	02/14→	➔	→ 02/14		<b>13.0460-0139.2 610139</b>	MAN
 <b>Bremsscheibe</b>							
1.6 CRDi 128	94	02/14→	➔	15"		<b>24.0126-0150.1 426150</b>	Ø 280 26 24,4 V
			➔	→ 02/14		<b>24.0126-0150.1 426150</b>	Ø 280 26 24,4 V
			➔	16"		<b>24.0128-0234.1 428234</b>	Ø 300 28 26,4 V
			➔	→ 02/14; + ABS		<b>24.0110-0362.1 410362</b>	Ø 262 10 8,4
			➔			<b>24.0110-0368.1 410368</b>	Ø 262 10 8,4
1.6 CRDi 136	100	04/15→	➔	15"		<b>24.0126-0150.1 426150</b>	Ø 280 26 24,4 V
1.6 CVVT	91	02/14→					
1.6 GDI	97	02/14→	➔	16"		<b>24.0128-0234.1 428234</b>	Ø 300 28 26,4 V
			➔			<b>24.0110-0368.1 410368</b>	Ø 262 10 8,4
1.6 TGDI	150	11/16→	➔	15"		<b>24.0126-0150.1 426150</b>	Ø 280 26 24,4 V
			➔	16"		<b>24.0128-0234.1 428234</b>	Ø 300 28 26,4 V
			➔	17"		<b>24.0128-0258.1 428258</b>	Ø 320 28,1 26,4 V
↓							



















	kw					! #		
<b>KIA - SOUL II (PS) 02/14→</b>								
 <b>Bremsscheibe</b>								
1.6 TGDI	150	11/16→	➔	15"		24.0110-0368.1	410368	Ø 262 10 8,4
2.0 CVVT	113	02/14→	➔	04/14→; 15"		24.0126-0150.1	426150	Ø 280 26 24,4 V
			➔	04/14→; 16"		24.0128-0234.1	428234	Ø 300 28 26,4 V
			➔	04/14→		24.0110-0368.1	410368	Ø 262 10 8,4
EV Electric	25	09/14→	➔			24.0128-0234.1	428234	Ø 300 28 26,4 V
EV Electric	26	03/17→	➔			24.0110-0400.1	410400	Ø 284 10 8,4
EV Electric	81	09/14→	➔					
<b>KIA - SPORTAGE (JE_, KM_) 09/04→</b>								
 <b>Bremsbelagsatz, Scheibenbremse</b>								
2.0	122	01/09→05/10	➔			13.0460-5873.2	605873	MAN 23891 16,9 + WK
			➔			13.0460-5833.2	605833	AKE 23543 14,4 + WK + Zub
2.0 16V 4WD	104	09/04→	➔	01/08→ 05/10		13.0460-5600.2	605600	SUM 24501 16,7 + WK
2.0 CRDi	83	02/05→	➔	→ 12/07		13.0460-5873.2	605873	MAN 23891 16,9 + WK
2.0 CRDi	100	01/06→	➔					
2.0 CRDi	103	01/06→	➔	01/07→ 05/10		13.0460-5780.2	605780	MAN 24320 15,3 + WK + Zub
2.0 CRDi 4WD	83	09/04→	➔					
2.0 CRDi 4WD	100	01/06→	➔	→ 12/06		13.0460-5833.2	605833	AKE 23543 14,4 + WK + Zub
2.0 CRDi 4WD	103	01/06→	➔					
2.0 i 16V	104	09/04→	➔					
2.0 CRDi	110	09/07→	➔	→ 05/10		13.0460-5600.2	605600	SUM 24501 16,7 + WK
2.0 CRDi 4WD	110	09/08→	➔	→ 05/10		13.0460-5780.2	605780	MAN 24320 15,3 + WK + Zub
2.7 V6 4WD	129	09/04→	➔	01/08→ 05/10		13.0460-5600.2	605600	SUM 24501 16,7 + WK
			➔	→ 12/07		13.0460-5873.2	605873	MAN 23891 16,9 + WK
			➔	→ 05/10		13.0460-5833.2	605833	AKE 23543 14,4 + WK + Zub
<b>Zubehörsatz, Scheibenbremsbelag</b>								
2.0 16V 4WD	104	09/04→	➔	→ 12/07		13.0460-0139.2	610139	MAN
2.0 CRDi	83	02/05→	➔					
2.0 CRDi	100	01/06→	➔					
2.0 CRDi	103	01/06→	➔					
2.0 CRDi 4WD	83	09/04→	➔					
2.0 CRDi 4WD	100	01/06→	➔					
2.0 CRDi 4WD	103	01/06→	➔					
2.0 i 16V	104	09/04→	➔					
2.7 V6 4WD	129	09/04→	➔					
 <b>Bremsscheibe</b>								
2.0	122	01/09→05/10	➔			24.0126-0128.1	426128	Ø 280 26 24,4 V
			➔			24.0110-0318.1	410318	Ø 262 10 8,4
2.0 16V 4WD	104	09/04→	➔	→ 12/07		24.0126-0128.1	426128	Ø 280 26 24,4 V
2.0 CRDi 4WD	83	09/04→	➔	01/08→ 05/10		24.0128-0280.1	428280	Ø 300 28 26,4 V
2.0 CRDi 4WD	100	01/06→	➔					
2.0 CRDi 4WD	103	01/06→	➔	→ 05/10		24.0110-0286.1	410286	Ø 284 10 8,4
2.7 V6 4WD	129	09/04→	➔					
2.0 CRDi	83	02/05→	➔	→ 12/07		24.0126-0128.1	426128	Ø 280 26 24,4 V
2.0 CRDi	100	01/06→	➔					
2.0 CRDi	103	01/06→	➔	01/08→ 05/10		24.0128-0280.1	428280	Ø 300 28 26,4 V
2.0 i 16V	104	09/04→	➔	→ 05/10		24.0110-0318.1	410318	Ø 262 10 8,4
2.0 CRDi	110	09/07→	➔	→ 05/10		24.0128-0280.1	428280	Ø 300 28 26,4 V
			➔	→ 05/10		24.0110-0318.1	410318	Ø 262 10 8,4
2.0 CRDi 4WD	110	09/08→	➔	→ 05/10		24.0128-0280.1	428280	Ø 300 28 26,4 V
			➔	→ 05/10		24.0110-0286.1	410286	Ø 284 10 8,4
<b>KIA - SPORTAGE (K00) 04/94→08/04</b>								
 <b>Bremsbelagsatz, Scheibenbremse</b>								
2.0	87	10/00→08/03	➔			13.0460-5896.2	605896	23442 15,3 + WK
2.0 4WD	87	10/00→08/03	➔					
2.0 i 16V	94	10/99→08/03	➔					
2.0 i 16V 4WD	94	04/94→08/03	➔	10/99→		13.0460-5896.2	605896	23442 15,3 + WK
2.0 i 16V 4WD	95	11/98→08/04	➔	10/99→ 08/03		13.0460-5896.2	605896	23442 15,3 + WK
2.0 TD 4WD	61	10/97→08/03	➔	06/99→		13.0460-5896.2	605896	23442 15,3 + WK
<b>KIA - SPORTAGE (QL, QLE) 09/15→</b>								
 <b>Bremsbelagsatz, Scheibenbremse</b>								
1.6 GDI	97	09/15→	➔			13.0460-5600.2	605600	SUM 24501 16,7 + WK
↓								

















	kw			 	! #		
<b>KIA - SPORTAGE (QL, QLE) 09/15→</b>							
 <b>Bremsbelagsatz, Scheibenbremse</b>							
1.6 GDI	130	09/15→	➡	+ eFSB		13.0460-5650.2 605650	AKE 25337 15,5 + WK + Zub
1.6 GDI AWD	130	09/15→	➡	- eFSB		13.0460-5781.2 605781	MAN + WK + Zub
1.7 CRDi	85	09/15→					
1.7 CRDi	104	11/16→					
2.0 CRDi	100	09/15→					
2.0	114	12/15→	⬅			13.0460-5600.2 605600	SUM 24501 16,7 + WK
			➡	+ eFSB		13.0460-5650.2 605650	AKE 25337 15,5 + WK + Zub
			➡	- eFSB		13.0460-5786.2 605786	AKE 24934 15,0 + WK + Zub
						13.0470-5786.2 LD5786	AKE 24934 15,0 + WK + Zub Ceramic
2.0 AWD	114	12/15→	⬅	Made in Slowakische Republik		13.0460-5600.2 605600	SUM 24501 16,7 + WK
			➡	+ eFSB		13.0460-5650.2 605650	AKE 25337 15,5 + WK + Zub
			➡	Made in Slowakische Republik; - eFSB		13.0460-5781.2 605781	MAN + WK + Zub
			➡	- eFSB		13.0460-5786.2 605786	AKE 24934 15,0 + WK + Zub
						13.0470-5786.2 LD5786	AKE 24934 15,0 + WK + Zub Ceramic
2.0 CRDi AWD	100	09/15→	⬅	Made in Slowakische Republik		13.0460-5600.2 605600	SUM 24501 16,7 + WK
2.0 CRDi AWD	136	09/15→	➡	Made in Republik Korea (Südkorea); + eFSB		13.0460-5650.2 605650	AKE 25337 15,5 + WK + Zub
			➡	Made in Slowakische Republik; + eFSB		13.0460-5650.2 605650	AKE 25337 15,5 + WK + Zub
			➡	Made in Slowakische Republik; - eFSB		13.0460-5781.2 605781	MAN + WK + Zub
			➡	Made in Republik Korea (Südkorea); - eFSB		13.0460-5786.2 605786	AKE 24934 15,0 + WK + Zub
						13.0470-5786.2 LD5786	AKE 24934 15,0 + WK + Zub Ceramic
 <b>Bremsscheibe</b>							
1.6 GDI	97	09/15→	⬅			24.0125-0213.1 425213	Ø 305 25 23,4 V
1.6 GDI	130	09/15→					
1.6 GDI AWD	130	09/15→					
1.7 CRDi	85	09/15→					
1.7 CRDi	104	11/16→					
2.0 CRDi	100	09/15→					
2.0 AWD	114	12/15→	⬅	Made in Slowakische Republik		24.0125-0213.1 425213	Ø 305 25 23,4 V
2.0 CRDi AWD	100	09/15→					
2.0 CRDi AWD	136	09/15→					
<b>KIA - SPORTAGE (SL) 09/09→</b>							
 <b>Bremsbelagsatz, Scheibenbremse</b>							
1.6 GDI	99	02/11→	⬅	→ 12/15		13.0460-5600.2 605600	SUM 24501 16,7 + WK
1.7 CRDi	85	12/10→	➡	→ 12/15		13.0460-5780.2 605780	MAN 24320 15,3 + WK + Zub
2.0 CRDi	100	07/10→					
2.0 CRDi	135	08/10→					
2.0 CRDi AWD	100	07/10→					
2.0 CRDi AWD	135	08/10→					
2.0 CVVT	120	07/10→					
2.0 CVVT	122	07/10→					
2.0 CVVT AWD	120	07/10→					
2.0 CVVT AWD	122	07/10→					
2.0 GDI	122	02/14→					
2.0 GDI AWD	122	02/14→					
2.0 CVVT	110	06/10→12/13	⬅			13.0460-5600.2 605600	SUM 24501 16,7 + WK
2.0 CVVT AWD	110	06/10→12/13	➡			13.0460-5780.2 605780	MAN 24320 15,3 + WK + Zub
2.0 CVVT	113	11/14→12/15	⬅	Made in Slowakische Republik		13.0460-5600.2 605600	SUM 24501 16,7 + WK
			➡	Made in Slowakische Republik		13.0460-5780.2 605780	MAN 24320 15,3 + WK + Zub
 <b>Bremsscheibe</b>							
1.6 GDI	99	02/11→	⬅	→ 12/15		24.0128-0256.1 428256	Ø 300 28 26,4 V
1.7 CRDi	85	12/10→	➡	→ 12/15		24.0110-0332.1 410332	Ø 262 10 8
2.0 CRDi	100	07/10→					
2.0 CRDi	135	08/10→					
2.0 CVVT	120	07/10→					
2.0 CVVT	122	07/10→					
2.0 GDI	122	02/14→					
2.0 CRDi AWD	100	07/10→	⬅	→ 12/15		24.0128-0256.1 428256	Ø 300 28 26,4 V
2.0 CRDi AWD	135	08/10→	➡	→ 12/15		24.0110-0286.1 410286	Ø 284 10 8,4
2.0 CVVT AWD	120	07/10→					
2.0 CVVT AWD	122	07/10→					
2.0 GDI AWD	122	02/14→					
2.0 CVVT	110	06/10→12/13	⬅			24.0128-0256.1 428256	Ø 300 28 26,4 V
			➡			24.0110-0332.1 410332	Ø 262 10 8
↓							































	kw			 	! #		
<b>KIA - SPORTAGE (SL) 09/09→</b>							
 <b>Bremsscheibe</b>							
2.0 CVVT	113	11/14→12/15	←	Made in Slowakische Republik		24.0128-0256.1 428256	Ø 300 28 26,4 V
			→			24.0110-0332.1 410332	Ø 262 10 8
2.0 CVVT AWD	110	06/10→12/13	←			24.0128-0256.1 428256	Ø 300 28 26,4 V
			→			24.0110-0286.1 410286	Ø 284 10 8,4
<b>KIA - STONIC (YB) 07/17→</b>							
 <b>Bremsscheibe</b>							
1.0 T-GDi	88	07/17→	→			24.0110-0398.1 410398	Ø 262 10 8,4
1.2 CVVT	62	07/17→					
1.4 CVVT	73	07/17→					
1.6 CRDi	81	07/17→					
<b>KIA - VENGA (YN) 02/10→</b>							
 <b>Bremsbelagsatz, Scheibenbremse</b>							
1.4 CRDi 75	55	02/10→	←			13.0460-2772.2 602772	TRW 25184 19,5 + WK + Zub
1.4 CRDi 75	57	02/10→	→			13.0460-2868.2 602868	TRW 23417 15,3 + WK + Zub
1.4 CRDi 90	66	02/10→					
1.4 CVVT	66	02/10→				13.0470-2868.2 LD2868	TRW 23417 15,3 + WK + Zub Ceramic
1.4 LPG	66	02/10→					
1.6 CRDi 115	85	02/10→					
1.6 CRDi 128	94	02/10→					
1.6 CVVT	92	02/10→					
 <b>Bremsscheibe</b>							
1.4 CRDi 75	55	02/10→	←			24.0126-0150.1 426150	Ø 280 26 24,4 V
1.4 CRDi 75	57	02/10→	→			24.0110-0357.1 410357	Ø 258 10 8
1.4 CRDi 90	66	02/10→					
1.4 CVVT	66	02/10→					
1.4 LPG	66	02/10→					
1.6 CRDi 115	85	02/10→					
1.6 CRDi 128	94	02/10→					
1.6 CVVT	92	02/10→					
<b>LADA - 110 (2110) 01/95→12/12</b>							
 <b>Bremsbelagsatz, Scheibenbremse</b>							
1.5	54	01/95→12/05	←			13.0460-2965.2 602965	TRW 21170 17,3 - WE / - WK
1.5	57	01/95→12/05					
1.5 16V	70	01/95→12/05					
1.6	66	01/00→04/07					
1.6	60	01/00→12/12	←	→ 08/07		13.0460-2965.2 602965	TRW 21170 17,3 - WE / - WK
 <b>Bremsscheibe</b>							
1.5	54	01/95→12/05	←	→ 09/00		24.0112-0125.1 412125	Ø 239 12 10,8
1.5	57	01/95→12/05				24.0312-0125.1 512125	Ø 239 12 10,8
1.5 16V	70	01/95→12/05					
1.5	56	10/00→12/05	←	passend für Felgengröße [Zoll]: 13		24.0120-0186.1 420186	Ø 239 19,5 18 V
2.0 i	110	08/96→07/00	←	passend für Felgengröße [Zoll]: 14		24.0120-0187.1 420187	Ø 260 20 18,5 V
Wankel	88	06/97→09/04					
1.5 16V	67	10/00→12/10	←	→ 08/07; passend für Felgengröße [Zoll]: 13		24.0120-0186.1 420186	Ø 239 19,5 18 V
			←	→ 08/07; passend für Felgengröße [Zoll]: 14		24.0120-0187.1 420187	Ø 260 20 18,5 V
1.6	60	01/00→12/12	←	→ 08/07		24.0112-0125.1 412125	Ø 239 12 10,8
						24.0312-0125.1 512125	Ø 239 12 10,8
1.6	66	01/00→04/07	←			24.0112-0125.1 412125	Ø 239 12 10,8
						24.0312-0125.1 512125	Ø 239 12 10,8
<b>LADA - 111 (2111) 01/95→</b>							
 <b>Bremsbelagsatz, Scheibenbremse</b>							
1.5	57	01/96→12/05	←			13.0460-2965.2 602965	TRW 21170 17,3 - WE / - WK
1.5 16V	70	01/95→08/02					
1.6	60	09/04→12/13	←	01/05→ 12/08		13.0460-2965.2 602965	TRW 21170 17,3 - WE / - WK
1.6	66	09/04→	←	03/06→ 12/08		13.0460-2965.2 602965	TRW 21170 17,3 - WE / - WK
 <b>Bremsscheibe</b>							
1.5	56	10/00→12/05	←	passend für Felgengröße [Zoll]: 13		24.0120-0186.1 420186	Ø 239 19,5 18 V
1.5	58	10/00→09/04					
1.5 16V	67	10/00→12/05	←	passend für Felgengröße [Zoll]: 14		24.0120-0187.1 420187	Ø 260 20 18,5 V
1.5	57	01/96→12/05	←	→ 09/00		24.0112-0125.1 412125	Ø 239 12 10,8
1.5 16V	70	01/95→08/02				24.0312-0125.1 512125	Ø 239 12 10,8
↓							









	kw					! #		
<b>LADA - 111 (2111) 01/95→</b>								
 <b>Bremsscheibe</b>								
1.6	60	09/04→12/13	←	01/05→12/08; passend für Felgengröße [Zoll]: 13		24.0120-0186.1	420186	Ø 239 19,5 18 V
			←	01/05→12/08; passend für Felgengröße [Zoll]: 14		24.0120-0187.1	420187	Ø 260 20 18,5 V
1.6	66	09/04→	←	03/06→12/08; passend für Felgengröße [Zoll]: 13		24.0120-0186.1	420186	Ø 239 19,5 18 V
			←	03/06→12/08; passend für Felgengröße [Zoll]: 14		24.0120-0187.1	420187	Ø 260 20 18,5 V
<b>LADA - 112 (2112) 01/95→12/11</b>								
 <b>Bremsbelagsatz, Scheibenbremse</b>								
1.5	54	01/95→10/00	←			13.0460-2965.2	602965	TRW 21170 17,3 - WE / - WK
1.5	57	01/95→09/04						
1.5 16V	70	01/95→09/00						
1.6	66	03/06→12/08						
1.6	60	01/05→12/11	←	→ 12/08		13.0460-2965.2	602965	TRW 21170 17,3 - WE / - WK
 <b>Bremsscheibe</b>								
1.5	54	01/95→10/00	←	→ 09/00		24.0112-0125.1	412125	Ø 239 12 10,8
1.5	57	01/95→09/04				24.0312-0125.1	512125	Ø 239 12 10,8
1.5	56	10/00→12/05	←	passend für Felgengröße [Zoll]: 13		24.0120-0186.1	420186	Ø 239 19,5 18 V
1.5 16V	67	10/00→12/05						
1.6	66	03/06→12/08	←	passend für Felgengröße [Zoll]: 14		24.0120-0187.1	420187	Ø 260 20 18,5 V
1.5 16V	70	01/95→09/00	←			24.0112-0125.1	412125	Ø 239 12 10,8
						24.0312-0125.1	512125	Ø 239 12 10,8
1.6	60	01/05→12/11	←	→ 12/08; passend für Felgengröße [Zoll]: 13		24.0120-0186.1	420186	Ø 239 19,5 18 V
			←	→ 12/08; passend für Felgengröße [Zoll]: 14		24.0120-0187.1	420187	Ø 260 20 18,5 V
<b>LADA - 1200-1600 01/70→12/05</b>								
 <b>Bremsbelagsatz, Scheibenbremse</b>								
1600 N/L (VAZ2106, VAZ2103)	57	03/79→12/05	←	→ 06/85		13.0460-2966.2	602966	TRW 20166 16,0 - WE / - WK
 <b>Bremsscheibe</b>								
1600 N/L (VAZ2106, VAZ2103)	57	03/79→12/05	←	→ 06/85		24.0111-0115.1	411115	Ø 252,5 10 9
<b>LADA - KALINA Kombi (1117) 10/04→</b>								
 <b>Bremsbelagsatz, Scheibenbremse</b>								
1.4 16V	66	11/08→12/13	←			13.0460-2965.2	602965	TRW 21170 17,3 - WE / - WK
1.4 16V LPG	65	11/08→						
1.6	60	10/04→12/13						
1.6	62	01/10→						
 <b>Bremsscheibe</b>								
1.4 16V	66	11/08→12/13	←			24.0120-0187.1	420187	Ø 260 20 18,5 V
1.4 16V LPG	65	11/08→						
1.6	60	10/04→12/13						
1.6	62	01/10→						
<b>LADA - KALINA Kombi (2194) 11/13→</b>								
 <b>Bremsbelagsatz, Scheibenbremse</b>								
1.6	64	11/13→	←			13.0460-2965.2	602965	TRW 21170 17,3 - WE / - WK
1.6	72	11/13→						
 <b>Bremsscheibe</b>								
1.6	64	11/13→	←			24.0120-0187.1	420187	Ø 260 20 18,5 V
1.6	72	11/13→						
<b>LADA - KALINA Schrägheck (1119) 10/04→12/13</b>								
 <b>Bremsbelagsatz, Scheibenbremse</b>								
1.4 16V	66	11/08→12/13	←			13.0460-2965.2	602965	TRW 21170 17,3 - WE / - WK
1.4 16V LPG	65	11/08→12/13						
1.6	60	10/04→12/13						
1.6	62	01/10→12/13						
1.6	66	10/04→12/13						
 <b>Bremsscheibe</b>								
1.4 16V	66	11/08→12/13	←			24.0120-0187.1	420187	Ø 260 20 18,5 V











	kw					! #		
<b>LADA - KALINA Schrägheck (1119) 10/04→12/13</b>								
 <b>Bremsscheibe</b>								
1.4 16V LPG	65	11/08→12/13	←			24.0120-0187.1	420187	Ø 260 20 18,5 V
1.6	60	10/04→12/13						
1.6	62	01/10→12/13						
1.6	66	10/04→12/13						
<b>LADA - KALINA Schrägheck (2192) 06/13→</b>								
 <b>Bremsbelagsatz, Scheibenbremse</b>								
1.6	64	06/13→	←			13.0460-2965.2	602965	TRW 21170 17,3 - WE / - WK
1.6	72	06/13→						
 <b>Bremsscheibe</b>								
1.6	64	06/13→	←			24.0120-0187.1	420187	Ø 260 20 18,5 V
1.6	72	06/13→						
<b>LADA - KALINA Stufenheck (1118) 10/04→</b>								
 <b>Bremsbelagsatz, Scheibenbremse</b>								
1.4 16V	66	11/08→12/09	←			13.0460-2965.2	602965	TRW 21170 17,3 - WE / - WK
1.4 16V LPG	65	11/08→12/13						
1.6	60	10/04→12/09						
1.6	62	01/10→						
1.6	66	10/04→						
 <b>Bremsscheibe</b>								
1.4 16V	66	11/08→12/09	←			24.0120-0187.1	420187	Ø 260 20 18,5 V
1.4 16V LPG	65	11/08→12/13						
1.6	60	10/04→12/09						
1.6	62	01/10→						
1.6	66	10/04→						
<b>LADA - NIVA Geländewagen geschlossen (2121, 2131) 12/76→</b>								
 <b>Bremsbelagsatz, Scheibenbremse</b>								
1700 i	59	06/96→12/06	←			13.0460-8006.2	608006	20660 15,6 - WE / - WK
1700 i 4x4	60	10/00→12/10						
1700 i 4x4	61	09/10→						
1900 Diesel	55	01/99→12/06						
1900 Diesel	48	01/93→08/99	←	03/93→		13.0460-8006.2	608006	20660 15,6 - WE / - WK
 <b>Bremsscheibe</b>								
1700 i	59	06/96→12/06	←			24.0112-0130.1	412130	Ø 272 11 9,9
1700 i 4x4	60	10/00→12/10						
1700 i 4x4	61	09/10→						
1900 Diesel	55	01/99→12/06						
1900 Diesel	48	01/93→08/99	←	03/93→		24.0112-0130.1	412130	Ø 272 11 9,9
<b>LADA - NOVA (2105) 05/81→04/12</b>								
 <b>Bremsbelagsatz, Scheibenbremse</b>								
1200 Junior/L (VAZ, WAS2105)	44	09/81→04/12	←	→ 12/96		13.0460-2966.2	602966	TRW 20166 16,0 - WE / - WK
1300 Spezial/L (VAZ, WAS2105)	48	05/81→04/12						
1500 S (WAS21093)	52	06/89→04/12						
1500 Special (VAZ2105, WAS21053)	55	03/85→04/12						
1600 (WAS21074)	56	01/88→10/01						
1700 i Classic (VAZ2107)	62	06/96→04/12						
 <b>Bremsscheibe</b>								
1200 Junior/L (VAZ, WAS2105)	44	09/81→04/12	←	→ 12/96		24.0111-0115.1	411115	Ø 252,5 10 9
1300 Spezial/L (VAZ, WAS2105)	48	05/81→04/12						
1500 S (WAS21093)	52	06/89→04/12						
1500 Special (VAZ2105, WAS21053)	55	03/85→04/12						
1600 (WAS21074)	56	01/88→10/01						
1700 i Classic (VAZ2107)	62	06/96→04/12						
<b>LADA - NOVA Kombi (2104) 09/84→04/12</b>								
 <b>Bremsbelagsatz, Scheibenbremse</b>								
1500	49	08/94→04/12	←	→ 12/96		13.0460-2966.2	602966	TRW 20166 16,0 - WE / - WK
1700	62	08/94→04/12						
↓								











	kw			 	! #		
<b>LADA - NOVA Kombi (2104) 09/84→04/12</b>							
 <b>Bremsscheibe</b>							
1500 1700	49 62	08/94→04/12 08/94→04/12	←	→ 12/96		24.0111-0115.1 411115	Ø 252,5 10 9
<b>LADA - PRIORA Kombi (2171) 10/09→</b>							
 <b>Bremsbelagsatz, Scheibenbremse</b>							
1.6	72	10/09→	←			13.0460-2965.2 602965	TRW 21170 17,3 - WE / - WK
<b>LADA - PRIORA Schrägheck (2172) 12/08→</b>							
 <b>Bremsbelagsatz, Scheibenbremse</b>							
1.6 1.6 1.6 LPG	60 72 71	12/08→12/13 12/08→ 12/08→	←			13.0460-2965.2 602965	TRW 21170 17,3 - WE / - WK
<b>LADA - PRIORA Stufenheck (2170) 04/07→</b>							
 <b>Bremsbelagsatz, Scheibenbremse</b>							
1.6 1.6 1.6 LPG	60 72 71	12/08→12/13 04/07→ 03/09→	←			13.0460-2965.2 602965	TRW 21170 17,3 - WE / - WK
<b>LADA - SAMARA (2108, 2109, 2115, 2113, 2114) 01/86→12/13</b>							
 <b>Bremsbelagsatz, Scheibenbremse</b>							
1.5 1500	56 52	04/96→12/13 02/95→12/06	←	→ 12/99		13.0460-2965.2 602965	TRW 21170 17,3 - WE / - WK
1100 1300 1300 1300 1500 1500	43 45 46 50 50 53	02/96→08/99 09/91→08/99 06/87→12/96 02/96→12/96 09/91→12/96 09/87→12/96	←			13.0460-2965.2 602965	TRW 21170 17,3 - WE / - WK
 <b>Bremsscheibe</b>							
1.5 1500	56 52	04/96→12/13 02/95→12/06	←	→ 12/99		24.0112-0125.1 412125 24.0312-0125.1 512125	Ø 239 12 10,8 Ø 239 12 10,8
1100 1300 1300 1300 1500 1500	43 45 46 50 50 53	02/96→08/99 09/91→08/99 06/87→12/96 02/96→12/96 09/91→12/96 09/87→12/96	←			24.0112-0125.1 412125 24.0312-0125.1 512125	Ø 239 12 10,8 Ø 239 12 10,8
<b>LADA - SAMARA FORMA Stufenheck (21099, 2115) 09/87→12/12</b>							
 <b>Bremsbelagsatz, Scheibenbremse</b>							
1100 1300 1300 1300 1500 1500 1500	39 45 46 48 50 52 53	07/91→08/99 07/91→08/99 05/90→08/99 05/89→07/97 07/91→12/96 11/94→12/06 09/91→12/96	←	→ 12/95		13.0460-2965.2 602965	TRW 21170 17,3 - WE / - WK
 <b>Bremsscheibe</b>							
1100 1300 1300 1300 1500 1500 1500	39 45 46 48 50 52 53	07/91→08/99 07/91→08/99 05/90→08/99 05/89→07/97 07/91→12/96 11/94→12/06 09/91→12/96	←	→ 12/95		24.0112-0125.1 412125 24.0312-0125.1 512125	Ø 239 12 10,8 Ø 239 12 10,8
<b>LADA - TAIGA II (2123) 09/02→</b>							
 <b>Bremsbelagsatz, Scheibenbremse</b>							
1.7 1.7 1.7 LPG	59 61 57	09/02→ 08/04→ 09/02→	←			13.0460-8006.2 608006	20660 15,6 - WE / - WK
 <b>Bremsscheibe</b>							
1.7 1.7 1.7 LPG	59 61 57	09/02→ 08/04→ 09/02→	←			24.0112-0130.1 412130	Ø 272 11 9,9















	kw			 	! #				
<b>LADA - TOSCANA (2107) 05/82→05/12</b>									
<b> Bremsbelagsatz, Scheibenbremse</b>									
1300	48	12/85→05/12	←	→ 12/96		13.0460-2966.2 602966	TRW 20166 16,0 - WE / - WK		
<b> Bremsscheibe</b>									
1300	48	12/85→05/12	←	→ 12/96		24.0111-0115.1 411115	∅ 252,5 10 9		
<b>LANCIA - DEDRA (835_) 01/89→07/99</b>									
<b> Bremsbelagsatz, Scheibenbremse</b>									
1.6 16V (835EI)	76	01/96→07/99	←			13.0460-2949.2 602949	TRW 20833 17,0 + WK		
1.6 LE Cat (835EB)	66	07/94→07/99	←			13.0460-7131.2 607131	ATE 21193 18,0 + WK		
1.6 i.e. (835AN)	55	04/93→07/99	←	11/93→		13.0460-2949.2 602949	TRW 20833 17,0 + WK		
			←	→ 10/93		13.0460-7131.2 607131	ATE 21193 18,0 + WK		
			→	→ 10/93; + ABS		13.0460-2949.2 602949	TRW 20833 17,0 + WK		
1.8 16V LE (835FG)	83	03/96→07/99	←			13.0460-2949.2 602949	TRW 20833 17,0 + WK		
			1.8 i.e. (835FA)	74	07/94→07/99	←		13.0460-7131.2 607131	ATE 21193 18,0 + WK
			→	ALU		13.0460-2826.2 602826	TRW 23177 14,2 - WK		
			→	GG		13.0460-2951.2 602951	TRW 21103 14,2 - WK		
1.8 GT 16V (835EH)	96	03/96→07/99	←			13.0460-7129.2 607129	ATE 20907 18,1 + WK		
			2.0 16V (835ED)	102	07/94→07/99	←		13.0460-2826.2 602826	TRW 23177 14,2 - WK
			→	ALU		13.0460-2951.2 602951	TRW 21103 14,2 - WK		
			→	GG		13.0460-2951.2 602951	TRW 21103 14,2 - WK		
1.8 i.e. (835AT)	66	08/93→07/99	←	→ 10/93		13.0460-2949.2 602949	TRW 20833 17,0 + WK		
			←	11/93→		13.0460-2949.2 602949	TRW 20833 17,0 + WK		
			→	11/93→; ALU		13.0460-7131.2 607131	ATE 21193 18,0 + WK		
			→	11/93→; GG		13.0460-2826.2 602826	TRW 23177 14,2 - WK		
			→	→ 10/93		13.0460-2951.2 602951	TRW 21103 14,2 - WK		
1.8 i.e. (835BD, 835AD)	77	09/89→07/99	←	01/90→ 10/93		13.0460-2949.2 602949	TRW 20833 17,0 + WK		
			2.0 i.e. (835AL)	83	09/89→07/99	←		13.0460-7131.2 607131	ATE 21193 18,0 + WK
			→	11/93→; ALU		13.0460-2826.2 602826	TRW 23177 14,2 - WK		
			→	01/90→ 10/93		13.0460-2951.2 602951	TRW 21103 14,2 - WK		
			→	11/93→; GG		13.0460-2951.2 602951	TRW 21103 14,2 - WK		
1.9 TDS (835EE, 835EF)	66	04/89→07/99	←	01/90→ 10/93		13.0460-2949.2 602949	TRW 20833 17,0 + WK		
			←	11/93→		13.0460-7065.2 607065	ATE 21927 17,9 + WK		
			→	11/93→; ALU		13.0460-2826.2 602826	TRW 23177 14,2 - WK		
			→	11/93→; GG		13.0460-2951.2 602951	TRW 21103 14,2 - WK		
			→	01/90→ 10/93		13.0460-2951.2 602951	TRW 21103 14,2 - WK		
2.0 i.e. Turbo (835AR)	119	04/91→07/99	←	11/93→		13.0460-2949.2 602949	TRW 20833 17,0 + WK		
			←	05/91→ 10/93		13.0460-7131.2 607131	ATE 21193 18,0 + WK		
			→	11/93→; ALU		13.0460-2979.2 602979	TRW 21147 19,0 + WK		
			→	11/93→; GG		13.0460-2826.2 602826	TRW 23177 14,2 - WK		
			→	05/91→ 10/93		13.0460-2951.2 602951	TRW 21103 14,2 - WK		
<b>Zubehörsatz, Scheibenbremsbelag</b>									
1.6 i.e. (835AN)	55	04/93→07/99	→	→ 10/93; + ABS		13.0460-0072.2 610072	TRW		
1.8 16V LE (835FG)	83	03/96→07/99	→	GG		13.0460-0072.2 610072	TRW		
1.8 GT 16V (835EH)	96	03/96→07/99	→						
1.8 i.e. (835FA)	74	07/94→07/99	→						
2.0 16V (835ED)	102	07/94→07/99	→						
1.8 i.e. (835AT)	66	08/93→07/99	→	11/93→; GG		13.0460-0072.2 610072	TRW		
			→	→ 10/93		13.0460-0072.2 610072	TRW		
1.8 i.e. (835BD, 835AD)	77	09/89→07/99	→	11/93→; GG		13.0460-0072.2 610072	TRW		
1.9 TDS (835EE, 835EF)	66	04/89→07/99	→	01/90→ 10/93		13.0460-0072.2 610072	TRW		
2.0 i.e. (835AL)	83	09/89→07/99	→						
2.0 i.e. Turbo (835AR)	119	04/91→07/99	→	11/93→; GG		13.0460-0072.2 610072	TRW		
			→	05/91→ 10/93		13.0460-0072.2 610072	TRW		
↓									















	kw			 	! #		
<b>LANCIA - DEDRA (835_) 01/89→07/99</b>							
<b> Bremsscheibe</b>							
1.6 16V (835EI)	76	01/96→07/99	←			24.0112-0127.1 412127 24.0120-0142.1 420142 24.0320-0142.1 520142	Ø 257,5 12 10,2 Ø 257,5 20 18,2 V Ø 257,5 20 18,2 V
			→			24.0111-0119.1 411119	Ø 240,5 11 9,2
1.6 i.e. (835AN)	55	04/93→07/99	←	11/93→		24.0112-0127.1 412127	Ø 257,5 12 10,2
			←	→ 10/93		24.0112-0127.1 412127	Ø 257,5 12 10,2
			←	01/96→		24.0120-0142.1 420142 24.0320-0142.1 520142	Ø 257,5 20 18,2 V Ø 257,5 20 18,2 V
			→	01/96→		24.0111-0119.1 411119	Ø 240,5 11 9,2
			→	→ 10/93; + ABS		24.0111-0119.1 411119	Ø 240,5 11 9,2
1.6 LE Cat (835EB)	66	07/94→07/99	←			24.0112-0127.1 412127	Ø 257,5 12 10,2
			←	01/96→		24.0120-0142.1 420142 24.0320-0142.1 520142	Ø 257,5 20 18,2 V Ø 257,5 20 18,2 V
			→	01/96→		24.0111-0119.1 411119	Ø 240,5 11 9,2
1.8 16V LE (835FG) 1.8 i.e. (835FA)	83 74	03/96→07/99 07/94→07/99	←			24.0120-0142.1 420142 24.0320-0142.1 520142	Ø 257,5 20 18,2 V Ø 257,5 20 18,2 V
			→			24.0111-0119.1 411119	Ø 240,5 11 9,2
1.8 GT 16V (835EH) 2.0 16V (835ED)	96 102	03/96→07/99 07/94→07/99	←			24.0122-0197.1 422197 24.0322-0197.1 522197	Ø 257,5 22 20,2 V Ø 257,5 22 20,2 V
			→			24.0111-0119.1 411119	Ø 240,5 11 9,2
1.8 i.e. (835AT)	66	08/93→07/99	←	→ 10/93		24.0112-0127.1 412127	Ø 257,5 12 10,2
			←	11/93→		24.0120-0142.1 420142 24.0320-0142.1 520142	Ø 257,5 20 18,2 V Ø 257,5 20 18,2 V
			→	11/93→		24.0111-0119.1 411119	Ø 240,5 11 9,2
			→	→ 10/93		24.0111-0119.1 411119	Ø 240,5 11 9,2
1.8 i.e. (835BD, 835AD)	77	09/89→07/99	←	01/90→ 10/93		24.0112-0127.1 412127	Ø 257,5 12 10,2
			←	11/93→		24.0120-0142.1 420142 24.0320-0142.1 520142	Ø 257,5 20 18,2 V Ø 257,5 20 18,2 V
			→	11/93→		24.0111-0119.1 411119	Ø 240,5 11 9,2
			→	01/90→ 10/93		24.0111-0119.1 411119	Ø 240,5 11 9,2
1.9 TDS (835EE, 835EF)	66	04/89→07/99	←	01/90→ 10/93		24.0112-0127.1 412127	Ø 257,5 12 10,2
			←	11/93→; ohne Katalysator		24.0112-0127.1 412127	Ø 257,5 12 10,2
			←	11/93→; mit geregeltem (3-Wege) Katalysator		24.0122-0147.1 422147	Ø 284 22 20,2 V
			→	11/93→		24.0111-0119.1 411119	Ø 240,5 11 9,2
			→	01/90→ 10/93		24.0111-0119.1 411119	Ø 240,5 11 9,2
2.0 i.e. (835AL)	83	09/89→07/99	←	01/90→ 10/93		24.0120-0142.1 420142 24.0320-0142.1 520142	Ø 257,5 20 18,2 V Ø 257,5 20 18,2 V
			←	11/93→		24.0120-0142.1 420142 24.0320-0142.1 520142	Ø 257,5 20 18,2 V Ø 257,5 20 18,2 V
			→	11/93→		24.0111-0119.1 411119	Ø 240,5 11 9,2
			→	01/90→ 10/93		24.0111-0119.1 411119	Ø 240,5 11 9,2
2.0 i.e. Turbo (835AR)	119	04/91→07/99	←	11/93→		24.0120-0142.1 420142 24.0320-0142.1 520142	Ø 257,5 20 18,2 V Ø 257,5 20 18,2 V
			←	05/91→ 10/93		24.0122-0107.1 422107	Ø 284 22 20,2 V
			→	05/91→ 10/93		24.0111-0119.1 411119	Ø 240,5 11 9,2
			→	11/93→		24.0111-0119.1 411119	Ø 240,5 11 9,2
<b>LANCIA - DEDRA SW (835_) 07/94→07/99</b>							
<b> Bremsbelagsatz, Scheibenbremse</b>							
1.6 (835EB) 1.6 16V (835EI)	66 76	10/94→07/99 01/96→07/99	←			13.0460-2949.2 602949 13.0460-7131.2 607131	TRW 20833 17,0 + WK ATE 21193 18,0 + WK
1.8 16V LE (835FG) 1.8 i.e. (835FA) 2.0 Integrale (835ED)	83 74 102	03/96→07/99 07/94→07/99 07/94→07/99	←			13.0460-2949.2 602949 13.0460-7131.2 607131	TRW 20833 17,0 + WK ATE 21193 18,0 + WK
			→	ALU		13.0460-2826.2 602826	TRW 23177 14,2 - WK
			→	GG		13.0460-2951.2 602951	TRW 21103 14,2 - WK
1.8 GT 16V (835EH) ↓	96	03/96→07/99	←			13.0460-7129.2 607129	ATE 20907 18,1 + WK

	kw			 	! #		
<b>LANCIA - DEDRA SW (835_) 07/94→07/99</b>							
<b> Bremsbelagsatz, Scheibenbremse</b>							
1.8 GT 16V (835EH)	96	03/96→07/99	➔	ALU		13.0460-2826.2 602826	TRW 23177 14,2 - WK
			➔	GG		13.0460-2951.2 602951	TRW 21103 14,2 - WK
1.9 TDS (835EE, 835EF)	66	07/94→07/99	➔			13.0460-7065.2 607065	ATE 21927 17,9 + WK
			➔	ALU		13.0460-2826.2 602826	TRW 23177 14,2 - WK
			➔	GG		13.0460-2951.2 602951	TRW 21103 14,2 - WK
2.0 16V (835ED)	102	07/94→07/99	➔			13.0460-2949.2 602949	TRW 20833 17,0 + WK
			➔			13.0460-7129.2 607129	ATE 20907 18,1 + WK
			➔			13.0460-7131.2 607131	ATE 21193 18,0 + WK
			➔	ALU		13.0460-2826.2 602826	TRW 23177 14,2 - WK
			➔	GG		13.0460-2951.2 602951	TRW 21103 14,2 - WK
<b>Zubehörsatz, Scheibenbremsbelag</b>							
1.8 16V LE (835FG)	83	03/96→07/99	➔	GG		13.0460-0072.2 610072	TRW
1.8 GT 16V (835EH)	96	03/96→07/99					
1.8 i.e. (835FA)	74	07/94→07/99					
1.9 TDS (835EE, 835EF)	66	07/94→07/99					
2.0 16V (835ED)	102	07/94→07/99					
2.0 Integrale (835ED)	102	07/94→07/99					
<b> Bremsscheibe</b>							
1.6 (835EB)	66	10/94→07/99	➔			24.0112-0127.1 412127	Ø 257,5 12 10,2
			➔	01/96→		24.0120-0142.1 420142	Ø 257,5 20 18,2 V
						24.0320-0142.1 520142	Ø 257,5 20 18,2 V
			➔	01/96→		24.0111-0119.1 411119	Ø 240,5 11 9,2
1.6 16V (835EI)	76	01/96→07/99	➔			24.0112-0127.1 412127	Ø 257,5 12 10,2
			➔			24.0120-0142.1 420142	Ø 257,5 20 18,2 V
						24.0320-0142.1 520142	Ø 257,5 20 18,2 V
			➔			24.0111-0119.1 411119	Ø 240,5 11 9,2
1.8 16V LE (835FG)	83	03/96→07/99	➔			24.0120-0142.1 420142	Ø 257,5 20 18,2 V
1.8 i.e. (835FA)	74	07/94→07/99	➔			24.0320-0142.1 520142	Ø 257,5 20 18,2 V
			➔			24.0111-0119.1 411119	Ø 240,5 11 9,2
1.8 GT 16V (835EH)	96	03/96→07/99	➔			24.0122-0197.1 422197	Ø 257,5 22 20,2 V
			➔			24.0322-0197.1 522197	Ø 257,5 22 20,2 V
			➔			24.0111-0119.1 411119	Ø 240,5 11 9,2
1.9 TDS (835EE, 835EF)	66	07/94→07/99	➔	ohne Katalysator		24.0112-0127.1 412127	Ø 257,5 12 10,2
			➔	mit geregeltm (3-Wege) Katalysator		24.0122-0147.1 422147	Ø 284 22 20,2 V
			➔			24.0111-0119.1 411119	Ø 240,5 11 9,2
2.0 16V (835ED)	102	07/94→07/99	➔			24.0120-0142.1 420142	Ø 257,5 20 18,2 V
			➔			24.0122-0197.1 422197	Ø 257,5 22 20,2 V
						24.0320-0142.1 520142	Ø 257,5 20 18,2 V
						24.0322-0197.1 522197	Ø 257,5 22 20,2 V
			➔			24.0111-0119.1 411119	Ø 240,5 11 9,2
2.0 Integrale (835ED)	102	07/94→07/99	➔			24.0120-0142.1 420142	Ø 257,5 20 18,2 V
			➔			24.0122-0107.1 422107	Ø 284 22 20,2 V
						24.0320-0142.1 520142	Ø 257,5 20 18,2 V
			➔			24.0111-0119.1 411119	Ø 240,5 11 9,2
<b>LANCIA - DELTA II (836_) 06/93→09/99</b>							
<b> Bremsbelagsatz, Scheibenbremse</b>							
1.4 i.e. (836AF, 836AH)	51	10/94→08/99	➔			13.0460-7064.2 607064	ATE 21930 17,9 + WK
1.6 i.e. (836AD)	55	06/93→08/99	➔	11/93→		13.0460-2949.2 602949	TRW 20833 17,0 + WK
						13.0460-7064.2 607064	ATE 21930 17,9 + WK
						13.0460-7065.2 607065	ATE 21927 17,9 + WK
			➔	→ 10/93		13.0460-3942.2 603942	BDX 20841 12,0 + WE / - WK
1.6 i.e. (836AP)	66	03/96→08/99	➔			13.0460-2949.2 602949	TRW 20833 17,0 + WK
1.6 i.e. 16V (836AO)	76	01/96→08/99	➔			13.0460-7064.2 607064	ATE 21930 17,9 + WK
						13.0460-7065.2 607065	ATE 21927 17,9 + WK
1.8 i.e. (836AE)	76	06/93→08/99	➔	11/93→		13.0460-2949.2 602949	TRW 20833 17,0 + WK
						13.0460-7065.2 607065	ATE 21927 17,9 + WK
			➔	11/93→; ALU		13.0460-2826.2 602826	TRW 23177 14,2 - WK
↓							











	kw			 	! #		
<b>LANCIA - DELTA II (836_) 06/93→09/99</b>							
 <b>Bremsbelagsatz, Scheibenbremse</b>							
1.8 i.e. (836AE)	76	06/93→08/99	➔	11/93→; GG		<b>13.0460-2951.2 602951</b>	TRW 21103 14,2 - WK
1.8 i.e. (836AG, 836AL)	66	07/94→08/99	➔			<b>13.0460-2949.2 602949</b>	TRW 20833 17,0 + WK
1.8 i.e. 16V (836AQ)	83	03/96→08/99	➔			<b>13.0460-7065.2 607065</b>	ATE 21927 17,9 + WK
1.8 i.e. 16V GT (836AR)	96	03/96→08/99	➔	ALU		<b>13.0460-2826.2 602826</b>	TRW 23177 14,2 - WK
1.9 TD (836AM, 836AN)	66	10/94→08/99	➔	GG		<b>13.0460-2951.2 602951</b>	TRW 21103 14,2 - WK
2.0 16V (836AA, 836CA)	102	06/93→08/99	➔	11/93→		<b>13.0460-2979.2 602979</b>	TRW 21147 19,0 + WK
			➔	11/93→; ALU		<b>13.0460-4958.2 604958</b>	BRE 21381 17,3 + WK
			➔	11/93→; GG		<b>13.0460-2826.2 602826</b>	TRW 23177 14,2 - WK
2.0 16V Turbo (836AB)	137	06/93→08/99	➔	11/93→		<b>13.0460-2979.2 602979</b>	TRW 21147 19,0 + WK
			➔	11/93→; ALU		<b>13.0460-2826.2 602826</b>	TRW 23177 14,2 - WK
			➔	11/93→; GG		<b>13.0460-2951.2 602951</b>	TRW 21103 14,2 - WK
2.0 16V Turbo (836AS)	142	07/96→08/99	➔			<b>13.0460-2979.2 602979</b>	TRW 21147 19,0 + WK
			➔	ALU		<b>13.0460-2826.2 602826</b>	TRW 23177 14,2 - WK
			➔	GG		<b>13.0460-2951.2 602951</b>	TRW 21103 14,2 - WK
<b>Zubehörsatz, Scheibenbremsbelag</b>							
1.8 i.e. (836AE)	76	06/93→08/99	➔	11/93→		<b>13.0460-0072.2 610072</b>	TRW
2.0 16V (836AA, 836CA)	102	06/93→08/99	➔				
2.0 16V Turbo (836AB)	137	06/93→08/99	➔				
1.8 i.e. (836AG, 836AL)	66	07/94→08/99	➔			<b>13.0460-0072.2 610072</b>	TRW
1.8 i.e. 16V (836AQ)	83	03/96→08/99	➔				
1.8 i.e. 16V GT (836AR)	96	03/96→08/99	➔				
1.9 TD (836AM, 836AN)	66	10/94→08/99	➔				
2.0 16V Turbo (836AS)	142	07/96→08/99	➔				
 <b>Bremsscheibe</b>							
1.4 i.e. (836AF, 836AH)	51	10/94→08/99	➔			<b>24.0111-0119.1 411119</b>	Ø 240,5 11 9,2
1.6 i.e. (836AD)	55	06/93→08/99	➔	→ 10/93		<b>24.0112-0112.1 412112</b>	Ø 257 12 10,8
			➔	11/93→		<b>24.0112-0127.1 412127</b>	Ø 257,5 12 10,2
			➔	→ 10/93		<b>24.0111-0130.1 411130</b>	Ø 227 10,8 9
1.6 i.e. (836AP)	66	03/96→08/99	➔			<b>24.0112-0127.1 412127</b>	Ø 257,5 12 10,2
1.6 i.e. 16V (836AO)	76	01/96→08/99	➔				
1.8 i.e. (836AE)	76	06/93→08/99	➔	11/93→		<b>24.0112-0127.1 412127</b>	Ø 257,5 12 10,2
			➔	11/93→		<b>24.0111-0119.1 411119</b>	Ø 240,5 11 9,2
1.8 i.e. (836AG, 836AL)	66	07/94→08/99	➔			<b>24.0112-0127.1 412127</b>	Ø 257,5 12 10,2
1.8 i.e. 16V (836AQ)	83	03/96→08/99	➔				
1.8 i.e. 16V GT (836AR)	96	03/96→08/99	➔			<b>24.0111-0119.1 411119</b>	Ø 240,5 11 9,2
1.9 TD (836AM, 836AN)	66	10/94→08/99	➔				
2.0 16V (836AA, 836CA)	102	06/93→08/99	➔	11/93→		<b>24.0122-0107.1 422107</b>	Ø 284 22 20,2 V
			➔	11/93→		<b>24.0126-0114.1 426114</b>	Ø 281 26 24,2 V
			➔	11/93→		<b>24.0110-0209.1 410209</b>	Ø 251,4 10 9
			➔	11/93→		<b>24.0111-0119.1 411119</b>	Ø 240,5 11 9,2
2.0 16V Turbo (836AB)	137	06/93→08/99	➔	11/93→		<b>24.0122-0147.1 422147</b>	Ø 284 22 20,2 V
			➔	11/93→		<b>24.0111-0119.1 411119</b>	Ø 240,5 11 9,2
2.0 16V Turbo (836AS)	142	07/96→08/99	➔			<b>24.0122-0147.1 422147</b>	Ø 284 22 20,2 V
			➔			<b>24.0111-0119.1 411119</b>	Ø 240,5 11 9,2
<b>LANCIA - DELTA III (844_) 08/08→08/14</b>							
 <b>Bremsbelagsatz, Scheibenbremse</b>							
1.4	88	09/08→08/14	➔	→ 10/09		<b>13.0460-3983.2 603983</b>	BOS 23708 19,4 + WK
1.6 D Multijet	85	08/08→08/14	➔			<b>13.0470-3983.2 LD3983</b>	BOS 23708 19,4 + WK Ceramic
1.6 D Multijet	88	09/08→08/14	➔	11/09→		<b>13.0460-3984.2 603984</b>	BOS 23711 19,4 + WK
			➔			<b>13.0470-3984.2 LD3984</b>	BOS 23711 19,4 + WK Ceramic
			➔			<b>13.0460-3861.2 603861</b>	BOS 23714 17,6 + WK + Zub
			➔			<b>13.0460-3991.2 603991</b>	BOS 23714 16,6 - WE / - WK
			➔			<b>13.0470-3861.2 LD3861</b>	BOS + WK + Zub Ceramic
1.4	110	09/08→08/14	➔			<b>13.0460-3984.2 603984</b>	BOS 23711 19,4 + WK
1.4 16V	103	07/10→08/14	➔			<b>13.0470-3984.2 LD3984</b>	BOS 23711 19,4 + WK Ceramic
1.4 Bifuel	88	07/11→08/14	➔				
1.6 D Multijet	77	04/11→08/14	➔			<b>13.0460-3861.2 603861</b>	BOS 23714 17,6 + WK + Zub
			➔			<b>13.0460-3991.2 603991</b>	BOS 23714 16,6 - WE / - WK
			➔			<b>13.0470-3861.2 LD3861</b>	BOS + WK + Zub Ceramic
↓							













	kW			 	! #		
<b>LANCIA - DELTA III (844_) 08/08→08/14</b>							
 <b>Bremsbelagsatz, Scheibenbremse</b>							
1.8	147	01/09→08/14	←			<b>13.0460-7265.2 607265</b>	ATE 24727 20,7 + WK
1.9 D Multijet	140	01/09→08/14	→			<b>13.0460-3861.2 603861</b>	BOS 23714 17,6 + WK + Zub
2.0 D Multijet	120	09/08→08/14				<b>13.0460-3991.2 603991</b>	BOS 23714 16,6 - WE / - WK
2.0 D Multijet	121	09/08→08/14				<b>13.0470-3861.2 LD3861</b>	BOS + WK + Zub Ceramic
 <b>Bremsscheibe</b>							
1.4	88	09/08→08/14	←	→ 10/09		<b>24.0122-0147.1 422147</b>	Ø 284 22 20,2 V
1.6 D Multijet	85	08/08→08/14	←	11/09→; für Leichtmetallfelgen		<b>24.0126-0125.1 426125</b>	Ø 281 26 24,2 V
1.6 D Multijet	88	09/08→08/14			→		<b>24.0110-0190.1 410190</b>
1.4	110	09/08→08/14	←	für Leichtmetallfelgen		<b>24.0126-0125.1 426125</b>	Ø 281 26 24,2 V
1.4 16V	103	07/10→08/14	→			<b>24.0110-0190.1 410190</b>	Ø 251,5 10 9
1.4 Bifuel	88	07/11→08/14					
1.6 D Multijet	77	04/11→08/14					
1.8	147	01/09→08/14	→			<b>24.0110-0190.1 410190</b>	Ø 251,5 10 9
1.9 D Multijet	140	01/09→08/14	←			<b>24.0128-0243.1 428243</b>	Ø 305 28 26 V
2.0 D Multijet	120	09/08→08/14	→			<b>24.0110-0190.1 410190</b>	Ø 251,5 10 9
2.0 D Multijet	121	09/08→08/14					
<b>LANCIA - FLAVIA Cabriolet (JS_) 03/12→12/14</b>							
 <b>Bremsbelagsatz, Scheibenbremse</b>							
2.4	125	03/12→12/14	←			<b>13.0460-5760.2 605760</b>	AKE 23584 16,4 + WK
2.4	129	03/12→12/14	→			<b>13.0460-5855.2 605855</b>	23582 16,0 - WK
 <b>Bremsscheibe</b>							
2.4	125	03/12→12/14	→			<b>24.0110-0372.1 410372</b>	Ø 302 10 8,4
2.4	129	03/12→12/14					
<b>LANCIA - KAPPA (838_) 08/94→10/01</b>							
 <b>Bremsbelagsatz, Scheibenbremse</b>							
2.0 16V Turbo (838AB1AA)	151	02/95→10/01	←	07/95→		<b>13.0460-2987.2 602987</b>	TRW 21147 19,0 + WK
			→	07/95→		<b>13.0460-2827.2 602827</b>	TRW 21606 16,7 - WK
2.0 20V (838AA1AA)	107	10/94→10/01	←	01/95→		<b>13.0460-2987.2 602987</b>	TRW 21147 19,0 + WK
2.4 20V (838AC1AA, 838AC11A)	129	08/94→10/01	→	01/95→		<b>13.0460-2827.2 602827</b>	TRW 21606 16,7 - WK
2.4 T.DS (838AE1AA, 838AH1AA)	91	08/94→10/01					
3.0 24V (838AD1AA, 838AD11A, 838XD1AA, 838ZD1AA)	150	08/94→10/01					
2.0 20V (838AG1AA, 838AG11A)	114	07/96→10/01	←			<b>13.0460-2987.2 602987</b>	TRW 21147 19,0 + WK
2.0 20V Turbo (838AM1AA)	162	06/98→10/01	→			<b>13.0460-2827.2 602827</b>	TRW 21606 16,7 - WK
2.4 JTD (838AL1AA)	100	06/98→10/01					
 <b>Bremsscheibe</b>							
2.0 16V Turbo (838AB1AA)	151	02/95→10/01	←	07/95→		<b>24.0126-0133.1 426133</b>	Ø 281 26 24,2 V
			→	07/95→		<b>24.0110-0290.1 410290</b>	Ø 276 10 9
2.0 20V (838AA1AA)	107	10/94→10/01	←	01/95→		<b>24.0122-0191.1 422191</b>	Ø 281 22 20,2 V
			→	01/95→		<b>24.0110-0290.1 410290</b>	Ø 276 10 9
2.0 20V (838AG1AA, 838AG11A)	114	07/96→10/01	←			<b>24.0122-0191.1 422191</b>	Ø 281 22 20,2 V
			→			<b>24.0110-0290.1 410290</b>	Ø 276 10 9
2.0 20V Turbo (838AM1AA)	162	06/98→10/01	←			<b>24.0126-0133.1 426133</b>	Ø 281 26 24,2 V
2.4 JTD (838AL1AA)	100	06/98→10/01	→			<b>24.0110-0290.1 410290</b>	Ø 276 10 9
2.4 20V (838AC1AA, 838AC11A)	129	08/94→10/01	←	01/95→		<b>24.0126-0133.1 426133</b>	Ø 281 26 24,2 V
2.4 T.DS (838AE1AA, 838AH1AA)	91	08/94→10/01	→	01/95→		<b>24.0110-0290.1 410290</b>	Ø 276 10 9
3.0 24V (838AD1AA, 838AD11A, 838XD1AA, 838ZD1AA)	150	08/94→10/01					
<b>LANCIA - KAPPA Coupe (838_) 07/96→03/01</b>							
 <b>Bremsbelagsatz, Scheibenbremse</b>							
2.0 16V Turbo (838CB)	151	11/96→03/01	←			<b>13.0460-2987.2 602987</b>	TRW 21147 19,0 + WK
2.0 20V	114	07/96→03/01	→			<b>13.0460-2827.2 602827</b>	TRW 21606 16,7 - WK
2.0 20V Turbo (838CM)	162	06/98→03/01					

	kw			 	! #		
<b>LANCIA - KAPPA Coupe (838_) 07/96→03/01</b>							
 <b>Bremsbelagsatz, Scheibenbremse</b>							
2.4 20V (838CC)	129	11/96→03/01	←			<b>13.0460-2987.2 602987</b>	TRW 21147 19,0 + WK
			→			<b>13.0460-2827.2 602827</b>	TRW 21606 16,7 - WK
3.0 24V (838CD, 838CD11A)	150	11/96→03/01	←	03/97→		<b>13.0460-4971.2 604971</b>	BRE 23092 16,0 + WK
			→			<b>13.0470-4971.2 LD4971</b>	BRE 23092 16,0 + WK Ceramic
			→			<b>13.0460-2827.2 602827</b>	TRW 21606 16,7 - WK
 <b>Bremsscheibe</b>							
2.0 16V Turbo (838CB)	151	11/96→03/01	←			<b>24.0126-0133.1 426133</b>	Ø 281 26 24,2 V
2.0 20V Turbo (838CM)	162	06/98→03/01	→			<b>24.0110-0290.1 410290</b>	Ø 276 10 9
2.4 20V (838CC)	129	11/96→03/01					
3.0 24V (838CD, 838CD11A)	150	11/96→03/01					
2.0 20V	114	07/96→03/01	←			<b>24.0122-0191.1 422191</b>	Ø 281 22 20,2 V
			→			<b>24.0110-0290.1 410290</b>	Ø 276 10 9
<b>LANCIA - KAPPA SW (838_) 07/96→10/01</b>							
 <b>Bremsbelagsatz, Scheibenbremse</b>							
2.0 16V Turbo (838BB1AA)	151	07/96→10/01	←			<b>13.0460-2987.2 602987</b>	TRW 21147 19,0 + WK
2.0 20V (838BG1AA)	114	07/96→10/01	→			<b>13.0460-2827.2 602827</b>	TRW 21606 16,7 - WK
2.0 20V Turbo (838BM1AA)	162	06/98→10/01					
2.4 20V (838BC1AA, 838BC11A)	129	07/96→10/01					
2.4 JTD (838BL1AA)	100	06/98→10/01					
2.4 T.DS (838BH1AA)	91	07/96→10/01					
3.0 24V (838BD11A)	150	07/96→10/01					
 <b>Bremsscheibe</b>							
2.0 16V Turbo (838BB1AA)	151	07/96→10/01	←			<b>24.0126-0133.1 426133</b>	Ø 281 26 24,2 V
2.0 20V Turbo (838BM1AA)	162	06/98→10/01	→			<b>24.0110-0290.1 410290</b>	Ø 276 10 9
2.4 20V (838BC1AA, 838BC11A)	129	07/96→10/01					
2.4 JTD (838BL1AA)	100	06/98→10/01					
2.4 T.DS (838BH1AA)	91	07/96→10/01					
3.0 24V (838BD11A)	150	07/96→10/01					
2.0 20V (838BG1AA)	114	07/96→10/01	←			<b>24.0122-0191.1 422191</b>	Ø 281 22 20,2 V
			→			<b>24.0110-0290.1 410290</b>	Ø 276 10 9
<b>LANCIA - LYBRA (839_) 07/99→10/05</b>							
 <b>Bremsbelagsatz, Scheibenbremse</b>							
1.6	76	10/00→10/05	←			<b>13.0460-7139.2 607139</b>	ATE 23140 19,4 + WK
			→			<b>13.0470-7139.2 LD7139</b>	ATE 23140 19,4 + WK Ceramic
			→			<b>13.0460-2867.2 602867</b>	TRW 23517 16,6 - WE / - WK
			→			<b>13.0470-2867.2 LD2867</b>	TRW 23517 16,6 - WE / - WK Ceramic
1.6 16V (839AXA1A)	76	07/99→10/05	←	10/99→ 02/00		<b>13.0460-7105.2 607105</b>	ATE 23140 19,4 + WK
			←	03/00→		<b>13.0460-7139.2 607139</b>	ATE 23140 19,4 + WK
						<b>13.0470-7139.2 LD7139</b>	ATE 23140 19,4 + WK Ceramic
			→	10/99→		<b>13.0460-2867.2 602867</b>	TRW 23517 16,6 - WE / - WK
			→			<b>13.0470-2867.2 LD2867</b>	TRW 23517 16,6 - WE / - WK Ceramic
1.8 16V (839AXB1A, 839AXG1A)	96	07/99→10/05	←	10/99→ 03/00		<b>13.0460-7069.2 607069</b>	ATE 21636 19,3 + WK
1.9 JTD (839AXD1A)	77	07/99→09/00	←	04/00→		<b>13.0460-7140.2 607140</b>	ATE 21637 19,3 + WK
2.0 20V (839AXC11, 839AXC1A)	113	07/99→09/00				<b>13.0470-7140.2 LD7140</b>	ATE 21637 19,3 + WK Ceramic
2.4 JTD (839AXE1A)	99	07/99→02/01	→	10/99→		<b>13.0460-2867.2 602867</b>	TRW 23517 16,6 - WE / - WK
						<b>13.0470-2867.2 LD2867</b>	TRW 23517 16,6 - WE / - WK Ceramic
1.9 JTD	85	05/01→10/05	←			<b>13.0460-7140.2 607140</b>	ATE 21637 19,3 + WK
1.9 JTD (839AXI1A)	81	09/00→05/01				<b>13.0470-7140.2 LD7140</b>	ATE 21637 19,3 + WK Ceramic
2.0 20V (839AXH1A)	110	09/00→10/05					
2.4 20V	125	10/01→10/05	→			<b>13.0460-2867.2 602867</b>	TRW 23517 16,6 - WE / - WK
2.4 JTD	110	05/02→10/05				<b>13.0470-2867.2 LD2867</b>	TRW 23517 16,6 - WE / - WK
2.4 JTD (839AXL1A)	103	09/00→05/02					Ceramic
↓							





































	kw			 	! #		
<b>LANCIA - LYBRA (839_) 07/99→10/05</b>							
 <b>Bremsscheibe</b>							
1.6	76	10/00→10/05	←			<b>24.0122-0147.1 422147</b>	Ø 284 22 20,2 V
1.9 JTD	85	05/01→10/05	→			<b>24.0110-0190.1 410190</b>	Ø 251,5 10 9
1.9 JTD (839AX1A)	81	09/00→05/01					
2.0 20V (839AXH1A)	110	09/00→10/05					
2.4 20V	125	10/01→10/05					
2.4 JTD	110	05/02→10/05					
2.4 JTD (839AXL1A)	103	09/00→05/02					
1.6 16V (839AXA1A)	76	07/99→10/05	←	10/99→		<b>24.0115-0112.1 415112</b>	Ø 281 15 13,2
			→	10/99→		<b>24.0110-0190.1 410190</b>	Ø 251,5 10 9
1.8 16V (839AXB1A, 839AXG1A)	96	07/99→10/05	←	10/99→		<b>24.0122-0147.1 422147</b>	Ø 284 22 20,2 V
1.9 JTD (839AXD1A)	77	07/99→09/00	→	10/99→		<b>24.0110-0190.1 410190</b>	Ø 251,5 10 9
2.0 20V (839AXC11, 839AXC1A)	113	07/99→09/00					
2.4 JTD (839AXE1A)	99	07/99→02/01					
<b>LANCIA - LYBRA SW (839_) 07/99→10/05</b>							
 <b>Bremsbelagsatz, Scheibenbremse</b>							
1.6	76	10/00→10/05	←			<b>13.0460-7139.2 607139</b>	ATE 23140 19,4 + WK
			→			<b>13.0470-7139.2 LD7139</b>	ATE 23140 19,4 + WK Ceramic
						<b>13.0460-2867.2 602867</b>	TRW 23517 16,6 - WE / - WK
						<b>13.0470-2867.2 LD2867</b>	TRW 23517 16,6 - WE / - WK Ceramic
1.6 16V (839BXA1A)	76	07/99→10/05	←	10/99→ 02/00		<b>13.0460-7105.2 607105</b>	ATE 23140 19,4 + WK
			←	03/00→		<b>13.0460-7139.2 607139</b>	ATE 23140 19,4 + WK
						<b>13.0470-7139.2 LD7139</b>	ATE 23140 19,4 + WK Ceramic
			→	10/99→		<b>13.0460-2867.2 602867</b>	TRW 23517 16,6 - WE / - WK
						<b>13.0470-2867.2 LD2867</b>	TRW 23517 16,6 - WE / - WK Ceramic
1.8 16V (839BXB1A, 839BXG1A)	96	07/99→10/05	←	10/99→ 03/00		<b>13.0460-7069.2 607069</b>	ATE 21636 19,3 + WK
1.9 JTD (839BXD1A)	77	07/99→09/01	←	04/00→		<b>13.0460-7140.2 607140</b>	ATE 21637 19,3 + WK
2.0 20V (839BXC11, 839BXC1A)	113	07/99→09/00	→	10/99→		<b>13.0470-7140.2 LD7140</b>	ATE 21637 19,3 + WK Ceramic
						<b>13.0460-2867.2 602867</b>	TRW 23517 16,6 - WE / - WK
						<b>13.0470-2867.2 LD2867</b>	TRW 23517 16,6 - WE / - WK Ceramic
1.9 JTD	85	05/01→10/05	←			<b>13.0460-7140.2 607140</b>	ATE 21637 19,3 + WK
1.9 JTD (839BXI1A)	81	09/00→05/01	→			<b>13.0470-7140.2 LD7140</b>	ATE 21637 19,3 + WK Ceramic
2.0 20V (839BXH1A)	110	09/00→10/05					
2.4 JTD	110	05/02→10/05					
2.4 JTD (839BXL1A)	103	09/00→10/05					
2.4 JTD (839BXE1A)	99	10/99→09/00	←	→ 03/00		<b>13.0460-7069.2 607069</b>	ATE 21636 19,3 + WK
			←	04/00→		<b>13.0460-7140.2 607140</b>	ATE 21637 19,3 + WK
						<b>13.0470-7140.2 LD7140</b>	ATE 21637 19,3 + WK Ceramic
			→			<b>13.0460-2867.2 602867</b>	TRW 23517 16,6 - WE / - WK
						<b>13.0470-2867.2 LD2867</b>	TRW 23517 16,6 - WE / - WK Ceramic
 <b>Bremsscheibe</b>							
1.6	76	10/00→10/05	←			<b>24.0122-0147.1 422147</b>	Ø 284 22 20,2 V
1.9 JTD	85	05/01→10/05	→			<b>24.0110-0190.1 410190</b>	Ø 251,5 10 9
1.9 JTD (839BXI1A)	81	09/00→05/01					
2.0 20V (839BXH1A)	110	09/00→10/05					
2.4 JTD	110	05/02→10/05					
2.4 JTD (839BXE1A)	99	10/99→09/00					
2.4 JTD (839BXL1A)	103	09/00→10/05					
1.6 16V (839BXA1A)	76	07/99→10/05	←	10/99→		<b>24.0115-0112.1 415112</b>	Ø 281 15 13,2
			→	10/99→		<b>24.0110-0190.1 410190</b>	Ø 251,5 10 9
1.8 16V (839BXB1A, 839BXG1A)	96	07/99→10/05	←	10/99→		<b>24.0122-0147.1 422147</b>	Ø 284 22 20,2 V
1.9 JTD (839BXD1A)	77	07/99→09/01	→	10/99→		<b>24.0110-0190.1 410190</b>	Ø 251,5 10 9
2.0 20V (839BXC11, 839BXC1A)	113	07/99→09/00					
<b>LANCIA - MUSA (350_) 10/04→09/12</b>							
 <b>Bremsbelagsatz, Scheibenbremse</b>							
1.3 D Multijet	51	10/04→09/12	←			<b>13.0460-3810.2 603810</b>	BOS 23705 18,1 - WE / - WK
1.4	57	09/05→09/12				<b>13.0460-3818.2 603818</b>	BOS 23706 18,1 + WK
1.4	66	10/07→09/12					
1.4	70	10/04→09/12					
↓							

	kW			 	! #		
<b>LANCIA - MUSA (350_) 10/04→09/12</b>							
 <b>Bremsbelagsatz, Scheibenbremse</b>							
1.4 LPG	57	11/10→09/12	←			<b>13.0460-3810.2 603810</b> <b>13.0460-3818.2 603818</b>	BOS 23705 18,1 - WE / - WK BOS 23706 18,1 + WK
1.3 D Multijet 1.9 D Multijet	66 74	09/06→09/12 10/04→09/12	←			<b>13.0460-3811.2 603811</b> <b>13.0460-3827.2 603827</b> <b>13.0470-3827.2 LD3827</b>	BOS 23708 19,2 - WE / - WK BOS 23709 19,6 + WK + Zub BOS 23709 19,6 + WK + Zub Ceramic
1.3 D Multijet	70	03/09→09/12	←	08/09→		<b>13.0460-3811.2 603811</b> <b>13.0460-3827.2 603827</b> <b>13.0470-3827.2 LD3827</b>	BOS 23708 19,2 - WE / - WK BOS 23709 19,6 + WK + Zub BOS 23709 19,6 + WK + Zub Ceramic
1.6 D Multijet 1.6 D Multijet	85 88	07/08→09/12 07/08→09/12	←			<b>13.0460-3811.2 603811</b> <b>13.0460-3827.2 603827</b> <b>13.0470-3827.2 LD3827</b>	BOS 23708 19,2 - WE / - WK BOS 23709 19,6 + WK + Zub BOS 23709 19,6 + WK + Zub Ceramic
			→			<b>13.0460-2879.2 602879</b> <b>13.0470-2879.2 LD2879</b>	TRW 23601 13,7 - WE / - WK TRW 23601 13,7 - WE / - WK Ceramic
 <b>Bremsscheibe</b>							
1.3 D Multijet 1.4 1.4 1.4 1.4 LPG	51 57 66 70 57	10/04→09/12 09/05→09/12 10/07→09/12 10/04→09/12 11/10→09/12	←			<b>24.0122-0197.1 422197</b> <b>24.0322-0197.1 522197</b>	∅ 257,5 22 20,2 V ∅ 257,5 22 20,2 V
1.3 D Multijet 1.9 D Multijet	66 74	09/06→09/12 10/04→09/12	←			<b>24.0122-0147.1 422147</b>	∅ 284 22 20,2 V
1.3 D Multijet	70	03/09→09/12	←	08/09→		<b>24.0122-0147.1 422147</b>	∅ 284 22 20,2 V
1.6 D Multijet 1.6 D Multijet	85 88	07/08→09/12 07/08→09/12	←			<b>24.0122-0147.1 422147</b> <b>24.0111-0119.1 411119</b>	∅ 284 22 20,2 V ∅ 240,5 11 9,2
<b>LANCIA - PHEDRA (179_) 09/02→11/10</b>							
 <b>Bremsbelagsatz, Scheibenbremse</b>							
2.0 (179AXA11) 2.0 D Multijet 2.0 JTD 2.0 JTD 2.0 JTD (179AXB1A) 2.2 JTD (179AXC1A)	100 100 79 88 80 94	09/02→11/10 07/06→11/10 07/03→11/10 06/06→11/10 09/02→11/10 09/02→11/10	←	→ 09/10		<b>13.0460-2863.2 602863</b> <b>13.0460-2819.2 602819</b>	TRW 20261 19,0 + WK + Zub TRW 20961 17,2 - WK
2.2 D Multijet 2.2 JTD	125 120	03/08→11/10 04/06→11/10	←	→ 09/10		<b>13.0460-2752.2 602752</b> <b>13.0460-2819.2 602819</b>	TRW 24839 19,4 + WK + Zub TRW 20961 17,2 - WK
3.0 V6	150	09/02→11/10	←	→ 09/10		<b>13.0460-4995.2 604995</b> <b>13.0460-2819.2 602819</b>	BRE 23575 15,6 + WK TRW 20961 17,2 - WK
<b>Zubehörsatz, Scheibenbremsbelag</b>							
2.0 (179AXA11) 2.0 D Multijet 2.0 JTD 2.0 JTD 2.0 JTD (179AXB1A) 2.2 D Multijet 2.2 JTD 2.2 JTD (179AXC1A) 3.0 V6	100 100 79 88 80 125 120 94 150	09/02→11/10 07/06→11/10 07/03→11/10 06/06→11/10 09/02→11/10 03/08→11/10 04/06→11/10 09/02→11/10 09/02→11/10	→	→ 09/10		<b>13.0460-0072.2 610072</b>	TRW
 <b>Bremsscheibe</b>							
2.0 (179AXA11) 2.0 D Multijet 2.0 JTD 2.0 JTD 2.0 JTD (179AXB1A) 2.2 JTD (179AXC1A)	100 100 79 88 80 94	09/02→11/10 07/06→11/10 07/03→11/10 06/06→11/10 09/02→11/10 09/02→11/10	←	→ 09/10		<b>24.0128-0136.1 428136</b> <b>24.0328-0136.1 528136</b> <b>24.0112-0156.1 412156</b>	∅ 285 28 26 V ∅ 285 28 26 V ∅ 272 12 10
2.2 D Multijet 2.2 JTD 3.0 V6	125 120 150	03/08→11/10 04/06→11/10 09/02→11/10	←	→ 09/10		<b>24.0132-0126.1 432126</b> <b>24.0112-0156.1 412156</b>	∅ 310 32 30 V ∅ 272 12 10
<b>LANCIA - THESIS (841_) 07/02→07/09</b>							
 <b>Bremsbelagsatz, Scheibenbremse</b>							
2.0 Turbo (841AXA1B03) 2.4 (841AXB1B00) 2.4 D Multijet	136 125 136	07/02→07/09 07/02→07/09 04/06→07/09	←	→ 12/07		<b>13.0460-2704.2 602704</b> <b>13.0460-2707.2 602707</b>	TRW 23761 18,8 + WK TRW 23760 17,7 - WE / - WK























	kw			 	! #		
<b>LANCIA - THESIS (841_) 07/02→07/09</b>							
 <b>Bremsbelagsatz, Scheibenbremse</b>							
2.4 JTD	120	09/03→07/09	➔	→ 12/07; + eFSB		<b>13.0470-2707.2 LD2707</b>	TRW 23760 17,7 - WE / - WK Ceramic
2.4 JTD	129	05/03→07/09					
2.4 JTD (841AXD1B02)	110	07/02→07/09					
3.2 V6	169	05/03→07/09					
3.0 V6 (841AXC1101)	158	07/02→07/09	➔	→ 12/07; nicht für gepanzerte Fahrzeuge		<b>13.0460-2704.2 602704</b>	TRW 23761 18,8 + WK
			➔	→ 12/07; + eFSB		<b>13.0460-2707.2 602707</b>	TRW 23760 17,7 - WE / - WK
						<b>13.0470-2707.2 LD2707</b>	TRW 23760 17,7 - WE / - WK Ceramic
 <b>Bremsscheibe</b>							
2.0 Turbo (841AXA1B03)	136	07/02→07/09	➔	→ 12/07		<b>24.0128-0179.1 428179</b>	Ø 305,5 28 26 V
2.4 (841AXB1B00)	125	07/02→07/09	➔	→ 12/07; + eFSB		<b>24.0122-0234.1 422234</b>	Ø 281 22 20,2 V
2.4 D Multijet	136	04/06→07/09					
2.4 JTD	120	09/03→07/09					
2.4 JTD	129	05/03→07/09					
2.4 JTD (841AXD1B02)	110	07/02→07/09					
3.2 V6	169	05/03→07/09					
3.0 V6 (841AXC1101)	158	07/02→07/09	➔	→ 12/07; nicht für gepanzerte Fahrzeuge		<b>24.0128-0179.1 428179</b>	Ø 305,5 28 26 V
			➔	→ 12/07; nicht für gepanzerte Fahrzeuge; + eFSB		<b>24.0122-0234.1 422234</b>	Ø 281 22 20,2 V
<b>LANCIA - Y (840_) 11/95→09/03</b>							
 <b>Bremsbelagsatz, Scheibenbremse</b>							
1.1 (840AE)	40	11/95→09/03	➔	05/97→ 12/98		<b>13.0460-3950.2 603950</b>	BDX 21436 17,0 - WK
						<b>13.0460-3951.2 603951</b>	BDX 21436 16,2 + WK
1.2 (840AA, 840AF1A)	44	03/96→09/03	➔	10/00→ 07/03; - ABS		<b>13.0460-3950.2 603950</b>	BDX 21436 17,0 - WK
			➔	→ 09/00		<b>13.0460-3950.2 603950</b>	BDX 21436 16,2 + WK
			➔	10/00→ 07/03; + ABS		<b>13.0460-3951.2 603951</b>	BDX 21436 16,2 + WK
			➔	10/00→ 07/03; + ABS		<b>13.0460-7114.2 607114</b>	ATE 21930 17,9 - WE / - WK
1.2 16V (840AD)	63	04/97→09/03	➔	05/97→ 09/00		<b>13.0460-7114.2 607114</b>	ATE 21930 17,9 - WE / - WK
1.2 16V (840AG1A)	59	10/00→09/03	➔	→ 07/03		<b>13.0460-7114.2 607114</b>	ATE 21930 17,9 - WE / - WK
1.4 12V (840AB)	59	10/96→09/03	➔	→ 12/98		<b>13.0460-2949.2 602949</b>	TRW 20833 17,0 + WK
1.4 12V (840AC)	55	03/96→09/03	➔	01/99→ 07/03		<b>13.0460-7114.2 607114</b>	ATE 21930 17,9 - WE / - WK
 <b>Bremsscheibe</b>							
1.1 (840AE)	40	11/95→09/03	➔	05/97→ 12/98		<b>24.0111-0119.1 411119</b>	Ø 240,5 11 9,2
1.2 (840AA, 840AF1A)	44	03/96→09/03	➔	10/00→ 07/03; - ABS		<b>24.0111-0119.1 411119</b>	Ø 240,5 11 9,2
			➔	→ 09/00		<b>24.0111-0119.1 411119</b>	Ø 240,5 11 9,2
			➔	10/00→ 07/03; + ABS		<b>24.0112-0127.1 412127</b>	Ø 257,5 12 10,2
1.2 16V (840AD)	63	04/97→09/03	➔	05/97→ 09/00		<b>24.0112-0127.1 412127</b>	Ø 257,5 12 10,2
1.2 16V (840AG1A)	59	10/00→09/03	➔	→ 07/03		<b>24.0112-0127.1 412127</b>	Ø 257,5 12 10,2
1.4 12V (840AB)	59	10/96→09/03	➔	→ 12/98		<b>24.0112-0127.1 412127</b>	Ø 257,5 12 10,2
1.4 12V (840AC)	55	03/96→09/03					
<b>LANCIA - YPSILON (312_) 05/11→</b>							
 <b>Bremsbelagsatz, Scheibenbremse</b>							
0.9 CNG	59	01/14→	➔			<b>13.0460-7289.2 607289</b>	ATE 25323 17,3 + WK
0.9 CNG	63	05/11→					
0.9 TwinAir	59	12/13→					
0.9 TwinAir	63	05/11→					
1.2	51	05/11→					
1.2 Bifuel	49	05/11→					
1.3 D Multijet	57	06/16→					
1.3 D Multijet	70	05/11→					
1.2 Bifuel	51	05/11→	➔	04/15→		<b>13.0460-7289.2 607289</b>	ATE 25323 17,3 + WK
 <b>Bremsscheibe</b>							
0.9 CNG	59	01/14→	➔			<b>24.0122-0197.1 422197</b>	Ø 257,5 22 20,2 V
0.9 CNG	63	05/11→				<b>24.0322-0197.1 522197</b>	Ø 257,5 22 20,2 V
0.9 TwinAir	59	12/13→					
0.9 TwinAir	63	05/11→					
1.3 D Multijet	57	06/16→					
1.3 D Multijet	70	05/11→					
1.2	51	05/11→	➔			<b>24.0112-0127.1 412127</b>	Ø 257,5 12 10,2
1.2 Bifuel	49	05/11→					
1.2 Bifuel	51	05/11→	➔	04/15→		<b>24.0112-0127.1 412127</b>	Ø 257,5 12 10,2







	kw			 	! #		
<b>LANCIA - YPSILON (843_) 10/03→12/11</b>							
 <b>Bremsbelagsatz, Scheibenbremse</b>							
1.2 1.4	44 57	10/03→12/11 02/06→12/11	←	08/06→ 06/11		13.0460-2724.2 602724	TRW 24073 16,7 + WK + Zub
			←	→ 07/06		13.0460-2878.2 602878	TRW 24073 16,7 - WK
			→	Scheibenbremse; MOMODesign		13.0460-2879.2 602879	TRW 23601 13,7 - WE / - WK
						13.0470-2879.2 LD2879	TRW 23601 13,7 - WE / - WK Ceramic
1.2 1.4 LPG	51 57	08/10→12/11 11/10→12/11	←	→ 06/11		13.0460-2724.2 602724	TRW 24073 16,7 + WK + Zub
1.2 1.3 JTD 1.4 16V	59 51 70	10/03→12/11 10/03→12/11 10/03→12/11	←	08/06→ 06/11		13.0460-2724.2 602724	TRW 24073 16,7 + WK + Zub
			←	→ 07/06		13.0460-2878.2 602878	TRW 24073 16,7 - WK
1.3 D Multijet 1.3 D Multijet	55 66	09/06→12/11 09/06→12/11	←	10/06→ 06/11		13.0460-2724.2 602724	TRW 24073 16,7 + WK + Zub
1.3 D Multijet	77	05/07→12/11	←	07/07→ 06/11		13.0460-2724.2 602724	TRW 24073 16,7 + WK + Zub
 <b>Bremsscheibe</b>							
1.2	44	10/03→12/11	←	→ 06/11		24.0112-0127.1 412127	Ø 257,5 12 10,2
			→	MOMODesign; Scheibenbremse		24.0111-0119.1 411119	Ø 240,5 11 9,2
1.2 1.2 1.3 JTD 1.4 16V 1.4 LPG	51 59 51 70 57	08/10→12/11 10/03→12/11 10/03→12/11 10/03→12/11 11/10→12/11	←	→ 06/11		24.0122-0197.1 422197	Ø 257,5 22 20,2 V
						24.0322-0197.1 522197	Ø 257,5 22 20,2 V
1.3 D Multijet 1.3 D Multijet	55 66	09/06→12/11 09/06→12/11	←	10/06→ 06/11		24.0122-0197.1 422197	Ø 257,5 22 20,2 V
						24.0322-0197.1 522197	Ø 257,5 22 20,2 V
1.3 D Multijet	77	05/07→12/11	←	07/07→ 06/11		24.0122-0197.1 422197	Ø 257,5 22 20,2 V
						24.0322-0197.1 522197	Ø 257,5 22 20,2 V
1.4	57	02/06→12/11	←	→ 06/11		24.0122-0197.1 422197	Ø 257,5 22 20,2 V
			→	MOMODesign; Scheibenbremse		24.0322-0197.1 522197	Ø 257,5 22 20,2 V
						24.0111-0119.1 411119	Ø 240,5 11 9,2
<b>LANCIA - ZETA (22_) 05/95→09/02</b>							
 <b>Bremsbelagsatz, Scheibenbremse</b>							
2.0 16V (220AL5) 2.0 16V (220AQ5) 2.0 JTD 2.0 JTD 16V (220AN5)	97 100 80 80	05/98→07/00 07/00→09/02 04/00→09/02 09/99→09/02	←			13.0460-2978.2 602978	TRW 21801 19,0 + WK
			→	+ ABS		13.0460-7061.2 607061	ATE 21275 17,0 + WK
2.0 Turbo (220AD5, 220CD5)	108	05/95→09/02	←			13.0460-2978.2 602978	TRW 21801 19,0 + WK
			→			13.0460-7061.2 607061	ATE 21275 17,0 + WK
2.1 TD (220AJ5)	80	05/96→09/99	←	06/96→		13.0460-2978.2 602978	TRW 21801 19,0 + WK
			→	06/96→		13.0460-7061.2 607061	ATE 21275 17,0 + WK
 <b>Bremsscheibe</b>							
2.0 16V (220AL5) 2.0 16V (220AQ5) 2.0 JTD 2.0 JTD 16V (220AN5)	97 100 80 80	05/98→07/00 07/00→09/02 04/00→09/02 09/99→09/02	←			24.0126-0104.1 426104	Ø 281 26 24,2 V
			→	+ ABS		24.0110-0218.1 410218	Ø 295 10 8
2.0 Turbo (220AD5, 220CD5)	108	05/95→09/02	←			24.0126-0104.1 426104	Ø 281 26 24,2 V
			→			24.0110-0218.1 410218	Ø 295 10 8
2.1 TD (220AJ5)	80	05/96→09/99	←	06/96→		24.0126-0104.1 426104	Ø 281 26 24,2 V
			→	06/96→		24.0110-0218.1 410218	Ø 295 10 8
<b>LAND ROVER - DEFENDER Cabrio (L316) 08/90→02/16</b>							
 <b>Bremsbelagsatz, Scheibenbremse</b>							
2.2 Td4 4x4 (L317)	90	08/11→02/16	←			13.0460-6925.2 606925	AP 21519 17,8 - WE / - WK + Zub
			→			13.0460-6924.2 606924	AP 23471 17,5 - WE / - WK + Zub
2.4 Td4 4x4 (L317)	90	05/07→02/16	←			13.0460-6925.2 606925	AP 21519 17,8 - WE / - WK + Zub
			→	(V)1A614447; Radstand [mm]: 3.302		13.0460-6923.2 606923	AP 23471 14,5 - WE / - WK
			→	(V)1A614447; Radstand [mm]: 2.794		13.0460-6923.2 606923	AP 23471 14,5 - WE / - WK
			→			13.0460-6924.2 606924	AP 23471 17,5 - WE / - WK + Zub
			→	(V)1A614448→; Radstand [mm]: 3.302		13.0460-6924.2 606924	AP 23471 17,5 - WE / - WK + Zub













	kw			 	! #		
<b>LAND ROVER - DEFENDER Cabrio (L316) 08/90→02/16</b>							
<b>Bremsbelagsatz, Scheibenbremse</b>							
2.4 Td4 4x4 (L317)	90	05/07→02/16	➡	(V)1A614448→; Radstand [mm]: 2.794		<b>13.0460-6924.2 606924</b>	AP 23471 17,5 - WE / - WK + Zub
2.5 D 4x4 (L316)	51	09/90→09/01	←			<b>13.0460-6922.2 606922</b>	AP 21459 17,5 - WE / - WK + Zub
2.5 Td5 4x4 (L316)	90	06/98→02/16	←	Radstand [mm]: 2.286; → (V)HA701009		<b>13.0460-6922.2 606922</b>	AP 21459 17,5 - WE / - WK + Zub
			←	(V)HA701010→		<b>13.0460-6925.2 606925</b>	AP 21519 17,8 - WE / - WK + Zub
			➡	→ (V)1A614447; Radstand [mm]: 3.302		<b>13.0460-6923.2 606923</b>	AP 23471 14,5 - WE / - WK
			➡	→ (V)1A614447; Radstand [mm]: 2.794		<b>13.0460-6923.2 606923</b>	AP 23471 14,5 - WE / - WK
			➡	(V)1A614448→; Radstand [mm]: 2.794		<b>13.0460-6924.2 606924</b>	AP 23471 17,5 - WE / - WK + Zub
			➡	(V)1A614448→; Radstand [mm]: 3.302		<b>13.0460-6924.2 606924</b>	AP 23471 17,5 - WE / - WK + Zub
2.5 TDI 4x4 (L316)	83	08/90→12/01	←	09/90→; Radstand [mm]: 2.286; → (V)HA701009		<b>13.0460-6922.2 606922</b>	AP 21459 17,5 - WE / - WK + Zub
			←	(V)HA701010→		<b>13.0460-6925.2 606925</b>	AP 21519 17,8 - WE / - WK + Zub
			➡	09/90→; → (V)1A614447; Radstand [mm]: 3.302		<b>13.0460-6923.2 606923</b>	AP 23471 14,5 - WE / - WK
			➡	09/90→; → (V)1A614447; Radstand [mm]: 2.794		<b>13.0460-6923.2 606923</b>	AP 23471 14,5 - WE / - WK
			➡	(V)1A614448→; Radstand [mm]: 3.302		<b>13.0460-6924.2 606924</b>	AP 23471 17,5 - WE / - WK + Zub
			➡	(V)1A614448→; Radstand [mm]: 2.794		<b>13.0460-6924.2 606924</b>	AP 23471 17,5 - WE / - WK + Zub
<b>Zubehörsatz, Scheibenbremsbelag</b>							
2.5 D 4x4 (L316)	51	09/90→09/01	←			<b>13.0460-0154.2 610154</b>	AP
2.5 Td5 4x4 (L316)	90	06/98→02/16	←	Radstand [mm]: 2.286; → (V)HA701009		<b>13.0460-0154.2 610154</b>	AP
2.5 TDI 4x4 (L316)	83	08/90→12/01	←	09/90→; Radstand [mm]: 2.286; → (V)HA701009		<b>13.0460-0154.2 610154</b>	AP
<b>Bremsscheibe</b>							
2.2 Td4 4x4 (L317)	90	08/11→02/16	←			<b>24.0114-0108.1 414108</b>	Ø 298,5 14 13
						<b>24.0124-0143.1 424143</b>	Ø 298,5 24 22 V
			➡			<b>24.0114-0115.1 414115</b>	Ø 298 14 13
2.4 Td4 4x4 (L317)	90	05/07→02/16	←			<b>24.0114-0108.1 414108</b>	Ø 298,5 14 13
						<b>24.0124-0143.1 424143</b>	Ø 298,5 24 22 V
			←	(V)LA930456→		<b>24.0124-0143.1 424143</b>	Ø 298,5 24 22 V
			➡	Radstand [mm]: 2.286		<b>24.0113-0189.1 413189</b>	Ø 290 12,5 11,7
			➡	→ (V)WA159806; - ABS; Radstand [mm]: 2.794		<b>24.0114-0108.1 414108</b>	Ø 298,5 14 13
			➡	→ (V)WA159806; - ABS; Radstand [mm]: 3.302		<b>24.0114-0108.1 414108</b>	Ø 298,5 14 13
			➡			<b>24.0114-0115.1 414115</b>	Ø 298 14 13
			➡	(V)XA159807→; Radstand [mm]: 3.302		<b>24.0114-0115.1 414115</b>	Ø 298 14 13
2.5 D 4x4 (L316)	51	09/90→09/01	←			<b>24.0124-0143.1 424143</b>	Ø 298,5 24 22 V
			➡			<b>24.0113-0189.1 413189</b>	Ø 290 12,5 11,7
2.5 Td5 4x4 (L316)	90	06/98→02/16	←			<b>24.0114-0108.1 414108</b>	Ø 298,5 14 13
			←	(V)LA930456→		<b>24.0124-0143.1 424143</b>	Ø 298,5 24 22 V
			➡	Radstand [mm]: 2.286		<b>24.0113-0189.1 413189</b>	Ø 290 12,5 11,7
			➡	→ (V)WA159806; - ABS; Radstand [mm]: 2.794		<b>24.0114-0108.1 414108</b>	Ø 298,5 14 13
			➡	→ (V)WA159806; - ABS; Radstand [mm]: 3.302		<b>24.0114-0108.1 414108</b>	Ø 298,5 14 13
			➡	(V)XA159807→; Radstand [mm]: 2.794		<b>24.0114-0115.1 414115</b>	Ø 298 14 13
			➡	(V)XA159807→; Radstand [mm]: 3.302		<b>24.0114-0115.1 414115</b>	Ø 298 14 13
2.5 TDI 4x4 (L316)	83	08/90→12/01	←	09/90→		<b>24.0114-0108.1 414108</b>	Ø 298,5 14 13
			←	(V)LA930456→		<b>24.0124-0143.1 424143</b>	Ø 298,5 24 22 V
			➡	09/90→; Radstand [mm]: 2.286		<b>24.0113-0189.1 413189</b>	Ø 290 12,5 11,7
			➡	09/90→; → (V)WA159806; - ABS; Radstand [mm]: 2.794		<b>24.0114-0108.1 414108</b>	Ø 298,5 14 13















	kW					! #		
<b>LAND ROVER - DEFENDER Cabrio (L316) 08/90→02/16</b>								
 <b>Bremsscheibe</b>								
2.5 TDI 4x4 (L316)	83	08/90→12/01	➔	09/90→; → (V)WA159806; - ABS; Radstand [mm]: 3.302	24.0114-0108.1	414108	Ø 298,5 14 13	
			➔	(V)XA159807→; Radstand [mm]: 2.794	24.0114-0115.1	414115	Ø 298 14 13	
			➔	(V)XA159807→; Radstand [mm]: 3.302	24.0114-0115.1	414115	Ø 298 14 13	
<b>LAND ROVER - DEFENDER Pick-up (L316) 10/95→02/16</b>								
 <b>Bremsbelagsatz, Scheibenbremse</b>								
2.2 Td4 4x4 (L317)	90	08/11→02/16	←		13.0460-6925.2	606925	AP 21519 17,8 - WE / - WK + Zub	
			➔		13.0460-6924.2	606924	AP 23471 17,5 - WE / - WK + Zub	
2.4 Td4 4x4 (L317)	90	05/07→02/16	←		13.0460-6925.2	606925	AP 21519 17,8 - WE / - WK + Zub	
			➔	→ (V)1A614447; Radstand [mm]: 3.302	13.0460-6923.2	606923	AP 23471 14,5 - WE / - WK	
			➔	→ (V)1A614447; Radstand [mm]: 2.794	13.0460-6923.2	606923	AP 23471 14,5 - WE / - WK	
			➔		13.0460-6924.2	606924	AP 23471 17,5 - WE / - WK + Zub	
			➔	(V)1A614448→; Radstand [mm]: 3.302	13.0460-6924.2	606924	AP 23471 17,5 - WE / - WK + Zub	
			➔	(V)1A614448→; Radstand [mm]: 2.794	13.0460-6924.2	606924	AP 23471 17,5 - WE / - WK + Zub	
2.5 Td5 4x4 (L316)	90	06/98→02/16	←	Radstand [mm]: 2.286; → (V)HA701009	13.0460-6922.2	606922	AP 21459 17,5 - WE / - WK + Zub	
			←	(V)HA701010→	13.0460-6925.2	606925	AP 21519 17,8 - WE / - WK + Zub	
			➔	→ (V)1A614447; Radstand [mm]: 3.302	13.0460-6923.2	606923	AP 23471 14,5 - WE / - WK	
			➔	→ (V)1A614447; Radstand [mm]: 2.794	13.0460-6923.2	606923	AP 23471 14,5 - WE / - WK	
			➔	(V)1A614448→; Radstand [mm]: 2.794	13.0460-6924.2	606924	AP 23471 17,5 - WE / - WK + Zub	
			➔	(V)1A614448→; Radstand [mm]: 3.302	13.0460-6924.2	606924	AP 23471 17,5 - WE / - WK + Zub	
<b>Zubehörsatz, Scheibenbremsbelag</b>								
2.5 Td5 4x4 (L316)	90	06/98→02/16	←	Radstand [mm]: 2.286; → (V)HA701009	13.0460-0154.2	610154	AP	
 <b>Bremsscheibe</b>								
2.2 Td4 4x4 (L317)	90	08/11→02/16	←		24.0114-0108.1	414108	Ø 298,5 14 13	
			➔		24.0124-0143.1	424143	Ø 298,5 24 22 V	
2.4 Td4 4x4 (L317)	90	05/07→02/16	←		24.0114-0108.1	414108	Ø 298,5 14 13	
			➔		24.0124-0143.1	424143	Ø 298,5 24 22 V	
			←	(V)LA930456→	24.0124-0143.1	424143	Ø 298,5 24 22 V	
			➔	Radstand [mm]: 2.286	24.0113-0189.1	413189	Ø 290 12,5 11,7	
			➔	→ (V)WA159806; - ABS; Radstand [mm]: 2.794	24.0114-0108.1	414108	Ø 298,5 14 13	
			➔	→ (V)WA159806; - ABS; Radstand [mm]: 3.302	24.0114-0108.1	414108	Ø 298,5 14 13	
2.5 Td5 4x4 (L316)	90	06/98→02/16	←		24.0114-0108.1	414108	Ø 298,5 14 13	
			←	(V)LA930456→	24.0124-0143.1	424143	Ø 298,5 24 22 V	
			➔	Radstand [mm]: 2.286	24.0113-0189.1	413189	Ø 290 12,5 11,7	
			➔	→ (V)WA159806; - ABS; Radstand [mm]: 2.794	24.0114-0108.1	414108	Ø 298,5 14 13	
			➔	→ (V)WA159806; - ABS; Radstand [mm]: 3.302	24.0114-0108.1	414108	Ø 298,5 14 13	
			➔	(V)XA159807→; Radstand [mm]: 2.794	24.0114-0115.1	414115	Ø 298 14 13	















	kw					! #			
<b>LAND ROVER - DEFENDER Pritsche/Fahrgestell (L316) 09/90→02/16</b>									
 <b>Bremsbelagsatz, Scheibenbremse</b>									
2.2 Td4 4x4 (L317)	90	08/11→02/16	←				<b>13.0460-6925.2</b>	<b>606925</b>	AP 21519 17,8 - WE / - WK + Zub
			→				<b>13.0460-6924.2</b>	<b>606924</b>	AP 23471 17,5 - WE / - WK + Zub
 <b>Bremsscheibe</b>									
2.2 Td4 4x4 (L317)	90	08/11→02/16	←				<b>24.0114-0108.1</b>	<b>414108</b>	Ø 298,5 14 13
			→				<b>24.0124-0143.1</b>	<b>424143</b>	Ø 298,5 24 22 V
<b>LAND ROVER - DEFENDER Station Wagon (L316) 08/90→02/16</b>									
 <b>Bremsbelagsatz, Scheibenbremse</b>									
2.2 Td4 4x4 (L317)	90	08/11→02/16	←				<b>13.0460-6925.2</b>	<b>606925</b>	AP 21519 17,8 - WE / - WK + Zub
			→				<b>13.0460-6917.2</b>	<b>606917</b>	AP 21237 15,5 + WK + Zub
							<b>13.0460-6924.2</b>	<b>606924</b>	AP 23471 17,5 - WE / - WK + Zub
2.2 Td4 4x4 (L317)	110	02/15→02/16	←				<b>13.0460-6925.2</b>	<b>606925</b>	AP 21519 17,8 - WE / - WK + Zub
			→				<b>13.0460-6924.2</b>	<b>606924</b>	AP 23471 17,5 - WE / - WK + Zub
2.4 Td4 4x4 (L316)	90	05/07→02/16	←				<b>13.0460-6925.2</b>	<b>606925</b>	AP 21519 17,8 - WE / - WK + Zub
			→				<b>13.0460-6917.2</b>	<b>606917</b>	AP 21237 15,5 + WK + Zub
			→	→ (V)1A614447; Radstand [mm]: 3.302		<b>13.0460-6923.2</b>	<b>606923</b>	AP 23471 14,5 - WE / - WK	
			→	→ (V)1A614447; Radstand [mm]: 2.794		<b>13.0460-6923.2</b>	<b>606923</b>	AP 23471 14,5 - WE / - WK	
			→	(V)1A614448→; Radstand [mm]: 3.302		<b>13.0460-6924.2</b>	<b>606924</b>	AP 23471 17,5 - WE / - WK + Zub	
			→	(V)1A614448→; Radstand [mm]: 2.794		<b>13.0460-6924.2</b>	<b>606924</b>	AP 23471 17,5 - WE / - WK + Zub	
2.5 D 4x4 (L316)	51	09/90→09/01	←				<b>13.0460-6922.2</b>	<b>606922</b>	AP 21459 17,5 - WE / - WK + Zub
2.5 Td5 4x4 (L316) 3.9 V8 4x4 (L316)	90 136	06/98→02/16 11/98→02/16	←	Radstand [mm]: 2.286; → (V)HA701009			<b>13.0460-6922.2</b>	<b>606922</b>	AP 21459 17,5 - WE / - WK + Zub
			←	(V)HA701010→			<b>13.0460-6925.2</b>	<b>606925</b>	AP 21519 17,8 - WE / - WK + Zub
			→	→ (V)1A614447; Radstand [mm]: 3.302		<b>13.0460-6923.2</b>	<b>606923</b>	AP 23471 14,5 - WE / - WK	
			→	→ (V)1A614447; Radstand [mm]: 2.794		<b>13.0460-6923.2</b>	<b>606923</b>	AP 23471 14,5 - WE / - WK	
			→	(V)1A614448→; Radstand [mm]: 2.794		<b>13.0460-6924.2</b>	<b>606924</b>	AP 23471 17,5 - WE / - WK + Zub	
			→	(V)1A614448→; Radstand [mm]: 3.302		<b>13.0460-6924.2</b>	<b>606924</b>	AP 23471 17,5 - WE / - WK + Zub	
2.5 TDI 4x4 (L316)	83	08/90→12/98	←	09/90→; Radstand [mm]: 2.286; → (V)HA701009			<b>13.0460-6922.2</b>	<b>606922</b>	AP 21459 17,5 - WE / - WK + Zub
			←	(V)HA701010→			<b>13.0460-6925.2</b>	<b>606925</b>	AP 21519 17,8 - WE / - WK + Zub
			→	09/90→; → (V)1A614447; Radstand [mm]: 3.302		<b>13.0460-6923.2</b>	<b>606923</b>	AP 23471 14,5 - WE / - WK	
			→	09/90→; → (V)1A614447; Radstand [mm]: 2.794		<b>13.0460-6923.2</b>	<b>606923</b>	AP 23471 14,5 - WE / - WK	
			→	(V)1A614448→; Radstand [mm]: 3.302		<b>13.0460-6924.2</b>	<b>606924</b>	AP 23471 17,5 - WE / - WK + Zub	
			→	(V)1A614448→; Radstand [mm]: 2.794		<b>13.0460-6924.2</b>	<b>606924</b>	AP 23471 17,5 - WE / - WK + Zub	
<b>Zubehörsatz, Scheibenbremsbelag</b>									
2.5 D 4x4 (L316)	51	09/90→09/01	←				<b>13.0460-0154.2</b>	<b>610154</b>	AP
2.5 Td5 4x4 (L316)	90	06/98→02/16	←	Radstand [mm]: 2.286; → (V)HA701009			<b>13.0460-0154.2</b>	<b>610154</b>	AP
3.9 V8 4x4 (L316)	136	11/98→02/16	←						
2.5 TDI 4x4 (L316)	83	08/90→12/98	←	09/90→; Radstand [mm]: 2.286; → (V)HA701009			<b>13.0460-0154.2</b>	<b>610154</b>	AP
 <b>Bremsscheibe</b>									
2.2 Td4 4x4 (L317)	90	08/11→02/16	←				<b>24.0114-0108.1</b>	<b>414108</b>	Ø 298,5 14 13
			→				<b>24.0124-0143.1</b>	<b>424143</b>	Ø 298,5 24 22 V
↓									













	kW					! #		
<b>LAND ROVER - DEFENDER Station Wagon (L316) 08/90→02/16</b>								
<b>Bremsscheibe</b>								
2.2 Td4 4x4 (L317)	90	08/11→02/16	➔				24.0113-0189.1 413189 24.0114-0115.1 414115	Ø 290 12,5 11,7 Ø 298 14 13
2.2 Td4 4x4 (L317)	110	02/15→02/16	➔				24.0114-0108.1 414108 24.0124-0143.1 424143	Ø 298,5 14 13 Ø 298,5 24 22 V
			➔				24.0114-0115.1 414115	Ø 298 14 13
2.4 Td4 4x4 (L316)	90	05/07→02/16	➔				24.0114-0108.1 414108 24.0124-0143.1 424143	Ø 298,5 14 13 Ø 298,5 24 22 V
			➔	(V)LA930456→			24.0124-0143.1 424143	Ø 298,5 24 22 V
			➔	Radstand [mm]: 2.286			24.0113-0189.1 413189	Ø 290 12,5 11,7
			➔				24.0113-0189.1 413189 24.0114-0115.1 414115	Ø 290 12,5 11,7 Ø 298 14 13
			➔	→ (V)WA159806; - ABS; Radstand [mm]: 3.302			24.0114-0108.1 414108	Ø 298,5 14 13
			➔	→ (V)WA159806; - ABS; Radstand [mm]: 2.794			24.0114-0108.1 414108	Ø 298,5 14 13
			➔	(V)XA159807→; Radstand [mm]: 3.302			24.0114-0115.1 414115	Ø 298 14 13
			➔	(V)XA159807→; Radstand [mm]: 2.794			24.0114-0115.1 414115	Ø 298 14 13
			2.5 D 4x4 (L316)	51	09/90→09/01	➔		
➔							24.0114-0108.1 414108	Ø 298,5 14 13
2.5 Td5 4x4 (L316) 3.9 V8 4x4 (L316)	90 136	06/98→02/16 11/98→02/16	➔				24.0114-0108.1 414108	Ø 298,5 14 13
			➔	(V)LA930456→			24.0124-0143.1 424143	Ø 298,5 24 22 V
			➔	Radstand [mm]: 2.286			24.0113-0189.1 413189	Ø 290 12,5 11,7
			➔	→ (V)WA159806; - ABS; Radstand [mm]: 2.794			24.0114-0108.1 414108	Ø 298,5 14 13
			➔	→ (V)WA159806; - ABS; Radstand [mm]: 3.302			24.0114-0108.1 414108	Ø 298,5 14 13
			➔	(V)XA159807→; Radstand [mm]: 2.794			24.0114-0115.1 414115	Ø 298 14 13
2.5 TDI 4x4 (L316)	83	08/90→12/98	➔	09/90→			24.0114-0108.1 414108	Ø 298,5 14 13
			➔	(V)LA930456→			24.0124-0143.1 424143	Ø 298,5 24 22 V
			➔	09/90→; Radstand [mm]: 2.286			24.0113-0189.1 413189	Ø 290 12,5 11,7
			➔	09/90→; → (V)WA159806; - ABS; Radstand [mm]: 3.302			24.0114-0108.1 414108	Ø 298,5 14 13
			➔	09/90→; → (V)WA159806; - ABS; Radstand [mm]: 2.794			24.0114-0108.1 414108	Ø 298,5 14 13
			➔	(V)XA159807→; Radstand [mm]: 2.794			24.0114-0115.1 414115	Ø 298 14 13
			➔	(V)XA159807→; Radstand [mm]: 3.302			24.0114-0115.1 414115	Ø 298 14 13
<b>LAND ROVER - DISCOVERY I (LJ) 06/89→12/98</b>								
<b>Bremsbelagsatz, Scheibenbremse</b>								
2.0 16 V 4x4	99	06/89→10/98	➔	MA081992→			13.0460-6916.2 606916 13.0460-6922.2 606922	AP 21459 18,5 + WK AP 21459 17,5 - WE / - WK + Zub
			➔	01/94→			13.0460-6916.2 606916 13.0460-6922.2 606922	AP 21459 18,5 + WK AP 21459 17,5 - WE / - WK + Zub
			➔	09/93→; → KA034313			13.0460-6926.2 606926	AP 20359 19,2 + WK + Zub
			➔	09/93→			13.0460-6917.2 606917	AP 21237 15,5 + WK + Zub
			➔	01/94→			13.0460-6917.2 606917	AP 21237 15,5 + WK + Zub
2.5 D 4x4	90	06/93→10/98	➔	MA081992→			13.0460-6916.2 606916 13.0460-6922.2 606922	AP 21459 18,5 + WK AP 21459 17,5 - WE / - WK + Zub
			➔	07/94→; → KA034313			13.0460-6926.2 606926	AP 20359 19,2 + WK + Zub
			➔	07/94→			13.0460-6917.2 606917	AP 21237 15,5 + WK + Zub
2.5 TDI 4x4	83	10/89→10/98	➔	MA081992→			13.0460-6916.2 606916 13.0460-6922.2 606922	AP 21459 18,5 + WK AP 21459 17,5 - WE / - WK + Zub
			➔	→ KA034313			13.0460-6926.2 606926	AP 20359 19,2 + WK + Zub
			➔				13.0460-6917.2 606917	AP 21237 15,5 + WK + Zub
4.0 4x4 ↓	134	09/93→10/98	➔	MA081992→			13.0460-6916.2 606916	AP 21459 18,5 + WK

	kW			 	! #		
<b>LAND ROVER - DISCOVERY I (LJ) 06/89→12/98</b>							
 <b>Bremsbelagsatz, Scheibenbremse</b>							
4.0 4x4	134	09/93→10/98	←	MA081992→		13.0460-6922.2 606922	AP 21459 17,5 - WE / - WK + Zub
			←	07/94→; → KA034313		13.0460-6926.2 606926	AP 20359 19,2 + WK + Zub
			←	→ KA034313		13.0460-6926.2 606926	AP 20359 19,2 + WK + Zub
			→	07/94→		13.0460-6917.2 606917	AP 21237 15,5 + WK + Zub
			→			13.0460-6917.2 606917	AP 21237 15,5 + WK + Zub
<b>Zubehörsatz, Scheibenbremsbelag</b>							
2.0 16 V 4x4	99	06/89→10/98	←	MA081992→		13.0460-0154.2 610154	AP
			←	01/94→		13.0460-0154.2 610154	AP
			→	09/93→		13.0460-0414.2 610414	AP
			→	01/94→		13.0460-0414.2 610414	AP
2.5 D 4x4	90	06/93→10/98	←	MA081992→		13.0460-0154.2 610154	AP
			→	07/94→		13.0460-0414.2 610414	AP
2.5 TDI 4x4	83	10/89→10/98	←	MA081992→		13.0460-0154.2 610154	AP
			→			13.0460-0414.2 610414	AP
4.0 4x4	134	09/93→10/98	←	MA081992→		13.0460-0154.2 610154	AP
			→			13.0460-0414.2 610414	AP
			→	07/94→		13.0460-0414.2 610414	AP
 <b>Bremsscheibe</b>							
2.0 16 V 4x4	99	06/89→10/98	←	05/95→		24.0114-0108.1 414108	Ø 298,5 14 13
			←	09/93→		24.0114-0108.1 414108	Ø 298,5 14 13
						24.0124-0143.1 424143	Ø 298,5 24 22 V
			←	01/94→ 04/95		24.0124-0143.1 424143	Ø 298,5 24 22 V
			→	01/94→		24.0113-0189.1 413189	Ø 290 12,5 11,7
			→	09/93→		24.0113-0189.1 413189	Ø 290 12,5 11,7
2.5 D 4x4	90	06/93→10/98	←	07/94→		24.0114-0108.1 414108	Ø 298,5 14 13
			→	07/94→		24.0124-0143.1 424143	Ø 298,5 24 22 V
			→	07/94→		24.0113-0189.1 413189	Ø 290 12,5 11,7
2.5 TDI 4x4	83	10/89→10/98	←			24.0114-0108.1 414108	Ø 298,5 14 13
						24.0124-0143.1 424143	Ø 298,5 24 22 V
			→			24.0113-0189.1 413189	Ø 290 12,5 11,7
4.0 4x4	134	09/93→10/98	←	07/94→		24.0114-0108.1 414108	Ø 298,5 14 13
						24.0124-0143.1 424143	Ø 298,5 24 22 V
			←			24.0114-0108.1 414108	Ø 298,5 14 13
						24.0124-0143.1 424143	Ø 298,5 24 22 V
			→			24.0113-0189.1 413189	Ø 290 12,5 11,7
			→	07/94→		24.0113-0189.1 413189	Ø 290 12,5 11,7
<b>LAND ROVER - DISCOVERY II (L318) 10/98→08/04</b>							
 <b>Bremsbelagsatz, Scheibenbremse</b>							
2.5 Td5 4x4	100	11/98→06/04	←	01/99→		13.0460-2720.2 602720	TRW 23452 19,0 - WE / - WK
			→	01/99→		13.0460-2721.2 602721	TRW 23458 15,6 - WE / - WK
2.5 Td5 4x4 4.0 V8 4x4	102	11/98→06/04	←			13.0460-2720.2 602720	TRW 23452 19,0 - WE / - WK
	136	11/98→06/04	→			13.0460-2721.2 602721	TRW 23458 15,6 - WE / - WK
 <b>Bremsscheibe</b>							
2.5 Td5 4x4	100	11/98→06/04	←	01/99→		24.0125-0176.1 425176	Ø 297,5 25 22 V
			→	01/99→		24.0113-0197.1 413197	Ø 304,5 12,6 11,7
2.5 Td5 4x4 4.0 V8 4x4	102	11/98→06/04	←			24.0125-0176.1 425176	Ø 297,5 25 22 V
	136	11/98→06/04	→			24.0113-0197.1 413197	Ø 304,5 12,6 11,7
<b>LAND ROVER - DISCOVERY III (L319) 07/04→09/09</b>							
 <b>Bremsbelagsatz, Scheibenbremse</b>							
2.7 TD 4x4 4.0 4x4 4.0 V6 4x4 ↓	140	07/04→09/09	←	08/06→ 08/09; nicht für gepanzerte Fahrzeuge		13.0460-2728.2 602728	TRW 24191 18,1 + WE / - WK + Zub
	160	02/05→09/09					
	160	10/04→09/09					







	kW					! #		
<b>LAND ROVER - DISCOVERY III (L319) 07/04→09/09</b>								
 <b>Bremsbelagsatz, Scheibenbremse</b>								
2.7 TD 4x4 4.0 4x4 4.0 V6 4x4	140 160 160	07/04→09/09 02/05→09/09 10/04→09/09	← →	→ 07/06; nicht für gepanzerte Fahrzeuge → 08/09; nicht für gepanzerte Fahrzeuge			13.0460-2728.2 602728 13.0460-2719.2 602719	TRW 24191 18,1 + WE / - WK + Zub TRW 24192 17,4 + WE / - WK + Zub
4.4 4x4	220	07/04→09/09	← ← →	08/06→ 08/09; nicht für gepanzerte Fahrzeuge → 07/06; nicht für gepanzerte Fahrzeuge → 08/09; für gepanzerte Fahrzeuge			13.0460-2728.2 602728 13.0460-2728.2 602728 13.0460-2719.2 602719	TRW 24191 18,1 + WE / - WK + Zub TRW 24191 18,1 + WE / - WK + Zub TRW 24192 17,4 + WE / - WK + Zub
<b>Warnkontakt, Bremsbelagverschleiß</b>								
2.7 TD 4x4 4.0 4x4 4.0 V6 4x4	140 160 160	07/04→09/09 02/05→09/09 10/04→09/09	← ← →	08/06→ 08/09; nicht für gepanzerte Fahrzeuge → 07/06; nicht für gepanzerte Fahrzeuge → 08/09; nicht für gepanzerte Fahrzeuge	1		24.8190-0946.2 620946 24.8190-1305.2 621305 24.8190-1306.2 621306	L= 1.175 L= 1.147 L= 1.156
4.4 4x4	220	07/04→09/09	← ← →	08/06→ 08/09; nicht für gepanzerte Fahrzeuge → 07/06; nicht für gepanzerte Fahrzeuge → 08/09; für gepanzerte Fahrzeuge	1		24.8190-0946.2 620946 24.8190-1305.2 621305 24.8190-1306.2 621306	L= 1.175 L= 1.147 L= 1.156
 <b>Bremsscheibe</b>								
2.7 TD 4x4 4.0 4x4	140 160	07/04→09/09 02/05→09/09	← →	→ 08/09; für gepanzerte Fahrzeuge → 08/09; nicht für gepanzerte Fahrzeuge			24.0130-0178.1 430178 24.0120-0210.1 420210	Ø 317 30 27 V Ø 325 20 17 V
4.0 V6 4x4	160	10/04→09/09	← →	→ 08/09; nicht für gepanzerte Fahrzeuge → 08/09; nicht für gepanzerte Fahrzeuge			24.0130-0178.1 430178 24.0120-0210.1 420210	Ø 317 30 27 V Ø 325 20 17 V
4.4 4x4	220	07/04→09/09	← →	→ 08/09; nicht für gepanzerte Fahrzeuge → 08/09; nicht für gepanzerte Fahrzeuge			24.0130-0188.1 430188 24.0120-0210.1 420210	Ø 337,5 30 27 V Ø 325 20 17 V
<b>LAND ROVER - DISCOVERY IV (L319) 09/09→</b>								
 <b>Bremsbelagsatz, Scheibenbremse</b>								
2.7 TD 4x4	140	09/09→	←				13.0460-2728.2 602728	TRW 24191 18,1 + WE / - WK + Zub
3.0 4x4 3.0 SDV6 4x4 3.0 TD 4x4 3.0 TD 4x4 3.0 TD 4x4 3.0 TD 4x4 4.0 4x4 5.0 V8 4x4	250 188 155 180 183 200 160 276	08/13→ 11/09→ 05/10→ 09/09→ 07/12→ 09/09→ 09/09→ 09/09→	← ← →	→ AA546302; nicht für gepanzerte Fahrzeuge			13.0460-2762.2 602762 13.0460-2731.2 602731	TRW 25021 18,5 + WE / - WK + Zub TRW 24192 17,1 + WE / - WK + Zub
<b>Warnkontakt, Bremsbelagverschleiß</b>								
2.7 TD 4x4	140	09/09→	→		1		24.8190-1306.2 621306	L= 1.156
3.0 4x4 3.0 SDV6 4x4 3.0 TD 4x4 3.0 TD 4x4 3.0 TD 4x4 3.0 TD 4x4 4.0 4x4 5.0 V8 4x4	250 188 155 180 183 200 160 276	08/13→ 11/09→ 05/10→ 09/09→ 07/12→ 09/09→ 09/09→ 09/09→	←		1		24.8190-0946.2 620946	L= 1.175
 <b>Bremsscheibe</b>								
2.7 TD 4x4	140	09/09→	← →				24.0130-0178.1 430178 24.0120-0210.1 420210	Ø 317 30 27 V Ø 325 20 17 V
3.0 4x4 3.0 SDV6 4x4 3.0 TD 4x4 3.0 TD 4x4 3.0 TD 4x4 3.0 TD 4x4 4.0 4x4 5.0 V8 4x4	250 188 155 180 183 200 160 276	08/13→ 11/09→ 05/10→ 09/09→ 07/12→ 09/09→ 09/09→ 09/09→	← →	→ AA222221 nicht für gepanzerte Fahrzeuge			24.0130-0195.1 430195 24.0120-0201.1 420201	Ø 360 30 27 V Ø 350 20 17 V
<b>LAND ROVER - DISCOVERY V (L462) 09/16→</b>								
 <b>Bremsbelagsatz, Scheibenbremse</b>								
2.0 4x4 2.0 D 4x4 ↓	221 132	09/17→ 09/16→	←	→ HA999999; Felgengröße [Zoll]: 19			13.0460-2762.2 602762	TRW 25021 18,5 + WE / - WK + Zub

























	kw			 	! #		
<b>LAND ROVER - DISCOVERY V (L462) 09/16→</b>							
 <b>Bremsbelagsatz, Scheibenbremse</b>							
2.0 D 4x4	177	09/16→	→	→ HA999999		13.0460-2604.2 602604	TRW 25720 17,7 + WE / - WK + Zub
3.0 4x4	250	09/16→					
3.0 D 4x4	155	09/16→					
3.0 D 4x4	183	09/16→					
3.0 D 4x4	190	09/16→					
<b>LAND ROVER - DISCOVERY SPORT (L550) 09/14→</b>							
 <b>Bremsbelagsatz, Scheibenbremse</b>							
2.0 4x4	177	11/14→	←	17"		13.0460-7330.2 607330	ATE 22145 18,6 + WE / - WK
2.0 4x4	177	12/17→					
2.0 4x4	213	08/17→	→	- Performance Parts		13.0460-7326.2 607326	ATE 22141 15,5 + WE / - WK
2.0 D 4x4	177	08/17→					
2.2 D 4x4	110	09/14→					
2.2 D 4x4	140	09/14→					
2.0 D	110	08/15→	←			13.0460-7228.2 607228	ATE 24123 20,3 - WE / - WK
2.0 D 4x4	110	12/14→				13.0470-7228.2 LD7228	ATE 24123 20,3 - WE / - WK Ceramic
2.0 D 4x4	132	06/15→					
			←	17"		13.0460-7330.2 607330	ATE 22145 18,6 + WE / - WK
			→	- Performance Parts		13.0460-7326.2 607326	ATE 22141 15,5 + WE / - WK
 <b>Bremsscheibe</b>							
2.0 D	110	08/15→	←			24.0128-0154.1 428154	Ø 300 28 26 V + S
						24.0328-0154.1 528154	Ø 300 28 26 V + S
<b>LAND ROVER - FREELANDER (L314) 02/98→10/06</b>							
 <b>Bremsbelagsatz, Scheibenbremse</b>							
1.8 16V 4x4	86	11/00→10/06	←	1A000001→		13.0460-2718.2 602718	TRW 23615 18,3 - WE / - WK
2.0 Td4 4x4	82	11/00→10/06					
2.5 V6 4x4	130	11/00→10/06	←	→ YA999999		13.0460-5830.2 605830	TRW 23158 17,5 - WK + Zub
1.8 i 16V 4x4	88	02/98→11/00	←			13.0460-5830.2 605830	TRW 23158 17,5 - WK + Zub
2.0 DI 4x4	72	02/98→11/00					
2.0 Td4 4x4	80	03/01→10/06	←	1A000001→		13.0460-2718.2 602718	TRW 23615 18,3 - WE / - WK
			←	11/01→; → YA999999		13.0460-5830.2 605830	TRW 23158 17,5 - WK + Zub
 <b>Bremsscheibe</b>							
1.8 16V 4x4	86	11/00→10/06	←	→ YA999999		24.0114-0113.1 414113	Ø 262 14 11
2.0 Td4 4x4	82	11/00→10/06					
2.5 V6 4x4	130	11/00→10/06	←	1A000001→		24.0121-0114.1 421114	Ø 277 21 18 V
1.8 i 16V 4x4	88	02/98→11/00	←			24.0114-0113.1 414113	Ø 262 14 11
2.0 DI 4x4	72	02/98→11/00					
2.0 Td4 4x4	80	03/01→10/06	←	11/01→; → YA999999		24.0114-0113.1 414113	Ø 262 14 11
			←	1A000001→		24.0121-0114.1 421114	Ø 277 21 18 V
<b>LAND ROVER - FREELANDER 2 (L359) 10/06→10/14</b>							
 <b>Bremsbelagsatz, Scheibenbremse</b>							
2.0 Si4 4x4	177	10/11→10/14	←			13.0460-7228.2 607228	ATE 24123 20,3 - WE / - WK
3.2 4x4	171	10/06→10/14				13.0470-7228.2 LD7228	ATE 24123 20,3 - WE / - WK Ceramic
2.2 eD4	110	08/10→10/14	←			13.0460-7228.2 607228	ATE 24123 20,3 - WE / - WK
2.2 TD4 4x4	110	10/06→10/14				13.0470-7228.2 LD7228	ATE 24123 20,3 - WE / - WK Ceramic
2.2 TD4 4x4	112	01/07→10/14					
2.2 TD4 4x4	115	10/06→10/14					
2.2 TD4 4x4	118	10/06→10/14	→			13.0460-2737.2 602737	TRW 24537 15,8 - WE / - WK + Zub
2.2 SD4 4x4	140	08/10→10/14	←			13.0460-7228.2 607228	ATE 24123 20,3 - WE / - WK
						13.0470-7228.2 LD7228	ATE 24123 20,3 - WE / - WK Ceramic
			→	→ CH999999		13.0460-2737.2 602737	TRW 24537 15,8 - WE / - WK + Zub
 <b>Bremsscheibe</b>							
2.0 Si4 4x4	177	10/11→10/14	→	→ CH999999		24.0120-0218.1 420218	Ø 302 20 18 V
2.2 eD4	110	08/10→10/14	←			24.0128-0154.1 428154	Ø 300 28 26 V + S
2.2 TD4 4x4	110	10/06→10/14				24.0328-0154.1 528154	Ø 300 28 26 V + S
2.2 TD4 4x4	112	01/07→10/14					
2.2 TD4 4x4	115	10/06→10/14	→			24.0112-0186.1 412186	Ø 302 12 10
2.2 TD4 4x4	118	10/06→10/14					
2.2 SD4 4x4	140	08/10→10/14	←			24.0128-0154.1 428154	Ø 300 28 26 V + S
						24.0328-0154.1 528154	Ø 300 28 26 V + S
↓							

	kw			 	! #		
<b>LAND ROVER - FREELANDER 2 (L359) 10/06→10/14</b>							
 <b>Bremsscheibe</b>							
2.2 SD4 4x4	140	08/10→10/14	➔	→ CH999999		24.0112-0186.1 412186	Ø 302 12 10
3.2 4x4	171	10/06→10/14	➔			24.0128-0162.1 428162	Ø 316 28 26 V + S
			➔			24.0328-0162.1 528162	Ø 316 28 26 V + S
			➔			24.0120-0218.1 420218	Ø 302 20 18 V
<b>LAND ROVER - FREELANDER Soft Top (L314) 02/98→10/06</b>							
 <b>Bremsbelagsatz, Scheibenbremse</b>							
1.8 4x4	86	10/00→10/06	➔	1A000001→		13.0460-2718.2 602718	TRW 23615 18,3 - WE / - WK
2.0 TD4 4x4	82	10/00→10/06	➔	11/00→; → YA999999		13.0460-5830.2 605830	TRW 23158 17,5 - WK + Zub
1.8 i 16V 4x4	88	02/98→10/06	➔	→ 11/00		13.0460-5830.2 605830	TRW 23158 17,5 - WK + Zub
2.0 DI 4x4	72	02/98→10/06					
 <b>Bremsscheibe</b>							
1.8 4x4	86	10/00→10/06	➔	11/00→; → YA999999		24.0114-0113.1 414113	Ø 262 14 11
2.0 TD4 4x4	82	10/00→10/06	➔	1A000001→		24.0121-0114.1 421114	Ø 277 21 18 V
1.8 i 16V 4x4	88	02/98→10/06	➔	→ 11/00		24.0114-0113.1 414113	Ø 262 14 11
2.0 DI 4x4	72	02/98→10/06					
<b>LAND ROVER - RANGE ROVER II (P38A) 07/94→03/02</b>							
 <b>Bremsbelagsatz, Scheibenbremse</b>							
2.5 D 4x4	83	08/94→03/02	➔			13.0460-2720.2 602720	TRW 23452 19,0 - WE / - WK
2.5 D 4x4	100	07/94→03/02	➔				
3.9 4x4	140	07/94→03/02	➔			13.0460-2721.2 602721	TRW 23458 15,6 - WE / - WK
4.6 4x4	160	06/98→03/02					
4.6 4x4	165	07/94→03/02					
4.6 4x4	168	09/95→03/02					
4.0 4x4	136	01/95→03/02	➔	06/98→		13.0460-2720.2 602720	TRW 23452 19,0 - WE / - WK
			➔	06/98→		13.0460-2721.2 602721	TRW 23458 15,6 - WE / - WK
 <b>Bremsscheibe</b>							
2.5 D 4x4	83	08/94→03/02	➔			24.0125-0164.1 425164	Ø 297 25 22 V
2.5 D 4x4	100	07/94→03/02	➔				
3.9 4x4	140	07/94→03/02	➔			24.0113-0197.1 413197	Ø 304,5 12,6 11,7
4.6 4x4	160	06/98→03/02					
4.6 4x4	165	07/94→03/02					
4.6 4x4	168	09/95→03/02					
4.0 4x4	136	01/95→03/02	➔	06/98→		24.0125-0164.1 425164	Ø 297 25 22 V
			➔	06/98→		24.0113-0197.1 413197	Ø 304,5 12,6 11,7
<b>LAND ROVER - RANGE ROVER III (L322) 03/02→12/12</b>							
 <b>Bremsbelagsatz, Scheibenbremse</b>							
3.0 D 4x4	130	03/02→08/12	➔	6A000001→;		13.0460-2728.2 602728	TRW 24191 18,1 + WE / - WK
4.4 4x4	210	03/02→08/05		nicht für gepanzerte Fahrzeuge			+ Zub
4.4 4x4	220	08/04→08/12	➔	→ 5A999999;		13.0460-7224.2 607224	ATE 23397 19,4 + WE / - WK
4.4 4x4	225	05/05→08/12	➔	nicht für gepanzerte Fahrzeuge			
			➔	6A000001→;		13.0460-2719.2 602719	TRW 24192 17,4 + WE / - WK
			➔	nicht für gepanzerte Fahrzeuge			+ Zub
			➔	→ 5A999999;		13.0460-7079.2 607079	ATE 21282 17,3 + WE / - WK
			➔	nicht für gepanzerte Fahrzeuge		13.0470-7079.2 LD7079	ATE 21282 17,3 + WE / - WK
							Ceramic
3.6 D 4x4	200	04/06→08/12	➔	BA347977→;		13.0460-2762.2 602762	TRW 25021 18,5 + WE / - WK
				nicht für gepanzerte Fahrzeuge			+ Zub
			➔	6A000001→ 9A999999;		13.0460-4837.2 604837	BRE 20217 17,1 + WE / - WK
				nicht für gepanzerte Fahrzeuge			
			➔	→ 5A999999;		13.0460-7224.2 607224	ATE 23397 19,4 + WE / - WK
			➔	nicht für gepanzerte Fahrzeuge			
			➔	6A000001→;		13.0460-2731.2 602731	TRW 24192 17,1 + WE / - WK
			➔	nicht für gepanzerte Fahrzeuge			+ Zub
			➔	→ 5A999999;		13.0460-7079.2 607079	ATE 21282 17,3 + WE / - WK
			➔	nicht für gepanzerte Fahrzeuge		13.0470-7079.2 LD7079	ATE 21282 17,3 + WE / - WK
							Ceramic
4.2 4x4	291	05/05→08/12	➔	6A000001→;		13.0460-4837.2 604837	BRE 20217 17,1 + WE / - WK
				nicht für gepanzerte Fahrzeuge			
			➔	→ 5A999999;		13.0460-7224.2 607224	ATE 23397 19,4 + WE / - WK
			➔	nicht für gepanzerte Fahrzeuge			
			➔	6A000001→;		13.0460-2719.2 602719	TRW 24192 17,4 + WE / - WK
			➔	nicht für gepanzerte Fahrzeuge			+ Zub





























	kw			 	! #		
<b>LAND ROVER - RANGE ROVER III (L322) 03/02→12/12</b>							
<b>Bremsbelagsatz, Scheibenbremse</b>							
4.2 4x4	291	05/05→08/12	➡	→ 5A999999; nicht für gepanzerte Fahrzeuge		13.0460-7079.2 607079 13.0470-7079.2 LD7079	ATE 21282 17,3 + WE / - WK ATE 21282 17,3 + WE / - WK Ceramic
5.0 4x4	276	09/09→08/12	⬅	BA347977→; nicht für gepanzerte Fahrzeuge		13.0460-2762.2 602762	TRW 25021 18,5 + WE / - WK + Zub
			➡	nicht für gepanzerte Fahrzeuge		13.0460-2731.2 602731	TRW 24192 17,1 + WE / - WK + Zub
<b>Warnkontakt, Bremsbelagverschleiß</b>							
3.0 D 4x4	130	03/02→08/12	⬅	→ 5A999999; nicht für gepanzerte Fahrzeuge	1	24.8190-0304.2 620304	L= 724
4.4 4x4	210	03/02→08/05					
4.4 4x4	220	08/04→08/12	⬅	6A000001→; nicht für gepanzerte Fahrzeuge	1	24.8190-0304.2 620304	L= 724
4.4 4x4	225	05/05→08/12	➡	6A000001→; nicht für gepanzerte Fahrzeuge	1	24.8190-0305.2 620305	L= 1.158
			➡	→ 5A999999; nicht für gepanzerte Fahrzeuge	1	24.8190-1308.2 621308	L= 1.118
3.6 D 4x4	200	04/06→08/12	⬅	→ 5A999999; nicht für gepanzerte Fahrzeuge	1	24.8190-0304.2 620304	L= 724
			⬅	6A000001→ 9A999999; nicht für gepanzerte Fahrzeuge	1	24.8190-0944.2 620944	L= 841,5
			➡	→ 5A999999; nicht für gepanzerte Fahrzeuge	1	24.8190-1308.2 621308	L= 1.118
4.2 4x4	291	05/05→08/12	⬅	→ 5A999999; nicht für gepanzerte Fahrzeuge	1	24.8190-0304.2 620304	L= 724
			⬅	6A000001→; nicht für gepanzerte Fahrzeuge	1	24.8190-0944.2 620944	L= 841,5
			➡	6A000001→; nicht für gepanzerte Fahrzeuge	1	24.8190-0305.2 620305	L= 1.158
			➡	→ 5A999999; nicht für gepanzerte Fahrzeuge	1	24.8190-1308.2 621308	L= 1.118
4.4 D 4x4	230	07/10→08/12	⬅	nicht für gepanzerte Fahrzeuge	1	24.8190-0973.2 620973	L= 841,5 L2= 224,5
5.0 4x4	375	09/09→08/12					
5.0 4x4	276	09/09→08/12	⬅		1	24.8190-0304.2 620304	L= 724
<b>Bremsscheibe</b>							
3.0 D 4x4	130	03/02→08/12	⬅	→ 5A999999; nicht für gepanzerte Fahrzeuge		24.0130-0184.1 430184	Ø 344 29,9 28,4 V
			⬅	6A000001→; nicht für gepanzerte Fahrzeuge		24.0130-0196.1 430196	Ø 344 30 27 V
			➡	3A129290→ 5A999999; nicht für gepanzerte Fahrzeuge		24.0112-0168.1 412168	Ø 354 11,9 10,4
			➡	→ 3A129289; nicht für gepanzerte Fahrzeuge		24.0113-0197.1 413197	Ø 304,5 12,6 11,7
			➡	6A000001→; nicht für gepanzerte Fahrzeuge		24.0120-0200.1 420200	Ø 354 20 17 V
3.6 D 4x4	200	04/06→08/12	⬅	→ 5A999999; nicht für gepanzerte Fahrzeuge		24.0130-0184.1 430184	Ø 344 29,9 28,4 V
			⬅	6A000001→ 9A999999; nicht für gepanzerte Fahrzeuge		24.0130-0197.1 430197	Ø 360 30 27 V
			➡	3A129290→ 9A999999; nicht für gepanzerte Fahrzeuge		24.0112-0168.1 412168	Ø 354 11,9 10,4
			➡	→ 3A129289; nicht für gepanzerte Fahrzeuge		24.0113-0197.1 413197	Ø 304,5 12,6 11,7
			➡	AA000001→; nicht für gepanzerte Fahrzeuge		24.0120-0200.1 420200	Ø 354 20 17 V
4.2 4x4	291	05/05→08/12	⬅	→ 5A999999; nicht für gepanzerte Fahrzeuge		24.0130-0184.1 430184	Ø 344 29,9 28,4 V
			⬅	6A000001→; nicht für gepanzerte Fahrzeuge		24.0130-0197.1 430197	Ø 360 30 27 V
			➡	3A129290→ 5A999999; nicht für gepanzerte Fahrzeuge		24.0112-0168.1 412168	Ø 354 11,9 10,4
			➡	→ 3A129289; nicht für gepanzerte Fahrzeuge		24.0113-0197.1 413197	Ø 304,5 12,6 11,7
			➡	6A000001→; nicht für gepanzerte Fahrzeuge		24.0120-0200.1 420200	Ø 354 20 17 V
4.4 4x4	210	03/02→08/05	⬅	nicht für gepanzerte Fahrzeuge		24.0130-0184.1 430184	Ø 344 29,9 28,4 V
			➡	3A129290→ 5A999999; nicht für gepanzerte Fahrzeuge		24.0112-0168.1 412168	Ø 354 11,9 10,4
			➡	→ 3A129289; nicht für gepanzerte Fahrzeuge		24.0113-0197.1 413197	Ø 304,5 12,6 11,7
			➡	6A000001→; nicht für gepanzerte Fahrzeuge		24.0120-0200.1 420200	Ø 354 20 17 V
↓							

















	kW					! #		
<b>LAND ROVER - RANGE ROVER III (L322) 03/02→12/12</b>								
 <b>Bremsscheibe</b>								
4.4 4x4 4.4 4x4	220 225	08/04→08/12 05/05→08/12	←	→ 5A999999; nicht für gepanzerte Fahrzeuge		24.0130-0184.1	430184	Ø 344 29,9 28,4 V
			←	6A000001→; nicht für gepanzerte Fahrzeuge		24.0130-0196.1	430196	Ø 344 30 27 V
			→	→ 5A999999; nicht für gepanzerte Fahrzeuge		24.0112-0168.1	412168	Ø 354 11,9 10,4
			→	6A000001→; nicht für gepanzerte Fahrzeuge		24.0120-0200.1	420200	Ø 354 20 17 V
5.0 4x4	276	09/09→08/12	←	nicht für gepanzerte Fahrzeuge		24.0130-0197.1	430197	Ø 360 30 27 V
			→	nicht für gepanzerte Fahrzeuge		24.0120-0200.1	420200	Ø 354 20 17 V
<b>LAND ROVER - RANGE ROVER IV (L405) 08/12→</b>								
 <b>Bremsbelagsatz, Scheibenbremse</b>								
2.0 PHEV 4x4	221	10/17→	←	→ HA999999; Felgenreöße [Zoll]: 19		13.0460-2762.2	602762	TRW 25021 18,5 + WE / - WK + Zub
			→	→ HA999999; Felgenreöße [Zoll]: 19		13.0460-2604.2	602604	TRW 25720 17,7 + WE / - WK + Zub
3.0 4x4	250	10/13→	←	Felgenreöße [Zoll]: 19		13.0460-2762.2	602762	TRW 25021 18,5 + WE / - WK + Zub
			→	→ HA999999; Felgenreöße [Zoll]: 19		13.0460-2604.2	602604	TRW 25720 17,7 + WE / - WK + Zub
3.0 4x4	280	06/15→	←	passend für Felgenreöße [Zoll]: 19		13.0460-2762.2	602762	TRW 25021 18,5 + WE / - WK + Zub
			→	passend für Felgenreöße [Zoll]: 19		13.0460-2604.2	602604	TRW 25720 17,7 + WE / - WK + Zub
3.0 D 4x4 3.0 D 4x4	155 183	10/13→ 08/12→	←	EA000001→		13.0460-2762.2	602762	TRW 25021 18,5 + WE / - WK + Zub
			→	EA000001→		13.0460-2604.2	602604	TRW 25720 17,7 + WE / - WK + Zub
3.0 D 4x4	190	08/12→	←	Felgenreöße [Zoll]: 19		13.0460-2762.2	602762	TRW 25021 18,5 + WE / - WK + Zub
			→	EA000001→; nicht für Ausstattungsvariante: AUTOBIO- OGRAPHY		13.0460-2604.2	602604	TRW 25720 17,7 + WE / - WK + Zub
3.0 D Hybrid 4x4	250	10/13→	→	EA000001→		13.0460-2604.2	602604	TRW 25720 17,7 + WE / - WK + Zub
4.4 D V8 4x4 5.0 4x4 5.0 4x4 5.0 4x4 5.0 4x4	250 375 386 416 276	08/12→ 08/12→ 11/17→ 11/17→ 12/13→	→	→ DA999999; nicht für Ausstattungsvariante: AUTOBIO- OGRAPHY		13.0460-2604.2	602604	TRW 25720 17,7 + WE / - WK + Zub
			→			13.0460-2604.2	602604	TRW 25720 17,7 + WE / - WK + Zub
<b>LAND ROVER - RANGE ROVER EVOQUE (L538) 06/11→</b>								
 <b>Bremsbelagsatz, Scheibenbremse</b>								
2.0 4x4 2.2 D 2.2 D 4x4 2.2 D 4x4	177 110 110 140	06/11→ 06/11→ 06/11→ 06/11→	←			13.0460-7228.2	607228	ATE 24123 20,3 - WE / - WK
			→			13.0470-7228.2	LD7228	ATE 24123 20,3 - WE / - WK Ceramic
			→			13.0460-2722.2	602722	TRW 24496 17,3 - WE / - WK + Zub
			→			13.0470-2722.2	LD2722	TRW 24496 17,3 - WE / - WK + Zub Ceramic
2.0 D 2.0 D 4x4 2.0 D 4x4	110 110 132	06/15→ 06/15→ 05/15→	←	Felgenreöße [Zoll]: 16		13.0460-7228.2	607228	ATE 24123 20,3 - WE / - WK
			←	Felgenreöße [Zoll]: 17		13.0470-7228.2	LD7228	ATE 24123 20,3 - WE / - WK Ceramic
			→	→ FH999999		13.0460-2722.2	602722	TRW 24496 17,3 - WE / - WK + Zub
			→			13.0470-2722.2	LD2722	TRW 24496 17,3 - WE / - WK + Zub Ceramic
			→	GH000001→		13.0460-7326.2	607326	ATE 22141 15,5 + WE / - WK
 <b>Bremsscheibe</b>								
2.0 4x4 2.2 D 2.2 D 4x4 2.2 D 4x4	177 110 110 140	06/11→ 06/11→ 06/11→ 06/11→	←			24.0128-0154.1	428154	Ø 300 28 26 V + S
			→			24.0328-0154.1	528154	Ø 300 28 26 V + S
			→			24.0111-0145.1	411145	Ø 302 10,9 9 + S
			→			24.0311-0145.1	511145	Ø 302 10,9 9
2.0 D 2.0 D 4x4 ↓	110 110	06/15→ 06/15→	←	Felgenreöße [Zoll]: 16		24.0128-0154.1	428154	Ø 300 28 26 V + S

















	kw					! #		
<b>LAND ROVER - RANGE ROVER EVOQUE (L538) 06/11→</b>								
 <b>Bremsscheibe</b>								
2.0 D 4x4	132	05/15→	←	Felgenreöße [Zoll]: 16		24.0328-0154.1	528154	Ø 300 28 26 V + S
			→	→ FH999999		24.0111-0145.1	411145	Ø 302 10,9 9 + S
						24.0311-0145.1	511145	Ø 302 10,9 9
<b>LAND ROVER - RANGE ROVER EVOQUE Cabriolet (L538) 11/15→</b>								
 <b>Bremsbelagsatz, Scheibenbremse</b>								
2.0 4x4	177	11/15→	←	für Bremsscheibendurchmesser [mm]: 300		13.0460-7228.2	607228	ATE 24123 20,3 - WE / - WK
2.0 D 4x4	110	11/15→				13.0470-7228.2	LD7228	ATE 24123 20,3 - WE / - WK Ceramic
2.0 D 4x4	132	11/15→	←	02/16→; für Bremsscheibendurchmesser [mm]: 325		13.0460-7330.2	607330	ATE 22145 18,6 + WE / - WK
			→	→ FH999999		13.0460-2722.2	602722	TRW 24496 17,3 - WE / - WK + Zub
						13.0470-2722.2	LD2722	TRW 24496 17,3 - WE / - WK + Zub Ceramic
			→	GH000001→		13.0460-7326.2	607326	ATE 22141 15,5 + WE / - WK
 <b>Bremsscheibe</b>								
2.0 4x4	177	11/15→	←	→ FH999999		24.0128-0154.1	428154	Ø 300 28 26 V + S
2.0 D 4x4	110	11/15→				24.0328-0154.1	528154	Ø 300 28 26 V + S
2.0 D 4x4	132	11/15→	→	→ FH999999		24.0111-0145.1	411145	Ø 302 10,9 9 + S
						24.0311-0145.1	511145	Ø 302 10,9 9
<b>LAND ROVER - RANGE ROVER SPORT (L320) 02/05→03/13</b>								
 <b>Bremsbelagsatz, Scheibenbremse</b>								
2.7 D 4x4	140	02/05→03/13	←	→ 6A999999		13.0460-2728.2	602728	TRW 24191 18,1 + WE / - WK + Zub
4.4 4x4	220	02/05→03/13	←	7A000001→; → 10/09		13.0460-2728.2	602728	TRW 24191 18,1 + WE / - WK + Zub
			←	→ 10/09		13.0460-4837.2	604837	BRE 20217 17,1 + WE / - WK
			→	→ 10/09		13.0460-2719.2	602719	TRW 24192 17,4 + WE / - WK + Zub
3.0 D 4x4	155	05/10→03/13	←			13.0460-2762.2	602762	TRW 25021 18,5 + WE / - WK + Zub
3.0 D 4x4	180	09/09→03/13						
3.0 D 4x4	183	08/12→03/13	→			13.0460-2731.2	602731	TRW 24192 17,1 + WE / - WK + Zub
3.0 D 4x4	188	06/11→03/13						
5.0 4x4	276	07/09→03/13						
5.0 4x4	372	04/09→03/13						
3.6 D 4x4	200	04/06→03/13	←	01/10→		13.0460-2762.2	602762	TRW 25021 18,5 + WE / - WK + Zub
			←	→ 12/09		13.0460-4837.2	604837	BRE 20217 17,1 + WE / - WK
			→			13.0460-2719.2	602719	TRW 24192 17,4 + WE / - WK + Zub
4.2 4x4	287	02/05→03/13	←	→ 6A999999		13.0460-4837.2	604837	BRE 20217 17,1 + WE / - WK
			←	7A000001→; → 10/09		13.0460-4837.2	604837	BRE 20217 17,1 + WE / - WK
			→	→ 10/09		13.0460-2719.2	602719	TRW 24192 17,4 + WE / - WK + Zub
5.0 4x4	375	09/09→03/13	←			13.0460-2762.2	602762	TRW 25021 18,5 + WE / - WK + Zub
<b>Warnkontakt, Bremsbelagverschleiß</b>								
2.7 D 4x4	140	02/05→03/13	←	→ 6A999999	1	24.8190-0945.2	620945	L= 1.227
4.4 4x4	220	02/05→03/13	←	7A000001→; → 10/09	1	24.8190-0949.2	620949	L= 1.228
			←	→ 10/09	1	24.8190-1307.2	621307	L= 1.185
			→	→ 10/09	1	24.8190-1306.2	621306	L= 1.156
3.0 D 4x4	155	05/10→03/13	←		1	24.8190-0945.2	620945	L= 1.227
3.0 D 4x4	180	09/09→03/13						
3.0 D 4x4	183	08/12→03/13						
3.0 D 4x4	188	06/11→03/13						
5.0 4x4	276	07/09→03/13						
3.6 D 4x4	200	04/06→03/13	←	→ 12/09	1	24.8190-1307.2	621307	L= 1.185
			→		1	24.8190-1306.2	621306	L= 1.156
4.2 4x4	287	02/05→03/13	←	7A000001→; → 10/09	1	24.8190-0948.2	620948	L= 1.212
			←	→ 6A999999	1	24.8190-1307.2	621307	L= 1.185
↓								



















	kw			 	! #		
<b>LAND ROVER - RANGE ROVER SPORT (L320) 02/05→03/13</b>							
<b>Warnkontakt, Bremsbelagverschleiß</b>							
4.2 4x4	287	02/05→03/13	➡	→ 10/09	1	24.8190-1306.2 621306	L= 1.156
4.2 4x4	298	09/05→02/10	⬅	7A000001→	1	24.8190-0948.2 620948	L= 1.212
<b> Bremsscheibe</b>							
2.7 D 4x4	140	02/05→03/13	⬅	→ 10/09; passend für Felgengröße [Zoll]: 17		24.0130-0178.1 430178	Ø 317 30 27 V
			⬅	→ 10/09; passend für Felgengröße [Zoll]: 18 / 19		24.0130-0195.1 430195	Ø 360 30 27 V
			➡	→ 10/09; passend für Felgengröße [Zoll]: 18 / 19		24.0120-0201.1 420201	Ø 350 20 17 V
			➡	→ 10/09; passend für Felgengröße [Zoll]: 17		24.0120-0210.1 420210	Ø 325 20 17 V
3.0 D 4x4	155	05/10→03/13	⬅	→ AA215622		24.0130-0195.1 430195	Ø 360 30 27 V
3.0 D 4x4	180	09/09→03/13	➡			24.0120-0201.1 420201	Ø 350 20 17 V
3.0 D 4x4	183	08/12→03/13	➡				
3.0 D 4x4	188	06/11→03/13	➡				
5.0 4x4	276	07/09→03/13	➡				
5.0 4x4	372	04/09→03/13	➡				
3.6 D 4x4	200	04/06→03/13	⬅			24.0130-0195.1 430195	Ø 360 30 27 V
			➡			24.0120-0201.1 420201	Ø 350 20 17 V
4.2 4x4	287	02/05→03/13	⬅	→ 10/09		24.0130-0195.1 430195	Ø 360 30 27 V
			➡	→ 10/09		24.0120-0201.1 420201	Ø 350 20 17 V
4.4 4x4	220	02/05→03/13	⬅	→ 10/09; passend für Felgengröße [Zoll]: 17		24.0130-0188.1 430188	Ø 337,5 30 27 V
			⬅	→ 10/09; passend für Felgengröße [Zoll]: 18 / 19		24.0130-0195.1 430195	Ø 360 30 27 V
			➡	→ 10/09		24.0120-0201.1 420201	Ø 350 20 17 V
5.0 4x4	375	09/09→03/13	⬅	→ AA215622		24.0130-0195.1 430195	Ø 360 30 27 V
<b>LAND ROVER - RANGE ROVER SPORT (L494) 04/13→</b>							
<b> Bremsbelagsatz, Scheibenbremse</b>							
2.0 4x4 2.0 PHEV 4x4	221	10/17→	⬅	Felgengröße [Zoll]: 19		13.0460-2762.2 602762	TRW 25021 18,5 + WE / - WK + Zub
	221	10/17→	➡	Felgengröße [Zoll]: 19		13.0460-2604.2 602604	TRW 25720 17,7 + WE / - WK + Zub
2.0 D 4x4 3.0 4x4 3.0 D 4x4	177	08/16→	⬅			13.0460-2762.2 602762	TRW 25021 18,5 + WE / - WK + Zub
	250	04/13→	➡			13.0460-2604.2 602604	TRW 25720 17,7 + WE / - WK + Zub
3.0 D 4x4	225	09/14→	➡			13.0460-2604.2 602604	TRW 25720 17,7 + WE / - WK + Zub
3.0 D 4x4 3.0 D 4x4	155	04/13→	⬅	→ 06/13		13.0460-2762.2 602762	TRW 25021 18,5 + WE / - WK + Zub
			⬅	passend für Felgengröße [Zoll]: 19		13.0460-2762.2 602762	TRW 25021 18,5 + WE / - WK + Zub
			➡	passend für Felgengröße [Zoll]: 19		13.0460-2604.2 602604	TRW 25720 17,7 + WE / - WK + Zub
			➡	→ 06/13		13.0460-2731.2 602731	TRW 24192 17,1 + WE / - WK + Zub
3.0 D 4x4 3.0 D 4x4	190	04/13→	⬅	→ 06/13		13.0460-2762.2 602762	TRW 25021 18,5 + WE / - WK + Zub
			⬅			13.0460-2762.2 602762	TRW 25021 18,5 + WE / - WK + Zub
			➡			13.0460-2604.2 602604	TRW 25720 17,7 + WE / - WK + Zub
			➡	→ 06/13		13.0460-2731.2 602731	TRW 24192 17,1 + WE / - WK + Zub
5.0 4x4	375	04/13→	⬅	→ 06/13		13.0460-2762.2 602762	TRW 25021 18,5 + WE / - WK + Zub
			➡			13.0460-2604.2 602604	TRW 25720 17,7 + WE / - WK + Zub
5.0 4x4	405	01/14→	➡			13.0460-2604.2 602604	TRW 25720 17,7 + WE / - WK + Zub
5.0 4x4	423	11/17→	➡			13.0460-2604.2 602604	TRW 25720 17,7 + WE / - WK + Zub
<b> Bremsscheibe</b>							
3.0 D 4x4	155	04/13→	⬅	→ AA215622		24.0130-0195.1 430195	Ø 360 30 27 V
3.0 D 4x4	183	04/13→	➡	→ 06/13		24.0120-0201.1 420201	Ø 350 20 17 V
3.0 D 4x4	190	04/13→	➡				
3.0 D 4x4	215	04/13→	➡				
5.0 4x4	375	04/13→	⬅	→ AA215622		24.0130-0195.1 430195	Ø 360 30 27 V















	kw			 	! #		
<b>LEXUS - CT (ZWA10_) 12/10→</b>							
 <b>Bremsbelagsatz, Scheibenbremse</b>							
200h (ZWA10_)	73	12/10→	←	03/11→		13.0460-5617.2 605617	24451 15,6 - WE / - WK
			→	03/11→		13.0460-5769.2 605769	24610 15,0 + WK
200h (ZWA10_)	100	09/11→	←			13.0460-5617.2 605617	24451 15,6 - WE / - WK
			→			13.0460-5769.2 605769	24610 15,0 + WK
 <b>Bremsscheibe</b>							
200h (ZWA10_)	73	12/10→	←	03/11→		24.0125-0196.1 425196	Ø 255 25 22 V
			→	03/11→		24.0109-0163.1 409163	Ø 259 9 7,5
						24.0110-0364.1 410364	Ø 279 10 8,5
200h (ZWA10_)	100	09/11→	←			24.0125-0196.1 425196	Ø 255 25 22 V
			→			24.0109-0163.1 409163	Ø 259 9 7,5
						24.0110-0364.1 410364	Ø 279 10 8,5
<b>LEXUS - ES (_V4_) 03/06→06/12</b>							
 <b>Bremsbelagsatz, Scheibenbremse</b>							
3.5 (GSV40_)	204	05/06→06/12	←			13.0460-5764.2 605764	AKE 24350 17,3 - WE / - WK + Zub
			→			13.0460-5765.2 605765	AKE 24338 15,5 - WE / - WK
 <b>Bremsscheibe</b>							
3.5 (GSV40_)	204	05/06→06/12	←			24.0128-0159.1 428159	Ø 296 28 25 V
<b>LEXUS - ES (_V6_) 06/12→</b>							
 <b>Bremsbelagsatz, Scheibenbremse</b>							
200 (ASV61_)	110	08/15→	←			13.0460-5764.2 605764	AKE 24350 17,3 - WE / - WK + Zub
250 (AVV60_, ASV60_)	135	06/12→				13.0460-5765.2 605765	AKE 24338 15,5 - WE / - WK
300h (ASV60_, AVV60_)	118	06/12→	→				
350 (GSV60_)	183	06/12→	←	01/14→		13.0460-5764.2 605764	AKE 24350 17,3 - WE / - WK + Zub
			→	01/14→		13.0460-5765.2 605765	AKE 24338 15,5 - WE / - WK
350 (GSV60_)	204	06/12→	←			13.0460-5764.2 605764	AKE 24350 17,3 - WE / - WK + Zub
			←	→ 06/12		13.0460-5764.2 605764	AKE 24350 17,3 - WE / - WK + Zub
			→	→ 06/12		13.0460-5765.2 605765	AKE 24338 15,5 - WE / - WK
			→			13.0460-5765.2 605765	AKE 24338 15,5 - WE / - WK
 <b>Bremsscheibe</b>							
200 (ASV61_)	110	08/15→	←			24.0128-0159.1 428159	Ø 296 28 25 V
250 (AVV60_, ASV60_)	135	06/12→					
300h (ASV60_, AVV60_)	118	06/12→					
350 (GSV60_)	183	06/12→	←	01/14→		24.0128-0159.1 428159	Ø 296 28 25 V
350 (GSV60_)	204	06/12→	←			24.0128-0159.1 428159	Ø 296 28 25 V
			←	→ 06/12		24.0128-0159.1 428159	Ø 296 28 25 V
<b>LEXUS - ES (MCV_, VZV_) 08/96→06/08</b>							
 <b>Bremsbelagsatz, Scheibenbremse</b>							
3.0 (MCV30_, MCV20_)	140	10/96→07/01	→			13.0460-5840.2 605840	AKE 21833 15,0 + WK
3.0 (MCV30_)	157	08/01→10/06	→			13.0460-5738.2 605738	23702 15,1 - WE / - WK
3.3 (MCV31_)	168	06/03→10/06					
 <b>Bremsscheibe</b>							
3.0 (MCV30_, MCV20_)	140	10/96→07/01	←			24.0128-0115.1 428115	Ø 275 28 26 V
<b>LEXUS - GS (_L1_) 09/11→</b>							
 <b>Bremsbelagsatz, Scheibenbremse</b>							
200t (ARL10_)	180	09/15→	←			13.0460-5789.2 605789	20325 17,2 + WK
250 (GRL11_)	154	01/12→					
250 (GRL11_)	158	01/12→					
300h (AWL10_)	133	10/13→					
350 (GRL10_, GWL10_)	234	01/12→					
350 (GRL10_)	233	03/12→					
350 AWD (GRL15_, GRL16_)	234	12/11→					















	kw			 	! #		
<b>LEXUS - GS (_L1_) 09/11→</b>							
 <b>Bremsbelagsatz, Scheibenbremse</b>							
450h (GRL10_, GWL10_)	215	01/12→	←			13.0460-5789.2 605789	20325 17,2 + WK
450h (GRL10_, GWL10_)	217	01/12→					
450h 4WD (GWL10_)	213	07/12→					
 <b>Bremsscheibe</b>							
200t (ARL10_)	180	09/15→	←	☐		24.0130-0201.1 430201	Ø 334 30 27 V
250 (GRL11_)	154	01/12→					
250 (GRL11_)	158	01/12→	←	☐		24.0130-0202.1 430202	Ø 334 30 27 V
<b>LEXUS - GS (_S16_) 08/97→12/04</b>							
 <b>Bremsbelagsatz, Scheibenbremse</b>							
300 (JZS160_)	161	10/00→12/04	→			13.0460-5748.2 605748	23429 15,5 + WK
300 (JZS160_)	163	08/97→10/00					
400 (UZS160_)	216	12/97→11/00					
430 (UZS161_)	208	11/00→12/04					
 <b>Bremsscheibe</b>							
300 (JZS160_)	161	10/00→12/04	←			24.0132-0701.1 432701	Ø 296 32 30 V
300 (JZS160_)	163	08/97→10/00					
400 (UZS160_)	216	12/97→11/00	→			24.0112-0703.1 412703	Ø 306,6 12 10,5
430 (UZS161_)	208	11/00→12/04	←	→ 10/01		24.0132-0701.1 432701	Ø 296 32 30 V
			→			24.0112-0703.1 412703	Ø 306,6 12 10,5
<b>LEXUS - GS (_S19_) 01/05→11/11</b>							
 <b>Bremsbelagsatz, Scheibenbremse</b>							
300 (GRS190_)	170	04/05→11/11	←			13.0460-5789.2 605789	20325 17,2 + WK
300 (GRS190_)	183	04/05→11/11					
430 (UZS190_)	208	04/05→11/11	→			13.0460-5790.2 605790	24323 15,5 + WK
450h (GRS191_, GWS191_)	218	02/06→11/11					
450h (GRS191_, GWS191_)	254	02/06→11/11					
350 AWD (GRS196_)	226	09/06→11/11	←	04/08→		13.0460-5789.2 605789	20325 17,2 + WK
			→	04/08→		13.0460-5790.2 605790	24323 15,5 + WK
460 (UZS190_, URS190_)	255	09/07→11/11	←	05/08→		13.0460-5789.2 605789	20325 17,2 + WK
 <b>Bremsscheibe</b>							
300 (GRS190_)	170	04/05→11/11	←	☐		24.0130-0201.1 430201	Ø 334 30 27 V
300 (GRS190_)	183	04/05→11/11					
430 (UZS190_)	208	04/05→11/11	←	☐		24.0130-0202.1 430202	Ø 334 30 27 V
450h (GRS191_, GWS191_)	218	02/06→11/11	→			24.0118-0147.1 418147	Ø 310 18 16,5 V
450h (GRS191_, GWS191_)	254	02/06→11/11					
350 AWD (GRS196_)	226	09/06→11/11	←	04/08→ 09/08		24.0130-0201.1 430201	Ø 334 30 27 V
			→	04/08→		24.0118-0147.1 418147	Ø 310 18 16,5 V
460 (UZS190_, URS190_)	255	09/07→11/11	←	☐; 05/08→		24.0130-0201.1 430201	Ø 334 30 27 V
			←	☐; 05/08→		24.0130-0202.1 430202	Ø 334 30 27 V
			→	05/08→		24.0118-0147.1 418147	Ø 310 18 16,5 V
<b>LEXUS - GX (_J12_) 11/01→11/09</b>							
 <b>Bremsbelagsatz, Scheibenbremse</b>							
470	175	11/01→11/09	←			13.0460-5747.2 605747	24024 17,0 + WK
470	199	11/01→11/09	→			13.0460-5744.2 605744	21947 15,4 - WE / - WK
 <b>Bremsscheibe</b>							
470	175	11/01→11/09	←			24.0128-0194.1 428194	Ø 338 28 26 V
470	199	11/01→11/09	→			24.0118-0709.1 418709	Ø 312 18 16 V
<b>LEXUS - GX (URJ15_) 11/09→</b>							
 <b>Bremsbelagsatz, Scheibenbremse</b>							
460 4WD	218	11/09→	←			13.0460-5747.2 605747	24024 17,0 + WK
460 4WD	225	01/10→	→			13.0460-5744.2 605744	21947 15,4 - WE / - WK

	kw					! #		
<b>LEXUS - IS I (_E1_) 04/99→07/05</b>								
 <b>Bremsbelagsatz, Scheibenbremse</b>								
200 (GXE10)	114	04/99→07/05	➔				13.0460-5748.2 605748	23429 15,5 + WK
300 (JCE10)	157	09/01→07/05						
 <b>Bremsscheibe</b>								
200 (GXE10)	114	04/99→07/05	←				24.0132-0701.1 432701	Ø 296 32 30 V
300 (JCE10)	157	09/01→07/05	➔				24.0112-0703.1 412703	Ø 306,6 12 10,5
<b>LEXUS - IS II (_E2_) 08/05→03/13</b>								
 <b>Bremsbelagsatz, Scheibenbremse</b>								
200d (ALE20_)	110	07/10→07/12	←				13.0460-5770.2 605770	23983 17,0
250 (GSE20_)	158	11/10→03/13	➔				13.0460-5790.2 605790	24323 15,5 + WK
250 AWD (GSE25_)	153	10/05→03/13						
250 AWD (GSE25_)	158	11/10→03/13						
300 (GSE22_)	170	08/08→03/13						
350 (GSE21)	234	01/08→03/13						
350 AWD (GSE21)	228	09/10→03/13						
220d (ALE20)	130	08/05→07/12	←	10/05→			13.0460-5770.2 605770	23983 17,0
250 (GSE20)	153	08/05→03/13	➔	10/05→			13.0460-5790.2 605790	24323 15,5 + WK
350 (GSE21_)	228	08/05→03/13						
IS F (USE20)	311	11/07→03/13	←				13.0460-4887.2 604887	BRE 24307 16,1 + WK
 <b>Bremsscheibe</b>								
200d (ALE20_)	110	07/10→07/12	←				24.0128-0740.1 428740	Ø 296 28 26 V
250 (GSE20_)	158	11/10→03/13	➔				24.0118-0147.1 418147	Ø 310 18 16,5 V
250 AWD (GSE25_)	158	11/10→03/13						
220d (ALE20)	130	08/05→07/12	←	10/05→			24.0128-0740.1 428740	Ø 296 28 26 V
250 (GSE20)	153	08/05→03/13	➔	10/05→ 06/06			24.0110-0335.1 410335	Ø 291 10 8,5
350 (GSE21_)	228	08/05→03/13		07/06→			24.0118-0147.1 418147	Ø 310 18 16,5 V
250 AWD (GSE25_)	153	10/05→03/13	←	→ 06/06			24.0110-0335.1 410335	Ø 291 10 8,5
			➔	07/06→			24.0118-0147.1 418147	Ø 310 18 16,5 V
300 (GSE22_)	170	08/08→03/13	←				24.0128-0740.1 428740	Ø 296 28 26 V
350 (GSE21)	234	01/08→03/13	➔				24.0110-0335.1 410335	Ø 291 10 8,5
350 AWD (GSE21)	228	09/10→03/13					24.0118-0147.1 418147	Ø 310 18 16,5 V
<b>LEXUS - IS III (_E3_) 04/13→</b>								
 <b>Bremsbelagsatz, Scheibenbremse</b>								
200t (ASE30)	180	08/15→	←				13.0460-5789.2 605789	20325 17,2 + WK
250 (GSE30_)	153	04/13→	←	F-Sport			13.0460-5770.2 605770	23983 17,0
300h (AVE30_)	131	04/13→	←				13.0460-5770.2 605770	23983 17,0
300h (AVE30_)	133	04/13→						
 <b>Bremsscheibe</b>								
200t (ASE30)	180	08/15→	←	<input type="checkbox"/>			24.0130-0201.1 430201	Ø 334 30 27 V
			←	<input type="checkbox"/>			24.0130-0202.1 430202	Ø 334 30 27 V
250 (GSE30_)	153	04/13→	←				24.0128-0740.1 428740	Ø 296 28 26 V
300h (AVE30_)	131	04/13→						
300h (AVE30_)	133	04/13→						
<b>LEXUS - IS C (GSE2_) 04/09→</b>								
 <b>Bremsbelagsatz, Scheibenbremse</b>								
250 (GSE20)	153	04/09→	←				13.0460-5770.2 605770	23983 17,0
			➔				13.0460-5790.2 605790	24323 15,5 + WK
 <b>Bremsscheibe</b>								
250 (GSE20)	153	04/09→	←				24.0128-0740.1 428740	Ø 296 28 26 V
			➔				24.0118-0147.1 418147	Ø 310 18 16,5 V
<b>LEXUS - IS SportCross (_E1_) 10/01→10/05</b>								
 <b>Bremsbelagsatz, Scheibenbremse</b>								
200 (GXE10_)	114	10/02→10/05	➔	→ 09/05			13.0460-5748.2 605748	23429 15,5 + WK
300 (JCE10_)	157	10/01→10/05						
↓								

	kw			 	! #		
<b>LEXUS - IS SportCross (_E1_) 10/01→10/05</b>							
 <b>Bremsscheibe</b>							
200 (GXE10_) 300 (JCE10_)	114 157	10/02→10/05 10/01→10/05	← →	→ 09/05 → 09/05		24.0132-0701.1 432701 24.0112-0703.1 412703	Ø 296 32 30 V Ø 306,6 12 10,5
<b>LEXUS - LS (_F4_) 04/06→</b>							
 <b>Bremsbelagsatz, Scheibenbremse</b>							
460	255	05/08→	← →	→ 08/09		13.0460-5607.2 605607 13.0460-5608.2 605608	24245 18,5 + WE / - WK 24244 18,5 + WE / - WK
460 460 (USF40) 460 4WD (USF4_) 460 AWD 600h (UVF45)	283 280 280 270 290	12/08→ 04/06→ 08/06→ 12/08→ 08/07→	← →			13.0460-5607.2 605607 13.0460-5608.2 605608	24245 18,5 + WE / - WK 24244 18,5 + WE / - WK
460 AWD	272	09/12→	→			13.0460-5608.2 605608	24244 18,5 + WE / - WK
<b>LEXUS - LX 09/95→12/97</b>							
 <b>Bremsbelagsatz, Scheibenbremse</b>							
450 4WD (FZJ80_)	151	09/95→12/97	← →			13.0460-5745.2 605745 13.0460-5744.2 605744	21775 15,0 + WK 21947 15,4 - WE / - WK
 <b>Bremsscheibe</b>							
450 4WD (FZJ80_)	151	09/95→12/97	←			24.0132-0111.1 432111	Ø 311 32 30 V
<b>LEXUS - LX (_J2_) 08/07→</b>							
 <b>Bremsbelagsatz, Scheibenbremse</b>							
450d (VDJ201_)	200	09/15→	←			13.0460-5618.2 605618	24386 17,9 + WK
570 570 (URJ201_) 570 (URJ201_)	285 270 282	08/07→ 11/07→ 11/07→	← →			13.0460-5618.2 605618 13.0460-5619.2 605619	24386 17,9 + WK 24653 17,3 - WE / - WK
<b>LEXUS - LX (UZJ100) 09/97→03/08</b>							
 <b>Bremsbelagsatz, Scheibenbremse</b>							
470 470 (UZJ100_) 470 (UZJ100_) 470 (UZJ100_)	170 173 197 202	05/98→03/08 05/98→03/08 05/98→10/02 08/02→03/08	← →			13.0460-5746.2 605746 13.0460-5749.2 605749	23524 17,4 + WK 23539 17,3 - WE / - WK
 <b>Bremsscheibe</b>							
470 470 (UZJ100_) 470 (UZJ100_) 470 (UZJ100_)	170 173 197 202	05/98→03/08 05/98→03/08 05/98→10/02 08/02→03/08	← →			24.0132-0148.1 432148 24.0118-0143.1 418143	Ø 313 32 30 V Ø 329,2 18 16 V
<b>LEXUS - NX (_Z1_) 07/14→</b>							
 <b>Bremsbelagsatz, Scheibenbremse</b>							
200 (ZGZ10_, AYZ10_, AGZ10) 200t (AGZ10_, AYZ10_, ZGZ10_) 200t AWD (AGZ15_, AYZ15_, ZGZ15_) 300h (AYZ10_, AGZ10_, ZGZ10_) 300h (AYZ10_, AGZ10_, ZGZ10_) 300h AWD (AYZ15_, AGZ15_, ZGZ15_) 300h AWD (AYZ15_, ZGZ15_, AGZ15_)	110 175 175 112 114 112 114	11/14→ 07/14→ 07/14→ 07/14→ 07/14→ 07/14→ 07/14→	←			13.0460-5634.2 605634 13.0470-5634.2 LD5634	ADV 24452 17,5 - WK + Zub ADV 24452 17,5 - WK + Zub Ceramic
<b>LEXUS - RC (_C1_) 08/14→</b>							
 <b>Bremsbelagsatz, Scheibenbremse</b>							
200t	180	08/15→	←	für Fahrzeuge mit Sportpaket		13.0460-5789.2 605789	20325 17,2 + WK
 <b>Bremsscheibe</b>							
300h (AVC10_)	133	09/14→	← ←	<input type="checkbox"/> <input type="checkbox"/>		24.0130-0201.1 430201 24.0130-0202.1 430202	Ø 334 30 27 V Ø 334 30 27 V



	kw			 	! #		
<b>LEXUS - RX (_L1_) 12/08→10/15</b>							
 <b>Bremsbelagsatz, Scheibenbremse</b>							
270 (AGL10_) 350 (GYL10_) 350 AWD (GGL15_) 450h (GYL10_) 450h AWD (GYL15_)	138 206 204 183 183	12/08→10/15 12/08→10/15 12/08→08/15 12/08→10/15 12/08→10/15	← ← ← → →	01/09→   01/09→  		13.0460-5634.2 605634 13.0470-5634.2 LD5634	ADV 24452 17,5 - WK + Zub ADV 24452 17,5 - WK + Zub Ceramic AKE 24918 15,0 - WK AKE 24918 15,0 - WK Ceramic
350 (GGL10_)	202	01/09→09/15	← →	Made in Japan Made in Japan		13.0460-5634.2 605634 13.0470-5634.2 LD5634	ADV 24452 17,5 - WK + Zub ADV 24452 17,5 - WK + Zub Ceramic AKE 24918 15,0 - WK AKE 24918 15,0 - WK Ceramic
350 AWD (GGL15_)	206	03/09→02/12	← →			13.0460-5634.2 605634 13.0470-5634.2 LD5634	ADV 24452 17,5 - WK + Zub ADV 24452 17,5 - WK + Zub Ceramic AKE 24918 15,0 - WK AKE 24918 15,0 - WK Ceramic
 <b>Bremsscheibe</b>							
350 (GYL10_) 350 AWD (GGL15_) 450h (GYL10_) 450h AWD (GYL15_)	206 204 183 183	12/08→10/15 12/08→08/15 12/08→10/15 12/08→10/15	← → → →	01/09→; Made in Kanada 01/09→; Made in Kanada		24.0134-0104.1 434104 24.0118-0157.1 418157	∅ 328 34 31 V ∅ 309 18 16,5 V
350 AWD (GGL15_)	206	03/09→02/12	← →	Made in Kanada Made in Kanada		24.0134-0104.1 434104 24.0118-0157.1 418157	∅ 328 34 31 V ∅ 309 18 16,5 V
<b>LEXUS - RX (_U3_) 02/03→12/08</b>							
 <b>Bremsbelagsatz, Scheibenbremse</b>							
300 (MCU35_) 350 AWD (GSU35_) 350 AWD (GSU35_) 400h (MHU38_) 400h AWD (MHU38_)	150 201 203 155 155	05/03→12/08 09/06→12/08 02/06→12/08 09/05→12/08 09/04→12/08	← → → → →			13.0460-5750.2 605750 13.0460-5734.2 605734	23734 16,8 - WK SUM 23967 15,1
330 (MCU38_) 330 AWD (MCU38)	171 171	04/03→01/06 04/03→12/08	← →	05/03→ 05/03→		13.0460-5750.2 605750 13.0460-5734.2 605734	23734 16,8 - WK SUM 23967 15,1
350 (GSU30_)	203	01/06→12/08	← →	02/06→ 02/06→		13.0460-5750.2 605750 13.0460-5734.2 605734	23734 16,8 - WK SUM 23967 15,1
 <b>Bremsscheibe</b>							
300 (MCU35_) 350 AWD (GSU35_) 350 AWD (GSU35_) 400h (MHU38_) 400h AWD (MHU38_)	150 201 203 155 155	05/03→12/08 09/06→12/08 02/06→12/08 09/05→12/08 09/04→12/08	← → → → →			24.0128-0753.1 428753 24.0110-0316.1 410316	∅ 319 28 26 V ∅ 288 10 8,5
330 (MCU38_) 330 AWD (MCU38)	171 171	04/03→01/06 04/03→12/08	← →	05/03→ 05/03→		24.0128-0753.1 428753 24.0110-0316.1 410316	∅ 319 28 26 V ∅ 288 10 8,5
350 (GSU30_)	203	01/06→12/08	← →	02/06→ 02/06→		24.0128-0753.1 428753 24.0110-0316.1 410316	∅ 319 28 26 V ∅ 288 10 8,5
<b>LEXUS - RX (MCU15) 01/98→05/03</b>							
 <b>Bremsbelagsatz, Scheibenbremse</b>							
300 (MCU10_) 300 (MCU10_) 300 AWD 300 AWD (MCU15_)	148 164 148 164	01/98→02/03 10/99→02/03 10/00→05/03 01/98→02/03	← → → →			13.0460-5882.2 605882 13.0460-5840.2 605840 13.0460-5840.2 605840	23703 17,9 + WK AKE 21833 15,0 + WK AKE 21833 15,0 + WK
 <b>Bremsscheibe</b>							
300 (MCU10_) 300 (MCU10_) 300 AWD 300 AWD (MCU15_)	148 164 148 164	01/98→02/03 10/99→02/03 10/00→05/03 01/98→02/03	← → → →			24.0128-0186.1 428186 24.0110-0712.1 410712 24.0128-0186.1 428186 24.0110-0712.1 410712	∅ 296 28 26 V ∅ 288 10 8,5 ∅ 296 28 26 V ∅ 288 10 8,5
<b>LEXUS - SC Cabriolet (UZZ40_) 01/01→07/10</b>							
 <b>Bremsbelagsatz, Scheibenbremse</b>							
430 (UZZ40_) 430 (UZZ40_) ↓	210 244	05/01→07/10 05/01→07/10	→ →			13.0460-5748.2 605748	23429 15,5 + WK

	kw			 	! #		
<b>LEXUS - SC Cabriolet (UZZ40_) 01/01→07/10</b>							
 <b>Bremsbelagsatz, Scheibenbremse</b>							
430 (UZZ40_)	215	01/01→07/10	➡	05/01→		<b>13.0460-5748.2 605748</b>	23429 15,5 + WK
 <b>Bremsscheibe</b>							
430 (UZZ40_)	210	05/01→07/10	←	→ 10/01		<b>24.0132-0701.1 432701</b>	Ø 296 32 30 V
430 (UZZ40_)	244	05/01→07/10	➡			<b>24.0112-0703.1 412703</b>	Ø 306,6 12 10,5
430 (UZZ40_)	215	01/01→07/10	←	05/01→ 10/01		<b>24.0132-0701.1 432701</b>	Ø 296 32 30 V
			➡	05/01→		<b>24.0112-0703.1 412703</b>	Ø 306,6 12 10,5
<b>MAYBACH - 57 (240_) 09/02→12/12</b>							
<b>Warnkontakt, Bremsbelagverschleiß</b>							
5.5 (240.078)	405	09/02→12/12	←		2	<b>24.8190-0410.2 620410</b>	L= 97,5
6.0	471	06/09→12/12	➡		1	<b>24.8190-0410.2 620410</b>	L= 97,5
6.0 (240.079)	463	01/11→12/12					
S 6.0 (240.079, 240.077)	450	09/05→12/12					
<b>MAZDA - 2 (DE_, DH_3) 07/07→06/15</b>							
 <b>Bremsbelagsatz, Scheibenbremse</b>							
1.3	55	10/07→06/15	←	→ 12/14		<b>13.0460-5794.2 605794</b>	TRW 24283 15,5 + WK + Zub
1.3	63	10/07→06/15					
1.3 MZR	62	01/10→06/15					
1.4 MZR-CD	50	01/08→06/15					
1.5	76	10/07→06/15					
1.5 MZR	75	06/11→06/15					
1.6 MZ-CD	66	10/08→06/15					
1.6 MZ-CD	70	06/11→06/15					
1.3 BiFuel	55	05/11→11/14	←			<b>13.0460-5794.2 605794</b>	TRW 24283 15,5 + WK + Zub
1.3 BiFuel	62	05/11→11/14					
 <b>Bremsscheibe</b>							
1.3	55	10/07→06/15	←	→ 12/14		<b>24.0123-0112.1 423112</b>	Ø 258 23 21 V
1.3	63	10/07→06/15					
1.3 MZR	62	01/10→06/15					
1.4 MZR-CD	50	01/08→06/15					
1.5	76	10/07→06/15					
1.5 MZR	75	06/11→06/15					
1.6 MZ-CD	66	10/08→06/15					
1.6 MZ-CD	70	06/11→06/15					
1.3 BiFuel	55	05/11→11/14	←			<b>24.0123-0112.1 423112</b>	Ø 258 23 21 V
1.3 BiFuel	62	05/11→11/14					
<b>MAZDA - 2 (DL, DJ) 08/14→</b>							
 <b>Bremsbelagsatz, Scheibenbremse</b>							
1.5	55	08/14→	←			<b>13.0460-5674.2 605674</b>	TRW 22235 15,3 + WK
1.5	66	08/14→					
1.5	85	08/14→					
1.5 D	77	08/14→02/18					
<b>MAZDA - 2 (DY) 02/03→06/07</b>							
 <b>Bremsbelagsatz, Scheibenbremse</b>							
1.2	55	02/03→06/07	←			<b>13.0460-7142.2 607142</b>	ATE 23202 18,3 - WE / - WK
1.25	55	04/03→06/07					
1.3 L	67	04/03→06/07					
1.4	59	02/03→06/07					
1.4	59	04/03→06/07					
1.4 CD	50	04/03→06/07					
1.6	74	02/03→06/07					
1.6	74	04/03→06/07					
 <b>Bremsscheibe</b>							
1.2	55	02/03→06/07	←			<b>24.0122-0172.1 422172</b>	Ø 258 22 20 V
1.25	55	04/03→06/07					
1.3 L	67	04/03→06/07				<b>24.0322-0172.1 522172</b>	Ø 258 22 20 V
1.4	59	02/03→06/07					
1.4	59	04/03→06/07					
1.4 CD	50	04/03→06/07					
1.6	74	02/03→06/07					
1.6	74	04/03→06/07					
<b>MAZDA - 3 (BK) 10/03→12/09</b>							
 <b>Bremsbelagsatz, Scheibenbremse</b>							
1.4	59	02/04→06/09	←	→ 05/09		<b>13.0460-7193.2 607193</b>	ATE 23723 18,1 - WE / - WK
1.6	77	10/03→06/09					
1.6 DI Turbo	80	06/04→06/09					
↓							

**MAZDA - 3 (BK) 10/03→12/09**

**Bremsbelagsatz, Scheibenbremse**

1.6 MZ-CD 2.0 2.0 MZR-CD	66 110 105	06/06→12/09 10/03→12/09 12/06→06/09	←	→ 05/09	13.0470-7193.2	LD7193	ATE 23723 18,1 - WE / - WK Ceramic
			→	→ 05/09			
1.4	62	10/03→06/09	←	→ 03/06	13.0460-7193.2	LD7193	ATE 23723 18,1 - WE / - WK Ceramic
			→	→ 03/06			
2.3 DiSi Turbo MPS	184	06/06→06/09	←		13.0460-7204.2	607204	ATE 23801 18,8 - WE / - WK Ceramic
			→				
2.3 MPS Turbo	191	12/06→06/09	←	→ 05/09	13.0460-7204.2	LD7204	ATE 23801 18,8 - WE / - WK Ceramic
			→	→ 05/09			
2.3 MZR	115	03/04→03/09	←		13.0460-7193.2	LD7193	ATE 23723 18,1 - WE / - WK Ceramic
			→				













**Bremsscheibe**











1.4 1.6 1.6 DI Turbo 1.6 MZ-CD	59 77 80 66	02/04→06/09 10/03→06/09 06/04→06/09 06/06→12/09	←	→ 05/09	24.0125-0165.1	425165	Ø 278 25 23 V
			→	→ 05/09			
1.4	62	10/03→06/09	←	→ 03/06	24.0125-0165.1	425165	Ø 278 25 23 V
			→	→ 03/06			
2.0 2.0 MZR-CD	110 105	10/03→12/09 12/06→06/09	←	→ 05/09	24.0125-0170.1	425170	Ø 300 25 23 V
			→	→ 05/09			
2.3 DiSi Turbo MPS	184	06/06→06/09	←		24.0125-0195.1	425195	Ø 320 25 23 V
			→				
2.3 MPS Turbo	191	12/06→06/09	←	→ 05/09	24.0125-0195.1	425195	Ø 320 25 23 V
			→	→ 05/09			
2.3 MZR	115	03/04→03/09	←		24.0125-0170.1	425170	Ø 300 25 23 V
			→				

**MAZDA - 3 (BL) 12/08→09/14**















**Bremsbelagsatz, Scheibenbremse**













1.6 MZR 2.0 MZR 2.5	77 110 122	12/08→09/14 01/09→09/14 03/09→09/14	←	06/09→ 11/13	13.0460-7193.2	607193	ATE 23723 18,1 - WE / - WK Ceramic
			→	06/09→ 11/13			
1.6 MZR 2.0 MZR	79 108	01/10→12/13 06/10→09/14	←	→ 11/13	13.0460-7193.2	LD7193	ATE 23723 18,1 - WE / - WK Ceramic
			→	→ 11/13			
1.6 MZR CD 2.0 DISI (BLEFP) 2.0 MZR DISI 2.2 MZR CD 2.2 MZR CD ↓	80 110 111 110 136	12/08→05/13 05/09→02/12 12/08→05/13 01/09→05/13 01/09→05/13	←	06/09→	13.0460-7193.2	LD7193	ATE 23723 18,1 - WE / - WK Ceramic
			→	06/09→			











	kw			 	! #		
<b>MAZDA - 3 (BL) 12/08→09/14</b>							
 <b>Bremsbelagsatz, Scheibenbremse</b>							
1.6 MZR CD 2.0 DISI (BLEFP) 2.0 MZR DISI 2.2 MZR CD 2.2 MZR CD	80 110 111 110 136	12/08→05/13 05/09→02/12 12/08→05/13 01/09→05/13 01/09→05/13	➡	06/09→		13.0470-7195.2 LD7195	ATE 23482 16,6 - WE / - WK Ceramic
1.6 MZR CD	85	09/10→05/13	➡	11/10→		13.0460-7193.2 607193 13.0470-7193.2 LD7193	ATE 23723 18,1 - WE / - WK Ceramic
			➡	11/10→		13.0460-7195.2 607195 13.0470-7195.2 LD7195	ATE 23482 16,6 - WE / - WK Ceramic
2.3 MPS Turbo	191	06/09→09/14	➡	→ 11/13		13.0460-7204.2 607204 13.0470-7204.2 LD7204	ATE 23801 18,8 - WE / - WK Ceramic
			➡	→ 11/13		13.0460-7195.2 607195 13.0470-7195.2 LD7195	ATE 23482 16,6 - WE / - WK Ceramic
 <b>Bremsscheibe</b>							
1.6 MZR	77	12/08→09/14	➡	06/09→ 11/13		24.0125-0165.1 425165	Ø 278 25 23 V
			➡	06/09→ 11/13		24.0111-0164.1 411164	Ø 265 11 9
1.6 MZR	79	01/10→12/13	➡	→ 11/13		24.0125-0165.1 425165	Ø 278 25 23 V
			➡	→ 11/13		24.0111-0164.1 411164	Ø 265 11 9
1.6 MZR CD	80	12/08→05/13	➡	06/09→		24.0125-0165.1 425165	Ø 278 25 23 V
			➡	06/09→		24.0111-0164.1 411164	Ø 265 11 9
1.6 MZR CD	85	09/10→05/13	➡	11/10→		24.0125-0165.1 425165	Ø 278 25 23 V
			➡	11/10→		24.0111-0164.1 411164	Ø 265 11 9
2.0 DISI (BLEFP) 2.0 MZR DISI 2.2 MZR CD 2.2 MZR CD	110 111 110 136	05/09→02/12 12/08→05/13 01/09→05/13 01/09→05/13	➡	06/09→		24.0125-0170.1 425170	Ø 300 25 23 V
			➡	06/09→		24.0111-0160.1 411160	Ø 280 11 9
2.0 MZR	108	06/10→09/14	➡	→ 11/13		24.0125-0170.1 425170	Ø 300 25 23 V
			➡	→ 11/13		24.0111-0164.1 411164	Ø 265 11 9
2.0 MZR 2.5	110 122	01/09→09/14 03/09→09/14	➡	06/09→ 11/13		24.0125-0170.1 425170	Ø 300 25 23 V
			➡	06/09→ 11/13		24.0111-0164.1 411164	Ø 265 11 9
2.3 MPS Turbo	191	06/09→09/14	➡	→ 11/13		24.0125-0195.1 425195	Ø 320 25 23 V
			➡	→ 11/13		24.0111-0160.1 411160	Ø 280 11 9
<b>MAZDA - 3 (BM, BN) 09/13→</b>							
 <b>Bremsbelagsatz, Scheibenbremse</b>							
1.5 1.5 1.5 D 1.6 2.0 2.0 2.0 2.2 D	74 88 77 77 88 110 121 110	09/13→ 10/13→ 02/16→ 09/13→ 09/13→ 11/13→ 09/13→ 09/13→	➡			13.0460-5658.2 605658 13.0460-5657.2 605657	AKE 25875 15,9 + WK 25878 13,8 + WK
 <b>Bremsscheibe</b>							
1.5 1.5 1.6	74 88 77	09/13→ 10/13→ 09/13→	➡			24.0125-0214.1 425214 24.0109-0181.1 409181	Ø 280 25 23 V Ø 265 9 7
1.5 D 2.0 2.0 2.2 D	77 88 110 121 110	02/16→ 09/13→ 11/13→ 09/13→ 09/13→	➡			24.0125-0208.1 425208 24.0109-0181.1 409181	Ø 295 25 23 V Ø 265 9 7
<b>MAZDA - 3 Stufenheck (BK) 09/99→12/09</b>							
 <b>Bremsbelagsatz, Scheibenbremse</b>							
1.6 1.6 DI Turbo 2.0 2.0 MZR-CD	77 80 110 105	02/04→06/09 06/04→06/09 10/03→12/09 12/06→06/09	➡	→ 05/09		13.0460-7193.2 607193 13.0470-7193.2 LD7193	ATE 23723 18,1 - WE / - WK Ceramic
			➡	→ 05/09		13.0460-7195.2 607195 13.0470-7195.2 LD7195	ATE 23482 16,6 - WE / - WK Ceramic
↓							













	kw			 	! #		
<b>MAZDA - 3 Stufenheck (BK) 09/99→12/09</b>							
 <b>Bremsbelagsatz, Scheibenbremse</b>							
2.0 2.0	104 108	04/04→06/06 09/03→06/06	← →			<b>13.0460-7193.2 607193</b> <b>13.0470-7193.2 LD7193</b>	ATE 23723 18,1 - WE / - WK ATE 23723 18,1 - WE / - WK Ceramic
			← →			<b>13.0460-7195.2 607195</b> <b>13.0470-7195.2 LD7195</b>	ATE 23482 16,6 - WE / - WK ATE 23482 16,6 - WE / - WK Ceramic
2.3	118	03/04→03/09	←	→ 09/04		<b>13.0460-7193.2 607193</b> <b>13.0470-7193.2 LD7193</b>	ATE 23723 18,1 - WE / - WK ATE 23723 18,1 - WE / - WK Ceramic
			← →	→ 09/04		<b>13.0460-7195.2 607195</b> <b>13.0470-7195.2 LD7195</b>	ATE 23482 16,6 - WE / - WK ATE 23482 16,6 - WE / - WK Ceramic
 <b>Bremsscheibe</b>							
1.6 1.6 DI Turbo	77 80	02/04→06/09 06/04→06/09	← →	→ 05/09		<b>24.0125-0165.1 425165</b> <b>24.0111-0164.1 411164</b>	∅ 278 25 23 V ∅ 265 11 9
2.0 2.0	104 108	04/04→06/06 09/03→06/06	← →			<b>24.0125-0170.1 425170</b> <b>24.0111-0160.1 411160</b>	∅ 300 25 23 V ∅ 280 11 9
2.0 2.0 MZR-CD	110 105	10/03→12/09 12/06→06/09	← →	→ 05/09		<b>24.0125-0170.1 425170</b> <b>24.0111-0160.1 411160</b>	∅ 300 25 23 V ∅ 280 11 9
2.3	118	03/04→03/09	← →	→ 09/04		<b>24.0125-0170.1 425170</b> <b>24.0111-0160.1 411160</b>	∅ 300 25 23 V ∅ 280 11 9
<b>MAZDA - 3 Stufenheck (BL) 12/08→</b>							
 <b>Bremsbelagsatz, Scheibenbremse</b>							
1.6 MZR 2.0 MZR 2.2 MZR CD	77 110 110	02/09→09/14 03/09→09/14 01/09→09/14	← →	06/09→ 11/13		<b>13.0460-7193.2 607193</b> <b>13.0470-7193.2 LD7193</b>	ATE 23723 18,1 - WE / - WK ATE 23723 18,1 - WE / - WK Ceramic
			← →	06/09→ 11/13		<b>13.0460-7195.2 607195</b> <b>13.0470-7195.2 LD7195</b>	ATE 23482 16,6 - WE / - WK ATE 23482 16,6 - WE / - WK Ceramic
1.6 MZR CD	85	09/10→05/13	← →	11/10→		<b>13.0460-7193.2 607193</b> <b>13.0470-7193.2 LD7193</b>	ATE 23723 18,1 - WE / - WK ATE 23723 18,1 - WE / - WK Ceramic
			← →	11/10→		<b>13.0460-7195.2 607195</b> <b>13.0470-7195.2 LD7195</b>	ATE 23482 16,6 - WE / - WK ATE 23482 16,6 - WE / - WK Ceramic
1.6 MZR CD (BL12) 2.0 MZR DISI	80 111	12/08→05/13 02/09→05/13	← →	06/09→		<b>13.0460-7193.2 607193</b> <b>13.0470-7193.2 LD7193</b>	ATE 23723 18,1 - WE / - WK ATE 23723 18,1 - WE / - WK Ceramic
			← →	06/09→		<b>13.0460-7195.2 607195</b> <b>13.0470-7195.2 LD7195</b>	ATE 23482 16,6 - WE / - WK ATE 23482 16,6 - WE / - WK Ceramic
2.0 2.2 MZR CD	113 136	09/11→09/14 06/09→05/13	← →			<b>13.0460-7193.2 607193</b> <b>13.0470-7193.2 LD7193</b>	ATE 23723 18,1 - WE / - WK ATE 23723 18,1 - WE / - WK Ceramic
			← →			<b>13.0460-7195.2 607195</b> <b>13.0470-7195.2 LD7195</b>	ATE 23482 16,6 - WE / - WK ATE 23482 16,6 - WE / - WK Ceramic
 <b>Bremsscheibe</b>							
1.6 MZR	77	02/09→09/14	← →	06/09→ 11/13		<b>24.0125-0165.1 425165</b> <b>24.0111-0164.1 411164</b>	∅ 278 25 23 V ∅ 265 11 9
1.6 MZR CD	85	09/10→05/13	← →	11/10→		<b>24.0125-0165.1 425165</b> <b>24.0111-0164.1 411164</b>	∅ 278 25 23 V ∅ 265 11 9
1.6 MZR CD (BL12)	80	12/08→05/13	← →	06/09→		<b>24.0125-0165.1 425165</b> <b>24.0111-0164.1 411164</b>	∅ 278 25 23 V ∅ 265 11 9
2.0	113	09/11→09/14	← →			<b>24.0125-0170.1 425170</b> <b>24.0111-0164.1 411164</b>	∅ 300 25 23 V ∅ 265 11 9
2.0 MZR	110	03/09→09/14	← →	06/09→ 11/13		<b>24.0125-0170.1 425170</b> <b>24.0111-0164.1 411164</b>	∅ 300 25 23 V ∅ 265 11 9
2.0 MZR DISI	111	02/09→05/13	←	06/09→		<b>24.0125-0170.1 425170</b>	∅ 300 25 23 V
↓							

















	kw					! #		
<b>MAZDA - 3 Stufenheck (BL) 12/08→</b>								
 <b>Bremsscheibe</b>								
2.0 MZR DISI	111	02/09→05/13	➔	06/09→			24.0111-0160.1 411160	Ø 280 11 9
2.2 MZR CD	110	01/09→09/14	➔	06/09→ 11/13			24.0125-0170.1 425170	Ø 300 25 23 V
			➔	06/09→ 11/13			24.0111-0160.1 411160	Ø 280 11 9
2.2 MZR CD	136	06/09→05/13	➔				24.0125-0170.1 425170	Ø 300 25 23 V
			➔				24.0111-0160.1 411160	Ø 280 11 9
<b>MAZDA - 3 Stufenheck (BM, BN) 09/13→</b>								
 <b>Bremsbelagsatz, Scheibenbremse</b>								
1.5	74	10/14→	➔				13.0460-5658.2 605658	AKE 25875 15,9 + WK
1.5	88	10/13→	➔					
1.5 D	77	06/16→	➔				13.0460-5657.2 605657	25878 13,8 + WK
1.6	77	09/13→						
2.0	88	09/13→						
2.0	110	11/13→						
2.0	121	11/14→						
2.2 D	110	09/13→						
 <b>Bremsscheibe</b>								
1.5	74	10/14→	➔				24.0125-0214.1 425214	Ø 280 25 23 V
1.5	88	10/13→	➔					
1.6	77	09/13→	➔				24.0109-0181.1 409181	Ø 265 9 7
1.5 D	77	06/16→	➔				24.0125-0208.1 425208	Ø 295 25 23 V
2.0	88	09/13→						
2.0	110	11/13→					24.0109-0181.1 409181	Ø 265 9 7
2.0	121	11/14→						
2.2 D	110	09/13→						
<b>MAZDA - 5 (CR19) 02/05→12/10</b>								
 <b>Bremsbelagsatz, Scheibenbremse</b>								
1.8	85	02/05→05/10	➔	03/05→			13.0460-7193.2 607193	ATE 23723 18,1 - WE / - WK
			➔				13.0470-7193.2 LD7193	ATE 23723 18,1 - WE / - WK Ceramic
2.0	107	02/05→05/10	➔					
			➔	03/05→			13.0460-7195.2 607195	ATE 23482 16,6 - WE / - WK
2.0 CD	81	02/05→05/10	➔				13.0470-7195.2 LD7195	ATE 23482 16,6 - WE / - WK Ceramic
			➔					
2.0 CD	105	02/05→05/10	➔	06/05→			13.0460-7193.2 607193	ATE 23723 18,1 - WE / - WK
			➔				13.0470-7193.2 LD7193	ATE 23723 18,1 - WE / - WK Ceramic
2.3	122	02/05→09/08	➔				13.0460-7195.2 607195	ATE 23482 16,6 - WE / - WK
			➔	06/05→			13.0470-7195.2 LD7195	ATE 23482 16,6 - WE / - WK Ceramic
 <b>Bremsscheibe</b>								
1.8	85	02/05→05/10	➔	03/05→; 15"			24.0125-0165.1 425165	Ø 278 25 23 V
			➔					
2.0	107	02/05→05/10	➔	03/05→; 16"			24.0125-0170.1 425170	Ø 300 25 23 V
			➔					
2.0 CD	81	02/05→05/10	➔	03/05→; 15"			24.0111-0160.1 411160	Ø 280 11 9
			➔	03/05→; 16"			24.0111-0165.1 411165	Ø 302 11 9
2.0 CD	105	02/05→05/10	➔	06/05→; 15"			24.0125-0165.1 425165	Ø 278 25 23 V
			➔					
2.3	122	02/05→09/08	➔	06/05→; 16"			24.0125-0170.1 425170	Ø 300 25 23 V
			➔	06/05→; 15"			24.0111-0160.1 411160	Ø 280 11 9
			➔	03/05→; 16"			24.0111-0165.1 411165	Ø 302 11 9
<b>MAZDA - 5 (CW) 09/10→</b>								
 <b>Bremsbelagsatz, Scheibenbremse</b>								
1.6 CD	85	09/10→	➔				13.0460-7193.2 607193	ATE 23723 18,1 - WE / - WK
1.8 MZR	85	09/10→	➔				13.0470-7193.2 LD7193	ATE 23723 18,1 - WE / - WK Ceramic
2.0	106	01/11→						
2.0	108	01/11→						
2.0	110	09/10→	➔				13.0460-7195.2 607195	ATE 23482 16,6 - WE / - WK
							13.0470-7195.2 LD7195	ATE 23482 16,6 - WE / - WK Ceramic
 <b>Bremsscheibe</b>								
1.6 CD	85	09/10→	➔	passend für Felgenreöße [Zoll]: 15			24.0125-0165.1 425165	Ø 278 25 23 V
1.8 MZR	85	09/10→	➔	passend für Felgenreöße [Zoll]: 16,17			24.0125-0170.1 425170	Ø 300 25 23 V
2.0	106	01/11→						
2.0	108	01/11→	➔	15"			24.0111-0160.1 411160	Ø 280 11 9
↓								















	kW			 	! #		
<b>MAZDA - 5 (CW) 09/10→</b>							
 <b>Bremsscheibe</b>							
2.0	110	09/10→	→	16"		24.0111-0165.1 411165	Ø 302 11 9
<b>MAZDA - 6 Hatchback (GG) 08/02→12/08</b>							
 <b>Bremsbelagsatz, Scheibenbremse</b>							
1.8	88	08/02→08/07	←	→ 07/07		13.0460-5822.2 605822	24246 16,8 + WK
			→	→ 07/07		13.0460-5804.2 605804	AKE 24045 13,7 - WE / - WK
2.0	104	08/02→08/07	←	→ 07/07		13.0460-5821.2 605821	AKE 24046 18,6 + WK
2.0 DI	89	08/02→08/07	→	→ 07/07		13.0460-5804.2 605804	AKE 24045 13,7 - WE / - WK
2.0 DI	100	08/02→08/07					
2.0 DI	105	06/05→08/07					
2.3	122	08/02→08/07					
<b>Zubehörsatz, Scheibenbremsbelag</b>							
1.8	88	08/02→08/07	←	→ 07/07		13.0460-0260.2 610260	
			→	→ 07/07		13.0460-0234.2 610234	
2.0	104	08/02→08/07	←	→ 07/07		13.0460-0261.2 610261	
2.0	108	03/05→08/07	→	→ 07/07		13.0460-0234.2 610234	
2.0 DI	89	08/02→08/07					
2.0 DI	100	08/02→08/07					
2.0 DI	105	06/05→08/07					
2.3	122	08/02→08/07					
 <b>Bremsscheibe</b>							
1.8	88	08/02→08/07	←	→ 07/07		24.0124-0175.1 424175	Ø 273,5 24 22 V
			→	→ 07/07		24.0110-0302.1 410302	Ø 280 10 8
2.0	104	08/02→08/07	←	→ 07/07		24.0125-0147.1 425147	Ø 282,5 25 23 V
2.0	108	03/05→08/07	→	→ 07/07		24.0110-0302.1 410302	Ø 280 10 8
2.0 DI	89	08/02→08/07					
2.0 DI	100	08/02→08/07					
2.0 DI	105	06/05→08/07					
2.3	122	08/02→08/07					
<b>MAZDA - 6 Kombi (GJ, GL) 12/12→</b>							
 <b>Bremsbelagsatz, Scheibenbremse</b>							
2.0	107	01/13→	→			13.0460-5654.2 605654	MAN 25688 14,4 + WK
2.0	114	12/12→					
2.0	121	01/13→					
2.2 D	129	12/12→					
2.2 D AWD	110	12/12→					
2.2 D AWD	129	02/15→					
2.2 D	110	12/12→	→	01/13→		13.0460-5654.2 605654	MAN 25688 14,4 + WK
2.5	141	12/12→					
 <b>Bremsscheibe</b>							
2.0	107	01/13→	←	Kombi		24.0128-0277.1 428277	Ø 297 28 26 V
2.0	114	12/12→				24.0128-0279.1 428279	Ø 297 28 26 V
2.0	121	01/13→	←				
2.2 D	129	12/12→					
2.2 D	110	12/12→	←	01/13→; Kombi		24.0128-0277.1 428277	Ø 297 28 26 V
			←	01/13→		24.0128-0279.1 428279	Ø 297 28 26 V
2.2 D AWD	110	12/12→	←	Kombi		24.0128-0277.1 428277	Ø 297 28 26 V
2.2 D AWD	129	02/15→					
2.5	141	12/12→	←	01/13→		24.0128-0279.1 428279	Ø 297 28 26 V
2.5	143	03/18→	←			24.0128-0279.1 428279	Ø 297 28 26 V
<b>MAZDA - 6 Sport (GH) 08/07→07/13</b>							
 <b>Bremsbelagsatz, Scheibenbremse</b>							
1.8 MZR	88	08/07→07/13	←	→ 12/12		13.0460-5610.2 605610	24582 17,4 + WK + Zub
2.0 MZR	108	08/07→07/13	→	→ 12/12		13.0460-5804.2 605804	AKE 24045 13,7 - WE / - WK
2.5 MZR	125	08/07→03/13					
2.0 MZR	114	01/10→12/12	←			13.0460-5610.2 605610	24582 17,4 + WK + Zub
2.0 MZR-CD	103	08/07→10/09	→			13.0460-5804.2 605804	AKE 24045 13,7 - WE / - WK
2.2 D	95	01/10→12/12					
2.2 MZR-CD	92	01/09→12/12					
2.2 MZR-CD	120	01/09→12/12					
2.2 MZR-CD	132	01/10→12/12					
2.2 MZR-CD	136	01/09→12/12					
<b>Zubehörsatz, Scheibenbremsbelag</b>							
1.8 MZR	88	08/07→07/13	→	→ 12/12		13.0460-0234.2 610234	
↓							













	kw			 	! #		
<b>MAZDA - 6 Sport (GH) 08/07→07/13</b>							
<b>Zubehörsatz, Scheibenbremsbelag</b>							
2.0 MZR	108	08/07→07/13	➡	→ 12/12		13.0460-0234.2 610234	
2.5 MZR	125	08/07→03/13					
2.0 MZR	114	01/10→12/12	➡			13.0460-0234.2 610234	
2.0 MZR-CD	103	08/07→10/09					
2.2 D	95	01/10→12/12					
2.2 MZR-CD	92	01/09→12/12					
2.2 MZR-CD	120	01/09→12/12					
2.2 MZR-CD	132	01/10→12/12					
2.2 MZR-CD	136	01/09→12/12					
<b> Bremsscheibe</b>							
1.8 MZR	88	08/07→07/13	⬅	→ 12/12		24.0125-0188.1 425188	Ø 299 25 23 V
2.0 MZR	108	08/07→07/13					
2.5 MZR	125	08/07→03/13	➡	→ 12/12		24.0110-0302.1 410302	Ø 280 10 8
2.0 MZR	114	01/10→12/12	⬅			24.0125-0188.1 425188	Ø 299 25 23 V
2.0 MZR-CD	103	08/07→10/09					
2.2 D	95	01/10→12/12	➡			24.0110-0302.1 410302	Ø 280 10 8
2.2 MZR-CD	92	01/09→12/12					
2.2 MZR-CD	120	01/09→12/12					
2.2 MZR-CD	132	01/10→12/12					
2.2 MZR-CD	136	01/09→12/12					
<b>MAZDA - 6 Sport Kombi (GH) 12/07→07/13</b>							
<b> Bremsbelagsatz, Scheibenbremse</b>							
1.8 MZR	88	02/08→07/13	⬅	→ 12/12		13.0460-5610.2 605610	24582 17,4 + WK + Zub
2.0 MZR	108	12/07→07/13					
2.0 MZR	114	01/10→07/13	➡	→ 12/12		13.0460-5804.2 605804	AKE 24045 13,7 - WE / - WK
2.2 D	95	01/10→07/13					
2.2 MZR-CD	132	01/10→07/13					
2.5 MZR	125	02/08→07/13					
2.0 MZR-CD	103	12/07→12/10	⬅			13.0460-5610.2 605610	24582 17,4 + WK + Zub
2.2 MZR-CD	92	01/09→12/10	➡			13.0460-5804.2 605804	AKE 24045 13,7 - WE / - WK
2.2 MZR-CD	120	08/08→07/13	⬅	01/09→ 12/12		13.0460-5610.2 605610	24582 17,4 + WK + Zub
			➡	01/09→ 12/12		13.0460-5804.2 605804	AKE 24045 13,7 - WE / - WK
2.2 MZR-CD	136	08/08→12/11	⬅	01/09→		13.0460-5610.2 605610	24582 17,4 + WK + Zub
			➡	01/09→		13.0460-5804.2 605804	AKE 24045 13,7 - WE / - WK
<b>Zubehörsatz, Scheibenbremsbelag</b>							
1.8 MZR	88	02/08→07/13	➡	→ 12/12		13.0460-0234.2 610234	
2.0 MZR	108	12/07→07/13					
2.0 MZR	114	01/10→07/13					
2.2 D	95	01/10→07/13					
2.2 MZR-CD	132	01/10→07/13					
2.5 MZR	125	02/08→07/13					
2.0 MZR-CD	103	12/07→12/10	➡			13.0460-0234.2 610234	
2.2 MZR-CD	92	01/09→12/10					
2.2 MZR-CD	120	08/08→07/13	➡	01/09→ 12/12		13.0460-0234.2 610234	
2.2 MZR-CD	136	08/08→12/11	➡	01/09→		13.0460-0234.2 610234	
<b> Bremsscheibe</b>							
1.8 MZR	88	02/08→07/13	⬅	→ 12/12		24.0125-0188.1 425188	Ø 299 25 23 V
2.0 MZR	108	12/07→07/13					
2.0 MZR	114	01/10→07/13	➡	→ 12/12		24.0110-0302.1 410302	Ø 280 10 8
2.2 D	95	01/10→07/13					
2.2 MZR-CD	132	01/10→07/13					
2.5 MZR	125	02/08→07/13					
2.0 MZR-CD	103	12/07→12/10	⬅			24.0125-0188.1 425188	Ø 299 25 23 V
2.2 MZR-CD	92	01/09→12/10	➡			24.0110-0302.1 410302	Ø 280 10 8
2.2 MZR-CD	120	08/08→07/13	⬅	01/09→ 12/12		24.0125-0188.1 425188	Ø 299 25 23 V
			➡	01/09→ 12/12		24.0110-0302.1 410302	Ø 280 10 8
2.2 MZR-CD	136	08/08→12/11	⬅	01/09→		24.0125-0188.1 425188	Ø 299 25 23 V
			➡	01/09→		24.0110-0302.1 410302	Ø 280 10 8
<b>MAZDA - 6 Station Wagon (GY) 01/02→02/08</b>							
<b> Bremsbelagsatz, Scheibenbremse</b>							
1.8	88	08/02→08/07	⬅	→ 07/07		13.0460-5821.2 605821	AKE 24046 18,6 + WK
2.0	104	08/02→08/07					
2.0	108	03/05→08/07	➡	→ 07/07		13.0460-5804.2 605804	AKE 24045 13,7 - WE / - WK
2.0 DI	89	08/02→08/07					
2.0 DI	105	06/05→08/07					
2.0 DI	100	08/02→02/05	⬅			13.0460-5821.2 605821	AKE 24046 18,6 + WK













	kw			 	! #		
<b>MAZDA - 6 Station Wagon (GY) 01/02→02/08</b>							
 <b>Bremsbelagsatz, Scheibenbremse</b>							
2.0 DI	100	08/02→02/05	➡			<b>13.0460-5804.2 605804</b>	AKE 24045 13,7 - WE / - WK
2.3	122	01/02→02/08	←	→ 07/07		<b>13.0460-5821.2 605821</b>	AKE 24046 18,6 + WK
2.3 AWD	119	11/02→08/07	➡	→ 07/07; Felgenreöße [Zoll]: 15 / 16 / 17		<b>13.0460-5804.2 605804</b>	AKE 24045 13,7 - WE / - WK
<b>Zubehörsatz, Scheibenbremsbelag</b>							
1.8	88	08/02→08/07	←	→ 07/07		<b>13.0460-0261.2 610261</b>	
2.0	104	08/02→08/07	➡	→ 07/07		<b>13.0460-0234.2 610234</b>	
2.0	108	03/05→08/07	➡	→ 07/07			
2.0 DI	89	08/02→08/07	➡				
2.0 DI	105	06/05→08/07	➡				
2.3	122	01/02→02/08	➡				
2.3 AWD	119	11/02→08/07	➡				
2.0 DI	100	08/02→02/05	←			<b>13.0460-0261.2 610261</b>	
			➡			<b>13.0460-0234.2 610234</b>	
 <b>Bremsscheibe</b>							
1.8	88	08/02→08/07	←	→ 07/07		<b>24.0125-0147.1 425147</b>	Ø 282,5 25 23 V
2.0	104	08/02→08/07	➡	→ 07/07		<b>24.0110-0302.1 410302</b>	Ø 280 10 8
2.0	108	03/05→08/07	➡	→ 07/07			
2.0 DI	89	08/02→08/07	➡				
2.0 DI	105	06/05→08/07	➡				
2.3	122	01/02→02/08	➡				
2.3 AWD	119	11/02→08/07	➡				
2.0 DI	100	08/02→02/05	←			<b>24.0125-0147.1 425147</b>	Ø 282,5 25 23 V
			➡			<b>24.0110-0302.1 410302</b>	Ø 280 10 8
<b>MAZDA - 6 Stufenheck (GG) 06/02→12/08</b>							
 <b>Bremsbelagsatz, Scheibenbremse</b>							
1.8	88	08/02→08/07	←	→ 07/07		<b>13.0460-5822.2 605822</b>	24246 16,8 + WK
			➡	→ 07/07		<b>13.0460-5804.2 605804</b>	AKE 24045 13,7 - WE / - WK
2.0	104	06/02→08/07	←	→ 07/07		<b>13.0460-5821.2 605821</b>	AKE 24046 18,6 + WK
2.0	108	03/05→08/07	➡	→ 07/07		<b>13.0460-5804.2 605804</b>	AKE 24045 13,7 - WE / - WK
2.0 DI	89	08/02→08/07	➡	→ 07/07			
2.0 DI	100	06/02→08/07	➡				
2.0 DI	105	06/05→08/07	➡				
2.3	122	06/02→08/07	➡				
2.3	120	03/05→07/07	←			<b>13.0460-5821.2 605821</b>	AKE 24046 18,6 + WK
			➡			<b>13.0460-5804.2 605804</b>	AKE 24045 13,7 - WE / - WK
<b>Zubehörsatz, Scheibenbremsbelag</b>							
1.8	88	08/02→08/07	←	→ 07/07		<b>13.0460-0260.2 610260</b>	
			➡	→ 07/07		<b>13.0460-0234.2 610234</b>	
2.0	104	06/02→08/07	←	→ 07/07		<b>13.0460-0261.2 610261</b>	
2.0	108	03/05→08/07	➡	→ 07/07		<b>13.0460-0234.2 610234</b>	
2.0 DI	89	08/02→08/07	➡	→ 07/07			
2.0 DI	100	06/02→08/07	➡				
2.0 DI	105	06/05→08/07	➡				
2.3	122	06/02→08/07	➡				
2.3	120	03/05→07/07	←			<b>13.0460-0261.2 610261</b>	
			➡			<b>13.0460-0234.2 610234</b>	
 <b>Bremsscheibe</b>							
1.8	88	08/02→08/07	←	→ 07/07		<b>24.0124-0175.1 424175</b>	Ø 273,5 24 22 V
			➡	→ 07/07		<b>24.0110-0302.1 410302</b>	Ø 280 10 8
2.0	104	06/02→08/07	←	→ 07/07		<b>24.0125-0147.1 425147</b>	Ø 282,5 25 23 V
2.0	108	03/05→08/07	➡	→ 07/07		<b>24.0110-0302.1 410302</b>	Ø 280 10 8
2.0 DI	89	08/02→08/07	➡	→ 07/07			
2.0 DI	100	06/02→08/07	➡				
2.0 DI	105	06/05→08/07	➡				
2.3	122	06/02→08/07	➡				
2.3	120	03/05→07/07	←			<b>24.0125-0147.1 425147</b>	Ø 282,5 25 23 V
			➡			<b>24.0110-0302.1 410302</b>	Ø 280 10 8
2.3 MPS Turbo	191	12/05→08/07	➡	→ 06/07; Felgenreöße [Zoll]: 15 / 16 / 17		<b>24.0110-0302.1 410302</b>	Ø 280 10 8
<b>MAZDA - 6 Stufenheck (GH) 08/07→12/13</b>							
 <b>Bremsbelagsatz, Scheibenbremse</b>							
1.8 MZR	88	08/07→07/13	←	→ 12/12		<b>13.0460-5610.2 605610</b>	24582 17,4 + WK + Zub
2.2 D	132	01/10→07/13					
↓							











	kW			 	! #		
<b>MAZDA - 6 Stufenheck (GH) 08/07→12/13</b>							
 <b>Bremsbelagsatz, Scheibenbremse</b>							
2.5 MZR	125	08/07→07/13	➔	→ 12/12		13.0460-5804.2 605804	AKE 24045 13,7 - WE / - WK
2.0 MZR	108	08/07→12/12	➔			13.0460-5610.2 605610	24582 17,4 + WK + Zub
2.0 MZR	114	01/10→12/12					
2.0 MZR-CD	103	08/07→10/10	➔			13.0460-5804.2 605804	AKE 24045 13,7 - WE / - WK
2.2 D	95	01/10→12/12					
2.2 MZR-CD	92	01/09→12/12					
2.2 MZR-CD	120	01/09→12/12					
2.2 MZR-CD	136	01/09→12/12					
<b>Zubehörsatz, Scheibenbremsbelag</b>							
1.8 MZR	88	08/07→07/13	➔	→ 12/12		13.0460-0234.2 610234	
2.2 D	132	01/10→07/13					
2.5 MZR	125	08/07→07/13	➔				
2.0 MZR	108	08/07→12/12	➔			13.0460-0234.2 610234	
2.0 MZR	114	01/10→12/12					
2.0 MZR-CD	103	08/07→10/10	➔				
2.2 D	95	01/10→12/12					
2.2 MZR-CD	92	01/09→12/12					
2.2 MZR-CD	120	01/09→12/12					
2.2 MZR-CD	136	01/09→12/12					
 <b>Bremsscheibe</b>							
1.8 MZR	88	08/07→07/13	➔	→ 12/12		24.0125-0188.1 425188	Ø 299 25 23 V
2.2 D	132	01/10→07/13					
2.5 MZR	125	08/07→07/13	➔	→ 12/12		24.0110-0302.1 410302	Ø 280 10 8
2.0 MZR	108	08/07→12/12	➔			24.0125-0188.1 425188	Ø 299 25 23 V
2.0 MZR	114	01/10→12/12					
2.0 MZR-CD	103	08/07→10/10	➔			24.0110-0302.1 410302	Ø 280 10 8
2.2 D	95	01/10→12/12					
2.2 MZR-CD	92	01/09→12/12					
2.2 MZR-CD	120	01/09→12/12					
2.2 MZR-CD	136	01/09→12/12					
<b>MAZDA - 6 Stufenheck (GJ, GL) 12/12→</b>							
 <b>Bremsbelagsatz, Scheibenbremse</b>							
2.0	110	12/12→	➔			13.0460-5654.2 605654	MAN 25688 14,4 + WK
2.0	121	01/13→					
2.0 (GJ2, GL2, GL6)	107	01/13→					
2.2 D	129	12/12→					
2.5	141	01/13→					
2.2 D	110	12/12→	➔	01/13→		13.0460-5654.2 605654	MAN 25688 14,4 + WK
 <b>Bremsscheibe</b>							
2.0	110	12/12→	➔			24.0128-0279.1 428279	Ø 297 28 26 V
2.5	141	01/13→					
2.5	143	03/18→					
2.0	121	01/13→	➔	Kombi		24.0128-0277.1 428277	Ø 297 28 26 V
2.0 (GJ2, GL2, GL6)	107	01/13→					
2.2 D	110	12/12→	➔			24.0128-0279.1 428279	Ø 297 28 26 V
2.2 D	129	12/12→					
<b>MAZDA - 121 II (DB) 11/90→05/97</b>							
 <b>Bremsbelagsatz, Scheibenbremse</b>							
1.3 16V	39	11/90→03/96	➔	04/91→ 02/96		13.0460-5944.2 605944	SUM 21654 15,0 + WK
1.3 i 16V	53	11/90→03/96					
<b>Zubehörsatz, Scheibenbremsbelag</b>							
1.3 16V	39	11/90→03/96	➔	04/91→ 02/96		13.0460-0339.2 610339	SUM
1.3 i 16V	53	11/90→03/96					
 <b>Bremsscheibe</b>							
1.3 16V	39	11/90→03/96	➔	04/91→ 02/96; Vollautomatik		24.0118-0113.1 418113	Ø 235 18 16 V
1.3 i 16V	53	11/90→03/96					
<b>MAZDA - 121 III (JASM, JBSM) 03/96→04/03</b>							
 <b>Bremsbelagsatz, Scheibenbremse</b>							
1.25	55	03/96→04/03	➔	→ 01/00; Vollautomatik		13.0460-7071.2 607071	ATE 20640 17,5 - WE / - WK
			➔	→ 01/00; Schaltgetriebe		13.0460-7073.2 607073	ATE 21202 16,9 - WE / - WK
			➔	02/00→ 03/03; + ABS		13.0460-7142.2 607142	ATE 23202 18,3 - WE / - WK
			➔	02/00→ 03/03; - ABS		13.0460-7148.2 607148	ATE 23200 18,0 - WE / - WK
1.3	37	03/96→04/03	➔	→ 01/00		13.0460-7073.2 607073	ATE 21202 16,9 - WE / - WK
1.3	44	03/96→04/03					
1.8 D	44	03/96→04/03	➔	02/00→ 03/03; + ABS		13.0460-7142.2 607142	ATE 23202 18,3 - WE / - WK
↓							















	kW					! #		
<b>MAZDA - 121 III (JASM, JBSM) 03/96→04/03</b>								
 <b>Bremsbelagsatz, Scheibenbremse</b>								
1.3 1.3 1.8 D	37 44 44	03/96→04/03 03/96→04/03 03/96→04/03	←	02/00→ 03/03; - ABS		13.0460-7148.2	607148	ATE 23200 18,0 - WE / - WK
 <b>Bremsscheibe</b>								
1.25	55	03/96→04/03	←	→ 01/00; Schaltgetriebe		24.0112-0141.1	412141	Ø 239,5 12 10
			←	→ 01/00; Vollautomatik		24.0312-0141.1	512141	Ø 239,5 12 10
			←	→ 01/00; Vollautomatik		24.0120-0147.1	420147	Ø 239,5 20 18 V
			←	→ 01/00; Vollautomatik		24.0320-0147.1	520147	Ø 239,5 20 18 V
			←	02/00→ 03/03; - ABS		24.0120-0147.1	420147	Ø 239,5 20 18 V
			←	02/00→ 03/03; - ABS		24.0320-0147.1	520147	Ø 239,5 20 18 V
			←	02/00→ 03/03; + ABS		24.0122-0172.1	422172	Ø 258 22 20 V
			←	02/00→ 03/03; + ABS		24.0322-0172.1	522172	Ø 258 22 20 V
1.3 1.3 1.8 D	37 44 44	03/96→04/03 03/96→04/03 03/96→04/03	←	→ 01/00		24.0112-0141.1	412141	Ø 239,5 12 10
			←	→ 01/00		24.0312-0141.1	512141	Ø 239,5 12 10
			←	02/00→ 03/03; - ABS		24.0120-0147.1	420147	Ø 239,5 20 18 V
			←	02/00→ 03/03; - ABS		24.0320-0147.1	520147	Ø 239,5 20 18 V
			←	02/00→ 03/03; + ABS		24.0122-0172.1	422172	Ø 258 22 20 V
			←	02/00→ 03/03; + ABS		24.0322-0172.1	522172	Ø 258 22 20 V
<b>MAZDA - 323 C IV (BG) 06/89→09/00</b>								
 <b>Bremsbelagsatz, Scheibenbremse</b>								
1.6	66	09/93→09/00	←	→ 12/94		13.0460-5944.2	605944	SUM 21654 15,0 + WK
			→	→ 12/94		13.0460-5972.2	605972	21559 11,5 - WE / - WK
<b>Zubehörsatz, Scheibenbremsbelag</b>								
1.6	66	09/93→09/00	←	→ 12/94		13.0460-0339.2	610339	SUM
 <b>Bremsscheibe</b>								
1.6	66	09/93→09/00	←	→ 12/94; Schaltgetriebe; für Fahrzeuge mit Trommelbremse an der Hinterachse		24.0118-0113.1	418113	Ø 235 18 16 V
			←	→ 12/94; Vollautomatik		24.0122-0166.1	422166	Ø 235 22 20 V
			←	→ 12/94; Schaltgetriebe; für Fahrzeuge mit Scheibenbremse an der Hinterachse		24.0122-0166.1	422166	Ø 235 22 20 V
			→	→ 12/94		24.0109-0127.1	409127	Ø 231 9 8
<b>MAZDA - 323 C V (BA) 08/94→01/01</b>								
 <b>Bremsbelagsatz, Scheibenbremse</b>								
1.3 16V 1.5 16V 1.8 16V	54 65 84	08/94→09/98 08/94→09/98 08/94→09/98	←	→ 08/98		13.0460-5944.2	605944	SUM 21654 15,0 + WK
			←	→ 08/98; Türenanzahl: 5		13.0460-5944.2	605944	SUM 21654 15,0 + WK
			←	→ 08/98; Türenanzahl: 3		13.0460-5974.2	605974	SUM 21539 15,0 + WK
			←	→ 08/98; Türenanzahl: 4		13.0460-5974.2	605974	SUM 21539 15,0 + WK
<b>Zubehörsatz, Scheibenbremsbelag</b>								
1.3 16V 1.5 16V 1.8 16V	54 65 84	08/94→09/98 08/94→09/98 08/94→09/98	←	→ 08/98		13.0460-0339.2	610339	SUM
			←	→ 08/98; Türenanzahl: 5		13.0460-0339.2	610339	SUM
 <b>Bremsscheibe</b>								
1.3 16V	54	08/94→09/98	←	→ 08/98		24.0118-0113.1	418113	Ø 235 18 16 V
1.5 16V	65	08/94→09/98	←	→ 08/98		24.0122-0166.1	422166	Ø 235 22 20 V
1.8 16V	84	08/94→09/98	←	→ 08/98		24.0122-0165.1	422165	Ø 257 22 20 V
<b>MAZDA - 323 F V (BA) 07/94→09/98</b>								
 <b>Bremsbelagsatz, Scheibenbremse</b>								
1.5 16V 1.8 16V	65 84	07/94→09/98 08/94→09/98	←	→ 08/98		13.0460-5944.2	605944	SUM 21654 15,0 + WK
			←	→ 08/98; Türenanzahl: 5		13.0460-5944.2	605944	SUM 21654 15,0 + WK
			←	→ 08/98; Türenanzahl: 3		13.0460-5974.2	605974	SUM 21539 15,0 + WK
			←	→ 08/98; Türenanzahl: 4		13.0460-5974.2	605974	SUM 21539 15,0 + WK
2.0 24V ↓	106	08/94→09/98	→	→ 08/98		13.0460-5865.2	605865	AKE 23387 12,6 + WK + Zub













	kw					! #		
<b>MAZDA - 323 F V (BA) 07/94→09/98</b>								
<b>Zubehörsatz, Scheibenbremsbelag</b>								
1.5 16V	65	07/94→09/98	←	→ 08/98			13.0460-0339.2 610339	SUM
1.8 16V	84	08/94→09/98	←	→ 08/98; Türenanzahl: 5			13.0460-0339.2 610339	SUM
<b> Bremsscheibe</b>								
1.5 16V	65	07/94→09/98	←	→ 08/98			24.0122-0166.1 422166	Ø 235 22 20 V
1.8 16V	84	08/94→09/98	←	→ 08/98			24.0122-0165.1 422165	Ø 257 22 20 V
<b>MAZDA - 323 F VI (BJ) 09/98→05/04</b>								
<b> Bremsbelagsatz, Scheibenbremse</b>								
1.4	53	01/01→05/04	←	→ 10/03			13.0460-5802.2 605802	23490 15,4 + WK + Zub
1.4 16V	54	09/98→01/01	←	→ 12/00			13.0460-5802.2 605802	23490 15,4 + WK + Zub
1.5 16V	65	09/98→01/01						
1.6	70	01/01→05/04	←	→ 10/03			13.0460-5954.2 605954	SUM 23845 15,8 + WK
1.6	72	01/01→05/04						
2.0 TD	74	01/01→05/04	→	→ 10/03			13.0460-5804.2 605804	AKE 24045 13,7 - WE / - WK
1.9 16V (BJ14)	84	09/98→01/01	←	→ 12/00			13.0460-5954.2 605954	SUM 23845 15,8 + WK
2.0 D	52	09/98→05/04						
2.0 TD	66	09/98→12/01	→	→ 12/00			13.0460-5804.2 605804	AKE 24045 13,7 - WE / - WK
2.0	96	01/01→05/04	←	→ 10/03; für Fahrzeuge mit Sportfahrwerk			13.0460-5831.2 605831	SUM 23777 16,0 + WK + Zub
			←	→ 10/03; für Fahrzeuge ohne Sportfahrwerk			13.0460-5954.2 605954	SUM 23845 15,8 + WK
			→	→ 10/03			13.0460-5804.2 605804	AKE 24045 13,7 - WE / - WK
<b>Zubehörsatz, Scheibenbremsbelag</b>								
1.6	70	01/01→05/04	→	→ 10/03			13.0460-0234.2 610234	
1.6	72	01/01→05/04						
2.0	96	01/01→05/04						
2.0 TD	74	01/01→05/04						
1.9 16V (BJ14)	84	09/98→01/01	→	→ 12/00			13.0460-0234.2 610234	
2.0 D	52	09/98→05/04						
2.0 TD	66	09/98→12/01						
<b> Bremsscheibe</b>								
1.4	53	01/01→05/04	←	→ 10/03			24.0122-0207.1 422207	Ø 235 22 20 V
1.4 16V	54	09/98→01/01	←	→ 12/00			24.0122-0207.1 422207	Ø 235 22 20 V
1.5 16V	65	09/98→01/01						
1.6	70	01/01→05/04	←	→ 10/03			24.0124-0164.1 424164	Ø 258 24 22 V
1.6	72	01/01→05/04						
2.0 TD	74	01/01→05/04	→	→ 10/03			24.0110-0269.1 410269	Ø 261 10 8
1.9 16V (BJ14)	84	09/98→01/01	←	→ 12/00			24.0124-0164.1 424164	Ø 258 24 22 V
2.0 D	52	09/98→05/04						
2.0 TD	66	09/98→12/01	→	→ 12/00			24.0110-0269.1 410269	Ø 261 10 8
2.0	96	01/01→05/04	←	→ 10/03; für Fahrzeuge ohne Sportfahrwerk			24.0124-0164.1 424164	Ø 258 24 22 V
			←	→ 10/03; für Fahrzeuge mit Sportfahrwerk			24.0124-0175.1 424175	Ø 273,5 24 22 V
			→	→ 10/03; für Fahrzeuge ohne Sportfahrwerk			24.0110-0269.1 410269	Ø 261 10 8
			→	→ 10/03; für Fahrzeuge mit Sportfahrwerk			24.0110-0302.1 410302	Ø 280 10 8
<b>MAZDA - 323 P V (BA) 10/96→09/98</b>								
<b> Bremsbelagsatz, Scheibenbremse</b>								
1.3 16V	54	10/96→09/98	←	→ 08/98			13.0460-5944.2 605944	SUM 21654 15,0 + WK
1.5 16V	65	10/96→09/98						
2.0 D	52	10/96→09/98	←	→ 08/98			13.0460-5974.2 605974	SUM 21539 15,0 + WK
<b>Zubehörsatz, Scheibenbremsbelag</b>								
1.3 16V	54	10/96→09/98	←	→ 08/98			13.0460-0339.2 610339	SUM
1.5 16V	65	10/96→09/98						
<b> Bremsscheibe</b>								
1.3 16V	54	10/96→09/98	←	→ 08/98			24.0118-0113.1 418113	Ø 235 18 16 V
1.5 16V	65	10/96→09/98	←	→ 08/98			24.0122-0166.1 422166	Ø 235 22 20 V
2.0 D	52	10/96→09/98	←	→ 08/98			24.0122-0165.1 422165	Ø 257 22 20 V

















	kw					! #		
<b>MAZDA - 323 S IV (BG) 06/89→10/96</b>								
 <b>Bremsbelagsatz, Scheibenbremse</b>								
1.6 16V	65	08/89→10/96	←	09/89→			13.0460-5944.2 605944	SUM 21654 15,0 + WK
			→	09/89→			13.0460-5972.2 605972	21559 11,5 - WE / - WK
<b>Zubehörsatz, Scheibenbremsbelag</b>								
1.6 16V	65	08/89→10/96	←	09/89→			13.0460-0339.2 610339	SUM
 <b>Bremsscheibe</b>								
1.6 16V	65	08/89→10/96	←	09/89→; Schaltgetriebe; für Fahrzeuge mit Trommelbremse an der Hinterachse			24.0118-0113.1 418113	Ø 235 18 16 V
			←	09/89→; Vollautomatik			24.0122-0166.1 422166	Ø 235 22 20 V
			←	09/89→; Schaltgetriebe; für Fahrzeuge mit Scheibenbremse an der Hinterachse			24.0122-0166.1 422166	Ø 235 22 20 V
			→	09/89→			24.0109-0127.1 409127	Ø 231 9 8
<b>MAZDA - 323 S V (BA) 09/92→12/03</b>								
 <b>Bremsbelagsatz, Scheibenbremse</b>								
1.3 16V	54	08/94→09/98	←	→ 08/98			13.0460-5944.2 605944	SUM 21654 15,0 + WK
1.5 16V	65	08/94→09/98	←	→ 08/98			13.0460-5974.2 605974	SUM 21539 15,0 + WK
1.6 TD	60	05/94→09/98	←	→ 08/98			13.0460-5974.2 605974	SUM 21539 15,0 + WK
2.0 D	52	10/96→09/98	←	→ 08/98; Türenanzahl: 5			13.0460-5974.2 605974	SUM 21539 15,0 + WK
1.8 16V	84	08/94→09/98	←	→ 08/98; Türenanzahl: 3			13.0460-5974.2 605974	SUM 21539 15,0 + WK
			←	→ 08/98; Türenanzahl: 4			13.0460-5974.2 605974	SUM 21539 15,0 + WK
<b>Zubehörsatz, Scheibenbremsbelag</b>								
1.3 16V	54	08/94→09/98	←	→ 08/98			13.0460-0339.2 610339	SUM
1.5 16V	65	08/94→09/98	←	→ 08/98; Türenanzahl: 5			13.0460-0339.2 610339	SUM
1.8 16V	84	08/94→09/98	←	→ 08/98; Türenanzahl: 5			13.0460-0339.2 610339	SUM
 <b>Bremsscheibe</b>								
1.3 16V	54	08/94→09/98	←	→ 08/98			24.0118-0113.1 418113	Ø 235 18 16 V
1.5 16V	65	08/94→09/98	←	→ 08/98			24.0122-0166.1 422166	Ø 235 22 20 V
1.6 TD	60	05/94→09/98	←	→ 08/98			24.0122-0165.1 422165	Ø 257 22 20 V
1.8 16V	84	08/94→09/98	←	→ 08/98			24.0122-0165.1 422165	Ø 257 22 20 V
2.0 D	52	10/96→09/98	←	→ 08/98			24.0122-0165.1 422165	Ø 257 22 20 V
<b>MAZDA - 323 S VI (BJ) 05/98→05/04</b>								
 <b>Bremsbelagsatz, Scheibenbremse</b>								
1.4	53	01/01→05/04	←	→ 10/03			13.0460-5802.2 605802	23490 15,4 + WK + Zub
1.4 16V	54	09/98→01/01	←	→ 12/00			13.0460-5802.2 605802	23490 15,4 + WK + Zub
1.5 16V	65	09/98→01/01	←	→ 12/00			13.0460-5802.2 605802	23490 15,4 + WK + Zub
1.6	70	01/01→05/04	←	→ 10/03			13.0460-5954.2 605954	SUM 23845 15,8 + WK
1.6	72	01/01→05/04	→	→ 10/03			13.0460-5804.2 605804	AKE 24045 13,7 - WE / - WK
1.6	80	09/98→02/01	←	01/01→			13.0460-5954.2 605954	SUM 23845 15,8 + WK
2.0 DiTD	74	10/00→10/02	→	01/01→			13.0460-5804.2 605804	AKE 24045 13,7 - WE / - WK
1.9 16V	84	09/98→05/04	←	→ 12/00			13.0460-5954.2 605954	SUM 23845 15,8 + WK
2.0 D (BJ1_)	52	09/98→05/04	→	→ 12/00			13.0460-5804.2 605804	AKE 24045 13,7 - WE / - WK
2.0 TD	66	09/98→05/04	→	→ 12/00			13.0460-5804.2 605804	AKE 24045 13,7 - WE / - WK
2.0	96	01/01→05/04	←	→ 10/03; für Fahrzeuge mit Sportfahrwerk			13.0460-5831.2 605831	SUM 23777 16,0 + WK + Zub
			←	→ 10/03; für Fahrzeuge ohne Sportfahrwerk			13.0460-5954.2 605954	SUM 23845 15,8 + WK
			→	→ 10/03			13.0460-5804.2 605804	AKE 24045 13,7 - WE / - WK
2.0 (SP20)	98	02/00→05/04	←	01/01→ 10/03; für Fahrzeuge mit Sportfahrwerk			13.0460-5831.2 605831	SUM 23777 16,0 + WK + Zub
			←	01/01→ 10/03; für Fahrzeuge ohne Sportfahrwerk			13.0460-5954.2 605954	SUM 23845 15,8 + WK
			→	01/01→ 10/03			13.0460-5804.2 605804	AKE 24045 13,7 - WE / - WK
<b>Zubehörsatz, Scheibenbremsbelag</b>								
1.6	70	01/01→05/04	→	→ 10/03			13.0460-0234.2 610234	
1.6	72	01/01→05/04	→	→ 10/03			13.0460-0234.2 610234	
2.0	96	01/01→05/04	→	→ 10/03			13.0460-0234.2 610234	
1.6	80	09/98→02/01	→	01/01→			13.0460-0234.2 610234	
2.0 DiTD	74	10/00→10/02	→	01/01→			13.0460-0234.2 610234	
↓								













	kw			 	! #		
<b>MAZDA - 323 S VI (BJ) 05/98→05/04</b>							
<b>Zubehörsatz, Scheibenbremsbelag</b>							
1.9 16V 2.0 D (BJ1_) 2.0 TD	84 52 66	09/98→05/04 09/98→05/04 09/98→05/04	➡	→ 12/00		13.0460-0234.2 610234	
2.0 (SP20)	98	02/00→05/04	➡	01/01→ 10/03		13.0460-0234.2 610234	
<b> Bremsscheibe</b>							
1.4	53	01/01→05/04	⬅	→ 10/03		24.0122-0207.1 422207	Ø 235 22 20 V
1.4 16V 1.5 16V	54 65	09/98→01/01 09/98→01/01	⬅	→ 12/00		24.0122-0207.1 422207	Ø 235 22 20 V
1.6 1.6	70 72	01/01→05/04 01/01→05/04	⬅ ➡	→ 10/03 → 10/03		24.0124-0164.1 424164 24.0110-0269.1 410269	Ø 258 24 22 V Ø 261 10 8
1.6 2.0 DiTD	80 74	09/98→02/01 10/00→10/02	⬅ ➡	01/01→ 01/01→		24.0124-0164.1 424164 24.0110-0269.1 410269	Ø 258 24 22 V Ø 261 10 8
1.9 16V 2.0 D (BJ1_) 2.0 TD	84 52 66	09/98→05/04 09/98→05/04 09/98→05/04	⬅ ➡	→ 12/00 → 12/00		24.0124-0164.1 424164 24.0110-0269.1 410269	Ø 258 24 22 V Ø 261 10 8
2.0	96	01/01→05/04	⬅	→ 10/03; für Fahrzeuge ohne Sportfahrwerk		24.0124-0164.1 424164	Ø 258 24 22 V
			⬅	→ 10/03; für Fahrzeuge mit Sportfahrwerk		24.0124-0175.1 424175	Ø 273,5 24 22 V
			➡	→ 10/03; für Fahrzeuge ohne Sportfahrwerk		24.0110-0269.1 410269	Ø 261 10 8
			➡	→ 10/03; für Fahrzeuge mit Sportfahrwerk		24.0110-0302.1 410302	Ø 280 10 8
2.0 (SP20)	98	02/00→05/04	⬅	01/01→ 10/03; für Fahrzeuge ohne Sportfahrwerk		24.0124-0164.1 424164	Ø 258 24 22 V
			⬅	01/01→ 10/03; für Fahrzeuge mit Sportfahrwerk		24.0124-0175.1 424175	Ø 273,5 24 22 V
			➡	01/01→ 10/03; für Fahrzeuge ohne Sportfahrwerk		24.0110-0269.1 410269	Ø 261 10 8
			➡	01/01→ 10/03; für Fahrzeuge mit Sportfahrwerk		24.0110-0302.1 410302	Ø 280 10 8
<b>MAZDA - 626 III Station Wagon (GV) 09/87→10/98</b>							
<b> Bremsbelagsatz, Scheibenbremse</b>							
2.0	66	10/88→09/97	⬅ ➡	04/92→ 04/92→		13.0460-5932.2 605932 13.0460-5995.2 605995	AKE 21378 15,0 + WK 21558 13,0 - WE / - WK
2.0 D	60	11/94→09/97	⬅ ➡	→ 04/96 → 04/96		13.0460-5932.2 605932 13.0460-5995.2 605995	AKE 21378 15,0 + WK 21558 13,0 - WE / - WK
2.0 D Complex	55	05/93→11/96	⬅ ➡			13.0460-5932.2 605932 13.0460-5995.2 605995	AKE 21378 15,0 + WK 21558 13,0 - WE / - WK
2.2 12V	85	03/89→11/96	⬅ ⬅ ➡ ➡	→ 10/90 04/92→ → 10/90 04/92→		13.0460-5932.2 605932 13.0460-5932.2 605932 13.0460-5995.2 605995 13.0460-5995.2 605995	AKE 21378 15,0 + WK AKE 21378 15,0 + WK 21558 13,0 - WE / - WK 21558 13,0 - WE / - WK
<b>Zubehörsatz, Scheibenbremsbelag</b>							
2.2 12V	85	03/89→11/96	⬅	→ 10/90		13.0460-0313.2 610313	AKE
<b> Bremsscheibe</b>							
2.0	66	10/88→09/97	⬅ ➡	04/92→ 04/92→		24.0124-0105.1 424105 24.0110-0256.1 410256	Ø 264 24 22 V Ø 259 10 8
2.0 D	60	11/94→09/97	⬅ ➡	→ 04/96 → 04/96		24.0124-0105.1 424105 24.0110-0256.1 410256	Ø 264 24 22 V Ø 259 10 8
2.0 D Complex	55	05/93→11/96	⬅ ➡			24.0124-0105.1 424105 24.0110-0256.1 410256	Ø 264 24 22 V Ø 259 10 8
2.2 12V	85	03/89→11/96	⬅ ⬅ ➡ ➡	→ 10/90 04/92→ 04/92→ → 10/90		24.0124-0105.1 424105 24.0124-0105.1 424105 24.0110-0256.1 410256 24.0110-0256.1 410256	Ø 264 24 22 V Ø 264 24 22 V Ø 259 10 8 Ø 259 10 8

















	kw			 	! #		
<b>MAZDA - 626 IV (GE) 08/91→08/98</b>							
 <b>Bremsbelagsatz, Scheibenbremse</b>							
1.8 i	66	08/94→04/97	←			13.0460-5954.2 605954	SUM 23845 15,8 + WK
1.8 i	77	01/92→04/97					
1.8 i	78	05/94→06/97	→			13.0460-5973.2 605973	21766 13,5 - WE / - WK
2.0 D	56	05/94→06/97					
2.0 D GLX Compreh	55	10/92→04/97					
2.0 i	85	01/92→04/97					
2.5 24V	121	01/92→04/97					
2.0 i 4WD	85	04/92→04/97	←			13.0460-5954.2 605954	SUM 23845 15,8 + WK
<b>Zubehörsatz, Scheibenbremsbelag</b>							
1.8 i	66	08/94→04/97	←			13.0460-0443.2 610443	SUM
1.8 i	77	01/92→04/97					
1.8 i	78	05/94→06/97	→			13.0460-0245.2 610245	
2.0 D	56	05/94→06/97					
2.0 D GLX Compreh	55	10/92→04/97					
2.0 i	85	01/92→04/97					
2.5 24V	121	01/92→04/97					
2.0 i 4WD	85	04/92→04/97	←			13.0460-0443.2 610443	SUM
 <b>Bremsscheibe</b>							
1.8 i	66	08/94→04/97	←			24.0124-0129.1 424129	Ø 258 24 22 V
1.8 i	77	01/92→04/97					
1.8 i	78	05/94→06/97	→			24.0110-0234.1 410234	Ø 261 10 8
2.0 D	56	05/94→06/97					
2.0 D GLX Compreh	55	10/92→04/97					
2.0 i	85	01/92→04/97					
2.0 i 4WD	85	04/92→04/97					
2.5 24V	121	01/92→04/97					
<b>MAZDA - 626 IV Hatchback (GE) 08/91→08/98</b>							
 <b>Bremsbelagsatz, Scheibenbremse</b>							
1.8	66	08/94→04/97	←			13.0460-5954.2 605954	SUM 23845 15,8 + WK
1.8	77	08/91→04/97					
2.0 D GLX Compreh	55	01/93→04/97	→			13.0460-5973.2 605973	21766 13,5 - WE / - WK
2.0 i	85	08/91→04/97					
2.5 24V	120	08/94→04/97					
2.5 24V	121	01/92→04/97					
2.0 i 4WD	85	04/92→04/97	←			13.0460-5932.2 605932	AKE 21378 15,0 + WK
<b>Zubehörsatz, Scheibenbremsbelag</b>							
1.8	66	08/94→04/97	←			13.0460-0443.2 610443	SUM
1.8	77	08/91→04/97					
2.0 D GLX Compreh	55	01/93→04/97	→			13.0460-0245.2 610245	
2.0 i	85	08/91→04/97					
2.5 24V	120	08/94→04/97					
2.5 24V	121	01/92→04/97					
 <b>Bremsscheibe</b>							
1.8	66	08/94→04/97	←			24.0124-0129.1 424129	Ø 258 24 22 V
1.8	77	08/91→04/97					
2.0 D GLX Compreh	55	01/93→04/97	→			24.0110-0234.1 410234	Ø 261 10 8
2.0 i	85	08/91→04/97					
2.5 24V	120	08/94→04/97					
2.5 24V	121	01/92→04/97					
2.0 i 4WD	85	04/92→04/97	←			24.0124-0105.1 424105	Ø 264 24 22 V
<b>MAZDA - 626 V (GF) 05/97→12/02</b>							
 <b>Bremsbelagsatz, Scheibenbremse</b>							
1.8	66	05/97→12/99	←	→ 11/99		13.0460-5954.2 605954	SUM 23845 15,8 + WK
1.8	74	12/99→10/02	←			13.0460-5831.2 605831	SUM 23777 16,0 + WK + Zub
2.0	85	05/97→10/02	←	12/99→		13.0460-5831.2 605831	SUM 23777 16,0 + WK + Zub
2.0	100	04/98→10/02					
2.0 DI TD	66	04/98→10/02	←	→ 11/99		13.0460-5954.2 605954	SUM 23845 15,8 + WK
2.0 Turbo DI	74	04/98→10/02	→			13.0460-5804.2 605804	AKE 24045 13,7 - WE / - WK
2.0 TD	81	10/00→10/02	←			13.0460-5831.2 605831	SUM 23777 16,0 + WK + Zub
			→			13.0460-5804.2 605804	AKE 24045 13,7 - WE / - WK
<b>Zubehörsatz, Scheibenbremsbelag</b>							
2.0	85	05/97→10/02	→			13.0460-0234.2 610234	
2.0	100	04/98→10/02					
2.0 DI TD	66	04/98→10/02					
2.0 TD	81	10/00→10/02					
2.0 Turbo DI	74	04/98→10/02					
↓							















	kw			 	! #		
<b>MAZDA - 626 V (GF) 05/97→12/02</b>							
 <b>Bremsscheibe</b>							
1.8	66	05/97→12/99	← → 11/99		24.0124-0129.1	424129	Ø 258 24 22 V
1.8	74	12/99→10/02	←		24.0124-0129.1	424129	Ø 258 24 22 V
2.0	85	05/97→10/02	←		24.0124-0129.1	424129	Ø 258 24 22 V
2.0	100	04/98→10/02	←				
2.0 DI TD	66	04/98→10/02	→		24.0110-0234.1	410234	Ø 261 10 8
2.0 TD	81	10/00→10/02					
2.0 Turbo DI	74	04/98→10/02					
<b>MAZDA - 626 V Hatchback (GF) 05/97→12/02</b>							
 <b>Bremsbelagsatz, Scheibenbremse</b>							
1.8	66	05/97→12/99	← → 11/99		13.0460-5954.2	605954	SUM 23845 15,8 + WK
1.8	74	12/99→10/02	←		13.0460-5831.2	605831	SUM 23777 16,0 + WK + Zub
2.0	85	05/97→10/02	← 12/99→		13.0460-5831.2	605831	SUM 23777 16,0 + WK + Zub
2.0 DITD	66	04/98→10/02	←				
2.0 H.P.	100	02/98→10/02	← → 11/99		13.0460-5954.2	605954	SUM 23845 15,8 + WK
2.0 Turbo DI	74	04/98→10/02	→		13.0460-5804.2	605804	AKE 24045 13,7 - WE / - WK
2.0 TD	81	10/00→10/02	←		13.0460-5831.2	605831	SUM 23777 16,0 + WK + Zub
			→		13.0460-5804.2	605804	AKE 24045 13,7 - WE / - WK
<b>Zubehörsatz, Scheibenbremsbelag</b>							
2.0	85	05/97→10/02	→		13.0460-0234.2	610234	
2.0 DITD	66	04/98→10/02					
2.0 H.P.	100	02/98→10/02					
2.0 TD	81	10/00→10/02					
2.0 Turbo DI	74	04/98→10/02					
 <b>Bremsscheibe</b>							
1.8	66	05/97→12/99	← → 11/99		24.0124-0129.1	424129	Ø 258 24 22 V
1.8	74	12/99→10/02	←		24.0124-0129.1	424129	Ø 258 24 22 V
2.0	85	05/97→10/02	←		24.0124-0129.1	424129	Ø 258 24 22 V
2.0 DITD	66	04/98→10/02	←				
2.0 H.P.	100	02/98→10/02	→		24.0110-0234.1	410234	Ø 261 10 8
2.0 TD	81	10/00→10/02					
2.0 Turbo DI	74	04/98→10/02					
<b>MAZDA - 626 V Station Wagon (GW) 01/98→12/02</b>							
 <b>Bremsbelagsatz, Scheibenbremse</b>							
1.8	66	02/98→01/00	← → 12/99		13.0460-5954.2	605954	SUM 23845 15,8 + WK
			→ 12/99		13.0460-5804.2	605804	AKE 24045 13,7 - WE / - WK
1.8	74	01/00→10/02	←		13.0460-5831.2	605831	SUM 23777 16,0 + WK + Zub
2.0 DITD	66	09/99→10/02	→		13.0460-5804.2	605804	AKE 24045 13,7 - WE / - WK
2.0 TD	81	10/00→10/02	→				
2.0	85	02/98→10/02	← 10/99→		13.0460-5831.2	605831	SUM 23777 16,0 + WK + Zub
2.0 H.P.	100	02/98→10/02	← → 09/99		13.0460-5954.2	605954	SUM 23845 15,8 + WK
2.0 Turbo DI	74	04/98→10/02	→		13.0460-5804.2	605804	AKE 24045 13,7 - WE / - WK
<b>Zubehörsatz, Scheibenbremsbelag</b>							
1.8	66	02/98→01/00	→ → 12/99		13.0460-0234.2	610234	
1.8	74	01/00→10/02	→		13.0460-0234.2	610234	
2.0	85	02/98→10/02	→				
2.0 DITD	66	09/99→10/02	→				
2.0 H.P.	100	02/98→10/02	→				
2.0 TD	81	10/00→10/02	→				
2.0 Turbo DI	74	04/98→10/02	→				
 <b>Bremsscheibe</b>							
1.8	66	02/98→01/00	← → 12/99		24.0124-0129.1	424129	Ø 258 24 22 V
			→ 12/99		24.0110-0234.1	410234	Ø 261 10 8
1.8	74	01/00→10/02	←		24.0124-0129.1	424129	Ø 258 24 22 V
2.0	85	02/98→10/02	←				
2.0 H.P.	100	02/98→10/02	→		24.0110-0234.1	410234	Ø 261 10 8
2.0 DITD	66	09/99→10/02	←		24.0124-0175.1	424175	Ø 273,5 24 22 V
2.0 TD	81	10/00→10/02	→				
2.0 Turbo DI	74	04/98→10/02	→		24.0110-0302.1	410302	Ø 280 10 8















	kw			 	! #		
<b>MAZDA - B-SERIE (UN) 11/98→11/06</b>							
 <b>Bremsbelagsatz, Scheibenbremse</b>							
2.5 D 4WD	62	12/02→11/06	←	→ 07/06		13.0460-5795.2 605795	24353 15,4 + WK + Zub
2.5 TD 4WD	80	06/99→07/06	←	08/02→		13.0460-5795.2 605795	24353 15,4 + WK + Zub
 <b>Bremsscheibe</b>							
2.5 D 4WD	62	12/02→11/06	←	→ 07/06		24.0128-0226.1 428226	Ø 289 28 26 V
2.5 TD 4WD	80	06/99→07/06	←	08/02→		24.0128-0226.1 428226	Ø 289 28 26 V
<b>MAZDA - BT-50 Pick-up (CD, UN) 08/06→12/15</b>							
 <b>Bremsbelagsatz, Scheibenbremse</b>							
2.5 MRZ-CD 4x4	105	12/06→12/15	←	→ 07/12		13.0460-5795.2 605795	24353 15,4 + WK + Zub
3.0 CDVi 4x4	115	10/06→12/15	←	12/06→ 07/12		13.0460-5795.2 605795	24353 15,4 + WK + Zub
 <b>Bremsscheibe</b>							
2.5 MRZ-CD 4x4	105	12/06→12/15	←	→ 07/12		24.0128-0226.1 428226	Ø 289 28 26 V
3.0 CDVi 4x4	115	10/06→12/15	←	12/06→ 07/12		24.0128-0226.1 428226	Ø 289 28 26 V
<b>MAZDA - BT-50 Pritsche/Fahrgestell (CD, UN) 08/06→</b>							
 <b>Bremsbelagsatz, Scheibenbremse</b>							
3.0 CDVi 4x4	115	12/06→	←	→ 07/12		13.0460-5795.2 605795	24353 15,4 + WK + Zub
 <b>Bremsscheibe</b>							
3.0 CDVi 4x4	115	12/06→	←	→ 07/12		24.0128-0226.1 428226	Ø 289 28 26 V
<b>MAZDA - CX-3 (DK) 01/15→</b>							
 <b>Bremsbelagsatz, Scheibenbremse</b>							
1.5 D	77	05/15→	←			13.0460-5658.2 605658	AKE 25875 15,9 + WK
1.5 D AWD	77	05/15→	→			13.0460-5664.2 605664	AKE 25540 14,5 + WK
2.0	88	05/15→				13.0470-5664.2 LD5664	AKE 25540 14,5 + WK Ceramic
2.0 AWD	109	07/15→					
2.0 AWD	110	05/15→					
1.8 D	85	02/18→	←			13.0460-5658.2 605658	AKE 25875 15,9 + WK
1.8 D AWD	85	02/18→					
 <b>Bremsscheibe</b>							
1.5 D AWD	77	05/15→	←			24.0125-0208.1 425208	Ø 295 25 23 V
2.0	88	05/15→					
2.0 AWD	109	07/15→					
2.0 AWD	110	05/15→					
1.8 D	85	02/18→	←			24.0125-0208.1 425208	Ø 295 25 23 V
1.8 D AWD	85	02/18→	→			24.0109-0181.1 409181	Ø 265 9 7
<b>MAZDA - CX-5 (KE, GH) 11/11→</b>							
 <b>Bremsbelagsatz, Scheibenbremse</b>							
2.0	110	02/12→02/17	→	→ 11/14		13.0460-5664.2 605664	AKE 25540 14,5 + WK
2.0	114	07/12→12/18				13.0470-5664.2 LD5664	AKE 25540 14,5 + WK Ceramic
2.0	121	11/11→02/17					
2.0 AWD	110	02/12→02/17					
2.0 AWD	118	11/11→02/17					
2.2 D	110	04/12→02/17					
2.2 D	129	04/12→02/17					
2.2 D 4WD	129	04/12→02/17					
2.2 D AWD	110	04/12→02/17					
2.2 D AWD	129	04/12→02/17					
2.0	113	04/15→02/17	→			13.0460-5664.2 605664	AKE 25540 14,5 + WK
2.5 AWD	141	02/15→02/17				13.0470-5664.2 LD5664	AKE 25540 14,5 + WK Ceramic
2.0	115	01/12→	→	07/12→ 11/14		13.0460-5664.2 605664	AKE 25540 14,5 + WK
			→			13.0470-5664.2 LD5664	AKE 25540 14,5 + WK Ceramic
 <b>Bremsscheibe</b>							
2.0	110	02/12→02/17	←	→ 08/15		24.0128-0277.1 428277	Ø 297 28 26 V
2.0	113	04/15→02/17					
2.0	114	07/12→12/18	→			24.0110-0381.1 410381	Ø 303 10 8
2.0	121	11/11→02/17					
2.0 AWD	110	02/12→02/17					
2.0 AWD	118	11/11→02/17					
2.2 D	110	04/12→02/17					
2.2 D	129	04/12→02/17					
↓							













	kw			 	! #		
<b>MAZDA - CX-5 (KE, GH) 11/11→</b>							
 <b>Bremsscheibe</b>							
2.2 D 4WD	129	04/12→02/17	←	→ 08/15		24.0128-0277.1 428277	Ø 297 28 26 V
2.2 D AWD	110	04/12→02/17	→			24.0110-0381.1 410381	Ø 303 10 8
2.2 D AWD	129	04/12→02/17					
2.5 AWD	141	02/15→02/17					
2.0	115	01/12→	←			24.0128-0277.1 428277	Ø 297 28 26 V
			→			24.0110-0381.1 410381	Ø 303 10 8
<b>MAZDA - CX-5 (KF) 11/16→</b>							
 <b>Bremsscheibe</b>							
2.0	121	05/17→	→			24.0110-0381.1 410381	Ø 303 10 8
2.0 AWD	118	05/17→					
2.2 D	110	05/17→					
2.2 D AWD	110	05/17→					
2.2 D AWD	129	05/17→					
2.5 AWD	143	05/17→					
<b>MAZDA - CX-7 (ER) 06/06→12/14</b>							
 <b>Bremsbelagsatz, Scheibenbremse</b>							
2.2 MZR-CD AWD	120	01/12→03/13	←			13.0460-5606.2 605606	24544 18,1 + WK + Zub
2.2 MZR-CD AWD	127	07/09→03/13	←	09/09→		13.0460-5606.2 605606	24544 18,1 + WK + Zub
2.3 MZR DISI Turbo AWD	191	06/09→03/13	→	09/09→		13.0460-5605.2 605605	24545 16,9 - WE / - WK + Zub
2.3 AWD	182	06/06→12/12	←	01/07→		13.0460-5606.2 605606	24544 18,1 + WK + Zub
			→	01/07→		13.0460-5605.2 605605	24545 16,9 - WE / - WK + Zub
2.3 DISI	182	01/12→12/14	←	→ 09/13		13.0460-5606.2 605606	24544 18,1 + WK + Zub
			→	→ 09/13		13.0460-5605.2 605605	24545 16,9 - WE / - WK + Zub
2.3 MZR DISI Turbo AWD	175	06/06→12/14	←	11/06→ 09/13		13.0460-5606.2 605606	24544 18,1 + WK + Zub
			→	11/06→ 09/13		13.0460-5605.2 605605	24545 16,9 - WE / - WK + Zub
2.3 MZR DISI Turbo AWD	190	10/07→08/09	←			13.0460-5606.2 605606	24544 18,1 + WK + Zub
			→			13.0460-5605.2 605605	24545 16,9 - WE / - WK + Zub
2.5 MZR	120	07/09→03/13	←	09/09→		13.0460-5606.2 605606	24544 18,1 + WK + Zub
 <b>Bremsscheibe</b>							
2.2 MZR-CD AWD	120	01/12→03/13	←			24.0128-0233.1 428233	Ø 320 28 26 V
			→			24.0118-0158.1 418158	Ø 324 18 16 V
2.2 MZR-CD AWD	127	07/09→03/13	←	09/09→; Vollautomatik		24.0128-0228.1 428228	Ø 295,6 28 26 V
			←	09/09→; Schaltgetriebe		24.0128-0233.1 428233	Ø 320 28 26 V
			→	09/09→		24.0118-0158.1 418158	Ø 324 18 16 V
2.3 AWD	182	06/06→12/12	→	01/07→		24.0118-0150.1 418150	Ø 301,6 18 16 V
2.3 DISI	182	01/12→12/14	←	Vollautomatik; → 09/13		24.0128-0228.1 428228	Ø 295,6 28 26 V
			←	Schaltgetriebe; → 09/13		24.0128-0233.1 428233	Ø 320 28 26 V
			→	→ 09/13		24.0118-0150.1 418150	Ø 301,6 18 16 V
2.3 MZR DISI Turbo AWD	175	06/06→12/14	←	11/06→; Vollautomatik; → 09/13		24.0128-0228.1 428228	Ø 295,6 28 26 V
			←	11/06→; Schaltgetriebe; → 09/13		24.0128-0233.1 428233	Ø 320 28 26 V
			→	11/06→ 09/13		24.0118-0150.1 418150	Ø 301,6 18 16 V
2.3 MZR DISI Turbo AWD	190	10/07→08/09	←	Vollautomatik		24.0128-0228.1 428228	Ø 295,6 28 26 V
			←	Schaltgetriebe		24.0128-0233.1 428233	Ø 320 28 26 V
			→			24.0118-0150.1 418150	Ø 301,6 18 16 V
2.3 MZR DISI Turbo AWD	191	06/09→03/13	←	09/09→; Vollautomatik		24.0128-0228.1 428228	Ø 295,6 28 26 V
			←	09/09→; Schaltgetriebe		24.0128-0233.1 428233	Ø 320 28 26 V
			→	09/09→		24.0118-0150.1 418150	Ø 301,6 18 16 V
2.5 MZR	120	07/09→03/13	←	09/09→		24.0128-0228.1 428228	Ø 295,6 28 26 V
			→	09/09→		24.0118-0150.1 418150	Ø 301,6 18 16 V
<b>MAZDA - CX-9 (TB) 09/06→</b>							
 <b>Bremsbelagsatz, Scheibenbremse</b>							
3.5	193	09/06→12/07	←			13.0460-5606.2 605606	24544 18,1 + WK + Zub
3.5 AWD	193	01/07→	→			13.0460-5605.2 605605	24545 16,9 - WE / - WK + Zub
3.7	204	01/07→					
3.7 AWD	204	01/07→					
↓							

	kW					! #		
<b>MAZDA - CX-9 (TB) 09/06→</b>								
 <b>Bremsscheibe</b>								
3.5	193	09/06→12/07	←			24.0128-0233.1	428233	Ø 320 28 26 V
3.5 AWD	193	01/07→	→					
3.7	204	01/07→				24.0118-0158.1	418158	Ø 324 18 16 V
3.7 AWD	204	01/07→						
<b>MAZDA - DEMIO (DW) 01/96→07/03</b>								
 <b>Bremsbelagsatz, Scheibenbremse</b>								
1.3 16V	46	08/98→07/03	←	→ 10/02		13.0460-5944.2	605944	SUM 21654 15,0 + WK
1.5 16V	55	04/00→07/03						
1.3 i 16V	53	08/98→04/00	←	→ 03/00		13.0460-5944.2	605944	SUM 21654 15,0 + WK
<b>Zubehörsatz, Scheibenbremsbelag</b>								
1.3 16V	46	08/98→07/03	←	→ 10/02		13.0460-0149.2	610149	SUM
1.5 16V	55	04/00→07/03						
1.3 i 16V	53	08/98→04/00	←	→ 03/00		13.0460-0149.2	610149	SUM
 <b>Bremsscheibe</b>								
1.3 16V	46	08/98→07/03	←	→ 10/02		24.0122-0166.1	422166	Ø 235 22 20 V
1.5 16V	55	04/00→07/03						
1.3 i 16V	53	08/98→04/00	←	→ 03/00		24.0122-0166.1	422166	Ø 235 22 20 V
<b>MAZDA - E-SERIE Bus 03/91→07/04</b>								
 <b>Bremsbelagsatz, Scheibenbremse</b>								
E2200 D	47	03/91→05/03	←	→ 03/97		13.0460-5806.2	605806	20002 15,0 + WK
<b>MAZDA - E-SERIE Kasten (SR2) 10/83→07/04</b>								
 <b>Bremsbelagsatz, Scheibenbremse</b>								
2200 D 4WD	47	03/91→05/03	←	→ 03/97		13.0460-5806.2	605806	20002 15,0 + WK
E2000	70	06/94→05/03						
E2200 D	47	11/88→12/03						
E2200 D	52	02/97→08/02						
E2200 D 4WD	52	02/97→05/03						
<b>MAZDA - E-SERIE Pritsche/Fahrgestell (SD1) 01/83→07/99</b>								
 <b>Bremsbelagsatz, Scheibenbremse</b>								
E2200 D	47	11/88→03/97	←			13.0460-5806.2	605806	20002 15,0 + WK
<b>MAZDA - MPV I (LV) 09/88→09/99</b>								
 <b>Bremsbelagsatz, Scheibenbremse</b>								
2.5 TD	85	05/96→09/99	→	→ 08/99		13.0460-5627.2	605627	AKE 21569 14,9 + WK
3.0 i V6	109	11/89→09/99	→	05/96→ 08/99		13.0460-5627.2	605627	AKE 21569 14,9 + WK
3.0 i V6 (LV10)	113	03/95→09/99	→	05/96→		13.0460-5627.2	605627	AKE 21569 14,9 + WK
<b>MAZDA - MPV II (LW) 08/99→12/06</b>								
 <b>Bremsbelagsatz, Scheibenbremse</b>								
2.0	88	08/00→07/02	←	→ 06/02		13.0460-5884.2	605884	SUM 23515 15,8 + WK + Zub
2.0	90	09/99→08/00	←	→ 07/00		13.0460-5884.2	605884	SUM 23515 15,8 + WK + Zub
2.0 DI	100	07/02→02/06	←	→ 10/05		13.0460-5884.2	605884	SUM 23515 15,8 + WK + Zub
2.3	104	07/02→02/06						
3.0 i V6	147	01/02→12/06	→	09/03→ 10/05		13.0460-5736.2	605736	24215 15,7 + WK + Zub
2.5 V6	125	09/99→03/02	←			13.0460-5884.2	605884	SUM 23515 15,8 + WK + Zub
 <b>Bremsscheibe</b>								
2.0	88	08/00→07/02	←	→ 06/02		24.0128-0175.1	428175	Ø 273,5 28 26 V
2.0	90	09/99→08/00	←	→ 07/00		24.0128-0175.1	428175	Ø 273,5 28 26 V
2.0 DI	100	07/02→02/06	←	→ 10/05		24.0128-0180.1	428180	Ø 296 28 26 V
3.0 i V6	147	01/02→12/06	→	09/03→ 10/05		24.0118-0148.1	418148	Ø 286 18 16 V
2.3	104	07/02→02/06	←	→ 10/05		24.0128-0175.1	428175	Ø 273,5 28 26 V
			→	09/03→ 10/05		24.0118-0148.1	418148	Ø 286 18 16 V
2.5 V6	125	09/99→03/02	←			24.0128-0175.1	428175	Ø 273,5 28 26 V















	kw			 	! #		
<b>MAZDA - MX-3 (EC) 07/91→09/98</b>							
 <b>Bremsbelagsatz, Scheibenbremse</b>							
1.6 i	65	07/91→10/97	←			13.0460-5974.2 605974	SUM 21539 15,0 + WK
1.6 i	79	01/94→10/97	→	+ ABS		13.0460-5824.2 605824	AKE 20008 13,0 - WE / - WK
1.8 i V6	95	01/94→10/97	←			13.0460-5974.2 605974	SUM 21539 15,0 + WK
1.8 i V6	99	01/96→10/97	→			13.0460-5824.2 605824	AKE 20008 13,0 - WE / - WK
 <b>Bremsscheibe</b>							
1.6 i	65	07/91→10/97	←			24.0122-0165.1 422165	Ø 257 22 20 V
1.6 i	79	01/94→10/97	→	+ ABS		24.0109-0131.1 409131	Ø 251 9 8
1.8 i V6	95	01/94→10/97	←			24.0122-0165.1 422165	Ø 257 22 20 V
1.8 i V6	99	01/96→10/97	→			24.0109-0131.1 409131	Ø 251 9 8
<b>MAZDA - MX-5 I (NA) 09/89→04/98</b>							
 <b>Bremsbelagsatz, Scheibenbremse</b>							
1.6	66	01/95→04/98	←			13.0460-5834.2 605834	SUM 23354 13,0 + WK + Zub
			→	+ ABS		13.0460-5865.2 605865	AKE 23387 12,6 + WK + Zub
			→	- ABS		13.0460-5972.2 605972	21559 11,5 - WE / - WK
1.8	96	01/93→04/98	←			13.0460-5834.2 605834	SUM 23354 13,0 + WK + Zub
1.8	96	09/93→12/97	→			13.0460-5865.2 605865	AKE 23387 12,6 + WK + Zub
<b>Zubehörsatz, Scheibenbremsbelag</b>							
1.6	66	01/95→04/98	←			13.0460-0278.2 610278	
1.8	96	01/93→04/98					
1.8	96	09/93→12/97					
 <b>Bremsscheibe</b>							
1.6	66	01/95→04/98	←	- ABS		24.0118-0113.1 418113	Ø 235 18 16 V
			←	+ ABS		24.0120-0169.1 420169	Ø 255 20 18 V
			→	- ABS		24.0109-0127.1 409127	Ø 231 9 8
			→	+ ABS		24.0109-0131.1 409131	Ø 251 9 8
1.8	96	01/93→04/98	←			24.0120-0169.1 420169	Ø 255 20 18 V
1.8	96	09/93→12/97	→			24.0109-0131.1 409131	Ø 251 9 8
<b>MAZDA - MX-5 II (NB) 01/98→10/05</b>							
 <b>Bremsbelagsatz, Scheibenbremse</b>							
1.6 16V	81	05/98→10/05	←	für Fahrzeuge ohne Sportpaket		13.0460-5834.2 605834	SUM 23354 13,0 + WK + Zub
			←	für Fahrzeuge mit Sportpaket		13.0460-5867.2 605867	23863 14,3 + WK + Zub
			→	08/03→; Sport		13.0460-5732.2 605732	AKE 24029 12,5 + WK + Zub
			→	→ 07/03		13.0460-5865.2 605865	AKE 23387 12,6 + WK + Zub
1.8	103	01/98→07/02	←	05/98→; für Fahrzeuge ohne Sportpaket		13.0460-5834.2 605834	SUM 23354 13,0 + WK + Zub
			→	05/98→		13.0460-5865.2 605865	AKE 23387 12,6 + WK + Zub
1.8 16V	102	11/00→10/05	←	für Fahrzeuge ohne Sportpaket		13.0460-5834.2 605834	SUM 23354 13,0 + WK + Zub
1.8 16V	107	11/00→10/05	←	für Fahrzeuge mit Sportpaket		13.0460-5867.2 605867	23863 14,3 + WK + Zub
			→			13.0460-5732.2 605732	AKE 24029 12,5 + WK + Zub
1.8 16V	103	05/98→10/05	←	für Fahrzeuge ohne Sportpaket		13.0460-5834.2 605834	SUM 23354 13,0 + WK + Zub
			→	08/03→		13.0460-5732.2 605732	AKE 24029 12,5 + WK + Zub
			→	→ 07/03		13.0460-5865.2 605865	AKE 23387 12,6 + WK + Zub
1.8 i Turbo	136	04/02→10/05	←			13.0460-5867.2 605867	23863 14,3 + WK + Zub
			→			13.0460-5732.2 605732	AKE 24029 12,5 + WK + Zub
<b>Zubehörsatz, Scheibenbremsbelag</b>							
1.6 16V	81	05/98→10/05	←	für Fahrzeuge ohne Sportpaket		13.0460-0278.2 610278	
1.8 16V	103	05/98→10/05					
1.8	103	01/98→07/02	←	05/98→; für Fahrzeuge ohne Sportpaket		13.0460-0278.2 610278	
 <b>Bremsscheibe</b>							
1.6 16V	81	05/98→10/05	←	für Fahrzeuge ohne Sportpaket		24.0120-0169.1 420169	Ø 255 20 18 V
			←	für Fahrzeuge mit Sportpaket		24.0122-0235.1 422235	Ø 270 22 20 V
↓							



















	kW			 	! #		
<b>MAZDA - MX-5 II (NB) 01/98→10/05</b>							
 <b>Bremsscheibe</b>							
1.6 16V	81	05/98→10/05	→	→ 07/03		24.0109-0131.1 409131	Ø 251 9 8
			→	08/03→; Sport		24.0110-0307.1 410307	Ø 276 10 8
1.8	103	01/98→07/02	←	05/98→; für Fahrzeuge ohne Sportpaket		24.0120-0169.1 420169	Ø 255 20 18 V
			→	05/98→		24.0109-0131.1 409131	Ø 251 9 8
1.8 16V	102	11/00→10/05	←	für Fahrzeuge mit Sportpaket		24.0122-0235.1 422235	Ø 270 22 20 V
			→	08/03→		24.0110-0307.1 410307	Ø 276 10 8
1.8 16V	103	05/98→10/05	←	für Fahrzeuge ohne Sportpaket		24.0120-0169.1 420169	Ø 255 20 18 V
			→	→ 07/03		24.0109-0131.1 409131	Ø 251 9 8
1.8 16V 1.8 i Turbo	107 136	11/00→10/05 04/02→10/05	←	für Fahrzeuge mit Sportpaket		24.0122-0235.1 422235	Ø 270 22 20 V
			→			24.0110-0307.1 410307	Ø 276 10 8
<b>MAZDA - MX-5 III (NC) 03/05→12/14</b>							
 <b>Bremsbelagsatz, Scheibenbremse</b>							
1.8 2.0	93 118	03/05→12/14 07/05→12/14	←			13.0460-5761.2 605761	24297 14,4 + WK + Zub
			→			13.0460-5762.2 605762	AKE 24298 14,0 + WK + Zub
 <b>Bremsscheibe</b>							
1.8 2.0	93 118	03/05→12/14 07/05→12/14	←			24.0122-0249.1 422249	Ø 290 22 20 V
			→			24.0110-0302.1 410302	Ø 280 10 8
<b>MAZDA - MX-5 IV (ND) 04/15→</b>							
 <b>Bremsbelagsatz, Scheibenbremse</b>							
1.5 2.0	96 118	06/15→ 06/15→	→			13.0460-5762.2 605762	AKE 24298 14,0 + WK + Zub
<b>MAZDA - MX-5 RF Targa (ND) 10/16→</b>							
 <b>Bremsbelagsatz, Scheibenbremse</b>							
1.5 2.0	96 118	08/17→ 12/16→	→			13.0460-5762.2 605762	AKE 24298 14,0 + WK + Zub
<b>MAZDA - MX-6 (GE) 07/91→09/97</b>							
 <b>Bremsbelagsatz, Scheibenbremse</b>							
2.0 2.5 24V 2.5 i 24V	85 121 120	02/92→02/97 02/92→09/97 08/94→02/97	←			13.0460-5954.2 605954	SUM 23845 15,8 + WK
			→			13.0460-5973.2 605973	21766 13,5 - WE / - WK
<b>Zubehörsatz, Scheibenbremsbelag</b>							
2.0 2.5 24V 2.5 i 24V	85 121 120	02/92→02/97 02/92→09/97 08/94→02/97	←			13.0460-0443.2 610443	SUM
			→			13.0460-0245.2 610245	
 <b>Bremsscheibe</b>							
2.0 2.5 24V 2.5 i 24V	85 121 120	02/92→02/97 02/92→09/97 08/94→02/97	←			24.0124-0129.1 424129	Ø 258 24 22 V
			→			24.0110-0234.1 410234	Ø 261 10 8
<b>MAZDA - PREMACY (CP) 07/99→03/05</b>							
 <b>Bremsbelagsatz, Scheibenbremse</b>							
1.9 2.0 TD	74 74	07/99→03/05 07/00→03/05	←	Anzahl Sitzplätze: 7		13.0460-5831.2 605831	SUM 23777 16,0 + WK + Zub
			←	Anzahl Sitzplätze: 5		13.0460-5954.2 605954	SUM 23845 15,8 + WK
			→	+ ABS		13.0460-5804.2 605804	AKE 24045 13,7 - WE / - WK
1.9	84	07/99→03/05	←	Anzahl Sitzplätze: 7		13.0460-5831.2 605831	SUM 23777 16,0 + WK + Zub
			←	Anzahl Sitzplätze: 5		13.0460-5954.2 605954	SUM 23845 15,8 + WK
			→			13.0460-5804.2 605804	AKE 24045 13,7 - WE / - WK
2.0	96	11/01→03/05	←	Anzahl Sitzplätze: 7		13.0460-5831.2 605831	SUM 23777 16,0 + WK + Zub
			→			13.0460-5804.2 605804	AKE 24045 13,7 - WE / - WK
2.0	107	02/05→03/05	←	03/05→		13.0460-7193.2 607193	ATE 23723 18,1 - WE / - WK
						13.0470-7193.2 LD7193	ATE 23723 18,1 - WE / - WK Ceramic
			→	03/05→		13.0460-7195.2 607195	ATE 23482 16,6 - WE / - WK
						13.0470-7195.2 LD7195	ATE 23482 16,6 - WE / - WK Ceramic
↓							

	kw					! #		
<b>MAZDA - PREMACY (CP) 07/99→03/05</b>								
 <b>Bremsbelagsatz, Scheibenbremse</b>								
2.0 TD	66	10/99→07/00	←	→ 06/00; Anzahl Sitzplätze: 7		13.0460-5831.2	605831	SUM 23777 16,0 + WK + Zub
			←	→ 06/00; Anzahl Sitzplätze: 5		13.0460-5954.2	605954	SUM 23845 15,8 + WK
			→	→ 06/00		13.0460-5804.2	605804	AKE 24045 13,7 - WE / - WK
<b>Zubehörsatz, Scheibenbremsbelag</b>								
1.9	74	07/99→03/05	→	+ ABS		13.0460-0234.2	610234	
2.0 TD	74	07/00→03/05	→			13.0460-0234.2	610234	
1.9	84	07/99→03/05	→			13.0460-0234.2	610234	
2.0	96	11/01→03/05	→			13.0460-0234.2	610234	
2.0 TD	66	10/99→07/00	→	→ 06/00		13.0460-0234.2	610234	
 <b>Bremsscheibe</b>								
1.9	74	07/99→03/05	←	Anzahl Sitzplätze: 5		24.0124-0129.1	424129	Ø 258 24 22 V
2.0 TD	74	07/00→03/05	←	Anzahl Sitzplätze: 7		24.0124-0175.1	424175	Ø 273,5 24 22 V
			→	+ ABS; Anzahl Sitzplätze: 5		24.0110-0234.1	410234	Ø 261 10 8
			→	+ ABS; Anzahl Sitzplätze: 7		24.0110-0302.1	410302	Ø 280 10 8
1.9	84	07/99→03/05	←	Anzahl Sitzplätze: 5		24.0124-0129.1	424129	Ø 258 24 22 V
			←	Anzahl Sitzplätze: 7		24.0124-0175.1	424175	Ø 273,5 24 22 V
			→	Anzahl Sitzplätze: 5		24.0110-0234.1	410234	Ø 261 10 8
			→	Anzahl Sitzplätze: 7		24.0110-0302.1	410302	Ø 280 10 8
2.0	96	11/01→03/05	←	Anzahl Sitzplätze: 7		24.0124-0175.1	424175	Ø 273,5 24 22 V
			→	Anzahl Sitzplätze: 5		24.0110-0234.1	410234	Ø 261 10 8
			→	Anzahl Sitzplätze: 7		24.0110-0302.1	410302	Ø 280 10 8
2.0	107	02/05→03/05	←	03/05→; 15"		24.0125-0165.1	425165	Ø 278 25 23 V
			←	03/05→; 16"		24.0125-0170.1	425170	Ø 300 25 23 V
			→	03/05→; 15"		24.0111-0160.1	411160	Ø 280 11 9
			→	03/05→; 16"		24.0111-0165.1	411165	Ø 302 11 9
2.0 TD	66	10/99→07/00	←	→ 06/00; Anzahl Sitzplätze: 5		24.0124-0129.1	424129	Ø 258 24 22 V
			←	→ 06/00; Anzahl Sitzplätze: 7		24.0124-0175.1	424175	Ø 273,5 24 22 V
			→	→ 06/00; Anzahl Sitzplätze: 5		24.0110-0234.1	410234	Ø 261 10 8
			→	→ 06/00; Anzahl Sitzplätze: 7		24.0110-0302.1	410302	Ø 280 10 8
<b>MAZDA - RX-8 (SE, FE) 10/03→06/12</b>								
 <b>Bremsbelagsatz, Scheibenbremse</b>								
1.3	141	10/03→06/12	←			13.0460-5877.2	605877	SUM 24042 16,3 - WE / - WK
1.3	170	10/03→06/12	←			13.0460-5856.2	605856	24039 14,4 + WK
1.3	177	11/03→06/12	→			13.0460-5856.2	605856	24039 14,4 + WK
1.3	151	10/03→06/12	←	für Fahrzeuge ohne Sportfahrwerk		13.0460-5877.2	605877	SUM 24042 16,3 - WE / - WK
			→			13.0460-5856.2	605856	24039 14,4 + WK
 <b>Bremsscheibe</b>								
1.3	141	10/03→06/12	←	für Fahrzeuge ohne Sportfahrwerk		24.0124-0217.1	424217	Ø 302,5 24 22 V
1.3	170	10/03→06/12	←	für Fahrzeuge mit Sportfahrwerk		24.0124-0218.1	424218	Ø 322,6 24 22 V
1.3	177	11/03→06/12	→	→ 09/05		24.0118-0149.1	418149	Ø 302 18 16 V
1.3	151	10/03→06/12	←	für Fahrzeuge ohne Sportfahrwerk		24.0124-0217.1	424217	Ø 302,5 24 22 V
			←	für Fahrzeuge mit Sportfahrwerk		24.0124-0218.1	424218	Ø 322,6 24 22 V
<b>MAZDA - TRIBUTE (EP) 03/00→05/08</b>								
 <b>Bremsbelagsatz, Scheibenbremse</b>								
2.0	91	03/00→05/08	←	→ 03/04		13.0460-7205.2	607205	ATE 23787 19,0 - WE / - WK
2.0 4WD	91	03/00→05/08	←			13.0460-7205.2	607205	ATE 23787 19,0 - WE / - WK
3.0 V6 24V 4WD	145	03/00→05/08	←			13.0460-7205.2	607205	ATE 23787 19,0 - WE / - WK
2.3 AWD	110	04/04→05/08	←	→ 02/05; für Fahrzeuge mit Trommelbremse an der Hinterachse		13.0460-7234.2	607234	ATE 24438 16,1 - WE / - WK
3.0 V6 AWD	149	04/04→05/08	←	für Fahrzeuge mit Scheibenbremse an der Hinterachse		13.0460-7235.2	607235	ATE 24670 18,0 - WE / - WK
			→	+ ABS		13.0460-7235.2	607235	ATE 24670 18,0 - WE / - WK
2.3 GX ↓	110	12/03→10/04	→			13.0460-7235.2	607235	ATE 24670 18,0 - WE / - WK

















	kW			 	! #		
<b>MAZDA - TRIBUTE (EP) 03/00→05/08</b>							
 <b>Bremsscheibe</b>							
2.0	91	03/00→05/08	←	→ 03/04		24.0124-0735.1 424735	Ø 278 24 22 V
2.0 4WD	91	03/00→05/08					
3.0 V6 24V 4WD	145	03/00→05/08					
2.3 AWD	110	04/04→05/08	→	+ ABS		24.0112-0181.1 412181	Ø 302 12 11
3.0 V6 AWD	149	04/04→05/08					
2.3 GX	110	12/03→10/04	←			24.0124-0735.1 424735	Ø 278 24 22 V
<b>MAZDA - XEDOS 6 (CA) 01/92→10/99</b>							
 <b>Bremsbelagsatz, Scheibenbremse</b>							
1.6 16V	79	06/94→10/99	←	→ 09/99		13.0460-5954.2 605954	SUM 23845 15,8 + WK
			→	→ 09/99		13.0460-5973.2 605973	21766 13,5 - WE / - WK
2.0 V6	103	06/94→10/99	←			13.0460-5954.2 605954	SUM 23845 15,8 + WK
			→			13.0460-5973.2 605973	21766 13,5 - WE / - WK
<b>Zubehörsatz, Scheibenbremsbelag</b>							
1.6 16V	79	06/94→10/99	←	→ 09/99		13.0460-0443.2 610443	SUM
			→	→ 09/99		13.0460-0245.2 610245	
2.0 V6	103	06/94→10/99	←			13.0460-0443.2 610443	SUM
			→			13.0460-0245.2 610245	
 <b>Bremsscheibe</b>							
1.6 16V	79	06/94→10/99	←	→ 09/99		24.0124-0129.1 424129	Ø 258 24 22 V
			→	→ 09/99		24.0110-0234.1 410234	Ø 261 10 8
2.0 V6	103	06/94→10/99	←			24.0124-0129.1 424129	Ø 258 24 22 V
			→			24.0110-0234.1 410234	Ø 261 10 8
<b>MAZDA - XEDOS 9 (TA) 07/93→09/02</b>							
 <b>Bremsbelagsatz, Scheibenbremse</b>							
2.0 24V	105	08/93→01/00	→	10/98→		13.0460-5625.2 605625	21319 14,9 + WK
2.3 24V	155	02/95→01/00	→			13.0460-5625.2 605625	21319 14,9 + WK
2.5 V6	120	07/00→09/02					
2.5 24V	123	07/93→07/00	→	10/98→ 06/00		13.0460-5625.2 605625	21319 14,9 + WK
 <b>Bremsscheibe</b>							
2.0 24V	105	08/93→01/00	←			24.0128-0175.1 428175	Ø 273,5 28 26 V
2.3 24V	155	02/95→01/00					
2.5 24V	123	07/93→07/00	←	→ 06/00		24.0128-0175.1 428175	Ø 273,5 28 26 V
<b>MERCEDES-BENZ - 100 Bus (631) 02/88→04/96</b>							
 <b>Bremsbelagsatz, Scheibenbremse</b>							
2.0 D	45	09/93→04/96	←	→ 02/96		13.0460-3945.2 603945	BDX 20932 14,0 - WE / - WK
D (631.333, 631.343, 631.334, 631.344)	55	12/90→02/96	←			13.0460-3945.2 603945	BDX 20932 14,0 - WE / - WK
<b>Zubehörsatz, Scheibenbremsbelag</b>							
2.0 D	45	09/93→04/96	←	→ 02/96		13.0460-0918.2 610918	BDX
D (631.333, 631.343, 631.334, 631.344)	55	12/90→02/96	←			13.0460-0918.2 610918	BDX
 <b>Bremsscheibe</b>							
2.0 D	45	09/93→04/96	←	→ 02/96		24.0116-0107.2 416107	Ø 238,5 16 14,5 + S
D (631.333, 631.343, 631.334, 631.344)	55	12/90→02/96	←			24.0116-0107.2 416107	Ø 238,5 16 14,5 + S
<b>MERCEDES-BENZ - 100 Kasten (631) 02/88→04/96</b>							
 <b>Bremsbelagsatz, Scheibenbremse</b>							
2.0 D	45	09/93→04/96	←	→ 02/96		13.0460-3945.2 603945	BDX 20932 14,0 - WE / - WK
D (631.332, 631.342)	55	12/90→02/96	←			13.0460-3945.2 603945	BDX 20932 14,0 - WE / - WK
<b>Zubehörsatz, Scheibenbremsbelag</b>							
2.0 D	45	09/93→04/96	←	→ 02/96		13.0460-0918.2 610918	BDX
D (631.332, 631.342)	55	12/90→02/96	←			13.0460-0918.2 610918	BDX
↓							







	kw			 	! #		
<b>MERCEDES-BENZ - 100 Kasten (631) 02/88→04/96</b>							
<b> Bremsscheibe</b>							
2.0 D	45	09/93→04/96	←	→ 02/96		24.0116-0107.2 416107	Ø 238,5 16 14,5 + S
D (631.332, 631.342)	55	12/90→02/96	←			24.0116-0107.2 416107	Ø 238,5 16 14,5 + S
<b>MERCEDES-BENZ - 100 Pritsche/Fahrgestell (631) 02/88→02/96</b>							
<b>Zubehörsatz, Scheibenbremsbelag</b>							
D (631.340)	55	12/90→02/96	←	Baumuster: 631.349		13.0460-0918.2 610918	BDX
<b>MERCEDES-BENZ - A-KLASSE (W168) 07/97→08/05</b>							
<b> Bremsbelagsatz, Scheibenbremse</b>							
A 140 (168.031, 168.131)	60	07/97→08/04	←	09/97→; langer Radstand; Baumuster: 168.131		13.0460-2776.2 602776	TRW 23070 17,0 + WE / - WK + Zub
			←	09/97→; kurzer Radstand; Baumuster: 168.031		13.0470-2776.2 LD2776	TRW 23070 17,0 + WE / - WK + Zub Ceramic
A 140 (168.031, 168.131)	60	01/01→08/04	←	langer Radstand; Baumuster: 168.131		13.0460-2776.2 602776	TRW 23070 17,0 + WE / - WK + Zub
			←	kurzer Radstand; Baumuster: 168.031		13.0470-2776.2 LD2776	TRW 23070 17,0 + WE / - WK + Zub Ceramic
A 160 (168.033, 168.133)	75	07/97→08/04	←	09/97→		13.0460-2776.2 602776	TRW 23070 17,0 + WE / - WK + Zub
			→	09/97→; langer Radstand; Baumuster: 168.133		13.0470-2776.2 LD2776	TRW 23070 17,0 + WE / - WK + Zub Ceramic
A 160 CDI (168.006)	55	02/01→08/04	←			13.0460-2833.2 602833	TRW 23070 17,0 + WE / - WK + Zub
			←			13.0470-2833.2 LD2833	TRW 23070 17,0 + WE / - WK + Zub Ceramic
A 160 CDI (168.007)	44	07/98→02/01	←	08/98→ 01/01		13.0460-2833.2 602833	TRW 23070 17,0 + WE / - WK + Zub
			←			13.0470-2833.2 LD2833	TRW 23070 17,0 + WE / - WK + Zub Ceramic
A 170 CDI (168.008)	66	07/98→02/01	←	→ 01/01		13.0460-2776.2 602776	TRW 23070 17,0 + WE / - WK + Zub
			←			13.0470-2776.2 LD2776	TRW 23070 17,0 + WE / - WK + Zub Ceramic
A 170 CDI (168.009, 168.109)	70	02/01→08/04	←			13.0460-2776.2 602776	TRW 23070 17,0 + WE / - WK + Zub
			→	langer Radstand; Baumuster: 168.109		13.0470-2776.2 LD2776	TRW 23070 17,0 + WE / - WK + Zub Ceramic
A 190 (168.032, 168.132)	92	03/99→08/04	←	05/99→		13.0460-2776.2 602776	TRW 23070 17,0 + WE / - WK + Zub
			→	05/99→		13.0470-2776.2 LD2776	TRW 23070 17,0 + WE / - WK + Zub Ceramic
A 190 (168.032, 168.132)	92	03/99→08/04	←	05/99→		13.0460-2855.2 602855	TRW 23138 14,6 - WE / - WK
			→	05/99→		13.0470-2855.2 LD2855	TRW 23138 14,6 - WE / - WK Ceramic
A 210 (168.035, 168.135)	103	12/01→08/04	→			13.0460-2855.2 602855	TRW 23138 14,6 - WE / - WK
			→			13.0470-2855.2 LD2855	TRW 23138 14,6 - WE / - WK Ceramic
<b>Warnkontakt, Bremsbelagverschleiß</b>							
A 140 (168.031, 168.131)	60	07/97→08/04	←	09/97→; langer Radstand; Baumuster: 168.131	1	24.8190-0401.2 620401	L= 95
			←	09/97→; kurzer Radstand; Baumuster: 168.031	1	24.8190-0401.2 620401	L= 95
A 140 (168.031, 168.131) ↓	60	01/01→08/04	←	langer Radstand; Baumuster: 168.131	1	24.8190-0401.2 620401	L= 95







	kW			 	! #		
<b>MERCEDES-BENZ - A-KLASSE (W168) 07/97→08/05</b>							
<b>Warnkontakt, Bremsbelagverschleiß</b>							
A 140 (168.031, 168.131)	60	01/01→08/04	←	kurzer Radstand; Baumuster: 168.031	1	24.8190-0401.2 620401	L= 95
A 160 (168.033, 168.133)	75	07/97→08/04	←	09/97→	1	24.8190-0401.2 620401	L= 95
			←	05/99→	1	24.8190-0401.2 620401	L= 95
A 160 CDI (168.006) A 170 CDI (168.009, 168.109)	55	02/01→08/04	←		1	24.8190-0401.2 620401	L= 95
	70	02/01→08/04					
A 210 (168.035, 168.135)	103	12/01→08/04					
A 160 CDI (168.007)	44	07/98→02/01	←	08/98→ 01/01	1	24.8190-0401.2 620401	L= 95
A 170 CDI (168.008)	66	07/98→02/01	←	→ 01/01	1	24.8190-0401.2 620401	L= 95
A 190 (168.032, 168.132)	92	03/99→08/04	←	05/99→	1	24.8190-0401.2 620401	L= 95
<b>Zubehörsatz, Scheibenbremsbelag</b>							
A 140 (168.031, 168.131)	60	07/97→08/04	←	09/97→; langer Radstand; Baumuster: 168.131		13.0460-0024.2 610024	
			←	09/97→; kurzer Radstand; Baumuster: 168.031		13.0460-0163.2 610163	TRW
A 140 (168.031, 168.131)	60	01/01→08/04	←	langer Radstand; Baumuster: 168.131		13.0460-0024.2 610024	
			←	kurzer Radstand; Baumuster: 168.031		13.0460-0163.2 610163	TRW
A 160 (168.033, 168.133)	75	07/97→08/04	←	09/97→		13.0460-0024.2 610024	
			→	09/97→; langer Radstand; Baumuster: 168.133		13.0460-0144.2 610144	TRW
A 160 CDI (168.006)	55	02/01→08/04	←			13.0460-0163.2 610163	TRW
A 160 CDI (168.007)	44	07/98→02/01	←	08/98→ 01/01		13.0460-0163.2 610163	TRW
A 170 CDI (168.008)	66	07/98→02/01	←	→ 01/01		13.0460-0024.2 610024	
A 170 CDI (168.009, 168.109)	70	02/01→08/04	←			13.0460-0024.2 610024	
			→	langer Radstand; Baumuster: 168.109		13.0460-0144.2 610144	TRW
A 190 (168.032, 168.132)	92	03/99→08/04	←	05/99→		13.0460-0024.2 610024	
			→	05/99→		13.0460-0144.2 610144	TRW
A 210 (168.035, 168.135)	103	12/01→08/04	→			13.0460-0144.2 610144	TRW
<b> Bremsscheibe</b>							
A 140 (168.031, 168.131)	60	07/97→08/04	←	09/97→; kurzer Radstand; Baumuster: 168.031		24.0112-0144.1 412144	∅ 260 12 10 + S
						24.0312-0144.1 512144	∅ 260 12 10 + S
			←	09/97→; langer Radstand; Baumuster: 168.131		24.0122-0168.1 422168	∅ 260 22 19,4 V + S
A 140 (168.031, 168.131)	60	01/01→08/04	←	kurzer Radstand; Baumuster: 168.031		24.0112-0144.1 412144	∅ 260 12 10 + S
						24.0312-0144.1 512144	∅ 260 12 10 + S
			←	langer Radstand; Baumuster: 168.131		24.0122-0168.1 422168	∅ 260 22 19,4 V + S
A 160 (168.033, 168.133)	75	07/97→08/04	←	09/97→		24.0122-0168.1 422168	∅ 260 22 19,4 V + S
						24.0322-0168.1 522168	∅ 260 22 19,4 V + S
			→	09/97→; langer Radstand; Baumuster: 168.133		24.0108-0111.1 408111	∅ 258 8 7
A 160 CDI (168.006)	55	02/01→08/04	←			24.0112-0144.1 412144	∅ 260 12 10 + S
						24.0312-0144.1 512144	∅ 260 12 10 + S
A 160 CDI (168.007)	44	07/98→02/01	←	08/98→ 01/01		24.0112-0144.1 412144	∅ 260 12 10 + S
A 170 CDI (168.008)	66	07/98→02/01	←	→ 01/01		24.0122-0168.1 422168	∅ 260 22 19,4 V + S
						24.0322-0168.1 522168	∅ 260 22 19,4 V + S
A 170 CDI (168.009, 168.109)	70	02/01→08/04	←			24.0122-0168.1 422168	∅ 260 22 19,4 V + S
			→	langer Radstand; Baumuster: 168.109		24.0108-0111.1 408111	∅ 258 8 7
A 190 (168.032, 168.132)	92	03/99→08/04	←	05/99→		24.0122-0168.1 422168	∅ 260 22 19,4 V + S
						24.0122-0208.1 422208	∅ 276 22 19,4 V
A 210 (168.035, 168.135)	103	12/01→08/04	→			24.0322-0168.1 522168	∅ 260 22 19,4 V + S
			→	05/99→		24.0108-0111.1 408111	∅ 258 8 7
						24.0308-0111.1 508111	∅ 258 8 7













	kw				! #		
<b>MERCEDES-BENZ - A-KLASSE (W168) 07/97→08/05</b>							
<b>Bremsscheibe</b>							
A 210 (168.035, 168.135)	103	12/01→08/04	→			24.0308-0111.1 508111	Ø 258 8 7
<b>MERCEDES-BENZ - A-KLASSE (W169) 09/04→06/12</b>							
<b>Bremsbelagsatz, Scheibenbremse</b>							
A 150 (169.031, 169.331)	70	09/04→06/12	← → 05/12			13.0460-2885.2 602885	TRW 24077 19,1 + WE / - WK + Zub
A 160 (169.031, 169.331)	70	04/09→06/12				13.0470-2885.2 LD2885	TRW 24077 19,1 + WE / - WK + Zub Ceramic
			→ 05/12			13.0460-2712.2 602712	TRW 23138 14,6 - WE / - WK + Zub
						13.0470-2712.2 LD2712	TRW 23138 14,6 - WE / - WK + Zub Ceramic
A 160 CDI (169.006, 169.306)	60	09/04→06/12	← J 215301→; → 05/12; nicht für erhöhte Nutzlast			13.0460-2711.2 602711	TRW 24077 19,1 + WE / - WK + Zub
			← → 05/12; für erhöhte Nutzlast			13.0470-2711.2 LD2711	TRW 24077 19,1 + WE / - WK + Zub Ceramic
			← → J 215300; nicht für erhöhte Nutzlast			13.0460-2885.2 602885	TRW 24077 19,1 + WE / - WK + Zub
			→ 05/12			13.0470-2885.2 LD2885	TRW 24077 19,1 + WE / - WK + Zub Ceramic
			→ 05/12			13.0460-2712.2 602712	TRW 23138 14,6 - WE / - WK + Zub
						13.0470-2712.2 LD2712	TRW 23138 14,6 - WE / - WK + Zub Ceramic
A 170 (169.032, 169.332)	85	09/04→06/12	← → 05/12			13.0460-2711.2 602711	TRW 24077 19,1 + WE / - WK + Zub
A 180 (169.032, 169.332)	85	04/09→06/12				13.0470-2711.2 LD2711	TRW 24077 19,1 + WE / - WK + Zub Ceramic
A 180 CDI (169.007, 169.307)	80	09/04→06/12	→			13.0460-2712.2 602712	TRW 23138 14,6 - WE / - WK + Zub
A 200 (169.033, 169.333)	100	09/04→06/12	→			13.0470-2712.2 LD2712	TRW 23138 14,6 - WE / - WK + Zub Ceramic
A 200 CDI (169.008, 169.308)	103	09/04→06/12	← → 05/12			13.0460-2708.2 602708	TRW 23881 20,0 + WE / - WK + Zub
A 200 CDI (169.308, 169.008)	100	09/04→06/12				13.0470-2708.2 LD2708	TRW 23881 20,0 + WE / - WK + Zub Ceramic
A 200 TURBO (169.034, 169.334)	142	09/05→06/12	→			13.0460-2712.2 602712	TRW 23138 14,6 - WE / - WK + Zub
						13.0470-2712.2 LD2712	TRW 23138 14,6 - WE / - WK + Zub Ceramic
E-CELL (169.090)	50	12/10→06/12	← → 05/12			13.0460-2708.2 602708	TRW 23881 20,0 + WE / - WK + Zub
			→ 05/12			13.0470-2708.2 LD2708	TRW 23881 20,0 + WE / - WK + Zub Ceramic
			→ 05/12			13.0460-2855.2 602855	TRW 23138 14,6 - WE / - WK + Zub
						13.0470-2855.2 LD2855	TRW 23138 14,6 - WE / - WK Ceramic
<b>Warnkontakt, Bremsbelagsverschleiß</b>							
A 150 (169.031, 169.331)	70	09/04→06/12	← → 05/12		1	24.8190-0410.2 620410	L= 97,5
A 160 (169.031, 169.331)	70	04/09→06/12					
A 170 (169.032, 169.332)	85	09/04→06/12					
A 180 (169.032, 169.332)	85	04/09→06/12					
A 180 CDI (169.007, 169.307)	80	09/04→06/12					
A 200 (169.033, 169.333)	100	09/04→06/12					
A 200 CDI (169.008, 169.308)	103	09/04→06/12					
A 200 CDI (169.308, 169.008)	100	09/04→06/12					
A 200 TURBO (169.034, 169.334)	142	09/05→06/12					
E-CELL (169.090)	50	12/10→06/12					
↓							









	kw			 	! #		
<b>MERCEDES-BENZ - A-KLASSE (W169) 09/04→06/12</b>							
<b>Warnkontakt, Bremsbelagverschleiß</b>							
A 160 CDI (169.006, 169.306)	60	09/04→06/12	←	J 215301→; → 05/12; nicht für erhöhte Nutzlast	1	24.8190-0410.2 620410	L= 97,5
			←	→ 05/12; für erhöhte Nutzlast	1	24.8190-0410.2 620410	L= 97,5
			←	→ J 215300; nicht für erhöhte Nutzlast	1	24.8190-0410.2 620410	L= 97,5
<b>Zubehörsatz, Scheibenbremsbelag</b>							
E-CELL (169.090)	50	12/10→06/12	→	→ 05/12		13.0460-0144.2 610144	TRW
<b> Bremsscheibe</b>							
A 150 (169.031, 169.331)	70	09/04→06/12	←	→ 05/12; nicht für erhöhte Nutzlast		24.0112-0167.1 412167	Ø 276 12 10 + S
A 160 (169.031, 169.331)	70	04/09→06/12	←	→ 05/12; für erhöhte Nutzlast		24.0312-0167.1 512167	Ø 276 12 10 + S
A 160 CDI (169.006, 169.306)	60	09/04→06/12	←			24.0122-0232.1 422232	Ø 276 22 19,4 V + S
			→	→ 05/12		24.0322-0232.1 522232	Ø 276 22 19,4 V + S
			→	→ 05/12		24.0108-0113.1 408113	Ø 258 8 7 + S
			→	→ 05/12		24.0308-0113.1 508113	Ø 258 8 7 + S
A 170 (169.032, 169.332)	85	09/04→06/12	←	→ 05/12		24.0122-0232.1 422232	Ø 276 22 19,4 V + S
A 180 (169.032, 169.332)	85	04/09→06/12	→	→ 05/12		24.0322-0232.1 522232	Ø 276 22 19,4 V + S
A 180 CDI (169.007, 169.307)	80	09/04→06/12	→			24.0108-0113.1 408113	Ø 258 8 7 + S
A 200 (169.033, 169.333)	100	09/04→06/12	→			24.0308-0113.1 508113	Ø 258 8 7 + S
A 200 CDI (169.008, 169.308)	103	09/04→06/12	←	→ 05/12		24.0125-0167.1 425167	Ø 288 25 22,4 V + S
A 200 CDI (169.308, 169.008)	100	09/04→06/12	→	→ 05/12		24.0325-0167.1 525167	Ø 288 25 22,4 V + S
A 200 TURBO (169.034, 169.334)	142	09/05→06/12	→			24.0108-0113.1 408113	Ø 258 8 7 + S
E-CELL (169.090)	50	12/10→06/12	→			24.0308-0113.1 508113	Ø 258 8 7 + S
<b>MERCEDES-BENZ - A-KLASSE (W176) 06/12→</b>							
<b> Bremsbelagsatz, Scheibenbremse</b>							
A 160 (176.041)	75	07/15→	←			13.0460-2779.2 602779	TRW 24869 19,3 + WE / - WK
A 200 (176.043)	115	06/12→				13.0470-2779.2 LD2779	TRW 24869 19,3 + WE / - WK
A 200 CDI / d (176.008)	100	02/14→					Ceramic
A 200 CDI / d 4-matic (176.002)	100	02/14→	→	+ eFSB		13.0460-2786.2 602786	TRW 24848 18,3 + WE / - WK + Zub
A 220 4-matic (176.047)	135	05/14→				13.0470-2786.2 LD2786	TRW 24848 18,3 + WE / - WK + Zub Ceramic
A 220 CDI (176.003)	120	01/14→					
A 220 CDI (176.003)	125	09/12→					
A 220 CDI 4-matic (176.005)	125	09/12→					
A 220 d (176.003)	130	07/15→					
A 220 d 4-matic (176.005)	130	07/15→					
A 250 (176.044)	155	06/12→06/15					
A 250 (176.050)	160	07/15→					
A 250 4-matic (176.051)	160	07/15→					
A 160 CDI / d (176.011)	66	06/13→	←	für Fahrzeuge ohne Sportpaket / für Fahrzeuge ohne AMG-Sportpaket		13.0460-2778.2 602778	TRW 25326 19,3 + WE / - WK
A 180 CDI / d (176.012)	80	06/12→				13.0470-2778.2 LD2778	TRW 25326 19,3 + WE / - WK
A 180 CDI (176.000)	80	06/12→	←	für Fahrzeuge mit Sportpaket / für Fahrzeuge mit AMG-Sportpaket		13.0460-2779.2 602779	TRW 24869 19,3 + WE / - WK
			←			13.0470-2779.2 LD2779	TRW 24869 19,3 + WE / - WK
			→	+ eFSB		13.0460-2786.2 602786	TRW 24848 18,3 + WE / - WK + Zub
			→			13.0470-2786.2 LD2786	TRW 24848 18,3 + WE / - WK + Zub Ceramic
A 180 (176.042)	90	06/12→	←	für Stahlfelgen		13.0460-2778.2 602778	TRW 25326 19,3 + WE / - WK
			←	für Leichtmetallfelgen		13.0470-2778.2 LD2778	TRW 25326 19,3 + WE / - WK
			←			13.0460-2779.2 602779	TRW 24869 19,3 + WE / - WK
			←			13.0470-2779.2 LD2779	TRW 24869 19,3 + WE / - WK
			→	+ eFSB		13.0460-2786.2 602786	TRW 24848 18,3 + WE / - WK + Zub
			→			13.0470-2786.2 LD2786	TRW 24848 18,3 + WE / - WK + Zub Ceramic
A 200 CDI (176.001)	100	06/12→	←	→ 02/14		13.0460-2779.2 602779	TRW 24869 19,3 + WE / - WK
						13.0470-2779.2 LD2779	TRW 24869 19,3 + WE / - WK
							Ceramic













	kw				! #		
<b>MERCEDES-BENZ - A-KLASSE (W176) 06/12→</b>							
<b>Bremsbelagsatz, Scheibenbremse</b>							
A 200 CDI (176.001)	100	06/12→	→	→ 02/14; + eFSB		<b>13.0460-2786.2 602786</b> <b>13.0470-2786.2 LD2786</b>	TRW 24848 18,3 + WE / - WK + Zub TRW 24848 18,3 + WE / - WK + Zub Ceramic
A 250 4-matic (176.046)	155	06/12→06/15	←	06/13→		<b>13.0460-2779.2 602779</b> <b>13.0470-2779.2 LD2779</b>	TRW 24869 19,3 + WE / - WK TRW 24869 19,3 + WE / - WK Ceramic
			→	06/13→; + eFSB		<b>13.0460-2786.2 602786</b> <b>13.0470-2786.2 LD2786</b>	TRW 24848 18,3 + WE / - WK + Zub TRW 24848 18,3 + WE / - WK + Zub Ceramic
<b>Warnkontakt, Bremsbelagverschleiß</b>							
A 160 (176.041)	75	07/15→	←		1	<b>24.8190-0067.2 620067</b>	L= 92,5
A 160 CDI / d (176.011)	66	06/13→					
A 180 (176.042)	90	06/12→					
A 180 CDI / d (176.012)	80	06/12→					
A 180 CDI (176.000)	80	06/12→					
A 200 (176.043)	115	06/12→					
A 200 CDI / d (176.008)	100	02/14→					
A 200 CDI / d 4-matic (176.002)	100	02/14→					
A 220 4-matic (176.047)	135	05/14→					
A 220 CDI (176.003)	120	01/14→					
A 220 CDI (176.003)	125	09/12→					
A 220 CDI 4-matic (176.005)	125	09/12→					
A 220 d (176.003)	130	07/15→					
A 220 d 4-matic (176.005)	130	07/15→					
A 250 (176.044)	155	06/12→06/15					
A 250 (176.050)	160	07/15→					
A 250 4-matic (176.051)	160	07/15→					
A 45 AMG 4-matic (176.052)	265	06/13→06/15					
AMG A 45 4-matic (176.052)	280	07/15→					
A 200 CDI (176.001)	100	06/12→	←	→ 02/14	1	<b>24.8190-0067.2 620067</b>	L= 92,5
A 250 4-matic (176.046)	155	06/12→06/15	←	06/13→	1	<b>24.8190-0067.2 620067</b>	L= 92,5
<b>Bremsscheibe</b>							
A 160 (176.041)	75	07/15→	←	für Fahrzeuge mit Sportpaket / für Fahrzeuge mit AMG-Sportpaket		<b>24.0128-0262.1 428262</b>	Ø 295 28 26 V• + S
A 200 (176.043)	115	06/12→					
A 200 CDI / d (176.008)	100	02/14→	←	für Fahrzeuge ohne Sportpaket / für Fahrzeuge ohne AMG-Sportpaket		<b>24.0128-0276.1 428276</b>	Ø 295 28 25,4 V + S
			→	+ eFSB		<b>24.0109-0173.1 409173</b>	Ø 276 9 7,3 + S
A 160 CDI / d (176.011)	66	06/13→	←	für Fahrzeuge ohne Sportpaket / für Fahrzeuge ohne AMG-Sportpaket		<b>24.0125-0200.1 425200</b>	Ø 280 25 22,4 V + S
A 180 CDI / d (176.012)	80	06/12→					
A 180 CDI (176.000)	80	06/12→	←	für Fahrzeuge mit Sportpaket / für Fahrzeuge mit AMG-Sportpaket		<b>24.0128-0262.1 428262</b>	Ø 295 28 26 V• + S
			→	+ eFSB		<b>24.0109-0173.1 409173</b>	Ø 276 9 7,3 + S
A 180 (176.042)	90	06/12→	←	für Fahrzeuge ohne Sportpaket / für Fahrzeuge ohne AMG-Sportpaket; mit Stahlfelge		<b>24.0125-0200.1 425200</b>	Ø 280 25 22,4 V + S
			←	für Fahrzeuge mit Sportpaket / für Fahrzeuge mit AMG-Sportpaket		<b>24.0128-0262.1 428262</b>	Ø 295 28 26 V• + S
			←	für Fahrzeuge ohne Sportpaket / für Fahrzeuge ohne AMG-Sportpaket; mit Leichtmetallfelge		<b>24.0128-0276.1 428276</b>	Ø 295 28 25,4 V + S
			→	+ eFSB		<b>24.0109-0173.1 409173</b>	Ø 276 9 7,3 + S
A 200 CDI / d 4-matic (176.002)	100	02/14→	←	für Fahrzeuge mit Sportpaket / für Fahrzeuge mit AMG-Sportpaket		<b>24.0128-0262.1 428262</b>	Ø 295 28 26 V• + S
			←	für Fahrzeuge ohne Sportpaket / für Fahrzeuge ohne AMG-Sportpaket		<b>24.0128-0276.1 428276</b>	Ø 295 28 25,4 V + S
			→	+ eFSB		<b>24.0110-0382.1 410382</b>	Ø 295 10 8,3 + S
A 200 CDI (176.001)	100	06/12→	←	für Fahrzeuge mit Sportpaket / für Fahrzeuge mit AMG-Sportpaket; → 02/14		<b>24.0128-0262.1 428262</b>	Ø 295 28 26 V• + S
			←	für Fahrzeuge ohne Sportpaket / für Fahrzeuge ohne AMG-Sportpaket; → 02/14		<b>24.0128-0276.1 428276</b>	Ø 295 28 25,4 V + S
			→	+ eFSB		<b>24.0109-0173.1 409173</b>	Ø 276 9 7,3 + S
A 220 4-matic (176.047)	135	05/14→	←	für Fahrzeuge ohne Sportpaket / für Fahrzeuge ohne AMG-Sportpaket		<b>24.0128-0275.1 428275</b>	Ø 295 28 25,4 V + S
↓							











	kw			 	! #		
<b>MERCEDES-BENZ - A-KLASSE (W176) 06/12→</b>							
<b>Bremsscheibe</b>							
A 220 4-matic (176.047)	135	05/14→	←	für Fahrzeuge mit Sportpaket / für Fahrzeuge mit AMG-Sportpaket		24.0130-0238.1 430238	Ø 320 30 28 V• + S
			→	nicht für Ausstattungsvariante: Sport Edition [P84]; + eFSB		24.0110-0382.1 410382	Ø 295 10 8,3 + S
A 220 CDI (176.003)	120	01/14→	←	für Fahrzeuge ohne Sportpaket / für Fahrzeuge ohne AMG-Sportpaket		24.0128-0275.1 428275	Ø 295 28 25,4 V + S
A 220 CDI (176.003)	125	09/12→					
A 220 CDI 4-matic (176.005)	125	09/12→	←	für Fahrzeuge mit Sportpaket / für Fahrzeuge mit AMG-Sportpaket		24.0130-0238.1 430238	Ø 320 30 28 V• + S
A 220 d (176.003)	130	07/15→	→	+ eFSB		24.0110-0382.1 410382	Ø 295 10 8,3 + S
A 220 d 4-matic (176.005)	130	07/15→					
A 250 (176.044)	155	06/12→06/15	←	für Fahrzeuge ohne Sportpaket / für Fahrzeuge ohne AMG-Sportpaket		24.0130-0237.1 430237	Ø 320 30 28 V + S
A 250 (176.050)	160	07/15→	←	für Fahrzeuge mit Sportpaket / für Fahrzeuge mit AMG-Sportpaket		24.0130-0238.1 430238	Ø 320 30 28 V• + S
			→	+ eFSB		24.0110-0382.1 410382	Ø 295 10 8,3 + S
A 250 4-matic (176.046)	155	06/12→06/15	←	06/13→; für Fahrzeuge ohne Sportpaket / für Fahrzeuge ohne AMG-Sportpaket		24.0130-0237.1 430237	Ø 320 30 28 V + S
			←	06/13→; für Fahrzeuge mit Sportpaket / für Fahrzeuge mit AMG-Sportpaket		24.0130-0238.1 430238	Ø 320 30 28 V• + S
			→	06/13→; nicht für Ausstattungsvariante: Sport Edition [P84]; + eFSB		24.0110-0382.1 410382	Ø 295 10 8,3 + S
A 250 4-matic (176.051)	160	07/15→	←	für Fahrzeuge ohne Sportpaket / für Fahrzeuge ohne AMG-Sportpaket		24.0130-0237.1 430237	Ø 320 30 28 V + S
			←	für Fahrzeuge mit Sportpaket / für Fahrzeuge mit AMG-Sportpaket		24.0130-0238.1 430238	Ø 320 30 28 V• + S
			→	nicht für Ausstattungsvariante: Sport Edition [P84]; + eFSB		24.0110-0382.1 410382	Ø 295 10 8,3 + S
A 45 AMG 4-matic (176.052)	265	06/13→06/15	←	+SA 660		24.0128-0262.1 428262	Ø 295 28 26 V• + S
AMG A 45 4-matic (176.052)	280	07/15→					
<b>MERCEDES-BENZ - A-KLASSE (W177) 03/18→</b>							
<b>Warnkontakt, Bremsbelagverschleiß</b>							
A 160 (177.082)	80	06/18→	←		1	24.8190-0067.2 620067	L= 92,5
A 180 (177.084)	100	06/18→					
A 180 d (177.003)	85	03/18→					
A 200 (177.087)	110	06/18→					
A 220 4-matic (177.045)	140	07/18→					
A 250 (177.046)	165	03/18→					
A 250 4-matic (177.047)	165	07/18→					
A 200 (177.087)	120	03/18→	←		2	24.8190-0067.2 620067	L= 92,5
<b>MERCEDES-BENZ - B-KLASSE (W245) 03/05→11/11</b>							
<b>Bremsbelagsatz, Scheibenbremse</b>							
B 150 (245.231)	70	03/05→11/11	←	→ 04/11		13.0460-2711.2 602711	TRW 24077 19,1 + WE / - WK + Zub
B 160 (245.231)	70	04/09→11/11					
B 170 (245.232)	85	03/05→11/11				13.0470-2711.2 LD2711	TRW 24077 19,1 + WE / - WK + Zub Ceramic
B 180 (245.232)	85	04/09→11/11	→	→ 04/11		13.0460-2712.2 602712	TRW 23138 14,6 - WE / - WK + Zub
						13.0470-2712.2 LD2712	TRW 23138 14,6 - WE / - WK + Zub Ceramic
B 170 NGT (245.233)	85	04/08→11/11	←	→ 04/09		13.0460-2708.2 602708	TRW 23881 20,0 + WE / - WK + Zub
						13.0470-2708.2 LD2708	TRW 23881 20,0 + WE / - WK + Zub Ceramic
			→	→ 04/09		13.0460-2712.2 602712	TRW 23138 14,6 - WE / - WK + Zub
						13.0470-2712.2 LD2712	TRW 23138 14,6 - WE / - WK + Zub Ceramic
B 180 CDI (245.207)	80	03/05→11/11	←	→ 04/11		13.0460-2708.2 602708	TRW 23881 20,0 + WE / - WK + Zub
B 200 (245.233)	100	03/05→11/11					
B 200 CDI (245.208)	100	03/05→11/11				13.0470-2708.2 LD2708	TRW 23881 20,0 + WE / - WK + Zub Ceramic
B 200 CDI (245.208)	103	03/05→11/11					
B 200 TURBO (245.234)	142	03/05→11/11	→	→ 04/11		13.0460-2712.2 602712	TRW 23138 14,6 - WE / - WK + Zub
						13.0470-2712.2 LD2712	TRW 23138 14,6 - WE / - WK + Zub Ceramic
↓							







	kw			 	! #		
<b>MERCEDES-BENZ - B-KLASSE (W245) 03/05→11/11</b>							
 <b>Bremsbelagsatz, Scheibenbremse</b>							
B 180 NGT (245.233)	85	04/08→11/11	←	04/09→ 04/11		<b>13.0460-2708.2 602708</b>	TRW 23881 20,0 + WE / - WK + Zub
						<b>13.0470-2708.2 LD2708</b>	TRW 23881 20,0 + WE / - WK + Zub Ceramic
			→	04/09→ 04/11		<b>13.0460-2712.2 602712</b>	TRW 23138 14,6 - WE / - WK + Zub
						<b>13.0470-2712.2 LD2712</b>	TRW 23138 14,6 - WE / - WK + Zub Ceramic
<b>Warnkontakt, Bremsbelagverschleiß</b>							
B 150 (245.231)	70	03/05→11/11	←	→ 04/11	1	<b>24.8190-0410.2 620410</b>	L= 97,5
B 160 (245.231)	70	04/09→11/11					
B 170 (245.232)	85	03/05→11/11					
B 180 (245.232)	85	04/09→11/11					
B 180 CDI (245.207)	80	03/05→11/11					
B 200 (245.233)	100	03/05→11/11					
B 200 CDI (245.208)	100	03/05→11/11					
B 200 CDI (245.208)	103	03/05→11/11					
B 200 TURBO (245.234)	142	03/05→11/11					
B 170 NGT (245.233)	85	04/08→11/11	←	→ 04/09	1	<b>24.8190-0410.2 620410</b>	L= 97,5
B 180 NGT (245.233)	85	04/08→11/11	←	04/09→ 04/11	1	<b>24.8190-0410.2 620410</b>	L= 97,5
 <b>Bremsscheibe</b>							
B 150 (245.231)	70	03/05→11/11	←	→ 04/11		<b>24.0122-0232.1 422232</b>	Ø 276 22 19,4 V + S
B 160 (245.231)	70	04/09→11/11				<b>24.0322-0232.1 522232</b>	Ø 276 22 19,4 V + S
B 170 (245.232)	85	03/05→11/11				<b>24.0108-0113.1 408113</b>	Ø 258 8 7 + S
B 180 (245.232)	85	04/09→11/11	→	→ 04/11		<b>24.0308-0113.1 508113</b>	Ø 258 8 7 + S
B 170 NGT (245.233)	85	04/08→11/11	←	→ 04/09		<b>24.0125-0167.1 425167</b>	Ø 288 25 22,4 V + S
			→	→ 04/09		<b>24.0325-0167.1 525167</b>	Ø 288 25 22,4 V + S
						<b>24.0108-0113.1 408113</b>	Ø 258 8 7 + S
						<b>24.0308-0113.1 508113</b>	Ø 258 8 7 + S
B 180 CDI (245.207)	80	03/05→11/11	←	04/05→ 10/11		<b>24.0125-0167.1 425167</b>	Ø 288 25 22,4 V + S
B 200 (245.233)	100	03/05→11/11				<b>24.0325-0167.1 525167</b>	Ø 288 25 22,4 V + S
B 200 CDI (245.208)	100	03/05→11/11				<b>24.0108-0113.1 408113</b>	Ø 258 8 7 + S
B 200 CDI (245.208)	103	03/05→11/11	→	→ 04/11		<b>24.0308-0113.1 508113</b>	Ø 258 8 7 + S
B 200 TURBO (245.234)	142	03/05→11/11					
B 180 NGT (245.233)	85	04/08→11/11	←	04/09→ 10/11		<b>24.0125-0167.1 425167</b>	Ø 288 25 22,4 V + S
			→	04/09→ 04/11		<b>24.0325-0167.1 525167</b>	Ø 288 25 22,4 V + S
						<b>24.0108-0113.1 408113</b>	Ø 258 8 7 + S
						<b>24.0308-0113.1 508113</b>	Ø 258 8 7 + S
<b>MERCEDES-BENZ - B-KLASSE (W246, W242) 10/11→</b>							
 <b>Bremsbelagsatz, Scheibenbremse</b>							
B 160 (246.241)	75	07/15→	←	für Fahrzeuge ohne Sportpaket		<b>13.0460-2778.2 602778</b>	TRW 25326 19,3 + WE / - WK
B 160 CDI / d (246.211)	66	05/13→				<b>13.0470-2778.2 LD2778</b>	TRW 25326 19,3 + WE / - WK Ceramic
B 180 (246.242)	90	11/11→					
B 180 CDI / d (246.212)	80	02/13→	←	für Fahrzeuge mit Sportpaket; für Taxifahrzeuge		<b>13.0460-2779.2 602779</b>	TRW 24869 19,3 + WE / - WK
B 180 CDI (246.200)	80	11/11→				<b>13.0470-2779.2 LD2779</b>	TRW 24869 19,3 + WE / - WK Ceramic
B 200 CDI (246.201)	100	11/11→	→	+ eFSB		<b>13.0460-2786.2 602786</b>	TRW 24848 18,3 + WE / - WK + Zub
						<b>13.0470-2786.2 LD2786</b>	TRW 24848 18,3 + WE / - WK + Zub Ceramic
B 200 (246.243)	115	11/11→	←			<b>13.0460-2779.2 602779</b>	TRW 24869 19,3 + WE / - WK
B 200 CDI / d (246.208)	100	08/14→				<b>13.0470-2779.2 LD2779</b>	TRW 24869 19,3 + WE / - WK Ceramic
B 200 CDI / d 4-matic (246.202)	100	08/14→					
B 200 Natural Gas Drive / B 200 c (242.848)	115	11/12→	→	+ eFSB		<b>13.0460-2786.2 602786</b>	TRW 24848 18,3 + WE / - WK + Zub
B 220 4-matic (246.247)	135	05/13→				<b>13.0470-2786.2 LD2786</b>	TRW 24848 18,3 + WE / - WK + Zub Ceramic
B 220 CDI / d (246.203)	120	06/13→					
B 220 CDI / d (246.203)	130	09/14→					
B 220 CDI / d 4-matic (246.205)	130	09/14→					
B 250 4-matic (246.246)	155	08/14→					
Electric Drive / B 250 e (242.890)	65	11/14→10/17					
Electric Drive / B 250 e (242.890)	132	11/14→10/17					
B 220 CDI / d (246.203)	125	11/11→	←	12/12→		<b>13.0460-2779.2 602779</b>	TRW 24869 19,3 + WE / - WK
↓							











	kw			 	! #			
<b>MERCEDES-BENZ - B-KLASSE (W246, W242) 10/11→</b>								
<b> Bremsbelagsatz, Scheibenbremse</b>								
B 220 CDI / d (246.203)	125	11/11→	←	12/12→		13.0470-2779.2	LD2779	TRW 24869 19,3 + WE / - WK Ceramic
			→	12/12→; + eFSB		13.0460-2786.2	602786	TRW 24848 18,3 + WE / - WK + Zub
B 250 (246.244)	155	05/12→	←	09/12→		13.0460-2779.2	602779	TRW 24869 19,3 + WE / - WK Ceramic
			→	09/12→; + eFSB		13.0460-2786.2	602786	TRW 24848 18,3 + WE / - WK + Zub
						13.0470-2786.2	LD2786	TRW 24848 18,3 + WE / - WK + Zub Ceramic
<b>Warnkontakt, Bremsbelagverschleiß</b>								
B 160 (246.241)	75	07/15→	←		1	24.8190-0067.2	620067	L= 92,5
B 160 CDI / d (246.211)	66	05/13→						
B 180 (246.242)	90	11/11→						
B 180 CDI / d (246.212)	80	02/13→						
B 180 CDI (246.200)	80	11/11→						
B 200 (246.243)	115	11/11→						
B 200 CDI / d (246.208)	100	08/14→						
B 200 CDI / d 4-matic (246.202)	100	08/14→						
B 200 CDI (246.201)	100	11/11→						
B 200 Natural Gas Drive / B 200 c (242.848)	115	11/12→						
B 220 4-matic (246.247)	135	05/13→						
B 220 CDI / d (246.203)	120	06/13→						
B 220 CDI / d (246.203)	130	09/14→						
B 220 CDI / d 4-matic (246.205)	130	09/14→						
B 250 4-matic (246.246)	155	08/14→						
Electric Drive / B 250 e (242.890)	65	11/14→10/17						
Electric Drive / B 250 e (242.890)	132	11/14→10/17						
B 220 CDI / d (246.203)	125	11/11→	←	12/12→	1	24.8190-0067.2	620067	L= 92,5
B 250 (246.244)	155	05/12→	←	09/12→	1	24.8190-0067.2	620067	L= 92,5
<b> Bremsscheibe</b>								
B 160 (246.241)	75	07/15→	←	für Fahrzeuge ohne Sportpaket		24.0125-0200.1	425200	Ø 280 25 22,4 V + S
B 160 CDI / d (246.211)	66	05/13→				24.0128-0276.1	428276	Ø 295 28 25,4 V + S
B 180 (246.242)	90	11/11→						
B 180 CDI / d (246.212)	80	02/13→	←	für Fahrzeuge mit Sportpaket		24.0128-0262.1	428262	Ø 295 28 26 V• + S
B 180 CDI (246.200)	80	11/11→	→	+ eFSB; nicht für Taxifahrzeuge		24.0109-0173.1	409173	Ø 276 9 7,3 + S
			→	für Taxifahrzeuge; + eFSB		24.0110-0382.1	410382	Ø 295 10 8,3 + S
B 200 (246.243)	115	11/11→	←	für Fahrzeuge mit Sportpaket; nicht für Taxifahrzeuge		24.0128-0262.1	428262	Ø 295 28 26 V• + S
B 200 CDI (246.201)	100	11/11→						
B 200 Natural Gas Drive / B 200 c (242.848)	115	11/12→	←	für Taxifahrzeuge		24.0128-0275.1	428275	Ø 295 28 25,4 V + S
			←	für Fahrzeuge ohne Sportpaket; nicht für Taxifahrzeuge		24.0128-0276.1	428276	Ø 295 28 25,4 V + S
			→	+ eFSB; nicht für Taxifahrzeuge		24.0109-0173.1	409173	Ø 276 9 7,3 + S
			→	für Taxifahrzeuge; + eFSB		24.0110-0382.1	410382	Ø 295 10 8,3 + S
B 200 CDI / d (246.208)	100	08/14→	←	für Fahrzeuge mit Sportpaket; nicht für Taxifahrzeuge		24.0128-0262.1	428262	Ø 295 28 26 V• + S
B 200 CDI / d 4-matic (246.202)	100	08/14→	←	für Taxifahrzeuge		24.0128-0275.1	428275	Ø 295 28 25,4 V + S
			←	für Fahrzeuge ohne Sportpaket; nicht für Taxifahrzeuge		24.0128-0276.1	428276	Ø 295 28 25,4 V + S
			→	+ eFSB		24.0110-0382.1	410382	Ø 295 10 8,3 + S
B 220 4-matic (246.247)	135	05/13→	←	für Fahrzeuge ohne Sportpaket		24.0128-0275.1	428275	Ø 295 28 25,4 V + S
B 220 CDI / d (246.203)	120	06/13→						
B 220 CDI / d (246.203)	130	09/14→	←	für Fahrzeuge mit Sportpaket		24.0130-0238.1	430238	Ø 320 30 28 V• + S
B 220 CDI / d 4-matic (246.205)	130	09/14→	→	+ eFSB		24.0110-0382.1	410382	Ø 295 10 8,3 + S
B 220 CDI / d (246.203)	125	11/11→	←	12/12→; für Fahrzeuge ohne Sportpaket		24.0128-0275.1	428275	Ø 295 28 25,4 V + S
			←	12/12→; für Fahrzeuge mit Sportpaket		24.0130-0238.1	430238	Ø 320 30 28 V• + S
			→	12/12→; + eFSB		24.0110-0382.1	410382	Ø 295 10 8,3 + S
B 250 (246.244)	155	05/12→	←	09/12→; für Fahrzeuge ohne Sportpaket		24.0130-0237.1	430237	Ø 320 30 28 V + S
			←	09/12→; für Fahrzeuge mit Sportpaket		24.0130-0238.1	430238	Ø 320 30 28 V• + S
↓								

	kw					! #		
<b>MERCEDES-BENZ - B-KLASSE (W246, W242) 10/11→</b>								
 <b>Bremsscheibe</b>								
B 250 (246.244)	155	05/12→	➔	09/12→; + eFSB		24.0110-0382.1	410382	Ø 295 10 8,3 + S
B 250 4-matic (246.246)	155	08/14→	➔	für Fahrzeuge ohne Sportpaket		24.0130-0237.1	430237	Ø 320 30 28 V + S
			➔	für Fahrzeuge mit Sportpaket		24.0130-0238.1	430238	Ø 320 30 28 V• + S
			➔	+ eFSB		24.0110-0382.1	410382	Ø 295 10 8,3 + S
Electric Drive / B 250 e (242.890)	65	11/14→10/17	➔	für Fahrzeuge mit Sportpaket		24.0128-0262.1	428262	Ø 295 28 26 V• + S
Electric Drive / B 250 e (242.890)	132	11/14→10/17	➔	für Fahrzeuge ohne Sportpaket		24.0128-0275.1	428275	Ø 295 28 25,4 V + S
			➔	+ eFSB		24.0110-0382.1	410382	Ø 295 10 8,3 + S
<b>MERCEDES-BENZ - CITAN Kasten (415) 11/12→</b>								
 <b>Bremsbelagsatz, Scheibenbremse</b>								
108 CDI (415.601, 415.603)	55	11/12→	➔	passend für Felgengröße [Zoll]: 14		13.0460-2709.2	602709	TRW 23973 17,1 - WE / - WK + Zub
109 CDI (415.601, 415.603, 415.605)	66	11/12→				13.0470-2709.2	LD2709	TRW 23973 17,1 - WE / - WK + Zub Ceramic
111 CDI (415.603, 415.605)	81	06/13→	➔	passend für Felgengröße [Zoll]: 15 / 16		13.0460-2742.2	602742	TRW 24693 17,5 - WE / - WK + Zub
112 (415.603)	84	06/13→	➔	passend für Felgengröße [Zoll]: 15 / 16		13.0460-2744.2	602744	TRW 24692 15,9 - WE / - WK + Zub
 <b>Bremsscheibe</b>								
108 CDI (415.601, 415.603)	55	11/12→	➔	passend für Felgengröße [Zoll]: 14		24.0122-0270.1	422270	Ø 258 22 19,8 V + S
109 CDI (415.601, 415.603, 415.605)	66	11/12→	➔	02/13→; + RUS / + RO / + TR / + SKA; passend für Felgengröße [Zoll]: 15 / 16		24.0124-0222.1	424222	Ø 280 24 21,8 V + S
			➔	passend für Felgengröße [Zoll]: 15 / 16		24.0124-0222.1	424222	Ø 280 24 21,8 V + S
			➔	→ 01/13; + RUS / + RO / + TR / + SKA; passend für Felgengröße [Zoll]: 15 / 16		24.0126-0180.1	426180	Ø 280 26 23,8 V + S
			➔	passend für Felgengröße [Zoll]: 15 / 16		24.0111-0182.2	411182	Ø 274 11 9,5 + LG / + ABS Ring
111 CDI (415.603, 415.605)	81	06/13→	➔	passend für Felgengröße [Zoll]: 14		24.0122-0270.1	422270	Ø 258 22 19,8 V + S
112 (415.603)	84	06/13→	➔	+ RUS / + RO / + TR / + SKA; passend für Felgengröße [Zoll]: 15 / 16		24.0124-0222.1	424222	Ø 280 24 21,8 V + S
			➔	passend für Felgengröße [Zoll]: 15 / 16		24.0124-0222.1	424222	Ø 280 24 21,8 V + S
			➔	passend für Felgengröße [Zoll]: 15 / 16		24.0111-0182.2	411182	Ø 274 11 9,5 + LG / + ABS Ring
<b>MERCEDES-BENZ - CITAN Kombi / Tourer (415) 11/12→</b>								
 <b>Bremsbelagsatz, Scheibenbremse</b>								
108 CDI (415.703)	55	11/12→	➔	passend für Felgengröße [Zoll]: 14		13.0460-2709.2	602709	TRW 23973 17,1 - WE / - WK + Zub
109 CDI (415.703)	66	11/12→				13.0470-2709.2	LD2709	TRW 23973 17,1 - WE / - WK + Zub Ceramic
111 CDI (415.703)	81	06/13→	➔	passend für Felgengröße [Zoll]: 15 / 16		13.0460-2742.2	602742	TRW 24693 17,5 - WE / - WK + Zub
112 (415.703)	84	06/13→	➔	passend für Felgengröße [Zoll]: 15 / 16		13.0460-2744.2	602744	TRW 24692 15,9 - WE / - WK + Zub
 <b>Bremsscheibe</b>								
108 CDI (415.703)	55	11/12→	➔	passend für Felgengröße [Zoll]: 14		24.0122-0270.1	422270	Ø 258 22 19,8 V + S
109 CDI (415.703)	66	11/12→	➔	02/13→; + RUS / + RO / + TR / + SKA; passend für Felgengröße [Zoll]: 15 / 16		24.0124-0222.1	424222	Ø 280 24 21,8 V + S
			➔	passend für Felgengröße [Zoll]: 15 / 16		24.0124-0222.1	424222	Ø 280 24 21,8 V + S
			➔	→ 01/13; + RUS / + RO / + TR / + SKA; passend für Felgengröße [Zoll]: 15 / 16		24.0126-0180.1	426180	Ø 280 26 23,8 V + S
			➔	passend für Felgengröße [Zoll]: 15 / 16		24.0111-0182.2	411182	Ø 274 11 9,5 + LG / + ABS Ring
111 CDI (415.703)	81	06/13→	➔	passend für Felgengröße [Zoll]: 14		24.0122-0270.1	422270	Ø 258 22 19,8 V + S
112 (415.703)	84	06/13→	➔	+ RUS / + RO / + TR / + SKA; passend für Felgengröße [Zoll]: 15 / 16		24.0124-0222.1	424222	Ø 280 24 21,8 V + S
			➔	passend für Felgengröße [Zoll]: 15 / 16		24.0124-0222.1	424222	Ø 280 24 21,8 V + S
			➔	passend für Felgengröße [Zoll]: 15 / 16		24.0111-0182.2	411182	Ø 274 11 9,5 + LG / + ABS Ring
<b>MERCEDES-BENZ - CITAN Mixto (415) 11/12→</b>								
 <b>Bremsbelagsatz, Scheibenbremse</b>								
109 CDI	66	11/12→	➔	passend für Felgengröße [Zoll]: 14		13.0460-2709.2	602709	TRW 23973 17,1 - WE / - WK + Zub
111 CDI (415.601, 415.603, 415.605)	81	06/13→						









	kw			 	! #		
<b>MERCEDES-BENZ - CITAN Mixto (415) 11/12→</b>							
 <b>Bremsbelagsatz, Scheibenbremse</b>							
109 CDI 111 CDI (415.601, 415.603, 415.605)	66 81	11/12→ 06/13→	←	passend für Felgengröße [Zoll]: 14		<b>13.0470-2709.2</b> <b>LD2709</b>	TRW 23973 17,1 - WE / - WK + Zub Ceramic
			←	passend für Felgengröße [Zoll]: 15 / 16		<b>13.0460-2742.2</b> <b>602742</b>	TRW 24693 17,5 - WE / - WK + Zub
			→	passend für Felgengröße [Zoll]: 15 / 16		<b>13.0460-2744.2</b> <b>602744</b>	TRW 24692 15,9 - WE / - WK + Zub
 <b>Bremsscheibe</b>							
109 CDI	66	11/12→	←	passend für Felgengröße [Zoll]: 14		<b>24.0122-0270.1</b> <b>422270</b>	Ø 258 22 19,8 V + S
			←	02/13→; + RUS / + RO / + TR / + SKA; passend für Felgengröße [Zoll]: 15 / 16		<b>24.0124-0222.1</b> <b>424222</b>	Ø 280 24 21,8 V + S
			←	passend für Felgengröße [Zoll]: 15 / 16		<b>24.0124-0222.1</b> <b>424222</b>	Ø 280 24 21,8 V + S
			←	→ 01/13; + RUS / + RO / + TR / + SKA; passend für Felgengröße [Zoll]: 15 / 16		<b>24.0126-0180.1</b> <b>426180</b>	Ø 280 26 23,8 V + S
			→	passend für Felgengröße [Zoll]: 15 / 16		<b>24.0111-0182.2</b> <b>411182</b>	Ø 274 11 9,5 + LG / + ABS Ring
111 CDI (415.601, 415.603, 415.605)	81	06/13→	←	passend für Felgengröße [Zoll]: 14		<b>24.0122-0270.1</b> <b>422270</b>	Ø 258 22 19,8 V + S
			←	+ RUS / + RO / + TR / + SKA; passend für Felgengröße [Zoll]: 15 / 16		<b>24.0124-0222.1</b> <b>424222</b>	Ø 280 24 21,8 V + S
			←	passend für Felgengröße [Zoll]: 15 / 16		<b>24.0124-0222.1</b> <b>424222</b>	Ø 280 24 21,8 V + S
			→	passend für Felgengröße [Zoll]: 15 / 16		<b>24.0111-0182.2</b> <b>411182</b>	Ø 274 11 9,5 + LG / + ABS Ring
<b>MERCEDES-BENZ - C-KLASSE (W202) 03/93→05/00</b>							
 <b>Bremsbelagsatz, Scheibenbremse</b>							
C 180 (202.018)	89	11/94→05/00	←			<b>13.0460-2975.2</b> <b>602975</b>	TRW 21439 20,3 + WE / - WK
C 180 (202.018)	90	03/93→05/00				<b>13.0470-2975.2</b> <b>LD2975</b>	TRW 21439 20,3 + WE / - WK Ceramic
C 200 (202.020)	100	01/94→05/00					
C 200 D (202.120)	55	03/93→05/00					
C 200 D (202.122)	65	10/96→05/00	→	→ A419828 / F443892		<b>13.0460-4034.2</b> <b>604034</b>	ATE 20687 15,5 - WE / - WK
C 220 D (202.021)	55	07/96→05/00	→	A419829 / F443893→		<b>13.0460-4060.2</b> <b>604060</b>	ATE 21900 15,0 - WK
C 220 D (202.121)	70	08/93→05/00					
C 200 CDI (202.134)	75	03/98→05/00	←			<b>13.0460-2975.2</b> <b>602975</b>	TRW 21439 20,3 + WE / - WK
C 220 CDI (202.133)	92	09/97→05/00				<b>13.0470-2975.2</b> <b>LD2975</b>	TRW 21439 20,3 + WE / - WK Ceramic
			→			<b>13.0460-4060.2</b> <b>604060</b>	ATE 21900 15,0 - WK
C 200 Kompressor (202.025)	132	10/95→05/00	←			<b>13.0460-7086.2</b> <b>607086</b>	ATE 21664 19,8 + WE / - WK
C 200 Kompressor (202.025)	141	11/96→05/00				<b>13.0470-7086.2</b> <b>LD7086</b>	ATE 21664 19,8 + WE / - WK Ceramic
C 230 Kompressor (202.024)	142	10/95→05/00	→	→ A487047 / F576240		<b>13.0460-3805.2</b> <b>603805</b>	ATE 21197 15,0 + WE / - WK
C 240 (202.026)	125	06/97→05/00				<b>13.0470-3805.2</b> <b>LD3805</b>	ATE 21197 15,0 + WE / - WK Ceramic
C 250 Turbo-D (202.128)	110	10/95→05/00	→	A487048 / F576241→		<b>13.0460-4064.2</b> <b>604064</b>	ATE 21919 15,3 - WE / - WK + Zub
						<b>13.0470-4064.2</b> <b>LD4064</b>	ATE 21919 15,3 - WE / - WK + Zub Ceramic
C 220 (202.022)	110	03/93→05/00	←	→ 08/96		<b>13.0460-2975.2</b> <b>602975</b>	TRW 21439 20,3 + WE / - WK
			→	→ A419828 / F443892		<b>13.0470-2975.2</b> <b>LD2975</b>	TRW 21439 20,3 + WE / - WK Ceramic
			→	A419829 / F443893→; → 08/96		<b>13.0460-4060.2</b> <b>604060</b>	ATE 21900 15,0 - WK
C 230 (202.023)	110	06/96→06/97	←	07/96→		<b>13.0460-2975.2</b> <b>602975</b>	TRW 21439 20,3 + WE / - WK
						<b>13.0470-2975.2</b> <b>LD2975</b>	TRW 21439 20,3 + WE / - WK Ceramic
			→	07/96→		<b>13.0460-4060.2</b> <b>604060</b>	ATE 21900 15,0 - WK
C 250 D (202.125)	83	05/93→05/00	←	06/93→ 08/95		<b>13.0460-2975.2</b> <b>602975</b>	TRW 21439 20,3 + WE / - WK
						<b>13.0470-2975.2</b> <b>LD2975</b>	TRW 21439 20,3 + WE / - WK Ceramic
			→	06/93→; → A419828 / F443892		<b>13.0460-4034.2</b> <b>604034</b>	ATE 20687 15,5 - WE / - WK
			→	A419829 / F443893→; → 08/95		<b>13.0460-4060.2</b> <b>604060</b>	ATE 21900 15,0 - WK
C 280 (202.028)	142	05/93→05/00	←	06/93→; → A344660 / F331440		<b>13.0460-2975.2</b> <b>602975</b>	TRW 21439 20,3 + WE / - WK
						<b>13.0470-2975.2</b> <b>LD2975</b>	TRW 21439 20,3 + WE / - WK Ceramic
			←	A344661 / F331441→		<b>13.0460-7086.2</b> <b>607086</b>	ATE 21664 19,8 + WE / - WK
						<b>13.0470-7086.2</b> <b>LD7086</b>	ATE 21664 19,8 + WE / - WK Ceramic
			→	06/93→ 05/97; + ASR / + ETS		<b>13.0460-3504.2</b> <b>603504</b>	ATE 21301 15,5 + WE / - WK
↓							

	kw			 	! #		
<b>MERCEDES-BENZ - C-KLASSE (W202) 03/93→05/00</b>							
<b>Bremsbelagsatz, Scheibenbremse</b>							
C 280 (202.028)	142	05/93→05/00	➡	A344661 / F331441→; → 05/97; - ASR / - ETS		<b>13.0460-3805.2 603805</b> <b>13.0470-3805.2 LD3805</b>	ATE 21197 15,0 + WE / - WK ATE 21197 15,0 + WE / - WK Ceramic
			➡	06/93→; → A344660 / F331440; - ASR / - ETS		<b>13.0460-4034.2 604034</b>	ATE 20687 15,5 - WE / - WK
C 280 (202.029)	145	06/97→05/00	←	→ A344660 / F331440		<b>13.0460-2975.2 602975</b> <b>13.0470-2975.2 LD2975</b>	TRW 21439 20,3 + WE / - WK TRW 21439 20,3 + WE / - WK Ceramic
			←	A344661 / F331441→		<b>13.0460-7086.2 607086</b> <b>13.0470-7086.2 LD7086</b>	ATE 21664 19,8 + WE / - WK ATE 21664 19,8 + WE / - WK Ceramic
			➡	→ A487047 / F576240		<b>13.0460-3805.2 603805</b> <b>13.0470-3805.2 LD3805</b>	ATE 21197 15,0 + WE / - WK ATE 21197 15,0 + WE / - WK Ceramic
			➡	A487048 / F576241→		<b>13.0460-4064.2 604064</b> <b>13.0470-4064.2 LD4064</b>	ATE 21919 15,3 - WE / - WK + Zub ATE 21919 15,3 - WE / - WK + Zub Ceramic
C 36 AMG (202.028)	206	05/94→05/00	←	→ 08/97		<b>13.0460-4201.2 604201</b>	ATE 21153 17,5 + WE / - WK
			➡	→ A344660 / F331440		<b>13.0460-3805.2 603805</b> <b>13.0470-3805.2 LD3805</b>	ATE 21197 15,0 + WE / - WK ATE 21197 15,0 + WE / - WK Ceramic
			➡	→ 08/97; A344661 / F331441→		<b>13.0460-4047.2 604047</b> <b>13.0470-4047.2 LD4047</b>	ATE 21305 15,7 + WE / - WK ATE 21305 15,7 + WE / - WK Ceramic
C 43 AMG (202.033)	225	08/97→05/00	←	09/97→		<b>13.0460-7183.2 607183</b>	ATE 21484 20,5 + WE / - WK
			➡	09/97→		<b>13.0460-4047.2 604047</b> <b>13.0470-4047.2 LD4047</b>	ATE 21305 15,7 + WE / - WK ATE 21305 15,7 + WE / - WK Ceramic
<b>Warnkontakt, Bremsbelagsverschleiß</b>							
C 180 (202.018)	89	11/94→05/00	←		2	<b>24.8190-0401.2 620401</b>	L= 95
C 180 (202.018)	90	03/93→05/00					
C 200 (202.020)	100	01/94→05/00					
C 200 CDI (202.134)	75	03/98→05/00					
C 200 D (202.120)	55	03/93→05/00					
C 200 D (202.122)	65	10/96→05/00					
C 220 CDI (202.133)	92	09/97→05/00					
C 220 D (202.021)	55	07/96→05/00					
C 220 D (202.121)	70	08/93→05/00					
C 200 Kompressor (202.025)	132	10/95→05/00	←		2	<b>24.8190-0401.2 620401</b>	L= 95
C 200 Kompressor (202.025)	141	11/96→05/00	➡	→ A487047 / F576240	1	<b>24.8190-0401.2 620401</b>	L= 95
C 230 Kompressor (202.024)	142	10/95→05/00					
C 240 (202.026)	125	06/97→05/00					
C 250 Turbo-D (202.128)	110	10/95→05/00					
C 220 (202.022)	110	03/93→05/00	←	→ 08/96	2	<b>24.8190-0401.2 620401</b>	L= 95
C 230 (202.023)	110	06/96→06/97	←	07/96→	2	<b>24.8190-0401.2 620401</b>	L= 95
C 250 D (202.125)	83	05/93→05/00	←	06/93→ 08/95	2	<b>24.8190-0401.2 620401</b>	L= 95
C 280 (202.028)	142	05/93→05/00	←	A344661 / F331441→	2	<b>24.8190-0401.2 620401</b>	L= 95
			←	06/93→; → A344660 / F331440	2	<b>24.8190-0401.2 620401</b>	L= 95
			➡	A344661 / F331441→; → 05/97; - ASR / - ETS	1	<b>24.8190-0401.2 620401</b>	L= 95
			➡	06/93→ 05/97; + ASR / + ETS	1	<b>24.8190-0401.2 620401</b>	L= 95
C 280 (202.029)	145	06/97→05/00	←	→ A344660 / F331440	2	<b>24.8190-0401.2 620401</b>	L= 95
			←	A344661 / F331441→	2	<b>24.8190-0401.2 620401</b>	L= 95
			➡	→ A487047 / F576240	1	<b>24.8190-0401.2 620401</b>	L= 95
C 36 AMG (202.028)	206	05/94→05/00	←	→ 08/97	2	<b>24.8190-0401.2 620401</b>	L= 95
			➡	→ 08/97; A344661 / F331441→	1	<b>24.8190-0401.2 620401</b>	L= 95
			➡	→ A344660 / F331440	1	<b>24.8190-0401.2 620401</b>	L= 95
C 43 AMG (202.033)	225	08/97→05/00	←	09/97→	2	<b>24.8190-0419.2 620419</b>	L= 74
			➡	09/97→	1	<b>24.8190-0401.2 620401</b>	L= 95
<b>Zubehörsatz, Scheibenbremsbelag</b>							
C 180 (202.018)	89	11/94→05/00	➡	→ A419828 / F443892		<b>13.0460-0186.2 610186</b>	ATE
↓							



















	kW			 	! #		
<b>MERCEDES-BENZ - C-KLASSE (W202) 03/93→05/00</b>							
<b>Zubehörsatz, Scheibenbremsbelag</b>							
C 180 (202.018)	90	03/93→05/00	➔	A419829 / F443893→		13.0460-0229.2 610229	ATE
C 200 (202.020)	100	01/94→05/00					
C 200 D (202.120)	55	03/93→05/00					
C 200 D (202.122)	65	10/96→05/00					
C 220 D (202.021)	55	07/96→05/00					
C 220 D (202.121)	70	08/93→05/00					
C 200 CDI (202.134)	75	03/98→05/00	➔			13.0460-0229.2 610229	ATE
C 220 CDI (202.133)	92	09/97→05/00					
C 200 Kompressor (202.025)	132	10/95→05/00	➔	A487048 / F576241→		13.0460-0229.2 610229	ATE
C 200 Kompressor (202.025)	141	11/96→05/00					
C 230 Kompressor (202.024)	142	10/95→05/00					
C 240 (202.026)	125	06/97→05/00					
C 250 Turbo-D (202.128)	110	10/95→05/00					
C 280 (202.029)	145	06/97→05/00					
C 220 (202.022)	110	03/93→05/00	➔	→ A419828 / F443892		13.0460-0186.2 610186	ATE
			➔	A419829 / F443893→; → 08/96		13.0460-0229.2 610229	ATE
C 230 (202.023)	110	06/96→06/97	➔	07/96→		13.0460-0229.2 610229	ATE
C 250 D (202.125)	83	05/93→05/00	➔	06/93→; → A419828 / F443892		13.0460-0186.2 610186	ATE
			➔	A419829 / F443893→; → 08/95		13.0460-0229.2 610229	ATE
C 280 (202.028)	142	05/93→05/00	➔	06/93→; → A344660 / F331440; - ASR / - ETS		13.0460-0186.2 610186	ATE
C 36 AMG (202.028)	206	05/94→05/00	➔	→ 08/97; A344661 / F331441→		13.0460-0236.2 610236	ATE
C 43 AMG (202.033)	225	08/97→05/00	➔	09/97→		13.0460-0236.2 610236	ATE
<b> Bremsscheibe</b>							
C 180 (202.018)	89	11/94→05/00	←			24.0112-0128.1 412128	Ø 284 12 10 + S
C 180 (202.018)	90	03/93→05/00					
C 200 D (202.120)	55	03/93→05/00	➔			24.0109-0120.1 409120	Ø 258 9 7,3 + S
C 200 D (202.122)	65	10/96→05/00				24.0309-0120.1 509120	Ø 258 9 7,3 + S
C 220 D (202.021)	55	07/96→05/00					
C 220 D (202.121)	70	08/93→05/00					
C 200 (202.020)	100	01/94→05/00	←			24.0122-0132.1 422132	Ø 284 22 19,4 V + S
C 200 CDI (202.134)	75	03/98→05/00				24.0322-0132.1 522132	Ø 284 22 19,4 V + S
C 220 CDI (202.133)	92	09/97→05/00					
			➔			24.0109-0120.1 409120	Ø 258 9 7,3 + S
						24.0309-0120.1 509120	Ø 258 9 7,3 + S
C 200 Kompressor (202.025)	132	10/95→05/00	←			24.0125-0110.1 425110	Ø 288 25 22,4 V + S
C 200 Kompressor (202.025)	141	11/96→05/00				24.0325-0110.1 525110	Ø 288 25 22,4 V + S
C 230 Kompressor (202.024)	142	10/95→05/00	➔			24.0109-0114.1 409114	Ø 278 9 7,3 + S
C 240 (202.026)	125	06/97→05/00				24.0309-0114.1 509114	Ø 278 9 7,3 + S
C 250 Turbo-D (202.128)	110	10/95→05/00					
C 220 (202.022)	110	03/93→05/00	←	→ 08/96		24.0122-0132.1 422132	Ø 284 22 19,4 V + S
						24.0322-0132.1 522132	Ø 284 22 19,4 V + S
			➔	→ 08/96		24.0109-0120.1 409120	Ø 258 9 7,3 + S
						24.0309-0120.1 509120	Ø 258 9 7,3 + S
C 230 (202.023)	110	06/96→06/97	←	A545906 / F647651→		24.0112-0128.1 412128	Ø 284 12 10 + S
			←	07/96→; → A545905 / F647650		24.0122-0132.1 422132	Ø 284 22 19,4 V + S
						24.0322-0132.1 522132	Ø 284 22 19,4 V + S
			➔	07/96→		24.0109-0120.1 409120	Ø 258 9 7,3 + S
						24.0309-0120.1 509120	Ø 258 9 7,3 + S
C 250 D (202.125)	83	05/93→05/00	←	06/93→ 08/95		24.0112-0128.1 412128	Ø 284 12 10 + S
			➔	06/93→ 08/95		24.0109-0120.1 409120	Ø 258 9 7,3 + S
						24.0309-0120.1 509120	Ø 258 9 7,3 + S
C 280 (202.028)	142	05/93→05/00	←	06/93→; → A344660 / F331440		24.0122-0132.1 422132	Ø 284 22 19,4 V + S
						24.0322-0132.1 522132	Ø 284 22 19,4 V + S
			←	A344661 / F331441→		24.0125-0110.1 425110	Ø 288 25 22,4 V + S
						24.0325-0110.1 525110	Ø 288 25 22,4 V + S
			➔	A344661 / F331441→; → 05/97		24.0109-0114.1 409114	Ø 278 9 7,3 + S
						24.0309-0114.1 509114	Ø 278 9 7,3 + S
			➔	06/93→; → A344660 / F331440		24.0109-0120.1 409120	Ø 258 9 7,3 + S
						24.0309-0120.1 509120	Ø 258 9 7,3 + S
C 280 (202.029)	145	06/97→05/00	←	→ A344660 / F331440		24.0122-0132.1 422132	Ø 284 22 19,4 V + S
						24.0322-0132.1 522132	Ø 284 22 19,4 V + S
↓							









	kw			 	! #		
<b>MERCEDES-BENZ - C-KLASSE (W202) 03/93→05/00</b>							
 <b>Bremsscheibe</b>							
C 280 (202.029)	145	06/97→05/00	←	A344661 / F331441→		24.0125-0110.1 425110	Ø 288 25 22,4 V + S
						24.0325-0110.1 525110	Ø 288 25 22,4 V + S
			→			24.0109-0114.1 409114	Ø 278 9 7,3 + S
						24.0309-0114.1 509114	Ø 278 9 7,3 + S
C 36 AMG (202.028)	206	05/94→05/00	←	→ 08/97; A344661 / F331441→		24.0128-0126.1 428126	Ø 316 28 25,4 V
			→	→ 08/97; A344661 / F331441→		24.0110-0217.1 410217	Ø 290 10 8,3 + S
						24.0310-0217.1 510217	Ø 290 10 8,3 + S
			→	→ A344660 / F331440		24.0124-0188.1 424188	Ø 278 24 21,4 V
C 43 AMG (202.033)	225	08/97→05/00	→	09/97→		24.0122-0228.1 422228	Ø 300 22 19,4 V
<b>MERCEDES-BENZ - C-KLASSE (W203) 05/00→12/07</b>							
 <b>Bremsbelagsatz, Scheibenbremse</b>							
C 180 (203.035)	95	10/00→05/02	←			13.0460-2726.2 602726	TRW 23144 19,8 + WE / - WK + Zub
						13.0470-2726.2 LD2726	TRW 23144 19,8 + WE / - WK + Zub Ceramic
			→			13.0460-4064.2 604064	ATE 21919 15,3 - WE / - WK + Zub
						13.0470-4064.2 LD4064	ATE 21919 15,3 - WE / - WK + Zub Ceramic
C 180 Kompressor (203.046)	105	05/02→02/07	←	für Fahrzeuge ohne Sportpaket / für Fahrzeuge ohne AMG-Sportpaket		13.0460-2726.2 602726	TRW 23144 19,8 + WE / - WK + Zub
C 200 CDI (203.007)	90	04/03→02/07				13.0470-2726.2 LD2726	TRW 23144 19,8 + WE / - WK + Zub Ceramic
C 200 CGI Kompressor (203.043)	125	07/03→02/07					
C 200 Kompressor (203.042)	120	05/02→02/07	←	→ A 660226 / F 565688; für Fahrzeuge mit Sportpaket / für Fahrzeuge mit AMG-Sportpaket		13.0460-4990.2 604990	BRE 23271 17,4 + WE / - WK Ceramic
			←	A 660227 / F 565689→; für Fahrzeuge mit Sportpaket / für Fahrzeuge mit AMG-Sportpaket		13.0460-4994.2 604994	BRE 23945 16,5 + WE / - WK Ceramic
			→	für Fahrzeuge ohne Sportpaket / für Fahrzeuge ohne AMG-Sportpaket		13.0460-4064.2 604064	ATE 21919 15,3 - WE / - WK + Zub
						13.0470-4064.2 LD4064	ATE 21919 15,3 - WE / - WK + Zub Ceramic
			→	für Fahrzeuge mit Sportpaket / für Fahrzeuge mit AMG-Sportpaket		13.0460-4065.2 604065	ATE 21899 15,3 + WE / - WK + Zub
						13.0470-4065.2 LD4065	ATE 21899 15,3 + WE / - WK + Zub Ceramic
C 200 CDI (203.004)	75	02/01→02/07	←	für Fahrzeuge ohne Sportpaket / für Fahrzeuge ohne AMG-Sportpaket		13.0460-2726.2 602726	TRW 23144 19,8 + WE / - WK + Zub
C 200 CDI (203.004)	85	09/00→02/07					
C 220 CDI (203.006)	100	05/00→02/07				13.0470-2726.2 LD2726	TRW 23144 19,8 + WE / - WK + Zub Ceramic
C 220 CDI (203.006)	105	05/00→02/07	←	für Fahrzeuge mit Sportpaket / für Fahrzeuge mit AMG-Sportpaket		13.0460-4990.2 604990	BRE 23271 17,4 + WE / - WK Ceramic
						13.0470-4990.2 LD4990	BRE 23271 17,4 + WE / - WK Ceramic
			→	für Fahrzeuge ohne Sportpaket / für Fahrzeuge ohne AMG-Sportpaket		13.0460-4064.2 604064	ATE 21919 15,3 - WE / - WK + Zub
						13.0470-4064.2 LD4064	ATE 21919 15,3 - WE / - WK + Zub Ceramic
			→	für Fahrzeuge mit Sportpaket / für Fahrzeuge mit AMG-Sportpaket		13.0460-4065.2 604065	ATE 21899 15,3 + WE / - WK + Zub
						13.0470-4065.2 LD4065	ATE 21899 15,3 + WE / - WK + Zub Ceramic
C 200 Kompressor (203.045)	120	05/00→06/02	←	→ 05/02		13.0460-2726.2 602726	TRW 23144 19,8 + WE / - WK + Zub
						13.0470-2726.2 LD2726	TRW 23144 19,8 + WE / - WK + Zub Ceramic
			→	→ 05/02		13.0460-4064.2 604064	ATE 21919 15,3 - WE / - WK + Zub
						13.0470-4064.2 LD4064	ATE 21919 15,3 - WE / - WK + Zub Ceramic
C 220 CDI (203.008)	110	02/03→02/07	←	02/04→; für Fahrzeuge ohne Sportpaket / für Fahrzeuge ohne AMG-Sportpaket		13.0460-2726.2 602726	TRW 23144 19,8 + WE / - WK + Zub
						13.0470-2726.2 LD2726	TRW 23144 19,8 + WE / - WK + Zub Ceramic
			←	02/04→; → A 660226 / F 565688; für Fahrzeuge mit Sportpaket / für Fahrzeuge mit AMG-Sportpaket		13.0460-4990.2 604990	BRE 23271 17,4 + WE / - WK Ceramic
						13.0470-4990.2 LD4990	BRE 23271 17,4 + WE / - WK Ceramic











	kw			 	! #		
<b>MERCEDES-BENZ - C-KLASSE (W203) 05/00→12/07</b>							
<b> Bremsbelagsatz, Scheibenbremse</b>							
C 220 CDI (203.008)	110	02/03→02/07	←	A 660227 / F 565689→; für Fahrzeuge mit Sportpaket / für Fahrzeuge mit AMG-Sportpaket	13.0460-4994.2	604994	BRE 23945 16,5 + WE / - WK BRE 23945 16,5 + WE / - WK Ceramic
			→	02/04→; für Fahrzeuge ohne Sportpaket / für Fahrzeuge ohne AMG-Sportpaket	13.0460-4064.2	604064	ATE 21919 15,3 - WE / - WK + Zub ATE 21919 15,3 - WE / - WK + Zub Ceramic
			→	02/04→; für Fahrzeuge mit Sportpaket / für Fahrzeuge mit AMG-Sportpaket	13.0460-4065.2	604065	ATE 21899 15,3 + WE / - WK + Zub ATE 21899 15,3 + WE / - WK + Zub Ceramic
C 230 (203.052) C 280 (203.054) C 280 4-matic (203.092)	150 170 170	01/05→02/07 01/05→02/07 01/05→02/07	←	06/05→; für Fahrzeuge ohne Sportpaket / für Fahrzeuge ohne AMG-Sportpaket	13.0460-2727.2	602727	TRW 23144 19,8 + WE / - WK + Zub TRW 23144 19,8 + WE / - WK + Zub Ceramic
			←	06/05→; für Fahrzeuge mit Sportpaket / für Fahrzeuge mit AMG-Sportpaket	13.0460-4994.2	604994	BRE 23945 16,5 + WE / - WK BRE 23945 16,5 + WE / - WK Ceramic
			→	06/05→	13.0460-4065.2	604065	ATE 21899 15,3 + WE / - WK + Zub ATE 21899 15,3 + WE / - WK + Zub Ceramic
C 230 Kompressor (203.040) C 240 (203.061) C 270 CDI (203.016) C 270 CDI (203.016) C 320 (203.064)	141 125 120 125 160	02/04→02/07 05/00→02/07 12/00→02/07 12/00→02/07 05/00→02/07	←	für Fahrzeuge ohne Sportpaket / für Fahrzeuge ohne AMG-Sportpaket	13.0460-2727.2	602727	TRW 23144 19,8 + WE / - WK + Zub TRW 23144 19,8 + WE / - WK + Zub Ceramic
			←	→ A 660226 / F 565688; für Fahrzeuge mit Sportpaket / für Fahrzeuge mit AMG-Sportpaket	13.0460-4990.2	604990	BRE 23271 17,4 + WE / - WK BRE 23271 17,4 + WE / - WK Ceramic
			←	A 660227 / F 565689→; für Fahrzeuge mit Sportpaket / für Fahrzeuge mit AMG-Sportpaket	13.0460-4994.2	604994	BRE 23945 16,5 + WE / - WK BRE 23945 16,5 + WE / - WK Ceramic
			→		13.0460-4065.2	604065	ATE 21899 15,3 + WE / - WK + Zub ATE 21899 15,3 + WE / - WK + Zub Ceramic
			→		13.0470-2727.2	LD2727	TRW 23144 19,8 + WE / - WK + Zub TRW 23144 19,8 + WE / - WK + Zub Ceramic
C 240 4-matic (203.081) C 320 4-matic (203.084)	125 160	07/02→02/07 07/02→02/07	←		13.0460-2727.2	602727	TRW 23144 19,8 + WE / - WK + Zub TRW 23144 19,8 + WE / - WK + Zub Ceramic
			→		13.0460-4065.2	604065	ATE 21899 15,3 + WE / - WK + Zub ATE 21899 15,3 + WE / - WK + Zub Ceramic
C 30 CDI AMG (203.018)	170	01/03→02/07	←		13.0460-4990.2	604990	BRE 23271 17,4 + WE / - WK BRE 23271 17,4 + WE / - WK Ceramic
			→		13.0460-4047.2	604047	ATE 21305 15,7 + WE / - WK ATE 21305 15,7 + WE / - WK Ceramic
C 320 CDI (203.020)	165	01/05→02/07	←	02/05→; für Fahrzeuge mit Sportpaket / für Fahrzeuge mit AMG-Sportpaket	13.0460-4990.2	604990	BRE 23271 17,4 + WE / - WK BRE 23271 17,4 + WE / - WK Ceramic
			←	02/05→; für Fahrzeuge ohne Sportpaket / für Fahrzeuge ohne AMG-Sportpaket	13.0460-4994.2	604994	BRE 23945 16,5 + WE / - WK BRE 23945 16,5 + WE / - WK Ceramic
			→	02/05→	13.0460-4065.2	604065	ATE 21899 15,3 + WE / - WK + Zub ATE 21899 15,3 + WE / - WK + Zub Ceramic
C 32 AMG Kompressor (203.065)	260	02/01→02/07	←	03/01→	13.0460-4990.2	604990	BRE 23271 17,4 + WE / - WK
			→	03/01→	13.0460-4047.2	604047	ATE 21305 15,7 + WE / - WK ATE 21305 15,7 + WE / - WK Ceramic
C 350 (203.056)	200	01/05→02/07	←	06/05→; für Fahrzeuge mit Sportpaket / für Fahrzeuge mit AMG-Sportpaket	13.0460-4990.2	604990	BRE 23271 17,4 + WE / - WK BRE 23271 17,4 + WE / - WK Ceramic
↓							







	kw			 	! #		
<b>MERCEDES-BENZ - C-KLASSE (W203) 05/00→12/07</b>							
<b> Bremsbelagsatz, Scheibenbremse</b>							
C 350 (203.056)	200	01/05→02/07	←	06/05→; für Fahrzeuge ohne Sportpaket / für Fahrzeuge ohne AMG-Sportpaket		13.0460-4994.2 604994 13.0470-4994.2 LD4994	BRE 23945 16,5 + WE / - WK BRE 23945 16,5 + WE / - WK Ceramic
			→	06/05→		13.0460-4065.2 604065 13.0470-4065.2 LD4065	ATE 21899 15,3 + WE / - WK + Zub ATE 21899 15,3 + WE / - WK + Zub Ceramic
C 350 4-matic (203.087)	200	01/05→02/07	←	06/05→		13.0460-4990.2 604990 13.0470-4990.2 LD4990	BRE 23271 17,4 + WE / - WK BRE 23271 17,4 + WE / - WK Ceramic
			→	06/05→		13.0460-4065.2 604065 13.0470-4065.2 LD4065	ATE 21899 15,3 + WE / - WK + Zub ATE 21899 15,3 + WE / - WK + Zub Ceramic
C 55 AMG (203.076)	270	02/04→02/07	←			13.0460-4990.2 604990	BRE 23271 17,4 + WE / - WK
			→			13.0460-4047.2 604047 13.0470-4047.2 LD4047	ATE 21305 15,7 + WE / - WK ATE 21305 15,7 + WE / - WK Ceramic
<b>Warnkontakt, Bremsbelagverschleiß</b>							
C 180 (203.035)	95	10/00→05/02	←		2	24.8190-0410.2 620410	L= 97,5
C 240 4-matic (203.081)	125	07/02→02/07	→		1	24.8190-0410.2 620410	L= 97,5
C 320 4-matic (203.084)	160	07/02→02/07	→		1	24.8190-0410.2 620410	L= 97,5
C 180 Kompressor (203.046)	105	05/02→02/07	←	A 660227 / F 565689→; für Fahrzeuge mit Sportpaket / für Fahr- zeuge mit AMG-Sportpaket	2	24.8190-0410.2 620410	L= 97,5
C 200 CDI (203.007)	90	04/03→02/07	←				
C 200 CGI Kompressor (203.043)	125	07/03→02/07	←	→ A 660226 / F 565688; für Fahrzeuge mit Sportpaket / für Fahr- zeuge mit AMG-Sportpaket	2	24.8190-0410.2 620410	L= 97,5
C 200 Kompressor (203.042)	120	05/02→02/07	←		2	24.8190-0410.2 620410	L= 97,5
			→	für Fahrzeuge ohne Sportpaket / für Fahrzeuge ohne AMG-Sportpaket	2	24.8190-0410.2 620410	L= 97,5
			→	für Fahrzeuge mit Sportpaket / für Fahr- zeuge mit AMG-Sportpaket	1	24.8190-0410.2 620410	L= 97,5
			→	für Fahrzeuge ohne Sportpaket / für Fahrzeuge ohne AMG-Sportpaket	1	24.8190-0410.2 620410	L= 97,5
C 200 CDI (203.004)	75	02/01→02/07	←	für Fahrzeuge mit Sportpaket / für Fahr- zeuge mit AMG-Sportpaket	2	24.8190-0410.2 620410	L= 97,5
C 200 CDI (203.004)	85	09/00→02/07	←				
C 220 CDI (203.006)	100	05/00→02/07	←	für Fahrzeuge ohne Sportpaket / für Fahrzeuge ohne AMG-Sportpaket	2	24.8190-0410.2 620410	L= 97,5
C 220 CDI (203.006)	105	05/00→02/07	→	für Fahrzeuge mit Sportpaket / für Fahr- zeuge mit AMG-Sportpaket	1	24.8190-0410.2 620410	L= 97,5
			→	für Fahrzeuge ohne Sportpaket / für Fahrzeuge ohne AMG-Sportpaket	1	24.8190-0410.2 620410	L= 97,5
C 200 Kompressor (203.045)	120	05/00→06/02	←	→ 05/02	2	24.8190-0410.2 620410	L= 97,5
			→	→ 05/02	1	24.8190-0410.2 620410	L= 97,5
C 220 CDI (203.008)	110	02/03→02/07	←	02/04→; → A 660226 / F 565688; für Fahrzeuge mit Sportpaket / für Fahr- zeuge mit AMG-Sportpaket	2	24.8190-0410.2 620410	L= 97,5
			←	A 660227 / F 565689→; für Fahrzeuge mit Sportpaket / für Fahr- zeuge mit AMG-Sportpaket	2	24.8190-0410.2 620410	L= 97,5
			←	02/04→; für Fahrzeuge ohne Sportpaket / für Fahrzeuge ohne AMG-Sportpaket	2	24.8190-0410.2 620410	L= 97,5
			→	02/04→; für Fahrzeuge mit Sportpaket / für Fahr- zeuge mit AMG-Sportpaket	1	24.8190-0410.2 620410	L= 97,5
			→	02/04→; für Fahrzeuge ohne Sportpaket / für Fahrzeuge ohne AMG-Sportpaket	1	24.8190-0410.2 620410	L= 97,5
C 230 (203.052)	150	01/05→02/07	←	06/05→; für Fahrzeuge mit Sportpaket / für Fahr- zeuge mit AMG-Sportpaket	2	24.8190-0410.2 620410	L= 97,5
C 280 (203.054)	170	01/05→02/07	←				
C 280 4-matic (203.092)	170	01/05→02/07	←				
C 350 (203.056)	200	01/05→02/07	←	06/05→; für Fahrzeuge ohne Sportpaket / für Fahrzeuge ohne AMG-Sportpaket	2	24.8190-0410.2 620410	L= 97,5
			→	06/05→	1	24.8190-0410.2 620410	L= 97,5
C 230 Kompressor (203.040)	141	02/04→02/07	←	A 660227 / F 565689→; für Fahrzeuge mit Sportpaket / für Fahr- zeuge mit AMG-Sportpaket	2	24.8190-0410.2 620410	L= 97,5
C 240 (203.061)	125	05/00→02/07	←				
C 270 CDI (203.016)	120	12/00→02/07	←	für Fahrzeuge ohne Sportpaket / für Fahrzeuge ohne AMG-Sportpaket	2	24.8190-0410.2 620410	L= 97,5
C 270 CDI (203.016)	125	12/00→02/07	←				
C 320 (203.064)	160	05/00→02/07	←				
↓							









	kW			 	! #		
<b>MERCEDES-BENZ - C-KLASSE (W203) 05/00→12/07</b>							
<b>Warnkontakt, Bremsbelagverschleiß</b>							
C 230 Kompressor (203.040)	141	02/04→02/07	←	→ A 660226 / F 565688; für Fahrzeuge mit Sportpaket / für Fahrzeuge mit AMG-Sportpaket	2	24.8190-0410.2 620410	L= 97,5
C 240 (203.061)	125	05/00→02/07					
C 270 CDI (203.016)	120	12/00→02/07	→		1	24.8190-0410.2 620410	L= 97,5
C 270 CDI (203.016)	125	12/00→02/07					
C 320 (203.064)	160	05/00→02/07					
C 30 CDI AMG (203.018)	170	01/03→02/07	←		2	24.8190-0410.2 620410	L= 97,5
C 55 AMG (203.076)	270	02/04→02/07	→		2	24.8190-0410.2 620410	L= 97,5
C 320 CDI (203.020)	165	01/05→02/07	←	02/05→; für Fahrzeuge mit Sportpaket / für Fahrzeuge mit AMG-Sportpaket	2	24.8190-0410.2 620410	L= 97,5
			←	02/05→; für Fahrzeuge ohne Sportpaket / für Fahrzeuge ohne AMG-Sportpaket	2	24.8190-0410.2 620410	L= 97,5
			→	02/05→	1	24.8190-0410.2 620410	L= 97,5
C 32 AMG Kompressor (203.065)	260	02/01→02/07	←	03/01→	2	24.8190-0410.2 620410	L= 97,5
			→	03/01→	2	24.8190-0410.2 620410	L= 97,5
C 350 4-matic (203.087)	200	01/05→02/07	←	06/05→	2	24.8190-0410.2 620410	L= 97,5
			→	06/05→	1	24.8190-0410.2 620410	L= 97,5
<b>Zubehörsatz, Scheibenbremsbelag</b>							
C 180 (203.035)	95	10/00→05/02	→			13.0460-0229.2 610229	ATE
C 180 Kompressor (203.046)	105	05/02→02/07	←	→ A 660226 / F 565688; für Fahrzeuge mit Sportpaket / für Fahrzeuge mit AMG-Sportpaket		13.0460-0275.2 610275	
C 200 CDI (203.007)	90	04/03→02/07					
C 200 CGI Kompressor (203.043)	125	07/03→02/07	→	für Fahrzeuge ohne Sportpaket / für Fahrzeuge ohne AMG-Sportpaket		13.0460-0229.2 610229	ATE
C 200 Kompressor (203.042)	120	05/02→02/07	→	für Fahrzeuge mit Sportpaket / für Fahrzeuge mit AMG-Sportpaket		13.0460-0231.2 610231	ATE
C 200 CDI (203.004)	75	02/01→02/07	←	für Fahrzeuge mit Sportpaket / für Fahrzeuge mit AMG-Sportpaket		13.0460-0275.2 610275	
C 200 CDI (203.004)	85	09/00→02/07					
C 220 CDI (203.006)	100	05/00→02/07	→	für Fahrzeuge ohne Sportpaket / für Fahrzeuge ohne AMG-Sportpaket		13.0460-0229.2 610229	ATE
C 220 CDI (203.006)	105	05/00→02/07	→	für Fahrzeuge mit Sportpaket / für Fahrzeuge mit AMG-Sportpaket		13.0460-0231.2 610231	ATE
C 200 Kompressor (203.045)	120	05/00→06/02	→	→ 05/02		13.0460-0229.2 610229	ATE
C 220 CDI (203.008)	110	02/03→02/07	←	02/04→; → A 660226 / F 565688; für Fahrzeuge mit Sportpaket / für Fahrzeuge mit AMG-Sportpaket		13.0460-0275.2 610275	
			→	02/04→; für Fahrzeuge ohne Sportpaket / für Fahrzeuge ohne AMG-Sportpaket		13.0460-0229.2 610229	ATE
			→	02/04→; für Fahrzeuge mit Sportpaket / für Fahrzeuge mit AMG-Sportpaket		13.0460-0231.2 610231	ATE
C 230 (203.052)	150	01/05→02/07	→	06/05→		13.0460-0231.2 610231	ATE
C 280 (203.054)	170	01/05→02/07					
C 280 4-matic (203.092)	170	01/05→02/07					
C 230 Kompressor (203.040)	141	02/04→02/07	←	→ A 660226 / F 565688; für Fahrzeuge mit Sportpaket / für Fahrzeuge mit AMG-Sportpaket		13.0460-0275.2 610275	
C 240 (203.061)	125	05/00→02/07					
C 270 CDI (203.016)	120	12/00→02/07	→			13.0460-0231.2 610231	ATE
C 270 CDI (203.016)	125	12/00→02/07					
C 320 (203.064)	160	05/00→02/07					
C 240 4-matic (203.081)	125	07/02→02/07	→			13.0460-0231.2 610231	ATE
C 320 4-matic (203.084)	160	07/02→02/07					
C 30 CDI AMG (203.018)	170	01/03→02/07	←			13.0460-0237.2 610237	BRE
C 55 AMG (203.076)	270	02/04→02/07	→			13.0460-0269.2 610269	ATE
C 320 CDI (203.020)	165	01/05→02/07	←	02/05→; für Fahrzeuge mit Sportpaket / für Fahrzeuge mit AMG-Sportpaket		13.0460-0237.2 610237	BRE
			→	02/05→		13.0460-0269.2 610269	ATE
C 32 AMG Kompressor (203.065)	260	02/01→02/07	←	03/01→		13.0460-0237.2 610237	BRE
			→	03/01→		13.0460-0269.2 610269	ATE
C 350 (203.056)	200	01/05→02/07	←	06/05→; für Fahrzeuge mit Sportpaket / für Fahrzeuge mit AMG-Sportpaket		13.0460-0237.2 610237	BRE
			→	06/05→		13.0460-0269.2 610269	ATE
↓							

















	kw			 	! #		
<b>MERCEDES-BENZ - C-KLASSE (W203) 05/00→12/07</b>							
<b>Zubehörsatz, Scheibenbremsbelag</b>							
C 350 4-matic (203.087)	200	01/05→02/07	←	06/05→		13.0460-0237.2 610237	BRE
			→	06/05→		13.0460-0269.2 610269	
						13.0460-0231.2 610231	ATE
<b> Bremsscheibe</b>							
C 180 (203.035)	95	10/00→05/02	←			24.0125-0110.1 425110	Ø 288 25 22,4 V + S
			→			24.0325-0110.1 525110	Ø 288 25 22,4 V + S
						24.0109-0114.1 409114	Ø 278 9 7,3 + S
						24.0309-0114.1 509114	Ø 278 9 7,3 + S
C 180 Kompressor (203.046)	105	05/02→02/07	←	für Fahrzeuge ohne Sportpaket / für Fahrzeuge ohne AMG-Sportpaket		24.0125-0110.1 425110	Ø 288 25 22,4 V + S
C 200 CDI (203.004)	75	02/01→02/07	←	für Fahrzeuge mit Sportpaket / für Fahrzeuge mit AMG-Sportpaket		24.0325-0110.1 525110	Ø 288 25 22,4 V + S
C 200 CDI (203.004)	85	09/00→02/07	←	für Fahrzeuge mit Sportpaket / für Fahrzeuge mit AMG-Sportpaket		24.0128-0177.1 428177	Ø 330 28 26 V•
C 200 CDI (203.007)	90	04/03→02/07	←	für Fahrzeuge mit Sportpaket / für Fahrzeuge mit AMG-Sportpaket		24.0128-0177.1 428177	Ø 330 28 26 V•
C 200 CGI Kompressor (203.043)	125	07/03→02/07	→	für Fahrzeuge ohne Sportpaket / für Fahrzeuge ohne AMG-Sportpaket		24.0109-0114.1 409114	Ø 278 9 7,3 + S
C 200 Kompressor (203.042)	120	05/02→02/07	→	für Fahrzeuge ohne Sportpaket / für Fahrzeuge ohne AMG-Sportpaket		24.0309-0114.1 509114	Ø 278 9 7,3 + S
C 220 CDI (203.006)	100	05/00→02/07	→	für Fahrzeuge mit Sportpaket / für Fahrzeuge mit AMG-Sportpaket		24.0110-0217.1 410217	Ø 290 10 8,3 + S
C 220 CDI (203.006)	105	05/00→02/07	→	für Fahrzeuge mit Sportpaket / für Fahrzeuge mit AMG-Sportpaket		24.0310-0217.1 510217	Ø 290 10 8,3 + S
C 200 Kompressor (203.045)	120	05/00→06/02	←	→ 05/02		24.0125-0110.1 425110	Ø 288 25 22,4 V + S
			→	→ 05/02		24.0325-0110.1 525110	Ø 288 25 22,4 V + S
						24.0109-0114.1 409114	Ø 278 9 7,3 + S
						24.0309-0114.1 509114	Ø 278 9 7,3 + S
C 220 CDI (203.008)	110	02/03→02/07	←	02/04→; für Fahrzeuge ohne Sportpaket / für Fahrzeuge ohne AMG-Sportpaket		24.0125-0110.1 425110	Ø 288 25 22,4 V + S
			←	02/04→; für Fahrzeuge ohne Sportpaket / für Fahrzeuge ohne AMG-Sportpaket		24.0325-0110.1 525110	Ø 288 25 22,4 V + S
			←	02/04→; für Fahrzeuge mit Sportpaket / für Fahrzeuge mit AMG-Sportpaket		24.0128-0177.1 428177	Ø 330 28 26 V•
			→	02/04→; für Fahrzeuge mit Sportpaket / für Fahrzeuge mit AMG-Sportpaket		24.0109-0114.1 409114	Ø 278 9 7,3 + S
			→	02/04→; für Fahrzeuge ohne Sportpaket / für Fahrzeuge ohne AMG-Sportpaket		24.0309-0114.1 509114	Ø 278 9 7,3 + S
			→	02/04→; für Fahrzeuge mit Sportpaket / für Fahrzeuge mit AMG-Sportpaket		24.0110-0217.1 410217	Ø 290 10 8,3 + S
			→	02/04→; für Fahrzeuge mit Sportpaket / für Fahrzeuge mit AMG-Sportpaket		24.0310-0217.1 510217	Ø 290 10 8,3 + S
C 230 (203.052)	150	01/05→02/07	←	06/05→; für Fahrzeuge ohne Sportpaket / für Fahrzeuge ohne AMG-Sportpaket		24.0128-0106.1 428106	Ø 300 28 25,4 V + S
			←	06/05→; für Fahrzeuge ohne Sportpaket / für Fahrzeuge ohne AMG-Sportpaket		24.0328-0106.1 528106	Ø 300 28 25,4 V + S
			←	06/05→; für Fahrzeuge mit Sportpaket / für Fahrzeuge mit AMG-Sportpaket		24.0128-0177.1 428177	Ø 330 28 26 V•
			→	06/05→; für Fahrzeuge mit Sportpaket / für Fahrzeuge mit AMG-Sportpaket		24.0109-0114.1 409114	Ø 278 9 7,3 + S
			→	06/05→; für Fahrzeuge ohne Sportpaket / für Fahrzeuge ohne AMG-Sportpaket		24.0309-0114.1 509114	Ø 278 9 7,3 + S
			→	06/05→; für Fahrzeuge mit Sportpaket / für Fahrzeuge mit AMG-Sportpaket		24.0110-0217.1 410217	Ø 290 10 8,3 + S
			→	06/05→; für Fahrzeuge mit Sportpaket / für Fahrzeuge mit AMG-Sportpaket		24.0310-0217.1 510217	Ø 290 10 8,3 + S
C 230 Kompressor (203.040)	141	02/04→02/07	←	für Fahrzeuge ohne Sportpaket / für Fahrzeuge ohne AMG-Sportpaket		24.0128-0106.1 428106	Ø 300 28 25,4 V + S
			←	für Fahrzeuge ohne Sportpaket / für Fahrzeuge ohne AMG-Sportpaket		24.0328-0106.1 528106	Ø 300 28 25,4 V + S
C 240 (203.061)	125	05/00→02/07	←	für Fahrzeuge mit Sportpaket / für Fahrzeuge mit AMG-Sportpaket		24.0128-0177.1 428177	Ø 330 28 26 V•
C 270 CDI (203.016)	120	12/00→02/07	←	für Fahrzeuge mit Sportpaket / für Fahrzeuge mit AMG-Sportpaket		24.0128-0177.1 428177	Ø 330 28 26 V•
C 270 CDI (203.016)	125	12/00→02/07	←	für Fahrzeuge mit Sportpaket / für Fahrzeuge mit AMG-Sportpaket		24.0128-0177.1 428177	Ø 330 28 26 V•
C 320 (203.064)	160	05/00→02/07	→			24.0110-0217.1 410217	Ø 290 10 8,3 + S
						24.0310-0217.1 510217	Ø 290 10 8,3 + S
C 240 4-matic (203.081)	125	07/02→02/07	←			24.0128-0106.1 428106	Ø 300 28 25,4 V + S
			←			24.0328-0106.1 528106	Ø 300 28 25,4 V + S
C 320 4-matic (203.084)	160	07/02→02/07	←			24.0110-0217.1 410217	Ø 290 10 8,3 + S
			→			24.0310-0217.1 510217	Ø 290 10 8,3 + S
C 280 (203.054)	170	01/05→02/07	←	06/05→; für Fahrzeuge ohne Sportpaket / für Fahrzeuge ohne AMG-Sportpaket		24.0128-0106.1 428106	Ø 300 28 25,4 V + S
			←	06/05→; für Fahrzeuge ohne Sportpaket / für Fahrzeuge ohne AMG-Sportpaket		24.0328-0106.1 528106	Ø 300 28 25,4 V + S
C 280 4-matic (203.092)	170	01/05→02/07	←	06/05→; für Fahrzeuge mit Sportpaket / für Fahrzeuge mit AMG-Sportpaket		24.0128-0177.1 428177	Ø 330 28 26 V•
			→	06/05→		24.0110-0217.1 410217	Ø 290 10 8,3 + S
						24.0310-0217.1 510217	Ø 290 10 8,3 + S
C 30 CDI AMG (203.018)	170	01/03→02/07	←			24.0130-0180.1 430180	Ø 345 30 28 V•
			←			24.0130-0180.1 430180	Ø 345 30 28 V•
C 55 AMG (203.076)	270	02/04→02/07	→			24.0122-0228.1 422228	Ø 300 22 19,4 V
C 320 CDI (203.020)	165	01/05→02/07	←	02/05→; für Fahrzeuge ohne Sportpaket / für Fahrzeuge ohne AMG-Sportpaket		24.0128-0188.1 428188	Ø 330 28 26 V + S









	kw			 	! #		
<b>MERCEDES-BENZ - C-KLASSE (W203) 05/00→12/07</b>							
<b>Bremsscheibe</b>							
C 320 CDI (203.020)	165	01/05→02/07	←	02/05→; für Fahrzeuge mit Sportpaket / für Fahrzeuge mit AMG-Sportpaket	24.0130-0180.1	430180	Ø 345 30 28 V•
			→	02/05→	24.0110-0217.1	410217	Ø 290 10 8,3 + S
					24.0310-0217.1	510217	Ø 290 10 8,3 + S
C 32 AMG Kompressor (203.065)	260	02/01→02/07	←	03/01→	24.0130-0180.1	430180	Ø 345 30 28 V•
			→	03/01→	24.0122-0228.1	422228	Ø 300 22 19,4 V
C 350 (203.056)	200	01/05→02/07	←	06/05→; für Fahrzeuge ohne Sportpaket / für Fahrzeuge ohne AMG-Sportpaket	24.0128-0188.1	428188	Ø 330 28 26 V + S
			←	06/05→; für Fahrzeuge mit Sportpaket / für Fahrzeuge mit AMG-Sportpaket	24.0130-0180.1	430180	Ø 345 30 28 V•
			→	06/05→	24.0110-0217.1	410217	Ø 290 10 8,3 + S
C 350 4-matic (203.087)	200	01/05→02/07	←	06/05→; für Fahrzeuge ohne Sportpaket / für Fahrzeuge ohne AMG-Sportpaket	24.0130-0171.1	430171	Ø 345 30 27,4 V
			←	06/05→; für Fahrzeuge mit Sportpaket / für Fahrzeuge mit AMG-Sportpaket	24.0130-0180.1	430180	Ø 345 30 28 V•
			→	06/05→	24.0110-0217.1	410217	Ø 290 10 8,3 + S
					24.0310-0217.1	510217	Ø 290 10 8,3 + S
<b>MERCEDES-BENZ - C-KLASSE (W204) 01/07→01/14</b>							
<b>Bremsbelagsatz, Scheibenbremse</b>							
C 180 CDI (204.000) C 180 Kompressor (204.044, 204.045) C 200 CDI (204.001)	88	01/11→01/14	←	für Fahrzeuge mit Sportpaket / für Fahrzeuge mit AMG-Sportpaket; - USA	13.0460-2732.2	602732	TRW 24306 20,3 + WE / - WK + Zub
	115	01/08→01/14			13.0470-2732.2	LD2732	TRW 24306 20,3 + WE / - WK + Zub Ceramic
	100	01/11→01/14	←	für Fahrzeuge ohne Sportpaket / für Fahrzeuge ohne AMG-Sportpaket	13.0460-2733.2	602733	TRW 24306 20,3 + WE / - WK + Zub
					13.0470-2733.2	LD2733	TRW 24306 20,3 + WE / - WK + Zub Ceramic
			←	für Fahrzeuge mit Sportpaket / für Fahrzeuge mit AMG-Sportpaket	13.0470-9000.2	LD9000	TRW 24306 20,3 + WE / - WK + Zub Ceramic
→		13.0460-7244.2	607244	ATE 24253 17,8 + WE / - WK			
				13.0470-7244.2	LD7244	ATE 24253 17,8 + WE / - WK Ceramic	
C 180 CGI (204.031) C 180 CGI (204.049)	115	01/08→01/14	←	04/09→; für Fahrzeuge mit Sportpaket / für Fahrzeuge mit AMG-Sportpaket; - USA	13.0460-2732.2	602732	TRW 24306 20,3 + WE / - WK + Zub
	115	01/07→01/14			13.0470-2732.2	LD2732	TRW 24306 20,3 + WE / - WK + Zub Ceramic
			←	04/09→; für Fahrzeuge ohne Sportpaket / für Fahrzeuge ohne AMG-Sportpaket	13.0460-2733.2	602733	TRW 24306 20,3 + WE / - WK + Zub
					13.0470-2733.2	LD2733	TRW 24306 20,3 + WE / - WK + Zub Ceramic
	←	04/09→; für Fahrzeuge mit Sportpaket / für Fahrzeuge mit AMG-Sportpaket	13.0470-9000.2	LD9000	TRW 24306 20,3 + WE / - WK + Zub Ceramic		
→	04/09→	13.0460-7244.2	607244	ATE 24253 17,8 + WE / - WK			
				13.0470-7244.2	LD7244	ATE 24253 17,8 + WE / - WK Ceramic	
C 180 Kompressor (204.046) C 200 CDI (204.007, 204.006)	115	01/07→01/14	←	03/07→; für Fahrzeuge mit Sportpaket / für Fahrzeuge mit AMG-Sportpaket; - USA	13.0460-2732.2	602732	TRW 24306 20,3 + WE / - WK + Zub
	100	01/07→12/10			13.0470-2732.2	LD2732	TRW 24306 20,3 + WE / - WK + Zub Ceramic
			←	03/07→; für Fahrzeuge ohne Sportpaket / für Fahrzeuge ohne AMG-Sportpaket	13.0460-2733.2	602733	TRW 24306 20,3 + WE / - WK + Zub
					13.0470-2733.2	LD2733	TRW 24306 20,3 + WE / - WK + Zub Ceramic
	←	03/07→; für Fahrzeuge mit Sportpaket / für Fahrzeuge mit AMG-Sportpaket	13.0470-9000.2	LD9000	TRW 24306 20,3 + WE / - WK + Zub Ceramic		
→	03/07→	13.0460-7244.2	607244	ATE 24253 17,8 + WE / - WK			
				13.0470-7244.2	LD7244	ATE 24253 17,8 + WE / - WK Ceramic	
C 200 (204.048)	137	05/11→01/14	←	- USA	13.0460-2732.2	602732	TRW 24306 20,3 + WE / - WK + Zub
C 220 CDI (204.002)	120	10/08→01/14					
C 220 CDI (204.002)	125	12/08→01/14					
↓							







	kw			 	! #		
<b>MERCEDES-BENZ - C-KLASSE (W204) 01/07→01/14</b>							
<b> Bremsbelagsatz, Scheibenbremse</b>							
C 220 CDI 4-matic (204.084)	125	02/13→01/14	←	- USA		13.0470-2732.2 LD2732	TRW 24306 20,3 + WE / - WK + Zub Ceramic
C 230 4-matic (204.085)	150	07/07→01/14	←			13.0470-9000.2 LD9000	TRW 24306 20,3 + WE / - WK + Zub Ceramic
C 250 CGI (204.047)	150	07/09→01/14	→			13.0460-7244.2 607244 13.0470-7244.2 LD7244	ATE 24253 17,8 + WE / - WK ATE 24253 17,8 + WE / - WK Ceramic
C 200 CGI (204.048)	135	01/07→01/14	←	04/09→; - USA		13.0460-2732.2 602732 13.0470-2732.2 LD2732	TRW 24306 20,3 + WE / - WK + Zub TRW 24306 20,3 + WE / - WK + Zub Ceramic
			←	04/09→		13.0470-9000.2 LD9000	TRW 24306 20,3 + WE / - WK + Zub Ceramic
			→	04/09→		13.0460-7244.2 607244 13.0470-7244.2 LD7244	ATE 24253 17,8 + WE / - WK ATE 24253 17,8 + WE / - WK Ceramic
			→	04/09→		13.0460-7244.2 607244 13.0470-7244.2 LD7244	ATE 24253 17,8 + WE / - WK ATE 24253 17,8 + WE / - WK Ceramic
C 200 Kompressor (204.041) C 220 CDI (204.008) C 220 CDI (204.008) C 230 (204.052)	135 120 125 150	01/07→01/14 01/07→11/08 01/07→11/08 01/07→01/14	←	03/07→; - USA		13.0460-2732.2 602732 13.0470-2732.2 LD2732	TRW 24306 20,3 + WE / - WK + Zub TRW 24306 20,3 + WE / - WK + Zub Ceramic
			←	03/07→		13.0470-9000.2 LD9000	TRW 24306 20,3 + WE / - WK + Zub Ceramic
			→	03/07→		13.0460-7244.2 607244 13.0470-7244.2 LD7244	ATE 24253 17,8 + WE / - WK ATE 24253 17,8 + WE / - WK Ceramic
			→	03/07→		13.0460-7244.2 607244 13.0470-7244.2 LD7244	ATE 24253 17,8 + WE / - WK ATE 24253 17,8 + WE / - WK Ceramic
C 250 CDI (204.003)	150	08/08→01/14	←	- USA		13.0460-2732.2 602732 13.0470-2732.2 LD2732	TRW 24306 20,3 + WE / - WK + Zub TRW 24306 20,3 + WE / - WK + Zub Ceramic
			←			13.0470-9000.2 LD9000	TRW 24306 20,3 + WE / - WK + Zub Ceramic
			→	ALU		13.0460-7244.2 607244 13.0470-7244.2 LD7244	ATE 24253 17,8 + WE / - WK ATE 24253 17,8 + WE / - WK Ceramic
			→	GG		13.0460-7257.2 607257 13.0470-7257.2 LD7257	ATE 24253 18,0 + WE / - WK ATE 24253 18,0 + WE / - WK Ceramic
C 250 CDI 4-matic (204.082) C 280 4-matic (204.081) C 300 (204.054)	150 170 170	01/11→01/14 07/07→01/14 07/09→01/14	←	für Fahrzeuge ohne Sportpaket / für Fahrzeuge ohne AMG-Sportpaket; - USA		13.0460-2732.2 602732 13.0470-2732.2 LD2732	TRW 24306 20,3 + WE / - WK + Zub TRW 24306 20,3 + WE / - WK + Zub Ceramic
			←	für Fahrzeuge mit Sportpaket / für Fahrzeuge mit AMG-Sportpaket		13.0460-2734.2 602734 13.0470-2734.2 LD2734	TRW 24310 19,0 + WE / - WK TRW 24310 19,0 + WE / - WK Ceramic
			←	für Fahrzeuge ohne Sportpaket / für Fahrzeuge ohne AMG-Sportpaket		13.0470-9000.2 LD9000	TRW 24306 20,3 + WE / - WK + Zub Ceramic
			→			13.0460-7244.2 607244 13.0470-7244.2 LD7244	ATE 24253 17,8 + WE / - WK ATE 24253 17,8 + WE / - WK Ceramic
C 280 (204.054)	170	01/07→01/14	←	03/07→; für Fahrzeuge ohne Sportpaket / für Fahrzeuge ohne AMG-Sportpaket; - USA		13.0460-2732.2 602732 13.0470-2732.2 LD2732	TRW 24306 20,3 + WE / - WK + Zub TRW 24306 20,3 + WE / - WK + Zub Ceramic
			←	03/07→; für Fahrzeuge mit Sportpaket / für Fahrzeuge mit AMG-Sportpaket		13.0460-2734.2 602734 13.0470-2734.2 LD2734	TRW 24310 19,0 + WE / - WK TRW 24310 19,0 + WE / - WK Ceramic
			←	03/07→; für Fahrzeuge ohne Sportpaket / für Fahrzeuge ohne AMG-Sportpaket		13.0470-9000.2 LD9000	TRW 24306 20,3 + WE / - WK + Zub Ceramic
			→	03/07→		13.0460-7244.2 607244 13.0470-7244.2 LD7244	ATE 24253 17,8 + WE / - WK ATE 24253 17,8 + WE / - WK Ceramic
C 300 (204.055) C 300 4-matic (204.080) C 350 (204.057) C 350 4-matic (204.088)	185 185 225 225	02/11→01/14 02/11→01/14 01/11→01/14 01/11→01/14	←			13.0460-2734.2 602734 13.0470-2734.2 LD2734	TRW 24310 19,0 + WE / - WK TRW 24310 19,0 + WE / - WK Ceramic
			→			13.0460-7244.2 607244 13.0470-7244.2 LD7244	ATE 24253 17,8 + WE / - WK ATE 24253 17,8 + WE / - WK Ceramic
↓							









	kw			 	! #		
<b>MERCEDES-BENZ - C-KLASSE (W204) 01/07→01/14</b>							
<b> Bremsbelagsatz, Scheibenbremse</b>							
C 300 4-matic (204.081)	170	07/07→01/14	←	04/09→; für Fahrzeuge ohne Sportpaket / für Fahrzeuge ohne AMG-Sportpaket; - USA		13.0460-2732.2 602732 13.0470-2732.2 LD2732	TRW 24306 20,3 + WE / - WK + Zub TRW 24306 20,3 + WE / - WK + Zub Ceramic
			←	04/09→; für Fahrzeuge mit Sportpaket / für Fahr- zeuge mit AMG-Sportpaket		13.0460-2734.2 602734 13.0470-2734.2 LD2734	TRW 24310 19,0 + WE / - WK TRW 24310 19,0 + WE / - WK Ceramic
			←	04/09→; für Fahrzeuge ohne Sportpaket / für Fahrzeuge ohne AMG-Sportpaket		13.0470-9000.2 LD9000	TRW 24306 20,3 + WE / - WK + Zub Ceramic
			→	04/09→		13.0460-7244.2 607244 13.0470-7244.2 LD7244	ATE 24253 17,8 + WE / - WK ATE 24253 17,8 + WE / - WK Ceramic
C 300 CDI 4-matic (204.092)	170	01/11→01/14	←			13.0460-2734.2 602734	TRW 24310 19,0 + WE / - WK
C 320 CDI 4-matic (204.089)	165	07/07→01/14				13.0470-2734.2 LD2734	TRW 24310 19,0 + WE / - WK Ceramic
C 350 CDI (204.022)	165	07/09→01/14	→	ALU		13.0460-7244.2 607244	ATE 24253 17,8 + WE / - WK
C 350 CDI (204.023)	195	06/11→01/14				13.0470-7244.2 LD7244	ATE 24253 17,8 + WE / - WK Ceramic
C 350 CDI (204.025)	170	10/09→01/14					
C 350 CDI 4-matic (204.089)	165	07/09→01/14	→	GG		13.0460-7257.2 607257 13.0470-7257.2 LD7257	ATE 24253 18,0 + WE / - WK ATE 24253 18,0 + WE / - WK Ceramic
C 350 CDI 4-matic (204.092)	170	10/09→01/14					
C 350 CGI (204.065)	215	09/08→01/14					
C 320 CDI (204.022)	165	01/07→01/14	←	03/07→		13.0460-2734.2 602734	TRW 24310 19,0 + WE / - WK
C 350 (204.056)	200	01/07→01/14				13.0470-2734.2 LD2734	TRW 24310 19,0 + WE / - WK Ceramic
			→	03/07→; ALU		13.0460-7244.2 607244 13.0470-7244.2 LD7244	ATE 24253 17,8 + WE / - WK ATE 24253 17,8 + WE / - WK Ceramic
			→	03/07→; GG		13.0460-7257.2 607257 13.0470-7257.2 LD7257	ATE 24253 18,0 + WE / - WK ATE 24253 18,0 + WE / - WK Ceramic
C 350 4-matic (204.087)	200	07/07→01/14	←			13.0460-2734.2 602734 13.0470-2734.2 LD2734	TRW 24310 19,0 + WE / - WK TRW 24310 19,0 + WE / - WK Ceramic
			→			13.0460-7244.2 607244 13.0470-7244.2 LD7244	ATE 24253 17,8 + WE / - WK ATE 24253 17,8 + WE / - WK Ceramic
			→	ALU		13.0460-7244.2 607244 13.0470-7244.2 LD7244	ATE 24253 17,8 + WE / - WK ATE 24253 17,8 + WE / - WK Ceramic
			→	GG		13.0460-7257.2 607257 13.0470-7257.2 LD7257	ATE 24253 18,0 + WE / - WK ATE 24253 18,0 + WE / - WK Ceramic
C 63 AMG (204.077)	336	02/08→01/14	←	nicht für Bremssattelfarbe: rot		13.0460-4839.2 604839	BRE 24455 16,8 + WE / - WK
C 63 AMG (204.077)	358	02/08→01/14					
C 63 AMG (204.077)	373	02/08→01/14					
C 63 AMG DR 520	383	07/10→01/14					
<b>Warnkontakt, Bremsbelagverschleiß</b>							
C 180 CDI (204.000)	88	01/11→01/14	←	für Fahrzeuge mit Sportpaket / für Fahr- zeuge mit AMG-Sportpaket	1	24.8190-0410.2 620410	L= 97,5
C 180 Kompressor (204.044, 204.045)	115	01/08→01/14					
C 200 CDI (204.001)	100	01/11→01/14	←	für Fahrzeuge ohne Sportpaket / für Fahrzeuge ohne AMG-Sportpaket	1	24.8190-0410.2 620410	L= 97,5
C 250 CDI 4-matic (204.082)	150	01/11→01/14	→		1	24.8190-0410.2 620410	L= 97,5
C 280 4-matic (204.081)	170	07/07→01/14					
C 300 (204.054)	170	07/09→01/14					
C 180 CGI (204.031)	115	01/08→01/14	←	04/09→; für Fahrzeuge mit Sportpaket / für Fahr- zeuge mit AMG-Sportpaket	1	24.8190-0410.2 620410	L= 97,5
C 180 CGI (204.049)	115	01/07→01/14					
C 300 4-matic (204.081)	170	07/07→01/14	←	04/09→; für Fahrzeuge ohne Sportpaket / für Fahrzeuge ohne AMG-Sportpaket	1	24.8190-0410.2 620410	L= 97,5
			→	04/09→	1	24.8190-0410.2 620410	L= 97,5
C 180 Kompressor (204.046)	115	01/07→01/14	←	03/07→; für Fahrzeuge ohne Sportpaket / für Fahrzeuge ohne AMG-Sportpaket	1	24.8190-0410.2 620410	L= 97,5
C 200 CDI (204.007, 204.006)	100	01/07→12/10					
C 280 (204.054)	170	01/07→01/14	←	03/07→; für Fahrzeuge mit Sportpaket / für Fahr- zeuge mit AMG-Sportpaket	1	24.8190-0410.2 620410	L= 97,5
↓							









	kW			 	! #		
<b>MERCEDES-BENZ - C-KLASSE (W204) 01/07→01/14</b>							
<b>Warnkontakt, Bremsbelagverschleiß</b>							
C 180 Kompressor (204.046)	115	01/07→01/14	➔	03/07→	1	24.8190-0410.2 620410	L= 97,5
C 200 CDI (204.007, 204.006)	100	01/07→12/10					
C 280 (204.054)	170	01/07→01/14					
C 200 (204.048)	137	05/11→01/14	➔		1	24.8190-0410.2 620410	L= 97,5
C 220 CDI (204.002)	120	10/08→01/14					
C 220 CDI (204.002)	125	12/08→01/14	➔		1	24.8190-0410.2 620410	L= 97,5
C 220 CDI 4-matic (204.084)	125	02/13→01/14					
C 230 4-matic (204.085)	150	07/07→01/14					
C 250 CDI (204.003)	150	08/08→01/14					
C 250 CGI (204.047)	150	07/09→01/14					
C 300 (204.055)	185	02/11→01/14					
C 300 4-matic (204.080)	185	02/11→01/14					
C 300 CDI 4-matic (204.092)	170	01/11→01/14					
C 320 CDI 4-matic (204.089)	165	07/07→01/14					
C 350 (204.057)	225	01/11→01/14					
C 350 4-matic (204.087)	200	07/07→01/14					
C 350 4-matic (204.088)	225	01/11→01/14					
C 350 CDI (204.022)	165	07/09→01/14					
C 350 CDI (204.023)	195	06/11→01/14					
C 350 CDI (204.025)	170	10/09→01/14					
C 350 CDI 4-matic (204.089)	165	07/09→01/14					
C 350 CDI 4-matic (204.092)	170	10/09→01/14					
C 350 CGI (204.065)	215	09/08→01/14					
C 200 CGI (204.048)	135	01/07→01/14	➔	04/09→	1	24.8190-0410.2 620410	L= 97,5
			➔	04/09→	1	24.8190-0410.2 620410	L= 97,5
C 200 Kompressor (204.041)	135	01/07→01/14	➔	03/07→	1	24.8190-0410.2 620410	L= 97,5
C 220 CDI (204.008)	120	01/07→11/08	➔	03/07→	1	24.8190-0410.2 620410	L= 97,5
C 220 CDI (204.008)	125	01/07→11/08					
C 230 (204.052)	150	01/07→01/14					
C 320 CDI (204.022)	165	01/07→01/14					
C 350 (204.056)	200	01/07→01/14					
C 63 AMG (204.077)	336	02/08→01/14	➔		1	24.8190-0420.2 620420	L= 119
C 63 AMG (204.077)	358	02/08→01/14					
C 63 AMG (204.077)	373	02/08→01/14	➔		1	24.8190-0420.2 620420	L= 119
C 63 AMG DR 520	383	07/10→01/14					
<b>Bremsscheibe</b>							
C 180 CDI (204.000)	88	01/11→01/14	➔	für Fahrzeuge ohne Sportpaket / für Fahrzeuge ohne AMG-Sportpaket		24.0125-0179.1 425179	Ø 288 25 22 V + S
C 180 Kompressor (204.044, 204.045)	115	01/08→01/14	➔	für Fahrzeuge ohne Sportpaket / für Fahrzeuge ohne AMG-Sportpaket		24.0325-0179.1 525179	Ø 288 25 22 V + S
			➔	für Fahrzeuge mit Sportpaket / für Fahrzeuge mit AMG-Sportpaket		24.0128-0100.1 428100	Ø 295 28 26 V• + S
			➔	für Fahrzeuge ohne Sportpaket / für Fahrzeuge ohne AMG-Sportpaket		24.0109-0154.1 409154	Ø 278 9 7,3 + S
			➔	für Fahrzeuge ohne AMG-Sportpaket		24.0309-0154.1 509154	Ø 278 9 7,3 + S
			➔	für Fahrzeuge mit Sportpaket / für Fahrzeuge mit AMG-Sportpaket		24.0110-0328.1 410328	Ø 300 10 8,3 + S
			➔	für Fahrzeuge mit AMG-Sportpaket		24.0310-0328.1 510328	Ø 300 10 8,3 + S
C 180 CGI (204.031)	115	01/08→01/14	➔	04/09→; für Fahrzeuge ohne Sportpaket / für Fahrzeuge ohne AMG-Sportpaket		24.0125-0179.1 425179	Ø 288 25 22 V + S
C 180 CGI (204.049)	115	01/07→01/14	➔	für Fahrzeuge ohne Sportpaket / für Fahrzeuge ohne AMG-Sportpaket		24.0325-0179.1 525179	Ø 288 25 22 V + S
			➔	04/09→; für Fahrzeuge mit Sportpaket / für Fahrzeuge mit AMG-Sportpaket		24.0128-0100.1 428100	Ø 295 28 26 V• + S
			➔	für Fahrzeuge ohne Sportpaket / für Fahrzeuge ohne AMG-Sportpaket		24.0109-0154.1 409154	Ø 278 9 7,3 + S
			➔	für Fahrzeuge ohne AMG-Sportpaket		24.0309-0154.1 509154	Ø 278 9 7,3 + S
			➔	04/09→; für Fahrzeuge mit Sportpaket / für Fahrzeuge mit AMG-Sportpaket		24.0110-0328.1 410328	Ø 300 10 8,3 + S
			➔	für Fahrzeuge mit AMG-Sportpaket		24.0310-0328.1 510328	Ø 300 10 8,3 + S
C 180 Kompressor (204.046)	115	01/07→01/14	➔	03/07→; für Fahrzeuge ohne Sportpaket / für Fahrzeuge ohne AMG-Sportpaket		24.0125-0179.1 425179	Ø 288 25 22 V + S
C 200 CDI (204.007, 204.006)	100	01/07→12/10	➔	für Fahrzeuge ohne Sportpaket / für Fahrzeuge ohne AMG-Sportpaket		24.0325-0179.1 525179	Ø 288 25 22 V + S
			➔	03/07→; für Fahrzeuge mit Sportpaket / für Fahrzeuge mit AMG-Sportpaket		24.0128-0100.1 428100	Ø 295 28 26 V• + S
			➔	für Fahrzeuge mit Sportpaket / für Fahrzeuge mit AMG-Sportpaket		24.0109-0154.1 409154	Ø 278 9 7,3 + S
			➔	für Fahrzeuge ohne Sportpaket / für Fahrzeuge ohne AMG-Sportpaket		24.0309-0154.1 509154	Ø 278 9 7,3 + S
			➔	03/07→; für Fahrzeuge mit Sportpaket / für Fahrzeuge mit AMG-Sportpaket		24.0110-0328.1 410328	Ø 300 10 8,3 + S
			➔	für Fahrzeuge mit AMG-Sportpaket		24.0310-0328.1 510328	Ø 300 10 8,3 + S
↓							

	kw			 	! #		
<b>MERCEDES-BENZ - C-KLASSE (W204) 01/07→01/14</b>							
<b>Bremsscheibe</b>							
C 200 (204.048)	137	05/11→01/14	←	für Fahrzeuge mit Sportpaket / für Fahrzeuge mit AMG-Sportpaket	24.0128-0100.1	428100	Ø 295 28 26 V• + S
C 220 CDI (204.002)	120	10/08→01/14	←	für Fahrzeuge ohne Sportpaket / für Fahrzeuge ohne AMG-Sportpaket	24.0128-0155.1	428155	Ø 295 28 25,4 V + S
C 220 CDI (204.002)	125	12/08→01/14	←	für Fahrzeuge ohne Sportpaket / für Fahrzeuge ohne AMG-Sportpaket	24.0328-0155.1	528155	Ø 295 28 25,4 V + S
C 220 CDI 4-matic (204.084)	125	02/13→01/14	←	für Fahrzeuge ohne Sportpaket / für Fahrzeuge ohne AMG-Sportpaket	24.0328-0155.1	528155	Ø 295 28 25,4 V + S
C 230 4-matic (204.085)	150	07/07→01/14	→		24.0110-0328.1	410328	Ø 300 10 8,3 + S
C 250 CGI (204.047)	150	07/09→01/14	→		24.0310-0328.1	510328	Ø 300 10 8,3 + S
C 200 CDI (204.001)	100	01/11→01/14	←	für Fahrzeuge ohne Sportpaket / für Fahrzeuge ohne AMG-Sportpaket	24.0125-0179.1	425179	Ø 288 25 22 V + S
			←	für Fahrzeuge mit Sportpaket / für Fahrzeuge mit AMG-Sportpaket	24.0325-0179.1	525179	Ø 288 25 22 V + S
			→	A 384603 / F 483836→; für Fahrzeuge ohne Sportpaket / für Fahrzeuge ohne AMG-Sportpaket	24.0109-0154.1	409154	Ø 278 9 7,3 + S
			→	A 384603 / F 483836→; für Fahrzeuge ohne Sportpaket / für Fahrzeuge ohne AMG-Sportpaket	24.0309-0154.1	509154	Ø 278 9 7,3 + S
			→	für Fahrzeuge mit Sportpaket / für Fahrzeuge mit AMG-Sportpaket	24.0110-0328.1	410328	Ø 300 10 8,3 + S
			→	für Fahrzeuge mit Sportpaket / für Fahrzeuge mit AMG-Sportpaket	24.0310-0328.1	510328	Ø 300 10 8,3 + S
			→	→ A 384602 / F 483835; für Fahrzeuge ohne Sportpaket / für Fahrzeuge ohne AMG-Sportpaket	24.0110-0328.1	410328	Ø 300 10 8,3 + S
			→	→ A 384602 / F 483835; für Fahrzeuge ohne Sportpaket / für Fahrzeuge ohne AMG-Sportpaket	24.0310-0328.1	510328	Ø 300 10 8,3 + S
C 200 CGI (204.048)	135	01/07→01/14	←	04/09→; für Fahrzeuge mit Sportpaket / für Fahrzeuge mit AMG-Sportpaket	24.0128-0100.1	428100	Ø 295 28 26 V• + S
			←	04/09→; für Fahrzeuge ohne Sportpaket / für Fahrzeuge ohne AMG-Sportpaket	24.0128-0155.1	428155	Ø 295 28 25,4 V + S
			←	04/09→; für Fahrzeuge ohne Sportpaket / für Fahrzeuge ohne AMG-Sportpaket	24.0328-0155.1	528155	Ø 295 28 25,4 V + S
			→	04/09→	24.0110-0328.1	410328	Ø 300 10 8,3 + S
			→	04/09→	24.0310-0328.1	510328	Ø 300 10 8,3 + S
C 200 Kompressor (204.041)	135	01/07→01/14	←	03/07→; für Fahrzeuge mit Sportpaket / für Fahrzeuge mit AMG-Sportpaket	24.0128-0100.1	428100	Ø 295 28 26 V• + S
C 220 CDI (204.008)	120	01/07→11/08	←	03/07→; für Fahrzeuge mit Sportpaket / für Fahrzeuge mit AMG-Sportpaket	24.0128-0155.1	428155	Ø 295 28 25,4 V + S
C 220 CDI (204.008)	125	01/07→11/08	←	03/07→; für Fahrzeuge ohne Sportpaket / für Fahrzeuge ohne AMG-Sportpaket	24.0328-0155.1	528155	Ø 295 28 25,4 V + S
C 230 (204.052)	150	01/07→01/14	←	03/07→; für Fahrzeuge ohne Sportpaket / für Fahrzeuge ohne AMG-Sportpaket	24.0328-0155.1	528155	Ø 295 28 25,4 V + S
			→	03/07→	24.0110-0328.1	410328	Ø 300 10 8,3 + S
			→	03/07→	24.0310-0328.1	510328	Ø 300 10 8,3 + S
C 250 CDI (204.003)	150	08/08→01/14	←	für Fahrzeuge mit Sportpaket / für Fahrzeuge mit AMG-Sportpaket	24.0128-0100.1	428100	Ø 295 28 26 V• + S
			←	für Fahrzeuge ohne Sportpaket / für Fahrzeuge ohne AMG-Sportpaket	24.0128-0155.1	428155	Ø 295 28 25,4 V + S
			←	für Fahrzeuge ohne Sportpaket / für Fahrzeuge ohne AMG-Sportpaket	24.0328-0155.1	528155	Ø 295 28 25,4 V + S
			→	10/08→	24.0120-0208.1	420208	Ø 300 22 19,4 V + S
C 250 CDI 4-matic (204.082)	150	01/11→01/14	←	für Fahrzeuge ohne Sportpaket / für Fahrzeuge ohne AMG-Sportpaket	24.0128-0155.1	428155	Ø 295 28 25,4 V + S
			←	für Fahrzeuge ohne Sportpaket / für Fahrzeuge ohne AMG-Sportpaket	24.0328-0155.1	528155	Ø 295 28 25,4 V + S
			←	für Fahrzeuge mit Sportpaket / für Fahrzeuge mit AMG-Sportpaket	24.0132-0100.1	432100	Ø 322 32 30 V• + S
			→	für Fahrzeuge mit Sportpaket / für Fahrzeuge mit AMG-Sportpaket	24.0110-0328.1	410328	Ø 300 10 8,3 + S
			→	für Fahrzeuge mit Sportpaket / für Fahrzeuge mit AMG-Sportpaket	24.0310-0328.1	510328	Ø 300 10 8,3 + S
			→	für Fahrzeuge ohne Sportpaket / für Fahrzeuge ohne AMG-Sportpaket	24.0120-0208.1	420208	Ø 300 22 19,4 V + S
C 280 (204.054)	170	01/07→01/14	←	03/07→; für Fahrzeuge ohne Sportpaket / für Fahrzeuge ohne AMG-Sportpaket	24.0128-0155.1	428155	Ø 295 28 25,4 V + S
			←	03/07→; für Fahrzeuge ohne Sportpaket / für Fahrzeuge ohne AMG-Sportpaket	24.0328-0155.1	528155	Ø 295 28 25,4 V + S
			←	03/07→; für Fahrzeuge mit Sportpaket / für Fahrzeuge mit AMG-Sportpaket	24.0132-0100.1	432100	Ø 322 32 30 V• + S
			→	03/07→	24.0110-0328.1	410328	Ø 300 10 8,3 + S
			→	03/07→	24.0310-0328.1	510328	Ø 300 10 8,3 + S
C 280 4-matic (204.081)	170	07/07→01/14	←	für Fahrzeuge ohne Sportpaket / für Fahrzeuge ohne AMG-Sportpaket	24.0128-0155.1	428155	Ø 295 28 25,4 V + S
C 300 (204.054)	170	07/09→01/14	←	für Fahrzeuge ohne Sportpaket / für Fahrzeuge ohne AMG-Sportpaket	24.0328-0155.1	528155	Ø 295 28 25,4 V + S
			←	für Fahrzeuge mit Sportpaket / für Fahrzeuge mit AMG-Sportpaket	24.0132-0100.1	432100	Ø 322 32 30 V• + S
			→		24.0110-0328.1	410328	Ø 300 10 8,3 + S
			→		24.0310-0328.1	510328	Ø 300 10 8,3 + S
C 300 (204.055)	185	02/11→01/14	←	für Fahrzeuge mit Sportpaket / für Fahrzeuge mit AMG-Sportpaket	24.0132-0100.1	432100	Ø 322 32 30 V• + S
C 300 4-matic (204.080)	185	02/11→01/14	←	für Fahrzeuge mit Sportpaket / für Fahrzeuge mit AMG-Sportpaket	24.0132-0100.1	432100	Ø 322 32 30 V• + S
C 300 CDI 4-matic (204.092)	170	01/11→01/14	←	für Fahrzeuge ohne Sportpaket / für Fahrzeuge ohne AMG-Sportpaket	24.0132-0101.1	432101	Ø 322 32 29,4 V + S
C 350 (204.057)	225	01/11→01/14	←	für Fahrzeuge ohne Sportpaket / für Fahrzeuge ohne AMG-Sportpaket	24.0332-0101.1	532101	Ø 322 32 29,4 V + S
C 350 CDI (204.023)	195	06/11→01/14	→		24.0120-0208.1	420208	Ø 300 22 19,4 V + S
C 350 CDI 4-matic (204.092)	170	10/09→01/14	→		24.0120-0208.1	420208	Ø 300 22 19,4 V + S
C 350 CGI (204.065)	215	09/08→01/14	→		24.0120-0208.1	420208	Ø 300 22 19,4 V + S
↓							



	kw			 	! #		
<b>MERCEDES-BENZ - C-KLASSE (W204) 01/07→01/14</b>							
<b>Bremsscheibe</b>							
C 300 4-matic (204.081)	170	07/07→01/14	←	04/09→; für Fahrzeuge ohne Sportpaket / für Fahrzeuge ohne AMG-Sportpaket	24.0128-0155.1 428155	24.0328-0155.1 528155	Ø 295 28 25,4 V + S
			←	04/09→; für Fahrzeuge mit Sportpaket / für Fahr- zeuge mit AMG-Sportpaket	24.0132-0100.1 432100		Ø 322 32 30 V• + S
			→	04/09→	24.0110-0328.1 410328	24.0310-0328.1 510328	Ø 300 10 8,3 + S
C 320 CDI (204.022) C 350 (204.056)	165 200	01/07→01/14 01/07→01/14	←	03/07→; für Fahrzeuge ohne Sportpaket / für Fahrzeuge ohne AMG-Sportpaket	24.0132-0100.1 432100	24.0132-0101.1 432101	Ø 322 32 30 V• + S
			←	03/07→; für Fahrzeuge mit Sportpaket / für Fahr- zeuge mit AMG-Sportpaket	24.0132-0100.1 432100	24.0332-0101.1 532101	Ø 322 32 29,4 V + S
			→	03/07→	24.0120-0208.1 420208		Ø 300 22 19,4 V + S
C 320 CDI 4-matic (204.089) C 350 4-matic (204.087) C 350 CDI (204.022) C 350 CDI 4-matic (204.089)	165 200 165 165	07/07→01/14 07/07→01/14 07/09→01/14 07/09→01/14	←	für Fahrzeuge mit Sportpaket / für Fahr- zeuge mit AMG-Sportpaket	24.0132-0100.1 432100		Ø 322 32 30 V• + S
			←	für Fahrzeuge ohne Sportpaket / für Fahrzeuge ohne AMG-Sportpaket	24.0132-0100.1 432100	24.0132-0101.1 432101	Ø 322 32 30 V• + S
			←	für Fahrzeuge ohne Sportpaket / für Fahrzeuge ohne AMG-Sportpaket	24.0132-0101.1 432101	24.0332-0101.1 532101	Ø 322 32 29,4 V + S
			→		24.0120-0208.1 420208		Ø 300 22 19,4 V + S
C 350 4-matic (204.088) C 350 CDI (204.025)	225 170	01/11→01/14 10/09→01/14	←	für Fahrzeuge ohne Sportpaket / für Fahrzeuge ohne AMG-Sportpaket	24.0132-0101.1 432101	24.0332-0101.1 532101	Ø 322 32 29,4 V + S
			←		24.0132-0101.1 432101	24.0332-0101.1 532101	Ø 322 32 29,4 V + S
			→		24.0120-0208.1 420208		Ø 300 22 19,4 V + S
C 63 AMG (204.077) C 63 AMG (204.077) C 63 AMG (204.077) C 63 AMG DR 520	336 358 373 383	02/08→01/14 02/08→01/14 02/08→01/14 07/10→01/14	←	- AMG-Performance P.	24.0136-0108.1 436108		Ø 360 36 34 V• + S
			←				
			←				
			←				
<b>MERCEDES-BENZ - C-KLASSE (W205) 07/13→</b>							
<b>Bremsbelagsatz, Scheibenbremse</b>							
C 160 (205.044) C 180 (205.040) C 180 BlueTEC / d (205.036)	95 115 85	04/15→ 03/14→ 05/14→	←	für Fahrzeuge ohne AMG-Sportpaket	13.0460-2792.2 602792	13.0470-2792.2 LD2792	TRW 22031 19,6 + WE / - WK Ceramic
			←	für Fahrzeuge mit AMG-Sportpaket	13.0460-4880.2 604880	13.0470-4880.2 LD4880	BRE 25997 18,7 + WE / - WK Ceramic
			→	+ eFSB	13.0460-7304.2 607304	13.0470-7304.2 LD7304	ATE 25353 16,2 + WE / - WK Ceramic
C 200 4-matic (205.043) C 200 BlueTEC / d (205.037) C 200 d (205.007) C 220 BlueTEC / d (205.003) C 220 d 4-matic (205.005)	135 100 100 120 125	04/15→ 05/14→ 10/15→ 03/14→04/16 04/15→	←	für Fahrzeuge ohne AMG-Sportpaket	13.0460-2792.2 602792	13.0470-2792.2 LD2792	TRW 22031 19,6 + WE / - WK Ceramic
			←	für Fahrzeuge mit AMG-Sportpaket	13.0460-4880.2 604880	13.0470-4880.2 LD4880	BRE 25997 18,7 + WE / - WK Ceramic
			→	+ USA	13.0460-7304.2 607304	13.0470-7304.2 LD7304	ATE 25353 16,2 + WE / - WK Ceramic
			→		13.0460-7304.2 607304	13.0470-7304.2 LD7304	ATE 25353 16,2 + WE / - WK Ceramic
C 180 d (205.000) C 200 d (205.011) C 200 EQ Boost (205.077) C 220 d (205.014)	90 110 135 143	05/18→ 05/18→ 04/18→ 04/18→	←	für Fahrzeuge ohne AMG-Sportpaket	13.0460-2792.2 602792	13.0470-2792.2 LD2792	TRW 22031 19,6 + WE / - WK Ceramic
			←	für Fahrzeuge mit AMG-Sportpaket	13.0460-4880.2 604880	13.0470-4880.2 LD4880	BRE 25997 18,7 + WE / - WK Ceramic
			→	+ USA	13.0460-7304.2 607304	13.0470-7304.2 LD7304	ATE 25353 16,2 + WE / - WK Ceramic
C 200 (205.042) C 220 BlueTEC / d (205.002, 205.004)	135 125	12/13→ 12/13→	←	02/14→; für Fahrzeuge ohne AMG-Sportpaket	13.0460-2792.2 602792	13.0470-2792.2 LD2792	TRW 22031 19,6 + WE / - WK Ceramic
			←	02/14→; für Fahrzeuge mit AMG-Sportpaket	13.0460-4880.2 604880	13.0470-4880.2 LD4880	BRE 25997 18,7 + WE / - WK Ceramic
			→	02/14→; + eFSB	13.0460-7304.2 607304	13.0470-7304.2 LD7304	ATE 25353 16,2 + WE / - WK Ceramic
C 200 d (205.001)	118	05/18→	←	für Fahrzeuge ohne AMG-Sportpaket	13.0460-2792.2 602792	13.0470-2792.2 LD2792	TRW 22031 19,6 + WE / - WK Ceramic
			←	für Fahrzeuge mit AMG-Sportpaket	13.0460-4880.2 604880	13.0470-4880.2 LD4880	BRE 25997 18,7 + WE / - WK Ceramic
			→	+ USA	13.0460-7304.2 607304		ATE 25353 16,2 + WE / - WK
↓							

	kw			 	! #		
<b>MERCEDES-BENZ - C-KLASSE (W205) 07/13→</b>							
<b> Bremsbelagsatz, Scheibenbremse</b>							
C 200 d (205.001)	118	05/18→	➔	+ USA; für Fahrzeuge mit AMG-Sportpaket		<b>13.0470-7304.2 LD7304</b>	ATE 25353 16,2 + WE / - WK Ceramic
C 200 EQ Boost 4-matic (205.078)	135	04/18→	➔	für Fahrzeuge ohne AMG-Sportpaket; für Fahrzeuge ohne elektr. Dämpferregulierung		<b>13.0460-2792.2 602792</b>	TRW 22031 19,6 + WE / - WK
C 220 d 4-matic (205.015)	143	05/18→	➔	für Fahrzeuge mit elektr. Dämpferregulierung		<b>13.0470-2792.2 LD2792</b>	TRW 22031 19,6 + WE / - WK Ceramic
			➔	für Fahrzeuge mit elektr. Dämpferregulierung		<b>13.0460-4880.2 604880</b> <b>13.0470-4880.2 LD4880</b>	BRE 25997 18,7 + WE / - WK Ceramic
			➔	für Fahrzeuge mit AMG-Sportpaket		<b>13.0460-4880.2 604880</b> <b>13.0470-4880.2 LD4880</b>	BRE 25997 18,7 + WE / - WK Ceramic
			➔	+ USA		<b>13.0460-7304.2 607304</b> <b>13.0470-7304.2 LD7304</b>	ATE 25353 16,2 + WE / - WK Ceramic
C 250 (205.045)	155	03/14→	➔	für Fahrzeuge ohne AMG-Sportpaket		<b>13.0460-4880.2 604880</b>	BRE 25997 18,7 + WE / - WK
C 250 BlueTEC / d (205.008, 205.006)	150	02/14→	➔	für Fahrzeuge ohne AMG-Sportpaket		<b>13.0470-4880.2 LD4880</b>	BRE 25997 18,7 + WE / - WK Ceramic
C 300 BlueTEC Hybrid / h (205.012)	150	05/14→	➔	für Fahrzeuge mit AMG-Sportpaket		<b>13.0460-4883.2 604883</b> <b>13.0470-4883.2 LD4883</b>	BRE 22061 18,7 + WE / - WK Ceramic
			➔	+ eFSB		<b>13.0460-7304.2 607304</b> <b>13.0470-7304.2 LD7304</b>	ATE 25353 16,2 + WE / - WK Ceramic
C 250 BlueTEC / d 4-matic (205.009)	150	02/14→	➔	05/14→; für Fahrzeuge ohne AMG-Sportpaket		<b>13.0460-2610.2 602610</b> <b>13.0470-2610.2 LD2610</b>	TRW 22076 19,6 + WE / - WK Ceramic
			➔	für Fahrzeuge mit AMG-Sportpaket		<b>13.0460-4883.2 604883</b> <b>13.0470-4883.2 LD4883</b>	BRE 22061 18,7 + WE / - WK Ceramic
			➔	+ eFSB		<b>13.0460-7304.2 607304</b> <b>13.0470-7304.2 LD7304</b>	ATE 25353 16,2 + WE / - WK Ceramic
C 300 (205.048)	180	09/15→	➔	für Fahrzeuge ohne AMG-Sportpaket		<b>13.0460-2610.2 602610</b> <b>13.0470-2610.2 LD2610</b>	TRW 22076 19,6 + WE / - WK Ceramic
			➔	für Fahrzeuge mit AMG-Sportpaket		<b>13.0460-4883.2 604883</b> <b>13.0470-4883.2 LD4883</b>	BRE 22061 18,7 + WE / - WK Ceramic
			➔	+ eFSB		<b>13.0460-7304.2 607304</b> <b>13.0470-7304.2 LD7304</b>	ATE 25353 16,2 + WE / - WK Ceramic
C 300 (205.083)	190	05/18→	➔	für Fahrzeuge ohne AMG-Sportpaket; + USA		<b>13.0460-2610.2 602610</b> <b>13.0470-2610.2 LD2610</b>	TRW 22076 19,6 + WE / - WK Ceramic
			➔	für Fahrzeuge mit AMG-Sportpaket		<b>13.0460-4883.2 604883</b> <b>13.0470-4883.2 LD4883</b>	BRE 22061 18,7 + WE / - WK Ceramic
			➔	+ USA		<b>13.0460-7304.2 607304</b> <b>13.0470-7304.2 LD7304</b>	ATE 25353 16,2 + WE / - WK Ceramic
C 300 d (205.018)	180	06/18→	➔	für Fahrzeuge ohne AMG-Sportpaket		<b>13.0460-4880.2 604880</b> <b>13.0470-4880.2 LD4880</b>	BRE 25997 18,7 + WE / - WK Ceramic
			➔	für Fahrzeuge mit AMG-Sportpaket		<b>13.0460-4883.2 604883</b> <b>13.0470-4883.2 LD4883</b>	BRE 22061 18,7 + WE / - WK Ceramic
			➔	+ USA		<b>13.0460-7304.2 607304</b> <b>13.0470-7304.2 LD7304</b>	ATE 25353 16,2 + WE / - WK Ceramic
C 300 d 4-matic (205.019)	180	06/18→	➔	für Fahrzeuge mit AMG-Sportpaket		<b>13.0460-4883.2 604883</b> <b>13.0470-4883.2 LD4883</b>	BRE 22061 18,7 + WE / - WK Ceramic
			➔	für Fahrzeuge mit elektr. Dämpferregulierung		<b>13.0460-4883.2 604883</b> <b>13.0470-4883.2 LD4883</b>	BRE 22061 18,7 + WE / - WK Ceramic
			➔	+ USA		<b>13.0460-7304.2 607304</b>	ATE 25353 16,2 + WE / - WK

	kW			 	! #		
<b>MERCEDES-BENZ - C-KLASSE (W205) 07/13→</b>							
<b> Bremsbelagsatz, Scheibenbremse</b>							
C 300 d 4-matic (205.019)	180	06/18→	➔	+ USA		13.0470-7304.2 LD7304	ATE 25353 16,2 + WE / - WK Ceramic
C 350 e (205.047)	155	02/15→	➔			13.0460-4883.2 604883	BRE 22061 18,7 + WE / - WK Ceramic
C 350 e (205.047)	205	02/15→	➔			13.0470-4883.2 LD4883	BRE 22061 18,7 + WE / - WK Ceramic
			➔	+ eFSB		13.0460-7304.2 607304	ATE 25353 16,2 + WE / - WK Ceramic
						13.0470-7304.2 LD7304	ATE 25353 16,2 + WE / - WK Ceramic
C 400 4-matic (205.066)	245	10/14→	➔			13.0460-4883.2 604883	BRE 22061 18,7 + WE / - WK Ceramic
			➔	+ eFSB		13.0460-7304.2 607304	ATE 25353 16,2 + WE / - WK Ceramic
						13.0470-7304.2 LD7304	ATE 25353 16,2 + WE / - WK Ceramic
<b>Warnkontakt, Bremsbelagsverschleiß</b>							
AMG C 43 4-matic (205.064)	270	04/16→	➔		1	24.8190-0067.2 620067	L= 92,5
AMG C 43 4-matic (205.064)	287	04/18→	➔		1	24.8190-0067.2 620067	L= 92,5
C 160 (205.044)	95	04/15→					
C 180 (205.040)	115	03/14→					
C 180 BlueTEC / d (205.036)	85	05/14→					
C 180 d (205.000)	90	05/18→					
C 200 4-matic (205.043)	135	04/15→					
C 200 BlueTEC / d (205.037)	100	05/14→					
C 200 d (205.001)	118	05/18→					
C 200 d (205.007)	100	10/15→					
C 200 d (205.011)	110	05/18→					
C 200 EQ Boost (205.077)	135	04/18→					
C 200 EQ Boost 4-matic (205.078)	135	04/18→					
C 220 BlueTEC / d (205.003)	120	03/14→04/16					
C 220 d (205.014)	143	04/18→					
C 220 d 4-matic (205.005)	125	04/15→					
C 250 (205.045)	155	03/14→					
C 250 BlueTEC / d (205.008, 205.006)	150	02/14→					
C 300 (205.048)	180	09/15→					
C 300 (205.083)	190	05/18→					
C 300 BlueTEC Hybrid / h (205.012)	150	05/14→					
C 300 d (205.018)	180	06/18→					
C 300 d 4-matic (205.019)	180	06/18→					
C 350 e (205.047)	155	02/15→					
C 350 e (205.047)	205	02/15→					
C 400 4-matic (205.066)	245	10/14→					
C 450 AMG 4-matic (205.064)	270	04/15→04/16					
AMG C 63 (205.086)	350	10/14→	➔		1	24.8190-0410.2 620410	L= 97,5
AMG C 63 S (205.087)	375	10/14→	➔				
C 200 (205.042)	135	12/13→	➔	02/14→	1	24.8190-0067.2 620067	L= 92,5
C 220 BlueTEC / d (205.002, 205.004)	125	12/13→	➔	02/14→	1	24.8190-0067.2 620067	L= 92,5
C 220 d 4-matic (205.015)	143	05/18→	➔		2	24.8190-0067.2 620067	L= 92,5
			➔		1	24.8190-0067.2 620067	L= 92,5
C 250 BlueTEC / d 4-matic (205.009)	150	02/14→	➔	für Fahrzeuge mit AMG-Sportpaket	1	24.8190-0067.2 620067	L= 92,5
			➔	05/14→; für Fahrzeuge ohne AMG-Sportpaket	1	24.8190-0067.2 620067	L= 92,5
			➔		1	24.8190-0067.2 620067	L= 92,5
<b> Bremsscheibe</b>							
AMG C 63 (205.086)	350	10/14→	➔	nicht für Bremssattelfarbe: rot; für Fahrzeuge ohne Keramikbremse		24.0136-0108.1 436108	Ø 360 36 34 V• + S
AMG C 63 S (205.087)	375	10/14→	➔				
C 160 (205.044)	95	04/15→	➔	für Fahrzeuge ohne AMG-Sportpaket		24.0124-0300.1 424300	Ø 295 24 21,4 V + S
C 180 (205.040)	115	03/14→	➔				
C 180 BlueTEC / d (205.036)	85	05/14→	➔			24.0112-0300.1 412300	Ø 300 12 10,3 + S
C 180 d (205.000)	90	05/18→					
C 200 BlueTEC / d (205.037)	100	05/14→					
↓							

**MERCEDES-BENZ - C-KLASSE (W205) 07/13→**









**Bremsscheibe**

C 200 (205.042)	135	12/13→	←	02/14→; für Fahrzeuge ohne AMG-Sportpaket	24.0128-0330.1	428330	∅ 305 28 25,4 V + S
			→	02/14→	24.0112-0300.1	412300	∅ 300 12 10,3 + S
C 200 4-matic (205.043)	135	04/15→	←	für Fahrzeuge ohne AMG-Sportpaket	24.0128-0330.1	428330	∅ 305 28 25,4 V + S
C 200 d (205.007)	100	10/15→	→		24.0112-0300.1	412300	∅ 300 12 10,3 + S
C 200 d (205.011)	110	05/18→					
C 200 EQ Boost (205.077)	135	04/18→					
C 220 BlueTEC / d (205.003)	120	03/14→04/16					
C 220 d (205.014)	143	04/18→	→		24.0112-0300.1	412300	∅ 300 12 10,3 + S
C 220 d 4-matic (205.005)	125	04/15→					
C 200 d (205.001)	118	05/18→	←	für Fahrzeuge ohne AMG-Sportpaket; Stahlfelge / Leichtmetallfelge; Felgenreöße [Zoll]: 16	24.0124-0300.1	424300	∅ 295 24 21,4 V + S
			←	für Fahrzeuge ohne AMG-Sportpaket; nicht für Felgenreöße [Zoll]: 16	24.0128-0330.1	428330	∅ 305 28 25,4 V + S
			→		24.0112-0300.1	412300	∅ 300 12 10,3 + S
C 200 EQ Boost 4-matic (205.078)	135	04/18→	←	für Fahrzeuge ohne AMG-Sportpaket; für Fahrzeuge ohne elektr. Dämpferregulierung	24.0128-0330.1	428330	∅ 305 28 25,4 V + S
C 220 d 4-matic (205.015)	143	05/18→	→		24.0112-0300.1	412300	∅ 300 12 10,3 + S
C 220 BlueTEC / d (205.002, 205.004)	125	12/13→	←		24.0128-0330.1	428330	∅ 305 28 25,4 V + S
			→	02/14→	24.0112-0300.1	412300	∅ 300 12 10,3 + S
C 250 (205.045)	155	03/14→	→		24.0112-0300.1	412300	∅ 300 12 10,3 + S
C 250 BlueTEC / d (205.008, 205.006)	150	02/14→					
C 250 BlueTEC / d 4-matic (205.009)	150	02/14→					
C 300 d (205.018)	180	06/18→	→		24.0112-0300.1	412300	∅ 300 12 10,3 + S
C 300 d 4-matic (205.019)	180	06/18→					







**MERCEDES-BENZ - C-KLASSE Cabriolet (A205) 06/16→**

**Bremsbelagsatz, Scheibenbremse**

AMG C 63 (205.486)	350	10/16→	→	für Fahrzeuge ohne Keramikbremse; nicht für Bremssattelfarbe: rot / silber; + USA	13.0460-7304.2	607304	ATE 25353 16,2 + WE / - WK		
AMG C 63 S (205.487)	375	10/16→			13.0470-7304.2	LD7304	ATE 25353 16,2 + WE / - WK Ceramic		
C 180 (205.440)	115	06/16→	←	für Fahrzeuge ohne AMG-Sportpaket	13.0460-2792.2	602792	TRW 22031 19,6 + WE / - WK		
C 200 (205.442)	135	06/16→			13.0470-2792.2	LD2792	TRW 22031 19,6 + WE / - WK Ceramic		
C 200 4-matic (205.443)	135	06/16→			←	für Fahrzeuge mit AMG-Sportpaket	13.0460-4880.2	604880	BRE 25997 18,7 + WE / - WK
C 220 d (205.404)	120	06/16→					13.0470-4880.2	LD4880	BRE 25997 18,7 + WE / - WK Ceramic
C 220 d (205.404)	125	06/16→	→		13.0460-7304.2	607304	ATE 25353 16,2 + WE / - WK		
C 220 d 4-matic (205.405)	125	06/16→			13.0470-7304.2	LD7304	ATE 25353 16,2 + WE / - WK Ceramic		
C 200 d (205.401)	118	07/18→	←	für Fahrzeuge ohne AMG-Sportpaket	13.0460-2792.2	602792	TRW 22031 19,6 + WE / - WK		
C 200 EQ Boost (205.477)	135	05/18→			13.0470-2792.2	LD2792	TRW 22031 19,6 + WE / - WK Ceramic		
C 220 d (205.414)	143	04/18→	←	für Fahrzeuge mit AMG-Sportpaket	13.0460-4880.2	604880	BRE 25997 18,7 + WE / - WK		
			→	+ USA	13.0460-7304.2	607304	ATE 25353 16,2 + WE / - WK		
			→		13.0470-7304.2	LD7304	ATE 25353 16,2 + WE / - WK Ceramic		
C 200 EQ Boost 4-matic (205.478)	135	05/18→	←	für Fahrzeuge ohne AMG-Sportpaket; für Fahrzeuge ohne elektr. Dämpferregulierung	13.0460-2792.2	602792	TRW 22031 19,6 + WE / - WK		
C 220 d 4-matic (205.415)	143	06/18→	←	für Fahrzeuge mit elektr. Dämpferregulierung	13.0460-4880.2	604880	BRE 25997 18,7 + WE / - WK		
			←	für Fahrzeuge mit AMG-Sportpaket	13.0470-4880.2	LD4880	BRE 25997 18,7 + WE / - WK Ceramic		
			→	+ USA	13.0460-7304.2	607304	ATE 25353 16,2 + WE / - WK		
			→		13.0470-7304.2	LD7304	ATE 25353 16,2 + WE / - WK Ceramic		
C 250 (205.445)	155	06/16→	←	für Fahrzeuge ohne AMG-Sportpaket	13.0460-2610.2	602610	TRW 22076 19,6 + WE / - WK		

	kW			 	! #		
<b>MERCEDES-BENZ - C-KLASSE Cabriolet (A205) 06/16 →</b>							
<b> Bremsbelagsatz, Scheibenbremse</b>							
C 250 d (205.408) C 300 (205.448)	150 180	06/16 → 06/16 →	←	für Fahrzeuge ohne AMG-Sportpaket		<b>13.0470-2610.2</b> <b>LD2610</b>	TRW 22076 19,6 + WE / - WK Ceramic
			←	für Fahrzeuge mit AMG-Sportpaket		<b>13.0460-4883.2</b> <b>604883</b>	BRE 22061 18,7 + WE / - WK
			←	für Fahrzeuge mit AMG-Sportpaket; - USA		<b>13.0470-4883.2</b> <b>LD4883</b>	BRE 22061 18,7 + WE / - WK Ceramic
			→			<b>13.0460-7304.2</b> <b>607304</b> <b>13.0470-7304.2</b> <b>LD7304</b>	ATE 25353 16,2 + WE / - WK ATE 25353 16,2 + WE / - WK Ceramic
C 300 (205.483)	190	05/18 →	←	für Fahrzeuge ohne AMG-Sportpaket; + USA		<b>13.0460-2610.2</b> <b>602610</b> <b>13.0470-2610.2</b> <b>LD2610</b>	TRW 22076 19,6 + WE / - WK Ceramic
			←	für Fahrzeuge mit AMG-Sportpaket		<b>13.0460-4883.2</b> <b>604883</b> <b>13.0470-4883.2</b> <b>LD4883</b>	BRE 22061 18,7 + WE / - WK BRE 22061 18,7 + WE / - WK Ceramic
			→	+ USA		<b>13.0460-7304.2</b> <b>607304</b> <b>13.0470-7304.2</b> <b>LD7304</b>	ATE 25353 16,2 + WE / - WK ATE 25353 16,2 + WE / - WK Ceramic
C 300 d (205.418)	180	07/18 →	←	für Fahrzeuge mit AMG-Sportpaket		<b>13.0460-4883.2</b> <b>604883</b> <b>13.0470-4883.2</b> <b>LD4883</b>	BRE 22061 18,7 + WE / - WK BRE 22061 18,7 + WE / - WK Ceramic
			→	+ USA		<b>13.0460-7304.2</b> <b>607304</b> <b>13.0470-7304.2</b> <b>LD7304</b>	ATE 25353 16,2 + WE / - WK ATE 25353 16,2 + WE / - WK Ceramic
C 400 4-matic (205.466)	245	06/16 →	←			<b>13.0460-4883.2</b> <b>604883</b>	BRE 22061 18,7 + WE / - WK
			→			<b>13.0460-7304.2</b> <b>607304</b> <b>13.0470-7304.2</b> <b>LD7304</b>	ATE 25353 16,2 + WE / - WK ATE 25353 16,2 + WE / - WK Ceramic
<b>Warnkontakt, Bremsbelagverschleiß</b>							
AMG C 43 4-matic (205.464)	270	10/16 →	←		1	<b>24.8190-0067.2</b> <b>620067</b>	L= 92,5
AMG C 43 4-matic (205.464)	287	04/18 →	→		1	<b>24.8190-0067.2</b> <b>620067</b>	L= 92,5
C 180 (205.440)	115	06/16 →					
C 200 (205.442)	135	06/16 →					
C 200 4-matic (205.443)	135	06/16 →					
C 200 d (205.401)	118	07/18 →					
C 200 EQ Boost (205.477)	135	05/18 →					
C 200 EQ Boost 4-matic (205.478)	135	05/18 →					
C 220 d (205.404)	120	06/16 →					
C 220 d (205.404)	125	06/16 →					
C 220 d (205.414)	143	04/18 →					
C 220 d 4-matic (205.405)	125	06/16 →					
C 220 d 4-matic (205.415)	143	06/18 →					
C 250 (205.445)	155	06/16 →					
C 250 d (205.408)	150	06/16 →					
C 300 (205.448)	180	06/16 →					
C 300 (205.483)	190	05/18 →					
C 300 d (205.418)	180	07/18 →					
C 400 4-matic (205.466)	245	06/16 →					
AMG C 63 (205.486)	350	10/16 →	←	für Fahrzeuge ohne Keramikbremse	1	<b>24.8190-0420.2</b> <b>620420</b>	L= 119
AMG C 63 S (205.487)	375	10/16 →	→		1	<b>24.8190-0410.2</b> <b>620410</b>	L= 97,5
<b> Bremsscheibe</b>							
AMG C 63 (205.486)	350	10/16 →	←	Bremssattelfarbe: silber; für Fahrzeuge ohne Keramikbremse		<b>24.0136-0108.1</b> <b>436108</b>	Ø 360 36 34 V• + S
AMG C 63 S (205.487)	375	10/16 →					
C 180 (205.440)	115	06/16 →	←	für Fahrzeuge ohne AMG-Sportpaket		<b>24.0124-0300.1</b> <b>424300</b>	Ø 295 24 21,4 V + S
			→			<b>24.0112-0300.1</b> <b>412300</b>	Ø 300 12 10,3 + S
C 200 (205.442)	135	06/16 →	←	für Fahrzeuge ohne AMG-Sportpaket		<b>24.0128-0330.1</b> <b>428330</b>	Ø 305 28 25,4 V + S
C 200 4-matic (205.443)	135	06/16 →					
C 220 d (205.404)	120	06/16 →	→			<b>24.0112-0300.1</b> <b>412300</b>	Ø 300 12 10,3 + S
C 220 d (205.404)	125	06/16 →					
C 220 d 4-matic (205.405)	125	06/16 →					
C 200 d (205.401)	118	07/18 →	←	für Fahrzeuge ohne AMG-Sportpaket		<b>24.0128-0330.1</b> <b>428330</b>	Ø 305 28 25,4 V + S
C 200 EQ Boost (205.477)	135	05/18 →	→	für Fahrzeuge ohne AMG-Sportpaket		<b>24.0112-0300.1</b> <b>412300</b>	Ø 300 12 10,3 + S
C 220 d (205.414)	143	04/18 →					
			↓				



	kw				! #		
<b>MERCEDES-BENZ - C-KLASSE Cabriolet (A205) 06/16→</b>							
<b>Bremsscheibe</b>							
C 200 EQ Boost 4-matic (205.478)	135	05/18→	←	für Fahrzeuge ohne AMG-Sportpaket; für Fahrzeuge ohne elektr. Dämpferregulierung		24.0128-0330.1 428330	∅ 305 28 25,4 V + S
C 220 d 4-matic (205.415)	143	06/18→	→	für Fahrzeuge ohne AMG-Sportpaket		24.0112-0300.1 412300	∅ 300 12 10,3 + S
C 250 (205.445)	155	06/16→	→	für Fahrzeuge ohne AMG-Sportpaket		24.0112-0300.1 412300	∅ 300 12 10,3 + S
C 250 d (205.408)	150	06/16→					
C 300 d (205.418)	180	07/18→					
<b>MERCEDES-BENZ - C-KLASSE Coupe (C204) 01/11→</b>							
<b>Bremsbelagsatz, Scheibenbremse</b>							
C 180 (204.331)	115	01/13→	←	für Fahrzeuge mit Sportpaket / für Fahrzeuge mit AMG-Sportpaket		13.0460-2732.2 602732	TRW 24306 20,3 + WE / - WK + Zub
C 180 (204.349)	115	06/11→	←	für Fahrzeuge ohne Sportpaket / für Fahrzeuge ohne AMG-Sportpaket		13.0470-2732.2 LD2732	TRW 24306 20,3 + WE / - WK + Zub Ceramic
			→			13.0460-2733.2 602733	TRW 24306 20,3 + WE / - WK + Zub
			→			13.0470-2733.2 LD2733	TRW 24306 20,3 + WE / - WK + Zub Ceramic
			→			13.0460-7244.2 607244	ATE 24253 17,8 + WE / - WK
			→			13.0470-7244.2 LD7244	ATE 24253 17,8 + WE / - WK Ceramic
C 200 CGI (204.348)	135	06/11→	←	nicht für Ausstattungsvariante: Sport Edition [P84]		13.0460-2732.2 602732	TRW 24306 20,3 + WE / - WK + Zub
C 250 (204.347)	150	06/11→	←	Sport Edition [P84]		13.0470-2732.2 LD2732	TRW 24306 20,3 + WE / - WK + Zub Ceramic
C 250 CDI (204.303)	150	06/11→	→			13.0460-2734.2 602734	TRW 24310 19,0 + WE / - WK
			→			13.0470-2734.2 LD2734	TRW 24310 19,0 + WE / - WK Ceramic
			→			13.0460-7244.2 607244	ATE 24253 17,8 + WE / - WK
			→			13.0470-7244.2 LD7244	ATE 24253 17,8 + WE / - WK Ceramic
C 220 CDI (204.302)	120	06/11→	←			13.0460-2732.2 602732	TRW 24306 20,3 + WE / - WK + Zub
C 220 CDI (204.302)	125	06/11→	→			13.0470-2732.2 LD2732	TRW 24306 20,3 + WE / - WK + Zub Ceramic
			→			13.0460-7244.2 607244	ATE 24253 17,8 + WE / - WK
			→			13.0470-7244.2 LD7244	ATE 24253 17,8 + WE / - WK Ceramic
C 350 (204.357)	225	06/11→	←			13.0460-2734.2 602734	TRW 24310 19,0 + WE / - WK
C 350 4-matic	225	09/13→	→			13.0470-2734.2 LD2734	TRW 24310 19,0 + WE / - WK Ceramic
			→			13.0460-7244.2 607244	ATE 24253 17,8 + WE / - WK
			→			13.0470-7244.2 LD7244	ATE 24253 17,8 + WE / - WK Ceramic
C 63 AMG (204.377)	336	06/11→	←	für Fahrzeuge ohne AMG-Performance Package		13.0460-4839.2 604839	BRE 24455 16,8 + WE / - WK
C 63 AMG (204.377)	358	01/12→					
C 63 AMG (204.377)	373	11/12→					
<b>Warnkontakt, Bremsbelagverschleiß</b>							
C 180 (204.331)	115	01/13→	←	für Fahrzeuge mit Sportpaket / für Fahrzeuge mit AMG-Sportpaket	2	24.8190-0410.2 620410	L= 97,5
C 180 (204.349)	115	06/11→	←	für Fahrzeuge ohne Sportpaket / für Fahrzeuge ohne AMG-Sportpaket	2	24.8190-0410.2 620410	L= 97,5
			→		2	24.8190-0410.2 620410	L= 97,5
C 200 CGI (204.348)	135	06/11→	←	nicht für Ausstattungsvariante: Sport Edition [P84]	2	24.8190-0410.2 620410	L= 97,5
C 250 (204.347)	150	06/11→	←	Sport Edition [P84]	2	24.8190-0410.2 620410	L= 97,5
C 250 CDI (204.303)	150	06/11→	→		2	24.8190-0410.2 620410	L= 97,5
			→		2	24.8190-0410.2 620410	L= 97,5
C 220 CDI (204.302)	120	06/11→	←		2	24.8190-0410.2 620410	L= 97,5
C 220 CDI (204.302)	125	06/11→	→		2	24.8190-0410.2 620410	L= 97,5
C 350 (204.357)	225	06/11→	→		2	24.8190-0410.2 620410	L= 97,5
C 350 4-matic	225	09/13→					
C 63 AMG (204.377)	336	06/11→	←		2	24.8190-0420.2 620420	L= 119
C 63 AMG (204.377)	358	01/12→	→		2	24.8190-0410.2 620410	L= 97,5
C 63 AMG (204.377)	373	11/12→	→		2	24.8190-0410.2 620410	L= 97,5
C 63 AMG (204.377)	380	01/12→	→		2	24.8190-0420.2 620420	L= 119
<b>Bremsscheibe</b>							
C 180 (204.331)	115	01/13→	←	für Fahrzeuge ohne Sportpaket / für Fahrzeuge ohne AMG-Sportpaket		24.0125-0179.1 425179	∅ 288 25 22 V + S
C 180 (204.349)	115	06/11→					

**MERCEDES-BENZ - C-KLASSE Coupe (C204) 01/11→**







**Bremsscheibe**









C 180 (204.331) C 180 (204.349)	115	01/13→	←	für Fahrzeuge ohne Sportpaket / für Fahrzeuge ohne AMG-Sportpaket	24.0325-0179.1	525179	Ø 288 25 22 V + S
	115	06/11→	←	für Fahrzeuge mit Sportpaket / für Fahrzeuge mit AMG-Sportpaket	24.0128-0100.1	428100	Ø 295 28 26 V• + S
			→	für Fahrzeuge ohne Sportpaket / für Fahrzeuge ohne AMG-Sportpaket	24.0109-0154.1	409154	Ø 278 9 7,3 + S
			→	für Fahrzeuge mit Sportpaket / für Fahrzeuge mit AMG-Sportpaket	24.0309-0154.1	509154	Ø 278 9 7,3 + S
C 200 CGI (204.348) C 250 (204.347)	135	06/11→	←	für Fahrzeuge mit Sportpaket / für Fahrzeuge mit AMG-Sportpaket; nicht für Ausstattungsvariante: Sport Edition [P84]	24.0128-0100.1	428100	Ø 295 28 26 V• + S
	150	06/11→	←	für Fahrzeuge ohne Sportpaket / für Fahrzeuge ohne AMG-Sportpaket; nicht für Ausstattungsvariante: Sport Edition [P84]	24.0128-0155.1	428155	Ø 295 28 25,4 V + S
			←	Sport Edition [P84]	24.0328-0155.1	528155	Ø 295 28 25,4 V + S
			→		24.0132-0168.1	432168	Ø 344 32 30 V• + S
C 220 CDI (204.302) C 220 CDI (204.302)	120	06/11→	←	für Fahrzeuge mit Sportpaket / für Fahrzeuge mit AMG-Sportpaket	24.0110-0328.1	410328	Ø 300 10 8,3 + S
	125	06/11→	←	für Fahrzeuge ohne Sportpaket / für Fahrzeuge ohne AMG-Sportpaket	24.0310-0328.1	510328	Ø 300 10 8,3 + S
			→		24.0128-0100.1	428100	Ø 295 28 26 V• + S
			→		24.0128-0155.1	428155	Ø 295 28 25,4 V + S
C 250 CDI (204.303)	150	06/11→	←	für Fahrzeuge mit Sportpaket / für Fahrzeuge mit AMG-Sportpaket; nicht für Ausstattungsvariante: Sport Edition [P84]	24.0128-0155.1	428155	Ø 295 28 25,4 V + S
			←	für Fahrzeuge ohne Sportpaket / für Fahrzeuge ohne AMG-Sportpaket; nicht für Ausstattungsvariante: Sport Edition [P84]	24.0328-0155.1	528155	Ø 295 28 25,4 V + S
			←	Sport Edition [P84]	24.0132-0168.1	432168	Ø 344 32 30 V• + S
			→		24.0120-0208.1	420208	Ø 300 22 19,4 V + S
C 350 (204.357) C 350 4-matic	225	06/11→	←	für Fahrzeuge mit Sportpaket / für Fahrzeuge mit AMG-Sportpaket	24.0132-0100.1	432100	Ø 322 32 30 V• + S
	225	09/13→	←	für Fahrzeuge ohne Sportpaket / für Fahrzeuge ohne AMG-Sportpaket	24.0132-0101.1	432101	Ø 322 32 29,4 V + S
			→		24.0332-0101.1	532101	Ø 322 32 29,4 V + S
C 63 AMG (204.377) C 63 AMG (204.377) C 63 AMG (204.377)	336	06/11→	←	- AMG-Performance P.	24.0120-0208.1	420208	Ø 300 22 19,4 V + S
	358	01/12→			24.0136-0108.1	436108	Ø 360 36 34 V• + S
	373	11/12→					

**MERCEDES-BENZ - C-KLASSE Coupe (C205) 10/15→**









**Bremsbelagsatz, Scheibenbremse**

AMG C 43 4-matic (205.364)	270	04/16→	→		13.0460-7316.2	607316	ATE 22423 16,4 + WE / - WK
					13.0470-7316.2	LD7316	ATE 22423 16,4 + WE / - WK Ceramic
C 180 (205.340) C 200 (205.342) C 200 4-matic (205.343) C 220 d (205.304) C 220 d (205.304) C 220 d 4-matic (205.305)	115	10/15→	←	für Fahrzeuge ohne AMG-Sportpaket	13.0460-2792.2	602792	TRW 22031 19,6 + WE / - WK
	135	10/15→			13.0470-2792.2	LD2792	TRW 22031 19,6 + WE / - WK Ceramic
	135	04/16→					
	120	10/15→	←	für Fahrzeuge mit AMG-Sportpaket	13.0460-4880.2	604880	BRE 25997 18,7 + WE / - WK
C 200 d (205.301) C 200 EQ Boost (205.377) C 220 d (205.314)	118	07/18→	←	für Fahrzeuge ohne AMG-Sportpaket	13.0460-4880.2	604880	BRE 25997 18,7 + WE / - WK
	135	05/18→			13.0470-4880.2	LD4880	BRE 25997 18,7 + WE / - WK Ceramic
	143	04/18→	←	für Fahrzeuge mit AMG-Sportpaket	13.0460-7304.2	607304	ATE 25353 16,2 + WE / - WK
			→	+ USA	13.0470-7304.2	LD7304	ATE 25353 16,2 + WE / - WK Ceramic
↓							









	kW			 	! #		
<b>MERCEDES-BENZ - C-KLASSE Coupe (C205) 10/15→</b>							
<b>Bremsbelagsatz, Scheibenbremse</b>							
C 200 EQ Boost 4-matic (205.378) C 220 d 4-matic (205.315)	135	05/18→	←	für Fahrzeuge ohne AMG-Sportpaket; für Fahrzeuge ohne elektr. Dämpferregulierung		<b>13.0460-2792.2 602792</b> <b>13.0470-2792.2 LD2792</b>	TRW 22031 19,6 + WE / - WK Ceramic
	143	06/18→	←	für Fahrzeuge mit elektr. Dämpferregulierung		<b>13.0460-4880.2 604880</b> <b>13.0470-4880.2 LD4880</b>	BRE 25997 18,7 + WE / - WK Ceramic
			←	für Fahrzeuge mit AMG-Sportpaket		<b>13.0460-4880.2 604880</b> <b>13.0470-4880.2 LD4880</b>	BRE 25997 18,7 + WE / - WK Ceramic
			→	+ USA		<b>13.0460-7304.2 607304</b> <b>13.0470-7304.2 LD7304</b>	ATE 25353 16,2 + WE / - WK Ceramic
C 250 (205.345)	155	10/15→	←			<b>13.0460-2610.2 602610</b> <b>13.0470-2610.2 LD2610</b>	TRW 22076 19,6 + WE / - WK Ceramic
			→			<b>13.0460-7304.2 607304</b> <b>13.0470-7304.2 LD7304</b>	ATE 25353 16,2 + WE / - WK Ceramic
C 250 d (205.308) C 250 d 4-matic (205.309) C 300 (205.348)	150	10/15→	←	für Fahrzeuge ohne AMG-Sportpaket		<b>13.0460-2610.2 602610</b> <b>13.0470-2610.2 LD2610</b>	TRW 22076 19,6 + WE / - WK Ceramic
	150	04/16→					
	180	10/15→	←	für Fahrzeuge mit AMG-Sportpaket		<b>13.0460-4883.2 604883</b> <b>13.0470-4883.2 LD4883</b>	BRE 22061 18,7 + WE / - WK Ceramic
			→			<b>13.0460-7304.2 607304</b> <b>13.0470-7304.2 LD7304</b>	ATE 25353 16,2 + WE / - WK Ceramic
C 300 (205.383)	190	05/18→	←	für Fahrzeuge ohne AMG-Sportpaket; + USA		<b>13.0460-2610.2 602610</b> <b>13.0470-2610.2 LD2610</b>	TRW 22076 19,6 + WE / - WK Ceramic
			←	für Fahrzeuge mit AMG-Sportpaket		<b>13.0460-4883.2 604883</b> <b>13.0470-4883.2 LD4883</b>	BRE 22061 18,7 + WE / - WK Ceramic
			→	+ USA		<b>13.0460-7304.2 607304</b> <b>13.0470-7304.2 LD7304</b>	ATE 25353 16,2 + WE / - WK Ceramic
C 300 d (205.318)	180	07/18→	←	für Fahrzeuge mit AMG-Sportpaket		<b>13.0460-4883.2 604883</b> <b>13.0470-4883.2 LD4883</b>	BRE 22061 18,7 + WE / - WK Ceramic
			→	+ USA		<b>13.0460-7304.2 607304</b> <b>13.0470-7304.2 LD7304</b>	ATE 25353 16,2 + WE / - WK Ceramic
C 300 d 4-matic (205.319)	180	07/18→	←	für Fahrzeuge mit AMG-Sportpaket		<b>13.0460-4883.2 604883</b> <b>13.0470-4883.2 LD4883</b>	BRE 22061 18,7 + WE / - WK Ceramic
			←	für Fahrzeuge mit elektr. Dämpferregulierung		<b>13.0460-4883.2 604883</b> <b>13.0470-4883.2 LD4883</b>	BRE 22061 18,7 + WE / - WK Ceramic
			→	+ USA		<b>13.0460-7304.2 607304</b> <b>13.0470-7304.2 LD7304</b>	ATE 25353 16,2 + WE / - WK Ceramic
C 400 4-matic (205.366)	245	04/16→	←			<b>13.0460-4883.2 604883</b>	BRE 22061 18,7 + WE / - WK
			→			<b>13.0460-7304.2 607304</b> <b>13.0470-7304.2 LD7304</b>	ATE 25353 16,2 + WE / - WK Ceramic
<b>Warnkontakt, Bremsbelagverschleiß</b>							
AMG C 43 4-matic (205.364)	270	04/16→	←		1	<b>24.8190-0067.2 620067</b>	L= 92,5
AMG C 43 4-matic (205.364)	287	04/18→	→		1	<b>24.8190-0067.2 620067</b>	L= 92,5
C 180 (205.340)	115	10/15→					
C 200 (205.342)	135	10/15→					
C 200 4-matic (205.343)	135	04/16→					
C 200 d (205.301)	118	07/18→					
C 200 EQ Boost (205.377)	135	05/18→					
C 200 EQ Boost 4-matic (205.378)	135	05/18→					
C 220 d (205.304)	120	10/15→					
↓							







	kW				! #		
<b>MERCEDES-BENZ - C-KLASSE Coupe (C205) 10/15→</b>							
<b>Warnkontakt, Bremsbelagverschleiß</b>							
C 220 d (205.304)	125	10/15→	←		1	24.8190-0067.2 620067	L= 92,5
C 220 d (205.314)	143	04/18→					
C 220 d 4-matic (205.305)	125	04/16→	→		1	24.8190-0067.2 620067	L= 92,5
C 220 d 4-matic (205.315)	143	06/18→					
C 250 (205.345)	155	10/15→					
C 250 d (205.308)	150	10/15→					
C 250 d 4-matic (205.309)	150	04/16→					
C 300 (205.348)	180	10/15→					
C 300 (205.383)	190	05/18→					
C 300 d (205.318)	180	07/18→					
C 300 d 4-matic (205.319)	180	07/18→					
C 400 4-matic (205.366)	245	04/16→					
AMG C 63 (205.386)	350	02/16→	←		1	24.8190-0420.2 620420	L= 119
AMG C 63 S (205.387)	375	02/16→	→		1	24.8190-0410.2 620410	L= 97,5
<b> Bremsscheibe</b>							
AMG C 63 S (205.387)	375	02/16→	←	nicht für Bremssattelfarbe: rot; für Fahrzeuge ohne Keramikbremse		24.0136-0108.1 436108	Ø 360 36 34 V• + S
C 180 (205.340)	115	10/15→	←	für Fahrzeuge ohne AMG-Sportpaket		24.0124-0300.1 424300	Ø 295 24 21,4 V + S
			→			24.0112-0300.1 412300	Ø 300 12 10,3 + S
C 200 (205.342)	135	10/15→	←	für Fahrzeuge ohne AMG-Sportpaket		24.0128-0330.1 428330	Ø 305 28 25,4 V + S
C 200 4-matic (205.343)	135	04/16→					
C 200 d (205.301)	118	07/18→	→			24.0112-0300.1 412300	Ø 300 12 10,3 + S
C 200 EQ Boost (205.377)	135	05/18→					
C 220 d (205.304)	120	10/15→					
C 220 d (205.304)	125	10/15→					
C 220 d (205.314)	143	04/18→					
C 220 d 4-matic (205.305)	125	04/16→					
C 200 EQ Boost 4-matic (205.378)	135	05/18→	←	für Fahrzeuge ohne AMG-Sportpaket; für Fahrzeuge ohne elektr. Dämpferregulierung		24.0128-0330.1 428330	Ø 305 28 25,4 V + S
C 220 d 4-matic (205.315)	143	06/18→	→			24.0112-0300.1 412300	Ø 300 12 10,3 + S
C 250 (205.345)	155	10/15→	→			24.0112-0300.1 412300	Ø 300 12 10,3 + S
C 250 d (205.308)	150	10/15→					
C 250 d 4-matic (205.309)	150	04/16→	→	für Fahrzeuge ohne AMG-Sportpaket		24.0112-0300.1 412300	Ø 300 12 10,3 + S
C 300 d (205.318)	180	07/18→					
C 300 d 4-matic (205.319)	180	07/18→					
<b>MERCEDES-BENZ - C-KLASSE Sportcoupe (CL203) 03/01→06/11</b>							
<b> Bremsbelagsatz, Scheibenbremse</b>							
C 160 Kompressor (203.730)	90	05/02→05/08	←	04/05→; für Bremsscheibendurchmesser [mm]: 288; für Bremsscheibendicke [mm]: 25		13.0460-2726.2 602726	TRW 23144 19,8 + WE / - WK + Zub
			→	04/05→		13.0470-2726.2 LD2726	TRW 23144 19,8 + WE / - WK + Zub Ceramic
						13.0460-4064.2 604064	ATE 21919 15,3 - WE / - WK + Zub
						13.0470-4064.2 LD4064	ATE 21919 15,3 - WE / - WK + Zub Ceramic
C 180 (203.735)	95	03/01→05/02	←	für Bremsscheibendurchmesser [mm]: 288; für Bremsscheibendicke [mm]: 25		13.0460-2726.2 602726	TRW 23144 19,8 + WE / - WK + Zub
C 180 Kompressor (203.746)	105	05/02→05/08					
C 200 Kompressor (203.742)	120	05/02→05/08				13.0470-2726.2 LD2726	TRW 23144 19,8 + WE / - WK + Zub Ceramic
C 200 Kompressor (203.745)	120	03/01→05/02	→			13.0460-4064.2 604064	ATE 21919 15,3 - WE / - WK + Zub
C 220	120	05/02→05/08				13.0470-4064.2 LD4064	ATE 21919 15,3 - WE / - WK + Zub Ceramic
C 220 CDI	100	03/01→01/04					
C 220 CDI (203.706)	105	03/01→01/04					
C 220 CDI (203.708)	110	02/04→05/08					
C 200 CDI (203.707)	90	03/03→05/08	←	07/03→; für Bremsscheibendurchmesser [mm]: 288; für Bremsscheibendicke [mm]: 25		13.0460-2726.2 602726	TRW 23144 19,8 + WE / - WK + Zub
C 200 CGI Kompressor (203.743)	125	03/03→05/08				13.0470-2726.2 LD2726	TRW 23144 19,8 + WE / - WK + Zub Ceramic
			→	07/03→		13.0460-4064.2 604064	ATE 21919 15,3 - WE / - WK + Zub
						13.0470-4064.2 LD4064	ATE 21919 15,3 - WE / - WK + Zub Ceramic
↓							

















	kW			 	! #		
<b>MERCEDES-BENZ - C-KLASSE Sportcoupe (CL203) 03/01→06/11</b>							
<b> Bremsbelagsatz, Scheibenbremse</b>							
C 230 (203.752)	150	01/05→05/08	←	06/05→; für Bremsscheibendurchmesser [mm]: 300; für Bremsscheibendicke [mm]: 28		13.0460-2727.2 602727	TRW 23144 19,8 + WE / - WK + Zub
						13.0470-2727.2 LD2727	TRW 23144 19,8 + WE / - WK + Zub Ceramic
			→	06/05→		13.0460-4065.2 604065	ATE 21899 15,3 + WE / - WK + Zub
						13.0470-4065.2 LD4065	ATE 21899 15,3 + WE / - WK + Zub Ceramic
C 230 Kompressor (203.740) C 230 Kompressor (203.747)	141	05/02→05/08	←	+ (AUS) (J) (USA)		13.0460-2726.2 602726	TRW 23144 19,8 + WE / - WK + Zub
	145	03/01→05/02				13.0470-2726.2 LD2726	TRW 23144 19,8 + WE / - WK + Zub Ceramic
			←			13.0460-2727.2 602727	TRW 23144 19,8 + WE / - WK + Zub
						13.0470-2727.2 LD2727	TRW 23144 19,8 + WE / - WK + Zub Ceramic
			→	+ (AUS) (J) (USA)		13.0460-4064.2 604064	ATE 21919 15,3 - WE / - WK + Zub
						13.0470-4064.2 LD4064	ATE 21919 15,3 - WE / - WK + Zub Ceramic
			→			13.0460-4065.2 604065	ATE 21899 15,3 + WE / - WK + Zub
						13.0470-4065.2 LD4065	ATE 21899 15,3 + WE / - WK + Zub Ceramic
C 30 CDI AMG (203.718)	170	09/02→05/08	←			13.0460-4990.2 604990	BRE 23271 17,4 + WE / - WK
						13.0470-4990.2 LD4990	BRE 23271 17,4 + WE / - WK Ceramic
			→	A 556573→		13.0460-4047.2 604047	ATE 21305 15,7 + WE / - WK
						13.0470-4047.2 LD4047	ATE 21305 15,7 + WE / - WK Ceramic
			→	→ A 556572		13.0460-4065.2 604065	ATE 21899 15,3 + WE / - WK + Zub
						13.0470-4065.2 LD4065	ATE 21899 15,3 + WE / - WK + Zub Ceramic
C 320 (203.764)	160	09/02→05/08	←	für Bremsscheibendurchmesser [mm]: 300; für Bremsscheibendicke [mm]: 28		13.0460-2727.2 602727	TRW 23144 19,8 + WE / - WK + Zub
						13.0470-2727.2 LD2727	TRW 23144 19,8 + WE / - WK + Zub Ceramic
			→			13.0460-4065.2 604065	ATE 21899 15,3 + WE / - WK + Zub
						13.0470-4065.2 LD4065	ATE 21899 15,3 + WE / - WK + Zub Ceramic
C 350 (203.756)	200	01/05→05/08	←	06/05→		13.0460-4994.2 604994	BRE 23945 16,5 + WE / - WK
						13.0470-4994.2 LD4994	BRE 23945 16,5 + WE / - WK Ceramic
			→	06/05→		13.0460-4065.2 604065	ATE 21899 15,3 + WE / - WK + Zub
						13.0470-4065.2 LD4065	ATE 21899 15,3 + WE / - WK + Zub Ceramic
<b>Warnkontakt, Bremsbelagverschleiß</b>							
C 160 Kompressor (203.730)	90	05/02→05/08	←	04/05→	1	24.8190-0410.2 620410	L= 97,5
			→	04/05→	1	24.8190-0410.2 620410	L= 97,5
C 180 (203.735) C 180 Kompressor (203.746)	95	03/01→05/02	←		1	24.8190-0410.2 620410	L= 97,5
	105	05/02→05/08	→		1	24.8190-0410.2 620410	L= 97,5
C 200 Kompressor (203.742)	120	05/02→05/08					
C 200 Kompressor (203.745)	120	03/01→05/02					
C 220	120	05/02→05/08					
C 220 CDI	100	03/01→01/04					
C 220 CDI (203.706)	105	03/01→01/04					
C 220 CDI (203.708)	110	02/04→05/08					
C 200 CDI (203.707) C 200 CGI Kompressor (203.743)	90	03/03→05/08	←	07/03→	1	24.8190-0410.2 620410	L= 97,5
	125	03/03→05/08	→	07/03→	1	24.8190-0410.2 620410	L= 97,5
C 230 (203.752)	150	01/05→05/08	←	06/05→	2	24.8190-0410.2 620410	L= 97,5
			→	06/05→	1	24.8190-0410.2 620410	L= 97,5
C 230 Kompressor (203.740) ↓	141	05/02→05/08	←		2	24.8190-0410.2 620410	L= 97,5











	kW			 	! #		
<b>MERCEDES-BENZ - C-KLASSE Sportcoupe (CL203) 03/01→06/11</b>							
<b>Warnkontakt, Bremsbelagverschleiß</b>							
C 230 Kompressor (203.747)	145	03/01→05/02	➔		1	24.8190-0410.2 620410	L= 97,5
C 320 (203.764)	160	09/02→05/08					
C 30 CDI AMG (203.718)	170	09/02→05/08	➔	☐	1	24.8190-0410.2 620410	L= 97,5
			➔	→ A 556572	1	24.8190-0410.2 620410	L= 97,5
			➔	A 556573→	1	24.8190-0410.2 620410	L= 97,5
C 350 (203.756)	200	01/05→05/08	➔	06/05→	1	24.8190-0410.2 620410	L= 97,5
			➔	06/05→	1	24.8190-0410.2 620410	L= 97,5
<b>Zubehörsatz, Scheibenbremsbelag</b>							
C 160 Kompressor (203.730)	90	05/02→05/08	➔	04/05→		13.0460-0229.2 610229	ATE
C 180 (203.735)	95	03/01→05/02	➔			13.0460-0229.2 610229	ATE
C 180 Kompressor (203.746)	105	05/02→05/08					
C 200 Kompressor (203.742)	120	05/02→05/08					
C 200 Kompressor (203.745)	120	03/01→05/02					
C 220	120	05/02→05/08					
C 220 CDI	100	03/01→01/04					
C 220 CDI (203.706)	105	03/01→01/04					
C 220 CDI (203.708)	110	02/04→05/08					
C 200 CDI (203.707)	90	03/03→05/08	➔	07/03→		13.0460-0229.2 610229	ATE
C 200 CGI Kompressor (203.743)	125	03/03→05/08					
C 230 (203.752)	150	01/05→05/08	➔	06/05→		13.0460-0258.2 610258	
C 350 (203.756)	200	01/05→05/08					
C 230 Kompressor (203.740)	141	05/02→05/08	➔	+ (AUS) (J) (USA)		13.0460-0229.2 610229	ATE
C 230 Kompressor (203.747)	145	03/01→05/02	➔			13.0460-0231.2 610231	ATE
C 30 CDI AMG (203.718)	170	09/02→05/08	➔			13.0460-0275.2 610275	
			➔	A 556573→		13.0460-0236.2 610236	ATE
			➔	→ A 556572		13.0460-0258.2 610258	
C 320 (203.764)	160	09/02→05/08	➔			13.0460-0258.2 610258	
<b> Bremsscheibe</b>							
C 160 Kompressor (203.730)	90	05/02→05/08	➔	04/05→		24.0125-0110.1 425110	Ø 288 25 22,4 V + S
						24.0325-0110.1 525110	Ø 288 25 22,4 V + S
			➔	04/05→		24.0109-0114.1 409114	Ø 278 9 7,3 + S
						24.0309-0114.1 509114	Ø 278 9 7,3 + S
C 180 (203.735)	95	03/01→05/02	➔			24.0125-0110.1 425110	Ø 288 25 22,4 V + S
C 180 Kompressor (203.746)	105	05/02→05/08				24.0325-0110.1 525110	Ø 288 25 22,4 V + S
C 200 Kompressor (203.742)	120	05/02→05/08	➔			24.0109-0114.1 409114	Ø 278 9 7,3 + S
C 200 Kompressor (203.745)	120	03/01→05/02				24.0309-0114.1 509114	Ø 278 9 7,3 + S
C 220	120	05/02→05/08					
C 220 CDI	100	03/01→01/04					
C 220 CDI (203.706)	105	03/01→01/04					
C 220 CDI (203.708)	110	02/04→05/08					
C 200 CDI (203.707)	90	03/03→05/08	➔	07/03→		24.0125-0110.1 425110	Ø 288 25 22,4 V + S
C 200 CGI Kompressor (203.743)	125	03/03→05/08				24.0325-0110.1 525110	Ø 288 25 22,4 V + S
			➔	07/03→		24.0109-0114.1 409114	Ø 278 9 7,3 + S
						24.0309-0114.1 509114	Ø 278 9 7,3 + S
C 230 (203.752)	150	01/05→05/08	➔	06/05→		24.0128-0106.1 428106	Ø 300 28 25,4 V + S
						24.0328-0106.1 528106	Ø 300 28 25,4 V + S
			➔	06/05→		24.0110-0217.1 410217	Ø 290 10 8,3 + S
						24.0310-0217.1 510217	Ø 290 10 8,3 + S
C 230 Kompressor (203.740)	141	05/02→05/08	➔	(AUS) (J) (USA)		24.0125-0110.1 425110	Ø 288 25 22,4 V + S
C 230 Kompressor (203.747)	145	03/01→05/02	➔			24.0325-0110.1 525110	Ø 288 25 22,4 V + S
			➔			24.0128-0106.1 428106	Ø 300 28 25,4 V + S
			➔	+ (AUS) (J) (USA)		24.0328-0106.1 528106	Ø 300 28 25,4 V + S
			➔			24.0109-0114.1 409114	Ø 278 9 7,3 + S
						24.0309-0114.1 509114	Ø 278 9 7,3 + S
			➔			24.0110-0217.1 410217	Ø 290 10 8,3 + S
						24.0310-0217.1 510217	Ø 290 10 8,3 + S
↓							







	kW			 	! #			
<b>MERCEDES-BENZ - C-KLASSE Sportcoupe (CL203) 03/01→06/11</b>								
<b>Bremsscheibe</b>								
C 30 CDI AMG (203.718)	170	09/02→05/08	←			<b>24.0130-0180.1</b>	<b>430180</b>	Ø 345 30 28 V•
			→	→ A 556572		<b>24.0110-0217.1</b>	<b>410217</b>	Ø 290 10 8,3 + S
						<b>24.0310-0217.1</b>	<b>510217</b>	Ø 290 10 8,3 + S
			→	A 556573→		<b>24.0122-0228.1</b>	<b>422228</b>	Ø 300 22 19,4 V
C 320 (203.764)	160	09/02→05/08	←			<b>24.0128-0106.1</b>	<b>428106</b>	Ø 300 28 25,4 V + S
						<b>24.0328-0106.1</b>	<b>528106</b>	Ø 300 28 25,4 V + S
			→			<b>24.0110-0217.1</b>	<b>410217</b>	Ø 290 10 8,3 + S
						<b>24.0310-0217.1</b>	<b>510217</b>	Ø 290 10 8,3 + S
C 350 (203.756)	200	01/05→05/08	←	06/05→		<b>24.0128-0188.1</b>	<b>428188</b>	Ø 330 28 26 V + S
			→	06/05→		<b>24.0110-0217.1</b>	<b>410217</b>	Ø 290 10 8,3 + S
						<b>24.0310-0217.1</b>	<b>510217</b>	Ø 290 10 8,3 + S
<b>MERCEDES-BENZ - C-KLASSE T-Model (S202) 06/96→03/01</b>								
<b>Bremsbelagsatz, Scheibenbremse</b>								
C 180 T (202.078) C 180 T (202.081) C 200 T CDI (202.194) C 200 T D (202.180) C 220 T CDI (202.193) C 220 T D (202.182) C 220 T D (202.182)	90 95 75 65 92 55 70	06/96→09/00 09/00→03/01 03/98→03/01 10/96→03/01 09/97→03/01 06/96→03/01 06/96→09/98	←			<b>13.0460-2975.2</b>	<b>602975</b>	TRW 21439 20,3 + WE / - WK
						<b>13.0470-2975.2</b>	<b>LD2975</b>	TRW 21439 20,3 + WE / - WK Ceramic
			→	→ F576240		<b>13.0460-3805.2</b>	<b>603805</b>	ATE 21197 15,0 + WE / - WK
						<b>13.0470-3805.2</b>	<b>LD3805</b>	ATE 21197 15,0 + WE / - WK Ceramic
			→	F576241→		<b>13.0460-4064.2</b>	<b>604064</b>	ATE 21919 15,3 - WE / - WK + Zub
						<b>13.0470-4064.2</b>	<b>LD4064</b>	ATE 21919 15,3 - WE / - WK + Zub Ceramic
			←			<b>13.0460-2975.2</b>	<b>602975</b>	TRW 21439 20,3 + WE / - WK
						<b>13.0460-7086.2</b>	<b>607086</b>	ATE 21664 19,8 + WE / - WK
C 200 T (202.080) C 200 T Kompressor (202.082)	100 141	06/96→03/01 11/96→03/01	←			<b>13.0460-2975.2</b>	<b>602975</b>	TRW 21439 20,3 + WE / - WK
						<b>13.0460-7086.2</b>	<b>607086</b>	ATE 21664 19,8 + WE / - WK
						<b>13.0470-2975.2</b>	<b>LD2975</b>	TRW 21439 20,3 + WE / - WK Ceramic
						<b>13.0470-7086.2</b>	<b>LD7086</b>	ATE 21664 19,8 + WE / - WK Ceramic
			→	→ F576240		<b>13.0460-3805.2</b>	<b>603805</b>	ATE 21197 15,0 + WE / - WK
						<b>13.0470-3805.2</b>	<b>LD3805</b>	ATE 21197 15,0 + WE / - WK Ceramic
			→	F576241→		<b>13.0460-4064.2</b>	<b>604064</b>	ATE 21919 15,3 - WE / - WK + Zub
						<b>13.0470-4064.2</b>	<b>LD4064</b>	ATE 21919 15,3 - WE / - WK + Zub Ceramic
C 200 T Kompressor (202.087) C 250 T Turbo-D (202.188)	120 110	09/00→03/01 06/96→03/01	←			<b>13.0460-7086.2</b>	<b>607086</b>	ATE 21664 19,8 + WE / - WK
						<b>13.0470-7086.2</b>	<b>LD7086</b>	ATE 21664 19,8 + WE / - WK Ceramic
			→	→ F576240		<b>13.0460-3805.2</b>	<b>603805</b>	ATE 21197 15,0 + WE / - WK
						<b>13.0470-3805.2</b>	<b>LD3805</b>	ATE 21197 15,0 + WE / - WK Ceramic
			→	F576241→		<b>13.0460-4064.2</b>	<b>604064</b>	ATE 21919 15,3 - WE / - WK + Zub
						<b>13.0470-4064.2</b>	<b>LD4064</b>	ATE 21919 15,3 - WE / - WK + Zub Ceramic
C 230 T (202.083)	110	06/96→06/98	←	→ 06/97		<b>13.0460-2975.2</b>	<b>602975</b>	TRW 21439 20,3 + WE / - WK
						<b>13.0470-2975.2</b>	<b>LD2975</b>	TRW 21439 20,3 + WE / - WK Ceramic
			→	→ F576240		<b>13.0460-3805.2</b>	<b>603805</b>	ATE 21197 15,0 + WE / - WK
						<b>13.0470-3805.2</b>	<b>LD3805</b>	ATE 21197 15,0 + WE / - WK Ceramic
C 230 T Kompressor (202.085) C 240 T (202.086) C 240 T (202.088) C 280 T (202.089)	142 125 125 145	06/97→09/00 06/97→09/00 09/00→03/01 06/97→03/01	←			<b>13.0460-7086.2</b>	<b>607086</b>	ATE 21664 19,8 + WE / - WK
						<b>13.0470-7086.2</b>	<b>LD7086</b>	ATE 21664 19,8 + WE / - WK Ceramic
			→			<b>13.0460-4064.2</b>	<b>604064</b>	ATE 21919 15,3 - WE / - WK + Zub
						<b>13.0470-4064.2</b>	<b>LD4064</b>	ATE 21919 15,3 - WE / - WK + Zub Ceramic
C 43 AMG (202.093)	225	08/97→03/01	←	09/97→		<b>13.0460-7183.2</b>	<b>607183</b>	ATE 21484 20,5 + WE / - WK
			→	09/97→		<b>13.0460-4047.2</b>	<b>604047</b>	ATE 21305 15,7 + WE / - WK
↓								









	kw					! #		
<b>MERCEDES-BENZ - C-KLASSE T-Model (S202) 06/96→03/01</b>								
<b>Bremsbelagsatz, Scheibenbremse</b>								
C 43 AMG (202.093)	225	08/97→03/01	➡	09/97→			<b>13.0470-4047.2 LD4047</b>	ATE 21305 15,7 + WE / - WK Ceramic
<b>Warnkontakt, Bremsbelagverschleiß</b>								
C 180 T (202.078)	90	06/96→09/00	←		2	<b>24.8190-0401.2 620401</b>	L= 95	
C 180 T (202.081)	95	09/00→03/01						
C 200 T (202.080)	100	06/96→03/01	➡	→ F576240	1	<b>24.8190-0401.2 620401</b>	L= 95	
C 200 T CDI (202.194)	75	03/98→03/01						
C 200 T D (202.180)	65	10/96→03/01						
C 200 T Kompressor (202.082)	141	11/96→03/01						
C 200 T Kompressor (202.087)	120	09/00→03/01						
C 220 T CDI (202.193)	92	09/97→03/01						
C 220 T D (202.182)	55	06/96→03/01						
C 220 T D (202.182)	70	06/96→09/98						
C 250 T Turbo-D (202.188)	110	06/96→03/01						
C 230 T (202.083)	110	06/96→06/98	←	→ 06/97	2	<b>24.8190-0401.2 620401</b>	L= 95	
			➡	→ F576240	1	<b>24.8190-0401.2 620401</b>	L= 95	
C 230 T Kompressor (202.085)	142	06/97→09/00	←		2	<b>24.8190-0401.2 620401</b>	L= 95	
C 240 T (202.086)	125	06/97→09/00						
C 240 T (202.088)	125	09/00→03/01						
C 280 T (202.089)	145	06/97→03/01						
C 43 AMG (202.093)	225	08/97→03/01	←	09/97→	2	<b>24.8190-0419.2 620419</b>	L= 74	
			➡	09/97→	1	<b>24.8190-0401.2 620401</b>	L= 95	
<b>Zubehörsatz, Scheibenbremsbelag</b>								
C 180 T (202.078)	90	06/96→09/00	➡	F576241→		<b>13.0460-0229.2 610229</b>	ATE	
C 180 T (202.081)	95	09/00→03/01						
C 200 T (202.080)	100	06/96→03/01						
C 200 T CDI (202.194)	75	03/98→03/01						
C 200 T D (202.180)	65	10/96→03/01						
C 200 T Kompressor (202.082)	141	11/96→03/01						
C 200 T Kompressor (202.087)	120	09/00→03/01						
C 220 T CDI (202.193)	92	09/97→03/01						
C 220 T D (202.182)	55	06/96→03/01						
C 220 T D (202.182)	70	06/96→09/98						
C 250 T Turbo-D (202.188)	110	06/96→03/01						
C 230 T (202.083)	110	06/96→06/98	➡	→ 06/97; F576241→		<b>13.0460-0229.2 610229</b>	ATE	
C 230 T Kompressor (202.085)	142	06/97→09/00	➡			<b>13.0460-0229.2 610229</b>	ATE	
C 240 T (202.086)	125	06/97→09/00						
C 240 T (202.088)	125	09/00→03/01						
C 280 T (202.089)	145	06/97→03/01						
C 43 AMG (202.093)	225	08/97→03/01	➡	09/97→		<b>13.0460-0236.2 610236</b>	ATE	
<b>Bremsscheibe</b>								
C 180 T (202.078)	90	06/96→09/00	←			<b>24.0122-0132.1 422132</b>	Ø 284 22 19,4 V + S	
C 180 T (202.081)	95	09/00→03/01				<b>24.0322-0132.1 522132</b>	Ø 284 22 19,4 V + S	
C 200 T CDI (202.194)	75	03/98→03/01						
C 200 T D (202.180)	65	10/96→03/01	➡			<b>24.0109-0114.1 409114</b>	Ø 278 9 7,3 + S	
C 220 T CDI (202.193)	92	09/97→03/01				<b>24.0309-0114.1 509114</b>	Ø 278 9 7,3 + S	
C 220 T D (202.182)	55	06/96→03/01						
C 220 T D (202.182)	70	06/96→09/98						
C 200 T (202.080)	100	06/96→03/01	←			<b>24.0122-0132.1 422132</b>	Ø 284 22 19,4 V + S	
C 200 T Kompressor (202.082)	141	11/96→03/01				<b>24.0125-0110.1 425110</b>	Ø 288 25 22,4 V + S	
						<b>24.0322-0132.1 522132</b>	Ø 284 22 19,4 V + S	
						<b>24.0325-0110.1 525110</b>	Ø 288 25 22,4 V + S	
			➡			<b>24.0109-0114.1 409114</b>	Ø 278 9 7,3 + S	
						<b>24.0309-0114.1 509114</b>	Ø 278 9 7,3 + S	
C 200 T Kompressor (202.087)	120	09/00→03/01	←			<b>24.0125-0110.1 425110</b>	Ø 288 25 22,4 V + S	
C 230 T Kompressor (202.085)	142	06/97→09/00	➡			<b>24.0325-0110.1 525110</b>	Ø 288 25 22,4 V + S	
C 240 T (202.086)	125	06/97→09/00				<b>24.0109-0114.1 409114</b>	Ø 278 9 7,3 + S	
C 240 T (202.088)	125	09/00→03/01				<b>24.0309-0114.1 509114</b>	Ø 278 9 7,3 + S	
C 250 T Turbo-D (202.188)	110	06/96→03/01						
C 280 T (202.089)	145	06/97→03/01						
C 230 T (202.083)	110	06/96→06/98	←	→ 06/97		<b>24.0122-0132.1 422132</b>	Ø 284 22 19,4 V + S	







	kw			 	! #			
<b>MERCEDES-BENZ - C-KLASSE T-Model (S202) 06/96→03/01</b>								
<b>Bremsscheibe</b>								
C 230 T (202.083)	110	06/96→06/98	←	→ 06/97		<b>24.0322-0132.1</b>	<b>522132</b>	Ø 284 22 19,4 V + S
			→	→ 06/97		<b>24.0109-0114.1</b>	<b>409114</b>	Ø 278 9 7,3 + S
						<b>24.0309-0114.1</b>	<b>509114</b>	Ø 278 9 7,3 + S
C 43 AMG (202.093)	225	08/97→03/01	→	09/97→		<b>24.0122-0228.1</b>	<b>422228</b>	Ø 300 22 19,4 V
<b>MERCEDES-BENZ - C-KLASSE T-Model (S203) 03/01→08/07</b>								
<b>Bremsbelagsatz, Scheibenbremse</b>								
C 180 (203.235)	95	03/01→05/02	←			<b>13.0460-2726.2</b>	<b>602726</b>	TRW 23144 19,8 + WE / - WK + Zub
						<b>13.0470-2726.2</b>	<b>LD2726</b>	TRW 23144 19,8 + WE / - WK + Zub Ceramic
			→			<b>13.0460-4065.2</b>	<b>604065</b>	ATE 21899 15,3 + WE / - WK + Zub
						<b>13.0470-4065.2</b>	<b>LD4065</b>	ATE 21899 15,3 + WE / - WK + Zub Ceramic
C 180 Kompressor (203.246)	105	05/02→08/07	←	für Fahrzeuge ohne Sportpaket / für Fahrzeuge ohne AMG-Sportpaket		<b>13.0460-2726.2</b>	<b>602726</b>	TRW 23144 19,8 + WE / - WK + Zub
C 200 CDI (203.207)	90	04/03→08/07				<b>13.0470-2726.2</b>	<b>LD2726</b>	TRW 23144 19,8 + WE / - WK + Zub Ceramic
C 200 CGI Kompressor (203.243)	125	07/03→08/07						
C 200 Kompressor (203.242)	120	05/02→08/07	←	→ A 660226 / F 565688; für Fahrzeuge mit Sportpaket / für Fahrzeuge mit AMG-Sportpaket		<b>13.0460-4990.2</b>	<b>604990</b>	BRE 23271 17,4 + WE / - WK Ceramic
C 220 CDI (203.208)	110	02/04→08/07	←	A 660227 / F 565689→; für Fahrzeuge mit Sportpaket / für Fahrzeuge mit AMG-Sportpaket		<b>13.0460-4994.2</b>	<b>604994</b>	BRE 23945 16,5 + WE / - WK Ceramic
			→			<b>13.0460-4065.2</b>	<b>604065</b>	ATE 21899 15,3 + WE / - WK + Zub
						<b>13.0470-4065.2</b>	<b>LD4065</b>	ATE 21899 15,3 + WE / - WK + Zub Ceramic
C 200 CDI (203.204, 203.207)	75	03/01→08/07	←	für Fahrzeuge ohne Sportpaket / für Fahrzeuge ohne AMG-Sportpaket		<b>13.0460-2726.2</b>	<b>602726</b>	TRW 23144 19,8 + WE / - WK + Zub
C 200 CDI (203.204)	85	03/01→08/07				<b>13.0470-2726.2</b>	<b>LD2726</b>	TRW 23144 19,8 + WE / - WK + Zub Ceramic
C 220 CDI (203.206)	105	03/01→08/07						
C 220 CDI (203.208)	100	08/06→08/07	←	für Fahrzeuge mit Sportpaket / für Fahrzeuge mit AMG-Sportpaket		<b>13.0460-4990.2</b>	<b>604990</b>	BRE 23271 17,4 + WE / - WK Ceramic
						<b>13.0470-4990.2</b>	<b>LD4990</b>	BRE 23271 17,4 + WE / - WK Ceramic
			→			<b>13.0460-4065.2</b>	<b>604065</b>	ATE 21899 15,3 + WE / - WK + Zub
						<b>13.0470-4065.2</b>	<b>LD4065</b>	ATE 21899 15,3 + WE / - WK + Zub Ceramic
C 200 Kompressor (203.245)	120	03/01→05/02	←	→ 04/02		<b>13.0460-2726.2</b>	<b>602726</b>	TRW 23144 19,8 + WE / - WK + Zub
						<b>13.0470-2726.2</b>	<b>LD2726</b>	TRW 23144 19,8 + WE / - WK + Zub Ceramic
			→	→ 04/02		<b>13.0460-4065.2</b>	<b>604065</b>	ATE 21899 15,3 + WE / - WK + Zub
						<b>13.0470-4065.2</b>	<b>LD4065</b>	ATE 21899 15,3 + WE / - WK + Zub Ceramic
C 230 (203.252)	150	01/05→08/07	←	06/05→; für Fahrzeuge ohne Sportpaket / für Fahrzeuge ohne AMG-Sportpaket		<b>13.0460-2727.2</b>	<b>602727</b>	TRW 23144 19,8 + WE / - WK + Zub
C 280 (203.254)	170	01/05→08/07				<b>13.0470-2727.2</b>	<b>LD2727</b>	TRW 23144 19,8 + WE / - WK + Zub Ceramic
C 280 4-matic (203.292)	170	01/05→08/07	←	06/05→; für Fahrzeuge mit Sportpaket / für Fahrzeuge mit AMG-Sportpaket		<b>13.0460-4994.2</b>	<b>604994</b>	BRE 23945 16,5 + WE / - WK Ceramic
						<b>13.0470-4994.2</b>	<b>LD4994</b>	BRE 23945 16,5 + WE / - WK Ceramic
			→	06/05→		<b>13.0460-4065.2</b>	<b>604065</b>	ATE 21899 15,3 + WE / - WK + Zub
						<b>13.0470-4065.2</b>	<b>LD4065</b>	ATE 21899 15,3 + WE / - WK + Zub Ceramic
C 230 Kompressor (203.240)	141	02/04→08/07	←	für Fahrzeuge ohne Sportpaket / für Fahrzeuge ohne AMG-Sportpaket		<b>13.0460-2727.2</b>	<b>602727</b>	TRW 23144 19,8 + WE / - WK + Zub
						<b>13.0470-2727.2</b>	<b>LD2727</b>	TRW 23144 19,8 + WE / - WK + Zub Ceramic
			←	für Fahrzeuge mit Sportpaket / für Fahrzeuge mit AMG-Sportpaket		<b>13.0460-4994.2</b>	<b>604994</b>	BRE 23945 16,5 + WE / - WK Ceramic
						<b>13.0470-4994.2</b>	<b>LD4994</b>	BRE 23945 16,5 + WE / - WK Ceramic
			→			<b>13.0460-4065.2</b>	<b>604065</b>	ATE 21899 15,3 + WE / - WK + Zub









	kw			 	! #		
<b>MERCEDES-BENZ - C-KLASSE T-Model (S203) 03/01→08/07</b>							
<b> Bremsbelagsatz, Scheibenbremse</b>							
C 230 Kompressor (203.240)	141	02/04→08/07	➔			<b>13.0470-4065.2 LD4065</b>	ATE 21899 15,3 + WE / - WK + Zub Ceramic
C 240 (203.261)	125	03/01→08/07	➔	für Fahrzeuge ohne Sportpaket / für Fahrzeuge ohne AMG-Sportpaket		<b>13.0460-2727.2 602727</b>	TRW 23144 19,8 + WE / - WK + Zub
C 270 CDI (203.216)	120	03/01→08/07				<b>13.0470-2727.2 LD2727</b>	TRW 23144 19,8 + WE / - WK + Zub Ceramic
C 270 CDI (203.216)	125	03/01→08/07					
C 320 (203.264)	160	03/01→08/07	➔	→ A 660226 / F 565688; für Fahrzeuge mit Sportpaket / für Fahrzeuge mit AMG-Sportpaket		<b>13.0460-4990.2 604990</b> <b>13.0470-4990.2 LD4990</b>	BRE 23271 17,4 + WE / - WK Ceramic
			➔	A 660227 / F 565689→; für Fahrzeuge mit Sportpaket / für Fahrzeuge mit AMG-Sportpaket		<b>13.0460-4994.2 604994</b> <b>13.0470-4994.2 LD4994</b>	BRE 23945 16,5 + WE / - WK Ceramic
			➔			<b>13.0460-4065.2 604065</b> <b>13.0470-4065.2 LD4065</b>	ATE 21899 15,3 + WE / - WK + Zub ATE 21899 15,3 + WE / - WK + Zub Ceramic
C 240 4-matic (203.281)	125	07/02→08/07	➔	für Fahrzeuge ohne Sportpaket / für Fahrzeuge ohne AMG-Sportpaket		<b>13.0460-2727.2 602727</b> <b>13.0470-2727.2 LD2727</b>	TRW 23144 19,8 + WE / - WK + Zub TRW 23144 19,8 + WE / - WK + Zub Ceramic
			➔			<b>13.0460-4065.2 604065</b> <b>13.0470-4065.2 LD4065</b>	ATE 21899 15,3 + WE / - WK + Zub ATE 21899 15,3 + WE / - WK + Zub Ceramic
C 30 CDI AMG (203.218)	170	01/03→08/07	➔			<b>13.0460-4990.2 604990</b> <b>13.0470-4990.2 LD4990</b>	BRE 23271 17,4 + WE / - WK Ceramic BRE 23271 17,4 + WE / - WK Ceramic
			➔			<b>13.0460-4047.2 604047</b> <b>13.0470-4047.2 LD4047</b>	ATE 21305 15,7 + WE / - WK Ceramic ATE 21305 15,7 + WE / - WK Ceramic
C 320 4-matic (203.284)	160	07/02→08/07	➔			<b>13.0460-2727.2 602727</b> <b>13.0470-2727.2 LD2727</b>	TRW 23144 19,8 + WE / - WK + Zub TRW 23144 19,8 + WE / - WK + Zub Ceramic
			➔			<b>13.0460-4065.2 604065</b> <b>13.0470-4065.2 LD4065</b>	ATE 21899 15,3 + WE / - WK + Zub ATE 21899 15,3 + WE / - WK + Zub Ceramic
C 320 CDI (203.220)	165	06/05→08/07	➔	für Fahrzeuge mit Sportpaket / für Fahrzeuge mit AMG-Sportpaket		<b>13.0460-4990.2 604990</b> <b>13.0470-4990.2 LD4990</b>	BRE 23271 17,4 + WE / - WK Ceramic BRE 23271 17,4 + WE / - WK Ceramic
			➔	für Fahrzeuge ohne Sportpaket / für Fahrzeuge ohne AMG-Sportpaket		<b>13.0460-4994.2 604994</b> <b>13.0470-4994.2 LD4994</b>	BRE 23945 16,5 + WE / - WK Ceramic BRE 23945 16,5 + WE / - WK Ceramic
			➔			<b>13.0460-4065.2 604065</b> <b>13.0470-4065.2 LD4065</b>	ATE 21899 15,3 + WE / - WK + Zub ATE 21899 15,3 + WE / - WK + Zub Ceramic
C 32 AMG Kompressor (203.265)	260	03/01→08/07	➔			<b>13.0460-4990.2 604990</b>	BRE 23271 17,4 + WE / - WK
C 55 AMG (203.276)	270	02/04→08/07	➔			<b>13.0460-4047.2 604047</b> <b>13.0470-4047.2 LD4047</b>	ATE 21305 15,7 + WE / - WK Ceramic ATE 21305 15,7 + WE / - WK Ceramic
C 350 (203.256)	200	01/05→08/07	➔	06/05→; für Fahrzeuge mit Sportpaket / für Fahrzeuge mit AMG-Sportpaket		<b>13.0460-4990.2 604990</b> <b>13.0470-4990.2 LD4990</b>	BRE 23271 17,4 + WE / - WK Ceramic BRE 23271 17,4 + WE / - WK Ceramic
			➔	06/05→; für Fahrzeuge ohne Sportpaket / für Fahrzeuge ohne AMG-Sportpaket		<b>13.0460-4994.2 604994</b> <b>13.0470-4994.2 LD4994</b>	BRE 23945 16,5 + WE / - WK Ceramic BRE 23945 16,5 + WE / - WK Ceramic
			➔	06/05→		<b>13.0460-4065.2 604065</b> <b>13.0470-4065.2 LD4065</b>	ATE 21899 15,3 + WE / - WK + Zub ATE 21899 15,3 + WE / - WK + Zub Ceramic
C 350 4-matic (203.287)	200	01/05→08/07	➔	06/05→		<b>13.0460-4990.2 604990</b> <b>13.0470-4990.2 LD4990</b>	BRE 23271 17,4 + WE / - WK Ceramic BRE 23271 17,4 + WE / - WK Ceramic
			➔	06/05→; für Fahrzeuge ohne Sportpaket / für Fahrzeuge ohne AMG-Sportpaket		<b>13.0460-4047.2 604047</b> <b>13.0470-4047.2 LD4047</b>	ATE 21305 15,7 + WE / - WK Ceramic ATE 21305 15,7 + WE / - WK Ceramic
↓							









	kw			 	! #		
<b>MERCEDES-BENZ - C-KLASSE T-Model (S203) 03/01→08/07</b>							
<b>Bremsbelagsatz, Scheibenbremse</b>							
C 350 4-matic (203.287)	200	01/05→08/07	➔	06/05→; für Fahrzeuge mit Sportpaket / für Fahrzeuge mit AMG-Sportpaket		<b>13.0460-4065.2 604065</b> <b>13.0470-4065.2 LD4065</b>	ATE 21899 15,3 + WE / - WK + Zub ATE 21899 15,3 + WE / - WK + Zub Ceramic
<b>Warnkontakt, Bremsbelagsverschleiß</b>							
C 180 (203.235)	95	03/01→05/02	←		2	<b>24.8190-0410.2 620410</b>	L= 97,5
C 30 CDI AMG (203.218)	170	01/03→08/07	➔		1	<b>24.8190-0410.2 620410</b>	L= 97,5
C 320 4-matic (203.284)	160	07/02→08/07					
C 32 AMG Kompressor (203.265)	260	03/01→08/07					
C 55 AMG (203.276)	270	02/04→08/07					
C 180 Kompressor (203.246)	105	05/02→08/07	←	A 660227 / F 565689→; für Fahrzeuge mit Sportpaket / für Fahrzeuge mit AMG-Sportpaket	2	<b>24.8190-0410.2 620410</b>	L= 97,5
C 200 CDI (203.207)	90	04/03→08/07					
C 200 CGI Kompressor (203.243)	125	07/03→08/07	←	für Fahrzeuge ohne Sportpaket / für Fahrzeuge ohne AMG-Sportpaket	2	<b>24.8190-0410.2 620410</b>	L= 97,5
C 200 Kompressor (203.242)	120	05/02→08/07	←	→ A 660226 / F 565688; für Fahrzeuge mit Sportpaket / für Fahrzeuge mit AMG-Sportpaket	2	<b>24.8190-0410.2 620410</b>	L= 97,5
C 220 CDI (203.208)	110	02/04→08/07					
C 240 (203.261)	125	03/01→08/07					
C 270 CDI (203.216)	120	03/01→08/07	➔		1	<b>24.8190-0410.2 620410</b>	L= 97,5
C 270 CDI (203.216)	125	03/01→08/07					
C 320 (203.264)	160	03/01→08/07					
C 200 CDI (203.204, 203.207)	75	03/01→08/07	←	für Fahrzeuge mit Sportpaket / für Fahrzeuge mit AMG-Sportpaket	2	<b>24.8190-0410.2 620410</b>	L= 97,5
C 200 CDI (203.204)	85	03/01→08/07	←	für Fahrzeuge ohne Sportpaket / für Fahrzeuge ohne AMG-Sportpaket	2	<b>24.8190-0410.2 620410</b>	L= 97,5
C 220 CDI (203.206)	105	03/01→08/07					
C 220 CDI (203.208)	100	08/06→08/07					
C 230 Kompressor (203.240)	141	02/04→08/07	➔		1	<b>24.8190-0410.2 620410</b>	L= 97,5
C 320 CDI (203.220)	165	06/05→08/07					
C 200 Kompressor (203.245)	120	03/01→05/02	←	→ 04/02	2	<b>24.8190-0410.2 620410</b>	L= 97,5
			➔	→ 04/02	1	<b>24.8190-0410.2 620410</b>	L= 97,5
C 230 (203.252)	150	01/05→08/07	←	06/05→; für Fahrzeuge mit Sportpaket / für Fahrzeuge mit AMG-Sportpaket	2	<b>24.8190-0410.2 620410</b>	L= 97,5
C 280 (203.254)	170	01/05→08/07					
C 280 4-matic (203.292)	170	01/05→08/07					
C 350 (203.256)	200	01/05→08/07	←	06/05→; für Fahrzeuge ohne Sportpaket / für Fahrzeuge ohne AMG-Sportpaket	2	<b>24.8190-0410.2 620410</b>	L= 97,5
			➔	06/05→	1	<b>24.8190-0410.2 620410</b>	L= 97,5
C 240 4-matic (203.281)	125	07/02→08/07	←	für Fahrzeuge ohne Sportpaket / für Fahrzeuge ohne AMG-Sportpaket	2	<b>24.8190-0410.2 620410</b>	L= 97,5
			➔		1	<b>24.8190-0410.2 620410</b>	L= 97,5
C 350 4-matic (203.287)	200	01/05→08/07	←	06/05→	2	<b>24.8190-0410.2 620410</b>	L= 97,5
			➔	06/05→; für Fahrzeuge mit Sportpaket / für Fahrzeuge mit AMG-Sportpaket	1	<b>24.8190-0410.2 620410</b>	L= 97,5
			➔	06/05→; für Fahrzeuge ohne Sportpaket / für Fahrzeuge ohne AMG-Sportpaket	1	<b>24.8190-0410.2 620410</b>	L= 97,5
<b>Zubehörsatz, Scheibenbremsbelag</b>							
C 180 (203.235)	95	03/01→05/02	➔			<b>13.0460-0231.2 610231</b>	ATE
C 230 Kompressor (203.240)	141	02/04→08/07					
C 240 4-matic (203.281)	125	07/02→08/07					
C 320 4-matic (203.284)	160	07/02→08/07					
C 180 Kompressor (203.246)	105	05/02→08/07	←	→ A 660226 / F 565688; für Fahrzeuge mit Sportpaket / für Fahrzeuge mit AMG-Sportpaket		<b>13.0460-0275.2 610275</b>	
C 200 CDI (203.207)	90	04/03→08/07					
C 200 CGI Kompressor (203.243)	125	07/03→08/07	➔			<b>13.0460-0231.2 610231</b>	ATE
C 200 Kompressor (203.242)	120	05/02→08/07					
C 220 CDI (203.208)	110	02/04→08/07					
C 240 (203.261)	125	03/01→08/07					
C 270 CDI (203.216)	120	03/01→08/07					
C 270 CDI (203.216)	125	03/01→08/07					
C 320 (203.264)	160	03/01→08/07					
C 200 CDI (203.204, 203.207)	75	03/01→08/07	←	für Fahrzeuge mit Sportpaket / für Fahrzeuge mit AMG-Sportpaket		<b>13.0460-0275.2 610275</b>	
C 200 CDI (203.204)	85	03/01→08/07	➔			<b>13.0460-0231.2 610231</b>	ATE
C 220 CDI (203.206)	105	03/01→08/07					
C 220 CDI (203.208)	100	08/06→08/07					
↓							







	kw			 	! #		
<b>MERCEDES-BENZ - C-KLASSE T-Model (S203) 03/01→08/07</b>							
<b>Zubehörsatz, Scheibenbremsbelag</b>							
C 200 Kompressor (203.245)	120	03/01→05/02	➡	→ 04/02		13.0460-0231.2 610231	ATE
C 230 (203.252)	150	01/05→08/07	➡	06/05→		13.0460-0231.2 610231	ATE
C 280 (203.254)	170	01/05→08/07					
C 280 4-matic (203.292)	170	01/05→08/07					
C 30 CDI AMG (203.218)	170	01/03→08/07	⬅			13.0460-0237.2 610237	BRE
C 32 AMG Kompressor (203.265)	260	03/01→08/07	➡			13.0460-0269.2 610269	ATE
C 55 AMG (203.276)	270	02/04→08/07					
C 320 CDI (203.220)	165	06/05→08/07	⬅	für Fahrzeuge mit Sportpaket / für Fahrzeuge mit AMG-Sportpaket		13.0460-0237.2 610237 13.0460-0269.2 610269	BRE
			➡			13.0460-0231.2 610231	ATE
C 350 (203.256)	200	01/05→08/07	⬅	06/05→; für Fahrzeuge mit Sportpaket / für Fahrzeuge mit AMG-Sportpaket		13.0460-0237.2 610237 13.0460-0269.2 610269	BRE
			➡	06/05→		13.0460-0231.2 610231	ATE
C 350 4-matic (203.287)	200	01/05→08/07	⬅	06/05→		13.0460-0237.2 610237 13.0460-0269.2 610269	BRE
			➡	06/05→; für Fahrzeuge mit Sportpaket / für Fahrzeuge mit AMG-Sportpaket		13.0460-0231.2 610231	ATE
			➡	06/05→; für Fahrzeuge ohne Sportpaket / für Fahrzeuge ohne AMG-Sportpaket		13.0460-0236.2 610236	ATE
<b> Bremsscheibe</b>							
C 180 (203.235)	95	03/01→05/02	⬅			24.0125-0110.1 425110 24.0325-0110.1 525110	Ø 288 25 22,4 V + S Ø 288 25 22,4 V + S
			➡			24.0110-0217.1 410217 24.0310-0217.1 510217	Ø 290 10 8,3 + S Ø 290 10 8,3 + S
C 180 Kompressor (203.246)	105	05/02→08/07	⬅	für Fahrzeuge ohne Sportpaket / für Fahrzeuge ohne AMG-Sportpaket		24.0125-0110.1 425110 24.0325-0110.1 525110	Ø 288 25 22,4 V + S Ø 288 25 22,4 V + S
C 200 CDI (203.204, 203.207)	75	03/01→08/07	⬅	für Fahrzeuge mit Sportpaket / für Fahrzeuge mit AMG-Sportpaket		24.0128-0177.1 428177	Ø 330 28 26 V*
C 200 CDI (203.204)	85	03/01→08/07					
C 200 CDI (203.207)	90	04/03→08/07	➡			24.0110-0217.1 410217	Ø 290 10 8,3 + S
C 200 CGI Kompressor (203.243)	125	07/03→08/07				24.0310-0217.1 510217	Ø 290 10 8,3 + S
C 200 Kompressor (203.242)	120	05/02→08/07					
C 220 CDI (203.206)	105	03/01→08/07					
C 220 CDI (203.208)	100	08/06→08/07					
C 220 CDI (203.208)	110	02/04→08/07					
C 200 Kompressor (203.245)	120	03/01→05/02	⬅	→ 04/02		24.0125-0110.1 425110 24.0325-0110.1 525110	Ø 288 25 22,4 V + S Ø 288 25 22,4 V + S
			➡	→ 04/02		24.0110-0217.1 410217 24.0310-0217.1 510217	Ø 290 10 8,3 + S Ø 290 10 8,3 + S
C 230 (203.252)	150	01/05→08/07	⬅	06/05→; für Fahrzeuge ohne Sportpaket / für Fahrzeuge ohne AMG-Sportpaket		24.0128-0106.1 428106 24.0328-0106.1 528106	Ø 300 28 25,4 V + S Ø 300 28 25,4 V + S
C 280 (203.254)	170	01/05→08/07					
C 280 4-matic (203.292)	170	01/05→08/07	⬅	06/05→; für Fahrzeuge mit Sportpaket / für Fahrzeuge mit AMG-Sportpaket		24.0128-0177.1 428177	Ø 330 28 26 V*
			➡	06/05→		24.0110-0217.1 410217 24.0310-0217.1 510217	Ø 290 10 8,3 + S Ø 290 10 8,3 + S
C 230 Kompressor (203.240)	141	02/04→08/07	⬅	für Fahrzeuge ohne Sportpaket / für Fahrzeuge ohne AMG-Sportpaket		24.0128-0106.1 428106 24.0328-0106.1 528106	Ø 300 28 25,4 V + S Ø 300 28 25,4 V + S
C 240 (203.261)	125	03/01→08/07					
C 270 CDI (203.216)	120	03/01→08/07	⬅	für Fahrzeuge mit Sportpaket / für Fahrzeuge mit AMG-Sportpaket		24.0128-0177.1 428177	Ø 330 28 26 V*
C 270 CDI (203.216)	125	03/01→08/07					
C 320 (203.264)	160	03/01→08/07	➡			24.0110-0217.1 410217 24.0310-0217.1 510217	Ø 290 10 8,3 + S Ø 290 10 8,3 + S
C 240 4-matic (203.281)	125	07/02→08/07	⬅			24.0128-0106.1 428106 24.0328-0106.1 528106	Ø 300 28 25,4 V + S Ø 300 28 25,4 V + S
C 320 4-matic (203.284)	160	07/02→08/07					
			➡			24.0110-0217.1 410217 24.0310-0217.1 510217	Ø 290 10 8,3 + S Ø 290 10 8,3 + S
C 30 CDI AMG (203.218)	170	01/03→08/07	⬅			24.0130-0180.1 430180	Ø 345 30 28 V*
C 32 AMG Kompressor (203.265)	260	03/01→08/07	➡			24.0122-0228.1 422228	Ø 300 22 19,4 V
C 55 AMG (203.276)	270	02/04→08/07					
			↓				







	kW			 	! #				
<b>MERCEDES-BENZ - C-KLASSE T-Model (S203) 03/01→08/07</b>									
<b>Bremsscheibe</b>									
C 320 CDI (203.220)	165	06/05→08/07	←	für Fahrzeuge ohne Sportpaket / für Fahrzeuge ohne AMG-Sportpaket	24.0128-0188.1	428188	Ø 330 28 26 V + S		
			←	für Fahrzeuge mit Sportpaket / für Fahrzeuge mit AMG-Sportpaket	24.0130-0180.1	430180	Ø 345 30 28 V*		
			→		24.0110-0217.1	410217	Ø 290 10 8,3 + S		
C 350 (203.256)	200	01/05→08/07	←	06/05→; für Fahrzeuge ohne Sportpaket / für Fahrzeuge ohne AMG-Sportpaket	24.0128-0188.1	428188	Ø 330 28 26 V + S		
			←	06/05→; für Fahrzeuge mit Sportpaket / für Fahrzeuge mit AMG-Sportpaket	24.0130-0180.1	430180	Ø 345 30 28 V*		
			→	06/05→	24.0110-0217.1	410217	Ø 290 10 8,3 + S		
C 350 4-matic (203.287)	200	01/05→08/07	←	06/05→; für Fahrzeuge ohne Sportpaket / für Fahrzeuge ohne AMG-Sportpaket	24.0130-0171.1	430171	Ø 345 30 27,4 V		
			←	06/05→; für Fahrzeuge mit Sportpaket / für Fahrzeuge mit AMG-Sportpaket	24.0130-0180.1	430180	Ø 345 30 28 V*		
			→	06/05→	24.0122-0228.1	422228	Ø 300 22 19,4 V		
<b>MERCEDES-BENZ - C-KLASSE T-Model (S204) 08/07→08/14</b>									
<b>Bremsbelagsatz, Scheibenbremse</b>									
C 180 (204.231) C 180 CDI (204.200) C 180 CGI (204.249) C 180 Kompressor (204.245) C 200 CDI (204.201)	115	02/12→08/14	←	für Fahrzeuge mit Sportpaket / für Fahrzeuge mit AMG-Sportpaket	13.0460-2732.2	602732	TRW 24306 20,3 + WE / - WK + Zub		
	88	01/11→08/14			13.0470-2732.2	LD2732	TRW 24306 20,3 + WE / - WK + Zub Ceramic		
	115	11/09→08/14			13.0470-9000.2	LD9000	TRW 24306 20,3 + WE / - WK + Zub Ceramic		
C 200 CDI (204.201)	100	08/10→08/14	←	für Fahrzeuge ohne Sportpaket / für Fahrzeuge ohne AMG-Sportpaket	13.0460-2733.2	602733	TRW 24306 20,3 + WE / - WK + Zub		
			←		13.0470-2733.2	LD2733	TRW 24306 20,3 + WE / - WK + Zub Ceramic		
			→		13.0460-7244.2	607244	ATE 24253 17,8 + WE / - WK Ceramic		
C 180 Kompressor (204.246) C 200 CDI (204.207)	115	08/07→08/14	←	09/07→; für Fahrzeuge mit Sportpaket / für Fahrzeuge mit AMG-Sportpaket	13.0460-2732.2	602732	TRW 24306 20,3 + WE / - WK + Zub		
	100	08/07→12/11			←	09/07→; für Fahrzeuge ohne Sportpaket / für Fahrzeuge ohne AMG-Sportpaket	13.0460-2733.2	602733	TRW 24306 20,3 + WE / - WK + Zub
					→	09/07→	13.0460-7244.2	607244	ATE 24253 17,8 + WE / - WK Ceramic
C 200 CGI (204.248)	135	08/07→08/14	←	04/09→	13.0460-2732.2	602732	TRW 24306 20,3 + WE / - WK + Zub		
			←		13.0470-2732.2	LD2732	TRW 24306 20,3 + WE / - WK + Zub Ceramic		
			→	04/09→	13.0470-9000.2	LD9000	TRW 24306 20,3 + WE / - WK + Zub Ceramic		
C 200 Kompressor (204.241) C 220 CDI (204.208) C 230 (204.252)	135	08/07→08/14	←	09/07→	13.0460-2732.2	602732	TRW 24306 20,3 + WE / - WK + Zub		
	125	08/07→11/08			13.0470-2732.2	LD2732	TRW 24306 20,3 + WE / - WK + Zub Ceramic		
	150	08/07→08/14			13.0470-9000.2	LD9000	TRW 24306 20,3 + WE / - WK + Zub Ceramic		
C 220 CDI (204.202) C 220 CDI (204.202) ↓	120	12/08→08/14	←		13.0460-2732.2	602732	TRW 24306 20,3 + WE / - WK + Zub		
	125	12/08→08/14			13.0460-7244.2	607244	ATE 24253 17,8 + WE / - WK Ceramic		
					13.0470-7244.2	LD7244	ATE 24253 17,8 + WE / - WK Ceramic		









	kw			 	! #		
<b>MERCEDES-BENZ - C-KLASSE T-Model (S204) 08/07→08/14</b>							
<b> Bremsbelagsatz, Scheibenbremse</b>							
C 220 CDI 4-matic (204.284) C 250 CGI (204.247)	125	02/13→08/14	←			<b>13.0470-2732.2</b> <b>LD2732</b>	TRW 24306 20,3 + WE / - WK + Zub Ceramic
	150	07/09→08/14	→			<b>13.0460-7244.2</b> <b>607244</b> <b>13.0470-7244.2</b> <b>LD7244</b>	ATE 24253 17,8 + WE / - WK ATE 24253 17,8 + WE / - WK Ceramic
			←			<b>13.0460-2732.2</b> <b>602732</b> <b>13.0470-2732.2</b> <b>LD2732</b> <b>13.0470-9000.2</b> <b>LD9000</b>	TRW 24306 20,3 + WE / - WK + Zub TRW 24306 20,3 + WE / - WK + Zub Ceramic TRW 24306 20,3 + WE / - WK + Zub Ceramic
C 220 CDI (204.208)	120	08/07→11/08	←			<b>13.0460-2732.2</b> <b>602732</b> <b>13.0470-2732.2</b> <b>LD2732</b> <b>13.0470-9000.2</b> <b>LD9000</b>	TRW 24306 20,3 + WE / - WK + Zub TRW 24306 20,3 + WE / - WK + Zub Ceramic TRW 24306 20,3 + WE / - WK + Zub Ceramic
			←	09/07→		<b>13.0460-2732.2</b> <b>602732</b> <b>13.0470-2732.2</b> <b>LD2732</b> <b>13.0470-9000.2</b> <b>LD9000</b>	TRW 24306 20,3 + WE / - WK + Zub TRW 24306 20,3 + WE / - WK + Zub Ceramic TRW 24306 20,3 + WE / - WK + Zub Ceramic
			→	09/07→		<b>13.0460-7244.2</b> <b>607244</b> <b>13.0470-7244.2</b> <b>LD7244</b>	ATE 24253 17,8 + WE / - WK ATE 24253 17,8 + WE / - WK Ceramic
			→			<b>13.0460-7244.2</b> <b>607244</b> <b>13.0470-7244.2</b> <b>LD7244</b>	ATE 24253 17,8 + WE / - WK ATE 24253 17,8 + WE / - WK Ceramic
			→			<b>13.0460-7244.2</b> <b>607244</b> <b>13.0470-7244.2</b> <b>LD7244</b>	ATE 24253 17,8 + WE / - WK ATE 24253 17,8 + WE / - WK Ceramic
C 250 CDI (204.203)	150	01/09→08/14	←	04/09→		<b>13.0460-2732.2</b> <b>602732</b> <b>13.0470-2732.2</b> <b>LD2732</b> <b>13.0470-9000.2</b> <b>LD9000</b>	TRW 24306 20,3 + WE / - WK + Zub TRW 24306 20,3 + WE / - WK + Zub Ceramic TRW 24306 20,3 + WE / - WK + Zub Ceramic
			→	04/09→; ALU		<b>13.0460-7244.2</b> <b>607244</b> <b>13.0470-7244.2</b> <b>LD7244</b>	ATE 24253 17,8 + WE / - WK ATE 24253 17,8 + WE / - WK Ceramic
			→	04/09→; GG		<b>13.0460-7257.2</b> <b>607257</b> <b>13.0470-7257.2</b> <b>LD7257</b>	ATE 24253 18,0 + WE / - WK ATE 24253 18,0 + WE / - WK Ceramic
C 250 CDI 4-matic (204.282)	150	04/10→08/14	←	für Fahrzeuge ohne Sportpaket / für Fahrzeuge ohne AMG-Sportpaket		<b>13.0460-2732.2</b> <b>602732</b> <b>13.0470-2732.2</b> <b>LD2732</b> <b>13.0470-9000.2</b> <b>LD9000</b>	TRW 24306 20,3 + WE / - WK + Zub TRW 24306 20,3 + WE / - WK + Zub Ceramic TRW 24306 20,3 + WE / - WK + Zub Ceramic
			←	für Fahrzeuge mit Sportpaket / für Fahrzeuge mit AMG-Sportpaket		<b>13.0460-2734.2</b> <b>602734</b> <b>13.0470-2734.2</b> <b>LD2734</b>	TRW 24310 19,0 + WE / - WK TRW 24310 19,0 + WE / - WK Ceramic
			→	für Fahrzeuge mit Sportpaket / für Fahrzeuge mit AMG-Sportpaket		<b>13.0460-7244.2</b> <b>607244</b> <b>13.0470-7244.2</b> <b>LD7244</b>	ATE 24253 17,8 + WE / - WK ATE 24253 17,8 + WE / - WK Ceramic
			→	für Fahrzeuge ohne Sportpaket / für Fahrzeuge ohne AMG-Sportpaket; ALU		<b>13.0460-7244.2</b> <b>607244</b> <b>13.0470-7244.2</b> <b>LD7244</b>	ATE 24253 17,8 + WE / - WK ATE 24253 17,8 + WE / - WK Ceramic
			→	für Fahrzeuge ohne Sportpaket / für Fahrzeuge ohne AMG-Sportpaket; GG		<b>13.0460-7257.2</b> <b>607257</b> <b>13.0470-7257.2</b> <b>LD7257</b>	ATE 24253 18,0 + WE / - WK ATE 24253 18,0 + WE / - WK Ceramic
C 280 (204.254)	170	08/07→08/14	←	09/07→; für Fahrzeuge ohne Sportpaket / für Fahrzeuge ohne AMG-Sportpaket		<b>13.0460-2732.2</b> <b>602732</b> <b>13.0470-2732.2</b> <b>LD2732</b> <b>13.0470-9000.2</b> <b>LD9000</b>	TRW 24306 20,3 + WE / - WK + Zub TRW 24306 20,3 + WE / - WK + Zub Ceramic TRW 24306 20,3 + WE / - WK + Zub Ceramic
			←	09/07→; für Fahrzeuge mit Sportpaket / für Fahrzeuge mit AMG-Sportpaket		<b>13.0460-2734.2</b> <b>602734</b> <b>13.0470-2734.2</b> <b>LD2734</b>	TRW 24310 19,0 + WE / - WK TRW 24310 19,0 + WE / - WK Ceramic
			→	09/07→		<b>13.0460-7244.2</b> <b>607244</b> <b>13.0470-7244.2</b> <b>LD7244</b>	ATE 24253 17,8 + WE / - WK ATE 24253 17,8 + WE / - WK Ceramic
C 300 (204.254) ↓	170	08/07→08/14	←	für Fahrzeuge ohne Sportpaket / für Fahrzeuge ohne AMG-Sportpaket		<b>13.0460-2732.2</b> <b>602732</b>	TRW 24306 20,3 + WE / - WK + Zub







	kw			 	! #		
<b>MERCEDES-BENZ - C-KLASSE T-Model (S204) 08/07→08/14</b>							
<b>Bremsbelagsatz, Scheibenbremse</b>							
C 300 (204.254)	170	08/07→08/14	←	für Fahrzeuge ohne Sportpaket / für Fahrzeuge ohne AMG-Sportpaket		13.0470-2732.2 LD2732	TRW 24306 20,3 + WE / - WK + Zub Ceramic
						13.0470-9000.2 LD9000	TRW 24306 20,3 + WE / - WK + Zub Ceramic
			←	für Fahrzeuge mit Sportpaket / für Fahrzeuge mit AMG-Sportpaket		13.0460-2734.2 602734	TRW 24310 19,0 + WE / - WK
			→			13.0470-2734.2 LD2734	TRW 24310 19,0 + WE / - WK Ceramic
			→			13.0460-7244.2 607244	ATE 24253 17,8 + WE / - WK
						13.0470-7244.2 LD7244	ATE 24253 17,8 + WE / - WK Ceramic
C 320 CDI (204.222)	165	08/07→08/14	←	09/07→		13.0460-2734.2 602734	TRW 24310 19,0 + WE / - WK
C 320 CDI 4-matic (204.289)	165	08/07→08/14				13.0470-2734.2 LD2734	TRW 24310 19,0 + WE / - WK Ceramic
C 350 (204.256)	200	08/07→08/14	→	09/07→; ALU		13.0460-7244.2 607244	ATE 24253 17,8 + WE / - WK
			→			13.0470-7244.2 LD7244	ATE 24253 17,8 + WE / - WK Ceramic
			→	09/07→; GG		13.0460-7257.2 607257	ATE 24253 18,0 + WE / - WK
						13.0470-7257.2 LD7257	ATE 24253 18,0 + WE / - WK Ceramic
C 350 CDI	165	08/07→08/14	←			13.0460-2734.2 602734	TRW 24310 19,0 + WE / - WK
C 350 CDI (204.223)	195	06/11→08/14				13.0470-2734.2 LD2734	TRW 24310 19,0 + WE / - WK Ceramic
C 350 CDI (204.225)	170	10/09→08/14					
C 350 CDI 4-matic (204.292)	170	10/09→08/14	→	ALU		13.0460-7244.2 607244	ATE 24253 17,8 + WE / - WK
			→			13.0470-7244.2 LD7244	ATE 24253 17,8 + WE / - WK Ceramic
			→	GG		13.0460-7257.2 607257	ATE 24253 18,0 + WE / - WK
						13.0470-7257.2 LD7257	ATE 24253 18,0 + WE / - WK Ceramic
C 350 CGI (204.257)	225	06/11→08/14	←			13.0460-2734.2 602734	TRW 24310 19,0 + WE / - WK
			→			13.0470-2734.2 LD2734	TRW 24310 19,0 + WE / - WK Ceramic
			→			13.0460-7244.2 607244	ATE 24253 17,8 + WE / - WK
						13.0470-7244.2 LD7244	ATE 24253 17,8 + WE / - WK Ceramic
C 63 AMG	373	06/13→08/14	←	nicht für Bremssattelfarbe: rot		13.0460-4839.2 604839	BRE 24455 16,8 + WE / - WK
C 63 AMG	382	07/10→08/14					
C 63 AMG (204.277)	336	02/08→08/14					
C 63 AMG (204.277)	358	01/12→08/14					
<b>Warnkontakt, Bremsbelagsverschleiß</b>							
C 180 (204.231)	115	02/12→08/14	←	für Fahrzeuge mit Sportpaket / für Fahrzeuge mit AMG-Sportpaket	1	24.8190-0410.2 620410	L= 97,5
C 180 CDI (204.200)	88	01/11→08/14					
C 180 CGI (204.249)	115	11/09→08/14	←	für Fahrzeuge ohne Sportpaket / für Fahrzeuge ohne AMG-Sportpaket	1	24.8190-0410.2 620410	L= 97,5
C 180 Kompressor (204.245)	115	01/08→08/14					
C 200 CDI (204.201)	100	08/10→08/14	→		1	24.8190-0410.2 620410	L= 97,5
C 300 (204.254)	170	08/07→08/14					
C 180 Kompressor (204.246)	115	08/07→08/14	←	09/07→; für Fahrzeuge mit Sportpaket / für Fahrzeuge mit AMG-Sportpaket	1	24.8190-0410.2 620410	L= 97,5
C 200 CDI (204.207)	100	08/07→12/11					
C 280 (204.254)	170	08/07→08/14	←	09/07→; für Fahrzeuge ohne Sportpaket / für Fahrzeuge ohne AMG-Sportpaket	1	24.8190-0410.2 620410	L= 97,5
			→		1	24.8190-0410.2 620410	L= 97,5
C 200 CGI (204.248)	135	08/07→08/14	←	04/09→	1	24.8190-0410.2 620410	L= 97,5
C 250 CDI (204.203)	150	01/09→08/14	→	04/09→	1	24.8190-0410.2 620410	L= 97,5
C 200 Kompressor (204.241)	135	08/07→08/14	←	09/07→	1	24.8190-0410.2 620410	L= 97,5
C 220 CDI (204.208)	125	08/07→11/08	→	09/07→	1	24.8190-0410.2 620410	L= 97,5
C 230 (204.252)	150	08/07→08/14					
C 320 CDI (204.222)	165	08/07→08/14					
C 320 CDI 4-matic (204.289)	165	08/07→08/14					
C 350 (204.256)	200	08/07→08/14					
C 220 CDI (204.202)	120	12/08→08/14	←		1	24.8190-0410.2 620410	L= 97,5
C 220 CDI 4-matic (204.284)	125	02/13→08/14	→		1	24.8190-0410.2 620410	L= 97,5
C 250 CGI (204.247)	150	07/09→08/14					
C 350 CDI	165	08/07→08/14					
C 350 CDI (204.223)	195	06/11→08/14					
C 350 CDI (204.225)	170	10/09→08/14					
C 350 CDI 4-matic (204.292)	170	10/09→08/14					











	kw			 	! #		
<b>MERCEDES-BENZ - C-KLASSE T-Model (S204) 08/07→08/14</b>							
<b>Warnkontakt, Bremsbelagverschleiß</b>							
C 350 CGI (204.257)	225	06/11→08/14	←		1	24.8190-0410.2 620410	L= 97,5
			→		1	24.8190-0410.2 620410	L= 97,5
C 220 CDI (204.202)	125	12/08→08/14	←		1	24.8190-0410.2 620410	L= 97,5
C 220 CDI (204.208)	120	08/07→11/08	←		1	24.8190-0410.2 620410	L= 97,5
			←	09/07→	1	24.8190-0410.2 620410	L= 97,5
			→		1	24.8190-0410.2 620410	L= 97,5
			→	09/07→	1	24.8190-0410.2 620410	L= 97,5
C 250 CDI 4-matic (204.282)	150	04/10→08/14	←	für Fahrzeuge mit Sportpaket / für Fahrzeuge mit AMG-Sportpaket	1	24.8190-0410.2 620410	L= 97,5
			←	für Fahrzeuge ohne Sportpaket / für Fahrzeuge ohne AMG-Sportpaket	1	24.8190-0410.2 620410	L= 97,5
			→	für Fahrzeuge mit Sportpaket / für Fahrzeuge mit AMG-Sportpaket	1	24.8190-0410.2 620410	L= 97,5
			→	für Fahrzeuge ohne Sportpaket / für Fahrzeuge ohne AMG-Sportpaket	1	24.8190-0410.2 620410	L= 97,5
C 63 AMG	373	06/13→08/14	←		1	24.8190-0420.2 620420	L= 119
C 63 AMG	382	07/10→08/14	←		1	24.8190-0420.2 620420	L= 119
C 63 AMG (204.277)	336	02/08→08/14	→		1	24.8190-0420.2 620420	L= 119
C 63 AMG (204.277)	358	01/12→08/14	→		1	24.8190-0420.2 620420	L= 119
<b>Bremsscheibe</b>							
C 180 (204.231)	115	02/12→08/14	←	für Fahrzeuge ohne Sportpaket / für Fahrzeuge ohne AMG-Sportpaket		24.0125-0179.1 425179	Ø 288 25 22 V + S
C 180 CDI (204.200)	88	01/11→08/14	←			24.0325-0179.1 525179	Ø 288 25 22 V + S
C 180 CGI (204.249)	115	11/09→08/14	←			24.0128-0100.1 428100	Ø 295 28 26 V• + S
C 180 Kompressor (204.245)	115	01/08→08/14	←	für Fahrzeuge mit Sportpaket / für Fahrzeuge mit AMG-Sportpaket			
C 200 CDI (204.201)	100	08/10→08/14	→	für Fahrzeuge ohne Sportpaket / für Fahrzeuge ohne AMG-Sportpaket		24.0109-0154.1 409154	Ø 278 9 7,3 + S
			→	für Fahrzeuge ohne AMG-Sportpaket		24.0309-0154.1 509154	Ø 278 9 7,3 + S
			→	für Fahrzeuge mit Sportpaket / für Fahrzeuge mit AMG-Sportpaket		24.0110-0328.1 410328	Ø 300 10 8,3 + S
			→	für Fahrzeuge mit AMG-Sportpaket		24.0310-0328.1 510328	Ø 300 10 8,3 + S
C 180 Kompressor (204.246)	115	08/07→08/14	←	09/07→; für Fahrzeuge ohne Sportpaket / für Fahrzeuge ohne AMG-Sportpaket		24.0125-0179.1 425179	Ø 288 25 22 V + S
			←			24.0325-0179.1 525179	Ø 288 25 22 V + S
			←	09/07→; für Fahrzeuge mit Sportpaket / für Fahrzeuge mit AMG-Sportpaket		24.0128-0100.1 428100	Ø 295 28 26 V• + S
			→	09/07→; für Fahrzeuge ohne Sportpaket / für Fahrzeuge ohne AMG-Sportpaket		24.0109-0154.1 409154	Ø 278 9 7,3 + S
			→			24.0309-0154.1 509154	Ø 278 9 7,3 + S
			→	09/07→; für Fahrzeuge mit Sportpaket / für Fahrzeuge mit AMG-Sportpaket		24.0110-0328.1 410328	Ø 300 10 8,3 + S
			→			24.0310-0328.1 510328	Ø 300 10 8,3 + S
C 200 CDI (204.207)	100	08/07→12/11	←	09/07→; für Fahrzeuge ohne Sportpaket / für Fahrzeuge ohne AMG-Sportpaket		24.0125-0179.1 425179	Ø 288 25 22 V + S
			←			24.0128-0155.1 428155	Ø 295 28 25,4 V + S
			←			24.0325-0179.1 525179	Ø 288 25 22 V + S
			←			24.0328-0155.1 528155	Ø 295 28 25,4 V + S
			←	09/07→; für Fahrzeuge mit Sportpaket / für Fahrzeuge mit AMG-Sportpaket		24.0128-0100.1 428100	Ø 295 28 26 V• + S
			→	09/07→; für Fahrzeuge ohne Sportpaket / für Fahrzeuge ohne AMG-Sportpaket		24.0109-0154.1 409154	Ø 278 9 7,3 + S
			→			24.0309-0154.1 509154	Ø 278 9 7,3 + S
			→	09/07→; für Fahrzeuge mit Sportpaket / für Fahrzeuge mit AMG-Sportpaket		24.0110-0328.1 410328	Ø 300 10 8,3 + S
			→			24.0310-0328.1 510328	Ø 300 10 8,3 + S
C 200 CGI (204.248)	135	08/07→08/14	←	04/09→; für Fahrzeuge mit Sportpaket / für Fahrzeuge mit AMG-Sportpaket		24.0128-0100.1 428100	Ø 295 28 26 V• + S
			←	04/09→; für Fahrzeuge ohne Sportpaket / für Fahrzeuge ohne AMG-Sportpaket		24.0128-0155.1 428155	Ø 295 28 25,4 V + S
			←			24.0328-0155.1 528155	Ø 295 28 25,4 V + S
			→	04/09→		24.0110-0328.1 410328	Ø 300 10 8,3 + S
			→			24.0310-0328.1 510328	Ø 300 10 8,3 + S
C 200 Kompressor (204.241)	135	08/07→08/14	←	09/07→; für Fahrzeuge mit Sportpaket / für Fahrzeuge mit AMG-Sportpaket		24.0128-0100.1 428100	Ø 295 28 26 V• + S
C 220 CDI (204.208)	125	08/07→11/08	←			24.0128-0155.1 428155	Ø 295 28 25,4 V + S
C 230 (204.252)	150	08/07→08/14	←	09/07→; für Fahrzeuge ohne Sportpaket / für Fahrzeuge ohne AMG-Sportpaket		24.0328-0155.1 528155	Ø 295 28 25,4 V + S
			→	09/07→		24.0110-0328.1 410328	Ø 300 10 8,3 + S
			→			24.0310-0328.1 510328	Ø 300 10 8,3 + S
↓							

	kw			 	! #		
<b>MERCEDES-BENZ - C-KLASSE T-Model (S204) 08/07→08/14</b>							
<b>Bremsscheibe</b>							
C 220 CDI (204.202)	120	12/08→08/14	←	für Fahrzeuge mit Sportpaket / für Fahrzeuge mit AMG-Sportpaket	24.0128-0100.1	428100	Ø 295 28 26 V• + S
C 220 CDI (204.202)	125	12/08→08/14	←	für Fahrzeuge mit Sportpaket / für Fahrzeuge mit AMG-Sportpaket	24.0128-0100.1	428100	Ø 295 28 26 V• + S
C 220 CDI 4-matic (204.284)	125	02/13→08/14	←	für Fahrzeuge ohne Sportpaket / für Fahrzeuge ohne AMG-Sportpaket	24.0128-0155.1	428155	Ø 295 28 25,4 V + S
C 250 CGI (204.247)	150	07/09→08/14	←	für Fahrzeuge ohne Sportpaket / für Fahrzeuge ohne AMG-Sportpaket	24.0328-0155.1	528155	Ø 295 28 25,4 V + S
			→		24.0110-0328.1	410328	Ø 300 10 8,3 + S
			→		24.0310-0328.1	510328	Ø 300 10 8,3 + S
C 220 CDI (204.208)	120	08/07→11/08	←	für Fahrzeuge mit Sportpaket / für Fahrzeuge mit AMG-Sportpaket	24.0128-0100.1	428100	Ø 295 28 26 V• + S
			←	09/07→; für Fahrzeuge mit Sportpaket / für Fahrzeuge mit AMG-Sportpaket	24.0128-0100.1	428100	Ø 295 28 26 V• + S
			←	für Fahrzeuge ohne Sportpaket / für Fahrzeuge ohne AMG-Sportpaket	24.0128-0155.1	428155	Ø 295 28 25,4 V + S
			←	für Fahrzeuge ohne Sportpaket / für Fahrzeuge ohne AMG-Sportpaket	24.0328-0155.1	528155	Ø 295 28 25,4 V + S
			←	09/07→; für Fahrzeuge ohne Sportpaket / für Fahrzeuge ohne AMG-Sportpaket	24.0128-0155.1	428155	Ø 295 28 25,4 V + S
			←	für Fahrzeuge ohne Sportpaket / für Fahrzeuge ohne AMG-Sportpaket	24.0328-0155.1	528155	Ø 295 28 25,4 V + S
			→	09/07→	24.0110-0328.1	410328	Ø 300 10 8,3 + S
			→		24.0310-0328.1	510328	Ø 300 10 8,3 + S
			→		24.0110-0328.1	410328	Ø 300 10 8,3 + S
			→		24.0310-0328.1	510328	Ø 300 10 8,3 + S
C 250 CDI (204.203)	150	01/09→08/14	←	04/09→; für Fahrzeuge mit Sportpaket / für Fahrzeuge mit AMG-Sportpaket	24.0128-0100.1	428100	Ø 295 28 26 V• + S
			←	04/09→; für Fahrzeuge ohne Sportpaket / für Fahrzeuge ohne AMG-Sportpaket	24.0128-0155.1	428155	Ø 295 28 25,4 V + S
			←	für Fahrzeuge ohne Sportpaket / für Fahrzeuge ohne AMG-Sportpaket	24.0328-0155.1	528155	Ø 295 28 25,4 V + S
			→	04/09→	24.0120-0208.1	420208	Ø 300 22 19,4 V + S
C 250 CDI 4-matic (204.282)	150	04/10→08/14	←	für Fahrzeuge ohne Sportpaket / für Fahrzeuge ohne AMG-Sportpaket	24.0128-0155.1	428155	Ø 295 28 25,4 V + S
			←	für Fahrzeuge ohne Sportpaket / für Fahrzeuge ohne AMG-Sportpaket	24.0328-0155.1	528155	Ø 295 28 25,4 V + S
			←	für Fahrzeuge mit Sportpaket / für Fahrzeuge mit AMG-Sportpaket	24.0132-0100.1	432100	Ø 322 32 30 V• + S
			→	für Fahrzeuge mit Sportpaket / für Fahrzeuge mit AMG-Sportpaket	24.0110-0328.1	410328	Ø 300 10 8,3 + S
			→	für Fahrzeuge mit Sportpaket / für Fahrzeuge mit AMG-Sportpaket	24.0310-0328.1	510328	Ø 300 10 8,3 + S
			→	für Fahrzeuge ohne Sportpaket / für Fahrzeuge ohne AMG-Sportpaket	24.0120-0208.1	420208	Ø 300 22 19,4 V + S
C 280 (204.254)	170	08/07→08/14	←	09/07→; für Fahrzeuge ohne Sportpaket / für Fahrzeuge ohne AMG-Sportpaket	24.0128-0155.1	428155	Ø 295 28 25,4 V + S
			←	für Fahrzeuge ohne Sportpaket / für Fahrzeuge ohne AMG-Sportpaket	24.0328-0155.1	528155	Ø 295 28 25,4 V + S
			←	09/07→; für Fahrzeuge mit Sportpaket / für Fahrzeuge mit AMG-Sportpaket	24.0132-0100.1	432100	Ø 322 32 30 V• + S
			→	09/07→	24.0110-0328.1	410328	Ø 300 10 8,3 + S
			→		24.0310-0328.1	510328	Ø 300 10 8,3 + S
C 300 (204.254)	170	08/07→08/14	←	für Fahrzeuge ohne Sportpaket / für Fahrzeuge ohne AMG-Sportpaket	24.0128-0155.1	428155	Ø 295 28 25,4 V + S
			←	für Fahrzeuge ohne Sportpaket / für Fahrzeuge ohne AMG-Sportpaket	24.0328-0155.1	528155	Ø 295 28 25,4 V + S
			←	für Fahrzeuge mit Sportpaket / für Fahrzeuge mit AMG-Sportpaket	24.0132-0100.1	432100	Ø 322 32 30 V• + S
			→		24.0110-0328.1	410328	Ø 300 10 8,3 + S
			→		24.0310-0328.1	510328	Ø 300 10 8,3 + S
C 320 CDI (204.222)	165	08/07→08/14	←	09/07→; für Fahrzeuge ohne Sportpaket / für Fahrzeuge ohne AMG-Sportpaket	24.0132-0100.1	432100	Ø 322 32 30 V• + S
			←	für Fahrzeuge ohne Sportpaket / für Fahrzeuge ohne AMG-Sportpaket	24.0132-0101.1	432101	Ø 322 32 29,4 V + S
			←	für Fahrzeuge ohne Sportpaket / für Fahrzeuge ohne AMG-Sportpaket	24.0332-0101.1	532101	Ø 322 32 29,4 V + S
			←	09/07→; für Fahrzeuge mit Sportpaket / für Fahrzeuge mit AMG-Sportpaket	24.0132-0100.1	432100	Ø 322 32 30 V• + S
			→	09/07→	24.0120-0208.1	420208	Ø 300 22 19,4 V + S
C 320 CDI 4-matic (204.289)	165	08/07→08/14	←	09/07→; für Fahrzeuge mit Sportpaket / für Fahrzeuge mit AMG-Sportpaket	24.0132-0100.1	432100	Ø 322 32 30 V• + S
C 350 (204.256)	200	08/07→08/14	←	09/07→; für Fahrzeuge mit Sportpaket / für Fahrzeuge mit AMG-Sportpaket	24.0132-0100.1	432100	Ø 322 32 30 V• + S
			←	09/07→; für Fahrzeuge ohne Sportpaket / für Fahrzeuge ohne AMG-Sportpaket	24.0132-0101.1	432101	Ø 322 32 29,4 V + S
			←	für Fahrzeuge ohne Sportpaket / für Fahrzeuge ohne AMG-Sportpaket	24.0332-0101.1	532101	Ø 322 32 29,4 V + S
			→	09/07→	24.0120-0208.1	420208	Ø 300 22 19,4 V + S
C 350 CDI	165	08/07→08/14	←	für Fahrzeuge mit Sportpaket / für Fahrzeuge mit AMG-Sportpaket	24.0132-0100.1	432100	Ø 322 32 30 V• + S
C 350 CDI (204.223)	195	06/11→08/14	←	für Fahrzeuge mit Sportpaket / für Fahrzeuge mit AMG-Sportpaket	24.0132-0100.1	432100	Ø 322 32 30 V• + S
C 350 CDI (204.225)	170	10/09→08/14	←	für Fahrzeuge ohne Sportpaket / für Fahrzeuge ohne AMG-Sportpaket	24.0132-0101.1	432101	Ø 322 32 29,4 V + S
C 350 CDI 4-matic (204.292)	170	10/09→08/14	←	für Fahrzeuge ohne Sportpaket / für Fahrzeuge ohne AMG-Sportpaket	24.0332-0101.1	532101	Ø 322 32 29,4 V + S
C 350 CGI (204.257)	225	06/11→08/14	→		24.0120-0208.1	420208	Ø 300 22 19,4 V + S
↓							









	kw			 	! #		
<b>MERCEDES-BENZ - C-KLASSE T-Model (S204) 08/07→08/14</b>							
 <b>Bremsscheibe</b>							
C 63 AMG C 63 AMG C 63 AMG (204.277) C 63 AMG (204.277)	373 382 336 358	06/13→08/14 07/10→08/14 02/08→08/14 01/12→08/14	←			24.0136-0108.1 436108	∅ 360 36 34 V• + S
<b>MERCEDES-BENZ - C-KLASSE T-Model (S205) 09/14→</b>							
 <b>Bremsbelagsatz, Scheibenbremse</b>							
C 160 (205.244) C 180 (205.240) C 180 BlueTEC / d (205.236)	95 115 85	04/15→ 09/14→ 09/14→	←	für Fahrzeuge ohne AMG-Sportpaket		13.0460-2792.2 602792 13.0470-2792.2 LD2792	TRW 22031 19,6 + WE / - WK TRW 22031 19,6 + WE / - WK Ceramic
C 200 (205.242) C 200 4-matic (205.243) C 200 BlueTEC / d (205.237)	135 135 100	09/14→ 04/15→ 09/14→	←	für Fahrzeuge mit AMG-Sportpaket		13.0460-4880.2 604880 13.0470-4880.2 LD4880	BRE 25997 18,7 + WE / - WK BRE 25997 18,7 + WE / - WK Ceramic
C 200 d (205.207) C 220 BlueTEC / d (205.204) C 220 BlueTEC / d (205.204) C 220 d 4-matic (205.205)	100 120 125 125	10/15→ 09/14→ 09/14→ 04/15→	→	+ eFSB		13.0460-7304.2 607304 13.0470-7304.2 LD7304	ATE 25353 16,2 + WE / - WK ATE 25353 16,2 + WE / - WK Ceramic
C 180 d (205.200) C 200 d (205.201) C 200 d (205.211) C 200 EQ Boost (205.277) C 220 d (205.214)	90 118 110 135 143	05/18→ 05/18→ 05/18→ 04/18→ 04/18→	←	für Fahrzeuge ohne AMG-Sportpaket		13.0460-2792.2 602792 13.0470-2792.2 LD2792	TRW 22031 19,6 + WE / - WK TRW 22031 19,6 + WE / - WK Ceramic
			←	für Fahrzeuge mit AMG-Sportpaket		13.0460-4880.2 604880 13.0470-4880.2 LD4880	BRE 25997 18,7 + WE / - WK BRE 25997 18,7 + WE / - WK Ceramic
			→	+ USA		13.0460-7304.2 607304 13.0470-7304.2 LD7304	ATE 25353 16,2 + WE / - WK ATE 25353 16,2 + WE / - WK Ceramic
C 200 EQ Boost 4-matic (205.278) C 220 d 4-matic (205.215)	135 143	04/18→ 05/18→	←	für Fahrzeuge ohne AMG-Sportpaket; für Fahrzeuge ohne elektr. Dämpferregulierung		13.0460-2792.2 602792 13.0470-2792.2 LD2792	TRW 22031 19,6 + WE / - WK TRW 22031 19,6 + WE / - WK Ceramic
			←	für Fahrzeuge mit elektr. Dämpferregulierung		13.0460-4880.2 604880 13.0470-4880.2 LD4880	BRE 25997 18,7 + WE / - WK BRE 25997 18,7 + WE / - WK Ceramic
			←	für Fahrzeuge mit AMG-Sportpaket		13.0460-4880.2 604880 13.0470-4880.2 LD4880	BRE 25997 18,7 + WE / - WK BRE 25997 18,7 + WE / - WK Ceramic
			→	+ USA		13.0460-7304.2 607304 13.0470-7304.2 LD7304	ATE 25353 16,2 + WE / - WK ATE 25353 16,2 + WE / - WK Ceramic
C 250 (205.245) C 250 BlueTEC / d (205.208) C 300 BlueTEC Hybrid / h (205.212)	155 150 150	09/14→ 09/14→ 10/14→	←	für Fahrzeuge ohne AMG-Sportpaket		13.0460-4880.2 604880 13.0470-4880.2 LD4880	BRE 25997 18,7 + WE / - WK BRE 25997 18,7 + WE / - WK Ceramic
			←	für Fahrzeuge mit AMG-Sportpaket		13.0460-4883.2 604883 13.0470-4883.2 LD4883	BRE 22061 18,7 + WE / - WK BRE 22061 18,7 + WE / - WK Ceramic
			→	+ eFSB		13.0460-7304.2 607304 13.0470-7304.2 LD7304	ATE 25353 16,2 + WE / - WK ATE 25353 16,2 + WE / - WK Ceramic
C 250 BlueTEC / d 4-matic (205.209) C 300 (205.248)	150 180	10/14→ 09/15→	←	für Fahrzeuge ohne AMG-Sportpaket		13.0460-2610.2 602610 13.0470-2610.2 LD2610	TRW 22076 19,6 + WE / - WK TRW 22076 19,6 + WE / - WK Ceramic
			←	für Fahrzeuge mit AMG-Sportpaket		13.0460-4883.2 604883 13.0470-4883.2 LD4883	BRE 22061 18,7 + WE / - WK BRE 22061 18,7 + WE / - WK Ceramic
			→	+ eFSB		13.0460-7304.2 607304 13.0470-7304.2 LD7304	ATE 25353 16,2 + WE / - WK ATE 25353 16,2 + WE / - WK Ceramic
C 300 (205.283)	190	05/18→	←	für Fahrzeuge ohne AMG-Sportpaket; + USA		13.0460-2610.2 602610 13.0470-2610.2 LD2610	TRW 22076 19,6 + WE / - WK TRW 22076 19,6 + WE / - WK Ceramic
			←	für Fahrzeuge mit AMG-Sportpaket		13.0460-4883.2 604883 13.0470-4883.2 LD4883	BRE 22061 18,7 + WE / - WK BRE 22061 18,7 + WE / - WK Ceramic
			→	+ USA		13.0460-7304.2 607304 13.0470-7304.2 LD7304	ATE 25353 16,2 + WE / - WK ATE 25353 16,2 + WE / - WK Ceramic
↓							







	kw			 	! #			
<b>MERCEDES-BENZ - C-KLASSE T-Model (S205) 09/14→</b>								
<b>Bremsbelagsatz, Scheibenbremse</b>								
C 300 d (205.218)	180	06/18→	←	für Fahrzeuge ohne AMG-Sportpaket	13.0460-4880.2	604880	BRE 25997 18,7 + WE / - WK BRE 25997 18,7 + WE / - WK Ceramic	
			←	für Fahrzeuge mit AMG-Sportpaket	13.0460-4883.2	604883	BRE 22061 18,7 + WE / - WK BRE 22061 18,7 + WE / - WK Ceramic	
			→	+ USA	13.0460-7304.2	607304	ATE 25353 16,2 + WE / - WK ATE 25353 16,2 + WE / - WK Ceramic	
C 300 d 4-matic (205.219)	180	06/18→	←	für Fahrzeuge mit AMG-Sportpaket	13.0460-4883.2	604883	BRE 22061 18,7 + WE / - WK BRE 22061 18,7 + WE / - WK Ceramic	
			←	für Fahrzeuge mit elektr. Dämpferregulierung	13.0460-4883.2	604883	BRE 22061 18,7 + WE / - WK BRE 22061 18,7 + WE / - WK Ceramic	
			→	+ USA	13.0460-7304.2	607304	ATE 25353 16,2 + WE / - WK ATE 25353 16,2 + WE / - WK Ceramic	
C 350 e (205.247) C 350 e (205.247)	155 205	02/15→ 02/15→	←		13.0460-4883.2	604883	BRE 22061 18,7 + WE / - WK BRE 22061 18,7 + WE / - WK Ceramic	
			→	+ eFSB	13.0460-7304.2	607304	ATE 25353 16,2 + WE / - WK ATE 25353 16,2 + WE / - WK Ceramic	
C 400 4-matic (205.266)	245	10/14→	←	für Fahrzeuge ohne AMG-Sportpaket	13.0460-4880.2	604880	BRE 25997 18,7 + WE / - WK	
			←	für Fahrzeuge mit AMG-Sportpaket	13.0460-4883.2	604883	BRE 22061 18,7 + WE / - WK	
			→	+ eFSB	13.0460-7304.2	607304	ATE 25353 16,2 + WE / - WK ATE 25353 16,2 + WE / - WK Ceramic	
C 450 AMG 4-matic (205.264)	270	04/15→04/16	→	für Fahrzeuge mit AMG-Sportpaket / + eFSB	13.0460-7304.2	607304	ATE 25353 16,2 + WE / - WK ATE 25353 16,2 + WE / - WK Ceramic	
			→	für Fahrzeuge ohne AMG-Sportpaket	13.0460-7316.2	607316	ATE 22423 16,4 + WE / - WK ATE 22423 16,4 + WE / - WK Ceramic	
<b>Warnkontakt, Bremsbelagverschleiß</b>								
AMG C 43 4-matic (205.264)	270	04/16→	←		1	24.8190-0067.2	620067	L= 92,5
AMG C 43 4-matic (205.264)	287	04/18→	→		1	24.8190-0067.2	620067	L= 92,5
C 160 (205.244)	95	04/15→						
C 180 (205.240)	115	09/14→						
C 180 BlueTEC / d (205.236)	85	09/14→						
C 180 d (205.200)	90	05/18→						
C 200 (205.242)	135	09/14→						
C 200 4-matic (205.243)	135	04/15→						
C 200 BlueTEC / d (205.237)	100	09/14→						
C 200 d (205.201)	118	05/18→						
C 200 d (205.207)	100	10/15→						
C 200 d (205.211)	110	05/18→						
C 200 EQ Boost (205.277)	135	04/18→						
C 200 EQ Boost 4-matic (205.278)	135	04/18→						
C 220 BlueTEC / d (205.204)	120	09/14→						
C 220 BlueTEC / d (205.204)	125	09/14→						
C 220 d (205.214)	143	04/18→						
C 220 d 4-matic (205.205)	125	04/15→						
C 220 d 4-matic (205.215)	143	05/18→						
C 250 (205.245)	155	09/14→						
C 250 BlueTEC / d (205.208)	150	09/14→						
C 250 BlueTEC / d 4-matic (205.209)	150	10/14→						
C 300 (205.248)	180	09/15→						
C 300 (205.283)	190	05/18→						
↓								









	kW			 	! #		
<b>MERCEDES-BENZ - C-KLASSE T-Model (S205) 09/14→</b>							
<b>Warnkontakt, Bremsbelagverschleiß</b>							
C 300 BlueTEC Hybrid / h (205.212)	150	10/14→	←		1	24.8190-0067.2 620067	L= 92,5
C 300 d (205.218)	180	06/18→	→		1	24.8190-0067.2 620067	L= 92,5
C 300 d 4-matic (205.219)	180	06/18→					
C 350 e (205.247)	155	02/15→					
C 350 e (205.247)	205	02/15→					
C 400 4-matic (205.266)	245	10/14→					
C 450 AMG 4-matic (205.264)	270	04/15→04/16	←	für Fahrzeuge ohne AMG-Sportpaket	1	24.8190-0067.2 620067	L= 92,5
			→		1	24.8190-0067.2 620067	L= 92,5
<b> Bremsscheibe</b>							
AMG C 63 (205.286)	350	10/15→	←	nicht für Bremssattelfarbe: rot; für Fahrzeuge ohne Keramikbremse		24.0136-0108.1 436108	Ø 360 36 34 V* + S
AMG C 63 S (205.287)	375	10/15→					
C 160 (205.244)	95	04/15→	←	für Fahrzeuge ohne AMG-Sportpaket		24.0124-0300.1 424300	Ø 295 24 21,4 V + S
C 180 BlueTEC / d (205.236)	85	09/14→	→	für Fahrzeuge ohne AMG-Sportpaket		24.0112-0300.1 412300	Ø 300 12 10,3 + S
C 180 d (205.200)	90	05/18→					
C 200 BlueTEC / d (205.237)	100	09/14→					
C 180 (205.240)	115	09/14→	←	für Fahrzeuge ohne AMG-Sportpaket		24.0124-0300.1 424300	Ø 295 24 21,4 V + S
			→			24.0112-0300.1 412300	Ø 300 12 10,3 + S
C 200 (205.242)	135	09/14→	←	für Fahrzeuge ohne AMG-Sportpaket		24.0128-0330.1 428330	Ø 305 28 25,4 V + S
C 220 BlueTEC / d (205.204)	120	09/14→	→			24.0112-0300.1 412300	Ø 300 12 10,3 + S
C 220 BlueTEC / d (205.204)	125	09/14→					
C 200 4-matic (205.243)	135	04/15→	←	für Fahrzeuge ohne AMG-Sportpaket		24.0128-0330.1 428330	Ø 305 28 25,4 V + S
C 200 d (205.207)	100	10/15→	→	für Fahrzeuge ohne AMG-Sportpaket		24.0112-0300.1 412300	Ø 300 12 10,3 + S
C 200 d (205.211)	110	05/18→					
C 200 EQ Boost (205.277)	135	04/18→					
C 220 d (205.214)	143	04/18→					
C 220 d 4-matic (205.205)	125	04/15→					
C 200 d (205.201)	118	05/18→	←	für Fahrzeuge ohne AMG-Sportpaket; Stahlfelge / Leichtmetallfelge; Felgenreöße [Zoll]: 16		24.0124-0300.1 424300	Ø 295 24 21,4 V + S
			←	für Fahrzeuge ohne AMG-Sportpaket; nicht für Felgenreöße [Zoll]: 16		24.0128-0330.1 428330	Ø 305 28 25,4 V + S
			→	für Fahrzeuge ohne AMG-Sportpaket		24.0112-0300.1 412300	Ø 300 12 10,3 + S
C 200 EQ Boost 4-matic (205.278)	135	04/18→	←	für Fahrzeuge ohne AMG-Sportpaket; für Fahrzeuge ohne elektr. Dämpferregulierung		24.0128-0330.1 428330	Ø 305 28 25,4 V + S
C 220 d 4-matic (205.215)	143	05/18→	→	für Fahrzeuge ohne AMG-Sportpaket		24.0112-0300.1 412300	Ø 300 12 10,3 + S
C 250 (205.245)	155	09/14→	→			24.0112-0300.1 412300	Ø 300 12 10,3 + S
C 250 BlueTEC / d (205.208)	150	09/14→					
C 250 BlueTEC / d 4-matic (205.209)	150	10/14→	→	für Fahrzeuge ohne AMG-Sportpaket		24.0112-0300.1 412300	Ø 300 12 10,3 + S
C 300 d (205.218)	180	06/18→					
C 300 d 4-matic (205.219)	180	06/18→					
<b>MERCEDES-BENZ - CLA Coupe (C117) 01/13→</b>							
<b> Bremsbelagsatz, Scheibenbremse</b>							
AMG CLA 45 4-matic (117.352)	280	07/15→	←	+SA 660		13.0460-2779.2 602779	TRW 24869 19,3 + WE / - WK
CLA 45 AMG 4-matic (117.352)	265	07/13→06/15					
CLA 180 (117.342)	90	01/13→	←			13.0460-2779.2 602779	TRW 24869 19,3 + WE / - WK
CLA 180 CDI / d (117.312)	80	10/13→				13.0470-2779.2 LD2779	TRW 24869 19,3 + WE / - WK Ceramic
CLA 200 (117.343)	115	01/13→	→	+ eFSB		13.0460-2786.2 602786	TRW 24848 18,3 + WE / - WK + Zub
CLA 200 CDI / d (117.308)	100	07/14→				13.0470-2786.2 LD2786	TRW 24848 18,3 + WE / - WK + Zub Ceramic
CLA 200 CDI / d 4-matic (117.302)	100	07/14→					
CLA 200 CDI (117.301)	100	06/13→					
CLA 220 CDI / d (117.303)	120	01/13→					
CLA 220 CDI / d (117.303)	125	01/13→					
CLA 220 CDI / d (117.303)	130	09/14→					
CLA 220 CDI / d 4-matic (117.305)	120	08/14→					























	kW			 	! #		
<b>MERCEDES-BENZ - CLA Coupe (C117) 01/13→</b>							
<b> Bremsbelagsatz, Scheibenbremse</b>							
CLA 220 CDI / d 4-matic (117.305)	130	09/14→	←			13.0460-2779.2 602779	TRW 24869 19,3 + WE / - WK
CLA 220 CDI 4-matic (117.305)	125	07/14→				13.0470-2779.2 LD2779	TRW 24869 19,3 + WE / - WK Ceramic
CLA 250 (117.344)	155	01/13→	→	+ eFSB		13.0460-2786.2 602786	TRW 24848 18,3 + WE / - WK + Zub
CLA 250 (117.350)	160	07/15→				13.0470-2786.2 LD2786	TRW 24848 18,3 + WE / - WK + Zub Ceramic
CLA 220 4-matic (117.347)	135	04/16→	←			13.0460-2779.2 602779	TRW 24869 19,3 + WE / - WK
						13.0470-2779.2 LD2779	TRW 24869 19,3 + WE / - WK Ceramic
			→	für Fahrzeuge ohne Sportpaket / für Fahrzeuge ohne AMG-Sportpaket / + eFSB		13.0460-2786.2 602786	TRW 24848 18,3 + WE / - WK + Zub
						13.0470-2786.2 LD2786	TRW 24848 18,3 + WE / - WK + Zub Ceramic
CLA 250 4-matic (117.346)	155	07/13→	←			13.0460-2779.2 602779	TRW 24869 19,3 + WE / - WK
CLA 250 4-matic (117.351)	160	07/15→				13.0470-2779.2 LD2779	TRW 24869 19,3 + WE / - WK Ceramic
<b>Warnkontakt, Bremsbelagsverschleiß</b>							
AMG CLA 45 4-matic (117.352)	280	07/15→	←		1	24.8190-0067.2 620067	L= 92,5
CLA 180 (117.342)	90	01/13→					
CLA 180 CDI / d (117.312)	80	10/13→					
CLA 200 (117.343)	115	01/13→					
CLA 200 CDI / d (117.308)	100	07/14→					
CLA 200 CDI / d 4-matic (117.302)	100	07/14→					
CLA 200 CDI (117.301)	100	06/13→					
CLA 220 4-matic (117.347)	135	04/16→					
CLA 220 CDI / d (117.303)	120	01/13→					
CLA 220 CDI / d (117.303)	125	01/13→					
CLA 220 CDI / d (117.303)	130	09/14→					
CLA 220 CDI / d 4-matic (117.305)	120	08/14→					
CLA 220 CDI / d 4-matic (117.305)	130	09/14→					
CLA 220 CDI 4-matic (117.305)	125	07/14→					
CLA 250 (117.344)	155	01/13→					
CLA 250 (117.350)	160	07/15→					
CLA 250 4-matic (117.346)	155	07/13→					
CLA 250 4-matic (117.351)	160	07/15→					
CLA 45 AMG 4-matic (117.352)	265	07/13→06/15					
<b> Bremsscheibe</b>							
AMG CLA 45 4-matic (117.352)	280	07/15→	←	+SA 660		24.0128-0262.1 428262	Ø 295 28 26 V• + S
CLA 45 AMG 4-matic (117.352)	265	07/13→06/15					
CLA 180 (117.342)	90	01/13→	←	für Fahrzeuge mit Sportpaket / für Fahrzeuge mit AMG-Sportpaket		24.0128-0262.1 428262	Ø 295 28 26 V• + S
CLA 180 CDI / d (117.312)	80	10/13→					
CLA 200 (117.343)	115	01/13→	←	für Fahrzeuge ohne Sportpaket / für Fahrzeuge ohne AMG-Sportpaket		24.0128-0276.1 428276	Ø 295 28 25,4 V + S
CLA 200 CDI / d (117.308)	100	07/14→	→			24.0110-0382.1 410382	Ø 295 10 8,3 + S
CLA 200 CDI (117.301)	100	06/13→					
CLA 200 CDI / d 4-matic (117.302)	100	07/14→	←	für Fahrzeuge mit Sportpaket / für Fahrzeuge mit AMG-Sportpaket		24.0128-0262.1 428262	Ø 295 28 26 V• + S
			←	für Fahrzeuge ohne Sportpaket / für Fahrzeuge ohne AMG-Sportpaket		24.0128-0276.1 428276	Ø 295 28 25,4 V + S
			→	→ 07/14		24.0110-0382.1 410382	Ø 295 10 8,3 + S
CLA 220 4-matic (117.347)	135	04/16→	←	für Fahrzeuge ohne Sportpaket / für Fahrzeuge ohne AMG-Sportpaket		24.0128-0276.1 428276	Ø 295 28 25,4 V + S
			←	für Fahrzeuge mit Sportpaket / für Fahrzeuge mit AMG-Sportpaket		24.0130-0238.1 430238	Ø 320 30 28 V• + S
			→	für Fahrzeuge ohne Sportpaket / für Fahrzeuge ohne AMG-Sportpaket		24.0110-0382.1 410382	Ø 295 10 8,3 + S
↓							







	kw			 	! #		
<b>MERCEDES-BENZ - CLA Coupe (C117) 01/13→</b>							
<b>Bremsscheibe</b>							
CLA 220 CDI / d (117.303)	120	01/13→	←	für Fahrzeuge ohne Sportpaket / für Fahrzeuge ohne AMG-Sportpaket		24.0128-0275.1 428275	Ø 295 28 25,4 V + S
CLA 220 CDI / d (117.303)	125	01/13→	←	für Fahrzeuge mit Sportpaket / für Fahrzeuge mit AMG-Sportpaket		24.0130-0238.1 430238	Ø 320 30 28 V• + S
CLA 220 CDI / d (117.303)	130	09/14→	→			24.0110-0382.1 410382	Ø 295 10 8,3 + S
CLA 220 CDI / d 4-matic (117.305)	120	08/14→	←	für Fahrzeuge ohne Sportpaket / für Fahrzeuge ohne AMG-Sportpaket		24.0128-0275.1 428275	Ø 295 28 25,4 V + S
CLA 220 CDI / d 4-matic (117.305)	130	09/14→	←	für Fahrzeuge mit Sportpaket / für Fahrzeuge mit AMG-Sportpaket		24.0130-0238.1 430238	Ø 320 30 28 V• + S
CLA 220 CDI 4-matic (117.305)	125	07/14→	←	für Fahrzeuge ohne Sportpaket / für Fahrzeuge ohne AMG-Sportpaket		24.0128-0275.1 428275	Ø 295 28 25,4 V + S
			←	für Fahrzeuge mit Sportpaket / für Fahrzeuge mit AMG-Sportpaket		24.0130-0238.1 430238	Ø 320 30 28 V• + S
			→	→ 07/14		24.0110-0382.1 410382	Ø 295 10 8,3 + S
CLA 250 (117.344) CLA 250 (117.350) CLA 250 4-matic (117.346)	155	01/13→	←	für Fahrzeuge ohne Sportpaket / für Fahrzeuge ohne AMG-Sportpaket		24.0130-0237.1 430237	Ø 320 30 28 V + S
	160	07/15→					
	155	07/13→	←	für Fahrzeuge mit Sportpaket / für Fahrzeuge mit AMG-Sportpaket		24.0130-0238.1 430238	Ø 320 30 28 V• + S
CLA 250 4-matic (117.351)	160	07/15→	←	für Fahrzeuge ohne Sportpaket / für Fahrzeuge ohne AMG-Sportpaket		24.0130-0237.1 430237	Ø 320 30 28 V + S
			←	für Fahrzeuge mit Sportpaket / für Fahrzeuge mit AMG-Sportpaket		24.0130-0238.1 430238	Ø 320 30 28 V• + S
			→	nicht für Ausstattungsvariante: Sport Edition [P84]		24.0110-0382.1 410382	Ø 295 10 8,3 + S
<b>MERCEDES-BENZ - CLA Shooting Brake (X117) 01/15→</b>							
<b>Bremsbelagsatz, Scheibenbremse</b>							
AMG CLA 45 4-matic (117.952)	280	07/15→	←	+SA 660		13.0460-2779.2 602779	TRW 24869 19,3 + WE / - WK
CLA 45 AMG 4-matic (117.952)	265	01/15→06/15					
CLA 180 (117.942)	90	01/15→	←			13.0460-2779.2 602779	TRW 24869 19,3 + WE / - WK
	80	07/15→				13.0470-2779.2 LD2779	TRW 24869 19,3 + WE / - WK Ceramic
CLA 200 (117.943)	115	01/15→					
CLA 200 CDI / d (117.908)	100	01/15→	→			13.0460-2786.2 602786	TRW 24848 18,3 + WE / - WK + Zub
CLA 200 CDI / d 4-matic (117.902)	100	01/15→				13.0470-2786.2 LD2786	TRW 24848 18,3 + WE / - WK + Zub Ceramic
CLA 220 CDI / d (117.903)	120	01/15→					
CLA 220 CDI / d (117.903)	130	01/15→					
CLA 220 CDI / d 4-matic (117.905)	120	09/15→					
CLA 220 CDI / d 4-matic (117.905)	130	01/15→					
CLA 250 (117.944)	155	01/15→					
CLA 220 d (117.903)	125	07/18→	→			13.0460-2786.2 602786	TRW 24848 18,3 + WE / - WK + Zub
						13.0470-2786.2 LD2786	TRW 24848 18,3 + WE / - WK + Zub Ceramic
CLA 250 4-matic (117.946)	155	01/15→	←			13.0460-2779.2 602779	TRW 24869 19,3 + WE / - WK
CLA 250 4-matic (117.951)	160	07/15→				13.0470-2779.2 LD2779	TRW 24869 19,3 + WE / - WK Ceramic
<b>Warnkontakt, Bremsbelagverschleiß</b>							
AMG CLA 45 4-matic (117.952)	280	07/15→	←		1	24.8190-0067.2 620067	L= 92,5
CLA 180 (117.942)	90	01/15→					
CLA 180 d (117.912)	80	07/15→					
CLA 200 (117.943)	115	01/15→					
CLA 200 CDI / d (117.908)	100	01/15→					
CLA 200 CDI / d 4-matic (117.902)	100	01/15→					
CLA 220 4-matic (117.947)	135	04/16→					
CLA 220 CDI / d (117.903)	120	01/15→					
CLA 220 CDI / d (117.903)	130	01/15→					
CLA 220 CDI / d 4-matic (117.905)	120	09/15→					
CLA 220 CDI / d 4-matic (117.905)	130	01/15→					
↓							







	kw				! #		
<b>MERCEDES-BENZ - CLA Shooting Brake (X117) 01/15→</b>							
<b>Warnkontakt, Bremsbelagverschleiß</b>							
CLA 220 d (117.903)	125	07/18→	←		1	24.8190-0067.2 620067	L= 92,5
CLA 220 d 4-matic (117.905)	125	07/18→					
CLA 250 (117.944)	155	01/15→					
CLA 250 4-matic (117.946)	155	01/15→					
CLA 250 4-matic (117.951)	160	07/15→					
CLA 45 AMG 4-matic (117.952)	265	01/15→06/15					
<b> Bremsscheibe</b>							
AMG CLA 45 4-matic (117.952)	280	07/15→	←	+SA 660		24.0128-0262.1 428262	Ø 295 28 26 V• + S
CLA 45 AMG 4-matic (117.952)	265	01/15→06/15					
CLA 180 (117.942)	90	01/15→	←	für Fahrzeuge mit AMG-Sportpaket		24.0128-0262.1 428262	Ø 295 28 26 V• + S
CLA 180 d (117.912)	80	07/15→					
CLA 200 (117.943)	115	01/15→	←	für Fahrzeuge ohne AMG-Sportpaket		24.0128-0276.1 428276	Ø 295 28 25,4 V + S
CLA 200 CDI / d (117.908)	100	01/15→	→			24.0110-0382.1 410382	Ø 295 10 8,3 + S
CLA 200 CDI / d 4-matic (117.902)	100	01/15→	←	für Fahrzeuge mit AMG-Sportpaket		24.0128-0262.1 428262	Ø 295 28 26 V• + S
			←	für Fahrzeuge ohne AMG-Sportpaket		24.0128-0276.1 428276	Ø 295 28 25,4 V + S
CLA 220 4-matic (117.947)	135	04/16→	←	für Fahrzeuge ohne AMG-Sportpaket		24.0128-0275.1 428275	Ø 295 28 25,4 V + S
CLA 220 CDI / d 4-matic (117.905)	120	09/15→	←	für Fahrzeuge mit AMG-Sportpaket		24.0130-0238.1 430238	Ø 320 30 28 V• + S
CLA 220 d 4-matic (117.905)	125	07/18→					
CLA 220 CDI / d (117.903)	120	01/15→	←	für Fahrzeuge ohne AMG-Sportpaket		24.0128-0275.1 428275	Ø 295 28 25,4 V + S
CLA 220 CDI / d (117.903)	130	01/15→	←	für Fahrzeuge mit AMG-Sportpaket		24.0130-0238.1 430238	Ø 320 30 28 V• + S
CLA 220 d (117.903)	125	07/18→	→			24.0110-0382.1 410382	Ø 295 10 8,3 + S
CLA 220 CDI / d 4-matic (117.905)	130	01/15→	←	für Fahrzeuge ohne AMG-Sportpaket		24.0128-0275.1 428275	Ø 295 28 25,4 V + S
			←	für Fahrzeuge mit AMG-Sportpaket		24.0130-0238.1 430238	Ø 320 30 28 V• + S
			→	für Fahrzeuge ohne AMG-Sportpaket		24.0110-0382.1 410382	Ø 295 10 8,3 + S
CLA 250 (117.944)	155	01/15→	←	für Fahrzeuge ohne AMG-Sportpaket		24.0130-0237.1 430237	Ø 320 30 28 V + S
			←	für Fahrzeuge mit AMG-Sportpaket		24.0130-0238.1 430238	Ø 320 30 28 V• + S
			→			24.0110-0382.1 410382	Ø 295 10 8,3 + S
CLA 250 4-matic (117.946)	155	01/15→	←	für Fahrzeuge ohne AMG-Sportpaket		24.0130-0237.1 430237	Ø 320 30 28 V + S
			←	für Fahrzeuge mit AMG-Sportpaket		24.0130-0238.1 430238	Ø 320 30 28 V• + S
CLA 250 4-matic (117.951)	160	07/15→	←	für Fahrzeuge ohne AMG-Sportpaket		24.0130-0237.1 430237	Ø 320 30 28 V + S
			←	für Fahrzeuge mit AMG-Sportpaket		24.0130-0238.1 430238	Ø 320 30 28 V• + S
			→	für Fahrzeuge ohne AMG-Sportpaket		24.0110-0382.1 410382	Ø 295 10 8,3 + S
<b>MERCEDES-BENZ - CLC-KLASSE (CL203) 05/08→06/11</b>							
<b> Bremsbelagsatz, Scheibenbremse</b>							
CLC 160 (203.731)	95	02/09→06/11	←	→ 10/10		13.0460-2726.2 602726	TRW 23144 19,8 + WE / - WK + Zub
						13.0470-2726.2 LD2726	TRW 23144 19,8 + WE / - WK + Zub Ceramic
			→	→ 10/10		13.0460-4064.2 604064	ATE 21919 15,3 - WE / - WK + Zub
						13.0470-4064.2 LD4064	ATE 21919 15,3 - WE / - WK + Zub Ceramic
CLC 180 Kompressor (203.746)	105	05/08→06/11	←	→ 10/10;		13.0460-2726.2 602726	TRW 23144 19,8 + WE / - WK + Zub
CLC 200 CDI (203.707)	90	05/08→06/11		für Bremsscheibendurchmesser [mm]: 288; für Bremsscheibendicke [mm]: 25		13.0470-2726.2 LD2726	TRW 23144 19,8 + WE / - WK + Zub Ceramic
CLC 220 CDI (203.708)	110	05/08→06/11					
			→	→ 10/10		13.0460-4064.2 604064	ATE 21919 15,3 - WE / - WK + Zub
						13.0470-4064.2 LD4064	ATE 21919 15,3 - WE / - WK + Zub Ceramic
CLC 200 Kompressor (203.741)	135	05/08→06/11	←	→ 10/10;		13.0460-2727.2 602727	TRW 23144 19,8 + WE / - WK + Zub
CLC 230 (203.752)	150	05/08→06/11		für Bremsscheibendurchmesser [mm]: 300; für Bremsscheibendicke [mm]: 28		13.0470-2727.2 LD2727	TRW 23144 19,8 + WE / - WK + Zub Ceramic
			→	→ 10/10		13.0460-4065.2 604065	ATE 21899 15,3 + WE / - WK + Zub









	kw			 	! #		
<b>MERCEDES-BENZ - CLC-KLASSE (CL203) 05/08→06/11</b>							
<b> Bremsbelagsatz, Scheibenbremse</b>							
CLC 200 Kompressor (203.741) CLC 230 (203.752)	135 150	05/08→06/11	➡	→ 10/10		<b>13.0470-4065.2 LD4065</b>	ATE 21899 15,3 + WE / - WK + Zub Ceramic
CLC 350 (203.756)	200	05/08→06/11	⬅	→ 10/10		<b>13.0460-4994.2 604994</b>	BRE 23945 16,5 + WE / - WK Ceramic
			➡	→ 10/10		<b>13.0470-4994.2 LD4994</b>	BRE 23945 16,5 + WE / - WK Ceramic
			➡	→ 10/10		<b>13.0460-4065.2 604065</b>	ATE 21899 15,3 + WE / - WK + Zub
						<b>13.0470-4065.2 LD4065</b>	ATE 21899 15,3 + WE / - WK + Zub Ceramic
<b>Warnkontakt, Bremsbelagverschleiß</b>							
CLC 160 (203.731) CLC 180 Kompressor (203.746)	95 105	02/09→06/11 05/08→06/11	⬅	→ 10/10	1	<b>24.8190-0410.2 620410</b>	L= 97,5
CLC 200 CDI (203.707) CLC 200 Kompressor (203.741)	90 135	05/08→06/11 05/08→06/11	➡	→ 10/10	1	<b>24.8190-0410.2 620410</b>	L= 97,5
CLC 220 CDI (203.708) CLC 230 (203.752) CLC 350 (203.756)	110 150 200	05/08→06/11 05/08→06/11 05/08→06/11					
<b>Zubehörsatz, Scheibenbremsbelag</b>							
CLC 160 (203.731) CLC 180 Kompressor (203.746)	95 105	02/09→06/11 05/08→06/11	➡	→ 10/10		<b>13.0460-0229.2 610229</b>	ATE
CLC 200 CDI (203.707) CLC 220 CDI (203.708)	90 110	05/08→06/11 05/08→06/11					
CLC 200 Kompressor (203.741) CLC 230 (203.752) CLC 350 (203.756)	135 150 200	05/08→06/11 05/08→06/11 05/08→06/11	➡	→ 10/10		<b>13.0460-0231.2 610231</b>	ATE
<b> Bremsscheibe</b>							
CLC 160 (203.731)	95	02/09→06/11	⬅	→ 10/10		<b>24.0125-0110.1 425110</b>	Ø 288 25 22,4 V + S
			➡	→ 10/10		<b>24.0325-0110.1 525110</b>	Ø 288 25 22,4 V + S
			➡	→ 10/10		<b>24.0109-0114.1 409114</b>	Ø 278 9 7,3 + S
CLC 180 Kompressor (203.746)	105	05/08→06/11	⬅	→ 10/10		<b>24.0125-0110.1 425110</b>	Ø 288 25 22,4 V + S
CLC 200 CDI (203.707) CLC 220 CDI (203.708)	90 110	05/08→06/11 05/08→06/11	➡	→ 10/10		<b>24.0325-0110.1 525110</b>	Ø 288 25 22,4 V + S
			➡	→ 10/10		<b>24.0109-0114.1 409114</b>	Ø 278 9 7,3 + S
						<b>24.0309-0114.1 509114</b>	Ø 278 9 7,3 + S
CLC 200 Kompressor (203.741)	135	05/08→06/11	⬅	→ 10/10		<b>24.0128-0106.1 428106</b>	Ø 300 28 25,4 V + S
CLC 230 (203.752)	150	05/08→06/11	➡	→ 10/10		<b>24.0328-0106.1 528106</b>	Ø 300 28 25,4 V + S
			➡	→ 10/10		<b>24.0110-0217.1 410217</b>	Ø 290 10 8,3 + S
						<b>24.0310-0217.1 510217</b>	Ø 290 10 8,3 + S
CLC 350 (203.756)	200	05/08→06/11	⬅	→ 10/10		<b>24.0128-0188.1 428188</b>	Ø 330 28 26 V + S
			➡	→ 10/10		<b>24.0110-0217.1 410217</b>	Ø 290 10 8,3 + S
						<b>24.0310-0217.1 510217</b>	Ø 290 10 8,3 + S
<b>MERCEDES-BENZ - CLK (C208) 06/97→12/03</b>							
<b> Bremsbelagsatz, Scheibenbremse</b>							
200 (208.335) 200 Kompressor (208.344)	100 120	06/97→06/02 06/00→06/02	⬅			<b>13.0460-7086.2 607086</b>	ATE 21664 19,8 + WE / - WK
200 Kompressor (208.345) 230 Kompressor (208.347)	141 142	06/97→06/00 06/97→06/00	➡	→ F 000850		<b>13.0470-7086.2 LD7086</b>	ATE 21664 19,8 + WE / - WK Ceramic
230 Kompressor (208.348)	145	06/00→06/02	➡	F 000851 / T 000001→		<b>13.0460-3805.2 603805</b>	ATE 21197 15,0 + WE / - WK
						<b>13.0470-3805.2 LD3805</b>	ATE 21197 15,0 + WE / - WK Ceramic
						<b>13.0460-4064.2 604064</b>	ATE 21919 15,3 - WE / - WK + Zub
						<b>13.0470-4064.2 LD4064</b>	ATE 21919 15,3 - WE / - WK + Zub Ceramic
320 (208.365)	160	06/97→06/02	⬅			<b>13.0460-7087.2 607087</b>	ATE 21670 19,3 + WE / - WK
			➡	→ F 196683 / T 098095		<b>13.0470-7087.2 LD7087</b>	ATE 21670 19,3 + WE / - WK Ceramic
			➡			<b>13.0460-4047.2 604047</b>	ATE 21305 15,7 + WE / - WK
						<b>13.0470-4047.2 LD4047</b>	ATE 21305 15,7 + WE / - WK Ceramic
			➡	F 196684 / T 098096→		<b>13.0460-4065.2 604065</b>	ATE 21899 15,3 + WE / - WK + Zub
↓							







	kw			 	! #		
<b>MERCEDES-BENZ - CLK (C208) 06/97→12/03</b>							
<b> Bremsbelagsatz, Scheibenbremse</b>							
320 (208.365)	160	06/97→06/02	➡	F 196684 / T 098096→		<b>13.0470-4065.2 LD4065</b>	ATE 21899 15,3 + WE / - WK + Zub Ceramic
430 (208.370)	205	07/98→06/02	←	→ F129678		<b>13.0460-4201.2 604201</b>	ATE 21153 17,5 + WE / - WK
			←			<b>13.0460-7087.2 607087</b>	ATE 21670 19,3 + WE / - WK
			←	F129679→		<b>13.0470-7087.2 LD7087</b>	ATE 21670 19,3 + WE / - WK Ceramic
			←			<b>13.0460-7183.2 607183</b>	ATE 21484 20,5 + WE / - WK
55 AMG (208.374)	255	08/99→06/02	←			<b>13.0460-4047.2 604047</b>	ATE 21305 15,7 + WE / - WK
			➡			<b>13.0470-4047.2 LD4047</b>	ATE 21305 15,7 + WE / - WK Ceramic
<b>Warnkontakt, Bremsbelagverschleiß</b>							
200 (208.335)	100	06/97→06/02	←		2	<b>24.8190-0401.2 620401</b>	L= 95
200 Kompressor (208.344)	120	06/00→06/02	←				
200 Kompressor (208.345)	141	06/97→06/00	←				
230 Kompressor (208.347)	142	06/97→06/00	←				
230 Kompressor (208.348)	145	06/00→06/02	←				
320 (208.365)	160	06/97→06/02	←		2	<b>24.8190-0401.2 620401</b>	L= 95
			➡	→ F 196683 / T 098095	1	<b>24.8190-0401.2 620401</b>	L= 95
430 (208.370)	205	07/98→06/02	←	→ F129678	2	<b>24.8190-0401.2 620401</b>	L= 95
			←		2	<b>24.8190-0401.2 620401</b>	L= 95
			←	F129679→	2	<b>24.8190-0419.2 620419</b>	L= 74
			➡		1	<b>24.8190-0401.2 620401</b>	L= 95
55 AMG (208.374)	255	08/99→06/02	←		2	<b>24.8190-0419.2 620419</b>	L= 74
			➡		1	<b>24.8190-0401.2 620401</b>	L= 95
<b>Zubehörsatz, Scheibenbremsbelag</b>							
200 (208.335)	100	06/97→06/02	➡	→ F 000850		<b>13.0460-0215.2 610215</b>	ATE
200 Kompressor (208.344)	120	06/00→06/02	➡	F 000851 / T 000001→		<b>13.0460-0229.2 610229</b>	ATE
200 Kompressor (208.345)	141	06/97→06/00	➡				
230 Kompressor (208.347)	142	06/97→06/00	➡				
230 Kompressor (208.348)	145	06/00→06/02	➡				
320 (208.365)	160	06/97→06/02	➡	F 196684 / T 098096→		<b>13.0460-0231.2 610231</b>	ATE
			➡	→ F 196683 / T 098095		<b>13.0460-0236.2 610236</b>	ATE
430 (208.370)	205	07/98→06/02	➡			<b>13.0460-0236.2 610236</b>	ATE
55 AMG (208.374)	255	08/99→06/02	➡				
<b> Bremsscheibe</b>							
200 (208.335)	100	06/97→06/02	←			<b>24.0125-0110.1 425110</b>	Ø 288 25 22,4 V + S
200 Kompressor (208.344)	120	06/00→06/02	←			<b>24.0325-0110.1 525110</b>	Ø 288 25 22,4 V + S
200 Kompressor (208.345)	141	06/97→06/00	➡			<b>24.0109-0114.1 409114</b>	Ø 278 9 7,3 + S
230 Kompressor (208.347)	142	06/97→06/00	➡			<b>24.0309-0114.1 509114</b>	Ø 278 9 7,3 + S
230 Kompressor (208.348)	145	06/00→06/02	➡				
320 (208.365)	160	06/97→06/02	←			<b>24.0128-0106.1 428106</b>	Ø 300 28 25,4 V + S
			←			<b>24.0328-0106.1 528106</b>	Ø 300 28 25,4 V + S
			➡			<b>24.0110-0217.1 410217</b>	Ø 290 10 8,3 + S
			➡			<b>24.0310-0217.1 510217</b>	Ø 290 10 8,3 + S
430 (208.370)	205	07/98→06/02	←	für Australien		<b>24.0128-0106.1 428106</b>	Ø 300 28 25,4 V + S
			←			<b>24.0328-0106.1 528106</b>	Ø 300 28 25,4 V + S
			←	→ F129678		<b>24.0128-0126.1 428126</b>	Ø 316 28 25,4 V
			←	F129679→		<b>24.0132-0159.1 432159</b>	Ø 330 32 29,4 V
			➡	→ F 129678		<b>24.0110-0217.1 410217</b>	Ø 290 10 8,3 + S



	kw			 	! #		
<b>MERCEDES-BENZ - CLK (C208) 06/97→12/03</b>							
<b>Bremsscheibe</b>							
430 (208.370)	205	07/98→06/02	→	→ F 129678		24.0310-0217.1 510217	Ø 290 10 8,3 + S
			→	F 126679→		24.0122-0228.1 422228	Ø 300 22 19,4 V
55 AMG (208.374)	255	08/99→06/02	→			24.0122-0228.1 422228	Ø 300 22 19,4 V
<b>MERCEDES-BENZ - CLK (C209) 06/02→05/09</b>							
<b>Bremsbelagsatz, Scheibenbremse</b>							
200 CGI (209.343) 200 Kompressor (209.342)	125 120	07/03→05/09 09/02→05/09	←	→ 04/09; für Fahrzeuge ohne Sportpaket / für Fahrzeuge ohne AMG-Sportpaket		13.0460-2726.2 602726 13.0470-2726.2 LD2726	TRW 23144 19,8 + WE / - WK + Zub TRW 23144 19,8 + WE / - WK + Zub Ceramic
			←	→ 04/09; für Fahrzeuge mit Sportpaket / für Fahr- zeuge mit AMG-Sportpaket		13.0460-4994.2 604994 13.0470-4994.2 LD4994	BRE 23945 16,5 + WE / - WK BRE 23945 16,5 + WE / - WK Ceramic
			→	→ 04/09; für Fahrzeuge ohne Sportpaket / für Fahrzeuge ohne AMG-Sportpaket		13.0460-4064.2 604064 13.0470-4064.2 LD4064	ATE 21919 15,3 - WE / - WK + Zub ATE 21919 15,3 - WE / - WK + Zub Ceramic
			→	→ 04/09; für Fahrzeuge mit Sportpaket / für Fahr- zeuge mit AMG-Sportpaket		13.0460-4065.2 604065 13.0470-4065.2 LD4065	ATE 21899 15,3 + WE / - WK + Zub ATE 21899 15,3 + WE / - WK + Zub Ceramic
200 Kompressor (209.341) 270 CDI (209.316)	135 125	10/06→05/09 10/02→05/09	←	→ 04/09; für Fahrzeuge ohne Sportpaket / für Fahrzeuge ohne AMG-Sportpaket		13.0460-2727.2 602727 13.0470-2727.2 LD2727	TRW 23144 19,8 + WE / - WK + Zub TRW 23144 19,8 + WE / - WK + Zub Ceramic
			←	→ 04/09; für Fahrzeuge mit Sportpaket / für Fahr- zeuge mit AMG-Sportpaket		13.0460-4994.2 604994 13.0470-4994.2 LD4994	BRE 23945 16,5 + WE / - WK BRE 23945 16,5 + WE / - WK Ceramic
			→	→ 04/09		13.0460-4065.2 604065 13.0470-4065.2 LD4065	ATE 21899 15,3 + WE / - WK + Zub ATE 21899 15,3 + WE / - WK + Zub Ceramic
220 CDI (209.308) 220 CDI (209.308)	100 110	01/05→05/09 01/05→05/09	←	05/05→ 04/09; für Fahrzeuge ohne Sportpaket / für Fahrzeuge ohne AMG-Sportpaket		13.0460-2726.2 602726 13.0470-2726.2 LD2726	TRW 23144 19,8 + WE / - WK + Zub TRW 23144 19,8 + WE / - WK + Zub Ceramic
			←	05/05→ 04/09; für Fahrzeuge mit Sportpaket / für Fahr- zeuge mit AMG-Sportpaket		13.0460-4994.2 604994 13.0470-4994.2 LD4994	BRE 23945 16,5 + WE / - WK BRE 23945 16,5 + WE / - WK Ceramic
			→	05/05→ 04/09; für Fahrzeuge ohne Sportpaket / für Fahrzeuge ohne AMG-Sportpaket		13.0460-4064.2 604064 13.0470-4064.2 LD4064	ATE 21919 15,3 - WE / - WK + Zub ATE 21919 15,3 - WE / - WK + Zub Ceramic
			→	05/05→ 04/09; für Fahrzeuge mit Sportpaket / für Fahr- zeuge mit AMG-Sportpaket		13.0460-4065.2 604065 13.0470-4065.2 LD4065	ATE 21899 15,3 + WE / - WK + Zub ATE 21899 15,3 + WE / - WK + Zub Ceramic
240 (209.361) 240 (209.361) 320 (209.365)	120 125 160	06/02→05/09 06/02→05/09 06/02→05/09	←	→ 04/09; für Bremsscheibendurchmesser [mm]: 300; für Bremsscheibendicke [mm]: 28		13.0460-2727.2 602727 13.0470-2727.2 LD2727	TRW 23144 19,8 + WE / - WK + Zub TRW 23144 19,8 + WE / - WK + Zub Ceramic
			→	→ 04/09		13.0460-4065.2 604065 13.0470-4065.2 LD4065	ATE 21899 15,3 + WE / - WK + Zub ATE 21899 15,3 + WE / - WK + Zub Ceramic
270 CDI (209.316)	120	02/03→06/05	←	für Fahrzeuge ohne Sportpaket / für Fahrzeuge ohne AMG-Sportpaket		13.0460-2727.2 602727 13.0470-2727.2 LD2727	TRW 23144 19,8 + WE / - WK + Zub TRW 23144 19,8 + WE / - WK + Zub Ceramic
			←	für Fahrzeuge mit Sportpaket / für Fahr- zeuge mit AMG-Sportpaket		13.0460-4994.2 604994 13.0470-4994.2 LD4994	BRE 23945 16,5 + WE / - WK BRE 23945 16,5 + WE / - WK Ceramic
			→			13.0460-4065.2 604065 13.0470-4065.2 LD4065	ATE 21899 15,3 + WE / - WK + Zub ATE 21899 15,3 + WE / - WK + Zub Ceramic
280 (209.354)	170	01/05→05/09	←	05/05→ 04/09; für Fahrzeuge ohne Sportpaket / für Fahrzeuge ohne AMG-Sportpaket		13.0460-2727.2 602727	TRW 23144 19,8 + WE / - WK + Zub

	kw			 	! #		
<b>MERCEDES-BENZ - CLK (C209) 06/02→05/09</b>							
<b>Bremsbelagsatz, Scheibenbremse</b>							
280 (209.354)	170	01/05→05/09	←	05/05→ 04/09; für Fahrzeuge ohne Sportpaket / für Fahrzeuge ohne AMG-Sportpaket		13.0470-2727.2 LD2727	TRW 23144 19,8 + WE / - WK + Zub Ceramic
			←	05/05→ 04/09; für Fahrzeuge mit Sportpaket / für Fahr- zeuge mit AMG-Sportpaket		13.0460-4994.2 604994 13.0470-4994.2 LD4994	BRE 23945 16,5 + WE / - WK BRE 23945 16,5 + WE / - WK Ceramic
			→	05/05→ 04/09		13.0460-4065.2 604065 13.0470-4065.2 LD4065	ATE 21899 15,3 + WE / - WK + Zub ATE 21899 15,3 + WE / - WK + Zub Ceramic
320 CDI (209.320) 350 (209.356)	165 200	01/05→05/09 01/05→05/09	←	05/05→ 04/09; für Fahrzeuge mit Sportpaket / für Fahr- zeuge mit AMG-Sportpaket		13.0460-4990.2 604990 13.0470-4990.2 LD4990	BRE 23271 17,4 + WE / - WK BRE 23271 17,4 + WE / - WK Ceramic
			←	05/05→ 04/09; für Fahrzeuge ohne Sportpaket / für Fahrzeuge ohne AMG-Sportpaket		13.0460-4994.2 604994 13.0470-4994.2 LD4994	BRE 23945 16,5 + WE / - WK BRE 23945 16,5 + WE / - WK Ceramic
			→	05/05→ 04/09		13.0460-4065.2 604065 13.0470-4065.2 LD4065	ATE 21899 15,3 + WE / - WK + Zub ATE 21899 15,3 + WE / - WK + Zub Ceramic
500 (209.372) 500 (209.375)	285 225	06/06→05/09 06/02→05/09	←	→ 04/09		13.0460-4990.2 604990	BRE 23271 17,4 + WE / - WK
			→	→ 04/09		13.0460-4047.2 604047 13.0470-4047.2 LD4047	ATE 21305 15,7 + WE / - WK ATE 21305 15,7 + WE / - WK Ceramic
55 AMG (209.376)	270	09/02→05/09	←	F 123375→; → 04/09		13.0460-4806.2 604806	BRE 23955 16,2 + WE / - WK
			←	→ F 123374		13.0460-4990.2 604990	BRE 23271 17,4 + WE / - WK
			→	→ F 123374		13.0460-4047.2 604047 13.0470-4047.2 LD4047	ATE 21305 15,7 + WE / - WK ATE 21305 15,7 + WE / - WK Ceramic
			→	F 123375→; → 04/09		13.0460-4819.2 604819	BRE 23478 14,6 + WE / - WK
63 AMG (209.377) 63 AMG (209.377)	354 373	04/06→05/09 05/07→05/09	←	→ 04/09		13.0460-4806.2 604806	BRE 23955 16,2 + WE / - WK
			→	→ 04/09		13.0460-4819.2 604819	BRE 23478 14,6 + WE / - WK
<b>Warnkontakt, Bremsbelagverschleiß</b>							
200 CGI (209.343) 200 Kompressor (209.342)	125 120	07/03→05/09 09/02→05/09	←	→ 04/09	1	24.8190-0410.2 620410	L= 97,5
			→	☐; → 04/09		24.8190-0410.2 620410	L= 97,5
200 Kompressor (209.341)	135	10/06→05/09	←	☐; → 04/09	1	24.8190-0410.2 620410	L= 97,5
			→	→ 04/09	1	24.8190-0410.2 620410	L= 97,5
270 CDI (209.316) 500 (209.372)	125 285	10/02→05/09 06/06→05/09	→	→ 04/09			
			→	→ 04/09			
500 (209.375)	225	06/02→05/09	→	→ 04/09			
			→	→ 04/09			
220 CDI (209.308) 220 CDI (209.308)	100 110	01/05→05/09 01/05→05/09	←	05/05→ 04/09	1	24.8190-0410.2 620410	L= 97,5
			→	☐; 05/05→ 04/09		24.8190-0410.2 620410	L= 97,5
240 (209.361) 240 (209.361)	120 125	06/02→05/09 06/02→05/09	←	→ 04/09	2	24.8190-0410.2 620410	L= 97,5
			→	→ 04/09	1	24.8190-0410.2 620410	L= 97,5
320 (209.365) 270 CDI (209.316)	160 120	06/02→05/09 02/03→06/05	→	→ 04/09			
			→	→ 04/09			
280 (209.354) 320 CDI (209.320)	170 165	01/05→05/09 01/05→05/09	←	☐; 05/05→ 04/09	1	24.8190-0410.2 620410	L= 97,5
			→	05/05→ 04/09	1	24.8190-0410.2 620410	L= 97,5
350 (209.356) 55 AMG (209.376)	200 270	01/05→05/09 09/02→05/09	→	05/05→ 04/09	1	24.8190-0410.2 620410	L= 97,5
			←	☐; → F 123374	1	24.8190-0410.2 620410	L= 97,5
			←	F 123375→; → 04/09	1	24.8190-0420.2 620420	L= 119
			→	→ F 123374	1	24.8190-0410.2 620410	L= 97,5
63 AMG (209.377) 63 AMG (209.377)	354 373	04/06→05/09 05/07→05/09	←	→ 04/09	1	24.8190-0420.2 620420	L= 119
			→	→ 04/09	1	24.8190-0410.2 620410	L= 97,5
<b>Zubehörsatz, Scheibenbremsbelag</b>							
200 CGI (209.343) 200 Kompressor (209.342)	125 120	07/03→05/09 09/02→05/09	→	→ 04/09		13.0460-0229.2 610229	ATE
			→	→ 04/09			
200 Kompressor (209.341) 270 CDI (209.316)	135 125	10/06→05/09 10/02→05/09	←	→ 04/09; für Fahrzeuge mit Sportpaket / für Fahr- zeuge mit AMG-Sportpaket		13.0460-0275.2 610275	
			→	→ 04/09		13.0460-0258.2 610258	
↓							

	kw			 	! #		
<b>MERCEDES-BENZ - CLK (C209) 06/02→05/09</b>							
<b>Zubehörsatz, Scheibenbremsbelag</b>							
220 CDI (209.308) 220 CDI (209.308)	100 110	01/05→05/09 01/05→05/09	➡	05/05→ 04/09		13.0460-0229.2 610229	ATE
240 (209.361) 240 (209.361) 320 (209.365)	120 125 160	06/02→05/09 06/02→05/09 06/02→05/09	➡	→ 04/09		13.0460-0258.2 610258	
270 CDI (209.316)	120	02/03→06/05	⬅	für Fahrzeuge mit Sportpaket / für Fahrzeuge mit AMG-Sportpaket		13.0460-0275.2 610275	
			➡			13.0460-0258.2 610258	
280 (209.354)	170	01/05→05/09	⬅	05/05→ 04/09; für Fahrzeuge mit Sportpaket / für Fahrzeuge mit AMG-Sportpaket		13.0460-0275.2 610275	
			➡	05/05→ 04/09		13.0460-0258.2 610258	
320 CDI (209.320) 350 (209.356)	165 200	01/05→05/09 01/05→05/09	⬅	05/05→ 04/09		13.0460-0275.2 610275	
			➡	05/05→ 04/09		13.0460-0258.2 610258	
500 (209.372) 500 (209.375)	285 225	06/06→05/09 06/02→05/09	⬅	→ 04/09		13.0460-0275.2 610275	
			➡	→ 04/09		13.0460-0236.2 610236	ATE
55 AMG (209.376)	270	09/02→05/09	⬅	→ F 123374		13.0460-0275.2 610275	
			➡	→ F 123374		13.0460-0236.2 610236	ATE
<b> Bremsscheibe</b>							
200 CGI (209.343) 200 Kompressor (209.342)	125 120	07/03→05/09 09/02→05/09	⬅	→ 04/09; für Fahrzeuge ohne Sportpaket / für Fahrzeuge ohne AMG-Sportpaket		24.0125-0110.1 425110 24.0325-0110.1 525110	Ø 288 25 22,4 V + S Ø 288 25 22,4 V + S
			⬅	→ 04/09; für Fahrzeuge mit Sportpaket / für Fahrzeuge mit AMG-Sportpaket		24.0128-0177.1 428177	Ø 330 28 26 V•
			➡	→ 04/09; für Fahrzeuge ohne Sportpaket / für Fahrzeuge ohne AMG-Sportpaket		24.0109-0114.1 409114 24.0309-0114.1 509114	Ø 278 9 7,3 + S Ø 278 9 7,3 + S
			➡	→ 04/09; für Fahrzeuge mit Sportpaket / für Fahrzeuge mit AMG-Sportpaket		24.0110-0217.1 410217 24.0310-0217.1 510217	Ø 290 10 8,3 + S Ø 290 10 8,3 + S
200 Kompressor (209.341) 270 CDI (209.316)	135 125	10/06→05/09 10/02→05/09	⬅	→ 04/09; für Fahrzeuge ohne Sportpaket / für Fahrzeuge ohne AMG-Sportpaket		24.0128-0106.1 428106 24.0328-0106.1 528106	Ø 300 28 25,4 V + S Ø 300 28 25,4 V + S
			⬅	→ 04/09; für Fahrzeuge mit Sportpaket / für Fahrzeuge mit AMG-Sportpaket		24.0128-0177.1 428177	Ø 330 28 26 V•
			➡	→ 04/09		24.0110-0217.1 410217 24.0310-0217.1 510217	Ø 290 10 8,3 + S Ø 290 10 8,3 + S
220 CDI (209.308) 220 CDI (209.308)	100 110	01/05→05/09 01/05→05/09	⬅	05/05→ 04/09; für Fahrzeuge ohne Sportpaket / für Fahrzeuge ohne AMG-Sportpaket		24.0125-0110.1 425110 24.0325-0110.1 525110	Ø 288 25 22,4 V + S Ø 288 25 22,4 V + S
			⬅	05/05→ 04/09; für Fahrzeuge mit Sportpaket / für Fahrzeuge mit AMG-Sportpaket		24.0128-0177.1 428177	Ø 330 28 26 V•
			➡	05/05→ 04/09; für Fahrzeuge ohne Sportpaket / für Fahrzeuge ohne AMG-Sportpaket		24.0109-0114.1 409114 24.0309-0114.1 509114	Ø 278 9 7,3 + S Ø 278 9 7,3 + S
			➡	05/05→ 04/09; für Fahrzeuge mit Sportpaket / für Fahrzeuge mit AMG-Sportpaket		24.0110-0217.1 410217 24.0310-0217.1 510217	Ø 290 10 8,3 + S Ø 290 10 8,3 + S
240 (209.361) 240 (209.361) 320 (209.365)	120 125 160	06/02→05/09 06/02→05/09 06/02→05/09	⬅	→ 04/09		24.0128-0106.1 428106 24.0328-0106.1 528106	Ø 300 28 25,4 V + S Ø 300 28 25,4 V + S
			➡	→ 04/09		24.0110-0217.1 410217 24.0310-0217.1 510217	Ø 290 10 8,3 + S Ø 290 10 8,3 + S
270 CDI (209.316)	120	02/03→06/05	⬅	für Fahrzeuge ohne Sportpaket / für Fahrzeuge ohne AMG-Sportpaket		24.0128-0106.1 428106 24.0328-0106.1 528106	Ø 300 28 25,4 V + S Ø 300 28 25,4 V + S
			⬅	für Fahrzeuge mit Sportpaket / für Fahrzeuge mit AMG-Sportpaket		24.0128-0177.1 428177	Ø 330 28 26 V•
			➡			24.0110-0217.1 410217 24.0310-0217.1 510217	Ø 290 10 8,3 + S Ø 290 10 8,3 + S
280 (209.354)	170	01/05→05/09	⬅	05/05→ 04/09; für Fahrzeuge ohne Sportpaket / für Fahrzeuge ohne AMG-Sportpaket		24.0128-0106.1 428106 24.0328-0106.1 528106	Ø 300 28 25,4 V + S Ø 300 28 25,4 V + S
			⬅	05/05→ 04/09; für Fahrzeuge mit Sportpaket / für Fahrzeuge mit AMG-Sportpaket		24.0128-0177.1 428177	Ø 330 28 26 V•
			➡	05/05→ 04/09		24.0110-0217.1 410217 24.0310-0217.1 510217	Ø 290 10 8,3 + S Ø 290 10 8,3 + S
↓							

	kw			 	! #			
<b>MERCEDES-BENZ - CLK (C209) 06/02→05/09</b>								
<b>Bremsscheibe</b>								
320 CDI (209.320) 350 (209.356)	165 200	01/05→05/09 01/05→05/09	←	05/05→ 04/09; für Fahrzeuge ohne Sportpaket / für Fahrzeuge ohne AMG-Sportpaket	24.0128-0188.1	428188	Ø 330 28 26 V + S	
			←	05/05→ 04/09; für Fahrzeuge mit Sportpaket / für Fahr- zeuge mit AMG-Sportpaket	24.0130-0180.1	430180	Ø 345 30 28 V•	
			→	05/05→ 04/09	24.0110-0217.1	410217	Ø 290 10 8,3 + S	
500 (209.372) 500 (209.375)	285 225	06/06→05/09 06/02→05/09	←	→ 04/09; für Fahrzeuge ohne Sportpaket / für Fahrzeuge ohne AMG-Sportpaket	24.0130-0171.1	430171	Ø 345 30 27,4 V	
			←	→ 04/09; für Fahrzeuge mit Sportpaket / für Fahr- zeuge mit AMG-Sportpaket	24.0130-0180.1	430180	Ø 345 30 28 V•	
			→	→ 04/09	24.0122-0228.1	422228	Ø 300 22 19,4 V	
55 AMG (209.376)	270	09/02→05/09	←	→ F 123374	24.0130-0180.1	430180	Ø 345 30 28 V•	
			→	→ F 123374	24.0122-0228.1	422228	Ø 300 22 19,4 V	
<b>MERCEDES-BENZ - CLK Cabriolet (A208) 03/98→03/02</b>								
<b>Bremsbelagsatz, Scheibenbremse</b>								
200 (208.435)	100	03/98→03/02	←	06/98→	13.0460-7086.2	607086	ATE 21664 19,8 + WE / - WK	
			→	06/98→	13.0470-7086.2	LD7086	ATE 21664 19,8 + WE / - WK Ceramic	
200 Kompressor (208.444) 230 Kompressor (208.448)	120 145	06/00→03/02 06/00→03/02	←		13.0460-7087.2	607087	ATE 21670 19,3 + WE / - WK	
			→	→ F 196683 / T 098095	13.0470-7087.2	LD7087	ATE 21670 19,3 + WE / - WK Ceramic	
			→	F 196684 / T 098096→	13.0460-4047.2	604047	ATE 21305 15,7 + WE / - WK	
200 Kompressor (208.445) 230 Kompressor (208.447) 320 (208.465)	141 142 160	03/98→06/00 03/98→06/00 03/98→03/02	←	06/98→	13.0460-4047.2	604047	ATE 21305 15,7 + WE / - WK	
			→	06/98→; → F 196683 / T 098095	13.0470-4047.2	LD4047	ATE 21305 15,7 + WE / - WK Ceramic	
			→	F 196684 / T 098096→	13.0460-4065.2	604065	ATE 21899 15,3 + WE / - WK	
430 (208.470)	205	09/98→03/02	←	06/99→	13.0460-4065.2	604065	ATE 21899 15,3 + WE / - WK	
			→	06/99→; → F 196683 / T 098095	13.0470-4065.2	LD4065	ATE 21899 15,3 + WE / - WK + Zub Ceramic	
			→	F 196684 / T 098096→	13.0460-7183.2	607183	ATE 21484 20,5 + WE / - WK	
55 AMG (208.474)	255	01/00→03/02	←		13.0460-7183.2	607183	ATE 21484 20,5 + WE / - WK	
			→	→ F 196683 / T 098095	13.0460-4047.2	604047	ATE 21305 15,7 + WE / - WK	
			→	F 196684 / T 098096→	13.0470-4047.2	LD4047	ATE 21305 15,7 + WE / - WK Ceramic	
<b>Warnkontakt, Bremsbelagsverschleiß</b>								
200 (208.435)	100	03/98→03/02	←	06/98→	2	24.8190-0401.2	620401	L= 95
200 Kompressor (208.444) ↓	120	06/00→03/02	←		2	24.8190-0401.2	620401	L= 95

**MERCEDES-BENZ - CLK Cabriolet (A208) 03/98→03/02**

**Warnkontakt, Bremsbelagverschleiß**

230 Kompressor (208.448)	145	06/00→03/02	➡	F 196684 / T 098096→	1	24.8190-0401.2	620401	L= 95
			➡	→ F 196683 / T 098095	1	24.8190-0401.2	620401	L= 95
200 Kompressor (208.445)	141	03/98→06/00	←	06/98→	2	24.8190-0401.2	620401	L= 95
230 Kompressor (208.447)	142	03/98→06/00	➡	06/98→; → F 196683 / T 098095	1	24.8190-0401.2	620401	L= 95
320 (208.465)	160	03/98→03/02	➡	F 196684 / T 098096→	1	24.8190-0401.2	620401	L= 95
430 (208.470)	205	09/98→03/02	←	06/99→	2	24.8190-0419.2	620419	L= 74
			➡	06/99→; → F 196683 / T 098095	1	24.8190-0401.2	620401	L= 95
			➡	F 196684 / T 098096→	1	24.8190-0401.2	620401	L= 95
55 AMG (208.474)	255	01/00→03/02	←		2	24.8190-0419.2	620419	L= 74
			➡	F 196684 / T 098096→	1	24.8190-0401.2	620401	L= 95
			➡	→ F 196683 / T 098095	1	24.8190-0401.2	620401	L= 95

**Zubehörsatz, Scheibenbremsbelag**

200 (208.435)	100	03/98→03/02	➡	06/98→		13.0460-0229.2	610229	ATE
200 Kompressor (208.444)	120	06/00→03/02	➡	→ F 196683 / T 098095		13.0460-0236.2	610236	ATE
230 Kompressor (208.448)	145	06/00→03/02						
55 AMG (208.474)	255	01/00→03/02						
200 Kompressor (208.445)	141	03/98→06/00	➡	06/98→; → F 196683 / T 098095		13.0460-0236.2	610236	ATE
230 Kompressor (208.447)	142	03/98→06/00						
320 (208.465)	160	03/98→03/02						
430 (208.470)	205	09/98→03/02	➡	06/99→; → F 196683 / T 098095		13.0460-0236.2	610236	ATE

**Bremsscheibe**









200 (208.435)	100	03/98→03/02	←	06/98→		24.0125-0110.1	425110	Ø 288 25 22,4 V + S
						24.0325-0110.1	525110	Ø 288 25 22,4 V + S
			➡	06/98→		24.0109-0114.1	409114	Ø 278 9 7,3 + S
						24.0309-0114.1	509114	Ø 278 9 7,3 + S
200 Kompressor (208.444)	120	06/00→03/02	←			24.0128-0106.1	428106	Ø 300 28 25,4 V + S
						24.0328-0106.1	528106	Ø 300 28 25,4 V + S
230 Kompressor (208.448)	145	06/00→03/02	➡			24.0110-0217.1	410217	Ø 290 10 8,3 + S
						24.0310-0217.1	510217	Ø 290 10 8,3 + S
200 Kompressor (208.445)	141	03/98→06/00	←	06/98→		24.0128-0106.1	428106	Ø 300 28 25,4 V + S
230 Kompressor (208.447)	142	03/98→06/00	➡	06/98→		24.0328-0106.1	528106	Ø 300 28 25,4 V + S
320 (208.465)	160	03/98→03/02	➡	06/98→		24.0110-0217.1	410217	Ø 290 10 8,3 + S
						24.0310-0217.1	510217	Ø 290 10 8,3 + S
430 (208.470)	205	09/98→03/02	←	06/99→		24.0132-0159.1	432159	Ø 330 32 29,4 V
			➡	06/99→		24.0122-0228.1	422228	Ø 300 22 19,4 V
55 AMG (208.474)	255	01/00→03/02	➡			24.0122-0228.1	422228	Ø 300 22 19,4 V







**MERCEDES-BENZ - CLK Cabriolet (A209) 02/03→03/10**







**Bremsbelagsatz, Scheibenbremse**









CLK 200 CGI (209.343)	125	07/03→03/10	←	→ 12/09		13.0460-2726.2	602726	TRW 23144 19,8 + WE / - WK + Zub
						13.0470-2726.2	LD2726	TRW 23144 19,8 + WE / - WK + Zub Ceramic
			➡	→ 12/09		13.0460-4064.2	604064	ATE 21919 15,3 - WE / - WK + Zub
						13.0470-4064.2	LD4064	ATE 21919 15,3 - WE / - WK + Zub Ceramic
CLK 200 Kompressor (209.441)	135	10/06→03/10	←	→ 12/09; für Fahrzeuge ohne Sportpaket / für Fahrzeuge ohne AMG-Sportpaket		13.0460-2727.2	602727	TRW 23144 19,8 + WE / - WK + Zub
						13.0470-2727.2	LD2727	TRW 23144 19,8 + WE / - WK + Zub Ceramic
			←	→ 12/09; für Fahrzeuge mit Sportpaket / für Fahrzeuge mit AMG-Sportpaket		13.0460-4994.2	604994	BRE 23945 16,5 + WE / - WK Ceramic
						13.0470-4994.2	LD4994	BRE 23945 16,5 + WE / - WK Ceramic
			➡	→ 12/09		13.0460-4065.2	604065	ATE 21899 15,3 + WE / - WK + Zub
						13.0470-4065.2	LD4065	ATE 21899 15,3 + WE / - WK + Zub Ceramic









	kw			 	! #			
<b>MERCEDES-BENZ - CLK Cabriolet (A209) 02/03→03/10</b>								
<b> Bremsbelagsatz, Scheibenbremse</b>								
CLK 200 Kompressor (209.442)	120	02/03→03/10	←	05/03→ 12/09; für Fahrzeuge ohne Sportpaket / für Fahrzeuge ohne AMG-Sportpaket	13.0460-2727.2	602727	TRW 23144 19,8 + WE / - WK + Zub	
					13.0470-2727.2	LD2727	TRW 23144 19,8 + WE / - WK + Zub Ceramic	
			←	05/03→ 12/09; für Fahrzeuge mit Sportpaket / für Fahr- zeuge mit AMG-Sportpaket	13.0460-4994.2	604994	BRE 23945 16,5 + WE / - WK	
			→	05/03→ 12/09	13.0470-4994.2	LD4994	BRE 23945 16,5 + WE / - WK Ceramic	
			→	05/03→ 12/09	13.0460-4065.2	604065	ATE 21899 15,3 + WE / - WK + Zub	
					13.0470-4065.2	LD4065	ATE 21899 15,3 + WE / - WK + Zub Ceramic	
CLK 240 (209.461) CLK 320 (209.465)	125 160	02/03→03/10 02/03→03/10	←	05/03→ 12/09	13.0460-2727.2	602727	TRW 23144 19,8 + WE / - WK + Zub	
					13.0470-2727.2	LD2727	TRW 23144 19,8 + WE / - WK + Zub Ceramic	
			→	05/03→ 12/09	13.0460-4065.2	604065	ATE 21899 15,3 + WE / - WK + Zub	
					13.0470-4065.2	LD4065	ATE 21899 15,3 + WE / - WK + Zub Ceramic	
CLK 280 (209.454)	170	01/05→03/10	←	05/05→ 12/09; für Fahrzeuge ohne Sportpaket / für Fahrzeuge ohne AMG-Sportpaket	13.0460-2727.2	602727	TRW 23144 19,8 + WE / - WK + Zub	
					13.0470-2727.2	LD2727	TRW 23144 19,8 + WE / - WK + Zub Ceramic	
			←	05/05→ 12/09; für Fahrzeuge mit Sportpaket / für Fahr- zeuge mit AMG-Sportpaket	13.0460-4994.2	604994	BRE 23945 16,5 + WE / - WK	
			→	05/05→ 12/09	13.0470-4994.2	LD4994	BRE 23945 16,5 + WE / - WK Ceramic	
			→	05/05→ 12/09	13.0460-4065.2	604065	ATE 21899 15,3 + WE / - WK + Zub	
					13.0470-4065.2	LD4065	ATE 21899 15,3 + WE / - WK + Zub Ceramic	
CLK 320 CDI (209.420) CLK 350 (209.456)	165 200	03/05→03/10 01/05→03/10	←	05/05→ 12/09; für Fahrzeuge mit Sportpaket / für Fahr- zeuge mit AMG-Sportpaket	13.0460-4990.2	604990	BRE 23271 17,4 + WE / - WK	
					13.0470-4990.2	LD4990	BRE 23271 17,4 + WE / - WK Ceramic	
			←	05/05→ 12/09; für Fahrzeuge ohne Sportpaket / für Fahrzeuge ohne AMG-Sportpaket	13.0460-4994.2	604994	BRE 23945 16,5 + WE / - WK	
			→	05/05→ 12/09	13.0470-4994.2	LD4994	BRE 23945 16,5 + WE / - WK Ceramic	
			→	05/05→ 12/09	13.0460-4065.2	604065	ATE 21899 15,3 + WE / - WK + Zub	
					13.0470-4065.2	LD4065	ATE 21899 15,3 + WE / - WK + Zub Ceramic	
CLK 500 (209.472)	285	06/06→03/10	←	→ 12/09	13.0460-4990.2	604990	BRE 23271 17,4 + WE / - WK	
			→	→ 12/09	13.0460-4047.2	604047	ATE 21305 15,7 + WE / - WK	
					13.0470-4047.2	LD4047	ATE 21305 15,7 + WE / - WK Ceramic	
CLK 500 (209.475)	225	02/03→03/10	←	05/03→ 12/09	13.0460-4990.2	604990	BRE 23271 17,4 + WE / - WK	
			→	05/03→ 12/09	13.0460-4047.2	604047	ATE 21305 15,7 + WE / - WK	
					13.0470-4047.2	LD4047	ATE 21305 15,7 + WE / - WK Ceramic	
CLK 55 AMG (209.476)	270	02/03→03/10	←	T 023346 / F 103001→; → 12/09	13.0460-4806.2	604806	BRE 23955 16,2 + WE / - WK	
			←	05/03→; → T 033979 / F 123374	13.0460-4990.2	604990	BRE 23271 17,4 + WE / - WK	
			→	05/03→; → T 033979 / F 123374	13.0460-4047.2	604047	ATE 21305 15,7 + WE / - WK	
					13.0470-4047.2	LD4047	ATE 21305 15,7 + WE / - WK Ceramic	
			→	T 023346 / F 103001→; → 12/09	13.0460-4819.2	604819	BRE 23478 14,6 + WE / - WK	
CLK 63 AMG (209.477)	354	04/06→03/10	←	→ 12/09	13.0460-4806.2	604806	BRE 23955 16,2 + WE / - WK	
			→	→ 12/09	13.0460-4819.2	604819	BRE 23478 14,6 + WE / - WK	
<b>Warnkontakt, Bremsbelagsverschleiß</b>								
CLK 200 CGI (209.343)	125	07/03→03/10	←	→ 12/09	1	24.8190-0410.2	620410	L= 97,5
CLK 200 Kompressor (209.441)	135	10/06→03/10	←	☐; → 12/09	1	24.8190-0410.2	620410	L= 97,5
			→	☐; → 12/09		24.8190-0410.2	620410	L= 97,5
CLK 200 Kompressor (209.442)	120	02/03→03/10	←	☐; 05/03→ 12/09	1	24.8190-0410.2	620410	L= 97,5
			→	☐; 05/03→ 12/09		24.8190-0410.2	620410	L= 97,5
CLK 240 (209.461) CLK 320 (209.465)	125 160	02/03→03/10 02/03→03/10	←	05/03→ 12/09	2	24.8190-0410.2	620410	L= 97,5
			→	☐; 05/03→ 12/09		24.8190-0410.2	620410	L= 97,5
↓								











	kw			 	! #		
<b>MERCEDES-BENZ - CLK Cabriolet (A209) 02/03→03/10</b>							
<b>Warnkontakt, Bremsbelagverschleiß</b>							
CLK 280 (209.454)	170	01/05→03/10	←	☐; 05/05→ 12/09	1	24.8190-0410.2 620410	L= 97,5
			→	☐; 05/05→ 12/09		24.8190-0410.2 620410	L= 97,5
CLK 320 CDI (209.420) CLK 350 (209.456)	165 200	03/05→03/10 01/05→03/10	←	☐; 05/05→ 12/09	1	24.8190-0410.2 620410	L= 97,5
			←	☐; 05/05→ 12/09	1	24.8190-0416.2 620416	L= 100
			→	☐; 05/05→ 12/09		24.8190-0410.2 620410	L= 97,5
CLK 500 (209.472)	285	06/06→03/10	←	☐; → 12/09	1	24.8190-0410.2 620410	L= 97,5
			→	→ 12/09	1	24.8190-0410.2 620410	L= 97,5
CLK 500 (209.475)	225	02/03→03/10	←	☐; 05/03→ 12/09	1	24.8190-0410.2 620410	L= 97,5
			→	05/03→ 12/09	1	24.8190-0410.2 620410	L= 97,5
CLK 55 AMG (209.476)	270	02/03→03/10	←	☐; 05/03→; → T 033979 / F 123374	1	24.8190-0410.2 620410	L= 97,5
			←	T 023346 / F 103001→; → 12/09	1	24.8190-0420.2 620420	L= 119
			→	05/03→; → T 033979 / F 123374	1	24.8190-0410.2 620410	L= 97,5
			→	T 023346 / F 103001→; → 12/09	1	24.8190-0410.2 620410	L= 97,5
CLK 63 AMG (209.477)	354	04/06→03/10	←	→ 12/09	1	24.8190-0420.2 620420	L= 119
			→	→ 12/09	1	24.8190-0410.2 620410	L= 97,5
<b>Zubehörsatz, Scheibenbremsbelag</b>							
CLK 200 CGI (209.343)	125	07/03→03/10	→	→ 12/09		13.0460-0229.2 610229	ATE
CLK 200 Kompressor (209.441)	135	10/06→03/10	→	→ 12/09		13.0460-0258.2 610258	
CLK 200 Kompressor (209.442)	120	02/03→03/10	→	05/03→ 12/09		13.0460-0258.2 610258	
CLK 240 (209.461)	125	02/03→03/10					
CLK 320 (209.465)	160	02/03→03/10					
CLK 280 (209.454)	170	01/05→03/10	→	05/05→ 12/09		13.0460-0258.2 610258	
CLK 320 CDI (209.420) CLK 350 (209.456)	165 200	03/05→03/10 01/05→03/10	←	05/05→ 12/09		13.0460-0275.2 610275	
			→	05/05→ 12/09		13.0460-0258.2 610258	
CLK 500 (209.472)	285	06/06→03/10	←	→ 12/09		13.0460-0275.2 610275	
			→	→ 12/09		13.0460-0236.2 610236	ATE
CLK 500 (209.475)	225	02/03→03/10	←	05/03→ 12/09		13.0460-0275.2 610275	
			→	05/03→ 12/09		13.0460-0236.2 610236	ATE
CLK 55 AMG (209.476)	270	02/03→03/10	←	05/03→; → T 033979 / F 123374		13.0460-0275.2 610275	
			→	05/03→; → T 033979 / F 123374		13.0460-0236.2 610236	ATE
<b>Bremsscheibe</b>							
CLK 200 CGI (209.343)	125	07/03→03/10	←	→ 12/09		24.0125-0110.1 425110	Ø 288 25 22,4 V + S
			→	→ 12/09		24.0325-0110.1 525110	Ø 288 25 22,4 V + S
			→	→ 12/09		24.0109-0114.1 409114	Ø 278 9 7,3 + S
			→	→ 12/09		24.0309-0114.1 509114	Ø 278 9 7,3 + S
CLK 200 Kompressor (209.441)	135	10/06→03/10	←	→ 12/09; für Fahrzeuge ohne Sportpaket / für Fahrzeuge ohne AMG-Sportpaket		24.0128-0106.1 428106	Ø 300 28 25,4 V + S
			←	→ 12/09; für Fahrzeuge mit Sportpaket / für Fahr- zeuge mit AMG-Sportpaket		24.0328-0106.1 528106	Ø 300 28 25,4 V + S
			→	→ 12/09		24.0128-0177.1 428177	Ø 330 28 26 V*
			→	→ 12/09		24.0110-0217.1 410217	Ø 290 10 8,3 + S
			→	→ 12/09		24.0310-0217.1 510217	Ø 290 10 8,3 + S
CLK 200 Kompressor (209.442)	120	02/03→03/10	←	05/03→ 12/09; für Fahrzeuge ohne Sportpaket / für Fahrzeuge ohne AMG-Sportpaket		24.0128-0106.1 428106	Ø 300 28 25,4 V + S
			←	05/03→ 12/09; für Fahrzeuge mit Sportpaket / für Fahr- zeuge mit AMG-Sportpaket		24.0328-0106.1 528106	Ø 300 28 25,4 V + S
			→	05/03→ 12/09		24.0128-0177.1 428177	Ø 330 28 26 V*
			→	05/03→ 12/09		24.0110-0217.1 410217	Ø 290 10 8,3 + S
			→	05/03→ 12/09		24.0310-0217.1 510217	Ø 290 10 8,3 + S
CLK 240 (209.461) CLK 320 (209.465)	125 160	02/03→03/10 02/03→03/10	←	05/03→ 12/09		24.0128-0106.1 428106	Ø 300 28 25,4 V + S
			→	05/03→ 12/09		24.0328-0106.1 528106	Ø 300 28 25,4 V + S
			→	05/03→ 12/09		24.0110-0217.1 410217	Ø 290 10 8,3 + S
			→	05/03→ 12/09		24.0310-0217.1 510217	Ø 290 10 8,3 + S
CLK 280 (209.454)	170	01/05→03/10	←	05/05→ 12/09; für Fahrzeuge ohne Sportpaket / für Fahrzeuge ohne AMG-Sportpaket		24.0128-0106.1 428106	Ø 300 28 25,4 V + S
						24.0328-0106.1 528106	Ø 300 28 25,4 V + S
↓							









	kw			 	! #		
<b>MERCEDES-BENZ - CLK Cabriolet (A209) 02/03→03/10</b>							
<b>Bremsscheibe</b>							
CLK 280 (209.454)	170	01/05→03/10	←	05/05→ 12/09; für Fahrzeuge mit Sportpaket / für Fahrzeuge mit AMG-Sportpaket	24.0128-0177.1	428177	Ø 330 28 26 V•
			→	05/05→ 12/09	24.0110-0217.1	410217	Ø 290 10 8,3 + S
					24.0310-0217.1	510217	Ø 290 10 8,3 + S
CLK 320 CDI (209.420) CLK 350 (209.456)	165 200	03/05→03/10 01/05→03/10	←	05/05→ 12/09; für Fahrzeuge ohne Sportpaket / für Fahrzeuge ohne AMG-Sportpaket	24.0128-0188.1	428188	Ø 330 28 26 V + S
			←	05/05→ 12/09; für Fahrzeuge mit Sportpaket / für Fahrzeuge mit AMG-Sportpaket	24.0130-0180.1	430180	Ø 345 30 28 V•
			→	05/05→ 12/09	24.0110-0217.1	410217	Ø 290 10 8,3 + S
CLK 500 (209.472)	285	06/06→03/10	←	→ 12/09; für Fahrzeuge ohne Sportpaket / für Fahrzeuge ohne AMG-Sportpaket	24.0130-0171.1	430171	Ø 345 30 27,4 V
			←	→ 12/09; für Fahrzeuge mit Sportpaket / für Fahrzeuge mit AMG-Sportpaket	24.0130-0180.1	430180	Ø 345 30 28 V•
			→	→ 12/09	24.0122-0228.1	422228	Ø 300 22 19,4 V
CLK 500 (209.475)	225	02/03→03/10	←	05/03→ 12/09; für Fahrzeuge ohne Sportpaket / für Fahrzeuge ohne AMG-Sportpaket	24.0130-0171.1	430171	Ø 345 30 27,4 V
			←	05/03→ 12/09; für Fahrzeuge mit Sportpaket / für Fahrzeuge mit AMG-Sportpaket	24.0130-0180.1	430180	Ø 345 30 28 V•
			→	05/03→ 12/09	24.0122-0228.1	422228	Ø 300 22 19,4 V
CLK 55 AMG (209.476)	270	02/03→03/10	←	05/03→; → T 033979 / F 123374	24.0130-0180.1	430180	Ø 345 30 28 V•
			→	05/03→; → T 033979 / F 123374	24.0122-0228.1	422228	Ø 300 22 19,4 V
<b>MERCEDES-BENZ - CLS (C218) 10/10→</b>							
<b>Bremsbelagsatz, Scheibenbremse</b>							
CLS 220 BlueTEC / d (218.301)	120	05/14→	←		13.0460-2734.2	602734	TRW 24310 19,0 + WE / - WK
					13.0470-2734.2	LD2734	TRW 24310 19,0 + WE / - WK Ceramic
CLS 220 BlueTEC / d (218.301)	125	05/14→	→		13.0460-7259.2	607259	ATE 24862 16,7 + WE / - WK
					13.0470-7259.2	LD7259	ATE 24862 16,7 + WE / - WK Ceramic
CLS 250 BlueTEC / d 4-matic (218.397)	150	05/14→					
CLS 250 CDI / BlueTEC / d (218.303, 218.304)	150	04/11→					
CLS 350 (218.359)	225	01/11→	←	für Fahrzeuge ohne Sportpaket / für Fahrzeuge ohne AMG-Sportpaket	13.0460-2734.2	602734	TRW 24310 19,0 + WE / - WK
					13.0470-2734.2	LD2734	TRW 24310 19,0 + WE / - WK Ceramic
CLS 350 BlueTEC / d (218.326)	190	06/14→					
CLS 350 CDI / d (218.323)	195	01/11→	←	für Fahrzeuge mit Sportpaket / für Fahrzeuge mit AMG-Sportpaket	13.0460-4863.2	604863	BRE 24976 17,5 + WE / - WK
CLS 350 CDI / d 4-matic (218.393)	195	09/11→	→		13.0460-7259.2	607259	ATE 24862 16,7 + WE / - WK
					13.0470-7259.2	LD7259	ATE 24862 16,7 + WE / - WK Ceramic
CLS 350 d 4-matic (218.394)	190	04/15→					
CLS 350 BlueTEC / d (218.326)	185	11/12→	←	01/13→; für Fahrzeuge ohne Sportpaket / für Fahrzeuge ohne AMG-Sportpaket	13.0460-2734.2	602734	TRW 24310 19,0 + WE / - WK
					13.0470-2734.2	LD2734	TRW 24310 19,0 + WE / - WK Ceramic
CLS 350 BlueTEC / d 4-matic (218.394)	185	11/12→	←	01/13→; für Fahrzeuge mit Sportpaket / für Fahrzeuge mit AMG-Sportpaket	13.0460-4863.2	604863	BRE 24976 17,5 + WE / - WK
			→	01/13→	13.0460-7259.2	607259	ATE 24862 16,7 + WE / - WK
CLS 400 (218.361)	245	07/14→					
CLS 400 (218.365)	245	05/14→	←		13.0460-4863.2	604863	BRE 24976 17,5 + WE / - WK
			→		13.0460-7259.2	607259	ATE 24862 16,7 + WE / - WK
CLS 400 4-matic (218.367)	245	07/14→			13.0470-7259.2	LD7259	ATE 24862 16,7 + WE / - WK Ceramic
CLS 500 (218.373)	300	02/11→					
CLS 500 4-matic (218.391)	300	09/11→					







	kW			 	! #		
<b>MERCEDES-BENZ - CLS (C218) 10/10→</b>							
<b>Warnkontakt, Bremsbelagverschleiß</b>							
CLS 220 BlueTEC / d (218.301)	120	05/14→	←		1	24.8190-0410.2 620410	L= 97,5
CLS 220 BlueTEC / d (218.301)	125	05/14→	→		1	24.8190-0410.2 620410	L= 97,5
CLS 220 BlueTEC / d (218.301)	130	05/14→					
CLS 250 BlueTEC / d 4-matic (218.397)	150	05/14→					
CLS 250 CDI / BlueTEC / d (218.303, 218.304)	150	04/11→					
CLS 400 (218.361)	245	07/14→					
CLS 400 (218.365)	245	05/14→					
CLS 400 4-matic (218.367)	245	05/14→					
CLS 400 4-matic (218.368)	245	07/14→					
CLS 500 (218.373)	300	02/11→					
CLS 500 4-matic (218.391)	300	09/11→					
CLS 350 (218.359)	225	01/11→	←	für Fahrzeuge mit Sportpaket / für Fahrzeuge mit AMG-Sportpaket	1	24.8190-0410.2 620410	L= 97,5
CLS 350 BlueTEC / d (218.326)	190	06/14→					
CLS 350 CDI / d (218.323)	195	01/11→	←	für Fahrzeuge ohne Sportpaket / für Fahrzeuge ohne AMG-Sportpaket	1	24.8190-0410.2 620410	L= 97,5
CLS 350 CDI / d 4-matic (218.393)	195	09/11→	→		1	24.8190-0410.2 620410	L= 97,5
CLS 350 d 4-matic (218.394)	190	04/15→					
CLS 350 BlueTEC / d (218.326)	185	11/12→	←	01/13→; für Fahrzeuge ohne Sportpaket / für Fahrzeuge ohne AMG-Sportpaket	1	24.8190-0410.2 620410	L= 97,5
CLS 350 BlueTEC / d 4-matic (218.394)	185	11/12→	←	01/13→; für Fahrzeuge mit Sportpaket / für Fahrzeuge mit AMG-Sportpaket	1	24.8190-0410.2 620410	L= 97,5
			→	01/13→	1	24.8190-0410.2 620410	L= 97,5
CLS 63 AMG (218.374)	386	02/11→	←	03/11→	1	24.8190-0420.2 620420	L= 119
			→	03/11→	1	24.8190-0420.2 620420	L= 119
CLS 63 AMG (218.374)	410	01/11→	←		1	24.8190-0420.2 620420	L= 119
			→		1	24.8190-0420.2 620420	L= 119
CLS 63 AMG (218.375)	430	02/13→	←	für Fahrzeuge ohne Keramikbremse	1	24.8190-0420.2 620420	L= 119
CLS 63 AMG 4-matic (218.376)	430	02/13→	→		1	24.8190-0420.2 620420	L= 119
CLS 63 AMG 4-matic (218.392)	410	05/13→					
<b> Bremsscheibe</b>							
CLS 220 BlueTEC / d (218.301)	120	05/14→	←			24.0132-0170.1 432170	Ø 322 32 30 V• + S
CLS 220 BlueTEC / d (218.301)	125	05/14→	→			24.0110-0278.1 410278	Ø 300 10 8,3 + S
CLS 220 BlueTEC / d (218.301)	130	05/14→				24.0310-0278.1 510278	Ø 300 10 8,3 + S
CLS 250 BlueTEC / d 4-matic (218.397)	150	05/14→					
CLS 250 CDI / BlueTEC / d (218.303, 218.304)	150	04/11→					
CLS 350 (218.359)	225	01/11→	←	für Fahrzeuge ohne Sportpaket / für Fahrzeuge ohne AMG-Sportpaket		24.0132-0170.1 432170	Ø 322 32 30 V• + S
CLS 350 BlueTEC / d (218.326)	190	06/14→					
CLS 350 CDI / d (218.323)	195	01/11→	←	für Fahrzeuge mit Sportpaket / für Fahrzeuge mit AMG-Sportpaket		24.0132-0180.1 432180	Ø 344 32 30 V• + S
CLS 350 CDI / d 4-matic (218.393)	195	09/11→	→			24.0122-0201.1 422201	Ø 300 22 19,4 V + S
CLS 350 d 4-matic (218.394)	190	04/15→					
CLS 350 BlueTEC / d (218.326)	185	11/12→	←	01/13→; für Fahrzeuge ohne Sportpaket / für Fahrzeuge ohne AMG-Sportpaket		24.0132-0170.1 432170	Ø 322 32 30 V• + S
CLS 350 BlueTEC / d 4-matic (218.394)	185	11/12→	←	01/13→; für Fahrzeuge mit Sportpaket / für Fahrzeuge mit AMG-Sportpaket		24.0132-0180.1 432180	Ø 344 32 30 V• + S
			→	01/13→		24.0122-0201.1 422201	Ø 300 22 19,4 V + S
CLS 400 (218.361)	245	07/14→	←			24.0132-0180.1 432180	Ø 344 32 30 V• + S
CLS 400 (218.365)	245	05/14→					
CLS 400 4-matic (218.367)	245	05/14→	→			24.0122-0201.1 422201	Ø 300 22 19,4 V + S
↓							









	kw			 	! #		
<b>MERCEDES-BENZ - CLS (C218) 10/10→</b>							
<b>Bremsscheibe</b>							
CLS 400 4-matic (218.368)	245	07/14→	←			24.0132-0180.1 432180	∅ 344 32 30 V + S
			→			24.0122-0201.1 422201	∅ 300 22 19,4 V + S
CLS 500 (218.373) CLS 500 4-matic (218.391)	300 300	02/11→ 09/11→	→			24.0124-0236.1 424236	∅ 320 24 21,1 V + S
<b>MERCEDES-BENZ - CLS (C219) 10/04→02/11</b>							
<b>Bremsbelagsatz, Scheibenbremse</b>							
CLS 280 (219.354) CLS 300 (219.354) CLS 350 (219.356) CLS 350 (219.357) CLS 350 CDI CLS 350 CDI (219.322)	170 170 200 215 200 165	07/08→12/10 04/09→12/10 10/04→12/10 04/06→12/10 04/09→12/10 04/09→12/10	←	→ 10/10		13.0460-4990.2 604990 13.0470-4990.2 LD4990	BRE 23271 17,4 + WE / - WK BRE 23271 17,4 + WE / - WK Ceramic
			→	→ 10/10		13.0460-7171.2 607171 13.0470-7171.2 LD7171	ATE 23334 16,7 + WE / - WK ATE 23334 16,7 + WE / - WK Ceramic
CLS 320 CDI CLS 320 CDI (219.322)	155 165	01/05→12/10 01/05→12/10	←	A 038332→; → 10/10		13.0460-4990.2 604990 13.0470-4990.2 LD4990	BRE 23271 17,4 + WE / - WK BRE 23271 17,4 + WE / - WK Ceramic
			←	05/05→; → A 038331		13.0460-4990.2 604990 13.0470-4990.2 LD4990	BRE 23271 17,4 + WE / - WK BRE 23271 17,4 + WE / - WK Ceramic
			→	05/05→ 10/10		13.0460-7171.2 607171 13.0470-7171.2 LD7171	ATE 23334 16,7 + WE / - WK ATE 23334 16,7 + WE / - WK Ceramic
CLS 500 (219.372)	285	04/06→12/10	←	→ A 069799		13.0460-4817.2 604817	BRE 23960 18,3 + WE / - WK
			←	A 069800→; → 10/10		13.0460-4817.2 604817	BRE 23960 18,3 + WE / - WK
			→	→ 10/10		13.0460-7171.2 607171 13.0470-7171.2 LD7171	ATE 23334 16,7 + WE / - WK ATE 23334 16,7 + WE / - WK Ceramic
CLS 500 (219.375)	225	10/04→12/10	←	→ 10/10		13.0460-4990.2 604990	BRE 23271 17,4 + WE / - WK
			→	→ 10/10		13.0460-7171.2 607171 13.0470-7171.2 LD7171	ATE 23334 16,7 + WE / - WK ATE 23334 16,7 + WE / - WK Ceramic
			→	→ 10/10		13.0460-4997.2 604997 13.0460-4998.2 604998	BRE 23943 17,5 + WE / - WK BRE 23478 16,5 + WE / - WK
CLS 55 AMG (219.376)	350	01/05→12/10	←	→ 10/10		13.0460-4997.2 604997	BRE 23943 17,5 + WE / - WK
			→	→ 10/10		13.0460-4998.2 604998	BRE 23478 16,5 + WE / - WK
CLS 63 AMG (219.377)	378	04/06→12/10	←	→ 10/10; für Fahrzeuge ohne AMG-Performance Package		13.0460-4839.2 604839	BRE 24455 16,8 + WE / - WK
<b>Warnkontakt, Bremsbelagsverschleiß</b>							
CLS 280 (219.354) CLS 300 (219.354) CLS 350 (219.357)	170 170 215	07/08→12/10 04/09→12/10 04/06→12/10	←	→ 10/10	1	24.8190-0410.2 620410	L= 97,5
			→	→ 10/10	1	24.8190-0410.2 620410	L= 97,5
CLS 320 CDI CLS 320 CDI (219.322)	155 165	01/05→12/10 01/05→12/10		05/05→; → A 038331	2	24.8190-0410.2 620410	L= 97,5
			←	☐; A 038332→; → 10/10		24.8190-0410.2 620410	L= 97,5
			←	☐; A 038332→; → 10/10		24.8190-0416.2 620416	L= 100
			→	05/05→ 10/10	1	24.8190-0410.2 620410	L= 97,5
CLS 350 (219.356) CLS 350 CDI CLS 350 CDI (219.322)	200 200 165	10/04→12/10 04/09→12/10 04/09→12/10	←	☐; → 10/10		24.8190-0410.2 620410	L= 97,5
			←	☐; → 10/10		24.8190-0416.2 620416	L= 100
			→	→ 10/10	1	24.8190-0410.2 620410	L= 97,5
CLS 500 (219.372)	285	04/06→12/10	←	→ A 069799	1	24.8190-0410.2 620410	L= 97,5
			←	A 069800→; → 10/10	1	24.8190-0420.2 620420	L= 119
			→	→ 10/10	1	24.8190-0410.2 620410	L= 97,5
CLS 500 (219.375) CLS 55 AMG (219.376)	225 350	10/04→12/10 01/05→12/10	←	☐; → 10/10	1	24.8190-0410.2 620410	L= 97,5
			←	☐; → 10/10	1	24.8190-0416.2 620416	L= 100
			→	→ 10/10	1	24.8190-0410.2 620410	L= 97,5
CLS 63 AMG (219.377)	378	04/06→12/10	←	→ 10/10	1	24.8190-0420.2 620420	L= 119
			→	→ 10/10	1	24.8190-0420.2 620420	L= 119
<b>Zubehörsatz, Scheibenbremsbelag</b>							
CLS 280 (219.354) CLS 300 (219.354) CLS 350 (219.356) CLS 350 (219.357) CLS 350 CDI	170 170 200 215 200	07/08→12/10 04/09→12/10 10/04→12/10 04/06→12/10 04/09→12/10	←	→ 10/10		13.0460-0155.2 610155	BRE











	kw			 	! #		
<b>MERCEDES-BENZ - CLS (C219) 10/04→02/11</b>							
<b>Zubehörsatz, Scheibenbremsbelag</b>							
CLS 350 CDI (219.322)	165	04/09→12/10	←	→ 10/10		13.0460-0155.2 610155	BRE
CLS 320 CDI	155	01/05→12/10	←	A 038332→; → 10/10		13.0460-0155.2 610155	BRE
CLS 320 CDI (219.322)	165	01/05→12/10	←	05/05→; → A 038331		13.0460-0275.2 610275	
CLS 500 (219.375)	225	10/04→12/10	←	→ 10/10		13.0460-0275.2 610275	
<b> Bremsscheibe</b>							
CLS 280 (219.354)	170	07/08→12/10	←	→ 10/10		24.0132-0144.1 432144	Ø 330 32 29,4 V + S
CLS 300 (219.354)	170	04/09→12/10				24.0332-0144.1 532144	Ø 330 32 29,4 V + S
CLS 350 (219.356)	200	10/04→12/10					
CLS 350 (219.357)	215	04/06→12/10	→	→ 10/10		24.0122-0201.1 422201	Ø 300 22 19,4 V + S
CLS 500 (219.375)	225	10/04→12/10					
CLS 320 CDI	155	01/05→12/10	←	05/05→ 10/10		24.0128-0142.1 428142	Ø 312 28 25,4 V
CLS 320 CDI (219.322)	165	01/05→12/10	←	05/05→ 10/10		24.0328-0142.1 528142	Ø 312 28 25,4 V
			→	05/05→ 10/10		24.0122-0201.1 422201	Ø 300 22 19,4 V + S
CLS 350 CDI	200	04/09→12/10	←	→ 10/10		24.0128-0142.1 428142	Ø 312 28 25,4 V
CLS 350 CDI (219.322)	165	04/09→12/10	←	→ 10/10		24.0328-0142.1 528142	Ø 312 28 25,4 V
			→	→ 10/10		24.0122-0201.1 422201	Ø 300 22 19,4 V + S
CLS 500 (219.372)	285	04/06→12/10	←	→ 10/10		24.0132-0139.1 432139	Ø 350 32 29,4 V + S
			→	→ 10/10		24.0124-0236.1 424236	Ø 320 24 21,1 V + S
CLS 55 AMG (219.376)	350	01/05→12/10	←	→ 10/10; für Fahrzeuge ohne AMG-Performance Package		24.0136-0102.1 436102	Ø 360 36 34 V•
			→	→ 10/10		24.0126-0136.1 426136	Ø 330 26 24 V•
CLS 63 AMG (219.377)	378	04/06→12/10	→	→ 10/10		24.0126-0136.1 426136	Ø 330 26 24 V•
<b>MERCEDES-BENZ - CLS (C257) 12/17→</b>							
<b> Bremsbelagsatz, Scheibenbremse</b>							
CLS 300 d (257.318)	180	04/18→	←	für Fahrzeuge ohne AMG-Sportpaket		13.0460-4883.2 604883 13.0470-4883.2 LD4883	BRE 22061 18,7 + WE / - WK BRE 22061 18,7 + WE / - WK Ceramic
<b>Warnkontakt, Bremsbelagverschleiß</b>							
CLS 300 d (257.318)	180	04/18→	←		1	24.8190-0067.2 620067	L= 92,5
CLS 350 d 4-matic (257.321)	183	12/17→	→		1	24.8190-0067.2 620067	L= 92,5
CLS 350 d 4-matic (257.321)	210	12/17→					
CLS 400 d 4-matic (257.323)	250	12/17→					
CLS 450 EQ Boost 4-matic (257.359)	270	12/17→					
<b>MERCEDES-BENZ - CLS Shooting Brake (X218) 10/12→</b>							
<b> Bremsbelagsatz, Scheibenbremse</b>							
CLS 220 BlueTEC / d (218.901)	120	05/14→	←			13.0460-2734.2 602734	TRW 24310 19,0 + WE / - WK
CLS 220 BlueTEC / d (218.901)	125	05/14→				13.0470-2734.2 LD2734	TRW 24310 19,0 + WE / - WK Ceramic
CLS 220 BlueTEC / d (218.901)	130	05/14→	→			13.0460-7259.2 607259	ATE 24862 16,7 + WE / - WK
CLS 250 BlueTEC / d 4-matic (218.997)	150	05/14→				13.0470-7259.2 LD7259	ATE 24862 16,7 + WE / - WK Ceramic
CLS 250 CDI / BlueTEC / d (218.903, 218.904)	150	10/12→					
CLS 350 (218.959)	225	10/12→	←	für Fahrzeuge ohne Sportpaket		13.0460-2734.2 602734	TRW 24310 19,0 + WE / - WK
CLS 350 BlueTEC / d (218.926)	190	05/14→				13.0470-2734.2 LD2734	TRW 24310 19,0 + WE / - WK Ceramic
CLS 350 BlueTEC / d 4-matic (218.994)	185	05/14→	←	für Fahrzeuge mit Sportpaket		13.0460-4863.2 604863	BRE 24976 17,5 + WE / - WK
CLS 350 CDI / d (218.923)	195	10/12→	→			13.0460-7259.2 607259	ATE 24862 16,7 + WE / - WK
CLS 350 CDI / d 4-matic (218.993)	195	10/12→	→			13.0470-7259.2 LD7259	ATE 24862 16,7 + WE / - WK Ceramic
CLS 350 d 4-matic (218.994)	190	04/15→					
CLS 400 (218.961)	245	07/14→	←			13.0460-4863.2 604863	BRE 24976 17,5 + WE / - WK
CLS 400 (218.965)	245	05/14→	→			13.0460-7259.2 607259	ATE 24862 16,7 + WE / - WK
						13.0470-7259.2 LD7259	ATE 24862 16,7 + WE / - WK Ceramic
↓							







	kW					! #		
<b>MERCEDES-BENZ - CLS Shooting Brake (X218) 10/12→</b>								
<b> Bremsbelagsatz, Scheibenbremse</b>								
CLS 400 4-matic (218.967)	245	05/14→	→				13.0460-7259.2 607259	ATE 24862 16,7 + WE / - WK
CLS 400 4-matic (218.968)	245	07/14→					13.0470-7259.2 LD7259	ATE 24862 16,7 + WE / - WK Ceramic
CLS 500 (218.973)	300	10/12→						
CLS 500 4-matic (218.991)	300	10/12→						
<b>Warnkontakt, Bremsbelagverschleiß</b>								
CLS 220 BlueTEC / d (218.901)	120	05/14→	←			1	24.8190-0410.2 620410	L= 97,5
CLS 220 BlueTEC / d (218.901)	125	05/14→	→			1	24.8190-0410.2 620410	L= 97,5
CLS 220 BlueTEC / d (218.901)	130	05/14→						
CLS 250 BlueTEC / d 4-matic (218.997)	150	05/14→						
CLS 250 CDI / BlueTEC / d (218.903, 218.904)	150	10/12→						
CLS 350 (218.959)	225	10/12→						
CLS 350 BlueTEC / d (218.926)	190	05/14→						
CLS 350 BlueTEC / d 4-matic (218.994)	185	05/14→						
CLS 350 CDI / d (218.923)	195	10/12→						
CLS 350 CDI / d 4-matic (218.993)	195	10/12→						
CLS 350 d 4-matic (218.994)	190	04/15→						
CLS 400 (218.961)	245	07/14→						
CLS 400 (218.965)	245	05/14→						
CLS 400 4-matic (218.967)	245	05/14→						
CLS 400 4-matic (218.968)	245	07/14→						
CLS 500 (218.973)	300	10/12→						
CLS 500 4-matic (218.991)	300	10/12→						
CLS 63 AMG (218.974)	386	10/12→	←	für Fahrzeuge ohne Keramikbremse		1	24.8190-0420.2 620420	L= 119
CLS 63 AMG (218.974)	410	05/13→						
CLS 63 AMG (218.975)	430	02/13→	→			1	24.8190-0420.2 620420	L= 119
CLS 63 AMG 4-matic (218.976)	430	02/13→						
CLS 63 AMG 4-matic (218.992)	410	05/13→						
<b> Bremsscheibe</b>								
CLS 220 BlueTEC / d (218.901)	120	05/14→	←				24.0132-0170.1 432170	Ø 322 32 30 V• + S
CLS 220 BlueTEC / d (218.901)	125	05/14→	→				24.0110-0278.1 410278	Ø 300 10 8,3 + S
CLS 220 BlueTEC / d (218.901)	130	05/14→					24.0310-0278.1 510278	Ø 300 10 8,3 + S
CLS 250 CDI / BlueTEC / d (218.903, 218.904)	150	10/12→						
CLS 250 BlueTEC / d 4-matic (218.997)	150	05/14→	←				24.0132-0170.1 432170	Ø 322 32 30 V• + S
			→				24.0110-0278.1 410278	Ø 300 10 8,3 + S
							24.0122-0201.1 422201	Ø 300 22 19,4 V + S
							24.0310-0278.1 510278	Ø 300 10 8,3 + S
CLS 350 (218.959)	225	10/12→	←	für Fahrzeuge ohne Sportpaket			24.0132-0170.1 432170	Ø 322 32 30 V• + S
CLS 350 BlueTEC / d (218.926)	190	05/14→	←	für Fahrzeuge mit Sportpaket			24.0132-0180.1 432180	Ø 344 32 30 V• + S
CLS 350 BlueTEC / d 4-matic (218.994)	185	05/14→	→				24.0122-0201.1 422201	Ø 300 22 19,4 V + S
CLS 350 CDI / d (218.923)	195	10/12→						
CLS 350 CDI / d 4-matic (218.993)	195	10/12→						
CLS 350 d 4-matic (218.994)	190	04/15→						
CLS 400 (218.961)	245	07/14→	←	+SA 802; für Fahrzeuge mit AMG-Sportpaket			24.0132-0170.1 432170	Ø 322 32 30 V• + S
CLS 400 (218.965)	245	05/14→						
CLS 400 4-matic (218.967)	245	05/14→	←	nicht für SA Code: 802			24.0132-0180.1 432180	Ø 344 32 30 V• + S
CLS 400 4-matic (218.968)	245	07/14→	→				24.0122-0201.1 422201	Ø 300 22 19,4 V + S
CLS 500 (218.973)	300	10/12→	→				24.0124-0236.1 424236	Ø 320 24 21,1 V + S
↓								









	kW				! #		
<b>MERCEDES-BENZ - CLS Shooting Brake (X218) 10/12 →</b>							
<b>Bremsscheibe</b>							
CLS 500 4-matic (218.991)	300	10/12 →	→			24.0124-0236.1 424236	Ø 320 24 21,1 V + S
<b>MERCEDES-BENZ - E-KLASSE (W210) 06/95 → 08/03</b>							
<b>Bremsbelagsatz, Scheibenbremse</b>							
E 200 (210.035) E 230 (210.037) E 290 Turbo-D (210.017) E 300 D (210.020)	100 110 95 100	06/95 → 08/00 06/95 → 06/97 03/96 → 07/99 06/95 → 06/97	←  → →			13.0460-7086.2 607086 13.0470-7086.2 LD7086  13.0460-3805.2 603805 13.0470-3805.2 LD3805  13.0460-4064.2 604064 13.0470-4064.2 LD4064	ATE 21664 19,8 + WE / - WK ATE 21664 19,8 + WE / - WK Ceramic  ATE 21197 15,0 + WE / - WK ATE 21197 15,0 + WE / - WK Ceramic  ATE 21919 15,3 - WE / - WK + Zub ATE 21919 15,3 - WE / - WK + Zub Ceramic
E 200 CDI (210.007) E 220 CDI (210.006)	75 92	06/98 → 03/02 06/98 → 07/99	← →	07/98 → 07/98 →		13.0460-7086.2 607086 13.0470-7086.2 LD7086  13.0460-4064.2 604064 13.0470-4064.2 LD4064	ATE 21664 19,8 + WE / - WK ATE 21664 19,8 + WE / - WK Ceramic  ATE 21919 15,3 - WE / - WK + Zub ATE 21919 15,3 - WE / - WK + Zub Ceramic
E 200 CDI (210.007) E 200 Kompressor (210.048) E 220 CDI (210.006) E 220 CDI (210.006)	85 120 100 105	07/99 → 03/02 08/00 → 03/02 07/99 → 03/02 07/99 → 03/02	← →			13.0460-7086.2 607086 13.0470-7086.2 LD7086  13.0460-4064.2 604064 13.0470-4064.2 LD4064	ATE 21664 19,8 + WE / - WK ATE 21664 19,8 + WE / - WK Ceramic  ATE 21919 15,3 - WE / - WK + Zub ATE 21919 15,3 - WE / - WK + Zub Ceramic
E 200 D (210.003)	65	01/96 → 03/02	← → →	10/96 → 10/96 →; → A379346 A379347 →		13.0460-7086.2 607086 13.0470-7086.2 LD7086  13.0460-3805.2 603805 13.0470-3805.2 LD3805  13.0460-4064.2 604064 13.0470-4064.2 LD4064	ATE 21664 19,8 + WE / - WK ATE 21664 19,8 + WE / - WK Ceramic  ATE 21197 15,0 + WE / - WK ATE 21197 15,0 + WE / - WK Ceramic  ATE 21919 15,3 - WE / - WK + Zub ATE 21919 15,3 - WE / - WK + Zub Ceramic
E 200 Kompressor (210.045)	137	06/97 → 03/02	← →	09/97 → 09/97 →		13.0460-7087.2 607087 13.0470-7087.2 LD7087  13.0460-4064.2 604064 13.0460-4065.2 604065 13.0470-4064.2 LD4064 13.0470-4065.2 LD4065	ATE 21670 19,3 + WE / - WK ATE 21670 19,3 + WE / - WK Ceramic  ATE 21919 15,3 - WE / - WK + Zub ATE 21899 15,3 + WE / - WK + Zub ATE 21919 15,3 - WE / - WK + Zub Ceramic ATE 21899 15,3 + WE / - WK + Zub Ceramic
E 220 D E 220 D (210.004)	55 70	05/96 → 03/02 06/95 → 07/99	← → →	→ 06/98 → A379346 → 06/98; A379347 →		13.0460-7086.2 607086 13.0470-7086.2 LD7086  13.0460-3805.2 603805 13.0470-3805.2 LD3805  13.0460-4064.2 604064 13.0470-4064.2 LD4064	ATE 21664 19,8 + WE / - WK ATE 21664 19,8 + WE / - WK Ceramic  ATE 21197 15,0 + WE / - WK ATE 21197 15,0 + WE / - WK Ceramic  ATE 21919 15,3 - WE / - WK + Zub ATE 21919 15,3 - WE / - WK + Zub Ceramic
E 240 (210.061)	125	06/97 → 08/00	← ← →	09/97 →; - ESP 09/97 →; + ESP 09/97 →; → A379346; - ESP		13.0460-7086.2 607086 13.0470-7086.2 LD7086  13.0460-7087.2 607087 13.0470-7087.2 LD7087  13.0460-3805.2 603805 13.0470-3805.2 LD3805	ATE 21664 19,8 + WE / - WK ATE 21664 19,8 + WE / - WK Ceramic  ATE 21670 19,3 + WE / - WK ATE 21670 19,3 + WE / - WK Ceramic  ATE 21197 15,0 + WE / - WK ATE 21197 15,0 + WE / - WK Ceramic







	kw			 	! #		
<b>MERCEDES-BENZ - E-KLASSE (W210) 06/95→08/03</b>							
<b> Bremsbelagsatz, Scheibenbremse</b>							
E 240 (210.061)	125	06/97→08/00	➡	09/97→; → A379346; + ESP		<b>13.0460-4047.2 604047</b> <b>13.0470-4047.2 LD4047</b>	ATE 21305 15,7 + WE / - WK ATE 21305 15,7 + WE / - WK Ceramic
			➡	A379347→; - ESP		<b>13.0460-4064.2 604064</b> <b>13.0470-4064.2 LD4064</b>	ATE 21919 15,3 - WE / - WK + Zub ATE 21919 15,3 - WE / - WK + Zub Ceramic
			➡	A379347→; + ESP		<b>13.0460-4065.2 604065</b> <b>13.0470-4065.2 LD4065</b>	ATE 21899 15,3 + WE / - WK + Zub ATE 21899 15,3 + WE / - WK + Zub Ceramic
E 240 (210.062)	125	08/00→03/02	←	- ESP		<b>13.0460-7086.2 607086</b> <b>13.0470-7086.2 LD7086</b>	ATE 21664 19,8 + WE / - WK ATE 21664 19,8 + WE / - WK Ceramic
			←	+ ESP		<b>13.0460-7087.2 607087</b> <b>13.0470-7087.2 LD7087</b>	ATE 21670 19,3 + WE / - WK ATE 21670 19,3 + WE / - WK Ceramic
			➡	→ A379346; - ESP		<b>13.0460-3805.2 603805</b> <b>13.0470-3805.2 LD3805</b>	ATE 21197 15,0 + WE / - WK ATE 21197 15,0 + WE / - WK Ceramic
			➡	→ A379346; + ESP		<b>13.0460-4047.2 604047</b> <b>13.0470-4047.2 LD4047</b>	ATE 21305 15,7 + WE / - WK ATE 21305 15,7 + WE / - WK Ceramic
			➡	A379347→; - ESP		<b>13.0460-4064.2 604064</b> <b>13.0470-4064.2 LD4064</b>	ATE 21919 15,3 - WE / - WK + Zub ATE 21919 15,3 - WE / - WK + Zub Ceramic
			➡	A379347→; + ESP		<b>13.0460-4065.2 604065</b> <b>13.0470-4065.2 LD4065</b>	ATE 21899 15,3 + WE / - WK + Zub ATE 21899 15,3 + WE / - WK + Zub Ceramic
E 250 D (210.010)	83	06/95→07/99	←			<b>13.0460-7086.2 607086</b> <b>13.0470-7086.2 LD7086</b>	ATE 21664 19,8 + WE / - WK ATE 21664 19,8 + WE / - WK Ceramic
			←	für Rechtslenker		<b>13.0460-7086.2 607086</b> <b>13.0470-7086.2 LD7086</b>	ATE 21664 19,8 + WE / - WK ATE 21664 19,8 + WE / - WK Ceramic
			➡	→ A379346		<b>13.0460-3805.2 603805</b> <b>13.0470-3805.2 LD3805</b>	ATE 21197 15,0 + WE / - WK ATE 21197 15,0 + WE / - WK Ceramic
			➡	A379347→		<b>13.0460-4064.2 604064</b> <b>13.0470-4064.2 LD4064</b>	ATE 21919 15,3 - WE / - WK + Zub ATE 21919 15,3 - WE / - WK + Zub Ceramic
E 250 Turbo-D (210.015)	110	06/97→07/99	←	09/97→		<b>13.0460-7086.2 607086</b> <b>13.0470-7086.2 LD7086</b>	ATE 21664 19,8 + WE / - WK ATE 21664 19,8 + WE / - WK Ceramic
			➡	09/97→		<b>13.0460-4064.2 604064</b> <b>13.0470-4064.2 LD4064</b>	ATE 21919 15,3 - WE / - WK + Zub ATE 21919 15,3 - WE / - WK + Zub Ceramic
E 270 CDI (210.016)	120	07/99→03/02	←			<b>13.0460-7087.2 607087</b>	ATE 21670 19,3 + WE / - WK
E 270 CDI (210.016)	125	07/99→03/02				<b>13.0470-7087.2 LD7087</b>	ATE 21670 19,3 + WE / - WK Ceramic
E 320 CDI (210.026)	145	07/99→03/02		➡			<b>13.0460-4065.2 604065</b> <b>13.0470-4065.2 LD4065</b>
E 280 (210.053) E 280 (210.063) E 280 4-matic (210.081) E 300 Turbo-D (210.025) E 320 (210.055) E 320 (210.065) E 320 4-matic (210.082)	142	01/96→06/97	←			<b>13.0460-7087.2 607087</b> <b>13.0470-7087.2 LD7087</b>	ATE 21670 19,3 + WE / - WK ATE 21670 19,3 + WE / - WK Ceramic
	150	12/96→03/02					
	150	12/96→03/02					
	130	12/96→07/99					
	162	06/95→06/97	➡	→ A379346		<b>13.0460-4047.2 604047</b> <b>13.0470-4047.2 LD4047</b>	ATE 21305 15,7 + WE / - WK ATE 21305 15,7 + WE / - WK Ceramic
	165	06/97→03/02	➡	A379347→		<b>13.0460-4065.2 604065</b> <b>13.0470-4065.2 LD4065</b>	ATE 21899 15,3 + WE / - WK + Zub ATE 21899 15,3 + WE / - WK + Zub Ceramic
↓							



















	kw			 	! #			
<b>MERCEDES-BENZ - E-KLASSE (W210) 06/95→08/03</b>								
<b> Bremsbelagsatz, Scheibenbremse</b>								
E 420 (210.072)	205	01/96→06/97	←	→ A 962231 / X 027613		13.0460-4201.2	604201	ATE 21153 17,5 + WE / - WK
			←	A 962232 / X 027614→		13.0460-7183.2	607183	ATE 21484 20,5 + WE / - WK
			→	→ A379346		13.0460-4047.2	604047	ATE 21305 15,7 + WE / - WK
			→	A379347→		13.0470-4047.2	LD4047	ATE 21305 15,7 + WE / - WK Ceramic
E 430 (210.070)	205	06/97→03/02	←	09/97→; → A 962231 / X 027613		13.0460-4201.2	604201	ATE 21153 17,5 + WE / - WK
			←	A 962232 / X 027614→		13.0460-7183.2	607183	ATE 21484 20,5 + WE / - WK
			→	09/97→; → A379346		13.0460-4047.2	604047	ATE 21305 15,7 + WE / - WK
			→	A379347→		13.0470-4047.2	LD4047	ATE 21305 15,7 + WE / - WK Ceramic
E 430 4-matic (210.083) E 55 AMG 4-matic (210.074)	205 260	05/99→03/02 03/01→03/02	←			13.0460-7183.2	607183	ATE 21484 20,5 + WE / - WK
			→			13.0460-4047.2	604047	ATE 21305 15,7 + WE / - WK
			→			13.0470-4047.2	LD4047	ATE 21305 15,7 + WE / - WK Ceramic
			→			13.0460-4065.2	604065	ATE 21899 15,3 + WE / - WK + Zub
E 50 AMG (210.072)	255	02/96→08/97	←			13.0460-7183.2	607183	ATE 21484 20,5 + WE / - WK
			→	Bremssattel mit 2 Haltestiften; nicht für Ausstattungsvariante: AMG Technikpaket		13.0460-4047.2	604047	ATE 21305 15,7 + WE / - WK
			→	Bremssattel mit 1 Haltestift; nicht für Ausstattungsvariante: AMG Technikpaket		13.0470-4047.2	LD4047	ATE 21305 15,7 + WE / - WK Ceramic
			→			13.0460-4065.2	604065	ATE 21899 15,3 + WE / - WK + Zub
E 55 AMG (210.074)	260	08/97→03/02	←	09/97→		13.0460-7183.2	607183	ATE 21484 20,5 + WE / - WK
			→	09/97→		13.0460-4047.2	604047	ATE 21305 15,7 + WE / - WK
			→			13.0470-4047.2	LD4047	ATE 21305 15,7 + WE / - WK Ceramic
			→			13.0460-4065.2	604065	ATE 21899 15,3 + WE / - WK + Zub
<b>Warnkontakt, Bremsbelagverschleiß</b>								
E 200 (210.035)	100	06/95→08/00	←		2	24.8190-0401.2	620401	L= 95
E 230 (210.037)	110	06/95→06/97	→	→ A379346	2	24.8190-0401.2	620401	L= 95
E 290 Turbo-D (210.017)	95	03/96→07/99	→		2	24.8190-0401.2	620401	L= 95
E 300 D (210.020)	100	06/95→06/97	→		2	24.8190-0401.2	620401	L= 95
E 200 CDI (210.007)	75	06/98→03/02	←	07/98→	2	24.8190-0401.2	620401	L= 95
E 220 CDI (210.006)	92	06/98→07/99	←		2	24.8190-0401.2	620401	L= 95
E 200 CDI (210.007)	85	07/99→03/02	←		2	24.8190-0401.2	620401	L= 95
E 200 Kompressor (210.048)	120	08/00→03/02	←		2	24.8190-0401.2	620401	L= 95
E 220 CDI (210.006)	100	07/99→03/02	←		2	24.8190-0401.2	620401	L= 95
E 220 CDI (210.006)	105	07/99→03/02	←		2	24.8190-0401.2	620401	L= 95
E 200 D (210.003)	65	01/96→03/02	←	10/96→	2	24.8190-0401.2	620401	L= 95
			→	10/96→; → A379346	2	24.8190-0401.2	620401	L= 95
E 200 Kompressor (210.045)	137	06/97→03/02	←	09/97→	2	24.8190-0401.2	620401	L= 95
			→	09/97→	2	24.8190-0401.2	620401	L= 95
E 220 D	55 70	05/96→03/02 06/95→07/99	←	→ 06/98	2	24.8190-0401.2	620401	L= 95
			→	→ A379346	2	24.8190-0401.2	620401	L= 95
E 240 (210.061)	125	06/97→08/00	←	09/97→	2	24.8190-0401.2	620401	L= 95
			→	09/97→; → A379346	2	24.8190-0401.2	620401	L= 95
			→	A379347→; + ESP	2	24.8190-0401.2	620401	L= 95
E 240 (210.062)	125	08/00→03/02	←		2	24.8190-0401.2	620401	L= 95
			→	→ A379346	2	24.8190-0401.2	620401	L= 95
			→	A379347→; + ESP	2	24.8190-0401.2	620401	L= 95
E 250 D (210.010)	83	06/95→07/99	←	für Rechtslenker	2	24.8190-0401.2	620401	L= 95
			←		2	24.8190-0401.2	620401	L= 95
			→	→ A379346	2	24.8190-0401.2	620401	L= 95
E 250 Turbo-D (210.015)	110	06/97→07/99	←	09/97→	2	24.8190-0401.2	620401	L= 95
↓								









	kW			 	! #		
<b>MERCEDES-BENZ - E-KLASSE (W210) 06/95→08/03</b>							
<b>Warnkontakt, Bremsbelagverschleiß</b>							
E 270 CDI (210.016)	120	07/99→03/02	←		2	24.8190-0401.2 620401	L= 95
E 270 CDI (210.016)	125	07/99→03/02	→		2	24.8190-0401.2 620401	L= 95
E 320 CDI (210.026)	145	07/99→03/02	→		2	24.8190-0401.2 620401	L= 95
E 280 (210.053)	142	01/96→06/97	←		2	24.8190-0401.2 620401	L= 95
E 280 (210.063)	150	12/96→03/02	→	A379347→	2	24.8190-0401.2 620401	L= 95
E 280 4-matic (210.081)	150	12/96→03/02	→	A379346	2	24.8190-0401.2 620401	L= 95
E 300 Turbo-D (210.025)	130	12/96→07/99	→	→ A379346	2	24.8190-0401.2 620401	L= 95
E 320 (210.055)	162	06/95→06/97	→				
E 320 (210.065)	165	06/97→03/02	→				
E 320 4-matic (210.082)	165	06/97→03/02	→				
E 420 (210.072)	205	01/96→06/97	←	→ A 962231 / X 027613	2	24.8190-0401.2 620401	L= 95
			←	A 962232 / X 027614→	2	24.8190-0419.2 620419	L= 74
			→	→ A379346	2	24.8190-0401.2 620401	L= 95
			→	A379347→	2	24.8190-0401.2 620401	L= 95
E 430 (210.070)	205	06/97→03/02	←	09/97→; → A 962231 / X 027613	2	24.8190-0401.2 620401	L= 95
			←	A 962232 / X 027614→	2	24.8190-0419.2 620419	L= 74
			→	09/97→; → A379346	2	24.8190-0401.2 620401	L= 95
			→	A379347→	2	24.8190-0401.2 620401	L= 95
E 430 4-matic (210.083)	205	05/99→03/02	←		2	24.8190-0419.2 620419	L= 74
E 55 AMG 4-matic (210.074)	260	03/01→03/02	→		2	24.8190-0401.2 620401	L= 95
E 50 AMG (210.072)	255	02/96→08/97	←		2	24.8190-0419.2 620419	L= 74
			→	Bremssattel mit 2 Haltestiften; nicht für Ausstattungsvariante: AMG Technikpaket	2	24.8190-0401.2 620401	L= 95
			→	AMG Technikpaket	2	24.8190-0401.2 620401	L= 95
			→	Bremssattel mit 1 Haltestift; nicht für Ausstattungsvariante: AMG Technikpaket	2	24.8190-0401.2 620401	L= 95
E 55 AMG (210.074)	260	08/97→03/02	←	09/97→	2	24.8190-0419.2 620419	L= 74
			→	09/97→	2	24.8190-0401.2 620401	L= 95
<b>Zubehörsatz, Scheibenbremsbelag</b>							
E 200 (210.035)	100	06/95→08/00	→	→ A379346		13.0460-0215.2 610215	ATE
E 230 (210.037)	110	06/95→06/97	→				
E 250 D (210.010)	83	06/95→07/99	→	A379347→		13.0460-0229.2 610229	ATE
E 290 Turbo-D (210.017)	95	03/96→07/99	→				
E 300 D (210.020)	100	06/95→06/97	→				
E 200 CDI (210.007)	75	06/98→03/02	→	07/98→		13.0460-0229.2 610229	ATE
E 220 CDI (210.006)	92	06/98→07/99	→				
E 200 CDI (210.007)	85	07/99→03/02	→			13.0460-0229.2 610229	ATE
E 200 Kompressor (210.048)	120	08/00→03/02	→				
E 220 CDI (210.006)	100	07/99→03/02	→				
E 220 CDI (210.006)	105	07/99→03/02	→				
E 200 D (210.003)	65	01/96→03/02	→	10/96→; → A379346		13.0460-0215.2 610215	ATE
			→	A379347→		13.0460-0229.2 610229	ATE
E 200 Kompressor (210.045)	137	06/97→03/02	→	09/97→		13.0460-0229.2 610229	ATE
			→			13.0460-0258.2 610258	
E 220 D	55	05/96→03/02	→	→ A379346		13.0460-0215.2 610215	ATE
E 220 D (210.004)	70	06/95→07/99	→	→ 06/98; A379347→		13.0460-0229.2 610229	ATE
E 240 (210.061)	125	06/97→08/00	→	09/97→; → A379346; - ESP		13.0460-0215.2 610215	ATE
			→	A379347→; - ESP		13.0460-0229.2 610229	ATE
			→	A379347→; + ESP		13.0460-0258.2 610258	
E 240 (210.062)	125	08/00→03/02	→	→ A379346; - ESP		13.0460-0215.2 610215	ATE
			→	A379347→; - ESP		13.0460-0229.2 610229	ATE
			→	A379347→; + ESP		13.0460-0258.2 610258	
E 250 Turbo-D (210.015)	110	06/97→07/99	→	09/97→		13.0460-0229.2 610229	ATE
E 270 CDI (210.016)	120	07/99→03/02	→			13.0460-0258.2 610258	
E 270 CDI (210.016)	125	07/99→03/02	→				
E 320 CDI (210.026)	145	07/99→03/02	→				
E 280 (210.053)	142	01/96→06/97	→	A379347→		13.0460-0258.2 610258	
E 280 (210.063)	150	12/96→03/02	→				
E 280 4-matic (210.081)	150	12/96→03/02	→				
E 300 Turbo-D (210.025)	130	12/96→07/99	→				
E 320 (210.055)	162	06/95→06/97	→				
E 320 (210.065)	165	06/97→03/02	→				
E 320 4-matic (210.082)	165	06/97→03/02	→				







	kw			 	! #		
<b>MERCEDES-BENZ - E-KLASSE (W210) 06/95→08/03</b>							
<b>Zubehörsatz, Scheibenbremsbelag</b>							
E 420 (210.072) E 430 (210.070)	205 205	01/96→06/97 06/97→03/02	➡	A379347→		13.0460-0258.2 610258	
E 430 4-matic (210.083)	205	05/99→03/02	➡			13.0460-0236.2 610236	ATE
E 50 AMG (210.072)	255	02/96→08/97	➡	Bremssattel mit 1 Haltestift; nicht für Ausstattungsvariante: AMG Technikpaket		13.0460-0258.2 610258	
<b> Bremsscheibe</b>							
E 200 (210.035) E 200 CDI (210.007) E 200 Kompressor (210.048)	100 85 120	06/95→08/00 07/99→03/02 08/00→03/02	←			24.0125-0110.1 425110 24.0325-0110.1 525110	Ø 288 25 22,4 V + S Ø 288 25 22,4 V + S
E 220 CDI (210.006) E 220 CDI (210.006) E 230 (210.037) E 290 Turbo-D (210.017) E 300 D (210.020)	100 105 110 95 100	07/99→03/02 07/99→03/02 06/95→06/97 03/96→07/99 06/95→06/97	➡			24.0109-0114.1 409114 24.0309-0114.1 509114	Ø 278 9 7,3 + S Ø 278 9 7,3 + S
E 200 CDI (210.007) E 220 CDI (210.006)	75 92	06/98→03/02 06/98→07/99	←	07/98→		24.0125-0110.1 425110 24.0325-0110.1 525110	Ø 288 25 22,4 V + S Ø 288 25 22,4 V + S
			➡	07/98→		24.0109-0114.1 409114 24.0309-0114.1 509114	Ø 278 9 7,3 + S Ø 278 9 7,3 + S
E 200 D (210.003)	65	01/96→03/02	←	10/96→; für Portugal		24.0125-0110.1 425110 24.0325-0110.1 525110	Ø 288 25 22,4 V + S Ø 288 25 22,4 V + S
			➡	10/96→; für Portugal		24.0109-0114.1 409114 24.0309-0114.1 509114	Ø 278 9 7,3 + S Ø 278 9 7,3 + S
E 200 Kompressor (210.045)	137	06/97→03/02	←	09/97→		24.0128-0106.1 428106 24.0328-0106.1 528106	Ø 300 28 25,4 V + S Ø 300 28 25,4 V + S
			➡	09/97→		24.0110-0217.1 410217 24.0310-0217.1 510217	Ø 290 10 8,3 + S Ø 290 10 8,3 + S
E 220 D E 220 D (210.004)	55 70	05/96→03/02 06/95→07/99	←	→ 06/98		24.0125-0110.1 425110 24.0325-0110.1 525110	Ø 288 25 22,4 V + S Ø 288 25 22,4 V + S
			➡	→ 06/98		24.0109-0114.1 409114 24.0309-0114.1 509114	Ø 278 9 7,3 + S Ø 278 9 7,3 + S
E 240 (210.061)	125	06/97→08/00	←	09/97→; - ESP		24.0125-0110.1 425110 24.0325-0110.1 525110	Ø 288 25 22,4 V + S Ø 288 25 22,4 V + S
			←	09/97→; + ESP		24.0128-0106.1 428106 24.0328-0106.1 528106	Ø 300 28 25,4 V + S Ø 300 28 25,4 V + S
			➡	09/97→		24.0109-0114.1 409114 24.0309-0114.1 509114	Ø 278 9 7,3 + S Ø 278 9 7,3 + S
E 240 (210.062)	125	08/00→03/02	←	- ESP		24.0125-0110.1 425110 24.0325-0110.1 525110	Ø 288 25 22,4 V + S Ø 288 25 22,4 V + S
			←	+ ESP		24.0128-0106.1 428106 24.0328-0106.1 528106	Ø 300 28 25,4 V + S Ø 300 28 25,4 V + S
			➡			24.0109-0114.1 409114 24.0309-0114.1 509114	Ø 278 9 7,3 + S Ø 278 9 7,3 + S
E 250 D (210.010)	83	06/95→07/99	←	für Rechtslenker		24.0125-0110.1 425110 24.0325-0110.1 525110	Ø 288 25 22,4 V + S Ø 288 25 22,4 V + S
			←	für Italien		24.0125-0110.1 425110 24.0325-0110.1 525110	Ø 288 25 22,4 V + S Ø 288 25 22,4 V + S
			➡	für Rechtslenker		24.0109-0114.1 409114 24.0309-0114.1 509114	Ø 278 9 7,3 + S Ø 278 9 7,3 + S
			➡	für Italien		24.0109-0114.1 409114 24.0309-0114.1 509114	Ø 278 9 7,3 + S Ø 278 9 7,3 + S
E 250 Turbo-D (210.015)	110	06/97→07/99	←	09/97→		24.0125-0110.1 425110 24.0325-0110.1 525110	Ø 288 25 22,4 V + S Ø 288 25 22,4 V + S
			➡	09/97→		24.0109-0114.1 409114 24.0309-0114.1 509114	Ø 278 9 7,3 + S Ø 278 9 7,3 + S
E 270 CDI (210.016) E 270 CDI (210.016) E 280 (210.053) E 280 (210.063) E 280 4-matic (210.081) E 300 Turbo-D (210.025) E 320 (210.055) E 320 (210.065) E 320 4-matic (210.082) E 320 CDI (210.026)	120 125 142 150 150 130 162 165 165 145	07/99→03/02 07/99→03/02 01/96→06/97 12/96→03/02 12/96→03/02 12/96→07/99 06/95→06/97 06/97→03/02 06/97→03/02 07/99→03/02	←			24.0128-0106.1 428106 24.0328-0106.1 528106	Ø 300 28 25,4 V + S Ø 300 28 25,4 V + S
			➡			24.0110-0217.1 410217 24.0310-0217.1 510217	Ø 290 10 8,3 + S Ø 290 10 8,3 + S
↓							







	kw			 	! #			
<b>MERCEDES-BENZ - E-KLASSE (W210) 06/95→08/03</b>								
<b>Bremsscheibe</b>								
E 420 (210.072)	205	01/96→06/97	←	→ A 962231 / X 027613		24.0128-0126.1 428126	Ø 316 28 25,4 V	
			←	A 962232 / X 027614→		24.0132-0159.1 432159	Ø 330 32 29,4 V	
			→			24.0110-0217.1 410217	Ø 290 10 8,3 + S	
			→			24.0310-0217.1 510217	Ø 290 10 8,3 + S	
E 430 (210.070)	205	06/97→03/02	←	09/97→; → A 962231 / X 027613		24.0128-0126.1 428126	Ø 316 28 25,4 V	
			←	A 962232 / X 027614→		24.0132-0159.1 432159	Ø 330 32 29,4 V	
			→	09/97→		24.0110-0217.1 410217	Ø 290 10 8,3 + S	
			→			24.0310-0217.1 510217	Ø 290 10 8,3 + S	
E 430 4-matic (210.083)	205	05/99→03/02	←			24.0132-0159.1 432159	Ø 330 32 29,4 V	
			→			24.0122-0228.1 422228	Ø 300 22 19,4 V	
E 50 AMG (210.072)	255	02/96→08/97	→			24.0122-0218.1 422218	Ø 300 22 19,4 V	
E 55 AMG (210.074)	260	08/97→03/02	→	09/97→		24.0122-0228.1 422228	Ø 300 22 19,4 V	
E 55 AMG 4-matic (210.074)	260	03/01→03/02	→			24.0122-0228.1 422228	Ø 300 22 19,4 V	
<b>MERCEDES-BENZ - E-KLASSE (W211) 03/02→03/09</b>								
<b>Bremsbelagsatz, Scheibenbremse</b>								
E 200 CDI (211.004)	75	07/02→12/08	←	für Fahrzeuge ohne Sportpaket / für Fahrzeuge ohne AMG-Sportpaket		13.0460-3999.2 603999	BOS 23743 20,1 + WK + Zub	
E 200 CDI (211.004)	90	07/02→12/08			13.0470-3999.2 LD3999	BOS 23743 20,1 + WK + Zub Ceramic		
E 200 CDI (211.007)	100	04/06→12/08	←	für Fahrzeuge mit Sportpaket / für Fahrzeuge mit AMG-Sportpaket		13.0460-4990.2 604990	BRE 23271 17,4 + WE / - WK	
E 200 Kompressor (211.041)	135	04/06→12/08			13.0470-4990.2 LD4990	BRE 23271 17,4 + WE / - WK Ceramic		
E 200 Kompressor (211.042)	120	11/02→12/08	→			13.0460-7171.2 607171	ATE 23334 16,7 + WE / - WK	
E 200 NGT (211.042)	120	03/04→12/08	→			13.0470-7171.2 LD7171	ATE 23334 16,7 + WE / - WK Ceramic	
E 220 CDI	120	03/03→12/08					13.0460-7171.2 607171	ATE 23334 16,7 + WE / - WK
E 220 CDI (211.006)	100	03/02→12/08					13.0470-7171.2 LD7171	ATE 23334 16,7 + WE / - WK Ceramic
E 220 CDI (211.006)	110	03/02→12/08						
E 220 CDI (211.008)	125	04/06→12/08						
E 230 (211.052)	150	09/07→12/08						
E 280 CDI (211.020)	140	03/05→12/08						
E 300 BlueTEC (211.024)	155	09/07→12/08						
E 320 CDI (211.022)	165	03/05→12/08						
E 240 (211.061)	130	03/02→12/08		←			13.0460-3999.2 603999	BOS 23743 20,1 + WK + Zub
E 270 CDI (211.016)	120	03/02→12/08					13.0470-3999.2 LD3999	BOS 23743 20,1 + WK + Zub Ceramic
E 270 CDI (211.016)	130	03/02→12/08					13.0460-7171.2 607171	ATE 23334 16,7 + WE / - WK
E 280 CDI (211.023)	130	05/04→12/08	→				13.0470-7171.2 LD7171	ATE 23334 16,7 + WE / - WK Ceramic
E 240 4-matic (211.080)	130	03/03→12/08	←			13.0460-7203.2 607203	ATE 21670 19,3 + WE / - WK	
			E 320 4-matic (211.082)	165	03/03→12/08	→		
			→			13.0460-7171.2 607171	ATE 23334 16,7 + WE / - WK	
			→			13.0470-7171.2 LD7171	ATE 23334 16,7 + WE / - WK Ceramic	
E 280 (211.054)	170	03/05→12/08	←	05/05→; für Fahrzeuge ohne Sportpaket / für Fahrzeuge ohne AMG-Sportpaket		13.0460-3999.2 603999	BOS 23743 20,1 + WK + Zub	
						13.0470-3999.2 LD3999	BOS 23743 20,1 + WK + Zub Ceramic	
			←	05/05→; für Fahrzeuge mit Sportpaket / für Fahrzeuge mit AMG-Sportpaket		13.0460-4990.2 604990	BRE 23271 17,4 + WE / - WK	
			→			13.0470-4990.2 LD4990	BRE 23271 17,4 + WE / - WK Ceramic	
			→	05/05→		13.0460-7171.2 607171	ATE 23334 16,7 + WE / - WK	
						13.0470-7171.2 LD7171	ATE 23334 16,7 + WE / - WK Ceramic	
E 280 4-matic (211.092)	170	01/06→12/08	←	→ A 870950; für Fahrzeuge mit Sportpaket / für Fahrzeuge mit AMG-Sportpaket		13.0460-7183.2 607183	ATE 21484 20,5 + WE / - WK	
			E 280 CDI 4-matic (211.084)	140	03/05→12/08			
E 320 CDI 4-matic (211.089)	165	03/05→12/08	←	für Fahrzeuge ohne Sportpaket / für Fahrzeuge ohne AMG-Sportpaket		13.0460-7203.2 607203	ATE 21670 19,3 + WE / - WK	
E 350 4-matic (211.087)	200	03/05→12/08	←	für Fahrzeuge ohne Sportpaket / für Fahrzeuge ohne AMG-Sportpaket		13.0470-7203.2 LD7203	ATE 21670 19,3 + WE / - WK Ceramic	
			←	A 870951→; für Fahrzeuge mit Sportpaket / für Fahrzeuge mit AMG-Sportpaket		13.0460-7220.2 607220	ATE 23922 21,0 + WE / - WK	
						13.0470-7220.2 LD7220	ATE 23922 21,0 + WE / - WK Ceramic	
			→			13.0460-7171.2 607171	ATE 23334 16,7 + WE / - WK	
						13.0470-7171.2 LD7171	ATE 23334 16,7 + WE / - WK Ceramic	
E 320 (211.065)	165	03/02→12/08	←	A 400548→		13.0460-3999.2 603999	BOS 23743 20,1 + WK + Zub	









	kw			 	! #		
<b>MERCEDES-BENZ - E-KLASSE (W211) 03/02→03/09</b>							
<b> Bremsbelagsatz, Scheibenbremse</b>							
E 320 CDI (211.026)	150	11/02→12/08	←	A 400548→		13.0470-3999.2 LD3999	BOS 23743 20,1 + WK + Zub Ceramic
			←	→ A 400547		13.0460-4990.2 604990 13.0470-4990.2 LD4990	BRE 23271 17,4 + WE / - WK Ceramic
			→			13.0460-7171.2 607171 13.0470-7171.2 LD7171	ATE 23334 16,7 + WE / - WK Ceramic
E 350 (211.056)	200	03/05→12/08	←			13.0460-4990.2 604990	BRE 23271 17,4 + WE / - WK
E 350 CGI (211.057)	215	09/07→12/08	←			13.0470-4990.2 LD4990	BRE 23271 17,4 + WE / - WK Ceramic
			→			13.0460-7171.2 607171 13.0470-7171.2 LD7171	ATE 23334 16,7 + WE / - WK Ceramic
E 400 CDI (211.028)	191	02/03→12/08	←	03/03→		13.0460-4990.2 604990 13.0470-4990.2 LD4990	BRE 23271 17,4 + WE / - WK Ceramic
			→	03/03→		13.0460-7171.2 607171 13.0470-7171.2 LD7171	ATE 23334 16,7 + WE / - WK Ceramic
E 420 CDI (211.029)	231	01/06→12/08	←			13.0460-4817.2 604817	BRE 23960 18,3 + WE / - WK
E 500 (211.072)	285	04/06→12/08	←			13.0460-7171.2 607171 13.0470-7171.2 LD7171	ATE 23334 16,7 + WE / - WK Ceramic
E 500 (211.070)	225	03/02→12/08	←			13.0460-4990.2 604990	BRE 23271 17,4 + WE / - WK
			→			13.0460-7171.2 607171 13.0470-7171.2 LD7171	ATE 23334 16,7 + WE / - WK Ceramic
E 500 4-matic (211.083)	225	10/03→12/08	←	→ A 870950		13.0460-7183.2 607183	ATE 21484 20,5 + WE / - WK
			←	A 870951→		13.0460-7220.2 607220 13.0470-7220.2 LD7220	ATE 23922 21,0 + WE / - WK Ceramic
			→			13.0460-7171.2 607171 13.0470-7171.2 LD7171	ATE 23334 16,7 + WE / - WK Ceramic
E 500 4-matic (211.090)	285	04/06→12/08	←			13.0460-7220.2 607220	ATE 23922 21,0 + WE / - WK
			→			13.0460-7171.2 607171 13.0470-7171.2 LD7171	ATE 23334 16,7 + WE / - WK Ceramic
E 55 AMG Kompressor (211.076)	350	10/02→12/08	←			13.0460-4997.2 604997	BRE 23943 17,5 + WE / - WK
			→			13.0460-4998.2 604998	BRE 23478 16,5 + WE / - WK
E 63 AMG (211.077)	378	03/06→12/08	←			13.0460-4839.2 604839	BRE 24455 16,8 + WE / - WK
<b>Warnkontakt, Bremsbelagverschleiß</b>							
E 200 CDI (211.004)	75	07/02→12/08	←			24.8190-0410.2 620410	L= 97,5
E 200 CDI (211.004)	90	07/02→12/08	←	für Fahrzeuge ohne Sportpaket / für Fahrzeuge ohne AMG-Sportpaket			
E 200 CDI (211.007)	100	04/06→12/08	←			24.8190-0410.2 620410	L= 97,5
E 200 Kompressor (211.041)	135	04/06→12/08	←	für Fahrzeuge mit Sportpaket / für Fahrzeuge mit AMG-Sportpaket			
E 200 Kompressor (211.042)	120	11/02→12/08	←			24.8190-0416.2 620416	L= 100
E 200 NGT (211.042)	120	03/04→12/08	←	für Fahrzeuge ohne Sportpaket / für Fahrzeuge ohne AMG-Sportpaket			
E 220 CDI	120	03/03→12/08	←				
E 220 CDI (211.006)	100	03/02→12/08	←	für Fahrzeuge ohne Sportpaket / für Fahrzeuge ohne AMG-Sportpaket			
E 220 CDI (211.006)	110	03/02→12/08	←			24.8190-0416.2 620416	L= 100
E 220 CDI (211.008)	125	04/06→12/08	←	für Fahrzeuge mit Sportpaket / für Fahrzeuge mit AMG-Sportpaket			
E 230 (211.052)	150	09/07→12/08	←				
E 280 CDI (211.020)	140	03/05→12/08	→		1	24.8190-0410.2 620410	L= 97,5
E 300 BlueTEC (211.024)	155	09/07→12/08	→				
E 320 CDI (211.022)	165	03/05→12/08	←			24.8190-0410.2 620410	L= 97,5
E 240 (211.061)	130	03/02→12/08	←				
E 240 4-matic (211.080)	130	03/03→12/08	←			24.8190-0416.2 620416	L= 100
E 270 CDI (211.016)	120	03/02→12/08	←				
E 270 CDI (211.016)	130	03/02→12/08	→		1	24.8190-0410.2 620410	L= 97,5
E 280 CDI (211.023)	130	05/04→12/08	→				
E 320 4-matic (211.082)	165	03/03→12/08	←				
E 350 (211.056)	200	03/05→12/08	←				
E 350 CGI (211.057)	215	09/07→12/08	←				
E 500 (211.070)	225	03/02→12/08	←				
↓							









	kw			 	! #		
<b>MERCEDES-BENZ - E-KLASSE (W211) 03/02→03/09</b>							
<b>Warnkontakt, Bremsbelagverschleiß</b>							
E 280 (211.054)	170	03/05→12/08	←	☐; 05/05→; für Fahrzeuge mit Sportpaket / für Fahrzeuge mit AMG-Sportpaket		24.8190-0410.2 620410	L= 97,5
			←	☐; 05/05→; für Fahrzeuge ohne Sportpaket / für Fahrzeuge ohne AMG-Sportpaket		24.8190-0410.2 620410	L= 97,5
			←	☐; 05/05→; für Fahrzeuge mit Sportpaket / für Fahrzeuge mit AMG-Sportpaket		24.8190-0416.2 620416	L= 100
			←	☐; 05/05→; für Fahrzeuge ohne Sportpaket / für Fahrzeuge ohne AMG-Sportpaket		24.8190-0416.2 620416	L= 100
			→	☐; 05/05→	1	24.8190-0410.2 620410	L= 97,5
E 280 4-matic (211.092)	170	01/06→12/08	←	☐; für Fahrzeuge ohne Sportpaket / für Fahrzeuge ohne AMG-Sportpaket		24.8190-0410.2 620410	L= 97,5
E 280 CDI 4-matic (211.084)	140	03/05→12/08					
E 320 CDI 4-matic (211.089)	165	03/05→12/08	←	☐; für Fahrzeuge ohne Sportpaket / für Fahrzeuge ohne AMG-Sportpaket		24.8190-0416.2 620416	L= 100
E 350 4-matic (211.087)	200	03/05→12/08	←	☐; → A 870950; für Fahrzeuge mit Sportpaket / für Fahrzeuge mit AMG-Sportpaket		24.8190-0425.2 620425	L= 98
			←	☐; A 870951→; für Fahrzeuge mit Sportpaket / für Fahrzeuge mit AMG-Sportpaket		24.8190-0425.2 620425	L= 98
			→	☐	1	24.8190-0410.2 620410	L= 97,5
E 320 (211.065)	165	03/02→12/08	←	☐; → A 400547		24.8190-0410.2 620410	L= 97,5
E 320 CDI (211.026)	150	11/02→12/08	←	☐; A 400548→		24.8190-0410.2 620410	L= 97,5
			←	☐; → A 400547		24.8190-0416.2 620416	L= 100
			←	☐; A 400548→		24.8190-0416.2 620416	L= 100
			→	☐	1	24.8190-0410.2 620410	L= 97,5
E 400 CDI (211.028)	191	02/03→12/08	←	☐; 03/03→		24.8190-0410.2 620410	L= 97,5
			←	☐; 03/03→		24.8190-0416.2 620416	L= 100
			→	☐; 03/03→	1	24.8190-0410.2 620410	L= 97,5
E 420 CDI (211.029)	231	01/06→12/08	←	☐		24.8190-0420.2 620420	L= 119
E 500 (211.072)	285	04/06→12/08	→	☐	1	24.8190-0410.2 620410	L= 97,5
E 500 4-matic (211.083)	225	10/03→12/08	←	☐; A 870951→		24.8190-0425.2 620425	L= 98
			←	☐; → A 870950		24.8190-0425.2 620425	L= 98
			←	☐; A 870951→		24.8190-0955.2 620955	L= 100
			→	☐	1	24.8190-0410.2 620410	L= 97,5
E 500 4-matic (211.090)	285	04/06→12/08	←	☐		24.8190-0425.2 620425	L= 98
			→	☐	1	24.8190-0410.2 620410	L= 97,5
E 55 AMG Kompressor (211.076)	350	10/02→12/08	←	☐		24.8190-0410.2 620410	L= 97,5
			←	☐		24.8190-0416.2 620416	L= 100
			→	☐		24.8190-0410.2 620410	L= 97,5
E 63 AMG (211.077)	378	03/06→12/08	←	☐		24.8190-0420.2 620420	L= 119
			→	☐		24.8190-0420.2 620420	L= 119
<b>Zubehörsatz, Scheibenbremsbelag</b>							
E 200 CDI (211.004)	75	07/02→12/08	←	für Fahrzeuge mit Sportpaket / für Fahrzeuge mit AMG-Sportpaket		13.0460-0155.2 610155	BRE
E 200 CDI (211.004)	90	07/02→12/08					
E 200 CDI (211.007)	100	04/06→12/08					
E 200 Kompressor (211.041)	135	04/06→12/08					
E 200 Kompressor (211.042)	120	11/02→12/08					
E 200 NGT (211.042)	120	03/04→12/08					
E 220 CDI	120	03/03→12/08					
E 220 CDI (211.006)	100	03/02→12/08					
E 220 CDI (211.006)	110	03/02→12/08					
E 220 CDI (211.008)	125	04/06→12/08					
E 230 (211.052)	150	09/07→12/08					
E 280 CDI (211.020)	140	03/05→12/08					
E 300 BlueTEC (211.024)	155	09/07→12/08					
E 320 CDI (211.022)	165	03/05→12/08					
↓							









	kW			 	! #		
<b>MERCEDES-BENZ - E-KLASSE (W211) 03/02→03/09</b>							
<b>Zubehörsatz, Scheibenbremsbelag</b>							
E 280 (211.054)	170	03/05→12/08	←	05/05→; für Fahrzeuge mit Sportpaket / für Fahrzeuge mit AMG-Sportpaket		13.0460-0155.2 610155 13.0460-0275.2 610275	BRE
E 320 (211.065) E 320 CDI (211.026)	165 150	03/02→12/08 11/02→12/08	←	→ A 400547		13.0460-0155.2 610155 13.0460-0275.2 610275	BRE
E 350 (211.056) E 350 CGI (211.057) E 500 (211.070)	200 215 225	03/05→12/08 09/07→12/08 03/02→12/08	←			13.0460-0155.2 610155 13.0460-0275.2 610275	BRE
E 400 CDI (211.028)	191	02/03→12/08	←	03/03→		13.0460-0155.2 610155 13.0460-0275.2 610275	BRE
<b>Bremsscheibe</b>							
E 200 CDI (211.004) E 200 CDI (211.004)	75 90	07/02→12/08 07/02→12/08	←	für Fahrzeuge ohne Sportpaket / für Fahrzeuge ohne AMG-Sportpaket		24.0128-0176.1 428176 24.0328-0176.1 528176	Ø 295 28 25,4 V + S Ø 295 28 25,4 V
			←	für Fahrzeuge mit Sportpaket / für Fahrzeuge mit AMG-Sportpaket		24.0132-0153.1 432153	Ø 330 32 30 V• + S
			→	nicht für Taxifahrzeuge; für Fahrzeuge ohne Sportpaket / für Fahrzeuge ohne AMG-Sportpaket		24.0110-0278.1 410278 24.0122-0201.1 422201	Ø 300 10 8,3 + S Ø 300 22 19,4 V + S
			→	für Taxifahrzeuge		24.0310-0278.1 510278	Ø 300 10 8,3 + S
			→	für Taxifahrzeuge		24.0122-0201.1 422201	Ø 300 22 19,4 V + S
E 200 CDI (211.007) E 200 Kompressor (211.041)	100 135	04/06→12/08 04/06→12/08	←	für Fahrzeuge ohne Sportpaket / für Fahrzeuge ohne AMG-Sportpaket		24.0128-0176.1 428176 24.0328-0176.1 528176	Ø 295 28 25,4 V + S Ø 295 28 25,4 V
E 200 NGT (211.042) E 220 CDI	120 120	03/04→12/08 03/03→12/08	←	für Fahrzeuge mit Sportpaket / für Fahrzeuge mit AMG-Sportpaket		24.0132-0153.1 432153	Ø 330 32 30 V• + S
E 220 CDI (211.006) E 220 CDI (211.006) E 220 CDI (211.008)	100 110 125	03/02→12/08 03/02→12/08 04/06→12/08	→	nicht für Taxifahrzeuge; für Fahrzeuge ohne Sportpaket / für Fahrzeuge ohne AMG-Sportpaket		24.0110-0278.1 410278 24.0310-0278.1 510278	Ø 300 10 8,3 + S Ø 300 10 8,3 + S
			→	nicht für Taxifahrzeuge; für Fahrzeuge mit Sportpaket / für Fahrzeuge mit AMG-Sportpaket		24.0122-0201.1 422201	Ø 300 22 19,4 V + S
			→	für Taxifahrzeuge		24.0122-0201.1 422201	Ø 300 22 19,4 V + S
E 200 Kompressor (211.042)	120	11/02→12/08	←	für Fahrzeuge ohne Sportpaket / für Fahrzeuge ohne AMG-Sportpaket		24.0128-0176.1 428176 24.0328-0176.1 528176	Ø 295 28 25,4 V + S Ø 295 28 25,4 V
			←			24.0132-0153.1 432153	Ø 330 32 30 V• + S
			→	nicht für Taxifahrzeuge; für Fahrzeuge ohne Sportpaket / für Fahrzeuge ohne AMG-Sportpaket		24.0110-0278.1 410278 24.0310-0278.1 510278	Ø 300 10 8,3 + S Ø 300 10 8,3 + S
			→	nicht für Taxifahrzeuge; für Fahrzeuge mit Sportpaket / für Fahrzeuge mit AMG-Sportpaket		24.0122-0201.1 422201	Ø 300 22 19,4 V + S
			→	für Taxifahrzeuge		24.0122-0201.1 422201	Ø 300 22 19,4 V + S
E 230 (211.052) E 280 CDI (211.020)	150 140	09/07→12/08 03/05→12/08	←	für Fahrzeuge ohne Sportpaket / für Fahrzeuge ohne AMG-Sportpaket		24.0128-0176.1 428176 24.0328-0176.1 528176	Ø 295 28 25,4 V + S Ø 295 28 25,4 V
			←	für Fahrzeuge mit Sportpaket / für Fahrzeuge mit AMG-Sportpaket		24.0132-0153.1 432153	Ø 330 32 30 V• + S
			→	für Fahrzeuge ohne Sportpaket / für Fahrzeuge ohne AMG-Sportpaket		24.0110-0278.1 410278 24.0310-0278.1 510278	Ø 300 10 8,3 + S Ø 300 10 8,3 + S
			→	für Fahrzeuge mit Sportpaket / für Fahrzeuge mit AMG-Sportpaket		24.0122-0201.1 422201	Ø 300 22 19,4 V + S
E 240 (211.061) E 270 CDI (211.016) E 270 CDI (211.016)	130 120 130	03/02→12/08 03/02→12/08 03/02→12/08	←			24.0128-0176.1 428176 24.0328-0176.1 528176	Ø 295 28 25,4 V + S Ø 295 28 25,4 V
			→	nicht für Taxifahrzeuge		24.0110-0278.1 410278 24.0310-0278.1 510278	Ø 300 10 8,3 + S Ø 300 10 8,3 + S
			→	für Taxifahrzeuge		24.0122-0201.1 422201	Ø 300 22 19,4 V + S
E 240 4-matic (211.080)	130	03/03→12/08	←			24.0130-0179.1 430179	Ø 304 30 27,4 V
			→			24.0110-0278.1 410278 24.0310-0278.1 510278	Ø 300 10 8,3 + S Ø 300 10 8,3 + S
E 280 (211.054)	170	03/05→12/08	←	05/05→; für Fahrzeuge ohne Sportpaket / für Fahrzeuge ohne AMG-Sportpaket		24.0128-0176.1 428176 24.0328-0176.1 528176	Ø 295 28 25,4 V + S Ø 295 28 25,4 V
			←	05/05→; für Fahrzeuge mit Sportpaket / für Fahrzeuge mit AMG-Sportpaket		24.0132-0153.1 432153	Ø 330 32 30 V• + S
			→	05/05→		24.0122-0201.1 422201	Ø 300 22 19,4 V + S
E 280 4-matic (211.092) E 280 CDI 4-matic (211.084)	170 140	01/06→12/08 03/05→12/08	←	für Fahrzeuge ohne Sportpaket / für Fahrzeuge ohne AMG-Sportpaket		24.0130-0179.1 430179	Ø 304 30 27,4 V
			←	für Fahrzeuge mit Sportpaket / für Fahrzeuge mit AMG-Sportpaket		24.0132-0136.1 432136	Ø 330 32 30 V•

	kW			 	! #		
<b>MERCEDES-BENZ - E-KLASSE (W211) 03/02→03/09</b>							
<b>Bremsscheibe</b>							
E 280 4-matic (211.092) E 280 CDI 4-matic (211.084)	170 140	01/06→12/08 03/05→12/08	➡	für Fahrzeuge ohne Sportpaket / für Fahrzeuge ohne AMG-Sportpaket		24.0110-0278.1 410278 24.0310-0278.1 510278	Ø 300 10 8,3 + S Ø 300 10 8,3 + S
			➡	für Fahrzeuge mit Sportpaket / für Fahrzeuge mit AMG-Sportpaket		24.0122-0201.1 422201	Ø 300 22 19,4 V + S
E 280 CDI (211.023)	130	05/04→12/08	⬅			24.0128-0176.1 428176 24.0328-0176.1 528176	Ø 295 28 25,4 V + S Ø 295 28 25,4 V
			➡			24.0122-0201.1 422201	Ø 300 22 19,4 V + S
E 300 BlueTEC (211.024) E 320 CDI (211.022)	155 165	09/07→12/08 03/05→12/08	⬅	für Fahrzeuge ohne Sportpaket / für Fahrzeuge ohne AMG-Sportpaket		24.0128-0176.1 428176 24.0328-0176.1 528176	Ø 295 28 25,4 V + S Ø 295 28 25,4 V
			⬅	für Fahrzeuge mit Sportpaket / für Fahrzeuge mit AMG-Sportpaket		24.0132-0153.1 432153	Ø 330 32 30 V* + S
			➡			24.0122-0201.1 422201	Ø 300 22 19,4 V + S
E 320 (211.065) E 320 CDI (211.026)	165 150	03/02→12/08 11/02→12/08	⬅	→ A 400547		24.0128-0142.1 428142 24.0328-0142.1 528142	Ø 312 28 25,4 V Ø 312 28 25,4 V
			⬅	A 400548→		24.0128-0176.1 428176 24.0328-0176.1 528176	Ø 295 28 25,4 V + S Ø 295 28 25,4 V
			➡	→ A 400547; nicht für Taxifahrzeuge		24.0110-0278.1 410278 24.0310-0278.1 510278	Ø 300 10 8,3 + S Ø 300 10 8,3 + S
			➡	A 400548→; nicht für Taxifahrzeuge		24.0122-0201.1 422201	Ø 300 22 19,4 V + S
			➡	für Taxifahrzeuge		24.0122-0201.1 422201	Ø 300 22 19,4 V + S
E 320 4-matic (211.082)	165	03/03→12/08	⬅			24.0130-0179.1 430179	Ø 304 30 27,4 V
			➡	X 122526→		24.0110-0278.1 410278 24.0310-0278.1 510278	Ø 300 10 8,3 + S Ø 300 10 8,3 + S
			➡	→ X 122525		24.0122-0201.1 422201	Ø 300 22 19,4 V + S
E 320 CDI 4-matic (211.089) E 350 4-matic (211.087)	165 200	03/05→12/08 03/05→12/08	⬅	für Fahrzeuge ohne Sportpaket / für Fahrzeuge ohne AMG-Sportpaket		24.0130-0179.1 430179	Ø 304 30 27,4 V
			⬅	für Fahrzeuge mit Sportpaket / für Fahrzeuge mit AMG-Sportpaket		24.0132-0136.1 432136	Ø 330 32 30 V*
			➡			24.0122-0201.1 422201	Ø 300 22 19,4 V + S
E 350 (211.056) E 350 CGI (211.057) E 500 (211.070)	200 215 225	03/05→12/08 09/07→12/08 03/02→12/08	⬅	für Fahrzeuge ohne Sportpaket / für Fahrzeuge ohne AMG-Sportpaket		24.0132-0144.1 432144 24.0332-0144.1 532144	Ø 330 32 29,4 V + S Ø 330 32 29,4 V + S
			⬅	für Fahrzeuge mit Sportpaket / für Fahrzeuge mit AMG-Sportpaket		24.0132-0153.1 432153	Ø 330 32 30 V* + S
			➡			24.0122-0201.1 422201	Ø 300 22 19,4 V + S
E 400 CDI (211.028)	191	02/03→12/08	⬅	03/03→		24.0132-0144.1 432144 24.0332-0144.1 532144	Ø 330 32 29,4 V + S Ø 330 32 29,4 V + S
			➡	03/03→		24.0122-0201.1 422201	Ø 300 22 19,4 V + S
E 420 CDI (211.029) E 500 (211.072)	231 285	01/06→12/08 04/06→12/08	⬅	für Fahrzeuge mit Sportpaket / für Fahrzeuge mit AMG-Sportpaket		24.0132-0138.1 432138	Ø 350 32 30 V* + S
			⬅	für Fahrzeuge ohne Sportpaket / für Fahrzeuge ohne AMG-Sportpaket		24.0132-0139.1 432139	Ø 350 32 29,4 V + S
			➡			24.0124-0236.1 424236	Ø 320 24 21,1 V + S
E 500 4-matic (211.083) E 500 4-matic (211.090)	225 285	10/03→12/08 04/06→12/08	⬅	für Fahrzeuge mit Sportpaket / für Fahrzeuge mit AMG-Sportpaket		24.0132-0136.1 432136	Ø 330 32 30 V*
			⬅	für Fahrzeuge ohne Sportpaket / für Fahrzeuge ohne AMG-Sportpaket		24.0132-0154.1 432154	Ø 330 32 29,4 V
			➡			24.0122-0201.1 422201	Ø 300 22 19,4 V + S
E 55 AMG Kompressor (211.076)	350	10/02→12/08	⬅			24.0136-0102.1 436102	Ø 360 36 34 V*
			➡			24.0126-0136.1 426136	Ø 330 26 24 V*
E 63 AMG (211.077)	378	03/06→12/08	➡			24.0126-0136.1 426136	Ø 330 26 24 V*
<b>MERCEDES-BENZ - E-KLASSE (W212) 01/09→</b>							
<b>Bremsbelagsatz, Scheibenbremse</b>							
E 200 (212.034) E 200 CGI (212.048, 212.148) E 200 NGT (212.035) E 200 NGT (212.041) E 220 BlueTEC (212.001)	135 135 115 120 130	01/13→ 08/09→ 07/13→ 03/11→ 05/14→	⬅	für Fahrzeuge ohne Sportpaket / für Fahrzeuge ohne AMG-Sportpaket		13.0460-2732.2 602732 13.0470-2732.2 LD2732 13.0470-9000.2 LD9000	TRW 24306 20,3 + WE / - WK + Zub TRW 24306 20,3 + WE / - WK + Zub Ceramic TRW 24306 20,3 + WE / - WK + Zub Ceramic
			⬅	für Fahrzeuge mit Sportpaket / für Fahrzeuge mit AMG-Sportpaket		13.0460-2734.2 602734 13.0470-2734.2 LD2734	TRW 24310 19,0 + WE / - WK TRW 24310 19,0 + WE / - WK Ceramic
			➡			13.0460-7259.2 607259	ATE 24862 16,7 + WE / - WK







	kW			 	! #		
<b>MERCEDES-BENZ - E-KLASSE (W212) 01/09→</b>							
<b> Bremsbelagsatz, Scheibenbremse</b>							
E 200 (212.034) E 200 CGI (212.048, 212.148) E 200 NGT (212.035) E 200 NGT (212.041) E 220 BlueTEC (212.001)	135 135 115 120 130	01/13→ 08/09→ 07/13→ 03/11→ 05/14→	→			13.0470-7259.2 LD7259 13.0470-9001.2 LD9001	ATE 24862 16,7 + WE / - WK Ceramic ATE 24862 16,7 + WE / - WK Ceramic
E 200 CDI / BlueTEC (212.005, 212.006) E 220 CDI E 220 CDI / BlueTEC (212.001, 212.002)	100 120 125	01/09→ 01/09→ 01/09→	←	03/09→; für Fahrzeuge ohne Sportpaket / für Fahrzeuge ohne AMG-Sportpaket		13.0460-2732.2 602732 13.0470-2732.2 LD2732 13.0470-9000.2 LD9000	TRW 24306 20,3 + WE / - WK + Zub TRW 24306 20,3 + WE / - WK + Zub Ceramic TRW 24306 20,3 + WE / - WK + Zub Ceramic
			←	03/09→; für Fahrzeuge mit Sportpaket / für Fahrzeuge mit AMG-Sportpaket		13.0460-2734.2 602734 13.0470-2734.2 LD2734	TRW 24310 19,0 + WE / - WK Ceramic TRW 24310 19,0 + WE / - WK Ceramic
			→	03/09→		13.0460-7259.2 607259 13.0470-7259.2 LD7259 13.0470-9001.2 LD9001	ATE 24862 16,7 + WE / - WK Ceramic ATE 24862 16,7 + WE / - WK Ceramic ATE 24862 16,7 + WE / - WK Ceramic
E 220 BlueTEC 4-matic (212.011) E 250 (212.036) E 250 CGI (212.047, 212.147) E 300 (212.055) E 300 4-matic (212.080) E 350 (212.059) E 350 4-matic (212.088) E 350 CDI (212.023) E 350 CDI 4-matic (212.089) E 350 CDI 4-matic (212.093)	125 155 150 185 185 225 225 195 170 195	01/15→ 01/13→ 01/09→ 07/11→ 07/11→ 09/11→ 09/11→ 03/11→ 09/09→ 03/11→	←			13.0460-2734.2 602734 13.0470-2734.2 LD2734	TRW 24310 19,0 + WE / - WK Ceramic TRW 24310 19,0 + WE / - WK Ceramic
			→			13.0460-7259.2 607259 13.0470-7259.2 LD7259 13.0470-9001.2 LD9001	ATE 24862 16,7 + WE / - WK Ceramic ATE 24862 16,7 + WE / - WK Ceramic ATE 24862 16,7 + WE / - WK Ceramic
E 250 CDI / BlueTEC (212.003, 212.004)	150	01/09→	←	03/09→; → A 001284; für Fahrzeuge ohne Sportpaket / für Fahrzeuge ohne AMG-Sportpaket		13.0460-2732.2 602732 13.0470-2732.2 LD2732 13.0470-9000.2 LD9000	TRW 24306 20,3 + WE / - WK + Zub TRW 24306 20,3 + WE / - WK + Zub Ceramic TRW 24306 20,3 + WE / - WK + Zub Ceramic
			←	03/09→; für Fahrzeuge mit Sportpaket / für Fahrzeuge mit AMG-Sportpaket		13.0460-2734.2 602734 13.0470-2734.2 LD2734	TRW 24310 19,0 + WE / - WK Ceramic TRW 24310 19,0 + WE / - WK Ceramic
			←	A 001285→; für Fahrzeuge ohne Sportpaket / für Fahrzeuge ohne AMG-Sportpaket		13.0460-2734.2 602734 13.0470-2734.2 LD2734	TRW 24310 19,0 + WE / - WK Ceramic TRW 24310 19,0 + WE / - WK Ceramic
			→	03/09→		13.0460-7259.2 607259 13.0470-7259.2 LD7259 13.0470-9001.2 LD9001	ATE 24862 16,7 + WE / - WK Ceramic ATE 24862 16,7 + WE / - WK Ceramic ATE 24862 16,7 + WE / - WK Ceramic
E 250 CDI / BlueTEC 4-matic (212.082, 212.097) E 300 (212.054) E 350 (212.056) E 350 4-matic (212.087) E 350 BlueTEC (212.024) E 350 CDI (212.025) E 350 CGI (212.057)	150 170 200 200 155 170 215	01/09→ 01/09→ 01/09→ 01/09→08/11 01/09→ 01/09→ 01/09→08/11	←	03/09→		13.0460-2734.2 602734 13.0470-2734.2 LD2734	TRW 24310 19,0 + WE / - WK Ceramic TRW 24310 19,0 + WE / - WK Ceramic
			→	03/09→		13.0460-7259.2 607259 13.0470-7259.2 LD7259 13.0470-9001.2 LD9001	ATE 24862 16,7 + WE / - WK Ceramic ATE 24862 16,7 + WE / - WK Ceramic ATE 24862 16,7 + WE / - WK Ceramic
E 300 CDI / BlueTEC (212.020, 212.021, 212.027)	170	03/11→	←	04/11→		13.0460-2734.2 602734 13.0470-2734.2 LD2734	TRW 24310 19,0 + WE / - WK Ceramic TRW 24310 19,0 + WE / - WK Ceramic
			→	04/11→		13.0460-7259.2 607259 13.0470-7259.2 LD7259 13.0470-9001.2 LD9001	ATE 24862 16,7 + WE / - WK Ceramic ATE 24862 16,7 + WE / - WK Ceramic ATE 24862 16,7 + WE / - WK Ceramic
E 300 Hybrid / BlueTEC Hybrid (212.098)	150	12/11→	←	06/12→		13.0460-2734.2 602734 13.0470-2734.2 LD2734	TRW 24310 19,0 + WE / - WK Ceramic TRW 24310 19,0 + WE / - WK Ceramic
			→	06/12→		13.0460-7259.2 607259	ATE 24862 16,7 + WE / - WK Ceramic











	kw			 	! #		
<b>MERCEDES-BENZ - E-KLASSE (W212) 01/09→</b>							
<b> Bremsbelagsatz, Scheibenbremse</b>							
E 300 Hybrid / BlueTEC Hybrid (212.098)	150	12/11→	➔	06/12→		<b>13.0470-7259.2 LD7259</b> <b>13.0470-9001.2 LD9001</b>	ATE 24862 16,7 + WE / - WK Ceramic ATE 24862 16,7 + WE / - WK Ceramic
E 350 BlueTEC E 350 BlueTEC 4-matic (212.094)	185	11/12→	←	01/13→; für Fahrzeuge ohne Sportpaket / für Fahrzeuge ohne AMG-Sportpaket		<b>13.0460-2734.2 602734</b> <b>13.0470-2734.2 LD2734</b>	TRW 24310 19,0 + WE / - WK Ceramic
	185	11/12→	←	01/13→; für Fahrzeuge mit Sportpaket / für Fahrzeuge mit AMG-Sportpaket		<b>13.0460-4863.2 604863</b>	BRE 24976 17,5 + WE / - WK
			➔	01/13→		<b>13.0460-7259.2 607259</b> <b>13.0470-7259.2 LD7259</b> <b>13.0470-9001.2 LD9001</b>	ATE 24862 16,7 + WE / - WK Ceramic ATE 24862 16,7 + WE / - WK Ceramic ATE 24862 16,7 + WE / - WK Ceramic
E 350 BlueTEC (212.026) E 350 BlueTEC 4-matic (212.094)	190	05/14→	←	für Fahrzeuge ohne Sportpaket / für Fahrzeuge ohne AMG-Sportpaket		<b>13.0460-2734.2 602734</b> <b>13.0470-2734.2 LD2734</b>	TRW 24310 19,0 + WE / - WK Ceramic
	190	05/14→	←	für Fahrzeuge mit Sportpaket / für Fahrzeuge mit AMG-Sportpaket		<b>13.0460-4863.2 604863</b>	BRE 24976 17,5 + WE / - WK
			➔			<b>13.0460-7259.2 607259</b> <b>13.0470-7259.2 LD7259</b> <b>13.0470-9001.2 LD9001</b>	ATE 24862 16,7 + WE / - WK Ceramic ATE 24862 16,7 + WE / - WK Ceramic ATE 24862 16,7 + WE / - WK Ceramic
E 400 (212.061) E 500 (212.073) E 500 4-matic (212.091)	245	07/14→	➔			<b>13.0460-7259.2 607259</b> <b>13.0470-7259.2 LD7259</b>	ATE 24862 16,7 + WE / - WK Ceramic
	300	09/11→				<b>13.0470-7259.2 LD7259</b>	ATE 24862 16,7 + WE / - WK Ceramic
	300	09/11→				<b>13.0470-9001.2 LD9001</b>	ATE 24862 16,7 + WE / - WK Ceramic
E 400 (212.065) E 400 4-matic (212.067) E 400 4-matic (212.099)	245	01/13→	←			<b>13.0460-4863.2 604863</b>	BRE 24976 17,5 + WE / - WK
	245	01/13→	➔			<b>13.0460-7259.2 607259</b> <b>13.0470-7259.2 LD7259</b>	ATE 24862 16,7 + WE / - WK Ceramic ATE 24862 16,7 + WE / - WK Ceramic
	245	07/14→	➔			<b>13.0470-9001.2 LD9001</b>	ATE 24862 16,7 + WE / - WK Ceramic
E 500 (212.072) E 500 4-matic (212.090)	285	01/09→	←	03/09→		<b>13.0460-4863.2 604863</b>	BRE 24976 17,5 + WE / - WK
	285	01/09→	➔	03/09→		<b>13.0460-7259.2 607259</b> <b>13.0470-7259.2 LD7259</b>	ATE 24862 16,7 + WE / - WK Ceramic ATE 24862 16,7 + WE / - WK Ceramic
						<b>13.0470-9001.2 LD9001</b>	ATE 24862 16,7 + WE / - WK Ceramic
E 63 AMG (212.077)	386	12/09→	←	für Fahrzeuge ohne Keramikbremse		<b>13.0460-4839.2 604839</b>	BRE 24455 16,8 + WE / - WK
<b>Warnkontakt, Bremsbelagverschleiß</b>							
E 200 (212.034) E 200 CGI (212.048, 212.148) E 200 NGT (212.035) E 200 NGT (212.041) E 220 BlueTEC (212.001) E 350 BlueTEC (212.026) E 350 BlueTEC 4-matic (212.094)	135	01/13→	←	für Fahrzeuge mit Sportpaket / für Fahrzeuge mit AMG-Sportpaket	1	<b>24.8190-0410.2 620410</b>	L= 97,5
	135	08/09→	←	für Fahrzeuge ohne Sportpaket / für Fahrzeuge ohne AMG-Sportpaket	1	<b>24.8190-0410.2 620410</b>	L= 97,5
	115 120 130	07/13→ 03/11→ 05/14→	➔			1	<b>24.8190-0410.2 620410</b>
E 200 CDI / BlueTEC (212.005, 212.006) E 220 CDI (212.001, 212.002)	100	01/09→	←	03/09→; für Fahrzeuge ohne Sportpaket / für Fahrzeuge ohne AMG-Sportpaket	1	<b>24.8190-0410.2 620410</b>	L= 97,5
	120	01/09→	←	03/09→; für Fahrzeuge mit Sportpaket / für Fahrzeuge mit AMG-Sportpaket	1	<b>24.8190-0410.2 620410</b>	L= 97,5
	125	01/09→	➔	03/09→	1	<b>24.8190-0410.2 620410</b>	L= 97,5
E 220 BlueTEC 4-matic (212.011) E 250 (212.036) E 250 CGI (212.047, 212.147) E 300 (212.055) E 300 4-matic (212.080) E 350 (212.059) E 350 4-matic (212.088) ↓	125	01/15→	←		1	<b>24.8190-0410.2 620410</b>	L= 97,5
	155	01/13→	➔		1	<b>24.8190-0410.2 620410</b>	L= 97,5
	150	01/09→					
	185	07/11→					
	185 225 225	07/11→ 09/11→ 09/11→					





















	kW			 	! #		
<b>MERCEDES-BENZ - E-KLASSE (W212) 01/09→</b>							
<b>Warnkontakt, Bremsbelagverschleiß</b>							
E 350 CDI (212.023)	195	03/11→	←		1	24.8190-0410.2 620410	L= 97,5
E 350 CDI 4-matic (212.089)	170	09/09→	→		1	24.8190-0410.2 620410	L= 97,5
E 350 CDI 4-matic (212.093)	195	03/11→					
E 400 (212.061)	245	07/14→					
E 400 (212.065)	245	01/13→					
E 400 4-matic (212.067)	245	01/13→					
E 400 4-matic (212.099)	245	07/14→					
E 500 (212.073)	300	09/11→					
E 500 4-matic (212.091)	300	09/11→					
E 250 CDI / BlueTEC (212.003, 212.004)	150	01/09→	←	03/09→; für Fahrzeuge mit Sportpaket / für Fahrzeuge mit AMG-Sportpaket	1	24.8190-0410.2 620410	L= 97,5
			←	A 001285→; für Fahrzeuge ohne Sportpaket / für Fahrzeuge ohne AMG-Sportpaket	1	24.8190-0410.2 620410	L= 97,5
			←	03/09→; → A 001284; für Fahrzeuge ohne Sportpaket / für Fahrzeuge ohne AMG-Sportpaket	1	24.8190-0410.2 620410	L= 97,5
			→	03/09→	1	24.8190-0410.2 620410	L= 97,5
E 250 CDI / BlueTEC 4-matic (212.082, 212.097)	150	01/09→	←	03/09→	1	24.8190-0410.2 620410	L= 97,5
E 300 (212.054)	170	01/09→	→	03/09→	1	24.8190-0410.2 620410	L= 97,5
E 350 (212.056)	200	01/09→					
E 350 4-matic (212.087)	200	01/09→08/11					
E 350 BlueTEC (212.024)	155	01/09→					
E 350 CDI (212.025)	170	01/09→					
E 350 CGI (212.057)	215	01/09→08/11					
E 500 (212.072)	285	01/09→					
E 500 4-matic (212.090)	285	01/09→					
E 300 CDI / BlueTEC (212.020, 212.021, 212.027)	170	03/11→	←	04/11→	1	24.8190-0410.2 620410	L= 97,5
			→	04/11→	1	24.8190-0410.2 620410	L= 97,5
E 300 Hybrid / BlueTEC Hybrid (212.098)	150	12/11→	←	06/12→	1	24.8190-0410.2 620410	L= 97,5
			→	06/12→	1	24.8190-0410.2 620410	L= 97,5
E 350 BlueTEC	185	11/12→	←	01/13→; für Fahrzeuge ohne Sportpaket / für Fahrzeuge ohne AMG-Sportpaket	1	24.8190-0410.2 620410	L= 97,5
E 350 BlueTEC 4-matic (212.094)	185	11/12→	←	01/13→; für Fahrzeuge mit Sportpaket / für Fahrzeuge mit AMG-Sportpaket	1	24.8190-0410.2 620410	L= 97,5
			→	01/13→	1	24.8190-0410.2 620410	L= 97,5
E 63 AMG (212.074)	386	02/11→	←	für Fahrzeuge ohne Keramikbremse	1	24.8190-0420.2 620420	L= 119
E 63 AMG (212.074)	410	02/11→					
E 63 AMG 4-matic (212.092)	410	02/11→	→		1	24.8190-0420.2 620420	L= 119
E 63 AMG (212.075)	430	02/13→	←	04/13→; für Fahrzeuge ohne Keramikbremse	1	24.8190-0420.2 620420	L= 119
E 63 AMG 4-matic (212.076)	430	02/13→	→	04/13→	1	24.8190-0420.2 620420	L= 119
E 63 AMG (212.077)	386	12/09→	←		1	24.8190-0420.2 620420	L= 119
			→		1	24.8190-0420.2 620420	L= 119
<b>Bremsscheibe</b>							
E 200 (212.034)	135	01/13→	←	für Fahrzeuge ohne Sportpaket / für Fahrzeuge ohne AMG-Sportpaket		24.0128-0155.1 428155	Ø 295 28 25,4 V + S
E 200 CGI (212.048, 212.148)	135	08/09→				24.0328-0155.1 528155	Ø 295 28 25,4 V + S
E 200 NGT (212.035)	115	07/13→	←	für Fahrzeuge mit Sportpaket / für Fahrzeuge mit AMG-Sportpaket		24.0132-0100.1 432100	Ø 322 32 30 V• + S
E 200 NGT (212.041)	120	03/11→					
E 220 BlueTEC (212.001)	130	05/14→	→			24.0110-0278.1 410278	Ø 300 10 8,3 + S
						24.0310-0278.1 510278	Ø 300 10 8,3 + S
E 200 CDI / BlueTEC (212.005, 212.006)	100	01/09→	←	03/09→; für Fahrzeuge ohne Sportpaket / für Fahrzeuge ohne AMG-Sportpaket		24.0128-0155.1 428155	Ø 295 28 25,4 V + S
E 220 CDI	120	01/09→				24.0328-0155.1 528155	Ø 295 28 25,4 V + S
E 220 CDI / BlueTEC (212.001, 212.002)	125	01/09→	←	03/09→; für Fahrzeuge mit Sportpaket / für Fahrzeuge mit AMG-Sportpaket		24.0132-0100.1 432100	Ø 322 32 30 V• + S
			→	03/09→		24.0110-0278.1 410278	Ø 300 10 8,3 + S
						24.0310-0278.1 510278	Ø 300 10 8,3 + S
E 220 BlueTEC 4-matic (212.011)	125	01/15→	←	für Fahrzeuge mit Sportpaket / für Fahrzeuge mit AMG-Sportpaket		24.0132-0100.1 432100	Ø 322 32 30 V• + S
E 250 (212.036)	155	01/13→	←	für Fahrzeuge ohne Sportpaket / für Fahrzeuge ohne AMG-Sportpaket		24.0132-0101.1 432101	Ø 322 32 29,4 V + S
E 250 CGI (212.047, 212.147)	150	01/09→				24.0332-0101.1 532101	Ø 322 32 29,4 V + S









	kw			 	! #		
<b>MERCEDES-BENZ - E-KLASSE (W212) 01/09→</b>							
<b>Bremsscheibe</b>							
E 220 BlueTEC 4-matic (212.011)	125	01/15→	➔			24.0110-0278.1 410278	Ø 300 10 8,3 + S
E 250 (212.036)	155	01/13→				24.0310-0278.1 510278	Ø 300 10 8,3 + S
E 250 CGI (212.047, 212.147)	150	01/09→					
E 250 CDI / BlueTEC (212.003, 212.004)	150	01/09→	➔	03/09→; → A 001284; für Fahrzeuge ohne Sportpaket / für Fahrzeuge ohne AMG-Sportpaket		24.0128-0155.1 428155 24.0328-0155.1 528155	Ø 295 28 25,4 V + S Ø 295 28 25,4 V + S
			➔	03/09→; für Fahrzeuge mit Sportpaket / für Fahrzeuge mit AMG-Sportpaket		24.0132-0100.1 432100	Ø 322 32 30 V• + S
			➔	A 001285→; für Fahrzeuge ohne Sportpaket / für Fahrzeuge ohne AMG-Sportpaket		24.0132-0101.1 432101 24.0332-0101.1 532101	Ø 322 32 29,4 V + S Ø 322 32 29,4 V + S
			➔	A 007599→		24.0110-0278.1 410278 24.0310-0278.1 510278	Ø 300 10 8,3 + S Ø 300 10 8,3 + S
			➔	03/09→; → A 007598		24.0122-0201.1 422201	Ø 300 22 19,4 V + S
E 250 CDI / BlueTEC 4-matic (212.082, 212.097)	150	01/09→	➔	03/09→; für Fahrzeuge mit Sportpaket / für Fahrzeuge mit AMG-Sportpaket		24.0132-0100.1 432100	Ø 322 32 30 V• + S
			➔	03/09→; für Fahrzeuge ohne Sportpaket / für Fahrzeuge ohne AMG-Sportpaket		24.0132-0101.1 432101 24.0332-0101.1 532101	Ø 322 32 29,4 V + S Ø 322 32 29,4 V + S
			➔	03/09→		24.0110-0278.1 410278 24.0310-0278.1 510278	Ø 300 10 8,3 + S Ø 300 10 8,3 + S
E 300 (212.054)	170	01/09→	➔	03/09→; für Fahrzeuge mit Sportpaket / für Fahrzeuge mit AMG-Sportpaket		24.0132-0100.1 432100	Ø 322 32 30 V• + S
E 350 (212.056)	200	01/09→					
E 350 4-matic (212.087)	200	01/09→08/11					
E 350 BlueTEC (212.024)	155	01/09→	➔	03/09→; für Fahrzeuge ohne Sportpaket / für Fahrzeuge ohne AMG-Sportpaket		24.0132-0101.1 432101 24.0332-0101.1 532101	Ø 322 32 29,4 V + S Ø 322 32 29,4 V + S
E 350 CDI (212.025)	170	01/09→					
E 350 CGI (212.057)	215	01/09→08/11	➔	03/09→		24.0122-0201.1 422201	Ø 300 22 19,4 V + S
E 300 (212.055)	185	07/11→	➔	für Fahrzeuge mit Sportpaket / für Fahrzeuge mit AMG-Sportpaket		24.0132-0100.1 432100	Ø 322 32 30 V• + S
E 300 4-matic (212.080)	185	07/11→					
E 350 (212.059)	225	09/11→	➔	für Fahrzeuge ohne Sportpaket / für Fahrzeuge ohne AMG-Sportpaket		24.0132-0101.1 432101 24.0332-0101.1 532101	Ø 322 32 29,4 V + S Ø 322 32 29,4 V + S
E 350 4-matic (212.088)	225	09/11→					
E 350 CDI (212.023)	195	03/11→					
E 350 CDI 4-matic (212.089)	170	09/09→	➔			24.0122-0201.1 422201	Ø 300 22 19,4 V + S
E 350 CDI 4-matic (212.093)	195	03/11→					
E 300 CDI / BlueTEC (212.020, 212.021, 212.027)	170	03/11→	➔	04/11→; für Fahrzeuge mit Sportpaket / für Fahrzeuge mit AMG-Sportpaket		24.0132-0100.1 432100	Ø 322 32 30 V• + S
			➔	04/11→; für Fahrzeuge ohne Sportpaket / für Fahrzeuge ohne AMG-Sportpaket		24.0132-0101.1 432101 24.0332-0101.1 532101	Ø 322 32 29,4 V + S Ø 322 32 29,4 V + S
			➔	04/11→		24.0122-0201.1 422201	Ø 300 22 19,4 V + S
E 300 Hybrid / BlueTEC Hybrid (212.098)	150	12/11→	➔	06/12→; für Fahrzeuge mit Sportpaket / für Fahrzeuge mit AMG-Sportpaket		24.0132-0100.1 432100	Ø 322 32 30 V• + S
			➔	06/12→; für Fahrzeuge ohne Sportpaket / für Fahrzeuge ohne AMG-Sportpaket		24.0132-0101.1 432101 24.0332-0101.1 532101	Ø 322 32 29,4 V + S Ø 322 32 29,4 V + S
			➔	06/12→		24.0122-0201.1 422201	Ø 300 22 19,4 V + S
E 350 BlueTEC	185	11/12→	➔	01/13→; für Fahrzeuge ohne Sportpaket / für Fahrzeuge ohne AMG-Sportpaket		24.0132-0101.1 432101 24.0332-0101.1 532101	Ø 322 32 29,4 V + S Ø 322 32 29,4 V + S
E 350 BlueTEC 4-matic (212.094)	185	11/12→	➔	01/13→; für Fahrzeuge mit Sportpaket / für Fahrzeuge mit AMG-Sportpaket		24.0132-0168.1 432168	Ø 344 32 30 V• + S
			➔	01/13→		24.0122-0201.1 422201	Ø 300 22 19,4 V + S
E 350 BlueTEC (212.026)	190	05/14→	➔	für Fahrzeuge ohne Sportpaket / für Fahrzeuge ohne AMG-Sportpaket		24.0132-0101.1 432101 24.0332-0101.1 532101	Ø 322 32 29,4 V + S Ø 322 32 29,4 V + S
			➔	für Fahrzeuge mit Sportpaket / für Fahrzeuge ohne AMG-Sportpaket		24.0132-0168.1 432168	Ø 344 32 30 V• + S
			➔			24.0122-0201.1 422201	Ø 300 22 19,4 V + S
E 350 BlueTEC 4-matic (212.094)	190	05/14→	➔	für Fahrzeuge ohne Sportpaket / für Fahrzeuge ohne AMG-Sportpaket		24.0132-0101.1 432101 24.0332-0101.1 532101	Ø 322 32 29,4 V + S Ø 322 32 29,4 V + S
			➔	für Fahrzeuge mit Sportpaket / für Fahrzeuge mit AMG-Sportpaket		24.0132-0168.1 432168	Ø 344 32 30 V• + S
			➔			24.0122-0201.1 422201	Ø 300 22 19,4 V + S
↓							











	kw					! #		
<b>MERCEDES-BENZ - E-KLASSE (W212) 01/09→</b>								
 <b>Bremsscheibe</b>								
E 400 (212.061)	245	07/14→	←			24.0132-0168.1	432168	Ø 344 32 30 V• + S
E 400 (212.065)	245	01/13→	→			24.0122-0201.1	422201	Ø 300 22 19,4 V + S
E 400 4-matic (212.067)	245	01/13→						
E 400 4-matic (212.099)	245	07/14→						
E 500 (212.072)	285	01/09→	←	03/09→		24.0132-0168.1	432168	Ø 344 32 30 V• + S
E 500 4-matic (212.090)	285	01/09→	→	03/09→		24.0124-0236.1	424236	Ø 320 24 21,1 V + S
E 500 (212.073)	300	09/11→	←			24.0136-0108.1	436108	Ø 360 36 34 V• + S
E 500 4-matic (212.091)	300	09/11→	→			24.0124-0236.1	424236	Ø 320 24 21,1 V + S
<b>MERCEDES-BENZ - E-KLASSE (W213) 01/16→</b>								
 <b>Bremsbelagsatz, Scheibenbremse</b>								
AMG E 53 EQ Boost 4-matic+ (213.061)	320	04/18→	←			13.0460-4870.2	604870	BRE 25179 17,8 + WE / - WK
E 180 (213.040)	115	01/17→	←	für Fahrzeuge ohne AMG-Sportpaket		13.0460-2792.2	602792	TRW 22031 19,6 + WE / - WK
E 200 (213.042)	135	01/16→				13.0470-2792.2	LD2792	TRW 22031 19,6 + WE / - WK Ceramic
E 200 d (213.013)	110	07/16→						
E 220 d (213.004)	120	01/16→						
E 220 d (213.004)	143	01/16→	←	für Fahrzeuge mit AMG-Sportpaket		13.0460-4883.2	604883	BRE 22061 18,7 + WE / - WK Ceramic
						13.0470-4883.2	LD4883	BRE 22061 18,7 + WE / - WK Ceramic
E 200 4-matic (213.043)	135	07/16→	←	für Fahrzeuge ohne AMG-Sportpaket		13.0460-2610.2	602610	TRW 22076 19,6 + WE / - WK
E 220 d 4-matic (213.005)	120	10/16→				13.0470-2610.2	LD2610	TRW 22076 19,6 + WE / - WK Ceramic
E 220 d 4-matic (213.005)	143	10/16→	←	für Fahrzeuge mit AMG-Sportpaket		13.0460-4883.2	604883	BRE 22061 18,7 + WE / - WK
E 250 (213.045)	155	07/16→				13.0470-4883.2	LD4883	BRE 22061 18,7 + WE / - WK Ceramic
E 300 d (213.008)	180	12/17→						
E 300 (213.048)	180	07/16→	←	für Fahrzeuge ohne AMG-Sportpaket		13.0460-4883.2	604883	BRE 22061 18,7 + WE / - WK
E 350 d (213.033)	190	01/16→				13.0470-4883.2	LD4883	BRE 22061 18,7 + WE / - WK Ceramic
E 350 e (213.050)	155	07/16→						
E 350 e (213.050)	210	07/16→						
E 350 d 4-matic (213.034)	190	06/17→	←	für Fahrzeuge mit AMG-Sportpaket; +SA 158		13.0460-4883.2	604883	BRE 22061 18,7 + WE / - WK
						13.0470-4883.2	LD4883	BRE 22061 18,7 + WE / - WK Ceramic
<b>Warnkontakt, Bremsbelagsverschleiß</b>								
AMG E 43 4-matic (213.064)	295	07/16→	←		1	24.8190-0067.2	620067	L= 92,5
E 180 (213.040)	115	01/17→	→		1	24.8190-0067.2	620067	L= 92,5
E 200 (213.042)	135	01/16→						
E 200 4-matic (213.043)	135	07/16→						
E 200 d (213.013)	110	07/16→						
E 220 d (213.004)	120	01/16→						
E 220 d (213.004)	143	01/16→						
E 220 d 4-matic (213.005)	120	10/16→						
E 220 d 4-matic (213.005)	143	10/16→						
E 250 (213.045)	155	07/16→						
E 300 (213.048)	180	07/16→						
E 300 d (213.008)	180	12/17→						
E 350 d (213.033)	190	01/16→						
E 350 d 4-matic (213.034)	190	06/17→						
E 350 e (213.050)	155	07/16→						
E 350 e (213.050)	210	07/16→						
E 400 4-matic (213.071)	245	07/16→						
E 400 d 4-matic (213.023)	250	04/18→						
AMG E 53 EQ Boost 4-matic+ (213.061)	320	04/18→	←			24.8190-0959.2	620959	L= 102
			→		1	24.8190-0067.2	620067	L= 92,5
AMG E 63 4-matic+ (213.088)	420	01/17→	←	für Fahrzeuge ohne Keramikbremse	1	24.8190-0420.2	620420	L= 119
AMG E 63 S 4-matic+ (213.089)	450	01/17→	→		1	24.8190-0067.2	620067	L= 92,5
			→	für Fahrzeuge mit Keramikbremse; Bremssattelfarbe: silber	1	24.8190-0410.2	620410	L= 97,5
E 400 4-matic (213.066)	245	06/16→	←	07/16→	1	24.8190-0067.2	620067	L= 92,5
			→	07/16→	1	24.8190-0067.2	620067	L= 92,5
 <b>Bremsscheibe</b>								
E 180 (213.040)	115	01/17→	←	für Fahrzeuge ohne AMG-Sportpaket		24.0128-0330.1	428330	Ø 305 28 25,4 V + S
E 200 (213.042)	135	01/16→						
E 200 d (213.013)	110	07/16→						
E 220 d (213.004)	120	01/16→						
E 220 d (213.004)	143	01/16→						











	kw					! #		
<b>MERCEDES-BENZ - E-KLASSE All-Terrain (S213) 01/17→</b>								
 <b>Bremsbelagsatz, Scheibenbremse</b>								
E 220 d 4-matic (213.217)	143	01/17→	←	für Fahrzeuge ohne AMG-Sportpaket			13.0460-2610.2 602610 13.0470-2610.2 LD2610	TRW 22076 19,6 + WE / - WK TRW 22076 19,6 + WE / - WK Ceramic
			←	für Fahrzeuge mit AMG-Sportpaket			13.0460-4883.2 604883 13.0470-4883.2 LD4883	BRE 22061 18,7 + WE / - WK BRE 22061 18,7 + WE / - WK Ceramic
<b>Warnkontakt, Bremsbelagverschleiß</b>								
E 220 d 4-matic (213.217)	143	01/17→	←		1	24.8190-0067.2 620067		L= 92,5
E 350 d 4-matic (213.237)	190	06/17→	→		1	24.8190-0067.2 620067		L= 92,5
<b>MERCEDES-BENZ - E-KLASSE Cabriolet (A124) 05/93→03/98</b>								
 <b>Bremsbelagsatz, Scheibenbremse</b>								
E 200 (124.060)	100	06/93→03/98	←				13.0460-2927.2 602927 13.0470-2927.2 LD2927	TRW 20941 19,3 + WE / - WK TRW 20941 19,3 + WE / - WK Ceramic
E 220 (124.062)	110	06/93→03/98	→				13.0460-3805.2 603805 13.0470-3805.2 LD3805	ATE 21197 15,0 + WE / - WK ATE 21197 15,0 + WE / - WK Ceramic
E 320 (124.066)	162	06/93→03/98	←	→ B 862121			13.0460-4201.2 604201	ATE 21153 17,5 + WE / - WK
			←	B 862122→			13.0460-4202.2 604202	ATE 21153 16,0 + WE / - WK
			→				13.0460-3805.2 603805 13.0470-3805.2 LD3805	ATE 21197 15,0 + WE / - WK ATE 21197 15,0 + WE / - WK Ceramic
E 36 AMG (124.066)	200	05/94→03/98	←				13.0460-4201.2 604201	ATE 21153 17,5 + WE / - WK
			→				13.0460-3805.2 603805 13.0470-3805.2 LD3805	ATE 21197 15,0 + WE / - WK ATE 21197 15,0 + WE / - WK Ceramic
<b>Warnkontakt, Bremsbelagverschleiß</b>								
E 200 (124.060)	100	06/93→03/98	←		2	24.8190-0402.2 620402		L= 68 L= 150
E 220 (124.062)	110	06/93→03/98	→		2	24.8190-0401.2 620401		L= 95
E 320 (124.066)	162	06/93→03/98	←	→ B 862121	2	24.8190-0401.2 620401		L= 95
			←	B 862122→	2	24.8190-0401.2 620401		L= 95
			→		2	24.8190-0401.2 620401		L= 95
E 36 AMG (124.066)	200	05/94→03/98	←		2	24.8190-0401.2 620401		L= 95
			→		2	24.8190-0401.2 620401		L= 95
<b>Zubehörsatz, Scheibenbremsbelag</b>								
E 200 (124.060)	100	06/93→03/98	→				13.0460-0186.2 610186	ATE
E 220 (124.062)	110	06/93→03/98	→					
E 36 AMG (124.066)	200	05/94→03/98	→					
E 320 (124.066)	162	06/93→03/98	←	B 862122→			13.0460-0268.2 610268	
			→				13.0460-0186.2 610186	ATE
 <b>Bremsscheibe</b>								
E 200 (124.060)	100	06/93→03/98	←				24.0122-0123.1 422123	∅ 284 22 19,4 V + S
E 220 (124.062)	110	06/93→03/98	→				24.0109-0114.1 409114 24.0309-0114.1 509114	∅ 278 9 7,3 + S ∅ 278 9 7,3 + S
E 320 (124.066)	162	06/93→03/98	←	→ B 862121			24.0122-0136.1 422136	∅ 295 22 19,4 V
			←	B 862122→			24.0125-0107.1 425107	∅ 294 25 22,4 V
			→				24.0109-0114.1 409114 24.0309-0114.1 509114	∅ 278 9 7,3 + S ∅ 278 9 7,3 + S
E 36 AMG (124.066)	200	05/94→03/98	←	☐			24.0130-0121.1 430121	∅ 320 30 28 V
			←	☐			24.0130-0122.1 430122	∅ 320 30 28 V
			→				24.0109-0114.1 409114 24.0309-0114.1 509114	∅ 278 9 7,3 + S ∅ 278 9 7,3 + S









	kw			 	! #		
<b>MERCEDES-BENZ - E-KLASSE Cabriolet (A207) 01/10→</b>							
<b> Bremsbelagsatz, Scheibenbremse</b>							
E 200 (207.434) E 220 BlueTEC (207.401)	135 130	03/13→ 05/14→	←	für Fahrzeuge ohne Sportpaket / für Fahrzeuge ohne AMG-Sportpaket	13.0460-2732.2	602732	TRW 24306 20,3 + WE / - WK + Zub
					13.0470-2732.2	LD2732	TRW 24306 20,3 + WE / - WK + Zub Ceramic
			←	für Fahrzeuge mit Sportpaket / für Fahr- zeuge mit AMG-Sportpaket	13.0460-2734.2	602734	TRW 24310 19,0 + WE / - WK
			→		13.0470-2734.2	LD2734	TRW 24310 19,0 + WE / - WK Ceramic
			→		13.0460-7244.2	607244	ATE 24253 17,8 + WE / - WK
					13.0470-7244.2	LD7244	ATE 24253 17,8 + WE / - WK Ceramic
E 200 CGI (207.448) E 220 CDI / BlueTEC / d (207.402, 207.401) E 220 CDI (207.402) E 250 CGI (207.447)	135 125 120 150	01/10→ 01/10→ 02/10→ 01/10→	←	03/10→; für Fahrzeuge ohne Sportpaket / für Fahrzeuge ohne AMG-Sportpaket	13.0460-2732.2	602732	TRW 24306 20,3 + WE / - WK + Zub
					13.0470-2732.2	LD2732	TRW 24306 20,3 + WE / - WK + Zub Ceramic
			←	03/10→; für Fahrzeuge mit Sportpaket / für Fahr- zeuge mit AMG-Sportpaket	13.0460-2734.2	602734	TRW 24310 19,0 + WE / - WK
			→		13.0470-2734.2	LD2734	TRW 24310 19,0 + WE / - WK Ceramic
			→	03/10→	13.0460-7244.2	607244	ATE 24253 17,8 + WE / - WK
					13.0470-7244.2	LD7244	ATE 24253 17,8 + WE / - WK Ceramic
E 250 (207.436) E 300 (207.455) E 320 (207.462) E 350 BlueTEC/ d (207.426) E 350 BlueTEC (207.426)	155 185 200 190	06/13→ 04/11→ 07/14→ 05/14→	←		13.0460-2734.2	602734	TRW 24310 19,0 + WE / - WK
					13.0470-2734.2	LD2734	TRW 24310 19,0 + WE / - WK Ceramic
			→		13.0460-7244.2	607244	ATE 24253 17,8 + WE / - WK
			→		13.0470-7244.2	LD7244	ATE 24253 17,8 + WE / - WK Ceramic
E 250 CDI / BlueTEC / d (207.403, 207.404)	150	01/10→	←	03/10→	13.0460-2734.2	602734	TRW 24310 19,0 + WE / - WK
					13.0470-2734.2	LD2734	TRW 24310 19,0 + WE / - WK Ceramic
			→	03/10→	13.0460-7244.2	607244	ATE 24253 17,8 + WE / - WK
					13.0470-7244.2	LD7244	ATE 24253 17,8 + WE / - WK Ceramic
E 350 (207.459) E 350 CDI	225 195	04/11→ 04/11→	←		13.0460-2734.2	602734	TRW 24310 19,0 + WE / - WK
					13.0470-2734.2	LD2734	TRW 24310 19,0 + WE / - WK Ceramic
			→	ALU	13.0460-7244.2	607244	ATE 24253 17,8 + WE / - WK
			→		13.0470-7244.2	LD7244	ATE 24253 17,8 + WE / - WK Ceramic
			→	GG	13.0460-7257.2	607257	ATE 24253 18,0 + WE / - WK
					13.0470-7257.2	LD7257	ATE 24253 18,0 + WE / - WK Ceramic
E 350 CDI (207.422) E 350 CGI (207.457)	170 215	01/10→ 01/10→	←	03/10→	13.0460-2734.2	602734	TRW 24310 19,0 + WE / - WK
					13.0470-2734.2	LD2734	TRW 24310 19,0 + WE / - WK Ceramic
			→	03/10→; ALU	13.0460-7244.2	607244	ATE 24253 17,8 + WE / - WK
			→		13.0470-7244.2	LD7244	ATE 24253 17,8 + WE / - WK Ceramic
			→	03/10→; GG	13.0460-7257.2	607257	ATE 24253 18,0 + WE / - WK
					13.0470-7257.2	LD7257	ATE 24253 18,0 + WE / - WK Ceramic
E 400 (207.461) E 400 (207.465)	245 245	07/14→ 06/13→	←		13.0460-2734.2	602734	TRW 24310 19,0 + WE / - WK
					13.0470-7244.2	LD7244	ATE 24253 17,8 + WE / - WK
			→		13.0460-7244.2	607244	ATE 24253 17,8 + WE / - WK
					13.0470-7244.2	LD7244	ATE 24253 17,8 + WE / - WK Ceramic
E 500 (207.472)	285	01/10→	←	03/10→	13.0460-2734.2	602734	TRW 24310 19,0 + WE / - WK
					13.0470-7244.2	LD7244	ATE 24253 17,8 + WE / - WK
			→	03/10→; ALU	13.0460-7244.2	607244	ATE 24253 17,8 + WE / - WK
			→		13.0470-7244.2	LD7244	ATE 24253 17,8 + WE / - WK Ceramic
			→	03/10→; GG	13.0460-7257.2	607257	ATE 24253 18,0 + WE / - WK
					13.0470-7257.2	LD7257	ATE 24253 18,0 + WE / - WK Ceramic
E 500 (207.473) E 550	300 299	09/11→ 09/11→	→	ALU	13.0460-7244.2	607244	ATE 24253 17,8 + WE / - WK
					13.0470-7244.2	LD7244	ATE 24253 17,8 + WE / - WK Ceramic
			→	GG	13.0460-7257.2	607257	ATE 24253 18,0 + WE / - WK
					13.0470-7257.2	LD7257	ATE 24253 18,0 + WE / - WK Ceramic







	kw			 	! #		
<b>MERCEDES-BENZ - E-KLASSE Cabriolet (A207) 01/10→</b>							
<b>Warnkontakt, Bremsbelagverschleiß</b>							
E 200 (207.434) E 220 BlueTEC (207.401)	135 130	03/13→ 05/14→	←	für Fahrzeuge mit Sportpaket / für Fahrzeuge mit AMG-Sportpaket	2	24.8190-0410.2 620410	L= 97,5
			←	für Fahrzeuge ohne Sportpaket / für Fahrzeuge ohne AMG-Sportpaket	2	24.8190-0410.2 620410	L= 97,5
			→		1	24.8190-0410.2 620410	L= 97,5
E 200 CGI (207.448) E 220 CDI / BlueTEC / d (207.402, 207.401) E 220 CDI (207.402) E 250 CGI (207.447)	135 125 120 150	01/10→ 01/10→ 02/10→ 01/10→	←	03/10→; für Fahrzeuge mit Sportpaket / für Fahrzeuge mit AMG-Sportpaket	2	24.8190-0410.2 620410	L= 97,5
			←	03/10→; für Fahrzeuge ohne Sportpaket / für Fahrzeuge ohne AMG-Sportpaket	2	24.8190-0410.2 620410	L= 97,5
			→	03/10→	1	24.8190-0410.2 620410	L= 97,5
E 250 (207.436) E 300 (207.455) E 320 (207.462) E 350 (207.459) E 350 BlueTEC/ d (207.426) E 350 BlueTEC (207.426) E 350 CDI E 400 (207.461) E 400 (207.465)	155 185 200 225 190 185 195 245 245	06/13→ 04/11→ 07/14→ 04/11→ 05/14→ 06/13→ 04/11→ 07/14→ 06/13→	←		2	24.8190-0410.2 620410	L= 97,5
			→		1	24.8190-0410.2 620410	L= 97,5
E 250 CDI / BlueTEC / d (207.403, 207.404) E 350 CDI (207.422) E 350 CGI (207.457) E 500 (207.472)	150 170 215 285	01/10→ 01/10→ 01/10→ 01/10→	←	03/10→	2	24.8190-0410.2 620410	L= 97,5
			→	03/10→	1	24.8190-0410.2 620410	L= 97,5
E 500 (207.473) E 550	300 299	09/11→ 09/11→	←		1	24.8190-0410.2 620410	L= 97,5
			→		1	24.8190-0410.2 620410	L= 97,5
<b>Bremsscheibe</b>							
E 200 (207.434) E 250 (207.436)	135 155	03/13→ 06/13→	←	für Fahrzeuge mit Sportpaket / für Fahrzeuge mit AMG-Sportpaket		24.0132-0100.1 432100	Ø 322 32 30 V• + S
			←	für Fahrzeuge ohne Sportpaket / für Fahrzeuge ohne AMG-Sportpaket		24.0132-0101.1 432101 24.0332-0101.1 532101	Ø 322 32 29,4 V + S Ø 322 32 29,4 V + S
			→			24.0110-0328.1 410328 24.0310-0328.1 510328	Ø 300 10 8,3 + S Ø 300 10 8,3 + S
E 200 CGI (207.448) E 220 CDI / BlueTEC / d (207.402, 207.401) E 220 CDI (207.402) E 250 CGI (207.447)	135 125 120 150	01/10→ 01/10→ 02/10→ 01/10→	←	03/10→; für Fahrzeuge ohne Sportpaket / für Fahrzeuge ohne AMG-Sportpaket		24.0128-0155.1 428155 24.0328-0155.1 528155	Ø 295 28 25,4 V + S Ø 295 28 25,4 V + S
			←	03/10→; für Fahrzeuge mit Sportpaket / für Fahrzeuge mit AMG-Sportpaket		24.0132-0100.1 432100	Ø 322 32 30 V• + S
			→	03/10→		24.0110-0328.1 410328 24.0310-0328.1 510328	Ø 300 10 8,3 + S Ø 300 10 8,3 + S
E 220 BlueTEC (207.401)	130	05/14→	←	für Fahrzeuge ohne Sportpaket / für Fahrzeuge ohne AMG-Sportpaket		24.0128-0155.1 428155 24.0328-0155.1 528155	Ø 295 28 25,4 V + S Ø 295 28 25,4 V + S
			←	für Fahrzeuge mit Sportpaket / für Fahrzeuge mit AMG-Sportpaket		24.0132-0100.1 432100	Ø 322 32 30 V• + S
			→			24.0110-0328.1 410328 24.0310-0328.1 510328	Ø 300 10 8,3 + S Ø 300 10 8,3 + S
E 250 CDI / BlueTEC / d (207.403, 207.404)	150	01/10→	←	03/10→; für Fahrzeuge mit Sportpaket / für Fahrzeuge mit AMG-Sportpaket		24.0132-0100.1 432100	Ø 322 32 30 V• + S
			←	03/10→; für Fahrzeuge ohne Sportpaket / für Fahrzeuge ohne AMG-Sportpaket		24.0132-0101.1 432101 24.0332-0101.1 532101	Ø 322 32 29,4 V + S Ø 322 32 29,4 V + S
			→	03/10→		24.0110-0328.1 410328 24.0310-0328.1 510328	Ø 300 10 8,3 + S Ø 300 10 8,3 + S
E 300 (207.455) E 350 (207.459) E 350 BlueTEC/ d (207.426) E 350 BlueTEC (207.426) E 350 CDI	185 225 190 185 195	04/11→ 04/11→ 05/14→ 06/13→ 04/11→	←	für Fahrzeuge mit Sportpaket / für Fahrzeuge mit AMG-Sportpaket		24.0132-0100.1 432100	Ø 322 32 30 V• + S
			←	für Fahrzeuge ohne Sportpaket / für Fahrzeuge ohne AMG-Sportpaket		24.0132-0101.1 432101 24.0332-0101.1 532101	Ø 322 32 29,4 V + S Ø 322 32 29,4 V + S
			→			24.0120-0208.1 420208	Ø 300 22 19,4 V + S
E 320 (207.462)	200	07/14→	←	für Fahrzeuge mit Sportpaket / für Fahrzeuge mit AMG-Sportpaket		24.0132-0100.1 432100	Ø 322 32 30 V• + S
			←	für Fahrzeuge ohne Sportpaket / für Fahrzeuge ohne AMG-Sportpaket		24.0132-0168.1 432168	Ø 344 32 30 V• + S
			→			24.0120-0208.1 420208	Ø 300 22 19,4 V + S
↓							













	kW				! #		
<b>MERCEDES-BENZ - E-KLASSE Cabriolet (A207) 01/10→</b>							
 <b>Bremsscheibe</b>							
E 350 CDI (207.422) E 350 CGI (207.457)	170 215	01/10→ 01/10→	←	03/10→; für Fahrzeuge mit Sportpaket / für Fahr- zeuge mit AMG-Sportpaket		24.0132-0100.1 432100	Ø 322 32 30 V• + S
			←	03/10→; für Fahrzeuge ohne Sportpaket / für Fahrzeuge ohne AMG-Sportpaket		24.0132-0101.1 432101 24.0332-0101.1 532101	Ø 322 32 29,4 V + S Ø 322 32 29,4 V + S
			→	03/10→		24.0120-0208.1 420208	Ø 300 22 19,4 V + S
E 400 (207.461) E 400 (207.465)	245 245	07/14→ 06/13→	←			24.0132-0168.1 432168	Ø 344 32 30 V• + S
			→			24.0120-0208.1 420208	Ø 300 22 19,4 V + S
E 500 (207.472)	285	01/10→	←	03/10→		24.0132-0168.1 432168	Ø 344 32 30 V• + S
			→	03/10→		24.0120-0208.1 420208	Ø 300 22 19,4 V + S
E 500 (207.473) E 550	300 299	09/11→ 09/11→	←			24.0136-0108.1 436108	Ø 360 36 34 V• + S
			→			24.0120-0208.1 420208	Ø 300 22 19,4 V + S
<b>MERCEDES-BENZ - E-KLASSE Cabriolet (A238) 06/17→</b>							
 <b>Bremsbelagsatz, Scheibenbremse</b>							
AMG E53 EQ Boost 4- matic+ (238.461)	320	05/18→	←			13.0460-4870.2 604870	BRE 25179 17,8 + WE / - WK
E 200 (238.442) E 220 d (238.414) E 220 d (238.414)	135 120 143	06/17→ 06/17→ 06/17→	←	für Fahrzeuge ohne AMG-Sportpaket; +SA 088		13.0460-2610.2 602610 13.0470-2610.2 LD2610	TRW 22076 19,6 + WE / - WK TRW 22076 19,6 + WE / - WK Ceramic
			←	für Fahrzeuge ohne AMG-Sportpaket; nicht für SA Code: 088		13.0460-2792.2 602792 13.0470-2792.2 LD2792	TRW 22031 19,6 + WE / - WK TRW 22031 19,6 + WE / - WK Ceramic
			←	für Fahrzeuge mit AMG-Sportpaket		13.0460-4883.2 604883 13.0470-4883.2 LD4883	BRE 22061 18,7 + WE / - WK BRE 22061 18,7 + WE / - WK Ceramic
E 200 4-matic (238.443) E 220 d 4-matic (238.415)	135 143	10/17→ 10/17→	←	für Fahrzeuge ohne AMG-Sportpaket		13.0460-2610.2 602610 13.0470-2610.2 LD2610	TRW 22076 19,6 + WE / - WK TRW 22076 19,6 + WE / - WK Ceramic
			←	für Fahrzeuge mit AMG-Sportpaket		13.0460-4883.2 604883 13.0470-4883.2 LD4883	BRE 22061 18,7 + WE / - WK BRE 22061 18,7 + WE / - WK Ceramic
E 300 (238.448) E 350 EQ Boost (238.485)	180 220	06/17→ 10/17→	←	für Fahrzeuge ohne AMG-Sportpaket		13.0460-4883.2 604883 13.0470-4883.2 LD4883	BRE 22061 18,7 + WE / - WK BRE 22061 18,7 + WE / - WK Ceramic
E 300 d (238.418)	180	05/18→	←	für Fahrzeuge mit AMG-Sportpaket		13.0460-4883.2 604883 13.0470-4883.2 LD4883	BRE 22061 18,7 + WE / - WK BRE 22061 18,7 + WE / - WK Ceramic
<b>Warnkontakt, Bremsbelagverschleiß</b>							
AMG E53 EQ Boost 4- matic+ (238.461)	320	05/18→	←			24.8190-0959.2 620959	L= 102
			→		1	24.8190-0067.2 620067	L= 92,5
E 200 (238.442) E 200 4-matic (238.443) E 220 d (238.414) E 220 d (238.414) E 220 d 4-matic (238.415) E 300 (238.448) E 300 d (238.418) E 350 d 4-matic (238.434) E 350 EQ Boost (238.485) E 400 4-matic (238.466)	135 135 120 143 143 180 180 190 220 245	06/17→ 10/17→ 06/17→ 06/17→ 10/17→ 06/17→ 05/18→ 06/17→ 10/17→ 06/17→	←		1	24.8190-0067.2 620067	L= 92,5
			→		1	24.8190-0067.2 620067	L= 92,5
 <b>Bremsscheibe</b>							
E 200 (238.442) E 220 d (238.414) E 220 d (238.414)	135 120 143	06/17→ 06/17→ 06/17→	←	für Fahrzeuge ohne AMG-Sportpaket; nicht für SA Code: 088		24.0128-0330.1 428330	Ø 305 28 25,4 V + S
<b>MERCEDES-BENZ - E-KLASSE Coupe (C124) 06/93→06/97</b>							
 <b>Bremsbelagsatz, Scheibenbremse</b>							
E 200 (124.040)	100	06/93→06/97	←			13.0460-2927.2 602927 13.0470-2927.2 LD2927	TRW 20941 19,3 + WE / - WK TRW 20941 19,3 + WE / - WK Ceramic
			←	→ 06/93		13.0460-2927.2 602927	TRW 20941 19,3 + WE / - WK

	kw			 	! #			
<b>MERCEDES-BENZ - E-KLASSE Coupe (C124) 06/93→06/97</b>								
<b> Bremsbelagsatz, Scheibenbremse</b>								
E 200 (124.040)	100	06/93→06/97	←	→ 06/93		<b>13.0470-2927.2</b>	<b>LD2927</b>	TRW 20941 19,3 + WE / - WK Ceramic
			→	→ 06/93		<b>13.0460-4034.2</b>	<b>604034</b>	ATE 20687 15,5 - WE / - WK
			→			<b>13.0460-4034.2</b>	<b>604034</b>	ATE 20687 15,5 - WE / - WK
E 220 (124.042)	110	06/93→06/97	←			<b>13.0460-2927.2</b>	<b>602927</b>	TRW 20941 19,3 + WE / - WK
			←			<b>13.0470-2927.2</b>	<b>LD2927</b>	TRW 20941 19,3 + WE / - WK Ceramic
			→			<b>13.0460-4034.2</b>	<b>604034</b>	ATE 20687 15,5 - WE / - WK
E 320 (124.052)	162	06/93→06/97	←	→ B 862121		<b>13.0460-4201.2</b>	<b>604201</b>	ATE 21153 17,5 + WE / - WK
			←	B 862122→		<b>13.0460-4202.2</b>	<b>604202</b>	ATE 21153 16,0 + WE / - WK
			→			<b>13.0460-3805.2</b>	<b>603805</b>	ATE 21197 15,0 + WE / - WK
			→			<b>13.0470-3805.2</b>	<b>LD3805</b>	ATE 21197 15,0 + WE / - WK Ceramic
E 36 AMG (124.052)	200	05/94→06/97	←			<b>13.0460-4201.2</b>	<b>604201</b>	ATE 21153 17,5 + WE / - WK
			→			<b>13.0460-3805.2</b>	<b>603805</b>	ATE 21197 15,0 + WE / - WK
			→			<b>13.0470-3805.2</b>	<b>LD3805</b>	ATE 21197 15,0 + WE / - WK Ceramic
<b>Warnkontakt, Bremsbelagverschleiß</b>								
E 200 (124.040)	100	06/93→06/97	←	→ 06/93	2	<b>24.8190-0402.2</b>	<b>620402</b>	L= 68 L= 150
			←		2	<b>24.8190-0402.2</b>	<b>620402</b>	L= 68 L= 150
E 220 (124.042)	110	06/93→06/97	←		2	<b>24.8190-0402.2</b>	<b>620402</b>	L= 68 L= 150
E 320 (124.052)	162	06/93→06/97	←	→ B 862121	2	<b>24.8190-0401.2</b>	<b>620401</b>	L= 95
			←	B 862122→	2	<b>24.8190-0401.2</b>	<b>620401</b>	L= 95
			→		2	<b>24.8190-0401.2</b>	<b>620401</b>	L= 95
E 36 AMG (124.052)	200	05/94→06/97	←		2	<b>24.8190-0401.2</b>	<b>620401</b>	L= 95
			→		2	<b>24.8190-0401.2</b>	<b>620401</b>	L= 95
<b>Zubehörsatz, Scheibenbremsbelag</b>								
E 200 (124.040)	100	06/93→06/97	→			<b>13.0460-0186.2</b>	<b>610186</b>	ATE
			→	→ 06/93		<b>13.0460-0186.2</b>	<b>610186</b>	ATE
E 220 (124.042)	110	06/93→06/97	→			<b>13.0460-0186.2</b>	<b>610186</b>	ATE
E 320 (124.052)	162	06/93→06/97						
E 36 AMG (124.052)	200	05/94→06/97						
<b> Bremsscheibe</b>								
E 200 (124.040)	100	06/93→06/97	←			<b>24.0122-0123.1</b>	<b>422123</b>	Ø 284 22 19,4 V + S
			←	→ 06/93		<b>24.0122-0123.1</b>	<b>422123</b>	Ø 284 22 19,4 V + S
			→			<b>24.0109-0120.1</b>	<b>409120</b>	Ø 258 9 7,3 + S
			→			<b>24.0309-0120.1</b>	<b>509120</b>	Ø 258 9 7,3 + S
			→	→ 06/93		<b>24.0109-0120.1</b>	<b>409120</b>	Ø 258 9 7,3 + S
E 220 (124.042)	110	06/93→06/97	←			<b>24.0122-0123.1</b>	<b>422123</b>	Ø 284 22 19,4 V + S
			→			<b>24.0109-0120.1</b>	<b>409120</b>	Ø 258 9 7,3 + S
			→			<b>24.0309-0120.1</b>	<b>509120</b>	Ø 258 9 7,3 + S
E 320 (124.052)	162	06/93→06/97	←	→ B 862121		<b>24.0122-0136.1</b>	<b>422136</b>	Ø 295 22 19,4 V
			←	B 862122→		<b>24.0125-0107.1</b>	<b>425107</b>	Ø 294 25 22,4 V
			→			<b>24.0109-0114.1</b>	<b>409114</b>	Ø 278 9 7,3 + S
			→			<b>24.0309-0114.1</b>	<b>509114</b>	Ø 278 9 7,3 + S
E 36 AMG (124.052)	200	05/94→06/97	←	☐		<b>24.0130-0121.1</b>	<b>430121</b>	Ø 320 30 28 V
			←	☐		<b>24.0130-0122.1</b>	<b>430122</b>	Ø 320 30 28 V
			→			<b>24.0109-0114.1</b>	<b>409114</b>	Ø 278 9 7,3 + S
			→			<b>24.0309-0114.1</b>	<b>509114</b>	Ø 278 9 7,3 + S
<b>MERCEDES-BENZ - E-KLASSE Coupe (C207) 01/09→</b>								
<b> Bremsbelagsatz, Scheibenbremse</b>								
E 200 (207.334)	135	06/13→	←	für Fahrzeuge ohne Sportpaket / für Fahrzeuge ohne AMG-Sportpaket		<b>13.0460-2732.2</b>	<b>602732</b>	TRW 24306 20,3 + WE / - WK + Zub
						<b>13.0470-2732.2</b>	<b>LD2732</b>	TRW 24306 20,3 + WE / - WK + Zub Ceramic
E 200 CGI (207.348)	135	01/10→						
E 220 BlueTEC (207.301)	130	05/14→						
E 220 CDI	120	07/14→	←	für Fahrzeuge mit Sportpaket / für Fahrzeuge mit AMG-Sportpaket		<b>13.0460-2734.2</b>	<b>602734</b>	TRW 24310 19,0 + WE / - WK
E 220 CDI / d (207.302, 207.301)	125	01/10→						
↓								









	kw			 	! #		
<b>MERCEDES-BENZ - E-KLASSE Coupe (C207) 01/09→</b>							
<b> Bremsbelagsatz, Scheibenbremse</b>							
E 200 (207.334) E 200 CGI (207.348) E 220 BlueTEC (207.301) E 220 CDI E 220 CDI / d (207.302, 207.301)	135 135 130 120 125	06/13→ 01/10→ 05/14→ 07/14→ 01/10→	← →	für Fahrzeuge mit Sportpaket / für Fahrzeuge mit AMG-Sportpaket		13.0470-2734.2 LD2734 13.0460-7244.2 607244 13.0470-7244.2 LD7244	TRW 24310 19,0 + WE / - WK Ceramic ATE 24253 17,8 + WE / - WK ATE 24253 17,8 + WE / - WK Ceramic
E 250 (207.336) E 320 (207.362) E 350 4-matic (207.388) E 350 BlueTEC E 350 BlueTEC / d (207.326)	155 200 225 185 190	06/13→ 07/14→ 02/13→ 03/13→ 05/14→	← →			13.0460-2734.2 602734 13.0470-2734.2 LD2734 13.0460-7244.2 607244 13.0470-7244.2 LD7244	TRW 24310 19,0 + WE / - WK Ceramic TRW 24310 19,0 + WE / - WK Ceramic ATE 24253 17,8 + WE / - WK ATE 24253 17,8 + WE / - WK Ceramic
E 250 CDI / BlueTEC / d (207.303, 207.304)	150	01/09→	← →	05/09→ 05/09→		13.0460-2734.2 602734 13.0470-2734.2 LD2734 13.0460-7244.2 607244 13.0470-7244.2 LD7244	TRW 24310 19,0 + WE / - WK Ceramic TRW 24310 19,0 + WE / - WK Ceramic ATE 24253 17,8 + WE / - WK ATE 24253 17,8 + WE / - WK Ceramic
E 250 CGI (207.347)	150	01/09→	← ← →	05/09→; für Fahrzeuge ohne Sportpaket / für Fahrzeuge ohne AMG-Sportpaket 05/09→; für Fahrzeuge mit Sportpaket / für Fahrzeuge mit AMG-Sportpaket 05/09→		13.0460-2732.2 602732 13.0470-2732.2 LD2732 13.0460-2734.2 602734 13.0470-2734.2 LD2734 13.0460-7244.2 607244 13.0470-7244.2 LD7244	TRW 24306 20,3 + WE / - WK + Zub TRW 24306 20,3 + WE / - WK + Zub Ceramic TRW 24310 19,0 + WE / - WK Ceramic TRW 24310 19,0 + WE / - WK Ceramic ATE 24253 17,8 + WE / - WK ATE 24253 17,8 + WE / - WK Ceramic
E 300 (207.355) E 350 (207.359) E 350 CDI	185 225 195	04/11→ 04/11→ 04/11→	← → →		ALU GG	13.0460-2734.2 602734 13.0470-2734.2 LD2734 13.0460-7244.2 607244 13.0470-7244.2 LD7244 13.0460-7257.2 607257 13.0470-7257.2 LD7257	TRW 24310 19,0 + WE / - WK Ceramic TRW 24310 19,0 + WE / - WK Ceramic ATE 24253 17,8 + WE / - WK ATE 24253 17,8 + WE / - WK Ceramic ATE 24253 18,0 + WE / - WK ATE 24253 18,0 + WE / - WK Ceramic
E 350 (207.356)	200	05/11→	←			13.0460-2734.2 602734 13.0470-2734.2 LD2734	TRW 24310 19,0 + WE / - WK TRW 24310 19,0 + WE / - WK Ceramic
E 350 CDI (207.322) E 350 CGI (207.357)	170 215	01/09→ 01/09→	← → →	05/09→ 05/09→; ALU 05/09→; GG		13.0460-2734.2 602734 13.0470-2734.2 LD2734 13.0460-7244.2 607244 13.0470-7244.2 LD7244 13.0460-7257.2 607257 13.0470-7257.2 LD7257	TRW 24310 19,0 + WE / - WK TRW 24310 19,0 + WE / - WK Ceramic ATE 24253 17,8 + WE / - WK ATE 24253 17,8 + WE / - WK Ceramic ATE 24253 18,0 + WE / - WK ATE 24253 18,0 + WE / - WK Ceramic
E 400 E 400 (207.361)	245 245	06/13→ 07/14→	← →			13.0460-2734.2 602734 13.0460-7244.2 607244 13.0470-7244.2 LD7244	TRW 24310 19,0 + WE / - WK ATE 24253 17,8 + WE / - WK ATE 24253 17,8 + WE / - WK Ceramic
E 500 (207.372)	285	01/09→	← → →	05/09→ 05/09→; ALU 05/09→; GG		13.0460-2734.2 602734 13.0460-7244.2 607244 13.0470-7244.2 LD7244 13.0460-7257.2 607257 13.0470-7257.2 LD7257	TRW 24310 19,0 + WE / - WK ATE 24253 17,8 + WE / - WK ATE 24253 17,8 + WE / - WK Ceramic ATE 24253 18,0 + WE / - WK ATE 24253 18,0 + WE / - WK Ceramic
E 500 (207.373)	300	09/11→	→ →	ALU GG		13.0460-7244.2 607244 13.0470-7244.2 LD7244 13.0460-7257.2 607257 13.0470-7257.2 LD7257	ATE 24253 17,8 + WE / - WK ATE 24253 17,8 + WE / - WK Ceramic ATE 24253 18,0 + WE / - WK ATE 24253 18,0 + WE / - WK Ceramic
↓							











	kw					! #		
<b>MERCEDES-BENZ - E-KLASSE Coupe (C207) 01/09→</b>								
<b>Warnkontakt, Bremsbelagverschleiß</b>								
E 200 (207.334)	135	06/13→	←	für Fahrzeuge mit Sportpaket / für Fahrzeuge mit AMG-Sportpaket	1	24.8190-0410.2	620410	L= 97,5
E 200 CGI (207.348)	135	01/10→	←	für Fahrzeuge ohne Sportpaket / für Fahrzeuge ohne AMG-Sportpaket	1	24.8190-0410.2	620410	L= 97,5
E 220 BlueTEC (207.301)	130	05/14→						
E 220 CDI	120	07/14→	→		1	24.8190-0410.2	620410	L= 97,5
E 220 CDI / d (207.302, 207.301)	125	01/10→						
E 250 (207.336)	155	06/13→	←		1	24.8190-0410.2	620410	L= 97,5
E 300 (207.355)	185	04/11→	→		1	24.8190-0410.2	620410	L= 97,5
E 320 (207.362)	200	07/14→						
E 350 (207.359)	225	04/11→						
E 350 4-matic (207.388)	225	02/13→						
E 350 BlueTEC	185	03/13→						
E 350 BlueTEC / d (207.326)	190	05/14→						
E 350 CDI	195	04/11→						
E 400	245	06/13→						
E 400 (207.361)	245	07/14→	→		1	24.8190-0410.2	620410	L= 97,5
E 500 (207.373)	300	09/11→						
E 250 CDI / BlueTEC / d (207.303, 207.304)	150	01/09→	←	05/09→	1	24.8190-0410.2	620410	L= 97,5
E 350 CDI (207.322)	170	01/09→	→	05/09→	1	24.8190-0410.2	620410	L= 97,5
E 350 CGI (207.357)	215	01/09→	←	05/09→; für Fahrzeuge mit Sportpaket / für Fahrzeuge mit AMG-Sportpaket	1	24.8190-0410.2	620410	L= 97,5
E 500 (207.372)	285	01/09→						
E 250 CGI (207.347)	150	01/09→						
			←	05/09→; für Fahrzeuge ohne Sportpaket / für Fahrzeuge ohne AMG-Sportpaket	1	24.8190-0410.2	620410	L= 97,5
			→	05/09→	1	24.8190-0410.2	620410	L= 97,5
E 350 (207.356)	200	05/11→	←		1	24.8190-0410.2	620410	L= 97,5
<b>Bremsscheibe</b>								
E 200 (207.334)	135	06/13→	←	für Fahrzeuge mit Sportpaket / für Fahrzeuge mit AMG-Sportpaket		24.0132-0100.1	432100	Ø 322 32 30 V• + S
E 250 (207.336)	155	06/13→						
			←	für Fahrzeuge ohne Sportpaket / für Fahrzeuge ohne AMG-Sportpaket		24.0132-0101.1	432101	Ø 322 32 29,4 V + S
						24.0332-0101.1	532101	Ø 322 32 29,4 V + S
			→			24.0110-0328.1	410328	Ø 300 10 8,3 + S
						24.0310-0328.1	510328	Ø 300 10 8,3 + S
E 200 CGI (207.348)	135	01/10→	←	für Fahrzeuge ohne Sportpaket / für Fahrzeuge ohne AMG-Sportpaket		24.0128-0155.1	428155	Ø 295 28 25,4 V + S
E 220 BlueTEC (207.301)	130	05/14→						
E 220 CDI	120	07/14→	←	für Fahrzeuge mit Sportpaket / für Fahrzeuge mit AMG-Sportpaket		24.0132-0100.1	432100	Ø 322 32 30 V• + S
E 220 CDI / d (207.302, 207.301)	125	01/10→						
			→			24.0110-0328.1	410328	Ø 300 10 8,3 + S
						24.0310-0328.1	510328	Ø 300 10 8,3 + S
E 250 CDI / BlueTEC / d (207.303, 207.304)	150	01/09→	←	05/09→; für Fahrzeuge mit Sportpaket / für Fahrzeuge mit AMG-Sportpaket		24.0132-0100.1	432100	Ø 322 32 30 V• + S
			←	05/09→; für Fahrzeuge ohne Sportpaket / für Fahrzeuge ohne AMG-Sportpaket		24.0132-0101.1	432101	Ø 322 32 29,4 V + S
						24.0332-0101.1	532101	Ø 322 32 29,4 V + S
			→	05/09→		24.0110-0328.1	410328	Ø 300 10 8,3 + S
						24.0310-0328.1	510328	Ø 300 10 8,3 + S
E 250 CGI (207.347)	150	01/09→	←	05/09→; für Fahrzeuge ohne Sportpaket / für Fahrzeuge ohne AMG-Sportpaket		24.0128-0155.1	428155	Ø 295 28 25,4 V + S
						24.0328-0155.1	528155	Ø 295 28 25,4 V + S
			←	05/09→; für Fahrzeuge mit Sportpaket / für Fahrzeuge mit AMG-Sportpaket		24.0132-0100.1	432100	Ø 322 32 30 V• + S
			→	05/09→		24.0110-0328.1	410328	Ø 300 10 8,3 + S
						24.0310-0328.1	510328	Ø 300 10 8,3 + S
E 300 (207.355)	185	04/11→	←	für Fahrzeuge mit Sportpaket / für Fahrzeuge mit AMG-Sportpaket		24.0132-0100.1	432100	Ø 322 32 30 V• + S
E 350 (207.356)	200	05/11→						
E 350 (207.359)	225	04/11→	←	für Fahrzeuge ohne Sportpaket / für Fahrzeuge ohne AMG-Sportpaket		24.0132-0101.1	432101	Ø 322 32 29,4 V + S
E 350 4-matic (207.388)	225	02/13→						
E 350 BlueTEC	185	03/13→						
E 350 BlueTEC / d (207.326)	190	05/14→						
E 350 CDI	195	04/11→	→			24.0120-0208.1	420208	Ø 300 22 19,4 V + S
E 320 (207.362)	200	07/14→	←			24.0132-0168.1	432168	Ø 344 32 30 V• + S
E 400	245	06/13→						
E 400 (207.361)	245	07/14→	→			24.0120-0208.1	420208	Ø 300 22 19,4 V + S
↓								









	kW			 	! #		
<b>MERCEDES-BENZ - E-KLASSE Coupe (C207) 01/09→</b>							
 <b>Bremsscheibe</b>							
E 350 CDI (207.322) E 350 CGI (207.357)	170 215	01/09→ 01/09→	←	05/09→; für Fahrzeuge mit Sportpaket / für Fahr- zeuge mit AMG-Sportpaket		24.0132-0100.1 432100	∅ 322 32 30 V• + S
			←	05/09→; für Fahrzeuge ohne Sportpaket / für Fahrzeuge ohne AMG-Sportpaket		24.0132-0101.1 432101 24.0332-0101.1 532101	∅ 322 32 29,4 V + S ∅ 322 32 29,4 V + S
			→	05/09→		24.0120-0208.1 420208	∅ 300 22 19,4 V + S
E 500 (207.372)	285	01/09→	←	05/09→		24.0132-0168.1 432168	∅ 344 32 30 V• + S
			→	05/09→		24.0120-0208.1 420208	∅ 300 22 19,4 V + S
E 500 (207.373)	300	09/11→	←			24.0136-0108.1 436108	∅ 360 36 34 V• + S
			→			24.0120-0208.1 420208	∅ 300 22 19,4 V + S
<b>MERCEDES-BENZ - E-KLASSE Coupe (C238) 12/16→</b>							
 <b>Bremsbelagsatz, Scheibenbremse</b>							
AMG E 53 EQ Boost 4- matic+ (238.361)	320	05/18→	←			13.0460-4870.2 604870	BRE 25179 17,8 + WE / - WK
E 200 (238.342) E 220 d (238.314) E 220 d (238.314)	135 120 143	12/16→ 12/16→ 12/16→	←	für Fahrzeuge ohne AMG-Sportpaket; +SA 088		13.0460-2610.2 602610 13.0470-2610.2 LD2610	TRW 22076 19,6 + WE / - WK TRW 22076 19,6 + WE / - WK Ceramic
			←	für Fahrzeuge ohne AMG-Sportpaket; nicht für SA Code: 088		13.0460-2792.2 602792 13.0470-2792.2 LD2792	TRW 22031 19,6 + WE / - WK TRW 22031 19,6 + WE / - WK Ceramic
			←	für Fahrzeuge mit AMG-Sportpaket		13.0460-4883.2 604883 13.0470-4883.2 LD4883	BRE 22061 18,7 + WE / - WK BRE 22061 18,7 + WE / - WK Ceramic
E 200 4-matic (238.343) E 220 d 4-matic (238.315)	135 143	06/17→ 03/17→	←	für Fahrzeuge ohne AMG-Sportpaket		13.0460-2610.2 602610 13.0470-2610.2 LD2610	TRW 22076 19,6 + WE / - WK TRW 22076 19,6 + WE / - WK Ceramic
			←	für Fahrzeuge mit AMG-Sportpaket		13.0460-4883.2 604883 13.0470-4883.2 LD4883	BRE 22061 18,7 + WE / - WK BRE 22061 18,7 + WE / - WK Ceramic
E 300 (238.348) E 350 EQ Boost (238.385)	180 220	12/16→ 10/17→	←	für Fahrzeuge ohne AMG-Sportpaket		13.0460-4883.2 604883 13.0470-4883.2 LD4883	BRE 22061 18,7 + WE / - WK BRE 22061 18,7 + WE / - WK Ceramic
E 300 d (238.318)	180	05/18→	←	für Fahrzeuge mit AMG-Sportpaket		13.0460-4883.2 604883 13.0470-4883.2 LD4883	BRE 22061 18,7 + WE / - WK BRE 22061 18,7 + WE / - WK Ceramic
<b>Warnkontakt, Bremsbelagverschleiß</b>							
AMG E 53 EQ Boost 4- matic+ (238.361)	320	05/18→	←		1	24.8190-0959.2 620959	L= 102
			→		1	24.8190-0067.2 620067	L= 92,5
E 200 (238.342) E 200 4-matic (238.343) E 220 d (238.314) E 220 d (238.314) E 220 d 4-matic (238.315) E 300 (238.348) E 300 d (238.318) E 350 d 4-matic (238.334) E 350 EQ Boost (238.385) E 400 4-matic (238.366)	135 135 120 143 143 180 180 190 220 245	12/16→ 06/17→ 12/16→ 12/16→ 03/17→ 12/16→ 05/18→ 06/17→ 10/17→ 12/16→	← ← →		1	24.8190-0067.2 620067	L= 92,5 L= 92,5
 <b>Bremsscheibe</b>							
E 200 (238.342) E 220 d (238.314) E 220 d (238.314)	135 120 143	12/16→ 12/16→ 12/16→	←	für Fahrzeuge ohne AMG-Sportpaket; nicht für SA Code: 088		24.0128-0330.1 428330	∅ 305 28 25,4 V + S
<b>MERCEDES-BENZ - E-KLASSE T-Model (S124) 06/93→06/96</b>							
 <b>Bremsbelagsatz, Scheibenbremse</b>							
E 200 T (124.079) E 220 T (124.082) E 250 TD (124.186) E 250 Turbo D E 280 T (124.088) E 280 T (124.088) E 300 T 4-matic (124.290) E 300 TD (124.191)	100 110 83 93 142 145 132 100	06/93→06/96 06/93→06/96 06/93→06/96 06/93→06/96 06/93→06/96 06/93→06/96 06/93→06/96 06/93→06/96	← ← →			13.0460-2927.2 602927 13.0470-2927.2 LD2927 13.0460-3805.2 603805 13.0470-3805.2 LD3805	TRW 20941 19,3 + WE / - WK TRW 20941 19,3 + WE / - WK Ceramic ATE 21197 15,0 + WE / - WK ATE 21197 15,0 + WE / - WK Ceramic



















	kW			 	! #		
<b>MERCEDES-BENZ - E-KLASSE T-Model (S124) 06/93→06/96</b>							
<b> Bremsbelagsatz, Scheibenbremse</b>							
E 300 T Turbo-D (124.193) E 300 T Turbo-D 4-matic (124.393)	108	06/93→06/96	←			13.0460-2927.2 602927	TRW 20941 19,3 + WE / - WK
	108	06/93→06/96	→			13.0470-2927.2 LD2927	TRW 20941 19,3 + WE / - WK Ceramic
			→			13.0460-3805.2 603805	ATE 21197 15,0 + WE / - WK
						13.0470-3805.2 LD3805	ATE 21197 15,0 + WE / - WK Ceramic
E 320 T (124.092)	162	06/93→06/96	←	→ F 242721		13.0460-4201.2 604201	ATE 21153 17,5 + WE / - WK
			←	F 242722→		13.0460-4202.2 604202	ATE 21153 16,0 + WE / - WK
			→	→ F 323055		13.0460-3805.2 603805	ATE 21197 15,0 + WE / - WK
						13.0470-3805.2 LD3805	ATE 21197 15,0 + WE / - WK Ceramic
			→	F 323056→		13.0460-4047.2 604047	ATE 21305 15,7 + WE / - WK
						13.0470-4047.2 LD4047	ATE 21305 15,7 + WE / - WK Ceramic
E 36 T AMG (124.092)	200	05/94→06/96	←			13.0460-4201.2 604201	ATE 21153 17,5 + WE / - WK
			→	→ F 323055		13.0460-3805.2 603805	ATE 21197 15,0 + WE / - WK
						13.0470-3805.2 LD3805	ATE 21197 15,0 + WE / - WK Ceramic
			→	F 323056→		13.0460-4047.2 604047	ATE 21305 15,7 + WE / - WK
						13.0470-4047.2 LD4047	ATE 21305 15,7 + WE / - WK Ceramic
<b>Warnkontakt, Bremsbelagverschleiß</b>							
E 200 T (124.079) E 220 T (124.082)	100 110	06/93→06/96 06/93→06/96	←		2	24.8190-0402.2 620402	L= 68 L= 150
E 250 TD (124.186) E 250 Turbo D E 280 T (124.088) E 280 T (124.088) E 300 T 4-matic (124.290) E 300 TD (124.191) E 300 T Turbo-D (124.193) E 300 T Turbo-D 4-matic (124.393)	83 93 142 145 132 100 108 108	06/93→06/96 06/93→06/96 06/93→06/96 06/93→06/96 06/93→06/96 06/93→06/96 06/93→06/96 06/93→06/96	→		2	24.8190-0401.2 620401	L= 95
E 320 T (124.092)	162	06/93→06/96	←	→ F 242721	2	24.8190-0401.2 620401	L= 95
			←	F 242722→	2	24.8190-0401.2 620401	L= 95
			→	→ F 323055	2	24.8190-0401.2 620401	L= 95
			→	F 323056→	2	24.8190-0401.2 620401	L= 95
E 36 T AMG (124.092)	200	05/94→06/96	←		2	24.8190-0401.2 620401	L= 95
			→	→ F 323055	2	24.8190-0401.2 620401	L= 95
			→	F 323056→	2	24.8190-0401.2 620401	L= 95
<b>Zubehörsatz, Scheibenbremsbelag</b>							
E 200 T (124.079) E 220 T (124.082) E 250 TD (124.186) E 250 Turbo D E 280 T (124.088) E 280 T (124.088) E 300 T 4-matic (124.290) E 300 TD (124.191) E 300 T Turbo-D (124.193) E 300 T Turbo-D 4-matic (124.393)	100 110 83 93 142 145 132 100 108 108	06/93→06/96 06/93→06/96 06/93→06/96 06/93→06/96 06/93→06/96 06/93→06/96 06/93→06/96 06/93→06/96 06/93→06/96 06/93→06/96	→			13.0460-0186.2 610186	ATE
E 320 T (124.092)	162	06/93→06/96	←	F 242722→		13.0460-0268.2 610268	
			→	→ F 323055		13.0460-0186.2 610186	ATE
			→	F 323056→		13.0460-0236.2 610236	ATE
E 36 T AMG (124.092)	200	05/94→06/96	→	→ F 323055		13.0460-0186.2 610186	ATE
			→	F 323056→		13.0460-0236.2 610236	ATE
<b> Bremsscheibe</b>							
E 200 T (124.079) E 220 T (124.082)	100 110	06/93→06/96 06/93→06/96	←			24.0122-0123.1 422123	Ø 284 22 19,4 V + S
E 250 Turbo D E 280 T (124.088)	93 142	06/93→06/96 06/93→06/96	→			24.0109-0114.1 409114	Ø 278 9 7,3 + S
						24.0309-0114.1 509114	Ø 278 9 7,3 + S







	kW			 	! #		
<b>MERCEDES-BENZ - E-KLASSE T-Model (S124) 06/93→06/96</b>							
<b> Bremsscheibe</b>							
E 280 T (124.088)	145	06/93→06/96	←			24.0122-0123.1 422123	Ø 284 22 19,4 V + S
E 300 TD (124.191)	100	06/93→06/96	→			24.0109-0114.1 409114	Ø 278 9 7,3 + S
E 300 T Turbo-D (124.193)	108	06/93→06/96				24.0309-0114.1 509114	Ø 278 9 7,3 + S
E 250 TD (124.186)	83	06/93→06/96	←			24.0112-0117.1 412117	Ø 284 12 10 + S
			→			24.0109-0114.1 409114	Ø 278 9 7,3 + S
						24.0309-0114.1 509114	Ø 278 9 7,3 + S
E 300 T 4-matic (124.290)	132	06/93→06/96	←			24.0122-0134.1 422134	Ø 284 22 19,4 V
E 300 T Turbo-D 4-matic (124.393)	108	06/93→06/96	→			24.0109-0114.1 409114	Ø 278 9 7,3 + S
						24.0309-0114.1 509114	Ø 278 9 7,3 + S
E 320 T (124.092)	162	06/93→06/96	←	→ F 242721		24.0122-0136.1 422136	Ø 295 22 19,4 V
			←	F 242722→		24.0125-0107.1 425107	Ø 294 25 22,4 V
			→	→ F 323055		24.0120-0199.1 420199	Ø 278 19,9 17,4 V
E 36 T AMG (124.092)	200	05/94→06/96	←			24.0130-0121.1 430121	Ø 320 30 28 V
			←			24.0130-0122.1 430122	Ø 320 30 28 V
			→	→ F 323055		24.0120-0199.1 420199	Ø 278 19,9 17,4 V
<b>MERCEDES-BENZ - E-KLASSE T-Model (S210) 06/96→03/03</b>							
<b> Bremsbelagsatz, Scheibenbremse</b>							
E 200 T (210.235)	100	06/96→08/00	←			13.0460-7086.2 607086	ATE 21664 19,8 + WE / - WK
E 200 T Kompressor (210.248)	120	08/00→03/03	→			13.0470-7086.2 LD7086	ATE 21664 19,8 + WE / - WK Ceramic
E 230 T (210.237)	110	06/96→06/97				13.0460-4047.2 604047	ATE 21305 15,7 + WE / - WK Ceramic
						13.0470-4047.2 LD4047	ATE 21305 15,7 + WE / - WK Ceramic
E 200 T Kompressor (210.245)	137	06/97→03/03	←	09/97→		13.0460-7087.2 607087	ATE 21670 19,3 + WE / - WK Ceramic
			→	09/97→		13.0460-4047.2 604047	ATE 21305 15,7 + WE / - WK Ceramic
						13.0470-4047.2 LD4047	ATE 21305 15,7 + WE / - WK Ceramic
E 220 T CDI (210.206)	100	05/99→03/03	←	Radstand [mm]: 2.833		13.0460-7086.2 607086	ATE 21664 19,8 + WE / - WK Ceramic
E 220 T CDI (210.206)	105	07/99→03/03	←	Radstand [mm]: 3.570		13.0470-7086.2 LD7086	ATE 21664 19,8 + WE / - WK Ceramic
E 290 T Turbo-D (210.217)	95	06/96→07/99				13.0460-7087.2 607087	ATE 21670 19,3 + WE / - WK Ceramic
			→			13.0460-4047.2 604047	ATE 21305 15,7 + WE / - WK Ceramic
						13.0470-4047.2 LD4047	ATE 21305 15,7 + WE / - WK Ceramic
E 220 T CDI (210.206)	92	06/98→07/99	←	07/98→; Radstand [mm]: 2.833		13.0460-7086.2 607086	ATE 21664 19,8 + WE / - WK Ceramic
			←	07/98→; Radstand [mm]: 3.570		13.0460-7087.2 607087	ATE 21670 19,3 + WE / - WK Ceramic
			→	07/98→		13.0460-4047.2 604047	ATE 21305 15,7 + WE / - WK Ceramic
						13.0470-4047.2 LD4047	ATE 21305 15,7 + WE / - WK Ceramic
E 240 T (210.261)	125	06/97→03/03	←	09/97→; - ESP		13.0460-7086.2 607086	ATE 21664 19,8 + WE / - WK Ceramic
			←	09/97→; + ESP		13.0460-7087.2 607087	ATE 21670 19,3 + WE / - WK Ceramic
			→	09/97→		13.0460-4047.2 604047	ATE 21305 15,7 + WE / - WK Ceramic
						13.0470-4047.2 LD4047	ATE 21305 15,7 + WE / - WK Ceramic
E 240 T (210.262)	125	08/00→03/03	←	- ESP		13.0460-7086.2 607086	ATE 21664 19,8 + WE / - WK Ceramic
			←	+ ESP		13.0460-7087.2 607087	ATE 21670 19,3 + WE / - WK Ceramic
			→			13.0470-7087.2 LD7087	ATE 21670 19,3 + WE / - WK Ceramic
						13.0460-4047.2 604047	ATE 21305 15,7 + WE / - WK Ceramic

















	kw			 	! #		
<b>MERCEDES-BENZ - E-KLASSE T-Model (S210) 06/96→03/03</b>							
<b> Bremsbelagsatz, Scheibenbremse</b>							
E 240 T (210.262)	125	08/00→03/03	➔			<b>13.0470-4047.2 LD4047</b>	ATE 21305 15,7 + WE / - WK Ceramic
E 250 T D (210.210)	83	06/96→07/99	➔	Radstand [mm]: 2.833		<b>13.0460-7086.2 607086</b> <b>13.0470-7086.2 LD7086</b>	ATE 21664 19,8 + WE / - WK Ceramic
			➔	für Rechtslenker; Radstand [mm]: 2.833		<b>13.0460-7086.2 607086</b> <b>13.0470-7086.2 LD7086</b>	ATE 21664 19,8 + WE / - WK Ceramic
			➔	Radstand [mm]: 3.570		<b>13.0460-7087.2 607087</b> <b>13.0470-7087.2 LD7087</b>	ATE 21670 19,3 + WE / - WK Ceramic
			➔	Radstand [mm]: 3.570		<b>13.0460-4047.2 604047</b> <b>13.0470-4047.2 LD4047</b>	ATE 21305 15,7 + WE / - WK Ceramic
			➔	für Rechtslenker; Radstand [mm]: 2.833		<b>13.0460-4047.2 604047</b> <b>13.0470-4047.2 LD4047</b>	ATE 21305 15,7 + WE / - WK Ceramic
			➔	Radstand [mm]: 2.833		<b>13.0460-4047.2 604047</b> <b>13.0470-4047.2 LD4047</b>	ATE 21305 15,7 + WE / - WK Ceramic
			➔	Radstand [mm]: 2.833		<b>13.0460-4047.2 604047</b> <b>13.0470-4047.2 LD4047</b>	ATE 21305 15,7 + WE / - WK Ceramic
E 250 T Turbo-D (210.215)	110	06/97→07/99	➔	09/97→		<b>13.0460-7086.2 607086</b> <b>13.0470-7086.2 LD7086</b>	ATE 21664 19,8 + WE / - WK Ceramic
			➔	09/97→		<b>13.0460-4047.2 604047</b> <b>13.0470-4047.2 LD4047</b>	ATE 21305 15,7 + WE / - WK Ceramic
E 270 T CDI E 270 T CDI (210.216) E 280 T 4-matic (210.281) E 300 T Turbo-D (210.225) E 320 T (210.265) E 320 T CDI (210.226)	120	02/00→03/03	➔			<b>13.0460-7087.2 607087</b>	ATE 21670 19,3 + WE / - WK
	125	07/99→03/03	➔			<b>13.0470-7087.2 LD7087</b>	ATE 21670 19,3 + WE / - WK Ceramic
	150	12/96→03/03	➔			<b>13.0460-4047.2 604047</b>	ATE 21305 15,7 + WE / - WK
	130	12/96→07/99	➔			<b>13.0470-4047.2 LD4047</b>	ATE 21305 15,7 + WE / - WK Ceramic
	145	07/99→03/03	➔			<b>13.0460-4047.2 604047</b>	ATE 21305 15,7 + WE / - WK Ceramic
E 280 T (210.263)	150	12/96→03/03	➔	Radstand [mm]: 3.570		<b>13.0460-7087.2 607087</b> <b>13.0470-7087.2 LD7087</b>	ATE 21670 19,3 + WE / - WK Ceramic
			➔	Radstand [mm]: 3.570		<b>13.0460-4047.2 604047</b> <b>13.0470-4047.2 LD4047</b>	ATE 21305 15,7 + WE / - WK Ceramic
E 320 T 4-matic (210.282)	165	12/96→03/03	➔	06/97→		<b>13.0460-7087.2 607087</b> <b>13.0470-7087.2 LD7087</b>	ATE 21670 19,3 + WE / - WK Ceramic
			➔	06/97→		<b>13.0460-4047.2 604047</b> <b>13.0470-4047.2 LD4047</b>	ATE 21305 15,7 + WE / - WK Ceramic
E 420 T (210.272)	205	06/96→06/97	➔	→ A 962231 / X 027613		<b>13.0460-4201.2 604201</b>	ATE 21153 17,5 + WE / - WK
			➔	A 962232 / X 027614→		<b>13.0460-7183.2 607183</b>	ATE 21484 20,5 + WE / - WK
			➔			<b>13.0460-4047.2 604047</b> <b>13.0470-4047.2 LD4047</b>	ATE 21305 15,7 + WE / - WK Ceramic
E 430 T (210.270)	205	06/97→03/03	➔	09/97→; → A 962231 / X 027613		<b>13.0460-4201.2 604201</b>	ATE 21153 17,5 + WE / - WK
			➔	A 962232 / X 027614→		<b>13.0460-7183.2 607183</b>	ATE 21484 20,5 + WE / - WK
			➔	09/97→		<b>13.0460-4047.2 604047</b> <b>13.0470-4047.2 LD4047</b>	ATE 21305 15,7 + WE / - WK Ceramic
E 430 T 4-matic (210.283) E 55 T AMG 4-matic (210.274)	205	05/99→03/03	➔			<b>13.0460-7183.2 607183</b>	ATE 21484 20,5 + WE / - WK
	260	03/01→03/03	➔			<b>13.0460-4047.2 604047</b> <b>13.0470-4047.2 LD4047</b>	ATE 21305 15,7 + WE / - WK Ceramic
E 55 T AMG (210.274)	260	08/97→03/03	➔	09/97→		<b>13.0460-7183.2 607183</b>	ATE 21484 20,5 + WE / - WK
			➔	09/97→		<b>13.0460-4047.2 604047</b> <b>13.0470-4047.2 LD4047</b>	ATE 21305 15,7 + WE / - WK Ceramic
<b>Warnkontakt, Bremsbelagverschleiß</b>							
E 200 T (210.235) ↓	100	06/96→08/00	➔		2	<b>24.8190-0401.2 620401</b>	L= 95







	kW			 	! #		
<b>MERCEDES-BENZ - E-KLASSE T-Model (S210) 06/96→03/03</b>							
<b>Warnkontakt, Bremsbelagverschleiß</b>							
E 200 T Kompressor (210.248)	120	08/00→03/03	➔		2	24.8190-0401.2 620401	L= 95
E 230 T (210.237)	110	06/96→06/97					
E 240 T (210.262)	125	08/00→03/03					
E 270 T CDI	120	02/00→03/03					
E 270 T CDI (210.216)	125	07/99→03/03					
E 280 T 4-matic (210.281)	150	12/96→03/03					
E 300 T Turbo-D (210.225)	130	12/96→07/99					
E 320 T (210.265)	165	12/96→03/03					
E 320 T CDI (210.226)	145	07/99→03/03					
E 200 T Kompressor (210.245)	137	06/97→03/03	➔	09/97→	2	24.8190-0401.2 620401	L= 95
E 240 T (210.261)	125	06/97→03/03	➔	09/97→	2	24.8190-0401.2 620401	L= 95
E 250 T Turbo-D (210.215)	110	06/97→07/99					
E 220 T CDI (210.206)	100	05/99→03/03	➔	Radstand [mm]: 3.570	2	24.8190-0401.2 620401	L= 95
E 220 T CDI (210.206)	105	07/99→03/03	➔	Radstand [mm]: 2.833	2	24.8190-0401.2 620401	L= 95
E 290 T Turbo-D (210.217)	95	06/96→07/99	➔		2	24.8190-0401.2 620401	L= 95
E 220 T CDI (210.206)	92	06/98→07/99	➔	07/98→; Radstand [mm]: 3.570	2	24.8190-0401.2 620401	L= 95
			➔	07/98→; Radstand [mm]: 2.833	2	24.8190-0401.2 620401	L= 95
			➔	07/98→	2	24.8190-0401.2 620401	L= 95
E 250 T D (210.210)	83	06/96→07/99	➔	für Rechtslenker; Radstand [mm]: 2.833	2	24.8190-0401.2 620401	L= 95
			➔	Radstand [mm]: 3.570	2	24.8190-0401.2 620401	L= 95
			➔	Radstand [mm]: 2.833	2	24.8190-0401.2 620401	L= 95
			➔	für Rechtslenker; Radstand [mm]: 2.833	2	24.8190-0401.2 620401	L= 95
			➔	Radstand [mm]: 2.833	2	24.8190-0401.2 620401	L= 95
			➔	Radstand [mm]: 3.570	2	24.8190-0401.2 620401	L= 95
E 280 T (210.263)	150	12/96→03/03	➔	Radstand [mm]: 3.570	2	24.8190-0401.2 620401	L= 95
			➔	Radstand [mm]: 3.570	2	24.8190-0401.2 620401	L= 95
E 320 T 4-matic (210.282)	165	12/96→03/03	➔	06/97→	2	24.8190-0401.2 620401	L= 95
			➔	06/97→	2	24.8190-0401.2 620401	L= 95
E 420 T (210.272)	205	06/96→06/97	➔	→ A 962231 / X 027613	2	24.8190-0401.2 620401	L= 95
			➔	A 962232 / X 027614→	2	24.8190-0419.2 620419	L= 74
			➔		2	24.8190-0401.2 620401	L= 95
E 430 T (210.270)	205	06/97→03/03	➔	09/97→; → A 962231 / X 027613	2	24.8190-0401.2 620401	L= 95
			➔	A 962232 / X 027614→	2	24.8190-0419.2 620419	L= 74
			➔	09/97→	2	24.8190-0401.2 620401	L= 95
E 430 T 4-matic (210.283)	205	05/99→03/03	➔		2	24.8190-0419.2 620419	L= 74
E 55 T AMG 4-matic (210.274)	260	03/01→03/03	➔		2	24.8190-0401.2 620401	L= 95
E 55 T AMG (210.274)	260	08/97→03/03	➔	09/97→	2	24.8190-0419.2 620419	L= 74
			➔	09/97→	2	24.8190-0401.2 620401	L= 95
<b>Zubehörsatz, Scheibenbremsbelag</b>							
E 200 T (210.235)	100	06/96→08/00	➔			13.0460-0239.2 610239	ATE
E 200 T Kompressor (210.248)	120	08/00→03/03					
E 220 T CDI (210.206)	100	05/99→03/03					
E 220 T CDI (210.206)	105	07/99→03/03					
E 230 T (210.237)	110	06/96→06/97					
E 240 T (210.262)	125	08/00→03/03					
E 270 T CDI	120	02/00→03/03					
E 270 T CDI (210.216)	125	07/99→03/03					
E 280 T 4-matic (210.281)	150	12/96→03/03					
E 290 T Turbo-D (210.217)	95	06/96→07/99					
E 300 T Turbo-D (210.225)	130	12/96→07/99					
E 320 T (210.265)	165	12/96→03/03					
E 320 T CDI (210.226)	145	07/99→03/03					
E 420 T (210.272)	205	06/96→06/97					
E 200 T Kompressor (210.245)	137	06/97→03/03	➔	09/97→		13.0460-0239.2 610239	ATE
E 240 T (210.261)	125	06/97→03/03					
			↓				









	kw			 	! #		
<b>MERCEDES-BENZ - E-KLASSE T-Model (S210) 06/96→03/03</b>							
<b>Zubehörsatz, Scheibenbremsbelag</b>							
E 250 T Turbo-D (210.215) E 430 T (210.270)	110 205	06/97→07/99 06/97→03/03	➡	09/97→		13.0460-0239.2 610239	ATE
E 220 T CDI (210.206)	92	06/98→07/99	➡	07/98→		13.0460-0239.2 610239	ATE
E 250 T D (210.210)	83	06/96→07/99	➡	für Rechtslenker; Radstand [mm]: 2.833		13.0460-0239.2 610239	ATE
			➡	Radstand [mm]: 3.570		13.0460-0239.2 610239	ATE
			➡	Radstand [mm]: 2.833		13.0460-0239.2 610239	ATE
E 280 T (210.263)	150	12/96→03/03	➡	Radstand [mm]: 3.570		13.0460-0239.2 610239	ATE
E 320 T 4-matic (210.282)	165	12/96→03/03	➡	06/97→		13.0460-0239.2 610239	ATE
E 430 T 4-matic (210.283)	205	05/99→03/03	➡			13.0460-0236.2 610236	ATE
E 55 T AMG 4-matic (210.274)	260	03/01→03/03	➡				
E 55 T AMG (210.274)	260	08/97→03/03	➡	09/97→		13.0460-0236.2 610236	ATE
<b> Bremsscheibe</b>							
E 200 T (210.235) E 200 T Kompressor (210.248)	100 120	06/96→08/00 08/00→03/03	←			24.0125-0110.1 425110 24.0325-0110.1 525110	Ø 288 25 22,4 V + S Ø 288 25 22,4 V + S
E 230 T (210.237)	110	06/96→06/97	➡			24.0112-0149.1 412149	Ø 290 12 10,3
E 200 T Kompressor (210.245)	137	06/97→03/03	←	09/97→		24.0128-0106.1 428106 24.0328-0106.1 528106	Ø 300 28 25,4 V + S Ø 300 28 25,4 V + S
			➡	09/97→		24.0112-0149.1 412149	Ø 290 12 10,3
E 220 T CDI (210.206) E 220 T CDI (210.206) E 290 T Turbo-D (210.217)	100 105 95	05/99→03/03 07/99→03/03 06/96→07/99	←	Radstand [mm]: 2.833		24.0125-0110.1 425110 24.0325-0110.1 525110	Ø 288 25 22,4 V + S Ø 288 25 22,4 V + S
			←	Radstand [mm]: 3.570		24.0128-0106.1 428106 24.0328-0106.1 528106	Ø 300 28 25,4 V + S Ø 300 28 25,4 V + S
			➡			24.0112-0149.1 412149	Ø 290 12 10,3
E 220 T CDI (210.206)	92	06/98→07/99	←	07/98→; Radstand [mm]: 2.833		24.0125-0110.1 425110 24.0325-0110.1 525110	Ø 288 25 22,4 V + S Ø 288 25 22,4 V + S
			←	07/98→; Radstand [mm]: 3.570		24.0128-0106.1 428106 24.0328-0106.1 528106	Ø 300 28 25,4 V + S Ø 300 28 25,4 V + S
			➡	07/98→		24.0112-0149.1 412149	Ø 290 12 10,3
E 240 T (210.261)	125	06/97→03/03	←	09/97→; - ESP		24.0125-0110.1 425110 24.0325-0110.1 525110	Ø 288 25 22,4 V + S Ø 288 25 22,4 V + S
			←	09/97→; + ESP		24.0128-0106.1 428106 24.0328-0106.1 528106	Ø 300 28 25,4 V + S Ø 300 28 25,4 V + S
			➡	09/97→		24.0112-0149.1 412149	Ø 290 12 10,3
E 240 T (210.262)	125	08/00→03/03	←	- ESP		24.0125-0110.1 425110 24.0325-0110.1 525110	Ø 288 25 22,4 V + S Ø 288 25 22,4 V + S
			←	+ ESP		24.0128-0106.1 428106 24.0328-0106.1 528106	Ø 300 28 25,4 V + S Ø 300 28 25,4 V + S
			➡			24.0112-0149.1 412149	Ø 290 12 10,3
E 250 T D (210.210)	83	06/96→07/99	←	Radstand [mm]: 2.833; für Italien		24.0125-0110.1 425110 24.0325-0110.1 525110	Ø 288 25 22,4 V + S Ø 288 25 22,4 V + S
			←	für Rechtslenker; Radstand [mm]: 2.833		24.0125-0110.1 425110 24.0325-0110.1 525110	Ø 288 25 22,4 V + S Ø 288 25 22,4 V + S
			←	Radstand [mm]: 3.570		24.0128-0106.1 428106 24.0328-0106.1 528106	Ø 300 28 25,4 V + S Ø 300 28 25,4 V + S
			➡	für Italien; Radstand [mm]: 2.833		24.0112-0149.1 412149	Ø 290 12 10,3
			➡	für Rechtslenker; Radstand [mm]: 2.833		24.0112-0149.1 412149	Ø 290 12 10,3
			➡	Radstand [mm]: 3.570		24.0112-0149.1 412149	Ø 290 12 10,3
E 250 T Turbo-D (210.215)	110	06/97→07/99	←	09/97→		24.0125-0110.1 425110 24.0325-0110.1 525110	Ø 288 25 22,4 V + S Ø 288 25 22,4 V + S
			➡	09/97→		24.0112-0149.1 412149	Ø 290 12 10,3
E 270 T CDI E 270 T CDI (210.216) E 280 T 4-matic (210.281)	120 125 150	02/00→03/03 07/99→03/03 12/96→03/03	←			24.0128-0106.1 428106 24.0328-0106.1 528106	Ø 300 28 25,4 V + S Ø 300 28 25,4 V + S
E 300 T Turbo-D (210.225) E 320 T (210.265) E 320 T CDI (210.226)	130 165 145	12/96→07/99 12/96→03/03 07/99→03/03	➡			24.0112-0149.1 412149	Ø 290 12 10,3
↓							



	kw			 	! #		
<b>MERCEDES-BENZ - E-KLASSE T-Model (S210) 06/96→03/03</b>							
<b>Bremsscheibe</b>							
E 280 T (210.263)	150	12/96→03/03	←	Radstand [mm]: 3.570		24.0128-0106.1 428106	Ø 300 28 25,4 V + S
			→	Radstand [mm]: 3.570		24.0328-0106.1 528106	Ø 300 28 25,4 V + S
E 320 T 4-matic (210.282)	165	12/96→03/03	←	06/97→		24.0128-0106.1 428106	Ø 300 28 25,4 V + S
			→	06/97→		24.0328-0106.1 528106	Ø 300 28 25,4 V + S
E 420 T (210.272)	205	06/96→06/97	←	→ A 962231 / X 027613		24.0128-0126.1 428126	Ø 316 28 25,4 V
			←	A 962232 / X 027614→		24.0132-0159.1 432159	Ø 330 32 29,4 V
			→			24.0112-0149.1 412149	Ø 290 12 10,3
E 430 T (210.270)	205	06/97→03/03	←	09/97→; → A 962231 / X 027613		24.0128-0126.1 428126	Ø 316 28 25,4 V
			←	A 962232 / X 027614→		24.0132-0159.1 432159	Ø 330 32 29,4 V
			→	09/97→		24.0112-0149.1 412149	Ø 290 12 10,3
E 430 T 4-matic (210.283)	205	05/99→03/03	←			24.0132-0159.1 432159	Ø 330 32 29,4 V
<b>MERCEDES-BENZ - E-KLASSE T-Model (S211) 02/03→07/09</b>							
<b>Bremsbelagsatz, Scheibenbremse</b>							
350 CGI (211.257)	215	05/06→07/09	←			13.0460-4990.2 604990	BRE 23271 17,4 + WE / - WK
E 230 T (211.252)	150	05/07→07/09				13.0470-4990.2 LD4990	BRE 23271 17,4 + WE / - WK Ceramic
E 280 T CDI (211.223)	130	05/04→07/09					
E 320 T (211.265)	165	03/03→07/09					
E 320 T CDI (211.222)	155	11/07→07/09	→			13.0460-7171.2 607171	ATE 23334 16,7 + WE / - WK
E 320 T CDI (211.222)	165	03/05→07/09				13.0470-7171.2 LD7171	ATE 23334 16,7 + WE / - WK Ceramic
E 320 T CDI (211.226)	150	03/03→07/09					
E 350 T (211.256)	200	03/05→07/09					
E 200 CDI (211.207)	100	04/06→07/09	←	für Fahrzeuge ohne Sportpaket / für Fahrzeuge ohne AMG-Sportpaket		13.0460-3999.2 603999	BOS 23743 20,1 + WK + Zub
E 200 Kompressor (211.241)	135	04/06→07/09				13.0470-3999.2 LD3999	BOS 23743 20,1 + WK + Zub Ceramic
E 200 T Kompressor (211.242)	120	03/03→07/09	←	für Fahrzeuge mit Sportpaket / für Fahrzeuge mit AMG-Sportpaket		13.0460-4990.2 604990	BRE 23271 17,4 + WE / - WK
E 220 CDI (211.206)	100	03/03→07/09				13.0470-4990.2 LD4990	BRE 23271 17,4 + WE / - WK Ceramic
E 220 T CDI	120	03/03→07/09					
E 220 T CDI (211.206)	110	03/03→07/09				13.0460-7171.2 607171	ATE 23334 16,7 + WE / - WK
E 220 T CDI (211.208)	125	04/06→07/09	→			13.0470-7171.2 LD7171	ATE 23334 16,7 + WE / - WK Ceramic
E 280 T CDI (211.220)	140	03/05→07/09					
E 240 T (211.261)	130	03/03→07/09	←			13.0460-3999.2 603999	BOS 23743 20,1 + WK + Zub
E 270 T CDI (211.216)	120	03/03→07/09				13.0470-3999.2 LD3999	BOS 23743 20,1 + WK + Zub Ceramic
E 270 T CDI (211.216)	130	03/03→07/09					
			→			13.0460-7171.2 607171	ATE 23334 16,7 + WE / - WK
						13.0470-7171.2 LD7171	ATE 23334 16,7 + WE / - WK Ceramic
E 240 T 4-matic (211.280)	130	07/03→07/09	←			13.0460-7203.2 607203	ATE 21670 19,3 + WE / - WK
E 320 T 4-matic (211.282)	165	07/03→07/09				13.0470-7203.2 LD7203	ATE 21670 19,3 + WE / - WK Ceramic
			→			13.0460-7171.2 607171	ATE 23334 16,7 + WE / - WK
						13.0470-7171.2 LD7171	ATE 23334 16,7 + WE / - WK Ceramic
E 280 T (211.254)	170	03/05→07/09	←	05/05→		13.0460-4990.2 604990	BRE 23271 17,4 + WE / - WK
						13.0470-4990.2 LD4990	BRE 23271 17,4 + WE / - WK Ceramic
			→	05/05→		13.0460-7171.2 607171	ATE 23334 16,7 + WE / - WK
						13.0470-7171.2 LD7171	ATE 23334 16,7 + WE / - WK Ceramic
E 280 T 4-matic (211.292)	170	03/05→07/09	←	05/05→; → A 870950; für Fahrzeuge mit Sportpaket / für Fahrzeuge mit AMG-Sportpaket		13.0460-7183.2 607183	ATE 21484 20,5 + WE / - WK
E 280 T CDI 4-matic (211.284)	140	03/05→07/09					
E 320 T CDI 4-matic (211.289)	165	03/05→07/09	←	05/05→; für Fahrzeuge ohne Sportpaket / für Fahrzeuge ohne AMG-Sportpaket		13.0460-7203.2 607203	ATE 21670 19,3 + WE / - WK
						13.0470-7203.2 LD7203	ATE 21670 19,3 + WE / - WK Ceramic
			←	A 870951→; für Fahrzeuge mit Sportpaket / für Fahrzeuge mit AMG-Sportpaket		13.0460-7220.2 607220	ATE 23922 21,0 + WE / - WK
						13.0470-7220.2 LD7220	ATE 23922 21,0 + WE / - WK Ceramic
			→	05/05→		13.0460-7171.2 607171	ATE 23334 16,7 + WE / - WK
						13.0470-7171.2 LD7171	ATE 23334 16,7 + WE / - WK Ceramic
E 350 T 4-matic (211.287)	200	03/05→07/09	←	→ A 870950; für Fahrzeuge mit Sportpaket / für Fahrzeuge mit AMG-Sportpaket		13.0460-7183.2 607183	ATE 21484 20,5 + WE / - WK

	kw			 	! #		
<b>MERCEDES-BENZ - E-KLASSE T-Model (S211) 02/03→07/09</b>							
<b> Bremsbelagsatz, Scheibenbremse</b>							
E 350 T 4-matic (211.287)	200	03/05→07/09	←	für Fahrzeuge ohne Sportpaket / für Fahrzeuge ohne AMG-Sportpaket		13.0460-7203.2 607203	ATE 21670 19,3 + WE / - WK
			←	A 870951→; für Fahrzeuge mit Sportpaket / für Fahrzeuge mit AMG-Sportpaket		13.0470-7203.2 LD7203	ATE 21670 19,3 + WE / - WK Ceramic
			→			13.0460-7171.2 607171	ATE 23334 16,7 + WE / - WK
E 500 T (211.270)	225	10/03→07/09	←			13.0460-4990.2 604990	BRE 23271 17,4 + WE / - WK
			→			13.0460-7171.2 607171	ATE 23334 16,7 + WE / - WK
E 500 T (211.272)	285	04/06→07/09	←			13.0460-4817.2 604817	BRE 23960 18,3 + WE / - WK
			→			13.0460-7171.2 607171	ATE 23334 16,7 + WE / - WK
E 500 T 4-matic (211.283)	225	10/03→07/09	←			13.0460-4990.2 604990	BRE 23271 17,4 + WE / - WK
			←	→ A 870950		13.0460-7183.2 607183	ATE 21484 20,5 + WE / - WK
			←	A 870951→		13.0460-7220.2 607220	ATE 23922 21,0 + WE / - WK
			→			13.0470-7220.2 LD7220	ATE 23922 21,0 + WE / - WK Ceramic
E 500 T 4-matic (211.290)	285	04/06→07/09	←			13.0460-7171.2 607171	ATE 23334 16,7 + WE / - WK
			→			13.0460-7171.2 607171	ATE 23334 16,7 + WE / - WK Ceramic
E 55 T AMG Kompressor (211.276)	350	07/03→07/09	←			13.0460-4997.2 604997	BRE 23943 17,5 + WE / - WK
			→			13.0460-4998.2 604998	BRE 23478 16,5 + WE / - WK
E 63 AMG (211.277)	378	03/06→07/09	←			13.0460-4839.2 604839	BRE 24455 16,8 + WE / - WK
<b>Warnkontakt, Bremsbelagverschleiß</b>							
350 CGI (211.257)	215	05/06→07/09	←		1	24.8190-0410.2 620410	L= 97,5
E 230 T (211.252)	150	05/07→07/09	←		1	24.8190-0416.2 620416	L= 100
E 240 T (211.261)	130	03/03→07/09	←				
E 240 T 4-matic (211.280)	130	07/03→07/09	→		1	24.8190-0410.2 620410	L= 97,5
E 270 T CDI (211.216)	120	03/03→07/09	←				
E 270 T CDI (211.216)	130	03/03→07/09	←				
E 320 T 4-matic (211.282)	165	07/03→07/09	←				
E 500 T (211.270)	225	10/03→07/09	←				
E 200 CDI (211.207)	100	04/06→07/09	←		1	24.8190-0410.2 620410	L= 97,5
E 200 Kompressor (211.241)	135	04/06→07/09	←				
E 200 T Kompressor (211.242)	120	03/03→07/09	←		1	24.8190-0410.2 620410	L= 97,5
E 220 CDI (211.206)	100	03/03→07/09	←				
E 220 T CDI	120	03/03→07/09	←				
E 220 T CDI (211.206)	110	03/03→07/09	←		1	24.8190-0416.2 620416	L= 100
E 220 T CDI (211.208)	125	04/06→07/09	←				
E 280 T CDI (211.220)	140	03/05→07/09	←		1	24.8190-0416.2 620416	L= 100
			→		1	24.8190-0410.2 620410	L= 97,5
E 280 T (211.254)	170	03/05→07/09	←	05/05→	1	24.8190-0410.2 620410	L= 97,5
			→			24.8190-0416.2 620416	L= 100
			→	05/05→	1	24.8190-0410.2 620410	L= 97,5
E 280 T 4-matic (211.292)	170	03/05→07/09	←	 ; 05/05→; → A 870950;	1	24.8190-0410.2 620410	L= 97,5
E 280 T CDI 4-matic (211.284)	140	03/05→07/09	←	für Fahrzeuge mit Sportpaket / für Fahrzeuge mit AMG-Sportpaket			
E 320 T CDI 4-matic (211.289)	165	03/05→07/09	←	 ; A 870951→;	1	24.8190-0410.2 620410	L= 97,5
			←	für Fahrzeuge mit Sportpaket / für Fahrzeuge mit AMG-Sportpaket			
			←	 ; 05/05→;	1	24.8190-0410.2 620410	L= 97,5
			←	für Fahrzeuge ohne Sportpaket / für Fahrzeuge ohne AMG-Sportpaket			

	kw			 	! #		
<b>MERCEDES-BENZ - E-KLASSE T-Model (S211) 02/03→07/09</b>							
<b>Warnkontakt, Bremsbelagverschleiß</b>							
E 280 T 4-matic (211.292)	170	03/05→07/09	←	☐; A 870951→; für Fahrzeuge mit Sportpaket / für Fahrzeuge mit AMG-Sportpaket	1	24.8190-0416.2 620416	L= 100
E 280 T CDI 4-matic (211.284)	140	03/05→07/09	←	☐; 05/05→; für Fahrzeuge ohne Sportpaket / für Fahrzeuge ohne AMG-Sportpaket	1	24.8190-0416.2 620416	L= 100
E 320 T CDI 4-matic (211.289)	165	03/05→07/09	←	☐; 05/05→; → A 870950; für Fahrzeuge mit Sportpaket / für Fahrzeuge mit AMG-Sportpaket	1	24.8190-0416.2 620416	L= 100
			→	05/05→	1	24.8190-0410.2 620410	L= 97,5
E 280 T CDI (211.223)	130	05/04→07/09	←		1	24.8190-0410.2 620410	L= 97,5
E 320 T (211.265)	165	03/03→07/09				24.8190-0416.2 620416	L= 100
E 320 T CDI (211.222)	155	11/07→07/09					
E 320 T CDI (211.222)	165	03/05→07/09	→		1	24.8190-0410.2 620410	L= 97,5
E 320 T CDI (211.226)	150	03/03→07/09					
E 350 T (211.256)	200	03/05→07/09					
E 350 T 4-matic (211.287)	200	03/05→07/09	←	☐; für Fahrzeuge ohne Sportpaket / für Fahrzeuge ohne AMG-Sportpaket	1	24.8190-0410.2 620410	L= 97,5
			←	☐; → A 870950; für Fahrzeuge mit Sportpaket / für Fahrzeuge mit AMG-Sportpaket	1	24.8190-0410.2 620410	L= 97,5
			←	☐; A 870951→; für Fahrzeuge mit Sportpaket / für Fahrzeuge mit AMG-Sportpaket	1	24.8190-0410.2 620410	L= 97,5
			←	☐; → A 870950; für Fahrzeuge mit Sportpaket / für Fahrzeuge mit AMG-Sportpaket	1	24.8190-0416.2 620416	L= 100
			←	☐; A 870951→; für Fahrzeuge mit Sportpaket / für Fahrzeuge mit AMG-Sportpaket	1	24.8190-0416.2 620416	L= 100
			←	☐; für Fahrzeuge ohne Sportpaket / für Fahrzeuge ohne AMG-Sportpaket	1	24.8190-0416.2 620416	L= 100
			→		1	24.8190-0410.2 620410	L= 97,5
E 500 T (211.272)	285	04/06→07/09	←	☐		24.8190-0420.2 620420	L= 119
			→		1	24.8190-0410.2 620410	L= 97,5
E 500 T 4-matic (211.283)	225	10/03→07/09	←	☐	1	24.8190-0410.2 620410	L= 97,5
			←	☐	1	24.8190-0416.2 620416	L= 100
			←	☐; A 870951→		24.8190-0425.2 620425	L= 98
			←	☐; → A 870950		24.8190-0425.2 620425	L= 98
			←	☐; → A 870950		24.8190-0955.2 620955	L= 100
			→		1	24.8190-0410.2 620410	L= 97,5
E 500 T 4-matic (211.290)	285	04/06→07/09	←	☐		24.8190-0425.2 620425	L= 98
			→		1	24.8190-0410.2 620410	L= 97,5
E 55 T AMG Kompressor (211.276)	350	07/03→07/09	←	☐		24.8190-0410.2 620410	L= 97,5
			←	☐		24.8190-0416.2 620416	L= 100
			→		1	24.8190-0410.2 620410	L= 97,5
E 63 AMG (211.277)	378	03/06→07/09	←		1	24.8190-0420.2 620420	L= 119
			→		1	24.8190-0420.2 620420	L= 119
<b>Zubehörsatz, Scheibenbremsbelag</b>							
350 CGI (211.257)	215	05/06→07/09	←			13.0460-0155.2 610155	BRE
E 230 T (211.252)	150	05/07→07/09					
E 200 CDI (211.207)	100	04/06→07/09	←	für Fahrzeuge mit Sportpaket / für Fahrzeuge mit AMG-Sportpaket		13.0460-0155.2 610155	BRE
E 200 Kompressor (211.241)	135	04/06→07/09					
E 200 T Kompressor (211.242)	120	03/03→07/09					
E 220 CDI (211.206)	100	03/03→07/09					
E 220 T CDI	120	03/03→07/09					
E 220 T CDI (211.206)	110	03/03→07/09					
E 220 T CDI (211.208)	125	04/06→07/09					
E 280 T CDI (211.220)	140	03/05→07/09					
E 280 T (211.254)	170	03/05→07/09	←	05/05→		13.0460-0155.2 610155 13.0460-0275.2 610275	BRE
E 280 T CDI (211.223)	130	05/04→07/09	←			13.0460-0155.2 610155 13.0460-0275.2 610275	BRE
E 320 T (211.265)	165	03/03→07/09					
E 320 T CDI (211.222)	155	11/07→07/09					
E 320 T CDI (211.222)	165	03/05→07/09					

	kw			 	! #		
<b>MERCEDES-BENZ - E-KLASSE T-Model (S211) 02/03→07/09</b>							
<b>Zubehörsatz, Scheibenbremsbelag</b>							
E 320 T CDI (211.226)	150	03/03→07/09	←			13.0460-0155.2 610155	BRE
E 350 T (211.256)	200	03/05→07/09				13.0460-0275.2 610275	
E 500 T (211.270)	225	10/03→07/09					
E 500 T 4-matic (211.283)	225	10/03→07/09					
<b> Bremsscheibe</b>							
350 CGI (211.257)	215	05/06→07/09	←	für Fahrzeuge ohne Sportpaket / für Fahrzeuge ohne AMG-Sportpaket		24.0132-0144.1 432144	Ø 330 32 29,4 V + S
E 350 T (211.256)	200	03/05→07/09				24.0332-0144.1 532144	Ø 330 32 29,4 V + S
E 500 T (211.270)	225	10/03→07/09					
			←	für Fahrzeuge mit Sportpaket / für Fahrzeuge mit AMG-Sportpaket		24.0132-0153.1 432153	Ø 330 32 30 V• + S
			→			24.0122-0201.1 422201	Ø 300 22 19,4 V + S
E 200 CDI (211.207)	100	04/06→07/09	←	für Fahrzeuge ohne Sportpaket / für Fahrzeuge ohne AMG-Sportpaket		24.0128-0176.1 428176	Ø 295 28 25,4 V + S
E 200 Kompressor (211.241)	135	04/06→07/09				24.0328-0176.1 528176	Ø 295 28 25,4 V
E 220 CDI (211.206)	100	03/03→07/09	←	für Fahrzeuge mit Sportpaket / für Fahrzeuge mit AMG-Sportpaket		24.0132-0153.1 432153	Ø 330 32 30 V• + S
E 220 T CDI	120	03/03→07/09					
E 220 T CDI (211.206)	110	03/03→07/09	→	nicht für Taxifahrzeuge;		24.0110-0278.1 410278	Ø 300 10 8,3 + S
E 220 T CDI (211.208)	125	04/06→07/09	→	für Fahrzeuge ohne Sportpaket / für Fahrzeuge ohne AMG-Sportpaket		24.0310-0278.1 510278	Ø 300 10 8,3 + S
			→	nicht für Taxifahrzeuge;		24.0122-0201.1 422201	Ø 300 22 19,4 V + S
			→	für Fahrzeuge mit Sportpaket / für Fahrzeuge mit AMG-Sportpaket			
			→	für Taxifahrzeuge		24.0122-0201.1 422201	Ø 300 22 19,4 V + S
E 200 T Kompressor (211.242)	120	03/03→07/09	←	für Fahrzeuge ohne Sportpaket / für Fahrzeuge ohne AMG-Sportpaket		24.0128-0176.1 428176	Ø 295 28 25,4 V + S
			←	für Fahrzeuge mit Sportpaket / für Fahrzeuge mit AMG-Sportpaket		24.0328-0176.1 528176	Ø 295 28 25,4 V
			→	nicht für Taxifahrzeuge		24.0110-0278.1 410278	Ø 300 10 8,3 + S
			→	für Fahrzeuge ohne Sportpaket / für Fahrzeuge ohne AMG-Sportpaket		24.0310-0278.1 510278	Ø 300 10 8,3 + S
			→	nicht für Taxifahrzeuge;		24.0122-0201.1 422201	Ø 300 22 19,4 V + S
			→	für Fahrzeuge mit Sportpaket / für Fahrzeuge mit AMG-Sportpaket			
			→	für Taxifahrzeuge		24.0122-0201.1 422201	Ø 300 22 19,4 V + S
E 230 T (211.252)	150	05/07→07/09	←	für Fahrzeuge ohne Sportpaket / für Fahrzeuge ohne AMG-Sportpaket		24.0128-0142.1 428142	Ø 312 28 25,4 V
			←	für Fahrzeuge mit Sportpaket / für Fahrzeuge mit AMG-Sportpaket		24.0328-0142.1 528142	Ø 312 28 25,4 V
			→			24.0132-0153.1 432153	Ø 330 32 30 V• + S
			→			24.0122-0201.1 422201	Ø 300 22 19,4 V + S
E 240 T (211.261)	130	03/03→07/09	←			24.0128-0176.1 428176	Ø 295 28 25,4 V + S
						24.0328-0176.1 528176	Ø 295 28 25,4 V
			→	nicht für Taxifahrzeuge		24.0110-0278.1 410278	Ø 300 10 8,3 + S
			→			24.0310-0278.1 510278	Ø 300 10 8,3 + S
			→	für Taxifahrzeuge		24.0122-0201.1 422201	Ø 300 22 19,4 V + S
E 240 T 4-matic (211.280)	130	07/03→07/09	←			24.0130-0179.1 430179	Ø 304 30 27,4 V
			→			24.0110-0278.1 410278	Ø 300 10 8,3 + S
						24.0310-0278.1 510278	Ø 300 10 8,3 + S
E 270 T CDI (211.216)	120	03/03→07/09	←			24.0128-0176.1 428176	Ø 295 28 25,4 V + S
E 270 T CDI (211.216)	130	03/03→07/09				24.0328-0176.1 528176	Ø 295 28 25,4 V
			→			24.0122-0201.1 422201	Ø 300 22 19,4 V + S
E 280 T (211.254)	170	03/05→07/09	←	05/05→;		24.0128-0142.1 428142	Ø 312 28 25,4 V
			←	für Fahrzeuge ohne Sportpaket / für Fahrzeuge ohne AMG-Sportpaket		24.0328-0142.1 528142	Ø 312 28 25,4 V
			←	05/05→;		24.0132-0153.1 432153	Ø 330 32 30 V• + S
			←	für Fahrzeuge mit Sportpaket / für Fahrzeuge mit AMG-Sportpaket			
			→	05/05→		24.0122-0201.1 422201	Ø 300 22 19,4 V + S
E 280 T 4-matic (211.292)	170	03/05→07/09	←	05/05→;		24.0130-0179.1 430179	Ø 304 30 27,4 V
E 280 T CDI 4-matic (211.284)	140	03/05→07/09		für Fahrzeuge ohne Sportpaket / für Fahrzeuge ohne AMG-Sportpaket			
E 320 T CDI 4-matic (211.289)	165	03/05→07/09	←	05/05→;		24.0132-0136.1 432136	Ø 330 32 30 V•
			←	für Fahrzeuge mit Sportpaket / für Fahrzeuge mit AMG-Sportpaket			
			→	05/05→		24.0122-0201.1 422201	Ø 300 22 19,4 V + S
E 280 T CDI (211.220)	140	03/05→07/09	←	für Fahrzeuge ohne Sportpaket / für Fahrzeuge ohne AMG-Sportpaket		24.0128-0176.1 428176	Ø 295 28 25,4 V + S
						24.0328-0176.1 528176	Ø 295 28 25,4 V
			←	für Fahrzeuge mit Sportpaket / für Fahrzeuge mit AMG-Sportpaket		24.0132-0153.1 432153	Ø 330 32 30 V• + S
↓							

**MERCEDES-BENZ - E-KLASSE T-Model (S211) 02/03→07/09**

**Bremsscheibe**









E 280 T CDI (211.220)	140	03/05→07/09	➔		24.0122-0201.1	422201	Ø 300 22 19,4 V + S
E 280 T CDI (211.223)	130	05/04→07/09	➔		24.0128-0142.1	428142	Ø 312 28 25,4 V
E 320 T (211.265)	165	03/03→07/09	➔		24.0328-0142.1	528142	Ø 312 28 25,4 V
E 320 T CDI (211.222)	155	11/07→07/09	➔				
E 320 T CDI (211.222)	165	03/05→07/09	➔		24.0122-0201.1	422201	Ø 300 22 19,4 V + S
E 320 T CDI (211.226)	150	03/03→07/09	➔				
E 320 T 4-matic (211.282)	165	07/03→07/09	➔		24.0130-0179.1	430179	Ø 304 30 27,4 V
			➔		24.0122-0201.1	422201	Ø 300 22 19,4 V + S
E 350 T 4-matic (211.287)	200	03/05→07/09	➔	für Fahrzeuge ohne Sportpaket / für Fahrzeuge ohne AMG-Sportpaket	24.0130-0179.1	430179	Ø 304 30 27,4 V
			➔	für Fahrzeuge mit Sportpaket / für Fahrzeuge mit AMG-Sportpaket	24.0132-0136.1	432136	Ø 330 32 30 V•
			➔		24.0122-0201.1	422201	Ø 300 22 19,4 V + S
E 500 T (211.272)	285	04/06→07/09	➔	für Fahrzeuge mit Sportpaket / für Fahrzeuge mit AMG-Sportpaket	24.0132-0138.1	432138	Ø 350 32 30 V• + S
			➔	für Fahrzeuge ohne Sportpaket / für Fahrzeuge ohne AMG-Sportpaket	24.0132-0139.1	432139	Ø 350 32 29,4 V + S
			➔		24.0124-0236.1	424236	Ø 320 24 21,1 V + S
E 500 T 4-matic (211.283)	225	10/03→07/09	➔	für Fahrzeuge mit Sportpaket / für Fahrzeuge mit AMG-Sportpaket	24.0132-0136.1	432136	Ø 330 32 30 V•
E 500 T 4-matic (211.290)	285	04/06→07/09	➔	für Fahrzeuge ohne Sportpaket / für Fahrzeuge ohne AMG-Sportpaket	24.0132-0154.1	432154	Ø 330 32 29,4 V
			➔		24.0122-0201.1	422201	Ø 300 22 19,4 V + S
E 55 T AMG Kompressor (211.276)	350	07/03→07/09	➔		24.0136-0102.1	436102	Ø 360 36 34 V•
			➔		24.0126-0136.1	426136	Ø 330 26 24 V•
E 63 AMG (211.277)	378	03/06→07/09	➔		24.0126-0136.1	426136	Ø 330 26 24 V•









**MERCEDES-BENZ - E-KLASSE T-Model (S212) 08/09→**

**Bremsbelagsatz, Scheibenbremse**







E 200 (212.234)	135	11/12→	➔	03/13→; für Fahrzeuge ohne Sportpaket / für Fahrzeuge ohne AMG-Sportpaket	13.0460-2732.2	602732	TRW 24306 20,3 + WE / - WK + Zub
			➔		13.0470-2732.2	LD2732	TRW 24306 20,3 + WE / - WK + Zub Ceramic
			➔		13.0470-9000.2	LD9000	TRW 24306 20,3 + WE / - WK + Zub Ceramic
			➔	03/13→; für Fahrzeuge mit Sportpaket / für Fahrzeuge mit AMG-Sportpaket	13.0460-2734.2	602734	TRW 24310 19,0 + WE / - WK Ceramic
			➔		13.0470-2734.2	LD2734	TRW 24310 19,0 + WE / - WK Ceramic
			➔	03/13→	13.0460-7259.2	607259	ATE 24862 16,7 + WE / - WK Ceramic
			➔		13.0470-7259.2	LD7259	ATE 24862 16,7 + WE / - WK Ceramic
			➔		13.0470-9001.2	LD9001	ATE 24862 16,7 + WE / - WK Ceramic
E 200 CDI / BlueTEC (212.205, 212.206)	100	11/09→	➔	für Fahrzeuge ohne Sportpaket / für Fahrzeuge ohne AMG-Sportpaket	13.0460-2732.2	602732	TRW 24306 20,3 + WE / - WK + Zub
E 200 CGI (212.248)	135	11/09→	➔		13.0470-2732.2	LD2732	TRW 24306 20,3 + WE / - WK + Zub Ceramic
E 220 BlueTEC	130	05/15→	➔				
E 220 CDI / BlueTEC (212.202, 212.201)	125	11/09→	➔		13.0470-9000.2	LD9000	TRW 24306 20,3 + WE / - WK + Zub Ceramic
			➔	für Fahrzeuge mit Sportpaket / für Fahrzeuge mit AMG-Sportpaket	13.0460-2734.2	602734	TRW 24310 19,0 + WE / - WK Ceramic
			➔		13.0470-2734.2	LD2734	TRW 24310 19,0 + WE / - WK Ceramic
			➔		13.0460-7259.2	607259	ATE 24862 16,7 + WE / - WK Ceramic
			➔		13.0470-7259.2	LD7259	ATE 24862 16,7 + WE / - WK Ceramic
			➔		13.0470-9001.2	LD9001	ATE 24862 16,7 + WE / - WK Ceramic
E 220 BlueTEC 4-matic (212.211)	125	12/14→	➔		13.0460-2734.2	602734	TRW 24310 19,0 + WE / - WK Ceramic
E 250 CDI / BlueTEC (212.203, 212.204)	150	11/09→	➔		13.0470-2734.2	LD2734	TRW 24310 19,0 + WE / - WK Ceramic
E 250 CDI / BlueTEC 4-matic (212.282, 212.297)	150	07/10→	➔		13.0460-7259.2	607259	ATE 24862 16,7 + WE / - WK Ceramic
E 250 CGI (212.247)	150	11/09→	➔		13.0470-7259.2	LD7259	ATE 24862 16,7 + WE / - WK Ceramic
E 300 (212.254)	170	11/09→	➔				
E 300 (212.255)	185	07/11→	➔		13.0470-9001.2	LD9001	ATE 24862 16,7 + WE / - WK Ceramic
E 300 4-matic (212.280)	185	07/11→	➔				
E 300 CDI / BlueTEC (212.227, 212.221)	170	11/09→	➔				
E 350 (212.259)	225	09/11→	➔				









	kW			 	! #		
<b>MERCEDES-BENZ - E-KLASSE T-Model (S212) 08/09 →</b>							
<b> Bremsbelagsatz, Scheibenbremse</b>							
E 350 4-matic (212.287)	200	11/09 →	←			13.0460-2734.2 602734	TRW 24310 19,0 + WE / - WK
E 350 4-matic (212.288, 212.287)	225	09/11 →				13.0470-2734.2 LD2734	TRW 24310 19,0 + WE / - WK Ceramic
E 350 BlueTEC (212.224)	155	11/09 →	→			13.0460-7259.2 607259	ATE 24862 16,7 + WE / - WK
E 350 CDI (212.223)	195	07/11 →				13.0470-7259.2 LD7259	ATE 24862 16,7 + WE / - WK Ceramic
E 350 CDI (212.225)	170	11/09 →					
E 350 CDI 4-matic (212.289)	170	11/09 →				13.0470-9001.2 LD9001	ATE 24862 16,7 + WE / - WK Ceramic
E 350 CGI (212.257)	215	11/09 →					
E 220 CDI (212.202)	120	08/09 →	←	11/09 →; für Fahrzeuge ohne Sportpaket / für Fahrzeuge ohne AMG-Sportpaket		13.0460-2732.2 602732	TRW 24306 20,3 + WE / - WK + Zub
						13.0470-2732.2 LD2732	TRW 24306 20,3 + WE / - WK + Zub Ceramic
						13.0470-9000.2 LD9000	TRW 24306 20,3 + WE / - WK + Zub Ceramic
			←	11/09 →; für Fahrzeuge mit Sportpaket / für Fahrzeuge mit AMG-Sportpaket		13.0460-2734.2 602734	TRW 24310 19,0 + WE / - WK
						13.0470-2734.2 LD2734	TRW 24310 19,0 + WE / - WK Ceramic
			→	11/09 →		13.0460-7259.2 607259	ATE 24862 16,7 + WE / - WK
						13.0470-7259.2 LD7259	ATE 24862 16,7 + WE / - WK Ceramic
						13.0470-9001.2 LD9001	ATE 24862 16,7 + WE / - WK Ceramic
E 250 (212.236)	155	11/12 →	←	03/13 →		13.0460-2734.2 602734	TRW 24310 19,0 + WE / - WK
						13.0470-2734.2 LD2734	TRW 24310 19,0 + WE / - WK Ceramic
			→	03/13 →		13.0460-7259.2 607259	ATE 24862 16,7 + WE / - WK
						13.0470-7259.2 LD7259	ATE 24862 16,7 + WE / - WK Ceramic
						13.0470-9001.2 LD9001	ATE 24862 16,7 + WE / - WK Ceramic
E 300 CDI (212.220)	150	12/09 → 12/10	←			13.0460-2734.2 602734	TRW 24310 19,0 + WE / - WK
						13.0470-2734.2 LD2734	TRW 24310 19,0 + WE / - WK Ceramic
E 300 Hybrid / BlueTEC Hybrid (212.298)	150	12/11 →	←	06/12 →		13.0460-2734.2 602734	TRW 24310 19,0 + WE / - WK
						13.0470-2734.2 LD2734	TRW 24310 19,0 + WE / - WK Ceramic
			→	06/12 →		13.0460-7259.2 607259	ATE 24862 16,7 + WE / - WK
						13.0470-7259.2 LD7259	ATE 24862 16,7 + WE / - WK Ceramic
						13.0470-9001.2 LD9001	ATE 24862 16,7 + WE / - WK Ceramic
E 350 (212.256)	200	08/09 →	←	11/09 →		13.0460-2734.2 602734	TRW 24310 19,0 + WE / - WK
						13.0470-2734.2 LD2734	TRW 24310 19,0 + WE / - WK Ceramic
			→	11/09 →		13.0460-7259.2 607259	ATE 24862 16,7 + WE / - WK
						13.0470-7259.2 LD7259	ATE 24862 16,7 + WE / - WK Ceramic
						13.0470-9001.2 LD9001	ATE 24862 16,7 + WE / - WK Ceramic
E 350 BlueTEC	185	11/12 →	←	01/13 →; für Fahrzeuge ohne Sportpaket / für Fahrzeuge ohne AMG-Sportpaket		13.0460-2734.2 602734	TRW 24310 19,0 + WE / - WK
E 350 BlueTEC 4-matic	185	11/12 →				13.0470-2734.2 LD2734	TRW 24310 19,0 + WE / - WK Ceramic
			←	01/13 →; für Fahrzeuge mit Sportpaket / für Fahrzeuge mit AMG-Sportpaket		13.0460-4863.2 604863	BRE 24976 17,5 + WE / - WK
			→	01/13 →		13.0460-7259.2 607259	ATE 24862 16,7 + WE / - WK
						13.0470-7259.2 LD7259	ATE 24862 16,7 + WE / - WK Ceramic
						13.0470-9001.2 LD9001	ATE 24862 16,7 + WE / - WK Ceramic
E 350 BlueTEC (212.226)	190	07/14 →	←	für Fahrzeuge ohne Sportpaket / für Fahrzeuge ohne AMG-Sportpaket		13.0460-2734.2 602734	TRW 24310 19,0 + WE / - WK
E 350 BlueTEC 4-matic (212.294)	190	07/14 →				13.0470-2734.2 LD2734	TRW 24310 19,0 + WE / - WK Ceramic
			←	für Fahrzeuge mit Sportpaket / für Fahrzeuge mit AMG-Sportpaket		13.0460-4863.2 604863	BRE 24976 17,5 + WE / - WK
			→			13.0460-7259.2 607259	ATE 24862 16,7 + WE / - WK
						13.0470-7259.2 LD7259	ATE 24862 16,7 + WE / - WK Ceramic











	kw			 	! #		
<b>MERCEDES-BENZ - E-KLASSE T-Model (S212) 08/09 →</b>							
<b> Bremsbelagsatz, Scheibenbremse</b>							
E 350 BlueTEC (212.226)	190	07/14 →	➔			<b>13.0470-9001.2 LD9001</b>	ATE 24862 16,7 + WE / - WK Ceramic
E 350 BlueTEC 4-matic (212.294)	190	07/14 →					
E 350 CDI 4-matic (212.293)	195	07/11 →	➔			<b>13.0460-2734.2 602734</b>	TRW 24310 19,0 + WE / - WK Ceramic
						<b>13.0470-2734.2 LD2734</b>	TRW 24310 19,0 + WE / - WK Ceramic
			➔	für Fahrzeuge mit AMG-Sportpaket / für Fahrzeuge mit Sportpaket		<b>13.0460-4863.2 604863</b>	BRE 24976 17,5 + WE / - WK
			➔			<b>13.0460-7259.2 607259</b>	ATE 24862 16,7 + WE / - WK Ceramic
						<b>13.0470-7259.2 LD7259</b>	ATE 24862 16,7 + WE / - WK Ceramic
						<b>13.0470-9001.2 LD9001</b>	ATE 24862 16,7 + WE / - WK Ceramic
E 400	245	01/13 →	➔			<b>13.0460-4863.2 604863</b>	BRE 24976 17,5 + WE / - WK
E 400 4-matic	245	01/13 →					
E 400 4-matic (212.299)	245	07/14 →	➔			<b>13.0460-7259.2 607259</b>	ATE 24862 16,7 + WE / - WK Ceramic
E 500 (212.272)	285	11/09 →				<b>13.0470-7259.2 LD7259</b>	ATE 24862 16,7 + WE / - WK Ceramic
						<b>13.0470-9001.2 LD9001</b>	ATE 24862 16,7 + WE / - WK Ceramic
E 400 (212.261)	245	07/14 →	➔			<b>13.0460-7259.2 607259</b>	ATE 24862 16,7 + WE / - WK Ceramic
E 500 (212.273)	300	09/11 →				<b>13.0470-7259.2 LD7259</b>	ATE 24862 16,7 + WE / - WK Ceramic
E 500 4-matic (212.291)	300	09/11 →				<b>13.0470-9001.2 LD9001</b>	ATE 24862 16,7 + WE / - WK Ceramic
<b>Warnkontakt, Bremsbelagverschleiß</b>							
E 200 (212.234)	135	11/12 →	➔	03/13 →; für Fahrzeuge mit Sportpaket / für Fahrzeuge mit AMG-Sportpaket	1	<b>24.8190-0410.2 620410</b>	L= 97,5
			➔	03/13 →; für Fahrzeuge ohne Sportpaket / für Fahrzeuge ohne AMG-Sportpaket	1	<b>24.8190-0410.2 620410</b>	L= 97,5
			➔	03/13 →	1	<b>24.8190-0410.2 620410</b>	L= 97,5
E 200 CDI / BlueTEC (212.205, 212.206)	100	11/09 →	➔	für Fahrzeuge mit Sportpaket / für Fahrzeuge mit AMG-Sportpaket	1	<b>24.8190-0410.2 620410</b>	L= 97,5
E 200 CGI (212.248)	135	11/09 →					
E 220 BlueTEC	130	05/15 →	➔	für Fahrzeuge ohne Sportpaket / für Fahrzeuge ohne AMG-Sportpaket	1	<b>24.8190-0410.2 620410</b>	L= 97,5
E 220 CDI / BlueTEC (212.202, 212.201)	125	11/09 →					
			➔		1	<b>24.8190-0410.2 620410</b>	L= 97,5
E 220 BlueTEC 4-matic (212.211)	125	12/14 →	➔		1	<b>24.8190-0410.2 620410</b>	L= 97,5
E 250 CDI / BlueTEC (212.203, 212.204)	150	11/09 →	➔		1	<b>24.8190-0410.2 620410</b>	L= 97,5
E 250 CDI / BlueTEC 4-matic (212.282, 212.297)	150	07/10 →					
E 250 CGI (212.247)	150	11/09 →					
E 300 (212.254)	170	11/09 →					
E 300 (212.255)	185	07/11 →					
E 300 4-matic (212.280)	185	07/11 →					
E 300 CDI / BlueTEC (212.227, 212.221)	170	11/09 →					
E 350 (212.259)	225	09/11 →					
E 350 4-matic (212.287)	200	11/09 →					
E 350 4-matic (212.288, 212.287)	225	09/11 →					
E 350 BlueTEC (212.224)	155	11/09 →					
E 350 CDI (212.223)	195	07/11 →					
E 350 CDI (212.225)	170	11/09 →					
E 350 CDI 4-matic (212.289)	170	11/09 →					
E 350 CDI 4-matic (212.293)	195	07/11 →					
E 350 CGI (212.257)	215	11/09 →					
E 500 (212.273)	300	09/11 →					
E 500 4-matic (212.291)	300	09/11 →					
E 220 CDI (212.202)	120	08/09 →	➔	11/09 →; für Fahrzeuge mit Sportpaket / für Fahrzeuge mit AMG-Sportpaket	1	<b>24.8190-0410.2 620410</b>	L= 97,5
			➔	11/09 →; für Fahrzeuge ohne Sportpaket / für Fahrzeuge ohne AMG-Sportpaket	1	<b>24.8190-0410.2 620410</b>	L= 97,5
			➔	11/09 →	1	<b>24.8190-0410.2 620410</b>	L= 97,5
E 250 (212.236)	155	11/12 →	➔	03/13 →	1	<b>24.8190-0410.2 620410</b>	L= 97,5
↓							











	kW			 	! #				
<b>MERCEDES-BENZ - E-KLASSE T-Model (S212) 08/09 →</b>									
<b>Warnkontakt, Bremsbelagverschleiß</b>									
E 250 (212.236)	155	11/12 →	➡	03/13 →	1	24.8190-0410.2 620410	L= 97,5		
E 300 CDI (212.220)	150	12/09 → 12/10	➡		1	24.8190-0410.2 620410	L= 97,5		
E 300 Hybrid / BlueTEC Hybrid (212.298)	150	12/11 →	➡	06/12 →	1	24.8190-0410.2 620410	L= 97,5		
			➡	06/12 →	1	24.8190-0410.2 620410	L= 97,5		
E 350 (212.256)	200	08/09 →	➡	11/09 →	1	24.8190-0410.2 620410	L= 97,5		
			➡	11/09 →	1	24.8190-0410.2 620410	L= 97,5		
E 350 BlueTEC E 350 BlueTEC 4-matic	185 185	11/12 → 11/12 →	➡	01/13 →; für Fahrzeuge ohne Sportpaket / für Fahrzeuge ohne AMG-Sportpaket	1	24.8190-0410.2 620410	L= 97,5		
			➡	01/13 →; für Fahrzeuge mit Sportpaket / für Fahr- zeuge mit AMG-Sportpaket	2	24.8190-0410.2 620410	L= 97,5		
			➡	01/13 →	1	24.8190-0410.2 620410	L= 97,5		
E 350 BlueTEC (212.226) E 350 BlueTEC 4-matic (212.294)	190 190	07/14 → 07/14 →	➡	für Fahrzeuge mit Sportpaket / für Fahr- zeuge mit AMG-Sportpaket	2	24.8190-0410.2 620410	L= 97,5		
			➡	für Fahrzeuge ohne Sportpaket / für Fahrzeuge ohne AMG-Sportpaket	1	24.8190-0410.2 620410	L= 97,5		
			➡		1	24.8190-0410.2 620410	L= 97,5		
E 400 E 400 (212.261) E 400 4-matic E 400 4-matic (212.299) E 500 (212.272)	245 245 245 245 285	01/13 → 07/14 → 01/13 → 07/14 → 11/09 →	➡		2	24.8190-0410.2 620410	L= 97,5		
			➡		1	24.8190-0410.2 620410	L= 97,5		
E 63 AMG (212.274) E 63 AMG (212.274) E 63 AMG 4-matic (212.292)	386 410 410	02/11 → 02/11 → 02/11 →	➡	für Fahrzeuge ohne Keramikbremse	2	24.8190-0420.2 620420	L= 119		
			➡		1	24.8190-0420.2 620420	L= 119		
E 63 AMG (212.275) E 63 AMG 4-matic (212.276)	430 430	02/13 → 02/13 →	➡	04/13 →; für Fahrzeuge ohne Keramikbremse	2	24.8190-0420.2 620420	L= 119		
			➡	04/13 →	1	24.8190-0420.2 620420	L= 119		
E 63 AMG (212.277)	386	08/09 →	➡	11/09 →	1	24.8190-0420.2 620420	L= 119		
			➡	11/09 →	1	24.8190-0420.2 620420	L= 119		
<b>Bremsscheibe</b>									
E 200 (212.234)	135	11/12 →	➡	03/13 →; für Fahrzeuge ohne Sportpaket / für Fahrzeuge ohne AMG-Sportpaket		24.0128-0155.1 428155 24.0328-0155.1 528155	∅ 295 28 25,4 V + S ∅ 295 28 25,4 V + S		
			➡	03/13 →; für Fahrzeuge mit Sportpaket / für Fahr- zeuge mit AMG-Sportpaket		24.0132-0100.1 432100	∅ 322 32 30 V• + S		
			➡	03/13 →		24.0110-0278.1 410278 24.0310-0278.1 510278	∅ 300 10 8,3 + S ∅ 300 10 8,3 + S		
E 200 CDI / BlueTEC (212.205, 212.206) E 200 CGI (212.248) E 220 BlueTEC E 220 CDI / BlueTEC (212.202, 212.201)	100 135 130 125	11/09 → 11/09 → 05/15 → 11/09 →	➡	für Fahrzeuge ohne Sportpaket / für Fahrzeuge ohne AMG-Sportpaket		24.0128-0155.1 428155 24.0328-0155.1 528155	∅ 295 28 25,4 V + S ∅ 295 28 25,4 V + S		
			➡	für Fahrzeuge mit Sportpaket / für Fahr- zeuge mit AMG-Sportpaket		24.0132-0100.1 432100	∅ 322 32 30 V• + S		
			➡			24.0110-0278.1 410278 24.0310-0278.1 510278	∅ 300 10 8,3 + S ∅ 300 10 8,3 + S		
E 220 BlueTEC 4-matic (212.211) E 250 CDI / BlueTEC (212.203, 212.204) E 250 CDI / BlueTEC 4-matic (212.282, 212.297) E 250 CGI (212.247)	125 150 150 150	12/14 → 11/09 → 07/10 → 11/09 →	➡	für Fahrzeuge mit Sportpaket / für Fahr- zeuge mit AMG-Sportpaket		24.0132-0100.1 432100	∅ 322 32 30 V• + S		
			➡	für Fahrzeuge ohne Sportpaket / für Fahrzeuge ohne AMG-Sportpaket		24.0132-0101.1 432101 24.0332-0101.1 532101	∅ 322 32 29,4 V + S ∅ 322 32 29,4 V + S		
			➡			24.0110-0278.1 410278 24.0310-0278.1 510278	∅ 300 10 8,3 + S ∅ 300 10 8,3 + S		
E 220 CDI (212.202)	120	08/09 →	➡	11/09 →; für Fahrzeuge ohne Sportpaket / für Fahrzeuge ohne AMG-Sportpaket		24.0128-0155.1 428155 24.0328-0155.1 528155	∅ 295 28 25,4 V + S ∅ 295 28 25,4 V + S		
			➡	11/09 →; für Fahrzeuge mit Sportpaket / für Fahr- zeuge mit AMG-Sportpaket		24.0132-0100.1 432100	∅ 322 32 30 V• + S		
			➡	11/09 →		24.0110-0278.1 410278 24.0310-0278.1 510278	∅ 300 10 8,3 + S ∅ 300 10 8,3 + S		
E 250 (212.236)	155	11/12 →	➡	03/13 →; für Fahrzeuge mit Sportpaket / für Fahr- zeuge mit AMG-Sportpaket		24.0132-0100.1 432100	∅ 322 32 30 V• + S		
			➡	03/13 →; für Fahrzeuge ohne Sportpaket / für Fahrzeuge ohne AMG-Sportpaket		24.0132-0101.1 432101 24.0332-0101.1 532101	∅ 322 32 29,4 V + S ∅ 322 32 29,4 V + S		
			➡	03/13 →		24.0110-0278.1 410278	∅ 300 10 8,3 + S		









	kW				! #		
<b>MERCEDES-BENZ - E-KLASSE T-Model (S212) 08/09→</b>							
<b>Bremsscheibe</b>							
E 250 (212.236)	155	11/12→	➔	03/13→		24.0310-0278.1 510278	Ø 300 10 8,3 + S
E 300 (212.254)	170	11/09→	➔	für Fahrzeuge mit Sportpaket / für Fahrzeuge mit AMG-Sportpaket		24.0132-0100.1 432100	Ø 322 32 30 V• + S
E 300 (212.255)	185	07/11→	➔				
E 300 4-matic (212.280)	185	07/11→	➔	für Fahrzeuge ohne Sportpaket / für Fahrzeuge ohne AMG-Sportpaket		24.0132-0101.1 432101	Ø 322 32 29,4 V + S
E 300 CDI / BlueTEC (212.227, 212.221)	170	11/09→	➔			24.0332-0101.1 532101	Ø 322 32 29,4 V + S
E 350 (212.259)	225	09/11→	➔			24.0122-0201.1 422201	Ø 300 22 19,4 V + S
E 350 4-matic (212.287)	200	11/09→	➔				
E 350 4-matic (212.288, 212.287)	225	09/11→	➔				
E 350 BlueTEC (212.224)	155	11/09→	➔				
E 350 CDI (212.223)	195	07/11→	➔				
E 350 CDI (212.225)	170	11/09→	➔				
E 350 CDI 4-matic (212.289)	170	11/09→	➔				
E 350 CDI 4-matic (212.293)	195	07/11→	➔				
E 350 CGI (212.257)	215	11/09→	➔				
E 300 Hybrid / BlueTEC Hybrid (212.298)	150	12/11→	➔	06/12→; für Fahrzeuge mit Sportpaket / für Fahrzeuge mit AMG-Sportpaket		24.0132-0100.1 432100	Ø 322 32 30 V• + S
			➔	06/12→; für Fahrzeuge ohne Sportpaket / für Fahrzeuge ohne AMG-Sportpaket		24.0132-0101.1 432101	Ø 322 32 29,4 V + S
			➔			24.0332-0101.1 532101	Ø 322 32 29,4 V + S
			➔	06/12→		24.0122-0201.1 422201	Ø 300 22 19,4 V + S
E 350 (212.256)	200	08/09→	➔	11/09→; für Fahrzeuge mit Sportpaket / für Fahrzeuge mit AMG-Sportpaket		24.0132-0100.1 432100	Ø 322 32 30 V• + S
			➔	11/09→; für Fahrzeuge ohne Sportpaket / für Fahrzeuge ohne AMG-Sportpaket		24.0132-0101.1 432101	Ø 322 32 29,4 V + S
			➔			24.0332-0101.1 532101	Ø 322 32 29,4 V + S
			➔	11/09→		24.0122-0201.1 422201	Ø 300 22 19,4 V + S
E 350 BlueTEC	185	11/12→	➔	01/13→; für Fahrzeuge ohne Sportpaket / für Fahrzeuge ohne AMG-Sportpaket		24.0132-0101.1 432101	Ø 322 32 29,4 V + S
E 350 BlueTEC 4-matic	185	11/12→	➔			24.0332-0101.1 532101	Ø 322 32 29,4 V + S
			➔	01/13→; für Fahrzeuge mit Sportpaket / für Fahrzeuge mit AMG-Sportpaket		24.0132-0168.1 432168	Ø 344 32 30 V• + S
			➔	01/13→		24.0122-0201.1 422201	Ø 300 22 19,4 V + S
E 350 BlueTEC (212.226)	190	07/14→	➔	für Fahrzeuge ohne Sportpaket / für Fahrzeuge ohne AMG-Sportpaket		24.0132-0101.1 432101	Ø 322 32 29,4 V + S
E 350 BlueTEC 4-matic (212.294)	190	07/14→	➔	für Fahrzeuge mit Sportpaket / für Fahrzeuge mit AMG-Sportpaket		24.0332-0101.1 532101	Ø 322 32 29,4 V + S
			➔			24.0132-0168.1 432168	Ø 344 32 30 V• + S
			➔			24.0122-0201.1 422201	Ø 300 22 19,4 V + S
E 400	245	01/13→	➔			24.0132-0168.1 432168	Ø 344 32 30 V• + S
E 400 (212.261)	245	07/14→	➔			24.0122-0201.1 422201	Ø 300 22 19,4 V + S
E 400 4-matic	245	01/13→	➔				
E 400 4-matic (212.299)	245	07/14→	➔				
E 500 (212.272)	285	11/09→	➔			24.0132-0168.1 432168	Ø 344 32 30 V• + S
			➔			24.0124-0236.1 424236	Ø 320 24 21,1 V + S
E 500 (212.273)	300	09/11→	➔			24.0136-0108.1 436108	Ø 360 36 34 V• + S
E 500 4-matic (212.291)	300	09/11→	➔			24.0124-0236.1 424236	Ø 320 24 21,1 V + S
<b>MERCEDES-BENZ - E-KLASSE T-Model (S213) 07/16→</b>							
<b>Bremsbelagsatz, Scheibenbremse</b>							
AMG E 53 EQ Boost 4-matic+ (213.261)	320	04/18→	➔			13.0460-4870.2 604870	BRE 25179 17,8 + WE / - WK
E 200 (213.242)	135	07/16→	➔	für Fahrzeuge ohne AMG-Sportpaket		13.0460-2792.2 602792	TRW 22031 19,6 + WE / - WK
E 200 d (213.213)	110	10/16→	➔			13.0470-2792.2 LD2792	TRW 22031 19,6 + WE / - WK Ceramic
E 220 d (213.204)	120	07/16→	➔				
E 220 d (213.204)	143	07/16→	➔	für Fahrzeuge mit AMG-Sportpaket		13.0460-4883.2 604883	BRE 22061 18,7 + WE / - WK Ceramic
			➔			13.0470-4883.2 LD4883	BRE 22061 18,7 + WE / - WK Ceramic
E 200 4-matic (213.243)	135	01/17→	➔	für Fahrzeuge ohne AMG-Sportpaket		13.0460-2610.2 602610	TRW 22076 19,6 + WE / - WK Ceramic
E 220 d 4-matic (213.205)	143	01/17→	➔			13.0470-2610.2 LD2610	TRW 22076 19,6 + WE / - WK Ceramic
E 250 (213.245)	155	07/16→	➔				
E 300 d (213.208)	180	12/17→	➔	für Fahrzeuge mit AMG-Sportpaket		13.0460-4883.2 604883	BRE 22061 18,7 + WE / - WK Ceramic
			➔			13.0470-4883.2 LD4883	BRE 22061 18,7 + WE / - WK Ceramic
E 350 d (213.233)	190	10/16→	➔	für Fahrzeuge ohne AMG-Sportpaket		13.0460-4883.2 604883	BRE 22061 18,7 + WE / - WK
↓							























	kW			 	! #		
<b>MERCEDES-BENZ - E-KLASSE T-Model (S213) 07/16 →</b>							
 <b>Bremsbelagsatz, Scheibenbremse</b>							
E 350 d (213.233)	190	10/16 →	←	für Fahrzeuge ohne AMG-Sportpaket		<b>13.0470-4883.2</b> <b>LD4883</b>	BRE 22061 18,7 + WE / - WK Ceramic
<b>Warnkontakt, Bremsbelagverschleiß</b>							
AMG E 43 4-matic (213.264)	295	10/16 →	←		1	<b>24.8190-0067.2</b> <b>620067</b>	L= 92,5
E 200 (213.242)	135	07/16 →	→		1	<b>24.8190-0067.2</b> <b>620067</b>	L= 92,5
E 200 4-matic (213.243)	135	01/17 →					
E 200 d (213.213)	110	10/16 →					
E 220 d (213.204)	120	07/16 →					
E 220 d (213.204)	143	07/16 →					
E 220 d 4-matic (213.205)	143	01/17 →					
E 250 (213.245)	155	07/16 →					
E 300 d (213.208)	180	12/17 →					
E 350 d (213.233)	190	10/16 →					
E 350 d 4-matic (213.234)	190	06/17 →					
E 400 4-matic (213.271)	245	10/16 →					
E 400 d 4-matic (213.223)	250	04/18 →					
AMG E 53 EQ Boost 4-matic+ (213.261)	320	04/18 →	←		1	<b>24.8190-0959.2</b> <b>620959</b>	L= 102
			→		1	<b>24.8190-0067.2</b> <b>620067</b>	L= 92,5
AMG E 63 4-matic+ (213.288)	420	05/17 →	←	für Fahrzeuge ohne Keramikbremse	1	<b>24.8190-0420.2</b> <b>620420</b>	L= 119
AMG E 63 S 4-matic+ (213.289)	450	05/17 →	→		1	<b>24.8190-0067.2</b> <b>620067</b>	L= 92,5
			→	für Fahrzeuge mit Keramikbremse; Bremssattelfarbe: silber	1	<b>24.8190-0410.2</b> <b>620410</b>	L= 97,5
 <b>Bremsscheibe</b>							
E 200 (213.242)	135	07/16 →	←	für Fahrzeuge ohne AMG-Sportpaket		<b>24.0128-0330.1</b> <b>428330</b>	Ø 305 28 25,4 V + S
E 200 d (213.213)	110	10/16 →					
E 220 d (213.204)	120	07/16 →					
E 220 d (213.204)	143	07/16 →					
<b>MERCEDES-BENZ - G-KLASSE (W461) 09/89 →</b>							
 <b>Bremsbelagsatz, Scheibenbremse</b>							
230 GE (461.238, 461.239)	90	09/89 → 07/96	←	02/93 →		<b>13.0460-4401.2</b> <b>604401</b>	ATE 20784 18,0 + WE / - WK
230 GE (461)	92	06/93 → 07/00	←			<b>13.0460-4401.2</b> <b>604401</b>	ATE 20784 18,0 + WE / - WK
290 GD/G 290 D (461.337, 461.338)	70	06/93 → 07/00					
G 300 CDI	135	04/10 →					
G 270 CDI	115	01/03 →	←			<b>13.0460-4401.2</b> <b>604401</b>	ATE 20784 18,0 + WE / - WK
G 280 CDI (461.304, 461.346, 461.370, 461.334, 461.339, ...)	135	04/09 →	→			<b>13.0460-3990.2</b> <b>603990</b>	BOS 23021 18,9 + WE / - WK
G 290 TD (461.335, 461.336)	88	07/97 →					
<b>Warnkontakt, Bremsbelagverschleiß</b>							
230 GE (461.238, 461.239)	90	09/89 → 07/96	←	02/93 →	2	<b>24.8190-0406.2</b> <b>620406</b>	L= 261
230 GE (461)	92	06/93 → 07/00	←		2	<b>24.8190-0406.2</b> <b>620406</b>	L= 261
290 GD/G 290 D (461.337, 461.338)	70	06/93 → 07/00					
G 300 CDI	135	04/10 →					
G 270 CDI	115	01/03 →	←		2	<b>24.8190-0406.2</b> <b>620406</b>	L= 261
G 280 CDI (461.304, 461.346, 461.370, 461.334, 461.339, ...)	135	04/09 →	→		2	<b>24.8190-0407.2</b> <b>620407</b>	L= 115 L= 185
G 290 TD (461.335, 461.336)	88	07/97 →					
<b>Zubehörsatz, Scheibenbremsbelag</b>							
230 GE (461.238, 461.239)	90	09/89 → 07/96	←	02/93 →		<b>13.0460-0158.2</b> <b>610158</b>	ATE
230 GE (461)	92	06/93 → 07/00	←			<b>13.0460-0158.2</b> <b>610158</b>	ATE
290 GD/G 290 D (461.337, 461.338)	70	06/93 → 07/00					
G 270 CDI	115	01/03 →					
G 290 TD (461.335, 461.336)	88	07/97 →					
 <b>Bremsscheibe</b>							
230 GE (461.238, 461.239)	90	09/89 → 07/96	←	02/93 →		<b>24.0116-0133.1</b> <b>416133</b>	Ø 303 16 13 + S
↓							













	kW			 	! #		
<b>MERCEDES-BENZ - G-KLASSE (W461) 09/89→</b>							
<b> Bremsscheibe</b>							
230 GE (461) 290 GD/G 290 D (461.337, 461.338)	92 70	06/93→07/00 06/93→07/00	←			24.0116-0133.1 416133	∅ 303 16 13 + S
G 270 CDI G 290 TD (461.335, 461.336)	115 88	01/03→ 07/97→	←			24.0116-0133.1 416133	∅ 303 16 13 + S
			→			24.0116-0110.1 416110	∅ 272 16 14 + S
G 280 CDI (461.304, 461.346, 461.370, 461.334, 461.339,...)	135	04/09→	←			24.0116-0133.1 416133	∅ 303 16 13 + S
			→			24.0130-0217.1 430217	∅ 315 30 27,4 V + S
			→			24.0116-0110.1 416110	∅ 272 16 14 + S
G 300 CDI	135	04/10→	←			24.0116-0133.1 416133	∅ 303 16 13 + S
			→			24.0130-0217.1 430217	∅ 315 30 27,4 V + S
<b>MERCEDES-BENZ - G-KLASSE (W463) 09/89→</b>							
<b> Bremsbelagsatz, Scheibenbremse</b>							
300 GE (463.227, 463.228)	128	06/90→08/97	←			13.0460-4401.2 604401	ATE 20784 18,0 + WE / - WK
350 Turbo GD (463.320, 463.321)	100	09/91→08/96					
G 36 AMG (463.230)	200	01/95→07/98					
G 270 CDI (463.322, 463.323)	115	10/01→	←			13.0460-4401.2 604401	ATE 20784 18,0 + WE / - WK
G 300 TD (463.330, 463.331)	130	08/96→07/00	→			13.0460-3990.2 603990	BOS 23021 18,9 + WE / - WK
G 320 (463.230, 463.231)	155	09/94→12/97					
G 320 (463.232, 463.233, 463.244, 463.245)	158	07/97→					
G 320 CDI (463.340, 463.341, 463.343)	165	09/06→					
G 350 CDI	155	07/11→					
G 350 d (463.348)	180	06/15→					
G 400 CDI (463.332, 463.333)	184	12/00→					
G 500 (463.222, 463.236, 463.237, 463.342)	285	05/08→					
G 500 (463.247, 463.248, 463.249, 463.240, 463.241)	218	04/98→					
G 55 AMG (463.243, 463.246)	260	04/99→	←			13.0460-4401.2 604401	ATE 20784 18,0 + WE / - WK
G 55 AMG (463.270, 463.271)	350	06/04→	→	Achsnummer: 741.144		13.0460-3990.2 603990	BOS 23021 18,9 + WE / - WK
G 55 AMG (463.270, 463.271)	368	08/06→	→	Achsnummer: 742.606		13.0460-7219.2 607219	ATE 23923 17,6 + WE / - WK
G 55 AMG (463.270, 463.271)	373	08/08→					
G 63 AMG (463.273)	400	05/12→	→	06/12→		13.0460-7219.2 607219	ATE 23923 17,6 + WE / - WK
G 65 AMG	450	05/12→					
<b>Warnkontakt, Bremsbelagverschleiß</b>							
300 GE (463.227, 463.228)	128	06/90→08/97	←		2	24.8190-0406.2 620406	L= 261
350 Turbo GD (463.320, 463.321)	100	09/91→08/96	←	V	2	24.8190-0411.2 620411	L= 72
G 36 AMG (463.230)	200	01/95→07/98					
G 270 CDI (463.322, 463.323)	115	10/01→	←		2	24.8190-0406.2 620406	L= 261
G 300 TD (463.330, 463.331)	130	08/96→07/00	←	V	2	24.8190-0411.2 620411	L= 72
			→		2	24.8190-0407.2 620407	L= 115 L= 185
G 320 (463.230, 463.231)	155	09/94→12/97					
G 320 (463.232, 463.233, 463.244, 463.245)	158	07/97→					
G 400 CDI (463.332, 463.333)	184	12/00→					
G 500 (463.247, 463.248, 463.249, 463.240, 463.241)	218	04/98→					
G 320 CDI (463.340, 463.341, 463.343)	165	09/06→	←		2	24.8190-0406.2 620406	L= 261
G 350 CDI	155	07/11→	→		2	24.8190-0407.2 620407	L= 115 L= 185
G 350 d (463.348)	180	06/15→					
G 500 (463.222, 463.236, 463.237, 463.342)	285	05/08→					
↓							











	kW			 	! #		
<b>MERCEDES-BENZ - G-KLASSE (W463) 09/89→</b>							
<b>Warnkontakt, Bremsbelagverschleiß</b>							
G 55 AMG (463.243, 463.246)	260	04/99→	←		2	24.8190-0406.2 620406	L= 261
G 55 AMG (463.270, 463.271)	350	06/04→	←	V	2	24.8190-0411.2 620411	L= 72
G 55 AMG (463.270, 463.271)	368	08/06→	→	Achsnummer: 741.144	2	24.8190-0407.2 620407	L= 115 L= 185
G 55 AMG (463.270, 463.271)	373	08/08→	→	Achsnummer: 742.606	2	24.8190-0425.2 620425	L= 98
G 63 AMG (463.273)	400	05/12→	→	06/12→	2	24.8190-0425.2 620425	L= 98
G 65 AMG	450	05/12→					
<b>Zubehörsatz, Scheibenbremsbelag</b>							
300 GE (463.227, 463.228)	128	06/90→08/97	←			13.0460-0158.2 610158	ATE
350 Turbo GD (463.320, 463.321)	100	09/91→08/96					
G 270 CDI (463.322, 463.323)	115	10/01→					
G 300 TD (463.330, 463.331)	130	08/96→07/00					
G 320 (463.230, 463.231)	155	09/94→12/97					
G 320 (463.232, 463.233, 463.244, 463.245)	158	07/97→					
G 36 AMG (463.230)	200	01/95→07/98					
G 400 CDI (463.332, 463.333)	184	12/00→					
G 500 (463.247, 463.248, 463.249, 463.240, 463.241)	218	04/98→					
G 55 AMG (463.243, 463.246)	260	04/99→					
G 55 AMG (463.270, 463.271)	350	06/04→					
G 55 AMG (463.270, 463.271)	368	08/06→					
G 55 AMG (463.270, 463.271)	373	08/08→					
<b> Bremsscheibe</b>							
300 GE (463.227, 463.228)	128	06/90→08/97	←			24.0116-0133.1 416133	Ø 303 16 13 + S
350 Turbo GD (463.320, 463.321)	100	09/91→08/96				24.0130-0217.1 430217	Ø 315 30 27,4 V + S
G 36 AMG (463.230)	200	01/95→07/98					
G 270 CDI (463.322, 463.323)	115	10/01→	←			24.0116-0133.1 416133	Ø 303 16 13 + S
G 300 TD (463.330, 463.331)	130	08/96→07/00	→			24.0130-0217.1 430217	Ø 315 30 27,4 V + S
G 320 (463.230, 463.231)	155	09/94→12/97				24.0116-0110.1 416110	Ø 272 16 14 + S
G 320 (463.232, 463.233, 463.244, 463.245)	158	07/97→					
G 320 CDI (463.340, 463.341, 463.343)	165	09/06→					
G 350 CDI	155	07/11→					
G 350 d (463.348)	180	06/15→					
G 400 CDI (463.332, 463.333)	184	12/00→					
G 500 (463.222, 463.236, 463.237, 463.342)	285	05/08→					
G 500 (463.247, 463.248, 463.249, 463.240, 463.241)	218	04/98→					
G 55 AMG (463.243, 463.246)	260	04/99→	←			24.0116-0133.1 416133	Ø 303 16 13 + S
G 55 AMG (463.270, 463.271)	350	06/04→				24.0130-0217.1 430217	Ø 315 30 27,4 V + S
G 55 AMG (463.270, 463.271)	368	08/06→	→	Achsnummer: 741.144		24.0116-0110.1 416110	Ø 272 16 14 + S
G 55 AMG (463.270, 463.271)	373	08/08→					
<b>MERCEDES-BENZ - G-KLASSE (W463) 01/18→</b>							
<b>Warnkontakt, Bremsbelagverschleiß</b>							
AMG G 63 (463.276)	430	03/18→	←		1	24.8190-0420.2 620420	L= 119
G 500 (463.260)	310	01/18→	←		1	24.8190-0067.2 620067	L= 92,5
			→		1	24.8190-0067.2 620067	L= 92,5











	kW					! #		
<b>MERCEDES-BENZ - G-KLASSE Cabrio (W463) 09/89→</b>								
<b> Bremsbelagsatz, Scheibenbremse</b>								
300 GD (463.307)	83	12/90→09/97	←				13.0460-4401.2 604401	ATE 20784 18,0 + WE / - WK
300 GE (463.207)	125	09/89→09/97						
320 GE (463.208)	155	09/94→11/97						
350 G Turbo-D (463.300)	100	09/91→09/97						
G 500 (463.202)	285	12/09→						
G 500 (463)	218	04/98→						
G 300 TD (463.308)	130	09/96→07/00	←				13.0460-4401.2 604401	ATE 20784 18,0 + WE / - WK
G 320 (463.209)	158	11/97→						
G 350 CDI	155	07/11→	→				13.0460-3990.2 603990	BOS 23021 18,9 + WE / - WK
G 400 CDI (463.309)	184	12/00→						
G 320 CDI (463.303)	165	09/06→	←	06/10→			13.0460-4401.2 604401	ATE 20784 18,0 + WE / - WK
			→				13.0460-3990.2 603990	BOS 23021 18,9 + WE / - WK
<b>Warnkontakt, Bremsbelagverschleiß</b>								
300 GD (463.307)	83	12/90→09/97	←		2	24.8190-0406.2 620406	L= 261	
300 GE (463.207)	125	09/89→09/97						
320 GE (463.208)	155	09/94→11/97						
350 G Turbo-D (463.300)	100	09/91→09/97						
G 500 (463.202)	285	12/09→						
G 500 (463)	218	04/98→						
G 300 TD (463.308)	130	09/96→07/00	←		2	24.8190-0406.2 620406	L= 261	
G 320 (463.209)	158	11/97→						
G 400 CDI (463.309)	184	12/00→	→		2	24.8190-0407.2 620407	L= 115 L= 185	
G 320 CDI (463.303)	165	09/06→	←	06/10→	2	24.8190-0406.2 620406	L= 261	
			→		2	24.8190-0407.2 620407	L= 115 L= 185	
G 350 CDI	155	07/11→	←		2	24.8190-0406.2 620406	L= 261	
			→		2	24.8190-0407.2 620407	L= 115 L= 185	
<b>Zubehörsatz, Scheibenbremsbelag</b>								
300 GD (463.307)	83	12/90→09/97	←			13.0460-0158.2 610158	ATE	
300 GE (463.207)	125	09/89→09/97						
320 GE (463.208)	155	09/94→11/97						
350 G Turbo-D (463.300)	100	09/91→09/97						
G 300 TD (463.308)	130	09/96→07/00						
G 320 (463.209)	158	11/97→						
G 400 CDI (463.309)	184	12/00→						
G 500 (463.202)	285	12/09→						
G 500 (463)	218	04/98→						
<b> Bremsscheibe</b>								
300 GD (463.307)	83	12/90→09/97	←			24.0116-0133.1 416133	Ø 303 16 13 + S	
300 GE (463.207)	125	09/89→09/97				24.0130-0217.1 430217	Ø 315 30 27,4 V + S	
320 GE (463.208)	155	09/94→11/97						
350 G Turbo-D (463.300)	100	09/91→09/97						
G 500 (463.202)	285	12/09→						
G 500 (463)	218	04/98→						
G 300 TD (463.308)	130	09/96→07/00	←			24.0116-0133.1 416133	Ø 303 16 13 + S	
G 320 (463.209)	158	11/97→				24.0130-0217.1 430217	Ø 315 30 27,4 V + S	
G 320 CDI (463.303)	165	09/06→						
G 350 CDI	155	07/11→	→			24.0116-0110.1 416110	Ø 272 16 14 + S	
G 400 CDI (463.309)	184	12/00→						
<b>MERCEDES-BENZ - GLA-KLASSE (X156) 12/13→</b>								
<b> Bremsbelagsatz, Scheibenbremse</b>								
GLA 180 (156.942)	90	02/15→	←			13.0460-2779.2 602779	TRW 24869 19,3 + WE / - WK	
GLA 180 CDI / d (156.912)	80	07/14→				13.0470-2779.2 LD2779	TRW 24869 19,3 + WE / - WK Ceramic	
GLA 200 (156.943)	115	12/13→						
GLA 200 CDI / d (156.908)	100	12/13→	→	+ eFSB		13.0460-2786.2 602786	TRW 24848 18,3 + WE / - WK + Zub	
GLA 200 CDI 4-matic (156.902)	100	12/13→				13.0470-2786.2 LD2786	TRW 24848 18,3 + WE / - WK + Zub Ceramic	
GLA 220 CDI / d (156.903)	120	12/13→						
GLA 220 CDI / d 4-matic (156.905)	120	12/13→						
GLA 220 CDI (156.903)	125	12/13→						
GLA 220 CDI 4-matic (156.905)	125	12/13→						
GLA 220 d (156.903)	130	07/15→						
GLA 220 d 4-matic (156.905)	130	07/15→						
GLA 250 (156.944)	155	12/13→						
↓								

	kW					! #		
<b>MERCEDES-BENZ - GLA-KLASSE (X156) 12/13→</b>								
<b> Bremsbelagsatz, Scheibenbremse</b>								
GLA 220 4-matic (156.947)	135	01/17→	←				<b>13.0460-2779.2 602779</b>	TRW 24869 19,3 + WE / - WK
GLA 250 4-matic (156.946)	155	12/13→					<b>13.0470-2779.2 LD2779</b>	TRW 24869 19,3 + WE / - WK Ceramic
<b>Warnkontakt, Bremsbelagverschleiß</b>								
AMG GLA 45 4-matic (156.952)	280	07/15→	←		1		<b>24.8190-0067.2 620067</b>	L= 92,5
GLA 180 (156.942)	90	02/15→						
GLA 180 CDI / d (156.912)	80	07/14→						
GLA 200 (156.943)	115	12/13→						
GLA 200 CDI / d (156.908)	100	12/13→						
GLA 200 CDI 4-matic (156.902)	100	12/13→						
GLA 220 4-matic (156.947)	135	01/17→						
GLA 220 CDI / d (156.903)	120	12/13→						
GLA 220 CDI / d 4-matic (156.905)	120	12/13→						
GLA 220 CDI (156.903)	125	12/13→						
GLA 220 CDI 4-matic (156.905)	125	12/13→						
GLA 220 d (156.903)	130	07/15→						
GLA 220 d 4-matic (156.905)	130	07/15→						
GLA 250 (156.944)	155	12/13→						
GLA 250 4-matic (156.946)	155	12/13→						
GLA 45 AMG 4-matic (156.952)	265	05/14→06/15						
<b> Bremsscheibe</b>								
GLA 180 (156.942)	90	02/15→	←	für Fahrzeuge mit AMG-Sportpaket			<b>24.0128-0262.1 428262</b>	Ø 295 28 26 V• + S
GLA 180 CDI / d (156.912)	80	07/14→	←	für Fahrzeuge ohne AMG-Sportpaket			<b>24.0128-0276.1 428276</b>	Ø 295 28 25,4 V + S
			→				<b>24.0110-0382.1 410382</b>	Ø 295 10 8,3 + S
GLA 200 (156.943)	115	12/13→	←	für Fahrzeuge mit Sportpaket			<b>24.0128-0262.1 428262</b>	Ø 295 28 26 V• + S
			←	für Fahrzeuge ohne AMG-Sportpaket			<b>24.0128-0276.1 428276</b>	Ø 295 28 25,4 V + S
			→				<b>24.0110-0382.1 410382</b>	Ø 295 10 8,3 + S
GLA 200 CDI / d (156.908)	100	12/13→	←	für Fahrzeuge mit AMG-Sportpaket			<b>24.0128-0262.1 428262</b>	Ø 295 28 26 V• + S
GLA 200 CDI 4-matic (156.902)	100	12/13→	←	für Fahrzeuge ohne AMG-Sportpaket			<b>24.0128-0275.1 428275</b>	Ø 295 28 25,4 V + S
			→				<b>24.0110-0382.1 410382</b>	Ø 295 10 8,3 + S
GLA 220 4-matic (156.947)	135	01/17→	←				<b>24.0130-0238.1 430238</b>	Ø 320 30 28 V• + S
GLA 250 4-matic (156.946)	155	12/13→	→	+ USA; Made in China-made			<b>24.0110-0382.1 410382</b>	Ø 295 10 8,3 + S
GLA 220 CDI / d (156.903)	120	12/13→	←	für Fahrzeuge ohne AMG-Sportpaket			<b>24.0128-0275.1 428275</b>	Ø 295 28 25,4 V + S
GLA 220 CDI / d 4-matic (156.905)	120	12/13→	←	für Fahrzeuge mit AMG-Sportpaket			<b>24.0130-0238.1 430238</b>	Ø 320 30 28 V• + S
GLA 220 CDI (156.903)	125	12/13→	→				<b>24.0110-0382.1 410382</b>	Ø 295 10 8,3 + S
GLA 220 CDI 4-matic (156.905)	125	12/13→						
GLA 220 d (156.903)	130	07/15→						
GLA 220 d 4-matic (156.905)	130	07/15→						
GLA 250 (156.944)	155	12/13→	←	für Fahrzeuge ohne AMG-Sportpaket			<b>24.0130-0237.1 430237</b>	Ø 320 30 28 V + S
			←	für Fahrzeuge mit AMG-Sportpaket			<b>24.0130-0238.1 430238</b>	Ø 320 30 28 V• + S
			→				<b>24.0110-0382.1 410382</b>	Ø 295 10 8,3 + S
<b>MERCEDES-BENZ - GLC (X253) 06/15→</b>								
<b> Bremsbelagsatz, Scheibenbremse</b>								
220 d 4-matic (253.905)	120	06/15→	←	für Fahrzeuge ohne AMG-Sportpaket			<b>13.0460-4883.2 604883</b>	BRE 22061 18,7 + WE / - WK
220 d 4-matic (253.905)	125	06/15→					<b>13.0470-4883.2 LD4883</b>	BRE 22061 18,7 + WE / - WK Ceramic
250 4-matic (253.946)	155	06/15→						
250 d 4-matic (253.909)	150	06/15→						
300 4-matic (253.949)	180	07/15→	→	+ eFSB			<b>13.0460-7316.2 607316</b>	ATE 22423 16,4 + WE / - WK
350 d 4-matic (253.925)	190	10/16→					<b>13.0470-7316.2 LD7316</b>	ATE 22423 16,4 + WE / - WK Ceramic
350 e 4-matic (253.954)	155	01/16→	→	+ eFSB			<b>13.0460-7316.2 607316</b>	ATE 22423 16,4 + WE / - WK
350 e 4-matic (253.954)	235	01/16→						
↓								









	kw			 	! #		
<b>MERCEDES-BENZ - GLC (X253) 06/15→</b>							
 <b>Bremsbelagsatz, Scheibenbremse</b>							
AMG 43 4-matic (253.964)	270	04/16→	➡	+ eFSB		13.0470-7316.2 LD7316	ATE 22423 16,4 + WE / - WK Ceramic
<b>Warnkontakt, Bremsbelagverschleiß</b>							
220 d 4-matic (253.905)	120	06/15→	←		1	24.8190-0067.2 620067	L= 92,5
220 d 4-matic (253.905)	125	06/15→	➡		1	24.8190-0067.2 620067	L= 92,5
250 4-matic (253.946)	155	06/15→					
250 d 4-matic (253.909)	150	06/15→					
300 4-matic (253.949)	180	07/15→					
350 d 4-matic (253.925)	190	10/16→					
350 e 4-matic (253.954)	155	01/16→					
350 e 4-matic (253.954)	235	01/16→					
AMG 43 4-matic (253.964)	270	04/16→					
<b>MERCEDES-BENZ - GLC Coupe (C253) 06/16→</b>							
 <b>Bremsbelagsatz, Scheibenbremse</b>							
220 d 4-matic (253.303, 253.305)	120	06/16→	←	für Fahrzeuge ohne AMG-Sportpaket		13.0460-4883.2 604883	BRE 22061 18,7 + WE / - WK
220 d 4-matic (253.303, 253.305)	125	06/16→	←	für Fahrzeuge ohne AMG-Sportpaket; - USA		13.0470-4883.2 LD4883	BRE 22061 18,7 + WE / - WK Ceramic
250 4-matic (253.346)	155	06/16→	➡			13.0460-7316.2 607316	ATE 22423 16,4 + WE / - WK
250 d 4-matic (253.309)	150	06/16→				13.0470-7316.2 LD7316	ATE 22423 16,4 + WE / - WK Ceramic
300 4-matic (253.349)	180	10/16→					
350 d 4-matic (253.325)	190	10/16→					
350 e 4-matic (253.354)	155	10/16→	➡			13.0460-7316.2 607316	ATE 22423 16,4 + WE / - WK
350 e 4-matic (253.354)	235	10/16→				13.0470-7316.2 LD7316	ATE 22423 16,4 + WE / - WK Ceramic
AMG 43 4-matic (253.364)	270	10/16→					
<b>Warnkontakt, Bremsbelagverschleiß</b>							
220 d 4-matic (253.303, 253.305)	120	06/16→	←		1	24.8190-0067.2 620067	L= 92,5
220 d 4-matic (253.303, 253.305)	125	06/16→	➡		1	24.8190-0067.2 620067	L= 92,5
250 4-matic (253.346)	155	06/16→					
250 d 4-matic (253.309)	150	06/16→					
300 4-matic (253.349)	180	10/16→					
350 d 4-matic (253.325)	190	10/16→					
AMG 43 4-matic (253.364)	270	10/16→					
350 e 4-matic (253.354)	155	10/16→	➡		1	24.8190-0067.2 620067	L= 92,5
350 e 4-matic (253.354)	235	10/16→					
<b>MERCEDES-BENZ - GLE (W166) 04/15→</b>							
 <b>Bremsbelagsatz, Scheibenbremse</b>							
250 d (166.006)	150	04/15→	←			13.0460-7282.2 607282	ATE 25190 21,3 - WK / + WK
250 d 4-matic (166.004)	150	04/15→				13.0470-7282.2 LD7282	ATE 25190 21,3 - WK / + WK Ceramic
350 d 4-matic (166.024)	190	04/15→	➡	für Fahrzeuge ohne AMG-Sportpaket; - USA		13.0460-2781.2 602781	TRW 25215 18,6 + WE / - WK + Zub
			➡			13.0470-2781.2 LD2781	TRW 25215 18,6 + WE / - WK + Zub Ceramic
			➡	für Fahrzeuge mit AMG-Sportpaket; - USA		13.0460-2782.2 602782	TRW + WE / - WK + Zub
						13.0470-2782.2 LD2782	TRW + WE / - WK + Zub Ceramic
320 4-matic (166.062)	200	10/15→	←	für Fahrzeuge ohne AMG-Sportpaket		13.0460-7282.2 607282	ATE 25190 21,3 - WK / + WK
						13.0470-7282.2 LD7282	ATE 25190 21,3 - WK / + WK Ceramic
			←	für Fahrzeuge mit AMG-Sportpaket		13.0460-7283.2 607283	ATE 25531 19,3 + WE / - WK
			➡			13.0460-2782.2 602782	TRW + WE / - WK + Zub
						13.0470-2782.2 LD2782	TRW + WE / - WK + Zub Ceramic
400 4-matic (166.056)	245	04/15→	←	für Fahrzeuge ohne AMG-Sportpaket		13.0460-7282.2 607282	ATE 25190 21,3 - WK / + WK
			←	für Fahrzeuge mit AMG-Sportpaket		13.0460-7283.2 607283	ATE 25531 19,3 + WE / - WK
			➡			13.0460-2782.2 602782	TRW + WE / - WK + Zub
						13.0470-2782.2 LD2782	TRW + WE / - WK + Zub Ceramic
450 AMG 4-matic (166.064)	270	10/15→04/16	←	für Fahrzeuge ohne Sportpaket		13.0460-7283.2 607283	ATE 25531 19,3 + WE / - WK
AMG 43 4-matic (166.064)	270	05/16→	➡	für Fahrzeuge ohne Sportpaket		13.0460-2782.2 602782	TRW + WE / - WK + Zub
						13.0470-2782.2 LD2782	TRW + WE / - WK + Zub Ceramic
500 4-matic (166.073)	320	04/15→	←			13.0460-7283.2 607283	ATE 25531 19,3 + WE / - WK
500 e 4-matic (166.063)	245	04/15→					
500 e 4-matic (166.063)	325	04/15→	➡			13.0460-2782.2 602782	TRW + WE / - WK + Zub
						13.0470-2782.2 LD2782	TRW + WE / - WK + Zub Ceramic
↓							





















	kW			 	! #		
<b>MERCEDES-BENZ - GLE (W166) 04/15→</b>							
 <b>Bremsbelagsatz, Scheibenbremse</b>							
AMG 63 4-matic (166.074)	386	04/15→05/17	←			13.0460-4839.2 604839	BRE 24455 16,8 + WE / - WK
AMG 63 4-matic (166.074)	410	04/15→					
<b>Warnkontakt, Bremsbelagverschleiß</b>							
250 d (166.006)	150	04/15→	←	<input type="checkbox"/>	1	24.8190-0425.2 620425	L= 98
250 d 4-matic (166.004)	150	04/15→					
320 4-matic (166.062)	200	10/15→	→		1	24.8190-0410.2 620410	L= 97,5
350 d 4-matic (166.024)	190	04/15→					
400 4-matic (166.056)	245	04/15→					
500 4-matic (166.073)	320	04/15→					
500 e 4-matic (166.063)	245	04/15→					
500 e 4-matic (166.063)	325	04/15→					
450 AMG 4-matic (166.064)	270	10/15→04/16	←		1	24.8190-0420.2 620420	L= 119
AMG 43 4-matic (166.064)	270	05/16→	←		1	24.8190-0425.2 620425	L= 98
			→		1	24.8190-0410.2 620410	L= 97,5
AMG 63 4-matic (166.074)	386	04/15→05/17	←		1	24.8190-0420.2 620420	L= 119
AMG 63 4-matic (166.074)	410	04/15→	→		1	24.8190-0410.2 620410	L= 97,5
AMG 63 S 4-matic (166.075)	430	04/15→					
 <b>Bremsscheibe</b>							
250 d (166.006)	150	04/15→	←			24.0132-0178.1 432178	Ø 330 32 29,4 V + S
250 d 4-matic (166.004)	150	04/15→	←			24.0132-0179.1 432179	Ø 350 32 29,4 V• + S
350 d 4-matic (166.024)	190	04/15→	→			24.0114-0119.1 414119	Ø 325 14 11,4 + S
			→			24.0122-0288.1 422288	Ø 330 22 19,4 V + S
320 4-matic (166.062)	200	10/15→	←	+ USA;		24.0132-0178.1 432178	Ø 330 32 29,4 V + S
400 4-matic (166.056)	245	04/15→	←	für Fahrzeuge ohne AMG-Sportpaket		24.0132-0179.1 432179	Ø 350 32 29,4 V• + S
			←	+ USA;		24.0132-0184.1 432184	Ø 350 32 29,4 V + S
			←	für Fahrzeuge mit AMG-Sportpaket		24.0122-0288.1 422288	Ø 330 22 19,4 V + S
			→	- USA;		24.0122-0296.1 422296	Ø 345 22 19,4 V + S
			→	für Fahrzeuge ohne AMG-Sportpaket		24.0122-0296.1 422296	Ø 345 22 19,4 V + S
			→	für Fahrzeuge mit AMG-Sportpaket			
450 AMG 4-matic (166.064)	270	10/15→04/16	→			24.0122-0296.1 422296	Ø 345 22 19,4 V + S
AMG 43 4-matic (166.064)	270	05/16→					
500 4-matic (166.073)	320	04/15→	→			24.0122-0296.1 422296	Ø 345 22 19,4 V + S
500 e 4-matic (166.063)	245	04/15→					
500 e 4-matic (166.063)	325	04/15→					
<b>MERCEDES-BENZ - GLE Coupe (C292) 03/15→</b>							
 <b>Bremsbelagsatz, Scheibenbremse</b>							
350 d 4-matic (292.323, 292.324)	190	03/15→	←			13.0460-7282.2 607282 13.0470-7282.2 LD7282	ATE 25190 21,3 - WK / + WK ATE 25190 21,3 - WK / + WK Ceramic
			→	für Fahrzeuge ohne AMG-Sportpaket		13.0460-2781.2 602781 13.0470-2781.2 LD2781	TRW 25215 18,6 + WE / - WK + Zub TRW 25215 18,6 + WE / - WK + Zub Ceramic
			→	für Fahrzeuge mit AMG-Sportpaket		13.0460-2782.2 602782 13.0470-2782.2 LD2782	TRW + WE / - WK + Zub TRW + WE / - WK + Zub Ceramic
400 4-matic (292.356)	245	03/15→	←			13.0460-7282.2 607282 13.0460-2783.2 607283 13.0460-2782.2 602782 13.0470-2782.2 LD2782	ATE 25190 21,3 - WK / + WK ATE 25531 19,3 + WE / - WK TRW + WE / - WK + Zub TRW + WE / - WK + Zub Ceramic
450 AMG 4-matic (292.364)	270	03/15→04/16	←			13.0460-7283.2 607283	ATE 25531 19,3 + WE / - WK
AMG 43 4-matic (292.364)	270	05/16→	→			13.0460-2782.2 602782 13.0470-2782.2 LD2782	TRW + WE / - WK + Zub TRW + WE / - WK + Zub Ceramic
500 4-matic (292.373)	335	10/15→	←			13.0460-7283.2 607283	ATE 25531 19,3 + WE / - WK
			→	für Fahrzeuge ohne Sportpaket		13.0460-2782.2 602782 13.0470-2782.2 LD2782	TRW + WE / - WK + Zub TRW + WE / - WK + Zub Ceramic

	kW			 	! #		
<b>MERCEDES-BENZ - GLE Coupe (C292) 03/15→</b>							
<b>Warnkontakt, Bremsbelagverschleiß</b>							
350 d 4-matic (292.323, 292.324)	190	03/15→	←			24.8190-0425.2 620425	L= 98
400 4-matic (292.356)	245	03/15→	→		1	24.8190-0410.2 620410	L= 97,5
450 AMG 4-matic (292.364)	270	03/15→04/16					
500 4-matic (292.373)	335	10/15→					
AMG 43 4-matic (292.364)	270	05/16→					
AMG 63 4-matic (292.374)	410	03/15→	←			24.8190-0420.2 620420	L= 119
AMG 63 S 4-matic (292.375)	430	03/15→	→		1	24.8190-0410.2 620410	L= 97,5
<b> Brems Scheibe</b>							
350 d 4-matic (292.323, 292.324)	190	03/15→	←	für Fahrzeuge ohne AMG-Sportpaket		24.0132-0178.1 432178	Ø 330 32 29,4 V + S
			←	für Fahrzeuge mit AMG-Sportpaket		24.0132-0179.1 432179	Ø 350 32 29,4 V• + S
			→	für Fahrzeuge ohne AMG-Sportpaket		24.0114-0119.1 414119	Ø 325 14 11,4 + S
			→	für Fahrzeuge mit AMG-Sportpaket		24.0122-0288.1 422288	Ø 330 22 19,4 V + S
400 4-matic (292.356)	245	03/15→	←	für Fahrzeuge ohne AMG-Sportpaket		24.0132-0184.1 432184	Ø 350 32 29,4 V + S
			→	für Fahrzeuge ohne AMG-Sportpaket		24.0122-0288.1 422288	Ø 330 22 19,4 V + S
			→	für Fahrzeuge mit AMG-Sportpaket		24.0122-0296.1 422296	Ø 345 22 19,4 V + S
450 AMG 4-matic (292.364)	270	03/15→04/16	→			24.0122-0296.1 422296	Ø 345 22 19,4 V + S
		AMG 43 4-matic (292.364)	270	05/16→			
500 4-matic (292.373)	335	10/15→	→	für Fahrzeuge ohne Sportpaket		24.0122-0296.1 422296	Ø 345 22 19,4 V + S
<b>MERCEDES-BENZ - GLK-KLASSE (X204) 06/08→</b>							
<b> Bremsbelagsatz, Scheibenbremse</b>							
200 (204.934)	135	08/13→06/15	←			13.0460-3852.2 603852	BOS 24867 20,7 + WE / - WK + Zub
200 CDI (204.901)	100	12/13→06/15					
200 CDI (204.901)	105	07/10→06/15				13.0470-3852.2 LD3852	BOS 24867 20,7 + WE / - WK + Zub Ceramic
250 (204.936)	155	08/13→06/15					
250 4-matic (204.937)	155	08/13→06/15					
250 CDI 4-matic (204.982, 204.904)	150	09/09→06/15	→			13.0460-7257.2 607257	ATE 24253 18,0 + WE / - WK
300 4-matic	185	09/09→06/15				13.0470-7257.2 LD7257	ATE 24253 18,0 + WE / - WK Ceramic
300 4-matic (204.981)	170	07/09→04/11					
350 (204.956)	200	04/09→06/15					
350 CDI 4-matic (204.992)	165	07/09→01/10					
350 CDI 4-matic (204.992)	170	02/10→05/10					
350 CDI 4-matic (204.993)	195	07/12→06/15					
220 CDI (204.902)	120	12/08→06/15	←	04/09→		13.0460-3852.2 603852	BOS 24867 20,7 + WE / - WK + Zub
220 CDI (204.902)	125	12/08→06/15					
220 CDI 4-matic (204.984, 204.997)	125	12/08→06/15				13.0470-3852.2 LD3852	BOS 24867 20,7 + WE / - WK + Zub Ceramic
220 CDI 4-matic (204.984)	120	12/08→06/15	→	04/09→		13.0460-7257.2 607257	ATE 24253 18,0 + WE / - WK
						13.0470-7257.2 LD7257	ATE 24253 18,0 + WE / - WK Ceramic
280 4-matic (204.981)	170	06/08→06/09	←	09/08→		13.0460-3852.2 603852	BOS 24867 20,7 + WE / - WK + Zub
320 CDI 4-matic (204.983)	165	06/08→06/15					
350 4-matic (204.987)	200	06/08→04/11				13.0470-3852.2 LD3852	BOS 24867 20,7 + WE / - WK + Zub Ceramic
350 4-matic (204.988)	225	06/08→06/15	→	09/08→		13.0460-7257.2 607257	ATE 24253 18,0 + WE / - WK
						13.0470-7257.2 LD7257	ATE 24253 18,0 + WE / - WK Ceramic
<b>Warnkontakt, Bremsbelagverschleiß</b>							
200 (204.934)	135	08/13→06/15	←		1	24.8190-0410.2 620410	L= 97,5
200 CDI (204.901)	100	12/13→06/15					
200 CDI (204.901)	105	07/10→06/15	→		1	24.8190-0410.2 620410	L= 97,5
250 (204.936)	155	08/13→06/15					
250 4-matic (204.937)	155	08/13→06/15					
250 CDI 4-matic (204.982, 204.904)	150	09/09→06/15					
300 4-matic	185	09/09→06/15					
300 4-matic (204.981)	170	07/09→04/11					
350 (204.956)	200	04/09→06/15					
350 CDI 4-matic (204.992)	165	07/09→01/10					
↓							











	kW			 	! #		
<b>MERCEDES-BENZ - GLK-KLASSE (X204) 06/08→</b>							
<b>Warnkontakt, Bremsbelagverschleiß</b>							
350 CDI 4-matic (204.992)	170	02/10→05/10	←		1	24.8190-0410.2 620410	L= 97,5
350 CDI 4-matic (204.993)	195	07/12→06/15	→		1	24.8190-0410.2 620410	L= 97,5
220 CDI (204.902)	120	12/08→06/15	←	04/09→	1	24.8190-0410.2 620410	L= 97,5
220 CDI (204.902)	125	12/08→06/15					
220 CDI 4-matic (204.984, 204.997)	125	12/08→06/15	→	04/09→	1	24.8190-0410.2 620410	L= 97,5
220 CDI 4-matic (204.984)	120	12/08→06/15					
280 4-matic (204.981)	170	06/08→06/09	←	09/08→	1	24.8190-0410.2 620410	L= 97,5
320 CDI 4-matic (204.983)	165	06/08→06/15	→	09/08→	1	24.8190-0410.2 620410	L= 97,5
350 4-matic (204.987)	200	06/08→04/11					
350 4-matic (204.988)	225	06/08→06/15					
<b> Brems Scheibe</b>							
200 (204.934)	135	08/13→06/15	←			24.0132-0144.1 432144	Ø 330 32 29,4 V + S
200 CDI (204.901)	100	12/13→06/15				24.0332-0144.1 532144	Ø 330 32 29,4 V + S
200 CDI (204.901)	105	07/10→06/15					
250 (204.936)	155	08/13→06/15	→			24.0122-0201.1 422201	Ø 300 22 19,4 V + S
250 4-matic (204.937)	155	08/13→06/15					
250 CDI 4-matic (204.982, 204.904)	150	09/09→06/15					
300 4-matic	185	09/09→06/15					
300 4-matic (204.981)	170	07/09→04/11					
350 (204.956)	200	04/09→06/15					
350 CDI 4-matic (204.992)	165	07/09→01/10					
350 CDI 4-matic (204.992)	170	02/10→05/10					
350 CDI 4-matic (204.993)	195	07/12→06/15					
220 CDI (204.902)	120	12/08→06/15	←	04/09→		24.0132-0144.1 432144	Ø 330 32 29,4 V + S
220 CDI (204.902)	125	12/08→06/15				24.0332-0144.1 532144	Ø 330 32 29,4 V + S
220 CDI 4-matic (204.984, 204.997)	125	12/08→06/15	→	04/09→		24.0122-0201.1 422201	Ø 300 22 19,4 V + S
220 CDI 4-matic (204.984)	120	12/08→06/15					
280 4-matic (204.981)	170	06/08→06/09	←	09/08→		24.0132-0144.1 432144	Ø 330 32 29,4 V + S
320 CDI 4-matic (204.983)	165	06/08→06/15				24.0332-0144.1 532144	Ø 330 32 29,4 V + S
350 4-matic (204.987)	200	06/08→04/11	→	09/08→		24.0122-0201.1 422201	Ø 300 22 19,4 V + S
350 4-matic (204.988)	225	06/08→06/15					
<b>MERCEDES-BENZ - GL-KLASSE (X164) 09/06→</b>							
<b> Bremsbelagsatz, Scheibenbremse</b>							
GL 320 CDI / 350 BlueTEC 4-matic (164.824, 164.825)	155	12/09→	←	→ 06/12; nicht für Fahrzeuge mit verstärkter Bremse		13.0460-7220.2 607220	ATE 23922 21,0 + WE / - WK
GL 350 CDI 4-matic (164.822)	165	05/09→	←	→ 06/12; für Fahrzeuge mit verstärkter Bremse		13.0470-7220.2 LD7220	ATE 23922 21,0 + WE / - WK Ceramic
GL 350 CDI 4-matic (164.823)	195	10/10→	→	→ 06/12		13.0460-7271.2 607271	ATE 24151 21,0 + WE / - WK
						13.0460-7219.2 607219	ATE 23923 17,6 + WE / - WK
						13.0470-7219.2 LD7219	ATE 23923 17,6 + WE / - WK Ceramic
GL 320 CDI 4-matic (164.822)	165	09/06→05/09	←	nicht für Fahrzeuge mit verstärkter Bremse		13.0460-7220.2 607220	ATE 23922 21,0 + WE / - WK
			←	für Fahrzeuge mit verstärkter Bremse		13.0470-7220.2 LD7220	ATE 23922 21,0 + WE / - WK Ceramic
			→			13.0460-7271.2 607271	ATE 24151 21,0 + WE / - WK
						13.0460-7219.2 607219	ATE 23923 17,6 + WE / - WK
						13.0470-7219.2 LD7219	ATE 23923 17,6 + WE / - WK Ceramic
GL 420 CDI 4-matic (164.828)	225	09/06→05/09	←			13.0460-7271.2 607271	ATE 24151 21,0 + WE / - WK
			→			13.0460-7219.2 607219	ATE 23923 17,6 + WE / - WK
						13.0470-7219.2 LD7219	ATE 23923 17,6 + WE / - WK Ceramic
GL 450 4-matic (164.871)	250	09/06→	←	→ 06/12		13.0460-7271.2 607271	ATE 24151 21,0 + WE / - WK
GL 450 CDI 4-matic (164.828)	225	05/09→	→	→ 06/12		13.0460-7219.2 607219	ATE 23923 17,6 + WE / - WK
GL 500 4-matic (164.886)	285	09/06→				13.0470-7219.2 LD7219	ATE 23923 17,6 + WE / - WK Ceramic









	kW			 	! #		
<b>MERCEDES-BENZ - GL-KLASSE (X164) 09/06→</b>							
<b>Warnkontakt, Bremsbelagverschleiß</b>							
GL 320 CDI / 350 BlueTEC 4-matic (164.824, 164.825)	155	12/09→	←	→ 06/12	1	24.8190-0425.2 620425	L= 98
			→	→ 06/12	1	24.8190-0425.2 620425	L= 98
GL 350 CDI 4-matic (164.822)	165	05/09→					
GL 350 CDI 4-matic (164.823)	195	10/10→					
GL 450 4-matic (164.871)	250	09/06→					
GL 450 CDI 4-matic (164.828)	225	05/09→					
GL 500 4-matic (164.886)	285	09/06→					
GL 320 CDI 4-matic (164.822)	165	09/06→05/09	←		1	24.8190-0425.2 620425	L= 98
GL 420 CDI 4-matic (164.828)	225	09/06→05/09	→		1	24.8190-0425.2 620425	L= 98
<b> Bremsscheibe</b>							
GL 320 CDI / 350 BlueTEC 4-matic (164.824, 164.825)	155	12/09→	←	→ 06/12; nicht für Fahrzeuge mit verstärkter Bremse		24.0132-0157.1 432157	Ø 350 32 29,4 V + S
GL 350 CDI 4-matic (164.822)	165	05/09→	←	→ 06/12; für Fahrzeuge mit verstärkter Bremse		24.0132-0167.1 432167	Ø 375 32 29,4 V + S
GL 350 CDI 4-matic (164.823)	195	10/10→	→	→ 06/12		24.0122-0226.1 422226	Ø 330 22 19,4 V + S
GL 320 CDI 4-matic (164.822)	165	09/06→05/09	←	nicht für Fahrzeuge mit verstärkter Bremse		24.0132-0157.1 432157	Ø 350 32 29,4 V + S
			←	für Fahrzeuge mit verstärkter Bremse		24.0132-0167.1 432167	Ø 375 32 29,4 V + S
			→			24.0122-0226.1 422226	Ø 330 22 19,4 V + S
GL 420 CDI 4-matic (164.828)	225	09/06→05/09	←			24.0132-0167.1 432167	Ø 375 32 29,4 V + S
			→			24.0122-0226.1 422226	Ø 330 22 19,4 V + S
GL 450 4-matic (164.871)	250	09/06→	←	→ 06/12		24.0132-0167.1 432167	Ø 375 32 29,4 V + S
GL 450 CDI 4-matic (164.828)	225	05/09→	→	→ 06/12		24.0122-0226.1 422226	Ø 330 22 19,4 V + S
GL 500 4-matic (164.886)	285	09/06→					
<b>MERCEDES-BENZ - GL-KLASSE (X166) 07/12→</b>							
<b> Bremsbelagsatz, Scheibenbremse</b>							
GL 350 CDI / BlueTec 4-matic (166.823, 166.824)	190	07/12→	←	für Fahrzeuge ohne AMG-Sportpaket		13.0460-7282.2 607282 13.0470-7282.2 LD7282	ATE 25190 21,3 - WK / + WK ATE 25190 21,3 - WK / + WK Ceramic
			←	für Fahrzeuge mit AMG-Sportpaket		13.0460-7283.2 607283	ATE 25531 19,3 + WE / - WK
			→			13.0460-2782.2 602782 13.0470-2782.2 LD2782	TRW + WE / - WK + Zub TRW + WE / - WK + Zub Ceramic
GL 400 4-matic (166.856)	245	08/13→	←	für Fahrzeuge ohne AMG-Sportpaket		13.0460-7282.2 607282	ATE 25190 21,3 - WK / + WK
			←	für Fahrzeuge mit AMG-Sportpaket		13.0460-7283.2 607283	ATE 25531 19,3 + WE / - WK
			→			13.0460-2782.2 602782 13.0470-2782.2 LD2782	TRW + WE / - WK + Zub TRW + WE / - WK + Zub Ceramic
GL 500 4-matic (166.873, 166.874)	320	07/12→	←			13.0460-7283.2 607283	ATE 25531 19,3 + WE / - WK
			→			13.0460-2782.2 602782 13.0470-2782.2 LD2782	TRW + WE / - WK + Zub TRW + WE / - WK + Zub Ceramic
GL 63 AMG 4-matic (166.874)	410	07/12→	←			13.0460-4839.2 604839	BRE 24455 16,8 + WE / - WK
<b>Warnkontakt, Bremsbelagverschleiß</b>							
GL 350 CDI / BlueTec 4-matic (166.823, 166.824)	190	07/12→	←	<input type="checkbox"/>	1	24.8190-0425.2 620425	L= 98
GL 400 4-matic (166.856)	245	08/13→	→		1	24.8190-0410.2 620410	L= 97,5
GL 500 4-matic (166.873, 166.874)	320	07/12→					
GL 63 AMG 4-matic (166.874)	410	07/12→	←	<input type="checkbox"/>	1	24.8190-0420.2 620420	L= 119
			→		1	24.8190-0410.2 620410	L= 97,5
<b> Bremsscheibe</b>							
GL 350 CDI / BlueTec 4-matic (166.823, 166.824)	190	07/12→	←	für Fahrzeuge ohne AMG-Sportpaket		24.0132-0184.1 432184	Ø 350 32 29,4 V + S
GL 400 4-matic (166.856)	245	08/13→	→	für Fahrzeuge ohne AMG-Sportpaket		24.0122-0296.1 422296	Ø 345 22 19,4 V + S









	kw			 	! #				
<b>MERCEDES-BENZ - GLS (X166) 11/15→</b>									
 <b>Bremsbelagsatz, Scheibenbremse</b>									
350 d 4-matic (166.824)	190	11/15→	←	für Fahrzeuge ohne AMG-Sportpaket	13.0460-7282.2	607282	ATE 25190 21,3 - WK / + WK		
			→		13.0470-7282.2	LD7282	ATE 25190 21,3 - WK / + WK Ceramic		
			←	für Fahrzeuge mit AMG-Sportpaket	13.0460-7283.2	607283	ATE 25531 19,3 + WE / - WK		
400 4-matic (166.856)	245	11/15→	←	für Fahrzeuge ohne AMG-Sportpaket	13.0460-2782.2	602782	TRW + WE / - WK + Zub		
			→		13.0470-2782.2	LD2782	TRW + WE / - WK + Zub Ceramic		
			←	für Fahrzeuge mit AMG-Sportpaket	13.0460-2783.2	602783	ATE 25190 21,3 - WK / + WK		
500 4-matic (166.873)	335	11/15→	←	für Fahrzeuge ohne AMG-Sportpaket	13.0460-2782.2	602782	ATE 25531 19,3 + WE / - WK		
			→		13.0470-2782.2	LD2782	TRW + WE / - WK + Zub		
			←	für Fahrzeuge mit AMG-Sportpaket	13.0460-2783.2	602783	ATE 25531 19,3 + WE / - WK		
			→		13.0460-2782.2	602782	TRW + WE / - WK + Zub		
			→		13.0470-2782.2	LD2782	TRW + WE / - WK + Zub Ceramic		
			→		13.0460-2782.2	602782	TRW + WE / - WK + Zub		
			→		13.0470-2782.2	LD2782	TRW + WE / - WK + Zub Ceramic		
			<b>Warnkontakt, Bremsbelagverschleiß</b>						
			350 d 4-matic (166.824)	190	11/15→	←		1	24.8190-0425.2
400 4-matic (166.856)	245	11/15→	→		1	24.8190-0410.2	620410	L= 97,5	
500 4-matic (166.873)	335	11/15→	→		1	24.8190-0420.2	620420	L= 119	
AMG 63 4-matic (166.875, 166.874)	430	11/15→	←		1	24.8190-0410.2	620410	L= 97,5	
			→		1	24.8190-0410.2	620410	L= 97,5	
			<b>Bremsscheibe</b>						
350 d 4-matic (166.824)	190	11/15→	←	für Fahrzeuge ohne AMG-Sportpaket	24.0132-0184.1	432184	Ø 350 32 29,4 V + S		
400 4-matic (166.856)	245	11/15→	→	für Fahrzeuge ohne AMG-Sportpaket	24.0122-0296.1	422296	Ø 345 22 19,4 V + S		
<b>MERCEDES-BENZ - M-KLASSE (W163) 02/98→06/05</b>									
 <b>Bremsbelagsatz, Scheibenbremse</b>									
ML 230 (163.136)	110	02/98→06/05	←	03/98→	13.0460-8004.2	608004	23193 16,4 + WK + Zub		
			→	03/98→ 11/98	13.0460-8005.2	608005	23189 16,7 + WK + Zub		
			→	12/98→	13.0460-8007.2	608007	23189 16,7 + WK		
ML 270 CDI (163.113)	120	12/99→06/05	←	X754620→	13.0460-4984.2	604984	BRE 23271 17,4 + WE / - WK		
			→		13.0470-4984.2	LD4984	BRE 23271 17,4 + WE / - WK Ceramic		
			←	A289560→	13.0460-4984.2	604984	BRE 23271 17,4 + WE / - WK		
			→		13.0470-4984.2	LD4984	BRE 23271 17,4 + WE / - WK Ceramic		
			←	→ A289559	13.0460-8004.2	608004	23193 16,4 + WK + Zub		
			←	→ X754619	13.0460-8004.2	608004	23193 16,4 + WK + Zub		
			→	X754620→	13.0460-4977.2	604977	BRE 23157 15,8 + WE / - WK + Zub		
			→		13.0470-4977.2	LD4977	BRE 23157 15,8 + WE / - WK + Zub Ceramic		
			→	A289560→	13.0460-4977.2	604977	BRE 23157 15,8 + WE / - WK + Zub		
			→		13.0470-4977.2	LD4977	BRE 23157 15,8 + WE / - WK + Zub Ceramic		
			→	→ X754619	13.0460-8007.2	608007	23189 16,7 + WK		
			→	→ A289559	13.0460-8007.2	608007	23189 16,7 + WK		
ML 320 (163.154)	160	02/98→08/02	←	X754620→	13.0460-4984.2	604984	BRE 23271 17,4 + WE / - WK		
			→		13.0470-4984.2	LD4984	BRE 23271 17,4 + WE / - WK Ceramic		
			←	A289560→	13.0460-4984.2	604984	BRE 23271 17,4 + WE / - WK		
			→		13.0470-4984.2	LD4984	BRE 23271 17,4 + WE / - WK Ceramic		
			←	03/98→; → X754619	13.0460-8004.2	608004	23193 16,4 + WK + Zub		
			←	03/98→; → A289559	13.0460-8004.2	608004	23193 16,4 + WK + Zub		
			→	X754620→	13.0460-4977.2	604977	BRE 23157 15,8 + WE / - WK + Zub		
			→		13.0470-4977.2	LD4977	BRE 23157 15,8 + WE / - WK + Zub Ceramic		
			→	A289560→	13.0460-4977.2	604977	BRE 23157 15,8 + WE / - WK + Zub		
			→		13.0470-4977.2	LD4977	BRE 23157 15,8 + WE / - WK + Zub Ceramic		
			→		13.0460-4977.2	604977	BRE 23157 15,8 + WE / - WK + Zub		
			→		13.0470-4977.2	LD4977	BRE 23157 15,8 + WE / - WK + Zub Ceramic		
			→		13.0460-4977.2	604977	BRE 23157 15,8 + WE / - WK + Zub		
			→		13.0470-4977.2	LD4977	BRE 23157 15,8 + WE / - WK + Zub Ceramic		
			→		13.0460-4977.2	604977	BRE 23157 15,8 + WE / - WK + Zub		
			→		13.0470-4977.2	LD4977	BRE 23157 15,8 + WE / - WK + Zub Ceramic		
			→		13.0460-4977.2	604977	BRE 23157 15,8 + WE / - WK + Zub		
			→		13.0470-4977.2	LD4977	BRE 23157 15,8 + WE / - WK + Zub Ceramic		
			→		13.0460-4977.2	604977	BRE 23157 15,8 + WE / - WK + Zub		
			→		13.0470-4977.2	LD4977	BRE 23157 15,8 + WE / - WK + Zub Ceramic		
			→		13.0460-4977.2	604977	BRE 23157 15,8 + WE / - WK + Zub		
			→		13.0470-4977.2	LD4977	BRE 23157 15,8 + WE / - WK + Zub Ceramic		
			→		13.0460-4977.2	604977	BRE 23157 15,8 + WE / - WK + Zub		
			→		13.0470-4977.2	LD4977	BRE 23157 15,8 + WE / - WK + Zub Ceramic		

















	kw			 	! #			
<b>MERCEDES-BENZ - M-KLASSE (W163) 02/98→06/05</b>								
<b> Bremsbelagsatz, Scheibenbremse</b>								
ML 320 (163.154)	160	02/98→08/02	➡	A289560→		13.0470-4977.2	LD4977	BRE 23157 15,8 + WE / - WK + Zub Ceramic
			➡	03/98→ 11/98		13.0460-8005.2	608005	23189 16,7 + WK + Zub
			➡	12/98→; → A289559		13.0460-8007.2	608007	23189 16,7 + WK
			➡	12/98→; → X754619		13.0460-8007.2	608007	23189 16,7 + WK
ML 350	173	02/03→06/05	←			13.0460-4984.2	604984	BRE 23271 17,4 + WE / - WK
						13.0470-4984.2	LD4984	BRE 23271 17,4 + WE / - WK Ceramic
			➡			13.0460-4977.2	604977	BRE 23157 15,8 + WE / - WK + Zub
			➡			13.0470-4977.2	LD4977	BRE 23157 15,8 + WE / - WK + Zub Ceramic
ML 350 (163.157)	180	08/02→06/05	←	09/02→		13.0460-4984.2	604984	BRE 23271 17,4 + WE / - WK
						13.0470-4984.2	LD4984	BRE 23271 17,4 + WE / - WK Ceramic
			➡	09/02→		13.0460-4977.2	604977	BRE 23157 15,8 + WE / - WK + Zub
						13.0470-4977.2	LD4977	BRE 23157 15,8 + WE / - WK + Zub Ceramic
ML 400 CDI (163.128) ML 500 (163.175) ML 55 AMG (163.174)	184 215 255	09/01→06/05 09/01→06/05 02/00→06/05	←			13.0460-4984.2	604984	BRE 23271 17,4 + WE / - WK
			➡			13.0460-4977.2	604977	BRE 23157 15,8 + WE / - WK + Zub
						13.0470-4977.2	LD4977	BRE 23157 15,8 + WE / - WK + Zub Ceramic
ML 430 (163.172)	200	02/98→06/05	←	A145273→		13.0460-4984.2	604984	BRE 23271 17,4 + WE / - WK
			←	X707756→		13.0460-4984.2	604984	BRE 23271 17,4 + WE / - WK
			←	09/98→; → X707755		13.0460-8004.2	608004	23193 16,4 + WK + Zub
			←	09/98→; → A145272		13.0460-8004.2	608004	23193 16,4 + WK + Zub
			➡	X707756→		13.0460-4977.2	604977	BRE 23157 15,8 + WE / - WK + Zub
						13.0470-4977.2	LD4977	BRE 23157 15,8 + WE / - WK + Zub Ceramic
			➡	A145273→		13.0460-4977.2	604977	BRE 23157 15,8 + WE / - WK + Zub
						13.0470-4977.2	LD4977	BRE 23157 15,8 + WE / - WK + Zub Ceramic
			➡	09/98→ 11/98		13.0460-8005.2	608005	23189 16,7 + WK + Zub
			➡	12/98→; → A145272		13.0460-8007.2	608007	23189 16,7 + WK
			➡	12/98→; → X707755		13.0460-8007.2	608007	23189 16,7 + WK
<b>Warnkontakt, Bremsbelagverschleiß</b>								
ML 230 (163.136)	110	02/98→06/05	←	03/98→	2	24.8190-0961.2	620961	L= 100
ML 270 CDI (163.113)	120	12/99→06/05	←	A289560→	2	24.8190-0412.2	620412	L= 114
			←	X754620→	2	24.8190-0412.2	620412	L= 114
			←	→ X754619	2	24.8190-0961.2	620961	L= 100
			←	→ A289559	2	24.8190-0961.2	620961	L= 100
			➡	X754620→	2	24.8190-0411.2	620411	L= 72
			➡	A289560→	2	24.8190-0411.2	620411	L= 72
ML 320 (163.154)	160	02/98→08/02	←	X754620→	2	24.8190-0412.2	620412	L= 114
			←	A289560→	2	24.8190-0412.2	620412	L= 114
			←	03/98→; → X754619	2	24.8190-0961.2	620961	L= 100
			←	03/98→; → A289559	2	24.8190-0961.2	620961	L= 100
			➡	A289560→	2	24.8190-0411.2	620411	L= 72
			➡	X754620→	2	24.8190-0411.2	620411	L= 72
ML 350 ML 400 CDI (163.128) ML 500 (163.175) ML 55 AMG (163.174)	173 184 215 255	02/03→06/05 09/01→06/05 09/01→06/05 02/00→06/05	←		2	24.8190-0412.2	620412	L= 114
			➡		2	24.8190-0411.2	620411	L= 72
			←	09/02→	2	24.8190-0412.2	620412	L= 114
ML 350 (163.157)	180	08/02→06/05	➡	09/02→	2	24.8190-0411.2	620411	L= 72
ML 430 (163.172)	200	02/98→06/05	←	A145273→	2	24.8190-0412.2	620412	L= 114
			↓					











	kw			 	! #		
<b>MERCEDES-BENZ - M-KLASSE (W163) 02/98→06/05</b>							
<b>Warnkontakt, Bremsbelagverschleiß</b>							
ML 430 (163.172)	200	02/98→06/05	←	X707756→	2	24.8190-0412.2 620412	L= 114
			←	09/98→; → A145272	2	24.8190-0961.2 620961	L= 100
			←	09/98→; → X707755	2	24.8190-0961.2 620961	L= 100
			→	A145273→	2	24.8190-0411.2 620411	L= 72
			→	X707756→	2	24.8190-0411.2 620411	L= 72
<b>Zubehörsatz, Scheibenbremsbelag</b>							
ML 270 CDI (163.113)	120	12/99→06/05	←	X754620→		13.0460-0269.2 610269	
ML 320 (163.154)	160	02/98→08/02	←	A289560→		13.0460-0269.2 610269	
ML 350	173	02/03→06/05	←			13.0460-0269.2 610269	
ML 400 CDI (163.128)	184	09/01→06/05					
ML 500 (163.175)	215	09/01→06/05					
ML 55 AMG (163.174)	255	02/00→06/05					
ML 350 (163.157)	180	08/02→06/05	←	09/02→		13.0460-0269.2 610269	
ML 430 (163.172)	200	02/98→06/05	←	A145273→		13.0460-0269.2 610269	
			←	X707756→		13.0460-0269.2 610269	
<b> Bremsscheibe</b>							
ML 230 (163.136)	110	02/98→06/05	←	03/98→		24.0126-0116.1 426116	Ø 303 26 23 V
			→	03/98→		24.0115-0111.1 415111	Ø 285 15 13
ML 270 CDI (163.113)	120	12/99→06/05	←	→ A289559		24.0126-0116.1 426116	Ø 303 26 23 V
			←	→ X754619		24.0126-0116.1 426116	Ø 303 26 23 V
			←	A289560→		24.0132-0114.1 432114	Ø 345 31,9 30 V
			←	X754620→		24.0132-0114.1 432114	Ø 345 31,9 30 V
			→	X754620→		24.0114-0111.1 414111	Ø 331 13,9 12,3
			→	A289560→		24.0114-0111.1 414111	Ø 331 13,9 12,3
			→	→ A289559		24.0115-0111.1 415111	Ø 285 15 13
ML 320 (163.154)	160	02/98→08/02	←	03/98→; → A289559		24.0126-0116.1 426116	Ø 303 26 23 V
			←	03/98→; → X754619		24.0126-0116.1 426116	Ø 303 26 23 V
			←	A289560→		24.0132-0114.1 432114	Ø 345 31,9 30 V
			←	X754620→		24.0132-0114.1 432114	Ø 345 31,9 30 V
			→	X754620→		24.0114-0111.1 414111	Ø 331 13,9 12,3
			→	A289560→		24.0114-0111.1 414111	Ø 331 13,9 12,3
			→	03/98→; → X754619		24.0115-0111.1 415111	Ø 285 15 13
ML 350	173	02/03→06/05	←			24.0132-0114.1 432114	Ø 345 31,9 30 V
			→			24.0114-0111.1 414111	Ø 331 13,9 12,3
			→				
ML 400 CDI (163.128)	184	09/01→06/05					
ML 500 (163.175)	215	09/01→06/05					
ML 55 AMG (163.174)	255	02/00→06/05					
ML 350 (163.157)	180	08/02→06/05	←	09/02→		24.0132-0114.1 432114	Ø 345 31,9 30 V
			→	09/02→		24.0114-0111.1 414111	Ø 331 13,9 12,3
ML 430 (163.172)	200	02/98→06/05	←	09/98→; → X707755		24.0126-0116.1 426116	Ø 303 26 23 V
			←	09/98→; → A145272		24.0126-0116.1 426116	Ø 303 26 23 V
			←	A145273→		24.0132-0114.1 432114	Ø 345 31,9 30 V
			←	X707756→		24.0132-0114.1 432114	Ø 345 31,9 30 V
			→	A145273→		24.0114-0111.1 414111	Ø 331 13,9 12,3
			→	X707756→		24.0114-0111.1 414111	Ø 331 13,9 12,3
			→	09/98→; → A145272		24.0115-0111.1 415111	Ø 285 15 13
→	09/98→; → X707755		24.0115-0111.1 415111	Ø 285 15 13			
<b>MERCEDES-BENZ - M-KLASSE (W164) 02/05→12/12</b>							
<b> Bremsbelagsatz, Scheibenbremse</b>							
ML 280 CDI 4-matic (164.120)	140	07/05→07/09	←			13.0460-7220.2 607220	ATE 23922 21,0 + WE / - WK
ML 320 CDI 4-matic (164.122)	155	07/05→07/11				13.0470-7220.2 LD7220	ATE 23922 21,0 + WE / - WK Ceramic
ML 320 CDI 4-matic (164.122)	165	07/05→07/09	→			13.0460-7219.2 607219	ATE 23923 17,6 + WE / - WK
↓							









	kW					! #			
<b>MERCEDES-BENZ - M-KLASSE (W164) 02/05→12/12</b>									
<b> Bremsbelagsatz, Scheibenbremse</b>									
ML 280 CDI 4-matic (164.120)	140	07/05→07/09	➡				<b>13.0470-7219.2</b>	<b>LD7219</b>	ATE 23923 17,6 + WE / - WK Ceramic
ML 320 CDI 4-matic (164.122)	155	07/05→07/11							
ML 320 CDI 4-matic (164.122)	165	07/05→07/09							
ML 300 4-matic (164.182)	170	03/10→	⬅	→ 05/11			<b>13.0460-7220.2</b>	<b>607220</b>	ATE 23922 21,0 + WE / - WK
ML 300 CDI 4-matic (164.120)	140	07/09→12/11					<b>13.0470-7220.2</b>	<b>LD7220</b>	ATE 23922 21,0 + WE / - WK Ceramic
ML 300 CDI 4-matic (164.121)	150	02/10→12/11	➡	→ 05/11			<b>13.0460-7219.2</b>	<b>607219</b>	ATE 23923 17,6 + WE / - WK
ML 350 4-matic (164.186)	200	02/05→12/11					<b>13.0470-7219.2</b>	<b>LD7219</b>	ATE 23923 17,6 + WE / - WK Ceramic
ML 350 CDI 4-matic (164.122)	165	07/09→12/11							
ML 350 CDI 4-matic (164.125)	155	09/09→12/11							
ML 350 CDI 4-matic (164.125)	170	02/10→12/11							
ML 450 CDI 4-matic (164.128)	225	09/09→12/11							
ML 500 4-matic (164.175)	225	07/05→12/11							
ML 420 CDI 4-matic (164.128)	225	02/06→09/09	⬅	04/06→			<b>13.0460-7220.2</b>	<b>607220</b>	ATE 23922 21,0 + WE / - WK
							<b>13.0470-7220.2</b>	<b>LD7220</b>	ATE 23922 21,0 + WE / - WK Ceramic
			➡	04/06→			<b>13.0460-7219.2</b>	<b>607219</b>	ATE 23923 17,6 + WE / - WK
							<b>13.0470-7219.2</b>	<b>LD7219</b>	ATE 23923 17,6 + WE / - WK Ceramic
ML 500 4-matic (164.172)	285	12/07→12/11	⬅	→ 05/11			<b>13.0460-7220.2</b>	<b>607220</b>	ATE 23922 21,0 + WE / - WK
			➡	→ 05/11			<b>13.0460-7219.2</b>	<b>607219</b>	ATE 23923 17,6 + WE / - WK
							<b>13.0470-7219.2</b>	<b>LD7219</b>	ATE 23923 17,6 + WE / - WK Ceramic
<b>Warnkontakt, Bremsbelagverschleiß</b>									
ML 280 CDI 4-matic (164.120)	140	07/05→07/09	⬅			1	<b>24.8190-0425.2</b>	<b>620425</b>	L= 98
ML 320 CDI 4-matic (164.122)	155	07/05→07/11	➡			1	<b>24.8190-0425.2</b>	<b>620425</b>	L= 98
ML 320 CDI 4-matic (164.122)	165	07/05→07/09							
ML 300 4-matic (164.182)	170	03/10→	⬅	→ 05/11		1	<b>24.8190-0425.2</b>	<b>620425</b>	L= 98
ML 300 CDI 4-matic (164.120)	140	07/09→12/11	➡	→ 05/11		1	<b>24.8190-0425.2</b>	<b>620425</b>	L= 98
ML 300 CDI 4-matic (164.121)	150	02/10→12/11							
ML 350 4-matic (164.186)	200	02/05→12/11							
ML 350 CDI 4-matic (164.122)	165	07/09→12/11							
ML 350 CDI 4-matic (164.125)	155	09/09→12/11							
ML 350 CDI 4-matic (164.125)	170	02/10→12/11							
ML 450 CDI 4-matic (164.128)	225	09/09→12/11							
ML 500 4-matic (164.172)	285	12/07→12/11							
ML 500 4-matic (164.175)	225	07/05→12/11							
ML 63 AMG 4-matic (164.177)	375	01/06→12/11							
ML 420 CDI 4-matic (164.128)	225	02/06→09/09	⬅	04/06→		1	<b>24.8190-0425.2</b>	<b>620425</b>	L= 98
			➡	04/06→		1	<b>24.8190-0425.2</b>	<b>620425</b>	L= 98
<b> Bremsscheibe</b>									
ML 280 CDI 4-matic (164.120)	140	07/05→07/09	⬅	passend für Felgenreöße [Zoll]: 18			<b>24.0132-0157.1</b>	<b>432157</b>	Ø 350 32 29,4 V + S
ML 320 CDI 4-matic (164.122)	155	07/05→07/11	⬅	nicht für Felgenreöße [Zoll]: 18			<b>24.0132-0158.1</b>	<b>432158</b>	Ø 330 32 29,4 V + S
ML 320 CDI 4-matic (164.122)	165	07/05→07/09	➡	nicht für Felgenreöße [Zoll]: 18			<b>24.0332-0158.1</b>	<b>532158</b>	Ø 330 32 29,4 V + S
ML 320 CDI 4-matic (164.122)	165	07/05→07/09	➡	passend für Felgenreöße [Zoll]: 18			<b>24.0114-0114.1</b>	<b>414114</b>	Ø 330 14 11,4 + S
			➡	passend für Felgenreöße [Zoll]: 18			<b>24.0122-0226.1</b>	<b>422226</b>	Ø 330 22 19,4 V + S
ML 300 4-matic (164.182)	170	03/10→	⬅	→ 05/11; passend für Felgenreöße [Zoll]: 18			<b>24.0132-0157.1</b>	<b>432157</b>	Ø 350 32 29,4 V + S
↓									









	kw			 	! #		
<b>MERCEDES-BENZ - M-KLASSE (W164) 02/05→12/12</b>							
<b>Bremsscheibe</b>							
ML 300 CDI 4-matic (164.120)	140	07/09→12/11	←	→ 05/11; nicht für Felgengröße [Zoll]: 18		<b>24.0132-0158.1 432158</b>	Ø 330 32 29,4 V + S
ML 300 CDI 4-matic (164.121)	150	02/10→12/11	→	→ 05/11; nicht für Felgengröße [Zoll]: 18		<b>24.0332-0158.1 532158</b>	Ø 330 32 29,4 V + S
ML 350 4-matic (164.186)	200	02/05→12/11	→	→ 05/11; passend für Felgengröße [Zoll]: 18		<b>24.0114-0114.1 414114</b>	Ø 330 14 11,4 + S
ML 350 CDI 4-matic (164.122)	165	07/09→12/11				<b>24.0122-0226.1 422226</b>	Ø 330 22 19,4 V + S
ML 350 CDI 4-matic (164.125)	155	09/09→12/11					
ML 350 CDI 4-matic (164.125)	170	02/10→12/11					
ML 450 CDI 4-matic (164.128)	225	09/09→12/11					
ML 500 4-matic (164.172)	285	12/07→12/11					
ML 500 4-matic (164.175)	225	07/05→12/11					
ML 420 CDI 4-matic (164.128)	225	02/06→09/09	←	04/06→; passend für Felgengröße [Zoll]: 18		<b>24.0132-0157.1 432157</b>	Ø 350 32 29,4 V + S
			←	04/06→; nicht für Felgengröße [Zoll]: 18		<b>24.0132-0158.1 432158</b>	Ø 330 32 29,4 V + S
			→	04/06→; nicht für Felgengröße [Zoll]: 18		<b>24.0332-0158.1 532158</b>	Ø 330 32 29,4 V + S
			→	04/06→; passend für Felgengröße [Zoll]: 18		<b>24.0114-0114.1 414114</b>	Ø 330 14 11,4 + S
			→	04/06→; passend für Felgengröße [Zoll]: 18		<b>24.0122-0226.1 422226</b>	Ø 330 22 19,4 V + S
<b>MERCEDES-BENZ - M-KLASSE (W166) 06/11→12/15</b>							
<b>Bremsbelagsatz, Scheibenbremse</b>							
ML 250 CDI / BlueTEC 4-matic (166.004, 166.003)	150	06/11→12/15	←			<b>13.0460-7282.2 607282</b>	ATE 25190 21,3 - WK / + WK
ML 350 BlueTEC 4-matic (166.024)	190	06/11→02/15	→	für Fahrzeuge ohne AMG-Sportpaket; - USA		<b>13.0470-7282.2 LD7282</b>	ATE 25190 21,3 - WK / + WK Ceramic
			→	für Fahrzeuge mit AMG-Sportpaket; - USA		<b>13.0460-2781.2 602781</b>	TRW 25215 18,6 + WE / - WK + Zub
			→	für Fahrzeuge mit AMG-Sportpaket; - USA		<b>13.0470-2781.2 LD2781</b>	TRW 25215 18,6 + WE / - WK + Zub Ceramic
ML 300 4-matic (166.055)	183	08/12→02/15	←	04/14→		<b>13.0460-7282.2 607282</b>	ATE 25190 21,3 - WK / + WK
ML 300 4-matic (166.055)	185	08/12→02/15	→	04/14→; für Fahrzeuge ohne AMG-Sportpaket; - USA		<b>13.0470-7282.2 LD7282</b>	ATE 25190 21,3 - WK / + WK Ceramic
			→	04/14→; für Fahrzeuge mit AMG-Sportpaket; - USA		<b>13.0460-2781.2 602781</b>	TRW 25215 18,6 + WE / - WK + Zub
			→	04/14→; für Fahrzeuge mit AMG-Sportpaket; - USA		<b>13.0470-2781.2 LD2781</b>	TRW 25215 18,6 + WE / - WK + Zub Ceramic
ML 350 4-matic (166.057)	225	06/11→12/15	←	für Fahrzeuge ohne AMG-Sportpaket		<b>13.0460-7282.2 607282</b>	ATE 25190 21,3 - WK / + WK
			←	für Fahrzeuge mit AMG-Sportpaket		<b>13.0470-7282.2 LD7282</b>	ATE 25190 21,3 - WK / + WK Ceramic
			→			<b>13.0460-2782.2 602782</b>	TRW + WE / - WK + Zub
			→			<b>13.0470-2782.2 LD2782</b>	TRW + WE / - WK + Zub Ceramic
ML 400 4-matic (166.056)	245	08/13→02/15	←	für Fahrzeuge ohne AMG-Sportpaket		<b>13.0460-7282.2 607282</b>	ATE 25190 21,3 - WK / + WK
			←	für Fahrzeuge mit AMG-Sportpaket		<b>13.0460-2783.2 602783</b>	ATE 25531 19,3 + WE / - WK
			→			<b>13.0460-2782.2 602782</b>	TRW + WE / - WK + Zub
			→			<b>13.0470-2782.2 LD2782</b>	TRW + WE / - WK + Zub Ceramic
ML 500 4-matic (166.073)	300	02/12→02/15	←			<b>13.0460-7283.2 607283</b>	ATE 25531 19,3 + WE / - WK
			→			<b>13.0460-2782.2 602782</b>	TRW + WE / - WK + Zub
			→			<b>13.0470-2782.2 LD2782</b>	TRW + WE / - WK + Zub Ceramic
ML 63 AMG 4-matic (166.074)	386	11/11→02/15	←	04/12→		<b>13.0460-4839.2 604839</b>	BRE 24455 16,8 + WE / - WK
ML 63 AMG 4-matic (166.074)	410	11/11→02/15					
<b>Warnkontakt, Bremsbelagsverschleiß</b>							
ML 250 CDI / BlueTEC 4-matic (166.004, 166.003)	150	06/11→12/15	←		1	<b>24.8190-0425.2 620425</b>	L= 98
ML 350 4-matic (166.057)	225	06/11→12/15	→		1	<b>24.8190-0410.2 620410</b>	L= 97,5









	kW					! #		
<b>MERCEDES-BENZ - M-KLASSE (W166) 06/11→12/15</b>								
<b>Warnkontakt, Bremsbelagverschleiß</b>								
ML 350 BlueTEC 4-matic (166.024)	190	06/11→02/15	←	☐		1	24.8190-0425.2 620425	L= 98
ML 400 4-matic (166.056)	245	08/13→02/15	→			1	24.8190-0410.2 620410	L= 97,5
ML 500 4-matic (166.073)	300	02/12→02/15						
ML 300 4-matic (166.055)	183	08/12→02/15	←	☐; 04/14→		1	24.8190-0425.2 620425	L= 98
ML 300 4-matic (166.055)	185	08/12→02/15	→	04/14→		1	24.8190-0410.2 620410	L= 97,5
ML 63 AMG 4-matic (166.074)	386	11/11→02/15	←	04/12→		1	24.8190-0420.2 620420	L= 119
ML 63 AMG 4-matic (166.074)	410	11/11→02/15	→	04/12→		1	24.8190-0410.2 620410	L= 97,5
<b>Bremsscheibe</b>								
ML 250 CDI / BlueTEC 4-matic (166.004, 166.003)	150	06/11→12/15	←		für Fahrzeuge ohne AMG-Sportpaket		24.0132-0178.1 432178	Ø 330 32 29,4 V + S
			←		für Fahrzeuge mit AMG-Sportpaket		24.0132-0179.1 432179	Ø 350 32 29,4 V• + S
ML 350 BlueTEC 4-matic (166.024)	190	06/11→02/15	→		→ L 174198; für Fahrzeuge ohne AMG-Sportpaket		24.0114-0119.1 414119	Ø 325 14 11,4 + S
			→		L 174199→; für Fahrzeuge ohne AMG-Sportpaket		24.0114-0119.1 414119	Ø 325 14 11,4 + S
			→		→ L 174198; für Fahrzeuge mit AMG-Sportpaket		24.0122-0287.1 422287	Ø 330 22 19,4 V• + S
			→		L 174199→; für Fahrzeuge mit AMG-Sportpaket		24.0122-0288.1 422288	Ø 330 22 19,4 V + S
ML 300 4-matic (166.055)	183	08/12→02/15	←		04/14→; für Fahrzeuge ohne AMG-Sportpaket		24.0132-0178.1 432178	Ø 330 32 29,4 V + S
ML 300 4-matic (166.055)	185	08/12→02/15	←		04/14→; für Fahrzeuge mit AMG-Sportpaket		24.0132-0179.1 432179	Ø 350 32 29,4 V• + S
			→		04/14→; für Fahrzeuge ohne AMG-Sportpaket		24.0114-0119.1 414119	Ø 325 14 11,4 + S
			→		04/14→; für Fahrzeuge mit AMG-Sportpaket		24.0122-0288.1 422288	Ø 330 22 19,4 V + S
ML 350 4-matic (166.057)	225	06/11→12/15	←		+ USA; für Fahrzeuge ohne AMG-Sportpaket		24.0132-0178.1 432178	Ø 330 32 29,4 V + S
			←		+ USA; für Fahrzeuge mit AMG-Sportpaket		24.0132-0179.1 432179	Ø 350 32 29,4 V• + S
			←		- USA; für Fahrzeuge ohne AMG-Sportpaket		24.0132-0184.1 432184	Ø 350 32 29,4 V + S
			→		A 174199→; für Fahrzeuge ohne AMG-Sportpaket		24.0122-0288.1 422288	Ø 330 22 19,4 V + S
			→		→ A 174198; für Fahrzeuge ohne AMG-Sportpaket		24.0122-0288.1 422288	Ø 330 22 19,4 V + S
			→		A 174199→; für Fahrzeuge mit AMG-Sportpaket		24.0122-0296.1 422296	Ø 345 22 19,4 V + S
ML 400 4-matic (166.056)	245	08/13→02/15	←		+ USA; für Fahrzeuge ohne AMG-Sportpaket		24.0132-0178.1 432178	Ø 330 32 29,4 V + S
			←		+ USA; für Fahrzeuge mit AMG-Sportpaket		24.0132-0179.1 432179	Ø 350 32 29,4 V• + S
			←		- USA; für Fahrzeuge ohne AMG-Sportpaket		24.0132-0184.1 432184	Ø 350 32 29,4 V + S
			→		für Fahrzeuge ohne AMG-Sportpaket		24.0122-0288.1 422288	Ø 330 22 19,4 V + S
			→		für Fahrzeuge mit AMG-Sportpaket		24.0122-0296.1 422296	Ø 345 22 19,4 V + S
ML 500 4-matic (166.073)	300	02/12→02/15	→		L 174199→		24.0122-0296.1 422296	Ø 345 22 19,4 V + S
<b>MERCEDES-BENZ - R-KLASSE (W251, V251) 01/05→</b>								
<b>Bremsbelagsatz, Scheibenbremse</b>								
R 280 (251.054, 251.154)	170	01/07→	←				13.0460-7220.2 607220	ATE 23922 21,0 + WE / - WK
R 280 4-matic (251.062)	170	05/07→					13.0470-7220.2 LD7220	ATE 23922 21,0 + WE / - WK Ceramic
R 280 CDI (251.121, 251.026, 251.126)	140	05/06→	→				13.0460-7219.2 607219	ATE 23923 17,6 + WE / - WK
R 280 CDI 4-matic (251.020)	140	05/06→					13.0470-7219.2 LD7219	ATE 23923 17,6 + WE / - WK Ceramic
R 300 (251.054, 251.154)	170	07/09→						
R 300 CDI (251.021, 251.121, 251.026, 251.126)	140	07/09→						
R 300 CDI 4-matic (251.020)	140	07/09→						
R 320 CDI 4-matic (251.022, 251.122)	165	01/06→						











	kW			 	! #		
<b>MERCEDES-BENZ - R-KLASSE (W251, V251) 01/05→</b>							
<b> Bremsbelagsatz, Scheibenbremse</b>							
R 320 CDI 4-matic (251.125)	155	01/06→	←			<b>13.0460-7220.2 607220</b>	ATE 23922 21,0 + WE / - WK
R 350 (251.056, 251.156)	200	01/07→				<b>13.0470-7220.2 LD7220</b>	ATE 23922 21,0 + WE / - WK Ceramic
R 350 4-matic (251.065, 251.165)	200	01/06→	→			<b>13.0460-7219.2 607219</b>	ATE 23923 17,6 + WE / - WK
R 350 CDI 4-matic (251.022, 251.122)	165	07/09→				<b>13.0470-7219.2 LD7219</b>	ATE 23923 17,6 + WE / - WK Ceramic
R 350 CDI 4-matic (251.023, 251.123)	195	08/10→					
R 350 CGI 4-matic (251.057, 251.157)	225	01/06→					
R 500 4-matic (251.075, 251.175)	225	01/06→					
R 350 CDI 4-matic (251.124, 251.125)	155	01/06→	←	05/09→		<b>13.0460-7220.2 607220</b>	ATE 23922 21,0 + WE / - WK
			→	05/09→		<b>13.0470-7220.2 LD7220</b>	ATE 23922 21,0 + WE / - WK Ceramic
			→	05/09→		<b>13.0460-7219.2 607219</b>	ATE 23923 17,6 + WE / - WK
			→	05/09→		<b>13.0470-7219.2 LD7219</b>	ATE 23923 17,6 + WE / - WK Ceramic
R 500 4-matic (251.072, 251.172)	285	01/07→	←			<b>13.0460-7220.2 607220</b>	ATE 23922 21,0 + WE / - WK
			→			<b>13.0460-7219.2 607219</b>	ATE 23923 17,6 + WE / - WK
			→			<b>13.0470-7219.2 LD7219</b>	ATE 23923 17,6 + WE / - WK Ceramic
<b>Warnkontakt, Bremsbelagverschleiß</b>							
R 280 (251.054, 251.154)	170	01/07→	←		1	<b>24.8190-0425.2 620425</b>	L= 98
R 280 4-matic (251.062)	170	05/07→	→		1	<b>24.8190-0425.2 620425</b>	L= 98
R 280 CDI (251.121, 251.026, 251.126)	140	05/06→					
R 280 CDI 4-matic (251.020)	140	05/06→					
R 300 (251.054, 251.154)	170	07/09→					
R 300 CDI (251.021, 251.121, 251.026, 251.126)	140	07/09→					
R 300 CDI 4-matic (251.020)	140	07/09→					
R 320 CDI 4-matic (251.022, 251.122)	165	01/06→					
R 320 CDI 4-matic (251.125)	155	01/06→					
R 350 (251.056, 251.156)	200	01/07→					
R 350 4-matic (251.065, 251.165)	200	01/06→					
R 350 CDI 4-matic (251.022, 251.122)	165	07/09→					
R 350 CDI 4-matic (251.023, 251.123)	195	08/10→					
R 350 CGI 4-matic (251.057, 251.157)	225	01/06→					
R 500 4-matic (251.072, 251.172)	285	01/07→					
R 500 4-matic (251.075, 251.175)	225	01/06→					
R 63 AMG 4-matic (251.077, 251.177)	375	02/06→					
R 350 CDI 4-matic (251.124, 251.125)	155	01/06→	←	05/09→	1	<b>24.8190-0425.2 620425</b>	L= 98
			→	05/09→	1	<b>24.8190-0425.2 620425</b>	L= 98
<b> Bremsscheibe</b>							
R 280 (251.054, 251.154)	170	01/07→	←			<b>24.0132-0158.1 432158</b>	Ø 330 32 29,4 V + S
R 280 4-matic (251.062)	170	05/07→				<b>24.0332-0158.1 532158</b>	Ø 330 32 29,4 V + S
R 300 (251.054, 251.154)	170	07/09→	→			<b>24.0114-0114.1 414114</b>	Ø 330 14 11,4 + S
R 300 CDI (251.021, 251.121, 251.026, 251.126)	140	07/09→				<b>24.0122-0226.1 422226</b>	Ø 330 22 19,4 V + S
R 320 CDI 4-matic (251.125)	155	01/06→					
R 350 (251.056, 251.156)	200	01/07→					
R 350 4-matic (251.065, 251.165)	200	01/06→					
↓							









	kW			 	! #		
<b>MERCEDES-BENZ - R-KLASSE (W251, V251) 01/05→</b>							
 <b>Bremsscheibe</b>							
R 280 CDI (251.121, 251.026, 251.126)	140	05/06→	←	passend für Felgengröße [Zoll]: 18		<b>24.0132-0157.1 432157</b>	Ø 350 32 29,4 V + S
			←	nicht für Felgengröße [Zoll]: 18		<b>24.0132-0158.1 432158</b>	Ø 330 32 29,4 V + S
						<b>24.0332-0158.1 532158</b>	Ø 330 32 29,4 V + S
			→			<b>24.0114-0114.1 414114</b>	Ø 330 14 11,4 + S
			→			<b>24.0122-0226.1 422226</b>	Ø 330 22 19,4 V + S
R 280 CDI 4-matic (251.020) R 300 CDI 4-matic (251.020) R 320 CDI 4-matic (251.022, 251.122) R 350 CDI 4-matic (251.022, 251.122)	140	05/06→	←	für Fahrzeuge mit Sportpaket		<b>24.0132-0157.1 432157</b>	Ø 350 32 29,4 V + S
	140	07/09→	←	für Fahrzeuge ohne Sportpaket		<b>24.0132-0158.1 432158</b>	Ø 330 32 29,4 V + S
						<b>24.0332-0158.1 532158</b>	Ø 330 32 29,4 V + S
	165	01/06→	→	für Fahrzeuge ohne Sportpaket		<b>24.0114-0114.1 414114</b>	Ø 330 14 11,4 + S
	165	07/09→	→	für Fahrzeuge mit Sportpaket / für Fahrzeuge mit 3. Sitzreihe		<b>24.0122-0226.1 422226</b>	Ø 330 22 19,4 V + S
R 350 CDI 4-matic (251.023, 251.123)	195	08/10→	←	für Fahrzeuge mit 3. Sitzreihe		<b>24.0132-0157.1 432157</b>	Ø 350 32 29,4 V + S
			←			<b>24.0132-0158.1 432158</b>	Ø 330 32 29,4 V + S
						<b>24.0332-0158.1 532158</b>	Ø 330 32 29,4 V + S
			→			<b>24.0114-0114.1 414114</b>	Ø 330 14 11,4 + S
			→			<b>24.0122-0226.1 422226</b>	Ø 330 22 19,4 V + S
R 350 CDI 4-matic (251.124, 251.125)	155	01/06→	←	05/09→; passend für Felgengröße [Zoll]: 18		<b>24.0132-0157.1 432157</b>	Ø 350 32 29,4 V + S
			←	05/09→; nicht für Felgengröße [Zoll]: 18		<b>24.0132-0158.1 432158</b>	Ø 330 32 29,4 V + S
						<b>24.0332-0158.1 532158</b>	Ø 330 32 29,4 V + S
			→	05/09→		<b>24.0114-0114.1 414114</b>	Ø 330 14 11,4 + S
					<b>24.0122-0226.1 422226</b>	Ø 330 22 19,4 V + S	
R 350 CGI 4-matic (251.057, 251.157) R 500 4-matic (251.072, 251.172) R 500 4-matic (251.075, 251.175)	225	01/06→	←			<b>24.0132-0157.1 432157</b>	Ø 350 32 29,4 V + S
	285	01/07→	→			<b>24.0114-0114.1 414114</b>	Ø 330 14 11,4 + S
	225	01/06→	→			<b>24.0122-0226.1 422226</b>	Ø 330 22 19,4 V + S
R 63 AMG 4-matic (251.077, 251.177)	375	02/06→	←			<b>24.0132-0157.1 432157</b>	Ø 350 32 29,4 V + S
<b>MERCEDES-BENZ - S-KLASSE (W140) 02/91→10/98</b>							
 <b>Bremsbelagsatz, Scheibenbremse</b>							
300 SE, SEL/S320 (140.032, 140.033)	170	03/91→10/98	←	04/91→; → A023718; ohne Leichtmetallfelge		<b>13.0460-6036.2 606036</b>	ATE 21304 18,5 + WE / - WK
			←	04/91→; → A050547; mit Leichtmetallfelge		<b>13.0460-6036.2 606036</b>	ATE 21304 18,5 + WE / - WK
			←	→ 06/93; A050548→; mit Leichtmetallfelge		<b>13.0460-9033.2 609033</b>	ATE 21303 18,9 + WE / - WK
			←	07/93→		<b>13.0460-9033.2 609033</b>	ATE 21303 18,9 + WE / - WK
			←	→ 06/93; A023719→; ohne Leichtmetallfelge		<b>13.0460-9033.2 609033</b>	ATE 21303 18,9 + WE / - WK
			→	04/91→ 06/93		<b>13.0460-4047.2 604047</b>	ATE 21305 15,7 + WE / - WK
						<b>13.0470-4047.2 LD4047</b>	ATE 21305 15,7 + WE / - WK Ceramic
			→	07/93→		<b>13.0460-4047.2 604047</b>	ATE 21305 15,7 + WE / - WK
			<b>13.0470-4047.2 LD4047</b>	ATE 21305 15,7 + WE / - WK Ceramic			
300 SE 2.8 (140.028) S 280 (140.028)	145	01/93→10/98	←	07/93→		<b>13.0460-9033.2 609033</b>	ATE 21303 18,9 + WE / - WK
	142	02/93→10/98	←	→ 06/93		<b>13.0460-9033.2 609033</b>	ATE 21303 18,9 + WE / - WK
			→	→ 06/93		<b>13.0460-4047.2 604047</b>	ATE 21305 15,7 + WE / - WK
						<b>13.0470-4047.2 LD4047</b>	ATE 21305 15,7 + WE / - WK Ceramic
			→	07/93→		<b>13.0460-4047.2 604047</b>	ATE 21305 15,7 + WE / - WK
					<b>13.0470-4047.2 LD4047</b>	ATE 21305 15,7 + WE / - WK Ceramic	
400 SE, SEL/S420 (140.042, 140.043) 500 SE, SEL (140.050, 140.051)	210	02/91→10/98	←	04/91→ 06/93		<b>13.0460-9033.2 609033</b>	ATE 21303 18,9 + WE / - WK
	240	02/91→10/98	←	07/93→		<b>13.0460-9033.2 609033</b>	ATE 21303 18,9 + WE / - WK
			→	04/91→ 06/93		<b>13.0460-4047.2 604047</b>	ATE 21305 15,7 + WE / - WK
						<b>13.0470-4047.2 LD4047</b>	ATE 21305 15,7 + WE / - WK Ceramic
		→	07/93→		<b>13.0460-4047.2 604047</b>	ATE 21305 15,7 + WE / - WK	
					<b>13.0470-4047.2 LD4047</b>	ATE 21305 15,7 + WE / - WK Ceramic	
S 300 Turbo-D (140.135)	130	05/96→10/98	←			<b>13.0460-9033.2 609033</b>	ATE 21303 18,9 + WE / - WK









	kW			 	! #		
<b>MERCEDES-BENZ - S-KLASSE (W140) 02/91→10/98</b>							
<b> Bremsbelagsatz, Scheibenbremse</b>							
S 300 Turbo-D (140.135)	130	05/96→10/98	➡			<b>13.0460-4047.2 604047</b> <b>13.0470-4047.2 LD4047</b>	ATE 21305 15,7 + WE / - WK ATE 21305 15,7 + WE / - WK Ceramic
S 350 Turbo-D (140.134)	110	01/93→10/98	⬅	07/93→06/96		<b>13.0460-9033.2 609033</b>	ATE 21303 18,9 + WE / - WK
			⬅	03/93→06/93		<b>13.0460-9033.2 609033</b>	ATE 21303 18,9 + WE / - WK
			➡	07/93→06/96		<b>13.0460-4047.2 604047</b> <b>13.0470-4047.2 LD4047</b>	ATE 21305 15,7 + WE / - WK ATE 21305 15,7 + WE / - WK Ceramic
			➡	03/93→06/93		<b>13.0460-4047.2 604047</b> <b>13.0470-4047.2 LD4047</b>	ATE 21305 15,7 + WE / - WK ATE 21305 15,7 + WE / - WK Ceramic
S 420 (140.042)	205	01/93→10/98	⬅	07/93→		<b>13.0460-9033.2 609033</b>	ATE 21303 18,9 + WE / - WK
S 500 (140.050, 140.051)	235	01/93→10/98	➡	07/93→		<b>13.0460-4047.2 604047</b>	ATE 21305 15,7 + WE / - WK
S 600 (140.056, 140.057)	290	01/93→10/98				<b>13.0470-4047.2 LD4047</b>	ATE 21305 15,7 + WE / - WK Ceramic
<b>Warnkontakt, Bremsbelagverschleiß</b>							
300 SE, SEL/S320 (140.032, 140.033)	170	03/91→10/98	⬅	→ 06/93; A050548→; mit Leichtmetallfelge	4	<b>24.8190-0401.2 620401</b>	L= 95
			⬅	07/93→	4	<b>24.8190-0401.2 620401</b>	L= 95
			⬅	→ 06/93; A023719→; ohne Leichtmetallfelge	4	<b>24.8190-0401.2 620401</b>	L= 95
			⬅	04/91→; → A050547; mit Leichtmetallfelge	4	<b>24.8190-0401.2 620401</b>	L= 95
			⬅	04/91→; → A023718; ohne Leichtmetallfelge	4	<b>24.8190-0401.2 620401</b>	L= 95
			➡	07/93→; + ASR	4	<b>24.8190-0401.2 620401</b>	L= 95
			➡	04/91→06/93; + ASR	4	<b>24.8190-0401.2 620401</b>	L= 95
300 SE 2.8 (140.028) S 280 (140.028)	145 142	01/93→10/98 02/93→10/98	⬅	07/93→	4	<b>24.8190-0401.2 620401</b>	L= 95
			⬅	→ 06/93	4	<b>24.8190-0401.2 620401</b>	L= 95
			➡	→ 06/93; + ASR	4	<b>24.8190-0401.2 620401</b>	L= 95
			➡	07/93→; + ASR	4	<b>24.8190-0401.2 620401</b>	L= 95
400 SE, SEL/S420 (140.042, 140.043) 500 SE, SEL (140.050, 140.051)	210	02/91→10/98	⬅	07/93→	4	<b>24.8190-0401.2 620401</b>	L= 95
			⬅	04/91→06/93	4	<b>24.8190-0401.2 620401</b>	L= 95
	240	02/91→10/98	➡	07/93→; + ASR	4	<b>24.8190-0401.2 620401</b>	L= 95
			➡	04/91→06/93; + ASR	4	<b>24.8190-0401.2 620401</b>	L= 95
S 300 Turbo-D (140.135)	130	05/96→10/98	⬅		4	<b>24.8190-0401.2 620401</b>	L= 95
			➡	+ ASR	4	<b>24.8190-0401.2 620401</b>	L= 95
S 350 Turbo-D (140.134)	110	01/93→10/98	⬅	03/93→06/93	4	<b>24.8190-0401.2 620401</b>	L= 95
			⬅	07/93→06/96	4	<b>24.8190-0401.2 620401</b>	L= 95
			➡	07/93→06/96; + ASR	4	<b>24.8190-0401.2 620401</b>	L= 95
			➡	03/93→06/93; + ASR	4	<b>24.8190-0401.2 620401</b>	L= 95
S 420 (140.042) S 500 (140.050, 140.051) S 600 (140.056, 140.057)	205 235	01/93→10/98 01/93→10/98	⬅	07/93→	4	<b>24.8190-0401.2 620401</b>	L= 95
			➡	07/93→; + ASR	4	<b>24.8190-0401.2 620401</b>	L= 95
S 420 (140.042) S 500 (140.050, 140.051) S 600 (140.056, 140.057)	205 235	01/93→10/98 01/93→10/98	⬅	07/93→	4	<b>24.8190-0401.2 620401</b>	L= 95
			➡	07/93→; + ASR	4	<b>24.8190-0401.2 620401</b>	L= 95
<b>Zubehörsatz, Scheibenbremsbelag</b>							
300 SE, SEL/S320 (140.032, 140.033)	170	03/91→10/98	⬅	07/93→		<b>13.0460-0263.2 610263</b>	
			⬅	→ 06/93; A050548→; mit Leichtmetallfelge		<b>13.0460-0263.2 610263</b>	
			⬅	→ 06/93; A023719→; ohne Leichtmetallfelge		<b>13.0460-0263.2 610263</b>	
			➡	07/93→		<b>13.0460-0236.2 610236</b>	ATE
			➡	04/91→06/93		<b>13.0460-0239.2 610239</b>	ATE
300 SE 2.8 (140.028) S 280 (140.028)	145 142	01/93→10/98 02/93→10/98	⬅	07/93→		<b>13.0460-0263.2 610263</b>	
			⬅	→ 06/93		<b>13.0460-0263.2 610263</b>	
			➡	07/93→		<b>13.0460-0236.2 610236</b>	ATE
			➡	→ 06/93		<b>13.0460-0239.2 610239</b>	ATE
↓							







	kw			 	! #		
<b>MERCEDES-BENZ - S-KLASSE (W140) 02/91→10/98</b>							
<b>Zubehörsatz, Scheibenbremsbelag</b>							
400 SE, SEL/S420 (140.042, 140.043) 500 SE, SEL (140.050, 140.051)	210	02/91→10/98	←	04/91→ 06/93		13.0460-0263.2 610263	
	240	02/91→10/98	←	07/93→		13.0460-0263.2 610263	
			→	04/91→ 06/93		13.0460-0236.2 610236	ATE
			→	07/93→		13.0460-0236.2 610236	ATE
S 300 Turbo-D (140.135)	130	05/96→10/98	←			13.0460-0263.2 610263	
			→			13.0460-0236.2 610236	ATE
S 350 Turbo-D (140.134)	110	01/93→10/98	←	07/93→ 06/96		13.0460-0263.2 610263	
			←	03/93→ 06/93		13.0460-0263.2 610263	
			→	07/93→ 06/96		13.0460-0236.2 610236	ATE
			→	03/93→ 06/93		13.0460-0239.2 610239	ATE
S 420 (140.042)	205	01/93→10/98	←	07/93→		13.0460-0263.2 610263	
	235	01/93→10/98	→	07/93→		13.0460-0236.2 610236	ATE
S 500 (140.050, 140.051)	290	01/93→10/98				13.0460-0239.2 610239	ATE
S 600 (140.056, 140.057)							
<b> Bremsscheibe</b>							
300 SE, SEL/S320 (140.032, 140.033)	170	03/91→10/98	←	04/91→; → A023718; ohne Leichtmetallfelge		24.0128-0127.1 428127	Ø 310 28 25,4 V
			←	04/91→; → A050547; mit Leichtmetallfelge		24.0128-0127.1 428127	Ø 310 28 25,4 V
			←	→ 06/93; A050548→; mit Leichtmetallfelge		24.0130-0100.1 430100	Ø 320 30 27,4 V
			←	07/93→		24.0130-0100.1 430100	Ø 320 30 27,4 V
			←	→ 06/93; A023719→; ohne Leichtmetallfelge		24.0130-0100.1 430100	Ø 320 30 27,4 V
			→	04/91→ 06/93		24.0112-0129.1 412129	Ø 290 12 9,8
			→	07/93→		24.0112-0129.1 412129	Ø 290 12 9,8
300 SE 2.8 (140.028) S 280 (140.028)	145	01/93→10/98	←	07/93→		24.0130-0100.1 430100	Ø 320 30 27,4 V
	142	02/93→10/98	←	→ 06/93		24.0130-0100.1 430100	Ø 320 30 27,4 V
			→	07/93→		24.0112-0129.1 412129	Ø 290 12 9,8
			→	→ 06/93		24.0112-0129.1 412129	Ø 290 12 9,8
400 SE, SEL/S420 (140.042, 140.043) 500 SE, SEL (140.050, 140.051)	210	02/91→10/98	←	04/91→ 06/93		24.0130-0100.1 430100	Ø 320 30 27,4 V
	240	02/91→10/98	←	07/93→		24.0130-0100.1 430100	Ø 320 30 27,4 V
			→	04/91→ 06/93		24.0122-0133.1 422133	Ø 300 22 19,4 V
			→	07/93→		24.0122-0133.1 422133	Ø 300 22 19,4 V
S 300 Turbo-D (140.135)	130	05/96→10/98	←			24.0130-0100.1 430100	Ø 320 30 27,4 V
			→			24.0112-0129.1 412129	Ø 290 12 9,8
S 350 Turbo-D (140.134)	110	01/93→10/98	←	07/93→ 06/96		24.0130-0100.1 430100	Ø 320 30 27,4 V
			←	03/93→ 06/93		24.0130-0100.1 430100	Ø 320 30 27,4 V
			→	07/93→ 06/96		24.0112-0129.1 412129	Ø 290 12 9,8
			→	03/93→ 06/93		24.0112-0129.1 412129	Ø 290 12 9,8
S 420 (140.042)	205	01/93→10/98	←	07/93→		24.0130-0100.1 430100	Ø 320 30 27,4 V
	235	01/93→10/98	→	07/93→		24.0122-0133.1 422133	Ø 300 22 19,4 V
S 500 (140.050, 140.051)	290	01/93→10/98					
S 600 (140.056, 140.057)							
<b>MERCEDES-BENZ - S-KLASSE (W220) 10/98→08/05</b>							
<b> Bremsbelagsatz, Scheibenbremse</b>							
S 280 (220.063, 220.163) S 320 (220.065, 220.165)	150	10/98→08/05	←	11/98→ 08/02		13.0460-4984.2 604984	BRE 23271 17,4 + WE / - WK
	165	10/98→08/05				13.0470-4984.2 LD4984	BRE 23271 17,4 + WE / - WK Ceramic
			←	09/02→		13.0460-4984.2 604984	BRE 23271 17,4 + WE / - WK
						13.0460-4990.2 604990	BRE 23271 17,4 + WE / - WK
					13.0470-4984.2 LD4984	BRE 23271 17,4 + WE / - WK Ceramic	
					13.0470-4990.2 LD4990	BRE 23271 17,4 + WE / - WK Ceramic	
↓							







	kw			 	! #		
<b>MERCEDES-BENZ - S-KLASSE (W220) 10/98→08/05</b>							
<b> Bremsbelagsatz, Scheibenbremse</b>							
S 280 (220.063, 220.163) S 320 (220.065, 220.165)	150 165	10/98→08/05	➔	11/98→		<b>13.0460-4069.2 604069</b>	ATE 23078 15,9 + WE / - WK
S 320 CDI (220.025, 220.125) S 350 (220.067, 220.167) S 400 CDI (220.028, 220.128)	150 180 191	09/02→08/05	➔			<b>13.0460-4984.2 604984</b> <b>13.0460-4990.2 604990</b> <b>13.0470-4984.2 LD4984</b> <b>13.0470-4990.2 LD4990</b>	BRE 23271 17,4 + WE / - WK BRE 23271 17,4 + WE / - WK BRE 23271 17,4 + WE / - WK Ceramic BRE 23271 17,4 + WE / - WK Ceramic
			➔			<b>13.0460-7171.2 607171</b> <b>13.0470-7171.2 LD7171</b>	ATE 23334 16,7 + WE / - WK ATE 23334 16,7 + WE / - WK Ceramic
S 320 CDI (220.026, 220.126)	145	08/99→09/02	➔	09/02→		<b>13.0460-4984.2 604984</b> <b>13.0460-4990.2 604990</b> <b>13.0470-4984.2 LD4984</b> <b>13.0470-4990.2 LD4990</b>	BRE 23271 17,4 + WE / - WK BRE 23271 17,4 + WE / - WK BRE 23271 17,4 + WE / - WK Ceramic BRE 23271 17,4 + WE / - WK Ceramic
			➔	→ 08/02		<b>13.0460-4984.2 604984</b> <b>13.0470-4984.2 LD4984</b>	BRE 23271 17,4 + WE / - WK BRE 23271 17,4 + WE / - WK Ceramic
			➔			<b>13.0460-4069.2 604069</b>	ATE 23078 15,9 + WE / - WK
S 350 4-matic (220.087, 220.187)	180	06/03→08/05	➔			<b>13.0460-7203.2 607203</b> <b>13.0460-7171.2 607171</b> <b>13.0470-7171.2 LD7171</b>	ATE 21670 19,3 + WE / - WK ATE 23334 16,7 + WE / - WK ATE 23334 16,7 + WE / - WK Ceramic
S 400 CDI (220.028, 220.128)	184	06/00→08/05	➔	08/00→ 08/02		<b>13.0460-4984.2 604984</b>	BRE 23271 17,4 + WE / - WK
			➔	09/02→		<b>13.0460-4984.2 604984</b> <b>13.0460-4990.2 604990</b> <b>13.0470-4984.2 LD4984</b> <b>13.0470-4990.2 LD4990</b>	BRE 23271 17,4 + WE / - WK BRE 23271 17,4 + WE / - WK BRE 23271 17,4 + WE / - WK Ceramic BRE 23271 17,4 + WE / - WK Ceramic
			➔	08/00→ 09/02		<b>13.0460-4069.2 604069</b>	ATE 23078 15,9 + WE / - WK
			➔	10/02→		<b>13.0460-7171.2 607171</b> <b>13.0470-7171.2 LD7171</b>	ATE 23334 16,7 + WE / - WK ATE 23334 16,7 + WE / - WK Ceramic
S 430 (220.070, 220.170)	205	10/98→08/05	➔	11/98→ 08/02		<b>13.0460-4984.2 604984</b>	BRE 23271 17,4 + WE / - WK
			➔	09/02→		<b>13.0460-4984.2 604984</b> <b>13.0460-4990.2 604990</b> <b>13.0470-4984.2 LD4984</b> <b>13.0470-4990.2 LD4990</b>	BRE 23271 17,4 + WE / - WK BRE 23271 17,4 + WE / - WK BRE 23271 17,4 + WE / - WK Ceramic BRE 23271 17,4 + WE / - WK Ceramic
			➔	11/98→ 09/02		<b>13.0460-4069.2 604069</b>	ATE 23078 15,9 + WE / - WK
			➔	10/02→		<b>13.0460-7171.2 607171</b> <b>13.0470-7171.2 LD7171</b>	ATE 23334 16,7 + WE / - WK ATE 23334 16,7 + WE / - WK Ceramic
S 430 4-matic (220.083, 220.183) S 500 4-matic (220.084, 220.184)	205 225	09/02→08/05	➔			<b>13.0460-7183.2 607183</b> <b>13.0460-7171.2 607171</b> <b>13.0470-7171.2 LD7171</b>	ATE 21484 20,5 + WE / - WK ATE 23334 16,7 + WE / - WK ATE 23334 16,7 + WE / - WK Ceramic
S 500 (220.075, 220.175, 220.875) S 500 (220.075, 220.175, 220.875)	220 225	10/98→12/03 10/98→08/05	➔	09/02→; nicht für gepanzerte Fahrzeuge		<b>13.0460-4984.2 604984</b> <b>13.0460-4990.2 604990</b>	BRE 23271 17,4 + WE / - WK BRE 23271 17,4 + WE / - WK
			➔	11/98→ 08/02; nicht für gepanzerte Fahrzeuge		<b>13.0460-4984.2 604984</b>	BRE 23271 17,4 + WE / - WK
			➔	11/98→; für gepanzerte Fahrzeuge		<b>13.0460-4047.2 604047</b> <b>13.0470-4047.2 LD4047</b>	ATE 21305 15,7 + WE / - WK ATE 21305 15,7 + WE / - WK Ceramic
			➔	11/98→ 09/02; nicht für gepanzerte Fahrzeuge		<b>13.0460-4069.2 604069</b>	ATE 23078 15,9 + WE / - WK
			➔	10/02→; nicht für gepanzerte Fahrzeuge		<b>13.0460-7171.2 607171</b> <b>13.0470-7171.2 LD7171</b>	ATE 23334 16,7 + WE / - WK ATE 23334 16,7 + WE / - WK Ceramic
S 55 AMG (220.073, 220.173) ↓	265	04/99→08/05	➔	→ 08/02		<b>13.0460-4984.2 604984</b>	BRE 23271 17,4 + WE / - WK









	kW			 	! #		
<b>MERCEDES-BENZ - S-KLASSE (W220) 10/98→08/05</b>							
<b> Bremsbelagsatz, Scheibenbremse</b>							
S 55 AMG (220.073, 220.173)	265	04/99→08/05	←	09/02→		13.0460-4984.2 604984	BRE 23271 17,4 + WE / - WK
			→	→ 09/02		13.0460-4990.2 604990	BRE 23271 17,4 + WE / - WK
			→			13.0460-4069.2 604069	ATE 23078 15,9 + WE / - WK
S 55 AMG Kompressor (220.074, 220.174)	368	06/02→08/05	←			13.0460-4997.2 604997	BRE 23943 17,5 + WE / - WK
			→			13.0460-4998.2 604998	BRE 23478 16,5 + WE / - WK
S 600 (220.176)	368	09/02→08/05	←	nicht für gepanzerte Fahrzeuge		13.0460-4984.2 604984	BRE 23271 17,4 + WE / - WK
S 600 (220.878, 220.178)	270	01/00→08/05	→	für gepanzerte Fahrzeuge		13.0460-4990.2 604990	BRE 23271 17,4 + WE / - WK
			→			13.0460-4047.2 604047	ATE 21305 15,7 + WE / - WK
			→			13.0470-4047.2 LD4047	ATE 21305 15,7 + WE / - WK Ceramic
			→	nicht für gepanzerte Fahrzeuge		13.0460-7171.2 607171	ATE 23334 16,7 + WE / - WK
			→			13.0470-7171.2 LD7171	ATE 23334 16,7 + WE / - WK Ceramic
S 63 AMG	326	09/01→08/05	←			13.0460-4997.2 604997	BRE 23943 17,5 + WE / - WK
S 65 AMG (220.179)	450	03/04→08/05	→			13.0460-4819.2 604819	BRE 23478 14,6 + WE / - WK
<b>Warnkontakt, Bremsbelagsverschleiß</b>							
S 280 (220.063, 220.163)	150	10/98→08/05	←	☐; 09/02→	1	24.8190-0410.2 620410	L= 97,5
S 320 (220.065, 220.165)	165	10/98→08/05	←	11/98→ 08/02	2	24.8190-0410.2 620410	L= 97,5
			←	☐; 09/02→	1	24.8190-0416.2 620416	L= 100
			→	11/98→	1	24.8190-0410.2 620410	L= 97,5
S 320 CDI (220.025, 220.125)	150	09/02→08/05	←	☐	1	24.8190-0410.2 620410	L= 97,5
S 350 (220.067, 220.167)	180	09/02→08/05	←	☐	1	24.8190-0416.2 620416	L= 100
S 350 4-matic (220.087, 220.187)	180	06/03→08/05	→		1	24.8190-0410.2 620410	L= 97,5
S 400 CDI (220.028, 220.128)	191	06/03→08/05					
S 320 CDI (220.026, 220.126)	145	08/99→09/02	←	☐; 09/02→	1	24.8190-0410.2 620410	L= 97,5
			←	→ 08/02	2	24.8190-0410.2 620410	L= 97,5
			←	☐; 09/02→	1	24.8190-0416.2 620416	L= 100
			→		1	24.8190-0410.2 620410	L= 97,5
S 400 CDI (220.028, 220.128)	184	06/00→08/05	←	☐; 09/02→	1	24.8190-0410.2 620410	L= 97,5
			←	08/00→ 08/02	2	24.8190-0410.2 620410	L= 97,5
			←	☐; 09/02→	1	24.8190-0416.2 620416	L= 100
			→	10/02→	1	24.8190-0410.2 620410	L= 97,5
			→	08/00→ 09/02	1	24.8190-0410.2 620410	L= 97,5
S 430 (220.070, 220.170)	205	10/98→08/05	←	☐; 09/02→	1	24.8190-0410.2 620410	L= 97,5
			←	11/98→ 08/02	2	24.8190-0410.2 620410	L= 97,5
			←	☐; 09/02→	1	24.8190-0416.2 620416	L= 100
			→	10/02→	1	24.8190-0410.2 620410	L= 97,5
			→	11/98→ 09/02	1	24.8190-0410.2 620410	L= 97,5
S 430 4-matic (220.083, 220.183)	205	09/02→08/05	←		1	24.8190-0425.2 620425	L= 98
S 500 4-matic (220.084, 220.184)	225	09/02→08/05	→		1	24.8190-0410.2 620410	L= 97,5
S 500 (220.075, 220.175, 220.875)	220	10/98→12/03	←	11/98→; für gepanzerte Fahrzeuge	2	24.8190-0410.2 620410	L= 97,5
S 500 (220.075, 220.175, 220.875)	225	10/98→08/05	←	11/98→ 08/02; nicht für gepanzerte Fahrzeuge	2	24.8190-0410.2 620410	L= 97,5
			←	☐; 09/02→; nicht für gepanzerte Fahrzeuge	1	24.8190-0410.2 620410	L= 97,5
			←	☐; 09/02→; nicht für gepanzerte Fahrzeuge	1	24.8190-0416.2 620416	L= 100
			→	11/98→ 09/02; nicht für gepanzerte Fahrzeuge	1	24.8190-0410.2 620410	L= 97,5
			→	10/02→; nicht für gepanzerte Fahrzeuge	1	24.8190-0410.2 620410	L= 97,5
			→	11/98→; für gepanzerte Fahrzeuge	1	24.8190-0410.2 620410	L= 97,5
S 55 AMG (220.073, 220.173)	265	04/99→08/05	←	☐; 09/02→	1	24.8190-0410.2 620410	L= 97,5
			←	→ 08/02	2	24.8190-0410.2 620410	L= 97,5
			←	☐; 09/02→	1	24.8190-0416.2 620416	L= 100
↓							

	kw			 	! #		
<b>MERCEDES-BENZ - S-KLASSE (W220) 10/98→08/05</b>							
<b>Warnkontakt, Bremsbelagverschleiß</b>							
S 55 AMG (220.073, 220.173)	265	04/99→08/05	➡	→ 09/02	1	24.8190-0410.2 620410	L= 97,5
S 55 AMG Kompressor (220.074, 220.174)	368	06/02→08/05	⬅		2	24.8190-0410.2 620410	L= 97,5
S 63 AMG	326	09/01→08/05	➡		1	24.8190-0410.2 620410	L= 97,5
S 65 AMG (220.179)	450	03/04→08/05					
S 600 (220.176)	368	09/02→08/05	⬅	für gepanzerte Fahrzeuge	2	24.8190-0410.2 620410	L= 97,5
S 600 (220.878, 220.178)	270	01/00→08/05	⬅	☐; nicht für gepanzerte Fahrzeuge	1	24.8190-0410.2 620410	L= 97,5
			⬅	☐; nicht für gepanzerte Fahrzeuge	1	24.8190-0416.2 620416	L= 100
			➡		1	24.8190-0410.2 620410	L= 97,5
<b>Zubehörsatz, Scheibenbremsbelag</b>							
S 280 (220.063, 220.163)	150	10/98→08/05	⬅	11/98→ 08/02		13.0460-0275.2 610275	
S 320 (220.065, 220.165)	165	10/98→08/05	⬅	09/02→		13.0460-0275.2 610275	
S 320 CDI (220.025, 220.125)	150	09/02→08/05	⬅			13.0460-0275.2 610275	
S 350 (220.067, 220.167)	180	09/02→08/05					
S 400 CDI (220.028, 220.128)	191	06/03→08/05					
S 320 CDI (220.026, 220.126)	145	08/99→09/02	⬅	→ 08/02		13.0460-0275.2 610275	
			⬅	09/02→		13.0460-0275.2 610275	
S 400 CDI (220.028, 220.128)	184	06/00→08/05	⬅	08/00→ 08/02		13.0460-0269.2 610269	
			⬅	09/02→		13.0460-0275.2 610275	
S 430 (220.070, 220.170)	205	10/98→08/05	⬅	11/98→ 08/02		13.0460-0269.2 610269	
			⬅	09/02→		13.0460-0275.2 610275	
S 500 (220.075, 220.175, 220.875)	220	10/98→12/03	⬅	11/98→ 08/02; nicht für gepanzerte Fahrzeuge		13.0460-0269.2 610269	
S 500 (220.075, 220.175, 220.875)	225	10/98→08/05	⬅	09/02→; nicht für gepanzerte Fahrzeuge		13.0460-0275.2 610275	
			➡	11/98→; für gepanzerte Fahrzeuge		13.0460-0236.2 610236	ATE
S 55 AMG (220.073, 220.173)	265	04/99→08/05	⬅	→ 08/02		13.0460-0269.2 610269	
			⬅	09/02→		13.0460-0275.2 610275	
S 600 (220.176)	368	09/02→08/05	⬅	nicht für gepanzerte Fahrzeuge		13.0460-0275.2 610275	
S 600 (220.878, 220.178)	270	01/00→08/05	➡	für gepanzerte Fahrzeuge		13.0460-0236.2 610236	ATE
<b> Brems Scheibe</b>							
S 280 (220.063, 220.163)	150	10/98→08/05	⬅	11/98→		24.0128-0125.1 428125	Ø 312 28 26 V•
S 320 (220.065, 220.165)	165	10/98→08/05	➡	11/98→		24.0111-0153.1 411153	Ø 300 11 9,3
S 320 CDI (220.025, 220.125)	150	09/02→08/05	⬅			24.0132-0115.1 432115	Ø 330 32 30 V•
S 320 CDI (220.026, 220.126)	145	08/99→09/02	➡			24.0111-0153.1 411153	Ø 300 11 9,3
S 350 (220.067, 220.167)	180	09/02→08/05	⬅			24.0128-0125.1 428125	Ø 312 28 26 V•
			➡			24.0111-0153.1 411153	Ø 300 11 9,3
S 350 4-matic (220.087, 220.187)	180	06/03→08/05	⬅			24.0130-0172.1 430172	Ø 304 30 27,4 V•
			➡			24.0122-0192.1 422192	Ø 300 22 19,4 V
S 400 CDI (220.028, 220.128)	184	06/00→08/05	⬅	08/00→		24.0132-0115.1 432115	Ø 330 32 30 V•
			➡	08/00→		24.0122-0192.1 422192	Ø 300 22 19,4 V
S 400 CDI (220.028, 220.128)	191	06/03→08/05	⬅			24.0132-0115.1 432115	Ø 330 32 30 V•
			➡			24.0122-0192.1 422192	Ø 300 22 19,4 V
S 430 (220.070, 220.170)	205	10/98→08/05	⬅	11/98→		24.0132-0115.1 432115	Ø 330 32 30 V•
			➡	10/02→		24.0111-0153.1 411153	Ø 300 11 9,3
			➡			24.0122-0192.1 422192	Ø 300 22 19,4 V
S 430 4-matic (220.083, 220.183)	205	09/02→08/05	⬅			24.0132-0136.1 432136	Ø 330 32 30 V•
S 500 4-matic (220.084, 220.184)	225	09/02→08/05	➡			24.0122-0192.1 422192	Ø 300 22 19,4 V
S 500 (220.075, 220.175, 220.875)	220	10/98→12/03	⬅	11/98→; nicht für gepanzerte Fahrzeuge		24.0132-0115.1 432115	Ø 330 32 30 V•
S 500 (220.075, 220.175, 220.875)	225	10/98→08/05	➡	11/98→; nicht für gepanzerte Fahrzeuge		24.0122-0192.1 422192	Ø 300 22 19,4 V
↓							









	kw			 	! #		
<b>MERCEDES-BENZ - S-KLASSE (W220) 10/98→08/05</b>							
<b>Bremsscheibe</b>							
S 55 AMG (220.073, 220.173)	265	04/99→08/05	←			24.0132-0125.1 432125	Ø 345 32 30 V•
			→			24.0122-0213.1 422213	Ø 315 22 19,4 V
S 55 AMG Kompressor (220.074, 220.174)	368	06/02→08/05	←			24.0136-0105.1 436105	Ø 360 36 34 V•
			→			24.0126-0137.1 426137	Ø 330 26 24 V•
S 600 (220.176)	368	09/02→08/05	←	nicht für gepanzerte Fahrzeuge		24.0132-0125.1 432125	Ø 345 32 30 V•
S 600 (220.878, 220.178)	270	01/00→08/05	→	nicht für gepanzerte Fahrzeuge		24.0122-0213.1 422213	Ø 315 22 19,4 V
<b>MERCEDES-BENZ - S-KLASSE (W221) 09/05→12/13</b>							
<b>Bremsbelagsatz, Scheibenbremse</b>							
S 250 CDI (221.003, 221.103)	150	01/11→12/13	←	→ 05/13		13.0460-4817.2 604817	BRE 23960 18,3 + WE / - WK
S 280 (221.054)	170	08/06→12/13	←	→ 05/13		13.0460-4817.2 604817	BRE 23960 18,3 + WE / - WK
S 300 (221.054, 221.154)	170	08/06→12/13	→	→ 05/13		13.0460-7171.2 607171 13.0470-7171.2 LD7171	ATE 23334 16,7 + WE / - WK ATE 23334 16,7 + WE / - WK Ceramic
S 320 CDI	155	10/05→12/13	←	12/05→ 05/13		13.0460-4817.2 604817	BRE 23960 18,3 + WE / - WK
S 350 (221.056, 221.156)	200	10/05→12/13	→	12/05→; → A 289058		13.0460-7171.2 607171	ATE 23334 16,7 + WE / - WK
S 500 (221.071, 221.171)	285	10/05→12/13				13.0470-7171.2 LD7171	ATE 23334 16,7 + WE / - WK Ceramic
S 320 CDI (221.022, 221.122)	173	12/05→06/09	←			13.0460-4817.2 604817	BRE 23960 18,3 + WE / - WK
S 320 CDI 4-matic (221.080, 221.180)	155	10/05→12/13	→	→ A 289058		13.0460-7171.2 607171	ATE 23334 16,7 + WE / - WK
S 350 CDI 4-matic (221.080, 221.081)	155	01/09→12/10				13.0470-7171.2 LD7171	ATE 23334 16,7 + WE / - WK Ceramic
S 320 CDI 4-matic (221.080, 221.180)	173	10/06→12/13	←	→ 05/13		13.0460-4817.2 604817	BRE 23960 18,3 + WE / - WK
S 350 4-matic (221.087, 221.187)	200	02/08→12/13	→	→ A 289058		13.0460-7171.2 607171	ATE 23334 16,7 + WE / - WK
S 350 CDI	173	06/09→12/13				13.0470-7171.2 LD7171	ATE 23334 16,7 + WE / - WK Ceramic
S 350 BlueTec (221.026, 221.126)	190	04/11→12/13	←	→ 05/13		13.0460-4817.2 604817	BRE 23960 18,3 + WE / - WK
S 350 BlueTEC 4-matic (221.083, 221.183)	190	04/11→12/13	→	für Fahrzeuge ohne AMG-Sportpaket; → 05/13		13.0460-7171.2 607171	ATE 23334 16,7 + WE / - WK
S 350 CGI (221.057, 221.157)	225	04/11→12/13				13.0470-7171.2 LD7171	ATE 23334 16,7 + WE / - WK Ceramic
S 350 CGI 4-matic (221.082, 221.182)	225	04/11→12/13					
S 400 Hybrid (221.095, 221.195)	205	01/09→12/13	←	06/09→ 05/13		13.0460-4817.2 604817	BRE 23960 18,3 + WE / - WK
			→	06/09→; → A 289058		13.0460-7171.2 607171	ATE 23334 16,7 + WE / - WK
						13.0470-7171.2 LD7171	ATE 23334 16,7 + WE / - WK Ceramic
S 420 CDI (221.028, 221.128)	235	10/06→12/09	←			13.0460-4817.2 604817	BRE 23960 18,3 + WE / - WK
S 450 CDI (221.028, 221.128)	235	01/09→12/13	←	für gepanzerte Fahrzeuge	2	13.0460-4984.2 604984	BRE 23271 17,4 + WE / - WK
			→			13.0460-7171.2 607171	ATE 23334 16,7 + WE / - WK
						13.0470-7171.2 LD7171	ATE 23334 16,7 + WE / - WK Ceramic
S 450 (221.070, 221.170)	250	12/05→12/13	←	04/06→ 05/13		13.0460-4817.2 604817	BRE 23960 18,3 + WE / - WK
S 450 4-matic (221.084, 221.184)	250	12/05→12/13	→	04/06→; → A 289058		13.0460-7171.2 607171	ATE 23334 16,7 + WE / - WK
S 500 4-matic (221.086, 221.186)	285	10/05→12/13				13.0470-7171.2 LD7171	ATE 23334 16,7 + WE / - WK Ceramic
S 600 (221.176)	380	12/05→12/13	←	A 000101→; → 05/13		13.0460-4839.2 604839	BRE 24455 16,8 + WE / - WK
			←	→ A 000100; für Fahrzeuge mit AMG-Sportpaket		13.0460-4839.2 604839	BRE 24455 16,8 + WE / - WK
			←	A 000101→; → 05/13; für gepanzerte Fahrzeuge	2	13.0460-4984.2 604984	BRE 23271 17,4 + WE / - WK
			←	→ A 000100; für gepanzerte Fahrzeuge	2	13.0460-4984.2 604984	BRE 23271 17,4 + WE / - WK
			←	→ A 000100; für Fahrzeuge ohne AMG-Sportpaket		13.0460-4997.2 604997	BRE 23943 17,5 + WE / - WK
			→	→ 05/13; nicht für gepanzerte Fahrzeuge		13.0460-4998.2 604998	BRE 23478 16,5 + WE / - WK
<b>Warnkontakt, Bremsbelagverschleiß</b>							
S 250 CDI (221.003, 221.103)	150	01/11→12/13	←	→ 05/13	1	24.8190-0420.2 620420	L= 119
S 280 (221.054)	170	08/06→12/13	→	→ 05/13	1	24.8190-0410.2 620410	L= 97,5
S 300 (221.054, 221.154)	170	08/06→12/13					
↓							









	kw			 	! #		
<b>MERCEDES-BENZ - S-KLASSE (W221) 09/05→12/13</b>							
<b>Warnkontakt, Bremsbelagverschleiß</b>							
S 350 BlueTec (221.026, 221.126)	190	04/11→12/13	←	→ 05/13	1	24.8190-0420.2 620420	L= 119
S 350 BlueTEC 4-matic (221.083, 221.183)	190	04/11→12/13	→	→ 05/13	1	24.8190-0410.2 620410	L= 97,5
S 350 CGI (221.057, 221.157)	225	04/11→12/13					
S 350 CGI 4-matic (221.082, 221.182)	225	04/11→12/13					
S 320 CDI	155	10/05→12/13	←	12/05→ 05/13	1	24.8190-0420.2 620420	L= 119
S 350 (221.056, 221.156)	200	10/05→12/13	→	A 289059→; → 05/13	1	24.8190-0410.2 620410	L= 97,5
S 500 (221.071, 221.171)	285	10/05→12/13	→	12/05→; → A 289058	1	24.8190-0410.2 620410	L= 97,5
S 320 CDI (221.022, 221.122)	173	12/05→06/09	←		1	24.8190-0420.2 620420	L= 119
S 320 CDI 4-matic (221.080, 221.180)	155	10/05→12/13	→	→ A 289058	1	24.8190-0410.2 620410	L= 97,5
S 350 CDI 4-matic (221.080, 221.081)	155	01/09→12/10	→	A 289059→	1	24.8190-0410.2 620410	L= 97,5
S 320 CDI 4-matic (221.080, 221.180)	173	10/06→12/13	←	→ 05/13	1	24.8190-0420.2 620420	L= 119
S 350 4-matic (221.087, 221.187)	200	02/08→12/13	→	A 289059→; → 05/13	1	24.8190-0410.2 620410	L= 97,5
S 350 CDI	173	06/09→12/13	→	→ A 289058	1	24.8190-0410.2 620410	L= 97,5
S 400 Hybrid (221.095, 221.195)	205	01/09→12/13	←	06/09→ 05/13	1	24.8190-0420.2 620420	L= 119
			→	06/09→; → A 289058	1	24.8190-0410.2 620410	L= 97,5
			→	A 289059→; → 05/13	1	24.8190-0410.2 620410	L= 97,5
S 420 CDI (221.028, 221.128)	235	10/06→12/09	←	für gepanzerte Fahrzeuge	1	24.8190-0410.2 620410	L= 97,5
S 450 CDI (221.028, 221.128)	235	01/09→12/13	←		1	24.8190-0420.2 620420	L= 119
			→		1	24.8190-0410.2 620410	L= 97,5
S 450 (221.070, 221.170)	250	12/05→12/13	←	04/06→ 05/13	1	24.8190-0420.2 620420	L= 119
S 450 4-matic (221.084, 221.184)	250	12/05→12/13	→	A 289059→; → 05/13	1	24.8190-0410.2 620410	L= 97,5
S 500 4-matic (221.086, 221.186)	285	10/05→12/13	→	04/06→; → A 289058	1	24.8190-0410.2 620410	L= 97,5
S 500 CGI (221.073, 221.173)	320	04/11→12/13	→	→ 05/13	1	24.8190-0410.2 620410	L= 97,5
S 500 CGI 4-matic (221.094, 221.194)	320	03/11→12/13					
S 600 (221.176)	380	12/05→12/13	←	→ A 000100	1	24.8190-0410.2 620410	L= 97,5
			←	A 000101→; → 05/13; für gepanzerte Fahrzeuge	1	24.8190-0410.2 620410	L= 97,5
			←	A 000101→; → 05/13	1	24.8190-0420.2 620420	L= 119
			→	→ 05/13	1	24.8190-0410.2 620410	L= 97,5
S 63 AMG (221.074, 221.174)	400	03/11→12/13	←	→ 05/13	1	24.8190-0420.2 620420	L= 119
S 63 AMG (221.074, 221.174)	420	02/12→12/13	→	→ 05/13	1	24.8190-0420.2 620420	L= 119
S 65 AMG (221.179)	463	04/11→12/13					
S 63 AMG (221.077, 221.177)	386	10/06→12/13	←	01/07→ 05/13	1	24.8190-0420.2 620420	L= 119
			→	01/07→ 05/13	1	24.8190-0420.2 620420	L= 119
S 65 AMG (221.179)	450	12/05→12/13	←	04/06→ 05/13	1	24.8190-0420.2 620420	L= 119
			→	04/06→ 05/13	1	24.8190-0420.2 620420	L= 119
<b>Bremsscheibe</b>							
S 250 CDI (221.003, 221.103)	150	01/11→12/13	←	für Fahrzeuge ohne AMG-Sportpaket; → 05/13		24.0132-0137.1 432137	Ø 335 32 30 V• + S
			←	für Fahrzeuge mit AMG-Sportpaket; → 05/13		24.0132-0138.1 432138	Ø 350 32 30 V• + S
			→	für Fahrzeuge ohne AMG-Sportpaket; → 05/13		24.0112-0183.1 412183	Ø 300 12 10 + S
			→	für Fahrzeuge mit AMG-Sportpaket; → 05/13		24.0124-0212.1 424212	Ø 320 24 21,4 V + S
S 280 (221.054)	170	08/06→12/13	←	für Fahrzeuge ohne AMG-Sportpaket; → 05/13		24.0132-0137.1 432137	Ø 335 32 30 V• + S
S 300 (221.054, 221.154)	170	08/06→12/13	←	für Fahrzeuge ohne AMG-Sportpaket; → 05/13		24.0132-0137.1 432137	Ø 335 32 30 V• + S
S 350 4-matic (221.087, 221.187)	200	02/08→12/13	←	für Fahrzeuge mit AMG-Sportpaket; → 05/13		24.0132-0138.1 432138	Ø 350 32 30 V• + S
S 350 CDI	173	06/09→12/13	→	→ A 265575		24.0112-0183.1 412183	Ø 300 12 10 + S
			→	A 265576→; → 05/13; für Fahrzeuge ohne AMG-Sportpaket		24.0122-0229.1 422229	Ø 300 22 19,4 V
↓							









	kw			 	! #		
<b>MERCEDES-BENZ - S-KLASSE (W221) 09/05→12/13</b>							
<b>Bremsscheibe</b>							
S 280 (221.054) S 300 (221.054, 221.154) S 350 4-matic (221.087, 221.187) S 350 CDI	170 170 200 173	08/06→12/13 08/06→12/13 02/08→12/13 06/09→12/13	➔	A 265576→; → 05/13; für Fahrzeuge mit AMG-Sportpaket		24.0124-0212.1 424212	Ø 320 24 21,4 V + S
S 320 CDI S 350 (221.056, 221.156)	155 200	10/05→12/13 10/05→12/13	➔	12/05→; für Fahrzeuge ohne AMG-Sportpaket; → 05/13		24.0132-0137.1 432137	Ø 335 32 30 V• + S
			➔	12/05→; für Fahrzeuge mit AMG-Sportpaket; → 05/13		24.0132-0138.1 432138	Ø 350 32 30 V• + S
			➔	12/05→; → A 265575		24.0112-0183.1 412183	Ø 300 12 10 + S
			➔	A 265576→; → 05/13; für Fahrzeuge ohne AMG-Sportpaket		24.0122-0229.1 422229	Ø 300 22 19,4 V
			➔	A 265576→; → 05/13; für Fahrzeuge mit AMG-Sportpaket		24.0124-0212.1 424212	Ø 320 24 21,4 V + S
S 320 CDI (221.022, 221.122)	173	12/05→06/09	➔	für Fahrzeuge ohne AMG-Sportpaket		24.0132-0137.1 432137	Ø 335 32 30 V• + S
			➔	für Fahrzeuge mit AMG-Sportpaket		24.0132-0138.1 432138	Ø 350 32 30 V• + S
			➔	→ A 265575		24.0112-0183.1 412183	Ø 300 12 10 + S
			➔	A 265576→; für Fahrzeuge ohne AMG-Sportpaket		24.0122-0229.1 422229	Ø 300 22 19,4 V
			➔	A 265576→; für Fahrzeuge mit AMG-Sportpaket		24.0124-0212.1 424212	Ø 320 24 21,4 V + S
S 320 CDI 4-matic (221.080, 221.180) S 350 CDI 4-matic (221.080, 221.081)	155 155	10/05→12/13 01/09→12/10	➔			24.0132-0138.1 432138	Ø 350 32 30 V• + S
			➔	→ A 265575		24.0112-0183.1 412183	Ø 300 12 10 + S
			➔	A 265576→; für Fahrzeuge ohne AMG-Sportpaket		24.0122-0229.1 422229	Ø 300 22 19,4 V
			➔	A 265576→; für Fahrzeuge mit AMG-Sportpaket		24.0124-0212.1 424212	Ø 320 24 21,4 V + S
S 320 CDI 4-matic (221.080, 221.180)	173	10/06→12/13	➔	→ 05/13		24.0132-0138.1 432138	Ø 350 32 30 V• + S
			➔	→ A 265575		24.0112-0183.1 412183	Ø 300 12 10 + S
			➔	A 265576→; → 05/13; für Fahrzeuge ohne AMG-Sportpaket		24.0122-0229.1 422229	Ø 300 22 19,4 V
			➔	A 265576→; → 05/13; für Fahrzeuge mit AMG-Sportpaket		24.0124-0212.1 424212	Ø 320 24 21,4 V + S
S 350 BlueTec (221.026, 221.126) S 350 CGI (221.057, 221.157) S 350 CGI 4-matic (221.082, 221.182)	190 225 225	04/11→12/13 04/11→12/13 04/11→12/13	➔	für Fahrzeuge ohne AMG-Sportpaket; → 05/13		24.0132-0137.1 432137	Ø 335 32 30 V• + S
			➔	für Fahrzeuge mit AMG-Sportpaket; → 05/13		24.0132-0138.1 432138	Ø 350 32 30 V• + S
			➔	→ 05/13; für Fahrzeuge ohne AMG-Sportpaket		24.0122-0229.1 422229	Ø 300 22 19,4 V
			➔	für Fahrzeuge mit AMG-Sportpaket; → 05/13		24.0124-0212.1 424212	Ø 320 24 21,4 V + S
S 350 BlueTEC 4-matic (221.083, 221.183)	190	04/11→12/13	➔	→ 05/13		24.0132-0138.1 432138	Ø 350 32 30 V• + S
			➔	→ 05/13; für Fahrzeuge ohne AMG-Sportpaket		24.0122-0229.1 422229	Ø 300 22 19,4 V
			➔	für Fahrzeuge mit AMG-Sportpaket; → 05/13		24.0124-0212.1 424212	Ø 320 24 21,4 V + S
S 400 Hybrid (221.095, 221.195)	205	01/09→12/13	➔	06/09→; für Fahrzeuge ohne AMG-Sportpaket; → 05/13		24.0132-0137.1 432137	Ø 335 32 30 V• + S
			➔	06/09→; für Fahrzeuge mit AMG-Sportpaket; → 05/13		24.0132-0138.1 432138	Ø 350 32 30 V• + S
			➔	06/09→; für Fahrzeuge ohne AMG-Sportpaket; → 05/13		24.0112-0183.1 412183	Ø 300 12 10 + S
			➔	06/09→; für Fahrzeuge mit AMG-Sportpaket; → 05/13		24.0124-0212.1 424212	Ø 320 24 21,4 V + S
S 420 CDI (221.028, 221.128) S 450 CDI (221.028, 221.128)	235 235	10/06→12/09 01/09→12/13	➔			24.0132-0138.1 432138	Ø 350 32 30 V• + S
			➔			24.0124-0212.1 424212	Ø 320 24 21,4 V + S
S 450 (221.070, 221.170) S 450 4-matic (221.084, 221.184) S 500 4-matic (221.086, 221.186)	250 250 285	12/05→12/13 12/05→12/13 10/05→12/13	➔	04/06→ 05/13		24.0132-0138.1 432138	Ø 350 32 30 V• + S
			➔	04/06→ 05/13		24.0124-0212.1 424212	Ø 320 24 21,4 V + S
			↓				





















	kw			 	! #		
<b>MERCEDES-BENZ - S-KLASSE (W221) 09/05→12/13</b>							
<b> Bremsscheibe</b>							
S 500 (221.071, 221.171)	285	10/05→12/13	←	12/05→; für Fahrzeuge ohne AMG-Sportpaket; → 05/13	24.0132-0137.1	432137	Ø 335 32 30 V• + S
			←	12/05→; für Fahrzeuge mit AMG-Sportpaket; → 05/13	24.0132-0138.1	432138	Ø 350 32 30 V• + S
			→	12/05→ 05/13	24.0124-0212.1	424212	Ø 320 24 21,4 V + S
S 500 CGI (221.073, 221.173)	320	04/11→12/13	←	→ 05/13	24.0136-0102.1	436102	Ø 360 36 34 V•
S 500 CGI 4-matic (221.094, 221.194)	320	03/11→12/13	→	→ 05/13	24.0124-0212.1	424212	Ø 320 24 21,4 V + S
S 600 (221.176)	380	12/05→12/13	←	→ 05/13	24.0136-0108.1	436108	Ø 360 36 34 V• + S
			→	→ 05/13	24.0126-0149.1	426149	Ø 330 26 23,4 V + S
<b>MERCEDES-BENZ - S-KLASSE (W222, V222, X222) 05/13→</b>							
<b> Bremsbelagsatz, Scheibenbremse</b>							
S 300 BlueTEC Hybrid / h (222.004, 222.104)	150	02/14→	←	für Fahrzeuge mit AMG-Sportpaket	13.0460-4870.2	604870	BRE 25179 17,8 + WE / - WK
S 300 BlueTEC Hybrid / h (222.104)	170	02/14→	→		13.0460-2780.2	602780	TRW 25071 18,8 + WE / - WK + Zub
S 320 (222.162)	200	05/14→	←	für Fahrzeuge ohne AMG-Sportpaket	13.0460-4869.2	604869	BRE 25183 17,9 + WE / - WK
			←	für Fahrzeuge mit AMG-Sportpaket	13.0460-4870.2	604870	BRE 25179 17,8 + WE / - WK
S 350 BlueTEC / d (222.132, 222.032, 222.123)	190	05/13→	→		13.0460-2780.2	602780	TRW 25071 18,8 + WE / - WK + Zub
S 350 BlueTEC / d 4-matic (222.033, 222.133)	190	02/14→					
S 350 BlueTEC 4-matic (222.133)	185	02/14→					
S 400 Hybrid / h (222.057, 222.157)	225	05/13→					
S 350 d (222.020, 222.120)	210	07/17→	←	für Fahrzeuge ohne AMG-Sportpaket / für Fahrzeuge ohne Sportpaket	13.0460-4869.2	604869	BRE 25183 17,9 + WE / - WK
S 350 d 4-matic (222.021, 222.121)	210	05/17→	←	für Fahrzeuge mit AMG-Sportpaket / für Fahrzeuge mit Sportpaket	13.0460-4870.2	604870	BRE 25179 17,8 + WE / - WK
			→		13.0460-2780.2	602780	TRW 25071 18,8 + WE / - WK + Zub
S 400 (222.165)	245	03/14→	←		13.0460-4870.2	604870	BRE 25179 17,8 + WE / - WK
S 400 4-matic (222.067)	245	11/14→					
S 400 d (222.034, 222.134)	250	07/17→	→		13.0460-2780.2	602780	TRW 25071 18,8 + WE / - WK + Zub
S 400 d 4-matic (222.035, 222.135)	250	05/17→					
S 500 (222.082, 222.182)	320	09/13→					
S 500 (222.082, 222.182)	335	05/13→					
S 500 Hybrid / e (222.163)	245	07/14→					
S 450 (222.066, 222.166)	270	02/17→	←	nicht für gepanzerte Fahrzeuge	13.0460-4870.2	604870	BRE 25179 17,8 + WE / - WK
S 450 4-matic (222.064, 222.164)	270	02/17→	→		13.0460-2780.2	602780	TRW 25071 18,8 + WE / - WK + Zub
S 500 4-matic (222.085, 222.185)	335	05/13→	←	09/13→	13.0460-4870.2	604870	BRE 25179 17,8 + WE / - WK
			→	09/13→	13.0460-2780.2	602780	TRW 25071 18,8 + WE / - WK + Zub
S 500 Maybach (222.982)	335	12/14→	←	nicht für gepanzerte Fahrzeuge	13.0460-4870.2	604870	BRE 25179 17,8 + WE / - WK
			→	nicht für gepanzerte Fahrzeuge	13.0460-2780.2	602780	TRW 25071 18,8 + WE / - WK + Zub
S 500 Maybach 4-matic (222.985)	335	04/15→	←	nicht für gepanzerte Fahrzeuge	13.0460-4870.2	604870	BRE 25179 17,8 + WE / - WK
S 560 Maybach (222.983)	345	07/17→	→	nicht für gepanzerte Fahrzeuge; nicht für Fahrzeuge mit verstärkter Bremse	13.0460-2780.2	602780	TRW 25071 18,8 + WE / - WK + Zub
S 560 (222.083, 222.183)	345	07/17→	←		13.0460-4870.2	604870	BRE 25179 17,8 + WE / - WK
S 560 4-matic (222.086, 222.186)	345	05/17→	→	nicht für Fahrzeuge mit verstärkter Bremse	13.0460-2780.2	602780	TRW 25071 18,8 + WE / - WK + Zub
S 63 AMG (222.077, 222.177)	430	05/13→	←	09/13→; für Fahrzeuge ohne Keramikbremse	13.0460-4839.2	604839	BRE 24455 16,8 + WE / - WK
S 63 AMG 4-matic (222.178)	430	05/13→					
S 65 AMG (222.179)	463	02/14→	←	03/14→; für Fahrzeuge ohne Keramikbremse	13.0460-4839.2	604839	BRE 24455 16,8 + WE / - WK

	kW			 	! #		
<b>MERCEDES-BENZ - S-KLASSE (W222, V222, X222) 05/13→</b>							
<b>Warnkontakt, Bremsbelagverschleiß</b>							
AMG S 63 4-matic+ (222.188)	450	05/17→	←	für Fahrzeuge ohne Keramikbremse	1	24.8190-0420.2 620420	L= 119
			→		1	24.8190-0410.2 620410	L= 97,5
S 300 BlueTEC Hybrid / h (222.004, 222.104)	150	02/14→	←		2	24.8190-0959.2 620959	L= 102
			→		2	24.8190-0410.2 620410	L= 97,5
S 300 BlueTEC Hybrid / h (222.104)	170	02/14→	→				
S 320 (222.162)	200	05/14→					
S 350 BlueTEC / d (222.132, 222.032, 222.123)	190	05/13→					
S 350 BlueTEC / d 4-matic (222.033, 222.133)	190	02/14→					
S 350 BlueTEC 4-matic (222.133)	185	02/14→					
S 400 (222.165)	245	03/14→					
S 400 4-matic (222.067)	245	11/14→					
S 400 Hybrid / h (222.057, 222.157)	225	05/13→					
S 500 (222.082, 222.182)	320	09/13→					
S 500 (222.082, 222.182)	335	05/13→					
S 500 Hybrid / e (222.163)	245	07/14→					
S 350 d (222.020, 222.120)	210	07/17→	←		1	24.8190-0959.2 620959	L= 102
S 350 d 4-matic (222.021, 222.121)	210	05/17→	→		1	24.8190-0410.2 620410	L= 97,5
S 400 d (222.034, 222.134)	250	07/17→					
S 450 (222.066, 222.166)	270	02/17→					
S 450 4-matic (222.064, 222.164)	270	02/17→					
S 500 Maybach 4-matic (222.985)	335	04/15→					
S 560 4-matic (222.086, 222.186)	345	05/17→					
S 560 Maybach (222.983)	345	07/17→					
S 400 d 4-matic (222.035, 222.135)	250	05/17→	←			24.8190-0959.2 620959	L= 102
			→		1	24.8190-0410.2 620410	L= 97,5
S 500 4-matic (222.085, 222.185)	335	05/13→	←	09/13→	2	24.8190-0959.2 620959	L= 102
			→	09/13→	2	24.8190-0410.2 620410	L= 97,5
S 500 Maybach (222.982)	335	12/14→	←	nicht für gepanzerte Fahrzeuge	2	24.8190-0959.2 620959	L= 102
			→	nicht für gepanzerte Fahrzeuge	2	24.8190-0410.2 620410	L= 97,5
S 560 (222.083, 222.183)	345	07/17→	←		1	24.8190-0959.2 620959	L= 102
S 600 (222.176)	390	02/14→	←	04/14→	1	24.8190-0420.2 620420	L= 119
			→	04/14→	1	24.8190-0410.2 620410	L= 97,5
S 600 Maybach (222.976)	390	12/14→	←	nicht für gepanzerte Fahrzeuge	1	24.8190-0420.2 620420	L= 119
			→	nicht für gepanzerte Fahrzeuge	1	24.8190-0410.2 620410	L= 97,5
S 63 AMG (222.077, 222.177)	430	05/13→	←	09/13→; für Fahrzeuge ohne Keramikbremse	1	24.8190-0420.2 620420	L= 119
			→	09/13→	1	24.8190-0410.2 620410	L= 97,5
S 63 AMG 4-matic (222.178)	430	05/13→					
S 65 AMG (222.179)	463	02/14→	←	03/14→; für Fahrzeuge ohne Keramikbremse	1	24.8190-0420.2 620420	L= 119
			→	03/14→	1	24.8190-0410.2 620410	L= 97,5
<b>MERCEDES-BENZ - S-KLASSE Cabriolet (A217) 12/15→</b>							
<b> Bremsbelagsatz, Scheibenbremse</b>							
S 500 (217.482)	335	12/15→	←			13.0460-4870.2 604870	BRE 25179 17,8 + WE / - WK
			→			13.0460-2780.2 602780	TRW 25071 18,8 + WE / - WK + Zub
<b>Warnkontakt, Bremsbelagverschleiß</b>							
AMG S 63 4-matic (217.478)	430	12/15→	←	☐; für Fahrzeuge ohne Keramikbremse		24.8190-0420.2 620420	L= 119
AMG S 65 (217.479)	463	04/16→	→	☐		24.8190-0410.2 620410	L= 97,5
S 500 (217.482)	335	12/15→	←			24.8190-0959.2 620959	L= 102
			→			24.8190-0410.2 620410	L= 97,5









	kw			 	! #		
<b>MERCEDES-BENZ - S-KLASSE Coupe (C140) 07/92→02/99</b>							
<b> Bremsbelagsatz, Scheibenbremse</b>							
CL 500	225	09/96→12/97	←			<b>13.0460-9033.2 609033</b>	ATE 21303 18,9 + WE / - WK
			→			<b>13.0460-4047.2 604047</b>	ATE 21305 15,7 + WE / - WK
						<b>13.0470-4047.2 LD4047</b>	ATE 21305 15,7 + WE / - WK Ceramic
SEC/CL 420 (140.063)	205	10/94→02/99	←	06/96→		<b>13.0460-9033.2 609033</b>	ATE 21303 18,9 + WE / - WK
			←	→ 05/96		<b>13.0460-9033.2 609033</b>	ATE 21303 18,9 + WE / - WK
			→	06/96→		<b>13.0460-4047.2 604047</b>	ATE 21305 15,7 + WE / - WK
						<b>13.0470-4047.2 LD4047</b>	ATE 21305 15,7 + WE / - WK Ceramic
			→	→ 05/96		<b>13.0460-4047.2 604047</b>	ATE 21305 15,7 + WE / - WK
			→	→ 05/96		<b>13.0470-4047.2 LD4047</b>	ATE 21305 15,7 + WE / - WK Ceramic
SEC/CL 500 (140.070) SEC/CL 600 (140.076)	235 290	10/92→02/99 09/92→02/99	←	06/96→		<b>13.0460-9033.2 609033</b>	ATE 21303 18,9 + WE / - WK
			←	07/93→ 05/96		<b>13.0460-9033.2 609033</b>	ATE 21303 18,9 + WE / - WK
			←	→ 06/93		<b>13.0460-9033.2 609033</b>	ATE 21303 18,9 + WE / - WK
			→	07/93→ 05/96		<b>13.0460-4047.2 604047</b>	ATE 21305 15,7 + WE / - WK
						<b>13.0470-4047.2 LD4047</b>	ATE 21305 15,7 + WE / - WK Ceramic
			→	06/96→		<b>13.0460-4047.2 604047</b>	ATE 21305 15,7 + WE / - WK
						→	→ 06/93
<b>Warnkontakt, Bremsbelagsverschleiß</b>							
CL 500	225	09/96→12/97	←		4	<b>24.8190-0401.2 620401</b>	L= 95
			→	+ ASR	4	<b>24.8190-0401.2 620401</b>	L= 95
SEC/CL 420 (140.063)	205	10/94→02/99	←	→ 05/96	4	<b>24.8190-0401.2 620401</b>	L= 95
			←	06/96→	4	<b>24.8190-0401.2 620401</b>	L= 95
			→	→ 05/96; + ASR	4	<b>24.8190-0401.2 620401</b>	L= 95
			→	06/96→; + ASR	4	<b>24.8190-0401.2 620401</b>	L= 95
SEC/CL 500 (140.070) SEC/CL 600 (140.076)	235 290	10/92→02/99 09/92→02/99	←	07/93→ 05/96	4	<b>24.8190-0401.2 620401</b>	L= 95
			←	→ 06/93	4	<b>24.8190-0401.2 620401</b>	L= 95
			←	06/96→	4	<b>24.8190-0401.2 620401</b>	L= 95
			→	→ 06/93; + ASR	4	<b>24.8190-0401.2 620401</b>	L= 95
			→	06/96→; + ASR	4	<b>24.8190-0401.2 620401</b>	L= 95
			→	07/93→ 05/96; + ASR	4	<b>24.8190-0401.2 620401</b>	L= 95
<b>Zubehörsatz, Scheibenbremsbelag</b>							
CL 500	225	09/96→12/97	←			<b>13.0460-0263.2 610263</b>	
			→			<b>13.0460-0236.2 610236</b>	ATE
SEC/CL 420 (140.063)	205	10/94→02/99	←	→ 05/96		<b>13.0460-0263.2 610263</b>	
			←	06/96→		<b>13.0460-0263.2 610263</b>	
			→	06/96→		<b>13.0460-0236.2 610236</b>	ATE
			→	→ 05/96		<b>13.0460-0236.2 610236</b>	ATE
						<b>13.0460-0239.2 610239</b>	ATE
SEC/CL 500 (140.070) SEC/CL 600 (140.076)	235 290	10/92→02/99 09/92→02/99	←	06/96→		<b>13.0460-0263.2 610263</b>	
			←	07/93→ 05/96		<b>13.0460-0263.2 610263</b>	
			←	→ 06/93		<b>13.0460-0263.2 610263</b>	
			→	07/93→ 05/96		<b>13.0460-0236.2 610236</b>	ATE
						<b>13.0460-0239.2 610239</b>	ATE
			→	06/96→		<b>13.0460-0236.2 610236</b>	ATE
			→	→ 06/93		<b>13.0460-0236.2 610236</b>	ATE
<b> Bremsscheibe</b>							
CL 500	225	09/96→12/97	←			<b>24.0130-0100.1 430100</b>	Ø 320 30 27,4 V
			→			<b>24.0122-0133.1 422133</b>	Ø 300 22 19,4 V
SEC/CL 420 (140.063)	205	10/94→02/99	←	06/96→		<b>24.0130-0100.1 430100</b>	Ø 320 30 27,4 V
↓							

	kW					! #		
<b>MERCEDES-BENZ - S-KLASSE Coupe (C140) 07/92→02/99</b>								
<b> Bremsscheibe</b>								
SEC/CL 420 (140.063)	205	10/94→02/99	←	→ 05/96			24.0130-0100.1 430100	Ø 320 30 27,4 V
			→	→ 05/96			24.0122-0133.1 422133	Ø 300 22 19,4 V
			→	06/96→			24.0122-0133.1 422133	Ø 300 22 19,4 V
SEC/CL 500 (140.070)	235	10/92→02/99	←	06/96→			24.0130-0100.1 430100	Ø 320 30 27,4 V
SEC/CL 600 (140.076)	290	09/92→02/99	←	07/93→ 05/96			24.0130-0100.1 430100	Ø 320 30 27,4 V
			←	→ 06/93			24.0130-0100.1 430100	Ø 320 30 27,4 V
			→	07/93→ 05/96			24.0122-0133.1 422133	Ø 300 22 19,4 V
			→	06/96→			24.0122-0133.1 422133	Ø 300 22 19,4 V
			→	→ 06/93			24.0122-0133.1 422133	Ø 300 22 19,4 V
<b>MERCEDES-BENZ - S-KLASSE Coupe (C215) 03/99→12/06</b>								
<b> Bremsbelagsatz, Scheibenbremse</b>								
CL 500 (215.375)	225	03/99→03/06	←				13.0460-4984.2 604984	BRE 23271 17,4 + WE / - WK
CL 55 AMG (215.373)	265	10/99→03/06	→				13.0460-4069.2 604069	ATE 23078 15,9 + WE / - WK
CL 600 (215.376)	368	09/02→03/06						
CL 600 (215.378)	270	03/99→03/06						
CL 55 AMG Kompressor (215.374)	368	06/02→03/06	←				13.0460-4997.2 604997	BRE 23943 17,5 + WE / - WK
			→				13.0460-4998.2 604998	BRE 23478 16,5 + WE / - WK
CL 65 AMG (215.379)	450	09/03→03/06	←				13.0460-4997.2 604997	BRE 23943 17,5 + WE / - WK
			→				13.0460-4819.2 604819	BRE 23478 14,6 + WE / - WK
<b>Warnkontakt, Bremsbelagsverschleiß</b>								
CL 500 (215.375)	225	03/99→03/06	←		2	24.8190-0410.2 620410		L= 97,5
CL 55 AMG (215.373)	265	10/99→03/06	→		1	24.8190-0410.2 620410		L= 97,5
CL 55 AMG Kompressor (215.374)	368	06/02→03/06						
CL 600 (215.376)	368	09/02→03/06						
CL 600 (215.378)	270	03/99→03/06						
CL 65 AMG (215.379)	450	09/03→03/06						
<b>Zubehörsatz, Scheibenbremsbelag</b>								
CL 500 (215.375)	225	03/99→03/06	←				13.0460-0269.2 610269	
CL 55 AMG (215.373)	265	10/99→03/06						
CL 600 (215.376)	368	09/02→03/06						
CL 600 (215.378)	270	03/99→03/06						
<b> Bremsscheibe</b>								
CL 500 (215.375)	225	03/99→03/06	←				24.0132-0115.1 432115	Ø 330 32 30 V*
			→				24.0122-0192.1 422192	Ø 300 22 19,4 V
CL 55 AMG (215.373)	265	10/99→03/06	←				24.0132-0125.1 432125	Ø 345 32 30 V*
CL 600 (215.376)	368	09/02→03/06	→				24.0122-0213.1 422213	Ø 315 22 19,4 V
CL 600 (215.378)	270	03/99→03/06						
CL 55 AMG Kompressor (215.374)	368	06/02→03/06	←				24.0136-0105.1 436105	Ø 360 36 34 V*
			→				24.0126-0137.1 426137	Ø 330 26 24 V*
<b>MERCEDES-BENZ - S-KLASSE Coupe (C216) 05/06→12/13</b>								
<b> Bremsbelagsatz, Scheibenbremse</b>								
CL 500 (216.371)	285	06/06→12/13	←	07/06→			13.0460-4817.2 604817	BRE 23960 18,3 + WE / - WK
			→	07/06→			13.0460-7171.2 607171	ATE 23334 16,7 + WE / - WK
							13.0470-7171.2 LD7171	ATE 23334 16,7 + WE / - WK Ceramic
CL 500 4-matic (216.386)	285	02/08→12/13	←	03/08→			13.0460-4817.2 604817	BRE 23960 18,3 + WE / - WK
			→	03/08→			13.0460-7171.2 607171	ATE 23334 16,7 + WE / - WK
							13.0470-7171.2 LD7171	ATE 23334 16,7 + WE / - WK Ceramic
CL 600 (216.376)	380	05/06→12/13	←	07/06→			13.0460-4839.2 604839	BRE 24455 16,8 + WE / - WK
			→	07/06→			13.0460-4998.2 604998	BRE 23478 16,5 + WE / - WK
<b>Warnkontakt, Bremsbelagsverschleiß</b>								
CL 500 (216.371)	285	06/06→12/13	←	07/06→	1	24.8190-0420.2 620420		L= 119
CL 600 (216.376)	380	05/06→12/13	→	07/06→	1	24.8190-0410.2 620410		L= 97,5
CL 500 (216.373)	320	02/11→12/13	←		1	24.8190-0410.2 620410		L= 97,5
CL 500 4-matic (216.394)	320	02/11→12/13	→		1	24.8190-0410.2 620410		L= 97,5
↓								



	kW				! #		
<b>MERCEDES-BENZ - S-KLASSE Coupe (C216) 05/06→12/13</b>							
<b>Warnkontakt, Bremsbelagverschleiß</b>							
CL 500 4-matic (216.386)	285	02/08→12/13	←	03/08→	1	24.8190-0420.2 620420	L= 119
			→	03/08→	1	24.8190-0410.2 620410	L= 97,5
CL 63 AMG (216.374)	400	02/11→12/13	←		1	24.8190-0420.2 620420	L= 119
CL 63 AMG (216.374)	420	01/10→12/13	←				
CL 65 AMG (216.379)	463	02/11→12/13	→		1	24.8190-0420.2 620420	L= 119
CL 63 AMG (216.377)	386	10/06→12/13	←	01/07→	1	24.8190-0420.2 620420	L= 119
CL 65 AMG (216.379)	450	10/06→12/10	→	01/07→	1	24.8190-0420.2 620420	L= 119
<b>Bremsscheibe</b>							
CL 500 (216.371)	285	06/06→12/13	←	07/06→		24.0132-0138.1 432138	Ø 350 32 30 V• + S
			→	07/06→		24.0124-0212.1 424212	Ø 320 24 21,4 V + S
CL 500 (216.373)	320	02/11→12/13	←			24.0136-0102.1 436102	Ø 360 36 34 V•
CL 500 4-matic (216.394)	320	02/11→12/13	→			24.0124-0212.1 424212	Ø 320 24 21,4 V + S
CL 500 4-matic (216.386)	285	02/08→12/13	←	03/08→		24.0132-0138.1 432138	Ø 350 32 30 V• + S
			→	03/08→		24.0124-0212.1 424212	Ø 320 24 21,4 V + S
CL 600 (216.376)	380	05/06→12/13	←	07/06→		24.0136-0108.1 436108	Ø 360 36 34 V• + S
			→	07/06→		24.0126-0149.1 426149	Ø 330 26 23,4 V + S
<b>MERCEDES-BENZ - S-KLASSE Coupe (C217) 04/14→</b>							
<b>Brembelagsatz, Scheibenbremse</b>							
S 400 4-matic (217.364)	270	10/15→	←	für Fahrzeuge ohne AMG-Sportpaket		13.0460-4870.2 604870	BRE 25179 17,8 + WE / - WK
S 500 (217.382)	335	11/14→	→	nicht für Fahrzeuge mit verstärkter Bremse		13.0460-2780.2 602780	TRW 25071 18,8 + WE / - WK + Zub
S 500 4-matic (217.385)	335	04/14→	→				
S 63 AMG 4-matic (217.378)	430	04/14→	→	für Fahrzeuge ohne Keramikbremse		13.0460-2780.2 602780	TRW 25071 18,8 + WE / - WK + Zub
<b>Warnkontakt, Bremsbelagverschleiß</b>							
S 400 4-matic (217.364)	270	10/15→	←	☐	1	24.8190-0959.2 620959	L= 102
			→	☐	1	24.8190-0410.2 620410	L= 97,5
S 500 (217.382)	335	11/14→	→				
S 500 4-matic (217.385)	335	04/14→	→				
S 63 AMG (217.377)	430	07/14→	←	☐; für Fahrzeuge ohne Keramikbremse	1	24.8190-0420.2 620420	L= 119
S 65 AMG (217.379)	463	07/14→	→		1	24.8190-0410.2 620410	L= 97,5
S 63 AMG 4-matic (217.378)	430	04/14→	←	☐; für Fahrzeuge ohne Keramikbremse	1	24.8190-0420.2 620420	L= 119
			→	☐	1	24.8190-0410.2 620410	L= 97,5
<b>MERCEDES-BENZ - SL (R129) 03/89→12/01</b>							
<b>Brembelagsatz, Scheibenbremse</b>							
280 (129.058) 320 (129.063)	142 170	08/93→10/01 09/93→10/01	←	→ 09/01		13.0460-4201.2 604201	ATE 21153 17,5 + WE / - WK
			→	→ F 125157		13.0460-3805.2 603805	ATE 21197 15,0 + WE / - WK
			→	F 125158→; → 09/01		13.0470-3805.2 LD3805	ATE 21197 15,0 + WE / - WK Ceramic
			→	F 125158→; → 09/01		13.0460-4047.2 604047	ATE 21305 15,7 + WE / - WK
			→	F 125158→; → 09/01		13.0470-4047.2 LD4047	ATE 21305 15,7 + WE / - WK Ceramic
280 (129.059) 320 (129.064)	150 165	05/98→10/01 05/98→10/01	←	→ F 187941; - ESP		13.0460-4201.2 604201	ATE 21153 17,5 + WE / - WK
			←	F 187942→; → 09/01		13.0460-4984.2 604984	BRE 23271 17,4 + WE / - WK
						13.0470-4984.2 LD4984	BRE 23271 17,4 + WE / - WK Ceramic
			←	→ F 187941; + ESP		13.0460-4984.2 604984	BRE 23271 17,4 + WE / - WK
			→	→ 09/01		13.0470-4984.2 LD4984	BRE 23271 17,4 + WE / - WK Ceramic
			→	→ 09/01		13.0460-4047.2 604047	ATE 21305 15,7 + WE / - WK
			→	→ 09/01		13.0470-4047.2 LD4047	ATE 21305 15,7 + WE / - WK Ceramic
500 (129.067)	235	09/92→10/01	←	08/93→ 09/01		13.0460-4201.2 604201	ATE 21153 17,5 + WE / - WK
			→	08/93→; → F 125157		13.0460-3805.2 603805	ATE 21197 15,0 + WE / - WK
			→	F 125158→; → 09/01		13.0460-4047.2 604047	ATE 21305 15,7 + WE / - WK
			→	F 125158→; → 09/01		13.0470-4047.2 LD4047	ATE 21305 15,7 + WE / - WK Ceramic
500 (129.068) 55 AMG	225 260	05/98→10/01 03/00→10/01	←	→ 09/01		13.0460-4984.2 604984	BRE 23271 17,4 + WE / - WK
			→	→ 09/01		13.0460-4047.2 604047	ATE 21305 15,7 + WE / - WK
600 (129.076)	290	07/92→10/01	←	08/93→ 09/01; - ESP		13.0460-4201.2 604201	ATE 21153 17,5 + WE / - WK
			←	→ 07/93		13.0460-4201.2 604201	ATE 21153 17,5 + WE / - WK
↓							



	kw			 	! #		
<b>MERCEDES-BENZ - SL (R129) 03/89→12/01</b>							
<b> Bremsbelagsatz, Scheibenbremse</b>							
600 (129.076)	290	07/92→10/01	←	08/93→ 09/01; + ESP		13.0460-4984.2 604984	BRE 23271 17,4 + WE / - WK
			→	08/93→ 09/01		13.0460-4047.2 604047	ATE 21305 15,7 + WE / - WK
			→	→ 07/93		13.0460-4047.2 604047 13.0470-4047.2 LD4047	ATE 21305 15,7 + WE / - WK ATE 21305 15,7 + WE / - WK Ceramic
60 AMG (129.067)	280	05/97→10/01	←	→ 09/01		13.0460-4201.2 604201	ATE 21153 17,5 + WE / - WK
			→	→ F 125157		13.0460-3805.2 603805	ATE 21197 15,0 + WE / - WK
			→	F 125158→; → 09/01		13.0460-4047.2 604047	ATE 21305 15,7 + WE / - WK
SL 73 AMG (129.076)	386	01/99→12/01	←	→ 09/01; - ESP		13.0460-4201.2 604201	ATE 21153 17,5 + WE / - WK
			←	→ 09/01; + ESP		13.0460-4984.2 604984	BRE 23271 17,4 + WE / - WK
			→	→ 09/01		13.0460-4047.2 604047	ATE 21305 15,7 + WE / - WK
<b>Warnkontakt, Bremsbelagverschleiß</b>							
280 (129.058)	142	08/93→10/01	←	→ 09/01	2	24.8190-0401.2 620401	L= 95
320 (129.063)	170	09/93→10/01	→	→ F 125157; + ASR	4	24.8190-0401.2 620401	L= 95
60 AMG (129.067)	280	05/97→10/01	→	F 125158→; → 09/01	1	24.8190-0401.2 620401	L= 95
280 (129.059)	150	05/98→10/01	←	F 187942→; → 09/01	2	24.8190-0401.2 620401	L= 95
			←	→ F 187941	2	24.8190-0401.2 620401	L= 95
			→	→ 09/01	1	24.8190-0401.2 620401	L= 95
500 (129.067)	235	09/92→10/01	←	08/93→ 09/01	2	24.8190-0401.2 620401	L= 95
			→	08/93→; → F 125157; + ASR	4	24.8190-0401.2 620401	L= 95
			→	F 125158→; → 09/01	1	24.8190-0401.2 620401	L= 95
500 (129.068)	225	05/98→10/01	←	→ 09/01	2	24.8190-0401.2 620401	L= 95
			→	→ 09/01	1	24.8190-0401.2 620401	L= 95
			←	→ 07/93	4	24.8190-0401.2 620401	L= 95
55 AMG	260	03/00→10/01	←	→ 09/01	1	24.8190-0401.2 620401	L= 95
			←	→ 09/01	1	24.8190-0401.2 620401	L= 95
			←	→ 07/93	4	24.8190-0401.2 620401	L= 95
SL 73 AMG (129.076)	386	01/99→12/01	←	→ 07/93	4	24.8190-0401.2 620401	L= 95
			←	08/93→ 09/01	2	24.8190-0401.2 620401	L= 95
			→	→ 07/93; + ASR	4	24.8190-0401.2 620401	L= 95
600 (129.076)	290	07/92→10/01	→	08/93→ 09/01	1	24.8190-0401.2 620401	L= 95
			→	08/93→ 09/01	1	24.8190-0401.2 620401	L= 95
			→	08/93→ 09/01	1	24.8190-0401.2 620401	L= 95
<b>Zubehörsatz, Scheibenbremsbelag</b>							
280 (129.058)	142	08/93→10/01	←	→ 09/01		13.0460-0219.2 610219	ATE
			→	→ F 125157		13.0460-0215.2 610215	ATE
			→	F 125158→; → 09/01		13.0460-0236.2 610236	ATE
320 (129.063)	170	09/93→10/01	←	→ F 187941		13.0460-0219.2 610219	ATE
			←	F 187942→; → 09/01		13.0460-0269.2 610269	
			←	→ F 187941; + ESP		13.0460-0269.2 610269	
60 AMG (129.067)	280	05/97→10/01	→	→ 09/01		13.0460-0236.2 610236	ATE
			←	08/93→ 09/01		13.0460-0219.2 610219	ATE
			→	08/93→; → F 125157		13.0460-0215.2 610215	ATE
280 (129.059)	150	05/98→10/01	→	F 125158→; → 09/01		13.0460-0236.2 610236	ATE
			←	→ 09/01		13.0460-0269.2 610269	
			←	→ 09/01		13.0460-0236.2 610236	ATE
320 (129.064)	165	05/98→10/01	←	→ 09/01		13.0460-0269.2 610269	
			←	→ F 187941		13.0460-0219.2 610219	ATE
			←	F 187942→; → 09/01		13.0460-0269.2 610269	
500 (129.067)	235	09/92→10/01	→	→ 09/01		13.0460-0236.2 610236	ATE
			←	08/93→ 09/01		13.0460-0219.2 610219	ATE
			→	08/93→; → F 125157		13.0460-0215.2 610215	ATE
500 (129.068)	225	05/98→10/01	→	F 125158→; → 09/01		13.0460-0236.2 610236	ATE
			←	→ 09/01		13.0460-0269.2 610269	
			→	→ 09/01		13.0460-0236.2 610236	ATE
55 AMG	260	03/00→10/01	←	→ 09/01		13.0460-0236.2 610236	ATE
			←	→ 09/01		13.0460-0269.2 610269	
			→	→ 09/01		13.0460-0236.2 610236	ATE
600 (129.076)	290	07/92→10/01	←	08/93→ 09/01		13.0460-0219.2 610219	ATE
			←	→ 07/93		13.0460-0219.2 610219	ATE
			←	08/93→ 09/01; + ESP		13.0460-0269.2 610269	
			→	→ 07/93		13.0460-0236.2 610236	ATE
			→	08/93→ 09/01		13.0460-0236.2 610236	ATE
SL 73 AMG (129.076)	386	01/99→12/01	←	→ 09/01		13.0460-0219.2 610219	ATE
			←	→ 09/01; + ESP		13.0460-0269.2 610269	
			→	→ 09/01		13.0460-0236.2 610236	ATE
<b> Bremsscheibe</b>							
280 (129.058)	142	08/93→10/01	←	→ 09/01; - ESP		24.0128-0103.1 428103	∅ 300 28 25,4 V
			←	☐; → 09/01; + ESP		24.0130-0121.1 430121	∅ 320 30 28 V
			←	☐; → 09/01; + ESP		24.0130-0122.1 430122	∅ 320 30 28 V
320 (129.063)	170	09/93→10/01	←	→ 09/01; - ESP		24.0128-0103.1 428103	∅ 300 28 25,4 V
			←	☐; → 09/01; + ESP		24.0130-0121.1 430121	∅ 320 30 28 V
			←	☐; → 09/01; + ESP		24.0130-0122.1 430122	∅ 320 30 28 V
↓							



**MERCEDES-BENZ - SL (R129) 03/89→12/01**

**Bremsscheibe**









280 (129.058) 320 (129.063)	142 170	08/93→10/01 09/93→10/01	➔	→ F 125157	24.0109-0103.1	409103	Ø 278 9 7,3
			➔	F 125158→; → 09/01; - ESP	24.0110-0293.1	410293	Ø 290 10 8,3
			➔	F 125158→; → 09/01; + ESP	24.0122-0218.1	422218	Ø 300 22 19,4 V
280 (129.059) 320 (129.064)	150 165	05/98→10/01 05/98→10/01	➔	→ F 187941; - ESP	24.0128-0103.1	428103	Ø 300 28 25,4 V
			➔	F 187942→; → 09/01; + SL Edition	24.0132-0147.1	432147	Ø 334 32 30 V*
			➔	→ F 187941; - ESP	24.0110-0293.1	410293	Ø 290 10 8,3
			➔	F 187942→; → 09/01; + ESP; - SL Edition	24.0122-0218.1	422218	Ø 300 22 19,4 V
			➔	→ F 187941; + ESP	24.0122-0218.1	422218	Ø 300 22 19,4 V
500 (129.067)	235	09/92→10/01	➔	08/93→; → F103936; - AMG Technikpaket	24.0128-0103.1	428103	Ø 300 28 25,4 V
			➔	☐; 08/93→ 09/01; + AMG Technikpaket	24.0130-0121.1	430121	Ø 320 30 28 V
			➔	☐; F103937→; → 09/01; - AMG Technikpaket	24.0130-0121.1	430121	Ø 320 30 28 V
			➔	☐; F103937→; → 09/01; - AMG Technikpaket	24.0130-0122.1	430122	Ø 320 30 28 V
			➔	☐; 08/93→ 09/01; + AMG Technikpaket	24.0130-0122.1	430122	Ø 320 30 28 V
			➔	08/93→; → F 103936	24.0109-0103.1	409103	Ø 278 9 7,3
			➔	F 125158→; → 09/01; - ESP	24.0110-0293.1	410293	Ø 290 10 8,3
			➔	F 125158→; → 09/01; + ESP	24.0122-0218.1	422218	Ø 300 22 19,4 V
500 (129.068) 55 AMG	225 260	05/98→10/01 03/00→10/01	➔	→ 09/01; + SL Edition	24.0132-0147.1	432147	Ø 334 32 30 V*
			➔	→ 09/01; + ESP; - SL Edition	24.0122-0218.1	422218	Ø 300 22 19,4 V
600 (129.076)	290	07/92→10/01	➔	☐; 08/93→ 09/01	24.0130-0121.1	430121	Ø 320 30 28 V
			➔	☐; → 07/93	24.0130-0121.1	430121	Ø 320 30 28 V
			➔	☐; 08/93→ 09/01	24.0130-0122.1	430122	Ø 320 30 28 V
			➔	☐; → 07/93	24.0130-0122.1	430122	Ø 320 30 28 V
			➔	08/93→ 09/01	24.0122-0218.1	422218	Ø 300 22 19,4 V
			➔	→ 07/93	24.0122-0218.1	422218	Ø 300 22 19,4 V
60 AMG (129.067)	280	05/97→10/01	➔	→ F103936	24.0128-0103.1	428103	Ø 300 28 25,4 V
			➔	☐; F103937→; → 09/01	24.0130-0121.1	430121	Ø 320 30 28 V
			➔	☐; F103937→; → 09/01	24.0130-0122.1	430122	Ø 320 30 28 V
			➔	→ F 103936	24.0109-0103.1	409103	Ø 278 9 7,3
			➔	F 125158→; → 09/01; - ESP	24.0110-0293.1	410293	Ø 290 10 8,3
			➔	F 125158→; → 09/01; + ESP	24.0122-0218.1	422218	Ø 300 22 19,4 V
SL 73 AMG (129.076)	386	01/99→12/01	➔	☐; → 09/01	24.0130-0121.1	430121	Ø 320 30 28 V
			➔	☐; → 09/01	24.0130-0122.1	430122	Ø 320 30 28 V
			➔	→ 09/01	24.0122-0218.1	422218	Ø 300 22 19,4 V

**MERCEDES-BENZ - SL (R230) 10/01→01/12**







**Bremsbelagsatz, Scheibenbremse**











280 (230.454) 300 (230.454) 350 (230.456)	170 170 200	03/08→01/12 04/09→01/12 03/06→01/12	➔	→ 11/11; für Fahrzeuge mit Sportpaket	13.0460-4817.2	604817	BRE 23960 18,3 + WE / - WK
			➔	→ 11/11; für Fahrzeuge ohne Sportpaket	13.0460-4990.2	604990	BRE 23271 17,4 + WE / - WK
			➔	→ 11/11	13.0470-4990.2	LD4990	BRE 23271 17,4 + WE / - WK Ceramic
350 (230.458)	232	04/08→01/12	➔	→ 11/11	13.0460-7171.2	607171	ATE 23334 16,7 + WE / - WK
			➔	→ 11/11	13.0470-7171.2	LD7171	ATE 23334 16,7 + WE / - WK Ceramic
			➔	→ 11/11	13.0460-4817.2	604817	BRE 23960 18,3 + WE / - WK
350 (230.467)	180	03/03→01/12	➔	→ 11/11; für Fahrzeuge mit Sportpaket	13.0460-4990.2	604990	BRE 23271 17,4 + WE / - WK
			➔	→ 11/11; für Fahrzeuge ohne Sportpaket	13.0460-4990.2	604990	BRE 23271 17,4 + WE / - WK
			➔	→ 11/11	13.0460-7171.2	607171	ATE 23334 16,7 + WE / - WK
			➔	→ 11/11	13.0470-7171.2	LD7171	ATE 23334 16,7 + WE / - WK Ceramic
			➔	→ 11/11	13.0460-7171.2	607171	ATE 23334 16,7 + WE / - WK
			➔	→ 11/11	13.0470-7171.2	LD7171	ATE 23334 16,7 + WE / - WK Ceramic

↓









	kw			 	! #		
<b>MERCEDES-BENZ - SL (R230) 10/01—01/12</b>							
<b> Bremsbelagsatz, Scheibenbremse</b>							
500 (230.471)	285	03/06→01/12	← → 11/11 → 11/11			13.0460-4817.2 604817 13.0460-7171.2 607171 13.0470-7171.2 LD7171	BRE 23960 18,3 + WE / - WK ATE 23334 16,7 + WE / - WK ATE 23334 16,7 + WE / - WK Ceramic
500 (230.475)	225	10/01→01/12	← → 11/11 → 11/11			13.0460-4990.2 604990 13.0460-7171.2 607171 13.0470-7171.2 LD7171	BRE 23271 17,4 + WE / - WK ATE 23334 16,7 + WE / - WK ATE 23334 16,7 + WE / - WK Ceramic
55 AMG (230.472)	380	03/06→01/12	← → 11/11; für Fahrzeuge ohne AMG-Performance Package			13.0460-4839.2 604839	BRE 24455 16,8 + WE / - WK
55 AMG (230.474)	350	10/01→06/02	← →			13.0460-4997.2 604997 13.0460-4998.2 604998	BRE 23943 17,5 + WE / - WK BRE 23478 16,5 + WE / - WK
55 AMG Kompressor (230.474)	368	06/02→01/12	← → 11/11 → 11/11			13.0460-4997.2 604997 13.0460-4998.2 604998	BRE 23943 17,5 + WE / - WK BRE 23478 16,5 + WE / - WK
600 (230.476) 600 (230.477)	368 380	04/03→01/12 03/06→01/12	← → F 134504 → 11/11			13.0460-4997.2 604997 13.0460-4998.2 604998	BRE 23943 17,5 + WE / - WK BRE 23478 16,5 + WE / - WK
63 AMG (230.470) 65 AMG Black Series (230.479)	386 493	03/08→01/12 07/08→01/12	← → 11/11			13.0460-4839.2 604839	BRE 24455 16,8 + WE / - WK
65 AMG (230.479)	450	03/04→01/12	← → F 122820 → F 122820			13.0460-4997.2 604997 13.0460-4819.2 604819	BRE 23943 17,5 + WE / - WK BRE 23478 14,6 + WE / - WK
<b>Warnkontakt, Bremsbelagsverschleiß</b>							
280 (230.454) 300 (230.454) 350 (230.456) 350 (230.458) 500 (230.475)	170 170 200 232 225	03/08→01/12 04/09→01/12 03/06→01/12 04/08→01/12 10/01→01/12	← → 11/11; für Fahrzeuge ohne Sportpaket → 11/11; für Fahrzeuge mit Sportpaket → 11/11	2 2 1	24.8190-0410.2 620410 24.8190-0420.2 620420 24.8190-0410.2 620410	L= 97,5 L= 119 L= 97,5	
350 (230.467) 55 AMG Kompressor (230.474)	180 368	03/03→01/12 06/02→01/12	← → 11/11 → 11/11	2 1	24.8190-0410.2 620410 24.8190-0410.2 620410	L= 97,5 L= 97,5	
500 (230.471)	285	03/06→01/12	← → 11/11 → 11/11	2 1	24.8190-0420.2 620420 24.8190-0410.2 620410	L= 119 L= 97,5	
55 AMG (230.472) 63 AMG (230.470) 65 AMG Black Series (230.479)	380 386 493	03/06→01/12 03/08→01/12 07/08→01/12	← → 11/11 → 11/11	2 1	24.8190-0420.2 620420 24.8190-0420.2 620420	L= 119 L= 119	
55 AMG (230.474)	350	10/01→06/02	← →	2 1	24.8190-0410.2 620410 24.8190-0410.2 620410	L= 97,5 L= 97,5	
600 (230.476) 600 (230.477)	368 380	04/03→01/12 03/06→01/12	← → F 134504 ← F 134505→; → 11/11 → 11/11	2 2 1	24.8190-0410.2 620410 24.8190-0420.2 620420 24.8190-0410.2 620410	L= 97,5 L= 119 L= 97,5	
65 AMG (230.479)	450	03/04→01/12	← → F 122820 ← F 122821→; → 11/11 → F 122820 → F 122821→; → 11/11	2 2 1 1	24.8190-0410.2 620410 24.8190-0420.2 620420 24.8190-0410.2 620410 24.8190-0420.2 620420	L= 97,5 L= 119 L= 97,5 L= 119	
<b>Zubehörsatz, Scheibenbremsbelag</b>							
280 (230.454) 300 (230.454) 350 (230.456) 350 (230.458)	170 170 200 232	03/08→01/12 04/09→01/12 03/06→01/12 04/08→01/12	← → 11/11; für Fahrzeuge ohne Sportpaket		13.0460-0275.2 610275		
350 (230.467) 500 (230.475)	180 225	03/03→01/12 10/01→01/12	← → 11/11		13.0460-0275.2 610275		
<b> Bremsscheibe</b>							
280 (230.454) 300 (230.454)	170 170	03/08→01/12 04/09→01/12	← → 11/11; für Fahrzeuge mit Sportpaket ← → 11/11; für Fahrzeuge ohne Sportpaket → 11/11; für Fahrzeuge ohne Sportpaket → 11/11; für Fahrzeuge mit Sportpaket		24.0132-0138.1 432138 24.0132-0153.1 432153 24.0112-0183.1 412183 24.0124-0226.1 424226	∅ 350 32 30 V• + S ∅ 330 32 30 V• + S ∅ 300 12 10 + S ∅ 320 24 22 V• + S	
350 (230.456) 350 (230.458)	200 232	03/06→01/12 04/08→01/12	← → 11/11; für Fahrzeuge mit Sportpaket ← → 11/11; für Fahrzeuge ohne Sportpaket → 11/11; für Fahrzeuge ohne Sportpaket		24.0132-0138.1 432138 24.0132-0153.1 432153 24.0112-0183.1 412183	∅ 350 32 30 V• + S ∅ 330 32 30 V• + S ∅ 300 12 10 + S	
↓							



















	kw				! #		
<b>MERCEDES-BENZ - SL (R230) 10/01—01/12</b>							
<b>Bremsscheibe</b>							
350 (230.456) 350 (230.458)	200 232	03/06→01/12 04/08→01/12	➡	für Fahrzeuge ohne Sportpaket		24.0122-0229.1 422229	Ø 300 22 19,4 V
			➡	→ 11/11; für Fahrzeuge mit Sportpaket		24.0124-0226.1 424226	Ø 320 24 22 V• + S
350 (230.467)	180	03/03→01/12	⬅	→ 11/11		24.0128-0163.1 428163	Ø 312 28 26 V•
			➡	→ 11/11		24.0110-0351.1 410351	Ø 300 10 8,3 + S
500 (230.471)	285	03/06→01/12	⬅	→ 11/11		24.0132-0138.1 432138	Ø 350 32 30 V• + S
			➡	→ 11/11; für Fahrzeuge ohne Sportpaket		24.0124-0212.1 424212	Ø 320 24 21,4 V + S
			➡	→ 11/11; für Fahrzeuge mit Sportpaket		24.0124-0226.1 424226	Ø 320 24 22 V• + S
500 (230.475)	225	10/01→01/12	⬅	→ 11/11		24.0132-0153.1 432153	Ø 330 32 30 V• + S
			➡	→ 11/11		24.0122-0229.1 422229	Ø 300 22 19,4 V
55 AMG (230.474)	350	10/01→06/02	⬅	für Fahrzeuge ohne AMG-Performance Package		24.0136-0102.1 436102	Ø 360 36 34 V•
55 AMG Kompressor (230.474)	368	06/02→01/12	⬅	→ 11/11; für Fahrzeuge ohne AMG-Performance Package		24.0136-0102.1 436102	Ø 360 36 34 V•
600 (230.476) 600 (230.477)	368 380	04/03→01/12 03/06→01/12	⬅	→ 11/11		24.0136-0102.1 436102	Ø 360 36 34 V•
			➡	→ 11/11		24.0126-0149.1 426149	Ø 330 26 23,4 V + S
<b>MERCEDES-BENZ - SL (R231) 01/12→</b>							
<b>Bremsbelagsatz, Scheibenbremse</b>							
350 (231.457) 500 (231.473)	225 320	02/12→ 01/12→	⬅	03/12→ 11/12; für Fahrzeuge ohne AMG-Sportpaket		13.0460-4869.2 604869	BRE 25183 17,9 + WE / - WK
			⬅	03/12→ 11/12; für Fahrzeuge mit AMG-Sportpaket; für Fahrzeuge mit verstärkter Bremse		13.0460-4870.2 604870	BRE 25179 17,8 + WE / - WK
			⬅	12/12→; für Fahrzeuge mit AMG-Sportpaket; für Fahrzeuge mit verstärkter Bremse		13.0460-4870.2 604870	BRE 25179 17,8 + WE / - WK
			➡	03/12→		13.0460-2780.2 602780	TRW 25071 18,8 + WE / - WK + Zub
400 (231.465) 400 (231.466) 500 (231.473)	245 270 335	04/14→ 01/16→ 04/15→	⬅	für Fahrzeuge mit AMG-Sportpaket; für Fahrzeuge mit verstärkter Bremse		13.0460-4870.2 604870	BRE 25179 17,8 + WE / - WK
			➡			13.0460-2780.2 602780	TRW 25071 18,8 + WE / - WK + Zub
<b>Warnkontakt, Bremsbelagverschleiß</b>							
350 (231.457) 500 (231.473)	225 320	02/12→ 01/12→	⬅	☐; 12/12→	1	24.8190-0959.2 620959	L= 102
			⬅	☐; 03/12→ 11/12	1	24.8190-0959.2 620959	L= 102
			➡	03/12→	1	24.8190-0410.2 620410	L= 97,5
400 (231.465) 400 (231.466) 500 (231.473)	245 270 335	04/14→ 01/16→ 04/15→	⬅	☐	1	24.8190-0959.2 620959	L= 102
			➡		1	24.8190-0410.2 620410	L= 97,5
63 AMG (231.474) 63 AMG (231.474)	395 415	01/12→ 01/12→	⬅	☐; 03/12→	1	24.8190-0420.2 620420	L= 119
			➡	03/12→	1	24.8190-0410.2 620410	L= 97,5
63 AMG (231.474) 65 AMG (231.479)	430 463	04/14→ 05/12→	⬅	☐	1	24.8190-0420.2 620420	L= 119
			➡		1	24.8190-0410.2 620410	L= 97,5
<b>MERCEDES-BENZ - SLC (R172) 01/16→</b>							
<b>Bremsbelagsatz, Scheibenbremse</b>							
180 (172.431)	115	01/16→	⬅	für Fahrzeuge ohne Sportpaket / für Fahrzeuge ohne AMG-Sportpaket		13.0460-2732.2 602732	TRW 24306 20,3 + WE / - WK + Zub
						13.0470-2732.2 LD2732	TRW 24306 20,3 + WE / - WK + Zub Ceramic
			⬅	für Fahrzeuge mit Sportpaket / für Fahrzeuge mit AMG-Sportpaket		13.0460-2734.2 602734	TRW 24310 19,0 + WE / - WK
						13.0470-2734.2 LD2734	TRW 24310 19,0 + WE / - WK Ceramic
			➡			13.0460-2786.2 602786	TRW 24848 18,3 + WE / - WK + Zub
						13.0470-2786.2 LD2786	TRW 24848 18,3 + WE / - WK + Zub Ceramic
200 (172.434) 250 d (172.404) 300 (172.438)	135 150 180	01/16→ 01/16→10/17 01/16→	⬅			13.0460-2734.2 602734	TRW 24310 19,0 + WE / - WK
						13.0470-2734.2 LD2734	TRW 24310 19,0 + WE / - WK Ceramic
			➡			13.0460-2786.2 602786	TRW 24848 18,3 + WE / - WK + Zub
↓							







	kW					! #		
<b>MERCEDES-BENZ - SLC (R172) 01/16→</b>								
 <b>Bremsbelagsatz, Scheibenbremse</b>								
200 (172.434) 250 d (172.404) 300 (172.438)	135 150 180	01/16→ 01/16→10/17 01/16→	→				<b>13.0470-2786.2 LD2786</b>	TRW 24848 18,3 + WE / - WK + Zub Ceramic
<b>Warnkontakt, Bremsbelagverschleiß</b>								
180 (172.431)	115	01/16→	←	<input type="checkbox"/>		1	<b>24.8190-0410.2 620410</b>	L= 97,5
			→			1	<b>24.8190-0410.2 620410</b>	L= 97,5
200 (172.434) 250 d (172.404) 300 (172.438)	135 150 180	01/16→ 01/16→10/17 01/16→	←			1	<b>24.8190-0410.2 620410</b>	L= 97,5
			→			1	<b>24.8190-0410.2 620410</b>	L= 97,5
 <b>Bremsscheibe</b>								
180 (172.431)	115	01/16→	←	für Fahrzeuge ohne Sportpaket / für Fahrzeuge ohne AMG-Sportpaket			<b>24.0128-0155.1 428155</b>	Ø 295 28 25,4 V + S
			←	für Fahrzeuge mit Sportpaket / für Fahrzeuge mit AMG-Sportpaket			<b>24.0328-0155.1 528155</b>	Ø 295 28 25,4 V + S
			→				<b>24.0132-0175.1 432175</b>	Ø 344 32 30 V* + S
			→				<b>24.0110-0391.1 410391</b>	Ø 300 10 8,3 + S
200 (172.434) 250 d (172.404) 300 (172.438)	135 150 180	01/16→ 01/16→10/17 01/16→	←	für Fahrzeuge ohne Sportpaket / für Fahrzeuge ohne AMG-Sportpaket			<b>24.0132-0101.1 432101</b>	Ø 322 32 29,4 V + S
			←	für Fahrzeuge mit Sportpaket / für Fahrzeuge mit AMG-Sportpaket			<b>24.0332-0101.1 532101</b>	Ø 322 32 29,4 V + S
			→				<b>24.0132-0175.1 432175</b>	Ø 344 32 30 V* + S
			→				<b>24.0110-0391.1 410391</b>	Ø 300 10 8,3 + S
<b>MERCEDES-BENZ - SLK (R170) 04/96→04/04</b>								
 <b>Bremsbelagsatz, Scheibenbremse</b>								
200 (170.435) 200 Kompressor (170.445) 230 Kompressor (170.447)	100 141 142	09/96→03/00 10/96→03/00 09/96→03/00	←				<b>13.0460-7086.2 607086</b>	ATE 21664 19,8 + WE / - WK
			→	→ F017687			<b>13.0470-7086.2 LD7086</b>	ATE 21664 19,8 + WE / - WK Ceramic
			→	F017688→			<b>13.0460-3805.2 603805</b>	ATE 21197 15,0 + WE / - WK
			→				<b>13.0470-3805.2 LD3805</b>	ATE 21197 15,0 + WE / - WK Ceramic
			→				<b>13.0460-4064.2 604064</b>	ATE 21919 15,3 - WE / - WK + Zub
			→				<b>13.0470-4064.2 LD4064</b>	ATE 21919 15,3 - WE / - WK + Zub Ceramic
200 Kompressor (170.444) 230 Kompressor (170.449)	120 145	03/00→04/04 03/00→04/04	←	→ 03/04			<b>13.0460-7086.2 607086</b>	ATE 21664 19,8 + WE / - WK
			→	→ 03/04			<b>13.0470-7086.2 LD7086</b>	ATE 21664 19,8 + WE / - WK Ceramic
			→				<b>13.0460-4064.2 604064</b>	ATE 21919 15,3 - WE / - WK + Zub
			→				<b>13.0470-4064.2 LD4064</b>	ATE 21919 15,3 - WE / - WK + Zub Ceramic
320 (170.465)	160	03/00→04/04	←	04/00→ 03/04			<b>13.0460-7087.2 607087</b>	ATE 21670 19,3 + WE / - WK
			→	04/00→ 03/04			<b>13.0470-7087.2 LD7087</b>	ATE 21670 19,3 + WE / - WK Ceramic
			→				<b>13.0460-4064.2 604064</b>	ATE 21919 15,3 - WE / - WK + Zub
			→				<b>13.0470-4064.2 LD4064</b>	ATE 21919 15,3 - WE / - WK + Zub Ceramic
32 AMG Kompressor (170.466)	260	03/01→04/04	←	→ 03/04			<b>13.0460-7183.2 607183</b>	ATE 21484 20,5 + WE / - WK
			→	→ 03/04			<b>13.0460-4047.2 604047</b>	ATE 21305 15,7 + WE / - WK
<b>Warnkontakt, Bremsbelagverschleiß</b>								
200 (170.435) 200 Kompressor (170.445) 230 Kompressor (170.447)	100 141 142	09/96→03/00 10/96→03/00 09/96→03/00	←			2	<b>24.8190-0401.2 620401</b>	L= 95
			→	→ F017687		2	<b>24.8190-0401.2 620401</b>	L= 95
200 Kompressor (170.444) 230 Kompressor (170.449)	120 145	03/00→04/04 03/00→04/04	←	→ 03/04		2	<b>24.8190-0401.2 620401</b>	L= 95
320 (170.465)	160	03/00→04/04	←	04/00→ 03/04		2	<b>24.8190-0401.2 620401</b>	L= 95
32 AMG Kompressor (170.466)	260	03/01→04/04	←	→ 03/04		2	<b>24.8190-0419.2 620419</b>	L= 74
<b>Zubehörsatz, Scheibenbremsbelag</b>								
200 (170.435) ↓	100	09/96→03/00	→	F017688→			<b>13.0460-0229.2 610229</b>	ATE













	kw			 	! #		
<b>MERCEDES-BENZ - SLK (R170) 04/96→04/04</b>							
<b>Zubehörsatz, Scheibenbremsbelag</b>							
200 Kompressor (170.445)	141	10/96→03/00	➡	F017688→		13.0460-0229.2 610229	ATE
230 Kompressor (170.447)	142	09/96→03/00					
200 Kompressor (170.444)	120	03/00→04/04	➡	→ 03/04		13.0460-0229.2 610229	ATE
230 Kompressor (170.449)	145	03/00→04/04					
320 (170.465)	160	03/00→04/04	➡	04/00→ 03/04		13.0460-0229.2 610229	ATE
32 AMG Kompressor (170.466)	260	03/01→04/04	➡	→ 03/04		13.0460-0236.2 610236	ATE
<b> Bremsscheibe</b>							
200 (170.435)	100	09/96→03/00	⬅			24.0125-0110.1 425110	Ø 288 25 22,4 V + S
200 Kompressor (170.445)	141	10/96→03/00				24.0325-0110.1 525110	Ø 288 25 22,4 V + S
230 Kompressor (170.447)	142	09/96→03/00	➡			24.0109-0114.1 409114	Ø 278 9 7,3 + S
						24.0309-0114.1 509114	Ø 278 9 7,3 + S
200 Kompressor (170.444)	120	03/00→04/04	⬅	→ 03/04		24.0125-0110.1 425110	Ø 288 25 22,4 V + S
230 Kompressor (170.449)	145	03/00→04/04	➡	→ 03/04		24.0325-0110.1 525110	Ø 288 25 22,4 V + S
						24.0109-0114.1 409114	Ø 278 9 7,3 + S
						24.0309-0114.1 509114	Ø 278 9 7,3 + S
320 (170.465)	160	03/00→04/04	⬅	04/00→ 03/04		24.0128-0106.1 428106	Ø 300 28 25,4 V + S
						24.0328-0106.1 528106	Ø 300 28 25,4 V + S
			➡	04/00→ 03/04		24.0109-0114.1 409114	Ø 278 9 7,3 + S
						24.0309-0114.1 509114	Ø 278 9 7,3 + S
32 AMG Kompressor (170.466)	260	03/01→04/04	⬅	→ 03/04		24.0132-0159.1 432159	Ø 330 32 29,4 V
			➡	→ 03/04		24.0122-0228.1 422228	Ø 300 22 19,4 V
<b>MERCEDES-BENZ - SLK (R171) 03/04→12/11</b>							
<b> Bremsbelagsatz, Scheibenbremse</b>							
200 Kompressor (171.442)	120	03/04→02/11	⬅	→ 01/11; für Fahrzeuge ohne Sportpaket		13.0460-2726.2 602726	TRW 23144 19,8 + WE / - WK + Zub
						13.0470-2726.2 LD2726	TRW 23144 19,8 + WE / - WK + Zub Ceramic
			⬅	→ 01/11; für Fahrzeuge mit Sportpaket		13.0460-4994.2 604994	BRE 23945 16,5 + WE / - WK
						13.0470-4994.2 LD4994	BRE 23945 16,5 + WE / - WK Ceramic
			➡	→ 01/11; für Fahrzeuge ohne Sportpaket		13.0460-4064.2 604064	ATE 21919 15,3 - WE / - WK + Zub
						13.0470-4064.2 LD4064	ATE 21919 15,3 - WE / - WK + Zub Ceramic
			➡	→ 01/11; für Fahrzeuge mit Sportpaket		13.0460-4065.2 604065	ATE 21899 15,3 + WE / - WK + Zub
						13.0470-4065.2 LD4065	ATE 21899 15,3 + WE / - WK + Zub Ceramic
200 Kompressor (171.445)	135	01/08→02/11	⬅	→ 01/11; für Fahrzeuge ohne Sportpaket		13.0460-2727.2 602727	TRW 23144 19,8 + WE / - WK + Zub
300 (171.454)	170	04/09→02/11				13.0470-2727.2 LD2727	TRW 23144 19,8 + WE / - WK + Zub Ceramic
			⬅	→ 01/11; für Fahrzeuge mit Sportpaket		13.0460-4994.2 604994	BRE 23945 16,5 + WE / - WK
						13.0470-4994.2 LD4994	BRE 23945 16,5 + WE / - WK Ceramic
			➡	→ 01/11; für Fahrzeuge ohne Sportpaket		13.0460-4064.2 604064	ATE 21919 15,3 - WE / - WK + Zub
						13.0470-4064.2 LD4064	ATE 21919 15,3 - WE / - WK + Zub Ceramic
			➡	→ 01/11; für Fahrzeuge mit Sportpaket		13.0460-4065.2 604065	ATE 21899 15,3 + WE / - WK + Zub
						13.0470-4065.2 LD4065	ATE 21899 15,3 + WE / - WK + Zub Ceramic
280 (171.454)	170	01/05→02/11	⬅	04/05→ 01/11; für Fahrzeuge ohne Sportpaket		13.0460-2727.2 602727	TRW 23144 19,8 + WE / - WK + Zub
						13.0470-2727.2 LD2727	TRW 23144 19,8 + WE / - WK + Zub Ceramic
			⬅	04/05→ 01/11; für Fahrzeuge mit Sportpaket		13.0460-4994.2 604994	BRE 23945 16,5 + WE / - WK
						13.0470-4994.2 LD4994	BRE 23945 16,5 + WE / - WK Ceramic

	kw			 	! #		
<b>MERCEDES-BENZ - SLK (R171) 03/04→12/11</b>							
<b> Bremsbelagsatz, Scheibenbremse</b>							
280 (171.454)	170	01/05→02/11	➡	04/05→ 01/11; für Fahrzeuge ohne Sportpaket		<b>13.0460-4064.2 604064</b>	ATE 21919 15,3 - WE / - WK + Zub
					<b>13.0470-4064.2 LD4064</b>	ATE 21919 15,3 - WE / - WK + Zub Ceramic	
			➡	04/05→ 01/11; für Fahrzeuge mit Sportpaket		<b>13.0460-4065.2 604065</b>	ATE 21899 15,3 + WE / - WK + Zub
					<b>13.0470-4065.2 LD4065</b>	ATE 21899 15,3 + WE / - WK + Zub Ceramic	
350 (171.456)	200	06/04→02/11	←	→ F 117328		<b>13.0460-4990.2 604990</b>	BRE 23271 17,4 + WE / - WK
					<b>13.0470-4990.2 LD4990</b>	BRE 23271 17,4 + WE / - WK Ceramic	
			←	F 117329→; → 01/11		<b>13.0460-4994.2 604994</b>	BRE 23945 16,5 + WE / - WK
			➡	→ 01/11		<b>13.0470-4994.2 LD4994</b>	BRE 23945 16,5 + WE / - WK Ceramic
			➡	→ 01/11		<b>13.0460-4065.2 604065</b>	ATE 21899 15,3 + WE / - WK + Zub
						<b>13.0470-4065.2 LD4065</b>	ATE 21899 15,3 + WE / - WK + Zub Ceramic
350 (171.458)	224	01/08→02/11	←	→ 01/11		<b>13.0460-4994.2 604994</b>	BRE 23945 16,5 + WE / - WK
					<b>13.0470-4994.2 LD4994</b>	BRE 23945 16,5 + WE / - WK Ceramic	
			➡	→ 01/11		<b>13.0460-4065.2 604065</b>	ATE 21899 15,3 + WE / - WK + Zub
						<b>13.0470-4065.2 LD4065</b>	ATE 21899 15,3 + WE / - WK + Zub Ceramic
55 AMG (171.473) 55 AMG (171.473)	265 294	06/04→02/11 06/06→02/11	←	→ F 197201		<b>13.0460-4806.2 604806</b>	BRE 23955 16,2 + WE / - WK
			←	F 197202→; → 01/11		<b>13.0460-4990.2 604990</b>	BRE 23271 17,4 + WE / - WK
			➡	→ 01/11		<b>13.0460-4819.2 604819</b>	BRE 23478 14,6 + WE / - WK
<b>Warnkontakt, Bremsbelagsverschleiß</b>							
200 Kompressor (171.442)	120	03/04→02/11	←	→ 01/11	1	<b>24.8190-0410.2 620410</b>	L= 97,5
			➡	→ 01/11; für Fahrzeuge mit Sportpaket	1	<b>24.8190-0410.2 620410</b>	L= 97,5
200 Kompressor (171.445) 300 (171.454)	135 170	01/08→02/11 04/09→02/11	←	→ 01/11; für Fahrzeuge ohne Sportpaket	2	<b>24.8190-0410.2 620410</b>	L= 97,5
			←	→ 01/11; für Fahrzeuge mit Sportpaket	1	<b>24.8190-0410.2 620410</b>	L= 97,5
			➡	→ 01/11; für Fahrzeuge mit Sportpaket	1	<b>24.8190-0410.2 620410</b>	L= 97,5
280 (171.454)	170	01/05→02/11	←	04/05→ 01/11; für Fahrzeuge mit Sportpaket	1	<b>24.8190-0410.2 620410</b>	L= 97,5
			←	04/05→ 01/11; für Fahrzeuge ohne Sportpaket	2	<b>24.8190-0410.2 620410</b>	L= 97,5
			➡	04/05→ 01/11; für Fahrzeuge mit Sportpaket	1	<b>24.8190-0410.2 620410</b>	L= 97,5
350 (171.456)	200	06/04→02/11	←	F 117329→; → 01/11	1	<b>24.8190-0410.2 620410</b>	L= 97,5
			←	☐; → F 117328	1	<b>24.8190-0410.2 620410</b>	L= 97,5
			➡	→ 01/11	1	<b>24.8190-0410.2 620410</b>	L= 97,5
350 (171.458)	224	01/08→02/11	←	→ 01/11	1	<b>24.8190-0410.2 620410</b>	L= 97,5
			➡	→ 01/11	1	<b>24.8190-0410.2 620410</b>	L= 97,5
55 AMG (171.473) 55 AMG (171.473)	265 294	06/04→02/11 06/06→02/11	←	→ F 197201	1	<b>24.8190-0420.2 620420</b>	L= 119
			←	F 197202→; → 01/11	1	<b>24.8190-0420.2 620420</b>	L= 119
			➡	→ 01/11	1	<b>24.8190-0410.2 620410</b>	L= 97,5
<b>Zubehörsatz, Scheibenbremsbelag</b>							
200 Kompressor (171.442)	120	03/04→02/11	←	→ 01/11; für Fahrzeuge mit Sportpaket		<b>13.0460-0155.2 610155</b>	BRE
200 Kompressor (171.445) 300 (171.454)	135 170	01/08→02/11 04/09→02/11	➡	→ 01/11; für Fahrzeuge ohne Sportpaket		<b>13.0460-0229.2 610229</b>	ATE
			➡	→ 01/11; für Fahrzeuge mit Sportpaket		<b>13.0460-0258.2 610258</b>	
280 (171.454)	170	01/05→02/11	←	04/05→ 01/11; für Fahrzeuge mit Sportpaket		<b>13.0460-0155.2 610155</b>	BRE
			➡	04/05→ 01/11; für Fahrzeuge ohne Sportpaket		<b>13.0460-0229.2 610229</b>	ATE
			➡	04/05→ 01/11; für Fahrzeuge mit Sportpaket		<b>13.0460-0258.2 610258</b>	
350 (171.456)	200	06/04→02/11	←	F 117329→; → 01/11		<b>13.0460-0155.2 610155</b>	BRE
			←	→ F 117328		<b>13.0460-0275.2 610275</b>	
			➡	→ 01/11		<b>13.0460-0258.2 610258</b>	
↓							











	kw			 	! #		
<b>MERCEDES-BENZ - SLK (R171) 03/04→12/11</b>							
<b>Zubehörsatz, Scheibenbremsbelag</b>							
350 (171.458)	224	01/08→02/11	←	→ 01/11		13.0460-0155.2 610155	BRE
			→	→ 01/11		13.0460-0258.2 610258	
<b> Bremsscheibe</b>							
200 Kompressor (171.442)	120	03/04→02/11	←	→ 01/11; für Fahrzeuge ohne Sportpaket	24.0125-0110.1 425110	Ø 288 25 22,4 V + S	
					24.0325-0110.1 525110	Ø 288 25 22,4 V + S	
			←	→ 01/11; für Fahrzeuge mit Sportpaket	24.0128-0177.1 428177	Ø 330 28 26 V•	
			→	→ 01/11; für Fahrzeuge ohne Sportpaket	24.0109-0114.1 409114	Ø 278 9 7,3 + S	
					24.0309-0114.1 509114	Ø 278 9 7,3 + S	
200 Kompressor (171.445) 300 (171.454)	170	01/08→02/11 04/09→02/11	←	→ 01/11; für Fahrzeuge ohne Sportpaket	24.0128-0106.1 428106	Ø 300 28 25,4 V + S	
					24.0328-0106.1 528106	Ø 300 28 25,4 V + S	
			←	→ 01/11; für Fahrzeuge mit Sportpaket	24.0128-0177.1 428177	Ø 330 28 26 V•	
			→	→ 01/11; für Fahrzeuge ohne Sportpaket	24.0109-0114.1 409114	Ø 278 9 7,3 + S	
					24.0309-0114.1 509114	Ø 278 9 7,3 + S	
280 (171.454)	170	01/05→02/11	←	04/05→ 01/11; für Fahrzeuge ohne Sportpaket	24.0128-0106.1 428106	Ø 300 28 25,4 V + S	
					24.0328-0106.1 528106	Ø 300 28 25,4 V + S	
			←	04/05→ 01/11; für Fahrzeuge mit Sportpaket	24.0128-0177.1 428177	Ø 330 28 26 V•	
			→	04/05→ 01/11; für Fahrzeuge ohne Sportpaket	24.0109-0114.1 409114	Ø 278 9 7,3 + S	
					24.0309-0114.1 509114	Ø 278 9 7,3 + S	
350 (171.456) 350 (171.458)	200 224	06/04→02/11 01/08→02/11	←	→ 01/11	24.0128-0177.1 428177	Ø 330 28 26 V•	
					24.0110-0217.1 410217	Ø 290 10 8,3 + S	
			→	→ 01/11	24.0310-0217.1 510217	Ø 290 10 8,3 + S	
					24.0110-0217.1 410217	Ø 290 10 8,3 + S	
					24.0310-0217.1 510217	Ø 290 10 8,3 + S	
55 AMG (171.473) 55 AMG (171.473)	265 294	06/04→02/11 06/06→02/11	←	F 194374→; → 01/11; - AMG Black Series	24.0130-0180.1 430180	Ø 345 30 28 V•	
			→	F 197202→; → 01/11	24.0122-0228.1 422228	Ø 300 22 19,4 V	
<b>MERCEDES-BENZ - SLK (R172) 01/11→</b>							
<b> Bremsbelagsatz, Scheibenbremse</b>							
200 (172.434) 250 CDI / d (172.403) 300 (172.438) 350 (172.457)	135 150 180 225	04/15→ 01/12→ 07/15→ 02/11→	←		13.0460-2734.2 602734	TRW 24310 19,0 + WE / - WK	
					13.0470-2734.2 LD2734	TRW 24310 19,0 + WE / - WK Ceramic	
			→		13.0460-2786.2 602786	TRW 24848 18,3 + WE / - WK + Zub	
					13.0470-2786.2 LD2786	TRW 24848 18,3 + WE / - WK + Zub Ceramic	
200 (172.448) 250 (172.447)	135 150	02/11→ 02/11→	←	für Fahrzeuge ohne Sportpaket / für Fahrzeuge ohne AMG-Sportpaket	13.0460-2732.2 602732	TRW 24306 20,3 + WE / - WK + Zub	
					13.0470-2732.2 LD2732	TRW 24306 20,3 + WE / - WK + Zub Ceramic	
			←	für Fahrzeuge mit Sportpaket / für Fahrzeuge mit AMG-Sportpaket	13.0460-2734.2 602734	TRW 24310 19,0 + WE / - WK	
					13.0470-2734.2 LD2734	TRW 24310 19,0 + WE / - WK Ceramic	
			→		13.0460-2786.2 602786	TRW 24848 18,3 + WE / - WK + Zub	
		13.0470-2786.2 LD2786	TRW 24848 18,3 + WE / - WK + Zub Ceramic				
<b>Warnkontakt, Bremsbelagverschleiß</b>							
200 (172.434) 250 CDI / d (172.403) 300 (172.438) 350 (172.457) 55 AMG (172.475)	135 150 180 225 310	04/15→ 01/12→ 07/15→ 02/11→ 01/12→	←		1	24.8190-0410.2 620410	L= 97,5
			→		1	24.8190-0410.2 620410	L= 97,5
			←		1	24.8190-0410.2 620410	L= 97,5
			→		1	24.8190-0410.2 620410	L= 97,5
↓							







	kw			 	! #		
<b>MERCEDES-BENZ - SLK (R172) 01/11→</b>							
<b>Bremsscheibe</b>							
200 (172.434) 250 (172.447) 250 CDI / d (172.403) 300 (172.438)	135 150 150 180	04/15→ 02/11→ 01/12→ 07/15→	←	für Fahrzeuge ohne Sportpaket / für Fahrzeuge ohne AMG-Sportpaket	24.0132-0101.1 24.0332-0101.1	432101 532101	Ø 322 32 29,4 V + S Ø 322 32 29,4 V + S
			←	für Fahrzeuge mit Sportpaket / für Fahrzeuge mit AMG-Sportpaket	24.0132-0175.1	432175	Ø 344 32 30 V• + S
			→		24.0110-0391.1	410391	Ø 300 10 8,3 + S
200 (172.448)	135	02/11→	←	für Fahrzeuge ohne Sportpaket / für Fahrzeuge ohne AMG-Sportpaket	24.0128-0155.1 24.0328-0155.1 24.0332-0101.1	428155 528155 532101	Ø 295 28 25,4 V + S Ø 295 28 25,4 V + S Ø 322 32 29,4 V + S
			←	für Fahrzeuge mit Sportpaket / für Fahrzeuge mit AMG-Sportpaket	24.0132-0175.1	432175	Ø 344 32 30 V• + S
			→		24.0110-0391.1	410391	Ø 300 10 8,3 + S
350 (172.457)	225	02/11→	←		24.0132-0175.1	432175	Ø 344 32 30 V• + S
			→		24.0110-0391.1	410391	Ø 300 10 8,3 + S
55 AMG (172.475)	310	01/12→	←	für Fahrzeuge ohne AMG-Performance Package	24.0136-0102.1	436102	Ø 360 36 34 V•
<b>MERCEDES-BENZ - SLR (R199) 04/04→</b>							
<b>Warnkontakt, Bremsbelagverschleiß</b>							
5.4 (199.376)	460	04/04→	←	→ 12/09	2	24.8190-0410.2 620410	L= 97,5
<b>MERCEDES-BENZ - SLR Roadster (R199) 10/06→</b>							
<b>Warnkontakt, Bremsbelagverschleiß</b>							
5.4	460	04/07→	←	→ 12/09	2	24.8190-0410.2 620410	L= 97,5
<b>MERCEDES-BENZ - SLS AMG (C197) 03/10→</b>							
<b>Warnkontakt, Bremsbelagverschleiß</b>							
6.2 (197.377) 6.2 GT	420 435	03/10→ 06/13→	←	→ 04/14; für Fahrzeuge ohne Keramikbremse	1	24.8190-0420.2 620420	L= 119
			→	→ 04/14	1	24.8190-0420.2 620420	L= 119
<b>MERCEDES-BENZ - SLS AMG Roadster (R197) 06/11→</b>							
<b>Warnkontakt, Bremsbelagverschleiß</b>							
6.2 (197.477) 6.2 GT (197.478)	420 435	06/11→ 06/13→	←	→ 04/14; für Fahrzeuge ohne Keramikbremse	1	24.8190-0420.2 620420	L= 119
			→	→ 04/14	1	24.8190-0420.2 620420	L= 119
<b>MERCEDES-BENZ - SPRINTER 2-t Bus (901, 902) 01/95→05/06</b>							
<b>Bremsbelagsatz, Scheibenbremse</b>							
208 CDI 208 D 210 D 211 CDI 212 D 213 CDI 214 (902.071, 902.072, 902.671, 902.672) 214 NGT 216 CDI	60 58 75 80 90 95 105 95 115	04/00→05/06 02/95→04/00 03/97→04/00 04/00→05/06 02/95→04/00 04/00→05/06 02/95→05/06 02/95→05/06 04/00→05/06	←		13.0460-7196.2 13.0460-7909.2	607196 607909	ATE 21576 20,7 + WE / - WK PER 29153 20,0 + WE / - WK + Zub
			→		13.0460-3990.2 13.0460-7083.2 13.0460-7084.2	603990 607083 607084	BOS 23021 18,9 + WE / - WK ATE 21621 17,3 + WE / - WK ATE 21592 18,8 + WE / - WK
<b>Warnkontakt, Bremsbelagverschleiß</b>							
208 CDI 208 D 210 D 211 CDI 212 D 213 CDI 214 (902.071, 902.072, 902.671, 902.672) 214 NGT 216 CDI	60 58 75 80 90 95 105 95 115	04/00→05/06 02/95→04/00 03/97→04/00 04/00→05/06 02/95→04/00 04/00→05/06 02/95→05/06 02/95→05/06 04/00→05/06	←	nur in Verbindung mit: 13.0460-7196.2	2	24.8190-0417.2 24.8190-0417.2	L= 99 L= 167 L= 99 L= 167
			→		2	24.8190-0407.2 620407	L= 115 L= 185
<b>Zubehörsatz, Scheibenbremsbelag</b>							
208 CDI 208 D 210 D 211 CDI 212 D 213 CDI 214 (902.071, 902.072, 902.671, 902.672) 214 NGT ↓	60 58 75 80 90 95 105 95	04/00→05/06 02/95→04/00 03/97→04/00 04/00→05/06 02/95→04/00 04/00→05/06 02/95→05/06 02/95→05/06	←	nur in Verbindung mit: Vornr.13.0460-7904.2	13.0460-0281.2	610281	PER
			→		13.0460-0250.2	610250	BOS



	kW					! #		
<b>MERCEDES-BENZ - SPRINTER 2-t Bus (901, 902) 01/95→05/06</b>								
<b>Zubehörsatz, Scheibenbremsbelag</b>								
216 CDI	115	04/00→05/06	←	nur in Verbindung mit: Vornr.13.0460-7904.2			13.0460-0281.2 610281	PER
			→				13.0460-0250.2 610250	BOS
<b> Bremsscheibe</b>								
208 CDI	60	04/00→05/06	←				24.0122-0161.1 422161	Ø 276 22 19 V + S
208 D	58	02/95→04/00					24.0322-0161.1 522161	Ø 276 22 19 V + S
210 D	75	03/97→04/00						
211 CDI	80	04/00→05/06	→				24.0112-0142.1 412142	Ø 258 12 10 + S
212 D	90	02/95→04/00					24.0116-0110.1 416110	Ø 272 16 14 + S
213 CDI	95	04/00→05/06						
214 (902.071, 902.072, 902.671, 902.672)	105	02/95→05/06						
214 NGT	95	02/95→05/06						
216 CDI	115	04/00→05/06						
<b>MERCEDES-BENZ - SPRINTER 2-t Kasten (901, 902) 01/95→05/06</b>								
<b> Bremsbelagsatz, Scheibenbremse</b>								
208 CDI	60	04/00→05/06	←				13.0460-7196.2 607196	ATE 21576 20,7 + WE / - WK
208 D	58	02/95→04/00					13.0460-7909.2 607909	PER 29153 20,0 + WE / - WK + Zub
208 D	60	10/96→04/00						
210 D	75	01/97→04/00						
211 CDI	80	04/00→05/06	→				13.0460-3990.2 603990	BOS 23021 18,9 + WE / - WK
212 D	90	02/95→04/00					13.0460-7083.2 607083	ATE 21621 17,3 + WE / - WK
213 CDI	95	04/00→05/06					13.0460-7084.2 607084	ATE 21592 18,8 + WE / - WK
214	105	02/95→05/06						
214 NGT	95	02/95→05/06						
216 CDI	115	04/00→05/06						
<b>Warnkontakt, Bremsbelagsverschleiß</b>								
208 CDI	60	04/00→05/06	←	nur in Verbindung mit: 13.0460-7196.2		2	24.8190-0417.2 620417	L= 99 L= 167
208 D	58	02/95→04/00	←			2	24.8190-0417.2 620417	L= 99 L= 167
208 D	60	10/96→04/00	←					
210 D	75	01/97→04/00	→			2	24.8190-0407.2 620407	L= 115 L= 185
211 CDI	80	04/00→05/06						
212 D	90	02/95→04/00						
213 CDI	95	04/00→05/06						
214	105	02/95→05/06						
214 NGT	95	02/95→05/06						
216 CDI	115	04/00→05/06						
<b>Zubehörsatz, Scheibenbremsbelag</b>								
208 CDI	60	04/00→05/06	←	nur in Verbindung mit: Vornr.13.0460-7904.2			13.0460-0281.2 610281	PER
208 D	58	02/95→04/00						
208 D	60	10/96→04/00	→				13.0460-0250.2 610250	BOS
210 D	75	01/97→04/00						
211 CDI	80	04/00→05/06						
212 D	90	02/95→04/00						
213 CDI	95	04/00→05/06						
214	105	02/95→05/06						
214 NGT	95	02/95→05/06						
216 CDI	115	04/00→05/06						
<b> Bremsscheibe</b>								
208 CDI	60	04/00→05/06	←				24.0122-0161.1 422161	Ø 276 22 19 V + S
208 D	58	02/95→04/00					24.0322-0161.1 522161	Ø 276 22 19 V + S
208 D	60	10/96→04/00						
210 D	75	01/97→04/00	→				24.0112-0142.1 412142	Ø 258 12 10 + S
211 CDI	80	04/00→05/06					24.0116-0110.1 416110	Ø 272 16 14 + S
212 D	90	02/95→04/00						
213 CDI	95	04/00→05/06						
214	105	02/95→05/06						
214 NGT	95	02/95→05/06						
216 CDI	115	04/00→05/06						
<b>MERCEDES-BENZ - SPRINTER 2-t Pritsche/Fahrgestell (901, 902) 01/95→05/06</b>								
<b> Bremsbelagsatz, Scheibenbremse</b>								
208 CDI	60	04/00→05/06	←				13.0460-7196.2 607196	ATE 21576 20,7 + WE / - WK
208 D	60	09/96→04/00					13.0460-7909.2 607909	PER 29153 20,0 + WE / - WK + Zub
210 D	75	01/97→04/00						
211 CDI	80	04/00→05/06	→				13.0460-3990.2 603990	BOS 23021 18,9 + WE / - WK
212 D	90	02/95→04/00					13.0460-7083.2 607083	ATE 21621 17,3 + WE / - WK
213 CDI	95	04/00→05/06					13.0460-7084.2 607084	ATE 21592 18,8 + WE / - WK
214 (902.011, 902.012, 902.611, 902.612)	105	02/95→05/06						
214 NGT	95	02/95→05/06						
216 CDI	115	04/00→05/06						
208 D	58	01/95→04/00	←	02/95→			13.0460-7196.2 607196	ATE 21576 20,7 + WE / - WK
↓								



	kW					! #		
<b>MERCEDES-BENZ - SPRINTER 2-t Pritsche/Fahrgestell (901, 902) 01/95—05/06</b>								
<b> Bremsbelagsatz, Scheibenbremse</b>								
208 D	58	01/95→04/00	←	02/95→			<b>13.0460-7909.2 607909</b>	PER 29153 20,0 + WE / - WK + Zub
			→	02/95→			<b>13.0460-3990.2 603990</b>	BOS 23021 18,9 + WE / - WK
							<b>13.0460-7083.2 607083</b>	ATE 21621 17,3 + WE / - WK
							<b>13.0460-7084.2 607084</b>	ATE 21592 18,8 + WE / - WK
<b>Warnkontakt, Bremsbelagverschleiß</b>								
208 CDI	60	04/00→05/06	←	nur in Verbindung mit: 13.0460-7196.2	2	<b>24.8190-0417.2 620417</b>	L= 99 L= 167	
208 D	60	09/96→04/00	←		2	<b>24.8190-0417.2 620417</b>	L= 99 L= 167	
210 D	75	01/97→04/00	←		2	<b>24.8190-0417.2 620417</b>	L= 99 L= 167	
211 CDI	80	04/00→05/06	→		2	<b>24.8190-0407.2 620407</b>	L= 115 L= 185	
212 D	90	02/95→04/00	→					
213 CDI	95	04/00→05/06	→					
214 (902.011, 902.012, 902.611, 902.612)	105	02/95→05/06	→					
214 NGT	95	02/95→05/06	→					
216 CDI	115	04/00→05/06	→					
208 D	58	01/95→04/00	←	02/95→	2	<b>24.8190-0417.2 620417</b>	L= 99 L= 167	
			←	02/95→; nur in Verbindung mit: 13.0460-7196.2	2	<b>24.8190-0417.2 620417</b>	L= 99 L= 167	
			→	02/95→	2	<b>24.8190-0407.2 620407</b>	L= 115 L= 185	
<b>Zubehörsatz, Scheibenbremsbelag</b>								
208 CDI	60	04/00→05/06	←	nur in Verbindung mit: Vornr.13.0460-7904.2		<b>13.0460-0281.2 610281</b>	PER	
208 D	60	09/96→04/00	←					
210 D	75	01/97→04/00	→			<b>13.0460-0250.2 610250</b>	BOS	
211 CDI	80	04/00→05/06	→					
212 D	90	02/95→04/00	→					
213 CDI	95	04/00→05/06	→					
214 (902.011, 902.012, 902.611, 902.612)	105	02/95→05/06	→					
214 NGT	95	02/95→05/06	→					
216 CDI	115	04/00→05/06	→					
208 D	58	01/95→04/00	←	02/95→; nur in Verbindung mit: Vornr.13.0460-7904.2		<b>13.0460-0281.2 610281</b>	PER	
			→	02/95→		<b>13.0460-0250.2 610250</b>	BOS	
<b> Brems Scheibe</b>								
208 CDI	60	04/00→05/06	←			<b>24.0122-0161.1 422161</b>	Ø 276 22 19 V + S	
208 D	60	09/96→04/00	←			<b>24.0322-0161.1 522161</b>	Ø 276 22 19 V + S	
210 D	75	01/97→04/00	←					
211 CDI	80	04/00→05/06	→			<b>24.0112-0142.1 412142</b>	Ø 258 12 10 + S	
213 CDI	95	04/00→05/06	→			<b>24.0116-0110.1 416110</b>	Ø 272 16 14 + S	
214 (902.011, 902.012, 902.611, 902.612)	105	02/95→05/06	→					
214 NGT	95	02/95→05/06	→					
216 CDI	115	04/00→05/06	→					
208 D	58	01/95→04/00	←	02/95→		<b>24.0122-0161.1 422161</b>	Ø 276 22 19 V + S	
			←			<b>24.0322-0161.1 522161</b>	Ø 276 22 19 V + S	
			→	02/95→		<b>24.0112-0142.1 412142</b>	Ø 258 12 10 + S	
			→			<b>24.0116-0110.1 416110</b>	Ø 272 16 14 + S	
212 D	90	02/95→04/00	←			<b>24.0122-0161.1 422161</b>	Ø 276 22 19 V + S	
			←			<b>24.0322-0161.1 522161</b>	Ø 276 22 19 V + S	
			→			<b>24.0112-0142.1 412142</b>	Ø 258 12 10 + S	
<b>MERCEDES-BENZ - SPRINTER 3,5-t Bus (906) 06/06→</b>								
<b> Bremsbelagsatz, Scheibenbremse</b>								
310 CDI (906.731, 906.733, 906.735)	70	03/09→12/13	←			<b>13.0460-4826.2 604826</b>	BRE 29192 20,7 + WE / - WK + Zub	
311 CDI (906.731, 906.733, 906.735)	80	06/06→12/09	←			<b>13.0460-4877.2 604877</b>	BRE 29192 20,3 + WE / - WK + Zub	
311 CDI (906.731, 906.733, 906.735)	84	05/16→	→			<b>13.0460-3837.2 603837</b>	BOS 29190 20,2 + WK + Zub	
311 CDI 4x4 (906.731, 906.733, 906.735)	80	02/08→12/09	→					
313 CDI (906.731, 906.733, 906.735)	95	08/11→05/16	→					
313 CDI 4x4 (906.731, 906.733, 906.735)	95	08/11→05/16	→					
314 CDI (906.731, 906.733, 906.735)	105	05/16→	→					
314 CDI 4x4 (906.731, 906.733, 906.735)	105	05/16→	→					

	kW					! #		
<b>MERCEDES-BENZ - SPRINTER 3,5-t Bus (906) 06/06→</b>								
<b>Bremsbelagsatz, Scheibenbremse</b>								
315 CDI (906.731, 906.733, 906.735)	110	06/06→12/09	←				<b>13.0460-4826.2 604826</b>	BRE 29192 20,7 + WE / - WK + Zub
315 CDI 4x4 (906.731, 906.733, 906.735)	110	02/08→12/09					<b>13.0460-4877.2 604877</b>	BRE 29192 20,3 + WE / - WK + Zub
316 (906.733, 906.735)	115	09/08→						
316 CDI (906.731, 906.733, 906.735)	120	08/11→	→				<b>13.0460-3837.2 603837</b>	BOS 29190 20,2 + WK + Zub
316 CDI 4x4 (906.731, 906.733, 906.735)	120	08/11→						
316 LGT	115	09/08→						
316 NGT (906.733, 906.735)	115	09/08→						
318 CDI (906.731, 906.733, 906.735)	135	02/08→12/09						
318 CDI 4x4 (906.731, 906.733, 906.735)	135	02/08→12/09						
319 CDI / BlueTEC (906.731, 906.733, 906.735)	140	03/09→						
319 CDI / BlueTEC 4x4 (906.731, 906.733, 906.735)	140	03/09→						
324 (906.733, 906.735)	190	06/06→12/13						
<b>Warnkontakt, Bremsbelagverschleiß</b>								
310 CDI (906.731, 906.733, 906.735)	70	03/09→12/13	←			2	<b>24.8190-0424.2 620424</b>	L= 103,2
311 CDI (906.731, 906.733, 906.735)	80	06/06→12/09	→	nur in Verbindung mit: 13.0460-3837.2		2	<b>24.8190-0418.2 620418</b>	L= 95
311 CDI (906.731, 906.733, 906.735)	84	05/16→						
311 CDI 4x4 (906.731, 906.733, 906.735)	80	02/08→12/09						
313 CDI (906.731, 906.733, 906.735)	95	08/11→05/16						
313 CDI 4x4 (906.731, 906.733, 906.735)	95	08/11→05/16						
314 CDI (906.731, 906.733, 906.735)	105	05/16→						
314 CDI 4x4 (906.731, 906.733, 906.735)	105	05/16→						
315 CDI (906.731, 906.733, 906.735)	110	06/06→12/09						
315 CDI 4x4 (906.731, 906.733, 906.735)	110	02/08→12/09						
316 (906.733, 906.735)	115	09/08→						
316 CDI (906.731, 906.733, 906.735)	120	08/11→						
316 CDI 4x4 (906.731, 906.733, 906.735)	120	08/11→						
316 LGT	115	09/08→						
316 NGT (906.733, 906.735)	115	09/08→						
318 CDI (906.731, 906.733, 906.735)	135	02/08→12/09						
318 CDI 4x4 (906.731, 906.733, 906.735)	135	02/08→12/09						
319 CDI / BlueTEC (906.731, 906.733, 906.735)	140	03/09→						
319 CDI / BlueTEC 4x4 (906.731, 906.733, 906.735)	140	03/09→						
324 (906.733, 906.735)	190	06/06→12/13						
<b>Bremsscheibe</b>								
310 CDI (906.731, 906.733, 906.735)	70	03/09→12/13	←				<b>24.0128-0203.1 428203</b>	Ø 300 28 25 V + S
311 CDI (906.731, 906.733, 906.735)	80	06/06→12/09	→				<b>24.0116-0121.1 416121</b>	Ø 298 16 14 + S
311 CDI (906.731, 906.733, 906.735)	84	05/16→						
311 CDI 4x4 (906.731, 906.733, 906.735)	80	02/08→12/09						
313 CDI (906.731, 906.733, 906.735)	95	08/11→05/16						
313 CDI 4x4 (906.731, 906.733, 906.735)	95	08/11→05/16						
314 CDI (906.731, 906.733, 906.735)	105	05/16→						
314 CDI 4x4 (906.731, 906.733, 906.735)	105	05/16→						
↓								

**MERCEDES-BENZ - SPRINTER 3,5-t Bus (906) 06/06→**









 **Bremsscheibe**

315 CDI (906.731, 906.733, 906.735)	110	06/06→12/09	←					Ø 300 28 25 V + S
315 CDI 4x4 (906.731, 906.733, 906.735)	110	02/08→12/09	→					Ø 298 16 14 + S
316 (906.733, 906.735)	115	09/08→						
316 CDI (906.731, 906.733, 906.735)	120	08/11→						
316 CDI 4x4 (906.731, 906.733, 906.735)	120	08/11→						
316 LGT	115	09/08→						
316 NGT (906.733, 906.735)	115	09/08→						
318 CDI (906.731, 906.733, 906.735)	135	02/08→12/09						
318 CDI 4x4 (906.731, 906.733, 906.735)	135	02/08→12/09						
319 CDI / BlueTEC (906.731, 906.733, 906.735)	140	03/09→						
319 CDI / BlueTEC 4x4 (906.731, 906.733, 906.735)	140	03/09→						
324 (906.733, 906.735)	190	06/06→12/13						

**MERCEDES-BENZ - SPRINTER 3,5-t Kasten (906) 06/06→**

 **Bremsbelagsatz, Scheibenbremse**

309 CDI (906.631, 906.633, 906.635, 906.637)	65	06/06→12/09	←					BRE 29192 20,7 + WE / - WK + Zub
310 CDI (906.631, 906.633, 906.635, 906.637)	70	03/09→						BRE 29192 20,3 + WE / - WK + Zub
311 CDI (906.631, 906.633, 906.635, 906.637)	80	06/06→12/09	→					BOS 29190 20,2 + WK + Zub
311 CDI (906.631, 906.633, 906.635, 906.637)	84	05/16→						
311 CDI 4x4 (906.631, 906.633, 906.635, 906.637)	80	02/08→12/09						
313 CDI (906.631, 906.633, 906.635, 906.637)	95	06/06→						
313 CDI (906.631, 906.633, 906.635, 906.637)	95	05/09→						
313 CDI 4x4 (906.631, 906.633, 906.635, 906.637)	95	05/09→						
314 CDI (906.631, 906.633, 906.635, 906.637)	105	05/16→						
314 CDI 4x4 (906.631, 906.633, 906.635, 906.637)	105	05/16→						
315 CDI (906.631, 906.633, 906.635, 906.637)	110	06/06→12/09						
315 CDI 4x4 (906.631, 906.633, 906.635, 906.637)	110	02/08→12/09						
316 (906.635, 906.633)	115	09/08→						
316 CDI (906.631, 906.633, 906.635, 906.637)	120	03/09→						
316 CDI 4x4 (906.631, 906.633, 906.635, 906.637)	120	03/09→						
316 LGT (906.633, 906.635)	115	09/08→						
316 NGT (906.633, 906.635)	115	09/08→						
318 CDI (906.631, 906.633, 906.635, 906.637)	135	06/06→12/09						
318 CDI 4x4 (906.631, 906.633, 906.635, 906.637)	135	02/08→12/09						
319 CDI / BlueTEC (906.631, 906.633, 906.635, 906.637)	140	03/09→						
↓								

	kW			 	! #		
<b>MERCEDES-BENZ - SPRINTER 3,5-t Kasten (906) 06/06→</b>							
<b> Bremsbelagsatz, Scheibenbremse</b>							
319 CDI / BlueTEC 4x4 (906.631, 906.633, 906.635,...	140	03/09→	←			<b>13.0460-4826.2 604826</b>	BRE 29192 20,7 + WE / - WK + Zub
324 (906.633, 906.635, 906.637)	190	06/06→12/13	→			<b>13.0460-4877.2 604877</b>	BRE 29192 20,3 + WE / - WK + Zub
						<b>13.0460-3837.2 603837</b>	BOS 29190 20,2 + WK + Zub
<b>Warnkontakt, Bremsbelagverschleiß</b>							
309 CDI (906.631, 906.633, 906.635, 906.637)	65	06/06→12/09	←		2	<b>24.8190-0424.2 620424</b>	L= 103,2
			→	nur in Verbindung mit: 13.0460-3837.2	2	<b>24.8190-0418.2 620418</b>	L= 95
310 CDI (906.631, 906.633, 906.635, 906.637)	70	03/09→					
311 CDI (906.631, 906.633, 906.635, 906.637)	80	06/06→12/09					
311 CDI (906.631, 906.633, 906.635, 906.637)	84	05/16→					
311 CDI 4x4 (906.631, 906.633, 906.635, 906.637)	80	02/08→12/09					
313 CDI (906.631, 906.633, 906.635, 906.637)	95	06/06→					
313 CDI (906.631, 906.633, 906.635, 906.637)	95	05/09→					
313 CDI 4x4 (906.631, 906.633, 906.635, 906.637)	95	05/09→					
314 CDI (906.631, 906.633, 906.635, 906.637)	105	05/16→					
314 CDI 4x4 (906.631, 906.633, 906.635, 906.637)	105	05/16→					
315 CDI (906.631, 906.633, 906.635, 906.637)	110	06/06→12/09					
315 CDI 4x4 (906.631, 906.633, 906.635, 906.637)	110	02/08→12/09					
316 (906.635, 906.633)	115	09/08→					
316 CDI (906.631, 906.633, 906.635, 906.637)	120	03/09→					
316 CDI 4x4 (906.631, 906.633, 906.635, 906.637)	120	03/09→					
316 LGT (906.633, 906.635)	115	09/08→					
316 NGT (906.633, 906.635)	115	09/08→					
318 CDI (906.631, 906.633, 906.635, 906.637)	135	06/06→12/09					
318 CDI 4x4 (906.631, 906.633, 906.635, 906.637)	135	02/08→12/09					
319 CDI / BlueTEC (906.631, 906.633, 906.635, 906.637)	140	03/09→					
319 CDI / BlueTEC 4x4 (906.631, 906.633, 906.635, ...)	140	03/09→					
324 (906.633, 906.635, 906.637)	190	06/06→12/13					
<b> Bremsscheibe</b>							
309 CDI (906.631, 906.633, 906.635, 906.637)	65	06/06→12/09	←			<b>24.0128-0203.1 428203</b>	Ø 300 28 25 V + S
			→			<b>24.0116-0121.1 416121</b>	Ø 298 16 14 + S
310 CDI (906.631, 906.633, 906.635, 906.637)	70	03/09→					
311 CDI (906.631, 906.633, 906.635, 906.637)	80	06/06→12/09					
311 CDI (906.631, 906.633, 906.635, 906.637)	84	05/16→					
↓							

**MERCEDES-BENZ - SPRINTER 3,5-t Kasten (906) 06/06→**

 **Bremsscheibe**

311 CDI 4x4 (906.631, 906.633, 906.635, 906.637)	80	02/08→12/09	←					24.0128-0203.1 428203 Ø 300 28 25 V + S
			→					24.0116-0121.1 416121 Ø 298 16 14 + S
313 CDI (906.631, 906.633, 906.635, 906.637)	95	06/06→						
313 CDI (906.631, 906.633, 906.635, 906.637)	95	05/09→						
313 CDI 4x4 (906.631, 906.633, 906.635, 906.637)	95	05/09→						
314 CDI (906.631, 906.633, 906.635, 906.637)	105	05/16→						
314 CDI 4x4 (906.631, 906.633, 906.635, 906.637)	105	05/16→						
315 CDI (906.631, 906.633, 906.635, 906.637)	110	06/06→12/09						
315 CDI 4x4 (906.631, 906.633, 906.635, 906.637)	110	02/08→12/09						
316 (906.635, 906.633)	115	09/08→						
316 CDI (906.631, 906.633, 906.635, 906.637)	120	03/09→						
316 CDI 4x4 (906.631, 906.633, 906.635, 906.637)	120	03/09→						
316 LGT (906.633, 906.635)	115	09/08→						
316 NGT (906.633, 906.635)	115	09/08→						
318 CDI (906.631, 906.633, 906.635, 906.637)	135	06/06→12/09						
318 CDI 4x4 (906.631, 906.633, 906.635, 906.637)	135	02/08→12/09						
319 CDI / BlueTEC (906.631, 906.633, 906.635, 906.637)	140	03/09→						
319 CDI / BlueTEC 4x4 (906.631, 906.633, 906.635,....)	140	03/09→						
324 (906.633, 906.635, 906.637)	190	06/06→12/13						









**MERCEDES-BENZ - SPRINTER 3,5-t Pritsche/Fahrgestell (906) 06/06→**

 **Bremsbelagsatz, Scheibenbremse**

309 CDI (906.131, 906.133, 906.135, 906.231, 906.233,....)	65	06/06→12/09	←					13.0460-4826.2 604826 BRE 29192 20,7 + WE / - WK + Zub
310 CDI (906.131, 906.133, 906.135, 906.231, 906.233,....)	70	03/09→05/16						13.0460-4877.2 604877 BRE 29192 20,3 + WE / - WK + Zub
311 CDI (906.131, 906.133, 906.135, 906.231, 906.233,....)	80	06/06→12/09	→					13.0460-3837.2 603837 BOS 29190 20,2 + WK + Zub
311 CDI (906.131, 906.133, 906.135, 906.231, 906.233,....)	84	05/16→						
311 CDI 4x4 (906.131, 906.133, 906.135, 906.231, 906.233,....)	80	02/08→12/09						
313 CDI (906.131, 906.133, 906.135, 906.231, 906.233,....)	95	06/06→05/16						
313 CDI 4x4 (906.131, 906.133, 906.135, 906.231, 906.233,....)	95	06/06→05/16						
314 CDI (906.131, 906.133, 906.135, 906.231, 906.233,....)	105	05/16→						
314 CDI 4x4 (906.131, 906.133, 906.135, 906.231, 906.233,....)	105	05/16→						
315 CDI (906.131, 906.133, 906.135, 906.231, 906.233,....)	110	06/06→12/09						





	kW			 	! #		
<b>MERCEDES-BENZ - SPRINTER 3,5-t Pritsche/Fahrgestell (906) 06/06→</b>							
<b> Bremsbelagsatz, Scheibenbremse</b>							
315 CDI 4x4 (906.131, 906.133, 906.135, 906.231, 906.233,...	110	02/08→12/09	←			<b>13.0460-4826.2 604826</b>	BRE 29192 20,7 + WE / - WK + Zub
316 (906.133, 906.135, 906.233, 906.235)	115	09/08→				<b>13.0460-4877.2 604877</b>	BRE 29192 20,3 + WE / - WK + Zub
316 CDI (906.131, 906.133, 906.135, 906.231, 906.233,...	120	03/09→	→			<b>13.0460-3837.2 603837</b>	BOS 29190 20,2 + WK + Zub
316 CDI 4x4 (906.131, 906.133, 906.135, 906.231, 906.233,...	120	03/09→					
316 LGT (906.133, 906.135, 906.233, 906.235)	115	09/08→					
316 NGT (906.133, 906.135, 906.233, 906.235)	115	09/08→					
318 CDI (906.131, 906.133, 906.135, 906.231, 906.233,...	135	06/06→12/09					
318 CDI 4x4 (906.131, 906.133, 906.135, 906.231, 906.233,...	135	02/08→12/09					
319 CDI / BlueTEC (906.131, 906.133, 906.135, 906.231,...	140	03/09→					
319 CDI / BlueTEC 4x4 (906.131, 906.133, 906.135,...	140	05/11→					
324 (906.133, 906.135, 906.233, 906.235)	190	06/06→12/13					
<b>Warnkontakt, Bremsbelagsverschleiß</b>							
309 CDI (906.131, 906.133, 906.135, 906.231, 906.233,...	65	06/06→12/09	←		2	<b>24.8190-0424.2 620424</b>	L= 103,2
310 CDI (906.131, 906.133, 906.135, 906.231, 906.233,...	70	03/09→05/16	→	nur in Verbindung mit: 13.0460-3837.2	2	<b>24.8190-0418.2 620418</b>	L= 95
311 CDI (906.131, 906.133, 906.135, 906.231, 906.233,...	80	06/06→12/09					
311 CDI (906.131, 906.133, 906.135, 906.231, 906.233,...	84	05/16→					
311 CDI 4x4 (906.131, 906.133, 906.135, 906.231, 906.233,...	80	02/08→12/09					
313 CDI (906.131, 906.133, 906.135, 906.231, 906.233,...	95	06/06→05/16					
313 CDI 4x4 (906.131, 906.133, 906.135, 906.231, 906.233,...	95	06/06→05/16					
314 CDI (906.131, 906.133, 906.135, 906.231, 906.233,...	105	05/16→					
314 CDI 4x4 (906.131, 906.133, 906.135, 906.231, 906.233,...	105	05/16→					
315 CDI (906.131, 906.133, 906.135, 906.231, 906.233,...	110	06/06→12/09					
315 CDI 4x4 (906.131, 906.133, 906.135, 906.231, 906.233,...	110	02/08→12/09					
316 (906.133, 906.135, 906.233, 906.235)	115	09/08→					
316 CDI (906.131, 906.133, 906.135, 906.231, 906.233,...	120	03/09→					
316 CDI 4x4 (906.131, 906.133, 906.135, 906.231, 906.233,...	120	03/09→					
316 LGT (906.133, 906.135, 906.233, 906.235)	115	09/08→					
316 NGT (906.133, 906.135, 906.233, 906.235)	115	09/08→					
318 CDI (906.131, 906.133, 906.135, 906.231, 906.233,...	135	06/06→12/09					
↓							

**MERCEDES-BENZ - SPRINTER 3,5-t Pritsche/Fahrgestell (906) 06/06→**

**Warnkontakt, Bremsbelagverschleiß**

318 CDI 4x4 (906.131, 906.133, 906.135, 906.231, 906.233,...	135	02/08→12/09	←		2	<b>24.8190-0424.2</b>	<b>620424</b>	L= 103,2
			→	nur in Verbindung mit: 13.0460-3837.2	2	<b>24.8190-0418.2</b>	<b>620418</b>	L= 95
319 CDI / BlueTEC (906.131, 906.133, 906.135, 906.231,...	140	03/09→						
319 CDI / BlueTEC 4x4 (906.131, 906.133, 906.135,...	140	05/11→						
324 (906.133, 906.135, 906.233, 906.235)	190	06/06→12/13						









 **Bremsscheibe**











309 CDI (906.131, 906.133, 906.135, 906.231, 906.233,...	65	06/06→12/09	←			<b>24.0128-0203.1</b>	<b>428203</b>	Ø 300 28 25 V + S
			→			<b>24.0116-0121.1</b>	<b>416121</b>	Ø 298 16 14 + S
310 CDI (906.131, 906.133, 906.135, 906.231, 906.233,...	70	03/09→05/16						
311 CDI (906.131, 906.133, 906.135, 906.231, 906.233,...	80	06/06→12/09						
311 CDI (906.131, 906.133, 906.135, 906.231, 906.233,...	84	05/16→						
311 CDI 4x4 (906.131, 906.133, 906.135, 906.231, 906.233,...	80	02/08→12/09						
313 CDI (906.131, 906.133, 906.135, 906.231, 906.233,...	95	06/06→05/16						
313 CDI 4x4 (906.131, 906.133, 906.135, 906.231, 906.233,...	95	06/06→05/16						
314 CDI (906.131, 906.133, 906.135, 906.231, 906.233,...	105	05/16→						
314 CDI 4x4 (906.131, 906.133, 906.135, 906.231, 906.233,...	105	05/16→						
315 CDI (906.131, 906.133, 906.135, 906.231, 906.233,...	110	06/06→12/09						
315 CDI 4x4 (906.131, 906.133, 906.135, 906.231, 906.233,...	110	02/08→12/09						
316 (906.133, 906.135, 906.233, 906.235)	115	09/08→						
316 CDI (906.131, 906.133, 906.135, 906.231, 906.233,...	120	03/09→						
316 CDI 4x4 (906.131, 906.133, 906.135, 906.231, 906.233,...	120	03/09→						
316 LGT (906.133, 906.135, 906.233, 906.235)	115	09/08→						
316 NGT (906.133, 906.135, 906.233, 906.235)	115	09/08→						
318 CDI (906.131, 906.133, 906.135, 906.231, 906.233,...	135	06/06→12/09						
318 CDI 4x4 (906.131, 906.133, 906.135, 906.231, 906.233,...	135	02/08→12/09						
319 CDI / BlueTEC (906.131, 906.133, 906.135, 906.231,...	140	03/09→						
319 CDI / BlueTEC 4x4 (906.131, 906.133, 906.135,...	140	05/11→						
324 (906.133, 906.135, 906.233, 906.235)	190	06/06→12/13						









**MERCEDES-BENZ - SPRINTER 3-t Bus (903) 01/95→05/06**

 **Bremsbelagsatz, Scheibenbremse**

308 CDI 308 D 308 D (903.371, 903.372, 903.373)	60 58 60	04/00→05/06 02/95→04/00 03/97→04/00	←			<b>13.0460-7196.2</b>	<b>607196</b>	ATE 21576 20,7 + WE / - WK
			→			<b>13.0460-7909.2</b>	<b>607909</b>	PER 29153 20,0 + WE / - WK + Zub
↓						<b>13.0460-3990.2</b>	<b>603990</b>	BOS 23021 18,9 + WE / - WK

	kW			 	! #		
<b>MERCEDES-BENZ - SPRINTER 3-t Bus (903) 01/95→05/06</b>							
<b> Bremsbelagsatz, Scheibenbremse</b>							
310 D (903.371, 903.372, 903.373)	75	01/97→12/99	➔			<b>13.0460-7084.2 607084</b>	ATE 21592 18,8 + WE / - WK
310 D 4x4	75	05/97→08/02					
311 CDI	80	04/00→05/06					
311 CDI 4x4	80	08/02→05/06					
312 D 2.9	90	02/95→04/00					
312 D 2.9 4x4	90	05/97→08/02					
313 CDI	95	04/00→05/06					
313 CDI 4x4	95	08/02→05/06					
314 (903.071, 903.072, 903.073, 903.671, 903.672,...)	105	02/95→05/06					
314 4x4	105	08/02→05/06					
314 NGT	95	02/95→05/06					
316 CDI	115	04/00→05/06					
316 CDI 4x4	115	08/02→05/06					
<b>Warnkontakt, Bremsbelagsverschleiß</b>							
308 CDI	60	04/00→05/06	←		2	<b>24.8190-0417.2 620417</b>	L= 99 L= 167
308 D	58	02/95→04/00					
308 D (903.371, 903.372, 903.373)	60	03/97→04/00	➔		2	<b>24.8190-0407.2 620407</b>	L= 115 L= 185
310 D (903.371, 903.372, 903.373)	75	01/97→12/99					
310 D 4x4	75	05/97→08/02					
311 CDI	80	04/00→05/06					
311 CDI 4x4	80	08/02→05/06					
312 D 2.9	90	02/95→04/00					
312 D 2.9 4x4	90	05/97→08/02					
313 CDI	95	04/00→05/06					
313 CDI 4x4	95	08/02→05/06					
314 (903.071, 903.072, 903.073, 903.671, 903.672,...)	105	02/95→05/06					
314 4x4	105	08/02→05/06					
314 NGT	95	02/95→05/06					
316 CDI	115	04/00→05/06					
316 CDI 4x4	115	08/02→05/06					
<b>Zubehörsatz, Scheibenbremsbelag</b>							
308 CDI	60	04/00→05/06	←	nur in Verbindung mit: Vornr.13.0460-7904.2		<b>13.0460-0281.2 610281</b>	PER
308 D	58	02/95→04/00					
308 D (903.371, 903.372, 903.373)	60	03/97→04/00	➔			<b>13.0460-0250.2 610250</b>	BOS
310 D (903.371, 903.372, 903.373)	75	01/97→12/99					
310 D 4x4	75	05/97→08/02					
311 CDI	80	04/00→05/06					
311 CDI 4x4	80	08/02→05/06					
312 D 2.9	90	02/95→04/00					
312 D 2.9 4x4	90	05/97→08/02					
313 CDI	95	04/00→05/06					
313 CDI 4x4	95	08/02→05/06					
314 (903.071, 903.072, 903.073, 903.671, 903.672,...)	105	02/95→05/06					
314 4x4	105	08/02→05/06					
314 NGT	95	02/95→05/06					
316 CDI	115	04/00→05/06					
316 CDI 4x4	115	08/02→05/06					
<b> Bremsscheibe</b>							
308 CDI	60	04/00→05/06	←	für Bremsscheibendurchmesser [mm]: 276		<b>24.0122-0161.1 422161</b>	Ø 276 22 19 V + S
308 D	58	02/95→04/00				<b>24.0322-0161.1 522161</b>	Ø 276 22 19 V + S
308 D (903.371, 903.372, 903.373)	60	03/97→04/00	←	für Bremsscheibendurchmesser [mm]: 285		<b>24.0122-0245.1 422245</b>	Ø 285 22 19 V
310 D (903.371, 903.372, 903.373)	75	01/97→12/99					
310 D 4x4	75	05/97→08/02	➔			<b>24.0116-0110.1 416110</b>	Ø 272 16 14 + S
311 CDI	80	04/00→05/06					
311 CDI 4x4	80	08/02→05/06					
312 D 2.9	90	02/95→04/00					
312 D 2.9 4x4	90	05/97→08/02					
313 CDI	95	04/00→05/06					
313 CDI 4x4	95	08/02→05/06					
314 (903.071, 903.072, 903.073, 903.671, 903.672,...)	105	02/95→05/06					
314 4x4	105	08/02→05/06					
314 NGT	95	02/95→05/06					
316 CDI	115	04/00→05/06					
316 CDI 4x4	115	08/02→05/06					

	kW			 	! #		
<b>MERCEDES-BENZ - SPRINTER 3-t Bus (906) 06/06→</b>							
<b> Bremsbelagsatz, Scheibenbremse</b>							
210 CDI (906.711, 906.713)	70	03/09→12/13	←			<b>13.0460-4826.2 604826</b>	BRE 29192 20,7 + WE / - WK + Zub
211 CDI (906.711, 906.713)	80	06/06→12/09				<b>13.0460-4877.2 604877</b>	BRE 29192 20,3 + WE / - WK + Zub
211 CDI (906.711, 906.713)	84	04/16→					
213 CDI (906.711, 906.713)	95	06/06→05/16	→			<b>13.0460-3837.2 603837</b>	BOS 29190 20,2 + WK + Zub
214 CDI (906.711, 906.713)	105	04/16→					
215 CDI (906.711, 906.713)	110	06/06→12/09					
216 (906.713)	115	09/08→					
224 (906.713)	190	06/06→12/13					
216 CDI (906.711, 906.713)	120	06/06→	←	03/09→		<b>13.0460-4826.2 604826</b>	BRE 29192 20,7 + WE / - WK + Zub
						<b>13.0460-4877.2 604877</b>	BRE 29192 20,3 + WE / - WK + Zub
			→	03/09→		<b>13.0460-3837.2 603837</b>	BOS 29190 20,2 + WK + Zub
<b>Warnkontakt, Bremsbelagverschleiß</b>							
210 CDI (906.711, 906.713)	70	03/09→12/13	←		2	<b>24.8190-0424.2 620424</b>	L= 103,2
211 CDI (906.711, 906.713)	80	06/06→12/09	→	nur in Verbindung mit: 13.0460-3837.2	2	<b>24.8190-0418.2 620418</b>	L= 95
211 CDI (906.711, 906.713)	84	04/16→					
213 CDI (906.711, 906.713)	95	06/06→05/16					
214 CDI (906.711, 906.713)	105	04/16→					
215 CDI (906.711, 906.713)	110	06/06→12/09					
216 (906.713)	115	09/08→					
224 (906.713)	190	06/06→12/13					
216 CDI (906.711, 906.713)	120	06/06→	←	03/09→	2	<b>24.8190-0424.2 620424</b>	L= 103,2
			→	03/09→; nur in Verbindung mit: 13.0460-3837.2	2	<b>24.8190-0418.2 620418</b>	L= 95
<b> Brems Scheibe</b>							
210 CDI (906.711, 906.713)	70	03/09→12/13	←			<b>24.0128-0203.1 428203</b>	Ø 300 28 25 V + S
211 CDI (906.711, 906.713)	80	06/06→12/09	→			<b>24.0116-0121.1 416121</b>	Ø 298 16 14 + S
211 CDI (906.711, 906.713)	84	04/16→					
213 CDI (906.711, 906.713)	95	06/06→05/16					
214 CDI (906.711, 906.713)	105	04/16→					
215 CDI (906.711, 906.713)	110	06/06→12/09					
216 (906.713)	115	09/08→					
224 (906.713)	190	06/06→12/13					
216 CDI (906.711, 906.713)	120	06/06→	←	03/09→		<b>24.0128-0203.1 428203</b>	Ø 300 28 25 V + S
			→	03/09→		<b>24.0116-0121.1 416121</b>	Ø 298 16 14 + S
<b>MERCEDES-BENZ - SPRINTER 3-t Kasten (903) 01/95→05/06</b>							
<b> Bremsbelagsatz, Scheibenbremse</b>							
308 CDI	60	04/00→05/06	←			<b>13.0460-7196.2 607196</b>	ATE 21576 20,7 + WE / - WK
308 D 2.3	58	02/95→04/00				<b>13.0460-7909.2 607909</b>	PER 29153 20,0 + WE / - WK + Zub
308 D 2.3	60	02/95→04/00					
310 D 2.9	75	02/95→04/00					
311 CDI	80	04/00→05/06	→			<b>13.0460-3990.2 603990</b>	BOS 23021 18,9 + WE / - WK
311 CDI 4x4	80	08/02→05/06				<b>13.0460-7084.2 607084</b>	ATE 21592 18,8 + WE / - WK
312 D 2.9	90	02/95→04/00					
312 D 2.9 4x4	90	05/97→08/02					
313 CDI	95	04/00→05/06					
313 CDI 4x4	95	08/02→05/06					
314	105	02/95→05/06					
314 4x4	105	08/02→05/06					
314 NGT (903.661)	95	02/95→05/06					
316 CDI	115	04/00→05/06					
316 CDI 4x4	115	08/02→05/06					
<b>Warnkontakt, Bremsbelagverschleiß</b>							
308 CDI	60	04/00→05/06	←		2	<b>24.8190-0417.2 620417</b>	L= 99 L= 167
308 D 2.3	58	02/95→04/00					
↓							

	kW			 	! #		
<b>MERCEDES-BENZ - SPRINTER 3-t Kasten (903) 01/95→05/06</b>							
<b>Warnkontakt, Bremsbelagverschleiß</b>							
308 D 2.3	60	02/95→04/00	➔		2	24.8190-0407.2 620407	L= 115 L= 185
310 D 2.9	75	02/95→04/00					
311 CDI	80	04/00→05/06					
311 CDI 4x4	80	08/02→05/06					
312 D 2.9	90	02/95→04/00					
312 D 2.9 4x4	90	05/97→08/02					
313 CDI	95	04/00→05/06					
313 CDI 4x4	95	08/02→05/06					
314	105	02/95→05/06					
314 4x4	105	08/02→05/06					
314 NGT (903.661)	95	02/95→05/06					
316 CDI	115	04/00→05/06					
316 CDI 4x4	115	08/02→05/06					
<b>Zubehörsatz, Scheibenbremsbelag</b>							
308 CDI	60	04/00→05/06	←	nur in Verbindung mit: Vornr.13.0460-7904.2		13.0460-0281.2 610281	PER
308 D 2.3	58	02/95→04/00					
308 D 2.3	60	02/95→04/00	➔			13.0460-0250.2 610250	BOS
310 D 2.9	75	02/95→04/00					
311 CDI	80	04/00→05/06					
311 CDI 4x4	80	08/02→05/06					
312 D 2.9	90	02/95→04/00					
312 D 2.9 4x4	90	05/97→08/02					
313 CDI	95	04/00→05/06					
313 CDI 4x4	95	08/02→05/06					
314	105	02/95→05/06					
314 4x4	105	08/02→05/06					
314 NGT (903.661)	95	02/95→05/06					
316 CDI	115	04/00→05/06					
316 CDI 4x4	115	08/02→05/06					
<b> Brems Scheibe</b>							
308 CDI	60	04/00→05/06	←	für Brems Scheibendurchmesser [mm]: 276		24.0122-0161.1 422161	Ø 276 22 19 V + S
308 D 2.3	58	02/95→04/00				24.0322-0161.1 522161	Ø 276 22 19 V + S
308 D 2.3	60	02/95→04/00	➔				
310 D 2.9	75	02/95→04/00	←	für Brems Scheibendurchmesser [mm]: 285		24.0122-0245.1 422245	Ø 285 22 19 V
311 CDI	80	04/00→05/06					
311 CDI 4x4	80	08/02→05/06	➔			24.0116-0110.1 416110	Ø 272 16 14 + S
312 D 2.9	90	02/95→04/00					
312 D 2.9 4x4	90	05/97→08/02					
313 CDI	95	04/00→05/06					
313 CDI 4x4	95	08/02→05/06					
314	105	02/95→05/06					
314 4x4	105	08/02→05/06					
314 NGT (903.661)	95	02/95→05/06					
316 CDI	115	04/00→05/06					
316 CDI 4x4	115	08/02→05/06					
<b>MERCEDES-BENZ - SPRINTER 3-t Kasten (906) 06/06→</b>							
<b> Bremsbelagsatz, Scheibenbremse</b>							
209 CDI (906.611, 906.613)	65	06/06→12/09	←			13.0460-4826.2 604826	BRE 29192 20,7 + WE / - WK + Zub
210 CDI (906.611, 906.613)	70	03/09→				13.0460-4877.2 604877	BRE 29192 20,3 + WE / - WK + Zub
211 CDI (906.611, 906.613)	80	06/06→12/09	➔			13.0460-3837.2 603837	BOS 29190 20,2 + WK + Zub
211 CDI (906.611, 906.613)	84	04/16→					
213 CDI (906.611, 906.613)	95	06/06→					
213 CDI (906.611, 906.613)	95	06/06→12/09					
214 CDI (906.611, 906.613)	105	04/16→					
215 CDI (906.611, 906.613)	110	06/06→12/09					
216 (906.613)	115	09/08→					
216 CDI (906.611, 906.613)	120	03/09→					
218 CDI (906.611, 906.613)	135	06/06→12/09					
219 CDI / BlueTEC (906.611, 906.613)	140	03/09→					
224 (906.613)	190	06/06→					
<b>Warnkontakt, Bremsbelagverschleiß</b>							
209 CDI (906.611, 906.613)	65	06/06→12/09	←		2	24.8190-0424.2 620424	L= 103,2
210 CDI (906.611, 906.613)	70	03/09→	➔	nur in Verbindung mit: 13.0460-3837.2	2	24.8190-0418.2 620418	L= 95
↓							



**MERCEDES-BENZ - SPRINTER 3-t Kasten (906) 06/06→**

**Warnkontakt, Bremsbelagverschleiß**

211 CDI (906.611, 906.613)	80	06/06→12/09	←		2	24.8190-0424.2	620424	L= 103,2
211 CDI (906.611, 906.613)	84	04/16→	→	nur in Verbindung mit: 13.0460-3837.2	2	24.8190-0418.2	620418	L= 95
213 CDI (906.611, 906.613)	95	06/06→						
213 CDI (906.611, 906.613)	95	06/06→12/09						
214 CDI (906.611, 906.613)	105	04/16→						
215 CDI (906.611, 906.613)	110	06/06→12/09						
216 (906.613)	115	09/08→						
216 CDI (906.611, 906.613)	120	03/09→						
218 CDI (906.611, 906.613)	135	06/06→12/09						
219 CDI / BlueTEC (906.611, 906.613)	140	03/09→						
224 (906.613)	190	06/06→						

**Bremsscheibe**

209 CDI (906.611, 906.613)	65	06/06→12/09	←			24.0128-0203.1	428203	Ø 300 28 25 V + S
210 CDI (906.611, 906.613)	70	03/09→	→			24.0116-0121.1	416121	Ø 298 16 14 + S
211 CDI (906.611, 906.613)	80	06/06→12/09						
211 CDI (906.611, 906.613)	84	04/16→						
213 CDI (906.611, 906.613)	95	06/06→						
213 CDI (906.611, 906.613)	95	06/06→12/09						
214 CDI (906.611, 906.613)	105	04/16→						
215 CDI (906.611, 906.613)	110	06/06→12/09						
216 (906.613)	115	09/08→						
216 CDI (906.611, 906.613)	120	03/09→						
218 CDI (906.611, 906.613)	135	06/06→12/09						
219 CDI / BlueTEC (906.611, 906.613)	140	03/09→						
224 (906.613)	190	06/06→						









**MERCEDES-BENZ - SPRINTER 3-t Pritsche/Fahrgestell (903) 01/95→05/06**









**Bremsbelagsatz, Scheibenbremse**











308 CDI	60	04/00→05/06	←			13.0460-7196.2	607196	ATE 21576 20,7 + WE / - WK
308 D 2.3	58	02/95→04/00				13.0460-7909.2	607909	PER 29153 20,0 + WE / - WK + Zub
308 D 2.3	60	11/96→04/00						
310 D 2.9	75	01/97→04/00						
311 CDI	80	04/00→05/06	→			13.0460-3990.2	603990	BOS 23021 18,9 + WE / - WK
311 CDI 4x4	80	08/02→05/06				13.0460-7084.2	607084	ATE 21592 18,8 + WE / - WK
312 D 2.9	90	02/95→04/00						
312 D 2.9 (903.411, 903.412, 903.413, 903.421, 903.422,....)	85	12/98→09/01						
313 CDI	95	04/00→05/06						
313 CDI 4x4	95	08/02→05/06						
314 (903.011, 903.012, 903.013, 903.022, 903.611,....)	105	02/95→05/06						
314 4x4	105	08/02→05/06						
314 NGT (903.611, 903.612)	95	02/95→05/06						
316 CDI	115	04/00→05/06						
316 CDI 4x4	115	08/02→05/06						











**Warnkontakt, Bremsbelagverschleiß**

308 CDI	60	04/00→05/06	←		2	24.8190-0417.2	620417	L= 99 L= 167
308 D 2.3	58	02/95→04/00						
308 D 2.3	60	11/96→04/00	→		2	24.8190-0407.2	620407	L= 115 L= 185
310 D 2.9	75	01/97→04/00						
311 CDI	80	04/00→05/06						
311 CDI 4x4	80	08/02→05/06						
312 D 2.9	90	02/95→04/00						
312 D 2.9 (903.411, 903.412, 903.413, 903.421, 903.422,....)	85	12/98→09/01						
313 CDI	95	04/00→05/06						









	kW			 	! #		
<b>MERCEDES-BENZ - SPRINTER 3-t Pritsche/Fahrgestell (903) 01/95→05/06</b>							
<b>Warnkontakt, Bremsbelagverschleiß</b>							
313 CDI 4x4	95	08/02→05/06	←		2	24.8190-0417.2 620417	L= 99 L= 167
314 (903.011, 903.012, 903.013, 903.022, 903.611,...	105	02/95→05/06	→		2	24.8190-0407.2 620407	L= 115 L= 185
314 4x4	105	08/02→05/06					
314 NGT (903.611, 903.612)	95	02/95→05/06					
316 CDI	115	04/00→05/06					
316 CDI 4x4	115	08/02→05/06					
<b>Zubehörsatz, Scheibenbremsbelag</b>							
308 CDI	60	04/00→05/06	←	nur in Verbindung mit: Vomr.13.0460-7904.2		13.0460-0281.2 610281	PER
308 D 2.3	58	02/95→04/00					
308 D 2.3	60	11/96→04/00	→			13.0460-0250.2 610250	BOS
310 D 2.9	75	01/97→04/00					
311 CDI	80	04/00→05/06					
311 CDI 4x4	80	08/02→05/06					
312 D 2.9	90	02/95→04/00					
312 D 2.9 (903.411, 903.412, 903.413, 903.421, 903.422,...	85	12/98→09/01					
313 CDI	95	04/00→05/06					
313 CDI 4x4	95	08/02→05/06					
314 (903.011, 903.012, 903.013, 903.022, 903.611,...	105	02/95→05/06					
314 4x4	105	08/02→05/06					
314 NGT (903.611, 903.612)	95	02/95→05/06					
316 CDI	115	04/00→05/06					
316 CDI 4x4	115	08/02→05/06					
<b> Bremsscheibe</b>							
308 CDI	60	04/00→05/06	←	für Bremsscheibendurchmesser [mm]: 276		24.0122-0161.1 422161	Ø 276 22 19 V + S
308 D 2.3	58	02/95→04/00				24.0322-0161.1 522161	Ø 276 22 19 V + S
308 D 2.3	60	11/96→04/00					
310 D 2.9	75	01/97→04/00	←	für Bremsscheibendurchmesser [mm]: 285		24.0122-0245.1 422245	Ø 285 22 19 V
311 CDI	80	04/00→05/06					
311 CDI 4x4	80	08/02→05/06	→			24.0116-0110.1 416110	Ø 272 16 14 + S
312 D 2.9	90	02/95→04/00					
312 D 2.9 (903.411, 903.412, 903.413, 903.421, 903.422,...	85	12/98→09/01					
313 CDI	95	04/00→05/06					
313 CDI 4x4	95	08/02→05/06					
314 (903.011, 903.012, 903.013, 903.022, 903.611,...	105	02/95→05/06					
314 4x4	105	08/02→05/06					
314 NGT (903.611, 903.612)	95	02/95→05/06					
316 CDI	115	04/00→05/06					
316 CDI 4x4	115	08/02→05/06					
<b>MERCEDES-BENZ - SPRINTER 3-t Pritsche/Fahrgestell (906) 06/06→</b>							
<b> Bremsbelagsatz, Scheibenbremse</b>							
209 CDI (906.111, 906.113, 906.211, 906.213)	65	06/06→12/09	←			13.0460-4826.2 604826	BRE 29192 20,7 + WE / - WK + Zub
210 CDI (906.111, 906.113, 906.211, 906.213)	70	03/09→05/16				13.0460-4877.2 604877	BRE 29192 20,3 + WE / - WK + Zub
211 CDI (906.111, 906.113, 906.211, 906.213)	80	06/06→12/09	→			13.0460-3837.2 603837	BOS 29190 20,2 + WK + Zub
211 CDI (906.111, 906.113, 906.211, 906.213)	84	04/16→					
213 CDI (906.111, 906.113, 906.211, 906.213)	95	06/06→12/09					
213 CDI (906.111, 906.113, 906.211, 906.213)	95	03/09→05/16					
214 CDI (906.111, 906.113, 906.211, 906.213)	105	04/16→					
215 CDI (906.111, 906.113, 906.211, 906.213)	110	06/06→12/09					
216 (906.113, 906.213)	115	09/08→05/16					
↓							







	kW					! #		
<b>MERCEDES-BENZ - SPRINTER 3-t Pritsche/Fahrgestell (906) 06/06 →</b>								
<b> Bremsbelagsatz, Scheibenbremse</b>								
216 CDI (906.111, 906.113, 906.211, 906.213)	120	03/09 →	←				<b>13.0460-4826.2 604826</b>	BRE 29192 20,7 + WE / - WK + Zub
218 CDI (906.111, 906.113, 906.211, 906.213)	135	06/06 → 12/09					<b>13.0460-4877.2 604877</b>	BRE 29192 20,3 + WE / - WK + Zub
219 CDI / BlueTEC (906.111, 906.113, 906.211, 906.213)	140	03/09 → 05/16	→				<b>13.0460-3837.2 603837</b>	BOS 29190 20,2 + WK + Zub
224 (906.113, 906.213)	190	06/06 → 12/13						
<b>Warnkontakt, Bremsbelagverschleiß</b>								
209 CDI (906.111, 906.113, 906.211, 906.213)	65	06/06 → 12/09	←			2	<b>24.8190-0424.2 620424</b>	L= 103,2
210 CDI (906.111, 906.113, 906.211, 906.213)	70	03/09 → 05/16	→	nur in Verbindung mit: 13.0460-3837.2		2	<b>24.8190-0418.2 620418</b>	L= 95
211 CDI (906.111, 906.113, 906.211, 906.213)	80	06/06 → 12/09						
211 CDI (906.111, 906.113, 906.211, 906.213)	84	04/16 →						
213 CDI (906.111, 906.113, 906.211, 906.213)	95	06/06 → 12/09						
213 CDI (906.111, 906.113, 906.211, 906.213)	95	03/09 → 05/16						
214 CDI (906.111, 906.113, 906.211, 906.213)	105	04/16 →						
215 CDI (906.111, 906.113, 906.211, 906.213)	110	06/06 → 12/09						
216 (906.113, 906.213)	115	09/08 → 05/16						
216 CDI (906.111, 906.113, 906.211, 906.213)	120	03/09 →						
218 CDI (906.111, 906.113, 906.211, 906.213)	135	06/06 → 12/09						
219 CDI / BlueTEC (906.111, 906.113, 906.211, 906.213)	140	03/09 → 05/16						
224 (906.113, 906.213)	190	06/06 → 12/13						
<b> Bremsscheibe</b>								
209 CDI (906.111, 906.113, 906.211, 906.213)	65	06/06 → 12/09	←				<b>24.0128-0203.1 428203</b>	Ø 300 28 25 V + S
210 CDI (906.111, 906.113, 906.211, 906.213)	70	03/09 → 05/16	→				<b>24.0116-0121.1 416121</b>	Ø 298 16 14 + S
211 CDI (906.111, 906.113, 906.211, 906.213)	80	06/06 → 12/09						
211 CDI (906.111, 906.113, 906.211, 906.213)	84	04/16 →						
213 CDI (906.111, 906.113, 906.211, 906.213)	95	06/06 → 12/09						
213 CDI (906.111, 906.113, 906.211, 906.213)	95	03/09 → 05/16						
214 CDI (906.111, 906.113, 906.211, 906.213)	105	04/16 →						
215 CDI (906.111, 906.113, 906.211, 906.213)	110	06/06 → 12/09						
216 (906.113, 906.213)	115	09/08 → 05/16						
216 CDI (906.111, 906.113, 906.211, 906.213)	120	03/09 →						
218 CDI (906.111, 906.113, 906.211, 906.213)	135	06/06 → 12/09						
219 CDI / BlueTEC (906.111, 906.113, 906.211, 906.213)	140	03/09 → 05/16						
↓								

	kW					! #		
<b>MERCEDES-BENZ - SPRINTER 3-t Pritsche/Fahrgestell (906) 06/06 →</b>								
 <b>Bremsscheibe</b>								
224 (906.113, 906.213)	190	06/06 → 12/13	←			24.0128-0203.1	428203	Ø 300 28 25 V + S
			→			24.0116-0121.1	416121	Ø 298 16 14 + S
<b>MERCEDES-BENZ - SPRINTER 4,6-t Kasten (906) 06/06 →</b>								
 <b>Bremsbelagsatz, Scheibenbremse</b>								
411 CDI (906.653, 906.655, 906.657)	80	06/09 → 12/09	←			13.0460-4827.2	604827	BRE 29200 21,0 + WE / - WK + Zub
413 CDI (906.653, 906.655, 906.657)	95	06/06 → 05/16	→			13.0460-3842.2	603842	BOS 29217 20,5 + WE / - WK
414 CDI	105	05/16 →						
415 CDI (906.653, 906.655, 906.657)	110	06/09 → 12/09						
416 CDI (906.653, 906.655, 906.657)	120	03/09 →						
418 CDI (906.653, 906.655, 906.657)	135	06/09 → 05/16						
419 CDI (906.653, 906.655, 906.657)	140	03/09 →						
424 (906.655, 906.657, 906.653)	190	06/06 → 12/13						
<b>Warnkontakt, Bremsbelagsverschleiß</b>								
411 CDI (906.653, 906.655, 906.657)	80	06/09 → 12/09	←		2	24.8190-0424.2	620424	L= 103,2
413 CDI (906.653, 906.655, 906.657)	95	06/06 → 05/16	→		2	24.8190-0005.2	620005	L= 84
414 CDI	105	05/16 →						
415 CDI (906.653, 906.655, 906.657)	110	06/09 → 12/09						
416 CDI (906.653, 906.655, 906.657)	120	03/09 →						
418 CDI (906.653, 906.655, 906.657)	135	06/09 → 05/16						
419 CDI (906.653, 906.655, 906.657)	140	03/09 →						
424 (906.655, 906.657, 906.653)	190	06/06 → 12/13						
 <b>Bremsscheibe</b>								
411 CDI (906.653, 906.655, 906.657)	80	06/09 → 12/09	←			24.0128-0203.1	428203	Ø 300 28 25 V + S
413 CDI (906.653, 906.655, 906.657)	95	06/06 → 05/16	→			24.0128-0202.1	428202	Ø 303 28 25 V
414 CDI	105	05/16 →						
415 CDI (906.653, 906.655, 906.657)	110	06/09 → 12/09						
416 CDI (906.653, 906.655, 906.657)	120	03/09 →						
418 CDI (906.653, 906.655, 906.657)	135	06/09 → 05/16						
419 CDI (906.653, 906.655, 906.657)	140	03/09 →						
424 (906.655, 906.657, 906.653)	190	06/06 → 12/13						
<b>MERCEDES-BENZ - SPRINTER 4,6-t Pritsche/Fahrgestell (906) 06/06 →</b>								
 <b>Bremsbelagsatz, Scheibenbremse</b>								
411 CDI (906.153, 906.155, 906.253, 906.255)	80	06/09 → 12/09	←			13.0460-4827.2	604827	BRE 29200 21,0 + WE / - WK + Zub
413 CDI	95	03/09 →	→			13.0460-3842.2	603842	BOS 29217 20,5 + WE / - WK
414 CDI	105	05/16 →						
415 CDI (906.153, 906.155, 906.253, 906.255)	110	06/06 → 12/09						
416 CDI (906.153, 906.155, 906.253, 906.255)	120	03/09 →						
418 CDI (906.153, 906.155, 906.253, 906.255)	135	06/06 → 12/09						
419 CDI (906.153, 906.155, 906.253, 906.255)	140	03/09 →						
424 (906.153, 906.155, 906.253, 906.255)	190	06/06 → 12/13						
			↓					











	kW			 	! #		
<b>MERCEDES-BENZ - SPRINTER 4,6-t Pritsche/Fahrgestell (906) 06/06→</b>							
<b>Warnkontakt, Bremsbelagverschleiß</b>							
411 CDI (906.153, 906.155, 906.253, 906.255)	80	06/09→12/09	←		2	24.8190-0424.2 620424	L= 103,2
			→		2	24.8190-0005.2 620005	L= 84
413 CDI	95	03/09→					
414 CDI	105	05/16→					
415 CDI (906.153, 906.155, 906.253, 906.255)	110	06/06→12/09					
416 CDI (906.153, 906.155, 906.253, 906.255)	120	03/09→					
418 CDI (906.153, 906.155, 906.253, 906.255)	135	06/06→12/09					
419 CDI (906.153, 906.155, 906.253, 906.255)	140	03/09→					
424 (906.153, 906.155, 906.253, 906.255)	190	06/06→12/13					
<b> Brems Scheibe</b>							
411 CDI (906.153, 906.155, 906.253, 906.255)	80	06/09→12/09	←			24.0128-0203.1 428203	Ø 300 28 25 V + S
			→			24.0128-0202.1 428202	Ø 303 28 25 V
413 CDI	95	03/09→					
414 CDI	105	05/16→					
415 CDI (906.153, 906.155, 906.253, 906.255)	110	06/06→12/09					
416 CDI (906.153, 906.155, 906.253, 906.255)	120	03/09→					
418 CDI (906.153, 906.155, 906.253, 906.255)	135	06/06→12/09					
419 CDI (906.153, 906.155, 906.253, 906.255)	140	03/09→					
424 (906.153, 906.155, 906.253, 906.255)	190	06/06→12/13					
<b>MERCEDES-BENZ - SPRINTER 4-t Bus (904) 02/96→05/06</b>							
<b> Bremsbelagsatz, Scheibenbremse</b>							
408 CDI	60	04/00→05/06	←			13.0460-7196.2 607196	ATE 21576 20,7 + WE / - WK
411 CDI	80	04/00→05/06				13.0460-7909.2 607909	PER 29153 20,0 + WE / - WK + Zub
413 CDI	95	04/00→05/06					
414	105	02/96→05/06					
416 CDI	115	04/00→05/06	→			13.0460-7909.2 607909	PER 29153 20,0 + WE / - WK + Zub
<b>Warnkontakt, Bremsbelagverschleiß</b>							
408 CDI	60	04/00→05/06	←		2	24.8190-0417.2 620417	L= 99 L= 167
411 CDI	80	04/00→05/06					
413 CDI	95	04/00→05/06	→		2	24.8190-0417.2 620417	L= 99 L= 167
414	105	02/96→05/06					
416 CDI	115	04/00→05/06					
<b>Zubehörsatz, Scheibenbremsbelag</b>							
408 CDI	60	04/00→05/06	←	nur in Verbindung mit: Vomr.13.0460-7904.2		13.0460-0281.2 610281	PER
411 CDI	80	04/00→05/06					
413 CDI	95	04/00→05/06	→	nur in Verbindung mit: Vomr.13.0460-7904.2		13.0460-0281.2 610281	PER
414	105	02/96→05/06					
416 CDI	115	04/00→05/06					
<b> Brems Scheibe</b>							
408 CDI	60	04/00→05/06	←	für Brems Scheibendurchmesser [mm]: 276		24.0122-0161.1 422161	Ø 276 22 19 V + S
411 CDI	80	04/00→05/06				24.0322-0161.1 522161	Ø 276 22 19 V + S
413 CDI	95	04/00→05/06					
414	105	02/96→05/06	←	für Brems Scheibendurchmesser [mm]: 285		24.0122-0245.1 422245	Ø 285 22 19 V
416 CDI	115	04/00→05/06	→			24.0122-0196.1 422196	Ø 285 21,9 19 V
<b>MERCEDES-BENZ - SPRINTER 4-t Kasten (904) 02/96→05/06</b>							
<b> Bremsbelagsatz, Scheibenbremse</b>							
408 CDI	60	04/00→05/06	←			13.0460-7196.2 607196	ATE 21576 20,7 + WE / - WK
408 D	58	02/96→05/06				13.0460-7909.2 607909	PER 29153 20,0 + WE / - WK + Zub
410 D 4x4	75	05/97→05/06					
411 CDI	80	04/00→05/06					
411 CDI 4x4	80	04/00→05/06					
↓							











	kW				! #		
<b>MERCEDES-BENZ - SPRINTER 4-t Kasten (904) 02/96→05/06</b>							
<b> Bremsbelagsatz, Scheibenbremse</b>							
412 D	85	02/96→05/06	➔			<b>13.0460-7909.2 607909</b>	PER 29153 20,0 + WE / - WK + Zub
412 D	90	02/96→05/06					
412 D 4x4	85	05/97→05/06					
412 D 4x4	90	05/97→05/06					
413 CDI	95	04/00→05/06					
413 CDI 4x4	95	04/00→05/06					
414 (904.062, 904.063, 904.662, 904.663)	105	02/96→05/06					
414 4x4 (904.062, 904.063, 904.662, 904.663)	105	05/97→05/06					
416 CDI	115	04/00→05/06					
416 CDI 4x4	115	04/00→05/06					
410 D	75	02/96→05/06	➔	09/96→		<b>13.0460-7196.2 607196</b>	ATE 21576 20,7 + WE / - WK
						<b>13.0460-7909.2 607909</b>	PER 29153 20,0 + WE / - WK + Zub
			➔	09/96→		<b>13.0460-7909.2 607909</b>	PER 29153 20,0 + WE / - WK + Zub
<b>Warnkontakt, Bremsbelagsverschleiß</b>							
408 CDI	60	04/00→05/06	➔		2	<b>24.8190-0417.2 620417</b>	L= 99 L= 167
408 D	58	02/96→05/06					
410 D 4x4	75	05/97→05/06	➔		2	<b>24.8190-0417.2 620417</b>	L= 99 L= 167
411 CDI	80	04/00→05/06					
411 CDI 4x4	80	04/00→05/06					
412 D	85	02/96→05/06					
412 D	90	02/96→05/06					
412 D 4x4	85	05/97→05/06					
412 D 4x4	90	05/97→05/06					
413 CDI	95	04/00→05/06					
413 CDI 4x4	95	04/00→05/06					
414 (904.062, 904.063, 904.662, 904.663)	105	02/96→05/06					
414 4x4 (904.062, 904.063, 904.662, 904.663)	105	05/97→05/06					
416 CDI	115	04/00→05/06					
416 CDI 4x4	115	04/00→05/06					
410 D	75	02/96→05/06	➔	09/96→	2	<b>24.8190-0417.2 620417</b>	L= 99 L= 167
			➔	09/96→	2	<b>24.8190-0417.2 620417</b>	L= 99 L= 167
<b>Zubehörsatz, Scheibenbremsbelag</b>							
408 CDI	60	04/00→05/06	➔	nur in Verbindung mit: Vornr.13.0460-7904.2		<b>13.0460-0281.2 610281</b>	PER
408 D	58	02/96→05/06					
410 D 4x4	75	05/97→05/06	➔	nur in Verbindung mit: Vornr.13.0460-7904.2		<b>13.0460-0281.2 610281</b>	PER
411 CDI	80	04/00→05/06					
411 CDI 4x4	80	04/00→05/06					
412 D	85	02/96→05/06					
412 D	90	02/96→05/06					
412 D 4x4	85	05/97→05/06					
412 D 4x4	90	05/97→05/06					
413 CDI	95	04/00→05/06					
413 CDI 4x4	95	04/00→05/06					
414 (904.062, 904.063, 904.662, 904.663)	105	02/96→05/06					
414 4x4 (904.062, 904.063, 904.662, 904.663)	105	05/97→05/06					
416 CDI	115	04/00→05/06					
416 CDI 4x4	115	04/00→05/06					
410 D	75	02/96→05/06	➔	09/96→; nur in Verbindung mit: Vornr.13.0460-7904.2		<b>13.0460-0281.2 610281</b>	PER
			➔	09/96→; nur in Verbindung mit: Vornr.13.0460-7904.2		<b>13.0460-0281.2 610281</b>	PER
<b> Bremsscheibe</b>							
408 CDI	60	04/00→05/06	➔	für Bremsscheibendurchmesser [mm]: 276		<b>24.0122-0161.1 422161</b>	Ø 276 22 19 V + S
408 D	58	02/96→05/06				<b>24.0322-0161.1 522161</b>	Ø 276 22 19 V + S
410 D 4x4	75	05/97→05/06					
411 CDI	80	04/00→05/06	➔	für Bremsscheibendurchmesser [mm]: 285		<b>24.0122-0245.1 422245</b>	Ø 285 22 19 V
411 CDI 4x4	80	04/00→05/06					
412 D	85	02/96→05/06	➔			<b>24.0122-0196.1 422196</b>	Ø 285 21,9 19 V
412 D	90	02/96→05/06					
412 D 4x4	85	05/97→05/06					
412 D 4x4	90	05/97→05/06					
413 CDI	95	04/00→05/06					
413 CDI 4x4	95	04/00→05/06					
↓							

	kW					! #		
<b>MERCEDES-BENZ - SPRINTER 4-t Kasten (904) 02/96→05/06</b>								
<b>Bremsscheibe</b>								
414 (904.062, 904.063, 904.662, 904.663)	105	02/96→05/06	←	für Bremsscheibendurchmesser [mm]: 276			24.0122-0161.1 422161	Ø 276 22 19 V + S
414 4x4 (904.062, 904.063, 904.662, 904.663)	105	05/97→05/06	←	für Bremsscheibendurchmesser [mm]: 285			24.0322-0161.1 522161	Ø 276 22 19 V + S
416 CDI	115	04/00→05/06	→				24.0122-0196.1 422196	Ø 285 22 19 V
416 CDI 4x4	115	04/00→05/06	→				24.0122-0196.1 422196	Ø 285 21,9 19 V
410 D	75	02/96→05/06	←	09/96→; für Bremsscheibendurchmesser [mm]: 276			24.0122-0161.1 422161	Ø 276 22 19 V + S
			←	09/96→; für Bremsscheibendurchmesser [mm]: 285			24.0322-0161.1 522161	Ø 276 22 19 V + S
			→	09/96→			24.0122-0245.1 422245	Ø 285 22 19 V
			→	09/96→			24.0122-0196.1 422196	Ø 285 21,9 19 V
<b>MERCEDES-BENZ - SPRINTER 4-t Pritsche/Fahrgestell (904) 02/96→05/06</b>								
<b>Bremsbelagsatz, Scheibenbremse</b>								
408 CDI	60	04/00→05/06	←				13.0460-7196.2 607196	ATE 21576 20,7 + WE / - WK
408 D	58	02/96→05/06	←				13.0460-7909.2 607909	PER 29153 20,0 + WE / - WK + Zub
410 D 4x4	75	05/97→05/06	←				13.0460-7909.2 607909	PER 29153 20,0 + WE / - WK + Zub
411 CDI	80	04/00→05/06	→				13.0460-7909.2 607909	PER 29153 20,0 + WE / - WK + Zub
411 CDI 4x4	80	04/00→05/06	→				13.0460-7909.2 607909	PER 29153 20,0 + WE / - WK + Zub
412 D	85	02/96→05/06	→				13.0460-7909.2 607909	PER 29153 20,0 + WE / - WK + Zub
412 D	90	02/96→05/06	→				13.0460-7909.2 607909	PER 29153 20,0 + WE / - WK + Zub
412 D 4x4	85	05/97→05/06	→				13.0460-7909.2 607909	PER 29153 20,0 + WE / - WK + Zub
412 D 4x4	90	05/97→05/06	→				13.0460-7909.2 607909	PER 29153 20,0 + WE / - WK + Zub
413 CDI	95	04/00→05/06	→				13.0460-7909.2 607909	PER 29153 20,0 + WE / - WK + Zub
413 CDI 4x4	95	04/00→05/06	→				13.0460-7909.2 607909	PER 29153 20,0 + WE / - WK + Zub
414 (904.012, 904.013, 904.612, 904.613)	105	02/95→05/06	→				13.0460-7909.2 607909	PER 29153 20,0 + WE / - WK + Zub
414 4x4 (904.012, 904.013, 904.612, 904.613)	105	05/97→05/06	→				13.0460-7909.2 607909	PER 29153 20,0 + WE / - WK + Zub
416 CDI	115	04/00→05/06	→				13.0460-7909.2 607909	PER 29153 20,0 + WE / - WK + Zub
416 CDI 4x4	115	04/00→05/06	→				13.0460-7909.2 607909	PER 29153 20,0 + WE / - WK + Zub
410 D	75	02/96→05/06	←	09/96→			13.0460-7196.2 607196	ATE 21576 20,7 + WE / - WK
			←	09/96→			13.0460-7909.2 607909	PER 29153 20,0 + WE / - WK + Zub
			→	09/96→			13.0460-7909.2 607909	PER 29153 20,0 + WE / - WK + Zub
<b>Warnkontakt, Bremsbelagsverschleiß</b>								
408 CDI	60	04/00→05/06	←		2	24.8190-0417.2 620417	L= 99 L= 167	
408 D	58	02/96→05/06	←		2	24.8190-0417.2 620417	L= 99 L= 167	
410 D 4x4	75	05/97→05/06	→		2	24.8190-0417.2 620417	L= 99 L= 167	
411 CDI	80	04/00→05/06	→		2	24.8190-0417.2 620417	L= 99 L= 167	
411 CDI 4x4	80	04/00→05/06	→		2	24.8190-0417.2 620417	L= 99 L= 167	
412 D	85	02/96→05/06	→		2	24.8190-0417.2 620417	L= 99 L= 167	
412 D	90	02/96→05/06	→		2	24.8190-0417.2 620417	L= 99 L= 167	
412 D 4x4	85	05/97→05/06	→		2	24.8190-0417.2 620417	L= 99 L= 167	
412 D 4x4	90	05/97→05/06	→		2	24.8190-0417.2 620417	L= 99 L= 167	
413 CDI	95	04/00→05/06	→		2	24.8190-0417.2 620417	L= 99 L= 167	
413 CDI 4x4	95	04/00→05/06	→		2	24.8190-0417.2 620417	L= 99 L= 167	
414 (904.012, 904.013, 904.612, 904.613)	105	02/95→05/06	→		2	24.8190-0417.2 620417	L= 99 L= 167	
414 4x4 (904.012, 904.013, 904.612, 904.613)	105	05/97→05/06	→		2	24.8190-0417.2 620417	L= 99 L= 167	
416 CDI	115	04/00→05/06	→		2	24.8190-0417.2 620417	L= 99 L= 167	
416 CDI 4x4	115	04/00→05/06	→		2	24.8190-0417.2 620417	L= 99 L= 167	
410 D	75	02/96→05/06	←	09/96→	2	24.8190-0417.2 620417	L= 99 L= 167	
			→	09/96→	2	24.8190-0417.2 620417	L= 99 L= 167	
<b>Zubehörsatz, Scheibenbremsbelag</b>								
408 CDI	60	04/00→05/06	←	nur in Verbindung mit: Vornr.13.0460-7904.2			13.0460-0281.2 610281	PER
408 D	58	02/96→05/06	←	nur in Verbindung mit: Vornr.13.0460-7904.2			13.0460-0281.2 610281	PER
410 D 4x4	75	05/97→05/06	→	nur in Verbindung mit: Vornr.13.0460-7904.2			13.0460-0281.2 610281	PER
411 CDI	80	04/00→05/06	→	nur in Verbindung mit: Vornr.13.0460-7904.2			13.0460-0281.2 610281	PER
411 CDI 4x4	80	04/00→05/06	→	nur in Verbindung mit: Vornr.13.0460-7904.2			13.0460-0281.2 610281	PER
412 D	85	02/96→05/06	→	nur in Verbindung mit: Vornr.13.0460-7904.2			13.0460-0281.2 610281	PER
412 D	90	02/96→05/06	→	nur in Verbindung mit: Vornr.13.0460-7904.2			13.0460-0281.2 610281	PER
412 D 4x4	85	05/97→05/06	→	nur in Verbindung mit: Vornr.13.0460-7904.2			13.0460-0281.2 610281	PER
412 D 4x4	90	05/97→05/06	→	nur in Verbindung mit: Vornr.13.0460-7904.2			13.0460-0281.2 610281	PER
413 CDI	95	04/00→05/06	→	nur in Verbindung mit: Vornr.13.0460-7904.2			13.0460-0281.2 610281	PER
413 CDI 4x4	95	04/00→05/06	→	nur in Verbindung mit: Vornr.13.0460-7904.2			13.0460-0281.2 610281	PER
414 (904.012, 904.013, 904.612, 904.613)	105	02/95→05/06	→	nur in Verbindung mit: Vornr.13.0460-7904.2			13.0460-0281.2 610281	PER
↓								



	kw				! #		
<b>MERCEDES-BENZ - SPRINTER 4-t Pritsche/Fahrgestell (904) 02/96→05/06</b>							
<b>Zubehörsatz, Scheibenbremsbelag</b>							
414 4x4 (904.012, 904.013, 904.612, 904.613)	105	05/97→05/06	←	nur in Verbindung mit: Vornr.13.0460-7904.2		13.0460-0281.2 610281	PER
416 CDI	115	04/00→05/06	→	nur in Verbindung mit: Vornr.13.0460-7904.2		13.0460-0281.2 610281	PER
416 CDI 4x4	115	04/00→05/06	→	nur in Verbindung mit: Vornr.13.0460-7904.2		13.0460-0281.2 610281	PER
410 D	75	02/96→05/06	←	09/96→; nur in Verbindung mit: Vornr.13.0460-7904.2		13.0460-0281.2 610281	PER
			→	09/96→; nur in Verbindung mit: Vornr.13.0460-7904.2		13.0460-0281.2 610281	PER
<b> Bremsscheibe</b>							
408 CDI	60	04/00→05/06	←	für Bremsscheibendurchmesser [mm]: 276		24.0122-0161.1 422161	Ø 276 22 19 V + S
408 D	58	02/96→05/06	→			24.0322-0161.1 522161	Ø 276 22 19 V + S
410 D 4x4	75	05/97→05/06	→				
411 CDI	80	04/00→05/06	←	für Bremsscheibendurchmesser [mm]: 285		24.0122-0245.1 422245	Ø 285 22 19 V
411 CDI 4x4	80	04/00→05/06	→				
412 D	85	02/96→05/06	→			24.0122-0196.1 422196	Ø 285 21,9 19 V
412 D	90	02/96→05/06	→				
412 D 4x4	85	05/97→05/06	→				
412 D 4x4	90	05/97→05/06	→				
413 CDI	95	04/00→05/06	→				
413 CDI 4x4	95	04/00→05/06	→				
414 (904.012, 904.013, 904.612, 904.613)	105	02/95→05/06	→				
414 4x4 (904.012, 904.013, 904.612, 904.613)	105	05/97→05/06	→				
416 CDI	115	04/00→05/06	→				
416 CDI 4x4	115	04/00→05/06	→				
410 D	75	02/96→05/06	←	09/96→; für Bremsscheibendurchmesser [mm]: 276		24.0122-0161.1 422161	Ø 276 22 19 V + S
			←	09/96→; für Bremsscheibendurchmesser [mm]: 285		24.0322-0161.1 522161	Ø 276 22 19 V + S
			←	09/96→; für Bremsscheibendurchmesser [mm]: 285		24.0122-0245.1 422245	Ø 285 22 19 V
			→	09/96→		24.0122-0196.1 422196	Ø 285 21,9 19 V
<b>MERCEDES-BENZ - SPRINTER 5-t Bus 06/06→</b>							
<b> Bremsbelagsatz, Scheibenbremse</b>							
513 CDI (906.653, 906.655, 906.657)	95	06/06→	←	03/09→		13.0460-4827.2 604827	BRE 29200 21,0 + WE / - WK + Zub
			→	03/09→		13.0460-3842.2 603842	BOS 29217 20,5 + WE / - WK
516 CDI	120	03/09→	←			13.0460-4827.2 604827	BRE 29200 21,0 + WE / - WK + Zub
519 CDI / BlueTEC	140	03/09→	→			13.0460-3842.2 603842	BOS 29217 20,5 + WE / - WK
<b>Warnkontakt, Bremsbelagsverschleiß</b>							
513 CDI (906.653, 906.655, 906.657)	95	06/06→	←	03/09→	2	24.8190-0424.2 620424	L= 103,2
			→	03/09→	2	24.8190-0005.2 620005	L= 84
516 CDI	120	03/09→	←		2	24.8190-0424.2 620424	L= 103,2
519 CDI / BlueTEC	140	03/09→	→		2	24.8190-0005.2 620005	L= 84
<b> Bremsscheibe</b>							
513 CDI (906.653, 906.655, 906.657)	95	06/06→	←	03/09→		24.0128-0203.1 428203	Ø 300 28 25 V + S
			→	03/09→		24.0128-0202.1 428202	Ø 303 28 25 V
516 CDI	120	03/09→	←			24.0128-0203.1 428203	Ø 300 28 25 V + S
519 CDI / BlueTEC	140	03/09→	→			24.0128-0202.1 428202	Ø 303 28 25 V
<b>MERCEDES-BENZ - SPRINTER 5-t Kasten (906) 06/06→</b>							
<b> Bremsbelagsatz, Scheibenbremse</b>							
509 CDI (906.653, 906.655, 906.657)	65	06/06→12/09	←			13.0460-4827.2 604827	BRE 29200 21,0 + WE / - WK + Zub
510 CDI (906.653, 906.655, 906.657)	70	03/09→05/16	→			13.0460-3842.2 603842	BOS 29217 20,5 + WE / - WK
511 CDI (906.653, 906.655, 906.657)	80	06/06→12/09	→				
511 CDI (906.653, 906.655, 906.657)	84	05/16→	→				
511 CDI 4x4 (906.653, 906.655, 906.657)	80	06/06→12/09	→				
↓							

	kW			 	! #		
<b>MERCEDES-BENZ - SPRINTER 5-t Kasten (906) 06/06→</b>							
<b> Bremsbelagsatz, Scheibenbremse</b>							
513 CDI 4x4 (906.653, 906.655, 906.657)	95	06/06→	←			<b>13.0460-4827.2 604827</b>	BRE 29200 21,0 + WE / - WK + Zub
514 CDI (906.653, 906.655, 906.657)	105	05/16→	→			<b>13.0460-3842.2 603842</b>	BOS 29217 20,5 + WE / - WK
514 CDI 4x4 (906.653, 906.655, 906.657)	105	05/16→					
515 CDI (906.653, 906.655, 906.657)	110	06/06→12/09					
515 CDI 4x4 (906.653, 906.655, 906.657)	110	06/06→12/09					
516 CDI (906.653, 906.655, 906.657)	120	03/09→					
516 CDI 4x4 (906.653, 906.655, 906.657)	120	06/06→					
518 CDI (906.653, 906.655, 906.657)	135	06/06→12/09					
518 CDI 4x4 (906.653, 906.655, 906.657)	135	06/06→12/09					
519 CDI / BlueTEC (906.653, 906.655, 906.657)	140	03/09→					
519 CDI / BlueTEC 4x4 (906.653, 906.655, 906.657)	140	03/09→					
524 (906.653, 906.655, 906.657)	190	06/06→12/13					
513 CDI (906.653, 906.655, 906.657)	95	06/06→	←	03/09→		<b>13.0460-4827.2 604827</b>	BRE 29200 21,0 + WE / - WK + Zub
			→	03/09→		<b>13.0460-3842.2 603842</b>	BOS 29217 20,5 + WE / - WK
<b>Warnkontakt, Bremsbelagverschleiß</b>							
509 CDI (906.653, 906.655, 906.657)	65	06/06→12/09	←		2	<b>24.8190-0424.2 620424</b>	L= 103,2
510 CDI (906.653, 906.655, 906.657)	70	03/09→05/16	→		2	<b>24.8190-0005.2 620005</b>	L= 84
511 CDI (906.653, 906.655, 906.657)	80	06/06→12/09					
511 CDI (906.653, 906.655, 906.657)	84	05/16→					
511 CDI 4x4 (906.653, 906.655, 906.657)	80	06/06→12/09					
513 CDI 4x4 (906.653, 906.655, 906.657)	95	06/06→					
514 CDI (906.653, 906.655, 906.657)	105	05/16→					
514 CDI 4x4 (906.653, 906.655, 906.657)	105	05/16→					
515 CDI (906.653, 906.655, 906.657)	110	06/06→12/09					
515 CDI 4x4 (906.653, 906.655, 906.657)	110	06/06→12/09					
516 CDI (906.653, 906.655, 906.657)	120	03/09→					
516 CDI 4x4 (906.653, 906.655, 906.657)	120	06/06→					
518 CDI (906.653, 906.655, 906.657)	135	06/06→12/09					
518 CDI 4x4 (906.653, 906.655, 906.657)	135	06/06→12/09					
519 CDI / BlueTEC (906.653, 906.655, 906.657)	140	03/09→					
519 CDI / BlueTEC 4x4 (906.653, 906.655, 906.657)	140	03/09→					
524 (906.653, 906.655, 906.657)	190	06/06→12/13					
513 CDI (906.653, 906.655, 906.657)	95	06/06→	←	03/09→	2	<b>24.8190-0424.2 620424</b>	L= 103,2
			→	03/09→	2	<b>24.8190-0005.2 620005</b>	L= 84
<b> Bremsscheibe</b>							
509 CDI (906.653, 906.655, 906.657)	65	06/06→12/09	←			<b>24.0128-0203.1 428203</b>	Ø 300 28 25 V + S
510 CDI (906.653, 906.655, 906.657)	70	03/09→05/16	→			<b>24.0128-0202.1 428202</b>	Ø 303 28 25 V
511 CDI (906.653, 906.655, 906.657)	80	06/06→12/09					
511 CDI (906.653, 906.655, 906.657)	84	05/16→					
511 CDI 4x4 (906.653, 906.655, 906.657)	80	06/06→12/09					
↓							



**MERCEDES-BENZ - SPRINTER 5-t Kasten (906) 06/06→**

<b>Bremsscheibe</b>							
513 CDI 4x4 (906.653, 906.655, 906.657) 514 CDI (906.653, 906.655, 906.657) 514 CDI 4x4 (906.653, 906.655, 906.657) 515 CDI (906.653, 906.655, 906.657) 515 CDI 4x4 (906.653, 906.655, 906.657) 516 CDI (906.653, 906.655, 906.657) 516 CDI 4x4 (906.653, 906.655, 906.657) 518 CDI (906.653, 906.655, 906.657) 518 CDI 4x4 (906.653, 906.655, 906.657) 519 CDI / BlueTEC (906.653, 906.655, 906.657) 519 CDI / BlueTEC 4x4 (906.653, 906.655, 906.657) 524 (906.653, 906.655, 906.657)	95	06/06→	←		24.0128-0203.1	428203	Ø 300 28 25 V + S
	105	05/16→	→		24.0128-0202.1	428202	Ø 303 28 25 V
105	05/16→						
110	06/06→12/09						
110	06/06→12/09						
120	03/09→						
120	06/06→						
135	06/06→12/09						
135	06/06→12/09						
140	03/09→						
140	03/09→						
190	06/06→12/13						
513 CDI (906.653, 906.655, 906.657)	95	06/06→	←	03/09→	24.0128-0203.1	428203	Ø 300 28 25 V + S
			→	03/09→	24.0128-0202.1	428202	Ø 303 28 25 V

**MERCEDES-BENZ - SPRINTER 5-t Pritsche/Fahrgestell (905) 04/01→05/06**

<b>Bremsbelagsatz, Scheibenbremse</b>							
616 CDI (905.612, 905.613, 905.622, 905.623)	115	04/01→05/06	←		13.0460-4975.2	604975	BRE 29160 20,8 + WE / - WK
			→		13.0460-7909.2	607909	PER 29153 20,0 + WE / - WK + Zub
					13.0460-6015.2	606015	ATE 29835 22,0 + WE / - WK

**Warnkontakt, Bremsbelagverschleiß**

616 CDI (905.612, 905.613, 905.622, 905.623)	115	04/01→05/06	←	nur in Verbindung mit: 13.0460-4975.2	2	24.8190-0415.2	620415	L= 238 L2= 148
			←		2	24.8190-0417.2	620417	L= 99 L= 167
				→	nur in Verbindung mit: 13.0460-6015.2	2	24.8190-0423.2	620423

**Zubehörsatz, Scheibenbremsbelag**









616 CDI (905.612, 905.613, 905.622, 905.623)	115	04/01→05/06	←	nur in Verbindung mit: Vornr.13.0460-7904.2		13.0460-0281.2	610281	PER
--	-----	-------------	---	--	--	----------------	--------	-----









<b>Bremsscheibe</b>							
616 CDI (905.612, 905.613, 905.622, 905.623)	115	04/01→05/06	←		24.0122-0161.1	422161	Ø 276 22 19 V + S
					24.0126-0144.1	426144	Ø 290 26 23 V
					24.0322-0161.1	522161	Ø 276 22 19 V + S













**MERCEDES-BENZ - SPRINTER 5-t Pritsche/Fahrgestell (906) 06/06→**













<b>Bremsbelagsatz, Scheibenbremse</b>							
509 CDI (906.153, 906.155, 906.253, 906.255) 510 CDI (906.153, 906.155, 906.253, 906.255)	65	06/06→12/09	←		13.0460-4827.2	604827	BRE 29200 21,0 + WE / - WK + Zub
	70	03/09→	→		13.0460-3842.2	603842	BOS 29217 20,5 + WE / - WK
511 CDI (906.153, 906.155, 906.253, 906.255)	80	06/06→12/09					
511 CDI (906.153, 906.155, 906.253, 906.255)	84	05/16→					
511 CDI 4x4 (906.155, 906.253, 906.255)	80	06/06→12/09					
513 CDI 4x4 (906.155, 906.253, 906.255)	95	05/11→05/16					
514 CDI (906.153, 906.155, 906.253, 906.255)	105	05/16→					
514 CDI 4x4 (906.153, 906.155, 906.253, 906.255)	105	05/16→					















	kW			 	! #		
<b>MERCEDES-BENZ - SPRINTER 5-t Pritsche/Fahrgestell (906) 06/06 →</b>							
<b> Bremsbelagsatz, Scheibenbremse</b>							
515 CDI (906.153, 906.155, 906.253, 906.255)	110	06/06 → 12/09	←			<b>13.0460-4827.2 604827</b>	BRE 29200 21,0 + WE / - WK + Zub
515 CDI 4x4 (906.153, 906.155, 906.253, 906.255)	110	06/06 → 12/09	→			<b>13.0460-3842.2 603842</b>	BOS 29217 20,5 + WE / - WK
516 (906.153, 906.155, 906.253, 906.255)	115	09/08 →					
516 CDI (906.153, 906.155, 906.253, 906.255)	120	03/09 →					
516 CDI 4x4 (906.153, 906.155, 906.255)	120	05/11 →					
516 NGT (906.153, 906.155, 906.253, 906.255)	115	09/08 →					
518 CDI (906.153, 906.155, 906.253, 906.255)	135	06/06 → 12/09					
518 CDI 4x4 (906.153, 906.155, 906.253, 906.255)	135	06/06 → 12/09					
519 CDI / BlueTEC (906.153, 906.155, 906.253, 906.255)	140	03/09 →					
519 CDI / BlueTEC 4x4 (906.153, 906.155, 906.253, ...)	140	03/09 →					
524 (906.153, 906.155, 906.253, 906.255)	190	06/06 → 12/13					
513 CDI (906.155, 906.253, 906.255)	95	06/06 → 05/16	←	03/09 →		<b>13.0460-4827.2 604827</b>	BRE 29200 21,0 + WE / - WK + Zub
			→	03/09 →		<b>13.0460-3842.2 603842</b>	BOS 29217 20,5 + WE / - WK
<b>Warnkontakt, Bremsbelagverschleiß</b>							
509 CDI (906.153, 906.155, 906.253, 906.255)	65	06/06 → 12/09	←		2	<b>24.8190-0424.2 620424</b>	L= 103,2
510 CDI (906.153, 906.155, 906.253, 906.255)	70	03/09 →	→		2	<b>24.8190-0005.2 620005</b>	L= 84
511 CDI (906.153, 906.155, 906.253, 906.255)	80	06/06 → 12/09					
511 CDI (906.153, 906.155, 906.253, 906.255)	84	05/16 →					
511 CDI 4x4 (906.153, 906.253, 906.255)	80	06/06 → 12/09					
513 CDI 4x4 (906.153, 906.253, 906.255)	95	05/11 → 05/16					
514 CDI (906.153, 906.155, 906.253, 906.255)	105	05/16 →					
514 CDI 4x4 (906.153, 906.155, 906.253, 906.255)	105	05/16 →					
515 CDI (906.153, 906.155, 906.253, 906.255)	110	06/06 → 12/09					
515 CDI 4x4 (906.153, 906.155, 906.253, 906.255)	110	06/06 → 12/09					
516 (906.153, 906.155, 906.253, 906.255)	115	09/08 →					
516 CDI (906.153, 906.155, 906.253, 906.255)	120	03/09 →					
516 CDI 4x4 (906.153, 906.155, 906.255)	120	05/11 →					
516 NGT (906.153, 906.155, 906.253, 906.255)	115	09/08 →					
518 CDI (906.153, 906.155, 906.253, 906.255)	135	06/06 → 12/09					
518 CDI 4x4 (906.153, 906.155, 906.253, 906.255)	135	06/06 → 12/09					
519 CDI / BlueTEC (906.153, 906.155, 906.253, 906.255)	140	03/09 →					
↓							







	kW					! #		
<b>MERCEDES-BENZ - SPRINTER 5-t Pritsche/Fahrgestell (906) 06/06 →</b>								
<b>Warnkontakt, Bremsbelagverschleiß</b>								
519 CDI / BlueTEC 4x4 (906.153, 906.155, 906.253,... 524 (906.153, 906.155, 906.253, 906.255))	140	03/09 →	←		2	24.8190-0424.2	620424	L= 103,2
			→		2	24.8190-0005.2	620005	L= 84
513 CDI (906.155, 906.253, 906.255)	95	06/06 → 05/16	←	03/09 →	2	24.8190-0424.2	620424	L= 103,2
			→	03/09 →	2	24.8190-0005.2	620005	L= 84
<b> Bremsscheibe</b>								
509 CDI (906.153, 906.155, 906.253, 906.255)	65	06/06 → 12/09	←			24.0128-0203.1	428203	Ø 300 28 25 V + S
			→			24.0128-0202.1	428202	Ø 303 28 25 V
510 CDI (906.153, 906.155, 906.253, 906.255)	70	03/09 →						
511 CDI (906.153, 906.155, 906.253, 906.255)	80	06/06 → 12/09						
511 CDI (906.153, 906.155, 906.253, 906.255)	84	05/16 →						
511 CDI 4x4 (906.155, 906.253, 906.255)	80	06/06 → 12/09						
513 CDI 4x4 (906.155, 906.253, 906.255)	95	05/11 → 05/16						
514 CDI (906.153, 906.155, 906.253, 906.255)	105	05/16 →						
514 CDI 4x4 (906.153, 906.155, 906.253, 906.255)	105	05/16 →						
515 CDI (906.153, 906.155, 906.253, 906.255)	110	06/06 → 12/09						
515 CDI 4x4 (906.153, 906.155, 906.253, 906.255)	110	06/06 → 12/09						
516 (906.153, 906.155, 906.253, 906.255)	115	09/08 →						
516 CDI (906.153, 906.155, 906.253, 906.255)	120	03/09 →						
516 CDI 4x4 (906.153, 906.155, 906.255)	120	05/11 →						
516 NGT (906.153, 906.155, 906.253, 906.255)	115	09/08 →						
518 CDI (906.153, 906.155, 906.253, 906.255)	135	06/06 → 12/09						
518 CDI 4x4 (906.153, 906.155, 906.253, 906.255)	135	06/06 → 12/09						
519 CDI / BlueTEC (906.153, 906.155, 906.253, 906.255)	140	03/09 →						
519 CDI / BlueTEC 4x4 (906.153, 906.155, 906.253,... 524 (906.153, 906.155, 906.253, 906.255))	140	03/09 →						
513 CDI (906.155, 906.253, 906.255)	95	06/06 → 05/16	←	03/09 →		24.0128-0203.1	428203	Ø 300 28 25 V + S
			→	03/09 →		24.0128-0202.1	428202	Ø 303 28 25 V
<b>MERCEDES-BENZ - SPRINTER CLASSIC 3,5-t Kasten (909) 09/13 →</b>								
<b> Bremsbelagsatz, Scheibenbremse</b>								
311 CDI (909.632, 909.633)	80	09/13 →	←			13.0460-4826.2	604826	BRE 29192 20,7 + WE / - WK + Zub
			→			13.0460-4877.2	604877	BRE 29192 20,3 + WE / - WK + Zub
			→			13.0460-3837.2	603837	BOS 29190 20,2 + WK + Zub
<b>Warnkontakt, Bremsbelagverschleiß</b>								
311 CDI (909.632, 909.633)	80	09/13 →	←		2	24.8190-0424.2	620424	L= 103,2
			→	nur in Verbindung mit: 13.0460-3837.2	2	24.8190-0418.2	620418	L= 95
↓								







	kw			 	! #		
<b>MERCEDES-BENZ - SPRINTER CLASSIC 3,5-t Kasten (909) 09/13→</b>							
 <b>Bremsscheibe</b>							
311 CDI (909.632, 909.633)	80	09/13→	←			24.0128-0203.1 428203	Ø 300 28 25 V + S
			→			24.0116-0121.1 416121	Ø 298 16 14 + S
<b>MERCEDES-BENZ - SPRINTER CLASSIC 4,6-t Bus (909) 09/13→</b>							
 <b>Bremsbelagsatz, Scheibenbremse</b>							
411 CDI (909.843)	80	09/13→	←			13.0460-4827.2 604827	BRE 29200 21,0 + WE / - WK + Zub
			→			13.0460-3842.2 603842	BOS 29217 20,5 + WE / - WK
<b>Warnkontakt, Bremsbelagverschleiß</b>							
411 CDI (909.843)	80	09/13→	←		2	24.8190-0424.2 620424	L= 103,2
			→		2	24.8190-0005.2 620005	L= 84
 <b>Bremsscheibe</b>							
411 CDI (909.843)	80	09/13→	←			24.0128-0203.1 428203	Ø 300 28 25 V + S
			→			24.0128-0202.1 428202	Ø 303 28 25 V
<b>MERCEDES-BENZ - SPRINTER Kipper (905) 04/01→</b>							
 <b>Bremsbelagsatz, Scheibenbremse</b>							
616 CDI (905.612, 905.622, 905.623)	115	04/01→	←	→ 05/06		13.0460-4975.2 604975	BRE 29160 20,8 + WE / - WK + Zub
			→	→ 05/06		13.0460-7909.2 607909	PER 29153 20,0 + WE / - WK + Zub
			→	→ 05/06		13.0460-6015.2 606015	ATE 29835 22,0 + WE / - WK
<b>Warnkontakt, Bremsbelagverschleiß</b>							
616 CDI (905.612, 905.622, 905.623)	115	04/01→	←	→ 05/06; nur in Verbindung mit: 13.0460-4975.2	2	24.8190-0415.2 620415	L= 238 L2= 148
			←	→ 05/06	2	24.8190-0417.2 620417	L= 99 L= 167
			→	→ 05/06; nur in Verbindung mit: 13.0460-6015.2	2	24.8190-0423.2 620423	L= 199 L2= 144
<b>Zubehörsatz, Scheibenbremsbelag</b>							
616 CDI (905.612, 905.622, 905.623)	115	04/01→	←	→ 05/06; nur in Verbindung mit: Vomnr.13.0460-7904.2		13.0460-0281.2 610281	PER
 <b>Bremsscheibe</b>							
616 CDI (905.612, 905.622, 905.623)	115	04/01→	←	→ 05/06		24.0122-0161.1 422161	Ø 276 22 19 V + S
						24.0126-0144.1 426144	Ø 290 26 23 V
						24.0322-0161.1 522161	Ø 276 22 19 V + S
<b>MERCEDES-BENZ - T1 Bus (601) 05/77→02/96</b>							
 <b>Bremsbelagsatz, Scheibenbremse</b>							
208 D 2.3	60	10/88→02/96	←			13.0460-4401.2 604401	ATE 20784 18,0 + WE / - WK
208 D 2.3 (601.371, 601.372, 601.376, 601.377)	58	10/88→02/96					
210 2.3	77	05/89→02/96					
210 D 2.8	70	11/88→02/96					
210 D 2.8	72	11/88→02/96					
<b>Warnkontakt, Bremsbelagverschleiß</b>							
208 D 2.3	60	10/88→02/96	←		4	24.8190-0401.2 620401	L= 95
208 D 2.3 (601.371, 601.372, 601.376, 601.377)	58	10/88→02/96					
210 2.3	77	05/89→02/96					
210 D 2.8	70	11/88→02/96					
210 D 2.8	72	11/88→02/96					
<b>Zubehörsatz, Scheibenbremsbelag</b>							
208 D 2.3	60	10/88→02/96	←			13.0460-0158.2 610158	ATE
208 D 2.3 (601.371, 601.372, 601.376, 601.377)	58	10/88→02/96					
210 2.3	77	05/89→02/96					
210 D 2.8	70	11/88→02/96					
210 D 2.8	72	11/88→02/96					
↓							

	kw			 	! #		
<b>MERCEDES-BENZ - T1 Bus (601) 05/77→02/96</b>							
 <b>Bremsscheibe</b>							
208 D 2.3	60	10/88→02/96	←			24.0116-0100.1 416100	Ø 280 16 13
208 D 2.3 (601.371, 601.372, 601.376, 601.377)	58	10/88→02/96					
210 2.3	77	05/89→02/96					
210 D 2.8	70	11/88→02/96					
210 D 2.8	72	11/88→02/96					
<b>MERCEDES-BENZ - T1 Bus (602) 04/77→02/96</b>							
 <b>Bremsbelagsatz, Scheibenbremse</b>							
308 D 2.3	58	05/90→02/96	←			13.0460-4401.2 604401	ATE 20784 18,0 + WE / - WK
308 D 2.3	60	06/89→02/96					
310 D 2.9	70	06/89→02/96					
310 D 2.9	72	06/90→02/96					
<b>Warnkontakt, Bremsbelagverschleiß</b>							
308 D 2.3	58	05/90→02/96	←		4	24.8190-0401.2 620401	L= 95
308 D 2.3	60	06/89→02/96					
310 D 2.9	70	06/89→02/96					
310 D 2.9	72	06/90→02/96					
<b>Zubehörsatz, Scheibenbremsbelag</b>							
308 D 2.3	58	05/90→02/96	←			13.0460-0158.2 610158	ATE
308 D 2.3	60	06/89→02/96				13.0460-0160.2 610160	ATE
310 D 2.9	70	06/89→02/96					
310 D 2.9	72	06/90→02/96					
 <b>Bremsscheibe</b>							
308 D 2.3	58	05/90→02/96	←	→ VA:A025460		24.0116-0100.1 416100	Ø 280 16 13
308 D 2.3	60	06/89→02/96					
310 D 2.9	70	06/89→02/96	←	VA:A025461→		24.0122-0140.1 422140	Ø 280 22 19
310 D 2.9	72	06/90→02/96					
<b>MERCEDES-BENZ - T1 Kasten (601, 611) 05/77→02/96</b>							
 <b>Bremsbelagsatz, Scheibenbremse</b>							
208 D 2.3	58	11/88→02/96	←			13.0460-4401.2 604401	ATE 20784 18,0 + WE / - WK
208 D 2.3	60	10/88→02/96					
210 2.3	70	07/82→02/96					
210 2.3	77	05/89→02/96					
210 D 2.8	70	10/88→02/96					
210 D 2.8	72	10/88→02/96					
<b>Warnkontakt, Bremsbelagverschleiß</b>							
208 D 2.3	58	11/88→02/96	←		4	24.8190-0401.2 620401	L= 95
208 D 2.3	60	10/88→02/96					
210 2.3	70	07/82→02/96					
210 2.3	77	05/89→02/96					
210 D 2.8	70	10/88→02/96					
210 D 2.8	72	10/88→02/96					
<b>Zubehörsatz, Scheibenbremsbelag</b>							
208 D 2.3	58	11/88→02/96	←			13.0460-0158.2 610158	ATE
208 D 2.3	60	10/88→02/96					
210 2.3	70	07/82→02/96					
210 2.3	77	05/89→02/96					
210 D 2.8	70	10/88→02/96					
210 D 2.8	72	10/88→02/96					
 <b>Bremsscheibe</b>							
208 D 2.3	58	11/88→02/96	←			24.0116-0100.1 416100	Ø 280 16 13
208 D 2.3	60	10/88→02/96					
210 2.3	70	07/82→02/96					
210 2.3	77	05/89→02/96					
210 D 2.8	70	10/88→02/96					
210 D 2.8	72	10/88→02/96					
<b>MERCEDES-BENZ - T1 Kasten (602) 10/82→02/96</b>							
 <b>Bremsbelagsatz, Scheibenbremse</b>							
308 D 2.3	58	11/88→02/96	←			13.0460-4401.2 604401	ATE 20784 18,0 + WE / - WK
308 D 2.3	60	06/89→02/96					
310 2.3	70	06/89→02/96					
310 D 2.9	70	06/89→02/96					
310 D 2.9	72	06/89→02/96					
<b>Warnkontakt, Bremsbelagverschleiß</b>							
308 D 2.3	58	11/88→02/96	←		4	24.8190-0401.2 620401	L= 95
308 D 2.3	60	06/89→02/96					
↓							

	kw			 	! #		
<b>MERCEDES-BENZ - T1 Kasten (602) 10/82→02/96</b>							
<b>Warnkontakt, Bremsbelagverschleiß</b>							
310 2.3	70	06/89→02/96	←		4	24.8190-0401.2 620401	L= 95
310 D 2.9	70	06/89→02/96					
310 D 2.9	72	06/89→02/96					
<b>Zubehörsatz, Scheibenbremsbelag</b>							
308 D 2.3	58	11/88→02/96	←			13.0460-0158.2 610158	ATE
308 D 2.3	60	06/89→02/96				13.0460-0160.2 610160	ATE
310 2.3	70	06/89→02/96					
310 D 2.9	70	06/89→02/96					
310 D 2.9	72	06/89→02/96					
<b> Bremsscheibe</b>							
308 D 2.3	58	11/88→02/96	←	→ VA:A025460		24.0116-0100.1 416100	Ø 280 16 13
308 D 2.3	60	06/89→02/96					
310 2.3	70	06/89→02/96	←	VA:A025461→		24.0122-0140.1 422140	Ø 280 22 19
310 D 2.9	70	06/89→02/96					
310 D 2.9	72	06/89→02/96					
<b>MERCEDES-BENZ - T1 Pritsche/Fahrgestell (601) 01/77→02/96</b>							
<b> Bremsbelagsatz, Scheibenbremse</b>							
208 D 2.3	58	11/88→02/96	←			13.0460-4401.2 604401	ATE 20784 18,0 + WE / - WK
208 D 2.3	60	06/89→02/96					
210 D 2.8	72	11/88→02/96					
210 D 2.9	70	11/88→02/96					
<b>Warnkontakt, Bremsbelagverschleiß</b>							
208 D 2.3	58	11/88→02/96	←		4	24.8190-0401.2 620401	L= 95
208 D 2.3	60	06/89→02/96					
210 D 2.8	72	11/88→02/96					
210 D 2.9	70	11/88→02/96					
<b>Zubehörsatz, Scheibenbremsbelag</b>							
208 D 2.3	58	11/88→02/96	←			13.0460-0158.2 610158	ATE
208 D 2.3	60	06/89→02/96					
210 D 2.8	72	11/88→02/96					
210 D 2.9	70	11/88→02/96					
<b> Bremsscheibe</b>							
208 D 2.3	58	11/88→02/96	←			24.0116-0100.1 416100	Ø 280 16 13
208 D 2.3	60	06/89→02/96					
210 D 2.8	72	11/88→02/96					
210 D 2.9	70	11/88→02/96					
<b>MERCEDES-BENZ - T1 Pritsche/Fahrgestell (602) 01/77→02/96</b>							
<b> Bremsbelagsatz, Scheibenbremse</b>							
308 D 2.3	58	06/89→02/96	←			13.0460-4401.2 604401	ATE 20784 18,0 + WE / - WK
308 D 2.3	60	06/89→02/96					
310 D 2.9	70	06/89→02/96					
310 D 2.9	72	06/89→02/96					
<b>Warnkontakt, Bremsbelagverschleiß</b>							
308 D 2.3	58	06/89→02/96	←		4	24.8190-0401.2 620401	L= 95
308 D 2.3	60	06/89→02/96					
310 D 2.9	70	06/89→02/96					
310 D 2.9	72	06/89→02/96					
<b>Zubehörsatz, Scheibenbremsbelag</b>							
308 D 2.3	58	06/89→02/96	←			13.0460-0158.2 610158	ATE
308 D 2.3	60	06/89→02/96				13.0460-0160.2 610160	ATE
310 D 2.9	70	06/89→02/96					
310 D 2.9	72	06/89→02/96					
<b> Bremsscheibe</b>							
308 D 2.3	58	06/89→02/96	←	→ VA:A025460		24.0116-0100.1 416100	Ø 280 16 13
308 D 2.3	60	06/89→02/96					
310 D 2.9	70	06/89→02/96	←	VA:A025461→		24.0122-0140.1 422140	Ø 280 22 19
310 D 2.9	72	06/89→02/96					
<b>MERCEDES-BENZ - Vaneo (414) 02/02→07/05</b>							
<b> Bremsbelagsatz, Scheibenbremse</b>							
1.6 (414.700)	60	02/02→07/05	←			13.0460-2828.2 602828	TRW 23070 19,5 + WE / - WK
1.6 (414.700)	75	02/02→07/05					
1.7 CDI (414.700)	55	02/02→07/05	→			13.0460-2855.2 602855	TRW 23138 14,6 - WE / - WK
1.7 CDI (414.700)	67	02/02→07/05				13.0470-2855.2 LD2855	TRW 23138 14,6 - WE / - WK
1.9 (414.700)	92	02/02→07/05					Ceramic
↓							



	kW					! #		
<b>MERCEDES-BENZ - Vaneo (414) 02/02→07/05</b>								
<b>Warnkontakt, Bremsbelagverschleiß</b>								
1.6 (414.700)	60	02/02→07/05	←			1	24.8190-0410.2 620410	L= 97,5
1.6 (414.700)	75	02/02→07/05						
1.7 CDI (414.700)	55	02/02→07/05						
1.7 CDI (414.700)	67	02/02→07/05						
1.9 (414.700)	92	02/02→07/05						
<b>Zubehörsatz, Scheibenbremsbelag</b>								
1.6 (414.700)	60	02/02→07/05	←				13.0460-0257.2 610257	
1.6 (414.700)	75	02/02→07/05						
1.7 CDI (414.700)	55	02/02→07/05	→				13.0460-0144.2 610144	TRW
1.7 CDI (414.700)	67	02/02→07/05						
1.9 (414.700)	92	02/02→07/05						
<b>Bremsscheibe</b>								
1.6 (414.700)	60	02/02→07/05	←				24.0122-0199.1 422199	Ø 270 22 19,4 V
1.6 (414.700)	75	02/02→07/05					24.0322-0199.1 522199	Ø 270 22 19,4 V
1.7 CDI (414.700)	55	02/02→07/05						
1.7 CDI (414.700)	67	02/02→07/05	→				24.0108-0111.1 408111	Ø 258 8 7
1.9 (414.700)	92	02/02→07/05					24.0308-0111.1 508111	Ø 258 8 7
<b>MERCEDES-BENZ - VARIO Bus 09/96→</b>								
<b>Bremsbelagsatz, Scheibenbremse</b>								
O 810 (670.373, 670.374)	75	09/96→12/10	←				13.0460-6015.2 606015	ATE 29835 22,0 + WE / - WK
O 812 (670.373, 670.674)	90	09/96→12/10	→	Achsnummer: 742.501/742.505			13.0460-6015.2 606015	ATE 29835 22,0 + WE / - WK
O 814 (670.373, 670.374)	100	09/96→12/10	→	Achsnummer: 741.130/741.131			13.0460-7909.2 607909	PER 29153 20,0 + WE / - WK + Zub
O 815 (670.373, 670.374)	112	09/96→12/10						
O 813 (670.373, 670.374)	95	01/06→	←	→ 12/13			13.0460-6015.2 606015	ATE 29835 22,0 + WE / - WK
O 816 D (670.373, 670.374)	115	01/06→	→	→ 12/13; Achsnummer: 742.501/742.505			13.0460-6015.2 606015	ATE 29835 22,0 + WE / - WK
O 818 D (670.373, 670.374)	130	09/06→	→	→ 12/13; Achsnummer: 741.130/741.131			13.0460-7909.2 607909	PER 29153 20,0 + WE / - WK + Zub
<b>Warnkontakt, Bremsbelagverschleiß</b>								
O 810 (670.373, 670.374)	75	09/96→12/10	←			2	24.8190-0415.2 620415	L= 238 L2= 148
O 812 (670.373, 670.674)	90	09/96→12/10						
O 814 (670.373, 670.374)	100	09/96→12/10						
O 815 (670.373, 670.374)	112	09/96→12/10						
O 813 (670.373, 670.374)	95	01/06→	←	→ 12/13		2	24.8190-0415.2 620415	L= 238 L2= 148
O 816 D (670.373, 670.374)	115	01/06→						
O 818 D (670.373, 670.374)	130	09/06→						
<b>Bremsscheibe</b>								
O 810 (670.373, 670.374)	75	09/96→12/10	←				24.0130-0103.1 430103	Ø 324 30 26 V
O 812 (670.373, 670.674)	90	09/96→12/10	→	Achsnummer: 741.130/741.131			24.0130-0198.1 430198	Ø 304 30 26 V
			→	Achsnummer: 742.501			24.0122-0196.1 422196	Ø 285 21,9 19 V
			→	Achsnummer: 742.501			24.0130-0190.1 430190	Ø 304 29,9 26 V
O 813 (670.373, 670.374)	95	01/06→	←	→ 12/13			24.0130-0103.1 430103	Ø 324 30 26 V
O 816 D (670.373, 670.374)	115	01/06→	→	→ 12/13; Achsnummer: 741.130/741.131			24.0130-0198.1 430198	Ø 304 30 26 V
O 818 D (670.373, 670.374)	130	09/06→	→	→ 12/13; Achsnummer: 742.501			24.0122-0196.1 422196	Ø 285 21,9 19 V
			→	→ 12/13; Achsnummer: 742.501			24.0130-0191.1 430191	Ø 324 29,9 26 V
O 814 (670.373, 670.374)	100	09/96→12/10	←				24.0130-0103.1 430103	Ø 324 30 26 V
O 815 (670.373, 670.374)	112	09/96→12/10	→	Achsnummer: 741.130/741.131			24.0130-0198.1 430198	Ø 304 30 26 V
			→	Achsnummer: 742.501			24.0122-0196.1 422196	Ø 285 21,9 19 V
			→	Achsnummer: 742.501			24.0130-0191.1 430191	Ø 324 29,9 26 V
<b>MERCEDES-BENZ - VARIO Kasten/Kombi 09/96→</b>								
<b>Bremsbelagsatz, Scheibenbremse</b>								
512 D (667.351, 667.352, 667.353)	90	09/96→12/10	←				13.0460-6015.2 606015	ATE 29835 22,0 + WE / - WK
612 D (668.351, 668.352, 668.353)	90	09/96→12/10	→	Achsnummer: 742.501/742.505			13.0460-6015.2 606015	ATE 29835 22,0 + WE / - WK
↓								

	kW					! #		
<b>MERCEDES-BENZ - VARIO Kasten/Kombi 09/96→</b>								
<b>Bremsbelagsatz, Scheibenbremse</b>								
613 D, 614 D (668.351, 668.352, 668.353)	95	09/96→12/13	➡	Achsnnummer: 741.130/741.131			<b>13.0460-7909.2 607909</b>	PER 29153 20,0 + WE / - WK + Zub
613 D, 614 D (668.351, 668.352, 668.353)	100	09/96→12/11						
812 D (670.351, 670.352, 670.353)	90	09/96→12/10						
813 D, 814 D (670.351, 670.352, 670.353)	95	09/96→12/13						
813 D, 814 D (670.351, 670.352, 670.353)	100	09/96→12/13						
813 DA, 814 DA 4x4 (669.599, 670.451, 670.452, 670.453)	95	09/96→12/13						
815 D, 816 D (670.351, 670.352, 670.353)	112	09/96→12/10						
815 D, 816 D (670.351, 670.352, 670.353)	115	09/96→12/13						
815 DA, 816 DA 4x4 (669.599, 670.451, 670.452, 670.453)	112	09/96→12/10						
815 DA, 816 DA 4x4 (669.599, 670.451, 670.452, 670.453)	115	09/96→12/13						
615 D, 616 D (668.351, 668.352, 668.353)	112	09/98→	←	→ 12/13			<b>13.0460-6015.2 606015</b>	ATE 29835 22,0 + WE / - WK
615 D, 616 D (668.351, 668.352, 668.353)	115	09/98→	➡	→ 12/13; Achsnnummer: 742.501/742.505			<b>13.0460-6015.2 606015</b>	ATE 29835 22,0 + WE / - WK
618 D	130	09/06→	➡	→ 12/13; Achsnnummer: 741.130/741.131			<b>13.0460-7909.2 607909</b>	PER 29153 20,0 + WE / - WK + Zub
813 DA, 814 DA 4x4 (669.599, 670.451, 670.452, 670.453)	100	09/96→						
818 D (670.351, 670.352, 670.353)	130	09/06→						
<b>Warnkontakt, Bremsbelagsverschleiß</b>								
512 D (667.351, 667.352, 667.353)	90	09/96→12/10	←			2	<b>24.8190-0415.2 620415</b>	L= 238 L2= 148
612 D (668.351, 668.352, 668.353)	90	09/96→12/10						
613 D, 614 D (668.351, 668.352, 668.353)	95	09/96→12/13						
613 D, 614 D (668.351, 668.352, 668.353)	100	09/96→12/11						
812 D (670.351, 670.352, 670.353)	90	09/96→12/10						
813 D, 814 D (670.351, 670.352, 670.353)	95	09/96→12/13						
813 D, 814 D (670.351, 670.352, 670.353)	100	09/96→12/13						
813 DA, 814 DA 4x4 (669.599, 670.451, 670.452, 670.453)	95	09/96→12/13						
815 D, 816 D (670.351, 670.352, 670.353)	112	09/96→12/10						
815 D, 816 D (670.351, 670.352, 670.353)	115	09/96→12/13						
815 DA, 816 DA 4x4 (669.599, 670.451, 670.452, 670.453)	112	09/96→12/10						
815 DA, 816 DA 4x4 (669.599, 670.451, 670.452, 670.453)	115	09/96→12/13						
615 D, 616 D (668.351, 668.352, 668.353)	112	09/98→	←	→ 12/13		2	<b>24.8190-0415.2 620415</b>	L= 238 L2= 148
615 D, 616 D (668.351, 668.352, 668.353)	115	09/98→						
618 D	130	09/06→						
813 DA, 814 DA 4x4 (669.599, 670.451, 670.452, 670.453)	100	09/96→						
818 D (670.351, 670.352, 670.353)	130	09/06→						
<b>Bremsscheibe</b>								
512 D (667.351, 667.352, 667.353)	90	09/96→12/10	←				<b>24.0130-0103.1 430103</b>	Ø 324 30 26 V
612 D (668.351, 668.352, 668.353)	90	09/96→12/10					<b>24.0130-0198.1 430198</b>	Ø 304 30 26 V
812 D (670.351, 670.352, 670.353)	90	09/96→12/10	➡	Achsnnummer: 741.130/741.131			<b>24.0122-0196.1 422196</b>	Ø 285 21,9 19 V
812 D (670.351, 670.352, 670.353)	90	09/96→12/10	➡	Achsnnummer: 742.501			<b>24.0130-0190.1 430190</b>	Ø 304 29,9 26 V
613 D, 614 D (668.351, 668.352, 668.353)	95	09/96→12/13	←				<b>24.0130-0103.1 430103</b>	Ø 324 30 26 V
							<b>24.0130-0198.1 430198</b>	Ø 304 30 26 V

**MERCEDES-BENZ - VARIO Kasten/Kombi 09/96→**

 **Bremsscheibe**

613 D, 614 D (668.351, 668.352, 668.353)	100	09/96→12/11	➔	Achsnummer: 741.130/741.131		<b>24.0122-0196.1</b>	<b>422196</b>	Ø 285 21,9 19 V
813 D, 814 D (670.351, 670.352, 670.353)	95	09/96→12/13	➔	Achsnummer: 742.501		<b>24.0130-0191.1</b>	<b>430191</b>	Ø 324 29,9 26 V
813 D, 814 D (670.351, 670.352, 670.353)	100	09/96→12/13						
813 DA, 814 DA 4x4 (669.599, 670.451, 670.452, 670.453)	95	09/96→12/13						
815 D, 816 D (670.351, 670.352, 670.353)	112	09/96→12/10						
815 D, 816 D (670.351, 670.352, 670.353)	115	09/96→12/13						
815 DA, 816 DA 4x4 (669.599, 670.451, 670.452, 670.453)	112	09/96→12/10						
815 DA, 816 DA 4x4 (669.599, 670.451, 670.452, 670.453)	115	09/96→12/13						
615 D, 616 D (668.351, 668.352, 668.353)	112	09/98→	←	→ 12/13		<b>24.0130-0103.1</b>	<b>430103</b>	Ø 324 30 26 V
615 D, 616 D (668.351, 668.352, 668.353)	115	09/98→	➔	→ 12/13; Achsnummer: 741.130/741.131		<b>24.0122-0196.1</b>	<b>422196</b>	Ø 285 21,9 19 V
618 D	130	09/06→	➔	→ 12/13; Achsnummer: 742.501		<b>24.0130-0191.1</b>	<b>430191</b>	Ø 324 29,9 26 V
813 DA, 814 DA 4x4 (669.599, 670.451, 670.452, 670.453)	100	09/96→	➔	→ 12/13; Achsnummer: 742.501		<b>24.0130-0191.1</b>	<b>430191</b>	Ø 324 29,9 26 V
818 D (670.351, 670.352, 670.353)	130	09/06→						









**MERCEDES-BENZ - VARIO Kipper 09/96→**









 **Bremsbelagsatz, Scheibenbremse**

612 D (668.331, 668.332)	90	09/96→12/10	←			<b>13.0460-6015.2</b>	<b>606015</b>	ATE 29835 22,0 + WE / - WK
613 D, 614 D (668.331, 668.332)	95	09/96→12/13	➔	Achsnummer: 742.501/742.505		<b>13.0460-6015.2</b>	<b>606015</b>	ATE 29835 22,0 + WE / - WK
613 D, 614 D (668.331, 668.332)	100	09/96→11/12	➔	Achsnummer: 741.130/741.131		<b>13.0460-7909.2</b>	<b>607909</b>	PER 29153 20,0 + WE / - WK + Zub
812 D (670.331, 670.332)	90	09/96→12/10						
813 D, 814 D (670.331, 670.332)	95	09/96→12/13						
813 D, 814 D (670.331, 670.332)	100	09/96→12/13						
813 DA, 814 DA 4x4 (670.431, 670.432)	95	09/96→12/13						
813 DA, 814 DA 4x4 (670.431, 670.432)	100	09/96→12/13						
815 D, 816 D (670.331, 670.332)	115	09/96→12/13						
815 DA, 816 DA 4x4 (670.431, 670.432)	112	09/96→12/10						
815 DA, 816 DA 4x4 (670.431, 670.432)	115	09/96→12/13						
615 D, 616 D (668.331, 668.332)	112	09/98→	←	→ 12/13		<b>13.0460-6015.2</b>	<b>606015</b>	ATE 29835 22,0 + WE / - WK
615 D, 616 D (668.331, 668.332)	115	09/98→	➔	→ 12/13; Achsnummer: 742.501/742.505		<b>13.0460-6015.2</b>	<b>606015</b>	ATE 29835 22,0 + WE / - WK
618 D	130	09/06→	➔	→ 12/13; Achsnummer: 741.130/741.131		<b>13.0460-7909.2</b>	<b>607909</b>	PER 29153 20,0 + WE / - WK + Zub
815 D, 816 D (670.331, 670.332)	112	09/96→						
818 D (670.321, 670.322)	130	09/06→						
818 DA 4x4	130	09/06→						

**Warnkontakt, Bremsbelagverschleiß**

612 D (668.331, 668.332)	90	09/96→12/10	←		2	<b>24.8190-0415.2</b>	<b>620415</b>	L= 238 L2= 148
613 D, 614 D (668.331, 668.332)	95	09/96→12/13						
613 D, 614 D (668.331, 668.332)	100	09/96→11/12						
812 D (670.331, 670.332)	90	09/96→12/10						
813 D, 814 D (670.331, 670.332)	95	09/96→12/13						
813 D, 814 D (670.331, 670.332)	100	09/96→12/13						
813 DA, 814 DA 4x4 (670.431, 670.432)	95	09/96→12/13						
813 DA, 814 DA 4x4 (670.431, 670.432)	100	09/96→12/13						

	kW			 	! #		
<b>MERCEDES-BENZ - VARIO Kipper 09/96→</b>							
<b>Warnkontakt, Bremsbelagverschleiß</b>							
815 D, 816 D (670.331, 670.332)	115	09/96→12/13	←		2	<b>24.8190-0415.2 620415</b>	L= 238 L2= 148
815 DA, 816 DA 4x4 (670.431, 670.432)	112	09/96→12/10					
815 DA, 816 DA 4x4 (670.431, 670.432)	115	09/96→12/13					
615 D, 616 D (668.331, 668.332)	112	09/98→	←	→ 12/13	2	<b>24.8190-0415.2 620415</b>	L= 238 L2= 148
615 D, 616 D (668.331, 668.332)	115	09/98→					
618 D	130	09/06→					
815 D, 816 D (670.331, 670.332)	112	09/96→					
818 D (670.321, 670.322)	130	09/06→					
818 DA 4x4	130	09/06→					
<b> Brems Scheibe</b>							
612 D (668.331, 668.332)	90	09/96→12/10	←			<b>24.0130-0103.1 430103</b>	Ø 324 30 26 V
812 D (670.331, 670.332)	90	09/96→12/10				<b>24.0130-0198.1 430198</b>	Ø 304 30 26 V
			→	Achsnummer: 741.130/741.131		<b>24.0122-0196.1 422196</b>	Ø 285 21,9 19 V
			→	Achsnummer: 742.501		<b>24.0130-0190.1 430190</b>	Ø 304 29,9 26 V
613 D, 614 D (668.331, 668.332)	95	09/96→12/13	←			<b>24.0130-0103.1 430103</b>	Ø 324 30 26 V
613 D, 614 D (668.331, 668.332)	100	09/96→11/12				<b>24.0130-0198.1 430198</b>	Ø 304 30 26 V
			→	Achsnummer: 741.130/741.131		<b>24.0122-0196.1 422196</b>	Ø 285 21,9 19 V
813 D, 814 D (670.331, 670.332)	95	09/96→12/13	→	Achsnummer: 742.501		<b>24.0130-0191.1 430191</b>	Ø 324 29,9 26 V
813 D, 814 D (670.331, 670.332)	100	09/96→12/13					
813 DA, 814 DA 4x4 (670.431, 670.432)	95	09/96→12/13					
813 DA, 814 DA 4x4 (670.431, 670.432)	100	09/96→12/13					
815 D, 816 D (670.331, 670.332)	115	09/96→12/13					
815 DA, 816 DA 4x4 (670.431, 670.432)	112	09/96→12/10					
815 DA, 816 DA 4x4 (670.431, 670.432)	115	09/96→12/13					
615 D, 616 D (668.331, 668.332)	112	09/98→	←	→ 12/13		<b>24.0130-0103.1 430103</b>	Ø 324 30 26 V
615 D, 616 D (668.331, 668.332)	115	09/98→				<b>24.0130-0198.1 430198</b>	Ø 304 30 26 V
			→	→ 12/13; Achsnummer: 741.130/741.131		<b>24.0122-0196.1 422196</b>	Ø 285 21,9 19 V
618 D	130	09/06→	→	→ 12/13; Achsnummer: 742.501		<b>24.0130-0191.1 430191</b>	Ø 324 29,9 26 V
815 D, 816 D (670.331, 670.332)	112	09/96→					
818 D (670.321, 670.322)	130	09/06→					
818 DA 4x4	130	09/06→					
<b>MERCEDES-BENZ - VARIO Pritsche/Fahrgestell 09/96→</b>							
<b> Bremsbelagsatz, Scheibenbremse</b>							
512 D (667.321, 667.322, 667.323)	90	09/96→12/10	←			<b>13.0460-6015.2 606015</b>	ATE 29835 22,0 + WE / - WK
612 D (668.321, 668.322, 668.323)	90	09/96→12/10	→	Achsnummer: 742.501/742.505		<b>13.0460-6015.2 606015</b>	ATE 29835 22,0 + WE / - WK
613 D, 614 D (668.321, 668.322, 668.323)	100	09/96→12/11	→	Achsnummer: 741.130/741.131		<b>13.0460-7909.2 607909</b>	PER 29153 20,0 + WE / - WK + Zub
812 D (670.321, 670.322, 670.323, 670.324)	90	09/96→12/10					
813 D, 814 D (670.321, 670.322, 670.323, 670.324)	95	09/96→12/13					
813 D, 814 D (670.321, 670.322, 670.323, 670.324)	100	09/96→12/13					
813 DA, 814 DA 4x4 (670.421, 670.422, 670.423)	95	09/96→12/13					
813 DA, 814 DA 4x4 (670.421, 670.422, 670.423)	100	09/96→12/13					
815 D, 816 D (670.321, 670.322, 670.323, 670.324)	112	09/96→12/10					
815 D, 816 D (670.321, 670.322, 670.323, 670.324)	115	09/96→12/13					
↓							

	kW				! #		
<b>MERCEDES-BENZ - VARIO Pritsche/Fahrgestell 09/96 →</b>							
<b> Bremsbelagsatz, Scheibenbremse</b>							
815 DA, 816 DA 4x4 (670.421, 670.422, 670.423)	112	09/96 → 12/10	←			<b>13.0460-6015.2 606015</b>	ATE 29835 22,0 + WE / - WK
			→	Achsnummer: 742.501/742.505		<b>13.0460-6015.2 606015</b>	ATE 29835 22,0 + WE / - WK
815 DA, 816 DA 4x4 (670.421, 670.422, 670.423)	115	09/96 → 12/13	→	Achsnummer: 741.130/741.131		<b>13.0460-7909.2 607909</b>	PER 29153 20,0 + WE / - WK + Zub
613 D, 614 D (668.321, 668.322, 668.323)	95	09/96 →	←	→ 12/13		<b>13.0460-6015.2 606015</b>	ATE 29835 22,0 + WE / - WK
615 D, 616 D (668.321, 668.322, 668.323)	112	09/98 →	→	→ 12/13; Achsnummer: 742.501/742.505		<b>13.0460-6015.2 606015</b>	ATE 29835 22,0 + WE / - WK
615 D, 616 D (668.321, 668.322, 668.323)	115	09/98 →	→	→ 12/13; Achsnummer: 741.130/741.131		<b>13.0460-7909.2 607909</b>	PER 29153 20,0 + WE / - WK + Zub
618 D (668.321, 668.322, 668.323)	130	09/06 →					
818 D (670.321, 670.322, 670.323, 670.324)	130	09/06 →					
818 DA 4x4	130	09/06 →					
<b>Warnkontakt, Bremsbelagverschleiß</b>							
512 D (667.321, 667.322, 667.323)	90	09/96 → 12/10	←		2	<b>24.8190-0415.2 620415</b>	L= 238 L2= 148
612 D (668.321, 668.322, 668.323)	90	09/96 → 12/10					
613 D, 614 D (668.321, 668.322, 668.323)	100	09/96 → 12/11					
812 D (670.321, 670.322, 670.323, 670.324)	90	09/96 → 12/10					
813 D, 814 D (670.321, 670.322, 670.323, 670.324)	95	09/96 → 12/13					
813 D, 814 D (670.321, 670.322, 670.323, 670.324)	100	09/96 → 12/13					
813 DA, 814 DA 4x4 (670.421, 670.422, 670.423)	95	09/96 → 12/13					
813 DA, 814 DA 4x4 (670.421, 670.422, 670.423)	100	09/96 → 12/13					
815 D, 816 D (670.321, 670.322, 670.323, 670.324)	112	09/96 → 12/10					
815 D, 816 D (670.321, 670.322, 670.323, 670.324)	115	09/96 → 12/13					
815 DA, 816 DA 4x4 (670.421, 670.422, 670.423)	112	09/96 → 12/10					
815 DA, 816 DA 4x4 (670.421, 670.422, 670.423)	115	09/96 → 12/13					
613 D, 614 D (668.321, 668.322, 668.323)	95	09/96 →	←	→ 12/13	2	<b>24.8190-0415.2 620415</b>	L= 238 L2= 148
615 D, 616 D (668.321, 668.322, 668.323)	112	09/98 →					
615 D, 616 D (668.321, 668.322, 668.323)	115	09/98 →					
618 D (668.321, 668.322, 668.323)	130	09/06 →					
818 D (670.321, 670.322, 670.323, 670.324)	130	09/06 →					
818 DA 4x4	130	09/06 →					
<b> Bremsscheibe</b>							
512 D (667.321, 667.322, 667.323)	90	09/96 → 12/10	←			<b>24.0130-0103.1 430103</b>	Ø 324 30 26 V
612 D (668.321, 668.322, 668.323)	90	09/96 → 12/10	→	Achsnummer: 741.130/741.131		<b>24.0130-0198.1 430198</b>	Ø 304 30 26 V
812 D (670.321, 670.322, 670.323, 670.324)	90	09/96 → 12/10	→	Achsnummer: 742.501		<b>24.0122-0196.1 422196</b>	Ø 285 21,9 19 V
			→	Achsnummer: 742.501		<b>24.0130-0190.1 430190</b>	Ø 304 29,9 26 V
613 D, 614 D (668.321, 668.322, 668.323)	95	09/96 →	←	→ 12/13		<b>24.0130-0103.1 430103</b>	Ø 324 30 26 V
615 D, 616 D (668.321, 668.322, 668.323)	112	09/98 →	→	→ 12/13; Achsnummer: 741.130/741.131		<b>24.0130-0198.1 430198</b>	Ø 304 30 26 V
615 D, 616 D (668.321, 668.322, 668.323)	115	09/98 →	→	→ 12/13; Achsnummer: 741.130/741.131		<b>24.0122-0196.1 422196</b>	Ø 285 21,9 19 V
618 D (668.321, 668.322, 668.323)	130	09/06 →				<b>24.0130-0191.1 430191</b>	Ø 324 29,9 26 V
↓							



**MERCEDES-BENZ - VARIO Pritsche/Fahrgestell 09/96→**

**Bremsscheibe**

818 D (670.321, 670.322, 670.323, 670.324) 818 DA 4x4	130	09/06→	←	→ 12/13		24.0130-0103.1 430103	∅ 324 30 26 V
						24.0130-0198.1 430198	∅ 304 30 26 V
				→	→ 12/13; Achsnummer: 741.130/741.131	24.0122-0196.1 422196	∅ 285 21,9 19 V
613 D, 614 D (668.321, 668.322, 668.323) 813 D, 814 D (670.321, 670.322, 670.323, 670.324) 813 D, 814 D (670.321, 670.322, 670.323, 670.324) 813 DA, 814 DA 4x4 (670.421, 670.422, 670.423) 813 DA, 814 DA 4x4 (670.421, 670.422, 670.423) 815 D, 816 D (670.321, 670.322, 670.323, 670.324) 815 D, 816 D (670.321, 670.322, 670.323, 670.324) 815 DA, 816 DA 4x4 (670.421, 670.422, 670.423) 815 DA, 816 DA 4x4 (670.421, 670.422, 670.423)	130	09/06→	←	→ 12/13		24.0130-0103.1 430103	∅ 324 30 26 V
	95	09/96→12/13	→	Achsnummer: 741.130/741.131		24.0130-0198.1 430198	∅ 304 30 26 V
	100	09/96→12/13	→	Achsnummer: 742.501		24.0130-0191.1 430191	∅ 324 29,9 26 V

**MERCEDES-BENZ - VARIO Triebkopf 09/96→**

**Bremsbelagsatz, Scheibenbremse**









613 D, 614 D (669.599, 669.899) 615 D, 616 D (669.599, 669.899) 618 D (669.599, 669.899) 814 DT (670.398) 816 DT (670.398)	95	01/06→	←	→ 12/13		13.0460-6015.2 606015	ATE 29835 22,0 + WE / - WK
	115	01/06→	→	→ 12/13; Achsnummer: 742.501/742.505		13.0460-6015.2 606015	ATE 29835 22,0 + WE / - WK
	130	09/06→	→	→ 12/13; Achsnummer: 741.130/741.131		13.0460-7909.2 607909	PER 29153 20,0 + WE / - WK + Zub
810 DT (670.398) 812 DT	75	09/96→12/10	←			13.0460-6015.2 606015	ATE 29835 22,0 + WE / - WK
	90	09/96→12/10	→	Achsnummer: 742.501/742.505		13.0460-6015.2 606015	ATE 29835 22,0 + WE / - WK
			→	Achsnummer: 741.130/741.131		13.0460-7909.2 607909	PER 29153 20,0 + WE / - WK + Zub







**Warnkontakt, Bremsbelagverschleiß**







613 D, 614 D (669.599, 669.899) 615 D, 616 D (669.599, 669.899) 618 D (669.599, 669.899) 814 DT (670.398) 816 DT (670.398)	95	01/06→	←	→ 12/13	2	24.8190-0415.2 620415	L= 238 L2= 148
	115	01/06→					
	130	09/06→					
	100 112	09/96→ 09/96→					
810 DT (670.398) 812 DT	75 90	09/96→12/10 09/96→12/10	←		2	24.8190-0415.2 620415	L= 238 L2= 148











**Bremsscheibe**

613 D, 614 D (669.599, 669.899) 615 D, 616 D (669.599, 669.899) 618 D (669.599, 669.899)	95	01/06→	←	→ 12/13		24.0130-0103.1 430103	∅ 324 30 26 V
	115	01/06→	→	→ 12/13; Achsnummer: 741.130/741.131		24.0130-0198.1 430198	∅ 304 30 26 V
	130	09/06→	→	→ 12/13; Achsnummer: 742.501		24.0130-0191.1 430191	∅ 324 29,9 26 V
810 DT (670.398) 812 DT	75	09/96→12/10	←			24.0130-0103.1 430103	∅ 324 30 26 V
	90	09/96→12/10	→	Achsnummer: 741.130/741.131		24.0130-0198.1 430198	∅ 304 30 26 V
			→	Achsnummer: 742.501		24.0130-0190.1 430190	∅ 304 29,9 26 V
814 DT (670.398) 816 DT (670.398)	100	09/96→	←	→ 12/13		24.0130-0103.1 430103	∅ 324 30 26 V
	112	09/96→	→	→ 12/13; Achsnummer: 741.130/741.131		24.0130-0198.1 430198	∅ 304 30 26 V
			→	→ 12/13; Achsnummer: 742.501		24.0130-0190.1 430190	∅ 304 29,9 26 V

	kW			 	! #		
<b>MERCEDES-BENZ - VIANO (W639) 09/03→</b>							
<b> Bremsbelagsatz, Scheibenbremse</b>							
3,0 (639.711, 639.811)	140	09/03→	←	→ 342257		<b>13.0460-3819.2 603819</b>	BOS 24007 20,8 + WK
3.2 (639.713, 639.813, 639.815)	160	09/03→	←	342258→; → 02/14		<b>13.0460-4826.2 604826</b>	BRE 29192 20,7 + WE / - WK + Zub
3.5 (639.811, 639.813, 639.815)	190	09/07→				<b>13.0460-4877.2 604877</b>	BRE 29192 20,3 + WE / - WK + Zub
3.7 (639.815)	170	06/04→					
CDI 2.0 (639.711, 639.713, 639.811, 639.813, 639.815)	80	09/03→	→	→ 02/14		<b>13.0460-3821.2 603821</b>	BOS 24008 18,3 + WK
CDI 2.0 (639.711, 639.713, 639.811, 639.813, 639.815)	85	08/05→					
CDI 2.0 (639.811, 639.813, 639.815)	100	07/10→					
CDI 2.2 (639.711, 639.713, 639.811, 639.813, 639.815)	110	09/03→					
CDI 2.2 (639.811, 639.813, 639.815)	120	07/10→					
CDI 3.0 (639.811, 639.813, 639.815)	150	03/06→					
CDI 3.0 (639.811, 639.813, 639.815)	165	07/10→					
CDI 2.0 4-matic (639.713)	80	07/05→	←	07/10→; → 407625		<b>13.0460-3819.2 603819</b>	BOS 24007 20,8 + WK
CDI 2.2 4-matic (639.711, 639.713, 639.811, 639.813, ...)	110	07/05→	←	407626→; → 02/14		<b>13.0460-4826.2 604826</b>	BRE 29192 20,7 + WE / - WK + Zub
						<b>13.0460-4877.2 604877</b>	BRE 29192 20,3 + WE / - WK + Zub
			→	07/10→ 02/14		<b>13.0460-3821.2 603821</b>	BOS 24008 18,3 + WK
CDI 2.0 4-matic (639.811, 639.813, 639.815)	100	07/10→	←	→ 407625		<b>13.0460-3819.2 603819</b>	BOS 24007 20,8 + WK
CDI 2.2 4-matic (639.811, 639.813, 639.815)	120	07/10→	←	407626→; → 02/14		<b>13.0460-4826.2 604826</b>	BRE 29192 20,7 + WE / - WK + Zub
						<b>13.0460-4877.2 604877</b>	BRE 29192 20,3 + WE / - WK + Zub
			→	→ 02/14		<b>13.0460-3821.2 603821</b>	BOS 24008 18,3 + WK
<b>Warnkontakt, Bremsbelagsverschleiß</b>							
3,0 (639.711, 639.811)	140	09/03→	←	→ 342257	2	<b>24.8190-0418.2 620418</b>	L= 95
3.2 (639.713, 639.813, 639.815)	160	09/03→	←	342258→; → 02/14	2	<b>24.8190-0424.2 620424</b>	L= 103,2
3.5 (639.811, 639.813, 639.815)	190	09/07→	→	→ 02/14	2	<b>24.8190-0418.2 620418</b>	L= 95
3.7 (639.815)	170	06/04→					
CDI 2.0 (639.711, 639.713, 639.811, 639.813, 639.815)	80	09/03→					
CDI 2.0 (639.711, 639.713, 639.811, 639.813, 639.815)	85	08/05→					
CDI 2.0 (639.811, 639.813, 639.815)	100	07/10→					
CDI 2.2 (639.711, 639.713, 639.811, 639.813, 639.815)	110	09/03→					
CDI 2.2 (639.811, 639.813, 639.815)	120	07/10→					
CDI 3.0 (639.811, 639.813, 639.815)	150	03/06→					
CDI 3.0 (639.811, 639.813, 639.815)	165	07/10→					
CDI 2.0 4-matic (639.713)	80	07/05→	←	07/10→; → 407625	2	<b>24.8190-0418.2 620418</b>	L= 95
CDI 2.2 4-matic (639.711, 639.713, 639.811, 639.813, ...)	110	07/05→	←	407626→; → 02/14	2	<b>24.8190-0424.2 620424</b>	L= 103,2
			→	07/10→ 02/14	2	<b>24.8190-0418.2 620418</b>	L= 95
CDI 2.0 4-matic (639.811, 639.813, 639.815)	100	07/10→	←	→ 407625	2	<b>24.8190-0418.2 620418</b>	L= 95
CDI 2.2 4-matic (639.811, 639.813, 639.815)	120	07/10→	←	407626→; → 02/14	2	<b>24.8190-0424.2 620424</b>	L= 103,2
			→	→ 02/14	2	<b>24.8190-0418.2 620418</b>	L= 95
<b> Bremsscheibe</b>							
3,0 (639.711, 639.811)	140	09/03→	←	→ 02/14		<b>24.0128-0145.1 428145</b>	Ø 300 28 25 V + S
3.2 (639.713, 639.813, 639.815)	160	09/03→	→	→ 02/14		<b>24.0110-0280.1 410280</b>	Ø 296 10 8 + S
3.5 (639.811, 639.813, 639.815)	190	09/07→					
3.7 (639.815)	170	06/04→					







	kW			 	! #		
<b>MERCEDES-BENZ - VIANO (W639) 09/03→</b>							
<b>Bremsscheibe</b>							
CDI 2.0 (639.711, 639.713, 639.811, 639.813, 639.815)	80	09/03→	←	→ 02/14		24.0128-0145.1 428145	Ø 300 28 25 V + S
			→	→ 02/14			24.0110-0280.1 410280
CDI 2.0 (639.711, 639.713, 639.811, 639.813, 639.815)	85	08/05→					
CDI 2.0 (639.811, 639.813, 639.815)	100	07/10→					
CDI 2.0 4-matic (639.811, 639.813, 639.815)	100	07/10→					
CDI 2.2 (639.711, 639.713, 639.811, 639.813, 639.815)	110	09/03→					
CDI 2.2 (639.811, 639.813, 639.815)	120	07/10→					
CDI 2.2 4-matic (639.811, 639.813, 639.815)	120	07/10→					
CDI 3.0 (639.811, 639.813, 639.815)	150	03/06→					
CDI 3.0 (639.811, 639.813, 639.815)	165	07/10→					
CDI 2.0 4-matic (639.713)	80	07/05→	←	07/10→ 02/14		24.0128-0145.1 428145	Ø 300 28 25 V + S
CDI 2.2 4-matic (639.711, 639.713, 639.811, 639.813, ...)	110	07/05→	→	07/10→ 02/14		24.0110-0280.1 410280	Ø 296 10 8 + S
<b>MERCEDES-BENZ - VITO / MIXTO Kasten (W639) 09/03→</b>							
<b>Bremsbelagsatz, Scheibenbremse</b>							
109 CDI (639.601, 639.603, 639.605)	65	09/03→	←	→ 342257		13.0460-3819.2 603819	BOS 24007 20,8 + WK
109 CDI (639.601, 639.603, 639.605)	70	08/06→	←	342258→; → 02/14		13.0460-4826.2 604826	BRE 29192 20,7 + WE / - WK + Zub
110 CDI (639.601, 639.603, 639.605)	70	09/10→				13.0460-4877.2 604877	BRE 29192 20,3 + WE / - WK + Zub
111 CDI (639.601, 639.603, 639.605)	80	09/03→	→	→ 02/14		13.0460-3821.2 603821	BOS 24008 18,3 + WK
111 CDI (639.601, 639.603)	85	09/07→					
113 CDI (639.601, 639.603, 639.605)	100	09/10→					
115 CDI (639.601, 639.603, 639.605)	110	09/03→					
116 CDI (639.601, 639.603, 639.605)	120	09/10→					
119 (639.601, 639.603, 639.605)	140	09/03→					
122 (639.601, 639.603, 639.605)	160	09/03→					
122 CDI (639.601, 639.603, 639.605)	165	09/10→					
126 (639.601, 639.603, 639.605)	190	09/07→					
111 CDI 4x4 (639.601, 639.603, 639.605)	80	09/07→	←	→ 407625		13.0460-3819.2 603819	BOS 24007 20,8 + WK
113 CDI 4x4 (639.601, 639.603, 639.605)	100	09/10→	←	407626→; → 02/14		13.0460-4826.2 604826	BRE 29192 20,7 + WE / - WK + Zub
116 CDI 4x4 (639.601, 639.603, 639.605)	120	09/10→				13.0460-4877.2 604877	BRE 29192 20,3 + WE / - WK + Zub
			→	→ 02/14		13.0460-3821.2 603821	BOS 24008 18,3 + WK
115 CDI 4x4 (639.601, 639.603, 639.605)	110	07/06→	←	09/07→; → 407625		13.0460-3819.2 603819	BOS 24007 20,8 + WK
			←	407626→; → 02/14		13.0460-4826.2 604826	BRE 29192 20,7 + WE / - WK + Zub
						13.0460-4877.2 604877	BRE 29192 20,3 + WE / - WK + Zub
			→	09/07→ 02/14		13.0460-3821.2 603821	BOS 24008 18,3 + WK
120 CDI (639.601, 639.603, 639.605)	150	07/06→	←	09/07→; → 342257		13.0460-3819.2 603819	BOS 24007 20,8 + WK
			←	342258→; → 02/14		13.0460-4826.2 604826	BRE 29192 20,7 + WE / - WK + Zub
						13.0460-4877.2 604877	BRE 29192 20,3 + WE / - WK + Zub
			→	09/07→ 02/14		13.0460-3821.2 603821	BOS 24008 18,3 + WK
123 (639.601, 639.603, 639.605)	165	06/04→07/08	←	→ 342257		13.0460-3819.2 603819	BOS 24007 20,8 + WK
123 (639.601)	170	06/04→07/08	←	342258→		13.0460-4826.2 604826	BRE 29192 20,7 + WE / - WK + Zub









	kw			 	! #		
<b>MERCEDES-BENZ - VITO / MIXTO Kasten (W639) 09/03→</b>							
<b>Bremsbelagsatz, Scheibenbremse</b>							
123 (639.601, 639.603, 639.605) 123 (639.601)	165 170	06/04→07/08 06/04→07/08	← →	342258→		13.0460-4877.2 604877 13.0460-3821.2 603821	BRE 29192 20,3 + WE / - WK + Zub BOS 24008 18,3 + WK
E-CELL (639.601, 639.603, 639.605)	60	03/12→	← →	→ 02/14 → 02/14		13.0460-3819.2 603819 13.0460-4826.2 604826 13.0460-4877.2 604877 13.0460-3821.2 603821	BOS 24007 20,8 + WK BRE 29192 20,7 + WE / - WK + Zub BRE 29192 20,3 + WE / - WK + Zub BOS 24008 18,3 + WK
<b>Warnkontakt, Bremsbelagverschleiß</b>							
109 CDI (639.601, 639.603, 639.605) 109 CDI (639.601, 639.603, 639.605) 110 CDI (639.601, 639.603, 639.605) 111 CDI (639.601, 639.603, 639.605) 111 CDI (639.601, 639.603) 113 CDI (639.601, 639.603, 639.605) 115 CDI (639.601, 639.603, 639.605) 116 CDI (639.601, 639.603, 639.605) 119 (639.601, 639.603, 639.605) 122 (639.601, 639.603, 639.605) 122 CDI (639.601, 639.603, 639.605) 126 (639.601, 639.603, 639.605)	65 70 70 80 85 100 110 120 140 160 165 190	09/03→ 08/06→ 09/10→ 09/03→ 09/07→ 09/10→ 09/03→ 09/10→ 09/03→ 09/03→ 09/10→ 09/07→	← ← →	→ 342257 342258→; → 02/14 → 02/14	2 2 2	24.8190-0418.2 620418 24.8190-0424.2 620424 24.8190-0418.2 620418	L= 95 L= 103,2 L= 95
111 CDI 4x4 (639.601, 639.603, 639.605) 113 CDI 4x4 (639.601, 639.603, 639.605) 116 CDI 4x4 (639.601, 639.603, 639.605)	80 100 120	09/07→ 09/10→ 09/10→	← ← →	→ 407625 407626→; → 02/14 → 02/14	2 2 2	24.8190-0418.2 620418 24.8190-0424.2 620424 24.8190-0418.2 620418	L= 95 L= 103,2 L= 95
115 CDI 4x4 (639.601, 639.603, 639.605)	110	07/06→	← ← →	09/07→; → 407625 407626→; → 02/14 09/07→ 02/14	2 2 2	24.8190-0418.2 620418 24.8190-0424.2 620424 24.8190-0418.2 620418	L= 95 L= 103,2 L= 95
120 CDI (639.601, 639.603, 639.605)	150	07/06→	← ← →	09/07→; → 342257 342258→; → 02/14 09/07→ 02/14	2 2 2	24.8190-0418.2 620418 24.8190-0424.2 620424 24.8190-0418.2 620418	L= 95 L= 103,2 L= 95
123 (639.601, 639.603, 639.605) 123 (639.601)	165 170	06/04→07/08 06/04→07/08	← ← →	→ 342257 342258→	2 2 2	24.8190-0418.2 620418 24.8190-0424.2 620424 24.8190-0418.2 620418	L= 95 L= 103,2 L= 95
E-CELL (639.601, 639.603, 639.605)	60	03/12→	← →	→ 02/14 → 02/14	2 2	24.8190-0418.2 620418 24.8190-0424.2 620424 24.8190-0418.2 620418	L= 95 L= 103,2 L= 95
<b>Bremsscheibe</b>							
109 CDI (639.601, 639.603, 639.605) 109 CDI (639.601, 639.603, 639.605) 110 CDI (639.601, 639.603, 639.605) 111 CDI (639.601, 639.603, 639.605) 111 CDI (639.601, 639.603) 111 CDI 4x4 (639.601, 639.603, 639.605) 113 CDI (639.601, 639.603, 639.605) 113 CDI 4x4 (639.601, 639.603, 639.605) 115 CDI (639.601, 639.603, 639.605) ↓	65 70 70 80 85 80 100 100 110	09/03→ 08/06→ 09/10→ 09/03→ 09/07→ 09/07→ 09/10→ 09/10→ 09/03→	← →	→ 02/14 → 02/14		24.0128-0145.1 428145 24.0110-0280.1 410280	Ø 300 28 25 V + S Ø 296 10 8 + S









	kW					! #		
<b>MERCEDES-BENZ - VITO / MIXTO Kasten (W639) 09/03→</b>								
 <b>Bremsscheibe</b>								
116 CDI (639.601, 639.603, 639.605)	120	09/10→	←	→ 02/14			24.0128-0145.1 428145	Ø 300 28 25 V + S
116 CDI 4x4 (639.601, 639.603, 639.605)	120	09/10→	→	→ 02/14			24.0110-0280.1 410280	Ø 296 10 8 + S
119 (639.601, 639.603, 639.605)	140	09/03→						
122 (639.601, 639.603, 639.605)	160	09/03→						
E-CELL (639.601, 639.603, 639.605)	60	03/12→						
115 CDI 4x4 (639.601, 639.603, 639.605)	110	07/06→	←	09/07→ 02/14			24.0128-0145.1 428145	Ø 300 28 25 V + S
120 CDI (639.601, 639.603, 639.605)	150	07/06→	→	09/07→ 02/14			24.0110-0280.1 410280	Ø 296 10 8 + S
122 CDI (639.601, 639.603, 639.605)	165	09/10→	←	444280→; → 02/14			24.0128-0145.1 428145	Ø 300 28 25 V + S
126 (639.601, 639.603, 639.605)	190	09/07→	←	→ 444279			24.0128-0145.1 428145	Ø 300 28 25 V + S
			→	→ 02/14			24.0110-0280.1 410280	Ø 296 10 8 + S
123 (639.601, 639.603, 639.605)	165	06/04→07/08	←				24.0128-0145.1 428145	Ø 300 28 25 V + S
123 (639.601)	170	06/04→07/08	→				24.0110-0280.1 410280	Ø 296 10 8 + S
<b>MERCEDES-BENZ - VITO Bus (638) 02/96→07/03</b>								
 <b>Bremsbelagsatz, Scheibenbremse</b>								
108 CDI 2.2 (638.194)	60	03/99→07/03	←				13.0460-3980.2 603980	BOS 23022 20,9 + WE / - WK
110 CDI 2.2 (638.194)	75	03/99→07/03					13.0460-7196.2 607196	ATE 21576 20,7 + WE / - WK
112 CDI 2.2 (638.194)	90	03/99→07/03						
114 2.3 (638.134, 638.194)	105	12/96→07/03	→				13.0460-3985.2 603985	BOS 23020 17,9 - WK
							13.0460-7085.2 607085	ATE 21278 16,9 + WK
108 D 2.3 (638.164)	58	02/96→07/03	←	03/96→			13.0460-3980.2 603980	BOS 23022 20,9 + WE / - WK
110 TD 2.3 (638.174)	72	02/96→07/03					13.0460-7196.2 607196	ATE 21576 20,7 + WE / - WK
113 2.0 (638.114, 638.194)	95	02/96→07/03	→	03/96→			13.0460-3985.2 603985	BOS 23020 17,9 - WK
							13.0460-7085.2 607085	ATE 21278 16,9 + WK
<b>Warnkontakt, Bremsbelagverschleiß</b>								
108 CDI 2.2 (638.194)	60	03/99→07/03	←		2		24.8190-0407.2 620407	L= 115 L= 185
110 CDI 2.2 (638.194)	75	03/99→07/03					24.8190-0417.2 620417	L= 99 L= 167
112 CDI 2.2 (638.194)	90	03/99→07/03						
114 2.3 (638.134, 638.194)	105	12/96→07/03	→					
108 D 2.3 (638.164)	58	02/96→07/03	←	03/96→	2		24.8190-0407.2 620407	L= 115 L= 185
110 TD 2.3 (638.174)	72	02/96→07/03					24.8190-0417.2 620417	L= 99 L= 167
113 2.0 (638.114, 638.194)	95	02/96→07/03	→					
<b>Zubehörsatz, Scheibenbremsbelag</b>								
108 CDI 2.2 (638.194)	60	03/99→07/03	←				13.0460-0250.2 610250	BOS
110 CDI 2.2 (638.194)	75	03/99→07/03						
112 CDI 2.2 (638.194)	90	03/99→07/03	→				13.0460-0288.2 610288	BOS
114 2.3 (638.134, 638.194)	105	12/96→07/03						
108 D 2.3 (638.164)	58	02/96→07/03	←	03/96→			13.0460-0250.2 610250	BOS
110 TD 2.3 (638.174)	72	02/96→07/03						
113 2.0 (638.114, 638.194)	95	02/96→07/03	→	03/96→			13.0460-0288.2 610288	BOS
 <b>Bremsscheibe</b>								
108 CDI 2.2 (638.194)	60	03/99→07/03	←				24.0122-0162.1 422162	Ø 276 22 19 V + S
110 CDI 2.2 (638.194)	75	03/99→07/03					24.0322-0162.1 522162	Ø 276 22 19 V + S
112 CDI 2.2 (638.194)	90	03/99→07/03						
114 2.3 (638.134, 638.194)	105	12/96→07/03	→				24.0110-0228.1 410228	Ø 280 10 8 + S
108 D 2.3 (638.164)	58	02/96→07/03	←	03/96→			24.0122-0162.1 422162	Ø 276 22 19 V + S
110 TD 2.3 (638.174)	72	02/96→07/03					24.0322-0162.1 522162	Ø 276 22 19 V + S
113 2.0 (638.114, 638.194)	95	02/96→07/03	→	03/96→			24.0110-0228.1 410228	Ø 280 10 8 + S
<b>MERCEDES-BENZ - VITO Bus (W639) 09/03→</b>								
 <b>Bremsbelagsatz, Scheibenbremse</b>								
109 CDI (639.701, 639.703)	70	09/06→	←	→ 342257			13.0460-3819.2 603819	BOS 24007 20,8 + WK
109 CDI (639.701)	65	09/03→	←	342258→; → 02/14			13.0460-4826.2 604826	BRE 29192 20,7 + WE / - WK + Zub
110 CDI (639.701, 639.703, 639.705)	70	09/10→					13.0460-4877.2 604877	BRE 29192 20,3 + WE / - WK + Zub
111 CDI (639.701, 639.703, 639.705)	80	09/03→	→	→ 02/14			13.0460-3821.2 603821	BOS 24008 18,3 + WK

























	kw			 	! #		
<b>MERCEDES-BENZ - VITO Bus (W639) 09/03→</b>							
<b>Bremsbelagsatz, Scheibenbremse</b>							
111 CDI (639.701, 639.703, 639.705)	85	09/07→	←	→ 342257		<b>13.0460-3819.2 603819</b>	BOS 24007 20,8 + WK
113 CDI (639.701, 639.703, 639.705)	100	09/10→	←	342258→; → 02/14		<b>13.0460-4826.2 604826</b>	BRE 29192 20,7 + WE / - WK + Zub
115 CDI (639.701, 639.703, 639.705)	110	09/03→				<b>13.0460-4877.2 604877</b>	BRE 29192 20,3 + WE / - WK + Zub
116 CDI (639.701, 639.703, 639.705)	120	09/10→	→	→ 02/14		<b>13.0460-3821.2 603821</b>	BOS 24008 18,3 + WK
119 (639.701, 639.703, 639.705)	140	09/03→					
122 (639.701, 639.703, 639.705)	160	09/03→					
122 CDI (639.701, 639.703, 639.705)	165	09/10→					
123 (639.701)	170	06/04→					
126 (639.701, 639.703, 639.705)	190	09/07→					
109 CDI 4x4 (639.701)	70	09/07→	←	→ 407625		<b>13.0460-3819.2 603819</b>	BOS 24007 20,8 + WK
111 CDI 4x4 (639.701, 639.703, 639.705)	80	09/07→	←	407626→; → 02/14		<b>13.0460-4826.2 604826</b>	BRE 29192 20,7 + WE / - WK + Zub
113 CDI 4x4 (639.701, 639.703, 639.705)	100	09/10→				<b>13.0460-4877.2 604877</b>	BRE 29192 20,3 + WE / - WK + Zub
115 CDI 4x4 (639.701, 639.705)	110	09/07→					
116 CDI 4x4 (639.701, 639.703, 639.705)	120	09/10→	→	→ 02/14		<b>13.0460-3821.2 603821</b>	BOS 24008 18,3 + WK
120 CDI (639.701, 639.703, 639.705)	150	07/06→	←	09/07→; → 342257		<b>13.0460-3819.2 603819</b>	BOS 24007 20,8 + WK
			←	342258→; → 02/14		<b>13.0460-4826.2 604826</b>	BRE 29192 20,7 + WE / - WK + Zub
						<b>13.0460-4877.2 604877</b>	BRE 29192 20,3 + WE / - WK + Zub
			→	09/07→ 02/14		<b>13.0460-3821.2 603821</b>	BOS 24008 18,3 + WK
123 (639.701, 639.703, 639.705)	165	06/04→07/08	←	→ 342257		<b>13.0460-3819.2 603819</b>	BOS 24007 20,8 + WK
			←	342258→		<b>13.0460-4826.2 604826</b>	BRE 29192 20,7 + WE / - WK + Zub
						<b>13.0460-4877.2 604877</b>	BRE 29192 20,3 + WE / - WK + Zub
			→			<b>13.0460-3821.2 603821</b>	BOS 24008 18,3 + WK
E-CELL (639.703)	60	03/12→	←	→ 02/14		<b>13.0460-3819.2 603819</b>	BOS 24007 20,8 + WK
						<b>13.0460-4826.2 604826</b>	BRE 29192 20,7 + WE / - WK + Zub
						<b>13.0460-4877.2 604877</b>	BRE 29192 20,3 + WE / - WK + Zub
			→	→ 02/14		<b>13.0460-3821.2 603821</b>	BOS 24008 18,3 + WK
<b>Warnkontakt, Bremsbelagverschleiß</b>							
109 CDI (639.701, 639.703)	70	09/06→	←	→ 342257	2	<b>24.8190-0418.2 620418</b>	L= 95
109 CDI (639.701)	65	09/03→	←	342258→; → 02/14	2	<b>24.8190-0424.2 620424</b>	L= 103,2
110 CDI (639.701, 639.703, 639.705)	70	09/10→	→	→ 02/14	2	<b>24.8190-0418.2 620418</b>	L= 95
111 CDI (639.701, 639.703, 639.705)	80	09/03→					
111 CDI (639.701, 639.703, 639.705)	85	09/07→					
113 CDI (639.701, 639.703, 639.705)	100	09/10→					
115 CDI (639.701, 639.703, 639.705)	110	09/03→					
116 CDI (639.701, 639.703, 639.705)	120	09/10→					
119 (639.701, 639.703, 639.705)	140	09/03→					
122 (639.701, 639.703, 639.705)	160	09/03→					
122 CDI (639.701, 639.703, 639.705)	165	09/10→					
123 (639.701)	170	06/04→					
126 (639.701, 639.703, 639.705)	190	09/07→					
109 CDI 4x4 (639.701)	70	09/07→	←	→ 407625	2	<b>24.8190-0418.2 620418</b>	L= 95
111 CDI 4x4 (639.701, 639.703, 639.705)	80	09/07→	←	407626→; → 02/14	2	<b>24.8190-0424.2 620424</b>	L= 103,2
113 CDI 4x4 (639.701, 639.703, 639.705)	100	09/10→	→	→ 02/14	2	<b>24.8190-0418.2 620418</b>	L= 95
115 CDI 4x4 (639.701, 639.705)	110	09/07→					
↓							







	kW			 	! #		
<b>MERCEDES-BENZ - VITO Bus (W639) 09/03→</b>							
<b>Warnkontakt, Bremsbelagverschleiß</b>							
116 CDI 4x4 (639.701, 639.703, 639.705)	120	09/10→	←	→ 407625	2	24.8190-0418.2 620418	L= 95
			←	407626→; → 02/14	2	24.8190-0424.2 620424	L= 103,2
			→	→ 02/14	2	24.8190-0418.2 620418	L= 95
120 CDI (639.701, 639.703, 639.705)	150	07/06→	←	09/07→; → 342257	2	24.8190-0418.2 620418	L= 95
			←	342258→; → 02/14	2	24.8190-0424.2 620424	L= 103,2
			→	09/07→ 02/14	2	24.8190-0418.2 620418	L= 95
123 (639.701, 639.703, 639.705)	165	06/04→07/08	←	→ 342257	2	24.8190-0418.2 620418	L= 95
			←	342258→	2	24.8190-0424.2 620424	L= 103,2
			→		2	24.8190-0418.2 620418	L= 95
E-CELL (639.703)	60	03/12→	←	→ 02/14	2	24.8190-0418.2 620418	L= 95
						24.8190-0424.2 620424	L= 103,2
			→	→ 02/14	2	24.8190-0418.2 620418	L= 95
<b> Bremsscheibe</b>							
109 CDI (639.701, 639.703)	70	09/06→	←	→ 02/14		24.0128-0145.1 428145	Ø 300 28 25 V + S
109 CDI (639.701)	65	09/03→	→	→ 02/14		24.0110-0280.1 410280	Ø 296 10 8 + S
109 CDI 4x4 (639.701)	70	09/07→					
110 CDI (639.701, 639.703, 639.705)	70	09/10→					
111 CDI (639.701, 639.703, 639.705)	80	09/03→					
111 CDI (639.701, 639.703, 639.705)	85	09/07→					
111 CDI 4x4 (639.701, 639.703, 639.705)	80	09/07→					
113 CDI (639.701, 639.703, 639.705)	100	09/10→					
113 CDI 4x4 (639.701, 639.703, 639.705)	100	09/10→					
115 CDI (639.701, 639.703, 639.705)	110	09/03→					
115 CDI 4x4 (639.701, 639.705)	110	09/07→					
116 CDI (639.701, 639.703, 639.705)	120	09/10→					
116 CDI 4x4 (639.701, 639.703, 639.705)	120	09/10→					
119 (639.701, 639.703, 639.705)	140	09/03→					
122 (639.701, 639.703, 639.705)	160	09/03→					
123 (639.701)	170	06/04→					
E-CELL (639.703)	60	03/12→					
120 CDI (639.701, 639.703, 639.705)	150	07/06→	←	09/07→ 02/14		24.0128-0145.1 428145	Ø 300 28 25 V + S
			→	09/07→ 02/14		24.0110-0280.1 410280	Ø 296 10 8 + S
122 CDI (639.701, 639.703, 639.705)	165	09/10→	←	444280→; → 02/14		24.0128-0145.1 428145	Ø 300 28 25 V + S
126 (639.701, 639.703, 639.705)	190	09/07→	←	→ 444279		24.0128-0145.1 428145	Ø 300 28 25 V + S
			→	→ 02/14		24.0110-0280.1 410280	Ø 296 10 8 + S
123 (639.701, 639.703, 639.705)	165	06/04→07/08	←			24.0128-0145.1 428145	Ø 300 28 25 V + S
			→			24.0110-0280.1 410280	Ø 296 10 8 + S
<b>MERCEDES-BENZ - VITO Kasten (638) 03/97→07/03</b>							
<b> Bremsbelagsatz, Scheibenbremse</b>							
108 CDI 2.2 (638.094)	60	03/99→07/03	←			13.0460-3980.2 603980	BOS 23022 20,9 + WE / - WK
108 D 2.3 (638.064, 638.068)	58	03/97→07/03				13.0460-7196.2 607196	ATE 21576 20,7 + WE / - WK
110 CDI 2.2 (638.094)	75	03/99→07/03	→			13.0460-3985.2 603985	BOS 23020 17,9 - WK
110 D 2.3 (638.074, 638.078)	72	03/97→07/03				13.0460-7085.2 607085	ATE 21278 16,9 + WK
112 CDI 2.2 (638.094)	90	03/99→07/03					
113 2.0 (638.014, 638.094)	95	03/97→07/03					
114 2.3 (638.034, 638.094)	105	03/97→07/03					
<b>Warnkontakt, Bremsbelagverschleiß</b>							
108 CDI 2.2 (638.094)	60	03/99→07/03	←		2	24.8190-0407.2 620407	L= 115 L= 185
108 D 2.3 (638.064, 638.068)	58	03/97→07/03				24.8190-0417.2 620417	L= 99 L= 167
110 CDI 2.2 (638.094)	75	03/99→07/03					
↓							















	kW					! #		
<b>MERCEDES-BENZ - VITO Kasten (638) 03/97→07/03</b>								
<b>Warnkontakt, Bremsbelagverschleiß</b>								
110 D 2.3 (638.074, 638.078)	72	03/97→07/03	←			2	24.8190-0407.2 620407	L= 115 L= 185
112 CDI 2.2 (638.094)	90	03/99→07/03					24.8190-0417.2 620417	L= 99 L= 167
113 2.0 (638.014, 638.094)	95	03/97→07/03						
114 2.3 (638.034, 638.094)	105	03/97→07/03						
<b>Zubehörsatz, Scheibenbremsbelag</b>								
108 CDI 2.2 (638.094)	60	03/99→07/03	←				13.0460-0250.2 610250	BOS
108 D 2.3 (638.064, 638.068)	58	03/97→07/03	→				13.0460-0288.2 610288	BOS
110 CDI 2.2 (638.094)	75	03/99→07/03						
110 D 2.3 (638.074, 638.078)	72	03/97→07/03						
112 CDI 2.2 (638.094)	90	03/99→07/03						
113 2.0 (638.014, 638.094)	95	03/97→07/03						
114 2.3 (638.034, 638.094)	105	03/97→07/03						
<b> Bremsscheibe</b>								
108 CDI 2.2 (638.094)	60	03/99→07/03	←				24.0122-0162.1 422162	Ø 276 22 19 V + S
108 D 2.3 (638.064, 638.068)	58	03/97→07/03					24.0322-0162.1 522162	Ø 276 22 19 V + S
110 CDI 2.2 (638.094)	75	03/99→07/03	→				24.0110-0228.1 410228	Ø 280 10 8 + S
110 D 2.3 (638.074, 638.078)	72	03/97→07/03						
112 CDI 2.2 (638.094)	90	03/99→07/03						
113 2.0 (638.014, 638.094)	95	03/97→07/03						
114 2.3 (638.034, 638.094)	105	03/97→07/03						
<b>MERCEDES-BENZ - VITO Kasten (W447) 10/14→</b>								
<b> Bremsbelagsatz, Scheibenbremse</b>								
109 CDI (447.601, 447.603, 447.605)	65	10/14→	←				13.0460-4826.2 604826	BRE 29192 20,7 + WE / - WK + Zub
111 CDI (447.601, 447.603, 447.605)	84	10/14→					13.0460-4877.2 604877	BRE 29192 20,3 + WE / - WK + Zub
			→				13.0460-4882.2 604882	BRE 22102 18,2 + WE / - WK
							13.0470-4882.2 LD4882	BRE 22102 18,2 + WE / - WK Ceramic
114 CDI (447.601, 447.603, 447.605)	100	10/14→	←				13.0460-4826.2 604826	BRE 29192 20,7 + WE / - WK + Zub
116 CDI (447.601, 447.603, 447.605)	120	10/14→					13.0460-4877.2 604877	BRE 29192 20,3 + WE / - WK + Zub
116 CDI 4x4 (447.601, 447.603, 447.605)	120	07/15→					13.0460-4884.2 604884	BRE 22062 20,7 + WE / - WK
							13.0470-4884.2 LD4884	BRE 22062 20,7 + WE / - WK Ceramic
			→				13.0460-4882.2 604882	BRE 22102 18,2 + WE / - WK
							13.0470-4882.2 LD4882	BRE 22102 18,2 + WE / - WK Ceramic
114 CDI 4x4 (447.601, 447.603, 447.605)	100	07/15→	←				13.0460-4884.2 604884	BRE 22062 20,7 + WE / - WK
119 CDI / BlueTEC (447.601, 447.603, 447.605)	140	10/14→					13.0470-4884.2 LD4884	BRE 22062 20,7 + WE / - WK Ceramic
119 CDI / BlueTEC 4x4 (447.601, 447.603, 447.605)	140	07/15→					13.0460-4882.2 604882	BRE 22102 18,2 + WE / - WK
			→				13.0470-4882.2 LD4882	BRE 22102 18,2 + WE / - WK Ceramic
<b>Warnkontakt, Bremsbelagverschleiß</b>								
109 CDI (447.601, 447.603, 447.605)	65	10/14→	←			1	24.8190-0424.2 620424	L= 103,2
111 CDI (447.601, 447.603, 447.605)	84	10/14→	→			1	24.8190-0424.2 620424	L= 103,2
114 CDI (447.601, 447.603, 447.605)	100	10/14→						
114 CDI 4x4 (447.601, 447.603, 447.605)	100	07/15→						
116 CDI (447.601, 447.603, 447.605)	120	10/14→						
116 CDI 4x4 (447.601, 447.603, 447.605)	120	07/15→						
119 CDI / BlueTEC (447.601, 447.603, 447.605)	140	10/14→						















	kW					! #		
<b>MERCEDES-BENZ - VITO Kasten (W447) 10/14→</b>								
<b>Warnkontakt, Bremsbelagverschleiß</b>								
119 CDI / BlueTEC 4x4 (447.601, 447.603, 447.605)	140	07/15→	←			1	24.8190-0424.2 620424	L= 103,2
			→			1	24.8190-0424.2 620424	L= 103,2
<b> Bremsscheibe</b>								
109 CDI (447.601, 447.603, 447.605)	65	10/14→	←	für Stahlfelgen			24.0128-0145.1 428145	Ø 300 28 25 V + S
111 CDI (447.601, 447.603, 447.605)	84	10/14→	→	für Leichtmetallfelgen			24.0112-0213.1 412213	Ø 300 12 9 + S
114 CDI (447.601, 447.603, 447.605)	100	10/14→	←				24.0128-0145.1 428145	Ø 300 28 25 V + S
114 CDI 4x4 (447.601, 447.603, 447.605)	100	07/15→	→	für Leichtmetallfelgen			24.0112-0213.1 412213	Ø 300 12 9 + S
116 CDI (447.601, 447.603, 447.605)	120	10/14→						
116 CDI 4x4 (447.601, 447.603, 447.605)	120	07/15→						
119 CDI / BlueTEC (447.601, 447.603, 447.605)	140	10/14→						
119 CDI / BlueTEC 4x4 (447.601, 447.603, 447.605)	140	07/15→	←				24.0128-0145.1 428145	Ø 300 28 25 V + S
<b>MERCEDES-BENZ - VITO Mixto (W447) 10/14→</b>								
<b> Bremsbelagsatz, Scheibenbremse</b>								
109 CDI (447.701, 447.703, 447.705)	65	10/14→	←				13.0460-4826.2 604826	BRE 29192 20,7 + WE / - WK + Zub
111 CDI (447.701, 447.703, 447.705)	84	10/14→	→				13.0460-4877.2 604877	BRE 29192 20,3 + WE / - WK + Zub
			→				13.0460-4882.2 604882	BRE 22102 18,2 + WE / - WK
							13.0470-4882.2 LD4882	BRE 22102 18,2 + WE / - WK Ceramic
114 CDI (447.701, 447.703, 447.705)	100	10/14→	←				13.0460-4826.2 604826	BRE 29192 20,7 + WE / - WK + Zub
116 CDI (447.701, 447.703, 447.705)	120	10/14→					13.0460-4877.2 604877	BRE 29192 20,3 + WE / - WK + Zub
116 CDI 4x4 (447.701, 447.703, 447.705)	120	07/15→					13.0460-4884.2 604884	BRE 22062 20,7 + WE / - WK
							13.0470-4884.2 LD4884	BRE 22062 20,7 + WE / - WK Ceramic
			→				13.0460-4882.2 604882	BRE 22102 18,2 + WE / - WK
							13.0470-4882.2 LD4882	BRE 22102 18,2 + WE / - WK Ceramic
114 CDI 4x4 (447.701, 447.703, 447.705)	100	07/15→	←				13.0460-4884.2 604884	BRE 22062 20,7 + WE / - WK
119 BlueTEC (447.701, 447.703, 447.705)	140	10/14→					13.0470-4884.2 LD4884	BRE 22062 20,7 + WE / - WK Ceramic
119 BlueTEC 4x4 (447.701, 447.703, 447.705)	140	12/14→	→				13.0460-4882.2 604882	BRE 22102 18,2 + WE / - WK
							13.0470-4882.2 LD4882	BRE 22102 18,2 + WE / - WK Ceramic
<b>Warnkontakt, Bremsbelagverschleiß</b>								
109 CDI (447.701, 447.703, 447.705)	65	10/14→	←			1	24.8190-0424.2 620424	L= 103,2
111 CDI (447.701, 447.703, 447.705)	84	10/14→	→			1	24.8190-0424.2 620424	L= 103,2
114 CDI (447.701, 447.703, 447.705)	100	10/14→						
114 CDI 4x4 (447.701, 447.703, 447.705)	100	07/15→						
116 CDI (447.701, 447.703, 447.705)	120	10/14→						
116 CDI 4x4 (447.701, 447.703, 447.705)	120	07/15→						
119 BlueTEC (447.701, 447.703, 447.705)	140	10/14→						
119 BlueTEC 4x4 (447.701, 447.703, 447.705)	140	12/14→						
<b> Bremsscheibe</b>								
109 CDI (447.701, 447.703, 447.705)	65	10/14→	←	für Stahlfelgen			24.0128-0145.1 428145	Ø 300 28 25 V + S
111 CDI (447.701, 447.703, 447.705)	84	10/14→	→	für Leichtmetallfelgen			24.0112-0213.1 412213	Ø 300 12 9 + S
114 CDI (447.701, 447.703, 447.705)	100	10/14→	←				24.0128-0145.1 428145	Ø 300 28 25 V + S
↓								







	kw					! #		
<b>MERCEDES-BENZ - VITO Mixto (W447) 10/14→</b>								
 <b>Bremsscheibe</b>								
114 CDI 4x4 (447.701, 447.703, 447.705) 116 CDI (447.701, 447.703, 447.705) 116 CDI 4x4 (447.701, 447.703, 447.705) 119 BlueTEC (447.701, 447.703, 447.705)	100 120 120 140	07/15→ 10/14→ 07/15→ 10/14→	→	für Leichtmetallfelgen			24.0112-0213.1 412213	Ø 300 12 9 + S
119 BlueTEC 4x4 (447.701, 447.703, 447.705)	140	12/14→	←				24.0128-0145.1 428145	Ø 300 28 25 V + S
<b>MERCEDES-BENZ - VITO Tourer (W447) 10/14→</b>								
 <b>Bremsbelagsatz, Scheibenbremse</b>								
109 CDI / 109 BlueTEC (447.701, 447.703, 447.705) 111 CDI / 111 BlueTEC (447.701, 447.703, 447.705)	65 84	10/14→ 10/14→	←				13.0460-4826.2 604826 13.0460-4877.2 604877	BRE 29192 20,7 + WE / - WK + Zub BRE 29192 20,3 + WE / - WK + Zub
			→				13.0460-4882.2 604882 13.0470-4882.2 LD4882	BRE 22102 18,2 + WE / - WK BRE 22102 18,2 + WE / - WK Ceramic
114 CDI / 114 BlueTEC (447.701, 447.703, 447.705) 116 CDI / 116 BlueTEC (447.701, 447.703, 447.705) 116 CDI / 116 BlueTEC 4x4 (447.701, 447.703, 447.705)	100 120 120	10/14→ 10/14→ 07/15→	←				13.0460-4826.2 604826 13.0460-4877.2 604877 13.0460-4884.2 604884 13.0470-4884.2 LD4884	BRE 29192 20,7 + WE / - WK + Zub BRE 29192 20,3 + WE / - WK + Zub BRE 22062 20,7 + WE / - WK BRE 22062 20,7 + WE / - WK Ceramic
			→				13.0460-4882.2 604882 13.0470-4882.2 LD4882	BRE 22102 18,2 + WE / - WK BRE 22102 18,2 + WE / - WK Ceramic
114 CDI / 114 BlueTEC 4x4 (447.701, 447.703, 447.705) 119 BlueTEC (447.701, 447.703, 447.705) 119 CDI / 119 BlueTEC 4x4 (447.701, 447.703, 447.705)	100 140 140	07/15→ 10/14→ 12/14→	←				13.0460-4884.2 604884 13.0470-4884.2 LD4884 13.0460-4882.2 604882 13.0470-4882.2 LD4882	BRE 22062 20,7 + WE / - WK BRE 22062 20,7 + WE / - WK Ceramic BRE 22102 18,2 + WE / - WK BRE 22102 18,2 + WE / - WK Ceramic
			→					
<b>Warnkontakt, Bremsbelagsverschleiß</b>								
109 CDI / 109 BlueTEC (447.701, 447.703, 447.705) 111 CDI / 111 BlueTEC (447.701, 447.703, 447.705)	65 84	10/14→ 10/14→	←			1	24.8190-0424.2 620424	L= 103,2
			→			1	24.8190-0424.2 620424	L= 103,2
114 CDI / 114 BlueTEC (447.701, 447.703, 447.705) 114 CDI / 114 BlueTEC 4x4 (447.701, 447.703, 447.705) 116 CDI / 116 BlueTEC (447.701, 447.703, 447.705) 116 CDI / 116 BlueTEC 4x4 (447.701, 447.703, 447.705) 119 BlueTEC (447.701, 447.703, 447.705) 119 CDI / 119 BlueTEC 4x4 (447.701, 447.703, 447.705)	100 100 120 120 140 140	10/14→ 10/14→ 07/15→ 10/14→ 07/15→ 10/14→ 12/14→	←					
			→					
 <b>Bremsscheibe</b>								
109 CDI / 109 BlueTEC (447.701, 447.703, 447.705) 111 CDI / 111 BlueTEC (447.701, 447.703, 447.705)	65 84	10/14→ 10/14→	←	für Stahlfelgen			24.0128-0145.1 428145	Ø 300 28 25 V + S
			→	für Leichtmetallfelgen			24.0112-0213.1 412213	Ø 300 12 9 + S
114 CDI / 114 BlueTEC (447.701, 447.703, 447.705) 114 CDI / 114 BlueTEC 4x4 (447.701, 447.703, 447.705)	100 100	10/14→ 07/15→	←				24.0128-0145.1 428145	Ø 300 28 25 V + S
			→	für Leichtmetallfelgen			24.0112-0213.1 412213	Ø 300 12 9 + S















	kw					! #		
<b>MERCEDES-BENZ - VITO Tourer (W447) 10/14→</b>								
<b>Bremsscheibe</b>								
116 CDI / 116 BlueTEC (447.701, 447.703, 447.705)	120	10/14→	←			24.0128-0145.1	428145	Ø 300 28 25 V + S
			→	für Leichtmetallfelgen		24.0112-0213.1	412213	Ø 300 12 9 + S
116 CDI / 116 BlueTEC 4x4 (447.701, 447.703, 447.705)	120	07/15→						
119 BlueTEC (447.701, 447.703, 447.705)	140	10/14→						
119 CDI / 119 BlueTEC 4x4 (447.701, 447.703, 447.705)	140	12/14→	←			24.0128-0145.1	428145	Ø 300 28 25 V + S
<b>MERCEDES-BENZ - V-KLASSE (638/2) 02/96→07/03</b>								
<b>Bremsbelagsatz, Scheibenbremse</b>								
V 200 (638.214, 638.294)	95	02/97→07/03	←			13.0460-3980.2	603980	BOS 23022 20,9 + WE / - WK
V 200 CDI (638.294)	75	03/99→07/03				13.0460-7196.2	607196	ATE 21576 20,7 + WE / - WK
V 220 CDI (638.294)	90	03/99→07/03	→			13.0460-3985.2	603985	BOS 23020 17,9 - WK
V 230 (638.234, 638.294)	105	10/96→07/03				13.0460-7085.2	607085	ATE 21278 16,9 + WK
V 230 TD (638.274)	72	09/96→07/03						
V 280 (638.244, 638.294)	128	08/97→07/03	←	09/97→		13.0460-3980.2	603980	BOS 23022 20,9 + WE / - WK
			→	09/97→		13.0460-7196.2	607196	ATE 21576 20,7 + WE / - WK
						13.0460-3985.2	603985	BOS 23020 17,9 - WK
						13.0460-7085.2	607085	ATE 21278 16,9 + WK
<b>Warnkontakt, Bremsbelagverschleiß</b>								
V 200 (638.214, 638.294)	95	02/97→07/03	←	für Bosch System	2	24.8190-0407.2	620407	L= 115 L= 185
V 200 CDI (638.294)	75	03/99→07/03	←	für ATE System	2	24.8190-0417.2	620417	L= 99 L= 167
V 220 CDI (638.294)	90	03/99→07/03						
V 230 (638.234, 638.294)	105	10/96→07/03						
V 230 TD (638.274)	72	09/96→07/03						
V 280 (638.244, 638.294)	128	08/97→07/03	←	09/97→; für Bosch System	2	24.8190-0407.2	620407	L= 115 L= 185
			←	09/97→; für ATE System	2	24.8190-0417.2	620417	L= 99 L= 167
<b>Zubehörsatz, Scheibenbremsbelag</b>								
V 200 (638.214, 638.294)	95	02/97→07/03	←			13.0460-0250.2	610250	BOS
V 200 CDI (638.294)	75	03/99→07/03	→			13.0460-0288.2	610288	BOS
V 220 CDI (638.294)	90	03/99→07/03						
V 230 (638.234, 638.294)	105	10/96→07/03						
V 230 TD (638.274)	72	09/96→07/03						
V 280 (638.244, 638.294)	128	08/97→07/03	←	09/97→		13.0460-0250.2	610250	BOS
			→	09/97→		13.0460-0288.2	610288	BOS
<b>Bremsscheibe</b>								
V 200 (638.214, 638.294)	95	02/97→07/03	←			24.0122-0162.1	422162	Ø 276 22 19 V + S
V 200 CDI (638.294)	75	03/99→07/03				24.0322-0162.1	522162	Ø 276 22 19 V + S
V 220 CDI (638.294)	90	03/99→07/03	→			24.0110-0228.1	410228	Ø 280 10 8 + S
V 230 (638.234, 638.294)	105	10/96→07/03						
V 230 TD (638.274)	72	09/96→07/03						
V 280 (638.244, 638.294)	128	08/97→07/03	←	09/97→		24.0122-0162.1	422162	Ø 276 22 19 V + S
			→	09/97→		24.0322-0162.1	522162	Ø 276 22 19 V + S
						24.0110-0228.1	410228	Ø 280 10 8 + S
<b>MERCEDES-BENZ - V-KLASSE (W447) 03/14→</b>								
<b>Bremsbelagsatz, Scheibenbremse</b>								
V 200 CDI / d (447.811, 447.813, 447.815)	100	03/14→	←			13.0460-4826.2	604826	BRE 29192 20,7 + WE / - WK + Zub
						13.0460-4877.2	604877	BRE 29192 20,3 + WE / - WK + Zub
						13.0460-4884.2	604884	BRE 22062 20,7 + WE / - WK
						13.0470-4884.2	LD4884	BRE 22062 20,7 + WE / - WK Ceramic
			→			13.0460-4882.2	604882	BRE 22102 18,2 + WE / - WK
						13.0470-4882.2	LD4882	BRE 22102 18,2 + WE / - WK Ceramic
↓								











	kW					! #		
<b>MERCEDES-BENZ - V-KLASSE (W447) 03/14→</b>								
 <b>Bremsbelagsatz, Scheibenbremse</b>								
V 200 CDI / d 4-matic V 220 CDI / d (447.811, 447.813, 447.815)	100 120	04/15→ 03/14→	←				13.0460-4884.2 604884 13.0470-4884.2 LD4884	BRE 22062 20,7 + WE / - WK BRE 22062 20,7 + WE / - WK Ceramic
V 220 CDI / d 4-matic V 250 BlueTEC / d (447.811, 447.813, 447.815)	120 140	04/15→ 03/14→	→				13.0460-4882.2 604882 13.0470-4882.2 LD4882	BRE 22102 18,2 + WE / - WK BRE 22102 18,2 + WE / - WK Ceramic
V 250 BlueTEC / d 4- matic	140	12/14→						
<b>Warnkontakt, Bremsbelagsverschleiß</b>								
V 200 CDI / d (447.811, 447.813, 447.815)	100	03/14→	←		1	24.8190-0424.2 620424		L= 103,2
V 200 CDI / d 4-matic V 220 CDI / d (447.811, 447.813, 447.815)	100 120	04/15→ 03/14→						
V 220 CDI / d 4-matic V 250 BlueTEC / d (447.811, 447.813, 447.815)	120 140	04/15→ 03/14→						
V 250 BlueTEC / d 4- matic	140	12/14→						
 <b>Bremsscheibe</b>								
V 200 CDI / d (447.811, 447.813, 447.815)	100	03/14→	←	für Stahlfelgen		24.0128-0145.1 428145		Ø 300 28 25 V + S
V 200 CDI / d 4-matic V 220 CDI / d (447.811, 447.813, 447.815)	100 120	04/15→ 03/14→	→	für Leichtmetallfelgen		24.0112-0213.1 412213		Ø 300 12 9 + S
V 220 CDI / d 4-matic V 250 BlueTEC / d (447.811, 447.813, 447.815)	120 140	04/15→ 03/14→						
V 250 BlueTEC / d 4- matic	140	12/14→						
<b>MG - EXPRESS Kasten 03/03→05/05</b>								
 <b>Bremsbelagsatz, Scheibenbremse</b>								
1.4	76	03/03→05/05	←			13.0460-2803.2 602803		TRW 21515 17,5 + WK
1.8	86	03/03→05/05						
2.0 TD	74	03/03→05/05	→			13.0460-5998.2 605998		AKE 21312 12,8 + WK
2.0 TD	83	03/03→05/05						
160	118	03/03→05/05	←			13.0460-5825.2 605825		TRW 23094 16,5 + WK + Zub
			→			13.0460-5929.2 605929		AKE 21719 15,0 + WK
<b>Zubehörsatz, Scheibenbremsbelag</b>								
1.4	76	03/03→05/05	←			13.0460-0142.2 610142		
1.8	86	03/03→05/05						
2.0 TD	74	03/03→05/05						
2.0 TD	83	03/03→05/05						
 <b>Bremsscheibe</b>								
1.4	76	03/03→05/05	←			24.0113-0198.1 413198		Ø 262 13 11
1.8	86	03/03→05/05				24.0121-0105.1 421105		Ø 262 21 19 V + S
2.0 TD	74	03/03→05/05	→			24.0110-0212.1 410212		Ø 238,5 10 8 + S
2.0 TD	83	03/03→05/05						
160	118	03/03→05/05	←			24.0125-0161.1 425161		Ø 282 25 23 V
			→			24.0110-0326.1 410326		Ø 260 10 8
<b>MG - MGF (RD) 03/95→03/02</b>								
 <b>Bremsbelagsatz, Scheibenbremse</b>								
1.6	82	02/00→03/02	←			13.0460-2804.2 602804		TRW 21518 17,0 - WK
1.8 i 16V	88	03/95→03/02						
1.8 i VVC	107	03/95→03/02						
 <b>Bremsscheibe</b>								
1.6	82	02/00→03/02	←			24.0122-0177.1 422177		Ø 240,5 22 20 V
1.8 i 16V	88	03/95→03/02						
1.8 i VVC	107	03/95→03/02						
<b>MG - MG TF 03/02→12/09</b>								
 <b>Bremsbelagsatz, Scheibenbremse</b>								
115	85	03/02→12/09	←	→ 12/05		13.0460-2804.2 602804		TRW 21518 17,0 - WK
120	88	03/02→12/09						
135	100	03/02→12/09						
↓								











	kW			 	! #		
<b>MG - MG TF 03/02→12/09</b>							
 <b>Bremsscheibe</b>							
115 120 135	85 88 100	03/02→12/09 03/02→12/09 03/02→12/09	← ← ←	→ 12/05		24.0122-0177.1 422177	Ø 240,5 22 20 V
<b>MG - MG ZR 06/01→04/05</b>							
 <b>Bremsbelagsatz, Scheibenbremse</b>							
105 120 2.0 TD 160	76 86 74 118	06/01→04/05 06/01→04/05 06/01→04/05 06/01→04/05	← ← → ←			13.0460-2803.2 602803 13.0460-5998.2 605998 13.0460-5825.2 605825 13.0460-5929.2 605929	TRW 21515 17,5 + WK AKE 21312 12,8 + WK TRW 23094 16,5 + WK + Zub AKE 21719 15,0 + WK
<b>Zubehörsatz, Scheibenbremsbelag</b>							
105 120 2.0 TD	76 86 74	06/01→04/05 06/01→04/05 06/01→04/05	← ← ←			13.0460-0142.2 610142	
 <b>Bremsscheibe</b>							
105 120 2.0 TD 160	76 86 74 118	06/01→04/05 06/01→04/05 06/01→04/05 06/01→04/05	← ← → ←			24.0113-0198.1 413198 24.0121-0105.1 421105 24.0110-0212.1 410212 24.0125-0161.1 425161 24.0110-0326.1 410326	Ø 262 13 11 Ø 262 21 19 V + S Ø 238,5 10 8 + S Ø 282 25 23 V Ø 260 10 8
<b>MG - MG ZS 07/01→04/05</b>							
 <b>Bremsbelagsatz, Scheibenbremse</b>							
120 180 2.0 TD 2.0 TD	86 130 74 83	07/01→04/05 07/01→04/05 01/04→04/05 01/04→04/05	← ← → →			13.0460-5825.2 605825	TRW 23094 16,5 + WK + Zub
 <b>Bremsscheibe</b>							
120 180 2.0 TD 2.0 TD	86 130 74 83	07/01→04/05 07/01→04/05 01/04→04/05 01/04→04/05	← ← → →			24.0125-0161.1 425161 24.0110-0326.1 410326	Ø 282 25 23 V Ø 260 10 8
<b>MG - MG ZS Hatchback 07/01→10/05</b>							
 <b>Bremsbelagsatz, Scheibenbremse</b>							
120 180 2.0 TD 2.0 TD	86 130 74 83	07/01→10/05 07/01→10/05 01/04→10/05 01/04→10/05	← ← → →			13.0460-5825.2 605825	TRW 23094 16,5 + WK + Zub
 <b>Bremsscheibe</b>							
120 180 2.0 TD 2.0 TD	86 130 74 83	07/01→10/05 07/01→10/05 01/04→10/05 01/04→10/05	← ← → →			24.0125-0161.1 425161 24.0110-0326.1 410326	Ø 282 25 23 V Ø 260 10 8
<b>MG - MG ZT 06/01→10/05</b>							
 <b>Bremsbelagsatz, Scheibenbremse</b>							
1.8 T 16V 160 180 2.0 CDTi 2.0 CDTi	118 118 130 85 96	01/03→07/05 06/01→07/05 02/04→10/05 06/02→09/03 11/02→07/05	← ← → →	für Bremsscheibendurchmesser [mm]: 284		13.0460-7144.2 607144 13.0460-3605.2 603605 13.0470-3605.2 LD3605	ATE 23112 19,1 + WE / - WK ATE 20180 17,3 + WE / - WK ATE 20180 17,3 + WE / - WK Ceramic
190	140	06/01→07/05	← →	für Bremsscheibendurchmesser [mm]: 325		13.0460-7155.2 607155 13.0470-7155.2 LD7155 13.0460-3605.2 603605 13.0470-3605.2 LD3605	ATE 21676 20,3 + WE / - WK ATE 21676 20,3 + WE / - WK Ceramic ATE 20180 17,3 + WE / - WK ATE 20180 17,3 + WE / - WK Ceramic
260	191	10/03→07/05	←	für Bremsscheibendurchmesser [mm]: 325		13.0460-7155.2 607155 13.0470-7155.2 LD7155	ATE 21676 20,3 + WE / - WK ATE 21676 20,3 + WE / - WK Ceramic
<b>Warnkontakt, Bremsbelagverschleiß</b>							
1.8 16V ↓	88	01/03→07/05	←		1	24.8190-2801.2 622801	L= 1.103









	kW			 	! #		
<b>MG - MG ZT 06/01→10/05</b>							
<b>Warnkontakt, Bremsbelagverschleiß</b>							
1.8 T 16V 160 180 2.0 CDTi 2.0 CDTi	118 118 130 85 96	01/03→07/05 06/01→07/05 02/04→10/05 06/02→09/03 11/02→07/05	← → →	für Bremsscheibendurchmesser [mm]: 284	1	24.8190-2801.2 622801	L= 1.103
190 260	140 191	06/01→07/05 10/03→07/05	← →	für Bremsscheibendurchmesser [mm]: 325	1	24.8190-2801.2 622801	L= 1.103
					1	24.8190-2802.2 622802	L= 846
<b>Bremsscheibe</b>							
1.8 T 16V 160 180 2.0 CDTi 2.0 CDTi	118 118 130 85 96	01/03→07/05 06/01→07/05 02/04→10/05 06/02→09/03 11/02→07/05	← → →			24.0122-0206.1 422206	Ø 284 22 19 V
190	140	06/01→07/05	→			24.0110-0270.1 410270	Ø 280 10 8
						24.0110-0270.1 410270	Ø 280 10 8
<b>MG - MG ZT- T 10/01→10/05</b>							
<b>Bremsbelagsatz, Scheibenbremse</b>							
1.8 T 16V 160 180 2.0 CDTi	118 118 130 96	01/03→07/05 10/01→07/05 02/04→10/05 11/02→07/05	← → →	für Bremsscheibendurchmesser [mm]: 284		13.0460-7144.2 607144	ATE 23112 19,1 + WE / - WK
						13.0460-3605.2 603605	ATE 20180 17,3 + WE / - WK
						13.0470-3605.2 LD3605	ATE 20180 17,3 + WE / - WK Ceramic
190	140	10/01→07/05	← →	für Bremsscheibendurchmesser [mm]: 325		13.0460-7155.2 607155	ATE 21676 20,3 + WE / - WK
						13.0470-7155.2 LD7155	ATE 21676 20,3 + WE / - WK Ceramic
						13.0460-3605.2 603605	ATE 20180 17,3 + WE / - WK
						13.0470-3605.2 LD3605	ATE 20180 17,3 + WE / - WK Ceramic
2.0 CDTi	85	06/02→07/05	← →	→ 09/03; für Bremsscheibendurchmesser [mm]: 284		13.0460-7144.2 607144	ATE 23112 19,1 + WE / - WK
				→ 09/03		13.0460-3605.2 603605	ATE 20180 17,3 + WE / - WK
						13.0470-3605.2 LD3605	ATE 20180 17,3 + WE / - WK Ceramic
260	191	10/03→07/05	←	für Bremsscheibendurchmesser [mm]: 325		13.0460-7155.2 607155	ATE 21676 20,3 + WE / - WK
						13.0470-7155.2 LD7155	ATE 21676 20,3 + WE / - WK Ceramic
<b>Warnkontakt, Bremsbelagverschleiß</b>							
1.8 16V	88	01/03→07/05	←		1	24.8190-2801.2 622801	L= 1.103
1.8 T 16V 160 180 2.0 CDTi	118 118 130 96	01/03→07/05 10/01→07/05 02/04→10/05 11/02→07/05	← → →	für Bremsscheibendurchmesser [mm]: 284	1	24.8190-2801.2 622801	L= 1.103
					1	24.8190-2802.2 622802	L= 846
190 260	140 191	10/01→07/05 10/03→07/05	← →	für Bremsscheibendurchmesser [mm]: 325	1	24.8190-2801.2 622801	L= 1.103
					1	24.8190-2802.2 622802	L= 846
2.0 CDTi	85	06/02→07/05	← →	→ 09/03; für Bremsscheibendurchmesser [mm]: 284	1	24.8190-2801.2 622801	L= 1.103
				→ 09/03	1	24.8190-2802.2 622802	L= 846
<b>Bremsscheibe</b>							
1.8 T 16V 160 180 2.0 CDTi	118 118 130 96	01/03→07/05 10/01→07/05 02/04→10/05 11/02→07/05	← → →	für Bremsscheibendurchmesser [mm]: 284		24.0122-0206.1 422206	Ø 284 22 19 V
190	140	10/01→07/05	→			24.0110-0270.1 410270	Ø 280 10 8
						24.0110-0270.1 410270	Ø 280 10 8
2.0 CDTi	85	06/02→07/05	← →	→ 09/03; für Bremsscheibendurchmesser [mm]: 284		24.0122-0206.1 422206	Ø 284 22 19 V
				→ 09/03		24.0110-0270.1 410270	Ø 280 10 8
<b>MINI - MINI (F55) 09/13→</b>							
<b>Bremsbelagsatz, Scheibenbremse</b>							
Cooper Cooper D One D ↓	100 85 70	09/13→ 10/13→ 02/14→	←	10/14→		13.0460-2795.2 602795	TRW 23915 17,6 + WE / - WK + Zub









	kW			 	! #		
<b>MINI - MINI (F55) 09/13→</b>							
<b> Bremsbelagsatz, Scheibenbremse</b>							
Cooper Cooper D One D	100 85 70	09/13→ 10/13→ 02/14→	← →	10/14→ 10/14→		13.0470-2795.2 LD2795 13.0460-2797.2 602797 13.0470-2797.2 LD2797	TRW 23915 17,6 + WE / - WK + Zub Ceramic TRW 25980 16,8 + WE / - WK + Zub TRW 25980 16,8 + WE / - WK + Zub Ceramic
Cooper S Cooper S Cooper SD Cooper SD	120 141 120 125	09/13→ 09/13→ 09/13→ 09/13→	← →	10/14→ 10/14→		13.0460-2613.2 602613 13.0470-2613.2 LD2613 13.0460-2797.2 602797 13.0470-2797.2 LD2797	TRW 22187 18,6 + WE / - WK TRW 22187 18,6 + WE / - WK Ceramic TRW 25980 16,8 + WE / - WK + Zub TRW 25980 16,8 + WE / - WK + Zub Ceramic
Cooper S JCW	155	09/13→	→			13.0460-2797.2 602797 13.0470-2797.2 LD2797	TRW 25980 16,8 + WE / - WK + Zub TRW 25980 16,8 + WE / - WK + Zub Ceramic
One	75	05/14→10/17	← → →	10/14→ für Fahrzeuge mit Sportpaket 10/14→		13.0460-2795.2 602795 13.0470-2795.2 LD2795 13.0460-2716.2 602716 13.0470-2716.2 LD2716 13.0460-2797.2 602797 13.0470-2797.2 LD2797	TRW 23915 17,6 + WE / - WK + Zub TRW 23915 17,6 + WE / - WK + Zub Ceramic TRW 24703 17,8 + WE / - WK + Zub TRW 24703 17,8 + WE / - WK + Zub Ceramic TRW 25980 16,8 + WE / - WK + Zub TRW 25980 16,8 + WE / - WK + Zub Ceramic
One First	55	06/14→10/17	← →	03/15→ 03/15→		13.0460-2795.2 602795 13.0470-2795.2 LD2795 13.0460-2797.2 602797 13.0470-2797.2 LD2797	TRW 23915 17,6 + WE / - WK + Zub TRW 23915 17,6 + WE / - WK + Zub Ceramic TRW 25980 16,8 + WE / - WK + Zub TRW 25980 16,8 + WE / - WK + Zub Ceramic
One First	55	11/17→	← →			13.0460-2795.2 602795 13.0470-2795.2 LD2795 13.0460-2797.2 602797 13.0470-2797.2 LD2797	TRW 23915 17,6 + WE / - WK + Zub TRW 23915 17,6 + WE / - WK + Zub Ceramic TRW 25980 16,8 + WE / - WK + Zub TRW 25980 16,8 + WE / - WK + Zub Ceramic
<b>Warnkontakt, Bremsbelagsverschleiß</b>							
Cooper Cooper D Cooper S Cooper S Cooper SD Cooper SD One One D	100 85 120 141 120 125 75 70	09/13→ 10/13→ 09/13→ 09/13→ 09/13→ 09/13→ 05/14→10/17 02/14→	← →	 ; 10/14→ 10/14→	1 1	24.8190-0941.2 620941 24.8190-0942.2 620942	L= 648 L= 641
Cooper S JCW One First	155 55	09/13→ 11/17→	← →	 10/14→	1 1	24.8190-0941.2 620941 24.8190-0942.2 620942	L= 648 L= 641
One First	55	06/14→10/17	← →	 ; 03/15→ 03/15→	1 1	24.8190-0941.2 620941 24.8190-0942.2 620942	L= 648 L= 641
<b> Bremsscheibe</b>							
Cooper Cooper D One D	100 85 70	09/13→ 10/13→ 02/14→	← →	10/14→ 10/14→		24.0122-0292.1 422292 24.0110-0396.1 410396	Ø 280 22 20,4 V + S Ø 259 10 8,4 + S
Cooper S Cooper S Cooper SD Cooper SD	120 141 120 125	09/13→ 09/13→ 09/13→ 09/13→	→	10/14→		24.0110-0396.1 410396	Ø 259 10 8,4 + S
Cooper S JCW	155	09/13→	→			24.0110-0396.1 410396	Ø 259 10 8,4 + S
One ↓	75	05/14→10/17	←	10/14→		24.0122-0292.1 422292	Ø 280 22 20,4 V + S











	kw			 	! #		
<b>MINI - MINI (F55) 09/13→</b>							
 <b>Bremsscheibe</b>							
One	75	05/14→10/17	←	☐; für Fahrzeuge mit Sportpaket		24.0136-0132.2 436132	Ø 348 36 34,4 V Bremsscheibe zweiteilig / + S
			←	☐; für Fahrzeuge mit Sportpaket		24.0136-0133.2 436133	Ø 348 36 34,4 V Bremsscheibe zweiteilig / + S
			→	10/14→		24.0110-0396.1 410396	Ø 259 10 8,4 + S
One First	55	06/14→10/17	←	03/15→		24.0122-0292.1 422292	Ø 280 22 20,4 V + S
			→	03/15→		24.0110-0396.1 410396	Ø 259 10 8,4 + S
One First	55	11/17→	←			24.0122-0292.1 422292	Ø 280 22 20,4 V + S
			→			24.0110-0396.1 410396	Ø 259 10 8,4 + S
<b>MINI - MINI (F56) 12/13→</b>							
 <b>Bremsbelagsatz, Scheibenbremse</b>							
Cooper	100	12/13→	←			13.0460-2795.2 602795	TRW 23915 17,6 + WE / - WK + Zub
Cooper D	85	12/13→					
One	75	04/14→10/17				13.0470-2795.2 LD2795	TRW 23915 17,6 + WE / - WK + Zub Ceramic
One	75	11/17→					
One D	70	03/14→					
One First	55	07/14→10/17	→			13.0460-2797.2 602797	TRW 25980 16,8 + WE / - WK + Zub
One First	55	11/17→				13.0470-2797.2 LD2797	TRW 25980 16,8 + WE / - WK + Zub Ceramic
Cooper S	120	11/14→	←			13.0460-2613.2 602613	TRW 22187 18,6 + WE / - WK
Cooper S	141	12/13→					
Cooper SD	120	06/14→				13.0470-2613.2 LD2613	TRW 22187 18,6 + WE / - WK Ceramic
Cooper SD	125	06/14→	→			13.0460-2797.2 602797	TRW 25980 16,8 + WE / - WK + Zub
						13.0470-2797.2 LD2797	TRW 25980 16,8 + WE / - WK + Zub Ceramic
Cooper S JCW	155	12/13→	→	03/15→		13.0460-2797.2 602797	TRW 25980 16,8 + WE / - WK + Zub
						13.0470-2797.2 LD2797	TRW 25980 16,8 + WE / - WK + Zub Ceramic
John Cooper Works	170	03/15→	→			13.0460-2797.2 602797	TRW 25980 16,8 + WE / - WK + Zub
						13.0470-2797.2 LD2797	TRW 25980 16,8 + WE / - WK + Zub Ceramic
<b>Warnkontakt, Bremsbelagverschleiß</b>							
Cooper	100	12/13→	←	☐	1	24.8190-0941.2 620941	L= 648
Cooper D	85	12/13→					
Cooper S	120	11/14→	→		1	24.8190-0942.2 620942	L= 641
Cooper S	141	12/13→					
Cooper SD	120	06/14→					
Cooper SD	125	06/14→					
John Cooper Works	170	03/15→					
One	75	04/14→10/17					
One	75	11/17→					
One D	70	03/14→					
One First	55	07/14→10/17					
One First	55	11/17→					
Cooper S JCW	155	12/13→	←	☐; 03/15→	1	24.8190-0941.2 620941	L= 648
			→	03/15→	1	24.8190-0942.2 620942	L= 641
 <b>Bremsscheibe</b>							
Cooper	100	12/13→	←			24.0122-0292.1 422292	Ø 280 22 20,4 V + S
Cooper D	85	12/13→	→				
One	75	04/14→10/17				24.0110-0396.1 410396	Ø 259 10 8,4 + S
One	75	11/17→					
One D	70	03/14→					
One First	55	07/14→10/17					
One First	55	11/17→					
Cooper S	120	11/14→	→			24.0110-0396.1 410396	Ø 259 10 8,4 + S
Cooper S	141	12/13→					
Cooper SD	120	06/14→					
Cooper SD	125	06/14→					
John Cooper Works	170	03/15→					
Cooper S JCW	155	12/13→	→	03/15→		24.0110-0396.1 410396	Ø 259 10 8,4 + S
<b>MINI - MINI (R50, R53) 06/01→09/06</b>							
 <b>Bremsbelagsatz, Scheibenbremse</b>							
Cooper ↓	85	06/01→09/06	←			13.0460-7161.2 607161	ATE 23281 18,3 + WE / - WK











	kW			 	! #		
<b>MINI - MINI (R50, R53) 06/01→09/06</b>							
 <b>Bremsbelagsatz, Scheibenbremse</b>							
Cooper S	125	07/04→09/06	←			13.0470-7161.2 LD7161	ATE 23281 18,3 + WE / - WK Ceramic
One	55	04/03→09/06	→			13.0460-7162.2 607162	ATE 23716 15,8 + WE / - WK
One	66	06/01→09/06	→			13.0470-7162.2 LD7162	ATE 23716 15,8 + WE / - WK Ceramic
One D	55	06/03→09/06	→				
One D	65	06/03→09/06	→				
Cooper S	120	03/02→09/06	←	07/02→		13.0460-7161.2 607161	ATE 23281 18,3 + WE / - WK
			→	07/02→		13.0470-7161.2 LD7161	ATE 23281 18,3 + WE / - WK Ceramic
			→	07/02→		13.0460-7162.2 607162	ATE 23716 15,8 + WE / - WK
			→	07/02→		13.0470-7162.2 LD7162	ATE 23716 15,8 + WE / - WK Ceramic
S Works	149	11/03→06/05	←			13.0460-2725.2 602725	TRW 23984 17,8 + WE / - WK + Zub
			→			13.0470-2725.2 LD2725	TRW 23984 17,8 + WE / - WK + Zub Ceramic
			→			13.0460-7162.2 607162	ATE 23716 15,8 + WE / - WK
			→			13.0470-7162.2 LD7162	ATE 23716 15,8 + WE / - WK Ceramic
Works	155	11/03→09/06	←	→ 02/06		13.0460-2725.2 602725	TRW 23984 17,8 + WE / - WK + Zub
			→			13.0470-2725.2 LD2725	TRW 23984 17,8 + WE / - WK + Zub Ceramic
			←	03/06→		13.0460-2725.2 602725	TRW 23984 17,8 + WE / - WK + Zub
			→			13.0470-2725.2 LD2725	TRW 23984 17,8 + WE / - WK + Zub Ceramic
			→			13.0460-7162.2 607162	ATE 23716 15,8 + WE / - WK
			→			13.0470-7162.2 LD7162	ATE 23716 15,8 + WE / - WK Ceramic
<b>Warnkontakt, Bremsbelagverschleiß</b>							
Cooper	85	06/01→09/06	←		1	24.8190-0235.2 620235	L= 883
Cooper S	125	07/04→09/06	→		1	24.8190-0236.2 620236	L= 1.130
One	55	04/03→09/06	→				
One	66	06/01→09/06	→				
One D	55	06/03→09/06	→				
One D	65	06/03→09/06	→				
S Works	149	11/03→06/05	→				
Cooper S	120	03/02→09/06	←	07/02→	1	24.8190-0235.2 620235	L= 883
			→	07/02→	1	24.8190-0236.2 620236	L= 1.130
Works	155	11/03→09/06	←	→ 02/06	1	24.8190-0235.2 620235	L= 883
			←	03/06→	1	24.8190-0235.2 620235	L= 883
			→		1	24.8190-0236.2 620236	L= 1.130
 <b>Bremsscheibe</b>							
Cooper	85	06/01→09/06	←			24.0122-0204.1 422204	Ø 276 22 20,4 V
Cooper S	125	07/04→09/06	→			24.0322-0204.1 522204	Ø 276 22 19,6 V
One	55	04/03→09/06	→			24.0110-0271.1 410271	Ø 259 10 8,4
One	66	06/01→09/06	→			24.0310-0271.1 510271	Ø 259 10 7,6
One D	55	06/03→09/06	→				
One D	65	06/03→09/06	→				
Cooper S	120	03/02→09/06	←	07/02→		24.0122-0204.1 422204	Ø 276 22 20,4 V
			→	07/02→		24.0322-0204.1 522204	Ø 276 22 19,6 V
			→	07/02→		24.0110-0271.1 410271	Ø 259 10 8,4
			→	07/02→		24.0310-0271.1 510271	Ø 259 10 7,6
S Works	149	11/03→06/05	←			24.0122-0244.1 422244	Ø 294 22 20,4 V
Works	155	11/03→09/06	→			24.0110-0271.1 410271	Ø 259 10 8,4
			→			24.0310-0271.1 510271	Ø 259 10 7,6
<b>MINI - MINI (R56) 11/05→01/14</b>							
 <b>Bremsbelagsatz, Scheibenbremse</b>							
Cooper	85	09/06→11/13	←	03/10→		13.0460-2710.2 602710	TRW 23915 17,6 + WE / - WK + Zub
Cooper	90	09/09→11/13	→			13.0470-2710.2 LD2710	TRW 23915 17,6 + WE / - WK + Zub Ceramic
			→	09/10→		13.0460-2714.2 602714	TRW 24289 16,9 + WE / - WK + Zub
↓							









	kw			 	! #			
<b>MINI - MINI (R56) 11/05→01/14</b>								
<b> Bremsbelagsatz, Scheibenbremse</b>								
Cooper Cooper	85 90	09/06→11/13 09/09→11/13	➡	09/10→		13.0470-2714.2	LD2714	TRW 24289 16,9 + WE / - WK + Zub Ceramic
			➡	03/10→ 08/10		13.0460-2714.2	602714	TRW 24289 16,9 + WE / - WK + Zub
						13.0470-2714.2	LD2714	TRW 24289 16,9 + WE / - WK + Zub Ceramic
Cooper	88	10/06→02/12	←	11/06→		13.0460-2710.2	602710	TRW 23915 17,6 + WE / - WK + Zub
						13.0470-2710.2	LD2710	TRW 23915 17,6 + WE / - WK + Zub Ceramic
			➡	11/06→ 08/10		13.0460-2714.2	602714	TRW 24289 16,9 + WE / - WK + Zub
						13.0470-2714.2	LD2714	TRW 24289 16,9 + WE / - WK + Zub Ceramic
Cooper D	80	11/06→09/10	←	04/07→		13.0460-2710.2	602710	TRW 23915 17,6 + WE / - WK + Zub
						13.0470-2710.2	LD2710	TRW 23915 17,6 + WE / - WK + Zub Ceramic
			➡	04/07→ 08/10		13.0460-2714.2	602714	TRW 24289 16,9 + WE / - WK + Zub
						13.0470-2714.2	LD2714	TRW 24289 16,9 + WE / - WK + Zub Ceramic
			➡	09/10→		13.0460-2714.2	602714	TRW 24289 16,9 + WE / - WK + Zub
						13.0470-2714.2	LD2714	TRW 24289 16,9 + WE / - WK + Zub Ceramic
Cooper D One One One D	82 55 72 66	06/10→11/13 03/10→11/13 03/10→11/13 07/10→11/13	←			13.0460-2710.2	602710	TRW 23915 17,6 + WE / - WK + Zub
						13.0470-2710.2	LD2710	TRW 23915 17,6 + WE / - WK + Zub Ceramic
			➡	09/10→		13.0460-2714.2	602714	TRW 24289 16,9 + WE / - WK + Zub
						13.0470-2714.2	LD2714	TRW 24289 16,9 + WE / - WK + Zub Ceramic
			➡	→ 08/10		13.0460-2714.2	602714	TRW 24289 16,9 + WE / - WK + Zub
						13.0470-2714.2	LD2714	TRW 24289 16,9 + WE / - WK + Zub Ceramic
Cooper D Cooper SD Cooper SD One	82 100 105 55	02/11→11/13 02/11→11/13 02/11→11/13 03/09→03/10	←			13.0460-2710.2	602710	TRW 23915 17,6 + WE / - WK + Zub
						13.0470-2710.2	LD2710	TRW 23915 17,6 + WE / - WK + Zub Ceramic
			➡			13.0460-2714.2	602714	TRW 24289 16,9 + WE / - WK + Zub
						13.0470-2714.2	LD2714	TRW 24289 16,9 + WE / - WK + Zub Ceramic
Cooper S Cooper S	120 135	03/10→11/13 03/10→11/13	←			13.0460-2725.2	602725	TRW 23984 17,8 + WE / - WK + Zub
						13.0470-2725.2	LD2725	TRW 23984 17,8 + WE / - WK + Zub Ceramic
			➡	09/10→		13.0460-2714.2	602714	TRW 24289 16,9 + WE / - WK + Zub
						13.0470-2714.2	LD2714	TRW 24289 16,9 + WE / - WK + Zub Ceramic
			➡	→ 08/10		13.0460-2714.2	602714	TRW 24289 16,9 + WE / - WK + Zub
						13.0470-2714.2	LD2714	TRW 24289 16,9 + WE / - WK + Zub Ceramic
Cooper S	128	10/06→02/10	←	11/06→		13.0460-2725.2	602725	TRW 23984 17,8 + WE / - WK + Zub
						13.0470-2725.2	LD2725	TRW 23984 17,8 + WE / - WK + Zub Ceramic
			➡	11/06→		13.0460-2714.2	602714	TRW 24289 16,9 + WE / - WK + Zub
						13.0470-2714.2	LD2714	TRW 24289 16,9 + WE / - WK + Zub Ceramic
↓								









	kw			 	! #		
<b>MINI - MINI (R56) 11/05→01/14</b>							
<b> Bremsbelagsatz, Scheibenbremse</b>							
Cooper S	147	01/12→11/13	←			13.0460-2725.2 602725	TRW 23984 17,8 + WE / - WK + Zub
			→			13.0470-2725.2 LD2725	TRW 23984 17,8 + WE / - WK + Zub Ceramic
			→			13.0460-2714.2 602714	TRW 24289 16,9 + WE / - WK + Zub
						13.0470-2714.2 LD2714	TRW 24289 16,9 + WE / - WK + Zub Ceramic
Cooper S John Cooper Works	141	11/06→02/10	→	03/08→		13.0460-2714.2 602714	TRW 24289 16,9 + WE / - WK + Zub
						13.0470-2714.2 LD2714	TRW 24289 16,9 + WE / - WK + Zub Ceramic
John Cooper Works	155	11/07→11/13	→	03/08→ 08/10		13.0460-2714.2 602714	TRW 24289 16,9 + WE / - WK + Zub
						13.0470-2714.2 LD2714	TRW 24289 16,9 + WE / - WK + Zub Ceramic
			→	09/10→		13.0460-2714.2 602714	TRW 24289 16,9 + WE / - WK + Zub
						13.0470-2714.2 LD2714	TRW 24289 16,9 + WE / - WK + Zub Ceramic
John Cooper Works GP	160	09/12→11/13	→			13.0460-2714.2 602714	TRW 24289 16,9 + WE / - WK + Zub
						13.0470-2714.2 LD2714	TRW 24289 16,9 + WE / - WK + Zub Ceramic
One	70	11/06→03/10	←	04/07→		13.0460-2710.2 602710	TRW 23915 17,6 + WE / - WK + Zub
						13.0470-2710.2 LD2710	TRW 23915 17,6 + WE / - WK + Zub Ceramic
			→	04/07→		13.0460-2714.2 602714	TRW 24289 16,9 + WE / - WK + Zub
						13.0470-2714.2 LD2714	TRW 24289 16,9 + WE / - WK + Zub Ceramic
One D	66	06/09→07/10	←	03/10→		13.0460-2710.2 602710	TRW 23915 17,6 + WE / - WK + Zub
						13.0470-2710.2 LD2710	TRW 23915 17,6 + WE / - WK + Zub Ceramic
			→	03/10→		13.0460-2714.2 602714	TRW 24289 16,9 + WE / - WK + Zub
						13.0470-2714.2 LD2714	TRW 24289 16,9 + WE / - WK + Zub Ceramic
<b>Warnkontakt, Bremsbelagverschleiß</b>							
Cooper	85	09/06→11/13	←	03/10→	1	24.8190-0277.2 620277	L= 802
Cooper	90	09/09→11/13	→	09/10→	1	24.8190-0010.2 620010	L= 1.141
			→	03/10→ 08/10	1	24.8190-0278.2 620278	L= 1.130
Cooper	88	10/06→02/12	←	11/06→	1	24.8190-0277.2 620277	L= 802
			→	09/10→	1	24.8190-0010.2 620010	L= 1.141
			→	11/06→ 08/10	1	24.8190-0278.2 620278	L= 1.130
Cooper D	80	11/06→09/10	←	04/07→	1	24.8190-0277.2 620277	L= 802
			→	09/10→	1	24.8190-0010.2 620010	L= 1.141
			→	04/07→ 08/10	1	24.8190-0278.2 620278	L= 1.130
Cooper D	82	06/10→11/13	←		1	24.8190-0277.2 620277	L= 802
Cooper S	120	03/10→11/13	→	09/10→	1	24.8190-0010.2 620010	L= 1.141
Cooper S	135	03/10→11/13	→	→ 08/10	1	24.8190-0278.2 620278	L= 1.130
One	55	03/10→11/13	→				
One	72	03/10→11/13	→				
One D	66	07/10→11/13	→				
Cooper D	82	02/11→11/13	←		1	24.8190-0277.2 620277	L= 802
Cooper S	147	01/12→11/13	→		1	24.8190-0010.2 620010	L= 1.141
Cooper SD	100	02/11→11/13	→				
Cooper SD	105	02/11→11/13	→				
John Cooper Works GP	160	09/12→11/13	→				
Cooper S	128	10/06→02/10	←	11/06→	1	24.8190-0277.2 620277	L= 802
			→	11/06→	1	24.8190-0278.2 620278	L= 1.130
Cooper S John Cooper Works	141	11/06→02/10	←	03/08→	1	24.8190-0277.2 620277	L= 802
			→	03/08→	1	24.8190-0278.2 620278	L= 1.130
John Cooper Works	155	11/07→11/13	←	03/08→	1	24.8190-0277.2 620277	L= 802
↓							

	kW			 	! #		
<b>MINI - MINI (R56) 11/05→01/14</b>							
<b>Warnkontakt, Bremsbelagverschleiß</b>							
John Cooper Works	155	11/07→11/13	➡	09/10→	1	24.8190-0010.2 620010	L= 1.141
			➡	03/08→ 08/10	1	24.8190-0278.2 620278	L= 1.130
One	55	03/09→03/10	➡		1	24.8190-0277.2 620277	L= 802
			➡		1	24.8190-0278.2 620278	L= 1.130
One	70	11/06→03/10	➡	04/07→	1	24.8190-0277.2 620277	L= 802
			➡	04/07→	1	24.8190-0278.2 620278	L= 1.130
One D	66	06/09→07/10	➡	03/10→	1	24.8190-0277.2 620277	L= 802
			➡	03/10→	1	24.8190-0278.2 620278	L= 1.130
<b> Brems Scheibe</b>							
Cooper	85	09/06→11/13	➡	03/10→		24.0122-0248.1 422248	Ø 280 22 20,4 V
Cooper	90	09/09→11/13				24.0322-0248.1 522248	Ø 280 22 19,6 V
One D	66	06/09→07/10	➡	03/10→		24.0110-0271.1 410271	Ø 259 10 8,4
Cooper	88	10/06→02/12	➡	11/06→		24.0122-0248.1 422248	Ø 280 22 20,4 V
			➡	11/06→		24.0322-0248.1 522248	Ø 280 22 19,6 V
			➡	11/06→		24.0110-0271.1 410271	Ø 259 10 8,4
Cooper D	80	11/06→09/10	➡	04/07→		24.0122-0248.1 422248	Ø 280 22 20,4 V
One	70	11/06→03/10				24.0322-0248.1 522248	Ø 280 22 19,6 V
			➡	04/07→		24.0110-0271.1 410271	Ø 259 10 8,4
Cooper D	82	06/10→11/13	➡			24.0122-0248.1 422248	Ø 280 22 20,4 V
Cooper D	82	02/11→11/13				24.0322-0248.1 522248	Ø 280 22 19,6 V
Cooper SD	100	02/11→11/13	➡			24.0110-0271.1 410271	Ø 259 10 8,4
Cooper SD	105	02/11→11/13					
One	55	03/09→03/10					
One	55	03/10→11/13					
One	72	03/10→11/13					
One D	66	07/10→11/13					
Cooper S	120	03/10→11/13	➡			24.0122-0247.1 422247	Ø 294 22 20,4 V
Cooper S	135	03/10→11/13				24.0322-0247.1 522247	Ø 294 22 19,6 V
Cooper S	147	01/12→11/13	➡			24.0110-0271.1 410271	Ø 259 10 8,4
Cooper S	128	10/06→02/10	➡	11/06→		24.0122-0247.1 422247	Ø 294 22 20,4 V
			➡	11/06→		24.0322-0247.1 522247	Ø 294 22 19,6 V
			➡	11/06→		24.0110-0271.1 410271	Ø 259 10 8,4
<b>MINI - MINI Cabriolet (F57) 11/14→</b>							
<b> Bremsbelagsatz, Scheibenbremse</b>							
Cooper	100	11/14→	➡	11/15→		13.0460-2795.2 602795	TRW 23915 17,6 + WE / - WK + Zub
Cooper D	85	12/14→				13.0470-2795.2 LD2795	TRW 23915 17,6 + WE / - WK + Zub Ceramic
			➡	11/15→		13.0460-2797.2 602797	TRW 25980 16,8 + WE / - WK + Zub
						13.0470-2797.2 LD2797	TRW 25980 16,8 + WE / - WK + Zub Ceramic
Cooper S	120	11/14→	➡	11/15→		13.0460-2613.2 602613	TRW 22187 18,6 + WE / - WK
Cooper S	141	11/14→				13.0470-2613.2 LD2613	TRW 22187 18,6 + WE / - WK Ceramic
			➡	11/15→		13.0460-2797.2 602797	TRW 25980 16,8 + WE / - WK + Zub
						13.0470-2797.2 LD2797	TRW 25980 16,8 + WE / - WK + Zub Ceramic
Cooper SD	120	05/15→	➡	03/16→		13.0460-2613.2 602613	TRW 22187 18,6 + WE / - WK
Cooper SD	125	05/15→				13.0470-2613.2 LD2613	TRW 22187 18,6 + WE / - WK Ceramic
			➡	03/16→		13.0460-2797.2 602797	TRW 25980 16,8 + WE / - WK + Zub
						13.0470-2797.2 LD2797	TRW 25980 16,8 + WE / - WK + Zub Ceramic
Cooper S JCW	155	11/14→	➡	03/16→		13.0460-2797.2 602797	TRW 25980 16,8 + WE / - WK + Zub
John Cooper Works	170	05/15→				13.0470-2797.2 LD2797	TRW 25980 16,8 + WE / - WK + Zub Ceramic
One	75	06/15→10/17	➡	03/16→		13.0460-2795.2 602795	TRW 23915 17,6 + WE / - WK + Zub
↓							



	kW			 	! #		
<b>MINI - MINI Cabriolet (F57) 11/14→</b>							
 <b>Bremsbelagsatz, Scheibenbremse</b>							
One	75	06/15→10/17	←	03/16→		13.0470-2795.2 LD2795	TRW 23915 17,6 + WE / - WK + Zub Ceramic
			→	03/16→		13.0460-2797.2 602797	TRW 25980 16,8 + WE / - WK + Zub
						13.0470-2797.2 LD2797	TRW 25980 16,8 + WE / - WK + Zub Ceramic
One	75	11/17→	←			13.0460-2795.2 602795	TRW 23915 17,6 + WE / - WK + Zub
						13.0470-2795.2 LD2795	TRW 23915 17,6 + WE / - WK + Zub Ceramic
			→			13.0460-2797.2 602797	TRW 25980 16,8 + WE / - WK + Zub
						13.0470-2797.2 LD2797	TRW 25980 16,8 + WE / - WK + Zub Ceramic
<b>Warnkontakt, Bremsbelagverschleiß</b>							
Cooper	100	11/14→	→	11/15→	1	24.8190-0942.2 620942	L= 641
Cooper D	85	12/14→					
Cooper S	120	11/14→					
Cooper S	141	11/14→					
Cooper SD	120	05/15→	→	03/16→	1	24.8190-0942.2 620942	L= 641
Cooper SD	125	05/15→					
One	75	06/15→10/17					
Cooper S JCW	155	11/14→	←	☐; 03/16→	1	24.8190-0941.2 620941	L= 648
John Cooper Works	170	05/15→	→	03/16→	1	24.8190-0942.2 620942	L= 641
One	75	11/17→	→		1	24.8190-0942.2 620942	L= 641
 <b>Bremsscheibe</b>							
Cooper	100	11/14→	←	11/15→		24.0122-0292.1 422292	Ø 280 22 20,4 V + S
Cooper D	85	12/14→	→	11/15→		24.0110-0396.1 410396	Ø 259 10 8,4 + S
Cooper S	120	11/14→	→	11/15→		24.0110-0396.1 410396	Ø 259 10 8,4 + S
Cooper S	141	11/14→					
Cooper SD	120	05/15→	→	03/16→		24.0110-0396.1 410396	Ø 259 10 8,4 + S
Cooper SD	125	05/15→					
Cooper S JCW	155	11/14→					
John Cooper Works	170	05/15→					
One	75	06/15→10/17	←	03/16→		24.0122-0292.1 422292	Ø 280 22 20,4 V + S
			→	03/16→		24.0110-0396.1 410396	Ø 259 10 8,4 + S
One	75	11/17→	←			24.0122-0292.1 422292	Ø 280 22 20,4 V + S
			→			24.0110-0396.1 410396	Ø 259 10 8,4 + S
<b>MINI - MINI Cabriolet (R52) 07/04→01/08</b>							
 <b>Bremsbelagsatz, Scheibenbremse</b>							
Cooper	85	07/04→11/07	←			13.0460-7161.2 607161	ATE 23281 18,3 + WE / - WK
Cooper S	120	07/04→11/07				13.0470-7161.2 LD7161	ATE 23281 18,3 + WE / - WK Ceramic
Cooper S	125	07/04→11/07					
One	66	07/04→11/07	→			13.0460-7162.2 607162	ATE 23716 15,8 + WE / - WK
						13.0470-7162.2 LD7162	ATE 23716 15,8 + WE / - WK Ceramic
John Cooper Works	155	07/04→11/07	←	→ 05/06		13.0460-2725.2 602725	TRW 23984 17,8 + WE / - WK + Zub
						13.0470-2725.2 LD2725	TRW 23984 17,8 + WE / - WK + Zub Ceramic
			←	06/06→		13.0460-2725.2 602725	TRW 23984 17,8 + WE / - WK + Zub
						13.0470-2725.2 LD2725	TRW 23984 17,8 + WE / - WK + Zub Ceramic
			→			13.0460-7162.2 607162	ATE 23716 15,8 + WE / - WK
						13.0470-7162.2 LD7162	ATE 23716 15,8 + WE / - WK Ceramic
<b>Warnkontakt, Bremsbelagverschleiß</b>							
Cooper	85	07/04→11/07	←		1	24.8190-0235.2 620235	L= 883
Cooper S	120	07/04→11/07	→		1	24.8190-0236.2 620236	L= 1.130
Cooper S	125	07/04→11/07					
One	66	07/04→11/07					
John Cooper Works	155	07/04→11/07	←	→ 05/06	1	24.8190-0235.2 620235	L= 883
			←	06/06→	1	24.8190-0235.2 620235	L= 883
↓							

	kw			 	! #		
<b>MINI - MINI Cabriolet (R52) 07/04→01/08</b>							
<b>Warnkontakt, Bremsbelagverschleiß</b>							
John Cooper Works	155	07/04→11/07	➡		1	24.8190-0236.2 620236	L= 1.130
<b> Brems Scheibe</b>							
Cooper	85	07/04→11/07	←			24.0122-0204.1 422204	Ø 276 22 20,4 V
Cooper S	120	07/04→11/07				24.0322-0204.1 522204	Ø 276 22 19,6 V
Cooper S	125	07/04→11/07				24.0110-0271.1 410271	Ø 259 10 8,4
One	66	07/04→11/07	➡			24.0310-0271.1 510271	Ø 259 10 7,6
John Cooper Works	155	07/04→11/07	←			24.0122-0244.1 422244	Ø 294 22 20,4 V
			➡			24.0110-0271.1 410271	Ø 259 10 8,4
						24.0310-0271.1 510271	Ø 259 10 7,6
<b>MINI - MINI Cabriolet (R57) 10/07→06/15</b>							
<b> Bremsbelagsatz, Scheibenbremse</b>							
Cooper	85	10/07→06/10	←	01/09→		13.0460-2710.2 602710	TRW 23915 17,6 + WE / - WK + Zub
						13.0470-2710.2 LD2710	TRW 23915 17,6 + WE / - WK + Zub Ceramic
			➡	01/09→		13.0460-2714.2 602714	TRW 24289 16,9 + WE / - WK + Zub
						13.0470-2714.2 LD2714	TRW 24289 16,9 + WE / - WK + Zub Ceramic
Cooper	88	10/07→06/15	←	01/09→ 06/14		13.0460-2710.2 602710	TRW 23915 17,6 + WE / - WK + Zub
						13.0470-2710.2 LD2710	TRW 23915 17,6 + WE / - WK + Zub Ceramic
			➡	09/10→ 06/14		13.0460-2714.2 602714	TRW 24289 16,9 + WE / - WK + Zub
						13.0470-2714.2 LD2714	TRW 24289 16,9 + WE / - WK + Zub Ceramic
			➡	01/09→ 08/10		13.0460-2714.2 602714	TRW 24289 16,9 + WE / - WK + Zub
						13.0470-2714.2 LD2714	TRW 24289 16,9 + WE / - WK + Zub Ceramic
Cooper One	90 72	09/09→06/15 09/09→06/15	←	03/10→ 06/14		13.0460-2710.2 602710	TRW 23915 17,6 + WE / - WK + Zub
						13.0470-2710.2 LD2710	TRW 23915 17,6 + WE / - WK + Zub Ceramic
			➡	09/10→ 06/14		13.0460-2714.2 602714	TRW 24289 16,9 + WE / - WK + Zub
						13.0470-2714.2 LD2714	TRW 24289 16,9 + WE / - WK + Zub Ceramic
			➡	03/10→ 08/10		13.0460-2714.2 602714	TRW 24289 16,9 + WE / - WK + Zub
						13.0470-2714.2 LD2714	TRW 24289 16,9 + WE / - WK + Zub Ceramic
Cooper D	82	05/09→11/13	←	06/10→		13.0460-2710.2 602710	TRW 23915 17,6 + WE / - WK + Zub
						13.0470-2710.2 LD2710	TRW 23915 17,6 + WE / - WK + Zub Ceramic
			➡	06/10→ 08/10		13.0460-2714.2 602714	TRW 24289 16,9 + WE / - WK + Zub
						13.0470-2714.2 LD2714	TRW 24289 16,9 + WE / - WK + Zub Ceramic
			➡	09/10→		13.0460-2714.2 602714	TRW 24289 16,9 + WE / - WK + Zub
						13.0470-2714.2 LD2714	TRW 24289 16,9 + WE / - WK + Zub Ceramic
Cooper D	82	02/11→05/15	←	→ 06/14		13.0460-2710.2 602710	TRW 23915 17,6 + WE / - WK + Zub
						13.0470-2710.2 LD2710	TRW 23915 17,6 + WE / - WK + Zub Ceramic
			➡	→ 06/14		13.0460-2714.2 602714	TRW 24289 16,9 + WE / - WK + Zub
						13.0470-2714.2 LD2714	TRW 24289 16,9 + WE / - WK + Zub Ceramic
Cooper S	120	10/07→06/15	←	01/09→ 06/14		13.0460-2725.2 602725	TRW 23984 17,8 + WE / - WK + Zub
						13.0470-2725.2 LD2725	TRW 23984 17,8 + WE / - WK + Zub Ceramic
↓							

	kw			 	! #		
<b>MINI - MINI Cabriolet (R57) 10/07→06/15</b>							
<b> Bremsbelagsatz, Scheibenbremse</b>							
Cooper S	120	10/07→06/15	➡	09/10→ 06/14		<b>13.0460-2714.2 602714</b>	TRW 24289 16,9 + WE / - WK + Zub
						<b>13.0470-2714.2 LD2714</b>	TRW 24289 16,9 + WE / - WK + Zub Ceramic
			➡	01/09→ 08/10		<b>13.0460-2714.2 602714</b>	TRW 24289 16,9 + WE / - WK + Zub
						<b>13.0470-2714.2 LD2714</b>	TRW 24289 16,9 + WE / - WK + Zub Ceramic
Cooper S Cooper S	128 141	04/08→07/10 04/08→07/10	←	01/09→		<b>13.0460-2725.2 602725</b>	TRW 23984 17,8 + WE / - WK + Zub
						<b>13.0470-2725.2 LD2725</b>	TRW 23984 17,8 + WE / - WK + Zub Ceramic
			➡	01/09→		<b>13.0460-2714.2 602714</b>	TRW 24289 16,9 + WE / - WK + Zub
						<b>13.0470-2714.2 LD2714</b>	TRW 24289 16,9 + WE / - WK + Zub Ceramic
Cooper S Cooper S	135 147	02/10→06/15 02/10→06/15	←	03/10→ 06/14		<b>13.0460-2725.2 602725</b>	TRW 23984 17,8 + WE / - WK + Zub
						<b>13.0470-2725.2 LD2725</b>	TRW 23984 17,8 + WE / - WK + Zub Ceramic
			➡	09/10→ 06/14		<b>13.0460-2714.2 602714</b>	TRW 24289 16,9 + WE / - WK + Zub
						<b>13.0470-2714.2 LD2714</b>	TRW 24289 16,9 + WE / - WK + Zub Ceramic
			➡	03/10→ 08/10		<b>13.0460-2714.2 602714</b>	TRW 24289 16,9 + WE / - WK + Zub
						<b>13.0470-2714.2 LD2714</b>	TRW 24289 16,9 + WE / - WK + Zub Ceramic
			➡	02/11→ 06/14		<b>13.0460-2710.2 602710</b>	TRW 23915 17,6 + WE / - WK + Zub
Cooper SD Cooper SD	100 105	01/11→05/15 06/09→05/15	←	02/11→ 06/14		<b>13.0470-2710.2 LD2710</b>	TRW 23915 17,6 + WE / - WK + Zub Ceramic
						<b>13.0460-2714.2 602714</b>	TRW 24289 16,9 + WE / - WK + Zub
			➡	02/11→ 06/14		<b>13.0470-2714.2 LD2714</b>	TRW 24289 16,9 + WE / - WK + Zub Ceramic
						<b>13.0460-2714.2 602714</b>	TRW 24289 16,9 + WE / - WK + Zub
John Cooper Works	155	08/08→05/15	➡	09/10→ 06/14		<b>13.0460-2714.2 602714</b>	TRW 24289 16,9 + WE / - WK + Zub
						<b>13.0470-2714.2 LD2714</b>	TRW 24289 16,9 + WE / - WK + Zub Ceramic
			➡	03/09→ 08/10		<b>13.0460-2714.2 602714</b>	TRW 24289 16,9 + WE / - WK + Zub
						<b>13.0470-2714.2 LD2714</b>	TRW 24289 16,9 + WE / - WK + Zub Ceramic
<b>Warnkontakt, Bremsbelagsverschleiß</b>							
Cooper	85	10/07→06/10	←	01/09→	1	<b>24.8190-0277.2 620277</b>	L= 802
Cooper S	128	04/08→07/10	➡	01/09→	1	<b>24.8190-0278.2 620278</b>	L= 1.130
Cooper S	141	04/08→07/10	➡	01/09→	1	<b>24.8190-0278.2 620278</b>	L= 1.130
Cooper	88	10/07→06/15	←	01/09→ 06/14	1	<b>24.8190-0277.2 620277</b>	L= 802
Cooper S	120	10/07→06/15	➡	09/10→ 06/14	1	<b>24.8190-0010.2 620010</b>	L= 1.141
			➡	01/09→ 08/10	1	<b>24.8190-0278.2 620278</b>	L= 1.130
Cooper	90	09/09→06/15	←	03/10→ 06/14	1	<b>24.8190-0277.2 620277</b>	L= 802
Cooper S	135	02/10→06/15	➡	09/10→ 06/14	1	<b>24.8190-0010.2 620010</b>	L= 1.141
Cooper S	147	02/10→06/15	➡	09/10→ 06/14	1	<b>24.8190-0010.2 620010</b>	L= 1.141
One	72	09/09→06/15	➡	03/10→ 08/10	1	<b>24.8190-0278.2 620278</b>	L= 1.130
Cooper D	82	05/09→11/13	←	06/10→	1	<b>24.8190-0277.2 620277</b>	L= 802
			➡	09/10→	1	<b>24.8190-0010.2 620010</b>	L= 1.141
			➡	06/10→ 08/10	1	<b>24.8190-0278.2 620278</b>	L= 1.130
Cooper D	82	02/11→05/15	←	→ 06/14	1	<b>24.8190-0277.2 620277</b>	L= 802
			➡	→ 06/14	1	<b>24.8190-0010.2 620010</b>	L= 1.141
Cooper SD	100	01/11→05/15	←	02/11→ 06/14	1	<b>24.8190-0277.2 620277</b>	L= 802
Cooper SD	105	06/09→05/15	➡	02/11→ 06/14	1	<b>24.8190-0010.2 620010</b>	L= 1.141
John Cooper Works	155	08/08→05/15	←	03/09→ 06/14	1	<b>24.8190-0277.2 620277</b>	L= 802
			➡	09/10→ 06/14	1	<b>24.8190-0010.2 620010</b>	L= 1.141
			➡	03/09→ 08/10	1	<b>24.8190-0278.2 620278</b>	L= 1.130
↓							

### MINI - MINI Cabriolet (R57) 10/07→06/15

#### **Bremsscheibe**

Cooper	85	10/07→06/10	←	01/09→	24.0122-0248.1	422248	∅ 280 22 20,4 V
			→	01/09→	24.0322-0248.1	522248	∅ 280 22 19,6 V
Cooper	88	10/07→06/15	←	01/09→ 06/14	24.0122-0248.1	422248	∅ 280 22 20,4 V
			→	01/09→ 06/14	24.0322-0248.1	522248	∅ 280 22 19,6 V
Cooper One	90 72	09/09→06/15 09/09→06/15	←	03/10→ 06/14	24.0122-0248.1	422248	∅ 280 22 20,4 V
			→	03/10→ 06/14	24.0322-0248.1	522248	∅ 280 22 19,6 V
Cooper D	82	05/09→11/13	←	06/10→	24.0122-0248.1	422248	∅ 280 22 20,4 V
			→	06/10→	24.0322-0248.1	522248	∅ 280 22 19,6 V
Cooper D	82	02/11→05/15	←	→ 06/14	24.0122-0248.1	422248	∅ 280 22 20,4 V
			→	→ 06/14	24.0322-0248.1	522248	∅ 280 22 19,6 V
Cooper S	120	10/07→06/15	←	01/09→ 06/14	24.0122-0247.1	422247	∅ 294 22 20,4 V
			→	01/09→ 06/14	24.0322-0247.1	522247	∅ 294 22 19,6 V
Cooper S Cooper S	128 141	04/08→07/10 04/08→07/10	←	01/09→	24.0122-0247.1	422247	∅ 294 22 20,4 V
			→	01/09→	24.0322-0247.1	522247	∅ 294 22 19,6 V
Cooper S Cooper S	135 147	02/10→06/15 02/10→06/15	←	03/10→ 06/14	24.0122-0247.1	422247	∅ 294 22 20,4 V
			→	03/10→ 06/14	24.0322-0247.1	522247	∅ 294 22 19,6 V
Cooper SD Cooper SD	100 105	01/11→05/15 06/09→05/15	←	02/11→ 06/14	24.0122-0248.1	422248	∅ 280 22 20,4 V
			→	02/11→ 06/14	24.0322-0248.1	522248	∅ 280 22 19,6 V









### MINI - MINI CLUBMAN (F54) 11/14→

#### **Bremsbelagsatz, Scheibenbremse**











Cooper Cooper D Cooper D	100 100 110	12/14→ 12/14→ 12/14→	←	07/15→	13.0460-2613.2	602613	TRW 22187 18,6 + WE / - WK
			→	07/15→; + eFSB	13.0470-2613.2	LD2613	TRW 22187 18,6 + WE / - WK Ceramic
Cooper S Cooper S Cooper S JCW	120 141 155	11/14→ 11/14→ 11/14→	←	07/15→	13.0460-2601.2	602601	TRW 25617 18,5 + WE / - WK
			→	07/15→; + eFSB	13.0460-7315.2	607315	ATE 25331 16,2 + WE / - WK
Cooper S ALL4 Cooper S ALL4 Cooper SD ALL4 Cooper SD ALL4 Cooper S JCW ALL4	120 141 120 140 155	04/15→ 04/15→ 04/15→ 04/15→ 11/14→	←	01/16→	13.0460-2601.2	602601	TRW 25617 18,5 + WE / - WK
			→	01/16→; + eFSB	13.0460-7315.2	607315	ATE 25331 16,2 + WE / - WK
Cooper SD Cooper SD	120 140	02/15→ 02/15→	←	11/15→	13.0460-2601.2	602601	TRW 25617 18,5 + WE / - WK
			→	11/15→; + eFSB	13.0460-7315.2	607315	ATE 25331 16,2 + WE / - WK
John Cooper Works	170	11/15→	→	+ eFSB	13.0460-7315.2	607315	ATE 25331 16,2 + WE / - WK
One One D	75 85	02/15→ 02/15→	←	11/15→	13.0460-2795.2	602795	TRW 23915 17,6 + WE / - WK + Zub
			→	11/15→; + eFSB	13.0470-2795.2	LD2795	TRW 23915 17,6 + WE / - WK + Zub Ceramic
			←		13.0460-7315.2	607315	ATE 25331 16,2 + WE / - WK
			→		13.0470-7315.2	LD7315	ATE 25331 16,2 + WE / - WK Ceramic











#### **Warnkontakt, Bremsbelagverschleiß**







Cooper Cooper D Cooper D ↓	100 100 110	12/14→ 12/14→ 12/14→	→	07/15→	1	24.8190-0942.2	620942	L= 641
-------------------------------------	-------------------	----------------------------	---	--------	---	----------------	--------	--------









	kw			 	! #		
<b>MINI - MINI CLUBMAN (F54) 11/14→</b>							
<b>Warnkontakt, Bremsbelagverschleiß</b>							
Cooper S Cooper S Cooper S JCW	120 141 155	11/14→ 11/14→ 11/14→	➡	07/15→	1	24.8190-0942.2 620942	L= 641
Cooper S ALL4 Cooper S ALL4 Cooper SD ALL4 Cooper SD ALL4 Cooper S JCW ALL4	120 141 120 140 155	04/15→ 04/15→ 04/15→ 04/15→ 11/14→	➡	01/16→	1	24.8190-0942.2 620942	L= 641
Cooper SD Cooper SD One One D	120 140 75 85	02/15→ 02/15→ 02/15→ 02/15→	➡	11/15→	1	24.8190-0942.2 620942	L= 641
John Cooper Works	170	11/15→	➡		1	24.8190-0942.2 620942	L= 641
<b> Bremsscheibe</b>							
Cooper Cooper D Cooper D	100 100 110	12/14→ 12/14→ 12/14→	➡	07/15→		24.0110-0401.1 410401	Ø 280 10 8,4 + S
Cooper S Cooper S Cooper S JCW	120 141 155	11/14→ 11/14→ 11/14→	➡	07/15→		24.0124-0260.1 424260	Ø 307 24 22,4 V + S
Cooper S ALL4 Cooper S ALL4 Cooper SD ALL4 Cooper SD ALL4 Cooper S JCW ALL4	120 141 120 140 155	04/15→ 04/15→ 04/15→ 04/15→ 11/14→	➡	07/15→		24.0110-0401.1 410401	Ø 280 10 8,4 + S
Cooper S ALL4 Cooper S ALL4 Cooper SD ALL4 Cooper SD ALL4 Cooper S JCW ALL4	120 141 120 140 155	04/15→ 04/15→ 04/15→ 04/15→ 11/14→	➡	01/16→		24.0124-0260.1 424260	Ø 307 24 22,4 V + S
Cooper SD Cooper SD	120 140	02/15→ 02/15→	➡	01/16→		24.0110-0401.1 410401	Ø 280 10 8,4 + S
Cooper SD Cooper SD	120 140	02/15→ 02/15→	➡	11/15→		24.0124-0260.1 424260	Ø 307 24 22,4 V + S
Cooper SD Cooper SD	120 140	02/15→ 02/15→	➡	11/15→		24.0110-0401.1 410401	Ø 280 10 8,4 + S
John Cooper Works	170	11/15→	➡			24.0120-0244.1 420244	Ø 300 20 18,4 V + S
One One D	75 85	02/15→ 02/15→	➡	07/15→		24.0122-0292.1 422292	Ø 280 22 20,4 V + S
One One D	75 85	02/15→ 02/15→	➡	11/15→		24.0110-0401.1 410401	Ø 280 10 8,4 + S
One D One D	85 85	02/15→ 02/15→	➡	11/15→		24.0122-0292.1 422292	Ø 280 22 20,4 V + S
One D One D	85 85	02/15→ 02/15→	➡	11/15→		24.0110-0401.1 410401	Ø 280 10 8,4 + S
<b>MINI - MINI CLUBMAN (R55) 10/06→12/15</b>							
<b> Bremsbelagsatz, Scheibenbremse</b>							
Cooper Cooper Cooper Cooper D One One D	85 88 90 82 72 66	03/10→06/14 10/07→12/13 03/10→06/14 03/10→06/14 03/10→06/14 03/10→06/14	➡			13.0460-2710.2 602710	TRW 23915 17,6 + WE / - WK + Zub
Cooper Cooper D One One D	88 82 72 66	10/07→12/13 03/10→06/14 03/10→06/14 03/10→06/14	➡			13.0470-2710.2 LD2710	TRW 23915 17,6 + WE / - WK + Zub Ceramic
Cooper Cooper D One One D	85 88 90 82 72 66	03/10→06/14 10/07→12/13 03/10→06/14 03/10→06/14 03/10→06/14 03/10→06/14	➡	09/10→		13.0460-2714.2 602714	TRW 24289 16,9 + WE / - WK + Zub
Cooper Cooper D One One D	85 88 90 82 72 66	03/10→06/14 10/07→12/13 03/10→06/14 03/10→06/14 03/10→06/14 03/10→06/14	➡			13.0470-2714.2 LD2714	TRW 24289 16,9 + WE / - WK + Zub Ceramic
Cooper Cooper D One One D	85 88 90 82 72 66	03/10→06/14 10/07→12/13 03/10→06/14 03/10→06/14 03/10→06/14 03/10→06/14	➡	→ 08/10		13.0460-2714.2 602714	TRW 24289 16,9 + WE / - WK + Zub
Cooper Cooper D One One D	85 88 90 82 72 66	03/10→06/14 10/07→12/13 03/10→06/14 03/10→06/14 03/10→06/14 03/10→06/14	➡			13.0470-2714.2 LD2714	TRW 24289 16,9 + WE / - WK + Zub Ceramic
Cooper D Cooper D Cooper SD Cooper SD One	80 82 100 105 70	10/07→02/10 02/11→06/14 02/11→06/14 02/11→06/14 03/09→02/10	➡			13.0460-2710.2 602710	TRW 23915 17,6 + WE / - WK + Zub
Cooper D Cooper D Cooper SD Cooper SD One	80 82 100 105 70	10/07→02/10 02/11→06/14 02/11→06/14 02/11→06/14 03/09→02/10	➡			13.0470-2710.2 LD2710	TRW 23915 17,6 + WE / - WK + Zub Ceramic
Cooper D Cooper D Cooper SD Cooper SD One	80 82 100 105 70	10/07→02/10 02/11→06/14 02/11→06/14 02/11→06/14 03/09→02/10	➡			13.0460-2714.2 602714	TRW 24289 16,9 + WE / - WK + Zub
Cooper D Cooper D Cooper SD Cooper SD One	80 82 100 105 70	10/07→02/10 02/11→06/14 02/11→06/14 02/11→06/14 03/09→02/10	➡			13.0470-2714.2 LD2714	TRW 24289 16,9 + WE / - WK + Zub Ceramic
Cooper S Cooper S	120 128	10/07→02/10 10/07→02/10	➡			13.0460-2725.2 602725	TRW 23984 17,8 + WE / - WK + Zub
Cooper S Cooper S	120 128	10/07→02/10 10/07→02/10	➡			13.0470-2725.2 LD2725	TRW 23984 17,8 + WE / - WK + Zub Ceramic
Cooper S Cooper S	120 128	10/07→02/10 10/07→02/10	➡			13.0460-2714.2 602714	TRW 24289 16,9 + WE / - WK + Zub
Cooper S Cooper S	120 128	10/07→02/10 10/07→02/10	➡			13.0470-2714.2 LD2714	TRW 24289 16,9 + WE / - WK + Zub Ceramic
Cooper S Cooper S	135 147	03/10→06/14 03/10→06/14	➡			13.0460-2725.2 602725	TRW 23984 17,8 + WE / - WK + Zub
Cooper S Cooper S	135 147	03/10→06/14 03/10→06/14	➡			13.0470-2725.2 LD2725	TRW 23984 17,8 + WE / - WK + Zub Ceramic
↓			➡	09/10→		13.0460-2714.2 602714	TRW 24289 16,9 + WE / - WK + Zub













	kW			 	! #		
<b>MINI - MINI CLUBMAN (R55) 10/06→12/15</b>							
<b> Bremsbelagsatz, Scheibenbremse</b>							
Cooper S Cooper S	135 147	03/10→06/14 03/10→06/14	➡	09/10→		13.0470-2714.2 LD2714	TRW 24289 16,9 + WE / - WK + Zub Ceramic
			➡	→ 08/10		13.0460-2714.2 602714 13.0470-2714.2 LD2714	TRW 24289 16,9 + WE / - WK + Zub TRW 24289 16,9 + WE / - WK + Zub Ceramic
Cooper S John Cooper Works	141	10/08→02/10	➡			13.0460-2714.2 602714 13.0470-2714.2 LD2714	TRW 24289 16,9 + WE / - WK + Zub TRW 24289 16,9 + WE / - WK + Zub Ceramic
John Cooper Works	155	11/07→06/14	➡	03/08→ 08/10		13.0460-2714.2 602714 13.0470-2714.2 LD2714	TRW 24289 16,9 + WE / - WK + Zub TRW 24289 16,9 + WE / - WK + Zub Ceramic
			➡	09/10→		13.0460-2714.2 602714 13.0470-2714.2 LD2714	TRW 24289 16,9 + WE / - WK + Zub TRW 24289 16,9 + WE / - WK + Zub Ceramic
<b>Warnkontakt, Bremsbelagverschleiß</b>							
Cooper Cooper Cooper Cooper D Cooper S Cooper S One One D	85 88 90 82 135 147 72 66	03/10→06/14 10/07→12/13 03/10→06/14 03/10→06/14 03/10→06/14 03/10→06/14 03/10→06/14 03/10→06/14	← ➡	09/10→	1	24.8190-0277.2 620277 24.8190-0010.2 620010 24.8190-0278.2 620278	L= 802 L= 1.141 L= 1.130
Cooper D Cooper S Cooper S Cooper S John Cooper Works One	80 120 128 141 70	10/07→02/10 10/07→02/10 10/07→02/10 10/08→02/10 03/09→02/10	← ➡		1	24.8190-0277.2 620277 24.8190-0278.2 620278	L= 802 L= 1.130
Cooper D Cooper SD Cooper SD	82 100 105	02/11→06/14 02/11→06/14 02/11→06/14	← ➡		1	24.8190-0277.2 620277 24.8190-0010.2 620010	L= 802 L= 1.141
John Cooper Works	155	11/07→06/14	← ➡ ➡	03/08→ 09/10→ 03/08→ 08/10	1 1 1	24.8190-0277.2 620277 24.8190-0010.2 620010 24.8190-0278.2 620278	L= 802 L= 1.141 L= 1.130
<b> Bremsscheibe</b>							
Cooper Cooper Cooper Cooper D Cooper D Cooper D Cooper SD Cooper SD One One D	85 88 90 80 82 82 100 105 72 66	03/10→06/14 10/07→12/13 03/10→06/14 10/07→02/10 03/10→06/14 02/11→06/14 02/11→06/14 02/11→06/14 03/10→06/14 03/10→06/14	← ➡			24.0122-0248.1 422248 24.0322-0248.1 522248 24.0110-0271.1 410271 24.0310-0271.1 510271	Ø 280 22 20,4 V Ø 280 22 19,6 V Ø 259 10 8,4 Ø 259 10 7,6
Cooper S Cooper S Cooper S Cooper S	120 128 135 147	10/07→02/10 10/07→02/10 03/10→06/14 03/10→06/14	← ➡			24.0122-0247.1 422247 24.0322-0247.1 522247 24.0110-0271.1 410271 24.0310-0271.1 510271	Ø 294 22 20,4 V Ø 294 22 19,6 V Ø 259 10 8,4 Ø 259 10 7,6
One	70	03/09→02/10	← ➡			24.0122-0248.1 422248 24.0322-0248.1 522248 24.0110-0271.1 410271	Ø 280 22 20,4 V Ø 280 22 19,6 V Ø 259 10 8,4
<b>MINI - MINI CLUBVAN (R55) 12/12→06/14</b>							
<b> Bremsbelagsatz, Scheibenbremse</b>							
Cooper Cooper D One	90 82 72	12/12→06/14 12/12→06/14 12/12→06/14	← ➡			13.0460-2710.2 602710 13.0470-2710.2 LD2710 13.0460-2714.2 602714 13.0470-2714.2 LD2714	TRW 23915 17,6 + WE / - WK + Zub TRW 23915 17,6 + WE / - WK + Zub Ceramic TRW 24289 16,9 + WE / - WK + Zub TRW 24289 16,9 + WE / - WK + Zub Ceramic
↓							











	kw			 	! #		
<b>MINI - MINI CLUBVAN (R55) 12/12→06/14</b>							
<b>Warnkontakt, Bremsbelagverschleiß</b>							
Cooper	90	12/12→06/14	←		1	24.8190-0009.2 620009	L= 808
Cooper D	82	12/12→06/14					
One	72	12/12→06/14	→		1	24.8190-0010.2 620010	L= 1.141
<b> Bremsscheibe</b>							
Cooper	90	12/12→06/14	←			24.0122-0248.1 422248	Ø 280 22 20,4 V
Cooper D	82	12/12→06/14				24.0322-0248.1 522248	Ø 280 22 19,6 V
One	72	12/12→06/14	→			24.0110-0271.1 410271	Ø 259 10 8,4
<b>MINI - MINI COUNTRYMAN (F60) 10/16→</b>							
<b> Bremsbelagsatz, Scheibenbremse</b>							
Cooper	100	10/16→	←			13.0460-2601.2 602601	TRW 25617 18,5 + WE / - WK
Cooper ALL4	100	10/16→					
Cooper D	100	10/16→	→			13.0460-7315.2 607315	ATE 25331 16,2 + WE / - WK
Cooper D	110	10/16→				13.0470-7315.2 LD7315	ATE 25331 16,2 + WE / - WK Ceramic
Cooper D ALL4	100	10/16→					
Cooper D ALL4	110	10/16→					
Cooper S	120	10/16→					
Cooper S	141	10/16→					
Cooper S ALL4	120	10/16→					
Cooper S ALL4	141	10/16→					
Cooper SD	120	10/16→					
Cooper SD	140	10/16→					
Cooper SD ALL4	120	10/16→					
Cooper SD ALL4	140	10/16→					
Cooper SE ALL4	100	01/17→					
Cooper SE ALL4	165	01/17→					
John Cooper Works ALL4	170	01/17→	→			13.0460-7315.2 607315	ATE 25331 16,2 + WE / - WK
						13.0470-7315.2 LD7315	ATE 25331 16,2 + WE / - WK Ceramic
One	75	07/17→	←			13.0460-2613.2 602613	TRW 22187 18,6 + WE / - WK
One D	85	07/17→				13.0460-7315.2 607315	ATE 25331 16,2 + WE / - WK
						13.0470-2613.2 LD2613	TRW 22187 18,6 + WE / - WK Ceramic
						13.0470-7315.2 LD7315	ATE 25331 16,2 + WE / - WK Ceramic
<b>Warnkontakt, Bremsbelagverschleiß</b>							
Cooper	100	10/16→	→		1	24.8190-0942.2 620942	L= 641
Cooper ALL4	100	10/16→					
Cooper D	100	10/16→					
Cooper D	110	10/16→					
Cooper D ALL4	100	10/16→					
Cooper D ALL4	110	10/16→					
Cooper S	120	10/16→					
Cooper S	141	10/16→					
Cooper S ALL4	120	10/16→					
Cooper S ALL4	141	10/16→					
Cooper SD	120	10/16→					
Cooper SD	140	10/16→					
Cooper SD ALL4	120	10/16→					
Cooper SD ALL4	140	10/16→					
Cooper SE ALL4	100	01/17→					
Cooper SE ALL4	165	01/17→					
John Cooper Works ALL4	170	01/17→					
One	75	07/17→	←	☐	1	24.8190-0941.2 620941	L= 648
One D	85	07/17→	→		1	24.8190-0942.2 620942	L= 641
<b> Bremsscheibe</b>							
Cooper	100	10/16→	←			24.0124-0260.1 424260	Ø 307 24 22,4 V + S
Cooper ALL4	100	10/16→					
Cooper D	100	10/16→	→			24.0110-0401.1 410401	Ø 280 10 8,4 + S
Cooper D	110	10/16→					
Cooper D ALL4	100	10/16→					
Cooper D ALL4	110	10/16→					
Cooper S	120	10/16→	←			24.0124-0259.1 424259	Ø 330 24 22,4 V + S
Cooper S	141	10/16→					
Cooper S ALL4	120	10/16→	→			24.0110-0401.1 410401	Ø 280 10 8,4 + S
Cooper S ALL4	141	10/16→					
Cooper SD	120	10/16→					
Cooper SD	140	10/16→					
Cooper SD ALL4	120	10/16→					
Cooper SD ALL4	140	10/16→					
Cooper SE ALL4	100	01/17→	←			24.0124-0259.1 424259	Ø 330 24 22,4 V + S
Cooper SE ALL4	165	01/17→					













	kW			 	! #		
<b>MINI - MINI COUNTRYMAN (F60) 10/16→</b>							
<b>Bremsscheibe</b>							
Cooper SE ALL4 Cooper SE ALL4	100 165	01/17→ 01/17→	→			24.0120-0244.1 420244	Ø 300 20 18,4 V + S
John Cooper Works ALL4	170	01/17→	→			24.0120-0244.1 420244	Ø 300 20 18,4 V + S
One One D	75 85	07/17→ 07/17→	→			24.0110-0401.1 410401	Ø 280 10 8,4 + S
<b>MINI - MINI COUNTRYMAN (R60) 01/10→10/16</b>							
<b>Bremsbelagsatz, Scheibenbremse</b>							
Cooper Cooper Cooper Cooper D Cooper D ALL4 Cooper D ALL4 Cooper S Cooper S ALL4 Cooper S ALL4 One One D	85 88 90 82 82 82 135 120 135 72 66	01/10→10/16 01/10→10/16 01/10→10/16 01/10→10/16 01/10→09/16 07/10→09/16 01/10→10/16 01/10→10/16 01/10→10/16 01/10→09/16 01/10→10/16	← → →	09/10→  09/10→		13.0460-2725.2 602725 13.0470-2725.2 LD2725 13.0460-2713.2 602713 13.0470-2713.2 LD2713	TRW 23984 17,8 + WE / - WK + Zub TRW 23984 17,8 + WE / - WK + Zub Ceramic TRW 23623 17,4 + WE / - WK + Zub TRW 23623 17,4 + WE / - WK + Zub Ceramic
Cooper ALL4 Cooper ALL4	90 90	11/12→09/16 11/12→10/16	← →	11/14→ 11/14→		13.0460-2725.2 602725 13.0470-2725.2 LD2725 13.0460-2713.2 602713 13.0470-2713.2 LD2713	TRW 23984 17,8 + WE / - WK + Zub TRW 23984 17,8 + WE / - WK + Zub Ceramic TRW 23623 17,4 + WE / - WK + Zub TRW 23623 17,4 + WE / - WK + Zub Ceramic
Cooper S Cooper S ALL4	140 140	01/10→10/16 01/10→10/16	← →			13.0460-2725.2 602725 13.0470-2725.2 LD2725 13.0460-2713.2 602713 13.0470-2713.2 LD2713	TRW 23984 17,8 + WE / - WK + Zub TRW 23984 17,8 + WE / - WK + Zub Ceramic TRW 23623 17,4 + WE / - WK + Zub TRW 23623 17,4 + WE / - WK + Zub Ceramic
Cooper S	147	01/10→10/16	← →	02/12→ 02/12→		13.0460-2725.2 602725 13.0470-2725.2 LD2725 13.0460-2713.2 602713 13.0470-2713.2 LD2713	TRW 23984 17,8 + WE / - WK + Zub TRW 23984 17,8 + WE / - WK + Zub Ceramic TRW 23623 17,4 + WE / - WK + Zub TRW 23623 17,4 + WE / - WK + Zub Ceramic
Cooper SD Cooper SD Cooper SD ALL4 Cooper SD ALL4	100 105 100 105	01/10→10/16 01/10→10/16 01/10→09/16 01/10→09/16	← →	02/11→ 02/11→		13.0460-2725.2 602725 13.0470-2725.2 LD2725 13.0460-2713.2 602713 13.0470-2713.2 LD2713	TRW 23984 17,8 + WE / - WK + Zub TRW 23984 17,8 + WE / - WK + Zub Ceramic TRW 23623 17,4 + WE / - WK + Zub TRW 23623 17,4 + WE / - WK + Zub Ceramic
John Cooper Works ALL4	160	04/11→10/16	← →	09/12→ 09/12→		13.0460-2725.2 602725 13.0470-2725.2 LD2725 13.0460-2713.2 602713 13.0470-2713.2 LD2713	TRW 23984 17,8 + WE / - WK + Zub TRW 23984 17,8 + WE / - WK + Zub Ceramic TRW 23623 17,4 + WE / - WK + Zub TRW 23623 17,4 + WE / - WK + Zub Ceramic
<b>Warnkontakt, Bremsbelagsverschleiß</b>							
Cooper Cooper Cooper Cooper D Cooper D ALL4 Cooper D ALL4 Cooper S Cooper S ALL4 Cooper S ALL4 One One D	85 88 90 82 82 82 135 120 135 72 66	01/10→10/16 01/10→10/16 01/10→10/16 01/10→10/16 01/10→09/16 07/10→09/16 01/10→10/16 01/10→10/16 01/10→10/16 01/10→09/16 01/10→10/16	← →	09/10→ 09/10→	1 1	24.8190-0306.2 620306 24.8190-0307.2 620307	L= 908 L= 957
Cooper ALL4	90	11/12→09/16	←	11/14→	1	24.8190-0306.2 620306	L= 908









	kW			 	! #		
<b>MINI - MINI COUNTRYMAN (R60) 01/10→10/16</b>							
<b>Warnkontakt, Bremsbelagverschleiß</b>							
Cooper ALL4	90	11/12→10/16	➡	11/14→	1	24.8190-0307.2 620307	L= 957
Cooper S	140	01/10→10/16	←		1	24.8190-0306.2 620306	L= 908
Cooper S ALL4	140	01/10→10/16	➡		1	24.8190-0307.2 620307	L= 957
Cooper S	147	01/10→10/16	←	02/12→	1	24.8190-0306.2 620306	L= 908
			➡	02/12→	1	24.8190-0307.2 620307	L= 957
Cooper SD	100	01/10→10/16	←	02/11→	1	24.8190-0306.2 620306	L= 908
Cooper SD	105	01/10→10/16	➡	02/11→	1	24.8190-0307.2 620307	L= 957
Cooper SD ALL4	100	01/10→09/16	➡	02/11→	1	24.8190-0307.2 620307	L= 957
Cooper SD ALL4	105	01/10→09/16	➡	02/11→	1	24.8190-0307.2 620307	L= 957
John Cooper Works ALL4	160	04/11→10/16	←	09/12→	1	24.8190-0306.2 620306	L= 908
			➡	09/12→	1	24.8190-0307.2 620307	L= 957
<b> Bremsscheibe</b>							
Cooper	85	01/10→10/16	←	09/10→		24.0122-0271.1 422271	Ø 294 22 20,4 V + S
Cooper	88	01/10→10/16	➡	09/10→		24.0110-0358.1 410358	Ø 280 10 8,4 + S
Cooper	90	01/10→10/16	➡	09/10→		24.0110-0358.1 410358	Ø 280 10 8,4 + S
Cooper D	82	01/10→10/16	➡	09/10→		24.0110-0358.1 410358	Ø 280 10 8,4 + S
Cooper D ALL4	82	01/10→09/16	➡	09/10→		24.0110-0358.1 410358	Ø 280 10 8,4 + S
Cooper D ALL4	82	07/10→09/16	➡	09/10→		24.0110-0358.1 410358	Ø 280 10 8,4 + S
One	72	01/10→09/16	➡	09/10→		24.0110-0358.1 410358	Ø 280 10 8,4 + S
One D	66	01/10→10/16	➡	09/10→		24.0110-0358.1 410358	Ø 280 10 8,4 + S
Cooper ALL4	90	11/12→09/16	←	11/14→		24.0122-0271.1 422271	Ø 294 22 20,4 V + S
Cooper ALL4	90	11/12→10/16	➡	11/14→		24.0110-0358.1 410358	Ø 280 10 8,4 + S
Cooper S	135	01/10→10/16	←	09/10→		24.0124-0240.1 424240	Ø 307 24 22,4 V + S
Cooper S ALL4	120	01/10→10/16	➡	09/10→		24.0110-0358.1 410358	Ø 280 10 8,4 + S
Cooper S ALL4	135	01/10→10/16	➡	09/10→		24.0110-0358.1 410358	Ø 280 10 8,4 + S
Cooper S	140	01/10→10/16	←	09/10→		24.0124-0240.1 424240	Ø 307 24 22,4 V + S
Cooper S ALL4	140	01/10→10/16	➡	09/10→		24.0110-0358.1 410358	Ø 280 10 8,4 + S
Cooper S	147	01/10→10/16	←	02/12→		24.0124-0240.1 424240	Ø 307 24 22,4 V + S
			➡	02/12→		24.0110-0358.1 410358	Ø 280 10 8,4 + S
Cooper SD	100	01/10→10/16	←	02/11→		24.0122-0271.1 422271	Ø 294 22 20,4 V + S
Cooper SD	105	01/10→10/16	➡	02/11→		24.0110-0358.1 410358	Ø 280 10 8,4 + S
Cooper SD ALL4	100	01/10→09/16	➡	02/11→		24.0110-0358.1 410358	Ø 280 10 8,4 + S
Cooper SD ALL4	105	01/10→09/16	➡	02/11→		24.0110-0358.1 410358	Ø 280 10 8,4 + S
John Cooper Works ALL4	160	04/11→10/16	←	09/12→		24.0124-0240.1 424240	Ø 307 24 22,4 V + S
<b>MINI - MINI Coupe (R58) 12/10→05/15</b>							
<b> Bremsbelagsatz, Scheibenbremse</b>							
Cooper	85	12/10→04/15	←	10/11→		13.0460-2710.2 602710	TRW 23915 17,6 + WE / - WK + Zub
Cooper	90	12/10→04/15	➡	10/11→		13.0470-2710.2 LD2710	TRW 23915 17,6 + WE / - WK + Zub Ceramic
Cooper SD	100	12/10→05/15	➡	10/11→		13.0460-2714.2 602714	TRW 24289 16,9 + WE / - WK + Zub
Cooper SD	105	12/10→05/15	➡	10/11→		13.0470-2714.2 LD2714	TRW 24289 16,9 + WE / - WK + Zub Ceramic
Cooper S	120	12/10→04/15	←	10/11→		13.0460-2725.2 602725	TRW 23984 17,8 + WE / - WK + Zub
Cooper S	135	12/10→04/15	➡	10/11→		13.0470-2725.2 LD2725	TRW 23984 17,8 + WE / - WK + Zub Ceramic
Cooper S JCW	147	12/10→04/15	➡	10/11→		13.0460-2714.2 602714	TRW 24289 16,9 + WE / - WK + Zub
			➡	10/11→		13.0470-2714.2 LD2714	TRW 24289 16,9 + WE / - WK + Zub Ceramic
John Cooper Works	155	12/10→05/15	➡	10/11→		13.0460-2714.2 602714	TRW 24289 16,9 + WE / - WK + Zub
			➡	10/11→		13.0470-2714.2 LD2714	TRW 24289 16,9 + WE / - WK + Zub Ceramic
<b>Warnkontakt, Bremsbelagverschleiß</b>							
Cooper	85	12/10→04/15	←	10/11→	1	24.8190-0009.2 620009	L= 808
Cooper	90	12/10→04/15	➡	10/11→	1	24.8190-0010.2 620010	L= 1.141
Cooper S	120	12/10→04/15	➡	10/11→	1	24.8190-0010.2 620010	L= 1.141
Cooper S	135	12/10→04/15	➡	10/11→	1	24.8190-0010.2 620010	L= 1.141
Cooper SD	100	12/10→05/15	➡	10/11→	1	24.8190-0010.2 620010	L= 1.141
Cooper SD	105	12/10→05/15	➡	10/11→	1	24.8190-0010.2 620010	L= 1.141
Cooper S JCW	147	12/10→04/15	➡	10/11→	1	24.8190-0010.2 620010	L= 1.141
John Cooper Works	155	12/10→05/15	➡	10/11→	1	24.8190-0010.2 620010	L= 1.141
↓							











	kW			 	! #		
<b>MINI - MINI Coupe (R58) 12/10→05/15</b>							
<b> Bremsscheibe</b>							
Cooper	85	12/10→04/15	←	10/11→		24.0122-0248.1 422248	Ø 280 22 20,4 V
Cooper	90	12/10→04/15				24.0322-0248.1 522248	Ø 280 22 19,6 V
Cooper SD	100	12/10→05/15					
Cooper SD	105	12/10→05/15	→	10/11→		24.0110-0271.1 410271	Ø 259 10 8,4
						24.0310-0271.1 510271	Ø 259 10 7,6
Cooper S	120	12/10→04/15	←	10/11→		24.0122-0247.1 422247	Ø 294 22 20,4 V
Cooper S	135	12/10→04/15				24.0322-0247.1 522247	Ø 294 22 19,6 V
Cooper S JCW	147	12/10→04/15					
			→	10/11→		24.0110-0271.1 410271	Ø 259 10 8,4
						24.0310-0271.1 510271	Ø 259 10 7,6
<b>MINI - MINI PACEMAN (R61) 03/12→09/16</b>							
<b> Bremsbelagsatz, Scheibenbremse</b>							
Cooper	88	04/12→09/16	←	11/12→		13.0460-2725.2 602725	TRW 23984 17,8 + WE / - WK + Zub
Cooper	90	04/12→09/16					
Cooper D	82	04/12→09/16				13.0470-2725.2 LD2725	TRW 23984 17,8 + WE / - WK + Zub Ceramic
Cooper D	82	07/12→09/16					
Cooper D ALL4	82	04/12→09/16					
Cooper D ALL4	82	03/12→09/16	→	11/12→		13.0460-2713.2 602713	TRW 23623 17,4 + WE / - WK + Zub
Cooper S	135	04/12→09/16					
Cooper S	140	04/12→09/16				13.0470-2713.2 LD2713	TRW 23623 17,4 + WE / - WK + Zub Ceramic
Cooper S ALL4	120	03/12→09/16					
Cooper S ALL4	135	03/12→09/16					
Cooper S ALL4	140	03/12→09/16					
Cooper SD	105	03/12→09/16					
Cooper SD ALL4	100	04/12→09/16					
Cooper SD ALL4	105	04/12→09/16					
John Cooper Works	160	09/12→09/16					
Cooper ALL4	90	11/12→09/16	←	07/14→		13.0460-2725.2 602725	TRW 23984 17,8 + WE / - WK + Zub
Cooper ALL4	90	02/13→09/16				13.0470-2725.2 LD2725	TRW 23984 17,8 + WE / - WK + Zub Ceramic
			→	07/14→		13.0460-2713.2 602713	TRW 23623 17,4 + WE / - WK + Zub
						13.0470-2713.2 LD2713	TRW 23623 17,4 + WE / - WK + Zub Ceramic
<b>Warnkontakt, Bremsbelagverschleiß</b>							
Cooper	88	04/12→09/16	←	11/12→	1	24.8190-0306.2 620306	L= 908
Cooper	90	04/12→09/16					
Cooper D	82	04/12→09/16	→	11/12→	2	24.8190-0307.2 620307	L= 957
Cooper D	82	07/12→09/16					
Cooper D ALL4	82	04/12→09/16					
Cooper D ALL4	82	03/12→09/16					
Cooper S	135	04/12→09/16					
Cooper S	140	04/12→09/16					
Cooper S ALL4	120	03/12→09/16					
Cooper S ALL4	135	03/12→09/16					
Cooper S ALL4	140	03/12→09/16					
Cooper SD	105	03/12→09/16					
Cooper SD ALL4	100	04/12→09/16					
Cooper SD ALL4	105	04/12→09/16					
John Cooper Works	160	09/12→09/16					
Cooper ALL4	90	11/12→09/16	←	07/14→	1	24.8190-0306.2 620306	L= 908
Cooper ALL4	90	02/13→09/16					
			→	07/14→	2	24.8190-0307.2 620307	L= 957
<b> Bremsscheibe</b>							
Cooper	88	04/12→09/16	←	11/12→		24.0122-0271.1 422271	Ø 294 22 20,4 V + S
Cooper	90	04/12→09/16					
Cooper D	82	04/12→09/16	→	11/12→		24.0110-0358.1 410358	Ø 280 10 8,4 + S
Cooper D	82	07/12→09/16					
Cooper D ALL4	82	04/12→09/16					
Cooper D ALL4	82	03/12→09/16					
Cooper SD	105	03/12→09/16					
Cooper SD ALL4	100	04/12→09/16					
Cooper SD ALL4	105	04/12→09/16					
Cooper ALL4	90	11/12→09/16	←	07/14→		24.0122-0271.1 422271	Ø 294 22 20,4 V + S
Cooper ALL4	90	02/13→09/16				24.0110-0358.1 410358	Ø 280 10 8,4 + S
			→	07/14→			
Cooper S	135	04/12→09/16	←	11/12→		24.0124-0240.1 424240	Ø 307 24 22,4 V + S
Cooper S	140	04/12→09/16					
Cooper S ALL4	120	03/12→09/16	→	11/12→		24.0110-0358.1 410358	Ø 280 10 8,4 + S
Cooper S ALL4	135	03/12→09/16					
Cooper S ALL4	140	03/12→09/16					
John Cooper Works	160	09/12→09/16	←	11/12→		24.0124-0240.1 424240	Ø 307 24 22,4 V + S

















	kw			 	! #		
<b>MINI - MINI Roadster (R59) 01/11→04/15</b>							
<b> Bremsbelagsatz, Scheibenbremse</b>							
Cooper Cooper Cooper SD Cooper SD	85 90 100 105	11/11→04/15 11/11→04/15 11/11→04/15 11/11→04/15	← ← → →	02/12→   02/12→		13.0460-2710.2 602710 13.0470-2710.2 LD2710	TRW 23915 17,6 + WE / - WK + Zub TRW 23915 17,6 + WE / - WK + Zub Ceramic
				02/12→		13.0460-2714.2 602714 13.0470-2714.2 LD2714	TRW 24289 16,9 + WE / - WK + Zub TRW 24289 16,9 + WE / - WK + Zub Ceramic
Cooper S Cooper S Cooper S JCW	120 135 147	11/11→04/15 11/11→04/15 11/11→04/15	← ← →	02/12→  02/12→		13.0460-2725.2 602725 13.0470-2725.2 LD2725	TRW 23984 17,8 + WE / - WK + Zub TRW 23984 17,8 + WE / - WK + Zub Ceramic
				02/12→		13.0460-2714.2 602714 13.0470-2714.2 LD2714	TRW 24289 16,9 + WE / - WK + Zub TRW 24289 16,9 + WE / - WK + Zub Ceramic
John Cooper Works	155	11/11→04/15	→	02/12→		13.0460-2714.2 602714 13.0470-2714.2 LD2714	TRW 24289 16,9 + WE / - WK + Zub TRW 24289 16,9 + WE / - WK + Zub Ceramic
<b>Warnkontakt, Bremsbelagverschleiß</b>							
Cooper Cooper Cooper S Cooper S Cooper SD Cooper SD Cooper S JCW John Cooper Works	85 90 120 135 100 105 147 155	11/11→04/15 11/11→04/15 11/11→04/15 11/11→04/15 11/11→04/15 11/11→04/15 11/11→04/15 11/11→04/15	← ← → →    	02/12→  02/12→    	1  1	24.8190-0009.2 620009 24.8190-0010.2 620010	L= 808 L= 1.141
<b> Bremsscheibe</b>							
Cooper Cooper Cooper SD Cooper SD	85 90 100 105	11/11→04/15 11/11→04/15 11/11→04/15 11/11→04/15	← ← → →	02/12→  02/12→  		24.0122-0248.1 422248 24.0322-0248.1 522248	Ø 280 22 20,4 V Ø 280 22 19,6 V
				02/12→		24.0110-0271.1 410271 24.0310-0271.1 510271	Ø 259 10 8,4 Ø 259 10 7,6
Cooper S Cooper S Cooper S JCW	120 135 147	11/11→04/15 11/11→04/15 11/11→04/15	← ← →	02/12→  02/12→		24.0122-0247.1 422247 24.0322-0247.1 522247	Ø 294 22 20,4 V Ø 294 22 19,6 V
				02/12→		24.0110-0271.1 410271 24.0310-0271.1 510271	Ø 259 10 8,4 Ø 259 10 7,6
<b>MITSUBISHI - ASX (GA_W_) 01/10→</b>							
<b> Bremsbelagsatz, Scheibenbremse</b>							
1.6 DI-D 1.6 DI-D 4WD 2.2 Di-D 4WD	84 84 110	07/15→ 07/15→ 04/13→	← ← →	   		13.0460-5760.2 605760 13.0460-5654.2 605654	AKE 23584 16,4 + WK MAN 25688 14,4 + WK
1.6 MIVEC	85	05/10→	← → →	06/10→  07/12→  06/10→ 06/12		13.0460-5760.2 605760 13.0460-5654.2 605654 13.0460-5855.2 605855	AKE 23584 16,4 + WK MAN 25688 14,4 + WK 23582 16,0 - WK
1.6 MIVEC 1.8 1.8 DI-D 1.8 DI-D 1.8 DI-D 4WD 1.8 DI-D 4WD 2.0 i 2.0 i 4WD	86 102 85 110 85 110 110 110	06/10→ 02/10→ 06/10→ 06/10→ 06/10→ 06/10→ 06/10→ 06/10→	← ← → → → → → →	  07/12→  → 06/12   		13.0460-5760.2 605760 13.0460-5654.2 605654 13.0460-5855.2 605855	AKE 23584 16,4 + WK MAN 25688 14,4 + WK 23582 16,0 - WK
<b> Bremsscheibe</b>							
1.6 DI-D 1.6 DI-D 4WD 2.2 Di-D 4WD	84 84 110	07/15→ 07/15→ 04/13→	← ← →	   		24.0126-0170.1 426170 24.0110-0395.1 410395	Ø 294 26 24,4 V Ø 302 10 8,4
1.6 MIVEC	85	05/10→	← → →	06/10→  06/10→ 06/12  07/12→		24.0126-0170.1 426170 24.0110-0360.1 410360 24.0110-0395.1 410395	Ø 294 26 24,4 V Ø 302 10 8,4 Ø 302 10 8,4
1.6 MIVEC 1.8 1.8 DI-D 1.8 DI-D 1.8 DI-D 4WD 1.8 DI-D 4WD	86 102 85 110 85 110	06/10→ 02/10→ 06/10→ 06/10→ 06/10→ 06/10→	← ← → → → →	  → 06/12  07/12→  		24.0126-0170.1 426170 24.0110-0360.1 410360 24.0110-0395.1 410395	Ø 294 26 24,4 V Ø 302 10 8,4 Ø 302 10 8,4















	kw			 	! #		
<b>MITSUBISHI - ASX (GA_W_) 01/10→</b>							
 <b>Bremsscheibe</b>							
2.0 i 2.0 i 4WD	110 110	06/10→ 06/10→	←			24.0126-0170.1 426170	Ø 294 26 24,4 V
			→	→ 06/12		24.0110-0360.1 410360	Ø 302 10 8,4
			→	07/12→		24.0110-0395.1 410395	Ø 302 10 8,4
<b>MITSUBISHI - ASX Van (GA_W_) 06/10→</b>							
 <b>Bremsbelagsatz, Scheibenbremse</b>							
1.8 DI-D 4WD	110	06/10→	←			13.0460-5760.2 605760	AKE 23584 16,4 + WK
			→	07/12→		13.0460-5654.2 605654	MAN 25688 14,4 + WK
			→	→ 06/12		13.0460-5855.2 605855	23582 16,0 - WK
 <b>Bremsscheibe</b>							
1.8 DI-D 4WD	110	06/10→	←			24.0126-0170.1 426170	Ø 294 26 24,4 V
			→	→ 06/12		24.0110-0360.1 410360	Ø 302 10 8,4
			→	07/12→		24.0110-0395.1 410395	Ø 302 10 8,4
<b>MITSUBISHI - ATTRAGE Stufenheck (A1_A) 07/13→</b>							
 <b>Bremsbelagsatz, Scheibenbremse</b>							
1.2 (A13A)	59	10/13→	←			13.0460-5709.2 605709	AKE 24229 14,8 + WK + Zub
<b>MITSUBISHI - CARISMA (DA_) 07/95→06/06</b>							
 <b>Bremsbelagsatz, Scheibenbremse</b>							
1.6 (DA1A)	66	07/95→06/06	←	03/99→ 06/00; für Bremsscheibendurchmesser [mm]: 256		13.0460-2830.2 602830	TRW 21920 14,6 + WK + Zub
			←	07/00→; für Bremsscheibendurchmesser [mm]: 281		13.0460-2853.2 602853	TRW 21983 17,2 + WK
			←	→ 02/99; für Bremsscheibendurchmesser [mm]: 236		13.0460-5987.2 605987	TRW 23080 15,0 - WK
			→	06/99→; + ABS		13.0460-2831.2 602831	TRW 21861 15,2 + WK
			→	→ 05/99; + ABS		13.0460-5826.2 605826	AKE 21872 14,5 + WK
1.6 (DA1A) 1.6 (DA1A)	70 73	12/98→06/06 05/97→06/06	←	für Bremsscheibendurchmesser [mm]: 236		13.0460-5987.2 605987	TRW 23080 15,0 - WK
			→	+ ABS		13.0460-5826.2 605826	AKE 21872 14,5 + WK
1.6 (DA1A) 1.8 GDI (DA2A)	76 90	09/00→06/06 10/00→06/06	←	für Bremsscheibendurchmesser [mm]: 281		13.0460-2853.2 602853	TRW 21983 17,2 + WK
			→	+ ABS		13.0460-2831.2 602831	TRW 21861 15,2 + WK
1.8 (DA2A) 1.8 MSX - 16V (DA2A)	85 103	07/95→07/97 07/95→07/97	←	für Bremsscheibendurchmesser [mm]: 256		13.0460-2830.2 602830	TRW 21920 14,6 + WK + Zub
			→	+ ABS		13.0460-5826.2 605826	AKE 21872 14,5 + WK
1.8 16V GDI (DA2A)	92	09/97→06/06	←	→ 08/00; für Bremsscheibendurchmesser [mm]: 256		13.0460-2830.2 602830	TRW 21920 14,6 + WK + Zub
			←	09/00→; für Bremsscheibendurchmesser [mm]: 281		13.0460-2853.2 602853	TRW 21983 17,2 + WK
			→	06/99→; + ABS		13.0460-2831.2 602831	TRW 21861 15,2 + WK
			→	→ 05/99; + ABS		13.0460-5826.2 605826	AKE 21872 14,5 + WK
1.9 DI-D 1.9 DI-D (DA5A)	85 75	09/00→06/06 09/00→06/06	←	für Bremsscheibendurchmesser [mm]: 281		13.0460-2853.2 602853	TRW 21983 17,2 + WK
			→			13.0460-2831.2 602831	TRW 21861 15,2 + WK
1.9 TD (DA4A)	66	10/96→09/00	←	03/99→; für Bremsscheibendurchmesser [mm]: 256		13.0460-2830.2 602830	TRW 21920 14,6 + WK + Zub
			←	→ 02/99; für Bremsscheibendurchmesser [mm]: 236		13.0460-5987.2 605987	TRW 23080 15,0 - WK
			→	+ ABS		13.0460-5826.2 605826	AKE 21872 14,5 + WK
<b>Zubehörsatz, Scheibenbremsbelag</b>							
1.6 (DA1A) 1.8 16V GDI (DA2A)	66 92	07/95→06/06 09/97→06/06	→	→ 05/99; + ABS		13.0460-0116.2 610116	
1.6 (DA1A) 1.6 (DA1A) 1.8 (DA2A)	70 73 85	12/98→06/06 05/97→06/06 07/95→07/97	→	+ ABS		13.0460-0116.2 610116	











	kw					! #		
<b>MITSUBISHI - CARISMA (DA_) 07/95→06/06</b>								
<b>Zubehörsatz, Scheibenbremsbelag</b>								
1.8 MSX - 16V (DA2A) 1.9 TD (DA4A)	103 66	07/95→07/97 10/96→09/00	➡	+ ABS			13.0460-0116.2 610116	
<b> Bremsscheibe</b>								
1.6 (DA1A)	66	07/95→06/06	←	→ 02/99		24.0118-0120.1 418120	Ø 236 18 16,4 V	
			←	03/99→ 06/00		24.0124-0136.1 424136	Ø 256 24 21,5 V	
			←	07/00→		24.0124-0159.1 424159	Ø 281 23,9 21,5 V	
						24.0324-0159.1 524159	Ø 281 23,9 21,5 V	
			➡	06/99→; + ABS		24.0110-0229.1 410229	Ø 260 10 8,4	
			➡	→ 05/99; + ABS		24.0110-0266.1 410266	Ø 236 10 8,4	
1.6 (DA1A) 1.6 (DA1A)	70 73	12/98→06/06 05/97→06/06	←			24.0118-0120.1 418120	Ø 236 18 16,4 V	
			➡	+ ABS		24.0110-0266.1 410266	Ø 236 10 8,4	
1.6 (DA1A) 1.8 GDI (DA2A)	76 90	09/00→06/06 10/00→06/06	←			24.0124-0159.1 424159	Ø 281 23,9 21,5 V	
						24.0324-0159.1 524159	Ø 281 23,9 21,5 V	
			➡	+ ABS		24.0110-0229.1 410229	Ø 260 10 8,4	
1.8 (DA2A) 1.8 MSX - 16V (DA2A)	85 103	07/95→07/97 07/95→07/97	←			24.0124-0136.1 424136	Ø 256 24 21,5 V	
			➡	+ ABS		24.0110-0229.1 410229	Ø 260 10 8,4	
1.8 16V GDI (DA2A)	92	09/97→06/06	←	→ 08/00		24.0124-0136.1 424136	Ø 256 24 21,5 V	
			←	09/00→		24.0124-0159.1 424159	Ø 281 23,9 21,5 V	
						24.0324-0159.1 524159	Ø 281 23,9 21,5 V	
			➡	+ ABS		24.0110-0229.1 410229	Ø 260 10 8,4	
1.9 DI-D 1.9 DI-D (DA5A)	85 75	09/00→06/06 09/00→06/06	←			24.0124-0159.1 424159	Ø 281 23,9 21,5 V	
						24.0324-0159.1 524159	Ø 281 23,9 21,5 V	
			➡			24.0110-0229.1 410229	Ø 260 10 8,4	
1.9 TD (DA4A)	66	10/96→09/00	←	→ 02/99		24.0118-0120.1 418120	Ø 236 18 16,4 V	
			←	03/99→		24.0124-0136.1 424136	Ø 256 24 21,5 V	
			➡	+ ABS		24.0110-0266.1 410266	Ø 236 10 8,4	
<b>MITSUBISHI - CARISMA Stufenheck (DA_) 09/96→06/06</b>								
<b> Bremsbelagsatz, Scheibenbremse</b>								
1.3 16V 1.9 DI-D 1.9 DI-D (DA5A)	60 85 75	09/00→10/04 09/00→06/06 09/00→06/06	←	für Bremsscheibendurchmesser [mm]: 281		13.0460-2853.2 602853	TRW 21983 17,2 + WK	
			➡			13.0460-2831.2 602831	TRW 21861 15,2 + WK	
1.6 (DA1A)	66	09/96→06/06	←	03/99→ 06/00; für Bremsscheibendurchmesser [mm]: 256		13.0460-2830.2 602830	TRW 21920 14,6 + WK + Zub	
			←	07/00→; für Bremsscheibendurchmesser [mm]: 281		13.0460-2853.2 602853	TRW 21983 17,2 + WK	
			←	→ 02/99; für Bremsscheibendurchmesser [mm]: 236		13.0460-5987.2 605987	TRW 23080 15,0 - WK	
			➡	06/99→; + ABS		13.0460-2831.2 602831	TRW 21861 15,2 + WK	
			➡	→ 05/99; + ABS		13.0460-5826.2 605826	AKE 21872 14,5 + WK	
1.6 (DA1A) 1.6 (DA1A)	70 73	12/98→06/06 05/97→06/06	←	für Bremsscheibendurchmesser [mm]: 236		13.0460-5987.2 605987	TRW 23080 15,0 - WK	
			➡	+ ABS		13.0460-5826.2 605826	AKE 21872 14,5 + WK	
1.6 (DA1A) 1.8 GDI (DA2A)	76 90	09/00→06/06 10/00→06/06	←	für Bremsscheibendurchmesser [mm]: 281		13.0460-2853.2 602853	TRW 21983 17,2 + WK	
			➡	+ ABS		13.0460-2831.2 602831	TRW 21861 15,2 + WK	
1.8 (DA2A)	85	09/96→09/97	←	für Bremsscheibendurchmesser [mm]: 256		13.0460-2830.2 602830	TRW 21920 14,6 + WK + Zub	
			➡	+ ABS		13.0460-5826.2 605826	AKE 21872 14,5 + WK	
1.8 16V GDI (DA2A)	92	09/97→06/06	←	→ 08/00; für Bremsscheibendurchmesser [mm]: 256		13.0460-2830.2 602830	TRW 21920 14,6 + WK + Zub	
			←	09/00→; für Bremsscheibendurchmesser [mm]: 281		13.0460-2853.2 602853	TRW 21983 17,2 + WK	
			➡	06/99→; + ABS		13.0460-2831.2 602831	TRW 21861 15,2 + WK	
			➡	→ 05/99; + ABS		13.0460-5826.2 605826	AKE 21872 14,5 + WK	
1.9 TD (DA4A)	66	10/96→09/00	←	03/99→; für Bremsscheibendurchmesser [mm]: 256		13.0460-2830.2 602830	TRW 21920 14,6 + WK + Zub	

	kw			 	! #		
<b>MITSUBISHI - CARISMA Stufenheck (DA_) 09/96→06/06</b>							
 <b>Bremsbelagsatz, Scheibenbremse</b>							
1.9 TD (DA4A)	66	10/96→09/00	←	→ 02/99; für Bremsscheibendurchmesser [mm]: 236		13.0460-5987.2 605987	TRW 23080 15,0 - WK
			→	+ ABS		13.0460-5826.2 605826	AKE 21872 14,5 + WK
2.0 16V GT EVO VI/VII	206	11/99→06/06	←	→ 08/03		13.0460-4973.2 604973	BRE 23092 16,0 + WK
			→	→ 08/03		13.0460-4974.2 604974	BRE 21580 14,6 + WK
<b>Zubehörsatz, Scheibenbremsbelag</b>							
1.6 (DA1A)	66	09/96→06/06	→	→ 05/99; + ABS		13.0460-0116.2 610116	
1.8 16V GDI (DA2A)	92	09/97→06/06					
1.6 (DA1A)	70	12/98→06/06	→	+ ABS		13.0460-0116.2 610116	
1.6 (DA1A)	73	05/97→06/06					
1.8 (DA2A)	85	09/96→09/97					
1.9 TD (DA4A)	66	10/96→09/00					
 <b>Bremsscheibe</b>							
1.3 16V	60	09/00→10/04	←			24.0124-0159.1 424159	Ø 281 23,9 21,5 V
1.9 DI-D	85	09/00→06/06				24.0324-0159.1 524159	Ø 281 23,9 21,5 V
1.9 DI-D (DA5A)	75	09/00→06/06	→			24.0110-0229.1 410229	Ø 260 10 8,4
1.6 (DA1A)	66	09/96→06/06	←	→ 02/99		24.0118-0120.1 418120	Ø 236 18 16,4 V
			←	03/99→ 06/00		24.0124-0136.1 424136	Ø 256 24 21,5 V
			←	07/00→		24.0124-0159.1 424159	Ø 281 23,9 21,5 V
						24.0324-0159.1 524159	Ø 281 23,9 21,5 V
			→	06/99→; + ABS		24.0110-0229.1 410229	Ø 260 10 8,4
			→	→ 05/99; + ABS		24.0110-0266.1 410266	Ø 236 10 8,4
1.6 (DA1A)	70	12/98→06/06	←			24.0118-0120.1 418120	Ø 236 18 16,4 V
1.6 (DA1A)	73	05/97→06/06	→	+ ABS		24.0110-0266.1 410266	Ø 236 10 8,4
1.6 (DA1A)	76	09/00→06/06	←			24.0124-0159.1 424159	Ø 281 23,9 21,5 V
1.8 GDI (DA2A)	90	10/00→06/06				24.0324-0159.1 524159	Ø 281 23,9 21,5 V
			→	+ ABS		24.0110-0229.1 410229	Ø 260 10 8,4
1.8 (DA2A)	85	09/96→09/97	←			24.0124-0136.1 424136	Ø 256 24 21,5 V
			→	+ ABS		24.0110-0229.1 410229	Ø 260 10 8,4
1.8 16V GDI (DA2A)	92	09/97→06/06	←	→ 08/00		24.0124-0136.1 424136	Ø 256 24 21,5 V
			←	09/00→		24.0124-0159.1 424159	Ø 281 23,9 21,5 V
						24.0324-0159.1 524159	Ø 281 23,9 21,5 V
			→	+ ABS		24.0110-0229.1 410229	Ø 260 10 8,4
1.9 TD (DA4A)	66	10/96→09/00	←	→ 02/99		24.0118-0120.1 418120	Ø 236 18 16,4 V
			←	03/99→		24.0124-0136.1 424136	Ø 256 24 21,5 V
			→	+ ABS		24.0110-0266.1 410266	Ø 236 10 8,4
<b>MITSUBISHI - COLT IV (CA_A) 03/92→04/96</b>							
 <b>Bremsbelagsatz, Scheibenbremse</b>							
1.3 GLi 12V (CA1A)	55	04/92→04/96	←			13.0460-5953.2 605953	SUM 21650 15,0 - WE / - WK
1.6 (CA4A)	66	02/94→04/96	←			13.0460-5953.2 605953	SUM 21650 15,0 - WE / - WK
1.6 GLXi 16V (CA4A)	83	04/92→04/96	→			13.0460-5826.2 605826	AKE 21872 14,5 + WK
1.8 GTi 16V (CA5A)	103	04/92→04/96	←			13.0460-5952.2 605952	SUM 21647 16,0 + WK
			→			13.0460-5826.2 605826	AKE 21872 14,5 + WK
<b>Zubehörsatz, Scheibenbremsbelag</b>							
1.3 GLi 12V (CA1A)	55	04/92→04/96	←			13.0460-0233.2 610233	SUM
1.6 (CA4A)	66	02/94→04/96					
1.6 GLXi 16V (CA4A)	83	04/92→04/96					
1.8 GTi 16V (CA5A)	103	04/92→04/96	←			13.0460-0442.2 610442	SUM
 <b>Bremsscheibe</b>							
1.3 GLi 12V (CA1A)	55	04/92→04/96	←			24.0113-0186.1 413186	Ø 234 13 11,4
			←	→ 11/93		24.0118-0120.1 418120	Ø 236 18 16,4 V
1.6 (CA4A)	66	02/94→04/96	←			24.0118-0120.1 418120	Ø 236 18 16,4 V
1.6 GLXi 16V (CA4A)	83	04/92→04/96	→			24.0110-0266.1 410266	Ø 236 10 8,4











	kw					! #		
<b>MITSUBISHI - COLT V (CJ_, CP_) 09/95→08/04</b>								
 <b>Bremsbelagsatz, Scheibenbremse</b>								
1.5 16V (CJ2A)	69	10/99→09/03	←	→ 08/00			13.0460-5889.2 605889	SUM 21650 15,0 + WK
1600 GLX (CJ4A)	66	05/96→09/00	←					
1300 (CJ1A)	60	06/00→09/03	←	09/00→ 06/03			13.0460-5889.2 605889	SUM 21650 15,0 + WK
1300 GL, GLX (CJ1A)	55	05/96→06/00	←				13.0460-5889.2 605889	SUM 21650 15,0 + WK
1600	76	09/00→09/03	←	→ 06/03			13.0460-5889.2 605889	SUM 21650 15,0 + WK
<b>Zubehörsatz, Scheibenbremsbelag</b>								
1.5 16V (CJ2A)	69	10/99→09/03	←	→ 08/00			13.0460-0233.2 610233	SUM
1600 GLX (CJ4A)	66	05/96→09/00	←					
1300 (CJ1A)	60	06/00→09/03	←	09/00→ 06/03			13.0460-0233.2 610233	SUM
1300 GL, GLX (CJ1A)	55	05/96→06/00	←				13.0460-0233.2 610233	SUM
1600	76	09/00→09/03	←	→ 06/03			13.0460-0233.2 610233	SUM
 <b>Bremsscheibe</b>								
1.5 16V (CJ2A)	69	10/99→09/03	←	→ 08/00			24.0118-0120.1 418120	Ø 236 18 16,4 V
1600 GLX (CJ4A)	66	05/96→09/00	←					
1300 (CJ1A)	60	06/00→09/03	←	09/00→ 06/03			24.0118-0120.1 418120	Ø 236 18 16,4 V
1300 GL, GLX (CJ1A)	55	05/96→06/00	←				24.0118-0120.1 418120	Ø 236 18 16,4 V
1600	76	09/00→09/03	←	→ 06/03			24.0118-0120.1 418120	Ø 236 18 16,4 V
<b>MITSUBISHI - COLT VI (Z3_A, Z2_A) 10/02→12/12</b>								
 <b>Bremsbelagsatz, Scheibenbremse</b>								
1.1	55	10/04→06/12	←				13.0460-2896.2 602896	TRW 21920 16,6 + WK + Zub
1.1 LPG	55	10/04→06/12	→				13.0460-2831.2 602831	TRW 21861 15,2 + WK
1.3	68	10/04→06/12	←				13.0460-2896.2 602896	TRW 21920 16,6 + WK + Zub
1.3	70	06/04→06/12	→					
1.3 LPG	70	06/04→06/12	→				13.0460-2831.2 602831	TRW 21861 15,2 + WK
1.5	80	06/04→06/12	→				13.0460-2897.2 602897	TRW 21861 15,2 + WK
1.5 DI-D	50	08/04→06/12	→					
1.5 DI-D	70	08/04→06/12	→					
1.5 CZT	110	03/05→06/12	←				13.0460-2619.2 602619	TRW + WK
1.5 Ralliart R	132	02/10→06/12	→				13.0460-2831.2 602831	TRW 21861 15,2 + WK
			→				13.0460-2897.2 602897	TRW 21861 15,2 + WK
 <b>Bremsscheibe</b>								
1.1	55	10/04→06/12	←				24.0124-0192.1 424192	Ø 256 24 21,5 V
1.1 LPG	55	10/04→06/12	→					
1.3	68	10/04→06/12	→				24.0110-0304.1 410304	Ø 250 10 8
1.3	70	06/04→06/12	→					
1.3 LPG	70	06/04→06/12	→					
1.5	80	06/04→06/12	→					
1.5 DI-D	50	08/04→06/12	→					
1.5 DI-D	70	08/04→06/12	→					
1.5 CZT	110	03/05→06/12	→				24.0110-0304.1 410304	Ø 250 10 8
1.5 Ralliart R	132	02/10→06/12	→					
<b>MITSUBISHI - COLT CZC Cabriolet (RG) 05/06→07/09</b>								
 <b>Bremsbelagsatz, Scheibenbremse</b>								
1.5 (Z23)	80	05/06→07/09	←				13.0460-2896.2 602896	TRW 21920 16,6 + WK + Zub
			→				13.0460-2831.2 602831	TRW 21861 15,2 + WK
1.5 Turbo (Z23)	110	05/06→07/09	←				13.0460-2619.2 602619	TRW + WK
			→				13.0460-2831.2 602831	TRW 21861 15,2 + WK
 <b>Bremsscheibe</b>								
1.5 (Z23)	80	05/06→07/09	←				24.0124-0192.1 424192	Ø 256 24 21,5 V
			→				24.0110-0304.1 410304	Ø 250 10 8
1.5 Turbo (Z23)	110	05/06→07/09	→				24.0110-0304.1 410304	Ø 250 10 8
<b>MITSUBISHI - DELICA / SPACE GEAR 01/94→01/07</b>								
 <b>Bremsbelagsatz, Scheibenbremse</b>								
2.0	83	09/95→10/02	←	08/96→ 05/00			13.0460-5890.2 605890	AKE 23290 15,5 + WK
2.4	97	05/95→05/00	←				13.0460-5890.2 605890	AKE 23290 15,5 + WK































	kw					! #		
<b>MITSUBISHI - ECLIPSE II (D3_A) 04/94→04/99</b>								
 <b>Bremsbelagsatz, Scheibenbremse</b>								
2000 GS 16V (D32A)	107	12/95→04/99	←			13.0460-5952.2	605952	SUM 21647 16,0 + WK
2000 GT 16V	157	12/95→04/99						
2400 GS 16V	105	09/98→04/99	→			13.0460-5980.2	605980	21706 15,5 + WK
<b>Zubehörsatz, Scheibenbremsbelag</b>								
2000 GS 16V (D32A)	107	12/95→04/99	→			13.0460-0150.2	610150	AKE
2000 GT 16V	157	12/95→04/99						
2400 GS 16V	105	09/98→04/99						
 <b>Bremsscheibe</b>								
2000 GS 16V (D32A)	107	12/95→04/99	←			24.0124-0142.1	424142	Ø 256 24 22,4 V
2000 GT 16V	157	12/95→04/99						
2400 GS 16V	105	09/98→04/99	→			24.0110-0704.1	410704	Ø 262 10 8,4
<b>MITSUBISHI - ECLIPSE CROSS (GK_) 10/17→</b>								
 <b>Bremsscheibe</b>								
1.5 T-Mivec	120	10/17→	←			24.0126-0170.1	426170	Ø 294 26 24,4 V
1.5 T-Mivec 4WD	120	10/17→	→			24.0110-0395.1	410395	Ø 302 10 8,4
<b>MITSUBISHI - FTO Coupe (DE_A) 09/94→07/01</b>								
 <b>Bremsbelagsatz, Scheibenbremse</b>								
2.0 (DE3A)	127	09/94→07/01	←			13.0460-5952.2	605952	SUM 21647 16,0 + WK
			→			13.0460-5980.2	605980	21706 15,5 + WK
 <b>Bremsscheibe</b>								
2.0 (DE3A)	127	09/94→07/01	←			24.0124-0136.1	424136	Ø 256 24 21,5 V
			→			24.0110-0240.1	410240	Ø 262 10 8,4
<b>MITSUBISHI - GALANT V (E5_A, E7_A, E8_A) 11/92→10/96</b>								
 <b>Bremsbelagsatz, Scheibenbremse</b>								
1.8 (E52A)	85	02/94→08/96	←			13.0460-5952.2	605952	SUM 21647 16,0 + WK
1.8 GLSI (E52A)	93	11/92→08/96	→		+ ABS; passend für Felgengröße [Zoll]: 14	13.0460-5980.2	605980	21706 15,5 + WK
2.0 GLSI (E55A)	101	11/92→08/96	←			13.0460-5952.2	605952	SUM 21647 16,0 + WK
2.0 GLSI 4WD (E75A)	101	11/92→08/96						
2.0 GLSTD (E57A)	66	11/92→08/96	→		passend für Felgengröße [Zoll]: 14	13.0460-5980.2	605980	21706 15,5 + WK
2.0 V6-24 (E64A, E54A)	110	11/92→08/96						
<b>Zubehörsatz, Scheibenbremsbelag</b>								
1.8 (E52A)	85	02/94→08/96	←			13.0460-0442.2	610442	SUM
1.8 GLSI (E52A)	93	11/92→08/96	→		+ ABS	13.0460-0150.2	610150	AKE
2.0 GLSI (E55A)	101	11/92→08/96	←			13.0460-0442.2	610442	SUM
2.0 GLSI 4WD (E75A)	101	11/92→08/96						
2.0 GLSTD (E57A)	66	11/92→08/96	→			13.0460-0150.2	610150	AKE
2.0 V6-24 (E64A, E54A)	110	11/92→08/96						
2.5 (E88A)	125	11/92→09/96	←			13.0460-0235.2	610235	
2.5 V6-24 4WD (E88A)	125	11/92→08/96						
 <b>Bremsscheibe</b>								
1.8 (E52A)	85	02/94→08/96	←			24.0124-0136.1	424136	Ø 256 24 21,5 V
1.8 GLSI (E52A)	93	11/92→08/96	→		+ ABS	24.0110-0240.1	410240	Ø 262 10 8,4
2.0 GLSI (E55A)	101	11/92→08/96	←			24.0124-0136.1	424136	Ø 256 24 21,5 V
2.0 GLSI 4WD (E75A)	101	11/92→08/96						
2.0 GLSTD (E57A)	66	11/92→08/96	→			24.0110-0240.1	410240	Ø 262 10 8,4
2.0 V6-24 (E64A, E54A)	110	11/92→08/96						
<b>MITSUBISHI - GALANT V Stufenheck (E5_A, E7_A, E8_A) 11/92→12/98</b>								
 <b>Bremsbelagsatz, Scheibenbremse</b>								
1.8 (E52A)	85	02/94→08/96	←			13.0460-5952.2	605952	SUM 21647 16,0 + WK
1.8 GLSI (E52A)	93	11/92→08/96	→		+ ABS; passend für Felgengröße [Zoll]: 14	13.0460-5980.2	605980	21706 15,5 + WK
2.0 GLSI (E55A)	101	11/92→08/96	←			13.0460-5952.2	605952	SUM 21647 16,0 + WK
2.0 GLSI 4WD (E75A)	101	11/92→08/96						
2.0 GLSTD (E57A)	66	11/92→08/96	→		passend für Felgengröße [Zoll]: 14	13.0460-5980.2	605980	21706 15,5 + WK
2.0 V6-24 (E64A, E54A)	110	11/92→08/96						
<b>Zubehörsatz, Scheibenbremsbelag</b>								
1.8 (E52A)	85	02/94→08/96	←			13.0460-0442.2	610442	SUM
↓								

	kw			 	! #		
<b>MITSUBISHI - GALANT V Stufenheck (E5_A, E7_A, E8_A) 11/92→12/98</b>							
<b>Zubehörsatz, Scheibenbremsbelag</b>							
1.8 GLSI (E52A)	93	11/92→08/96	➔	+ ABS		13.0460-0150.2 610150	AKE
2.0 GLSI (E55A)	101	11/92→08/96	➔			13.0460-0442.2 610442	SUM
2.0 GLSI 4WD (E75A)	101	11/92→08/96	➔			13.0460-0150.2 610150	AKE
2.0 GLSTD (E57A)	66	11/92→08/96	➔				
2.0 V6-24 (E64A, E54A)	110	11/92→08/96	➔				
2.5 V6-24 4WD (E88A)	125	11/92→08/96	➔			13.0460-0235.2 610235	
<b> Bremsscheibe</b>							
1.8 (E52A)	85	02/94→08/96	➔			24.0124-0136.1 424136	Ø 256 24 21,5 V
1.8 GLSI (E52A)	93	11/92→08/96	➔	+ ABS		24.0110-0240.1 410240	Ø 262 10 8,4
2.0 GLSI (E55A)	101	11/92→08/96	➔			24.0124-0136.1 424136	Ø 256 24 21,5 V
2.0 GLSI 4WD (E75A)	101	11/92→08/96	➔			24.0110-0240.1 410240	Ø 262 10 8,4
2.0 GLSTD (E57A)	66	11/92→08/96	➔				
2.0 V6-24 (E64A, E54A)	110	11/92→08/96	➔				
<b>MITSUBISHI - GALANT VI (EA_) 09/96→10/04</b>							
<b> Bremsbelagsatz, Scheibenbremse</b>							
2.0 (EA2A)	98	09/00→10/04	➔	→ 10/03		13.0460-5760.2 605760	AKE 23584 16,4 + WK
2.4 GDI (EA3A)	106	09/00→10/04	➔	→ 10/03		13.0460-5980.2 605980	21706 15,5 + WK
2.0 (EA2A)	100	09/96→09/00	➔	04/00→		13.0460-5760.2 605760	AKE 23584 16,4 + WK
			➔	10/96→ 11/97		13.0460-5952.2 605952	SUM 21647 16,0 + WK
			➔	12/97→ 03/00		13.0460-5958.2 605958	AKE 21363 15,8 + WK
			➔	10/96→		13.0460-5980.2 605980	21706 15,5 + WK
			➔	03/00→ 05/03		13.0460-5760.2 605760	AKE 23584 16,4 + WK
2.0 GDI	107	01/97→10/04	➔	→ 02/00		13.0460-5952.2 605952	SUM 21647 16,0 + WK
			➔	→ 05/03		13.0460-5980.2 605980	21706 15,5 + WK
			➔	10/96→ 07/01		13.0460-5952.2 605952	SUM 21647 16,0 + WK
2.4 GDI (EA3A)	110	02/99→09/00	➔	04/00→		13.0460-5760.2 605760	AKE 23584 16,4 + WK
			➔	03/99→ 03/00		13.0460-5958.2 605958	AKE 21363 15,8 + WK
			➔	03/99→		13.0460-5980.2 605980	21706 15,5 + WK
			➔	04/00→ 05/03		13.0460-5760.2 605760	AKE 23584 16,4 + WK
2.5 Type S	151	10/99→10/04	➔	→ 03/00		13.0460-5958.2 605958	AKE 21363 15,8 + WK
			➔	→ 05/03		13.0460-5980.2 605980	21706 15,5 + WK
			➔	04/00→		13.0460-5760.2 605760	AKE 23584 16,4 + WK
2.5 V6 24V 2.5 V6 24V (EA5A)	206 120	09/96→10/02 09/96→09/00	➔	10/96→ 11/97		13.0460-5952.2 605952	SUM 21647 16,0 + WK
			➔	12/97→ 03/00		13.0460-5958.2 605958	AKE 21363 15,8 + WK
			➔	04/00→		13.0460-5980.2 605980	21706 15,5 + WK
			➔	10/96→		13.0460-5980.2 605980	21706 15,5 + WK
			➔	→ 10/03		13.0460-5760.2 605760	AKE 23584 16,4 + WK
<b>Zubehörsatz, Scheibenbremsbelag</b>							
2.0 (EA2A)	98	09/00→10/04	➔	→ 10/03		13.0460-0235.2 610235	
2.4 GDI (EA3A)	106	09/00→10/04	➔	→ 10/03		13.0460-0235.2 610235	
2.5 V6 24V (EA5A)	118	09/00→10/04	➔	→ 10/03			
2.0 (EA2A)	100	09/96→09/00	➔	12/97→ 03/00			
2.5 V6 24V	206	09/96→10/02	➔	04/00→		13.0460-0235.2 610235	
2.5 V6 24V (EA5A)	120	09/96→09/00	➔	03/00→ 05/03		13.0460-0235.2 610235	
2.0 GDI	107	01/97→10/04	➔	03/99→ 03/00		13.0460-0235.2 610235	
2.4 GDI (EA3A)	110	02/99→09/00	➔	04/00→		13.0460-0235.2 610235	
			➔	04/00→		13.0460-0235.2 610235	
2.5 Type S	151	10/99→10/04	➔	04/00→ 05/03		13.0460-0235.2 610235	
			➔	→ 03/00		13.0460-0235.2 610235	
<b> Bremsscheibe</b>							
2.0 (EA2A)	98	09/00→10/04	➔	→ 10/03		24.0126-0131.1 426131	Ø 276 26 24,4 V
2.4 GDI (EA3A)	106	09/00→10/04	➔	→ 10/03		24.0110-0240.1 410240	Ø 262 10 8,4
2.5 V6 24V (EA5A)	118	09/00→10/04	➔	→ 10/03		24.0124-0136.1 424136	Ø 256 24 21,5 V
2.0 (EA2A)	100	09/96→09/00	➔	10/96→ 11/97			
2.5 V6 24V	206	09/96→10/02	➔	12/97→ 03/00			
2.5 V6 24V (EA5A)	120	09/96→09/00	➔	04/00→		24.0124-0170.1 424170	Ø 276 24 22,4 V
↓			➔	04/00→		24.0126-0131.1 426131	Ø 276 26 24,4 V



























	kW			 	! #		
<b>MITSUBISHI - GALANT VI (EA_) 09/96→10/04</b>							
 <b>Bremsscheibe</b>							
2.0 (EA2A) 2.5 V6 24V 2.5 V6 24V (EA5A)	100 206 120	09/96→09/00 09/96→10/02 09/96→09/00	→	10/96→		24.0110-0240.1 410240	Ø 262 10 8,4
2.0 GDI	107	01/97→10/04	←	→ 02/00		24.0124-0136.1 424136	Ø 256 24 21,5 V
			←	03/00→ 05/03		24.0126-0131.1 426131	Ø 276 26 24,4 V
			→	→ 05/03		24.0110-0240.1 410240	Ø 262 10 8,4
2.0 TDI (EA6A)	66	09/96→10/04	←	10/96→ 07/01		24.0124-0136.1 424136	Ø 256 24 21,5 V
2.4 GDI (EA3A)	110	02/99→09/00	←	03/99→ 03/00		24.0124-0170.1 424170	Ø 276 24 22,4 V
			←	04/00→		24.0126-0131.1 426131	Ø 276 26 24,4 V
			→	03/99→		24.0110-0240.1 410240	Ø 262 10 8,4
2.5 Type S	151	10/99→10/04	←	→ 03/00		24.0124-0170.1 424170	Ø 276 24 22,4 V
			←	04/00→ 05/03		24.0126-0131.1 426131	Ø 276 26 24,4 V
<b>MITSUBISHI - GALANT VI Kombi (EA_) 09/96→10/03</b>							
 <b>Bremsbelagsatz, Scheibenbremse</b>							
2.0 (EA2W) 2.4 GDI (EA3W)	98 106	09/00→10/03 09/00→10/03	←			13.0460-5760.2 605760	AKE 23584 16,4 + WK
2.0 (EA2W)	100	09/96→09/00	→			13.0460-5980.2 605980	21706 15,5 + WK
			←	04/00→		13.0460-5760.2 605760	AKE 23584 16,4 + WK
			←	10/96→ 11/97		13.0460-5952.2 605952	SUM 21647 16,0 + WK
			←	12/97→ 03/00		13.0460-5958.2 605958	AKE 21363 15,8 + WK
			→	10/96→		13.0460-5980.2 605980	21706 15,5 + WK
2.0 TDI (EA6W)	66	09/96→10/03	←	10/96→ 07/01		13.0460-5952.2 605952	SUM 21647 16,0 + WK
2.4 GDI (EA3W)	110	02/99→10/03	←	04/00→		13.0460-5760.2 605760	AKE 23584 16,4 + WK
			←	03/99→ 03/00		13.0460-5958.2 605958	AKE 21363 15,8 + WK
			→	03/99→		13.0460-5980.2 605980	21706 15,5 + WK
2.5 V6 24V 2.5 V6 24V (EA5W)	206 120	09/96→10/02 09/96→09/00	←	04/00→		13.0460-5760.2 605760	AKE 23584 16,4 + WK
			←	10/96→ 11/97		13.0460-5952.2 605952	SUM 21647 16,0 + WK
			←	12/97→ 03/00		13.0460-5958.2 605958	AKE 21363 15,8 + WK
			→	04/00→		13.0460-5980.2 605980	21706 15,5 + WK
			→	10/96→		13.0460-5980.2 605980	21706 15,5 + WK
2.5 V6 24V (EA5W)	118	09/00→10/03	←			13.0460-5760.2 605760	AKE 23584 16,4 + WK
2.8 TD	92	10/96→07/01	←	04/00→		13.0460-5760.2 605760	AKE 23584 16,4 + WK
			←	→ 11/97		13.0460-5952.2 605952	SUM 21647 16,0 + WK
			←	12/97→ 03/00		13.0460-5958.2 605958	AKE 21363 15,8 + WK
			→			13.0460-5980.2 605980	21706 15,5 + WK
			→	04/00→		13.0460-5980.2 605980	21706 15,5 + WK
<b>Zubehörsatz, Scheibenbremsbelag</b>							
2.0 (EA2W) 2.4 GDI (EA3W) 2.5 V6 24V (EA5W)	98 106 118	09/00→10/03 09/00→10/03 09/00→10/03	←			13.0460-0235.2 610235	
2.0 (EA2W) 2.5 V6 24V 2.5 V6 24V (EA5W) 2.8 TD	100 206 120 92	09/96→09/00 09/96→10/02 09/96→09/00 10/96→07/01	←	12/97→ 03/00		13.0460-0235.2 610235	
			←	04/00→		13.0460-0235.2 610235	
			←	03/99→ 03/00		13.0460-0235.2 610235	
2.4 GDI (EA3W)	110	02/99→10/03	←	04/00→		13.0460-0235.2 610235	
			←	04/00→		13.0460-0235.2 610235	
 <b>Bremsscheibe</b>							
2.0 (EA2W) 2.4 GDI (EA3W) 2.5 V6 24V (EA5W)	98 106 118	09/00→10/03 09/00→10/03 09/00→10/03	←			24.0126-0131.1 426131	Ø 276 26 24,4 V
2.0 (EA2W) 2.5 V6 24V 2.5 V6 24V (EA5W)	100 206 120	09/96→09/00 09/96→10/02 09/96→09/00	←	10/96→ 11/97		24.0124-0136.1 424136	Ø 256 24 21,5 V
			←	12/97→ 03/00		24.0124-0170.1 424170	Ø 276 24 22,4 V
			←	04/00→		24.0126-0131.1 426131	Ø 276 26 24,4 V
			→	10/96→		24.0110-0240.1 410240	Ø 262 10 8,4
			←	10/96→ 07/01		24.0124-0136.1 424136	Ø 256 24 21,5 V
2.4 GDI (EA3W)	110	02/99→10/03	←	03/99→ 03/00		24.0124-0170.1 424170	Ø 276 24 22,4 V
↓							













	kw			 	! #		
<b>MITSUBISHI - GALANT VI Kombi (EA_) 09/96→10/03</b>							
 <b>Bremsscheibe</b>							
2.4 GDI (EA3W)	110	02/99→10/03	←	04/00→		24.0126-0131.1 426131	Ø 276 26 24,4 V
			→	03/99→		24.0110-0240.1 410240	Ø 262 10 8,4
2.8 TD	92	10/96→07/01	←	→ 11/97		24.0124-0136.1 424136	Ø 256 24 21,5 V
			←	12/97→ 03/00		24.0124-0170.1 424170	Ø 276 24 22,4 V
			←	04/00→		24.0126-0131.1 426131	Ø 276 26 24,4 V
			→			24.0110-0240.1 410240	Ø 262 10 8,4
<b>MITSUBISHI - GALANT Stufenheck (DJ_, ED_, EF_) 10/03→</b>							
 <b>Bremsbelagsatz, Scheibenbremse</b>							
2.4	116	10/03→	←			13.0460-5760.2 605760	AKE 23584 16,4 + WK
2.4	118	12/04→					
<b>MITSUBISHI - GALLOPER (JK-01) 09/98→12/03</b>							
 <b>Bremsbelagsatz, Scheibenbremse</b>							
2.5 TD	65	09/98→12/03	←	01/99→		13.0460-5885.2 605885	SUM 23518 17,0 + WK + Zub
2.5 TD intercooler	73	09/98→12/03					
3.0 V6	104	09/98→12/03					
 <b>Bremsscheibe</b>							
2.5 TD	65	09/98→12/03	←	01/99→; + ABS		24.0122-0237.1 422237	Ø 277 22 20,4 V
2.5 TD intercooler	73	09/98→12/03					
3.0 V6	104	09/98→12/03					
<b>MITSUBISHI - GRANDIS (NA_W) 03/03→12/11</b>							
 <b>Bremsbelagsatz, Scheibenbremse</b>							
2.0 DI-D (NA8W)	100	09/05→03/10	←			13.0460-5853.2 605853	SUM 23488 15,4 + WK
2.0 DI-D (NA8W)	103	02/07→03/10	→			13.0460-5855.2 605855	23582 16,0 - WK
2.4 MIVEC (NA4W)	121	04/04→12/11	←	→ 08/10		13.0460-5853.2 605853	SUM 23488 15,4 + WK
2.4 MIVEC (NA4W)	130	04/04→12/11	→	→ 08/10		13.0460-5855.2 605855	23582 16,0 - WK
2.4 MIVEC 4WD (NA4W)	121	04/04→12/11					
<b>Zubehörsatz, Scheibenbremsbelag</b>							
2.0 DI-D (NA8W)	100	09/05→03/10	←			13.0460-0222.2 610222	SUM
2.0 DI-D (NA8W)	103	02/07→03/10	→			13.0460-0137.2 610137	
2.4 MIVEC (NA4W)	121	04/04→12/11	←	→ 08/10		13.0460-0222.2 610222	SUM
2.4 MIVEC (NA4W)	130	04/04→12/11	→	→ 08/10		13.0460-0137.2 610137	
2.4 MIVEC 4WD (NA4W)	121	04/04→12/11					
 <b>Bremsscheibe</b>							
2.0 DI-D (NA8W)	100	09/05→03/10	←			24.0126-0162.1 426162	Ø 290 26 24,4 V
2.0 DI-D (NA8W)	103	02/07→03/10	→			24.0110-0344.1 410344	Ø 302 10 8,4
2.4 MIVEC (NA4W)	121	04/04→12/11	←	→ 08/10		24.0126-0162.1 426162	Ø 290 26 24,4 V
2.4 MIVEC (NA4W)	130	04/04→12/11	→	→ 08/10		24.0110-0344.1 410344	Ø 302 10 8,4
2.4 MIVEC 4WD (NA4W)	121	04/04→12/11					
<b>MITSUBISHI - i (HA_) 01/06→</b>							
 <b>Bremsbelagsatz, Scheibenbremse</b>							
0.7	38	01/10→	←	für Rechtslenker		13.0460-5621.2 605621	24423 14,6 + WK
MiEV (HA4W)	35	07/09→	←			13.0460-5621.2 605621	24423 14,6 + WK
MiEV (HA4W)	47	07/09→					
MiEV (HA4W)	49	02/11→	←	→ 04/14		13.0460-5621.2 605621	24423 14,6 + WK
 <b>Bremsscheibe</b>							
MiEV (HA4W)	35	07/09→	←			24.0117-0110.1 417110	Ø 257 17 15 V
MiEV (HA4W)	47	07/09→					
MiEV (HA4W)	49	02/11→	←	→ 04/14		24.0117-0110.1 417110	Ø 257 17 15 V
<b>MITSUBISHI - L200 (KJ_, KK_, KL_) 11/14→</b>							
 <b>Bremsbelagsatz, Scheibenbremse</b>							
2.4 DI-D	133	01/15→	←	09/15→		13.0460-5631.2 605631	24529 16,0 + WK
2.4 DI-D 4WD	133	11/14→					
2.4 DI-D (KJ0T)	113	09/15→	←			13.0460-5631.2 605631	24529 16,0 + WK
2.4 DI-D 4WD (KJ0T)	113	09/15→					

	kw					! #		
<b>MITSUBISHI - L 200 / TRITON (KA_T, KB_T) 01/04→12/15</b>								
 <b>Bremsbelagsatz, Scheibenbremse</b>								
2.5 DiD (KA4T)	100	11/05→12/15	←	01/06→			13.0460-5631.2 605631	24529 16,0 + WK
2.5 DI-D 4WD (KB4T)	100	11/05→12/15	←					
2.5 DI-D (KA4T)	94	04/10→12/15	←				13.0460-5631.2 605631	24529 16,0 + WK
2.5 DI-D (KA4T)	123	08/07→12/15	←					
2.5 DI-D 16V 4WD	98	04/07→12/15	←					
2.5 DI-D 4WD (KB4T)	123	10/07→12/15	←					
2.5 DI-D 4WD (KB4T)	131	04/10→12/15	←					
2.5 DI-D (KA4T)	131	01/10→12/15	←	03/13→			13.0460-5631.2 605631	24529 16,0 + WK
3.5 4WD (KB9T)	147	05/07→12/15	←	04/10→			13.0460-5631.2 605631	24529 16,0 + WK
3.5 Flex 4WD (KB9T)	147	09/09→12/15	←					
<b>MITSUBISHI - L 200 / TRITON Pritsche/Fahrgestell (KA_T, KB_T) 03/06→12/15</b>								
 <b>Bremsbelagsatz, Scheibenbremse</b>								
2.5 DI-D 4WD (KB4T)	131	09/09→12/15	←	04/10→			13.0460-5631.2 605631	24529 16,0 + WK
<b>MITSUBISHI - L 200 (K3_T, K2_T, K1_T, K0_T) 01/86→10/96</b>								
 <b>Bremsbelagsatz, Scheibenbremse</b>								
2.0 (K12T, K32T)	75	11/86→08/96	←				13.0460-5940.2 605940	SUM 21373 16,0 + WK
2.0 4WD (K32T, K22T)	75	11/86→08/96	←	→ 05/92			13.0460-5940.2 605940	SUM 21373 16,0 + WK
2.5 D (K14T)	51	11/86→10/96	←	→ 08/96			13.0460-5940.2 605940	SUM 21373 16,0 + WK
2.5 TD 4WD (K34T)	64	11/92→08/96	←	→ 04/93			13.0460-5940.2 605940	SUM 21373 16,0 + WK
			←	05/93→; für Fahrzeuge ohne Servolenkung			13.0460-5940.2 605940	SUM 21373 16,0 + WK
			←	05/93→; für Fahrzeuge mit Servolenkung			13.0460-5958.2 605958	AKE 21363 15,8 + WK
<b>Zubehörsatz, Scheibenbremsbelag</b>								
2.0 (K12T, K32T)	75	11/86→08/96	←				13.0460-0335.2 610335	SUM
2.0 4WD (K32T, K22T)	75	11/86→08/96	←	→ 05/92			13.0460-0335.2 610335	SUM
2.5 D (K14T)	51	11/86→10/96	←	→ 08/96			13.0460-0335.2 610335	SUM
2.5 TD 4WD (K34T)	64	11/92→08/96	←	05/93→; für Fahrzeuge mit Servolenkung			13.0460-0235.2 610235	
			←	→ 04/93			13.0460-0335.2 610335	SUM
			←	05/93→; für Fahrzeuge ohne Servolenkung			13.0460-0335.2 610335	SUM
 <b>Bremsscheibe</b>								
2.5 TD 4WD (K34T)	64	11/92→08/96	←	05/93→; für Fahrzeuge mit Servolenkung			24.0124-0140.1 424140	Ø 276 24 22,4 V
<b>MITSUBISHI - L 200 (K7_T, K6_T) 01/96→12/07</b>								
 <b>Bremsbelagsatz, Scheibenbremse</b>								
2.0 (K62T)	90	06/96→12/07	←	→ 05/00			13.0460-5890.2 605890	AKE 23290 15,5 + WK
2.4 4WD (K75T)	97	06/96→12/07	←	→ 05/00; - ABS			13.0460-5890.2 605890	AKE 23290 15,5 + WK
			←	01/99→ 07/01; + ABS			13.0460-5958.2 605958	AKE 21363 15,8 + WK
2.5 D (K64T)	55	06/96→12/07	←	→ 05/00; - ABS			13.0460-5890.2 605890	AKE 23290 15,5 + WK
			←	06/00→ 07/01; + ABS			13.0460-5958.2 605958	AKE 21363 15,8 + WK
2.5 TD 4WD (K74T)	73	06/96→12/07	←	→ 05/00; - ABS			13.0460-5890.2 605890	AKE 23290 15,5 + WK
			←	→ 07/01; + ABS			13.0460-5958.2 605958	AKE 21363 15,8 + WK
<b>Zubehörsatz, Scheibenbremsbelag</b>								
2.0 (K62T)	90	06/96→12/07	←	→ 05/00			13.0460-0235.2 610235	
2.4 4WD (K75T)	97	06/96→12/07	←	01/99→ 07/01; + ABS			13.0460-0235.2 610235	
			←	→ 05/00; - ABS			13.0460-0235.2 610235	
2.5 D (K64T)	55	06/96→12/07	←	06/00→ 07/01; + ABS			13.0460-0235.2 610235	
			←	→ 05/00; - ABS			13.0460-0235.2 610235	
2.5 TD 4WD (K74T)	73	06/96→12/07	←	→ 07/01; + ABS			13.0460-0235.2 610235	
			←	→ 05/00; - ABS			13.0460-0235.2 610235	
 <b>Bremsscheibe</b>								
2.0 (K62T)	90	06/96→12/07	←	→ 07/01			24.0124-0207.1 424207	Ø 254 24 22,4 V
2.5 D (K64T)	55	06/96→12/07	←					
2.4 4WD (K75T)	97	06/96→12/07	←	→ 07/01			24.0124-0140.1 424140	Ø 276 24 22,4 V
2.5 TD 4WD (K74T)	73	06/96→12/07	←					
↓								





























	kw					! #		
<b>MITSUBISHI - L 200 (K7_T, K6_T) 01/96→12/07</b>								
 <b>Bremsscheibe</b>								
2.5 TD 4WD (K74T)	85	09/01→12/07	←	→ 04/06; 15"		24.0124-0140.1	424140	Ø 276 24 22,4 V
2.5 TD 4WD (K74T)	98	08/01→12/07	←	→ 04/06; 16"		24.0124-0724.1	424724	Ø 314 24 22,4 V
3.0 4WD	133	10/96→10/06	←	08/01→ 04/06; 15"		24.0124-0140.1	424140	Ø 276 24 22,4 V
			←	08/01→ 04/06; 16"		24.0124-0724.1	424724	Ø 314 24 22,4 V
<b>MITSUBISHI - L 300 III Bus (P0_W, P1_W, P2_W) 11/86→12/13</b>								
 <b>Bremsbelagsatz, Scheibenbremse</b>								
1.6 (P02W, P12W)	51	11/86→05/04	←	11/88→ 05/94		13.0460-5940.2	605940	SUM 21373 16,0 + WK
2.0	82	06/94→05/03	←	→ 04/00		13.0460-5940.2	605940	SUM 21373 16,0 + WK
2.0 (P03W, P13W)	64	11/86→05/04	←	→ 05/94		13.0460-5940.2	605940	SUM 21373 16,0 + WK
2.0 (P03W, P13W)	66	11/86→05/04						
2.4 (P04W, P14W)	82	11/90→05/04						
2.4 4WD (P24W)	82	08/86→05/04						
2.5 D (P05W, P15W, P25W)	51	11/86→05/04						
2.5 TD 4WD (P25W)	64	11/88→05/04						
2.0 4WD (P23W, P03W, P13W)	65	12/86→05/04	←	07/88→ 10/92		13.0460-5940.2	605940	SUM 21373 16,0 + WK
2.0 4WD (P23W, P03W, P13W)	66	11/86→05/04	←	→ 10/92		13.0460-5940.2	605940	SUM 21373 16,0 + WK
2.0 i (P00W, P03W, P13W)	83	06/94→10/98	←			13.0460-5940.2	605940	SUM 21373 16,0 + WK
2.4 i (P04W, P14V)	97	09/94→05/04	←	→ 05/99		13.0460-5940.2	605940	SUM 21373 16,0 + WK
2.5 D (P05W, P15W)	55	09/91→09/03	←	06/94→ 05/99		13.0460-5940.2	605940	SUM 21373 16,0 + WK
<b>Zubehörsatz, Scheibenbremsbelag</b>								
1.6 (P02W, P12W)	51	11/86→05/04	←	11/88→ 05/94		13.0460-0335.2	610335	SUM
2.0 (P03W, P13W)	64	11/86→05/04	←	→ 05/94		13.0460-0335.2	610335	SUM
2.0 (P03W, P13W)	66	11/86→05/04						
2.4 (P04W, P14W)	82	11/90→05/04						
2.4 4WD (P24W)	82	08/86→05/04						
2.5 D (P05W, P15W, P25W)	51	11/86→05/04						
2.5 TD 4WD (P25W)	64	11/88→05/04						
2.0 4WD (P23W, P03W, P13W)	65	12/86→05/04	←	07/88→ 10/92		13.0460-0335.2	610335	SUM
2.0 4WD (P23W, P03W, P13W)	66	11/86→05/04	←	→ 10/92		13.0460-0335.2	610335	SUM
<b>MITSUBISHI - L 300 III Kasten (P0_V, P1_V, P_2V) 11/86→09/13</b>								
 <b>Bremsbelagsatz, Scheibenbremse</b>								
2.0 (P03V, P13V)	64	11/86→05/96	←	→ 05/94		13.0460-5940.2	605940	SUM 21373 16,0 + WK
2.5 D (P05V, P05W, P15V)	51	11/86→02/06						
2.0 (P23W, P23V)	82	06/94→05/02	←	→ 04/00		13.0460-5940.2	605940	SUM 21373 16,0 + WK
2.5 D	55	09/91→09/03	←	06/94→ 05/99		13.0460-5940.2	605940	SUM 21373 16,0 + WK
2.5 TD 4WD	64	11/91→05/03						
<b>Zubehörsatz, Scheibenbremsbelag</b>								
2.0 (P03V, P13V)	64	11/86→05/96	←	→ 05/94		13.0460-0335.2	610335	SUM
2.5 D (P05V, P05W, P15V)	51	11/86→02/06						
<b>MITSUBISHI - L 300 III Pritsche/Fahrgestell (P1_T ) 04/94→04/00</b>								
 <b>Bremsbelagsatz, Scheibenbremse</b>								
2.0 (P13T)	85	07/94→04/00	←			13.0460-5940.2	605940	SUM 21373 16,0 + WK
2.5 TD (P15T)	64	11/94→04/00	←	→ 05/99		13.0460-5940.2	605940	SUM 21373 16,0 + WK
<b>MITSUBISHI - L 400 Bus (PD_W, PC_W, PA_V, PB_V, PA_W) 06/94→04/07</b>								
 <b>Bremsbelagsatz, Scheibenbremse</b>								
2.0 (PA3W)	83	09/95→10/02	←	08/96→		13.0460-5890.2	605890	AKE 23290 15,5 + WK
			←	06/96→		13.0460-5890.2	605890	AKE 23290 15,5 + WK
2.0 16V (PA3V/W, PB3V, PA3W)	85	05/95→05/00	←			13.0460-5890.2	605890	AKE 23290 15,5 + WK
2.5 TD (PA5V/W, PB5V)	73	05/95→05/00						
2.4	94	09/96→06/05	←			13.0460-5958.2	605958	AKE 21363 15,8 + WK
2.4 4WD	94	09/96→06/05						
2.4	97	05/95→10/02	←			13.0460-5890.2	605890	AKE 23290 15,5 + WK
↓								

	kW					! #		
<b>MITSUBISHI - L 400 Bus (PD_W, PC_W, PA_V, PB_V, PA_W) 06/94→04/07</b>								
 <b>Bremsbelagsatz, Scheibenbremse</b>								
2.4	97	05/95→10/02	←	06/96→			13.0460-5958.2 605958	AKE 21363 15,8 + WK
2.4 i 4WD (PD4V/W)	97	05/95→05/00	←				13.0460-5958.2 605958	AKE 21363 15,8 + WK
2.5 TD 4WD (PD5V/W)	73	05/95→05/00	→				13.0460-5980.2 605980	21706 15,5 + WK
2500 TD	64	05/95→06/05	←	06/96→ 05/99; - ABS			13.0460-5890.2 605890	AKE 23290 15,5 + WK
			←	06/99→; + ABS			13.0460-5958.2 605958	AKE 21363 15,8 + WK
<b>Zubehörsatz, Scheibenbremsbelag</b>								
2.0 (PA3W)	83	09/95→10/02	←	08/96→			13.0460-0235.2 610235	
			←	06/96→			13.0460-0235.2 610235	
2.0 16V (PA3V/W, PB3V, PA3W)	85	05/95→05/00	←				13.0460-0235.2 610235	
2.4	94	09/96→06/05						
2.4 4WD	94	09/96→06/05						
2.4 i 4WD (PD4V/W)	97	05/95→05/00						
2.5 TD (PA5V/W, PB5V)	73	05/95→05/00						
2.5 TD 4WD (PD5V/W)	73	05/95→05/00						
2.4	97	05/95→10/02	←				13.0460-0235.2 610235	
			←	06/96→			13.0460-0235.2 610235	
2500 TD	64	05/95→06/05	←	06/96→ 05/99; - ABS			13.0460-0235.2 610235	
			←	06/99→; + ABS			13.0460-0235.2 610235	
 <b>Bremsscheibe</b>								
2.4	94	09/96→06/05	←				24.0124-0202.1 424202	Ø 276 24 22,4 V
2.4	97	05/95→10/02	←	06/96→			24.0124-0202.1 424202	Ø 276 24 22,4 V
2.4 4WD	94	09/96→06/05	←				24.0124-0202.1 424202	Ø 276 24 22,4 V
2.4 i 4WD (PD4V/W)	97	05/95→05/00						
2.5 TD 4WD (PD5V/W)	73	05/95→05/00	→				24.0118-0140.1 418140	Ø 315 18 16,4
<b>MITSUBISHI - L 400 Kasten (PD_W, PC_W, PB_V, PA_W, PA_V) 12/94→04/07</b>								
 <b>Bremsbelagsatz, Scheibenbremse</b>								
2.0 (PA3W)	83	12/94→10/02	←	06/96→			13.0460-5890.2 605890	AKE 23290 15,5 + WK
2.4	97	06/96→10/02	←				13.0460-5958.2 605958	AKE 21363 15,8 + WK
2500 TD (PD5W, PD5V, PA5W, PA5V)	64	09/96→06/05	←	→ 05/99; - ABS			13.0460-5890.2 605890	AKE 23290 15,5 + WK
			←	06/99→; + ABS			13.0460-5958.2 605958	AKE 21363 15,8 + WK
<b>Zubehörsatz, Scheibenbremsbelag</b>								
2.0 (PA3W)	83	12/94→10/02	←	06/96→			13.0460-0235.2 610235	
2.4	97	06/96→10/02	←				13.0460-0235.2 610235	
2500 TD (PD5W, PD5V, PA5W, PA5V)	64	09/96→06/05	←	06/99→; + ABS			13.0460-0235.2 610235	
			←	→ 05/99; - ABS			13.0460-0235.2 610235	
 <b>Bremsscheibe</b>								
2.4	97	06/96→10/02	←				24.0124-0202.1 424202	Ø 276 24 22,4 V
<b>MITSUBISHI - LANCER V (CB_A, CD_A, CE_A) 09/91→12/96</b>								
 <b>Bremsbelagsatz, Scheibenbremse</b>								
1.3 (CB1A)	55	06/92→12/96	←	→ 04/96			13.0460-5953.2 605953	SUM 21650 15,0 - WE / - WK
1.6 (CB4A)	66	02/94→12/96	←	→ 04/96			13.0460-5953.2 605953	SUM 21650 15,0 - WE / - WK
1.6 16V (CB4A)	83	06/92→12/96						
2.0 Diesel (CB8A)	50	06/92→12/96	→	→ 04/96			13.0460-5826.2 605826	AKE 21872 14,5 + WK
1.6 16V 4WD (CD4A)	83	06/92→12/96	←	→ 04/96			13.0460-5953.2 605953	SUM 21650 15,0 - WE / - WK
			→	→ 11/93			13.0460-5826.2 605826	AKE 21872 14,5 + WK
EVO III (CE9A)	198	08/95→07/96	←				13.0460-5958.2 605958	AKE 21363 15,8 + WK
<b>Zubehörsatz, Scheibenbremsbelag</b>								
1.3 (CB1A)	55	06/92→12/96	←	→ 04/96			13.0460-0233.2 610233	SUM
1.6 (CB4A)	66	02/94→12/96						
1.6 16V (CB4A)	83	06/92→12/96						
1.6 16V 4WD (CD4A)	83	06/92→12/96						
2.0 Diesel (CB8A)	50	06/92→12/96						











	kw					! #		
<b>MITSUBISHI - LANCER V (CB_A, CD_A, CE_A) 09/91→12/96</b>								
 <b>Bremsscheibe</b>								
1.3 (CB1A)	55	06/92→12/96	←	→ 04/96			24.0113-0186.1 413186 24.0118-0120.1 418120	Ø 234 13 11,4 Ø 236 18 16,4 V
1.6 (CB4A)	66	02/94→12/96	←	→ 04/96			24.0118-0120.1 418120	Ø 236 18 16,4 V
1.6 16V (CB4A)	83	06/92→12/96	→	→ 04/96			24.0110-0266.1 410266	Ø 236 10 8,4
2.0 Diesel (CB8A)	50	06/92→12/96	→	→ 04/96			24.0110-0266.1 410266	Ø 236 10 8,4
1.6 16V 4WD (CD4A)	83	06/92→12/96	←	→ 04/96			24.0118-0120.1 418120	Ø 236 18 16,4 V
			→	→ 11/93			24.0110-0266.1 410266	Ø 236 10 8,4
<b>MITSUBISHI - LANCER V Station Wagon (CB_W, CD_W) 09/92→10/03</b>								
 <b>Bremsbelagsatz, Scheibenbremse</b>								
1.6 16V (CB4W)	83	12/92→10/03	←	→ 09/96			13.0460-5953.2 605953	SUM 21650 15,0 - WE / - WK
2.0 D	65	03/95→10/03	→	→ 09/96; + ABS			13.0460-5826.2 605826	AKE 21872 14,5 + WK
2.0 D (CB8W)	50	12/92→10/03	→	→ 09/96; + ABS			13.0460-5826.2 605826	AKE 21872 14,5 + WK
1.6 16V 4WD (CD4W)	83	12/92→10/03	←	→ 02/95			13.0460-5952.2 605952	SUM 21647 16,0 + WK
1.8 i	88	03/95→10/03	←	→ 04/96			13.0460-5952.2 605952	SUM 21647 16,0 + WK
			→	→ 04/96			13.0460-5826.2 605826	AKE 21872 14,5 + WK
<b>Zubehörsatz, Scheibenbremsbelag</b>								
1.6 16V (CB4W)	83	12/92→10/03	←	→ 09/96			13.0460-0233.2 610233	SUM
2.0 D	65	03/95→10/03	→	→ 09/96; + ABS			13.0460-0233.2 610233	SUM
2.0 D (CB8W)	50	12/92→10/03	→	→ 09/96; + ABS			13.0460-0233.2 610233	SUM
1.6 16V 4WD (CD4W)	83	12/92→10/03	←	→ 02/95			13.0460-0442.2 610442	SUM
1.8 i	88	03/95→10/03	←	→ 04/96			13.0460-0442.2 610442	SUM
 <b>Bremsscheibe</b>								
1.6 16V (CB4W)	83	12/92→10/03	←	→ 09/96			24.0118-0120.1 418120	Ø 236 18 16,4 V
2.0 D	65	03/95→10/03	→	→ 09/96; + ABS			24.0110-0266.1 410266	Ø 236 10 8,4
2.0 D (CB8W)	50	12/92→10/03	→	→ 09/96; + ABS			24.0110-0266.1 410266	Ø 236 10 8,4
1.6 16V 4WD (CD4W)	83	12/92→10/03	←	→ 02/95			24.0124-0136.1 424136	Ø 256 24 21,5 V
<b>MITSUBISHI - LANCER VI (CJ-CP_) 09/95→08/03</b>								
 <b>Bremsbelagsatz, Scheibenbremse</b>								
1.3 12V (CK1A)	55	12/95→08/03	←	05/96→ 07/01			13.0460-5889.2 605889	SUM 21650 15,0 + WK
1.6 16V (CK4A)	66	12/95→08/03	→	→ 08/00			13.0460-5889.2 605889	SUM 21650 15,0 + WK
1.5 12V (CK2A)	69	07/96→08/03	←	→ 08/00			13.0460-5889.2 605889	SUM 21650 15,0 + WK
EVO VI (CP9A)	207	01/99→02/01	←				13.0460-4973.2 604973	BRE 23092 16,0 + WK
			→				13.0460-4974.2 604974	BRE 21580 14,6 + WK
<b>Zubehörsatz, Scheibenbremsbelag</b>								
1.3 12V (CK1A)	55	12/95→08/03	←	05/96→ 07/01			13.0460-0233.2 610233	SUM
1.6 16V (CK4A)	66	12/95→08/03	→	→ 08/00			13.0460-0233.2 610233	SUM
1.5 12V (CK2A)	69	07/96→08/03	←	→ 08/00			13.0460-0233.2 610233	SUM
 <b>Bremsscheibe</b>								
1.3 12V (CK1A)	55	12/95→08/03	←	05/96→ 07/01			24.0118-0120.1 418120	Ø 236 18 16,4 V
1.6 16V (CK4A)	66	12/95→08/03	→	→ 08/00			24.0118-0120.1 418120	Ø 236 18 16,4 V
1.5 12V (CK2A)	69	07/96→08/03	←	→ 08/00			24.0118-0120.1 418120	Ø 236 18 16,4 V
<b>MITSUBISHI - LANCER VII (CS_A, CT_A) 03/00→12/13</b>								
 <b>Bremsbelagsatz, Scheibenbremse</b>								
1.3	60	09/03→	←	→ 03/07			13.0460-5760.2 605760	AKE 23584 16,4 + WK
1.6 (CS3A)	72	09/03→	→	→ 03/07			13.0460-5735.2 605735	AKE 24014 16,0 + WK
2.0 (CS9A)	99	12/03→	→	→ 03/07			13.0460-5735.2 605735	AKE 24014 16,0 + WK
1.6 (CS3A)	77	06/00→12/07	←				13.0460-5760.2 605760	AKE 23584 16,4 + WK
EVO IX (CT9A)	213	08/05→09/06	→				13.0460-5735.2 605735	AKE 24014 16,0 + WK
2.0 i	113	10/07→	←				13.0460-5760.2 605760	AKE 23584 16,4 + WK
			←	+ RUS			13.0460-5958.2 605958	AKE 21363 15,8 + WK
			→				13.0460-5735.2 605735	AKE 24014 16,0 + WK
EVO IX (CT9A)	206	01/05→09/07	←	01/06→ 08/07			13.0460-5760.2 605760	AKE 23584 16,4 + WK
			→	01/06→ 08/07			13.0460-5735.2 605735	AKE 24014 16,0 + WK
EVO IX - FQ-300 (CT9A)	227	06/05→12/06	←				13.0460-4973.2 604973	BRE 23092 16,0 + WK
EVO IX - FQ-320 (CT9A)	243	06/05→12/06	←				13.0460-4973.2 604973	BRE 23092 16,0 + WK
EVO IX - FQ-340 (CT9A)	257	06/05→12/07	←				13.0460-4973.2 604973	BRE 23092 16,0 + WK
EVO VIII - FQ-300 (CT9A)	225	04/03→04/04	←				13.0460-4973.2 604973	BRE 23092 16,0 + WK
↓								























	kW					! #		
<b>MITSUBISHI - LANCER VII (CS_A, CT_A) 03/00→12/13</b>								
 <b>Bremsbelagsatz, Scheibenbremse</b>								
EVO VIII - FQ-300 (CT9A)	227	04/03→04/04	←				13.0460-4973.2 604973	BRE 23092 16,0 + WK
EVO VIII - FQ-320 (CT9A)	243	04/04→08/06						
EVO VIII - FQ-340 (CT9A)	255	04/04→03/05						
EVO VIII - FQ-400 (CT9A)	302	10/04→08/06						
EVO VIII - 260 (CT9A)	195	03/04→07/05	←				13.0460-5958.2 605958	AKE 21363 15,8 + WK
EVO VIII - FQ-330 (CT9A)	246	10/03→08/06	←	12/03→			13.0460-4973.2 604973	BRE 23092 16,0 + WK
<b>Zubehörsatz, Scheibenbremsbelag</b>								
EVO VIII - 260 (CT9A)	195	03/04→07/05	←				13.0460-0235.2 610235	
 <b>Bremsscheibe</b>								
1.3	60	09/03→	←	→ 03/07			24.0126-0131.1 426131	Ø 276 26 24,4 V
1.6 (CS3A)	72	09/03→					24.0126-0134.1 426134	Ø 276 26 24,4 V
2.0 (CS9A)	99	12/03→	→	→ 03/07			24.0110-0240.1 410240	Ø 262 10 8,4
							24.0110-0704.1 410704	Ø 262 10 8,4
1.6 (CS3A)	77	06/00→12/07	←				24.0126-0131.1 426131	Ø 276 26 24,4 V
EVO IX (CT9A)	213	08/05→09/06					24.0126-0134.1 426134	Ø 276 26 24,4 V
			→				24.0110-0240.1 410240	Ø 262 10 8,4
							24.0110-0704.1 410704	Ø 262 10 8,4
2.0 i	113	10/07→	←				24.0126-0164.1 426164	Ø 276 26 24,4 V
			→				24.0110-0345.1 410345	Ø 262 10 8,4
EVO IX (CT9A)	206	01/05→09/07	→	01/06→ 08/07			24.0110-0704.1 410704	Ø 262 10 8,4
<b>MITSUBISHI - LANCER VII Kombi (CS_W, CT_W) 09/03→12/08</b>								
 <b>Bremsbelagsatz, Scheibenbremse</b>								
1.6	72	09/03→10/08	←	→ 03/07			13.0460-5760.2 605760	AKE 23584 16,4 + WK
2.0	99	09/03→12/07	→	→ 03/07			13.0460-5735.2 605735	AKE 24014 16,0 + WK
 <b>Bremsscheibe</b>								
1.6	72	09/03→10/08	←	→ 03/07			24.0126-0131.1 426131	Ø 276 26 24,4 V
2.0	99	09/03→12/07	→	→ 03/07			24.0110-0240.1 410240	Ø 262 10 8,4
							24.0110-0704.1 410704	Ø 262 10 8,4
<b>MITSUBISHI - LANCER VIII (CY_A, CZ_A) 03/07→</b>								
 <b>Bremsbelagsatz, Scheibenbremse</b>								
1.5	80	06/08→	←				13.0460-5760.2 605760	AKE 23584 16,4 + WK
1.5 Bifuel	80	02/10→	→					
1.6 MIVEC	86	05/10→					13.0460-5735.2 605735	AKE 24014 16,0 + WK
1.8	103	05/10→						
1.8	105	02/08→						
1.8 Bifuel	105	01/10→						
1.8 DI-D	85	05/10→						
1.8 DI-D (CY9A)	110	06/10→						
1.8 Flexfuel	103	03/09→						
1.8 Flexfuel (CY3A)	105	01/10→						
1.8 MIVEC (CY3A, CY6A)	102	03/09→						
2.0	108	01/09→						
2.0 DI-D	103	01/08→						
2.0 i Ralliart 4WD (CY4A)	177	10/08→	←	10/11→			13.0460-5760.2 605760	AKE 23584 16,4 + WK
			←	→ 09/11			13.0460-5958.2 605958	AKE 21363 15,8 + WK
			→	10/11→			13.0460-5735.2 605735	AKE 24014 16,0 + WK
			→	→ 09/11			13.0460-5855.2 605855	23582 16,0 - WK
 <b>Bremsscheibe</b>								
1.5	80	06/08→	←				24.0126-0164.1 426164	Ø 276 26 24,4 V
1.5 Bifuel	80	02/10→	→					
1.6 MIVEC	86	05/10→					24.0110-0345.1 410345	Ø 262 10 8,4
1.8	103	05/10→						
1.8 Bifuel	105	01/10→						
1.8 DI-D	85	05/10→						
1.8 DI-D (CY9A)	110	06/10→						
1.8 Flexfuel	103	03/09→						











	kW			 	! #			
<b>MITSUBISHI - LANCER VIII (CY_A, CZ_A) 03/07→</b>								
 <b>Bremsscheibe</b>								
1.8 Flexfuel (CY3A)	105	01/10→	←			24.0126-0164.1	426164	Ø 276 26 24,4 V
1.8 MIVEC (CY3A, CY6A)	102	03/09→	→			24.0110-0345.1	410345	Ø 262 10 8,4
2.0	108	01/09→						
2.0 DI-D	103	01/08→						
1.8	105	02/08→	←	04/09→		24.0126-0164.1	426164	Ø 276 26 24,4 V
			→			24.0110-0345.1	410345	Ø 262 10 8,4
2.0 i Ralliart 4WD (CY4A)	177	10/08→	←	→ 03/09		24.0124-0215.1	424215	Ø 294 24 22,4 V
			←	10/11→		24.0126-0164.1	426164	Ø 276 26 24,4 V
			→			24.0110-0345.1	410345	Ø 262 10 8,4
<b>MITSUBISHI - LANCER VIII Sportback (CX_A) 10/07→</b>								
 <b>Bremsbelagsatz, Scheibenbremse</b>								
1.5	80	06/08→	←			13.0460-5760.2	605760	AKE 23584 16,4 + WK
1.5 Bifuel	80	03/10→	→					
1.6 MIVEC	86	05/10→				13.0460-5735.2	605735	AKE 24014 16,0 + WK
1.8 (CX3A)	105	06/08→						
1.8 Bifuel	105	02/10→						
1.8 DI-D	85	05/10→						
1.8 DI-D (CX9A)	110	06/10→						
1.8 Flex	103	03/09→						
1.8 MIVEC	103	03/09→						
2.0 DI-D	103	06/08→						
2.0 Ralliart 4WD (CX4A)	177	10/08→	→			13.0460-5855.2	605855	23582 16,0 - WK
<b>Zubehörsatz, Scheibenbremsbelag</b>								
2.0 Ralliart 4WD (CX4A)	177	10/08→	→			13.0460-0137.2	610137	
 <b>Bremsscheibe</b>								
1.5	80	06/08→	←			24.0126-0164.1	426164	Ø 276 26 24,4 V
1.5 Bifuel	80	03/10→	→					
1.6 MIVEC	86	05/10→				24.0110-0345.1	410345	Ø 262 10 8,4
1.8 (CX3A)	105	06/08→						
1.8 Bifuel	105	02/10→						
1.8 DI-D	85	05/10→						
1.8 DI-D (CX9A)	110	06/10→						
1.8 Flex	103	03/09→						
1.8 MIVEC	103	03/09→						
2.0 DI-D	103	06/08→						
2.0 Ralliart 4WD (CX4A)	177	10/08→	←			24.0124-0215.1	424215	Ø 294 24 22,4 V
			→			24.0110-0330.1	410330	Ø 302 10 8
<b>MITSUBISHI - MIRAGE Schrägheck (CJ_A) 09/95→07/03</b>								
 <b>Bremsbelagsatz, Scheibenbremse</b>								
1.3	55	09/95→07/03	←	05/96→ 08/00		13.0460-5889.2	605889	SUM 21650 15,0 + WK
1.5 (CJ2A)	81	09/95→08/99	←			13.0460-5889.2	605889	SUM 21650 15,0 + WK
1.6	84	09/99→07/03	←	09/00→ 06/03		13.0460-5889.2	605889	SUM 21650 15,0 + WK
1.6	128	09/95→08/99	←	05/96→		13.0460-5889.2	605889	SUM 21650 15,0 + WK
<b>Zubehörsatz, Scheibenbremsbelag</b>								
1.3	55	09/95→07/03	←	05/96→ 08/00		13.0460-0233.2	610233	SUM
1.5 (CJ2A)	81	09/95→08/99	←			13.0460-0233.2	610233	SUM
1.6	84	09/99→07/03	←	09/00→ 06/03		13.0460-0233.2	610233	SUM
1.6	128	09/95→08/99	←	05/96→		13.0460-0233.2	610233	SUM
 <b>Bremsscheibe</b>								
1.3	55	09/95→07/03	←	05/96→ 08/00		24.0118-0120.1	418120	Ø 236 18 16,4 V
1.5 (CJ2A)	81	09/95→08/99	←			24.0118-0120.1	418120	Ø 236 18 16,4 V
1.6	84	09/99→07/03	←	09/00→ 06/03		24.0118-0120.1	418120	Ø 236 18 16,4 V
1.6	128	09/95→08/99	←	05/96→		24.0118-0120.1	418120	Ø 236 18 16,4 V
<b>MITSUBISHI - MIRAGE Stufenheck (CK_A) 09/95→07/03</b>								
 <b>Bremsbelagsatz, Scheibenbremse</b>								
1.5 (CK2A)	81	09/95→12/00	←	05/96→		13.0460-5889.2	605889	SUM 21650 15,0 + WK
↓								













	kW					! #		
<b>MITSUBISHI - MIRAGE Stufenheck (CK_A) 09/95→07/03</b>								
<b>Zubehörsatz, Scheibenbremsbelag</b>								
1.5 (CK2A)	81	09/95→12/00	←	05/96→			13.0460-0233.2 610233	SUM
<b> Bremsscheibe</b>								
1.5 (CK2A)	81	09/95→12/00	←	05/96→			24.0118-0120.1 418120	Ø 236 18 16,4 V
<b>MITSUBISHI - OUTLANDER I (CU_W) 03/01→07/08</b>								
<b> Bremsbelagsatz, Scheibenbremse</b>								
2.0 (CU2W)	100	05/03→10/06	←				13.0460-5958.2 605958	AKE 21363 15,8 + WK
2.0 4WD (CU2W)	93	05/03→10/06	→				13.0460-5735.2 605735	AKE 24014 16,0 + WK
2.0 4WD (CU2W)	100	05/03→10/06	→				13.0460-5735.2 605735	AKE 24014 16,0 + WK
2.0 Turbo 4WD (CU2W)	148	04/04→10/06	→				13.0460-5735.2 605735	AKE 24014 16,0 + WK
2.4 4WD	102	05/03→10/06	→				13.0460-5735.2 605735	AKE 24014 16,0 + WK
2.4 4WD (CU5W)	118	11/03→10/06	→				13.0460-5735.2 605735	AKE 24014 16,0 + WK
2.4 4WD (CU5W)	119	05/03→10/06	→				13.0460-5735.2 605735	AKE 24014 16,0 + WK
2.0 Turbo-R 4WD	177	01/02→10/06	←	05/03→			13.0460-5958.2 605958	AKE 21363 15,8 + WK
			→	05/03→			13.0460-5735.2 605735	AKE 24014 16,0 + WK
2.4 HDD Mivec (CU5W)	118	03/01→12/06	←	07/03→ 10/06			13.0460-5958.2 605958	AKE 21363 15,8 + WK
			→	07/03→ 10/06			13.0460-5735.2 605735	AKE 24014 16,0 + WK
<b>Zubehörsatz, Scheibenbremsbelag</b>								
2.0 (CU2W)	100	05/03→10/06	←				13.0460-0235.2 610235	
2.0 4WD (CU2W)	93	05/03→10/06	→				13.0460-0235.2 610235	
2.0 4WD (CU2W)	100	05/03→10/06	→				13.0460-0235.2 610235	
2.0 Turbo 4WD (CU2W)	148	04/04→10/06	→				13.0460-0235.2 610235	
2.4 4WD	102	05/03→10/06	→				13.0460-0235.2 610235	
2.4 4WD (CU5W)	118	11/03→10/06	→				13.0460-0235.2 610235	
2.4 4WD (CU5W)	119	05/03→10/06	→				13.0460-0235.2 610235	
2.0 Turbo-R 4WD	177	01/02→10/06	←	05/03→			13.0460-0235.2 610235	
			→	05/03→			13.0460-0235.2 610235	
2.4 HDD Mivec (CU5W)	118	03/01→12/06	←	07/03→ 10/06			13.0460-0235.2 610235	
			→	07/03→ 10/06			13.0460-0235.2 610235	
<b> Bremsscheibe</b>								
2.0 (CU2W)	100	05/03→10/06	←				24.0124-0215.1 424215	Ø 294 24 22,4 V
2.0 4WD (CU2W)	93	05/03→10/06	→				24.0110-0704.1 410704	Ø 262 10 8,4
2.0 4WD (CU2W)	100	05/03→10/06	→				24.0110-0704.1 410704	Ø 262 10 8,4
2.0 Turbo 4WD (CU2W)	148	04/04→10/06	→				24.0110-0704.1 410704	Ø 262 10 8,4
2.4 4WD	102	05/03→10/06	→				24.0110-0704.1 410704	Ø 262 10 8,4
2.4 4WD (CU5W)	118	11/03→10/06	→				24.0110-0704.1 410704	Ø 262 10 8,4
2.4 4WD (CU5W)	119	05/03→10/06	→				24.0110-0704.1 410704	Ø 262 10 8,4
2.0 Turbo-R 4WD	177	01/02→10/06	←	05/03→			24.0124-0215.1 424215	Ø 294 24 22,4 V
			→	05/03→			24.0110-0704.1 410704	Ø 262 10 8,4
2.4 HDD Mivec (CU5W)	118	03/01→12/06	←	07/03→ 10/06			24.0124-0215.1 424215	Ø 294 24 22,4 V
			→	07/03→ 10/06			24.0110-0704.1 410704	Ø 262 10 8,4
<b>MITSUBISHI - OUTLANDER II (CW_W) 11/06→12/12</b>								
<b> Bremsbelagsatz, Scheibenbremse</b>								
2.0	108	11/06→11/12	←				13.0460-5958.2 605958	AKE 21363 15,8 + WK
			→				13.0460-5735.2 605735	AKE 24014 16,0 + WK
2.0 4WD	108	11/06→11/12	←				13.0460-5958.2 605958	AKE 21363 15,8 + WK
2.0 DI-D	103	02/07→11/12	→				13.0460-5855.2 605855	23582 16,0 - WK
2.2 DI-D	130	11/06→11/12	→				13.0460-5855.2 605855	23582 16,0 - WK
2.2 DI-D 4WD	103	09/10→11/12	→				13.0460-5855.2 605855	23582 16,0 - WK
2.2 DI-D 4WD	115	08/07→11/12	→				13.0460-5855.2 605855	23582 16,0 - WK
2.2 DI-D 4WD	130	11/06→11/12	→				13.0460-5855.2 605855	23582 16,0 - WK
2.4 (CW5W)	125	11/06→11/12	←				13.0460-5760.2 605760	AKE 23584 16,4 + WK
2.4 4WD (CW5W)	125	09/07→11/12	→				13.0460-5958.2 605958	AKE 21363 15,8 + WK
2.4 Flex 4WD	125	09/07→11/12	→				13.0460-5958.2 605958	AKE 21363 15,8 + WK
3.0 4WD (CW6W)	162	11/06→11/12	→				13.0460-5855.2 605855	23582 16,0 - WK
<b>Zubehörsatz, Scheibenbremsbelag</b>								
2.0	108	11/06→11/12	←				13.0460-0235.2 610235	
3.0 AWD	164	11/06→12/10	←				13.0460-0235.2 610235	
2.0 4WD	108	11/06→11/12	←				13.0460-0235.2 610235	
2.0 DI-D	103	02/07→11/12	→				13.0460-0137.2 610137	
2.2 DI-D	130	11/06→11/12	→				13.0460-0137.2 610137	
2.2 DI-D 4WD	103	09/10→11/12	→				13.0460-0137.2 610137	
2.2 DI-D 4WD	115	08/07→11/12	→				13.0460-0137.2 610137	
2.2 DI-D 4WD	130	11/06→11/12	→				13.0460-0137.2 610137	
2.4 (CW5W)	125	11/06→11/12	→				13.0460-0137.2 610137	
2.4 4WD (CW5W)	125	09/07→11/12	→				13.0460-0137.2 610137	
2.4 Flex 4WD	125	09/07→11/12	→				13.0460-0137.2 610137	
3.0 4WD (CW6W)	162	11/06→11/12	→				13.0460-0137.2 610137	

	kw			 	! #		
<b>MITSUBISHI - OUTLANDER II (CW_W) 11/06→12/12</b>							
<b> Bremsscheibe</b>							
2.0	108	11/06→11/12	←			24.0124-0215.1 424215	Ø 294 24 22,4 V
			→			24.0110-0360.1 410360	Ø 302 10 8,4
						24.0110-0704.1 410704	Ø 262 10 8,4
2.0 4WD	108	11/06→11/12	←			24.0124-0215.1 424215	Ø 294 24 22,4 V
2.2 DI-D	130	11/06→11/12	→			24.0110-0360.1 410360	Ø 302 10 8,4
2.2 DI-D 4WD	103	09/10→11/12	→			24.0110-0360.1 410360	Ø 302 10 8,4
2.0 DI-D	103	02/07→11/12	←			24.0124-0215.1 424215	Ø 294 24 22,4 V
			→	für Fahrzeuge mit 3. Sitzreihe		24.0110-0330.1 410330	Ø 302 10 8
			→	für Fahrzeuge ohne 3. Sitzreihe		24.0110-0360.1 410360	Ø 302 10 8,4
2.2 DI-D 4WD	115	08/07→11/12	←			24.0124-0215.1 424215	Ø 294 24 22,4 V
3.0 4WD (CW6W)	162	11/06→11/12	→			24.0110-0330.1 410330	Ø 302 10 8
2.2 DI-D 4WD	130	11/06→11/12	←			24.0124-0215.1 424215	Ø 294 24 22,4 V
			→	09/10→; für Fahrzeuge mit 3. Sitzreihe		24.0110-0330.1 410330	Ø 302 10 8
			→	für Fahrzeuge ohne 3. Sitzreihe		24.0110-0360.1 410360	Ø 302 10 8,4
2.4 (CW5W)	125	11/06→11/12	←			24.0124-0215.1 424215	Ø 294 24 22,4 V
			→	→ 08/09		24.0110-0330.1 410330	Ø 302 10 8
			→	09/09→		24.0110-0360.1 410360	Ø 302 10 8,4
			→			24.0110-0704.1 410704	Ø 262 10 8,4
2.4 4WD (CW5W)	125	09/07→11/12	←			24.0124-0215.1 424215	Ø 294 24 22,4 V
			→			24.0110-0330.1 410330	Ø 302 10 8
			→			24.0110-0360.1 410360	Ø 302 10 8,4
			→			24.0110-0704.1 410704	Ø 262 10 8,4
2.4 Flex 4WD	125	09/07→11/12	←			24.0124-0215.1 424215	Ø 294 24 22,4 V
			→	CVT-Automatikgetriebe (Stufenlos)		24.0110-0330.1 410330	Ø 302 10 8
			→	Schaltgetriebe		24.0110-0360.1 410360	Ø 302 10 8,4
<b>MITSUBISHI - OUTLANDER III (GG_W, GF_W, ZJ) 08/12→</b>							
<b> Bremsbelagsatz, Scheibenbremse</b>							
2.0	112	04/13→	←			13.0460-5958.2 605958	AKE 21363 15,8 + WK
2.0 (GF2W)	107	10/12→	→			13.0460-5654.2 605654	MAN 25688 14,4 + WK
2.0 (GF7W)	110	08/12→	→			13.0460-5654.2 605654	MAN 25688 14,4 + WK
2.0 4WD (GF2W)	107	10/12→	→			13.0460-5654.2 605654	MAN 25688 14,4 + WK
2.0 4WD (GF7W)	110	08/12→	→			13.0460-5654.2 605654	MAN 25688 14,4 + WK
2.0 Hybrid 4WD (GG2W)	87	01/14→	→			24.0110-0395.1 410395	Ø 302 10 8,4
2.0 Hybrid 4WD (GG2W)	89	12/12→	→			24.0110-0395.1 410395	Ø 302 10 8,4
2.0 Hybrid 4WD (GG2W)	139	12/12→	→			24.0110-0395.1 410395	Ø 302 10 8,4
2.2 Di-D (GF6W)	110	08/12→	→			24.0110-0395.1 410395	Ø 302 10 8,4
2.2 Di-D 4WD (GF6W)	110	08/12→	→			24.0110-0395.1 410395	Ø 302 10 8,4
2.4 4WD	123	10/12→	←			13.0460-5760.2 605760	AKE 23584 16,4 + WK
2.4 4WD (GF3W)	124	10/12→	→			13.0460-5654.2 605654	MAN 25688 14,4 + WK
3.0 4WD	169	03/14→	←			13.0460-5760.2 605760	AKE 23584 16,4 + WK
			→	04/14→		13.0460-5654.2 605654	MAN 25688 14,4 + WK
<b>Zubehörsatz, Scheibenbremsbelag</b>							
2.0	112	04/13→	←			13.0460-0235.2 610235	
2.0 (GF2W)	107	10/12→	→			24.0110-0395.1 410395	Ø 302 10 8,4
2.0 (GF7W)	110	08/12→	→			24.0110-0395.1 410395	Ø 302 10 8,4
2.0 4WD (GF2W)	107	10/12→	→			24.0110-0395.1 410395	Ø 302 10 8,4
2.0 4WD (GF7W)	110	08/12→	→			24.0110-0395.1 410395	Ø 302 10 8,4
2.0 Hybrid 4WD (GG2W)	87	01/14→	→			24.0110-0395.1 410395	Ø 302 10 8,4
2.0 Hybrid 4WD (GG2W)	89	12/12→	→			24.0110-0395.1 410395	Ø 302 10 8,4
2.0 Hybrid 4WD (GG2W)	139	12/12→	→			24.0110-0395.1 410395	Ø 302 10 8,4
2.2 Di-D (GF6W)	110	08/12→	→			24.0110-0395.1 410395	Ø 302 10 8,4
2.2 Di-D 4WD (GF6W)	110	08/12→	→			24.0110-0395.1 410395	Ø 302 10 8,4
<b> Bremsscheibe</b>							
2.0	112	04/13→	←			24.0124-0215.1 424215	Ø 294 24 22,4 V
2.0 (GF2W)	107	10/12→	→			24.0110-0395.1 410395	Ø 302 10 8,4
2.0 (GF7W)	110	08/12→	→			24.0110-0395.1 410395	Ø 302 10 8,4
2.0 4WD (GF2W)	107	10/12→	→			24.0110-0395.1 410395	Ø 302 10 8,4
2.0 4WD (GF7W)	110	08/12→	→			24.0110-0395.1 410395	Ø 302 10 8,4
2.2 Di-D (GF6W)	110	08/12→	→			24.0110-0395.1 410395	Ø 302 10 8,4
2.2 Di-D 4WD (GF6W)	110	08/12→	→			24.0110-0395.1 410395	Ø 302 10 8,4
2.0 Hybrid 4WD (GG2W)	87	01/14→	→			24.0110-0395.1 410395	Ø 302 10 8,4
2.0 Hybrid 4WD (GG2W)	89	12/12→	→			24.0110-0395.1 410395	Ø 302 10 8,4
2.0 Hybrid 4WD (GG2W)	139	12/12→	→			24.0110-0395.1 410395	Ø 302 10 8,4
↓							











	kw				! #		
<b>MITSUBISHI - OUTLANDER III (GG_W, GF_W, ZJ) 08/12→</b>							
 <b>Bremsscheibe</b>							
2.4 4WD	123	10/12→	←			24.0126-0170.1 426170	Ø 294 26 24,4 V
2.4 4WD (GF3W)	124	10/12→					
3.0 4WD	169	03/14→	→			24.0110-0395.1 410395	Ø 302 10 8,4
<b>MITSUBISHI - PAJERO II (V3_W, V2_W, V4_W) 12/90→06/00</b>							
 <b>Bremsbelagsatz, Scheibenbremse</b>							
2.4 (V21W, V21C)	82	04/91→10/99	←			13.0460-5958.2 605958	AKE 21363 15,8 + WK
2.5 TD 4WD (V24C, V24W)	73	12/90→10/99	→			13.0460-5981.2 605981	21840 14,4 + WK
2.5 TDiC (V44W, V24W)	73	03/91→08/99					
2.8 TD (V46W, V26W)	92	06/94→10/99					
3.0 V6 24V (V43W, V23W)	130	06/97→10/99					
3.0 V6 24V (V43W, V23W)	133	06/94→05/97					
3.5 V6 24V (V25W, V45W)	153	06/94→10/99					
3.5 V6 24V (V45W, V25W)	143	07/97→10/99					
<b>Zubehörsatz, Scheibenbremsbelag</b>							
2.4 (V21W, V21C)	82	04/91→10/99	←			13.0460-0235.2 610235	
2.5 TD 4WD (V24C, V24W)	73	12/90→10/99					
2.5 TDiC (V44W, V24W)	73	03/91→08/99					
2.8 TD (V46W, V26W)	92	06/94→10/99					
3.0 V6 24V (V43W, V23W)	130	06/97→10/99					
3.0 V6 24V (V43W, V23W)	133	06/94→05/97					
3.5 V6 24V (V25W, V45W)	153	06/94→10/99					
3.5 V6 24V (V45W, V25W)	143	07/97→10/99					
 <b>Bremsscheibe</b>							
2.4 (V21W, V21C)	82	04/91→10/99	←			24.0124-0140.1 424140	Ø 276 24 22,4 V
2.5 TD 4WD (V24C, V24W)	73	12/90→10/99	→			24.0118-0140.1 418140	Ø 315 18 16,4
2.5 TDiC (V44W, V24W)	73	03/91→08/99					
2.8 TD (V46W, V26W)	92	06/94→10/99					
3.0 V6 24V (V43W, V23W)	130	06/97→10/99					
3.0 V6 24V (V43W, V23W)	133	06/94→05/97					
3.5 V6 24V (V25W, V45W)	153	06/94→10/99	→			24.0118-0140.1 418140	Ø 315 18 16,4
3.5 V6 24V (V45W, V25W)	143	07/97→10/99					
<b>MITSUBISHI - PAJERO II (V3_W) 04/00→09/07</b>							
 <b>Bremsbelagsatz, Scheibenbremse</b>							
3.2 DiD 4WD	118	05/05→09/07	←			13.0460-5853.2 605853	SUM 23488 15,4 + WK
			→			13.0460-5855.2 605855	23582 16,0 - WK
3.2 DiD 4WD	121	04/00→09/07	←			13.0460-5853.2 605853	SUM 23488 15,4 + WK
			←	→ 09/01		13.0460-5958.2 605958	AKE 21363 15,8 + WK
			→			13.0460-5855.2 605855	23582 16,0 - WK
<b>Zubehörsatz, Scheibenbremsbelag</b>							
3.2 DiD 4WD	121	04/00→09/07	←	→ 09/01		13.0460-0235.2 610235	
			→			13.0460-0137.2 610137	
 <b>Bremsscheibe</b>							
3.2 DiD 4WD	118	05/05→09/07	←			24.0126-0145.1 426145	Ø 290 26 24,4 V
			→			24.0122-0724.1 422724	Ø 300 22 20,4 V
3.2 DiD 4WD	121	04/00→09/07	←	→ 09/01; passend für Felgenreöße [Zoll]: 15		24.0124-0140.1 424140	Ø 276 24 22,4 V
			←	passend für Felgenreöße [Zoll]: 16		24.0126-0145.1 426145	Ø 290 26 24,4 V
			→			24.0122-0724.1 422724	Ø 300 22 20,4 V

	kW			 	! #		
<b>MITSUBISHI - PAJERO II Canvas Top (V2_W, V4_W) 12/90→04/00</b>							
 <b>Bremsbelagsatz, Scheibenbremse</b>							
1.8 GDI	96	06/98→04/00	←	10/99→		<b>13.0460-5854.2 605854</b>	SUM 23487 15,5 - WE / - WK
			→	10/99→		<b>13.0460-5980.2 605980</b>	21706 15,5 + WK
2.4 (V41W, V21W, V21C)	82	04/91→04/00	←	→ 03/00		<b>13.0460-5958.2 605958</b>	AKE 21363 15,8 + WK
2.5 TD 4WD (V24C, V24W)	73	12/90→04/00	→	→ 03/00		<b>13.0460-5981.2 605981</b>	21840 14,4 + WK
3.0 V6 24V (V23C)	130	06/94→04/00					
3.0 V6 24V (V23W, V23C)	133	06/94→04/00					
<b>Zubehörsatz, Scheibenbremsbelag</b>							
1.8 GDI	96	06/98→04/00	→	10/99→		<b>13.0460-0150.2 610150</b>	AKE
2.4 (V41W, V21W, V21C)	82	04/91→04/00	←	→ 03/00		<b>13.0460-0235.2 610235</b>	
2.5 TD 4WD (V24C, V24W)	73	12/90→04/00					
3.0 V6 24V (V23C)	130	06/94→04/00					
3.0 V6 24V (V23W, V23C)	133	06/94→04/00					
 <b>Bremsscheibe</b>							
1.8 GDI	96	06/98→04/00	←	10/99→		<b>24.0122-0230.1 422230</b>	Ø 285 22 20,4 V
			→	10/99→		<b>24.0110-0281.1 410281</b>	Ø 262 9,5 8,4
2.4 (V41W, V21W, V21C)	82	04/91→04/00	←	→ 03/00		<b>24.0124-0140.1 424140</b>	Ø 276 24 22,4 V
2.5 TD 4WD (V24C, V24W)	73	12/90→04/00	→	→ 03/00		<b>24.0118-0140.1 418140</b>	Ø 315 18 16,4
3.0 V6 24V (V23C)	130	06/94→04/00					
3.0 V6 24V (V23W, V23C)	133	06/94→04/00					
<b>MITSUBISHI - PAJERO III (V7_W, V6_W) 01/99→09/07</b>							
 <b>Bremsbelagsatz, Scheibenbremse</b>							
2.5 TDi	73	04/00→12/06	←			<b>13.0460-5853.2 605853</b>	SUM 23488 15,4 + WK
2.5 TDi	85	09/01→12/06	→			<b>13.0460-5958.2 605958</b>	AKE 21363 15,8 + WK
			→			<b>13.0460-5855.2 605855</b>	23582 16,0 - WK
3.2 Di-D	121	04/00→10/01	←			<b>13.0460-5853.2 605853</b>	SUM 23488 15,4 + WK
			←	→ 09/01		<b>13.0460-5958.2 605958</b>	AKE 21363 15,8 + WK
			→			<b>13.0460-5855.2 605855</b>	23582 16,0 - WK
3.2 Di-D (V68W)	118	04/00→12/06	←	10/01→ 08/06		<b>13.0460-5853.2 605853</b>	SUM 23488 15,4 + WK
			→	10/01→ 08/06		<b>13.0460-5958.2 605958</b>	AKE 21363 15,8 + WK
			→	10/01→ 08/06		<b>13.0460-5855.2 605855</b>	23582 16,0 - WK
3.5	149	04/00→01/07	←	→ 08/06		<b>13.0460-5853.2 605853</b>	SUM 23488 15,4 + WK
3.8 (V67W)	184	03/03→01/07	→	→ 08/06		<b>13.0460-5958.2 605958</b>	AKE 21363 15,8 + WK
			→	→ 08/06		<b>13.0460-5855.2 605855</b>	23582 16,0 - WK
<b>Zubehörsatz, Scheibenbremsbelag</b>							
2.5 TDi	73	04/00→12/06	←			<b>13.0460-0235.2 610235</b>	
2.5 TDi	85	09/01→12/06	→			<b>13.0460-0137.2 610137</b>	
3.2 Di-D	121	04/00→10/01	←	→ 09/01		<b>13.0460-0235.2 610235</b>	
			→			<b>13.0460-0137.2 610137</b>	
3.2 Di-D (V68W)	118	04/00→12/06	←	10/01→ 08/06		<b>13.0460-0235.2 610235</b>	
			→	10/01→ 08/06		<b>13.0460-0137.2 610137</b>	
3.5	149	04/00→01/07	←	→ 08/06		<b>13.0460-0235.2 610235</b>	
3.8 (V67W)	184	03/03→01/07	→	→ 08/06		<b>13.0460-0137.2 610137</b>	
			→	→ 08/06		<b>13.0460-0137.2 610137</b>	
 <b>Bremsscheibe</b>							
2.5 TDi	73	04/00→12/06	←	passend für Felgenreöße [Zoll]: 15		<b>24.0124-0140.1 424140</b>	Ø 276 24 22,4 V
			←	passend für Felgenreöße [Zoll]: 16		<b>24.0126-0145.1 426145</b>	Ø 290 26 24,4 V
			→			<b>24.0122-0724.1 422724</b>	Ø 300 22 20,4 V
2.5 TDi	85	09/01→12/06	←	passend für Felgenreöße [Zoll]: 15		<b>24.0124-0140.1 424140</b>	Ø 276 24 22,4 V
			←	passend für Felgenreöße [Zoll]: 16		<b>24.0126-0145.1 426145</b>	Ø 290 26 24,4 V
			→			<b>24.0118-0140.1 418140</b>	Ø 315 18 16,4
↓							





























	kw			 	! #		
<b>MITSUBISHI - PAJERO III (V7_W, V6_W) 01/99→09/07</b>							
 <b>Bremsscheibe</b>							
3.2 Di-D	121	04/00→10/01	←	→ 09/01; passend für Felgenreöße [Zoll]: 15	24.0124-0140.1	424140	Ø 276 24 22,4 V
			←	passend für Felgenreöße [Zoll]: 16	24.0126-0145.1	426145	Ø 290 26 24,4 V
			→		24.0122-0724.1	422724	Ø 300 22 20,4 V
3.2 Di-D (V68W)	118	04/00→12/06	←	10/01→ 08/06; passend für Felgenreöße [Zoll]: 15	24.0124-0140.1	424140	Ø 276 24 22,4 V
			←	10/01→ 08/06; passend für Felgenreöße [Zoll]: 16	24.0126-0145.1	426145	Ø 290 26 24,4 V
			→	10/01→ 08/06	24.0122-0724.1	422724	Ø 300 22 20,4 V
3.5 3.8 (V67W)	149 184	04/00→01/07 03/03→01/07	←	→ 08/06; passend für Felgenreöße [Zoll]: 15	24.0124-0140.1	424140	Ø 276 24 22,4 V
			←	→ 08/06; passend für Felgenreöße [Zoll]: 16	24.0126-0145.1	426145	Ø 290 26 24,4 V
			→	→ 08/06	24.0122-0724.1	422724	Ø 300 22 20,4 V
<b>MITSUBISHI - PAJERO III Canvas Top (V6_W, V7_W) 02/00→12/06</b>							
 <b>Bremsbelagsatz, Scheibenbremse</b>							
2.5 TDi (V64W, V74W) 2.5 TDi (V64W, V74W)	73 85	04/00→12/06 09/01→12/06	←		13.0460-5853.2	605853	SUM 23488 15,4 + WK
			←		13.0460-5958.2	605958	AKE 21363 15,8 + WK
			→		13.0460-5855.2	605855	23582 16,0 - WK
3.2 DI-D (V68W, V78W) 3.5 V6 GDI (V65W, V75W)	118 149	10/01→12/06 04/00→12/06	←	→ 08/06	13.0460-5853.2	605853	SUM 23488 15,4 + WK
			←		13.0460-5958.2	605958	AKE 21363 15,8 + WK
			→	→ 08/06	13.0460-5855.2	605855	23582 16,0 - WK
3.2 DI-D (V68W, V78W)	121	04/00→12/06	←		13.0460-5853.2	605853	SUM 23488 15,4 + WK
			←	→ 09/01	13.0460-5958.2	605958	AKE 21363 15,8 + WK
			→		13.0460-5855.2	605855	23582 16,0 - WK
<b>Zubehörsatz, Scheibenbremsbelag</b>							
2.5 TDi (V64W, V74W) 2.5 TDi (V64W, V74W)	73 85	04/00→12/06 09/01→12/06	←		13.0460-0235.2	610235	
			←		13.0460-0137.2	610137	
			→				
3.2 DI-D (V68W, V78W) 3.5 V6 GDI (V65W, V75W)	118 149	10/01→12/06 04/00→12/06	←	→ 08/06	13.0460-0235.2	610235	
			←		13.0460-0137.2	610137	
			→	→ 08/06			
3.2 DI-D (V68W, V78W)	121	04/00→12/06	←	→ 09/01	13.0460-0235.2	610235	
			←		13.0460-0137.2	610137	
			→				
 <b>Bremsscheibe</b>							
2.5 TDi (V64W, V74W)	73	04/00→12/06	←	passend für Felgenreöße [Zoll]: 15	24.0124-0140.1	424140	Ø 276 24 22,4 V
			←	passend für Felgenreöße [Zoll]: 16	24.0126-0145.1	426145	Ø 290 26 24,4 V
			→		24.0122-0724.1	422724	Ø 300 22 20,4 V
2.5 TDi (V64W, V74W)	85	09/01→12/06	←	passend für Felgenreöße [Zoll]: 15	24.0124-0140.1	424140	Ø 276 24 22,4 V
			←	passend für Felgenreöße [Zoll]: 16	24.0126-0145.1	426145	Ø 290 26 24,4 V
			→		24.0118-0140.1	418140	Ø 315 18 16,4
3.2 DI-D (V68W, V78W) 3.5 V6 GDI (V65W, V75W)	118 149	10/01→12/06 04/00→12/06	←	→ 08/06; passend für Felgenreöße [Zoll]: 15	24.0124-0140.1	424140	Ø 276 24 22,4 V
			←	→ 08/06; passend für Felgenreöße [Zoll]: 16	24.0126-0145.1	426145	Ø 290 26 24,4 V
			→	→ 08/06	24.0122-0724.1	422724	Ø 300 22 20,4 V
3.2 DI-D (V68W, V78W)	121	04/00→12/06	←	→ 09/01; passend für Felgenreöße [Zoll]: 15	24.0124-0140.1	424140	Ø 276 24 22,4 V
			←	passend für Felgenreöße [Zoll]: 16	24.0126-0145.1	426145	Ø 290 26 24,4 V
			→		24.0122-0724.1	422724	Ø 300 22 20,4 V
<b>MITSUBISHI - PAJERO IV (V8_W, V9_W) 10/06→</b>							
 <b>Bremsbelagsatz, Scheibenbremse</b>							
3.0 4WD	131	02/07→	←		13.0460-5747.2	605747	24024 17,0 + WK
			→		13.0460-5744.2	605744	21947 15,4 - WE / - WK
3.2 DI-D	121	01/10→	←	Baumuster: V88W	13.0460-5853.2	605853	SUM 23488 15,4 + WK
			→	Baumuster: V88W	13.0460-5855.2	605855	23582 16,0 - WK
3.2 DI-D 3.2 DI-D (V88W, V98W) 3.2 DI-D (V88W, V98W)	123 118 125	02/07→ 02/07→ 02/07→	←	Baumuster: V98W	13.0460-5747.2	605747	24024 17,0 + WK
			←	Baumuster: V88W	13.0460-5853.2	605853	SUM 23488 15,4 + WK
			↓				































	kW			 	! #		
<b>MITSUBISHI - PAJERO IV (V8_W, V9_W) 10/06→</b>							
 <b>Bremsbelagsatz, Scheibenbremse</b>							
3.2 DI-D 4WD (V98W, V88W)	147	01/09→	➡	Baumuster: V98W		<b>13.0460-5744.2 605744</b>	21947 15,4 - WE / - WK
3.2 DI-D GLS	124	02/07→	➡	Baumuster: V88W		<b>13.0460-5855.2 605855</b>	23582 16,0 - WK
3.2 DI-D 4WD (V98W, V88W)	140	02/07→	⬅	01/09→; Baumuster: V98W		<b>13.0460-5747.2 605747</b>	24024 17,0 + WK
			⬅			<b>13.0460-5853.2 605853</b>	SUM 23488 15,4 + WK
			⬅	01/09→; Baumuster: V88W		<b>13.0460-5853.2 605853</b>	SUM 23488 15,4 + WK
			➡	01/09→; Baumuster: V98W		<b>13.0460-5744.2 605744</b>	21947 15,4 - WE / - WK
			➡			<b>13.0460-5855.2 605855</b>	23582 16,0 - WK
			➡	01/09→; Baumuster: V88W		<b>13.0460-5855.2 605855</b>	23582 16,0 - WK
3.8 V6 3.8 V6 (V87W, V97W)	182	10/06→	⬅	Baumuster: V97W		<b>13.0460-5747.2 605747</b>	24024 17,0 + WK
	184	02/07→	⬅	Baumuster: V87W		<b>13.0460-5853.2 605853</b>	SUM 23488 15,4 + WK
			➡	Baumuster: V97W		<b>13.0460-5744.2 605744</b>	21947 15,4 - WE / - WK
			➡	Baumuster: V87W		<b>13.0460-5855.2 605855</b>	23582 16,0 - WK
<b>Zubehörsatz, Scheibenbremsbelag</b>							
3.2 DI-D	121	01/10→	➡	Baumuster: V88W		<b>13.0460-0137.2 610137</b>	
3.2 DI-D	123	02/07→					
3.2 DI-D (V88W, V98W)	118	02/07→					
3.2 DI-D (V88W, V98W)	125	02/07→					
3.2 DI-D 4WD (V98W, V88W)	147	01/09→					
3.2 DI-D GLS	124	02/07→					
3.2 DI-D 4WD (V98W, V88W)	140	02/07→	➡			<b>13.0460-0137.2 610137</b>	
			➡	01/09→; Baumuster: V88W		<b>13.0460-0137.2 610137</b>	
3.8 V6	182	10/06→	➡	Baumuster: V87W		<b>13.0460-0137.2 610137</b>	
3.8 V6 (V87W, V97W)	184	02/07→					
 <b>Bremsscheibe</b>							
3.0 4WD	131	02/07→	⬅			<b>24.0128-0215.1 428215</b>	Ø 332 28 26 V
			➡			<b>24.0118-0146.1 418146</b>	Ø 332 18 16 V
3.2 DI-D	121	01/10→	⬅	Baumuster: V88W		<b>24.0126-0145.1 426145</b>	Ø 290 26 24,4 V
			➡	Baumuster: V88W		<b>24.0122-0724.1 422724</b>	Ø 300 22 20,4 V
3.2 DI-D	123	02/07→	⬅	Baumuster: V88W		<b>24.0126-0145.1 426145</b>	Ø 290 26 24,4 V
3.2 DI-D (V88W, V98W)	118	02/07→	⬅	Baumuster: V98W		<b>24.0128-0215.1 428215</b>	Ø 332 28 26 V
3.2 DI-D (V88W, V98W)	125	02/07→	⬅	Baumuster: V98W		<b>24.0128-0215.1 428215</b>	Ø 332 28 26 V
3.2 DI-D 4WD (V98W, V88W)	147	01/09→	➡	Baumuster: V98W		<b>24.0118-0146.1 418146</b>	Ø 332 18 16 V
3.2 DI-D GLS	124	02/07→	➡	Baumuster: V88W		<b>24.0122-0724.1 422724</b>	Ø 300 22 20,4 V
3.2 DI-D 4WD (V98W, V88W)	140	02/07→	⬅			<b>24.0126-0145.1 426145</b>	Ø 290 26 24,4 V
			⬅	01/09→; Baumuster: V88W		<b>24.0126-0145.1 426145</b>	Ø 290 26 24,4 V
			⬅	01/09→; Baumuster: V98W		<b>24.0128-0215.1 428215</b>	Ø 332 28 26 V
			➡	01/09→; Baumuster: V98W		<b>24.0118-0146.1 418146</b>	Ø 332 18 16 V
			➡			<b>24.0122-0724.1 422724</b>	Ø 300 22 20,4 V
			➡	01/09→; Baumuster: V88W		<b>24.0122-0724.1 422724</b>	Ø 300 22 20,4 V
3.8 V6 3.8 V6 (V87W, V97W)	182	10/06→	⬅	Baumuster: V87W		<b>24.0126-0145.1 426145</b>	Ø 290 26 24,4 V
	184	02/07→	⬅	Baumuster: V97W		<b>24.0128-0215.1 428215</b>	Ø 332 28 26 V
			➡	Baumuster: V97W		<b>24.0118-0146.1 418146</b>	Ø 332 18 16 V
			➡	Baumuster: V87W		<b>24.0122-0724.1 422724</b>	Ø 300 22 20,4 V
<b>MITSUBISHI - PAJERO IV Van (V90, V80, V8_V) 11/06→</b>							
 <b>Bremsbelagsatz, Scheibenbremse</b>							
3.2 DI-D	118	11/06→	⬅	02/07→; Baumuster: V98W		<b>13.0460-5747.2 605747</b>	24024 17,0 + WK
			⬅	02/07→; Baumuster: V88W		<b>13.0460-5853.2 605853</b>	SUM 23488 15,4 + WK
			➡	02/07→; Baumuster: V98W		<b>13.0460-5744.2 605744</b>	21947 15,4 - WE / - WK
			➡	02/07→; Baumuster: V88W		<b>13.0460-5855.2 605855</b>	23582 16,0 - WK
3.2 DI-D 4WD	140	02/07→	⬅			<b>13.0460-5853.2 605853</b>	SUM 23488 15,4 + WK
			➡			<b>13.0460-5855.2 605855</b>	23582 16,0 - WK
3.2 TD 4WD	147	01/10→	⬅	Baumuster: V98W		<b>13.0460-5747.2 605747</b>	24024 17,0 + WK
			⬅	Baumuster: V88W		<b>13.0460-5853.2 605853</b>	SUM 23488 15,4 + WK
			➡	Baumuster: V98W		<b>13.0460-5744.2 605744</b>	21947 15,4 - WE / - WK
↓							













	kw					! #		
<b>MITSUBISHI - PAJERO IV Van (V90, V80, V8_V) 11/06→</b>								
 <b>Bremsbelagsatz, Scheibenbremse</b>								
3.2 TD 4WD	147	01/10→	➡	Baumuster: V88W		13.0460-5855.2	605855	23582 16,0 - WK
<b>Zubehörsatz, Scheibenbremsbelag</b>								
3.2 DI-D	118	11/06→	➡	02/07→; Baumuster: V88W		13.0460-0137.2	610137	
3.2 DI-D 4WD	140	02/07→	➡			13.0460-0137.2	610137	
3.2 TD 4WD	147	01/10→	➡	Baumuster: V88W		13.0460-0137.2	610137	
 <b>Bremsscheibe</b>								
3.2 DI-D	118	11/06→	←	02/07→; Baumuster: V88W		24.0126-0145.1	426145	Ø 290 26 24,4 V
			←	02/07→; Baumuster: V98W		24.0128-0215.1	428215	Ø 332 28 26 V
			➡	02/07→; Baumuster: V98W		24.0118-0146.1	418146	Ø 332 18 16 V
			➡	02/07→; Baumuster: V88W		24.0122-0724.1	422724	Ø 300 22 20,4 V
3.2 DI-D 4WD	140	02/07→	←			24.0126-0145.1	426145	Ø 290 26 24,4 V
			➡			24.0122-0724.1	422724	Ø 300 22 20,4 V
3.2 TD 4WD	147	01/10→	←	Baumuster: V88W		24.0126-0145.1	426145	Ø 290 26 24,4 V
			←	Baumuster: V98W		24.0128-0215.1	428215	Ø 332 28 26 V
			➡	Baumuster: V98W		24.0118-0146.1	418146	Ø 332 18 16 V
			➡	Baumuster: V88W		24.0122-0724.1	422724	Ø 300 22 20,4 V
<b>MITSUBISHI - PAJERO CLASSIC (V2_W) 07/01→</b>								
 <b>Bremsbelagsatz, Scheibenbremse</b>								
2.5 TD	85	07/01→	←	→ 01/07		13.0460-5853.2	605853	SUM 23488 15,4 + WK
			➡	→ 01/07		13.0460-5958.2	605958	AKE 21363 15,8 + WK
3.2 DiD	125	09/06→	←	02/07→; Baumuster: V98W		13.0460-5747.2	605747	24024 17,0 + WK
			←	02/07→; Baumuster: V88W		13.0460-5853.2	605853	SUM 23488 15,4 + WK
			➡	02/07→; Baumuster: V98W		13.0460-5744.2	605744	21947 15,4 - WE / - WK
			➡	02/07→; Baumuster: V88W		13.0460-5855.2	605855	23582 16,0 - WK
<b>Zubehörsatz, Scheibenbremsbelag</b>								
2.5 TD	85	07/01→	←	→ 01/07		13.0460-0235.2	610235	
			➡	→ 01/07		13.0460-0137.2	610137	
3.2 DiD	125	09/06→	➡	02/07→; Baumuster: V88W		13.0460-0137.2	610137	
 <b>Bremsscheibe</b>								
2.5 TD	85	07/01→	←	→ 01/07; passend für Felgenreöße [Zoll]: 15		24.0124-0140.1	424140	Ø 276 24 22,4 V
			←	→ 01/07; passend für Felgenreöße [Zoll]: 16		24.0126-0145.1	426145	Ø 290 26 24,4 V
			➡	→ 01/07		24.0118-0140.1	418140	Ø 315 18 16,4
3.2 DiD	125	09/06→	←	02/07→; Baumuster: V88W		24.0126-0145.1	426145	Ø 290 26 24,4 V
			←	02/07→; Baumuster: V98W		24.0128-0215.1	428215	Ø 332 28 26 V
			➡	02/07→; Baumuster: V98W		24.0118-0146.1	418146	Ø 332 18 16 V
			➡	02/07→; Baumuster: V88W		24.0122-0724.1	422724	Ø 300 22 20,4 V
<b>MITSUBISHI - PAJERO PININ (H6_W, H7_W) 03/99→06/07</b>								
 <b>Bremsbelagsatz, Scheibenbremse</b>								
1.8 (H76W, H66W)	84	11/01→06/07	←	→ 02/05		13.0460-5854.2	605854	SUM 23487 15,5 - WE / - WK
2.0 GDI (H67W, H77W)	95	10/00→06/07	➡	→ 02/05		13.0460-5980.2	605980	21706 15,5 + WK
1.8 GDI (H66W, H76W)	88	10/99→10/01	←			13.0460-5854.2	605854	SUM 23487 15,5 - WE / - WK
			➡			13.0460-5980.2	605980	21706 15,5 + WK
<b>Zubehörsatz, Scheibenbremsbelag</b>								
1.8 (H76W, H66W)	84	11/01→06/07	➡	→ 02/05		13.0460-0150.2	610150	AKE
2.0 GDI (H67W, H77W)	95	10/00→06/07	➡					
1.8 GDI (H66W, H76W)	88	10/99→10/01	➡			13.0460-0150.2	610150	AKE
 <b>Bremsscheibe</b>								
1.8 (H76W, H66W)	84	11/01→06/07	←	→ 02/05		24.0122-0230.1	422230	Ø 285 22 20,4 V















	kW					! #		
<b>MITSUBISHI - PAJERO PININ (H6_W, H7_W) 03/99→06/07</b>								
 <b>Bremsscheibe</b>								
2.0 GDI (H67W, H77W)	95	10/00→06/07	➔	→ 02/05		24.0110-0281.1	410281	Ø 262 9,5 8,4
1.8 GDI (H66W, H76W)	88	10/99→10/01	➔			24.0122-0230.1	422230	Ø 285 22 20,4 V
			➔			24.0110-0281.1	410281	Ø 262 9,5 8,4
<b>MITSUBISHI - PAJERO SPORT I (K7_, K9_) 07/96→</b>								
 <b>Bremsbelagsatz, Scheibenbremse</b>								
1.8 4WD	84	03/01→02/05	➔	11/01→		13.0460-5854.2	605854	SUM 23487 15,5 - WE / - WK
			➔	11/01→		13.0460-5980.2	605980	21706 15,5 + WK
2.5 TD (K94W, K74T)	85	07/02→	➔	→ 02/09		13.0460-5958.2	605958	AKE 21363 15,8 + WK
2.5 TD (K94W)	73	11/98→						
2.5 TD (K94W)	98	08/03→						
3.0 V6 (K96W)	123	03/03→						
3.0 V6 (K96W)	125	06/00→						
2.8 TDi (K77T)	92	11/98→10/03	➔			13.0460-5958.2	605958	AKE 21363 15,8 + WK
3.0 4WD	129	09/96→12/01	➔	08/98→		13.0460-5958.2	605958	AKE 21363 15,8 + WK
3.0 V6 (K96W)	130	11/98→	➔	→ 09/01		13.0460-5958.2	605958	AKE 21363 15,8 + WK
<b>Zubehörsatz, Scheibenbremsbelag</b>								
1.8 4WD	84	03/01→02/05	➔	11/01→		13.0460-0150.2	610150	AKE
2.5 TD (K94W, K74T)	85	07/02→	➔	→ 02/09		13.0460-0235.2	610235	
2.5 TD (K94W)	73	11/98→						
2.5 TD (K94W)	98	08/03→						
3.0 V6 (K96W)	123	03/03→						
3.0 V6 (K96W)	125	06/00→						
2.8 TDi (K77T)	92	11/98→10/03	➔			13.0460-0235.2	610235	
3.0 4WD	129	09/96→12/01	➔	08/98→		13.0460-0235.2	610235	
3.0 V6 (K96W)	130	11/98→	➔	→ 09/01		13.0460-0235.2	610235	
 <b>Bremsscheibe</b>								
1.8 4WD	84	03/01→02/05	➔	11/01→		24.0122-0230.1	422230	Ø 285 22 20,4 V
			➔	11/01→		24.0110-0281.1	410281	Ø 262 9,5 8,4
2.5 TD (K94W, K74T)	85	07/02→	➔	→ 02/09		24.0124-0140.1	424140	Ø 276 24 22,4 V
2.5 TD (K94W)	73	11/98→						
2.5 TD (K94W)	98	08/03→	➔	→ 02/09		24.0118-0140.1	418140	Ø 315 18 16,4
2.8 TDi (K77T)	92	11/98→10/03	➔			24.0124-0140.1	424140	Ø 276 24 22,4 V
			➔			24.0118-0140.1	418140	Ø 315 18 16,4
3.0 4WD	129	09/96→12/01	➔	08/98→		24.0124-0724.1	424724	Ø 314 24 22,4 V
			➔	08/98→		24.0118-0140.1	418140	Ø 315 18 16,4
3.0 V6 (K96W)	123	03/03→	➔	→ 02/09		24.0124-0724.1	424724	Ø 314 24 22,4 V
3.0 V6 (K96W)	125	06/00→	➔	→ 02/09		24.0118-0140.1	418140	Ø 315 18 16,4
3.0 V6 (K96W)	130	11/98→	➔	→ 09/01		24.0124-0724.1	424724	Ø 314 24 22,4 V
			➔	→ 09/01		24.0118-0140.1	418140	Ø 315 18 16,4
<b>MITSUBISHI - PAJERO SPORT II (KH_, KG_) 07/08→</b>								
 <b>Bremsbelagsatz, Scheibenbremse</b>								
2.5 DI-D	131	07/08→	➔	11/09→		13.0460-5631.2	605631	24529 16,0 + WK
2.5 DI-D 4WD (KH4W)	131	07/08→						
3.0 4WD	162	09/08→						
3.2 DI-D 4WD	118	07/08→						
2.5 TD	98	09/08→	➔	→ 02/09		13.0460-5958.2	605958	AKE 21363 15,8 + WK
3.5 V6 24V	153	09/08→	➔			13.0460-5631.2	605631	24529 16,0 + WK
<b>Zubehörsatz, Scheibenbremsbelag</b>								
2.5 TD	98	09/08→	➔	→ 02/09		13.0460-0235.2	610235	
 <b>Bremsscheibe</b>								
2.5 TD	98	09/08→	➔	→ 02/09		24.0124-0140.1	424140	Ø 276 24 22,4 V
			➔	→ 02/09		24.0118-0140.1	418140	Ø 315 18 16,4
<b>MITSUBISHI - PAJERO SPORT VAN I (K90) 12/99→01/08</b>								
 <b>Bremsbelagsatz, Scheibenbremse</b>								
2.5 TD	85	12/99→01/08	➔	07/02→		13.0460-5958.2	605958	AKE 21363 15,8 + WK
↓								

	kw					! #		
<b>MITSUBISHI - PAJERO SPORT VAN I (K90) 12/99→01/08</b>								
 <b>Bremsbelagsatz, Scheibenbremse</b>								
3.0 V6	125	12/99→01/08	←	06/00→		13.0460-5958.2	605958	AKE 21363 15,8 + WK
<b>Zubehörsatz, Scheibenbremsbelag</b>								
2.5 TD	85	12/99→01/08	←	07/02→		13.0460-0235.2	610235	
3.0 V6	125	12/99→01/08	←	06/00→		13.0460-0235.2	610235	
 <b>Bremsscheibe</b>								
2.5 TD	85	12/99→01/08	←	07/02→		24.0124-0140.1	424140	Ø 276 24 22,4 V
			→	07/02→		24.0118-0140.1	418140	Ø 315 18 16,4
3.0 V6	125	12/99→01/08	←	06/00→		24.0124-0724.1	424724	Ø 314 24 22,4 V
			→	06/00→		24.0118-0140.1	418140	Ø 315 18 16,4
<b>MITSUBISHI - SANTAMO 03/99→12/04</b>								
 <b>Bremsbelagsatz, Scheibenbremse</b>								
2.0 16V	102	05/99→12/04	←			13.0460-5952.2	605952	SUM 21647 16,0 + WK
2.0 16V 4WD	102	05/99→12/04	→	+ ABS		13.0460-5980.2	605980	21706 15,5 + WK
 <b>Bremsscheibe</b>								
2.0 16V	102	05/99→12/04	←	- ABS		24.0124-0136.1	424136	Ø 256 24 21,5 V
			←	+ ABS		24.0124-0146.1	424146	Ø 256 24 22,4 V
2.0 16V 4WD	102	05/99→12/04	→	+ ABS		24.0110-0240.1	410240	Ø 262 10 8,4
<b>MITSUBISHI - SIGMA (F2_A, F1_A) 10/90→07/96</b>								
 <b>Bremsbelagsatz, Scheibenbremse</b>								
3.0 V6	130	12/90→07/96	→			13.0460-5980.2	605980	21706 15,5 + WK
3.0 V6	151	12/90→07/96	→					
<b>Zubehörsatz, Scheibenbremsbelag</b>								
3.0 V6	130	12/90→07/96	←			13.0460-0235.2	610235	
3.0 V6	151	12/90→07/96	←					
<b>MITSUBISHI - SIGMA Station Wagon (F0_W) 06/92→10/96</b>								
 <b>Bremsbelagsatz, Scheibenbremse</b>								
3.0	125	06/92→10/96	→	01/93→ 07/96		13.0460-5980.2	605980	21706 15,5 + WK
<b>Zubehörsatz, Scheibenbremsbelag</b>								
3.0	125	06/92→10/96	←	01/93→ 07/96		13.0460-0235.2	610235	
<b>MITSUBISHI - SPACE RUNNER (N1_W, N2_W) 10/91→08/99</b>								
 <b>Bremsbelagsatz, Scheibenbremse</b>								
1.8 (N11W)	85	06/96→08/99	←			13.0460-5952.2	605952	SUM 21647 16,0 + WK
1.8 (N11W)	90	10/91→08/99	→			13.0460-5980.2	605980	21706 15,5 + WK
1.8 4WD (N21W)	85	06/96→08/99	→					
1.8 4WD (N21W)	90	10/91→08/99	→					
2.0 TD (N18W)	60	10/92→08/99	←			13.0460-5952.2	605952	SUM 21647 16,0 + WK
<b>Zubehörsatz, Scheibenbremsbelag</b>								
1.8 (N11W)	85	06/96→08/99	←			13.0460-0442.2	610442	SUM
1.8 (N11W)	90	10/91→08/99	←					
1.8 4WD (N21W)	85	06/96→08/99	←					
1.8 4WD (N21W)	90	10/91→08/99	←					
2.0 TD (N18W)	60	10/92→08/99	←					
 <b>Bremsscheibe</b>								
1.8 (N11W)	85	06/96→08/99	←	- ABS; für Fahrzeuge mit Trommelbremse an der Hinterachse		24.0124-0136.1	424136	Ø 256 24 21,5 V
			←	+ ABS; für Fahrzeuge mit Scheibenbremse an der Hinterachse		24.0124-0146.1	424146	Ø 256 24 22,4 V
1.8 4WD (N21W)	85	06/96→08/99	→			24.0110-0240.1	410240	Ø 262 10 8,4
			→					
1.8 4WD (N21W)	90	10/91→08/99	←	- ABS		24.0124-0136.1	424136	Ø 256 24 21,5 V
1.8 4WD (N21W)	90	10/91→08/99	←	- ABS				











	kw			 	! #		
<b>MITSUBISHI - SPACE RUNNER (N6_W) 08/99→01/03</b>							
 <b>Bremsbelagsatz, Scheibenbremse</b>							
2.0	98	05/00→08/02	←			<b>13.0460-5760.2 605760</b>	AKE 23584 16,4 + WK
			→			<b>13.0460-5980.2 605980</b>	21706 15,5 + WK
2.0 (N63W)	100	08/99→08/02	←	05/00→		<b>13.0460-5760.2 605760</b>	AKE 23584 16,4 + WK
2.4 GDI	108	08/99→08/02	←	09/99→ 04/00		<b>13.0460-5958.2 605958</b>	AKE 21363 15,8 + WK
2.4 GDI	110	08/99→01/03	←			<b>13.0460-5980.2 605980</b>	21706 15,5 + WK
			→	09/99→			
<b>Zubehörsatz, Scheibenbremsbelag</b>							
2.0	98	05/00→08/02	←			<b>13.0460-0235.2 610235</b>	
			→			<b>13.0460-0150.2 610150</b>	AKE
2.0 (N63W)	100	08/99→08/02	←	05/00→		<b>13.0460-0235.2 610235</b>	
2.4 GDI	108	08/99→08/02	←	09/99→ 04/00		<b>13.0460-0235.2 610235</b>	
2.4 GDI	110	08/99→01/03	←			<b>13.0460-0150.2 610150</b>	AKE
			→	09/99→			
 <b>Bremsscheibe</b>							
2.0	98	05/00→08/02	←			<b>24.0126-0134.1 426134</b>	Ø 276 26 24,4 V
			→			<b>24.0110-0704.1 410704</b>	Ø 262 10 8,4
2.0 (N63W)	100	08/99→08/02	←	09/99→ 04/00		<b>24.0124-0182.1 424182</b>	Ø 276 24 22,4 V
2.4 GDI	108	08/99→08/02	←			<b>24.0126-0134.1 426134</b>	Ø 276 26 24,4 V
2.4 GDI	110	08/99→01/03	←	05/00→		<b>24.0126-0134.1 426134</b>	Ø 276 26 24,4 V
			→	09/99→		<b>24.0110-0704.1 410704</b>	Ø 262 10 8,4
<b>MITSUBISHI - SPACE STAR Großraumlimousine (DG_A) 06/98→12/04</b>							
 <b>Bremsbelagsatz, Scheibenbremse</b>							
1.3 16V (DG1A)	60	09/00→12/04	←			<b>13.0460-2830.2 602830</b>	TRW 21920 14,6 + WK + Zub
1.3 16V (DG1A)	61	12/98→12/04	→				
1.8 GDI (DG5A)	87	06/98→12/04	→	+ ABS		<b>13.0460-2831.2 602831</b>	TRW 21861 15,2 + WK
1.8 GDI (DG5A)	90	06/98→12/04	→				
1.8 MPI	82	10/02→12/04	→				
1.3 16V (DG1A)	63	06/98→12/04	←	→ 07/00		<b>13.0460-2830.2 602830</b>	TRW 21920 14,6 + WK + Zub
			→	→ 07/00; + ABS		<b>13.0460-2831.2 602831</b>	TRW 21861 15,2 + WK
1.6	72	04/01→12/04	←	09/01→		<b>13.0460-2830.2 602830</b>	TRW 21920 14,6 + WK + Zub
1.6 16V (DG3A)	72	01/01→12/04	→	09/01→		<b>13.0460-2831.2 602831</b>	TRW 21861 15,2 + WK
1.9 DI-D	85	10/02→12/04	←			<b>13.0460-2830.2 602830</b>	TRW 21920 14,6 + WK + Zub
1.9 DI-D (DG4A)	75	02/01→12/04	→			<b>13.0460-2831.2 602831</b>	TRW 21861 15,2 + WK
 <b>Bremsscheibe</b>							
1.3 16V (DG1A)	60	09/00→12/04	←			<b>24.0124-0136.1 424136</b>	Ø 256 24 21,5 V
1.3 16V (DG1A)	61	12/98→12/04	→				
1.8 GDI (DG5A)	87	06/98→12/04	→	+ ABS		<b>24.0110-0229.1 410229</b>	Ø 260 10 8,4
1.8 GDI (DG5A)	90	06/98→12/04	→				
1.8 MPI	82	10/02→12/04	→				
1.3 16V (DG1A)	63	06/98→12/04	←	→ 07/00		<b>24.0124-0136.1 424136</b>	Ø 256 24 21,5 V
			→	→ 07/00; + ABS		<b>24.0110-0229.1 410229</b>	Ø 260 10 8,4
1.6	72	04/01→12/04	←	09/01→		<b>24.0124-0136.1 424136</b>	Ø 256 24 21,5 V
1.6 16V (DG3A)	72	01/01→12/04	→	09/01→		<b>24.0110-0229.1 410229</b>	Ø 260 10 8,4
1.9 DI-D	85	10/02→12/04	←			<b>24.0124-0136.1 424136</b>	Ø 256 24 21,5 V
1.9 DI-D (DG4A)	75	02/01→12/04	→			<b>24.0110-0229.1 410229</b>	Ø 260 10 8,4
<b>MITSUBISHI - SPACE STAR Schrägheck (A0_A) 01/12→</b>							
 <b>Bremsbelagsatz, Scheibenbremse</b>							
1.0 (A05A)	52	05/12→	←			<b>13.0460-5709.2 605709</b>	AKE 24229 14,8 + WK + Zub
1.2 (A03A)	59	10/12→	→				
1.2 (A03A)	57	01/12→	←	05/12→		<b>13.0460-5709.2 605709</b>	AKE 24229 14,8 + WK + Zub
<b>MITSUBISHI - SPACE WAGON (N3_W, N4_W) 05/91→11/00</b>							
 <b>Bremsbelagsatz, Scheibenbremse</b>							
1.8 (N31W)	90	10/91→10/98	←	→ 05/92		<b>13.0460-5952.2 605952</b>	SUM 21647 16,0 + WK
1.8 4WD (N41W)	90	10/91→10/98	→			<b>13.0460-5980.2 605980</b>	21706 15,5 + WK
1.8 TD (N35W)	55	10/91→10/98	→				
2.0 (N33W)	77	05/91→10/97	←	06/92→		<b>13.0460-5952.2 605952</b>	SUM 21647 16,0 + WK
			→	06/92→		<b>13.0460-5980.2 605980</b>	21706 15,5 + WK
↓							























	kw					! #		
<b>MITSUBISHI - SPACE WAGON (N3_W, N4_W) 05/91→11/00</b>								
<b> Bremsbelagsatz, Scheibenbremse</b>								
2.0 (N33W)	98	10/92→10/98	←				13.0460-5952.2 605952	SUM 21647 16,0 + WK
2.0 4WD (N43W)	98	10/92→10/98	←				13.0460-5980.2 605980	21706 15,5 + WK
2.0 TD (N38W)	60	10/92→10/98	→					
2.4	88	10/91→10/97	←	06/92→ 05/96			13.0460-5952.2 605952	SUM 21647 16,0 + WK
			→	06/92→ 05/96			13.0460-5980.2 605980	21706 15,5 + WK
2.4 i (N34W)	102	10/92→10/98	←	→ 05/96			13.0460-5952.2 605952	SUM 21647 16,0 + WK
			→	→ 05/96			13.0460-5980.2 605980	21706 15,5 + WK
<b>Zubehörsatz, Scheibenbremsbelag</b>								
1.8 (N31W)	90	10/91→10/98	←	→ 05/92			13.0460-0442.2 610442	SUM
1.8 4WD (N41W)	90	10/91→10/98	←					
1.8 TD (N35W)	55	10/91→10/98	←					
2.0 (N33W)	77	05/91→10/97	←	06/92→			13.0460-0442.2 610442	SUM
2.0 (N33W)	98	10/92→10/98	←				13.0460-0442.2 610442	SUM
2.0 4WD (N43W)	98	10/92→10/98	←					
2.0 TD (N38W)	60	10/92→10/98	←					
2.4	88	10/91→10/97	←	06/92→ 05/96			13.0460-0442.2 610442	SUM
2.4 i (N34W)	102	10/92→10/98	←	→ 05/96			13.0460-0442.2 610442	SUM
<b> Bremsscheibe</b>								
1.8 (N31W)	90	10/91→10/98	←	→ 05/92; für Fahrzeuge mit Trommelbremse an der Hinterachse			24.0124-0136.1 424136	Ø 256 24 21,5 V
1.8 4WD (N41W)	90	10/91→10/98	←	→ 05/92; für Fahrzeuge mit Scheibenbremse an der Hinterachse			24.0124-0146.1 424146	Ø 256 24 22,4 V
1.8 TD (N35W)	55	10/91→10/98	→	→ 05/92			24.0110-0240.1 410240	Ø 262 10 8,4
2.0 (N33W)	77	05/91→10/97	←	06/92→; für Fahrzeuge mit Trommelbremse an der Hinterachse			24.0124-0136.1 424136	Ø 256 24 21,5 V
			←	06/92→; für Fahrzeuge mit Scheibenbremse an der Hinterachse			24.0124-0146.1 424146	Ø 256 24 22,4 V
			→	06/92→			24.0110-0240.1 410240	Ø 262 10 8,4
2.0 (N33W)	98	10/92→10/98	←	für Fahrzeuge mit Trommelbremse an der Hinterachse			24.0124-0136.1 424136	Ø 256 24 21,5 V
2.0 4WD (N43W)	98	10/92→10/98	←	für Fahrzeuge mit Trommelbremse an der Hinterachse			24.0124-0136.1 424136	Ø 256 24 21,5 V
2.0 TD (N38W)	60	10/92→10/98	←	für Fahrzeuge mit Scheibenbremse an der Hinterachse			24.0124-0146.1 424146	Ø 256 24 22,4 V
			→				24.0110-0240.1 410240	Ø 262 10 8,4
2.4	88	10/91→10/97	←	06/92→ 05/96; für Fahrzeuge mit Trommelbremse an der Hinterachse			24.0124-0136.1 424136	Ø 256 24 21,5 V
			←	06/92→ 05/96; für Fahrzeuge mit Scheibenbremse an der Hinterachse			24.0124-0146.1 424146	Ø 256 24 22,4 V
			→	06/92→ 05/96			24.0110-0240.1 410240	Ø 262 10 8,4
2.4 i (N34W)	102	10/92→10/98	←	→ 05/96; für Fahrzeuge mit Trommelbremse an der Hinterachse			24.0124-0136.1 424136	Ø 256 24 21,5 V
			←	→ 05/96; für Fahrzeuge mit Scheibenbremse an der Hinterachse			24.0124-0146.1 424146	Ø 256 24 22,4 V
			→	→ 05/96			24.0110-0240.1 410240	Ø 262 10 8,4
<b>MITSUBISHI - SPACE WAGON (N9_W, N8_W) 07/98→12/04</b>								
<b> Bremsbelagsatz, Scheibenbremse</b>								
2.0	98	10/98→12/04	←	05/02→			13.0460-5958.2 605958	AKE 21363 15,8 + WK
2.0 (N83W)	80	12/98→06/02	←	→ 04/02			13.0460-5958.2 605958	AKE 21363 15,8 + WK
2.4 GDI	108	09/00→12/04	←	→ 08/03			13.0460-5958.2 605958	AKE 21363 15,8 + WK
2.4 GDI	110	10/98→12/04	←					
2.4 GDI 4WD	108	09/00→12/04	←					
2.4 GDI 4WD	110	10/98→12/04	←					
<b>Zubehörsatz, Scheibenbremsbelag</b>								
2.0	98	10/98→12/04	←	05/02→			13.0460-0235.2 610235	
2.0 (N83W)	80	12/98→06/02	←	→ 04/02			13.0460-0235.2 610235	
2.4 GDI	108	09/00→12/04	←	→ 08/03			13.0460-0235.2 610235	
2.4 GDI	110	10/98→12/04	←					
2.4 GDI 4WD	108	09/00→12/04	←					
↓								

	kw					! #		
<b>MITSUBISHI - SPACE WAGON (N9_W, N8_W) 07/98→12/04</b>								
<b>Zubehörsatz, Scheibenbremsbelag</b>								
2.4 GDI 4WD	110	10/98→12/04	←	→ 08/03			13.0460-0235.2 610235	
<b> Bremsscheibe</b>								
2.0	98	10/98→12/04	←	05/02→			24.0124-0182.1 424182	Ø 276 24 22,4 V
2.0 (N83W)	80	12/98→06/02	←	→ 04/02			24.0124-0182.1 424182	Ø 276 24 22,4 V
2.4 GDI	108	09/00→12/04	←	→ 08/03			24.0124-0182.1 424182	Ø 276 24 22,4 V
2.4 GDI	110	10/98→12/04						
2.4 GDI 4WD	108	09/00→12/04						
2.4 GDI 4WD	110	10/98→12/04						
<b>NISSAN - 200 SX (S14) 10/93→12/99</b>								
<b> Bremsscheibe</b>								
2.0 i 16V	118	10/93→12/99	→	04/94→			24.0109-0147.1 409147	Ø 258 9 8
2.0 i 16V Turbo	147	10/93→12/99						
<b>NISSAN - 350 Z Coupe (Z33) 09/02→11/09</b>								
<b> Bremsbelagsatz, Scheibenbremse</b>								
3.5	206	10/03→12/06	←				13.0460-4818.2 604818	BRE 23142 15,1 + WK + Zub
3.5	214	11/04→01/07						
3.5	221	09/02→12/08	→				13.0460-4974.2 604974	BRE 21580 14,6 + WK
3.5	230	09/05→12/08						
<b> Bremsscheibe</b>								
3.5	206	10/03→12/06	←				24.0130-0215.1 430215	Ø 324 30 28,4 V
3.5	214	11/04→01/07						
3.5	221	09/02→12/08	→				24.0122-0268.1 422268	Ø 322 22 20,2 V
3.5	230	09/05→12/08						
<b>NISSAN - 350 Z Roadster (Z33) 10/03→12/09</b>								
<b> Bremsbelagsatz, Scheibenbremse</b>								
3.5	206	03/05→12/07	←				13.0460-4818.2 604818	BRE 23142 15,1 + WK + Zub
3.5	221	11/04→01/07	→				13.0460-4974.2 604974	BRE 21580 14,6 + WK
3.5	230	09/05→12/09	←	→ 05/09			13.0460-4818.2 604818	BRE 23142 15,1 + WK + Zub
			→	→ 05/09			13.0460-4974.2 604974	BRE 21580 14,6 + WK
<b> Bremsscheibe</b>								
3.5	206	03/05→12/07	←				24.0130-0215.1 430215	Ø 324 30 28,4 V
3.5	221	11/04→01/07	→				24.0122-0268.1 422268	Ø 322 22 20,2 V
3.5	230	09/05→12/09	←	→ 05/09			24.0130-0215.1 430215	Ø 324 30 28,4 V
			→	→ 05/09			24.0122-0268.1 422268	Ø 322 22 20,2 V
<b>NISSAN - ALMERA I (N15) 07/95→07/00</b>								
<b> Bremsbelagsatz, Scheibenbremse</b>								
1.4	64	09/95→07/00	←	→ 04/00; + ABS			13.0460-5717.2 605717	23502 16,0 + WK
1.4 GX,LX	55	09/95→07/00	←	→ 04/00; - ABS			13.0460-5988.2 605988	AKE 23004 15,9 + WK
2.0 D	55	11/95→07/00	→	→ 12/97; + ABS			13.0460-5841.2 605841	SUM 23023 14,8 + WK
			→	01/98→ 04/00; + ABS			13.0460-5983.2 605983	21713 16,5 - WE / - WK
1.6	73	09/95→07/00	←	→ 04/00; + ABS			13.0460-5717.2 605717	23502 16,0 + WK
1.6 SLX	66	09/95→07/00	←	01/98→ 04/00; - ABS			13.0460-5717.2 605717	23502 16,0 + WK
			←	→ 12/97; - ABS			13.0460-5988.2 605988	AKE 23004 15,9 + WK
			→	→ 12/97; + ABS			13.0460-5841.2 605841	SUM 23023 14,8 + WK
			→	01/98→ 04/00; + ABS			13.0460-5983.2 605983	21713 16,5 - WE / - WK
1.6	75	07/95→03/00	←	01/98→; - ABS			13.0460-5717.2 605717	23502 16,0 + WK
			←	+ ABS			13.0460-5717.2 605717	23502 16,0 + WK
			←	→ 12/97; - ABS			13.0460-5988.2 605988	AKE 23004 15,9 + WK
			→	→ 12/97; + ABS			13.0460-5841.2 605841	SUM 23023 14,8 + WK
			→	01/98→; + ABS			13.0460-5983.2 605983	21713 16,5 - WE / - WK
<b>Zubehörsatz, Scheibenbremsbelag</b>								
1.4	64	09/95→07/00	←	→ 04/00; - ABS			13.0460-0283.2 610283	
1.4 GX,LX	55	09/95→07/00	←	→ 04/00; + ABS			13.0460-0285.2 610285	
2.0 D	55	11/95→07/00						
↓								



























	kW			 	! #		
<b>NISSAN - ALMERA I (N15) 07/95→07/00</b>							
<b>Zubehörsatz, Scheibenbremsbelag</b>							
1.4 1.4 GX,LX 2.0 D	64 55 55	09/95→07/00 09/95→07/00 11/95→07/00	➡ ➡ ➡	→ 12/97; + ABS 01/98→ 04/00; + ABS		13.0460-0284.2 610284 13.0460-0332.2 610332	
1.6 1.6 SLX	73 66	09/95→07/00 09/95→07/00	⬅ ⬅ ⬅ ➡ ➡	→ 12/97; - ABS → 04/00; + ABS 01/98→ 04/00; - ABS → 12/97; + ABS 01/98→ 04/00; + ABS		13.0460-0283.2 610283 13.0460-0285.2 610285 13.0460-0285.2 610285 13.0460-0284.2 610284 13.0460-0332.2 610332	
1.6	75	07/95→03/00	⬅ ⬅ ⬅ ➡ ➡	→ 12/97; - ABS 01/98→; - ABS + ABS → 12/97; + ABS 01/98→; + ABS		13.0460-0283.2 610283 13.0460-0285.2 610285 13.0460-0285.2 610285 13.0460-0284.2 610284 13.0460-0332.2 610332	
<b> Bremsscheibe</b>							
1.4 1.4 GX,LX	64 55	09/95→07/00 09/95→07/00	⬅ ⬅ ⬅ ➡	01/98→ 04/00; - ABS → 12/97; - ABS → 04/00; + ABS → 12/97; + ABS		24.0118-0117.1 418117 Ø 247 18 16 V 24.0118-0118.1 418118 Ø 232 18 16 V 24.0120-0203.1 420203 Ø 252 20 18 V 24.0107-0108.1 407108 Ø 234 7 6	
1.6 1.6 SLX 2.0 D	73 66 55	09/95→07/00 09/95→07/00 11/95→07/00	⬅ ⬅ ➡	→ 04/00; - ABS → 04/00; + ABS → 12/97; + ABS		24.0118-0117.1 418117 Ø 247 18 16 V 24.0120-0203.1 420203 Ø 252 20 18 V 24.0107-0108.1 407108 Ø 234 7 6	
1.6	75	07/95→03/00	⬅ ⬅ ➡	- ABS + ABS → 12/97; + ABS		24.0118-0117.1 418117 Ø 247 18 16 V 24.0120-0203.1 420203 Ø 252 20 18 V 24.0107-0108.1 407108 Ø 234 7 6	
<b>NISSAN - ALMERA I Hatchback (N15) 07/95→01/01</b>							
<b> Bremsbelagsatz, Scheibenbremse</b>							
1.4 1.4 S,GX,LX 2.0 D	64 55 55	09/95→03/00 09/95→03/00 11/95→03/00	⬅ ⬅ ➡ ➡	+ ABS - ABS → 12/97; + ABS 01/98→; + ABS		13.0460-5717.2 605717 23502 16,0 + WK 13.0460-5988.2 605988 AKE 23004 15,9 + WK 13.0460-5841.2 605841 SUM 23023 14,8 + WK 13.0460-5983.2 605983 21713 16,5 - WE / - WK	
1.6 1.6 1.6 SR,SLX	73 75 66	09/95→03/00 07/95→03/00 09/95→03/00	⬅ ⬅ ⬅ ➡ ➡ ➡	01/98→; - ABS + ABS → 12/97; - ABS → 12/97; + ABS 01/98→; + ABS		13.0460-5717.2 605717 23502 16,0 + WK 13.0460-5717.2 605717 23502 16,0 + WK 13.0460-5988.2 605988 AKE 23004 15,9 + WK 13.0460-5841.2 605841 SUM 23023 14,8 + WK 13.0460-5983.2 605983 21713 16,5 - WE / - WK	
2.0 GTi	105	07/96→03/00	➡			13.0460-5983.2 605983 21713 16,5 - WE / - WK	
<b>Zubehörsatz, Scheibenbremsbelag</b>							
1.4 1.4 S,GX,LX 2.0 D	64 55 55	09/95→03/00 09/95→03/00 11/95→03/00	⬅ ⬅ ➡ ➡	- ABS + ABS → 12/97; + ABS 01/98→; + ABS		13.0460-0283.2 610283 13.0460-0285.2 610285 13.0460-0284.2 610284 13.0460-0332.2 610332	
1.6 1.6 1.6 SR,SLX	73 75 66	09/95→03/00 07/95→03/00 09/95→03/00	⬅ ⬅ ⬅ ➡ ➡ ➡	→ 12/97; - ABS 01/98→; - ABS + ABS → 12/97; + ABS 01/98→; + ABS		13.0460-0283.2 610283 13.0460-0285.2 610285 13.0460-0285.2 610285 13.0460-0284.2 610284 13.0460-0332.2 610332	
2.0 GTi	105	07/96→03/00	➡			13.0460-0332.2 610332	
<b> Bremsscheibe</b>							
1.4 1.4 S,GX,LX ↓	64 55	09/95→03/00 09/95→03/00	⬅ ⬅ ⬅	01/98→; - ABS → 12/97; - ABS + ABS		24.0118-0117.1 418117 Ø 247 18 16 V 24.0118-0118.1 418118 Ø 232 18 16 V 24.0120-0203.1 420203 Ø 252 20 18 V	













	kW					! #		
<b>NISSAN - ALMERA I Hatchback (N15) 07/95→01/01</b>								
 <b>Bremsscheibe</b>								
1.4 1.4 S,GX,LX	64 55	09/95→03/00 09/95→03/00	➡	→ 12/97; + ABS			24.0107-0108.1 407108	Ø 234 7 6
1.6 1.6 1.6 SR,SLX 2.0 D	73 75 66 55	09/95→03/00 07/95→03/00 09/95→03/00 11/95→03/00	←	- ABS			24.0118-0117.1 418117	Ø 247 18 16 V
			←	+ ABS			24.0120-0203.1 420203	Ø 252 20 18 V
			➡	→ 12/97; + ABS			24.0107-0108.1 407108	Ø 234 7 6
2.0 GTi	105	07/96→03/00	←				24.0126-0112.1 426112	Ø 257 26 24 V
<b>NISSAN - ALMERA II (N16) 04/00→</b>								
 <b>Bremsbelagsatz, Scheibenbremse</b>								
1.5	66	07/00→11/06	←	+ ABS			13.0460-5807.2 605807	TRW 23093 16,6 - WK
			←	→ 03/01; + ABS; Made in Japan			13.0460-5807.2 605807	TRW 23093 16,6 - WK
			←	- ABS			13.0460-5950.2 605950	TRW 21546 16,7 - WK
			←	→ 03/01; - ABS; Made in Japan			13.0460-5950.2 605950	TRW 21546 16,7 - WK
			➡	→ 03/01; + ABS; Made in Japan			13.0460-5983.2 605983	21713 16,5 - WE / - WK
			➡	+ ABS			13.0460-5986.2 605986	TRW 21545 14,9 - WK
1.5 1.5 dCi	72 60	10/02→09/06 01/03→09/06	←	+ ABS			13.0460-5807.2 605807	TRW 23093 16,6 - WK
			←	- ABS			13.0460-5950.2 605950	TRW 21546 16,7 - WK
			➡	+ ABS			13.0460-5986.2 605986	TRW 21545 14,9 - WK
1.8 2.2 Di	84 81	07/00→11/02 07/00→04/03	←				13.0460-5807.2 605807	TRW 23093 16,6 - WK
			←	→ 03/01; Made in Japan			13.0460-5807.2 605807	TRW 23093 16,6 - WK
			➡	→ 03/01; Made in Japan			13.0460-5983.2 605983	21713 16,5 - WE / - WK
			➡				13.0460-5986.2 605986	TRW 21545 14,9 - WK
1.8 2.2 dCi 2.2 dCi	85 82 100	10/02→09/06 09/03→09/06 09/03→09/06	←				13.0460-5807.2 605807	TRW 23093 16,6 - WK
			➡				13.0460-5986.2 605986	TRW 21545 14,9 - WK
<b>Zubehörsatz, Scheibenbremsbelag</b>								
1.5	66	07/00→11/06	←	→ 03/01; + ABS; Made in Japan			13.0460-0148.2 610148	TRW
			←	+ ABS			13.0460-0148.2 610148	TRW
1.5 1.5 dCi	72 60	10/02→09/06 01/03→09/06	←	+ ABS			13.0460-0148.2 610148	TRW
1.8 2.2 Di	84 81	07/00→11/02 07/00→04/03	←				13.0460-0148.2 610148	TRW
			←	→ 03/01; Made in Japan			13.0460-0148.2 610148	TRW
1.8 2.2 dCi 2.2 dCi	85 82 100	10/02→09/06 09/03→09/06 09/03→09/06	←				13.0460-0148.2 610148	TRW
 <b>Bremsscheibe</b>								
1.5	66	07/00→11/06	←	→ 03/01; - ABS; Made in Japan			24.0122-0146.1 422146	Ø 257 22 20 V
			←	- ABS			24.0122-0146.1 422146	Ø 257 22 20 V
			←	→ 03/01; + ABS; Made in Japan			24.0122-0179.1 422179	Ø 280 22 20 V
			←	+ ABS			24.0122-0179.1 422179	Ø 280 22 20 V
			➡	+ ABS			24.0110-0215.1 410215	Ø 258 10 9
			➡	→ 03/01; + ABS; Made in Japan			24.0110-0215.1 410215	Ø 258 10 9
1.5 1.5 dCi	72 60	10/02→09/06 01/03→09/06	←	- ABS			24.0122-0146.1 422146	Ø 257 22 20 V
			←	+ ABS			24.0122-0179.1 422179	Ø 280 22 20 V
			➡	+ ABS			24.0110-0215.1 410215	Ø 258 10 9
1.8 2.2 Di	84 81	07/00→11/02 07/00→04/03	←	→ 03/01; Made in Japan			24.0122-0179.1 422179	Ø 280 22 20 V
			←				24.0122-0179.1 422179	Ø 280 22 20 V
			➡	→ 03/01; Made in Japan			24.0110-0215.1 410215	Ø 258 10 9
			➡				24.0110-0215.1 410215	Ø 258 10 9
1.8 2.2 dCi 2.2 dCi	85 82 100	10/02→09/06 09/03→09/06 09/03→09/06	←				24.0122-0179.1 422179	Ø 280 22 20 V
			➡				24.0110-0215.1 410215	Ø 258 10 9
<b>NISSAN - ALMERA II Hatchback (N16) 01/00→</b>								
 <b>Bremsbelagsatz, Scheibenbremse</b>								
1.5	66	03/00→11/06	←	+ ABS			13.0460-5807.2 605807	TRW 23093 16,6 - WK
			←	→ 03/01; + ABS; Made in Japan			13.0460-5807.2 605807	TRW 23093 16,6 - WK
↓								











	kw			 	! #		
<b>NISSAN - ALMERA II Hatchback (N16) 01/00→</b>							
 <b>Bremsbelagsatz, Scheibenbremse</b>							
1.5	66	03/00→11/06	←	- ABS		13.0460-5950.2 605950	TRW 21546 16,7 - WK
			←	→ 03/01; - ABS; Made in Japan		13.0460-5950.2 605950	TRW 21546 16,7 - WK
			→	→ 03/01; + ABS; Made in Japan		13.0460-5983.2 605983	21713 16,5 - WE / - WK
			→	+ ABS		13.0460-5986.2 605986	TRW 21545 14,9 - WK
1.5 1.5 dCi	72 60	10/02→09/06 01/03→09/06	←	+ ABS		13.0460-5807.2 605807	TRW 23093 16,6 - WK
			←	- ABS		13.0460-5950.2 605950	TRW 21546 16,7 - WK
			→	+ ABS		13.0460-5986.2 605986	TRW 21545 14,9 - WK
1.8	84	01/00→11/02	←	03/00→ 03/01; Made in Japan		13.0460-5807.2 605807	TRW 23093 16,6 - WK
			←	02/00→		13.0460-5807.2 605807	TRW 23093 16,6 - WK
			→	03/00→ 03/01; Made in Japan		13.0460-5983.2 605983	21713 16,5 - WE / - WK
			→	02/00→		13.0460-5986.2 605986	TRW 21545 14,9 - WK
1.8 2.2 dCi 2.2 dCi	85 82 100	10/02→09/06 09/03→09/06 09/03→09/06	←			13.0460-5807.2 605807	TRW 23093 16,6 - WK
2.2 Di	81	03/00→04/03	←			13.0460-5807.2 605807	TRW 23093 16,6 - WK
			←	→ 03/01; Made in Japan		13.0460-5807.2 605807	TRW 23093 16,6 - WK
			→	→ 03/01; Made in Japan		13.0460-5983.2 605983	21713 16,5 - WE / - WK
			→			13.0460-5986.2 605986	TRW 21545 14,9 - WK
<b>Zubehörsatz, Scheibenbremsbelag</b>							
1.5	66	03/00→11/06	←	→ 03/01; + ABS; Made in Japan		13.0460-0148.2 610148	TRW
			←	+ ABS		13.0460-0148.2 610148	TRW
1.5 1.5 dCi	72 60	10/02→09/06 01/03→09/06	←	+ ABS		13.0460-0148.2 610148	TRW
1.8	84	01/00→11/02	←	03/00→ 03/01; Made in Japan		13.0460-0148.2 610148	TRW
			←	02/00→		13.0460-0148.2 610148	TRW
1.8 2.2 dCi 2.2 dCi	85 82 100	10/02→09/06 09/03→09/06 09/03→09/06	←			13.0460-0148.2 610148	TRW
2.2 Di	81	03/00→04/03	←			13.0460-0148.2 610148	TRW
			←	→ 03/01; Made in Japan		13.0460-0148.2 610148	TRW
 <b>Bremsscheibe</b>							
1.5	66	03/00→11/06	←	→ 03/01; - ABS; Made in Japan		24.0122-0146.1 422146	Ø 257 22 20 V
			←	- ABS		24.0122-0146.1 422146	Ø 257 22 20 V
			→	→ 03/01; + ABS; Made in Japan		24.0122-0179.1 422179	Ø 280 22 20 V
			←	+ ABS		24.0122-0179.1 422179	Ø 280 22 20 V
			→	+ ABS		24.0110-0215.1 410215	Ø 258 10 9
			→	→ 03/01; + ABS; Made in Japan		24.0110-0215.1 410215	Ø 258 10 9
1.5 1.5 dCi	72 60	10/02→09/06 01/03→09/06	←	- ABS		24.0122-0146.1 422146	Ø 257 22 20 V
			←	+ ABS		24.0122-0179.1 422179	Ø 280 22 20 V
			→	+ ABS		24.0110-0215.1 410215	Ø 258 10 9
1.8	84	01/00→11/02	←	02/00→		24.0122-0179.1 422179	Ø 280 22 20 V
			←	03/00→ 03/01; Made in Japan		24.0122-0179.1 422179	Ø 280 22 20 V
			→	02/00→		24.0110-0215.1 410215	Ø 258 10 9
			→	03/00→ 03/01; Made in Japan		24.0110-0215.1 410215	Ø 258 10 9
1.8 2.2 dCi 2.2 dCi	85 82 100	10/02→09/06 09/03→09/06 09/03→09/06	←			24.0122-0179.1 422179	Ø 280 22 20 V
2.2 Di	81	03/00→04/03	←	→ 03/01; Made in Japan		24.0122-0179.1 422179	Ø 280 22 20 V
			←			24.0122-0179.1 422179	Ø 280 22 20 V
			→	→ 03/01; Made in Japan		24.0110-0215.1 410215	Ø 258 10 9
			→			24.0110-0215.1 410215	Ø 258 10 9
<b>NISSAN - ALMERA TINO (V10) 12/98→02/06</b>							
 <b>Bremsbelagsatz, Scheibenbremse</b>							
1.8	84	08/00→02/06	←	→ 01/03		13.0460-5825.2 605825	TRW 23094 16,5 + WK + Zub
			←	02/03→ 11/05		13.0460-5825.2 605825	TRW 23094 16,5 + WK + Zub
↓							















	kW					! #		
<b>NISSAN - ALMERA TINO (V10) 12/98→02/06</b>								
<b> Bremsbelagsatz, Scheibenbremse</b>								
1.8	84	08/00→02/06	➔	→ 11/05			<b>13.0460-5986.2 605986</b>	TRW 21545 14,9 - WK
1.8	85	12/02→02/06	➔	→ 11/05			<b>13.0460-5825.2 605825</b>	TRW 23094 16,5 + WK + Zub
2.2 dCi	82	09/03→02/06	➔	→ 11/05			<b>13.0460-5986.2 605986</b>	TRW 21545 14,9 - WK
2.2 dCi	100	09/03→02/06	➔	→ 11/05			<b>13.0460-5986.2 605986</b>	TRW 21545 14,9 - WK
1.8	88	12/98→02/03	➔				<b>13.0460-5825.2 605825</b>	TRW 23094 16,5 + WK + Zub
2.0	100	08/00→01/03	➔				<b>13.0460-5986.2 605986</b>	TRW 21545 14,9 - WK
2.2 dCi	84	08/00→02/06	➔	02/03→ 08/03			<b>13.0460-5825.2 605825</b>	TRW 23094 16,5 + WK + Zub
			➔	→ 01/03			<b>13.0460-5825.2 605825</b>	TRW 23094 16,5 + WK + Zub
			➔	→ 08/03			<b>13.0460-5986.2 605986</b>	TRW 21545 14,9 - WK
<b>Zubehörsatz, Scheibenbremsbelag</b>								
1.8	84	08/00→02/06	➔	→ 01/03			<b>13.0460-0282.2 610282</b>	
			➔	02/03→ 11/05			<b>13.0460-0282.2 610282</b>	
1.8	85	12/02→02/06	➔	→ 11/05			<b>13.0460-0282.2 610282</b>	
2.2 dCi	82	09/03→02/06	➔	→ 11/05			<b>13.0460-0282.2 610282</b>	
2.2 dCi	100	09/03→02/06	➔	→ 11/05			<b>13.0460-0282.2 610282</b>	
1.8	88	12/98→02/03	➔				<b>13.0460-0282.2 610282</b>	
2.0	100	08/00→01/03	➔				<b>13.0460-0282.2 610282</b>	
2.2 dCi	84	08/00→02/06	➔	02/03→ 08/03			<b>13.0460-0282.2 610282</b>	
			➔	→ 01/03			<b>13.0460-0282.2 610282</b>	
<b> Bremsscheibe</b>								
1.8	84	08/00→02/06	➔	→ 11/05			<b>24.0128-0140.1 428140</b>	Ø 280 28 26 V
1.8	85	12/02→02/06	➔	→ 11/05			<b>24.0110-0285.1 410285</b>	Ø 278 10 9
2.2 dCi	82	09/03→02/06	➔	→ 11/05			<b>24.0110-0285.1 410285</b>	Ø 278 10 9
2.2 dCi	100	09/03→02/06	➔	→ 11/05			<b>24.0110-0285.1 410285</b>	Ø 278 10 9
1.8	88	12/98→02/03	➔				<b>24.0128-0140.1 428140</b>	Ø 280 28 26 V
2.0	100	08/00→01/03	➔				<b>24.0110-0285.1 410285</b>	Ø 278 10 9
2.2 dCi	84	08/00→02/06	➔	→ 08/03			<b>24.0128-0140.1 428140</b>	Ø 280 28 26 V
			➔	→ 08/03			<b>24.0110-0285.1 410285</b>	Ø 278 10 9
<b>NISSAN - CABSTAR (F23, H41, H42) 07/92→09/11</b>								
<b> Bremsbelagsatz, Scheibenbremse</b>								
2.5 D	56	07/92→12/00	➔				<b>13.0460-3856.2 603856</b>	BOS 23434 18,0 + WK
<b> Bremsscheibe</b>								
2.5 D	56	07/92→12/00	➔	Starrachse			<b>24.0124-0229.1 424229</b>	Ø 263 24 22 V
<b>NISSAN - CABSTAR (F24M, F24W) 09/06→12/13</b>								
<b> Bremsbelagsatz, Scheibenbremse</b>								
28.11 DCI, 32.11 DCI, 35.11 DCI 2.5 (F24M)	81	09/06→12/13	➔	→ 11/09			<b>13.0460-4866.2 604866</b>	BRE 29229 20,7 + WK
			➔	→ 09/11			<b>13.0460-4859.2 604859</b>	BRE 23921 20,1 + WK + Zub
28.12 DCI, 32.12 DCI, 34.12 DCI, 35.12 DCI 2.5 (F24M)	90	09/06→12/13	➔	10/11→			<b>13.0460-4866.2 604866</b>	BRE 29229 20,7 + WK
			➔	10/11→			<b>13.0460-4859.2 604859</b>	BRE 23921 20,1 + WK + Zub
34.110 DCI 2.5 (F24M)	82	01/07→04/12	➔				<b>13.0460-4866.2 604866</b>	BRE 29229 20,7 + WK
			➔				<b>13.0460-4859.2 604859</b>	BRE 23921 20,1 + WK + Zub
35.13 DCI, 45.13 DCI 2.5 (F24M)	96	09/06→12/12	➔	10/06→ 09/11; zul. Gesamtgewicht [kg]: 4.500			<b>13.0460-4865.2 604865</b>	BRE 29160 20,3 + WK + Zub
			➔	10/06→ 11/09; zul. Gesamtgewicht [kg]: 3.500			<b>13.0460-4866.2 604866</b>	BRE 29229 20,7 + WK
			➔	10/06→ 09/11			<b>13.0460-4859.2 604859</b>	BRE 23921 20,1 + WK + Zub
			➔	10/06→ 09/11; zul. Gesamtgewicht [kg]: 4.500			<b>13.0460-4861.2 604861</b>	BRE 29121 20,3 + WK + Zub
35.14 DCI, 45.14 DCI 2.5 (F24M)	100	09/06→12/13	➔	10/11→; zul. Gesamtgewicht [kg]: 4.500			<b>13.0460-4865.2 604865</b>	BRE 29160 20,3 + WK + Zub
			➔	10/11→			<b>13.0460-4866.2 604866</b>	BRE 29229 20,7 + WK
			➔	10/11→			<b>13.0460-4859.2 604859</b>	BRE 23921 20,1 + WK + Zub
			➔	10/11→; zul. Gesamtgewicht [kg]: 4.500			<b>13.0460-4861.2 604861</b>	BRE 29121 20,3 + WK + Zub
35.14 DCI 3.0 (F24M) 35.15 DCI, 45.15 DCI 3.0 (F24M)	101 110	09/06→12/13 09/06→12/13	➔	10/06→; zul. Gesamtgewicht [kg]: 4.500			<b>13.0460-4865.2 604865</b>	BRE 29160 20,3 + WK + Zub
			➔	10/06→; zul. Gesamtgewicht [kg]: 3.500			<b>13.0460-4866.2 604866</b>	BRE 29229 20,7 + WK
			➔	10/06→; zul. Gesamtgewicht [kg]: 3.500			<b>13.0460-4859.2 604859</b>	BRE 23921 20,1 + WK + Zub
			➔	10/06→; zul. Gesamtgewicht [kg]: 4.500			<b>13.0460-4861.2 604861</b>	BRE 29121 20,3 + WK + Zub
↓								













	kw			 	! #		
<b>NISSAN - CABSTAR (F24M, F24W) 09/06→12/13</b>							
 <b>Bremsscheibe</b>							
28.11 DCI, 32.11 DCI, 35.11 DCI 2.5 (F24M)	81	09/06→12/13	←	→ 09/11		24.0128-0244.1 428244	Ø 276 28 26 V
			→	→ 09/11; Brems-/Fahrdyn. Artikelbezug: + ABS	24.0116-0131.1 416131	Ø 280 16 13 + ABS Ring	
			→	→ 09/11; Brems-/Fahrdyn. Artikelbezug: - ABS	24.0116-0132.1 416132	Ø 280 16 13	
28.12 DCI, 32.12 DCI, 34.12 DCI, 35.12 DCI 2.5 (F24M)	90	09/06→12/13	←	10/11→		24.0128-0244.1 428244	Ø 276 28 26 V
			→	10/11→; Brems-/Fahrdyn. Artikelbezug: + ABS	24.0116-0131.1 416131	Ø 280 16 13 + ABS Ring	
			→	10/11→; Brems-/Fahrdyn. Artikelbezug: - ABS	24.0116-0132.1 416132	Ø 280 16 13	
34.110 DCI 2.5 (F24M)	82	01/07→04/12	←			24.0126-0163.1 426163	Ø 290 26 23 V
			→	Brems-/Fahrdyn. Artikelbezug: + ABS	24.0116-0131.1 416131	Ø 280 16 13 + ABS Ring	
			→	Brems-/Fahrdyn. Artikelbezug: - ABS	24.0116-0132.1 416132	Ø 280 16 13	
35.13 DCI, 45.13 DCI 2.5 (F24M)	96	09/06→12/12	←	10/06→ 09/11; zul. Gesamtgewicht [kg]: 4.500		24.0126-0163.1 426163	Ø 290 26 23 V
			←	10/06→ 09/11		24.0128-0244.1 428244	Ø 276 28 26 V
			→	10/06→ 09/11; Brems-/Fahrdyn. Artikelbezug: + ABS	24.0116-0131.1 416131	Ø 280 16 13 + ABS Ring	
			→	10/06→ 09/11; Brems-/Fahrdyn. Artikelbezug: - ABS	24.0116-0132.1 416132	Ø 280 16 13	
			→	10/06→ 09/11; zul. Gesamtgewicht [kg]: 4.500	24.0122-0264.1 422264	Ø 290 22 19 V	
35.14 DCI, 45.14 DCI 2.5 (F24M)	100	09/06→12/13	←	10/11→; zul. Gesamtgewicht [kg]: 4.500		24.0126-0163.1 426163	Ø 290 26 23 V
			←	10/11→		24.0128-0244.1 428244	Ø 276 28 26 V
			→	10/11→; Brems-/Fahrdyn. Artikelbezug: + ABS	24.0116-0131.1 416131	Ø 280 16 13 + ABS Ring	
			→	10/11→; Brems-/Fahrdyn. Artikelbezug: - ABS	24.0116-0132.1 416132	Ø 280 16 13	
			→	10/11→; zul. Gesamtgewicht [kg]: 4.500	24.0122-0264.1 422264	Ø 290 22 19 V	
35.14 DCI 3.0 (F24M) 35.15 DCI, 45.15 DCI 3.0 (F24M)	101 110	09/06→12/13 09/06→12/13	←	10/06→; zul. Gesamtgewicht [kg]: 4.500		24.0126-0163.1 426163	Ø 290 26 23 V
			←	10/06→		24.0128-0244.1 428244	Ø 276 28 26 V
			→	10/06→; zul. Gesamtgewicht [kg]: 3.500; Brems-/Fahrdyn. Artikelbezug: + ABS	24.0116-0131.1 416131	Ø 280 16 13 + ABS Ring	
			→	10/06→; zul. Gesamtgewicht [kg]: 3.500; Brems-/Fahrdyn. Artikelbezug: - ABS	24.0116-0132.1 416132	Ø 280 16 13	
			→	10/06→; zul. Gesamtgewicht [kg]: 4.500	24.0122-0264.1 422264	Ø 290 22 19 V	
→	10/06→; zul. Gesamtgewicht [kg]: 4.500; Schaltgetriebe 5 Gang	24.0122-0264.1 422264	Ø 290 22 19 V				
<b>NISSAN - CABSTAR E (TL_, VL_) 07/92→11/06</b>							
 <b>Bremsbelagsatz, Scheibenbremse</b>							
105.35, 110.35, 110.45 (TL0)	78	10/98→10/06	←	09/01→ 12/03		13.0460-3856.2 603856	BOS 23434 18,0 + WK
120.35, 120.45 (TL0)	88	10/98→10/06					
75.28 (TL0)	55	10/98→10/06					
90.32, 90.28, 95.32, 95.28 (TL0)	66	10/98→10/06					
3.0 110.35 (TL0)	81	10/00→04/04	←			13.0460-3856.2 603856	BOS 23434 18,0 + WK
95.32	70	04/02→06/04	←	Starrachse		13.0460-3856.2 603856	BOS 23434 18,0 + WK
 <b>Bremsscheibe</b>							
105.35, 110.35, 110.45 (TL0)	78	10/98→10/06	←	Multi-link Achse		24.0126-0163.1 426163	Ø 290 26 23 V
120.35, 120.45 (TL0)	88	10/98→10/06					
125.35, 125.45 (TL0, VL0)	92	10/98→10/06	←	Doppelquerlenkerachse; zul. Gesamtgewicht [kg]: 4.500		24.0126-0163.1 426163	Ø 290 26 23 V
3.0 110.35 (TL0)	81	10/00→04/04	←	Starrachse		24.0124-0229.1 424229	Ø 263 24 22 V
<b>NISSAN - CEFIRO III Stufenheck (A33) 01/99→12/07</b>							
 <b>Bremsbelagsatz, Scheibenbremse</b>							
2.0	103	01/00→09/03	←	→ 08/03		13.0460-5880.2 605880	23184 14,8 + WK
3.0	147	01/00→09/03	→	→ 08/03		13.0460-5626.2 605626	AKE 21713 16,0 + WK
 <b>Bremsscheibe</b>							
2.0	103	01/00→09/03	←	→ 08/03		24.0128-0140.1 428140	Ø 280 28 26 V
3.0	147	01/00→09/03					

















	kw			 	! #		
<b>NISSAN - CUBE (Z12) 09/07→</b>							
 <b>Bremsbelagsatz, Scheibenbremse</b>							
1.5 dCi 1.5 dCi 1.6 16V	78 81 81	03/10→ 03/10→ 03/10→	← ← ←	→ 03/11		13.0460-5716.2 605716	21561 17,0 + WK
<b>Zubehörsatz, Scheibenbremsbelag</b>							
1.5 dCi 1.5 dCi 1.6 16V	78 81 81	03/10→ 03/10→ 03/10→	← ← ←	→ 03/11		13.0460-0170.2 610170	
 <b>Bremsscheibe</b>							
1.5 dCi 1.5 dCi 1.6 16V	78 81 81	03/10→ 03/10→ 03/10→	← ← →	→ 03/11		24.0124-0238.1 424238	Ø 280 24 22 V
				→ 03/11		24.0109-0166.1 409166	Ø 292 9 8
<b>NISSAN - EVALIA Bus 07/10→</b>							
 <b>Bremsbelagsatz, Scheibenbremse</b>							
e- (ME0)	80	07/14→	←			13.0460-5783.2 605783	TOK 24227 16,7 + WK
 <b>Bremsscheibe</b>							
1.5 dci (M20, M20M, M20K, M20KK) 1.5 dci (M20, M20M) 1.5 dci (M20, M20M) 1.6 16V (M20, M20M)	63 66 81 81	07/10→ 04/11→ 04/11→ 07/10→	← ← ← ←			24.0126-0175.1 426175	Ø 257 26 24 V
e- (ME0)	80	07/14→	← →			24.0128-0268.1 428268	Ø 283 28 26 V
						24.0109-0157.1 409157	Ø 291,5 9 8
<b>NISSAN - INTERSTAR Bus (X70) 04/02→</b>							
 <b>Bremsbelagsatz, Scheibenbremse</b>							
dCi 100 dCi 100 dCi 120 dCi 150	73 74 88 107	11/03→ 04/06→ 09/06→ 09/06→	← ← → →	→ 06/10 → 06/10		13.0460-3800.2 603800 13.0460-3806.2 603806	BOS 23613 17,7 - WE / - WK BOS 23669 16,8 - WE / - WK
dCi 120	84	07/02→08/06	← →			13.0460-3800.2 603800 13.0460-3806.2 603806	BOS 23613 17,7 - WE / - WK BOS 23669 16,8 - WE / - WK
dCi 140 dCi 90	100 66	11/03→ 07/02→	← →	→ 08/06 → 08/06		13.0460-3800.2 603800 13.0460-3806.2 603806	BOS 23613 17,7 - WE / - WK BOS 23669 16,8 - WE / - WK
dCi 80	60	04/02→08/06	← →	07/02→ 07/02→		13.0460-3800.2 603800 13.0460-3806.2 603806	BOS 23613 17,7 - WE / - WK BOS 23669 16,8 - WE / - WK
<b>Zubehörsatz, Scheibenbremsbelag</b>							
dCi 100 dCi 100 dCi 120 dCi 150	73 74 88 107	11/03→ 04/06→ 09/06→ 09/06→	← ← → →	→ 06/10 → 06/10		13.0460-0344.2 610344 13.0460-0344.2 610344	
dCi 120	84	07/02→08/06	← →			13.0460-0344.2 610344 13.0460-0344.2 610344	
dCi 140 dCi 90	100 66	11/03→ 07/02→	← →	→ 08/06 → 08/06		13.0460-0344.2 610344 13.0460-0344.2 610344	
dCi 80	60	04/02→08/06	← →	07/02→ 07/02→		13.0460-0344.2 610344 13.0460-0344.2 610344	
 <b>Bremsscheibe</b>							
dCi 100 dCi 100 dCi 120 dCi 150	73 74 88 107	11/03→ 04/06→ 09/06→ 09/06→	← ← → →	→ 06/10 → 06/10		24.0128-0129.1 428129 24.0328-0129.1 528129 24.0112-0155.1 412155	Ø 305,5 28 25 V + S Ø 305,5 28 25 V + S Ø 305 12 10,5 + S
dCi 120	84	07/02→08/06	← →			24.0128-0129.1 428129 24.0328-0129.1 528129 24.0112-0155.1 412155	Ø 305,5 28 25 V + S Ø 305,5 28 25 V + S Ø 305 12 10,5 + S
dCi 140 dCi 90	100 66	11/03→ 07/02→	← →	→ 08/06 → 08/06		24.0128-0129.1 428129 24.0328-0129.1 528129 24.0112-0155.1 412155	Ø 305,5 28 25 V + S Ø 305,5 28 25 V + S Ø 305 12 10,5 + S
dCi 80	60	04/02→08/06	← →	07/02→ 07/02→		24.0128-0129.1 428129 24.0328-0129.1 528129 24.0112-0155.1 412155	Ø 305,5 28 25 V + S Ø 305,5 28 25 V + S Ø 305 12 10,5 + S

















	kw			 	! #		
<b>NISSAN - INTERSTAR Kasten (X70) 04/02→</b>							
 <b>Bremsbelagsatz, Scheibenbremse</b>							
dCi 100	73	11/03→	←	→ 06/10		13.0460-3800.2 603800	BOS 23613 17,7 - WE / - WK
dCi 100	74	04/06→	→	→ 06/10		13.0460-3806.2 603806	BOS 23669 16,8 - WE / - WK
dCi 120	88	09/06→					
dCi 150	107	09/06→					
dCi 120	84	04/02→	←	→ 08/06		13.0460-3800.2 603800	BOS 23613 17,7 - WE / - WK
dCi 140	100	11/03→	→	→ 08/06		13.0460-3806.2 603806	BOS 23669 16,8 - WE / - WK
dCi 90	66	07/02→					
dCi 80	60	04/02→08/06	←	07/02→		13.0460-3800.2 603800	BOS 23613 17,7 - WE / - WK
			→	07/02→		13.0460-3806.2 603806	BOS 23669 16,8 - WE / - WK
<b>Zubehörsatz, Scheibenbremsbelag</b>							
dCi 100	73	11/03→	←	→ 06/10		13.0460-0344.2 610344	
dCi 100	74	04/06→					
dCi 120	88	09/06→					
dCi 150	107	09/06→					
dCi 120	84	04/02→	←	→ 08/06		13.0460-0344.2 610344	
dCi 140	100	11/03→					
dCi 90	66	07/02→					
dCi 80	60	04/02→08/06	←	07/02→		13.0460-0344.2 610344	
<b>Bremsscheibe</b>							
dCi 100	73	11/03→	←	→ 06/10		24.0128-0129.1 428129	Ø 305,5 28 25 V + S
dCi 100	74	04/06→				24.0328-0129.1 528129	Ø 305,5 28 25 V + S
dCi 120	88	09/06→	→	→ 06/10		24.0112-0155.1 412155	Ø 305 12 10,5 + S
dCi 150	107	09/06→					
dCi 120	84	04/02→	←	→ 08/06		24.0128-0129.1 428129	Ø 305,5 28 25 V + S
dCi 140	100	11/03→	→	→ 08/06		24.0328-0129.1 528129	Ø 305,5 28 25 V + S
dCi 90	66	07/02→					
			→	→ 08/06		24.0112-0155.1 412155	Ø 305 12 10,5 + S
dCi 80	60	04/02→08/06	←	07/02→		24.0128-0129.1 428129	Ø 305,5 28 25 V + S
						24.0328-0129.1 528129	Ø 305,5 28 25 V + S
			→	07/02→		24.0112-0155.1 412155	Ø 305 12 10,5 + S
<b>NISSAN - INTERSTAR Pritsche/Fahrgestell 08/03→</b>							
 <b>Bremsbelagsatz, Scheibenbremse</b>							
dCi 100	73	02/04→	←	→ 06/10		13.0460-3800.2 603800	BOS 23613 17,7 - WE / - WK
			→	→ 06/10		13.0460-3806.2 603806	BOS 23669 16,8 - WE / - WK
dCi 120	84	08/03→	←	→ 08/06		13.0460-3800.2 603800	BOS 23613 17,7 - WE / - WK
dCi 140	100	11/03→	→	→ 08/06		13.0460-3806.2 603806	BOS 23669 16,8 - WE / - WK
dCi 120	88	08/06→	←	09/06→ 06/10		13.0460-3800.2 603800	BOS 23613 17,7 - WE / - WK
dCi 150	107	08/06→	→	09/06→ 06/10		13.0460-3806.2 603806	BOS 23669 16,8 - WE / - WK
<b>Zubehörsatz, Scheibenbremsbelag</b>							
dCi 100	73	02/04→	←	→ 06/10		13.0460-0344.2 610344	
dCi 120	84	08/03→	←	→ 08/06		13.0460-0344.2 610344	
dCi 140	100	11/03→					
dCi 120	88	08/06→	←	09/06→ 06/10		13.0460-0344.2 610344	
dCi 150	107	08/06→					
<b>Bremsscheibe</b>							
dCi 100	73	02/04→	←	→ 06/10		24.0128-0129.1 428129	Ø 305,5 28 25 V + S
						24.0328-0129.1 528129	Ø 305,5 28 25 V + S
			→	→ 06/10		24.0112-0155.1 412155	Ø 305 12 10,5 + S
dCi 120	84	08/03→	←	→ 08/06		24.0128-0129.1 428129	Ø 305,5 28 25 V + S
dCi 140	100	11/03→	→	→ 08/06		24.0328-0129.1 528129	Ø 305,5 28 25 V + S
						24.0112-0155.1 412155	Ø 305 12 10,5 + S
dCi 120	88	08/06→	←	09/06→ 06/10		24.0128-0129.1 428129	Ø 305,5 28 25 V + S
dCi 150	107	08/06→	→	09/06→ 06/10		24.0328-0129.1 528129	Ø 305,5 28 25 V + S
						24.0112-0155.1 412155	Ø 305 12 10,5 + S
<b>NISSAN - JUKE (F15) 06/10→</b>							
 <b>Bremsbelagsatz, Scheibenbremse</b>							
1.2 DIG-T	85	05/14→	←			13.0460-5716.2 605716	21561 17,0 + WK
1.5 dCi	81	06/10→					
1.6	69	01/13→					
1.6	86	06/10→					
1.6 DIG-T	140	06/10→					
↓							















	kw				! #		
<b>NISSAN - JUKE (F15) 06/10→</b>							
 <b>Bremsbelagsatz, Scheibenbremse</b>							
1.6 DIG-T 4x4 1.6 DIG-T NISMO 1.6 DIG-T NISMO 4x4 1.6 LPG	140 147 147 85	06/10→ 03/13→07/14 02/13→07/14 01/12→	←			13.0460-5716.2 605716	21561 17,0 + WK
<b>Zubehörsatz, Scheibenbremsbelag</b>							
1.2 DIG-T 1.5 dCi 1.6 1.6 1.6 LPG	85 81 69 86 85	05/14→ 06/10→ 01/13→ 06/10→ 01/12→	←			13.0460-0170.2 610170	
 <b>Bremsscheibe</b>							
1.2 DIG-T 1.5 dCi 1.6 1.6	85 81 69 86	05/14→ 06/10→ 01/13→ 06/10→	← →			24.0124-0247.1 424247 24.0109-0157.1 409157	Ø 280 24 22 V Ø 291,5 9 8
1.6 DIG-T 1.6 DIG-T 4x4	140 140	06/10→ 06/10→	← →	Made in Großbritannien		24.0126-0177.1 426177 24.0109-0157.1 409157	Ø 296 26 24 V Ø 291,5 9 8
1.6 DIG-T NISMO	147	03/13→07/14	← →			24.0126-0177.1 426177 24.0109-0157.1 409157	Ø 296 26 24 V Ø 291,5 9 8
1.6 DIG-T NISMO 4x4	147	02/13→07/14	←			24.0126-0177.1 426177	Ø 296 26 24 V
1.6 DIG-T NISMO RS	160	08/14→	← →			24.0128-0242.1 428242 24.0109-0157.1 409157	Ø 320 28 26 V Ø 291,5 9 8
1.6 DIG-T NISMO RS 4x4	157	08/14→	←			24.0128-0242.1 428242	Ø 320 28 26 V
1.6 LPG	85	01/12→	←			24.0124-0247.1 424247	Ø 280 24 22 V
<b>NISSAN - KUBISTAR Kasten (X76) 08/03→</b>							
 <b>Bremsbelagsatz, Scheibenbremse</b>							
1.2 1.5 dCi 1.5 dCi 1.5 dCi	44 42 48 60	08/03→ 08/03→10/09 08/03→ 08/03→	←	→ 08/05		13.0460-3977.2 603977	BOS 21980 18,0 + WE / - WK
1.2 16V 1.6 16V	55 70	04/06→ 08/03→	←	→ 10/09		13.0460-3977.2 603977	BOS 21980 18,0 + WE / - WK
1.4 1.5 dCi 70 dCi 85	55 51 62	08/03→10/09 09/05→10/09 04/06→10/09	←			13.0460-3977.2 603977	BOS 21980 18,0 + WE / - WK
1.5 dCi	45	08/05→	←	09/05→ 10/09		13.0460-3977.2 603977	BOS 21980 18,0 + WE / - WK
 <b>Bremsscheibe</b>							
1.2 1.5 dCi 1.5 dCi 1.5 dCi	44 42 48 60	08/03→ 08/03→10/09 08/03→ 08/03→	←	→ 08/05; - ABS → 08/05; + ABS		24.0120-0125.1 420125 24.0121-0106.1 421106	Ø 238 20,1 17,7 V + S Ø 259 20,7 17,7 V + S
1.2 16V 1.6 16V	55 70	04/06→ 08/03→	←	→ 10/09; - ABS → 10/09; + ABS		24.0120-0125.1 420125 24.0121-0106.1 421106	Ø 238 20,1 17,7 V + S Ø 259 20,7 17,7 V + S
1.4 1.5 dCi 70 dCi 85	55 51 62	08/03→10/09 09/05→10/09 04/06→10/09	←	- ABS + ABS		24.0120-0125.1 420125 24.0121-0106.1 421106	Ø 238 20,1 17,7 V + S Ø 259 20,7 17,7 V + S
1.5 dCi	45	08/05→	←	09/05→ 10/09; - ABS 09/05→ 10/09; + ABS		24.0120-0125.1 420125 24.0121-0106.1 421106	Ø 238 20,1 17,7 V + S Ø 259 20,7 17,7 V + S
<b>NISSAN - LEAF (ZE0) 11/10→</b>							
 <b>Bremsbelagsatz, Scheibenbremse</b>							
Electric	80	11/10→	←			13.0460-5783.2 605783	TOK 24227 16,7 + WK
 <b>Bremsscheibe</b>							
Electric	80	11/10→	← →			24.0128-0268.1 428268 24.0116-0119.1 416119	Ø 283 28 26 V Ø 292 16 14 V
<b>NISSAN - LEAF (ZE1) 08/17→</b>							
 <b>Bremsscheibe</b>							
Electric	110	08/17→	←			24.0128-0268.1 428268	Ø 283 28 26 V

















	kw					! #		
<b>NISSAN - MAXIMA / MAXIMA QX V (A33) 04/99→11/03</b>								
 <b>Bremsbelagsatz, Scheibenbremse</b>								
2.0 V6 24V	103	03/00→11/03	←			13.0460-5880.2	605880	23184 14,8 + WK
2.5 V6 24V	154	03/00→11/03						
3.0 V6 24V	147	03/00→11/03	→			13.0460-5626.2	605626	AKE 21713 16,0 + WK
<b>Zubehörsatz, Scheibenbremsbelag</b>								
2.0 V6 24V	103	03/00→11/03	←			13.0460-0112.2	610112	
2.5 V6 24V	154	03/00→11/03						
3.0 V6 24V	147	03/00→11/03	→			13.0460-0295.2	610295	
 <b>Bremsscheibe</b>								
2.0 V6 24V	103	03/00→11/03	←			24.0128-0140.1	428140	Ø 280 28 26 V
2.5 V6 24V	154	03/00→11/03						
3.0 V6 24V	147	03/00→11/03						
<b>NISSAN - MICRA II (K11) 01/92→12/07</b>								
 <b>Bremsbelagsatz, Scheibenbremse</b>								
1.0 i 16V	40	08/92→09/00	←	→ 07/00		13.0460-5956.2	605956	AKE 21626 15,0 - WE / - WK
1.3 i 16V	55	08/92→09/00	→	→ 08/00; + ABS		13.0460-5989.2	605989	AKE 23454 14,9 - WE / - WK
1.0 i 16V	44	09/00→02/03	←	→ 12/02		13.0460-5956.2	605956	AKE 21626 15,0 - WE / - WK
1.4 i 16V	60	09/00→02/03	→	→ 12/02; + ABS		13.0460-5989.2	605989	AKE 23454 14,9 - WE / - WK
1.5 D	42	02/98→02/03	←	→ 12/02		13.0460-5956.2	605956	AKE 21626 15,0 - WE / - WK
<b>Zubehörsatz, Scheibenbremsbelag</b>								
1.0 i 16V	40	08/92→09/00	←	→ 07/00; - ABS		13.0460-0452.2	610452	AKE
1.3 i 16V	55	08/92→09/00	→	→ 08/00; + ABS		13.0460-0248.2	610248	AKE
1.0 i 16V	44	09/00→02/03	←	→ 12/02; - ABS		13.0460-0452.2	610452	AKE
1.4 i 16V	60	09/00→02/03	→	→ 12/02; + ABS		13.0460-0248.2	610248	AKE
1.5 D	42	02/98→02/03	←	→ 12/02; - ABS		13.0460-0452.2	610452	AKE
 <b>Bremsscheibe</b>								
1.0 i 16V	40	08/92→09/00	←	→ 07/00; - ABS		24.0112-0137.1	412137	Ø 234 12 10
1.3 i 16V	55	08/92→09/00	→	→ 08/00; + ABS		24.0107-0109.1	407109	Ø 240 7 6
1.0 i 16V	44	09/00→02/03	←	→ 12/02; - ABS		24.0112-0137.1	412137	Ø 234 12 10
1.4 i 16V	60	09/00→02/03	→	→ 12/02; + ABS		24.0118-0139.1	418139	Ø 238 18 16 V
			→	→ 12/02; + ABS		24.0107-0109.1	407109	Ø 240 7 6
1.5 D	42	02/98→02/03	←	→ 12/02; - ABS		24.0112-0137.1	412137	Ø 234 12 10
			←	08/00→ 12/02; + ABS		24.0118-0139.1	418139	Ø 238 18 16 V
<b>NISSAN - MICRA III (K12) 03/02→06/10</b>								
 <b>Bremsbelagsatz, Scheibenbremse</b>								
1.0 16V	48	01/03→06/10	←			13.0460-5801.2	605801	TRW 23973 17,1 - WE / - WK
1.2 16V	48	01/03→06/10						
1.2 16V	59	01/03→06/10						
1.2 LPG	59	10/02→06/10						
1.4 16V	65	01/03→06/10						
1.5 dCi	48	01/03→06/10						
1.5 dCi	50	06/05→06/10						
1.5 dCi	60	09/03→06/10						
1.5 dCi	63	06/05→06/10						
160 SR	81	05/05→06/10						
<b>Zubehörsatz, Scheibenbremsbelag</b>								
1.0 16V	48	01/03→06/10	←			13.0460-0291.2	610291	
1.2 16V	48	01/03→06/10						
1.2 16V	59	01/03→06/10						
1.2 LPG	59	10/02→06/10						
1.4 16V	65	01/03→06/10						
1.5 dCi	48	01/03→06/10						
1.5 dCi	50	06/05→06/10						
1.5 dCi	60	09/03→06/10						
1.5 dCi	63	06/05→06/10						
160 SR	81	05/05→06/10						
 <b>Bremsscheibe</b>								
1.0 16V	48	01/03→06/10	←			24.0122-0216.1	422216	Ø 260 22 19,8 V + S
1.2 16V	48	01/03→06/10						
1.2 16V	59	01/03→06/10						
1.2 LPG	59	10/02→06/10						













	kW			 	! #		
<b>NISSAN - MICRA III (K12) 03/02→06/10</b>							
 <b>Bremsscheibe</b>							
1.4 16V	65	01/03→06/10	←			24.0122-0216.1 422216	Ø 260 22 19,8 V + S
1.5 dCi	48	01/03→06/10					
1.5 dCi	50	06/05→06/10					
1.5 dCi	60	09/03→06/10					
1.5 dCi	63	06/05→06/10					
160 SR	81	05/05→06/10					
<b>NISSAN - MICRA IV (K13) 05/10→</b>							
 <b>Bremsbelagsatz, Scheibenbremse</b>							
1.2	56	05/10→	←	→ 09/15		13.0460-2774.2 602774	TRW 23973 17,4 + WK
1.2	58	05/10→					
1.2	59	05/10→	←			13.0460-2774.2 602774	TRW 23973 17,4 + WK
1.2 DIG-S	72	04/11→					
 <b>Bremsscheibe</b>							
1.2	56	05/10→	←	→ 09/15		24.0122-0277.1 422277	Ø 260 22 20 V
1.2	58	05/10→					
1.2	59	05/10→	←			24.0122-0277.1 422277	Ø 260 22 20 V
1.2 DIG-S	72	04/11→					
<b>NISSAN - MICRA V (K14) 12/16→</b>							
 <b>Bremsscheibe</b>							
0.9 IG-T	66	12/16→	←	03/17→		24.0122-0216.1 422216	Ø 260 22 19,8 V + S
1.0	54	12/16→					
1.5 DCI	66	12/16→					
1.0	52	12/16→	←			24.0122-0216.1 422216	Ø 260 22 19,8 V + S
<b>NISSAN - MICRA C+C III (K12) 08/05→</b>							
 <b>Bremsbelagsatz, Scheibenbremse</b>							
1.4 16V	65	08/05→	←	→ 12/10		13.0460-5801.2 605801	TRW 23973 17,1 - WE / - WK
1.6 160 SR	81	08/05→					
<b>Zubehörsatz, Scheibenbremsbelag</b>							
1.4 16V	65	08/05→	←	→ 12/10		13.0460-0291.2 610291	
1.6 160 SR	81	08/05→					
 <b>Bremsscheibe</b>							
1.4 16V	65	08/05→	←	→ 12/10		24.0122-0216.1 422216	Ø 260 22 19,8 V + S
1.6 160 SR	81	08/05→					
<b>NISSAN - MURANO I (Z50) 08/03→09/08</b>							
 <b>Bremsbelagsatz, Scheibenbremse</b>							
3.5 4x4	170	01/06→09/08	←	→ 06/08		13.0460-5778.2 605778	SUM 23698 16,8 + WK
3.5 4x4	172	08/03→09/08	←	→ 06/08		13.0460-5778.2 605778	SUM 23698 16,8 + WK
			→	→ 07/05		13.0460-5843.2 605843	AKE 23871 14,3 + WK
<b>Zubehörsatz, Scheibenbremsbelag</b>							
3.5 4x4	170	01/06→09/08	←	→ 06/08		13.0460-0017.2 610017	
3.5 4x4	172	08/03→09/08	←	→ 06/08		13.0460-0017.2 610017	
			→	→ 07/05		13.0460-0341.2 610341	
 <b>Bremsscheibe</b>							
3.5 4x4	170	01/06→09/08	←	→ 06/08		24.0128-0153.1 428153	Ø 320 28 26 V
3.5 4x4	172	08/03→09/08	→	→ 06/08		24.0116-0122.1 416122	Ø 308 16 14 V
<b>NISSAN - MURANO II (Z51) 10/07→09/14</b>							
 <b>Bremsbelagsatz, Scheibenbremse</b>							
2.5 dCi 4x4	140	01/10→09/14	←			13.0460-5778.2 605778	SUM 23698 16,8 + WK
3.5 4x4	183	12/10→09/14					
3.5 4x4	188	10/08→09/14					
3.5 4x4	191	12/09→09/14	←	01/11→		13.0460-5778.2 605778	SUM 23698 16,8 + WK
 <b>Bremsscheibe</b>							
2.5 dCi 4x4	140	01/10→09/14	←			24.0128-0153.1 428153	Ø 320 28 26 V
3.5 4x4	183	12/10→09/14					
3.5 4x4	188	10/08→09/14	→			24.0116-0122.1 416122	Ø 308 16 14 V
3.5 4x4	191	12/09→09/14	←	01/11→		24.0128-0153.1 428153	Ø 320 28 26 V
			→	01/11→		24.0116-0122.1 416122	Ø 308 16 14 V













	kw			 	! #		
<b>NISSAN - NAVARA (D21) 11/85→03/08</b>							
 <b>Bremsbelagsatz, Scheibenbremse</b>							
2.5 D 4x4	59	01/86→03/08	←	→ 02/98		13.0460-5937.2 605937	AKE 21119 17,0 + WK
<b>Zubehörsatz, Scheibenbremsbelag</b>							
2.5 D 4x4	59	01/86→03/08	←	→ 02/98		13.0460-0322.2 610322	AKE
 <b>Bremsscheibe</b>							
2.5 D 4x4	59	01/86→03/08	←	→ 02/98		24.0122-0180.1 422180	Ø 267 22 20 V
<b>NISSAN - NAVARA (D22_) 01/97→</b>							
 <b>Bremsbelagsatz, Scheibenbremse</b>							
2.5 D 4x4	98	11/01→	←	→ 04/05		13.0460-5632.2 605632	23970 16,8 + WK
3.2 D 4x4	76	01/98→10/01	←	10/98→		13.0460-5957.2 605957	AKE 21347 17,0 + WK
3.3 4x4	125	11/01→04/07	←			13.0460-5632.2 605632	23970 16,8 + WK
<b>Zubehörsatz, Scheibenbremsbelag</b>							
3.2 D 4x4	76	01/98→10/01	←	10/98→		13.0460-0289.2 610289	
 <b>Bremsscheibe</b>							
2.5 D 4x4	98	11/01→	←	→ 04/05		24.0128-0166.1 428166	Ø 300 28 26 V
3.3 4x4	125	11/01→04/07	←			24.0128-0166.1 428166	Ø 300 28 26 V
<b>NISSAN - NAVARA Pritsche/Fahrgestell (D22) 03/97→</b>							
 <b>Bremsbelagsatz, Scheibenbremse</b>							
2.5 Di	98	02/02→	←	→ 04/05		13.0460-5957.2 605957	AKE 21347 17,0 + WK
2.5 Di 4WD	98	02/02→	←	→ 04/05		13.0460-5632.2 605632	23970 16,8 + WK
<b>Zubehörsatz, Scheibenbremsbelag</b>							
2.5 Di	98	02/02→	←	→ 04/05		13.0460-0289.2 610289	
 <b>Bremsscheibe</b>							
2.5 Di 4WD	98	02/02→	←	→ 04/05		24.0128-0166.1 428166	Ø 300 28 26 V
<b>NISSAN - NOTE (E11, NE11) 01/05→06/12</b>							
 <b>Bremsbelagsatz, Scheibenbremse</b>							
1.4	65	03/06→06/12	←			13.0460-2709.2 602709	TRW 23973 17,1 - WE / - WK + Zub
1.5 dCi	50	03/06→06/12				13.0470-2709.2 LD2709	TRW 23973 17,1 - WE / - WK + Zub Ceramic
1.5 dCi	63	03/06→06/12					
1.5 dCi	66	09/10→06/12					
1.5 dCi	76	07/08→06/12					
1.6	81	03/06→06/12					
 <b>Bremsscheibe</b>							
1.4	65	03/06→06/12	←			24.0122-0216.1 422216	Ø 260 22 19,8 V + S
1.5 dCi	50	03/06→06/12					
1.5 dCi	63	03/06→06/12					
1.5 dCi	66	09/10→06/12					
1.5 dCi	76	07/08→06/12					
1.6	81	03/06→06/12					
<b>NISSAN - NOTE (E12) 09/12→</b>							
 <b>Bremsbelagsatz, Scheibenbremse</b>							
1.2	58	06/13→	←			13.0460-2774.2 602774	TRW 23973 17,4 + WK
1.2	59	06/13→					
1.2 DIG-S	72	06/13→					
1.2 LPG	56	03/15→					
1.5 dCi	66	06/13→					
 <b>Bremsscheibe</b>							
1.2	58	06/13→	←			24.0122-0277.1 422277	Ø 260 22 20 V
1.2	59	06/13→					
1.2 DIG-S	72	06/13→					
1.2 LPG	56	03/15→					
1.5 dCi	66	06/13→					

















	kw					! #		
<b>NISSAN - NP300 NAVARA (D40) 10/04→</b>								
 <b>Bremsbelagsatz, Scheibenbremse</b>								
2.5 dCi	106	07/05→	←	17"		13.0460-5778.2	605778	SUM 23698 16,8 + WK
2.5 dCi	120	10/06→						
2.5 dCi	128	12/05→	←	16"		13.0460-5783.2	605783	TOK 24227 16,7 + WK
2.5 dCi 4WD	106	10/08→						
2.5 dCi 4WD	126	10/06→						
2.5 dCi 4WD	128	07/05→						
2.5 dCi 4WD (D40TT, D40T, D40M, D40BB)	140	12/09→						
3.0 dCi 4WD	170	02/10→	←			13.0460-5778.2	605778	SUM 23698 16,8 + WK
<b>Zubehörsatz, Scheibenbremsbelag</b>								
2.5 dCi	106	07/05→	←	16"		13.0460-0017.2	610017	
2.5 dCi	120	10/06→						
2.5 dCi	128	12/05→						
2.5 dCi 4WD	106	10/08→						
2.5 dCi 4WD	126	10/06→						
2.5 dCi 4WD	128	07/05→						
2.5 dCi 4WD (D40TT, D40T, D40M, D40BB)	140	12/09→						
 <b>Bremsscheibe</b>								
2.5 dCi	106	07/05→	←	passend für Felgengröße [Zoll]: 17		24.0128-0240.1	428240	Ø 320 28 26 V
2.5 dCi	120	10/06→						
2.5 dCi	128	12/05→	←	16"		24.0128-0241.1	428241	Ø 296 28 26 V
2.5 dCi 4WD	106	10/08→						
2.5 dCi 4WD	126	10/06→						
2.5 dCi 4WD	128	07/05→						
2.5 dCi 4WD (D40TT, D40T, D40M, D40BB)	140	12/09→						
3.0 dCi 4WD	170	02/10→	←			24.0128-0240.1	428240	Ø 320 28 26 V
<b>NISSAN - NP300 NAVARA Pritsche/Fahrgestell (D40) 08/08→</b>								
 <b>Bremsbelagsatz, Scheibenbremse</b>								
2.5 dCi	140	03/10→	←	17"		13.0460-5778.2	605778	SUM 23698 16,8 + WK
2.5 dCi 4WD	126	08/08→	←	16"		13.0460-5783.2	605783	TOK 24227 16,7 + WK
2.5 dCi 4WD	106	08/08→	←	10/08→; 17"		13.0460-5778.2	605778	SUM 23698 16,8 + WK
			←	10/08→; 16"		13.0460-5783.2	605783	TOK 24227 16,7 + WK
3.0 dCi	170	03/10→	←			13.0460-5778.2	605778	SUM 23698 16,8 + WK
<b>Zubehörsatz, Scheibenbremsbelag</b>								
2.5 dCi	140	03/10→	←	16"		13.0460-0017.2	610017	
2.5 dCi 4WD	126	08/08→						
2.5 dCi 4WD	106	08/08→	←	10/08→; 16"		13.0460-0017.2	610017	
 <b>Bremsscheibe</b>								
2.5 dCi	140	03/10→	←	passend für Felgengröße [Zoll]: 17		24.0128-0240.1	428240	Ø 320 28 26 V
2.5 dCi 4WD	126	08/08→	←	16"		24.0128-0241.1	428241	Ø 296 28 26 V
2.5 dCi 4WD	106	08/08→	←	10/08→; passend für Felgengröße [Zoll]: 17		24.0128-0240.1	428240	Ø 320 28 26 V
			←	10/08→; 16"		24.0128-0241.1	428241	Ø 296 28 26 V
3.0 dCi	170	03/10→	←			24.0128-0240.1	428240	Ø 320 28 26 V
<b>NISSAN - NP300 PICKUP (D22) 04/08→</b>								
 <b>Bremsbelagsatz, Scheibenbremse</b>								
2.5 dCi	98	04/08→	←			13.0460-5783.2	605783	TOK 24227 16,7 + WK
2.5 dCi 4x4	98	04/08→						
 <b>Bremsscheibe</b>								
2.5 dCi	98	04/08→	←			24.0128-0241.1	428241	Ø 296 28 26 V
2.5 dCi 4x4	98	04/08→						
<b>NISSAN - NT400 CABSTAR (F24F) 08/09→</b>								
 <b>Bremsbelagsatz, Scheibenbremse</b>								
28.12, 32.12, 35.12 (F91AN)	90	01/14→	←	02/14→		13.0460-4866.2	604866	BRE 29229 20,7 + WK
			→	02/14→		13.0460-4859.2	604859	BRE 23921 20,1 + WK + Zub
35.13	96	09/16→	←			13.0460-4866.2	604866	BRE 29229 20,7 + WK
			→			13.0460-4859.2	604859	BRE 23921 20,1 + WK + Zub
↓								















	kw					! #		
<b>NISSAN - NT400 CABSTAR (F24F) 08/09→</b>								
 <b>Bremsbelagsatz, Scheibenbremse</b>								
35.14, 45.14	100	01/14→	←	02/14→		13.0460-4865.2	604865	BRE 29160 20,3 + WK + Zub
			←	02/14→; zul. Gesamtgewicht [kg]: 3.500		13.0460-4866.2	604866	BRE 29229 20,7 + WK
			→	02/14→; zul. Gesamtgewicht [kg]: 3.500		13.0460-4859.2	604859	BRE 23921 20,1 + WK + Zub
			→	02/14→; zul. Gesamtgewicht [kg]: 4.500		13.0460-4861.2	604861	BRE 29121 20,3 + WK + Zub
35.15, 45.15	107	01/14→	←	02/14→; zul. Gesamtgewicht [kg]: 4.500		13.0460-4865.2	604865	BRE 29160 20,3 + WK + Zub
			←	02/14→; zul. Gesamtgewicht [kg]: 3.500		13.0460-4866.2	604866	BRE 29229 20,7 + WK
			→	02/14→; zul. Gesamtgewicht [kg]: 3.500		13.0460-4859.2	604859	BRE 23921 20,1 + WK + Zub
			→	02/14→; zul. Gesamtgewicht [kg]: 4.500		13.0460-4861.2	604861	BRE 29121 20,3 + WK + Zub
 <b>Bremsscheibe</b>								
28.12, 32.12, 35.12 (F91AN)	90	01/14→	←	02/14→		24.0128-0244.1	428244	Ø 276 28 26 V
			→	02/14→; Brems-/Fahrdyn. Artikelbezug: + ABS		24.0116-0131.1	416131	Ø 280 16 13 + ABS Ring
			→	02/14→; Brems-/Fahrdyn. Artikelbezug: - ABS		24.0116-0132.1	416132	Ø 280 16 13
35.13	96	09/16→	→			24.0116-0131.1	416131	Ø 280 16 13 + ABS Ring
35.14, 45.14	100	01/14→	←	02/14→; zul. Gesamtgewicht [kg]: 4.500		24.0126-0163.1	426163	Ø 290 26 23 V
			←	02/14→; zul. Gesamtgewicht [kg]: 3.500		24.0128-0244.1	428244	Ø 276 28 26 V
			→	02/14→; zul. Gesamtgewicht [kg]: 3.500; Brems-/Fahrdyn. Artikelbezug: + ABS		24.0116-0131.1	416131	Ø 280 16 13 + ABS Ring
			→	02/14→; zul. Gesamtgewicht [kg]: 3.500; Brems-/Fahrdyn. Artikelbezug: - ABS		24.0116-0132.1	416132	Ø 280 16 13
			→	02/14→; zul. Gesamtgewicht [kg]: 4.500		24.0122-0264.1	422264	Ø 290 22 19 V
35.15, 45.15	107	01/14→	←	02/14→; zul. Gesamtgewicht [kg]: 4.500		24.0126-0163.1	426163	Ø 290 26 23 V
			←	02/14→; zul. Gesamtgewicht [kg]: 3.500		24.0128-0244.1	428244	Ø 276 28 26 V
			→	02/14→; Brems-/Fahrdyn. Artikelbezug: + ABS		24.0116-0131.1	416131	Ø 280 16 13 + ABS Ring
			→	02/14→; Brems-/Fahrdyn. Artikelbezug: - ABS		24.0116-0132.1	416132	Ø 280 16 13
			→	02/14→; zul. Gesamtgewicht [kg]: 4.500		24.0122-0264.1	422264	Ø 290 22 19 V
<b>NISSAN - NV200 Kasten/Kombi 02/10→</b>								
 <b>Bremsbelagsatz, Scheibenbremse</b>								
e-NV (ME0)	80	05/14→	←			13.0460-5783.2	605783	TOK 24227 16,7 + WK
 <b>Bremsscheibe</b>								
1.5 dci (M20, M20M)	63	02/10→	←			24.0126-0175.1	426175	Ø 257 26 24 V
1.5 dci (M20, M20M)	66	04/11→						
1.5 dci (M20, M20M)	81	04/11→						
1.6 16V (M20, M20M)	81	02/10→						
e-NV (ME0)	80	05/14→	←			24.0128-0268.1	428268	Ø 283 28 26 V
			→			24.0109-0157.1	409157	Ø 291,5 9 8
<b>NISSAN - NV300 Kasten (X82) 09/16→</b>								
 <b>Bremsscheibe</b>								
1.6 dci 120	89	09/16→	←			24.0128-0287.1	428287	Ø 296 28 23,4 V + S
1.6 dci 125	92	09/16→						
1.6 dci 145	107	09/16→						
1.6 dci 95	70	09/16→						
<b>NISSAN - NV300 Kombi (X82) 09/16→</b>								
 <b>Bremsscheibe</b>								
1.6 dCi 125	92	09/16→	←			24.0128-0287.1	428287	Ø 296 28 23,4 V + S
1.6 dCi 145	107	09/16→						
1.6 dci 95	70	09/16→						
<b>NISSAN - NV300 Pritsche/Fahrgestell (X82) 09/16→</b>								
 <b>Bremsscheibe</b>								
1.6 dci 125	92	09/16→	←			24.0128-0287.1	428287	Ø 296 28 23,4 V + S
1.6 dci 145	107	09/16→						
<b>NISSAN - NV400 Bus (X62, X62B) 11/11→</b>								
 <b>Bremsbelagsatz, Scheibenbremse</b>								
dCi 100	74	11/11→06/14	→			13.0460-4858.2	604858	BRE 25112 18,4 + WK

















	kw					! #		
<b>NISSAN - NV400 Bus (X62, X62B) 11/11→</b>								
 <b>Bremsbelagsatz, Scheibenbremse</b>								
dCi 110	81	06/14→09/16	➔				13.0460-4858.2 604858	BRE 25112 18,4 + WK
dCi 125	92	11/11→09/16						
dCi 140	100	06/14→09/16						
dCi 145	107	11/11→02/14						
dCi 150	110	02/14→09/16						
dCi 160	120	06/14→09/16						
dCi 170	125	07/15→						
 <b>Bremsscheibe</b>								
dCi 100	74	11/11→06/14	➔				24.0128-0252.1 428252	Ø 302 28 24,5 V + S
dCi 110	81	06/14→09/16						
dCi 125	92	11/11→09/16	➔				24.0112-0191.1 412191	Ø 305 12 10 + S
dCi 140	100	06/14→09/16						
dCi 145	107	11/11→02/14						
dCi 150	110	02/14→09/16						
dCi 160	120	06/14→09/16						
dCi 170	125	07/15→						
<b>NISSAN - NV400 Kasten (X62, X62B) 11/11→</b>								
 <b>Bremsbelagsatz, Scheibenbremse</b>								
2.3 dCi 150	110	02/14→09/16	➔				13.0460-4858.2 604858	BRE 25112 18,4 + WK
2.3 dCi 165	120	06/14→09/16						
dCi 100	74	11/11→05/14						
dCi 110	81	06/14→						
dCi 125	92	11/11→09/16						
dCi 140	100	06/14→09/16						
dCi 145	107	11/11→02/14						
dCi 170	125	09/16→						
dCi 130	96	09/16→	➔	für Einfachbereifung			13.0460-4858.2 604858	BRE 25112 18,4 + WK
dCi 130 RWD	96	09/16→						
 <b>Bremsscheibe</b>								
2.3 dCi 145 RWD	107	11/11→02/14	➔				24.0128-0252.1 428252	Ø 302 28 24,5 V + S
dCi 125 RWD	92	11/11→09/16						
dCi 140 RWD	100	06/14→09/16	➔	mit Einfachbereifung			24.0112-0190.1 412190	Ø 305 12 10 + S
dCi 150 RWD	110	02/14→09/16	➔					
dCi 165 RWD	120	06/14→09/16	➔	mit Doppelbereifung			24.0118-0153.1 418153	Ø 302 18 15
2.3 dCi 150	110	02/14→09/16	➔				24.0128-0252.1 428252	Ø 302 28 24,5 V + S
2.3 dCi 165	120	06/14→09/16						
dCi 100	74	11/11→05/14	➔				24.0112-0191.1 412191	Ø 305 12 10 + S
dCi 110	81	06/14→						
dCi 125	92	11/11→09/16						
dCi 140	100	06/14→09/16						
dCi 145	107	11/11→02/14						
dCi 170	125	09/16→						
dCi 130	96	09/16→	➔				24.0128-0252.1 428252	Ø 302 28 24,5 V + S
			➔	für Einfachbereifung			24.0112-0191.1 412191	Ø 305 12 10 + S
			➔	für Doppelbereifung			24.0118-0153.1 418153	Ø 302 18 15
dCi 130 RWD	96	09/16→	➔				24.0128-0252.1 428252	Ø 302 28 24,5 V + S
			➔	für Einfachbereifung			24.0112-0190.1 412190	Ø 305 12 10 + S
			➔	für Doppelbereifung			24.0118-0153.1 418153	Ø 302 18 15
<b>NISSAN - NV400 Pritsche/Fahrgestell (X62, X62B) 11/11→</b>								
 <b>Bremsbelagsatz, Scheibenbremse</b>								
dCi 100	74	11/11→06/14	➔				13.0460-4858.2 604858	BRE 25112 18,4 + WK
dCi 110	81	06/14→06/16						
dCi 125	92	11/11→06/16						
dCi 125 RWD	92	11/11→06/16						
dCi 130	96	06/16→						
dCi 140	100	06/14→06/16						
dCi 140 RWD	100	06/14→06/16						
dCi 145	107	11/11→06/16						
dCi 145 RWD	107	11/11→06/16						
dCi 150	110	08/14→06/16						
dCi 150 RWD	110	08/14→06/16						
dCi 165	120	06/14→06/16						
dCi 165 RWD	120	06/14→						
dCi 170	125	06/16→						
dCi 130 RWD	96	06/16→	➔	für Einfachbereifung			13.0460-4858.2 604858	BRE 25112 18,4 + WK
 <b>Bremsscheibe</b>								
dCi 100	74	11/11→06/14	➔				24.0128-0252.1 428252	Ø 302 28 24,5 V + S
dCi 110	81	06/14→06/16						
dCi 125	92	11/11→06/16	➔				24.0112-0191.1 412191	Ø 305 12 10 + S
dCi 130	96	06/16→						

	kw				! #		
<b>NISSAN - NV400 Pritsche/Fahrgestell (X62, X62B) 11/11→</b>							
 <b>Bremsscheibe</b>							
dCi 140	100	06/14→06/16	←			24.0128-0252.1 428252	Ø 302 28 24,5 V + S
dCi 145	107	11/11→06/16					
dCi 150	110	08/14→06/16	→			24.0112-0191.1 412191	Ø 305 12 10 + S
dCi 165	120	06/14→06/16					
dCi 170	125	06/16→					
dCi 125 RWD	92	11/11→06/16	←			24.0128-0252.1 428252	Ø 302 28 24,5 V + S
dCi 140 RWD	100	06/14→06/16					
dCi 145 RWD	107	11/11→06/16	→	mit Einfachbereifung		24.0112-0190.1 412190	Ø 305 12 10 + S
dCi 150 RWD	110	08/14→06/16	→	mit Doppelbereifung		24.0118-0153.1 418153	Ø 302 18 15
dCi 165 RWD	120	06/14→					
dCi 130 RWD	96	06/16→	←			24.0128-0252.1 428252	Ø 302 28 24,5 V + S
			→	für Einfachbereifung		24.0112-0190.1 412190	Ø 305 12 10 + S
			→	für Doppelbereifung		24.0118-0153.1 418153	Ø 302 18 15
<b>NISSAN - PATHFINDER II (R50) 09/95→07/05</b>							
 <b>Bremsscheibe</b>							
2.7 TD 4WD	96	09/97→12/04	←	03/98→ 10/00		24.0128-0166.1 428166	Ø 300 28 26 V
3.2 TD 4WD	110	09/97→12/04					
3.3 V6 4WD	110	03/98→10/00	←			24.0128-0166.1 428166	Ø 300 28 26 V
3.3 V6 4WD	125	09/97→12/04					
3.5 V6 4WD	162	11/00→12/04					
<b>NISSAN - PATHFINDER III (R51) 01/05→</b>							
 <b>Bremsbelagsatz, Scheibenbremse</b>							
2.5 dCi	128	01/05→	←	17"		13.0460-5778.2 605778	SUM 23698 16,8 + WK
2.5 dCi 4WD	120	01/05→					
2.5 dCi 4WD	126	10/06→	←	16"		13.0460-5783.2 605783	TOK 24227 16,7 + WK
2.5 dCi 4WD	128	03/05→	→			13.0460-5784.2 605784	24240 16,6 + WK
2.5 dCi 4WD	140	08/10→					
3.0 dCi	170	08/10→	←	17"		13.0460-5778.2 605778	SUM 23698 16,8 + WK
4.0 4WD	198	09/05→	→			13.0460-5784.2 605784	24240 16,6 + WK
<b>Zubehörsatz, Scheibenbremsbelag</b>							
2.5 dCi	128	01/05→	←	16"		13.0460-0017.2 610017	
2.5 dCi 4WD	120	01/05→					
2.5 dCi 4WD	126	10/06→					
2.5 dCi 4WD	128	03/05→					
2.5 dCi 4WD	140	08/10→					
 <b>Bremsscheibe</b>							
2.5 dCi	128	01/05→	←	17"		24.0128-0240.1 428240	Ø 320 28 26 V
2.5 dCi 4WD	120	01/05→					
2.5 dCi 4WD	126	10/06→	←	16"		24.0128-0241.1 428241	Ø 296 28 26 V
2.5 dCi 4WD	128	03/05→	→			24.0118-0724.1 418724	Ø 308 18 16 V
2.5 dCi 4WD	140	08/10→					
3.0 dCi	170	08/10→	←			24.0128-0240.1 428240	Ø 320 28 26 V
			→			24.0118-0724.1 418724	Ø 308 18 16 V
4.0 4WD	198	09/05→	←	17"		24.0128-0240.1 428240	Ø 320 28 26 V
			→			24.0118-0724.1 418724	Ø 308 18 16 V
<b>NISSAN - PATROL GR IV (Y60, GR) 08/87→02/98</b>							
 <b>Bremsbelagsatz, Scheibenbremse</b>							
2.8 TD (Y60A)	85	09/88→06/97	←			13.0460-5960.2 605960	SUM 20863 16,5 - WE / - WK
4.2 Cat	121	11/88→02/98	←	10/91→ 06/97		13.0460-5960.2 605960	SUM 20863 16,5 - WE / - WK
<b>Zubehörsatz, Scheibenbremsbelag</b>							
2.8 TD (Y60A)	85	09/88→06/97	←			13.0460-0448.2 610448	SUM
4.2 Cat	121	11/88→02/98	←	10/91→ 06/97		13.0460-0448.2 610448	SUM
 <b>Bremsscheibe</b>							
2.8 TD (Y60A)	85	09/88→06/97	←			24.0120-0119.1 420119	Ø 295 20 18 V
			→	10/91→		24.0118-0136.1 418136	Ø 316 18 16 V
4.2 Cat	121	11/88→02/98	←	10/91→ 06/97		24.0120-0119.1 420119	Ø 295 20 18 V
			→	10/91→ 06/97		24.0118-0136.1 418136	Ø 316 18 16 V











	kw					! #		
<b>NISSAN - PATROL GR V Pritsche/Fahrgestell (Y61) 05/98→</b>								
 <b>Bremsbelagsatz, Scheibenbremse</b>								
3.0 D 4x4 (TY61)	118	09/07→	←	→ 03/10		13.0460-5879.2	605879	AKE 23611 18,8 + WK
			→	→ 03/10		13.0460-5751.2	605751	23502 16,0 + WK
 <b>Bremsscheibe</b>								
3.0 D 4x4 (TY61)	118	09/07→	→	→ 03/10		24.0118-0136.1	418136	Ø 316 18 16 V
<b>NISSAN - PATROL GR V Wagon (Y61) 06/97→</b>								
 <b>Bremsbelagsatz, Scheibenbremse</b>								
2.7 TD	73	05/98→06/01	←			13.0460-5960.2	605960	SUM 20863 16,5 - WE / - WK
2.8 TD	95	06/97→05/00	←	→ 04/00		13.0460-5879.2	605879	AKE 23611 18,8 + WK
			→	→ 04/00		13.0460-5751.2	605751	23502 16,0 + WK
2.8 TDiC (Y61)	96	10/97→02/00	←			13.0460-5879.2	605879	AKE 23611 18,8 + WK
			→			13.0460-5751.2	605751	23502 16,0 + WK
3.0 DTi	116	05/00→	←	→ 08/04		13.0460-5879.2	605879	AKE 23611 18,8 + WK
			→	→ 08/04		13.0460-5751.2	605751	23502 16,0 + WK
3.0 DTi	118	05/00→	←	→ 03/10		13.0460-5879.2	605879	AKE 23611 18,8 + WK
			→	→ 03/10		13.0460-5751.2	605751	23502 16,0 + WK
3.2 D	70	05/98→06/01	←	→ 04/01		13.0460-5960.2	605960	SUM 20863 16,5 - WE / - WK
4.8	180	03/00→	←	05/00→ 03/10		13.0460-5879.2	605879	AKE 23611 18,8 + WK
<b>Zubehörsatz, Scheibenbremsbelag</b>								
4.8	180	03/00→	←	05/00→ 03/10		13.0460-0117.2	610117	
			→	05/00→ 03/10		13.0460-0203.2	610203	
 <b>Bremsscheibe</b>								
2.7 TD	73	05/98→06/01	←			24.0120-0119.1	420119	Ø 295 20 18 V
2.8 TD	95	06/97→05/00	→	→ 04/00		24.0118-0136.1	418136	Ø 316 18 16 V
2.8 TDiC (Y61)	96	10/97→02/00	→			24.0118-0136.1	418136	Ø 316 18 16 V
3.0 DTi	116	05/00→	→	→ 08/04		24.0118-0136.1	418136	Ø 316 18 16 V
3.0 DTi	118	05/00→	→	→ 03/10		24.0118-0136.1	418136	Ø 316 18 16 V
3.2 D	70	05/98→06/01	←	→ 04/01		24.0120-0119.1	420119	Ø 295 20 18 V
<b>NISSAN - PATROL III/2 Hardtop (K260) 10/84→04/98</b>								
 <b>Bremsbelagsatz, Scheibenbremse</b>								
2.8 D	66	03/89→03/96	←	04/89→ 11/95		13.0460-5960.2	605960	SUM 20863 16,5 - WE / - WK
2.8 D	76	03/89→04/98						
<b>Zubehörsatz, Scheibenbremsbelag</b>								
2.8 D	66	03/89→03/96	←	04/89→ 11/95		13.0460-0448.2	610448	SUM
2.8 D	76	03/89→04/98						
 <b>Bremsscheibe</b>								
2.8 D	66	03/89→03/96	←	04/89→ 11/95		24.0120-0119.1	420119	Ø 295 20 18 V
2.8 D	76	03/89→04/98						
<b>NISSAN - PATROL III/2 Station Wagon (W260) 08/88→04/98</b>								
 <b>Bremsbelagsatz, Scheibenbremse</b>								
2.8 D 4x4	66	03/89→03/96	←	04/89→ 11/95		13.0460-5960.2	605960	SUM 20863 16,5 - WE / - WK
2.8 D 4x4	76	03/89→04/98						
<b>Zubehörsatz, Scheibenbremsbelag</b>								
2.8 D 4x4	66	03/89→03/96	←	04/89→ 11/95		13.0460-0448.2	610448	SUM
2.8 D 4x4	76	03/89→04/98						
 <b>Bremsscheibe</b>								
2.8 D 4x4	66	03/89→03/96	←	04/89→ 11/95		24.0120-0119.1	420119	Ø 295 20 18 V
2.8 D 4x4	76	03/89→04/98						
<b>NISSAN - PICK UP (D21) 09/85→12/08</b>								
 <b>Bremsbelagsatz, Scheibenbremse</b>								
2.4 i 12V 4WD	93	04/92→02/98	←			13.0460-5937.2	605937	AKE 21119 17,0 + WK
2.5 D	55	09/87→02/98						
2.5 D	59	09/94→08/96						
↓								

	kw			 	! #		
<b>NISSAN - PICK UP (D21) 09/85→12/08</b>							
 <b>Bremsbelagsatz, Scheibenbremse</b>							
2.5 D	61	08/92→02/98	←			13.0460-5937.2 605937	AKE 21119 17,0 + WK
2.5 D 4WD	59	08/87→02/98					
2.5 D 4WD	61	03/96→02/98					
<b>Zubehörsatz, Scheibenbremsbelag</b>							
2.4 i 12V 4WD	93	04/92→02/98	←			13.0460-0322.2 610322	AKE
2.5 D	55	09/87→02/98					
2.5 D	59	09/94→08/96					
2.5 D	61	08/92→02/98					
2.5 D 4WD	59	08/87→02/98					
2.5 D 4WD	61	03/96→02/98					
 <b>Bremsscheibe</b>							
2.4 i 12V 4WD	93	04/92→02/98	←			24.0122-0180.1 422180	Ø 267 22 20 V
2.5 D 4WD	59	08/87→02/98					
2.5 D 4WD	61	03/96→02/98					
<b>NISSAN - PICK UP (D22) 01/97→</b>							
 <b>Bremsbelagsatz, Scheibenbremse</b>							
2.4	110	01/03→04/05	←			13.0460-5957.2 605957	AKE 21347 17,0 + WK
2.4 4WD	110	11/01→04/05	←			13.0460-5632.2 605632	23970 16,8 + WK
2.4 i 4WD	98	03/02→04/05					
2.4 i	88	02/98→04/05	←	→ 10/01		13.0460-5957.2 605957	AKE 21347 17,0 + WK
2.4 i 4WD	88	02/98→04/05					
2.5 D	61	02/98→04/05					
2.5 TD 4WD	76	05/98→04/05					
2.5 D 4WD	61	02/98→04/05	←	05/98→ 10/01		13.0460-5957.2 605957	AKE 21347 17,0 + WK
2.5 D 4WD	96	01/97→04/05	←	11/01→		13.0460-5632.2 605632	23970 16,8 + WK
2.5 dCi 4WD	98	03/02→	←	→ 05/12		13.0460-5632.2 605632	23970 16,8 + WK
2.5 Di	98	03/02→12/10	←	→ 04/05		13.0460-5957.2 605957	AKE 21347 17,0 + WK
3.2 D 4WD	76	12/98→04/05	←	11/01→		13.0460-5632.2 605632	23970 16,8 + WK
			←	→ 10/01		13.0460-5957.2 605957	AKE 21347 17,0 + WK
<b>Zubehörsatz, Scheibenbremsbelag</b>							
2.4	110	01/03→04/05	←			13.0460-0289.2 610289	
2.4 i	88	02/98→04/05	←	→ 10/01		13.0460-0289.2 610289	
2.4 i 4WD	88	02/98→04/05					
2.5 D	61	02/98→04/05					
2.5 TD 4WD	76	05/98→04/05					
3.2 D 4WD	76	12/98→04/05					
2.5 D 4WD	61	02/98→04/05	←	05/98→ 10/01		13.0460-0289.2 610289	
2.5 Di	98	03/02→12/10	←	→ 04/05		13.0460-0289.2 610289	
 <b>Bremsscheibe</b>							
2.4 4WD	110	11/01→04/05	←			24.0128-0166.1 428166	Ø 300 28 26 V
2.4 i 4WD	98	03/02→04/05					
2.5 dCi 4WD	98	03/02→					
2.4 i 4WD	88	02/98→04/05	←	→ 03/01		24.0126-0109.1 426109	Ø 277 26 24 V
2.5 TD 4WD	76	05/98→04/05					
2.5 D 4WD	61	02/98→04/05	←	05/98→ 03/01		24.0126-0109.1 426109	Ø 277 26 24 V
2.5 D 4WD	96	01/97→04/05	←	11/01→		24.0128-0166.1 428166	Ø 300 28 26 V
3.2 D 4WD	76	12/98→04/05					
<b>NISSAN - PIXO (UA0) 03/09→</b>							
 <b>Bremsbelagsatz, Scheibenbremse</b>							
1.0	50	06/09→	←	→ 04/13		13.0460-5887.2 605887	SUM 23507 15,2 + WK
 <b>Bremsscheibe</b>							
1.0	50	06/09→	←	→ 04/13		24.0120-0225.1 420225	Ø 231 20 18 V
<b>NISSAN - PRIMASTAR Bus (X83) 03/01→</b>							
 <b>Bremsbelagsatz, Scheibenbremse</b>							
2.0	86	04/06→	←			13.0460-2870.2 602870	TRW 23099 18,4 - WK
2.0	88	03/01→					
dCi 115	84	09/08→	→			13.0460-2840.2 602840	TRW 23980 16,5 + WE / - WK
dCi 120	84	09/06→					
dCi 150	107	09/06→					
dCi 90	66	09/06→					
dCi 100	74	03/01→	←	→ 08/06		13.0460-2870.2 602870	TRW 23099 18,4 - WK
↓							

	kw			 	! #		
<b>NISSAN - PRIMASTAR Bus (X83) 03/01→</b>							
 <b>Bremsbelagsatz, Scheibenbremse</b>							
dCi 140 dCi 80	99 60	07/03→ 03/01→	→	→ 08/06		13.0460-2840.2 602840	TRW 23980 16,5 + WE / - WK
 <b>Bremsscheibe</b>							
2.0 2.0 dCi 115 dCi 120 dCi 150 dCi 90	86 88 84 84 107 66	04/06→ 03/01→ 09/08→ 09/06→ 09/06→ 09/06→	← →			24.0128-0132.1 428132 24.0112-0177.2 412177	∅ 305 28 24 V + S ∅ 280 12 10 + LG / + ABS Ring
dCi 100 dCi 140 dCi 80	74 99 60	03/01→ 07/03→ 03/01→	← →	→ 08/06 → 08/06		24.0128-0132.1 428132 24.0112-0177.2 412177	∅ 305 28 24 V + S ∅ 280 12 10 + LG / + ABS Ring
<b>NISSAN - PRIMASTAR Kasten (X83) 09/02→</b>							
 <b>Bremsbelagsatz, Scheibenbremse</b>							
1.9 dCi 100 1.9 dCi 80 2.5 dCi 140	74 60 99	09/02→ 09/02→ 07/03→	← →	→ 08/06 → 08/06		13.0460-2870.2 602870 13.0460-2840.2 602840	TRW 23099 18,4 - WK TRW 23980 16,5 + WE / - WK
2.0 2.0 dCi 115 2.0 dCi 90 2.5 dCi 115 2.5 dCi 150	88 84 66 84 107	02/03→ 09/06→ 09/06→ 09/08→ 09/06→	← →			13.0460-2870.2 602870 13.0460-2840.2 602840	TRW 23099 18,4 - WK TRW 23980 16,5 + WE / - WK
 <b>Bremsscheibe</b>							
1.9 dCi 100 1.9 dCi 80 2.5 dCi 140	74 60 99	09/02→ 09/02→ 07/03→	← →	→ 08/06 → 08/06		24.0128-0132.1 428132 24.0112-0177.2 412177	∅ 305 28 24 V + S ∅ 280 12 10 + LG / + ABS Ring
2.0 2.0 dCi 115 2.0 dCi 90 2.5 dCi 115 2.5 dCi 150	88 84 66 84 107	02/03→ 09/06→ 09/06→ 09/08→ 09/06→	← →			24.0128-0132.1 428132 24.0112-0177.2 412177	∅ 305 28 24 V + S ∅ 280 12 10 + LG / + ABS Ring
<b>NISSAN - PRIMASTAR Pritsche/Fahrgestell (X83) 07/02→08/06</b>							
 <b>Bremsbelagsatz, Scheibenbremse</b>							
1.9 dCi 100 1.9 dCi 80 2.0 2.5 dCi 140	74 60 88 99	07/02→08/06 07/02→08/06 07/02→08/06 07/02→08/06	← →			13.0460-2870.2 602870 13.0460-2840.2 602840	TRW 23099 18,4 - WK TRW 23980 16,5 + WE / - WK
2.5 dCi 150	107	04/06→	← →	09/06→ 09/06→		13.0460-2870.2 602870 13.0460-2840.2 602840	TRW 23099 18,4 - WK TRW 23980 16,5 + WE / - WK
 <b>Bremsscheibe</b>							
1.9 dCi 100 1.9 dCi 80 2.0 2.5 dCi 140	74 60 88 99	07/02→08/06 07/02→08/06 07/02→08/06 07/02→08/06	← →			24.0128-0132.1 428132 24.0112-0177.2 412177	∅ 305 28 24 V + S ∅ 280 12 10 + LG / + ABS Ring
2.5 dCi 150	107	04/06→	← →	09/06→ 09/06→		24.0128-0132.1 428132 24.0112-0177.2 412177	∅ 305 28 24 V + S ∅ 280 12 10 + LG / + ABS Ring
<b>NISSAN - PRIMERA (P10) 06/90→06/96</b>							
 <b>Bremsbelagsatz, Scheibenbremse</b>							
1.6 1.6	66 71	06/90→01/96 06/90→01/96	← ← →	- ABS 05/93→; + ABS 05/93→; + ABS		13.0460-5949.2 605949 13.0460-5950.2 605950 13.0460-5986.2 605986	AKE 21280 16,0 - WE / - WK TRW 21546 16,7 - WK TRW 21545 14,9 - WK
1.6	75	06/93→01/96	← ← →	- ABS + ABS + ABS		13.0460-5949.2 605949 13.0460-5950.2 605950 13.0460-5986.2 605986	AKE 21280 16,0 - WE / - WK TRW 21546 16,7 - WK TRW 21545 14,9 - WK
2.0 2.0 i	96 92	06/90→05/96 01/95→06/96	← →	→ 01/96 → 01/96		13.0460-5950.2 605950 13.0460-5986.2 605986	TRW 21546 16,7 - WK TRW 21545 14,9 - WK
2.0 16V 2.0 16V 4x4 2.0 GT	85 85 110	06/90→01/96 04/91→06/96 06/90→01/96	← →			13.0460-5950.2 605950 13.0460-5986.2 605986	TRW 21546 16,7 - WK TRW 21545 14,9 - WK
2.0 D	55	01/91→01/96	← ← →	→ 04/93 05/93→ 05/93→		13.0460-5949.2 605949 13.0460-5950.2 605950 13.0460-5986.2 605986	AKE 21280 16,0 - WE / - WK TRW 21546 16,7 - WK TRW 21545 14,9 - WK
↓							





	kw			 	! #		
<b>NISSAN - PRIMERA (P10) 06/90→06/96</b>							
<b>Zubehörsatz, Scheibenbremsbelag</b>							
1.6 1.6 1.6	66 71 75	06/90→01/96 06/90→01/96 06/93→01/96	←	- ABS		13.0460-0440.2 610440	AKE
2.0 D	55	01/91→01/96	←	→ 04/93		13.0460-0440.2 610440	AKE
<b> Bremsscheibe</b>							
1.6 1.6	66 71	06/90→01/96 06/90→01/96	←	- ABS		24.0120-0152.1 420152	Ø 242 20 18 V
			←	05/93→; + ABS		24.0122-0146.1 422146	Ø 257 22 20 V
			→	05/93→; + ABS		24.0110-0215.1 410215	Ø 258 10 9
1.6	75	06/93→01/96	←	- ABS		24.0120-0152.1 420152	Ø 242 20 18 V
			←	+ ABS		24.0122-0146.1 422146	Ø 257 22 20 V
			→	+ ABS		24.0110-0215.1 410215	Ø 258 10 9
2.0 2.0 i	96 92	06/90→05/96 01/95→06/96	←	→ 01/96		24.0122-0146.1 422146	Ø 257 22 20 V
			→	→ 01/96		24.0110-0215.1 410215	Ø 258 10 9
2.0 16V 2.0 16V 4x4 2.0 GT	85 85 110	06/90→01/96 04/91→06/96 06/90→01/96	←			24.0122-0146.1 422146	Ø 257 22 20 V
			→			24.0110-0215.1 410215	Ø 258 10 9
2.0 D	55	01/91→01/96	←	→ 04/93		24.0120-0152.1 420152	Ø 242 20 18 V
			←	05/93→		24.0122-0146.1 422146	Ø 257 22 20 V
			→	05/93→		24.0110-0215.1 410215	Ø 258 10 9
<b>NISSAN - PRIMERA (P11) 06/96→12/01</b>							
<b> Bremsbelagsatz, Scheibenbremse</b>							
1.6 16V 1.6 16V 1.6 16V 2.0 TD	66 73 78 66	09/96→12/01 09/96→10/00 06/96→12/01 09/96→12/01	←	04/98→ → 03/98		13.0460-5807.2 605807 13.0460-5950.2 605950	TRW 23093 16,6 - WK TRW 21546 16,7 - WK
1.8 16V	84	08/99→12/01	←			13.0460-5807.2 605807	TRW 23093 16,6 - WK
			→	+ ABS		13.0460-5986.2 605986	TRW 21545 14,9 - WK
2.0 16V 2.0 16V	85 96	09/96→12/01 09/96→12/01	←	04/98→ → 03/98		13.0460-5807.2 605807 13.0460-5950.2 605950	TRW 23093 16,6 - WK TRW 21546 16,7 - WK
			→			13.0460-5986.2 605986	TRW 21545 14,9 - WK
2.0 16V 2.0 16V	103 110	08/99→12/01 09/96→12/01	←			13.0460-5727.2 605727 13.0460-5807.2 605807	ATE 23160 17,3 - WE / - WK TRW 23093 16,6 - WK
			→			13.0460-5986.2 605986	TRW 21545 14,9 - WK
<b>Zubehörsatz, Scheibenbremsbelag</b>							
1.6 16V 1.6 16V 1.6 16V 2.0 16V 2.0 16V 2.0 TD	66 73 78 85 96 66	09/96→12/01 09/96→10/00 06/96→12/01 09/96→12/01 09/96→12/01 09/96→12/01	←	04/98→		13.0460-0148.2 610148	TRW
1.8 16V 2.0 16V 2.0 16V	84 103 110	08/99→12/01 08/99→12/01 09/96→12/01	←			13.0460-0148.2 610148	TRW
<b> Bremsscheibe</b>							
1.6 16V 1.6 16V 1.6 16V 2.0 TD	66 73 78 66	09/96→12/01 09/96→10/00 06/96→12/01 09/96→12/01	←	→ 05/99 06/99→		24.0122-0146.1 422146 24.0122-0179.1 422179	Ø 257 22 20 V Ø 280 22 20 V
1.8 16V	84	08/99→12/01	←			24.0122-0179.1 422179	Ø 280 22 20 V
			→	+ ABS		24.0110-0310.1 410310	Ø 278 10 9
2.0 16V 2.0 16V	85 96	09/96→12/01 09/96→12/01	←	→ 05/99 06/99→		24.0122-0146.1 422146 24.0122-0179.1 422179	Ø 257 22 20 V Ø 280 22 20 V
			→	→ 05/99 06/99→		24.0110-0215.1 410215 24.0110-0310.1 410310	Ø 258 10 9 Ø 278 10 9
2.0 16V	103	08/99→12/01	←			24.0122-0179.1 422179	Ø 280 22 20 V
			→			24.0110-0215.1 410215 24.0110-0310.1 410310	Ø 258 10 9 Ø 278 10 9
2.0 16V	110	09/96→12/01	←			24.0122-0179.1 422179	Ø 280 22 20 V
			→	→ 05/99 06/99→		24.0110-0215.1 410215 24.0110-0310.1 410310	Ø 258 10 9 Ø 278 10 9

**NISSAN - PRIMERA (P12) 01/02→**

**Bremsbelagsatz, Scheibenbremse**

1.6 1.8 1.8 LPG 1.9 dCi 2.0	78	03/02→08/08	←			<b>13.0460-5825.2</b>	<b>605825</b>	TRW 23094 16,5 + WK + Zub
	85	03/02→10/08	→			<b>13.0460-7137.2</b>	<b>607137</b>	ATE 23482 15,8 - WE / - WK
	85	03/02→	→			<b>13.0470-7137.2</b>	<b>LD7137</b>	ATE 23482 15,8 - WE / - WK
	88	04/03→10/07						ATE 23482 15,8 - WE / - WK Ceramic
1.6	80	01/02→04/06	←	03/02→		<b>13.0460-5825.2</b>	<b>605825</b>	TRW 23094 16,5 + WK + Zub
			→	03/02→		<b>13.0460-7137.2</b>	<b>607137</b>	ATE 23482 15,8 - WE / - WK
						<b>13.0470-7137.2</b>	<b>LD7137</b>	ATE 23482 15,8 - WE / - WK Ceramic
1.9 dCi	85	08/02→10/07	←	04/03→		<b>13.0460-5825.2</b>	<b>605825</b>	TRW 23094 16,5 + WK + Zub
			→	04/03→		<b>13.0460-7137.2</b>	<b>607137</b>	ATE 23482 15,8 - WE / - WK
						<b>13.0470-7137.2</b>	<b>LD7137</b>	ATE 23482 15,8 - WE / - WK Ceramic
2.2 dCi	102	04/03→	←	→ 10/07		<b>13.0460-5825.2</b>	<b>605825</b>	TRW 23094 16,5 + WK + Zub
			→	→ 10/07		<b>13.0460-7137.2</b>	<b>607137</b>	ATE 23482 15,8 - WE / - WK
						<b>13.0470-7137.2</b>	<b>LD7137</b>	ATE 23482 15,8 - WE / - WK Ceramic
2.2 Di	93	03/02→05/07	←	→ 04/03		<b>13.0460-5825.2</b>	<b>605825</b>	TRW 23094 16,5 + WK + Zub
			→	→ 04/03		<b>13.0460-7137.2</b>	<b>607137</b>	ATE 23482 15,8 - WE / - WK
						<b>13.0470-7137.2</b>	<b>LD7137</b>	ATE 23482 15,8 - WE / - WK Ceramic

**Zubehörsatz, Scheibenbremsbelag**

1.6 1.8 1.8 LPG 1.9 dCi 2.0	78	03/02→08/08	←			<b>13.0460-0282.2</b>	<b>610282</b>	
	85	03/02→10/08	→					
	85	03/02→	→					
	88	04/03→10/07						
	103	03/02→10/08						
1.6	80	01/02→04/06	←	03/02→		<b>13.0460-0282.2</b>	<b>610282</b>	
1.9 dCi	85	08/02→10/07	←	04/03→		<b>13.0460-0282.2</b>	<b>610282</b>	
2.2 dCi	102	04/03→	←	→ 10/07		<b>13.0460-0282.2</b>	<b>610282</b>	
2.2 Di	93	03/02→05/07	←	→ 04/03		<b>13.0460-0282.2</b>	<b>610282</b>	











**Bremsscheibe**













1.6 1.8 1.8 LPG 1.9 dCi 2.0	78	03/02→08/08	←			<b>24.0128-0140.1</b>	<b>428140</b>	Ø 280 28 26 V
	85	03/02→10/08	→			<b>24.0110-0285.1</b>	<b>410285</b>	Ø 278 10 9
	85	03/02→	→					
	88	04/03→10/07						
	103	03/02→10/08						
1.6	80	01/02→04/06	←	03/02→		<b>24.0128-0140.1</b>	<b>428140</b>	Ø 280 28 26 V
			→	03/02→		<b>24.0110-0285.1</b>	<b>410285</b>	Ø 278 10 9
1.9 dCi	85	08/02→10/07	←	04/03→		<b>24.0128-0140.1</b>	<b>428140</b>	Ø 280 28 26 V
			→	04/03→		<b>24.0110-0285.1</b>	<b>410285</b>	Ø 278 10 9
2.2 dCi	102	04/03→	←	→ 10/07		<b>24.0128-0140.1</b>	<b>428140</b>	Ø 280 28 26 V
			→	→ 10/07		<b>24.0110-0285.1</b>	<b>410285</b>	Ø 278 10 9
2.2 Di	93	03/02→05/07	←	→ 04/03		<b>24.0128-0140.1</b>	<b>428140</b>	Ø 280 28 26 V
			→	→ 04/03		<b>24.0110-0285.1</b>	<b>410285</b>	Ø 278 10 9











**NISSAN - PRIMERA Hatchback (P10) 06/90→06/96**

**Bremsbelagsatz, Scheibenbremse**











1.6	66	06/90→01/96	←	- ABS		<b>13.0460-5949.2</b>	<b>605949</b>	AKE 21280 16,0 - WE / - WK
			←	05/93→; + ABS		<b>13.0460-5950.2</b>	<b>605950</b>	TRW 21546 16,7 - WK
			→	05/93→; + ABS		<b>13.0460-5986.2</b>	<b>605986</b>	TRW 21545 14,9 - WK
1.6	75	06/93→01/96	←	- ABS		<b>13.0460-5949.2</b>	<b>605949</b>	AKE 21280 16,0 - WE / - WK
			←	+ ABS		<b>13.0460-5950.2</b>	<b>605950</b>	TRW 21546 16,7 - WK
			→	+ ABS		<b>13.0460-5986.2</b>	<b>605986</b>	TRW 21545 14,9 - WK
2.0	110	06/90→01/96	←			<b>13.0460-5950.2</b>	<b>605950</b>	TRW 21546 16,7 - WK
			→			<b>13.0460-5986.2</b>	<b>605986</b>	TRW 21545 14,9 - WK
2.0 16V	85	06/90→01/96						
2.0 16V 4x4	85	04/91→06/96						
2.0 D	55	01/91→01/96	←	→ 04/93		<b>13.0460-5949.2</b>	<b>605949</b>	AKE 21280 16,0 - WE / - WK
			←	05/93→		<b>13.0460-5950.2</b>	<b>605950</b>	TRW 21546 16,7 - WK
			→	05/93→		<b>13.0460-5986.2</b>	<b>605986</b>	TRW 21545 14,9 - WK
↓								











	kw					! #		
<b>NISSAN - PRIMERA Hatchback (P10) 06/90→06/96</b>								
 <b>Bremsbelagsatz, Scheibenbremse</b>								
2.0 i	92	01/95→06/96	←	→ 01/96		13.0460-5950.2	605950	TRW 21546 16,7 - WK
			→	→ 01/96		13.0460-5986.2	605986	TRW 21545 14,9 - WK
<b>Zubehörsatz, Scheibenbremsbelag</b>								
1.6	66	06/90→01/96	←	- ABS		13.0460-0440.2	610440	AKE
1.6	75	06/93→01/96	←	- ABS		13.0460-0440.2	610440	AKE
2.0 D	55	01/91→01/96	←	→ 04/93		13.0460-0440.2	610440	AKE
 <b>Bremsscheibe</b>								
1.6	66	06/90→01/96	←	- ABS		24.0120-0152.1	420152	Ø 242 20 18 V
			←	05/93→; + ABS		24.0122-0146.1	422146	Ø 257 22 20 V
			→	05/93→; + ABS		24.0110-0215.1	410215	Ø 258 10 9
1.6	75	06/93→01/96	←	- ABS		24.0120-0152.1	420152	Ø 242 20 18 V
			←	+ ABS		24.0122-0146.1	422146	Ø 257 22 20 V
			→	+ ABS		24.0110-0215.1	410215	Ø 258 10 9
2.0	110	06/90→01/96	←			24.0122-0146.1	422146	Ø 257 22 20 V
2.0	112	09/90→01/96	←			24.0122-0146.1	422146	Ø 257 22 20 V
2.0 16V	85	06/90→01/96	→			24.0110-0215.1	410215	Ø 258 10 9
2.0 16V 4x4	85	04/91→06/96	→			24.0110-0215.1	410215	Ø 258 10 9
2.0 D	55	01/91→01/96	←	→ 04/93		24.0120-0152.1	420152	Ø 242 20 18 V
			←	05/93→		24.0122-0146.1	422146	Ø 257 22 20 V
			→	05/93→		24.0110-0215.1	410215	Ø 258 10 9
2.0 i	92	01/95→06/96	←	→ 01/96		24.0122-0146.1	422146	Ø 257 22 20 V
			→	→ 01/96		24.0110-0215.1	410215	Ø 258 10 9
<b>NISSAN - PRIMERA Hatchback (P11) 06/96→07/02</b>								
 <b>Bremsbelagsatz, Scheibenbremse</b>								
1.6 16V	66	09/96→07/02	←	04/98→ 02/02		13.0460-5807.2	605807	TRW 23093 16,6 - WK
1.6 16V	73	09/96→07/02	←	→ 03/98		13.0460-5950.2	605950	TRW 21546 16,7 - WK
2.0 TD	66	09/96→07/02	←	→ 02/02		13.0460-5807.2	605807	TRW 23093 16,6 - WK
1.6 16V	78	09/00→07/02	←	→ 02/02		13.0460-5807.2	605807	TRW 23093 16,6 - WK
1.8 16V	84	08/99→07/02	←	→ 02/02		13.0460-5807.2	605807	TRW 23093 16,6 - WK
1.8 16V LPG	84	08/99→07/02	→	→ 02/02; + ABS		13.0460-5986.2	605986	TRW 21545 14,9 - WK
2.0 16V	85	09/96→07/02	←	04/98→ 02/02		13.0460-5807.2	605807	TRW 23093 16,6 - WK
2.0 16V	96	09/96→07/02	←	→ 03/98		13.0460-5950.2	605950	TRW 21546 16,7 - WK
2.0 16V LPG	96	09/96→07/02	→	→ 02/02		13.0460-5986.2	605986	TRW 21545 14,9 - WK
2.0 16V	103	08/99→07/02	←	→ 02/02		13.0460-5727.2	605727	ATE 23160 17,3 - WE / - WK
2.0 16V	110	09/96→07/02	←	→ 02/02		13.0460-5807.2	605807	TRW 23093 16,6 - WK
			→	→ 02/02		13.0460-5986.2	605986	TRW 21545 14,9 - WK
<b>Zubehörsatz, Scheibenbremsbelag</b>								
1.6 16V	66	09/96→07/02	←	04/98→ 02/02		13.0460-0148.2	610148	TRW
1.6 16V	73	09/96→07/02	←			13.0460-0148.2	610148	TRW
2.0 16V	85	09/96→07/02	←			13.0460-0148.2	610148	TRW
2.0 16V	96	09/96→07/02	←			13.0460-0148.2	610148	TRW
2.0 16V LPG	96	09/96→07/02	←			13.0460-0148.2	610148	TRW
2.0 TD	66	09/96→07/02	←			13.0460-0148.2	610148	TRW
1.6 16V	78	09/00→07/02	←	→ 02/02		13.0460-0148.2	610148	TRW
1.8 16V	84	08/99→07/02	←	→ 02/02		13.0460-0148.2	610148	TRW
1.8 16V LPG	84	08/99→07/02	←	→ 02/02		13.0460-0148.2	610148	TRW
2.0 16V	103	08/99→07/02	←	→ 02/02		13.0460-0148.2	610148	TRW
2.0 16V	110	09/96→07/02	←	→ 02/02		13.0460-0148.2	610148	TRW
 <b>Bremsscheibe</b>								
1.6 16V	66	09/96→07/02	←	→ 05/99		24.0122-0146.1	422146	Ø 257 22 20 V
1.6 16V	73	09/96→07/02	←	06/99→ 02/02		24.0122-0179.1	422179	Ø 280 22 20 V
2.0 TD	66	09/96→07/02	←	→ 02/02		24.0122-0179.1	422179	Ø 280 22 20 V
1.6 16V	78	09/00→07/02	←	→ 02/02		24.0122-0179.1	422179	Ø 280 22 20 V
1.8 16V	84	08/99→07/02	←	→ 02/02		24.0122-0179.1	422179	Ø 280 22 20 V
1.8 16V LPG	84	08/99→07/02	→	→ 02/02; + ABS		24.0110-0310.1	410310	Ø 278 10 9
2.0 16V	85	09/96→07/02	←	→ 05/99		24.0122-0146.1	422146	Ø 257 22 20 V
2.0 16V	96	09/96→07/02	←	06/99→ 02/02		24.0122-0179.1	422179	Ø 280 22 20 V
2.0 16V LPG	96	09/96→07/02	→	→ 05/99		24.0110-0215.1	410215	Ø 258 10 9
↓								



















	kW			 	! #		
<b>NISSAN - PRIMERA Hatchback (P11) 06/96→07/02</b>							
 <b>Bremsscheibe</b>							
2.0 16V	85	09/96→07/02	➔	06/99→ 02/02		24.0110-0310.1 410310	Ø 278 10 9
2.0 16V	96	09/96→07/02					
2.0 16V LPG	96	09/96→07/02					
2.0 16V	103	08/99→07/02	➔	→ 02/02		24.0122-0179.1 422179	Ø 280 22 20 V
			➔	→ 02/02		24.0110-0215.1 410215	Ø 258 10 9
						24.0110-0310.1 410310	Ø 278 10 9
2.0 16V	110	09/96→07/02	➔	→ 02/02		24.0122-0179.1 422179	Ø 280 22 20 V
			➔	→ 05/99		24.0110-0215.1 410215	Ø 258 10 9
			➔	06/99→ 02/02		24.0110-0310.1 410310	Ø 278 10 9
<b>NISSAN - PRIMERA Hatchback (P12) 01/02→</b>							
 <b>Bremsbelagsatz, Scheibenbremse</b>							
1.6	78	07/02→08/08	➔			13.0460-5825.2 605825	TRW 23094 16,5 + WK + Zub
1.6	80	07/02→04/06					
1.8	85	07/02→10/08	➔			13.0460-7137.2 607137	ATE 23482 15,8 - WE / - WK
1.9 dCi	88	04/03→10/07				13.0470-7137.2 LD7137	ATE 23482 15,8 - WE / - WK Ceramic
2.0	103	07/02→10/08					
1.9 dCi	85	08/02→10/07	➔	04/03→		13.0460-5825.2 605825	TRW 23094 16,5 + WK + Zub
			➔	04/03→		13.0460-7137.2 607137	ATE 23482 15,8 - WE / - WK
						13.0470-7137.2 LD7137	ATE 23482 15,8 - WE / - WK Ceramic
2.2 dCi	102	04/03→	➔	→ 10/07		13.0460-5825.2 605825	TRW 23094 16,5 + WK + Zub
			➔	→ 10/07		13.0460-7137.2 607137	ATE 23482 15,8 - WE / - WK
						13.0470-7137.2 LD7137	ATE 23482 15,8 - WE / - WK Ceramic
2.2 Di	93	07/02→05/07	➔	→ 04/03		13.0460-5825.2 605825	TRW 23094 16,5 + WK + Zub
			➔	→ 04/03		13.0460-7137.2 607137	ATE 23482 15,8 - WE / - WK
						13.0470-7137.2 LD7137	ATE 23482 15,8 - WE / - WK Ceramic
<b>Zubehörsatz, Scheibenbremsbelag</b>							
1.6	78	07/02→08/08	➔			13.0460-0282.2 610282	
1.6	80	07/02→04/06					
1.8	85	07/02→10/08					
1.9 dCi	88	04/03→10/07					
2.0	103	07/02→10/08					
1.9 dCi	85	08/02→10/07	➔	04/03→		13.0460-0282.2 610282	
2.2 dCi	102	04/03→	➔	→ 10/07		13.0460-0282.2 610282	
2.2 Di	93	07/02→05/07	➔	→ 04/03		13.0460-0282.2 610282	
 <b>Bremsscheibe</b>							
1.6	78	07/02→08/08	➔			24.0128-0140.1 428140	Ø 280 28 26 V
1.6	80	07/02→04/06					
1.8	85	07/02→10/08	➔			24.0110-0285.1 410285	Ø 278 10 9
1.9 dCi	88	04/03→10/07					
2.0	103	07/02→10/08					
1.9 dCi	85	08/02→10/07	➔	04/03→		24.0128-0140.1 428140	Ø 280 28 26 V
			➔	04/03→		24.0110-0285.1 410285	Ø 278 10 9
2.2 dCi	102	04/03→	➔	→ 10/07		24.0128-0140.1 428140	Ø 280 28 26 V
			➔	→ 10/07		24.0110-0285.1 410285	Ø 278 10 9
2.2 Di	93	07/02→05/07	➔	→ 04/03		24.0128-0140.1 428140	Ø 280 28 26 V
			➔	→ 04/03		24.0110-0285.1 410285	Ø 278 10 9
<b>NISSAN - PRIMERA Traveller (W10) 07/90→03/98</b>							
 <b>Bremsbelagsatz, Scheibenbremse</b>							
1.6 i	66	07/90→03/98	➔			13.0460-5933.2 605933	AKE 21725 16,8 + WK
1.6 i	75	02/91→03/98	➔	+ ABS		13.0460-5983.2 605983	21713 16,5 - WE / - WK
2.0 i	85	07/90→03/98	➔	→ 12/95		13.0460-5933.2 605933	AKE 21725 16,8 + WK
			➔	→ 12/95		13.0460-5983.2 605983	21713 16,5 - WE / - WK
 <b>Bremsscheibe</b>							
1.6 i	66	07/90→03/98	➔			24.0122-0146.1 422146	Ø 257 22 20 V
1.6 i	75	02/91→03/98	➔	+ ABS		24.0109-0129.1 409129	Ø 258 9 8
↓							

















	kW			 	! #		
<b>NISSAN - PRIMERA Traveller (W10) 07/90→03/98</b>							
 <b>Bremsscheibe</b>							
2.0 i	85	07/90→03/98	←	→ 12/95		24.0122-0146.1 422146	Ø 257 22 20 V
			→	→ 12/95		24.0109-0129.1 409129	Ø 258 9 8
<b>NISSAN - PRIMERA Traveller (WP11) 06/96→01/02</b>							
 <b>Bremsbelagsatz, Scheibenbremse</b>							
1.6 16V	66	04/98→12/01	←			13.0460-5807.2 605807	TRW 23093 16,6 - WK
1.6 16V	73	04/98→12/01	→			13.0460-5986.2 605986	TRW 21545 14,9 - WK
1.6 16V	81	04/98→01/02	→				
1.8 16V	84	08/99→12/01					
1.8 16V LPG	84	08/99→12/01					
2.0 TD	66	04/98→12/01					
2.0 16V	85	06/96→12/01	←	07/99→		13.0460-5727.2 605727	ATE 23160 17,3 - WE / - WK
			←	04/98→ 06/99		13.0460-5807.2 605807	TRW 23093 16,6 - WK
			→	04/98→		13.0460-5986.2 605986	TRW 21545 14,9 - WK
2.0 16V	96	04/98→12/01	←	07/99→		13.0460-5727.2 605727	ATE 23160 17,3 - WE / - WK
			←	→ 06/99		13.0460-5807.2 605807	TRW 23093 16,6 - WK
			→			13.0460-5986.2 605986	TRW 21545 14,9 - WK
2.0 16V	103	08/99→12/01	←			13.0460-5727.2 605727	ATE 23160 17,3 - WE / - WK
			→			13.0460-5986.2 605986	TRW 21545 14,9 - WK
<b>Zubehörsatz, Scheibenbremsbelag</b>							
1.6 16V	66	04/98→12/01	←			13.0460-0148.2 610148	TRW
1.6 16V	73	04/98→12/01					
1.6 16V	81	04/98→01/02					
1.8 16V	84	08/99→12/01					
1.8 16V LPG	84	08/99→12/01					
2.0 TD	66	04/98→12/01					
2.0 16V	85	06/96→12/01	←	04/98→ 06/99		13.0460-0148.2 610148	TRW
2.0 16V	96	04/98→12/01	←	→ 06/99		13.0460-0148.2 610148	TRW
 <b>Bremsscheibe</b>							
1.6 16V	66	04/98→12/01	←			24.0122-0179.1 422179	Ø 280 22 20 V
1.6 16V	73	04/98→12/01	→	04/01→		24.0110-0215.1 410215	Ø 258 10 9
1.8 16V	84	08/99→12/01	→				
1.8 16V LPG	84	08/99→12/01	→	→ 03/01		24.0110-0310.1 410310	Ø 278 10 9
2.0 16V	96	04/98→12/01					
2.0 16V	103	08/99→12/01					
2.0 TD	66	04/98→12/01					
1.6 16V	81	04/98→01/02	←	→ 05/99		24.0122-0146.1 422146	Ø 257 22 20 V
			←			24.0122-0179.1 422179	Ø 280 22 20 V
			←	06/99→		24.0122-0179.1 422179	Ø 280 22 20 V
			→	04/01→		24.0110-0215.1 410215	Ø 258 10 9
			→	→ 03/01		24.0110-0310.1 410310	Ø 278 10 9
2.0 16V	85	06/96→12/01	←	04/98→		24.0122-0179.1 422179	Ø 280 22 20 V
			→	04/01→		24.0110-0215.1 410215	Ø 258 10 9
			→	04/98→ 03/01		24.0110-0310.1 410310	Ø 278 10 9
<b>NISSAN - PRIMERA Traveller (WP12) 01/02→</b>							
 <b>Bremsbelagsatz, Scheibenbremse</b>							
1.6 Visia	80	01/02→04/06	←	03/02→		13.0460-5825.2 605825	TRW 23094 16,5 + WK + Zub
			→	03/02→		13.0460-7137.2 607137	ATE 23482 15,8 - WE / - WK
						13.0470-7137.2 LD7137	ATE 23482 15,8 - WE / - WK Ceramic
1.8 2.2 Di	85 93	03/02→05/07 03/02→04/03	←			13.0460-5825.2 605825	TRW 23094 16,5 + WK + Zub
			→			13.0460-7137.2 607137	ATE 23482 15,8 - WE / - WK
						13.0470-7137.2 LD7137	ATE 23482 15,8 - WE / - WK Ceramic
1.9 dCi	85	08/02→10/07	←	04/03→		13.0460-5825.2 605825	TRW 23094 16,5 + WK + Zub
			→	04/03→		13.0460-7137.2 607137	ATE 23482 15,8 - WE / - WK
						13.0470-7137.2 LD7137	ATE 23482 15,8 - WE / - WK Ceramic
1.9 dCi 2.2 dCi	88 102	04/03→ 04/03→	←	→ 10/07		13.0460-5825.2 605825	TRW 23094 16,5 + WK + Zub
			→	→ 10/07		13.0460-7137.2 607137	ATE 23482 15,8 - WE / - WK
↓							

















	kw			 	! #		
<b>NISSAN - PRIMERA Traveller (WP12) 01/02→</b>							
 <b>Bremsbelagsatz, Scheibenbremse</b>							
1.9 dCi 2.2 dCi	88 102	04/03→ 04/03→	→	→ 10/07		13.0470-7137.2 LD7137	ATE 23482 15,8 - WE / - WK Ceramic
2.0	103	03/02→	←	→ 10/08		13.0460-5825.2 605825	TRW 23094 16,5 + WK + Zub
			→	→ 10/08		13.0460-7137.2 607137 13.0470-7137.2 LD7137	ATE 23482 15,8 - WE / - WK ATE 23482 15,8 - WE / - WK Ceramic
<b>Zubehörsatz, Scheibenbremsbelag</b>							
1.6 Visia	80	01/02→04/06	←	03/02→		13.0460-0282.2 610282	
1.8 2.2 Di	85 93	03/02→05/07 03/02→04/03	←			13.0460-0282.2 610282	
			→				
1.9 dCi	85	08/02→10/07	←	04/03→		13.0460-0282.2 610282	
1.9 dCi 2.2 dCi	88 102	04/03→ 04/03→	←	→ 10/07		13.0460-0282.2 610282	
			→	→ 10/07			
2.0	103	03/02→	←	→ 10/08		13.0460-0282.2 610282	
<b>Bremsscheibe</b>							
1.6 Visia	80	01/02→04/06	←	03/02→		24.0128-0140.1 428140	Ø 280 28 26 V
			→	03/02→		24.0110-0285.1 410285	Ø 278 10 9
1.8 2.2 Di	85 93	03/02→05/07 03/02→04/03	←			24.0128-0140.1 428140	Ø 280 28 26 V
			→			24.0110-0285.1 410285	Ø 278 10 9
1.9 dCi	85	08/02→10/07	←	04/03→		24.0128-0140.1 428140	Ø 280 28 26 V
			→	04/03→		24.0110-0285.1 410285	Ø 278 10 9
1.9 dCi 2.2 dCi	88 102	04/03→ 04/03→	←	→ 10/07		24.0128-0140.1 428140	Ø 280 28 26 V
			→	→ 10/07		24.0110-0285.1 410285	Ø 278 10 9
2.0	103	03/02→	←	→ 10/08		24.0128-0140.1 428140	Ø 280 28 26 V
			→	→ 10/08		24.0110-0285.1 410285	Ø 278 10 9
<b>NISSAN - PULSAR Schrägheck (C13) 08/12→</b>							
 <b>Bremsbelagsatz, Scheibenbremse</b>							
1.2 DIG-T 1.5 dCi 1.6 DIG-T	85 81 140	10/14→ 10/14→ 02/15→	←			13.0460-5716.2 605716	21561 17,0 + WK
<b>Bremsscheibe</b>							
1.2 DIG-T 1.5 dCi	85 81	10/14→ 10/14→	←			24.0124-0247.1 424247	Ø 280 24 22 V
			→			24.0109-0157.1 409157	Ø 291,5 9 8
1.6 DIG-T	140	02/15→	←			24.0126-0177.1 426177	Ø 296 26 24 V
			→			24.0109-0157.1 409157	Ø 291,5 9 8
<b>NISSAN - QASHQAI / QASHQAI +2 I (J10, JJ10) 12/06→12/13</b>							
 <b>Bremsbelagsatz, Scheibenbremse</b>							
1.5 dCi 1.5 dCi 1.6	76 78 84	07/08→12/13 02/07→12/13 02/07→12/13	←	kurzer Radstand		13.0460-5752.2 605752 13.0470-5752.2 LD5752	24632 17,0 - WK 24632 17,0 - WK Ceramic
			←	11/10→; kurzer Radstand		13.0460-5752.2 605752 13.0470-5752.2 LD5752	24632 17,0 - WK 24632 17,0 - WK Ceramic
			←	kurzer Radstand		13.0460-5752.2 605752 13.0470-5752.2 LD5752	24632 17,0 - WK 24632 17,0 - WK Ceramic
1.6 1.6 dCi 1.6 dCi Allrad	86 96 96	11/10→12/13 10/11→12/13 10/11→12/13	←	kurzer Radstand		13.0460-5752.2 605752 13.0470-5752.2 LD5752	24632 17,0 - WK 24632 17,0 - WK Ceramic
			←	langer Radstand		13.0460-5778.2 605778	SUM 23698 16,8 + WK
2.0 2.0 2.0 Allrad 2.0 Allrad 2.0 dCi 2.0 dCi Allrad	102 104 102 104 110 110	02/07→12/13 02/07→12/13 02/07→12/13 02/07→12/13 02/07→12/13 02/07→12/13	←	kurzer Radstand		13.0460-5752.2 605752 13.0470-5752.2 LD5752	24632 17,0 - WK 24632 17,0 - WK Ceramic
			←	08/08→; langer Radstand		13.0460-5778.2 605778	SUM 23698 16,8 + WK
			←	kurzer Radstand		13.0460-5752.2 605752 13.0470-5752.2 LD5752	24632 17,0 - WK 24632 17,0 - WK Ceramic
			←	kurzer Radstand		13.0460-5752.2 605752 13.0470-5752.2 LD5752	24632 17,0 - WK 24632 17,0 - WK Ceramic
			←	08/08→; langer Radstand		13.0460-5778.2 605778	SUM 23698 16,8 + WK
<b>Zubehörsatz, Scheibenbremsbelag</b>							
1.5 dCi 1.5 dCi 1.6 1.6 1.6 dCi 1.6 dCi Allrad 2.0 ↓	76 78 84 86 96 96 102	07/08→12/13 02/07→12/13 02/07→12/13 11/10→12/13 10/11→12/13 10/11→12/13 02/07→12/13	←	kurzer Radstand		13.0460-0212.2 610212	ATE
			→			13.0460-0213.2 610213	ATE
			←				
			→				
			←				
			→				











	kW			 	! #		
<b>NISSAN - QASHQAI / QASHQAI +2 I (J10, JJ10) 12/06→12/13</b>							
<b>Zubehörsatz, Scheibenbremsbelag</b>							
2.0	104	02/07→12/13	←	kurzer Radstand		13.0460-0212.2	610212 ATE
2.0 Allrad	102	02/07→12/13	→			13.0460-0213.2	610213 ATE
2.0 Allrad	104	02/07→12/13	→				
2.0 dCi	110	02/07→12/13	→				
2.0 dCi Allrad	110	02/07→12/13	→				
1.5 dCi	81	01/10→12/13	←	11/10→; kurzer Radstand		13.0460-0212.2	610212 ATE
			→	11/10→		13.0460-0213.2	610213 ATE
<b> Bremsscheibe</b>							
1.5 dCi	76	07/08→12/13	←	kurzer Radstand		24.0126-0154.1	426154 Ø 295,5 26 24 V
1.5 dCi	78	02/07→12/13	→	kurzer Radstand		24.0109-0157.1	409157 Ø 291,5 9 8
1.6	84	02/07→12/13	→	08/08→; langer Radstand		24.0116-0119.1	416119 Ø 292 16 14 V
1.5 dCi	81	01/10→12/13	←	11/10→; kurzer Radstand		24.0126-0154.1	426154 Ø 295,5 26 24 V
			→	11/10→; kurzer Radstand		24.0109-0157.1	409157 Ø 291,5 9 8
			→	02/10→; langer Radstand		24.0116-0119.1	416119 Ø 292 16 14 V
1.6	86	11/10→12/13	←	kurzer Radstand		24.0126-0154.1	426154 Ø 295,5 26 24 V
1.6 dCi	96	10/11→12/13	←	langer Radstand		24.0128-0242.1	428242 Ø 320 28 26 V
1.6 dCi Allrad	96	10/11→12/13	→	kurzer Radstand		24.0109-0157.1	409157 Ø 291,5 9 8
			→	langer Radstand		24.0116-0119.1	416119 Ø 292 16 14 V
2.0	102	02/07→12/13	←	kurzer Radstand		24.0126-0154.1	426154 Ø 295,5 26 24 V
2.0 Allrad	102	02/07→12/13	←	08/08→; langer Radstand		24.0128-0242.1	428242 Ø 320 28 26 V
			→	kurzer Radstand		24.0109-0157.1	409157 Ø 291,5 9 8
2.0	104	02/07→12/13	←	kurzer Radstand		24.0126-0154.1	426154 Ø 295,5 26 24 V
2.0 Allrad	104	02/07→12/13	←	08/08→; langer Radstand		24.0128-0242.1	428242 Ø 320 28 26 V
2.0 dCi	110	02/07→12/13	→	kurzer Radstand		24.0109-0157.1	409157 Ø 291,5 9 8
2.0 dCi Allrad	110	02/07→12/13	→	08/08→; langer Radstand		24.0116-0119.1	416119 Ø 292 16 14 V
<b>NISSAN - QASHQAI II Geländewagen geschlossen (J11, J11_) 11/13→</b>							
<b> Bremsbelagsatz, Scheibenbremse</b>							
1.2 DIG-T	85	11/13→	←	02/14→		13.0460-5652.2	605652 AKE 22065 17,7 + WK
1.6 dCi	96	11/13→	→	02/14→		13.0460-2600.2	602600 TRW 25965 15,0 + WK
1.6 dCi ALL MODE 4x4-i	96	11/13→	→				
1.5 dCi	81	11/13→	←	02/14→		13.0460-5652.2	605652 AKE 22065 17,7 + WK
			←	→ 01/14; kurzer Radstand		13.0460-5752.2	605752 24632 17,0 - WK
						13.0470-5752.2	LD5752 24632 17,0 - WK Ceramic
			→	02/14→		13.0460-2600.2	602600 TRW 25965 15,0 + WK
1.6 DIG-T	120	10/14→	←			13.0460-5652.2	605652 AKE 22065 17,7 + WK
2.0	103	01/15→	→				
2.0 (J11E)	106	06/14→	→			13.0460-2600.2	602600 TRW 25965 15,0 + WK
2.0 ALL MODE 4x4-i (J11R)	106	10/15→	→				
<b>Zubehörsatz, Scheibenbremsbelag</b>							
1.5 dCi	81	11/13→	←	→ 01/14; kurzer Radstand		13.0460-0212.2	610212 ATE
			→	→ 01/14		13.0460-0213.2	610213 ATE
<b> Bremsscheibe</b>							
1.2 DIG-T	85	11/13→	←	02/14→		24.0126-0185.1	426185 Ø 296 26 24 V
1.6 dCi	96	11/13→	→	02/14→		24.0113-0200.1	413200 Ø 290 13 11
1.6 dCi ALL MODE 4x4-i	96	11/13→	→				
1.5 dCi	81	11/13→	←	→ 01/14; kurzer Radstand		24.0126-0154.1	426154 Ø 295,5 26 24 V
			←	02/14→		24.0126-0185.1	426185 Ø 296 26 24 V
			→	→ 01/14; kurzer Radstand		24.0109-0157.1	409157 Ø 291,5 9 8
			→	02/14→		24.0113-0200.1	413200 Ø 290 13 11
			→	→ 01/14; langer Radstand		24.0116-0119.1	416119 Ø 292 16 14 V
1.6 DIG-T	120	10/14→	←			24.0126-0185.1	426185 Ø 296 26 24 V
2.0	103	01/15→	→				
2.0 (J11E)	106	06/14→	→			24.0113-0200.1	413200 Ø 290 13 11
2.0 ALL MODE 4x4-i (J11R)	106	10/15→	→				













	kW					! #		
<b>NISSAN - SENTRA VII (B17) 08/12→</b>								
 <b>Bremsbelagsatz, Scheibenbremse</b>								
1.6	86	08/14→	←			13.0460-5716.2	605716	21561 17,0 + WK
 <b>Bremsscheibe</b>								
1.6	86	08/14→	←			24.0124-0247.1	424247	Ø 280 24 22 V
			→			24.0109-0157.1	409157	Ø 291,5 9 8
<b>NISSAN - SERENA (C23) 06/91→09/01</b>								
 <b>Bremsbelagsatz, Scheibenbremse</b>								
1.6	71	02/93→09/01	←	Bremssattel(1-Kolben)		13.0460-5881.2	605881	21099 17,0 - WE / - WK
2.3 D	55	01/95→09/01	←	Bremssattel(2-Kolben)		13.0460-5959.2	605959	TRW 21481 15,5 - WK
2.0	93	11/92→09/01	←			13.0460-5959.2	605959	TRW 21481 15,5 - WK
2.0 D	49	11/92→09/01	←	→ 08/94; Bremssattel(1-Kolben)		13.0460-5881.2	605881	21099 17,0 - WE / - WK
			←	→ 08/94; Bremssattel(2-Kolben)		13.0460-5959.2	605959	TRW 21481 15,5 - WK
<b>Zubehörsatz, Scheibenbremsbelag</b>								
1.6	71	02/93→09/01	←	Bremssattel(1-Kolben)		13.0460-0322.2	610322	AKE
2.3 D	55	01/95→09/01	←					
2.0 D	49	11/92→09/01	←	→ 08/94; Bremssattel(1-Kolben)		13.0460-0322.2	610322	AKE
 <b>Bremsscheibe</b>								
1.6	71	02/93→09/01	←	Bremssattel(1-Kolben)		24.0122-0193.1	422193	Ø 250 22 20 V
2.3 D	55	01/95→09/01	←	Bremssattel(2-Kolben)		24.0126-0108.1	426108	Ø 257 26 24 V
2.0	93	11/92→09/01	←			24.0126-0108.1	426108	Ø 257 26 24 V
2.0 D	49	11/92→09/01	←	→ 08/94; Bremssattel(1-Kolben)		24.0122-0193.1	422193	Ø 250 22 20 V
			←	→ 08/94; Bremssattel(2-Kolben)		24.0126-0108.1	426108	Ø 257 26 24 V
<b>NISSAN - SUNNY III Kasten (Y10) 11/90→03/00</b>								
 <b>Bremsbelagsatz, Scheibenbremse</b>								
1.6 i 16V	66	10/92→03/00	←			13.0460-5808.2	605808	21716 16,0 + WK
1.7 D	40	11/90→03/00						
 <b>Bremsscheibe</b>								
1.6 i 16V	66	10/92→03/00	←			24.0118-0107.1	418107	Ø 240 18 16 V
1.7 D	40	11/90→03/00						
<b>NISSAN - SUNNY III Traveller (Y10) 11/90→03/00</b>								
 <b>Bremsbelagsatz, Scheibenbremse</b>								
1.6	75	07/95→03/00	←			13.0460-5808.2	605808	21716 16,0 + WK
1.6 i	66	06/91→03/00						
1.6 i 16V 4x4	75	10/92→03/00						
2.0 D	55	06/91→03/00						
 <b>Bremsscheibe</b>								
1.6	75	07/95→03/00	←			24.0118-0107.1	418107	Ø 240 18 16 V
1.6 i	66	06/91→03/00						
1.6 i 16V 4x4	75	10/92→03/00						
2.0 D	55	06/91→03/00						
<b>NISSAN - TEANA I (J31) 02/03→09/08</b>								
 <b>Bremsbelagsatz, Scheibenbremse</b>								
2.0	103	10/03→06/08	←			13.0460-5716.2	605716	21561 17,0 + WK
2.3	127	10/03→06/08						
3.5	170	10/03→06/08	→			13.0460-5843.2	605843	AKE 23871 14,3 + WK
<b>NISSAN - TERRANO (D10) 09/13→</b>								
 <b>Bremsscheibe</b>								
1.6	75	03/14→	←	+ ESP		24.0124-0221.1	424221	Ø 280 24 21,8 V + S
2.0	98	03/14→						
<b>NISSAN - TERRANO I (WD21) 07/86→02/96</b>								
 <b>Bremsbelagsatz, Scheibenbremse</b>								
2.7 TD 4WD	73	02/89→02/96	←	→ 10/93		13.0460-5957.2	605957	AKE 21347 17,0 + WK
↓								















	kW			 	! #		
<b>NISSAN - TERRANO I (WD21) 07/86→02/96</b>							
<b>Zubehörsatz, Scheibenbremsbelag</b>							
2.7 TD 4WD	73	02/89→02/96	←	→ 10/93		13.0460-0289.2 610289	
<b> Bremsscheibe</b>							
2.7 TD 4WD	73	02/89→02/96	←	→ 10/93		24.0126-0109.1 426109	Ø 277 26 24 V
<b>NISSAN - TERRANO II (R20) 10/92→09/07</b>							
<b> Bremsbelagsatz, Scheibenbremse</b>							
2.4 4WD	85	05/96→01/02	←			13.0460-5959.2 605959	TRW 21481 15,5 - WK
2.7 TD 4WD	74	02/93→01/02	←				
2.4 4WD	87	05/96→09/07	←	→ 11/05		13.0460-5959.2 605959	TRW 21481 15,5 - WK
2.7 TDi 4WD	92	05/96→09/07	←				
2.4 i 12V 4WD	91	02/93→12/97	←	→ 04/96		13.0460-5959.2 605959	TRW 21481 15,5 - WK
3.0 Di 4WD	113	05/02→09/07	←	→ 04/06		13.0460-5959.2 605959	TRW 21481 15,5 - WK
<b> Bremsscheibe</b>							
2.4 4WD	85	05/96→01/02	←			24.0126-0109.1 426109	Ø 277 26 24 V
2.7 TD 4WD	74	02/93→01/02	←				
2.4 4WD	87	05/96→09/07	←	→ 11/05		24.0126-0109.1 426109	Ø 277 26 24 V
2.7 TDi 4WD	92	05/96→09/07	←				
2.4 i 12V 4WD	91	02/93→12/97	←	→ 04/96		24.0126-0109.1 426109	Ø 277 26 24 V
3.0 Di 4WD	113	05/02→09/07	←	→ 04/06		24.0126-0109.1 426109	Ø 277 26 24 V
<b>NISSAN - TERRANO II Van (R20) 06/98→09/07</b>							
<b> Bremsbelagsatz, Scheibenbremse</b>							
2.7 TDi 4WD	92	06/98→09/07	←	→ 11/05		13.0460-5959.2 605959	TRW 21481 15,5 - WK
3.0 Di 4WD	113	04/03→09/07	←	→ 04/06		13.0460-5959.2 605959	TRW 21481 15,5 - WK
<b> Bremsscheibe</b>							
2.7 TDi 4WD	92	06/98→09/07	←	→ 11/05		24.0126-0109.1 426109	Ø 277 26 24 V
3.0 Di 4WD	113	04/03→09/07	←	→ 04/06		24.0126-0109.1 426109	Ø 277 26 24 V
<b>NISSAN - TIIDA Schrägheck (C11) 05/04→12/13</b>							
<b> Bremsbelagsatz, Scheibenbremse</b>							
1.5 dCi	78	09/07→12/11	←	→ 04/11		13.0460-5716.2 605716	21561 17,0 + WK
1.6	81	09/07→12/11					
1.8	93	09/07→12/11					
<b>Zubehörsatz, Scheibenbremsbelag</b>							
1.5 dCi	78	09/07→12/11	←	→ 04/11		13.0460-0170.2 610170	
1.6	81	09/07→12/11					
1.8	93	09/07→12/11	→	→ 05/10		13.0460-0213.2 610213	ATE
<b> Bremsscheibe</b>							
1.5 dCi	78	09/07→12/11	←	→ 04/11		24.0124-0238.1 424238	Ø 280 24 22 V
1.6	81	09/07→12/11					
1.8	93	09/07→12/11	→	→ 04/11		24.0109-0166.1 409166	Ø 292 9 8
<b>NISSAN - TIIDA Stufenheck (SC11) 05/04→12/13</b>							
<b> Bremsbelagsatz, Scheibenbremse</b>							
1.5 dCi	76	01/07→12/12	←	→ 04/11		13.0460-5716.2 605716	21561 17,0 + WK
1.5 dCi	78	09/07→12/12					
1.6	81	09/07→12/12					
1.8	93	09/07→12/12					
<b>Zubehörsatz, Scheibenbremsbelag</b>							
1.5 dCi	76	01/07→12/12	←	→ 04/11		13.0460-0170.2 610170	
1.5 dCi	78	09/07→12/12					
1.6	81	09/07→12/12	→	→ 05/10		13.0460-0213.2 610213	ATE
1.8	93	09/07→12/12					
<b> Bremsscheibe</b>							
1.5 dCi	76	01/07→12/12	←	→ 04/11		24.0124-0238.1 424238	Ø 280 24 22 V
1.5 dCi	78	09/07→12/12					
1.6	81	09/07→12/12	→	→ 04/11		24.0109-0166.1 409166	Ø 292 9 8
1.8	93	09/07→12/12					

















	kW					! #		
<b>NISSAN - TRADE Pritsche/Fahrgestell 11/98→09/04</b>								
 <b>Bremsscheibe</b>								
2.7 TD 3.0 TD	73 81	11/98→09/04 11/98→09/04	←			24.0124-0229.1	424229	Ø 263 24 22 V
<b>NISSAN - URVAN Bus (E24) 06/86→05/97</b>								
 <b>Bremsbelagsatz, Scheibenbremse</b>								
2.5 D	59	05/89→10/96	←			13.0460-5957.2	605957	AKE 21347 17,0 + WK
<b>NISSAN - URVAN Kasten (E24) 06/86→05/97</b>								
 <b>Bremsbelagsatz, Scheibenbremse</b>								
2.0	64	05/87→05/97	←			13.0460-5957.2	605957	AKE 21347 17,0 + WK
2.3 D	51	01/88→05/97	←	→ 12/88		13.0460-5957.2	605957	AKE 21347 17,0 + WK
2.5 D	59	12/88→05/97	←	01/89→		13.0460-5957.2	605957	AKE 21347 17,0 + WK
<b>NISSAN - VANETTE CARGO Bus (HC 23) 09/94→05/01</b>								
 <b>Bremsbelagsatz, Scheibenbremse</b>								
1.6 i 2.3 D	72 55	01/96→05/01 09/94→05/01	←	Bremssattel(1-Kolben)		13.0460-5881.2	605881	21099 17,0 - WE / - WK
			←	Bremssattel(2-Kolben)		13.0460-5959.2	605959	TRW 21481 15,5 - WK
<b>Zubehörsatz, Scheibenbremsbelag</b>								
1.6 i 2.3 D	72 55	01/96→05/01 09/94→05/01	←	Bremssattel(1-Kolben)		13.0460-0322.2	610322	AKE
 <b>Bremsscheibe</b>								
1.6 i 2.3 D	72 55	01/96→05/01 09/94→05/01	←	Bremssattel(1-Kolben)		24.0122-0193.1	422193	Ø 250 22 20 V
			←	Bremssattel(2-Kolben)		24.0126-0108.1	426108	Ø 257 26 24 V
<b>NISSAN - VANETTE CARGO Kasten (HC 23) 09/94→05/02</b>								
 <b>Bremsbelagsatz, Scheibenbremse</b>								
1.6 i	71	09/94→05/01	←	Bremssattel(1-Kolben)		13.0460-5881.2	605881	21099 17,0 - WE / - WK
			←	Bremssattel(2-Kolben)		13.0460-5959.2	605959	TRW 21481 15,5 - WK
2.3 D	55	09/94→05/02	←	→ 11/01; Bremssattel(1-Kolben)		13.0460-5881.2	605881	21099 17,0 - WE / - WK
			←	→ 11/01; Bremssattel(2-Kolben)		13.0460-5959.2	605959	TRW 21481 15,5 - WK
<b>Zubehörsatz, Scheibenbremsbelag</b>								
1.6 i 2.3 D	71 55	09/94→05/01 09/94→05/02	←	Bremssattel(1-Kolben)		13.0460-0322.2	610322	AKE
			←	→ 11/01; Bremssattel(1-Kolben)		13.0460-0322.2	610322	AKE
 <b>Bremsscheibe</b>								
1.6 i	71	09/94→05/01	←	Bremssattel(1-Kolben)		24.0122-0193.1	422193	Ø 250 22 20 V
			←	Bremssattel(2-Kolben)		24.0126-0108.1	426108	Ø 257 26 24 V
2.3 D	55	09/94→05/02	←	→ 11/01; Bremssattel(1-Kolben)		24.0122-0193.1	422193	Ø 250 22 20 V
			←	→ 11/01; Bremssattel(2-Kolben)		24.0126-0108.1	426108	Ø 257 26 24 V
<b>NISSAN - X-TRAIL (T30) 01/01→12/13</b>								
 <b>Bremsbelagsatz, Scheibenbremse</b>								
2.0 2.0 2.0 4x4 2.0 4x4 2.0 4x4 2.2 dCi 2.2 dCi 4x4 2.5 4x4	103 110 103 110 206 100 100 132	07/01→01/13 09/01→01/13 07/01→01/13 09/01→01/13 06/01→01/13 12/03→01/13 12/03→01/13 11/02→01/13	←	→ 02/07		13.0460-5842.2	605842	23420 16,5 - WE / - WK
			→	→ 02/07		13.0460-5843.2	605843	AKE 23871 14,3 + WK
2.2 DCi FWD	84	06/01→09/03	←	07/01→		13.0460-5842.2	605842	23420 16,5 - WE / - WK
			→	07/01→		13.0460-5843.2	605843	AKE 23871 14,3 + WK
2.2 Di 4x4	84	07/01→10/05	←	→ 09/03		13.0460-5842.2	605842	23420 16,5 - WE / - WK
			→	→ 09/03		13.0460-5843.2	605843	AKE 23871 14,3 + WK
2.5 4x4	121	09/02→01/13	←	01/03→ 02/07		13.0460-5842.2	605842	23420 16,5 - WE / - WK
↓			→	01/03→ 02/07		13.0460-5843.2	605843	AKE 23871 14,3 + WK













	kW			 	! #			
<b>NISSAN - X-TRAIL (T30) 01/01→12/13</b>								
<b>Zubehörsatz, Scheibenbremsbelag</b>								
2.0	103	07/01→01/13	←	→ 02/07		13.0460-0340.2	610340	
2.0	110	09/01→01/13	→	→ 02/07		13.0460-0341.2	610341	
2.0 4x4	103	07/01→01/13	→	→ 02/07				
2.0 4x4	110	09/01→01/13						
2.0 4x4	206	06/01→01/13						
2.2 dCi	100	12/03→01/13						
2.2 dCi 4x4	100	12/03→01/13						
2.5 4x4	132	11/02→01/13						
2.2 DCi FWD	84	06/01→09/03	←	07/01→		13.0460-0340.2	610340	
			→	07/01→		13.0460-0341.2	610341	
2.2 Di 4x4	84	07/01→10/05	←	→ 09/03		13.0460-0340.2	610340	
			→	→ 09/03		13.0460-0341.2	610341	
2.5 4x4	121	09/02→01/13	←	01/03→ 02/07		13.0460-0340.2	610340	
			→	01/03→ 02/07		13.0460-0341.2	610341	
<b> Bremsscheibe</b>								
2.0	103	07/01→01/13	←	→ 02/07		24.0128-0140.1	428140	Ø 280 28 26 V
2.0	110	09/01→01/13	→	→ 02/07		24.0116-0119.1	416119	Ø 292 16 14 V
2.0 4x4	103	07/01→01/13	→	→ 02/07				
2.0 4x4	110	09/01→01/13						
2.0 4x4	206	06/01→01/13						
2.2 dCi	100	12/03→01/13						
2.2 dCi 4x4	100	12/03→01/13						
2.5 4x4	132	11/02→01/13						
2.2 DCi FWD	84	06/01→09/03	←	07/01→		24.0128-0140.1	428140	Ø 280 28 26 V
			→	07/01→		24.0116-0119.1	416119	Ø 292 16 14 V
2.2 Di 4x4	84	07/01→10/05	←	→ 09/03		24.0128-0140.1	428140	Ø 280 28 26 V
			→	→ 09/03		24.0116-0119.1	416119	Ø 292 16 14 V
2.5 4x4	121	09/02→01/13	←	01/03→ 02/07		24.0128-0140.1	428140	Ø 280 28 26 V
			→	01/03→ 02/07		24.0116-0119.1	416119	Ø 292 16 14 V
<b>NISSAN - X-TRAIL (T31) 03/07→07/14</b>								
<b> Bremsbelagsatz, Scheibenbremse</b>								
2.0	101	06/07→11/13	←			13.0460-5752.2	605752	24632 17,0 - WK
2.0	102	06/08→02/14				13.0470-5752.2	LD5752	24632 17,0 - WK Ceramic
2.0	103	06/08→11/13						
2.0	104	06/07→11/13						
2.0 dCi	127	06/07→11/13						
2.0 dCi 4x4	110	06/07→11/13						
2.0 dCi FWD	110	06/07→11/13						
2.0 FWD	103	06/08→11/13						
2.0 FWD	104	03/07→11/13						
2.5	132	09/07→						
2.5 4x4	124	06/07→11/13						
<b>Zubehörsatz, Scheibenbremsbelag</b>								
2.0	101	06/07→11/13	←			13.0460-0212.2	610212	ATE
2.0	102	06/08→02/14	→			13.0460-0213.2	610213	ATE
2.0	103	06/08→11/13	→					
2.0	104	06/07→11/13						
2.0 dCi	127	06/07→11/13						
2.0 dCi 4x4	110	06/07→11/13						
2.0 dCi FWD	110	06/07→11/13						
2.0 FWD	103	06/08→11/13						
2.0 FWD	104	03/07→11/13						
2.5	132	09/07→						
2.5 4x4	124	06/07→11/13						
<b> Bremsscheibe</b>								
2.0	101	06/07→11/13	←	→ 12/10		24.0126-0154.1	426154	Ø 295,5 26 24 V
2.0	102	06/08→02/14	←	01/11→		24.0126-0177.1	426177	Ø 296 26 24 V
2.0	103	06/08→11/13	→					
2.0	104	06/07→11/13	→			24.0116-0119.1	416119	Ø 292 16 14 V
2.0 dCi	127	06/07→11/13						
2.0 dCi 4x4	110	06/07→11/13						
2.0 dCi FWD	110	06/07→11/13						
2.0 FWD	103	06/08→11/13						
2.0 FWD	104	03/07→11/13						
2.5 4x4	124	06/07→11/13						
2.5	132	09/07→	←	→ 07/10		24.0126-0154.1	426154	Ø 295,5 26 24 V
			←	08/10→		24.0126-0177.1	426177	Ø 296 26 24 V
			→			24.0116-0119.1	416119	Ø 292 16 14 V

	kw			 	! #		
<b>NISSAN - X-TRAIL (T32_) 10/13→</b>							
 <b>Bremsbelagsatz, Scheibenbremse</b>							
1.6 dCi (T32)	96	04/14→	➔			13.0460-2600.2 602600	TRW 25965 15,0 + WK
1.6 dCi ALL MODE 4x4-i (NT32)	96	04/14→					
1.6 DIG-T (T32)	120	06/15→					
2.0 (T32)	106	09/14→					
2.0 ALL MODE 4x4-i (NT32)	106	09/14→					
2.0 dCi (T32)	130	10/16→					
2.0 dCi ALL MODE 4x4-i (NT32)	130	10/16→					
2.5 ALL MODE 4x4-i (NT32)	126	12/13→	➔	12/14→		13.0460-2600.2 602600	TRW 25965 15,0 + WK
 <b>Bremsscheibe</b>							
1.6 dCi (T32)	96	04/14→	⬅	für Fahrzeuge ohne 3. Sitzreihe		24.0126-0185.1 426185	Ø 296 26 24 V
1.6 dCi ALL MODE 4x4-i (NT32)	96	04/14→	⬅	für Fahrzeuge mit 3. Sitzreihe		24.0128-0291.1 428291	Ø 320 28 26 V
1.6 DIG-T (T32)	120	06/15→					
2.0 (T32)	106	09/14→					
2.0 ALL MODE 4x4-i (NT32)	106	09/14→					
2.0 dCi (T32)	130	10/16→					
2.0 dCi ALL MODE 4x4-i (NT32)	130	10/16→					
2.5 ALL MODE 4x4-i (NT32)	126	12/13→	⬅	12/14→; für Fahrzeuge ohne 3. Sitzreihe		24.0126-0185.1 426185	Ø 296 26 24 V
			⬅	12/14→; für Fahrzeuge mit 3. Sitzreihe		24.0128-0291.1 428291	Ø 320 28 26 V
<b>OPEL - ADAM (M13) 10/12→</b>							
 <b>Bremsbelagsatz, Scheibenbremse</b>							
1.0	66	07/14→	⬅	für Bremsscheibendurchmesser [mm]: 257		13.0460-3839.2 603839	BOS 23707 17,9 + WK + Zub
1.0	85	07/14→				13.0470-3839.2 LD3839	BOS 23707 17,9 + WK + Zub Ceramic
1.4 LPG	64	07/13→					
1.4 S	110	11/14→					
			⬅	für Bremsscheibendurchmesser [mm]: 308		13.0460-7179.2 607179	ATE 23832 20,2 - WK / + WK
						13.0470-7179.2 LD7179	ATE 23832 20,2 - WK / + WK Ceramic
			⬅	für Bremsscheibendurchmesser [mm]: 284		13.0460-7308.2 607308	ATE 22123 18,2 + WK + Zub
			➔			13.0460-2793.2 602793	TRW 25973 17,2 + WK + Zub
1.2	51	10/12→	⬅	01/13→; für Bremsscheibendurchmesser [mm]: 257		13.0460-3839.2 603839	BOS 23707 17,9 + WK + Zub
1.4	64	10/12→				13.0470-3839.2 LD3839	BOS 23707 17,9 + WK + Zub Ceramic
1.4	74	10/12→					
			⬅	01/13→; für Bremsscheibendurchmesser [mm]: 308		13.0460-7179.2 607179	ATE 23832 20,2 - WK / + WK
						13.0470-7179.2 LD7179	ATE 23832 20,2 - WK / + WK Ceramic
			⬅	01/13→; für Bremsscheibendurchmesser [mm]: 284		13.0460-7308.2 607308	ATE 22123 18,2 + WK + Zub
			➔	01/13→		13.0460-2793.2 602793	TRW 25973 17,2 + WK + Zub
 <b>Bremsscheibe</b>							
1.0	66	07/14→	⬅			24.0122-0231.1 422231	Ø 257 22 20 V + S
1.0	85	07/14→				24.0122-0241.1 422241	Ø 284 22 20 V + S
1.4 LPG	64	07/13→				24.0125-0142.1 425142	Ø 308 25 22 V + S
1.4 S	110	11/14→				24.0322-0231.1 522231	Ø 257 22 20 V + S
						24.0325-0142.1 525142	Ø 308 25 23 V + S
			➔			24.0110-0323.1 410323	Ø 264 10 8
						24.0110-0347.1 410347	Ø 264 10 8
1.2	51	10/12→	⬅	01/13→		24.0122-0231.1 422231	Ø 257 22 20 V + S
1.4	64	10/12→				24.0122-0241.1 422241	Ø 284 22 20 V + S
1.4	74	10/12→				24.0125-0142.1 425142	Ø 308 25 22 V + S
						24.0322-0231.1 522231	Ø 257 22 20 V + S
						24.0325-0142.1 525142	Ø 308 25 23 V + S
			➔	01/13→		24.0110-0323.1 410323	Ø 264 10 8
						24.0110-0347.1 410347	Ø 264 10 8
<b>OPEL - AGILA (A) (H00) 09/00→12/07</b>							
 <b>Bremsbelagsatz, Scheibenbremse</b>							
1.0 (F68)	44	08/03→12/07	⬅	→ 07/07		13.0460-3995.2 603995	BOS 23605 15,7 + WK + Zub
1.0 12V (F68)	43	09/00→12/07					







	kW					! #		
<b>OPEL - AGILA (A) (H00) 09/00→12/07</b>								
 <b>Bremsbelagsatz, Scheibenbremse</b>								
1.2 16V (F68)	55	09/00→12/07	←	→ 07/07			13.0460-3995.2 603995	BOS 23605 15,7 + WK + Zub
1.2 16V Twinport (F68)	59	07/04→12/07						
1.3 CDTI (F68)	51	08/03→12/07						
 <b>Bremsscheibe</b>								
1.0 (F68)	44	08/03→12/07	←	→ 3G002367			24.0112-0153.1 412153	Ø 247 12 10,5
1.0 12V (F68)	43	09/00→12/07						
1.2 16V (F68)	55	09/00→12/07	←	3G002368-; → 07/07			24.0117-0106.1 417106	Ø 253 17 15 V
1.2 16V Twinport (F68)	59	07/04→12/07						
1.3 CDTI (F68)	51	08/03→12/07						
<b>OPEL - AGILA (B) (H08) 04/08→10/14</b>								
 <b>Bremsbelagsatz, Scheibenbremse</b>								
1.0 (F68)	48	04/08→06/11	←				13.0460-5700.2 605700	TRW 23973 17,0 + WK
1.0 (F68)	50	07/11→07/14						
1.0 LPG (F68)	48	01/10→06/11						
1.2 (F68)	63	04/08→10/12						
1.2 (F68)	69	04/10→10/14						
1.2 LPG (F68)	63	04/08→10/10						
1.3 CDTI (F68)	55	04/08→04/10						
 <b>Bremsscheibe</b>								
1.0 (F68)	48	04/08→06/11	←				24.0120-0211.1 420211	Ø 252 20 18 V + S
1.0 (F68)	50	07/11→07/14						
1.0 LPG (F68)	48	01/10→06/11						
1.2 (F68)	63	04/08→10/12						
1.2 (F68)	69	04/10→10/14						
1.2 LPG (F68)	63	04/08→10/10						
1.3 CDTI (F68)	55	04/08→04/10						
<b>OPEL - AMPERA (R12) 11/11→03/15</b>								
 <b>Bremsbelagsatz, Scheibenbremse</b>								
EV 150	111	11/11→03/15	←				13.0460-7263.2 607263	24034 19,1 + WK + Zub
			→	+ eFSB			13.0470-7263.2 LD7263	24034 19,1 + WK + Zub Ceramic
							13.0460-7264.2 607264	ATE 25096 17,0 + WK + Zub
							13.0470-7264.2 LD7264	ATE 25096 17,0 + WK + Zub Ceramic
 <b>Bremsscheibe</b>								
EV 150	111	11/11→03/15	←				24.0126-0166.1 426166	Ø 300 26 23 V + S
							24.0326-0166.1 526166	Ø 300 26 23 V + S
			→	+ eFSB			24.0112-0189.1 412189	Ø 292 12 10 + S
							24.0312-0189.1 512189	Ø 292 12 10 + S
<b>OPEL - ANTARA (L07) 05/06→</b>								
 <b>Bremsbelagsatz, Scheibenbremse</b>								
2.0 CDTI	93	03/07→12/11	←				13.0460-5785.2 605785	24510 17,0 + WK
2.0 CDTI	93	09/08→12/11						
2.0 CDTI	110	08/06→12/11	→				13.0460-5788.2 605788	24498 14,7 + WK
2.0 CDTI	125	01/16→						
2.0 CDTI 4x4	110	07/06→12/11						
2.0 CDTI 4x4	125	01/16→						
2.2 CDTi	120	12/10→12/15						
2.2 CDTi 4x4	120	12/10→12/15						
2.2 CDTi 4x4	135	12/10→12/15						
2.4	103	09/08→12/11						
2.4	104	07/06→12/11						
2.4	123	12/10→						
2.4 4x4	103	08/06→12/11						
2.4 4x4	123	12/10→						
2.4 LPG	103	10/08→						
2.4 LPG 4x4	103	08/06→12/10						
3.2 V6	167	07/06→12/11						
3.0	190	11/10→12/15	←	12/10→			13.0460-5785.2 605785	24510 17,0 + WK
			→	12/10→			13.0460-5788.2 605788	24498 14,7 + WK
<b>Zubehörsatz, Scheibenbremsbelag</b>								
2.0 CDTI	93	03/07→12/11	→				13.0460-0135.2 610135	
2.0 CDTI	93	09/08→12/11						
2.0 CDTI	110	08/06→12/11						
2.0 CDTI	125	01/16→						
2.0 CDTI 4x4	110	07/06→12/11						
2.0 CDTI 4x4	125	01/16→						
2.2 CDTi	120	12/10→12/15						

	kW			 	! #			
<b>OPEL - ANTARA (L07) 05/06→</b>								
<b>Zubehörsatz, Scheibenbremsbelag</b>								
2.2 CDTi 4x4	120	12/10→12/15	➔			13.0460-0135.2	610135	
2.2 CDTi 4x4	135	12/10→12/15						
2.4	103	09/08→12/11						
2.4	104	07/06→12/11						
2.4	123	12/10→						
2.4 4x4	103	08/06→12/11						
2.4 4x4	123	12/10→						
2.4 LPG	103	10/08→						
2.4 LPG 4x4	103	08/06→12/10						
3.2 V6	167	07/06→12/11						
3.0	190	11/10→12/15	➔	12/10→		13.0460-0135.2	610135	
<b> Bremsscheibe</b>								
2.0 CDTi	93	03/07→12/11	➔			24.0129-0101.1	429101	Ø 296 29 27,5 V
2.0 CDTi	93	09/08→12/11						
2.0 CDTi	110	08/06→12/11	➔			24.0120-0209.1	420209	Ø 303 20 18,4 V
2.0 CDTi	125	01/16→						
2.0 CDTi 4x4	110	07/06→12/11						
2.0 CDTi 4x4	125	01/16→						
2.2 CDTi	120	12/10→12/15						
2.2 CDTi 4x4	120	12/10→12/15						
2.2 CDTi 4x4	135	12/10→12/15						
2.4	103	09/08→12/11						
2.4	104	07/06→12/11						
2.4	123	12/10→						
2.4 4x4	103	08/06→12/11						
2.4 4x4	123	12/10→						
2.4 LPG	103	10/08→						
2.4 LPG 4x4	103	08/06→12/10						
3.2 V6	167	07/06→12/11						
3.0	190	11/10→12/15	➔	12/10→		24.0129-0101.1	429101	Ø 296 29 27,5 V
			➔	12/10→		24.0120-0209.1	420209	Ø 303 20 18,4 V
<b>OPEL - ARENA Bus (A97) 01/97→12/01</b>								
<b> Bremsbelagsatz, Scheibenbremse</b>								
1.9 D (TF1G/M, THBJ/L)	44	01/97→12/01	➔	03/98→09/01		13.0460-3969.2	603969	BDX 20926 18,5 + WK
2.5 D (TF1G/M, THBG/M)	55	01/97→12/01						
<b> Bremsscheibe</b>								
1.9 D (TF1G/M, THBJ/L)	44	01/97→12/01	➔	03/98→09/01		24.0124-0103.1	424103	Ø 252,5 24 22 V
2.5 D (TF1G/M, THBG/M)	55	01/97→12/01						
<b>OPEL - ARENA Combi (A97) 03/98→08/01</b>								
<b> Bremsbelagsatz, Scheibenbremse</b>								
1.9 D	44	03/98→08/01	➔			13.0460-3969.2	603969	BDX 20926 18,5 + WK
2.5 D	55	03/98→08/01						
<b> Bremsscheibe</b>								
1.9 D	44	03/98→08/01	➔			24.0124-0103.1	424103	Ø 252,5 24 22 V
2.5 D	55	03/98→08/01						
<b>OPEL - ARENA Kasten (A97) 01/97→12/01</b>								
<b> Bremsbelagsatz, Scheibenbremse</b>								
1.9 D (TF1J/L, THBJ/L)	44	01/97→12/01	➔	03/98→09/01		13.0460-3969.2	603969	BDX 20926 18,5 + WK
2.5 D (TF1G/M, THBG/M)	55	01/97→12/01						
<b> Bremsscheibe</b>								
1.9 D (TF1J/L, THBJ/L)	44	01/97→12/01	➔	03/98→09/01		24.0124-0103.1	424103	Ø 252,5 24 22 V
2.5 D (TF1G/M, THBG/M)	55	01/97→12/01						
<b>OPEL - ARENA Kasten (TB, TF) 03/98→08/01</b>								
<b> Bremsbelagsatz, Scheibenbremse</b>								
1.9 D	44	03/98→08/01	➔			13.0460-3969.2	603969	BDX 20926 18,5 + WK
2.5 D	55	03/98→08/01						
<b> Bremsscheibe</b>								
1.9 D	44	03/98→08/01	➔			24.0124-0103.1	424103	Ø 252,5 24 22 V
2.5 D	55	03/98→08/01						





















	kw					! #		
<b>OPEL - ASTRA CLASSIC Schrägheck (A04) 01/09→</b>								
 <b>Bremsbelagsatz, Scheibenbremse</b>								
1.3 CDTi (L48) 1.6 (L48)	66 85	01/09→ 01/09→	←	→ 11/10			13.0460-7179.2 607179 13.0470-7179.2 LD7179	ATE 23832 20,2 - WK / + WK ATE 23832 20,2 - WK / + WK Ceramic
			→	→ 11/10			13.0460-2868.2 602868 13.0470-2868.2 LD2868	TRW 23417 15,3 + WK + Zub TRW 23417 15,3 + WK + Zub Ceramic
<b>Warnkontakt, Bremsbelagverschleiß</b>								
1.3 CDTi (L48) 1.6 (L48)	66 85	01/09→ 01/09→	←	→ 11/10	1	24.8190-0720.2 620720	L= 287	
 <b>Bremsscheibe</b>								
1.3 CDTi (L48) 1.6 (L48)	66 85	01/09→ 01/09→	←	→ 11/10; Felge Lochzahl: 5		24.0125-0131.1 425131 24.0325-0131.1 525131	Ø 280 24,8 22 V + S Ø 280 24,8 22 V + S	
			←	→ 11/10; Felge Lochzahl: 4		24.0125-0198.1 425198 24.0325-0198.1 525198	Ø 280 25 22 V + S Ø 280 25 22 V + S	
			→	→ 11/10; Felge Lochzahl: 5		24.0110-0250.1 410250 24.0310-0250.1 510250	Ø 264 9,8 8 + S Ø 264 9,8 8 + S	
			→	→ 11/10; Felge Lochzahl: 4		24.0110-0251.1 410251 24.0310-0251.1 510251	Ø 240 9,8 8 + S Ø 240 9,8 8 + S	
<b>OPEL - ASTRA F (T92) 09/91→09/98</b>								
 <b>Bremsbelagsatz, Scheibenbremse</b>								
1.4 (F19, M19) 1.4 i 16V (F19, M19) 1.4 Si (F19, M19) 1.7 D (F19, M19) 1.7 TD (F19, M19) 1.7 TDS (F19, M19)	60 66 60 44 50 60	09/92→09/98 02/96→09/98 03/92→09/98 07/92→09/98 11/94→09/98 03/92→09/98	←	nicht für Fahrzeuge mit verstärkter Bremse		13.0460-7051.2 607051	ATE 20547 16,5 + WE / - WK	
			←	für Fahrzeuge mit verstärkter Bremse		13.0460-7052.2 607052	ATE 21190 17,5 + WE / - WK	
1.4 i (F19, M19)	44	09/91→09/98	←	10/91→		13.0460-7051.2 607051	ATE 20547 16,5 + WE / - WK	
1.6 (F19, M19) 1.6 i (F19, M19) 1.6 i (F19, M19)	55 52 55	09/95→09/98 05/93→07/96 03/92→09/98	←	Motorcode: C16NZ / X16SZR		13.0460-7051.2 607051	ATE 20547 16,5 + WE / - WK	
			←	nicht für Motorcode: C16NZ / X16SZR		13.0460-7052.2 607052	ATE 21190 17,5 + WE / - WK	
1.6 i 16V (F19, M19) 2.0 i (F19, M19)	74 85	08/94→09/98 03/92→09/98	←			13.0460-7052.2 607052	ATE 21190 17,5 + WE / - WK	
1.8 i (F19, M19)	66	03/92→09/98	←			13.0460-7051.2 607051	ATE 20547 16,5 + WE / - WK	
1.8 i 16V (F19, M19) 1.8 i 16V (F19, M19) 1.8 i 16V (F19, M19) 2.0 i 16V (F19, M19)	82 85 85 100	09/95→09/96 11/94→09/98 09/95→08/97 02/95→09/98	← ← →			13.0460-7052.2 607052 13.0460-4043.2 604043	ATE 21190 17,5 + WE / - WK ATE 21140 15,0 - WE / - WK	
<b>Warnkontakt, Bremsbelagverschleiß</b>								
1.4 (F19, M19) 1.4 i 16V (F19, M19) 1.4 Si (F19, M19) 1.7 D (F19, M19) 1.7 TD (F19, M19) 1.7 TDS (F19, M19)	60 66 60 44 50 60	09/92→09/98 02/96→09/98 03/92→09/98 07/92→09/98 11/94→09/98 03/92→09/98	←	für Fahrzeuge mit verstärkter Bremse	2	24.8190-0705.2 620705	L= 670	
			←	nicht für Fahrzeuge mit verstärkter Bremse	2	24.8190-0707.2 620707	L= 685	
1.4 i (F19, M19)	44	09/91→09/98	←	10/91→	2	24.8190-0707.2 620707	L= 685	
1.6 (F19, M19) 1.6 i (F19, M19) 1.6 i (F19, M19)	55 52 55	09/95→09/98 05/93→07/96 03/92→09/98	←	nicht für Motorcode: C16NZ / X16SZR	2	24.8190-0705.2 620705	L= 670	
			←	Motorcode: C16NZ / X16SZR	2	24.8190-0707.2 620707	L= 685	
1.6 i 16V (F19, M19) 1.8 i 16V (F19, M19) 1.8 i 16V (F19, M19) 1.8 i 16V (F19, M19) 2.0 i (F19, M19) 2.0 i 16V (F19, M19)	74 82 85 85 85 100	08/94→09/98 09/95→09/96 11/94→09/98 09/95→08/97 03/92→09/98 02/95→09/98	←		2	24.8190-0705.2 620705	L= 670	
1.8 i (F19, M19)	66	03/92→09/98	←		2	24.8190-0707.2 620707	L= 685	
<b>Zubehörsatz, Scheibenbremsbelag</b>								
1.8 i 16V (F19, M19) 1.8 i 16V (F19, M19) 1.8 i 16V (F19, M19) 2.0 i 16V (F19, M19)	82 85 85 100	09/95→09/96 11/94→09/98 09/95→08/97 02/95→09/98	→			13.0460-0217.2 610217	ATE	
 <b>Bremsscheibe</b>								
1.4 (F19, M19) 1.6 i 16V (F19, M19)	60 74	09/92→09/98 08/94→09/98	←			24.0120-0115.1 420115 24.0124-0115.1 424115 24.0320-0115.1 520115 24.0324-0115.1 524115	Ø 236 20 17 V + S Ø 256 24 21 V + S Ø 236 20 17 V + S Ø 256 24 21 V + S	
↓								











	kw			 	! #		
<b>OPEL - ASTRA F (T92) 09/91→09/98</b>							
<b>Bremsscheibe</b>							
1.4 i (F19, M19)	44	09/91→09/98	←	10/91→		24.0113-0161.1 413161 24.0313-0161.1 513161	Ø 236 12,7 9,7 + S Ø 236 12,7 9,7 + S
1.4 i 16V (F19, M19) 1.4 Si (F19, M19)	66 60	02/96→09/98 03/92→09/98	←	Schaltgetriebe; nicht für Fahrzeuge mit verstärkter Bremse		24.0113-0161.1 413161 24.0313-0161.1 513161	Ø 236 12,7 9,7 + S Ø 236 12,7 9,7 + S
			←	Vollautomatik; nicht für Fahrzeuge mit verstärkter Bremse		24.0120-0115.1 420115 24.0320-0115.1 520115	Ø 236 20 17 V + S Ø 236 20 17 V + S
			←	für Fahrzeuge mit verstärkter Bremse		24.0124-0115.1 424115 24.0324-0115.1 524115	Ø 256 24 21 V + S Ø 256 24 21 V + S
1.6 (F19, M19) 1.6 i (F19, M19) 1.6 i (F19, M19)	55 52 55	09/95→09/98 05/93→07/96 03/92→09/98	←	→ T5000073; Schaltgetriebe		24.0113-0161.1 413161 24.0313-0161.1 513161	Ø 236 12,7 9,7 + S Ø 236 12,7 9,7 + S
			←	Vollautomatik		24.0120-0115.1 420115 24.0320-0115.1 520115	Ø 236 20 17 V + S Ø 236 20 17 V + S
			←	T5000074→; Schaltgetriebe		24.0120-0115.1 420115 24.0320-0115.1 520115	Ø 236 20 17 V + S Ø 236 20 17 V + S
			←			24.0124-0115.1 424115 24.0324-0115.1 524115	Ø 256 24 21 V + S Ø 256 24 21 V + S
1.7 D (F19, M19) 1.7 TD (F19, M19) 1.7 TDS (F19, M19)	44 50 60	07/92→09/98 11/94→09/98 03/92→09/98	←	nicht für Fahrzeuge mit verstärkter Bremse		24.0120-0115.1 420115 24.0320-0115.1 520115	Ø 236 20 17 V + S Ø 236 20 17 V + S
			←	für Fahrzeuge mit verstärkter Bremse		24.0124-0115.1 424115 24.0324-0115.1 524115	Ø 256 24 21 V + S Ø 256 24 21 V + S
1.8 i (F19, M19)	66	03/92→09/98	←			24.0120-0140.1 420140	Ø 256 20 17 V + S
1.8 i 16V (F19, M19) 1.8 i 16V (F19, M19) 1.8 i 16V (F19, M19) 2.0 i 16V (F19, M19)	82 85 85 100	09/95→09/96 11/94→09/98 09/95→08/97 02/95→09/98	←			24.0124-0115.1 424115 24.0324-0115.1 524115 24.0110-0204.1 410204	Ø 256 24 21 V + S Ø 256 24 21 V + S Ø 260 10 8
2.0 i (F19, M19)	85	03/92→09/98	←			24.0124-0115.1 424115 24.0324-0115.1 524115	Ø 256 24 21 V + S Ø 256 24 21 V + S
<b>OPEL - ASTRA F Cabriolet (T92) 03/93→03/01</b>							
<b>Bremsbelagsatz, Scheibenbremse</b>							
1.4 i 16V 1.4 Si	66 60	01/96→03/01 05/93→03/01	←			13.0460-7051.2 607051	ATE 20547 16,5 + WE / - WK
			←	→ 09/98; nicht für Fahrzeuge mit verstärkter Bremse		13.0460-7051.2 607051	ATE 20547 16,5 + WE / - WK
			←	→ 09/98; für Fahrzeuge mit verstärkter Bremse		13.0460-7052.2 607052	ATE 21190 17,5 + WE / - WK
1.6 i	52	03/93→08/96	←			13.0460-7051.2 607051	ATE 20547 16,5 + WE / - WK
			←	Motorcode: C16NZ / X16SZR		13.0460-7051.2 607051	ATE 20547 16,5 + WE / - WK
1.6 i	55	01/96→03/01	←			13.0460-7051.2 607051	ATE 20547 16,5 + WE / - WK
			←	→ 09/98; Motorcode: C16NZ / X16SZR		13.0460-7051.2 607051	ATE 20547 16,5 + WE / - WK
			←	→ 09/98; nicht für Motorcode: C16NZ / X16SZR		13.0460-7052.2 607052	ATE 21190 17,5 + WE / - WK
1.8 i 16V	85	11/94→03/01	←			13.0460-7052.2 607052	ATE 21190 17,5 + WE / - WK
			←	→ 09/98		13.0460-7052.2 607052	ATE 21190 17,5 + WE / - WK
			→	→ 09/98		13.0460-4043.2 604043	ATE 21140 15,0 - WE / - WK
<b>Warnkontakt, Bremsbelagverschleiß</b>							
1.4 i 16V 1.4 Si	66 60	01/96→03/01 05/93→03/01	←	→ 09/98; für Fahrzeuge mit verstärkter Bremse	2	24.8190-0705.2 620705	L= 670
			←	→ 09/98; nicht für Fahrzeuge mit verstärkter Bremse	2	24.8190-0707.2 620707	L= 685
			←		2	24.8190-0707.2 620707	L= 685
1.6 i	52	03/93→08/96	←		2	24.8190-0707.2 620707	L= 685
			←	Motorcode: C16NZ / X16SZR	2	24.8190-0707.2 620707	L= 685
1.6 i	55	01/96→03/01	←	→ 09/98; nicht für Motorcode: C16NZ / X16SZR	2	24.8190-0705.2 620705	L= 670
			←	→ 09/98; Motorcode: C16NZ / X16SZR	2	24.8190-0707.2 620707	L= 685
			←		2	24.8190-0707.2 620707	L= 685
1.8 i 16V	85	11/94→03/01	←		2	24.8190-0705.2 620705	L= 670
			←	→ 09/98	2	24.8190-0705.2 620705	L= 670
↓							















	kW			 	! #		
<b>OPEL - ASTRA F Cabriolet (T92) 03/93→03/01</b>							
<b>Zubehörsatz, Scheibenbremsbelag</b>							
1.8 i 16V	85	11/94→03/01	➡	→ 09/98		13.0460-0217.2 610217	ATE
<b> Bremsscheibe</b>							
1.4 i 16V 1.4 Si	66 60	01/96→03/01 05/93→03/01	←	→ 09/98; Schaltgetriebe; nicht für Fahrzeuge mit verstärkter Bremse		24.0113-0161.1 413161 24.0313-0161.1 513161	Ø 236 12,7 9,7 + S Ø 236 12,7 9,7 + S
			←			24.0120-0115.1 420115 24.0320-0115.1 520115	Ø 236 20 17 V + S Ø 236 20 17 V + S
			←	→ 09/98; Vollautomatik; nicht für Fahrzeuge mit verstärkter Bremse		24.0120-0115.1 420115 24.0320-0115.1 520115	Ø 236 20 17 V + S Ø 236 20 17 V + S
			←	→ 09/98; für Fahrzeuge mit verstärkter Bremse		24.0124-0115.1 424115 24.0324-0115.1 524115	Ø 256 24 21 V + S Ø 256 24 21 V + S
1.6 i	52	03/93→08/96	←			24.0120-0115.1 420115 24.0320-0115.1 520115	Ø 236 20 17 V + S Ø 236 20 17 V + S
1.6 i	55	01/96→03/01	←			24.0120-0115.1 420115 24.0320-0115.1 520115	Ø 236 20 17 V + S Ø 236 20 17 V + S
			←	→ 09/98		24.0124-0115.1 424115 24.0324-0115.1 524115	Ø 256 24 21 V + S Ø 256 24 21 V + S
1.8 i 16V	85	11/94→03/01	←			24.0124-0115.1 424115 24.0324-0115.1 524115	Ø 256 24 21 V + S Ø 256 24 21 V + S
			←	→ 09/98		24.0124-0115.1 424115 24.0324-0115.1 524115	Ø 256 24 21 V + S Ø 256 24 21 V + S
			➡	→ 09/98		24.0110-0204.1 410204	Ø 260 10 8
<b>OPEL - ASTRA F Caravan (T92) 09/91→01/98</b>							
<b> Bremsbelagsatz, Scheibenbremse</b>							
1.4 (F08, C05) 1.4 i 16V (F08, C05) 1.4 Si (F08, C05) 1.7 D (F08, C05) 1.7 TD (F08, C05) 1.7 TDS (F08, C05)	60 66 60 44 50 60	09/92→01/98 02/96→01/98 03/92→01/98 07/92→01/98 11/94→01/98 12/91→01/98	←	nicht für Fahrzeuge mit verstärkter Bremse		13.0460-7051.2 607051	ATE 20547 16,5 + WE / - WK
			←	für Fahrzeuge mit verstärkter Bremse		13.0460-7052.2 607052	ATE 21190 17,5 + WE / - WK
1.4 i (F08, C05) 1.8 i (F08, C05)	44 66	09/91→01/98 09/91→01/98	←	10/91→		13.0460-7051.2 607051	ATE 20547 16,5 + WE / - WK
1.6 (F08, C05)	55	09/95→01/98	←			13.0460-7051.2 607051	ATE 20547 16,5 + WE / - WK
			←	Motorcode: C16NZ / X16SZR		13.0460-7051.2 607051	ATE 20547 16,5 + WE / - WK
			←	nicht für Motorcode: C16NZ / X16SZR		13.0460-7052.2 607052	ATE 21190 17,5 + WE / - WK
1.6 i (F08, C05)	52	05/93→07/96	←			13.0460-7051.2 607051	ATE 20547 16,5 + WE / - WK
1.6 i (F08, C05)	55	09/91→01/98	←	10/91→; Motorcode: C16NZ / X16SZR		13.0460-7051.2 607051	ATE 20547 16,5 + WE / - WK
			←	10/91→		13.0460-7051.2 607051	ATE 20547 16,5 + WE / - WK
			←	10/91→; nicht für Motorcode: C16NZ / X16SZR		13.0460-7052.2 607052	ATE 21190 17,5 + WE / - WK
1.6 i 16V (F08, C05) 2.0 i 16V (F08, C05) 2.0 i 16V (F08, C05)	74 100 110	08/94→01/98 02/95→01/98 03/93→01/98	←			13.0460-7052.2 607052	ATE 21190 17,5 + WE / - WK
1.8 i 16V (F08, C05) 1.8 i 16V (F08, C05)	85 92	07/94→01/98 06/93→01/98	←			13.0460-7052.2 607052	ATE 21190 17,5 + WE / - WK
			➡			13.0460-4043.2 604043	ATE 21140 15,0 - WE / - WK
<b>Warnkontakt, Bremsbelagverschleiß</b>							
1.4 (F08, C05) 1.4 i 16V (F08, C05) 1.4 Si (F08, C05) 1.7 D (F08, C05) 1.7 TD (F08, C05) 1.7 TDS (F08, C05)	60 66 60 44 50 60	09/92→01/98 02/96→01/98 03/92→01/98 07/92→01/98 11/94→01/98 12/91→01/98	←	für Fahrzeuge mit verstärkter Bremse	2	24.8190-0705.2 620705	L= 670
			←	nicht für Fahrzeuge mit verstärkter Bremse	2	24.8190-0707.2 620707	L= 685
1.4 i (F08, C05) 1.8 i (F08, C05)	44 66	09/91→01/98 09/91→01/98	←	10/91→	2	24.8190-0707.2 620707	L= 685
1.6 (F08, C05)	55	09/95→01/98	←	nicht für Motorcode: C16NZ / X16SZR	2	24.8190-0705.2 620705	L= 670
			←		2	24.8190-0707.2 620707	L= 685
			←	Motorcode: C16NZ / X16SZR	2	24.8190-0707.2 620707	L= 685
1.6 i (F08, C05)	52	05/93→07/96	←		2	24.8190-0707.2 620707	L= 685
1.6 i (F08, C05)	55	09/91→01/98	←	10/91→; nicht für Motorcode: C16NZ / X16SZR	2	24.8190-0705.2 620705	L= 670
			←	10/91→; Motorcode: C16NZ / X16SZR	2	24.8190-0707.2 620707	L= 685
			←	10/91→	2	24.8190-0707.2 620707	L= 685
↓							











	kw			 	! #		
<b>OPEL - ASTRA F Caravan (T92) 09/91→01/98</b>							
<b>Warnkontakt, Bremsbelagverschleiß</b>							
1.6 i 16V (F08, C05)	74	08/94→01/98	←		2	24.8190-0705.2 620705	L= 670
1.8 i 16V (F08, C05)	85	07/94→01/98					
1.8 i 16V (F08, C05)	92	06/93→01/98					
2.0 i 16V (F08, C05)	100	02/95→01/98					
2.0 i 16V (F08, C05)	110	03/93→01/98					
<b>Zubehörsatz, Scheibenbremsbelag</b>							
1.8 i 16V (F08, C05)	85	07/94→01/98	→			13.0460-0217.2 610217	ATE
1.8 i 16V (F08, C05)	92	06/93→01/98					
<b> Brems Scheibe</b>							
1.4 (F08, C05)	60	09/92→01/98	←			24.0120-0115.1 420115	Ø 236 20 17 V + S
1.6 (F08, C05)	55	09/95→01/98				24.0124-0115.1 424115	Ø 256 24 21 V + S
						24.0320-0115.1 520115	Ø 236 20 17 V + S
						24.0324-0115.1 524115	Ø 256 24 21 V + S
1.4 i (F08, C05)	44	09/91→01/98	←	10/91→		24.0113-0161.1 413161	Ø 236 12,7 9,7 + S
						24.0313-0161.1 513161	Ø 236 12,7 9,7 + S
1.4 i 16V (F08, C05)	66	02/96→01/98	←	Schaltgetriebe; nicht für Fahrzeuge mit verstärkter Bremse		24.0113-0161.1 413161	Ø 236 12,7 9,7 + S
1.4 Si (F08, C05)	60	03/92→01/98				24.0313-0161.1 513161	Ø 236 12,7 9,7 + S
			←	Vollautomatik; nicht für Fahrzeuge mit verstärkter Bremse		24.0120-0115.1 420115	Ø 236 20 17 V + S
						24.0320-0115.1 520115	Ø 236 20 17 V + S
			←	für Fahrzeuge mit verstärkter Bremse		24.0124-0115.1 424115	Ø 256 24 21 V + S
						24.0324-0115.1 524115	Ø 256 24 21 V + S
1.6 i (F08, C05)	52	05/93→07/96	←			24.0120-0115.1 420115	Ø 236 20 17 V + S
						24.0320-0115.1 520115	Ø 236 20 17 V + S
1.6 i (F08, C05)	55	09/91→01/98	←	10/91→		24.0120-0115.1 420115	Ø 236 20 17 V + S
						24.0124-0115.1 424115	Ø 256 24 21 V + S
						24.0320-0115.1 520115	Ø 236 20 17 V + S
						24.0324-0115.1 524115	Ø 256 24 21 V + S
1.6 i 16V (F08, C05)	74	08/94→01/98	←			24.0124-0115.1 424115	Ø 256 24 21 V + S
2.0 i 16V (F08, C05)	100	02/95→01/98				24.0324-0115.1 524115	Ø 256 24 21 V + S
2.0 i 16V (F08, C05)	110	03/93→01/98					
1.7 D (F08, C05)	44	07/92→01/98	←	nicht für Fahrzeuge mit verstärkter Bremse		24.0120-0115.1 420115	Ø 236 20 17 V + S
1.7 TD (F08, C05)	50	11/94→01/98				24.0320-0115.1 520115	Ø 236 20 17 V + S
1.7 TDS (F08, C05)	60	12/91→01/98				24.0124-0115.1 424115	Ø 256 24 21 V + S
			←	für Fahrzeuge mit verstärkter Bremse		24.0324-0115.1 524115	Ø 256 24 21 V + S
1.8 i (F08, C05)	66	09/91→01/98	←	10/91→		24.0120-0140.1 420140	Ø 256 20 17 V + S
1.8 i 16V (F08, C05)	85	07/94→01/98	←			24.0124-0115.1 424115	Ø 256 24 21 V + S
1.8 i 16V (F08, C05)	92	06/93→01/98				24.0324-0115.1 524115	Ø 256 24 21 V + S
			→			24.0110-0204.1 410204	Ø 260 10 8
<b>OPEL - ASTRA F CC (T92) 09/91→02/98</b>							
<b> Bremsbelagsatz, Scheibenbremse</b>							
1.4 (F08, M08, F68, M68)	60	09/92→01/98	←	nicht für Fahrzeuge mit verstärkter Bremse		13.0460-7051.2 607051	ATE 20547 16,5 + WE / - WK
1.4 i 16V (F08, M08, F68, M68)	66	09/96→02/98	←	für Fahrzeuge mit verstärkter Bremse		13.0460-7052.2 607052	ATE 21190 17,5 + WE / - WK
1.4 Si (F08, M08, F68, M68)	60	03/92→01/98					
1.7 D (F08, M08, F68, M68)	44	07/92→01/98					
1.7 TD (F08, M08, F68, M68)	50	11/94→01/98					
1.7 TDS (F08, M08, F68, M68)	60	12/91→01/98					
1.4 i (F08, M08, F68, M68)	44	09/91→01/98	←			13.0460-7051.2 607051	ATE 20547 16,5 + WE / - WK
1.6 (F08, M08, F68, M68)	55	09/95→01/98	←	Motorcode: C16NZ / X16SZR		13.0460-7051.2 607051	ATE 20547 16,5 + WE / - WK
1.6 i (F08, M08, F68, M68)	52	05/93→07/96	←	nicht für Motorcode: C16NZ / X16SZR		13.0460-7052.2 607052	ATE 21190 17,5 + WE / - WK
1.6 i (F08, M08, F68, M68)	55	09/91→01/98	←	10/91→; Motorcode: C16NZ / X16SZR		13.0460-7051.2 607051	ATE 20547 16,5 + WE / - WK
			←	10/91→; nicht für Motorcode: C16NZ / X16SZR		13.0460-7052.2 607052	ATE 21190 17,5 + WE / - WK
1.6 i 16V (F08, M08, F68, M68)	74	08/94→01/98	←			13.0460-7052.2 607052	ATE 21190 17,5 + WE / - WK
1.8 i (F08, M08, F68, M68)	66	09/91→01/98	←	10/91→		13.0460-7051.2 607051	ATE 20547 16,5 + WE / - WK
↓							



















	kw			 	! #			
<b>OPEL - ASTRA F CC (T92) 09/91→02/98</b>								
<b> Bremsbelagsatz, Scheibenbremse</b>								
1.8 i 16V (F08, M08, F68, M68)	85	09/94→01/98	←			<b>13.0460-7052.2 607052</b>	ATE 21190 17,5 + WE / - WK	
2.0 i 16V (F08, M08, F68, M68)	100	02/95→01/98	→			<b>13.0460-4043.2 604043</b>	ATE 21140 15,0 - WE / - WK	
2.0 GSI 16V (F08, M08, F68, M68)	110	09/91→01/98	←	10/91→		<b>13.0460-7052.2 607052</b>	ATE 21190 17,5 + WE / - WK	
			→	10/91→		<b>13.0460-4043.2 604043</b>	ATE 21140 15,0 - WE / - WK	
2.0 i (F08, M08, F68, M68)	85	09/91→01/98	←	10/91→		<b>13.0460-7052.2 607052</b>	ATE 21190 17,5 + WE / - WK	
<b>Warnkontakt, Bremsbelagverschleiß</b>								
1.4 (F08, M08, F68, M68)	60	09/92→01/98	←	für Fahrzeuge mit verstärkter Bremse	2	<b>24.8190-0705.2 620705</b>	L= 670	
1.4 i 16V (F08, M08, F68, M68)	66	09/96→02/98	←	nicht für Fahrzeuge mit verstärkter Bremse	2	<b>24.8190-0707.2 620707</b>	L= 685	
1.4 Si (F08, M08, F68, M68)	60	03/92→01/98						
1.7 D (F08, M08, F68, M68)	44	07/92→01/98						
1.7 TD (F08, M08, F68, M68)	50	11/94→01/98						
1.7 TDS (F08, M08, F68, M68)	60	12/91→01/98						
1.4 i (F08, M08, F68, M68)	44	09/91→01/98	←		2	<b>24.8190-0707.2 620707</b>	L= 685	
1.6 (F08, M08, F68, M68)	55	09/95→01/98	←	nicht für Motorcode: C16NZ / X16SZR	2	<b>24.8190-0705.2 620705</b>	L= 670	
	52	05/93→07/96	←	Motorcode: C16NZ / X16SZR	2	<b>24.8190-0707.2 620707</b>	L= 685	
1.6 i (F08, M08, F68, M68)	55	09/91→01/98	←	10/91→; nicht für Motorcode: C16NZ / X16SZR	2	<b>24.8190-0705.2 620705</b>	L= 670	
			←	10/91→; Motorcode: C16NZ / X16SZR	2	<b>24.8190-0707.2 620707</b>	L= 685	
1.6 i 16V (F08, M08, F68, M68)	74	08/94→01/98	←		2	<b>24.8190-0705.2 620705</b>	L= 670	
1.8 i 16V (F08, M08, F68, M68)	85	09/94→01/98						
2.0 i 16V (F08, M08, F68, M68)	100	02/95→01/98						
1.8 i (F08, M08, F68, M68)	66	09/91→01/98	←	10/91→	2	<b>24.8190-0707.2 620707</b>	L= 685	
2.0 GSI 16V (F08, M08, F68, M68)	110	09/91→01/98	←	10/91→	2	<b>24.8190-0705.2 620705</b>	L= 670	
2.0 i (F08, M08, F68, M68)	85	09/91→01/98						
<b>Zubehörsatz, Scheibenbremsbelag</b>								
1.8 i 16V (F08, M08, F68, M68)	85	09/94→01/98	→			<b>13.0460-0217.2 610217</b>	ATE	
2.0 i 16V (F08, M08, F68, M68)	100	02/95→01/98						
2.0 GSI 16V (F08, M08, F68, M68)	110	09/91→01/98	→	10/91→		<b>13.0460-0217.2 610217</b>	ATE	
<b> Bremsscheibe</b>								
1.4 (F08, M08, F68, M68)	60	09/92→01/98	←			<b>24.0120-0115.1 420115</b>	Ø 236 20 17 V + S	
1.6 i 16V (F08, M08, F68, M68)	74	08/94→01/98				<b>24.0124-0115.1 424115</b>	Ø 256 24 21 V + S	
						<b>24.0320-0115.1 520115</b>	Ø 236 20 17 V + S	
						<b>24.0324-0115.1 524115</b>	Ø 256 24 21 V + S	
1.4 i (F08, M08, F68, M68)	44	09/91→01/98	←			<b>24.0113-0161.1 413161</b>	Ø 236 12,7 9,7 + S	
						<b>24.0313-0161.1 513161</b>	Ø 236 12,7 9,7 + S	
1.4 i 16V (F08, M08, F68, M68)	66	09/96→02/98	←	Schaltgetriebe; nicht für Fahrzeuge mit verstärkter Bremse		<b>24.0113-0161.1 413161</b>	Ø 236 12,7 9,7 + S	
			03/92→01/98	←	Vollautomatik; nicht für Fahrzeuge mit verstärkter Bremse		<b>24.0313-0161.1 513161</b>	Ø 236 12,7 9,7 + S
				←	für Fahrzeuge mit verstärkter Bremse		<b>24.0120-0115.1 420115</b>	Ø 236 20 17 V + S
							<b>24.0320-0115.1 520115</b>	Ø 236 20 17 V + S
1.4 Si (F08, M08, F68, M68)	60	03/92→01/98	←	für Fahrzeuge mit verstärkter Bremse		<b>24.0124-0115.1 424115</b>	Ø 256 24 21 V + S	
						<b>24.0324-0115.1 524115</b>	Ø 256 24 21 V + S	
1.6 (F08, M08, F68, M68)	55	09/95→01/98	←	→ T5000073; Schaltgetriebe		<b>24.0113-0161.1 413161</b>	Ø 236 12,7 9,7 + S	
						<b>24.0313-0161.1 513161</b>	Ø 236 12,7 9,7 + S	
1.6 i (F08, M08, F68, M68)	52	05/93→07/96	←	Vollautomatik		<b>24.0120-0115.1 420115</b>	Ø 236 20 17 V + S	
						<b>24.0320-0115.1 520115</b>	Ø 236 20 17 V + S	
			←	T5000074→; Schaltgetriebe		<b>24.0120-0115.1 420115</b>	Ø 236 20 17 V + S	
						<b>24.0320-0115.1 520115</b>	Ø 236 20 17 V + S	
↓								









	kw			 	! #		
<b>OPEL - ASTRA F CC (T92) 09/91→02/98</b>							
 <b>Bremsscheibe</b>							
1.6 (F08, M08, F68, M68)	55	09/95→01/98	←			24.0124-0115.1 424115	Ø 256 24 21 V + S
1.6 i (F08, M08, F68, M68)	52	05/93→07/96				24.0324-0115.1 524115	Ø 256 24 21 V + S
1.6 i (F08, M08, F68, M68)	55	09/91→01/98	←	10/91→; → T5000073; Schaltgetriebe		24.0113-0161.1 413161	Ø 236 12,7 9,7 + S
						24.0313-0161.1 513161	Ø 236 12,7 9,7 + S
			←	10/91→; Vollautomatik		24.0120-0115.1 420115	Ø 236 20 17 V + S
						24.0320-0115.1 520115	Ø 236 20 17 V + S
			←	T5000074 →; Schaltgetriebe		24.0120-0115.1 420115	Ø 236 20 17 V + S
			←	10/91→		24.0124-0115.1 424115	Ø 256 24 21 V + S
						24.0324-0115.1 524115	Ø 256 24 21 V + S
1.7 D (F08, M08, F68, M68)	44	07/92→01/98	←	nicht für Fahrzeuge mit verstärkter Bremse		24.0120-0115.1 420115	Ø 236 20 17 V + S
1.7 TD (F08, M08, F68, M68)	50	11/94→01/98				24.0320-0115.1 520115	Ø 236 20 17 V + S
1.7 TDS (F08, M08, F68, M68)	60	12/91→01/98	←	für Fahrzeuge mit verstärkter Bremse		24.0124-0115.1 424115	Ø 256 24 21 V + S
						24.0324-0115.1 524115	Ø 256 24 21 V + S
1.8 i (F08, M08, F68, M68)	66	09/91→01/98	←	10/91→		24.0120-0140.1 420140	Ø 256 20 17 V + S
1.8 i 16V (F08, M08, F68, M68)	85	09/94→01/98	←			24.0124-0115.1 424115	Ø 256 24 21 V + S
						24.0324-0115.1 524115	Ø 256 24 21 V + S
2.0 i 16V (F08, M08, F68, M68)	100	02/95→01/98	→			24.0110-0204.1 410204	Ø 260 10 8
2.0 GSI 16V (F08, M08, F68, M68)	110	09/91→01/98	←	10/91→		24.0124-0115.1 424115	Ø 256 24 21 V + S
						24.0324-0115.1 524115	Ø 256 24 21 V + S
			→	10/91→		24.0110-0204.1 410204	Ø 260 10 8
2.0 i (F08, M08, F68, M68)	85	09/91→01/98	←	10/91→		24.0124-0115.1 424115	Ø 256 24 21 V + S
						24.0324-0115.1 524115	Ø 256 24 21 V + S
<b>OPEL - ASTRA F CLASSIC Caravan (T92) 01/98→01/05</b>							
 <b>Bremsbelagsatz, Scheibenbremse</b>							
1.4 i (F35, M35)	44	01/98→01/05	←			13.0460-7051.2 607051	ATE 20547 16,5 + WE / - WK
1.6 i (F35, M35)	55	01/98→01/05					
1.6 i 16V (F35, M35)	74	01/98→01/05	←			13.0460-7052.2 607052	ATE 21190 17,5 + WE / - WK
 <b>Bremsscheibe</b>							
1.4 i (F35, M35)	44	01/98→01/05	←			24.0113-0161.1 413161	Ø 236 12,7 9,7 + S
1.6 i (F35, M35)	55	01/98→01/05	←			24.0120-0115.1 420115	Ø 236 20 17 V + S
1.6 i 16V (F35, M35)	74	01/98→01/05	←			24.0124-0115.1 424115	Ø 256 24 21 V + S
<b>OPEL - ASTRA F CLASSIC CC (T92) 01/98→08/02</b>							
 <b>Bremsbelagsatz, Scheibenbremse</b>							
1.4 i (M08, M68, F08, F68)	44	01/98→08/02	←			13.0460-7051.2 607051	ATE 20547 16,5 + WE / - WK
1.6 i (F08, M08, F68, M68)	55	01/98→08/02					
1.6 i 16V (F08, M08, F68, M68)	74	01/98→08/02	←			13.0460-7052.2 607052	ATE 21190 17,5 + WE / - WK
<b>Warnkontakt, Bremsbelagverschleiß</b>							
1.4 i (M08, M68, F08, F68)	44	01/98→08/02	←		2	24.8190-0707.2 620707	L= 685
1.6 i (F08, M08, F68, M68)	55	01/98→08/02					
1.6 i 16V (F08, M08, F68, M68)	74	01/98→08/02					
 <b>Bremsscheibe</b>							
1.4 i (M08, M68, F08, F68)	44	01/98→08/02	←			24.0113-0161.1 413161	Ø 236 12,7 9,7 + S
						24.0313-0161.1 513161	Ø 236 12,7 9,7 + S
1.6 i (F08, M08, F68, M68)	55	01/98→08/02	←			24.0120-0115.1 420115	Ø 236 20 17 V + S
						24.0320-0115.1 520115	Ø 236 20 17 V + S
1.6 i 16V (F08, M08, F68, M68)	74	01/98→08/02	←			24.0124-0115.1 424115	Ø 256 24 21 V + S
						24.0324-0115.1 524115	Ø 256 24 21 V + S









	kw					! #		
<b>OPEL - ASTRA F CLASSIC Stufenheck (T92) 01/98→08/02</b>								
 <b>Bremsbelagsatz, Scheibenbremse</b>								
1.4 i (F19, M19)	44	01/98→08/02	←				<b>13.0460-7051.2 607051</b>	ATE 20547 16,5 + WE / - WK
1.6 i (F19, M19)	55	01/98→08/02	←					
1.6 i 16V (F19, M19)	74	01/98→08/02	←				<b>13.0460-7052.2 607052</b>	ATE 21190 17,5 + WE / - WK
<b>Warnkontakt, Bremsbelagverschleiß</b>								
1.4 i (F19, M19)	44	01/98→08/02	←			2	<b>24.8190-0707.2 620707</b>	L= 685
1.6 i (F19, M19)	55	01/98→08/02	←					
1.6 i 16V (F19, M19)	74	01/98→08/02	←					
 <b>Bremsscheibe</b>								
1.4 i (F19, M19)	44	01/98→08/02	←				<b>24.0113-0161.1 413161</b>	Ø 236 12,7 9,7 + S
							<b>24.0313-0161.1 513161</b>	Ø 236 12,7 9,7 + S
1.6 i (F19, M19)	55	01/98→08/02	←				<b>24.0120-0115.1 420115</b>	Ø 236 20 17 V + S
							<b>24.0320-0115.1 520115</b>	Ø 236 20 17 V + S
1.6 i 16V (F19, M19)	74	01/98→08/02	←				<b>24.0124-0115.1 424115</b>	Ø 256 24 21 V + S
							<b>24.0324-0115.1 524115</b>	Ø 256 24 21 V + S
<b>OPEL - ASTRA F Van (T92) 10/91→01/99</b>								
 <b>Bremsbelagsatz, Scheibenbremse</b>								
1.4 i (F70)	44	10/91→01/99	←	→ 09/98			<b>13.0460-7051.2 607051</b>	ATE 20547 16,5 + WE / - WK
1.6 i (F70)	52	02/93→07/96	←				<b>13.0460-7051.2 607051</b>	ATE 20547 16,5 + WE / - WK
			←	Motorcode: C16NZ / X16SZR			<b>13.0460-7051.2 607051</b>	ATE 20547 16,5 + WE / - WK
			←	nicht für Motorcode: C16NZ / X16SZR			<b>13.0460-7052.2 607052</b>	ATE 21190 17,5 + WE / - WK
1.6 i 16V (F70)	74	08/94→03/98	←				<b>13.0460-7052.2 607052</b>	ATE 21190 17,5 + WE / - WK
1.7 D (F70)	44	07/92→01/99	←	→ 09/98; nicht für Fahrzeuge mit verstärkter Bremse			<b>13.0460-7051.2 607051</b>	ATE 20547 16,5 + WE / - WK
1.7 TD (F70)	50	08/94→01/99	←	→ 09/98; für Fahrzeuge mit verstärkter Bremse			<b>13.0460-7052.2 607052</b>	ATE 21190 17,5 + WE / - WK
1.7 TD (F70)	60	03/95→02/98	←	nicht für Fahrzeuge mit verstärkter Bremse			<b>13.0460-7051.2 607051</b>	ATE 20547 16,5 + WE / - WK
			←	für Fahrzeuge mit verstärkter Bremse			<b>13.0460-7052.2 607052</b>	ATE 21190 17,5 + WE / - WK
<b>Warnkontakt, Bremsbelagverschleiß</b>								
1.4 i (F70)	44	10/91→01/99	←	→ 09/98		2	<b>24.8190-0707.2 620707</b>	L= 685
1.6 i (F70)	52	02/93→07/96	←	nicht für Motorcode: C16NZ / X16SZR		2	<b>24.8190-0705.2 620705</b>	L= 670
			←			2	<b>24.8190-0707.2 620707</b>	L= 685
			←	Motorcode: C16NZ / X16SZR		2	<b>24.8190-0707.2 620707</b>	L= 685
1.6 i 16V (F70)	74	08/94→03/98	←			2	<b>24.8190-0705.2 620705</b>	L= 670
1.7 D (F70)	44	07/92→01/99	←	→ 09/98; für Fahrzeuge mit verstärkter Bremse		2	<b>24.8190-0705.2 620705</b>	L= 670
1.7 TD (F70)	50	08/94→01/99	←	→ 09/98; nicht für Fahrzeuge mit verstärkter Bremse		2	<b>24.8190-0707.2 620707</b>	L= 685
1.7 TD (F70)	60	03/95→02/98	←	für Fahrzeuge mit verstärkter Bremse		2	<b>24.8190-0705.2 620705</b>	L= 670
			←	nicht für Fahrzeuge mit verstärkter Bremse		2	<b>24.8190-0707.2 620707</b>	L= 685
 <b>Bremsscheibe</b>								
1.4 i (F70)	44	10/91→01/99	←	→ 09/98			<b>24.0113-0161.1 413161</b>	Ø 236 12,7 9,7 + S
							<b>24.0313-0161.1 513161</b>	Ø 236 12,7 9,7 + S
1.6 i (F70)	52	02/93→07/96	←				<b>24.0120-0115.1 420115</b>	Ø 236 20 17 V + S
							<b>24.0124-0115.1 424115</b>	Ø 256 24 21 V + S
							<b>24.0320-0115.1 520115</b>	Ø 236 20 17 V + S
							<b>24.0324-0115.1 524115</b>	Ø 256 24 21 V + S
1.6 i 16V (F70)	74	08/94→03/98	←				<b>24.0124-0115.1 424115</b>	Ø 256 24 21 V + S
							<b>24.0324-0115.1 524115</b>	Ø 256 24 21 V + S
1.7 D (F70)	44	07/92→01/99	←	→ 09/98; nicht für Fahrzeuge mit verstärkter Bremse			<b>24.0120-0115.1 420115</b>	Ø 236 20 17 V + S
1.7 TD (F70)	50	08/94→01/99	←	→ 09/98; für Fahrzeuge mit verstärkter Bremse			<b>24.0320-0115.1 520115</b>	Ø 236 20 17 V + S
			←	→ 09/98; für Fahrzeuge mit verstärkter Bremse			<b>24.0124-0115.1 424115</b>	Ø 256 24 21 V + S
			←	→ 09/98; für Fahrzeuge mit verstärkter Bremse			<b>24.0324-0115.1 524115</b>	Ø 256 24 21 V + S
1.7 TD (F70)	60	03/95→02/98	←	nicht für Fahrzeuge mit verstärkter Bremse			<b>24.0120-0115.1 420115</b>	Ø 236 20 17 V + S
			←	für Fahrzeuge mit verstärkter Bremse			<b>24.0320-0115.1 520115</b>	Ø 236 20 17 V + S
			←	für Fahrzeuge mit verstärkter Bremse			<b>24.0124-0115.1 424115</b>	Ø 256 24 21 V + S









	kw			 	! #		
<b>OPEL - ASTRA F Van (T92) 10/91→01/99</b>							
 <b>Bremsscheibe</b>							
1.7 TD (F70)	60	03/95→02/98	←	für Fahrzeuge mit verstärkter Bremse		24.0324-0115.1 524115	Ø 256 24 21 V + S
<b>OPEL - ASTRA G Cabriolet (T98) 03/01→10/05</b>							
 <b>Bremsbelagsatz, Scheibenbremse</b>							
1.6 (F67) 1.6 16V (F67)	76 74	01/03→10/05 03/01→10/05	←			13.0460-7115.2 607115	ATE 23063 17,5 ohne integrierten Verschleiß- sensor / + WK
			→			13.0470-7115.2 LD7115	ATE 23063 17,5 - WK / + WK Ceramic
			→			13.0460-2868.2 602868 13.0460-3976.2 603976 13.0470-2868.2 LD2868	TRW 23417 15,3 + WK + Zub BOS 23258 16,5 + WK + Zub TRW 23417 15,3 + WK + Zub Ceramic
1.8 16V (F67)	92	03/01→10/05	←	- ABS		13.0460-7115.2 607115	ATE 23063 17,5 ohne integrierten Verschleiß- sensor / + WK
			←	+ ABS		13.0460-7116.2 607116 13.0470-7116.2 LD7116	ATE 23057 20,2 - WK / + WK Ceramic
			→			13.0460-2868.2 602868 13.0460-3976.2 603976 13.0470-2868.2 LD2868	TRW 23417 15,3 + WK + Zub BOS 23258 16,5 + WK + Zub TRW 23417 15,3 + WK + Zub Ceramic
2.0 16V Turbo (F67) 2.0 OPC (F67)	147 141	11/02→10/05 03/02→10/05	←			13.0460-7173.2 607173	ATE 21829 20,3 - WK / + WK
			→			13.0460-2868.2 602868 13.0460-3976.2 603976 13.0470-2868.2 LD2868	TRW 23417 15,3 + WK + Zub BOS 23258 16,5 + WK + Zub TRW 23417 15,3 + WK + Zub Ceramic
			→			13.0460-2868.2 602868 13.0460-3976.2 603976 13.0470-2868.2 LD2868	TRW 23417 15,3 + WK + Zub BOS 23258 16,5 + WK + Zub TRW 23417 15,3 + WK + Zub Ceramic
2.2 16V (F67) 2.2 DTI (F67)	108 92	03/01→10/05 09/02→10/05	←			13.0460-7116.2 607116 13.0470-7116.2 LD7116	ATE 23057 20,2 - WK / + WK Ceramic
			→			13.0460-2868.2 602868 13.0460-3976.2 603976 13.0470-2868.2 LD2868	TRW 23417 15,3 + WK + Zub BOS 23258 16,5 + WK + Zub TRW 23417 15,3 + WK + Zub Ceramic
			→			13.0460-2868.2 602868 13.0460-3976.2 603976 13.0470-2868.2 LD2868	TRW 23417 15,3 + WK + Zub BOS 23258 16,5 + WK + Zub TRW 23417 15,3 + WK + Zub Ceramic
<b>Warnkontakt, Bremsbelagsverschleiß</b>							
1.6 (F67)	76	01/03→10/05	←	42187759→	2	24.8190-0018.2 620018	L= 755
1.6 16V (F67)	74	03/01→10/05	←	→ 42187758	2	24.8190-0718.2 620718	L= 720
1.8 16V (F67)	92	03/01→10/05	←				
2.0 16V Turbo (F67)	147	11/02→10/05	←				
2.0 OPC (F67)	141	03/02→10/05	←				
2.2 16V (F67)	108	03/01→10/05	←				
2.2 DTI (F67)	92	09/02→10/05	←				
 <b>Bremsscheibe</b>							
1.6 (F67) 1.6 16V (F67)	76 74	01/03→10/05 03/01→10/05	←	Felge Lochzahl: 4		24.0124-0152.1 424152 24.0324-0152.1 524152	Ø 256 23,8 21 V + S Ø 256 23,8 21 V + S
			→	Felge Lochzahl: 4		24.0110-0251.1 410251 24.0310-0251.1 510251	Ø 240 9,8 8 + S Ø 240 9,8 8 + S
			→	Felge Lochzahl: 4		24.0110-0250.1 410250 24.0310-0250.1 510250	Ø 264 9,8 8 + S Ø 264 9,8 8 + S
1.8 16V (F67)	92	03/01→10/05	←	- ABS; Felge Lochzahl: 4		24.0124-0152.1 424152 24.0324-0152.1 524152	Ø 256 23,8 21 V + S Ø 256 23,8 21 V + S
			←	+ ABS; Felge Lochzahl: 5		24.0125-0131.1 425131 24.0325-0131.1 525131	Ø 280 24,8 22 V + S Ø 280 24,8 22 V + S
			→	+ ABS; Felge Lochzahl: 5		24.0110-0250.1 410250 24.0310-0250.1 510250	Ø 264 9,8 8 + S Ø 264 9,8 8 + S
			→	- ABS; Felge Lochzahl: 4		24.0110-0251.1 410251 24.0310-0251.1 510251	Ø 240 9,8 8 + S Ø 240 9,8 8 + S
			→	- ABS; Felge Lochzahl: 4		24.0110-0250.1 410250 24.0310-0250.1 510250	Ø 264 9,8 8 + S Ø 264 9,8 8 + S
			→	- ABS; Felge Lochzahl: 4		24.0110-0251.1 410251 24.0310-0251.1 510251	Ø 240 9,8 8 + S Ø 240 9,8 8 + S
2.0 16V Turbo (F67) 2.0 OPC (F67)	147 141	11/02→10/05 03/02→10/05	←			24.0125-0142.1 425142 24.0325-0142.1 525142	Ø 308 25 22 V + S Ø 308 25 23 V + S
			→	Felge Lochzahl: 5		24.0110-0250.1 410250 24.0310-0250.1 510250	Ø 264 9,8 8 + S Ø 264 9,8 8 + S
			→	Felge Lochzahl: 5		24.0110-0250.1 410250 24.0310-0250.1 510250	Ø 264 9,8 8 + S Ø 264 9,8 8 + S
2.2 16V (F67) 2.2 DTI (F67)	108 92	03/01→10/05 09/02→10/05	←	Felge Lochzahl: 5		24.0125-0131.1 425131 24.0325-0131.1 525131	Ø 280 24,8 22 V + S Ø 280 24,8 22 V + S
			→	Felge Lochzahl: 5		24.0110-0250.1 410250	Ø 264 9,8 8 + S
			→	Felge Lochzahl: 5		24.0110-0250.1 410250	Ø 264 9,8 8 + S







	kw			 	! #		
<b>OPEL - ASTRA G Cabriolet (T98) 03/01→10/05</b>							
<b>Bremsscheibe</b>							
2.2 16V (F67) 2.2 DTI (F67)	108 92	03/01→10/05 09/02→10/05	➡	Felge Lochzahl: 5		24.0310-0250.1 510250	Ø 264 9,8 8 + S
<b>OPEL - ASTRA G Caravan (T98) 02/98→12/09</b>							
<b>Bremsbelagsatz, Scheibenbremse</b>							
1.2 16V (F35) 1.6 (F35) 1.6 16V (F35) 1.7 TD (F35)	48 55 74 50	02/98→09/00 02/98→09/00 02/98→07/04 02/98→08/00	←	04/98→		13.0460-7115.2 607115	ATE 23063 17,5 ohne integrierten Verschleiß- sensor / + WK
			➡	04/98→		13.0470-7115.2 LD7115	ATE 23063 17,5 - WK / + WK Ceramic
			➡	04/98→		13.0460-2868.2 602868	TRW 23417 15,3 + WK + Zub
			➡	04/98→		13.0460-3976.2 603976	BOS 23258 16,5 + WK + Zub
			➡	04/98→		13.0470-2868.2 LD2868	TRW 23417 15,3 + WK + Zub Ceramic
1.2 16V (F35) 1.4 16V (F35) 1.6 (F35) 1.6 (F35) 1.7 CDTI (F35) 1.7 DTI 16V (F35)	55 66 62 76 59 55	09/00→07/04 06/98→07/04 09/00→07/04 12/02→07/09 04/03→07/09 02/00→07/04	←			13.0460-7115.2 607115	ATE 23063 17,5 ohne integrierten Verschleiß- sensor / + WK
			➡			13.0470-7115.2 LD7115	ATE 23063 17,5 - WK / + WK Ceramic
			➡			13.0460-2868.2 602868	TRW 23417 15,3 + WK + Zub
			➡			13.0460-3976.2 603976	BOS 23258 16,5 + WK + Zub
			➡			13.0470-2868.2 LD2868	TRW 23417 15,3 + WK + Zub Ceramic
1.4 (F35)	66	10/04→12/09	←	09/07→		13.0460-7115.2 607115	ATE 23063 17,5 ohne integrierten Verschleiß- sensor / + WK
			➡	09/07→		13.0470-7115.2 LD7115	ATE 23063 17,5 - WK / + WK Ceramic
			➡			13.0460-2868.2 602868	TRW 23417 15,3 + WK + Zub
			➡			13.0460-3976.2 603976	BOS 23258 16,5 + WK + Zub
			➡			13.0470-2868.2 LD2868	TRW 23417 15,3 + WK + Zub Ceramic
1.6 CNG (F35) 2.0 DTI 16V (F35) 2.2 16V (F35) 2.2 DTI (F35) 2.2 DTI (F35)	71 74 108 86 92	03/03→07/04 08/99→07/04 03/01→07/04 09/02→07/04 09/02→07/04	←			13.0460-7116.2 607116	ATE 23057 20,2 - WK / + WK
			➡			13.0470-7116.2 LD7116	ATE 23057 20,2 - WK / + WK Ceramic
			➡			13.0460-2868.2 602868	TRW 23417 15,3 + WK + Zub
			➡			13.0460-3976.2 603976	BOS 23258 16,5 + WK + Zub
			➡			13.0470-2868.2 LD2868	TRW 23417 15,3 + WK + Zub Ceramic
1.8 16V (F35)	85	02/98→09/00	←	04/98→; - ABS		13.0460-7115.2 607115	ATE 23063 17,5 ohne integrierten Verschleiß- sensor / + WK
			➡	04/98→		13.0470-7115.2 LD7115	ATE 23063 17,5 - WK / + WK Ceramic
			←	04/98→; + ABS		13.0460-7116.2 607116	ATE 23057 20,2 - WK / + WK
			←	04/98→; + ABS		13.0470-7116.2 LD7116	ATE 23057 20,2 - WK / + WK Ceramic
			➡	04/98→		13.0460-2868.2 602868	TRW 23417 15,3 + WK + Zub
			➡	04/98→		13.0460-3976.2 603976	BOS 23258 16,5 + WK + Zub
			➡	04/98→		13.0470-2868.2 LD2868	TRW 23417 15,3 + WK + Zub Ceramic
1.8 16V (F35)	92	09/00→07/04	←	- ABS		13.0460-7115.2 607115	ATE 23063 17,5 ohne integrierten Verschleiß- sensor / + WK
			➡			13.0470-7115.2 LD7115	ATE 23063 17,5 - WK / + WK Ceramic
			←	+ ABS		13.0460-7116.2 607116	ATE 23057 20,2 - WK / + WK
			←	+ ABS		13.0470-7116.2 LD7116	ATE 23057 20,2 - WK / + WK Ceramic
			➡			13.0460-2868.2 602868	TRW 23417 15,3 + WK + Zub
			➡			13.0460-3976.2 603976	BOS 23258 16,5 + WK + Zub
			➡			13.0470-2868.2 LD2868	TRW 23417 15,3 + WK + Zub Ceramic
2.0 16V (F35)	100	02/98→07/04	←	04/98→		13.0460-7116.2 607116	ATE 23057 20,2 - WK / + WK
			➡	04/98→		13.0470-7116.2 LD7116	ATE 23057 20,2 - WK / + WK Ceramic
			➡	04/98→		13.0460-2868.2 602868	TRW 23417 15,3 + WK + Zub
			➡	04/98→		13.0460-3976.2 603976	BOS 23258 16,5 + WK + Zub







	kw			 	! #		
<b>OPEL - ASTRA G Caravan (T98) 02/98→12/09</b>							
<b> Bremsbelagsatz, Scheibenbremse</b>							
2.0 16V (F35)	100	02/98→07/04	➡	04/98→		<b>13.0470-2868.2 LD2868</b>	TRW 23417 15,3 + WK + Zub Ceramic
2.0 DI (F35)	60	02/98→07/04	←	04/98→		<b>13.0460-7115.2 607115</b>	ATE 23063 17,5 ohne integrierten Verschleißsensor / + WK
						<b>13.0470-7115.2 LD7115</b>	ATE 23063 17,5 - WK / + WK Ceramic
				04/98→; + ABS		<b>13.0460-7116.2 607116</b>	ATE 23057 20,2 - WK / + WK
						<b>13.0470-7116.2 LD7116</b>	ATE 23057 20,2 - WK / + WK Ceramic
			➡	04/98→		<b>13.0460-2868.2 602868</b>	TRW 23417 15,3 + WK + Zub
						<b>13.0460-3976.2 603976</b>	BOS 23258 16,5 + WK + Zub
						<b>13.0470-2868.2 LD2868</b>	TRW 23417 15,3 + WK + Zub Ceramic
2.0 OPC (F35)	141	09/02→07/04	←			<b>13.0460-7173.2 607173</b>	ATE 21829 20,3 - WK / + WK
2.0 OPC (F35)	147	11/02→07/04	➡			<b>13.0460-2868.2 602868</b>	TRW 23417 15,3 + WK + Zub
						<b>13.0460-3976.2 603976</b>	BOS 23258 16,5 + WK + Zub
						<b>13.0470-2868.2 LD2868</b>	TRW 23417 15,3 + WK + Zub Ceramic
<b>Warnkontakt, Bremsbelagverschleiß</b>							
1.2 16V (F35)	48	02/98→09/00	←	04/98→; 42187759→	2	<b>24.8190-0018.2 620018</b>	L= 755
1.6 (F35)	55	02/98→09/00	←	04/98→; → 42187758	2	<b>24.8190-0718.2 620718</b>	L= 720
1.6 16V (F35)	74	02/98→07/04					
1.7 TD (F35)	50	02/98→08/00					
1.8 16V (F35)	85	02/98→09/00					
2.0 16V (F35)	100	02/98→07/04					
1.2 16V (F35)	55	09/00→07/04					
1.4 16V (F35)	66	06/98→07/04	←	→ 42187758	2	<b>24.8190-0718.2 620718</b>	L= 720
1.6 (F35)	62	09/00→07/04					
1.6 (F35)	76	12/02→07/09					
1.6 CNG (F35)	71	03/03→07/04					
1.7 CDTI (F35)	59	04/03→07/09					
1.7 DTI 16V (F35)	55	02/00→07/04					
1.8 16V (F35)	92	09/00→07/04					
2.0 DTI 16V (F35)	74	08/99→07/04					
2.0 OPC (F35)	141	09/02→07/04					
2.0 OPC (F35)	147	11/02→07/04					
2.2 16V (F35)	108	03/01→07/04					
2.2 DTI (F35)	86	09/02→07/04					
2.2 DTI (F35)	92	09/02→07/04					
1.4 (F35)	66	10/04→12/09					
			←	09/07→; → 42187758	2	<b>24.8190-0718.2 620718</b>	L= 720
2.0 DI (F35)	60	02/98→07/04	←	04/98→; 42187759→	2	<b>24.8190-0018.2 620018</b>	L= 755
			←	04/98→; + ABS; 42187759→	2	<b>24.8190-0018.2 620018</b>	L= 755
			←	04/98→; + ABS; → 42187758	2	<b>24.8190-0718.2 620718</b>	L= 720
			←	04/98→; → 42187758	2	<b>24.8190-0718.2 620718</b>	L= 720
<b> Bremsscheibe</b>							
1.2 16V (F35)	48	02/98→09/00	←	04/98→; → 18999999; für Fahrzeuge mit Trommelbremse an der Hinterachse		<b>24.0111-0141.1 411141</b>	Ø 256 10,8 8
					<b>24.0311-0141.1 511141</b>	Ø 256 10,8 8	
				04/98→; → 18999999; für Fahrzeuge mit Scheibenbremse an der Hinterachse; Felge Lochzahl: 4		<b>24.0124-0152.1 424152</b>	Ø 256 23,8 21 V + S
					<b>24.0324-0152.1 524152</b>	Ø 256 23,8 21 V + S	
				22000001→; Felge Lochzahl: 4		<b>24.0124-0152.1 424152</b>	Ø 256 23,8 21 V + S
			➡	04/98→; Felge Lochzahl: 4		<b>24.0310-0251.1 510251</b>	Ø 240 9,8 8 + S
						<b>24.0110-0251.1 410251</b>	Ø 240 9,8 8 + S
1.2 16V (F35)	55	09/00→07/04	←	→ 18999999; für Fahrzeuge mit Trommelbremse an der Hinterachse		<b>24.0111-0141.1 411141</b>	Ø 256 10,8 8
					<b>24.0311-0141.1 511141</b>	Ø 256 10,8 8	
				22000001→; Felge Lochzahl: 4		<b>24.0124-0152.1 424152</b>	Ø 256 23,8 21 V + S
					<b>24.0324-0152.1 524152</b>	Ø 256 23,8 21 V + S	
				→ 18999999; für Fahrzeuge mit Scheibenbremse an der Hinterachse; Felge Lochzahl: 4		<b>24.0124-0152.1 424152</b>	Ø 256 23,8 21 V + S
			➡	Felge Lochzahl: 4		<b>24.0324-0152.1 524152</b>	Ø 256 23,8 21 V + S
						<b>24.0110-0251.1 410251</b>	Ø 240 9,8 8 + S
						<b>24.0310-0251.1 510251</b>	Ø 240 9,8 8 + S
1.4 (F35) ↓	66	10/04→12/09	←	09/07→; Felge Lochzahl: 4		<b>24.0124-0152.1 424152</b>	Ø 256 23,8 21 V + S











	kw			 	! #		
<b>OPEL - ASTRA G Caravan (T98) 02/98→12/09</b>							
<b>Bremsscheibe</b>							
1.4 (F35)	66	10/04→12/09	←	09/07→; Felge Lochzahl: 4		24.0324-0152.1 524152	Ø 256 23,8 21 V + S
			→	09/07→; Felge Lochzahl: 4		24.0110-0251.1 410251	Ø 240 9,8 8 + S
1.4 16V (F35) 1.7 CDTI (F35) 1.7 DTI 16V (F35)	66 59 55	06/98→07/04 04/03→07/09 02/00→07/04	←	Felge Lochzahl: 4		24.0124-0152.1 424152	Ø 256 23,8 21 V + S
			→	Felge Lochzahl: 4		24.0324-0152.1 524152	Ø 256 23,8 21 V + S
						24.0110-0251.1 410251	Ø 240 9,8 8 + S
						24.0310-0251.1 510251	Ø 240 9,8 8 + S
1.6 (F35)	55	02/98→09/00	←	04/98→; Felge Lochzahl: 4		24.0124-0152.1 424152	Ø 256 23,8 21 V + S
						24.0324-0152.1 524152	Ø 256 23,8 21 V + S
			←	04/98→; Felge Lochzahl: 5		24.0125-0131.1 425131	Ø 280 24,8 22 V + S
						24.0325-0131.1 525131	Ø 280 24,8 22 V + S
			→	04/98→; Felge Lochzahl: 4		24.0110-0251.1 410251	Ø 240 9,8 8 + S
						24.0310-0251.1 510251	Ø 240 9,8 8 + S
1.6 (F35) 1.6 (F35)	62 76	09/00→07/04 12/02→07/09	←	Felge Lochzahl: 4		24.0124-0152.1 424152	Ø 256 23,8 21 V + S
						24.0324-0152.1 524152	Ø 256 23,8 21 V + S
			←	Felge Lochzahl: 5		24.0125-0131.1 425131	Ø 280 24,8 22 V + S
						24.0325-0131.1 525131	Ø 280 24,8 22 V + S
			→	Felge Lochzahl: 4		24.0110-0251.1 410251	Ø 240 9,8 8 + S
						24.0310-0251.1 510251	Ø 240 9,8 8 + S
1.6 16V (F35)	74	02/98→07/04	←	04/98→; Felge Lochzahl: 4		24.0124-0152.1 424152	Ø 256 23,8 21 V + S
						24.0324-0152.1 524152	Ø 256 23,8 21 V + S
			←	04/98→; Felge Lochzahl: 5		24.0125-0131.1 425131	Ø 280 24,8 22 V + S
						24.0325-0131.1 525131	Ø 280 24,8 22 V + S
			→	04/98→; Felge Lochzahl: 5		24.0110-0250.1 410250	Ø 264 9,8 8 + S
						24.0310-0250.1 510250	Ø 264 9,8 8 + S
			→	04/98→; Felge Lochzahl: 4		24.0110-0251.1 410251	Ø 240 9,8 8 + S
						24.0310-0251.1 510251	Ø 240 9,8 8 + S
1.6 CNG (F35) 2.0 DTI 16V (F35) 2.2 16V (F35) 2.2 DTI (F35) 2.2 DTI (F35)	71 74 108 86 92	03/03→07/04 08/99→07/04 03/01→07/04 09/02→07/04 09/02→07/04	←	Felge Lochzahl: 5		24.0125-0131.1 425131	Ø 280 24,8 22 V + S
						24.0325-0131.1 525131	Ø 280 24,8 22 V + S
			→	Felge Lochzahl: 5		24.0110-0250.1 410250	Ø 264 9,8 8 + S
						24.0310-0250.1 510250	Ø 264 9,8 8 + S
1.7 TD (F35)	50	02/98→08/00	←	04/98→; Felge Lochzahl: 4		24.0124-0152.1 424152	Ø 256 23,8 21 V + S
						24.0324-0152.1 524152	Ø 256 23,8 21 V + S
			→	04/98→; Felge Lochzahl: 4		24.0110-0251.1 410251	Ø 240 9,8 8 + S
						24.0310-0251.1 510251	Ø 240 9,8 8 + S
1.8 16V (F35) 2.0 DI (F35)	85 60	02/98→09/00 02/98→07/04	←	04/98→; - ABS; Felge Lochzahl: 4		24.0124-0152.1 424152	Ø 256 23,8 21 V + S
						24.0324-0152.1 524152	Ø 256 23,8 21 V + S
			←	04/98→; + ABS; Felge Lochzahl: 5		24.0125-0131.1 425131	Ø 280 24,8 22 V + S
						24.0325-0131.1 525131	Ø 280 24,8 22 V + S
			→	04/98→; + ABS; Felge Lochzahl: 5		24.0110-0250.1 410250	Ø 264 9,8 8 + S
						24.0310-0250.1 510250	Ø 264 9,8 8 + S
			→	04/98→; - ABS; Felge Lochzahl: 4		24.0110-0251.1 410251	Ø 240 9,8 8 + S
						24.0310-0251.1 510251	Ø 240 9,8 8 + S
1.8 16V (F35)	92	09/00→07/04	←	- ABS; Felge Lochzahl: 4		24.0124-0152.1 424152	Ø 256 23,8 21 V + S
						24.0324-0152.1 524152	Ø 256 23,8 21 V + S
			←	+ ABS; Felge Lochzahl: 5		24.0125-0131.1 425131	Ø 280 24,8 22 V + S
						24.0325-0131.1 525131	Ø 280 24,8 22 V + S
			→	+ ABS; Felge Lochzahl: 5		24.0110-0250.1 410250	Ø 264 9,8 8 + S
						24.0310-0250.1 510250	Ø 264 9,8 8 + S
			→	- ABS; Felge Lochzahl: 4		24.0110-0251.1 410251	Ø 240 9,8 8 + S
						24.0310-0251.1 510251	Ø 240 9,8 8 + S
2.0 16V (F35)	100	02/98→07/04	←	04/98→; Felge Lochzahl: 5		24.0125-0131.1 425131	Ø 280 24,8 22 V + S
						24.0325-0131.1 525131	Ø 280 24,8 22 V + S
			→	04/98→; Felge Lochzahl: 5		24.0110-0250.1 410250	Ø 264 9,8 8 + S
						24.0310-0250.1 510250	Ø 264 9,8 8 + S
2.0 OPC (F35) 2.0 OPC (F35)	141 147	09/02→07/04 11/02→07/04	←			24.0125-0142.1 425142	Ø 308 25 22 V + S
						24.0325-0142.1 525142	Ø 308 25 23 V + S
			→	Felge Lochzahl: 5		24.0110-0250.1 410250	Ø 264 9,8 8 + S
						24.0310-0250.1 510250	Ø 264 9,8 8 + S













	kw			 	! #		
<b>OPEL - ASTRA G CC (T98) 02/98→12/09</b>							
<b> Bremsbelagsatz, Scheibenbremse</b>							
1.2 16V (F08, F48) 1.4 16V (F08, F48) 1.6 (F08, F48) 1.6 16V (F08, F48) 1.7 TD (F08, F48)	48 66 55 74 50	02/98→09/00 02/98→01/05 02/98→09/00 02/98→01/05 02/98→08/00	← →	04/98→ 04/98→		13.0460-7115.2 607115 13.0470-7115.2 LD7115	ATE 23063 17,5 ohne integrierten Verschleiß- sensor / + WK ATE 23063 17,5 - WK / + WK Ceramic
1.2 16V (F08, F48) 1.4 (F08, F48) 1.6 (F08, F48) 1.6 (F08, F48) 1.7 CDTI (F08, F48) 1.7 DTI 16V (F08, F48)	55 66 62 76 59 55	09/00→01/05 09/07→12/09 09/00→01/05 12/02→12/09 04/03→12/09 02/00→01/05	← →			13.0460-7115.2 607115 13.0470-7115.2 LD7115 13.0460-2868.2 602868 13.0460-3976.2 603976 13.0470-2868.2 LD2868	ATE 23063 17,5 ohne integrierten Verschleiß- sensor / + WK ATE 23063 17,5 - WK / + WK Ceramic TRW 23417 15,3 + WK + Zub BOS 23258 16,5 + WK + Zub TRW 23417 15,3 + WK + Zub Ceramic
1.8 16V (F08, F48)	85	02/98→09/00	← ← →	04/98→; - ABS 04/98→; + ABS 04/98→		13.0460-7115.2 607115 13.0470-7115.2 LD7115 13.0460-7116.2 607116 13.0470-7116.2 LD7116 13.0460-2868.2 602868 13.0460-3976.2 603976 13.0470-2868.2 LD2868	ATE 23063 17,5 ohne integrierten Verschleiß- sensor / + WK ATE 23063 17,5 - WK / + WK Ceramic ATE 23057 20,2 - WK / + WK ATE 23057 20,2 - WK / + WK Ceramic TRW 23417 15,3 + WK + Zub BOS 23258 16,5 + WK + Zub TRW 23417 15,3 + WK + Zub Ceramic
1.8 16V (F08, F48)	92	09/00→01/05	← ← →	- ABS + ABS		13.0460-7115.2 607115 13.0470-7115.2 LD7115 13.0460-7116.2 607116 13.0470-7116.2 LD7116 13.0460-2868.2 602868 13.0460-3976.2 603976 13.0470-2868.2 LD2868	ATE 23063 17,5 ohne integrierten Verschleiß- sensor / + WK ATE 23063 17,5 - WK / + WK Ceramic ATE 23057 20,2 - WK / + WK ATE 23057 20,2 - WK / + WK Ceramic TRW 23417 15,3 + WK + Zub BOS 23258 16,5 + WK + Zub TRW 23417 15,3 + WK + Zub Ceramic
2.0 16V (F08, F48)	100	02/98→01/05	← →	04/98→ 04/98→		13.0460-7116.2 607116 13.0470-7116.2 LD7116 13.0460-2868.2 602868 13.0460-3976.2 603976 13.0470-2868.2 LD2868	ATE 23057 20,2 - WK / + WK ATE 23057 20,2 - WK / + WK Ceramic TRW 23417 15,3 + WK + Zub BOS 23258 16,5 + WK + Zub TRW 23417 15,3 + WK + Zub Ceramic
2.0 16V OPC (F08, F48) 2.0 OPC (F08, F48) 2.0 OPC (F08, F48)	118 141 147	11/99→09/02 09/02→01/05 11/02→01/05	← →			13.0460-7173.2 607173 13.0460-2868.2 602868 13.0460-3976.2 603976 13.0470-2868.2 LD2868	ATE 21829 20,3 - WK / + WK TRW 23417 15,3 + WK + Zub BOS 23258 16,5 + WK + Zub TRW 23417 15,3 + WK + Zub Ceramic
2.0 DI (F08, F48)	60	02/98→01/05	← ← →	04/98→ 04/98→; + ABS 04/98→		13.0460-7115.2 607115 13.0470-7115.2 LD7115 13.0460-7116.2 607116 13.0470-7116.2 LD7116 13.0460-2868.2 602868 13.0460-3976.2 603976 13.0470-2868.2 LD2868	ATE 23063 17,5 ohne integrierten Verschleiß- sensor / + WK ATE 23063 17,5 - WK / + WK Ceramic ATE 23057 20,2 - WK / + WK ATE 23057 20,2 - WK / + WK Ceramic TRW 23417 15,3 + WK + Zub BOS 23258 16,5 + WK + Zub TRW 23417 15,3 + WK + Zub Ceramic
2.0 DTI 16V (F08, F48) 2.2 DTI (F08, F48) 2.2 DTI (F08, F48) ↓	74 86 92	08/99→01/05 09/02→01/05 09/02→01/05	←			13.0460-7116.2 607116	ATE 23057 20,2 - WK / + WK

	kw					! #		
<b>OPEL - ASTRA G CC (T98) 02/98→12/09</b>								
<b>Bremsbelagsatz, Scheibenbremse</b>								
2.0 DTI 16V (F08, F48) 2.2 DTI (F08, F48) 2.2 DTI (F08, F48)	74 86 92	08/99→01/05 09/02→01/05 09/02→01/05	← →				13.0470-7116.2 LD7116 13.0460-2868.2 602868 13.0460-3976.2 603976 13.0470-2868.2 LD2868	ATE 23057 20,2 - WK / + WK Ceramic TRW 23417 15,3 + WK + Zub BOS 23258 16,5 + WK + Zub TRW 23417 15,3 + WK + Zub Ceramic
2.2 16V (F08, F48)	108	06/00→01/05	← →	09/00→ 09/00→			13.0460-7116.2 607116 13.0470-7116.2 LD7116 13.0460-2868.2 602868 13.0460-3976.2 603976 13.0470-2868.2 LD2868	ATE 23057 20,2 - WK / + WK Ceramic ATE 23057 20,2 - WK / + WK Ceramic TRW 23417 15,3 + WK + Zub BOS 23258 16,5 + WK + Zub TRW 23417 15,3 + WK + Zub Ceramic
<b>Warnkontakt, Bremsbelagsverschleiß</b>								
1.2 16V (F08, F48) 1.4 16V (F08, F48) 1.6 (F08, F48) 1.6 16V (F08, F48) 1.7 TD (F08, F48) 1.8 16V (F08, F48) 2.0 16V (F08, F48)	48 66 55 74 50 85 100	02/98→09/00 02/98→01/05 02/98→09/00 02/98→01/05 02/98→08/00 02/98→09/00 02/98→01/05	← ← ← ← ← ← ←	04/98→; 42187759→ 04/98→; → 42187758		2 2	24.8190-0018.2 620018 24.8190-0718.2 620718	L= 755 L= 720
1.2 16V (F08, F48) 1.4 (F08, F48) 1.6 (F08, F48) 1.6 (F08, F48) 1.7 CDTI (F08, F48) 1.7 DTI 16V (F08, F48) 1.8 16V (F08, F48) 2.0 16V OPC (F08, F48) 2.0 DTI 16V (F08, F48) 2.0 OPC (F08, F48) 2.0 OPC (F08, F48) 2.2 DTI (F08, F48) 2.2 DTI (F08, F48)	55 66 62 76 59 55 92 118 74 141 147 86 92	09/00→01/05 09/07→12/09 09/00→01/05 12/02→12/09 04/03→12/09 02/00→01/05 09/00→01/05 11/99→09/02 08/99→01/05 09/02→01/05 11/02→01/05 09/02→01/05 09/02→01/05	← ← ← ← ← ← ← ← ← ← ← ← ←	42187759→ → 42187758		2 2	24.8190-0018.2 620018 24.8190-0718.2 620718	L= 755 L= 720
2.0 DI (F08, F48)	60	02/98→01/05	← ← ← ←	04/98→; 42187759→ 04/98→; + ABS; 42187759→ 04/98→; + ABS; → 42187758 04/98→; → 42187758		2 2 2 2	24.8190-0018.2 620018 24.8190-0018.2 620018 24.8190-0718.2 620718 24.8190-0718.2 620718	L= 755 L= 755 L= 720 L= 720
2.2 16V (F08, F48)	108	06/00→01/05	← ←	09/00→; 42187759→ 09/00→; → 42187758		2 2	24.8190-0018.2 620018 24.8190-0718.2 620718	L= 755 L= 720
<b>Bremsscheibe</b>								
1.2 16V (F08, F48)	48	02/98→09/00	← ← ← →	04/98→; → 18999999; für Fahrzeuge mit Trommelbremse an der Hinterachse 04/98→; → 18999999; für Fahrzeuge mit Scheibenbremse an der Hinterachse; Felge Lochzahl: 4 22000001→; Felge Lochzahl: 4 04/98→; Felge Lochzahl: 4			24.0111-0141.1 411141 24.0311-0141.1 511141 24.0124-0152.1 424152 24.0324-0152.1 524152 24.0124-0152.1 424152 24.0324-0152.1 524152 24.0110-0251.1 410251 24.0310-0251.1 510251	Ø 256 10,8 8 Ø 256 10,8 8 Ø 256 23,8 21 V + S Ø 256 23,8 21 V + S Ø 256 23,8 21 V + S Ø 256 23,8 21 V + S Ø 240 9,8 8 + S Ø 240 9,8 8 + S
1.2 16V (F08, F48)	55	09/00→01/05	← ← ← →	→ 18999999; für Fahrzeuge mit Trommelbremse an der Hinterachse 22000001→; Felge Lochzahl: 4 → 18999999; für Fahrzeuge mit Scheibenbremse an der Hinterachse; Felge Lochzahl: 4 Felge Lochzahl: 4			24.0111-0141.1 411141 24.0311-0141.1 511141 24.0124-0152.1 424152 24.0324-0152.1 524152 24.0124-0152.1 424152 24.0324-0152.1 524152 24.0110-0251.1 410251 24.0310-0251.1 510251	Ø 256 10,8 8 Ø 256 10,8 8 Ø 256 23,8 21 V + S Ø 256 23,8 21 V + S Ø 256 23,8 21 V + S Ø 256 23,8 21 V + S Ø 240 9,8 8 + S Ø 240 9,8 8 + S
1.4 (F08, F48) 1.7 CDTI (F08, F48) 1.7 DTI 16V (F08, F48)	66 59 55	09/07→12/09 04/03→12/09 02/00→01/05	← →	Felge Lochzahl: 4 Felge Lochzahl: 4			24.0124-0152.1 424152 24.0324-0152.1 524152 24.0110-0251.1 410251 24.0310-0251.1 510251	Ø 256 23,8 21 V + S Ø 256 23,8 21 V + S Ø 240 9,8 8 + S Ø 240 9,8 8 + S
1.4 16V (F08, F48) 1.7 TD (F08, F48)	66 50	02/98→01/05 02/98→08/00	←	04/98→; Felge Lochzahl: 4			24.0124-0152.1 424152 24.0324-0152.1 524152	Ø 256 23,8 21 V + S Ø 256 23,8 21 V + S
↓								

	kw			 	! #		
<b>OPEL - ASTRA G CC (T98) 02/98→12/09</b>							
<b>Bremsscheibe</b>							
1.4 16V (F08, F48) 1.7 TD (F08, F48)	66 50	02/98→01/05 02/98→08/00	➔	04/98→; Felge Lochzahl: 4		24.0110-0251.1 410251 24.0310-0251.1 510251	Ø 240 9,8 8 + S Ø 240 9,8 8 + S
1.6 (F08, F48)	55	02/98→09/00	➔	04/98→; Felge Lochzahl: 4		24.0124-0152.1 424152 24.0324-0152.1 524152	Ø 256 23,8 21 V + S Ø 256 23,8 21 V + S
			➔	04/98→; Felge Lochzahl: 5		24.0125-0131.1 425131 24.0325-0131.1 525131	Ø 280 24,8 22 V + S Ø 280 24,8 22 V + S
			➔	04/98→; Felge Lochzahl: 4		24.0110-0251.1 410251 24.0310-0251.1 510251	Ø 240 9,8 8 + S Ø 240 9,8 8 + S
1.6 (F08, F48) 1.6 (F08, F48)	62 76	09/00→01/05 12/02→12/09	➔	Felge Lochzahl: 4		24.0124-0152.1 424152 24.0324-0152.1 524152	Ø 256 23,8 21 V + S Ø 256 23,8 21 V + S
			➔	Felge Lochzahl: 5		24.0125-0131.1 425131 24.0325-0131.1 525131	Ø 280 24,8 22 V + S Ø 280 24,8 22 V + S
			➔	Felge Lochzahl: 4		24.0110-0251.1 410251 24.0310-0251.1 510251	Ø 240 9,8 8 + S Ø 240 9,8 8 + S
1.6 16V (F08, F48)	74	02/98→01/05	➔	04/98→; Felge Lochzahl: 4		24.0124-0152.1 424152 24.0324-0152.1 524152	Ø 256 23,8 21 V + S Ø 256 23,8 21 V + S
			➔	04/98→; Felge Lochzahl: 5		24.0125-0131.1 425131 24.0325-0131.1 525131	Ø 280 24,8 22 V + S Ø 280 24,8 22 V + S
			➔	04/98→; Felge Lochzahl: 5		24.0110-0250.1 410250 24.0310-0250.1 510250	Ø 264 9,8 8 + S Ø 264 9,8 8 + S
			➔	04/98→; Felge Lochzahl: 4		24.0110-0251.1 410251 24.0310-0251.1 510251	Ø 240 9,8 8 + S Ø 240 9,8 8 + S
1.8 16V (F08, F48) 2.0 DI (F08, F48)	85 60	02/98→09/00 02/98→01/05	➔	04/98→; - ABS; Felge Lochzahl: 4		24.0124-0152.1 424152 24.0324-0152.1 524152	Ø 256 23,8 21 V + S Ø 256 23,8 21 V + S
			➔	04/98→; + ABS; Felge Lochzahl: 5		24.0125-0131.1 425131 24.0325-0131.1 525131	Ø 280 24,8 22 V + S Ø 280 24,8 22 V + S
			➔	04/98→; + ABS; Felge Lochzahl: 5		24.0110-0250.1 410250 24.0310-0250.1 510250	Ø 264 9,8 8 + S Ø 264 9,8 8 + S
			➔	04/98→; - ABS; Felge Lochzahl: 4		24.0110-0251.1 410251 24.0310-0251.1 510251	Ø 240 9,8 8 + S Ø 240 9,8 8 + S
1.8 16V (F08, F48)	92	09/00→01/05	➔	- ABS; Felge Lochzahl: 4		24.0124-0152.1 424152 24.0324-0152.1 524152	Ø 256 23,8 21 V + S Ø 256 23,8 21 V + S
			➔	+ ABS; Felge Lochzahl: 5		24.0125-0131.1 425131 24.0325-0131.1 525131	Ø 280 24,8 22 V + S Ø 280 24,8 22 V + S
			➔	+ ABS; Felge Lochzahl: 5		24.0110-0250.1 410250 24.0310-0250.1 510250	Ø 264 9,8 8 + S Ø 264 9,8 8 + S
			➔	- ABS; Felge Lochzahl: 4		24.0110-0251.1 410251 24.0310-0251.1 510251	Ø 240 9,8 8 + S Ø 240 9,8 8 + S
2.0 16V (F08, F48)	100	02/98→01/05	➔	04/98→; Felge Lochzahl: 5		24.0125-0131.1 425131 24.0325-0131.1 525131	Ø 280 24,8 22 V + S Ø 280 24,8 22 V + S
			➔	04/98→; Felge Lochzahl: 5		24.0110-0250.1 410250 24.0310-0250.1 510250	Ø 264 9,8 8 + S Ø 264 9,8 8 + S
2.0 16V OPC (F08, F48) 2.0 OPC (F08, F48) 2.0 OPC (F08, F48)	118 141 147	11/99→09/02 09/02→01/05 11/02→01/05	➔			24.0125-0142.1 425142 24.0325-0142.1 525142	Ø 308 25 22 V + S Ø 308 25 23 V + S
			➔	Felge Lochzahl: 5		24.0110-0250.1 410250 24.0310-0250.1 510250	Ø 264 9,8 8 + S Ø 264 9,8 8 + S
2.0 DTI 16V (F08, F48) 2.2 DTI (F08, F48) 2.2 DTI (F08, F48)	74 86 92	08/99→01/05 09/02→01/05 09/02→01/05	➔	Felge Lochzahl: 5		24.0125-0131.1 425131 24.0325-0131.1 525131	Ø 280 24,8 22 V + S Ø 280 24,8 22 V + S
			➔	Felge Lochzahl: 5		24.0110-0250.1 410250 24.0310-0250.1 510250	Ø 264 9,8 8 + S Ø 264 9,8 8 + S
2.2 16V (F08, F48)	108	06/00→01/05	➔	09/00→; Felge Lochzahl: 5		24.0125-0131.1 425131 24.0325-0131.1 525131	Ø 280 24,8 22 V + S Ø 280 24,8 22 V + S
			➔	09/00→; Felge Lochzahl: 5		24.0110-0250.1 410250 24.0310-0250.1 510250	Ø 264 9,8 8 + S Ø 264 9,8 8 + S
<b>OPEL - ASTRA G Coupe (T98) 03/00→05/05</b>							
<b>Bremsbelagsatz, Scheibenbremse</b>							
1.6 16V (F07) 1.6 16V (F07)	74 76	03/00→05/05 03/00→05/05	➔			13.0460-7115.2 607115 13.0470-7115.2 LD7115	ATE 23063 17,5 ohne integrierten Verschleiß- sensor / + WK ATE 23063 17,5 - WK / + WK Ceramic
↓							

	kW			 	! #		
<b>OPEL - ASTRA G Coupe (T98) 03/00→05/05</b>							
 <b>Bremsbelagsatz, Scheibenbremse</b>							
1.6 16V (F07) 1.6 16V (F07)	74 76	03/00→05/05 03/00→05/05	→			<b>13.0460-2868.2 602868</b> <b>13.0460-3976.2 603976</b> <b>13.0470-2868.2 LD2868</b>	TRW 23417 15,3 + WK + Zub BOS 23258 16,5 + WK + Zub TRW 23417 15,3 + WK + Zub Ceramic
1.8 16V (F07) 1.8 16V (F07) 2.2 16V (F07) 2.2 DTI (F07)	85 92 108 92	03/00→10/00 09/00→05/05 09/00→05/05 09/02→05/05	←			<b>13.0460-7116.2 607116</b> <b>13.0470-7116.2 LD7116</b>	ATE 23057 20,2 - WK / + WK ATE 23057 20,2 - WK / + WK Ceramic
			→			<b>13.0460-2868.2 602868</b> <b>13.0460-3976.2 603976</b> <b>13.0470-2868.2 LD2868</b>	TRW 23417 15,3 + WK + Zub BOS 23258 16,5 + WK + Zub TRW 23417 15,3 + WK + Zub Ceramic
2.0 16V Turbo (F07) 2.0 16V Turbo (F07) 2.0 16V Turbo (F07)	140 141 147	09/00→08/01 08/01→05/05 11/02→05/05	←			<b>13.0460-7173.2 607173</b>	ATE 21829 20,3 - WK / + WK
			→			<b>13.0460-2868.2 602868</b> <b>13.0460-3976.2 603976</b> <b>13.0470-2868.2 LD2868</b>	TRW 23417 15,3 + WK + Zub BOS 23258 16,5 + WK + Zub TRW 23417 15,3 + WK + Zub Ceramic
<b>Warnkontakt, Bremsbelagsverschleiß</b>							
1.6 16V (F07) 1.6 16V (F07) 1.8 16V (F07) 1.8 16V (F07) 2.0 16V Turbo (F07) 2.0 16V Turbo (F07) 2.0 16V Turbo (F07) 2.2 16V (F07) 2.2 DTI (F07)	74 76 85 92 140 141 147 108 92	03/00→05/05 03/00→05/05 03/00→10/00 09/00→05/05 09/00→08/01 08/01→05/05 11/02→05/05 09/00→05/05 09/02→05/05	←	42187759→	2	<b>24.8190-0018.2 620018</b>	L= 755
			←	→ 42187758	2	<b>24.8190-0718.2 620718</b>	L= 720
 <b>Bremsscheibe</b>							
1.6 16V (F07) 1.6 16V (F07)	74 76	03/00→05/05 03/00→05/05	←	Felge Lochzahl: 4		<b>24.0124-0152.1 424152</b> <b>24.0324-0152.1 524152</b>	Ø 256 23,8 21 V + S Ø 256 23,8 21 V + S
			←	Felge Lochzahl: 5		<b>24.0125-0131.1 425131</b> <b>24.0325-0131.1 525131</b>	Ø 280 24,8 22 V + S Ø 280 24,8 22 V + S
			→	Felge Lochzahl: 5		<b>24.0110-0250.1 410250</b> <b>24.0310-0250.1 510250</b>	Ø 264 9,8 8 + S Ø 264 9,8 8 + S
			→	Felge Lochzahl: 4		<b>24.0110-0251.1 410251</b> <b>24.0310-0251.1 510251</b>	Ø 240 9,8 8 + S Ø 240 9,8 8 + S
1.8 16V (F07) 1.8 16V (F07) 2.2 16V (F07) 2.2 DTI (F07)	85 92 108 92	03/00→10/00 09/00→05/05 09/00→05/05 09/02→05/05	←	Felge Lochzahl: 5		<b>24.0125-0131.1 425131</b> <b>24.0325-0131.1 525131</b>	Ø 280 24,8 22 V + S Ø 280 24,8 22 V + S
			→	Felge Lochzahl: 5		<b>24.0110-0250.1 410250</b> <b>24.0310-0250.1 510250</b>	Ø 264 9,8 8 + S Ø 264 9,8 8 + S
2.0 16V Turbo (F07) 2.0 16V Turbo (F07) 2.0 16V Turbo (F07)	140 141 147	09/00→08/01 08/01→05/05 11/02→05/05	←			<b>24.0125-0142.1 425142</b> <b>24.0325-0142.1 525142</b>	Ø 308 25 22 V + S Ø 308 25 23 V + S
			→	Felge Lochzahl: 5		<b>24.0110-0250.1 410250</b> <b>24.0310-0250.1 510250</b>	Ø 264 9,8 8 + S Ø 264 9,8 8 + S
<b>OPEL - ASTRA G Kasten (F70) 01/99→04/05</b>							
 <b>Bremsbelagsatz, Scheibenbremse</b>							
1.6 (F70) 1.6 (F70) 1.6 (F70) 1.7 DTI 16V (F70) 1.7 TD (F70)	55 62 76 55 50	01/99→09/00 09/00→04/05 10/04→04/05 02/00→04/05 01/99→04/05	←			<b>13.0460-7115.2 607115</b> <b>13.0470-7115.2 LD7115</b>	ATE 23063 17,5 ohne integrierten Verschleiß- sensor / + WK ATE 23063 17,5 - WK / + WK Ceramic
			→			<b>13.0460-2868.2 602868</b> <b>13.0460-3976.2 603976</b> <b>13.0470-2868.2 LD2868</b>	TRW 23417 15,3 + WK + Zub BOS 23258 16,5 + WK + Zub TRW 23417 15,3 + WK + Zub Ceramic
2.0 DI (F70)	60	01/99→04/05	←			<b>13.0460-7115.2 607115</b> <b>13.0470-7115.2 LD7115</b>	ATE 23063 17,5 ohne integrierten Verschleiß- sensor / + WK ATE 23063 17,5 - WK / + WK Ceramic
			←	+ ABS		<b>13.0460-7116.2 607116</b> <b>13.0470-7116.2 LD7116</b>	ATE 23057 20,2 - WK / + WK ATE 23057 20,2 - WK / + WK Ceramic
			→			<b>13.0460-2868.2 602868</b> <b>13.0460-3976.2 603976</b>	TRW 23417 15,3 + WK + Zub BOS 23258 16,5 + WK + Zub
↓							

	kw			 	! #		
<b>OPEL - ASTRA G Kasten (F70) 01/99→04/05</b>							
 <b>Bremsbelagsatz, Scheibenbremse</b>							
2.0 DI (F70)	60	01/99→04/05	➡			<b>13.0470-2868.2 LD2868</b>	TRW 23417 15,3 + WK + Zub Ceramic
<b>Warnkontakt, Bremsbelagverschleiß</b>							
1.6 (F70)	55	01/99→09/00	←	42187759→	2	<b>24.8190-0018.2 620018</b>	L= 755
1.6 (F70)	62	09/00→04/05		→ 42187758	2	<b>24.8190-0718.2 620718</b>	L= 720
1.6 (F70)	76	10/04→04/05	←				
1.7 DTI 16V (F70)	55	02/00→04/05					
1.7 TD (F70)	50	01/99→04/05					
2.0 DI (F70)	60	01/99→04/05	←	+ ABS; 42187759→	2	<b>24.8190-0018.2 620018</b>	L= 755
			←	42187759→	2	<b>24.8190-0018.2 620018</b>	L= 755
			←	→ 42187758	2	<b>24.8190-0718.2 620718</b>	L= 720
			←	+ ABS; → 42187758	2	<b>24.8190-0718.2 620718</b>	L= 720
 <b>Bremsscheibe</b>							
1.6 (F70)	55	01/99→09/00	←	Felge Lochzahl: 4		<b>24.0124-0152.1 424152</b>	Ø 256 23,8 21 V + S
1.6 (F70)	62	09/00→04/05				<b>24.0324-0152.1 524152</b>	Ø 256 23,8 21 V + S
			←	Felge Lochzahl: 5		<b>24.0125-0131.1 425131</b>	Ø 280 24,8 22 V + S
						<b>24.0325-0131.1 525131</b>	Ø 280 24,8 22 V + S
			➡	Felge Lochzahl: 4		<b>24.0110-0251.1 410251</b>	Ø 240 9,8 8 + S
						<b>24.0310-0251.1 510251</b>	Ø 240 9,8 8 + S
1.6 (F70)	76	10/04→04/05	←	Felge Lochzahl: 4		<b>24.0124-0152.1 424152</b>	Ø 256 23,8 21 V + S
						<b>24.0324-0152.1 524152</b>	Ø 256 23,8 21 V + S
			←	Felge Lochzahl: 5		<b>24.0125-0131.1 425131</b>	Ø 280 24,8 22 V + S
						<b>24.0325-0131.1 525131</b>	Ø 280 24,8 22 V + S
			➡	Felge Lochzahl: 5		<b>24.0110-0250.1 410250</b>	Ø 264 9,8 8 + S
						<b>24.0310-0250.1 510250</b>	Ø 264 9,8 8 + S
			➡	Felge Lochzahl: 4		<b>24.0110-0251.1 410251</b>	Ø 240 9,8 8 + S
						<b>24.0310-0251.1 510251</b>	Ø 240 9,8 8 + S
1.7 DTI 16V (F70)	55	02/00→04/05	←	Felge Lochzahl: 4		<b>24.0124-0152.1 424152</b>	Ø 256 23,8 21 V + S
1.7 TD (F70)	50	01/99→04/05				<b>24.0324-0152.1 524152</b>	Ø 256 23,8 21 V + S
			➡	Felge Lochzahl: 4		<b>24.0110-0251.1 410251</b>	Ø 240 9,8 8 + S
						<b>24.0310-0251.1 510251</b>	Ø 240 9,8 8 + S
2.0 DI (F70)	60	01/99→04/05	←	- ABS; Felge Lochzahl: 4		<b>24.0124-0152.1 424152</b>	Ø 256 23,8 21 V + S
						<b>24.0324-0152.1 524152</b>	Ø 256 23,8 21 V + S
			←	+ ABS; Felge Lochzahl: 5		<b>24.0125-0131.1 425131</b>	Ø 280 24,8 22 V + S
						<b>24.0325-0131.1 525131</b>	Ø 280 24,8 22 V + S
			➡	+ ABS; Felge Lochzahl: 5		<b>24.0110-0250.1 410250</b>	Ø 264 9,8 8 + S
						<b>24.0310-0250.1 510250</b>	Ø 264 9,8 8 + S
			➡	- ABS; Felge Lochzahl: 4		<b>24.0110-0251.1 410251</b>	Ø 240 9,8 8 + S
						<b>24.0310-0251.1 510251</b>	Ø 240 9,8 8 + S
<b>OPEL - ASTRA G Stufenheck (T98) 09/98→12/09</b>							
 <b>Bremsbelagsatz, Scheibenbremse</b>							
1.2 16V (F69)	48	09/98→09/00	←			<b>13.0460-7115.2 607115</b>	ATE 23063 17,5 ohne integrierten Verschleißsensor / + WK
1.2 16V (F69)	55	09/00→01/05					
1.4 (F69)	66	09/07→12/09					
1.4 16V (F69)	66	09/98→01/05				<b>13.0470-7115.2 LD7115</b>	ATE 23063 17,5 - WK / + WK Ceramic
1.6 (F69)	55	09/98→09/00					
1.6 (F69)	62	09/00→01/05					
1.6 (F69)	76	12/02→12/09	➡			<b>13.0460-2868.2 602868</b>	TRW 23417 15,3 + WK + Zub
1.6 16V (F69)	74	09/98→01/05				<b>13.0460-3976.2 603976</b>	BOS 23258 16,5 + WK + Zub
1.7 CDTI (F69)	59	04/03→12/09				<b>13.0470-2868.2 LD2868</b>	TRW 23417 15,3 + WK + Zub Ceramic
1.7 DTI 16V (F69)	55	02/00→01/05					
1.7 TD (F69)	50	09/98→08/00					
1.8 16V (F69)	85	09/98→09/00	←	- ABS		<b>13.0460-7115.2 607115</b>	ATE 23063 17,5 ohne integrierten Verschleißsensor / + WK
1.8 16V (F69)	92	06/00→01/05				<b>13.0470-7115.2 LD7115</b>	ATE 23063 17,5 - WK / + WK Ceramic
			←	+ ABS		<b>13.0460-7116.2 607116</b>	ATE 23057 20,2 - WK / + WK
						<b>13.0470-7116.2 LD7116</b>	ATE 23057 20,2 - WK / + WK Ceramic
			➡			<b>13.0460-2868.2 602868</b>	TRW 23417 15,3 + WK + Zub
						<b>13.0460-3976.2 603976</b>	BOS 23258 16,5 + WK + Zub
						<b>13.0470-2868.2 LD2868</b>	TRW 23417 15,3 + WK + Zub Ceramic
↓							





### OPEL - ASTRA G Stufenheck (T98) 09/98→12/09

#### Bremsbelagsatz, Scheibenbremse

2.0 16V (F69) 2.0 DTI 16V (F69) 2.2 16V (F69) 2.2 DTI (F69)	100	09/98→01/05	←		13.0460-7116.2	607116	ATE 23057 20,2 - WK / + WK
	74	08/99→01/05			13.0470-7116.2	LD7116	ATE 23057 20,2 - WK / + WK Ceramic
	108	03/01→01/05					
	86	09/02→01/05	→		13.0460-2868.2	602868	TRW 23417 15,3 + WK + Zub
	92	09/02→01/05			13.0460-3976.2	603976	BOS 23258 16,5 + WK + Zub
					13.0470-2868.2	LD2868	TRW 23417 15,3 + WK + Zub Ceramic
2.0 DI (F69)	60	09/98→01/05	←		13.0460-7115.2	607115	ATE 23063 17,5 ohne integrierten Verschleißsensor / + WK
					13.0470-7115.2	LD7115	ATE 23063 17,5 - WK / + WK Ceramic
			←	+ ABS	13.0460-7116.2	607116	ATE 23057 20,2 - WK / + WK
					13.0470-7116.2	LD7116	ATE 23057 20,2 - WK / + WK Ceramic
			→		13.0460-2868.2	602868	TRW 23417 15,3 + WK + Zub
					13.0460-3976.2	603976	BOS 23258 16,5 + WK + Zub
				13.0470-2868.2	LD2868	TRW 23417 15,3 + WK + Zub Ceramic	







#### Warnkontakt, Bremsbelagverschleiß









1.2 16V (F69) 1.2 16V (F69) 1.4 (F69) 1.4 16V (F69) 1.6 (F69) 1.6 (F69) 1.6 (F69) 1.6 16V (F69) 1.7 CDTI (F69) 1.7 DTI 16V (F69) 1.7 TD (F69) 1.8 16V (F69) 1.8 16V (F69) 2.0 16V (F69) 2.0 DTI 16V (F69) 2.2 16V (F69) 2.2 DTI (F69) 2.2 DTI (F69)	48	09/98→09/00	←	42187759→	2	24.8190-0018.2	620018	L= 755
	55	09/00→01/05	←	→ 42187758	2	24.8190-0718.2	620718	L= 720
	66	09/07→12/09						
	66	09/98→01/05						
	55	09/98→09/00						
	62	09/00→01/05						
	76	12/02→12/09						
	74	09/98→01/05						
	59	04/03→12/09						
	55	02/00→01/05						
	50	09/98→08/00						
	85	09/98→09/00						
	92	06/00→01/05						
	100	09/98→01/05						
	74	08/99→01/05						
	108	03/01→01/05						
	86	09/02→01/05						
	92	09/02→01/05						
	2.0 DI (F69)	60	09/98→01/05	←	+ ABS; 42187759→	2	24.8190-0018.2	620018
←				42187759→	2	24.8190-0018.2	620018	L= 755
←				→ 42187758	2	24.8190-0718.2	620718	L= 720
←				+ ABS; → 42187758	2	24.8190-0718.2	620718	L= 720







#### Bremsscheibe







1.2 16V (F69) 1.2 16V (F69)	48	09/98→09/00	←	→ 18999999; für Fahrzeuge mit Trommelbremse an der Hinterachse	24.0111-0141.1	411141	Ø 256 10,8 8	
	55	09/00→01/05	←	22000001→; Felge Lochzahl: 4	24.0124-0152.1	424152	Ø 256 23,8 21 V + S	
					24.0324-0152.1	524152	Ø 256 23,8 21 V + S	
				←	→ 18999999; für Fahrzeuge mit Scheibenbremse an der Hinterachse; Felge Lochzahl: 4	24.0124-0152.1	424152	Ø 256 23,8 21 V + S
				→	Felge Lochzahl: 4	24.0110-0251.1	410251	Ø 240 9,8 8 + S
					24.0310-0251.1	510251	Ø 240 9,8 8 + S	
1.4 (F69) 1.4 16V (F69) 1.7 CDTI (F69)	66	09/07→12/09	←	Felge Lochzahl: 4	24.0124-0152.1	424152	Ø 256 23,8 21 V + S	
	66	09/98→01/05			24.0324-0152.1	524152	Ø 256 23,8 21 V + S	
	59	04/03→12/09						
1.7 DTI 16V (F69) 1.7 TD (F69)	55	02/00→01/05	→	Felge Lochzahl: 4	24.0110-0251.1	410251	Ø 240 9,8 8 + S	
	50	09/98→08/00			24.0310-0251.1	510251	Ø 240 9,8 8 + S	
1.6 (F69) 1.6 (F69) 1.6 (F69)	55	09/98→09/00	←	Felge Lochzahl: 4	24.0124-0152.1	424152	Ø 256 23,8 21 V + S	
	62	09/00→01/05			24.0324-0152.1	524152	Ø 256 23,8 21 V + S	
	76	12/02→12/09	←	Felge Lochzahl: 5	24.0125-0131.1	425131	Ø 280 24,8 22 V + S	
					24.0325-0131.1	525131	Ø 280 24,8 22 V + S	
				→	Felge Lochzahl: 4	24.0110-0251.1	410251	Ø 240 9,8 8 + S
					24.0310-0251.1	510251	Ø 240 9,8 8 + S	
1.6 16V (F69)	74	09/98→01/05	←	Felge Lochzahl: 4	24.0124-0152.1	424152	Ø 256 23,8 21 V + S	
					24.0324-0152.1	524152	Ø 256 23,8 21 V + S	
			←	Felge Lochzahl: 5	24.0125-0131.1	425131	Ø 280 24,8 22 V + S	
					24.0325-0131.1	525131	Ø 280 24,8 22 V + S	











	kW			 	! #		
<b>OPEL - ASTRA G Stufenheck (T98) 09/98→12/09</b>							
<b>Bremsscheibe</b>							
1.6 16V (F69)	74	09/98→01/05	➔	Felge Lochzahl: 5		24.0110-0250.1 410250 24.0310-0250.1 510250	Ø 264 9,8 8 + S Ø 264 9,8 8 + S
			➔	Felge Lochzahl: 4		24.0110-0251.1 410251 24.0310-0251.1 510251	Ø 240 9,8 8 + S Ø 240 9,8 8 + S
1.8 16V (F69)	85	09/98→09/00	➔	- ABS; Felge Lochzahl: 4		24.0124-0152.1 424152	Ø 256 23,8 21 V + S
1.8 16V (F69)	92	06/00→01/05				24.0324-0152.1 524152	Ø 256 23,8 21 V + S
2.0 DI (F69)	60	09/98→01/05	➔	+ ABS; Felge Lochzahl: 5		24.0125-0131.1 425131 24.0325-0131.1 525131	Ø 280 24,8 22 V + S Ø 280 24,8 22 V + S
			➔	+ ABS; Felge Lochzahl: 5		24.0110-0250.1 410250 24.0310-0250.1 510250	Ø 264 9,8 8 + S Ø 264 9,8 8 + S
			➔	- ABS; Felge Lochzahl: 4		24.0110-0251.1 410251 24.0310-0251.1 510251	Ø 240 9,8 8 + S Ø 240 9,8 8 + S
2.0 16V (F69)	100	09/98→01/05	➔	Felge Lochzahl: 5		24.0125-0131.1 425131	Ø 280 24,8 22 V + S
2.0 DTI 16V (F69)	74	08/99→01/05				24.0325-0131.1 525131	Ø 280 24,8 22 V + S
2.2 16V (F69)	108	03/01→01/05					
2.2 DTI (F69)	86	09/02→01/05	➔	Felge Lochzahl: 5		24.0110-0250.1 410250	Ø 264 9,8 8 + S
2.2 DTI (F69)	92	09/02→01/05				24.0310-0250.1 510250	Ø 264 9,8 8 + S
<b>OPEL - ASTRA H (A04) 01/04→05/14</b>							
<b>Bremsbelagsatz, Scheibenbremse</b>							
1.2 (L48)	59	08/05→10/10	➔			13.0460-7179.2 607179	ATE 23832 20,2 - WK / + WK
1.3 CDTI (L48)	66	08/05→10/10				13.0470-7179.2 LD7179	ATE 23832 20,2 - WK / + WK Ceramic
1.4 (L48)	55	04/04→10/04					
1.4 (L48)	66	03/04→10/10					
1.4 LPG (L48)	66	08/09→10/10	➔			13.0460-2868.2 602868	TRW 23417 15,3 + WK + Zub
1.6 (L48)	77	03/04→10/10				13.0470-2868.2 LD2868	TRW 23417 15,3 + WK + Zub Ceramic
1.6 Turbo (L48)	132	02/07→10/10					
1.7 CDTI (L48)	59	03/04→10/10					
1.7 CDTI (L48)	74	03/04→10/10					
1.8 (L48)	92	01/04→10/10					
1.8 (L48)	103	01/06→10/10					
1.9 CDTI (L48)	74	09/05→10/10					
1.9 CDTI (L48)	110	09/04→10/10					
2.0 Turbo (L48)	125	03/04→10/10					
2.0 Turbo (L48)	147	09/04→10/10					
1.6 (L48)	85	12/06→05/14	➔	01/07→ 11/10		13.0460-7179.2 607179 13.0470-7179.2 LD7179	ATE 23832 20,2 - WK / + WK ATE 23832 20,2 - WK / + WK Ceramic
			➔	01/07→ 11/10		13.0460-2868.2 602868 13.0470-2868.2 LD2868	TRW 23417 15,3 + WK + Zub TRW 23417 15,3 + WK + Zub Ceramic
1.7 CDTI (L48)	81	02/07→05/14	➔	04/07→ 11/10		13.0460-7179.2 607179 13.0470-7179.2 LD7179	ATE 23832 20,2 - WK / + WK ATE 23832 20,2 - WK / + WK Ceramic
1.7 CDTI (L48)	92	02/07→05/14					
			➔	04/07→ 11/10		13.0460-2868.2 602868 13.0470-2868.2 LD2868	TRW 23417 15,3 + WK + Zub TRW 23417 15,3 + WK + Zub Ceramic
1.9 CDTI (L48)	88	06/04→10/10	➔	09/04→		13.0460-7179.2 607179 13.0470-7179.2 LD7179	ATE 23832 20,2 - WK / + WK ATE 23832 20,2 - WK / + WK Ceramic
1.9 CDTI 16V (L48)	88	04/04→10/10					
			➔	09/04→		13.0460-2868.2 602868 13.0470-2868.2 LD2868	TRW 23417 15,3 + WK + Zub TRW 23417 15,3 + WK + Zub Ceramic
2.0 Turbo (L48)	177	03/05→10/10	➔	für Bremssattel mit Kunststoffkolben		13.0460-7172.2 607172 13.0470-7172.2 LD7172	ATE 23378 20,1 + WE / - WK ATE 23378 20,1 + WE / - WK Ceramic
			➔	für Bremssattel mit Stahlkolben		13.0460-7212.2 607212	ATE 23738 20,1 + WE / - WK
			➔			13.0460-2868.2 602868 13.0470-2868.2 LD2868	TRW 23417 15,3 + WK + Zub TRW 23417 15,3 + WK + Zub Ceramic
<b>Warnkontakt, Bremsbelagverschleiß</b>							
1.2 (L48)	59	08/05→10/10	➔		1	24.8190-0720.2 620720	L= 287
1.3 CDTI (L48)	66	08/05→10/10					
1.4 (L48)	55	04/04→10/04					
1.4 (L48)	66	03/04→10/10					
1.4 LPG (L48)	66	08/09→10/10					
1.6 (L48)	77	03/04→10/10					
1.6 Turbo (L48)	132	02/07→10/10					
1.7 CDTI (L48)	59	03/04→10/10					
1.7 CDTI (L48)	74	03/04→10/10					

	kW			 	! #		
<b>OPEL - ASTRA H (A04) 01/04→05/14</b>							
<b>Warnkontakt, Bremsbelagverschleiß</b>							
1.8 (L48)	92	01/04→10/10	←		1	24.8190-0720.2 620720	L= 287
1.8 (L48)	103	01/06→10/10					
1.9 CDTI (L48)	74	09/05→10/10					
1.9 CDTI (L48)	110	09/04→10/10					
2.0 Turbo (L48)	125	03/04→10/10					
2.0 Turbo (L48)	147	09/04→10/10					
2.0 Turbo (L48)	177	03/05→10/10					
1.6 (L48)	85	12/06→05/14	←	01/07→ 11/10	1	24.8190-0720.2 620720	L= 287
1.7 CDTI (L48)	81	02/07→05/14	←	04/07→ 11/10	1	24.8190-0720.2 620720	L= 287
1.7 CDTI (L48)	92	02/07→05/14					
1.9 CDTI (L48)	88	06/04→10/10	←	09/04→	1	24.8190-0720.2 620720	L= 287
1.9 CDTI 16V (L48)	88	04/04→10/10					
<b> Bremsscheibe</b>							
1.2 (L48)	59	08/05→10/10	←	Felge Lochzahl: 5		24.0125-0131.1 425131	Ø 280 24,8 22 V + S
1.3 CDTI (L48)	66	08/05→10/10				24.0325-0131.1 525131	Ø 280 24,8 22 V + S
1.4 (L48)	55	04/04→10/04					
1.4 (L48)	66	03/04→10/10	←	Felge Lochzahl: 4		24.0125-0198.1 425198	Ø 280 25 22 V + S
1.4 LPG (L48)	66	08/09→10/10				24.0325-0198.1 525198	Ø 280 25 22 V + S
1.6 (L48)	77	03/04→10/10					
1.7 CDTI (L48)	59	03/04→10/10	→	Felge Lochzahl: 5		24.0110-0250.1 410250	Ø 264 9,8 8 + S
1.7 CDTI (L48)	74	03/04→10/10				24.0310-0250.1 510250	Ø 264 9,8 8 + S
1.8 (L48)	92	01/04→10/10	→	Felge Lochzahl: 4		24.0110-0251.1 410251	Ø 240 9,8 8 + S
1.8 (L48)	103	01/06→10/10				24.0310-0251.1 510251	Ø 240 9,8 8 + S
1.6 (L48)	85	12/06→05/14	←	01/07→ 11/10; Felge Lochzahl: 5		24.0125-0131.1 425131	Ø 280 24,8 22 V + S
						24.0325-0131.1 525131	Ø 280 24,8 22 V + S
			←	01/07→ 11/10; Felge Lochzahl: 4		24.0125-0198.1 425198	Ø 280 25 22 V + S
						24.0325-0198.1 525198	Ø 280 25 22 V + S
			→	01/07→ 11/10; Felge Lochzahl: 5		24.0110-0250.1 410250	Ø 264 9,8 8 + S
						24.0310-0250.1 510250	Ø 264 9,8 8 + S
			→	01/07→ 11/10; Felge Lochzahl: 4		24.0110-0251.1 410251	Ø 240 9,8 8 + S
						24.0310-0251.1 510251	Ø 240 9,8 8 + S
1.6 Turbo (L48)	132	02/07→10/10	←	Felge Lochzahl: 5		24.0125-0142.1 425142	Ø 308 25 22 V + S
1.9 CDTI (L48)	74	09/05→10/10				24.0325-0142.1 525142	Ø 308 25 23 V + S
1.9 CDTI (L48)	110	09/04→10/10					
2.0 Turbo (L48)	125	03/04→10/10	←	Felge Lochzahl: 4		24.0125-0198.1 425198	Ø 280 25 22 V + S
2.0 Turbo (L48)	147	09/04→10/10				24.0325-0198.1 525198	Ø 280 25 22 V + S
			→	Felge Lochzahl: 5		24.0110-0250.1 410250	Ø 264 9,8 8 + S
						24.0310-0250.1 510250	Ø 264 9,8 8 + S
			→	Felge Lochzahl: 4		24.0110-0251.1 410251	Ø 240 9,8 8 + S
						24.0310-0251.1 510251	Ø 240 9,8 8 + S
1.7 CDTI (L48)	81	02/07→05/14	←	04/07→ 11/10; Felge Lochzahl: 5		24.0125-0131.1 425131	Ø 280 24,8 22 V + S
						24.0325-0131.1 525131	Ø 280 24,8 22 V + S
			←	04/07→ 11/10; Felge Lochzahl: 4		24.0125-0198.1 425198	Ø 280 25 22 V + S
						24.0325-0198.1 525198	Ø 280 25 22 V + S
			→	04/07→ 11/10; Felge Lochzahl: 5		24.0110-0250.1 410250	Ø 264 9,8 8 + S
						24.0310-0250.1 510250	Ø 264 9,8 8 + S
			→	04/07→ 11/10; Felge Lochzahl: 4		24.0110-0251.1 410251	Ø 240 9,8 8 + S
						24.0310-0251.1 510251	Ø 240 9,8 8 + S
1.7 CDTI (L48)	92	02/07→05/14	←	04/07→ 11/10; Felge Lochzahl: 5		24.0125-0142.1 425142	Ø 308 25 22 V + S
						24.0325-0142.1 525142	Ø 308 25 23 V + S
			←	04/07→ 11/10; Felge Lochzahl: 4		24.0125-0198.1 425198	Ø 280 25 22 V + S
						24.0325-0198.1 525198	Ø 280 25 22 V + S
			→	04/07→ 11/10; Felge Lochzahl: 5		24.0110-0250.1 410250	Ø 264 9,8 8 + S
						24.0310-0250.1 510250	Ø 264 9,8 8 + S
			→	04/07→ 11/10; Felge Lochzahl: 4		24.0110-0251.1 410251	Ø 240 9,8 8 + S
						24.0310-0251.1 510251	Ø 240 9,8 8 + S
1.9 CDTI (L48)	88	06/04→10/10	←	09/04→; Felge Lochzahl: 5		24.0125-0142.1 425142	Ø 308 25 22 V + S
1.9 CDTI 16V (L48)	88	04/04→10/10				24.0325-0142.1 525142	Ø 308 25 23 V + S
			←	09/04→; Felge Lochzahl: 4		24.0125-0198.1 425198	Ø 280 25 22 V + S
						24.0325-0198.1 525198	Ø 280 25 22 V + S
			→	09/04→; Felge Lochzahl: 5		24.0110-0250.1 410250	Ø 264 9,8 8 + S
						24.0310-0250.1 510250	Ø 264 9,8 8 + S
			→	09/04→; Felge Lochzahl: 4		24.0110-0251.1 410251	Ø 240 9,8 8 + S
						24.0310-0251.1 510251	Ø 240 9,8 8 + S
2.0 Turbo (L48)	177	03/05→10/10	←	Felge Lochzahl: 5		24.0128-0201.1 428201	Ø 321 28 25 V
			→			24.0110-0339.1 410339	Ø 278 10 8 + S











	kw			 	! #		
<b>OPEL - ASTRA H Caravan (A04) 08/04→05/14</b>							
<b>Bremsbelagsatz, Scheibenbremse</b>							
1.3 CDTI (L35)	66	08/05→10/10	←			<b>13.0460-7179.2 607179</b>	ATE 23832 20,2 - WK / + WK
1.4 (L35)	55	08/04→10/10				<b>13.0470-7179.2 LD7179</b>	ATE 23832 20,2 - WK / + WK Ceramic
1.4 (L35)	66	08/04→10/10					
1.4 LPG (L35)	66	08/09→10/10					
1.6 (L35)	77	08/04→10/10	→			<b>13.0460-2868.2 602868</b>	TRW 23417 15,3 + WK + Zub
1.6 LPG (L35)	85	08/09→10/10				<b>13.0470-2868.2 LD2868</b>	TRW 23417 15,3 + WK + Zub Ceramic
1.6 Turbo (L35)	132	02/07→10/10					
1.7 CDTI (L35)	59	08/04→10/10					
1.7 CDTI (L35)	74	08/04→10/10					
1.8 (L35)	103	08/05→10/10					
1.9 CDTI (L35)	74	09/05→10/10					
1.9 CDTI (L35)	88	09/05→10/10					
1.9 CDTI (L35)	110	09/04→10/10					
1.9 CDTI 16V (L35)	88	08/04→10/10					
2.0 Turbo (L35)	125	08/04→10/10					
2.0 Turbo (L35)	147	09/04→10/10					
1.6 (L35)	85	12/06→05/14	←	01/07→ 11/10		<b>13.0460-7179.2 607179</b>	ATE 23832 20,2 - WK / + WK
						<b>13.0470-7179.2 LD7179</b>	ATE 23832 20,2 - WK / + WK Ceramic
			→	01/07→ 11/10		<b>13.0460-2868.2 602868</b>	TRW 23417 15,3 + WK + Zub
						<b>13.0470-2868.2 LD2868</b>	TRW 23417 15,3 + WK + Zub Ceramic
1.7 CDTI (L35)	81	02/07→05/14	←	04/07→ 11/10		<b>13.0460-7179.2 607179</b>	ATE 23832 20,2 - WK / + WK
1.7 CDTI (L35)	92	02/07→05/14				<b>13.0470-7179.2 LD7179</b>	ATE 23832 20,2 - WK / + WK Ceramic
			→	04/07→ 11/10		<b>13.0460-2868.2 602868</b>	TRW 23417 15,3 + WK + Zub
						<b>13.0470-2868.2 LD2868</b>	TRW 23417 15,3 + WK + Zub Ceramic
1.8 (L35)	92	08/04→10/10	←	09/04→		<b>13.0460-7179.2 607179</b>	ATE 23832 20,2 - WK / + WK
						<b>13.0470-7179.2 LD7179</b>	ATE 23832 20,2 - WK / + WK Ceramic
			→	09/04→		<b>13.0460-2868.2 602868</b>	TRW 23417 15,3 + WK + Zub
						<b>13.0470-2868.2 LD2868</b>	TRW 23417 15,3 + WK + Zub Ceramic
<b>Warnkontakt, Bremsbelagverschleiß</b>							
1.3 CDTI (L35)	66	08/05→10/10	←		1	<b>24.8190-0720.2 620720</b>	L= 287
1.4 (L35)	55	08/04→10/10					
1.4 (L35)	66	08/04→10/10					
1.4 LPG (L35)	66	08/09→10/10					
1.6 (L35)	77	08/04→10/10					
1.6 LPG (L35)	85	08/09→10/10					
1.6 Turbo (L35)	132	02/07→10/10					
1.7 CDTI (L35)	59	08/04→10/10					
1.7 CDTI (L35)	74	08/04→10/10					
1.8 (L35)	103	08/05→10/10					
1.9 CDTI (L35)	74	09/05→10/10					
1.9 CDTI (L35)	88	09/05→10/10					
1.9 CDTI (L35)	110	09/04→10/10					
1.9 CDTI 16V (L35)	88	08/04→10/10					
2.0 Turbo (L35)	125	08/04→10/10					
2.0 Turbo (L35)	147	09/04→10/10					
1.6 (L35)	85	12/06→05/14	←	01/07→ 11/10	1	<b>24.8190-0720.2 620720</b>	L= 287
1.7 CDTI (L35)	81	02/07→05/14	←	04/07→ 11/10	1	<b>24.8190-0720.2 620720</b>	L= 287
1.7 CDTI (L35)	92	02/07→05/14					
1.8 (L35)	92	08/04→10/10	←	09/04→	1	<b>24.8190-0720.2 620720</b>	L= 287
<b>Bremsscheibe</b>							
1.3 CDTI (L35)	66	08/05→10/10	←	Felge Lochzahl: 5		<b>24.0125-0131.1 425131</b>	Ø 280 24,8 22 V + S
1.4 (L35)	55	08/04→10/10				<b>24.0125-0198.1 425198</b>	Ø 280 25 22 V + S
1.4 (L35)	66	08/04→10/10	←	Felge Lochzahl: 4		<b>24.0325-0198.1 525198</b>	Ø 280 25 22 V + S
1.4 LPG (L35)	66	08/09→10/10					
1.6 (L35)	77	08/04→10/10	→	Felge Lochzahl: 5		<b>24.0110-0250.1 410250</b>	Ø 264 9,8 8 + S
1.6 LPG (L35)	85	08/09→10/10				<b>24.0310-0250.1 510250</b>	Ø 264 9,8 8 + S
1.7 CDTI (L35)	59	08/04→10/10					
1.7 CDTI (L35)	74	08/04→10/10	→	Felge Lochzahl: 4		<b>24.0110-0251.1 410251</b>	Ø 240 9,8 8 + S
1.8 (L35)	103	08/05→10/10				<b>24.0310-0251.1 510251</b>	Ø 240 9,8 8 + S
1.6 (L35)	85	12/06→05/14	←	01/07→ 11/10; Felge Lochzahl: 5		<b>24.0125-0131.1 425131</b>	Ø 280 24,8 22 V + S
			←	01/07→ 11/10; Felge Lochzahl: 4		<b>24.0125-0198.1 425198</b>	Ø 280 25 22 V + S
						<b>24.0325-0198.1 525198</b>	Ø 280 25 22 V + S
			→	01/07→ 11/10; Felge Lochzahl: 5		<b>24.0110-0250.1 410250</b>	Ø 264 9,8 8 + S
						<b>24.0310-0250.1 510250</b>	Ø 264 9,8 8 + S
			→	01/07→ 11/10; Felge Lochzahl: 4		<b>24.0110-0251.1 410251</b>	Ø 240 9,8 8 + S
↓							











	kw			 	! #		
<b>OPEL - ASTRA H Caravan (A04) 08/04→05/14</b>							
<b>Bremsscheibe</b>							
1.6 (L35)	85	12/06→05/14	➔	01/07→ 11/10; Felge Lochzahl: 4		24.0310-0251.1 510251	Ø 240 9,8 8 + S
1.6 Turbo (L35)	132	02/07→10/10	➔	Felge Lochzahl: 5		24.0125-0142.1 425142	Ø 308 25 22 V + S
1.9 CDTI (L35)	74	09/05→10/10				24.0325-0142.1 525142	Ø 308 25 23 V + S
1.9 CDTI (L35)	88	09/05→10/10					
1.9 CDTI (L35)	110	09/04→10/10	➔	Felge Lochzahl: 4		24.0125-0198.1 425198	Ø 280 25 22 V + S
1.9 CDTI 16V (L35)	88	08/04→10/10				24.0325-0198.1 525198	Ø 280 25 22 V + S
2.0 Turbo (L35)	125	08/04→10/10	➔	Felge Lochzahl: 5		24.0110-0250.1 410250	Ø 264 9,8 8 + S
2.0 Turbo (L35)	147	09/04→10/10	➔	Felge Lochzahl: 4		24.0310-0250.1 510250	Ø 264 9,8 8 + S
			➔	Felge Lochzahl: 4		24.0110-0251.1 410251	Ø 240 9,8 8 + S
			➔	Felge Lochzahl: 4		24.0310-0251.1 510251	Ø 240 9,8 8 + S
1.7 CDTI (L35)	81	02/07→05/14	➔	04/07→ 11/10; Felge Lochzahl: 5		24.0125-0131.1 425131	Ø 280 24,8 22 V + S
			➔	04/07→ 11/10; Felge Lochzahl: 4		24.0125-0198.1 425198	Ø 280 25 22 V + S
						24.0325-0198.1 525198	Ø 280 25 22 V + S
			➔	04/07→ 11/10; Felge Lochzahl: 5		24.0110-0250.1 410250	Ø 264 9,8 8 + S
			➔	04/07→ 11/10; Felge Lochzahl: 4		24.0310-0250.1 510250	Ø 264 9,8 8 + S
			➔	04/07→ 11/10; Felge Lochzahl: 4		24.0110-0251.1 410251	Ø 240 9,8 8 + S
			➔	04/07→ 11/10; Felge Lochzahl: 4		24.0310-0251.1 510251	Ø 240 9,8 8 + S
1.7 CDTI (L35)	92	02/07→05/14	➔	04/07→ 11/10; Felge Lochzahl: 5		24.0125-0142.1 425142	Ø 308 25 22 V + S
			➔	04/07→ 11/10; Felge Lochzahl: 4		24.0125-0198.1 425198	Ø 280 25 22 V + S
						24.0325-0198.1 525198	Ø 280 25 22 V + S
			➔	04/07→ 11/10; Felge Lochzahl: 5		24.0110-0250.1 410250	Ø 264 9,8 8 + S
			➔	04/07→ 11/10; Felge Lochzahl: 4		24.0310-0250.1 510250	Ø 264 9,8 8 + S
			➔	04/07→ 11/10; Felge Lochzahl: 4		24.0110-0251.1 410251	Ø 240 9,8 8 + S
			➔	04/07→ 11/10; Felge Lochzahl: 4		24.0310-0251.1 510251	Ø 240 9,8 8 + S
1.8 (L35)	92	08/04→10/10	➔	09/04→; Felge Lochzahl: 5		24.0125-0131.1 425131	Ø 280 24,8 22 V + S
						24.0325-0131.1 525131	Ø 280 24,8 22 V + S
			➔	09/04→; Felge Lochzahl: 4		24.0125-0198.1 425198	Ø 280 25 22 V + S
						24.0325-0198.1 525198	Ø 280 25 22 V + S
			➔	09/04→; Felge Lochzahl: 5		24.0110-0250.1 410250	Ø 264 9,8 8 + S
			➔	09/04→; Felge Lochzahl: 4		24.0310-0250.1 510250	Ø 264 9,8 8 + S
			➔	09/04→; Felge Lochzahl: 4		24.0110-0251.1 410251	Ø 240 9,8 8 + S
			➔	09/04→; Felge Lochzahl: 4		24.0310-0251.1 510251	Ø 240 9,8 8 + S
<b>OPEL - ASTRA H GTC (A04) 03/05→10/10</b>							
<b>Bremsbelagsatz, Scheibenbremse</b>							
1.2 (L08)	59	08/05→10/10	➔			13.0460-7179.2 607179	ATE 23832 20,2 - WK / + WK
1.4 (L08)	55	03/05→10/10				13.0470-7179.2 LD7179	ATE 23832 20,2 - WK / + WK Ceramic
1.4 (L08)	66	03/05→10/10					
1.6 (L08)	77	03/05→10/10					
1.6 Turbo (L08)	132	02/07→10/10	➔			13.0460-2868.2 602868	TRW 23417 15,3 + WK + Zub
1.7 CDTi (L08)	74	03/05→10/10				13.0470-2868.2 LD2868	TRW 23417 15,3 + WK + Zub Ceramic
1.7 CDTI (L08)	59	03/05→10/10					
1.8 (L08)	92	03/05→10/10					
1.8 (L08)	103	01/06→10/10					
1.9 CDTi (L08)	110	03/05→10/10					
1.9 CDTI (L08)	74	01/06→10/10					
1.9 CDTI (L08)	88	09/05→10/10					
1.9 CDTi 16V (L08)	88	03/05→10/10					
2.0 Turbo (L08)	125	03/05→10/10					
2.0 Turbo (L08)	147	03/05→10/10					
1.3 CDTI (L08)	66	04/05→10/10	➔	08/05→		13.0460-7179.2 607179	ATE 23832 20,2 - WK / + WK Ceramic
			➔	08/05→		13.0470-7179.2 LD7179	ATE 23832 20,2 - WK / + WK Ceramic
			➔	08/05→		13.0460-2868.2 602868	TRW 23417 15,3 + WK + Zub
			➔	08/05→		13.0470-2868.2 LD2868	TRW 23417 15,3 + WK + Zub Ceramic
1.6 (L08)	85	12/06→10/10	➔	01/07→		13.0460-7179.2 607179	ATE 23832 20,2 - WK / + WK Ceramic
						13.0470-7179.2 LD7179	ATE 23832 20,2 - WK / + WK Ceramic
			➔	01/07→		13.0460-2868.2 602868	TRW 23417 15,3 + WK + Zub
			➔	01/07→		13.0470-2868.2 LD2868	TRW 23417 15,3 + WK + Zub Ceramic
1.7 CDTI (L08)	81	02/07→10/10	➔	04/07→		13.0460-7179.2 607179	ATE 23832 20,2 - WK / + WK Ceramic
1.7 CDTI (L08)	92	02/07→10/10				13.0470-7179.2 LD7179	ATE 23832 20,2 - WK / + WK Ceramic
			➔	04/07→		13.0460-2868.2 602868	TRW 23417 15,3 + WK + Zub























	kW			 	! #		
<b>OPEL - ASTRA H GTC (A04) 03/05→10/10</b>							
<b> Bremsbelagsatz, Scheibenbremse</b>							
1.7 CDTi (L08) 1.7 CDTi (L08)	81 92	02/07→10/10 02/07→10/10	➡	04/07→		<b>13.0470-2868.2 LD2868</b>	TRW 23417 15,3 + WK + Zub Ceramic
2.0 Turbo (L08)	177	08/05→10/10	←	für Bremssattel mit Kunststoffkolben		<b>13.0460-7172.2 607172</b> <b>13.0470-7172.2 LD7172</b>	ATE 23378 20,1 + WE / - WK ATE 23378 20,1 + WE / - WK Ceramic
			←	für Bremssattel mit Stahlkolben		<b>13.0460-7212.2 607212</b>	ATE 23738 20,1 + WE / - WK
			➡			<b>13.0460-2868.2 602868</b> <b>13.0470-2868.2 LD2868</b>	TRW 23417 15,3 + WK + Zub TRW 23417 15,3 + WK + Zub Ceramic
<b>Warnkontakt, Bremsbelagverschleiß</b>							
1.2 (L08) 1.4 (L08) 1.4 (L08) 1.6 (L08) 1.6 Turbo (L08) 1.7 CDTi (L08) 1.7 CDTi (L08) 1.8 (L08) 1.8 (L08) 1.9 CDTi (L08) 1.9 CDTi (L08) 1.9 CDTi (L08) 1.9 CDTi 16V (L08) 2.0 Turbo (L08) 2.0 Turbo (L08) 2.0 Turbo (L08)	59 55 66 77 132 74 59 92 103 110 74 88 88 125 147 177	08/05→10/10 03/05→10/10 03/05→10/10 03/05→10/10 02/07→10/10 03/05→10/10 03/05→10/10 03/05→10/10 01/06→10/10 03/05→10/10 01/06→10/10 09/05→10/10 03/05→10/10 03/05→10/10 03/05→10/10 08/05→10/10	←		1	<b>24.8190-0720.2 620720</b>	L= 287
1.3 CDTi (L08)	66	04/05→10/10	←	08/05→	1	<b>24.8190-0720.2 620720</b>	L= 287
1.6 (L08)	85	12/06→10/10	←	01/07→	1	<b>24.8190-0720.2 620720</b>	L= 287
1.7 CDTi (L08) 1.7 CDTi (L08)	81 92	02/07→10/10 02/07→10/10	←	04/07→	1	<b>24.8190-0720.2 620720</b>	L= 287
<b> Bremsscheibe</b>							
1.2 (L08) 1.4 (L08) 1.4 (L08) 1.6 (L08) 1.7 CDTi (L08) 1.7 CDTi (L08) 1.8 (L08) 1.8 (L08)	59 55 66 77 74 59 92 103	08/05→10/10 03/05→10/10 03/05→10/10 03/05→10/10 03/05→10/10 03/05→10/10 03/05→10/10 01/06→10/10	←	Felge Lochzahl: 5		<b>24.0125-0131.1 425131</b> <b>24.0325-0131.1 525131</b>	Ø 280 24,8 22 V + S Ø 280 24,8 22 V + S
1.3 CDTi (L08)	66	04/05→10/10	←	Felge Lochzahl: 4		<b>24.0125-0198.1 425198</b> <b>24.0325-0198.1 525198</b>	Ø 280 25 22 V + S Ø 280 25 22 V + S
			➡	Felge Lochzahl: 5		<b>24.0110-0250.1 410250</b> <b>24.0310-0250.1 510250</b>	Ø 264 9,8 8 + S Ø 264 9,8 8 + S
			➡	Felge Lochzahl: 4		<b>24.0110-0251.1 410251</b> <b>24.0310-0251.1 510251</b>	Ø 240 9,8 8 + S Ø 240 9,8 8 + S
			←	Felge Lochzahl: 5		<b>24.0125-0131.1 425131</b> <b>24.0325-0131.1 525131</b>	Ø 280 24,8 22 V + S Ø 280 24,8 22 V + S
1.6 (L08)	85	12/06→10/10	←	Felge Lochzahl: 4		<b>24.0125-0198.1 425198</b> <b>24.0325-0198.1 525198</b>	Ø 280 25 22 V + S Ø 280 25 22 V + S
			➡	Felge Lochzahl: 5		<b>24.0110-0250.1 410250</b> <b>24.0310-0250.1 510250</b>	Ø 264 9,8 8 + S Ø 264 9,8 8 + S
			➡	Felge Lochzahl: 4		<b>24.0110-0251.1 410251</b> <b>24.0310-0251.1 510251</b>	Ø 240 9,8 8 + S Ø 240 9,8 8 + S
			←	Felge Lochzahl: 5		<b>24.0125-0131.1 425131</b> <b>24.0325-0131.1 525131</b>	Ø 280 24,8 22 V + S Ø 280 24,8 22 V + S
1.6 Turbo (L08) 1.9 CDTi (L08) 1.9 CDTi (L08) 1.9 CDTi (L08) 1.9 CDTi 16V (L08) 2.0 Turbo (L08) 2.0 Turbo (L08)	132 110 74 88 88 125 147	02/07→10/10 03/05→10/10 01/06→10/10 09/05→10/10 03/05→10/10 03/05→10/10 03/05→10/10	←	Felge Lochzahl: 5		<b>24.0125-0142.1 425142</b> <b>24.0325-0142.1 525142</b>	Ø 308 25 22 V + S Ø 308 25 23 V + S
			←	Felge Lochzahl: 4		<b>24.0125-0198.1 425198</b> <b>24.0325-0198.1 525198</b>	Ø 280 25 22 V + S Ø 280 25 22 V + S
			➡	Felge Lochzahl: 5		<b>24.0110-0250.1 410250</b> <b>24.0310-0250.1 510250</b>	Ø 264 9,8 8 + S Ø 264 9,8 8 + S
			➡	Felge Lochzahl: 4		<b>24.0110-0251.1 410251</b> <b>24.0310-0251.1 510251</b>	Ø 240 9,8 8 + S Ø 240 9,8 8 + S
1.7 CDTi (L08)	81	02/07→10/10	←	04/07→; Felge Lochzahl: 5		<b>24.0125-0131.1 425131</b> <b>24.0325-0131.1 525131</b>	Ø 280 24,8 22 V + S Ø 280 24,8 22 V + S













	kw					! #		
<b>OPEL - ASTRA H GTC (A04) 03/05→10/10</b>								
 <b>Bremsscheibe</b>								
1.7 CDTI (L08)	81	02/07→10/10	←	04/07→; Felge Lochzahl: 4	24.0125-0198.1	425198	∅ 280 25 22 V + S	
					24.0325-0198.1	525198	∅ 280 25 22 V + S	
			→	04/07→; Felge Lochzahl: 5	24.0110-0250.1	410250	∅ 264 9,8 8 + S	
					24.0310-0250.1	510250	∅ 264 9,8 8 + S	
1.7 CDTI (L08)	92	02/07→10/10	→	04/07→; Felge Lochzahl: 4	24.0110-0251.1	410251	∅ 240 9,8 8 + S	
					24.0310-0251.1	510251	∅ 240 9,8 8 + S	
			←	04/07→; Felge Lochzahl: 5	24.0125-0142.1	425142	∅ 308 25 22 V + S	
					24.0325-0142.1	525142	∅ 308 25 23 V + S	
1.7 CDTI (L08)	92	02/07→10/10	←	04/07→; Felge Lochzahl: 4	24.0125-0198.1	425198	∅ 280 25 22 V + S	
					24.0325-0198.1	525198	∅ 280 25 22 V + S	
			→	04/07→; Felge Lochzahl: 5	24.0110-0250.1	410250	∅ 264 9,8 8 + S	
					24.0310-0250.1	510250	∅ 264 9,8 8 + S	
2.0 Turbo (L08)	177	08/05→10/10	←	Felge Lochzahl: 5	24.0128-0201.1	428201	∅ 321 28 25 V	
			→		24.0110-0339.1	410339	∅ 278 10 8 + S	
<b>OPEL - ASTRA H Kasten (L70) 02/04→12/13</b>								
 <b>Bremsbelagsatz, Scheibenbremse</b>								
1.3 CDTI (L70)	66	08/05→10/10	←		13.0460-7179.2	607179	ATE 23832 20,2 - WK / + WK	
					13.0470-7179.2	LD7179	ATE 23832 20,2 - WK / + WK	
			→		13.0460-2868.2	602868	TRW 23417 15,3 + WK + Zub	
					13.0470-2868.2	LD2868	TRW 23417 15,3 + WK + Zub	
1.9 CDTI (L70)	88	09/05→10/10					Ceramic	
1.9 CDTI (L70)	110	09/04→10/10						
1.9 CDTI 16V (L70)	88	08/04→10/10	→		13.0460-2868.2	602868	TRW 23417 15,3 + WK + Zub	
					13.0470-2868.2	LD2868	TRW 23417 15,3 + WK + Zub	
1.7 CDTI (L70)	74	03/04→10/10	←	08/04→	13.0460-7179.2	607179	ATE 23832 20,2 - WK / + WK	
					13.0470-7179.2	LD7179	ATE 23832 20,2 - WK / + WK	
			→	08/04→	13.0460-2868.2	602868	TRW 23417 15,3 + WK + Zub	
					13.0470-2868.2	LD2868	TRW 23417 15,3 + WK + Zub	
1.7 CDTI (L70)	81	02/07→10/10	←	04/07→	13.0460-7179.2	607179	ATE 23832 20,2 - WK / + WK	
					13.0470-7179.2	LD7179	ATE 23832 20,2 - WK / + WK	
			→	04/07→	13.0460-2868.2	602868	TRW 23417 15,3 + WK + Zub	
					13.0470-2868.2	LD2868	TRW 23417 15,3 + WK + Zub	
1.7 CDTI (L70)	92	02/07→10/10					Ceramic	
<b>Warnkontakt, Bremsbelagsverschleiß</b>								
1.3 CDTI (L70)	66	08/05→10/10	←		1	24.8190-0720.2	620720	L= 287
1.9 CDTI (L70)	88	09/05→10/10						
1.9 CDTI (L70)	110	09/04→10/10						
1.9 CDTI 16V (L70)	88	08/04→10/10						
1.7 CDTI (L70)	74	03/04→10/10	←	08/04→	1	24.8190-0720.2	620720	L= 287
1.7 CDTI (L70)	81	02/07→10/10	←	04/07→	1	24.8190-0720.2	620720	L= 287
1.7 CDTI (L70)	92	02/07→10/10						
 <b>Bremsscheibe</b>								
1.3 CDTI (L70)	66	08/05→10/10	←	Felge Lochzahl: 5	24.0125-0131.1	425131	∅ 280 24,8 22 V + S	
			←	Felge Lochzahl: 4	24.0125-0198.1	425198	∅ 280 25 22 V + S	
					24.0325-0198.1	525198	∅ 280 25 22 V + S	
			→	Felge Lochzahl: 5	24.0110-0250.1	410250	∅ 264 9,8 8 + S	
					24.0310-0250.1	510250	∅ 264 9,8 8 + S	
			→	Felge Lochzahl: 4	24.0110-0251.1	410251	∅ 240 9,8 8 + S	
					24.0310-0251.1	510251	∅ 240 9,8 8 + S	
1.7 CDTI (L70)	74	03/04→10/10	←	08/04→; Felge Lochzahl: 5	24.0125-0131.1	425131	∅ 280 24,8 22 V + S	
			←	08/04→; Felge Lochzahl: 4	24.0125-0198.1	425198	∅ 280 25 22 V + S	
					24.0325-0198.1	525198	∅ 280 25 22 V + S	
			→	08/04→; Felge Lochzahl: 5	24.0110-0250.1	410250	∅ 264 9,8 8 + S	
					24.0310-0250.1	510250	∅ 264 9,8 8 + S	
			→	08/04→; Felge Lochzahl: 4	24.0110-0251.1	410251	∅ 240 9,8 8 + S	
					24.0310-0251.1	510251	∅ 240 9,8 8 + S	
1.7 CDTI (L70)	81	02/07→10/10	←	04/07→; Felge Lochzahl: 5	24.0125-0131.1	425131	∅ 280 24,8 22 V + S	
			←	04/07→; Felge Lochzahl: 4	24.0125-0198.1	425198	∅ 280 25 22 V + S	

	kw			 	! #			
<b>OPEL - ASTRA H Kasten (L70) 02/04→12/13</b>								
 <b>Bremsscheibe</b>								
1.7 CDTi (L70)	81	02/07→10/10	←	04/07→; Felge Lochzahl: 4	24.0325-0198.1	525198	Ø 280 25 22 V + S	
			→	04/07→; Felge Lochzahl: 5	24.0110-0250.1	410250	Ø 264 9,8 8 + S	
					24.0310-0250.1	510250	Ø 264 9,8 8 + S	
			→	04/07→; Felge Lochzahl: 4	24.0110-0251.1	410251	Ø 240 9,8 8 + S	
				24.0310-0251.1	510251	Ø 240 9,8 8 + S		
1.7 CDTi (L70)	92	02/07→10/10	←	04/07→; Felge Lochzahl: 5	24.0125-0142.1	425142	Ø 308 25 22 V + S	
					24.0325-0142.1	525142	Ø 308 25 23 V + S	
			←	04/07→; Felge Lochzahl: 4	24.0125-0198.1	425198	Ø 280 25 22 V + S	
					24.0325-0198.1	525198	Ø 280 25 22 V + S	
			→	04/07→; Felge Lochzahl: 5	24.0110-0250.1	410250	Ø 264 9,8 8 + S	
				24.0310-0250.1	510250	Ø 264 9,8 8 + S		
			→	04/07→; Felge Lochzahl: 4	24.0110-0251.1	410251	Ø 240 9,8 8 + S	
					24.0310-0251.1	510251	Ø 240 9,8 8 + S	
1.9 CDTi (L70) 1.9 CDTi (L70) 1.9 CDTi 16V (L70)	88	09/05→10/10	←	Felge Lochzahl: 5	24.0125-0142.1	425142	Ø 308 25 22 V + S	
	110	09/04→10/10			24.0325-0142.1	525142	Ø 308 25 23 V + S	
	88	08/04→10/10	←	Felge Lochzahl: 4	24.0125-0198.1	425198	Ø 280 25 22 V + S	
					24.0325-0198.1	525198	Ø 280 25 22 V + S	
				→	Felge Lochzahl: 5	24.0110-0250.1	410250	Ø 264 9,8 8 + S
						24.0310-0250.1	510250	Ø 264 9,8 8 + S
			→	Felge Lochzahl: 4	24.0110-0251.1	410251	Ø 240 9,8 8 + S	
					24.0310-0251.1	510251	Ø 240 9,8 8 + S	
<b>OPEL - ASTRA H Stufenheck (A04) 02/07→05/14</b>								
 <b>Bremsbelagsatz, Scheibenbremse</b>								
1.3 CDTi (L69) 1.7 CDTi (L69) 1.8 (L69)	66	02/07→10/10	←		13.0460-7179.2	607179	ATE 23832 20,2 - WK / + WK	
	74	02/07→10/10			13.0470-7179.2	LD7179	ATE 23832 20,2 - WK / + WK	
	103	02/07→10/10	→		13.0460-2868.2	602868	TRW 23417 15,3 + WK + Zub	
					13.0470-2868.2	LD2868	TRW 23417 15,3 + WK + Zub	
							Ceramic	
1.6 (L69)	85	02/07→05/14	←	→ 11/10	13.0460-7179.2	607179	ATE 23832 20,2 - WK / + WK	
					13.0470-7179.2	LD7179	ATE 23832 20,2 - WK / + WK	
			→	→ 11/10	13.0460-2868.2	602868	TRW 23417 15,3 + WK + Zub	
					13.0470-2868.2	LD2868	TRW 23417 15,3 + WK + Zub	
							Ceramic	
1.7 CDTi (L69)	81	02/07→05/14	←	04/07→ 11/10	13.0460-7179.2	607179	ATE 23832 20,2 - WK / + WK	
					13.0470-7179.2	LD7179	ATE 23832 20,2 - WK / + WK	
			→	04/07→ 11/10	13.0460-2868.2	602868	TRW 23417 15,3 + WK + Zub	
					13.0470-2868.2	LD2868	TRW 23417 15,3 + WK + Zub	
							Ceramic	
<b>Warnkontakt, Bremsbelagverschleiß</b>								
1.3 CDTi (L69) 1.7 CDTi (L69) 1.8 (L69)	66	02/07→10/10	←		1	24.8190-0720.2	620720	L= 287
	74	02/07→10/10						
	103	02/07→10/10						
1.6 (L69)	85	02/07→05/14	←	→ 11/10	1	24.8190-0720.2	620720	L= 287
1.7 CDTi (L69)	81	02/07→05/14	←	04/07→ 11/10	1	24.8190-0720.2	620720	L= 287
 <b>Bremsscheibe</b>								
1.3 CDTi (L69) 1.7 CDTi (L69) 1.8 (L69)	66 74 103	02/07→10/10	←	Felge Lochzahl: 5	24.0125-0131.1	425131	Ø 280 24,8 22 V + S	
					24.0325-0131.1	525131	Ø 280 24,8 22 V + S	
			←	Felge Lochzahl: 4	24.0125-0198.1	425198	Ø 280 25 22 V + S	
					24.0325-0198.1	525198	Ø 280 25 22 V + S	
			→	Felge Lochzahl: 5	24.0110-0250.1	410250	Ø 264 9,8 8 + S	
				24.0310-0250.1	510250	Ø 264 9,8 8 + S		
			→	Felge Lochzahl: 4	24.0110-0251.1	410251	Ø 240 9,8 8 + S	
					24.0310-0251.1	510251	Ø 240 9,8 8 + S	
1.6 (L69)	85	02/07→05/14	←	→ 11/10; Felge Lochzahl: 5	24.0125-0131.1	425131	Ø 280 24,8 22 V + S	
					24.0325-0131.1	525131	Ø 280 24,8 22 V + S	
			←	→ 11/10; Felge Lochzahl: 4	24.0125-0198.1	425198	Ø 280 25 22 V + S	
					24.0325-0198.1	525198	Ø 280 25 22 V + S	
			→	→ 11/10; Felge Lochzahl: 5	24.0110-0250.1	410250	Ø 264 9,8 8 + S	













	kw			 	! #		
<b>OPEL - ASTRA H Stufenheck (A04) 02/07→05/14</b>							
 <b>Bremsscheibe</b>							
1.6 (L69)	85	02/07→05/14	→	→ 11/10; Felge Lochzahl: 5		<b>24.0310-0250.1 510250</b>	Ø 264 9,8 8 + S
			→	→ 11/10; Felge Lochzahl: 4		<b>24.0110-0251.1 410251</b>	Ø 240 9,8 8 + S
1.7 CDTi (L69)	81	02/07→05/14	←	04/07→ 11/10; Felge Lochzahl: 5		<b>24.0125-0131.1 425131</b>	Ø 280 24,8 22 V + S
			←	04/07→ 11/10; Felge Lochzahl: 4		<b>24.0325-0131.1 525131</b>	Ø 280 24,8 22 V + S
			←	04/07→ 11/10; Felge Lochzahl: 4		<b>24.0125-0198.1 425198</b>	Ø 280 25 22 V + S
			←	04/07→ 11/10; Felge Lochzahl: 4		<b>24.0325-0198.1 525198</b>	Ø 280 25 22 V + S
			→	04/07→ 11/10; Felge Lochzahl: 5		<b>24.0110-0250.1 410250</b>	Ø 264 9,8 8 + S
			→	04/07→ 11/10; Felge Lochzahl: 4		<b>24.0310-0250.1 510250</b>	Ø 264 9,8 8 + S
			→	04/07→ 11/10; Felge Lochzahl: 5		<b>24.0110-0251.1 410251</b>	Ø 240 9,8 8 + S
			→	04/07→ 11/10; Felge Lochzahl: 4		<b>24.0310-0251.1 510251</b>	Ø 240 9,8 8 + S
<b>OPEL - ASTRA H TwinTop (A04) 09/05→10/10</b>							
 <b>Bremsbelagsatz, Scheibenbremse</b>							
1.6 (L67)	77	09/05→10/10	←	03/06→		<b>13.0460-7179.2 607179</b>	ATE 23832 20,2 - WK / + WK
1.8 (L67)	92	09/05→10/10	←			<b>13.0470-7179.2 LD7179</b>	ATE 23832 20,2 - WK / + WK
1.8 (L67)	103	09/05→10/10	←				Ceramic
1.9 CDTi (L67)	110	09/05→10/10	←				
2.0 Turbo (L67)	125	09/05→10/10	→	03/06→		<b>13.0460-2868.2 602868</b>	TRW 23417 15,3 + WK + Zub
2.0 Turbo (L67)	147	09/05→10/10	→			<b>13.0470-2868.2 LD2868</b>	TRW 23417 15,3 + WK + Zub
							Ceramic
1.6 (L67)	85	12/06→10/10	←			<b>13.0460-7179.2 607179</b>	ATE 23832 20,2 - WK / + WK
1.6 Turbo (L67)	132	02/07→10/10	←			<b>13.0470-7179.2 LD7179</b>	ATE 23832 20,2 - WK / + WK
			→			<b>13.0460-2868.2 602868</b>	TRW 23417 15,3 + WK + Zub
			→			<b>13.0470-2868.2 LD2868</b>	TRW 23417 15,3 + WK + Zub
							Ceramic
<b>Warnkontakt, Bremsbelagverschleiß</b>							
1.6 (L67)	77	09/05→10/10	←	03/06→	1	<b>24.8190-0720.2 620720</b>	L= 287
1.8 (L67)	92	09/05→10/10	←				
1.8 (L67)	103	09/05→10/10	←				
1.9 CDTi (L67)	110	09/05→10/10	←				
2.0 Turbo (L67)	125	09/05→10/10	←				
2.0 Turbo (L67)	147	09/05→10/10	←				
1.6 (L67)	85	12/06→10/10	←		1	<b>24.8190-0720.2 620720</b>	L= 287
1.6 Turbo (L67)	132	02/07→10/10	←				
 <b>Bremsscheibe</b>							
1.6 (L67)	77	09/05→10/10	←	03/06→; Felge Lochzahl: 5		<b>24.0125-0131.1 425131</b>	Ø 280 24,8 22 V + S
1.8 (L67)	92	09/05→10/10	←			<b>24.0325-0131.1 525131</b>	Ø 280 24,8 22 V + S
1.8 (L67)	103	09/05→10/10	←	03/06→; Felge Lochzahl: 4		<b>24.0125-0198.1 425198</b>	Ø 280 25 22 V + S
			→	03/06→; Felge Lochzahl: 4		<b>24.0325-0198.1 525198</b>	Ø 280 25 22 V + S
			→	03/06→; Felge Lochzahl: 5		<b>24.0110-0250.1 410250</b>	Ø 264 9,8 8 + S
			→	03/06→; Felge Lochzahl: 4		<b>24.0110-0291.1 410291</b>	Ø 264 10 8 + S
			→			<b>24.0310-0291.1 510291</b>	Ø 264 10 8 + S
1.6 (L67)	85	12/06→10/10	←	Felge Lochzahl: 5		<b>24.0125-0131.1 425131</b>	Ø 280 24,8 22 V + S
			←	Felge Lochzahl: 4		<b>24.0325-0131.1 525131</b>	Ø 280 24,8 22 V + S
			←	Felge Lochzahl: 4		<b>24.0125-0198.1 425198</b>	Ø 280 25 22 V + S
			←	Felge Lochzahl: 4		<b>24.0325-0198.1 525198</b>	Ø 280 25 22 V + S
			→	Felge Lochzahl: 5		<b>24.0110-0250.1 410250</b>	Ø 264 9,8 8 + S
			→	Felge Lochzahl: 4		<b>24.0110-0291.1 410291</b>	Ø 264 10 8 + S
			→			<b>24.0310-0291.1 510291</b>	Ø 264 10 8 + S
1.6 Turbo (L67)	132	02/07→10/10	←	Felge Lochzahl: 5		<b>24.0125-0142.1 425142</b>	Ø 308 25 22 V + S
			←	Felge Lochzahl: 4		<b>24.0125-0198.1 425198</b>	Ø 280 25 22 V + S
			←			<b>24.0325-0198.1 525198</b>	Ø 280 25 22 V + S
			←			<b>24.0325-0142.1 525142</b>	Ø 308 25 23 V + S
			→	Felge Lochzahl: 5		<b>24.0110-0250.1 410250</b>	Ø 264 9,8 8 + S
			→	Felge Lochzahl: 4		<b>24.0110-0291.1 410291</b>	Ø 264 10 8 + S
			→			<b>24.0310-0291.1 510291</b>	Ø 264 10 8 + S
1.9 CDTi (L67)	110	09/05→10/10	←	03/06→; Felge Lochzahl: 5		<b>24.0125-0142.1 425142</b>	Ø 308 25 22 V + S
2.0 Turbo (L67)	125	09/05→10/10	←			<b>24.0125-0198.1 425198</b>	Ø 280 25 22 V + S
2.0 Turbo (L67)	147	09/05→10/10	←	03/06→; Felge Lochzahl: 4		<b>24.0325-0198.1 525198</b>	Ø 280 25 22 V + S
			←			<b>24.0325-0142.1 525142</b>	Ø 308 25 23 V + S











	kW				! #					
<b>OPEL - ASTRA H TwinTop (A04) 09/05→10/10</b>										
 <b>Bremsscheibe</b>										
1.9 CDTi (L67)	110	09/05→10/10	➡	03/06→; Felge Lochzahl: 5		<b>24.0110-0250.1 410250</b>	Ø 264 9,8 8 + S			
2.0 Turbo (L67)	125	09/05→10/10	➡	03/06→; Felge Lochzahl: 4		<b>24.0110-0291.1 410291</b>	Ø 264 10 8 + S			
2.0 Turbo (L67)	147	09/05→10/10					<b>24.0310-0291.1 510291</b>	Ø 264 10 8 + S		
<b>OPEL - ASTRA J (P10) 09/09→10/15</b>										
 <b>Bremsbelagsatz, Scheibenbremse</b>										
1.3 CDTi (68)	70	12/09→10/15	←	für Bremsscheibendurchmesser [mm]: 321		<b>13.0460-5612.2 605612</b>	MAN 24412 19,0 + WK + Zub			
1.4 (68)	64	12/09→10/15					<b>13.0470-5612.2 LD5612</b>	MAN 24412 19,0 + WK + Zub Ceramic		
1.4 (68)	74	12/09→10/15								
1.4 LPG (68)	103	01/12→10/15								
1.4 Turbo (68)	103	12/09→10/15	←	für Bremsscheibendurchmesser [mm]: 276		<b>13.0460-7262.2 607262</b>	25031 19,1 + WK + Zub			
1.6 (68)	85	12/09→10/15					<b>13.0470-7262.2 LD7262</b>	25031 19,1 + WK + Zub Ceramic		
1.6 CDTi (68)	81	02/14→10/15	←	für Bremsscheibendurchmesser [mm]: 300		<b>13.0460-7263.2 607263</b>	24034 19,1 + WK + Zub			
1.6 CDTi (68)	100	11/13→10/15					<b>13.0470-7263.2 LD7263</b>	24034 19,1 + WK + Zub Ceramic		
1.6 SIDI (68)	125	12/12→10/15								
1.6 Turbo (68)	132	12/09→10/15								
1.7 CDTi (68)	74	10/10→10/15	➡			<b>13.0460-7264.2 607264</b>	ATE 25096 17,0 + WK + Zub			
1.7 CDTi (68)	81	09/09→10/15					<b>13.0470-7264.2 LD7264</b>	ATE 25096 17,0 + WK + Zub Ceramic		
1.7 CDTi (68)	92	12/09→10/15								
1.7 CDTi (68)	96	07/11→10/15								
2.0 BiTurbo CDTi (68)	143	09/12→10/15								
2.0 CDTi (68)	118	09/09→10/15								
2.0 CDTi (68)	121	06/11→10/15								
1.4 Turbo (68)	88	10/10→10/15	←	11/10→; für Bremsscheibendurchmesser [mm]: 321		<b>13.0460-5612.2 605612</b>	MAN 24412 19,0 + WK + Zub			
			←	11/10→; für Bremsscheibendurchmesser [mm]: 276		<b>13.0460-7262.2 607262</b>	<b>13.0470-7262.2 LD7262</b>	25031 19,1 + WK + Zub 25031 19,1 + WK + Zub Ceramic		
			←	11/10→; für Bremsscheibendurchmesser [mm]: 300		<b>13.0460-7263.2 607263</b>	<b>13.0470-7263.2 LD7263</b>	24034 19,1 + WK + Zub 24034 19,1 + WK + Zub Ceramic		
			➡	11/10→		<b>13.0460-7264.2 607264</b>	<b>13.0470-7264.2 LD7264</b>	ATE 25096 17,0 + WK + Zub ATE 25096 17,0 + WK + Zub Ceramic		
 <b>Bremsscheibe</b>										
1.3 CDTi (68)	70	12/09→10/15	←			<b>24.0126-0165.1 426165</b>	Ø 276 26 23 V + S			
1.4 (68)	64	12/09→10/15					<b>24.0126-0166.1 426166</b>	Ø 300 26 23 V + S		
1.4 (68)	74	12/09→10/15								
1.4 LPG (68)	103	01/12→10/15					<b>24.0130-0224.1 430224</b>	Ø 321 30 27 V + S		
1.4 Turbo (68)	103	12/09→10/15					<b>24.0326-0165.1 526165</b>	Ø 276 26 23 V + S		
1.6 (68)	85	12/09→10/15					<b>24.0326-0166.1 526166</b>	Ø 300 26 23 V + S		
1.6 CDTi (68)	81	02/14→10/15			➡			<b>24.0112-0188.1 412188</b>	Ø 268 12 10 + S	
1.6 CDTi (68)	100	11/13→10/15							<b>24.0112-0189.1 412189</b>	Ø 292 12 10 + S
1.6 SIDI (68)	125	12/12→10/15								
1.6 Turbo (68)	132	12/09→10/15								
1.7 CDTi (68)	74	10/10→10/15						<b>24.0312-0188.1 512188</b>	Ø 268 12 10 + S	
1.7 CDTi (68)	81	09/09→10/15							<b>24.0312-0189.1 512189</b>	Ø 292 12 10 + S
1.7 CDTi (68)	92	12/09→10/15								
1.7 CDTi (68)	96	07/11→10/15								
2.0 BiTurbo CDTi (68)	143	09/12→10/15								
2.0 CDTi (68)	118	09/09→10/15								
2.0 CDTi (68)	121	06/11→10/15								
1.4 Turbo (68)	88	10/10→10/15	←	11/10→		<b>24.0126-0165.1 426165</b>	Ø 276 26 23 V + S			
			←				<b>24.0126-0166.1 426166</b>	Ø 300 26 23 V + S		
						<b>24.0130-0224.1 430224</b>	Ø 321 30 27 V + S			
						<b>24.0326-0165.1 526165</b>	Ø 276 26 23 V + S			
						<b>24.0326-0166.1 526166</b>	Ø 300 26 23 V + S			
			➡	11/10→		<b>24.0112-0188.1 412188</b>	Ø 268 12 10 + S			
						<b>24.0112-0189.1 412189</b>	Ø 292 12 10 + S			
						<b>24.0312-0188.1 512188</b>	Ø 268 12 10 + S			
						<b>24.0312-0189.1 512189</b>	Ø 292 12 10 + S			
<b>OPEL - ASTRA J Caravan (P10) 10/10→10/15</b>										
 <b>Bremsbelagsatz, Scheibenbremse</b>										
1.3 CDTi (35)	70	10/10→10/14	←	11/10→; für Bremsscheibendurchmesser [mm]: 321		<b>13.0460-5612.2 605612</b>	MAN 24412 19,0 + WK + Zub			
1.4 (35)	64	10/10→10/15					<b>13.0470-5612.2 LD5612</b>	MAN 24412 19,0 + WK + Zub Ceramic		
1.4 (35)	74	10/10→10/15	←	11/10→; für Bremsscheibendurchmesser [mm]: 276		<b>13.0460-7262.2 607262</b>	25031 19,1 + WK + Zub			
1.4 Turbo (35)	88	10/10→10/15					<b>13.0470-7262.2 LD7262</b>	25031 19,1 + WK + Zub Ceramic		
1.4 Turbo (35)	103	10/10→10/15								
1.6 (35)	85	10/10→10/15								
1.6 Turbo (35)	132	10/10→10/15								
1.7 CDTi (35)	74	10/10→10/15								



























	kw			 	! #		
<b>OPEL - ASTRA J Caravan (P10) 10/10→10/15</b>							
 <b>Bremsbelagsatz, Scheibenbremse</b>							
1.7 CDTi (35)	81	10/10→10/15	←	11/10→; für Bremsscheibendurchmesser [mm]: 300	<b>13.0460-7263.2</b>	<b>607263</b>	24034 19,1 + WK + Zub
1.7 CDTi (35)	92	10/10→10/15			<b>13.0470-7263.2</b>	<b>LD7263</b>	24034 19,1 + WK + Zub Ceramic
1.7 CDTi (35)	96	10/10→10/15					
2.0 CDTi (35)	118	10/10→10/15	→	11/10→	<b>13.0460-7264.2</b>	<b>607264</b>	ATE 25096 17,0 + WK + Zub
					<b>13.0470-7264.2</b>	<b>LD7264</b>	ATE 25096 17,0 + WK + Zub Ceramic
1.4 LPG (35)	103	12/11→10/15	←	für Bremsscheibendurchmesser [mm]: 321	<b>13.0460-5612.2</b>	<b>605612</b>	MAN 24412 19,0 + WK + Zub
1.6 CDTi (35)	81	02/14→10/15			<b>13.0470-5612.2</b>	<b>LD5612</b>	MAN 24412 19,0 + WK + Zub Ceramic
1.6 CDTi (35)	100	11/13→10/15					
1.6 LPG (35)	84	10/12→10/15					
1.6 SIDI (35)	125	12/12→10/15	←	für Bremsscheibendurchmesser [mm]: 276	<b>13.0460-7262.2</b>	<b>607262</b>	25031 19,1 + WK + Zub
2.0 BiTurbo CDTi (35)	143	09/12→10/15			<b>13.0470-7262.2</b>	<b>LD7262</b>	25031 19,1 + WK + Zub Ceramic
2.0 CDTi (35)	96	01/14→10/15	←	für Bremsscheibendurchmesser [mm]: 300	<b>13.0460-7263.2</b>	<b>607263</b>	24034 19,1 + WK + Zub
2.0 CDTi (35)	121	08/11→10/15			<b>13.0470-7263.2</b>	<b>LD7263</b>	24034 19,1 + WK + Zub Ceramic
			→		<b>13.0460-7264.2</b>	<b>607264</b>	ATE 25096 17,0 + WK + Zub
					<b>13.0470-7264.2</b>	<b>LD7264</b>	ATE 25096 17,0 + WK + Zub Ceramic
 <b>Bremsscheibe</b>							
1.3 CDTi (35)	70	10/10→10/14	←	11/10→	<b>24.0126-0165.1</b>	<b>426165</b>	Ø 276 26 23 V + S
1.4 (35)	64	10/10→10/15			<b>24.0126-0166.1</b>	<b>426166</b>	Ø 300 26 23 V + S
1.4 (35)	74	10/10→10/15					
1.4 Turbo (35)	88	10/10→10/15			<b>24.0130-0224.1</b>	<b>430224</b>	Ø 321 30 27 V + S
1.4 Turbo (35)	103	10/10→10/15					
1.6 (35)	85	10/10→10/15			<b>24.0326-0165.1</b>	<b>526165</b>	Ø 276 26 23 V + S
1.6 Turbo (35)	132	10/10→10/15			<b>24.0326-0166.1</b>	<b>526166</b>	Ø 300 26 23 V + S
1.7 CDTi (35)	74	10/10→10/15	→	11/10→	<b>24.0112-0188.1</b>	<b>412188</b>	Ø 268 12 10 + S
1.7 CDTi (35)	81	10/10→10/15			<b>24.0112-0189.1</b>	<b>412189</b>	Ø 292 12 10 + S
1.7 CDTi (35)	92	10/10→10/15			<b>24.0312-0188.1</b>	<b>512188</b>	Ø 268 12 10 + S
1.7 CDTi (35)	96	10/10→10/15					
2.0 CDTi (35)	118	10/10→10/15			<b>24.0312-0189.1</b>	<b>512189</b>	Ø 292 12 10 + S
1.4 LPG (35)	103	12/11→10/15	←		<b>24.0126-0165.1</b>	<b>426165</b>	Ø 276 26 23 V + S
1.6 CDTi (35)	81	02/14→10/15			<b>24.0126-0166.1</b>	<b>426166</b>	Ø 300 26 23 V + S
1.6 CDTi (35)	100	11/13→10/15			<b>24.0130-0224.1</b>	<b>430224</b>	Ø 321 30 27 V + S
1.6 LPG (35)	84	10/12→10/15					
1.6 SIDI (35)	125	12/12→10/15			<b>24.0326-0165.1</b>	<b>526165</b>	Ø 276 26 23 V + S
2.0 BiTurbo CDTi (35)	143	09/12→10/15			<b>24.0326-0166.1</b>	<b>526166</b>	Ø 300 26 23 V + S
2.0 CDTi (35)	96	01/14→10/15					
2.0 CDTi (35)	121	08/11→10/15	→		<b>24.0112-0188.1</b>	<b>412188</b>	Ø 268 12 10 + S
					<b>24.0112-0189.1</b>	<b>412189</b>	Ø 292 12 10 + S
					<b>24.0312-0188.1</b>	<b>512188</b>	Ø 268 12 10 + S
					<b>24.0312-0189.1</b>	<b>512189</b>	Ø 292 12 10 + S
<b>OPEL - ASTRA J GTC 10/11→</b>							
 <b>Bremsbelagsatz, Scheibenbremse</b>							
1.4 (08)	74	10/11→10/15	←	für Bremsscheibendurchmesser [mm]: 321	<b>13.0460-5612.2</b>	<b>605612</b>	MAN 24412 19,0 + WK + Zub
1.4 (08)	88	10/11→			<b>13.0470-5612.2</b>	<b>LD5612</b>	MAN 24412 19,0 + WK + Zub Ceramic
1.4 (08)	103	10/11→					
1.6 (08)	132	10/11→					
1.6 CDTi (08)	81	07/14→	←	für Bremsscheibendurchmesser [mm]: 276	<b>13.0460-7262.2</b>	<b>607262</b>	25031 19,1 + WK + Zub
1.6 CDTi (08)	100	07/14→			<b>13.0470-7262.2</b>	<b>LD7262</b>	25031 19,1 + WK + Zub Ceramic
1.6 SIDI (08)	125	12/12→					
1.6 SIDI (08)	147	07/13→	←	für Bremsscheibendurchmesser [mm]: 300	<b>13.0460-7263.2</b>	<b>607263</b>	24034 19,1 + WK + Zub
1.7 CDTi (08)	81	10/11→10/15			<b>13.0470-7263.2</b>	<b>LD7263</b>	24034 19,1 + WK + Zub Ceramic
1.7 CDTi (08)	96	10/11→10/15	→		<b>13.0460-7264.2</b>	<b>607264</b>	ATE 25096 17,0 + WK + Zub
1.8 (08)	103	10/11→10/15			<b>13.0470-7264.2</b>	<b>LD7264</b>	ATE 25096 17,0 + WK + Zub Ceramic
2.0 CDTi (08)	121	10/11→10/15					
2.0 (08)	206	04/12→	←	06/12→	<b>13.0460-4855.2</b>	<b>604855</b>	BRE 23325 16,4 + WK
			→	F0000001→	<b>13.0460-7309.2</b>	<b>607309</b>	ATE 25096 16,7 + WK + Zub
					<b>13.0470-7309.2</b>	<b>LD7309</b>	ATE 25096 16,7 + WK + Zub Ceramic
2.0 BiTurbo CDTi (08)	143	10/12→10/15	←	12/12→; für Bremsscheibendurchmesser [mm]: 321	<b>13.0460-5612.2</b>	<b>605612</b>	MAN 24412 19,0 + WK + Zub
					<b>13.0470-5612.2</b>	<b>LD5612</b>	MAN 24412 19,0 + WK + Zub Ceramic
			←	12/12→; für Bremsscheibendurchmesser [mm]: 276	<b>13.0460-7262.2</b>	<b>607262</b>	25031 19,1 + WK + Zub
					<b>13.0470-7262.2</b>	<b>LD7262</b>	25031 19,1 + WK + Zub Ceramic
			←	12/12→; für Bremsscheibendurchmesser [mm]: 300	<b>13.0460-7263.2</b>	<b>607263</b>	24034 19,1 + WK + Zub
					<b>13.0470-7263.2</b>	<b>LD7263</b>	24034 19,1 + WK + Zub Ceramic
			→	12/12→	<b>13.0460-7264.2</b>	<b>607264</b>	ATE 25096 17,0 + WK + Zub
					<b>13.0470-7264.2</b>	<b>LD7264</b>	ATE 25096 17,0 + WK + Zub Ceramic















	kw					! #		
<b>OPEL - ASTRA J GTC 10/11→</b>								
 <b>Bremsscheibe</b>								
1.4 (08)	74	10/11→10/15	←			24.0126-0165.1	426165	Ø 276 26 23 V + S
1.4 (08)	88	10/11→				24.0126-0166.1	426166	Ø 300 26 23 V + S
1.4 (08)	103	10/11→				24.0130-0224.1	430224	Ø 321 30 27 V + S
1.6 (08)	132	10/11→				24.0326-0165.1	526165	Ø 276 26 23 V + S
1.6 CDTi (08)	81	07/14→				24.0326-0166.1	526166	Ø 300 26 23 V + S
1.6 CDTi (08)	100	07/14→				24.0112-0188.1	412188	Ø 268 12 10 + S
1.6 SIDI (08)	125	12/12→				24.0112-0189.1	412189	Ø 292 12 10 + S
1.6 SIDI (08)	147	07/13→	→			24.0312-0188.1	512188	Ø 268 12 10 + S
1.7 CDTi (08)	81	10/11→10/15				24.0312-0189.1	512189	Ø 292 12 10 + S
1.7 CDTi (08)	96	10/11→10/15						
1.8 (08)	103	10/11→10/15						
2.0 CDTi (08)	121	10/11→10/15						
2.0 BiTurbo CDTi (08)	143	10/12→10/15	←	12/12→		24.0126-0165.1	426165	Ø 276 26 23 V + S
						24.0126-0166.1	426166	Ø 300 26 23 V + S
						24.0130-0224.1	430224	Ø 321 30 27 V + S
						24.0326-0165.1	526165	Ø 276 26 23 V + S
						24.0326-0166.1	526166	Ø 300 26 23 V + S
			→	12/12→		24.0112-0188.1	412188	Ø 268 12 10 + S
						24.0112-0189.1	412189	Ø 292 12 10 + S
						24.0312-0188.1	512188	Ø 268 12 10 + S
						24.0312-0189.1	512189	Ø 292 12 10 + S
<b>OPEL - ASTRA J Stufenheck 06/12→</b>								
 <b>Bremsbelagsatz, Scheibenbremse</b>								
1.3 CDTi (69)	70	06/12→10/15	←	für Bremsscheibendurchmesser [mm]:		13.0460-5612.2	605612	MAN 24412 19,0 + WK + Zub
1.4 (69)	74	06/12→10/15		321		13.0470-5612.2	LD5612	MAN 24412 19,0 + WK + Zub
1.4 LPG (69)	103	07/14→						Ceramic
1.4 Turbo (69)	88	06/12→10/15						
1.4 Turbo (69)	103	06/12→	←	für Bremsscheibendurchmesser [mm]:		13.0460-7262.2	607262	25031 19,1 + WK + Zub
1.6 (69)	85	06/12→		276		13.0470-7262.2	LD7262	25031 19,1 + WK + Zub Ceramic
1.6 CDTi (69)	81	04/14→						
1.6 CDTi (69)	100	01/14→	←	für Bremsscheibendurchmesser [mm]:		13.0460-7263.2	607263	24034 19,1 + WK + Zub
1.6 SIDI (69)	125	12/12→10/16		300		13.0470-7263.2	LD7263	24034 19,1 + WK + Zub Ceramic
1.6 Turbo (69)	132	06/12→10/13						
1.7 CDTi (69)	81	06/12→10/15	→			13.0460-7264.2	607264	ATE 25096 17,0 + WK + Zub
1.7 CDTi (69)	96	06/12→10/15				13.0470-7264.2	LD7264	ATE 25096 17,0 + WK + Zub Ceramic
 <b>Bremsscheibe</b>								
1.3 CDTi (69)	70	06/12→10/15	←			24.0126-0165.1	426165	Ø 276 26 23 V + S
1.4 (69)	74	06/12→10/15				24.0126-0166.1	426166	Ø 300 26 23 V + S
1.4 LPG (69)	103	07/14→				24.0130-0224.1	430224	Ø 321 30 27 V + S
1.4 Turbo (69)	88	06/12→10/15				24.0326-0165.1	526165	Ø 276 26 23 V + S
1.4 Turbo (69)	103	06/12→				24.0326-0166.1	526166	Ø 300 26 23 V + S
1.6 (69)	85	06/12→				24.0112-0188.1	412188	Ø 268 12 10 + S
1.6 CDTi (69)	81	04/14→				24.0112-0189.1	412189	Ø 292 12 10 + S
1.6 CDTi (69)	100	01/14→	→			24.0312-0188.1	512188	Ø 268 12 10 + S
1.6 SIDI (69)	125	12/12→10/16				24.0312-0189.1	512189	Ø 292 12 10 + S
1.6 Turbo (69)	132	06/12→10/13						
1.7 CDTi (69)	81	06/12→10/15						
1.7 CDTi (69)	96	06/12→10/15						
<b>OPEL - ASTRA K (B16) 06/15→</b>								
 <b>Bremsbelagsatz, Scheibenbremse</b>								
1.0 Turbo (68)	77	06/15→	←	für Bremsscheibendurchmesser [mm]:		13.0460-7324.2	607324	ATE 22345 19,7 + WK
1.4 CNG (68)	81	10/17→		300		13.0470-7324.2	LD7324	ATE 22345 19,7 + WK Ceramic
1.4 Turbo (68)	74	06/15→						
1.4 Turbo (68)	92	06/15→	←	für Bremsscheibendurchmesser [mm]:		13.0460-7325.2	607325	ATE 22342 19,8 + WK
1.4 Turbo (68)	110	06/15→		276		13.0470-7325.2	LD7325	ATE 22342 19,8 + WK Ceramic
1.6 CDTi (68)	70	06/15→						
1.6 CDTi (68)	81	06/15→	→			13.0460-2615.2	602615	TRW 22129 17,4 + WK + Zub
1.6 CDTi (68)	100	06/15→				13.0470-2615.2	LD2615	TRW + WK + Zub Ceramic
1.6 CDTi (68)	118	11/15→						
1.6 Turbo (68)	147	11/15→						
 <b>Bremsscheibe</b>								
1.0 Turbo (68)	77	06/15→	←			24.0126-0187.1	426187	Ø 276 26 23 V + S
1.4 CNG (68)	81	10/17→				24.0126-0188.1	426188	Ø 300 26 23 V + S
1.4 Turbo (68)	74	06/15→						
1.4 Turbo (68)	92	06/15→	→			24.0110-0404.1	410404	Ø 264 10 8 + S
1.4 Turbo (68)	110	06/15→						
1.6 CDTi (68)	70	06/15→						
1.6 CDTi (68)	81	06/15→						
1.6 CDTi (68)	100	06/15→						
1.6 CDTi (68)	118	11/15→						
1.6 Turbo (68)	147	11/15→						

	kw				! #		
<b>OPEL - ASTRA K Sports Tourer (B16) 11/15→</b>							
 <b>Bremsbelagsatz, Scheibenbremse</b>							
1.0 Turbo (35)	77	11/15→	←	für Bremsscheibendurchmesser [mm]:		<b>13.0460-7324.2 607324</b>	ATE 22345 19,7 + WK
1.4 Turbo (35)	74	11/15→		300		<b>13.0470-7324.2 LD7324</b>	ATE 22345 19,7 + WK Ceramic
1.4 Turbo (35)	92	11/15→					
1.4 Turbo (35)	110	11/15→	←	für Bremsscheibendurchmesser [mm]:		<b>13.0460-7325.2 607325</b>	ATE 22342 19,8 + WK
1.6 CDTi (35)	70	11/15→		276		<b>13.0470-7325.2 LD7325</b>	ATE 22342 19,8 + WK Ceramic
1.6 CDTi (35)	81	11/15→					
1.6 CDTi (35)	100	11/15→	→			<b>13.0460-2615.2 602615</b>	TRW 22129 17,4 + WK + Zub
1.6 CDTi (35)	118	11/15→				<b>13.0470-2615.2 LD2615</b>	TRW + WK + Zub Ceramic
1.6 Turbo (35)	147	11/15→					
 <b>Bremsscheibe</b>							
1.0 Turbo (35)	77	11/15→	←			<b>24.0126-0187.1 426187</b>	Ø 276 26 23 V + S
1.4 Turbo (35)	74	11/15→				<b>24.0126-0188.1 426188</b>	Ø 300 26 23 V + S
1.4 Turbo (35)	92	11/15→					
1.4 Turbo (35)	110	11/15→	→			<b>24.0110-0404.1 410404</b>	Ø 264 10 8 + S
1.6 CDTi (35)	70	11/15→					
1.6 CDTi (35)	81	11/15→					
1.6 CDTi (35)	100	11/15→					
1.6 CDTi (35)	118	11/15→					
1.6 Turbo (35)	147	11/15→					
<b>OPEL - CALIBRA A (C89) 08/89→07/97</b>							
 <b>Bremsbelagsatz, Scheibenbremse</b>							
2.0 i (M07)	85	08/89→12/96	←			<b>13.0460-7052.2 607052</b>	ATE 21190 17,5 + WE / - WK
2.0 i 16V (M07)	100	02/94→07/97					
2.0 i 16V 4x4 (M07)	100	02/94→07/97	→			<b>13.0460-4043.2 604043</b>	ATE 21140 15,0 - WE / - WK
2.0 i 4x4 (M07)	85	06/90→07/97					
2.0 i Turbo 4x4 (M07)	150	08/91→07/97	←	→ S9999999		<b>13.0460-7080.2 607080</b>	ATE 21411 17,5 - WK
			←	T1000001→		<b>13.0460-7091.2 607091</b>	ATE 21829 20,3 + WE / - WK
			→			<b>13.0460-4043.2 604043</b>	ATE 21140 15,0 - WE / - WK
2.5 i V6 (M07)	125	04/93→07/97	←	→ S9999999		<b>13.0460-7080.2 607080</b>	ATE 21411 17,5 - WK
			←	T1000001→		<b>13.0460-7091.2 607091</b>	ATE 21829 20,3 + WE / - WK
			→	T1000001→		<b>13.0460-4040.2 604040</b>	ATE 21050 15,8 - WE / - WK
			→	→ S9999999		<b>13.0460-4043.2 604043</b>	ATE 21140 15,0 - WE / - WK
<b>Warnkontakt, Bremsbelagverschleiß</b>							
2.0 i (M07)	85	08/89→12/96	←		2	<b>24.8190-0705.2 620705</b>	L= 670
2.0 i 16V (M07)	100	02/94→07/97					
2.0 i 16V 4x4 (M07)	100	02/94→07/97					
2.0 i 4x4 (M07)	85	06/90→07/97					
2.0 i Turbo 4x4 (M07)	150	08/91→07/97	←	→ S9999999	2	<b>24.8190-0707.2 620707</b>	L= 685
2.5 i V6 (M07)	125	04/93→07/97	←	T1000001→	2	<b>24.8190-0713.2 620713</b>	L= 685
<b>Zubehörsatz, Scheibenbremsbelag</b>							
2.0 i (M07)	85	08/89→12/96	→			<b>13.0460-0217.2 610217</b>	ATE
2.0 i 16V (M07)	100	02/94→07/97					
2.0 i 16V 4x4 (M07)	100	02/94→07/97					
2.0 i 4x4 (M07)	85	06/90→07/97					
2.0 i Turbo 4x4 (M07)	150	08/91→07/97					
2.5 i V6 (M07)	125	04/93→07/97	→	→ S9999999		<b>13.0460-0217.2 610217</b>	ATE
			→	T1000001→		<b>13.0460-0347.2 610347</b>	
 <b>Bremsscheibe</b>							
2.0 i (M07)	85	08/89→12/96	←			<b>24.0124-0115.1 424115</b>	Ø 256 24 21 V + S
2.0 i 16V (M07)	100	02/94→07/97				<b>24.0324-0115.1 524115</b>	Ø 256 24 21 V + S
2.0 i 16V 4x4 (M07)	100	02/94→07/97					
2.0 i 4x4 (M07)	85	06/90→07/97	→			<b>24.0110-0205.1 410205</b>	Ø 270 9,9 8
2.0 i Turbo 4x4 (M07)	150	08/91→07/97	←	→ S9999999		<b>24.0124-0133.1 424133</b>	Ø 284 24 21 V
2.5 i V6 (M07)	125	04/93→07/97	←	T1000001→		<b>24.0125-0119.1 425119</b>	Ø 288 25 22 V + S
			→			<b>24.0325-0119.1 525119</b>	Ø 288 25 22 V + S
			→			<b>24.0110-0253.1 410253</b>	Ø 270 10 8
<b>OPEL - CAMPO (TF0, TF1) 08/87→06/02</b>							
 <b>Bremsbelagsatz, Scheibenbremse</b>							
2.2 D (TFR52)	39	08/91→09/96	←	01/92→ 08/96		<b>13.0460-5942.2 605942</b>	AKE 21543 16,5 + WK
2.2 D 4x4 (TF52)	39	08/91→09/96	←	→ 08/96		<b>13.0460-5942.2 605942</b>	AKE 21543 16,5 + WK
2.3 (TFR16)	72	08/94→09/96					
2.3 4x4 (TFS16)	72	08/94→09/96					
2.5 TD (TFR54)	56	07/94→06/01					
2.5 TD 4x4 (TFS54)	56	07/94→06/01					











	kW					! #		
<b>OPEL - CAMPO (TF0, TF1) 08/87→06/02</b>								
 <b>Bremsbelagsatz, Scheibenbremse</b>								
2.5 DTI	74	07/01→12/01	←				13.0460-5942.2 605942	AKE 21543 16,5 + WK
2.5 DTI 4x4	74	07/01→12/01	←					
3.1 TD (TFR69)	80	12/92→06/01	←	→ 08/96			13.0460-5942.2 605942	AKE 21543 16,5 + WK
3.1 TD 4x4 (TFS69)	80	12/92→06/01	←	09/96→			13.0460-5942.2 605942	AKE 21543 16,5 + WK
<b>Zubehörsatz, Scheibenbremsbelag</b>								
2.2 D (TFR52)	39	08/91→09/96	←	01/92→ 08/96			13.0460-0337.2 610337	AKE
2.2 D 4x4 (TFS52)	39	08/91→09/96	←	→ 08/96			13.0460-0337.2 610337	AKE
2.3 (TFR16)	72	08/94→09/96						
2.3 4x4 (TFS16)	72	08/94→09/96						
2.5 TD (TFR54)	56	07/94→06/01						
2.5 TD 4x4 (TFS54)	56	07/94→06/01						
2.5 DTI	74	07/01→12/01	←				13.0460-0337.2 610337	AKE
2.5 DTI 4x4	74	07/01→12/01	←					
3.1 TD (TFR69)	80	12/92→06/01	←	→ 08/96			13.0460-0337.2 610337	AKE
3.1 TD 4x4 (TFS69)	80	12/92→06/01	←	09/96→			13.0460-0337.2 610337	AKE
 <b>Bremsscheibe</b>								
2.2 D (TFR52)	39	08/91→09/96	←	01/92→ 08/96			24.0122-0156.1 422156	Ø 257 22 20,6 V
2.2 D 4x4 (TFS52)	39	08/91→09/96	←	→ 08/96			24.0122-0156.1 422156	Ø 257 22 20,6 V
2.3 (TFR16)	72	08/94→09/96						
2.3 4x4 (TFS16)	72	08/94→09/96						
2.5 TD (TFR54)	56	07/94→06/01						
2.5 TD 4x4 (TFS54)	56	07/94→06/01						
2.5 DTI	74	07/01→12/01	←				24.0122-0156.1 422156	Ø 257 22 20,6 V
2.5 DTI 4x4	74	07/01→12/01	←					
3.1 TD (TFR69)	80	12/92→06/01	←	→ 08/96			24.0122-0156.1 422156	Ø 257 22 20,6 V
3.1 TD 4x4 (TFS69)	80	12/92→06/01	←	09/96→			24.0122-0156.1 422156	Ø 257 22 20,6 V
<b>OPEL - CASCADA (W13) 03/13→</b>								
 <b>Bremsbelagsatz, Scheibenbremse</b>								
1.4	88	03/13→	←				13.0460-5612.2 605612	MAN 24412 19,0 + WK + Zub
1.4 Turbo	103	03/13→	←				13.0470-5612.2 LD5612	MAN 24412 19,0 + WK + Zub
1.6	147	11/13→						Ceramic
1.6 SIDI	125	03/13→	→					
2.0 CDTI	121	03/13→	→				13.0460-7264.2 607264	ATE 25096 17,0 + WK + Zub
2.0 CDTI	125	07/15→					13.0470-7264.2 LD7264	ATE 25096 17,0 + WK + Zub
2.0 CDTI	143	03/13→						Ceramic
 <b>Bremsscheibe</b>								
1.4	88	03/13→	←				24.0130-0224.1 430224	Ø 321 30 27 V + S
1.4 Turbo	103	03/13→	←					
1.6	147	11/13→	→				24.0112-0189.1 412189	Ø 292 12 10 + S
1.6 SIDI	125	03/13→					24.0312-0189.1 512189	Ø 292 12 10 + S
2.0 CDTI	121	03/13→						
2.0 CDTI	125	07/15→						
2.0 CDTI	143	03/13→						
<b>OPEL - COMBO (71_) 07/94→10/01</b>								
 <b>Bremsbelagsatz, Scheibenbremse</b>								
1.2	33	07/94→10/01	←	→ 09/00			13.0460-7051.2 607051	ATE 20547 16,5 + WE / - WK
1.4	44	07/94→10/01	←					
1.4	60	07/94→10/01	←					
1.7 D	44	07/94→10/01	←					
1.4 16V	66	08/99→10/01	←	10/01→; → 43033898, 53000000; für erhöhte Nutzlast			13.0460-2857.2 602857	TRW 23225 17,0 + WK + Zub
			←				13.0470-2857.2 LD2857	TRW 23225 17,0 + WK + Zub
			←	10/01→; nicht für erhöhte Nutzlast			13.0460-2857.2 602857	TRW 23225 17,0 + WK + Zub
			←				13.0470-2857.2 LD2857	TRW 23225 17,0 + WK + Zub
			←	43033899, 53000001→; für erhöhte Nutzlast			13.0460-7179.2 607179	ATE 23832 20,2 - WK / + WK
			←				13.0470-7179.2 LD7179	ATE 23832 20,2 - WK / + WK
			→	10/01→			13.0460-2868.2 602868	TRW 23417 15,3 + WK + Zub
			→				13.0470-2868.2 LD2868	TRW 23417 15,3 + WK + Zub
								Ceramic
 <b>Bremsscheibe</b>								
1.2	33	07/94→10/01	←	→ 09/00			24.0120-0115.1 420115	Ø 236 20 17 V + S
1.4	44	07/94→10/01	←				24.0320-0115.1 520115	Ø 236 20 17 V + S
1.4	60	07/94→10/01	←					
↓								













	kw			 	! #		
<b>OPEL - COMBO (71_) 07/94→10/01</b>							
 <b>Bremsscheibe</b>							
1.7 D	44	07/94→10/01	←	→ 09/00		24.0120-0115.1 420115 24.0320-0115.1 520115	Ø 236 20 17 V + S Ø 236 20 17 V + S
1.4 16V	66	08/99→10/01	←	10/01→; → 43033898, 53000000; für erhöhte Nutzlast		24.0124-0166.1 424166 24.0324-0166.1 524166	Ø 260 24 21 V + S Ø 260 24 21 V
			←	10/01→; nicht für erhöhte Nutzlast		24.0124-0166.1 424166 24.0324-0166.1 524166	Ø 260 24 21 V + S Ø 260 24 21 V
			←	43033899, 53000001→; für erhöhte Nutzlast		24.0125-0148.1 425148 24.0325-0148.1 525148	Ø 280 25 22 V + S Ø 280 25 22 V + S
			→	10/01→		24.0110-0291.1 410291 24.0310-0291.1 510291	Ø 264 10 8 + S Ø 264 10 8 + S
<b>OPEL - COMBO Combi / Tour (X12) 02/12→</b>							
 <b>Bremsbelagsatz, Scheibenbremse</b>							
1.3 CDTI (C26, D26, E26, C05)	66	02/12→	←	für Bremsscheibendurchmesser [mm]: 284		13.0460-3827.2 603827 13.0470-3827.2 LD3827	BOS 23709 19,6 + WK + Zub BOS 23709 19,6 + WK + Zub Ceramic
1.4 (C26, D26, E26, C06)	70	02/12→					
1.4 (C26, D26, E26, C06)	88	02/12→	←	für Bremsscheibendurchmesser [mm]: 305		13.0460-7265.2 607265	ATE 24727 20,7 + WK
1.4 CNG (C26, D26, E26, C05)	88	02/12→					
1.6 CDTI (C26, D26, E26, C05)	66	02/12→					
1.6 CDTI (C26, D26, E26, C05)	70	03/15→					
1.6 CDTI (C26, D26, E26, C05)	77	02/12→					
1.6 CDTI (C26, D26, E26, C05)	88	03/15→					
2.0 CDTI (C26, D26, E26, C05)	99	02/12→					
 <b>Bremsscheibe</b>							
1.3 CDTI (C26, D26, E26, C05)	66	02/12→	←			24.0122-0145.1 422145 24.0128-0253.1 428253	Ø 284 22 20,2 V Ø 305 28 26 V
1.4 (C26, D26, E26, C06)	70	02/12→					
1.4 (C26, D26, E26, C06)	88	02/12→					
1.4 CNG (C26, D26, E26, C05)	88	02/12→					
1.6 CDTI (C26, D26, E26, C05)	66	02/12→					
1.6 CDTI (C26, D26, E26, C05)	70	03/15→					
1.6 CDTI (C26, D26, E26, C05)	77	02/12→					
1.6 CDTI (C26, D26, E26, C05)	88	03/15→					
2.0 CDTI (C26, D26, E26, C05)	99	02/12→					
<b>OPEL - COMBO Kasten/Kombi 10/01→</b>							
 <b>Bremsbelagsatz, Scheibenbremse</b>							
1.3 CDTI 16V	51	08/05→	←	→ 43033898, 53000000; für erhöhte Nutzlast		13.0460-2857.2 602857 13.0470-2857.2 LD2857	TRW 23225 17,0 + WK + Zub TRW 23225 17,0 + WK + Zub Ceramic
1.3 CDTI 16V	55	10/05→12/12					
1.4 16V	66	08/05→					
1.6	64	10/01→	←	→ 10/11; nicht für erhöhte Nutzlast		13.0460-2857.2 602857 13.0470-2857.2 LD2857	TRW 23225 17,0 + WK + Zub TRW 23225 17,0 + WK + Zub Ceramic
1.7 DI 16V	48	10/01→					
1.7 DTI 16V	55	10/01→	←	43033899, 53000001→; → 10/11; für erhöhte Nutzlast		13.0460-7179.2 607179 13.0470-7179.2 LD7179	ATE 23832 20,2 - WK / + WK ATE 23832 20,2 - WK / + WK Ceramic
			→	→ 10/11		13.0460-2868.2 602868 13.0470-2868.2 LD2868	TRW 23417 15,3 + WK + Zub TRW 23417 15,3 + WK + Zub Ceramic
1.6 CNG 16V	69	06/06→	←	→ 10/11		13.0460-7179.2 607179 13.0470-7179.2 LD7179	ATE 23832 20,2 - WK / + WK ATE 23832 20,2 - WK / + WK Ceramic
1.6 CNG 16V	71	04/05→					
1.7 CDTI 16V	74	12/04→	→	→ 10/11		13.0460-2868.2 602868 13.0470-2868.2 LD2868	TRW 23417 15,3 + WK + Zub TRW 23417 15,3 + WK + Zub Ceramic
↓							





















	kw			 	! #		
<b>OPEL - COMBO Kasten/Kombi 10/01→</b>							
 <b>Bremsscheibe</b>							
1.3 CDTI 16V	51	08/05→	←	→ 10/11; nicht für erhöhte Nutzlast		24.0124-0166.1 424166	Ø 260 24 21 V + S
1.3 CDTI 16V	55	10/05→12/12				24.0324-0166.1 524166	Ø 260 24 21 V
1.4 16V	66	08/05→					
1.6	64	10/01→	←	→ 43033898, 53000000; für erhöhte Nutzlast		24.0124-0166.1 424166	Ø 260 24 21 V + S
1.7 DI 16V	48	10/01→				24.0324-0166.1 524166	Ø 260 24 21 V
1.7 DTI 16V	55	10/01→	←	43033899, 53000001→; → 10/11; für erhöhte Nutzlast		24.0125-0148.1 425148	Ø 280 25 22 V + S
						24.0325-0148.1 525148	Ø 280 25 22 V + S
			→	→ 10/11		24.0110-0291.1 410291	Ø 264 10 8 + S
						24.0310-0291.1 510291	Ø 264 10 8 + S
1.6 CNG 16V	69	06/06→	←	→ 10/11		24.0125-0148.1 425148	Ø 280 25 22 V + S
1.6 CNG 16V	71	04/05→				24.0325-0148.1 525148	Ø 280 25 22 V + S
			→	→ 10/11		24.0110-0291.1 410291	Ø 264 10 8 + S
						24.0310-0291.1 510291	Ø 264 10 8 + S
1.7 CDTI 16V	74	12/04→	←	→ 10/11		24.0125-0131.1 425131	Ø 280 24,8 22 V + S
						24.0325-0131.1 525131	Ø 280 24,8 22 V + S
			→	→ 10/11		24.0110-0250.1 410250	Ø 264 9,8 8 + S
<b>OPEL - COMBO Kasten/Kombi (X12) 02/12→</b>							
 <b>Bremsbelagsatz, Scheibenbremse</b>							
1.3 CDTI (B05)	55	02/12→	←	03/15→; für Bremsscheibendurchmesser [mm]: 284		13.0460-3827.2 603827	BOS 23709 19,6 + WK + Zub
						13.0470-3827.2 LD3827	BOS 23709 19,6 + WK + Zub Ceramic
			←	03/15→; für Bremsscheibendurchmesser [mm]: 305		13.0460-7265.2 607265	ATE 24727 20,7 + WK
1.3 CDTI (B05)	66	02/12→	←	für Bremsscheibendurchmesser [mm]: 284		13.0460-3827.2 603827	BOS 23709 19,6 + WK + Zub
1.3 CDTI (B05)	70	03/16→				13.0470-3827.2 LD3827	BOS 23709 19,6 + WK + Zub Ceramic
1.4 (B05)	70	02/12→					
1.4 (B05)	88	02/12→					
1.4 CNG (B05)	88	02/12→	←	für Bremsscheibendurchmesser [mm]: 305		13.0460-7265.2 607265	ATE 24727 20,7 + WK
1.6 CDTI (B05)	66	02/12→					
1.6 CDTI (B05)	74	02/12→					
1.6 CDTI (B05)	77	02/12→					
1.6 CDTI (B05)	88	04/15→					
2.0 CDTI (B05)	99	02/12→					
 <b>Bremsscheibe</b>							
1.3 CDTI (B05)	55	02/12→	←	03/15→		24.0122-0145.1 422145	Ø 284 22 20,2 V
						24.0128-0253.1 428253	Ø 305 28 26 V
1.3 CDTI (B05)	66	02/12→	←			24.0122-0145.1 422145	Ø 284 22 20,2 V
1.3 CDTI (B05)	70	03/16→				24.0128-0253.1 428253	Ø 305 28 26 V
1.4 (B05)	70	02/12→					
1.4 (B05)	88	02/12→					
1.4 CNG (B05)	88	02/12→					
1.6 CDTI (B05)	66	02/12→					
1.6 CDTI (B05)	74	02/12→					
1.6 CDTI (B05)	77	02/12→					
1.6 CDTI (B05)	88	04/15→					
2.0 CDTI (B05)	99	02/12→					
<b>OPEL - COMBO Pritsche/Fahrgestell (X12) 08/12→</b>							
 <b>Bremsbelagsatz, Scheibenbremse</b>							
2.0 CDTI	99	08/12→	←	für Bremsscheibendurchmesser [mm]: 284		13.0460-3827.2 603827	BOS 23709 19,6 + WK + Zub
						13.0470-3827.2 LD3827	BOS 23709 19,6 + WK + Zub Ceramic
			←	für Bremsscheibendurchmesser [mm]: 305		13.0460-7265.2 607265	ATE 24727 20,7 + WK
 <b>Bremsscheibe</b>							
2.0 CDTI	99	08/12→	←			24.0122-0145.1 422145	Ø 284 22 20,2 V
						24.0128-0253.1 428253	Ø 305 28 26 V
<b>OPEL - COMBO Tour 10/01→12/11</b>							
 <b>Bremsbelagsatz, Scheibenbremse</b>							
1.3 CDTI 16V	51	06/04→01/11	←	nicht für erhöhte Nutzlast		13.0460-2857.2 602857	TRW 23225 17,0 + WK + Zub
1.6	64	10/01→09/06				13.0470-2857.2 LD2857	TRW 23225 17,0 + WK + Zub Ceramic
1.7 DI 16V	48	10/01→06/04					
1.7 DTI 16V	55	10/01→06/04	←	→ 43033898, 53000000; für erhöhte Nutzlast		13.0460-2857.2 602857	TRW 23225 17,0 + WK + Zub
						13.0470-2857.2 LD2857	TRW 23225 17,0 + WK + Zub Ceramic













	kw			 	! #		
<b>OPEL - COMBO Tour 10/01→12/11</b>							
 <b>Bremsbelagsatz, Scheibenbremse</b>							
1.3 CDTI 16V 1.6 1.7 DI 16V 1.7 DTI 16V	51 64 48 55	06/04→01/11 10/01→09/06 10/01→06/04 10/01→06/04	← →	43033899, 53000001→; für erhöhte Nutzlast		13.0460-7179.2 607179 13.0470-7179.2 LD7179	ATE 23832 20,2 - WK / + WK ATE 23832 20,2 - WK / + WK Ceramic
			→			13.0460-2868.2 602868 13.0470-2868.2 LD2868	TRW 23417 15,3 + WK + Zub Ceramic
1.3 CDTI 16V 1.4	55 66	10/05→12/11 10/04→12/11	← ← ← →	→ 43033898, 53000000; für erhöhte Nutzlast → 10/11; nicht für erhöhte Nutzlast 43033899, 53000001→; → 10/11; für erhöhte Nutzlast → 10/11		13.0460-2857.2 602857 13.0470-2857.2 LD2857 13.0460-2857.2 602857 13.0470-2857.2 LD2857 13.0460-7179.2 607179 13.0470-7179.2 LD7179 13.0460-2868.2 602868 13.0470-2868.2 LD2868	TRW 23225 17,0 + WK + Zub Ceramic TRW 23225 17,0 + WK + Zub Ceramic ATE 23832 20,2 - WK / + WK ATE 23832 20,2 - WK / + WK Ceramic TRW 23417 15,3 + WK + Zub Ceramic
1.6 CNG 1.7 CDTI 16V	69 74	06/06→12/11 07/04→12/11	← →	→ 10/11 → 10/11		13.0460-7179.2 607179 13.0470-7179.2 LD7179 13.0460-2868.2 602868 13.0470-2868.2 LD2868	ATE 23832 20,2 - WK / + WK ATE 23832 20,2 - WK / + WK Ceramic TRW 23417 15,3 + WK + Zub Ceramic
1.6 CNG	71	04/05→01/11	← →			13.0460-7179.2 607179 13.0470-7179.2 LD7179 13.0460-2868.2 602868 13.0470-2868.2 LD2868	ATE 23832 20,2 - WK / + WK ATE 23832 20,2 - WK / + WK Ceramic TRW 23417 15,3 + WK + Zub Ceramic
 <b>Bremsscheibe</b>							
1.3 CDTI 16V 1.6 1.7 DI 16V 1.7 DTI 16V	51 64 48 55	06/04→01/11 10/01→09/06 10/01→06/04 10/01→06/04	← ← ← →	nicht für erhöhte Nutzlast → 43033898, 53000000; für erhöhte Nutzlast 43033899, 53000001→; für erhöhte Nutzlast		24.0124-0166.1 424166 24.0324-0166.1 524166 24.0124-0166.1 424166 24.0324-0166.1 524166 24.0125-0148.1 425148 24.0325-0148.1 525148	Ø 260 24 21 V + S Ø 260 24 21 V Ø 260 24 21 V + S Ø 260 24 21 V Ø 280 25 22 V + S Ø 280 25 22 V + S
			→			24.0110-0291.1 410291 24.0310-0291.1 510291	Ø 264 10 8 + S Ø 264 10 8 + S
1.3 CDTI 16V 1.4	55 66	10/05→12/11 10/04→12/11	← ← ← →	→ 10/11; nicht für erhöhte Nutzlast → 43033898, 53000000; für erhöhte Nutzlast 43033899, 53000001→; → 10/11; für erhöhte Nutzlast → 10/11		24.0124-0166.1 424166 24.0324-0166.1 524166 24.0125-0148.1 425148 24.0325-0148.1 525148 24.0110-0291.1 410291 24.0310-0291.1 510291	Ø 260 24 21 V + S Ø 260 24 21 V Ø 260 24 21 V + S Ø 260 24 21 V Ø 280 25 22 V + S Ø 280 25 22 V + S
1.6 CNG	69	06/06→12/11	← →	→ 10/11 → 10/11		24.0125-0148.1 425148 24.0325-0148.1 525148 24.0110-0291.1 410291 24.0310-0291.1 510291	Ø 280 25 22 V + S Ø 280 25 22 V + S Ø 264 10 8 + S Ø 264 10 8 + S
1.6 CNG	71	04/05→01/11	← →			24.0125-0148.1 425148 24.0325-0148.1 525148 24.0110-0291.1 410291 24.0310-0291.1 510291	Ø 280 25 22 V + S Ø 280 25 22 V + S Ø 264 10 8 + S Ø 264 10 8 + S
1.7 CDTI 16V	74	07/04→12/11	← →	→ 10/11 → 10/11		24.0125-0131.1 425131 24.0325-0131.1 525131 24.0110-0250.1 410250	Ø 280 24,8 22 V + S Ø 280 24,8 22 V + S Ø 264 9,8 8 + S
<b>OPEL - CORSA B (S93) 03/93→12/02</b>							
 <b>Bremsbelagsatz, Scheibenbremse</b>							
1.0 i 12V (F08, F68, M68)	40	11/96→09/00	←			13.0460-7051.2 607051	ATE 20547 16,5 + WE / - WK
1.2 i (F08, F68, M68) ↓	33	03/93→09/00					











	kW			 	! #		
<b>OPEL - CORSA B (S93) 03/93→12/02</b>							
 <b>Bremsbelagsatz, Scheibenbremse</b>							
1.4 i (F08, F68, M68)	40	03/93→09/00	←			13.0460-7051.2 607051	ATE 20547 16,5 + WE / - WK
1.4 i (F08, F68, M68)	44	03/93→09/00					
1.4 i 16V (F08, F68, M68)	63	08/97→09/00					
1.4 i 16V (F08, F68, M68)	66	09/94→09/00					
1.4 Si (F08, F68, M68)	60	03/93→09/00					
1.5 D (F08, F68, M68)	37	03/93→09/00					
1.5 TD (F08, F68, M68)	49	03/93→09/00					
1.6 i 16V (F08, F68, M68)	74	08/97→09/00					
1.6 i 16V (F08, F68, M68)	78	09/94→09/00					
1.7 D (F08, F68, M68)	44	02/96→09/00					
1.2 i 16V (F08, F68, M68)	48	03/98→09/00	←	04/98→		13.0460-7051.2 607051	ATE 20547 16,5 + WE / - WK
1.6 GSI 16V (F08, F68, M68)	80	03/93→09/00	←	09/93→		13.0460-7051.2 607051	ATE 20547 16,5 + WE / - WK
 <b>Bremsscheibe</b>							
1.0 i 12V (F08, F68, M68)	40	11/96→09/00	←			24.0113-0161.1 413161	Ø 236 12,7 9,7 + S
1.2 i (F08, F68, M68)	33	03/93→09/00				24.0313-0161.1 513161	Ø 236 12,7 9,7 + S
1.5 D (F08, F68, M68)	37	03/93→09/00					
1.5 TD (F08, F68, M68)	49	03/93→09/00					
1.7 D (F08, F68, M68)	44	02/96→09/00					
1.2 i 16V (F08, F68, M68)	48	03/98→09/00	←	04/98→; für Fahrzeuge ohne Klimaanlage; für Automatikgetriebe		24.0113-0161.1 413161 24.0313-0161.1 513161	Ø 236 12,7 9,7 + S Ø 236 12,7 9,7 + S
			←	04/98→; für Schaltgetriebe		24.0113-0161.1 413161 24.0313-0161.1 513161	Ø 236 12,7 9,7 + S Ø 236 12,7 9,7 + S
			←	04/98→; für Fahrzeuge mit Klimaanlage; für Automatikgetriebe		24.0120-0115.1 420115 24.0320-0115.1 520115	Ø 236 20 17 V + S Ø 236 20 17 V + S
			←	04/98→		24.0120-0115.1 420115 24.0320-0115.1 520115	Ø 236 20 17 V + S Ø 236 20 17 V + S
1.4 i (F08, F68, M68)	40	03/93→09/00	←	für Automatikgetriebe; für Fahrzeuge ohne Klimaanlage		24.0113-0161.1 413161 24.0313-0161.1 513161	Ø 236 12,7 9,7 + S Ø 236 12,7 9,7 + S
1.4 i (F08, F68, M68)	44	03/93→09/00					
1.4 i 16V (F08, F68, M68)	63	08/97→09/00	←	für Schaltgetriebe		24.0113-0161.1 413161 24.0313-0161.1 513161	Ø 236 12,7 9,7 + S Ø 236 12,7 9,7 + S
			←			24.0120-0115.1 420115 24.0320-0115.1 520115	Ø 236 20 17 V + S Ø 236 20 17 V + S
			←	für Fahrzeuge mit Klimaanlage; für Automatikgetriebe		24.0120-0115.1 420115 24.0320-0115.1 520115	Ø 236 20 17 V + S Ø 236 20 17 V + S
1.4 i 16V (F08, F68, M68)	66	09/94→09/00	←			24.0120-0115.1 420115 24.0320-0115.1 520115	Ø 236 20 17 V + S Ø 236 20 17 V + S
1.4 Si (F08, F68, M68)	60	03/93→09/00					
1.6 GSI 16V (F08, F68, M68)	80	03/93→09/00	←	09/93→		24.0120-0140.1 420140	Ø 256 20 17 V + S
1.6 i 16V (F08, F68, M68)	74	08/97→09/00	←			24.0120-0140.1 420140	Ø 256 20 17 V + S
1.6 i 16V (F08, F68, M68)	78	09/94→09/00					
<b>OPEL - CORSA B Caravan (S93) 01/99→12/02</b>							
 <b>Bremsbelagsatz, Scheibenbremse</b>							
1.4 i 16V (F35)	66	01/99→12/02	←	→ 09/00		13.0460-7051.2 607051	ATE 20547 16,5 + WE / - WK
1.7 D (F35)	44	01/99→12/02					
 <b>Bremsscheibe</b>							
1.4 i 16V (F35)	66	01/99→12/02	←	→ 09/00		24.0120-0115.1 420115 24.0320-0115.1 520115	Ø 236 20 17 V + S Ø 236 20 17 V + S
1.7 D (F35)	44	01/99→12/02	←	→ 09/00		24.0113-0161.1 413161 24.0313-0161.1 513161	Ø 236 12,7 9,7 + S Ø 236 12,7 9,7 + S
<b>OPEL - CORSA B Kasten (S93) 08/99→09/00</b>							
 <b>Bremsbelagsatz, Scheibenbremse</b>							
1.4 i (F08, W5L)	44	08/99→09/00	←			13.0460-7051.2 607051	ATE 20547 16,5 + WE / - WK
1.7 D (F08, W5L)	44	08/99→09/00					
 <b>Bremsscheibe</b>							
1.4 i (F08, W5L)	44	08/99→09/00	←			24.0120-0115.1 420115	Ø 236 20 17 V + S
↓							













	kw			 	! #		
<b>OPEL - CORSA B Kasten (S93) 08/99→09/00</b>							
 <b>Bremsscheibe</b>							
1.4 i (F08, W5L)	44	08/99→09/00	←			24.0320-0115.1 520115	Ø 236 20 17 V + S
1.7 D (F08, W5L)	44	08/99→09/00	←			24.0113-0161.1 413161	Ø 236 12,7 9,7 + S
						24.0313-0161.1 513161	Ø 236 12,7 9,7 + S
<b>OPEL - CORSA C (X01) 09/00→12/09</b>							
 <b>Bremsbelagsatz, Scheibenbremse</b>							
1.0 (F08, F68)	43	09/00→06/03	←			13.0460-2857.2 602857	TRW 23225 17,0 + WK + Zub
						13.0470-2857.2 LD2857	TRW 23225 17,0 + WK + Zub Ceramic
1.0 (F08, F68)	44	06/03→12/09	←	→ 09/06		13.0460-2857.2 602857	TRW 23225 17,0 + WK + Zub
1.2 (F08, F68)	55	09/00→12/09	←			13.0470-2857.2 LD2857	TRW 23225 17,0 + WK + Zub Ceramic
1.2 Twinport (F08, F68)	59	07/04→12/09	←				
1.3 CDTI (F08, F68)	51	06/03→12/09	←	→ 09/06		13.0460-2857.2 602857	TRW 23225 17,0 + WK + Zub
1.4 (F08, F68)	66	09/00→12/09	←			13.0470-2857.2 LD2857	TRW 23225 17,0 + WK + Zub Ceramic
1.4 Twinport (F08, F68)	66	06/03→12/09	←				
1.7 DI (F08, F68)	48	09/00→12/09	←				
1.7 DTI (F08, F68)	55	09/00→12/09	→	→ 09/06		13.0460-2858.2 602858	TRW 23284 14,0 + WK
1.8 (F08, F68)	92	09/00→12/09	→			13.0470-2858.2 LD2858	TRW 23284 14,0 + WK Ceramic
1.7 CDTI (F08, F68)	74	06/03→12/09	←	→ 09/06		13.0460-7179.2 607179	ATE 23832 20,2 - WK / + WK
						13.0470-7179.2 LD7179	ATE 23832 20,2 - WK / + WK Ceramic
			→	→ 09/06		13.0460-2858.2 602858	TRW 23284 14,0 + WK
						13.0470-2858.2 LD2858	TRW 23284 14,0 + WK Ceramic
 <b>Bremsscheibe</b>							
1.0 (F08, F68)	43	09/00→06/03	←	- ABS		24.0111-0152.1 411152	Ø 240 11 8
			←	+ ABS		24.0120-0174.1 420174	Ø 240 20 17 V + S
1.0 (F08, F68)	44	06/03→12/09	←	- ABS; → 09/06		24.0111-0152.1 411152	Ø 240 11 8
1.2 (F08, F68)	55	09/00→12/09	←				
1.2 Twinport (F08, F68)	59	07/04→12/09	←	+ ABS; → 09/06		24.0120-0174.1 420174	Ø 240 20 17 V + S
1.3 CDTI (F08, F68)	51	06/03→12/09	←	→ 09/06		24.0124-0166.1 424166	Ø 260 24 21 V + S
1.4 (F08, F68)	66	09/00→12/09	←			24.0324-0166.1 524166	Ø 260 24 21 V
1.4 Twinport (F08, F68)	66	06/03→12/09	←				
1.7 DTI (F08, F68)	55	09/00→12/09	→	→ 09/06		24.0110-0268.1 410268	Ø 240 10,2 8,2
1.8 (F08, F68)	92	09/00→12/09	→			24.0110-0291.1 410291	Ø 264 10 8 + S
						24.0310-0291.1 510291	Ø 264 10 8 + S
1.7 CDTI (F08, F68)	74	06/03→12/09	←	→ 09/06		24.0125-0131.1 425131	Ø 280 24,8 22 V + S
						24.0325-0131.1 525131	Ø 280 24,8 22 V + S
			→	→ 09/06		24.0110-0250.1 410250	Ø 264 9,8 8 + S
						24.0310-0250.1 510250	Ø 264 9,8 8 + S
1.7 DI (F08, F68)	48	09/00→12/09	←	→ 09/06		24.0120-0174.1 420174	Ø 240 20 17 V + S
			→	→ 09/06		24.0110-0268.1 410268	Ø 240 10,2 8,2
						24.0110-0291.1 410291	Ø 264 10 8 + S
						24.0310-0291.1 510291	Ø 264 10 8 + S
<b>OPEL - CORSA C Kasten (X01) 09/00→</b>							
 <b>Bremsbelagsatz, Scheibenbremse</b>							
1.2 (F08, W5L)	59	07/05→	←			13.0460-2857.2 602857	TRW 23225 17,0 + WK + Zub
1.2 16V (F08, W5L)	55	09/00→	←			13.0470-2857.2 LD2857	TRW 23225 17,0 + WK + Zub Ceramic
1.3 CDTI 16V (F08, W5L)	51	08/05→	←			13.0460-2857.2 602857	TRW 23225 17,0 + WK + Zub
1.7 DI 16V (F08, W5L)	48	09/00→	←			13.0470-2857.2 LD2857	TRW 23225 17,0 + WK + Zub Ceramic
1.7 DTI 16V (F08, W5L)	55	09/00→	→			13.0460-2858.2 602858	TRW 23284 14,0 + WK
						13.0470-2858.2 LD2858	TRW 23284 14,0 + WK Ceramic
1.4 (W5L, F08)	66	08/03→	←	→ 09/06		13.0460-2857.2 602857	TRW 23225 17,0 + WK + Zub
						13.0470-2857.2 LD2857	TRW 23225 17,0 + WK + Zub Ceramic
			→	→ 09/06		13.0460-2858.2 602858	TRW 23284 14,0 + WK
						13.0470-2858.2 LD2858	TRW 23284 14,0 + WK Ceramic
1.7 CDTi (F08, W5L)	74	08/03→	←	→ 09/06		13.0460-7179.2 607179	ATE 23832 20,2 - WK / + WK
						13.0470-7179.2 LD7179	ATE 23832 20,2 - WK / + WK Ceramic
			→	→ 09/06		13.0460-2858.2 602858	TRW 23284 14,0 + WK
						13.0470-2858.2 LD2858	TRW 23284 14,0 + WK Ceramic















	kw			 	! #		
<b>OPEL - CORSA C Kasten (X01) 09/00→</b>							
<b>Bremsscheibe</b>							
1.2 (F08, W5L) 1.2 16V (F08, W5L)	59 55	07/05→ 09/00→	← ←	- ABS + ABS		24.0111-0152.1 411152 24.0120-0174.1 420174	Ø 240 11 8 Ø 240 20 17 V + S
1.3 CDTi 16V (F08, W5L) 1.7 DTi 16V (F08, W5L)	51 55	08/05→ 09/00→	← →			24.0124-0166.1 424166 24.0324-0166.1 524166 24.0110-0268.1 410268 24.0110-0291.1 410291 24.0310-0291.1 510291	Ø 260 24 21 V + S Ø 260 24 21 V Ø 240 10,2 8,2 Ø 264 10 8 + S Ø 264 10 8 + S
1.4 (W5L, F08)	66	08/03→	← →	→ 09/06 → 09/06		24.0124-0166.1 424166 24.0324-0166.1 524166 24.0110-0268.1 410268 24.0110-0291.1 410291 24.0310-0291.1 510291	Ø 260 24 21 V + S Ø 260 24 21 V Ø 240 10,2 8,2 Ø 264 10 8 + S Ø 264 10 8 + S
1.7 CDTi (F08, W5L)	74	08/03→	← →	→ 09/06 → 09/06		24.0125-0131.1 425131 24.0325-0131.1 525131 24.0110-0250.1 410250 24.0310-0250.1 510250	Ø 280 24,8 22 V + S Ø 280 24,8 22 V + S Ø 264 9,8 8 + S Ø 264 9,8 8 + S
1.7 DI 16V (F08, W5L)	48	09/00→	← →			24.0120-0174.1 420174 24.0110-0268.1 410268 24.0110-0291.1 410291 24.0310-0291.1 510291	Ø 240 20 17 V + S Ø 240 10,2 8,2 Ø 264 10 8 + S Ø 264 10 8 + S
<b>OPEL - CORSA D (S07) 07/06→08/14</b>							
<b>Bremsbelagsatz, Scheibenbremse</b>							
1.0 (L08, L68)	44	07/06→12/10	← ←	10/06→; V 10/06→		13.0460-3839.2 603839 13.0470-3839.2 LD3839 13.0460-3839.2 603839 13.0470-3839.2 LD3839	BOS 23707 17,9 + WK + Zub BOS 23707 17,9 + WK + Zub Ceramic BOS 23707 17,9 + WK + Zub BOS 23707 17,9 + WK + Zub Ceramic
1.0 (L08, L68)	48	12/09→08/14	← ←	V		13.0460-3839.2 603839 13.0470-3839.2 LD3839 13.0460-3839.2 603839 13.0470-3839.2 LD3839	BOS 23707 17,9 + WK + Zub BOS 23707 17,9 + WK + Zub Ceramic BOS 23707 17,9 + WK + Zub BOS 23707 17,9 + WK + Zub Ceramic
1.2 (L08, L68) 1.2 (L08, L68) 1.2 LPG (L08, L68) 1.2 LPG (L08, L68) 1.2 LPG (L08, L68) 1.2 LPG (L08, L68) 1.4 (L08, L68) 1.4 (L08, L68) 1.4 LPG (L08, L68)	51 63 55 59 61 63 64 74 64	12/09→08/14 12/09→08/14 09/09→12/11 08/06→08/14 06/11→08/14 06/11→08/14 09/09→08/14 12/09→08/14 09/09→08/14	←			13.0460-3839.2 603839 13.0470-3839.2 LD3839	BOS 23707 17,9 + WK + Zub BOS 23707 17,9 + WK + Zub Ceramic
1.2 (L08, L68) 1.4 (L08, L68) 1.4 LPG (L08, L68)	59 66 66	07/06→08/14 07/06→08/14 08/06→12/11	←	10/06→		13.0460-3839.2 603839 13.0470-3839.2 LD3839	BOS 23707 17,9 + WK + Zub BOS 23707 17,9 + WK + Zub Ceramic
1.3 CDTi (L08, L68)	55	07/06→08/14	← ←	10/06→; für Bremsscheibendurchmesser [mm]: 257 10/06→; für Bremsscheibendurchmesser [mm]: 284		13.0460-3839.2 603839 13.0470-3839.2 LD3839 13.0460-3840.2 603840 13.0470-3840.2 LD3840	BOS 23707 17,9 + WK + Zub BOS 23707 17,9 + WK + Zub Ceramic BOS 23981 19,6 + WK + Zub BOS 23981 19,6 + WK + Zub Ceramic
1.3 CDTi (L08, L68)	66	07/06→06/11	←	10/06→		13.0460-3840.2 603840 13.0470-3840.2 LD3840	BOS 23981 19,6 + WK + Zub BOS 23981 19,6 + WK + Zub Ceramic
1.3 CDTi (L08, L68)	70	06/09→08/14	← ←	für Bremsscheibendurchmesser [mm]: 257 für Bremsscheibendurchmesser [mm]: 284		13.0460-3839.2 603839 13.0470-3839.2 LD3839 13.0460-3840.2 603840 13.0470-3840.2 LD3840	BOS 23707 17,9 + WK + Zub BOS 23707 17,9 + WK + Zub Ceramic BOS 23981 19,6 + WK + Zub BOS 23981 19,6 + WK + Zub Ceramic
1.4 (L08, L68) 1.7 CDTi (L08, L68)	88 96	07/12→08/14 12/09→08/14	← →			13.0460-3841.2 603841 13.0460-3848.2 603848	BOS 24550 19,5 + WK + Zub BOS 24349 17,6 - WE / - WK + Zub
1.6 Turbo (L08, L68) ↓	110	05/07→08/14	←	06/07→		13.0460-7179.2 607179	ATE 23832 20,2 - WK / + WK











	kW			 	! #		
<b>OPEL - CORSA D (S07) 07/06→08/14</b>							
 <b>Bremsbelagsatz, Scheibenbremse</b>							
1.6 Turbo (L08, L68)	110	05/07→08/14	←	06/07→		13.0470-7179.2 LD7179	ATE 23832 20,2 - WK / + WK Ceramic
			→	06/07→		13.0460-3848.2 603848	BOS 24349 17,6 - WE / - WK + Zub
1.6 Turbo (L08, L68)	141	11/06→08/14	←	03/07→		13.0460-7179.2 607179	ATE 23832 20,2 - WK / + WK Ceramic
			→	03/07→		13.0460-3848.2 603848	BOS 24349 17,6 - WE / - WK + Zub
1.6 Turbo (L08, L68)	155	06/11→08/14	→			13.0460-3848.2 603848	BOS 24349 17,6 - WE / - WK + Zub
1.7 CDTI (L08, L68)	92	08/06→12/11	←	10/06→		13.0460-3841.2 603841	BOS 24550 19,5 + WK + Zub
			→	10/06→		13.0460-3848.2 603848	BOS 24349 17,6 - WE / - WK + Zub
 <b>Bremsscheibe</b>							
1.0 (L08, L68)	44	07/06→12/10	←	10/06→		24.0112-0184.1 412184	Ø 257 12 10 + S
						24.0122-0231.1 422231	Ø 257 22 20 V + S
						24.0322-0231.1 522231	Ø 257 22 20 V + S
1.0 (L08, L68)	48	12/09→08/14	←			24.0112-0184.1 412184	Ø 257 12 10 + S
						24.0122-0231.1 422231	Ø 257 22 20 V + S
						24.0322-0231.1 522231	Ø 257 22 20 V + S
1.2 (L08, L68)	51	12/09→08/14	←			24.0122-0231.1 422231	Ø 257 22 20 V + S
1.2 (L08, L68)	63	12/09→08/14				24.0322-0231.1 522231	Ø 257 22 20 V + S
1.2 LPG (L08, L68)	55	09/09→12/11					
1.2 LPG (L08, L68)	59	08/06→08/14					
1.2 LPG (L08, L68)	61	06/11→08/14					
1.2 LPG (L08, L68)	63	06/11→08/14					
1.4 (L08, L68)	64	09/09→08/14					
1.4 LPG (L08, L68)	64	09/09→08/14					
1.2 (L08, L68)	59	07/06→08/14	←	10/06→		24.0122-0231.1 422231	Ø 257 22 20 V + S
1.4 (L08, L68)	66	07/06→08/14				24.0322-0231.1 522231	Ø 257 22 20 V + S
1.4 LPG (L08, L68)	66	08/06→12/11					
1.3 CDTI (L08, L68)	55	07/06→08/14	←	10/06→; für Bremsscheibendurchmesser [mm]: 257		24.0122-0231.1 422231	Ø 257 22 20 V + S
			←	10/06→; für Bremsscheibendurchmesser [mm]: 284		24.0122-0241.1 422241	Ø 284 22 20 V + S
1.3 CDTI (L08, L68)	66	07/06→06/11	←	10/06→		24.0122-0241.1 422241	Ø 284 22 20 V + S
1.3 CDTI (L08, L68)	70	06/09→08/14	←	für Bremsscheibendurchmesser [mm]: 257		24.0122-0231.1 422231	Ø 257 22 20 V + S
			←	für Bremsscheibendurchmesser [mm]: 284		24.0122-0241.1 422241	Ø 284 22 20 V + S
1.4 (L08, L68)	74	12/09→08/14	←	für Bremsscheibendurchmesser [mm]: 257		24.0122-0231.1 422231	Ø 257 22 20 V + S
						24.0322-0231.1 522231	Ø 257 22 20 V + S
1.4 (L08, L68)	88	07/12→08/14	←			24.0126-0146.1 426146	Ø 278 26 23 V
1.7 CDTI (L08, L68)	96	12/09→08/14	→			24.0110-0347.1 410347	Ø 264 10 8
1.6 Turbo (L08, L68)	110	05/07→08/14	←	06/07→		24.0125-0142.1 425142	Ø 308 25 22 V + S
			→	06/07→		24.0325-0142.1 525142	Ø 308 25 23 V + S
			→	06/07→		24.0110-0347.1 410347	Ø 264 10 8
1.6 Turbo (L08, L68)	141	11/06→08/14	←	03/07→; nicht für Ausstattungsvariante: Nuerburg- ring Edit.		24.0125-0142.1 425142	Ø 308 25 22 V + S
			→	03/07→		24.0325-0142.1 525142	Ø 308 25 23 V + S
			→	03/07→		24.0110-0347.1 410347	Ø 264 10 8
1.6 Turbo (L08, L68)	155	06/11→08/14	←	nicht für Ausstattungsvariante: Nuerburg- ring Edit.		24.0125-0142.1 425142	Ø 308 25 22 V + S
			→			24.0325-0142.1 525142	Ø 308 25 23 V + S
			→			24.0110-0347.1 410347	Ø 264 10 8
1.7 CDTI (L08, L68)	92	08/06→12/11	←	10/06→		24.0126-0146.1 426146	Ø 278 26 23 V
			→	10/06→		24.0110-0347.1 410347	Ø 264 10 8
<b>OPEL - CORSA D Van (S07) 07/06→</b>							
 <b>Bremsbelagsatz, Scheibenbremse</b>							
1.0 (L08)	44	07/06→	←	10/06→; V		13.0460-3839.2 603839	BOS 23707 17,9 + WK + Zub
			←	10/06→		13.0470-3839.2 LD3839	BOS 23707 17,9 + WK + Zub Ceramic
			←	10/06→		13.0460-3839.2 603839	BOS 23707 17,9 + WK + Zub









	kW			 	! #		
<b>OPEL - CORSA D Van (S07) 07/06→</b>							
 <b>Bremsbelagsatz, Scheibenbremse</b>							
1.0 (L08)	44	07/06→	←	10/06→		<b>13.0470-3839.2 LD3839</b>	BOS 23707 17,9 + WK + Zub Ceramic
1.0 (L08)	48	01/10→	←	V		<b>13.0460-3839.2 603839</b>	BOS 23707 17,9 + WK + Zub
			←			<b>13.0470-3839.2 LD3839</b>	BOS 23707 17,9 + WK + Zub Ceramic
1.2 (L08)	59	07/09→	←			<b>13.0460-3839.2 603839</b>	BOS 23707 17,9 + WK + Zub
			←			<b>13.0470-3839.2 LD3839</b>	BOS 23707 17,9 + WK + Zub Ceramic
1.2 (L08)	63	06/10→	←			<b>13.0460-3839.2 603839</b>	BOS 23707 17,9 + WK + Zub
1.3 CDTI (L08)	55	07/06→	←	10/06→; für Bremsscheibendurchmesser [mm]: 257		<b>13.0460-3839.2 603839</b>	BOS 23707 17,9 + WK + Zub
			←	10/06→; für Bremsscheibendurchmesser [mm]: 284		<b>13.0470-3839.2 LD3839</b>	BOS 23707 17,9 + WK + Zub Ceramic
1.3 CDTI (L08)	66	07/06→	←	10/06→		<b>13.0460-3840.2 603840</b>	BOS 23981 19,6 + WK + Zub
			←	10/06→		<b>13.0470-3840.2 LD3840</b>	BOS 23981 19,6 + WK + Zub Ceramic
1.3 CDTI (L08)	70	06/10→	←	für Bremsscheibendurchmesser [mm]: 257		<b>13.0460-3839.2 603839</b>	BOS 23707 17,9 + WK + Zub
			←	für Bremsscheibendurchmesser [mm]: 284		<b>13.0470-3839.2 LD3839</b>	BOS 23707 17,9 + WK + Zub Ceramic
1.3 CDTI (L08)	70	06/10→	←	für Bremsscheibendurchmesser [mm]: 257		<b>13.0460-3840.2 603840</b>	BOS 23981 19,6 + WK + Zub
			←	für Bremsscheibendurchmesser [mm]: 284		<b>13.0470-3840.2 LD3840</b>	BOS 23981 19,6 + WK + Zub Ceramic
 <b>Bremsscheibe</b>							
1.0 (L08)	44	07/06→	←	10/06→		<b>24.0112-0184.1 412184</b>	Ø 257 12 10 + S
			←	10/06→		<b>24.0122-0231.1 422231</b>	Ø 257 22 20 V + S
			←	10/06→		<b>24.0322-0231.1 522231</b>	Ø 257 22 20 V + S
1.0 (L08)	48	01/10→	←	10/06→		<b>24.0112-0184.1 412184</b>	Ø 257 12 10 + S
			←	10/06→		<b>24.0122-0231.1 422231</b>	Ø 257 22 20 V + S
			←	10/06→		<b>24.0322-0231.1 522231</b>	Ø 257 22 20 V + S
1.2 (L08)	59	07/09→	←	10/06→		<b>24.0122-0231.1 422231</b>	Ø 257 22 20 V + S
			←	10/06→		<b>24.0322-0231.1 522231</b>	Ø 257 22 20 V + S
1.3 CDTI (L08)	55	07/06→	←	10/06→; für Bremsscheibendurchmesser [mm]: 257		<b>24.0122-0231.1 422231</b>	Ø 257 22 20 V + S
			←	10/06→; für Bremsscheibendurchmesser [mm]: 284		<b>24.0322-0231.1 522231</b>	Ø 257 22 20 V + S
1.3 CDTI (L08)	66	07/06→	←	10/06→		<b>24.0122-0241.1 422241</b>	Ø 284 22 20 V + S
			←	10/06→		<b>24.0322-0231.1 522231</b>	Ø 257 22 20 V + S
1.3 CDTI (L08)	70	06/10→	←	für Bremsscheibendurchmesser [mm]: 257		<b>24.0122-0241.1 422241</b>	Ø 284 22 20 V + S
			←	für Bremsscheibendurchmesser [mm]: 284		<b>24.0322-0231.1 522231</b>	Ø 257 22 20 V + S
<b>OPEL - CORSA E (X15) 09/14→</b>							
 <b>Bremsbelagsatz, Scheibenbremse</b>							
1.0 (08, 68)	66	09/14→	←	11/14→; für Bremsscheibendurchmesser [mm]: 308		<b>13.0460-7179.2 607179</b>	ATE 23832 20,2 - WK / + WK
			←	11/14→; für Bremsscheibendurchmesser [mm]: 308		<b>13.0470-7179.2 LD7179</b>	ATE 23832 20,2 - WK / + WK Ceramic
1.2 (08, 68)	51	09/14→	←	11/14→; für Bremsscheibendurchmesser [mm]: 284		<b>13.0460-7308.2 607308</b>	ATE 22123 18,2 + WK + Zub
1.3 CDTI (08, 68)	55	09/14→	←	11/14→; für Bremsscheibendurchmesser [mm]: 284		<b>13.0460-7310.2 607310</b>	ATE 22143 17,5 + WK + Zub
1.4 (08, 68)	66	09/14→	←	11/14→; für Bremsscheibendurchmesser [mm]: 257		<b>13.0460-7179.2 607179</b>	ATE 23832 20,2 - WK / + WK
1.4 Turbo (08, 68)	74	09/14→	←	11/14→; für Bremsscheibendurchmesser [mm]: 257		<b>13.0460-7310.2 607310</b>	ATE 22143 17,5 + WK + Zub
1.4 LPG (08, 68)	64	11/15→	←	11/14→		<b>13.0460-2793.2 602793</b>	TRW 25973 17,2 + WK + Zub
			←	11/15→; für Bremsscheibendurchmesser [mm]: 308		<b>13.0460-7179.2 607179</b>	ATE 23832 20,2 - WK / + WK
1.4 LPG (08, 68)	66	03/15→	←	11/15→; für Bremsscheibendurchmesser [mm]: 308		<b>13.0470-7179.2 LD7179</b>	ATE 23832 20,2 - WK / + WK Ceramic
			←	11/15→; für Bremsscheibendurchmesser [mm]: 284		<b>13.0460-7308.2 607308</b>	ATE 22123 18,2 + WK + Zub
1.4 Turbo (08, 68)	110	03/15→	←	11/15→; für Bremsscheibendurchmesser [mm]: 257		<b>13.0460-7310.2 607310</b>	ATE 22143 17,5 + WK + Zub
↓							

	kw			 	! #		
<b>OPEL - CORSA E (X15) 09/14→</b>							
 <b>Bremsbelagsatz, Scheibenbremse</b>							
1.4 LPG (08, 68)	64	11/15→	➔			13.0460-2793.2 602793	TRW 25973 17,2 + WK + Zub
1.4 LPG (08, 68)	66	03/15→					
1.4 Turbo (08, 68)	110	03/15→					
1.6 Turbo (08, 68)	152	03/15→	➔			13.0460-2793.2 602793	TRW 25973 17,2 + WK + Zub
 <b>Bremsscheibe</b>							
1.0 (08, 68)	66	09/14→	←	11/14→		24.0122-0231.1 422231	Ø 257 22 20 V + S
1.0 (08, 68)	85	09/14→				24.0122-0241.1 422241	Ø 284 22 20 V + S
1.2 (08, 68)	51	09/14→				24.0125-0142.1 425142	Ø 308 25 22 V + S
1.3 CDTI (08, 68)	55	09/14→				24.0322-0231.1 522231	Ø 257 22 20 V + S
1.3 CDTI (08, 68)	70	09/14→				24.0325-0142.1 525142	Ø 308 25 23 V + S
1.4 (08, 68)	55	09/14→				24.0325-0142.1 525142	Ø 308 25 23 V + S
1.4 (08, 68)	66	09/14→					
1.4 Turbo (08, 68)	74	09/14→	➔	11/14→; +POC J67		24.0110-0323.1 410323	Ø 264 10 8
			➔	11/14→; +POC J7A		24.0110-0347.1 410347	Ø 264 10 8
1.4 LPG (08, 68)	64	11/15→	←			24.0122-0231.1 422231	Ø 257 22 20 V + S
1.4 LPG (08, 68)	66	03/15→				24.0122-0241.1 422241	Ø 284 22 20 V + S
1.4 Turbo (08, 68)	110	03/15→				24.0125-0142.1 425142	Ø 308 25 22 V + S
						24.0322-0231.1 522231	Ø 257 22 20 V + S
						24.0325-0142.1 525142	Ø 308 25 23 V + S
			➔	+POC J67		24.0110-0323.1 410323	Ø 264 10 8
			➔	+POC J7A		24.0110-0347.1 410347	Ø 264 10 8
1.6 Turbo (08, 68)	152	03/15→	➔			24.0110-0347.1 410347	Ø 264 10 8
<b>OPEL - CORSA E Van (X15) 09/14→</b>							
 <b>Bremsbelagsatz, Scheibenbremse</b>							
1.2 (08)	51	01/15→	←	für Bremsscheibendurchmesser [mm]: 308		13.0460-7179.2 607179	ATE 23832 20,2 - WK / + WK
1.3 CDTI (08)	55	01/15→				13.0470-7179.2 LD7179	ATE 23832 20,2 - WK / + WK Ceramic
			←	für Bremsscheibendurchmesser [mm]: 284		13.0460-7308.2 607308	ATE 22123 18,2 + WK + Zub
			←	für Bremsscheibendurchmesser [mm]: 257		13.0460-7310.2 607310	ATE 22143 17,5 + WK + Zub
			➔			13.0460-2793.2 602793	TRW 25973 17,2 + WK + Zub
1.3 CDTI (08)	70	09/14→	←	11/14→; für Bremsscheibendurchmesser [mm]: 308		13.0460-7179.2 607179	ATE 23832 20,2 - WK / + WK
1.4 (08)	55	09/14→				13.0470-7179.2 LD7179	ATE 23832 20,2 - WK / + WK Ceramic
1.4 (08)	66	09/14→				13.0460-7308.2 607308	ATE 22123 18,2 + WK + Zub
			←	11/14→; für Bremsscheibendurchmesser [mm]: 284		13.0460-7310.2 607310	ATE 22143 17,5 + WK + Zub
			←	11/14→; für Bremsscheibendurchmesser [mm]: 257		13.0460-7310.2 607310	ATE 22143 17,5 + WK + Zub
			➔	11/14→		13.0460-2793.2 602793	TRW 25973 17,2 + WK + Zub
 <b>Bremsscheibe</b>							
1.2 (08)	51	01/15→	←			24.0122-0231.1 422231	Ø 257 22 20 V + S
1.3 CDTI (08)	55	01/15→				24.0122-0241.1 422241	Ø 284 22 20 V + S
						24.0125-0142.1 425142	Ø 308 25 22 V + S
						24.0322-0231.1 522231	Ø 257 22 20 V + S
						24.0325-0142.1 525142	Ø 308 25 23 V + S
			➔	+POC J67		24.0110-0323.1 410323	Ø 264 10 8
			➔	+POC J7A		24.0110-0347.1 410347	Ø 264 10 8
1.3 CDTI (08)	70	09/14→	←	11/14→		24.0122-0231.1 422231	Ø 257 22 20 V + S
1.4 (08)	55	09/14→				24.0122-0241.1 422241	Ø 284 22 20 V + S
1.4 (08)	66	09/14→				24.0125-0142.1 425142	Ø 308 25 22 V + S
						24.0322-0231.1 522231	Ø 257 22 20 V + S
						24.0325-0142.1 525142	Ø 308 25 23 V + S
			➔	11/14→; +POC J67		24.0110-0323.1 410323	Ø 264 10 8
			➔	11/14→; +POC J7A		24.0110-0347.1 410347	Ø 264 10 8
<b>OPEL - CROSSLAND X (P17) 03/17→</b>							
 <b>Bremsscheibe</b>							
1.2 (08, 68)	60	03/17→	←	RPO Nummer: JAC; 14"		24.0122-0194.1 422194	Ø 266 22 20 V + S
1.2 (08, 68)	81	03/17→					
1.2 (08, 68)	96	03/17→	←	RPO Nummer: JAB; 15"		24.0126-0120.1 426120	Ø 283 26 24 V + S
↓							











	kw			 	! #		
<b>OPEL - CROSSLAND X (P17) 03/17→</b>							
 <b>Bremsscheibe</b>							
1.2 LPG (08, 68)	60	10/17→	→	→ 03122017		24.0109-0100.2 409100	Ø 249 9 7 + LG / + ABS Ring
1.6 Turbo D (08, 68)	73	03/17→					
1.6 Turbo D (08, 68)	85	08/17→					
1.6 Turbo D (08, 68)	88	03/17→					
<b>OPEL - FRONTERA A (U92) 03/92→10/98</b>							
 <b>Bremsbelagsatz, Scheibenbremse</b>							
2.2 i (54MWWL4)	100	03/95→10/98	←	SV720103→		13.0460-5926.2 605926	AKE 21845 16,5 + WK
2.3 TD (5JMWWL4)	74	03/92→10/98					
2.4 i (53MWWL4)	92	03/92→10/98	←	→ SV720102		13.0460-5942.2 605942	AKE 21543 16,5 + WK
2.5 TDS	85	09/96→10/98	→	SV720103→		13.0460-5927.2 605927	AKE 21875 16,0 + WK
2.8 TD (5BMWWL4)	83	03/95→10/98					
<b>Zubehörsatz, Scheibenbremsbelag</b>							
2.2 i (54MWWL4)	100	03/95→10/98	←	→ SV720102		13.0460-0337.2 610337	AKE
2.3 TD (5JMWWL4)	74	03/92→10/98					
2.4 i (53MWWL4)	92	03/92→10/98	←	SV720103→		13.0460-0446.2 610446	AKE
2.5 TDS	85	09/96→10/98	→	SV720103→		13.0460-0447.2 610447	AKE
2.8 TD (5BMWWL4)	83	03/95→10/98					
 <b>Bremsscheibe</b>							
2.2 i (54MWWL4)	100	03/95→10/98	←	→ SV720102		24.0122-0156.1 422156	Ø 257 22 20,6 V
2.3 TD (5JMWWL4)	74	03/92→10/98					
2.4 i (53MWWL4)	92	03/92→10/98	←	SV720103→		24.0126-0111.1 426111	Ø 280 26 24,6 V
2.5 TDS	85	09/96→10/98	→	SV720103→		24.0118-0122.1 418122	Ø 313,5 18 16,6 V
2.8 TD (5BMWWL4)	83	03/95→10/98					
<b>OPEL - FRONTERA A Sport (U92) 03/92→10/98</b>							
 <b>Bremsbelagsatz, Scheibenbremse</b>							
2.0 i (52SUD2, 55SUD2)	85	03/92→10/98	←	SV720103→		13.0460-5926.2 605926	AKE 21845 16,5 + WK
2.5 TDS	85	09/96→10/98					
2.8 TD (5BSUD2)	83	03/95→08/96	←	→ SV720102		13.0460-5942.2 605942	AKE 21543 16,5 + WK
			→	SV720103→		13.0460-5927.2 605927	AKE 21875 16,0 + WK
<b>Zubehörsatz, Scheibenbremsbelag</b>							
2.0 i (52SUD2, 55SUD2)	85	03/92→10/98	←	→ SV720102		13.0460-0337.2 610337	AKE
2.5 TDS	85	09/96→10/98					
2.8 TD (5BSUD2)	83	03/95→08/96	←	SV720103→		13.0460-0446.2 610446	AKE
			→	SV720103→		13.0460-0447.2 610447	AKE
 <b>Bremsscheibe</b>							
2.0 i (52SUD2, 55SUD2)	85	03/92→10/98	←	→ SV720102		24.0122-0156.1 422156	Ø 257 22 20,6 V
2.5 TDS	85	09/96→10/98					
2.8 TD (5BSUD2)	83	03/95→08/96	←	SV720103→		24.0126-0111.1 426111	Ø 280 26 24,6 V
			→	SV720103→		24.0118-0122.1 418122	Ø 313,5 18 16,6 V
<b>OPEL - FRONTERA B (U99) 10/98→09/02</b>							
 <b>Bremsbelagsatz, Scheibenbremse</b>							
2.2 DTI (6B_66, 6B_76)	88	09/02→	←	→ 02/04;		13.0460-5926.2 605926	AKE 21845 16,5 + WK
2.2 i (6B_ZC, 6B_VF, 6B_66, 6B_76)	100	10/98→		für Fahrzeuge ohne Bordcomputer			
3.2 i (6B1VF, 6B1_6)	151	10/98→	→	→ 02/04		13.0460-5927.2 605927	AKE 21875 16,0 + WK
2.2 DTI (6B_ZC, 6B_VF, 6B_66, 6B_76)	85	10/98→09/02	←	für Fahrzeuge ohne Bordcomputer		13.0460-5926.2 605926	AKE 21845 16,5 + WK
			→			13.0460-5927.2 605927	AKE 21875 16,0 + WK
<b>Zubehörsatz, Scheibenbremsbelag</b>							
2.2 DTI (6B_66, 6B_76)	88	09/02→	→	→ 02/04		13.0460-0447.2 610447	AKE
2.2 i (6B_ZC, 6B_VF, 6B_66, 6B_76)	100	10/98→					
3.2 i (6B1VF, 6B1_6)	151	10/98→					
2.2 DTI (6B_ZC, 6B_VF, 6B_66, 6B_76)	85	10/98→09/02	→			13.0460-0447.2 610447	AKE
 <b>Bremsscheibe</b>							
2.2 DTI (6B_66, 6B_76)	88	09/02→	←	→ 02/04		24.0126-0111.1 426111	Ø 280 26 24,6 V
2.2 i (6B_ZC, 6B_VF, 6B_66, 6B_76)	100	10/98→	→	→ 02/04		24.0118-0122.1 418122	Ø 313,5 18 16,6 V
3.2 i (6B1VF, 6B1_6)	151	10/98→					
2.2 DTI (6B_ZC, 6B_VF, 6B_66, 6B_76)	85	10/98→09/02	←			24.0126-0111.1 426111	Ø 280 26 24,6 V
			→			24.0118-0122.1 418122	Ø 313,5 18 16,6 V

	kw			 	! #		
<b>OPEL - GT Cabriolet (M07) 06/07→12/11</b>							
 <b>Bremsbelagsatz, Scheibenbremse</b>							
2.0 (G67)	194	06/07→12/11	➔	→ 07/09		<b>13.0460-7195.2 607195</b> <b>13.0470-7195.2 LD7195</b>	ATE 23482 16,6 - WE / - WK ATE 23482 16,6 - WE / - WK Ceramic
<b>OPEL - INSIGNIA A (G09) 07/08→03/17</b>							
 <b>Bremsbelagsatz, Scheibenbremse</b>							
1.4 (68)	103	04/11→03/17	⬅	06/11→; für Bremsscheibendurchmesser [mm]: 337		<b>13.0460-2754.2 602754</b>	TRW 24418 17,0 + WK + Zub
			⬅	06/11→; für Bremsscheibendurchmesser [mm]: 296		<b>13.0460-5611.2 605611</b> <b>13.0470-5611.2 LD5611</b>	MAN 24415 19,1 + WK + Zub MAN 24415 19,1 + WK + Zub Ceramic
			⬅	06/11→; für Bremsscheibendurchmesser [mm]: 321		<b>13.0460-5612.2 605612</b> <b>13.0470-5612.2 LD5612</b>	MAN 24412 19,0 + WK + Zub MAN 24412 19,0 + WK + Zub Ceramic
			➔	06/11→; für Bremsscheibendurchmesser [mm]: 315		<b>13.0460-2755.2 602755</b> <b>13.0470-2755.2 LD2755</b>	TRW 24421 17,2 + WK + Zub TRW 24421 17,2 + WK + Zub Ceramic
			➔	06/11→; für Bremsscheibendurchmesser [mm]: 292		<b>13.0460-2758.2 602758</b> <b>13.0470-2758.2 LD2758</b>	TRW 24421 17,2 + WK + Zub TRW 24421 17,2 + WK + Zub Ceramic
1.4 LPG (68)	103	07/12→03/17	⬅	für Bremsscheibendurchmesser [mm]: 337		<b>13.0460-2754.2 602754</b>	TRW 24418 17,0 + WK + Zub
1.6 (68)	85	07/08→03/17					
1.6 CDTi (68)	88	07/15→03/17	⬅	für Bremsscheibendurchmesser [mm]: 296		<b>13.0460-5611.2 605611</b> <b>13.0470-5611.2 LD5611</b>	MAN 24415 19,1 + WK + Zub MAN 24415 19,1 + WK + Zub Ceramic
1.6 CDTi (68)	100	07/15→03/17					
1.6 SIDI (68)	125	03/13→03/17					
1.8 (68)	103	07/08→03/17					
2.0 Biturbo CDTi (68)	140	07/08→12/11	⬅	für Bremsscheibendurchmesser [mm]: 321		<b>13.0460-5612.2 605612</b> <b>13.0470-5612.2 LD5612</b>	MAN 24412 19,0 + WK + Zub MAN 24412 19,0 + WK + Zub Ceramic
2.0 Biturbo CDTi (68)	143	01/12→03/17					
2.0 Biturbo CDTi 4x4 (68)	140	05/09→12/11					
2.0 Biturbo CDTi 4x4 (68)	143	01/12→03/17	➔	für Bremsscheibendurchmesser [mm]: 315		<b>13.0460-2755.2 602755</b> <b>13.0470-2755.2 LD2755</b>	TRW 24421 17,2 + WK + Zub TRW 24421 17,2 + WK + Zub Ceramic
2.0 CDTi (68)	81	07/08→03/17					
2.0 CDTi (68)	96	07/08→03/17					
2.0 CDTi (68)	103	06/13→03/17	➔	für Bremsscheibendurchmesser [mm]: 292		<b>13.0460-2758.2 602758</b> <b>13.0470-2758.2 LD2758</b>	TRW 24421 17,2 + WK + Zub TRW 24421 17,2 + WK + Zub Ceramic
2.0 CDTi (68)	118	07/08→03/17					
2.0 CDTi (68)	120	07/13→03/17					
2.0 CDTi (68)	125	11/14→03/17					
2.0 CDTi 4x4 (68)	118	06/10→03/17					
2.0 CDTi 4x4 (68)	120	07/13→03/17					
2.0 CDTi 4x4 (68)	125	11/14→03/17					
2.0 E85 Turbo (68)	162	10/10→03/17					
2.0 Turbo (68)	162	07/08→03/17					
2.0 Turbo (68)	184	04/14→03/17					
2.0 Turbo 4x4 (68)	162	07/08→03/17					
2.0 Turbo 4x4 (68)	184	07/11→03/17					
1.6 Turbo (68)	132	07/08→03/17	⬅	10/08→; für Bremsscheibendurchmesser [mm]: 337		<b>13.0460-2754.2 602754</b>	TRW 24418 17,0 + WK + Zub
			⬅	10/08→; für Bremsscheibendurchmesser [mm]: 296		<b>13.0460-5611.2 605611</b> <b>13.0470-5611.2 LD5611</b>	MAN 24415 19,1 + WK + Zub MAN 24415 19,1 + WK + Zub Ceramic
			⬅	10/08→; für Bremsscheibendurchmesser [mm]: 321		<b>13.0460-5612.2 605612</b> <b>13.0470-5612.2 LD5612</b>	MAN 24412 19,0 + WK + Zub MAN 24412 19,0 + WK + Zub Ceramic
			➔	10/08→; für Bremsscheibendurchmesser [mm]: 315		<b>13.0460-2755.2 602755</b> <b>13.0470-2755.2 LD2755</b>	TRW 24421 17,2 + WK + Zub TRW 24421 17,2 + WK + Zub Ceramic
			➔	10/08→; für Bremsscheibendurchmesser [mm]: 292		<b>13.0460-2758.2 602758</b> <b>13.0470-2758.2 LD2758</b>	TRW 24421 17,2 + WK + Zub TRW 24421 17,2 + WK + Zub Ceramic
2.0 CDTi (68)	88	03/12→03/17	⬅	03/13→; für Bremsscheibendurchmesser [mm]: 337		<b>13.0460-2754.2 602754</b>	TRW 24418 17,0 + WK + Zub
			⬅	03/13→; für Bremsscheibendurchmesser [mm]: 296		<b>13.0460-5611.2 605611</b> <b>13.0470-5611.2 LD5611</b>	MAN 24415 19,1 + WK + Zub MAN 24415 19,1 + WK + Zub Ceramic
			⬅	03/13→; für Bremsscheibendurchmesser [mm]: 321		<b>13.0460-5612.2 605612</b> <b>13.0470-5612.2 LD5612</b>	MAN 24412 19,0 + WK + Zub MAN 24412 19,0 + WK + Zub Ceramic
			➔	03/13→; für Bremsscheibendurchmesser [mm]: 315		<b>13.0460-2755.2 602755</b>	TRW 24421 17,2 + WK + Zub



	kW			 	! #		
<b>OPEL - INSIGNIA A (G09) 07/08→03/17</b>							
<b> Bremsbelagsatz, Scheibenbremse</b>							
2.0 CDTI (68)	88	03/12→03/17	➔	03/13→; für Bremsscheibendurchmesser [mm]: 315	13.0470-2755.2	LD2755	TRW 24421 17,2 + WK + Zub Ceramic
			➔	03/13→; für Bremsscheibendurchmesser [mm]: 292	13.0460-2758.2	602758	TRW 24421 17,2 + WK + Zub
2.8 V6 Turbo 4x4 (68)	191	07/08→03/17	←	für Bremsscheibendurchmesser [mm]: 337	13.0460-2754.2	602754	TRW 24418 17,0 + WK + Zub
			➔		13.0460-2755.2	602755	TRW 24421 17,2 + WK + Zub
2.8 V6 Turbo OPC 4x4 (68)	239	07/09→03/17	←		13.0460-4855.2	604855	BRE 23325 16,4 + WK
			➔		13.0460-2755.2	602755	TRW 24421 17,2 + WK + Zub
<b> Bremsscheibe</b>							
1.4 (68)	103	04/11→03/17	←	06/11→	24.0130-0207.1	430207	Ø 296 30 27 V + S
			➔	06/11→	24.0130-0208.1	430208	Ø 337 30 27 V + S
1.4 LPG (68)	103	07/12→03/17	←		24.0130-0209.1	430209	Ø 321 30 27 V + S
			➔		24.0330-0207.1	530207	Ø 296 30 27 V + S
1.6 (68)	85	07/08→03/17	←		24.0330-0209.1	530209	Ø 321 30 27 V + S
			➔		24.0112-0187.1	412187	Ø 292 12 10,5 + S
1.6 CDTi (68)	88	07/15→03/17	←		24.0123-0114.1	423114	Ø 315 22,9 21,5 V + S
			➔		24.0312-0187.1	512187	Ø 292 12 10,5 + S
1.6 CDTi (68)	100	07/15→03/17	←		24.0323-0114.1	523114	Ø 315 22,9 21,5 V + S
			➔				
1.6 SIDI (68)	125	03/13→03/17	←				
			➔				
1.8 (68)	103	07/08→03/17	←				
			➔				
2.0 Biturbo CDTI (68)	140	07/08→12/11	←				
			➔				
2.0 Biturbo CDTI (68)	143	01/12→03/17	←				
			➔				
2.0 Biturbo CDTI 4x4 (68)	140	05/09→12/11	←				
			➔				
2.0 Biturbo CDTI 4x4 (68)	143	01/12→03/17	←				
			➔				
2.0 CDTI (68)	81	07/08→03/17	←				
			➔				
2.0 CDTI (68)	96	07/08→03/17	←				
			➔				
2.0 CDTI (68)	103	06/13→03/17	←				
			➔				
2.0 CDTI (68)	118	07/08→03/17	←				
			➔				
2.0 CDTI (68)	120	07/13→03/17	←				
			➔				
2.0 CDTI (68)	125	11/14→03/17	←				
			➔				
2.0 CDTI 4x4 (68)	118	06/10→03/17	←				
			➔				
2.0 CDTI 4x4 (68)	120	07/13→03/17	←				
			➔				
2.0 CDTI 4x4 (68)	125	11/14→03/17	←				
			➔				
2.0 E85 Turbo (68)	162	10/10→03/17	←				
			➔				
2.0 Turbo (68)	162	07/08→03/17	←				
			➔				
2.0 Turbo (68)	184	04/14→03/17	←				
			➔				
2.0 Turbo 4x4 (68)	162	07/08→03/17	←				
			➔				
2.0 Turbo 4x4 (68)	184	07/11→03/17	←				
			➔				
1.6 Turbo (68)	132	07/08→03/17	←	10/08→	24.0130-0207.1	430207	Ø 296 30 27 V + S
			➔	10/08→	24.0130-0208.1	430208	Ø 337 30 27 V + S
2.0 CDTI (68)	88	03/12→03/17	←	03/13→	24.0130-0209.1	430209	Ø 321 30 27 V + S
			➔	03/13→	24.0330-0207.1	530207	Ø 296 30 27 V + S
2.8 V6 Turbo 4x4 (68)	191	07/08→03/17	←		24.0330-0209.1	530209	Ø 321 30 27 V + S
			➔		24.0112-0187.1	412187	Ø 292 12 10,5 + S
↓			←		24.0123-0114.1	423114	Ø 315 22,9 21,5 V + S
			➔		24.0312-0187.1	512187	Ø 292 12 10,5 + S
↓			←		24.0323-0114.1	523114	Ø 315 22,9 21,5 V + S
			➔				



	kw			 	! #		
<b>OPEL - INSIGNIA A (G09) 07/08→03/17</b>							
 <b>Bremsscheibe</b>							
2.8 V6 Turbo OPC 4x4 (68)	239	07/09→03/17	➔			24.0123-0114.1 423114 24.0323-0114.1 523114	Ø 315 22,9 21,5 V + S Ø 315 22,9 21,5 V + S
<b>OPEL - INSIGNIA A Country Tourer (G09) 07/08→03/17</b>							
 <b>Bremsbelagsatz, Scheibenbremse</b>							
2.0 CDTi 4x4 (47) 2.0 Turbo 4x4 (47)	120 184	09/13→03/17 09/13→03/17	←	für Bremsscheibendurchmesser [mm]: 337		13.0460-2754.2 602754	TRW 24418 17,0 + WK + Zub
			←	für Bremsscheibendurchmesser [mm]: 296		13.0460-5611.2 605611 13.0470-5611.2 LD5611	MAN 24415 19,1 + WK + Zub MAN 24415 19,1 + WK + Zub Ceramic
			←	für Bremsscheibendurchmesser [mm]: 321		13.0460-5612.2 605612 13.0470-5612.2 LD5612	MAN 24412 19,0 + WK + Zub MAN 24412 19,0 + WK + Zub Ceramic
			➔	für Bremsscheibendurchmesser [mm]: 315		13.0460-2755.2 602755 13.0470-2755.2 LD2755	TRW 24421 17,2 + WK + Zub TRW 24421 17,2 + WK + Zub Ceramic
			➔	für Bremsscheibendurchmesser [mm]: 292		13.0460-2758.2 602758 13.0470-2758.2 LD2758	TRW 24421 17,2 + WK + Zub TRW 24421 17,2 + WK + Zub Ceramic
 <b>Bremsscheibe</b>							
2.0 CDTi 4x4 (47) 2.0 Turbo 4x4 (47)	120 184	09/13→03/17 09/13→03/17	←			24.0130-0207.1 430207 24.0130-0208.1 430208 24.0130-0209.1 430209 24.0330-0207.1 530207 24.0330-0209.1 530209	Ø 296 30 27 V + S Ø 337 30 27 V + S Ø 321 30 27 V + S Ø 296 30 27 V + S Ø 321 30 27 V + S
			➔			24.0112-0187.1 412187 24.0123-0114.1 423114 24.0312-0187.1 512187 24.0323-0114.1 523114	Ø 292 12 10,5 + S Ø 315 22,9 21,5 V + S Ø 292 12 10,5 + S Ø 315 22,9 21,5 V + S
<b>OPEL - INSIGNIA A Stufenheck (G09) 07/08→03/17</b>							
 <b>Bremsbelagsatz, Scheibenbremse</b>							
1.4 (69)	103	04/11→03/17	←	06/11→; für Bremsscheibendurchmesser [mm]: 337		13.0460-2754.2 602754	TRW 24418 17,0 + WK + Zub
			←	06/11→; für Bremsscheibendurchmesser [mm]: 296		13.0460-5611.2 605611 13.0470-5611.2 LD5611	MAN 24415 19,1 + WK + Zub MAN 24415 19,1 + WK + Zub Ceramic
			←	06/11→; für Bremsscheibendurchmesser [mm]: 321		13.0460-5612.2 605612 13.0470-5612.2 LD5612	MAN 24412 19,0 + WK + Zub MAN 24412 19,0 + WK + Zub Ceramic
			➔	06/11→; für Bremsscheibendurchmesser [mm]: 315		13.0460-2755.2 602755 13.0470-2755.2 LD2755	TRW 24421 17,2 + WK + Zub TRW 24421 17,2 + WK + Zub Ceramic
			➔	06/11→; für Bremsscheibendurchmesser [mm]: 292		13.0460-2758.2 602758 13.0470-2758.2 LD2758	TRW 24421 17,2 + WK + Zub TRW 24421 17,2 + WK + Zub Ceramic
1.4 LPG (69) 1.6 (69) 1.6 CDTi (69) 1.6 CDTi (69) 1.6 SIDI (69) 1.6 Turbo (69) 1.8 (69) 2.0 Biturbo CDTi (69) 2.0 Biturbo CDTi (69) 2.0 Biturbo CDTi 4x4 (69) 2.0 Biturbo CDTi 4x4 (69) 2.0 CDTi (69) 2.0 CDTi (69) 2.0 CDTi (69) 2.0 CDTi (69) 2.0 CDTi (69) 2.0 CDTi 4x4 (69) 2.0 CDTi 4x4 (69) 2.0 CDTi 4x4 (69) 2.0 Turbo (69)	103 85 88 100 125 132 103 140 143 140 81 96 103 118 120 125 118 120 125 162	07/12→03/17 07/08→03/17 07/15→03/17 07/15→03/17 03/13→03/17 07/08→03/17 07/08→03/17 07/08→12/11 01/12→03/17 07/08→12/11 01/12→03/17 07/08→03/17 07/08→03/17 06/13→03/17 07/08→03/17 07/13→03/17 11/14→03/17 06/10→03/17 07/13→03/17 11/14→03/17 07/08→03/17	←	für Bremsscheibendurchmesser [mm]: 337		13.0460-2754.2 602754	TRW 24418 17,0 + WK + Zub
			←	für Bremsscheibendurchmesser [mm]: 296		13.0460-5611.2 605611 13.0470-5611.2 LD5611	MAN 24415 19,1 + WK + Zub MAN 24415 19,1 + WK + Zub Ceramic
			←	für Bremsscheibendurchmesser [mm]: 321		13.0460-5612.2 605612 13.0470-5612.2 LD5612	MAN 24412 19,0 + WK + Zub MAN 24412 19,0 + WK + Zub Ceramic
			➔	für Bremsscheibendurchmesser [mm]: 315		13.0460-2755.2 602755 13.0470-2755.2 LD2755	TRW 24421 17,2 + WK + Zub TRW 24421 17,2 + WK + Zub Ceramic
			➔	für Bremsscheibendurchmesser [mm]: 292		13.0460-2758.2 602758 13.0470-2758.2 LD2758	TRW 24421 17,2 + WK + Zub TRW 24421 17,2 + WK + Zub Ceramic



**OPEL - INSIGNIA A Stufenheck (G09) 07/08→03/17**

**Bremsscheibe**

2.0 CDTi (69)	88	03/12→03/17	←	03/13→		24.0130-0207.1 430207	Ø 296 30 27 V + S
						24.0130-0208.1 430208	Ø 337 30 27 V + S
			→	03/13→		24.0130-0209.1 430209	Ø 321 30 27 V + S
						24.0330-0207.1 530207	Ø 296 30 27 V + S
						24.0330-0209.1 530209	Ø 321 30 27 V + S
						24.0112-0187.1 412187	Ø 292 12 10,5 + S
						24.0123-0114.1 423114	Ø 315 22,9 21,5 V + S
						24.0312-0187.1 512187	Ø 292 12 10,5 + S
						24.0323-0114.1 523114	Ø 315 22,9 21,5 V + S
2.8 V6 Turbo 4x4 (69)	191	07/08→03/17	←			24.0130-0208.1 430208	Ø 337 30 27 V + S
			→			24.0123-0114.1 423114	Ø 315 22,9 21,5 V + S
			→			24.0323-0114.1 523114	Ø 315 22,9 21,5 V + S
2.8 V6 Turbo OPC 4x4 (69)	239	07/09→03/17	→			24.0123-0114.1 423114	Ø 315 22,9 21,5 V + S
						24.0323-0114.1 523114	Ø 315 22,9 21,5 V + S

**OPEL - INSIGNIA Caravan 07/08→03/17**

**Bremsbelagsatz, Scheibenbremse**

1.4 (35)	103	09/11→06/13	←	für Bremsscheibendurchmesser [mm]:		13.0460-2754.2 602754	TRW 24418 17,0 + WK + Zub
				337			
1.4 LPG (35)	103	07/12→06/13					
1.6 (35)	85	07/08→06/12	←	für Bremsscheibendurchmesser [mm]:		13.0460-5611.2 605611	MAN 24415 19,1 + WK + Zub
1.6 CDTi (35)	88	07/15→01/17		296		13.0470-5611.2 LD5611	MAN 24415 19,1 + WK + Zub Ceramic
1.6 CDTi (35)	100	07/15→12/16					
1.6 SIDI (35)	125	03/13→11/14					
1.6 Turbo (35)	132	01/09→06/13	←	für Bremsscheibendurchmesser [mm]:		13.0460-5612.2 605612	MAN 24412 19,0 + WK + Zub
1.8 (35)	103	07/08→06/13		321		13.0470-5612.2 LD5612	MAN 24412 19,0 + WK + Zub Ceramic
2.0 Biturbo CDTi (35)	140	07/08→03/17					
2.0 Biturbo CDTi (35)	143	01/12→06/15					
2.0 Biturbo CDTi 4x4 (35)	140	07/08→03/17	→	für Bremsscheibendurchmesser [mm]:		13.0460-2755.2 602755	TRW 24421 17,2 + WK + Zub
2.0 Biturbo CDTi 4x4 (35)	143	01/12→06/15		315		13.0470-2755.2 LD2755	TRW 24421 17,2 + WK + Zub Ceramic
2.0 CDTi (35)	81	07/08→06/13	→	für Bremsscheibendurchmesser [mm]:		13.0460-2758.2 602758	TRW 24421 17,2 + WK + Zub
2.0 CDTi (35)	96	07/08→06/15		292		13.0470-2758.2 LD2758	TRW 24421 17,2 + WK + Zub Ceramic
2.0 CDTi (35)	103	07/13→06/15					
2.0 CDTi (35)	118	07/08→06/15					
2.0 CDTi (35)	120	07/13→06/15					
2.0 CDTi (35)	125	11/14→12/16					
2.0 CDTi 4x4 (35)	118	06/10→06/15					
2.0 CDTi 4x4 (35)	120	07/13→06/15					
2.0 CDTi 4x4 (35)	125	11/14→12/16					
2.0 E85 Turbo (35)	162	09/10→11/11					
2.0 Turbo (35)	162	07/08→06/13					
2.0 Turbo (35)	184	04/14→11/14					
2.0 Turbo 4x4 (35)	162	07/08→06/11					
2.0 Turbo 4x4 (35)	184	09/11→06/13					
2.0 CDTi (35)	88	03/12→06/15	←	03/13→;		13.0460-2754.2 602754	TRW 24418 17,0 + WK + Zub
				für Bremsscheibendurchmesser [mm]:			
				337		13.0460-5611.2 605611	MAN 24415 19,1 + WK + Zub
			←	03/13→;		13.0470-5611.2 LD5611	MAN 24415 19,1 + WK + Zub Ceramic
				für Bremsscheibendurchmesser [mm]:			
	296						
			←	03/13→;		13.0460-5612.2 605612	MAN 24412 19,0 + WK + Zub
				für Bremsscheibendurchmesser [mm]:		13.0470-5612.2 LD5612	MAN 24412 19,0 + WK + Zub Ceramic
				321			
			→	03/13→;		13.0460-2755.2 602755	TRW 24421 17,2 + WK + Zub
				für Bremsscheibendurchmesser [mm]:		13.0470-2755.2 LD2755	TRW 24421 17,2 + WK + Zub Ceramic
				315			
			→	03/13→;		13.0460-2758.2 602758	TRW 24421 17,2 + WK + Zub
				für Bremsscheibendurchmesser [mm]:		13.0470-2758.2 LD2758	TRW 24421 17,2 + WK + Zub Ceramic
				292			
2.8 V6 Turbo 4x4 (35)	191	10/08→06/13	←	für Bremsscheibendurchmesser [mm]:		13.0460-2754.2 602754	TRW 24418 17,0 + WK + Zub
				337			
			→			13.0460-2755.2 602755	TRW 24421 17,2 + WK + Zub
						13.0470-2755.2 LD2755	TRW 24421 17,2 + WK + Zub Ceramic
2.8 V6 Turbo OPC 4x4 (35)	239	07/09→06/15	←			13.0460-4855.2 604855	BRE 23325 16,4 + WK
			→			13.0460-2755.2 602755	TRW 24421 17,2 + WK + Zub
						13.0470-2755.2 LD2755	TRW 24421 17,2 + WK + Zub Ceramic

**OPEL - INSIGNIA Caravan 07/08→03/17**

<b>Bremsscheibe</b>							
1.4 (35)	103	09/11→06/13	←			24.0130-0207.1 430207	Ø 296 30 27 V + S
1.4 LPG (35)	103	07/12→06/13				24.0130-0208.1 430208	Ø 337 30 27 V + S
1.6 (35)	85	07/08→06/12				24.0130-0209.1 430209	Ø 321 30 27 V + S
1.6 CDTi (35)	88	07/15→01/17				24.0330-0207.1 530207	Ø 296 30 27 V + S
1.6 CDTi (35)	100	07/15→12/16				24.0330-0209.1 530209	Ø 321 30 27 V + S
1.6 SIDI (35)	125	03/13→11/14					
1.6 Turbo (35)	132	01/09→06/13					
1.8 (35)	103	07/08→06/13	→			24.0112-0187.1 412187	Ø 292 12 10,5 + S
2.0 Biturbo CDTi (35)	140	07/08→03/17				24.0123-0114.1 423114	Ø 315 22,9 21,5 V + S
2.0 Biturbo CDTi (35)	143	01/12→06/15				24.0312-0187.1 512187	Ø 292 12 10,5 + S
2.0 Biturbo CDTi 4x4 (35)	140	07/08→03/17				24.0323-0114.1 523114	Ø 315 22,9 21,5 V + S
2.0 Biturbo CDTi 4x4 (35)	143	01/12→06/15					
2.0 CDTi (35)	81	07/08→06/13					
2.0 CDTi (35)	96	07/08→06/15					
2.0 CDTi (35)	103	07/13→06/15					
2.0 CDTi (35)	118	07/08→06/15					
2.0 CDTi (35)	120	07/13→06/15					
2.0 CDTi (35)	125	11/14→12/16					
2.0 CDTi 4x4 (35)	118	06/10→06/15					
2.0 CDTi 4x4 (35)	120	07/13→06/15					
2.0 CDTi 4x4 (35)	125	11/14→12/16					
2.0 E85 Turbo (35)	162	09/10→11/11					
2.0 Turbo (35)	162	07/08→06/13					
2.0 Turbo (35)	184	04/14→11/14					
2.0 Turbo 4x4 (35)	162	07/08→06/11					
2.0 Turbo 4x4 (35)	184	09/11→06/13					
2.0 CDTi (35)	88	03/12→06/15	←	03/13→		24.0130-0207.1 430207	Ø 296 30 27 V + S
						24.0130-0208.1 430208	Ø 337 30 27 V + S
						24.0130-0209.1 430209	Ø 321 30 27 V + S
						24.0330-0207.1 530207	Ø 296 30 27 V + S
						24.0330-0209.1 530209	Ø 321 30 27 V + S
			→	03/13→		24.0112-0187.1 412187	Ø 292 12 10,5 + S
						24.0123-0114.1 423114	Ø 315 22,9 21,5 V + S
						24.0312-0187.1 512187	Ø 292 12 10,5 + S
						24.0323-0114.1 523114	Ø 315 22,9 21,5 V + S
2.8 V6 Turbo 4x4 (35)	191	10/08→06/13	←			24.0130-0208.1 430208	Ø 337 30 27 V + S
			→			24.0123-0114.1 423114	Ø 315 22,9 21,5 V + S
						24.0323-0114.1 523114	Ø 315 22,9 21,5 V + S
2.8 V6 Turbo OPC 4x4 (35)	239	07/09→06/15	→			24.0123-0114.1 423114	Ø 315 22,9 21,5 V + S
						24.0323-0114.1 523114	Ø 315 22,9 21,5 V + S

**OPEL - KARL (C16) 01/15→**











<b>Bremsbelagsatz, Scheibenbremse</b>							
1.0	55	01/15→	←			13.0460-5673.2 605673	AKE 22326 18,0 + WK + Zub
1.0 LPG	54	02/15→					















<b>Bremsscheibe</b>							
1.0	55	01/15→	←			24.0120-0249.1 420249	Ø 236 20 18 V
1.0 LPG	54	02/15→					

**OPEL - MERIVA A Großraumlimousine (X03) 05/03→05/10**













<b>Bremsbelagsatz, Scheibenbremse</b>							
1.3 CDTi (E75)	51	04/05→05/10	←			13.0460-7179.2 607179	ATE 23832 20,2 - WK / + WK
1.3 CDTi (E75)	55	09/03→05/10				13.0470-7179.2 LD7179	ATE 23832 20,2 - WK / + WK Ceramic
1.6 (E75)	77	01/06→05/10					
1.6 16V (E75)	74	05/03→01/06					
1.6 Turbo (E75)	132	09/05→05/10	→			13.0460-2868.2 602868	TRW 23417 15,3 + WK + Zub
1.7 CDTi (E75)	74	09/03→05/10				13.0470-2868.2 LD2868	TRW 23417 15,3 + WK + Zub Ceramic
1.7 CDTi (E75)	92	09/06→05/10					
1.7 DTi (E75)	55	09/03→05/10					
1.8 (E75)	92	05/03→05/10					
1.4 16V Twinport (E75)	66	07/04→05/10	←	Felge Lochzahl: 4		13.0460-2857.2 602857	TRW 23225 17,0 + WK + Zub
1.4 16V Twinport LPG (E75)	66	07/04→05/10				13.0470-2857.2 LD2857	TRW 23225 17,0 + WK + Zub Ceramic
			←	Felge Lochzahl: 5		13.0460-7179.2 607179	ATE 23832 20,2 - WK / + WK Ceramic
						13.0470-7179.2 LD7179	ATE 23832 20,2 - WK / + WK Ceramic
			→			13.0460-2868.2 602868	TRW 23417 15,3 + WK + Zub
						13.0470-2868.2 LD2868	TRW 23417 15,3 + WK + Zub Ceramic
1.6 (E75)	64	05/03→05/10	←			13.0460-2857.2 602857	TRW 23225 17,0 + WK + Zub













	kW			 	! #		
<b>OPEL - MERIVA A Großraumlimousine (X03) 05/03→05/10</b>							
 <b>Bremsbelagsatz, Scheibenbremse</b>							
1.6 (E75)	64	05/03→05/10	←			13.0470-2857.2 LD2857	TRW 23225 17,0 + WK + Zub Ceramic
			→			13.0460-2868.2 602868	TRW 23417 15,3 + WK + Zub
						13.0470-2868.2 LD2868	TRW 23417 15,3 + WK + Zub Ceramic
 <b>Bremsscheibe</b>							
1.3 CDTi (E75)	51	04/05→05/10	←	Felge Lochzahl: 5		24.0125-0131.1 425131	Ø 280 24,8 22 V + S
1.3 CDTi (E75)	55	09/03→05/10				24.0325-0131.1 525131	Ø 280 24,8 22 V + S
1.6 (E75)	77	01/06→05/10					
1.6 16V (E75)	74	05/03→01/06	←	Felge Lochzahl: 4		24.0125-0148.1 425148	Ø 280 25 22 V + S
1.7 DTi (E75)	55	09/03→05/10				24.0325-0148.1 525148	Ø 280 25 22 V + S
1.8 (E75)	92	05/03→05/10	→	Felge Lochzahl: 5		24.0110-0250.1 410250	Ø 264 9,8 8 + S
						24.0310-0250.1 510250	Ø 264 9,8 8 + S
			→	Felge Lochzahl: 4		24.0110-0291.1 410291	Ø 264 10 8 + S
						24.0310-0291.1 510291	Ø 264 10 8 + S
1.4 16V Twinport (E75)	66	07/04→05/10	←	Felge Lochzahl: 4		24.0124-0166.1 424166	Ø 260 24 21 V + S
1.4 16V Twinport LPG (E75)	66	07/04→05/10				24.0324-0166.1 524166	Ø 260 24 21 V
1.6 (E75)	64	05/03→05/10	←	Felge Lochzahl: 5		24.0125-0131.1 425131	Ø 280 24,8 22 V + S
						24.0325-0131.1 525131	Ø 280 24,8 22 V + S
			→	Felge Lochzahl: 5		24.0110-0250.1 410250	Ø 264 9,8 8 + S
						24.0310-0250.1 510250	Ø 264 9,8 8 + S
			→	Felge Lochzahl: 4		24.0110-0251.1 410251	Ø 240 9,8 8 + S
						24.0310-0251.1 510251	Ø 240 9,8 8 + S
1.6 Turbo (E75)	132	09/05→05/10	←			24.0125-0142.1 425142	Ø 308 25 22 V + S
						24.0325-0142.1 525142	Ø 308 25 23 V + S
			→	Felge Lochzahl: 5		24.0110-0250.1 410250	Ø 264 9,8 8 + S
						24.0310-0250.1 510250	Ø 264 9,8 8 + S
1.7 CDTi (E75)	74	09/03→05/10	←	Felge Lochzahl: 5		24.0125-0131.1 425131	Ø 280 24,8 22 V + S
1.7 CDTi (E75)	92	09/06→05/10				24.0325-0131.1 525131	Ø 280 24,8 22 V + S
			→	Felge Lochzahl: 5		24.0110-0250.1 410250	Ø 264 9,8 8 + S
						24.0310-0250.1 510250	Ø 264 9,8 8 + S
<b>OPEL - MERIVA B Großraumlimousine (S10) 06/10→03/17</b>							
 <b>Bremsbelagsatz, Scheibenbremse</b>							
1.3 CDTi (75)	55	06/10→10/13	←			13.0460-7179.2 607179	ATE 23832 20,2 - WK / + WK
1.3 CDTi (75)	70	06/10→11/14				13.0470-7179.2 LD7179	ATE 23832 20,2 - WK / + WK Ceramic
1.4 (75)	74	06/10→03/17					
1.4 (75)	88	06/10→03/17					
1.4 (75)	103	06/10→03/17	→			13.0460-2868.2 602868	TRW 23417 15,3 + WK + Zub
1.4 LPG (75)	88	06/11→03/17				13.0470-2868.2 LD2868	TRW 23417 15,3 + WK + Zub Ceramic
1.6 CDTi (75)	100	08/13→01/17					
1.6 CDTi (75)	81	03/14→03/17					
1.7 CDTi (75)	74	06/10→01/17					
1.7 CDTi (75)	81	06/10→06/15					
1.7 CDTi (75)	96	06/10→10/13					
1.6 CDTi (75)	70	01/14→01/17	←	03/14→		13.0460-7179.2 607179	ATE 23832 20,2 - WK / + WK
						13.0470-7179.2 LD7179	ATE 23832 20,2 - WK / + WK Ceramic
			→	03/14→		13.0460-2868.2 602868	TRW 23417 15,3 + WK + Zub
						13.0470-2868.2 LD2868	TRW 23417 15,3 + WK + Zub Ceramic
 <b>Bremsscheibe</b>							
1.3 CDTi (75)	55	06/10→10/13	←			24.0125-0131.1 425131	Ø 280 24,8 22 V + S
1.3 CDTi (75)	70	06/10→11/14				24.0325-0131.1 525131	Ø 280 24,8 22 V + S
1.4 (75)	74	06/10→03/17	→			24.0110-0250.1 410250	Ø 264 9,8 8 + S
						24.0310-0250.1 510250	Ø 264 9,8 8 + S
1.4 (75)	88	06/10→03/17	←			24.0125-0131.1 425131	Ø 280 24,8 22 V + S
1.4 LPG (75)	88	06/11→03/17				24.0125-0142.1 425142	Ø 308 25 22 V + S
1.7 CDTi (75)	74	06/10→01/17				24.0325-0131.1 525131	Ø 280 24,8 22 V + S
1.7 CDTi (75)	81	06/10→06/15					
1.7 CDTi (75)	96	06/10→10/13	→			24.0110-0250.1 410250	Ø 264 9,8 8 + S
						24.0310-0250.1 510250	Ø 264 9,8 8 + S
1.4 (75)	103	06/10→03/17	←			24.0125-0142.1 425142	Ø 308 25 22 V + S
1.6 CDTi (75)	100	08/13→01/17				24.0110-0250.1 410250	Ø 264 9,8 8 + S
1.6 CDTi (75)	81	03/14→03/17	→			24.0310-0250.1 510250	Ø 264 9,8 8 + S
↓							











	kW					! #		
<b>OPEL - MERIVA B Großraumlimousine (S10) 06/10→03/17</b>								
 <b>Bremsscheibe</b>								
1.6 CDTI (75)	70	01/14→01/17	←	03/14→		24.0125-0142.1	425142	Ø 308 25 22 V + S
			→	03/14→		24.0110-0250.1	410250	Ø 264 9,8 8 + S
						24.0310-0250.1	510250	Ø 264 9,8 8 + S
<b>OPEL - MOKKA / MOKKA X (J13) 06/12→</b>								
 <b>Bremsbelagsatz, Scheibenbremse</b>								
1.4 ( _76)	103	04/13→	←			13.0460-7263.2	607263	24034 19,1 + WK + Zub
1.4 4x4 ( _76)	103	06/12→				13.0470-7263.2	LD7263	24034 19,1 + WK + Zub Ceramic
1.4 4x4 ( _76)	112	06/16→						
1.4 LPG ( _76)	103	04/13→	→			13.0460-7264.2	607264	ATE 25096 17,0 + WK + Zub
1.6 ( _76)	85	06/12→				13.0470-7264.2	LD7264	ATE 25096 17,0 + WK + Zub Ceramic
1.6 CDTI ( _76)	81	06/15→						
1.6 CDTI ( _76)	100	01/15→						
1.6 CDTI 4x4 ( _76)	100	01/15→						
1.7 CDTI ( _76)	96	06/12→						
1.7 CDTI 4x4 ( _76)	96	06/12→						
1.8 ( _76)	103	01/13→						
1.8 4x4 ( _76)	103	01/13→						
 <b>Bremsscheibe</b>								
1.4 ( _76)	103	04/13→	←			24.0126-0182.1	426182	Ø 300 26 23 V + S
1.4 4x4 ( _76)	103	06/12→						
1.4 4x4 ( _76)	112	06/16→	→			24.0112-0188.1	412188	Ø 268 12 10 + S
1.4 LPG ( _76)	103	04/13→				24.0312-0188.1	512188	Ø 268 12 10 + S
1.6 ( _76)	85	06/12→						
1.6 CDTI ( _76)	81	06/15→						
1.6 CDTI ( _76)	100	01/15→						
1.6 CDTI 4x4 ( _76)	100	01/15→						
1.7 CDTI ( _76)	96	06/12→						
1.7 CDTI 4x4 ( _76)	96	06/12→						
1.8 ( _76)	103	01/13→						
1.8 4x4 ( _76)	103	01/13→						
<b>OPEL - MONTEREY A (M92) 09/91→07/98</b>								
 <b>Bremsbelagsatz, Scheibenbremse</b>								
3.1 TD (UBS69D, UBS69G)	84	09/91→07/98	←			13.0460-5926.2	605926	AKE 21845 16,5 + WK
3.2 (UBS25D, UBS25G)	130	06/92→07/98	→			13.0460-5927.2	605927	AKE 21875 16,0 + WK
<b>Zubehörsatz, Scheibenbremsbelag</b>								
3.1 TD (UBS69D, UBS69G)	84	09/91→07/98	←			13.0460-0446.2	610446	AKE
3.2 (UBS25D, UBS25G)	130	06/92→07/98	→			13.0460-0447.2	610447	AKE
 <b>Bremsscheibe</b>								
3.1 TD (UBS69D, UBS69G)	84	09/91→07/98	←			24.0126-0111.1	426111	Ø 280 26 24,6 V
3.2 (UBS25D, UBS25G)	130	06/92→07/98	→			24.0118-0122.1	418122	Ø 313,5 18 16,6 V
<b>OPEL - MONTEREY B (M98) 07/98→08/99</b>								
 <b>Bremsbelagsatz, Scheibenbremse</b>								
3.0 DTI (UBS73D, UBS73G)	117	07/98→08/99	←			13.0460-5926.2	605926	AKE 21845 16,5 + WK
3.5 V6 24V (UBS26D, UBS26G)	158	07/98→08/99	→			13.0460-5927.2	605927	AKE 21875 16,0 + WK
<b>Zubehörsatz, Scheibenbremsbelag</b>								
3.0 DTI (UBS73D, UBS73G)	117	07/98→08/99	←			13.0460-0446.2	610446	AKE
3.5 V6 24V (UBS26D, UBS26G)	158	07/98→08/99	→			13.0460-0447.2	610447	AKE
 <b>Bremsscheibe</b>								
3.0 DTI (UBS73D, UBS73G)	117	07/98→08/99	←			24.0126-0111.1	426111	Ø 280 26 24,6 V
3.5 V6 24V (UBS26D, UBS26G)	158	07/98→08/99	→			24.0118-0122.1	418122	Ø 313,5 18 16,6 V
<b>OPEL - MOVANO B Bus (X62) 12/10→</b>								
 <b>Bremsbelagsatz, Scheibenbremse</b>								
2.3 CDTI FWD (JV)	74	12/10→	←			13.0460-4856.2	604856	BRE 25147 18,4 + WK
2.3 CDTI FWD (JV)	81	05/14→						
2.3 CDTI FWD (JV)	92	12/10→	→		für Doppelbereifung	13.0460-4857.2	604857	BRE 25172 18,4 + WK
2.3 CDTI FWD (JV)	100	05/14→						
2.3 CDTI FWD (JV)	107	12/10→	→		für Einfachbereifung	13.0460-4858.2	604858	BRE 25112 18,4 + WK
↓								













	kw			 	! #		
<b>OPEL - MOVANO B Bus (X62) 12/10→</b>							
 <b>Bremsbelagsatz, Scheibenbremse</b>							
2.3 CDTI FWD (JV)	110	01/13→	←			<b>13.0460-4856.2 604856</b>	BRE 25147 18,4 + WK
2.3 CDTI FWD (JV)	120	05/14→	→	für Doppelbereifung		<b>13.0460-4857.2 604857</b>	BRE 25172 18,4 + WK
2.3 CDTI FWD (JV)	125	07/15→	→	für Einfachbereifung		<b>13.0460-4858.2 604858</b>	BRE 25112 18,4 + WK
 <b>Bremsscheibe</b>							
2.3 CDTI FWD (JV)	74	12/10→	←			<b>24.0128-0252.1 428252</b>	Ø 302 28 24,5 V + S
2.3 CDTI FWD (JV)	81	05/14→	→			<b>24.0112-0191.1 412191</b>	Ø 305 12 10 + S
2.3 CDTI FWD (JV)	92	12/10→					
2.3 CDTI FWD (JV)	100	05/14→					
2.3 CDTI FWD (JV)	107	12/10→					
2.3 CDTI FWD (JV)	110	01/13→					
2.3 CDTI FWD (JV)	120	05/14→					
2.3 CDTI FWD (JV)	125	07/15→					
<b>OPEL - MOVANO B Kasten (X62) 05/10→</b>							
 <b>Bremsbelagsatz, Scheibenbremse</b>							
2.3 CDTI FWD (FV)	74	05/10→	←			<b>13.0460-4856.2 604856</b>	BRE 25147 18,4 + WK
2.3 CDTI FWD (FV)	92	05/10→	→	für Doppelbereifung		<b>13.0460-4857.2 604857</b>	BRE 25172 18,4 + WK
2.3 CDTI FWD (FV)	96	11/16→	→	für Einfachbereifung		<b>13.0460-4858.2 604858</b>	BRE 25112 18,4 + WK
2.3 CDTI FWD (FV)	100	05/14→					
2.3 CDTI FWD (FV)	107	05/10→					
2.3 CDTI FWD (FV)	110	01/13→					
2.3 CDTI FWD (FV)	120	05/14→					
2.3 CDTI FWD (FV)	125	11/16→					
2.3 CDTI RWD (FV)	74	05/10→					
2.3 CDTI RWD (FV)	92	05/10→					
2.3 CDTI RWD (FV)	96	11/16→					
2.3 CDTI RWD (FV)	100	05/14→					
2.3 CDTI RWD (FV)	107	05/10→					
2.3 CDTI RWD (FV)	110	01/13→					
2.3 CDTI RWD (FV)	120	05/14→					
2.3 CDTI FWD (FV)	81	02/12→	←	05/14→		<b>13.0460-4856.2 604856</b>	BRE 25147 18,4 + WK
			→	05/14→; für Doppelbereifung		<b>13.0460-4857.2 604857</b>	BRE 25172 18,4 + WK
			→	05/14→; für Einfachbereifung		<b>13.0460-4858.2 604858</b>	BRE 25112 18,4 + WK
 <b>Bremsscheibe</b>							
2.3 CDTI FWD (FV)	74	05/10→	←			<b>24.0128-0252.1 428252</b>	Ø 302 28 24,5 V + S
2.3 CDTI FWD (FV)	92	05/10→	→			<b>24.0112-0191.1 412191</b>	Ø 305 12 10 + S
2.3 CDTI FWD (FV)	96	11/16→					
2.3 CDTI FWD (FV)	100	05/14→					
2.3 CDTI FWD (FV)	107	05/10→					
2.3 CDTI FWD (FV)	110	01/13→					
2.3 CDTI FWD (FV)	120	05/14→					
2.3 CDTI FWD (FV)	125	11/16→					
2.3 CDTI FWD (FV)	81	02/12→	←	05/14→		<b>24.0128-0252.1 428252</b>	Ø 302 28 24,5 V + S
			→	05/14→		<b>24.0112-0191.1 412191</b>	Ø 305 12 10 + S
2.3 CDTI RWD (FV)	74	05/10→	←			<b>24.0128-0252.1 428252</b>	Ø 302 28 24,5 V + S
2.3 CDTI RWD (FV)	92	05/10→	→	für Einfachbereifung		<b>24.0112-0190.1 412190</b>	Ø 305 12 10 + S
2.3 CDTI RWD (FV)	96	11/16→	→	für Doppelbereifung		<b>24.0118-0153.1 418153</b>	Ø 302 18 15
2.3 CDTI RWD (FV)	100	05/14→					
2.3 CDTI RWD (FV)	107	05/10→					
2.3 CDTI RWD (FV)	110	01/13→					
2.3 CDTI RWD (FV)	120	05/14→					
<b>OPEL - MOVANO B Pritsche/Fahrgestell (X62) 05/10→</b>							
 <b>Bremsbelagsatz, Scheibenbremse</b>							
2.3 CDTI FWD (EV, HV, UV)	74	05/10→	←			<b>13.0460-4856.2 604856</b>	BRE 25147 18,4 + WK
2.3 CDTI FWD (EV, HV, UV)	81	05/14→	→	für Doppelbereifung		<b>13.0460-4857.2 604857</b>	BRE 25172 18,4 + WK
2.3 CDTI FWD (EV, HV, UV)	92	05/10→	→	für Einfachbereifung		<b>13.0460-4858.2 604858</b>	BRE 25112 18,4 + WK
2.3 CDTI FWD (EV, HV, UV)	96	11/16→					
2.3 CDTI FWD (EV, HV, UV)	100	05/14→					
2.3 CDTI FWD (EV, HV, UV)	107	05/10→					
2.3 CDTI FWD (EV, HV, UV)	110	01/13→					
2.3 CDTI FWD (EV, HV, UV)	120	05/14→					
2.3 CDTI FWD (EV, HV, UV)	125	11/16→					
↓							

	kw			 	! #		
<b>OPEL - MOVANO B Pritsche/Fahrgestell (X62) 05/10→</b>							
 <b>Bremsbelagsatz, Scheibenbremse</b>							
2.3 CDTI RWD (EV, HV, UV)	74	05/10→	←			<b>13.0460-4856.2 604856</b>	BRE 25147 18,4 + WK
2.3 CDTI RWD (EV, HV, UV)	92	05/10→	→	für Doppelbereifung		<b>13.0460-4857.2 604857</b>	BRE 25172 18,4 + WK
2.3 CDTI RWD (EV, HV, UV)	96	11/16→	→	für Einfachbereifung		<b>13.0460-4858.2 604858</b>	BRE 25112 18,4 + WK
2.3 CDTI RWD (EV, HV, UV)	100	05/14→					
2.3 CDTI RWD (EV, HV, UV)	107	05/10→					
2.3 CDTI RWD (EV, HV, UV)	110	01/13→					
2.3 CDTI RWD (EV, HV, UV)	120	05/14→					
 <b>Bremsscheibe</b>							
2.3 CDTI FWD (EV, HV, UV)	74	05/10→	←			<b>24.0128-0252.1 428252</b>	Ø 302 28 24,5 V + S
2.3 CDTI FWD (EV, HV, UV)	81	05/14→	→			<b>24.0112-0191.1 412191</b>	Ø 305 12 10 + S
2.3 CDTI FWD (EV, HV, UV)	92	05/10→					
2.3 CDTI FWD (EV, HV, UV)	96	11/16→					
2.3 CDTI FWD (EV, HV, UV)	100	05/14→					
2.3 CDTI FWD (EV, HV, UV)	107	05/10→					
2.3 CDTI FWD (EV, HV, UV)	110	01/13→					
2.3 CDTI FWD (EV, HV, UV)	120	05/14→					
2.3 CDTI FWD (EV, HV, UV)	125	11/16→					
2.3 CDTI RWD (EV, HV, UV)	74	05/10→	←			<b>24.0128-0252.1 428252</b>	Ø 302 28 24,5 V + S
2.3 CDTI RWD (EV, HV, UV)	92	05/10→	→	für Einfachbereifung		<b>24.0112-0190.1 412190</b>	Ø 305 12 10 + S
2.3 CDTI RWD (EV, HV, UV)	96	11/16→	→	für Doppelbereifung		<b>24.0118-0153.1 418153</b>	Ø 302 18 15
2.3 CDTI RWD (EV, HV, UV)	100	05/14→					
2.3 CDTI RWD (EV, HV, UV)	107	05/10→					
2.3 CDTI RWD (EV, HV, UV)	110	01/13→					
2.3 CDTI RWD (EV, HV, UV)	120	05/14→					
<b>OPEL - MOVANO Combi (X70) 07/98→</b>							
 <b>Bremsbelagsatz, Scheibenbremse</b>							
1.9 DTI (JD)	59	09/00→10/01	←	passend für Felgengröße [Zoll]: 16		<b>13.0460-3800.2 603800</b>	BOS 23613 17,7 - WE / - WK
2.5 D (JD)	59	07/98→09/00	←	passend für Felgengröße [Zoll]: 15		<b>13.0460-3946.2 603946</b>	BDX 23302 18,0 + WE / - WK
2.8 DTI (JD)	84	07/98→10/01	→			<b>13.0460-3806.2 603806</b>	BOS 23669 16,8 - WE / - WK
1.9 DTI (JD)	60	10/01→	←	→ 01/10;		<b>13.0460-3800.2 603800</b>	BOS 23613 17,7 - WE / - WK
2.2 DTI (JD)	66	09/00→	←	passend für Felgengröße [Zoll]: 16			
2.5 CDTI (JD)	74	09/07→	←	→ 01/10;		<b>13.0460-3946.2 603946</b>	BDX 23302 18,0 + WE / - WK
2.5 DTI (JD)	84	10/01→	→	passend für Felgengröße [Zoll]: 15			
3.0 DTI (JD)	100	10/03→	→	→ 01/10		<b>13.0460-3806.2 603806</b>	BOS 23669 16,8 - WE / - WK
2.5 CDTI (JD)	73	10/03→12/06	←	09/06→;		<b>13.0460-3800.2 603800</b>	BOS 23613 17,7 - WE / - WK
			←	passend für Felgengröße [Zoll]: 16			
			←	09/06→;		<b>13.0460-3946.2 603946</b>	BDX 23302 18,0 + WE / - WK
			→	passend für Felgengröße [Zoll]: 15			
			→	09/06→		<b>13.0460-3806.2 603806</b>	BOS 23669 16,8 - WE / - WK
2.5 CDTI (JD)	88	08/06→	←	09/06→ 01/10;		<b>13.0460-3800.2 603800</b>	BOS 23613 17,7 - WE / - WK
2.5 CDTI (JD)	107	08/06→	←	passend für Felgengröße [Zoll]: 16			
			←	09/06→ 01/10;		<b>13.0460-3946.2 603946</b>	BDX 23302 18,0 + WE / - WK
			→	passend für Felgengröße [Zoll]: 15			
			→	09/06→ 01/10		<b>13.0460-3806.2 603806</b>	BOS 23669 16,8 - WE / - WK
<b>Zubehörsatz, Scheibenbremsbelag</b>							
1.9 DTI (JD)	59	09/00→10/01	←	passend für Felgengröße [Zoll]: 16		<b>13.0460-0344.2 610344</b>	
2.5 D (JD)	59	07/98→09/00					
2.8 DTI (JD)	84	07/98→10/01					
1.9 DTI (JD)	60	10/01→	←	→ 01/10;		<b>13.0460-0344.2 610344</b>	
2.2 DTI (JD)	66	09/00→		passend für Felgengröße [Zoll]: 16			
↓							





















	kw			 	! #			
<b>OPEL - MOVANO Combi (X70) 07/98→</b>								
<b>Zubehörsatz, Scheibenbremsbelag</b>								
2.5 CDTI (JD)	74	09/07→	←	→ 01/10;		13.0460-0344.2	610344	
2.5 DTI (JD)	84	10/01→		passend für Felgengröße [Zoll]: 16				
3.0 DTi (JD)	100	10/03→						
2.5 CDTI (JD)	73	10/03→12/06	←	09/06→;		13.0460-0344.2	610344	
				passend für Felgengröße [Zoll]: 16				
2.5 CDTI (JD)	88	08/06→	←	09/06→ 01/10;		13.0460-0344.2	610344	
2.5 CDTI (JD)	107	08/06→		passend für Felgengröße [Zoll]: 16				
<b> Bremsscheibe</b>								
1.9 DTI (JD)	59	09/00→10/01	←	passend für Felgengröße [Zoll]: 15		24.0124-0162.1	424162	Ø 280 24 21 V
2.5 D (JD)	59	07/98→09/00	←	passend für Felgengröße [Zoll]: 16		24.0128-0129.1	428129	Ø 305,5 28 25 V + S
2.8 DTi (JD)	84	07/98→10/01				24.0328-0129.1	528129	Ø 305,5 28 25 V + S
			→			24.0112-0155.1	412155	Ø 305 12 10,5 + S
1.9 DTI (JD)	60	10/01→	←	→ 01/10;		24.0124-0162.1	424162	Ø 280 24 21 V
2.2 DTI (JD)	66	09/00→		passend für Felgengröße [Zoll]: 15				
2.5 CDTI (JD)	74	09/07→	←	→ 01/10;		24.0128-0129.1	428129	Ø 305,5 28 25 V + S
2.5 DTI (JD)	84	10/01→		passend für Felgengröße [Zoll]: 16		24.0328-0129.1	528129	Ø 305,5 28 25 V + S
3.0 DTi (JD)	100	10/03→	→	→ 01/10		24.0112-0155.1	412155	Ø 305 12 10,5 + S
2.5 CDTI (JD)	73	10/03→12/06	←	09/06→;		24.0124-0162.1	424162	Ø 280 24 21 V
				passend für Felgengröße [Zoll]: 15				
			←	09/06→;		24.0128-0129.1	428129	Ø 305,5 28 25 V + S
				passend für Felgengröße [Zoll]: 16		24.0328-0129.1	528129	Ø 305,5 28 25 V + S
			→	09/06→		24.0112-0155.1	412155	Ø 305 12 10,5 + S
2.5 CDTI (JD)	88	08/06→	←	09/06→ 01/10;		24.0124-0162.1	424162	Ø 280 24 21 V
2.5 CDTI (JD)	107	08/06→		passend für Felgengröße [Zoll]: 15				
			←	09/06→ 01/10;		24.0128-0129.1	428129	Ø 305,5 28 25 V + S
				passend für Felgengröße [Zoll]: 16		24.0328-0129.1	528129	Ø 305,5 28 25 V + S
			→	09/06→ 01/10		24.0112-0155.1	412155	Ø 305 12 10,5 + S
<b>OPEL - MOVANO Kasten (X70) 01/99→</b>								
<b> Bremsbelagsatz, Scheibenbremse</b>								
1.9 DTI (FD)	59	09/00→10/01	←	passend für Felgengröße [Zoll]: 16		13.0460-3800.2	603800	BOS 23613 17,7 - WE / - WK
2.5 D (FD)	59	01/99→09/00	←	passend für Felgengröße [Zoll]: 15		13.0460-3946.2	603946	BDX 23302 18,0 + WE / - WK
2.8 DTi (FD)	84	01/99→10/01				13.0460-3806.2	603806	BOS 23669 16,8 - WE / - WK
			→					
1.9 DTI (FD)	60	10/01→	←	→ 01/10;		13.0460-3800.2	603800	BOS 23613 17,7 - WE / - WK
2.2 DTI (FD)	66	09/00→		passend für Felgengröße [Zoll]: 16				
2.5 DTi (FD)	73	10/03→	←	→ 01/10;		13.0460-3946.2	603946	BDX 23302 18,0 + WE / - WK
2.5 DTI (FD)	84	10/01→		passend für Felgengröße [Zoll]: 15				
3.0 DTi (FD)	100	10/03→	→	→ 01/10		13.0460-3806.2	603806	BOS 23669 16,8 - WE / - WK
2.5 CDTI (FD)	74	10/03→	←	09/06→ 01/10;		13.0460-3800.2	603800	BOS 23613 17,7 - WE / - WK
2.5 CDTI (FD)	88	10/03→		passend für Felgengröße [Zoll]: 16				
2.5 CDTI (FD)	107	10/03→	←	09/06→ 01/10;		13.0460-3946.2	603946	BDX 23302 18,0 + WE / - WK
				passend für Felgengröße [Zoll]: 15				
			→	09/06→ 01/10		13.0460-3806.2	603806	BOS 23669 16,8 - WE / - WK
<b>Zubehörsatz, Scheibenbremsbelag</b>								
1.9 DTI (FD)	59	09/00→10/01	←	passend für Felgengröße [Zoll]: 16		13.0460-0344.2	610344	
2.5 D (FD)	59	01/99→09/00						
2.8 DTi (FD)	84	01/99→10/01						
1.9 DTI (FD)	60	10/01→	←	→ 01/10;		13.0460-0344.2	610344	
2.2 DTI (FD)	66	09/00→		passend für Felgengröße [Zoll]: 16				
2.5 DTi (FD)	73	10/03→						
2.5 DTI (FD)	84	10/01→						
3.0 DTi (FD)	100	10/03→						
2.5 CDTI (FD)	74	10/03→	←	09/06→ 01/10;		13.0460-0344.2	610344	
2.5 CDTI (FD)	88	10/03→		passend für Felgengröße [Zoll]: 16				
2.5 CDTI (FD)	107	10/03→						
<b> Bremsscheibe</b>								
1.9 DTI (FD)	59	09/00→10/01	←	passend für Felgengröße [Zoll]: 15		24.0124-0162.1	424162	Ø 280 24 21 V
2.5 D (FD)	59	01/99→09/00	←	passend für Felgengröße [Zoll]: 16		24.0128-0129.1	428129	Ø 305,5 28 25 V + S
2.8 DTi (FD)	84	01/99→10/01				24.0328-0129.1	528129	Ø 305,5 28 25 V + S
			→			24.0112-0155.1	412155	Ø 305 12 10,5 + S
1.9 DTI (FD)	60	10/01→	←	→ 01/10;		24.0124-0162.1	424162	Ø 280 24 21 V
2.2 DTI (FD)	66	09/00→		passend für Felgengröße [Zoll]: 15				
2.5 DTi (FD)	73	10/03→	←	→ 01/10;		24.0128-0129.1	428129	Ø 305,5 28 25 V + S
2.5 DTI (FD)	84	10/01→		passend für Felgengröße [Zoll]: 16		24.0328-0129.1	528129	Ø 305,5 28 25 V + S
3.0 DTi (FD)	100	10/03→						









	kw			 	! #		
<b>OPEL - MOVANO Kasten (X70) 01/99→</b>							
 <b>Bremsscheibe</b>							
1.9 DTI (FD)	60	10/01→	→	→ 01/10		24.0112-0155.1 412155	Ø 305 12 10,5 + S
2.2 DTI (FD)	66	09/00→					
2.5 DTI (FD)	73	10/03→					
2.5 DTI (FD)	84	10/01→					
3.0 DTI (FD)	100	10/03→					
2.5 CDTI (FD)	74	10/03→	←	09/06→ 01/10; passend für Felgenreöße [Zoll]: 15		24.0124-0162.1 424162	Ø 280 24 21 V
2.5 CDTI (FD)	88	10/03→					
2.5 CDTI (FD)	107	10/03→	←	09/06→ 01/10; passend für Felgenreöße [Zoll]: 16		24.0128-0129.1 428129 24.0328-0129.1 528129	Ø 305,5 28 25 V + S Ø 305,5 28 25 V + S
			→	09/06→ 01/10		24.0112-0155.1 412155	Ø 305 12 10,5 + S
<b>OPEL - MOVANO Kipper (X70) 01/99→</b>							
 <b>Bremsbelagsatz, Scheibenbremse</b>							
2.2 DTI (ED, HD, UD0, UD4)	66	09/00→	←	→ 01/10; passend für Felgenreöße [Zoll]: 16		13.0460-3800.2 603800	BOS 23613 17,7 - WE / - WK
2.5 DTI (ED, HD, UD0, UD4)	73	10/03→	←	→ 01/10; passend für Felgenreöße [Zoll]: 15		13.0460-3946.2 603946	BDX 23302 18,0 + WE / - WK
2.5 DTI (ED, HD, UD0, UD4)	84	10/01→	→	→ 01/10		13.0460-3806.2 603806	BOS 23669 16,8 - WE / - WK
3.0 DTI (ED, HD, UD0, UD4)	100	10/03→					
2.5 CDTI (ED, HD, UD0, UD4)	74	08/06→	←	09/06→ 01/10; passend für Felgenreöße [Zoll]: 16		13.0460-3800.2 603800	BOS 23613 17,7 - WE / - WK
2.5 CDTI (ED, HD, UD0, UD4)	88	08/06→	←	09/06→ 01/10; passend für Felgenreöße [Zoll]: 15		13.0460-3946.2 603946	BDX 23302 18,0 + WE / - WK
2.5 CDTI (ED, HD, UD0, UD4)	107	08/06→	→	09/06→ 01/10		13.0460-3806.2 603806	BOS 23669 16,8 - WE / - WK
2.5 D (ED, HD, UD0, UD4)	59	01/99→09/00	←	passend für Felgenreöße [Zoll]: 16		13.0460-3800.2 603800	BOS 23613 17,7 - WE / - WK
2.8 DTI (ED, HD, UD0, UD4)	84	01/99→10/01	←	passend für Felgenreöße [Zoll]: 15		13.0460-3946.2 603946	BDX 23302 18,0 + WE / - WK
			→			13.0460-3806.2 603806	BOS 23669 16,8 - WE / - WK
<b>Zubehörsatz, Scheibenbremsbelag</b>							
2.2 DTI (ED, HD, UD0, UD4)	66	09/00→	←	→ 01/10; passend für Felgenreöße [Zoll]: 16		13.0460-0344.2 610344	
2.5 DTI (ED, HD, UD0, UD4)	73	10/03→					
2.5 DTI (ED, HD, UD0, UD4)	84	10/01→					
3.0 DTI (ED, HD, UD0, UD4)	100	10/03→					
2.5 CDTI (ED, HD, UD0, UD4)	74	08/06→	←	09/06→ 01/10; passend für Felgenreöße [Zoll]: 16		13.0460-0344.2 610344	
2.5 CDTI (ED, HD, UD0, UD4)	88	08/06→					
2.5 CDTI (ED, HD, UD0, UD4)	107	08/06→					
2.5 D (ED, HD, UD0, UD4)	59	01/99→09/00	←	passend für Felgenreöße [Zoll]: 16		13.0460-0344.2 610344	
2.8 DTI (ED, HD, UD0, UD4)	84	01/99→10/01					
 <b>Bremsscheibe</b>							
2.2 DTI (ED, HD, UD0, UD4)	66	09/00→	←	→ 01/10; passend für Felgenreöße [Zoll]: 15		24.0124-0162.1 424162	Ø 280 24 21 V
2.5 DTI (ED, HD, UD0, UD4)	73	10/03→	←	→ 01/10; passend für Felgenreöße [Zoll]: 16		24.0128-0129.1 428129 24.0328-0129.1 528129	Ø 305,5 28 25 V + S Ø 305,5 28 25 V + S
2.5 DTI (ED, HD, UD0, UD4)	84	10/01→	→	→ 01/10		24.0112-0155.1 412155	Ø 305 12 10,5 + S
3.0 DTI (ED, HD, UD0, UD4)	100	10/03→					
2.5 CDTI (ED, HD, UD0, UD4)	74	08/06→	←	09/06→ 01/10; passend für Felgenreöße [Zoll]: 15		24.0124-0162.1 424162	Ø 280 24 21 V
2.5 CDTI (ED, HD, UD0, UD4)	88	08/06→	←	09/06→ 01/10; passend für Felgenreöße [Zoll]: 16		24.0128-0129.1 428129 24.0328-0129.1 528129	Ø 305,5 28 25 V + S Ø 305,5 28 25 V + S
2.5 CDTI (ED, HD, UD0, UD4)	107	08/06→	→	09/06→ 01/10		24.0112-0155.1 412155	Ø 305 12 10,5 + S
2.5 D (ED, HD, UD0, UD4)	59	01/99→09/00	←	passend für Felgenreöße [Zoll]: 15		24.0124-0162.1 424162	Ø 280 24 21 V
2.8 DTI (ED, HD, UD0, UD4)	84	01/99→10/01	←	passend für Felgenreöße [Zoll]: 16		24.0128-0129.1 428129 24.0328-0129.1 528129	Ø 305,5 28 25 V + S Ø 305,5 28 25 V + S
			→			24.0112-0155.1 412155	Ø 305 12 10,5 + S











	kw				! #		
<b>OPEL - MOVANO Pritsche/Fahrgestell (X70) 07/98→</b>							
 <b>Bremsbelagsatz, Scheibenbremse</b>							
2.2 DTI (ED, HD, UD0, UD4)	66	09/00→	←	→ 01/10; passend für Felgengröße [Zoll]: 16		<b>13.0460-3800.2 603800</b>	BOS 23613 17,7 - WE / - WK
2.5 DTi (ED, HD, UD0, UD4)	73	10/03→	←	→ 01/10; passend für Felgengröße [Zoll]: 15		<b>13.0460-3946.2 603946</b>	BDX 23302 18,0 + WE / - WK
2.5 DTI (ED, HD, UD0, UD4)	84	10/01→	→	→ 01/10		<b>13.0460-3806.2 603806</b>	BOS 23669 16,8 - WE / - WK
3.0 DTI (ED, HD, UD0, UD4)	100	10/03→					
2.5 CDTI (ED, HD, UD0, UD4)	74	08/06→	←	09/06→ 01/10; passend für Felgengröße [Zoll]: 16		<b>13.0460-3800.2 603800</b>	BOS 23613 17,7 - WE / - WK
2.5 CDTI (ED, HD, UD0, UD4)	88	08/06→	←	09/06→ 01/10; passend für Felgengröße [Zoll]: 15		<b>13.0460-3946.2 603946</b>	BDX 23302 18,0 + WE / - WK
2.5 CDTI (ED, HD, UD0, UD4)	107	08/06→	→	09/06→ 01/10		<b>13.0460-3806.2 603806</b>	BOS 23669 16,8 - WE / - WK
2.5 D (ED, HD, UD0, UD4)	59	07/98→09/00	←	passend für Felgengröße [Zoll]: 16		<b>13.0460-3800.2 603800</b>	BOS 23613 17,7 - WE / - WK
2.8 DTI (ED, HD, UD0, UD4)	84	07/98→10/01	←	passend für Felgengröße [Zoll]: 15		<b>13.0460-3946.2 603946</b>	BDX 23302 18,0 + WE / - WK
			→			<b>13.0460-3806.2 603806</b>	BOS 23669 16,8 - WE / - WK
<b>Zubehörsatz, Scheibenbremsbelag</b>							
2.2 DTI (ED, HD, UD0, UD4)	66	09/00→	←	→ 01/10; passend für Felgengröße [Zoll]: 16		<b>13.0460-0344.2 610344</b>	
2.5 DTi (ED, HD, UD0, UD4)	73	10/03→					
2.5 DTI (ED, HD, UD0, UD4)	84	10/01→					
3.0 DTI (ED, HD, UD0, UD4)	100	10/03→					
2.5 CDTI (ED, HD, UD0, UD4)	74	08/06→	←	09/06→ 01/10; passend für Felgengröße [Zoll]: 16		<b>13.0460-0344.2 610344</b>	
2.5 CDTI (ED, HD, UD0, UD4)	88	08/06→					
2.5 CDTI (ED, HD, UD0, UD4)	107	08/06→					
2.5 D (ED, HD, UD0, UD4)	59	07/98→09/00	←	passend für Felgengröße [Zoll]: 16		<b>13.0460-0344.2 610344</b>	
2.8 DTI (ED, HD, UD0, UD4)	84	07/98→10/01					
 <b>Bremsscheibe</b>							
2.2 DTI (ED, HD, UD0, UD4)	66	09/00→	←	→ 01/10; passend für Felgengröße [Zoll]: 15		<b>24.0124-0162.1 424162</b>	Ø 280 24 21 V
2.5 DTi (ED, HD, UD0, UD4)	73	10/03→	←	→ 01/10; passend für Felgengröße [Zoll]: 16		<b>24.0128-0129.1 428129</b>	Ø 305,5 28 25 V + S
2.5 DTI (ED, HD, UD0, UD4)	84	10/01→				<b>24.0328-0129.1 528129</b>	Ø 305,5 28 25 V + S
3.0 DTI (ED, HD, UD0, UD4)	100	10/03→	→	→ 01/10		<b>24.0112-0155.1 412155</b>	Ø 305 12 10,5 + S
2.5 CDTI (ED, HD, UD0, UD4)	74	08/06→	←	09/06→ 01/10; passend für Felgengröße [Zoll]: 15		<b>24.0124-0162.1 424162</b>	Ø 280 24 21 V
2.5 CDTI (ED, HD, UD0, UD4)	88	08/06→	←	09/06→ 01/10; passend für Felgengröße [Zoll]: 16		<b>24.0128-0129.1 428129</b>	Ø 305,5 28 25 V + S
2.5 CDTI (ED, HD, UD0, UD4)	107	08/06→	→	09/06→ 01/10		<b>24.0328-0129.1 528129</b>	Ø 305,5 28 25 V + S
						<b>24.0112-0155.1 412155</b>	Ø 305 12 10,5 + S
2.5 D (ED, HD, UD0, UD4)	59	07/98→09/00	←	passend für Felgengröße [Zoll]: 15		<b>24.0124-0162.1 424162</b>	Ø 280 24 21 V
2.8 DTI (ED, HD, UD0, UD4)	84	07/98→10/01	←	passend für Felgengröße [Zoll]: 16		<b>24.0128-0129.1 428129</b>	Ø 305,5 28 25 V + S
						<b>24.0328-0129.1 528129</b>	Ø 305,5 28 25 V + S
			→			<b>24.0112-0155.1 412155</b>	Ø 305 12 10,5 + S
<b>OPEL - OMEGA B (V94) 03/94→07/03</b>							
 <b>Bremsbelagsatz, Scheibenbremse</b>							
2.0 (F69, M69, P69)	85	03/94→09/99	←	W1000001→		<b>13.0460-2815.2 602815</b>	TRW 21368 18,3 - WK
2.0 16V (F69, M69, P69)	100	03/94→09/99	←	→ V1999999; nicht für Sonderfahrzeuge / nicht für Polizei-fahrzeuge		<b>13.0460-7080.2 607080</b>	ATE 21411 17,5 - WK
			→			<b>13.0460-4040.2 604040</b>	ATE 21050 15,8 - WE / - WK
2.0 (F69, M69, P69)	85	03/94→12/00	←	W1000001→; → 09/99		<b>13.0460-2815.2 602815</b>	TRW 21368 18,3 - WK
			←	→ V1999999; nicht für Sonderfahrzeuge / nicht für Polizei-fahrzeuge		<b>13.0460-7080.2 607080</b>	ATE 21411 17,5 - WK
			→	→ 09/99		<b>13.0460-4040.2 604040</b>	ATE 21050 15,8 - WE / - WK
2.0 DTI 16V (F69, M69, P69)	74	09/97→09/00	←	→ 08/00		<b>13.0460-2815.2 602815</b>	TRW 21368 18,3 - WK
			→	→ 08/00		<b>13.0460-4040.2 604040</b>	ATE 21050 15,8 - WE / - WK
↓							









	kw			 	! #		
<b>OPEL - OMEGA B (V94) 03/94→07/03</b>							
<b> Bremsbelagsatz, Scheibenbremse</b>							
2.2 16V (F69, M69, P69)	106	09/99→07/03	←	10/99→		<b>13.0460-2815.2 602815</b>	TRW 21368 18,3 - WK
			→	10/99→		<b>13.0460-4040.2 604040</b>	ATE 21050 15,8 - WE / - WK
2.2 DTI 16V (F69, M69, P69)	81	09/00→07/03	←			<b>13.0460-2815.2 602815</b>	TRW 21368 18,3 - WK
2.2 DTI 16V (F69, M69, P69)	88	09/00→07/03	→			<b>13.0460-4040.2 604040</b>	ATE 21050 15,8 - WE / - WK
2.5 D (F69, M69, P69)	96	05/94→05/99					
2.5 DTI (F69, M69, P69)	110	09/01→07/03					
2.5 TD (F69, M69, P69)	96	04/94→07/03					
2.5 V6 (F69, M69, P69)	125	03/94→09/00					
2.6 V6 (F69, M69, P69)	132	09/00→07/03					
3.2 V6 (F69, M69, P69)	160	02/01→07/03					
3.0 V6 (F69, M69, P69)	155	04/94→02/01	←	→ 01/01		<b>13.0460-2815.2 602815</b>	TRW 21368 18,3 - WK
			→	→ 01/01		<b>13.0460-4040.2 604040</b>	ATE 21050 15,8 - WE / - WK
<b>Warnkontakt, Bremsbelagverschleiß</b>							
2.0 (F69, M69, P69)	85	03/94→09/99	←	→ V1999999; nicht für Sonderfahrzeuge / nicht für Polizei- fahrzeuge	2	<b>24.8190-0710.2 620710</b>	L= 730
2.0 16V (F69, M69, P69)	100	03/94→09/99	←	W1000001→	2	<b>24.8190-0711.2 620711</b>	L= 730
2.0 (F69, M69, P69)	85	03/94→12/00	←	→ V1999999; nicht für Sonderfahrzeuge / nicht für Polizei- fahrzeuge	2	<b>24.8190-0710.2 620710</b>	L= 730
			←	W1000001→; → 09/99	2	<b>24.8190-0711.2 620711</b>	L= 730
2.0 DTI 16V (F69, M69, P69)	74	09/97→09/00	←	→ 08/00	2	<b>24.8190-0711.2 620711</b>	L= 730
2.2 16V (F69, M69, P69)	106	09/99→07/03	←	10/99→	2	<b>24.8190-0711.2 620711</b>	L= 730
2.2 DTI 16V (F69, M69, P69)	81	09/00→07/03	←		2	<b>24.8190-0711.2 620711</b>	L= 730
2.2 DTI 16V (F69, M69, P69)	88	09/00→07/03					
2.5 D (F69, M69, P69)	96	05/94→05/99					
2.5 DTI (F69, M69, P69)	110	09/01→07/03					
2.5 TD (F69, M69, P69)	96	04/94→07/03					
2.5 V6 (F69, M69, P69)	125	03/94→09/00					
2.6 V6 (F69, M69, P69)	132	09/00→07/03					
3.2 V6 (F69, M69, P69)	160	02/01→07/03					
3.0 V6 (F69, M69, P69)	155	04/94→02/01	←	→ 01/01	2	<b>24.8190-0711.2 620711</b>	L= 730
<b>Zubehörsatz, Scheibenbremsbelag</b>							
2.0 (F69, M69, P69)	85	03/94→09/99	→			<b>13.0460-0246.2 610246</b>	
2.0 16V (F69, M69, P69)	100	03/94→09/99					
2.2 DTI 16V (F69, M69, P69)	81	09/00→07/03					
2.2 DTI 16V (F69, M69, P69)	88	09/00→07/03					
2.5 D (F69, M69, P69)	96	05/94→05/99					
2.5 DTI (F69, M69, P69)	110	09/01→07/03					
2.5 TD (F69, M69, P69)	96	04/94→07/03					
2.5 V6 (F69, M69, P69)	125	03/94→09/00					
2.6 V6 (F69, M69, P69)	132	09/00→07/03					
3.2 V6 (F69, M69, P69)	160	02/01→07/03					
2.0 (F69, M69, P69)	85	03/94→12/00	→	→ 09/99		<b>13.0460-0246.2 610246</b>	
2.0 DTI 16V (F69, M69, P69)	74	09/97→09/00	→	→ 08/00		<b>13.0460-0246.2 610246</b>	
2.2 16V (F69, M69, P69)	106	09/99→07/03	→	10/99→		<b>13.0460-0246.2 610246</b>	
3.0 V6 (F69, M69, P69)	155	04/94→02/01	→	→ 01/01		<b>13.0460-0246.2 610246</b>	
<b> Bremsscheibe</b>							
2.0 (F69, M69, P69)	85	03/94→09/99	←	→ V1999999; nicht für Sonderfahrzeuge / nicht für Polizei- fahrzeuge		<b>24.0124-0119.1 424119</b>	Ø 286 24 21 V
2.0 16V (F69, M69, P69)	100	03/94→09/99	←	W1000001→		<b>24.0128-0104.1 428104</b>	Ø 296 28 25 V + S
			→			<b>24.0112-0131.1 412131</b>	Ø 286 12 10
						<b>24.0120-0171.1 420171</b>	Ø 286 20 18 V
2.0 (F69, M69, P69)	85	03/94→12/00	←	→ V1999999; nicht für Sonderfahrzeuge / nicht für Polizei- fahrzeuge		<b>24.0124-0119.1 424119</b>	Ø 286 24 21 V
			←	W1000001→; → 09/99		<b>24.0128-0104.1 428104</b>	Ø 296 28 25 V + S
			→	→ 09/99		<b>24.0112-0131.1 412131</b>	Ø 286 12 10
						<b>24.0120-0171.1 420171</b>	Ø 286 20 18 V
↓							













	kw			 	! #		
<b>OPEL - OMEGA B (V94) 03/94→07/03</b>							
<b>Bremsscheibe</b>							
2.0 DTI 16V (F69, M69, P69)	74	09/97→09/00	←	→ 08/00		24.0128-0104.1 428104	∅ 296 28 25 V + S
			→	→ 08/00		24.0112-0131.1 412131	∅ 286 12 10
2.2 16V (F69, M69, P69)	106	09/99→07/03	←	10/99→		24.0128-0104.1 428104	∅ 296 28 25 V + S
			→	10/99→		24.0112-0131.1 412131	∅ 286 12 10
2.2 DTI 16V (F69, M69, P69)	81	09/00→07/03	←			24.0128-0104.1 428104	∅ 296 28 25 V + S
			→			24.0112-0131.1 412131	∅ 286 12 10
2.2 DTI 16V (F69, M69, P69)	88	09/00→07/03	→			24.0120-0171.1 420171	∅ 286 20 18 V
2.5 D (F69, M69, P69)	96	05/94→05/99					
2.5 DTI (F69, M69, P69)	110	09/01→07/03					
2.5 TD (F69, M69, P69)	96	04/94→07/03					
2.5 V6 (F69, M69, P69)	125	03/94→09/00					
2.6 V6 (F69, M69, P69)	132	09/00→07/03					
3.2 V6 (F69, M69, P69)	160	02/01→07/03					
3.0 V6 (F69, M69, P69)	155	04/94→02/01	←	→ 01/01		24.0128-0104.1 428104	∅ 296 28 25 V + S
			→	→ 01/01		24.0112-0131.1 412131	∅ 286 12 10
						24.0120-0171.1 420171	∅ 286 20 18 V
<b>OPEL - OMEGA B Caravan (V94) 03/94→07/03</b>							
<b>Bremsbelagsatz, Scheibenbremse</b>							
2.0 (F35, M35, P35)	85	03/94→09/99	←	W1000001→		13.0460-2815.2 602815	TRW 21368 18,3 - WK
			→	→ V1999999; nicht für Sonderfahrzeuge / nicht für Polizei- fahrzeuge		13.0460-7080.2 607080	ATE 21411 17,5 - WK
2.0 16V (F35, M35, P35)	100	03/94→09/99	→			13.0460-4040.2 604040	ATE 21050 15,8 - WE / - WK
2.0 DTI 16V (F35, M35, P35)	74	09/97→09/00	←	→ 08/00		13.0460-2815.2 602815	TRW 21368 18,3 - WK
			→	→ 08/00		13.0460-4040.2 604040	ATE 21050 15,8 - WE / - WK
2.2 16V (F35, M35, P35)	106	09/99→07/03	←	10/99→		13.0460-2815.2 602815	TRW 21368 18,3 - WK
			→	10/99→		13.0460-4040.2 604040	ATE 21050 15,8 - WE / - WK
2.2 DTI 16V (F35, M35, P35)	81	09/00→07/03	←			13.0460-2815.2 602815	TRW 21368 18,3 - WK
			→			13.0460-4040.2 604040	ATE 21050 15,8 - WE / - WK
2.2 DTI 16V (F35, M35, P35)	88	09/00→07/03					
2.5 DTI (F35, M35, P35)	110	09/01→07/03					
2.5 TD (F35, M35, P35)	96	04/94→07/01					
2.5 V6 (F35, M35, P35)	125	03/94→09/00					
2.6 V6 (F35, M35, P35)	132	09/00→07/03					
3.2 V6 (F35, M35, P35)	160	02/01→07/03					
3.0 V6 (F35, M35, P35)	155	04/94→02/01	←	→ 01/01		13.0460-2815.2 602815	TRW 21368 18,3 - WK
			→	→ 01/01		13.0460-4040.2 604040	ATE 21050 15,8 - WE / - WK
<b>Warnkontakt, Bremsbelagverschleiß</b>							
2.0 (F35, M35, P35)	85	03/94→09/99	←	→ V1999999; nicht für Sonderfahrzeuge / nicht für Polizei- fahrzeuge	2	24.8190-0710.2 620710	L= 730
			→	W1000001→	2	24.8190-0711.2 620711	L= 730
2.0 16V (F35, M35, P35)	100	03/94→09/99	←	→ 08/00	2	24.8190-0711.2 620711	L= 730
2.2 16V (F35, M35, P35)	106	09/99→07/03	←	10/99→	2	24.8190-0711.2 620711	L= 730
2.2 DTI 16V (F35, M35, P35)	81	09/00→07/03	←		2	24.8190-0711.2 620711	L= 730
			→				
2.2 DTI 16V (F35, M35, P35)	88	09/00→07/03					
2.5 DTI (F35, M35, P35)	110	09/01→07/03					
2.5 TD (F35, M35, P35)	96	04/94→07/01					
2.5 V6 (F35, M35, P35)	125	03/94→09/00					
2.6 V6 (F35, M35, P35)	132	09/00→07/03					
3.2 V6 (F35, M35, P35)	160	02/01→07/03					
3.0 V6 (F35, M35, P35)	155	04/94→02/01	←	→ 01/01	2	24.8190-0711.2 620711	L= 730
<b>Zubehörsatz, Scheibenbremsbelag</b>							
2.0 (F35, M35, P35)	85	03/94→09/99	→			13.0460-0246.2 610246	
2.0 16V (F35, M35, P35)	100	03/94→09/99					
2.2 DTI 16V (F35, M35, P35)	81	09/00→07/03					
2.2 DTI 16V (F35, M35, P35)	88	09/00→07/03					
2.5 DTI (F35, M35, P35)	110	09/01→07/03					
2.5 TD (F35, M35, P35)	96	04/94→07/01					
↓							













	kw			 	! #		
<b>OPEL - OMEGA B Caravan (V94) 03/94→07/03</b>							
<b>Zubehörsatz, Scheibenbremsbelag</b>							
2.5 V6 (F35, M35, P35)	125	03/94→09/00	➡			13.0460-0246.2	610246
2.6 V6 (F35, M35, P35)	132	09/00→07/03					
3.2 V6 (F35, M35, P35)	160	02/01→07/03					
2.0 DTI 16V (F35, M35, P35)	74	09/97→09/00	➡	→ 08/00		13.0460-0246.2	610246
2.2 16V (F35, M35, P35)	106	09/99→07/03	➡	10/99→		13.0460-0246.2	610246
3.0 V6 (F35, M35, P35)	155	04/94→02/01	➡	→ 01/01		13.0460-0246.2	610246
<b> Bremsscheibe</b>							
2.0 (F35, M35, P35)	85	03/94→09/99	⬅	→ V1999999;		24.0124-0119.1	424119
2.0 16V (F35, M35, P35)	100	03/94→09/99		nicht für Sonderfahrzeuge / nicht für Polizeifahrzeuge			∅ 286 24 21 V
			⬅	W1000001→		24.0128-0104.1	428104
			➡			24.0112-0131.1	412131
						24.0120-0171.1	420171
							∅ 286 12 10
							∅ 286 20 18 V
2.0 DTI 16V (F35, M35, P35)	74	09/97→09/00	⬅	→ 08/00		24.0128-0104.1	428104
			➡	→ 08/00		24.0112-0131.1	412131
						24.0120-0171.1	420171
							∅ 296 28 25 V + S
2.2 16V (F35, M35, P35)	106	09/99→07/03	⬅	10/99→		24.0128-0104.1	428104
			➡	10/99→		24.0112-0131.1	412131
						24.0120-0171.1	420171
							∅ 296 28 25 V + S
2.2 DTI 16V (F35, M35, P35)	81	09/00→07/03	⬅			24.0128-0104.1	428104
2.2 DTI 16V (F35, M35, P35)	88	09/00→07/03	➡			24.0112-0131.1	412131
2.5 DTI (F35, M35, P35)	110	09/01→07/03				24.0120-0171.1	420171
2.5 TD (F35, M35, P35)	96	04/94→07/01					∅ 286 12 10
2.5 V6 (F35, M35, P35)	125	03/94→09/00					∅ 286 20 18 V
2.6 V6 (F35, M35, P35)	132	09/00→07/03					
3.2 V6 (F35, M35, P35)	160	02/01→07/03					
3.0 V6 (F35, M35, P35)	155	04/94→02/01	⬅	→ 01/01		24.0128-0104.1	428104
			➡	→ 01/01		24.0112-0131.1	412131
						24.0120-0171.1	420171
							∅ 296 28 25 V + S
							∅ 286 12 10
							∅ 286 20 18 V
<b>OPEL - SIGNUM CC (Z03) 05/03→12/08</b>							
<b> Bremsbelagsatz, Scheibenbremse</b>							
1.8 (F48)	90	05/03→07/05	⬅	für Bremssattel mit Kunststoffkolben		13.0460-7172.2	607172
1.9 CDTI (F48)	88	04/04→02/08				13.0470-7172.2	LD7172
1.9 CDTI (F48)	110	04/04→02/08					ATE 23378 20,1 + WE / - WK Ceramic
2.0 DTI (F48)	74	05/03→04/04	⬅	für Bremssattel mit Stahlkolben		13.0460-7212.2	607212
2.2 DTI (F48)	92	05/03→04/04	➡	→ 41096248 / 48091178		13.0460-7194.2	607194
						13.0470-7194.2	LD7194
							ATE 23482 16,6 - WE / - WK Ceramic
			➡	41096249 / 48091179→		13.0460-7195.2	607195
						13.0470-7195.2	LD7195
							ATE 23482 16,6 - WE / - WK Ceramic
1.8 (F48)	103	09/05→12/08	⬅	→ 05/08;		13.0460-7172.2	607172
				für Bremssattel mit Kunststoffkolben		13.0470-7172.2	LD7172
			⬅	→ 05/08; für Bremssattel mit Stahlkolben		13.0460-7212.2	607212
			➡	→ 05/08		13.0460-7194.2	607194
						13.0460-7195.2	607195
						13.0470-7194.2	LD7194
							ATE 23482 16,6 - WE / - WK Ceramic
						13.0470-7195.2	LD7195
							ATE 23482 16,6 - WE / - WK Ceramic
1.9 CDTI (F48)	74	08/05→02/08	⬅	für Bremssattel mit Kunststoffkolben		13.0460-7172.2	607172
			⬅	für Bremssattel mit Stahlkolben		13.0460-7212.2	607212
			➡			13.0460-7194.2	607194
						13.0460-7195.2	607195
						13.0470-7194.2	LD7194
							ATE 23482 16,6 - WE / - WK Ceramic
						13.0470-7195.2	LD7195
							ATE 23482 16,6 - WE / - WK Ceramic
↓							











	kw			 	! #		
<b>OPEL - SIGNUM CC (Z03) 05/03→12/08</b>							
<b> Bremsbelagsatz, Scheibenbremse</b>							
2.0 Turbo (F48) 2.2 direct (F48)	129 114	05/03→12/08 05/03→09/08	←	→ 05/08; für Bremssattel mit Kunststoffkolben		<b>13.0460-7172.2 607172</b>	ATE 23378 20,1 + WE / - WK
						<b>13.0470-7172.2 LD7172</b>	ATE 23378 20,1 + WE / - WK Ceramic
			←	→ 05/08; für Bremssattel mit Stahlkolben		<b>13.0460-7212.2 607212</b>	ATE 23738 20,1 + WE / - WK
			→	→ 41096248 / 48091178		<b>13.0460-7194.2 607194</b> <b>13.0470-7194.2 LD7194</b>	ATE 23482 16,6 - WE / - WK Ceramic
			→	41096249 / 48091179 →; → 05/08		<b>13.0460-7195.2 607195</b> <b>13.0470-7195.2 LD7195</b>	ATE 23482 16,6 - WE / - WK Ceramic
2.8 V6 Turbo (F48) 3.0 V6 CDTI (F48)	169 135	09/05→12/08 09/05→12/08	←	61000001→; → 05/08		<b>13.0460-7199.2 607199</b>	ATE 23404 20,6 + WE / - WK
			→	→ 05/08		<b>13.0460-7194.2 607194</b> <b>13.0460-7195.2 607195</b> <b>13.0470-7194.2 LD7194</b> <b>13.0470-7195.2 LD7195</b>	ATE 23482 16,6 - WE / - WK Ceramic
2.8 V6 Turbo (F48)	184	01/06→12/08	←	03/06→ 05/08		<b>13.0460-7199.2 607199</b>	ATE 23404 20,6 + WE / - WK
			→	03/06→ 05/08		<b>13.0460-7194.2 607194</b> <b>13.0460-7195.2 607195</b> <b>13.0470-7194.2 LD7194</b> <b>13.0470-7195.2 LD7195</b>	ATE 23482 16,6 - WE / - WK Ceramic
							ATE 23482 16,6 - WE / - WK Ceramic
							ATE 23482 16,6 - WE / - WK Ceramic
3.0 V6 CDTI (F48) 3.2 V6 (F48)	130 155	05/03→07/05 05/03→07/05	←	→ 31068238; für Bremssattel mit Kunststoffkolben		<b>13.0460-7172.2 607172</b> <b>13.0470-7172.2 LD7172</b>	ATE 23378 20,1 + WE / - WK Ceramic
			←	31068239→		<b>13.0460-7199.2 607199</b>	ATE 23404 20,6 + WE / - WK
			←	→ 31068238; für Bremssattel mit Stahlkolben		<b>13.0460-7212.2 607212</b>	ATE 23738 20,1 + WE / - WK
			→	→ 41096248 / 48091178		<b>13.0460-7194.2 607194</b> <b>13.0470-7194.2 LD7194</b>	ATE 23482 16,6 - WE / - WK Ceramic
			→	41096249 / 48091179→		<b>13.0460-7195.2 607195</b> <b>13.0470-7195.2 LD7195</b>	ATE 23482 16,6 - WE / - WK Ceramic
<b>Warnkontakt, Bremsbelagverschleiß</b>							
1.8 (F48)	90	05/03→07/05	←	bis Bj. 08.2004	1	<b>24.8190-0719.2 620719</b>	L= 685,5
1.9 CDTI (F48)	74	08/05→02/08	←	ab Bj. 09.2004	1	<b>24.8190-0720.2 620720</b>	L= 287
1.9 CDTI (F48)	88	04/04→02/08					
1.9 CDTI (F48)	110	04/04→02/08					
2.0 DTI (F48)	74	05/03→04/04					
2.2 DTI (F48)	92	05/03→04/04					
1.8 (F48) 2.0 Turbo (F48)	103 129	09/05→12/08 05/03→12/08	←	→ 05/08; bis Bj. 08.2004	1	<b>24.8190-0719.2 620719</b>	L= 685,5
			←	→ 05/08; ab Bj. 09.2004	1	<b>24.8190-0720.2 620720</b>	L= 287
2.8 V6 Turbo (F48) 3.0 V6 CDTI (F48)	169 135	09/05→12/08 09/05→12/08	←	61000001→; → 05/08; bis ChNr. 41048790	1	<b>24.8190-0721.2 620721</b>	L= 700
			←	61000001→; → 05/08; ab ChNr. 41048791	1	<b>24.8190-0722.2 620722</b>	L= 302
2.8 V6 Turbo (F48)	184	01/06→12/08	←	03/06→ 05/08; bis ChNr. 41048790	1	<b>24.8190-0721.2 620721</b>	L= 700
			←	03/06→ 05/08; ab ChNr. 41048791	1	<b>24.8190-0722.2 620722</b>	L= 302
3.0 V6 CDTI (F48) 3.2 V6 (F48)	130 155	05/03→07/05 05/03→07/05	←	→ 31068238; bis Bj. 08.2004	1	<b>24.8190-0719.2 620719</b>	L= 685,5
			←	→ 31068238; ab Bj. 09.2004	1	<b>24.8190-0720.2 620720</b>	L= 287
			←	31068239→; bis ChNr. 41048790	1	<b>24.8190-0721.2 620721</b>	L= 700
			←	31068239→; ab ChNr. 41048791	1	<b>24.8190-0722.2 620722</b>	L= 302
<b> Bremsscheibe</b>							
1.8 (F48) 1.9 CDTI (F48)	90 88	05/03→07/05 04/04→02/08	←	für Fahrzeuge ohne Sportfahrwerk		<b>24.0125-0141.1 425141</b> <b>24.0325-0141.1 525141</b>	Ø 285 24,9 22 V + S
			←	für Fahrzeuge mit Sportfahrwerk		<b>24.0128-0137.1 428137</b> <b>24.0328-0137.1 528137</b>	Ø 302 28 25 V + S
1.9 CDTI (F48) 2.0 DTI (F48)	110 74	04/04→02/08 05/03→04/04	←			<b>24.0112-0157.1 412157</b> <b>24.0120-0173.1 420173</b>	Ø 278 11,9 10 + S
			→			<b>24.0312-0157.1 512157</b>	Ø 292 19,9 18 V + S
2.2 DTI (F48)	92	05/03→04/04				<b>24.0312-0157.1 512157</b>	Ø 278 11,9 10 + S







	kw			 	! #		
<b>OPEL - SIGNUM CC (Z03) 05/03→12/08</b>							
 <b>Bremsscheibe</b>							
1.8 (F48)	90	05/03→07/05	➔			24.0320-0173.1 520173	Ø 292 19,9 18 V + S
1.9 CDTI (F48)	88	04/04→02/08					
1.9 CDTI (F48)	110	04/04→02/08					
2.0 DTI (F48)	74	05/03→04/04					
2.2 DTI (F48)	92	05/03→04/04					
1.8 (F48)	103	09/05→12/08	➔	→ 05/08; nicht für Polizeifahrzeuge; für Fahrzeuge mit Sportfahrwerk		24.0125-0141.1 425141 24.0325-0141.1 525141	Ø 285 24,9 22 V + S Ø 285 24,9 22 V + S
			➔	→ 05/08; für Polizeifahrzeuge; für Fahrzeuge mit Sportfahrwerk		24.0128-0137.1 428137 24.0328-0137.1 528137	Ø 302 28 25 V + S Ø 302 28 25 V + S
			➔	→ 05/08		24.0112-0157.1 412157 24.0120-0173.1 420173 24.0312-0157.1 512157 24.0320-0173.1 520173	Ø 278 11,9 10 + S Ø 292 19,9 18 V + S Ø 278 11,9 10 + S Ø 292 19,9 18 V + S
1.9 CDTI (F48)	74	08/05→02/08	➔	nicht für Polizeifahrzeuge		24.0125-0141.1 425141 24.0325-0141.1 525141	Ø 285 24,9 22 V + S Ø 285 24,9 22 V + S
			➔	für Polizeifahrzeuge		24.0128-0137.1 428137 24.0328-0137.1 528137	Ø 302 28 25 V + S Ø 302 28 25 V + S
			➔			24.0112-0157.1 412157 24.0120-0173.1 420173 24.0312-0157.1 512157 24.0320-0173.1 520173	Ø 278 11,9 10 + S Ø 292 19,9 18 V + S Ø 278 11,9 10 + S Ø 292 19,9 18 V + S
2.0 Turbo (F48)	129	05/03→12/08	➔	→ 05/08		24.0128-0137.1 428137 24.0328-0137.1 528137	Ø 302 28 25 V + S Ø 302 28 25 V + S
			➔	→ 05/08		24.0120-0173.1 420173 24.0320-0173.1 520173	Ø 292 19,9 18 V + S Ø 292 19,9 18 V + S
2.2 direct (F48)	114	05/03→09/08	➔	für Fahrzeuge ohne Sportfahrwerk; → 05/08		24.0125-0141.1 425141 24.0325-0141.1 525141	Ø 285 24,9 22 V + S Ø 285 24,9 22 V + S
			➔	für Fahrzeuge mit Sportfahrwerk; → 05/08		24.0128-0137.1 428137 24.0328-0137.1 528137	Ø 302 28 25 V + S Ø 302 28 25 V + S
			➔	→ 05/08		24.0112-0157.1 412157 24.0120-0173.1 420173 24.0312-0157.1 512157 24.0320-0173.1 520173	Ø 278 11,9 10 + S Ø 292 19,9 18 V + S Ø 278 11,9 10 + S Ø 292 19,9 18 V + S
2.8 V6 Turbo (F48)	169	09/05→12/08	➔	61000001→; → 05/08		24.0128-0164.1 428164	Ø 314 28 25 V + S
3.0 V6 CDTI (F48)	135	09/05→12/08	➔	→ 05/08		24.0112-0157.1 412157 24.0120-0173.1 420173 24.0312-0157.1 512157 24.0320-0173.1 520173	Ø 278 11,9 10 + S Ø 292 19,9 18 V + S Ø 278 11,9 10 + S Ø 292 19,9 18 V + S
2.8 V6 Turbo (F48)	184	01/06→12/08	➔	03/06→ 05/08		24.0128-0164.1 428164	Ø 314 28 25 V + S
			➔	03/06→ 05/08		24.0112-0157.1 412157 24.0120-0173.1 420173 24.0312-0157.1 512157 24.0320-0173.1 520173	Ø 278 11,9 10 + S Ø 292 19,9 18 V + S Ø 278 11,9 10 + S Ø 292 19,9 18 V + S
3.0 V6 CDTI (F48)	130	05/03→07/05	➔	→ 31068238		24.0128-0137.1 428137 24.0328-0137.1 528137	Ø 302 28 25 V + S Ø 302 28 25 V + S
3.2 V6 (F48)	155	05/03→07/05	➔	31068239→		24.0128-0164.1 428164	Ø 314 28 25 V + S
			➔			24.0120-0173.1 420173 24.0320-0173.1 520173	Ø 292 19,9 18 V + S Ø 292 19,9 18 V + S
<b>OPEL - SINTRA (APV) 11/96→04/99</b>							
 <b>Bremsbelagsatz, Scheibenbremse</b>							
2.2 DTI	85	07/97→04/99	➔			13.0460-8002.2 608002	23358 18,0 + WK
2.2 i 16V (OUN16, Y94)	104	11/96→04/99					
3.0 i 24V (OUN16, Y94)	148	11/96→04/99	➔			13.0460-8011.2 608011	23361 14,2 + WK
 <b>Bremsscheibe</b>							
2.2 DTI	85	07/97→04/99	➔			24.0132-0110.1 432110	Ø 278 32,2 30,7 V
2.2 i 16V (OUN16, Y94)	104	11/96→04/99					
3.0 i 24V (OUN16, Y94)	148	11/96→04/99	➔			24.0111-0133.1 411133	Ø 278 11 9
<b>OPEL - SPEEDSTER (E01) 06/00→08/06</b>							
 <b>Bremsscheibe</b>							
2.0 Turbo (R97)	147	08/02→08/06	➔	→ 09/05		24.0125-0119.1 425119 24.0325-0119.1 525119	Ø 288 25 22 V + S Ø 288 25 22 V + S
↓							











	kW					! #		
<b>OPEL - SPEEDSTER (E01) 06/00→08/06</b>								
 <b>Bremsscheibe</b>								
2.0 Turbo (R97)	147	08/02→08/06	➔	→ 09/05			24.0125-0119.1 425119 24.0325-0119.1 525119	Ø 288 25 22 V + S Ø 288 25 22 V + S
2.2 (R97)	108	06/00→08/05	➔				24.0125-0119.1 425119 24.0325-0119.1 525119	Ø 288 25 22 V + S Ø 288 25 22 V + S
			➔				24.0125-0119.1 425119 24.0325-0119.1 525119	Ø 288 25 22 V + S Ø 288 25 22 V + S
			➔				24.0125-0119.1 425119 24.0325-0119.1 525119	Ø 288 25 22 V + S Ø 288 25 22 V + S
<b>OPEL - TIGRA (S93) 07/94→12/00</b>								
 <b>Bremsbelagsatz, Scheibenbremse</b>								
1.4 16V (F07)	63	08/97→12/00	➔				13.0460-7051.2 607051	ATE 20547 16,5 + WE / - WK
1.4 16V (F07)	66	07/94→12/00						
1.6 16V (F07)	74	08/97→08/98						
1.6 16V (F07)	78	07/94→08/98						
 <b>Bremsscheibe</b>								
1.4 16V (F07)	63	08/97→12/00	➔				24.0120-0140.1 420140	Ø 256 20 17 V + S
1.4 16V (F07)	66	07/94→12/00						
1.6 16V (F07)	74	08/97→08/98						
1.6 16V (F07)	78	07/94→08/98						
<b>OPEL - TIGRA TwinTop (X04) 06/04→12/10</b>								
 <b>Bremsbelagsatz, Scheibenbremse</b>								
1.3 CDTI (R97)	51	06/04→12/10	➔	→ 08/09			13.0460-2857.2 602857	TRW 23225 17,0 + WK + Zub
1.4 (R97)	66	06/04→12/10					13.0470-2857.2 LD2857	TRW 23225 17,0 + WK + Zub Ceramic
1.8 (R97)	92	06/04→12/10						
			➔	→Orga 6E999999			13.0460-2858.2 602858 13.0470-2858.2 LD2858	TRW 23284 14,0 + WK TRW 23284 14,0 + WK Ceramic
			➔	Orga 7E000001→; → 08/09			13.0460-2858.2 602858 13.0470-2858.2 LD2858	TRW 23284 14,0 + WK TRW 23284 14,0 + WK Ceramic
 <b>Bremsscheibe</b>								
1.3 CDTI (R97)	51	06/04→12/10	➔	→ 08/09			24.0124-0166.1 424166	Ø 260 24 21 V + S
1.4 (R97)	66	06/04→12/10					24.0324-0166.1 524166	Ø 260 24 21 V
1.8 (R97)	92	06/04→12/10						
			➔	→ 08/09			24.0110-0268.1 410268	Ø 240 10,2 8,2
<b>OPEL - VECTRA B (J96) 09/95→04/02</b>								
 <b>Bremsbelagsatz, Scheibenbremse</b>								
1.6 i (F19)	55	10/95→04/02	➔	→ W7999999			13.0460-7052.2 607052	ATE 21190 17,5 + WE / - WK
2.0 DI 16V (F19)	60	11/96→04/02	➔	X1000001→			13.0460-7091.2 607091	ATE 21829 20,3 + WE / - WK
1.6 i 16V (F19)	74	10/95→04/02	➔	→ W7999999			13.0460-7052.2 607052	ATE 21190 17,5 + WE / - WK
1.8 i 16V (F19)	85	10/95→09/00						
1.8 i 16V (F19)	92	09/00→04/02	➔	X1000001→			13.0460-7091.2 607091	ATE 21829 20,3 + WE / - WK
2.0 DTI 16V (F19)	74	06/97→04/02	➔				13.0460-4040.2 604040	ATE 21050 15,8 - WE / - WK
1.7 TD (F19)	60	10/95→12/98	➔	→ 11/96			13.0460-7052.2 607052	ATE 21190 17,5 + WE / - WK
			➔	→ 11/96			13.0460-4040.2 604040	ATE 21050 15,8 - WE / - WK
2.0 i (F19)	82	10/95→04/02	➔				13.0460-7091.2 607091	ATE 21829 20,3 + WE / - WK
2.0 i 16V (F19)	100	10/95→06/00						
2.2 DTI 16V (F19)	88	09/00→04/02	➔				13.0460-4040.2 604040	ATE 21050 15,8 - WE / - WK
2.2 DTI 16V (F19)	92	09/00→04/02						
2.2 i 16V (F19)	108	09/00→04/02						
2.5 i V6 (F19)	125	10/95→09/00						
2.6 i V6 (F19)	125	09/00→04/02						
i 500 2.5 (F19)	143	05/98→09/00						
<b>Warnkontakt, Bremsbelagverschleiß</b>								
1.6 i (F19)	55	10/95→04/02	➔	X1000001→	2	24.8190-0714.2 620714	L= 660	
1.6 i 16V (F19)	74	10/95→04/02						
1.8 i 16V (F19)	85	10/95→09/00	➔	→ W7999999	2	24.8190-0715.2 620715	L= 660	
1.8 i 16V (F19)	92	09/00→04/02						
2.0 DI 16V (F19)	60	11/96→04/02						
2.0 DTI 16V (F19)	74	06/97→04/02						
1.7 TD (F19)	60	10/95→12/98	➔	→ 11/96	2	24.8190-0715.2 620715	L= 660	
2.0 i (F19)	82	10/95→04/02	➔		2	24.8190-0714.2 620714	L= 660	
2.0 i 16V (F19)	100	10/95→06/00						
2.2 DTI 16V (F19)	88	09/00→04/02						
2.2 DTI 16V (F19)	92	09/00→04/02						
2.2 i 16V (F19)	108	09/00→04/02						
2.5 i V6 (F19)	125	10/95→09/00						
2.6 i V6 (F19)	125	09/00→04/02						
↓								

	kw			 	! #		
<b>OPEL - VECTRA B (J96) 09/95→04/02</b>							
<b>Zubehörsatz, Scheibenbremsbelag</b>							
1.6 i 16V (F19)	74	10/95→04/02	➔			13.0460-0347.2 610347	
1.8 i 16V (F19)	85	10/95→09/00					
1.8 i 16V (F19)	92	09/00→04/02					
2.0 DTI 16V (F19)	74	06/97→04/02					
2.0 i (F19)	82	10/95→04/02					
2.0 i 16V (F19)	100	10/95→06/00					
2.2 DTI 16V (F19)	88	09/00→04/02					
2.2 DTI 16V (F19)	92	09/00→04/02					
2.2 i 16V (F19)	108	09/00→04/02					
2.5 i V6 (F19)	125	10/95→09/00					
2.6 i V6 (F19)	125	09/00→04/02					
i 500 2.5 (F19)	143	05/98→09/00					
1.7 TD (F19)	60	10/95→12/98	➔	→ 11/96		13.0460-0347.2 610347	
<b> Bremsscheibe</b>							
1.6 i (F19)	55	10/95→04/02	➔	→ W7999999		24.0124-0115.1 424115	Ø 256 24 21 V + S
2.0 DI 16V (F19)	60	11/96→04/02				24.0324-0115.1 524115	Ø 256 24 21 V + S
			➔	X1000001→		24.0125-0119.1 425119	Ø 288 25 22 V + S
						24.0325-0119.1 525119	Ø 288 25 22 V + S
1.6 i 16V (F19)	74	10/95→04/02	➔	→ W7999999		24.0124-0115.1 424115	Ø 256 24 21 V + S
1.8 i 16V (F19)	85	10/95→09/00				24.0324-0115.1 524115	Ø 256 24 21 V + S
1.8 i 16V (F19)	92	09/00→04/02					
2.0 DTI 16V (F19)	74	06/97→04/02	➔	X1000001→		24.0125-0119.1 425119	Ø 288 25 22 V + S
						24.0325-0119.1 525119	Ø 288 25 22 V + S
			➔	→ W7999999		24.0110-0225.1 410225	Ø 270 10 8 + S
						24.0310-0225.1 510225	Ø 270 10 8 + S
			➔	X1000001→		24.0110-0226.1 410226	Ø 286 10 8 + S
						24.0310-0226.1 510226	Ø 286 10 8 + S
1.7 TD (F19)	60	10/95→12/98	➔	→ 11/96		24.0124-0115.1 424115	Ø 256 24 21 V + S
						24.0324-0115.1 524115	Ø 256 24 21 V + S
			➔	→ 11/96		24.0110-0225.1 410225	Ø 270 10 8 + S
						24.0310-0225.1 510225	Ø 270 10 8 + S
2.0 i (F19)	82	10/95→04/02	➔			24.0125-0119.1 425119	Ø 288 25 22 V + S
2.0 i 16V (F19)	100	10/95→06/00				24.0325-0119.1 525119	Ø 288 25 22 V + S
2.2 DTI 16V (F19)	88	09/00→04/02					
2.2 DTI 16V (F19)	92	09/00→04/02	➔			24.0110-0226.1 410226	Ø 286 10 8 + S
2.2 i 16V (F19)	108	09/00→04/02				24.0310-0226.1 510226	Ø 286 10 8 + S
2.5 i V6 (F19)	125	10/95→09/00					
2.6 i V6 (F19)	125	09/00→04/02					
i 500 2.5 (F19)	143	05/98→09/00	➔			24.0125-0142.1 425142	Ø 308 25 22 V + S
						24.0325-0142.1 525142	Ø 308 25 23 V + S
			➔			24.0110-0226.1 410226	Ø 286 10 8 + S
						24.0310-0226.1 510226	Ø 286 10 8 + S
<b>OPEL - VECTRA B Caravan (J96) 11/96→07/03</b>							
<b> Bremsbelagsatz, Scheibenbremse</b>							
1.6 i (F35)	55	11/96→06/00	➔	→ W7999999		13.0460-7052.2 607052	ATE 21190 17,5 + WE / - WK
			➔	X1000001→		13.0460-7091.2 607091	ATE 21829 20,3 + WE / - WK
1.6 i 16V (F35)	74	11/96→07/02	➔	→ W7999999		13.0460-7052.2 607052	ATE 21190 17,5 + WE / - WK
1.8 i 16V (F35)	92	09/00→07/03					
2.0 DTI 16V (F35)	74	06/97→07/03	➔	X1000001→; → 04/02		13.0460-7091.2 607091	ATE 21829 20,3 + WE / - WK
			➔	→ 04/02		13.0460-4040.2 604040	ATE 21050 15,8 - WE / - WK
1.7 TD (F35)	60	11/96→12/97	➔	→ 11/96		13.0460-7052.2 607052	ATE 21190 17,5 + WE / - WK
			➔	→ 11/96		13.0460-4040.2 604040	ATE 21050 15,8 - WE / - WK
1.8 i 16V (F35)	85	11/96→09/00	➔	→ W7999999		13.0460-7052.2 607052	ATE 21190 17,5 + WE / - WK
2.0 DI 16V (F35)	60	11/96→06/00	➔	X1000001→		13.0460-7091.2 607091	ATE 21829 20,3 + WE / - WK
			➔			13.0460-4040.2 604040	ATE 21050 15,8 - WE / - WK
2.0 i (F35)	82	11/96→02/02	➔			13.0460-7091.2 607091	ATE 21829 20,3 + WE / - WK
2.0 i 16V (F35)	100	11/96→09/00					
2.2 DTI 16V (F35)	88	09/00→04/02	➔			13.0460-4040.2 604040	ATE 21050 15,8 - WE / - WK
2.5 i V6 (F35)	125	11/96→09/00					
i 500 2.5 (F35)	143	05/98→09/00					
2.2 DTI 16V (F35)	92	09/00→07/03	➔	→ 04/02		13.0460-7091.2 607091	ATE 21829 20,3 + WE / - WK
2.2 i 16V (F35)	108	09/00→07/03					
2.6 i V6 (F35)	125	09/00→07/03	➔	→ 04/02		13.0460-4040.2 604040	ATE 21050 15,8 - WE / - WK
<b>Warnkontakt, Bremsbelagverschleiß</b>							
1.6 i (F35)	55	11/96→06/00	➔	X1000001→	2	24.8190-0714.2 620714	L= 660
1.8 i 16V (F35)	85	11/96→09/00					
2.0 DI 16V (F35)	60	11/96→06/00	➔	→ W7999999	2	24.8190-0715.2 620715	L= 660
↓							



















	kW			 	! #		
<b>OPEL - VECTRA B Caravan (J96) 11/96→07/03</b>							
<b>Warnkontakt, Bremsbelagverschleiß</b>							
1.6 i 16V (F35)	74	11/96→07/02	←	X1000001→; → 04/02	2	24.8190-0714.2 620714	L= 660
1.8 i 16V (F35)	92	09/00→07/03	←	→ W7999999	2	24.8190-0715.2 620715	L= 660
2.0 DTI 16V (F35)	74	06/97→07/03	←				
1.7 TD (F35)	60	11/96→12/97	←	→ 11/96	2	24.8190-0715.2 620715	L= 660
2.0 i (F35)	82	11/96→02/02	←		2	24.8190-0714.2 620714	L= 660
2.0 i 16V (F35)	100	11/96→09/00					
2.2 DTI 16V (F35)	88	09/00→04/02					
2.5 i V6 (F35)	125	11/96→09/00					
2.2 DTI 16V (F35)	92	09/00→07/03	←	→ 04/02	2	24.8190-0714.2 620714	L= 660
2.2 i 16V (F35)	108	09/00→07/03					
2.6 i V6 (F35)	125	09/00→07/03					
<b>Zubehörsatz, Scheibenbremsbelag</b>							
1.6 i 16V (F35)	74	11/96→07/02	→	→ 04/02		13.0460-0347.2 610347	
1.8 i 16V (F35)	92	09/00→07/03					
2.0 DTI 16V (F35)	74	06/97→07/03					
2.2 DTI 16V (F35)	92	09/00→07/03					
2.2 i 16V (F35)	108	09/00→07/03					
2.6 i V6 (F35)	125	09/00→07/03					
1.7 TD (F35)	60	11/96→12/97	→	→ 11/96		13.0460-0347.2 610347	
1.8 i 16V (F35)	85	11/96→09/00	→			13.0460-0347.2 610347	
2.0 DI 16V (F35)	60	11/96→06/00					
2.0 i (F35)	82	11/96→02/02					
2.0 i 16V (F35)	100	11/96→09/00					
2.2 DTI 16V (F35)	88	09/00→04/02					
2.5 i V6 (F35)	125	11/96→09/00					
i 500 2.5 (F35)	143	05/98→09/00					
<b>Bremsscheibe</b>							
1.6 i (F35)	55	11/96→06/00	←	→ W7999999		24.0124-0115.1 424115	Ø 256 24 21 V + S
			←	X1000001→		24.0324-0115.1 524115	Ø 256 24 21 V + S
			←	X1000001→		24.0125-0119.1 425119	Ø 288 25 22 V + S
			←	X1000001→		24.0325-0119.1 525119	Ø 288 25 22 V + S
1.6 i 16V (F35)	74	11/96→07/02	←	→ W7999999		24.0124-0115.1 424115	Ø 256 24 21 V + S
1.8 i 16V (F35)	92	09/00→07/03	←	→ W7999999		24.0324-0115.1 524115	Ø 256 24 21 V + S
2.0 DTI 16V (F35)	74	06/97→07/03	←	X1000001→; → 04/02		24.0125-0119.1 425119	Ø 288 25 22 V + S
			←	X1000001→; → 04/02		24.0325-0119.1 525119	Ø 288 25 22 V + S
			→	→ W7999999		24.0110-0225.1 410225	Ø 270 10 8 + S
			→	→ W7999999		24.0310-0225.1 510225	Ø 270 10 8 + S
			→	X1000001→; → 04/02		24.0110-0226.1 410226	Ø 286 10 8 + S
			→	X1000001→; → 04/02		24.0310-0226.1 510226	Ø 286 10 8 + S
1.7 TD (F35)	60	11/96→12/97	←	→ 11/96		24.0124-0115.1 424115	Ø 256 24 21 V + S
			←	→ 11/96		24.0324-0115.1 524115	Ø 256 24 21 V + S
			→	→ 11/96		24.0110-0225.1 410225	Ø 270 10 8 + S
			→	→ 11/96		24.0310-0225.1 510225	Ø 270 10 8 + S
1.8 i 16V (F35)	85	11/96→09/00	←	→ W7999999		24.0124-0115.1 424115	Ø 256 24 21 V + S
2.0 DI 16V (F35)	60	11/96→06/00	←	X1000001→		24.0324-0115.1 524115	Ø 256 24 21 V + S
			←	X1000001→		24.0125-0119.1 425119	Ø 288 25 22 V + S
			←	X1000001→		24.0325-0119.1 525119	Ø 288 25 22 V + S
			→	→ W7999999		24.0110-0225.1 410225	Ø 270 10 8 + S
			→	→ W7999999		24.0310-0225.1 510225	Ø 270 10 8 + S
			→	X1000001→		24.0110-0226.1 410226	Ø 286 10 8 + S
			→	X1000001→		24.0310-0226.1 510226	Ø 286 10 8 + S
2.0 i (F35)	82	11/96→02/02	←			24.0125-0119.1 425119	Ø 288 25 22 V + S
2.0 i 16V (F35)	100	11/96→09/00				24.0325-0119.1 525119	Ø 288 25 22 V + S
2.2 DTI 16V (F35)	88	09/00→04/02				24.0110-0226.1 410226	Ø 286 10 8 + S
2.5 i V6 (F35)	125	11/96→09/00	→			24.0310-0226.1 510226	Ø 286 10 8 + S
2.2 DTI 16V (F35)	92	09/00→07/03	←	→ 04/02		24.0125-0119.1 425119	Ø 288 25 22 V + S
2.2 i 16V (F35)	108	09/00→07/03	←	→ 04/02		24.0325-0119.1 525119	Ø 288 25 22 V + S
2.6 i V6 (F35)	125	09/00→07/03	→	→ 04/02		24.0110-0226.1 410226	Ø 286 10 8 + S
			→	→ 04/02		24.0310-0226.1 510226	Ø 286 10 8 + S
i 500 2.5 (F35)	143	05/98→09/00	←			24.0125-0142.1 425142	Ø 308 25 22 V + S
			←			24.0325-0142.1 525142	Ø 308 25 23 V + S
			→			24.0110-0226.1 410226	Ø 286 10 8 + S
			→			24.0310-0226.1 510226	Ø 286 10 8 + S









	kw			 	! #		
<b>OPEL - VECTRA B CC (J96) 10/95→07/03</b>							
<b> Bremsbelagsatz, Scheibenbremse</b>							
1.6 i (F68)	55	10/95→07/03	←	→ W7999999		<b>13.0460-7052.2 607052</b>	ATE 21190 17,5 + WE / - WK
			←	X1000001→; → 04/02		<b>13.0460-7091.2 607091</b>	ATE 21829 20,3 + WE / - WK
1.6 i 16V (F68)	74	10/95→07/02	←	→ W7999999		<b>13.0460-7052.2 607052</b>	ATE 21190 17,5 + WE / - WK
1.8 i 16V (F68)	92	09/00→07/03	←	→ W7999999		<b>13.0460-7052.2 607052</b>	ATE 21190 17,5 + WE / - WK
2.0 DTI 16V (F68)	74	06/97→07/03	←	X1000001→; → 04/02		<b>13.0460-7091.2 607091</b>	ATE 21829 20,3 + WE / - WK
			→	→ 04/02		<b>13.0460-4040.2 604040</b>	ATE 21050 15,8 - WE / - WK
1.7 TD (F68)	60	10/95→12/98	←	→ 11/96		<b>13.0460-7052.2 607052</b>	ATE 21190 17,5 + WE / - WK
			→	→ 11/96		<b>13.0460-4040.2 604040</b>	ATE 21050 15,8 - WE / - WK
1.8 i 16V (F68)	85	10/95→09/00	←	→ W7999999		<b>13.0460-7052.2 607052</b>	ATE 21190 17,5 + WE / - WK
			←	X1000001→		<b>13.0460-7091.2 607091</b>	ATE 21829 20,3 + WE / - WK
			→			<b>13.0460-4040.2 604040</b>	ATE 21050 15,8 - WE / - WK
2.0 DI 16V (F68)	60	11/96→06/00	←	→ W7999999		<b>13.0460-7052.2 607052</b>	ATE 21190 17,5 + WE / - WK
			←	X1000001→		<b>13.0460-7091.2 607091</b>	ATE 21829 20,3 + WE / - WK
2.0 i (F68)	82	10/95→02/02	←			<b>13.0460-7091.2 607091</b>	ATE 21829 20,3 + WE / - WK
2.0 i 16V (F68)	100	10/95→06/00	→			<b>13.0460-4040.2 604040</b>	ATE 21050 15,8 - WE / - WK
2.2 DTI 16V (F68)	88	09/00→04/02	→			<b>13.0460-4040.2 604040</b>	ATE 21050 15,8 - WE / - WK
2.5 (F68)	144	10/99→06/00					
2.5 i V6 (F68)	125	10/95→09/00					
2.2 DTI 16V (F68)	92	09/00→07/03	←	→ 04/02		<b>13.0460-7091.2 607091</b>	ATE 21829 20,3 + WE / - WK
2.2 i 16V (F68)	108	09/00→07/03	→	→ 04/02		<b>13.0460-4040.2 604040</b>	ATE 21050 15,8 - WE / - WK
2.6 i V6 (F68)	125	09/00→07/03	→	→ 04/02		<b>13.0460-4040.2 604040</b>	ATE 21050 15,8 - WE / - WK
<b>Warnkontakt, Bremsbelagsverschleiß</b>							
1.6 i (F68)	55	10/95→07/03	←	X1000001→; → 04/02	2	<b>24.8190-0714.2 620714</b>	L= 660
1.6 i 16V (F68)	74	10/95→07/02	←	→ W7999999	2	<b>24.8190-0715.2 620715</b>	L= 660
1.8 i 16V (F68)	92	09/00→07/03	←	→ W7999999	2	<b>24.8190-0715.2 620715</b>	L= 660
2.0 DTI 16V (F68)	74	06/97→07/03	←	→ W7999999	2	<b>24.8190-0715.2 620715</b>	L= 660
1.7 TD (F68)	60	10/95→12/98	←	→ 11/96	2	<b>24.8190-0715.2 620715</b>	L= 660
1.8 i 16V (F68)	85	10/95→09/00	←	X1000001→	2	<b>24.8190-0714.2 620714</b>	L= 660
2.0 DI 16V (F68)	60	11/96→06/00	←	→ W7999999	2	<b>24.8190-0715.2 620715</b>	L= 660
2.0 i (F68)	82	10/95→02/02	←		2	<b>24.8190-0714.2 620714</b>	L= 660
2.0 i 16V (F68)	100	10/95→06/00	→		2	<b>24.8190-0714.2 620714</b>	L= 660
2.2 DTI 16V (F68)	88	09/00→04/02	→		2	<b>24.8190-0714.2 620714</b>	L= 660
2.5 (F68)	144	10/99→06/00			2	<b>24.8190-0714.2 620714</b>	L= 660
2.5 i V6 (F68)	125	10/95→09/00			2	<b>24.8190-0714.2 620714</b>	L= 660
2.2 DTI 16V (F68)	92	09/00→07/03	←	→ 04/02	2	<b>24.8190-0714.2 620714</b>	L= 660
2.2 i 16V (F68)	108	09/00→07/03	→	→ 04/02	2	<b>24.8190-0714.2 620714</b>	L= 660
2.6 i V6 (F68)	125	09/00→07/03	→	→ 04/02	2	<b>24.8190-0714.2 620714</b>	L= 660
<b>Zubehörsatz, Scheibenbremsbelag</b>							
1.6 i 16V (F68)	74	10/95→07/02	→	→ 04/02		<b>13.0460-0347.2 610347</b>	
1.8 i 16V (F68)	92	09/00→07/03	→	→ 04/02		<b>13.0460-0347.2 610347</b>	
2.0 DTI 16V (F68)	74	06/97→07/03	→	→ 04/02		<b>13.0460-0347.2 610347</b>	
2.2 DTI 16V (F68)	92	09/00→07/03	→	→ 04/02		<b>13.0460-0347.2 610347</b>	
2.2 i 16V (F68)	108	09/00→07/03	→	→ 04/02		<b>13.0460-0347.2 610347</b>	
2.6 i V6 (F68)	125	09/00→07/03	→	→ 04/02		<b>13.0460-0347.2 610347</b>	
1.7 TD (F68)	60	10/95→12/98	→	→ 11/96		<b>13.0460-0347.2 610347</b>	
1.8 i 16V (F68)	85	10/95→09/00	→	→ 04/02		<b>13.0460-0347.2 610347</b>	
2.0 i (F68)	82	10/95→02/02	→	→ 04/02		<b>13.0460-0347.2 610347</b>	
2.0 i 16V (F68)	100	10/95→06/00	→	→ 04/02		<b>13.0460-0347.2 610347</b>	
2.2 DTI 16V (F68)	88	09/00→04/02	→	→ 04/02		<b>13.0460-0347.2 610347</b>	
2.5 (F68)	144	10/99→06/00	→	→ 04/02		<b>13.0460-0347.2 610347</b>	
2.5 i V6 (F68)	125	10/95→09/00	→	→ 04/02		<b>13.0460-0347.2 610347</b>	
<b> Bremsscheibe</b>							
1.6 i (F68)	55	10/95→07/03	←	→ W7999999		<b>24.0124-0115.1 424115</b>	Ø 256 24 21 V + S
			←	X1000001→; → 04/02		<b>24.0324-0115.1 524115</b>	Ø 256 24 21 V + S
			←	X1000001→; → 04/02		<b>24.0125-0119.1 425119</b>	Ø 288 25 22 V + S
			←	X1000001→; → 04/02		<b>24.0325-0119.1 525119</b>	Ø 288 25 22 V + S
1.6 i 16V (F68)	74	10/95→07/02	←	→ W7999999		<b>24.0124-0115.1 424115</b>	Ø 256 24 21 V + S
1.8 i 16V (F68)	92	09/00→07/03	←	→ W7999999		<b>24.0124-0115.1 424115</b>	Ø 256 24 21 V + S
2.0 DTI 16V (F68)	74	06/97→07/03	←	X1000001→; → 04/02		<b>24.0324-0115.1 524115</b>	Ø 256 24 21 V + S
			←	X1000001→; → 04/02		<b>24.0125-0119.1 425119</b>	Ø 288 25 22 V + S
			←	X1000001→; → 04/02		<b>24.0325-0119.1 525119</b>	Ø 288 25 22 V + S
			→	→ W7999999		<b>24.0110-0225.1 410225</b>	Ø 270 10 8 + S
			→	→ W7999999		<b>24.0310-0225.1 510225</b>	Ø 270 10 8 + S
			→	→ W7999999		<b>24.0110-0226.1 410226</b>	Ø 286 10 8 + S
			→	→ W7999999		<b>24.0310-0226.1 510226</b>	Ø 286 10 8 + S
1.7 TD (F68)	60	10/95→12/98	←	→ 11/96		<b>24.0124-0115.1 424115</b>	Ø 256 24 21 V + S
↓							









	kW			 	! #		
<b>OPEL - VECTRA B CC (J96) 10/95→07/03</b>							
<b>Bremsscheibe</b>							
1.7 TD (F68)	60	10/95→12/98	←	→ 11/96		24.0324-0115.1 524115	Ø 256 24 21 V + S
			→	→ 11/96		24.0110-0225.1 410225	Ø 270 10 8 + S
						24.0310-0225.1 510225	Ø 270 10 8 + S
1.8 i 16V (F68)	85	10/95→09/00	←	→ W7999999		24.0124-0115.1 424115	Ø 256 24 21 V + S
						24.0324-0115.1 524115	Ø 256 24 21 V + S
			←	X1000001→		24.0125-0119.1 425119	Ø 288 25 22 V + S
						24.0325-0119.1 525119	Ø 288 25 22 V + S
			→	→ W7999999		24.0110-0225.1 410225	Ø 270 10 8 + S
						24.0310-0225.1 510225	Ø 270 10 8 + S
2.0 DI 16V (F68)	60	11/96→06/00	←	→ W7999999		24.0124-0115.1 424115	Ø 256 24 21 V + S
						24.0324-0115.1 524115	Ø 256 24 21 V + S
			←	X1000001→		24.0125-0119.1 425119	Ø 288 25 22 V + S
						24.0325-0119.1 525119	Ø 288 25 22 V + S
						24.0110-0226.1 410226	Ø 286 10 8 + S
2.0 i (F68) 2.0 i 16V (F68) 2.2 DTI 16V (F68) 2.5 (F68) 2.5 i V6 (F68)	82 100 88 144 125	10/95→02/02 10/95→06/00 09/00→04/02 10/99→06/00 10/95→09/00	←			24.0125-0119.1 425119	Ø 288 25 22 V + S
						24.0325-0119.1 525119	Ø 288 25 22 V + S
			→			24.0110-0226.1 410226	Ø 286 10 8 + S
						24.0310-0226.1 510226	Ø 286 10 8 + S
2.2 DTI 16V (F68) 2.2 i 16V (F68) 2.6 i V6 (F68)	92 108 125	09/00→07/03 09/00→07/03 09/00→07/03	←	→ 04/02		24.0125-0119.1 425119	Ø 288 25 22 V + S
						24.0325-0119.1 525119	Ø 288 25 22 V + S
			→	→ 04/02		24.0110-0226.1 410226	Ø 286 10 8 + S
						24.0310-0226.1 510226	Ø 286 10 8 + S
<b>OPEL - VECTRA C (Z02) 04/02→01/09</b>							
<b>Bremsbelagsatz, Scheibenbremse</b>							
1.6 (F69) 1.8 (F69) 1.9 CDTi (F69)	77 103 74	08/05→08/08 08/05→08/08 10/05→08/08	←	für Bremssattel mit Kunststoffkolben		13.0460-7172.2 607172	ATE 23378 20,1 + WE / - WK
						13.0470-7172.2 LD7172	ATE 23378 20,1 + WE / - WK Ceramic
			←	für Bremssattel mit Stahlkolben		13.0460-7212.2 607212	ATE 23738 20,1 + WE / - WK
1.6 16V (F69) 1.8 (F69) 1.8 16V 1.9 CDTi (F69) 2.0 16V Turbo (F69) 2.0 DTI 16V (F69) 2.2 DGi (F69) 2.2 DTI 16V (F69) 2.2 DTI 16V (F69)	74 81 90 110 129 74 114 86 92	06/04→09/08 04/02→07/08 04/02→09/08 04/04→08/08 03/03→08/08 04/02→08/06 10/03→08/08 04/02→12/04 04/02→07/04	→			13.0460-7194.2 607194	ATE 23482 16,6 - WE / - WK
						13.0460-7195.2 607195	ATE 23482 16,6 - WE / - WK
						13.0470-7194.2 LD7194	ATE 23482 16,6 - WE / - WK Ceramic
						13.0470-7195.2 LD7195	ATE 23482 16,6 - WE / - WK Ceramic
			←	für Bremssattel mit Stahlkolben		13.0460-7212.2 607212	ATE 23738 20,1 + WE / - WK
			→	→ 41096248 / 48091178		13.0460-7194.2 607194	ATE 23482 16,6 - WE / - WK
						13.0470-7194.2 LD7194	ATE 23482 16,6 - WE / - WK Ceramic
1.9 CDTi (F69) 2.2 16V (F69)	88 108	04/04→01/09 04/02→12/08	←	→ 10/08; für Bremssattel mit Kunststoffkolben		13.0460-7172.2 607172	ATE 23378 20,1 + WE / - WK
						13.0470-7172.2 LD7172	ATE 23378 20,1 + WE / - WK Ceramic
			←	→ 10/08; für Bremssattel mit Stahlkolben		13.0460-7212.2 607212	ATE 23738 20,1 + WE / - WK
			→	→ 41096248 / 48091178		13.0460-7194.2 607194	ATE 23482 16,6 - WE / - WK
			13.0470-7194.2 LD7194	ATE 23482 16,6 - WE / - WK Ceramic			
			→	41096249 / 48091179→		13.0460-7195.2 607195	ATE 23482 16,6 - WE / - WK
						13.0470-7195.2 LD7195	ATE 23482 16,6 - WE / - WK Ceramic
2.8 V6 Turbo (F69) 2.8 V6 Turbo (F69) 3.0 CDTi (F69)	169 184 135	08/05→10/06 08/05→08/08 08/05→08/08	←			13.0460-7199.2 607199	ATE 23404 20,6 + WE / - WK
			→			13.0460-7194.2 607194	ATE 23482 16,6 - WE / - WK
						13.0460-7195.2 607195	ATE 23482 16,6 - WE / - WK
						13.0470-7194.2 LD7194	ATE 23482 16,6 - WE / - WK Ceramic
						13.0470-7195.2 LD7195	ATE 23482 16,6 - WE / - WK Ceramic
↓							

	kw			 	! #		
<b>OPEL - VECTRA C (Z02) 04/02→01/09</b>							
<b> Bremsbelagsatz, Scheibenbremse</b>							
2.8 V6 Turbo (F69) 2.8 V6 Turbo OPC (F69)	188 206	08/05→09/06 09/06→08/08	➔			13.0460-7194.2 607194 13.0460-7195.2 607195 13.0470-7194.2 LD7194 13.0470-7195.2 LD7195	ATE 23482 16,6 - WE / - WK ATE 23482 16,6 - WE / - WK ATE 23482 16,6 - WE / - WK Ceramic ATE 23482 16,6 - WE / - WK Ceramic
3.0 CDTI (F69)	130	02/03→07/05	➔			13.0460-7199.2 607199 13.0470-7194.2 LD7194	ATE 23404 20,6 + WE / - WK ATE 23482 16,6 - WE / - WK Ceramic
			➔	→ 41096248 / 48091178		13.0460-7194.2 607194 13.0470-7194.2 LD7194	ATE 23482 16,6 - WE / - WK ATE 23482 16,6 - WE / - WK Ceramic
			➔	41096249 / 48091179→		13.0460-7195.2 607195 13.0470-7195.2 LD7195	ATE 23482 16,6 - WE / - WK ATE 23482 16,6 - WE / - WK Ceramic
3.2 V6 (F69)	155	08/02→07/06	➔	→ 31070293 / 38047797; für Bremssattel mit Kunststoffkolben		13.0460-7172.2 607172 13.0470-7172.2 LD7172	ATE 23378 20,1 + WE / - WK ATE 23378 20,1 + WE / - WK Ceramic
			➔	31070294 / 38047798→ 48045597		13.0460-7199.2 607199	ATE 23404 20,6 + WE / - WK
			➔	48045598→		13.0460-7199.2 607199	ATE 23404 20,6 + WE / - WK
			➔	→ 31070293 / 38047797; für Bremssattel mit Stahlkolben		13.0460-7212.2 607212	ATE 23738 20,1 + WE / - WK
			➔	→ 41096248 / 48091178		13.0460-7194.2 607194 13.0470-7194.2 LD7194	ATE 23482 16,6 - WE / - WK ATE 23482 16,6 - WE / - WK Ceramic
			➔	41096249 / 48091179→		13.0460-7195.2 607195 13.0470-7195.2 LD7195	ATE 23482 16,6 - WE / - WK ATE 23482 16,6 - WE / - WK Ceramic
<b>Warnkontakt, Bremsbelagverschleiß</b>							
1.6 (F69) 1.6 16V (F69) 1.8 (F69) 1.8 (F69) 1.8 16V 1.9 CDTI (F69) 1.9 CDTI (F69) 2.0 16V Turbo (F69) 2.0 DTI 16V (F69) 2.2 DGi (F69) 2.2 DTI 16V (F69) 2.2 DTI 16V (F69)	77 74 81 103 90 74 110 129 74 114 86 92	08/05→08/08 06/04→09/08 04/02→07/08 08/05→08/08 04/02→09/08 10/05→08/08 04/04→08/08 03/03→08/08 04/02→08/06 10/03→08/08 04/02→12/04 04/02→07/04	➔	→ 48045597	1	24.8190-0719.2 620719	L= 685,5
			➔	48045598→	1	24.8190-0720.2 620720	L= 287
1.9 CDTI (F69) 2.2 16V (F69)	88 108	04/04→01/09 04/02→12/08	➔	→ 10/08; → 48045597	1	24.8190-0719.2 620719	L= 685,5
			➔	→ 10/08; 48045598→	1	24.8190-0720.2 620720	L= 287
2.8 V6 Turbo (F69) 2.8 V6 Turbo (F69) 3.0 CDTi (F69) 3.0 CDTi (F69)	169 184 135 130	08/05→10/06 08/05→08/08 08/05→08/08 02/03→07/05	➔	→ 48045597	1	24.8190-0721.2 620721 24.8190-0722.2 620722	L= 700 L= 302
			➔	48045598→	1	24.8190-0722.2 620722	L= 302
2.8 V6 Turbo (F69) 2.8 V6 Turbo OPC (F69)	188 206	08/05→09/06 09/06→08/08	➔		1	24.8190-0722.2 620722	L= 302
3.2 V6 (F69)	155	08/02→07/06	➔	→ 31070293 / 38047797	1	24.8190-0719.2 620719	L= 685,5
			➔	31070294 / 38047798→ 48045597	1	24.8190-0721.2 620721	L= 700
			➔	48045598→	1	24.8190-0722.2 620722	L= 302
<b> Bremsscheibe</b>							
1.6 (F69) 1.6 16V (F69) 1.9 CDTI (F69) 2.0 DTI 16V (F69)	77 74 110 74	08/05→08/08 06/04→09/08 04/04→08/08 04/02→08/06	➔			24.0125-0141.1 425141 24.0325-0141.1 525141	Ø 285 24,9 22 V + S Ø 285 24,9 22 V + S
			➔			24.0112-0157.1 412157 24.0120-0173.1 420173 24.0312-0157.1 512157 24.0320-0173.1 520173	Ø 278 11,9 10 + S Ø 292 19,9 18 V + S Ø 278 11,9 10 + S Ø 292 19,9 18 V + S
1.8 (F69) 1.8 16V 2.2 DGi (F69) 2.2 DTI 16V (F69) 2.2 DTI 16V (F69)	81 90 114 86 92	04/02→07/08 04/02→09/08 10/03→08/08 04/02→12/04 04/02→07/04	➔	für Fahrzeuge ohne Sportfahrwerk		24.0125-0141.1 425141 24.0325-0141.1 525141	Ø 285 24,9 22 V + S Ø 285 24,9 22 V + S
			➔	für Fahrzeuge mit Sportfahrwerk		24.0128-0137.1 428137 24.0328-0137.1 528137	Ø 302 28 25 V + S Ø 302 28 25 V + S
			➔			24.0112-0157.1 412157 24.0120-0173.1 420173 24.0312-0157.1 512157 24.0320-0173.1 520173	Ø 278 11,9 10 + S Ø 292 19,9 18 V + S Ø 278 11,9 10 + S Ø 292 19,9 18 V + S
↓							

















	kw			 	! #		
<b>OPEL - VECTRA C (Z02) 04/02→01/09</b>							
<b>Bremsscheibe</b>							
1.8 (F69)	103	08/05→08/08	←	für Fahrzeuge mit Sportfahrwerk; nicht für Polizeifahrzeuge	24.0125-0141.1 425141	Ø 285 24,9 22 V + S	
			←	für Fahrzeuge mit Sportfahrwerk; für Polizeifahrzeuge	24.0128-0137.1 428137	Ø 302 28 25 V + S	
			→		24.0112-0157.1 412157	Ø 278 11,9 10 + S	
			→		24.0120-0173.1 420173	Ø 292 19,9 18 V + S	
1.9 CDTI (F69)	74	10/05→08/08	←	nicht für Polizeifahrzeuge	24.0125-0141.1 425141	Ø 285 24,9 22 V + S	
			←	für Polizeifahrzeuge	24.0128-0137.1 428137	Ø 302 28 25 V + S	
			→		24.0112-0157.1 412157	Ø 278 11,9 10 + S	
			→		24.0120-0173.1 420173	Ø 292 19,9 18 V + S	
1.9 CDTI (F69)	88	04/04→01/09	←	→ 10/08	24.0125-0141.1 425141	Ø 285 24,9 22 V + S	
			→	→ 10/08	24.0112-0157.1 412157	Ø 278 11,9 10 + S	
			→		24.0120-0173.1 420173	Ø 292 19,9 18 V + S	
			→		24.0312-0157.1 512157	Ø 278 11,9 10 + S	
2.0 16V Turbo (F69)	129	03/03→08/08	←		24.0128-0137.1 428137	Ø 302 28 25 V + S	
			→		24.0328-0137.1 528137	Ø 302 28 25 V + S	
			→		24.0112-0157.1 412157	Ø 278 11,9 10 + S	
			→		24.0120-0173.1 420173	Ø 292 19,9 18 V + S	
2.2 16V (F69)	108	04/02→12/08	←	für Fahrzeuge ohne Sportfahrwerk; → 10/08	24.0125-0141.1 425141	Ø 285 24,9 22 V + S	
			←	für Fahrzeuge mit Sportfahrwerk; → 10/08	24.0128-0137.1 428137	Ø 302 28 25 V + S	
			→	→ 10/08	24.0328-0137.1 528137	Ø 302 28 25 V + S	
			→		24.0112-0157.1 412157	Ø 278 11,9 10 + S	
2.8 V6 Turbo (F69) 3.0 CDTi (F69)	169 135	08/05→10/06 08/05→08/08	←	61000001→	24.0128-0164.1 428164	Ø 314 28 25 V + S	
			→		24.0112-0157.1 412157	Ø 278 11,9 10 + S	
			→		24.0120-0173.1 420173	Ø 292 19,9 18 V + S	
			→		24.0312-0157.1 512157	Ø 278 11,9 10 + S	
2.8 V6 Turbo (F69)	184	08/05→08/08	←		24.0320-0173.1 520173	Ø 292 19,9 18 V + S	
			→		24.0112-0157.1 412157	Ø 278 11,9 10 + S	
			→		24.0120-0173.1 420173	Ø 292 19,9 18 V + S	
			→		24.0312-0157.1 512157	Ø 278 11,9 10 + S	
2.8 V6 Turbo (F69) 2.8 V6 Turbo OPC (F69)	188 206	08/05→09/06 09/06→08/08	←	61000001→	24.0130-0189.1 430189	Ø 345 29,9 27,5 V	
			→		24.0112-0157.1 412157	Ø 278 11,9 10 + S	
			→		24.0120-0173.1 420173	Ø 292 19,9 18 V + S	
			→		24.0312-0157.1 512157	Ø 278 11,9 10 + S	
3.0 CDTI (F69) 3.2 V6 (F69)	130 155	02/03→07/05 08/02→07/06	←	→ 31070293	24.0320-0173.1 520173	Ø 292 19,9 18 V + S	
			←	31070294→	24.0128-0137.1 428137	Ø 302 28 25 V + S	
			→		24.0328-0137.1 528137	Ø 302 28 25 V + S	
			→		24.0128-0164.1 428164	Ø 314 28 25 V + S	
			→		24.0112-0157.1 412157	Ø 278 11,9 10 + S	
			→		24.0120-0173.1 420173	Ø 292 19,9 18 V + S	
			→		24.0312-0157.1 512157	Ø 278 11,9 10 + S	
			→		24.0320-0173.1 520173	Ø 292 19,9 18 V + S	







	kw			 	! #		
<b>OPEL - VECTRA C Caravan (Z02) 10/03→01/09</b>							
<b>Bremsbelagsatz, Scheibenbremse</b>							
1.6 (F35)	77	12/05→08/08	←	06/06→; für Bremssattel mit Kunststoffkolben		<b>13.0460-7172.2 607172</b> <b>13.0470-7172.2 LD7172</b>	ATE 23378 20,1 + WE / - WK Ceramic
			←	06/06→; für Bremssattel mit Stahlkolben		<b>13.0460-7212.2 607212</b>	ATE 23738 20,1 + WE / - WK
			→	06/06→; → 41096248 / 48091178		<b>13.0460-7194.2 607194</b> <b>13.0470-7194.2 LD7194</b>	ATE 23482 16,6 - WE / - WK Ceramic
			→	41096249 / 48091179→		<b>13.0460-7195.2 607195</b> <b>13.0470-7195.2 LD7195</b>	ATE 23482 16,6 - WE / - WK Ceramic
1.6 16V (F35) 1.8 (F35) 1.8 (F35) 1.9 CDTI (F35) 1.9 CDTI (F35) 2.0 DTI (F35) 2.0 Turbo (F35) 2.2 direct (F35) 2.2 DTI (F35)	74 90 103 74 110 74 129 114 92	06/04→09/05 10/03→09/06 08/05→08/08 06/05→08/08 04/04→08/08 10/03→08/05 10/03→08/08 10/03→08/08 10/03→12/05	←	für Bremssattel mit Kunststoffkolben		<b>13.0460-7172.2 607172</b> <b>13.0470-7172.2 LD7172</b>	ATE 23378 20,1 + WE / - WK Ceramic
			←	für Bremssattel mit Stahlkolben		<b>13.0460-7212.2 607212</b>	ATE 23738 20,1 + WE / - WK
			→	→ 41096248 / 48091178		<b>13.0460-7194.2 607194</b> <b>13.0470-7194.2 LD7194</b>	ATE 23482 16,6 - WE / - WK Ceramic
			→	41096249 / 48091179→		<b>13.0460-7195.2 607195</b> <b>13.0470-7195.2 LD7195</b>	ATE 23482 16,6 - WE / - WK Ceramic
1.9 CDTI (F35)	88	04/04→01/09	←	→ 10/08; für Bremssattel mit Kunststoffkolben		<b>13.0460-7172.2 607172</b> <b>13.0470-7172.2 LD7172</b>	ATE 23378 20,1 + WE / - WK Ceramic
			←	→ 10/08; für Bremssattel mit Stahlkolben		<b>13.0460-7212.2 607212</b>	ATE 23738 20,1 + WE / - WK
			→	→ 41096248 / 48091178		<b>13.0460-7194.2 607194</b> <b>13.0470-7194.2 LD7194</b>	ATE 23482 16,6 - WE / - WK Ceramic
			→	41096249 / 48091179→; → 10/08		<b>13.0460-7195.2 607195</b> <b>13.0470-7195.2 LD7195</b>	ATE 23482 16,6 - WE / - WK Ceramic
2.8 V6 Turbo (F35) 2.8 V6 Turbo (F35) 3.0 V6 CDTI (F35) 3.0 V6 CDTI (F35) 3.2 V6 (F35)	169 184 130 135 155	08/05→10/08 08/05→08/08 10/03→07/05 08/05→08/08 10/03→07/05	←			<b>13.0460-7199.2 607199</b>	ATE 23404 20,6 + WE / - WK
			→	→ 41096248 / 48091178		<b>13.0460-7194.2 607194</b> <b>13.0470-7194.2 LD7194</b>	ATE 23482 16,6 - WE / - WK Ceramic
			→	41096249 / 48091179→		<b>13.0460-7195.2 607195</b> <b>13.0470-7195.2 LD7195</b>	ATE 23482 16,6 - WE / - WK Ceramic
2.8 V6 Turbo (F35) 2.8 V6 Turbo (F35)	188 206	08/05→09/08 07/06→08/08	→	→ 41096248 / 48091178		<b>13.0460-7194.2 607194</b> <b>13.0470-7194.2 LD7194</b>	ATE 23482 16,6 - WE / - WK Ceramic
			→	41096249 / 48091179→		<b>13.0460-7195.2 607195</b> <b>13.0470-7195.2 LD7195</b>	ATE 23482 16,6 - WE / - WK Ceramic
<b>Warnkontakt, Bremsbelagsverschleiß</b>							
1.6 (F35)	77	12/05→08/08	←	06/06→; → 48045597	1	<b>24.8190-0719.2 620719</b>	L= 685,5
			←	06/06→; 48045598→	1	<b>24.8190-0720.2 620720</b>	L= 287
1.6 16V (F35) 1.8 (F35) 1.8 (F35) 1.9 CDTI (F35) 1.9 CDTI (F35) 2.0 DTI (F35) 2.0 Turbo (F35) 2.2 direct (F35) 2.2 DTI (F35)	74 90 103 74 110 74 129 114 92	06/04→09/05 10/03→09/06 08/05→08/08 06/05→08/08 04/04→08/08 10/03→08/05 10/03→08/08 10/03→08/08 10/03→12/05	←	→ 48045597	1	<b>24.8190-0719.2 620719</b>	L= 685,5
			←	48045598→	1	<b>24.8190-0720.2 620720</b>	L= 287
1.9 CDTI (F35)	88	04/04→01/09	←	→ 10/08; → 48045597	1	<b>24.8190-0719.2 620719</b>	L= 685,5
			←	→ 10/08; 48045598→	1	<b>24.8190-0720.2 620720</b>	L= 287
2.8 V6 Turbo (F35) 2.8 V6 Turbo (F35) 3.0 V6 CDTI (F35) 3.0 V6 CDTI (F35) 3.2 V6 (F35)	169 184 130 135 155	08/05→10/08 08/05→08/08 10/03→07/05 08/05→08/08 10/03→07/05	←	→ 48045597	1	<b>24.8190-0721.2 620721</b>	L= 700
			←	48045598→	1	<b>24.8190-0722.2 620722</b>	L= 302
2.8 V6 Turbo (F35) 2.8 V6 Turbo (F35)	188 206	08/05→09/08 07/06→08/08	←		1	<b>24.8190-0722.2 620722</b>	L= 302
<b>Bremsscheibe</b>							
1.6 (F35) ↓	77	12/05→08/08	←	06/06→		<b>24.0125-0141.1 425141</b>	Ø 285 24,9 22 V + S























	kw			 	! #		
<b>OPEL - VECTRA C Caravan (Z02) 10/03→01/09</b>							
<b>Bremsscheibe</b>							
1.6 (F35)	77	12/05→08/08	←	06/06→		24.0325-0141.1 525141	Ø 285 24,9 22 V + S
			→	06/06→		24.0112-0157.1 412157	Ø 278 11,9 10 + S
						24.0120-0173.1 420173	Ø 292 19,9 18 V + S
						24.0312-0157.1 512157	Ø 278 11,9 10 + S
1.6 16V (F35) 2.0 DTI (F35)	74 74	06/04→09/05 10/03→08/05	←			24.0125-0141.1 425141	Ø 285 24,9 22 V + S
			→			24.0325-0141.1 525141	Ø 285 24,9 22 V + S
						24.0112-0157.1 412157	Ø 278 11,9 10 + S
						24.0120-0173.1 420173	Ø 292 19,9 18 V + S
1.8 (F35) 1.9 CDTI (F35) 2.2 direct (F35) 2.2 DTI (F35)	90 110 114 92	10/03→09/06 04/04→08/08 10/03→08/08 10/03→12/05	←	für Fahrzeuge ohne Sportfahrwerk		24.0125-0141.1 425141	Ø 285 24,9 22 V + S
						24.0325-0141.1 525141	Ø 285 24,9 22 V + S
			←	für Fahrzeuge mit Sportfahrwerk		24.0128-0137.1 428137	Ø 302 28 25 V + S
			→			24.0328-0137.1 528137	Ø 302 28 25 V + S
1.8 (F35)	103	08/05→08/08	←	für Fahrzeuge mit Sportfahrwerk; nicht für Polizeifahrzeuge		24.0125-0141.1 425141	Ø 285 24,9 22 V + S
						24.0325-0141.1 525141	Ø 285 24,9 22 V + S
			←	für Fahrzeuge mit Sportfahrwerk; für Polizeifahrzeuge		24.0128-0137.1 428137	Ø 302 28 25 V + S
			→			24.0328-0137.1 528137	Ø 302 28 25 V + S
1.9 CDTI (F35)	74	06/05→08/08	←	für Fahrzeuge ohne Sportfahrwerk; nicht für Polizeifahrzeuge		24.0112-0157.1 412157	Ø 278 11,9 10 + S
						24.0120-0173.1 420173	Ø 292 19,9 18 V + S
			←	für Fahrzeuge mit Sportfahrwerk; für Polizeifahrzeuge		24.0312-0157.1 512157	Ø 278 11,9 10 + S
			→			24.0320-0173.1 520173	Ø 292 19,9 18 V + S
1.9 CDTI (F35)	88	04/04→01/09	←	→ 10/08; für Fahrzeuge ohne Sportfahrwerk; nicht für Polizeifahrzeuge		24.0125-0141.1 425141	Ø 285 24,9 22 V + S
						24.0325-0141.1 525141	Ø 285 24,9 22 V + S
			←	→ 10/08; für Fahrzeuge mit Sportfahrwerk; für Polizeifahrzeuge		24.0128-0137.1 428137	Ø 302 28 25 V + S
			→	→ 10/08		24.0328-0137.1 528137	Ø 302 28 25 V + S
2.0 Turbo (F35)	129	10/03→08/08	←			24.0112-0157.1 412157	Ø 278 11,9 10 + S
						24.0120-0173.1 420173	Ø 292 19,9 18 V + S
			←			24.0312-0157.1 512157	Ø 278 11,9 10 + S
			→			24.0320-0173.1 520173	Ø 292 19,9 18 V + S
2.8 V6 Turbo (F35)	169	08/05→10/08	←	61000001→		24.0128-0164.1 428164	Ø 314 28 25 V + S
			→			24.0112-0157.1 412157	Ø 278 11,9 10 + S
						24.0120-0173.1 420173	Ø 292 19,9 18 V + S
						24.0312-0157.1 512157	Ø 278 11,9 10 + S
2.8 V6 Turbo (F35) 3.0 V6 CDTI (F35)	184 135	08/05→08/08 08/05→08/08	←			24.0320-0173.1 520173	Ø 292 19,9 18 V + S
			→			24.0128-0164.1 428164	Ø 314 28 25 V + S
						24.0112-0157.1 412157	Ø 278 11,9 10 + S
						24.0120-0173.1 420173	Ø 292 19,9 18 V + S
2.8 V6 Turbo (F35)	188	08/05→09/08	←	61000001→		24.0312-0157.1 512157	Ø 278 11,9 10 + S
						24.0120-0173.1 420173	Ø 292 19,9 18 V + S
						24.0312-0157.1 512157	Ø 278 11,9 10 + S
						24.0320-0173.1 520173	Ø 292 19,9 18 V + S
↓						24.0130-0189.1 430189	Ø 345 29,9 27,5 V















	kw			 	! #		
<b>OPEL - VECTRA C Caravan (Z02) 10/03→01/09</b>							
<b>Bremsscheibe</b>							
2.8 V6 Turbo (F35)	188	08/05→09/08	➔			24.0112-0157.1 412157 24.0120-0173.1 420173 24.0312-0157.1 512157 24.0320-0173.1 520173	Ø 278 11,9 10 + S Ø 292 19,9 18 V + S Ø 278 11,9 10 + S Ø 292 19,9 18 V + S
2.8 V6 Turbo (F35)	206	07/06→08/08	➔			24.0112-0157.1 412157 24.0120-0173.1 420173 24.0312-0157.1 512157 24.0320-0173.1 520173	Ø 278 11,9 10 + S Ø 292 19,9 18 V + S Ø 278 11,9 10 + S Ø 292 19,9 18 V + S
3.0 V6 CDTI (F35) 3.2 V6 (F35)	130 155	10/03→07/05 10/03→07/05	➔	→ 31070293		24.0128-0137.1 428137 24.0328-0137.1 528137	Ø 302 28 25 V + S Ø 302 28 25 V + S
			➔	31070294→		24.0128-0164.1 428164	Ø 314 28 25 V + S
			➔			24.0112-0157.1 412157 24.0120-0173.1 420173 24.0312-0157.1 512157 24.0320-0173.1 520173	Ø 278 11,9 10 + S Ø 292 19,9 18 V + S Ø 278 11,9 10 + S Ø 292 19,9 18 V + S
<b>OPEL - VECTRA C CC (Z02) 08/02→01/09</b>							
<b>Bremsbelagsatz, Scheibenbremse</b>							
1.6 (F68) 1.6 (F68) 1.8 (F68) 1.9 CDTI (F68)	74 77 103 74	08/05→08/08 01/06→08/08 08/05→08/08 06/05→08/08	➔	für Bremssattel mit Kunststoffkolben		13.0460-7172.2 607172 13.0470-7172.2 LD7172	ATE 23378 20,1 + WE / - WK ATE 23378 20,1 + WE / - WK Ceramic
			➔	für Bremssattel mit Stahlkolben		13.0460-7212.2 607212	ATE 23738 20,1 + WE / - WK
			➔			13.0460-7194.2 607194 13.0460-7195.2 607195 13.0470-7194.2 LD7194 13.0470-7195.2 LD7195	ATE 23482 16,6 - WE / - WK ATE 23482 16,6 - WE / - WK ATE 23482 16,6 - WE / - WK ATE 23482 16,6 - WE / - WK Ceramic
1.8 16V (F68) 1.8 16V (F68) 1.9 CDTI (F68) 2.0 16V Turbo (F68) 2.0 DTI 16V (F68) 2.2 16V (F68) 2.2 DGi (F68) 2.2 DTI 16V (F68) 2.2 DTI 16V (F68)	81 90 110 129 74 108 114 86 92	08/02→12/06 08/02→09/08 04/04→08/08 03/03→08/08 08/02→08/05 08/02→08/08 10/03→08/08 08/02→06/08 08/02→07/06	➔	für Bremssattel mit Kunststoffkolben		13.0460-7172.2 607172 13.0470-7172.2 LD7172	ATE 23378 20,1 + WE / - WK ATE 23378 20,1 + WE / - WK Ceramic
			➔	für Bremssattel mit Stahlkolben		13.0460-7212.2 607212	ATE 23738 20,1 + WE / - WK
			➔	→ 41096248 / 48091178		13.0460-7194.2 607194 13.0470-7194.2 LD7194	ATE 23482 16,6 - WE / - WK ATE 23482 16,6 - WE / - WK Ceramic
			➔	41096249 / 48091179→		13.0460-7195.2 607195 13.0470-7195.2 LD7195	ATE 23482 16,6 - WE / - WK ATE 23482 16,6 - WE / - WK Ceramic
1.9 CDTI (F68)	88	04/04→01/09	➔	→ 10/08; für Bremssattel mit Kunststoffkolben		13.0460-7172.2 607172 13.0470-7172.2 LD7172	ATE 23378 20,1 + WE / - WK ATE 23378 20,1 + WE / - WK Ceramic
			➔	→ 10/08; für Bremssattel mit Stahlkolben		13.0460-7212.2 607212	ATE 23738 20,1 + WE / - WK
			➔	→ 41096248 / 48091178		13.0460-7194.2 607194 13.0470-7194.2 LD7194	ATE 23482 16,6 - WE / - WK ATE 23482 16,6 - WE / - WK Ceramic
			➔	41096249 / 48091179→; → 10/08		13.0460-7195.2 607195 13.0470-7195.2 LD7195	ATE 23482 16,6 - WE / - WK ATE 23482 16,6 - WE / - WK Ceramic
2.8 V6 Turbo (F68) 2.8 V6 Turbo (F68) 3.0 CDTi (F68)	169 184 135	08/05→08/08 08/05→08/08 08/05→08/08	➔			13.0460-7199.2 607199 13.0460-7194.2 607194 13.0460-7195.2 607195 13.0470-7194.2 LD7194 13.0470-7195.2 LD7195	ATE 23404 20,6 + WE / - WK ATE 23482 16,6 - WE / - WK ATE 23482 16,6 - WE / - WK ATE 23482 16,6 - WE / - WK ATE 23482 16,6 - WE / - WK Ceramic
2.8 V6 Turbo (F68) 2.8 V6 Turbo (F68)	188 206	08/05→09/08 08/06→08/08	➔			13.0460-7194.2 607194 13.0460-7195.2 607195 13.0470-7194.2 LD7194 13.0470-7195.2 LD7195	ATE 23482 16,6 - WE / - WK ATE 23482 16,6 - WE / - WK ATE 23482 16,6 - WE / - WK ATE 23482 16,6 - WE / - WK Ceramic
3.0 CDTi (F68)	130	06/03→07/05	➔			13.0460-7199.2 607199	ATE 23404 20,6 + WE / - WK
			➔	→ 41096248 / 48091178		13.0460-7194.2 607194	ATE 23482 16,6 - WE / - WK









	kw				! #		
<b>OPEL - VECTRA C CC (Z02) 08/02→01/09</b>							
<b>Bremsbelagsatz, Scheibenbremse</b>							
3.0 CDTi (F68)	130	06/03→07/05	➡	→ 41096248 / 48091178		<b>13.0470-7194.2</b> <b>LD7194</b>	ATE 23482 16,6 - WE / - WK Ceramic
			➡	41096249 / 48091179→		<b>13.0460-7195.2</b> <b>607195</b> <b>13.0470-7195.2</b> <b>LD7195</b>	ATE 23482 16,6 - WE / - WK Ceramic
3.2 V6 (F68)	155	08/02→07/06	⬅	→ 31070293 / 38047797; für Bremssattel mit Kunststoffkolben		<b>13.0460-7172.2</b> <b>607172</b> <b>13.0470-7172.2</b> <b>LD7172</b>	ATE 23378 20,1 + WE / - WK Ceramic
			⬅	31070294 / 38047798→ 48045597		<b>13.0460-7199.2</b> <b>607199</b>	ATE 23404 20,6 + WE / - WK
			⬅	48045598→		<b>13.0460-7199.2</b> <b>607199</b>	ATE 23404 20,6 + WE / - WK
			⬅	→ 31070293 / 38047797; für Bremssattel mit Stahlkolben		<b>13.0460-7212.2</b> <b>607212</b>	ATE 23738 20,1 + WE / - WK
			➡	→ 41096248 / 48091178		<b>13.0460-7194.2</b> <b>607194</b> <b>13.0470-7194.2</b> <b>LD7194</b>	ATE 23482 16,6 - WE / - WK Ceramic
			➡	41096249 / 48091179→		<b>13.0460-7195.2</b> <b>607195</b> <b>13.0470-7195.2</b> <b>LD7195</b>	ATE 23482 16,6 - WE / - WK Ceramic
<b>Warnkontakt, Bremsbelagverschleiß</b>							
1.6 (F68)	74	08/05→08/08	⬅	→ 48045597	1	<b>24.8190-0719.2</b> <b>620719</b>	L= 685,5
1.6 (F68)	77	01/06→08/08					
1.8 (F68)	103	08/05→08/08	⬅	48045598→	1	<b>24.8190-0720.2</b> <b>620720</b>	L= 287
1.8 16V (F68)	81	08/02→12/06					
1.8 16V (F68)	90	08/02→09/08					
1.9 CDTi (F68)	74	06/05→08/08					
1.9 CDTi (F68)	110	04/04→08/08					
2.0 16V Turbo (F68)	129	03/03→08/08					
2.0 DTi 16V (F68)	74	08/02→08/05					
2.2 16V (F68)	108	08/02→08/08					
2.2 DGi (F68)	114	10/03→08/08					
2.2 DTi 16V (F68)	86	08/02→06/08					
2.2 DTi 16V (F68)	92	08/02→07/06					
1.9 CDTi (F68)	88	04/04→01/09	⬅	→ 10/08; → 48045597	1	<b>24.8190-0719.2</b> <b>620719</b>	L= 685,5
			⬅	→ 10/08; 48045598→	1	<b>24.8190-0720.2</b> <b>620720</b>	L= 287
2.8 V6 Turbo (F68)	169	08/05→08/08	⬅	→ 48045597	1	<b>24.8190-0721.2</b> <b>620721</b>	L= 700
2.8 V6 Turbo (F68)	184	08/05→08/08					
3.0 CDTi (F68)	135	08/05→08/08	⬅	48045598→	1	<b>24.8190-0722.2</b> <b>620722</b>	L= 302
3.0 CDTi (F68)	130	06/03→07/05					
2.8 V6 Turbo (F68)	188	08/05→09/08	⬅		1	<b>24.8190-0722.2</b> <b>620722</b>	L= 302
2.8 V6 Turbo (F68)	206	08/06→08/08					
3.2 V6 (F68)	155	08/02→07/06	⬅	→ 31070293 / 38047797	1	<b>24.8190-0719.2</b> <b>620719</b>	L= 685,5
			⬅	31070294 / 38047798→ 48045597	1	<b>24.8190-0721.2</b> <b>620721</b>	L= 700
			⬅	48045598→	1	<b>24.8190-0722.2</b> <b>620722</b>	L= 302
<b>Bremsscheibe</b>							
1.6 (F68)	74	08/05→08/08	⬅			<b>24.0125-0141.1</b> <b>425141</b>	Ø 285 24,9 22 V + S
1.6 (F68)	77	01/06→08/08				<b>24.0325-0141.1</b> <b>525141</b>	Ø 285 24,9 22 V + S
1.9 CDTi (F68)	110	04/04→08/08					
2.0 DTi 16V (F68)	74	08/02→08/05	➡			<b>24.0112-0157.1</b> <b>412157</b>	Ø 278 11,9 10 + S
						<b>24.0120-0173.1</b> <b>420173</b>	Ø 292 19,9 18 V + S
						<b>24.0312-0157.1</b> <b>512157</b>	Ø 278 11,9 10 + S
						<b>24.0320-0173.1</b> <b>520173</b>	Ø 292 19,9 18 V + S
1.8 (F68)	103	08/05→08/08	⬅	für Fahrzeuge mit Sportfahrwerk; nicht für Polizeifahrzeuge		<b>24.0125-0141.1</b> <b>425141</b> <b>24.0325-0141.1</b> <b>525141</b>	Ø 285 24,9 22 V + S Ø 285 24,9 22 V + S
			⬅	für Fahrzeuge mit Sportfahrwerk; für Polizeifahrzeuge		<b>24.0128-0137.1</b> <b>428137</b> <b>24.0328-0137.1</b> <b>528137</b>	Ø 302 28 25 V + S Ø 302 28 25 V + S
			➡			<b>24.0112-0157.1</b> <b>412157</b> <b>24.0120-0173.1</b> <b>420173</b> <b>24.0312-0157.1</b> <b>512157</b> <b>24.0320-0173.1</b> <b>520173</b>	Ø 278 11,9 10 + S Ø 292 19,9 18 V + S Ø 278 11,9 10 + S Ø 292 19,9 18 V + S
1.8 16V (F68)	81	08/02→12/06	⬅	für Fahrzeuge ohne Sportfahrwerk		<b>24.0125-0141.1</b> <b>425141</b> <b>24.0325-0141.1</b> <b>525141</b>	Ø 285 24,9 22 V + S Ø 285 24,9 22 V + S
1.8 16V (F68)	90	08/02→09/08					
2.2 16V (F68)	108	08/02→08/08					
2.2 DGi (F68)	114	10/03→08/08	⬅	für Fahrzeuge mit Sportfahrwerk		<b>24.0128-0137.1</b> <b>428137</b> <b>24.0328-0137.1</b> <b>528137</b>	Ø 302 28 25 V + S Ø 302 28 25 V + S
2.2 DTi 16V (F68)	86	08/02→06/08					
2.2 DTi 16V (F68)	92	08/02→07/06	➡			<b>24.0112-0157.1</b> <b>412157</b> <b>24.0120-0173.1</b> <b>420173</b> <b>24.0312-0157.1</b> <b>512157</b>	Ø 278 11,9 10 + S Ø 292 19,9 18 V + S Ø 278 11,9 10 + S







	kw			 	! #		
<b>OPEL - VECTRA C CC (Z02) 08/02→01/09</b>							
<b>Bremsscheibe</b>							
1.8 16V (F68)	81	08/02→12/06	➔			24.0320-0173.1 520173	Ø 292 19,9 18 V + S
1.8 16V (F68)	90	08/02→09/08					
2.2 16V (F68)	108	08/02→08/08					
2.2 DGi (F68)	114	10/03→08/08					
2.2 DTI 16V (F68)	86	08/02→06/08					
2.2 DTI 16V (F68)	92	08/02→07/06					
1.9 CDTI (F68)	74	06/05→08/08	➔	nicht für Polizeifahrzeuge		24.0125-0141.1 425141	Ø 285 24,9 22 V + S
			➔	für Polizeifahrzeuge		24.0325-0141.1 525141	Ø 285 24,9 22 V + S
			➔			24.0128-0137.1 428137	Ø 302 28 25 V + S
			➔			24.0328-0137.1 528137	Ø 302 28 25 V + S
			➔			24.0112-0157.1 412157	Ø 278 11,9 10 + S
			➔			24.0120-0173.1 420173	Ø 292 19,9 18 V + S
			➔			24.0312-0157.1 512157	Ø 278 11,9 10 + S
			➔			24.0320-0173.1 520173	Ø 292 19,9 18 V + S
1.9 CDTI (F68)	88	04/04→01/09	➔	→ 10/08		24.0125-0141.1 425141	Ø 285 24,9 22 V + S
			➔	→ 10/08		24.0325-0141.1 525141	Ø 285 24,9 22 V + S
			➔			24.0112-0157.1 412157	Ø 278 11,9 10 + S
			➔			24.0120-0173.1 420173	Ø 292 19,9 18 V + S
			➔			24.0312-0157.1 512157	Ø 278 11,9 10 + S
			➔			24.0320-0173.1 520173	Ø 292 19,9 18 V + S
2.0 16V Turbo (F68)	129	03/03→08/08	➔			24.0128-0137.1 428137	Ø 302 28 25 V + S
			➔			24.0328-0137.1 528137	Ø 302 28 25 V + S
			➔			24.0112-0157.1 412157	Ø 278 11,9 10 + S
			➔			24.0120-0173.1 420173	Ø 292 19,9 18 V + S
			➔			24.0312-0157.1 512157	Ø 278 11,9 10 + S
			➔			24.0320-0173.1 520173	Ø 292 19,9 18 V + S
2.8 V6 Turbo (F68)	169	08/05→08/08	➔	61000001→		24.0128-0164.1 428164	Ø 314 28 25 V + S
3.0 CDTi (F68)	135	08/05→08/08	➔			24.0112-0157.1 412157	Ø 278 11,9 10 + S
			➔			24.0120-0173.1 420173	Ø 292 19,9 18 V + S
			➔			24.0312-0157.1 512157	Ø 278 11,9 10 + S
			➔			24.0320-0173.1 520173	Ø 292 19,9 18 V + S
2.8 V6 Turbo (F68)	184	08/05→08/08	➔			24.0128-0164.1 428164	Ø 314 28 25 V + S
			➔			24.0112-0157.1 412157	Ø 278 11,9 10 + S
			➔			24.0120-0173.1 420173	Ø 292 19,9 18 V + S
			➔			24.0312-0157.1 512157	Ø 278 11,9 10 + S
			➔			24.0320-0173.1 520173	Ø 292 19,9 18 V + S
2.8 V6 Turbo (F68)	188	08/05→09/08	➔	61000001→		24.0130-0189.1 430189	Ø 345 29,9 27,5 V
2.8 V6 Turbo (F68)	206	08/06→08/08	➔			24.0112-0157.1 412157	Ø 278 11,9 10 + S
			➔			24.0120-0173.1 420173	Ø 292 19,9 18 V + S
			➔			24.0312-0157.1 512157	Ø 278 11,9 10 + S
			➔			24.0320-0173.1 520173	Ø 292 19,9 18 V + S
3.0 CDTI (F68)	130	06/03→07/05	➔	→ 31070293		24.0128-0137.1 428137	Ø 302 28 25 V + S
3.2 V6 (F68)	155	08/02→07/06	➔			24.0328-0137.1 528137	Ø 302 28 25 V + S
			➔	31070294→		24.0128-0164.1 428164	Ø 314 28 25 V + S
			➔			24.0112-0157.1 412157	Ø 278 11,9 10 + S
			➔			24.0120-0173.1 420173	Ø 292 19,9 18 V + S
			➔			24.0312-0157.1 512157	Ø 278 11,9 10 + S
			➔			24.0320-0173.1 520173	Ø 292 19,9 18 V + S
<b>OPEL - VIVARO A Combi (X83) 08/01→</b>							
<b>Bremsbelagsatz, Scheibenbremse</b>							
1.9 DI (F7, J7, A07)	60	08/01→	➔	→ 06/14		13.0460-2870.2 602870	TRW 23099 18,4 - WK
1.9 DTI (F7, J7, A07)	74	08/01→					
2.0 16V (F7, J7, A07)	88	08/01→	➔	→ 06/14		13.0460-2840.2 602840	TRW 23980 16,5 + WE / - WK
2.0 CDTI (F7, J7, A07)	66	08/06→					
2.0 CDTI (F7, J7, A07)	84	08/06→					
2.0 ECOTEC (F7, A07, J7)	86	08/06→					
2.5 CDTI (F7, J7, A07)	84	08/06→					
2.5 CDTI (F7, J7, A07)	107	08/06→					
2.5 DTI (F7, J7, A07)	99	05/03→					
<b>Zubehörsatz, Scheibenbremsbelag</b>							
1.9 DI (F7, J7, A07)	60	08/01→	➔	→ 06/14		13.0460-0072.2 610072	TRW
1.9 DTI (F7, J7, A07)	74	08/01→					
2.0 16V (F7, J7, A07)	88	08/01→					
↓							











	kw			 	! #		
<b>OPEL - VIVARO A Combi (X83) 08/01→</b>							
<b>Zubehörsatz, Scheibenbremsbelag</b>							
2.0 CDTI (F7, J7, A07)	66	08/06→	➔	→ 06/14		13.0460-0072.2 610072	TRW
2.0 CDTI (F7, J7, A07)	84	08/06→					
2.0 ECOTEC (F7, A07, J7)	86	08/06→					
2.5 CDTI (F7, J7, A07)	84	08/06→					
2.5 CDTI (F7, J7, A07)	107	08/06→					
2.5 DTI (F7, J7, A07)	99	05/03→					
<b> Bremsscheibe</b>							
1.9 DI (F7, J7, A07)	60	08/01→	➔	→ 06/14		24.0128-0132.1 428132	Ø 305 28 24 V + S
1.9 DTI (F7, J7, A07)	74	08/01→					
2.0 16V (F7, J7, A07)	88	08/01→	➔	→ 06/14		24.0112-0177.2 412177	Ø 280 12 10 + LG / + ABS Ring
2.0 CDTI (F7, J7, A07)	66	08/06→					
2.0 CDTI (F7, J7, A07)	84	08/06→					
2.0 ECOTEC (F7, A07, J7)	86	08/06→					
2.5 CDTI (F7, J7, A07)	84	08/06→					
2.5 CDTI (F7, J7, A07)	107	08/06→					
2.5 DTI (F7, J7, A07)	99	05/03→					
<b>OPEL - VIVARO A Kasten (X83) 08/01→</b>							
<b> Bremsbelagsatz, Scheibenbremse</b>							
1.9 DI (F7)	60	08/01→	➔	→ 06/14		13.0460-2870.2 602870	TRW 23099 18,4 - WK
1.9 DTI (F7)	74	08/01→					
2.0 16V (F7)	88	08/01→	➔	→ 06/14		13.0460-2840.2 602840	TRW 23980 16,5 + WE / - WK
2.0 CDTI (F7)	66	08/06→					
2.0 CDTI (F7)	84	08/06→					
2.0 ECOTEC (F7)	86	08/06→					
2.5 CDTI (F7)	84	08/06→					
2.5 CDTI (F7)	107	08/06→					
2.5 DTI (F7)	99	05/03→					
<b>Zubehörsatz, Scheibenbremsbelag</b>							
1.9 DI (F7)	60	08/01→	➔	→ 06/14		13.0460-0072.2 610072	TRW
1.9 DTI (F7)	74	08/01→					
2.0 16V (F7)	88	08/01→					
2.0 CDTI (F7)	66	08/06→					
2.0 CDTI (F7)	84	08/06→					
2.0 ECOTEC (F7)	86	08/06→					
2.5 CDTI (F7)	84	08/06→					
2.5 CDTI (F7)	107	08/06→					
2.5 DTI (F7)	99	05/03→					
<b> Bremsscheibe</b>							
1.9 DI (F7)	60	08/01→	➔	→ 06/14		24.0128-0132.1 428132	Ø 305 28 24 V + S
1.9 DTI (F7)	74	08/01→					
2.0 16V (F7)	88	08/01→	➔	→ 06/14		24.0112-0177.2 412177	Ø 280 12 10 + LG / + ABS Ring
2.0 CDTI (F7)	66	08/06→					
2.0 CDTI (F7)	84	08/06→					
2.0 ECOTEC (F7)	86	08/06→					
2.5 CDTI (F7)	84	08/06→					
2.5 CDTI (F7)	107	08/06→					
2.5 DTI (F7)	99	05/03→					
<b>OPEL - VIVARO A Pritsche/Fahrgestell (X83) 08/01→</b>							
<b> Bremsbelagsatz, Scheibenbremse</b>							
1.9 Di	60	08/01→	➔	08/06→ 06/14		13.0460-2870.2 602870	TRW 23099 18,4 - WK
2.0 CDTI	66	01/06→					
2.5 DTI	99	08/03→	➔	08/06→ 06/14		13.0460-2840.2 602840	TRW 23980 16,5 + WE / - WK
1.9 DTI	74	08/06→	➔	→ 06/14		13.0460-2870.2 602870	TRW 23099 18,4 - WK
2.0 16V	88	08/03→					
2.0 CDTI	84	08/06→	➔	→ 06/14		13.0460-2840.2 602840	TRW 23980 16,5 + WE / - WK
2.0 ECOTEC	86	08/06→					
2.5 CDTI	84	08/06→					
2.5 CDTI	107	08/06→					
<b>Zubehörsatz, Scheibenbremsbelag</b>							
1.9 Di	60	08/01→	➔	08/06→ 06/14		13.0460-0072.2 610072	TRW
2.0 CDTI	66	01/06→					
2.5 DTI	99	08/03→					
1.9 DTI	74	08/06→	➔	→ 06/14		13.0460-0072.2 610072	TRW
2.0 16V	88	08/03→					
2.0 CDTI	84	08/06→					
2.0 ECOTEC	86	08/06→					
2.5 CDTI	84	08/06→					
2.5 CDTI	107	08/06→					
↓							













	kw				! #		
<b>OPEL - VIVARO A Pritsche/Fahrgestell (X83) 08/01→</b>							
 <b>Bremsscheibe</b>							
1.9 Di	60	08/01→	←	08/06→ 06/14		24.0128-0132.1 428132	Ø 305 28 24 V + S
2.0 CDTI	66	01/06→	→	08/06→ 06/14		24.0112-0177.2 412177	Ø 280 12 10 + LG / + ABS Ring
2.5 DTI	99	08/03→					
1.9 DTI	74	08/06→	←	→ 06/14		24.0128-0132.1 428132	Ø 305 28 24 V + S
2.0 16V	88	08/03→	→	→ 06/14		24.0112-0177.2 412177	Ø 280 12 10 + LG / + ABS Ring
2.0 CDTI	84	08/06→					
2.0 ECOTEC	86	08/06→					
2.5 CDTI	84	08/06→					
2.5 CDTI	107	08/06→					
<b>OPEL - VIVARO B Combi (X82) 06/14→</b>							
 <b>Bremsbelagsatz, Scheibenbremse</b>							
1.6 CDTI (06)	66	06/14→	→	07/14→		13.0460-2840.2 602840	TRW 23980 16,5 + WE / - WK
1.6 CDTI (06)	85	06/14→					
1.6 CDTI (06)	88	06/14→					
1.6 CDTI (06)	103	06/14→					
1.6 CDTI (06)	70	04/15→	→			13.0460-2840.2 602840	TRW 23980 16,5 + WE / - WK
1.6 CDTI (06)	92	04/15→					
1.6 CDTI (06)	107	04/15→					
 <b>Bremsscheibe</b>							
1.6 CDTI (06)	66	06/14→	←	07/14→		24.0128-0287.1 428287	Ø 296 28 23,4 V + S
1.6 CDTI (06)	85	06/14→	→	07/14→		24.0112-0217.2 412217	Ø 280 12 10 + LG / + ABS Ring
1.6 CDTI (06)	88	06/14→					
1.6 CDTI (06)	103	06/14→					
1.6 CDTI (06)	70	04/15→	←			24.0128-0287.1 428287	Ø 296 28 23,4 V + S
1.6 CDTI (06)	92	04/15→	→			24.0112-0217.2 412217	Ø 280 12 10 + LG / + ABS Ring
1.6 CDTI (06)	107	04/15→					
<b>OPEL - VIVARO B Kasten (X82) 06/14→</b>							
 <b>Bremsbelagsatz, Scheibenbremse</b>							
1.6 CDTI (05)	66	06/14→	→	07/14→		13.0460-2840.2 602840	TRW 23980 16,5 + WE / - WK
1.6 CDTI (05)	85	06/14→					
1.6 CDTI (05)	88	06/14→					
1.6 CDTI (05)	103	06/14→					
1.6 CDTI (05)	70	08/16→	→			13.0460-2840.2 602840	TRW 23980 16,5 + WE / - WK
1.6 CDTI (05)	92	03/16→					
1.6 CDTI (05)	107	03/16→					
 <b>Bremsscheibe</b>							
1.6 CDTI (05)	66	06/14→	←	07/14→		24.0128-0287.1 428287	Ø 296 28 23,4 V + S
1.6 CDTI (05)	85	06/14→	→	07/14→		24.0112-0217.2 412217	Ø 280 12 10 + LG / + ABS Ring
1.6 CDTI (05)	88	06/14→					
1.6 CDTI (05)	103	06/14→					
1.6 CDTI (05)	70	08/16→	←			24.0128-0287.1 428287	Ø 296 28 23,4 V + S
1.6 CDTI (05)	92	03/16→	→			24.0112-0217.2 412217	Ø 280 12 10 + LG / + ABS Ring
1.6 CDTI (05)	107	03/16→					
<b>OPEL - VIVARO B Pritsche/Fahrgestell (X82) 06/14→</b>							
 <b>Bremsbelagsatz, Scheibenbremse</b>							
1.6 CDTI (03)	85	06/14→	→	07/14→		13.0460-2840.2 602840	TRW 23980 16,5 + WE / - WK
1.6 CDTI (03)	88	08/15→	→			13.0460-2840.2 602840	TRW 23980 16,5 + WE / - WK
1.6 CDTI (03)	92	11/16→					
1.6 CDTI (03)	103	08/15→					
1.6 CDTI (03)	107	11/16→					
 <b>Bremsscheibe</b>							
1.6 CDTI (03)	85	06/14→	←	07/14→		24.0128-0287.1 428287	Ø 296 28 23,4 V + S
			→	07/14→		24.0112-0217.2 412217	Ø 280 12 10 + LG / + ABS Ring
1.6 CDTI (03)	88	08/15→	←			24.0128-0287.1 428287	Ø 296 28 23,4 V + S
1.6 CDTI (03)	92	11/16→	→			24.0112-0217.2 412217	Ø 280 12 10 + LG / + ABS Ring
1.6 CDTI (03)	103	08/15→					
1.6 CDTI (03)	107	11/16→					
<b>OPEL - ZAFIRA A Großraumlimousine (T98) 04/99→06/05</b>							
 <b>Bremsbelagsatz, Scheibenbremse</b>							
1.6 (F75)	76	10/03→06/05	←	- ABS		13.0460-7115.2 607115	ATE 23063 17,5 ohne integrierten Verschleißsensor / + WK
1.6 16V (F75)	74	04/99→06/05					
1.6 CNG (F75)	71	09/01→06/05					
1.8 16V (F75)	85	04/99→09/00				13.0470-7115.2 LD7115	ATE 23063 17,5 - WK / + WK Ceramic
1.8 16V (F75)	92	09/00→06/05					
2.0 DTI 16V (F75)	74	09/00→06/05	←	+ ABS		13.0460-7116.2 607116	ATE 23057 20,2 - WK / + WK
↓							

	kw			 	! #		
<b>OPEL - ZAFIRA A Großraumlimousine (T98) 04/99→06/05</b>							
<b> Bremsbelagsatz, Scheibenbremse</b>							
1.6 (F75)	76	10/03→06/05	←	+ ABS		13.0470-7116.2 LD7116	ATE 23057 20,2 - WK / + WK Ceramic
1.6 16V (F75)	74	04/99→06/05					
1.6 CNG (F75)	71	09/01→06/05	→			13.0460-2868.2 602868	TRW 23417 15,3 + WK + Zub
1.8 16V (F75)	85	04/99→09/00				13.0460-3976.2 603976	BOS 23258 16,5 + WK + Zub
1.8 16V (F75)	92	09/00→06/05				13.0470-2868.2 LD2868	TRW 23417 15,3 + WK + Zub Ceramic
2.0 DTI 16V (F75)	74	09/00→06/05					
2.0 DI (F75)	63	07/99→06/00	←	06/00→; - ABS		13.0460-7115.2 607115	ATE 23063 17,5 ohne integrierten Verschleißsensor / + WK
						13.0470-7115.2 LD7115	ATE 23063 17,5 - WK / + WK Ceramic
			←	06/00→; + ABS		13.0460-7116.2 607116	ATE 23057 20,2 - WK / + WK
						13.0470-7116.2 LD7116	ATE 23057 20,2 - WK / + WK Ceramic
			→	06/00→		13.0460-2868.2 602868	TRW 23417 15,3 + WK + Zub
						13.0460-3976.2 603976	BOS 23258 16,5 + WK + Zub
						13.0470-2868.2 LD2868	TRW 23417 15,3 + WK + Zub Ceramic
2.0 DI 16V (F75)	60	07/99→06/05	←	10/99→; - ABS		13.0460-7115.2 607115	ATE 23063 17,5 ohne integrierten Verschleißsensor / + WK
						13.0470-7115.2 LD7115	ATE 23063 17,5 - WK / + WK Ceramic
			←	10/99→; + ABS		13.0460-7116.2 607116	ATE 23057 20,2 - WK / + WK
						13.0470-7116.2 LD7116	ATE 23057 20,2 - WK / + WK Ceramic
			→	10/99→		13.0460-2868.2 602868	TRW 23417 15,3 + WK + Zub
						13.0460-3976.2 603976	BOS 23258 16,5 + WK + Zub
						13.0470-2868.2 LD2868	TRW 23417 15,3 + WK + Zub Ceramic
2.0 OPC (F75)	141	09/01→06/05	←			13.0460-7173.2 607173	ATE 21829 20,3 - WK / + WK
2.0 OPC (F75)	147	11/02→06/05	→			13.0460-2868.2 602868	TRW 23417 15,3 + WK + Zub
						13.0460-3976.2 603976	BOS 23258 16,5 + WK + Zub
						13.0470-2868.2 LD2868	TRW 23417 15,3 + WK + Zub Ceramic
2.2 16V (F75)	108	09/00→06/05	←			13.0460-7116.2 607116	ATE 23057 20,2 - WK / + WK
2.2 DTI 16V (F75)	86	01/02→06/05				13.0470-7116.2 LD7116	ATE 23057 20,2 - WK / + WK Ceramic
2.2 DTI 16V (F75)	92	01/02→06/05	→			13.0460-2868.2 602868	TRW 23417 15,3 + WK + Zub
						13.0460-3976.2 603976	BOS 23258 16,5 + WK + Zub
						13.0470-2868.2 LD2868	TRW 23417 15,3 + WK + Zub Ceramic
<b>Warnkontakt, Bremsbelagsverschleiß</b>							
1.6 (F75)	76	10/03→06/05	←	42187759→	2	24.8190-0018.2 620018	L= 755
1.6 16V (F75)	74	04/99→06/05					
1.6 CNG (F75)	71	09/01→06/05	←	→ 42187758	2	24.8190-0718.2 620718	L= 720
1.8 16V (F75)	85	04/99→09/00					
1.8 16V (F75)	92	09/00→06/05					
2.0 DTI 16V (F75)	74	09/00→06/05					
2.0 OPC (F75)	141	09/01→06/05					
2.0 OPC (F75)	147	11/02→06/05					
2.0 DI (F75)	63	07/99→06/00	←	06/00→; 42187759→	2	24.8190-0018.2 620018	L= 755
			←	06/00→; → 42187758	2	24.8190-0718.2 620718	L= 720
2.0 DI 16V (F75)	60	07/99→06/05	←	10/99→; 42187759→	2	24.8190-0018.2 620018	L= 755
			←	10/99→; → 42187758	2	24.8190-0718.2 620718	L= 720
2.2 16V (F75)	108	09/00→06/05	←		2	24.8190-0718.2 620718	L= 720
2.2 DTI 16V (F75)	86	01/02→06/05					
2.2 DTI 16V (F75)	92	01/02→06/05					
<b> Bremsscheibe</b>							
1.6 (F75)	76	10/03→06/05	←			24.0125-0131.1 425131	Ø 280 24,8 22 V + S
1.6 16V (F75)	74	04/99→06/05				24.0325-0131.1 525131	Ø 280 24,8 22 V + S
1.6 CNG (F75)	71	09/01→06/05					
1.8 16V (F75)	85	04/99→09/00	→			24.0110-0250.1 410250	Ø 264 9,8 8 + S
1.8 16V (F75)	92	09/00→06/05				24.0310-0250.1 510250	Ø 264 9,8 8 + S
2.0 DTI 16V (F75)	74	09/00→06/05					
2.2 16V (F75)	108	09/00→06/05					
2.2 DTI 16V (F75)	86	01/02→06/05					
2.2 DTI 16V (F75)	92	01/02→06/05					
↓							











	kw			 	! #		
<b>OPEL - ZAFIRA A Großraumlimousine (T98) 04/99→06/05</b>							
<b>Bremsscheibe</b>							
2.0 DI (F75)	63	07/99→06/00	←	06/00→		24.0125-0131.1 425131 24.0325-0131.1 525131	Ø 280 24,8 22 V + S Ø 280 24,8 22 V + S
			→	06/00→		24.0110-0250.1 410250 24.0310-0250.1 510250	Ø 264 9,8 8 + S Ø 264 9,8 8 + S
2.0 DI 16V (F75)	60	07/99→06/05	←	10/99→		24.0125-0131.1 425131 24.0325-0131.1 525131	Ø 280 24,8 22 V + S Ø 280 24,8 22 V + S
			→	10/99→		24.0110-0250.1 410250 24.0310-0250.1 510250	Ø 264 9,8 8 + S Ø 264 9,8 8 + S
2.0 OPC (F75) 2.0 OPC (F75)	141 147	09/01→06/05 11/02→06/05	←			24.0125-0142.1 425142 24.0325-0142.1 525142	Ø 308 25 22 V + S Ø 308 25 23 V + S
			→			24.0110-0250.1 410250 24.0310-0250.1 510250	Ø 264 9,8 8 + S Ø 264 9,8 8 + S
<b>OPEL - ZAFIRA B (A05) 07/05→04/15</b>							
<b>Bremsbelagsatz, Scheibenbremse</b>							
1.6 (M75) 1.6 (M75) 1.6 CNG (M75) 1.6 CNG Turbo (M75) 1.7 CDTI (M75) 1.7 CDTI (M75) 1.8 (M75) 1.8 (M75) 1.9 CDTI (M75) 1.9 CDTI (M75) 1.9 CDTI (M75) 2.0 (M75) 2.2 (M75)	77 85 69 110 81 92 88 103 74 88 110 147 110	07/05→09/12 01/08→04/15 07/05→04/15 02/09→04/15 01/08→04/15 01/08→04/15 06/13→04/15 07/05→04/15 07/05→12/10 07/05→04/15 07/05→04/15 07/05→12/10 07/05→12/12	←			13.0460-7179.2 607179 13.0470-7179.2 LD7179	ATE 23832 20,2 - WK / + WK ATE 23832 20,2 - WK / + WK Ceramic
			→			13.0460-2868.2 602868 13.0470-2868.2 LD2868	TRW 23417 15,3 + WK + Zub TRW 23417 15,3 + WK + Zub Ceramic
2.0 (M75)	177	01/06→12/10	←	für Bremssattel mit Kunststoffkolben		13.0460-7172.2 607172 13.0470-7172.2 LD7172	ATE 23378 20,1 + WE / - WK ATE 23378 20,1 + WE / - WK Ceramic
			←	für Bremssattel mit Stahlkolben		13.0460-7212.2 607212	ATE 23738 20,1 + WE / - WK
			→			13.0460-2868.2 602868 13.0470-2868.2 LD2868	TRW 23417 15,3 + WK + Zub TRW 23417 15,3 + WK + Zub Ceramic
<b>Warnkontakt, Bremsbelagverschleiß</b>							
1.6 (M75) 1.6 (M75) 1.6 CNG (M75) 1.6 CNG Turbo (M75) 1.7 CDTI (M75) 1.7 CDTI (M75) 1.8 (M75) 1.8 (M75) 1.9 CDTI (M75) 1.9 CDTI (M75) 1.9 CDTI (M75) 2.0 (M75) 2.0 (M75) 2.2 (M75)	77 85 69 110 81 92 88 103 74 88 110 147 177 110	07/05→09/12 01/08→04/15 07/05→04/15 02/09→04/15 01/08→04/15 01/08→04/15 06/13→04/15 07/05→04/15 07/05→12/10 07/05→04/15 07/05→04/15 07/05→12/10 01/06→12/10 07/05→12/12	←		1	24.8190-0720.2 620720	L= 287
<b>Bremsscheibe</b>							
1.6 (M75) 1.6 (M75)	77 85	07/05→09/12 01/08→04/15	←			24.0125-0131.1 425131 24.0325-0131.1 525131	Ø 280 24,8 22 V + S Ø 280 24,8 22 V + S
			→			24.0110-0250.1 410250 24.0310-0250.1 510250	Ø 264 9,8 8 + S Ø 264 9,8 8 + S
1.6 CNG (M75) 1.6 CNG Turbo (M75)	69 110	07/05→04/15 02/09→04/15	←			24.0125-0142.1 425142 24.0325-0142.1 525142	Ø 308 25 22 V + S Ø 308 25 23 V + S
1.7 CDTI (M75) 1.7 CDTI (M75) 1.8 (M75) 1.8 (M75)	81 92 88 103	01/08→04/15 01/08→04/15 06/13→04/15 07/05→04/15	←			24.0125-0131.1 425131 24.0125-0142.1 425142 24.0325-0131.1 525131 24.0325-0142.1 525142	Ø 280 24,8 22 V + S Ø 308 25 22 V + S Ø 280 24,8 22 V + S Ø 308 25 23 V + S
			→	nicht für Fahrzeuge mit verstärkter Bremse		24.0110-0250.1 410250 24.0310-0250.1 510250	Ø 264 9,8 8 + S Ø 264 9,8 8 + S
			→	für Fahrzeuge mit verstärkter Bremse		24.0110-0339.1 410339	Ø 278 10 8 + S
1.9 CDTI (M75) 1.9 CDTI (M75) 1.9 CDTI (M75) 2.2 (M75)	74 88 110 110	07/05→12/10 07/05→04/15 07/05→04/15 07/05→12/12	←			24.0125-0142.1 425142 24.0325-0142.1 525142	Ø 308 25 22 V + S Ø 308 25 23 V + S













	kw			 	! #		
<b>OPEL - ZAFIRA B (A05) 07/05→04/15</b>							
 <b>Bremsscheibe</b>							
1.9 CDTi (M75)	74	07/05→12/10	➔	nicht für Fahrzeuge mit verstärkter Bremse		24.0110-0250.1 410250	Ø 264 9,8 8 + S
1.9 CDTi (M75)	88	07/05→04/15				24.0310-0250.1 510250	Ø 264 9,8 8 + S
1.9 CDTi (M75)	110	07/05→04/15					
2.2 (M75)	110	07/05→12/12	➔	für Fahrzeuge mit verstärkter Bremse		24.0110-0339.1 410339	Ø 278 10 8 + S
2.0 (M75)	147	07/05→12/10	➔			24.0125-0142.1 425142	Ø 308 25 22 V + S
						24.0325-0142.1 525142	Ø 308 25 23 V + S
			➔	→ 52999999		24.0110-0250.1 410250	Ø 264 9,8 8 + S
			➔	62000001→		24.0310-0250.1 510250	Ø 264 9,8 8 + S
2.0 (M75)	177	01/06→12/10	➔			24.0110-0339.1 410339	Ø 278 10 8 + S
			➔			24.0128-0201.1 428201	Ø 321 28 25 V
<b>OPEL - ZAFIRA B Van (A05) 07/05→04/15</b>							
 <b>Bremsbelagsatz, Scheibenbremse</b>							
1.6 CNG Turbo (M75)	110	02/09→04/15	➔			13.0460-7179.2 607179	ATE 23832 20,2 - WK / + WK
1.7 CDTi (M75)	81	01/08→04/15				13.0470-7179.2 LD7179	ATE 23832 20,2 - WK / + WK Ceramic
1.7 CDTi (M75)	92	01/08→04/15					
1.8 (M75)	103	07/05→04/15	➔			13.0460-2868.2 602868	TRW 23417 15,3 + WK + Zub
						13.0470-2868.2 LD2868	TRW 23417 15,3 + WK + Zub Ceramic
<b>Warnkontakt, Bremsbelagsverschleiß</b>							
1.6 CNG Turbo (M75)	110	02/09→04/15	➔		1	24.8190-0720.2 620720	L= 287
1.7 CDTi (M75)	81	01/08→04/15					
1.7 CDTi (M75)	92	01/08→04/15					
1.8 (M75)	103	07/05→04/15					
 <b>Bremsscheibe</b>							
1.6 CNG Turbo (M75)	110	02/09→04/15	➔			24.0125-0142.1 425142	Ø 308 25 22 V + S
						24.0325-0142.1 525142	Ø 308 25 23 V + S
1.7 CDTi (M75)	81	01/08→04/15	➔			24.0125-0131.1 425131	Ø 280 24,8 22 V + S
						24.0125-0142.1 425142	Ø 308 25 22 V + S
1.7 CDTi (M75)	92	01/08→04/15	➔			24.0325-0131.1 525131	Ø 280 24,8 22 V + S
						24.0325-0142.1 525142	Ø 308 25 23 V + S
1.8 (M75)	103	07/05→04/15	➔	nicht für Fahrzeuge mit verstärkter Bremse		24.0110-0250.1 410250	Ø 264 9,8 8 + S
						24.0310-0250.1 510250	Ø 264 9,8 8 + S
			➔	für Fahrzeuge mit verstärkter Bremse		24.0110-0339.1 410339	Ø 278 10 8 + S
<b>OPEL - ZAFIRA TOURER C (P12) 10/11→</b>							
 <b>Bremsbelagsatz, Scheibenbremse</b>							
1.4 (75)	88	10/11→	➔	11/11→;		13.0460-5612.2 605612	MAN 24412 19,0 + WK + Zub
1.4 (75)	103	10/11→		für Bremsscheibendurchmesser [mm]:		13.0470-5612.2 LD5612	MAN 24412 19,0 + WK + Zub Ceramic
1.4 LPG (75)	103	10/11→		321			
1.6 CNG (75)	110	10/11→	➔	11/11→;		13.0460-7263.2 607263	24034 19,1 + WK + Zub
1.8 (75)	85	10/11→		für Bremsscheibendurchmesser [mm]:		13.0470-7263.2 LD7263	24034 19,1 + WK + Zub Ceramic
1.8 (75)	103	10/11→		300			
2.0 CDTi (75)	81	10/11→	➔	F0000001→;		13.0460-7264.2 607264	ATE 25096 17,0 + WK + Zub
2.0 CDTi (75)	96	10/11→		für Bremsscheibendurchmesser [mm]:		13.0470-7264.2 LD7264	ATE 25096 17,0 + WK + Zub Ceramic
2.0 CDTi (75)	118	10/11→		292			
2.0 CDTi (75)	121	10/11→	➔	11/11→;		13.0460-7264.2 607264	ATE 25096 17,0 + WK + Zub
				für Bremsscheibendurchmesser [mm]:		13.0470-7264.2 LD7264	ATE 25096 17,0 + WK + Zub Ceramic
			➔	292; → E9999999			
			➔	F0000001→;		13.0460-7309.2 607309	ATE 25096 16,7 + WK + Zub
				für Bremsscheibendurchmesser [mm]:		13.0470-7309.2 LD7309	ATE 25096 16,7 + WK + Zub Ceramic
				315			
1.6 CDTi (75)	88	07/14→	➔	für Bremsscheibendurchmesser [mm]:		13.0460-5612.2 605612	MAN 24412 19,0 + WK + Zub
				321		13.0470-5612.2 LD5612	MAN 24412 19,0 + WK + Zub Ceramic
2.0 CDTi (75)	125	01/15→	➔	für Bremsscheibendurchmesser [mm]:		13.0460-7263.2 607263	24034 19,1 + WK + Zub
				300		13.0470-7263.2 LD7263	24034 19,1 + WK + Zub Ceramic
			➔	für Bremsscheibendurchmesser [mm]:		13.0460-7264.2 607264	ATE 25096 17,0 + WK + Zub
				292		13.0470-7264.2 LD7264	ATE 25096 17,0 + WK + Zub Ceramic
			➔	für Bremsscheibendurchmesser [mm]:		13.0460-7309.2 607309	ATE 25096 16,7 + WK + Zub
				315		13.0470-7309.2 LD7309	ATE 25096 16,7 + WK + Zub Ceramic
↓							

	kW			 	! #			
<b>OPEL - ZAFIRA TOURER C (P12) 10/11→</b>								
 <b>Bremsbelagsatz, Scheibenbremse</b>								
1.6 CDTI (75) 1.6 SIDI (75) 1.6 SIDI (75) 2.0 BiTurbo CDTI (75)	99	11/16→	←	für Bremsscheibendurchmesser [mm]: 321	13.0460-5612.2	605612	MAN 24412 19,0 + WK + Zub	
	125	12/12→			13.0470-5612.2	LD5612	MAN 24412 19,0 + WK + Zub Ceramic	
	147	07/13→	←	für Bremsscheibendurchmesser [mm]: 300	13.0460-7263.2	607263	24034 19,1 + WK + Zub	
	143	01/13→		→	für Bremsscheibendurchmesser [mm]: 292; → E9999999	13.0460-7264.2	607264	ATE 25096 17,0 + WK + Zub
				→	F0000001→; für Bremsscheibendurchmesser [mm]: 292	13.0470-7264.2	LD7264	ATE 25096 17,0 + WK + Zub Ceramic
			→	F0000001→; für Bremsscheibendurchmesser [mm]: 315	13.0460-7309.2	607309	ATE 25096 16,7 + WK + Zub	
			→	F0000001→; für Bremsscheibendurchmesser [mm]: 315	13.0470-7309.2	LD7309	ATE 25096 16,7 + WK + Zub Ceramic	
1.6 CDTI (75)	100	02/13→	←	03/13→; für Bremsscheibendurchmesser [mm]: 321	13.0460-5612.2	605612	MAN 24412 19,0 + WK + Zub	
					13.0470-5612.2	LD5612	MAN 24412 19,0 + WK + Zub Ceramic	
			←	03/13→; für Bremsscheibendurchmesser [mm]: 300	13.0460-7263.2	607263	24034 19,1 + WK + Zub	
					13.0470-7263.2	LD7263	24034 19,1 + WK + Zub Ceramic	
			→	F0000001→; für Bremsscheibendurchmesser [mm]: 292	13.0460-7264.2	607264	ATE 25096 17,0 + WK + Zub	
			→	F0000001→; für Bremsscheibendurchmesser [mm]: 292	13.0470-7264.2	LD7264	ATE 25096 17,0 + WK + Zub Ceramic	
			→	03/13→; für Bremsscheibendurchmesser [mm]: 292; → E9999999	13.0460-7264.2	607264	ATE 25096 17,0 + WK + Zub	
			→	F0000001→; für Bremsscheibendurchmesser [mm]: 315	13.0470-7264.2	LD7264	ATE 25096 17,0 + WK + Zub Ceramic	
			→	F0000001→; für Bremsscheibendurchmesser [mm]: 315	13.0460-7309.2	607309	ATE 25096 16,7 + WK + Zub	
			→	F0000001→; für Bremsscheibendurchmesser [mm]: 315	13.0470-7309.2	LD7309	ATE 25096 16,7 + WK + Zub Ceramic	
 <b>Bremsscheibe</b>								
1.4 (75) 1.4 (75) 1.4 LPG (75) 1.6 CNG (75) 1.8 (75) 1.8 (75) 2.0 CDTi (75) 2.0 CDTi (75) 2.0 CDTi (75) 2.0 CDTi (75)	88	10/11→	←	11/11→	24.0126-0166.1	426166	Ø 300 26 23 V + S	
	103	10/11→			24.0130-0224.1	430224	Ø 321 30 27 V + S	
	103	10/11→			24.0326-0166.1	526166	Ø 300 26 23 V + S	
	110	10/11→						
	85	10/11→	→	11/11→	24.0112-0189.1	412189	Ø 292 12 10 + S	
	103	10/11→			24.0123-0116.1	423116	Ø 315 23 20 V + S	
	81	10/11→			24.0312-0189.1	512189	Ø 292 12 10 + S	
	96	10/11→						
	118	10/11→						
	121	10/11→						
1.6 CDTI (75) 1.6 CDTI (75) 1.6 SIDI (75) 1.6 SIDI (75) 2.0 BiTurbo CDTI (75) 2.0 CDTi (75)	88	07/14→	←		24.0126-0166.1	426166	Ø 300 26 23 V + S	
	99	11/16→			24.0130-0224.1	430224	Ø 321 30 27 V + S	
	125	12/12→			24.0326-0166.1	526166	Ø 300 26 23 V + S	
	147	07/13→						
	143	01/13→	→		24.0112-0189.1	412189	Ø 292 12 10 + S	
	125	01/15→			24.0123-0116.1	423116	Ø 315 23 20 V + S	
					24.0312-0189.1	512189	Ø 292 12 10 + S	
1.6 CDTI (75)	100	02/13→	←	03/13→	24.0126-0166.1	426166	Ø 300 26 23 V + S	
					24.0130-0224.1	430224	Ø 321 30 27 V + S	
					24.0326-0166.1	526166	Ø 300 26 23 V + S	
			→	03/13→	24.0112-0189.1	412189	Ø 292 12 10 + S	
					24.0123-0116.1	423116	Ø 315 23 20 V + S	
				24.0312-0189.1	512189	Ø 292 12 10 + S		
<b>PEUGEOT - 106 I (1A, 1C) 08/91→04/96</b>								
 <b>Bremsbelagsatz, Scheibenbremse</b>								
1.0 1.0 1.1	33 37 44	09/91→04/96	←	→ S 50994342; - ABS; Felge Lochzahl: 4	13.0460-3943.2	603943	BDX 20905 18,0 + WK	
				+ ABS	13.0460-3943.2	603943	BDX 20905 18,0 + WK	
			←	S 50994343→; - ABS; Felge Lochzahl: 4	13.0460-3962.2	603962	BDX 20905 18,0 + WE / - WK	
			←	→ S 50994342; - ABS; Felge Lochzahl: 3	13.0460-4042.2	604042	ATE 21191 16,8 + WK	
			←	S 50994343→; - ABS; Felge Lochzahl: 3	13.0460-4066.2	604066	ATE 21857 17,7 - WE / - WK	
1.3 1.6	72 76	10/93→04/96 01/94→04/96	←	→ S 51132346	13.0460-3943.2	603943	BDX 20905 18,0 + WK	
			←	S 51132347→	13.0460-7088.2	607088	ATE 21430 17,3 - WE / - WK	
1.4 1.4 1.4 D 1.5 D ↓	51 55 37 40	08/91→03/96 09/91→04/96 09/92→04/96 06/94→04/96	←	→ S 51132346; + ABS	13.0460-3943.2	603943	BDX 20905 18,0 + WK	
			←	→ S 50994342; - ABS	13.0460-3943.2	603943	BDX 20905 18,0 + WK	

























	kW					! #		
<b>PEUGEOT - 106 I (1A, 1C) 08/91→04/96</b>								
<b> Bremsbelagsatz, Scheibenbremse</b>								
1.5 D 1.6	43 65	06/94→04/96 06/93→04/96	←	S 50994343→; - ABS		13.0460-3962.2	603962	BDX 20905 18,0 + WE / - WK
			←	S 51132347→; + ABS		13.0460-7088.2	607088	ATE 21430 17,3 - WE / - WK
1.4 1.4	69 72	09/91→04/96 08/91→03/96	←			13.0460-3943.2	603943	BDX 20905 18,0 + WK
<b>Zubehörsatz, Scheibenbremsbelag</b>								
1.0 1.0 1.1	33 37 44	09/91→04/96 09/91→04/96 09/91→04/96	←	S 50994343→; - ABS; Felge Lochzahl: 4		13.0460-0403.2	610403	BDX
			←	→ S 50994342; - ABS; Felge Lochzahl: 4		13.0460-0403.2	610403	BDX
			←	+ ABS		13.0460-0406.2	610406	BDX
			←	S 50994343→; - ABS; Felge Lochzahl: 3		13.0460-0424.2	610424	ATE
			←	→ S 50994342; - ABS; Felge Lochzahl: 3		13.0460-0424.2	610424	ATE
1.3 1.6	72 76	10/93→04/96 01/94→04/96	←	→ S 51132346		13.0460-0406.2	610406	BDX
1.4 1.4 1.4 D 1.5 D 1.5 D 1.6	51 55 37 40 43 65	08/91→03/96 09/91→04/96 09/92→04/96 06/94→04/96 06/94→04/96 06/93→04/96	←	→ S 50994342; - ABS		13.0460-0403.2	610403	BDX
			←	S 50994343→; - ABS		13.0460-0403.2	610403	BDX
			←	→ S 51132346; + ABS		13.0460-0406.2	610406	BDX
			←			13.0460-0406.2	610406	BDX
1.4 1.4	69 72	09/91→04/96 08/91→03/96	←			13.0460-0406.2	610406	BDX
<b> Bremsscheibe</b>								
1.0 1.0 1.1	33 37 44	09/91→04/96 09/91→04/96 09/91→04/96	←	- ABS; Felge Lochzahl: 3		24.0108-0107.1	408107	∅ 238 8 6 + S
			←	- ABS; Felge Lochzahl: 4		24.0110-0187.1	410187	∅ 247 10 9 + S
			←	+ ABS		24.0120-0132.1	420132	∅ 247 20,4 18,5 V + S
						24.0320-0132.1	520132	∅ 247 20,4 18,5 V + S
1.3 1.4 1.4	72 69 72	10/93→04/96 09/91→04/96 08/91→03/96	←			24.0120-0132.1	420132	∅ 247 20,4 18,5 V + S
						24.0320-0132.1	520132	∅ 247 20,4 18,5 V + S
1.4 1.4 1.4 D 1.5 D 1.5 D 1.6	51 55 37 40 43 65	08/91→03/96 09/91→04/96 09/92→04/96 06/94→04/96 06/94→04/96 06/93→04/96	←	- ABS		24.0110-0187.1	410187	∅ 247 10 9 + S
			←	+ ABS		24.0120-0132.1	420132	∅ 247 20,4 18,5 V + S
						24.0320-0132.1	520132	∅ 247 20,4 18,5 V + S
			←	- ABS		24.0110-0187.1	410187	∅ 247 10 9 + S
			←	07/94→; + ABS		24.0120-0132.1	420132	∅ 247 20,4 18,5 V + S
						24.0320-0132.1	520132	∅ 247 20,4 18,5 V + S
1.6	76	01/94→04/96	←	07/94→		24.0120-0132.1	420132	∅ 247 20,4 18,5 V + S
						24.0320-0132.1	520132	∅ 247 20,4 18,5 V + S
<b>PEUGEOT - 106 II (1) 04/96→05/05</b>								
<b> Bremsbelagsatz, Scheibenbremse</b>								
1.0 i 1.0 i 1.1 i	33 37 40	05/96→10/99 01/97→03/01 01/97→03/01	←	Felge Lochzahl: 4		13.0460-3943.2	603943	BDX 20905 18,0 + WK
			←	Felge Lochzahl: 3		13.0460-3962.2	603962	BDX 20905 18,0 + WE / - WK
			←			13.0460-4042.2	604042	ATE 21191 16,8 + WK
			←			13.0460-4066.2	604066	ATE 21857 17,7 - WE / - WK
1.1 i	44	05/96→07/04	←	→ 03/04; Felge Lochzahl: 4		13.0460-3943.2	603943	BDX 20905 18,0 + WK
			←	→ 03/04; Felge Lochzahl: 3		13.0460-3962.2	603962	BDX 20905 18,0 + WE / - WK
						13.0460-4042.2	604042	ATE 21191 16,8 + WK
						13.0460-4066.2	604066	ATE 21857 17,7 - WE / - WK
1.4 i	55	05/96→07/04	←	→ 03/04		13.0460-3943.2	603943	BDX 20905 18,0 + WK
						13.0460-3962.2	603962	BDX 20905 18,0 + WE / - WK
1.5 D 1.6 i	40 65	05/96→03/01 05/96→10/99	←			13.0460-3943.2	603943	BDX 20905 18,0 + WK
						13.0460-3962.2	603962	BDX 20905 18,0 + WE / - WK
1.5 D	42	04/98→07/04	←	10/00→ 03/04		13.0460-3943.2	603943	BDX 20905 18,0 + WK
						13.0460-3962.2	603962	BDX 20905 18,0 + WE / - WK
1.6 i 1.6 S16	74 88	05/96→01/01 04/98→09/01	←			13.0460-7088.2	607088	ATE 21430 17,3 - WE / - WK
			→			13.0460-3954.2	603954	BDX 20973 11,0 - WK
1.6 S16	87	05/96→07/04	←	→ 03/04		13.0460-7088.2	607088	ATE 21430 17,3 - WE / - WK
			→	→ 03/04		13.0460-3954.2	603954	BDX 20973 11,0 - WK
<b>Zubehörsatz, Scheibenbremsbelag</b>								
1.0 i 1.0 i ↓	33 37	05/96→10/99 01/97→03/01	←	Felge Lochzahl: 4		13.0460-0406.2	610406	BDX









	kw			 	! #		
<b>PEUGEOT - 106 II (1) 04/96→05/05</b>							
<b>Zubehörsatz, Scheibenbremsbelag</b>							
1.1 i	40	01/97→03/01	←	Felge Lochzahl: 3		13.0460-0424.2 610424	ATE
1.1 i	44	05/96→07/04	←	→ 03/04; Felge Lochzahl: 4		13.0460-0406.2 610406	BDX
			←	→ 03/04; Felge Lochzahl: 3		13.0460-0424.2 610424	ATE
1.4 i	55	05/96→07/04	←	→ 03/04		13.0460-0403.2 610403	BDX
1.5 D	40	05/96→03/01	←			13.0460-0403.2 610403	BDX
1.6 i	65	05/96→10/99					
1.5 D	42	04/98→07/04	←	10/00→ 03/04		13.0460-0403.2 610403	BDX
1.6 i	74	05/96→01/01	→			13.0460-0435.2 610435	BDX
1.6 S16	88	04/98→09/01					
1.6 S16	87	05/96→07/04	→	→ 03/04		13.0460-0435.2 610435	BDX
<b> Bremsscheibe</b>							
1.0 i	33	05/96→10/99	←	Felge Lochzahl: 3		24.0108-0107.1 408107	Ø 238 8 6 + S
1.0 i	37	01/97→03/01					
1.1 i	40	01/97→03/01	←	Felge Lochzahl: 4		24.0110-0187.1 410187	Ø 247 10 9 + S
1.1 i	44	05/96→07/04	←	→ 03/04; Felge Lochzahl: 3		24.0108-0107.1 408107	Ø 238 8 6 + S
			←	→ 03/04; Felge Lochzahl: 4		24.0110-0187.1 410187	Ø 247 10 9 + S
1.4 i	55	05/96→07/04	←	→ 03/04		24.0110-0187.1 410187	Ø 247 10 9 + S
1.5 D	40	05/96→03/01	←			24.0110-0187.1 410187	Ø 247 10 9 + S
1.6 i	65	05/96→10/99					
Electric	20	04/96→07/04					
1.5 D	42	04/98→07/04	←	10/00→ 03/04		24.0110-0187.1 410187	Ø 247 10 9 + S
1.6 i	74	05/96→01/01	←			24.0120-0132.1 420132	Ø 247 20,4 18,5 V + S
1.6 S16	88	04/98→09/01				24.0320-0132.1 520132	Ø 247 20,4 18,5 V + S
			→			24.0108-0106.1 408106	Ø 247 8 6 + S
1.6 S16	87	05/96→07/04	←	→ 03/04		24.0120-0132.1 420132	Ø 247 20,4 18,5 V + S
			←			24.0320-0132.1 520132	Ø 247 20,4 18,5 V + S
			→	→ 03/04		24.0108-0106.1 408106	Ø 247 8 6 + S
<b>PEUGEOT - 106 Van (1_) 08/91→03/01</b>							
<b> Bremsbelagsatz, Scheibenbremse</b>							
1.0	33	09/91→03/01	←	05/96→; Felge Lochzahl: 4		13.0460-3943.2 603943	BDX 20905 18,0 + WK
			←	05/96→; Felge Lochzahl: 3		13.0460-3962.2 603962	BDX 20905 18,0 + WE / - WK
			←			13.0460-4042.2 604042	ATE 21191 16,8 + WK
			←			13.0460-4066.2 604066	ATE 21857 17,7 - WE / - WK
1.5 D	40	05/96→03/01	←			13.0460-3943.2 603943	BDX 20905 18,0 + WK
1.5 D	42	10/00→03/01				13.0460-3962.2 603962	BDX 20905 18,0 + WE / - WK
<b>Zubehörsatz, Scheibenbremsbelag</b>							
1.0	33	09/91→03/01	←	05/96→; Felge Lochzahl: 4		13.0460-0406.2 610406	BDX
			←	05/96→; Felge Lochzahl: 3		13.0460-0424.2 610424	ATE
1.5 D	40	05/96→03/01	←			13.0460-0403.2 610403	BDX
1.5 D	42	10/00→03/01					
<b> Bremsscheibe</b>							
1.0	33	09/91→03/01	←	05/96→; Felge Lochzahl: 3		24.0108-0107.1 408107	Ø 238 8 6 + S
			←	05/96→; Felge Lochzahl: 4		24.0110-0187.1 410187	Ø 247 10 9 + S
1.5 D	40	05/96→03/01	←			24.0110-0187.1 410187	Ø 247 10 9 + S
1.5 D	42	10/00→03/01					
Electric	20	04/96→03/01					
<b>PEUGEOT - 107 06/05→</b>							
<b> Bremsbelagsatz, Scheibenbremse</b>							
1.0	50	06/05→	←	→ 05/14		13.0460-3829.2 603829	BOS 23959 17,0 - WE / - WK + Zub
1.4 HDi	40	06/05→05/14	←			13.0460-3829.2 603829	BOS 23959 17,0 - WE / - WK + Zub
<b> Bremsscheibe</b>							
1.0	50	06/05→	←	→ 05/14		24.0120-0180.1 420180	Ø 247 20 18 V + S
1.4 HDi	40	06/05→05/14	←			24.0120-0180.1 420180	Ø 247 20 18 V + S









	kw					! #		
<b>PEUGEOT - 108 05/14→</b>								
 <b>Bremsbelagsatz, Scheibenbremse</b>								
1.0 VTi 1.0 VTi 72 1.2	51 53 60	05/14→ 05/18→ 05/14→	←				<b>13.0460-3829.2 603829</b>	BOS 23959 17,0 - WE / - WK + Zub
 <b>Bremsscheibe</b>								
1.0 VTi 1.0 VTi 72 1.2	51 53 60	05/14→ 05/18→ 05/14→	←				<b>24.0120-0180.1 420180</b>	Ø 247 20 18 V + S
<b>PEUGEOT - 205 II (20A/C) 01/87→12/00</b>								
 <b>Bremsbelagsatz, Scheibenbremse</b>								
1.0	33	10/87→09/98	←	09/90→			<b>13.0460-2956.2 602956</b> <b>13.0460-3911.2 603911</b>	TRW 20989 17,7 + WK BDX 20905 18,0 + WK
1.0	37	08/92→05/97	←				<b>13.0460-2956.2 602956</b> <b>13.0460-3911.2 603911</b>	TRW 20989 17,7 + WK BDX 20905 18,0 + WK
1.1	44	07/89→09/98	←	09/90→			<b>13.0460-2956.2 602956</b> <b>13.0460-3911.2 603911</b>	TRW 20989 17,7 + WK BDX 20905 18,0 + WK
			←	09/89→ 08/90			<b>13.0460-2956.2 602956</b> <b>13.0460-3911.2 603911</b>	TRW 20989 17,7 + WK BDX 20905 18,0 + WK
1.4 1.9 Diesel	55 47	07/88→09/98 10/87→09/98	←	09/90→			<b>13.0460-2956.2 602956</b> <b>13.0460-3911.2 603911</b>	TRW 20989 17,7 + WK BDX 20905 18,0 + WK
			←	09/88→ 08/90			<b>13.0460-2956.2 602956</b> <b>13.0460-3911.2 603911</b>	TRW 20989 17,7 + WK BDX 20905 18,0 + WK
1.6 1.6	53 55	10/87→09/98 10/87→09/98	←	09/90→			<b>13.0460-2956.2 602956</b> <b>13.0460-3911.2 603911</b>	TRW 20989 17,7 + WK BDX 20905 18,0 + WK
			←	→ 08/90			<b>13.0460-2956.2 602956</b> <b>13.0460-3911.2 603911</b>	TRW 20989 17,7 + WK BDX 20905 18,0 + WK
1.6 Aut. 1.6 Aut.	58 65	10/87→09/98 05/90→09/98	←	09/90→			<b>13.0460-2956.2 602956</b> <b>13.0460-3911.2 603911</b>	TRW 20989 17,7 + WK BDX 20905 18,0 + WK
			←	→ 08/90; Automatikgetriebe			<b>13.0460-2956.2 602956</b> <b>13.0460-3911.2 603911</b>	TRW 20989 17,7 + WK BDX 20905 18,0 + WK
1.7 Diesel	44	07/87→09/98	←	03/94→			<b>13.0460-2956.2 602956</b> <b>13.0460-3911.2 603911</b>	TRW 20989 17,7 + WK BDX 20905 18,0 + WK
			←	→ 08/90			<b>13.0460-2956.2 602956</b> <b>13.0460-3911.2 603911</b>	TRW 20989 17,7 + WK BDX 20905 18,0 + WK
1.8 TD	57	01/90→09/98	←	09/90→			<b>13.0460-3911.2 603911</b> <b>13.0460-7058.2 607058</b>	BDX 20905 18,0 + WK ATE 21430 17,3 + WK
1.9 GTI	94	10/87→09/98	←	09/90→			<b>13.0460-2955.2 602955</b> <b>13.0460-7058.2 607058</b>	TRW 20772 18,0 + WK ATE 21430 17,3 + WK
			←	→ 08/88			<b>13.0460-2955.2 602955</b>	TRW 20772 18,0 + WK
			→	09/90→			<b>13.0460-3954.2 603954</b>	BDX 20973 11,0 - WK
			→	→ 08/88			<b>13.0460-3954.2 603954</b>	BDX 20973 11,0 - WK
<b>Zubehörsatz, Scheibenbremsbelag</b>								
1.0	33	10/87→09/98	←	09/90→			<b>13.0460-0060.2 610060</b> <b>13.0460-0402.2 610402</b>	TRW BDX
1.0	37	08/92→05/97	←				<b>13.0460-0060.2 610060</b> <b>13.0460-0402.2 610402</b>	TRW BDX
1.1	44	07/89→09/98	←	09/90→			<b>13.0460-0060.2 610060</b> <b>13.0460-0404.2 610404</b>	TRW BDX
			←	09/89→ 08/90			<b>13.0460-0060.2 610060</b> <b>13.0460-0404.2 610404</b>	TRW BDX
1.4	55	07/88→09/98	←	09/90→			<b>13.0460-0060.2 610060</b> <b>13.0460-0404.2 610404</b>	TRW BDX
			←	09/88→ 08/90			<b>13.0460-0060.2 610060</b> <b>13.0460-0404.2 610404</b>	TRW BDX
1.6 1.6	53 55	10/87→09/98 10/87→09/98	←	→ 08/90			<b>13.0460-0060.2 610060</b> <b>13.0460-0402.2 610402</b>	TRW BDX
			←	09/90→			<b>13.0460-0060.2 610060</b> <b>13.0460-0402.2 610402</b>	TRW BDX
1.6 Aut.	58	10/87→09/98	←	09/90→			<b>13.0460-0060.2 610060</b> <b>13.0460-0402.2 610402</b>	TRW BDX
			←	→ 08/90; Automatikgetriebe			<b>13.0460-0060.2 610060</b>	TRW

	kW			 	! #		
<b>PEUGEOT - 205 II (20A/C) 01/87→12/00</b>							
<b>Zubehörsatz, Scheibenbremsbelag</b>							
1.6 Aut.	58	10/87→09/98	←	→ 08/90; Automatikgetriebe		13.0460-0402.2 610402	BDX
1.6 Aut.	65	05/90→09/98	←	09/90→		13.0460-0060.2 610060	TRW
						13.0460-0404.2 610404	BDX
			←	→ 08/90; Automatikgetriebe		13.0460-0060.2 610060	TRW
						13.0460-0402.2 610402	BDX
1.7 Diesel	44	07/87→09/98	←	03/94→		13.0460-0060.2 610060	TRW
						13.0460-0402.2 610402	BDX
			←	→ 08/90		13.0460-0060.2 610060	TRW
						13.0460-0402.2 610402	BDX
1.8 TD	57	01/90→09/98	←	09/90→		13.0460-0402.2 610402	BDX
1.9 Diesel	47	10/87→09/98	←	09/90→		13.0460-0060.2 610060	TRW
						13.0460-0402.2 610402	BDX
			←	09/88→ 08/90		13.0460-0060.2 610060	TRW
						13.0460-0402.2 610402	BDX
1.9 GTI	94	10/87→09/98	→	→ 08/88		13.0460-0435.2 610435	BDX
			→	09/90→		13.0460-0435.2 610435	BDX
<b> Bremsscheibe</b>							
1.0	33	10/87→09/98	←	09/90→		24.0110-0187.1 410187	Ø 247 10 9 + S
1.0	37	08/92→05/97	←			24.0110-0187.1 410187	Ø 247 10 9 + S
1.1	44	07/89→09/98	←	→ 08/90		24.0110-0187.1 410187	Ø 247 10 9 + S
						24.0110-0187.1 410187	Ø 247 10 9 + S
			←	09/90→		24.0120-0131.1 420131	Ø 247 20,4 18,5 V
1.4	55	07/88→09/98	←	→ 08/90		24.0110-0187.1 410187	Ø 247 10 9 + S
						24.0120-0131.1 420131	Ø 247 20,4 18,5 V
			←	09/90→		24.0120-0131.1 420131	Ø 247 20,4 18,5 V
1.6	53	10/87→09/98	←	→ 08/90		24.0120-0131.1 420131	Ø 247 20,4 18,5 V
						24.0120-0131.1 420131	Ø 247 20,4 18,5 V
1.6	55	10/87→09/98	←	09/90→		24.0120-0131.1 420131	Ø 247 20,4 18,5 V
1.6 Aut.	58	10/87→09/98	←	09/90→		24.0120-0131.1 420131	Ø 247 20,4 18,5 V
						24.0120-0131.1 420131	Ø 247 20,4 18,5 V
			←	→ 08/90; Automatikgetriebe		24.0120-0131.1 420131	Ø 247 20,4 18,5 V
1.6 Aut.	65	05/90→09/98	←			24.0110-0187.1 410187	Ø 247 10 9 + S
						24.0120-0131.1 420131	Ø 247 20,4 18,5 V
			←	09/90→		24.0120-0131.1 420131	Ø 247 20,4 18,5 V
			←	→ 08/90; Automatikgetriebe		24.0120-0131.1 420131	Ø 247 20,4 18,5 V
1.7 Diesel	44	07/87→09/98	←	→ 08/90		24.0110-0187.1 410187	Ø 247 10 9 + S
						24.0110-0187.1 410187	Ø 247 10 9 + S
			←	09/90→		24.0110-0187.1 410187	Ø 247 10 9 + S
1.8 TD	57	01/90→09/98	←	09/90→		24.0110-0187.1 410187	Ø 247 10 9 + S
						24.0120-0132.1 420132	Ø 247 20,4 18,5 V + S
			←	01/91→		24.0320-0132.1 520132	Ø 247 20,4 18,5 V + S
						24.0320-0132.1 520132	Ø 247 20,4 18,5 V + S
1.8 XDT	58	08/90→05/97	←			24.0120-0132.1 420132	Ø 247 20,4 18,5 V + S
						24.0320-0132.1 520132	Ø 247 20,4 18,5 V + S
1.9 Diesel	47	10/87→09/98	←	09/90→		24.0110-0187.1 410187	Ø 247 10 9 + S
						24.0110-0187.1 410187	Ø 247 10 9 + S
			←	09/88→ 08/90		24.0110-0187.1 410187	Ø 247 10 9 + S
1.9 GTI	94	10/87→09/98	←	→ 08/88		24.0120-0132.1 420132	Ø 247 20,4 18,5 V + S
						24.0320-0132.1 520132	Ø 247 20,4 18,5 V + S
			←	09/90→		24.0120-0132.1 420132	Ø 247 20,4 18,5 V + S
						24.0320-0132.1 520132	Ø 247 20,4 18,5 V + S
			→	→ 08/88		24.0108-0105.1 408105	Ø 247,5 8 6,5
			→	09/90→		24.0108-0105.1 408105	Ø 247,5 8 6,5
<b>PEUGEOT - 205 Kasten 03/94→05/97</b>							
<b> Bremsbelagsatz, Scheibenbremse</b>							
1.7 Diesel	44	03/94→05/97	←			13.0460-2956.2 602956	TRW 20989 17,7 + WK
						13.0460-3911.2 603911	BDX 20905 18,0 + WK
<b>Zubehörsatz, Scheibenbremsbelag</b>							
1.7 Diesel	44	03/94→05/97	←			13.0460-0060.2 610060	TRW
						13.0460-0402.2 610402	BDX
<b> Bremsscheibe</b>							
1.7 Diesel	44	03/94→05/97	←			24.0110-0187.1 410187	Ø 247 10 9 + S

























	kw			 	! #		
<b>PEUGEOT - 206 CC (2D) 09/00→</b>							
 <b>Bremsbelagsatz, Scheibenbremse</b>							
1.6 1.6 16V	81 80	09/01→12/08 09/00→	←	Orga 10950→; → 01/07	13.0460-2862.2	602862	TRW 23346 19,0 - WK
			←	→Orga 09078	13.0460-3978.2	603978	BOS 23332 18,0 - WK + Zub
			←	Orga 09079→ Orga 10949	13.0460-3994.2	603994	BOS 23599 19,0 - WE / - WK + Zub
			←		13.0470-3994.2	LD3994	BOS 23599 19,0 - WE / - WK + Zub Ceramic
			→	→ 01/07	13.0460-3823.2	603823	BOS 20974 11,0 - WK
1.6 HDi 110	80	04/05→	←	→ 01/07	13.0460-3994.2	603994	BOS 23599 19,0 - WE / - WK + Zub
			←		13.0470-3994.2	LD3994	BOS 23599 19,0 - WE / - WK + Zub Ceramic
			→	→ 01/07	13.0460-3823.2	603823	BOS 20974 11,0 - WK
2.0 S16	100	09/00→	←	→Orga 09078	13.0460-3978.2	603978	BOS 23332 18,0 - WK + Zub
			←	Orga 09079→; → 01/07	13.0460-3994.2	603994	BOS 23599 19,0 - WE / - WK + Zub
			←		13.0470-3994.2	LD3994	BOS 23599 19,0 - WE / - WK + Zub Ceramic
			→	→ 01/07	13.0460-3823.2	603823	BOS 20974 11,0 - WK
<b>Zubehörsatz, Scheibenbremsbelag</b>							
1.6 1.6 16V	81 80	09/01→12/08 09/00→	←	Orga 09079→ Orga 10949	13.0460-0454.2	610454	BOS
			→	→ 01/07	13.0460-0435.2	610435	BDX
1.6 HDi 110	80	04/05→	←	→ 01/07	13.0460-0454.2	610454	BOS
			→	→ 01/07	13.0460-0435.2	610435	BDX
2.0 S16	100	09/00→	←	Orga 09079→; → 01/07	13.0460-0454.2	610454	BOS
			→	→ 01/07	13.0460-0435.2	610435	BDX
<b>Bremsscheibe</b>							
1.6 1.6 16V 2.0 S16	81 80 100	09/01→12/08 09/00→	←	→Orga 09078	24.0120-0133.1	420133	Ø 266 20,5 18,5 V + S
			←		24.0320-0133.1	520133	Ø 266 20,5 18,5 V + S
			←	Orga 09079→; → 01/07	24.0122-0194.1	422194	Ø 266 22 20 V + S
			→	→ 01/07	24.0108-0106.1	408106	Ø 247 8 6 + S
1.6 HDi 110	80	04/05→	←	→ 01/07	24.0122-0194.1	422194	Ø 266 22 20 V + S
			→	→ 01/07	24.0108-0106.1	408106	Ø 247 8 6 + S
<b>PEUGEOT - 206 Schrägheck (2A/C) 08/98→</b>							
 <b>Bremsbelagsatz, Scheibenbremse</b>							
1.1	40	08/98→07/00	←	09/98→	13.0460-3975.2	603975	BOS 23597 18,0 - WK
1.1 i 1.4 HDi eco 70	44 50	09/98→ 09/01→	←	→ 02/09	13.0460-3975.2	603975	BOS 23597 18,0 - WK
			←				
1.4 16V 1.6 HDi 110	65 80	10/03→ 05/04→	←	→ 02/09	13.0460-3994.2	603994	BOS 23599 19,0 - WE / - WK + Zub
			←		13.0470-3994.2	LD3994	BOS 23599 19,0 - WE / - WK + Zub Ceramic
			→	→ 02/09	13.0460-3823.2	603823	BOS 20974 11,0 - WK
1.4 CNG 1.4 HDi 1.4 LPG 1.6 i 1.9 D	55 51 55 65 51	05/06→09/07 09/02→02/07 05/06→09/07 09/98→12/00 09/98→11/01	←		13.0460-3975.2	603975	BOS 23597 18,0 - WK
			←				
			←				
			←				
1.6 1.6 16V	81 79	05/05→07/08 06/01→04/09	←	Orga 10950→	13.0460-2862.2	602862	TRW 23346 19,0 - WK
			←	→Orga 09078	13.0460-3978.2	603978	BOS 23332 18,0 - WK + Zub
			←	Orga 09079→	13.0460-3994.2	603994	BOS 23599 19,0 - WE / - WK + Zub
			←		13.0470-3994.2	LD3994	BOS 23599 19,0 - WE / - WK + Zub Ceramic
			→	→ 02/09	13.0460-3823.2	603823	BOS 20974 11,0 - WK
1.6 16V	80	12/00→	←	Orga 10950→; → 02/09	13.0460-2862.2	602862	TRW 23346 19,0 - WK
			←	→Orga 09078	13.0460-3978.2	603978	BOS 23332 18,0 - WK + Zub
			←	Orga 09079→; → 02/09	13.0460-3994.2	603994	BOS 23599 19,0 - WE / - WK + Zub
↓							























	kw			 	! #			
<b>PEUGEOT - 206 Schrägheck (2A/C) 08/98→</b>								
<b>Bremsbelagsatz, Scheibenbremse</b>								
1.6 16V	80	12/00→	←	Orga 09079→; → 02/09		<b>13.0470-3994.2</b>	<b>LD3994</b>	BOS 23599 19,0 - WE / - WK + Zub Ceramic
			→	→ 02/09		<b>13.0460-3823.2</b>	<b>603823</b>	BOS 20974 11,0 - WK
1.6 8V	66	05/99→10/03	←	→ 12/00		<b>13.0460-3975.2</b>	<b>603975</b>	BOS 23597 18,0 - WK
2.0 HDI 90	66	12/99→	←	Orga 10892→; → 02/09		<b>13.0460-2862.2</b>	<b>602862</b>	TRW 23346 19,0 - WK
			←	→Orga 09078		<b>13.0460-3978.2</b>	<b>603978</b>	BOS 23332 18,0 - WK + Zub
			←	Orga 09079→; → 02/09		<b>13.0460-3994.2</b>	<b>603994</b>	BOS 23599 19,0 - WE / - WK + Zub
						<b>13.0470-3994.2</b>	<b>LD3994</b>	BOS 23599 19,0 - WE / - WK + Zub Ceramic
2.0 RC	130	07/03→	←	→ 02/09		<b>13.0460-3966.2</b>	<b>603966</b>	BOS 23600 19,4 - WE / - WK + Zub
			→	→ 02/09		<b>13.0470-3966.2</b>	<b>LD3966</b>	BOS 23600 19,4 - WE / - WK + Zub Ceramic
2.0 S16	99	04/99→10/00	←			<b>13.0460-3978.2</b>	<b>603978</b>	BOS 23332 18,0 - WK + Zub
			→			<b>13.0460-3823.2</b>	<b>603823</b>	BOS 20974 11,0 - WK
2.0 S16	100	06/99→	←	10/00→; →Orga 09078		<b>13.0460-3978.2</b>	<b>603978</b>	BOS 23332 18,0 - WK + Zub
			←	Orga 09079→; → 02/09		<b>13.0460-3994.2</b>	<b>603994</b>	BOS 23599 19,0 - WE / - WK + Zub
						<b>13.0470-3994.2</b>	<b>LD3994</b>	BOS 23599 19,0 - WE / - WK + Zub Ceramic
			→	10/00→ 02/09		<b>13.0460-3823.2</b>	<b>603823</b>	BOS 20974 11,0 - WK
<b>Zubehörsatz, Scheibenbremsbelag</b>								
1.4 16V 1.6 HDi 110	65	10/03→	←	→ 02/09		<b>13.0460-0454.2</b>	<b>610454</b>	BOS
	80	05/04→	→	→ 02/09		<b>13.0460-0435.2</b>	<b>610435</b>	BDX
1.6 1.6 16V	81	05/05→07/08	←	Orga 09079→		<b>13.0460-0454.2</b>	<b>610454</b>	BOS
	79	06/01→04/09	→			<b>13.0460-0435.2</b>	<b>610435</b>	BDX
1.6 16V	80	12/00→	←	Orga 09079→; → 02/09		<b>13.0460-0454.2</b>	<b>610454</b>	BOS
			→	→ 02/09		<b>13.0460-0435.2</b>	<b>610435</b>	BDX
2.0 HDI 90	66	12/99→	←	Orga 09079→; → 02/09		<b>13.0460-0454.2</b>	<b>610454</b>	BOS
2.0 RC	130	07/03→	→	→ 02/09		<b>13.0460-0435.2</b>	<b>610435</b>	BDX
2.0 S16	99	04/99→10/00	→			<b>13.0460-0435.2</b>	<b>610435</b>	BDX
2.0 S16	100	06/99→	←	Orga 09079→; → 02/09		<b>13.0460-0454.2</b>	<b>610454</b>	BOS
			→	10/00→ 02/09		<b>13.0460-0435.2</b>	<b>610435</b>	BDX
<b>Bremsscheibe</b>								
1.1	40	08/98→07/00	←	09/98→; →Orga 08988; - D; - ABS		<b>24.0110-0187.1</b>	<b>410187</b>	Ø 247 10 9 + S
			←	Orga 08989→ Orga 09974; - D; - ABS		<b>24.0113-0185.1</b>	<b>413185</b>	Ø 247,5 13 11 + S
						<b>24.0313-0185.1</b>	<b>513185</b>	Ø 247,5 13 11 + S
			←	09/98→		<b>24.0113-0185.1</b>	<b>413185</b>	Ø 247,5 13 11 + S
						<b>24.0313-0185.1</b>	<b>513185</b>	Ø 247,5 13 11 + S
			←	Orga 09975→		<b>24.0120-0132.1</b>	<b>420132</b>	Ø 247 20,4 18,5 V + S
						<b>24.0320-0132.1</b>	<b>520132</b>	Ø 247 20,4 18,5 V + S
1.1 i	44	09/98→	←	→Orga 08988; - D; - ABS		<b>24.0110-0187.1</b>	<b>410187</b>	Ø 247 10 9 + S
			←	Orga 08989→ Orga 09974; - D; - ABS		<b>24.0113-0185.1</b>	<b>413185</b>	Ø 247,5 13 11 + S
						<b>24.0313-0185.1</b>	<b>513185</b>	Ø 247,5 13 11 + S
			←	→ 02/09		<b>24.0113-0185.1</b>	<b>413185</b>	Ø 247,5 13 11 + S
						<b>24.0313-0185.1</b>	<b>513185</b>	Ø 247,5 13 11 + S
			←	Orga 09975→; → 02/09		<b>24.0120-0132.1</b>	<b>420132</b>	Ø 247 20,4 18,5 V + S
						<b>24.0320-0132.1</b>	<b>520132</b>	Ø 247 20,4 18,5 V + S
1.4 16V 1.6 HDi 110	65	10/03→	←	→ 02/09		<b>24.0122-0194.1</b>	<b>422194</b>	Ø 266 22 20 V + S
	80	05/04→	→	→ 02/09		<b>24.0108-0106.1</b>	<b>408106</b>	Ø 247 8 6 + S
1.4 CNG 1.4 LPG	55	05/06→09/07	←	- Roland Garros		<b>24.0113-0185.1</b>	<b>413185</b>	Ø 247,5 13 11 + S
	55	05/06→09/07				<b>24.0313-0185.1</b>	<b>513185</b>	Ø 247,5 13 11 + S
				←			<b>24.0120-0132.1</b>	<b>420132</b>
						<b>24.0320-0132.1</b>	<b>520132</b>	Ø 247 20,4 18,5 V + S
1.4 HDi	51	09/02→02/07	←			<b>24.0113-0185.1</b>	<b>413185</b>	Ø 247,5 13 11 + S
						<b>24.0120-0132.1</b>	<b>420132</b>	Ø 247 20,4 18,5 V + S















	kw			 	! #		
<b>PEUGEOT - 206 Schrägheck (2A/C) 08/98→</b>							
 <b>Bremsscheibe</b>							
1.4 HDi	51	09/02→02/07	←			24.0313-0185.1 513185 24.0320-0132.1 520132	Ø 247,5 13 11 + S Ø 247 20,4 18,5 V + S
1.4 HDi eco 70	50	09/01→	←	→ 02/09		24.0113-0185.1 413185 24.0120-0132.1 420132 24.0313-0185.1 513185 24.0320-0132.1 520132	Ø 247,5 13 11 + S Ø 247 20,4 18,5 V + S Ø 247,5 13 11 + S Ø 247 20,4 18,5 V + S
1.4 i	55	09/98→	←	→ 02/09; - Roland Garros		24.0113-0185.1 413185 24.0313-0185.1 513185	Ø 247,5 13 11 + S Ø 247,5 13 11 + S
			←	→ 02/09		24.0120-0132.1 420132 24.0320-0132.1 520132	Ø 247 20,4 18,5 V + S Ø 247 20,4 18,5 V + S
1.6 1.6 16V	81 79	05/05→07/08 06/01→04/09	←	→Orga 09078		24.0120-0133.1 420133 24.0320-0133.1 520133	Ø 266 20,5 18,5 V + S Ø 266 20,5 18,5 V + S
			←	Orga 09079→		24.0122-0194.1 422194	Ø 266 22 20 V + S
			→			24.0108-0106.1 408106	Ø 247 8 6 + S
1.6 16V	80	12/00→	←	→Orga 09078		24.0120-0133.1 420133 24.0320-0133.1 520133	Ø 266 20,5 18,5 V + S Ø 266 20,5 18,5 V + S
			←	Orga 09079→; → 02/09		24.0122-0194.1 422194	Ø 266 22 20 V + S
			→	→ 02/09		24.0108-0106.1 408106	Ø 247 8 6 + S
1.6 8V	66	05/99→10/03	←	→ 12/00		24.0120-0132.1 420132 24.0320-0132.1 520132	Ø 247 20,4 18,5 V + S Ø 247 20,4 18,5 V + S
1.6 i 1.9 D	65 51	09/98→12/00 09/98→11/01	←			24.0120-0132.1 420132 24.0320-0132.1 520132	Ø 247 20,4 18,5 V + S Ø 247 20,4 18,5 V + S
2.0 HDI 90	66	12/99→	←	→Orga 09078		24.0120-0133.1 420133 24.0320-0133.1 520133	Ø 266 20,5 18,5 V + S Ø 266 20,5 18,5 V + S
			←	Orga 09079→; → 02/09		24.0122-0194.1 422194	Ø 266 22 20 V + S
2.0 RC	130	07/03→	←	→ 02/09		24.0126-0120.1 426120 24.0326-0120.1 526120	Ø 283 26 24 V + S Ø 283 26 24 V + S
			→	→ 02/09		24.0108-0106.1 408106	Ø 247 8 6 + S
2.0 S16	99	04/99→10/00	←			24.0120-0133.1 420133 24.0320-0133.1 520133	Ø 266 20,5 18,5 V + S Ø 266 20,5 18,5 V + S
			→			24.0108-0106.1 408106	Ø 247 8 6 + S
2.0 S16	100	06/99→	←	10/00→; →Orga 09078		24.0120-0133.1 420133 24.0320-0133.1 520133	Ø 266 20,5 18,5 V + S Ø 266 20,5 18,5 V + S
			←	Orga 09079→; → 02/09		24.0122-0194.1 422194	Ø 266 22 20 V + S
			→	10/00→ 02/09		24.0108-0106.1 408106	Ø 247 8 6 + S
<b>PEUGEOT - 206 Stufenheck 03/07→</b>							
 <b>Bremsbelagsatz, Scheibenbremse</b>							
1.4 1.4 HDi eco 70	55 50	03/07→ 09/08→	←	→ 02/09		13.0460-3975.2 603975	BOS 23597 18,0 - WK
1.6 16V	80	03/07→	←	Orga 10950→; → 02/09		13.0460-2862.2 602862	TRW 23346 19,0 - WK
			←	→Orga 09078		13.0460-3978.2 603978	BOS 23332 18,0 - WK + Zub
			←	Orga 09079→; → 02/09		13.0460-3994.2 603994 13.0470-3994.2 LD3994	BOS 23599 19,0 - WE / - WK + Zub BOS 23599 19,0 - WE / - WK + Zub Ceramic
			→	→ 02/09		13.0460-3823.2 603823	BOS 20974 11,0 - WK
<b>Zubehörsatz, Scheibenbremsbelag</b>							
1.6 16V	80	03/07→	←	Orga 09079→; → 02/09		13.0460-0454.2 610454	BOS
			→	→ 02/09		13.0460-0435.2 610435	BDX
 <b>Bremsscheibe</b>							
1.4	55	03/07→	←	→ 02/09; - Roland Garros		24.0113-0185.1 413185 24.0313-0185.1 513185	Ø 247,5 13 11 + S Ø 247,5 13 11 + S
			←	→ 02/09		24.0120-0132.1 420132 24.0320-0132.1 520132	Ø 247 20,4 18,5 V + S Ø 247 20,4 18,5 V + S
1.4 HDi eco 70	50	09/08→	←	→ 02/09		24.0113-0185.1 413185 24.0120-0132.1 420132 24.0313-0185.1 513185	Ø 247,5 13 11 + S Ø 247 20,4 18,5 V + S Ø 247,5 13 11 + S
↓							











	kW			 	! #			
<b>PEUGEOT - 206 Stufenheck 03/07→</b>								
 <b>Bremsscheibe</b>								
1.4 HDi eco 70	50	09/08→	←	→ 02/09		24.0320-0132.1 520132	Ø 247 20,4 18,5 V + S	
1.6 16V	80	03/07→	←	→ Orga 09078		24.0120-0133.1 420133	Ø 266 20,5 18,5 V + S	
			←	Orga 09079→; → 02/09		24.0320-0133.1 520133	Ø 266 20,5 18,5 V + S	
			→	→ 02/09		24.0122-0194.1 422194	Ø 266 22 20 V + S	
			→	→ 02/09		24.0108-0106.1 408106	Ø 247 8 6 + S	
<b>PEUGEOT - 206 SW (2E/K) 07/02→</b>								
 <b>Bremsbelagsatz, Scheibenbremse</b>								
1.1	44	07/02→	←	→ 05/07		13.0460-3975.2 603975	BOS 23597 18,0 - WK	
1.4	55	07/02→						
1.4 HDi	50	07/02→						
1.4 16V	65	10/03→	←	→ 05/07		13.0460-3994.2 603994	BOS 23599 19,0 - WE / - WK + Zub	
			1.6 HDi 110	80	05/04→		13.0470-3994.2 LD3994	BOS 23599 19,0 - WE / - WK + Zub Ceramic
			→	→ 05/07		13.0460-3823.2 603823	BOS 20974 11,0 - WK	
1.6 16V	81	05/05→07/08	←	Orga 10809→		13.0460-2862.2 602862	TRW 23346 19,0 - WK	
			07/02→	←	→ Orga 10808		13.0460-3994.2 603994	BOS 23599 19,0 - WE / - WK + Zub
				→	→ 05/07		13.0470-3994.2 LD3994	BOS 23599 19,0 - WE / - WK + Zub Ceramic
	80		→	→ 05/07		13.0460-3823.2 603823	BOS 20974 11,0 - WK	
2.0 16V	100	07/02→02/07	←			13.0460-3994.2 603994	BOS 23599 19,0 - WE / - WK + Zub	
						13.0470-3994.2 LD3994	BOS 23599 19,0 - WE / - WK + Zub Ceramic	
			→			13.0460-3823.2 603823	BOS 20974 11,0 - WK	
2.0 HDi	66	07/02→	←	Orga 10809→		13.0460-2862.2 602862	TRW 23346 19,0 - WK	
			←	→ Orga 10808		13.0460-3994.2 603994	BOS 23599 19,0 - WE / - WK + Zub	
						13.0470-3994.2 LD3994	BOS 23599 19,0 - WE / - WK + Zub Ceramic	
<b>Zubehörsatz, Scheibenbremsbelag</b>								
1.4 16V	65	10/03→	←	→ 05/07		13.0460-0454.2 610454	BOS	
1.6 HDi 110	80	05/04→	→	→ 05/07		13.0460-0435.2 610435	BDX	
1.6 16V	81	05/05→07/08	←	→ Orga 10808		13.0460-0454.2 610454	BOS	
			07/02→	→	→ 05/07		13.0460-0435.2 610435	BDX
2.0 16V	100	07/02→02/07	←			13.0460-0454.2 610454	BOS	
			→			13.0460-0435.2 610435	BDX	
2.0 HDi	66	07/02→	←	→ Orga 10808		13.0460-0454.2 610454	BOS	
 <b>Bremsscheibe</b>								
1.1	44	07/02→	←	→ 05/07		24.0113-0185.1 413185	Ø 247,5 13 11 + S	
						24.0313-0185.1 513185	Ø 247,5 13 11 + S	
1.4 1.4 HDi	55	07/02→	←	→ 05/07		24.0113-0185.1 413185	Ø 247,5 13 11 + S	
			07/02→				24.0120-0132.1 420132	Ø 247 20,4 18,5 V + S
							24.0313-0185.1 513185	Ø 247,5 13 11 + S
1.4 16V	65	10/03→	←	→ 05/07		24.0122-0194.1 422194	Ø 266 22 20 V + S	
			1.6 16V	81	05/05→07/08	→	→ 05/07	
1.6 16V	80	07/02→						
1.6 HDi 110	80	05/04→	←			24.0122-0194.1 422194	Ø 266 22 20 V + S	
			→			24.0108-0106.1 408106	Ø 247 8 6 + S	
2.0 16V	100	07/02→02/07	←			24.0122-0194.1 422194	Ø 266 22 20 V + S	
			→			24.0108-0106.1 408106	Ø 247 8 6 + S	
2.0 HDi	66	07/02→	←	→ 05/07		24.0122-0194.1 422194	Ø 266 22 20 V + S	
<b>PEUGEOT - 206 Van 04/99→03/09</b>								
 <b>Bremsbelagsatz, Scheibenbremse</b>								
1.4 HDi	50	09/01→03/09	←	→ 02/09		13.0460-3975.2 603975	BOS 23597 18,0 - WK	
1.9 D	51	04/99→05/07	←			13.0460-3975.2 603975	BOS 23597 18,0 - WK	
 <b>Bremsscheibe</b>								
1.4 HDi	50	09/01→03/09	←	→ 02/09		24.0113-0185.1 413185	Ø 247,5 13 11 + S	











	kW			 	! #		
<b>PEUGEOT - 206 Van 04/99→03/09</b>							
 <b>Bremsscheibe</b>							
1.4 HDi	50	09/01→03/09	←	→ 02/09		24.0120-0132.1 420132 24.0313-0185.1 513185 24.0320-0132.1 520132	Ø 247 20,4 18,5 V + S Ø 247,5 13 11 + S Ø 247 20,4 18,5 V + S
1.9 D	51	04/99→05/07	←			24.0120-0132.1 420132 24.0320-0132.1 520132	Ø 247 20,4 18,5 V + S Ø 247 20,4 18,5 V + S
<b>PEUGEOT - 206+ (2L_, 2M_) 01/09→</b>							
 <b>Bremsbelagsatz, Scheibenbremse</b>							
1.1 1.4 HDi eco 70 1.4 i 1.4 i	44 50 54 55	01/09→ 01/09→ 09/10→ 01/09→	←	+ D; → 05/13		13.0460-3975.2 603975	BOS 23597 18,0 - WK
1.6 16V	80	07/10→	←	→ 05/13		13.0460-3994.2 603994 13.0470-3994.2 LD3994	BOS 23599 19,0 - WE / - WK + Zub BOS 23599 19,0 - WE / - WK + Zub Ceramic
 <b>Bremsscheibe</b>							
1.1 1.4 HDi eco 70 1.4 i 1.4 i	44 50 54 55	01/09→ 01/09→ 09/10→ 01/09→	←	- D; → 05/13		24.0113-0185.1 413185 24.0313-0185.1 513185	Ø 247,5 13 11 + S Ø 247,5 13 11 + S
			←	+ D; → 05/13		24.0120-0132.1 420132 24.0320-0132.1 520132	Ø 247 20,4 18,5 V + S Ø 247 20,4 18,5 V + S
1.6 16V	80	07/10→	←	→ 05/13		24.0122-0194.1 422194	Ø 266 22 20 V + S
<b>PEUGEOT - 207 (WA_, WC_) 02/06→</b>							
 <b>Bremsbelagsatz, Scheibenbremse</b>							
1.4 1.4 1.4 1.4 16V 1.4 Bioflex 1.4 HDi 1.4 HDi 1.6 HDi	53 54 55 65 60 50 52 68	02/06→ 12/07→ 08/08→ 02/06→ 08/08→ 02/06→ 02/11→ 11/09→	←	→ 06/12		13.0460-3994.2 603994 13.0470-3994.2 LD3994	BOS 23599 19,0 - WE / - WK + Zub BOS 23599 19,0 - WE / - WK + Zub Ceramic
1.4 16V	70	06/07→	←	08/07→ 06/12		13.0460-3966.2 603966 13.0470-3966.2 LD3966	BOS 23600 19,4 - WE / - WK + Zub BOS 23600 19,4 - WE / - WK + Zub Ceramic
1.4 16V	72	10/09→	←	→ 06/12		13.0460-3966.2 603966 13.0470-3966.2 LD3966	BOS 23600 19,4 - WE / - WK + Zub BOS 23600 19,4 - WE / - WK + Zub Ceramic
1.6 1.6 1.6 16V 1.6 16V Turbo 1.6 16V VTi 1.6 HDi 1.6 HDi 110	81 90 80 110 88 80 82	08/08→ 09/07→12/13 02/06→ 02/06→ 02/07→ 02/06→ 08/09→	←	→ 06/12		13.0460-3966.2 603966 13.0470-3966.2 LD3966	BOS 23600 19,4 - WE / - WK + Zub BOS 23600 19,4 - WE / - WK + Zub Ceramic
			→	Orga 11635→; → 06/12		13.0460-2740.2 602740 13.0470-2740.2 LD2740	TRW 23554 17,0 - WE / - WK + Zub TRW 23554 17,0 - WE / - WK + Zub Ceramic
			→	→Orga 11634		13.0460-3813.2 603813 13.0460-3851.2 603851 13.0470-3813.2 LD3813	BOS 24150 17,6 - WE / - WK + Zub BOS 24150 17,6 - WE / - WK + Zub BOS 24150 17,6 - WE / - WK + Zub Ceramic
1.6 16V RC	128	02/07→	←	→ 06/12		13.0460-7230.2 607230 13.0470-7202.2 LD7202 13.0470-7230.2 LD7230	ATE 24557 19,4 - WE / - WK ATE 23589 19,1 - WE / - WK Ceramic ATE 24557 19,4 - WE / - WK Ceramic
			→	Orga 11628→; → 06/12		13.0460-2740.2 602740 13.0470-2740.2 LD2740	TRW 23554 17,0 - WE / - WK + Zub TRW 23554 17,0 - WE / - WK + Zub Ceramic
			→	→Orga 11627		13.0460-3851.2 603851	BOS 24150 17,6 - WE / - WK + Zub
1.6 16V Turbo	115	10/09→	←	01/10→ 06/12		13.0460-3966.2 603966	BOS 23600 19,4 - WE / - WK + Zub
↓							













	kW			 	! #		
<b>PEUGEOT - 207 (WA_, WC_) 02/06→</b>							
 <b>Bremsbelagsatz, Scheibenbremse</b>							
1.6 16V Turbo	115	10/09→	←	01/10→ 06/12	13.0470-3966.2	LD3966	BOS 23600 19,4 - WE / - WK + Zub Ceramic
			→	Orga 11635→; → 06/12	13.0460-2740.2	602740	TRW 23554 17,0 - WE / - WK + Zub
			→	→Orga 11634	13.0470-2740.2	LD2740	TRW 23554 17,0 - WE / - WK + Zub Ceramic
			→		13.0460-3813.2	603813	BOS 24150 17,6 - WE / - WK + Zub
			→		13.0460-3851.2	603851	BOS 24150 17,6 - WE / - WK + Zub
			→		13.0470-3813.2	LD3813	BOS 24150 17,6 - WE / - WK + Zub Ceramic
1.6 HDi	66	02/06→10/13	←	für Bremsscheibendurchmesser [mm]: 283; → 06/12	13.0460-3966.2	603966	BOS 23600 19,4 - WE / - WK + Zub
			←	für Bremsscheibendurchmesser [mm]: 266; → 06/12	13.0470-3966.2	LD3966	BOS 23600 19,4 - WE / - WK + Zub Ceramic
			←		13.0460-3994.2	603994	BOS 23599 19,0 - WE / - WK + Zub
			→	Orga 11635→; → 06/12	13.0470-3994.2	LD3994	BOS 23599 19,0 - WE / - WK + Zub Ceramic
			→		13.0460-2740.2	602740	TRW 23554 17,0 - WE / - WK + Zub
			→		13.0470-2740.2	LD2740	TRW 23554 17,0 - WE / - WK + Zub Ceramic
			→		13.0460-3813.2	603813	BOS 24150 17,6 - WE / - WK + Zub
			→		13.0460-3851.2	603851	BOS 24150 17,6 - WE / - WK + Zub
			→		13.0470-3813.2	LD3813	BOS 24150 17,6 - WE / - WK + Zub Ceramic
			→				
			→				
 <b>Bremsscheibe</b>							
1.4 1.4 1.4 1.4 16V 1.4 Bioflex 1.4 HDi 1.4 HDi 1.6 HDi	53 54 55 65 60 50 52 68	02/06→	←	→ 06/12	24.0122-0194.1	422194	Ø 266 22 20 V + S
			→				
			→				
			→				
			→				
			→				
			→				
1.4 16V	70	06/07→	←	08/07→ 06/12	24.0126-0120.1	426120	Ø 283 26 24 V + S
			→		24.0326-0120.1	526120	Ø 283 26 24 V + S
1.4 16V	72	10/09→	←	→ 06/12	24.0126-0120.1	426120	Ø 283 26 24 V + S
			→		24.0326-0120.1	526120	Ø 283 26 24 V + S
1.6 1.6 1.6 16V 1.6 16V Turbo 1.6 16V VTI 1.6 HDi 1.6 HDi 110	81 90 80 110 88 80 82	08/08→ 09/07→12/13 02/06→	←	→ 06/12	24.0126-0120.1	426120	Ø 283 26 24 V + S
			→		24.0326-0120.1	526120	Ø 283 26 24 V + S
			→		24.0109-0100.2	409100	Ø 249 9 7 + LG / + ABS Ring
			→				
			→				
1.6 16V RC	128	02/07→	←	→ 06/12	24.0126-0140.1	426140	Ø 302 26 24 außenbelüftet + S
			→		24.0109-0100.2	409100	Ø 249 9 7 + LG / + ABS Ring
1.6 16V Turbo	115	10/09→	←	01/10→ 06/12	24.0126-0120.1	426120	Ø 283 26 24 V + S
			→		24.0326-0120.1	526120	Ø 283 26 24 V + S
			→		24.0109-0100.2	409100	Ø 249 9 7 + LG / + ABS Ring
1.6 HDi	66	02/06→10/13	←	→ 06/12	24.0122-0194.1	422194	Ø 266 22 20 V + S
			→		24.0126-0120.1	426120	Ø 283 26 24 V + S
			→		24.0326-0120.1	526120	Ø 283 26 24 V + S
			→		24.0109-0100.2	409100	Ø 249 9 7 + LG / + ABS Ring
<b>PEUGEOT - 207 CC (WD_) 02/07→</b>							
 <b>Bremsbelagsatz, Scheibenbremse</b>							
1.6 1.6 16V	90 88	09/10→12/11 02/07→	←		13.0460-3966.2	603966	BOS 23600 19,4 - WE / - WK + Zub
			→	Orga 1164282→	13.0470-3966.2	LD3966	BOS 23600 19,4 - WE / - WK + Zub Ceramic
			→		13.0460-2740.2	602740	TRW 23554 17,0 - WE / - WK + Zub
↓							











	kw			 	! #		
<b>PEUGEOT - 207 CC (WD_) 02/07→</b>							
 <b>Bremsbelagsatz, Scheibenbremse</b>							
1.6 1.6 16V	90 88	09/10→12/11 02/07→	➡	Orga 1164282→		<b>13.0470-2740.2</b> <b>LD2740</b>	TRW 23554 17,0 - WE / - WK + Zub Ceramic
			➡	→Orga 1164182		<b>13.0460-3851.2</b> <b>603851</b>	BOS 24150 17,6 - WE / - WK + Zub
1.6 16V Turbo 1.6 16V Turbo 1.6 HDi	110 115 80	02/07→ 10/09→ 02/07→	←			<b>13.0460-3966.2</b> <b>603966</b>	BOS 23600 19,4 - WE / - WK + Zub
			➡	Orga 1163582→		<b>13.0460-2740.2</b> <b>602740</b>	TRW 23554 17,0 - WE / - WK + Zub
			➡	→Orga 1163482		<b>13.0460-3851.2</b> <b>603851</b>	BOS 24150 17,6 - WE / - WK + Zub
1.6 HDi	82	08/09→	←			<b>13.0460-3966.2</b> <b>603966</b>	BOS 23600 19,4 - WE / - WK + Zub
			➡			<b>13.0460-2740.2</b> <b>602740</b>	TRW 23554 17,0 - WE / - WK + Zub
			➡			<b>13.0470-2740.2</b> <b>LD2740</b>	TRW 23554 17,0 - WE / - WK + Zub Ceramic
 <b>Bremsscheibe</b>							
1.6 1.6 16V	90 88	09/10→12/11 02/07→	←			<b>24.0126-0120.1</b> <b>426120</b>	Ø 283 26 24 V + S
1.6 16V Turbo 1.6 16V Turbo	110 115	02/07→ 10/09→	➡			<b>24.0326-0120.1</b> <b>526120</b>	Ø 283 26 24 V + S
1.6 HDi 1.6 HDi	80 82	02/07→ 08/09→				<b>24.0109-0100.2</b> <b>409100</b>	Ø 249 9 7 + LG / + ABS Ring
<b>PEUGEOT - 207 Stufenheck 12/07→</b>							
 <b>Bremsbelagsatz, Scheibenbremse</b>							
1.4	54	12/07→	←	→ 06/12		<b>13.0460-3994.2</b> <b>603994</b>	BOS 23599 19,0 - WE / - WK + Zub
						<b>13.0470-3994.2</b> <b>LD3994</b>	BOS 23599 19,0 - WE / - WK + Zub Ceramic
 <b>Bremsscheibe</b>							
1.4	54	12/07→	←	→ 06/12		<b>24.0122-0194.1</b> <b>422194</b>	Ø 266 22 20 V + S
<b>PEUGEOT - 207 SW (WK_) 02/07→</b>							
 <b>Bremsbelagsatz, Scheibenbremse</b>							
1.4	54	06/07→	←	→ 07/13		<b>13.0460-3994.2</b> <b>603994</b>	BOS 23599 19,0 - WE / - WK + Zub
						<b>13.0470-3994.2</b> <b>LD3994</b>	BOS 23599 19,0 - WE / - WK + Zub Ceramic
1.4 16V 1.4 16V	70 72	06/07→ 11/09→	←	→ 07/13		<b>13.0460-3966.2</b> <b>603966</b>	BOS 23600 19,4 - WE / - WK + Zub
						<b>13.0470-3966.2</b> <b>LD3966</b>	BOS 23600 19,4 - WE / - WK + Zub Ceramic
1.6 16V 1.6 16V Turbo	88 110	06/07→ 02/07→	←	→ 07/13		<b>13.0460-3966.2</b> <b>603966</b>	BOS 23600 19,4 - WE / - WK + Zub
			➡	Orga 11628→; → 07/13		<b>13.0460-2740.2</b> <b>602740</b>	TRW 23554 17,0 - WE / - WK + Zub
			➡	→Orga 11627		<b>13.0460-3851.2</b> <b>603851</b>	BOS 24150 17,6 - WE / - WK + Zub
1.6 16V RC	128	02/07→	←	11/07→ 07/13		<b>13.0460-7230.2</b> <b>607230</b>	ATE 24557 19,4 - WE / - WK
						<b>13.0470-7202.2</b> <b>LD7202</b>	ATE 23589 19,1 - WE / - WK Ceramic
						<b>13.0470-7230.2</b> <b>LD7230</b>	ATE 24557 19,4 - WE / - WK Ceramic
			➡	Orga 11628→; → 07/13		<b>13.0460-2740.2</b> <b>602740</b>	TRW 23554 17,0 - WE / - WK + Zub
						<b>13.0470-2740.2</b> <b>LD2740</b>	TRW 23554 17,0 - WE / - WK + Zub Ceramic









	kW			 	! #		
<b>PEUGEOT - 207 SW (WK_) 02/07→</b>							
 <b>Bremsbelagsatz, Scheibenbremse</b>							
1.6 16V RC	128	02/07→	➔	11/07→; →Orga 11627		<b>13.0460-3851.2 603851</b>	BOS 24150 17,6 - WE / - WK + Zub
1.6 HDi	66	06/07→12/12	➔			<b>13.0460-3966.2 603966</b>	BOS 23600 19,4 - WE / - WK + Zub
						<b>13.0470-3966.2 LD3966</b>	BOS 23600 19,4 - WE / - WK + Zub Ceramic
				➔	Orga 11634→	<b>13.0460-2740.2 602740</b>	TRW 23554 17,0 - WE / - WK + Zub
			➔	→Orga 11634		<b>13.0470-2740.2 LD2740</b>	TRW 23554 17,0 - WE / - WK + Zub Ceramic
			➔			<b>13.0460-3851.2 603851</b>	BOS 24150 17,6 - WE / - WK + Zub
1.6 HDi	68	11/09→	➔	→ 07/13		<b>13.0460-3966.2 603966</b>	BOS 23600 19,4 - WE / - WK + Zub
						<b>13.0470-3966.2 LD3966</b>	BOS 23600 19,4 - WE / - WK + Zub Ceramic
				➔	→ 07/13	<b>13.0460-2740.2 602740</b>	TRW 23554 17,0 - WE / - WK + Zub
			➔			<b>13.0470-2740.2 LD2740</b>	TRW 23554 17,0 - WE / - WK + Zub Ceramic
1.6 HDi	80	06/07→12/12	➔			<b>13.0460-3966.2 603966</b>	BOS 23600 19,4 - WE / - WK + Zub
						<b>13.0470-3966.2 LD3966</b>	BOS 23600 19,4 - WE / - WK + Zub Ceramic
				➔	Orga 11635→	<b>13.0460-2740.2 602740</b>	TRW 23554 17,0 - WE / - WK + Zub
			➔	→Orga 11634		<b>13.0470-2740.2 LD2740</b>	TRW 23554 17,0 - WE / - WK + Zub Ceramic
			➔			<b>13.0460-3851.2 603851</b>	BOS 24150 17,6 - WE / - WK + Zub
1.6 HDi	82	08/09→	➔	→ 07/13		<b>13.0460-3966.2 603966</b>	BOS 23600 19,4 - WE / - WK + Zub
						<b>13.0470-3966.2 LD3966</b>	BOS 23600 19,4 - WE / - WK + Zub Ceramic
				➔	→ 07/13; Orga 11631→	<b>13.0460-2740.2 602740</b>	TRW 23554 17,0 - WE / - WK + Zub
			➔			<b>13.0470-2740.2 LD2740</b>	TRW 23554 17,0 - WE / - WK + Zub Ceramic
			➔	→Orga 11631		<b>13.0460-3851.2 603851</b>	BOS 24150 17,6 - WE / - WK + Zub
 <b>Bremsscheibe</b>							
1.4	54	06/07→	➔	→ 07/13		<b>24.0122-0194.1 422194</b>	Ø 266 22 20 V + S
1.4 16V	70	06/07→	➔	→ 07/13		<b>24.0126-0120.1 426120</b>	Ø 283 26 24 V + S
	72	11/09→			<b>24.0326-0120.1 526120</b>	Ø 283 26 24 V + S	
1.6 16V	88	06/07→	➔	→ 07/13		<b>24.0126-0120.1 426120</b>	Ø 283 26 24 V + S
	1.6 16V Turbo	110			02/07→	<b>24.0326-0120.1 526120</b>	Ø 283 26 24 V + S
	1.6 HDi	68			11/09→		
1.6 HDi	82	08/09→	➔	→ 07/13		<b>24.0109-0100.2 409100</b>	Ø 249 9 7 + LG / + ABS Ring
1.6 16V RC	128	02/07→	➔	11/07→ 07/13		<b>24.0126-0140.1 426140</b>	Ø 302 26 24 außenbelüftet + S
					06/07→ 07/13	<b>24.0109-0100.2 409100</b>	Ø 249 9 7 + LG / + ABS Ring
1.6 HDi	66	06/07→12/12	➔			<b>24.0126-0120.1 426120</b>	Ø 283 26 24 V + S
1.6 HDi	80	06/07→12/12				<b>24.0326-0120.1 526120</b>	Ø 283 26 24 V + S
			➔			<b>24.0109-0100.2 409100</b>	Ø 249 9 7 + LG / + ABS Ring
<b>PEUGEOT - 207 Van 04/07→</b>							
 <b>Bremsbelagsatz, Scheibenbremse</b>							
1.4	54	06/07→10/08	➔			<b>13.0460-3994.2 603994</b>	BOS 23599 19,0 - WE / - WK + Zub
						<b>13.0470-3994.2 LD3994</b>	BOS 23599 19,0 - WE / - WK + Zub Ceramic
1.4 HDi	50	04/07→	➔	→ 06/12		<b>13.0460-3994.2 603994</b>	BOS 23599 19,0 - WE / - WK + Zub
							<b>13.0470-3994.2 LD3994</b>
1.6 HDi	66	04/07→10/12	➔	für Bremsscheibendurchmesser [mm]: 283; → 06/12		<b>13.0460-3966.2 603966</b>	BOS 23600 19,4 - WE / - WK + Zub
1.6 HDi	68	11/09→					

	kw			 	! #		
<b>PEUGEOT - 207 Van 04/07→</b>							
 <b>Bremsbelagsatz, Scheibenbremse</b>							
1.6 HDi 1.6 HDi	66 68	04/07→10/12 11/09→	←	für Bremsscheibendurchmesser [mm]: 283; → 06/12		<b>13.0470-3966.2</b> <b>LD3966</b>	BOS 23600 19,4 - WE / - WK + Zub Ceramic
			←	für Bremsscheibendurchmesser [mm]: 266; → 06/12		<b>13.0460-3994.2</b> <b>603994</b> <b>13.0470-3994.2</b> <b>LD3994</b>	BOS 23599 19,0 - WE / - WK + Zub BOS 23599 19,0 - WE / - WK + Zub Ceramic
			→	Orga 11635→; → 06/12		<b>13.0460-2740.2</b> <b>602740</b> <b>13.0470-2740.2</b> <b>LD2740</b>	TRW 23554 17,0 - WE / - WK + Zub TRW 23554 17,0 - WE / - WK + Zub Ceramic
			→	→Orga 11634		<b>13.0460-3813.2</b> <b>603813</b> <b>13.0460-3851.2</b> <b>603851</b> <b>13.0470-3813.2</b> <b>LD3813</b>	BOS 24150 17,6 - WE / - WK + Zub BOS 24150 17,6 - WE / - WK + Zub BOS 24150 17,6 - WE / - WK + Zub Ceramic
 <b>Bremsscheibe</b>							
1.4	54	06/07→10/08	←			<b>24.0122-0194.1</b> <b>422194</b>	Ø 266 22 20 V + S
1.4 HDi	50	04/07→	←	→ 06/12		<b>24.0122-0194.1</b> <b>422194</b>	Ø 266 22 20 V + S
1.6 HDi 1.6 HDi	66 68	04/07→10/12 11/09→	←	→ 06/12		<b>24.0122-0194.1</b> <b>422194</b> <b>24.0126-0120.1</b> <b>426120</b> <b>24.0326-0120.1</b> <b>526120</b>	Ø 266 22 20 V + S Ø 283 26 24 V + S Ø 283 26 24 V + S
			→	→ 06/12		<b>24.0109-0100.2</b> <b>409100</b>	Ø 249 9 7 + LG / + ABS Ring
<b>PEUGEOT - 208 (CA_, CC_) 03/12→</b>							
 <b>Bremsbelagsatz, Scheibenbremse</b>							
1.0 1.2 1.2 GPL 1.2 THP 1.4 GPL 1.4 HDi 1.4 VTi 1.6 1.6 1.6 BlueHDi 100 1.6 BlueHDi 120 1.6 HDi 1.6 HDi 1.6 HDi 1.6 HDi 1.6 HDi / BlueHDi 75 1.6 THP 165	50 60 60 81 70 50 70 88 115 73 88 68 69 84 85 55 121	03/12→ 03/12→ 06/15→ 01/13→ 10/13→ 03/12→ 03/12→ 03/12→ 03/12→ 01/15→ 11/13→ 03/12→ 09/16→ 03/12→ 04/14→ 01/13→ 03/15→	←	für Bremsscheibendurchmesser [mm]: 266		<b>13.0460-3994.2</b> <b>603994</b> <b>13.0470-3994.2</b> <b>LD3994</b>	BOS 23599 19,0 - WE / - WK + Zub BOS 23599 19,0 - WE / - WK + Zub Ceramic
			←	für Bremsscheibendurchmesser [mm]: 302		<b>13.0460-7202.2</b> <b>607202</b> <b>13.0460-7230.2</b> <b>607230</b> <b>13.0470-7202.2</b> <b>LD7202</b>	ATE 23589 19,1 - WE / - WK ATE 24557 19,4 - WE / - WK ATE 23589 19,1 - WE / - WK Ceramic
			→			<b>13.0460-2740.2</b> <b>602740</b> <b>13.0470-2740.2</b> <b>LD2740</b>	TRW 23554 17,0 - WE / - WK + Zub TRW 23554 17,0 - WE / - WK + Zub Ceramic
1.2 1.5 BlueHDi 100	50 75	08/16→ 05/18→	←	für Bremsscheibendurchmesser [mm]: 266		<b>13.0460-3994.2</b> <b>603994</b> <b>13.0470-3994.2</b> <b>LD3994</b>	BOS 23599 19,0 - WE / - WK + Zub BOS 23599 19,0 - WE / - WK + Zub Ceramic
			←	für Bremsscheibendurchmesser [mm]: 302		<b>13.0460-7202.2</b> <b>607202</b> <b>13.0470-7202.2</b> <b>LD7202</b>	ATE 23589 19,1 - WE / - WK ATE 23589 19,1 - WE / - WK Ceramic
			→			<b>13.0460-2740.2</b> <b>602740</b> <b>13.0470-2740.2</b> <b>LD2740</b>	TRW 23554 17,0 - WE / - WK + Zub TRW 23554 17,0 - WE / - WK + Zub Ceramic
1.6 GTi	147	08/12→	←	03/13→		<b>13.0460-7230.2</b> <b>607230</b> <b>13.0470-7230.2</b> <b>LD7230</b>	ATE 24557 19,4 - WE / - WK ATE 24557 19,4 - WE / - WK Ceramic
			→	03/13→		<b>13.0460-2740.2</b> <b>602740</b> <b>13.0470-2740.2</b> <b>LD2740</b>	TRW 23554 17,0 - WE / - WK + Zub TRW 23554 17,0 - WE / - WK + Zub Ceramic
1.6 GTi	153	10/14→	→			<b>13.0460-2740.2</b> <b>602740</b> <b>13.0470-2740.2</b> <b>LD2740</b>	TRW 23554 17,0 - WE / - WK + Zub TRW 23554 17,0 - WE / - WK + Zub Ceramic
 <b>Bremsscheibe</b>							
1.0 1.2 1.2 GPL ↓	50 60 60	03/12→ 03/12→ 06/15→	←			<b>24.0122-0194.1</b> <b>422194</b> <b>24.0126-0159.1</b> <b>426159</b>	Ø 266 22 20 V + S Ø 302 26 24 V + S







	kw					! #		
<b>PEUGEOT - 208 (CA_, CC_) 03/12→</b>								
 <b>Bremsscheibe</b>								
1.2 THP	81	01/13→	→				24.0109-0100.2 409100	Ø 249 9 7 + LG / + ABS Ring
1.4 GPL	70	10/13→						
1.4 HDi	50	03/12→						
1.4 VTi	70	03/12→						
1.6	88	03/12→						
1.6	115	03/12→						
1.6 BlueHDi 100	73	01/15→						
1.6 BlueHDi 120	88	11/13→						
1.6 HDi	68	03/12→						
1.6 HDi	69	09/16→						
1.6 HDi	84	03/12→						
1.6 HDi	85	04/14→						
1.6 HDi / BlueHDi 75	55	01/13→						
1.6 THP 165	121	03/15→						
1.2	50	08/16→	←				24.0122-0194.1 422194	Ø 266 22 20 V + S
1.5 BlueHDi 100	75	05/18→					24.0126-0159.1 426159	Ø 302 26 24 V + S
			→	→Orga 15007			24.0109-0100.2 409100	Ø 249 9 7 + LG / + ABS Ring
1.6 GTi	147	08/12→	←	03/13→			24.0126-0159.1 426159	Ø 302 26 24 V + S
			→	03/13→			24.0109-0100.2 409100	Ø 249 9 7 + LG / + ABS Ring
1.6 GTi	153	10/14→	→				24.0109-0100.2 409100	Ø 249 9 7 + LG / + ABS Ring
<b>PEUGEOT - 208 Kasten (CR_) 10/12→</b>								
 <b>Bremsbelagsatz, Scheibenbremse</b>								
1.4 HDi	50	10/12→	←	für Bremsscheibendurchmesser [mm]: 266			13.0460-3994.2 603994	BOS 23599 19,0 - WE / - WK + Zub
1.6 BlueHDi 75	55	04/15→					13.0470-3994.2 LD3994	BOS 23599 19,0 - WE / - WK + Zub Ceramic
1.6 HDi	68	03/14→	←	für Bremsscheibendurchmesser [mm]: 302			13.0460-7202.2 607202	ATE 23589 19,1 - WE / - WK
							13.0460-7230.2 607230	ATE 24557 19,4 - WE / - WK
							13.0470-7202.2 LD7202	ATE 23589 19,1 - WE / - WK Ceramic
							13.0470-7230.2 LD7230	ATE 24557 19,4 - WE / - WK Ceramic
			→				13.0460-2740.2 602740	TRW 23554 17,0 - WE / - WK + Zub
							13.0470-2740.2 LD2740	TRW 23554 17,0 - WE / - WK + Zub Ceramic
 <b>Bremsscheibe</b>								
1.4 HDi	50	10/12→	←				24.0122-0194.1 422194	Ø 266 22 20 V + S
1.6 BlueHDi 75	55	04/15→					24.0126-0159.1 426159	Ø 302 26 24 V + S
1.6 HDi	68	03/14→	→				24.0109-0100.2 409100	Ø 249 9 7 + LG / + ABS Ring
<b>PEUGEOT - 301 11/12→</b>								
 <b>Bremsbelagsatz, Scheibenbremse</b>								
1.2 VTi 72	53	11/12→	←				13.0460-3867.2 603867	MAN 25250 18,9 - WE / - WK + Zub
1.2 VTi 82	60	12/14→						
1.6 BlueHDi 100	73	04/14→	←	V			13.0460-3994.2 603994	BOS 23599 19,0 - WE / - WK + Zub
1.6 HDi 90	68	11/12→					13.0470-3994.2 LD3994	BOS 23599 19,0 - WE / - WK + Zub Ceramic
1.6 VTi 115	85	11/12→						
1.6 VTi 115	86	09/16→						
 <b>Bremsscheibe</b>								
1.2 VTi 72	53	11/12→	←				24.0113-0184.1 413184	Ø 266 13 11 + S
1.2 VTi 82	60	12/14→					24.0122-0194.1 422194	Ø 266 22 20 V + S
1.6 BlueHDi 100	73	04/14→					24.0313-0184.1 513184	Ø 266 13 11 + S
1.6 HDi 90	68	11/12→						
1.6 VTi 115	85	11/12→						
1.6 VTi 115	86	09/16→						
<b>PEUGEOT - 306 (7B, N3, N5) 04/93→10/03</b>								
 <b>Bremsbelagsatz, Scheibenbremse</b>								
1.1	44	06/94→05/01	←	→ 04/97; - ABS			13.0460-3952.2 603952	BDX 20905 18,0 + WK
			←	→ 04/97; + ABS			13.0460-7058.2 607058	ATE 21430 17,3 + WK
							13.0460-7088.2 607088	ATE 21430 17,3 - WE / - WK
1.4 SL	55	06/94→05/01	←	Orga 08576→; + ABS			13.0460-2829.2 602829	TRW 23124 19,0 + WK
							13.0460-3978.2 603978	BOS 23332 18,0 - WK + Zub
			←	10/94→ 04/97; - ABS			13.0460-3952.2 603952	BDX 20905 18,0 + WK
↓								









	kw			 	! #		
<b>PEUGEOT - 306 (7B, N3, N5) 04/93→10/03</b>							
<b> Bremsbelagsatz, Scheibenbremse</b>							
1.4 SL	55	06/94→05/01	←	05/97→; - ABS		13.0460-3975.2 603975	BOS 23597 18,0 - WK
			←	10/94→; →Orga 08575; + ABS		13.0460-7058.2 607058 13.0460-7088.2 607088	ATE 21430 17,3 + WK ATE 21430 17,3 - WE / - WK
1.6	72	10/00→05/01	←	+ ABS		13.0460-2829.2 602829	TRW 23124 19,0 + WK
			←	- ABS		13.0460-3978.2 603978 13.0460-7058.2 607058 13.0460-7088.2 607088	BOS 23332 18,0 - WK + Zub ATE 21430 17,3 + WK ATE 21430 17,3 - WE / - WK
1.6 SR	65	06/94→10/00	←	Orga 08576→; + ABS		13.0460-2829.2 602829	TRW 23124 19,0 + WK
			←	10/94→; →Orga 08575		13.0460-3978.2 603978 13.0460-7058.2 607058 13.0460-7088.2 607088	BOS 23332 18,0 - WK + Zub ATE 21430 17,3 + WK ATE 21430 17,3 - WE / - WK
			←	Orga 08576→; - ABS		13.0460-7058.2 607058 13.0460-7088.2 607088	ATE 21430 17,3 + WK ATE 21430 17,3 - WE / - WK
1.8	74	06/94→05/01	←	Orga 08576→		13.0460-2829.2 602829	TRW 23124 19,0 + WK
			←	Orga 08576→; - ABS		13.0460-3978.2 603978 13.0460-7058.2 607058 13.0460-7088.2 607088	BOS 23332 18,0 - WK + Zub ATE 21430 17,3 + WK ATE 21430 17,3 - WE / - WK
			←	→Orga 08575		13.0460-7058.2 607058 13.0460-7088.2 607088	ATE 21430 17,3 + WK ATE 21430 17,3 - WE / - WK
1.8 16V 2.0 HDI 90	81 66	03/97→05/01 06/99→12/01	←			13.0460-2829.2 602829	TRW 23124 19,0 + WK
			→			13.0460-3978.2 603978 13.0460-3823.2 603823 13.0460-3954.2 603954	BOS 23332 18,0 - WK + Zub BOS 20974 11,0 - WK BDX 20973 11,0 - WK
1.8 16V	82	03/97→07/01	←	→ 05/01		13.0460-2829.2 602829	TRW 23124 19,0 + WK
			→	→ 05/01		13.0460-3978.2 603978 13.0460-3823.2 603823 13.0460-3954.2 603954	BOS 23332 18,0 - WK + Zub BOS 20974 11,0 - WK BDX 20973 11,0 - WK
1.8 ST	74	06/94→05/01	←	Orga 08576→; - ABS		13.0460-2829.2 602829	TRW 23124 19,0 + WK
			←	→Orga 08575		13.0460-3978.2 603978 13.0460-7058.2 607058 13.0460-7088.2 607088	BOS 23332 18,0 - WK + Zub ATE 21430 17,3 + WK ATE 21430 17,3 - WE / - WK
1.9 D	51	09/98→05/01	←	Orga 08576→; + ABS		13.0460-2829.2 602829	TRW 23124 19,0 + WK
			←	Orga 08576→; - ABS		13.0460-3978.2 603978 13.0460-7058.2 607058 13.0460-7088.2 607088	BOS 23332 18,0 - WK + Zub ATE 21430 17,3 + WK ATE 21430 17,3 - WE / - WK
			←	→Orga 08575		13.0460-7058.2 607058 13.0460-7088.2 607088	ATE 21430 17,3 + WK ATE 21430 17,3 - WE / - WK
1.9 D	55	03/98→05/01	←			13.0460-7058.2 607058	ATE 21430 17,3 + WK
1.9 D	68	02/94→12/97	←			13.0460-7088.2 607088	ATE 21430 17,3 - WE / - WK
			←	10/94→		13.0460-7058.2 607058 13.0460-7088.2 607088	ATE 21430 17,3 + WK ATE 21430 17,3 - WE / - WK
1.9 SLD 1.9 SLD 1.9 SRDT	47 50 66	06/94→05/01 06/94→05/01 06/94→05/01	←	10/94→		13.0460-7058.2 607058	ATE 21430 17,3 + WK
						13.0460-7088.2 607088	ATE 21430 17,3 - WE / - WK
2.0	97	03/97→05/01	←			13.0460-2829.2 602829	TRW 23124 19,0 + WK
			←	→ 04/97		13.0460-3978.2 603978 13.0460-2869.2 602869	BOS 23332 18,0 - WK + Zub TRW 23169 19,4 + WK
			→			13.0460-3823.2 603823 13.0460-3954.2 603954	BOS 20974 11,0 - WK BDX 20973 11,0 - WK
2.0 S16 2.0 ST	110 89	06/94→05/01 07/94→05/01	←	05/97→		13.0460-2829.2 602829	TRW 23124 19,0 + WK
			←	→ 04/97		13.0460-3978.2 603978 13.0460-2869.2 602869	BOS 23332 18,0 - WK + Zub TRW 23169 19,4 + WK
			→			13.0460-3823.2 603823 13.0460-3954.2 603954	BOS 20974 11,0 - WK BDX 20973 11,0 - WK
2.0 S16	112	06/94→05/01	←	05/97→		13.0460-2829.2 602829	TRW 23124 19,0 + WK
			←	07/94→ 04/97		13.0460-3978.2 603978 13.0460-2869.2 602869	BOS 23332 18,0 - WK + Zub TRW 23169 19,4 + WK
↓							























	kw			 	! #		
<b>PEUGEOT - 306 (7B, N3, N5) 04/93→10/03</b>							
<b> Bremsbelagsatz, Scheibenbremse</b>							
2.0 S16	112	06/94→05/01	➡	07/94→		13.0460-3823.2 603823 13.0460-3954.2 603954	BOS 20974 11,0 - WK BDX 20973 11,0 - WK
<b>Zubehörsatz, Scheibenbremsbelag</b>							
1.1	44	06/94→05/01	←	→ 04/97; - ABS		13.0460-0403.2 610403	BDX
1.4 SL	55	06/94→05/01	←	10/94→ 04/97; - ABS		13.0460-0403.2 610403	BDX
1.8 16V 2.0 2.0 HDI 90 2.0 S16 2.0 ST	81 97 66 110 89	03/97→05/01 03/97→05/01 06/99→12/01 06/94→05/01 07/94→05/01	➡			13.0460-0435.2 610435	BDX
1.8 16V	82	03/97→07/01	➡	→ 05/01		13.0460-0435.2 610435	BDX
2.0 S16	112	06/94→05/01	➡	07/94→		13.0460-0435.2 610435	BDX
<b> Bremsscheibe</b>							
1.1	44	06/94→05/01	←	→ 04/97; - ABS		24.0110-0187.1 410187	Ø 247 10 9 + S
			←	→ 04/97; + ABS		24.0120-0132.1 420132	Ø 247 20,4 18,5 V + S
						24.0320-0132.1 520132	Ø 247 20,4 18,5 V + S
1.4 SL	55	06/94→05/01	←	10/94→ 04/97; - ABS		24.0110-0187.1 410187	Ø 247 10 9 + S
			←	05/97→; - ABS		24.0113-0185.1 413185	Ø 247,5 13 11 + S
						24.0313-0185.1 513185	Ø 247,5 13 11 + S
			←	10/94→; →Orga 08575; + ABS		24.0120-0132.1 420132	Ø 247 20,4 18,5 V + S
						24.0320-0132.1 520132	Ø 247 20,4 18,5 V + S
1.6	72	10/00→05/01	←	- ABS		24.0120-0132.1 420132	Ø 247 20,4 18,5 V + S
						24.0320-0132.1 520132	Ø 247 20,4 18,5 V + S
			←	+ ABS		24.0120-0133.1 420133	Ø 266 20,5 18,5 V + S
1.6 SR	65	06/94→10/00	←	10/94→ 05/00		24.0120-0132.1 420132	Ø 247 20,4 18,5 V + S
						24.0320-0132.1 520132	Ø 247 20,4 18,5 V + S
			←	Orga 08576→; - ABS		24.0120-0132.1 420132	Ø 247 20,4 18,5 V + S
						24.0320-0132.1 520132	Ø 247 20,4 18,5 V + S
			←	05/00→; + ABS		24.0120-0133.1 420133	Ø 266 20,5 18,5 V + S
1.8	74	06/94→05/01	←	Orga 08576→; - ABS		24.0120-0132.1 420132	Ø 247 20,4 18,5 V + S
						24.0320-0132.1 520132	Ø 247 20,4 18,5 V + S
			←	→Orga 08575		24.0120-0132.1 420132	Ø 247 20,4 18,5 V + S
						24.0320-0132.1 520132	Ø 247 20,4 18,5 V + S
			←	05/00→; + ABS		24.0120-0133.1 420133	Ø 266 20,5 18,5 V + S
1.8 16V 2.0 2.0 HDI 90 2.0 ST	81 97 66 89	03/97→05/01 03/97→05/01 06/99→12/01 07/94→05/01	←			24.0120-0133.1 420133	Ø 266 20,5 18,5 V + S
						24.0320-0133.1 520133	Ø 266 20,5 18,5 V + S
			➡			24.0108-0106.1 408106	Ø 247 8 6 + S
			←	→ 05/01		24.0120-0133.1 420133	Ø 266 20,5 18,5 V + S
						24.0320-0133.1 520133	Ø 266 20,5 18,5 V + S
1.8 16V	82	03/97→07/01	←	→ 05/01		24.0120-0133.1 420133	Ø 266 20,5 18,5 V + S
						24.0320-0133.1 520133	Ø 266 20,5 18,5 V + S
			➡	→ 05/01		24.0108-0106.1 408106	Ø 247 8 6 + S
			←	→ 05/01		24.0120-0133.1 420133	Ø 266 20,5 18,5 V + S
						24.0320-0133.1 520133	Ø 266 20,5 18,5 V + S
1.8 ST 1.9 D	74 51	06/94→05/01 09/98→05/01	←	Orga 08576→; - ABS		24.0120-0132.1 420132	Ø 247 20,4 18,5 V + S
						24.0320-0132.1 520132	Ø 247 20,4 18,5 V + S
			←	→Orga 08575		24.0120-0132.1 420132	Ø 247 20,4 18,5 V + S
						24.0320-0132.1 520132	Ø 247 20,4 18,5 V + S
1.9 D	55	03/98→05/01	←			24.0120-0132.1 420132	Ø 247 20,4 18,5 V + S
						24.0320-0132.1 520132	Ø 247 20,4 18,5 V + S
			←	10/94→		24.0120-0132.1 420132	Ø 247 20,4 18,5 V + S
1.9 SLD ↓	47	06/94→05/01	←	10/94→		24.0120-0132.1 420132	Ø 247 20,4 18,5 V + S
						24.0320-0132.1 520132	Ø 247 20,4 18,5 V + S
			←	10/94→		24.0120-0132.1 420132	Ø 247 20,4 18,5 V + S











	kw			 	! #		
<b>PEUGEOT - 306 (7B, N3, N5) 04/93→10/03</b>							
<b>Bremsscheibe</b>							
1.9 SLD 1.9 SRDT	50 66	06/94→05/01 06/94→05/01	←	10/94→		24.0320-0132.1 520132	Ø 247 20,4 18,5 V + S
2.0 S16	110	06/94→05/01	←	05/97→		24.0120-0133.1 420133	Ø 266 20,5 18,5 V + S
			←	→ 04/97		24.0320-0133.1 520133	Ø 266 20,5 18,5 V + S
			←			24.0122-0142.1 422142	Ø 283 22 20 V
2.0 S16	112	06/94→05/01	→			24.0108-0106.1 408106	Ø 247 8 6 + S
			←	05/97→		24.0120-0133.1 420133	Ø 266 20,5 18,5 V + S
			←	07/94→ 04/97		24.0320-0133.1 520133	Ø 266 20,5 18,5 V + S
			←	07/94→		24.0122-0142.1 422142	Ø 283 22 20 V
			→			24.0108-0106.1 408106	Ø 247 8 6 + S
<b>PEUGEOT - 306 Break (7E, N3, N5) 06/94→04/02</b>							
<b>Bremsbelagsatz, Scheibenbremse</b>							
1.4 1.6 1.9 D	55 72 50	03/97→04/02 10/00→04/02 03/97→04/02	←	→ 03/02; + ABS		13.0460-2829.2 602829	TRW 23124 19,0 + WK
1.9 D 1.9 D	51 55	09/98→04/02 03/98→04/02	←	→ 03/02; - ABS		13.0460-3978.2 603978	BOS 23332 18,0 - WK + Zub
			←			13.0460-7088.2 607088	ATE 21430 17,3 - WE / - WK
1.6 1.9 D	65 51	03/97→10/00 05/97→05/99	←	+ ABS		13.0460-2829.2 602829	TRW 23124 19,0 + WK
			←	- ABS		13.0460-3978.2 603978	BOS 23332 18,0 - WK + Zub
			←			13.0460-7088.2 607088	ATE 21430 17,3 - WE / - WK
1.8	74	03/97→04/02	←	→ 03/02		13.0460-2829.2 602829	TRW 23124 19,0 + WK
			←			13.0460-3978.2 603978	BOS 23332 18,0 - WK + Zub
1.8 16V 2.0 2.0 16V 2.0 HDI 90	81 97 99 66	03/97→04/02 03/97→04/02 03/97→04/02 06/99→04/02	←	→ 03/02		13.0460-2829.2 602829	TRW 23124 19,0 + WK
			←			13.0460-3978.2 603978	BOS 23332 18,0 - WK + Zub
			→	→ 03/02		13.0460-3823.2 603823	BOS 20974 11,0 - WK
			→			13.0460-3954.2 603954	BDX 20973 11,0 - WK
1.8 16V	82	03/97→07/01	←			13.0460-2829.2 602829	TRW 23124 19,0 + WK
			→			13.0460-3978.2 603978	BOS 23332 18,0 - WK + Zub
			→			13.0460-3823.2 603823	BOS 20974 11,0 - WK
			→			13.0460-3954.2 603954	BDX 20973 11,0 - WK
1.9 Td	52	07/95→08/00	←	03/97→		13.0460-2829.2 602829	TRW 23124 19,0 + WK
			←			13.0460-3978.2 603978	BOS 23332 18,0 - WK + Zub
1.9 TD	66	02/97→04/02	←	03/97→ 03/02		13.0460-2829.2 602829	TRW 23124 19,0 + WK
			←			13.0460-3978.2 603978	BOS 23332 18,0 - WK + Zub
<b>Zubehörsatz, Scheibenbremsbelag</b>							
1.8 16V 2.0 2.0 16V 2.0 HDI 90	81 97 99 66	03/97→04/02 03/97→04/02 03/97→04/02 06/99→04/02	→	→ 03/02		13.0460-0435.2 610435	BDX
1.8 16V	82	03/97→07/01	→			13.0460-0435.2 610435	BDX
<b>Bremsscheibe</b>							
1.4 1.6 1.9 D	55 72 50	03/97→04/02 10/00→04/02 03/97→04/02	←	→ 03/02; - ABS		24.0120-0132.1 420132	Ø 247 20,4 18,5 V + S
1.9 D 1.9 D	51 55	09/98→04/02 03/98→04/02	←	→ 03/02; + ABS		24.0320-0132.1 520132	Ø 247 20,4 18,5 V + S
			←			24.0120-0133.1 420133	Ø 266 20,5 18,5 V + S
			←			24.0320-0133.1 520133	Ø 266 20,5 18,5 V + S
1.6 1.9 D	65 51	03/97→10/00 05/97→05/99	←	- ABS		24.0120-0132.1 420132	Ø 247 20,4 18,5 V + S
			←	+ ABS		24.0320-0132.1 520132	Ø 247 20,4 18,5 V + S
			←			24.0120-0133.1 420133	Ø 266 20,5 18,5 V + S
			←			24.0320-0133.1 520133	Ø 266 20,5 18,5 V + S
1.8	74	03/97→04/02	←	→ 03/02		24.0120-0133.1 420133	Ø 266 20,5 18,5 V + S
			←			24.0320-0133.1 520133	Ø 266 20,5 18,5 V + S
1.8 16V 2.0 2.0 16V 2.0 HDI 90	81 97 99 66	03/97→04/02 03/97→04/02 03/97→04/02 06/99→04/02	←	→ 03/02		24.0120-0133.1 420133	Ø 266 20,5 18,5 V + S
			←			24.0320-0133.1 520133	Ø 266 20,5 18,5 V + S
			→	→ 03/02		24.0108-0106.1 408106	Ø 247 8 6 + S
1.8 16V	82	03/97→07/01	←			24.0120-0133.1 420133	Ø 266 20,5 18,5 V + S
			→			24.0320-0133.1 520133	Ø 266 20,5 18,5 V + S
			→			24.0108-0106.1 408106	Ø 247 8 6 + S
1.9 Td	52	07/95→08/00	←	03/97→		24.0120-0133.1 420133	Ø 266 20,5 18,5 V + S
			←			24.0320-0133.1 520133	Ø 266 20,5 18,5 V + S
1.9 TD	66	02/97→04/02	←	03/97→ 03/02		24.0120-0133.1 420133	Ø 266 20,5 18,5 V + S
			←			24.0320-0133.1 520133	Ø 266 20,5 18,5 V + S









	kw			 	! #		
<b>PEUGEOT - 306 Cabriolet (7D, N3, N5) 01/94→04/02</b>							
<b> Bremsbelagsatz, Scheibenbremse</b>							
1.6	65	04/96→10/00	←	Orga 08576→; + ABS		13.0460-2829.2 602829 13.0460-3978.2 603978	TRW 23124 19,0 + WK BOS 23332 18,0 - WK + Zub
			←	05/00→; - ABS		13.0460-7058.2 607058 13.0460-7088.2 607088	ATE 21430 17,3 + WK ATE 21430 17,3 - WE / - WK
			←	→Orga 08575		13.0460-7058.2 607058 13.0460-7088.2 607088	ATE 21430 17,3 + WK ATE 21430 17,3 - WE / - WK
1.6	72	10/00→04/02	←			13.0460-2829.2 602829 13.0460-3978.2 603978	TRW 23124 19,0 + WK BOS 23332 18,0 - WK + Zub
1.8	74	03/94→04/02	←	Orga 08576→; → 10/00; + ABS		13.0460-2829.2 602829 13.0460-3978.2 603978	TRW 23124 19,0 + WK BOS 23332 18,0 - WK + Zub
			←	05/00→ 10/00; - ABS		13.0460-7058.2 607058 13.0460-7088.2 607088	ATE 21430 17,3 + WK ATE 21430 17,3 - WE / - WK
			←	→Orga 08575		13.0460-7058.2 607058 13.0460-7088.2 607088	ATE 21430 17,3 + WK ATE 21430 17,3 - WE / - WK
1.8	74	05/97→04/99	←	Orga 08576→; + ABS		13.0460-2829.2 602829 13.0460-3978.2 603978	TRW 23124 19,0 + WK BOS 23332 18,0 - WK + Zub
			←	→Orga 08575		13.0460-7058.2 607058 13.0460-7088.2 607088	ATE 21430 17,3 + WK ATE 21430 17,3 - WE / - WK
1.8 16V	81	05/97→04/02	←			13.0460-2829.2 602829 13.0460-3978.2 603978	TRW 23124 19,0 + WK BOS 23332 18,0 - WK + Zub
			←	- ABS		13.0460-7058.2 607058 13.0460-7088.2 607088	ATE 21430 17,3 + WK ATE 21430 17,3 - WE / - WK
			←	→Orga 08575		13.0460-7058.2 607058 13.0460-7088.2 607088	ATE 21430 17,3 + WK ATE 21430 17,3 - WE / - WK
			→			13.0460-3823.2 603823 13.0460-3954.2 603954	BOS 20974 11,0 - WK BDX 20973 11,0 - WK
2.0 2.0	89 90	03/94→04/02 02/95→11/97	←	→ 04/97		13.0460-2829.2 602829 13.0460-3978.2 603978	TRW 23124 19,0 + WK BOS 23332 18,0 - WK + Zub
			←			13.0460-2869.2 602869	TRW 23169 19,4 + WK
			→	→ 04/97		13.0460-3823.2 603823 13.0460-3954.2 603954	BOS 20974 11,0 - WK BDX 20973 11,0 - WK
2.0 16V	97	03/97→04/02	←	→ 10/00		13.0460-2829.2 602829 13.0460-3978.2 603978	TRW 23124 19,0 + WK BOS 23332 18,0 - WK + Zub
			→	→ 10/00		13.0460-3823.2 603823 13.0460-3954.2 603954	BOS 20974 11,0 - WK BDX 20973 11,0 - WK
2.0 16V	99	03/97→04/02	←			13.0460-2829.2 602829 13.0460-3978.2 603978	TRW 23124 19,0 + WK BOS 23332 18,0 - WK + Zub
			→			13.0460-3823.2 603823 13.0460-3954.2 603954	BOS 20974 11,0 - WK BDX 20973 11,0 - WK
<b>Zubehörsatz, Scheibenbremsbelag</b>							
1.8 16V 2.0 16V	81 99	05/97→04/02 03/97→04/02				13.0460-0435.2 610435	BDX
2.0 2.0	89 90	03/94→04/02 02/95→11/97		→ 04/97		13.0460-0435.2 610435	BDX
2.0 16V	97	03/97→04/02		→ 10/00		13.0460-0435.2 610435	BDX
<b> Bremsscheibe</b>							
1.6 1.8	65 74	04/96→10/00 05/97→04/99	←	Orga 08576→; - ABS		24.0120-0132.1 420132 24.0320-0132.1 520132	Ø 247 20,4 18,5 V + S Ø 247 20,4 18,5 V + S
			←	→Orga 08575		24.0120-0132.1 420132 24.0320-0132.1 520132	Ø 247 20,4 18,5 V + S Ø 247 20,4 18,5 V + S
			←	Orga 08576→; + ABS		24.0120-0133.1 420133 24.0320-0133.1 520133	Ø 266 20,5 18,5 V + S Ø 266 20,5 18,5 V + S
1.6	72	10/00→04/02	←			24.0120-0133.1 420133 24.0320-0133.1 520133	Ø 266 20,5 18,5 V + S Ø 266 20,5 18,5 V + S
1.8	74	03/94→04/02	←	Orga 08576→; → 10/00; - ABS		24.0120-0132.1 420132 24.0320-0132.1 520132	Ø 247 20,4 18,5 V + S Ø 247 20,4 18,5 V + S
			←	→Orga 08575		24.0120-0132.1 420132 24.0320-0132.1 520132	Ø 247 20,4 18,5 V + S Ø 247 20,4 18,5 V + S
			←	Orga 08576→; → 10/00; + ABS		24.0120-0133.1 420133 24.0320-0133.1 520133	Ø 266 20,5 18,5 V + S Ø 266 20,5 18,5 V + S
↓							







	kw					! #		
<b>PEUGEOT - 306 Cabriolet (7D, N3, N5) 01/94→04/02</b>								
 <b>Bremsscheibe</b>								
1.8 16V 2.0 16V	81 99	05/97→04/02 03/97→04/02	←			24.0120-0133.1 420133 24.0320-0133.1 520133	∅ 266 20,5 18,5 V + S ∅ 266 20,5 18,5 V + S	
			→			24.0108-0106.1 408106	∅ 247 8 6 + S	
2.0 2.0	89 90	03/94→04/02 02/95→11/97	←	→ 04/97		24.0120-0133.1 420133 24.0320-0133.1 520133	∅ 266 20,5 18,5 V + S ∅ 266 20,5 18,5 V + S	
			→	→ 04/97		24.0108-0106.1 408106	∅ 247 8 6 + S	
2.0 16V	97	03/97→04/02	←	→ 10/00		24.0120-0133.1 420133 24.0320-0133.1 520133	∅ 266 20,5 18,5 V + S ∅ 266 20,5 18,5 V + S	
			→	→ 10/00		24.0108-0106.1 408106	∅ 247 8 6 + S	
<b>PEUGEOT - 306 Kasten/Kombi (N_, 7_) 07/93→08/02</b>								
 <b>Bremsbelagsatz, Scheibenbremse</b>								
1.4	55	03/96→07/01	←	Orga 08576→; → 05/01; + ABS		13.0460-2829.2 602829 13.0460-3978.2 603978	TRW 23124 19,0 + WK BOS 23332 18,0 - WK + Zub	
			←	→ 04/97; - ABS		13.0460-3952.2 603952	BDX 20905 18,0 + WK	
			←	05/97→ 05/01		13.0460-3975.2 603975	BOS 23597 18,0 - WK	
			←	→Orga 08575; + ABS		13.0460-7058.2 607058 13.0460-7088.2 607088	ATE 21430 17,3 + WK ATE 21430 17,3 - WE / - WK	
1.9 D	51	02/99→08/02	←	→ 03/02; + ABS		13.0460-2829.2 602829 13.0460-3978.2 603978	TRW 23124 19,0 + WK BOS 23332 18,0 - WK + Zub	
			←	→ 03/02; - ABS		13.0460-7088.2 607088	ATE 21430 17,3 - WE / - WK	
1.9 D	69	02/94→04/99	←			13.0460-7058.2 607058 13.0460-7088.2 607088	ATE 21430 17,3 + WK ATE 21430 17,3 - WE / - WK	
1.9 STD	51	02/94→05/99	←	Orga 08576→; - ABS		13.0460-7058.2 607058 13.0460-7088.2 607088	ATE 21430 17,3 + WK ATE 21430 17,3 - WE / - WK	
			←	→Orga 08575		13.0460-7058.2 607058 13.0460-7088.2 607088	ATE 21430 17,3 + WK ATE 21430 17,3 - WE / - WK	
<b>Zubehörsatz, Scheibenbremsbelag</b>								
1.4	55	03/96→07/01	←	→ 04/97; - ABS		13.0460-0403.2 610403	BDX	
 <b>Bremsscheibe</b>								
1.4	55	03/96→07/01	←	→ 04/97; - ABS		24.0110-0187.1 410187	∅ 247 10 9 + S	
			←	05/97→ 05/01; - ABS		24.0113-0185.1 413185 24.0313-0185.1 513185	∅ 247,5 13 11 + S ∅ 247,5 13 11 + S	
			←	→Orga 08575; + ABS		24.0120-0132.1 420132 24.0320-0132.1 520132	∅ 247 20,4 18,5 V + S ∅ 247 20,4 18,5 V + S	
			←	Orga 08576→; → 05/01; + ABS		24.0120-0133.1 420133 24.0320-0133.1 520133	∅ 266 20,5 18,5 V + S ∅ 266 20,5 18,5 V + S	
1.9 D	51	02/99→08/02	←	→ 03/02; - ABS		24.0120-0132.1 420132 24.0320-0132.1 520132	∅ 247 20,4 18,5 V + S ∅ 247 20,4 18,5 V + S	
			←	→ 03/02; + ABS		24.0120-0133.1 420133 24.0320-0133.1 520133	∅ 266 20,5 18,5 V + S ∅ 266 20,5 18,5 V + S	
1.9 D	69	02/94→04/99	←			24.0120-0132.1 420132 24.0320-0132.1 520132	∅ 247 20,4 18,5 V + S ∅ 247 20,4 18,5 V + S	
1.9 STD	51	02/94→05/99	←	09/98→; + ABS		24.0120-0132.1 420132 24.0320-0132.1 520132	∅ 247 20,4 18,5 V + S ∅ 247 20,4 18,5 V + S	
			←	09/98→; →Orga 08575		24.0120-0132.1 420132 24.0320-0132.1 520132	∅ 247 20,4 18,5 V + S ∅ 247 20,4 18,5 V + S	
			←	Orga 08576→; - ABS		24.0120-0132.1 420132 24.0320-0132.1 520132	∅ 247 20,4 18,5 V + S ∅ 247 20,4 18,5 V + S	
			←	Orga 08576→; + ABS		24.0120-0133.1 420133 24.0320-0133.1 520133	∅ 266 20,5 18,5 V + S ∅ 266 20,5 18,5 V + S	
<b>PEUGEOT - 306 Kasten/Schrägheck 04/93→08/01</b>								
 <b>Bremsbelagsatz, Scheibenbremse</b>								
1.4	55	03/96→07/01	←	Orga 08576→; → 05/01; + ABS		13.0460-2829.2 602829 13.0460-3978.2 603978	TRW 23124 19,0 + WK BOS 23332 18,0 - WK + Zub	
			←	→ 04/97; - ABS		13.0460-3952.2 603952	BDX 20905 18,0 + WK	
			←	05/97→ 05/01		13.0460-3975.2 603975	BOS 23597 18,0 - WK	
↓								









	kw			 	! #		
<b>PEUGEOT - 306 Kasten/Schrägheck 04/93→08/01</b>							
 <b>Bremsbelagsatz, Scheibenbremse</b>							
1.4	55	03/96→07/01	←	→Orga 08575; + ABS		13.0460-7058.2 607058 13.0460-7088.2 607088	ATE 21430 17,3 + WK ATE 21430 17,3 - WE / - WK
1.8 D	44	04/93→05/99	←			13.0460-7058.2 607058	ATE 21430 17,3 + WK
1.9 D	50	05/97→05/99				13.0460-7088.2 607088	ATE 21430 17,3 - WE / - WK
1.9 D	69	02/94→04/99					
1.9 D	51	02/99→08/01	←	05/00→ 05/01; + ABS		13.0460-2829.2 602829 13.0460-3978.2 603978	TRW 23124 19,0 + WK BOS 23332 18,0 - WK + Zub
			←	Orga 08576→; → 05/01; - ABS		13.0460-7058.2 607058 13.0460-7088.2 607088	ATE 21430 17,3 + WK ATE 21430 17,3 - WE / - WK
			←	→Orga 08575		13.0460-7058.2 607058 13.0460-7088.2 607088	ATE 21430 17,3 + WK ATE 21430 17,3 - WE / - WK
<b>Zubehörsatz, Scheibenbremsbelag</b>							
1.4	55	03/96→07/01	←	→ 04/97; - ABS		13.0460-0403.2 610403	BDX
 <b>Bremsscheibe</b>							
1.4	55	03/96→07/01	←	→ 04/97; - ABS		24.0110-0187.1 410187	∅ 247 10 9 + S
			←	05/97→ 05/01; - ABS		24.0113-0185.1 413185	∅ 247,5 13 11 + S
						24.0313-0185.1 513185	∅ 247,5 13 11 + S
			←	→Orga 08575; + ABS		24.0120-0132.1 420132	∅ 247 20,4 18,5 V + S
						24.0320-0132.1 520132	∅ 247 20,4 18,5 V + S
			←	Orga 08576→; → 05/01; + ABS		24.0120-0133.1 420133	∅ 266 20,5 18,5 V + S
						24.0320-0133.1 520133	∅ 266 20,5 18,5 V + S
1.8 D	44	04/93→05/99	←			24.0120-0132.1 420132	∅ 247 20,4 18,5 V + S
1.9 D	50	05/97→05/99				24.0320-0132.1 520132	∅ 247 20,4 18,5 V + S
1.9 D	69	02/94→04/99					
1.9 D	51	02/99→08/01	←	→ 10/00; + ABS		24.0120-0132.1 420132	∅ 247 20,4 18,5 V + S
						24.0320-0132.1 520132	∅ 247 20,4 18,5 V + S
			←	Orga 08576→; → 05/01; - ABS		24.0120-0132.1 420132	∅ 247 20,4 18,5 V + S
						24.0320-0132.1 520132	∅ 247 20,4 18,5 V + S
			←	→Orga 08575		24.0120-0132.1 420132	∅ 247 20,4 18,5 V + S
						24.0320-0132.1 520132	∅ 247 20,4 18,5 V + S
			←	Orga 08576→; → 05/01; + ABS		24.0120-0133.1 420133	∅ 266 20,5 18,5 V + S
						24.0320-0133.1 520133	∅ 266 20,5 18,5 V + S
<b>PEUGEOT - 306 Schrägheck (7A, 7C, N3, N5) 01/93→10/03</b>							
 <b>Bremsbelagsatz, Scheibenbremse</b>							
1.1	44	05/93→05/01	←	03/94→ 04/97; - ABS		13.0460-3952.2 603952	BDX 20905 18,0 + WK
			←	03/94→ 04/97; + ABS		13.0460-7058.2 607058 13.0460-7088.2 607088	ATE 21430 17,3 + WK ATE 21430 17,3 - WE / - WK
1.4	55	04/93→07/01	←	Orga 08576→; + ABS		13.0460-2829.2 602829 13.0460-3978.2 603978	TRW 23124 19,0 + WK BOS 23332 18,0 - WK + Zub
			←	→ 04/97; - ABS		13.0460-3952.2 603952	BDX 20905 18,0 + WK
			←	05/97→		13.0460-3975.2 603975	BOS 23597 18,0 - WK
			←			13.0460-7058.2 607058 13.0460-7088.2 607088	ATE 21430 17,3 + WK ATE 21430 17,3 - WE / - WK
			←	→Orga 08575; + ABS		13.0460-7058.2 607058 13.0460-7088.2 607088	ATE 21430 17,3 + WK ATE 21430 17,3 - WE / - WK
1.6	65	05/93→10/00	←	Orga 08576→; + ABS		13.0460-2829.2 602829 13.0460-3978.2 603978	TRW 23124 19,0 + WK BOS 23332 18,0 - WK + Zub
			←	→Orga 08575		13.0460-7058.2 607058 13.0460-7088.2 607088	ATE 21430 17,3 + WK ATE 21430 17,3 - WE / - WK
			←	05/00→; - ABS		13.0460-7058.2 607058 13.0460-7088.2 607088	ATE 21430 17,3 + WK ATE 21430 17,3 - WE / - WK
1.6	72	10/00→05/01	←	+ ABS		13.0460-2829.2 602829 13.0460-3978.2 603978	TRW 23124 19,0 + WK BOS 23332 18,0 - WK + Zub
			←	- ABS		13.0460-7058.2 607058 13.0460-7088.2 607088	ATE 21430 17,3 + WK ATE 21430 17,3 - WE / - WK
1.8	74	05/93→05/01	←	Orga 08576→; + ABS		13.0460-2829.2 602829 13.0460-3978.2 603978	TRW 23124 19,0 + WK BOS 23332 18,0 - WK + Zub
			←	Orga 08576→		13.0460-2829.2 602829 13.0460-3978.2 603978	TRW 23124 19,0 + WK BOS 23332 18,0 - WK + Zub
↓							









	kw			 	! #		
<b>PEUGEOT - 306 Schrägheck (7A, 7C, N3, N5) 01/93→10/03</b>							
<b> Bremsbelagsatz, Scheibenbremse</b>							
1.8	74	05/93→05/01	←	Orga 08576→; - ABS		13.0460-7058.2 607058	ATE 21430 17,3 + WK
			←	→Orga 08575		13.0460-7088.2 607088	ATE 21430 17,3 - WE / - WK
			←			13.0460-7058.2 607058	ATE 21430 17,3 + WK
			←			13.0460-7088.2 607088	ATE 21430 17,3 - WE / - WK
1.8 16V 2.0 16V 2.0 HDI 90	81 97 66	03/97→05/01 03/97→05/01 06/99→12/02	←			13.0460-2829.2 602829	TRW 23124 19,0 + WK
			←			13.0460-3978.2 603978	BOS 23332 18,0 - WK + Zub
			→			13.0460-3823.2 603823	BOS 20974 11,0 - WK
			→			13.0460-3954.2 603954	BDX 20973 11,0 - WK
1.8 16V	82	03/97→10/03	←	→ 05/01		13.0460-2829.2 602829	TRW 23124 19,0 + WK
			←			13.0460-3978.2 603978	BOS 23332 18,0 - WK + Zub
			→	→ 05/01		13.0460-3823.2 603823	BOS 20974 11,0 - WK
			→			13.0460-3954.2 603954	BDX 20973 11,0 - WK
1.8 D 1.8 D 1.9 Td	43 44 52	05/93→05/01 04/93→05/99 07/95→08/00	←			13.0460-7058.2 607058	ATE 21430 17,3 + WK
			←			13.0460-7088.2 607088	ATE 21430 17,3 - WE / - WK
1.9 D 1.9 D 1.9 D	47 50 55	05/93→05/01 06/94→05/01 03/98→05/01	←	10/00→; + ABS		13.0460-2829.2 602829	TRW 23124 19,0 + WK
			←			13.0460-3978.2 603978	BOS 23332 18,0 - WK + Zub
			←			13.0460-7058.2 607058	ATE 21430 17,3 + WK
			←			13.0460-7088.2 607088	ATE 21430 17,3 - WE / - WK
			←	09/98→ 10/00; + ABS		13.0460-7058.2 607058	ATE 21430 17,3 + WK
			←			13.0460-7088.2 607088	ATE 21430 17,3 - WE / - WK
1.9 D	51	04/93→05/99	←	Orga 08576→; + ABS		13.0460-2829.2 602829	TRW 23124 19,0 + WK
			←	09/98→; →Orga 08575		13.0460-3978.2 603978	BOS 23332 18,0 - WK + Zub
			←			13.0460-7058.2 607058	ATE 21430 17,3 + WK
			←			13.0460-7088.2 607088	ATE 21430 17,3 - WE / - WK
			←	Orga 08576→; - ABS		13.0460-7058.2 607058	ATE 21430 17,3 + WK
			←			13.0460-7088.2 607088	ATE 21430 17,3 - WE / - WK
			←	→Orga 08575		13.0460-7058.2 607058	ATE 21430 17,3 + WK
			←			13.0460-7088.2 607088	ATE 21430 17,3 - WE / - WK
1.9 D	51	09/98→05/01	←	10/00→; + ABS		13.0460-2829.2 602829	TRW 23124 19,0 + WK
			←			13.0460-3978.2 603978	BOS 23332 18,0 - WK + Zub
			←	05/00→; + ABS		13.0460-2829.2 602829	TRW 23124 19,0 + WK
			←			13.0460-3978.2 603978	BOS 23332 18,0 - WK + Zub
			←	→ 10/00; + ABS		13.0460-7058.2 607058	ATE 21430 17,3 + WK
			←			13.0460-7088.2 607088	ATE 21430 17,3 - WE / - WK
			←	→Orga 08575		13.0460-7058.2 607058	ATE 21430 17,3 + WK
			←			13.0460-7088.2 607088	ATE 21430 17,3 - WE / - WK
			←	Orga 08576→; - ABS		13.0460-7058.2 607058	ATE 21430 17,3 + WK
			←			13.0460-7088.2 607088	ATE 21430 17,3 - WE / - WK
1.9 D	52	01/99→08/03	←	05/00→ 05/01; + ABS		13.0460-2829.2 602829	TRW 23124 19,0 + WK
			←			13.0460-3978.2 603978	BOS 23332 18,0 - WK + Zub
			←	Orga 08576→; → 05/01; - ABS		13.0460-7058.2 607058	ATE 21430 17,3 + WK
			←			13.0460-7088.2 607088	ATE 21430 17,3 - WE / - WK
			←	→Orga 08575		13.0460-7058.2 607058	ATE 21430 17,3 + WK
			←			13.0460-7088.2 607088	ATE 21430 17,3 - WE / - WK
1.9 D	68	01/93→12/97	←	10/94→		13.0460-7058.2 607058	ATE 21430 17,3 + WK
			←			13.0460-7088.2 607088	ATE 21430 17,3 - WE / - WK
			←	10/93→		13.0460-7058.2 607058	ATE 21430 17,3 + WK
			←			13.0460-7088.2 607088	ATE 21430 17,3 - WE / - WK
1.9 DT	66	05/93→05/01	←	10/93→		13.0460-7058.2 607058	ATE 21430 17,3 + WK
			←			13.0460-7088.2 607088	ATE 21430 17,3 - WE / - WK
2.0 16V	99	03/97→06/00	←			13.0460-2829.2 602829	TRW 23124 19,0 + WK
			←	→ 04/97		13.0460-3978.2 603978	BOS 23332 18,0 - WK + Zub
			→			13.0460-2869.2 602869	TRW 23169 19,4 + WK
			→			13.0460-3823.2 603823	BOS 20974 11,0 - WK
			→			13.0460-3954.2 603954	BDX 20973 11,0 - WK
2.0 S16	110	06/94→05/01	←	→ 04/97		13.0460-2817.2 602817	TRW 21674 19,0 + WK
			←	05/97→		13.0460-2829.2 602829	TRW 23124 19,0 + WK
			←			13.0460-3978.2 603978	BOS 23332 18,0 - WK + Zub
			→			13.0460-3823.2 603823	BOS 20974 11,0 - WK
			→			13.0460-3954.2 603954	BDX 20973 11,0 - WK
↓							









	kw				! #		
<b>PEUGEOT - 306 Schrägheck (7A, 7C, N3, N5) 01/93→10/03</b>							
<b> Bremsbelagsatz, Scheibenbremse</b>							
2.0 S16	112	05/93→05/01	←	07/94→ 04/97		13.0460-2817.2 602817	TRW 21674 19,0 + WK
			←	05/97→		13.0460-2829.2 602829	TRW 23124 19,0 + WK
						13.0460-3978.2 603978	BOS 23332 18,0 - WK + Zub
			→	07/94→		13.0460-3823.2 603823	BOS 20974 11,0 - WK
						13.0460-3954.2 603954	BDX 20973 11,0 - WK
2.0 S16	120	07/96→05/01	←			13.0460-2817.2 602817	TRW 21674 19,0 + WK
			→			13.0460-3823.2 603823	BOS 20974 11,0 - WK
						13.0460-3954.2 603954	BDX 20973 11,0 - WK
2.0 XSi	89	05/93→05/01	←	05/97→		13.0460-2829.2 602829	TRW 23124 19,0 + WK
						13.0460-3978.2 603978	BOS 23332 18,0 - WK + Zub
			←	03/94→ 04/97		13.0460-2869.2 602869	TRW 23169 19,4 + WK
			→	03/94→		13.0460-3823.2 603823	BOS 20974 11,0 - WK
						13.0460-3954.2 603954	BDX 20973 11,0 - WK
<b>Zubehörsatz, Scheibenbremsbelag</b>							
1.1	44	05/93→05/01	←	03/94→ 04/97; - ABS		13.0460-0403.2 610403	BDX
1.4	55	04/93→07/01	←	→ 04/97; - ABS		13.0460-0403.2 610403	BDX
1.8 16V	81	03/97→05/01	→			13.0460-0435.2 610435	BDX
2.0 16V	97	03/97→05/01					
2.0 16V	99	03/97→06/00					
2.0 HDI 90	66	06/99→12/02					
2.0 S16	110	06/94→05/01					
2.0 S16	120	07/96→05/01					
1.8 16V	82	03/97→10/03	→	→ 05/01		13.0460-0435.2 610435	BDX
2.0 S16	112	05/93→05/01	→	07/94→		13.0460-0435.2 610435	BDX
2.0 XSi	89	05/93→05/01	→	03/94→		13.0460-0435.2 610435	BDX
<b> Bremsscheibe</b>							
1.1	44	05/93→05/01	←	03/94→ 04/97; - ABS		24.0110-0187.1 410187	Ø 247 10 9 + S
			←	03/94→ 04/97; + ABS		24.0120-0132.1 420132	Ø 247 20,4 18,5 V + S
						24.0320-0132.1 520132	Ø 247 20,4 18,5 V + S
1.4	55	04/93→07/01	←	→ 04/97; - ABS		24.0110-0187.1 410187	Ø 247 10 9 + S
			←	05/97→; - ABS		24.0113-0185.1 413185	Ø 247,5 13 11 + S
						24.0313-0185.1 513185	Ø 247,5 13 11 + S
			←			24.0120-0132.1 420132	Ø 247 20,4 18,5 V + S
						24.0320-0132.1 520132	Ø 247 20,4 18,5 V + S
			←	→Orga 08575; + ABS		24.0120-0132.1 420132	Ø 247 20,4 18,5 V + S
						24.0320-0132.1 520132	Ø 247 20,4 18,5 V + S
			←	Orga 08576→; + ABS		24.0120-0133.1 420133	Ø 266 20,5 18,5 V + S
						24.0320-0133.1 520133	Ø 266 20,5 18,5 V + S
1.6	65	05/93→10/00	←	Orga 08576→; - ABS		24.0120-0132.1 420132	Ø 247 20,4 18,5 V + S
			←	→Orga 08575		24.0120-0132.1 420132	Ø 247 20,4 18,5 V + S
						24.0320-0132.1 520132	Ø 247 20,4 18,5 V + S
			←	Orga 08576→; + ABS		24.0120-0133.1 420133	Ø 266 20,5 18,5 V + S
						24.0320-0133.1 520133	Ø 266 20,5 18,5 V + S
1.6	72	10/00→05/01	←	- ABS		24.0120-0132.1 420132	Ø 247 20,4 18,5 V + S
			←	+ ABS		24.0120-0133.1 420133	Ø 266 20,5 18,5 V + S
						24.0320-0133.1 520133	Ø 266 20,5 18,5 V + S
1.8	74	05/93→05/01	←	Orga 08576→; - ABS		24.0120-0132.1 420132	Ø 247 20,4 18,5 V + S
			←	→Orga 08575		24.0120-0132.1 420132	Ø 247 20,4 18,5 V + S
						24.0320-0132.1 520132	Ø 247 20,4 18,5 V + S
			←	05/00→; + ABS		24.0120-0133.1 420133	Ø 266 20,5 18,5 V + S
						24.0320-0133.1 520133	Ø 266 20,5 18,5 V + S
			←	Orga 08576→; + ABS		24.0120-0133.1 420133	Ø 266 20,5 18,5 V + S
						24.0320-0133.1 520133	Ø 266 20,5 18,5 V + S
1.8 16V	81	03/97→05/01	←			24.0120-0133.1 420133	Ø 266 20,5 18,5 V + S
2.0 16V	97	03/97→05/01					
2.0 16V	99	03/97→06/00					
2.0 HDI 90	66	06/99→12/02	→			24.0108-0106.1 408106	Ø 247 8 6 + S
↓							









	kW			 	! #		
<b>PEUGEOT - 306 Schrägheck (7A, 7C, N3, N5) 01/93→10/03</b>							
<b>Bremsscheibe</b>							
1.8 16V	82	03/97→10/03	←	→ 05/01		24.0120-0133.1 420133	Ø 266 20,5 18,5 V + S
			→	→ 05/01		24.0320-0133.1 520133	Ø 266 20,5 18,5 V + S
			←			24.0108-0106.1 408106	Ø 247 8 6 + S
1.8 D	43	05/93→05/01	←			24.0120-0132.1 420132	Ø 247 20,4 18,5 V + S
			←			24.0320-0132.1 520132	Ø 247 20,4 18,5 V + S
1.8 D	44	04/93→05/99	←			24.0120-0132.1 420132	Ø 247 20,4 18,5 V + S
1.9 Td	52	07/95→08/00	←			24.0320-0132.1 520132	Ø 247 20,4 18,5 V + S
1.9 D	47	05/93→05/01	←			24.0120-0132.1 420132	Ø 247 20,4 18,5 V + S
			←			24.0320-0132.1 520132	Ø 247 20,4 18,5 V + S
1.9 D	50	06/94→05/01	←			24.0120-0133.1 420133	Ø 266 20,5 18,5 V + S
1.9 D	55	03/98→05/01	←	10/00→; + ABS		24.0320-0133.1 520133	Ø 266 20,5 18,5 V + S
1.9 D	51	04/93→05/99	←	09/98→; + ABS		24.0120-0132.1 420132	Ø 247 20,4 18,5 V + S
			←	09/98→; →Orga 08575		24.0320-0132.1 520132	Ø 247 20,4 18,5 V + S
			←	Orga 08576→; - ABS		24.0120-0132.1 420132	Ø 247 20,4 18,5 V + S
			←	Orga 08576→; + ABS		24.0320-0132.1 520132	Ø 247 20,4 18,5 V + S
			←	Orga 08576→; + ABS		24.0120-0133.1 420133	Ø 266 20,5 18,5 V + S
			←	Orga 08576→; + ABS		24.0320-0133.1 520133	Ø 266 20,5 18,5 V + S
1.9 D	51	09/98→05/01	←	Orga 08576→; - ABS		24.0120-0132.1 420132	Ø 247 20,4 18,5 V + S
			←	→ 10/00; + ABS		24.0320-0132.1 520132	Ø 247 20,4 18,5 V + S
			←	→Orga 08575		24.0120-0132.1 420132	Ø 247 20,4 18,5 V + S
			←	Orga 08576→; + ABS		24.0320-0132.1 520132	Ø 247 20,4 18,5 V + S
			←	Orga 08576→; + ABS		24.0120-0133.1 420133	Ø 266 20,5 18,5 V + S
			←	10/00→; + ABS		24.0320-0133.1 520133	Ø 266 20,5 18,5 V + S
1.9 D	52	01/99→08/03	←	→ 10/00; + ABS		24.0120-0132.1 420132	Ø 247 20,4 18,5 V + S
			←	Orga 08576→; → 05/01; - ABS		24.0320-0132.1 520132	Ø 247 20,4 18,5 V + S
			←	→Orga 08575		24.0120-0132.1 420132	Ø 247 20,4 18,5 V + S
			←	Orga 08576→; → 05/01; + ABS		24.0320-0132.1 520132	Ø 247 20,4 18,5 V + S
			←	Orga 08576→; → 05/01; + ABS		24.0120-0133.1 420133	Ø 266 20,5 18,5 V + S
			←	10/00→; + ABS		24.0320-0133.1 520133	Ø 266 20,5 18,5 V + S
1.9 D	68	01/93→12/97	←	10/94→		24.0120-0132.1 420132	Ø 247 20,4 18,5 V + S
			←	10/93→		24.0320-0132.1 520132	Ø 247 20,4 18,5 V + S
			←	10/93→		24.0120-0132.1 420132	Ø 247 20,4 18,5 V + S
			←	10/93→		24.0320-0132.1 520132	Ø 247 20,4 18,5 V + S
1.9 DT	66	05/93→05/01	←	10/93→		24.0120-0132.1 420132	Ø 247 20,4 18,5 V + S
			←	10/93→		24.0320-0132.1 520132	Ø 247 20,4 18,5 V + S
2.0 S16	110	06/94→05/01	←	05/97→		24.0120-0133.1 420133	Ø 266 20,5 18,5 V + S
			←	→ 04/97		24.0320-0133.1 520133	Ø 266 20,5 18,5 V + S
			→			24.0122-0142.1 422142	Ø 283 22 20 V
			←			24.0108-0106.1 408106	Ø 247 8 6 + S
2.0 S16	112	05/93→05/01	←	05/97→		24.0120-0133.1 420133	Ø 266 20,5 18,5 V + S
			←	07/94→ 04/97		24.0320-0133.1 520133	Ø 266 20,5 18,5 V + S
			→	07/94→		24.0122-0142.1 422142	Ø 283 22 20 V
			←			24.0108-0106.1 408106	Ø 247 8 6 + S
2.0 S16	120	07/96→05/01	←			24.0122-0142.1 422142	Ø 283 22 20 V
			→			24.0108-0106.1 408106	Ø 247 8 6 + S
2.0 XSi	89	05/93→05/01	←	03/94→		24.0120-0133.1 420133	Ø 266 20,5 18,5 V + S
			←	03/94→		24.0320-0133.1 520133	Ø 266 20,5 18,5 V + S
			→	03/94→		24.0108-0106.1 408106	Ø 247 8 6 + S
<b>PEUGEOT - 307 (3A/C) 08/00→</b>							
<b>Bremsbelagsatz, Scheibenbremse</b>							
1.4 1.4 HDi ↓	55 50	08/00→ 10/01→	←	→ 07/07		13.0460-3994.2 603994	BOS 23599 19,0 - WE / - WK + Zub

	kw			 	! #			
<b>PEUGEOT - 307 (3A/C) 08/00→</b>								
<b> Bremsbelagsatz, Scheibenbremse</b>								
1.4 1.4 HDi	55 50	08/00→ 10/01→	←	→ 07/07		<b>13.0470-3994.2</b>	<b>LD3994</b>	BOS 23599 19,0 - WE / - WK + Zub Ceramic
			→	→ 07/07		<b>13.0460-2820.2</b>	<b>602820</b>	TRW 20961 17,2 - WK
			→	→Orga 10656		<b>13.0470-2820.2</b>	<b>LD2820</b>	TRW 20961 17,2 - WK Ceramic
			→	→Orga 10656		<b>13.0460-3813.2</b>	<b>603813</b>	BOS 24150 17,6 - WE / - WK + Zub
			→	→Orga 10656		<b>13.0470-3813.2</b>	<b>LD3813</b>	BOS 24150 17,6 - WE / - WK + Zub Ceramic
1.4 16V 1.6 HDi	65 66	11/03→ 04/05→	←	→Orga 10550; + ESP		<b>13.0460-3966.2</b>	<b>603966</b>	BOS 23600 19,4 - WE / - WK + Zub
						<b>13.0470-3966.2</b>	<b>LD3966</b>	BOS 23600 19,4 - WE / - WK + Zub Ceramic
			←	Orga 10551→; → 07/07; + ESP		<b>13.0460-3994.2</b>	<b>603994</b>	BOS 23599 19,0 - WE / - WK + Zub
						<b>13.0470-3994.2</b>	<b>LD3994</b>	BOS 23599 19,0 - WE / - WK + Zub Ceramic
			←	→ 07/07; - ESP		<b>13.0460-3994.2</b>	<b>603994</b>	BOS 23599 19,0 - WE / - WK + Zub
						<b>13.0470-3994.2</b>	<b>LD3994</b>	BOS 23599 19,0 - WE / - WK + Zub Ceramic
			→	→ 07/07		<b>13.0460-2820.2</b>	<b>602820</b>	TRW 20961 17,2 - WK
			→	→Orga 10656		<b>13.0470-2820.2</b>	<b>LD2820</b>	TRW 20961 17,2 - WK Ceramic
			→	→Orga 10656		<b>13.0460-3813.2</b>	<b>603813</b>	BOS 24150 17,6 - WE / - WK + Zub
			→	→Orga 10656		<b>13.0470-3813.2</b>	<b>LD3813</b>	BOS 24150 17,6 - WE / - WK + Zub Ceramic
1.6	81	07/06→	←	→ 07/07; Vollautomatik		<b>13.0460-3966.2</b>	<b>603966</b>	BOS 23600 19,4 - WE / - WK + Zub
						<b>13.0470-3966.2</b>	<b>LD3966</b>	BOS 23600 19,4 - WE / - WK + Zub Ceramic
			←	→ 07/07; + ESP; Schaltgetriebe		<b>13.0460-3994.2</b>	<b>603994</b>	BOS 23599 19,0 - WE / - WK + Zub
						<b>13.0470-3994.2</b>	<b>LD3994</b>	BOS 23599 19,0 - WE / - WK + Zub Ceramic
			→	→ 07/07		<b>13.0460-2820.2</b>	<b>602820</b>	TRW 20961 17,2 - WK
			→	→Orga 10656		<b>13.0470-2820.2</b>	<b>LD2820</b>	TRW 20961 17,2 - WK Ceramic
1.6	85	08/05→12/09	←	07/06→ 07/07; Vollautomatik		<b>13.0460-3966.2</b>	<b>603966</b>	BOS 23600 19,4 - WE / - WK + Zub
						<b>13.0470-3966.2</b>	<b>LD3966</b>	BOS 23600 19,4 - WE / - WK + Zub Ceramic
			←	07/06→ 07/07; + ESP; Schaltgetriebe		<b>13.0460-3994.2</b>	<b>603994</b>	BOS 23599 19,0 - WE / - WK + Zub
						<b>13.0470-3994.2</b>	<b>LD3994</b>	BOS 23599 19,0 - WE / - WK + Zub Ceramic
			→	07/06→ 07/07		<b>13.0460-2820.2</b>	<b>602820</b>	TRW 20961 17,2 - WK
			→	→Orga 10656		<b>13.0470-2820.2</b>	<b>LD2820</b>	TRW 20961 17,2 - WK Ceramic
1.6 16V	80	08/00→11/07	←	→ 07/07; Vollautomatik		<b>13.0460-3966.2</b>	<b>603966</b>	BOS 23600 19,4 - WE / - WK + Zub
						<b>13.0470-3966.2</b>	<b>LD3966</b>	BOS 23600 19,4 - WE / - WK + Zub Ceramic
			←	→Orga 10550; + ESP; Schaltgetriebe		<b>13.0460-3966.2</b>	<b>603966</b>	BOS 23600 19,4 - WE / - WK + Zub
						<b>13.0470-3966.2</b>	<b>LD3966</b>	BOS 23600 19,4 - WE / - WK + Zub Ceramic
			←	Orga 10551→; → 07/07; + ESP; Schaltgetriebe		<b>13.0460-3994.2</b>	<b>603994</b>	BOS 23599 19,0 - WE / - WK + Zub
						<b>13.0470-3994.2</b>	<b>LD3994</b>	BOS 23599 19,0 - WE / - WK + Zub Ceramic
			←	→ 07/07; Schaltgetriebe; - ESP		<b>13.0460-3994.2</b>	<b>603994</b>	BOS 23599 19,0 - WE / - WK + Zub
						<b>13.0470-3994.2</b>	<b>LD3994</b>	BOS 23599 19,0 - WE / - WK + Zub Ceramic
			→	→ 07/07		<b>13.0460-2820.2</b>	<b>602820</b>	TRW 20961 17,2 - WK
			→	→Orga 10656		<b>13.0470-2820.2</b>	<b>LD2820</b>	TRW 20961 17,2 - WK Ceramic
			→	→Orga 10656		<b>13.0460-3813.2</b>	<b>603813</b>	BOS 24150 17,6 - WE / - WK + Zub
			→	→Orga 10656		<b>13.0470-3813.2</b>	<b>LD3813</b>	BOS 24150 17,6 - WE / - WK + Zub Ceramic
↓								







	kW			 	! #		
<b>PEUGEOT - 307 (3A/C) 08/00→</b>							
<b>Bremsbelagsatz, Scheibenbremse</b>							
1.6 BioFlex	80	09/07→	←			<b>13.0460-3966.2 603966</b> <b>13.0470-3966.2 LD3966</b>	BOS 23600 19,4 - WE / - WK + Zub BOS 23600 19,4 - WE / - WK + Zub Ceramic
1.6 HDi 110 2.0 16V 2.0 HDi 110	80 103 79	02/04→ 03/05→ 08/00→	←	→ 07/07		<b>13.0460-3966.2 603966</b> <b>13.0470-3966.2 LD3966</b>	BOS 23600 19,4 - WE / - WK + Zub BOS 23600 19,4 - WE / - WK + Zub Ceramic
			→	→ 07/07		<b>13.0460-2820.2 602820</b> <b>13.0470-2820.2 LD2820</b>	TRW 20961 17,2 - WK TRW 20961 17,2 - WK Ceramic
			→	→Orga 10656		<b>13.0460-3813.2 603813</b> <b>13.0470-3813.2 LD3813</b>	BOS 24150 17,6 - WE / - WK + Zub BOS 24150 17,6 - WE / - WK + Zub Ceramic
2.0	105	08/08→	→	→Orga 10656		<b>13.0460-3813.2 603813</b> <b>13.0470-3813.2 LD3813</b>	BOS 24150 17,6 - WE / - WK + Zub BOS 24150 17,6 - WE / - WK + Zub Ceramic
2.0 16V	100	08/00→06/05	←			<b>13.0460-3966.2 603966</b> <b>13.0470-3966.2 LD3966</b>	BOS 23600 19,4 - WE / - WK + Zub BOS 23600 19,4 - WE / - WK + Zub Ceramic
			→			<b>13.0460-2820.2 602820</b> <b>13.0470-2820.2 LD2820</b>	TRW 20961 17,2 - WK TRW 20961 17,2 - WK Ceramic
			→	→Orga 10656		<b>13.0460-3813.2 603813</b> <b>13.0470-3813.2 LD3813</b>	BOS 24150 17,6 - WE / - WK + Zub BOS 24150 17,6 - WE / - WK + Zub Ceramic
2.0 16V 2.0 HDi 135	130 100	06/05→ 10/03→	←	→ 07/07		<b>13.0460-7230.2 607230</b> <b>13.0470-7202.2 LD7202</b> <b>13.0470-7230.2 LD7230</b>	ATE 24557 19,4 - WE / - WK ATE 23589 19,1 - WE / - WK Ceramic ATE 24557 19,4 - WE / - WK Ceramic
			→	→ 07/07		<b>13.0460-2820.2 602820</b> <b>13.0470-2820.2 LD2820</b>	TRW 20961 17,2 - WK TRW 20961 17,2 - WK Ceramic
			→	→Orga 10656		<b>13.0460-3813.2 603813</b> <b>13.0470-3813.2 LD3813</b>	BOS 24150 17,6 - WE / - WK + Zub BOS 24150 17,6 - WE / - WK + Zub Ceramic
2.0 HDi 90	66	08/00→	←	→Orga 09519		<b>13.0460-3966.2 603966</b> <b>13.0470-3966.2 LD3966</b>	BOS 23600 19,4 - WE / - WK + Zub BOS 23600 19,4 - WE / - WK + Zub Ceramic
			←	Orga 09520→; + ESP; → 07/07		<b>13.0460-3966.2 603966</b> <b>13.0470-3966.2 LD3966</b>	BOS 23600 19,4 - WE / - WK + Zub BOS 23600 19,4 - WE / - WK + Zub Ceramic
			←	Orga 09520→; → 07/07; - ESP		<b>13.0460-3994.2 603994</b> <b>13.0470-3994.2 LD3994</b>	BOS 23599 19,0 - WE / - WK + Zub BOS 23599 19,0 - WE / - WK + Zub Ceramic
			→	→ 07/07		<b>13.0460-2820.2 602820</b> <b>13.0470-2820.2 LD2820</b>	TRW 20961 17,2 - WK TRW 20961 17,2 - WK Ceramic
			→	→Orga 10656		<b>13.0460-3813.2 603813</b> <b>13.0470-3813.2 LD3813</b>	BOS 24150 17,6 - WE / - WK + Zub BOS 24150 17,6 - WE / - WK + Zub Ceramic
<b>Zubehörsatz, Scheibenbremsbelag</b>							
1.4 1.4 HDi 2.0 16V 2.0 HDi 135	55 50 130 100	08/00→ 10/01→ 06/05→ 10/03→	→	→ 07/07		<b>13.0460-0072.2 610072</b>	TRW
1.4 16V 1.6 HDi	65 66	11/03→ 04/05→	←	→Orga 10550; + ESP		<b>13.0460-0454.2 610454</b>	BOS
			→	→ 07/07		<b>13.0460-0072.2 610072</b>	TRW
1.6	81	07/06→	←	→ 07/07; Vollautomatik		<b>13.0460-0454.2 610454</b>	BOS
			→	→ 07/07		<b>13.0460-0072.2 610072</b>	TRW
1.6 ↓	85	08/05→12/09	←	07/06→ 07/07; Vollautomatik		<b>13.0460-0454.2 610454</b>	BOS



















	kW			 	! #		
<b>PEUGEOT - 307 (3A/C) 08/00→</b>							
<b>Zubehörsatz, Scheibenbremsbelag</b>							
1.6	85	08/05→12/09	➡	07/06→ 07/07		13.0460-0072.2 610072	TRW
1.6 16V	80	08/00→11/07	←	→Orga 10550; + ESP; Schaltgetriebe		13.0460-0454.2 610454	BOS
			←	→ 07/07; Vollautomatik		13.0460-0454.2 610454	BOS
			➡	→ 07/07		13.0460-0072.2 610072	TRW
1.6 BioFlex	80	09/07→	←			13.0460-0454.2 610454	BOS
1.6 HDi 110 2.0 16V	80 103	02/04→ 03/05→	←	→ 07/07		13.0460-0454.2 610454	BOS
			➡	→ 07/07		13.0460-0072.2 610072	TRW
2.0 HDi 110	79	08/00→	➡			13.0460-0072.2 610072	TRW
2.0 16V	100	08/00→06/05	←			13.0460-0454.2 610454	BOS
			➡			13.0460-0072.2 610072	TRW
2.0 HDi 90	66	08/00→	←	Orga 09520→; + ESP; → 07/07		13.0460-0454.2 610454	BOS
			←	→Orga 09519		13.0460-0454.2 610454	BOS
			➡	→ 07/07		13.0460-0072.2 610072	TRW
<b> Bremsscheibe</b>							
1.4 1.4 HDi	55 50	08/00→ 10/01→	←	→ 07/07		24.0122-0194.1 422194	Ø 266 22 20 V + S
			➡	Orga 10898→; → 07/07		24.0109-0100.2 409100	Ø 249 9 7 + LG / + ABS Ring
			➡	→ 07/07		24.0109-0137.1 409137	Ø 247 9 8 + S
			➡	→Orga 10897		24.0109-0150.2 409150	Ø 249 9 8 + LG / + ABS Ring
1.4 16V 1.6 HDi	65 66	11/03→ 04/05→	←	Orga 10551→; → 07/07; + ESP		24.0122-0194.1 422194	Ø 266 22 20 V + S
			←	→ 07/07; - ESP		24.0122-0194.1 422194	Ø 266 22 20 V + S
			←	→Orga 10550; + ESP		24.0126-0120.1 426120	Ø 283 26 24 V + S
						24.0326-0120.1 526120	Ø 283 26 24 V + S
			➡	Orga 10898→; → 07/07		24.0109-0100.2 409100	Ø 249 9 7 + LG / + ABS Ring
			➡	→ 07/07		24.0109-0137.1 409137	Ø 247 9 8 + S
1.6	81	07/06→	←	→ 07/07; + ESP; Schaltgetriebe		24.0122-0194.1 422194	Ø 266 22 20 V + S
			←	→ 07/07; Vollautomatik		24.0126-0120.1 426120	Ø 283 26 24 V + S
						24.0326-0120.1 526120	Ø 283 26 24 V + S
			➡	Orga 10898→; → 07/07		24.0109-0100.2 409100	Ø 249 9 7 + LG / + ABS Ring
1.6	85	08/05→12/09	➡	→ 07/07		24.0109-0137.1 409137	Ø 247 9 8 + S
			➡	→Orga 10897		24.0109-0150.2 409150	Ø 249 9 8 + LG / + ABS Ring
			➡	07/06→ 07/07; + ESP; Schaltgetriebe		24.0122-0194.1 422194	Ø 266 22 20 V + S
			←	07/06→ 07/07; Vollautomatik		24.0126-0120.1 426120	Ø 283 26 24 V + S
1.6 16V	80	08/00→11/07	←	Orga 10551→; + ESP; → 07/07; Schaltgetriebe		24.0122-0194.1 422194	Ø 266 22 20 V + S
			←	→ 07/07; Schaltgetriebe; - ESP		24.0122-0194.1 422194	Ø 266 22 20 V + S
			←	+ ESP; → 07/07; Schaltgetriebe		24.0126-0120.1 426120	Ø 283 26 24 V + S
						24.0326-0120.1 526120	Ø 283 26 24 V + S
			←	→ 07/07; Vollautomatik		24.0126-0120.1 426120	Ø 283 26 24 V + S
						24.0326-0120.1 526120	Ø 283 26 24 V + S
			➡	Orga 10898→; → 07/07		24.0109-0100.2 409100	Ø 249 9 7 + LG / + ABS Ring
			➡	→ 07/07		24.0109-0137.1 409137	Ø 247 9 8 + S
			➡	→Orga 10897		24.0109-0150.2 409150	Ø 249 9 8 + LG / + ABS Ring
			1.6 BioFlex	80	09/07→	←	
						24.0326-0120.1 526120	Ø 283 26 24 V + S
1.6 HDi 110 2.0 16V 2.0 HDi 110	80 103 79	02/04→ 03/05→ 08/00→	←	→ 07/07		24.0126-0120.1 426120	Ø 283 26 24 V + S
						24.0326-0120.1 526120	Ø 283 26 24 V + S
			➡	Orga 10898→; → 07/07		24.0109-0100.2 409100	Ø 249 9 7 + LG / + ABS Ring
			➡	→ 07/07		24.0109-0137.1 409137	Ø 247 9 8 + S
2.0	105	08/08→	➡	→Orga 10897		24.0109-0150.2 409150	Ø 249 9 8 + LG / + ABS Ring
2.0 16V ↓	100	08/00→06/05	←			24.0126-0120.1 426120	Ø 283 26 24 V + S

	kw			 	! #		
<b>PEUGEOT - 307 (3A/C) 08/00→</b>							
 <b>Bremsscheibe</b>							
2.0 16V	100	08/00→06/05	←		24.0326-0120.1	526120	Ø 283 26 24 V + S
			→	Orga 10898→	24.0109-0100.2	409100	Ø 249 9 7 + LG / + ABS Ring
			→		24.0109-0137.1	409137	Ø 247 9 8 + S
			→	→Orga 10897	24.0109-0150.2	409150	Ø 249 9 8 + LG / + ABS Ring
2.0 16V	130	06/05→	←	→ 07/07	24.0126-0140.1	426140	Ø 302 26 24 außenbelüftet + S
			→	→ 07/07	24.0109-0137.1	409137	Ø 247 9 8 + S
2.0 HDi 135	100	10/03→	←	→ 07/07	24.0126-0140.1	426140	Ø 302 26 24 außenbelüftet + S
			→	Orga 10898→; → 07/07	24.0109-0100.2	409100	Ø 249 9 7 + LG / + ABS Ring
			→	→ 07/07	24.0109-0137.1	409137	Ø 247 9 8 + S
			→	→Orga 10897	24.0109-0150.2	409150	Ø 249 9 8 + LG / + ABS Ring
2.0 HDi 90	66	08/00→	←	Orga 09520→; → 07/07; - ESP	24.0122-0194.1	422194	Ø 266 22 20 V + S
			←	→Orga 09519	24.0126-0120.1	426120	Ø 283 26 24 V + S
					24.0326-0120.1	526120	Ø 283 26 24 V + S
			←	Orga 09520→; → 07/07; + ESP	24.0126-0120.1	426120	Ø 283 26 24 V + S
					24.0326-0120.1	526120	Ø 283 26 24 V + S
			→	Orga 10898→; → 07/07	24.0109-0100.2	409100	Ø 249 9 7 + LG / + ABS Ring
			→	→ 07/07	24.0109-0137.1	409137	Ø 247 9 8 + S
		→Orga 10897	24.0109-0150.2	409150	Ø 249 9 8 + LG / + ABS Ring		
<b>PEUGEOT - 307 Break (3E) 03/02→12/09</b>							
 <b>Bremsbelagsatz, Scheibenbremse</b>							
1.4	55	04/02→09/03	←	→Orga 10550; + ESP	13.0460-3966.2	603966	BOS 23600 19,4 - WE / - WK + Zub
					13.0470-3966.2	LD3966	BOS 23600 19,4 - WE / - WK + Zub Ceramic
			←	Orga 10551→	13.0460-3994.2	603994	BOS 23599 19,0 - WE / - WK + Zub
					13.0470-3994.2	LD3994	BOS 23599 19,0 - WE / - WK + Zub Ceramic
			←	- ESP	13.0460-3994.2	603994	BOS 23599 19,0 - WE / - WK + Zub
					13.0470-3994.2	LD3994	BOS 23599 19,0 - WE / - WK + Zub Ceramic
			→	→Orga 12056	13.0460-2820.2	602820	TRW 20961 17,2 - WK
		13.0470-2820.2	LD2820	TRW 20961 17,2 - WK Ceramic			
		→Orga 12057→	13.0460-3813.2	603813	BOS 24150 17,6 - WE / - WK + Zub		
			13.0470-3813.2	LD3813	BOS 24150 17,6 - WE / - WK + Zub Ceramic		
		→Orga 10656	13.0460-3813.2	603813	BOS 24150 17,6 - WE / - WK + Zub		
			13.0470-3813.2	LD3813	BOS 24150 17,6 - WE / - WK + Zub Ceramic		
1.4 16V	65	11/03→07/07	←	→Orga 10550; + ESP	13.0460-3966.2	603966	BOS 23600 19,4 - WE / - WK + Zub
					13.0470-3966.2	LD3966	BOS 23600 19,4 - WE / - WK + Zub Ceramic
			←	Orga 10551→; + ESP	13.0460-3994.2	603994	BOS 23599 19,0 - WE / - WK + Zub
					13.0470-3994.2	LD3994	BOS 23599 19,0 - WE / - WK + Zub Ceramic
			←	- ESP	13.0460-3994.2	603994	BOS 23599 19,0 - WE / - WK + Zub
					13.0470-3994.2	LD3994	BOS 23599 19,0 - WE / - WK + Zub Ceramic
			→	→Orga 12056	13.0460-2820.2	602820	TRW 20961 17,2 - WK
		13.0470-2820.2	LD2820	TRW 20961 17,2 - WK Ceramic			
		→Orga 12057→	13.0460-3813.2	603813	BOS 24150 17,6 - WE / - WK + Zub		
			13.0470-3813.2	LD3813	BOS 24150 17,6 - WE / - WK + Zub Ceramic		
		→Orga 10656	13.0460-3813.2	603813	BOS 24150 17,6 - WE / - WK + Zub		



















	kw			 	! #		
<b>PEUGEOT - 307 Break (3E) 03/02→12/09</b>							
<b>Bremsbelagsatz, Scheibenbremse</b>							
1.4 16V	65	11/03→07/07	➡	→Orga 10656		<b>13.0470-3813.2 LD3813</b>	BOS 24150 17,6 - WE / - WK + Zub Ceramic
1.4 HDi	50	03/02→06/05	←			<b>13.0460-3994.2 603994</b>	BOS 23599 19,0 - WE / - WK + Zub
						<b>13.0470-3994.2 LD3994</b>	BOS 23599 19,0 - WE / - WK + Zub Ceramic
			➡	→Orga 12056		<b>13.0460-2820.2 602820</b>	TRW 20961 17,2 - WK
						<b>13.0470-2820.2 LD2820</b>	TRW 20961 17,2 - WK Ceramic
			➡	→Orga 10656		<b>13.0460-3813.2 603813</b>	BOS 24150 17,6 - WE / - WK + Zub
					<b>13.0470-3813.2 LD3813</b>	BOS 24150 17,6 - WE / - WK + Zub Ceramic	
			➡	Orga 12057→		<b>13.0460-3813.2 603813</b>	BOS 24150 17,6 - WE / - WK + Zub
						<b>13.0470-3813.2 LD3813</b>	BOS 24150 17,6 - WE / - WK + Zub Ceramic
1.6 16V 1.6 HDi 1.6 HDi 110 2.0 2.0 16V 2.0 HDi 90	80 66 80 100 103 66	03/02→04/08 04/05→04/08 02/04→04/08 03/02→06/05 03/05→04/08 03/02→04/08	←			<b>13.0460-3966.2 603966</b>	BOS 23600 19,4 - WE / - WK + Zub
						<b>13.0470-3966.2 LD3966</b>	BOS 23600 19,4 - WE / - WK + Zub Ceramic
			➡	→Orga 12056		<b>13.0460-2820.2 602820</b>	TRW 20961 17,2 - WK
						<b>13.0470-2820.2 LD2820</b>	TRW 20961 17,2 - WK Ceramic
			➡	→Orga 10656		<b>13.0460-3813.2 603813</b>	BOS 24150 17,6 - WE / - WK + Zub
					<b>13.0470-3813.2 LD3813</b>	BOS 24150 17,6 - WE / - WK + Zub Ceramic	
			➡	Orga 12057→		<b>13.0460-3813.2 603813</b>	BOS 24150 17,6 - WE / - WK + Zub
						<b>13.0470-3813.2 LD3813</b>	BOS 24150 17,6 - WE / - WK + Zub Ceramic
1.6 BioFlex	80	09/07→04/08	←			<b>13.0460-3966.2 603966</b>	BOS 23600 19,4 - WE / - WK + Zub
						<b>13.0470-3966.2 LD3966</b>	BOS 23600 19,4 - WE / - WK + Zub Ceramic
			➡	→Orga 12056		<b>13.0460-2820.2 602820</b>	TRW 20961 17,2 - WK
						<b>13.0470-2820.2 LD2820</b>	TRW 20961 17,2 - WK Ceramic
2.0 16V 2.0 HDi 135	130 100	06/05→04/08 02/04→04/08	←			<b>13.0460-7230.2 607230</b>	ATE 24557 19,4 - WE / - WK
						<b>13.0470-7202.2 LD7202</b>	ATE 23589 19,1 - WE / - WK Ceramic
						<b>13.0470-7230.2 LD7230</b>	ATE 24557 19,4 - WE / - WK Ceramic
			➡	→Orga 12056		<b>13.0460-2820.2 602820</b>	TRW 20961 17,2 - WK
						<b>13.0470-2820.2 LD2820</b>	TRW 20961 17,2 - WK Ceramic
			➡	→Orga 10656		<b>13.0460-3813.2 603813</b>	BOS 24150 17,6 - WE / - WK + Zub
						<b>13.0470-3813.2 LD3813</b>	BOS 24150 17,6 - WE / - WK + Zub Ceramic
			➡	Orga 12057→		<b>13.0460-3813.2 603813</b>	BOS 24150 17,6 - WE / - WK + Zub
						<b>13.0470-3813.2 LD3813</b>	BOS 24150 17,6 - WE / - WK + Zub Ceramic
2.0 HDi 110	79	03/02→12/09	←	→ 04/08		<b>13.0460-3966.2 603966</b>	BOS 23600 19,4 - WE / - WK + Zub
						<b>13.0470-3966.2 LD3966</b>	BOS 23600 19,4 - WE / - WK + Zub Ceramic
			➡	→Orga 12056		<b>13.0460-2820.2 602820</b>	TRW 20961 17,2 - WK
						<b>13.0470-2820.2 LD2820</b>	TRW 20961 17,2 - WK Ceramic
			➡	Orga 12057→; → 04/08		<b>13.0460-3813.2 603813</b>	BOS 24150 17,6 - WE / - WK + Zub
						<b>13.0470-3813.2 LD3813</b>	BOS 24150 17,6 - WE / - WK + Zub Ceramic
			➡	→Orga 10656		<b>13.0460-3813.2 603813</b>	BOS 24150 17,6 - WE / - WK + Zub
						<b>13.0470-3813.2 LD3813</b>	BOS 24150 17,6 - WE / - WK + Zub Ceramic
<b>Zubehörsatz, Scheibenbremsbelag</b>							
1.4 1.4 16V ↓	55 65	04/02→09/03 11/03→07/07	←	→Orga 10550; + ESP		<b>13.0460-0454.2 610454</b>	BOS







	kW			 	! #		
<b>PEUGEOT - 307 Break (3E) 03/02→12/09</b>							
<b>Zubehörsatz, Scheibenbremsbelag</b>							
1.4 1.4 16V	55 65	04/02→09/03 11/03→07/07	➡	→Orga 12056		13.0460-0072.2 610072	TRW
1.4 HDi 2.0 16V 2.0 HDi 135	50 130 100	03/02→06/05 06/05→04/08 02/04→04/08	➡	→Orga 12056		13.0460-0072.2 610072	TRW
1.6 16V 1.6 BioFlex	80 80	03/02→04/08 09/07→04/08	⬅			13.0460-0454.2 610454	BOS
1.6 HDi 1.6 HDi 110 2.0 2.0 16V 2.0 HDi 90	66 80 100 103 66	04/05→04/08 02/04→04/08 03/02→06/05 03/05→04/08 03/02→04/08	➡	→Orga 12056		13.0460-0072.2 610072	TRW
2.0 HDi 110	79	03/02→12/09	⬅	→ 04/08		13.0460-0454.2 610454	BOS
			➡	→Orga 12056		13.0460-0072.2 610072	TRW
<b> Bremsscheibe</b>							
1.4 1.4 16V	55 65	04/02→09/03 11/03→07/07	⬅	Orga 10551→; + ESP		24.0122-0194.1 422194	Ø 266 22 20 V + S
			⬅	- ESP		24.0122-0194.1 422194	Ø 266 22 20 V + S
			⬅	→Orga 10550; + ESP		24.0126-0120.1 426120	Ø 283 26 24 V + S
						24.0326-0120.1 526120	Ø 283 26 24 V + S
			➡	Orga 10898→		24.0109-0100.2 409100	Ø 249 9 7 + LG / + ABS Ring
			➡			24.0109-0137.1 409137	Ø 247 9 8 + S
			➡	→Orga 10897		24.0109-0150.2 409150	Ø 249 9 8 + LG / + ABS Ring
1.4 HDi	50	03/02→06/05	⬅			24.0122-0194.1 422194	Ø 266 22 20 V + S
			➡	Orga 10898→		24.0109-0100.2 409100	Ø 249 9 7 + LG / + ABS Ring
			➡			24.0109-0137.1 409137	Ø 247 9 8 + S
			➡	→Orga 10897		24.0109-0150.2 409150	Ø 249 9 8 + LG / + ABS Ring
1.6 16V 1.6 BioFlex 1.6 HDi 1.6 HDi 110 2.0 2.0 16V 2.0 HDi 90	80 80 66 80 100 103 66	03/02→04/08 09/07→04/08 04/05→04/08 02/04→04/08 03/02→06/05 03/05→04/08 03/02→04/08	⬅			24.0126-0120.1 426120	Ø 283 26 24 V + S
						24.0326-0120.1 526120	Ø 283 26 24 V + S
			➡	Orga 10898→		24.0109-0100.2 409100	Ø 249 9 7 + LG / + ABS Ring
			➡			24.0109-0137.1 409137	Ø 247 9 8 + S
			➡	→Orga 10897		24.0109-0150.2 409150	Ø 249 9 8 + LG / + ABS Ring
2.0 16V	130	06/05→04/08	⬅			24.0126-0140.1 426140	Ø 302 26 24 außenbelüftet + S
			➡			24.0109-0137.1 409137	Ø 247 9 8 + S
2.0 HDi 110	79	03/02→12/09	⬅	→ 04/08		24.0126-0120.1 426120	Ø 283 26 24 V + S
						24.0326-0120.1 526120	Ø 283 26 24 V + S
			➡	Orga 10898→; → 04/08		24.0109-0100.2 409100	Ø 249 9 7 + LG / + ABS Ring
			➡	→ 04/08		24.0109-0137.1 409137	Ø 247 9 8 + S
			➡	→Orga 10897		24.0109-0150.2 409150	Ø 249 9 8 + LG / + ABS Ring
2.0 HDi 135	100	02/04→04/08	⬅			24.0126-0140.1 426140	Ø 302 26 24 außenbelüftet + S
			➡	Orga 10898→		24.0109-0100.2 409100	Ø 249 9 7 + LG / + ABS Ring
			➡			24.0109-0137.1 409137	Ø 247 9 8 + S
			➡	→Orga 10897		24.0109-0150.2 409150	Ø 249 9 8 + LG / + ABS Ring
<b>PEUGEOT - 307 CC (3B) 10/03→</b>							
<b> Bremsbelagsatz, Scheibenbremse</b>							
1.6 16V	80	02/05→	⬅	03/05→ 02/09		13.0460-3966.2 603966	BOS 23600 19,4 - WE / - WK + Zub
						13.0470-3966.2 LD3966	BOS 23600 19,4 - WE / - WK + Zub Ceramic
			➡	03/05→; →Orga 12056		13.0460-2820.2 602820	TRW 20961 17,2 - WK
						13.0470-2820.2 LD2820	TRW 20961 17,2 - WK Ceramic
			➡	03/05→; →Orga 10656		13.0460-3813.2 603813	BOS 24150 17,6 - WE / - WK + Zub
						13.0470-3813.2 LD3813	BOS 24150 17,6 - WE / - WK + Zub Ceramic
			➡	Orga 12057→; → 02/09		13.0460-3813.2 603813	BOS 24150 17,6 - WE / - WK + Zub
						13.0470-3813.2 LD3813	BOS 24150 17,6 - WE / - WK + Zub Ceramic
2.0 16V ↓	100	10/03→	⬅			13.0460-3966.2 603966	BOS 23600 19,4 - WE / - WK + Zub











	kw			 	! #			
<b>PEUGEOT - 307 CC (3B) 10/03→</b>								
<b>Bremsbelagsatz, Scheibenbremse</b>								
2.0 16V	100	10/03→	←			<b>13.0470-3966.2</b>	<b>LD3966</b>	BOS 23600 19,4 - WE / - WK + Zub Ceramic
			→	→Orga 12056		<b>13.0460-2820.2</b>	<b>602820</b>	TRW 20961 17,2 - WK
			→	→Orga 10656		<b>13.0470-2820.2</b>	<b>LD2820</b>	TRW 20961 17,2 - WK Ceramic
			→	→Orga 10656		<b>13.0460-3813.2</b>	<b>603813</b>	BOS 24150 17,6 - WE / - WK + Zub
			→	Orga 12057→		<b>13.0470-3813.2</b>	<b>LD3813</b>	BOS 24150 17,6 - WE / - WK + Zub Ceramic
			→	Orga 12057→		<b>13.0460-3813.2</b>	<b>603813</b>	BOS 24150 17,6 - WE / - WK + Zub
			→	Orga 12057→		<b>13.0470-3813.2</b>	<b>LD3813</b>	BOS 24150 17,6 - WE / - WK + Zub Ceramic
2.0 16V	103	12/04→12/09	←	→ 02/09		<b>13.0460-3966.2</b>	<b>603966</b>	BOS 23600 19,4 - WE / - WK + Zub
			→	→Orga 12056		<b>13.0470-3966.2</b>	<b>LD3966</b>	BOS 23600 19,4 - WE / - WK + Zub Ceramic
			→	→Orga 12056		<b>13.0460-2820.2</b>	<b>602820</b>	TRW 20961 17,2 - WK
			→	→Orga 10656		<b>13.0470-2820.2</b>	<b>LD2820</b>	TRW 20961 17,2 - WK Ceramic
			→	→Orga 10656		<b>13.0460-3813.2</b>	<b>603813</b>	BOS 24150 17,6 - WE / - WK + Zub
			→	→Orga 10656		<b>13.0470-3813.2</b>	<b>LD3813</b>	BOS 24150 17,6 - WE / - WK + Zub Ceramic
			→	Orga 12057→; → 02/09		<b>13.0460-3813.2</b>	<b>603813</b>	BOS 24150 17,6 - WE / - WK + Zub
			→	Orga 12057→; → 02/09		<b>13.0470-3813.2</b>	<b>LD3813</b>	BOS 24150 17,6 - WE / - WK + Zub Ceramic
2.0 16V 2.0 HDi 135	130 100	10/03→ 06/05→	←	→ 02/09		<b>13.0460-7230.2</b>	<b>607230</b>	ATE 24557 19,4 - WE / - WK
			→	→Orga 12056		<b>13.0470-7202.2</b>	<b>LD7202</b>	ATE 23589 19,1 - WE / - WK Ceramic
			→	→Orga 12056		<b>13.0470-7230.2</b>	<b>LD7230</b>	ATE 24557 19,4 - WE / - WK Ceramic
			→	→Orga 12056		<b>13.0460-2820.2</b>	<b>602820</b>	TRW 20961 17,2 - WK
			→	→Orga 10656		<b>13.0470-2820.2</b>	<b>LD2820</b>	TRW 20961 17,2 - WK Ceramic
			→	→Orga 10656		<b>13.0460-3813.2</b>	<b>603813</b>	BOS 24150 17,6 - WE / - WK + Zub
			→	→Orga 10656		<b>13.0470-3813.2</b>	<b>LD3813</b>	BOS 24150 17,6 - WE / - WK + Zub Ceramic
			→	Orga 12057→; → 02/09		<b>13.0460-3813.2</b>	<b>603813</b>	BOS 24150 17,6 - WE / - WK + Zub
			→	Orga 12057→; → 02/09		<b>13.0470-3813.2</b>	<b>LD3813</b>	BOS 24150 17,6 - WE / - WK + Zub Ceramic
<b>Zubehörsatz, Scheibenbremsbelag</b>								
1.6 16V	80	02/05→	←	03/05→ 02/09		<b>13.0460-0454.2</b>	<b>610454</b>	BOS
			→	03/05→; →Orga 12056		<b>13.0460-0072.2</b>	<b>610072</b>	TRW
2.0 16V	100	10/03→	←			<b>13.0460-0454.2</b>	<b>610454</b>	BOS
			→	→Orga 12056		<b>13.0460-0072.2</b>	<b>610072</b>	TRW
2.0 16V	103	12/04→12/09	←	→ 02/09		<b>13.0460-0454.2</b>	<b>610454</b>	BOS
			→	→Orga 12056		<b>13.0460-0072.2</b>	<b>610072</b>	TRW
2.0 16V 2.0 HDi 135	130 100	10/03→ 06/05→	→	→Orga 12056		<b>13.0460-0072.2</b>	<b>610072</b>	TRW
<b>Bremsscheibe</b>								
1.6 16V	80	02/05→	←	03/05→ 02/09		<b>24.0126-0120.1</b>	<b>426120</b>	Ø 283 26 24 V + S
			→	03/05→ 02/09		<b>24.0326-0120.1</b>	<b>526120</b>	Ø 283 26 24 V + S
			→	Orga 10898→; → 02/09		<b>24.0109-0100.2</b>	<b>409100</b>	Ø 249 9 7 + LG / + ABS Ring
			→	03/05→ 02/09		<b>24.0109-0137.1</b>	<b>409137</b>	Ø 247 9 8 + S
			→	03/05→; →Orga 10897		<b>24.0109-0150.2</b>	<b>409150</b>	Ø 249 9 8 + LG / + ABS Ring
2.0 16V	100	10/03→	←			<b>24.0126-0120.1</b>	<b>426120</b>	Ø 283 26 24 V + S
			→			<b>24.0326-0120.1</b>	<b>526120</b>	Ø 283 26 24 V + S
			→	Orga 10898→		<b>24.0109-0100.2</b>	<b>409100</b>	Ø 249 9 7 + LG / + ABS Ring
			→			<b>24.0109-0137.1</b>	<b>409137</b>	Ø 247 9 8 + S
			→	→Orga 10897		<b>24.0109-0150.2</b>	<b>409150</b>	Ø 249 9 8 + LG / + ABS Ring
2.0 16V	103	12/04→12/09	←	→ 02/09		<b>24.0126-0120.1</b>	<b>426120</b>	Ø 283 26 24 V + S
			→			<b>24.0326-0120.1</b>	<b>526120</b>	Ø 283 26 24 V + S
↓								



	kw			 	! #		
<b>PEUGEOT - 307 CC (3B) 10/03→</b>							
 <b>Bremsscheibe</b>							
2.0 16V	103	12/04→12/09	➔	Orga 10898→; → 02/09	24.0109-0100.2	409100	Ø 249 9 7 + LG / + ABS Ring
			➔	→ 02/09	24.0109-0137.1	409137	Ø 247 9 8 + S
			➔	→Orga 10897	24.0109-0150.2	409150	Ø 249 9 8 + LG / + ABS Ring
2.0 16V	130	10/03→	➔	→ 02/09	24.0126-0140.1	426140	Ø 302 26 24 außenbelüftet + S
			➔	→ 02/09	24.0109-0137.1	409137	Ø 247 9 8 + S
2.0 HDi 135	100	06/05→	➔	→ 02/09	24.0126-0140.1	426140	Ø 302 26 24 außenbelüftet + S
			➔	Orga 10898→; → 02/09	24.0109-0100.2	409100	Ø 249 9 7 + LG / + ABS Ring
			➔	→ 02/09	24.0109-0137.1	409137	Ø 247 9 8 + S
			➔	→Orga 10897	24.0109-0150.2	409150	Ø 249 9 8 + LG / + ABS Ring
<b>PEUGEOT - 307 SW (3H) 03/02→12/09</b>							
 <b>Bremsbelagsatz, Scheibenbremse</b>							
1.4	55	04/02→09/03	➔	→Orga 10550; + ESP	13.0460-3966.2	603966	BOS 23600 19,4 - WE / - WK + Zub
					13.0470-3966.2	LD3966	BOS 23600 19,4 - WE / - WK + Zub Ceramic
			➔	Orga 10551→; + ESP	13.0460-3994.2	603994	BOS 23599 19,0 - WE / - WK + Zub
					13.0470-3994.2	LD3994	BOS 23599 19,0 - WE / - WK + Zub Ceramic
			➔	- ESP	13.0460-3994.2	603994	BOS 23599 19,0 - WE / - WK + Zub
					13.0470-3994.2	LD3994	BOS 23599 19,0 - WE / - WK + Zub Ceramic
1.4 16V	65	11/03→07/07	➔	→Orga 10550; + ESP	13.0460-3966.2	603966	BOS 23600 19,4 - WE / - WK + Zub
					13.0470-3966.2	LD3966	BOS 23600 19,4 - WE / - WK + Zub Ceramic
			➔	Orga 10551→; + ESP	13.0460-3994.2	603994	BOS 23599 19,0 - WE / - WK + Zub
					13.0470-3994.2	LD3994	BOS 23599 19,0 - WE / - WK + Zub Ceramic
			➔	- ESP	13.0460-3994.2	603994	BOS 23599 19,0 - WE / - WK + Zub
					13.0470-3994.2	LD3994	BOS 23599 19,0 - WE / - WK + Zub Ceramic
1.4 HDi 70	50	03/02→06/05	➔	→ 01/05	13.0460-3994.2	603994	BOS 23599 19,0 - WE / - WK + Zub
					13.0470-3994.2	LD3994	BOS 23599 19,0 - WE / - WK + Zub Ceramic
			➔	→ 01/05	13.0460-2820.2	602820	TRW 20961 17,2 - WK
					13.0460-3813.2	603813	BOS 24150 17,6 - WE / - WK + Zub
					13.0470-2820.2	LD2820	TRW 20961 17,2 - WK Ceramic
					13.0470-3813.2	LD3813	BOS 24150 17,6 - WE / - WK + Zub Ceramic
1.6 16V 1.6 BioFlex 1.6 HDi 90	80 80 66	03/02→04/08 09/07→04/08 12/06→04/08	➔		13.0460-3966.2	603966	BOS 23600 19,4 - WE / - WK + Zub
					13.0470-3966.2	LD3966	BOS 23600 19,4 - WE / - WK + Zub Ceramic
↓							

	kw			 	! #		
<b>PEUGEOT - 307 SW (3H) 03/02→12/09</b>							
<b>Bremsbelagsatz, Scheibenbremse</b>							
1.6 16V 1.6 BioFlex 1.6 HDI 90	80 80 66	03/02→04/08 09/07→04/08 12/06→04/08	→ → →	→Orga 12056  →Orga 10656  Orga 12057→		<b>13.0460-2820.2 602820</b> <b>13.0470-2820.2 LD2820</b> <b>13.0460-3813.2 603813</b> <b>13.0470-3813.2 LD3813</b> <b>13.0460-3813.2 603813</b> <b>13.0470-3813.2 LD3813</b>	TRW 20961 17,2 - WK TRW 20961 17,2 - WK Ceramic BOS 24150 17,6 - WE / - WK + Zub BOS 24150 17,6 - WE / - WK + Zub Ceramic BOS 24150 17,6 - WE / - WK + Zub BOS 24150 17,6 - WE / - WK + Zub Ceramic
1.6 HDI 110 2.0 16V 2.0 16V 2.0 HDI 110 2.0 HDI 90	80 100 103 79 66	02/04→ 03/02→ 03/05→ 03/02→12/09 03/02→	← → → →	→ 04/08  →Orga 12056 Orga 12057→; → 04/08 →Orga 10656		<b>13.0460-3966.2 603966</b> <b>13.0470-3966.2 LD3966</b> <b>13.0460-2820.2 602820</b> <b>13.0470-2820.2 LD2820</b> <b>13.0460-3813.2 603813</b> <b>13.0470-3813.2 LD3813</b> <b>13.0460-3813.2 603813</b> <b>13.0470-3813.2 LD3813</b>	BOS 23600 19,4 - WE / - WK + Zub BOS 23600 19,4 - WE / - WK + Zub Ceramic TRW 20961 17,2 - WK TRW 20961 17,2 - WK Ceramic BOS 24150 17,6 - WE / - WK + Zub BOS 24150 17,6 - WE / - WK + Zub Ceramic BOS 24150 17,6 - WE / - WK + Zub BOS 24150 17,6 - WE / - WK + Zub Ceramic
2.0 HDi 135	100	02/04→	← → → →	→ 04/08  →Orga 12056 Orga 12057→; → 04/08 →Orga 10656		<b>13.0460-7230.2 607230</b> <b>13.0470-7202.2 LD7202</b> <b>13.0470-7230.2 LD7230</b> <b>13.0460-2820.2 602820</b> <b>13.0470-2820.2 LD2820</b> <b>13.0460-3813.2 603813</b> <b>13.0470-3813.2 LD3813</b> <b>13.0460-3813.2 603813</b> <b>13.0470-3813.2 LD3813</b>	ATE 24557 19,4 - WE / - WK ATE 23589 19,1 - WE / - WK Ceramic ATE 24557 19,4 - WE / - WK Ceramic TRW 20961 17,2 - WK TRW 20961 17,2 - WK Ceramic BOS 24150 17,6 - WE / - WK + Zub BOS 24150 17,6 - WE / - WK + Zub Ceramic BOS 24150 17,6 - WE / - WK + Zub BOS 24150 17,6 - WE / - WK + Zub Ceramic
<b>Zubehörsatz, Scheibenbremsbelag</b>							
1.4 1.4 16V	55 65	04/02→09/03 11/03→07/07	← →	→Orga 10550; + ESP →Orga 12056		<b>13.0460-0454.2 610454</b> <b>13.0460-0072.2 610072</b>	BOS TRW
1.4 HDi 70	50	03/02→06/05	→	→ 01/05		<b>13.0460-0072.2 610072</b>	TRW
1.6 16V 1.6 BioFlex 1.6 HDI 90	80 80 66	03/02→04/08 09/07→04/08 12/06→04/08	← → →	  →Orga 12056		<b>13.0460-0454.2 610454</b> <b>13.0460-0072.2 610072</b>	BOS TRW
1.6 HDI 110 2.0 16V 2.0 16V 2.0 HDI 110 2.0 HDI 90	80 100 103 79 66	02/04→ 03/02→ 03/05→ 03/02→12/09 03/02→	← → →	→ 04/08  →Orga 12056		<b>13.0460-0454.2 610454</b> <b>13.0460-0072.2 610072</b>	BOS TRW
2.0 HDi 135	100	02/04→	→	→Orga 12056		<b>13.0460-0072.2 610072</b>	TRW
<b>Bremsscheibe</b>							
1.4 1.4 16V	55 65	04/02→09/03 11/03→07/07	← ← ← → → →	Orga 10551→; + ESP - ESP →Orga 10550; + ESP Orga 10898→ →Orga 10897		<b>24.0122-0194.1 422194</b> <b>24.0122-0194.1 422194</b> <b>24.0126-0120.1 426120</b> <b>24.0326-0120.1 526120</b> <b>24.0109-0100.2 409100</b> <b>24.0109-0137.1 409137</b> <b>24.0109-0150.2 409150</b>	∅ 266 22 20 V + S ∅ 266 22 20 V + S ∅ 283 26 24 V + S ∅ 283 26 24 V + S ∅ 249 9 7 + LG / + ABS Ring ∅ 247 9 8 + S ∅ 249 9 8 + LG / + ABS Ring
1.4 HDi 70	50	03/02→06/05	← → → →	→ 01/05 Orga 10898→; → 01/05 → 01/05 →Orga 10897		<b>24.0122-0194.1 422194</b> <b>24.0109-0100.2 409100</b> <b>24.0109-0137.1 409137</b> <b>24.0109-0150.2 409150</b>	∅ 266 22 20 V + S ∅ 249 9 7 + LG / + ABS Ring ∅ 247 9 8 + S ∅ 249 9 8 + LG / + ABS Ring
↓							

	kW			 	! #		
<b>PEUGEOT - 307 SW (3H) 03/02→12/09</b>							
<b>Bremsscheibe</b>							
1.6 16V 1.6 HDI 90	80 66	03/02→04/08 12/06→04/08	←			24.0126-0120.1 426120 24.0326-0120.1 526120	∅ 283 26 24 V + S ∅ 283 26 24 V + S
			→	Orga 10898→		24.0109-0100.2 409100	∅ 249 9 7 + LG / + ABS Ring
			→			24.0109-0137.1 409137	∅ 247 9 8 + S
			→	→Orga 10897		24.0109-0150.2 409150	∅ 249 9 8 + LG / + ABS Ring
1.6 BioFlex	80	09/07→04/08	←			24.0126-0120.1 426120 24.0326-0120.1 526120	∅ 283 26 24 V + S ∅ 283 26 24 V + S
			→			24.0109-0137.1 409137	∅ 247 9 8 + S
1.6 HDi 110 2.0 16V 2.0 16V 2.0 HDi 110 2.0 HDi 90	80 100 103 79 66	02/04→ 03/02→ 03/05→ 03/02→12/09 03/02→	←	→ 04/08		24.0126-0120.1 426120 24.0326-0120.1 526120	∅ 283 26 24 V + S ∅ 283 26 24 V + S
			→	Orga 10898→; → 04/08		24.0109-0100.2 409100	∅ 249 9 7 + LG / + ABS Ring
			→	→ 04/08		24.0109-0137.1 409137	∅ 247 9 8 + S
			→	→Orga 10897		24.0109-0150.2 409150	∅ 249 9 8 + LG / + ABS Ring
2.0 HDi 135	100	02/04→	←	→ 04/08		24.0126-0140.1 426140	∅ 302 26 24 außenbelüftet + S
			→	Orga 10898→; → 04/08		24.0109-0100.2 409100	∅ 249 9 7 + LG / + ABS Ring
			→	→ 04/08		24.0109-0137.1 409137	∅ 247 9 8 + S
			→	→Orga 10897		24.0109-0150.2 409150	∅ 249 9 8 + LG / + ABS Ring
<b>PEUGEOT - 308 (4A_, 4C_) 09/07→</b>							
<b>Bremsbelagsatz, Scheibenbremse</b>							
1.4 16V 1.4 16V 1.6 16V 1.6 16V 1.6 16V 1.6 BioFlex 1.6 HDi 1.6 HDi 1.6 HDi 1.6 HDi 1.6 HDi 2.0 HDi	70 72 88 103 110 80 66 68 80 82 84 103	09/07→ 12/09→ 09/07→ 09/07→ 09/07→ 04/08→ 09/07→ 11/09→ 09/07→ 12/09→ 03/13→ 07/10→	←	→ 07/13		13.0460-3847.2 603847 13.0470-3847.2 LD3847	BOS 24660 17,8 - WE / - WK + Zub BOS 24660 17,8 - WE / - WK + Zub Ceramic
			→	→ 07/13		13.0460-2740.2 602740 13.0470-2740.2 LD2740	TRW 23554 17,0 - WE / - WK + Zub TRW 23554 17,0 - WE / - WK + Zub Ceramic
1.6 2.0 HDi	120 110	01/12→ 10/11→	→	→ 07/13		13.0460-2740.2 602740 13.0470-2740.2 LD2740	TRW 23554 17,0 - WE / - WK + Zub TRW 23554 17,0 - WE / - WK + Zub Ceramic
1.6 16V	115	10/09→	←	→ 07/13		13.0460-3847.2 603847 13.0460-7202.2 607202 13.0460-7230.2 607230 13.0470-3847.2 LD3847 13.0470-7202.2 LD7202 13.0470-7230.2 LD7230	BOS 24660 17,8 - WE / - WK + Zub ATE 23589 19,1 - WE / - WK ATE 24557 19,4 - WE / - WK BOS 24660 17,8 - WE / - WK + Zub Ceramic ATE 23589 19,1 - WE / - WK Ceramic ATE 24557 19,4 - WE / - WK Ceramic
			→	→ 07/13		13.0460-2740.2 602740 13.0470-2740.2 LD2740	TRW 23554 17,0 - WE / - WK + Zub TRW 23554 17,0 - WE / - WK + Zub Ceramic
1.6 16V 2.0 HDi	128 120	03/08→ 04/12→	←	→ 07/13		13.0460-7202.2 607202 13.0460-7230.2 607230 13.0470-7202.2 LD7202 13.0470-7230.2 LD7230	ATE 23589 19,1 - WE / - WK ATE 24557 19,4 - WE / - WK ATE 23589 19,1 - WE / - WK Ceramic ATE 24557 19,4 - WE / - WK Ceramic
			→	→ 07/13		13.0460-2740.2 602740 13.0470-2740.2 LD2740	TRW 23554 17,0 - WE / - WK + Zub TRW 23554 17,0 - WE / - WK + Zub Ceramic
1.6 GTi	147	07/10→	←	→ 07/13		13.0460-7279.2 607279 13.0470-7279.2 LD7279	ATE 25069 17,3 + WK ATE 25069 17,3 + WK Ceramic
			→	→ 07/13		13.0460-2761.2 602761	TRW 24922 16,5 - WK + Zub
2.0 Bioflex ↓	103	01/08→01/12	←			13.0460-3847.2 603847	BOS 24660 17,8 - WE / - WK + Zub

	kW			 	! #		
<b>PEUGEOT - 308 (4A_, 4C_) 09/07→</b>							
 <b>Bremsbelagsatz, Scheibenbremse</b>							
2.0 Bioflex	103	01/08→01/12	←			<b>13.0470-3847.2 LD3847</b>	BOS 24660 17,8 - WE / - WK + Zub Ceramic
			→			<b>13.0460-2740.2 602740</b>	TRW 23554 17,0 - WE / - WK + Zub
						<b>13.0470-2740.2 LD2740</b>	TRW 23554 17,0 - WE / - WK + Zub Ceramic
2.0 HDi	100	09/07→	←	Orga 11678→; → 07/13		<b>13.0460-3847.2 603847</b>	BOS 24660 17,8 - WE / - WK + Zub
						<b>13.0470-3847.2 LD3847</b>	BOS 24660 17,8 - WE / - WK + Zub Ceramic
			←	→Orga 11678		<b>13.0460-7202.2 607202</b>	ATE 23589 19,1 - WE / - WK
						<b>13.0460-7230.2 607230</b>	ATE 24557 19,4 - WE / - WK
						<b>13.0470-7202.2 LD7202</b>	ATE 23589 19,1 - WE / - WK Ceramic
						<b>13.0470-7230.2 LD7230</b>	ATE 24557 19,4 - WE / - WK Ceramic
			→	→ 07/13		<b>13.0460-2740.2 602740</b>	TRW 23554 17,0 - WE / - WK + Zub
						<b>13.0470-2740.2 LD2740</b>	TRW 23554 17,0 - WE / - WK + Zub Ceramic
 <b>Bremsscheibe</b>							
1.4 16V	70	09/07→	←	→ 07/13		<b>24.0126-0120.1 426120</b>	Ø 283 26 24 V + S
1.4 16V	72	12/09→				<b>24.0326-0120.1 526120</b>	Ø 283 26 24 V + S
1.6 16V	88	09/07→	→	→ 07/13		<b>24.0109-0171.2 409171</b>	Ø 249 9 8 + LG / + ABS Ring
1.6 16V	103	09/07→					
1.6 16V	110	09/07→					
1.6 BioFlex	80	04/08→					
1.6 HDi	66	09/07→					
1.6 HDi	68	11/09→					
1.6 HDi	80	09/07→					
1.6 HDi	82	12/09→					
1.6 HDi	84	03/13→					
2.0 HDi	103	07/10→					
1.6	120	01/12→	→	→ 07/13		<b>24.0109-0171.2 409171</b>	Ø 249 9 8 + LG / + ABS Ring
2.0 HDi	110	10/11→					
1.6 16V	115	10/09→	←	→ 07/13		<b>24.0126-0159.1 426159</b>	Ø 302 26 24 V + S
1.6 16V	128	03/08→					
2.0 HDi	120	04/12→	→	→ 07/13		<b>24.0109-0171.2 409171</b>	Ø 249 9 8 + LG / + ABS Ring
1.6 GTi	147	07/10→	←	→ 07/13		<b>24.0130-0230.1 430230</b>	Ø 340 30 28 V + S
			→	→ 07/13		<b>24.0112-0198.1 412198</b>	Ø 290 12 10 + S
2.0 Bioflex	103	01/08→01/12	←			<b>24.0126-0120.1 426120</b>	Ø 283 26 24 V + S
						<b>24.0326-0120.1 526120</b>	Ø 283 26 24 V + S
			→			<b>24.0109-0171.2 409171</b>	Ø 249 9 8 + LG / + ABS Ring
2.0 HDi	100	09/07→	←	→ 07/13		<b>24.0126-0120.1 426120</b>	Ø 283 26 24 V + S
						<b>24.0326-0120.1 526120</b>	Ø 283 26 24 V + S
			←	Orga 11678→; → 07/13		<b>24.0126-0120.1 426120</b>	Ø 283 26 24 V + S
						<b>24.0326-0120.1 526120</b>	Ø 283 26 24 V + S
			←	→Orga 11678		<b>24.0126-0159.1 426159</b>	Ø 302 26 24 V + S
			→	→ 07/13		<b>24.0109-0171.2 409171</b>	Ø 249 9 8 + LG / + ABS Ring
<b>PEUGEOT - 308 II 09/13→</b>							
 <b>Bremsbelagsatz, Scheibenbremse</b>							
1.2 THP 110	81	11/13→	←	für Bremsscheibendurchmesser [mm]: 266		<b>13.0460-3869.2 603869</b>	MAN 25250 18,9 - WE / - WK + Zub
1.2 THP 130	96	11/13→				<b>13.0470-3869.2 LD3869</b>	MAN 25250 18,9 - WE / - WK + Zub Ceramic
1.2 VTi 72	60	09/13→					
1.6	115	09/13→					
1.6 BlueHDi 120	88	11/13→	←	für Bremsscheibendurchmesser [mm]: 283		<b>13.0460-3870.2 603870</b>	BOS 25895 18,5 - WE / - WK + Zub
1.6 GT 205	151	06/14→				<b>13.0470-3870.2 LD3870</b>	BOS 25895 18,5 - WE / - WK + Zub Ceramic
1.6 GTi	184	08/15→					
1.6 GTi	200	06/15→					
1.6 HDi	68	09/13→					
1.6 HDi / BlueHDi 115	85	09/13→	←	für Bremsscheibendurchmesser [mm]: 330		<b>13.0460-3876.2 603876</b>	BOS 22218 18,3 + WE / - WK + Zub
1.6 HDi 100	73	04/14→					
1.6 THP 125	92	09/13→	←	für Bremsscheibendurchmesser [mm]: 304		<b>13.0460-7300.2 607300</b>	ATE 25833 17,3 + WE / - WK
1.6 THP 150	110	03/14→				<b>13.0470-7300.2 LD7300</b>	ATE 25833 17,3 + WE / - WK Ceramic
1.6 THP 163	120	06/14→					
2.0 BlueHDi 150	110	11/13→					
2.0 GT HDi 180 / BlueHDi 180	133	06/14→	→	für Bremsscheibendurchmesser [mm]: 268; + eFSB		<b>13.0460-3871.2 603871</b>	BOS 25839 17,8 - WE / - WK + Zub
↓							

**PEUGEOT - 308 II 09/13→**











**Bremsbelagsatz, Scheibenbremse**









1.2 THP 110	81	11/13→	➔	für Bremsscheibendurchmesser [mm]: 268; + eFSB	13.0470-3871.2	LD3871	BOS 25839 17,8 - WE / - WK + Zub Ceramic
1.2 THP 130	96	11/13→					
1.2 VTi 72	60	09/13→	➔	für Bremsscheibendurchmesser [mm]: 290	13.0460-3872.2	603872	BOS 25827 17,7 - WE / - WK + Zub
1.6	115	09/13→					
1.6 BlueHDi 120	88	11/13→					
1.6 GT 205	151	06/14→			13.0470-3872.2	LD3872	BOS 25827 17,7 - WE / - WK + Zub Ceramic
1.6 GTi	184	08/15→					
1.6 GTi	200	06/15→	➔	für Bremsscheibendurchmesser [mm]: 268; - eFSB	13.0460-7295.2	607295	ATE 25968 16,1 - WE / - WK
1.6 HDi	68	09/13→					
1.6 HDi / BlueHDi 115	85	09/13→			13.0470-7295.2	LD7295	ATE 25968 16,1 - WE / - WK Ceramic
1.6 HDi 100	73	04/14→					
1.6 THP 125	92	09/13→	➔	für Bremsscheibendurchmesser [mm]: 249; - eFSB	13.0460-7301.2	607301	ATE 25841 16,1 - WE / - WK
1.6 THP 150	110	03/14→					
1.6 THP 163	120	06/14→	➔	für Bremsscheibendurchmesser [mm]: 249	13.0470-7301.2	LD7301	ATE 25841 16,1 - WE / - WK Ceramic
2.0 BlueHDi 150	110	11/13→					
2.0 GT HDi 180 / BlueHDi 180	133	06/14→					
1.5 BlueHDi 100	75	05/18→	←	für Bremsscheibendurchmesser [mm]: 266	13.0460-3869.2	603869	MAN 25250 18,9 - WE / - WK + Zub
1.5 BlueHDi 130	96	06/17→					
			←	für Bremsscheibendurchmesser [mm]: 283	13.0460-3870.2	603870	BOS 25895 18,5 - WE / - WK + Zub
			←	für Bremsscheibendurchmesser [mm]: 330	13.0460-3876.2	603876	BOS 22218 18,3 + WE / - WK + Zub
			←	für Bremsscheibendurchmesser [mm]: 304	13.0460-7300.2	607300	ATE 25833 17,3 + WE / - WK
					13.0470-7300.2	LD7300	ATE 25833 17,3 + WE / - WK Ceramic
			➔	für Bremsscheibendurchmesser [mm]: 268; + eFSB	13.0460-3871.2	603871	BOS 25839 17,8 - WE / - WK + Zub
			➔	für Bremsscheibendurchmesser [mm]: 290	13.0460-3872.2	603872	BOS 25827 17,7 - WE / - WK + Zub
			➔	für Bremsscheibendurchmesser [mm]: 268; - eFSB	13.0460-7295.2	607295	ATE 25968 16,1 - WE / - WK
			➔	für Bremsscheibendurchmesser [mm]: 249	13.0460-7301.2	607301	ATE 25841 16,1 - WE / - WK
2.0 GT BlueHDi 180	130	06/17→	➔	für Bremsscheibendurchmesser [mm]: 268	13.0460-3871.2	603871	BOS 25839 17,8 - WE / - WK + Zub
			➔	für Bremsscheibendurchmesser [mm]: 290	13.0460-3872.2	603872	BOS 25827 17,7 - WE / - WK + Zub
					13.0470-3871.2	LD3871	BOS 25839 17,8 - WE / - WK + Zub Ceramic
					13.0470-3872.2	LD3872	BOS 25827 17,7 - WE / - WK + Zub Ceramic











**Bremsscheibe**









1.2 THP 110	81	11/13→	←	für Bremsscheibendurchmesser [mm]: 266	24.0122-0291.1	422291	Ø 266 22 20 V + S
1.2 THP 130	96	11/13→					
1.2 VTi 72	60	09/13→	←	für Bremsscheibendurchmesser [mm]: 283	24.0126-0183.1	426183	Ø 283 26 24 V + S
1.6	115	09/13→					
1.6 BlueHDi 120	88	11/13→					
1.6 GT 205	151	06/14→	←	für Bremsscheibendurchmesser [mm]: 304	24.0128-0269.1	428269	Ø 304 28 26 V + S
1.6 GTi	184	08/15→					
1.6 HDi	68	09/13→	←	für Bremsscheibendurchmesser [mm]: 330	24.0130-0241.1	430241	Ø 330 30 28 V + S
1.6 HDi / BlueHDi 115	85	09/13→					
1.6 HDi 100	73	04/14→	➔	für Bremsscheibendurchmesser [mm]: 268	24.0112-0211.1	412211	Ø 268 12 10 + S
1.6 THP 125	92	09/13→					
1.6 THP 150	110	03/14→	➔	für Bremsscheibendurchmesser [mm]: 290	24.0112-0212.1	412212	Ø 290 12 10 + S
1.6 THP 163	120	06/14→					
2.0 BlueHDi 150	110	11/13→					
2.0 GT HDi 180 / BlueHDi 180	133	06/14→					
1.5 BlueHDi 100	75	05/18→	←		24.0122-0291.1	422291	Ø 266 22 20 V + S
1.5 BlueHDi 130	96	06/17→					
					24.0126-0183.1	426183	Ø 283 26 24 V + S
					24.0130-0241.1	430241	Ø 330 30 28 V + S
			←	für Bremsscheibendurchmesser [mm]: 304	24.0128-0269.1	428269	Ø 304 28 26 V + S
			➔		24.0112-0211.1	412211	Ø 268 12 10 + S













	kw			 	! #		
<b>PEUGEOT - 308 II 09/13→</b>							
 <b>Bremsscheibe</b>							
1.5 BlueHDI 100	75	05/18→	→			24.0112-0212.1 412212	Ø 290 12 10 + S
1.5 BlueHDI 130	96	06/17→					
1.6 GTi	200	06/15→	←	für Bremsscheibendurchmesser [mm]: 266	24.0122-0291.1 422291	Ø 266 22 20 V + S	
			←	+PR 283	24.0126-0183.1 426183	Ø 283 26 24 V + S	
			←	für Bremsscheibendurchmesser [mm]: 304	24.0128-0269.1 428269	Ø 304 28 26 V + S	
			←	für Bremsscheibendurchmesser [mm]: 330	24.0130-0241.1 430241	Ø 330 30 28 V + S	
			→	für Bremsscheibendurchmesser [mm]: 268	24.0112-0211.1 412211	Ø 268 12 10 + S	
			→	für Bremsscheibendurchmesser [mm]: 290	24.0112-0212.1 412212	Ø 290 12 10 + S	
2.0 GT BlueHDI 180	130	06/17→	←		24.0128-0269.1 428269	Ø 304 28 26 V + S	
			→		24.0112-0211.1 412211	Ø 268 12 10 + S	
			→		24.0112-0212.1 412212	Ø 290 12 10 + S	
<b>PEUGEOT - 308 CC (4B_) 02/09→</b>							
 <b>Bremsbelagsatz, Scheibenbremse</b>							
1.6 16V	88	06/09→	←		13.0460-3847.2 603847	BOS 24660 17,8 - WE / - WK + Zub	
	82	06/09→					
1.6 HDi	84	03/13→			13.0470-3847.2 LD3847	BOS 24660 17,8 - WE / - WK + Zub Ceramic	
			→		13.0460-2740.2 602740	TRW 23554 17,0 - WE / - WK + Zub	
					13.0470-2740.2 LD2740	TRW 23554 17,0 - WE / - WK + Zub Ceramic	
1.6 16V 1.6 16V 2.0 CVVT 2.0 HDi 2.0 HDi 2.0 HDi	103	06/09→	←		13.0460-7230.2 607230	ATE 24557 19,4 - WE / - WK	
	110	06/09→			13.0470-7202.2 LD7202	ATE 23589 19,1 - WE / - WK Ceramic	
	103	07/09→11/14			13.0470-7230.2 LD7230	ATE 24557 19,4 - WE / - WK Ceramic	
	100	04/09→					
	103	04/09→					
	120	06/09→					
			→		13.0460-2740.2 602740	TRW 23554 17,0 - WE / - WK + Zub	
					13.0470-2740.2 LD2740	TRW 23554 17,0 - WE / - WK + Zub Ceramic	
1.6 16V	115	06/09→	←	09/09→	13.0460-7230.2 607230	ATE 24557 19,4 - WE / - WK	
					13.0470-7202.2 LD7202	ATE 23589 19,1 - WE / - WK Ceramic	
					13.0470-7230.2 LD7230	ATE 24557 19,4 - WE / - WK Ceramic	
			→	09/09→	13.0460-2740.2 602740	TRW 23554 17,0 - WE / - WK + Zub	
					13.0470-2740.2 LD2740	TRW 23554 17,0 - WE / - WK + Zub Ceramic	
1.6 THP	147	10/10→	←		13.0460-7279.2 607279	ATE 25069 17,3 + WK	
					13.0470-7279.2 LD7279	ATE 25069 17,3 + WK Ceramic	
			→		13.0460-2761.2 602761	TRW 24922 16,5 - WK + Zub	
 <b>Bremsscheibe</b>							
1.6 16V	88	06/09→	←		24.0126-0120.1 426120	Ø 283 26 24 V + S	
	82	06/09→			24.0326-0120.1 526120	Ø 283 26 24 V + S	
1.6 HDi	84	03/13→	→		24.0109-0171.2 409171	Ø 249 9 8 + LG / + ABS Ring	
1.6 16V 1.6 16V 2.0 CVVT 2.0 HDi 2.0 HDi 2.0 HDi	103	06/09→	←		24.0126-0159.1 426159	Ø 302 26 24 V + S	
	110	06/09→	→				
	103	07/09→11/14			24.0109-0171.2 409171	Ø 249 9 8 + LG / + ABS Ring	
	100	04/09→					
	103	04/09→					
	120	06/09→					
1.6 16V	115	06/09→	←	09/09→	24.0126-0159.1 426159	Ø 302 26 24 V + S	
			→	09/09→	24.0109-0171.2 409171	Ø 249 9 8 + LG / + ABS Ring	
1.6 THP	147	10/10→	←		24.0130-0230.1 430230	Ø 340 30 28 V + S	
			→		24.0112-0198.1 412198	Ø 290 12 10 + S	

	kw			 	! #		
<b>PEUGEOT - 308 SW (4E_, 4H_) 09/07→</b>							
<b> Bremsbelagsatz, Scheibenbremse</b>							
1.4 16V 1.6 16V 1.6 HDi 1.6 HDi	70 88 66 80	09/07→ 09/07→ 09/07→ 09/07→	←	05/08→ 04/14		<b>13.0460-3847.2 603847</b> <b>13.0470-3847.2 LD3847</b>	BOS 24660 17,8 - WE / - WK + Zub BOS 24660 17,8 - WE / - WK + Zub Ceramic
			→	05/08→; - Break Loisirs; → 04/14		<b>13.0460-2740.2 602740</b> <b>13.0470-2740.2 LD2740</b>	TRW 23554 17,0 - WE / - WK + Zub TRW 23554 17,0 - WE / - WK + Zub Ceramic
			→	05/08→; + Break Loisirs; → 04/14		<b>13.0460-2745.2 602745</b>	TRW 24765 16,5 - WE / - WK + Zub
1.4 16V 1.6 Bioflex 1.6 HDi 1.6 HDi 1.6 HDi	72 82 68 82 84	12/09→ 03/09→ 11/09→ 12/09→ 03/13→03/17	←	→ 04/14		<b>13.0460-3847.2 603847</b> <b>13.0470-3847.2 LD3847</b>	BOS 24660 17,8 - WE / - WK + Zub BOS 24660 17,8 - WE / - WK + Zub Ceramic
			→	- Break Loisirs; → 04/14		<b>13.0460-2740.2 602740</b> <b>13.0470-2740.2 LD2740</b>	TRW 23554 17,0 - WE / - WK + Zub TRW 23554 17,0 - WE / - WK + Zub Ceramic
			→	+ Break Loisirs; → 04/14		<b>13.0460-2745.2 602745</b>	TRW 24765 16,5 - WE / - WK + Zub
1.6 16V 1.6 16V 1.6 16V 2.0 HDi	103 110 128 100	09/07→ 09/07→ 03/08→ 09/07→	←	05/08→ 04/14		<b>13.0460-7202.2 607202</b> <b>13.0460-7230.2 607230</b> <b>13.0470-7202.2 LD7202</b> <b>13.0470-7230.2 LD7230</b>	ATE 23589 19,1 - WE / - WK ATE 24557 19,4 - WE / - WK ATE 23589 19,1 - WE / - WK Ceramic ATE 24557 19,4 - WE / - WK Ceramic
			→	05/08→; - Break Loisirs; → 04/14		<b>13.0460-2740.2 602740</b> <b>13.0470-2740.2 LD2740</b>	TRW 23554 17,0 - WE / - WK + Zub TRW 23554 17,0 - WE / - WK + Zub Ceramic
			→	05/08→; + Break Loisirs; → 04/14		<b>13.0460-2745.2 602745</b>	TRW 24765 16,5 - WE / - WK + Zub
1.6 16V 2.0 HDi 2.0 HDi	115 110 120	10/09→ 04/11→ 06/09→	←	→ 04/14		<b>13.0460-7202.2 607202</b> <b>13.0460-7230.2 607230</b> <b>13.0470-7202.2 LD7202</b> <b>13.0470-7230.2 LD7230</b>	ATE 23589 19,1 - WE / - WK ATE 24557 19,4 - WE / - WK ATE 23589 19,1 - WE / - WK Ceramic ATE 24557 19,4 - WE / - WK Ceramic
			→	- Break Loisirs; → 04/14		<b>13.0460-2740.2 602740</b> <b>13.0470-2740.2 LD2740</b>	TRW 23554 17,0 - WE / - WK + Zub TRW 23554 17,0 - WE / - WK + Zub Ceramic
			→	+ Break Loisirs; → 04/14		<b>13.0460-2745.2 602745</b>	TRW 24765 16,5 - WE / - WK + Zub
2.0 Bioflex	103	01/08→	←	Orga 11679→; → 04/14		<b>13.0460-3847.2 603847</b> <b>13.0470-3847.2 LD3847</b>	BOS 24660 17,8 - WE / - WK + Zub BOS 24660 17,8 - WE / - WK + Zub Ceramic
			←	05/08→; →Orga 11678		<b>13.0460-7202.2 607202</b> <b>13.0460-7230.2 607230</b> <b>13.0470-7202.2 LD7202</b> <b>13.0470-7230.2 LD7230</b>	ATE 23589 19,1 - WE / - WK ATE 24557 19,4 - WE / - WK ATE 23589 19,1 - WE / - WK Ceramic ATE 24557 19,4 - WE / - WK Ceramic
			→	05/08→; - Break Loisirs; → 04/14		<b>13.0460-2740.2 602740</b> <b>13.0470-2740.2 LD2740</b>	TRW 23554 17,0 - WE / - WK + Zub TRW 23554 17,0 - WE / - WK + Zub Ceramic
			→	05/08→; + Break Loisirs; → 04/14		<b>13.0460-2745.2 602745</b>	TRW 24765 16,5 - WE / - WK + Zub
2.0 HDi	103	09/07→	←	12/08→ 04/14		<b>13.0460-7202.2 607202</b> <b>13.0460-7230.2 607230</b> <b>13.0470-7202.2 LD7202</b> <b>13.0470-7230.2 LD7230</b>	ATE 23589 19,1 - WE / - WK ATE 24557 19,4 - WE / - WK ATE 23589 19,1 - WE / - WK Ceramic ATE 24557 19,4 - WE / - WK Ceramic
			→	12/08→; - Break Loisirs; → 04/14		<b>13.0460-2740.2 602740</b>	TRW 23554 17,0 - WE / - WK + Zub
↓							











	kw			 	! #		
<b>PEUGEOT - 308 SW (4E_, 4H_) 09/07→</b>							
 <b>Bremsbelagsatz, Scheibenbremse</b>							
2.0 HDi	103	09/07→	➡	12/08→; - Break Loisirs; → 04/14		<b>13.0470-2740.2</b> <b>LD2740</b>	TRW 23554 17,0 - WE / - WK + Zub Ceramic
			➡	12/08→; + Break Loisirs; → 04/14		<b>13.0460-2745.2</b> <b>602745</b>	TRW 24765 16,5 - WE / - WK + Zub
 <b>Bremsscheibe</b>							
1.4 16V	70	09/07→	←	05/08→ 04/14		<b>24.0126-0120.1</b> <b>426120</b>	Ø 283 26 24 V + S
1.6 16V	88	09/07→				<b>24.0326-0120.1</b> <b>526120</b>	Ø 283 26 24 V + S
1.6 HDi	66	09/07→	➡	05/08→; - Break Loisirs; → 04/14		<b>24.0109-0171.2</b> <b>409171</b>	Ø 249 9 8 + LG / + ABS Ring
1.6 HDi	80	09/07→	➡	05/08→ 04/14; + Break Loisirs		<b>24.0112-0194.2</b> <b>412194</b>	Ø 268 12 10 + LG / + ABS Ring
1.4 16V	72	12/09→	←	→ 04/14		<b>24.0126-0120.1</b> <b>426120</b>	Ø 283 26 24 V + S
1.6 Bioflex	82	03/09→	➡	außer Break Loisirs; → 04/14		<b>24.0109-0171.2</b> <b>409171</b>	Ø 249 9 8 + LG / + ABS Ring
			➡	+ Break Loisirs; → 04/14		<b>24.0112-0194.2</b> <b>412194</b>	Ø 268 12 10 + LG / + ABS Ring
1.6 16V	103	09/07→	←	05/08→ 04/14		<b>24.0126-0159.1</b> <b>426159</b>	Ø 302 26 24 V + S
1.6 16V	110	09/07→	➡	05/08→; - Break Loisirs; → 04/14		<b>24.0109-0171.2</b> <b>409171</b>	Ø 249 9 8 + LG / + ABS Ring
1.6 16V	128	03/08→	➡	05/08→ 04/14; + Break Loisirs		<b>24.0112-0194.2</b> <b>412194</b>	Ø 268 12 10 + LG / + ABS Ring
2.0 HDi	100	09/07→	➡	05/08→ 04/14; + Break Loisirs		<b>24.0112-0194.2</b> <b>412194</b>	Ø 268 12 10 + LG / + ABS Ring
1.6 16V	115	10/09→	←	→ 04/14		<b>24.0126-0159.1</b> <b>426159</b>	Ø 302 26 24 V + S
2.0 HDi	110	04/11→	➡	- Break Loisirs; → 04/14		<b>24.0109-0171.2</b> <b>409171</b>	Ø 249 9 8 + LG / + ABS Ring
			➡	+ Break Loisirs; → 04/14		<b>24.0112-0194.2</b> <b>412194</b>	Ø 268 12 10 + LG / + ABS Ring
1.6 HDi	68	11/09→	←	→ 04/14		<b>24.0126-0120.1</b> <b>426120</b>	Ø 283 26 24 V + S
1.6 HDi	82	12/09→				<b>24.0326-0120.1</b> <b>526120</b>	Ø 283 26 24 V + S
1.6 HDi	84	03/13→03/17	➡	- Break Loisirs; → 04/14		<b>24.0109-0171.2</b> <b>409171</b>	Ø 249 9 8 + LG / + ABS Ring
			➡	+ Break Loisirs; → 04/14		<b>24.0112-0194.2</b> <b>412194</b>	Ø 268 12 10 + LG / + ABS Ring
2.0 Bioflex	103	01/08→	←	Orga 11679→; → 04/14		<b>24.0126-0120.1</b> <b>426120</b>	Ø 283 26 24 V + S
						<b>24.0326-0120.1</b> <b>526120</b>	Ø 283 26 24 V + S
			←	05/08→; →Orga 11678		<b>24.0126-0159.1</b> <b>426159</b>	Ø 302 26 24 V + S
			➡	05/08→; - Break Loisirs; → 04/14		<b>24.0109-0171.2</b> <b>409171</b>	Ø 249 9 8 + LG / + ABS Ring
			➡	05/08→ 04/14; + Break Loisirs		<b>24.0112-0194.2</b> <b>412194</b>	Ø 268 12 10 + LG / + ABS Ring
2.0 HDi	103	09/07→	←	12/08→ 04/14		<b>24.0126-0159.1</b> <b>426159</b>	Ø 302 26 24 V + S
			➡	12/08→; - Break Loisirs; → 04/14		<b>24.0109-0171.2</b> <b>409171</b>	Ø 249 9 8 + LG / + ABS Ring
			➡	12/08→; + Break Loisirs; → 04/14		<b>24.0112-0194.2</b> <b>412194</b>	Ø 268 12 10 + LG / + ABS Ring
2.0 HDi	120	06/09→	←	→ 04/14		<b>24.0126-0159.1</b> <b>426159</b>	Ø 302 26 24 V + S
			➡	außer Break Loisirs; → 04/14		<b>24.0109-0171.2</b> <b>409171</b>	Ø 249 9 8 + LG / + ABS Ring
			➡	+ Break Loisirs; → 04/14		<b>24.0112-0194.2</b> <b>412194</b>	Ø 268 12 10 + LG / + ABS Ring
<b>PEUGEOT - 308 SW II 03/14→</b>							
 <b>Bremsbelagsatz, Scheibenbremse</b>							
1.2 THP 110	81	03/14→	←	08/14→; für Bremsscheibendurchmesser [mm]: 266		<b>13.0460-3869.2</b> <b>603869</b>	MAN 25250 18,9 - WE / - WK + Zub
						<b>13.0470-3869.2</b> <b>LD3869</b>	MAN 25250 18,9 - WE / - WK + Zub Ceramic
			←	08/14→; für Bremsscheibendurchmesser [mm]: 283		<b>13.0460-3870.2</b> <b>603870</b>	BOS 25895 18,5 - WE / - WK + Zub
						<b>13.0470-3870.2</b> <b>LD3870</b>	BOS 25895 18,5 - WE / - WK + Zub Ceramic
			←	08/14→; für Bremsscheibendurchmesser [mm]: 330		<b>13.0460-3876.2</b> <b>603876</b>	BOS 22218 18,3 + WE / - WK + Zub
			←	08/14→; für Bremsscheibendurchmesser [mm]: 304		<b>13.0460-7300.2</b> <b>607300</b>	ATE 25833 17,3 + WE / - WK Ceramic
						<b>13.0470-7300.2</b> <b>LD7300</b>	ATE 25833 17,3 + WE / - WK Ceramic
			➡	08/14→; für Bremsscheibendurchmesser [mm]: 268; + eFSB		<b>13.0460-3871.2</b> <b>603871</b>	BOS 25839 17,8 - WE / - WK + Zub
						<b>13.0470-3871.2</b> <b>LD3871</b>	BOS 25839 17,8 - WE / - WK + Zub Ceramic
			➡	08/14→; für Bremsscheibendurchmesser [mm]: 290		<b>13.0460-3872.2</b> <b>603872</b>	BOS 25827 17,7 - WE / - WK + Zub
						<b>13.0470-3872.2</b> <b>LD3872</b>	BOS 25827 17,7 - WE / - WK + Zub Ceramic
↓							











	kw			 	! #					
<b>PEUGEOT - 308 SW II 03/14→</b>										
<b> Bremsbelagsatz, Scheibenbremse</b>										
1.2 THP 110	81	03/14→	➔	08/14→; für Bremsscheibendurchmesser [mm]: 268; - eFSB	<b>13.0460-7295.2</b> <b>13.0470-7295.2</b>	<b>607295</b> <b>LD7295</b>	ATE 25968 16,1 - WE / - WK ATE 25968 16,1 - WE / - WK Ceramic			
			➔	08/14→; für Bremsscheibendurchmesser [mm]: 249	<b>13.0460-7301.2</b> <b>13.0470-7301.2</b>	<b>607301</b> <b>LD7301</b>	ATE 25841 16,1 - WE / - WK ATE 25841 16,1 - WE / - WK Ceramic			
1.2 THP 130 1.6 BlueHDi 100 1.6 BlueHDi 120 1.6 GT 205 1.6 HDi / BlueHDi 115 1.6 HDi 92 1.6 THP 125 1.6 THP 150 1.6 THP 155 1.6 VTi 2.0 BlueHDi 150 2.0 GT BlueHDi 180	96 73 88 151 85 68 92 110 115 85 110 132	03/14→ 04/14→ 03/14→ 06/14→ 03/14→ 03/14→ 03/14→ 03/14→ 03/14→ 03/14→ 06/17→	←	für Bremsscheibendurchmesser [mm]: 266	<b>13.0460-3869.2</b> <b>13.0470-3869.2</b>	<b>603869</b> <b>LD3869</b>	MAN 25250 18,9 - WE / - WK + Zub MAN 25250 18,9 - WE / - WK + Zub Ceramic			
			←	für Bremsscheibendurchmesser [mm]: 283	<b>13.0460-3870.2</b> <b>13.0470-3870.2</b>	<b>603870</b> <b>LD3870</b>	BOS 25895 18,5 - WE / - WK + Zub BOS 25895 18,5 - WE / - WK + Zub Ceramic			
			←	für Bremsscheibendurchmesser [mm]: 330	<b>13.0460-3876.2</b> <b>13.0470-3876.2</b>	<b>603876</b> <b>LD3876</b>	BOS 22218 18,3 + WE / - WK + Zub			
			←	für Bremsscheibendurchmesser [mm]: 304	<b>13.0460-7300.2</b> <b>13.0470-7300.2</b>	<b>607300</b> <b>LD7300</b>	ATE 25833 17,3 + WE / - WK ATE 25833 17,3 + WE / - WK Ceramic			
			➔	für Bremsscheibendurchmesser [mm]: 268; + eFSB	<b>13.0460-3871.2</b> <b>13.0470-3871.2</b>	<b>603871</b> <b>LD3871</b>	BOS 25839 17,8 - WE / - WK + Zub BOS 25839 17,8 - WE / - WK + Zub Ceramic			
			➔	für Bremsscheibendurchmesser [mm]: 290	<b>13.0460-3872.2</b> <b>13.0470-3872.2</b>	<b>603872</b> <b>LD3872</b>	BOS 25827 17,7 - WE / - WK + Zub BOS 25827 17,7 - WE / - WK + Zub Ceramic			
			➔	für Bremsscheibendurchmesser [mm]: 268; - eFSB	<b>13.0460-7295.2</b> <b>13.0470-7295.2</b>	<b>607295</b> <b>LD7295</b>	ATE 25968 16,1 - WE / - WK ATE 25968 16,1 - WE / - WK Ceramic			
			➔	für Bremsscheibendurchmesser [mm]: 249	<b>13.0460-7301.2</b> <b>13.0470-7301.2</b>	<b>607301</b> <b>LD7301</b>	ATE 25841 16,1 - WE / - WK ATE 25841 16,1 - WE / - WK Ceramic			
			2.0 GT HDi 180 / BlueHDi 180	133	06/14→	←	für Bremsscheibendurchmesser [mm]: 266	<b>13.0460-3869.2</b> <b>13.0470-3869.2</b>	<b>603869</b> <b>LD3869</b>	MAN 25250 18,9 - WE / - WK + Zub MAN 25250 18,9 - WE / - WK + Zub Ceramic
						←	für Bremsscheibendurchmesser [mm]: 283	<b>13.0460-3870.2</b> <b>13.0470-3870.2</b>	<b>603870</b> <b>LD3870</b>	BOS 25895 18,5 - WE / - WK + Zub BOS 25895 18,5 - WE / - WK + Zub Ceramic
←	für Bremsscheibendurchmesser [mm]: 330	<b>13.0460-3876.2</b> <b>13.0470-3876.2</b>				<b>603876</b> <b>LD3876</b>	BOS 22218 18,3 + WE / - WK + Zub			
←	für Bremsscheibendurchmesser [mm]: 304	<b>13.0460-7300.2</b> <b>13.0470-7300.2</b>				<b>607300</b> <b>LD7300</b>	ATE 25833 17,3 + WE / - WK ATE 25833 17,3 + WE / - WK Ceramic			
➔	für Bremsscheibendurchmesser [mm]: 268; + eFSB	<b>13.0460-3871.2</b> <b>13.0470-3871.2</b>				<b>603871</b> <b>LD3871</b>	BOS 25839 17,8 - WE / - WK + Zub BOS 25839 17,8 - WE / - WK + Zub Ceramic			
➔	für Bremsscheibendurchmesser [mm]: 290	<b>13.0460-3872.2</b> <b>13.0470-3872.2</b>				<b>603872</b> <b>LD3872</b>	BOS 25827 17,7 - WE / - WK + Zub BOS 25827 17,7 - WE / - WK + Zub Ceramic			
➔	für Bremsscheibendurchmesser [mm]: 268; - eFSB	<b>13.0460-7295.2</b> <b>13.0470-7295.2</b>				<b>607295</b> <b>LD7295</b>	ATE 25968 16,1 - WE / - WK ATE 25968 16,1 - WE / - WK Ceramic			
➔	09/14→; für Bremsscheibendurchmesser [mm]: 249	<b>13.0460-7301.2</b> <b>13.0470-7301.2</b>				<b>607301</b> <b>LD7301</b>	ATE 25841 16,1 - WE / - WK ATE 25841 16,1 - WE / - WK Ceramic			
<b> Bremsscheibe</b>										
1.2 THP 110	81	03/14→	←	08/14→; für Bremsscheibendurchmesser [mm]: 266	<b>24.0122-0291.1</b>	<b>422291</b>	Ø 266 22 20 V + S			
			←	08/14→; für Bremsscheibendurchmesser [mm]: 283	<b>24.0126-0183.1</b>	<b>426183</b>	Ø 283 26 24 V + S			
↓										

	kW			 	! #			
<b>PEUGEOT - 308 SW II 03/14→</b>								
 <b>Bremsscheibe</b>								
1.2 THP 110	81	03/14→	←	08/14→; für Bremsscheibendurchmesser [mm]: 304	24.0128-0269.1	428269	Ø 304 28 26 V + S	
			←	08/14→; für Bremsscheibendurchmesser [mm]: 330	24.0130-0241.1	430241	Ø 330 30 28 V + S	
			→	08/14→; für Bremsscheibendurchmesser [mm]: 268	24.0112-0211.1	412211	Ø 268 12 10 + S	
			→	für Bremsscheibendurchmesser [mm]: 290	24.0112-0212.1	412212	Ø 290 12 10 + S	
1.2 THP 130 1.6 BlueHdI 100 1.6 BlueHdI 120 1.6 GT 205 1.6 HdI / BlueHdI 115 1.6 HdI 92 1.6 THP 125 1.6 THP 150 1.6 THP 155 1.6 VTi 2.0 BlueHdI 150 2.0 GT BlueHdI 180	96	03/14→	←	für Bremsscheibendurchmesser [mm]: 266	24.0122-0291.1	422291	Ø 266 22 20 V + S	
	73	04/14→	←	für Bremsscheibendurchmesser [mm]: 283	24.0126-0183.1	426183	Ø 283 26 24 V + S	
	88	03/14→	←	für Bremsscheibendurchmesser [mm]: 304	24.0128-0269.1	428269	Ø 304 28 26 V + S	
	151	06/14→	←	für Bremsscheibendurchmesser [mm]: 330	24.0130-0241.1	430241	Ø 330 30 28 V + S	
	85	03/14→	→	für Bremsscheibendurchmesser [mm]: 268	24.0112-0211.1	412211	Ø 268 12 10 + S	
	68	03/14→	→	für Bremsscheibendurchmesser [mm]: 290	24.0112-0212.1	412212	Ø 290 12 10 + S	
	92	03/14→	←	für Bremsscheibendurchmesser [mm]: 266	24.0122-0291.1	422291	Ø 266 22 20 V + S	
	110	03/14→	←	für Bremsscheibendurchmesser [mm]: 283	24.0126-0183.1	426183	Ø 283 26 24 V + S	
	115	03/14→	←	für Bremsscheibendurchmesser [mm]: 304	24.0128-0269.1	428269	Ø 304 28 26 V + S	
	85	03/14→	→	für Bremsscheibendurchmesser [mm]: 268	24.0112-0211.1	412211	Ø 268 12 10 + S	
2.0 GT HdI 180 / BlueHdI 180	110	03/14→	→	für Bremsscheibendurchmesser [mm]: 290	24.0112-0212.1	412212	Ø 290 12 10 + S	
	132	06/17→	→	für Bremsscheibendurchmesser [mm]: 290	24.0112-0212.1	412212	Ø 290 12 10 + S	
	1.6	66	08/92→05/97	←	09/92→ 10/95	13.0460-2971.2	602971	TRW 21209 18,5 + WK
				←	09/92→ 12/93	13.0460-3911.2	603911	BDX 20905 18,0 + WK
				→	09/92→ 12/93	13.0460-2842.2	602842	TRW 20961 15,2 - WK
				←	09/92→ 10/95	13.0460-2971.2	602971	TRW 21209 18,5 + WK
→				09/92→ 10/95; + ABS	13.0460-2842.2	602842	TRW 20961 15,2 - WK	
<b>Zubehörsatz, Scheibenbremsbelag</b>								
1.6	66	08/92→05/97	←	09/92→ 10/95	13.0460-0403.2	610403	BDX	
1.9	90	01/92→11/97	→	09/92→ 12/93	13.0460-0072.2	610072	TRW	
1.9 TD	69	08/92→05/97	→	09/92→ 10/95; + ABS	13.0460-0072.2	610072	TRW	
 <b>Bremsscheibe</b>								
1.6	66	08/92→05/97	←	09/92→ 10/95	24.0110-0183.1	410183	Ø 266 10 8	
1.9	90	01/92→11/97	←	09/92→ 12/93	24.0120-0133.1	420133	Ø 266 20,5 18,5 V + S	
			→	09/92→ 12/93	24.0320-0133.1	520133	Ø 266 20,5 18,5 V + S	
1.9 TD	69	08/92→05/97	←	09/92→ 10/95	24.0110-0199.1	410199	Ø 247 10 8	
			→	09/92→ 10/95; + ABS	24.0120-0133.1	420133	Ø 266 20,5 18,5 V + S	
<b>PEUGEOT - 405 II (4B) 01/92→11/99</b>								
 <b>Bremsbelagsatz, Scheibenbremse</b>								
1.4	55	08/92→10/96	←	09/92→ 10/95	13.0460-3911.2	603911	BDX 20905 18,0 + WK	
1.6	65	08/92→10/96	←	09/92→ 10/95	13.0460-2971.2	602971	TRW 21209 18,5 + WK	
			←	08/92→10/96	13.0460-3911.2	603911	BDX 20905 18,0 + WK	
1.8	74	08/92→10/96	←	09/92→ 10/95	13.0460-2971.2	602971	TRW 21209 18,5 + WK	
1.9 D	47	08/92→10/96						
1.9 D	52	08/92→10/98						
↓								
<b>PEUGEOT - 405 II Break (4E) 08/92→10/98</b>								
 <b>Bremsbelagsatz, Scheibenbremse</b>								
1.4	55	08/92→10/96	←	09/92→ 10/95	13.0460-3911.2	603911	BDX 20905 18,0 + WK	
1.6	65	08/92→10/96	←	09/92→ 10/95	13.0460-2971.2	602971	TRW 21209 18,5 + WK	
			←	08/92→10/96	13.0460-3911.2	603911	BDX 20905 18,0 + WK	
1.8	74	08/92→10/96	←	09/92→ 10/95	13.0460-2971.2	602971	TRW 21209 18,5 + WK	
1.9 D	47	08/92→10/96						
1.9 D	52	08/92→10/98						

































	kW			 	! #		
<b>PEUGEOT - 405 II Break (4E) 08/92→10/98</b>							
<b> Bremsbelagsatz, Scheibenbremse</b>							
1.9 D	50	06/94→10/96	←	→ 10/95		13.0460-2971.2 602971	TRW 21209 18,5 + WK
1.9 TD	66	08/92→10/96	←	09/92→ 10/95		13.0460-2971.2 602971	TRW 21209 18,5 + WK
1.9 TD	69	08/92→10/96	→	09/92→ 10/95; + ABS		13.0460-2842.2 602842	TRW 20961 15,2 - WK
2.0	89	08/92→10/96	←	09/92→ 10/95		13.0460-2971.2 602971	TRW 21209 18,5 + WK
			→	09/92→ 10/95		13.0460-2842.2 602842	TRW 20961 15,2 - WK
2.0 4x4	89	08/92→10/96	←	09/92→ 10/95		13.0460-2971.2 602971	TRW 21209 18,5 + WK
			→	09/92→ 10/95		13.0460-2937.2 602937	TRW 20961 15,2 - WK + Zub
<b>Zubehörsatz, Scheibenbremsbelag</b>							
1.4	55	08/92→10/96	←	09/92→ 10/95		13.0460-0403.2 610403	BDX
1.6	65	08/92→10/96					
1.6	80	08/92→10/96					
1.9 TD	66	08/92→10/96	→	09/92→ 10/95; + ABS		13.0460-0072.2 610072	TRW
1.9 TD	69	08/92→10/96					
2.0	89	08/92→10/96	→	09/92→ 10/95		13.0460-0072.2 610072	TRW
2.0 4x4	89	08/92→10/96	→	09/92→ 10/95		13.0460-0419.2 610419	TRW
<b> Bremsscheibe</b>							
1.4	55	08/92→10/96	←	09/92→ 10/95		24.0110-0183.1 410183	Ø 266 10 8
1.6	65	08/92→10/96					
1.6	80	08/92→10/96					
1.8	74	08/92→10/96	←	09/92→ 10/95		24.0120-0133.1 420133	Ø 266 20,5 18,5 V + S
1.9 D	47	08/92→10/96				24.0320-0133.1 520133	Ø 266 20,5 18,5 V + S
1.9 D	52	08/92→10/98					
1.9 D	50	06/94→10/96	←	→ 10/95		24.0120-0133.1 420133	Ø 266 20,5 18,5 V + S
						24.0320-0133.1 520133	Ø 266 20,5 18,5 V + S
1.9 TD	66	08/92→10/96	←	09/92→ 10/95		24.0120-0133.1 420133	Ø 266 20,5 18,5 V + S
1.9 TD	69	08/92→10/96				24.0320-0133.1 520133	Ø 266 20,5 18,5 V + S
			→	09/92→ 10/95; + ABS		24.0110-0199.1 410199	Ø 247 10 8
2.0	89	08/92→10/96	←	09/92→ 10/95		24.0120-0133.1 420133	Ø 266 20,5 18,5 V + S
			→	09/92→ 10/95		24.0320-0133.1 520133	Ø 266 20,5 18,5 V + S
			→	09/92→ 10/95		24.0110-0199.1 410199	Ø 247 10 8
2.0 4x4	89	08/92→10/96	←	09/92→ 10/95		24.0120-0133.1 420133	Ø 266 20,5 18,5 V + S
						24.0320-0133.1 520133	Ø 266 20,5 18,5 V + S
			→	09/92→ 10/95		24.0110-0187.1 410187	Ø 247 10 9 + S
<b>PEUGEOT - 406 (8B) 10/95→01/05</b>							
<b> Bremsbelagsatz, Scheibenbremse</b>							
1.6	65	11/95→05/04	←	→ 04/04		13.0460-2816.2 602816	TRW 21724 19,3 + WK
1.8	66	05/97→05/04					
1.9 D	55	10/96→05/04					
1.8	74	10/96→03/99	←			13.0460-2816.2 602816	TRW 21724 19,3 + WK
1.8 16V	81	11/95→10/00					
1.8 16V	85	10/00→05/04	←	→ 04/04		13.0460-2816.2 602816	TRW 21724 19,3 + WK
			→	→ S 80012040		13.0460-4059.2 604059	ATE 21278 16,4 + WK
			→	S 80012041→; → 04/04		13.0460-7134.2 607134	ATE 21278 16,4 - WE / - WK
1.8 Bifuel	81	04/99→05/03	←	→ 10/00		13.0460-2816.2 602816	TRW 21724 19,3 + WK
1.9 TD	66	01/96→05/04	←	→ 04/04		13.0460-2817.2 602817	TRW 21674 19,0 + WK
1.9 TD	68	01/96→05/04					
1.9 TD	69	10/95→10/97	←	01/96→		13.0460-2817.2 602817	TRW 21674 19,0 + WK
2.0	104	11/96→03/99	←			13.0460-2817.2 602817	TRW 21674 19,0 + WK
3.0 24V	143	01/98→06/99	→	→ S 80012040		13.0460-4059.2 604059	ATE 21278 16,4 + WK
			→	S 80012041→		13.0460-7134.2 607134	ATE 21278 16,4 - WE / - WK
2.0 16V	97	11/95→05/04	←	→ 04/04		13.0460-2817.2 602817	TRW 21674 19,0 + WK
2.0 16V	100	08/00→06/04					
2.0 16V HPi	103	05/01→05/04	→	→ S 80012040		13.0460-4059.2 604059	ATE 21278 16,4 + WK
2.0 HDi 110	79	08/01→05/04	→	S 80012041→; → 04/04		13.0460-7134.2 607134	ATE 21278 16,4 - WE / - WK
2.0 HDi 90	66	02/99→05/04					
2.0 Turbo	108	04/96→05/04					
2.1 TD 12V	80	01/96→05/04					
2.2	116	07/00→05/04					
2.2 HDi	98	03/00→05/04					
3.0 24V	140	10/96→05/04					
3.0 V6	152	03/00→05/04					
2.0 16V	99	01/99→08/00	←			13.0460-2817.2 602817	TRW 21674 19,0 + WK
↓							

	kW			 	! #		
<b>PEUGEOT - 406 (8B) 10/95→01/05</b>							
 <b>Bremsbelagsatz, Scheibenbremse</b>							
2.0 16V	99	01/99→08/00	➔			<b>13.0460-4059.2 604059</b>	ATE 21278 16,4 + WK
2.0 HDi 110	80	06/98→08/01	➔	02/99→		<b>13.0460-2817.2 602817</b>	TRW 21674 19,0 + WK
			➔	02/99→		<b>13.0460-4059.2 604059</b>	ATE 21278 16,4 + WK
3.0 V6	154	03/99→12/01	➔	03/00→		<b>13.0460-2817.2 602817</b>	TRW 21674 19,0 + WK
			➔	03/00→; → S 80012040		<b>13.0460-4059.2 604059</b>	ATE 21278 16,4 + WK
			➔	S 80012041→		<b>13.0460-7134.2 607134</b>	ATE 21278 16,4 - WE / - WK
<b>Zubehörsatz, Scheibenbremsbelag</b>							
1.8 16V	85	10/00→05/04	➔	→ S 80012040		<b>13.0460-0409.2 610409</b>	ATE
2.0	104	11/96→03/99					
2.0 16V	97	11/95→05/04					
2.0 16V	100	08/00→06/04					
2.0 16V HPi	103	05/01→05/04					
2.0 HDi 110	79	08/01→05/04					
2.0 HDi 90	66	02/99→05/04					
2.0 Turbo	108	04/96→05/04					
2.1 TD 12V	80	01/96→05/04					
2.2	116	07/00→05/04					
2.2 HDi	98	03/00→05/04					
3.0 24V	140	10/96→05/04					
3.0 24V	143	01/98→06/99					
3.0 V6	152	03/00→05/04					
2.0 16V	99	01/99→08/00	➔			<b>13.0460-0409.2 610409</b>	ATE
2.0 HDi 110	80	06/98→08/01	➔	02/99→		<b>13.0460-0409.2 610409</b>	ATE
3.0 V6	154	03/99→12/01	➔	03/00→; → S 80012040		<b>13.0460-0409.2 610409</b>	ATE
 <b>Bremsscheibe</b>							
1.6	65	11/95→05/04	➔	→ 04/04		<b>24.0124-0139.1 424139</b>	Ø 260 24 22 V + S
1.8	66	05/97→05/04					
1.9 D	55	10/96→05/04					
1.8	74	10/96→03/99	➔			<b>24.0124-0139.1 424139</b>	Ø 260 24 22 V + S
1.8 16V	81	11/95→10/00					
1.8 16V	85	10/00→05/04	➔	→ 04/04		<b>24.0124-0139.1 424139</b>	Ø 260 24 22 V + S
			➔	→ 04/04		<b>24.0110-0230.1 410230</b>	Ø 290,5 10 8
1.8 Bifuel	81	04/99→05/03	➔	→ 10/00		<b>24.0124-0139.1 424139</b>	Ø 260 24 22 V + S
1.9 TD	66	01/96→05/04	➔	→ 04/04		<b>24.0126-0106.1 426106</b>	Ø 283 26 24,2 V + S
1.9 TD	68	01/96→05/04				<b>24.0326-0106.1 526106</b>	Ø 283 26 24,2 V + S
1.9 TD	69	10/95→10/97	➔	01/96→		<b>24.0126-0106.1 426106</b>	Ø 283 26 24,2 V + S
			➔			<b>24.0326-0106.1 526106</b>	Ø 283 26 24,2 V + S
2.0	104	11/96→03/99	➔			<b>24.0126-0106.1 426106</b>	Ø 283 26 24,2 V + S
2.0 16V	99	01/99→08/00				<b>24.0326-0106.1 526106</b>	Ø 283 26 24,2 V + S
3.0 24V	143	01/98→06/99	➔			<b>24.0110-0230.1 410230</b>	Ø 290,5 10 8
2.0 16V	97	11/95→05/04	➔	→ 04/04		<b>24.0126-0106.1 426106</b>	Ø 283 26 24,2 V + S
			➔			<b>24.0326-0106.1 526106</b>	Ø 283 26 24,2 V + S
2.0 16V	100	08/00→06/04					
2.0 16V HPi	103	05/01→05/04					
2.0 HDi 110	79	08/01→05/04	➔	→ 04/04		<b>24.0110-0230.1 410230</b>	Ø 290,5 10 8
2.0 HDi 90	66	02/99→05/04					
2.0 Turbo	108	04/96→05/04					
2.1 TD 12V	80	01/96→05/04					
2.2	116	07/00→05/04					
2.2 HDi	98	03/00→05/04					
3.0 24V	140	10/96→05/04					
3.0 V6	152	03/00→05/04					
2.0 HDi 110	80	06/98→08/01	➔	02/99→		<b>24.0126-0106.1 426106</b>	Ø 283 26 24,2 V + S
			➔			<b>24.0326-0106.1 526106</b>	Ø 283 26 24,2 V + S
			➔	02/99→		<b>24.0110-0230.1 410230</b>	Ø 290,5 10 8
			➔				
3.0 V6	154	03/99→12/01	➔	03/00→		<b>24.0126-0106.1 426106</b>	Ø 283 26 24,2 V + S
			➔			<b>24.0326-0106.1 526106</b>	Ø 283 26 24,2 V + S
			➔	03/00→		<b>24.0110-0230.1 410230</b>	Ø 290,5 10 8
<b>PEUGEOT - 406 Break (8E/F) 10/96→10/04</b>							
 <b>Bremsbelagsatz, Scheibenbremse</b>							
1.8	66	05/97→10/04	➔	→ 04/04		<b>13.0460-2816.2 602816</b>	TRW 21724 19,3 + WK
1.9 D	55	10/96→10/04					
1.8 16V	81	10/96→10/00	➔			<b>13.0460-2816.2 602816</b>	TRW 21724 19,3 + WK
1.8 16V	85	10/00→10/04	➔	→ 04/04		<b>13.0460-2816.2 602816</b>	TRW 21724 19,3 + WK
			➔	→ S 80012040		<b>13.0460-4059.2 604059</b>	ATE 21278 16,4 + WK
↓							























	kW			 	! #		
<b>PEUGEOT - 406 Break (8E/F) 10/96→10/04</b>							
 <b>Bremsbelagsatz, Scheibenbremse</b>							
1.8 16V	85	10/00→10/04	➡	S 80012041→; → 04/04		13.0460-7134.2 607134	ATE 21278 16,4 - WE / - WK
1.9 TD	66	10/96→10/04	←	→ 04/04		13.0460-2817.2 602817	TRW 21674 19,0 + WK
2.0	104	11/96→03/99	←			13.0460-2817.2 602817	TRW 21674 19,0 + WK
			➡	→ S 80012040		13.0460-4059.2 604059	ATE 21278 16,4 + WK
			➡	S 80012041→		13.0460-7134.2 607134	ATE 21278 16,4 - WE / - WK
2.0 16V	97	10/96→10/04	←	→ 04/04		13.0460-2817.2 602817	TRW 21674 19,0 + WK
2.0 16V	100	10/00→10/04	←	→ 04/04		13.0460-2817.2 602817	TRW 21674 19,0 + WK
2.0 16V HPi	103	05/01→10/04	➡	→ S 80012040		13.0460-4059.2 604059	ATE 21278 16,4 + WK
2.0 HDi 110	79	08/01→10/04	➡	S 80012041→; → 04/04		13.0460-7134.2 607134	ATE 21278 16,4 - WE / - WK
2.0 HDi 90	66	02/99→10/04	➡				
2.0 Turbo	108	10/96→10/04	➡				
2.1 TD 12V	80	10/96→10/04	➡				
2.2	116	07/00→10/04	➡				
2.2 HDi	98	03/00→10/04	➡				
3.0 24V	140	10/96→10/04	➡				
3.0 V6	152	03/00→10/04	➡				
2.0 16V	99	01/99→10/00	←			13.0460-2817.2 602817	TRW 21674 19,0 + WK
			➡			13.0460-4059.2 604059	ATE 21278 16,4 + WK
2.0 HDi 110	80	02/99→04/04	←	→ 08/01		13.0460-2817.2 602817	TRW 21674 19,0 + WK
			➡	→ 08/01		13.0460-4059.2 604059	ATE 21278 16,4 + WK
<b>Zubehörsatz, Scheibenbremsbelag</b>							
1.8 16V	85	10/00→10/04	➡	→ S 80012040		13.0460-0409.2 610409	ATE
2.0	104	11/96→03/99	➡				
2.0 16V	97	10/96→10/04	➡				
2.0 16V	100	10/00→10/04	➡				
2.0 16V HPi	103	05/01→10/04	➡				
2.0 HDi 110	79	08/01→10/04	➡				
2.0 HDi 90	66	02/99→10/04	➡				
2.0 Turbo	108	10/96→10/04	➡				
2.1 TD 12V	80	10/96→10/04	➡				
2.2	116	07/00→10/04	➡				
2.2 HDi	98	03/00→10/04	➡				
3.0 24V	140	10/96→10/04	➡				
3.0 V6	152	03/00→10/04	➡				
2.0 16V	99	01/99→10/00	➡			13.0460-0409.2 610409	ATE
2.0 HDi 110	80	02/99→04/04	➡	→ 08/01		13.0460-0409.2 610409	ATE
 <b>Bremsscheibe</b>							
1.8	66	05/97→10/04	←	→ 04/04		24.0124-0139.1 424139	Ø 260 24 22 V + S
1.9 D	55	10/96→10/04	←				
1.8 16V	81	10/96→10/00	←			24.0124-0139.1 424139	Ø 260 24 22 V + S
1.8 16V	85	10/00→10/04	←	→ 04/04		24.0124-0139.1 424139	Ø 260 24 22 V + S
			➡	→ 04/04		24.0110-0230.1 410230	Ø 290,5 10 8
1.9 TD	66	10/96→10/04	←	→ 04/04		24.0126-0106.1 426106	Ø 283 26 24,2 V + S
			➡			24.0326-0106.1 526106	Ø 283 26 24,2 V + S
2.0	104	11/96→03/99	←			24.0126-0106.1 426106	Ø 283 26 24,2 V + S
			➡			24.0326-0106.1 526106	Ø 283 26 24,2 V + S
2.0 16V	99	01/99→10/00	➡			24.0110-0230.1 410230	Ø 290,5 10 8
2.0 16V	97	10/96→10/04	←	→ 04/04		24.0126-0106.1 426106	Ø 283 26 24,2 V + S
			➡			24.0326-0106.1 526106	Ø 283 26 24,2 V + S
2.0 16V HPi	103	05/01→10/04	➡				
2.0 HDi 110	79	08/01→10/04	➡	→ 04/04		24.0110-0230.1 410230	Ø 290,5 10 8
2.0 HDi 90	66	02/99→10/04	➡				
2.0 Turbo	108	10/96→10/04	➡				
2.1 TD 12V	80	10/96→10/04	➡				
2.2	116	07/00→10/04	➡				
2.2 HDi	98	03/00→10/04	➡				
3.0 24V	140	10/96→10/04	➡				
3.0 V6	152	03/00→10/04	➡				
2.0 HDi 110	80	02/99→04/04	←	→ 08/01		24.0126-0106.1 426106	Ø 283 26 24,2 V + S
			➡			24.0326-0106.1 526106	Ø 283 26 24,2 V + S
			➡	→ 08/01		24.0110-0230.1 410230	Ø 290,5 10 8
<b>PEUGEOT - 406 Coupe (8C) 03/97→02/05</b>							
 <b>Bremsbelagsatz, Scheibenbremse</b>							
2.0 16V	97	03/97→12/04	←			13.0460-2817.2 602817	TRW 21674 19,0 + WK
2.0 16V	100	10/00→12/04	➡	→ S 80012040		13.0460-4059.2 604059	ATE 21278 16,4 + WK
2.2	116	03/02→12/04	➡				
↓							











	kW			 	! #		
<b>PEUGEOT - 406 Coupe (8C) 03/97→02/05</b>							
<b> Bremsbelagsatz, Scheibenbremse</b>							
2.0 16V	97	03/97→12/04	➡	S 80012041→		13.0460-7134.2 607134	ATE 21278 16,4 - WE / - WK
2.0 16V	100	10/00→12/04					
2.2	116	03/02→12/04					
2.0 16V	99	01/99→10/00	⬅			13.0460-2817.2 602817	TRW 21674 19,0 + WK
			➡			13.0460-4059.2 604059	ATE 21278 16,4 + WK
2.0 16V	99	04/99→09/04	⬅	→ 10/00		13.0460-2817.2 602817	TRW 21674 19,0 + WK
			➡	→ 10/00		13.0460-4059.2 604059	ATE 21278 16,4 + WK
2.2 HDI	98	03/00→12/04	⬅	06/02→		13.0460-2817.2 602817	TRW 21674 19,0 + WK
			⬅	→ 06/02		13.0460-4969.2 604969	BRE 23753 18,0 + WK
			➡	→ S 80012040		13.0460-4059.2 604059	ATE 21278 16,4 + WK
			➡	S 80012041→		13.0460-7134.2 607134	ATE 21278 16,4 - WE / - WK
3.0 24V	143	05/97→06/99	⬅			13.0460-4969.2 604969	BRE 23753 18,0 + WK
3.0 V6	152	03/00→12/04	➡	→ S 80012040		13.0460-4059.2 604059	ATE 21278 16,4 + WK
3.0 V6 24V	140	03/97→12/04	➡	S 80012041→		13.0460-7134.2 607134	ATE 21278 16,4 - WE / - WK
3.0 V6	154	03/99→06/01	⬅	03/00→		13.0460-4969.2 604969	BRE 23753 18,0 + WK
			➡	03/00→; → S 80012040		13.0460-4059.2 604059	ATE 21278 16,4 + WK
			➡	S 80012041→		13.0460-7134.2 607134	ATE 21278 16,4 - WE / - WK
<b>Zubehörsatz, Scheibenbremsbelag</b>							
2.0 16V	97	03/97→12/04	➡	→ S 80012040		13.0460-0409.2 610409	ATE
2.0 16V	100	10/00→12/04					
2.2	116	03/02→12/04					
2.2 HDI	98	03/00→12/04					
3.0 24V	143	05/97→06/99					
3.0 V6	152	03/00→12/04					
3.0 V6 24V	140	03/97→12/04					
2.0 16V	99	01/99→10/00	➡			13.0460-0409.2 610409	ATE
2.0 16V	99	04/99→09/04	➡	→ 10/00		13.0460-0409.2 610409	ATE
3.0 V6	154	03/99→06/01	➡	03/00→; → S 80012040		13.0460-0409.2 610409	ATE
<b> Bremsscheibe</b>							
2.0 16V	97	03/97→12/04	⬅			24.0126-0106.1 426106	Ø 283 26 24,2 V + S
2.0 16V	99	01/99→10/00				24.0326-0106.1 526106	Ø 283 26 24,2 V + S
2.0 16V	100	10/00→12/04					
2.2	116	03/02→12/04	➡			24.0110-0230.1 410230	Ø 290,5 10 8
2.0 16V	99	04/99→09/04	⬅	→ 10/00		24.0126-0106.1 426106	Ø 283 26 24,2 V + S
			➡	→ 10/00		24.0326-0106.1 526106	Ø 283 26 24,2 V + S
			➡			24.0110-0230.1 410230	Ø 290,5 10 8
2.2 HDI	98	03/00→12/04	⬅	06/02→		24.0126-0106.1 426106	Ø 283 26 24,2 V + S
			⬅	→ 06/02		24.0326-0106.1 526106	Ø 283 26 24,2 V + S
			➡			24.0128-0143.1 428143	Ø 305 28 26 V
			➡			24.0110-0230.1 410230	Ø 290,5 10 8
3.0 24V	143	05/97→06/99	⬅			24.0128-0143.1 428143	Ø 305 28 26 V
3.0 V6	152	03/00→12/04					
3.0 V6 24V	140	03/97→12/04	➡			24.0110-0230.1 410230	Ø 290,5 10 8
3.0 V6	154	03/99→06/01	⬅	03/00→		24.0128-0143.1 428143	Ø 305 28 26 V
			➡	03/00→		24.0110-0230.1 410230	Ø 290,5 10 8
<b>PEUGEOT - 407 (6D_) 05/04→</b>							
<b> Bremsbelagsatz, Scheibenbremse</b>							
1.6 HDi 110	80	05/04→	⬅	→ 02/11		13.0460-2891.2 602891	TRW 24134 19,6 + WK
1.8	85	05/04→				13.0470-2891.2 LD2891	TRW 24134 19,6 + WK Ceramic
1.8 16V	92	09/05→					
2.0	100	05/04→	➡	→ 02/11		13.0460-2893.2 602893	TRW 24135 17,7 - WK
2.0 16V	103	09/05→				13.0470-2893.2 LD2893	TRW 24135 17,7 - WK Ceramic
2.0 Bioflex	103	09/07→					
2.0 16V	105	08/08→12/09	⬅			13.0460-2891.2 602891	TRW 24134 19,6 + WK
			➡			13.0470-2891.2 LD2891	TRW 24134 19,6 + WK Ceramic
			➡			13.0460-2893.2 602893	TRW 24135 17,7 - WK
			➡			13.0470-2893.2 LD2893	TRW 24135 17,7 - WK Ceramic
2.0 HDi	103	06/09→12/10	⬅			13.0460-7252.2 607252	ATE 24084 19,3 + WK
			➡			13.0470-7252.2 LD7252	ATE 24084 19,3 + WK Ceramic
			➡			13.0460-2893.2 602893	TRW 24135 17,7 - WK
			➡			13.0470-2893.2 LD2893	TRW 24135 17,7 - WK Ceramic
↓							











	kw			 	! #		
<b>PEUGEOT - 407 (6D_) 05/04→</b>							
<b> Bremsbelagsatz, Scheibenbremse</b>							
2.0 HDi	110	02/10→	←	10/10→ 02/11		<b>13.0460-7252.2 607252</b>	ATE 24084 19,3 + WK
			→	→ 02/11		<b>13.0470-7252.2 LD7252</b>	ATE 24084 19,3 + WK Ceramic
			→	→ 02/11		<b>13.0460-2893.2 602893</b>	TRW 24135 17,7 - WK
2.0 HDi	120	07/09→	←	→ 02/11		<b>13.0460-7252.2 607252</b>	ATE 24084 19,3 + WK
			→	→ 02/11		<b>13.0470-7252.2 LD7252</b>	ATE 24084 19,3 + WK Ceramic
			→	→ 02/11		<b>13.0460-2893.2 602893</b>	TRW 24135 17,7 - WK
2.0 HDi 135	100	05/04→	←	→Orga 11682		<b>13.0460-2891.2 602891</b>	TRW 24134 19,6 + WK
			←	Orga 11683→; → 02/11		<b>13.0470-2891.2 LD2891</b>	TRW 24134 19,6 + WK Ceramic
			→	→ 02/11		<b>13.0460-7252.2 607252</b>	ATE 24084 19,3 + WK
2.2 2.2 16V 2.2 HDi 170 2.7 HDi	116 120 125 150	05/04→ 09/05→ 05/06→ 10/05→	←	→ 02/11		<b>13.0470-2892.2 LD2892</b>	ATE 24084 19,3 + WK Ceramic
			→	→ 02/11		<b>13.0460-2892.2 602892</b>	TRW 24133 18,6 + WK + Zub
			→	→ 02/11		<b>13.0470-2892.2 LD2892</b>	TRW 24133 18,6 + WK + Zub Ceramic
2.2 HDi	120	06/08→	←			<b>13.0460-2893.2 602893</b>	TRW 24135 17,7 - WK
			→			<b>13.0470-2893.2 LD2893</b>	TRW 24135 17,7 - WK Ceramic
			←			<b>13.0460-2892.2 602892</b>	TRW 24133 18,6 + WK + Zub
3.0	155	05/04→	←	→Orga 12410		<b>13.0470-2892.2 LD2892</b>	TRW 24133 18,6 + WK + Zub Ceramic
			←	Orga 12411→; → 02/11		<b>13.0460-2892.2 602892</b>	TRW 24133 18,6 + WK + Zub
			→	→ 02/11		<b>13.0470-2892.2 LD2892</b>	TRW 24133 18,6 + WK + Zub Ceramic
			←			<b>13.0460-7279.2 607279</b>	ATE 25069 17,3 + WK
			←			<b>13.0470-7279.2 LD7279</b>	ATE 25069 17,3 + WK Ceramic
			→	→ 02/11		<b>13.0460-2893.2 602893</b>	TRW 24135 17,7 - WK
			→			<b>13.0470-2893.2 LD2893</b>	TRW 24135 17,7 - WK Ceramic
			→			<b>13.0460-2893.2 602893</b>	TRW 24135 17,7 - WK
			→			<b>13.0470-2893.2 LD2893</b>	TRW 24135 17,7 - WK Ceramic
<b> Bremsscheibe</b>							
1.6 HDi 110 1.8 1.8 16V	80 85 92	05/04→ 05/04→ 09/05→	←	→ 02/11		<b>24.0126-0121.1 426121</b>	Ø 283 26 24 V + S
			→	→ 02/11		<b>24.0112-0162.1 412162</b>	Ø 290 12 10 + S
			→	→ 02/11		<b>24.0126-0121.1 426121</b>	Ø 283 26 24 V + S
2.0 2.0 16V 2.0 Bioflex	100 103 103	05/04→ 09/05→ 09/07→	←			<b>24.0112-0162.1 412162</b>	Ø 290 12 10 + S
			→			<b>24.0126-0121.1 426121</b>	Ø 283 26 24 V + S
			→			<b>24.0112-0162.1 412162</b>	Ø 290 12 10 + S
2.0 HDi	103	06/09→12/10	←			<b>24.0128-0216.1 428216</b>	Ø 304 28 26 V + S
			→			<b>24.0112-0162.1 412162</b>	Ø 290 12 10 + S
			←			<b>24.0128-0216.1 428216</b>	Ø 304 28 26 V + S
2.0 HDi	110	02/10→	←	10/10→ 02/11		<b>24.0112-0162.1 412162</b>	Ø 290 12 10 + S
			→	→ 02/11		<b>24.0128-0216.1 428216</b>	Ø 304 28 26 V + S
			→	→ 02/11		<b>24.0112-0162.1 412162</b>	Ø 290 12 10 + S
2.0 HDi	120	07/09→	←	→ 02/11		<b>24.0128-0269.1 428269</b>	Ø 304 28 26 V + S
			→	→ 02/11		<b>24.0112-0162.1 412162</b>	Ø 290 12 10 + S
			←	→ 02/11		<b>24.0128-0269.1 428269</b>	Ø 304 28 26 V + S
2.0 HDi 135	100	05/04→	←	→Orga 11682		<b>24.0126-0121.1 426121</b>	Ø 283 26 24 V + S
			←	Orga 11683→; → 02/11		<b>24.0128-0216.1 428216</b>	Ø 304 28 26 V + S
			→	→ 02/11		<b>24.0112-0162.1 412162</b>	Ø 290 12 10 + S
2.2 2.2 16V 2.2 HDi 170 2.7 HDi	116 120 125 150	05/04→ 09/05→ 05/06→ 10/05→	←	→Orga 11193		<b>24.0130-0181.1 430181</b>	Ø 330 30 28 V + S
			←	Orga 11194→; → 02/11		<b>24.0130-0206.1 430206</b>	Ø 330 30 28 V + S
			→	→ 02/11		<b>24.0112-0162.1 412162</b>	Ø 290 12 10 + S
2.2 HDi	120	06/08→	←	→Orga 11193		<b>24.0130-0181.1 430181</b>	Ø 330 30 28 V + S
			←	Orga 11194→		<b>24.0130-0206.1 430206</b>	Ø 330 30 28 V + S
			→			<b>24.0112-0162.1 412162</b>	Ø 290 12 10 + S
3.0	155	05/04→	←	→Orga 11193		<b>24.0130-0181.1 430181</b>	Ø 330 30 28 V + S
			←	Orga 11194→ Orga 12410		<b>24.0130-0206.1 430206</b>	Ø 330 30 28 V + S
			←	Orga 12411→; → 02/11		<b>24.0130-0227.1 430227</b>	Ø 340 30 28 V + S
			→	→ 02/11		<b>24.0112-0162.1 412162</b>	Ø 290 12 10 + S













	kw			 	! #		
<b>PEUGEOT - 407 Coupe (6C_) 10/05→</b>							
<b> Bremsbelagsatz, Scheibenbremse</b>							
2.0 HDi	100	10/05→	←	07/07→ 12/11	13.0460-2892.2	602892	TRW 24133 18,6 + WK + Zub
			→	07/07→ 12/11	13.0470-2892.2	LD2892	TRW 24133 18,6 + WK + Zub Ceramic
2.0 HDi	103	09/08→12/09	←		13.0460-2893.2	602893	TRW 24135 17,7 - WK
			→		13.0470-2893.2	LD2893	TRW 24135 17,7 - WK Ceramic
2.0 HDi 2.0 HDi	110 120	02/10→ 06/09→	←	→ 12/11	13.0460-7252.2	607252	ATE 24084 19,3 + WK
			→	→ 12/11	13.0470-7252.2	LD7252	ATE 24084 19,3 + WK Ceramic
2.2 16V 2.7 HDi	120 150	10/05→ 10/05→	←	→ 12/11	13.0460-2892.2	602892	TRW 24133 18,6 + WK + Zub
			→	→ 12/11	13.0470-2892.2	LD2892	TRW 24133 18,6 + WK + Zub Ceramic
3.0 HDi	177	06/09→	←	→ 12/11	13.0460-2893.2	602893	TRW 24135 17,7 - WK
			→	→ 12/11	13.0470-2893.2	LD2893	TRW 24135 17,7 - WK Ceramic
3.0 V6	155	10/05→	←	→Orga 12410	13.0460-2892.2	602892	TRW 24133 18,6 + WK + Zub
			←	Orga 12411→; → 12/11	13.0470-2892.2	LD2892	TRW 24133 18,6 + WK + Zub Ceramic
			→	→ 12/11	13.0460-7279.2	607279	ATE 25069 17,3 + WK
					13.0470-7279.2	LD7279	ATE 25069 17,3 + WK Ceramic
					13.0460-2893.2	602893	TRW 24135 17,7 - WK
					13.0470-2893.2	LD2893	TRW 24135 17,7 - WK Ceramic
<b> Bremsscheibe</b>							
2.0 HDi	100	10/05→	←	07/07→ 12/11	24.0130-0206.1	430206	Ø 330 30 28 V + S
			→	07/07→ 12/11	24.0112-0162.1	412162	Ø 290 12 10 + S
2.0 HDi	103	09/08→12/09	←		24.0112-0174.1	412174	Ø 290 12 10
			→		24.0130-0206.1	430206	Ø 330 30 28 V + S
2.0 HDi	110	02/10→	←	→ 12/11	24.0112-0162.1	412162	Ø 290 12 10 + S
			→	→ 12/11	24.0112-0174.1	412174	Ø 290 12 10
2.0 HDi	120	06/09→	←	→ 12/11	24.0128-0216.1	428216	Ø 304 28 26 V + S
			→	→ 12/11	24.0112-0162.1	412162	Ø 290 12 10 + S
2.2 16V 2.7 HDi	120 150	10/05→ 10/05→	←	→Orga 11193	24.0112-0174.1	412174	Ø 290 12 10
			←	Orga 11194→; → 12/11	24.0130-0181.1	430181	Ø 330 30 28 V + S
			→	→ 12/11	24.0130-0206.1	430206	Ø 330 30 28 V + S
			→	→ 12/11	24.0112-0174.1	412174	Ø 290 12 10
3.0 HDi	177	06/09→	←	→ 12/11	24.0130-0227.1	430227	Ø 340 30 28 V + S
			→	→ 12/11	24.0112-0162.1	412162	Ø 290 12 10 + S
					24.0112-0174.1	412174	Ø 290 12 10
3.0 V6	155	10/05→	←	→Orga 11193	24.0130-0206.1	430206	Ø 330 30 28 V + S
			←	Orga 11194→ Orga 12410	24.0130-0181.1	430181	Ø 330 30 28 V + S
			←	Orga 12411→; → 12/11	24.0130-0227.1	430227	Ø 340 30 28 V + S
			→	→ 12/11	24.0112-0174.1	412174	Ø 290 12 10
<b>PEUGEOT - 407 SW (6E_) 05/04→</b>							
<b> Bremsbelagsatz, Scheibenbremse</b>							
1.6 HDi 110	80	05/04→	←	→ 02/11	13.0460-2891.2	602891	TRW 24134 19,6 + WK
1.8	85	05/04→			13.0470-2891.2	LD2891	TRW 24134 19,6 + WK Ceramic
1.8 16V	92	09/05→					
2.0	100	05/04→	→	→ 02/11	13.0460-2893.2	602893	TRW 24135 17,7 - WK
2.0 16V	103	09/05→			13.0470-2893.2	LD2893	TRW 24135 17,7 - WK Ceramic
2.0 Bioflex	103	01/08→					
↓							

	kw			 	! #		
<b>PEUGEOT - 407 SW (6E_) 05/04→</b>							
 <b>Bremsbelagsatz, Scheibenbremse</b>							
2.0 HDi 2.0 HDi 135	93 100	11/04→10/07 07/04→12/10	←	→Orga 11682		<b>13.0460-2891.2 602891</b>	TRW 24134 19,6 + WK
			←	Orga 11683→		<b>13.0470-2891.2 LD2891</b>	TRW 24134 19,6 + WK Ceramic
			→			<b>13.0460-7252.2 607252</b>	ATE 24084 19,3 + WK
			→			<b>13.0470-7252.2 LD7252</b>	ATE 24084 19,3 + WK Ceramic
			→			<b>13.0460-2893.2 602893</b>	TRW 24135 17,7 - WK
			→			<b>13.0470-2893.2 LD2893</b>	TRW 24135 17,7 - WK Ceramic
2.0 HDi 2.0 HDi	103 120	08/08→ 07/09→	←	→ 02/11		<b>13.0460-7252.2 607252</b>	ATE 24084 19,3 + WK
			←	→ 02/11		<b>13.0470-7252.2 LD7252</b>	ATE 24084 19,3 + WK Ceramic
			→	→ 02/11		<b>13.0460-2893.2 602893</b>	TRW 24135 17,7 - WK
			→	→ 02/11		<b>13.0470-2893.2 LD2893</b>	TRW 24135 17,7 - WK Ceramic
2.0 HDi	110	02/10→	←	10/10→ 02/11		<b>13.0460-7252.2 607252</b>	ATE 24084 19,3 + WK
			←	→ 02/11		<b>13.0470-7252.2 LD7252</b>	ATE 24084 19,3 + WK Ceramic
			→	→ 02/11		<b>13.0460-2893.2 602893</b>	TRW 24135 17,7 - WK
			→	→ 02/11		<b>13.0470-2893.2 LD2893</b>	TRW 24135 17,7 - WK Ceramic
2.2 2.2 16V 2.2 HDi 2.2 HDi 170 2.7 HDi	116 120 120 125 150	05/04→ 09/05→ 06/08→ 05/06→ 10/05→	←	→ 02/11		<b>13.0460-2892.2 602892</b>	TRW 24133 18,6 + WK + Zub
			←	→ 02/11		<b>13.0470-2892.2 LD2892</b>	TRW 24133 18,6 + WK + Zub Ceramic
			→	→ 02/11		<b>13.0460-2893.2 602893</b>	TRW 24135 17,7 - WK
			→	→ 02/11		<b>13.0470-2893.2 LD2893</b>	TRW 24135 17,7 - WK Ceramic
3.0	155	05/04→	←	→Orga 12410		<b>13.0460-2892.2 602892</b>	TRW 24133 18,6 + WK + Zub
			←	Orga 12411→; → 02/11		<b>13.0470-2892.2 LD2892</b>	TRW 24133 18,6 + WK + Zub Ceramic
			←	Orga 12411→; → 02/11		<b>13.0460-7279.2 607279</b>	ATE 25069 17,3 + WK
			←	→ 02/11		<b>13.0470-7279.2 LD7279</b>	ATE 25069 17,3 + WK Ceramic
			→	→ 02/11		<b>13.0460-2893.2 602893</b>	TRW 24135 17,7 - WK
			→	→ 02/11		<b>13.0470-2893.2 LD2893</b>	TRW 24135 17,7 - WK Ceramic
 <b>Bremsscheibe</b>							
1.6 HDi 110 1.8 1.8 16V 2.0 2.0 16V 2.0 Bioflex	80 85 92 100 103 103	05/04→ 05/04→ 09/05→ 05/04→ 09/05→ 01/08→	←	→ 02/11		<b>24.0126-0121.1 426121</b>	Ø 283 26 24 V + S
			→	→ 02/11		<b>24.0112-0162.1 412162</b>	Ø 290 12 10 + S
2.0 HDi 2.0 HDi 135	93 100	11/04→10/07 07/04→12/10	←	→Orga 11682		<b>24.0126-0121.1 426121</b>	Ø 283 26 24 V + S
			←	Orga 11683→		<b>24.0128-0216.1 428216</b>	Ø 304 28 26 V + S
			→			<b>24.0112-0162.1 412162</b>	Ø 290 12 10 + S
2.0 HDi	103	08/08→	←	→ 02/11		<b>24.0128-0216.1 428216</b>	Ø 304 28 26 V + S
			→	→ 02/11		<b>24.0112-0162.1 412162</b>	Ø 290 12 10 + S
2.0 HDi	110	02/10→	←	10/10→ 02/11		<b>24.0128-0216.1 428216</b>	Ø 304 28 26 V + S
			→	→ 02/11		<b>24.0112-0162.1 412162</b>	Ø 290 12 10 + S
2.0 HDi	120	07/09→	←	→ 02/11		<b>24.0128-0269.1 428269</b>	Ø 304 28 26 V + S
			→	→ 02/11		<b>24.0112-0162.1 412162</b>	Ø 290 12 10 + S
2.2 2.2 16V 2.2 HDi 2.2 HDi 170 2.7 HDi	116 120 120 125 150	05/04→ 09/05→ 06/08→ 05/06→ 10/05→	←	→Orga 11193		<b>24.0130-0181.1 430181</b>	Ø 330 30 28 V + S
			←	Orga 11194→; → 02/11		<b>24.0130-0206.1 430206</b>	Ø 330 30 28 V + S
			→	→ 02/11		<b>24.0112-0162.1 412162</b>	Ø 290 12 10 + S
3.0	155	05/04→	←	→Orga 11193		<b>24.0130-0181.1 430181</b>	Ø 330 30 28 V + S
			←	Orga 11194→ Orga 12410		<b>24.0130-0206.1 430206</b>	Ø 330 30 28 V + S
			←	Orga 12411→; → 02/11		<b>24.0130-0227.1 430227</b>	Ø 340 30 28 V + S
			→	→ 02/11		<b>24.0112-0162.1 412162</b>	Ø 290 12 10 + S
<b>PEUGEOT - 508 I (8D_) 11/10→</b>							
 <b>Bremsbelagsatz, Scheibenbremse</b>							
1.6 1.6 1.6 BlueHDi 120 1.6 HDi 1.6 HDi 1.6 HDi 1.6 THP 1.6 THP 1.6 VTi 1.6 VTi ↓	120 121 88 82 84 85 110 115 85 88	01/12→ 09/11→ 03/14→ 11/10→ 02/12→ 09/14→ 11/10→ 11/10→ 11/10→ 11/10→ ↓	←	für Bremsscheibendurchmesser [mm]: 283; für Bremsscheibendicke [mm]: 26		<b>13.0460-7276.2 607276</b>	ATE 25222 17,3 + WK
			←	für Bremsscheibendurchmesser [mm]: 304; für Bremsscheibendicke [mm]: 28		<b>13.0460-7277.2 607277</b>	ATE 24084 19,3 + WK
			←	für Bremsscheibendurchmesser [mm]: 340; für Bremsscheibendicke [mm]: 30		<b>13.0460-7279.2 607279</b>	ATE 25069 17,3 + WK
			→			<b>13.0470-7279.2 LD7279</b>	ATE 25069 17,3 + WK Ceramic
			→			<b>13.0460-7278.2 607278</b>	ATE 23482 16,6 - WE / - WK

	kW			 	! #				
<b>PEUGEOT - 508 I (8D_) 11/10→</b>									
 <b>Bremsbelagsatz, Scheibenbremse</b>									
2.0 BlueHdi 150	110	04/14→	←	für Bremsscheibendurchmesser [mm]: 283; für Bremsscheibendicke [mm]: 26	13.0460-7276.2	607276	ATE 25222 17,3 + WK		
2.0 BlueHdi 180	133	04/14→	←	für Bremsscheibendurchmesser [mm]: 304; für Bremsscheibendicke [mm]: 28	13.0460-7277.2	607277	ATE 24084 19,3 + WK		
2.0 HDi	100	11/10→							
2.0 HDi	103	11/10→	←	für Bremsscheibendurchmesser [mm]: 340; für Bremsscheibendicke [mm]: 30	13.0460-7279.2	607279	ATE 25069 17,3 + WK		
2.0 HDi	120	11/10→							
2.2 HDi	150	11/10→	→		13.0460-7278.2	607278	ATE 23482 16,6 - WE / - WK		
2.0 HDi Hybrid4 AWC	120	11/10→	←	für Bremsscheibendurchmesser [mm]: 283; für Bremsscheibendicke [mm]: 26	13.0460-7276.2	607276	ATE 25222 17,3 + WK		
			←	für Bremsscheibendurchmesser [mm]: 304; für Bremsscheibendicke [mm]: 28	13.0460-7277.2	607277	ATE 24084 19,3 + WK		
			←	für Bremsscheibendurchmesser [mm]: 340; für Bremsscheibendicke [mm]: 30	13.0460-7279.2	607279	ATE 25069 17,3 + WK		
			→		13.0470-7279.2	LD7279	ATE 25069 17,3 + WK Ceramic		
			→		13.0460-2761.2	602761	TRW 24922 16,5 - WK + Zub		
2.0 HDi Hybrid4 AWC	147	11/10→	←	06/12→; für Bremsscheibendurchmesser [mm]: 283; für Bremsscheibendicke [mm]: 26	13.0460-7276.2	607276	ATE 25222 17,3 + WK		
			←	06/12→; für Bremsscheibendurchmesser [mm]: 304; für Bremsscheibendicke [mm]: 28	13.0460-7277.2	607277	ATE 24084 19,3 + WK		
			←	06/12→; für Bremsscheibendurchmesser [mm]: 340; für Bremsscheibendicke [mm]: 30	13.0460-7279.2	607279	ATE 25069 17,3 + WK		
			→		13.0470-7279.2	LD7279	ATE 25069 17,3 + WK Ceramic		
			→	06/12→	13.0460-2761.2	602761	TRW 24922 16,5 - WK + Zub		
 <b>Bremsscheibe</b>									
1.6	120	01/12→	←		24.0126-0121.1	426121	Ø 283 26 24 V + S		
1.6	121	09/11→			24.0128-0269.1	428269	Ø 304 28 26 V + S		
1.6 BlueHdi 120	88	03/14→			24.0130-0227.1	430227	Ø 340 30 28 V + S		
1.6 HDi	82	11/10→	→		24.0112-0197.1	412197	Ø 290 12 10 + S		
1.6 HDi	84	02/12→							
1.6 HDi	85	09/14→							
1.6 THP	110	11/10→							
1.6 THP	115	11/10→							
1.6 VTi	85	11/10→							
1.6 VTi	88	11/10→							
2.0 BlueHdi 150	110	04/14→							
2.0 BlueHdi 180	133	04/14→							
2.0 HDi	100	11/10→							
2.0 HDi	103	11/10→							
2.0 HDi	120	11/10→							
2.0 HDi Hybrid4 AWC	120	11/10→	←		24.0126-0121.1	426121	Ø 283 26 24 V + S		
2.2 HDi	150	11/10→			24.0128-0269.1	428269	Ø 304 28 26 V + S		
					24.0130-0227.1	430227	Ø 340 30 28 V + S		
			→	+ eFSB	24.0112-0162.1	412162	Ø 290 12 10 + S		
			→	- eFSB	24.0112-0197.1	412197	Ø 290 12 10 + S		
2.0 HDi Hybrid4 AWC	147	11/10→	←	06/12→	24.0126-0121.1	426121	Ø 283 26 24 V + S		
					24.0128-0269.1	428269	Ø 304 28 26 V + S		
					24.0130-0227.1	430227	Ø 340 30 28 V + S		
					→	06/12→; + eFSB	24.0112-0162.1	412162	Ø 290 12 10 + S
					→	06/12→; - eFSB	24.0112-0197.1	412197	Ø 290 12 10 + S
<b>PEUGEOT - 508 SW I (8E_) 11/10→</b>									
 <b>Bremsbelagsatz, Scheibenbremse</b>									
1.6	121	02/12→	←	für Bremsscheibendurchmesser [mm]: 283; →Orga 12774; für Bremsscheibendicke [mm]: 26	13.0460-7276.2	607276	ATE 25222 17,3 + WK		
1.6 HDi	82	11/10→							
1.6 HDi	84	02/12→	←	Orga 12775→; für Bremsscheibendurchmesser [mm]: 283; für Bremsscheibendicke [mm]: 26	13.0460-7276.2	607276	ATE 25222 17,3 + WK		
1.6 HDi	85	09/14→							
1.6 THP	110	11/10→							
1.6 THP	115	11/10→	←	für Bremsscheibendurchmesser [mm]: 304; →Orga 12774; für Bremsscheibendicke [mm]: 28	13.0460-7277.2	607277	ATE 24084 19,3 + WK		
1.6 VTi	85	11/10→							
1.6 VTi	88	11/10→	←	Orga 12775→; für Bremsscheibendurchmesser [mm]: 304; für Bremsscheibendicke [mm]: 28	13.0460-7277.2	607277	ATE 24084 19,3 + WK		
2.0 HDi	100	11/10→							
2.0 HDi	103	11/10→							
2.0 HDi	120	11/10→							
2.2 HDi	150	11/10→							
			←	für Bremsscheibendurchmesser [mm]: 340; für Bremsscheibendicke [mm]: 30	13.0460-7279.2	607279	ATE 25069 17,3 + WK		
			→		13.0470-7279.2	LD7279	ATE 25069 17,3 + WK Ceramic		
			→		13.0460-7278.2	607278	ATE 23482 16,6 - WE / - WK		
↓									

	kw			 	! #		
<b>PEUGEOT - 508 SW I (8E_) 11/10→</b>							
 <b>Bremsbelagsatz, Scheibenbremse</b>							
1.6 BlueHDi 120 2.0 BlueHDi 150 2.0 BlueHDi 180	88 110 133	03/14→ 04/14→ 04/14→	←	für Bremsscheibendurchmesser [mm]: 283; für Bremsscheibendicke [mm]: 26	<b>13.0460-7276.2</b>	<b>607276</b>	ATE 25222 17,3 + WK
			←	für Bremsscheibendurchmesser [mm]: 304; für Bremsscheibendicke [mm]: 28	<b>13.0460-7277.2</b>	<b>607277</b>	ATE 24084 19,3 + WK
			←	für Bremsscheibendurchmesser [mm]: 340; für Bremsscheibendicke [mm]: 30	<b>13.0460-7279.2</b> <b>13.0470-7279.2</b>	<b>607279</b> <b>LD7279</b>	ATE 25069 17,3 + WK ATE 25069 17,3 + WK Ceramic
			→		<b>13.0460-7278.2</b>	<b>607278</b>	ATE 23482 16,6 - WE / - WK
2.0 HDi 180 RXH	133	10/14→	←	für Bremsscheibendurchmesser [mm]: 283; für Bremsscheibendicke [mm]: 26	<b>13.0460-7276.2</b>	<b>607276</b>	ATE 25222 17,3 + WK
			←		<b>13.0460-7277.2</b>	<b>607277</b>	ATE 24084 19,3 + WK
			←	für Bremsscheibendurchmesser [mm]: 340; für Bremsscheibendicke [mm]: 30	<b>13.0460-7279.2</b> <b>13.0470-7279.2</b>	<b>607279</b> <b>LD7279</b>	ATE 25069 17,3 + WK ATE 25069 17,3 + WK Ceramic
			→	+ eFSB	<b>13.0460-2761.2</b>	<b>602761</b>	TRW 24922 16,5 - WK + Zub
2.0 HDi RXH Hybrid4	120	11/10→	←	Orga 12775→; für Bremsscheibendurchmesser [mm]: 283; für Bremsscheibendicke [mm]: 26	<b>13.0460-7276.2</b>	<b>607276</b>	ATE 25222 17,3 + WK
			←	für Bremsscheibendurchmesser [mm]: 283; →Orga 12774; für Bremsscheibendicke [mm]: 26	<b>13.0460-7276.2</b>	<b>607276</b>	ATE 25222 17,3 + WK
			←	für Bremsscheibendurchmesser [mm]: 304; →Orga 12774; für Bremsscheibendicke [mm]: 28	<b>13.0460-7277.2</b>	<b>607277</b>	ATE 24084 19,3 + WK
			←	Orga 12775→; für Bremsscheibendurchmesser [mm]: 304; für Bremsscheibendicke [mm]: 28	<b>13.0460-7277.2</b>	<b>607277</b>	ATE 24084 19,3 + WK
			←	für Bremsscheibendurchmesser [mm]: 340; für Bremsscheibendicke [mm]: 30	<b>13.0460-7279.2</b> <b>13.0470-7279.2</b>	<b>607279</b> <b>LD7279</b>	ATE 25069 17,3 + WK ATE 25069 17,3 + WK Ceramic
			→	+ eFSB	<b>13.0460-2761.2</b>	<b>602761</b>	TRW 24922 16,5 - WK + Zub
 <b>Bremsscheibe</b>							
1.6 1.6 BlueHDi 120 1.6 HDi 1.6 HDi 1.6 HDi 1.6 THP 1.6 THP 1.6 VTi 1.6 VTi 2.0 BlueHDi 150 2.0 HDi 2.0 HDi 2.0 HDi	121 88 82 84 85 110 115 85 88 110 100 103 120	02/12→ 03/14→ 11/10→ 02/12→ 09/14→ 11/10→ 11/10→ 11/10→ 11/10→ 04/14→ 11/10→ 11/10→ 11/10→	←		<b>24.0126-0121.1</b> <b>24.0128-0269.1</b> <b>24.0130-0227.1</b>	<b>426121</b> <b>428269</b> <b>430227</b>	Ø 283 26 24 V + S Ø 304 28 26 V + S Ø 340 30 28 V + S
			→		<b>24.0112-0197.1</b>	<b>412197</b>	Ø 290 12 10 + S
2.0 BlueHDi 180	133	04/14→	←		<b>24.0126-0121.1</b> <b>24.0128-0269.1</b> <b>24.0130-0227.1</b>	<b>426121</b> <b>428269</b> <b>430227</b>	Ø 283 26 24 V + S Ø 304 28 26 V + S Ø 340 30 28 V + S
			→		<b>24.0112-0216.1</b>	<b>412216</b>	Ø 290 12 10 + S
2.0 HDi 180 RXH 2.0 HDi RXH Hybrid4	133 120	10/14→ 11/10→	←		<b>24.0126-0121.1</b> <b>24.0128-0269.1</b> <b>24.0130-0227.1</b>	<b>426121</b> <b>428269</b> <b>430227</b>	Ø 283 26 24 V + S Ø 304 28 26 V + S Ø 340 30 28 V + S
			→	+ eFSB	<b>24.0112-0162.1</b>	<b>412162</b>	Ø 290 12 10 + S
2.2 HDi	150	11/10→	←		<b>24.0126-0121.1</b> <b>24.0128-0269.1</b> <b>24.0130-0227.1</b>	<b>426121</b> <b>428269</b> <b>430227</b>	Ø 283 26 24 V + S Ø 304 28 26 V + S Ø 340 30 28 V + S
			→	+ eFSB	<b>24.0112-0162.1</b>	<b>412162</b>	Ø 290 12 10 + S
			→	- eFSB	<b>24.0112-0197.1</b>	<b>412197</b>	Ø 290 12 10 + S
<b>PEUGEOT - 605 (6B) 06/89→09/99</b>							
 <b>Bremsbelagsatz, Scheibenbremse</b>							
2.0 2.0 2.0 3.0	79 84 89 123	02/90→09/99 06/89→09/99 06/89→09/99 10/89→09/99	←	04/90→; → S 90807683	<b>13.0460-3902.2</b>	<b>603902</b>	BDX 20035 17,0 + WK
			←	S 90807684→	<b>13.0460-3948.2</b>	<b>603948</b>	BDX 21508 17,0 + WK
			→	04/90→; → S 91036112	<b>13.0460-4014.2</b>	<b>604014</b>	ATE 21278 16,4 + WK
			→	S 91036113→	<b>13.0460-7107.2</b>	<b>607107</b>	ATE 21278 16,4 - WE / - WK
2.0 16V 2.0 Turbo 2.5 Turbo Diesel	97 108 95	07/94→09/99 07/91→09/99 07/94→09/99	←	09/94→	<b>13.0460-3948.2</b>	<b>603948</b>	BDX 21508 17,0 + WK
			→	09/94→; → S 91036112	<b>13.0460-4014.2</b>	<b>604014</b>	ATE 21278 16,4 + WK
			→	S 91036113→	<b>13.0460-7107.2</b>	<b>607107</b>	ATE 21278 16,4 - WE / - WK
↓							

	kW			 	! #		
<b>PEUGEOT - 605 (6B) 06/89→09/99</b>							
 <b>Bremsbelagsatz, Scheibenbremse</b>							
2.0 Turbo	104	07/92→09/99	←	12/92→; → S 90807683		<b>13.0460-3902.2 603902</b>	BDX 20035 17,0 + WK
			←	→ 08/94; S 90807684→		<b>13.0460-3948.2 603948</b>	BDX 21508 17,0 + WK
			→	12/92→ 08/94		<b>13.0460-4014.2 604014</b>	ATE 21278 16,4 + WK
2.1 TD 12V	80	08/94→09/99	←	→ S 90807863		<b>13.0460-3902.2 603902</b>	BDX 20035 17,0 + WK
			←	S 90807684→		<b>13.0460-3948.2 603948</b>	BDX 21508 17,0 + WK
			→	→ S 91036112		<b>13.0460-4014.2 604014</b>	ATE 21278 16,4 + WK
2.1 Turbo Diesel	80	06/89→09/99	←	10/90→; → S 90807863		<b>13.0460-3902.2 603902</b>	BDX 20035 17,0 + WK
			←	S 90807684→		<b>13.0460-3948.2 603948</b>	BDX 21508 17,0 + WK
			→	10/90→; → S 91036112		<b>13.0460-4014.2 604014</b>	ATE 21278 16,4 + WK
3.0 SV 24	147	08/89→09/99	←	04/90→; → S 90807683		<b>13.0460-3902.2 603902</b>	BDX 20035 17,0 + WK
			→	04/90→; → S 91036112		<b>13.0460-4014.2 604014</b>	ATE 21278 16,4 + WK
			→	S 91036113→		<b>13.0460-7107.2 607107</b>	ATE 21278 16,4 - WE / - WK
3.0 V6	140	04/97→09/99	→			<b>13.0460-7107.2 607107</b>	ATE 21278 16,4 - WE / - WK
<b>Zubehörsatz, Scheibenbremsbelag</b>							
2.0	79	02/90→09/99	←	04/90→; → S 90807683		<b>13.0460-0206.2 610206</b>	BDX
2.0	84	06/89→09/99	→	04/90→; → S 91036112		<b>13.0460-0409.2 610409</b>	ATE
2.0	89	06/89→09/99	→				
3.0	123	10/89→09/99	→				
3.0 SV 24	147	08/89→09/99	→				
2.0 16V	97	07/94→09/99	→	09/94→; → S 91036112		<b>13.0460-0409.2 610409</b>	ATE
2.0 Turbo	108	07/91→09/99	→				
2.5 Turbo Diesel	95	07/94→09/99	→				
2.0 Turbo	104	07/92→09/99	←	12/92→; → S 90807683		<b>13.0460-0206.2 610206</b>	BDX
			→	12/92→ 08/94		<b>13.0460-0409.2 610409</b>	ATE
2.1 TD 12V	80	08/94→09/99	←	→ S 90807863		<b>13.0460-0206.2 610206</b>	BDX
			→	→ S 91036112		<b>13.0460-0409.2 610409</b>	ATE
2.1 Turbo Diesel	80	06/89→09/99	←	10/90→; → S 90807863		<b>13.0460-0206.2 610206</b>	BDX
			→	10/90→; → S 91036112		<b>13.0460-0409.2 610409</b>	ATE
 <b>Bremsscheibe</b>							
2.0	79	02/90→09/99	←	04/90→; → S 90807683		<b>24.0122-0141.1 422141</b>	Ø 276 22 20 V
2.0	84	06/89→09/99	←	S 90807684→		<b>24.0126-0100.1 426100</b>	Ø 283 26 24 V
2.0	89	06/89→09/99	←				
3.0	123	10/89→09/99	→	04/90→		<b>24.0110-0231.1 410231</b>	Ø 290 10 8
2.0 16V	97	07/94→09/99	←	09/94→		<b>24.0126-0100.1 426100</b>	Ø 283 26 24 V
2.0 Turbo	108	07/91→09/99	→	09/94→		<b>24.0110-0231.1 410231</b>	Ø 290 10 8
2.5 Turbo Diesel	95	07/94→09/99	→				
2.0 Turbo	104	07/92→09/99	←	12/92→; → S 90807683		<b>24.0122-0141.1 422141</b>	Ø 276 22 20 V
			←	→ 08/94; S 90807684→		<b>24.0126-0100.1 426100</b>	Ø 283 26 24 V
			→	12/92→ 08/94		<b>24.0110-0231.1 410231</b>	Ø 290 10 8
2.1 TD 12V	80	08/94→09/99	←	→ S 90807863		<b>24.0122-0141.1 422141</b>	Ø 276 22 20 V
			←	S 90807684→		<b>24.0126-0100.1 426100</b>	Ø 283 26 24 V
			→			<b>24.0110-0231.1 410231</b>	Ø 290 10 8
2.1 Turbo Diesel	80	06/89→09/99	←	10/90→; → S 90807863		<b>24.0122-0141.1 422141</b>	Ø 276 22 20 V
			←	S 90807684→		<b>24.0126-0100.1 426100</b>	Ø 283 26 24 V
			→	10/90→		<b>24.0110-0231.1 410231</b>	Ø 290 10 8
3.0 SV 24	147	08/89→09/99	←	04/90→; → S 90807683		<b>24.0122-0141.1 422141</b>	Ø 276 22 20 V
			←	S 90807684→		<b>24.0128-0195.1 428195</b>	Ø 295 28 26 V
			→	04/90→		<b>24.0110-0231.1 410231</b>	Ø 290 10 8
3.0 V6	140	04/97→09/99	←			<b>24.0126-0100.1 426100</b>	Ø 283 26 24 V
			→			<b>24.0110-0231.1 410231</b>	Ø 290 10 8
<b>PEUGEOT - 607 (9D, 9U) 01/00→</b>							
 <b>Bremsbelagsatz, Scheibenbremse</b>							
2.0	100	02/00→08/05	←	→ 11/04		<b>13.0460-2844.2 602844</b>	TRW 21674 19,4 + WK + Zub
2.0 HDI	80	05/00→09/05	←				
2.2 16V	116	02/00→08/05	←	12/04→		<b>13.0460-2892.2 602892</b>	TRW 24133 18,6 + WK + Zub
↓							



**PEUGEOT - 607 (9D, 9U) 01/00→**

**Bremsbelagsatz, Scheibenbremse**

2.2 HDi	98	02/00→02/06	←	12/04→	13.0470-2892.2	LD2892	TRW 24133 18,6 + WK + Zub Ceramic
			→	12/04→	13.0460-2893.2	602893	TRW 24135 17,7 - WK
			→	→ 11/04	13.0470-2893.2	LD2893	TRW 24135 17,7 - WK Ceramic
2.0 HDi	79	03/01→09/04	←	→ 07/04	13.0460-2844.2	602844	TRW 21674 19,4 + WK + Zub
			→	→ 07/04	13.0460-7134.2	607134	ATE 21278 16,4 - WE / - WK
2.0 HDi 2.7 HDi 24V 3.0 V6 24V	100 150 155	09/05→07/11 12/04→07/11 03/04→07/11	←	→ 12/10	13.0460-2892.2	602892	TRW 24133 18,6 + WK + Zub
			→	→ 12/10	13.0470-2892.2	LD2892	TRW 24133 18,6 + WK + Zub Ceramic
2.2 16V 2.2 HDi	120 125	09/05→06/10 05/06→06/10	←		13.0460-2892.2	602892	TRW 24133 18,6 + WK + Zub
			→		13.0470-2892.2	LD2892	TRW 24133 18,6 + WK + Zub Ceramic
3.0 V6 24V	152	02/00→07/04	←		13.0460-2893.2	602893	TRW 24135 17,7 - WK
			→		13.0470-2893.2	LD2893	TRW 24135 17,7 - WK Ceramic
3.0 V6 24V	152	02/00→07/04	←		13.0460-4972.2	604972	BRE 23575 16,0 + WK + Zub
			→		13.0460-7134.2	607134	ATE 21278 16,4 - WE / - WK

**Zubehörsatz, Scheibenbremsbelag**

2.0 2.0 HDi 2.2 16V 2.2 HDi	100 80 116 98	02/00→08/05 05/00→09/05 02/00→08/05 02/00→02/06	→	→ 11/04	13.0460-0409.2	610409	ATE
2.0 HDi	79	03/01→09/04	→	→ 07/04	13.0460-0409.2	610409	ATE
3.0 V6 24V	152	02/00→07/04	→		13.0460-0409.2	610409	ATE











**Bremsscheibe**











2.0 2.0 HDi 2.2 16V 2.2 HDi	100 80 116 98	02/00→08/05 05/00→09/05 02/00→08/05 02/00→02/06	←	→ 11/04	24.0126-0121.1	426121	Ø 283 26 24 V + S
			→	12/04→	24.0130-0181.1	430181	Ø 330 30 28 V + S
2.0 HDi	79	03/01→09/04	←	→ 11/04	24.0110-0272.1	410272	Ø 290 10 8
			→	12/04→	24.0112-0162.1	412162	Ø 290 12 10 + S
2.0 HDi	79	03/01→09/04	←	→ 07/04	24.0126-0121.1	426121	Ø 283 26 24 V + S
			→	→ 07/04	24.0110-0272.1	410272	Ø 290 10 8
2.0 HDi 2.7 HDi 24V 3.0 V6 24V	100 150 155	09/05→07/11 12/04→07/11 03/04→07/11	←	→ 12/10	24.0130-0181.1	430181	Ø 330 30 28 V + S
			→	→ 12/10	24.0112-0162.1	412162	Ø 290 12 10 + S
2.2 16V 2.2 HDi	120 125	09/05→06/10 05/06→06/10	←		24.0130-0181.1	430181	Ø 330 30 28 V + S
			→		24.0112-0162.1	412162	Ø 290 12 10 + S
3.0 V6 24V	152	02/00→07/04	←		24.0132-0152.1	432152	Ø 309 32 30 V
			→		24.0110-0272.1	410272	Ø 290 10 8











**PEUGEOT - 806 (221) 06/94→08/02**















**Bremsbelagsatz, Scheibenbremse**

1.8	73	07/95→08/02	←	10/96→ 06/02	13.0460-3957.2	603957	BDX 23042 19,0 + WK + Zub
			→	10/96→ 06/02; + ABS	13.0460-7061.2	607061	ATE 21275 17,0 + WK
1.9 TD 1.9 TD 2.0 HDi 2.0 HDi 16V	66 68 80 80	07/95→08/02 05/97→08/02 08/99→08/02 08/99→08/02	←	→ 06/02	13.0460-2978.2	602978	TRW 21801 19,0 + WK
			→	→ 06/02; + ABS	13.0460-7061.2	607061	ATE 21275 17,0 + WK
2.0	89	06/94→08/02	←	08/94→ 06/02	13.0460-2978.2	602978	TRW 21801 19,0 + WK
			→	08/94→ 06/02; + ABS	13.0460-7061.2	607061	ATE 21275 17,0 + WK
2.0 16V	97	05/98→09/00	←	10/98→	13.0460-2978.2	602978	TRW 21801 19,0 + WK
			→	10/98→	13.0460-7061.2	607061	ATE 21275 17,0 + WK
2.0 16V	100	09/00→08/02	←	→ 06/02	13.0460-2978.2	602978	TRW 21801 19,0 + WK
			→	→ 06/02	13.0460-7061.2	607061	ATE 21275 17,0 + WK
2.0 Turbo	108	06/94→08/02	←	08/94→ 06/02	13.0460-2978.2	602978	TRW 21801 19,0 + WK
			→	08/94→ 06/02	13.0460-7061.2	607061	ATE 21275 17,0 + WK
2.1 td 12V ↓	80	06/96→08/99	←		13.0460-2978.2	602978	TRW 21801 19,0 + WK















	kW			 	! #		
<b>PEUGEOT - 806 (221) 06/94 → 08/02</b>							
 <b>Bremsbelagsatz, Scheibenbremse</b>							
2.1 td 12V	80	06/96 → 08/99	➡			<b>13.0460-7061.2 607061</b>	ATE 21275 17,0 + WK
 <b>Bremsscheibe</b>							
1.8	73	07/95 → 08/02	←	10/96 → 06/02		<b>24.0120-0155.1 420155</b>	Ø 257,5 20 18,2 V
			➡	10/96 → 06/02; + ABS		<b>24.0110-0218.1 410218</b>	Ø 295 10 8
1.9 TD	66	07/95 → 08/02	←	→ 06/02		<b>24.0126-0104.1 426104</b>	Ø 281 26 24,2 V
1.9 TD	68	05/97 → 08/02	➡	→ 06/02; + ABS		<b>24.0110-0218.1 410218</b>	Ø 295 10 8
2.0 HDi	80	08/99 → 08/02					
2.0 HDi 16V	80	08/99 → 08/02					
2.0	89	06/94 → 08/02	←	08/94 → 06/02		<b>24.0126-0104.1 426104</b>	Ø 281 26 24,2 V
			➡	08/94 → 06/02; + ABS		<b>24.0110-0218.1 410218</b>	Ø 295 10 8
2.0 16V	97	05/98 → 09/00	←	10/98 →		<b>24.0126-0104.1 426104</b>	Ø 281 26 24,2 V
			➡	10/98 →		<b>24.0110-0218.1 410218</b>	Ø 295 10 8
2.0 16V	100	09/00 → 08/02	←	→ 06/02		<b>24.0126-0104.1 426104</b>	Ø 281 26 24,2 V
			➡	→ 06/02		<b>24.0110-0218.1 410218</b>	Ø 295 10 8
2.0 Turbo	108	06/94 → 08/02	←	08/94 → 06/02		<b>24.0126-0104.1 426104</b>	Ø 281 26 24,2 V
			➡	08/94 → 06/02		<b>24.0110-0218.1 410218</b>	Ø 295 10 8
2.1 td 12V	80	06/96 → 08/99	←			<b>24.0126-0104.1 426104</b>	Ø 281 26 24,2 V
			➡			<b>24.0110-0218.1 410218</b>	Ø 295 10 8
<b>PEUGEOT - 807 (E) 06/02 →</b>							
 <b>Bremsbelagsatz, Scheibenbremse</b>							
2.0	100	06/02 →	←	→ 06/14		<b>13.0460-2863.2 602863</b>	TRW 20261 19,0 + WK + Zub
2.0 16V	103	09/05 →	➡	→ 06/14		<b>13.0460-2819.2 602819</b>	TRW 20961 17,2 - WK
2.0 HDi	79	06/02 →					
2.0 HDi	100	06/06 →					
2.2	116	06/02 →					
2.2 HDi	94	06/02 →					
2.2 HDi	100	04/04 →					
2.0 HDi	80	04/04 → 05/06	←	→ 05/06		<b>13.0460-2863.2 602863</b>	TRW 20261 19,0 + WK + Zub
			➡	→ 05/06		<b>13.0460-2819.2 602819</b>	TRW 20961 17,2 - WK
2.0 HDi	88	02/06 →	←	11/06 → 06/14		<b>13.0460-2863.2 602863</b>	TRW 20261 19,0 + WK + Zub
			➡	11/06 → 06/14		<b>13.0460-2819.2 602819</b>	TRW 20961 17,2 - WK
2.0 HDi	120	06/09 →	←	→ 06/14		<b>13.0460-2752.2 602752</b>	TRW 24839 19,4 + WK + Zub
			➡	→ 06/14		<b>13.0460-2819.2 602819</b>	TRW 20961 17,2 - WK
2.2 HDi	120	06/06 →	←	01/07 → 06/14		<b>13.0460-2752.2 602752</b>	TRW 24839 19,4 + WK + Zub
2.2 HDi	125	06/06 →	➡	10/07 → 06/14		<b>13.0460-2819.2 602819</b>	TRW 20961 17,2 - WK
3.0 V6	150	06/02 →	←	→ 06/14		<b>13.0460-4995.2 604995</b>	BRE 23575 15,6 + WK
			➡	→ 06/14		<b>13.0460-2819.2 602819</b>	TRW 20961 17,2 - WK
<b>Zubehörsatz, Scheibenbremsbelag</b>							
2.0	100	06/02 →	➡	→ 06/14		<b>13.0460-0072.2 610072</b>	TRW
2.0 16V	103	09/05 →					
2.0 HDi	79	06/02 →					
2.0 HDi	120	06/09 →					
2.0 HDi	100	06/06 →					
2.2	116	06/02 →					
2.2 HDi	94	06/02 →					
2.2 HDi	100	04/04 →					
3.0 V6	150	06/02 →					
2.0 HDi	80	04/04 → 05/06	➡	→ 05/06		<b>13.0460-0072.2 610072</b>	TRW
2.0 HDi	88	02/06 →	➡	11/06 → 06/14		<b>13.0460-0072.2 610072</b>	TRW
2.2 HDi	120	06/06 →	➡	10/07 → 06/14		<b>13.0460-0072.2 610072</b>	TRW
2.2 HDi	125	06/06 →					
 <b>Bremsscheibe</b>							
2.0	100	06/02 →	←	→ 06/14		<b>24.0128-0136.1 428136</b>	Ø 285 28 26 V
2.0 16V	103	09/05 →				<b>24.0328-0136.1 528136</b>	Ø 285 28 26 V
2.0 HDi	79	06/02 →	➡	→ 06/14		<b>24.0112-0156.1 412156</b>	Ø 272 12 10
2.0 HDi	120	06/09 →					
2.0 HDi	100	06/06 →					
2.2	116	06/02 →					
2.2 HDi	94	06/02 →					
2.2 HDi	100	04/04 →					
2.0 HDi	80	04/04 → 05/06	←	→ 05/06		<b>24.0128-0136.1 428136</b>	Ø 285 28 26 V
↓							











	kW			 	! #		
<b>PEUGEOT - 807 (E) 06/02→</b>							
 <b>Bremsscheibe</b>							
2.0 HDi	80	04/04→05/06	←	→ 05/06		24.0328-0136.1 528136	Ø 285 28 26 V
			→	→ 05/06		24.0112-0156.1 412156	Ø 272 12 10
2.0 HDi	88	02/06→	←	11/06→ 06/14		24.0128-0136.1 428136	Ø 285 28 26 V
			→	11/06→ 06/14		24.0328-0136.1 528136	Ø 285 28 26 V
			→	11/06→ 06/14		24.0112-0156.1 412156	Ø 272 12 10
2.2 HDi	120	06/06→	←	10/07→ 06/14		24.0132-0126.1 432126	Ø 310 32 30 V
2.2 HDi	125	06/06→	→	10/07→ 06/14		24.0112-0156.1 412156	Ø 272 12 10
3.0 V6	150	06/02→	←	→ 06/14		24.0132-0126.1 432126	Ø 310 32 30 V
			→	→ 06/14		24.0112-0156.1 412156	Ø 272 12 10
<b>PEUGEOT - 1007 (KM_) 04/05→</b>							
 <b>Bremsbelagsatz, Scheibenbremse</b>							
1.4	54	04/05→	←	→ 02/11		13.0460-3994.2 603994	BOS 23599 19,0 - WE / - WK + Zub
1.4 16V	65	10/05→					
1.4 HDi	50	04/05→				13.0470-3994.2 LD3994	BOS 23599 19,0 - WE / - WK + Zub Ceramic
1.6 16V	80	04/05→	←	→ 02/11		13.0460-3994.2 603994	BOS 23599 19,0 - WE / - WK + Zub
			→	→ 02/11		13.0470-3994.2 LD3994	BOS 23599 19,0 - WE / - WK + Zub Ceramic
			→	→ 02/11		13.0460-2820.2 602820	TRW 20961 17,2 - WK
			→	→ 02/11		13.0470-2820.2 LD2820	TRW 20961 17,2 - WK Ceramic
1.6 HDi	80	06/07→	←	→ 02/11		13.0460-3966.2 603966	BOS 23600 19,4 - WE / - WK + Zub
			→	→ 02/11		13.0470-3966.2 LD3966	BOS 23600 19,4 - WE / - WK + Zub Ceramic
			→	→ 02/11		13.0460-2820.2 602820	TRW 20961 17,2 - WK
			→	→ 02/11		13.0470-2820.2 LD2820	TRW 20961 17,2 - WK Ceramic
 <b>Bremsscheibe</b>							
1.4	54	04/05→	←	→ 02/11		24.0122-0194.1 422194	Ø 266 22 20 V + S
1.4 16V	65	10/05→					
1.4 HDi	50	04/05→					
1.6 16V	80	04/05→	←	→ 02/11		24.0122-0194.1 422194	Ø 266 22 20 V + S
			→	→ 02/11		24.0109-0137.1 409137	Ø 247 9 8 + S
1.6 HDi	80	06/07→	←	→ 02/11		24.0126-0120.1 426120	Ø 283 26 24 V + S
			→	→ 02/11		24.0326-0120.1 526120	Ø 283 26 24 V + S
			→	→ 02/11		24.0109-0137.1 409137	Ø 247 9 8 + S
<b>PEUGEOT - 2008 (CU_) 03/13→</b>							
 <b>Bremsbelagsatz, Scheibenbremse</b>							
1.2 PureTech 82	61	03/18→	←	für Bremsscheibendurchmesser [mm]: 283; →Orga 14783		13.0460-3855.2 603855	BOS 24883 18,0 - WE / - WK + Zub
1.5 BlueHDI 100	75	05/18→					
1.5 BlueHDI 120	88	05/18→				13.0470-3855.2 LD3855	BOS 24883 18,0 - WE / - WK + Zub Ceramic
			←	für Bremsscheibendurchmesser [mm]: 266		13.0460-3994.2 603994	BOS 23599 19,0 - WE / - WK + Zub
						13.0470-3994.2 LD3994	BOS 23599 19,0 - WE / - WK + Zub Ceramic
			→	Made in Frankreich		13.0460-2740.2 602740	TRW 23554 17,0 - WE / - WK + Zub
						13.0470-2740.2 LD2740	TRW 23554 17,0 - WE / - WK + Zub Ceramic
1.2 THP 110	81	01/15→	←	für Bremsscheibendurchmesser [mm]: 283; →Orga 14783		13.0460-3855.2 603855	BOS 24883 18,0 - WE / - WK + Zub
1.2 THP 130	96	01/15→					
1.2 VTi	60	03/13→	←	für Bremsscheibendurchmesser [mm]: 266		13.0460-3994.2 603994	BOS 23599 19,0 - WE / - WK + Zub
1.4 HDi	50	06/13→					
1.6 BlueHDI 100	73	01/15→				13.0470-3994.2 LD3994	BOS 23599 19,0 - WE / - WK + Zub Ceramic
1.6 BlueHDI 120	88	07/14→					
1.6 BlueHDI 75	55	01/15→					
1.6 HDi	68	03/13→	←	für Bremsscheibendurchmesser [mm]: 283		13.0470-3855.2 LD3855	BOS 24883 18,0 - WE / - WK + Zub Ceramic
1.6 HDi	84	03/13→					
1.6 HDi	85	07/14→					
1.6 VTi	88	03/13→	→			13.0460-2740.2 602740	TRW 23554 17,0 - WE / - WK + Zub
						13.0470-2740.2 LD2740	TRW 23554 17,0 - WE / - WK + Zub Ceramic

	kW			 	! #		
<b>PEUGEOT - 2008 (CU_) 03/13→</b>							
 <b>Bremsscheibe</b>							
1.2 PureTech 82	61	03/18→	←			24.0122-0194.1 422194	Ø 266 22 20 V + S
1.5 BlueHDI 100	75	05/18→				24.0126-0120.1 426120	Ø 283 26 24 V + S
1.5 BlueHDI 120	88	05/18→	→			24.0109-0100.2 409100	Ø 249 9 7 + LG / + ABS Ring
1.2 THP 110	81	01/15→	←			24.0122-0194.1 422194	Ø 266 22 20 V + S
1.2 THP 130	96	01/15→				24.0126-0120.1 426120	Ø 283 26 24 V + S
1.2 VTi	60	03/13→				24.0326-0120.1 526120	Ø 283 26 24 V + S
1.4 HDi	50	06/13→					
1.6 BlueHDI 100	73	01/15→	→			24.0109-0100.2 409100	Ø 249 9 7 + LG / + ABS Ring
1.6 BlueHDI 120	88	07/14→					
1.6 BlueHDI 75	55	01/15→					
1.6 HDi	68	03/13→					
1.6 HDi	84	03/13→					
1.6 HDi	85	07/14→					
1.6 VTi	88	03/13→					
<b>PEUGEOT - 3008 Großraumlimousine (0U_) 06/09→12/16</b>							
 <b>Bremsbelagsatz, Scheibenbremse</b>							
1.2	96	01/15→	←			13.0460-3847.2 603847	BOS 24660 17,8 - WE / - WK + Zub
1.6 BlueHDI 120	88	05/14→				13.0470-3847.2 LD3847	BOS 24660 17,8 - WE / - WK + Zub Ceramic
1.6 HDi	80	06/09→					
1.6 HDi	82	12/09→08/16					
1.6 HDi	84	03/13→	→			13.0460-2761.2 602761	TRW 24922 16,5 - WK + Zub
1.6 HDi 115 / BlueHDI 115	85	02/13→					
1.6 VTi	88	06/09→					
1.6 THP	110	06/09→	←			13.0460-7202.2 607202	ATE 23589 19,1 - WE / - WK
1.6 THP	115	06/09→				13.0460-7230.2 607230	ATE 24557 19,4 - WE / - WK
1.6 Turbo	121	05/14→				13.0470-7202.2 LD7202	ATE 23589 19,1 - WE / - WK Ceramic
2.0 HDi	100	09/11→				13.0470-7230.2 LD7230	ATE 24557 19,4 - WE / - WK Ceramic
2.0 HDi	120	06/09→					
2.0 HDi 150 / BlueHDI 150	110	06/09→	→			13.0460-2761.2 602761	TRW 24922 16,5 - WK + Zub
2.0 BlueHDI 135 Hybrid	100	01/15→12/16	→	für Bremsscheibendurchmesser [mm]: 268		13.0460-3871.2 603871	BOS 25839 17,8 - WE / - WK + Zub
2.0 BlueHDI 150 Hybrid	110	01/15→12/16				13.0470-3871.2 LD3871	BOS 25839 17,8 - WE / - WK + Zub Ceramic
			→	für Bremsscheibendurchmesser [mm]: 290		13.0460-3872.2 603872	BOS 25827 17,7 - WE / - WK + Zub
						13.0470-3872.2 LD3872	BOS 25827 17,7 - WE / - WK + Zub Ceramic
2.0 HDi Hybrid4	120	02/11→	←			13.0460-7230.2 607230	ATE 24557 19,4 - WE / - WK
2.0 HDi Hybrid4	147	11/11→				13.0470-7230.2 LD7230	ATE 24557 19,4 - WE / - WK Ceramic
			→			13.0460-2761.2 602761	TRW 24922 16,5 - WK + Zub
 <b>Bremsscheibe</b>							
1.2	96	01/15→	←			24.0126-0120.1 426120	Ø 283 26 24 V + S
1.6 BlueHDI 120	88	05/14→				24.0326-0120.1 526120	Ø 283 26 24 V + S
1.6 HDi	80	06/09→	→			24.0112-0194.2 412194	Ø 268 12 10 + LG / + ABS Ring
1.6 HDi	82	12/09→08/16					
1.6 HDi	84	03/13→					
1.6 HDi 115 / BlueHDI 115	85	02/13→					
1.6 VTi	88	06/09→					
1.6 THP	110	06/09→	←			24.0126-0159.1 426159	Ø 302 26 24 V + S
1.6 THP	115	06/09→	→			24.0112-0194.2 412194	Ø 268 12 10 + LG / + ABS Ring
1.6 Turbo	121	05/14→	←			24.0126-0140.1 426140	Ø 302 26 24 außenbelüftet + S
			→			24.0112-0194.2 412194	Ø 268 12 10 + LG / + ABS Ring
2.0 BlueHDI 135 Hybrid	100	01/15→12/16	←			24.0128-0269.1 428269	Ø 304 28 26 V + S
2.0 BlueHDI 150 Hybrid	110	01/15→12/16	→			24.0112-0211.1 412211	Ø 268 12 10 + S
						24.0112-0212.1 412212	Ø 290 12 10 + S
2.0 HDi	100	09/11→	←			24.0126-0140.1 426140	Ø 302 26 24 außenbelüftet + S
2.0 HDi	120	06/09→				24.0126-0159.1 426159	Ø 302 26 24 V + S
2.0 HDi 150 / BlueHDI 150	110	06/09→	→			24.0112-0194.2 412194	Ø 268 12 10 + LG / + ABS Ring
2.0 HDi Hybrid4	120	02/11→	←			24.0126-0140.1 426140	Ø 302 26 24 außenbelüftet + S
2.0 HDi Hybrid4	147	11/11→				24.0126-0159.1 426159	Ø 302 26 24 V + S
			→			24.0112-0198.1 412198	Ø 290 12 10 + S







	kw			 	! #		
<b>PEUGEOT - 3008 SUV (M_) 05/16→</b>							
 <b>Bremsbelagsatz, Scheibenbremse</b>							
1.2	96	05/16→	➔	für Bremsscheibendurchmesser [mm]: 268	13.0460-3871.2	603871	BOS 25839 17,8 - WE / - WK + Zub
1.5 BlueHDi 130	96	02/18→					
1.6 BlueHDi 100	73	11/16→	➔	für Bremsscheibendurchmesser [mm]: 290	13.0470-3871.2	LD3871	BOS 25839 17,8 - WE / - WK + Zub Ceramic
1.6 BlueHDi 115	85	11/16→					
1.6 BlueHDi 120	88	05/16→	➔	für Bremsscheibendurchmesser [mm]: 290	13.0460-3872.2	603872	BOS 25827 17,7 - WE / - WK + Zub
1.6 THP 165	121	05/16→					
2.0 BlueHDi 136	100	11/16→	➔	für Bremsscheibendurchmesser [mm]: 290	13.0470-3872.2	LD3872	BOS 25827 17,7 - WE / - WK + Zub Ceramic
2.0 BlueHDi 150	110	05/16→					
2.0 BlueHDi 180	130	01/18→					
2.0 BlueHDi 180	133	05/16→					
 <b>Bremsscheibe</b>							
1.2	96	05/16→	➔		24.0128-0269.1	428269	Ø 304 28 26 V + S
1.5 BlueHDi 130	96	02/18→					
1.6 BlueHDi 100	73	11/16→	➔		24.0112-0211.1	412211	Ø 268 12 10 + S
1.6 BlueHDi 115	85	11/16→					
1.6 BlueHDi 120	88	05/16→	➔		24.0112-0212.1	412212	Ø 290 12 10 + S
1.6 THP 165	121	05/16→					
2.0 BlueHDi 136	100	11/16→					
2.0 BlueHDi 150	110	05/16→					
2.0 BlueHDi 180	130	01/18→					
2.0 BlueHDi 180	133	05/16→					
<b>PEUGEOT - 4007 (GP_) 02/07→</b>							
 <b>Bremsbelagsatz, Scheibenbremse</b>							
2.0	108	11/10→	➔	→ 11/12	13.0460-5958.2	605958	AKE 21363 15,8 + WK
2.0 4x4	108	11/10→					
2.2 HDi	115	02/07→	➔	→ 11/12	13.0460-5855.2	605855	23582 16,0 - WK
2.4 16V	125	01/08→					
<b>Zubehörsatz, Scheibenbremsbelag</b>							
2.0	108	11/10→	➔	→ 11/12	13.0460-0235.2	610235	
2.0 4x4	108	11/10→					
2.2 HDi	115	02/07→	➔	→ 11/12	13.0460-0137.2	610137	
2.4 16V	125	01/08→					
 <b>Bremsscheibe</b>							
2.0	108	11/10→	➔	→ 11/12	24.0124-0215.1	424215	Ø 294 24 22,4 V
2.0 4x4	108	11/10→					
2.2 HDi	115	02/07→	➔	→ 11/12	24.0110-0360.1	410360	Ø 302 10 8,4
2.4 16V	125	01/08→					
2.2 HDi	115	02/07→	➔	→ 11/12	24.0124-0215.1	424215	Ø 294 24 22,4 V
2.4 16V	125	01/08→					
2.4 16V	125	01/08→	➔	→ 11/12	24.0110-0330.1	410330	Ø 302 10 8
<b>PEUGEOT - 4008 05/12→</b>							
 <b>Bremsbelagsatz, Scheibenbremse</b>							
1.6	86	05/12→	➔		13.0460-5760.2	605760	AKE 23584 16,4 + WK
1.6 HDi	84	05/12→					
1.6 HDi AWC	84	05/12→	➔	Orga 13115→	13.0460-5654.2	605654	MAN 25688 14,4 + WK
1.8 HDi	110	05/12→					
1.8 HDi AWC	110	05/12→	➔	→Orga 13114	13.0460-5855.2	605855	23582 16,0 - WK
2.0 AWC	110	05/12→					
 <b>Bremsscheibe</b>							
1.6	86	05/12→	➔		24.0126-0170.1	426170	Ø 294 26 24,4 V
1.6 HDi	84	05/12→					
1.6 HDi AWC	84	05/12→	➔	→Orga 13114	24.0110-0360.1	410360	Ø 302 10 8,4
1.8 HDi	110	05/12→					
1.8 HDi AWC	110	05/12→	➔	Orga 13115→	24.0110-0395.1	410395	Ø 302 10 8,4
2.0 AWC	110	05/12→					
<b>PEUGEOT - 5008 (OU_, 0E_) 06/09→</b>							
 <b>Bremsbelagsatz, Scheibenbremse</b>							
1.2	96	01/15→	➔		13.0460-7230.2	607230	ATE 24557 19,4 - WE / - WK
1.6 16V	115	09/09→					
1.6 BlueHDi 120	88	05/14→03/17	➔		13.0470-7230.2	LD7230	ATE 24557 19,4 - WE / - WK Ceramic
1.6 THP 150	110	02/12→					
1.6 THP 163	120	02/12→	➔		13.0460-2761.2	602761	TRW 24922 16,5 - WK + Zub
1.6 THP 165	121	02/12→					
2.0 HDi	120	09/09→	➔				
2.0 HDi 136 / BlueHDi 136	100	02/12→					
1.6 16V	88	09/09→	➔		13.0460-7229.2	607229	ATE 24538 18,5 - WE / - WK
1.6 HDi	80	09/09→					
1.6 HDi	82	08/10→	➔		13.0470-7229.2	LD7229	ATE 24538 18,5 - WE / - WK Ceramic
1.6 HDi	84	03/13→					
			➔		13.0460-2761.2	602761	TRW 24922 16,5 - WK + Zub
↓							















	kw					! #		
<b>PEUGEOT - 5008 (0U_, 0E_) 06/09→</b>								
 <b>Bremsbelagsatz, Scheibenbremse</b>								
2.0 HDi 150 / BlueHDi 150	110	06/09→	←	09/09→		13.0460-7230.2	607230	ATE 24557 19,4 - WE / - WK
						13.0470-7230.2	LD7230	ATE 24557 19,4 - WE / - WK Ceramic
			→	09/09→		13.0460-2761.2	602761	TRW 24922 16,5 - WK + Zub
 <b>Bremsscheibe</b>								
1.2	96	01/15→	←			24.0126-0159.1	426159	Ø 302 26 24 V + S
1.6 16V	115	09/09→						
1.6 BlueHDi 120	88	05/14→03/17	→			24.0112-0194.2	412194	Ø 268 12 10 + LG / + ABS Ring
1.6 THP 150	110	02/12→						
1.6 THP 163	120	02/12→						
1.6 THP 165	121	02/12→						
2.0 HDi	120	09/09→						
2.0 HDi 136 / BlueHDi 136	100	02/12→						
1.6 16V	88	09/09→	←			24.0126-0120.1	426120	Ø 283 26 24 V + S
1.6 HDi	80	09/09→				24.0326-0120.1	526120	Ø 283 26 24 V + S
1.6 HDi	82	08/10→						
1.6 HDi	84	03/13→	→			24.0112-0194.2	412194	Ø 268 12 10 + LG / + ABS Ring
2.0 HDi 150 / BlueHDi 150	110	06/09→	←	09/09→		24.0126-0159.1	426159	Ø 302 26 24 V + S
			→	09/09→		24.0112-0194.2	412194	Ø 268 12 10 + LG / + ABS Ring
<b>PEUGEOT - 5008 II 12/16→</b>								
 <b>Bremsbelagsatz, Scheibenbremse</b>								
1.2	96	12/16→	→	für Bremsscheibendurchmesser [mm]: 290		13.0460-3872.2	603872	BOS 25827 17,7 - WE / - WK + Zub
1.6 BlueHDi 100	73	12/16→				13.0470-3872.2	LD3872	BOS 25827 17,7 - WE / - WK + Zub Ceramic
1.6 BlueHDi 115	85	12/16→						
1.6 BlueHDi 120	88	12/16→						
1.6 THP 165	121	12/16→						
2.0 BlueHDi 136	100	12/16→						
2.0 BlueHDi 150	110	12/16→						
2.0 BlueHDi 180	133	12/16→						
1.5 BlueHDi 130	96	02/18→	→			13.0460-3872.2	603872	BOS 25827 17,7 - WE / - WK + Zub
2.0 BlueHDi 180	130	01/18→				13.0470-3872.2	LD3872	BOS 25827 17,7 - WE / - WK + Zub Ceramic
 <b>Bremsscheibe</b>								
1.2	96	12/16→	←			24.0128-0269.1	428269	Ø 304 28 26 V + S
1.6 BlueHDi 100	73	12/16→						
1.6 BlueHDi 115	85	12/16→	→	für Bremsscheibendurchmesser [mm]: 290		24.0112-0212.1	412212	Ø 290 12 10 + S
1.6 BlueHDi 120	88	12/16→						
1.6 THP 165	121	12/16→						
2.0 BlueHDi 136	100	12/16→						
2.0 BlueHDi 150	110	12/16→						
2.0 BlueHDi 180	133	12/16→						
1.5 BlueHDi 130	96	02/18→	←			24.0128-0269.1	428269	Ø 304 28 26 V + S
2.0 BlueHDi 180	130	01/18→	→			24.0112-0212.1	412212	Ø 290 12 10 + S
<b>PEUGEOT - BIPPER (AA_) 02/08→</b>								
 <b>Bremsbelagsatz, Scheibenbremse</b>								
1.3 HDi 75	55	10/10→	←			13.0460-3863.2	603863	BOS 23706 18,0 + WK + Zub
1.4	54	02/08→	←			13.0460-3818.2	603818	BOS 23706 18,1 + WK
1.4 HDi	50	02/08→						
 <b>Bremsscheibe</b>								
1.3 HDi 75	55	10/10→	←			24.0122-0197.1	422197	Ø 257,5 22 20,2 V
1.4	54	02/08→				24.0322-0197.1	522197	Ø 257,5 22 20,2 V
1.4 HDi	50	02/08→	←	Schaltgetriebe, automatisch betätigt		24.0122-0147.1	422147	Ø 284 22 20,2 V
			←	Schaltgetriebe		24.0122-0197.1	422197	Ø 257,5 22 20,2 V
						24.0322-0197.1	522197	Ø 257,5 22 20,2 V
<b>PEUGEOT - BIPPER Tepee 04/08→</b>								
 <b>Bremsbelagsatz, Scheibenbremse</b>								
1.3 HDi 75	55	10/10→	←			13.0460-3863.2	603863	BOS 23706 18,0 + WK + Zub
1.3 HDi 80	59	12/15→						
1.4	54	04/08→	←			13.0460-3818.2	603818	BOS 23706 18,1 + WK
1.4 HDi	50	04/08→						
↓								









	kw				! #		
<b>PEUGEOT - BIPPER Tepee 04/08→</b>							
 <b>Bremsscheibe</b>							
1.3 HDi 75	55	10/10→	←			24.0122-0197.1 422197	Ø 257,5 22 20,2 V
1.3 HDi 80	59	12/15→				24.0322-0197.1 522197	Ø 257,5 22 20,2 V
1.4	54	04/08→					
1.4 HDi	50	04/08→	←	Schaltgetriebe, automatisch betätigt		24.0122-0147.1 422147	Ø 284 22 20,2 V
			←	Schaltgetriebe		24.0122-0197.1 422197	Ø 257,5 22 20,2 V
						24.0322-0197.1 522197	Ø 257,5 22 20,2 V
<b>PEUGEOT - BOXER Bus 09/05→</b>							
 <b>Bremsbelagsatz, Scheibenbremse</b>							
2.0 BlueHDi 110	81	07/15→	←	Nutzlast 12Q/14Q; Nutzlast ab [kg] 1.200		13.0460-4807.2 604807	BRE 24468 19,1 + WK + Zub
2.0 BlueHDi 130	96	07/15→		Nutzlast bis [kg] 1.400			
2.0 BlueHDi 160	120	07/15→	←	Nutzlast leicht 16Q; Nutzlast [kg]: 1.600; nicht für erhöhte Nutzlast		13.0460-4809.2 604809	BRE 24468 19,1 + WK + Zub
			←	Nutzlast 20Q; Nutzlast [kg]: 2.000		13.0460-4811.2 604811	BRE 24466 19,1 + WK + Zub
			←	Nutzlast schwer 16Q; Nutzlast [kg]: 1.600; für erhöhte Nutzlast		13.0460-4811.2 604811	BRE 24466 19,1 + WK + Zub
			→	Nutzlast 12Q/14Q/16Q; Nutzlast ab [kg] 1.200 Nutzlast bis [kg] 1.600		13.0460-4889.2 604889	BOS 22041 19,2 + WK + Zub
			→	Nutzlast 20Q; Nutzlast [kg]: 2.000		13.0460-4890.2 604890	BRE + WK + Zub
2.2 HDi 100	74	04/06→	←	Nutzlast 12Q/14Q; Nutzlast ab [kg] 1.200		13.0460-4807.2 604807	BRE 24468 19,1 + WK + Zub
2.2 HDi 110	81	03/11→		Nutzlast bis [kg] 1.400			
2.2 HDi 120	88	04/06→	←	Nutzlast leicht 16Q; Nutzlast [kg]: 1.600; nicht für erhöhte Nutzlast		13.0460-4809.2 604809	BRE 24468 19,1 + WK + Zub
2.2 HDi 130	96	03/11→					
2.2 HDi 150	110	03/11→					
3.0 HDi 145	107	04/10→	←	Nutzlast schwer 16Q; Nutzlast [kg]: 1.600; für erhöhte Nutzlast		13.0460-4810.2 604810	BRE 24466 19,1 + WK + Zub
3.0 HDi 160	116	04/06→					
3.0 HDi 175	130	03/11→	←	Nutzlast 20Q; Nutzlast [kg]: 2.000		13.0460-4811.2 604811	BRE 24466 19,1 + WK + Zub
			→			13.0460-4812.2 604812	BOS 24465 19,2 - WE / - WK + Zub
 <b>Bremsscheibe</b>							
2.0 BlueHDi 110	81	07/15→	←	Nutzlast leicht 12Q; Nutzlast ab [kg] 1.200		24.0124-0127.1 424127	Ø 280 24 21,9 V
2.0 BlueHDi 130	96	07/15→		Nutzlast bis [kg] 1.400			
2.0 BlueHDi 160	120	07/15→	→	Nutzlast 12Q/14Q + / leicht 16Q; Nutzlast ab [kg] 1.200 Nutzlast bis [kg] 1.600; nicht für erhöhte Nutzlast		24.0116-0124.1 416124	Ø 280 16 14,2
			→	Nutzlast schwer 16Q; Nutzlast [kg]: 1.600; für erhöhte Nutzlast		24.0116-0125.1 416125	Ø 280 16 14,2
2.2 HDi 100	74	04/06→	←	Nutzlast 12Q/14Q; Nutzlast ab [kg] 1.200		24.0124-0127.1 424127	Ø 280 24 21,9 V
2.2 HDi 110	81	03/11→		Nutzlast bis [kg] 1.400			
2.2 HDi 120	88	04/06→	←	Nutzlast schwer 16Q; Nutzlast [kg]: 1.600; für erhöhte Nutzlast		24.0124-0138.1 424138	Ø 300 24 21,9 V
2.2 HDi 130	96	03/11→					
2.2 HDi 150	110	03/11→	←	Nutzlast leicht 16Q; Nutzlast [kg]: 1.600; nicht für erhöhte Nutzlast		24.0128-0213.1 428213	Ø 280 28 25,9 V
3.0 HDi 145	107	04/10→					
3.0 HDi 160	116	04/06→	←	Nutzlast 20Q; Nutzlast [kg]: 2.000		24.0132-0131.1 432131	Ø 300 32 29,9 V
3.0 HDi 175	130	03/11→	→	Nutzlast 20Q; Nutzlast [kg]: 2.000		24.0116-0123.1 416123	Ø 300 16 14,2
			→	Nutzlast 12Q/14Q + / leicht 16Q; Nutzlast ab [kg] 1.200 Nutzlast bis [kg] 1.600; nicht für erhöhte Nutzlast		24.0116-0124.1 416124	Ø 280 16 14,2
			→	Nutzlast schwer 16Q; Nutzlast [kg]: 1.600; für erhöhte Nutzlast		24.0116-0125.1 416125	Ø 280 16 14,2
<b>PEUGEOT - BOXER Bus (230P) 03/94→04/02</b>							
 <b>Bremsbelagsatz, Scheibenbremse</b>							
1.9 D	51	03/94→04/02	←	01/00→ 10/01; Nutzlast [kg]: 1.000		13.0460-2850.2 602850	TRW 21797 19,7 + WK
			←	→ 12/99; Nutzlast [kg]: 1.000		13.0460-2976.2 602976	TRW 21797 19,7 + WK
			←	11/01→ 03/02; Nutzlast [kg]: 1.000		13.0460-4978.2 604978	BRE 23917 19,3 + WK + Zub
			→	11/01→ 03/02; Nutzlast [kg]: 1.000		13.0460-4980.2 604980	BRE 23921 20,3 - WE / - WK + Zub
1.9 TD	66	08/94→04/02	←	01/00→ 10/01; Nutzlast ab [kg] 1.000		13.0460-2850.2 602850	TRW 21797 19,7 + WK
1.9 TD	68	03/94→04/02		Nutzlast bis [kg] 1.400			
1.9 TD 4x4	68	07/96→04/02	←	→ 12/99; Nutzlast ab [kg] 1.000 Nutzlast bis [kg] 1.400		13.0460-2976.2 602976	TRW 21797 19,7 + WK
			←	11/01→ 03/02; Nutzlast ab [kg] 1.000 Nutzlast bis [kg] 1.400		13.0460-4978.2 604978	BRE 23917 19,3 + WK + Zub
			→	11/01→ 03/02; Nutzlast ab [kg] 1.000 Nutzlast bis [kg] 1.400		13.0460-4980.2 604980	BRE 23921 20,3 - WE / - WK + Zub
2.0 i	80	03/94→04/02	←	01/00→ 10/01; Nutzlast ab [kg] 1.000		13.0460-2850.2 602850	TRW 21797 19,7 + WK
2.0 i 4x4	80	08/96→04/02	←	Nutzlast bis [kg] 1.400			
			←	01/00→ 10/01; Nutzlast [kg]: 1.800		13.0460-2852.2 602852	TRW 21799 19,7 + WK









	kw				! #		
<b>PEUGEOT - BOXER Bus (230P) 03/94→04/02</b>							
<b> Bremsbelagsatz, Scheibenbremse</b>							
2.0 i 2.0 i 4x4	80 80	03/94→04/02 08/96→04/02	←	→ 12/99; Nutzlast ab [kg] 1.000 Nutzlast bis [kg] 1.400	13.0460-2976.2	602976	TRW 21797 19,7 + WK
			←	→ 12/99; Nutzlast [kg]: 1.800	13.0460-2977.2	602977	TRW 21799 19,7 + WK
			←	11/01→ 03/02; Nutzlast ab [kg] 1.000 Nutzlast bis [kg] 1.400	13.0460-4978.2	604978	BRE 23917 19,3 + WK + Zub
			←	11/01→ 03/02; Nutzlast [kg]: 1.800	13.0460-4979.2	604979	BRE 23919 19,3 + WK + Zub
			→	11/01→ 03/02; Nutzlast ab [kg] 1.000 Nutzlast bis [kg] 1.800	13.0460-4980.2	604980	BRE 23921 20,3 - WE / - WK + Zub
2.5 D 2.5 D 4x4 2.5 TD 4x4 2.5 TDI 2.5 TDI 4x4	63 63 76 79 79	08/94→04/02 07/96→04/02 07/96→04/02 01/97→04/02 01/97→04/02	←	01/00→ 10/01; Nutzlast [kg]: 1.400	13.0460-2850.2	602850	TRW 21797 19,7 + WK
			←	01/00→ 10/01; Nutzlast [kg]: 1.800	13.0460-2852.2	602852	TRW 21799 19,7 + WK
			←	→ 12/99; Nutzlast [kg]: 1.400	13.0460-2976.2	602976	TRW 21797 19,7 + WK
			←	→ 12/99; Nutzlast [kg]: 1.800	13.0460-2977.2	602977	TRW 21799 19,7 + WK
			←	11/01→ 03/02; Nutzlast [kg]: 1.400	13.0460-4978.2	604978	BRE 23917 19,3 + WK + Zub
			←	11/01→ 03/02; Nutzlast [kg]: 1.800	13.0460-4979.2	604979	BRE 23919 19,3 + WK + Zub
			→	11/01→ 03/02; Nutzlast ab [kg] 1.400 Nutzlast bis [kg] 1.800	13.0460-4980.2	604980	BRE 23921 20,3 - WE / - WK + Zub
2.5 DT	62	10/97→11/01	←	01/00→ 10/01; Nutzlast [kg]: 1.400	13.0460-2850.2	602850	TRW 21797 19,7 + WK
			←	01/00→ 10/01; Nutzlast [kg]: 1.800	13.0460-2852.2	602852	TRW 21799 19,7 + WK
			←	→ 12/99; Nutzlast [kg]: 1.400	13.0460-2976.2	602976	TRW 21797 19,7 + WK
			←	→ 12/99; Nutzlast [kg]: 1.800	13.0460-2977.2	602977	TRW 21799 19,7 + WK
			←	11/01→; Nutzlast [kg]: 1.400	13.0460-4978.2	604978	BRE 23917 19,3 + WK + Zub
			←	11/01→; Nutzlast [kg]: 1.800	13.0460-4979.2	604979	BRE 23919 19,3 + WK + Zub
			→	11/01→; Nutzlast ab [kg] 1.400 Nutzlast bis [kg] 1.800	13.0460-4980.2	604980	BRE 23921 20,3 - WE / - WK + Zub
2.5 TD	76	07/94→04/02	←	01/00→ 10/01; Nutzlast [kg]: 1.400	13.0460-2850.2	602850	TRW 21797 19,7 + WK
			←	01/00→ 10/01; Nutzlast [kg]: 1.800	13.0460-2852.2	602852	TRW 21799 19,7 + WK
			←	08/94→ 12/99; Nutzlast [kg]: 1.400	13.0460-2976.2	602976	TRW 21797 19,7 + WK
			←	08/94→ 12/99; Nutzlast [kg]: 1.800	13.0460-2977.2	602977	TRW 21799 19,7 + WK
			←	11/01→ 03/02; Nutzlast [kg]: 1.400	13.0460-4978.2	604978	BRE 23917 19,3 + WK + Zub
			←	11/01→ 03/02; Nutzlast [kg]: 1.800	13.0460-4979.2	604979	BRE 23919 19,3 + WK + Zub
			→	11/01→ 03/02; Nutzlast ab [kg] 1.400 Nutzlast bis [kg] 1.800	13.0460-4980.2	604980	BRE 23921 20,3 - WE / - WK + Zub
2.8 D	64	01/99→02/02	←	→ S 16206253; Nutzlast [kg]: 1.400	13.0460-2850.2	602850	TRW 21797 19,7 + WK
			←	→ S 16205352; Nutzlast [kg]: 1.800	13.0460-2976.2	602976	TRW 21797 19,7 + WK
			←	S 16204256→; Nutzlast [kg]: 1.400	13.0460-2977.2	602977	TRW 21799 19,7 + WK
			←	S 16204256→; → 03/02; Nutzlast ab [kg] 1.000 Nutzlast bis [kg] 1.400	13.0460-4978.2	604978	BRE 23917 19,3 + WK + Zub
			←	S 16194400→; Nutzlast [kg]: 1.800	13.0460-4979.2	604979	BRE 23919 19,3 + WK + Zub
2.8 HDi	93	10/00→11/01	→	11/01→; Nutzlast ab [kg] 1.400 Nutzlast bis [kg] 1.800	13.0460-4980.2	604980	BRE 23921 20,3 - WE / - WK + Zub
			←	→ 10/01; Nutzlast [kg]: 1.400	13.0460-2850.2	602850	TRW 21797 19,7 + WK
			←	→ 10/01; Nutzlast [kg]: 1.800	13.0460-2852.2	602852	TRW 21799 19,7 + WK
			←	11/01→ 03/02; Nutzlast [kg]: 1.400	13.0460-4978.2	604978	BRE 23917 19,3 + WK + Zub
			←	11/01→ 03/02; Nutzlast [kg]: 1.800	13.0460-4979.2	604979	BRE 23919 19,3 + WK + Zub
2.8 HDi 4x4	94	11/00→04/02	←	11/01→ 03/02; Nutzlast ab [kg] 1.400 Nutzlast bis [kg] 1.800	13.0460-4980.2	604980	BRE 23921 20,3 - WE / - WK + Zub
			←	→ S 16206253; Nutzlast ab [kg] 1.000 Nutzlast bis [kg] 1.400	13.0460-2850.2	602850	TRW 21797 19,7 + WK
			←	→ S 16205352; Nutzlast [kg]: 1.800	13.0460-2976.2	602976	TRW 21797 19,7 + WK
			←	→ S 16205352; Nutzlast [kg]: 1.800	13.0460-2977.2	602977	TRW 21799 19,7 + WK
			←	S 16204256→; → 03/02; Nutzlast ab [kg] 1.000 Nutzlast bis [kg] 1.400	13.0460-4978.2	604978	BRE 23917 19,3 + WK + Zub
			←	S 16194400→; → 03/02; Nutzlast [kg]: 1.800	13.0460-4979.2	604979	BRE 23919 19,3 + WK + Zub
2.8 HDi Allrad	93	10/00→11/01	→	S 16194400→; → 03/02; Nutzlast ab [kg] 1.000 Nutzlast bis [kg] 1.400	13.0460-4980.2	604980	BRE 23921 20,3 - WE / - WK + Zub
			→	S 16194400→; → 03/02; Nutzlast [kg]: 1.800	13.0460-4980.2	604980	BRE 23921 20,3 - WE / - WK + Zub
			←	→ S 16206253; Nutzlast ab [kg] 1.000 Nutzlast bis [kg] 1.400	13.0460-2850.2	602850	TRW 21797 19,7 + WK







	kw			 	! #		
<b>PEUGEOT - BOXER Bus (230P) 03/94→04/02</b>							
<b>Bremsbelagsatz, Scheibenbremse</b>							
2.8 HDi Allrad	93	10/00→11/01	←	→ S 16206253; Nutzlast ab [kg] 1.000 Nutzlast bis [kg] 1.400	13.0460-2976.2	602976	TRW 21797 19,7 + WK
			←	→ S 16205352; Nutzlast [kg]: 1.800	13.0460-2852.2	602852	TRW 21799 19,7 + WK
					13.0460-2977.2	602977	TRW 21799 19,7 + WK
			←	S 16204256→; Nutzlast ab [kg] 1.000 Nutzlast bis [kg] 1.400	13.0460-4978.2	604978	BRE 23917 19,3 + WK + Zub
			←	S 16194400→; Nutzlast [kg]: 1.800	13.0460-4979.2	604979	BRE 23919 19,3 + WK + Zub
			→	S 16194400→; Nutzlast [kg]: 1.800	13.0460-4980.2	604980	BRE 23921 20,3 - WE / - WK + Zub
			→ S 16194400→; Nutzlast ab [kg] 1.000 Nutzlast bis [kg] 1.400	13.0460-4980.2	604980	BRE 23921 20,3 - WE / - WK + Zub	
<b>Bremsscheibe</b>							
1.9 D	51	03/94→04/02	←	→ 03/02; Nutzlast [kg]: 1.000	24.0118-0108.1	418108	Ø 280 18 15,9
			→	11/01→ 03/02; Nutzlast [kg]: 1.000	24.0116-0124.1	416124	Ø 280 16 14,2
1.9 TD 1.9 TD 1.9 TD 4x4	66	08/94→04/02	←	→ 03/02; Nutzlast ab [kg] 1.000 Nutzlast bis [kg] 1.400	24.0118-0108.1	418108	Ø 280 18 15,9
	68	03/94→04/02					
	68	07/96→04/02	→	11/01→ 03/02; Nutzlast ab [kg] 1.000 Nutzlast bis [kg] 1.400	24.0116-0124.1	416124	Ø 280 16 14,2
2.0 i 2.0 i 4x4	80	03/94→04/02 08/96→04/02	←	→ 03/02; Nutzlast ab [kg] 1.000 Nutzlast bis [kg] 1.400	24.0118-0108.1	418108	Ø 280 18 15,9
			←	→ 03/02; Nutzlast [kg]: 1.800	24.0124-0138.1	424138	Ø 300 24 21,9 V
			→	11/01→ 03/02; Nutzlast ab [kg] 1.000 Nutzlast bis [kg] 1.400	24.0116-0124.1	416124	Ø 280 16 14,2
			→	11/01→ 03/02; Nutzlast [kg]: 1.800	24.0116-0125.1	416125	Ø 280 16 14,2
2.5 D 2.5 D 4x4	63	08/94→04/02 07/96→04/02	←	→ 03/02; Nutzlast [kg]: 1.400	24.0118-0108.1	418108	Ø 280 18 15,9
			←	→ 03/02; Nutzlast [kg]: 1.800	24.0124-0138.1	424138	Ø 300 24 21,9 V
			→	11/01→ 03/02; Nutzlast [kg]: 1.400	24.0116-0124.1	416124	Ø 280 16 14,2
			→	11/01→ 03/02; Nutzlast [kg]: 1.800	24.0116-0125.1	416125	Ø 280 16 14,2
2.5 DT	62	10/97→11/01	←	Nutzlast [kg]: 1.400	24.0118-0108.1	418108	Ø 280 18 15,9
			←	Nutzlast [kg]: 1.800	24.0124-0138.1	424138	Ø 300 24 21,9 V
			→	11/01→; Nutzlast [kg]: 1.400	24.0116-0124.1	416124	Ø 280 16 14,2
			→	11/01→; Nutzlast [kg]: 1.800	24.0116-0125.1	416125	Ø 280 16 14,2
2.5 TD	76	07/94→04/02	←	08/94→ 03/02; Nutzlast [kg]: 1.400	24.0124-0127.1	424127	Ø 280 24 21,9 V
			←	08/94→ 03/02; Nutzlast [kg]: 1.800	24.0124-0138.1	424138	Ø 300 24 21,9 V
			→	11/01→ 03/02; Nutzlast [kg]: 1.400	24.0116-0124.1	416124	Ø 280 16 14,2
			→	11/01→ 03/02; Nutzlast [kg]: 1.800	24.0116-0125.1	416125	Ø 280 16 14,2
2.5 TD 4x4 2.5 TDI 2.5 TDI 4x4	76	07/96→04/02	←	→ 03/02; Nutzlast [kg]: 1.400	24.0124-0127.1	424127	Ø 280 24 21,9 V
	79	01/97→04/02	←	→ 03/02; Nutzlast [kg]: 1.800	24.0124-0138.1	424138	Ø 300 24 21,9 V
	79	01/97→04/02	→	11/01→ 03/02; Nutzlast [kg]: 1.400	24.0116-0124.1	416124	Ø 280 16 14,2
			→	11/01→ 03/02; Nutzlast [kg]: 1.800	24.0116-0125.1	416125	Ø 280 16 14,2
2.8 D	64	01/99→02/02	←	→ S 16206253; Nutzlast [kg]: 1.400	24.0118-0108.1	418108	Ø 280 18 15,9
			←	S 16204256→; Nutzlast [kg]: 1.400	24.0124-0127.1	424127	Ø 280 24 21,9 V
			←	Nutzlast [kg]: 1.800	24.0124-0138.1	424138	Ø 300 24 21,9 V
			→	S 16194400→; Nutzlast [kg]: 1.400	24.0116-0124.1	416124	Ø 280 16 14,2
			→	S 16194400→; Nutzlast [kg]: 1.800	24.0116-0125.1	416125	Ø 280 16 14,2
2.8 HDi	94	11/00→04/02	←	→ 03/02; Nutzlast [kg]: 1.400	24.0124-0127.1	424127	Ø 280 24 21,9 V
			→	11/01→ 03/02; Nutzlast [kg]: 1.400	24.0116-0124.1	416124	Ø 280 16 14,2
			→	11/01→ 03/02; Nutzlast [kg]: 1.800	24.0116-0125.1	416125	Ø 280 16 14,2
2.8 HDi 4x4	94	10/00→04/02	←	→ S 16206253; Nutzlast ab [kg] 1.000 Nutzlast bis [kg] 1.400	24.0118-0108.1	418108	Ø 280 18 15,9
			←	S 16204256→; → 03/02; Nutzlast ab [kg] 1.000 Nutzlast bis [kg] 1.400	24.0124-0127.1	424127	Ø 280 24 21,9 V
			←	→ 03/02; Nutzlast [kg]: 1.800	24.0124-0138.1	424138	Ø 300 24 21,9 V
			→	S 16194400→; → 03/02; Nutzlast ab [kg] 1.000 Nutzlast bis [kg] 1.400	24.0116-0124.1	416124	Ø 280 16 14,2
			→	S 16194400→; → 03/02; Nutzlast [kg]: 1.800	24.0116-0125.1	416125	Ø 280 16 14,2
2.8 HDi Allrad	93	10/00→11/01	←	→ S 16206253; Nutzlast ab [kg] 1.000 Nutzlast bis [kg] 1.400	24.0118-0108.1	418108	Ø 280 18 15,9
↓							











	kw					! #		
<b>PEUGEOT - BOXER Bus (230P) 03/94→04/02</b>								
 <b>Bremsscheibe</b>								
2.8 HDi Allrad	93	10/00→11/01	←	S 16204256→; Nutzlast ab [kg] 1.000 Nutzlast bis [kg] 1.400	24.0124-0127.1	424127	Ø 280 24 21,9 V	
			←	Nutzlast [kg]: 1.800	24.0124-0138.1	424138	Ø 300 24 21,9 V	
			→	S 16194400→; Nutzlast ab [kg] 1.000 Nutzlast bis [kg] 1.400	24.0116-0124.1	416124	Ø 280 16 14,2	
			→	S 16194400→; Nutzlast [kg]: 1.800	24.0116-0125.1	416125	Ø 280 16 14,2	
<b>PEUGEOT - BOXER Bus (244, Z_) 12/01→</b>								
 <b>Bremsbelagsatz, Scheibenbremse</b>								
2.0	81	04/02→	←	→ 03/06; Nutzlast ab [kg] 1.000 Nutzlast bis [kg] 1.400	13.0460-4978.2	604978	BRE 23917 19,3 + WK + Zub	
2.0 HDi	62	04/02→	←	→ 03/06; Nutzlast [kg]: 1.800	13.0460-4979.2	604979	BRE 23919 19,3 + WK + Zub	
2.2 HDi	74	04/02→	←	→ 03/06; Nutzlast ab [kg] 1.000 Nutzlast bis [kg] 1.800	13.0460-4980.2	604980	BRE 23921 20,3 - WE / - WK + Zub	
2.8 HDi	94	04/02→	←	→ 03/06; Nutzlast ab [kg] 1.000 Nutzlast bis [kg] 1.800	13.0460-4978.2	604978	BRE 23917 19,3 + WK + Zub	
2.8 HDi	107	04/04→	→	→ 03/06; Nutzlast ab [kg] 1.000 Nutzlast bis [kg] 1.800	13.0460-4979.2	604979	BRE 23919 19,3 + WK + Zub	
2.8 HDi 4x4	94	04/02→	→	→ 03/06; Nutzlast ab [kg] 1.000 Nutzlast bis [kg] 1.800	13.0460-4980.2	604980	BRE 23921 20,3 - WE / - WK + Zub	
2.0 BiFuel	81	12/01→06/06	←	04/02→ 03/06; Nutzlast ab [kg] 1.000 Nutzlast bis [kg] 1.400	13.0460-4978.2	604978	BRE 23917 19,3 + WK + Zub	
			←	04/02→ 03/06; Nutzlast [kg]: 1.800	13.0460-4979.2	604979	BRE 23919 19,3 + WK + Zub	
			→	04/02→ 03/06; Nutzlast ab [kg] 1.000 Nutzlast bis [kg] 1.800	13.0460-4980.2	604980	BRE 23921 20,3 - WE / - WK + Zub	
 <b>Bremsscheibe</b>								
2.0	81	04/02→	←	→ 03/06; Nutzlast ab [kg] 1.000 Nutzlast bis [kg] 1.400	24.0124-0127.1	424127	Ø 280 24 21,9 V	
2.0 HDi	62	04/02→	←	→ 03/06; Nutzlast [kg]: 1.800	24.0124-0138.1	424138	Ø 300 24 21,9 V	
2.2 HDi	74	04/02→	←	→ 03/06; Nutzlast ab [kg] 1.000 Nutzlast bis [kg] 1.400	24.0116-0124.1	416124	Ø 280 16 14,2	
2.8 HDi	94	04/02→	←	→ 03/06; Nutzlast ab [kg] 1.000 Nutzlast bis [kg] 1.400	24.0116-0125.1	416125	Ø 280 16 14,2	
2.8 HDi	107	04/04→	→	→ 03/06; Nutzlast ab [kg] 1.000 Nutzlast bis [kg] 1.400	24.0116-0124.1	416124	Ø 280 16 14,2	
2.8 HDi 4x4	94	04/02→	→	→ 03/06; Nutzlast [kg]: 1.800	24.0116-0125.1	416125	Ø 280 16 14,2	
2.0 BiFuel	81	12/01→06/06	←	04/02→ 03/06; Nutzlast ab [kg] 1.000 Nutzlast bis [kg] 1.400	24.0124-0127.1	424127	Ø 280 24 21,9 V	
			→	04/02→ 03/06; Nutzlast ab [kg] 1.000 Nutzlast bis [kg] 1.400	24.0116-0124.1	416124	Ø 280 16 14,2	
			→	04/02→ 03/06; Nutzlast [kg]: 1.800	24.0116-0125.1	416125	Ø 280 16 14,2	
<b>PEUGEOT - BOXER Kasten 04/06→</b>								
 <b>Bremsbelagsatz, Scheibenbremse</b>								
2.0 BlueHDi 110	81	07/15→	←	Nutzlast 12Q/14Q; Nutzlast ab [kg] 1.200 Nutzlast bis [kg] 1.400	13.0460-4807.2	604807	BRE 24468 19,1 + WK + Zub	
2.0 BlueHDi 130	96	07/15→	←	Nutzlast leicht 16Q; Nutzlast [kg]: 1.600; nicht für erhöhte Nutzlast	13.0460-4809.2	604809	BRE 24468 19,1 + WK + Zub	
2.0 BlueHDi 160	120	07/15→	←	Nutzlast 20Q; Nutzlast [kg]: 2.000	13.0460-4811.2	604811	BRE 24466 19,1 + WK + Zub	
			←	Nutzlast schwer 16Q; Nutzlast [kg]: 1.600; für erhöhte Nutzlast	13.0460-4811.2	604811	BRE 24466 19,1 + WK + Zub	
			→	Nutzlast 12Q/14Q/16Q; Nutzlast ab [kg] 1.200 Nutzlast bis [kg] 1.600	13.0460-4889.2	604889	BOS 22041 19,2 + WK + Zub	
			→	Nutzlast 20Q; Nutzlast [kg]: 2.000	13.0460-4890.2	604890	BRE + WK + Zub	
2.2 HDi 100	74	04/06→	←	Nutzlast 12Q/14Q; Nutzlast ab [kg] 1.200 Nutzlast bis [kg] 1.400	13.0460-4807.2	604807	BRE 24468 19,1 + WK + Zub	
2.2 HDi 110	81	03/11→	←	Nutzlast leicht 16Q; Nutzlast [kg]: 1.600; nicht für erhöhte Nutzlast	13.0460-4809.2	604809	BRE 24468 19,1 + WK + Zub	
2.2 HDi 120	88	04/06→	←	Nutzlast leicht 16Q; Nutzlast [kg]: 1.600; nicht für erhöhte Nutzlast	13.0460-4810.2	604810	BRE 24466 19,1 + WK + Zub	
2.2 HDi 130	96	03/11→	←	Nutzlast schwer 16Q; Nutzlast [kg]: 1.600; für erhöhte Nutzlast	13.0460-4811.2	604811	BRE 24466 19,1 + WK + Zub	
2.2 HDi 150	110	03/11→	←	Nutzlast 20Q; Nutzlast [kg]: 2.000	13.0460-4811.2	604811	BRE 24466 19,1 + WK + Zub	
3.0 D	116	09/08→12/09	←	Nutzlast 20Q; Nutzlast [kg]: 2.000	13.0460-4812.2	604812	BOS 24465 19,2 - WE / - WK + Zub	
3.0 HDi	115	07/06→	←	Nutzlast 20Q; Nutzlast [kg]: 2.000	13.0460-4811.2	604811	BRE 24466 19,1 + WK + Zub	
3.0 HDi 145	107	04/10→	←	Nutzlast 20Q; Nutzlast [kg]: 2.000	13.0460-4811.2	604811	BRE 24466 19,1 + WK + Zub	
3.0 HDi 160	116	04/06→	→		13.0460-4812.2	604812	BOS 24465 19,2 - WE / - WK + Zub	
3.0 HDi 175	130	03/11→	→		13.0460-4812.2	604812	BOS 24465 19,2 - WE / - WK + Zub	
 <b>Bremsscheibe</b>								
2.0 BlueHDi 110	81	07/15→	←	Nutzlast leicht 12Q; Nutzlast ab [kg] 1.200 Nutzlast bis [kg] 1.400	24.0124-0127.1	424127	Ø 280 24 21,9 V	
2.0 BlueHDi 130	96	07/15→	→	Nutzlast 12Q/14Q + / leicht 16Q; Nutzlast ab [kg] 1.200 Nutzlast bis [kg] 1.600; nicht für erhöhte Nutzlast	24.0116-0124.1	416124	Ø 280 16 14,2	
2.0 BlueHDi 160	120	07/15→	→	Nutzlast schwer 16Q; Nutzlast [kg]: 1.600; für erhöhte Nutzlast	24.0116-0125.1	416125	Ø 280 16 14,2	
2.2 HDi 100	74	04/06→	←	Nutzlast 12Q/14Q; Nutzlast ab [kg] 1.200 Nutzlast bis [kg] 1.400	24.0124-0127.1	424127	Ø 280 24 21,9 V	
2.2 HDi 110	81	03/11→	←	Nutzlast schwer 16Q; Nutzlast [kg]: 1.600; für erhöhte Nutzlast	24.0124-0138.1	424138	Ø 300 24 21,9 V	
2.2 HDi 120	88	04/06→	←	Nutzlast leicht 16Q; Nutzlast [kg]: 1.600; nicht für erhöhte Nutzlast	24.0128-0213.1	428213	Ø 280 28 25,9 V	
2.2 HDi 130	96	03/11→	←	Nutzlast leicht 16Q; Nutzlast [kg]: 1.600; nicht für erhöhte Nutzlast	24.0128-0213.1	428213	Ø 280 28 25,9 V	
2.2 HDi 150	110	03/11→	←	Nutzlast leicht 16Q; Nutzlast [kg]: 1.600; nicht für erhöhte Nutzlast	24.0128-0213.1	428213	Ø 280 28 25,9 V	
3.0 D	116	09/08→12/09	←	Nutzlast leicht 16Q; Nutzlast [kg]: 1.600; nicht für erhöhte Nutzlast	24.0128-0213.1	428213	Ø 280 28 25,9 V	









	kw			 	! #		
<b>PEUGEOT - BOXER Kasten 04/06→</b>							
 <b>Bremsscheibe</b>							
3.0 HDi	115	07/06→	←	Nutzlast 20Q; Nutzlast [kg]: 2.000	24.0132-0131.1	432131	Ø 300 32 29,9 V
3.0 HDi 145	107	04/10→	→	Nutzlast 20Q; Nutzlast [kg]: 2.000	24.0116-0123.1	416123	Ø 300 16 14,2
3.0 HDi 160	116	04/06→	→	Nutzlast 12Q/14Q + / leicht 16Q; Nutzlast ab [kg] 1.200 Nutzlast bis [kg] 1.600; nicht für erhöhte Nutzlast	24.0116-0124.1	416124	Ø 280 16 14,2
3.0 HDi 175	130	03/11→	→	Nutzlast schwer 16Q; Nutzlast [kg]: 1.600; für erhöhte Nutzlast	24.0116-0125.1	416125	Ø 280 16 14,2
<b>PEUGEOT - BOXER Kasten (230L) 03/94→06/03</b>							
 <b>Bremsbelagsatz, Scheibenbremse</b>							
1.9 D	50	07/99→04/02	←	01/00→ 10/01; Nutzlast [kg]: 1.000	13.0460-2850.2	602850	TRW 21797 19,7 + WK
1.9 D	51	03/94→04/02	←	→ 12/99; Nutzlast [kg]: 1.000	13.0460-2976.2	602976	TRW 21797 19,7 + WK
			←	11/01→ 03/02; Nutzlast [kg]: 1.000	13.0460-4978.2	604978	BRE 23917 19,3 + WK + Zub
			→	11/01→ 03/02; Nutzlast [kg]: 1.000	13.0460-4980.2	604980	BRE 23921 20,3 - WE / - WK + Zub
1.9 DT 4x4	66	03/96→09/98	←	Nutzlast ab [kg] 1.000 Nutzlast bis [kg] 1.400	13.0460-2976.2	602976	TRW 21797 19,7 + WK
1.9 TD	66	07/99→04/02	←	01/00→ 10/01; Nutzlast ab [kg] 1.000 Nutzlast bis [kg] 1.400	13.0460-2850.2	602850	TRW 21797 19,7 + WK
1.9 TD	68	03/94→04/02	←	→ 12/99; Nutzlast ab [kg] 1.000 Nutzlast bis [kg] 1.400	13.0460-2976.2	602976	TRW 21797 19,7 + WK
			←	11/01→ 03/02; Nutzlast ab [kg] 1.000 Nutzlast bis [kg] 1.400	13.0460-4978.2	604978	BRE 23917 19,3 + WK + Zub
			→	11/01→ 03/02; Nutzlast ab [kg] 1.000 Nutzlast bis [kg] 1.400	13.0460-4980.2	604980	BRE 23921 20,3 - WE / - WK + Zub
2.0 4x4	80	03/96→09/98	←	Nutzlast ab [kg] 1.000 Nutzlast bis [kg] 1.400	13.0460-2976.2	602976	TRW 21797 19,7 + WK
			←	Nutzlast [kg]: 1.800	13.0460-2977.2	602977	TRW 21799 19,7 + WK
2.0 HDI	62	08/01→04/02	←	→ 10/01; Nutzlast ab [kg] 1.000 Nutzlast bis [kg] 1.400	13.0460-2850.2	602850	TRW 21797 19,7 + WK
			←	11/01→ 03/02; Nutzlast ab [kg] 1.000 Nutzlast bis [kg] 1.400	13.0460-4978.2	604978	BRE 23917 19,3 + WK + Zub
			→	11/01→ 03/02; Nutzlast ab [kg] 1.000 Nutzlast bis [kg] 1.800	13.0460-4980.2	604980	BRE 23921 20,3 - WE / - WK + Zub
2.0 i	80	06/94→04/02	←	01/00→ 10/01; Nutzlast ab [kg] 1.000 Nutzlast bis [kg] 1.400	13.0460-2850.2	602850	TRW 21797 19,7 + WK
			←	01/00→ 10/01; Nutzlast [kg]: 1.800	13.0460-2852.2	602852	TRW 21799 19,7 + WK
			←	→ 12/99; Nutzlast ab [kg] 1.000 Nutzlast bis [kg] 1.400	13.0460-2976.2	602976	TRW 21797 19,7 + WK
			←	→ 12/99; Nutzlast [kg]: 1.800	13.0460-2977.2	602977	TRW 21799 19,7 + WK
			←	11/01→ 03/02; Nutzlast ab [kg] 1.000 Nutzlast bis [kg] 1.400	13.0460-4978.2	604978	BRE 23917 19,3 + WK + Zub
			←	11/01→ 03/02; Nutzlast [kg]: 1.800	13.0460-4979.2	604979	BRE 23919 19,3 + WK + Zub
			→	11/01→ 03/02; Nutzlast ab [kg] 1.000 Nutzlast bis [kg] 1.800	13.0460-4980.2	604980	BRE 23921 20,3 - WE / - WK + Zub
2.5 D	63	03/94→04/02	←	01/00→ 10/01; Nutzlast [kg]: 1.400	13.0460-2850.2	602850	TRW 21797 19,7 + WK
2.5 D 4x4	63	07/99→04/02	←	01/00→ 10/01; Nutzlast [kg]: 1.800	13.0460-2852.2	602852	TRW 21799 19,7 + WK
2.5 TDI	79	01/97→04/02	←	→ 12/99; Nutzlast [kg]: 1.400	13.0460-2976.2	602976	TRW 21797 19,7 + WK
2.5 TDI 4x4	79	07/99→04/02	←	→ 12/99; Nutzlast [kg]: 1.800	13.0460-2977.2	602977	TRW 21799 19,7 + WK
			←	11/01→ 03/02; Nutzlast [kg]: 1.400	13.0460-4978.2	604978	BRE 23917 19,3 + WK + Zub
			←	11/01→ 03/02; Nutzlast [kg]: 1.800	13.0460-4979.2	604979	BRE 23919 19,3 + WK + Zub
			→	11/01→ 03/02; Nutzlast ab [kg] 1.400 Nutzlast bis [kg] 1.800	13.0460-4980.2	604980	BRE 23921 20,3 - WE / - WK + Zub
2.5 DT	62	10/97→11/01	←	01/00→ 10/01; Nutzlast [kg]: 1.400	13.0460-2850.2	602850	TRW 21797 19,7 + WK
			←	01/00→ 10/01; Nutzlast [kg]: 1.800	13.0460-2852.2	602852	TRW 21799 19,7 + WK
			←	→ 12/99; Nutzlast [kg]: 1.400	13.0460-2976.2	602976	TRW 21797 19,7 + WK
			←	→ 12/99; Nutzlast [kg]: 1.800	13.0460-2977.2	602977	TRW 21799 19,7 + WK
			←	11/01→; Nutzlast [kg]: 1.400	13.0460-4978.2	604978	BRE 23917 19,3 + WK + Zub
			←	11/01→; Nutzlast [kg]: 1.800	13.0460-4979.2	604979	BRE 23919 19,3 + WK + Zub
			→	11/01→; Nutzlast ab [kg] 1.400 Nutzlast bis [kg] 1.800	13.0460-4980.2	604980	BRE 23921 20,3 - WE / - WK + Zub
2.5 TD	76	03/94→04/02	←	01/00→ 10/01; Nutzlast [kg]: 1.400	13.0460-2850.2	602850	TRW 21797 19,7 + WK
			←	01/00→ 10/01; Nutzlast [kg]: 1.800	13.0460-2852.2	602852	TRW 21799 19,7 + WK
↓							

	kw			 	! #		
<b>PEUGEOT - BOXER Kasten (230L) 03/94→06/03</b>							
<b> Bremsbelagsatz, Scheibenbremse</b>							
2.5 TD	76	03/94→04/02	←	→ 12/99; Nutzlast [kg]: 1.400	13.0460-2976.2	602976	TRW 21797 19,7 + WK
			←	→ 12/99; Nutzlast [kg]: 1.800	13.0460-2977.2	602977	TRW 21799 19,7 + WK
			←	11/01→ 03/02; Nutzlast [kg]: 1.400	13.0460-4978.2	604978	BRE 23917 19,3 + WK + Zub
			←	11/01→ 03/02; Nutzlast [kg]: 1.800	13.0460-4979.2	604979	BRE 23919 19,3 + WK + Zub
2.8 D	64	01/99→02/02	←	→ S 16206253; Nutzlast [kg]: 1.400	13.0460-2850.2	602850	TRW 21797 19,7 + WK
			←	→ S 16205352; Nutzlast [kg]: 1.800	13.0460-2976.2	602976	TRW 21797 19,7 + WK
			←	S 16204256→; Nutzlast [kg]: 1.400	13.0460-2852.2	602852	TRW 21799 19,7 + WK
			←	S 16194400→; Nutzlast [kg]: 1.800	13.0460-2977.2	602977	TRW 21799 19,7 + WK
			←	S 16204256→; Nutzlast [kg]: 1.400	13.0460-4978.2	604978	BRE 23917 19,3 + WK + Zub
			←	S 16194400→; Nutzlast [kg]: 1.800	13.0460-4979.2	604979	BRE 23919 19,3 + WK + Zub
2.8 HDi	93	10/00→11/01	→	11/01→; Nutzlast ab [kg] 1.400 Nutzlast bis [kg] 1.800	13.0460-4980.2	604980	BRE 23921 20,3 - WE / - WK + Zub
2.8 HDi	94	11/00→04/02	←	→ 10/01; Nutzlast [kg]: 1.400	13.0460-2850.2	602850	TRW 21797 19,7 + WK
			←	→ 10/01; Nutzlast [kg]: 1.800	13.0460-2852.2	602852	TRW 21799 19,7 + WK
			←	11/01→ 03/02; Nutzlast [kg]: 1.400	13.0460-4978.2	604978	BRE 23917 19,3 + WK + Zub
			←	11/01→ 03/02; Nutzlast [kg]: 1.800	13.0460-4979.2	604979	BRE 23919 19,3 + WK + Zub
			→	11/01→ 03/02; Nutzlast ab [kg] 1.400 Nutzlast bis [kg] 1.800	13.0460-4980.2	604980	BRE 23921 20,3 - WE / - WK + Zub
2.8 HDi 4x4	93	10/00→11/01	←	→ 10/01; Nutzlast [kg]: 1.400	13.0460-2850.2	602850	TRW 21797 19,7 + WK
			←	→ 10/01; Nutzlast [kg]: 1.800	13.0460-2852.2	602852	TRW 21799 19,7 + WK
			←	11/01→; Nutzlast [kg]: 1.800	13.0460-4979.2	604979	BRE 23919 19,3 + WK + Zub
			→	11/01→; Nutzlast ab [kg] 1.400 Nutzlast bis [kg] 1.800	13.0460-4980.2	604980	BRE 23921 20,3 - WE / - WK + Zub
2.8 HDi 4x4	94	10/00→04/02	←	→ 10/01; Nutzlast [kg]: 1.400	13.0460-2850.2	602850	TRW 21797 19,7 + WK
			←	→ 10/01; Nutzlast [kg]: 1.800	13.0460-2852.2	602852	TRW 21799 19,7 + WK
			←	11/01→ 03/02; Nutzlast [kg]: 1.800	13.0460-4979.2	604979	BRE 23919 19,3 + WK + Zub
			→	11/01→ 03/02; Nutzlast ab [kg] 1.400 Nutzlast bis [kg] 1.800	13.0460-4980.2	604980	BRE 23921 20,3 - WE / - WK + Zub
<b> Bremsscheibe</b>							
1.9 D	50	07/99→04/02	←	→ 03/02; Nutzlast [kg]: 1.000	24.0118-0108.1	418108	Ø 280 18 15,9
1.9 D	51	03/94→04/02	→	11/01→ 03/02; Nutzlast [kg]: 1.000	24.0116-0124.1	416124	Ø 280 16 14,2
1.9 DT 4x4	66	03/96→09/98	←	Nutzlast ab [kg] 1.000 Nutzlast bis [kg] 1.400	24.0118-0108.1	418108	Ø 280 18 15,9
1.9 TD	66	07/99→04/02	←	→ 03/02; Nutzlast ab [kg] 1.000 Nutzlast bis [kg] 1.400	24.0118-0108.1	418108	Ø 280 18 15,9
			→	11/01→ 03/02; Nutzlast ab [kg] 1.000 Nutzlast bis [kg] 1.400	24.0116-0124.1	416124	Ø 280 16 14,2
2.0 4x4	80	03/96→09/98	←	Nutzlast ab [kg] 1.000 Nutzlast bis [kg] 1.400	24.0118-0108.1	418108	Ø 280 18 15,9
			←	Nutzlast [kg]: 1.800	24.0124-0138.1	424138	Ø 300 24 21,9 V
2.0 HDi	62	08/01→04/02	←	→ 03/02; Nutzlast [kg]: 1.800	24.0124-0138.1	424138	Ø 300 24 21,9 V
			→	11/01→ 03/02; Nutzlast ab [kg] 1.000 Nutzlast bis [kg] 1.400	24.0116-0124.1	416124	Ø 280 16 14,2
2.0 i	80	06/94→04/02	←	→ 03/02; Nutzlast ab [kg] 1.000 Nutzlast bis [kg] 1.400	24.0118-0108.1	418108	Ø 280 18 15,9
			←	→ 03/02; Nutzlast [kg]: 1.800	24.0124-0138.1	424138	Ø 300 24 21,9 V
			→	11/01→ 03/02; Nutzlast ab [kg] 1.000 Nutzlast bis [kg] 1.400	24.0116-0124.1	416124	Ø 280 16 14,2
			→	11/01→ 03/02; Nutzlast [kg]: 1.800	24.0116-0125.1	416125	Ø 280 16 14,2
2.5 D 2.5 D 4x4	63	03/94→04/02 07/99→04/02	←	→ 03/02; Nutzlast [kg]: 1.400	24.0118-0108.1	418108	Ø 280 18 15,9
			←	→ 03/02; Nutzlast [kg]: 1.800	24.0124-0138.1	424138	Ø 300 24 21,9 V
			→	11/01→ 03/02; Nutzlast [kg]: 1.400	24.0116-0124.1	416124	Ø 280 16 14,2
			→	11/01→ 03/02; Nutzlast [kg]: 1.800	24.0116-0125.1	416125	Ø 280 16 14,2
2.5 DT	62	10/97→11/01	←	Nutzlast [kg]: 1.400	24.0118-0108.1	418108	Ø 280 18 15,9
			←	Nutzlast [kg]: 1.800	24.0124-0138.1	424138	Ø 300 24 21,9 V
			→	11/01→; Nutzlast [kg]: 1.400	24.0116-0124.1	416124	Ø 280 16 14,2
			→	11/01→; Nutzlast [kg]: 1.800	24.0116-0125.1	416125	Ø 280 16 14,2
↓							







	kw					! #		
<b>PEUGEOT - BOXER Kasten (230L) 03/94→06/03</b>								
<b>Bremsscheibe</b>								
2.5 TD	76	03/94→04/02	←	→ 03/02; Nutzlast [kg]: 1.400		24.0124-0127.1	424127	Ø 280 24 21,9 V
2.5 TDI	79	01/97→04/02	←	→ 03/02; Nutzlast [kg]: 1.800		24.0124-0138.1	424138	Ø 300 24 21,9 V
2.5 TDI 4x4	79	07/99→04/02	←	→ 03/02; Nutzlast [kg]: 1.800		24.0124-0138.1	424138	Ø 300 24 21,9 V
2.8 HDi	94	11/00→04/02	→	11/01→ 03/02; Nutzlast [kg]: 1.400		24.0116-0124.1	416124	Ø 280 16 14,2
2.8 HDi 4x4	94	10/00→04/02	→	11/01→ 03/02; Nutzlast [kg]: 1.800		24.0116-0125.1	416125	Ø 280 16 14,2
2.8 D	64	01/99→02/02	←	→ S 16206253; Nutzlast [kg]: 1.400		24.0118-0108.1	418108	Ø 280 18 15,9
			←	S 16204256→; Nutzlast [kg]: 1.400		24.0124-0127.1	424127	Ø 280 24 21,9 V
			←	Nutzlast [kg]: 1.800		24.0124-0138.1	424138	Ø 300 24 21,9 V
			→	S 16194400→; Nutzlast [kg]: 1.400		24.0116-0124.1	416124	Ø 280 16 14,2
			→	S 16194400→; Nutzlast [kg]: 1.800		24.0116-0125.1	416125	Ø 280 16 14,2
2.8 HDi 4x4	93	10/00→11/01	←	Nutzlast [kg]: 1.400		24.0124-0127.1	424127	Ø 280 24 21,9 V
			←	Nutzlast [kg]: 1.800		24.0124-0138.1	424138	Ø 300 24 21,9 V
			→	11/01→; Nutzlast [kg]: 1.400		24.0116-0124.1	416124	Ø 280 16 14,2
			→	11/01→; Nutzlast [kg]: 1.800		24.0116-0125.1	416125	Ø 280 16 14,2
<b>PEUGEOT - BOXER Kasten (244) 12/01→</b>								
<b>Bremsbelagsatz, Scheibenbremse</b>								
2.0	81	04/02→	←	→ 03/06; Nutzlast ab [kg] 1.000 Nutzlast bis [kg] 1.400		13.0460-4978.2	604978	BRE 23917 19,3 + WK + Zub
2.0 HDi	62	04/02→	←	→ 03/06; Nutzlast [kg]: 1.800		13.0460-4979.2	604979	BRE 23919 19,3 + WK + Zub
2.2 HDi	74	04/02→	←	→ 03/06; Nutzlast [kg]: 1.800		13.0460-4979.2	604979	BRE 23919 19,3 + WK + Zub
2.8 HDi	93	09/05→09/09	→	→ 03/06; Nutzlast ab [kg] 1.000 Nutzlast bis [kg] 1.800		13.0460-4980.2	604980	BRE 23921 20,3 - WE / - WK + Zub
2.8 HDi	94	04/02→	→	→ 03/06; Nutzlast ab [kg] 1.000 Nutzlast bis [kg] 1.800		13.0460-4980.2	604980	BRE 23921 20,3 - WE / - WK + Zub
2.8 HDi	107	04/04→	→	→ 03/06; Nutzlast ab [kg] 1.000 Nutzlast bis [kg] 1.800		13.0460-4980.2	604980	BRE 23921 20,3 - WE / - WK + Zub
2.8 HDi 4x4	94	04/02→	→	→ 03/06; Nutzlast ab [kg] 1.000 Nutzlast bis [kg] 1.800		13.0460-4980.2	604980	BRE 23921 20,3 - WE / - WK + Zub
2.0 BiFuel	81	12/01→06/06	←	04/02→ 03/06; Nutzlast ab [kg] 1.000 Nutzlast bis [kg] 1.400		13.0460-4978.2	604978	BRE 23917 19,3 + WK + Zub
			←	04/02→ 03/06; Nutzlast [kg]: 1.800		13.0460-4979.2	604979	BRE 23919 19,3 + WK + Zub
			→	04/02→ 03/06; Nutzlast ab [kg] 1.000 Nutzlast bis [kg] 1.800		13.0460-4980.2	604980	BRE 23921 20,3 - WE / - WK + Zub
<b>Bremsscheibe</b>								
2.0	81	04/02→	←	→ 03/06; Nutzlast ab [kg] 1.000 Nutzlast bis [kg] 1.400		24.0124-0127.1	424127	Ø 280 24 21,9 V
2.0 HDi	62	04/02→	←	→ 03/06; Nutzlast [kg]: 1.800		24.0124-0138.1	424138	Ø 300 24 21,9 V
2.2 HDi	74	04/02→	←	→ 03/06; Nutzlast [kg]: 1.800		24.0124-0138.1	424138	Ø 300 24 21,9 V
2.8 HDi	93	09/05→09/09	→	→ 03/06; Nutzlast ab [kg] 1.000 Nutzlast bis [kg] 1.400		24.0116-0124.1	416124	Ø 280 16 14,2
2.8 HDi	94	04/02→	→	→ 03/06; Nutzlast ab [kg] 1.000 Nutzlast bis [kg] 1.400		24.0116-0124.1	416124	Ø 280 16 14,2
2.8 HDi	107	04/04→	→	→ 03/06; Nutzlast ab [kg] 1.000 Nutzlast bis [kg] 1.400		24.0116-0124.1	416124	Ø 280 16 14,2
2.8 HDi 4x4	94	04/02→	→	→ 03/06; Nutzlast [kg]: 1.800		24.0116-0125.1	416125	Ø 280 16 14,2
2.0 BiFuel	81	12/01→06/06	←	04/02→ 03/06; Nutzlast ab [kg] 1.000 Nutzlast bis [kg] 1.400		24.0124-0127.1	424127	Ø 280 24 21,9 V
			→	04/02→ 03/06; Nutzlast ab [kg] 1.000 Nutzlast bis [kg] 1.400		24.0116-0124.1	416124	Ø 280 16 14,2
			→	04/02→ 03/06; Nutzlast [kg]: 1.800		24.0116-0125.1	416125	Ø 280 16 14,2
<b>PEUGEOT - BOXER Pritsche/Fahrgestell 04/06→</b>								
<b>Bremsbelagsatz, Scheibenbremse</b>								
2.0 BlueHDi 110	81	07/15→	←	Nutzlast 12Q/14Q; Nutzlast ab [kg] 1.200 Nutzlast bis [kg] 1.400		13.0460-4807.2	604807	BRE 24468 19,1 + WK + Zub
2.0 BlueHDi 130	96	07/15→	←	Nutzlast leicht 16Q; Nutzlast [kg]: 1.600; nicht für erhöhte Nutzlast		13.0460-4809.2	604809	BRE 24468 19,1 + WK + Zub
2.0 BlueHDi 160	120	07/15→	←	Nutzlast 20Q; Nutzlast [kg]: 2.000		13.0460-4811.2	604811	BRE 24466 19,1 + WK + Zub
			←	Nutzlast schwer 16Q; Nutzlast [kg]: 1.600; für erhöhte Nutzlast		13.0460-4811.2	604811	BRE 24466 19,1 + WK + Zub
			→	Nutzlast 12Q/14Q/16Q; Nutzlast ab [kg] 1.200 Nutzlast bis [kg] 1.600		13.0460-4889.2	604889	BOS 22041 19,2 + WK + Zub
			→	Nutzlast 20Q; Nutzlast [kg]: 2.000		13.0460-4890.2	604890	BRE + WK + Zub
2.2 HDi 100	74	04/06→	←	Nutzlast 12Q/14Q; Nutzlast ab [kg] 1.200 Nutzlast bis [kg] 1.400		13.0460-4807.2	604807	BRE 24468 19,1 + WK + Zub
2.2 HDi 110	81	03/11→	←	Nutzlast leicht 16Q; Nutzlast [kg]: 1.600; nicht für erhöhte Nutzlast		13.0460-4809.2	604809	BRE 24468 19,1 + WK + Zub
2.2 HDi 120	88	04/06→	←	Nutzlast leicht 16Q; Nutzlast [kg]: 1.600; nicht für erhöhte Nutzlast		13.0460-4809.2	604809	BRE 24468 19,1 + WK + Zub
2.2 HDi 130	96	03/11→	←	Nutzlast leicht 16Q; Nutzlast [kg]: 1.600; nicht für erhöhte Nutzlast		13.0460-4809.2	604809	BRE 24468 19,1 + WK + Zub
2.2 HDi 150	110	03/11→	←	Nutzlast leicht 16Q; Nutzlast [kg]: 1.600; nicht für erhöhte Nutzlast		13.0460-4810.2	604810	BRE 24466 19,1 + WK + Zub
3.0 HDi	115	02/07→	←	Nutzlast schwer 16Q; Nutzlast [kg]: 1.600; für erhöhte Nutzlast		13.0460-4810.2	604810	BRE 24466 19,1 + WK + Zub
3.0 HDi 145	107	04/10→	←	Nutzlast schwer 16Q; Nutzlast [kg]: 1.600; für erhöhte Nutzlast		13.0460-4810.2	604810	BRE 24466 19,1 + WK + Zub
3.0 HDi 160	116	04/06→	←	Nutzlast 20Q; Nutzlast [kg]: 2.000		13.0460-4811.2	604811	BRE 24466 19,1 + WK + Zub
3.0 HDi 175	130	03/11→	→			13.0460-4812.2	604812	BOS 24465 19,2 - WE / - WK + Zub
↓								













	kw			 	! #		
<b>PEUGEOT - BOXER Pritsche/Fahrgestell 04/06→</b>							
 <b>Bremsscheibe</b>							
2.0 BlueHDi 110 2.0 BlueHDi 130 2.0 BlueHDi 160	81 96 120	07/15→ 07/15→ 07/15→	← → →	Nutzlast leicht 12Q; Nutzlast ab [kg] 1.200 Nutzlast bis [kg] 1.400 Nutzlast 12Q/14Q + / leicht 16Q; Nutzlast ab [kg] 1.200 Nutzlast bis [kg] 1.600; nicht für erhöhte Nutzlast Nutzlast schwer 16Q; Nutzlast [kg]: 1.600; für erhöhte Nutzlast	24.0124-0127.1 24.0116-0124.1 24.0116-0125.1	424127 416124 416125	Ø 280 24 21,9 V Ø 280 16 14,2 Ø 280 16 14,2
2.2 HDi 100 2.2 HDi 110 2.2 HDi 120 2.2 HDi 130 2.2 HDi 150 3.0 HDi 3.0 HDi 145 3.0 HDi 160 3.0 HDi 175	74 81 88 96 110 115 107 116 130	04/06→ 03/11→ 04/06→ 03/11→ 03/11→ 02/07→ 04/10→ 04/06→ 03/11→	← ← ← ← ← ← ← → →	Nutzlast 12Q/14Q; Nutzlast ab [kg] 1.200 Nutzlast bis [kg] 1.400 Nutzlast schwer 16Q; Nutzlast [kg]: 1.600; für erhöhte Nutzlast Nutzlast leicht 16Q; Nutzlast [kg]: 1.600; nicht für erhöhte Nutzlast Nutzlast 20Q; Nutzlast [kg]: 2.000 Nutzlast 20Q; Nutzlast [kg]: 2.000 Nutzlast 12Q/14Q + / leicht 16Q; Nutzlast ab [kg] 1.200 Nutzlast bis [kg] 1.600; nicht für erhöhte Nutzlast Nutzlast schwer 16Q; Nutzlast [kg]: 1.600; für erhöhte Nutzlast	24.0124-0127.1 24.0124-0138.1 24.0128-0213.1 24.0132-0131.1 24.0116-0123.1 24.0116-0124.1 24.0116-0125.1	424127 424138 428213 432131 416123 416124 416125	Ø 280 24 21,9 V Ø 300 24 21,9 V Ø 280 28 25,9 V Ø 300 32 29,9 V Ø 300 16 14,2 Ø 280 16 14,2 Ø 280 16 14,2
<b>PEUGEOT - BOXER Pritsche/Fahrgestell (244) 12/01→</b>							
 <b>Bremsbelagsatz, Scheibenbremse</b>							
2.0 BiFuel	81	12/01→06/06	← ← →	04/02→ 03/06; Nutzlast ab [kg] 1.000 Nutzlast bis [kg] 1.400 04/02→ 03/06; Nutzlast [kg]: 1.800 04/02→ 03/06; Nutzlast ab [kg] 1.000 Nutzlast bis [kg] 1.800	13.0460-4978.2 13.0460-4979.2 13.0460-4980.2	604978 604979 604980	BRE 23917 19,3 + WK + Zub BRE 23919 19,3 + WK + Zub BRE 23921 20,3 - WE / - WK + Zub
2.0 HDi 2.2 HDi 2.8 HDi 2.8 HDi 2.8 HDi 4x4	62 74 94 107 94	04/02→ 04/02→ 04/02→ 04/04→ 04/02→	← ← → →	→ 03/06; Nutzlast ab [kg] 1.000 Nutzlast bis [kg] 1.400 → 03/06; Nutzlast [kg]: 1.800 → 03/06; Nutzlast ab [kg] 1.000 Nutzlast bis [kg] 1.800	13.0460-4978.2 13.0460-4979.2 13.0460-4980.2	604978 604979 604980	BRE 23917 19,3 + WK + Zub BRE 23919 19,3 + WK + Zub BRE 23921 20,3 - WE / - WK + Zub
 <b>Bremsscheibe</b>							
2.0 BiFuel	81	12/01→06/06	← → →	04/02→ 03/06; Nutzlast ab [kg] 1.000 Nutzlast bis [kg] 1.400 04/02→ 03/06; Nutzlast ab [kg] 1.000 Nutzlast bis [kg] 1.400 04/02→ 03/06; Nutzlast [kg]: 1.800	24.0124-0127.1 24.0116-0124.1 24.0116-0125.1	424127 416124 416125	Ø 280 24 21,9 V Ø 280 16 14,2 Ø 280 16 14,2
2.0 HDi 2.2 HDi 2.8 HDi 2.8 HDi 2.8 HDi 4x4	62 74 94 107 94	04/02→ 04/02→ 04/02→ 04/04→ 04/02→	← ← → →	→ 03/06; Nutzlast ab [kg] 1.000 Nutzlast bis [kg] 1.400 → 03/06; Nutzlast [kg]: 1.800 → 03/06; Nutzlast ab [kg] 1.000 Nutzlast bis [kg] 1.400 → 03/06; Nutzlast [kg]: 1.800	24.0124-0127.1 24.0124-0138.1 24.0116-0124.1 24.0116-0125.1	424127 424138 416124 416125	Ø 280 24 21,9 V Ø 300 24 21,9 V Ø 280 16 14,2 Ø 280 16 14,2
<b>PEUGEOT - BOXER Pritsche/Fahrgestell (ZCT_) 03/94→04/02</b>							
 <b>Bremsbelagsatz, Scheibenbremse</b>							
1.9 D	51	03/94→04/02	← ← →	→ S 16206253; Nutzlast ab [kg] 1.000 Nutzlast bis [kg] 1.400 S 16204256→; Nutzlast ab [kg] 1.000 Nutzlast bis [kg] 1.400 S 16194400→; Nutzlast ab [kg] 1.000 Nutzlast bis [kg] 1.400	13.0460-2850.2 13.0460-2976.2 13.0460-4978.2	602850 602976 604978	TRW 21797 19,7 + WK TRW 21797 19,7 + WK BRE 23917 19,3 + WK + Zub
1.9 TD	66	06/94→04/02	← ← ← →	01/00→ 10/01; Nutzlast ab [kg] 1.000 Nutzlast bis [kg] 1.400 12/98→ 12/99; Nutzlast ab [kg] 1.000 Nutzlast bis [kg] 1.400 11/01→ 03/02; Nutzlast ab [kg] 1.000 Nutzlast bis [kg] 1.400 11/01→ 03/02; Nutzlast ab [kg] 1.000 Nutzlast bis [kg] 1.400	13.0460-2850.2 13.0460-2976.2 13.0460-4978.2 13.0460-4980.2	602850 602976 604978 604980	TRW 21797 19,7 + WK TRW 21797 19,7 + WK BRE 23917 19,3 + WK + Zub BRE 23921 20,3 - WE / - WK + Zub
1.9 TD	68	07/94→04/02	← ← ←	01/00→ 10/01; Nutzlast ab [kg] 1.000 Nutzlast bis [kg] 1.400 07/96→ 12/99; Nutzlast ab [kg] 1.000 Nutzlast bis [kg] 1.400 11/01→ 03/02; Nutzlast ab [kg] 1.000 Nutzlast bis [kg] 1.400	13.0460-2850.2 13.0460-2976.2 13.0460-4978.2	602850 602976 604978	TRW 21797 19,7 + WK TRW 21797 19,7 + WK BRE 23917 19,3 + WK + Zub
↓							

















	kw			 	! #			
<b>PEUGEOT - BOXER Pritsche/Fahrgestell (ZCT_) 03/94→04/02</b>								
<b>Bremsbelagsatz, Scheibenbremse</b>								
1.9 TD	68	07/94→04/02	➔	11/01→ 03/02; Nutzlast ab [kg] 1.000 Nutzlast bis [kg] 1.400		13.0460-4980.2 604980	BRE 23921 20,3 - WE / - WK + Zub	
2.0	81	12/01→04/02	➔	→ 03/02; Nutzlast ab [kg] 1.000 Nutzlast bis [kg] 1.400		13.0460-4978.2 604978	BRE 23917 19,3 + WK + Zub	
			➔	→ 03/02; Nutzlast [kg]: 1.800		13.0460-4979.2 604979	BRE 23919 19,3 + WK + Zub	
			➔	→ 03/02; Nutzlast ab [kg] 1.000 Nutzlast bis [kg] 1.800		13.0460-4980.2 604980	BRE 23921 20,3 - WE / - WK + Zub	
2.0 i	80	06/94→04/02	➔	01/00→ 10/01; Nutzlast ab [kg] 1.000 Nutzlast bis [kg] 1.400		13.0460-2850.2 602850	TRW 21797 19,7 + WK	
			➔	01/00→ 10/01; Nutzlast [kg]: 1.800		13.0460-2852.2 602852	TRW 21799 19,7 + WK	
			➔	→ 12/99; Nutzlast ab [kg] 1.000 Nutzlast bis [kg] 1.400		13.0460-2976.2 602976	TRW 21797 19,7 + WK	
			➔	→ 12/99; Nutzlast [kg]: 1.800		13.0460-2977.2 602977	TRW 21799 19,7 + WK	
			➔	11/01→ 03/02; Nutzlast ab [kg] 1.000 Nutzlast bis [kg] 1.400		13.0460-4978.2 604978	BRE 23917 19,3 + WK + Zub	
			➔	11/01→ 03/02; Nutzlast [kg]: 1.800		13.0460-4979.2 604979	BRE 23919 19,3 + WK + Zub	
			➔	11/01→ 03/02; Nutzlast ab [kg] 1.000 Nutzlast bis [kg] 1.800		13.0460-4980.2 604980	BRE 23921 20,3 - WE / - WK + Zub	
2.5 D 2.5 D 4x4 2.5 TD 2.5 TDI 2.5 TDI 4x4	63	03/94→04/02	➔	01/00→ 10/01; Nutzlast [kg]: 1.400		13.0460-2850.2 602850	TRW 21797 19,7 + WK	
	63	07/99→04/02	➔	01/00→ 10/01; Nutzlast [kg]: 1.800		13.0460-2852.2 602852	TRW 21799 19,7 + WK	
	76	03/94→04/02	➔	→ 12/99; Nutzlast [kg]: 1.400		13.0460-2976.2 602976	TRW 21797 19,7 + WK	
	79	01/97→04/02	➔	→ 12/99; Nutzlast [kg]: 1.800		13.0460-2977.2 602977	TRW 21799 19,7 + WK	
	79	07/99→04/02	➔	11/01→ 03/02; Nutzlast [kg]: 1.400		13.0460-4978.2 604978	BRE 23917 19,3 + WK + Zub	
				➔	11/01→ 03/02; Nutzlast [kg]: 1.800		13.0460-4979.2 604979	BRE 23919 19,3 + WK + Zub
				➔	11/01→ 03/02; Nutzlast ab [kg] 1.400 Nutzlast bis [kg] 1.800		13.0460-4980.2 604980	BRE 23921 20,3 - WE / - WK + Zub
				➔	11/01→ 03/02; Nutzlast ab [kg] 1.400 Nutzlast bis [kg] 1.800		13.0460-4980.2 604980	BRE 23921 20,3 - WE / - WK + Zub
2.8 D	64	01/99→02/02	➔	→ S 16206253; Nutzlast [kg]: 1.400		13.0460-2850.2 602850	TRW 21797 19,7 + WK	
			➔	→ S 16205352; Nutzlast [kg]: 1.800		13.0460-2976.2 602976	TRW 21797 19,7 + WK	
			➔	→ S 16204256→; Nutzlast [kg]: 1.400		13.0460-4978.2 604978	BRE 23917 19,3 + WK + Zub	
			➔	S 16194400→; Nutzlast [kg]: 1.800		13.0460-4979.2 604979	BRE 23919 19,3 + WK + Zub	
			➔	S 16194400→; Nutzlast ab [kg] 1.400 Nutzlast bis [kg] 1.800		13.0460-4980.2 604980	BRE 23921 20,3 - WE / - WK + Zub	
2.8 HDi	93	10/00→11/01	➔	11/01→; Nutzlast ab [kg] 1.400 Nutzlast bis [kg] 1.800		13.0460-4980.2 604980	BRE 23921 20,3 - WE / - WK + Zub	
2.8 HDI	94	11/00→04/02	➔	→ 10/01; Nutzlast [kg]: 1.400		13.0460-2850.2 602850	TRW 21797 19,7 + WK	
			➔	→ 10/01; Nutzlast [kg]: 1.800		13.0460-2852.2 602852	TRW 21799 19,7 + WK	
			➔	11/01→ 03/02; Nutzlast [kg]: 1.400		13.0460-4978.2 604978	BRE 23917 19,3 + WK + Zub	
			➔	11/01→ 03/02; Nutzlast [kg]: 1.800		13.0460-4979.2 604979	BRE 23919 19,3 + WK + Zub	
			➔	11/01→ 03/02; Nutzlast ab [kg] 1.400 Nutzlast bis [kg] 1.800		13.0460-4980.2 604980	BRE 23921 20,3 - WE / - WK + Zub	
2.8 HDi Allrad	93	10/00→11/01	➔	→ 10/01; Nutzlast [kg]: 1.400		13.0460-2850.2 602850	TRW 21797 19,7 + WK	
			➔	→ 10/01; Nutzlast [kg]: 1.800		13.0460-2852.2 602852	TRW 21799 19,7 + WK	
			➔	11/01→; Nutzlast [kg]: 1.400		13.0460-4978.2 604978	BRE 23917 19,3 + WK + Zub	
			➔	11/01→; Nutzlast [kg]: 1.800		13.0460-4979.2 604979	BRE 23919 19,3 + WK + Zub	
			➔	11/01→; Nutzlast ab [kg] 1.400 Nutzlast bis [kg] 1.800		13.0460-4980.2 604980	BRE 23921 20,3 - WE / - WK + Zub	
<b>Bremsscheibe</b>								
1.9 D	51	03/94→04/02	➔	→ S 16206253; Nutzlast ab [kg] 1.000 Nutzlast bis [kg] 1.400		24.0118-0108.1 418108	Ø 280 18 15,9	
			➔	S 16204256→; Nutzlast ab [kg] 1.000 Nutzlast bis [kg] 1.400		24.0124-0127.1 424127	Ø 280 24 21,9 V	
			➔	S 16194400→; Nutzlast ab [kg] 1.000 Nutzlast bis [kg] 1.400		24.0116-0124.1 416124	Ø 280 16 14,2	
1.9 TD	66	06/94→04/02	➔	12/98→ 12/99; Nutzlast ab [kg] 1.000 Nutzlast bis [kg] 1.400		24.0118-0108.1 418108	Ø 280 18 15,9	
			➔	11/01→ 03/02; Nutzlast ab [kg] 1.000 Nutzlast bis [kg] 1.400		24.0116-0124.1 416124	Ø 280 16 14,2	
1.9 TD	68	07/94→04/02	➔	07/96→ 12/99; Nutzlast ab [kg] 1.000 Nutzlast bis [kg] 1.400		24.0118-0108.1 418108	Ø 280 18 15,9	
			➔	11/01→ 03/02; Nutzlast ab [kg] 1.000 Nutzlast bis [kg] 1.400		24.0116-0124.1 416124	Ø 280 16 14,2	
2.0 ↓	81	12/01→04/02	➔	→ 03/02; Nutzlast [kg]: 1.800		24.0124-0138.1 424138	Ø 300 24 21,9 V	























	kw					! #		
<b>PEUGEOT - BOXER Pritsche/Fahrgestell (ZCT_) 03/94→04/02</b>								
<b>Bremsscheibe</b>								
2.0	81	12/01→04/02	→	→ 03/02; Nutzlast ab [kg] 1.000 Nutzlast bis [kg] 1.400		24.0116-0124.1	416124	Ø 280 16 14,2
			→	→ 03/02; Nutzlast [kg]: 1.800		24.0116-0125.1	416125	Ø 280 16 14,2
2.0 i	80	06/94→04/02	←	→ 12/99; Nutzlast ab [kg] 1.000 Nutzlast bis [kg] 1.400		24.0118-0108.1	418108	Ø 280 18 15,9
			←	→ 03/02; Nutzlast [kg]: 1.800		24.0124-0138.1	424138	Ø 300 24 21,9 V
			→	11/01→ 03/02; Nutzlast ab [kg] 1.000 Nutzlast bis [kg] 1.400		24.0116-0124.1	416124	Ø 280 16 14,2
			→	11/01→ 03/02; Nutzlast [kg]: 1.800		24.0116-0125.1	416125	Ø 280 16 14,2
2.5 D 2.5 D 4x4	63 63	03/94→04/02 07/99→04/02	←	→ 12/99; Nutzlast [kg]: 1.400		24.0118-0108.1	418108	Ø 280 18 15,9
			←	→ 03/02; Nutzlast [kg]: 1.800		24.0124-0138.1	424138	Ø 300 24 21,9 V
			→	11/01→ 03/02; Nutzlast [kg]: 1.400		24.0116-0124.1	416124	Ø 280 16 14,2
			→	11/01→ 03/02; Nutzlast [kg]: 1.800		24.0116-0125.1	416125	Ø 280 16 14,2
2.5 TD 2.5 TDI 2.5 TDI 4x4 2.8 HDI	76 79 79 94	03/94→04/02 01/97→04/02 07/99→04/02 11/00→04/02	←	→ 03/02; Nutzlast [kg]: 1.400		24.0124-0127.1	424127	Ø 280 24 21,9 V
			←	→ 03/02; Nutzlast [kg]: 1.800		24.0124-0138.1	424138	Ø 300 24 21,9 V
			→	11/01→ 03/02; Nutzlast [kg]: 1.400		24.0116-0124.1	416124	Ø 280 16 14,2
			→	11/01→ 03/02; Nutzlast [kg]: 1.800		24.0116-0125.1	416125	Ø 280 16 14,2
2.8 D	64	01/99→02/02	←	→ S 16206253; Nutzlast [kg]: 1.400		24.0118-0108.1	418108	Ø 280 18 15,9
			←	S 16204256→; Nutzlast [kg]: 1.400		24.0124-0127.1	424127	Ø 280 24 21,9 V
			←	Nutzlast [kg]: 1.800		24.0124-0138.1	424138	Ø 300 24 21,9 V
			→	S 16194400→; Nutzlast [kg]: 1.400		24.0116-0124.1	416124	Ø 280 16 14,2
			→	S 16194400→; Nutzlast [kg]: 1.800		24.0116-0125.1	416125	Ø 280 16 14,2
2.8 HDi Allrad	93	10/00→11/01	←	Nutzlast [kg]: 1.400		24.0124-0127.1	424127	Ø 280 24 21,9 V
			←	Nutzlast [kg]: 1.800		24.0124-0138.1	424138	Ø 300 24 21,9 V
			→	11/01→; Nutzlast [kg]: 1.400		24.0116-0124.1	416124	Ø 280 16 14,2
<b>PEUGEOT - EXPERT (224_) 10/95→12/06</b>								
<b>Bremsbelagsatz, Scheibenbremse</b>								
1.6	58	02/96→09/00	←	Orga 09793→		13.0460-2863.2	602863	TRW 20261 19,0 + WK + Zub
			←	→Orga 09792		13.0460-2978.2	602978	TRW 21801 19,0 + WK
			←	→Orga 09155		13.0460-3957.2	603957	BDX 23042 19,0 + WK + Zub
1.8 1.9 TD	74 66	10/96→09/00 02/96→09/00	←	Orga 09793→		13.0460-2863.2	602863	TRW 20261 19,0 + WK + Zub
2.0 HDi 2.0 HDi 2.0 HDi 16V	69 80 80	10/00→10/06 07/00→12/06 07/00→12/06	←	→Orga 09792		13.0460-2978.2	602978	TRW 21801 19,0 + WK
1.9 D 1.9 D	51 51	02/96→12/98 12/03→12/06	←	→Orga 09155		13.0460-2978.2	602978	TRW 21801 19,0 + WK
			←	Orga 09156→		13.0460-3957.2	603957	BDX 23042 19,0 + WK + Zub
1.9 TD	68	02/96→05/98	←	Orga 09793→		13.0460-2863.2	602863	TRW 20261 19,0 + WK + Zub
			←	04/96→; →Orga 09792		13.0460-2978.2	602978	TRW 21801 19,0 + WK
2.0	100	07/00→12/06	←	Orga 09793→		13.0460-2863.2	602863	TRW 20261 19,0 + WK + Zub
			←	Orga 09156→ Orga 09792		13.0460-2978.2	602978	TRW 21801 19,0 + WK
			←	→Orga 09155		13.0460-3957.2	603957	BDX 23042 19,0 + WK + Zub
<b>Bremsscheibe</b>								
1.6	58	02/96→09/00	←	→Orga 09155		24.0120-0155.1	420155	Ø 257,5 20 18,2 V
1.8	74	10/96→09/00	←	→Orga 09792		24.0126-0104.1	426104	Ø 281 26 24,2 V
1.9 D 1.9 D	51 51	02/96→12/98 12/03→12/06	←	Orga 09793→		24.0128-0136.1	428136	Ø 285 28 26 V
1.9 TD 2.0	66 100	02/96→09/00 07/00→12/06	←	Orga 09793→		24.0328-0136.1	528136	Ø 285 28 26 V
2.0 HDi 2.0 HDi 2.0 HDi 16V	69 80 80	10/00→10/06 07/00→12/06 07/00→12/06	←	Orga 09793→		24.0128-0136.1	428136	Ø 285 28 26 V
1.9 TD	68	02/96→05/98	←	04/96→; →Orga 09155		24.0120-0155.1	420155	Ø 257,5 20 18,2 V
			←	04/96→; →Orga 09792		24.0126-0104.1	426104	Ø 281 26 24,2 V
			←	Orga 09793→		24.0128-0136.1	428136	Ø 285 28 26 V
			←	Orga 09793→		24.0328-0136.1	528136	Ø 285 28 26 V

	kw			 	! #		
<b>PEUGEOT - EXPERT Kasten 04/16→</b>							
 <b>Bremsbelagsatz, Scheibenbremse</b>							
1.6 BlueHDi 115 1.6 BlueHDi 95 2.0 BlueHDi 120 2.0 BlueHDi 150 2.0 BlueHDi 180	85 70 90 110 130	04/16→ 04/16→ 04/16→ 04/16→ 04/16→	←	für Bremsscheibendurchmesser [mm]: 304		13.0460-7331.2 607331	ATE 22593 18,0 + WE / - WK
 <b>Bremsscheibe</b>							
1.6 BlueHDi 115 1.6 BlueHDi 95 2.0 BlueHDi 120 2.0 BlueHDi 150 2.0 BlueHDi 180	85 70 90 110 130	04/16→ 04/16→ 04/16→ 04/16→ 04/16→	→			24.0112-0212.1 412212	Ø 290 12 10 + S
<b>PEUGEOT - EXPERT Kasten (222) 07/95→12/06</b>							
 <b>Bremsbelagsatz, Scheibenbremse</b>							
1.6 1.8 1.9 D 1.9 D 70 1.9 TD 2.0 2.0 HDI 2.0 HDI	58 74 51 51 66 100 69 80	02/96→09/00 10/96→09/00 02/96→12/98 12/98→12/06 02/96→09/00 09/02→12/06 07/00→12/06 07/00→12/06	←	Orga 09793→; Nutzlast [kg]: 800 / 900		13.0460-2863.2 602863	TRW 20261 19,0 + WK + Zub
			←	→Orga 09792; Nutzlast [kg]: 900		13.0460-2978.2 602978	TRW 21801 19,0 + WK
			←	Orga 09156→ Orga 09792; Nutzlast [kg]: 800		13.0460-2978.2 602978	TRW 21801 19,0 + WK
			←	→Orga 09155; Nutzlast [kg]: 800		13.0460-3957.2 603957	BDX 23042 19,0 + WK + Zub
1.9 TD	68	02/96→05/98	←	Orga 09793→; Nutzlast [kg]: 800 / 900		13.0460-2863.2 602863	TRW 20261 19,0 + WK + Zub
			←	04/96→; →Orga 09792; Nutzlast [kg]: 900		13.0460-2978.2 602978	TRW 21801 19,0 + WK
			←	Orga 09156→ Orga 09792; Nutzlast [kg]: 800		13.0460-2978.2 602978	TRW 21801 19,0 + WK
			←	04/96→; →Orga 09155; Nutzlast [kg]: 800		13.0460-3957.2 603957	BDX 23042 19,0 + WK + Zub
 <b>Bremsscheibe</b>							
1.6 1.8 1.9 D 1.9 D 70 1.9 TD 2.0 2.0 HDI 2.0 HDI	58 74 51 51 66 100 69 80	02/96→09/00 10/96→09/00 02/96→12/98 12/98→12/06 02/96→09/00 09/02→12/06 07/00→12/06 07/00→12/06	←	→Orga 09155; Nutzlast [kg]: 800		24.0120-0155.1 420155	Ø 257,5 20 18,2 V
			←	→Orga 09792; Nutzlast [kg]: 900		24.0126-0104.1 426104	Ø 281 26 24,2 V
			←	Orga 09156→ Orga 09792; Nutzlast [kg]: 800		24.0126-0104.1 426104	Ø 281 26 24,2 V
			←	Orga 09793→; Nutzlast [kg]: 800		24.0128-0136.1 428136	Ø 285 28 26 V
			←	Orga 09793→; Nutzlast [kg]: 900		24.0128-0136.1 428136	Ø 285 28 26 V
			←	Orga 09793→; Nutzlast [kg]: 800		24.0328-0136.1 528136	Ø 285 28 26 V
1.9 TD	68	02/96→05/98	←	04/96→; →Orga 09155; Nutzlast [kg]: 800		24.0120-0155.1 420155	Ø 257,5 20 18,2 V
			←	04/96→; →Orga 09792; Nutzlast [kg]: 900		24.0126-0104.1 426104	Ø 281 26 24,2 V
			←	Orga 09156→ Orga 09792; Nutzlast [kg]: 800		24.0126-0104.1 426104	Ø 281 26 24,2 V
			←	Orga 09793→; Nutzlast [kg]: 900		24.0128-0136.1 428136	Ø 285 28 26 V
			←	Orga 09793→; Nutzlast [kg]: 800		24.0128-0136.1 428136	Ø 285 28 26 V
			←	Orga 09793→; Nutzlast [kg]: 800		24.0328-0136.1 528136	Ø 285 28 26 V
<b>PEUGEOT - EXPERT Kasten (VF3A_, VF3U_, VF3X_) 01/07→</b>							
 <b>Bremsbelagsatz, Scheibenbremse</b>							
1.6 HDi 90 16V 1.6 HDi 90 8V 2.0 HDi 100 2.0 HDi 120 2.0 HDi 120 4x4 2.0 HDi 130 2.0 HDi 130 4x4 2.0 HDi 140 2.0 HDi 165 2.0 16V	66 66 72 88 88 94 94 100 120 103	01/07→ 01/07→ 03/11→ 01/07→ 01/10→ 03/11→ 01/12→ 01/07→ 09/09→ 01/07→	←			13.0460-2738.2 602738	TRW 24595 18,5 + WK + Zub
			→			13.0460-2739.2 602739	TRW 24578 16,5 - WE / - WK + Zub
			←			13.0460-2738.2 602738	TRW 24595 18,5 + WK + Zub
			→	langer Radstand		13.0460-2739.2 602739	TRW 24578 16,5 - WE / - WK + Zub
 <b>Bremsscheibe</b>							
1.6 HDi 90 16V 1.6 HDi 90 8V	66 66	01/07→ 01/07→	←	für Fahrzeuge mit Trommelbremse an der Hinterachse		24.0128-0214.1 428214	Ø 280 28 26 V + S
			←	für Fahrzeuge mit Scheibenbremse an der Hinterachse		24.0128-0216.1 428216	Ø 304 28 26 V + S
↓							

	kW					! #			
<b>PEUGEOT - EXPERT Kasten (VF3A_, VF3U_, VF3X_) 01/07→</b>									
 <b>Bremsscheibe</b>									
1.6 HDi 90 16V	66	01/07→	→				24.0114-0116.1	414116	Ø 290 14 12 + S
1.6 HDi 90 8V	66	01/07→							
2.0 16V	103	01/07→	←				24.0128-0216.1	428216	Ø 304 28 26 V + S
			→	langer Radstand			24.0114-0116.1	414116	Ø 290 14 12 + S
2.0 HDi 100	72	03/11→	←				24.0128-0216.1	428216	Ø 304 28 26 V + S
2.0 HDi 120	88	01/07→							
2.0 HDi 120 4x4	88	01/10→	→				24.0114-0116.1	414116	Ø 290 14 12 + S
2.0 HDi 130	94	03/11→							
2.0 HDi 130 4x4	94	01/12→							
2.0 HDi 140	100	01/07→							
2.0 HDi 165	120	09/09→							
<b>PEUGEOT - EXPERT Pritsche/Fahrgestell 09/16→</b>									
 <b>Bremsbelagsatz, Scheibenbremse</b>									
1.6 BlueHDi 95	70	09/16→	←	für Bremsscheibendurchmesser [mm]:			13.0460-7331.2	607331	ATE 22593 18,0 + WE / - WK
2.0 BlueHDi 120	90	09/16→		304					
2.0 BlueHDi 150	110	09/16→							
 <b>Bremsscheibe</b>									
1.6 BlueHDi 95	70	09/16→	→				24.0112-0212.1	412212	Ø 290 12 10 + S
2.0 BlueHDi 120	90	09/16→							
2.0 BlueHDi 150	110	09/16→							
<b>PEUGEOT - EXPERT Pritsche/Fahrgestell 01/07→</b>									
 <b>Bremsbelagsatz, Scheibenbremse</b>									
1.6 HDi 90 16V	66	01/07→	←				13.0460-2738.2	602738	TRW 24595 18,5 + WK + Zub
1.6 HDi 90 8V	66	01/07→							
2.0 HDi 120	88	01/07→	→				13.0460-2739.2	602739	TRW 24578 16,5 - WE / - WK + Zub
2.0 HDi 130	94	03/11→							
2.0 HDi 140	100	01/07→							
2.0 HDi 165	120	09/09→							
 <b>Bremsscheibe</b>									
1.6 HDi 90 16V	66	01/07→	←	für Fahrzeuge mit Trommelbremse an der Hinterachse			24.0128-0214.1	428214	Ø 280 28 26 V + S
1.6 HDi 90 8V	66	01/07→	←	für Fahrzeuge mit Scheibenbremse an der Hinterachse			24.0128-0216.1	428216	Ø 304 28 26 V + S
			→				24.0114-0116.1	414116	Ø 290 14 12 + S
2.0 HDi 120	88	01/07→	←				24.0128-0216.1	428216	Ø 304 28 26 V + S
2.0 HDi 130	94	03/11→							
2.0 HDi 140	100	01/07→	→				24.0114-0116.1	414116	Ø 290 14 12 + S
2.0 HDi 165	120	09/09→							
<b>PEUGEOT - EXPERT Pritsche/Fahrgestell (223) 12/95→12/06</b>									
 <b>Bremsbelagsatz, Scheibenbremse</b>									
1.6	58	02/96→09/00	←	Orga 09793→			13.0460-2863.2	602863	TRW 20261 19,0 + WK + Zub
1.9 D	51	02/96→12/98							
1.9 D	51	06/98→09/01	←	→Orga 09792			13.0460-2978.2	602978	TRW 21801 19,0 + WK
1.9 TD	66	02/96→09/00							
2.0 HDi	69	10/00→10/06							
2.0 HDi	80	10/00→10/06							
1.9 TD	68	02/96→05/98	←	Orga 09793→			13.0460-2863.2	602863	TRW 20261 19,0 + WK + Zub
			←	04/96→; →Orga 09792			13.0460-2978.2	602978	TRW 21801 19,0 + WK
 <b>Bremsscheibe</b>									
1.6	58	02/96→09/00	←	→Orga 09792			24.0126-0104.1	426104	Ø 281 26 24,2 V
1.9 D	51	02/96→12/98							
1.9 D	51	06/98→09/01	←	Orga 09793→			24.0128-0136.1	428136	Ø 285 28 26 V
1.9 TD	66	02/96→09/00					24.0328-0136.1	528136	Ø 285 28 26 V
2.0 HDi	69	10/00→10/06							
2.0 HDi	80	10/00→10/06							
1.9 TD	68	02/96→05/98	←	04/96→; →Orga 09792			24.0126-0104.1	426104	Ø 281 26 24,2 V
			←	Orga 09793→			24.0128-0136.1	428136	Ø 285 28 26 V
							24.0328-0136.1	528136	Ø 285 28 26 V
<b>PEUGEOT - EXPERT Tepee (VF3X_) 01/07→</b>									
 <b>Bremsbelagsatz, Scheibenbremse</b>									
1.6 HDi 90 16V	66	01/07→	←				13.0460-2738.2	602738	TRW 24595 18,5 + WK + Zub
1.6 HDi 90 8V	66	01/07→							
2.0 HDi 100	72	03/11→	→				13.0460-2739.2	602739	TRW 24578 16,5 - WE / - WK + Zub
2.0 HDi 120	88	01/07→							
2.0 HDi 120 4x4	88	01/07→							



	kw			 	! #		
<b>PEUGEOT - EXPERT Tepee (VF3X_) 01/07→</b>							
 <b>Bremsbelagsatz, Scheibenbremse</b>							
2.0 HDi 130	94	03/11→	←			13.0460-2738.2 602738	TRW 24595 18,5 + WK + Zub
2.0 HDi 130 4x4	94	03/11→	→			13.0460-2739.2 602739	TRW 24578 16,5 - WE / - WK + Zub
2.0 HDi 140	100	01/07→					
2.0 HDi 165	120	09/09→					
2.0 16V	103	01/07→	←			13.0460-2738.2 602738	TRW 24595 18,5 + WK + Zub
			→	langer Radstand		13.0460-2739.2 602739	TRW 24578 16,5 - WE / - WK + Zub
 <b>Bremsscheibe</b>							
1.6 HDi 90 16V	66	01/07→	←	für Fahrzeuge mit Trommelbremse an der Hinterachse		24.0128-0214.1 428214	Ø 280 28 26 V + S
1.6 HDi 90 8V	66	01/07→	←	für Fahrzeuge mit Scheibenbremse an der Hinterachse		24.0128-0216.1 428216	Ø 304 28 26 V + S
			→			24.0114-0116.1 414116	Ø 290 14 12 + S
2.0 16V	103	01/07→	←			24.0128-0216.1 428216	Ø 304 28 26 V + S
			→	langer Radstand		24.0114-0116.1 414116	Ø 290 14 12 + S
2.0 HDi 100	72	03/11→	←			24.0128-0216.1 428216	Ø 304 28 26 V + S
2.0 HDi 120	88	01/07→	→			24.0114-0116.1 414116	Ø 290 14 12 + S
2.0 HDi 120 4x4	88	01/07→					
2.0 HDi 130	94	03/11→					
2.0 HDi 130 4x4	94	03/11→					
2.0 HDi 140	100	01/07→					
2.0 HDi 165	120	09/09→					
<b>PEUGEOT - ION 11/10→</b>							
 <b>Bremsbelagsatz, Scheibenbremse</b>							
Electric	35	11/10→	←			13.0460-5621.2 605621	24423 14,6 + WK
Electric	47	11/10→					
Electric	49	10/14→					
 <b>Bremsscheibe</b>							
Electric	35	11/10→	←			24.0117-0110.1 417110	Ø 257 17 15 V
Electric	47	11/10→					
Electric	49	10/14→					
<b>PEUGEOT - PARTNER Combispace (5F) 05/96→12/15</b>							
 <b>Bremsbelagsatz, Scheibenbremse</b>							
1.1	44	06/96→10/02	←	07/96→ 09/02		13.0460-2829.2 602829	TRW 23124 19,0 + WK
			←	10/02→		13.0460-3994.2 603994	BOS 23599 19,0 - WE / - WK + Zub
						13.0470-3994.2 LD3994	BOS 23599 19,0 - WE / - WK + Zub Ceramic
1.4	54	11/02→10/06	←			13.0460-2829.2 602829	TRW 23124 19,0 + WK
						13.0460-3994.2 603994	BOS 23599 19,0 - WE / - WK + Zub
						13.0470-3994.2 LD3994	BOS 23599 19,0 - WE / - WK + Zub Ceramic
1.4	55	06/96→12/15	←	07/96→ 09/02		13.0460-2829.2 602829	TRW 23124 19,0 + WK
			←	10/02→ 03/08		13.0460-3994.2 603994	BOS 23599 19,0 - WE / - WK + Zub
						13.0470-3994.2 LD3994	BOS 23599 19,0 - WE / - WK + Zub Ceramic
1.6 16V	80	07/01→03/08	←	→Orga 09127		13.0460-2829.2 602829	TRW 23124 19,0 + WK
2.0 HDi 4x4	66	04/04→08/05	←	Orga 09128→; + ESP		13.0460-3811.2 603811	BOS 23708 19,2 - WE / - WK
			←	Orga 09128→; - ESP		13.0460-3994.2 603994	BOS 23599 19,0 - WE / - WK + Zub
						13.0470-3994.2 LD3994	BOS 23599 19,0 - WE / - WK + Zub Ceramic
			→	+ ESP		13.0460-2820.2 602820	TRW 20961 17,2 - WK
						13.0470-2820.2 LD2820	TRW 20961 17,2 - WK Ceramic
1.6 Flexfuel	80	09/00→10/02	←	07/01→; →Orga 09127		13.0460-2829.2 602829	TRW 23124 19,0 + WK
			←	Orga 09128→; + ESP		13.0460-3811.2 603811	BOS 23708 19,2 - WE / - WK
			←	Orga 09128→; - ESP		13.0460-3994.2 603994	BOS 23599 19,0 - WE / - WK + Zub
						13.0470-3994.2 LD3994	BOS 23599 19,0 - WE / - WK + Zub Ceramic
			→	07/01→; + ESP		13.0460-2820.2 602820	TRW 20961 17,2 - WK
						13.0470-2820.2 LD2820	TRW 20961 17,2 - WK Ceramic
↓							

	kw			 	! #		
<b>PEUGEOT - PARTNER Combispace (5F) 05/96→12/15</b>							
<b> Bremsbelagsatz, Scheibenbremse</b>							
1.6 HDi 75	55	02/06→12/13	←	→ 03/08; + ESP	13.0460-3811.2	603811	BOS 23708 19,2 - WE / - WK
			←	→ 03/08; - ESP	13.0460-3994.2	603994	BOS 23599 19,0 - WE / - WK + Zub
			→	→ 03/08; + ESP	13.0470-3994.2	LD3994	BOS 23599 19,0 - WE / - WK + Zub Ceramic
1.6 HDi 90	66	10/05→12/15	←	02/06→ 03/08; + ESP	13.0460-3811.2	603811	BOS 23708 19,2 - WE / - WK
			←	02/06→ 03/08; - ESP	13.0460-3994.2	603994	BOS 23599 19,0 - WE / - WK + Zub
			→	02/06→ 03/08; + ESP	13.0470-3994.2	LD3994	BOS 23599 19,0 - WE / - WK + Zub Ceramic
1.8	66	05/97→12/03	←	→Orga 09127	13.0460-2829.2	602829	TRW 20961 17,2 - WK
			←	Orga 09128→	13.0460-3994.2	603994	TRW 20961 17,2 - WK Ceramic
			←	→ 03/08; + ESP	13.0460-2820.2	602820	BOS 23599 19,0 - WE / - WK + Zub
1.9 D	50	06/96→12/02	←	07/96→; →Orga 09127	13.0460-3994.2	603994	BOS 23599 19,0 - WE / - WK + Zub
			←	Orga 09128→	13.0470-3994.2	LD3994	BOS 23599 19,0 - WE / - WK + Zub Ceramic
			←	→Orga 09127	13.0460-2829.2	602829	TRW 23124 19,0 + WK
1.9 D	51	05/96→12/98	←	12/98→; →Orga 09127	13.0460-3994.2	603994	BOS 23599 19,0 - WE / - WK + Zub
			←	Orga 09128→	13.0470-3994.2	LD3994	BOS 23599 19,0 - WE / - WK + Zub Ceramic
			←	→Orga 09127	13.0460-2829.2	602829	TRW 23124 19,0 + WK
1.9 D	51	12/98→07/08	←	→Orga 09127	13.0460-3994.2	603994	BOS 23599 19,0 - WE / - WK + Zub
			←	Orga 09128→; → 03/08	13.0470-3994.2	LD3994	BOS 23599 19,0 - WE / - WK + Zub Ceramic
			←	→Orga 09127	13.0460-2829.2	602829	TRW 23124 19,0 + WK
1.9 D 4x4	51	04/04→08/05	←		13.0460-3994.2	603994	BOS 23599 19,0 - WE / - WK + Zub
			←		13.0470-3994.2	LD3994	BOS 23599 19,0 - WE / - WK + Zub Ceramic
			←	→Orga 09127	13.0460-2829.2	602829	TRW 23124 19,0 + WK
2.0 HDI	66	02/00→07/08	←	→Orga 09127	13.0460-3811.2	603811	BOS 23708 19,2 - WE / - WK
			←	Orga 09128→; → 03/08; + ESP	13.0460-3994.2	603994	BOS 23599 19,0 - WE / - WK + Zub
			←	Orga 09128→; → 03/08; - ESP	13.0470-3994.2	LD3994	BOS 23599 19,0 - WE / - WK + Zub Ceramic
			→	→ 03/08; + ESP	13.0460-2820.2	602820	TRW 20961 17,2 - WK
Electric	28	01/98→12/01	←		13.0470-2820.2	LD2820	TRW 20961 17,2 - WK Ceramic
			←		13.0460-2829.2	602829	TRW 23124 19,0 + WK
			←				
<b> Bremsscheibe</b>							
1.1	44	06/96→10/02	←	07/96→ 09/02	24.0113-0184.1	413184	Ø 266 13 11 + S
			←	10/02→	24.0313-0184.1	513184	Ø 266 13 11 + S
1.4 1.9 D 4x4	54 51	11/02→10/06 04/04→08/05	←		24.0122-0194.1	422194	Ø 266 22 20 V + S
			←				
1.4	55	06/96→12/15	←	07/96→ 09/02	24.0113-0184.1	413184	Ø 266 13 11 + S
			←		24.0313-0184.1	513184	Ø 266 13 11 + S
			←	10/02→; →Orga 09127	24.0120-0133.1	420133	Ø 266 20,5 18,5 V + S
			←	Orga 09128→; → 03/08	24.0320-0133.1	520133	Ø 266 20,5 18,5 V + S
1.6 16V	80	07/01→03/08	←	→Orga 09127	24.0122-0194.1	422194	Ø 266 22 20 V + S
			←	→Orga 09127	24.0120-0133.1	420133	Ø 266 20,5 18,5 V + S
			←	Orga 09128→; - ESP	24.0320-0133.1	520133	Ø 266 20,5 18,5 V + S
			←	Orga 09128→; + ESP	24.0126-0120.1	426120	Ø 283 26 24 V + S
					24.0326-0120.1	526120	Ø 283 26 24 V + S



**PEUGEOT - PARTNER Combispace (5F) 05/96→12/15**











**Bremsscheibe**











1.6 16V	80	07/01→03/08	➔	+ ESP	24.0109-0137.1	409137	Ø 247 9 8 + S
1.6 Flexfuel	80	09/00→10/02	➔	07/01→; →Orga 09127	24.0120-0133.1	420133	Ø 266 20,5 18,5 V + S
			➔	07/01→; + ESP	24.0320-0133.1	520133	Ø 266 20,5 18,5 V + S
			➔	Orga 09128→; - ESP	24.0122-0194.1	422194	Ø 266 22 20 V + S
			➔	Orga 09128→; + ESP	24.0126-0120.1	426120	Ø 283 26 24 V + S
			➔	Orga 09128→; + ESP	24.0326-0120.1	526120	Ø 283 26 24 V + S
1.6 HDi 75	55	02/06→12/13	➔	07/01→; + ESP	24.0109-0137.1	409137	Ø 247 9 8 + S
			➔	→ 03/08; - ESP	24.0122-0194.1	422194	Ø 266 22 20 V + S
			➔	→ 03/08; + ESP	24.0126-0120.1	426120	Ø 283 26 24 V + S
1.6 HDi 90	66	10/05→12/15	➔	→ 03/08; + ESP	24.0326-0120.1	526120	Ø 283 26 24 V + S
			➔	→ 03/08; + ESP	24.0109-0137.1	409137	Ø 247 9 8 + S
			➔	→ 03/08; - ESP	24.0122-0194.1	422194	Ø 266 22 20 V + S
1.6 HDi 90	66	10/05→12/15	➔	02/06→ 03/08; - ESP	24.0126-0120.1	426120	Ø 283 26 24 V + S
			➔	02/06→ 03/08; + ESP	24.0326-0120.1	526120	Ø 283 26 24 V + S
			➔	02/06→ 03/08; + ESP	24.0109-0137.1	409137	Ø 247 9 8 + S
1.8	66	05/97→12/03	➔	→Orga 09127	24.0120-0133.1	420133	Ø 266 20,5 18,5 V + S
			➔	Orga 09128→	24.0320-0133.1	520133	Ø 266 20,5 18,5 V + S
1.9 D	50	06/96→12/02	➔	→Orga 09127	24.0122-0194.1	422194	Ø 266 22 20 V + S
			➔	07/96→; →Orga 09127	24.0120-0133.1	420133	Ø 266 20,5 18,5 V + S
1.9 D	51	05/96→12/98	➔	→Orga 09127	24.0320-0133.1	520133	Ø 266 20,5 18,5 V + S
			➔	12/98→; →Orga 09127	24.0120-0133.1	420133	Ø 266 20,5 18,5 V + S
1.9 D	51	12/98→07/08	➔	Orga 09128→	24.0122-0194.1	422194	Ø 266 22 20 V + S
			➔	→Orga 09127	24.0120-0133.1	420133	Ø 266 20,5 18,5 V + S
2.0 HDI	66	02/00→07/08	➔	→Orga 09127	24.0320-0133.1	520133	Ø 266 20,5 18,5 V + S
			➔	Orga 09128→; → 03/08; - ESP	24.0122-0194.1	422194	Ø 266 22 20 V + S
			➔	Orga 09128→; → 03/08; + ESP	24.0126-0120.1	426120	Ø 283 26 24 V + S
			➔	→ 03/08; + ESP	24.0326-0120.1	526120	Ø 283 26 24 V + S
			➔	→ 03/08; + ESP	24.0109-0137.1	409137	Ø 247 9 8 + S
2.0 HDi 4x4	66	04/04→08/05	➔	→Orga 09127	24.0120-0133.1	420133	Ø 266 20,5 18,5 V + S
			➔	Orga 09128→; - ESP	24.0320-0133.1	520133	Ø 266 20,5 18,5 V + S
			➔	Orga 09128→; + ESP	24.0122-0194.1	422194	Ø 266 22 20 V + S
			➔	Orga 09128→; + ESP	24.0126-0120.1	426120	Ø 283 26 24 V + S
			➔	+ ESP	24.0326-0120.1	526120	Ø 283 26 24 V + S
Electric	28	01/98→12/01	➔		24.0109-0137.1	409137	Ø 247 9 8 + S
					24.0120-0133.1	420133	Ø 266 20,5 18,5 V + S
					24.0320-0133.1	520133	Ø 266 20,5 18,5 V + S













**PEUGEOT - PARTNER Kasten 04/08→**















**Bremsbelagsatz, Scheibenbremse**

1.6	66	04/08→	➔		13.0460-7229.2	607229	ATE 24538 18,5 - WE / - WK
1.6	72	11/10→	➔		13.0470-7229.2	LD7229	ATE 24538 18,5 - WE / - WK
1.6	80	04/08→	➔				Ceramic
1.6	88	04/10→	➔				
1.6 BlueHDI 100	73	04/15→	➔		13.0460-2745.2	602745	TRW 24765 16,5 - WE / - WK
1.6 BlueHDI 120	88	04/15→	➔				+ Zub
1.6 HDi	55	04/08→	➔				
1.6 HDi	66	12/11→	➔				
1.6 HDi	67	09/09→12/12	➔				
1.6 HDi	80	04/08→	➔				
1.6 HDi	84	03/13→	➔				
1.6 HDi 16V	66	04/08→	➔				
1.6 HDi 16V 4x4	66	04/12→	➔				
1.6 HDi 90	68	04/10→	➔				
Électrique	49	06/13→	➔				













	kw			 	! #		
<b>PEUGEOT - PARTNER Kasten 04/08→</b>							
 <b>Bremsbelagsatz, Scheibenbremse</b>							
1.6 HDi / BlueHDi 75	55	07/11→	←	01/15→		<b>13.0460-7229.2 607229</b> <b>13.0470-7229.2 LD7229</b>	ATE 24538 18,5 - WE / - WK ATE 24538 18,5 - WE / - WK Ceramic
			→	01/15→		<b>13.0460-2745.2 602745</b>	TRW 24765 16,5 - WE / - WK + Zub
 <b>Bremsscheibe</b>							
1.6	66	04/08→	←			<b>24.0126-0120.1 426120</b>	Ø 283 26 24 V + S
1.6	72	11/10→				<b>24.0326-0120.1 526120</b>	Ø 283 26 24 V + S
1.6	80	04/08→					
1.6	88	04/10→	→			<b>24.0112-0194.2 412194</b>	Ø 268 12 10 + LG / + ABS Ring
1.6 BlueHDi 100	73	04/15→					
1.6 BlueHDi 120	88	04/15→					
1.6 HDi	55	04/08→					
1.6 HDi	66	12/11→					
1.6 HDi	67	09/09→12/12					
1.6 HDi	80	04/08→					
1.6 HDi	84	03/13→					
1.6 HDi 16V	66	04/08→					
1.6 HDi 16V 4x4	66	04/12→					
1.6 HDi 90	68	04/10→					
Électrique	49	06/13→					
1.6 HDi / BlueHDi 75	55	07/11→	←	01/15→		<b>24.0126-0120.1 426120</b> <b>24.0326-0120.1 526120</b>	Ø 283 26 24 V + S Ø 283 26 24 V + S
			→	01/15→		<b>24.0112-0194.2 412194</b>	Ø 268 12 10 + LG / + ABS Ring
<b>PEUGEOT - PARTNER Kasten (5) 04/96→12/15</b>							
 <b>Bremsbelagsatz, Scheibenbremse</b>							
1.1	44	06/96→09/05	←	07/96→ 09/02		<b>13.0460-2829.2 602829</b>	TRW 23124 19,0 + WK
			←	10/02→		<b>13.0460-3994.2 603994</b> <b>13.0470-3994.2 LD3994</b>	BOS 23599 19,0 - WE / - WK + Zub BOS 23599 19,0 - WE / - WK + Zub Ceramic
1.4	54	11/02→10/06	←			<b>13.0460-3994.2 603994</b>	BOS 23599 19,0 - WE / - WK + Zub
1.4 BiFuel	55	04/03→10/06					
1.6	80	09/00→10/02				<b>13.0470-3994.2 LD3994</b>	BOS 23599 19,0 - WE / - WK + Zub Ceramic
1.6 Bioflex	80	09/00→10/02					
1.4	55	06/96→12/15	←	07/96→ 09/02		<b>13.0460-2829.2 602829</b>	TRW 23124 19,0 + WK
			←	10/02→ 03/08		<b>13.0460-3994.2 603994</b> <b>13.0470-3994.2 LD3994</b>	BOS 23599 19,0 - WE / - WK + Zub BOS 23599 19,0 - WE / - WK + Zub Ceramic
1.6 HDi 75	55	02/06→07/08	←	→ 03/08		<b>13.0460-3994.2 603994</b>	BOS 23599 19,0 - WE / - WK + Zub
1.6 HDi 90	66	02/06→12/15				<b>13.0470-3994.2 LD3994</b>	BOS 23599 19,0 - WE / - WK + Zub Ceramic
1.8	66	03/97→08/00	←			<b>13.0460-2829.2 602829</b>	TRW 23124 19,0 + WK
1.8 D	43	06/96→12/02	←	07/96→; →Orga 09127		<b>13.0460-2829.2 602829</b>	TRW 23124 19,0 + WK
1.9 D	51	06/96→12/02	←	Orga 09128→		<b>13.0460-3994.2 603994</b> <b>13.0470-3994.2 LD3994</b>	BOS 23599 19,0 - WE / - WK + Zub BOS 23599 19,0 - WE / - WK + Zub Ceramic
1.8 D	44	11/96→02/98	←	→Orga 09127		<b>13.0460-2829.2 602829</b>	TRW 23124 19,0 + WK
1.9 D	50	05/96→12/98					
1.9 D 4x4	51	04/04→11/07	←	Orga 09128→		<b>13.0460-3994.2 603994</b> <b>13.0470-3994.2 LD3994</b>	BOS 23599 19,0 - WE / - WK + Zub BOS 23599 19,0 - WE / - WK + Zub Ceramic
1.9 D	51	06/96→12/15	←	07/96→; →Orga 09127		<b>13.0460-2829.2 602829</b>	TRW 23124 19,0 + WK
			←	Orga 09128→; → 03/08		<b>13.0460-3994.2 603994</b> <b>13.0470-3994.2 LD3994</b>	BOS 23599 19,0 - WE / - WK + Zub BOS 23599 19,0 - WE / - WK + Zub Ceramic
2.0 HDi	66	04/00→07/08	←	→Orga 09127		<b>13.0460-2829.2 602829</b>	TRW 23124 19,0 + WK
			←	Orga 09128→; → 03/08; + ESP		<b>13.0460-3811.2 603811</b>	BOS 23708 19,2 - WE / - WK
			←	Orga 09128→; → 03/08; - ESP		<b>13.0460-3994.2 603994</b> <b>13.0470-3994.2 LD3994</b>	BOS 23599 19,0 - WE / - WK + Zub BOS 23599 19,0 - WE / - WK + Zub Ceramic
			→	→ 03/08; + ESP		<b>13.0460-2820.2 602820</b>	TRW 20961 17,2 - WK











	kw			 	! #		
<b>PEUGEOT - PARTNER Kasten (5) 04/96→12/15</b>							
 <b>Bremsbelagsatz, Scheibenbremse</b>							
2.0 HDi	66	04/00→07/08	➡	→ 03/08; + ESP		<b>13.0470-2820.2 LD2820</b>	TRW 20961 17,2 - WK Ceramic
2.0 HDi 4x4	66	04/04→08/05	⬅	→Orga 09127		<b>13.0460-2829.2 602829</b>	TRW 23124 19,0 + WK
			⬅	Orga 09128→; + ESP		<b>13.0460-3811.2 603811</b>	BOS 23708 19,2 - WE / - WK
			⬅	Orga 09128→; - ESP		<b>13.0460-3994.2 603994</b>	BOS 23599 19,0 - WE / - WK + Zub
			➡	+ ESP		<b>13.0470-3994.2 LD3994</b>	BOS 23599 19,0 - WE / - WK + Zub Ceramic
Electric	25	04/96→12/02	⬅	01/98→		<b>13.0460-3994.2 603994</b>	BOS 23599 19,0 - WE / - WK + Zub
						<b>13.0470-3994.2 LD3994</b>	BOS 23599 19,0 - WE / - WK + Zub Ceramic
 <b>Bremsscheibe</b>							
1.1	44	06/96→09/05	⬅	07/96→ 09/02		<b>24.0113-0184.1 413184</b>	Ø 266 13 11 + S
			⬅	10/02→		<b>24.0313-0184.1 513184</b>	Ø 266 13 11 + S
1.4 1.4 BiFuel 1.6 1.6 Bioflex	54	11/02→10/06	⬅			<b>24.0122-0194.1 422194</b>	Ø 266 22 20 V + S
	55	04/03→10/06					
	80	09/00→10/02					
1.4	55	06/96→12/15	⬅	07/96→ 09/02		<b>24.0113-0184.1 413184</b>	Ø 266 13 11 + S
			⬅	10/02→ 03/08		<b>24.0313-0184.1 513184</b>	Ø 266 13 11 + S
1.6 HDi 75 1.6 HDi 90	55	02/06→07/08	⬅	→ 03/08		<b>24.0122-0194.1 422194</b>	Ø 266 22 20 V + S
	66	02/06→12/15					
1.8	66	03/97→08/00	⬅			<b>24.0113-0184.1 413184</b>	Ø 266 13 11 + S
						<b>24.0120-0133.1 420133</b>	Ø 266 20,5 18,5 V + S
						<b>24.0313-0184.1 513184</b>	Ø 266 13 11 + S
						<b>24.0320-0133.1 520133</b>	Ø 266 20,5 18,5 V + S
1.8 D 1.9 D	43	06/96→12/02	⬅	07/96→; →Orga 09127		<b>24.0120-0133.1 420133</b>	Ø 266 20,5 18,5 V + S
	51	06/96→12/02	⬅	Orga 09128→		<b>24.0320-0133.1 520133</b>	Ø 266 20,5 18,5 V + S
1.8 D 1.9 D 1.9 D 4x4	44	11/96→02/98	⬅	→Orga 09127		<b>24.0122-0194.1 422194</b>	Ø 266 22 20 V + S
			50	05/96→12/98			
1.9 D	51	04/04→11/07	⬅	Orga 09128→		<b>24.0120-0133.1 420133</b>	Ø 266 20,5 18,5 V + S
			⬅	07/96→; →Orga 09127		<b>24.0122-0194.1 422194</b>	Ø 266 22 20 V + S
2.0 HDi	66	04/00→07/08	⬅	→Orga 09127		<b>24.0120-0133.1 420133</b>	Ø 266 20,5 18,5 V + S
			⬅	Orga 09128→; → 03/08; - ESP		<b>24.0320-0133.1 520133</b>	Ø 266 20,5 18,5 V + S
			⬅	Orga 09128→; → 03/08; + ESP		<b>24.0122-0194.1 422194</b>	Ø 266 22 20 V + S
			➡	→ 03/08; + ESP		<b>24.0126-0120.1 426120</b>	Ø 283 26 24 V + S
2.0 HDi 4x4	66	04/04→08/05	⬅	→Orga 09127		<b>24.0326-0120.1 526120</b>	Ø 283 26 24 V + S
			⬅	→ 03/08; + ESP		<b>24.0109-0137.1 409137</b>	Ø 247 9 8 + S
			⬅	→Orga 09127		<b>24.0120-0133.1 420133</b>	Ø 266 20,5 18,5 V + S
			⬅	Orga 09128→; - ESP		<b>24.0320-0133.1 520133</b>	Ø 266 20,5 18,5 V + S
2.0 HDi	66	11/02→07/08	⬅	→Orga 09127		<b>24.0122-0194.1 422194</b>	Ø 266 22 20 V + S
			⬅	Orga 09128→; + ESP		<b>24.0126-0120.1 426120</b>	Ø 283 26 24 V + S
			➡	+ ESP		<b>24.0326-0120.1 526120</b>	Ø 283 26 24 V + S
Electric	25	04/96→12/02	⬅	01/98→		<b>24.0109-0137.1 409137</b>	Ø 247 9 8 + S
						<b>24.0122-0194.1 422194</b>	Ø 266 22 20 V + S
<b>PEUGEOT - PARTNER Pritsche/Fahrgestell 01/99→07/08</b>							
 <b>Bremsbelagsatz, Scheibenbremse</b>							
1.9 D	51	01/99→07/08	⬅	→Orga 09127		<b>13.0460-2829.2 602829</b>	TRW 23124 19,0 + WK
			⬅	Orga 09128→; → 03/08		<b>13.0460-3994.2 603994</b>	BOS 23599 19,0 - WE / - WK + Zub
2.0 HDi	66	11/02→07/08	⬅	→Orga 09127		<b>13.0470-3994.2 LD3994</b>	BOS 23599 19,0 - WE / - WK + Zub Ceramic
			↓				









	kw					! #		
<b>PEUGEOT - PARTNER Pritsche/Fahrgestell 01/99→07/08</b>								
 <b>Bremsbelagsatz, Scheibenbremse</b>								
2.0 HDi	66	11/02→07/08	←	Orga 09128→; → 03/08; + ESP		13.0460-3811.2	603811	BOS 23708 19,2 - WE / - WK
			←	Orga 09128→; → 03/08; - ESP		13.0460-3994.2	603994	BOS 23599 19,0 - WE / - WK + Zub
						13.0470-3994.2	LD3994	BOS 23599 19,0 - WE / - WK + Zub Ceramic
			→	→ 03/08; + ESP		13.0460-2820.2	602820	TRW 20961 17,2 - WK
						13.0470-2820.2	LD2820	TRW 20961 17,2 - WK Ceramic
 <b>Bremsscheibe</b>								
1.9 D	51	01/99→07/08	←	→Orga 09127		24.0120-0133.1	420133	Ø 266 20,5 18,5 V + S
						24.0320-0133.1	520133	Ø 266 20,5 18,5 V + S
			←	Orga 09128→; → 03/08		24.0122-0194.1	422194	Ø 266 22 20 V + S
2.0 HDi	66	11/02→07/08	←	→Orga 09127		24.0120-0133.1	420133	Ø 266 20,5 18,5 V + S
						24.0320-0133.1	520133	Ø 266 20,5 18,5 V + S
			←	Orga 09128→; → 03/08; - ESP		24.0122-0194.1	422194	Ø 266 22 20 V + S
			←	Orga 09128→; → 03/08; + ESP		24.0126-0120.1	426120	Ø 283 26 24 V + S
						24.0326-0120.1	526120	Ø 283 26 24 V + S
			→	→ 03/08; + ESP		24.0109-0137.1	409137	Ø 247 9 8 + S
<b>PEUGEOT - PARTNER Pritsche/Fahrgestell 01/09→</b>								
 <b>Bremsbelagsatz, Scheibenbremse</b>								
1.6 HDi	55	01/09→	←			13.0460-7229.2	607229	ATE 24538 18,5 - WE / - WK
1.6 HDi	66	03/13→				13.0470-7229.2	LD7229	ATE 24538 18,5 - WE / - WK Ceramic
1.6 HDi 16V	66	01/09→	→			13.0460-2745.2	602745	TRW 24765 16,5 - WE / - WK + Zub
 <b>Bremsscheibe</b>								
1.6 HDi	55	01/09→	←			24.0126-0120.1	426120	Ø 283 26 24 V + S
1.6 HDi	66	03/13→				24.0326-0120.1	526120	Ø 283 26 24 V + S
1.6 HDi 16V	66	01/09→	→			24.0112-0194.2	412194	Ø 268 12 10 + LG / + ABS Ring
<b>PEUGEOT - PARTNER Tepee 04/08→</b>								
 <b>Bremsbelagsatz, Scheibenbremse</b>								
1.2 THP	81	02/16→	←			13.0460-7229.2	607229	ATE 24538 18,5 - WE / - WK
1.6	66	04/08→				13.0470-7229.2	LD7229	ATE 24538 18,5 - WE / - WK Ceramic
1.6	72	08/10→						
1.6	80	04/08→	→			13.0460-2745.2	602745	TRW 24765 16,5 - WE / - WK + Zub
1.6	88	04/10→						
1.6 BlueHDi 100	73	12/14→						
1.6 BlueHDi 100 4x4	73	04/15→						
1.6 BlueHDi 120	88	12/14→						
1.6 HDi	55	04/08→						
1.6 HDi	66	03/13→						
1.6 HDi	80	04/08→						
1.6 HDi	82	08/10→						
1.6 HDi	84	03/13→						
1.6 HDi / BlueHDi 75	55	01/15→						
1.6 HDi 16V	66	04/08→						
1.6 HDi 90	68	04/10→						
1.6	81	09/08→	←	04/10→		13.0460-7229.2	607229	ATE 24538 18,5 - WE / - WK
						13.0470-7229.2	LD7229	ATE 24538 18,5 - WE / - WK Ceramic
			→	04/10→		13.0460-2745.2	602745	TRW 24765 16,5 - WE / - WK + Zub
 <b>Bremsscheibe</b>								
1.2 THP	81	02/16→	←			24.0126-0120.1	426120	Ø 283 26 24 V + S
1.6	66	04/08→				24.0326-0120.1	526120	Ø 283 26 24 V + S
1.6	72	08/10→	→			24.0112-0194.2	412194	Ø 268 12 10 + LG / + ABS Ring
1.6	80	04/08→						
1.6	88	04/10→						
1.6 BlueHDi 100	73	12/14→						
1.6 BlueHDi 100 4x4	73	04/15→						
1.6 BlueHDi 120	88	12/14→						
1.6 HDi	55	04/08→						
1.6 HDi	66	03/13→						
1.6 HDi	80	04/08→						
1.6 HDi	82	08/10→						
1.6 HDi	84	03/13→						

	kW			 	! #		
<b>PEUGEOT - PARTNER Tepee 04/08→</b>							
 <b>Bremsscheibe</b>							
1.6 HDi / BlueHDi 75 1.6 HDi 16V 1.6 HDi 90	55 66 68	01/15→ 04/08→ 04/10→	← →			24.0126-0120.1 426120 24.0326-0120.1 526120 24.0112-0194.2 412194	Ø 283 26 24 V + S Ø 283 26 24 V + S Ø 268 12 10 + LG / + ABS Ring
1.6	81	09/08→	← →	04/10→ 04/10→		24.0126-0120.1 426120 24.0326-0120.1 526120 24.0112-0194.2 412194	Ø 283 26 24 V + S Ø 283 26 24 V + S Ø 268 12 10 + LG / + ABS Ring
<b>PEUGEOT - RCZ 03/10→</b>							
 <b>Bremsbelagsatz, Scheibenbremse</b>							
1.6 16V 1.6 THP 150	115 110	03/10→ 03/11→	← →			13.0460-7202.2 607202 13.0460-7230.2 607230 13.0470-7202.2 LD7202 13.0470-7230.2 LD7230	ATE 23589 19,1 - WE / - WK ATE 24557 19,4 - WE / - WK ATE 23589 19,1 - WE / - WK Ceramic ATE 24557 19,4 - WE / - WK Ceramic
1.6 16V	147	06/10→	← →			13.0460-2761.2 602761 13.0460-7279.2 607279 13.0470-7279.2 LD7279	TRW 24922 16,5 - WK + Zub ATE 25069 17,3 + WK ATE 25069 17,3 + WK Ceramic
1.6 THP 270	199	06/13→	→	10/13→		13.0460-2761.2 602761	TRW 24922 16,5 - WK + Zub
2.0 HDi	120	03/10→	← ← →	Raddurchmesser [Zoll]: 18 Raddurchmesser [Zoll]: 19		13.0460-7202.2 607202 13.0460-7230.2 607230 13.0470-7202.2 LD7202 13.0470-7230.2 LD7230 13.0460-7279.2 607279 13.0470-7279.2 LD7279 13.0460-2761.2 602761	ATE 23589 19,1 - WE / - WK ATE 24557 19,4 - WE / - WK ATE 23589 19,1 - WE / - WK Ceramic ATE 24557 19,4 - WE / - WK Ceramic ATE 25069 17,3 + WK ATE 25069 17,3 + WK Ceramic TRW 24922 16,5 - WK + Zub
 <b>Bremsscheibe</b>							
1.6 16V 1.6 THP 150	115 110	03/10→ 03/11→	← →			24.0126-0176.1 426176 24.0112-0162.1 412162	Ø 302 26 24 V + S Ø 290 12 10 + S
1.6 16V	147	06/10→	← →			24.0130-0229.1 430229 24.0112-0162.1 412162	Ø 340 30 28 V + S Ø 290 12 10 + S
1.6 THP 270	199	06/13→	→	10/13→		24.0112-0162.1 412162	Ø 290 12 10 + S
2.0 HDi	120	03/10→	← ← →	Raddurchmesser [Zoll]: 18 Raddurchmesser [Zoll]: 19		24.0126-0176.1 426176 24.0130-0229.1 430229 24.0112-0162.1 412162	Ø 302 26 24 V + S Ø 340 30 28 V + S Ø 290 12 10 + S
<b>PEUGEOT - RIFTER 09/18→</b>							
 <b>Bremsbelagsatz, Scheibenbremse</b>							
1.2 THP 1.5 BlueHDi 100 1.5 BlueHDi 130 1.5 BlueHDi 75	81 75 96 56	09/18→ 09/18→ 09/18→ 09/18→	→	+ eFSB		13.0460-3871.2 603871 13.0470-3871.2 LD3871	BOS 25839 17,8 - WE / - WK + Zub BOS 25839 17,8 - WE / - WK + Zub Ceramic
 <b>Bremsscheibe</b>							
1.2 THP 1.5 BlueHDi 100 1.5 BlueHDi 130 1.5 BlueHDi 75	81 75 96 56	09/18→ 09/18→ 09/18→ 09/18→	← →			24.0128-0269.1 428269 24.0112-0211.1 412211	Ø 304 28 26 V + S Ø 268 12 10 + S
<b>PEUGEOT - TRAVELLER 04/16→</b>							
 <b>Bremsbelagsatz, Scheibenbremse</b>							
1.6 BlueHDi 115 1.6 BlueHDi 95 2.0 BlueHDi 150 2.0 BlueHDi 180	85 70 110 130	04/16→ 04/16→ 04/16→ 04/16→	←	für Bremsscheibendurchmesser [mm]: 304		13.0460-7331.2 607331	ATE 22593 18,0 + WE / - WK
 <b>Bremsscheibe</b>							
1.6 BlueHDi 115 1.6 BlueHDi 95 2.0 BlueHDi 150 2.0 BlueHDi 180	85 70 110 130	04/16→ 04/16→ 04/16→ 04/16→	→			24.0112-0212.1 412212	Ø 290 12 10 + S



	kw					! #		
<b>PONTIAC - TRANS SPORT 03/97→12/99</b>								
 <b>Bremsbelagsatz, Scheibenbremse</b>								
3.4	134	03/97→09/98	←			13.0460-8002.2	608002	23358 18,0 + WK
3.4	137	09/98→12/99						
 <b>Bremsscheibe</b>								
3.4	134	03/97→09/98	←			24.0132-0110.1	432110	Ø 278 32,2 30,7 V
3.4	137	09/98→12/99	→			24.0111-0133.1	411133	Ø 278 11 9
<b>PORSCHE - 718 BOXSTER (982) 04/16→</b>								
 <b>Bremsbelagsatz, Scheibenbremse</b>								
2.0	220	04/16→	→	für Fahrzeuge ohne Keramikbremse		13.0460-4816.2	604816	BRE 24541 15,5 + WE / - WK
2.5 GTS	269	10/17→						
S 2.5	257	04/16→						
<b>Warnkontakt, Bremsbelagverschleiß</b>								
2.0	220	04/16→	←	für Fahrzeuge mit Keramikbremse	2	24.8190-0952.2	620952	L= 300
2.5 GTS	269	10/17→						
S 2.5	257	04/16→	→		2	24.8190-0070.2	620070	L= 268
 <b>Bremsscheibe</b>								
2.0	220	04/16→	←	☐; für Fahrzeuge ohne Keramikbremse		24.0128-0246.1	428246	Ø 330 28 26 V•
			←	☐; für Fahrzeuge ohne Keramikbremse		24.0128-0247.1	428247	Ø 330 28 26 V•
			→	für Fahrzeuge ohne Keramikbremse		24.0120-0212.1	420212	Ø 299 20 18 V•
2.5 GTS	269	10/17→	→	für Fahrzeuge ohne Keramikbremse		24.0120-0212.1	420212	Ø 299 20 18 V•
S 2.5	257	04/16→						
<b>PORSCHE - 718 CAYMAN (982) 04/16→</b>								
 <b>Bremsbelagsatz, Scheibenbremse</b>								
2.0	220	04/16→	→	für Fahrzeuge ohne Keramikbremse		13.0460-4816.2	604816	BRE 24541 15,5 + WE / - WK
2.5 GTS	269	10/17→						
S 2.5	257	04/16→						
<b>Warnkontakt, Bremsbelagverschleiß</b>								
2.0	220	04/16→	←	für Fahrzeuge mit Keramikbremse	2	24.8190-0952.2	620952	L= 300
2.5 GTS	269	10/17→						
S 2.5	257	04/16→	→		2	24.8190-0070.2	620070	L= 268
 <b>Bremsscheibe</b>								
2.0	220	04/16→	←	☐; für Fahrzeuge ohne Keramikbremse		24.0128-0246.1	428246	Ø 330 28 26 V•
			←	☐; für Fahrzeuge ohne Keramikbremse		24.0128-0247.1	428247	Ø 330 28 26 V•
			→	für Fahrzeuge ohne Keramikbremse		24.0120-0212.1	420212	Ø 299 20 18 V•
2.5 GTS	269	10/17→	→	für Fahrzeuge ohne Keramikbremse		24.0120-0212.1	420212	Ø 299 20 18 V•
S 2.5	257	04/16→						
<b>PORSCHE - 911 (991) 12/11→</b>								
<b>Warnkontakt, Bremsbelagverschleiß</b>								
3.0 Carrera	272	11/15→	←	für Fahrzeuge mit Keramikbremse	2	24.8190-0952.2	620952	L= 300
3.0 Carrera 4	272	11/15→						
3.0 Carrera 4 GTS	331	03/17→	→		2	24.8190-0953.2	620953	L= 215
3.0 Carrera 4S	309	11/15→						
3.0 Carrera GTS	331	03/17→						
3.0 Carrera S	309	11/15→						
3.0 Carrera T	272	01/18→						
3.4 Carrera	257	12/11→	←	für Fahrzeuge ohne Keramikbremse	2	24.8190-0069.2	620069	L= 248
			←	für Fahrzeuge mit Keramikbremse	2	24.8190-0952.2	620952	L= 300
			→		2	24.8190-0953.2	620953	L= 215
3.4 Carrera 4	257	11/12→	←	für Fahrzeuge ohne Keramikbremse	2	24.8190-0106.2	620106	L= 270
3.8 Carrera 4S	294	11/12→						
3.8 Carrera 4S / 4 GTS	316	11/12→	←	für Fahrzeuge mit Keramikbremse	2	24.8190-0952.2	620952	L= 300
3.8 Carrera S	294	12/11→						
3.8 Carrera S / GTS	316	07/12→	→		2	24.8190-0953.2	620953	L= 215
3.8 GT3	350	08/13→	←	für Fahrzeuge ohne Keramikbremse	2	24.8190-0106.2	620106	L= 270
4.0 GT3 RS / R	368	04/15→	←	für Fahrzeuge mit Keramikbremse	2	24.8190-0952.2	620952	L= 300
			→	für Fahrzeuge ohne Keramikbremse	2	24.8190-0953.2	620953	L= 215
3.8 Turbo	383	09/13→	←		2	24.8190-0952.2	620952	L= 300
3.8 Turbo	397	01/16→						
3.8 Turbo S	412	09/13→	→	für Fahrzeuge mit Keramikbremse	2	24.8190-0953.2	620953	L= 215
3.8 Turbo S	427	01/16→						
3.8 Turbo S	446	08/17→						
↓								

	kw			 	! #		
<b>PORSCHE - 911 (991) 12/11→</b>							
 <b>Bremsscheibe</b>							
3.0 Carrera	272	11/15→	→	☐; für Fahrzeuge ohne Keramikbremse	24.0128-0196.1	428196	Ø 330 28 26 V•
3.0 Carrera 4	272	11/15→	→	☐; für Fahrzeuge ohne Keramikbremse	24.0128-0197.1	428197	Ø 330 28 26 V•
3.0 Carrera 4 GTS	331	03/17→					
3.0 Carrera 4S	309	11/15→					
3.0 Carrera GTS	331	03/17→					
3.0 Carrera S	309	11/15→					
3.0 Carrera T	272	01/18→					
3.4 Carrera 4	257	11/12→					
3.8 Carrera 4S	294	11/12→					
3.8 Carrera 4S / 4 GTS	316	11/12→					
3.8 Carrera S	294	12/11→					
3.8 Carrera S / GTS	316	07/12→					
3.4 Carrera	257	12/11→	←	☐; für Fahrzeuge ohne Keramikbremse	24.0128-0246.1	428246	Ø 330 28 26 V•
			←	☐; für Fahrzeuge ohne Keramikbremse	24.0128-0247.1	428247	Ø 330 28 26 V•
<b>PORSCHE - 911 (993) 10/93→09/97</b>							
 <b>Bremsbelagsatz, Scheibenbremse</b>							
3.6 Carrera	210	08/95→09/97	→		13.0460-4016.2	604016	ATE 20877 17,5 + WE / - WK
3.6 Carrera 4	210	08/95→09/97					
3.8 Carrera	210	06/95→09/97					
3.8 Carrera	221	08/95→09/97					
3.8 Carrera 4	210	06/95→09/97					
3.6 Turbo 4	300	03/95→09/97	←		13.0460-4056.2	604056	BRE 21402 17,5 + WE / - WK
3.6 Turbo GT2	316	03/95→09/97					
3.6 Turbo GT2 4	316	08/95→09/97					
3.6 Turbo GT2 4	331	06/97→09/97					
3.8 Carrera 4	221	08/95→09/97					
3.8 Carrera RS	221	06/95→09/97					
<b>Warnkontakt, Bremsbelagverschleiß</b>							
3.6 Carrera	210	08/95→09/97	←		2	24.8190-0917.2	620917 L= 518
3.6 Carrera 4	210	08/95→09/97	→				
3.8 Carrera	210	06/95→09/97	→		2	24.8190-0920.2	620920 L= 698
3.8 Carrera	221	08/95→09/97					
3.8 Carrera 4	210	06/95→09/97					
3.6 Turbo 4	300	03/95→09/97	←		2	24.8190-0926.2	620926 L= 475
3.6 Turbo GT2	316	03/95→09/97					
3.6 Turbo GT2 4	316	08/95→09/97	→		2	24.8190-0920.2	620920 L= 698
3.6 Turbo GT2 4	331	06/97→09/97					
3.8 Carrera 4	221	08/95→09/97					
3.8 Carrera RS	221	06/95→09/97					
 <b>Bremsscheibe</b>							
3.6 Carrera	210	08/95→09/97	←	☐	24.0132-0142.1	432142	Ø 304 32 30 V•
3.6 Carrera 4	210	08/95→09/97	←	☐	24.0132-0143.1	432143	Ø 304 32 30 V•
3.8 Carrera	210	06/95→09/97	←	☐			
3.8 Carrera	221	08/95→09/97	→		24.0124-0183.1	424183	Ø 299 24 22 V•
3.8 Carrera 4	210	06/95→09/97					
3.6 Turbo 4	300	03/95→09/97	←	☐	24.0132-0163.2	432163	Ø 322 32 30 V• Bremsscheibe zweiteilig
3.6 Turbo GT2	316	03/95→09/97					
3.6 Turbo GT2 4	316	08/95→09/97	←	☐	24.0132-0164.2	432164	Ø 322 32 30 V• Bremsscheibe zweiteilig
3.6 Turbo GT2 4	331	06/97→09/97					
<b>PORSCHE - 911 (996) 09/97→09/05</b>							
 <b>Bremsbelagsatz, Scheibenbremse</b>							
3.4 Carrera	221	09/97→09/01	←		13.0460-4987.2	604987	BRE 23329 17,0 + WE / - WK
3.4 Carrera 4	221	09/97→09/01	→		13.0460-4988.2	604988	BRE 21792 15,2 + WE / - WK
3.4 Carrera	235	05/01→08/05	←	→ 09/01	13.0460-4987.2	604987	BRE 23329 17,0 + WE / - WK
3.4 Carrera 4	235	05/01→08/05	→	→ 09/01	13.0460-4988.2	604988	BRE 21792 15,2 + WE / - WK
3.6 Carrera	235	10/01→08/05	←		13.0460-4987.2	604987	BRE 23329 17,0 + WE / - WK
3.6 Carrera S	254	02/03→08/05	→	für Fahrzeuge ohne Keramikbremse	13.0460-4987.2	604987	BRE 23329 17,0 + WE / - WK
3.6 Carrera 4	235	10/01→08/05	←	für Fahrzeuge ohne Keramikbremse	13.0460-4999.2	604999	BRE 23330 17,0 + WE / - WK
			→	01/02→; für Fahrzeuge ohne Keramikbremse	13.0460-4987.2	604987	BRE 23329 17,0 + WE / - WK
			→		13.0460-4988.2	604988	BRE 21792 15,2 + WE / - WK
3.6 Carrera 4S	254	02/03→08/05	←	für Fahrzeuge ohne Keramikbremse	13.0460-4999.2	604999	BRE 23330 17,0 + WE / - WK
			→	für Fahrzeuge ohne Keramikbremse	13.0460-4987.2	604987	BRE 23329 17,0 + WE / - WK
			→		13.0460-4988.2	604988	BRE 21792 15,2 + WE / - WK
3.6 GT3	265	03/99→08/05	→	für Fahrzeuge ohne Keramikbremse	13.0460-4987.2	604987	BRE 23329 17,0 + WE / - WK
3.6 GT3	280	03/03→08/05					
3.6 S	331	08/04→08/05	←	für Fahrzeuge ohne Keramikbremse	13.0460-4999.2	604999	BRE 23330 17,0 + WE / - WK
↓							

	kw			 	! #		
<b>PORSCHE - 911 (996) 09/97→09/05</b>							
<b> Bremsbelagsatz, Scheibenbremse</b>							
3.6 Turbo 4S	331	02/03→08/05	➡	für Fahrzeuge ohne Keramikbremse		13.0460-4987.2 604987	BRE 23329 17,0 + WE / - WK
3.6 Turbo 4	309	06/00→08/05	⬅	für Fahrzeuge ohne Keramikbremse		13.0460-4999.2 604999	BRE 23330 17,0 + WE / - WK
			➡	01/02→; für Fahrzeuge ohne Keramikbremse		13.0460-4987.2 604987	BRE 23329 17,0 + WE / - WK
<b>Warnkontakt, Bremsbelagverschleiß</b>							
3.4 Carrera	221	09/97→09/01	⬅		2	24.8190-0921.2 620921	L= 440
3.4 Carrera 4	221	09/97→09/01	➡		2	24.8190-0921.2 620921	L= 440
3.4 Carrera	235	05/01→08/05	⬅	→ 09/01	2	24.8190-0921.2 620921	L= 440
			➡	→ 09/01	2	24.8190-0921.2 620921	L= 440
3.6 Carrera	235	10/01→08/05	⬅		2	24.8190-0921.2 620921	L= 440
			⬅	01/03→; für Fahrzeuge mit Keramikbremse	2	24.8190-0938.2 620938	L= 495
			➡	für Fahrzeuge ohne Keramikbremse	2	24.8190-0921.2 620921	L= 440
			➡	01/03→; für Fahrzeuge mit Keramikbremse	2	24.8190-0943.2 620943	L= 504,6
3.6 Carrera 4	235	10/01→08/05	⬅	für Fahrzeuge ohne Keramikbremse	2	24.8190-0921.2 620921	L= 440
			⬅	01/03→; für Fahrzeuge mit Keramikbremse	2	24.8190-0938.2 620938	L= 495
			➡		2	24.8190-0921.2 620921	L= 440
			➡	01/02→; für Fahrzeuge ohne Keramikbremse	2	24.8190-0921.2 620921	L= 440
			➡	01/03→; für Fahrzeuge mit Keramikbremse	2	24.8190-0943.2 620943	L= 504,6
3.6 Carrera 4S	254	02/03→08/05	⬅	für Fahrzeuge ohne Keramikbremse	2	24.8190-0921.2 620921	L= 440
			⬅	für Fahrzeuge mit Keramikbremse	2	24.8190-0938.2 620938	L= 495
			➡	für Fahrzeuge ohne Keramikbremse	2	24.8190-0921.2 620921	L= 440
			➡		2	24.8190-0921.2 620921	L= 440
			➡	für Fahrzeuge mit Keramikbremse	2	24.8190-0943.2 620943	L= 504,6
3.6 Carrera S	254	02/03→08/05	⬅		2	24.8190-0921.2 620921	L= 440
			⬅	für Fahrzeuge mit Keramikbremse	2	24.8190-0938.2 620938	L= 495
			➡	für Fahrzeuge ohne Keramikbremse	2	24.8190-0921.2 620921	L= 440
			➡	für Fahrzeuge mit Keramikbremse	2	24.8190-0943.2 620943	L= 504,6
3.6 GT2	340	04/01→08/05	⬅		2	24.8190-0938.2 620938	L= 495
			➡		2	24.8190-0943.2 620943	L= 504,6
3.6 GT2	355	10/03→08/05	⬅		2	24.8190-0938.2 620938	L= 495
			➡		2	24.8190-0943.2 620943	L= 504,6
			⬅	01/03→; für Fahrzeuge ohne Keramikbremse	2	24.8190-0921.2 620921	L= 440
			⬅	→ 12/02; für Fahrzeuge ohne Keramikbremse	2	24.8190-0921.2 620921	L= 440
			⬅	01/03→; für Fahrzeuge mit Keramikbremse	2	24.8190-0938.2 620938	L= 495
			➡	für Fahrzeuge ohne Keramikbremse	2	24.8190-0921.2 620921	L= 440
3.6 GT3	265	03/99→08/05	➡	01/04→; für Fahrzeuge mit Keramikbremse	2	24.8190-0938.2 620938	L= 495
			➡	→ 12/03; für Fahrzeuge mit Keramikbremse	2	24.8190-0938.2 620938	L= 495
			➡		2	24.8190-0938.2 620938	L= 495
3.6 GT3	280	03/03→08/05	⬅	für Fahrzeuge ohne Keramikbremse	2	24.8190-0921.2 620921	L= 440
			⬅	für Fahrzeuge mit Keramikbremse	2	24.8190-0938.2 620938	L= 495
			➡	für Fahrzeuge ohne Keramikbremse	2	24.8190-0921.2 620921	L= 440
			➡	→ 12/03; für Fahrzeuge mit Keramikbremse	2	24.8190-0938.2 620938	L= 495
			➡	01/04→; für Fahrzeuge mit Keramikbremse	2	24.8190-0938.2 620938	L= 495
3.6 S	331	08/04→08/05	⬅	für Fahrzeuge ohne Keramikbremse	2	24.8190-0921.2 620921	L= 440
			⬅	für Fahrzeuge mit Keramikbremse	2	24.8190-0938.2 620938	L= 495
			➡	für Fahrzeuge ohne Keramikbremse	2	24.8190-0921.2 620921	L= 440
			➡	für Fahrzeuge mit Keramikbremse	2	24.8190-0943.2 620943	L= 504,6
3.6 Turbo 4S	331	02/03→08/05	⬅	für Fahrzeuge ohne Keramikbremse	2	24.8190-0921.2 620921	L= 440
			⬅	für Fahrzeuge mit Keramikbremse	2	24.8190-0938.2 620938	L= 495
			➡	für Fahrzeuge ohne Keramikbremse	2	24.8190-0921.2 620921	L= 440
			➡	für Fahrzeuge mit Keramikbremse	2	24.8190-0943.2 620943	L= 504,6
3.6 Turbo 4	309	06/00→08/05	⬅	für Fahrzeuge ohne Keramikbremse	2	24.8190-0921.2 620921	L= 440
			⬅	für Fahrzeuge mit Keramikbremse	2	24.8190-0938.2 620938	L= 495
			➡	01/02→; für Fahrzeuge ohne Keramikbremse	2	24.8190-0921.2 620921	L= 440
↓							

**PORSCHE - 911 (996) 09/97 → 09/05**

**Warnkontakt, Bremsbelagverschleiß**

3.6 Turbo 4	309	06/00 → 08/05	➡	für Fahrzeuge mit Keramikbremse	2	24.8190-0943.2 620943	L= 504,6
-------------	-----	---------------	---	---------------------------------	---	-----------------------	----------

**Bremsscheibe**

3.4 Carrera 3.4 Carrera 4	221 221	09/97 → 09/01 09/97 → 09/01	←	☐		24.0128-0130.1 428130	Ø 318 28 26 V•
			←	☐		24.0128-0131.1 428131	Ø 318 28 26 V•
			➡			24.0124-0176.1 424176	Ø 299 24 22 V•
3.4 Carrera 3.4 Carrera 4	235 235	05/01 → 08/05 05/01 → 08/05	←	☐; → 09/01		24.0128-0130.1 428130	Ø 318 28 26 V•
			←	☐; → 09/01		24.0128-0131.1 428131	Ø 318 28 26 V•
			➡	→ 09/01		24.0124-0176.1 424176	Ø 299 24 22 V•
3.6 Carrera 3.6 Carrera 4	235 235	10/01 → 08/05 10/01 → 08/05	←	☐		24.0128-0130.1 428130	Ø 318 28 26 V•
			←	☐		24.0128-0131.1 428131	Ø 318 28 26 V•
			←	☐; 01/02 →; für Fahrzeuge ohne Keramikbremse		24.0134-0101.1 434101	Ø 330 34 32 V•
			←	☐; 01/02 →; für Fahrzeuge ohne Keramikbremse		24.0134-0102.1 434102	Ø 330 34 32 V•
			➡			24.0124-0176.1 424176	Ø 299 24 22 V•
			➡	☐; 01/02 →; für Fahrzeuge ohne Keramikbremse		24.0128-0196.1 428196	Ø 330 28 26 V•
			➡	☐; 01/02 →; für Fahrzeuge ohne Keramikbremse		24.0128-0197.1 428197	Ø 330 28 26 V•
3.6 Carrera 4S 3.6 Carrera S	254 254	02/03 → 08/05 02/03 → 08/05	←	☐		24.0128-0130.1 428130	Ø 318 28 26 V•
			←	☐		24.0128-0131.1 428131	Ø 318 28 26 V•
			←	☐; für Fahrzeuge ohne Keramikbremse		24.0134-0101.1 434101	Ø 330 34 32 V•
			←	☐; für Fahrzeuge ohne Keramikbremse		24.0134-0102.1 434102	Ø 330 34 32 V•
			➡			24.0124-0176.1 424176	Ø 299 24 22 V•
			➡	☐; für Fahrzeuge ohne Keramikbremse		24.0128-0196.1 428196	Ø 330 28 26 V•
			➡	☐; für Fahrzeuge ohne Keramikbremse		24.0128-0197.1 428197	Ø 330 28 26 V•
3.6 GT2 3.6 GT2 3.6 GT3 3.6 GT3 3.6 S	340 355 265 280 331	04/01 → 08/05 10/03 → 08/05 03/99 → 08/05 03/03 → 08/05 08/04 → 08/05	➡	☐; für Fahrzeuge ohne Keramikbremse		24.0128-0196.1 428196	Ø 330 28 26 V•
			➡	☐; für Fahrzeuge ohne Keramikbremse		24.0128-0197.1 428197	Ø 330 28 26 V•
			➡				
			➡				
			➡				
3.6 Turbo 4 3.6 Turbo 4S	309 331	06/00 → 08/05 02/03 → 08/05	←	☐; für Fahrzeuge ohne Keramikbremse		24.0134-0101.1 434101	Ø 330 34 32 V•
			←	☐; für Fahrzeuge ohne Keramikbremse		24.0134-0102.1 434102	Ø 330 34 32 V•
			➡	☐; für Fahrzeuge ohne Keramikbremse		24.0128-0196.1 428196	Ø 330 28 26 V•
			➡	☐; für Fahrzeuge ohne Keramikbremse		24.0128-0197.1 428197	Ø 330 28 26 V•

**PORSCHE - 911 (997) 07/04 → 12/12**







**Bremsbelagsatz, Scheibenbremse**

3.6 Carrera 3.6 Carrera	235 239	08/04 → 07/05 07/04 → 12/08	←	für Fahrzeuge ohne Keramikbremse		13.0460-4842.2 604842	BRE 24049 17,0 + WE / - WK
			➡	für Fahrzeuge ohne Keramikbremse		13.0460-4988.2 604988	BRE 21792 15,2 + WE / - WK
3.6 Carrera 3.6 Carrera 4	242 239	07/04 → 12/08 07/04 → 12/08	➡				
			←	für Fahrzeuge ohne Keramikbremse		13.0460-4999.2 604999	BRE 23330 17,0 + WE / - WK
3.8 Carrera 4S 3.8 Carrera 4S	261 280	07/04 → 12/08 08/05 → 12/08	←	für Fahrzeuge ohne Keramikbremse		13.0460-4999.2 604999	BRE 23330 17,0 + WE / - WK
			➡	für Fahrzeuge ohne Keramikbremse		13.0460-4842.2 604842	BRE 24049 17,0 + WE / - WK
3.8 Carrera S 3.8 Carrera S	264 280	07/04 → 12/08 08/05 → 12/08	➡				
			←	für Fahrzeuge ohne Keramikbremse		13.0460-4842.2 604842	BRE 24049 17,0 + WE / - WK
3.8 Carrera GTS 3.8 Carrera GTS	300 300	06/09 → 12/12 06/09 → 12/11	←	für Fahrzeuge ohne Keramikbremse		13.0460-4999.2 604999	BRE 23330 17,0 + WE / - WK
			←	für Fahrzeuge ohne Keramikbremse		13.0460-4842.2 604842	BRE 24049 17,0 + WE / - WK

**Warnkontakt, Bremsbelagverschleiß**

3.6 Carrera 3.6 Carrera 3.6 Carrera	235 239 242	08/04 → 07/05 07/04 → 12/08 07/04 → 12/08	←	☐; für Fahrzeuge ohne Keramikbremse		24.8190-0024.2 620024	L= 369,6
			←	☐; für Fahrzeuge ohne Keramikbremse		24.8190-0025.2 620025	L= 349,6
			←	☐; für Fahrzeuge mit Keramikbremse		24.8190-0956.2 620956	L= 454,6
			←	☐; für Fahrzeuge mit Keramikbremse		24.8190-0957.2 620957	L= 394,6
			➡	für Fahrzeuge ohne Keramikbremse	2	24.8190-0921.2 620921	L= 440
			➡	für Fahrzeuge mit Keramikbremse	2	24.8190-0943.2 620943	L= 504,6
3.6 Carrera	254	06/08 → 12/11	←	für Fahrzeuge ohne Keramikbremse	2	24.8190-0016.2 620016	L= 359,6
			←	☐; für Fahrzeuge mit Keramikbremse		24.8190-0956.2 620956	L= 454,6



	kw			 	! #		
<b>PORSCHE - 911 (997) 07/04 → 12/12</b>							
<b>Warnkontakt, Bremsbelagverschleiß</b>							
3.6 Carrera	254	06/08 → 12/11	←	☐; für Fahrzeuge mit Keramikbremse	2	24.8190-0957.2 620957	L= 394,6
			→	für Fahrzeuge ohne Keramikbremse	2	24.8190-0023.2 620023	L= 484,6
			→	für Fahrzeuge mit Keramikbremse	2	24.8190-0943.2 620943	L= 504,6
3.6 Carrera 4	239	07/04 → 12/08	←		2	24.8190-0938.2 620938	L= 495
			→	für Fahrzeuge ohne Keramikbremse	2	24.8190-0921.2 620921	L= 440
			→	für Fahrzeuge mit Keramikbremse	2	24.8190-0943.2 620943	L= 504,6
3.6 Carrera 4	254	06/08 → 12/12	←		2	24.8190-0938.2 620938	L= 495
			→	für Fahrzeuge ohne Keramikbremse	2	24.8190-0023.2 620023	L= 484,6
			→	für Fahrzeuge mit Keramikbremse	2	24.8190-0943.2 620943	L= 504,6
3.6 GT 2 3.6 Turbo	390 353	09/07 → 12/12 03/06 → 12/09	←		2	24.8190-0938.2 620938	L= 495
			→		2	24.8190-0023.2 620023	L= 484,6
3.6 GT2 RS 3.8 GT3 RS 4.0 GT3 RS	456 331 368	05/10 → 12/12 08/09 → 12/11 07/11 → 12/12	←		2	24.8190-0951.2 620951	L= 500
			→		2	24.8190-0023.2 620023	L= 484,6
			→		2	24.8190-0023.2 620023	L= 484,6
3.6 GT3	305	03/06 → 12/09	←	für Fahrzeuge ohne Keramikbremse; → 12/08	2	24.8190-0951.2 620951	L= 500
			→	für Fahrzeuge mit Keramikbremse	2	24.8190-0023.2 620023	L= 484,6
			→	01/07 → 12/07; für Fahrzeuge ohne Keramikbremse	2	24.8190-0023.2 620023	L= 484,6
			→	für Fahrzeuge ohne Keramikbremse; → 12/06	2	24.8190-0023.2 620023	L= 484,6
3.8 Carrera 4 GTS	300	06/09 → 12/12	←	☐; für Fahrzeuge ohne Keramikbremse	1	24.8190-0931.2 620931	L= 336
			←	☐; für Fahrzeuge ohne Keramikbremse	1	24.8190-0933.2 620933	L= 305
			←	für Fahrzeuge ohne Keramikbremse	2	24.8190-0950.2 620950	L= 525
			←	☐; für Fahrzeuge mit Keramikbremse		24.8190-0956.2 620956	L= 454,6
			←	☐; für Fahrzeuge mit Keramikbremse		24.8190-0957.2 620957	L= 394,6
			→	für Fahrzeuge ohne Keramikbremse	2	24.8190-0943.2 620943	L= 504,6
3.8 Carrera 4S 3.8 Carrera 4S 3.8 Carrera 4S	261 280 283	07/04 → 12/08 08/05 → 12/08 06/08 → 12/12	←	für Fahrzeuge mit Keramikbremse	2	24.8190-0938.2 620938	L= 495
			←	für Fahrzeuge ohne Keramikbremse	2	24.8190-0950.2 620950	L= 525
			→		2	24.8190-0943.2 620943	L= 504,6
			→		2	24.8190-0943.2 620943	L= 504,6
3.8 Carrera GTS	300	06/09 → 12/11	←	☐; für Fahrzeuge ohne Keramikbremse		24.8190-0931.2 620931	L= 336
			←	☐; für Fahrzeuge ohne Keramikbremse	1	24.8190-0931.2 620931	L= 336
			←	☐; für Fahrzeuge ohne Keramikbremse	1	24.8190-0933.2 620933	L= 305
			←	☐; für Fahrzeuge ohne Keramikbremse		24.8190-0933.2 620933	L= 305
			←	für Fahrzeuge ohne Keramikbremse	2	24.8190-0938.2 620938	L= 495
			←	☐; für Fahrzeuge mit Keramikbremse		24.8190-0956.2 620956	L= 454,6
			←	☐; für Fahrzeuge mit Keramikbremse		24.8190-0957.2 620957	L= 394,6
			→		2	24.8190-0943.2 620943	L= 504,6
			→	für Fahrzeuge ohne Keramikbremse	2	24.8190-0943.2 620943	L= 504,6
			→		2	24.8190-0943.2 620943	L= 504,6
3.8 Carrera S 3.8 Carrera S 3.8 Carrera S 3.8 Carrera S	261 264 280 283	07/04 → 12/08 07/04 → 12/08 08/05 → 12/08 06/08 → 12/11	←	☐; für Fahrzeuge ohne Keramikbremse		24.8190-0931.2 620931	L= 336
			←	☐; für Fahrzeuge ohne Keramikbremse		24.8190-0933.2 620933	L= 305
			←	☐; für Fahrzeuge mit Keramikbremse		24.8190-0956.2 620956	L= 454,6
			←	☐; für Fahrzeuge mit Keramikbremse		24.8190-0957.2 620957	L= 394,6
3.8 GT3	320	05/09 → 12/11	→		2	24.8190-0943.2 620943	L= 504,6
			←	für Fahrzeuge mit Keramikbremse	2	24.8190-0938.2 620938	L= 495
			←	für Fahrzeuge ohne Keramikbremse	2	24.8190-0951.2 620951	L= 500
3.8 Turbo	368	09/09 → 12/12	→		2	24.8190-0023.2 620023	L= 484,6
			←	für Fahrzeuge mit Keramikbremse; → 12/10	2	24.8190-0938.2 620938	L= 495
			←	01/11 →; für Fahrzeuge ohne Keramikbremse	2	24.8190-0938.2 620938	L= 495
			←	für Fahrzeuge ohne Motorbremse	2	24.8190-0938.2 620938	L= 495
3.8 Turbo S	390	02/10 → 12/12	→		2	24.8190-0023.2 620023	L= 484,6
			←	für Fahrzeuge mit Keramikbremse; → 12/10	2	24.8190-0938.2 620938	L= 495
			←	01/11 →; für Fahrzeuge mit Keramikbremse	2	24.8190-0938.2 620938	L= 495
↓			→		2	24.8190-0023.2 620023	L= 484,6





**PORSCHE - 911 (997) 07/04 → 12/12**

**Bremsscheibe**











3.6 Carrera 3.6 Carrera 3.6 Carrera 3.6 Carrera 4	235	08/04 → 07/05	←	☐; für Fahrzeuge ohne Keramikbremse	24.0128-0130.1	428130	∅ 318 28 26 V•
	239	07/04 → 12/08	←	☐; für Fahrzeuge ohne Keramikbremse	24.0128-0131.1	428131	∅ 318 28 26 V•
	242	07/04 → 12/08	→	☐; für Fahrzeuge ohne Keramikbremse	24.0124-0176.1	424176	∅ 299 24 22 V•
	239	07/04 → 12/08	→	☐; für Fahrzeuge ohne Keramikbremse	24.0128-0130.1	428130	∅ 318 28 26 V•
3.6 Carrera 3.6 Carrera 4	254 254	06/08 → 12/11 06/08 → 12/12	←	☐; für Fahrzeuge ohne Keramikbremse	24.0128-0246.1	428246	∅ 330 28 26 V•
			←	☐; für Fahrzeuge ohne Keramikbremse	24.0128-0247.1	428247	∅ 330 28 26 V•
			→	☐; → 12/10; für Fahrzeuge ohne Keramikbremse	24.0128-0196.1	428196	∅ 330 28 26 V•
			→	☐; 01/11 →; für Fahrzeuge ohne Keramikbremse	24.0128-0196.1	428196	∅ 330 28 26 V•
			→	☐; 01/11 →; für Fahrzeuge ohne Keramikbremse	24.0128-0197.1	428197	∅ 330 28 26 V•
			→	☐; → 12/10; für Fahrzeuge ohne Keramikbremse	24.0128-0197.1	428197	∅ 330 28 26 V•
3.6 GT3	305	03/06 → 12/09	←	☐; für Fahrzeuge ohne Keramikbremse	24.0134-0105.1	434105	∅ 350 34 32 V•
			←	☐; für Fahrzeuge ohne Keramikbremse	24.0134-0106.1	434106	∅ 350 34 32 V•
			→	☐; für Fahrzeuge ohne Keramikbremse	24.0128-0264.1	428264	∅ 350 28 26 V•
			→	☐; für Fahrzeuge ohne Keramikbremse	24.0128-0265.1	428265	∅ 350 28 26 V•
3.6 Turbo 3.8 Turbo 3.8 Turbo S	353	03/06 → 12/09	→	☐; für Fahrzeuge ohne Keramikbremse	24.0128-0264.1	428264	∅ 350 28 26 V•
	368	09/09 → 12/12	→	☐; für Fahrzeuge ohne Keramikbremse	24.0128-0265.1	428265	∅ 350 28 26 V•
	390	02/10 → 12/12	→	☐; für Fahrzeuge ohne Keramikbremse	24.0128-0265.1	428265	∅ 350 28 26 V•
3.8 Carrera 4 GTS 3.8 Carrera 4S 3.8 Carrera 4S 3.8 Carrera GTS 3.8 Carrera S 3.8 Carrera S	300	06/09 → 12/12	←	☐; für Fahrzeuge ohne Keramikbremse	24.0134-0101.1	434101	∅ 330 34 32 V•
	261	07/04 → 12/08	←	☐; für Fahrzeuge ohne Keramikbremse	24.0134-0102.1	434102	∅ 330 34 32 V•
	280	08/05 → 12/08	←	☐; für Fahrzeuge ohne Keramikbremse	24.0134-0102.1	434102	∅ 330 34 32 V•
	300	06/09 → 12/11	→	☐; für Fahrzeuge ohne Keramikbremse	24.0128-0196.1	428196	∅ 330 28 26 V•
	261	07/04 → 12/08	→	☐; für Fahrzeuge ohne Keramikbremse	24.0128-0197.1	428197	∅ 330 28 26 V•
3.8 Carrera 4S 3.8 Carrera S	283 283	06/08 → 12/12 06/08 → 12/11	←	☐; 01/11 →; für Fahrzeuge ohne Keramikbremse	24.0134-0101.1	434101	∅ 330 34 32 V•
			←	☐; für Fahrzeuge ohne Keramikbremse; → 12/10	24.0134-0101.1	434101	∅ 330 34 32 V•
			←	☐; 01/11 →; für Fahrzeuge ohne Keramikbremse	24.0134-0102.1	434102	∅ 330 34 32 V•
			←	☐; für Fahrzeuge ohne Keramikbremse; → 12/10	24.0134-0102.1	434102	∅ 330 34 32 V•
			→	☐; 01/11 →; für Fahrzeuge ohne Keramikbremse	24.0128-0196.1	428196	∅ 330 28 26 V•
			→	☐; → 12/10; für Fahrzeuge ohne Keramikbremse	24.0128-0196.1	428196	∅ 330 28 26 V•
			→	☐; 01/11 →; für Fahrzeuge ohne Keramikbremse	24.0128-0197.1	428197	∅ 330 28 26 V•
			→	☐; → 12/10; für Fahrzeuge ohne Keramikbremse	24.0128-0197.1	428197	∅ 330 28 26 V•
3.8 Carrera S	280	08/05 → 12/08	←	☐	24.0134-0101.1	434101	∅ 330 34 32 V•
			←	☐	24.0134-0102.1	434102	∅ 330 34 32 V•
			→	☐; für Fahrzeuge ohne Keramikbremse	24.0128-0196.1	428196	∅ 330 28 26 V•
			→	☐; für Fahrzeuge ohne Keramikbremse	24.0128-0197.1	428197	∅ 330 28 26 V•









**PORSCHE - 911 Cabriolet (991) 03/12 →**







**Warnkontakt, Bremsbelagverschleiß**

3.0 Carrera 3.0 Carrera 4	272	11/15 →	←	für Fahrzeuge mit Keramikbremse	2	24.8190-0952.2	620952	L= 300
	272	11/15 →	→		2	24.8190-0953.2	620953	L= 215
3.0 Carrera 4 GTS 3.0 Carrera 4S 3.0 Carrera GTS 3.0 Carrera S	331	03/17 →	→		2	24.8190-0952.2	620952	L= 300
	309	11/15 →	→		2	24.8190-0953.2	620953	L= 215
	331	03/17 →	→		2	24.8190-0952.2	620952	L= 300
3.4 Carrera 3.8 Turbo 3.8 Turbo	257	03/12 →	←	für Fahrzeuge ohne Keramikbremse	2	24.8190-0069.2	620069	L= 248
	383	12/13 →	←	für Fahrzeuge mit Keramikbremse	2	24.8190-0952.2	620952	L= 300
	397	01/16 →	→		2	24.8190-0953.2	620953	L= 215
3.4 Carrera 4 3.8 Carrera 4S 3.8 Carrera 4S / 4 GTS 3.8 Turbo S 3.8 Turbo S	257	11/12 →	→		2	24.8190-0953.2	620953	L= 215
	294	11/12 →	→		2	24.8190-0953.2	620953	L= 215
	316	11/12 →	→		2	24.8190-0953.2	620953	L= 215
	412	12/13 →	→		2	24.8190-0953.2	620953	L= 215
3.8 Carrera S 3.8 Carrera S / GTS	294	03/12 →	←	für Fahrzeuge ohne Keramikbremse	2	24.8190-0106.2	620106	L= 270
	316	07/12 →	←	für Fahrzeuge mit Keramikbremse	2	24.8190-0952.2	620952	L= 300
			→		2	24.8190-0953.2	620953	L= 215







↓

	kw			 	! #			
<b>PORSCHE - 911 Cabriolet (991) 03/12→</b>								
 <b>Bremsscheibe</b>								
3.0 Carrera	272	11/15→	→	☐; für Fahrzeuge ohne Keramikbremse	24.0128-0196.1	428196	Ø 330 28 26 V•	
3.0 Carrera 4	272	11/15→	→	☐; für Fahrzeuge ohne Keramikbremse	24.0128-0197.1	428197	Ø 330 28 26 V•	
3.0 Carrera 4 GTS	331	03/17→	→					
3.0 Carrera 4S	309	11/15→	→					
3.0 Carrera GTS	331	03/17→	→					
3.0 Carrera S	309	11/15→	→					
3.4 Carrera	257	03/12→	←	☐; für Fahrzeuge ohne Keramikbremse	24.0128-0246.1	428246	Ø 330 28 26 V•	
			←	☐; für Fahrzeuge ohne Keramikbremse	24.0128-0247.1	428247	Ø 330 28 26 V•	
3.8 Carrera 4S	294	11/12→	→	☐; für Fahrzeuge ohne Keramikbremse	24.0128-0196.1	428196	Ø 330 28 26 V•	
3.8 Carrera 4S / 4 GTS	316	11/12→	→					
3.8 Carrera S	294	03/12→	→	☐; für Fahrzeuge ohne Keramikbremse	24.0128-0197.1	428197	Ø 330 28 26 V•	
3.8 Carrera S / GTS	316	07/12→	→					
3.8 Turbo S	412	12/13→	→					
3.8 Turbo S	427	01/16→	→					
<b>PORSCHE - 911 Cabriolet (993) 07/94→12/97</b>								
 <b>Bremsbelagsatz, Scheibenbremse</b>								
3.6 Carrera	210	08/95→09/97	→		13.0460-4016.2	604016	ATE 20877 17,5 + WE / - WK	
3.6 Carrera 4	210	08/95→09/97	→					
3.8 Carrera	210	06/95→09/97	→					
3.8 Carrera 4	210	06/95→09/97	→					
3.8 Carrera	221	08/95→09/97	←		13.0460-4056.2	604056	BRE 21402 17,5 + WE / - WK	
3.8 Carrera 4	221	08/95→09/97	←					
<b>Warnkontakt, Bremsbelagverschleiß</b>								
3.6 Carrera	210	08/95→09/97	←		2	24.8190-0917.2	620917	L= 518
3.6 Carrera 4	210	08/95→09/97	←					
3.8 Carrera	210	06/95→09/97	→		2	24.8190-0920.2	620920	L= 698
3.8 Carrera 4	210	06/95→09/97	→					
3.8 Carrera	221	08/95→09/97	←		2	24.8190-0926.2	620926	L= 475
3.8 Carrera 4	221	08/95→09/97	←					
			→		2	24.8190-0920.2	620920	L= 698
 <b>Bremsscheibe</b>								
3.6 Carrera	210	08/95→09/97	←	☐	24.0132-0142.1	432142	Ø 304 32 30 V•	
3.6 Carrera 4	210	08/95→09/97	←	☐	24.0132-0143.1	432143	Ø 304 32 30 V•	
3.8 Carrera	210	06/95→09/97	←	☐				
3.8 Carrera 4	210	06/95→09/97	→		24.0124-0183.1	424183	Ø 299 24 22 V•	
<b>PORSCHE - 911 Cabriolet (996) 02/98→08/05</b>								
 <b>Bremsbelagsatz, Scheibenbremse</b>								
3.4 Carrera	221	02/98→09/01	←		13.0460-4987.2	604987	BRE 23329 17,0 + WE / - WK	
3.4 Carrera 4	221	02/98→09/01	→	für Fahrzeuge ohne Keramikbremse	13.0460-4987.2	604987	BRE 23329 17,0 + WE / - WK	
			→		13.0460-4988.2	604988	BRE 21792 15,2 + WE / - WK	
3.4 Carrera	235	05/01→08/05	←	→ 09/01	13.0460-4987.2	604987	BRE 23329 17,0 + WE / - WK	
3.4 Carrera 4	235	05/01→08/05	→	→ 09/01; für Fahrzeuge ohne Keramikbremse	13.0460-4987.2	604987	BRE 23329 17,0 + WE / - WK	
			→	→ 09/01	13.0460-4988.2	604988	BRE 21792 15,2 + WE / - WK	
3.6 Carrera	235	10/01→08/05	←		13.0460-4987.2	604987	BRE 23329 17,0 + WE / - WK	
3.6 Carrera 4	235	10/01→08/05	←	01/02→; für Fahrzeuge ohne Keramikbremse	13.0460-4999.2	604999	BRE 23330 17,0 + WE / - WK	
			→	für Fahrzeuge ohne Keramikbremse	13.0460-4987.2	604987	BRE 23329 17,0 + WE / - WK	
			→		13.0460-4988.2	604988	BRE 21792 15,2 + WE / - WK	
3.6 Carrera 4S	254	06/02→08/05	←		13.0460-4987.2	604987	BRE 23329 17,0 + WE / - WK	
3.6 Carrera S	254	06/02→08/05	←	für Fahrzeuge ohne Keramikbremse	13.0460-4999.2	604999	BRE 23330 17,0 + WE / - WK	
			→	für Fahrzeuge ohne Keramikbremse	13.0460-4987.2	604987	BRE 23329 17,0 + WE / - WK	
			→		13.0460-4988.2	604988	BRE 21792 15,2 + WE / - WK	
3.6 Turbo 4	309	10/03→08/05	←	für Fahrzeuge ohne Keramikbremse	13.0460-4999.2	604999	BRE 23330 17,0 + WE / - WK	
3.6 Turbo 4S	331	10/03→08/05	→	für Fahrzeuge ohne Keramikbremse	13.0460-4987.2	604987	BRE 23329 17,0 + WE / - WK	
<b>Warnkontakt, Bremsbelagverschleiß</b>								
3.4 Carrera	221	02/98→09/01	←		2	24.8190-0921.2	620921	L= 440
3.4 Carrera 4	221	02/98→09/01	→	für Fahrzeuge ohne Keramikbremse	2	24.8190-0921.2	620921	L= 440
			→		2	24.8190-0921.2	620921	L= 440
3.4 Carrera	235	05/01→08/05	←	→ 09/01	2	24.8190-0921.2	620921	L= 440
3.4 Carrera 4	235	05/01→08/05	→	→ 09/01	2	24.8190-0921.2	620921	L= 440
↓								























	kw			 	! #		
<b>PORSCHE - 911 Cabriolet (996) 02/98→08/05</b>							
<b>Warnkontakt, Bremsbelagverschleiß</b>							
3.4 Carrera 3.4 Carrera 4	235 235	05/01→08/05 05/01→08/05	➡	→ 09/01; für Fahrzeuge ohne Keramikbremse	2	24.8190-0921.2 620921	L= 440
3.6 Carrera 3.6 Carrera 4	235 235	10/01→08/05 10/01→08/05	⬅		2	24.8190-0921.2 620921	L= 440
			⬅	01/02→; für Fahrzeuge ohne Keramikbremse	2	24.8190-0921.2 620921	L= 440
			⬅	01/03→; für Fahrzeuge mit Keramikbremse	2	24.8190-0938.2 620938	L= 495
			➡	für Fahrzeuge ohne Keramikbremse	2	24.8190-0921.2 620921	L= 440
			➡		2	24.8190-0921.2 620921	L= 440
			➡	01/03→; für Fahrzeuge mit Keramikbremse	2	24.8190-0943.2 620943	L= 504,6
3.6 Carrera 4S 3.6 Carrera S	254 254	06/02→08/05 06/02→08/05	⬅		2	24.8190-0921.2 620921	L= 440
			⬅	für Fahrzeuge ohne Keramikbremse	2	24.8190-0921.2 620921	L= 440
			⬅	01/03→; für Fahrzeuge mit Keramikbremse	2	24.8190-0938.2 620938	L= 495
			➡		2	24.8190-0921.2 620921	L= 440
			➡	für Fahrzeuge ohne Keramikbremse	2	24.8190-0921.2 620921	L= 440
			➡	01/03→; für Fahrzeuge mit Keramikbremse	2	24.8190-0943.2 620943	L= 504,6
3.6 Turbo 4 3.6 Turbo 4S	309 331	10/03→08/05 10/03→08/05	⬅	für Fahrzeuge ohne Keramikbremse	2	24.8190-0921.2 620921	L= 440
			⬅	für Fahrzeuge mit Keramikbremse	2	24.8190-0938.2 620938	L= 495
			➡	für Fahrzeuge ohne Keramikbremse	2	24.8190-0921.2 620921	L= 440
			➡	für Fahrzeuge mit Keramikbremse	2	24.8190-0943.2 620943	L= 504,6
<b> Brems Scheibe</b>							
3.4 Carrera 3.4 Carrera 4	221 221	02/98→09/01 02/98→09/01	⬅	☐		24.0128-0130.1 428130	Ø 318 28 26 V•
			⬅	☐		24.0128-0131.1 428131	Ø 318 28 26 V•
			➡			24.0124-0176.1 424176	Ø 299 24 22 V•
3.4 Carrera 3.4 Carrera 4	235 235	05/01→08/05 05/01→08/05	⬅	☐; → 09/01		24.0128-0130.1 428130	Ø 318 28 26 V•
			⬅	☐; → 09/01		24.0128-0131.1 428131	Ø 318 28 26 V•
			➡	→ 09/01		24.0124-0176.1 424176	Ø 299 24 22 V•
3.6 Carrera 3.6 Carrera 4	235 235	10/01→08/05 10/01→08/05	⬅	☐		24.0128-0130.1 428130	Ø 318 28 26 V•
			⬅	☐		24.0128-0131.1 428131	Ø 318 28 26 V•
			⬅	☐; 01/02→; für Fahrzeuge ohne Keramikbremse		24.0134-0101.1 434101	Ø 330 34 32 V•
			⬅	☐; 01/02→; für Fahrzeuge ohne Keramikbremse		24.0134-0102.1 434102	Ø 330 34 32 V•
			➡			24.0124-0176.1 424176	Ø 299 24 22 V•
			➡	☐; 01/02→; für Fahrzeuge ohne Keramikbremse		24.0128-0196.1 428196	Ø 330 28 26 V•
			➡	☐; 01/02→; für Fahrzeuge ohne Keramikbremse		24.0128-0197.1 428197	Ø 330 28 26 V•
3.6 Carrera 4S 3.6 Carrera S	254 254	06/02→08/05 06/02→08/05	⬅	☐		24.0128-0130.1 428130	Ø 318 28 26 V•
			⬅	☐		24.0128-0131.1 428131	Ø 318 28 26 V•
			⬅	☐; für Fahrzeuge ohne Keramikbremse		24.0134-0101.1 434101	Ø 330 34 32 V•
			⬅	☐; für Fahrzeuge ohne Keramikbremse		24.0134-0102.1 434102	Ø 330 34 32 V•
			➡			24.0124-0176.1 424176	Ø 299 24 22 V•
			➡	☐; für Fahrzeuge ohne Keramikbremse		24.0128-0196.1 428196	Ø 330 28 26 V•
			➡	☐; für Fahrzeuge ohne Keramikbremse		24.0128-0197.1 428197	Ø 330 28 26 V•
3.6 Turbo 4 3.6 Turbo 4S	309 331	10/03→08/05 10/03→08/05	⬅	☐; für Fahrzeuge ohne Keramikbremse		24.0134-0101.1 434101	Ø 330 34 32 V•
			⬅	☐; für Fahrzeuge ohne Keramikbremse		24.0134-0102.1 434102	Ø 330 34 32 V•
			➡	☐; für Fahrzeuge ohne Keramikbremse		24.0128-0196.1 428196	Ø 330 28 26 V•
			➡	☐; für Fahrzeuge ohne Keramikbremse		24.0128-0197.1 428197	Ø 330 28 26 V•
<b>PORSCHE - 911 Cabriolet (997) 04/05→12/12</b>							
<b> Bremsbelagsatz, Scheibenbremse</b>							
3.6 Carrera 3.6 Carrera 3.6 Carrera	235 239 242	04/05→07/05 04/05→12/08 04/05→12/08	⬅	für Fahrzeuge ohne Keramikbremse; für Fahrzeuge mit Sportpaket		13.0460-4842.2 604842	BRE 24049 17,0 + WE / - WK
			⬅	für Fahrzeuge ohne Keramikbremse; für Fahrzeuge ohne Sportpaket		13.0460-4987.2 604987	BRE 23329 17,0 + WE / - WK
↓							

	kW			 	! #			
<b>PORSCHE - 911 Cabriolet (997) 04/05→12/12</b>								
<b>Bremsbelagsatz, Scheibenbremse</b>								
3.6 Carrera	235	04/05→07/05	➡	für Fahrzeuge ohne Keramikbremse;		13.0460-4843.2	604843	BRE + WE / - WK
3.6 Carrera	239	04/05→12/08		für Fahrzeuge mit Sportpaket				
3.6 Carrera	242	04/05→12/08	➡	für Fahrzeuge ohne Keramikbremse;		13.0460-4988.2	604988	BRE 21792 15,2 + WE / - WK
				für Fahrzeuge ohne Sportpaket				
3.6 Carrera 4	239	04/05→12/08	⬅	für Fahrzeuge ohne Keramikbremse		13.0460-4842.2	604842	BRE 24049 17,0 + WE / - WK
3.6 Carrera 4	242	04/05→12/08	➡	für Fahrzeuge ohne Keramikbremse		13.0460-4988.2	604988	BRE 21792 15,2 + WE / - WK
3.6 Carrera 4	254	06/08→12/12	⬅	für Fahrzeuge ohne Keramikbremse		13.0460-4842.2	604842	BRE 24049 17,0 + WE / - WK
3.6 Turbo	353	09/07→12/09						
3.8 Carrera GTS	300	06/09→12/11						
3.8 Turbo	368	09/09→12/12						
3.8 Turbo S	390	02/10→12/12						
3.8 Carrera 4 GTS	300	06/09→12/12	⬅	für Fahrzeuge ohne Keramikbremse		13.0460-4999.2	604999	BRE 23330 17,0 + WE / - WK
3.8 Carrera 4S	280	08/05→12/08						
3.8 Carrera 4S	283	06/08→12/12						
3.8 Carrera S	280	08/05→12/08						
3.8 Carrera S	283	06/08→12/11						
3.8 Carrera 4S	261	04/05→12/08	⬅	für Fahrzeuge ohne Keramikbremse		13.0460-4999.2	604999	BRE 23330 17,0 + WE / - WK
3.8 Carrera 4S	264	04/05→12/10						
3.8 Carrera S	261	04/05→12/08	➡	für Fahrzeuge ohne Keramikbremse		13.0460-4842.2	604842	BRE 24049 17,0 + WE / - WK
3.8 Carrera S	264	04/05→12/08						
<b>Warnkontakt, Bremsbelagverschleiß</b>								
3.6 Carrera	235	04/05→07/05	⬅		2	24.8190-0931.2	620931	L= 336
3.6 Carrera	239	04/05→12/08						
3.6 Carrera	242	04/05→12/08	➡	für Fahrzeuge ohne Keramikbremse;	2	24.8190-0921.2	620921	L= 440
				für Fahrzeuge ohne Sportpaket				
3.6 Carrera	254	06/08→12/11	⬅	für Fahrzeuge ohne Keramikbremse	2	24.8190-0016.2	620016	L= 359,6
			⬅	für Fahrzeuge mit Keramikbremse	2	24.8190-0952.2	620952	L= 300
			➡	für Fahrzeuge ohne Keramikbremse	2	24.8190-0023.2	620023	L= 484,6
3.6 Carrera 4	239	04/05→12/08	⬅	für Fahrzeuge ohne Keramikbremse	2	24.8190-0938.2	620938	L= 495
3.6 Carrera 4	242	04/05→12/08	➡	für Fahrzeuge ohne Keramikbremse	2	24.8190-0921.2	620921	L= 440
3.6 Carrera 4	254	06/08→12/12	⬅	für Fahrzeuge ohne Keramikbremse	2	24.8190-0938.2	620938	L= 495
			⬅	für Fahrzeuge mit Keramikbremse	2	24.8190-0952.2	620952	L= 300
			➡	für Fahrzeuge ohne Keramikbremse	2	24.8190-0023.2	620023	L= 484,6
3.6 Turbo	353	09/07→12/09	⬅	für Fahrzeuge ohne Keramikbremse	2	24.8190-0938.2	620938	L= 495
3.8 Carrera GTS	300	06/09→12/11						
3.8 Turbo	368	09/09→12/12	➡		2	24.8190-0943.2	620943	L= 504,6
3.8 Turbo S	390	02/10→12/12						
3.8 Carrera 4 GTS	300	06/09→12/12	⬅	☐; für Fahrzeuge ohne Keramikbremse	1	24.8190-0931.2	620931	L= 336
			⬅	☐; für Fahrzeuge ohne Keramikbremse	1	24.8190-0933.2	620933	L= 305
3.8 Carrera 4S	261	04/05→12/08	⬅	für Fahrzeuge ohne Keramikbremse	2	24.8190-0950.2	620950	L= 525
3.8 Carrera 4S	264	04/05→12/10						
3.8 Carrera 4S	280	08/05→12/08	➡		2	24.8190-0943.2	620943	L= 504,6
3.8 Carrera 4S	283	06/08→12/12						
3.8 Carrera S	261	04/05→12/08	⬅	☐; für Fahrzeuge ohne Keramikbremse	1	24.8190-0931.2	620931	L= 336
3.8 Carrera S	264	04/05→12/08						
3.8 Carrera S	280	08/05→12/08	⬅	☐; für Fahrzeuge ohne Keramikbremse	1	24.8190-0933.2	620933	L= 305
3.8 Carrera S	283	06/08→12/11	➡		2	24.8190-0943.2	620943	L= 504,6
<b>Bremsscheibe</b>								
3.6 Carrera	235	04/05→07/05	⬅	☐; für Fahrzeuge ohne Keramikbremse		24.0128-0130.1	428130	Ø 318 28 26 V•
3.6 Carrera	239	04/05→12/08						
3.6 Carrera	242	04/05→12/08	⬅	☐; für Fahrzeuge ohne Keramikbremse		24.0128-0131.1	428131	Ø 318 28 26 V•
3.6 Carrera 4	239	04/05→12/08						
3.6 Carrera 4	242	04/05→12/08	➡	für Fahrzeuge ohne Keramikbremse		24.0124-0176.1	424176	Ø 299 24 22 V•
3.6 Carrera	254	06/08→12/11	⬅	☐; für Fahrzeuge ohne Keramikbremse		24.0128-0246.1	428246	Ø 330 28 26 V•
3.6 Carrera 4	254	06/08→12/12	⬅	☐; für Fahrzeuge ohne Keramikbremse		24.0128-0247.1	428247	Ø 330 28 26 V•
			➡	☐; für Fahrzeuge ohne Keramikbremse		24.0128-0196.1	428196	Ø 330 28 26 V•
			➡	☐; für Fahrzeuge ohne Keramikbremse		24.0128-0197.1	428197	Ø 330 28 26 V•
3.6 Turbo	353	09/07→12/09	⬅	☐; für Fahrzeuge ohne Keramikbremse		24.0134-0101.1	434101	Ø 330 34 32 V•
			⬅	☐; für Fahrzeuge ohne Keramikbremse		24.0134-0102.1	434102	Ø 330 34 32 V•
			➡	☐; für Fahrzeuge ohne Keramikbremse		24.0128-0264.1	428264	Ø 350 28 26 V•
			➡	☐; für Fahrzeuge ohne Keramikbremse		24.0128-0265.1	428265	Ø 350 28 26 V•
3.8 Carrera 4 GTS	300	06/09→12/12	⬅	☐; für Fahrzeuge ohne Keramikbremse		24.0134-0101.1	434101	Ø 330 34 32 V•
3.8 Carrera 4S	261	04/05→12/08						
3.8 Carrera 4S	264	04/05→12/10	⬅	☐; für Fahrzeuge ohne Keramikbremse		24.0134-0102.1	434102	Ø 330 34 32 V•
3.8 Carrera 4S	280	08/05→12/08						
3.8 Carrera 4S	283	06/08→12/12	➡	☐; für Fahrzeuge ohne Keramikbremse		24.0128-0196.1	428196	Ø 330 28 26 V•
3.8 Carrera GTS	300	06/09→12/11	➡	☐; für Fahrzeuge ohne Keramikbremse		24.0128-0197.1	428197	Ø 330 28 26 V•



	kW					! #		
<b>PORSCHE - 911 Cabriolet (997) 04/05→12/12</b>								
<b>Bremsscheibe</b>								
3.8 Carrera S	261	04/05→12/08	←	☐	für Fahrzeuge ohne Keramikbremse		24.0134-0101.1 434101	Ø 330 34 32 V•
3.8 Carrera S	264	04/05→12/08	←	☐	für Fahrzeuge ohne Keramikbremse		24.0134-0102.1 434102	Ø 330 34 32 V•
3.8 Carrera S	280	08/05→12/08	←	☐	für Fahrzeuge ohne Keramikbremse		24.0134-0102.1 434102	Ø 330 34 32 V•
3.8 Carrera S	283	06/08→12/11	→	☐	für Fahrzeuge ohne Keramikbremse		24.0128-0196.1 428196	Ø 330 28 26 V•
3.8 Turbo	368	09/09→12/12	→	☐	für Fahrzeuge ohne Keramikbremse		24.0128-0196.1 428196	Ø 330 28 26 V•
3.8 Turbo S	390	02/10→12/12	→	☐	für Fahrzeuge ohne Keramikbremse		24.0128-0197.1 428197	Ø 330 28 26 V•
<b>PORSCHE - 911 Targa (991) 05/14→</b>								
<b>Warnkontakt, Bremsbelagverschleiß</b>								
3.0 Carrera 4	272	11/15→	←		für Fahrzeuge mit Keramikbremse	2	24.8190-0952.2 620952	L= 300
3.0 Carrera 4 GTS	331	03/17→	→			2	24.8190-0953.2 620953	L= 215
3.0 Carrera 4S	309	11/15→	→			2	24.8190-0953.2 620953	L= 215
3.4 Carrera 4	257	05/14→	←		für Fahrzeuge ohne Keramikbremse	2	24.8190-0069.2 620069	L= 248
			←		für Fahrzeuge mit Keramikbremse	2	24.8190-0952.2 620952	L= 300
			→			2	24.8190-0953.2 620953	L= 215
3.8 Carrera 4S	294	05/14→	←		für Fahrzeuge ohne Keramikbremse	2	24.8190-0106.2 620106	L= 270
3.8 Carrera 4S / 4 GTS	316	05/14→	←		für Fahrzeuge mit Keramikbremse	2	24.8190-0952.2 620952	L= 300
			→			2	24.8190-0953.2 620953	L= 215
<b>Bremsscheibe</b>								
3.0 Carrera 4	272	11/15→	→	☐	für Fahrzeuge ohne Keramikbremse		24.0128-0196.1 428196	Ø 330 28 26 V•
3.0 Carrera 4 GTS	331	03/17→	→	☐	für Fahrzeuge ohne Keramikbremse		24.0128-0197.1 428197	Ø 330 28 26 V•
3.0 Carrera 4S	309	11/15→	→	☐	für Fahrzeuge ohne Keramikbremse		24.0128-0197.1 428197	Ø 330 28 26 V•
3.8 Carrera 4S	294	05/14→	→					
3.8 Carrera 4S / 4 GTS	316	05/14→	→					
3.4 Carrera 4	257	05/14→	←	☐	für Fahrzeuge ohne Keramikbremse		24.0128-0246.1 428246	Ø 330 28 26 V•
			←	☐	für Fahrzeuge ohne Keramikbremse		24.0128-0247.1 428247	Ø 330 28 26 V•
<b>PORSCHE - 911 Targa (993) 01/94→09/97</b>								
<b>Bremsbelagsatz, Scheibenbremse</b>								
3.6 Carrera	210	08/95→09/97	→				13.0460-4016.2 604016	ATE 20877 17,5 + WE / - WK
<b>Warnkontakt, Bremsbelagverschleiß</b>								
3.6 Carrera	210	08/95→09/97	←			2	24.8190-0917.2 620917	L= 518
			→			2	24.8190-0920.2 620920	L= 698
<b>Bremsscheibe</b>								
3.6 Carrera	210	08/95→09/97	←	☐			24.0132-0142.1 432142	Ø 304 32 30 V•
			←	☐			24.0132-0143.1 432143	Ø 304 32 30 V•
			→				24.0124-0183.1 424183	Ø 299 24 22 V•
<b>PORSCHE - 911 Targa (996) 12/01→08/05</b>								
<b>Bremsbelagsatz, Scheibenbremse</b>								
3.6	235	12/01→08/05	←				13.0460-4987.2 604987	BRE 23329 17,0 + WE / - WK
			→				13.0460-4988.2 604988	BRE 21792 15,2 + WE / - WK
<b>Warnkontakt, Bremsbelagverschleiß</b>								
3.6	235	12/01→08/05	←			2	24.8190-0921.2 620921	L= 440
			→			2	24.8190-0921.2 620921	L= 440
<b>Bremsscheibe</b>								
3.6	235	12/01→08/05	←	☐			24.0128-0130.1 428130	Ø 318 28 26 V•
			←	☐			24.0128-0131.1 428131	Ø 318 28 26 V•
			→				24.0124-0176.1 424176	Ø 299 24 22 V•
<b>PORSCHE - 911 Targa (997) 07/06→12/12</b>								
<b>Warnkontakt, Bremsbelagverschleiß</b>								
3.6 Carrera 4	239	07/06→12/08	←		11/06→; für Fahrzeuge ohne Keramikbremse	2	24.8190-0027.2 620027	L= 514,6
3.8 Carrera 4S	261	07/06→12/08	→		11/06→; für Fahrzeuge ohne Keramikbremse	2	24.8190-0023.2 620023	L= 484,6
3.6 Carrera 4	254	10/08→12/12	←		für Fahrzeuge ohne Keramikbremse	2	24.8190-0027.2 620027	L= 514,6
			→		für Fahrzeuge ohne Keramikbremse	2	24.8190-0023.2 620023	L= 484,6
↓								



	kw					! #		
<b>PORSCHE - 911 Targa (997) 07/06→12/12</b>								
<b>Warnkontakt, Bremsbelagverschleiß</b>								
3.8 Carrera 4S	283	10/08→12/12	←	für Fahrzeuge ohne Keramikbremse	2	24.8190-0950.2	620950	L= 525
			→	für Fahrzeuge ohne Keramikbremse	2	24.8190-0023.2	620023	L= 484,6
<b> Bremsscheibe</b>								
3.6 Carrera 4	239	07/06→12/08	←	 ; 11/06→; für Fahrzeuge ohne Keramikbremse		24.0128-0130.1	428130	Ø 318 28 26 V•
3.8 Carrera 4S	261	07/06→12/08	←	 ; 11/06→; für Fahrzeuge ohne Keramikbremse		24.0128-0131.1	428131	Ø 318 28 26 V•
			→	11/06→; für Fahrzeuge ohne Keramikbremse		24.0124-0176.1	424176	Ø 299 24 22 V•
3.6 Carrera 4	254	10/08→12/12	←	 ; für Fahrzeuge ohne Keramikbremse		24.0128-0246.1	428246	Ø 330 28 26 V•
			←	 ; für Fahrzeuge ohne Keramikbremse		24.0128-0247.1	428247	Ø 330 28 26 V•
			→	für Fahrzeuge ohne Keramikbremse		24.0124-0176.1	424176	Ø 299 24 22 V•
3.8 Carrera 4S	283	10/08→12/12	←	 ; für Fahrzeuge ohne Keramikbremse		24.0134-0101.1	434101	Ø 330 34 32 V•
			←	 ; für Fahrzeuge ohne Keramikbremse		24.0134-0102.1	434102	Ø 330 34 32 V•
			→	 ; für Fahrzeuge ohne Keramikbremse		24.0128-0196.1	428196	Ø 330 28 26 V•
			→	 ; für Fahrzeuge ohne Keramikbremse		24.0128-0197.1	428197	Ø 330 28 26 V•
<b>PORSCHE - BOXSTER (981) 04/12→</b>								
<b> Bremsbelagsatz, Scheibenbremse</b>								
2.7 GTS 3.4 S 3.4	195 243 232	04/12→ 02/14→ 04/12→	→	für Fahrzeuge ohne Keramikbremse		13.0460-4816.2	604816	BRE 24541 15,5 + WE / - WK
<b>Warnkontakt, Bremsbelagverschleiß</b>								
2.7 GTS 3.4 S 3.4	195 243 232	04/12→ 02/14→ 04/12→	←	für Fahrzeuge ohne Keramikbremse	2	24.8190-0069.2	620069	L= 248
			←	für Fahrzeuge mit Keramikbremse	2	24.8190-0952.2	620952	L= 300
			→	für Fahrzeuge mit Keramikbremse	2	24.8190-0070.2	620070	L= 268
<b> Bremsscheibe</b>								
2.7	195	04/12→	←	 ; für Fahrzeuge ohne Keramikbremse		24.0128-0260.1	428260	Ø 315 28 26 V•
			←	 ; für Fahrzeuge ohne Keramikbremse		24.0128-0273.1	428273	Ø 315 28 26 V•
			→	für Fahrzeuge ohne Keramikbremse		24.0120-0212.1	420212	Ø 299 20 18 V•
GTS 3.4 S 3.4	243 232	02/14→ 04/12→	←	 ; für Fahrzeuge ohne Keramikbremse		24.0128-0260.1	428260	Ø 315 28 26 V•
			←	 ; für Fahrzeuge ohne Keramikbremse		24.0128-0273.1	428273	Ø 315 28 26 V•
<b>PORSCHE - BOXSTER (986) 09/96→12/04</b>								
<b> Bremsbelagsatz, Scheibenbremse</b>								
2.5	150	09/96→08/99	←	→ 07/99		13.0460-4814.2	604814	BRE 21937 15,5 + WE / - WK
						13.0470-4814.2	LD4814	BRE 21937 15,5 + WE / - WK Ceramic
			→	→ 07/99		13.0460-4988.2	604988	BRE 21792 15,2 + WE / - WK
2.7	155	06/99→12/02	←	08/99→ 06/02		13.0460-4814.2	604814	BRE 21937 15,5 + WE / - WK
						13.0470-4814.2	LD4814	BRE 21937 15,5 + WE / - WK Ceramic
			→	08/99→ 06/02		13.0460-4988.2	604988	BRE 21792 15,2 + WE / - WK
2.7	162	08/99→07/02	←	→ 06/02		13.0460-4814.2	604814	BRE 21937 15,5 + WE / - WK
						13.0470-4814.2	LD4814	BRE 21937 15,5 + WE / - WK Ceramic
			→	→ 06/02		13.0460-4988.2	604988	BRE 21792 15,2 + WE / - WK
2.7	168	07/02→12/04	←			13.0460-4814.2	604814	BRE 21937 15,5 + WE / - WK
						13.0470-4814.2	LD4814	BRE 21937 15,5 + WE / - WK Ceramic
			→			13.0460-4988.2	604988	BRE 21792 15,2 + WE / - WK
S 3.2 S 3.2	191 196	07/02→12/04 01/04→12/04	←			13.0460-4987.2	604987	BRE 23329 17,0 + WE / - WK
			→			13.0460-4988.2	604988	BRE 21792 15,2 + WE / - WK
S 3.2	185	08/99→07/02	←	→ 06/02		13.0460-4987.2	604987	BRE 23329 17,0 + WE / - WK
			→	→ 06/02		13.0460-4988.2	604988	BRE 21792 15,2 + WE / - WK
<b>Warnkontakt, Bremsbelagverschleiß</b>								
2.5	150	09/96→08/99	←	→ 07/99	2	24.8190-0921.2	620921	L= 440
↓								

**PORSCHE - BOXSTER (986) 09/96→12/04**

**Warnkontakt, Bremsbelagverschleiß**

2.5	150	09/96→08/99	➡	→ 07/99	2	24.8190-0922.2	620922	L= 440
2.7	155	06/99→12/02	⬅	08/99→ 06/02	2	24.8190-0921.2	620921	L= 440
			➡	08/99→ 06/02	2	24.8190-0922.2	620922	L= 440
2.7 S 3.2	162 185	08/99→07/02 08/99→07/02	⬅	→ 06/02	2	24.8190-0921.2	620921	L= 440
			➡	→ 06/02	2	24.8190-0922.2	620922	L= 440
2.7 S 3.2 S 3.2	168 191 196	07/02→12/04 07/02→12/04 01/04→12/04	⬅		2	24.8190-0921.2	620921	L= 440
			➡		2	24.8190-0922.2	620922	L= 440
			➡		2	24.8190-0922.2	620922	L= 440

**Bremsscheibe**

2.5	150	09/96→08/99	⬅	→ 07/99		24.0124-0165.1	424165	∅ 298 24 22 V
			➡	→ 07/99		24.0120-0176.1	420176	∅ 292 20 18 V
2.7	155	06/99→12/02	⬅	08/99→ 06/02		24.0124-0165.1	424165	∅ 298 24 22 V
			➡	08/99→ 06/02		24.0120-0176.1	420176	∅ 292 20 18 V
2.7	162	08/99→07/02	⬅	→ 06/02		24.0124-0165.1	424165	∅ 298 24 22 V
			➡	→ 06/02		24.0120-0176.1	420176	∅ 292 20 18 V
2.7	168	07/02→12/04	⬅			24.0124-0165.1	424165	∅ 298 24 22 V
			➡			24.0120-0176.1	420176	∅ 292 20 18 V
S 3.2 S 3.2	191 196	07/02→12/04 01/04→12/04	⬅	☐		24.0128-0130.1	428130	∅ 318 28 26 V•
			⬅	☐		24.0128-0131.1	428131	∅ 318 28 26 V•
			➡			24.0124-0194.1	424194	∅ 299 24 22 V•
S 3.2	185	08/99→07/02	⬅	☐; → 06/02		24.0128-0130.1	428130	∅ 318 28 26 V•
			⬅	☐; → 06/02		24.0128-0131.1	428131	∅ 318 28 26 V•
			➡	→ 06/02		24.0124-0194.1	424194	∅ 299 24 22 V•

**PORSCHE - BOXSTER (987) 11/04→12/11**









**Bremsbelagsatz, Scheibenbremse**









2.7	176	11/04→12/06	⬅	→ 07/06		13.0460-4815.2	604815	BRE 21937 15,5 + WE / - WK
			➡	→ 07/06		13.0470-4814.2	LD4814	BRE 21937 15,5 + WE / - WK Ceramic
2.7	180	07/06→12/09	⬅			13.0460-4815.2	604815	BRE 21937 15,5 + WE / - WK
			➡			13.0470-4814.2	LD4814	BRE 21937 15,5 + WE / - WK Ceramic
			➡			13.0460-4816.2	604816	BRE 24541 15,5 + WE / - WK
2.9	188	06/09→12/11	➡	→ 09/11		13.0460-4816.2	604816	BRE 24541 15,5 + WE / - WK
S 3.2	206	11/04→12/06	➡	→ 07/06; für Fahrzeuge ohne Keramikbremse		13.0460-4988.2	604988	BRE 21792 15,2 + WE / - WK
S 3.4	217	07/06→12/09	➡	für Fahrzeuge ohne Keramikbremse		13.0460-4988.2	604988	BRE 21792 15,2 + WE / - WK
S 3.4	223	08/08→12/09	➡	06/09→; für Fahrzeuge ohne Keramikbremse		13.0460-4988.2	604988	BRE 21792 15,2 + WE / - WK
S 3.4	228	06/09→12/11	➡	→ 09/11; für Fahrzeuge ohne Keramikbremse		13.0460-4988.2	604988	BRE 21792 15,2 + WE / - WK









**Warnkontakt, Bremsbelagverschleiß**

2.7	176	11/04→12/06	⬅	☐; → 07/06	1	24.8190-0933.2	620933	L= 305
			⬅	☐; → 07/06	1	24.8190-0934.2	620934	L= 295
			➡	→ 07/06	2	24.8190-0932.2	620932	L= 461
2.7	180	07/06→12/09	⬅	☐	1	24.8190-0933.2	620933	L= 305
			⬅	☐	1	24.8190-0934.2	620934	L= 295
			➡		2	24.8190-0932.2	620932	L= 461
2.9	188	06/09→12/11	⬅	☐; → 09/11; für Fahrzeuge ohne Keramikbremse	1	24.8190-0024.2	620024	L= 369,6
			⬅	☐; → 09/11; für Fahrzeuge ohne Keramikbremse	1	24.8190-0025.2	620025	L= 349,6
			➡	→ 09/11	2	24.8190-0932.2	620932	L= 461
S 3.2	206	11/04→12/06	⬅	☐; → 07/06; für Fahrzeuge ohne Keramikbremse	1	24.8190-0024.2	620024	L= 369,6
			⬅	☐; → 07/06; für Fahrzeuge ohne Keramikbremse	1	24.8190-0025.2	620025	L= 349,6









↓







	kw				! #		
<b>PORSCHE - BOXSTER (987) 11/04→12/11</b>							
<b>Warnkontakt, Bremsbelagverschleiß</b>							
S 3.2	206	11/04→12/06	➔	→ 07/06; für Fahrzeuge ohne Keramikbremse	2	24.8190-0922.2 620922	L= 440
S 3.4	217	07/06→12/09	➔	☐; für Fahrzeuge ohne Keramikbremse	1	24.8190-0024.2 620024	L= 369,6
			➔	☐; für Fahrzeuge ohne Keramikbremse	1	24.8190-0025.2 620025	L= 349,6
			➔	für Fahrzeuge ohne Keramikbremse	2	24.8190-0922.2 620922	L= 440
S 3.4	223	08/08→12/09	➔	☐; 06/09→; für Fahrzeuge ohne Keramikbremse	1	24.8190-0024.2 620024	L= 369,6
			➔	☐; 06/09→; für Fahrzeuge ohne Keramikbremse	1	24.8190-0025.2 620025	L= 349,6
			➔	06/09→; für Fahrzeuge ohne Keramikbremse	2	24.8190-0922.2 620922	L= 440
S 3.4	228	06/09→12/11	➔	☐; → 09/11; für Fahrzeuge ohne Keramikbremse	1	24.8190-0024.2 620024	L= 369,6
			➔	☐; → 09/11; für Fahrzeuge ohne Keramikbremse	1	24.8190-0025.2 620025	L= 349,6
			➔	→ 09/11; für Fahrzeuge ohne Keramikbremse	2	24.8190-0922.2 620922	L= 440
<b> Bremsscheibe</b>							
2.7	176	11/04→12/06	➔	☐; → 07/06		24.0124-0210.1 424210	Ø 298 24 22 V•
			➔	☐; → 07/06		24.0124-0211.1 424211	Ø 298 24 22 V•
			➔	→ 07/06		24.0120-0212.1 420212	Ø 299 20 18 V•
2.7	180	07/06→12/09	➔	☐		24.0124-0210.1 424210	Ø 298 24 22 V•
			➔	☐		24.0124-0211.1 424211	Ø 298 24 22 V•
			➔			24.0120-0212.1 420212	Ø 299 20 18 V•
2.9	188	06/09→12/11	➔	☐; → 09/11; für Fahrzeuge ohne Keramikbremse		24.0128-0130.1 428130	Ø 318 28 26 V•
			➔	☐; → 09/11; für Fahrzeuge ohne Keramikbremse		24.0128-0131.1 428131	Ø 318 28 26 V•
			➔	→ 09/11		24.0120-0212.1 420212	Ø 299 20 18 V•
S 3.2	206	11/04→12/06	➔	☐; → 07/06; für Fahrzeuge ohne Keramikbremse		24.0128-0130.1 428130	Ø 318 28 26 V•
			➔	☐; → 07/06; für Fahrzeuge ohne Keramikbremse		24.0128-0131.1 428131	Ø 318 28 26 V•
			➔	→ 07/06; für Fahrzeuge ohne Keramikbremse		24.0124-0194.1 424194	Ø 299 24 22 V•
S 3.4	217	07/06→12/09	➔	☐; für Fahrzeuge ohne Keramikbremse		24.0128-0130.1 428130	Ø 318 28 26 V•
			➔	☐; für Fahrzeuge ohne Keramikbremse		24.0128-0131.1 428131	Ø 318 28 26 V•
			➔	für Fahrzeuge ohne Keramikbremse		24.0124-0194.1 424194	Ø 299 24 22 V•
S 3.4	223	08/08→12/09	➔	☐; 06/09→; für Fahrzeuge ohne Keramikbremse		24.0128-0130.1 428130	Ø 318 28 26 V•
			➔	☐; 06/09→; für Fahrzeuge ohne Keramikbremse		24.0128-0131.1 428131	Ø 318 28 26 V•
			➔	06/09→; für Fahrzeuge ohne Keramikbremse		24.0124-0194.1 424194	Ø 299 24 22 V•
S 3.4	228	06/09→12/11	➔	☐; → 09/11; für Fahrzeuge ohne Keramikbremse		24.0128-0130.1 428130	Ø 318 28 26 V•
			➔	☐; → 09/11; für Fahrzeuge ohne Keramikbremse		24.0128-0131.1 428131	Ø 318 28 26 V•
			➔	→ 09/11; für Fahrzeuge ohne Keramikbremse		24.0124-0194.1 424194	Ø 299 24 22 V•
<b>PORSCHE - BOXSTER Spyder (981) 07/15→</b>							
<b>Warnkontakt, Bremsbelagverschleiß</b>							
3.8	276	07/15→	➔	für Fahrzeuge ohne Keramikbremse	2	24.8190-0952.2 620952	L= 300
			➔	für Fahrzeuge mit Keramikbremse	2	24.8190-0952.2 620952	L= 300
			➔	für Fahrzeuge ohne Keramikbremse	2	24.8190-0953.2 620953	L= 215
<b>PORSCHE - BOXSTER Spyder (987) 09/07→12/11</b>							
<b> Bremsbelagsatz, Scheibenbremse</b>							
3.4 RS 60	223	09/07→12/08	➔	08/08→; für Fahrzeuge ohne Keramikbremse		13.0460-4988.2 604988	BRE 21792 15,2 + WE / - WK
<b>Warnkontakt, Bremsbelagverschleiß</b>							
3.4	231	09/09→12/11	➔	☐; 06/10→ 09/11; für Fahrzeuge ohne Keramikbremse	1	24.8190-0024.2 620024	L= 369,6
↓							







	kw					! #		
<b>PORSCHE - BOXSTER Spyder (987) 09/07→12/11</b>								
<b>Warnkontakt, Bremsbelagverschleiß</b>								
3.4	231	09/09→12/11	←	☐; 06/10→ 09/11; für Fahrzeuge ohne Keramikbremse	1	24.8190-0025.2	620025	L= 349,6
3.4	235	06/10→12/11	←	☐; → 09/11; für Fahrzeuge ohne Keramikbremse	1	24.8190-0024.2	620024	L= 369,6
			←	☐; → 09/11; für Fahrzeuge ohne Keramikbremse	1	24.8190-0025.2	620025	L= 349,6
3.4 RS 60	223	09/07→12/08	←	☐; 08/08→; für Fahrzeuge ohne Keramikbremse	1	24.8190-0024.2	620024	L= 369,6
			←	☐; 08/08→; für Fahrzeuge ohne Keramikbremse	1	24.8190-0025.2	620025	L= 349,6
			→	08/08→; für Fahrzeuge ohne Keramikbremse	2	24.8190-0922.2	620922	L= 440
<b> Brems Scheibe</b>								
3.4 RS 60	223	09/07→12/08	←	☐; 08/08→; für Fahrzeuge ohne Keramikbremse		24.0128-0130.1	428130	Ø 318 28 26 V•
			←	☐; 08/08→; für Fahrzeuge ohne Keramikbremse		24.0128-0131.1	428131	Ø 318 28 26 V•
			→	08/08→; für Fahrzeuge ohne Keramikbremse		24.0124-0194.1	424194	Ø 299 24 22 V•
<b>PORSCHE - CARRERA GT (980) 07/03→12/06</b>								
<b>Warnkontakt, Bremsbelagverschleiß</b>								
5.7	450	07/03→12/06	→		2	24.8190-0938.2	620938	L= 495
<b>PORSCHE - CAYENNE (9PA) 09/02→12/10</b>								
<b> Bremsbelagsatz, Scheibenbremse</b>								
3.0 TDI	176	02/09→09/10	←	→ 04/10; passend für Felgengröße [Zoll]: 19; Bremsattelfarbe: rot		13.0460-4840.2	604840	BRE 23961 16,8 + WE / - WK
			←	→ 04/10; passend für Felgengröße [Zoll]: 18; Bremsattelfarbe: rot		13.0460-4852.2	604852	BRE 24553 15,8 + WE / - WK + Zub
						13.0460-4993.2	604993	BRE 23693 16,6 + WE / - WK
			←	→ 04/10; passend für Felgengröße [Zoll]: 17; Bremsattelfarbe: schwarz		13.0460-4992.2	604992	BRE 23692 16,6 + WE / - WK
						13.0470-4992.2	LD4992	BRE 23692 16,6 + WE / - WK Ceramic
			←	→ 04/10; passend für Felgengröße [Zoll]: 18; Bremsattelfarbe: silber		13.0460-4993.2	604993	BRE 23693 16,6 + WE / - WK
						13.0470-4993.2	LD4993	BRE 23693 16,6 + WE / - WK Ceramic
3.2	177	08/03→09/07	→	→ 12/09; passend für Felgengröße [Zoll]: 18		13.0460-4850.2	604850	BRE 24296 15,5 + WE / - WK
						13.0470-4850.2	LD4850	BRE 24296 15,5 + WE / - WK Ceramic
			→	→ 12/09; passend für Felgengröße [Zoll]: 17		13.0460-4976.2	604976	BRE 23694 16,7 + WE / - WK
						13.0470-4976.2	LD4976	BRE 23694 16,4 + WE / - WK Ceramic
			←	01/05→ 12/06; passend für Felgengröße [Zoll]: 19		13.0460-4840.2	604840	BRE 23961 16,8 + WE / - WK
			←	10/03→ 12/06; passend für Felgengröße [Zoll]: 18; Bremsattelfarbe: rot		13.0460-4852.2	604852	BRE 24553 15,8 + WE / - WK + Zub
						13.0460-4993.2	604993	BRE 23693 16,6 + WE / - WK
3.2	184	10/03→09/07	←	10/03→ 12/06; passend für Felgengröße [Zoll]: 17; Bremsattelfarbe: schwarz		13.0460-4992.2	604992	BRE 23692 16,6 + WE / - WK
						13.0470-4992.2	LD4992	BRE 23692 16,6 + WE / - WK Ceramic
			←	10/03→ 12/06; passend für Felgengröße [Zoll]: 18; Bremsattelfarbe: silber		13.0460-4993.2	604993	BRE 23693 16,6 + WE / - WK
						13.0470-4993.2	LD4993	BRE 23693 16,6 + WE / - WK Ceramic
			→	01/05→ 12/06; passend für Felgengröße [Zoll]: 18		13.0460-4976.2	604976	BRE 23694 16,7 + WE / - WK
						13.0470-4976.2	LD4976	BRE 23694 16,4 + WE / - WK Ceramic
			→	10/03→ 12/06; passend für Felgengröße [Zoll]: 17		13.0460-4976.2	604976	BRE 23694 16,7 + WE / - WK
			13.0470-4976.2	LD4976	BRE 23694 16,4 + WE / - WK Ceramic			
3.2	184	10/03→09/07	←	01/05→ 12/06; passend für Felgengröße [Zoll]: 19		13.0460-4840.2	604840	BRE 23961 16,8 + WE / - WK
			←	→ 12/06; Bremsattelfarbe: rot; passend für Felgengröße [Zoll]: 18		13.0460-4852.2	604852	BRE 24553 15,8 + WE / - WK + Zub
						13.0460-4993.2	604993	BRE 23693 16,6 + WE / - WK
↓								







	kw			 	! #		
<b>PORSCHE - CAYENNE (9PA) 09/02→12/10</b>							
<b> Bremsbelagsatz, Scheibenbremse</b>							
3.2	184	10/03→09/07	←	→ 12/06; passend für Felgengröße [Zoll]: 17; Bremsstättelfarbe: schwarz	13.0460-4992.2	604992	BRE 23692 16,6 + WE / - WK
			←	→ 12/06; passend für Felgengröße [Zoll]: 18; Bremsstättelfarbe: silber	13.0470-4992.2	LD4992	BRE 23692 16,6 + WE / - WK Ceramic
			→	→ 12/06; passend für Felgengröße [Zoll]: 17	13.0460-4976.2	604976	BRE 23694 16,7 + WE / - WK
			→	01/05→ 12/06; passend für Felgengröße [Zoll]: 18	13.0470-4976.2	LD4976	BRE 23694 16,4 + WE / - WK Ceramic
3.6	213	02/07→09/10	←	→ 04/10; passend für Felgengröße [Zoll]: 19	13.0460-4840.2	604840	BRE 23961 16,8 + WE / - WK
			←	→ 04/10; passend für Felgengröße [Zoll]: 18; Bremsstättelfarbe: rot	13.0460-4852.2	604852	BRE 24553 15,8 + WE / - WK + Zub
			←	→ 04/10; passend für Felgengröße [Zoll]: 17; Bremsstättelfarbe: schwarz	13.0460-4992.2	604992	BRE 23692 16,6 + WE / - WK
			←	→ 04/10; passend für Felgengröße [Zoll]: 18; Bremsstättelfarbe: silber	13.0470-4992.2	LD4992	BRE 23692 16,6 + WE / - WK Ceramic
			→	→ 12/09; passend für Felgengröße [Zoll]: 18	13.0460-4993.2	604993	BRE 23693 16,6 + WE / - WK Ceramic
			→	→ 12/09; passend für Felgengröße [Zoll]: 17	13.0470-4993.2	LD4993	BRE 23693 16,6 + WE / - WK Ceramic
GTS 4.8	298	10/07→09/10	←	→ 04/10; passend für Felgengröße [Zoll]: 19; Bremsstättelfarbe: rot	13.0460-4840.2	604840	BRE 23961 16,8 + WE / - WK
			←	→ 04/10; passend für Felgengröße [Zoll]: 18; Bremsstättelfarbe: rot	13.0460-4852.2	604852	BRE 24553 15,8 + WE / - WK + Zub
			←	→ 04/10; passend für Felgengröße [Zoll]: 18; Bremsstättelfarbe: rot	13.0460-4993.2	604993	BRE 23693 16,6 + WE / - WK
			←	→ 04/10; passend für Felgengröße [Zoll]: 17; Bremsstättelfarbe: schwarz	13.0460-4992.2	604992	BRE 23692 16,6 + WE / - WK
			←	→ 04/10; passend für Felgengröße [Zoll]: 18; Bremsstättelfarbe: silber	13.0460-4993.2	604993	BRE 23693 16,6 + WE / - WK
			→	→ 12/09; passend für Felgengröße [Zoll]: 17; Bremsstättelfarbe: rot	13.0460-4976.2	604976	BRE 23694 16,7 + WE / - WK
S 4.5	250	09/02→09/07	←	01/05→ 12/06; passend für Felgengröße [Zoll]: 19; Bremsstättelfarbe: rot	13.0460-4840.2	604840	BRE 23961 16,8 + WE / - WK
			←	→ 12/06; Bremsstättelfarbe: rot; passend für Felgengröße [Zoll]: 18	13.0460-4852.2	604852	BRE 24553 15,8 + WE / - WK + Zub
			←	→ 12/06; passend für Felgengröße [Zoll]: 17; Bremsstättelfarbe: schwarz	13.0460-4992.2	604992	BRE 23692 16,6 + WE / - WK
			←	passend für Felgengröße [Zoll]: 18; Bremsstättelfarbe: rot	13.0460-4993.2	604993	BRE 23693 16,6 + WE / - WK
			←	→ 12/06; passend für Felgengröße [Zoll]: 18; Bremsstättelfarbe: silber	13.0460-4993.2	604993	BRE 23693 16,6 + WE / - WK
			→	→ 12/06; passend für Felgengröße [Zoll]: 17	13.0460-4976.2	604976	BRE 23694 16,7 + WE / - WK
			→	01/05→ 12/06; passend für Felgengröße [Zoll]: 18	13.0470-4976.2	LD4976	BRE 23694 16,4 + WE / - WK Ceramic
S 4.8 Turbo S 4.8	283 368	02/07→09/10 02/07→09/10	←	→ 04/10; passend für Felgengröße [Zoll]: 19; Bremsstättelfarbe: rot	13.0460-4840.2	604840	BRE 23961 16,8 + WE / - WK
			←	→ 04/10; passend für Felgengröße [Zoll]: 18; Bremsstättelfarbe: rot	13.0460-4852.2	604852	BRE 24553 15,8 + WE / - WK + Zub
			←	→ 04/10; passend für Felgengröße [Zoll]: 17; Bremsstättelfarbe: schwarz	13.0460-4992.2	604992	BRE 23692 16,6 + WE / - WK









	kw			 	! #			
<b>PORSCHE - CAYENNE (9PA) 09/02→12/10</b>								
<b> Bremsbelagsatz, Scheibenbremse</b>								
S 4.8 Turbo S 4.8	283 368	02/07→09/10 02/07→09/10	←	→ 04/10; passend für Felgengröße [Zoll]: 18; Bremsstelfarbe: silber	13.0460-4993.2	604993	BRE 23693 16,6 + WE / - WK	
			→	→ 12/09; passend für Felgengröße [Zoll]: 18	13.0460-4850.2	604850	BRE 24296 15,5 + WE / - WK	
			→	→ 12/09; passend für Felgengröße [Zoll]: 17	13.0470-4850.2	LD4850	BRE 24296 15,5 + WE / - WK Ceramic	
Turbo 4.5	331	09/02→09/07	←	→ 12/09; passend für Felgengröße [Zoll]: 17	13.0460-4976.2	604976	BRE 23694 16,7 + WE / - WK	
			←	→ 12/09; passend für Felgengröße [Zoll]: 17	13.0470-4976.2	LD4976	BRE 23694 16,4 + WE / - WK Ceramic	
			←	01/05→ 12/06; passend für Felgengröße [Zoll]: 19	13.0460-4840.2	604840	BRE 23961 16,8 + WE / - WK	
			←	→ 12/06; Bremsstelfarbe: rot; passend für Felgengröße [Zoll]: 18	13.0460-4852.2	604852	BRE 24553 15,8 + WE / - WK + Zub	
			←	→ 12/06; passend für Felgengröße [Zoll]: 17; Bremsstelfarbe: schwarz	13.0460-4993.2	604993	BRE 23693 16,6 + WE / - WK	
			←	→ 12/06; passend für Felgengröße [Zoll]: 18	13.0460-4992.2	604992	BRE 23692 16,6 + WE / - WK	
Turbo S 4.5	368	01/04→09/07	←	→ 12/06; passend für Felgengröße [Zoll]: 18	13.0460-4993.2	604993	BRE 23693 16,6 + WE / - WK	
			→	→ 12/06; passend für Felgengröße [Zoll]: 17	13.0460-4976.2	604976	BRE 23694 16,7 + WE / - WK	
			→	→ 12/06; passend für Felgengröße [Zoll]: 17	13.0470-4976.2	LD4976	BRE 23694 16,4 + WE / - WK Ceramic	
			→	01/05→ 12/06; passend für Felgengröße [Zoll]: 18	13.0460-4976.2	604976	BRE 23694 16,7 + WE / - WK	
			→	01/05→ 12/06; passend für Felgengröße [Zoll]: 18	13.0470-4976.2	LD4976	BRE 23694 16,4 + WE / - WK Ceramic	
			←	passend für Felgengröße [Zoll]: 19; Bremsstelfarbe: rot	13.0460-4840.2	604840	BRE 23961 16,8 + WE / - WK	
Turbo S 4.5	383	03/06→09/07	←	passend für Felgengröße [Zoll]: 18; Bremsstelfarbe: rot	13.0460-4852.2	604852	BRE 24553 15,8 + WE / - WK + Zub	
			←	passend für Felgengröße [Zoll]: 18; Bremsstelfarbe: rot	13.0460-4993.2	604993	BRE 23693 16,6 + WE / - WK	
			←	passend für Felgengröße [Zoll]: 17; Bremsstelfarbe: schwarz	13.0460-4992.2	604992	BRE 23692 16,6 + WE / - WK	
			←	passend für Felgengröße [Zoll]: 18; Bremsstelfarbe: silber	13.0460-4993.2	604993	BRE 23693 16,6 + WE / - WK	
Turbo S 4.5	383	03/06→09/07	←	passend für Felgengröße [Zoll]: 19; Bremsstelfarbe: rot	13.0460-4840.2	604840	BRE 23961 16,8 + WE / - WK	
			←	passend für Felgengröße [Zoll]: 19; Bremsstelfarbe: rot	13.0460-4852.2	604852	BRE 24553 15,8 + WE / - WK + Zub	
			←	passend für Felgengröße [Zoll]: 19; Bremsstelfarbe: rot	13.0460-4993.2	604993	BRE 23693 16,6 + WE / - WK	
Turbo S 4.5	383	03/06→09/07	←	passend für Felgengröße [Zoll]: 17; Bremsstelfarbe: schwarz	13.0460-4992.2	604992	BRE 23692 16,6 + WE / - WK	
			←	passend für Felgengröße [Zoll]: 18; Bremsstelfarbe: silber	13.0460-4993.2	604993	BRE 23693 16,6 + WE / - WK	
			←	passend für Felgengröße [Zoll]: 18; Bremsstelfarbe: silber	13.0460-4993.2	604993	BRE 23693 16,6 + WE / - WK	
Turbo S 4.8	397	02/07→09/10	←	→ 04/10; passend für Felgengröße [Zoll]: 19; Bremsstelfarbe: rot	13.0460-4840.2	604840	BRE 23961 16,8 + WE / - WK	
			←	→ 04/10; passend für Felgengröße [Zoll]: 18; Bremsstelfarbe: rot	13.0460-4852.2	604852	BRE 24553 15,8 + WE / - WK + Zub	
			←	→ 04/10; passend für Felgengröße [Zoll]: 18; Bremsstelfarbe: rot	13.0460-4993.2	604993	BRE 23693 16,6 + WE / - WK	
			←	→ 12/09; passend für Felgengröße [Zoll]: 17; Bremsstelfarbe: schwarz	13.0460-4992.2	604992	BRE 23692 16,6 + WE / - WK	
Turbo S 4.8	404	08/08→09/10	←	→ 04/10; passend für Felgengröße [Zoll]: 18; Bremsstelfarbe: schwarz	13.0460-4993.2	604993	BRE 23693 16,6 + WE / - WK	
			←	→ 04/10; passend für Felgengröße [Zoll]: 18; Bremsstelfarbe: silber	13.0460-4993.2	604993	BRE 23693 16,6 + WE / - WK	
			←	→ 04/10; passend für Felgengröße [Zoll]: 19; Bremsstelfarbe: rot	13.0460-4840.2	604840	BRE 23961 16,8 + WE / - WK	
			←	→ 04/10; passend für Felgengröße [Zoll]: 18; Bremsstelfarbe: rot	13.0460-4852.2	604852	BRE 24553 15,8 + WE / - WK + Zub	
Turbo S 4.8	404	08/08→09/10	←	→ 04/10; passend für Felgengröße [Zoll]: 18; Bremsstelfarbe: rot	13.0460-4993.2	604993	BRE 23693 16,6 + WE / - WK	
			←	→ 04/10; passend für Felgengröße [Zoll]: 17; Bremsstelfarbe: schwarz	13.0460-4992.2	604992	BRE 23692 16,6 + WE / - WK	
Turbo S 4.8	404	08/08→09/10	←	→ 04/10; passend für Felgengröße [Zoll]: 17; Bremsstelfarbe: schwarz	13.0460-4992.2	604992	BRE 23692 16,6 + WE / - WK	
			←	→ 04/10; passend für Felgengröße [Zoll]: 18; Bremsstelfarbe: silber	13.0460-4993.2	604993	BRE 23693 16,6 + WE / - WK	
<b>Warnkontakt, Bremsbelagsverschleiß</b>								
3.0 TDI ↓	176	02/09→09/10	←	→ 04/10; passend für Felgengröße [Zoll]: 19; Bremsstelfarbe: rot	2	24.8190-0066.2	620066	L= 397,4

	kw			 	! #		
<b>PORSCHE - CAYENNE (9PA) 09/02→12/10</b>							
<b>Warnkontakt, Bremsbelagverschleiß</b>							
3.0 TDI	176	02/09→09/10	←	→ 04/10; passend für Felgengröße [Zoll]: 18; Bremsattelfarbe: rot	2	24.8190-0929.2 620929 24.8190-0936.2 620936	L= 417,4 L= 367,4
			←	→ 04/10; passend für Felgengröße [Zoll]: 17; Bremsattelfarbe: schwarz	2	24.8190-0929.2 620929	L= 417,4
			←	→ 04/10; passend für Felgengröße [Zoll]: 18; Bremsattelfarbe: silber	2	24.8190-0929.2 620929	L= 417,4
			←	→ 04/10; Bremsattelfarbe: gelb; passend für Felgengröße [Zoll]: 20	2	24.8190-0954.2 620954	L= 365
			→	01/10→; passend für Felgengröße [Zoll]: 17; → 04/10	2	24.8190-0930.2 620930	L= 252,4
			→	→ 12/09; passend für Felgengröße [Zoll]: 17	2	24.8190-0930.2 620930	L= 252,4
			→	01/10→; passend für Felgengröße [Zoll]: 18; → 04/10	2	24.8190-0937.2 620937	L= 247,4
			→	→ 12/09; passend für Felgengröße [Zoll]: 18	2	24.8190-0937.2 620937	L= 247,4
			→	→ 04/10; passend für Felgengröße [Zoll]: 19; Bremsattelfarbe: gelb	2	24.8190-0937.2 620937	L= 247,4
3.2	177	08/03→09/07	←	01/05→ 12/06; passend für Felgengröße [Zoll]: 19	2	24.8190-0066.2 620066	L= 397,4
			←	10/03→ 12/06; passend für Felgengröße [Zoll]: 18; Bremsattelfarbe: rot	2	24.8190-0929.2 620929 24.8190-0936.2 620936	L= 417,4 L= 367,4
			←	10/03→ 12/06; passend für Felgengröße [Zoll]: 17; Bremsattelfarbe: schwarz	2	24.8190-0929.2 620929	L= 417,4
			←	10/03→ 12/06; passend für Felgengröße [Zoll]: 18; Bremsattelfarbe: silber	2	24.8190-0929.2 620929	L= 417,4
			←	01/05→; passend für Felgengröße [Zoll]: 20; Bremsattelfarbe: gelb; → 12/06	2	24.8190-0954.2 620954	L= 365
			→	01/05→ 12/06; passend für Felgengröße [Zoll]: 18	2	24.8190-0930.2 620930	L= 252,4
			→	10/03→ 12/06; passend für Felgengröße [Zoll]: 17	2	24.8190-0930.2 620930	L= 252,4
			→	01/05→ 12/06; passend für Felgengröße [Zoll]: 19; Bremsattelfarbe: gelb	2	24.8190-0937.2 620937	L= 247,4
3.2	184	10/03→09/07	←	01/05→ 12/06; passend für Felgengröße [Zoll]: 19	2	24.8190-0066.2 620066	L= 397,4
			←	→ 12/06; passend für Felgengröße [Zoll]: 18; Bremsattelfarbe: rot	2	24.8190-0929.2 620929 24.8190-0936.2 620936	L= 417,4 L= 367,4
			←	→ 12/06; passend für Felgengröße [Zoll]: 17; Bremsattelfarbe: schwarz	2	24.8190-0929.2 620929	L= 417,4
			←	→ 12/06; passend für Felgengröße [Zoll]: 18; Bremsattelfarbe: silber	2	24.8190-0929.2 620929	L= 417,4
			←	01/05→; passend für Felgengröße [Zoll]: 20; Bremsattelfarbe: gelb; → 12/06	2	24.8190-0954.2 620954	L= 365
			→	01/05→ 12/06; passend für Felgengröße [Zoll]: 18	2	24.8190-0930.2 620930	L= 252,4
			→	→ 12/06; passend für Felgengröße [Zoll]: 17	2	24.8190-0930.2 620930	L= 252,4
			→	01/05→ 12/06; passend für Felgengröße [Zoll]: 19; Bremsattelfarbe: gelb	2	24.8190-0937.2 620937	L= 247,4
3.6	213	02/07→09/10	←	→ 04/10; passend für Felgengröße [Zoll]: 19	2	24.8190-0066.2 620066	L= 397,4
			←	→ 04/10; passend für Felgengröße [Zoll]: 17; Bremsattelfarbe: schwarz	2	24.8190-0929.2 620929	L= 417,4
			←	→ 04/10; passend für Felgengröße [Zoll]: 18; Bremsattelfarbe: silber	2	24.8190-0929.2 620929	L= 417,4
			←	→ 04/10; passend für Felgengröße [Zoll]: 18; Bremsattelfarbe: rot	2	24.8190-0936.2 620936	L= 367,4
↓							

	kw			 	! #		
<b>PORSCHE - CAYENNE (9PA) 09/02→12/10</b>							
<b>Warnkontakt, Bremsbelagverschleiß</b>							
3.6	213	02/07→09/10	←	→ 04/10; Bremssattelfarbe: gelb; passend für Felgengröße [Zoll]: 20	2	24.8190-0954.2 620954	L= 365
			→	01/10→; passend für Felgengröße [Zoll]: 17; → 04/10	2	24.8190-0930.2 620930	L= 252,4
			→	→ 12/09; passend für Felgengröße [Zoll]: 17	2	24.8190-0930.2 620930	L= 252,4
			→	01/10→; passend für Felgengröße [Zoll]: 18; → 04/10	2	24.8190-0937.2 620937	L= 247,4
			→	→ 12/09; passend für Felgengröße [Zoll]: 18	2	24.8190-0937.2 620937	L= 247,4
			→	→ 04/10; passend für Felgengröße [Zoll]: 19; Bremssattelfarbe: gelb	2	24.8190-0937.2 620937	L= 247,4
GTS 4.8	298	10/07→09/10	←	→ 04/10; passend für Felgengröße [Zoll]: 19; Bremssattelfarbe: rot	2	24.8190-0066.2 620066	L= 397,4
			←	→ 04/10; passend für Felgengröße [Zoll]: 18; Bremssattelfarbe: rot	2	24.8190-0929.2 620929 24.8190-0936.2 620936	L= 417,4 L= 367,4
			←	→ 04/10; passend für Felgengröße [Zoll]: 17; Bremssattelfarbe: schwarz	2	24.8190-0929.2 620929	L= 417,4
			←	→ 04/10; passend für Felgengröße [Zoll]: 18; Bremssattelfarbe: silber	2	24.8190-0929.2 620929	L= 417,4
			←	→ 04/10; Bremssattelfarbe: gelb; passend für Felgengröße [Zoll]: 20	2	24.8190-0954.2 620954	L= 365
			→	01/10→; Version: 17; Bremssattelfarbe: rot; → 04/10	2	24.8190-0930.2 620930	L= 252,4
			→	→ 12/09; passend für Felgengröße [Zoll]: 17; Bremssattelfarbe: rot	2	24.8190-0930.2 620930	L= 252,4
			→	→ 04/10; passend für Felgengröße [Zoll]: 19; Bremssattelfarbe: gelb	2	24.8190-0937.2 620937	L= 247,4
			S 4.5	250	09/02→09/07	←	01/05→ 12/06; passend für Felgengröße [Zoll]: 19; Bremssattelfarbe: rot
←	→ 12/06; passend für Felgengröße [Zoll]: 18; Bremssattelfarbe: silber	2				24.8190-0929.2 620929	L= 417,4
←	→ 12/06; passend für Felgengröße [Zoll]: 17; Bremssattelfarbe: schwarz	2				24.8190-0929.2 620929	L= 417,4
←	passend für Felgengröße [Zoll]: 18; Bremssattelfarbe: rot	2				24.8190-0929.2 620929	L= 417,4
←	→ 12/06; Bremssattelfarbe: rot; passend für Felgengröße [Zoll]: 18	2				24.8190-0936.2 620936	L= 367,4
←	01/05→; passend für Felgengröße [Zoll]: 20; Bremssattelfarbe: gelb; → 12/06	2				24.8190-0954.2 620954	L= 365
→	01/05→ 12/06; passend für Felgengröße [Zoll]: 18	2				24.8190-0930.2 620930	L= 252,4
→	→ 12/06; passend für Felgengröße [Zoll]: 17	2				24.8190-0930.2 620930	L= 252,4
→	01/05→ 12/06; passend für Felgengröße [Zoll]: 19; Bremssattelfarbe: gelb	2				24.8190-0937.2 620937	L= 247,4
S 4.8 Turbo S 4.8	283 368	02/07→09/10 02/07→09/10	←	→ 04/10; passend für Felgengröße [Zoll]: 19; Bremssattelfarbe: rot	2	24.8190-0066.2 620066	L= 397,4
			←	→ 04/10; passend für Felgengröße [Zoll]: 17; Bremssattelfarbe: schwarz	2	24.8190-0929.2 620929	L= 417,4
			←	→ 04/10; passend für Felgengröße [Zoll]: 18; Bremssattelfarbe: silber	2	24.8190-0929.2 620929	L= 417,4
			←	→ 04/10; passend für Felgengröße [Zoll]: 18; Bremssattelfarbe: rot	2	24.8190-0936.2 620936	L= 367,4
			←	→ 04/10; Bremssattelfarbe: gelb; passend für Felgengröße [Zoll]: 20	2	24.8190-0954.2 620954	L= 365
			→	01/10→; passend für Felgengröße [Zoll]: 17; → 04/10	2	24.8190-0930.2 620930	L= 252,4
			↓				

	kw			 	! #		
<b>PORSCHE - CAYENNE (9PA) 09/02→12/10</b>							
<b>Warnkontakt, Bremsbelagverschleiß</b>							
S 4.8 Turbo S 4.8	283 368	02/07→09/10 02/07→09/10	➡	→ 12/09; passend für Felgengröße [Zoll]: 17	2	24.8190-0930.2 620930	L= 252,4
			➡	01/10→; passend für Felgengröße [Zoll]: 18; → 04/10	2	24.8190-0937.2 620937	L= 247,4
			➡	→ 12/09; passend für Felgengröße [Zoll]: 18	2	24.8190-0937.2 620937	L= 247,4
			➡	→ 04/10; passend für Felgengröße [Zoll]: 19; Bremsattelfarbe: gelb	2	24.8190-0937.2 620937	L= 247,4
Turbo 4.5	331	09/02→09/07	←	01/05→ 12/06; passend für Felgengröße [Zoll]: 19	2	24.8190-0066.2 620066	L= 397,4
			←	→ 12/06; passend für Felgengröße [Zoll]: 18; Bremsattelfarbe: rot	2	24.8190-0929.2 620929 24.8190-0936.2 620936	L= 417,4 L= 367,4
			←	→ 12/06; passend für Felgengröße [Zoll]: 18	2	24.8190-0929.2 620929	L= 417,4
			←	→ 12/06; passend für Felgengröße [Zoll]: 17; Bremsattelfarbe: schwarz	2	24.8190-0929.2 620929	L= 417,4
			←	01/05→; passend für Felgengröße [Zoll]: 20; Bremsattelfarbe: gelb; → 12/06	2	24.8190-0954.2 620954	L= 365
			➡	01/05→ 12/06; passend für Felgengröße [Zoll]: 18	2	24.8190-0930.2 620930	L= 252,4
			➡	→ 12/06; passend für Felgengröße [Zoll]: 17	2	24.8190-0930.2 620930	L= 252,4
			➡	01/05→ 12/06; passend für Felgengröße [Zoll]: 19; Bremsattelfarbe: gelb	2	24.8190-0937.2 620937	L= 247,4
			Turbo S 4.5	368	01/04→09/07	←	passend für Felgengröße [Zoll]: 19; Bremsattelfarbe: rot
←	passend für Felgengröße [Zoll]: 17; Bremsattelfarbe: schwarz	2				24.8190-0929.2 620929	L= 417,4
←	passend für Felgengröße [Zoll]: 18; Bremsattelfarbe: silber	2				24.8190-0929.2 620929	L= 417,4
←	passend für Felgengröße [Zoll]: 18; Bremsattelfarbe: rot	2				24.8190-0929.2 620929 24.8190-0936.2 620936	L= 417,4 L= 367,4
←	Bremsattelfarbe: gelb; passend für Felgengröße [Zoll]: 20	2				24.8190-0954.2 620954	L= 365
➡	passend für Felgengröße [Zoll]: 19; Bremsattelfarbe: gelb	2				24.8190-0937.2 620937	L= 247,4
Turbo S 4.5	383	03/06→09/07	←	passend für Felgengröße [Zoll]: 19; Bremsattelfarbe: rot	2	24.8190-0066.2 620066 24.8190-0929.2 620929 24.8190-0936.2 620936	L= 397,4 L= 417,4 L= 367,4
			←	passend für Felgengröße [Zoll]: 18; Bremsattelfarbe: silber	2	24.8190-0929.2 620929	L= 417,4
			←	passend für Felgengröße [Zoll]: 17; Bremsattelfarbe: schwarz	2	24.8190-0929.2 620929	L= 417,4
			←	Bremsattelfarbe: gelb; passend für Felgengröße [Zoll]: 20	2	24.8190-0954.2 620954	L= 365
			➡	passend für Felgengröße [Zoll]: 19; Bremsattelfarbe: gelb	2	24.8190-0937.2 620937	L= 247,4
Turbo S 4.8	397	02/07→09/10	←	→ 04/10; passend für Felgengröße [Zoll]: 19; Bremsattelfarbe: rot	2	24.8190-0066.2 620066	L= 397,4
			←	→ 12/09; passend für Felgengröße [Zoll]: 17; Bremsattelfarbe: schwarz	2	24.8190-0929.2 620929	L= 417,4
			←	→ 04/10; passend für Felgengröße [Zoll]: 18; Bremsattelfarbe: rot	2	24.8190-0929.2 620929 24.8190-0936.2 620936	L= 417,4 L= 367,4
			←	→ 04/10; passend für Felgengröße [Zoll]: 18; Bremsattelfarbe: silber	2	24.8190-0929.2 620929	L= 417,4
			←	→ 04/10; Bremsattelfarbe: gelb; passend für Felgengröße [Zoll]: 20	2	24.8190-0954.2 620954	L= 365
			➡	→ 04/10; passend für Felgengröße [Zoll]: 19; Bremsattelfarbe: gelb	2	24.8190-0937.2 620937	L= 247,4
			←	→ 04/10; passend für Felgengröße [Zoll]: 19; Bremsattelfarbe: rot	2	24.8190-0066.2 620066	L= 397,4
Turbo S 4.8	404	08/08→09/10	←	→ 04/10; passend für Felgengröße [Zoll]: 17; Bremsattelfarbe: schwarz	2	24.8190-0929.2 620929	L= 417,4
			←	→ 04/10; passend für Felgengröße [Zoll]: 19; Bremsattelfarbe: rot	2	24.8190-0066.2 620066	L= 397,4
↓							

	kw			 	! #		
<b>PORSCHE - CAYENNE (9PA) 09/02→12/10</b>							
<b>Warnkontakt, Bremsbelagverschleiß</b>							
Turbo S 4.8	404	08/08→09/10	←	→ 04/10; passend für Felgenreöße [Zoll]: 18; Bremsattelfarbe: rot	2	24.8190-0929.2 620929 24.8190-0936.2 620936	L= 417,4 L= 367,4
			←	→ 04/10; passend für Felgenreöße [Zoll]: 18; Bremsattelfarbe: silber	2	24.8190-0929.2 620929	L= 417,4
			←	→ 04/10; Bremsattelfarbe: gelb; passend für Felgenreöße [Zoll]: 20	2	24.8190-0954.2 620954	L= 365
			→	→ 04/10; passend für Felgenreöße [Zoll]: 19; Bremsattelfarbe: gelb	2	24.8190-0937.2 620937	L= 247,4
<b>Zubehörsatz, Scheibenbremsbelag</b>							
3.0 TDI 3.6 S 4.8	176 213 283	02/09→09/10 02/07→09/10 02/07→09/10	←	→ 04/10; passend für Felgenreöße [Zoll]: 17; Bremsattelfarbe: schwarz		13.0460-0279.2 610279	
			←	→ 04/10; passend für Felgenreöße [Zoll]: 18; Bremsattelfarbe: silber		13.0460-0279.2 610279	
			→	→ 12/09; passend für Felgenreöße [Zoll]: 17		13.0460-0280.2 610280	
3.2	177	08/03→09/07	←	10/03→ 12/06; passend für Felgenreöße [Zoll]: 17; Bremsattelfarbe: schwarz		13.0460-0279.2 610279	
			←	10/03→ 12/06; passend für Felgenreöße [Zoll]: 18; Bremsattelfarbe: silber		13.0460-0279.2 610279	
			→	10/03→ 12/06; passend für Felgenreöße [Zoll]: 17		13.0460-0280.2 610280	
3.2 S 4.5	184 250	10/03→09/07 09/02→09/07	←	→ 12/06; passend für Felgenreöße [Zoll]: 18; Bremsattelfarbe: silber		13.0460-0279.2 610279	
			←	→ 12/06; passend für Felgenreöße [Zoll]: 17; Bremsattelfarbe: schwarz		13.0460-0279.2 610279	
			→	→ 12/06; passend für Felgenreöße [Zoll]: 17		13.0460-0280.2 610280	
GTS 4.8	298	10/07→09/10	←	→ 04/10; passend für Felgenreöße [Zoll]: 17; Bremsattelfarbe: schwarz		13.0460-0279.2 610279	
			←	→ 04/10; passend für Felgenreöße [Zoll]: 18; Bremsattelfarbe: silber		13.0460-0279.2 610279	
			→	→ 12/09; passend für Felgenreöße [Zoll]: 17; Bremsattelfarbe: rot		13.0460-0280.2 610280	
Turbo 4.5	331	09/02→09/07	←	→ 12/06; passend für Felgenreöße [Zoll]: 17; Bremsattelfarbe: schwarz		13.0460-0279.2 610279	
			←	→ 12/06; passend für Felgenreöße [Zoll]: 18		13.0460-0279.2 610279	
			→	→ 12/06; passend für Felgenreöße [Zoll]: 17		13.0460-0280.2 610280	
Turbo S 4.5 Turbo S 4.5	368 383	01/04→09/07 03/06→09/07	←	passend für Felgenreöße [Zoll]: 17; Bremsattelfarbe: schwarz		13.0460-0279.2 610279	
			←	passend für Felgenreöße [Zoll]: 18; Bremsattelfarbe: silber		13.0460-0279.2 610279	
Turbo S 4.8	368	02/07→09/10	←	→ 04/10; passend für Felgenreöße [Zoll]: 17; Bremsattelfarbe: schwarz		13.0460-0279.2 610279	
			→	→ 12/09; passend für Felgenreöße [Zoll]: 17		13.0460-0280.2 610280	
Turbo S 4.8	397	02/07→09/10	←	→ 12/09; passend für Felgenreöße [Zoll]: 17; Bremsattelfarbe: schwarz		13.0460-0279.2 610279	
			←	→ 04/10; passend für Felgenreöße [Zoll]: 18; Bremsattelfarbe: silber		13.0460-0279.2 610279	
Turbo S 4.8  ↓	404	08/08→09/10	←	→ 04/10; passend für Felgenreöße [Zoll]: 17; Bremsattelfarbe: schwarz		13.0460-0279.2 610279	
			←	→ 04/10; passend für Felgenreöße [Zoll]: 18; Bremsattelfarbe: silber		13.0460-0279.2 610279	



**PORSCHE - CAYENNE (9PA) 09/02→12/10**









**Bremsscheibe**









































3.0 TDI 3.6 S 4.8 Turbo S 4.8	176 213 283 368	02/09→09/10 02/07→09/10 02/07→09/10 02/07→09/10	←	☐; → 04/10; passend für Felgengröße [Zoll]: 17	24.0132-0117.1	432117	Ø 330 32 30 V + S
			←	☐; → 04/10; passend für Felgengröße [Zoll]: 17	24.0132-0118.1	432118	Ø 330 32 30 V + S
			←	☐; → 04/10; passend für Felgengröße [Zoll]: 18	24.0134-0123.1	434123	Ø 350 34 32 V
			←	☐; → 04/10; passend für Felgengröße [Zoll]: 18	24.0134-0124.1	434124	Ø 350 34 32 V
			←	→ 04/10; passend für Felgengröße [Zoll]: 18; Bremsattelfarbe: rot	24.0136-0111.1	436111	Ø 368 36 34 V
			→	→ 04/10	24.0128-0149.1	428149	Ø 330 28 26 V + S
			→	passend für Felgengröße [Zoll]: 18; → 04/10	24.0128-0169.1	428169	Ø 358 28 26 V
3.2	177	08/03→09/07	←	☐; 10/03→; passend für Felgengröße [Zoll]: 17	24.0132-0117.1	432117	Ø 330 32 30 V + S
			←	☐; 10/03→; passend für Felgengröße [Zoll]: 17	24.0132-0118.1	432118	Ø 330 32 30 V + S
			←	☐; 10/03→; passend für Felgengröße [Zoll]: 18	24.0134-0123.1	434123	Ø 350 34 32 V
			←	☐; 10/03→; passend für Felgengröße [Zoll]: 18	24.0134-0124.1	434124	Ø 350 34 32 V
			→	01/05→ 12/06	24.0128-0149.1	428149	Ø 330 28 26 V + S
				24.0128-0169.1	428169	Ø 358 28 26 V	
3.2 S 4.5 Turbo 4.5	184 250 331	10/03→09/07 09/02→09/07 09/02→09/07	←	☐; passend für Felgengröße [Zoll]: 17	24.0132-0117.1	432117	Ø 330 32 30 V + S
			←	☐; passend für Felgengröße [Zoll]: 17	24.0132-0118.1	432118	Ø 330 32 30 V + S
			←	☐; passend für Felgengröße [Zoll]: 18	24.0134-0123.1	434123	Ø 350 34 32 V
			←	☐; passend für Felgengröße [Zoll]: 18	24.0134-0124.1	434124	Ø 350 34 32 V
			→	01/05→ 12/06	24.0128-0149.1	428149	Ø 330 28 26 V + S
				24.0128-0169.1	428169	Ø 358 28 26 V	
GTS 4.8	298	10/07→09/10	←	☐; → 04/10; passend für Felgengröße [Zoll]: 18	24.0134-0123.1	434123	Ø 350 34 32 V
			←	☐; → 04/10; passend für Felgengröße [Zoll]: 18	24.0134-0124.1	434124	Ø 350 34 32 V
			→	→ 04/10	24.0128-0149.1	428149	Ø 330 28 26 V + S
			→	passend für Felgengröße [Zoll]: 18; → 04/10	24.0128-0169.1	428169	Ø 358 28 26 V
Turbo S 4.5 Turbo S 4.5	368 383	01/04→09/07 03/06→09/07	→		24.0128-0149.1	428149	Ø 330 28 26 V + S
			→	passend für Felgengröße [Zoll]: 18	24.0128-0169.1	428169	Ø 358 28 26 V
Turbo S 4.8	397	02/07→09/10	→	→ 04/10	24.0128-0149.1	428149	Ø 330 28 26 V + S
			→	passend für Felgengröße [Zoll]: 18; → 04/10	24.0128-0169.1	428169	Ø 358 28 26 V
Turbo S 4.8	404	08/08→09/10	→	→ 04/10	24.0128-0149.1	428149	Ø 330 28 26 V + S
					24.0128-0169.1	428169	Ø 358 28 26 V

**PORSCHE - CAYENNE (92A) 06/10→**







**Bremsbelagsatz, Scheibenbremse**









3.0 Diesel 3.0 Diesel 3.0 Diesel	155 176 180	06/10→ 06/10→ 06/11→	→	Bremsattelfarbe: rot; + 18" plus Rad	13.0460-4872.2	604872	BRE + WE / - WK
			→	Bremsattelfarbe: silber / rot; passend für Felgengröße [Zoll]: 17 / 18	13.0470-4872.2	LD4872	BRE + WE / - WK Ceramic
3.0 S E-Hybrid 3.6 4.2 S Diesel 4.8 GTS 4.8 S 4.8 Turbo 4.8 Turbo	245 220 281 309 294 368 397	06/10→ 06/10→ 10/12→ 06/12→ 06/10→ 06/10→ 06/10→	→	10/14→	13.0460-4872.2	604872	BRE + WE / - WK
					13.0470-4872.2	LD4872	BRE + WE / - WK Ceramic
			→		13.0460-4872.2	604872	BRE + WE / - WK
			→		13.0470-4872.2	LD4872	BRE + WE / - WK Ceramic
			→				
			→				
			→				
4.8 Turbo S	405	10/12→	→	Bremsattelfarbe: rot; + 18" plus Rad	13.0460-4872.2	604872	BRE + WE / - WK
			→	Bremsattelfarbe: rot / silber; passend für Felgengröße [Zoll]: 17 / 18	13.0470-4872.2	LD4872	BRE + WE / - WK Ceramic
4.8 Turbo S ↓	419	01/15→	→	Bremsattelfarbe: rot; + 18" plus Rad	13.0460-4872.2	604872	BRE + WE / - WK

	kw			 	! #		
<b>PORSCHE - CAYENNE (92A) 06/10→</b>							
<b> Bremsbelagsatz, Scheibenbremse</b>							
4.8 Turbo S	419	01/15→	➡	passend für Felgengröße [Zoll]: 18		13.0470-4872.2 LD4872	BRE + WE / - WK Ceramic
<b>Warnkontakt, Bremsbelagverschleiß</b>							
3.0 Diesel	155	06/10→	←	Bremssattelfarbe: silber / rot; passend für Felgengröße [Zoll]: 18 / 19	2	24.8190-0014.2 620014	L= 296
3.0 Diesel	176	06/10→	←	Bremssattelfarbe: schwarz; passend für Felgengröße [Zoll]: 18	2	24.8190-0014.2 620014	L= 296
3.0 Diesel	180	06/11→	←	Bremssattelfarbe: schwarz; passend für Felgengröße [Zoll]: 18	2	24.8190-0014.2 620014	L= 296
3.0 S E-Hybrid	245	06/10→	←	Bremssattelfarbe: grün; passend für Felgengröße [Zoll]: 18	2	24.8190-0014.2 620014	L= 296
4.2 S Diesel	281	10/12→	←	Bremssattelfarbe: grün; passend für Felgengröße [Zoll]: 18	2	24.8190-0014.2 620014	L= 296
4.8 GTS	309	06/12→	←	Bremssattelfarbe: grün; passend für Felgengröße [Zoll]: 18	2	24.8190-0014.2 620014	L= 296
4.8 S	294	06/10→	←	Bremssattelfarbe: gelb; passend für Felgengröße [Zoll]: 19 / 20	2	24.8190-0939.2 620939	L= 372,4
			➡	Bremssattelfarbe: silber / rot; passend für Felgengröße [Zoll]: 17 / 18	2	24.8190-0015.2 620015	L= 138
			➡	Bremssattelfarbe: rot; + 18" plus Rad	2	24.8190-0015.2 620015	L= 138
			➡	Bremssattelfarbe: gelb; passend für Felgengröße [Zoll]: 19	2	24.8190-0940.2 620940	L= 227,4
3.0 Diesel	184	08/14→	←	10/14→	2	24.8190-0014.2 620014 24.8190-0939.2 620939	L= 296 L= 372,4
			➡	10/14→	2	24.8190-0015.2 620015 24.8190-0940.2 620940	L= 138 L= 227,4
3.0 Diesel	193	10/14→	←		2	24.8190-0014.2 620014	L= 296
3.0 S E-Hybrid	306	10/14→	←		2	24.8190-0939.2 620939	L= 372,4
3.6 GTS	324	02/15→	←		2	24.8190-0939.2 620939	L= 372,4
3.6 S	309	10/14→	➡		2	24.8190-0015.2 620015	L= 138
4.2 S Diesel	283	10/14→	➡		2	24.8190-0940.2 620940	L= 227,4
4.8 Turbo	382	10/14→	➡		2	24.8190-0940.2 620940	L= 227,4
3.6	220	06/10→	←	Bremssattelfarbe: silber / rot; passend für Felgengröße [Zoll]: 18 / 19	2	24.8190-0014.2 620014	L= 296
			←	Bremssattelfarbe: schwarz	2	24.8190-0014.2 620014	L= 296
			←	Bremssattelfarbe: grün; passend für Felgengröße [Zoll]: 18	2	24.8190-0014.2 620014	L= 296
			←	Bremssattelfarbe: gelb; passend für Felgengröße [Zoll]: 19 / 20	2	24.8190-0939.2 620939	L= 372,4
			➡	Bremssattelfarbe: rot; + 18" plus Rad	2	24.8190-0015.2 620015	L= 138
			➡	Bremssattelfarbe: silber / rot; passend für Felgengröße [Zoll]: 17 / 18	2	24.8190-0015.2 620015	L= 138
			➡	Bremssattelfarbe: gelb	2	24.8190-0940.2 620940	L= 227,4
4.8 Turbo	368	06/10→	←	passend für Felgengröße [Zoll]: 19 / 18; Bremssattelfarbe: silber / rot	2	24.8190-0014.2 620014	L= 296
4.8 Turbo	397	06/10→	←	Bremssattelfarbe: schwarz; passend für Felgengröße [Zoll]: 18	2	24.8190-0014.2 620014	L= 296
			←	Bremssattelfarbe: grün; passend für Felgengröße [Zoll]: 18	2	24.8190-0014.2 620014	L= 296
			←	Bremssattelfarbe: gelb; passend für Felgengröße [Zoll]: 19 / 20	2	24.8190-0939.2 620939	L= 372,4
			➡	Bremssattelfarbe: silber / rot; passend für Felgengröße [Zoll]: 17 / 18	2	24.8190-0015.2 620015	L= 138
			➡	Bremssattelfarbe: rot; + 18" plus Rad	2	24.8190-0015.2 620015	L= 138
			➡	Bremssattelfarbe: gelb; passend für Felgengröße [Zoll]: 19	2	24.8190-0940.2 620940	L= 227,4
4.8 Turbo S	405	10/12→	←	passend für Felgengröße [Zoll]: 18 / 19; Bremssattelfarbe: rot / silber	2	24.8190-0014.2 620014	L= 296
			←	Bremssattelfarbe: schwarz; passend für Felgengröße [Zoll]: 18	2	24.8190-0014.2 620014	L= 296
			←	Bremssattelfarbe: grün; passend für Felgengröße [Zoll]: 18	2	24.8190-0014.2 620014	L= 296
			←	Bremssattelfarbe: gelb; passend für Felgengröße [Zoll]: 19 / 20	2	24.8190-0939.2 620939	L= 372,4
			➡	Bremssattelfarbe: rot / silber; passend für Felgengröße [Zoll]: 17 / 18	2	24.8190-0015.2 620015	L= 138
			➡	Bremssattelfarbe: rot; + 18" plus Rad	2	24.8190-0015.2 620015	L= 138
			➡	Bremssattelfarbe: gelb; passend für Felgengröße [Zoll]: 19	2	24.8190-0940.2 620940	L= 227,4
4.8 Turbo S	419	01/15→	←	Bremssattelfarbe: rot; passend für Felgengröße [Zoll]: 19	2	24.8190-0014.2 620014	L= 296
			←	Bremssattelfarbe: schwarz; passend für Felgengröße [Zoll]: 18	2	24.8190-0014.2 620014	L= 296
			←	Bremssattelfarbe: grün; passend für Felgengröße [Zoll]: 18	2	24.8190-0014.2 620014	L= 296
			←	Bremssattelfarbe: gelb; passend für Felgengröße [Zoll]: 19 / 20	2	24.8190-0939.2 620939	L= 372,4
↓							











	kw			 	! #		
<b>PORSCHE - CAYENNE (92A) 06/10→</b>							
<b>Warnkontakt, Bremsbelagverschleiß</b>							
4.8 Turbo S	419	01/15→	➡	passend für Felgengröße [Zoll]: 18	2	24.8190-0015.2 620015	L= 138
			➡	Bremssattelfarbe: rot; + 18" plus Rad	2	24.8190-0015.2 620015	L= 138
			➡	Bremssattelfarbe: gelb; passend für Felgengröße [Zoll]: 19	2	24.8190-0940.2 620940	L= 227,4
<b> Bremsscheibe</b>							
3.0 Diesel	155	06/10→	←	 ; Bremssattelfarbe: schwarz; passend für Felgengröße [Zoll]: 18		24.0134-0123.1 434123	Ø 350 34 32 V
3.0 Diesel	176	06/10→	←	 ; Bremssattelfarbe: schwarz; passend für Felgengröße [Zoll]: 18		24.0134-0124.1 434124	Ø 350 34 32 V
3.0 Diesel	180	06/11→	←	 ; Bremssattelfarbe: schwarz; passend für Felgengröße [Zoll]: 18		24.0134-0124.1 434124	Ø 350 34 32 V
3.6	220	06/10→	←	 ; Bremssattelfarbe: grün; passend für Felgengröße [Zoll]: 18		24.0136-0123.1 436123	Ø 360 36 34 V + S
4.2 S Diesel	281	10/12→	←	 ; Bremssattelfarbe: grün; passend für Felgengröße [Zoll]: 18		24.0136-0123.1 436123	Ø 360 36 34 V + S
4.8 GTS	309	06/12→	←	 ; Bremssattelfarbe: grün; passend für Felgengröße [Zoll]: 18		24.0136-0123.1 436123	Ø 360 36 34 V + S
4.8 Turbo	368	06/10→	←	 ; Bremssattelfarbe: grün; passend für Felgengröße [Zoll]: 18		24.0136-0124.1 436124	Ø 360 36 34 V + S
4.8 Turbo	397	06/10→	←	 ; Bremssattelfarbe: grün; passend für Felgengröße [Zoll]: 18		24.0136-0124.1 436124	Ø 360 36 34 V + S
4.8 Turbo S	405	10/12→	←	 ; Bremssattelfarbe: grün; passend für Felgengröße [Zoll]: 18		24.0136-0124.1 436124	Ø 360 36 34 V + S
			➡	Bremssattelfarbe: silber; passend für Felgengröße [Zoll]: 18		24.0136-0124.1 436124	Ø 360 36 34 V + S
			➡	Bremssattelfarbe: silber / rot; passend für Felgengröße [Zoll]: 17 / 18		24.0128-0149.1 428149	Ø 330 28 26 V + S
			➡	Bremssattelfarbe: rot; 18" plus Rad		24.0128-0169.1 428169	Ø 358 28 26 V
3.0 Diesel	184	08/14→	←	 ; 10/14→		24.0134-0123.1 434123	Ø 350 34 32 V
			←	 ; 10/14→		24.0136-0123.1 436123	Ø 360 36 34 V + S
			←	 ; 10/14→		24.0134-0124.1 434124	Ø 350 34 32 V
			←	 ; 10/14→		24.0136-0124.1 436124	Ø 360 36 34 V + S
			➡	10/14→; Bremssattelfarbe: silber / rot; passend für Felgengröße [Zoll]: 17 / 18		24.0128-0149.1 428149	Ø 330 28 26 V + S
			➡	10/14→; Bremssattelfarbe: rot; 18" plus Rad		24.0128-0169.1 428169	Ø 358 28 26 V
3.0 Diesel	193	10/14→	←			24.0134-0123.1 434123	Ø 350 34 32 V
3.0 S E-Hybrid	306	10/14→	←			24.0136-0123.1 436123	Ø 360 36 34 V + S
3.6 S	309	10/14→	←			24.0134-0124.1 434124	Ø 350 34 32 V
4.2 S Diesel	283	10/14→	←			24.0136-0124.1 436124	Ø 360 36 34 V + S
			➡	Bremssattelfarbe: silber / rot; passend für Felgengröße [Zoll]: 17 / 18		24.0128-0149.1 428149	Ø 330 28 26 V + S
			➡	Bremssattelfarbe: rot; 18" plus Rad		24.0128-0169.1 428169	Ø 358 28 26 V
3.0 S E-Hybrid	245	06/10→	←	 ; Bremssattelfarbe: schwarz; passend für Felgengröße [Zoll]: 18		24.0134-0123.1 434123	Ø 350 34 32 V
			←	 ; Bremssattelfarbe: schwarz; passend für Felgengröße [Zoll]: 18		24.0134-0124.1 434124	Ø 350 34 32 V
			←	 ; 10/14→		24.0136-0123.1 436123	Ø 360 36 34 V + S
			←	 ; Bremssattelfarbe: grün; passend für Felgengröße [Zoll]: 18		24.0136-0123.1 436123	Ø 360 36 34 V + S
			←	 ; Bremssattelfarbe: silber; passend für Felgengröße [Zoll]: 18		24.0136-0123.1 436123	Ø 360 36 34 V + S
			←	 ; 10/14→		24.0136-0124.1 436124	Ø 360 36 34 V + S
			←	 ; Bremssattelfarbe: silber; passend für Felgengröße [Zoll]: 18		24.0136-0124.1 436124	Ø 360 36 34 V + S
			←	 ; Bremssattelfarbe: grün; passend für Felgengröße [Zoll]: 18		24.0136-0124.1 436124	Ø 360 36 34 V + S
			➡	Bremssattelfarbe: silber / rot; passend für Felgengröße [Zoll]: 17 / 18		24.0128-0149.1 428149	Ø 330 28 26 V + S
			➡	Bremssattelfarbe: rot; 18" plus Rad		24.0128-0169.1 428169	Ø 358 28 26 V
3.6 GTS	324	02/15→	←			24.0134-0123.1 434123	Ø 350 34 32 V
4.8 Turbo	382	10/14→	←			24.0136-0123.1 436123	Ø 360 36 34 V + S
			←			24.0134-0124.1 434124	Ø 350 34 32 V
			←			24.0136-0124.1 436124	Ø 360 36 34 V + S
			➡	Bremssattelfarbe: rot / silber; passend für Felgengröße [Zoll]: 17 / 18		24.0128-0149.1 428149	Ø 330 28 26 V + S
			➡	Bremssattelfarbe: rot; 18" plus Rad		24.0128-0169.1 428169	Ø 358 28 26 V
4.8 S	294	06/10→	←	 ; Bremssattelfarbe: schwarz; passend für Felgengröße [Zoll]: 18		24.0134-0123.1 434123	Ø 350 34 32 V
			←	 ; Bremssattelfarbe: schwarz; passend für Felgengröße [Zoll]: 18		24.0134-0124.1 434124	Ø 350 34 32 V
			←	 ; Bremssattelfarbe: grün; passend für Felgengröße [Zoll]: 18		24.0136-0123.1 436123	Ø 360 36 34 V + S
			←	 ; Bremssattelfarbe: silber; passend für Felgengröße [Zoll]: 18		24.0136-0123.1 436123	Ø 360 36 34 V + S

























	kw					! #		
<b>PORSCHE - CAYENNE (92A) 06/10→</b>								
<b>Bremsscheibe</b>								
4.8 S	294	06/10→	←	☐; Bremssattelfarbe: silber; passend für Felgengröße [Zoll]: 18	24.0136-0124.1	436124	Ø 360 36 34 V + S	
			←	☐; Bremssattelfarbe: grün; passend für Felgengröße [Zoll]: 18	24.0136-0124.1	436124	Ø 360 36 34 V + S	
			→	Bremssattelfarbe: schwarz / rot; passend für Felgengröße [Zoll]: 17 / 18	24.0128-0149.1	428149	Ø 330 28 26 V + S	
			→	Bremssattelfarbe: rot; 18" plus Rad	24.0128-0169.1	428169	Ø 358 28 26 V	
4.8 Turbo S	419	01/15→	←	☐; Bremssattelfarbe: schwarz; passend für Felgengröße [Zoll]: 18	24.0134-0123.1	434123	Ø 350 34 32 V	
			←	☐; Bremssattelfarbe: schwarz; passend für Felgengröße [Zoll]: 18	24.0134-0124.1	434124	Ø 350 34 32 V	
			←	☐; Bremssattelfarbe: grün; passend für Felgengröße [Zoll]: 18	24.0136-0123.1	436123	Ø 360 36 34 V + S	
			←	☐; Bremssattelfarbe: grün; passend für Felgengröße [Zoll]: 18	24.0136-0124.1	436124	Ø 360 36 34 V + S	
			→	passend für Felgengröße [Zoll]: 18	24.0128-0149.1	428149	Ø 330 28 26 V + S	
			→	+ 18" plus Rad; Bremssattelfarbe: rot	24.0128-0169.1	428169	Ø 358 28 26 V	
<b>PORSCHE - CAYMAN (981) 03/13→</b>								
<b>Bremsbelagsatz, Scheibenbremse</b>								
2.7 GTS 3.4 S 3.4	202 250 239	03/13→ 02/14→ 03/13→	→	für Fahrzeuge ohne Keramikbremse	13.0460-4816.2	604816	BRE 24541 15,5 + WE / - WK	
<b>Warnkontakt, Bremsbelagverschleiß</b>								
2.7 GTS 3.4 S 3.4	202 250 239	03/13→ 02/14→ 03/13→	←	für Fahrzeuge ohne Keramikbremse	2	24.8190-0069.2	620069	L= 248
			←	für Fahrzeuge mit Keramikbremse	2	24.8190-0952.2	620952	L= 300
			→		2	24.8190-0070.2	620070	L= 268
3.8 GT4	283	01/15→	←		2	24.8190-0952.2	620952	L= 300
			→		2	24.8190-0952.2	620952	L= 300
<b>Bremsscheibe</b>								
2.7 GTS 3.4 S 3.4	202 250 239	03/13→ 02/14→ 03/13→	←	☐; für Fahrzeuge ohne Keramikbremse	24.0128-0260.1	428260	Ø 315 28 26 V•	
			←	☐; für Fahrzeuge ohne Keramikbremse	24.0128-0273.1	428273	Ø 315 28 26 V•	
			→	für Fahrzeuge ohne Keramikbremse	24.0120-0212.1	420212	Ø 299 20 18 V•	
<b>PORSCHE - CAYMAN (987) 11/05→12/13</b>								
<b>Bremsbelagsatz, Scheibenbremse</b>								
2.7	180	07/06→12/09	←		13.0460-4815.2	604815	BRE 21937 15,5 + WE / - WK	
			→		13.0470-4814.2	LD4814	BRE 21937 15,5 + WE / - WK Ceramic	
2.9 S 3,4 Sport S 3.4	195 223 235	02/09→12/12 08/08→12/12 02/09→06/13	→	→ 05/12	13.0460-4816.2	604816	BRE 24541 15,5 + WE / - WK	
			→	→ 05/12; für Fahrzeuge ohne Keramikbremse	13.0460-4816.2	604816	BRE 24541 15,5 + WE / - WK	
S 3.4	217	11/05→12/09	→	für Fahrzeuge ohne Keramikbremse	13.0460-4988.2	604988	BRE 21792 15,2 + WE / - WK	
<b>Warnkontakt, Bremsbelagverschleiß</b>								
2.7	180	07/06→12/09	←	☐	1	24.8190-0933.2	620933	L= 305
			←	☐	1	24.8190-0934.2	620934	L= 295
			→		2	24.8190-0932.2	620932	L= 461
2.9	195	02/09→12/12	←	☐; → 05/12	1	24.8190-0024.2	620024	L= 369,6
			←	☐; → 05/12	1	24.8190-0025.2	620025	L= 349,6
			→	→ 05/12	2	24.8190-0932.2	620932	L= 461
R 3.4	243	11/10→12/12	←	☐; → 05/12; für Fahrzeuge ohne Keramikbremse	1	24.8190-0024.2	620024	L= 369,6
			←	☐; → 05/12; für Fahrzeuge ohne Keramikbremse	1	24.8190-0935.2	620935	L= 315
			←	☐; → 05/12; für Fahrzeuge mit Keramikbremse	1	24.8190-0956.2	620956	L= 454,6
			←	☐; → 05/12; für Fahrzeuge mit Keramikbremse	1	24.8190-0957.2	620957	L= 394,6
↓								















	kw					! #		
<b>PORSCHE - CAYMAN (987) 11/05→12/13</b>								
<b>Warnkontakt, Bremsbelagverschleiß</b>								
R 3.4	243	11/10→12/12	➡	→ 05/12		2	24.8190-0922.2 620922	L= 440
S 3.4 Sport S 3.4	223 235	08/08→12/12 02/09→06/13	⬅	☐; → 05/12; für Fahrzeuge ohne Keramikbremse		1	24.8190-0024.2 620024	L= 369,6
			⬅	☐; → 05/12; für Fahrzeuge ohne Keramikbremse		1	24.8190-0935.2 620935	L= 315
			⬅	☐; → 05/12; für Fahrzeuge mit Keramikbremse		1	24.8190-0956.2 620956	L= 454,6
			⬅	☐; → 05/12; für Fahrzeuge mit Keramikbremse		1	24.8190-0957.2 620957	L= 394,6
			➡	→ 05/12		2	24.8190-0932.2 620932	L= 461
S 3.4	217	11/05→12/09	⬅	☐; für Fahrzeuge ohne Keramikbremse		1	24.8190-0024.2 620024	L= 369,6
			⬅	☐; für Fahrzeuge ohne Keramikbremse		1	24.8190-0935.2 620935	L= 315
			➡	☐; für Fahrzeuge ohne Keramikbremse		2	24.8190-0922.2 620922	L= 440
<b> Bremsscheibe</b>								
2.7	180	07/06→12/09	⬅	☐			24.0124-0210.1 424210	Ø 298 24 22 V•
			⬅	☐			24.0124-0211.1 424211	Ø 298 24 22 V•
			➡				24.0120-0212.1 420212	Ø 299 20 18 V•
2.9	195	02/09→12/12	⬅	☐; → 05/12; für Fahrzeuge ohne Keramikbremse			24.0128-0130.1 428130	Ø 318 28 26 V•
			⬅	☐; → 05/12; für Fahrzeuge ohne Keramikbremse			24.0128-0131.1 428131	Ø 318 28 26 V•
			➡	→ 05/12			24.0120-0212.1 420212	Ø 299 20 18 V•
R 3.4 S 3.4 Sport S 3.4	243 223 235	11/10→12/12 08/08→12/12 02/09→06/13	⬅	☐; → 05/12; für Fahrzeuge ohne Keramikbremse			24.0128-0130.1 428130	Ø 318 28 26 V•
			⬅	☐; → 05/12; für Fahrzeuge ohne Keramikbremse			24.0128-0131.1 428131	Ø 318 28 26 V•
S 3.4	217	11/05→12/09	⬅	☐; für Fahrzeuge ohne Keramikbremse			24.0128-0130.1 428130	Ø 318 28 26 V•
			⬅	☐; für Fahrzeuge ohne Keramikbremse			24.0128-0131.1 428131	Ø 318 28 26 V•
			➡	☐; für Fahrzeuge ohne Keramikbremse			24.0124-0194.1 424194	Ø 299 24 22 V•
<b>PORSCHE - MACAN (95B) 02/14→</b>								
<b> Bremsbelagsatz, Scheibenbremse</b>								
2.0 2.0 3.0 S Diesel 3.0 S Diesel 3.0 S Diesel	174 185 155 184 190	07/14→ 10/15→ 02/14→ 02/14→ 02/14→	⬅	+PR 1LG,1LH,1LY,1ZK			13.0460-4852.2 604852	BRE 24553 15,8 + WE / - WK + Zub
			⬅	+PR 1LA,1LE			13.0460-4879.2 604879	BRE 25643 16,8 + WE / - WK
			➡	+PR 1KD,1KE,1KY			13.0470-4879.2 LD4879	BRE 25643 17,0 + WE / - WK Ceramic
			➡	+PR 1KD,1KE,1KY			13.0460-2770.2 602770	TRW 24606 17,4 + WK + Zub
			➡	+PR 2EK			13.0470-2770.2 LD2770	TRW 24606 17,4 + WK + Zub Ceramic
3.0 GTS 3.0 S 3.6 Turbo 3.6 Turbo	265 250 294 324	10/15→ 02/14→ 02/14→ 09/16→	⬅	+PR 1LG,1LH,1LY,1ZK			13.0460-2799.2 602799	TRW 25642 18,1 + WE / - WK + Zub
			⬅	+PR 1LA,1LE			13.0460-4879.2 604879	BRE 25643 16,8 + WE / - WK
			➡	+PR 1KD,1KE,1KY			13.0460-2770.2 602770	TRW 24606 17,4 + WK + Zub
			➡	+PR 1KD,1KE,1KY			13.0470-2770.2 LD2770	TRW 24606 17,4 + WK + Zub Ceramic
			➡	+PR 2EK			13.0460-2799.2 602799	TRW 25642 18,1 + WE / - WK + Zub
							13.0470-2799.2 LD2799	TRW 25643 18,1 + WE / - WK + Zub Ceramic
<b>Warnkontakt, Bremsbelagverschleiß</b>								
2.0 2.0 3.0 GTS 3.0 S 3.0 S Diesel 3.0 S Diesel 3.0 S Diesel 3.6 Turbo 3.6 Turbo ↓	174 185 265 250 155 184 190 294 324	07/14→ 10/15→ 10/15→ 02/14→ 02/14→ 02/14→ 02/14→ 02/14→ 09/16→	⬅	+PR 1LB,1LF,1LG,1ZK		2	24.8190-0962.2 620962	L= 353
			⬅	+PR 1LG,1LH,1LY,1ZK		2	24.8190-0965.2 620965	L= 453
			➡	+PR 1KD,1KE,1KY		2	24.8190-0313.2 620313	L= 217
			➡	+PR 2EK		2	24.8190-0313.2 620313	L= 217
			➡	+PR 2EH		2	24.8190-0967.2 620967	L= 313





























	kw			 	! #		
<b>PORSCHE - MACAN (95B) 02/14→</b>							
 <b>Bremsscheibe</b>							
2.0	174	07/14→	←	+PR 1LA		24.0130-0222.1 430222	Ø 345 30 28 V + S
2.0	185	10/15→	→	+PR 1KD,1KE,1KY		24.0122-0272.1 422272	Ø 330 21,9 20 V + S
3.0 GTS	265	10/15→	→	+PR 2EK		24.0128-0289.1 428289	Ø 356 28 26 V + S
3.0 S	250	02/14→					
3.0 S Diesel	155	02/14→					
3.0 S Diesel	184	02/14→					
3.0 S Diesel	190	02/14→					
3.6 Turbo	294	02/14→					
3.6 Turbo	324	09/16→					
<b>PORSCHE - PANAMERA (970) 03/09→10/16</b>							
 <b>Brembelagsatz, Scheibenbremse</b>							
4.8 4S	294	09/09→07/13	←	für Fahrzeuge ohne Keramikbremse		13.0460-4852.2 604852	BRE 24553 15,8 + WE / - WK + Zub
4.8 S	294	09/09→07/13					
4.8 Turbo	368	09/09→07/13					
4.8 Turbo	382	07/13→10/16					
4.8 Turbo	397	08/10→07/13					
4.8 Turbo S	404	05/11→07/13					
4.8 GTS	316	01/12→07/13	←	- Sondermodell; für Fahrzeuge ohne Keramikbremse		13.0460-4852.2 604852	BRE 24553 15,8 + WE / - WK + Zub
4.8 GTS	324	07/13→10/16					
4.8 Turbo S	419	07/13→10/16	←	01/14→; für Fahrzeuge ohne Keramikbremse		13.0460-4852.2 604852	BRE 24553 15,8 + WE / - WK + Zub
<b>Warnkontakt, Bremsbelagverschleiß</b>							
3.0 4S	309	07/13→10/16	←	für Fahrzeuge ohne Keramikbremse	2	24.8190-0014.2 620014	L= 296
3.0 D	155	08/11→07/13	←	für Fahrzeuge mit Keramikbremse	2	24.8190-0939.2 620939	L= 372,4
3.0 D	184	08/11→07/13	←	für Fahrzeuge mit Keramikbremse	2	24.8190-0939.2 620939	L= 372,4
3.0 S	309	07/13→10/16			2	24.8190-0940.2 620940	L= 227,4
3.0 S E-Hybrid	245	03/11→07/13			2	24.8190-0940.2 620940	L= 227,4
3.0 S E-Hybrid	279	03/11→07/13	→		2	24.8190-0015.2 620015	L= 138
3.0 S E-Hybrid	306	07/13→10/16					
3.6	220	05/10→07/13					
3.6	228	07/13→10/16					
3.6 4	220	05/10→07/13					
3.6 4	228	07/13→10/16					
3.0 D	221	07/13→10/16	←	01/14→; für Fahrzeuge ohne Keramikbremse	2	24.8190-0014.2 620014	L= 296
			←	01/14→; für Fahrzeuge mit Keramikbremse	2	24.8190-0939.2 620939	L= 372,4
				01/14→	2	24.8190-0940.2 620940	L= 227,4
			→	01/14→	2	24.8190-0015.2 620015	L= 138
4.8 4S	294	09/09→07/13	←		2	24.8190-0939.2 620939	L= 372,4
4.8 S	294	09/09→07/13			2	24.8190-0940.2 620940	L= 227,4
4.8 GTS	316	01/12→07/13	←	+ Sondermodell; für Fahrzeuge ohne Keramikbremse	2	24.8190-0014.2 620014	L= 296
4.8 GTS	324	07/13→10/16	←	- Sondermodell; für Fahrzeuge ohne Keramikbremse	2	24.8190-0939.2 620939	L= 372,4
			←	für Fahrzeuge mit Keramikbremse	2	24.8190-0939.2 620939	L= 372,4
					2	24.8190-0940.2 620940	L= 227,4
				- Sondermodell	2	24.8190-0940.2 620940	L= 227,4
			→	+ Sondermodell	2	24.8190-0015.2 620015	L= 138
4.8 Turbo	368	09/09→07/13	←		2	24.8190-0939.2 620939	L= 372,4
4.8 Turbo	382	07/13→10/16			2	24.8190-0940.2 620940	L= 227,4
4.8 Turbo	397	08/10→07/13			2	24.8190-0940.2 620940	L= 227,4
4.8 Turbo S	404	05/11→07/13	→		2	24.8190-0940.2 620940	L= 227,4
4.8 Turbo S	419	07/13→10/16	←	01/14→	2	24.8190-0939.2 620939	L= 372,4
				01/14→	2	24.8190-0940.2 620940	L= 227,4
			→	01/14→	2	24.8190-0940.2 620940	L= 227,4
 <b>Bremsscheibe</b>							
3.0 4S	309	07/13→10/16	←	☐; für Fahrzeuge ohne Keramikbremse		24.0136-0127.1 436127	Ø 360 36 34 V/ + S
3.0 D	155	08/11→07/13	←	☐; für Fahrzeuge ohne Keramikbremse		24.0136-0128.1 436128	Ø 360 36 34 V/ + S
3.0 D	184	08/11→07/13	←	☐; für Fahrzeuge ohne Keramikbremse		24.0136-0128.1 436128	Ø 360 36 34 V/ + S
3.0 S	309	07/13→10/16	→	☐; für Fahrzeuge ohne Keramikbremse		24.0128-0282.1 428282	Ø 330 28 26 V/ + S
3.0 S E-Hybrid	245	03/11→07/13	→	☐; für Fahrzeuge ohne Keramikbremse		24.0128-0283.1 428283	Ø 330 28 26 V/ + S
3.0 S E-Hybrid	279	03/11→07/13	→	☐; für Fahrzeuge ohne Keramikbremse		24.0128-0283.1 428283	Ø 330 28 26 V/ + S
3.0 S E-Hybrid	306	07/13→10/16					
3.6	220	05/10→07/13					
3.6	228	07/13→10/16					
3.6 4	220	05/10→07/13					
3.6 4	228	07/13→10/16					
4.8 4S	294	09/09→07/13					
4.8 S	294	09/09→07/13					
↓							

	kw			 	! #		
<b>PORSCHE - PANAMERA (970) 03/09→10/16</b>							
 <b>Bremsscheibe</b>							
3.0 D	221	07/13→10/16	←	 ; 01/14→; für Fahrzeuge ohne Keramikbremse	24.0136-0127.1	436127	Ø 360 36 34 V/ + S
			←	 ; 01/14→; für Fahrzeuge ohne Keramikbremse	24.0136-0128.1	436128	Ø 360 36 34 V/ + S
			→	 ; 01/14→; für Fahrzeuge ohne Keramikbremse	24.0128-0282.1	428282	Ø 330 28 26 V/ + S
			→	 ; 01/14→; für Fahrzeuge ohne Keramikbremse	24.0128-0283.1	428283	Ø 330 28 26 V/ + S
4.8 GTS 4.8 GTS	316 324	01/12→07/13 07/13→10/16	←	 ; für Fahrzeuge ohne Keramikbremse	24.0136-0127.1	436127	Ø 360 36 34 V/ + S
			←	 ; für Fahrzeuge ohne Keramikbremse	24.0136-0128.1	436128	Ø 360 36 34 V/ + S
			→	 ; - Sondermodell; für Fahrzeuge ohne Keramikbremse	24.0128-0282.1	428282	Ø 330 28 26 V/ + S
			→	 ; - Sondermodell; für Fahrzeuge ohne Keramikbremse	24.0128-0283.1	428283	Ø 330 28 26 V/ + S
<b>PORSCHE - PANAMERA (971) 11/16→</b>							
 <b>Bremsscheibe</b>							
2.9 4 E-Hybrid	243	11/16→	→		24.0128-0282.1	428282	Ø 330 28 26 V/ + S
2.9 4 E-Hybrid	340	11/16→	→		24.0128-0283.1	428283	Ø 330 28 26 V/ + S
2.9 4S	324	11/16→					
3.0	243	11/16→					
3.0 4	243	11/16→					
4.0 4S Diesel	310	11/16→					
4.0 Turbo	404	11/16→					
4.0 Turbo S E-Hybrid	404	07/17→					
4.0 Turbo S E-Hybrid	500	07/17→					
<b>PROTON - JUMBUCK Pick-up 02/02→</b>							
 <b>Bremsscheibe</b>							
1.5	64	05/02→	←		24.0118-0120.1	418120	Ø 236 18 16,4 V
<b>PROTON - PERSONA 300 (C9_M) 03/96→07/04</b>							
 <b>Bremsbelagsatz, Scheibenbremse</b>							
313i	55	03/96→01/00	←		13.0460-5953.2	605953	SUM 21650 15,0 - WE / - WK
315 GLSi	64	09/96→07/00					
315 GLi/GLSi	66	03/96→07/00	←	07/00→	13.0460-5953.2	605953	SUM 21650 15,0 - WE / - WK
			←		13.0460-5953.2	605953	SUM 21650 15,0 - WE / - WK
316	70	03/96→07/04	←	→ 07/00	13.0460-5952.2	605952	SUM 21647 16,0 + WK
			→	→ 07/00	13.0460-5826.2	605826	AKE 21872 14,5 + WK
316 GLXi	83	03/96→07/00	←		13.0460-5952.2	605952	SUM 21647 16,0 + WK
			←	07/00→	13.0460-5953.2	605953	SUM 21650 15,0 - WE / - WK
			→		13.0460-5826.2	605826	AKE 21872 14,5 + WK
318 16V GTI	99	03/96→07/00	←	05/96→	13.0460-5952.2	605952	SUM 21647 16,0 + WK
			→	05/96→	13.0460-5826.2	605826	AKE 21872 14,5 + WK
<b>Zubehörsatz, Scheibenbremsbelag</b>							
313i	55	03/96→01/00	←		13.0460-0233.2	610233	SUM
315 GLSi	64	09/96→07/00					
315 GLi/GLSi	66	03/96→07/00	←		13.0460-0233.2	610233	SUM
			←	07/00→	13.0460-0233.2	610233	SUM
316 GLXi	83	03/96→07/00	←	07/00→	13.0460-0233.2	610233	SUM
 <b>Bremsscheibe</b>							
313i	55	03/96→01/00	←		24.0118-0120.1	418120	Ø 236 18 16,4 V
315 GLSi	64	09/96→07/00					
315 GLi/GLSi	66	03/96→07/00	←		24.0118-0120.1	418120	Ø 236 18 16,4 V
			←	07/00→	24.0118-0120.1	418120	Ø 236 18 16,4 V
316 GLXi	83	03/96→07/00	←	07/00→	24.0118-0120.1	418120	Ø 236 18 16,4 V
<b>PROTON - PERSONA 400 (C9_S) 01/94→02/08</b>							
 <b>Bremsbelagsatz, Scheibenbremse</b>							
413	55	01/94→06/03	←	→ 07/00	13.0460-5953.2	605953	SUM 21650 15,0 - WE / - WK
415 GLi/GLSi	66	01/94→07/00	←		13.0460-5953.2	605953	SUM 21650 15,0 - WE / - WK
420 TD	60	09/96→07/00					
↓							



















	kw					! #		
<b>PROTON - PERSONA 400 (C9_S) 01/94→02/08</b>								
 <b>Bremsbelagsatz, Scheibenbremse</b>								
416 GLXi 418	83 85	01/94→07/00 05/96→07/00	← →				13.0460-5952.2 605952	SUM 21647 16,0 + WK
							13.0460-5826.2 605826	AKE 21872 14,5 + WK
420 GLS D	48	05/96→04/99	←	09/96→			13.0460-5953.2 605953	SUM 21650 15,0 - WE / - WK
<b>Zubehörsatz, Scheibenbremsbelag</b>								
413	55	01/94→06/03	←	→ 07/00			13.0460-0233.2 610233	SUM
415 GLi/GLSi 420 TD	66 60	01/94→07/00 09/96→07/00	←				13.0460-0233.2 610233	SUM
420 GLS D	48	05/96→04/99	←	09/96→			13.0460-0233.2 610233	SUM
 <b>Bremsscheibe</b>								
413	55	01/94→06/03	←	→ 07/00			24.0118-0120.1 418120	Ø 236 18 16,4 V
415 GLi/GLSi 420 TD	66 60	01/94→07/00 09/96→07/00	←				24.0118-0120.1 418120	Ø 236 18 16,4 V
420 GLS D	48	05/96→04/99	←	09/96→			24.0118-0120.1 418120	Ø 236 18 16,4 V
<b>PROTON - PERSONA 400 Hatchback (C9_C, C9_S) 01/94→02/08</b>								
 <b>Bremsbelagsatz, Scheibenbremse</b>								
413 GLSi 415 GLi/GLSi 420 D	55 66 60	01/94→01/00 01/94→07/00 09/96→07/00	←				13.0460-5953.2 605953	SUM 21650 15,0 - WE / - WK
416 GLXi 416 i 418 GLXi	83 70 85	01/94→07/00 12/95→07/00 05/96→07/00	← →				13.0460-5952.2 605952 13.0460-5826.2 605826	SUM 21647 16,0 + WK AKE 21872 14,5 + WK
420 GLS D	48	05/96→04/99	←	09/96→			13.0460-5953.2 605953	SUM 21650 15,0 - WE / - WK
<b>Zubehörsatz, Scheibenbremsbelag</b>								
413 GLSi 415 GLi/GLSi 420 D	55 66 60	01/94→01/00 01/94→07/00 09/96→07/00	←				13.0460-0233.2 610233	SUM
420 GLS D	48	05/96→04/99	←	09/96→			13.0460-0233.2 610233	SUM
 <b>Bremsscheibe</b>								
413 GLSi 415 GLi/GLSi 420 D	55 66 60	01/94→01/00 01/94→07/00 09/96→07/00	←				24.0118-0120.1 418120	Ø 236 18 16,4 V
420 GLS D	48	05/96→04/99	←	09/96→			24.0118-0120.1 418120	Ø 236 18 16,4 V
<b>PROTON - SATRIA (C9_M) 04/96→05/06</b>								
 <b>Bremsbelagsatz, Scheibenbremse</b>								
1.3	55	07/96→05/06	←	08/00→			13.0460-5953.2 605953	SUM 21650 15,0 - WE / - WK
1.3 1.5	55 64	08/00→05/06 07/00→05/06	←				13.0460-5953.2 605953	SUM 21650 15,0 - WE / - WK
1.6 1.6	70 83	07/97→07/00 07/97→05/06	←	07/00→			13.0460-5953.2 605953	SUM 21650 15,0 - WE / - WK
1.8 GTi	103	08/00→05/06	← →				13.0460-5952.2 605952 13.0460-5826.2 605826	SUM 21647 16,0 + WK AKE 21872 14,5 + WK
<b>Zubehörsatz, Scheibenbremsbelag</b>								
1.3	55	07/96→05/06	←	08/00→			13.0460-0233.2 610233	SUM
1.3 1.5	55 64	08/00→05/06 07/00→05/06	←				13.0460-0233.2 610233	SUM
1.6 1.6	70 83	07/97→07/00 07/97→05/06	←	07/00→			13.0460-0233.2 610233	SUM
 <b>Bremsscheibe</b>								
1.3	55	07/96→05/06	←	08/00→			24.0113-0186.1 413186	Ø 234 13 11,4
1.3	55	08/00→05/06	←				24.0113-0186.1 413186	Ø 234 13 11,4
1.5	64	07/00→05/06	←				24.0118-0120.1 418120	Ø 236 18 16,4 V
1.6 1.6	70 83	07/97→07/00 07/97→05/06	←	07/00→			24.0118-0120.1 418120	Ø 236 18 16,4 V
<b>PROTON - SATRIA NEO 02/07→</b>								
 <b>Bremsbelagsatz, Scheibenbremse</b>								
1.3 ↓	70 81	02/07→09/08 02/07→	←				13.0460-5953.2 605953	SUM 21650 15,0 - WE / - WK

	kW					! #		
<b>PROTON - SATRIA NEO 02/07→</b>								
<b>Zubehörsatz, Scheibenbremsbelag</b>								
1.3 1.6	70 81	02/07→09/08 02/07→	←				13.0460-0233.2 610233	SUM
 <b>Bremsscheibe</b>								
1.3	70	02/07→09/08	←				24.0113-0186.1 413186	Ø 234 13 11,4
1.6	81	02/07→	←				24.0118-0120.1 418120	Ø 236 18 16,4 V
<b>PROTON - WIRA 05/95→</b>								
 <b>Bremsbelagsatz, Scheibenbremse</b>								
1.3 1.5	55 64	08/00→ 08/00→	←	→ 09/05			13.0460-5953.2 605953	SUM 21650 15,0 - WE / - WK
<b>Zubehörsatz, Scheibenbremsbelag</b>								
1.3 1.5	55 64	08/00→ 08/00→	←	→ 09/05			13.0460-0233.2 610233	SUM
 <b>Bremsscheibe</b>								
1.3	55	08/00→	←	→ 09/05			24.0113-0186.1 413186	Ø 234 13 11,4
1.5	64	08/00→	←	→ 09/05			24.0118-0120.1 418120	Ø 236 18 16,4 V
<b>PROTON - WIRA Hatchback 01/00→</b>								
 <b>Bremsbelagsatz, Scheibenbremse</b>								
1.3 1.5	55 64	08/00→ 08/00→	←	→ 09/05			13.0460-5953.2 605953	SUM 21650 15,0 - WE / - WK
<b>Zubehörsatz, Scheibenbremsbelag</b>								
1.3 1.5	55 64	08/00→ 08/00→	←	→ 09/05			13.0460-0233.2 610233	SUM
 <b>Bremsscheibe</b>								
1.3	55	08/00→	←	→ 09/05			24.0113-0186.1 413186	Ø 234 13 11,4
1.5	64	08/00→	←	→ 09/05			24.0118-0120.1 418120	Ø 236 18 16,4 V
<b>PUCH - G-MODELL (W 463) 09/89→12/99</b>								
<b>Warnkontakt, Bremsbelagverschleiß</b>								
350 G Turbo D	100	09/91→08/96					24.8190-0411.2 620411	L= 72
			←	H00248→	2		24.8190-0406.2 620406	L= 261
<b>RENAULT - 19 II Cabriolet (D53_, 853_) 04/92→06/01</b>								
 <b>Bremsbelagsatz, Scheibenbremse</b>								
1.8 1.8 16V (D53D)	86 99	01/95→06/01 04/92→06/96	←	→ 03/95			13.0460-2834.2 602834	TRW 21463 18,0 + WK
			→	→ 03/95			13.0460-3822.2 603822	BDX 21597 11,0 - WE / - WK
1.8 (853A)	66	09/93→06/96	←	→ 12/94			13.0460-2834.2 602834	TRW 21463 18,0 + WK
			→	+ ABS			13.0460-3822.2 603822	BDX 21597 11,0 - WE / - WK
1.8 (D53V, 853F, D53C)	79	07/94→06/96	←	09/94→			13.0460-2834.2 602834	TRW 21463 18,0 + WK
			→	09/94→ 12/95; + ABS			13.0460-3822.2 603822	BDX 21597 11,0 - WE / - WK
			→	09/94→; + ABS			13.0460-3822.2 603822	BDX 21597 11,0 - WE / - WK
1.8 (D53Y)	65	04/92→06/96	←	→ 12/94			13.0460-2834.2 602834	TRW 21463 18,0 + WK
			→	→ 12/95; + ABS			13.0460-3822.2 603822	BDX 21597 11,0 - WE / - WK
 <b>Bremsscheibe</b>								
1.8 1.8 16V (D53D)	86 99	01/95→06/01 04/92→06/96	←	→ 03/95			24.0121-0106.1 421106	Ø 259 20,7 17,7 V + S
			→	→ 03/95			24.0108-0108.1 408108	Ø 238 8 7 - ABS Ring
1.8 (853A)	66	09/93→06/96	←	- ABS			24.0120-0125.1 420125	Ø 238 20,1 17,7 V + S
			←	+ ABS			24.0121-0106.1 421106	Ø 259 20,7 17,7 V + S
			→	+ ABS			24.0108-0108.1 408108	Ø 238 8 7 - ABS Ring
1.8 (D53V, 853F, D53C)	79	07/94→06/96	←	09/94→			24.0121-0106.1 421106	Ø 259 20,7 17,7 V + S
			→	09/94→ 12/95; + ABS			24.0108-0108.1 408108	Ø 238 8 7 - ABS Ring
			→	09/94→; + ABS			24.0108-0108.1 408108	Ø 238 8 7 - ABS Ring
1.8 (D53Y)	65	04/92→06/96	←	→ 12/94; Vollautomatik			24.0120-0125.1 420125	Ø 238 20,1 17,7 V + S
			←	→ 12/94; Schaltgetriebe			24.0120-0125.1 420125	Ø 238 20,1 17,7 V + S
↓								

	kw					! #		
<b>RENAULT - 19 II Cabriolet (D53_, 853_) 04/92→06/01</b>								
 <b>Bremsscheibe</b>								
1.8 (D53Y)	65	04/92→06/96	➔		→ 12/94; + ABS		24.0108-0108.1 408108	Ø 238 8 7 - ABS Ring
<b>RENAULT - AVANTIME (DE0_) 09/01→05/03</b>								
 <b>Bremsbelagsatz, Scheibenbremse</b>								
2.0 16V Turbo (DE0U, DE0V)	120	11/01→05/03	←				13.0460-2870.2 602870	TRW 23099 18,4 - WK
3.0 V6 (DE04, DE0T)	152	09/01→05/03	➔				13.0460-2845.2 602845	TRW 23554 16,4 - WK + Zub
							13.0470-2845.2 LD2845	TRW 23554 16,4 - WK + Zub Ceramic
2.2 dCi (DE01)	110	05/02→05/03	←		für OE-Nummer: 60 25 371 662		13.0460-2870.2 602870	TRW 23099 18,4 - WK
							13.0460-2845.2 602845	TRW 23554 16,4 - WK + Zub
							13.0470-2845.2 LD2845	TRW 23554 16,4 - WK + Zub Ceramic
<b>Zubehörsatz, Scheibenbremsbelag</b>								
2.0 16V Turbo (DE0U, DE0V)	120	11/01→05/03	➔				13.0460-0077.2 610077	TRW
2.2 dCi (DE01)	110	05/02→05/03						
3.0 V6 (DE04, DE0T)	152	09/01→05/03						
 <b>Bremsscheibe</b>								
2.0 16V Turbo (DE0U, DE0V)	120	11/01→05/03	←				24.0128-0134.1 428134	Ø 305 28 26 V
2.2 dCi (DE01)	110	05/02→05/03	➔				24.0111-0151.1 411151	Ø 265 10,5 9,5
3.0 V6 (DE04, DE0T)	152	09/01→05/03						
<b>RENAULT - CAPTUR (J5_, H5_) 06/13→</b>								
 <b>Bremsbelagsatz, Scheibenbremse</b>								
0.9 TCe 90	66	06/13→	←				13.0460-2709.2 602709	TRW 23973 17,1 - WE / - WK + Zub
							13.0470-2709.2 LD2709	TRW 23973 17,1 - WE / - WK + Zub Ceramic
1.2 TCe 120	87	01/16→	←				13.0460-7266.2 607266	ATE 24538 17,9 - WE / - WK
1.2 TCe 120	88	06/13→						
1.5 dCi 110	81	01/15→					13.0470-7266.2 LD7266	ATE 24538 17,9 - WE / - WK Ceramic
1.5 dCi 90	66	06/13→						
 <b>Bremsscheibe</b>								
0.9 TCe 90	66	06/13→	←				24.0122-0270.1 422270	Ø 258 22 19,8 V + S
1.2 TCe 120	87	01/16→	←				24.0124-0253.1 424253	Ø 280 24 21,8 V + S
1.2 TCe 120	88	06/13→						
1.5 dCi 110	81	01/15→						
1.5 dCi 90	66	06/13→						
<b>RENAULT - CLIO I (B/C57_, 5/357_) 05/90→09/98</b>								
 <b>Bremsbelagsatz, Scheibenbremse</b>								
1.1	34	01/91→09/98	←		→ 04/92		13.0460-2834.2 602834	TRW 21463 18,0 + WK
							13.0460-3955.2 603955	BDX 20634 15,0 + WK
					05/92→		13.0460-2834.2 602834	TRW 21463 18,0 + WK
							13.0460-3911.2 603911	BDX 20905 18,0 + WK
1.2 (5/357Y, 5/357K)	40	01/96→09/98	←				13.0460-2834.2 602834	TRW 21463 18,0 + WK
1.2 (5/357Y, 5/357K)	43	01/96→09/98						
1.2 (B/C/S572)	44	05/90→03/96					13.0460-3911.2 603911	BDX 20905 18,0 + WK
1.2 (B/C/S577)	40	01/96→12/96	➔		+ ABS		13.0460-3822.2 603822	BDX 21597 11,0 - WE / - WK
1.4	59	01/91→09/98						
1.4 (B/C57T, B/C57Y)	58	01/91→09/98						
1.4 (B57J, C57J)	55	01/91→09/98						
1.8 (B/C578)	66	08/94→09/98						
1.9 D	40	01/97→09/98						
1.9 D	48	05/96→02/98						
1.9 D (B/C/S576, B/C/S57L)	47	01/91→09/98						
1.2 (B/C/S57A, B/C57S, 5/357F, 5/357J, 5/357L, 5/357R)	43	05/90→09/98	←				13.0460-2834.2 602834	TRW 21463 18,0 + WK
							13.0460-3911.2 603911	BDX 20905 18,0 + WK
							13.0460-2834.2 602834	TRW 21463 18,0 + WK
							13.0460-3911.2 603911	BDX 20905 18,0 + WK
					10/94→		13.0460-2834.2 602834	TRW 21463 18,0 + WK
							13.0460-3911.2 603911	BDX 20905 18,0 + WK
					+ ABS		13.0460-3822.2 603822	BDX 21597 11,0 - WE / - WK
					10/94→; + ABS		13.0460-3822.2 603822	BDX 21597 11,0 - WE / - WK
1.2 (B/C57R)	40	01/91→06/96	←		→ 01/96		13.0460-2834.2 602834	TRW 21463 18,0 + WK
							13.0460-3911.2 603911	BDX 20905 18,0 + WK
↓								



	kW			 	! #		
<b>RENAULT - CLIO I (B/C57_, 5/357_) 05/90→09/98</b>							
<b> Bremsbelagsatz, Scheibenbremse</b>							
1.2 (B/C57R)	40	01/91→06/96	➡	→ 01/96; + ABS		13.0460-3822.2 603822	BDX 21597 11,0 - WE / - WK
1.4	57	05/90→02/98	←	01/91→		13.0460-2834.2 602834	TRW 21463 18,0 + WK
			➡	01/91→; + ABS		13.0460-3911.2 603911	BDX 20905 18,0 + WK
1.8	66	08/90→04/96	←	08/94→		13.0460-2834.2 602834	TRW 21463 18,0 + WK
			➡	08/94→; + ABS		13.0460-3911.2 603911	BDX 20905 18,0 + WK
1.8	70	01/91→09/98	←			13.0460-2834.2 602834	TRW 21463 18,0 + WK
			➡	08/94→; + ABS		13.0460-3911.2 603911	BDX 20905 18,0 + WK
			➡	10/94→ 04/96; + ABS		13.0460-3822.2 603822	BDX 21597 11,0 - WE / - WK
			➡	10/94→; + ABS		13.0460-3822.2 603822	BDX 21597 11,0 - WE / - WK
			➡	09/96→; + ABS		13.0460-3822.2 603822	BDX 21597 11,0 - WE / - WK
			➡	08/94→ 04/96; + ABS		13.0460-3822.2 603822	BDX 21597 11,0 - WE / - WK
			➡	10/94→ 04/96		13.0460-3822.2 603822	BDX 21597 11,0 - WE / - WK
1.8 (B/C57C, B/C57U)	65	01/91→09/98	←			13.0460-2834.2 602834	TRW 21463 18,0 + WK
			➡	12/93→; + ABS		13.0460-3911.2 603911	BDX 20905 18,0 + WK
1.8 16V (C57D)	99	01/91→03/96	←	08/91→ 06/94		13.0460-2834.2 602834	TRW 21463 18,0 + WK
			➡	08/91→ 06/94		13.0460-3911.2 603911	BDX 20905 18,0 + WK
1.8 Rsi (B/C57H) Williams (B/C57M)	79	08/95→09/98	←			13.0460-2834.2 602834	TRW 21463 18,0 + WK
	108	01/94→09/98	←			13.0460-3911.2 603911	BDX 20905 18,0 + WK
Electric	21	05/96→02/98	←			13.0460-3822.2 603822	BDX 21597 11,0 - WE / - WK
			←			13.0460-3911.2 603911	BDX 20905 18,0 + WK
<b>Zubehörsatz, Scheibenbremsbelag</b>							
1.1	34	01/91→09/98	←	05/92→		13.0460-0411.2 610411	BDX
			←	→ 04/92		13.0460-0423.2 610423	BDX
1.2 (5/357Y, 5/357K)	40	01/96→09/98	←			13.0460-0411.2 610411	BDX
1.2 (5/357Y, 5/357K)	43	01/96→09/98	←				
1.2 (B/C/S572)	44	05/90→03/96	←				
1.2 (B/C/S577)	40	01/96→12/96	←				
1.4	59	01/91→09/98	←				
1.4 (B/C57T, B/C57Y)	58	01/91→09/98	←				
1.4 (B57J, C57J)	55	01/91→09/98	←				
1.8	70	01/91→09/98	←				
1.8 (B/C578)	66	08/94→09/98	←				
1.8 (B/C57C, B/C57U)	65	01/91→09/98	←				
1.8 Rsi (B/C57H)	79	08/95→09/98	←				
1.9 D	40	01/97→09/98	←				
1.9 D	48	05/96→02/98	←				
1.9 D (B/C/S576, B/C/S57L)	47	01/91→09/98	←				
Electric	21	05/96→02/98	←				
Williams (B/C57M)	108	01/94→09/98	←				
1.2 (B/C/S57A, B/C57S, 5/357F, 5/357J, 5/357L, 5/357R)	43	05/90→09/98	←			13.0460-0411.2 610411	BDX
			←	10/94→		13.0460-0411.2 610411	BDX
1.2 (B/C57R)	40	01/91→06/96	←	→ 01/96		13.0460-0411.2 610411	BDX
1.4	57	05/90→02/98	←	01/91→		13.0460-0411.2 610411	BDX
1.8	66	08/90→04/96	←	08/94→		13.0460-0411.2 610411	BDX
1.8 16V (C57D)	99	01/91→03/96	←	08/91→ 06/94		13.0460-0411.2 610411	BDX
<b> Bremsscheibe</b>							
1.1	34	01/91→09/98	←	→ 04/92		24.0108-0104.1 408104	Ø 238 8,2 7 + S
			←	05/92→		24.0112-0116.1 412116	Ø 238 12 10,5 + S
1.2 (5/357Y, 5/357K)	40	01/96→09/98	←			24.0112-0116.1 412116	Ø 238 12 10,5 + S
1.2 (5/357Y, 5/357K)	43	01/96→09/98	←				
1.2 (B/C/S572)	44	05/90→03/96	➡	+ ABS		24.0108-0109.1 408109	Ø 238 8 7
1.2 (B/C/S577)	40	01/96→12/96	←				
1.2 (B/C/S57A, B/C57S, 5/357F, 5/357J, 5/357L, 5/357R)	43	05/90→09/98	←			24.0112-0116.1 412116	Ø 238 12 10,5 + S
			←	10/94→		24.0112-0116.1 412116	Ø 238 12 10,5 + S
↓							

	kW			 	! #		
<b>RENAULT - CLIO I (B/C57_, 5/357_) 05/90→09/98</b>							
<b>Bremsscheibe</b>							
1.2 (B/C/S57A, B/C57S, 5/357F, 5/357J, 5/357L, 5/357R)	43	05/90→09/98	➔	+ ABS		24.0108-0109.1 408109	Ø 238 8 7
			➔	10/94→; + ABS		24.0108-0109.1 408109	Ø 238 8 7
1.2 (B/C57R)	40	01/91→06/96	➔	→ 01/96		24.0112-0116.1 412116	Ø 238 12 10,5 + S
			➔	→ 01/96; + ABS		24.0108-0109.1 408109	Ø 238 8 7
1.4	57	05/90→02/98	➔	01/91→ 03/96; Automatikgetriebe		24.0112-0116.1 412116	Ø 238 12 10,5 + S
			➔	01/91→; Schaltgetriebe		24.0112-0116.1 412116	Ø 238 12 10,5 + S
			➔	04/96→; Automatikgetriebe		24.0120-0125.1 420125	Ø 238 20,1 17,7 V + S
			➔	01/91→; + ABS		24.0108-0109.1 408109	Ø 238 8 7
1.4	59	01/91→09/98	➔	→ 03/96; Automatikgetriebe		24.0112-0116.1 412116	Ø 238 12 10,5 + S
1.4 (B/C57T, B/C57Y)	58	01/91→09/98	➔	Schaltgetriebe		24.0112-0116.1 412116	Ø 238 12 10,5 + S
1.4 (B57J, C57J)	55	01/91→09/98	➔			24.0120-0125.1 420125	Ø 238 20,1 17,7 V + S
			➔	04/96→; Automatikgetriebe		24.0120-0125.1 420125	Ø 238 20,1 17,7 V + S
			➔	+ ABS		24.0108-0109.1 408109	Ø 238 8 7
1.8	66	08/90→04/96	➔	08/94→		24.0120-0125.1 420125	Ø 238 20,1 17,7 V + S
			➔	08/94→; + ABS		24.0108-0109.1 408109	Ø 238 8 7
1.8	70	01/91→09/98	➔			24.0120-0125.1 420125	Ø 238 20,1 17,7 V + S
			➔	10/94→; + ABS		24.0108-0109.1 408109	Ø 238 8 7
			➔	08/94→; + ABS		24.0108-0109.1 408109	Ø 238 8 7
			➔	10/94→ 04/96; + ABS		24.0108-0109.1 408109	Ø 238 8 7
			➔	09/96→; + ABS		24.0108-0109.1 408109	Ø 238 8 7
			➔	10/94→ 04/96		24.0108-0109.1 408109	Ø 238 8 7
			➔	08/94→ 04/96; + ABS		24.0108-0109.1 408109	Ø 238 8 7
1.8 (B/C578)	66	08/94→09/98	➔			24.0120-0125.1 420125	Ø 238 20,1 17,7 V + S
1.9 D	40	01/97→09/98	➔				
1.9 D	48	05/96→02/98	➔	+ ABS		24.0108-0109.1 408109	Ø 238 8 7
1.8 (B/C57C, B/C57U)	65	01/91→09/98	➔			24.0120-0125.1 420125	Ø 238 20,1 17,7 V + S
			➔	12/93→; + ABS		24.0108-0109.1 408109	Ø 238 8 7
1.8 16V (C57D)	99	01/91→03/96	➔	08/91→ 06/94		24.0121-0106.1 421106	Ø 259 20,7 17,7 V + S
			➔	08/91→ 06/94		24.0108-0109.1 408109	Ø 238 8 7
1.8 Rsi (B/C57H)	79	08/95→09/98	➔			24.0120-0125.1 420125	Ø 238 20,1 17,7 V + S
			➔			24.0108-0109.1 408109	Ø 238 8 7
1.9 D (B/C/S576, B/C/S57L)	47	01/91→09/98	➔	→ 01/94		24.0112-0116.1 412116	Ø 238 12 10,5 + S
			➔	02/94→		24.0120-0125.1 420125	Ø 238 20,1 17,7 V + S
			➔	+ ABS		24.0108-0109.1 408109	Ø 238 8 7
Electric	21	05/96→02/98	➔			24.0112-0116.1 412116	Ø 238 12 10,5 + S
Williams (B/C57M)	108	01/94→09/98	➔			24.0121-0106.1 421106	Ø 259 20,7 17,7 V + S
			➔			24.0108-0109.1 408109	Ø 238 8 7











**RENAULT - CLIO I Kasten (S57\_) 01/91→09/98**







**Bremsbelagsatz, Scheibenbremse**











1.1	34	01/91→09/98	➔	05/92→		13.0460-2834.2 602834	TRW 21463 18,0 + WK
			➔	→ 04/92		13.0460-3911.2 603911	BDX 20905 18,0 + WK
			➔			13.0460-2834.2 602834	TRW 21463 18,0 + WK
			➔			13.0460-3955.2 603955	BDX 20634 15,0 + WK
1.2	40	01/91→09/98	➔			13.0460-2834.2 602834	TRW 21463 18,0 + WK
1.2	40	06/94→02/98	➔			13.0460-3911.2 603911	BDX 20905 18,0 + WK
1.2	44	01/91→09/98	➔			13.0460-3911.2 603911	BDX 20905 18,0 + WK
1.9 D	48	01/91→09/98	➔	+ ABS		13.0460-3822.2 603822	BDX 21597 11,0 - WE / - WK
1.9 RND	40	04/96→02/98	➔				

**Zubehörsatz, Scheibenbremsbelag**









1.1	34	01/91→09/98	➔	05/92→		13.0460-0411.2 610411	BDX
			➔	→ 04/92		13.0460-0423.2 610423	BDX
1.2	40	01/91→09/98	➔			13.0460-0411.2 610411	BDX
1.2	40	06/94→02/98	➔				
1.2	44	01/91→09/98	➔				
1.9 D	48	01/91→09/98	➔				
1.9 RND	40	04/96→02/98	➔				













	kW			 	! #		
<b>RENAULT - CLIO I Kasten (S57_) 01/91→09/98</b>							
 <b>Bremsscheibe</b>							
1.1	34	01/91→09/98	←	→ 04/92		24.0108-0104.1 408104	Ø 238 8,2 7 + S
			←	05/92→		24.0112-0116.1 412116	Ø 238 12 10,5 + S
1.2	40	01/91→09/98	←			24.0112-0116.1 412116	Ø 238 12 10,5 + S
1.2	40	06/94→02/98	←				
1.2	44	01/91→09/98	→	+ ABS		24.0108-0109.1 408109	Ø 238 8 7
1.9 D	48	01/91→09/98	←	→ 01/94		24.0112-0116.1 412116	Ø 238 12 10,5 + S
			←	02/94→		24.0120-0125.1 420125	Ø 238 20,1 17,7 V + S
			→	+ ABS		24.0108-0109.1 408109	Ø 238 8 7
1.9 RND	40	04/96→02/98	←			24.0120-0125.1 420125	Ø 238 20,1 17,7 V + S
			→	+ ABS		24.0108-0109.1 408109	Ø 238 8 7
<b>RENAULT - CLIO II (BB_, CB_) 09/98→</b>							
 <b>Bremsbelagsatz, Scheibenbremse</b>							
1.0	40	02/00→05/01	←			13.0460-2834.2 602834	TRW 21463 18,0 + WK
1.2 LPG (BB0A, CB0A)	44	03/99→05/01	←				
1.4 (B/CB0C)	55	09/98→05/05	←				
1.6	81	11/04→02/09	←				
1.6 (B/CB0D)	66	09/98→05/05	←				
1.6 Flex	81	05/00→12/06	←				
1.6 Hi-Flex (CB0H)	86	01/05→02/10	←				
1.9 D (B/CB0E)	47	09/98→05/05	←				
1.9 D (B/CB0J)	48	02/00→05/01	←				
1.2 (BB0A, BB0F, BB10, BB1K, BB28, BB2D, BB2H, CB0A,...)	43	09/98→	←	→ 12/12		13.0460-2834.2 602834	TRW 21463 18,0 + WK
1.2 16V	54	06/06→	→	+ ABS; → 12/12		13.0460-3926.2 603926	BDX 20974 10,8 - WE / - WK
1.2 16V (BB05, BB0W, BB11, BB27, BB2T, BB2U, BB2V, CB05,...)	55	06/01→					
1.4 16V (B/CB0P)	72	08/00→					
1.5 dCi	74	01/04→					
1.5 dCi (B/C2J)	50	08/04→					
1.5 dCi (B/CB07)	48	06/01→					
1.5 dCi (B/CB08)	60	06/01→					
1.2 LPG	43	09/98→06/09	←			13.0460-2834.2 602834	TRW 21463 18,0 + WK
1.5 dCi	42	06/01→12/06	←				
1.5 dCi (B/CB03)	59	06/01→10/03	→	+ ABS		13.0460-3926.2 603926	BDX 20974 10,8 - WE / - WK
1.5 dCi (BB3N, CB3N)	62	02/07→06/09	→				
1.4 16V (B/CB0L)	70	10/99→09/04	←	→ 07/00		13.0460-2834.2 602834	TRW 21463 18,0 + WK
1.5 dCi (B/CB3M)	47	06/05→	←	→ 12/12		13.0460-2834.2 602834	TRW 21463 18,0 + WK
1.6 16V (BB01, BB0H, BB0T, BB14, BB1D, BB1R, BB2KL, BB3G...)	79	09/98→	←				
1.9 dTi (B/CB0U)	59	12/99→05/05	←	02/00→		13.0460-2834.2 602834	TRW 21463 18,0 + WK
2.0 16V Sport	132	01/04→	←	→ 12/12		13.0460-2895.2 602895	TRW 23172 18,0 - WK
2.0 16V Sport (CB0M)	124	02/00→	→	→ 12/12		13.0460-3926.2 603926	BDX 20974 10,8 - WE / - WK
<b>Zubehörsatz, Scheibenbremsbelag</b>							
1.2 (BB0A, BB0F, BB10, BB1K, BB28, BB2D, BB2H, CB0A,...)	43	09/98→	→	+ ABS; → 12/12		13.0460-0435.2 610435	BDX
1.2 16V	54	06/06→					
1.2 16V (BB05, BB0W, BB11, BB27, BB2T, BB2U, BB2V, CB05,...)	55	06/01→					
1.4 16V (B/CB0P)	72	08/00→					
1.5 dCi	74	01/04→					
1.5 dCi (B/C2J)	50	08/04→					
1.5 dCi (B/CB07)	48	06/01→					
1.5 dCi (B/CB08)	60	06/01→					
1.2 LPG	43	09/98→06/09	→	+ ABS		13.0460-0435.2 610435	BDX
1.5 dCi	42	06/01→12/06					
1.5 dCi (B/CB03)	59	06/01→10/03					
1.5 dCi (BB3N, CB3N)	62	02/07→06/09					
2.0 16V Sport	132	01/04→	←	→ 12/12		13.0460-0262.2 610262	TRW
2.0 16V Sport (CB0M)	124	02/00→	→	→ 12/12		13.0460-0435.2 610435	BDX
 <b>Bremsscheibe</b>							
1.0	40	02/00→05/01	←	- ABS		24.0112-0116.1 412116	Ø 238 12 10,5 + S
			←	+ ABS		24.0120-0125.1 420125	Ø 238 20,1 17,7 V + S
			←			24.0121-0106.1 421106	Ø 259 20,7 17,7 V + S
↓							

	kW			 	! #		
<b>RENAULT - CLIO II (BB_, CB_) 09/98→</b>							
<b>Bremsscheibe</b>							
1.2 (BB0A, BB0F, BB10, BB1K, BB28, BB2D, BB2H, CB0A,...)	43	09/98→	←	→ 05/01; - ABS	24.0112-0116.1	412116	Ø 238 12 10,5 + S
			←	→ 05/01; + ABS	24.0120-0125.1	420125	Ø 238 20,1 17,7 V + S
			←	06/01→ 12/12	24.0121-0106.1	421106	Ø 259 20,7 17,7 V + S
			→	+ ABS; → 12/12	24.0108-0117.2	408117	Ø 238 8 7 + LG / + ABS Ring
1.2 16V 1.2 16V (BB05, BB0W, BB11, BB27, BB2T, BB2U, BB2V, CB05,...)	54 55	06/06→ 06/01→	←	- ABS; → 02/10	24.0112-0116.1	412116	Ø 238 12 10,5 + S
			←	+ ABS; → 12/12	24.0120-0125.1	420125	Ø 238 20,1 17,7 V + S
			→	+ ABS; → 12/12	24.0121-0106.1	421106	Ø 259 20,7 17,7 V + S
1.2 LPG	43	09/98→06/09	←	→ 05/01; - ABS	24.0112-0116.1	412116	Ø 238 12 10,5 + S
			←	- ABS	24.0112-0116.1	412116	Ø 238 12 10,5 + S
			←	→ 05/01; + ABS	24.0120-0125.1	420125	Ø 238 20,1 17,7 V + S
			←	+ ABS	24.0120-0125.1	420125	Ø 238 20,1 17,7 V + S
			←	06/01→	24.0121-0106.1	421106	Ø 259 20,7 17,7 V + S
			→	+ ABS	24.0108-0117.2	408117	Ø 238 8 7 + LG / + ABS Ring
			→	+ ABS	24.0108-0117.2	408117	Ø 238 8 7 + LG / + ABS Ring
1.2 LPG (BB0A, CB0A)	44	03/99→05/01	←	- ABS	24.0112-0116.1	412116	Ø 238 12 10,5 + S
			←	+ ABS	24.0120-0125.1	420125	Ø 238 20,1 17,7 V + S
1.4 (B/CB0C)	55	09/98→05/05	←	- ABS; Schaltgetriebe	24.0112-0116.1	412116	Ø 238 12 10,5 + S
			←	- ABS	24.0112-0116.1	412116	Ø 238 12 10,5 + S
			←	- ABS; Automatikgetriebe	24.0120-0125.1	420125	Ø 238 20,1 17,7 V + S
			←	+ ABS	24.0120-0125.1	420125	Ø 238 20,1 17,7 V + S
			←	+ ABS; Schaltgetriebe	24.0120-0125.1	420125	Ø 238 20,1 17,7 V + S
			←	+ ABS; Automatikgetriebe	24.0121-0106.1	421106	Ø 259 20,7 17,7 V + S
1.4 16V (B/CB0L)	70	10/99→09/04	←	→ 07/00; - ABS	24.0120-0125.1	420125	Ø 238 20,1 17,7 V + S
			←	→ 07/00; + ABS	24.0121-0106.1	421106	Ø 259 20,7 17,7 V + S
1.4 16V (B/CB0P)	72	08/00→	←	- ABS; → 12/12	24.0120-0125.1	420125	Ø 238 20,1 17,7 V + S
			←	+ ABS; → 12/12	24.0121-0106.1	421106	Ø 259 20,7 17,7 V + S
			→	12/02→ 12/12; + ESP	24.0108-0108.1	408108	Ø 238 8 7 - ABS Ring
			→	+ ABS; → 11/02	24.0108-0117.2	408117	Ø 238 8 7 + LG / + ABS Ring
1.5 dCi	42	06/01→12/06	←		24.0121-0106.1	421106	Ø 259 20,7 17,7 V + S
			→	+ ABS	24.0108-0117.2	408117	Ø 238 8 7 + LG / + ABS Ring
1.5 dCi 1.5 dCi (B/C2J) 1.5 dCi (B/CB07) 1.5 dCi (B/CB08)	74 50 48 60	01/04→ 08/04→ 06/01→ 06/01→	←	→ 12/12	24.0121-0106.1	421106	Ø 259 20,7 17,7 V + S
			→	+ ABS; → 12/12	24.0108-0117.2	408117	Ø 238 8 7 + LG / + ABS Ring
			←		24.0121-0106.1	421106	Ø 259 20,7 17,7 V + S
			→	12/02→; + ESP	24.0108-0108.1	408108	Ø 238 8 7 - ABS Ring
1.5 dCi (B/CB03)	59	06/01→10/03	←		24.0121-0106.1	421106	Ø 259 20,7 17,7 V + S
			→	+ ABS; → 11/02	24.0108-0117.2	408117	Ø 238 8 7 + LG / + ABS Ring
			→	+ ABS; → 11/02	24.0108-0117.2	408117	Ø 238 8 7 + LG / + ABS Ring
1.5 dCi (B/CB3M) 1.6 1.6 Flex 1.6 Hi-Flex (CB0H)	47 81 81 86	06/05→ 11/04→02/09 05/00→12/06 01/05→02/10	←		24.0121-0106.1	421106	Ø 259 20,7 17,7 V + S
			←	- ABS	24.0112-0116.1	412116	Ø 238 12 10,5 + S
			←	+ ABS	24.0120-0125.1	420125	Ø 238 20,1 17,7 V + S
1.5 dCi (BB3N, CB3N)	62	02/07→06/09	←	- ABS	24.0112-0116.1	412116	Ø 238 12 10,5 + S
			←	+ ABS	24.0120-0125.1	420125	Ø 238 20,1 17,7 V + S
			→	+ ABS	24.0108-0117.2	408117	Ø 238 8 7 + LG / + ABS Ring
1.6 (B/CB0D)	66	09/98→05/05	←	- ABS	24.0120-0125.1	420125	Ø 238 20,1 17,7 V + S
			←	+ ABS	24.0121-0106.1	421106	Ø 259 20,7 17,7 V + S
1.6 16V (BB01, BB0H, BB0T, BB14, BB1D, BB1R, BB2KL, BB3G...)	79	09/98→	←	→ 12/12	24.0121-0106.1	421106	Ø 259 20,7 17,7 V + S
1.9 D (B/CB0E) 1.9 D (B/CB0J)	47 48	09/98→05/05 02/00→05/01	←	- ABS; für Fahrzeuge ohne Klimaanlage	24.0112-0116.1	412116	Ø 238 12 10,5 + S
			←	+ ABS; für Fahrzeuge ohne Klimaanlage	24.0120-0125.1	420125	Ø 238 20,1 17,7 V + S
			←	+ ABS; für Fahrzeuge mit Klimaanlage	24.0121-0106.1	421106	Ø 259 20,7 17,7 V + S
1.9 dTi (B/CB0U)	59	12/99→05/05	←	02/00→	24.0121-0106.1	421106	Ø 259 20,7 17,7 V + S
2.0 16V Sport 2.0 16V Sport (CB0M)	132 124	01/04→ 02/00→	←	→ 12/12	24.0124-0158.1	424158	Ø 280 24 21,8 V + S
			←		24.0324-0158.1	524158	Ø 280 24 21,8 V + S
			→	→ 12/12	24.0108-0108.1	408108	Ø 238 8 7 - ABS Ring













	kw			 	! #		
<b>RENAULT - CLIO II Kasten (SB0/1/2_) 09/98→</b>							
 <b>Bremsbelagsatz, Scheibenbremse</b>							
1.2 (SB0A, SB0F, SB10) 1.5 dCi 1.9 D (SB0J) 1.9 D (SB0R) 1.9 DTi (SB0U)	44 59 48 40 59	03/99→10/03 06/01→10/04 02/00→05/01 03/99→01/00 02/00→05/01	←			13.0460-2834.2 602834	TRW 21463 18,0 + WK
1.2 (SB0A, SB0F, SB1K, SB2D) 1.5 dCi 1.5 dCi 1.5 dCi (SB07) 1.9 D (SB0E)	43 50 60 48 47	09/98→ 04/04→ 11/03→ 06/01→ 09/98→	←	→ 12/12		13.0460-2834.2 602834	TRW 21463 18,0 + WK
1.6 (SB0H)	79	11/03→	←	→ 04/05		13.0460-2834.2 602834	TRW 21463 18,0 + WK
 <b>Bremsscheibe</b>							
1.2 (SB0A, SB0F, SB10)	44	03/99→10/03	←	- ABS		24.0112-0116.1 412116	Ø 238 12 10,5 + S
1.2 (SB0A, SB0F, SB1K, SB2D)	43	09/98→	←	- ABS; → 12/12		24.0112-0116.1 412116	Ø 238 12 10,5 + S
			←	+ ABS; → 12/12		24.0120-0125.1 420125	Ø 238 20,1 17,7 V + S
1.5 dCi 1.5 dCi 1.5 dCi (SB07)	50 60 48	04/04→ 11/03→ 06/01→	←	→ 12/12		24.0121-0106.1 421106	Ø 259 20,7 17,7 V + S
			←			24.0121-0106.1 421106	Ø 259 20,7 17,7 V + S
			←			24.0121-0106.1 421106	Ø 259 20,7 17,7 V + S
1.6 (SB0H)	79	11/03→	←	→ 04/05		24.0121-0106.1 421106	Ø 259 20,7 17,7 V + S
1.9 D (SB0E)	47	09/98→	←	→ 12/12		24.0120-0125.1 420125	Ø 238 20,1 17,7 V + S
1.9 D (SB0J)	48	02/00→05/01	←	- ABS		24.0120-0125.1 420125	Ø 238 20,1 17,7 V + S
			←	+ ABS		24.0121-0106.1 421106	Ø 259 20,7 17,7 V + S
1.9 D (SB0R)	40	03/99→01/00	←			24.0120-0125.1 420125	Ø 238 20,1 17,7 V + S
<b>RENAULT - CLIO III (BR0/1, CR0/1) 01/05→</b>							
 <b>Bremsbelagsatz, Scheibenbremse</b>							
1.2	43	05/05→06/09	←	06/06→		13.0460-2709.2 602709	TRW 23973 17,1 - WE / - WK + Zub
			→	06/06→		13.0470-2709.2 LD2709	TRW 23973 17,1 - WE / - WK + Zub Ceramic
1.2 (BR01, BR03, BR0E, CR0E)	57	10/05→	←	→ 12/12		13.0460-2709.2 602709	TRW 23973 17,1 - WE / - WK + Zub
			→	→ 12/12		13.0470-2709.2 LD2709	TRW 23973 17,1 - WE / - WK + Zub Ceramic
1.2 16V	58	06/05→				13.0460-2845.2 602845	TRW 23554 16,4 - WK + Zub
1.2 16V	76	09/10→				13.0470-2845.2 LD2845	TRW 23554 16,4 - WK + Zub Ceramic
1.2 16V (BR02, BR0J, BR11, CR02, CR0J, CR11)	55	06/05→	→	→ 12/12		13.0460-2845.2 602845	TRW 23554 16,4 - WK + Zub
1.2 16V (BR0P, CR0P)	74	05/07→				13.0470-2845.2 LD2845	TRW 23554 16,4 - WK + Zub Ceramic
1.2 16V (BR0R, BR1D, BR1L, CR0R)	48	06/05→					
1.2 16V Hi-Flex (BR1U, CR1U)	55	07/08→					
1.2 Ethanol (CR1U, BR1U)	55	07/08→					
1.4 16V	72	06/05→					
1.5 dCi	55	08/10→					
1.5 dCi	60	11/07→					
1.5 dCi	65	08/10→					
1.5 dCi (BR0H, CR0H, CR1S, BR1S)	78	06/05→					
1.5 dCi (BR17, CR17)	63	06/05→					
1.5 dCi (BR1C, CR1C)	76	06/05→					
1.5 dCi (C/BR0G, C/BR1G)	50	06/05→					
1.6 16V (BR05, BR0B, BR0Y, BR15, BR1J, BR1M, BR1Y, CR0B,...)	82	06/05→					
1.6 16V (BR09, BR0T, CR09, CR0T)	65	06/05→					
1.6 16V GT (BR10, CR10)	94	06/09→					
1.2 16V	43	06/06→08/10	←			13.0460-2709.2 602709	TRW 23973 17,1 - WE / - WK + Zub
			→			13.0470-2709.2 LD2709	TRW 23973 17,1 - WE / - WK + Zub Ceramic
			→			13.0460-2845.2 602845	TRW 23554 16,4 - WK + Zub



























	kw			 	! #			
<b>RENAULT - CLIO III (BR0/1, CR0/1) 01/05→</b>								
<b> Bremsbelagsatz, Scheibenbremse</b>								
1.2 16V	43	06/06→08/10	➡			<b>13.0470-2845.2 LD2845</b>	TRW 23554 16,4 - WK + Zub Ceramic	
1.5 dCi	47	06/05→	←	→ 12/12		<b>13.0460-2709.2 602709</b>	TRW 23973 17,1 - WE / - WK + Zub	
			➡	+ ABS		<b>13.0470-2709.2 LD2709</b>	TRW 23973 17,1 - WE / - WK + Zub Ceramic	
1.5 dCi	48	05/05→	←	→ 10/06		<b>13.0460-2709.2 602709</b>	TRW 23973 17,1 - WE / - WK + Zub	
			➡	→ 10/06		<b>13.0470-2709.2 LD2709</b>	TRW 23973 17,1 - WE / - WK + Zub Ceramic	
2.0 16V (BR0C, BR0K, CR0C, CR0K)	102	09/06→	←	→ 12/12		<b>13.0460-2845.2 602845</b>	TRW 23554 16,4 - WK + Zub	
			➡	→ 12/12		<b>13.0470-2845.2 LD2845</b>	TRW 23554 16,4 - WK + Zub Ceramic	
2.0 16V Sport	148	09/08→	←	04/09→ 12/12		<b>13.0460-4805.2 604805</b>	BRE 24162 15,2 - WE / - WK	
			➡	→ 12/12		<b>13.0460-2845.2 602845</b>	TRW 23554 16,4 - WK + Zub	
2.0 16V Sport (CR0N, CR1P)	145	02/06→	←	→ 12/12		<b>13.0460-4805.2 604805</b>	BRE 24162 15,2 - WE / - WK	
			➡	→ 12/12		<b>13.0460-2845.2 602845</b>	TRW 23554 16,4 - WK + Zub	
<b> Bremsscheibe</b>								
1.2	43	05/05→06/09	←	06/06→		<b>24.0122-0216.1 422216</b>	Ø 260 22 19,8 V + S	
			➡	06/06→		<b>24.0108-0114.2 408114</b>	Ø 240 8 7 + LG / + ABS Ring	
1.2 (BR01, BR03, BR0E, CR0E) 1.2 16V 1.2 16V 1.2 16V (BR02, BR0J, BR11, CR02, CR0J, CR11) 1.2 16V (BR0P, CR0P) 1.2 16V Hi-Flex (BR1U, CR1U) 1.2 Ethanol (CR1U, BR1U) 1.4 16V 1.5 dCi 1.5 dCi 1.5 dCi 1.5 dCi (BR0H, CR0H, CR1S, BR1S) 1.5 dCi (BR17, CR17) 1.5 dCi (BR1C, CR1C) 1.5 dCi (C/BR0G, C/BR1G) 1.6 16V (BR05, BR0B, BR0Y, BR15, BR1J, BR1M, BR1Y, CR0B,...) 1.6 16V (BR09, BR0T, CR09, CR0T) 1.6 16V GT (BR10, CR10)	57	10/05→	←	→ 12/12		<b>24.0122-0216.1 422216</b>	Ø 260 22 19,8 V + S	
	58	06/05→	➡	→ 12/12		<b>24.0108-0114.2 408114</b>	Ø 240 8 7 + LG / + ABS Ring	
	76	09/10→						
	55	06/05→						
	74	05/07→						
	55	07/08→						
	55	07/08→						
	72	06/05→						
	55	08/10→						
	60	11/07→						
	65	08/10→						
	78	06/05→						
	63	06/05→						
	76	06/05→						
	50	06/05→						
	82	06/05→						
	65	06/05→						
94	06/09→							
1.2 16V	43	06/06→08/10	←			<b>24.0122-0216.1 422216</b>	Ø 260 22 19,8 V + S	
			➡			<b>24.0108-0114.2 408114</b>	Ø 240 8 7 + LG / + ABS Ring	
1.2 16V (BR0R, BR1D, BR1L, CR0R)	48	06/05→	←	→ 12/12		<b>24.0122-0216.1 422216</b>	Ø 260 22 19,8 V + S	
			➡	→ 12/12; Achszapfendurchmesser [mm]: 25		<b>24.0108-0114.2 408114</b>	Ø 240 8 7 + LG / + ABS Ring	
1.5 dCi	47	06/05→	←	→ 12/12		<b>24.0122-0216.1 422216</b>	Ø 260 22 19,8 V + S	
			➡	+ ABS		<b>24.0108-0114.2 408114</b>	Ø 240 8 7 + LG / + ABS Ring	
1.5 dCi	48	05/05→	←	→ 10/06		<b>24.0122-0216.1 422216</b>	Ø 260 22 19,8 V + S	
			➡	→ 10/06		<b>24.0108-0114.2 408114</b>	Ø 240 8 7 + LG / + ABS Ring	
2.0 16V (BR0C, BR0K, CR0C, CR0K)	102	09/06→	←	→ 12/12		<b>24.0124-0158.1 424158</b>	Ø 280 24 21,8 V + S	
						<b>24.0324-0158.1 524158</b>	Ø 280 24 21,8 V + S	

	kw			 	! #		
<b>RENAULT - CLIO III (BR0/1, CR0/1) 01/05→</b>							
 <b>Bremsscheibe</b>							
2.0 16V (BR0C, BR0K, CR0C, CR0K)	102	09/06→	→	→ 12/12		24.0108-0114.2 408114	Ø 240 8 7 + LG / + ABS Ring
2.0 16V Sport	148	09/08→	←	04/09→ 12/12		24.0128-0223.1 428223	Ø 312,5 28 26 V + S
			→	04/09→ 12/12		24.0111-0183.2 411183	Ø 300 11 9,5 + LG / + ABS Ring
2.0 16V Sport (CR0N, CR1P)	145	02/06→	←	→ 12/12		24.0128-0223.1 428223	Ø 312,5 28 26 V + S
			→	→ 12/12		24.0111-0183.2 411183	Ø 300 11 9,5 + LG / + ABS Ring
<b>RENAULT - CLIO III Kasten (SB_, SR_) 06/05→</b>							
 <b>Bremsbelagsatz, Scheibenbremse</b>							
1.2 (SR0J) 1.5 dCi (SR1H)	55	11/05→12/14	←	→ 12/12		13.0460-2709.2 602709	TRW 23973 17,1 - WE / - WK + Zub
	65	08/10→12/14				13.0470-2709.2 LD2709	TRW 23973 17,1 - WE / - WK + Zub Ceramic
			→	→ 12/12		13.0460-2845.2 602845	TRW 23554 16,4 - WK + Zub
						13.0470-2845.2 LD2845	TRW 23554 16,4 - WK + Zub Ceramic
1.2 (SR0P) 1.5 dCi	74	11/07→12/11	←			13.0460-2709.2 602709	TRW 23973 17,1 - WE / - WK + Zub
	50	10/05→07/10				13.0470-2709.2 LD2709	TRW 23973 17,1 - WE / - WK + Zub Ceramic
1.5 dCi	63	06/05→07/10	→			13.0460-2845.2 602845	TRW 23554 16,4 - WK + Zub
1.5 dCi	78	10/05→10/07				13.0470-2845.2 LD2845	TRW 23554 16,4 - WK + Zub Ceramic
 <b>Bremsscheibe</b>							
1.2 (SR0J) 1.5 dCi (SR1H)	55	11/05→12/14	←	→ 12/12		24.0122-0216.1 422216	Ø 260 22 19,8 V + S
	65	08/10→12/14	→	→ 12/12		24.0108-0114.2 408114	Ø 240 8 7 + LG / + ABS Ring
1.2 (SR0P) 1.5 dCi	74	11/07→12/11	←			24.0122-0216.1 422216	Ø 260 22 19,8 V + S
	50	10/05→07/10	→			24.0108-0114.2 408114	Ø 240 8 7 + LG / + ABS Ring
1.5 dCi	63	06/05→07/10					
1.5 dCi	78	10/05→10/07					
<b>RENAULT - CLIO IV (BH_) 11/12→</b>							
 <b>Bremsbelagsatz, Scheibenbremse</b>							
0.9 TCe 90 1.2 16V 1.2 LPG 16V 1.2 TCe 120 1.5 dCi 75 1.5 dCi 90	66	11/12→	←	→ 03/15		13.0460-2709.2 602709	TRW 23973 17,1 - WE / - WK + Zub
	54	11/12→				13.0460-7298.2 607298	ATE 25702 18,2 - WE / - WK
	54	11/12→				13.0470-2709.2 LD2709	TRW 23973 17,1 - WE / - WK + Zub Ceramic
	88	03/13→				13.0470-7298.2 LD7298	ATE 25702 18,2 - WE / - WK Ceramic
1.2 TCe 120	87	01/16→	←			13.0460-2709.2 602709	TRW 23973 17,1 - WE / - WK + Zub
						13.0470-2709.2 LD2709	TRW 23973 17,1 - WE / - WK + Zub Ceramic
1.6 RS 1.6 RS Trophy	147	03/13→	←			13.0460-7249.2 607249	ATE 24709 18,6 - WE / - WK
	162	03/15→				13.0470-7249.2 LD7249	ATE 24709 18,6 - WE / - WK Ceramic
			→			13.0460-2740.2 602740	TRW 23554 17,0 - WE / - WK + Zub
						13.0470-2740.2 LD2740	TRW 23554 17,0 - WE / - WK + Zub Ceramic
 <b>Bremsscheibe</b>							
0.9 TCe 90 0.9 TCe 90 LPG 1.2 16V 1.2 16V (BHA1, BHAK, BHMG, BHMK) 1.2 LPG 16V 1.5 dCi 75	66	11/12→	←			24.0122-0289.1 422289	Ø 258 22 19,8 V + S
	66	06/16→					
	54	11/12→					
	55	06/15→					
1.2 TCe 120	87	01/16→	←			24.0122-0270.1 422270	Ø 258 22 19,8 V + S
1.2 TCe 120	88	03/13→					
1.5 dCi 110	81	06/16→	←	Automatikgetriebe		24.0122-0270.1 422270	Ø 258 22 19,8 V + S
1.5 dCi 90	66	11/12→	←	Schaltgetriebe		24.0122-0289.1 422289	Ø 258 22 19,8 V + S
1.6 RS 1.6 RS Trophy	147	03/13→	←			24.0128-0245.1 428245	Ø 320 28 25,4 V + S
	162	03/15→	→			24.0108-0118.2 408118	Ø 260 8 7 + LG / + ABS Ring















	kw			 	! #			
<b>RENAULT - CLIO IV Grandtour (KH_) 01/13→</b>								
 <b>Bremsbelagsatz, Scheibenbremse</b>								
0.9 TCe 90	66	01/13→	←			<b>13.0460-2709.2</b>	<b>602709</b>	TRW 23973 17,1 - WE / - WK + Zub
1.2 16V	54	01/13→						
1.2 TCe 120	87	01/16→				<b>13.0470-2709.2</b>	<b>LD2709</b>	TRW 23973 17,1 - WE / - WK + Zub Ceramic
1.2 TCe 120	88	03/13→						
1.5 dCi 110	81	06/16→						
1.5 dCi 75	55	01/13→						
1.5 dCi 90	66	01/13→						
 <b>Bremsscheibe</b>								
0.9 TCe 90	66	01/13→	←			<b>24.0122-0270.1</b>	<b>422270</b>	Ø 258 22 19,8 V + S
1.2 16V	54	01/13→						
1.2 TCe 120	87	01/16→						
1.2 TCe 120	88	03/13→						
1.5 dCi 110	81	06/16→						
1.5 dCi 75	55	01/13→						
1.5 dCi 90	66	01/13→						
<b>RENAULT - CLIO IV Kasten 01/14→</b>								
 <b>Bremsbelagsatz, Scheibenbremse</b>								
0.9 TCe 90	66	01/14→	←	→ 03/15		<b>13.0460-2709.2</b>	<b>602709</b>	TRW 23973 17,1 - WE / - WK + Zub
1.2 16V	55	01/14→						
1.5 dCi 75	55	01/14→				<b>13.0460-7298.2</b>	<b>607298</b>	ATE 25702 18,2 - WE / - WK
1.5 dCi 90	66	01/14→				<b>13.0470-2709.2</b>	<b>LD2709</b>	TRW 23973 17,1 - WE / - WK + Zub Ceramic
						<b>13.0470-7298.2</b>	<b>LD7298</b>	ATE 25702 18,2 - WE / - WK Ceramic
 <b>Bremsscheibe</b>								
0.9 TCe 90	66	01/14→	←			<b>24.0122-0289.1</b>	<b>422289</b>	Ø 258 22 19,8 V + S
1.2 16V	55	01/14→						
1.5 dCi 75	55	01/14→						
1.5 dCi 90	66	01/14→	←	Automatikgetriebe		<b>24.0122-0270.1</b>	<b>422270</b>	Ø 258 22 19,8 V + S
			←	Schaltgetriebe		<b>24.0122-0289.1</b>	<b>422289</b>	Ø 258 22 19,8 V + S
<b>RENAULT - CLIO Grandtour (KR0/1_) 02/08→</b>								
 <b>Bremsbelagsatz, Scheibenbremse</b>								
1.2 16V	76	03/10→	←	→ 12/12		<b>13.0460-2709.2</b>	<b>602709</b>	TRW 23973 17,1 - WE / - WK + Zub
1.2 16V (KR02, KR0J)	55	02/08→						
1.2 16V (KR0E)	58	02/08→				<b>13.0470-2709.2</b>	<b>LD2709</b>	TRW 23973 17,1 - WE / - WK + Zub Ceramic
1.2 16V (KR0P)	74	02/08→						
1.2 16V Hi-Flex (KR0S)	55	07/08→						
1.4 16V	72	02/10→	→	+ ESP; → 12/12		<b>13.0460-2845.2</b>	<b>602845</b>	TRW 23554 16,4 - WK + Zub
1.5 dCi	48	02/10→				<b>13.0470-2845.2</b>	<b>LD2845</b>	TRW 23554 16,4 - WK + Zub Ceramic
1.5 dCi	55	08/10→						
1.5 dCi	65	08/10→						
1.5 dCi (KR0F)	63	02/08→						
1.5 dCi (KR0G)	50	02/08→						
1.5 dCi (KR1C, KR1N)	76	02/08→						
1.6 16V	80	02/08→						
1.6 16V (KR0B)	82	02/08→						
1.6 16V (KR10)	94	11/08→						
1.5 dCi (KR0H, KR1S)	78	02/08→12/12	←			<b>13.0460-2709.2</b>	<b>602709</b>	TRW 23973 17,1 - WE / - WK + Zub
						<b>13.0470-2709.2</b>	<b>LD2709</b>	TRW 23973 17,1 - WE / - WK + Zub Ceramic
			→	+ ESP		<b>13.0460-2845.2</b>	<b>602845</b>	TRW 23554 16,4 - WK + Zub
						<b>13.0470-2845.2</b>	<b>LD2845</b>	TRW 23554 16,4 - WK + Zub Ceramic
 <b>Bremsscheibe</b>								
1.2 16V	76	03/10→	←	→ 12/12		<b>24.0122-0216.1</b>	<b>422216</b>	Ø 260 22 19,8 V + S
1.2 16V (KR02, KR0J)	55	02/08→						
1.2 16V (KR0E)	58	02/08→	→	+ ESP; → 12/12		<b>24.0108-0114.2</b>	<b>408114</b>	Ø 240 8 7 + LG / + ABS Ring
1.2 16V (KR0P)	74	02/08→						
1.2 16V Hi-Flex (KR0S)	55	07/08→						
1.4 16V	72	02/10→						
1.5 dCi	48	02/10→						
1.5 dCi	55	08/10→						
1.5 dCi	65	08/10→						
1.5 dCi (KR0F)	63	02/08→						
1.5 dCi (KR0G)	50	02/08→						
1.5 dCi (KR1C, KR1N)	76	02/08→						
1.6 16V	80	02/08→						
1.6 16V (KR0B)	82	02/08→						
1.6 16V (KR10)	94	11/08→						
↓								













	kw			 	! #		
<b>RENAULT - CLIO Grandtour (KR0/1_) 02/08→</b>							
 <b>Bremsscheibe</b>							
1.5 dCi (KR0H, KR1S)	78	02/08→12/12	←		24.0122-0216.1	422216	Ø 260 22 19,8 V + S
			→	+ ESP	24.0108-0114.2	408114	Ø 240 8 7 + LG / + ABS Ring
<b>RENAULT - DOKKER 12/13→</b>							
 <b>Bremsbelagsatz, Scheibenbremse</b>							
1.5 dCi	66	12/13→	←	- ESP	13.0460-2709.2	602709	TRW 23973 17,1 - WE / - WK + Zub
1.6	62	12/13→	←		13.0470-2709.2	LD2709	TRW 23973 17,1 - WE / - WK + Zub Ceramic
			←	+ ESP	13.0460-7266.2	607266	ATE 24538 17,9 - WE / - WK
					13.0470-7266.2	LD7266	ATE 24538 17,9 - WE / - WK Ceramic
 <b>Bremsscheibe</b>							
1.5 dCi	66	12/13→	←	- ESP; nicht für erhöhte Nutzlast	24.0122-0270.1	422270	Ø 258 22 19,8 V + S
1.6	62	12/13→	←	- ESP; für erhöhte Nutzlast	24.0124-0253.1	424253	Ø 280 24 21,8 V + S
			←	+ ESP	24.0124-0253.1	424253	Ø 280 24 21,8 V + S
<b>RENAULT - DUSTER (HS_) 01/11→</b>							
 <b>Bremsbelagsatz, Scheibenbremse</b>							
1.5 dCi	66	06/11→	←	- ABS	13.0460-2709.2	602709	TRW 23973 17,1 - WE / - WK + Zub
2.0	98	02/12→	←		13.0470-2709.2	LD2709	TRW 23973 17,1 - WE / - WK + Zub Ceramic
			←	+ ABS	13.0460-7266.2	607266	ATE 24538 17,9 - WE / - WK
					13.0470-7266.2	LD7266	ATE 24538 17,9 - WE / - WK Ceramic
1.5 dCi 4x4	66	06/11→	←		13.0460-7266.2	607266	ATE 24538 17,9 - WE / - WK
2.0 4x4	99	02/12→	←		13.0470-7266.2	LD7266	ATE 24538 17,9 - WE / - WK Ceramic
1.6 16V	84	06/15→	←	- ESP	13.0460-2709.2	602709	TRW 23973 17,1 - WE / - WK + Zub
1.6 16V (HSAT)	75	02/12→	←		13.0470-2709.2	LD2709	TRW 23973 17,1 - WE / - WK + Zub Ceramic
1.6 16V 4x4	75	06/11→05/15	←		13.0460-7266.2	607266	ATE 24538 17,9 - WE / - WK
1.6 16V 4x4	84	06/15→	←	+ ESP	13.0470-7266.2	LD7266	ATE 24538 17,9 - WE / - WK Ceramic
 <b>Bremsscheibe</b>							
1.5 dCi	66	06/11→	←	- ABS	24.0123-0119.1	423119	Ø 269 22,5 19,8 V + S
2.0	98	02/12→	←	+ ABS	24.0124-0221.1	424221	Ø 280 24 21,8 V + S
1.5 dCi 4x4	66	06/11→	←		24.0124-0221.1	424221	Ø 280 24 21,8 V + S
2.0 4x4	99	02/12→	←		24.0123-0119.1	423119	Ø 269 22,5 19,8 V + S
1.6 16V	84	06/15→	←	- ESP	24.0124-0221.1	424221	Ø 280 24 21,8 V + S
1.6 16V (HSAT)	75	02/12→	←	+ ESP			
1.6 16V 4x4	75	06/11→05/15	←				
1.6 16V 4x4	84	06/15→	←				
<b>RENAULT - ESPACE II (J/S63_) 01/91→10/97</b>							
 <b>Bremsbelagsatz, Scheibenbremse</b>							
2.0 (J636)	76	01/91→10/96	←		13.0460-2810.2	602810	TRW 20236 18,0 + WK
			→	+ ABS; für Fahrzeuge mit Niveauregulierung	13.0460-3961.2	603961	BDX 20336 14,0 + WK
2.1 TD (J633, J634, J/S635, J/S63D)	65	01/91→10/96	←		13.0460-2810.2	602810	TRW 20236 18,0 + WK
2.1 TD (J63E)	66	11/94→10/96	→	für Fahrzeuge mit Niveauregulierung	13.0460-3961.2	603961	BDX 20336 14,0 + WK
2.2 (J/S637, J63G)	79	01/91→10/96	←		13.0460-2810.2	602810	TRW 20236 18,0 + WK
2.2 4x4 (J/S637, J63G)	79	03/91→12/96	→	05/93→; + ABS; für Fahrzeuge mit Niveauregulierung	13.0460-3961.2	603961	BDX 20336 14,0 + WK
2.8 V6 (J638, J63J)	110	01/91→10/96	←		13.0460-2983.2	602983	TRW 20919 18,0 + WK
			→		13.0460-3961.2	603961	BDX 20336 14,0 + WK
 <b>Bremsscheibe</b>							
2.0 (J636)	76	01/91→10/96	←		24.0120-0126.1	420126	Ø 259 20,2 17,7 V
2.2 (J/S637, J63G)	79	01/91→10/96	→	+ ABS; für Fahrzeuge mit Niveauregulierung	24.0112-0134.1	412134	Ø 253,8 12 10,5
↓							











	kw			 	! #		
<b>RENAULT - ESPACE II (J/S63_) 01/91→10/97</b>							
<b> Bremsscheibe</b>							
2.1 TD (J633, J634, J/S635, J/S63D)	65	01/91→10/96	←			24.0120-0126.1 420126	Ø 259 20,2 17,7 V
2.1 TD (J63E)	66	11/94→10/96	→	für Fahrzeuge mit Niveauregulierung		24.0112-0134.1 412134	Ø 253,8 12 10,5
2.2 4x4 (J/S637, J63G)	79	03/91→12/96	←			24.0120-0126.1 420126	Ø 259 20,2 17,7 V
			→	→ 10/96		24.0111-0150.1 411150	Ø 257 10,5 9,5
			→	05/93→; + ABS; für Fahrzeuge mit Niveauregulierung		24.0112-0134.1 412134	Ø 253,8 12 10,5
2.8 V6 (J638, J63J)	110	01/91→10/96	←			24.0122-0143.1 422143	Ø 280 22 20 V
			→			24.0112-0133.1 412133	Ø 253,8 12 10,5
<b>RENAULT - ESPACE III (JE0_) 11/96→10/02</b>							
<b> Bremsbelagsatz, Scheibenbremse</b>							
1.9 dTi (JE0M)	72	02/99→10/02	←			13.0460-2832.2 602832	TRW 21888 18,1 + WK
2.0 (JE0A)	84	11/96→10/00					
2.2 12V TD (JE0E, JE0H, JE0P)	83	11/96→10/00					
2.2 D	84	11/97→01/00					
2.0	102	09/01→10/02	←			13.0460-2832.2 602832	TRW 21888 18,1 + WK
			→			13.0460-2845.2 602845	TRW 23554 16,4 - WK + Zub
						13.0470-2845.2 LD2845	TRW 23554 16,4 - WK + Zub Ceramic
2.0 16V (JE0N, JE0L, JE02)	103	10/98→10/02	←			13.0460-2832.2 602832	TRW 21888 18,1 + WK
			→	07/00→		13.0460-2845.2 602845	TRW 23554 16,4 - WK + Zub
						13.0470-2845.2 LD2845	TRW 23554 16,4 - WK + Zub Ceramic
			→	→ 06/00		13.0460-4957.2 604957	BRE 20410 15,0 - WE / - WK
2.2 dCi (JE0K)	95	10/00→10/02	←			13.0460-2735.2 602735	TRW 23099 18,4 + WK + Zub
			→			13.0460-2870.2 602870	TRW 23099 18,4 - WK
						13.0460-2845.2 602845	TRW 23554 16,4 - WK + Zub
						13.0470-2845.2 LD2845	TRW 23554 16,4 - WK + Zub Ceramic
2.2 dCi (JE0S)	85	07/00→10/02	←			13.0460-2870.2 602870	TRW 23099 18,4 - WK
3.0 (JE0D)	123	11/96→10/98	←			13.0460-2832.2 602832	TRW 21888 18,1 + WK
			→			13.0460-4957.2 604957	BRE 20410 15,0 - WE / - WK
3.0 V6 24V (JE0G, JE0R)	140	10/98→10/02	←	→ 06/00		13.0460-2735.2 602735	TRW 23099 18,4 + WK + Zub
			←	07/00→		13.0460-2870.2 602870	TRW 23099 18,4 - WK
			→	07/00→		13.0460-2845.2 602845	TRW 23554 16,4 - WK + Zub
						13.0470-2845.2 LD2845	TRW 23554 16,4 - WK + Zub Ceramic
			→	→ 06/00		13.0460-4957.2 604957	BRE 20410 15,0 - WE / - WK
<b>Zubehörsatz, Scheibenbremsbelag</b>							
2.0 16V (JE0N, JE0L, JE02)	103	10/98→10/02	→	→ 06/00		13.0460-0438.2 610438	BRE
3.0 V6 24V (JE0G, JE0R)	140	10/98→10/02					
3.0 (JE0D)	123	11/96→10/98	→			13.0460-0438.2 610438	BRE
<b> Bremsscheibe</b>							
1.9 dTi (JE0M)	72	02/99→10/02	←			24.0124-0171.1 424171	Ø 280 24 21,8 V + S
2.0 (JE0A)	84	11/96→10/00				24.0324-0171.1 524171	Ø 280 24 21,8 V + S
2.2 12V TD (JE0E, JE0H, JE0P)	83	11/96→10/00					
2.2 D	84	11/97→01/00					
2.0	102	09/01→10/02	←			24.0124-0171.1 424171	Ø 280 24 21,8 V + S
2.0 16V (JE0N, JE0L, JE02)	103	10/98→10/02				24.0324-0171.1 524171	Ø 280 24 21,8 V + S
3.0 (JE0D)	123	11/96→10/98	→			24.0111-0151.1 411151	Ø 265 10,5 9,5
2.2 dCi (JE0K)	95	10/00→10/02	←			24.0128-0134.1 428134	Ø 305 28 26 V
			→			24.0111-0151.1 411151	Ø 265 10,5 9,5
2.2 dCi (JE0S)	85	07/00→10/02	←			24.0128-0134.1 428134	Ø 305 28 26 V
3.0 V6 24V (JE0G, JE0R)	140	10/98→10/02	←	07/00→		24.0128-0134.1 428134	Ø 305 28 26 V
			→			24.0111-0151.1 411151	Ø 265 10,5 9,5

























	kw					! #		
<b>RENAULT - ESPACE IV (JK0/1_) 11/02→</b>								
 <b>Bremsbelagsatz, Scheibenbremse</b>								
1.9 dCi (JK0U, JK0G)	88	11/02→	←				13.0460-7159.2 607159	ATE 23245 18,3 - WE / - WK
1.9 dCi (JK0U)	85	04/03→02/05					13.0470-7159.2 LD7159	ATE 23245 18,3 - WE / - WK Ceramic
2.0 (JK09)	100	11/02→						
2.0 (JK0A, JK1D, JK0N)	125	04/05→						
2.0 (JK0K)	98	11/02→02/05	→				13.0460-7137.2 607137	ATE 23482 15,8 - WE / - WK
2.0 dCi (JK01, JK02, JK1J, JK1K)	110	01/06→					13.0470-7137.2 LD7137	ATE 23482 15,8 - WE / - WK Ceramic
2.0 dCi (JK02, JK03)	96	01/06→						
2.0 dCi (JK03, JK04)	127	01/06→						
2.0 Turbo (JK0A, JK0B, JK0N)	120	11/02→						
2.2 dCi (JK07)	102	02/06→						
2.2 dCi (JK0H)	110	11/02→						
3.0 dCi (JK0E, JK0Y)	133	01/06→						
3.0 dCi (JK0J, JK0V)	130	11/02→						
3.5 V6 (JK00, JK0F, JK0P, JK0S, JK0W)	177	11/02→						
3.0 dCi	120	09/05→	←	09/09→			13.0460-7159.2 607159	ATE 23245 18,3 - WE / - WK
							13.0470-7159.2 LD7159	ATE 23245 18,3 - WE / - WK Ceramic
			→				13.0460-7137.2 607137	ATE 23482 15,8 - WE / - WK
							13.0470-7137.2 LD7137	ATE 23482 15,8 - WE / - WK Ceramic
 <b>Bremsscheibe</b>								
1.9 dCi (JK0U, JK0G)	88	11/02→	←	→ 09/03; für Leichtmetallfelgen			24.0128-0133.1 428133	Ø 324 28 25,4 V
2.0 (JK09)	100	11/02→	←	für Stahlfelgen			24.0128-0135.1 428135	Ø 308 28 25,8 V
			←	10/03→; für Leichtmetallfelgen			24.0128-0135.1 428135	Ø 308 28 25,8 V
			→	Achszapfendurchmesser [mm]: 30			24.0111-0100.2 411100	Ø 300 11 9,5 + LG / + ABS Ring
1.9 dCi (JK0U)	85	04/03→02/05	←				24.0128-0135.1 428135	Ø 308 28 25,8 V
2.0 (JK0A, JK1D, JK0N)	125	04/05→						
2.0 dCi (JK02, JK03)	96	01/06→	→	Achszapfendurchmesser [mm]: 30			24.0111-0100.2 411100	Ø 300 11 9,5 + LG / + ABS Ring
2.0 (JK0K)	98	11/02→02/05	←	für Leichtmetallfelgen			24.0128-0133.1 428133	Ø 324 28 25,4 V
			←	für Stahlfelgen			24.0128-0135.1 428135	Ø 308 28 25,8 V
			→	Achszapfendurchmesser [mm]: 30			24.0111-0100.2 411100	Ø 300 11 9,5 + LG / + ABS Ring
2.0 dCi (JK01, JK02, JK1J, JK1K)	110	01/06→	←				24.0128-0133.1 428133	Ø 324 28 25,4 V
2.0 dCi (JK03, JK04)	127	01/06→	→	Achszapfendurchmesser [mm]: 30			24.0111-0100.2 411100	Ø 300 11 9,5 + LG / + ABS Ring
2.2 dCi (JK07)	102	02/06→						
2.2 dCi (JK0H)	110	11/02→						
3.0 dCi	120	09/05→						
3.0 dCi (JK0E, JK0Y)	133	01/06→						
3.0 dCi (JK0J, JK0V)	130	11/02→						
3.5 V6 (JK00, JK0F, JK0P, JK0S, JK0W)	177	11/02→						
2.0 Turbo (JK0A, JK0B, JK0N)	120	11/02→	←	für Leichtmetallfelgen; Raddurchmesser [Zoll]: 18			24.0128-0133.1 428133	Ø 324 28 25,4 V
			←	→ 09/03; für Leichtmetallfelgen; Raddurchmesser [Zoll]: 17			24.0128-0133.1 428133	Ø 324 28 25,4 V
			←	→ 09/03; für Stahlfelgen			24.0128-0133.1 428133	Ø 324 28 25,4 V
			←	10/03→; für Stahlfelgen			24.0128-0135.1 428135	Ø 308 28 25,8 V
			←	10/03→; für Leichtmetallfelgen; Raddurchmesser [Zoll]: 17			24.0128-0135.1 428135	Ø 308 28 25,8 V
			→	Achszapfendurchmesser [mm]: 30			24.0111-0100.2 411100	Ø 300 11 9,5 + LG / + ABS Ring
<b>RENAULT - ESPACE V (JR_) 02/15→</b>								
 <b>Bremsscheibe</b>								
1.6 dCi 130	96	06/15→	←				24.0128-0245.1 428245	Ø 320 28 25,4 V + S
1.6 dCi 160	118	06/15→						
1.6 TCe 200	147	02/15→						
1.8 TCe 225	165	10/16→						
<b>RENAULT - EXPRESS Kasten/Kombi 07/95→03/98</b>								
 <b>Bremsbelagsatz, Scheibenbremse</b>								
1.9 D	47	07/95→03/98	←				13.0460-3911.2 603911	BDX 20905 18,0 + WK
<b>Zubehörsatz, Scheibenbremsbelag</b>								
1.9 D	47	07/95→03/98	←				13.0460-0411.2 610411	BDX
 <b>Bremsscheibe</b>								
1.9 D	47	07/95→03/98	←				24.0112-0116.1 412116	Ø 238 12 10,5 + S













	kw			 	! #		
<b>RENAULT - EXPRESS Pick-up 07/95→10/99</b>							
 <b>Bremsbelagsatz, Scheibenbremse</b>							
1.9 D	40	07/95→10/97	←	09/95→		13.0460-3911.2 603911	BDX 20905 18,0 + WK
1.9 D	47	07/95→10/99	←	→ 03/98		13.0460-3911.2 603911	BDX 20905 18,0 + WK
<b>Zubehörsatz, Scheibenbremsbelag</b>							
1.9 D	40	07/95→10/97	←	09/95→		13.0460-0411.2 610411	BDX
1.9 D	47	07/95→10/99	←	→ 03/98		13.0460-0411.2 610411	BDX
 <b>Bremsscheibe</b>							
1.9 D	40	07/95→10/97	←	09/95→		24.0112-0116.1 412116	Ø 238 12 10,5 + S
1.9 D	47	07/95→10/99	←	→ 03/98		24.0112-0116.1 412116	Ø 238 12 10,5 + S
<b>RENAULT - FLUENCE (L3_) 02/10→</b>							
 <b>Bremsbelagsatz, Scheibenbremse</b>							
1.5 dCi	70	07/14→	←			13.0460-7266.2 607266	ATE 24538 17,9 - WE / - WK
1.5 dCi (L30A)	63	02/10→	←			13.0470-7266.2 LD7266	ATE 24538 17,9 - WE / - WK
1.5 dCi (L30B)	78	02/10→	←				Ceramic
1.5 dCi (L30D, L30L, L306, L33F, L33L, L33M, L33V, L33W)	81	02/10→	→	- eFSB		13.0460-2740.2 602740	TRW 23554 17,0 - WE / - WK + Zub
1.5 dCi (L30S)	66	02/10→	→			13.0470-2740.2 LD2740	TRW 23554 17,0 - WE / - WK + Zub Ceramic
1.6 16V	78	02/10→	→				
1.6 16V (L301, L30F, L30P, L30R)	81	02/10→	→	+ eFSB		13.0460-2756.2 602756	TRW 24820 16,1 - WE / - WK + Zub
1.6 16V (L304, L305, L30H)	82	02/10→	→				
1.6 dCi	96	07/14→	←				
1.6 LPG 16V	81	01/12→	←				
2.0 16V (L30C, L30G, L30T, L30V)	103	02/10→	←				
1.6	86	01/13→	←			13.0460-7266.2 607266	ATE 24538 17,9 - WE / - WK
			→	- eFSB		13.0470-7266.2 LD7266	ATE 24538 17,9 - WE / - WK Ceramic
			→			13.0460-2740.2 602740	TRW 23554 17,0 - WE / - WK + Zub
			→			13.0470-2740.2 LD2740	TRW 23554 17,0 - WE / - WK + Zub Ceramic
Z.E.	70	02/12→	←			13.0460-7266.2 607266	ATE 24538 17,9 - WE / - WK
			→	+ eFSB; → 03/14		13.0470-7266.2 LD7266	ATE 24538 17,9 - WE / - WK Ceramic
			→			13.0460-2756.2 602756	TRW 24820 16,1 - WE / - WK + Zub
 <b>Bremsscheibe</b>							
1.5 dCi	70	07/14→	←			24.0124-0221.1 424221	Ø 280 24 21,8 V + S
1.5 dCi (L30A)	63	02/10→	→				
1.5 dCi (L30B)	78	02/10→	→			24.0108-0116.2 408116	Ø 260 8 7 + LG / + ABS Ring
1.5 dCi (L30D, L30L, L306, L33F, L33L, L33M, L33V, L33W)	81	02/10→	→				
1.5 dCi (L30S)	66	02/10→	→				
1.6	86	01/13→	→				
1.6 16V	78	02/10→	→				
1.6 16V (L301, L30F, L30P, L30R)	81	02/10→	→				
1.6 16V (L304, L305, L30H)	82	02/10→	→				
1.6 dCi	96	07/14→	←				
1.6 LPG 16V	81	01/12→	←				
2.0 16V (L30C, L30G, L30T, L30V)	103	02/10→	←				
Z.E.	70	02/12→	←			24.0124-0221.1 424221	Ø 280 24 21,8 V + S
			→			24.0111-0180.2 411180	Ø 274 11 9,5 + LG / + ABS Ring
<b>RENAULT - GRAND SCÉNIC II (JM0/1_) 04/04→</b>							
 <b>Bremsbelagsatz, Scheibenbremse</b>							
1.5 dCi	60	04/04→	←	→ 09/05		13.0460-3815.2 603815	BOS 23930 18,2 - WK + Zub
1.5 dCi (JM02, JM13)	74	04/04→	←			13.0470-3815.2 LD3815	BOS 23930 18,2 - WK + Zub
1.6	83	04/04→	←				Ceramic
1.9 dCi (JM0G, JM12, JM1G, JM2C)	88	04/04→	←	10/05→ 03/09		13.0460-7222.2 607222	ATE 23245 18,3 - WE / - WK
1.9 dCi (JM14)	96	05/05→	→	→ 03/09		13.0460-2845.2 602845	TRW 23554 16,4 - WK + Zub
1.9 dCi (JM15)	81	05/05→	→				
2.0	99	04/04→	→				











	kw			 	! #		
<b>RENAULT - GRAND SCÉNIC II (JM0/1_) 04/04→</b>							
 <b>Bremsbelagsatz, Scheibenbremse</b>							
2.0 2.0 dCi (JM1K)	120 110	04/04→ 09/05→	➡	→ 03/09		13.0470-2845.2 LD2845	TRW 23554 16,4 - WK + Zub Ceramic
1.5 dCi	76	06/06→11/08	←			13.0460-7222.2 607222	ATE 23245 18,3 - WE / - WK
1.6	82	06/06→11/08				13.0460-2845.2 602845	TRW 23554 16,4 - WK + Zub
1.6 Flex	82	06/06→11/08	➡			13.0470-2845.2 LD2845	TRW 23554 16,4 - WK + Zub Ceramic
1.5 dCi (JM1E)	78	05/05→	←	06/06→ 03/09		13.0460-7222.2 607222	ATE 23245 18,3 - WE / - WK
			➡	06/06→ 03/09		13.0460-2845.2 602845	TRW 23554 16,4 - WK + Zub
						13.0470-2845.2 LD2845	TRW 23554 16,4 - WK + Zub Ceramic
1.6	77	06/06→	←	→ 03/09		13.0460-7222.2 607222	ATE 23245 18,3 - WE / - WK
			➡	→ 03/09		13.0460-2845.2 602845	TRW 23554 16,4 - WK + Zub
						13.0470-2845.2 LD2845	TRW 23554 16,4 - WK + Zub Ceramic
1.9 dCi	85	05/05→01/09	←	→ 09/05		13.0460-3815.2 603815	BOS 23930 18,2 - WK + Zub
						13.0470-3815.2 LD3815	BOS 23930 18,2 - WK + Zub Ceramic
			←	10/05→		13.0460-7222.2 607222	ATE 23245 18,3 - WE / - WK
			➡			13.0460-2845.2 602845	TRW 23554 16,4 - WK + Zub
						13.0470-2845.2 LD2845	TRW 23554 16,4 - WK + Zub Ceramic
<b>Zubehörsatz, Scheibenbremsbelag</b>							
1.5 dCi	60	04/04→	➡	→ 03/09		13.0460-0072.2 610072	TRW
1.5 dCi (JM02, JM13)	74	04/04→					
1.6	77	06/06→					
1.6	83	04/04→					
1.9 dCi (JM0G, JM12, JM1G, JM2C)	88	04/04→					
1.9 dCi (JM14)	96	05/05→					
1.9 dCi (JM15)	81	05/05→					
2.0	99	04/04→					
2.0	120	04/04→					
2.0 dCi (JM1K)	110	09/05→					
1.5 dCi	76	06/06→11/08	➡			13.0460-0072.2 610072	TRW
1.6	82	06/06→11/08					
1.6 Flex	82	06/06→11/08					
1.9 dCi	85	05/05→01/09					
1.5 dCi (JM1E)	78	05/05→	➡	06/06→ 03/09		13.0460-0072.2 610072	TRW
 <b>Bremsscheibe</b>							
1.5 dCi	60	04/04→	←	→ 03/09		24.0124-0191.1 424191	Ø 300 24 21,8 V + S
1.5 dCi (JM02, JM13)	74	04/04→				24.0111-0148.2 411148	Ø 274 10,9 9,5 + LG / + ABS Ring
1.6	77	06/06→	➡	→ 03/09; Achszapfendurchmesser [mm]: 30			
1.6	83	04/04→					
1.9 dCi (JM0G, JM12, JM1G, JM2C)	88	04/04→					
1.9 dCi (JM14)	96	05/05→					
1.9 dCi (JM15)	81	05/05→					
1.5 dCi	76	06/06→11/08	←			24.0124-0191.1 424191	Ø 300 24 21,8 V + S
1.6	82	06/06→11/08				24.0111-0148.2 411148	Ø 274 10,9 9,5 + LG / + ABS Ring
1.6 Flex	82	06/06→11/08	➡	Achszapfendurchmesser [mm]: 30			
1.9 dCi	85	05/05→01/09					
2.0	99	04/04→					
1.5 dCi (JM1E)	78	05/05→	←	06/06→ 03/09		24.0124-0191.1 424191	Ø 300 24 21,8 V + S
			➡	06/06→ 03/09; Achszapfendurchmesser [mm]: 30		24.0111-0148.2 411148	Ø 274 10,9 9,5 + LG / + ABS Ring
2.0	120	04/04→	←	→ 03/09		24.0128-0223.1 428223	Ø 312,5 28 26 V + S
			➡	→ 03/09; Achszapfendurchmesser [mm]: 30		24.0111-0148.2 411148	Ø 274 10,9 9,5 + LG / + ABS Ring
2.0 dCi (JM1K)	110	09/05→	←	→ 03/09		24.0124-0224.1 424224	Ø 300 24 21,8 V + S
			➡	→ 03/09; Achszapfendurchmesser [mm]: 30		24.0111-0101.2 411101	Ø 274 10,9 9,5 + LG / + ABS Ring
<b>RENAULT - GRAND SCÉNIC III (JZ0/1_) 02/09→</b>							
 <b>Bremsbelagsatz, Scheibenbremse</b>							
1.2 TCe	85	04/12→	←			13.0460-7249.2 607249	ATE 24709 18,6 - WE / - WK
1.4 16V (JZ0F)	96	02/09→				13.0470-7249.2 LD7249	ATE 24709 18,6 - WE / - WK Ceramic
1.5 dCi	70	11/10→					
1.5 dCi	78	02/09→	➡	- eFSB		13.0460-2753.2 602753	TRW 23554 16,0 - WK + Zub
1.5 dCi	81	04/09→					

	kw			 	! #		
<b>RENAULT - GRAND SCÉNIC III (JZ0/1_) 02/09→</b>							
 <b>Bremsbelagsatz, Scheibenbremse</b>							
1.6 16V (JZ0U) 1.6 16V Bifuel 1.6 16V Bifuel 1.6 dCi (JZ00, JZ12) 1.6 E85 1.9 dCi 2.0 16V (JZ0G)	81 79 81 96 81 96 103	02/09→ 04/12→ 02/09→ 04/11→ 02/09→ 02/09→ 02/09→	➔	+ eFSB		13.0460-2757.2 602757	TRW 24820 16,1 - WE / - WK + Zub
1.2 TCe (JZ16)	97	01/13→	➔	03/13→		13.0460-7249.2 607249 13.0470-7249.2 LD7249	ATE 24709 18,6 - WE / - WK ATE 24709 18,6 - WE / - WK Ceramic
			➔	03/13→; - eFSB		13.0460-2753.2 602753	TRW 23554 16,0 - WK + Zub
			➔	03/13→; + eFSB		13.0460-2757.2 602757	TRW 24820 16,1 - WE / - WK + Zub
1.5 dCi	63	04/09→	➔			13.0460-7266.2 607266 13.0470-7266.2 LD7266	ATE 24538 17,9 - WE / - WK ATE 24538 17,9 - WE / - WK Ceramic
			➔	+ eFSB		13.0460-2757.2 602757	TRW 24820 16,1 - WE / - WK + Zub
2.0 dCi (JZ0L) 2.0 dCi (JZ0Y)	118 110	04/09→ 02/09→	➔			13.0460-7250.2 607250	ATE 24709 17,5 - WE / - WK
			➔	- eFSB		13.0460-2753.2 602753	TRW 23554 16,0 - WK + Zub
			➔	+ eFSB		13.0460-2757.2 602757	TRW 24820 16,1 - WE / - WK + Zub
 <b>Bremsscheibe</b>							
1.2 TCe 1.4 16V (JZ0F) 1.5 dCi 1.5 dCi 1.5 dCi 1.6 16V (JZ0U) 1.6 16V Bifuel 1.6 16V Bifuel 1.6 dCi (JZ00, JZ12) 1.6 E85 1.9 dCi 2.0 16V (JZ0G)	85 96 70 78 81 81 79 81 96 81 96 103	04/12→ 02/09→ 11/10→ 02/09→ 04/09→ 02/09→ 02/09→ 04/11→ 02/09→ 02/09→ 02/09→ 02/09→	➔			24.0126-0158.1 426158 24.0111-0180.2 411180	Ø 296 26 23,4 V + S Ø 274 11 9,5 + LG / + ABS Ring
1.2 TCe (JZ16)	97	01/13→	➔	03/13→		24.0126-0158.1 426158 24.0111-0180.2 411180	Ø 296 26 23,4 V + S Ø 274 11 9,5 + LG / + ABS Ring
1.5 dCi	63	04/09→	➔			24.0124-0221.1 424221 24.0108-0118.2 408118	Ø 280 24 21,8 V + S Ø 260 8 7 + LG / + ABS Ring
2.0 dCi (JZ0L) 2.0 dCi (JZ0Y)	118 110	04/09→ 02/09→	➔			24.0128-0245.1 428245 24.0111-0184.2 411184	Ø 320 28 25,4 V + S Ø 290 11 9,5 + LG / + ABS Ring
<b>RENAULT - GRAND SCÉNIC IV (R9_) 09/16→</b>							
 <b>Bremsbelagsatz, Scheibenbremse</b>							
1.2 TCe 115 1.2 TCe 130 1.5 dCi 110 1.5 dCi 110 Hybrid Assist 1.6 dCi 130 1.6 dCi 160	85 96 81 81 96 118	09/16→ 09/16→ 09/16→ 04/17→ 09/16→ 09/16→	➔	- eFSB		13.0460-2740.2 602740 13.0470-2740.2 LD2740	TRW 23554 17,0 - WE / - WK + Zub TRW 23554 17,0 - WE / - WK + Zub Ceramic
 <b>Bremsscheibe</b>							
1.2 TCe 115 1.2 TCe 130 1.5 dCi 110 1.5 dCi 110 Hybrid Assist 1.6 dCi 130 1.6 dCi 160	85 96 81 81 96 118	09/16→ 09/16→ 09/16→ 04/17→ 09/16→ 09/16→	➔			24.0128-0245.1 428245	Ø 320 28 25,4 V + S
<b>RENAULT - KADJAR (HA_, HL_) 06/15→</b>							
 <b>Bremsbelagsatz, Scheibenbremse</b>							
1.2 TCe 130 1.5 dCi 110 1.6 dCi 130 1.6 dCi 130 4x4 1.6 TCe 165	96 81 96 96 120	06/15→ 06/15→ 06/15→ 06/15→ 11/16→	➔			13.0460-5652.2 605652 13.0460-2600.2 602600	AKE 22065 17,7 + WK TRW 25965 15,0 + WK













	kw			 	! #			
<b>RENAULT - KADJAR (HA_, HL_) 06/15→</b>								
 <b>Bremsscheibe</b>								
1.2 TCe 130	96	06/15→	←			24.0126-0185.1 426185	Ø 296 26 24 V	
1.5 dCi 110	81	06/15→	→			24.0113-0200.1 413200	Ø 290 13 11	
1.6 dCi 130	96	06/15→						
1.6 dCi 130 4x4	96	06/15→						
1.6 TCe 165	120	11/16→						
<b>RENAULT - KANGOO / GRAND KANGOO (KW0/1_) 02/08→</b>								
 <b>Bremsbelagsatz, Scheibenbremse</b>								
1.2 TCe 115	84	07/13→	←			13.0460-2741.2 602741	TRW 24693 18,5 - WE / - WK + Zub	
1.5 dCi	55	11/12→						
1.5 dCi	66	11/12→						
1.5 dCi	78	02/08→						
1.5 dCi (KW0A)	50	02/08→						
1.5 dCi (KW0B)	63	02/08→						
1.5 dCi (KW0F)	76	02/08→						
1.5 dCi 110	80	09/10→		→			13.0460-2744.2 602744	TRW 24692 15,9 - WE / - WK + Zub
1.5 dCi 110	81	03/13→						
1.6 (KW00, KW0Y)	64	02/08→						
1.6 16V (KW0D)	78	02/08→						
1.6 16V Hi-Flex Z.E.	78	02/08→						
1.6 16V Hi-Flex Z.E.	44	10/11→						
1.5 dCi	67	08/17→	←	passend für Felgenreöße [Zoll]: 14		13.0460-2709.2 602709	TRW 23973 17,1 - WE / - WK + Zub	
1.6 16V LPG	78	12/08→			passend für Felgenreöße [Zoll]: 15,16		13.0470-2709.2 LD2709	TRW 23973 17,1 - WE / - WK + Zub Ceramic
					passend für Felgenreöße [Zoll]: 15,16; + WK		13.0460-2743.2 602743	TRW 24693 17,5 + WK
					passend für Felgenreöße [Zoll]: 15,16		13.0460-2744.2 602744	TRW 24692 15,9 - WE / - WK + Zub
 <b>Bremsscheibe</b>								
1.2 TCe 115	84	07/13→	←			24.0124-0222.1 424222	Ø 280 24 21,8 V + S	
1.5 dCi	55	11/12→					24.0126-0186.1 426186	Ø 280 26 23,8 V + S
1.5 dCi	66	11/12→	→			24.0111-0182.2 411182	Ø 274 11 9,5 + LG / + ABS Ring	
1.5 dCi 110	81	03/13→						
1.5 dCi	67	08/17→	←	passend für Felgenreöße [Zoll]: 14		24.0122-0270.1 422270	Ø 258 22 19,8 V + S	
					passend für Felgenreöße [Zoll]: 15,16		24.0124-0222.1 424222	Ø 280 24 21,8 V + S
					passend für Felgenreöße [Zoll]: 15,16		24.0126-0186.1 426186	Ø 280 26 23,8 V + S
					passend für Felgenreöße [Zoll]: 15,16		24.0111-0174.2 411174	Ø 274 11 9,5 + LG / + ABS Ring
						24.0111-0182.2 411182	Ø 274 11 9,5 + LG / + ABS Ring	
1.5 dCi	78	02/08→	←			24.0124-0222.1 424222	Ø 280 24 21,8 V + S	
1.5 dCi (KW0A)	50	02/08→						
1.5 dCi (KW0B)	63	02/08→						
1.5 dCi (KW0F)	76	02/08→		→	→ 10/11		24.0111-0174.2 411174	Ø 274 11 9,5 + LG / + ABS Ring
1.5 dCi 110	80	09/10→						
1.6 (KW00, KW0Y)	64	02/08→		→	11/11→		24.0111-0182.2 411182	Ø 274 11 9,5 + LG / + ABS Ring
1.6 16V (KW0D)	78	02/08→						
1.6 16V Hi-Flex	78	02/08→						
1.6 16V Hi-Flex	78	02/08→						
1.6 16V LPG	78	12/08→		←	passend für Felgenreöße [Zoll]: 14		24.0122-0270.1 422270	Ø 258 22 19,8 V + S
					passend für Felgenreöße [Zoll]: 15,16		24.0124-0222.1 424222	Ø 280 24 21,8 V + S
					passend für Felgenreöße [Zoll]: 15,16		24.0111-0182.2 411182	Ø 274 11 9,5 + LG / + ABS Ring
Z.E.	44	10/11→	←			24.0124-0222.1 424222	Ø 280 24 21,8 V + S	
							24.0126-0186.1 426186	Ø 280 26 23,8 V + S
					11/11→		24.0111-0182.2 411182	Ø 274 11 9,5 + LG / + ABS Ring
<b>RENAULT - KANGOO (KC0/1_) 08/97→</b>								
 <b>Bremsbelagsatz, Scheibenbremse</b>								
1.2 (KC0A, KC0K, KC0F, KC01)	43	08/97→	←	03/98→ 12/07; nicht für Postfahrzeuge		13.0460-3977.2 603977	BOS 21980 18,0 + WE / - WK	
1.4 (KC0C, KC0H, KC0B, KC0M)	55	08/97→						
D 55 1.9 (KC0D)	40	08/97→						
D 65 1.9 (KC0E, KC02, KC0J, KC0N)	47	08/97→						
1.2 16V (KC05, KC06, KC03, KC0T, KC0W, KC1D)	55	06/01→	←	→ 12/07; nicht für Postfahrzeuge		13.0460-3977.2 603977	BOS 21980 18,0 + WE / - WK	
1.5 dCi	42	07/03→						
1.5 dCi	45	04/05→06/10						
1.5 dCi	50	06/05→						
1.5 dCi	62	06/05→						













	kw				! #		
<b>RENAULT - KANGOO (KC0/1_) 08/97→</b>							
<b> Bremsbelagsatz, Scheibenbremse</b>							
1.5 dCi (KC07) 1.5 dCi (KC08, KC09)	48 60	12/01→ 07/02→	←	→ 12/07; nicht für Postfahrzeuge		13.0460-3977.2 603977	BOS 21980 18,0 + WE / - WK
1.6 16V bivalent 1.9 dTi (KC0U)	60 59	06/05→ 02/00→					
1.6 1.9 RXED Elect'road RE	66 48 22	09/99→06/01 09/99→06/01 01/02→12/04	←	nicht für Postfahrzeuge		13.0460-3977.2 603977	BOS 21980 18,0 + WE / - WK
1.6 16V	70	06/01→	←	→ 12/07; Frontantrieb; nicht für Postfahrzeuge		13.0460-3977.2 603977	BOS 21980 18,0 + WE / - WK
1.6 16V 4x4 (KC0P, KC0S, KC0L)	70	10/01→	←	→ 12/07		13.0460-3815.2 603815	BOS 23930 18,2 - WK + Zub
1.9 dCi 4x4 1.9 dCi 4x4 (KC0V)	62 59	10/03→ 10/01→				13.0470-3815.2 LD3815	BOS 23930 18,2 - WK + Zub Ceramic
			→	→ 12/07		13.0460-3988.2 603988 13.0470-3988.2 LD3988	BOS 23557 17,2 - WE / - WK Ceramic
<b> Bremsscheibe</b>							
1.2 (KC0A, KC0K, KC0F, KC01)	43	08/97→	←	03/98→ 12/07; - ABS		24.0120-0125.1 420125	Ø 238 20,1 17,7 V + S
D 55 1.9 (KC0D) D 65 1.9 (KC0E, KC02, KC0J, KC0N)	40 47	08/97→ 08/97→	←	03/98→ 12/07; + ABS		24.0121-0106.1 421106	Ø 259 20,7 17,7 V + S
1.2 16V (KC05, KC06, KC03, KC0T, KC0W, KC1D)	55	06/01→	←	→ 12/07; - ABS; für Fahrzeuge ohne verstärktes Fahrwerk		24.0120-0125.1 420125	Ø 238 20,1 17,7 V + S
			←	→ 12/07; + ABS; für Fahrzeuge mit verstärktem Fahrwerk		24.0121-0106.1 421106	Ø 259 20,7 17,7 V + S
1.4 (KC0C, KC0H, KC0B, KC0M)	55	08/97→	←	03/98→ 12/07; - ABS; für Fahrzeuge ohne verstärktes Fahrwerk		24.0120-0125.1 420125	Ø 238 20,1 17,7 V + S
			←	03/98→ 12/07; + ABS; für Fahrzeuge mit verstärktem Fahrwerk		24.0121-0106.1 421106	Ø 259 20,7 17,7 V + S
1.5 dCi 1.5 dCi 1.5 dCi 1.5 dCi (KC07) 1.5 dCi (KC08, KC09) 1.6 16V bivalent	42 50 62 48 60 60	07/03→ 06/05→ 06/05→ 12/01→ 07/02→ 06/05→	←	→ 12/07		24.0121-0106.1 421106	Ø 259 20,7 17,7 V + S
1.5 dCi 1.9 dTi (KC0U)	45 59	04/05→06/10 02/00→	←	→ 12/07; - ABS		24.0120-0125.1 420125	Ø 238 20,1 17,7 V + S
			←	→ 12/07; + ABS		24.0121-0106.1 421106	Ø 259 20,7 17,7 V + S
1.6	66	09/99→06/01	←			24.0121-0106.1 421106	Ø 259 20,7 17,7 V + S
1.6 16V	70	06/01→	←	→ 12/07; Frontantrieb		24.0121-0106.1 421106	Ø 259 20,7 17,7 V + S
1.6 16V 4x4 (KC0P, KC0S, KC0L)	70	10/01→	←	→ 12/07		24.0124-0158.1 424158	Ø 280 24 21,8 V + S
1.9 dCi 4x4 1.9 dCi 4x4 (KC0V)	62 59	10/03→ 10/01→	→	→ 12/07		24.0324-0158.1 524158 24.0112-0160.1 412160	Ø 280 24 21,8 V + S Ø 280,5 12 11
1.9 RXED	48	09/99→06/01	←	- ABS		24.0120-0125.1 420125	Ø 238 20,1 17,7 V + S
			←	+ ABS		24.0121-0106.1 421106	Ø 259 20,7 17,7 V + S
Elect'road RE	22	01/02→12/04	←			24.0120-0125.1 420125	Ø 238 20,1 17,7 V + S
<b>RENAULT - KANGOO BE BOP (KW0/1_) 02/09→</b>							
<b> Bremsbelagsatz, Scheibenbremse</b>							
1.5 dCi 1.5 dCi (KW0F) 1.5 dCi (KW0G) 1.5 dCi 75 1.6 (KW0D)	80 76 66 55 78	06/09→ 02/09→ 06/09→ 09/10→ 02/09→	←	passend für Felgengröße [Zoll]: 14; → 12/10		13.0460-2709.2 602709 13.0470-2709.2 LD2709	TRW 23973 17,1 - WE / - WK + Zub TRW 23973 17,1 - WE / - WK + Zub Ceramic
			←	passend für Felgengröße [Zoll]: 15 / 16; → 12/10		13.0460-2741.2 602741 13.0460-2742.2 602742 13.0460-2743.2 602743	TRW 24693 18,5 - WE / - WK + Zub TRW 24693 17,5 - WE / - WK + Zub TRW 24693 17,5 + WK
			→	passend für Felgengröße [Zoll]: 15 / 16; → 12/10		13.0460-2744.2 602744	TRW 24692 15,9 - WE / - WK + Zub
<b> Bremsscheibe</b>							
1.5 dCi 1.5 dCi (KW0F) 1.5 dCi (KW0G) 1.5 dCi 75 1.6 (KW0D)	80 76 66 55 78	06/09→ 02/09→ 06/09→ 09/10→ 02/09→	←	passend für Felgengröße [Zoll]: 14; → 12/10		24.0122-0270.1 422270	Ø 258 22 19,8 V + S
			←	passend für Felgengröße [Zoll]: 15 / 16; → 12/10		24.0124-0222.1 424222 24.0126-0186.1 426186	Ø 280 24 21,8 V + S Ø 280 26 23,8 V + S
			→	passend für Felgengröße [Zoll]: 15 / 16; → 12/10		24.0111-0174.2 411174	Ø 274 11 9,5 + LG / + ABS Ring







	kw			 	! #		
<b>RENAULT - KANGOO Express (FW0/1_) 02/08→</b>							
 <b>Bremsbelagsatz, Scheibenbremse</b>							
1.2 TCe 115 1.5 dCi 1.5 dCi (FW0F) 1.5 dCi 110 1.5 dCi 75 1.5 dCi 85 (FW0A, FW0B) 1.5 dCi 90 (FW0G) 1.6 1.6 16V 1.6 16V LPG	84 50 76 80 55 63 66 64 78 72	07/13→ 02/08→ 02/08→ 09/10→ 09/10→ 02/08→ 06/09→ 02/08→ 02/08→ 02/08→	← ← ← ← ← ← → →	passend für Felgenreöße [Zoll]: 14  passend für Felgenreöße [Zoll]: 15 / 16  passend für Felgenreöße [Zoll]: 15 / 16	  13.0460-2709.2 13.0470-2709.2  13.0460-2741.2 13.0460-2742.2 13.0460-2743.2 13.0460-2744.2	602709 LD2709  602741 602742 602743 602744	TRW 23973 17,1 - WE / - WK + Zub TRW 23973 17,1 - WE / - WK + Zub Ceramic TRW 24693 18,5 - WE / - WK + Zub TRW 24693 17,5 - WE / - WK + Zub TRW 24693 17,5 + WK TRW 24692 15,9 - WE / - WK + Zub
1.5 dCi 110	81	09/13→	← ← →	passend für Felgenreöße [Zoll]: 14  passend für Felgenreöße [Zoll]: 15 / 16	13.0460-2709.2 13.0470-2709.2  13.0460-2741.2 13.0460-2742.2 13.0460-2743.2 13.0460-2744.2	602709 LD2709  602741 602742 602743 602744	TRW 23973 17,1 - WE / - WK + Zub TRW 23973 17,1 - WE / - WK + Zub Ceramic TRW 24693 18,5 - WE / - WK + Zub TRW 24693 17,5 - WE / - WK + Zub TRW 24693 17,5 + WK TRW 24692 15,9 - WE / - WK + Zub
Z.E.	44	10/11→	← →	passend für Felgenreöße [Zoll]: 14  passend für Felgenreöße [Zoll]: 15 / 16	13.0460-2709.2 13.0470-2709.2  13.0460-2744.2	602709 LD2709  602744	TRW 23973 17,1 - WE / - WK + Zub TRW 23973 17,1 - WE / - WK + Zub Ceramic TRW 24692 15,9 - WE / - WK + Zub
 <b>Bremsscheibe</b>							
1.2 TCe 115	84	07/13→	← ← →	passend für Felgenreöße [Zoll]: 14  passend für Felgenreöße [Zoll]: 15 / 16  passend für Felgenreöße [Zoll]: 15 / 16	24.0122-0270.1 24.0124-0222.1 24.0111-0182.2	422270 424222 411182	Ø 258 22 19,8 V + S Ø 280 24 21,8 V + S Ø 274 11 9,5 + LG / + ABS Ring
1.5 dCi 1.5 dCi (FW0F) 1.5 dCi 110 1.5 dCi 75 1.5 dCi 85 (FW0A, FW0B) 1.5 dCi 90 (FW0G) 1.6 1.6 16V 1.6 16V LPG	50 76 80 55 63 66 64 78 72	02/08→ 02/08→ 09/10→ 09/10→ 02/08→ 06/09→ 02/08→ 02/08→ 02/08→	← ← ← → → →	passend für Felgenreöße [Zoll]: 14  passend für Felgenreöße [Zoll]: 15 / 16  passend für Felgenreöße [Zoll]: 15 / 16; → 10/11 11/11→; passend für Felgenreöße [Zoll]: 15 / 16	24.0122-0270.1 24.0124-0222.1 24.0111-0174.2 24.0111-0182.2	422270 424222 411174 411182	Ø 258 22 19,8 V + S Ø 280 24 21,8 V + S Ø 274 11 9,5 + LG / + ABS Ring Ø 274 11 9,5 + LG / + ABS Ring
1.5 dCi 110	81	09/13→	← ← →	passend für Felgenreöße [Zoll]: 14  passend für Felgenreöße [Zoll]: 15 / 16	24.0122-0270.1 24.0124-0222.1 24.0111-0182.2	422270 424222 411182	Ø 258 22 19,8 V + S Ø 280 24 21,8 V + S Ø 274 11 9,5 + LG / + ABS Ring
Z.E.	44	10/11→	← →	passend für Felgenreöße [Zoll]: 14  passend für Felgenreöße [Zoll]: 15 / 16	24.0122-0270.1 24.0111-0182.2	422270 411182	Ø 258 22 19,8 V + S Ø 274 11 9,5 + LG / + ABS Ring
<b>RENAULT - KANGOO Rapid (FC0/1_) 08/97→</b>							
 <b>Bremsbelagsatz, Scheibenbremse</b>							
1.0	50	01/02→01/07	←	07/03→	13.0460-3977.2	603977	BOS 21980 18,0 + WE / - WK
1.2 (FC01, FC0A, FC0F) 1.4 (FC0C, FC0B, FC0H, FC0M) D 55 1.9 (FC0D) D 65 1.9 (FC0E, FC02, FC0J, FC0N)	43 55 40 47	08/97→ 08/97→06/08 08/97→ 08/97→	←	03/98→ 12/07	13.0460-3977.2	603977	BOS 21980 18,0 + WE / - WK
1.2 (FC1A) 1.2 BiFuel 1.6 1.9 D (FC0J)	44 43 66 48	07/98→07/01 07/98→07/01 09/99→06/01 09/99→06/03	←		13.0460-3977.2	603977	BOS 21980 18,0 + WE / - WK
1.2 16V (FC05, FC0W, FC1D, FC1P, FC1K, FC0T) 1.5 dCi 1.5 dCi (FC07, FC1R) 1.5 dCi (FC08, FC09) 1.5 dCi (FC1E) 1.5 dCi (FC1G) 1.5 dCi (FC1R)	55 45 48 60 50 62 42	10/01→ 10/05→ 12/01→ 04/03→ 06/05→ 06/05→ 12/02→	←	→ 12/07	13.0460-3977.2	603977	BOS 21980 18,0 + WE / - WK









	kW			 	! #		
<b>RENAULT - KANGOO Rapid (FC0/1_) 08/97→</b>							
 <b>Bremsbelagsatz, Scheibenbremse</b>							
1.6 16V 1.6 16V bivalent 1.9 dCi (FC0V) 1.9 dTi (FC0U)	70 60 62 59	10/01→ 06/05→ 07/03→ 02/00→	←	→ 12/07		13.0460-3977.2 603977	BOS 21980 18,0 + WE / - WK
1.6 16V 4x4 (FC0L, FC0P, FC0S) 1.9 dCi 4x4 (FC0V) 1.9 dCi 4x4 (FC0V)	70 59 62	10/01→ 10/01→ 07/03→	←	→ 12/07		13.0460-3815.2 603815 13.0470-3815.2 LD3815	BOS 23930 18,2 - WK + Zub BOS 23930 18,2 - WK + Zub Ceramic
			→	→ 12/07		13.0460-3988.2 603988 13.0470-3988.2 LD3988	BOS 23557 17,2 - WE / - WK BOS 23557 17,2 - WE / - WK Ceramic
 <b>Bremsscheibe</b>							
1.0	50	01/02→01/07	←	07/03→; - ABS		24.0120-0125.1 420125	Ø 238 20,1 17,7 V + S
			←	07/03→		24.0121-0106.1 421106	Ø 259 20,7 17,7 V + S
1.2 (FC01, FC0A, FC0F) D 55 1.9 (FC0D) D 65 1.9 (FC0E, FC02, FC0J, FC0N)	43 40 47	08/97→ 08/97→ 08/97→	←	03/98→ 12/07; - ABS		24.0120-0125.1 420125	Ø 238 20,1 17,7 V + S
			←	03/98→ 12/07; + ABS		24.0121-0106.1 421106	Ø 259 20,7 17,7 V + S
1.2 (FC1A)	44	07/98→07/01	←	- ABS		24.0120-0125.1 420125	Ø 238 20,1 17,7 V + S
			←			24.0121-0106.1 421106	Ø 259 20,7 17,7 V + S
1.2 16V (FC05, FC0W, FC1D, FC1P, FC1K, FC0T) 1.5 dCi (FC08, FC09) 1.6 16V 1.6 16V bivalent 1.9 dCi (FC0V)	55 60 70 60 62	10/01→ 04/03→ 10/01→ 06/05→ 07/03→	←	→ 12/07		24.0121-0106.1 421106	Ø 259 20,7 17,7 V + S
1.2 BiFuel	43	07/98→07/01	←	- ABS		24.0120-0125.1 420125	Ø 238 20,1 17,7 V + S
			←	+ ABS		24.0121-0106.1 421106	Ø 259 20,7 17,7 V + S
1.4 (FC0C, FC0B, FC0H, FC0M)	55	08/97→06/08	←	03/98→ 12/07; - ABS; für Fahrzeuge ohne verstärktes Fahrwerk		24.0120-0125.1 420125	Ø 238 20,1 17,7 V + S
			←	03/98→ 12/07; + ABS; für Fahrzeuge mit verstärktem Fahrwerk		24.0121-0106.1 421106	Ø 259 20,7 17,7 V + S
1.5 dCi 1.5 dCi (FC07, FC1R) 1.5 dCi (FC1E)	45 48 50	10/05→ 12/01→ 06/05→	←	→ 12/07; - ABS		24.0120-0125.1 420125	Ø 238 20,1 17,7 V + S
			←	→ 12/07		24.0121-0106.1 421106	Ø 259 20,7 17,7 V + S
1.5 dCi (FC1G)	62	06/05→	←	→ 12/07; + ABS		24.0121-0106.1 421106	Ø 259 20,7 17,7 V + S
1.5 dCi (FC1R) 1.9 dTi (FC0U)	42 59	12/02→ 02/00→	←	→ 12/07; - ABS		24.0120-0125.1 420125	Ø 238 20,1 17,7 V + S
			←	→ 12/07; + ABS		24.0121-0106.1 421106	Ø 259 20,7 17,7 V + S
1.6	66	09/99→06/01	←			24.0121-0106.1 421106	Ø 259 20,7 17,7 V + S
1.6 16V 4x4 (FC0L, FC0P, FC0S)	70	10/01→	←	→ 12/07		24.0124-0158.1 424158 24.0324-0158.1 524158	Ø 280 24 21,8 V + S Ø 280 24 21,8 V + S
			→	→ 12/07		24.0112-0160.1 412160	Ø 280,5 12 11
1.9 D (FC0J)	48	09/99→06/03	←	+ ABS		24.0121-0106.1 421106	Ø 259 20,7 17,7 V + S
1.9 dCi 4x4 (FC0V) 1.9 dCi 4x4 (FC0V)	59 62	10/01→ 07/03→	←	→ 12/07		24.0121-0106.1 421106 24.0124-0158.1 424158 24.0324-0158.1 524158	Ø 259 20,7 17,7 V + S Ø 280 24 21,8 V + S Ø 280 24 21,8 V + S
			→	→ 12/07		24.0112-0160.1 412160	Ø 280,5 12 11
<b>RENAULT - KOLEOS I (HY_) 09/08→</b>							
 <b>Bremsbelagsatz, Scheibenbremse</b>							
2.0 dCi (HY0K) 2.0 dCi 4x4 (HY0B) 2.0 dCi 4x4 (HY0K) 2.5 (HY0C, HY0N) 2.5 4x4 (HY0C, HY0N)	110 127 110 126 126	09/08→ 09/08→ 09/08→ 09/08→ 09/08→	←			13.0460-5778.2 605778	SUM 23698 16,8 + WK
 <b>Bremsscheibe</b>							
2.0 dCi (HY0K) 2.0 dCi 4x4 (HY0B) 2.0 dCi 4x4 (HY0K) 2.5 (HY0C, HY0N) 2.5 4x4 (HY0C, HY0N)	110 127 110 126 126	09/08→ 09/08→ 09/08→ 09/08→ 09/08→	←			24.0128-0242.1 428242	Ø 320 28 26 V
			→			24.0116-0119.1 416119	Ø 292 16 14 V
<b>RENAULT - KOLEOS II 08/16→</b>							
 <b>Bremsbelagsatz, Scheibenbremse</b>							
1.6 dCi 130 2.0 dCi 175 (HCAK) ↓	96 130	08/16→ 08/16→	→	→ 03/18; + eFSB		13.0460-2600.2 602600	TRW 25965 15,0 + WK









	kw			 	! #		
<b>RENAULT - KOLEOS II 08/16→</b>							
 <b>Bremsbelagsatz, Scheibenbremse</b>							
2.0 dCi 175 4WD	130	08/16→	→	→ 03/18; + eFSB		<b>13.0460-2600.2 602600</b>	TRW 25965 15,0 + WK
 <b>Bremsscheibe</b>							
2.0 dCi 175 (HCAK)	130	08/16→	←			<b>24.0128-0291.1 428291</b>	Ø 320 28 26 V
2.0 dCi 175 4WD	130	08/16→					
<b>RENAULT - LAGUNA I (B56_, 556_) 11/93→08/02</b>							
 <b>Bremsbelagsatz, Scheibenbremse</b>							
1.6 16V (B568, B561)	79	11/97→03/01	←	04/99→ 02/01		<b>13.0460-2895.2 602895</b>	TRW 23172 18,0 - WK
			←	→ 03/99		<b>13.0460-2983.2 602983</b>	TRW 20919 18,0 + WK
1.8	69	06/95→02/01	←			<b>13.0460-2983.2 602983</b>	TRW 20919 18,0 + WK
1.8	70	06/95→06/98	→	→ 06/95; + ABS		<b>13.0460-4957.2 604957</b>	BRE 20410 15,0 - WE / - WK
1.8 (B56A/B)	66	11/93→03/01	←	→ 09/94; - ABS		<b>13.0460-2836.2 602836</b>	TRW 21595 18,3 + WK
			←	→ 02/01; + ABS		<b>13.0460-2983.2 602983</b>	TRW 20919 18,0 + WK
			→	→ 02/01; + ABS		<b>13.0460-4957.2 604957</b>	BRE 20410 15,0 - WE / - WK
1.8 (B56S/T/0)	66	08/95→03/01	←	→ 02/01		<b>13.0460-2983.2 602983</b>	TRW 20919 18,0 + WK
			→	→ 02/01; + ABS		<b>13.0460-4957.2 604957</b>	BRE 20410 15,0 - WE / - WK
1.8 (B56Z)	69	08/95→03/01	←	→ 02/01		<b>13.0460-2983.2 602983</b>	TRW 20919 18,0 + WK
1.8 16V (B563, B564)	88	04/98→03/01	←	04/99→ 02/01		<b>13.0460-2895.2 602895</b>	TRW 23172 18,0 - WK
1.9 dTi (B56J)	72	10/97→03/01	←	→ 03/99		<b>13.0460-2983.2 602983</b>	TRW 20919 18,0 + WK
			→	→ 02/01		<b>13.0460-4986.2 604986</b>	BRE 21965 15,0 - WE / - WK
1.9 dCi (B56W)	79	09/99→03/01	←	→ 02/01		<b>13.0460-2895.2 602895</b>	TRW 23172 18,0 - WK
2.0 16V (556A/B)	103	09/99→03/01	→	→ 02/01		<b>13.0460-4986.2 604986</b>	BRE 21965 15,0 - WE / - WK
2.0	80	03/99→03/01	←	04/99→ 02/01		<b>13.0460-2895.2 602895</b>	TRW 23172 18,0 - WK
			→	→ 02/01		<b>13.0460-4986.2 604986</b>	BRE 21965 15,0 - WE / - WK
2.0	84	06/95→02/01	←	04/99→		<b>13.0460-2895.2 602895</b>	TRW 23172 18,0 - WK
			←	→ 03/99		<b>13.0460-2983.2 602983</b>	TRW 20919 18,0 + WK
			→	Baccara		<b>13.0460-4957.2 604957</b>	BRE 20410 15,0 - WE / - WK
			→	→ 01/97; Initiale		<b>13.0460-4957.2 604957</b>	BRE 20410 15,0 - WE / - WK
			→	nicht für Ausstattungsvariante: Baccara/Initiale		<b>13.0460-4986.2 604986</b>	BRE 21965 15,0 - WE / - WK
			→	02/97→; Initiale		<b>13.0460-4986.2 604986</b>	BRE 21965 15,0 - WE / - WK
2.0 (556A)	102	09/99→02/01	←			<b>13.0460-2983.2 602983</b>	TRW 20919 18,0 + WK
			→			<b>13.0460-4986.2 604986</b>	BRE 21965 15,0 - WE / - WK
2.0 (B56C/H/N)	83	11/93→03/01	←	→ 02/01		<b>13.0460-2983.2 602983</b>	TRW 20919 18,0 + WK
			→	→ 02/01		<b>13.0460-4957.2 604957</b>	BRE 20410 15,0 - WE / - WK
			→	→ 06/95; + ABS		<b>13.0460-4957.2 604957</b>	BRE 20410 15,0 - WE / - WK
2.0 16V (B56D/M)	102	06/95→03/01	←	09/99→ 02/01		<b>13.0460-2983.2 602983</b>	TRW 20919 18,0 + WK
			←	→ 02/01		<b>13.0460-2983.2 602983</b>	TRW 20919 18,0 + WK
			→	→ 01/97; + ABS		<b>13.0460-4957.2 604957</b>	BRE 20410 15,0 - WE / - WK
			→	→ 12/97; - ABS		<b>13.0460-4957.2 604957</b>	BRE 20410 15,0 - WE / - WK
			→	01/98→ 02/01; - ABS		<b>13.0460-4986.2 604986</b>	BRE 21965 15,0 - WE / - WK
			→	09/99→ 02/01		<b>13.0460-4986.2 604986</b>	BRE 21965 15,0 - WE / - WK
			→	02/97→ 02/01; + ABS		<b>13.0460-4986.2 604986</b>	BRE 21965 15,0 - WE / - WK
2.2 D (B56F/2)	61	11/93→03/01	←	→ 02/94; - ABS		<b>13.0460-2836.2 602836</b>	TRW 21595 18,3 + WK
			←	→ 02/01; + ABS		<b>13.0460-2983.2 602983</b>	TRW 20919 18,0 + WK
			→	→ 06/95; + ABS		<b>13.0460-4957.2 604957</b>	BRE 20410 15,0 - WE / - WK
2.2 dT (B569)	83	03/96→03/01	←	09/99→ 02/01		<b>13.0460-2895.2 602895</b>	TRW 23172 18,0 - WK
			←	→ 08/99		<b>13.0460-2983.2 602983</b>	TRW 20919 18,0 + WK
			→	→ 12/97; - ABS		<b>13.0460-4957.2 604957</b>	BRE 20410 15,0 - WE / - WK
			→	→ 01/97; + ABS		<b>13.0460-4957.2 604957</b>	BRE 20410 15,0 - WE / - WK
			→	02/97→ 02/01; + ABS		<b>13.0460-4986.2 604986</b>	BRE 21965 15,0 - WE / - WK
			→	01/98→ 02/01; - ABS		<b>13.0460-4986.2 604986</b>	BRE 21965 15,0 - WE / - WK
3.0 (B56E/R, B565)	123	11/93→03/01	←	→ 02/01		<b>13.0460-2983.2 602983</b>	TRW 20919 18,0 + WK
			→	→ 01/97		<b>13.0460-4957.2 604957</b>	BRE 20410 15,0 - WE / - WK









	kw			 	! #		
<b>RENAULT - LAGUNA I (B56_, 556_) 11/93→08/02</b>							
<b>Bremsbelagsatz, Scheibenbremse</b>							
3.0 (B56E/R, B565)	123	11/93→03/01	➡	02/97→ 02/01		13.0460-4986.2 604986	BRE 21965 15,0 - WE / - WK
3.0 24V (B56V)	140	03/97→03/01	⬅	09/99→ 02/01		13.0460-2895.2 602895	TRW 23172 18,0 - WK
			⬅	→ 08/99		13.0460-2983.2 602983	TRW 20919 18,0 + WK
			➡	→ 02/01		13.0460-4986.2 604986	BRE 21965 15,0 - WE / - WK
<b>Zubehörsatz, Scheibenbremsbelag</b>							
1.6 16V (B568, B561)	79	11/97→03/01	⬅	04/99→ 02/01		13.0460-0262.2 610262	TRW
1.8 1.8 2.2 D (B56F/2)	69 70 61	06/95→02/01 06/95→06/98 11/93→03/01	➡	→ 06/95; + ABS		13.0460-0438.2 610438	BRE
			➡	→ 02/01; + ABS		13.0460-0438.2 610438	BRE
			⬅	04/99→ 02/01		13.0460-0262.2 610262	TRW
1.8 16V (B563, B564) 1.9 dTi (B56J) 2.0	88 72 80	04/98→03/01 10/97→03/01 03/99→03/01	⬅	04/99→ 02/01		13.0460-0262.2 610262	TRW
			➡	→ 02/01		13.0460-0438.2 610438	BRE
			⬅	→ 02/01		13.0460-0262.2 610262	TRW
1.9 dCi (B56W) 2.0 16V (556A/B)	79 103	09/99→03/01 09/99→03/01	⬅	→ 02/01		13.0460-0262.2 610262	TRW
			➡	→ 02/01		13.0460-0438.2 610438	BRE
			⬅	04/99→		13.0460-0262.2 610262	TRW
2.0	84	06/95→02/01	➡	nicht für Ausstattungsvariante: Baccara/ Initiale		13.0460-0438.2 610438	BRE
			➡	Baccara		13.0460-0438.2 610438	BRE
			➡	02/97→; Initiale		13.0460-0438.2 610438	BRE
			➡	→ 01/97; Initiale		13.0460-0438.2 610438	BRE
2.0 (556A)	102	09/99→02/01	➡			13.0460-0438.2 610438	BRE
2.0 (B56C/H/N)	83	11/93→03/01	➡	→ 02/01		13.0460-0438.2 610438	BRE
			➡	→ 06/95; + ABS		13.0460-0438.2 610438	BRE
2.0 16V (B56D/M)	102	06/95→03/01	➡	02/97→ 02/01; + ABS		13.0460-0438.2 610438	BRE
			➡	09/99→ 02/01		13.0460-0438.2 610438	BRE
			➡	→ 12/97; - ABS		13.0460-0438.2 610438	BRE
			➡	01/98→ 02/01; - ABS		13.0460-0438.2 610438	BRE
			➡	→ 01/97; + ABS		13.0460-0438.2 610438	BRE
2.2 dT (B569)	83	03/96→03/01	⬅	09/99→ 02/01		13.0460-0262.2 610262	TRW
			➡	02/97→ 02/01; + ABS		13.0460-0438.2 610438	BRE
			➡	→ 12/97; - ABS		13.0460-0438.2 610438	BRE
			➡	01/98→ 02/01; - ABS		13.0460-0438.2 610438	BRE
3.0 (B56E/R, B565)	123	11/93→03/01	➡	02/97→ 02/01		13.0460-0438.2 610438	BRE
			➡	→ 01/97		13.0460-0438.2 610438	BRE
			⬅	09/99→ 02/01		13.0460-0262.2 610262	TRW
3.0 24V (B56V)	140	03/97→03/01	➡	→ 02/01		13.0460-0438.2 610438	BRE
<b>Bremsscheibe</b>							
1.6 16V (B568, B561)	79	11/97→03/01	⬅	→ 02/01; Felge Lochzahl: 4		24.0124-0158.1 424158	Ø 280 24 21,8 V + S
						24.0324-0158.1 524158	Ø 280 24 21,8 V + S
1.8 1.8	69 70	06/95→02/01 06/95→06/98	⬅	Felge Lochzahl: 4		24.0122-0148.1 422148	Ø 262 22 19,8 V + S
			➡	→ 06/95; + ABS; Felge Lochzahl: 4		24.0110-0219.1 410219	Ø 265 10,5 9,5
1.8 (B56A/B)	66	11/93→03/01	⬅	→ 02/01; Felge Lochzahl: 4		24.0122-0148.1 422148	Ø 262 22 19,8 V + S
			➡	→ 02/01; + ABS; Felge Lochzahl: 4		24.0110-0219.1 410219	Ø 265 10,5 9,5
1.8 (B56S/T/0)	66	08/95→03/01	⬅	→ 04/98; Felge Lochzahl: 4		24.0122-0148.1 422148	Ø 262 22 19,8 V + S
			⬅	05/98→ 02/01; Felge Lochzahl: 4		24.0124-0158.1 424158	Ø 280 24 21,8 V + S
			➡	→ 02/01; + ABS; Felge Lochzahl: 4		24.0110-0219.1 410219	Ø 265 10,5 9,5
1.8 (B56Z)	69	08/95→03/01	⬅	→ 02/01; Felge Lochzahl: 4		24.0122-0148.1 422148	Ø 262 22 19,8 V + S
1.8 16V (B563, B564)	88	04/98→03/01	⬅	09/99→ 02/01; Felge Lochzahl: 4		24.0124-0158.1 424158	Ø 280 24 21,8 V + S
						24.0324-0158.1 524158	Ø 280 24 21,8 V + S
			⬅	→ 08/99; Felge Lochzahl: 5		24.0124-0171.1 424171	Ø 280 24 21,8 V + S
			➡	→ 08/99; Felge Lochzahl: 4		24.0324-0171.1 524171	Ø 280 24 21,8 V + S
			➡	→ 08/99; Felge Lochzahl: 4		24.0110-0219.1 410219	Ø 265 10,5 9,5











	kw			 	! #		
<b>RENAULT - LAGUNA I (B56_, 556_) 11/93→08/02</b>							
<b>Bremsscheibe</b>							
1.8 16V (B563, B564)	88	04/98→03/01	➔	09/99→ 02/01; Felge Lochzahl: 5		24.0110-0220.1 410220	Ø 265 10,5 9,5
1.9 dCi (B56W) 2.0 16V (556A/B)	79 103	09/99→03/01 09/99→03/01	➔	→ 02/01; Felge Lochzahl: 4		24.0124-0158.1 424158	Ø 280 24 21,8 V + S
			➔	→ 02/01; Felge Lochzahl: 4		24.0324-0158.1 524158	Ø 280 24 21,8 V + S
1.9 dTi (B56J) 2.0	72 80	10/97→03/01 03/99→03/01	➔	→ 02/01; Felge Lochzahl: 4		24.0110-0219.1 410219	Ø 265 10,5 9,5
			➔	→ 02/01; Felge Lochzahl: 4		24.0124-0158.1 424158	Ø 280 24 21,8 V + S
			➔	→ 02/01; Felge Lochzahl: 5		24.0324-0158.1 524158	Ø 280 24 21,8 V + S
			➔	→ 02/01; Felge Lochzahl: 5		24.0124-0171.1 424171	Ø 280 24 21,8 V + S
2.0	84	06/95→02/01	➔	→ 02/01; Felge Lochzahl: 5		24.0324-0171.1 524171	Ø 280 24 21,8 V + S
			➔	→ 02/01; Felge Lochzahl: 5		24.0110-0220.1 410220	Ø 265 10,5 9,5
			➔	→ 02/01; Felge Lochzahl: 5		24.0124-0171.1 424171	Ø 280 24 21,8 V + S
			➔	→ 02/01; Felge Lochzahl: 5		24.0324-0171.1 524171	Ø 280 24 21,8 V + S
			➔	→ 02/01; Felge Lochzahl: 5		24.0124-0158.1 424158	Ø 280 24 21,8 V + S
			➔	→ 02/01; Felge Lochzahl: 5		24.0324-0158.1 524158	Ø 280 24 21,8 V + S
			➔	→ 02/01; Felge Lochzahl: 5		24.0124-0171.1 424171	Ø 280 24 21,8 V + S
			➔	→ 02/01; Felge Lochzahl: 5		24.0324-0171.1 524171	Ø 280 24 21,8 V + S
2.0	103	06/95→02/01	➔	→ 04/98; Felge Lochzahl: 4		24.0110-0219.1 410219	Ø 265 10,5 9,5
			➔	→ 04/98; Felge Lochzahl: 5		24.0122-0148.1 422148	Ø 262 22 19,8 V + S
			➔	→ 04/98; Felge Lochzahl: 5		24.0122-0149.1 422149	Ø 262 22 19,8 V
			➔	→ 04/98; Felge Lochzahl: 5		24.0122-0149.1 422149	Ø 262 22 19,8 V
2.0 (556A)	102	09/99→02/01	➔	→ 05/98→; Felge Lochzahl: 4		24.0124-0158.1 424158	Ø 280 24 21,8 V + S
			➔	→ 05/98→; Felge Lochzahl: 4		24.0324-0158.1 524158	Ø 280 24 21,8 V + S
			➔	→ 05/98→; Felge Lochzahl: 5		24.0124-0171.1 424171	Ø 280 24 21,8 V + S
			➔	→ 05/98→; Felge Lochzahl: 5		24.0324-0171.1 524171	Ø 280 24 21,8 V + S
2.0 (B56C/H/N)	83	11/93→03/01	➔	→ 09/99→; Initiale; Felge Lochzahl: 4		24.0110-0219.1 410219	Ø 265 10,5 9,5
			➔	→ 09/99→; Initiale; Felge Lochzahl: 4		24.0110-0220.1 410220	Ø 265 10,5 9,5
			➔	→ 08/99; Initiale; Felge Lochzahl: 5		24.0110-0220.1 410220	Ø 265 10,5 9,5
			➔	→ 08/99; Initiale; Felge Lochzahl: 5		24.0110-0220.1 410220	Ø 265 10,5 9,5
2.0 16V (B56D/M)	102	06/95→03/01	➔	→ 08/99; Initiale; Felge Lochzahl: 5		24.0124-0171.1 424171	Ø 280 24 21,8 V + S
			➔	→ 08/99; Initiale; Felge Lochzahl: 5		24.0324-0171.1 524171	Ø 280 24 21,8 V + S
			➔	→ 08/99; Initiale; Felge Lochzahl: 5		24.0124-0171.1 424171	Ø 280 24 21,8 V + S
			➔	→ 08/99; Initiale; Felge Lochzahl: 5		24.0324-0171.1 524171	Ø 280 24 21,8 V + S
2.2 D (B56F/2)	61	11/93→03/01	➔	→ 02/01; Felge Lochzahl: 4		24.0110-0220.1 410220	Ø 265 10,5 9,5
			➔	→ 02/01; Felge Lochzahl: 4		24.0110-0220.1 410220	Ø 265 10,5 9,5
			➔	→ 02/01; Felge Lochzahl: 4		24.0110-0220.1 410220	Ø 265 10,5 9,5
			➔	→ 02/01; Felge Lochzahl: 4		24.0110-0220.1 410220	Ø 265 10,5 9,5
2.2 dT (B569) 3.0 24V (B56V)	83 140	03/96→03/01 03/97→03/01	➔	→ 02/01; Felge Lochzahl: 4		24.0124-0158.1 424158	Ø 280 24 21,8 V + S
			➔	→ 02/01; Felge Lochzahl: 4		24.0324-0158.1 524158	Ø 280 24 21,8 V + S
			➔	→ 08/99; Felge Lochzahl: 5		24.0124-0171.1 424171	Ø 280 24 21,8 V + S
			➔	→ 08/99; Felge Lochzahl: 5		24.0324-0171.1 524171	Ø 280 24 21,8 V + S
3.0 (B56E/R, B565)	123	11/93→03/01	➔	→ 09/99→ 02/01; Felge Lochzahl: 4		24.0110-0219.1 410219	Ø 265 10,5 9,5
			➔	→ 09/99→ 02/01; Felge Lochzahl: 4		24.0110-0220.1 410220	Ø 265 10,5 9,5
			➔	→ 09/99→ 02/01; Felge Lochzahl: 5		24.0110-0220.1 410220	Ø 265 10,5 9,5
			➔	→ 09/99→ 02/01; Felge Lochzahl: 5		24.0110-0220.1 410220	Ø 265 10,5 9,5
3.0 (B56E/R, B565)	123	11/93→03/01	➔	→ 02/01; Felge Lochzahl: 4		24.0124-0158.1 424158	Ø 280 24 21,8 V + S
			➔	→ 02/01; Felge Lochzahl: 4		24.0324-0158.1 524158	Ø 280 24 21,8 V + S
3.0 (B56E/R, B565)	123	11/93→03/01	➔	→ 02/01; Felge Lochzahl: 5		24.0124-0171.1 424171	Ø 280 24 21,8 V + S
			➔	→ 02/01; Felge Lochzahl: 5		24.0324-0171.1 524171	Ø 280 24 21,8 V + S
3.0 (B56E/R, B565)	123	11/93→03/01	➔	→ 02/01; Felge Lochzahl: 5		24.0110-0220.1 410220	Ø 265 10,5 9,5
			➔	→ 02/01; Felge Lochzahl: 5		24.0110-0220.1 410220	Ø 265 10,5 9,5

	kw			 	! #		
<b>RENAULT - LAGUNA I Grandtour (K56_) 09/95→08/02</b>							
<b> Bremsbelagsatz, Scheibenbremse</b>							
1.6 16V (K568)	79	11/97→03/01	←	02/99→ 02/01		<b>13.0460-2895.2 602895</b>	TRW 23172 18,0 - WK
			←	→ 02/01		<b>13.0460-2983.2 602983</b>	TRW 20919 18,0 + WK
1.8 (K56S/T/0)	66	09/95→03/01	←	→ 02/01		<b>13.0460-2983.2 602983</b>	TRW 20919 18,0 + WK
1.8 (K56Z)	69	09/95→03/01	→	→ 05/96; + ABS		<b>13.0460-4957.2 604957</b>	BRE 20410 15,0 - WE / - WK
2.2 D (K56F/2, S56F)	61	09/95→03/01	→	→ 05/96; + ABS		<b>13.0460-4957.2 604957</b>	BRE 20410 15,0 - WE / - WK
1.8 16V (K563, K564)	88	04/98→03/01	←	05/99→ 02/01		<b>13.0460-2895.2 602895</b>	TRW 23172 18,0 - WK
			←	→ 02/01		<b>13.0460-2983.2 602983</b>	TRW 20919 18,0 + WK
			←	02/99→ 02/01		<b>13.0460-2983.2 602983</b>	TRW 20919 18,0 + WK
			→	→ 02/01		<b>13.0460-4986.2 604986</b>	BRE 21965 15,0 - WE / - WK
1.9 dCi (K56W)	79	09/99→03/01	←	→ 02/01		<b>13.0460-2895.2 602895</b>	TRW 23172 18,0 - WK
2.0 16V (A56A/B)	103	09/99→03/01	→	→ 02/01		<b>13.0460-4986.2 604986</b>	BRE 21965 15,0 - WE / - WK
1.9 dTi (K56J)	72	10/97→03/01	←	→ 02/01		<b>13.0460-2983.2 602983</b>	TRW 20919 18,0 + WK
3.0 24V (K56V)	140	03/97→03/01	→	→ 02/01		<b>13.0460-4986.2 604986</b>	BRE 21965 15,0 - WE / - WK
2.0	84	10/98→01/01	←			<b>13.0460-2983.2 602983</b>	TRW 20919 18,0 + WK
			→	+ ABS		<b>13.0460-4957.2 604957</b>	BRE 20410 15,0 - WE / - WK
2.0 (K56C/H)	83	09/95→03/01	←	11/95→ 02/01		<b>13.0460-2983.2 602983</b>	TRW 20919 18,0 + WK
			←	→ 02/01		<b>13.0460-2983.2 602983</b>	TRW 20919 18,0 + WK
			→	→ 05/96; + ABS		<b>13.0460-4957.2 604957</b>	BRE 20410 15,0 - WE / - WK
			→	11/95→ 05/96; + ABS		<b>13.0460-4957.2 604957</b>	BRE 20410 15,0 - WE / - WK
2.0 16V (K56D/M)	102	09/95→03/01	←	09/99→ 02/01		<b>13.0460-2895.2 602895</b>	TRW 23172 18,0 - WK
			←	→ 02/01		<b>13.0460-2983.2 602983</b>	TRW 20919 18,0 + WK
			→	→ 02/01		<b>13.0460-4957.2 604957</b>	BRE 20410 15,0 - WE / - WK
			→	→ 01/97		<b>13.0460-4957.2 604957</b>	BRE 20410 15,0 - WE / - WK
			→	09/99→ 02/01		<b>13.0460-4986.2 604986</b>	BRE 21965 15,0 - WE / - WK
			→	02/97→ 02/01		<b>13.0460-4986.2 604986</b>	BRE 21965 15,0 - WE / - WK
2.2 dT (K569)	83	03/96→03/01	←	→ 02/01		<b>13.0460-2983.2 602983</b>	TRW 20919 18,0 + WK
			→	→ 01/97		<b>13.0460-4957.2 604957</b>	BRE 20410 15,0 - WE / - WK
			→	02/97→ 02/01		<b>13.0460-4986.2 604986</b>	BRE 21965 15,0 - WE / - WK
3.0 (K56R, K565)	123	02/96→03/01	←	→ 02/01		<b>13.0460-2983.2 602983</b>	TRW 20919 18,0 + WK
			→	→ 02/01		<b>13.0460-4957.2 604957</b>	BRE 20410 15,0 - WE / - WK
			→	03/96→ 02/01		<b>13.0460-4957.2 604957</b>	BRE 20410 15,0 - WE / - WK
<b>Zubehörsatz, Scheibenbremsbelag</b>							
1.6 16V (K568)	79	11/97→03/01	←	02/99→ 02/01		<b>13.0460-0262.2 610262</b>	TRW
1.8 (K56S/T/0)	66	09/95→03/01	→	→ 05/96; + ABS		<b>13.0460-0438.2 610438</b>	BRE
1.8 (K56Z)	69	09/95→03/01	→	→ 05/96; + ABS		<b>13.0460-0438.2 610438</b>	BRE
2.2 D (K56F/2, S56F)	61	09/95→03/01	→	→ 05/96; + ABS		<b>13.0460-0438.2 610438</b>	BRE
1.8 16V (K563, K564)	88	04/98→03/01	←	05/99→ 02/01		<b>13.0460-0262.2 610262</b>	TRW
			→	→ 02/01		<b>13.0460-0438.2 610438</b>	BRE
1.9 dCi (K56W)	79	09/99→03/01	←	→ 02/01		<b>13.0460-0262.2 610262</b>	TRW
2.0 16V (A56A/B)	103	09/99→03/01	→	→ 02/01		<b>13.0460-0438.2 610438</b>	BRE
1.9 dTi (K56J)	72	10/97→03/01	→	→ 02/01		<b>13.0460-0438.2 610438</b>	BRE
3.0 24V (K56V)	140	03/97→03/01	→	→ 02/01		<b>13.0460-0438.2 610438</b>	BRE
2.0	84	10/98→01/01	→	+ ABS		<b>13.0460-0438.2 610438</b>	BRE
2.0 (K56C/H)	83	09/95→03/01	→	11/95→ 05/96; + ABS		<b>13.0460-0438.2 610438</b>	BRE
			→	→ 05/96; + ABS		<b>13.0460-0438.2 610438</b>	BRE
2.0 16V (K56D/M)	102	09/95→03/01	←	09/99→ 02/01		<b>13.0460-0262.2 610262</b>	TRW
			→	→ 02/01		<b>13.0460-0438.2 610438</b>	BRE
			→	02/97→ 02/01		<b>13.0460-0438.2 610438</b>	BRE
			→	→ 01/97		<b>13.0460-0438.2 610438</b>	BRE
			→	09/99→ 02/01		<b>13.0460-0438.2 610438</b>	BRE
2.2 dT (K569)	83	03/96→03/01	→	02/97→ 02/01		<b>13.0460-0438.2 610438</b>	BRE
			→	→ 01/97		<b>13.0460-0438.2 610438</b>	BRE
3.0 (K56R, K565)	123	02/96→03/01	→	→ 02/01		<b>13.0460-0438.2 610438</b>	BRE
			→	03/96→ 02/01		<b>13.0460-0438.2 610438</b>	BRE
↓							

	kw			 	! #		
<b>RENAULT - LAGUNA I Grandtour (K56_) 09/95→08/02</b>							
<b>Bremsscheibe</b>							
1.6 16V (K568) 1.9 dCi (K56W)	79 79	11/97→03/01 09/99→03/01	←	→ 02/01; Felge Lochzahl: 4		24.0124-0158.1 424158 24.0324-0158.1 524158	Ø 280 24 21,8 V + S Ø 280 24 21,8 V + S
1.8 (K56S/T/0)	66	09/95→03/01	←	→ 02/01; Felge Lochzahl: 4		24.0122-0148.1 422148	Ø 262 22 19,8 V + S
			←	→ 04/98; Felge Lochzahl: 4		24.0122-0148.1 422148	Ø 262 22 19,8 V + S
			←	05/98→ 02/01; Felge Lochzahl: 4		24.0124-0158.1 424158 24.0324-0158.1 524158	Ø 280 24 21,8 V + S Ø 280 24 21,8 V + S
			→	→ 05/96; + ABS; Felge Lochzahl: 4		24.0110-0219.1 410219	Ø 265 10,5 9,5
1.8 (K56Z) 2.2 D (K56F/2, S56F)	69 61	09/95→03/01 09/95→03/01	←	→ 02/01; Felge Lochzahl: 4		24.0122-0148.1 422148	Ø 262 22 19,8 V + S
			→	→ 05/96; + ABS; Felge Lochzahl: 4		24.0110-0219.1 410219	Ø 265 10,5 9,5
1.8 16V (K563, K564)	88	04/98→03/01	←	→ 02/01; Felge Lochzahl: 4		24.0124-0158.1 424158 24.0324-0158.1 524158	Ø 280 24 21,8 V + S Ø 280 24 21,8 V + S
			←	02/99→ 02/01; Felge Lochzahl: 4		24.0124-0158.1 424158 24.0324-0158.1 524158	Ø 280 24 21,8 V + S Ø 280 24 21,8 V + S
			←	05/99→ 02/01; Felge Lochzahl: 4		24.0124-0158.1 424158 24.0324-0158.1 524158	Ø 280 24 21,8 V + S Ø 280 24 21,8 V + S
			←	→ 02/01; Felge Lochzahl: 5		24.0124-0171.1 424171 24.0324-0171.1 524171	Ø 280 24 21,8 V + S Ø 280 24 21,8 V + S
			→	→ 02/01; Felge Lochzahl: 5		24.0110-0220.1 410220	Ø 265 10,5 9,5
			←	→ 02/01; Felge Lochzahl: 4		24.0124-0158.1 424158 24.0324-0158.1 524158	Ø 280 24 21,8 V + S Ø 280 24 21,8 V + S
1.9 dTi (K56J)	72	10/97→03/01	←	→ 02/01; Felge Lochzahl: 4		24.0124-0158.1 424158 24.0324-0158.1 524158	Ø 280 24 21,8 V + S Ø 280 24 21,8 V + S
			→	→ 02/01; Felge Lochzahl: 5		24.0110-0220.1 410220	Ø 265 10,5 9,5
2.0	84	10/98→01/01	←	Felge Lochzahl: 4		24.0122-0148.1 422148	Ø 262 22 19,8 V + S
			→	+ ABS; Felge Lochzahl: 4		24.0110-0219.1 410219	Ø 265 10,5 9,5
2.0 (K56C/H)	83	09/95→03/01	←	11/95→ 04/98; Felge Lochzahl: 4		24.0122-0148.1 422148	Ø 262 22 19,8 V + S
			←	→ 02/01; Felge Lochzahl: 4		24.0122-0148.1 422148	Ø 262 22 19,8 V + S
			←	05/98→ 02/01; Felge Lochzahl: 4		24.0124-0158.1 424158 24.0324-0158.1 524158	Ø 280 24 21,8 V + S Ø 280 24 21,8 V + S
			→	→ 05/96; + ABS; Felge Lochzahl: 4		24.0110-0219.1 410219	Ø 265 10,5 9,5
			→	11/95→ 05/96; + ABS; Felge Lochzahl: 4		24.0110-0219.1 410219	Ø 265 10,5 9,5
2.0 16V (A56A/B)	103	09/99→03/01	←	→ 02/01; Felge Lochzahl: 4		24.0124-0158.1 424158 24.0324-0158.1 524158	Ø 280 24 21,8 V + S Ø 280 24 21,8 V + S
			←	→ 02/01; Felge Lochzahl: 5		24.0124-0171.1 424171 24.0324-0171.1 524171	Ø 280 24 21,8 V + S Ø 280 24 21,8 V + S
			→	→ 02/01; Felge Lochzahl: 5		24.0110-0220.1 410220	Ø 265 10,5 9,5
2.0 16V (K56D/M)	102	09/95→03/01	←	09/99→ 02/01; Felge Lochzahl: 4		24.0124-0158.1 424158 24.0324-0158.1 524158	Ø 280 24 21,8 V + S Ø 280 24 21,8 V + S
			←	→ 02/01; Felge Lochzahl: 5		24.0124-0171.1 424171 24.0324-0171.1 524171	Ø 280 24 21,8 V + S Ø 280 24 21,8 V + S
			→	09/99→ 02/01; Felge Lochzahl: 4		24.0110-0219.1 410219	Ø 265 10,5 9,5
			→	→ 02/01; Felge Lochzahl: 4		24.0110-0219.1 410219	Ø 265 10,5 9,5
			→	→ 02/01; Felge Lochzahl: 5		24.0110-0220.1 410220	Ø 265 10,5 9,5
2.2 dT (K569)	83	03/96→03/01	←	→ 02/01; Felge Lochzahl: 4		24.0124-0158.1 424158 24.0324-0158.1 524158	Ø 280 24 21,8 V + S Ø 280 24 21,8 V + S
			←	→ 02/01; Felge Lochzahl: 5		24.0124-0171.1 424171 24.0324-0171.1 524171	Ø 280 24 21,8 V + S Ø 280 24 21,8 V + S
			→	→ 02/01; Felge Lochzahl: 4		24.0110-0219.1 410219	Ø 265 10,5 9,5
			→	→ 02/01; Felge Lochzahl: 5		24.0110-0220.1 410220	Ø 265 10,5 9,5
			←	→ 02/01; Felge Lochzahl: 5		24.0124-0171.1 424171 24.0324-0171.1 524171	Ø 280 24 21,8 V + S Ø 280 24 21,8 V + S
3.0 (K56R, K565)	123	02/96→03/01	←	→ 02/01; Felge Lochzahl: 5		24.0124-0171.1 424171 24.0324-0171.1 524171	Ø 280 24 21,8 V + S Ø 280 24 21,8 V + S
			→	→ 02/01; Felge Lochzahl: 4		24.0110-0219.1 410219	Ø 265 10,5 9,5
			→	03/96→ 02/01; Felge Lochzahl: 4		24.0110-0219.1 410219	Ø 265 10,5 9,5
3.0 24V (K56V)	140	03/97→03/01	←	09/99→ 02/01; Felge Lochzahl: 4		24.0124-0158.1 424158 24.0324-0158.1 524158	Ø 280 24 21,8 V + S Ø 280 24 21,8 V + S
			←	→ 08/99; Felge Lochzahl: 5		24.0124-0171.1 424171 24.0324-0171.1 524171	Ø 280 24 21,8 V + S Ø 280 24 21,8 V + S
			→	→ 02/01; Felge Lochzahl: 5		24.0110-0220.1 410220	Ø 265 10,5 9,5



	kw			 	! #			
<b>RENAULT - LAGUNA II (BG0/1_) 03/01→12/07</b>								
<b> Bremsbelagsatz, Scheibenbremse</b>								
1.6	76	03/01→05/05	←	für Bremsscheibendurchmesser [mm]:		<b>13.0460-7157.2</b>	<b>607157</b>	ATE 23215 18,3 - WE / - WK
1.6 16V (BG0A, BG0L)	79	03/01→05/05		280		<b>13.0470-7157.2</b>	<b>LD7157</b>	ATE 23215 18,3 - WE / - WK
1.6 LPG	79	03/01→05/05						Ceramic
1.8 16V (BG04, BG0B, BG0C, BG0V)	86	03/01→05/05	←	für Bremsscheibendurchmesser [mm]:		<b>13.0460-7158.2</b>	<b>607158</b>	ATE 23245 18,3 - WE / - WK
1.8 16V (BG0B, BG0C, BG0J, BG0M, BG0V)	89	03/01→05/05		300		<b>13.0470-7158.2</b>	<b>LD7158</b>	ATE 23245 18,3 - WE / - WK
1.9 dCi (BG05)	68	03/04→05/05	→			<b>13.0460-7137.2</b>	<b>607137</b>	ATE 23482 15,8 - WE / - WK
1.9 dCi (BG0E)	77	06/01→05/05						
1.9 dCi (BG0R)	74	10/01→05/05				<b>13.0470-7137.2</b>	<b>LD7137</b>	ATE 23482 15,8 - WE / - WK
2.0 16V (BG00, BG0W, BG0K, BG0P)	98	08/02→12/06						Ceramic
1.6 16V (BG1G, BG1H)	82	02/05→08/07	←	→ 06/07;		<b>13.0460-7157.2</b>	<b>607157</b>	ATE 23215 18,3 - WE / - WK
1.8 16V (BG06, BG0J, BG0M)	85	03/01→12/07		für Bremsscheibendurchmesser [mm]:		<b>13.0470-7157.2</b>	<b>LD7157</b>	ATE 23215 18,3 - WE / - WK
1.8 16V (BG0B, BG0M)	88	03/01→09/07	←	280				Ceramic
1.9 dCi	79	03/01→09/07				<b>13.0460-7158.2</b>	<b>607158</b>	ATE 23245 18,3 - WE / - WK
1.9 dCi	92	09/05→12/07	←	→ 06/07;		<b>13.0470-7158.2</b>	<b>LD7158</b>	ATE 23245 18,3 - WE / - WK
1.9 dCi (BG08, BG0G)	88	03/01→09/07		für Bremsscheibendurchmesser [mm]:				Ceramic
1.9 dCi (BG12)	85	09/05→12/07		300				
1.9 dCi (BG1A, BG1V)	96	05/05→08/07	→	→ 06/07		<b>13.0460-7137.2</b>	<b>607137</b>	ATE 23482 15,8 - WE / - WK
1.9 dCi (BG1A, BG1W)	81	01/05→08/07				<b>13.0470-7137.2</b>	<b>LD7137</b>	ATE 23482 15,8 - WE / - WK
2.0 16V (BG00, BG0K, BG0P, BG0W)	99	08/02→12/07						Ceramic
2.0 16V IDE (BG0N)	103	04/01→09/07						
2.0 16V (BG03, BG0Z, BG0T, BG1Y)	125	01/05→09/07	←	→ 06/07		<b>13.0460-7159.2</b>	<b>607159</b>	ATE 23245 18,3 - WE / - WK
2.0 16V (BG1Y)	150	01/05→09/07				<b>13.0470-7159.2</b>	<b>LD7159</b>	ATE 23245 18,3 - WE / - WK
2.0 dCi (BG14, BG1S)	127	01/06→08/07						Ceramic
3.0 V6 24V (BG01, BG02, BG0D, BG0Y)	152	03/01→08/07	→	→ 06/07		<b>13.0460-7137.2</b>	<b>607137</b>	ATE 23482 15,8 - WE / - WK
						<b>13.0470-7137.2</b>	<b>LD7137</b>	ATE 23482 15,8 - WE / - WK
2.0 16V Turbo (BG0S, BG1L, BG1M)	120	01/03→03/05	←			<b>13.0460-7159.2</b>	<b>607159</b>	ATE 23245 18,3 - WE / - WK
2.0 dCi (BG1T)	110	08/05→08/06				<b>13.0470-7159.2</b>	<b>LD7159</b>	ATE 23245 18,3 - WE / - WK
2.9 V6 24V	155	03/01→08/07	→			<b>13.0460-7137.2</b>	<b>607137</b>	ATE 23482 15,8 - WE / - WK
						<b>13.0470-7137.2</b>	<b>LD7137</b>	ATE 23482 15,8 - WE / - WK
2.2 dCi	102	05/05→08/07	←	→ 06/07		<b>13.0460-7158.2</b>	<b>607158</b>	ATE 23245 18,3 - WE / - WK
			→	→ 06/07		<b>13.0470-7158.2</b>	<b>LD7158</b>	ATE 23245 18,3 - WE / - WK
			→	→ 06/07		<b>13.0460-7137.2</b>	<b>607137</b>	ATE 23482 15,8 - WE / - WK
						<b>13.0470-7137.2</b>	<b>LD7137</b>	ATE 23482 15,8 - WE / - WK
2.2 dCi (BG09)	85	04/04→10/05	←			<b>13.0460-7158.2</b>	<b>607158</b>	ATE 23245 18,3 - WE / - WK
						<b>13.0460-7159.2</b>	<b>607159</b>	ATE 23245 18,3 - WE / - WK
						<b>13.0470-7158.2</b>	<b>LD7158</b>	ATE 23245 18,3 - WE / - WK
						<b>13.0470-7159.2</b>	<b>LD7159</b>	ATE 23245 18,3 - WE / - WK
			→			<b>13.0460-7137.2</b>	<b>607137</b>	ATE 23482 15,8 - WE / - WK
						<b>13.0470-7137.2</b>	<b>LD7137</b>	ATE 23482 15,8 - WE / - WK
2.2 dCi (BG0F)	110	10/01→08/06	←	→ 11/01		<b>13.0460-7158.2</b>	<b>607158</b>	ATE 23245 18,3 - WE / - WK
			←	05/05→		<b>13.0460-7158.2</b>	<b>607158</b>	ATE 23245 18,3 - WE / - WK
						<b>13.0470-7158.2</b>	<b>LD7158</b>	ATE 23245 18,3 - WE / - WK
			←	12/01→ 04/05		<b>13.0460-7159.2</b>	<b>607159</b>	ATE 23245 18,3 - WE / - WK
						<b>13.0470-7159.2</b>	<b>LD7159</b>	ATE 23245 18,3 - WE / - WK
			→			<b>13.0460-7137.2</b>	<b>607137</b>	ATE 23482 15,8 - WE / - WK
						<b>13.0470-7137.2</b>	<b>LD7137</b>	ATE 23482 15,8 - WE / - WK
								Ceramic
<b> Bremsscheibe</b>								
1.6	76	03/01→05/05	←			<b>24.0124-0169.1</b>	<b>424169</b>	Ø 280 24 21,8 V
1.6 16V (BG0A, BG0L)	79	03/01→05/05				<b>24.0126-0123.1</b>	<b>426123</b>	Ø 300 26 22,8 V
1.6 LPG	79	03/01→05/05				<b>24.0326-0123.1</b>	<b>526123</b>	Ø 300 26 22,8 V
1.8 16V (BG04, BG0B, BG0C, BG0V)	86	03/01→05/05	→					
1.8 16V (BG0B, BG0C, BG0J, BG0M, BG0V)	89	03/01→05/05				<b>24.0111-0101.2</b>	<b>411101</b>	Ø 274 10,9 9,5 + LG / + ABS Ring

**RENAULT - LAGUNA II (BG0/1\_) 03/01→12/07**

**Bremsscheibe**









1.9 dCi (BG05)	68	03/04→05/05	←			24.0124-0169.1	424169	Ø 280 24 21,8 V
1.9 dCi (BG0E)	77	06/01→05/05				24.0126-0123.1	426123	Ø 300 26 22,8 V
1.9 dCi (BG0R)	74	10/01→05/05				24.0326-0123.1	526123	Ø 300 26 22,8 V
2.0 16V (BG00, BG0W, BG0K, BG0P)	98	08/02→12/06	→			24.0111-0101.2	411101	Ø 274 10,9 9,5 + LG / + ABS Ring
1.6 16V (BG1G, BG1H)	82	02/05→08/07	←	→ 06/07		24.0124-0169.1	424169	Ø 280 24 21,8 V
1.8 16V (BG06, BG0J, BG0M)	85	03/01→12/07				24.0126-0123.1	426123	Ø 300 26 22,8 V
1.8 16V (BG0B, BG0M)	88	03/01→09/07				24.0326-0123.1	526123	Ø 300 26 22,8 V
1.9 dCi	79	03/01→09/07	→	→ 06/07		24.0111-0101.2	411101	Ø 274 10,9 9,5 + LG / + ABS Ring
1.9 dCi	92	09/05→12/07						
1.9 dCi (BG08, BG0G)	88	03/01→09/07						
1.9 dCi (BG12)	85	09/05→12/07						
1.9 dCi (BG1A, BG1V)	96	05/05→08/07						
1.9 dCi (BG1A, BG1W)	81	01/05→08/07						
2.0 16V (BG00, BG0K, BG0P, BG0W)	99	08/02→12/07						
2.0 16V IDE (BG0N)	103	04/01→09/07						
2.0 16V (BG03, BG0Z, BG0T, BG1Y)	125	01/05→09/07	←	→ 06/07		24.0128-0182.1	428182	Ø 308 28 25,4 V
2.0 16V (BG1Y)	150	01/05→09/07	→	→ 06/07		24.0111-0101.2	411101	Ø 274 10,9 9,5 + LG / + ABS Ring
2.0 dCi (BG14, BG1S)	127	01/06→08/07						
2.0 16V Turbo (BG0S, BG1L, BG1M)	120	01/03→03/05	←			24.0128-0182.1	428182	Ø 308 28 25,4 V
2.0 dCi (BG1T)	110	08/05→08/06	→			24.0111-0101.2	411101	Ø 274 10,9 9,5 + LG / + ABS Ring
2.9 V6 24V	155	03/01→08/07						
2.2 dCi	102	05/05→08/07	←	→ 06/07		24.0126-0123.1	426123	Ø 300 26 22,8 V
			→	→ 06/07		24.0326-0123.1	526123	Ø 300 26 22,8 V
			→	→ 06/07		24.0111-0101.2	411101	Ø 274 10,9 9,5 + LG / + ABS Ring
2.2 dCi (BG09)	85	04/04→10/05	←	05/05→		24.0126-0123.1	426123	Ø 300 26 22,8 V
			←	→ 04/05		24.0326-0123.1	526123	Ø 300 26 22,8 V
			←	→ 04/05		24.0128-0182.1	428182	Ø 308 28 25,4 V
			→			24.0111-0101.2	411101	Ø 274 10,9 9,5 + LG / + ABS Ring
2.2 dCi (BG0F)	110	10/01→08/06	←	→ 11/01		24.0126-0123.1	426123	Ø 300 26 22,8 V
			←	05/05→		24.0326-0123.1	526123	Ø 300 26 22,8 V
			←	12/01→ 10/02		24.0126-0123.1	426123	Ø 300 26 22,8 V
			←	11/02→ 04/05		24.0128-0135.1	428135	Ø 308 28 25,8 V
			→			24.0128-0182.1	428182	Ø 308 28 25,4 V
			→			24.0111-0101.2	411101	Ø 274 10,9 9,5 + LG / + ABS Ring
3.0 V6 24V (BG01, BG02, BG0D, BG0Y)	152	03/01→08/07	←	07/01→ 06/07		24.0126-0123.1	426123	Ø 300 26 22,8 V
			←	→ 06/01		24.0326-0123.1	526123	Ø 300 26 22,8 V
			→	→ 06/07		24.0128-0182.1	428182	Ø 308 28 25,4 V
			→	→ 06/07		24.0111-0101.2	411101	Ø 274 10,9 9,5 + LG / + ABS Ring







**RENAULT - LAGUNA II Grandtour (KG0/1\_) 03/01→12/07**

**Bremsbelagsatz, Scheibenbremse**

1.6	76	03/01→10/05	←	für Bremsscheibendurchmesser [mm]: 280		13.0460-7157.2	607157	ATE 23215 18,3 - WE / - WK
1.6 FlexFuel	76	06/01→10/03				13.0470-7157.2	LD7157	ATE 23215 18,3 - WE / - WK Ceramic
1.8 16V	86	03/01→05/05						
1.8 16V	89	03/01→05/05						
1.8 16V (KG0B, KG0M)	88	03/01→05/05	←	für Bremsscheibendurchmesser [mm]: 300		13.0460-7158.2	607158	ATE 23245 18,3 - WE / - WK
1.8 16V (KG0J)	85	03/01→05/05				13.0470-7158.2	LD7158	ATE 23245 18,3 - WE / - WK Ceramic
1.9 dCi (KG05)	68	03/04→05/05						
1.9 dCi (KG0E, KG0R)	74	10/01→05/05	→			13.0460-7137.2	607137	ATE 23482 15,8 - WE / - WK
1.9 dCi (KG0E)	77	06/01→05/05				13.0470-7137.2	LD7137	ATE 23482 15,8 - WE / - WK Ceramic
2.0 Flex	95	09/02→05/05						
2.0 Flex	97	09/02→05/05						
1.6 16V	82	02/05→08/07	←	→ 06/07; für Bremsscheibendurchmesser [mm]: 280		13.0460-7157.2	607157	ATE 23215 18,3 - WE / - WK
1.6 16V (KG0A, KG0L)	79	03/01→12/07				13.0470-7157.2	LD7157	ATE 23215 18,3 - WE / - WK Ceramic
1.6 Bifuel	79	06/05→12/07						
1.9 dCi	79	03/01→12/07						
1.9 dCi	92	09/05→12/07	←	→ 06/07; für Bremsscheibendurchmesser [mm]: 300		13.0460-7158.2	607158	ATE 23245 18,3 - WE / - WK
1.9 dCi (KG0G)	88	03/01→09/07				13.0470-7158.2	LD7158	ATE 23245 18,3 - WE / - WK Ceramic
1.9 dCi (KG12)	85	08/05→09/07						
1.9 dCi (KG1A, KG1W)	81	01/05→12/07						
1.9 dCi (KG1V)	96	05/05→12/07	→	→ 06/07		13.0460-7137.2	607137	ATE 23482 15,8 - WE / - WK
2.0 16V (KG00, KG0K, KG0W, KG0P)	98	10/04→09/07				13.0470-7137.2	LD7137	ATE 23482 15,8 - WE / - WK Ceramic



	kw			 	! #		
<b>RENAULT - LAGUNA II Grandtour (KG0/1_) 03/01→12/07</b>							
<b> Bremsbelagsatz, Scheibenbremse</b>							
2.0 16V (KG00, KG0K, KG0W, KG0P) 2.0 16V IDE (KG0N)	99	08/02→12/07	←	→ 06/07; für Bremsscheibendurchmesser [mm]: 280	13.0460-7157.2	607157	ATE 23215 18,3 - WE / - WK
	103	04/01→09/07	←	→ 06/07; für Bremsscheibendurchmesser [mm]: 300	13.0460-7158.2	607158	ATE 23245 18,3 - WE / - WK
			→	→ 06/07	13.0460-7137.2	607137	ATE 23482 15,8 - WE / - WK
1.9 dCi	66	08/03→09/07	←	03/04→ 06/07; für Bremsscheibendurchmesser [mm]: 280	13.0460-7157.2	607157	ATE 23215 18,3 - WE / - WK
			←	03/04→ 06/07; für Bremsscheibendurchmesser [mm]: 300	13.0460-7158.2	607158	ATE 23245 18,3 - WE / - WK
			→	03/04→ 06/07	13.0460-7137.2	607137	ATE 23482 15,8 - WE / - WK
2.0 16V (KG03, KG0Z, KG0T, KG1Y) 2.0 16V (KG1Y) 2.0 dCi (KG1S) 3.0 V6 24V (KG0D)	125	01/05→09/07	←	→ 06/07	13.0460-7159.2	607159	ATE 23245 18,3 - WE / - WK
	150	01/05→09/07	←	→ 06/07	13.0460-7159.2	607159	ATE 23245 18,3 - WE / - WK
	127	01/06→12/07	→	→ 06/07	13.0460-7137.2	607137	ATE 23482 15,8 - WE / - WK
2.0 16V Turbo (KG0S, KG1L, KG03)	120	01/03→08/05	←		13.0460-7159.2	607159	ATE 23245 18,3 - WE / - WK
			→		13.0460-7137.2	607137	ATE 23482 15,8 - WE / - WK
2.0 dCi (KG1T)	110	08/05→08/06	←	passend für Felgengröße [Zoll]: 16	13.0460-7158.2	607158	ATE 23245 18,3 - WE / - WK
			←	passend für Felgengröße [Zoll]: 17	13.0460-7159.2	607159	ATE 23245 18,3 - WE / - WK
			→		13.0460-7137.2	607137	ATE 23482 15,8 - WE / - WK
2.2 dCi	102	05/05→12/07	←	→ 06/07	13.0460-7158.2	607158	ATE 23245 18,3 - WE / - WK
			→	→ 06/07	13.0460-7137.2	607137	ATE 23482 15,8 - WE / - WK
2.2 dCi (KG09)	85	04/04→10/05	←		13.0460-7158.2	607158	ATE 23245 18,3 - WE / - WK
			→		13.0460-7137.2	607137	ATE 23482 15,8 - WE / - WK
2.2 dCi (KG0F)	110	10/01→08/06	←	→ 11/01	13.0460-7158.2	607158	ATE 23245 18,3 - WE / - WK
			←	05/05→	13.0460-7158.2	607158	ATE 23245 18,3 - WE / - WK
			←	12/01→ 04/05	13.0460-7159.2	607159	ATE 23245 18,3 - WE / - WK
			→		13.0460-7137.2	607137	ATE 23482 15,8 - WE / - WK
<b> Bremsscheibe</b>							
1.6	76	03/01→10/05	←		24.0124-0169.1	424169	Ø 280 24 21,8 V
1.6 FlexFuel	76	06/01→10/03					
1.8 16V	86	03/01→05/05			24.0126-0123.1	426123	Ø 300 26 22,8 V
↓							

	kW			 	! #		
<b>RENAULT - LAGUNA II Grandtour (KG0/1_) 03/01→12/07</b>							
<b>Bremsscheibe</b>							
1.8 16V	89	03/01→05/05	←			24.0326-0123.1 526123	Ø 300 26 22,8 V
1.8 16V (KG0B, KG0M)	88	03/01→05/05	→			24.0111-0101.2 411101	Ø 274 10,9 9,5
1.8 16V (KG0J)	85	03/01→05/05					+ LG / + ABS Ring
1.9 dCi (KG05)	68	03/04→05/05					
1.9 dCi (KG0E, KG0R)	74	10/01→05/05					
1.9 dCi (KG0E)	77	06/01→05/05					
2.0 Flex	95	09/02→05/05					
2.0 Flex	97	09/02→05/05					
1.6 16V	82	02/05→08/07	←	→ 06/07		24.0124-0169.1 424169	Ø 280 24 21,8 V
1.6 16V (KG0A, KG0L)	79	03/01→12/07				24.0126-0123.1 426123	Ø 300 26 22,8 V
1.6 Bifuel	79	06/05→12/07				24.0326-0123.1 526123	Ø 300 26 22,8 V
1.9 dCi	79	03/01→12/07					
1.9 dCi	92	09/05→12/07	→	→ 06/07		24.0111-0101.2 411101	Ø 274 10,9 9,5
1.9 dCi (KG0G)	88	03/01→09/07					+ LG / + ABS Ring
1.9 dCi (KG12)	85	08/05→09/07					
1.9 dCi (KG1A, KG1W)	81	01/05→12/07					
1.9 dCi (KG1V)	96	05/05→12/07					
2.0 16V (KG00, KG0K, KG0W, KG0P)	98	10/04→09/07					
2.0 16V (KG00, KG0K, KG0W, KG0P)	99	08/02→12/07					
2.0 16V IDE (KG0N)	103	04/01→09/07					
1.9 dCi	66	08/03→09/07	←	03/04→ 06/07		24.0124-0169.1 424169	Ø 280 24 21,8 V
			→	03/04→ 06/07		24.0126-0123.1 426123	Ø 300 26 22,8 V
						24.0326-0123.1 526123	Ø 300 26 22,8 V
			→	03/04→ 06/07		24.0111-0101.2 411101	Ø 274 10,9 9,5
							+ LG / + ABS Ring
2.0 16V (KG03, KG0Z, KG0T, KG1Y)	125	01/05→09/07	←	→ 06/07		24.0128-0182.1 428182	Ø 308 28 25,4 V
2.0 16V (KG1Y)	150	01/05→09/07	→	→ 06/07		24.0111-0101.2 411101	Ø 274 10,9 9,5
2.0 dCi (KG1S)	127	01/06→12/07					+ LG / + ABS Ring
2.0 16V Turbo (KG0S, KG1L, KG03)	120	01/03→08/05	←			24.0128-0182.1 428182	Ø 308 28 25,4 V
			→			24.0111-0101.2 411101	Ø 274 10,9 9,5
							+ LG / + ABS Ring
2.0 dCi (KG1T)	110	08/05→08/06	←	passend für Felgenreöße [Zoll]: 16		24.0126-0123.1 426123	Ø 300 26 22,8 V
						24.0326-0123.1 526123	Ø 300 26 22,8 V
			←	passend für Felgenreöße [Zoll]: 17		24.0128-0182.1 428182	Ø 308 28 25,4 V
			→			24.0111-0101.2 411101	Ø 274 10,9 9,5
							+ LG / + ABS Ring
2.2 dCi	102	05/05→12/07	←	→ 06/07		24.0126-0123.1 426123	Ø 300 26 22,8 V
			→	→ 06/07		24.0326-0123.1 526123	Ø 300 26 22,8 V
						24.0111-0101.2 411101	Ø 274 10,9 9,5
							+ LG / + ABS Ring
2.2 dCi (KG09)	85	04/04→10/05	←			24.0126-0123.1 426123	Ø 300 26 22,8 V
			→			24.0326-0123.1 526123	Ø 300 26 22,8 V
						24.0111-0101.2 411101	Ø 274 10,9 9,5
							+ LG / + ABS Ring
2.2 dCi (KG0F)	110	10/01→08/06	←	→ 11/01		24.0126-0123.1 426123	Ø 300 26 22,8 V
						24.0326-0123.1 526123	Ø 300 26 22,8 V
			←	05/05→		24.0126-0123.1 426123	Ø 300 26 22,8 V
						24.0326-0123.1 526123	Ø 300 26 22,8 V
			←	12/01→ 10/02		24.0128-0135.1 428135	Ø 308 28 25,8 V
			←	11/02→ 04/05		24.0128-0182.1 428182	Ø 308 28 25,4 V
			→			24.0111-0101.2 411101	Ø 274 10,9 9,5
							+ LG / + ABS Ring
3.0 V6 24V (KG0D)	152	03/01→12/07	←	07/01→ 06/07		24.0128-0135.1 428135	Ø 308 28 25,8 V
			←	→ 06/01		24.0128-0182.1 428182	Ø 308 28 25,4 V
			→	→ 06/07		24.0111-0101.2 411101	Ø 274 10,9 9,5
							+ LG / + ABS Ring
<b>RENAULT - LAGUNA III (BT0/1) 10/07→12/15</b>							
<b>Bremsbelagsatz, Scheibenbremse</b>							
1.5 dCi (BT00, BT0A, BT0T, BT1J)	81	10/07→12/15	←			13.0460-7248.2 607248	ATE 23215 17,5 - WE / - WK
1.6 16V (BT04, BT0D, BT0U)	81	10/07→12/15	→			13.0460-7251.2 607251	ATE 23482 15,8 - WE / - WK
						13.0470-7251.2 LD7251	ATE 23482 15,8 - WE / - WK
							Ceramic
2.0 16V (BT05, BT0F, BT0W)	103	10/07→12/12	←			13.0460-7249.2 607249	ATE 24709 18,6 - WE / - WK
2.0 16V Hi-Flex (BT1H)	103	10/07→12/15				13.0470-7249.2 LD7249	ATE 24709 18,6 - WE / - WK
2.0 16V Turbo	125	10/07→12/15					Ceramic
↓							

**RENAULT - LAGUNA III (BT0/1) 10/07→12/15**

**Bremsbelagsatz, Scheibenbremse**

2.0 16V (BT05, BT0F, BT0W)	103	10/07→12/12	➔				ATE 23482 15,8 - WE / - WK
2.0 16V Hi-Flex (BT1H)	103	10/07→12/15					ATE 23482 15,8 - WE / - WK
2.0 16V Turbo	125	10/07→12/15					Ceramic
2.0 dCi (BT01, BT08, BT09, BT0E, BT0K, BT12, BT1C, BT1D,...)	110	10/07→12/15	➔	für Fahrzeuge ohne Vierradlenkung			ATE 24709 18,6 - WE / - WK
2.0 dCi (BT07, BT0J, BT14, BT1A, BT1S)	96	10/07→12/15	➔	für Fahrzeuge mit Vierradlenkung			ATE 24709 18,6 - WE / - WK
2.0 dCi (BT0M, BT0N, BT0S, BT19, BT1F)	127	01/08→12/15	➔				ATE 23482 15,8 - WE / - WK
2.0 dCi GT (BT11, BT1E, BT1N)	131	03/08→12/15					ATE 23482 15,8 - WE / - WK
2.0 GT	150	03/08→12/15	➔				ATE 24709 17,5 - WE / - WK
3.0 dCi (BT03, BT13)	173	09/08→12/15					ATE 23482 15,8 - WE / - WK
3.5 V6 (BT0C, BT0P)	175	04/08→12/15	➔				ATE 23482 15,8 - WE / - WK
							Ceramic

**Bremsscheibe**

1.5 dCi (BT00, BT0A, BT0T, BT1J)	81	10/07→12/15	➔				Ø 280 24 21,8 V + S
1.6 16V (BT04, BT0D, BT0U)	81	10/07→12/15	➔				Ø 300 11 9,5 + LG / + ABS Ring
2.0 16V (BT05, BT0F, BT0W)	103	10/07→12/12	➔				Ø 296 26 23,4 V + S
2.0 16V Hi-Flex (BT1H)	103	10/07→12/15	➔				Ø 300 11 9,5 + LG / + ABS Ring
2.0 16V Turbo	125	10/07→12/15					
2.0 dCi (BT01, BT08, BT09, BT0E, BT0K, BT12, BT1C, BT1D,...)	110	10/07→12/15	➔	für Fahrzeuge ohne Vierradlenkung			Ø 296 26 23,4 V + S
2.0 dCi (BT07, BT0J, BT14, BT1A, BT1S)	96	10/07→12/15	➔	für Fahrzeuge mit Vierradlenkung			Ø 320 28 25,4 V + S
2.0 dCi (BT0M, BT0N, BT0S, BT19, BT1F)	127	01/08→12/15	➔				Ø 300 11 9,5 + LG / + ABS Ring
2.0 dCi GT (BT11, BT1E, BT1N)	131	03/08→12/15					
2.0 GT	150	03/08→12/15	➔				Ø 320 28 25,4 V + S
3.0 dCi (BT03, BT13)	173	09/08→12/15					
3.5 V6 (BT0C, BT0P)	175	04/08→12/15	➔				Ø 300 11 9,5 + LG / + ABS Ring

**RENAULT - LAGUNA III Grandtour (KT0/1) 10/07→12/15**











**Bremsbelagsatz, Scheibenbremse**















1.5 dCi (KT0A)	81	10/07→12/15	➔				ATE 23215 17,5 - WE / - WK
1.6 16V (KT0D)	81	10/07→12/15	➔				ATE 23482 15,8 - WE / - WK
							ATE 23482 15,8 - WE / - WK
							Ceramic
2.0 16V (KT0F, KT0W)	103	10/07→12/15	➔				ATE 24709 18,6 - WE / - WK
2.0 16V Hi-Flex (KT1H)	103	10/07→12/15					ATE 24709 18,6 - WE / - WK
2.0 16V Turbo	125	10/07→12/15	➔				Ceramic
2.0 dCi (KT01, KT08, KT09, KT0K, KT12, KT1D, KT1W)	110	10/07→12/15	➔	für Fahrzeuge ohne Vierradlenkung			ATE 24709 18,6 - WE / - WK
2.0 dCi (KT07, KT0J, KT14, KT1A, KT1S)	96	10/07→12/15	➔	für Fahrzeuge mit Vierradlenkung			ATE 24709 18,6 - WE / - WK
2.0 dCi (KT0M, KT0N, KT0S, KT19, KT1F)	127	01/08→12/15	➔				ATE 24709 17,5 - WE / - WK
2.0 dCi GT (KT11, KT1E, KT1N)	131	03/08→12/15					ATE 23482 15,8 - WE / - WK
2.0 GT	150	03/08→12/15	➔				ATE 23482 15,8 - WE / - WK
3.0 dCi (KT03, KT13)	173	09/08→12/15					ATE 23482 15,8 - WE / - WK
3.5 V6 (KT0C, KT0P)	175	04/08→12/15	➔				ATE 23482 15,8 - WE / - WK
							Ceramic

**Bremsscheibe**

















1.5 dCi (KT0A)	81	10/07→12/15	➔				Ø 280 24 21,8 V + S
1.6 16V (KT0D)	81	10/07→12/15	➔				Ø 300 11 9,5 + LG / + ABS Ring
2.0 16V (KT0F, KT0W)	103	10/07→12/15	➔				Ø 296 26 23,4 V + S
2.0 16V Hi-Flex (KT1H)	103	10/07→12/15	➔				Ø 300 11 9,5 + LG / + ABS Ring
2.0 16V Turbo	125	10/07→12/15					













↓							
---	--	--	--	--	--	--	--











	kw			 	! #		
<b>RENAULT - LAGUNA III Grandtour (KT0/1) 10/07→12/15</b>							
 <b>Bremsscheibe</b>							
2.0 dCi (KT01, KT08, KT09, KT0K, KT12, KT1D, KT1W)	110	10/07→12/15	←	für Fahrzeuge ohne Vierradlenkung		24.0126-0158.1 426158	Ø 296 26 23,4 V + S
			←	für Fahrzeuge mit Vierradlenkung		24.0128-0245.1 428245	Ø 320 28 25,4 V + S
2.0 dCi (KT07, KT0J, KT14, KT1A, KT1S)	96	10/07→12/15	→			24.0111-0173.2 411173	Ø 300 11 9,5 + LG / + ABS Ring
2.0 dCi (KT0M, KT0N, KT0S, KT19, KT1F)	127	01/08→12/15					
2.0 dCi GT (KT11, KT1E, KT1N)	131	03/08→12/15					
2.0 GT	150	03/08→12/15	←			24.0128-0245.1 428245	Ø 320 28 25,4 V + S
3.0 dCi (KT03, KT13)	173	09/08→12/15					
3.5 V6 (KT0C, KT0P)	175	04/08→12/15	→			24.0111-0173.2 411173	Ø 300 11 9,5 + LG / + ABS Ring
<b>RENAULT - LAGUNA Coupe (DT0/1) 09/08→12/15</b>							
 <b>Bremsbelagsatz, Scheibenbremse</b>							
1.5 dCi	81	03/12→12/15	←			13.0460-7248.2 607248	ATE 23215 17,5 - WE / - WK
			→			13.0460-7251.2 607251	ATE 23482 15,8 - WE / - WK
						13.0470-7251.2 LD7251	ATE 23482 15,8 - WE / - WK Ceramic
2.0 16V Turbo 2.0 dCi (DT01, DT08, DT09, DT0K, DT12, DT1C, DT1D, DT1M,...)	125	09/08→12/15	←	für Fahrzeuge ohne Vierradlenkung		13.0460-7249.2 607249	ATE 24709 18,6 - WE / - WK
	110	09/08→12/15	←	für Fahrzeuge mit Vierradlenkung		13.0470-7249.2 LD7249	ATE 24709 18,6 - WE / - WK Ceramic
2.0 dCi (DT0M, DT0N, DT0S, DT19, DT1F)	127	09/08→12/15	←			13.0460-7250.2 607250	ATE 24709 17,5 - WE / - WK
	131	09/08→12/15	→			13.0460-7251.2 607251	ATE 23482 15,8 - WE / - WK
2.0 dCi GT (DT11, DT1E, DT1N)	131	09/08→12/15	→			13.0470-7251.2 LD7251	ATE 23482 15,8 - WE / - WK Ceramic
2.0 GT	150	09/08→12/15	←			13.0460-7250.2 607250	ATE 24709 17,5 - WE / - WK
3.0 dCi	177	01/12→12/15					
3.0 dCi (DT03)	173	09/08→12/15	→			13.0460-7251.2 607251	ATE 23482 15,8 - WE / - WK
3.5 V6 (DT0P)	175	09/08→12/15	→			13.0470-7251.2 LD7251	ATE 23482 15,8 - WE / - WK Ceramic
 <b>Bremsscheibe</b>							
1.5 dCi	81	03/12→12/15	←			24.0124-0221.1 424221	Ø 280 24 21,8 V + S
			→			24.0111-0181.2 411181	Ø 300 11 9,5 + LG / + ABS Ring
2.0 16V Turbo 2.0 dCi (DT01, DT08, DT09, DT0K, DT12, DT1C, DT1D, DT1M,...)	125	09/08→12/15	←	für Fahrzeuge ohne Vierradlenkung		24.0126-0158.1 426158	Ø 296 26 23,4 V + S
	110	09/08→12/15	←	für Fahrzeuge mit Vierradlenkung		24.0128-0245.1 428245	Ø 320 28 25,4 V + S
2.0 dCi (DT0M, DT0N, DT0S, DT19, DT1F)	127	09/08→12/15	→			24.0111-0181.2 411181	Ø 300 11 9,5 + LG / + ABS Ring
	131	09/08→12/15					
2.0 GT	150	09/08→12/15	←			24.0128-0245.1 428245	Ø 320 28 25,4 V + S
3.0 dCi	177	01/12→12/15	→			24.0111-0181.2 411181	Ø 300 11 9,5 + LG / + ABS Ring
3.0 dCi (DT03)	173	09/08→12/15	←			24.0126-0158.1 426158	Ø 296 26 23,4 V + S
3.5 V6 (DT0P)	175	09/08→12/15	→			24.0111-0181.2 411181	Ø 300 11 9,5 + LG / + ABS Ring
<b>RENAULT - LATITUDE (L70_) 07/10→</b>							
 <b>Bremsbelagsatz, Scheibenbremse</b>							
1.5 dCi (L70R)	81	07/10→	←	02/11→ 06/13		13.0460-7249.2 607249	ATE 24709 18,6 - WE / - WK
			→	02/11→ 06/13		13.0470-7249.2 LD7249	ATE 24709 18,6 - WE / - WK Ceramic
2.0 16V 2.0 16V (L70B) 2.0 16V eco2 Flexfuel (L70B)	102	02/11→	←	→ 06/13		13.0460-7249.2 607249	ATE 24709 18,6 - WE / - WK
	103	02/11→				13.0470-7249.2 LD7249	ATE 24709 18,6 - WE / - WK Ceramic
2.0 dCi 150 (L70H) 2.5 V6 (L702, L703, L704, L707)	110	02/11→	→	→ 06/13		13.0460-7287.2 607287	ATE 25265 16,6 + WE / - WK
	130	05/11→					
2.0 dCi 2.0 dCi 175 (L70Y)	130	02/11→	←	→ 06/13		13.0460-5716.2 605716	21561 17,0 + WK
	127	05/11→	→	→ 06/13		13.0460-7287.2 607287	ATE 25265 16,6 + WE / - WK
2.0 dCi 130	96	12/13→	←			13.0460-7249.2 607249	ATE 24709 18,6 - WE / - WK
			→			13.0470-7249.2 LD7249	ATE 24709 18,6 - WE / - WK Ceramic
3.0 dCi 240 (L70G)	177	02/11→	→			13.0460-7287.2 607287	ATE 25265 16,6 + WE / - WK
			←	→ 06/13		13.0460-7250.2 607250	ATE 24709 17,5 - WE / - WK
↓							

	kw			 	! #		
<b>RENAULT - LATITUDE (L70_) 07/10→</b>							
 <b>Bremsbelagsatz, Scheibenbremse</b>							
3.0 dCi 240 (L70G)	177	02/11→	➡	→ 06/13		<b>13.0460-7287.2 607287</b>	ATE 25265 16,6 + WE / - WK
 <b>Bremsscheibe</b>							
1.5 dCi (L70R)	81	07/10→	←	02/11→ 06/13		<b>24.0126-0158.1 426158</b>	Ø 296 26 23,4 V + S
			➡	02/11→ 06/13		<b>24.0111-0173.2 411173</b>	Ø 300 11 9,5 + LG / + ABS Ring
2.0 16V	102	02/11→	←	→ 06/13		<b>24.0126-0158.1 426158</b>	Ø 296 26 23,4 V + S
2.0 16V (L70B)	103	02/11→					
2.0 16V eco2 Flexfuel (L70B)	103	02/11→	➡	→ 06/13		<b>24.0111-0173.2 411173</b>	Ø 300 11 9,5 + LG / + ABS Ring
2.0 dCi	130	02/11→					
2.0 dCi 150 (L70H)	110	02/11→					
2.0 dCi 175 (L70Y)	127	05/11→					
2.5 V6 (L702, L703, L704, L707)	130	05/11→					
2.0 dCi 130	96	12/13→	←			<b>24.0126-0158.1 426158</b>	Ø 296 26 23,4 V + S
			➡			<b>24.0111-0173.2 411173</b>	Ø 300 11 9,5 + LG / + ABS Ring
3.0 dCi 240 (L70G)	177	02/11→	➡	→ 06/13		<b>24.0111-0173.2 411173</b>	Ø 300 11 9,5 + LG / + ABS Ring
<b>RENAULT - LOGAN I (LS_) 09/04→</b>							
 <b>Bremsbelagsatz, Scheibenbremse</b>							
1.4	55	09/04→	←	→ 04/13		<b>13.0460-2834.2 602834</b>	TRW 21463 18,0 + WK
1.5 dCi	48	06/11→					
1.5 dCi	50	04/07→					
1.5 dCi	63	02/08→06/15					
1.6	64	09/04→					
1.6 (LS0L, LS09, LS0V, LS0P, LS18, LS1S, LS1V, LS1Y,...)	77	04/07→					
 <b>Bremsscheibe</b>							
1.4	55	09/04→	←	→ 04/13; - ABS		<b>24.0112-0116.1 412116</b>	Ø 238 12 10,5 + S
1.6	64	09/04→	←	→ 04/13; + ABS		<b>24.0112-0171.1 412171</b>	Ø 259 12 10,6 + S
1.5 dCi	48	06/11→	←	→ 04/13		<b>24.0121-0106.1 421106</b>	Ø 259 20,7 17,7 V + S
1.5 dCi	50	04/07→					
1.5 dCi	63	02/08→06/15					
1.6 (LS0L, LS09, LS0V, LS0P, LS18, LS1S, LS1V, LS1Y,...)	77	04/07→					
<b>RENAULT - LOGAN I Kombi (KS_) 04/07→</b>							
 <b>Bremsbelagsatz, Scheibenbremse</b>							
1.4	55	10/07→	←	→ 04/13		<b>13.0460-2834.2 602834</b>	TRW 21463 18,0 + WK
1.5 dCi	48	06/11→					
1.5 dCi	50	04/07→					
1.5 dCi	63	02/08→06/15					
1.5 dCi	66	06/11→					
1.6	64	04/07→					
1.6 (KS0L, KS0M, KS0P, KS1S)	77	04/07→					
 <b>Bremsscheibe</b>							
1.4	55	10/07→	←	→ 04/13; - ABS		<b>24.0112-0116.1 412116</b>	Ø 238 12 10,5 + S
1.6	64	04/07→	←	→ 04/13; + ABS		<b>24.0112-0171.1 412171</b>	Ø 259 12 10,6 + S
1.5 dCi	48	06/11→	←	→ 04/13		<b>24.0121-0106.1 421106</b>	Ø 259 20,7 17,7 V + S
1.5 dCi	50	04/07→					
1.5 dCi	63	02/08→06/15					
1.6 (KS0L, KS0M, KS0P, KS1S)	77	04/07→					
1.5 dCi	66	06/11→	←	→ 04/13		<b>24.0121-0106.1 421106</b>	Ø 259 20,7 17,7 V + S
			←	→ 12/15		<b>24.0122-0289.1 422289</b>	Ø 258 22 19,8 V + S
<b>RENAULT - LOGAN II (L8_) 09/12→</b>							
 <b>Bremsbelagsatz, Scheibenbremse</b>							
1.2	55	11/13→	←			<b>13.0460-7298.2 607298</b>	ATE 25702 18,2 - WE / - WK
1.2 16V LPG	53	11/13→				<b>13.0470-7298.2 LD7298</b>	ATE 25702 18,2 - WE / - WK Ceramic
1.5 dCi	62	12/13→					
1.5 dCi	66	12/13→					
1.6	60	04/14→					
1.6	75	04/14→					
↓							























	kw					! #		
<b>RENAULT - LOGAN II (L8_) 09/12→</b>								
 <b>Bremsscheibe</b>								
1.2	55	11/13→	←			24.0112-0171.1	412171	Ø 259 12 10,6 + S
1.2 16V LPG	53	11/13→						
1.6	60	04/14→						
1.5 dCi	62	12/13→	←			24.0122-0289.1	422289	Ø 258 22 19,8 V + S
1.6	75	04/14→						
1.5 dCi	66	12/13→	←	→ 12/15		24.0122-0289.1	422289	Ø 258 22 19,8 V + S
<b>RENAULT - LOGAN II Kombi (K8_) 12/13→</b>								
 <b>Bremsbelagsatz, Scheibenbremse</b>								
1.2 16V	54	12/13→	←			13.0460-7298.2	607298	ATE 25702 18,2 - WE / - WK
1.2 16V LPG	53	12/13→						
1.5 dCi	62	12/13→				13.0470-7298.2	LD7298	ATE 25702 18,2 - WE / - WK Ceramic
1.5 dCi	66	12/13→						
1.6	59	12/13→						
 <b>Bremsscheibe</b>								
1.2 16V	54	12/13→	←			24.0122-0289.1	422289	Ø 258 22 19,8 V + S
1.2 16V LPG	53	12/13→						
1.5 dCi	62	12/13→						
1.6	59	12/13→						
1.5 dCi	66	12/13→	←	→ 12/15		24.0122-0289.1	422289	Ø 258 22 19,8 V + S
<b>RENAULT - LOGAN EXPRESS (US_) 04/07→</b>								
 <b>Bremsbelagsatz, Scheibenbremse</b>								
1.5 dCi	50	04/07→	←	→ 04/13		13.0460-2709.2	602709	TRW 23973 17,1 - WE / - WK + Zub
1.6	64	04/07→				13.0460-7270.2	607270	ATE 24673 18,0 - WE / - WK
						13.0470-2709.2	LD2709	TRW 23973 17,1 - WE / - WK + Zub Ceramic
 <b>Bremsscheibe</b>								
1.5 dCi	50	04/07→	←	→ 04/13		24.0122-0216.1	422216	Ø 260 22 19,8 V + S
1.6	64	04/07→						
<b>RENAULT - MASTER I Bus (T_) 08/80→07/98</b>								
 <b>Bremsbelagsatz, Scheibenbremse</b>								
28-35 2,5 TD	72	08/89→07/98	←			13.0460-2824.2	602824	TRW 20380 15,6 + WK
28-35 2.0	58	10/86→07/98						
28-35 2.1 D	44	08/80→07/98						
28-35 2.5 D	55	08/89→07/98						
30 2,2	67	08/80→07/98						
35 2,5 TD	69	08/89→07/98						
 <b>Bremsscheibe</b>								
28-35 2,5 TD	72	08/89→07/98	←			24.0124-0137.1	424137	Ø 278 24 22 V
28-35 2.0	58	10/86→07/98						
28-35 2.1 D	44	08/80→07/98						
28-35 2.5 D	55	08/89→07/98						
30 2,2	67	08/80→07/98						
35 2,5 TD	69	08/89→07/98						
<b>RENAULT - MASTER I Kasten (T_) 07/80→07/98</b>								
 <b>Bremsbelagsatz, Scheibenbremse</b>								
28-35 2,5 D	55	08/89→07/98	←			13.0460-2824.2	602824	TRW 20380 15,6 + WK
28-35 2,5 TD	72	08/89→07/98						
28-35 2.0	58	10/86→07/98						
28-35 2.1 D	44	08/80→07/98						
30 2,2	67	08/80→07/98						
35 2,5 TD	69	08/89→07/98						
 <b>Bremsscheibe</b>								
28-35 2,5 D	55	08/89→07/98	←			24.0124-0137.1	424137	Ø 278 24 22 V
28-35 2,5 TD	72	08/89→07/98						
28-35 2.0	58	10/86→07/98						
28-35 2.1 D	44	08/80→07/98						
30 2,2	67	08/80→07/98						
35 2,5 TD	69	08/89→07/98						
<b>RENAULT - MASTER I Pritsche/Fahrgestell (P_) 07/80→07/98</b>								
 <b>Bremsbelagsatz, Scheibenbremse</b>								
28-35 2.0	58	10/86→07/98	←			13.0460-2824.2	602824	TRW 20380 15,6 + WK
28-35 2.5 D	52	09/80→07/98	←	08/89→		13.0460-2824.2	602824	TRW 20380 15,6 + WK
↓								

	kw					! #		
<b>RENAULT - MASTER I Pritsche/Fahrgestell (P_) 07/80→07/98</b>								
 <b>Bremsscheibe</b>								
28-35 2.0	58	10/86→07/98	←				24.0124-0137.1 424137	Ø 278 24 22 V
28-35 2.5 D	52	09/80→07/98	←	08/89→			24.0124-0137.1 424137	Ø 278 24 22 V
<b>RENAULT - MASTER II Bus (JD) 03/98→</b>								
 <b>Bremsbelagsatz, Scheibenbremse</b>								
1.9 dCi 80	60	11/01→	←	→ 08/06			13.0460-3800.2 603800	BOS 23613 17,7 - WE / - WK
1.9 dTi	59	09/00→	→	→ 08/06			13.0460-3806.2 603806	BOS 23669 16,8 - WE / - WK
2.2 dCi 90	66	09/00→						
2.5 dCi 100 (JDCV)	73	10/03→						
2.5 dCi 120	84	10/01→						
3.0 dCi 140 (JD0T)	100	10/03→						
2.5 D	59	07/98→01/01	←	08/00→			13.0460-3800.2 603800	BOS 23613 17,7 - WE / - WK
2.8 dTi	84	07/98→10/01	←	→ 07/00			13.0460-3946.2 603946	BDX 23302 18,0 + WE / - WK
			→				13.0460-3806.2 603806	BOS 23669 16,8 - WE / - WK
2.5 dCi	74	08/06→	←	→ 12/10			13.0460-3800.2 603800	BOS 23613 17,7 - WE / - WK
2.5 dCi	88	08/06→	→	→ 12/10			13.0460-3806.2 603806	BOS 23669 16,8 - WE / - WK
2.5 dCi	107	08/06→	→	→ 12/10			13.0460-3806.2 603806	BOS 23669 16,8 - WE / - WK
<b>Zubehörsatz, Scheibenbremsbelag</b>								
2.5 dCi	74	08/06→	←	→ 12/10			13.0460-0344.2 610344	
2.5 dCi	88	08/06→						
2.5 dCi	107	08/06→						
 <b>Bremsscheibe</b>								
1.9 dCi 80	60	11/01→	←	→ 08/06; passend für Felgenreöße [Zoll]: 16			24.0128-0129.1 428129	Ø 305,5 28 25 V + S
1.9 dTi	59	09/00→					24.0328-0129.1 528129	Ø 305,5 28 25 V + S
2.2 dCi 90	66	09/00→	→	→ 08/06			24.0112-0155.1 412155	Ø 305 12 10,5 + S
2.5 dCi 100 (JDCV)	73	10/03→						
2.5 dCi 120	84	10/01→						
2.5 D	59	07/98→01/01	←	→ 07/00; passend für Felgenreöße [Zoll]: 15			24.0124-0162.1 424162	Ø 280 24 21 V
2.8 dTi	84	07/98→10/01	←	08/00→; passend für Felgenreöße [Zoll]: 16			24.0128-0129.1 428129	Ø 305,5 28 25 V + S
			→				24.0328-0129.1 528129	Ø 305,5 28 25 V + S
			→				24.0112-0155.1 412155	Ø 305 12 10,5 + S
2.5 dCi	74	08/06→	←	→ 12/10			24.0128-0129.1 428129	Ø 305,5 28 25 V + S
2.5 dCi	88	08/06→	→	→ 12/10			24.0328-0129.1 528129	Ø 305,5 28 25 V + S
2.5 dCi	107	08/06→	→	→ 12/10			24.0112-0155.1 412155	Ø 305 12 10,5 + S
3.0 dCi 140 (JD0T)	100	10/03→	←	→ 08/06			24.0128-0129.1 428129	Ø 305,5 28 25 V + S
			→	→ 08/06			24.0328-0129.1 528129	Ø 305,5 28 25 V + S
			→	→ 08/06			24.0112-0155.1 412155	Ø 305 12 10,5 + S
<b>RENAULT - MASTER II Kasten (FD) 07/98→</b>								
 <b>Bremsbelagsatz, Scheibenbremse</b>								
1.9 dCi 80	60	11/01→	←	→ 08/06			13.0460-3800.2 603800	BOS 23613 17,7 - WE / - WK
2.5 dCi 100 (FD0U, FD0V)	73	10/03→	→	→ 08/06			13.0460-3806.2 603806	BOS 23669 16,8 - WE / - WK
2.5 dCi 120	84	10/01→						
3.0 dCi 120	85	06/05→						
3.0 dCi 140 (HD0S, FD0S, HD1S)	100	10/03→						
3.0 dCi 160	115	06/05→						
1.9 dTi	59	09/00→	←	11/01→ 08/06			13.0460-3800.2 603800	BOS 23613 17,7 - WE / - WK
2.2 dCi 90	66	09/00→	→	→ 08/06			13.0460-3806.2 603806	BOS 23669 16,8 - WE / - WK
2.5 D	59	07/98→01/01	←	08/00→			13.0460-3800.2 603800	BOS 23613 17,7 - WE / - WK
2.8 dTi	84	07/98→10/01	←	→ 07/00			13.0460-3946.2 603946	BDX 23302 18,0 + WE / - WK
			→	08/00→			13.0460-3806.2 603806	BOS 23669 16,8 - WE / - WK
2.5 dCi	74	08/06→	←	→ 12/10			13.0460-3800.2 603800	BOS 23613 17,7 - WE / - WK
2.5 dCi	88	08/06→	→	→ 12/10			13.0460-3806.2 603806	BOS 23669 16,8 - WE / - WK
2.5 dCi	107	08/06→	→	→ 12/10			13.0460-3806.2 603806	BOS 23669 16,8 - WE / - WK
<b>Zubehörsatz, Scheibenbremsbelag</b>								
2.5 dCi	74	08/06→	←	→ 12/10			13.0460-0344.2 610344	
2.5 dCi	88	08/06→						
2.5 dCi	107	08/06→						
 <b>Bremsscheibe</b>								
1.9 dCi 80	60	11/01→	←	→ 08/06			24.0128-0129.1 428129	Ø 305,5 28 25 V + S
1.9 dTi	59	09/00→					24.0328-0129.1 528129	Ø 305,5 28 25 V + S
2.2 dCi 90	66	09/00→						
↓								

	kw			 	! #		
<b>RENAULT - MASTER II Kasten (FD) 07/98→</b>							
 <b>Bremsscheibe</b>							
2.5 dCi 100 (FD0U, FD0V)	73	10/03→	→	→ 08/06		24.0112-0155.1 412155	Ø 305 12 10,5 + S
2.5 dCi 120	84	10/01→					
3.0 dCi 120	85	06/05→					
3.0 dCi 140 (HD0S, FD0S, HD1S)	100	10/03→					
3.0 dCi 160	115	06/05→					
2.5 D	59	07/98→01/01	←	→ 07/00		24.0124-0162.1 424162	Ø 280 24 21 V
2.8 dTI	84	07/98→10/01	←	08/00→		24.0128-0129.1 428129	Ø 305,5 28 25 V + S
			→	08/00→		24.0328-0129.1 528129	Ø 305,5 28 25 V + S
			→	08/00→		24.0112-0155.1 412155	Ø 305 12 10,5 + S
2.5 dCi	74	08/06→	←	→ 12/10		24.0128-0129.1 428129	Ø 305,5 28 25 V + S
2.5 dCi	88	08/06→				24.0328-0129.1 528129	Ø 305,5 28 25 V + S
2.5 dCi	107	08/06→	→	→ 12/10		24.0112-0155.1 412155	Ø 305 12 10,5 + S
<b>RENAULT - MASTER II Pritsche/Fahrgestell (ED/HD/UD) 07/98→</b>							
 <b>Bremsbelagsatz, Scheibenbremse</b>							
2.2 dCi 90	66	09/00→	←	11/01→ 08/06		13.0460-3800.2 603800	BOS 23613 17,7 - WE / - WK
			←	→ 10/01		13.0460-3946.2 603946	BDX 23302 18,0 + WE / - WK
			→	→ 08/06		13.0460-3806.2 603806	BOS 23669 16,8 - WE / - WK
2.5 D	59	07/98→01/01	←			13.0460-3946.2 603946	BDX 23302 18,0 + WE / - WK
2.8 dTI	84	07/98→10/01	→	08/00→		13.0460-3806.2 603806	BOS 23669 16,8 - WE / - WK
2.5 dCi	74	08/06→	←	→ 12/10		13.0460-3800.2 603800	BOS 23613 17,7 - WE / - WK
2.5 dCi	88	08/06→					
2.5 dCi	107	08/06→	→	→ 12/10		13.0460-3806.2 603806	BOS 23669 16,8 - WE / - WK
2.5 dCi 100 (ED4V, ED8V)	73	10/03→	←	→ 08/06		13.0460-3800.2 603800	BOS 23613 17,7 - WE / - WK
2.5 dCi 120	84	10/01→	→	→ 08/06		13.0460-3806.2 603806	BOS 23669 16,8 - WE / - WK
3.0 dCi 120	85	06/05→					
3.0 dCi 140 (ED0S, UD0S)	100	10/03→					
3.0 dCi 160	115	06/05→					
<b>Zubehörsatz, Scheibenbremsbelag</b>							
2.5 dCi	74	08/06→	←	→ 12/10		13.0460-0344.2 610344	
2.5 dCi	88	08/06→					
2.5 dCi	107	08/06→					
 <b>Bremsscheibe</b>							
2.2 dCi 90	66	09/00→	←	→ 10/01		24.0124-0162.1 424162	Ø 280 24 21 V
			←	11/01→ 08/06		24.0128-0129.1 428129	Ø 305,5 28 25 V + S
						24.0328-0129.1 528129	Ø 305,5 28 25 V + S
			→	→ 08/06		24.0112-0155.1 412155	Ø 305 12 10,5 + S
2.5 D	59	07/98→01/01	←			24.0124-0162.1 424162	Ø 280 24 21 V
			→	08/00→		24.0112-0155.1 412155	Ø 305 12 10,5 + S
2.5 dCi	74	08/06→	←	→ 12/10		24.0128-0129.1 428129	Ø 305,5 28 25 V + S
2.5 dCi	88	08/06→				24.0328-0129.1 528129	Ø 305,5 28 25 V + S
2.5 dCi	107	08/06→	→	→ 12/10		24.0112-0155.1 412155	Ø 305 12 10,5 + S
2.5 dCi 100 (ED4V, ED8V)	73	10/03→	←	→ 08/06		24.0128-0129.1 428129	Ø 305,5 28 25 V + S
2.5 dCi 120	84	10/01→				24.0328-0129.1 528129	Ø 305,5 28 25 V + S
3.0 dCi 120	85	06/05→	→	→ 08/06		24.0112-0155.1 412155	Ø 305 12 10,5 + S
3.0 dCi 140 (ED0S, UD0S)	100	10/03→					
3.0 dCi 160	115	06/05→					
2.8 dTI	84	07/98→10/01	←	→ 07/00		24.0124-0162.1 424162	Ø 280 24 21 V
			←	08/00→ 08/01		24.0128-0129.1 428129	Ø 305,5 28 25 V + S
						24.0328-0129.1 528129	Ø 305,5 28 25 V + S
			→	08/00→		24.0112-0155.1 412155	Ø 305 12 10,5 + S
<b>RENAULT - MASTER III Bus (JV) 02/11→</b>							
 <b>Bremsbelagsatz, Scheibenbremse</b>							
2.3 dCi 100 FWD (JV0A, JV0B)	74	02/11→	←			13.0460-4856.2 604856	BRE 25147 18,4 + WK
2.3 dCi 110 FWD	81	09/14→	→	mit Doppelbereifung		13.0460-4857.2 604857	BRE 25172 18,4 + WK
2.3 dCi 125 FWD (JV0C, JV0D, JV0H)	92	02/11→	→	mit Einfachbereifung		13.0460-4858.2 604858	BRE 25112 18,4 + WK
2.3 dCi 135 FWD	100	07/14→					















	kw			 	! #		
<b>RENAULT - MASTER III Bus (JV) 02/11→</b>							
 <b>Bremsbelagsatz, Scheibenbremse</b>							
2.3 dCi 145 FWD (JV0F, JV0H)	107	02/11→	←			<b>13.0460-4856.2 604856</b>	BRE 25147 18,4 + WK
2.3 dCi 165 FWD	120	07/14→	→	mit Doppelbereifung		<b>13.0460-4857.2 604857</b>	BRE 25172 18,4 + WK
2.3 dCi 170 FWD	125	07/15→	→	mit Einfachbereifung		<b>13.0460-4858.2 604858</b>	BRE 25112 18,4 + WK
2.3 dCi 150 FWD	110	10/12→	←	01/13→		<b>13.0460-4856.2 604856</b>	BRE 25147 18,4 + WK
			→	01/13→; mit Doppelbereifung		<b>13.0460-4857.2 604857</b>	BRE 25172 18,4 + WK
			→	01/13→; mit Einfachbereifung		<b>13.0460-4858.2 604858</b>	BRE 25112 18,4 + WK
 <b>Bremsscheibe</b>							
2.3 dCi 100 FWD (JV0A, JV0B)	74	02/11→	←			<b>24.0128-0252.1 428252</b>	Ø 302 28 24,5 V + S
2.3 dCi 110 FWD	81	09/14→	→			<b>24.0112-0191.1 412191</b>	Ø 305 12 10 + S
2.3 dCi 125 FWD (JV0C, JV0D, JV0H)	92	02/11→					
2.3 dCi 145 FWD (JV0F, JV0H)	107	02/11→					
2.3 dCi 170 FWD	125	07/15→					
2.3 dCi 135 FWD	100	07/14→	←			<b>24.0128-0252.1 428252</b>	Ø 302 28 24,5 V + S
2.3 dCi 165 FWD	120	07/14→	→	mit Einfachbereifung		<b>24.0112-0190.1 412190</b>	Ø 305 12 10 + S
			→	mit Doppelbereifung		<b>24.0118-0153.1 418153</b>	Ø 302 18 15
2.3 dCi 150 FWD	110	10/12→	←	01/13→		<b>24.0128-0252.1 428252</b>	Ø 302 28 24,5 V + S
			→	01/13→		<b>24.0112-0191.1 412191</b>	Ø 305 12 10 + S
<b>RENAULT - MASTER III Kasten (FV) 02/10→</b>							
 <b>Bremsbelagsatz, Scheibenbremse</b>							
2.3 dCi 100 FWD (FV0A, FV0B, FV0G, FV0K)	74	02/10→	←			<b>13.0460-4856.2 604856</b>	BRE 25147 18,4 + WK
2.3 dCi 100 RWD (FV0B, FV0C, FV0D)	74	02/10→	→	mit Doppelbereifung		<b>13.0460-4857.2 604857</b>	BRE 25172 18,4 + WK
2.3 dCi 110 FWD	81	09/14→	→	mit Einfachbereifung		<b>13.0460-4858.2 604858</b>	BRE 25112 18,4 + WK
2.3 dCi 125 FWD (FV0C, FV0D)	92	02/10→					
2.3 dCi 125 RWD (FV0C, FV0D, FV0H, FV0J)	92	02/10→					
2.3 dCi 130 FWD	96	06/16→					
2.3 dCi 130 RWD	96	03/12→					
2.3 dCi 135 FWD	100	07/14→					
2.3 dCi 135 RWD	100	07/14→					
2.3 dCi 145 FWD (FV0E, FV0F, FV0H, FV0J)	107	02/10→					
2.3 dCi 145 RWD (FV0E, FV0F, FV0J)	107	02/10→					
2.3 dCi 150 FWD	110	03/13→					
2.3 dCi 150 RWD	110	03/13→					
2.3 dCi 165 FWD	120	07/14→					
2.3 dCi 165 RWD	120	07/14→					
2.3 dCi 170 FWD	125	07/15→					
 <b>Bremsscheibe</b>							
2.3 dCi 100 FWD (FV0A, FV0B, FV0G, FV0K)	74	02/10→	←			<b>24.0128-0252.1 428252</b>	Ø 302 28 24,5 V + S
2.3 dCi 110 FWD	81	09/14→	→			<b>24.0112-0191.1 412191</b>	Ø 305 12 10 + S
2.3 dCi 125 FWD (FV0C, FV0D)	92	02/10→					
2.3 dCi 130 FWD	96	06/16→					
2.3 dCi 135 FWD	100	07/14→					
2.3 dCi 145 FWD (FV0E, FV0F, FV0H, FV0J)	107	02/10→					
2.3 dCi 150 FWD	110	03/13→					
2.3 dCi 165 FWD	120	07/14→					
2.3 dCi 170 FWD	125	07/15→					
2.3 dCi 100 RWD (FV0B, FV0C, FV0D)	74	02/10→	←			<b>24.0128-0252.1 428252</b>	Ø 302 28 24,5 V + S
2.3 dCi 125 RWD (FV0C, FV0D, FV0H, FV0J)	92	02/10→	→	mit Einfachbereifung		<b>24.0112-0190.1 412190</b>	Ø 305 12 10 + S
			→	mit Doppelbereifung		<b>24.0118-0153.1 418153</b>	Ø 302 18 15
2.3 dCi 130 RWD	96	03/12→					
2.3 dCi 135 RWD	100	07/14→					
2.3 dCi 145 RWD (FV0E, FV0F, FV0J)	107	02/10→					
2.3 dCi 150 RWD	110	03/13→					
2.3 dCi 165 RWD	120	07/14→					









	kW					! #		
<b>RENAULT - MASTER III Pritsche/Fahrgestell (EV, HV, UV) 02/10→</b>								
 <b>Bremsbelagsatz, Scheibenbremse</b>								
2.3 dCi 100 FWD (EV0A, EV0B, HV0A, HV0B, HV0G, UV0A,...)	74	02/10→	←				<b>13.0460-4856.2 604856</b>	BRE 25147 18,4 + WK
			→	mit Doppelbereifung			<b>13.0460-4857.2 604857</b>	BRE 25172 18,4 + WK
2.3 dCi 100 RWD (UV0C, UV0D, HV0C, HV0D)	74	02/10→	→	mit Einfachbereifung			<b>13.0460-4858.2 604858</b>	BRE 25112 18,4 + WK
2.3 dCi 110 FWD	81	09/14→						
2.3 dCi 125 FWD (EV0C, EV0D, EV0J, HV0C, HV0D, HV0H,...)	92	02/10→						
2.3 dCi 125 RWD (HV0C, HV0D, UV0C, UV0D, UV0H, UV0J)	92	02/10→						
2.3 dCi 130 FWD	96	03/12→						
2.3 dCi 130 RWD	96	07/16→						
2.3 dCi 135 RWD	100	07/14→						
2.3 dCi 145 FWD (EV0E, EV0F, HV0E, HV0F, UV0E, UV0F)	107	02/10→						
2.3 dCi 145 RWD (UV0F, UV0E)	107	02/10→						
2.3 dCi 150 FWD	110	03/13→						
2.3 dCi 150 RWD	110	03/13→						
2.3 dCi 165 FWD	120	07/14→						
2.3 dCi 165 RWD	120	07/14→						
2.3 dCi 170 FWD	125	06/16→						
2.3 dCi 135 FWD	100	07/14→	→	mit Doppelbereifung			<b>13.0460-4857.2 604857</b>	BRE 25172 18,4 + WK
			→	mit Einfachbereifung			<b>13.0460-4858.2 604858</b>	BRE 25112 18,4 + WK
 <b>Bremsscheibe</b>								
2.3 dCi 100 FWD (EV0A, EV0B, HV0A, HV0B, HV0G, UV0A,...)	74	02/10→	←				<b>24.0128-0252.1 428252</b>	Ø 302 28 24,5 V + S
			→				<b>24.0112-0191.1 412191</b>	Ø 305 12 10 + S
2.3 dCi 110 FWD	81	09/14→						
2.3 dCi 125 FWD (EV0C, EV0D, EV0J, HV0C, HV0D, HV0H,...)	92	02/10→						
2.3 dCi 130 FWD	96	03/12→						
2.3 dCi 135 FWD	100	07/14→						
2.3 dCi 145 FWD (EV0E, EV0F, HV0E, HV0F, UV0E, UV0F)	107	02/10→						
2.3 dCi 150 FWD	110	03/13→						
2.3 dCi 165 FWD	120	07/14→						
2.3 dCi 170 FWD	125	06/16→						
2.3 dCi 100 RWD (UV0C, UV0D, HV0C, HV0D)	74	02/10→	←				<b>24.0128-0252.1 428252</b>	Ø 302 28 24,5 V + S
			→	für Einfachbereifung			<b>24.0112-0190.1 412190</b>	Ø 305 12 10 + S
2.3 dCi 125 RWD (HV0C, HV0D, UV0C, UV0D, UV0H, UV0J)	92	02/10→	→	für Doppelbereifung			<b>24.0118-0153.1 418153</b>	Ø 302 18 15
2.3 dCi 130 RWD	96	07/16→						
2.3 dCi 135 RWD	100	07/14→						
2.3 dCi 145 RWD (UV0F, UV0E)	107	02/10→						
2.3 dCi 150 RWD	110	03/13→						
2.3 dCi 165 RWD	120	07/14→						
<b>RENAULT - MEGANE I (BA0/1_) 08/95→12/04</b>								
 <b>Bremsbelagsatz, Scheibenbremse</b>								
1.4 16V (BA0D, BA1H, BA0W, BA10)	70	03/99→08/03	←	→ 12/02			<b>13.0460-2834.2 602834</b>	TRW 21463 18,0 + WK
			→	→ 12/02; + ASR			<b>13.0460-3954.2 603954</b>	BDX 20973 11,0 - WK
1.4 e (BA0E, BA0V)	55	01/96→08/03	←	→ 12/02			<b>13.0460-2834.2 602834</b>	TRW 21463 18,0 + WK
1.9 dT (B/SA0K, B/SA0Y)	66	01/96→08/03						
1.9 TDI	69	09/96→08/03						
2.0 i	80	03/99→08/03						
2.0 i (BA0G)	84	01/96→08/03						
1.4 Eco (BA0T)	52	01/96→03/99	←				<b>13.0460-2834.2 602834</b>	TRW 21463 18,0 + WK
1.6 e (BA0F, BA0S)	66	01/96→03/99						
1.6 i (BA0L)	55	01/96→03/99						
1.9 dT	76	08/98→10/99						
2.0	85	05/98→05/01						
1.6 16V	81	11/01→12/04	←	→ 12/02; für Fahrzeuge mit verstärktem Fahrwerk			<b>13.0460-2834.2 602834</b>	TRW 21463 18,0 + WK
			←	→ 12/02			<b>13.0460-2895.2 602895</b>	TRW 23172 18,0 - WK
			←	→ 12/02; für Fahrzeuge ohne verstärktes Fahrwerk			<b>13.0460-2895.2 602895</b>	TRW 23172 18,0 - WK
↓								















	kw			 	! #		
<b>RENAULT - MEGANE I (BA0/1_) 08/95→12/04</b>							
<b> Bremsbelagsatz, Scheibenbremse</b>							
1.6 16V	81	11/01→12/04	➔	→ 12/02; + ASR		<b>13.0460-3954.2 603954</b>	BDX 20973 11,0 - WK
1.6 16V (BA04, BA0B, BA11, BA1J, BA16, BA19, BA1K, BA1V,... 1.6 LPG	79	03/99→08/02	➔	für Fahrzeuge mit verstärktem Fahrwerk		<b>13.0460-2834.2 602834</b>	TRW 21463 18,0 + WK
			➔			<b>13.0460-2895.2 602895</b>	TRW 23172 18,0 - WK
	80	10/00→08/02	➔	für Fahrzeuge ohne verstärktes Fahrwerk		<b>13.0460-2895.2 602895</b>	TRW 23172 18,0 - WK
			➔	+ ASR		<b>13.0460-3954.2 603954</b>	BDX 20973 11,0 - WK
1.6 LPG	66	08/95→03/99	➔	01/96→		<b>13.0460-2834.2 602834</b>	TRW 21463 18,0 + WK
1.8 16V (BA06, BA12, BA1A, BA1M, BA1R)	85	01/01→08/03	➔	→ 12/02		<b>13.0460-2895.2 602895</b>	TRW 23172 18,0 - WK
			➔	→ 12/02		<b>13.0460-3954.2 603954</b>	BDX 20973 11,0 - WK
			➔	→ 12/02; + ASR		<b>13.0460-3954.2 603954</b>	BDX 20973 11,0 - WK
1.9 D	69	04/96→02/01	➔	09/96→		<b>13.0460-2834.2 602834</b>	TRW 21463 18,0 + WK
1.9 DCi 1.9 dTi (BA1U)	77	03/99→08/03	➔	→ 12/02		<b>13.0460-2895.2 602895</b>	TRW 23172 18,0 - WK
	59	02/01→08/03					
1.9 dCi (BA05, BA1F)	75	02/01→08/03	➔	→ 12/02		<b>13.0460-2895.2 602895</b>	TRW 23172 18,0 - WK
			➔	→ 12/02; + ASR		<b>13.0460-3954.2 603954</b>	BDX 20973 11,0 - WK
1.9 D Eco (BA0A, BA0U, BA0R)	47	01/96→08/03	➔	→ 12/02		<b>13.0460-2834.2 602834</b>	TRW 21463 18,0 + WK
			➔	06/98→ 12/02		<b>13.0460-2834.2 602834</b>	TRW 21463 18,0 + WK
1.9 dTi (BA08, BA0N)	72	03/97→02/01	➔			<b>13.0460-2834.2 602834</b>	TRW 21463 18,0 + WK
			➔	→ 03/99		<b>13.0460-2834.2 602834</b>	TRW 21463 18,0 + WK
			➔	04/99→		<b>13.0460-2895.2 602895</b>	TRW 23172 18,0 - WK
2.0 16V (BA0H)	108	07/96→08/03	➔	→ 12/02		<b>13.0460-2983.2 602983</b>	TRW 20919 18,0 + WK
			➔	→ 12/02		<b>13.0460-3954.2 603954</b>	BDX 20973 11,0 - WK
<b>Zubehörsatz, Scheibenbremsbelag</b>							
1.4 16V (BA0D, BA1H, BA0W, BA10)	70	03/99→08/03	➔	→ 12/02; + ASR		<b>13.0460-0435.2 610435</b>	BDX
1.6 16V	81	11/01→12/04	➔	→ 12/02		<b>13.0460-0262.2 610262</b>	TRW
			➔	→ 12/02; für Fahrzeuge ohne verstärktes Fahrwerk		<b>13.0460-0262.2 610262</b>	TRW
			➔	→ 12/02; + ASR		<b>13.0460-0435.2 610435</b>	BDX
1.6 16V (BA04, BA0B, BA11, BA1J, BA16, BA19, BA1K, BA1V,... 1.6 LPG	79	03/99→08/02	➔			<b>13.0460-0262.2 610262</b>	TRW
	80	10/00→08/02	➔	für Fahrzeuge ohne verstärktes Fahrwerk		<b>13.0460-0262.2 610262</b>	TRW
			➔	+ ASR		<b>13.0460-0435.2 610435</b>	BDX
1.8 16V (BA06, BA12, BA1A, BA1M, BA1R)	85	01/01→08/03	➔	→ 12/02		<b>13.0460-0262.2 610262</b>	TRW
			➔	→ 12/02		<b>13.0460-0435.2 610435</b>	BDX
			➔	→ 12/02; + ASR		<b>13.0460-0435.2 610435</b>	BDX
1.9 DCi 1.9 dTi (BA1U)	77	03/99→08/03	➔	→ 12/02		<b>13.0460-0262.2 610262</b>	TRW
	59	02/01→08/03					
1.9 dCi (BA05, BA1F)	75	02/01→08/03	➔	→ 12/02		<b>13.0460-0262.2 610262</b>	TRW
			➔	→ 12/02; + ASR		<b>13.0460-0435.2 610435</b>	BDX
1.9 dTi (BA08, BA0N)	72	03/97→02/01	➔	04/99→		<b>13.0460-0262.2 610262</b>	TRW
2.0 16V (BA0H)	108	07/96→08/03	➔	→ 12/02		<b>13.0460-0435.2 610435</b>	BDX
<b> Bremsscheibe</b>							
1.4 16V (BA0D, BA1H, BA0W, BA10)	70	03/99→08/03	➔	→ 12/02		<b>24.0121-0106.1 421106</b>	Ø 259 20,7 17,7 V + S
			➔	→ 12/02; + ASR		<b>24.0108-0108.1 408108</b>	Ø 238 8 7 - ABS Ring
1.4 e (BA0E, BA0V)	55	01/96→08/03	➔	→ 10/97		<b>24.0112-0116.1 412116</b>	Ø 238 12 10,5 + S
			➔	11/97→ 09/98		<b>24.0120-0125.1 420125</b>	Ø 238 20,1 17,7 V + S
			➔	06/98→ 12/02		<b>24.0121-0106.1 421106</b>	Ø 259 20,7 17,7 V + S
			➔	10/98→ 12/02		<b>24.0121-0106.1 421106</b>	Ø 259 20,7 17,7 V + S
1.4 Eco (BA0T)	52	01/96→03/99	➔	→ 10/97		<b>24.0112-0116.1 412116</b>	Ø 238 12 10,5 + S
			➔	11/97→		<b>24.0120-0125.1 420125</b>	Ø 238 20,1 17,7 V + S
1.6 16V 1.9 dCi (BA05, BA1F)	81	11/01→12/04	➔	→ 12/02		<b>24.0124-0158.1 424158</b>	Ø 280 24 21,8 V + S
	75	02/01→08/03				<b>24.0324-0158.1 524158</b>	Ø 280 24 21,8 V + S
			➔	→ 12/02; + ASR		<b>24.0108-0108.1 408108</b>	Ø 238 8 7 - ABS Ring
1.6 16V (BA04, BA0B, BA11, BA1J, BA16, BA19, BA1K, BA1V,... 1.6 LPG	79	03/99→08/02	➔			<b>24.0124-0158.1 424158</b>	Ø 280 24 21,8 V + S
	80	10/00→08/02	➔	+ ASR		<b>24.0324-0158.1 524158</b>	Ø 280 24 21,8 V + S
			➔			<b>24.0108-0108.1 408108</b>	Ø 238 8 7 - ABS Ring

	kW			 	! #		
<b>RENAULT - MEGANE I (BA0/1_) 08/95→12/04</b>							
<b>Bremsscheibe</b>							
1.6 e (BA0F, BA0S)	66	01/96→03/99	←	→ 09/98		<b>24.0120-0125.1 420125</b>	Ø 238 20,1 17,7 V + S
			←	10/98→		<b>24.0121-0106.1 421106</b>	Ø 259 20,7 17,7 V + S
1.6 i (BA0L)	55	01/96→03/99	←	→ 10/97		<b>24.0112-0116.1 412116</b>	Ø 238 12 10,5 + S
			←	11/97→ 09/98		<b>24.0120-0125.1 420125</b>	Ø 238 20,1 17,7 V + S
			←	10/98→		<b>24.0121-0106.1 421106</b>	Ø 259 20,7 17,7 V + S
1.6 LPG	66	08/95→03/99	←	01/96→ 09/98		<b>24.0120-0125.1 420125</b>	Ø 238 20,1 17,7 V + S
			←	10/98→		<b>24.0121-0106.1 421106</b>	Ø 259 20,7 17,7 V + S
1.8 16V (BA06, BA12, BA1A, BA1M, BA1R)	85	01/01→08/03	←	→ 12/02		<b>24.0124-0158.1 424158</b>	Ø 280 24 21,8 V + S
			→	→ 12/02		<b>24.0324-0158.1 524158</b>	Ø 280 24 21,8 V + S
			→	→ 12/02		<b>24.0108-0108.1 408108</b>	Ø 238 8 7 - ABS Ring
			→	→ 12/02; + ASR		<b>24.0108-0108.1 408108</b>	Ø 238 8 7 - ABS Ring
1.9 D	69	04/96→02/01	←	09/96→		<b>24.0121-0106.1 421106</b>	Ø 259 20,7 17,7 V + S
1.9 DCi 1.9 dTi (BA1U)	77	03/99→08/03	←	→ 12/02		<b>24.0124-0158.1 424158</b>	Ø 280 24 21,8 V + S
	59	02/01→08/03				<b>24.0324-0158.1 524158</b>	Ø 280 24 21,8 V + S
1.9 D Eco (BA0A, BA0U, BA0R)	47	01/96→08/03	←	→ 10/97		<b>24.0112-0116.1 412116</b>	Ø 238 12 10,5 + S
			←	11/97→ 09/98		<b>24.0120-0125.1 420125</b>	Ø 238 20,1 17,7 V + S
			←	11/97→ 12/02		<b>24.0120-0125.1 420125</b>	Ø 238 20,1 17,7 V + S
			←	06/98→ 12/02		<b>24.0121-0106.1 421106</b>	Ø 259 20,7 17,7 V + S
			←	→ 12/02		<b>24.0121-0106.1 421106</b>	Ø 259 20,7 17,7 V + S
			←	10/98→ 12/02		<b>24.0121-0106.1 421106</b>	Ø 259 20,7 17,7 V + S
1.9 dT	76	08/98→10/99	←			<b>24.0121-0106.1 421106</b>	Ø 259 20,7 17,7 V + S
2.0	85	05/98→05/01					
1.9 dT (B/SA0K, B/SA0Y) 1.9 TDI 2.0 i 2.0 i (BA0G)	66	01/96→08/03	←	→ 12/02		<b>24.0121-0106.1 421106</b>	Ø 259 20,7 17,7 V + S
	69	09/96→08/03					
	80	03/99→08/03					
	84	01/96→08/03					
1.9 dTi (BA08, BA0N)	72	03/97→02/01	←			<b>24.0121-0106.1 421106</b>	Ø 259 20,7 17,7 V + S
			←	→ 02/99		<b>24.0121-0106.1 421106</b>	Ø 259 20,7 17,7 V + S
			←	03/99→		<b>24.0124-0158.1 424158</b>	Ø 280 24 21,8 V + S
						<b>24.0324-0158.1 524158</b>	Ø 280 24 21,8 V + S
2.0 16V (BA0H)	108	07/96→08/03	←	→ 09/98		<b>24.0122-0148.1 422148</b>	Ø 262 22 19,8 V + S
			←	10/98→ 12/02		<b>24.0124-0158.1 424158</b>	Ø 280 24 21,8 V + S
						<b>24.0324-0158.1 524158</b>	Ø 280 24 21,8 V + S
			→	→ 12/02		<b>24.0108-0108.1 408108</b>	Ø 238 8 7 - ABS Ring
<b>RENAULT - MEGANE I Cabriolet (EA0/1_) 10/96→08/03</b>							
<b>Bremsbelagsatz, Scheibenbremse</b>							
1.4 16V (EA0D, EA1H, EA0W, EA10)	70	03/99→08/03	←			<b>13.0460-2834.2 602834</b>	TRW 21463 18,0 + WK
			←	10/00→		<b>13.0460-2895.2 602895</b>	TRW 23172 18,0 - WK
			→	10/00→; + ASR		<b>13.0460-3954.2 603954</b>	BDX 20973 11,0 - WK
1.6 16V (EA04, EA0B, EA11, EA1J)	79	03/99→07/03	←			<b>13.0460-2895.2 602895</b>	TRW 23172 18,0 - WK
			→	10/00→; + ASR		<b>13.0460-3954.2 603954</b>	BDX 20973 11,0 - WK
1.6 e (EA0F) 2.0 (EA0G) 2.0 i (EA0G)	66	10/96→03/99	←			<b>13.0460-2834.2 602834</b>	TRW 21463 18,0 + WK
	84	04/97→08/03					
	80	03/99→08/03					
2.0 16V	102	01/02→08/03	←			<b>13.0460-2895.2 602895</b>	TRW 23172 18,0 - WK
			→			<b>13.0460-3954.2 603954</b>	BDX 20973 11,0 - WK
2.0 16V (EA0H)	108	10/96→11/99	←			<b>13.0460-2983.2 602983</b>	TRW 20919 18,0 + WK
			→			<b>13.0460-3954.2 603954</b>	BDX 20973 11,0 - WK
2.0 16V IDE (EA03, EA0P, EA14)	103	11/99→08/03	←			<b>13.0460-2895.2 602895</b>	TRW 23172 18,0 - WK
			←	10/00→		<b>13.0460-2895.2 602895</b>	TRW 23172 18,0 - WK
			→			<b>13.0460-3954.2 603954</b>	BDX 20973 11,0 - WK
			→	10/00→		<b>13.0460-3954.2 603954</b>	BDX 20973 11,0 - WK
<b>Zubehörsatz, Scheibenbremsbelag</b>							
1.4 16V (EA0D, EA1H, EA0W, EA10)	70	03/99→08/03	←	10/00→		<b>13.0460-0262.2 610262</b>	TRW
			→	10/00→; + ASR		<b>13.0460-0435.2 610435</b>	BDX
↓							









	kw			 	! #		
<b>RENAULT - MEGANE I Cabriolet (EA0/1_) 10/96→08/03</b>							
<b>Zubehörsatz, Scheibenbremsbelag</b>							
1.6 16V (EA04, EA0B, EA11, EA1J)	79	03/99→07/03	←			13.0460-0262.2 610262	TRW
			→	10/00→; + ASR		13.0460-0435.2 610435	BDX
2.0 16V	102	01/02→08/03	←			13.0460-0262.2 610262	TRW
			→			13.0460-0435.2 610435	BDX
2.0 16V (EA0H)	108	10/96→11/99	→			13.0460-0435.2 610435	BDX
2.0 16V IDE (EA03, EA0P, EA14)	103	11/99→08/03	←			13.0460-0262.2 610262	TRW
			←	10/00→		13.0460-0262.2 610262	TRW
			→			13.0460-0435.2 610435	BDX
			→	10/00→		13.0460-0435.2 610435	BDX
<b> Bremsscheibe</b>							
1.4 16V (EA0D, EA1H, EA0W, EA10)	70	03/99→08/03	←			24.0121-0106.1 421106	Ø 259 20,7 17,7 V + S
			←	10/00→		24.0121-0106.1 421106	Ø 259 20,7 17,7 V + S
			→	10/00→; + ASR		24.0108-0108.1 408108	Ø 238 8 7 - ABS Ring
1.6 16V (EA04, EA0B, EA11, EA1J)	79	03/99→07/03	←			24.0124-0158.1 424158	Ø 280 24 21,8 V + S
			→	10/00→; + ASR		24.0108-0108.1 408108	Ø 238 8 7 - ABS Ring
1.6 e (EA0F)	66	10/96→03/99	←	→ 10/97		24.0120-0125.1 420125	Ø 238 20,1 17,7 V + S
			←	11/97→		24.0121-0106.1 421106	Ø 259 20,7 17,7 V + S
2.0 (EA0G)	84	04/97→08/03	←			24.0121-0106.1 421106	Ø 259 20,7 17,7 V + S
2.0 i (EA0G)	80	03/99→08/03	←			24.0121-0106.1 421106	Ø 259 20,7 17,7 V + S
2.0 16V	102	01/02→08/03	←			24.0124-0158.1 424158	Ø 280 24 21,8 V + S
						24.0324-0158.1 524158	Ø 280 24 21,8 V + S
			→			24.0108-0108.1 408108	Ø 238 8 7 - ABS Ring
2.0 16V (EA0H)	108	10/96→11/99	←	→ 08/98; für Linkslenker		24.0122-0148.1 422148	Ø 262 22 19,8 V + S
			←	für Rechtslenker		24.0124-0158.1 424158	Ø 280 24 21,8 V + S
						24.0324-0158.1 524158	Ø 280 24 21,8 V + S
			←	09/98→; für Linkslenker		24.0124-0158.1 424158	Ø 280 24 21,8 V + S
			→			24.0324-0158.1 524158	Ø 280 24 21,8 V + S
			→			24.0108-0108.1 408108	Ø 238 8 7 - ABS Ring
2.0 16V IDE (EA03, EA0P, EA14)	103	11/99→08/03	←	10/00→		24.0124-0158.1 424158	Ø 280 24 21,8 V + S
						24.0324-0158.1 524158	Ø 280 24 21,8 V + S
			←			24.0124-0158.1 424158	Ø 280 24 21,8 V + S
						24.0324-0158.1 524158	Ø 280 24 21,8 V + S
			→			24.0108-0108.1 408108	Ø 238 8 7 - ABS Ring
			→	10/00→		24.0108-0108.1 408108	Ø 238 8 7 - ABS Ring
<b>RENAULT - MEGANE I Classic (LA0/1_) 09/96→08/08</b>							
<b> Bremsbelagsatz, Scheibenbremse</b>							
1.4 (LA0E, LA0V)	55	09/96→08/03	←	04/98→ 12/02		13.0460-2834.2 602834	TRW 21463 18,0 + WK
			←	→ 12/02		13.0460-2834.2 602834	TRW 21463 18,0 + WK
1.4 16V (LA0D, LA1H, IA0W, LA10)	70	03/99→08/03	←	→ 12/02		13.0460-2834.2 602834	TRW 21463 18,0 + WK
			→	→ 12/02; + ASR		13.0460-2895.2 602895	TRW 23172 18,0 - WK
1.6 1.6 e (LA0F, LA0S) 1.6 i (LA0L) 1.9 dT 2.0 RT	64	02/00→09/00	←			13.0460-2834.2 602834	TRW 21463 18,0 + WK
	66	09/96→03/99	←			13.0460-2834.2 602834	TRW 21463 18,0 + WK
	55	09/96→03/99	←			13.0460-2834.2 602834	TRW 21463 18,0 + WK
	76	08/98→10/99	←			13.0460-2834.2 602834	TRW 21463 18,0 + WK
1.6 16V	81	09/99→12/01	←			13.0460-2834.2 602834	TRW 21463 18,0 + WK
			←	für Fahrzeuge mit verstärktem Fahrwerk		13.0460-2895.2 602895	TRW 23172 18,0 - WK
			←	für Fahrzeuge ohne verstärktes Fahrwerk		13.0460-2834.2 602834	TRW 21463 18,0 + WK
			→			13.0460-2895.2 602895	TRW 23172 18,0 - WK
1.6 16V (LA00, LA04, LA0B, LA11, LA16, LA19, LA1J, LA1K,...)	79	03/99→07/03	←	→ 12/02; für Fahrzeuge mit verstärktem Fahrwerk		13.0460-2834.2 602834	TRW 21463 18,0 + WK
			←	09/99→ 12/02		13.0460-2834.2 602834	TRW 21463 18,0 + WK
			←	→ 12/02		13.0460-2895.2 602895	TRW 23172 18,0 - WK
↓							

	kw			 	! #		
<b>RENAULT - MEGANE I Classic (LA0/1 ) 09/96→08/08</b>							
<b> Bremsbelagsatz, Scheibenbremse</b>							
1.6 16V (LA00, LA04, LA0B, LA11, LA16, LA19, LA1J, LA1K,...	79	03/99→07/03	←	→ 12/02; für Fahrzeuge ohne verstärktes Fahrwerk	13.0460-2895.2	602895	TRW 23172 18,0 - WK
			→	→ 12/02	13.0460-3954.2	603954	BDX 20973 11,0 - WK
1.8 16V (LA06, LA12, LA1A, LA1M, LA1R)	85	01/01→08/03	←	→ 12/02	13.0460-2895.2	602895	TRW 23172 18,0 - WK
			→	→ 12/02	13.0460-3954.2	603954	BDX 20973 11,0 - WK
			→	→ 12/02; + ASR	13.0460-3954.2	603954	BDX 20973 11,0 - WK
1.9 D (LA0A, LA0U, LA0R)	47	09/96→08/03	←	→ 12/02	13.0460-2834.2	602834	TRW 21463 18,0 + WK
			←	09/98→ 12/02	13.0460-2834.2	602834	TRW 21463 18,0 + WK
1.9 dCi (LA05, LA1F)	75	02/01→08/03	←	→ 12/02	13.0460-2895.2	602895	TRW 23172 18,0 - WK
			→	→ 12/02	13.0460-3954.2	603954	BDX 20973 11,0 - WK
1.9 dCi (LA05)	77	03/99→07/03	←		13.0460-2895.2	602895	TRW 23172 18,0 - WK
1.9 dT (LA0K, LA0Y)	66	09/96→08/03	←	→ 12/02	13.0460-2834.2	602834	TRW 21463 18,0 + WK
1.9 TDI	69	09/96→08/03	←				
1.9 dTi (LA08, LA0N)	72	03/97→02/01	←		13.0460-2834.2	602834	TRW 21463 18,0 + WK
			←	→ 02/99	13.0460-2834.2	602834	TRW 21463 18,0 + WK
			←	03/99→	13.0460-2983.2	602983	TRW 20919 18,0 + WK
1.9 dTi (LA1U)	59	02/01→08/03	←	→ 12/02	13.0460-2834.2	602834	TRW 21463 18,0 + WK
			←		13.0460-2895.2	602895	TRW 23172 18,0 - WK
2.0 i (LA07, LA0G)	84	09/96→08/03	←	→ 12/02	13.0460-2834.2	602834	TRW 21463 18,0 + WK
			←	→ 02/99	13.0460-2834.2	602834	TRW 21463 18,0 + WK
			←	03/99→ 12/02	13.0460-2895.2	602895	TRW 23172 18,0 - WK
2.0 i (LA0G)	80	03/99→08/03	←	→ 12/02	13.0460-2895.2	602895	TRW 23172 18,0 - WK
2.0 RT	103	03/01→08/03	←	→ 02/03	13.0460-2895.2	602895	TRW 23172 18,0 - WK
			→	→ 02/03	13.0460-3954.2	603954	BDX 20973 11,0 - WK
<b>Zubehörsatz, Scheibenbremsbelag</b>							
1.4 16V (LA0D, LA1H, IA0W, LA10)	70	03/99→08/03	←	→ 12/02	13.0460-0262.2	610262	TRW
			→	→ 12/02; + ASR	13.0460-0435.2	610435	BDX
1.6 16V	81	09/99→12/01	←		13.0460-0262.2	610262	TRW
			←	für Fahrzeuge ohne verstärktes Fahrwerk	13.0460-0262.2	610262	TRW
			→		13.0460-0435.2	610435	BDX
1.6 16V (LA00, LA04, LA0B, LA11, LA16, LA19, LA1J, LA1K,...	79	03/99→07/03	←	→ 12/02	13.0460-0262.2	610262	TRW
			←	→ 12/02; für Fahrzeuge ohne verstärktes Fahrwerk	13.0460-0262.2	610262	TRW
			→	→ 12/02	13.0460-0435.2	610435	BDX
1.8 16V (LA06, LA12, LA1A, LA1M, LA1R)	85	01/01→08/03	←	→ 12/02	13.0460-0262.2	610262	TRW
			→	→ 12/02	13.0460-0435.2	610435	BDX
			→	→ 12/02; + ASR	13.0460-0435.2	610435	BDX
1.9 dCi (LA05, LA1F)	75	02/01→08/03	←	→ 12/02	13.0460-0262.2	610262	TRW
			→	→ 12/02	13.0460-0435.2	610435	BDX
1.9 dCi (LA05)	77	03/99→07/03	←		13.0460-0262.2	610262	TRW
1.9 dTi (LA08, LA0N)	72	03/97→02/01	←	03/99→	13.0460-0262.2	610262	TRW
1.9 dTi (LA1U)	59	02/01→08/03	←	→ 12/02	13.0460-0262.2	610262	TRW
2.0 i (LA0G)	80	03/99→08/03	←				
2.0 i (LA07, LA0G)	84	09/96→08/03	←	03/99→ 12/02	13.0460-0262.2	610262	TRW
2.0 RT	103	03/01→08/03	←	→ 02/03	13.0460-0262.2	610262	TRW
			→	→ 02/03	13.0460-0435.2	610435	BDX
<b> Bremsscheibe</b>							
1.4 (LA0E, LA0V)	55	09/96→08/03	←	→ 10/97	24.0112-0116.1	412116	Ø 238 12 10,5 + S
			←	11/97→ 09/98	24.0120-0125.1	420125	Ø 238 20,1 17,7 V + S
			←	04/98→ 12/02	24.0121-0106.1	421106	Ø 259 20,7 17,7 V + S
			←	10/98→ 12/02	24.0121-0106.1	421106	Ø 259 20,7 17,7 V + S
1.4 16V (LA0D, LA1H, IA0W, LA10)	70	03/99→08/03	←	→ 12/02	24.0121-0106.1	421106	Ø 259 20,7 17,7 V + S
			→	→ 12/02; + ASR	24.0108-0108.1	408108	Ø 238 8 7 - ABS Ring
1.6	64	02/00→09/00	←		24.0121-0106.1	421106	Ø 259 20,7 17,7 V + S





















	kw			 	! #		
<b>RENAULT - MEGANE I Classic (LA0/1_) 09/96→08/08</b>							
<b>Bremsscheibe</b>							
1.9 dT 2.0 RT	76 112	08/98→10/99 10/96→02/99	←			24.0121-0106.1 421106	Ø 259 20,7 17,7 V + S
1.6 16V	81	09/99→12/01	←			24.0121-0106.1 421106	Ø 259 20,7 17,7 V + S
						24.0124-0158.1 424158	Ø 280 24 21,8 V + S
						24.0324-0158.1 524158	Ø 280 24 21,8 V + S
			→			24.0108-0108.1 408108	Ø 238 8 7 - ABS Ring
1.6 16V (LA00, LA04, LA0B, LA11, LA16, LA19, LA1J, LA1K,....	79	03/99→07/03	←	09/99→ 12/02		24.0121-0106.1 421106	Ø 259 20,7 17,7 V + S
			←	→ 12/02		24.0124-0158.1 424158	Ø 280 24 21,8 V + S
			←	→ 12/02		24.0324-0158.1 524158	Ø 280 24 21,8 V + S
			→	→ 12/02		24.0108-0108.1 408108	Ø 238 8 7 - ABS Ring
1.6 e (LA0F, LA0S)	66	09/96→03/99	←	→ 10/97		24.0120-0125.1 420125	Ø 238 20,1 17,7 V + S
			←	11/97→		24.0121-0106.1 421106	Ø 259 20,7 17,7 V + S
1.6 i (LA0L)	55	09/96→03/99	←	→ 10/97		24.0112-0116.1 412116	Ø 238 12 10,5 + S
			←	11/97→ 09/98		24.0120-0125.1 420125	Ø 238 20,1 17,7 V + S
			←	10/98→		24.0121-0106.1 421106	Ø 259 20,7 17,7 V + S
1.8 16V (LA06, LA12, LA1A, LA1M, LA1R)	85	01/01→08/03	←	→ 12/02		24.0124-0158.1 424158	Ø 280 24 21,8 V + S
			→	→ 12/02		24.0108-0108.1 408108	Ø 238 8 7 - ABS Ring
			→	→ 12/02; + ASR		24.0108-0108.1 408108	Ø 238 8 7 - ABS Ring
1.9 D (LA0A, LA0U, LA0R)	47	09/96→08/03	←	→ 10/97		24.0112-0116.1 412116	Ø 238 12 10,5 + S
			←	11/97→ 12/02		24.0120-0125.1 420125	Ø 238 20,1 17,7 V + S
			←	11/97→ 09/98		24.0120-0125.1 420125	Ø 238 20,1 17,7 V + S
			←	09/98→ 12/02		24.0121-0106.1 421106	Ø 259 20,7 17,7 V + S
			←	10/98→ 12/02		24.0121-0106.1 421106	Ø 259 20,7 17,7 V + S
1.9 dCi (LA05, LA1F)	75	02/01→08/03	←	→ 12/02		24.0124-0158.1 424158	Ø 280 24 21,8 V + S
			→	→ 12/02		24.0324-0158.1 524158	Ø 280 24 21,8 V + S
			→	→ 12/02		24.0108-0108.1 408108	Ø 238 8 7 - ABS Ring
1.9 dCi (LA05)	77	03/99→07/03	←			24.0124-0158.1 424158	Ø 280 24 21,8 V + S
						24.0324-0158.1 524158	Ø 280 24 21,8 V + S
1.9 dT (LA0K, LA0Y)	66	09/96→08/03	←	→ 12/02		24.0121-0106.1 421106	Ø 259 20,7 17,7 V + S
1.9 TDI	69	09/96→08/03	←			24.0121-0106.1 421106	Ø 259 20,7 17,7 V + S
1.9 dTi (LA08, LA0N)	72	03/97→02/01	←			24.0121-0106.1 421106	Ø 259 20,7 17,7 V + S
			←	→ 02/99		24.0121-0106.1 421106	Ø 259 20,7 17,7 V + S
			←	03/99→		24.0124-0158.1 424158	Ø 280 24 21,8 V + S
						24.0324-0158.1 524158	Ø 280 24 21,8 V + S
1.9 dTi (LA1U)	59	02/01→08/03	←	→ 12/02		24.0124-0158.1 424158	Ø 280 24 21,8 V + S
2.0 i (LA0G)	80	03/99→08/03	←			24.0324-0158.1 524158	Ø 280 24 21,8 V + S
2.0 i (LA07, LA0G)	84	09/96→08/03	←	→ 12/02		24.0121-0106.1 421106	Ø 259 20,7 17,7 V + S
			←	→ 02/99		24.0121-0106.1 421106	Ø 259 20,7 17,7 V + S
			←	03/99→ 12/02		24.0124-0158.1 424158	Ø 280 24 21,8 V + S
						24.0324-0158.1 524158	Ø 280 24 21,8 V + S
2.0 RT	103	03/01→08/03	←	→ 02/03		24.0124-0158.1 424158	Ø 280 24 21,8 V + S
						24.0324-0158.1 524158	Ø 280 24 21,8 V + S
			→	→ 02/03		24.0108-0108.1 408108	Ø 238 8 7 - ABS Ring
<b>RENAULT - MEGANE I Coach (DA0/1_) 03/96→08/03</b>							
<b>Bremsbelagsatz, Scheibenbremse</b>							
1.4 16V (DA0D, DA1H, DA0W, DA10)	70	03/99→07/03	←	→ 02/03		13.0460-2834.2 602834	TRW 21463 18,0 + WK
			←	10/00→ 02/03		13.0460-2895.2 602895	TRW 23172 18,0 - WK
			→	10/00→ 02/03; + ASR		13.0460-3954.2 603954	BDX 20973 11,0 - WK
1.6 16V (DA0B, DA04, DA11)	79	03/99→07/03	←	→ 02/03		13.0460-2895.2 602895	TRW 23172 18,0 - WK
			←	→ 04/99		13.0460-2983.2 602983	TRW 20919 18,0 + WK
			→	10/00→ 02/03; + ASR		13.0460-3954.2 603954	BDX 20973 11,0 - WK
1.6 e (DA0F)	66	03/96→03/99	←			13.0460-2834.2 602834	TRW 21463 18,0 + WK
1.9 dCi (DA05, DA1F)	75	02/01→08/03	←	→ 02/03		13.0460-2895.2 602895	TRW 23172 18,0 - WK
			→	→ 02/03; + ASR		13.0460-3954.2 603954	BDX 20973 11,0 - WK
1.9 dTi (DA0N)	72	03/97→02/01	←	05/97→ 02/99		13.0460-2834.2 602834	TRW 21463 18,0 + WK
↓							

















	kw			 	! #		
<b>RENAULT - MEGANE I Coach (DA0/1_) 03/96→08/03</b>							
<b> Bremsbelagsatz, Scheibenbremse</b>							
1.9 dTi (DA0N)	72	03/97→02/01	←	03/99→		13.0460-2895.2 602895	TRW 23172 18,0 - WK
			←	03/99→ 04/99		13.0460-2983.2 602983	TRW 20919 18,0 + WK
2.0 16V	102	01/02→08/03	←	→ 02/03		13.0460-2895.2 602895	TRW 23172 18,0 - WK
			→	→ 02/03		13.0460-3954.2 603954	BDX 20973 11,0 - WK
2.0 16V (DA0H)	108	03/96→11/99	←	09/98→		13.0460-2895.2 602895	TRW 23172 18,0 - WK
			←	→ 08/98		13.0460-2983.2 602983	TRW 20919 18,0 + WK
			→			13.0460-3954.2 603954	BDX 20973 11,0 - WK
2.0 16V IDE (DA03, DA0P, DA14)	103	11/99→08/03	←	→ 02/03		13.0460-2895.2 602895	TRW 23172 18,0 - WK
			←	10/00→ 02/03		13.0460-2895.2 602895	TRW 23172 18,0 - WK
			→	10/00→ 02/03		13.0460-3954.2 603954	BDX 20973 11,0 - WK
			→	→ 02/03		13.0460-3954.2 603954	BDX 20973 11,0 - WK
2.0 i	80	03/99→08/03	←	→ 02/03		13.0460-2834.2 602834	TRW 21463 18,0 + WK
2.0 i (DA0G)	84	03/96→08/03					
<b>Zubehörsatz, Scheibenbremsbelag</b>							
1.4 16V (DA0D, DA1H, DA0W, DA10)	70	03/99→07/03	←	10/00→ 02/03		13.0460-0262.2 610262	TRW
			→	10/00→ 02/03; + ASR		13.0460-0435.2 610435	BDX
1.6 16V (DA0B, DA04, DA11)	79	03/99→07/03	←	→ 02/03		13.0460-0262.2 610262	TRW
			→	10/00→ 02/03; + ASR		13.0460-0435.2 610435	BDX
1.9 dCi (DA05, DA1F)	75	02/01→08/03	←	→ 02/03		13.0460-0262.2 610262	TRW
			→	→ 02/03; + ASR		13.0460-0435.2 610435	BDX
1.9 dTi (DA0N)	72	03/97→02/01	←	03/99→		13.0460-0262.2 610262	TRW
2.0 16V	102	01/02→08/03	←	→ 02/03		13.0460-0262.2 610262	TRW
			→	→ 02/03		13.0460-0435.2 610435	BDX
2.0 16V (DA0H)	108	03/96→11/99	←	09/98→		13.0460-0262.2 610262	TRW
			→			13.0460-0435.2 610435	BDX
2.0 16V IDE (DA03, DA0P, DA14)	103	11/99→08/03	←	→ 02/03		13.0460-0262.2 610262	TRW
			←	10/00→ 02/03		13.0460-0262.2 610262	TRW
			→	10/00→ 02/03		13.0460-0435.2 610435	BDX
			→	→ 02/03		13.0460-0435.2 610435	BDX
<b> Bremsscheibe</b>							
1.4 16V (DA0D, DA1H, DA0W, DA10)	70	03/99→07/03	←	→ 02/03		24.0121-0106.1 421106	Ø 259 20,7 17,7 V + S
			←	10/00→ 02/03		24.0121-0106.1 421106	Ø 259 20,7 17,7 V + S
			→	10/00→ 02/03; + ASR		24.0108-0108.1 408108	Ø 238 8 7 - ABS Ring
1.6 16V (DA0B, DA04, DA11)	79	03/99→07/03	←	→ 02/03		24.0124-0158.1 424158	Ø 280 24 21,8 V + S
			→	10/00→ 02/03; + ASR		24.0324-0158.1 524158	Ø 280 24 21,8 V + S
			→	10/00→ 02/03; + ASR		24.0108-0108.1 408108	Ø 238 8 7 - ABS Ring
1.6 e (DA0F)	66	03/96→03/99	←	→ 10/97		24.0120-0125.1 420125	Ø 238 20,1 17,7 V + S
			←	11/97→		24.0121-0106.1 421106	Ø 259 20,7 17,7 V + S
1.9 dCi (DA05, DA1F)	75	02/01→08/03	←	→ 02/03		24.0124-0158.1 424158	Ø 280 24 21,8 V + S
			→	→ 02/03; + ASR		24.0324-0158.1 524158	Ø 280 24 21,8 V + S
			→	→ 02/03; + ASR		24.0108-0108.1 408108	Ø 238 8 7 - ABS Ring
1.9 dTi (DA0N)	72	03/97→02/01	←	05/97→ 02/99		24.0121-0106.1 421106	Ø 259 20,7 17,7 V + S
			←	03/99→		24.0124-0158.1 424158	Ø 280 24 21,8 V + S
						24.0324-0158.1 524158	Ø 280 24 21,8 V + S
2.0 16V	102	01/02→08/03	←	→ 02/03		24.0124-0158.1 424158	Ø 280 24 21,8 V + S
			→	→ 02/03		24.0324-0158.1 524158	Ø 280 24 21,8 V + S
			→	→ 02/03		24.0108-0108.1 408108	Ø 238 8 7 - ABS Ring
2.0 16V (DA0H)	108	03/96→11/99	←	→ 08/98; für Linkslenker		24.0122-0148.1 422148	Ø 262 22 19,8 V + S
			←	für Rechtslenker		24.0124-0158.1 424158	Ø 280 24 21,8 V + S
						24.0324-0158.1 524158	Ø 280 24 21,8 V + S
			←	09/98→; für Linkslenker		24.0124-0158.1 424158	Ø 280 24 21,8 V + S
						24.0324-0158.1 524158	Ø 280 24 21,8 V + S
			→			24.0108-0108.1 408108	Ø 238 8 7 - ABS Ring
↓							



	kw					! #		
<b>RENAULT - MEGANE I Coach (DA0/1_) 03/96→08/03</b>								
 <b>Bremsscheibe</b>								
2.0 16V IDE (DA03, DA0P, DA14)	103	11/99→08/03	←	10/00→ 02/03	24.0124-0158.1	424158	∅ 280 24 21,8 V + S	
			←	→ 02/03	24.0324-0158.1	524158	∅ 280 24 21,8 V + S	
			→	10/00→ 02/03	24.0124-0158.1	424158	∅ 280 24 21,8 V + S	
			→	→ 02/03	24.0324-0158.1	524158	∅ 280 24 21,8 V + S	
			→	10/00→ 02/03	24.0108-0108.1	408108	∅ 238 8 7 - ABS Ring	
2.0 i 2.0 i (DA0G)	80	03/99→08/03	←	→ 02/03	24.0121-0106.1	421106	∅ 259 20,7 17,7 V + S	
	84	03/96→08/03						
<b>RENAULT - MEGANE I Grandtour (KA0/1_) 03/99→08/03</b>								
 <b>Bremsbelagsatz, Scheibenbremse</b>								
1.4 16V (KA0D, KA1H, KA0W, KA10)	70	03/99→08/03	←		13.0460-2834.2	602834	TRW 21463 18,0 + WK	
			→		13.0460-2845.2	602845	TRW 23554 16,4 - WK + Zub	
					13.0470-2845.2	LD2845	TRW 23554 16,4 - WK + Zub Ceramic	
1.4 e (KA0V) 1.6 e (KA0F) 1.9 D (KA0J, KA0R)	55	03/99→08/03	←		13.0460-2834.2	602834	TRW 21463 18,0 + WK	
	66	03/99→08/03						
	47	04/99→08/03						
1.6 16V (KA0B, KA04, KA11)	79	03/99→08/03	←		13.0460-2895.2	602895	TRW 23172 18,0 - WK	
			→	07/99→	13.0460-2845.2	602845	TRW 23554 16,4 - WK + Zub	
					13.0470-2845.2	LD2845	TRW 23554 16,4 - WK + Zub Ceramic	
1.6 Bifuel	80	03/99→09/00	←		13.0460-2895.2	602895	TRW 23172 18,0 - WK	
1.8 16V (KA0S, KA12, KA1A, KA1M, KA1R) 1.9 dCi (KA05, KA1F) 1.9 dTi (KA1U)	85	01/01→08/03	←		13.0460-2895.2	602895	TRW 23172 18,0 - WK	
	75	02/01→08/03	→		13.0460-2845.2	602845	TRW 23554 16,4 - WK + Zub	
	59	02/01→08/03			13.0470-2845.2	LD2845	TRW 23554 16,4 - WK + Zub Ceramic	
1.9 dTi (KA0N)	72	03/99→02/01	←		13.0460-2983.2	602983	TRW 20919 18,0 + WK	
			→	07/99→	13.0460-2845.2	602845	TRW 23554 16,4 - WK + Zub	
					13.0470-2845.2	LD2845	TRW 23554 16,4 - WK + Zub Ceramic	
<b>Zubehörsatz, Scheibenbremsbelag</b>								
1.4 16V (KA0D, KA1H, KA0W, KA10)	70	03/99→08/03	→		13.0460-0072.2	610072	TRW	
1.6 16V (KA0B, KA04, KA11)	79	03/99→08/03	←		13.0460-0262.2	610262	TRW	
			→	07/99→	13.0460-0072.2	610072	TRW	
1.6 Bifuel	80	03/99→09/00	←		13.0460-0262.2	610262	TRW	
1.8 16V (KA0S, KA12, KA1A, KA1M, KA1R) 1.9 dCi (KA05, KA1F) 1.9 dTi (KA1U)	85	01/01→08/03	←		13.0460-0262.2	610262	TRW	
	75	02/01→08/03	→		13.0460-0072.2	610072	TRW	
	59	02/01→08/03						
1.9 dTi (KA0N)	72	03/99→02/01	→	07/99→	13.0460-0072.2	610072	TRW	
 <b>Bremsscheibe</b>								
1.4 16V (KA0D, KA1H, KA0W, KA10)	70	03/99→08/03	←		24.0121-0106.1	421106	∅ 259 20,7 17,7 V + S	
			→		24.0111-0166.2	411166	∅ 274 10,9 9,5 + LG / + ABS Ring	
1.4 e (KA0V) 1.6 e (KA0F) 1.9 D (KA0J, KA0R)	55	03/99→08/03	←		24.0121-0106.1	421106	∅ 259 20,7 17,7 V + S	
	66	03/99→08/03						
	47	04/99→08/03						
1.6 16V (KA0B, KA04, KA11) 1.9 dTi (KA0N)	79	03/99→08/03	←		24.0124-0158.1	424158	∅ 280 24 21,8 V + S	
	72	03/99→02/01	→	07/99→	24.0324-0158.1	524158	∅ 280 24 21,8 V + S	
					24.0111-0166.2	411166	∅ 274 10,9 9,5 + LG / + ABS Ring	
1.6 Bifuel	80	03/99→09/00	←		24.0124-0158.1	424158	∅ 280 24 21,8 V + S	
					24.0324-0158.1	524158	∅ 280 24 21,8 V + S	
1.8 16V (KA0S, KA12, KA1A, KA1M, KA1R) 1.9 dCi (KA05, KA1F) 1.9 dTi (KA1U)	85	01/01→08/03	←		24.0124-0158.1	424158	∅ 280 24 21,8 V + S	
	75	02/01→08/03	→		24.0324-0158.1	524158	∅ 280 24 21,8 V + S	
	59	02/01→08/03			24.0111-0166.2	411166	∅ 274 10,9 9,5 + LG / + ABS Ring	
<b>RENAULT - MEGANE II (BM0/1_, CM0/1_) 07/01→10/12</b>								
 <b>Bremsbelagsatz, Scheibenbremse</b>								
1.4 16V ↓	60	10/03→02/08	←	→ 09/05	13.0460-3814.2	603814	BOS 23934 18,2 - WE / - WK	











	kw			 	! #			
<b>RENAULT - MEGANE II (BM0/1_, CM0/1_) 07/01→10/12</b>								
<b> Bremsbelagsatz, Scheibenbremse</b>								
1.4 16V (BM0B, CM0B)	72	11/02→02/08	←	→ 09/05		13.0470-3814.2	LD3814	BOS 23934 18,2 - WE / - WK Ceramic
			←	10/05→		13.0460-7221.2	607221	ATE 23215 18,3 - WE / - WK
						13.0470-7221.2	LD7221	ATE 23215 18,3 - WE / - WK Ceramic
			→			13.0460-2845.2	602845	TRW 23554 16,4 - WK + Zub
			→	PR 1334		13.0460-7137.2	607137	ATE 23482 15,8 - WE / - WK
			→			13.0470-7137.2	LD7137	ATE 23482 15,8 - WE / - WK Ceramic
1.5 dCi (BM02, BM13, BM2A, CM02, CM13)	74	10/03→02/08	←	→ 09/05		13.0460-3815.2	603815	BOS 23930 18,2 - WK + Zub
						13.0470-3815.2	LD3815	BOS 23930 18,2 - WK + Zub Ceramic
			←	10/05→		13.0460-7221.2	607221	ATE 23215 18,3 - WE / - WK
						13.0470-7221.2	LD7221	ATE 23215 18,3 - WE / - WK Ceramic
			→	01/07→		13.0460-2845.2	602845	TRW 23554 16,4 - WK + Zub
			→	PR 1334		13.0460-7137.2	607137	ATE 23482 15,8 - WE / - WK
			→			13.0470-7137.2	LD7137	ATE 23482 15,8 - WE / - WK Ceramic
			→			13.0470-2845.2	LD2845	TRW 23554 16,4 - WK + Zub Ceramic
1.5 dCi (BM0F, BM0T, BM2B, CM0F, CM0T)	60	09/02→02/08	←	11/02→ 09/05		13.0460-3815.2	603815	BOS 23930 18,2 - WK + Zub
						13.0470-3815.2	LD3815	BOS 23930 18,2 - WK + Zub Ceramic
			←	10/05→		13.0460-7221.2	607221	ATE 23215 18,3 - WE / - WK
						13.0470-7221.2	LD7221	ATE 23215 18,3 - WE / - WK Ceramic
			→	11/02→		13.0460-2845.2	602845	TRW 23554 16,4 - WK + Zub
			→			13.0470-2845.2	LD2845	TRW 23554 16,4 - WK + Zub Ceramic
			→	11/02→; PR 1334		13.0460-7137.2	607137	ATE 23482 15,8 - WE / - WK
			→			13.0470-7137.2	LD7137	ATE 23482 15,8 - WE / - WK Ceramic
1.5 dCi (BM16, CM16) 1.9 dCi	76 96	01/07→03/09 05/05→12/09	←	→ 11/08		13.0460-7221.2	607221	ATE 23215 18,3 - WE / - WK
						13.0470-7221.2	LD7221	ATE 23215 18,3 - WE / - WK Ceramic
			→	→ 11/08		13.0460-2845.2	602845	TRW 23554 16,4 - WK + Zub
			→			13.0470-2845.2	LD2845	TRW 23554 16,4 - WK + Zub Ceramic
			→	→ 11/08; PR 1334		13.0460-7137.2	607137	ATE 23482 15,8 - WE / - WK
			→			13.0470-7137.2	LD7137	ATE 23482 15,8 - WE / - WK Ceramic
1.5 dCi (BM1E, CM1E) 1.6 1.6 16V 1.6 Flex-Fuel 2.0 2.0 dCi (BM1K, CM1K)	78 77 82 77 102 110	05/05→06/08 06/05→02/08 01/06→06/08 01/07→02/08 06/06→12/10 09/05→02/08	←			13.0460-7221.2	607221	ATE 23215 18,3 - WE / - WK
						13.0470-7221.2	LD7221	ATE 23215 18,3 - WE / - WK Ceramic
			→			13.0460-2845.2	602845	TRW 23554 16,4 - WK + Zub
						13.0470-2845.2	LD2845	TRW 23554 16,4 - WK + Zub Ceramic
			→	PR 1334		13.0460-7137.2	607137	ATE 23482 15,8 - WE / - WK
			→			13.0470-7137.2	LD7137	ATE 23482 15,8 - WE / - WK Ceramic
1.5 dCi (BM1F, CM1F) 1.6 16V (BM0C, CM0C) 1.9 dCi (BM0G, CM0G) 2.0 16V (BM0U, CM0U) 2.0 16V Turbo	63 83 88 99 120	05/05→02/08 11/02→02/08 11/02→02/08 11/02→02/08 05/04→02/08	←	→ 09/05		13.0460-3815.2	603815	BOS 23930 18,2 - WK + Zub
						13.0470-3815.2	LD3815	BOS 23930 18,2 - WK + Zub Ceramic
			←	10/05→		13.0460-7221.2	607221	ATE 23215 18,3 - WE / - WK
						13.0470-7221.2	LD7221	ATE 23215 18,3 - WE / - WK Ceramic
			→			13.0460-2845.2	602845	TRW 23554 16,4 - WK + Zub
			→			13.0470-2845.2	LD2845	TRW 23554 16,4 - WK + Zub Ceramic
			→	PR 1334		13.0460-7137.2	607137	ATE 23482 15,8 - WE / - WK
			→			13.0470-7137.2	LD7137	ATE 23482 15,8 - WE / - WK Ceramic
1.6 Bifuel ↓	77	06/05→02/08	←	01/07→		13.0460-7221.2	607221	ATE 23215 18,3 - WE / - WK









	kw			 	! #		
<b>RENAULT - MEGANE II (BM0/1_, CM0/1_) 07/01→10/12</b>							
<b>Bremsbelagsatz, Scheibenbremse</b>							
1.6 Bifuel	77	06/05→02/08	←	01/07→		13.0470-7221.2 LD7221	ATE 23215 18,3 - WE / - WK Ceramic
			→	01/07→		13.0460-2845.2 602845 13.0470-2845.2 LD2845	TRW 23554 16,4 - WK + Zub TRW 23554 16,4 - WK + Zub Ceramic
			→	01/07→; PR 1334		13.0460-7137.2 607137 13.0470-7137.2 LD7137	ATE 23482 15,8 - WE / - WK ATE 23482 15,8 - WE / - WK Ceramic
1.9 dCi	66	11/02→12/05	→			13.0460-2845.2 602845	TRW 23554 16,4 - WK + Zub
1.9 dCi 1.9 dCi 1.9 dCi	68 81 85	03/04→08/06 05/05→02/08 11/02→02/08	←	01/06→		13.0460-7221.2 607221 13.0470-7221.2 LD7221	ATE 23215 18,3 - WE / - WK ATE 23215 18,3 - WE / - WK Ceramic
			→	01/06→		13.0460-2845.2 602845 13.0470-2845.2 LD2845	TRW 23554 16,4 - WK + Zub TRW 23554 16,4 - WK + Zub Ceramic
			→	01/06→; PR 1334		13.0460-7137.2 607137 13.0470-7137.2 LD7137	ATE 23482 15,8 - WE / - WK ATE 23482 15,8 - WE / - WK Ceramic
2.0	169	08/06→02/08	←			13.0460-4805.2 604805	BRE 24162 15,2 - WE / - WK
			→			13.0460-2845.2 602845 13.0470-2845.2 LD2845	TRW 23554 16,4 - WK + Zub TRW 23554 16,4 - WK + Zub Ceramic
			→	PR 1334		13.0460-7137.2 607137 13.0470-7137.2 LD7137	ATE 23482 15,8 - WE / - WK ATE 23482 15,8 - WE / - WK Ceramic
2.0 dCi	127	01/07→02/08	←			13.0460-4805.2 604805	BRE 24162 15,2 - WE / - WK
			→			13.0460-2845.2 602845	TRW 23554 16,4 - WK + Zub
2.0 Renault Sport	165	05/04→10/09	←	→ 11/08		13.0460-4805.2 604805	BRE 24162 15,2 - WE / - WK
			→	→ 11/08		13.0460-2845.2 602845 13.0470-2845.2 LD2845	TRW 23554 16,4 - WK + Zub TRW 23554 16,4 - WK + Zub Ceramic
			→	→ 11/08; PR 1334		13.0460-7137.2 607137 13.0470-7137.2 LD7137	ATE 23482 15,8 - WE / - WK ATE 23482 15,8 - WE / - WK Ceramic
<b>Zubehörsatz, Scheibenbremsbelag</b>							
1.4 16V 1.4 16V (BM0B, CM0B) 1.5 dCi (BM1E, CM1E) 1.5 dCi (BM1F, CM1F) 1.6 1.6 16V 1.6 16V (BM0C, CM0C) 1.6 Flex-Fuel 1.9 dCi (BM0G, CM0G) 2.0 2.0 2.0 16V (BM0U, CM0U) 2.0 16V Turbo 2.0 dCi (BM1K, CM1K)	60 72 78 63 77 82 83 77 88 102 169 99 120 110	10/03→02/08 11/02→02/08 05/05→06/08 05/05→02/08 06/05→02/08 01/06→06/08 11/02→02/08 01/07→02/08 11/02→02/08 06/06→12/10 08/06→02/08 11/02→02/08 05/04→02/08 09/05→02/08	→			13.0460-0077.2 610077	TRW
1.5 dCi (BM02, BM13, BM2A, CM02, CM13) 1.6 Bifuel	74 77	10/03→02/08 06/05→02/08	→	01/07→		13.0460-0077.2 610077	TRW
1.5 dCi (BM0F, BM0T, BM2B, CM0F, CM0T)	60	09/02→02/08	→	11/02→		13.0460-0077.2 610077	TRW
1.5 dCi (BM16, CM16) 1.9 dCi 2.0 Renault Sport	76 96 165	01/07→03/09 05/05→12/09 05/04→10/09	→	→ 11/08		13.0460-0077.2 610077	TRW
1.9 dCi 1.9 dCi 1.9 dCi	68 81 85	03/04→08/06 05/05→02/08 11/02→02/08	→	01/06→		13.0460-0077.2 610077	TRW
<b>Bremsscheibe</b>							
1.4 16V 1.4 16V (BM0B, CM0B)	60 72	10/03→02/08 11/02→02/08	←			24.0122-0216.1 422216	Ø 260 22 19,8 V + S
			→			24.0108-0114.2 408114	Ø 240 8 7 + LG / + ABS Ring
1.5 dCi (BM02, BM13, BM2A, CM02, CM13) 1.5 dCi (BM1E, CM1E) 1.5 dCi (BM1F, CM1F) 1.6 1.6 16V ↓	74 78 63 77 82	10/03→02/08 05/05→06/08 05/05→02/08 06/05→02/08 01/06→06/08	←			24.0124-0158.1 424158 24.0324-0158.1 524158	Ø 280 24 21,8 V + S Ø 280 24 21,8 V + S
			→			24.0108-0114.2 408114	Ø 240 8 7 + LG / + ABS Ring







	kw			 	! #		
<b>RENAULT - MEGANE II (BM0/1_, CM0/1_) 07/01→10/12</b>							
<b>Bremsscheibe</b>							
1.6 16V (BM0C, CM0C) 1.6 Flex-Fuel 1.9 dCi (BM0G, CM0G) 2.0 2.0 16V (BM0U, CM0U) 2.0 16V Turbo	83 77 88 102 99 120	11/02→02/08 01/07→02/08 11/02→02/08 06/06→12/10 11/02→02/08 05/04→02/08	←  →   			24.0124-0158.1 424158 24.0324-0158.1 524158 24.0108-0114.2 408114	Ø 280 24 21,8 V + S Ø 280 24 21,8 V + S Ø 240 8 7 + LG / + ABS Ring
1.5 dCi (BM0F, BM0T, BM2B, CM0F, CM0T)	60	09/02→02/08	← →	11/02→ 11/02→		24.0124-0158.1 424158 24.0324-0158.1 524158 24.0108-0114.2 408114	Ø 280 24 21,8 V + S Ø 280 24 21,8 V + S Ø 240 8 7 + LG / + ABS Ring
1.5 dCi (BM16, CM16) 1.9 dCi	76 96	01/07→03/09 05/05→12/09	← →	→ 11/08 → 11/08		24.0124-0158.1 424158 24.0324-0158.1 524158 24.0108-0114.2 408114	Ø 280 24 21,8 V + S Ø 280 24 21,8 V + S Ø 240 8 7 + LG / + ABS Ring
1.6 Bifuel	77	06/05→02/08	← →	01/07→ 01/07→		24.0124-0158.1 424158 24.0324-0158.1 524158 24.0108-0114.2 408114	Ø 280 24 21,8 V + S Ø 280 24 21,8 V + S Ø 240 8 7 + LG / + ABS Ring
1.9 dCi 1.9 dCi 1.9 dCi	68 81 85	03/04→08/06 05/05→02/08 11/02→02/08	←  →	01/06→  01/06→		24.0124-0158.1 424158 24.0324-0158.1 524158 24.0108-0114.2 408114	Ø 280 24 21,8 V + S Ø 280 24 21,8 V + S Ø 240 8 7 + LG / + ABS Ring
2.0	169	08/06→02/08	←			24.0128-0223.1 428223	Ø 312,5 28 26 V + S
2.0 dCi	127	01/07→02/08	← →			24.0128-0223.1 428223 24.0111-0183.2 411183	Ø 312,5 28 26 V + S Ø 300 11 9,5 + LG / + ABS Ring
2.0 dCi (BM1K, CM1K)	110	09/05→02/08	← →			24.0124-0223.1 424223 24.0110-0389.2 410389	Ø 280 24 21,8 V + S Ø 270 10 9 + LG / + ABS Ring
2.0 Renault Sport	165	05/04→10/09	←	→ 11/08		24.0128-0223.1 428223	Ø 312,5 28 26 V + S
<b>RENAULT - MEGANE II Coupé-Cabriolet (EM0/1_) 09/03→03/10</b>							
<b>Bremsbelagsatz, Scheibenbremse</b>							
1.5 dCi (EM16) 2.0 dCi	76 110	01/07→06/09 09/05→03/09	← →			13.0460-7221.2 607221 13.0470-7221.2 LD7221	ATE 23215 18,3 - WE / - WK ATE 23215 18,3 - WE / - WK Ceramic
			→	04/07		13.0460-2845.2 602845 13.0470-2845.2 LD2845	TRW 23554 16,4 - WK + Zub TRW 23554 16,4 - WK + Zub Ceramic
			→	05/07→		13.0460-2845.2 602845	TRW 23554 16,4 - WK + Zub
1.5 dCi (EM1E)	78	03/06→01/09	← →	→ 06/08 → 04/07		13.0460-7221.2 607221 13.0470-7221.2 LD7221 13.0460-2845.2 602845 13.0470-2845.2 LD2845	ATE 23215 18,3 - WE / - WK ATE 23215 18,3 - WE / - WK Ceramic TRW 23554 16,4 - WK + Zub TRW 23554 16,4 - WK + Zub Ceramic
			→	05/07→ 06/08		13.0460-2845.2 602845	TRW 23554 16,4 - WK + Zub
1.6 1.6 1.9 dCi 1.9 dCi 2.0 16V Turbo	77 83 81 88 120	06/05→03/09 09/03→03/09 05/05→03/09 09/03→03/09 05/04→03/09	←  ← →	→ 09/05  10/05→ 05/07→ → 04/07		13.0460-3815.2 603815 13.0470-3815.2 LD3815 13.0460-7221.2 607221 13.0470-7221.2 LD7221 13.0460-2845.2 602845 13.0460-2845.2 602845 13.0470-2845.2 LD2845	BOS 23930 18,2 - WK + Zub BOS 23930 18,2 - WK + Zub Ceramic ATE 23215 18,3 - WE / - WK ATE 23215 18,3 - WE / - WK Ceramic TRW 23554 16,4 - WK + Zub TRW 23554 16,4 - WK + Zub Ceramic
1.6 16V	82	01/06→06/08	← →	01/07→ 01/07→ 04/07		13.0460-7221.2 607221 13.0470-7221.2 LD7221 13.0460-2845.2 602845 13.0470-2845.2 LD2845	ATE 23215 18,3 - WE / - WK ATE 23215 18,3 - WE / - WK Ceramic TRW 23554 16,4 - WK + Zub TRW 23554 16,4 - WK + Zub Ceramic
			→	05/07→		13.0460-2845.2 602845	TRW 23554 16,4 - WK + Zub
1.9 dCi	85	09/03→03/09	← →	01/06→ 01/06→ 04/07		13.0460-7221.2 607221 13.0470-7221.2 LD7221 13.0460-2845.2 602845	ATE 23215 18,3 - WE / - WK ATE 23215 18,3 - WE / - WK Ceramic TRW 23554 16,4 - WK + Zub



















	kW			 	! #		
<b>RENAULT - MEGANE II Coupé-Cabriolet (EM0/1_) 09/03→03/10</b>							
<b> Bremsbelagsatz, Scheibenbremse</b>							
1.9 dCi	85	09/03→03/09	➡	01/06→ 04/07		13.0470-2845.2 LD2845	TRW 23554 16,4 - WK + Zub Ceramic
			➡	05/07→		13.0460-2845.2 602845	TRW 23554 16,4 - WK + Zub
1.9 dCi 2.0	96 102	05/05→02/07 09/03→02/07	⬅	→ 09/05		13.0460-3815.2 603815 13.0470-3815.2 LD3815	BOS 23930 18,2 - WK + Zub BOS 23930 18,2 - WK + Zub Ceramic
			⬅	10/05→		13.0460-7221.2 607221 13.0470-7221.2 LD7221	ATE 23215 18,3 - WE / - WK ATE 23215 18,3 - WE / - WK Ceramic
			➡			13.0460-2845.2 602845 13.0470-2845.2 LD2845	TRW 23554 16,4 - WK + Zub TRW 23554 16,4 - WK + Zub Ceramic
2.0	99	09/03→12/09	⬅	→ 09/05		13.0460-3815.2 603815 13.0470-3815.2 LD3815	BOS 23930 18,2 - WK + Zub BOS 23930 18,2 - WK + Zub Ceramic
			⬅	10/05→ 03/07		13.0460-7221.2 607221 13.0470-7221.2 LD7221	ATE 23215 18,3 - WE / - WK ATE 23215 18,3 - WE / - WK Ceramic
			➡	→ 03/07		13.0460-2845.2 602845 13.0470-2845.2 LD2845	TRW 23554 16,4 - WK + Zub TRW 23554 16,4 - WK + Zub Ceramic
<b>Zubehörsatz, Scheibenbremsbelag</b>							
1.5 dCi (EM16) 1.5 dCi (EM1E) 1.6 1.6 1.9 dCi 1.9 dCi 2.0 16V Turbo 2.0 dCi	76 78 77 83 81 88 120 110	01/07→06/09 03/06→01/09 06/05→03/09 09/03→03/09 05/05→03/09 09/03→03/09 05/04→03/09 09/05→03/09	➡	→ 04/07		13.0460-0077.2 610077	TRW
1.6 16V	82	01/06→06/08	➡	01/07→ 04/07		13.0460-0077.2 610077	TRW
1.9 dCi	85	09/03→03/09	➡	01/06→ 04/07		13.0460-0077.2 610077	TRW
1.9 dCi 2.0	96 102	05/05→02/07 09/03→02/07	➡			13.0460-0077.2 610077	TRW
2.0	99	09/03→12/09	➡	→ 03/07		13.0460-0077.2 610077	TRW
<b> Bremsscheibe</b>							
1.5 dCi (EM16) 1.6 1.6 1.9 dCi 1.9 dCi 1.9 dCi 2.0 2.0 16V Turbo	76 77 83 81 88 96 102 120	01/07→06/09 06/05→03/09 09/03→03/09 05/05→03/09 09/03→03/09 05/05→02/07 09/03→02/07 05/04→03/09	⬅			24.0124-0158.1 424158 24.0324-0158.1 524158	∅ 280 24 21,8 V + S ∅ 280 24 21,8 V + S
			➡			24.0108-0114.2 408114	∅ 240 8 7 + LG / + ABS Ring
1.5 dCi (EM1E)	78	03/06→01/09	⬅	→ 06/08		24.0124-0158.1 424158 24.0324-0158.1 524158	∅ 280 24 21,8 V + S ∅ 280 24 21,8 V + S
			➡	→ 06/08		24.0108-0114.2 408114	∅ 240 8 7 + LG / + ABS Ring
1.6 16V	82	01/06→06/08	⬅	01/07→		24.0124-0158.1 424158 24.0324-0158.1 524158	∅ 280 24 21,8 V + S ∅ 280 24 21,8 V + S
			➡	01/07→		24.0108-0114.2 408114	∅ 240 8 7 + LG / + ABS Ring
1.9 dCi	85	09/03→03/09	⬅	01/06→		24.0124-0158.1 424158 24.0324-0158.1 524158	∅ 280 24 21,8 V + S ∅ 280 24 21,8 V + S
			➡	01/06→		24.0108-0114.2 408114	∅ 240 8 7 + LG / + ABS Ring
2.0	99	09/03→12/09	⬅	→ 03/07		24.0124-0158.1 424158 24.0324-0158.1 524158	∅ 280 24 21,8 V + S ∅ 280 24 21,8 V + S
			➡	→ 03/07		24.0108-0114.2 408114	∅ 240 8 7 + LG / + ABS Ring
2.0 dCi	110	09/05→03/09	⬅			24.0124-0158.1 424158 24.0124-0223.1 424223 24.0324-0158.1 524158	∅ 280 24 21,8 V + S ∅ 280 24 21,8 V + S ∅ 280 24 21,8 V + S
			➡			24.0110-0389.2 410389	∅ 270 10 9 + LG / + ABS Ring
<b>RENAULT - MEGANE II Grandtour (KM0/1_) 08/03→08/12</b>							
<b> Bremsbelagsatz, Scheibenbremse</b>							
1.4 1.6 ↓	72 83	08/03→07/09 08/03→07/09	⬅	09/03→ 09/05		13.0460-3815.2 603815	BOS 23930 18,2 - WK + Zub









	kw			 	! #			
<b>RENAULT - MEGANE II Grandtour (KM0/1_) 08/03→08/12</b>								
<b> Bremsbelagsatz, Scheibenbremse</b>								
1.9 dCi 2.0	88 99	08/03→07/09 08/03→07/09	←	09/03→ 09/05		13.0470-3815.2	LD3815	BOS 23930 18,2 - WK + Zub Ceramic
			←	10/05→ 12/08		13.0460-7221.2	607221	ATE 23215 18,3 - WE / - WK
			→	05/07→ 12/08		13.0470-7221.2	LD7221	ATE 23215 18,3 - WE / - WK Ceramic
			→	09/03→ 04/07		13.0460-2845.2	602845	TRW 23554 16,4 - WK + Zub
			→	09/03→ 04/07		13.0470-2845.2	LD2845	TRW 23554 16,4 - WK + Zub Ceramic
1.5 dCi (KM02, KM13) 1.9 dCi 1.9 dCi	74 66 68	02/04→03/06 04/04→12/05 03/04→02/07	←	→ 09/05		13.0460-3815.2	603815	BOS 23930 18,2 - WK + Zub
						13.0470-3815.2	LD3815	BOS 23930 18,2 - WK + Zub Ceramic
			←	10/05→		13.0460-7221.2	607221	ATE 23215 18,3 - WE / - WK
			→			13.0470-7221.2	LD7221	ATE 23215 18,3 - WE / - WK Ceramic
			→			13.0460-2845.2	602845	TRW 23554 16,4 - WK + Zub
			→			13.0470-2845.2	LD2845	TRW 23554 16,4 - WK + Zub Ceramic
1.5 dCi (KM0F, KM0T, KM2B)	60	08/03→05/06	←	09/03→ 09/05		13.0460-3815.2	603815	BOS 23930 18,2 - WK + Zub
						13.0470-3815.2	LD3815	BOS 23930 18,2 - WK + Zub Ceramic
			←	10/05→		13.0460-7221.2	607221	ATE 23215 18,3 - WE / - WK
			→			13.0470-7221.2	LD7221	ATE 23215 18,3 - WE / - WK Ceramic
			→	09/03→		13.0460-2845.2	602845	TRW 23554 16,4 - WK + Zub
			→			13.0470-2845.2	LD2845	TRW 23554 16,4 - WK + Zub Ceramic
1.5 dCi (KM16, KM1E)	78	05/05→06/08	←	→ 09/05		13.0460-3815.2	603815	BOS 23930 18,2 - WK + Zub
						13.0470-3815.2	LD3815	BOS 23930 18,2 - WK + Zub Ceramic
			←	10/05→		13.0460-7221.2	607221	ATE 23215 18,3 - WE / - WK
						13.0470-7221.2	LD7221	ATE 23215 18,3 - WE / - WK Ceramic
			→	→ 04/07		13.0460-2845.2	602845	TRW 23554 16,4 - WK + Zub
			→			13.0470-2845.2	LD2845	TRW 23554 16,4 - WK + Zub Ceramic
			→	05/07→		13.0460-2845.2	602845	TRW 23554 16,4 - WK + Zub
			→			13.0470-2845.2	LD2845	TRW 23554 16,4 - WK + Zub Ceramic
1.5 dCi (KM16) 2.0 dCi	76 110	01/07→07/09 09/05→07/09	←	→ 12/08		13.0460-7221.2	607221	ATE 23215 18,3 - WE / - WK
						13.0470-7221.2	LD7221	ATE 23215 18,3 - WE / - WK Ceramic
			→	→ 04/07		13.0460-2845.2	602845	TRW 23554 16,4 - WK + Zub
			→			13.0470-2845.2	LD2845	TRW 23554 16,4 - WK + Zub Ceramic
			→	05/07→ 12/08		13.0460-2845.2	602845	TRW 23554 16,4 - WK + Zub
1.5 dCi (KM1F) 1.9 dCi 1.9 dCi	63 81 85	05/05→07/09 05/05→07/09 05/05→07/09	←	→ 09/05		13.0460-3815.2	603815	BOS 23930 18,2 - WK + Zub
						13.0470-3815.2	LD3815	BOS 23930 18,2 - WK + Zub Ceramic
			←	10/05→ 12/08		13.0460-7221.2	607221	ATE 23215 18,3 - WE / - WK
						13.0470-7221.2	LD7221	ATE 23215 18,3 - WE / - WK Ceramic
			→	→ 04/07		13.0460-2845.2	602845	TRW 23554 16,4 - WK + Zub
			→			13.0470-2845.2	LD2845	TRW 23554 16,4 - WK + Zub Ceramic
			→	05/07→ 12/08		13.0460-2845.2	602845	TRW 23554 16,4 - WK + Zub
1.6 16V 1.6 16V	75 77	05/05→07/09 05/05→07/09	←	→ 09/05		13.0460-3815.2	603815	BOS 23930 18,2 - WK + Zub
						13.0470-3815.2	LD3815	BOS 23930 18,2 - WK + Zub Ceramic
			←			13.0460-7221.2	607221	ATE 23215 18,3 - WE / - WK
						13.0470-7221.2	LD7221	ATE 23215 18,3 - WE / - WK Ceramic
			→	05/07→		13.0460-2845.2	602845	TRW 23554 16,4 - WK + Zub
			→	→ 04/07		13.0460-2845.2	602845	TRW 23554 16,4 - WK + Zub
			→			13.0470-2845.2	LD2845	TRW 23554 16,4 - WK + Zub Ceramic
1.6 16V ↓	81	05/06→10/11	←	→ 07/09		13.0460-7221.2	607221	ATE 23215 18,3 - WE / - WK

	kW					! #		
<b>RENAULT - MEGANE II Grandtour (KM0/1_) 08/03→08/12</b>								
<b>Bremsbelagsatz, Scheibenbremse</b>								
1.6 16V	81	05/06→10/11	←	→ 07/09			13.0470-7221.2 LD7221	ATE 23215 18,3 - WE / - WK Ceramic
			→	05/07→ 07/09			13.0460-2845.2 602845	TRW 23554 16,4 - WK + Zub
			→	→ 04/07			13.0460-2845.2 602845 13.0470-2845.2 LD2845	TRW 23554 16,4 - WK + Zub TRW 23554 16,4 - WK + Zub Ceramic
1.6 16V	82	01/06→08/09	←	01/07→ 12/08			13.0460-7221.2 607221 13.0470-7221.2 LD7221	ATE 23215 18,3 - WE / - WK ATE 23215 18,3 - WE / - WK Ceramic
			→	01/07→ 04/07			13.0460-2845.2 602845 13.0470-2845.2 LD2845	TRW 23554 16,4 - WK + Zub TRW 23554 16,4 - WK + Zub Ceramic
			→	05/07→ 12/08			13.0460-2845.2 602845	TRW 23554 16,4 - WK + Zub
1.6 16V Hi-Flex	77	02/08→07/09	←	→ 12/08			13.0460-7221.2 607221 13.0470-7221.2 LD7221	ATE 23215 18,3 - WE / - WK ATE 23215 18,3 - WE / - WK Ceramic
			→	→ 12/08			13.0460-2845.2 602845	TRW 23554 16,4 - WK + Zub
1.6 LPG 16V	82	01/06→08/09	←				13.0460-7221.2 607221 13.0470-7221.2 LD7221	ATE 23215 18,3 - WE / - WK ATE 23215 18,3 - WE / - WK Ceramic
			→				13.0460-2845.2 602845 13.0470-2845.2 LD2845	TRW 23554 16,4 - WK + Zub TRW 23554 16,4 - WK + Zub Ceramic
1.9 dCi	96	05/05→07/09	←	→ 09/05			13.0460-3815.2 603815 13.0470-3815.2 LD3815	BOS 23930 18,2 - WK + Zub BOS 23930 18,2 - WK + Zub Ceramic
			←	10/05→ 02/07			13.0460-7221.2 607221 13.0470-7221.2 LD7221	ATE 23215 18,3 - WE / - WK ATE 23215 18,3 - WE / - WK Ceramic
			→	→ 02/07			13.0460-2845.2 602845 13.0470-2845.2 LD2845	TRW 23554 16,4 - WK + Zub TRW 23554 16,4 - WK + Zub Ceramic
2.0	102	12/06→01/11	←				13.0460-7221.2 607221 13.0470-7221.2 LD7221	ATE 23215 18,3 - WE / - WK ATE 23215 18,3 - WE / - WK Ceramic
			→	05/07→			13.0460-2845.2 602845	TRW 23554 16,4 - WK + Zub
			→	→ 04/07			13.0460-2845.2 602845 13.0470-2845.2 LD2845	TRW 23554 16,4 - WK + Zub TRW 23554 16,4 - WK + Zub Ceramic
<b>Zubehörsatz, Scheibenbremsbelag</b>								
1.4 1.6 1.9 dCi 2.0	72 83 88 99	08/03→07/09 08/03→07/09 08/03→07/09 08/03→07/09	→	09/03→ 04/07			13.0460-0077.2 610077	TRW
1.5 dCi (KM02, KM13) 1.6 LPG 16V 1.9 dCi 1.9 dCi	74 82 66 68	02/04→03/06 01/06→08/09 04/04→12/05 03/04→02/07	→				13.0460-0077.2 610077	TRW
1.5 dCi (KM0F, KM0T, KM2B)	60	08/03→05/06	→	09/03→			13.0460-0077.2 610077	TRW
1.5 dCi (KM16, KM1E) 1.5 dCi (KM16) 1.5 dCi (KM1F) 1.6 16V 1.6 16V 1.6 16V 1.9 dCi 1.9 dCi 2.0 2.0 dCi	78 76 63 75 77 81 81 85 102 110	05/05→06/08 01/07→07/09 05/05→07/09 05/05→07/09 05/05→07/09 05/06→10/11 05/05→07/09 05/05→07/09 12/06→01/11 09/05→07/09	→	→ 04/07			13.0460-0077.2 610077	TRW
1.6 16V	82	01/06→08/09	→	01/07→ 04/07			13.0460-0077.2 610077	TRW
1.9 dCi	96	05/05→07/09	→	→ 02/07			13.0460-0077.2 610077	TRW
<b>Bremsscheibe</b>								
1.4 1.6 1.9 dCi 2.0	72 83 88 99	08/03→07/09 08/03→07/09 08/03→07/09 08/03→07/09	←	09/03→ 12/08			24.0124-0158.1 424158 24.0324-0158.1 524158	Ø 280 24 21,8 V + S Ø 280 24 21,8 V + S
1.5 dCi (KM02, KM13)	74	02/04→03/06	←				24.0110-0325.2 410325	Ø 270 10 9 + LG / + ABS Ring
↓							24.0124-0158.1 424158	Ø 280 24 21,8 V + S









	kw			 	! #		
<b>RENAULT - MEGANE II Grandtour (KM0/1_) 08/03→08/12</b>							
<b>Bremsscheibe</b>							
1.5 dCi (KM16, KM1E)	78	05/05→06/08	←			24.0324-0158.1 524158	Ø 280 24 21,8 V + S
1.6 16V	75	05/05→07/09	→			24.0110-0325.2 410325	Ø 270 10 9 + LG / + ABS Ring
1.6 16V	77	05/05→07/09	→				
1.6 LPG 16V	82	01/06→08/09	→				
1.9 dCi	66	04/04→12/05	→				
1.9 dCi	68	03/04→02/07	→				
2.0	102	12/06→01/11	→				
1.5 dCi (KM0F, KM0T, KM2B)	60	08/03→05/06	←	09/03→		24.0124-0158.1 424158	Ø 280 24 21,8 V + S
			→	09/03→		24.0324-0158.1 524158	Ø 280 24 21,8 V + S
			→	09/03→		24.0110-0325.2 410325	Ø 270 10 9 + LG / + ABS Ring
1.5 dCi (KM16)	76	01/07→07/09	←	→ 12/08		24.0124-0158.1 424158	Ø 280 24 21,8 V + S
1.5 dCi (KM1F)	63	05/05→07/09	→			24.0324-0158.1 524158	Ø 280 24 21,8 V + S
1.6 16V Hi-Flex	77	02/08→07/09	→				
1.9 dCi	81	05/05→07/09	→	→ 12/08		24.0110-0325.2 410325	Ø 270 10 9 + LG / + ABS Ring
1.9 dCi	85	05/05→07/09	→				
1.6 16V	81	05/06→10/11	←	→ 07/09		24.0124-0158.1 424158	Ø 280 24 21,8 V + S
			→	→ 07/09		24.0324-0158.1 524158	Ø 280 24 21,8 V + S
			→	→ 07/09		24.0110-0325.2 410325	Ø 270 10 9 + LG / + ABS Ring
1.6 16V	82	01/06→08/09	←	01/07→ 12/08		24.0124-0158.1 424158	Ø 280 24 21,8 V + S
			→	01/07→ 12/08		24.0324-0158.1 524158	Ø 280 24 21,8 V + S
			→	01/07→ 12/08		24.0110-0325.2 410325	Ø 270 10 9 + LG / + ABS Ring
1.9 dCi	96	05/05→07/09	←	→ 02/07		24.0124-0158.1 424158	Ø 280 24 21,8 V + S
			→	→ 02/07		24.0324-0158.1 524158	Ø 280 24 21,8 V + S
			→	→ 02/07		24.0110-0325.2 410325	Ø 270 10 9 + LG / + ABS Ring
2.0 dCi	110	09/05→07/09	←	→ 12/08		24.0124-0158.1 424158	Ø 280 24 21,8 V + S
			→	→ 12/08		24.0124-0223.1 424223	Ø 280 24 21,8 V + S
			→	→ 12/08		24.0324-0158.1 524158	Ø 280 24 21,8 V + S
			→	→ 12/08		24.0110-0389.2 410389	Ø 270 10 9 + LG / + ABS Ring
<b>RENAULT - MEGANE II Stufenheck (LM0/1_) 08/03→</b>							
<b>Bremsbelagsatz, Scheibenbremse</b>							
1.4	60	09/03→	←	→ 08/06		13.0460-3814.2 603814	BOS 23934 18,2 - WE / - WK
			→	→ 08/06		13.0470-3814.2 LD3814	BOS 23934 18,2 - WE / - WK Ceramic
			→	→ 08/06; PR 1334		13.0460-2845.2 602845	TRW 23554 16,4 - WK + Zub
			→	→ 08/06; PR 1334		13.0470-2845.2 LD2845	TRW 23554 16,4 - WK + Zub Ceramic
			→	→ 08/06; PR 1334		13.0460-7137.2 607137	ATE 23482 15,8 - WE / - WK
			→	→ 08/06; PR 1334		13.0470-7137.2 LD7137	ATE 23482 15,8 - WE / - WK Ceramic
1.4	72	09/03→	←	→ 12/08		13.0460-3814.2 603814	BOS 23934 18,2 - WE / - WK
			→	→ 04/07		13.0470-3814.2 LD3814	BOS 23934 18,2 - WE / - WK Ceramic
			→	05/07→ 12/08		13.0460-2845.2 602845	TRW 23554 16,4 - WK + Zub
			→	→ 12/08; PR 1334		13.0470-2845.2 LD2845	TRW 23554 16,4 - WK + Zub Ceramic
			→	05/07→ 12/08		13.0460-2845.2 602845	TRW 23554 16,4 - WK + Zub
			→	→ 12/08; PR 1334		13.0460-7137.2 607137	ATE 23482 15,8 - WE / - WK
			→	→ 12/08; PR 1334		13.0470-7137.2 LD7137	ATE 23482 15,8 - WE / - WK Ceramic
1.5 dCi (LM02, LM13, LM2A)	74	02/04→12/10	←	→ 09/05		13.0460-3815.2 603815	BOS 23930 18,2 - WK + Zub
			←	10/05→ 03/06		13.0470-3815.2 LD3815	BOS 23930 18,2 - WK + Zub Ceramic
			→	→ 03/06		13.0460-7221.2 607221	ATE 23215 18,3 - WE / - WK
			→	→ 03/06		13.0470-7221.2 LD7221	ATE 23215 18,3 - WE / - WK Ceramic
			→	→ 03/06		13.0460-2845.2 602845	TRW 23554 16,4 - WK + Zub
			→	→ 03/06; PR 1334		13.0470-2845.2 LD2845	TRW 23554 16,4 - WK + Zub Ceramic
			→	→ 03/06; PR 1334		13.0460-7137.2 607137	ATE 23482 15,8 - WE / - WK
			→	→ 03/06; PR 1334		13.0470-7137.2 LD7137	ATE 23482 15,8 - WE / - WK Ceramic
1.5 dCi (LM0F, LM0T, LM2B)	60	08/03→12/10	←	09/03→ 09/05		13.0460-3815.2 603815	BOS 23930 18,2 - WK + Zub
			←	10/05→ 12/08		13.0470-3815.2 LD3815	BOS 23930 18,2 - WK + Zub Ceramic
			→	10/05→ 12/08		13.0460-7221.2 607221	ATE 23215 18,3 - WE / - WK











	kw			 	! #		
<b>RENAULT - MEGANE II Stufenheck (LM0/1_) 08/03→</b>							
<b> Bremsbelagsatz, Scheibenbremse</b>							
1.5 dCi (LM0F, LM0T, LM2B)	60	08/03→12/10	←	10/05→ 12/08		13.0470-7221.2 LD7221	ATE 23215 18,3 - WE / - WK Ceramic
			→	09/03→ 04/07		13.0460-2845.2 602845 13.0470-2845.2 LD2845	TRW 23554 16,4 - WK + Zub TRW 23554 16,4 - WK + Zub Ceramic
			→	05/07→ 12/08		13.0460-2845.2 602845	TRW 23554 16,4 - WK + Zub
			→	09/03→ 12/08; PR 1334		13.0460-7137.2 607137 13.0470-7137.2 LD7137	ATE 23482 15,8 - WE / - WK ATE 23482 15,8 - WE / - WK Ceramic
1.5 dCi (LM16) 1.6 16V (LM1R, LM0C)	76 82	10/03→12/10 01/06→	←	01/07→ 12/08		13.0460-7221.2 607221 13.0470-7221.2 LD7221	ATE 23215 18,3 - WE / - WK ATE 23215 18,3 - WE / - WK Ceramic
			→	01/07→ 04/07		13.0460-2845.2 602845 13.0470-2845.2 LD2845	TRW 23554 16,4 - WK + Zub TRW 23554 16,4 - WK + Zub Ceramic
			→	05/07→ 12/08		13.0460-2845.2 602845	TRW 23554 16,4 - WK + Zub
			→	01/07→ 12/08; PR 1334		13.0460-7137.2 607137 13.0470-7137.2 LD7137	ATE 23482 15,8 - WE / - WK ATE 23482 15,8 - WE / - WK Ceramic
1.5 dCi (LM1E) 1.5 dCi (LM1F) 1.6 1.6 1.9 dCi 1.9 dCi 1.9 dCi (LM0G, LM1G, LM2C) 1.9 dCi (LM14, LM1D) 2.0	78 63 77 83 68 96 88 81 99	05/05→12/10 05/05→12/10 05/05→ 09/03→ 03/04→ 05/05→ 09/03→ 05/05→ 09/03→	←	→ 09/05		13.0460-3815.2 603815 13.0470-3815.2 LD3815	BOS 23930 18,2 - WK + Zub BOS 23930 18,2 - WK + Zub Ceramic
			←	10/05→ 12/08		13.0460-7221.2 607221 13.0470-7221.2 LD7221	ATE 23215 18,3 - WE / - WK ATE 23215 18,3 - WE / - WK Ceramic
			→	→ 04/07		13.0460-2845.2 602845 13.0470-2845.2 LD2845	TRW 23554 16,4 - WK + Zub TRW 23554 16,4 - WK + Zub Ceramic
			→	05/07→ 12/08		13.0460-2845.2 602845	TRW 23554 16,4 - WK + Zub
			→	→ 12/08; PR 1334		13.0460-7137.2 607137 13.0470-7137.2 LD7137	ATE 23482 15,8 - WE / - WK ATE 23482 15,8 - WE / - WK Ceramic
			←	→ 09/05		13.0460-3815.2 603815 13.0470-3815.2 LD3815	BOS 23930 18,2 - WK + Zub BOS 23930 18,2 - WK + Zub Ceramic
			←	10/05→		13.0460-7221.2 607221 13.0470-7221.2 LD7221	ATE 23215 18,3 - WE / - WK ATE 23215 18,3 - WE / - WK Ceramic
			→	→ 04/07		13.0460-2845.2 602845 13.0470-2845.2 LD2845	TRW 23554 16,4 - WK + Zub TRW 23554 16,4 - WK + Zub Ceramic
1.6	81	09/03→11/08	→	05/07→		13.0460-2845.2 602845	TRW 23554 16,4 - WK + Zub
			→	PR 1334		13.0460-7137.2 607137 13.0470-7137.2 LD7137	ATE 23482 15,8 - WE / - WK ATE 23482 15,8 - WE / - WK Ceramic
			←	→ 12/08		13.0460-7221.2 607221 13.0470-7221.2 LD7221	ATE 23215 18,3 - WE / - WK ATE 23215 18,3 - WE / - WK Ceramic
			→	→ 04/07		13.0460-2845.2 602845 13.0470-2845.2 LD2845	TRW 23554 16,4 - WK + Zub TRW 23554 16,4 - WK + Zub Ceramic
			→	05/07→ 12/08		13.0460-2845.2 602845	TRW 23554 16,4 - WK + Zub
			→	→ 12/08; PR 1334		13.0460-7137.2 607137 13.0470-7137.2 LD7137	ATE 23482 15,8 - WE / - WK ATE 23482 15,8 - WE / - WK Ceramic
1.6 Hi-Flex 2.0 dCi	85 110	03/06→ 09/05→	←	→ 12/08		13.0460-7221.2 607221 13.0470-7221.2 LD7221	ATE 23215 18,3 - WE / - WK ATE 23215 18,3 - WE / - WK Ceramic
			→	→ 04/07		13.0460-2845.2 602845 13.0470-2845.2 LD2845	TRW 23554 16,4 - WK + Zub TRW 23554 16,4 - WK + Zub Ceramic
			→	05/07→ 12/08		13.0460-2845.2 602845	TRW 23554 16,4 - WK + Zub
			→	→ 12/08; PR 1334		13.0460-7137.2 607137 13.0470-7137.2 LD7137	ATE 23482 15,8 - WE / - WK ATE 23482 15,8 - WE / - WK Ceramic
1.9 dCi	66	09/03→12/05	←	→ 09/05		13.0460-3815.2 603815 13.0470-3815.2 LD3815	BOS 23930 18,2 - WK + Zub BOS 23930 18,2 - WK + Zub Ceramic
			←	10/05→		13.0460-7221.2 607221 13.0470-7221.2 LD7221	ATE 23215 18,3 - WE / - WK ATE 23215 18,3 - WE / - WK Ceramic
			→			13.0460-2845.2 602845 13.0470-2845.2 LD2845	TRW 23554 16,4 - WK + Zub TRW 23554 16,4 - WK + Zub Ceramic
			→	PR 1334		13.0460-7137.2 607137	ATE 23482 15,8 - WE / - WK









	kw					! #		
<b>RENAULT - MEGANE II Stufenheck (LM0/1_) 08/03→</b>								
<b> Bremsbelagsatz, Scheibenbremse</b>								
1.9 dCi	66	09/03→12/05	➡	PR 1334			<b>13.0470-7137.2 LD7137</b>	ATE 23482 15,8 - WE / - WK Ceramic
2.0	101	04/06→11/10	←				<b>13.0460-7221.2 607221</b>	ATE 23215 18,3 - WE / - WK
			➡				<b>13.0470-7221.2 LD7221</b>	ATE 23215 18,3 - WE / - WK Ceramic
							<b>13.0460-2845.2 602845</b>	TRW 23554 16,4 - WK + Zub
							<b>13.0470-2845.2 LD2845</b>	TRW 23554 16,4 - WK + Zub Ceramic
<b>Zubehörsatz, Scheibenbremsbelag</b>								
1.4	60	09/03→	➡	→ 08/06			<b>13.0460-0077.2 610077</b>	TRW
1.4	72	09/03→	➡	→ 04/07			<b>13.0460-0077.2 610077</b>	TRW
1.5 dCi (LM1E)	78	05/05→12/10						
1.5 dCi (LM1F)	63	05/05→12/10						
1.6	77	05/05→						
1.6	81	09/03→11/08						
1.6	83	09/03→						
1.6 Hi-Flex	85	03/06→						
1.9 dCi	68	03/04→						
1.9 dCi	96	05/05→						
1.9 dCi (LM0G, LM1G, LM2C)	88	09/03→						
1.9 dCi (LM14, LM1D)	81	05/05→						
2.0	99	09/03→						
2.0 dCi	110	09/05→						
1.5 dCi (LM02, LM13, LM2A)	74	02/04→12/10	➡	→ 03/06			<b>13.0460-0077.2 610077</b>	TRW
1.5 dCi (LM0F, LM0T, LM2B)	60	08/03→12/10	➡	09/03→ 04/07			<b>13.0460-0077.2 610077</b>	TRW
1.5 dCi (LM16)	76	10/03→12/10	➡	01/07→ 04/07			<b>13.0460-0077.2 610077</b>	TRW
1.6 16V (LM1R, LM0C)	82	01/06→						
1.9 dCi	66	09/03→12/05	➡				<b>13.0460-0077.2 610077</b>	TRW
2.0	101	04/06→11/10						
<b> Bremsscheibe</b>								
1.4	60	09/03→	←	→ 08/06			<b>24.0122-0216.1 422216</b>	Ø 260 22 19,8 V + S
			➡	→ 08/06			<b>24.0108-0114.2 408114</b>	Ø 240 8 7 + LG / + ABS Ring
1.4	72	09/03→	←	→ 12/08			<b>24.0122-0216.1 422216</b>	Ø 260 22 19,8 V + S
			➡	→ 12/08			<b>24.0108-0114.2 408114</b>	Ø 240 8 7 + LG / + ABS Ring
1.5 dCi (LM02, LM13, LM2A)	74	02/04→12/10	←	→ 03/06			<b>24.0124-0158.1 424158</b>	Ø 280 24 21,8 V + S
			➡	→ 03/06			<b>24.0324-0158.1 524158</b>	Ø 280 24 21,8 V + S
			➡	→ 03/06			<b>24.0108-0114.2 408114</b>	Ø 240 8 7 + LG / + ABS Ring
1.5 dCi (LM0F, LM0T, LM2B)	60	08/03→12/10	←	09/03→ 12/08			<b>24.0124-0158.1 424158</b>	Ø 280 24 21,8 V + S
			➡	09/03→ 12/08			<b>24.0324-0158.1 524158</b>	Ø 280 24 21,8 V + S
			➡	09/03→ 12/08			<b>24.0108-0114.2 408114</b>	Ø 240 8 7 + LG / + ABS Ring
1.5 dCi (LM16)	76	10/03→12/10	←	01/07→ 12/08			<b>24.0124-0158.1 424158</b>	Ø 280 24 21,8 V + S
			➡	01/07→ 12/08			<b>24.0324-0158.1 524158</b>	Ø 280 24 21,8 V + S
			➡	01/07→ 12/08			<b>24.0108-0114.2 408114</b>	Ø 240 8 7 + LG / + ABS Ring
1.5 dCi (LM1E)	78	05/05→12/10	←	→ 12/08			<b>24.0124-0158.1 424158</b>	Ø 280 24 21,8 V + S
1.5 dCi (LM1F)	63	05/05→12/10					<b>24.0324-0158.1 524158</b>	Ø 280 24 21,8 V + S
1.6	77	05/05→						
1.6	83	09/03→	➡	→ 12/08			<b>24.0108-0114.2 408114</b>	Ø 240 8 7 + LG / + ABS Ring
1.6 Hi-Flex	85	03/06→						
1.9 dCi	68	03/04→						
1.9 dCi	96	05/05→						
1.9 dCi (LM0G, LM1G, LM2C)	88	09/03→						
1.9 dCi (LM14, LM1D)	81	05/05→						
2.0	99	09/03→						
1.6	81	09/03→11/08	←				<b>24.0124-0158.1 424158</b>	Ø 280 24 21,8 V + S
			➡				<b>24.0324-0158.1 524158</b>	Ø 280 24 21,8 V + S
1.9 dCi	66	09/03→12/05					<b>24.0108-0114.2 408114</b>	Ø 240 8 7 + LG / + ABS Ring
2.0	101	04/06→11/10	➡					
2.0 dCi	110	09/05→	←	→ 12/08			<b>24.0124-0158.1 424158</b>	Ø 280 24 21,8 V + S
			➡	→ 12/08			<b>24.0124-0223.1 424223</b>	Ø 280 24 21,8 V + S
							<b>24.0324-0158.1 524158</b>	Ø 280 24 21,8 V + S
			➡	→ 12/08			<b>24.0110-0389.2 410389</b>	Ø 270 10 9 + LG / + ABS Ring













	kw			 	! #		
<b>RENAULT - MEGANE III Coupe (DZ0/1_) 11/08→</b>							
<b> Bremsbelagsatz, Scheibenbremse</b>							
1.2 TCe	85	03/12→	←			13.0460-7266.2 607266	ATE 24538 17,9 - WE / - WK
1.4 TCe (DZ0F, DZ1V)	96	04/09→				13.0470-7266.2 LD7266	ATE 24538 17,9 - WE / - WK
1.5 dCi	70	07/14→					Ceramic
1.5 dCi (DZ09, DZ0D, DZ1F, DZ1G)	81	02/09→	→	- eFSB		13.0460-2740.2 602740	TRW 23554 17,0 - WE / - WK + Zub
1.5 dCi (DZ0A)	63	11/08→					
1.5 dCi (DZ0B)	78	02/09→				13.0470-2740.2 LD2740	TRW 23554 17,0 - WE / - WK + Zub Ceramic
1.5 dCi (DZ0C, DZ1A)	66	11/08→					
1.6 16V (DZ0H)	74	11/08→	→	+ eFSB		13.0460-2756.2 602756	TRW 24820 16,1 - WE / - WK + Zub
1.6 16V (DZ0U, DZ1B, DZ1H)	81	11/08→					
1.6 16V Bifuel (DZ03, DZ1Y)	81	11/08→					
1.6 dCi (DZ00)	96	04/11→					
1.9 dCi (DZ0N, DZ0J, DZ1J, DZ1K)	96	11/08→					
2.0 CVT (DZ0G, DZ1E)	103	05/09→					
1.2 TCe (DZ16)	97	01/13→	←			13.0460-7266.2 607266	ATE 24538 17,9 - WE / - WK
						13.0470-7266.2 LD7266	ATE 24538 17,9 - WE / - WK Ceramic
			→	- eFSB		13.0460-2740.2 602740	TRW 23554 17,0 - WE / - WK + Zub
						13.0470-2740.2 LD2740	TRW 23554 17,0 - WE / - WK + Zub Ceramic
2.0 dCi	120	07/12→	←			13.0460-7249.2 607249	ATE 24709 18,6 - WE / - WK
						13.0470-7249.2 LD7249	ATE 24709 18,6 - WE / - WK Ceramic
2.0 dCi (DZ0L)	118	04/09→	←			13.0460-7249.2 607249	ATE 24709 18,6 - WE / - WK
2.0 dCi (DZ0Y)	110	04/09→				13.0470-7249.2 LD7249	ATE 24709 18,6 - WE / - WK Ceramic
2.0 TCe	140	06/12→					
2.0 TCe (DZ0K)	132	11/08→	→	- eFSB		13.0460-2740.2 602740	TRW 23554 17,0 - WE / - WK + Zub
2.0 TCe 220	162	11/13→				13.0470-2740.2 LD2740	TRW 23554 17,0 - WE / - WK + Zub Ceramic
			→	+ eFSB		13.0460-2756.2 602756	TRW 24820 16,1 - WE / - WK + Zub
2.0 R.S.	195	11/08→	←	08/11→		13.0460-4804.2 604804	BRE 23092 15,6 - WE / - WK
			→	08/11→; - eFSB		13.0460-2753.2 602753	TRW 23554 16,0 - WK + Zub
2.0 R.S.	201	07/14→	←			13.0460-4804.2 604804	BRE 23092 15,6 - WE / - WK
2.0 TCe (DZ1N)	184	05/09→	→	- eFSB		13.0460-2753.2 602753	TRW 23554 16,0 - WK + Zub
<b> Bremsscheibe</b>							
1.2 TCe	85	03/12→	←			24.0124-0221.1 424221	∅ 280 24 21,8 V + S
1.2 TCe (DZ16)	97	01/13→					
1.4 TCe (DZ0F, DZ1V)	96	04/09→	→			24.0108-0116.2 408116	∅ 260 8 7 + LG / + ABS Ring
1.5 dCi	70	07/14→					
1.5 dCi (DZ09, DZ0D, DZ1F, DZ1G)	81	02/09→					
1.5 dCi (DZ0A)	63	11/08→					
1.5 dCi (DZ0B)	78	02/09→					
1.5 dCi (DZ0C, DZ1A)	66	11/08→					
1.6 16V (DZ0H)	74	11/08→					
1.6 16V (DZ0U, DZ1B, DZ1H)	81	11/08→					
1.6 16V Bifuel (DZ03, DZ1Y)	81	11/08→					
1.6 dCi (DZ00)	96	04/11→					
1.9 dCi (DZ0N, DZ0J, DZ1J, DZ1K)	96	11/08→					
2.0 CVT (DZ0G, DZ1E)	103	05/09→					
2.0 dCi	120	07/12→	←			24.0126-0158.1 426158	∅ 296 26 23,4 V + S
2.0 dCi (DZ0L)	118	04/09→					
2.0 dCi (DZ0Y)	110	04/09→	→			24.0108-0116.2 408116	∅ 260 8 7 + LG / + ABS Ring
2.0 TCe	140	06/12→					
2.0 TCe (DZ0K)	132	11/08→					
2.0 R.S.	195	11/08→	←	08/11→		24.0128-0261.1 428261	∅ 340 28 26 V + S
			←	08/11→; CUP Edition		24.0128-0288.1 428288	∅ 340 28 26 V / + S
2.0 R.S.	201	07/14→	←			24.0128-0261.1 428261	∅ 340 28 26 V + S
			←	CUP Edition		24.0128-0288.1 428288	∅ 340 28 26 V / + S
2.0 TCe (DZ1N)	184	05/09→	←			24.0128-0261.1 428261	∅ 340 28 26 V + S
			←	CUP Edition		24.0128-0288.1 428288	∅ 340 28 26 V / + S
			→			24.0111-0186.2 411186	∅ 290 11 9,5 + LG / + ABS Ring
↓							

	kW			 	! #		
<b>RENAULT - MEGANE III Coupe (DZ0/1_) 11/08→</b>							
 <b>Bremsscheibe</b>							
2.0 TCe 220	162	11/13→	←		24.0128-0288.1	428288	Ø 340 28 26 V / + S
			→		24.0108-0116.2	408116	Ø 260 8 7 + LG / + ABS Ring
<b>RENAULT - MEGANE III Grandtour (KZ0/1) 11/08→</b>							
 <b>Bremsbelagsatz, Scheibenbremse</b>							
1.2 TCe	85	03/12→	←		13.0460-7266.2	607266	ATE 24538 17,9 - WE / - WK
1.2 TCe (KZ16)	97	01/13→			13.0470-7266.2	LD7266	ATE 24538 17,9 - WE / - WK Ceramic
1.4 TCe (KZ0F, KZ1V)	96	05/09→					
1.5 dCi	70	11/13→					
1.5 dCi (KZ09, KZ0D, KZ1G)	81	02/09→	→	- eFSB	13.0460-2740.2	602740	TRW 23554 17,0 - WE / - WK + Zub
1.5 dCi (KZ0C, KZ1A)	66	05/09→			13.0470-2740.2	LD2740	TRW 23554 17,0 - WE / - WK + Zub Ceramic
1.6 16V (KZ0H)	74	05/09→					
1.6 16V (KZ0U, KZ1B, KZ1U)	81	05/09→	→	+ eFSB	13.0460-2756.2	602756	TRW 24820 16,1 - WE / - WK + Zub
1.6 16V Bifuel (KZ03)	81	11/08→					
1.6 dCi (KZ00, KZ12)	96	04/11→					
1.9 dCi (KZ0J, KZ0N, KZ1S)	96	05/09→					
2.0 CVT (KZ0G, KZ1P)	103	05/09→					
1.5 dCi	63	03/09→	←	08/09→	13.0460-7266.2	607266	ATE 24538 17,9 - WE / - WK
					13.0470-7266.2	LD7266	ATE 24538 17,9 - WE / - WK Ceramic
			→	08/09→; - eFSB	13.0460-2740.2	602740	TRW 23554 17,0 - WE / - WK + Zub
					13.0470-2740.2	LD2740	TRW 23554 17,0 - WE / - WK + Zub Ceramic
			→	08/09→; + eFSB	13.0460-2756.2	602756	TRW 24820 16,1 - WE / - WK + Zub
1.5 dCi (KZ1M, KZ1W)	78	02/09→	←	05/09→	13.0460-7266.2	607266	ATE 24538 17,9 - WE / - WK
					13.0470-7266.2	LD7266	ATE 24538 17,9 - WE / - WK Ceramic
			→	05/09→; - eFSB	13.0460-2740.2	602740	TRW 23554 17,0 - WE / - WK + Zub
					13.0470-2740.2	LD2740	TRW 23554 17,0 - WE / - WK + Zub Ceramic
			→	05/09→; + eFSB	13.0460-2756.2	602756	TRW 24820 16,1 - WE / - WK + Zub
2.0 dCi	120	07/12→	←		13.0460-7249.2	607249	ATE 24709 18,6 - WE / - WK
					13.0470-7249.2	LD7249	ATE 24709 18,6 - WE / - WK Ceramic
			→	+ eFSB	13.0460-2756.2	602756	TRW 24820 16,1 - WE / - WK + Zub
2.0 dCi (KZ0L)	118	04/09→	←		13.0460-7249.2	607249	ATE 24709 18,6 - WE / - WK
2.0 dCi (KZ0Y)	110	10/10→			13.0470-7249.2	LD7249	ATE 24709 18,6 - WE / - WK Ceramic
2.0 TCe	140	09/12→					
2.0 TCe	162	09/12→					
			→	- eFSB	13.0460-2740.2	602740	TRW 23554 17,0 - WE / - WK + Zub
					13.0470-2740.2	LD2740	TRW 23554 17,0 - WE / - WK + Zub Ceramic
			→	+ eFSB	13.0460-2756.2	602756	TRW 24820 16,1 - WE / - WK + Zub
2.0 TCe (KZ0K, KZ1T)	132	11/08→	←	05/09→	13.0460-7249.2	607249	ATE 24709 18,6 - WE / - WK
					13.0470-7249.2	LD7249	ATE 24709 18,6 - WE / - WK Ceramic
			→	05/09→; - eFSB	13.0460-2740.2	602740	TRW 23554 17,0 - WE / - WK + Zub
					13.0470-2740.2	LD2740	TRW 23554 17,0 - WE / - WK + Zub Ceramic
			→	05/09→; + eFSB	13.0460-2756.2	602756	TRW 24820 16,1 - WE / - WK + Zub
 <b>Bremsscheibe</b>							
1.2 TCe	85	03/12→	←		24.0124-0221.1	424221	Ø 280 24 21,8 V + S
1.4 TCe (KZ0F, KZ1V)	96	05/09→					
1.5 dCi	70	11/13→	→		24.0108-0118.2	408118	Ø 260 8 7 + LG / + ABS Ring
1.5 dCi (KZ09, KZ0D, KZ1G)	81	02/09→					
1.5 dCi (KZ0C, KZ1A)	66	05/09→					
1.6 16V (KZ0H)	74	05/09→					
1.6 16V (KZ0U, KZ1B, KZ1U)	81	05/09→					
↓							























	kw			 	! #		
<b>RENAULT - MEGANE III Grandtour (KZ0/1) 11/08→</b>							
<b>Bremsscheibe</b>							
1.6 16V Bifuel (KZ03)	81	11/08→	←			24.0124-0221.1 424221	Ø 280 24 21,8 V + S
1.6 dCi (KZ00, KZ12)	96	04/11→	→				
1.9 dCi (KZ0J, KZ0N, KZ1S)	96	05/09→	→			24.0108-0118.2 408118	Ø 260 8 7 + LG / + ABS Ring
2.0 CVT (KZ0G, KZ1P)	103	05/09→					
1.2 TCe (KZ16)	97	01/13→	←			24.0124-0221.1 424221	Ø 280 24 21,8 V + S
			→			24.0108-0116.2 408116	Ø 260 8 7 + LG / + ABS Ring
1.5 dCi	63	03/09→	←	08/09→		24.0124-0221.1 424221	Ø 280 24 21,8 V + S
			→	08/09→		24.0108-0118.2 408118	Ø 260 8 7 + LG / + ABS Ring
1.5 dCi (KZ1M, KZ1W)	78	02/09→	←	05/09→		24.0124-0221.1 424221	Ø 280 24 21,8 V + S
			→	05/09→		24.0108-0118.2 408118	Ø 260 8 7 + LG / + ABS Ring
2.0 dCi	120	07/12→	←			24.0126-0158.1 426158	Ø 296 26 23,4 V + S
2.0 dCi (KZ0L)	118	04/09→	→			24.0108-0118.2 408118	Ø 260 8 7 + LG / + ABS Ring
2.0 dCi (KZ0Y)	110	10/10→	→				
2.0 TCe	140	09/12→	←			24.0126-0158.1 426158	Ø 296 26 23,4 V + S
			→			24.0108-0116.2 408116	Ø 260 8 7 + LG / + ABS Ring
2.0 TCe	162	09/12→	←			24.0128-0245.1 428245	Ø 320 28 25,4 V + S
			→			24.0108-0118.2 408118	Ø 260 8 7 + LG / + ABS Ring
2.0 TCe (KZ0K, KZ1T)	132	11/08→	←	05/09→		24.0126-0158.1 426158	Ø 296 26 23,4 V + S
			→	05/09→		24.0108-0118.2 408118	Ø 260 8 7 + LG / + ABS Ring
<b>RENAULT - MEGANE III Schrägheck (BZ0/1_) 11/08→</b>							
<b>Bremsbelagsatz, Scheibenbremse</b>							
1.2 TCe	85	03/12→	←			13.0460-7266.2 607266	ATE 24538 17,9 - WE / - WK
1.2 TCe (BZ16)	97	01/13→				13.0470-7266.2 LD7266	ATE 24538 17,9 - WE / - WK Ceramic
1.4 TCe (BZ0F, BZ1V)	96	04/09→					
1.5 dCi	63	12/09→	→	- eFSB		13.0460-2740.2 602740	TRW 23554 17,0 - WE / - WK + Zub
1.5 dCi	78	02/09→					
1.5 dCi (BZ09, BZ0D)	81	02/09→				13.0470-2740.2 LD2740	TRW 23554 17,0 - WE / - WK + Zub Ceramic
1.5 dCi (BZ0C)	66	11/08→					
1.5 dCi (BZ1G, BZ1W, BZ0R)	70	11/13→	→	+ eFSB		13.0460-2756.2 602756	TRW 24820 16,1 - WE / - WK + Zub
1.6 16V	82	11/08→					
1.6 16V	85	10/15→					
1.6 16V (BZ0H)	74	11/08→					
1.6 16V (BZ1B, BZ1H)	81	11/08→					
1.6 16V Bifuel (BZ03)	81	11/08→					
1.6 dCi (BZ00, BZ12)	96	04/11→					
1.9 dCi (BZ0N, BZ0J)	96	11/08→					
2.0	105	01/11→					
2.0 CVT (BZ0G, BZ1P)	103	02/09→					
2.0 dCi	120	07/12→	←			13.0460-7249.2 607249	ATE 24709 18,6 - WE / - WK
						13.0470-7249.2 LD7249	ATE 24709 18,6 - WE / - WK Ceramic
2.0 dCi (BZ0L)	118	04/09→	←			13.0460-7249.2 607249	ATE 24709 18,6 - WE / - WK
2.0 dCi (BZ0Y)	110	10/10→				13.0470-7249.2 LD7249	ATE 24709 18,6 - WE / - WK Ceramic
2.0 TCe	140	06/12→					
2.0 TCe (BZ0K)	132	11/08→	→	- eFSB		13.0460-2740.2 602740	TRW 23554 17,0 - WE / - WK + Zub
						13.0470-2740.2 LD2740	TRW 23554 17,0 - WE / - WK + Zub Ceramic
			→	+ eFSB		13.0460-2756.2 602756	TRW 24820 16,1 - WE / - WK + Zub
2.0 TCe 220	162	11/13→	←			13.0460-7249.2 607249	ATE 24709 18,6 - WE / - WK
						13.0460-7266.2 607266	ATE 24538 17,9 - WE / - WK
						13.0470-7249.2 LD7249	ATE 24709 18,6 - WE / - WK Ceramic
						13.0470-7266.2 LD7266	ATE 24538 17,9 - WE / - WK Ceramic
			→	- eFSB		13.0460-2740.2 602740	TRW 23554 17,0 - WE / - WK + Zub
						13.0470-2740.2 LD2740	TRW 23554 17,0 - WE / - WK + Zub Ceramic
			→	+ eFSB		13.0460-2756.2 602756	TRW 24820 16,1 - WE / - WK + Zub
<b>Bremsscheibe</b>							
1.2 TCe	85	03/12→	←			24.0124-0221.1 424221	Ø 280 24 21,8 V + S
1.2 TCe (BZ16)	97	01/13→					

	kw					! #		
<b>RENAULT - MEGANE III Schrägheck (BZ0/1_) 11/08→</b>								
 <b>Bremsscheibe</b>								
1.4 TCe (BZ0F, BZ1V)	96	04/09→	➔				<b>24.0108-0116.2 408116</b>	Ø 260 8 7 + LG / + ABS Ring
1.5 dCi	63	12/09→						
1.5 dCi	78	02/09→						
1.5 dCi (BZ09, BZ0D)	81	02/09→						
1.5 dCi (BZ0C)	66	11/08→						
1.5 dCi (BZ1G, BZ1W, BZ0R)	70	11/13→						
1.6 16V	82	11/08→						
1.6 16V	85	10/15→						
1.6 16V (BZ0H)	74	11/08→						
1.6 16V (BZ1B, BZ1H)	81	11/08→						
1.6 16V Bifuel (BZ03)	81	11/08→						
1.6 dCi (BZ00, BZ12)	96	04/11→						
1.9 dCi (BZ0N, BZ0J)	96	11/08→						
2.0	105	01/11→						
2.0 CVT (BZ0G, BZ1P)	103	02/09→						
2.0 dCi	120	07/12→	➔				<b>24.0126-0158.1 426158</b>	Ø 296 26 23,4 V + S
2.0 dCi (BZ0L)	118	04/09→	➔				<b>24.0126-0158.1 426158</b>	Ø 296 26 23,4 V + S
			➔				<b>24.0108-0116.2 408116</b>	Ø 260 8 7 + LG / + ABS Ring
2.0 dCi (BZ0Y)	110	10/10→	➔				<b>24.0126-0158.1 426158</b>	Ø 296 26 23,4 V + S
			➔				<b>24.0108-0116.2 408116</b>	Ø 260 8 7 + LG / + ABS Ring
			➔	07/12→			<b>24.0108-0116.2 408116</b>	Ø 260 8 7 + LG / + ABS Ring
2.0 TCe	140	06/12→	➔				<b>24.0126-0158.1 426158</b>	Ø 296 26 23,4 V + S
2.0 TCe (BZ0K)	132	11/08→	➔				<b>24.0128-0245.1 428245</b>	Ø 320 28 25,4 V + S
			➔				<b>24.0108-0116.2 408116</b>	Ø 260 8 7 + LG / + ABS Ring
2.0 TCe 220	162	11/13→	➔				<b>24.0126-0158.1 426158</b>	Ø 296 26 23,4 V + S
			➔				<b>24.0128-0245.1 428245</b>	Ø 320 28 25,4 V + S
			➔				<b>24.0128-0288.1 428288</b>	Ø 340 28 26 V / + S
			➔				<b>24.0108-0116.2 408116</b>	Ø 260 8 7 + LG / + ABS Ring
<b>RENAULT - MEGANE IV Grandtour (K9A/M/N_) 04/16→</b>								
 <b>Bremsbelagsatz, Scheibenbremse</b>								
1.2 TCe 100	74	04/16→	➔	- eFSB			<b>13.0460-2740.2 602740</b>	TRW 23554 17,0 - WE / - WK + Zub
1.2 TCe 130	97	04/16→					<b>13.0470-2740.2 LD2740</b>	TRW 23554 17,0 - WE / - WK + Zub Ceramic
1.5 dCi 110	81	04/16→						
1.6 dCi 130	96	04/16→						
1.6 TCe 165	121	07/17→	➔	+ eFSB			<b>13.0460-2756.2 602756</b>	TRW 24820 16,1 - WE / - WK + Zub
1.5 dCi 90	66	04/16→	➔				<b>13.0460-2709.2 602709</b>	TRW 23973 17,1 - WE / - WK + Zub
1.6 16V	84	04/16→	➔				<b>13.0470-2709.2 LD2709</b>	TRW 23973 17,1 - WE / - WK + Zub Ceramic
			➔	- eFSB			<b>13.0460-2740.2 602740</b>	TRW 23554 17,0 - WE / - WK + Zub
			➔				<b>13.0470-2740.2 LD2740</b>	TRW 23554 17,0 - WE / - WK + Zub Ceramic
			➔	+ eFSB			<b>13.0460-2756.2 602756</b>	TRW 24820 16,1 - WE / - WK + Zub
 <b>Bremsscheibe</b>								
1.2 TCe 100	74	04/16→	➔				<b>24.0124-0221.1 424221</b>	Ø 280 24 21,8 V + S
1.2 TCe 130	97	04/16→						
1.5 dCi 110	81	04/16→						
1.5 dCi 90	66	04/16→						
1.6 TCe 165	121	07/17→	➔				<b>24.0128-0245.1 428245</b>	Ø 320 28 25,4 V + S
<b>RENAULT - MEGANE IV Schrägheck (B9A/M/N_) 11/15→</b>								
 <b>Bremsbelagsatz, Scheibenbremse</b>								
1.2 TCe 100 (B9MS)	74	11/15→	➔				<b>13.0460-2709.2 602709</b>	TRW 23973 17,1 - WE / - WK + Zub
1.6 16V	84	11/15→	➔				<b>13.0470-2709.2 LD2709</b>	TRW 23973 17,1 - WE / - WK + Zub Ceramic
			➔	- eFSB			<b>13.0460-2740.2 602740</b>	TRW 23554 17,0 - WE / - WK + Zub
			➔				<b>13.0470-2740.2 LD2740</b>	TRW 23554 17,0 - WE / - WK + Zub Ceramic
			➔	+ eFSB			<b>13.0460-2756.2 602756</b>	TRW 24820 16,1 - WE / - WK + Zub
↓								





	kW			 	! #		
<b>RENAULT - MEGANE IV Schrägheck (B9A/M/N_) 11/15→</b>							
 <b>Bremsbelagsatz, Scheibenbremse</b>							
1.2 TCe 130 (B9MR)	97	11/15→	←	Schaltgetriebe		<b>13.0460-2709.2 602709</b>	TRW 23973 17,1 - WE / - WK + Zub
						<b>13.0470-2709.2 LD2709</b>	TRW 23973 17,1 - WE / - WK + Zub Ceramic
			→	- eFSB		<b>13.0460-2740.2 602740</b>	TRW 23554 17,0 - WE / - WK + Zub
			→	+ eFSB		<b>13.0470-2740.2 LD2740</b>	TRW 23554 17,0 - WE / - WK + Zub Ceramic
			→	+ eFSB		<b>13.0460-2756.2 602756</b>	TRW 24820 16,1 - WE / - WK + Zub
1.5 dCi 110 (B9A3) 1.5 dCi 90 (B9A1) 1.6 dCi 130 (B9A4) 1.6 TCe 165	81 66 96 121	11/15→ 11/15→ 11/15→ 07/17→	→	- eFSB		<b>13.0460-2740.2 602740</b>	TRW 23554 17,0 - WE / - WK + Zub
						<b>13.0470-2740.2 LD2740</b>	TRW 23554 17,0 - WE / - WK + Zub Ceramic
			→	+ eFSB		<b>13.0460-2756.2 602756</b>	TRW 24820 16,1 - WE / - WK + Zub
1.6 dCi 165	120	11/15→	→	- eFSB		<b>13.0460-2740.2 602740</b>	TRW 23554 17,0 - WE / - WK + Zub
						<b>13.0470-2740.2 LD2740</b>	TRW 23554 17,0 - WE / - WK + Zub Ceramic
 <b>Bremsscheibe</b>							
1.2 TCe 130 (B9MR)	97	11/15→	←			<b>24.0124-0221.1 424221</b>	Ø 280 24 21,8 V + S
1.5 dCi 110 (B9A3) 1.5 dCi 90 (B9A1)	81 66	11/15→ 11/15→	←	Automatikgetriebe		<b>24.0124-0221.1 424221</b>	Ø 280 24 21,8 V + S
1.6 dCi 165	120	11/15→	←			<b>24.0128-0245.1 428245</b>	Ø 320 28 25,4 V + S
1.6 TCe 165	121	07/17→	←				
<b>RENAULT - MEGANE IV Stufenheck 10/16→</b>							
 <b>Bremsbelagsatz, Scheibenbremse</b>							
1.2 Tce 130 1.5 dCi 110 1.6 dCi 130	97 81 96	10/16→ 10/16→ 10/16→	→	- eFSB		<b>13.0460-2740.2 602740</b>	TRW 23554 17,0 - WE / - WK + Zub
						<b>13.0470-2740.2 LD2740</b>	TRW 23554 17,0 - WE / - WK + Zub Ceramic
			→	+ eFSB		<b>13.0460-2756.2 602756</b>	TRW 24820 16,1 - WE / - WK + Zub
1.5 dCi 90 1.6 S Ce	66 84	10/16→ 10/16→	←			<b>13.0460-2709.2 602709</b>	TRW 23973 17,1 - WE / - WK + Zub
						<b>13.0470-2709.2 LD2709</b>	TRW 23973 17,1 - WE / - WK + Zub Ceramic
			→	- eFSB		<b>13.0460-2740.2 602740</b>	TRW 23554 17,0 - WE / - WK + Zub
						<b>13.0470-2740.2 LD2740</b>	TRW 23554 17,0 - WE / - WK + Zub Ceramic
			→	+ eFSB		<b>13.0460-2756.2 602756</b>	TRW 24820 16,1 - WE / - WK + Zub
<b>RENAULT - MEGANE CC (EZ0/1_) 06/10→</b>							
 <b>Bremsbelagsatz, Scheibenbremse</b>							
1.2 TCe (EZ16)	97	01/13→	←	04/13→		<b>13.0460-7266.2 607266</b>	ATE 24538 17,9 - WE / - WK
						<b>13.0470-7266.2 LD7266</b>	ATE 24538 17,9 - WE / - WK Ceramic
			→	04/13→; - eFSB		<b>13.0460-2740.2 602740</b>	TRW 23554 17,0 - WE / - WK + Zub
						<b>13.0470-2740.2 LD2740</b>	TRW 23554 17,0 - WE / - WK + Zub Ceramic
			→	04/13→; + eFSB		<b>13.0460-2756.2 602756</b>	TRW 24820 16,1 - WE / - WK + Zub
1.4 TCe (EZ0F, EZ1V) 1.5 dCi (EZ09, EZ1G, EZ0D) 1.6 16V (EZ0U, EZ1U) 1.9 dCi (EZ0J, EZ1S) 2.0 CVT (EZ0G, EZ1E, EZ1P)	96 81 81 96 103	06/10→ 06/10→ 06/10→ 06/10→ 06/10→	←			<b>13.0460-7266.2 607266</b>	ATE 24538 17,9 - WE / - WK
						<b>13.0470-7266.2 LD7266</b>	ATE 24538 17,9 - WE / - WK Ceramic
			→	- eFSB		<b>13.0460-2740.2 602740</b>	TRW 23554 17,0 - WE / - WK + Zub
						<b>13.0470-2740.2 LD2740</b>	TRW 23554 17,0 - WE / - WK + Zub Ceramic
			→	+ eFSB		<b>13.0460-2756.2 602756</b>	TRW 24820 16,1 - WE / - WK + Zub
1.6 dCi (EZ00)	96	04/11→	←			<b>13.0460-7266.2 607266</b>	ATE 24538 17,9 - WE / - WK
↓							

	kW			 	! #		
<b>RENAULT - MEGANE CC (EZ0/1_) 06/10→</b>							
 <b>Bremsbelagsatz, Scheibenbremse</b>							
1.6 dCi (EZ00)	96	04/11→	←			13.0470-7266.2 LD7266	ATE 24538 17,9 - WE / - WK Ceramic
			→	+ eFSB		13.0460-2756.2 602756	TRW 24820 16,1 - WE / - WK + Zub
2.0 dCi (EZ0L) 2.0 TCe (EZ1T) 2.0 Turbo	118 132 195	06/10→ 06/10→ 10/11→	←			13.0460-7249.2 607249	ATE 24709 18,6 - WE / - WK
			←			13.0470-7249.2 LD7249	ATE 24709 18,6 - WE / - WK Ceramic
			→	- eFSB		13.0460-2740.2 602740	TRW 23554 17,0 - WE / - WK + Zub
			→	+ eFSB		13.0470-2740.2 LD2740	TRW 23554 17,0 - WE / - WK + Zub Ceramic
			→	+ eFSB		13.0460-2756.2 602756	TRW 24820 16,1 - WE / - WK + Zub
 <b>Bremsscheibe</b>							
1.2 TCe (EZ16)	97	01/13→	←	04/13→		24.0124-0221.1 424221	Ø 280 24 21,8 V + S
			→	04/13→		24.0108-0118.2 408118	Ø 260 8 7 + LG / + ABS Ring
1.4 TCe (EZ0F, EZ1V) 1.6 dCi (EZ00)	96 96	06/10→ 04/11→	←			24.0124-0221.1 424221	Ø 280 24 21,8 V + S
			→			24.0108-0118.2 408118	Ø 260 8 7 + LG / + ABS Ring
1.5 dCi (EZ09, EZ1G, EZ0D) 1.6 16V (EZ0U, EZ1U) 1.9 dCi (EZ0J, EZ1S) 2.0 CVT (EZ0G, EZ1E, EZ1P)	81 81 96 103	06/10→ 06/10→ 06/10→ 06/10→	←			24.0124-0221.1 424221	Ø 280 24 21,8 V + S
			→			24.0108-0116.2 408116	Ø 260 8 7 + LG / + ABS Ring
2.0 dCi (EZ0L) 2.0 TCe (EZ1T) 2.0 Turbo	118 132 195	06/10→ 06/10→ 10/11→	←			24.0126-0158.1 426158	Ø 296 26 23,4 V + S
			→			24.0108-0116.2 408116	Ø 260 8 7 + LG / + ABS Ring
<b>RENAULT - MEGANE Scenic (JA0/1_) 10/96→12/01</b>							
 <b>Bremsbelagsatz, Scheibenbremse</b>							
1.4 i (JA0E) 1.6 i (JA0L)	55 55	01/97→09/99 01/97→09/99	←	→ 09/98		13.0460-2834.2 602834	TRW 21463 18,0 + WK
			←	10/98→		13.0460-2983.2 602983	TRW 20919 18,0 + WK
1.6 16V (JA0B, JA04, JA11)	79	04/98→10/99	←	04/99→ 09/99		13.0460-2895.2 602895	TRW 23172 18,0 - WK
			←	→ 03/99		13.0460-2983.2 602983	TRW 20919 18,0 + WK
			→	→ 09/99		13.0460-2845.2 602845 13.0470-2845.2 LD2845	TRW 23554 16,4 - WK + Zub TRW 23554 16,4 - WK + Zub Ceramic
1.6 e (JA0F)	66	10/96→10/99	←	11/96→ 09/98; Schaltgetriebe		13.0460-2834.2 602834	TRW 21463 18,0 + WK
			←	01/99→ 09/99; Vollautomatik		13.0460-2895.2 602895	TRW 23172 18,0 - WK
			←	01/99→ 09/99; Schaltgetriebe		13.0460-2895.2 602895	TRW 23172 18,0 - WK
			←	11/96→ 12/98; Vollautomatik		13.0460-2983.2 602983	TRW 20919 18,0 + WK
			←	10/98→ 12/98; Schaltgetriebe		13.0460-2983.2 602983	TRW 20919 18,0 + WK
1.9 D (JA0J)	47	03/97→09/99	←			13.0460-2895.2 602895	TRW 23172 18,0 - WK
			←	10/98→		13.0460-2983.2 602983	TRW 20919 18,0 + WK
			←	→ 09/98		13.0460-2983.2 602983	TRW 20919 18,0 + WK
1.9 dT (JA0K, JA0Y)	66	01/97→09/99	←	→ 12/97		13.0460-2983.2 602983	TRW 20919 18,0 + WK
1.9 dT (JA0Y) 2.0 i (JA02, JA0G) 2.0 i (JA0G)	69 80 84	03/97→08/99 01/99→09/99 01/97→09/99	←			13.0460-2983.2 602983	TRW 20919 18,0 + WK
			←	10/98→		13.0460-2895.2 602895	TRW 23172 18,0 - WK
			←	→ 09/98		13.0460-2983.2 602983	TRW 20919 18,0 + WK
1.9 dTi (JA0N)	72	04/97→09/99	←	10/98→		13.0460-2895.2 602895	TRW 23172 18,0 - WK
			←	→ 09/98		13.0460-2983.2 602983	TRW 20919 18,0 + WK
			←	03/98→		13.0460-2983.2 602983	TRW 20919 18,0 + WK
			→	+ ABS		13.0460-2845.2 602845 13.0470-2845.2 LD2845	TRW 23554 16,4 - WK + Zub TRW 23554 16,4 - WK + Zub Ceramic
2.0 RXE 4x4	84	05/97→10/99	←	→ 09/99		13.0460-2983.2 602983	TRW 20919 18,0 + WK
<b>Zubehörsatz, Scheibenbremsbelag</b>							
1.6 16V (JA0B, JA04, JA11)	79	04/98→10/99	←	04/99→ 09/99		13.0460-0262.2 610262	TRW
			→	→ 09/99		13.0460-0077.2 610077	TRW
1.6 e (JA0F)	66	10/96→10/99	←	01/99→ 09/99; Schaltgetriebe		13.0460-0262.2 610262	TRW
↓							



### RENAULT - MEGANE Scenic (JA0/1\_) 10/96→12/01

#### Zubehörsatz, Scheibenbremsbelag

1.6 e (JA0F)	66	10/96→10/99	←	01/99→ 09/99; Vollautomatik		<b>13.0460-0262.2</b>	<b>610262</b>	TRW
1.9 D (JA0J)	47	03/97→09/99	←			<b>13.0460-0262.2</b>	<b>610262</b>	TRW
			←	10/98→		<b>13.0460-0262.2</b>	<b>610262</b>	TRW
1.9 dTi (JA0N)	72	04/97→09/99	←	10/98→		<b>13.0460-0262.2</b>	<b>610262</b>	TRW
			→	+ ABS		<b>13.0460-0077.2</b>	<b>610077</b>	TRW











#### Bremsscheibe

1.4 i (JA0E) 1.6 i (JA0L)	55	01/97→09/99	←	→ 09/98		<b>24.0121-0106.1</b>	<b>421106</b>	Ø 259 20,7 17,7 V + S
	55	01/97→09/99	←	10/98→		<b>24.0124-0158.1</b>	<b>424158</b>	Ø 280 24 21,8 V + S
						<b>24.0324-0158.1</b>	<b>524158</b>	Ø 280 24 21,8 V + S
1.6 16V (JA0B, JA04, JA11)	79	04/98→10/99	←	→ 09/98		<b>24.0122-0148.1</b>	<b>422148</b>	Ø 262 22 19,8 V + S
			←	10/98→ 09/99		<b>24.0124-0158.1</b>	<b>424158</b>	Ø 280 24 21,8 V + S
			→	→ 09/99		<b>24.0111-0166.2</b>	<b>411166</b>	Ø 274 10,9 9,5 + LG / + ABS Ring
1.6 e (JA0F)	66	10/96→10/99	←	11/96→ 09/98; Schaltgetriebe		<b>24.0121-0106.1</b>	<b>421106</b>	Ø 259 20,7 17,7 V + S
			←	11/96→ 09/98; Vollautomatik		<b>24.0122-0148.1</b>	<b>422148</b>	Ø 262 22 19,8 V + S
			←	10/98→ 09/99		<b>24.0124-0158.1</b>	<b>424158</b>	Ø 280 24 21,8 V + S
						<b>24.0324-0158.1</b>	<b>524158</b>	Ø 280 24 21,8 V + S
1.9 D (JA0J)	47	03/97→09/99	←			<b>24.0122-0148.1</b>	<b>422148</b>	Ø 262 22 19,8 V + S
			←	→ 09/98		<b>24.0122-0148.1</b>	<b>422148</b>	Ø 262 22 19,8 V + S
			←	10/98→		<b>24.0124-0158.1</b>	<b>424158</b>	Ø 280 24 21,8 V + S
						<b>24.0324-0158.1</b>	<b>524158</b>	Ø 280 24 21,8 V + S
1.9 dT (JA0K, JA0Y)	66	01/97→09/99	←	→ 12/97		<b>24.0122-0148.1</b>	<b>422148</b>	Ø 262 22 19,8 V + S
1.9 dT (JA0Y)	69	03/97→08/99	←			<b>24.0122-0148.1</b>	<b>422148</b>	Ø 262 22 19,8 V + S
1.9 dTi (JA0N)	72	04/97→09/99	←	03/98→ 09/98		<b>24.0122-0148.1</b>	<b>422148</b>	Ø 262 22 19,8 V + S
			←	→ 09/98		<b>24.0122-0148.1</b>	<b>422148</b>	Ø 262 22 19,8 V + S
			←	10/98→		<b>24.0124-0158.1</b>	<b>424158</b>	Ø 280 24 21,8 V + S
			→	+ ABS		<b>24.0111-0166.2</b>	<b>411166</b>	Ø 274 10,9 9,5 + LG / + ABS Ring
						<b>24.0324-0158.1</b>	<b>524158</b>	Ø 280 24 21,8 V + S
2.0 i (JA02, JA0G)	80	01/99→09/99	←			<b>24.0124-0158.1</b>	<b>424158</b>	Ø 280 24 21,8 V + S
						<b>24.0324-0158.1</b>	<b>524158</b>	Ø 280 24 21,8 V + S
2.0 i (JA0G)	84	01/97→09/99	←	→ 09/98		<b>24.0122-0148.1</b>	<b>422148</b>	Ø 262 22 19,8 V + S
			←	10/98→		<b>24.0124-0158.1</b>	<b>424158</b>	Ø 280 24 21,8 V + S
						<b>24.0324-0158.1</b>	<b>524158</b>	Ø 280 24 21,8 V + S
2.0 RXE 4x4	84	05/97→10/99	←	→ 09/98		<b>24.0122-0148.1</b>	<b>422148</b>	Ø 262 22 19,8 V + S
			←	10/98→ 09/99		<b>24.0124-0158.1</b>	<b>424158</b>	Ø 280 24 21,8 V + S
						<b>24.0324-0158.1</b>	<b>524158</b>	Ø 280 24 21,8 V + S











### RENAULT - MODUS / GRAND MODUS (F/JP0\_) 09/04→

#### Bremsbelagsatz, Scheibenbremse











1.2 (JP0S)	76	04/11→	←	→ 06/13		<b>13.0460-2709.2</b>	<b>602709</b>	TRW 23973 17,1 - WE / - WK + Zub
	58	12/04→						
1.4 (JP01, JP0J)	72	12/04→				<b>13.0470-2709.2</b>	<b>LD2709</b>	TRW 23973 17,1 - WE / - WK + Zub Ceramic
1.5 dCi (FP0F, JP0F)	63	12/04→						
1.5 dCi (JP02)	76	05/07→						
1.5 dCi (JP0G, JP0H)	78	05/05→	→	→ 06/13		<b>13.0460-2845.2</b>	<b>602845</b>	TRW 23554 16,4 - WK + Zub
1.6 (JP03, JP0B, JP0U, JP0Y, JP1G)	82	12/04→				<b>13.0470-2845.2</b>	<b>LD2845</b>	TRW 23554 16,4 - WK + Zub Ceramic
1.6 (JP0L, JP0V)	65	12/04→						
1.2 (FP0C, FP0K, FP0P)	48	05/05→	←	→ 06/13		<b>13.0460-2709.2</b>	<b>602709</b>	TRW 23973 17,1 - WE / - WK + Zub
1.2 (JP0C, JP0K, FP0C, FP0K, FP0P, JP0P, JP0T)	55	12/04→				<b>13.0470-2709.2</b>	<b>LD2709</b>	TRW 23973 17,1 - WE / - WK + Zub Ceramic
1.2 16V (JP0W)	74	05/07→						
1.2 16V Hi-Flex	55	10/08→	→	+ ESP; → 06/13		<b>13.0460-2845.2</b>	<b>602845</b>	TRW 23554 16,4 - WK + Zub
1.5 dCi (FP0D, JP0D)	60	09/04→				<b>13.0470-2845.2</b>	<b>LD2845</b>	TRW 23554 16,4 - WK + Zub Ceramic
1.5 dCi (FP0E, JP0E)	48	12/04→						
1.5 dCi (FP0G, JP0G)	50	12/04→						
1.5 dCi 75	55	10/10→						
1.5 dCi 90	65	10/10→						













	kw				! #		
<b>RENAULT - MODUS / GRAND MODUS (F/JP0_) 09/04 →</b>							
 <b>Bremsscheibe</b>							
1.2	76	04/11 →	←	→ 06/13		24.0122-0216.1 422216	Ø 260 22 19,8 V + S
1.2 (FP0C, FP0K, FP0P)	48	05/05 →	←	→ 06/13		24.0122-0216.1 422216	Ø 260 22 19,8 V + S
			→	+ ESP; → 06/13; Achszapfendurchmesser [mm]: 25		24.0108-0114.2 408114	Ø 240 8 7 + LG / + ABS Ring
1.2 (JP0C, JP0K, FP0C, FP0K, FP0P, JP0P, JP0T)	55	12/04 →	←	→ 06/13		24.0122-0216.1 422216	Ø 260 22 19,8 V + S
			→	+ ESP; → 06/13		24.0108-0114.2 408114	Ø 240 8 7 + LG / + ABS Ring
1.2 16V (JP0W)	74	05/07 →					
1.2 16V Hi-Flex	55	10/08 →					
1.5 dCi (FP0D, JP0D)	60	09/04 →					
1.5 dCi (FP0E, JP0E)	48	12/04 →					
1.5 dCi (FP0G, JP0G)	50	12/04 →					
1.5 dCi 75	55	10/10 →					
1.5 dCi 90	65	10/10 →					
1.2 (JP0S)	58	12/04 →	←	→ 06/13		24.0122-0216.1 422216	Ø 260 22 19,8 V + S
1.4 (JP01, JP0J)	72	12/04 →					
1.5 dCi (JP0F, JP0F)	63	12/04 →	→	→ 06/13		24.0108-0114.2 408114	Ø 240 8 7 + LG / + ABS Ring
1.5 dCi (JP02)	76	05/07 →					
1.5 dCi (JP0G, JP0H)	78	05/05 →					
1.6 (JP03, JP0B, JP0U, JP0Y, JP1G)	82	12/04 →					
1.6 (JP0L, JP0V)	65	12/04 →					
<b>RENAULT - RAPID 09/94 → 03/98</b>							
 <b>Bremsbelagsatz, Scheibenbremse</b>							
1.9 D	47	09/94 → 03/98	←	07/95 →		13.0460-3911.2 603911	BDX 20905 18,0 + WK
<b>Zubehörsatz, Scheibenbremsbelag</b>							
1.9 D	47	09/94 → 03/98	←	07/95 →		13.0460-0411.2 610411	BDX
 <b>Bremsscheibe</b>							
1.9 D	47	09/94 → 03/98	←	07/95 →		24.0112-0116.1 412116	Ø 238 12 10,5 + S
<b>RENAULT - RAPID Kasten (F40_, G40_) 07/85 → 11/01</b>							
 <b>Bremsbelagsatz, Scheibenbremse</b>							
1.2	48	05/95 → 11/98	←			13.0460-2834.2 602834	TRW 21463 18,0 + WK
1.4	59	05/95 → 08/97				13.0460-3911.2 603911	BDX 20905 18,0 + WK
1.4 (F40U, F40V)	55	09/91 → 03/98					
1.4 Cat (F407)	43	08/88 → 03/98					
Electric	21	01/94 → 11/98					
1.2 (F406, G40A)	40	09/91 → 03/98	←			13.0460-2834.2 602834	TRW 21463 18,0 + WK
			←	10/92 →		13.0460-2834.2 602834	TRW 21463 18,0 + WK
			←			13.0460-3911.2 603911	BDX 20905 18,0 + WK
			←			13.0460-2834.2 602834	TRW 21463 18,0 + WK
			←	09/94 →		13.0460-2834.2 602834	TRW 21463 18,0 + WK
			←			13.0460-3911.2 603911	BDX 20905 18,0 + WK
			←			13.0460-2834.2 602834	TRW 21463 18,0 + WK
			←	07/86 →		13.0460-2834.2 602834	TRW 21463 18,0 + WK
			←			13.0460-3911.2 603911	BDX 20905 18,0 + WK
			←	→ 06/86		13.0460-3955.2 603955	BDX 20634 15,0 + WK
1.9 D (F40P, F40N, F40E)	47	09/91 → 03/98	←			13.0460-2834.2 602834	TRW 21463 18,0 + WK
			←	09/92 →		13.0460-2834.2 602834	TRW 21463 18,0 + WK
			←			13.0460-3911.2 603911	BDX 20905 18,0 + WK
			←	09/95 →		13.0460-3911.2 603911	BDX 20905 18,0 + WK
1.9 D (F40R)	40	09/94 → 03/98	←			13.0460-3911.2 603911	BDX 20905 18,0 + WK
<b>Zubehörsatz, Scheibenbremsbelag</b>							
1.2	48	05/95 → 11/98	←			13.0460-0411.2 610411	BDX
1.4	59	05/95 → 08/97					
1.4 (F40U, F40V)	55	09/91 → 03/98					
1.4 Cat (F407)	43	08/88 → 03/98					
1.9 D (F40R)	40	09/94 → 03/98					
Electric	21	01/94 → 11/98					
1.2 (F406, G40A)	40	09/91 → 03/98	←			13.0460-0411.2 610411	BDX
↓							





















	kW			 	! #		
<b>RENAULT - RAPID Kasten (F40_, G40_) 07/85→11/01</b>							
<b>Zubehörsatz, Scheibenbremsbelag</b>							
1.2 (F406, G40A)	40	09/91→03/98	←	10/92→		13.0460-0411.2 610411	BDX
1.4 (F40D)	58	01/94→03/98	←			13.0460-0411.2 610411	BDX
			←	09/94→		13.0460-0411.2 610411	BDX
1.6 D (F404)	40	03/86→08/98	←			13.0460-0411.2 610411	BDX
			←	07/86→		13.0460-0411.2 610411	BDX
			←	→ 06/86		13.0460-0423.2 610423	BDX
1.9 D (F40P, F40N, F40E)	47	09/91→03/98	←			13.0460-0411.2 610411	BDX
			←	09/95→		13.0460-0411.2 610411	BDX
			←	09/92→		13.0460-0411.2 610411	BDX
<b> Bremsscheibe</b>							
1.2	48	05/95→11/98	←			24.0112-0116.1 412116	Ø 238 12 10,5 + S
1.4	59	05/95→08/97	←				
1.4 (F40U, F40V)	55	09/91→03/98	←				
1.4 Cat (F407)	43	08/88→03/98	←				
1.9 D (F40R)	40	09/94→03/98	←				
Electric	21	01/94→11/98	←				
1.2 (F406, G40A)	40	09/91→03/98	←			24.0112-0116.1 412116	Ø 238 12 10,5 + S
			←	10/92→		24.0112-0116.1 412116	Ø 238 12 10,5 + S
1.4 (F40D)	58	01/94→03/98	←			24.0112-0116.1 412116	Ø 238 12 10,5 + S
			←	09/94→		24.0112-0116.1 412116	Ø 238 12 10,5 + S
1.6 D (F404)	40	03/86→08/98	←	→ 06/86		24.0108-0104.1 408104	Ø 238 8,2 7 + S
			←			24.0112-0116.1 412116	Ø 238 12 10,5 + S
			←	07/86→		24.0112-0116.1 412116	Ø 238 12 10,5 + S
1.9 D (F40P, F40N, F40E)	47	09/91→03/98	←			24.0112-0116.1 412116	Ø 238 12 10,5 + S
			←	09/95→		24.0112-0116.1 412116	Ø 238 12 10,5 + S
			←	09/92→		24.0112-0116.1 412116	Ø 238 12 10,5 + S
<b>RENAULT - SAFRANE I (B54_) 04/92→10/97</b>							
<b> Bremsbelagsatz, Scheibenbremse</b>							
2.0 (B540)	77	11/92→07/96	←			13.0460-2983.2 602983	TRW 20919 18,0 + WK
2.1 dT (B546)	65	11/93→07/96	→	→ 01/95; + ABS		13.0460-4957.2 604957	BRE 20410 15,0 - WE / - WK
2.2 (B541)	79	04/92→07/96	→			13.0460-4957.2 604957	BRE 20410 15,0 - WE / - WK
			→	02/95→		13.0460-4957.2 604957	BRE 20410 15,0 - WE / - WK
2.0 12V (B542, B54E)	97	04/92→07/96	←			13.0460-2983.2 602983	TRW 20919 18,0 + WK
2.2 (B543)	101	04/92→07/96	→			13.0460-4957.2 604957	BRE 20410 15,0 - WE / - WK
2.5 dT (B548)	83	12/92→07/96	→				
3.0 V6 (B54B, B544)	123	12/92→07/96	→				
3.0 V6 4x4 (B54B, B544)	123	12/92→07/96	→				
3.0	125	02/93→06/96	→			13.0460-4957.2 604957	BRE 20410 15,0 - WE / - WK
3.0	125	03/93→10/96	→	→ 07/96		13.0460-4957.2 604957	BRE 20410 15,0 - WE / - WK
<b>Zubehörsatz, Scheibenbremsbelag</b>							
2.0 (B540)	77	11/92→07/96	→	→ 01/95; + ABS		13.0460-0438.2 610438	BRE
2.1 dT (B546)	65	11/93→07/96	→			13.0460-0438.2 610438	BRE
2.2 (B541)	79	04/92→07/96	→	02/95→		13.0460-0438.2 610438	BRE
2.0 12V (B542, B54E)	97	04/92→07/96	→			13.0460-0438.2 610438	BRE
2.2 (B543)	101	04/92→07/96	→				
2.5 dT (B548)	83	12/92→07/96	→				
3.0	125	02/93→06/96	→				
3.0 V6 (B54B, B544)	123	12/92→07/96	→				
3.0	125	03/93→10/96	→	→ 07/96		13.0460-0438.2 610438	BRE
3.0 Biturbo 4x4 (B545)	193	02/93→07/96	→			13.0460-0423.2 610423	BDX
3.0 V6 4x4 (B54B, B544)	123	12/92→07/96	→	02/93→		13.0460-0423.2 610423	BDX
			→			13.0460-0438.2 610438	BRE
<b> Bremsscheibe</b>							
2.0 (B540)	77	11/92→07/96	←			24.0122-0148.1 422148	Ø 262 22 19,8 V + S
2.1 dT (B546)	65	11/93→07/96	→	→ 01/95; + ABS		24.0110-0219.1 410219	Ø 265 10,5 9,5
			→			24.0110-0219.1 410219	Ø 265 10,5 9,5
			→	02/95→		24.0110-0219.1 410219	Ø 265 10,5 9,5
2.0 12V (B542, B54E)	97	04/92→07/96	←	→ 01/95		24.0122-0148.1 422148	Ø 262 22 19,8 V + S
			←	02/95→		24.0122-0149.1 422149	Ø 262 22 19,8 V
2.2 (B543)	101	04/92→07/96	←				
↓							









	kw			 	! #		
<b>RENAULT - SAFRANE I (B54_) 04/92→10/97</b>							
 <b>Bremsscheibe</b>							
2.0 12V (B542, B54E) 2.2 (B543)	97 101	04/92→07/96 04/92→07/96	➔	→ 01/95		24.0110-0219.1 410219	Ø 265 10,5 9,5
			➔	02/95→		24.0110-0220.1 410220	Ø 265 10,5 9,5
2.2 (B541)	79	04/92→07/96	➔	→ 01/95		24.0122-0148.1 422148	Ø 262 22 19,8 V + S
			➔	02/95→		24.0122-0148.1 422148	Ø 262 22 19,8 V + S
			➔	→ 01/95; + ABS		24.0110-0219.1 410219	Ø 265 10,5 9,5
			➔	02/95→		24.0110-0219.1 410219	Ø 265 10,5 9,5
						24.0110-0220.1 410220	Ø 265 10,5 9,5
2.5 dT (B548)	83	12/92→07/96	➔	→ 06/93; Automatikgetriebe		24.0122-0149.1 422149	Ø 262 22 19,8 V
			➔	→ 05/94; Schaltgetriebe		24.0122-0149.1 422149	Ø 262 22 19,8 V
			➔	06/94→; Schaltgetriebe		24.0124-0171.1 424171	Ø 280 24 21,8 V + S
			➔	07/93→; Automatikgetriebe		24.0124-0171.1 424171	Ø 280 24 21,8 V + S
						24.0324-0171.1 524171	Ø 280 24 21,8 V + S
			➔			24.0110-0220.1 410220	Ø 265 10,5 9,5
3.0	125	02/93→06/96	➔			24.0110-0220.1 410220	Ø 265 10,5 9,5
3.0	125	03/93→10/96	➔	→ 07/96		24.0110-0220.1 410220	Ø 265 10,5 9,5
3.0 Biturbo 4x4 (B545)	193	02/93→07/96	➔			24.0111-0144.1 411144	Ø 265 10,5 9,5
3.0 V6 (B54B, B544)	123	12/92→07/96	➔			24.0124-0171.1 424171	Ø 280 24 21,8 V + S
			➔			24.0324-0171.1 524171	Ø 280 24 21,8 V + S
			➔			24.0110-0220.1 410220	Ø 265 10,5 9,5
3.0 V6 4x4 (B54B, B544)	123	12/92→07/96	➔			24.0124-0171.1 424171	Ø 280 24 21,8 V + S
			➔			24.0324-0171.1 524171	Ø 280 24 21,8 V + S
			➔			24.0110-0220.1 410220	Ø 265 10,5 9,5
			➔	02/93→		24.0111-0144.1 411144	Ø 265 10,5 9,5
<b>RENAULT - SAFRANE II (B54_) 07/96→12/00</b>							
 <b>Bremsbelagsatz, Scheibenbremse</b>							
2.0 16V (B54L) 2.2 dT (B54G) 2.5 20V (B54F)	100 83 121	07/96→12/00 07/96→12/00 07/96→12/00	➔	08/96→		13.0460-2983.2 602983	TRW 20919 18,0 + WK
2.9 24V (B54N)	140	03/99→12/00	➔			13.0460-4957.2 604957	BRE 20410 15,0 - WE / - WK
			➔			13.0460-2895.2 602895	TRW 23172 18,0 - WK
			➔			13.0460-4957.2 604957	BRE 20410 15,0 - WE / - WK
3.0 V6 (B54M)	123	07/96→12/00	➔	→ 07/96		13.0460-2983.2 602983	TRW 20919 18,0 + WK
			➔	08/96→		13.0460-2983.2 602983	TRW 20919 18,0 + WK
			➔	08/96→		13.0460-4957.2 604957	BRE 20410 15,0 - WE / - WK
			➔	→ 07/96		13.0460-4957.2 604957	BRE 20410 15,0 - WE / - WK
<b>Zubehörsatz, Scheibenbremsbelag</b>							
2.0 16V (B54L) 2.2 dT (B54G) 2.5 20V (B54F)	100 83 121	07/96→12/00 07/96→12/00 07/96→12/00	➔	08/96→		13.0460-0438.2 610438	BRE
2.9 24V (B54N)	140	03/99→12/00	➔			13.0460-0262.2 610262	TRW
			➔			13.0460-0438.2 610438	BRE
3.0 V6 (B54M)	123	07/96→12/00	➔	→ 07/96		13.0460-0438.2 610438	BRE
			➔	08/96→		13.0460-0438.2 610438	BRE
 <b>Bremsscheibe</b>							
2.0 16V (B54L)	100	07/96→12/00	➔	08/96→ 12/97		24.0122-0149.1 422149	Ø 262 22 19,8 V
			➔	01/98→		24.0124-0171.1 424171	Ø 280 24 21,8 V + S
			➔			24.0324-0171.1 524171	Ø 280 24 21,8 V + S
			➔	08/96→		24.0110-0220.1 410220	Ø 265 10,5 9,5
2.2 dT (B54G) 2.5 20V (B54F)	83 121	07/96→12/00 07/96→12/00	➔	08/96→		24.0124-0171.1 424171	Ø 280 24 21,8 V + S
			➔			24.0324-0171.1 524171	Ø 280 24 21,8 V + S
			➔	08/96→		24.0110-0220.1 410220	Ø 265 10,5 9,5
2.9 24V (B54N)	140	03/99→12/00	➔			24.0124-0171.1 424171	Ø 280 24 21,8 V + S
			➔			24.0324-0171.1 524171	Ø 280 24 21,8 V + S
			➔			24.0110-0220.1 410220	Ø 265 10,5 9,5
3.0 V6 (B54M)	123	07/96→12/00	➔	08/96→		24.0124-0171.1 424171	Ø 280 24 21,8 V + S









	kw			 	! #		
<b>RENAULT - SAFRANE II (B54_) 07/96→12/00</b>							
 <b>Bremsscheibe</b>							
3.0 V6 (B54M)	123	07/96→12/00	←	08/96→		24.0324-0171.1 524171	Ø 280 24 21,8 V + S
			←	→ 07/96		24.0124-0171.1 424171	Ø 280 24 21,8 V + S
			←			24.0324-0171.1 524171	Ø 280 24 21,8 V + S
			→	→ 07/96		24.0110-0220.1 410220	Ø 265 10,5 9,5
			→	08/96→		24.0110-0220.1 410220	Ø 265 10,5 9,5
<b>RENAULT - SANDERO/STEPWAY I (BS_) 11/07→</b>							
 <b>Bremsbelagsatz, Scheibenbremse</b>							
1.4	55	02/09→	←			13.0460-2834.2 602834	TRW 21463 18,0 + WK
1.6	62	11/10→					
1.6	64	02/09→					
1.6	75	12/07→					
1.6	76	12/07→					
1.6	77	12/12→					
 <b>Bremsscheibe</b>							
1.4	55	02/09→	←	- ABS		24.0112-0116.1 412116	Ø 238 12 10,5 + S
1.6	62	11/10→					
1.6	64	02/09→	←	+ ABS		24.0112-0171.1 412171	Ø 259 12 10,6 + S
1.6	75	12/07→	←			24.0121-0106.1 421106	Ø 259 20,7 17,7 V + S
1.6	76	12/07→					
1.6	77	12/12→					
<b>RENAULT - SANDERO/STEPWAY II (B8_) 11/13→</b>							
 <b>Bremsbelagsatz, Scheibenbremse</b>							
1.2 16V	54	12/13→	←			13.0460-7298.2 607298	ATE 25702 18,2 - WE / - WK
1.2 16V LPG	53	12/13→				13.0470-7298.2 LD7298	ATE 25702 18,2 - WE / - WK Ceramic
1.6	59	11/13→					
1.6	60	11/13→					
1.6 16V	75	04/14→					
 <b>Bremsscheibe</b>							
1.2 16V	54	12/13→	←			24.0112-0171.1 412171	Ø 259 12 10,6 + S
1.2 16V LPG	53	12/13→					
1.6	59	11/13→					
1.6	60	11/13→					
1.6 16V	75	04/14→					
1.5 dCi	62	12/13→	←			24.0122-0289.1 422289	Ø 258 22 19,8 V + S
<b>RENAULT - SCÉNIC I Großraumlimousine (JA0/1_, FA0_) 08/99→10/03</b>							
 <b>Bremsbelagsatz, Scheibenbremse</b>							
1.4 16V (JA0D, JA1H, Ja0W, JA10)	70	09/99→08/03	←	→ 06/03		13.0460-2895.2 602895	TRW 23172 18,0 - WK
1.6	75	03/01→08/03	→	→ 06/03; + ABS		13.0460-2845.2 602845	TRW 23554 16,4 - WK + Zub
1.6	81	06/01→09/03				13.0470-2845.2 LD2845	TRW 23554 16,4 - WK + Zub Ceramic
1.6 (JA00, JA16, JA15, JA19, JA1V, JA2B, JA2C, JA0B)	79	09/99→09/03					
1.6 16V	85	09/99→08/03					
1.6 BiFuel	75	03/01→08/03					
1.9 dTi (JA0N)	72	09/99→08/03					
1.6 BiFuel (JA04)	79	09/99→04/01	←			13.0460-2895.2 602895	TRW 23172 18,0 - WK
			→	+ ABS		13.0460-2845.2 602845	TRW 23554 16,4 - WK + Zub
						13.0470-2845.2 LD2845	TRW 23554 16,4 - WK + Zub Ceramic
1.8 16V (JA12, JA1R, JA1M, JA1A)	85	01/01→08/03	←	→ 06/03		13.0460-2895.2 602895	TRW 23172 18,0 - WK
1.9 dCi (JA05, JA1F)	75	09/99→08/03	→	→ 06/03		13.0460-2845.2 602845	TRW 23554 16,4 - WK + Zub
1.9 dTi (JA1U)	59	02/01→08/03				13.0470-2845.2 LD2845	TRW 23554 16,4 - WK + Zub Ceramic
2.0 16V	103	09/99→08/03					
2.0 16V (JA1B, JA1D)	102	07/00→08/03					
1.8 4x4	85	07/00→04/01	←			13.0460-2895.2 602895	TRW 23172 18,0 - WK
1.9 D (JA0J, FA0J)	47	09/99→03/01	→			13.0460-2845.2 602845	TRW 23554 16,4 - WK + Zub
						13.0470-2845.2 LD2845	TRW 23554 16,4 - WK + Zub Ceramic
1.9 dCi RX4	74	12/02→08/03	←			13.0460-7158.2 607158	ATE 23245 18,3 - WE / - WK
						13.0470-7158.2 LD7158	ATE 23245 18,3 - WE / - WK Ceramic
			→	→ 06/03		13.0460-2845.2 602845	TRW 23554 16,4 - WK + Zub
						13.0470-2845.2 LD2845	TRW 23554 16,4 - WK + Zub Ceramic
↓							













	kW			 	! #		
<b>RENAULT - SCÉNIC I Großraumlimousine (JA0/1_, FA0_) 08/99→10/03</b>							
<b> Bremsbelagsatz, Scheibenbremse</b>							
1.9 dCi RX4 2.0 16V RX4	75 102	11/00→08/03 06/00→08/03	←	→ 03/02		13.0460-2895.2 602895	TRW 23172 18,0 - WK
			←	04/02→		13.0460-7158.2 607158 13.0470-7158.2 LD7158	ATE 23245 18,3 - WE / - WK ATE 23245 18,3 - WE / - WK Ceramic
			→	→ 06/03		13.0460-2845.2 602845 13.0470-2845.2 LD2845	TRW 23554 16,4 - WK + Zub TRW 23554 16,4 - WK + Zub Ceramic
<b>Zubehörsatz, Scheibenbremsbelag</b>							
1.4 16V (JA0D, JA1H, Ja0W, JA10)	70	09/99→08/03	←	→ 06/03		13.0460-0262.2 610262	TRW
1.6 1.6	75 81	03/01→08/03 06/01→09/03	→	→ 06/03; + ABS		13.0460-0077.2 610077	TRW
1.6 (JA00, JA16, JA15, JA19, JA1V, JA2B, JA2C, JA0B)	79	09/99→09/03					
1.6 16V 1.6 BiFuel	85 75	09/99→08/03 03/01→08/03					
1.9 dTi (JA0N)	72	09/99→08/03					
1.6 BiFuel (JA04)	79	09/99→04/01	←			13.0460-0262.2 610262	TRW
			→	+ ABS		13.0460-0077.2 610077	TRW
1.8 16V (JA12, JA1R, JA1M, JA1A)	85	01/01→08/03	←	→ 06/03		13.0460-0262.2 610262	TRW
1.9 dCi (JA05, JA1F)	75	09/99→08/03	→	→ 06/03		13.0460-0077.2 610077	TRW
1.9 dTi (JA1U)	59	02/01→08/03					
2.0 16V	103	09/99→08/03					
2.0 16V (JA1B, JA1D)	102	07/00→08/03					
1.8 4x4 1.9 D (JA0J, FA0J)	85 47	07/00→04/01 09/99→03/01	←			13.0460-0262.2 610262	TRW
			→			13.0460-0077.2 610077	TRW
1.9 dCi RX4	74	12/02→08/03	→	→ 06/03		13.0460-0077.2 610077	TRW
1.9 dCi RX4 2.0 16V RX4	75 102	11/00→08/03 06/00→08/03	←	→ 03/02		13.0460-0262.2 610262	TRW
			→	→ 06/03		13.0460-0077.2 610077	TRW
<b> Bremsscheibe</b>							
1.4 16V (JA0D, JA1H, Ja0W, JA10)	70	09/99→08/03	←	→ 06/03		24.0124-0158.1 424158	Ø 280 24 21,8 V + S
1.6 1.6	75 81	03/01→08/03 06/01→09/03	→	→ 06/03; + ABS		24.0324-0158.1 524158 24.0111-0166.2 411166	Ø 280 24 21,8 V + S Ø 274 10,9 9,5 + LG / + ABS Ring
1.6 (JA00, JA16, JA15, JA19, JA1V, JA2B, JA2C, JA0B)	79	09/99→09/03					
1.6 16V 1.6 BiFuel	85 75	09/99→08/03 03/01→08/03					
1.9 dTi (JA0N)	72	09/99→08/03					
1.6 BiFuel (JA04)	79	09/99→04/01	←			24.0124-0158.1 424158 24.0324-0158.1 524158	Ø 280 24 21,8 V + S Ø 280 24 21,8 V + S
			→	+ ABS		24.0111-0166.2 411166	Ø 274 10,9 9,5 + LG / + ABS Ring
1.8 16V (JA12, JA1R, JA1M, JA1A)	85	01/01→08/03	←	→ 06/03		24.0124-0158.1 424158 24.0324-0158.1 524158	Ø 280 24 21,8 V + S Ø 280 24 21,8 V + S
1.9 dCi (JA05, JA1F)	75	09/99→08/03	→	→ 06/03		24.0111-0166.2 411166	Ø 274 10,9 9,5 + LG / + ABS Ring
1.9 dTi (JA1U)	59	02/01→08/03					
2.0 16V	103	09/99→08/03					
2.0 16V (JA1B, JA1D)	102	07/00→08/03					
1.8 4x4 1.9 D (JA0J, FA0J)	85 47	07/00→04/01 09/99→03/01	←			24.0124-0158.1 424158 24.0324-0158.1 524158	Ø 280 24 21,8 V + S Ø 280 24 21,8 V + S
			→			24.0111-0166.2 411166	Ø 274 10,9 9,5 + LG / + ABS Ring
1.9 dCi RX4	74	12/02→08/03	←	→ 06/03		24.0126-0142.1 426142	Ø 300 26 22,8 V
			→	→ 06/03		24.0111-0144.1 411144	Ø 265 10,5 9,5
1.9 dCi RX4 2.0 16V RX4	75 102	11/00→08/03 06/00→08/03	←	→ 02/02		24.0124-0171.1 424171 24.0324-0171.1 524171	Ø 280 24 21,8 V + S Ø 280 24 21,8 V + S
			←	03/02→ 06/03		24.0126-0142.1 426142	Ø 300 26 22,8 V
			→	→ 06/03		24.0111-0144.1 411144	Ø 265 10,5 9,5
<b>RENAULT - SCÉNIC II (JM0/1_) 06/03→</b>							
<b> Bremsbelagsatz, Scheibenbremse</b>							
1.4 (JM0B, JM0H, JM1A)	72	06/03→	←	→ 09/05		13.0460-3815.2 603815	BOS 23930 18,2 - WK + Zub
1.5 dCi (JM02, JM13)	74	11/03→					













	kw			 	! #		
<b>RENAULT - SCÉNIC II (JM0/1_) 06/03→</b>							
<b> Bremsbelagsatz, Scheibenbremse</b>							
1.5 dCi (JM0F)	60	06/03→	←	→ 09/05		13.0470-3815.2 LD3815	BOS 23930 18,2 - WK + Zub Ceramic
1.5 dCi (JM1E)	78	05/05→					
1.5 dCi (JM1F)	63	05/05→	←	10/05→ 03/09		13.0460-7221.2 607221	ATE 23215 18,3 - WE / - WK
1.6 (JM0C, JM0J, JM1B)	83	06/03→				13.0470-7221.2 LD7221	ATE 23215 18,3 - WE / - WK Ceramic
			→	→ 03/09		13.0460-2845.2 602845	TRW 23554 16,4 - WK + Zub
						13.0470-2845.2 LD2845	TRW 23554 16,4 - WK + Zub Ceramic
1.5 dCi (JM16)	76	01/07→	←	→ 03/09		13.0460-7221.2 607221	ATE 23215 18,3 - WE / - WK
1.6	77	06/06→				13.0470-7221.2 LD7221	ATE 23215 18,3 - WE / - WK Ceramic
			→	→ 03/09		13.0460-2845.2 602845	TRW 23554 16,4 - WK + Zub
						13.0470-2845.2 LD2845	TRW 23554 16,4 - WK + Zub Ceramic
1.6 16V (JM1R)	82	10/05→	←	01/07→ 03/09		13.0460-7221.2 607221	ATE 23215 18,3 - WE / - WK
						13.0470-7221.2 LD7221	ATE 23215 18,3 - WE / - WK Ceramic
			→	01/07→ 03/09		13.0460-2845.2 602845	TRW 23554 16,4 - WK + Zub
						13.0470-2845.2 LD2845	TRW 23554 16,4 - WK + Zub Ceramic
1.6 BiFuel	83	08/03→05/06	←	→ 09/05		13.0460-3815.2 603815	BOS 23930 18,2 - WK + Zub
1.6 Hi-Flex	81	03/05→07/10				13.0470-3815.2 LD3815	BOS 23930 18,2 - WK + Zub Ceramic
			←	10/05→		13.0460-7221.2 607221	ATE 23215 18,3 - WE / - WK
						13.0470-7221.2 LD7221	ATE 23215 18,3 - WE / - WK Ceramic
			→			13.0460-2845.2 602845	TRW 23554 16,4 - WK + Zub
						13.0470-2845.2 LD2845	TRW 23554 16,4 - WK + Zub Ceramic
1.9 D	85	06/06→	←	→ 03/09		13.0460-7222.2 607222	ATE 23245 18,3 - WE / - WK
2.0	101	02/08→04/09				13.0460-2845.2 602845	TRW 23554 16,4 - WK + Zub
2.0 dCi (JM1K)	110	09/05→	→	→ 03/09		13.0470-2845.2 LD2845	TRW 23554 16,4 - WK + Zub Ceramic
1.9 dCi	92	06/03→	←	→ 09/05		13.0460-3815.2 603815	BOS 23930 18,2 - WK + Zub
1.9 dCi (JM0G, JM12, JM1G, JM2C)	88	06/03→				13.0470-3815.2 LD3815	BOS 23930 18,2 - WK + Zub Ceramic
1.9 dCi (JM14)	96	05/05→					
1.9 dCi (JM15)	81	05/05→	←	10/05→ 03/09		13.0460-7222.2 607222	ATE 23245 18,3 - WE / - WK
2.0	103	06/03→07/10					
2.0 (JM05, JM0U, JM1N, JM1U, JM2V)	99	06/03→	→	→ 03/09		13.0460-2845.2 602845	TRW 23554 16,4 - WK + Zub
2.0 16V Turbo (JM0W)	120	05/04→				13.0470-2845.2 LD2845	TRW 23554 16,4 - WK + Zub Ceramic
1.9 dCi 130	97	10/05→12/09	←			13.0460-7222.2 607222	ATE 23245 18,3 - WE / - WK
			→			13.0460-2845.2 602845	TRW 23554 16,4 - WK + Zub
						13.0470-2845.2 LD2845	TRW 23554 16,4 - WK + Zub Ceramic
<b>Zubehörsatz, Scheibenbremsbelag</b>							
1.4 (JM0B, JM0H, JM1A)	72	06/03→	→	→ 03/09		13.0460-0077.2 610077	TRW
1.5 dCi (JM02, JM13)	74	11/03→					
1.5 dCi (JM0F)	60	06/03→					
1.5 dCi (JM16)	76	01/07→					
1.5 dCi (JM1E)	78	05/05→					
1.5 dCi (JM1F)	63	05/05→					
1.6	77	06/06→					
1.6 (JM0C, JM0J, JM1B)	83	06/03→					
1.9 D	85	06/06→					
1.9 dCi	92	06/03→					
1.9 dCi (JM0G, JM12, JM1G, JM2C)	88	06/03→					
1.9 dCi (JM14)	96	05/05→					
1.9 dCi (JM15)	81	05/05→					
2.0	101	02/08→04/09					
2.0	103	06/03→07/10					
2.0 (JM05, JM0U, JM1N, JM1U, JM2V)	99	06/03→					
2.0 16V Turbo (JM0W)	120	05/04→					
2.0 dCi (JM1K)	110	09/05→					
1.6 16V (JM1R)	82	10/05→	→	01/07→ 03/09		13.0460-0077.2 610077	TRW
1.6 BiFuel	83	08/03→05/06	→			13.0460-0077.2 610077	TRW
1.6 Hi-Flex	81	03/05→07/10					
1.9 dCi 130	97	10/05→12/09					













	kW			 	! #		
<b>RENAULT - SCÉNIC II (JM0/1_) 06/03→</b>							
<b>Bremsscheibe</b>							
1.4 (JM0B, JM0H, JM1A)	72	06/03→	←	→ 03/09		24.0124-0158.1 424158	Ø 280 24 21,8 V + S
1.5 dCi (JM02, JM13)	74	11/03→				24.0324-0158.1 524158	Ø 280 24 21,8 V + S
1.5 dCi (JM0F)	60	06/03→	→	→ 03/09;		24.0110-0325.2 410325	Ø 270 10 9 + LG / + ABS Ring
1.5 dCi (JM16)	76	01/07→		Achszapfendurchmesser [mm]: 25			
1.5 dCi (JM1E)	78	05/05→					
1.5 dCi (JM1F)	63	05/05→					
1.6	77	06/06→					
1.6 (JM0C, JM0J, JM1B)	83	06/03→					
1.6 16V (JM1R)	82	10/05→	←	01/07→ 03/09		24.0124-0158.1 424158	Ø 280 24 21,8 V + S
						24.0324-0158.1 524158	Ø 280 24 21,8 V + S
			→	01/07→ 03/09;		24.0110-0325.2 410325	Ø 270 10 9 + LG / + ABS Ring
				Achszapfendurchmesser [mm]: 25			
1.6 BiFuel	83	08/03→05/06	←			24.0124-0158.1 424158	Ø 280 24 21,8 V + S
1.6 Hi-Flex	81	03/05→07/10				24.0324-0158.1 524158	Ø 280 24 21,8 V + S
			→	Achszapfendurchmesser [mm]: 25		24.0110-0325.2 410325	Ø 270 10 9 + LG / + ABS Ring
1.9 D	85	06/06→	←	→ 03/09		24.0124-0191.1 424191	Ø 300 24 21,8 V + S
1.9 dCi	92	06/03→					
1.9 dCi (JM0G, JM12, JM1G, JM2C)	88	06/03→	→	→ 03/09;		24.0110-0325.2 410325	Ø 270 10 9 + LG / + ABS Ring
				Achszapfendurchmesser [mm]: 25			
1.9 dCi (JM14)	96	05/05→					
1.9 dCi (JM15)	81	05/05→					
2.0	101	02/08→04/09					
2.0	103	06/03→07/10					
2.0 (JM05, JM0U, JM1N, JM1U, JM2V)	99	06/03→					
2.0 16V Turbo (JM0W)	120	05/04→					
1.9 dCi 130	97	10/05→12/09	←			24.0124-0191.1 424191	Ø 300 24 21,8 V + S
			→	Achszapfendurchmesser [mm]: 25		24.0110-0325.2 410325	Ø 270 10 9 + LG / + ABS Ring
2.0 dCi (JM1K)	110	09/05→	←	→ 03/09		24.0124-0224.1 424224	Ø 300 24 21,8 V + S
			→	→ 03/09;		24.0110-0389.2 410389	Ø 270 10 9 + LG / + ABS Ring
				Achszapfendurchmesser [mm]: 25			
<b>RENAULT - SCÉNIC III (JZ0/1_) 02/09→</b>							
<b>Bremsbelagsatz, Scheibenbremse</b>							
1.2 TCe	85	04/12→	←			13.0460-7249.2 607249	ATE 24709 18,6 - WE / - WK
1.6 dCi (JZ00, JZ12)	96	04/11→				13.0470-7249.2 LD7249	ATE 24709 18,6 - WE / - WK Ceramic
			→	- eFSB		13.0460-2740.2 602740	TRW 23554 17,0 - WE / - WK + Zub
						13.0470-2740.2 LD2740	TRW 23554 17,0 - WE / - WK + Zub Ceramic
			→	+ eFSB		13.0460-2756.2 602756	TRW 24820 16,1 - WE / - WK + Zub
1.2 TCe (JZ16)	97	01/13→	←	03/13→		13.0460-7249.2 607249	ATE 24709 18,6 - WE / - WK
						13.0470-7249.2 LD7249	ATE 24709 18,6 - WE / - WK Ceramic
			→	03/13→; - eFSB		13.0460-2740.2 602740	TRW 23554 17,0 - WE / - WK + Zub
						13.0470-2740.2 LD2740	TRW 23554 17,0 - WE / - WK + Zub Ceramic
			→	03/13→; + eFSB		13.0460-2756.2 602756	TRW 24820 16,1 - WE / - WK + Zub
1.4 16V (JZ0F, JZ1V)	96	02/09→	←	04/09→		13.0460-7249.2 607249	ATE 24709 18,6 - WE / - WK
1.9 dCi (JZ0J, JZ1J, JZ1K, JZ1S)	96	02/09→				13.0470-7249.2 LD7249	ATE 24709 18,6 - WE / - WK Ceramic
2.0 16V (JZ0G, JZ0P, JZ1E, JZ1P)	103	02/09→	→	04/09→; - eFSB		13.0460-2740.2 602740	TRW 23554 17,0 - WE / - WK + Zub
						13.0470-2740.2 LD2740	TRW 23554 17,0 - WE / - WK + Zub Ceramic
			→	04/09→; + eFSB		13.0460-2756.2 602756	TRW 24820 16,1 - WE / - WK + Zub
1.5 dCi	63	04/09→	←	passend für Felgengröße [Zoll]: 15		13.0460-7266.2 607266	ATE 24538 17,9 - WE / - WK
						13.0470-7266.2 LD7266	ATE 24538 17,9 - WE / - WK Ceramic
			→	- eFSB		13.0460-2740.2 602740	TRW 23554 17,0 - WE / - WK + Zub
						13.0470-2740.2 LD2740	TRW 23554 17,0 - WE / - WK + Zub Ceramic
			→	+ eFSB		13.0460-2756.2 602756	TRW 24820 16,1 - WE / - WK + Zub
↓							













	kw			 	! #		
<b>RENAULT - SCÉNIC III (JZ0/1_) 02/09→</b>							
<b> Bremsbelagsatz, Scheibenbremse</b>							
1.5 dCi	78	02/09→	←	04/09→; passend für Felgengröße [Zoll]: 16 / 17	13.0460-7249.2	607249	ATE 24709 18,6 - WE / - WK
			←	04/09→; passend für Felgengröße [Zoll]: 15	13.0460-7266.2	607266	ATE 24538 17,9 - WE / - WK
			→	04/09→; - eFSB	13.0460-2740.2	602740	TRW 23554 17,0 - WE / - WK + Zub
			→	04/09→; + eFSB	13.0460-2756.2	602756	TRW 24820 16,1 - WE / - WK + Zub
1.5 dCi 1.5 dCi (JZ02, JZ0R) 1.6 16V Bifuel	81 70 79	04/09→ 11/10→ 04/12→	←	passend für Felgengröße [Zoll]: 16 / 17	13.0460-7249.2	607249	ATE 24709 18,6 - WE / - WK
			←	passend für Felgengröße [Zoll]: 15	13.0460-7266.2	607266	ATE 24538 17,9 - WE / - WK
			→	- eFSB	13.0460-2740.2	602740	TRW 23554 17,0 - WE / - WK + Zub
			→	+ eFSB	13.0460-2756.2	602756	TRW 24820 16,1 - WE / - WK + Zub
1.6 16V (JZ0U, JZ1B)	81	02/09→	←	04/09→; passend für Felgengröße [Zoll]: 17 / 16	13.0460-7249.2	607249	ATE 24709 18,6 - WE / - WK
			←	04/09→; passend für Felgengröße [Zoll]: 15	13.0460-7266.2	607266	ATE 24538 17,9 - WE / - WK
			→	04/09→; - eFSB	13.0460-2740.2	602740	TRW 23554 17,0 - WE / - WK + Zub
			→	04/09→; + eFSB	13.0460-2756.2	602756	TRW 24820 16,1 - WE / - WK + Zub
1.6 16V Bifuel 1.6 E85 (JZ03, JZ1Y)	81 81	02/09→ 02/09→	←	06/09→; passend für Felgengröße [Zoll]: 16 / 17	13.0460-7249.2	607249	ATE 24709 18,6 - WE / - WK
			←	06/09→; passend für Felgengröße [Zoll]: 15	13.0460-7266.2	607266	ATE 24538 17,9 - WE / - WK
			→	06/09→; - eFSB	13.0460-2740.2	602740	TRW 23554 17,0 - WE / - WK + Zub
			→	06/09→; + eFSB	13.0460-2756.2	602756	TRW 24820 16,1 - WE / - WK + Zub
2.0 dCi (JZ0L)	118	04/09→	←		13.0460-7249.2	607249	ATE 24709 18,6 - WE / - WK
			→	- eFSB	13.0460-2753.2	602753	TRW 23554 16,0 - WK + Zub
			→	+ eFSB	13.0460-2756.2	602756	TRW 24820 16,1 - WE / - WK + Zub
2.0 dCi (JZ0Y, JZ26)	110	02/09→	←	04/09→	13.0460-7249.2	607249	ATE 24709 18,6 - WE / - WK
			→	04/09→; - eFSB	13.0460-2753.2	602753	TRW 23554 16,0 - WK + Zub
			→	04/09→; + eFSB	13.0460-2756.2	602756	TRW 24820 16,1 - WE / - WK + Zub
<b> Bremsscheibe</b>							
1.2 TCe 1.6 dCi (JZ00, JZ12)	85 96	04/12→ 04/11→	←		24.0126-0158.1	426158	Ø 296 26 23,4 V + S
			→		24.0108-0118.2	408118	Ø 260 8 7 + LG / + ABS Ring
1.2 TCe (JZ16)	97	01/13→	←	03/13→	24.0126-0158.1	426158	Ø 296 26 23,4 V + S
			→	03/13→	24.0108-0118.2	408118	Ø 260 8 7 + LG / + ABS Ring
↓							

















	kw			 	! #		
<b>RENAULT - SCÉNIC III (JZ0/1_) 02/09→</b>							
 <b>Bremsscheibe</b>							
1.4 16V (JZ0F, JZ1V)	96	02/09→	←	04/09→		24.0126-0158.1 426158	Ø 296 26 23,4 V + S
1.9 dCi (JZ0J, JZ1J, JZ1K, JZ1S)	96	02/09→	→	04/09→		24.0108-0118.2 408118	Ø 260 8 7 + LG / + ABS Ring
2.0 16V (JZ0G, JZ0P, JZ1E, JZ1P)	103	02/09→					
1.5 dCi	63	04/09→	←	passend für Felgengröße [Zoll]: 15		24.0124-0221.1 424221	Ø 280 24 21,8 V + S
			→			24.0108-0118.2 408118	Ø 260 8 7 + LG / + ABS Ring
1.5 dCi	78	02/09→	←	04/09→;		24.0124-0221.1 424221	Ø 280 24 21,8 V + S
1.6 16V (JZ0U, JZ1B)	81	02/09→		passend für Felgengröße [Zoll]: 15			
			←	04/09→;		24.0126-0158.1 426158	Ø 296 26 23,4 V + S
			→	passend für Felgengröße [Zoll]: 16 / 17			
			→	04/09→		24.0108-0118.2 408118	Ø 260 8 7 + LG / + ABS Ring
1.5 dCi	81	04/09→	←	passend für Felgengröße [Zoll]: 15		24.0124-0221.1 424221	Ø 280 24 21,8 V + S
1.6 16V Bifuel	79	04/12→	←	passend für Felgengröße [Zoll]: 16 / 17		24.0126-0158.1 426158	Ø 296 26 23,4 V + S
			→			24.0108-0118.2 408118	Ø 260 8 7 + LG / + ABS Ring
1.5 dCi (JZ02, JZ0R)	70	11/10→	←	passend für Felgengröße [Zoll]: 15		24.0124-0221.1 424221	Ø 280 24 21,8 V + S
			←			24.0126-0158.1 426158	Ø 296 26 23,4 V + S
			→			24.0108-0118.2 408118	Ø 260 8 7 + LG / + ABS Ring
1.6 16V Bifuel	81	02/09→	←	06/09→;		24.0124-0221.1 424221	Ø 280 24 21,8 V + S
1.6 E85 (JZ03, JZ1Y)	81	02/09→	←	passend für Felgengröße [Zoll]: 15		24.0126-0158.1 426158	Ø 296 26 23,4 V + S
			←	06/09→;			
			→	passend für Felgengröße [Zoll]: 16 / 17			
			→	06/09→		24.0108-0118.2 408118	Ø 260 8 7 + LG / + ABS Ring
2.0 dCi (JZ0L)	118	04/09→	←			24.0126-0158.1 426158	Ø 296 26 23,4 V + S
			→			24.0111-0180.2 411180	Ø 274 11 9,5 + LG / + ABS Ring
2.0 dCi (JZ0Y, JZ26)	110	02/09→	←	04/09→		24.0126-0158.1 426158	Ø 296 26 23,4 V + S
			→	04/09→		24.0111-0180.2 411180	Ø 274 11 9,5 + LG / + ABS Ring
<b>RENAULT - SCÉNIC IV (J9_) 09/16→</b>							
 <b>Bremsbelagsatz, Scheibenbremse</b>							
1.2 TCe 115	85	09/16→	→	- eFSB		13.0460-2740.2 602740	TRW 23554 17,0 - WE / - WK + Zub
1.2 TCe 130	96	09/16→					
1.3 TCe 140	103	01/18→				13.0470-2740.2 LD2740	TRW 23554 17,0 - WE / - WK + Zub Ceramic
1.5 dCi 110	81	09/16→					
1.5 dCi 110 Hybrid Assist	81	04/17→					
1.5 dCi 95	70	09/16→					
1.6 dCi 130	96	09/16→					
1.6 dCi 160	118	09/16→					
 <b>Bremsscheibe</b>							
1.2 TCe 115	85	09/16→	←			24.0128-0245.1 428245	Ø 320 28 25,4 V + S
1.2 TCe 130	96	09/16→					
1.3 TCe 140	103	01/18→					
1.5 dCi 110	81	09/16→					
1.5 dCi 110 Hybrid Assist	81	04/17→					
1.5 dCi 95	70	09/16→					
1.6 dCi 130	96	09/16→					
1.6 dCi 160	118	09/16→					
<b>RENAULT - SUPER 5 (B/C40_) 10/84→12/96</b>							
 <b>Bremsbelagsatz, Scheibenbremse</b>							
1.4 Cat (B/C/407)	43	10/85→12/96	←			13.0460-2834.2 602834	TRW 21463 18,0 + WK
						13.0460-3911.2 603911	BDX 20905 18,0 + WK
1.6 D (B/C/404)	40	08/85→12/96	←	01/86→		13.0460-2834.2 602834	TRW 21463 18,0 + WK
						13.0460-3911.2 603911	BDX 20905 18,0 + WK
<b>Zubehörsatz, Scheibenbremsbelag</b>							
1.4 Cat (B/C/407)	43	10/85→12/96	←			13.0460-0411.2 610411	BDX
1.6 D (B/C/404)	40	08/85→12/96	←	01/86→		13.0460-0411.2 610411	BDX
 <b>Bremsscheibe</b>							
1.4 Cat (B/C/407)	43	10/85→12/96	←			24.0112-0116.1 412116	Ø 238 12 10,5 + S
1.6 D (B/C/404)	40	08/85→12/96					













	kW					! #		
<b>RENAULT - SUPER 5 Kasten (S40_) 10/84→12/96</b>								
 <b>Bremsbelagsatz, Scheibenbremse</b>								
1.1 (S401)	34	10/84→12/96	←	01/85→03/95			<b>13.0460-3955.2 603955</b>	BDX 20634 15,0 + WK
1.2 (S40F, S407)	44	01/87→12/96	←	→08/90			<b>13.0460-2834.2 602834</b> <b>13.0460-3911.2 603911</b>	TRW 21463 18,0 + WK BDX 20905 18,0 + WK
1.6 D (S404)	40	10/84→12/96	←	01/86→			<b>13.0460-2834.2 602834</b> <b>13.0460-3911.2 603911</b>	TRW 21463 18,0 + WK BDX 20905 18,0 + WK
<b>Zubehörsatz, Scheibenbremsbelag</b>								
1.2 (S40F, S407)	44	01/87→12/96	←	→08/90			<b>13.0460-0411.2 610411</b>	BDX
1.6 D (S404)	40	10/84→12/96	←	01/86→			<b>13.0460-0411.2 610411</b>	BDX
 <b>Bremsscheibe</b>								
1.1 (S401)	34	10/84→12/96	←	01/85→03/95			<b>24.0108-0104.1 408104</b>	Ø 238 8,2 7 + S
1.2 (S40F, S407)	44	01/87→12/96	←	→08/90			<b>24.0112-0116.1 412116</b>	Ø 238 12 10,5 + S
1.6 D (S404)	40	10/84→12/96	←	01/85→			<b>24.0112-0116.1 412116</b>	Ø 238 12 10,5 + S
<b>RENAULT - THALIA I (LB_) 02/98→</b>								
 <b>Bremsbelagsatz, Scheibenbremse</b>								
1.2 16V	55	04/02→	←				<b>13.0460-2834.2 602834</b>	TRW 21463 18,0 + WK
1.4	55	08/00→						
1.4	72	05/00→02/09						
1.4 16V	72	08/00→						
1.5 dCi	47	06/05→						
1.5 dCi	48	04/02→						
1.5 dCi	50	02/03→						
1.5 dCi	58	04/04→11/09						
1.5 dCi	60	06/01→						
1.6 16V	79	04/02→						
1.9 D	48	02/98→05/01						
1.6	66	03/98→	←	04/02→			<b>13.0460-2834.2 602834</b>	TRW 21463 18,0 + WK
 <b>Bremsscheibe</b>								
1.2 16V	55	04/02→	←				<b>24.0112-0116.1 412116</b> <b>24.0120-0125.1 420125</b>	Ø 238 12 10,5 + S Ø 238 20,1 17,7 V + S
1.4	55	08/00→	←				<b>24.0112-0116.1 412116</b>	Ø 238 12 10,5 + S
1.4	72	05/00→02/09						
1.4 16V	72	08/00→	←				<b>24.0120-0125.1 420125</b>	Ø 238 20,1 17,7 V + S
1.5 dCi	47	06/05→						
1.5 dCi	48	04/02→						
1.5 dCi	50	02/03→						
1.5 dCi	58	04/04→11/09						
1.5 dCi	60	06/01→						
1.6 16V	79	04/02→						
1.9 D	48	02/98→05/01						
1.6	66	03/98→	←	04/02→			<b>24.0120-0125.1 420125</b>	Ø 238 20,1 17,7 V + S
<b>RENAULT - THALIA II (LU1/2_) 09/08→</b>								
 <b>Bremsbelagsatz, Scheibenbremse</b>								
0.9 TCe	66	11/12→06/14	←				<b>13.0460-7298.2 607298</b> <b>13.0470-7298.2 LD7298</b>	ATE 25702 18,2 - WE / - WK ATE 25702 18,2 - WE / - WK Ceramic
1.2 16V (LU2V)	55	09/08→	←				<b>13.0460-2834.2 602834</b>	TRW 21463 18,0 + WK
1.2 LPG	55	01/10→12/13						
1.4	55	09/08→06/14						
1.5 dCi	47	09/08→						
1.5 dCi	48	01/09→						
1.5 dCi	55	11/12→06/14						
1.5 dCi	62	09/08→						
1.5 dCi	66	01/09→						
1.6 16V	77	09/08→						
 <b>Bremsscheibe</b>								
0.9 TCe	66	11/12→06/14	←				<b>24.0122-0289.1 422289</b>	Ø 258 22 19,8 V + S
1.2 16V (LU2V)	55	09/08→	←				<b>24.0112-0116.1 412116</b>	Ø 238 12 10,5 + S
1.2 LPG	55	01/10→12/13						
1.4	55	09/08→06/14						
1.5 dCi	47	09/08→	←				<b>24.0120-0125.1 420125</b>	Ø 238 20,1 17,7 V + S
1.5 dCi	48	01/09→						
1.5 dCi	55	11/12→06/14						
1.5 dCi	62	09/08→						
1.5 dCi	66	01/09→						
1.6 16V	77	09/08→	←				<b>24.0121-0106.1 421106</b>	Ø 259 20,7 17,7 V + S













	kw			 	! #		
<b>RENAULT - THALIA III (L8_) 12/13→</b>							
 <b>Bremsbelagsatz, Scheibenbremse</b>							
1.2 16V 1.5 dCi	55 66	12/13→ 12/13→	←			13.0460-7298.2 607298 13.0470-7298.2 LD7298	ATE 25702 18,2 - WE / - WK ATE 25702 18,2 - WE / - WK Ceramic
 <b>Bremsscheibe</b>							
1.2 16V 1.5 dCi	55 66	12/13→ 12/13→	←			24.0122-0289.1 422289	∅ 258 22 19,8 V + S
<b>RENAULT - TRAFIC II Bus (JL) 03/01→</b>							
 <b>Bremsbelagsatz, Scheibenbremse</b>							
1.9 dCi	59	04/01→07/03	←			13.0460-2870.2 602870	TRW 23099 18,4 - WK
			→			13.0460-2840.2 602840	TRW 23980 16,5 + WE / - WK
1.9 dCi 100 (JLOC) 1.9 dCi 80 (JLOB)	74 60	03/01→ 03/01→	←	→ 08/14		13.0460-2870.2 602870	TRW 23099 18,4 - WK
2.0 (JLOA) 2.0 16V 2.5 dCi 115 2.5 dCi 135 (JLOD)	88 86 84 99	03/01→ 08/06→ 02/08→ 05/03→	→	→ 08/14		13.0460-2840.2 602840	TRW 23980 16,5 + WE / - WK
2.0 dCi 115 (JLOH) 2.0 dCi 90 (JLOH)	84 66	08/06→ 08/06→	←	10/06→ 08/14		13.0460-2870.2 602870	TRW 23099 18,4 - WK
2.5 dCi 145 (JLOJ)	107	08/06→	→	10/06→ 08/14		13.0460-2840.2 602840	TRW 23980 16,5 + WE / - WK
<b>Zubehörsatz, Scheibenbremsbelag</b>							
1.9 dCi	59	04/01→07/03	→			13.0460-0072.2 610072	TRW
1.9 dCi 100 (JLOC) 1.9 dCi 80 (JLOB) 2.0 (JLOA) 2.0 16V 2.5 dCi 115 2.5 dCi 135 (JLOD)	74 60 88 86 84 99	03/01→ 03/01→ 03/01→ 08/06→ 02/08→ 05/03→	→	→ 08/14		13.0460-0072.2 610072	TRW
2.0 dCi 115 (JLOH) 2.0 dCi 90 (JLOH)	84 66	08/06→ 08/06→	→	10/06→ 08/14		13.0460-0072.2 610072	TRW
2.5 dCi 145 (JLOJ)	107	08/06→					
 <b>Bremsscheibe</b>							
1.9 dCi	59	04/01→07/03	←			24.0128-0132.1 428132	∅ 305 28 24 V + S
			→			24.0112-0177.2 412177	∅ 280 12 10 + LG / + ABS Ring
1.9 dCi 100 (JLOC) 1.9 dCi 80 (JLOB)	74 60	03/01→ 03/01→	←	→ 08/14		24.0128-0132.1 428132	∅ 305 28 24 V + S
2.0 (JLOA) 2.0 16V 2.5 dCi 115 2.5 dCi 135 (JLOD)	88 86 84 99	03/01→ 08/06→ 02/08→ 05/03→	→	→ 08/14		24.0112-0177.2 412177	∅ 280 12 10 + LG / + ABS Ring
2.0 dCi 115 (JLOH) 2.0 dCi 90 (JLOH)	84 66	08/06→ 08/06→	←	10/06→ 08/14		24.0128-0132.1 428132	∅ 305 28 24 V + S
2.5 dCi 145 (JLOJ)	107	08/06→	→	10/06→ 08/14		24.0112-0177.2 412177	∅ 280 12 10 + LG / + ABS Ring
<b>RENAULT - TRAFIC II Kasten (FL) 03/01→</b>							
 <b>Bremsbelagsatz, Scheibenbremse</b>							
1.9 dCi 2.5 DTi	59 99	04/01→07/03 03/03→07/03	←			13.0460-2870.2 602870	TRW 23099 18,4 - WK
			→			13.0460-2840.2 602840	TRW 23980 16,5 + WE / - WK
1.9 dCi 1.9 dCi 100 (FLOC) 1.9 dCi 80 (FLOB)	75 74 60	03/01→ 03/01→ 03/01→	←	→ 08/14		13.0460-2870.2 602870	TRW 23099 18,4 - WK
2.0 (FLOA) 2.0 16V 2.5 dCi 2.5 dCi 135 (FLOD)	88 86 84 99	03/01→ 08/06→ 08/07→ 05/03→	→	→ 08/14		13.0460-2840.2 602840	TRW 23980 16,5 + WE / - WK
2.0 dCi 115 (FLO1, FLOU) 2.0 dCi 90 (FLOH)	84 66	08/06→ 08/06→	←	10/06→ 08/14		13.0460-2870.2 602870	TRW 23099 18,4 - WK
2.5 dCi 145 (FLOJ)	107	08/06→	→	10/06→ 08/14		13.0460-2840.2 602840	TRW 23980 16,5 + WE / - WK
<b>Zubehörsatz, Scheibenbremsbelag</b>							
1.9 dCi 2.5 DTi	59 99	04/01→07/03 03/03→07/03	→			13.0460-0072.2 610072	TRW
1.9 dCi 1.9 dCi 100 (FLOC) 1.9 dCi 80 (FLOB) 2.0 (FLOA) 2.0 16V 2.5 dCi 2.5 dCi 135 (FLOD)	75 74 60 88 86 84 99	03/01→ 03/01→ 03/01→ 03/01→ 08/06→ 08/07→ 05/03→	→	→ 08/14		13.0460-0072.2 610072	TRW
↓							















	kw					! #		
<b>RENAULT - TRAFIC II Kasten (FL) 03/01→</b>								
<b>Zubehörsatz, Scheibenbremsbelag</b>								
2.0 dCi 115 (FL01, FL0U)	84	08/06→	➡	10/06→ 08/14			13.0460-0072.2 610072	TRW
2.0 dCi 90 (FL0H)	66	08/06→						
2.5 dCi 145 (FL0J)	107	08/06→						
<b> Bremsscheibe</b>								
1.9 dCi	59	04/01→07/03	←				24.0128-0132.1 428132	∅ 305 28 24 V + S
2.5 DTi	99	03/03→07/03	➡				24.0112-0177.2 412177	∅ 280 12 10 + LG / + ABS Ring
1.9 dCi	75	03/01→	←	→ 08/14			24.0128-0132.1 428132	∅ 305 28 24 V + S
1.9 dCi 100 (FL0C)	74	03/01→						
1.9 dCi 80 (FL0B)	60	03/01→	➡	→ 08/14			24.0112-0177.2 412177	∅ 280 12 10 + LG / + ABS Ring
2.0 (FL0A)	88	03/01→						
2.0 16V	86	08/06→						
2.5 dCi	84	08/07→						
2.5 dCi 135 (FL0D)	99	05/03→						
2.0 dCi 115 (FL01, FL0U)	84	08/06→	←	10/06→ 08/14			24.0128-0132.1 428132	∅ 305 28 24 V + S
2.0 dCi 90 (FL0H)	66	08/06→	➡	10/06→ 08/14			24.0112-0177.2 412177	∅ 280 12 10 + LG / + ABS Ring
2.5 dCi 145 (FL0J)	107	08/06→						
<b>RENAULT - TRAFIC II Pritsche/Fahrgestell (EL) 03/01→</b>								
<b> Bremsbelagsatz, Scheibenbremse</b>								
1.9 dCi	59	09/01→07/03	←				13.0460-2870.2 602870	TRW 23099 18,4 - WK
			➡				13.0460-2840.2 602840	TRW 23980 16,5 + WE / - WK
1.9 dCi 100 (EL0C)	74	03/01→	←	→ 08/14			13.0460-2870.2 602870	TRW 23099 18,4 - WK
1.9 dCi 80 (EL0B)	60	03/01→						
2.0 (EL0A)	88	03/01→	➡	→ 08/14			13.0460-2840.2 602840	TRW 23980 16,5 + WE / - WK
2.0 16V	86	08/06→						
2.5 dCi	84	08/07→						
2.0 dCi 115 (EL0H)	84	08/06→	←	10/06→ 08/14			13.0460-2870.2 602870	TRW 23099 18,4 - WK
2.0 dCi 90 (EL0H)	66	08/06→						
2.5 dCi 145 (EL0J)	107	08/06→	➡	10/06→ 08/14			13.0460-2840.2 602840	TRW 23980 16,5 + WE / - WK
2.5 dCi 135 (EL0D)	99	03/01→	←	05/03→ 08/14			13.0460-2870.2 602870	TRW 23099 18,4 - WK
			➡	05/03→ 08/14			13.0460-2840.2 602840	TRW 23980 16,5 + WE / - WK
<b>Zubehörsatz, Scheibenbremsbelag</b>								
1.9 dCi	59	09/01→07/03	➡				13.0460-0072.2 610072	TRW
1.9 dCi 100 (EL0C)	74	03/01→	➡	→ 08/14			13.0460-0072.2 610072	TRW
1.9 dCi 80 (EL0B)	60	03/01→						
2.0 (EL0A)	88	03/01→						
2.0 16V	86	08/06→						
2.5 dCi	84	08/07→						
2.0 dCi 115 (EL0H)	84	08/06→	➡	10/06→ 08/14			13.0460-0072.2 610072	TRW
2.0 dCi 90 (EL0H)	66	08/06→						
2.5 dCi 145 (EL0J)	107	08/06→						
2.5 dCi 135 (EL0D)	99	03/01→	➡	05/03→ 08/14			13.0460-0072.2 610072	TRW
<b> Bremsscheibe</b>								
1.9 dCi	59	09/01→07/03	←				24.0128-0132.1 428132	∅ 305 28 24 V + S
			➡				24.0112-0177.2 412177	∅ 280 12 10 + LG / + ABS Ring
1.9 dCi 100 (EL0C)	74	03/01→	←	→ 08/14			24.0128-0132.1 428132	∅ 305 28 24 V + S
1.9 dCi 80 (EL0B)	60	03/01→						
2.0 (EL0A)	88	03/01→	➡	→ 08/14			24.0112-0177.2 412177	∅ 280 12 10 + LG / + ABS Ring
2.0 16V	86	08/06→						
2.5 dCi	84	08/07→						
2.0 dCi 115 (EL0H)	84	08/06→	←	10/06→ 08/14			24.0128-0132.1 428132	∅ 305 28 24 V + S
2.0 dCi 90 (EL0H)	66	08/06→						
2.5 dCi 145 (EL0J)	107	08/06→	➡	10/06→ 08/14			24.0112-0177.2 412177	∅ 280 12 10 + LG / + ABS Ring
2.5 dCi 135 (EL0D)	99	03/01→	←	05/03→ 08/14			24.0128-0132.1 428132	∅ 305 28 24 V + S
			➡	05/03→ 08/14			24.0112-0177.2 412177	∅ 280 12 10 + LG / + ABS Ring
<b>RENAULT - TRAFIC III Bus (JG_) 05/14→</b>								
<b> Bremsbelagsatz, Scheibenbremse</b>								
1.6 dCi 115	85	05/14→	➡				13.0460-2840.2 602840	TRW 23980 16,5 + WE / - WK
1.6 dCi 120	88	05/14→						
1.6 dCi 125	92	07/15→						
1.6 dCi 140	103	05/14→						
1.6 dCi 145	107	07/15→						
1.6 dCi 90	66	05/14→						
1.6 dCi 95	70	07/15→						
↓								

















	kW					! #		
<b>RENAULT - TRAFIC III Bus (JG_) 05/14→</b>								
 <b>Bremsscheibe</b>								
1.6 dCi 115	85	05/14→	←			24.0128-0287.1	428287	Ø 296 28 23,4 V + S
1.6 dCi 120	88	05/14→						
1.6 dCi 125	92	07/15→	→			24.0112-0217.2	412217	Ø 280 12 10 + LG / + ABS Ring
1.6 dCi 140	103	05/14→						
1.6 dCi 145	107	07/15→						
1.6 dCi 90	66	05/14→						
1.6 dCi 95	70	07/15→						
<b>RENAULT - TRAFIC III Kasten (FG_) 05/14→</b>								
 <b>Bremsbelagsatz, Scheibenbremse</b>								
1.6 dCi 115	85	05/14→	→			13.0460-2840.2	602840	TRW 23980 16,5 + WE / - WK
1.6 dCi 120	88	05/14→						
1.6 dCi 125	92	07/15→						
1.6 dCi 140	103	05/14→						
1.6 dCi 145	107	07/15→						
1.6 dCi 90	66	05/14→						
1.6 dCi 95	70	07/15→						
 <b>Bremsscheibe</b>								
1.6 dCi 115	85	05/14→	←			24.0128-0287.1	428287	Ø 296 28 23,4 V + S
1.6 dCi 120	88	05/14→						
1.6 dCi 125	92	07/15→	→			24.0112-0217.2	412217	Ø 280 12 10 + LG / + ABS Ring
1.6 dCi 140	103	05/14→						
1.6 dCi 145	107	07/15→						
1.6 dCi 90	66	05/14→						
1.6 dCi 95	70	07/15→						
<b>RENAULT - TRAFIC III Pritsche/Fahrgestell (EG_) 05/14→</b>								
 <b>Bremsbelagsatz, Scheibenbremse</b>								
1.6 dCi 120	88	06/14→	→			13.0460-2840.2	602840	TRW 23980 16,5 + WE / - WK
1.6 dCi 125	92	07/15→						
1.6 dCi 140	103	06/14→						
1.6 dCi 145	107	07/15→						
 <b>Bremsscheibe</b>								
1.6 dCi 120	88	06/14→	←			24.0128-0287.1	428287	Ø 296 28 23,4 V + S
1.6 dCi 125	92	07/15→						
1.6 dCi 140	103	06/14→	→			24.0112-0217.2	412217	Ø 280 12 10 + LG / + ABS Ring
1.6 dCi 145	107	07/15→						
<b>RENAULT - TRAFIC Bus (TXW) 03/89→03/01</b>								
 <b>Bremsbelagsatz, Scheibenbremse</b>								
1.9 D	44	06/97→03/01	←			13.0460-3969.2	603969	BDX 20926 18,5 + WK
2.1 D	47	06/94→10/97						
2.2	74	06/94→10/97						
2.2 4x4	74	06/94→10/97						
2.5 D	55	05/89→03/01						
2.5 D 4x4	55	08/89→03/01						
 <b>Bremsscheibe</b>								
1.9 D	44	06/97→03/01	←			24.0124-0103.1	424103	Ø 252,5 24 22 V
2.1 D	47	06/94→10/97						
2.2	74	06/94→10/97						
2.2 4x4	74	06/94→10/97						
2.5 D	55	05/89→03/01						
2.5 D 4x4	55	08/89→03/01						
<b>RENAULT - TRAFIC Kasten (TXX) 03/89→12/01</b>								
 <b>Bremsbelagsatz, Scheibenbremse</b>								
1.9 D	44	06/97→03/01	←			13.0460-3969.2	603969	BDX 20926 18,5 + WK
2.2	74	06/94→10/97						
2.2 4x4	74	06/94→10/97						
2.5 D	55	05/89→03/01						
2.5 D 4x4	55	05/89→03/01						
2.1 D	47	06/94→10/97	←	→ 08/94		13.0460-3968.2	603968	BDX 20488 18,5 + WK + Zub
			←			13.0460-3969.2	603969	BDX 20926 18,5 + WK
			←	09/94→		13.0460-3969.2	603969	BDX 20926 18,5 + WK
 <b>Bremsscheibe</b>								
1.9 D	44	06/97→03/01	←			24.0124-0103.1	424103	Ø 252,5 24 22 V
2.1 D	47	06/94→10/97						
2.2	74	06/94→10/97						
2.2 4x4	74	06/94→10/97						
2.5 D	55	05/89→03/01						
2.5 D 4x4	55	05/89→03/01						

	kw			 	! #		
<b>RENAULT - TRAFIC Pritsche/Fahrgestell (PXX) 03/89→03/01</b>							
 <b>Bremsbelagsatz, Scheibenbremse</b>							
2.0 RWD 2.5 D	59 55	05/89→10/97 05/98→03/01	←			13.0460-3969.2 603969	BDX 20926 18,5 + WK
2.1 D	47	09/94→04/98	←	→ 10/97		13.0460-3969.2 603969	BDX 20926 18,5 + WK
2.1 D RWD	47	06/94→10/97	←	→ 0005150		13.0460-3968.2 603968	BDX 20488 18,5 + WK + Zub
			←			13.0460-3969.2 603969	BDX 20926 18,5 + WK
2.2 2.2 4x4 2.5 D 2.5 D 2.5 D 4x4	74 74 51 58 58	09/94→04/98 09/94→04/98 05/89→03/01 09/94→04/98 09/94→01/99	←	→ 12/97		13.0460-3969.2 603969	BDX 20926 18,5 + WK
 <b>Bremsscheibe</b>							
2.0 RWD 2.1 D RWD 2.5 D	59 47 55	05/89→10/97 06/94→10/97 05/98→03/01	←			24.0124-0103.1 424103	Ø 252,5 24 22 V
2.1 D	47	09/94→04/98	←	→ 10/97		24.0124-0103.1 424103	Ø 252,5 24 22 V
2.2 2.2 4x4 2.5 D 2.5 D 2.5 D 4x4	74 74 51 58 58	09/94→04/98 09/94→04/98 05/89→03/01 09/94→04/98 09/94→01/99	←	→ 12/97		24.0124-0103.1 424103	Ø 252,5 24 22 V
			←				
			←				
			←				
<b>RENAULT - TWINGO I (C06_) 03/93→10/12</b>							
 <b>Bremsbelagsatz, Scheibenbremse</b>							
1.2 (C063, C064)	40	03/93→10/96	←			13.0460-3953.2 603953 13.0460-3955.2 603955	BDX 20634 15,0 - WK BDX 20634 15,0 + WK
1.2 (C066, C068) 1.2 (C067)	43 40	05/96→06/07 05/96→03/07	←	Automatikgetriebe		13.0460-2834.2 602834	TRW 21463 18,0 + WK
			←	10/98→; Schaltgetriebe		13.0460-2834.2 602834	TRW 21463 18,0 + WK
			←	→ 09/98; Schaltgetriebe		13.0460-3953.2 603953 13.0460-3955.2 603955	BDX 20634 15,0 - WK BDX 20634 15,0 + WK
1.2 16V (C060) 1.2 16V (C06C, C06D, C06K)	44 55	08/04→06/07 01/01→06/07	←			13.0460-2834.2 602834	TRW 21463 18,0 + WK
1.2 LPG	44	10/03→06/07	←	08/04→		13.0460-2834.2 602834	TRW 21463 18,0 + WK
<b>Zubehörsatz, Scheibenbremsbelag</b>							
1.2 (C063, C064)	40	03/93→10/96	←			13.0460-0423.2 610423	BDX
1.2 (C066, C068) 1.2 (C067)	43 40	05/96→06/07 05/96→03/07	←	→ 09/98; Schaltgetriebe		13.0460-0423.2 610423	BDX
			←				
 <b>Bremsscheibe</b>							
1.2 (C063, C064)	40	03/93→10/96	←			24.0108-0104.1 408104	Ø 238 8,2 7 + S
1.2 (C066, C068)	43	05/96→06/07	←	→ 09/98; Schaltgetriebe		24.0108-0104.1 408104	Ø 238 8,2 7 + S
			←	10/98→ 08/00		24.0112-0116.1 412116	Ø 238 12 10,5 + S
			←	→ 09/98; Automatikgetriebe		24.0112-0116.1 412116	Ø 238 12 10,5 + S
			←	11/03→		24.0112-0171.1 412171	Ø 259 12 10,6 + S
			←	09/00→ 10/03		24.0121-0106.1 421106	Ø 259 20,7 17,7 V + S
1.2 (C067)	40	05/96→03/07	←	→ 09/98; Schaltgetriebe		24.0108-0104.1 408104	Ø 238 8,2 7 + S
			←	10/98→		24.0112-0116.1 412116	Ø 238 12 10,5 + S
			←	→ 09/98; Automatikgetriebe		24.0112-0116.1 412116	Ø 238 12 10,5 + S
1.2 16V (C060)	44	08/04→06/07	←			24.0121-0106.1 421106	Ø 259 20,7 17,7 V + S
1.2 16V (C06C, C06D, C06K)	55	01/01→06/07	←	→ 10/03; für Fahrzeuge mit verstärktem Fahrwerk		24.0112-0116.1 412116	Ø 238 12 10,5 + S
			←	11/03→		24.0112-0171.1 412171	Ø 259 12 10,6 + S
			←	→ 10/03; für Fahrzeuge ohne verstärktes Fahrwerk		24.0121-0106.1 421106	Ø 259 20,7 17,7 V + S
1.2 LPG	44	10/03→06/07	←	08/04→		24.0121-0106.1 421106	Ø 259 20,7 17,7 V + S
<b>RENAULT - TWINGO I Kasten (S06_) 03/93→06/12</b>							
 <b>Bremsbelagsatz, Scheibenbremse</b>							
1.2 (S063, S064)	40	03/93→05/96	←	→ 04/96		13.0460-3953.2 603953	BDX 20634 15,0 - WK
1.2 (S066, S068)	43	05/96→08/04	←	Vollautomatik		13.0460-2834.2 602834	TRW 21463 18,0 + WK
			←	10/98→; Schaltgetriebe		13.0460-2834.2 602834	TRW 21463 18,0 + WK
↓							













	kw				! #										
<b>RENAULT - TWINGO I Kasten (S06_) 03/93→06/12</b>															
 <b>Bremsbelagsatz, Scheibenbremse</b>															
1.2 (S066, S068)	43	05/96→08/04	←	→ 09/98; Schaltgetriebe		13.0460-3953.2 603953	BDX 20634 15,0 - WK								
<b>Zubehörsatz, Scheibenbremsbelag</b>															
1.2 (S063, S064)	40	03/93→05/96	←	→ 04/96		13.0460-0423.2 610423	BDX								
1.2 (S066, S068)	43	05/96→08/04	←	→ 09/98; Schaltgetriebe		13.0460-0423.2 610423	BDX								
 <b>Bremsscheibe</b>															
1.2 (S063, S064)	40	03/93→05/96	←	→ 04/96		24.0108-0104.1 408104	Ø 238 8,2 7 + S								
1.2 (S066, S068)	43	05/96→08/04	←	→ 09/98; Schaltgetriebe		24.0108-0104.1 408104	Ø 238 8,2 7 + S								
			←	10/98→ 08/00; Schaltgetriebe		24.0112-0116.1 412116	Ø 238 12 10,5 + S								
			←	→ 08/00; Automatikgetriebe		24.0112-0116.1 412116	Ø 238 12 10,5 + S								
			←	11/03→		24.0112-0171.1 412171	Ø 259 12 10,6 + S								
			←	09/00→; Schaltgetriebe		24.0121-0106.1 421106	Ø 259 20,7 17,7 V + S								
			←	09/00→; Vollautomatik		24.0121-0106.1 421106	Ø 259 20,7 17,7 V + S								
<b>RENAULT - TWINGO II (CN0_) 03/07→</b>															
 <b>Bremsbelagsatz, Scheibenbremse</b>															
1.2 (CN0D)	43	03/07→	←	→ 07/14		13.0460-2834.2 602834	TRW 21463 18,0 + WK								
1.2 16V	55	03/08→													
1.2 16V (CN04, CN0A, CN0B)	55	03/07→													
1.2 16V (CN0K, CN0V)	56	03/07→													
1.2 TCe 100 (CN0P)	75	02/11→													
1.2 Turbo (CN0C, CN0F)	74	03/07→													
1.5 dCi (CN0E)	47	03/07→													
1.5 dCi (CN0U)	62	04/08→													
1.5 dCi 75	55	10/10→													
1.5 dCi 90	63	10/10→													
1.6 RS (CN0N, CN0R, CN0S)	98	05/08→	←	→ 07/14		13.0460-7248.2 607248	ATE 23215 17,5 - WE / - WK								
			→	→ 07/14		13.0460-2845.2 602845	TRW 23554 16,4 - WK + Zub								
 <b>Bremsscheibe</b>															
1.2 (CN0D)	43	03/07→	←	→ 07/14		24.0112-0171.1 412171	Ø 259 12 10,6 + S								
1.5 dCi (CN0E)	47	03/07→				24.0121-0106.1 421106	Ø 259 20,7 17,7 V + S								
1.2 16V 1.2 16V (CN04, CN0A, CN0B) 1.2 16V (CN0K, CN0V) 1.2 TCe 100 (CN0P) 1.2 Turbo (CN0C, CN0F) 1.5 dCi (CN0U) 1.5 dCi 75 1.5 dCi 90	55 55 56 75 74 62 55 63	03/08→ 03/07→ 03/07→ 02/11→ 03/07→ 04/08→ 10/10→ 10/10→	←	→ 07/14		24.0121-0106.1 421106	Ø 259 20,7 17,7 V + S								
								1.6 RS (CN0N, CN0R, CN0S)	98	05/08→	←	→ 07/14		24.0124-0158.1 424158	Ø 280 24 21,8 V + S
											→	→ 07/14		24.0324-0158.1 524158	Ø 280 24 21,8 V + S
														24.0108-0114.2 408114	Ø 240 8 7 + LG / + ABS Ring
								<b>RENAULT - TWINGO III (BCM_) 09/14→</b>							
								 <b>Bremsbelagsatz, Scheibenbremse</b>							
								0.9 TCe 110	80	11/16→	←			13.0460-7298.2 607298	ATE 25702 18,2 - WE / - WK
								0.9 TCe 90	66	09/14→				13.0470-7298.2 LD7298	ATE 25702 18,2 - WE / - WK
1.0 SCe 70	51	09/15→					Ceramic								
1.0 SCe 70	52	09/14→													
 <b>Bremsscheibe</b>															
0.9 TCe 90	66	09/14→	←	für Fahrzeuge mit Start-Stopp-Funktion		24.0122-0289.1 422289	Ø 258 22 19,8 V + S								
1.0 SCe 70	51	09/15→													
1.0 SCe 70	52	09/14→													
<b>RENAULT - VEL SATIS (BJ0_) 06/02→</b>															
 <b>Bremsbelagsatz, Scheibenbremse</b>															
2.0 16 V Turbo	125	04/04→	←	→ 12/09		13.0460-7159.2 607159	ATE 23245 18,3 - WE / - WK								
2.0 16V Turbo (BJ0K)	120	06/02→				13.0470-7159.2 LD7159	ATE 23245 18,3 - WE / - WK								
2.0 dCi (BJ03, BJ0B)	127	01/06→					Ceramic								
2.0 dCi (BJ03)	110	08/05→													
2.0 Turbo	108	04/05→	→	→ 12/09		13.0460-7137.2 607137	ATE 23482 15,8 - WE / - WK								
2.2 dCi (BJ0E, BJ0F, BJ0G, BJ0H)	102	09/04→				13.0470-7137.2 LD7137	ATE 23482 15,8 - WE / - WK								
2.2 dCi (BJ0E, BJ0F)	110	06/02→					Ceramic								

















	kw					! #		
<b>RENAULT - VEL SATIS (BJ0_) 06/02→</b>								
 <b>Bremsbelagsatz, Scheibenbremse</b>								
2.2 dCi (BJ0H)	85	04/04→	←	→ 12/09			13.0460-7159.2 607159	ATE 23245 18,3 - WE / - WK
2.2 dCi (BJ0M)	83	12/04→					13.0470-7159.2 LD7159	ATE 23245 18,3 - WE / - WK
3.0 dCi (BJ0J, BJ0N)	130	06/02→						Ceramic
3.0 dCi (BJ0S)	133	06/06→						
3.5 (BJ01)	170	10/04→	→	→ 12/09			13.0460-7137.2 607137	ATE 23482 15,8 - WE / - WK
3.5 V6 (BJ0R, BJ0V, BJ0U)	177	06/02→					13.0470-7137.2 LD7137	ATE 23482 15,8 - WE / - WK
								Ceramic
 <b>Bremsscheibe</b>								
2.0 16 V Turbo	125	04/04→	←	→ 12/09			24.0128-0133.1 428133	Ø 324 28 25,4 V
2.0 dCi (BJ03, BJ0B)	127	01/06→						
2.0 dCi (BJ03)	110	08/05→	→	→ 12/09;			24.0111-0100.2 411100	Ø 300 11 9,5 + LG / + ABS Ring
2.0 Turbo	108	04/05→		Achszapfendurchmesser [mm]: 30				
2.2 dCi (BJ0E, BJ0F, BJ0G, BJ0H)	102	09/04→						
2.2 dCi (BJ0H)	85	04/04→						
2.2 dCi (BJ0M)	83	12/04→						
3.0 dCi (BJ0S)	133	06/06→						
3.5 (BJ01)	170	10/04→						
3.5 V6 (BJ0R, BJ0V, BJ0U)	177	06/02→						
2.0 16V Turbo (BJ0K)	120	06/02→	←	→ 12/09			24.0128-0133.1 428133	Ø 324 28 25,4 V
2.2 dCi (BJ0E, BJ0F)	110	06/02→						
3.0 dCi (BJ0J, BJ0N)	130	06/02→	→	Orga 020919→; → 12/09;			24.0111-0100.2 411100	Ø 300 11 9,5 + LG / + ABS Ring
				Achszapfendurchmesser [mm]: 30				
			→	→Orga 020918;			24.0111-0167.2 411167	Ø 300 11 9,5 + LG / + ABS Ring
				Achszapfendurchmesser [mm]: 30				
<b>RENAULT - WIND (E4M_) 07/10→</b>								
 <b>Bremsbelagsatz, Scheibenbremse</b>								
1.2 (E4MF)	74	07/10→	←	→ 09/13			13.0460-7248.2 607248	ATE 23215 17,5 - WE / - WK
1.2 TCe 100 (E4MA)	75	02/11→						
1.6 (E4MB, E4MC)	98	07/10→	→	→ 09/13			13.0460-2845.2 602845	TRW 23554 16,4 - WK + Zub
 <b>Bremsscheibe</b>								
1.2 (E4MF)	74	07/10→	←	→ 09/13			24.0124-0158.1 424158	Ø 280 24 21,8 V + S
1.2 TCe 100 (E4MA)	75	02/11→					24.0324-0158.1 524158	Ø 280 24 21,8 V + S
1.6 (E4MB, E4MC)	98	07/10→	→	→ 09/13			24.0108-0114.2 408114	Ø 240 8 7 + LG / + ABS Ring
<b>RENAULT - ZOE (BFM_) 06/12→</b>								
 <b>Bremsbelagsatz, Scheibenbremse</b>								
ZOE	65	06/12→	←				13.0460-5801.2 605801	TRW 23973 17,1 - WE / - WK
ZOE	68	09/16→						
 <b>Bremsscheibe</b>								
ZOE	65	06/12→	←				24.0122-0270.1 422270	Ø 258 22 19,8 V + S
ZOE	68	09/16→						
<b>RENAULT TRUCKS - MASCOTT Kasten/Kombi 01/99→12/10</b>								
 <b>Bremsbelagsatz, Scheibenbremse</b>								
110.35	78	01/99→06/04	←				13.0460-4847.2 604847	BRE 29160 20,3 + WE / - WK
110.50	78	01/99→06/04						+ Zub
130.35	92	01/99→06/04						
140.35	103	01/01→06/04	→				13.0460-4860.2 604860	BRE 29121 20,3 + WK + Zub
150.35 (A02300161)	107	10/01→06/04					13.0460-4966.2 604966	BRE 29121 20,3 + WE / - WK
110.55	78	01/99→06/04	←				13.0460-4860.2 604860	BRE 29121 20,3 + WK + Zub
130.55	92	01/99→06/04						
140.55	103	01/01→06/04	→				13.0460-4860.2 604860	BRE 29121 20,3 + WK + Zub
150.55 (A02300164)	107	10/01→06/04					13.0460-4966.2 604966	BRE 29121 20,3 + WE / - WK
150.65 (A00300166)	107	10/01→06/04						
120.35 (A02100003)	85	05/04→10/10	←				13.0460-4966.2 604966	BRE 29121 20,3 + WE / - WK
120.55 (A02300005)	85	05/04→10/10						
160.35 (A02100013)	115	05/04→10/10	→				13.0460-4966.2 604966	BRE 29121 20,3 + WE / - WK
160.55 (A02300015)	115	05/04→10/10						
90.35	63	01/99→12/01	←	→ 06/01			13.0460-4860.2 604860	BRE 29121 20,3 + WK + Zub
			→	→ 06/01			13.0460-4860.2 604860	BRE 29121 20,3 + WK + Zub
							13.0460-4966.2 604966	BRE 29121 20,3 + WE / - WK
 <b>Bremsscheibe</b>								
110.35	78	01/99→06/04	←				24.0122-0266.1 422266	Ø 290 22 19 V
110.50	78	01/99→06/04						
130.35	92	01/99→06/04	→				24.0122-0267.1 422267	Ø 290 22 19 V
140.35	103	01/01→06/04						
150.35 (A02300161)	107	10/01→06/04						
↓								













	kw					! #		
<b>RENAULT TRUCKS - MASCOTT Kasten/Kombi 01/99→12/10</b>								
 <b>Bremsscheibe</b>								
110.55	78	01/99→06/04	←			24.0126-0161.1	426161	Ø 290 26 23 V
130.55	92	01/99→06/04	→			24.0122-0267.1	422267	Ø 290 22 19 V
140.55	103	01/01→06/04						
150.55 (A02300164)	107	10/01→06/04						
150.65 (A00300166)	107	10/01→06/04						
90.35	63	01/99→12/01	←	→ 06/01		24.0122-0266.1	422266	Ø 290 22 19 V
			→	→ 06/01		24.0122-0267.1	422267	Ø 290 22 19 V
<b>RENAULT TRUCKS - MASCOTT Kipper 01/00→12/10</b>								
 <b>Bremsbelagsatz, Scheibenbremse</b>								
110	78	01/00→06/04	←			13.0460-4860.2	604860	BRE 29121 20,3 + WK + Zub
			→			13.0460-4860.2	604860	BRE 29121 20,3 + WK + Zub
						13.0460-4966.2	604966	BRE 29121 20,3 + WE / - WK
 <b>Bremsscheibe</b>								
110	78	01/00→06/04	←			24.0126-0161.1	426161	Ø 290 26 23 V
			→			24.0122-0267.1	422267	Ø 290 22 19 V
<b>RENAULT TRUCKS - MASCOTT Pritsche/Fahrgestell 01/99→12/13</b>								
 <b>Bremsbelagsatz, Scheibenbremse</b>								
110	78	01/99→06/04	←			13.0460-4847.2	604847	BRE 29160 20,3 + WE / - WK + Zub
140	103	01/01→06/04	→			13.0460-4860.2	604860	BRE 29121 20,3 + WK + Zub
150.35 (A00300161)	107	10/01→06/04						
150.35 (A00300164)	107	10/01→06/04						
120.35 (A00100003, A01100003)	85	05/04→12/10	←			13.0460-4966.2	604966	BRE 29121 20,3 + WE / - WK
120.55 (A00300005, A01300005)	85	05/04→12/10	→			13.0460-4966.2	604966	BRE 29121 20,3 + WE / - WK
160.35 (A00100013, A01100013)	115	05/04→12/10						
160.55 (A00300015, A01300015)	115	05/04→12/10						
120.65 (A00500007)	85	05/04→12/10						
160.65 (A00500017, A01500017, B03200017)	115	05/04→12/10	→			13.0460-4966.2	604966	BRE 29121 20,3 + WE / - WK
130	92	01/99→06/04	←			13.0460-4860.2	604860	BRE 29121 20,3 + WK + Zub
			→			13.0460-4860.2	604860	BRE 29121 20,3 + WK + Zub
						13.0460-4966.2	604966	BRE 29121 20,3 + WE / - WK
90	63	01/99→12/01	←	→ 06/01		13.0460-4860.2	604860	BRE 29121 20,3 + WK + Zub
			→	→ 06/01		13.0460-4860.2	604860	BRE 29121 20,3 + WK + Zub
						13.0460-4966.2	604966	BRE 29121 20,3 + WE / - WK
 <b>Bremsscheibe</b>								
110	78	01/99→06/04	←			24.0122-0266.1	422266	Ø 290 22 19 V
140	103	01/01→06/04	→			24.0122-0267.1	422267	Ø 290 22 19 V
150.35 (A00300161)	107	10/01→06/04						
150.35 (A00300164)	107	10/01→06/04						
130	92	01/99→06/04	←			24.0126-0161.1	426161	Ø 290 26 23 V
			→			24.0122-0267.1	422267	Ø 290 22 19 V
90	63	01/99→12/01	←	→ 06/01		24.0122-0266.1	422266	Ø 290 22 19 V
			→	→ 06/01		24.0122-0267.1	422267	Ø 290 22 19 V
<b>ROLLS-ROYCE - SILVER SERAPH 03/98→09/02</b>								
 <b>Bremsbelagsatz, Scheibenbremse</b>								
5.4	240	03/98→09/02	←			13.0460-7183.2	607183	ATE 21484 20,5 + WE / - WK
<b>ROVER - 25 Schrägheck (RF) 09/99→06/06</b>								
 <b>Bremsbelagsatz, Scheibenbremse</b>								
1.1 16V	55	01/04→05/05	←			13.0460-2803.2	602803	TRW 21515 17,5 + WK
1.4 16V	62	10/99→05/05	→			13.0460-5998.2	605998	AKE 21312 12,8 + WK
1.4 16V	76	10/99→05/05						
1.6 16V	80	10/99→05/05						
1.8 16V	85	10/99→05/05						
1.8 16V	107	02/00→05/05						
2.0 iDT	74	10/99→05/05						
2.0 iDT	83	01/02→12/04						
↓								



























	kW			 	! #		
<b>ROVER - 25 Schrägheck (RF) 09/99→06/06</b>							
<b>Zubehörsatz, Scheibenbremsbelag</b>							
1.1 16V	55	01/04→05/05	←			13.0460-0142.2	610142
1.4 16V	62	10/99→05/05					
1.4 16V	76	10/99→05/05					
1.6 16V	80	10/99→05/05					
1.8 16V	85	10/99→05/05					
1.8 16V	107	02/00→05/05					
2.0 iDT	74	10/99→05/05					
2.0 iDT	83	01/02→12/04					
<b> Bremsscheibe</b>							
1.1 16V	55	01/04→05/05	←			24.0113-0198.1	413198 Ø 262 13 11
1.4 16V	62	10/99→05/05				24.0121-0105.1	421105 Ø 262 21 19 V + S
1.4 16V	76	10/99→05/05					
1.6 16V	80	10/99→05/05	→			24.0110-0212.1	410212 Ø 238,5 10 8 + S
1.8 16V	85	10/99→05/05					
1.8 16V	107	02/00→05/05					
2.0 iDT	74	10/99→05/05					
2.0 iDT	83	01/02→12/04	←			24.0121-0105.1	421105 Ø 262 21 19 V + S
			→			24.0110-0212.1	410212 Ø 238,5 10 8 + S
<b>ROVER - 45 Schrägheck (RT) 02/00→05/05</b>							
<b> Bremsbelagsatz, Scheibenbremse</b>							
1.4	76	02/00→05/05	←			13.0460-2803.2	602803 TRW 21515 17,5 + WK
1.6	80	02/00→05/05					
1.8	86	02/00→05/05	→			13.0460-5998.2	605998 AKE 21312 12,8 + WK
2.0 iDT	74	02/00→05/05					
2.0 iDT	83	01/04→05/05					
2.0 V6	110	02/00→05/05					
<b>Zubehörsatz, Scheibenbremsbelag</b>							
1.4	76	02/00→05/05	←			13.0460-0142.2	610142
1.6	80	02/00→05/05					
1.8	86	02/00→05/05					
2.0 iDT	74	02/00→05/05					
2.0 iDT	83	01/04→05/05					
2.0 V6	110	02/00→05/05					
<b> Bremsscheibe</b>							
1.4	76	02/00→05/05	←			24.0121-0105.1	421105 Ø 262 21 19 V + S
1.6	80	02/00→05/05					
1.8	86	02/00→05/05	→			24.0110-0212.1	410212 Ø 238,5 10 8 + S
2.0 iDT	74	02/00→05/05					
2.0 iDT	83	01/04→05/05					
2.0 V6	110	02/00→05/05					
<b>ROVER - 45 Stufenheck (RT) 02/00→05/05</b>							
<b> Bremsbelagsatz, Scheibenbremse</b>							
1.4	76	02/00→05/05	←			13.0460-2803.2	602803 TRW 21515 17,5 + WK
1.6	80	02/00→05/05					
1.8	86	02/00→05/05	→			13.0460-5998.2	605998 AKE 21312 12,8 + WK
2.0 iDT	74	02/00→05/05					
2.0 iDT	83	01/04→05/05					
2.0 V6	110	02/00→05/05					
<b>Zubehörsatz, Scheibenbremsbelag</b>							
1.4	76	02/00→05/05	←			13.0460-0142.2	610142
1.6	80	02/00→05/05					
1.8	86	02/00→05/05					
2.0 iDT	74	02/00→05/05					
2.0 iDT	83	01/04→05/05					
2.0 V6	110	02/00→05/05					
<b> Bremsscheibe</b>							
1.4	76	02/00→05/05	←			24.0121-0105.1	421105 Ø 262 21 19 V + S
1.6	80	02/00→05/05					
1.8	86	02/00→05/05	→			24.0110-0212.1	410212 Ø 238,5 10 8 + S
2.0 iDT	74	02/00→05/05					
2.0 iDT	83	01/04→05/05					
2.0 V6	110	02/00→05/05					
<b>ROVER - 75 (RJ) 02/99→10/05</b>							
<b> Bremsbelagsatz, Scheibenbremse</b>							
1.8	88	02/99→05/05	←			13.0460-7144.2	607144 ATE 23112 19,1 + WE / - WK
1.8 Turbo	110	05/03→05/05					
2.0 CDT	85	02/99→05/05	→			13.0460-3605.2	603605 ATE 20180 17,3 + WE / - WK
2.0 CDTi	96	02/03→05/05					
↓							













	kw			 	! #		
<b>ROVER - 75 (RJ) 02/99→10/05</b>							
 <b>Bremsbelagsatz, Scheibenbremse</b>							
2.0 V6 2.5 V6 2.5 V6	110 129 130	02/99→05/05 02/99→10/01 10/01→05/05	➔			13.0470-3605.2 LD3605	ATE 20180 17,3 + WE / - WK Ceramic
<b>Warnkontakt, Bremsbelagverschleiß</b>							
1.8 1.8 Turbo 2.0 CDT 2.0 CDTi 2.0 V6 2.5 V6 2.5 V6	88 110 85 96 110 129 130	02/99→05/05 05/03→05/05 02/99→05/05 02/03→05/05 02/99→05/05 02/99→10/01 10/01→05/05	➔ ➔ ➔ ➔ ➔ ➔ ➔		1 1	24.8190-2801.2 622801 24.8190-2802.2 622802	L= 1.103 L= 846
 <b>Bremsscheibe</b>							
1.8 1.8 Turbo 2.0 CDT 2.0 CDTi 2.0 V6 2.5 V6 2.5 V6	88 110 85 96 110 129 130	02/99→05/05 05/03→05/05 02/99→05/05 02/03→05/05 02/99→05/05 02/99→10/01 10/01→05/05	➔ ➔ ➔ ➔ ➔ ➔ ➔			24.0122-0206.1 422206 24.0110-0270.1 410270	Ø 284 22 19 V Ø 280 10 8
<b>ROVER - 75 Tourer (RJ) 08/01→06/06</b>							
 <b>Bremsbelagsatz, Scheibenbremse</b>							
1.8 1.8 Turbo 2.0 CDT 2.0 CDTi 2.0 V6 2.5 V6	88 110 85 96 110 130	08/01→05/05 05/03→05/05 08/01→05/05 02/03→05/05 08/01→05/05 08/01→05/05	➔ ➔ ➔ ➔ ➔ ➔			13.0460-7144.2 607144 13.0460-3605.2 603605 13.0470-3605.2 LD3605	ATE 23112 19,1 + WE / - WK ATE 20180 17,3 + WE / - WK ATE 20180 17,3 + WE / - WK Ceramic
<b>Warnkontakt, Bremsbelagverschleiß</b>							
1.8 1.8 Turbo 2.0 CDT 2.0 CDTi 2.0 V6 2.5 V6	88 110 85 96 110 130	08/01→05/05 05/03→05/05 08/01→05/05 02/03→05/05 08/01→05/05 08/01→05/05	➔ ➔ ➔ ➔ ➔ ➔		1 1	24.8190-2801.2 622801 24.8190-2802.2 622802	L= 1.103 L= 846
 <b>Bremsscheibe</b>							
1.8 1.8 Turbo 2.0 CDT 2.0 CDTi 2.0 V6 2.5 V6	88 110 85 96 110 130	08/01→05/05 05/03→05/05 08/01→05/05 02/03→05/05 08/01→05/05 08/01→05/05	➔ ➔ ➔ ➔ ➔ ➔			24.0122-0206.1 422206 24.0110-0270.1 410270	Ø 284 22 19 V Ø 280 10 8
<b>ROVER - 100 / METRO Schrägheck (XP) 11/89→12/98</b>							
 <b>Bremsbelagsatz, Scheibenbremse</b>							
114 GTI/GT 16V Cat 114 S/L/GTA 114 GTI 16V	66 55 76	03/90→12/98 03/90→12/98 08/91→12/98	➔ ➔ ➔	05/90→		13.0460-2804.2 602804 13.0460-2804.2 602804	TRW 21518 17,0 - WK TRW 21518 17,0 - WK
 <b>Bremsscheibe</b>							
111 C/L/S 114 GTI/GT 16V Cat 114 S/L/GTA 114 GTI 16V	44 66 55 76	03/90→12/98 03/90→12/98 03/90→12/98 08/91→12/98	➔ ➔ ➔ ➔	05/90→		24.0113-0190.1 413190 24.0122-0177.1 422177 24.0113-0190.1 413190 24.0122-0177.1 422177	Ø 240 12,8 11,6 Ø 240,5 22 20 V Ø 240 12,8 11,6 Ø 240,5 22 20 V
<b>ROVER - 100 Cabriolet (XP) 04/94→12/98</b>							
 <b>Bremsbelagsatz, Scheibenbremse</b>							
114 114	55 75	04/94→10/97 03/97→10/98	➔			13.0460-2804.2 602804	TRW 21518 17,0 - WK
 <b>Bremsscheibe</b>							
111 114 114	44 55 75	04/94→10/97 04/94→10/97 03/97→10/98	➔ ➔ ➔			24.0113-0190.1 413190 24.0122-0177.1 422177	Ø 240 12,8 11,6 Ø 240,5 22 20 V
<b>ROVER - 200 Cabriolet (XW) 04/90→11/99</b>							
 <b>Bremsbelagsatz, Scheibenbremse</b>							
214 1.4 216 1.6i ↓	66 90	01/92→11/99 01/92→11/99	➔	→ 10/95; + ABS		13.0460-2803.2 602803	TRW 21515 17,5 + WK

	kW			 	! #		
<b>ROVER - 200 Cabriolet (XW) 04/90→11/99</b>							
 <b>Bremsbelagsatz, Scheibenbremse</b>							
214 1.4 216 1.6i	66 90	01/92→11/99 01/92→11/99	←	→ 10/95; - ABS		13.0460-2805.2 602805	TRW 21520 17,5 + WK
			→	→ 10/95		13.0460-5998.2 605998	AKE 21312 12,8 + WK
214 1.4i 16V	76	01/93→11/99	←	→ 10/95; + ABS		13.0460-2803.2 602803	TRW 21515 17,5 + WK
			←	→ 10/95; - ABS		13.0460-2805.2 602805	TRW 21520 17,5 + WK
<b>Zubehörsatz, Scheibenbremsbelag</b>							
214 1.4 216 1.6i	66 90	01/92→11/99 01/92→11/99	←	→ 10/95		13.0460-0142.2 610142	
			→	→ 10/95		13.0460-0430.2 610430	AKE
214 1.4i 16V	76	01/93→11/99	←	→ 10/95		13.0460-0142.2 610142	
 <b>Bremsscheibe</b>							
214 1.4 214 1.4i 16V	66 76	01/92→11/99 01/93→11/99	←	→ 10/95; + ABS		24.0121-0107.1 421107	Ø 262 21 19 V
			→	→ 10/95; + ABS		24.0110-0212.1 410212	Ø 238,5 10 8 + S
216 1.6i	90	01/92→11/99	←	→ 10/95		24.0121-0107.1 421107	Ø 262 21 19 V
<b>ROVER - 200 Coupe (XW) 10/92→06/99</b>							
 <b>Bremsbelagsatz, Scheibenbremse</b>							
216	82	01/96→12/97	←	+ ABS		13.0460-2803.2 602803	TRW 21515 17,5 + WK
			→	+ ABS		13.0460-5998.2 605998	AKE 21312 12,8 + WK
216 220 GSi	90 100	10/92→06/99 05/94→06/99	←	→ 10/95; + ABS		13.0460-2803.2 602803	TRW 21515 17,5 + WK
			←	→ 10/95; - ABS		13.0460-2805.2 602805	TRW 21520 17,5 + WK
220 Turbo	147	10/92→06/99	←	01/93→ 10/95; + ABS		13.0460-2803.2 602803	TRW 21515 17,5 + WK
			←	01/93→ 10/95; - ABS		13.0460-2805.2 602805	TRW 21520 17,5 + WK
			→	01/93→ 10/95		13.0460-5998.2 605998	AKE 21312 12,8 + WK
<b>Zubehörsatz, Scheibenbremsbelag</b>							
216	82	01/96→12/97	←	+ ABS		13.0460-0142.2 610142	
216 220 GSi	90 100	10/92→06/99 05/94→06/99	←	→ 10/95		13.0460-0142.2 610142	
220 Turbo	147	10/92→06/99	←	01/93→ 10/95		13.0460-0142.2 610142	
			→	01/93→ 10/95		13.0460-0430.2 610430	AKE
 <b>Bremsscheibe</b>							
216	82	01/96→12/97	←	+ ABS		24.0121-0105.1 421105	Ø 262 21 19 V + S
			→	+ ABS		24.0110-0212.1 410212	Ø 238,5 10 8 + S
216	90	10/92→06/99	←	→ 10/95		24.0121-0107.1 421107	Ø 262 21 19 V
			→	→ 10/95; + ABS		24.0110-0212.1 410212	Ø 238,5 10 8 + S
220 GSi	100	05/94→06/99	←	→ 10/95		24.0121-0107.1 421107	Ø 262 21 19 V
			→	→ 10/95		24.0110-0212.1 410212	Ø 238,5 10 8 + S
220 Turbo	147	10/92→06/99	←	01/93→ 10/95		24.0121-0107.1 421107	Ø 262 21 19 V
<b>ROVER - 200 Schrägheck (RF) 11/95→11/00</b>							
 <b>Bremsbelagsatz, Scheibenbremse</b>							
211	44	01/98→03/00	←			13.0460-2803.2 602803	TRW 21515 17,5 + WK
			→	+ ABS		13.0460-2805.2 602805	TRW 21520 17,5 + WK
			→	+ ABS		13.0460-5998.2 605998	AKE 21312 12,8 + WK
214 i 220 D/SD	55 63	11/95→03/00 11/95→03/00	←	01/96→		13.0460-2803.2 602803	TRW 21515 17,5 + WK
			→	01/96→; + ABS		13.0460-2805.2 602805	TRW 21520 17,5 + WK
			→	01/96→; + ABS		13.0460-5998.2 605998	AKE 21312 12,8 + WK
214 Si	76	11/95→03/00	←	+ ABS		13.0460-2803.2 602803	TRW 21515 17,5 + WK
			←	- ABS		13.0460-2805.2 602805	TRW 21520 17,5 + WK
			→	+ ABS		13.0460-5998.2 605998	AKE 21312 12,8 + WK
216 Si	82	11/95→06/99	←	+ ABS		13.0460-2803.2 602803	TRW 21515 17,5 + WK
			→	01/96→; + ABS		13.0460-5998.2 605998	AKE 21312 12,8 + WK
218 K Vi	107	11/95→03/00	←	01/96→		13.0460-2803.2 602803	TRW 21515 17,5 + WK
			→	01/97→; + ABS		13.0460-5998.2 605998	AKE 21312 12,8 + WK
218 Si	88	08/99→03/00	←			13.0460-2803.2 602803	TRW 21515 17,5 + WK
↓							

















	kW			 	! #		
<b>ROVER - 200 Schrägheck (RF) 11/95→11/00</b>							
 <b>Bremsbelagsatz, Scheibenbremse</b>							
218 Si	88	08/99→03/00	➡	+ ABS		13.0460-5998.2 605998	AKE 21312 12,8 + WK
220 SDi	77	11/95→03/00	⬅	01/96→; + ABS		13.0460-2803.2 602803	TRW 21515 17,5 + WK
			⬅	01/96→; - ABS		13.0460-2805.2 602805	TRW 21520 17,5 + WK
			➡	01/96→; + ABS		13.0460-5998.2 605998	AKE 21312 12,8 + WK
<b>Zubehörsatz, Scheibenbremsbelag</b>							
211	44	01/98→03/00	⬅			13.0460-0142.2 610142	
218 Si	88	08/99→03/00	⬅				
214 i	55	11/95→03/00	⬅	01/96→		13.0460-0142.2 610142	
218 K Vi	107	11/95→03/00	⬅				
220 D/SD	63	11/95→03/00	⬅				
214 Si	76	11/95→03/00	⬅	+ ABS		13.0460-0142.2 610142	
216 Si	82	11/95→06/99	⬅				
220 SDi	77	11/95→03/00	⬅	01/96→; + ABS		13.0460-0142.2 610142	
 <b>Bremsscheibe</b>							
211	44	01/98→03/00	⬅			24.0113-0198.1 413198	Ø 262 13 11
			➡	+ ABS		24.0121-0105.1 421105	Ø 262 21 19 V + S
			➡	+ ABS		24.0110-0212.1 410212	Ø 238,5 10 8 + S
214 i 220 D/SD	55 63	11/95→03/00 11/95→03/00	⬅	01/96→		24.0113-0198.1 413198	Ø 262 13 11
			⬅			24.0121-0105.1 421105	Ø 262 21 19 V + S
			➡	01/96→; + ABS		24.0110-0212.1 410212	Ø 238,5 10 8 + S
214 Si	76	11/95→03/00	⬅	- ABS		24.0113-0198.1 413198	Ø 262 13 11
			⬅	+ ABS		24.0121-0105.1 421105	Ø 262 21 19 V + S
			➡	+ ABS		24.0110-0212.1 410212	Ø 238,5 10 8 + S
216 Si	82	11/95→06/99	⬅	+ ABS		24.0121-0105.1 421105	Ø 262 21 19 V + S
			➡	01/96→; + ABS		24.0110-0212.1 410212	Ø 238,5 10 8 + S
218 K Vi	107	11/95→03/00	⬅	01/96→		24.0121-0105.1 421105	Ø 262 21 19 V + S
			➡	01/97→; + ABS		24.0110-0212.1 410212	Ø 238,5 10 8 + S
218 Si	88	08/99→03/00	⬅			24.0121-0105.1 421105	Ø 262 21 19 V + S
			➡	+ ABS		24.0110-0212.1 410212	Ø 238,5 10 8 + S
220 SDi	77	11/95→03/00	⬅	01/96→; - ABS		24.0113-0198.1 413198	Ø 262 13 11
			⬅	01/96→; + ABS		24.0121-0105.1 421105	Ø 262 21 19 V + S
			➡	01/96→; + ABS		24.0110-0212.1 410212	Ø 238,5 10 8 + S
<b>ROVER - 400 (RT) 05/95→03/00</b>							
 <b>Bremsbelagsatz, Scheibenbremse</b>							
414	55	03/96→12/99	⬅			13.0460-2803.2 602803	TRW 21515 17,5 + WK
414 Si	76	05/95→03/00	➡			13.0460-5998.2 605998	AKE 21312 12,8 + WK
420 D	63	11/95→03/00	➡				
420 Di	77	05/95→03/00	➡				
420 Si Lux	100	12/95→03/00	➡				
416 Si	82	05/95→03/00	⬅	06/95→		13.0460-2803.2 602803	TRW 21515 17,5 + WK
416 Si	83	05/95→03/00	➡			13.0460-5998.2 605998	AKE 21312 12,8 + WK
416 Si	85	05/95→03/00	➡	06/95→			
<b>Zubehörsatz, Scheibenbremsbelag</b>							
414	55	03/96→12/99	⬅			13.0460-0142.2 610142	
414 Si	76	05/95→03/00	⬅				
420 D	63	11/95→03/00	➡			13.0460-0430.2 610430	AKE
420 Di	77	05/95→03/00	➡				
420 Si Lux	100	12/95→03/00	➡				
416 Si	82	05/95→03/00	⬅	06/95→		13.0460-0142.2 610142	
416 Si	83	05/95→03/00	➡			13.0460-0430.2 610430	AKE
416 Si	85	05/95→03/00	➡	06/95→			
 <b>Bremsscheibe</b>							
414	55	03/96→12/99	⬅	- ABS		24.0113-0198.1 413198	Ø 262 13 11
			⬅	+ ABS		24.0121-0105.1 421105	Ø 262 21 19 V + S
			➡			24.0110-0212.1 410212	Ø 238,5 10 8 + S
414 Si	76	05/95→03/00	⬅	- ABS		24.0113-0198.1 413198	Ø 262 13 11
			⬅	06/95→; + ABS		24.0121-0105.1 421105	Ø 262 21 19 V + S
			➡	06/95→		24.0110-0212.1 410212	Ø 238,5 10 8 + S
416 Si	82	05/95→03/00	⬅	06/95→		24.0113-0198.1 413198	Ø 262 13 11











	kW				! #		
<b>ROVER - 400 (RT) 05/95→03/00</b>							
 <b>Bremsscheibe</b>							
416 Si	83	05/95→03/00	←	06/95→		24.0121-0105.1 421105	Ø 262 21 19 V + S
416 Si	85	05/95→03/00	→	06/95→		24.0110-0212.1 410212	Ø 238,5 10 8 + S
420 D	63	11/95→03/00	←			24.0113-0198.1 413198	Ø 262 13 11
420 Di	77	05/95→03/00				24.0121-0105.1 421105	Ø 262 21 19 V + S
420 Si Lux	100	12/95→03/00	→			24.0110-0212.1 410212	Ø 238,5 10 8 + S
<b>ROVER - 400 Schrägheck (RT) 05/95→03/00</b>							
 <b>Bremsbelagsatz, Scheibenbremse</b>							
414	55	03/96→12/97	←			13.0460-2803.2 602803	TRW 21515 17,5 + WK
414 Si	76	05/95→03/00	→			13.0460-5998.2 605998	AKE 21312 12,8 + WK
416 Si	83	06/95→03/00					
416 Si	85	06/95→03/00					
420 D	63	11/95→03/00					
420 Di	77	05/95→03/00					
420 Si Lux	100	12/95→03/00					
416 Si	82	05/95→03/00	←	06/95→		13.0460-2803.2 602803	TRW 21515 17,5 + WK
			→	06/95→		13.0460-5998.2 605998	AKE 21312 12,8 + WK
<b>Zubehörsatz, Scheibenbremsbelag</b>							
414	55	03/96→12/97	←			13.0460-0142.2 610142	
414 Si	76	05/95→03/00	→			13.0460-0430.2 610430	AKE
416 Si	83	06/95→03/00					
416 Si	85	06/95→03/00					
420 D	63	11/95→03/00					
420 Di	77	05/95→03/00					
420 Si Lux	100	12/95→03/00					
416 Si	82	05/95→03/00	←	06/95→		13.0460-0142.2 610142	
			→	06/95→		13.0460-0430.2 610430	AKE
 <b>Bremsscheibe</b>							
414	55	03/96→12/97	←	- ABS		24.0113-0198.1 413198	Ø 262 13 11
			←	+ ABS		24.0121-0105.1 421105	Ø 262 21 19 V + S
			→			24.0110-0212.1 410212	Ø 238,5 10 8 + S
414 Si	76	05/95→03/00	←	- ABS		24.0113-0198.1 413198	Ø 262 13 11
			←	06/95→; + ABS		24.0121-0105.1 421105	Ø 262 21 19 V + S
			→	06/95→		24.0110-0212.1 410212	Ø 238,5 10 8 + S
416 Si	82	05/95→03/00	←	06/95→		24.0113-0198.1 413198	Ø 262 13 11
			→	06/95→		24.0121-0105.1 421105	Ø 262 21 19 V + S
			→	06/95→		24.0110-0212.1 410212	Ø 238,5 10 8 + S
416 Si	83	06/95→03/00	←			24.0113-0198.1 413198	Ø 262 13 11
416 Si	85	06/95→03/00				24.0121-0105.1 421105	Ø 262 21 19 V + S
420 D	63	11/95→03/00					
420 Di	77	05/95→03/00	→			24.0110-0212.1 410212	Ø 238,5 10 8 + S
420 Si Lux	100	12/95→03/00					
<b>ROVER - 400 Tourer (XW) 09/93→11/98</b>							
 <b>Bremsbelagsatz, Scheibenbremse</b>							
1.6 i	82	05/94→11/98	←	→ 04/95; + ABS		13.0460-2803.2 602803	TRW 21515 17,5 + WK
1.6 i	90	05/94→11/98	←	→ 04/95; - ABS		13.0460-2805.2 602805	TRW 21520 17,5 + WK
1.8 TD	65	09/93→11/98	→	→ 04/95		13.0460-5998.2 605998	AKE 21312 12,8 + WK
2.0 i	100	05/94→11/98	←	→ 04/95; + ABS		13.0460-2803.2 602803	TRW 21515 17,5 + WK
			←	→ 04/95; - ABS		13.0460-2805.2 602805	TRW 21520 17,5 + WK
<b>Zubehörsatz, Scheibenbremsbelag</b>							
1.6 i	82	05/94→11/98	←	→ 04/95		13.0460-0142.2 610142	
1.6 i	90	05/94→11/98	→	→ 04/95		13.0460-0430.2 610430	AKE
1.8 TD	65	09/93→11/98					
2.0 i	100	05/94→11/98	←	→ 04/95		13.0460-0142.2 610142	
 <b>Bremsscheibe</b>							
1.6 i	82	05/94→11/98	←	→ 04/95		24.0121-0107.1 421107	Ø 262 21 19 V
1.6 i	90	05/94→11/98	→	→ 04/95; + ABS		24.0110-0212.1 410212	Ø 238,5 10 8 + S
1.8 TD	65	09/93→11/98					
2.0 i	100	05/94→11/98	←	→ 04/95		24.0121-0107.1 421107	Ø 262 21 19 V
			→	→ 04/95		24.0110-0212.1 410212	Ø 238,5 10 8 + S











	kw			 	! #		
<b>ROVER - 600 (RH) 08/93→10/00</b>							
 <b>Bremsbelagsatz, Scheibenbremse</b>							
618 i/Si	85	03/96→02/99	←			13.0460-5955.2 605955	AKE 21879 18,6 + WK
620 i	85	08/93→06/96					
620 Sdi	77	05/94→06/99	→			13.0460-5929.2 605929	AKE 21719 15,0 + WK
620 Si	96	08/93→02/99					
620 Ti Vitesse	147	05/94→08/98					
623 Si	116	08/93→06/99					
<b>Zubehörsatz, Scheibenbremsbelag</b>							
618 i/Si	85	03/96→02/99	←			13.0460-0453.2 610453	AKE
620 i	85	08/93→06/96					
620 Sdi	77	05/94→06/99					
620 Si	96	08/93→02/99					
620 Ti Vitesse	147	05/94→08/98					
623 Si	116	08/93→06/99					
 <b>Bremsscheibe</b>							
618 i/Si	85	03/96→02/99	←			24.0123-0103.1 423103	Ø 260 23 21 V
620 Si	96	08/93→02/99	→			24.0110-0233.1 410233	Ø 260 10 8 + S
620 i	85	08/93→06/96	←	passend für Felgenreöße [Zoll]: 14		24.0123-0103.1 423103	Ø 260 23 21 V
620 Sdi	77	05/94→06/99	→			24.0110-0233.1 410233	Ø 260 10 8 + S
620 Ti Vitesse	147	05/94→08/98	→			24.0110-0233.1 410233	Ø 260 10 8 + S
623 Si	116	08/93→06/99					
<b>ROVER - 800 (XS) 10/86→02/99</b>							
 <b>Bremsbelagsatz, Scheibenbremse</b>							
820 Sport	145	04/94→03/96	→			13.0460-2800.2 602800	TRW 20087 14,6 + WK
825 Si Lux (RS)	129	04/96→02/99					
825 D/SD (XS)	87	01/90→02/99	→	01/92→		13.0460-2800.2 602800	TRW 20087 14,6 + WK
827 Si/Sterling Catalytic-Conv (XS)	124	02/88→02/99	→	09/88→		13.0460-2800.2 602800	TRW 20087 14,6 + WK
<b>Zubehörsatz, Scheibenbremsbelag</b>							
820 Sport	145	04/94→03/96	←			13.0460-0142.2 610142	
825 Si Lux (RS)	129	04/96→02/99					
825 D/SD (XS)	87	01/90→02/99	←	01/92→		13.0460-0142.2 610142	
827 Si/Sterling Catalytic-Conv (XS)	124	02/88→02/99	←	09/88→		13.0460-0142.2 610142	
 <b>Bremsscheibe</b>							
820 16V Turbo (RS)	132	01/92→02/99	←			24.0121-0100.1 421100	Ø 285 21 19 V
825 Si Lux (RS)	129	04/96→02/99	→			24.0110-0255.1 410255	Ø 260 10 8
820 I/SI (RS)	100	01/92→02/99	←			24.0121-0110.1 421110	Ø 262 21 18 V
			→			24.0110-0255.1 410255	Ø 260 10 8
820 Sport	145	04/94→03/96	→			24.0110-0255.1 410255	Ø 260 10 8
825 D/SD (XS)	87	01/90→02/99	←	01/92→		24.0121-0110.1 421110	Ø 262 21 18 V
			→			24.0110-0255.1 410255	Ø 260 10 8
827 Si/Sterling Catalytic-Conv (XS)	124	02/88→02/99	←			24.0121-0100.1 421100	Ø 285 21 19 V
			→	09/88→		24.0110-0255.1 410255	Ø 260 10 8
<b>ROVER - 800 Coupe 08/92→02/99</b>							
 <b>Bremsbelagsatz, Scheibenbremse</b>							
825 SD	87	09/93→02/99	→			13.0460-2800.2 602800	TRW 20087 14,6 + WK
825 Si (RS)	129	04/96→02/99					
827 24V (RS)	124	08/92→02/99					
<b>Zubehörsatz, Scheibenbremsbelag</b>							
825 SD	87	09/93→02/99	←			13.0460-0142.2 610142	
825 Si (RS)	129	04/96→02/99					
827 24V (RS)	124	08/92→02/99					
 <b>Bremsscheibe</b>							
820 16V	100	07/97→02/99	←			24.0121-0110.1 421110	Ø 262 21 18 V
825 SD	87	09/93→02/99	→			24.0110-0255.1 410255	Ø 260 10 8
825 Si (RS)	129	04/96→02/99	←			24.0121-0100.1 421100	Ø 285 21 19 V
827 24V (RS)	124	08/92→02/99	→			24.0110-0255.1 410255	Ø 260 10 8











	kw			 	! #		
<b>ROVER - 800 Schrägheck (XS) 10/86→02/99</b>							
 <b>Bremsbelagsatz, Scheibenbremse</b>							
820 Sport	145	04/94→03/96	➔			13.0460-2800.2 602800	TRW 20087 14,6 + WK
825 D/SD (XS)	87	01/92→02/99					
827 24V I/Sl Cat (RS)	124	01/92→02/99					
<b>Zubehörsatz, Scheibenbremsbelag</b>							
820 Sport	145	04/94→03/96	➔			13.0460-0142.2 610142	
825 D/SD (XS)	87	01/92→02/99					
827 24V I/Sl Cat (RS)	124	01/92→02/99					
 <b>Bremsscheibe</b>							
820 16V Turbo (RS)	132	11/91→02/99	➔			24.0121-0100.1 421100	Ø 285 21 19 V
827 24V I/Sl Cat (RS)	124	01/92→02/99	➔			24.0110-0255.1 410255	Ø 260 10 8
820 I/Sl (XS)	100	01/91→02/99	➔			24.0121-0110.1 421110	Ø 262 21 18 V
825 D/SD (XS)	87	01/92→02/99	➔			24.0110-0255.1 410255	Ø 260 10 8
820 Sport	145	04/94→03/96	➔			24.0110-0255.1 410255	Ø 260 10 8
<b>ROVER - COUPE 03/96→11/99</b>							
 <b>Bremsbelagsatz, Scheibenbremse</b>							
1.8 16 V	107	03/96→11/99	➔			13.0460-2803.2 602803	TRW 21515 17,5 + WK
			➔	01/97→; + ABS		13.0460-5998.2 605998	AKE 21312 12,8 + WK
<b>Zubehörsatz, Scheibenbremsbelag</b>							
1.8 16 V	107	03/96→11/99	➔			13.0460-0142.2 610142	
 <b>Bremsscheibe</b>							
1.8 16 V	107	03/96→11/99	➔			24.0121-0105.1 421105	Ø 262 21 19 V + S
			➔	01/97→; + ABS		24.0110-0212.1 410212	Ø 238,5 10 8 + S
<b>ROVER - MINI Schrägheck 01/91→11/00</b>							
 <b>Bremsbelagsatz, Scheibenbremse</b>							
1300	37	04/92→10/96	➔	→ 04/95		13.0460-6914.2 606914	AP 20038 14,0 - WE / - WK
1300	37	10/92→11/00					
1300	46	01/92→11/00					
 <b>Bremsscheibe</b>							
1300	37	04/92→10/96	➔	→ 04/95		24.0110-0239.1 410239	Ø 213,5 9,6 8,6
1300	37	10/92→11/00					
1300	46	01/92→11/00					
<b>ROVER - STREETWISE Schrägheck 08/03→05/05</b>							
 <b>Bremsbelagsatz, Scheibenbremse</b>							
1.4	62	08/03→05/05	➔			13.0460-2803.2 602803	TRW 21515 17,5 + WK
1.4	76	08/03→05/05					
1.8	86	08/03→05/05					
2.0 TD	74	08/03→05/05					
<b>Zubehörsatz, Scheibenbremsbelag</b>							
1.4	62	08/03→05/05	➔			13.0460-0142.2 610142	
1.4	76	08/03→05/05					
1.8	86	08/03→05/05					
2.0 TD	74	08/03→05/05					
 <b>Bremsscheibe</b>							
1.4	62	08/03→05/05	➔			24.0113-0198.1 413198	Ø 262 13 11
1.4	76	08/03→05/05				24.0121-0105.1 421105	Ø 262 21 19 V + S
1.8	86	08/03→05/05					
2.0 TD	74	08/03→05/05					
<b>SAAB - 9-3 (YS3D) 02/98→08/03</b>							
 <b>Bremsbelagsatz, Scheibenbremse</b>							
2.0 i	96	02/98→09/02	➔			13.0460-7173.2 607173	ATE 21829 20,3 - WK / + WK
2.0 SE Turbo	147	02/98→09/02	➔				
2.0 Turbo	110	03/99→09/02	➔			13.0460-4040.2 604040	ATE 21050 15,8 - WE / - WK
2.0 Turbo	113	10/98→09/02					
2.0 Turbo	136	02/98→09/02					
2.0 Turbo	151	10/99→09/02					
2.2 TiD	85	02/98→11/00					
2.2 TiD	92	11/00→09/02					
2.3	169	09/99→01/02					
2.3 i	110	02/98→09/02					

	kW			 	! #		
<b>SAAB - 9-3 (YS3D) 02/98→08/03</b>							
 <b>Bremsbelagsatz, Scheibenbremse</b>							
2.3 Turbo	165	10/98→09/02	←			<b>13.0460-7173.2 607173</b>	ATE 21829 20,3 - WK / + WK
			→			<b>13.0460-4040.2 604040</b>	ATE 21050 15,8 - WE / - WK
<b>Warnkontakt, Bremsbelagverschleiß</b>							
2.0 i	96	02/98→09/02	←		2	<b>24.8190-0718.2 620718</b>	L= 720
2.0 SE Turbo	147	02/98→09/02					
2.0 Turbo	110	03/99→09/02					
2.0 Turbo	113	10/98→09/02					
2.0 Turbo	136	02/98→09/02					
2.0 Turbo	151	10/99→09/02					
2.2 TiD	85	02/98→11/00					
2.2 TiD	92	11/00→09/02					
2.3	169	09/99→01/02					
2.3 i	110	02/98→09/02					
2.3 Turbo	165	10/98→09/02					
<b>Zubehörsatz, Scheibenbremsbelag</b>							
2.0 i	96	02/98→09/02	→			<b>13.0460-0347.2 610347</b>	
2.0 SE Turbo	147	02/98→09/02					
2.0 Turbo	110	03/99→09/02					
2.0 Turbo	113	10/98→09/02					
2.0 Turbo	136	02/98→09/02					
2.0 Turbo	151	10/99→09/02					
2.2 TiD	85	02/98→11/00					
2.2 TiD	92	11/00→09/02					
2.3	169	09/99→01/02					
2.3 i	110	02/98→09/02					
2.3 Turbo	165	10/98→09/02					
 <b>Bremsscheibe</b>							
2.0 i	96	02/98→09/02	←			<b>24.0125-0119.1 425119</b>	Ø 288 25 22 V + S
2.0 SE Turbo	147	02/98→09/02				<b>24.0325-0119.1 525119</b>	Ø 288 25 22 V + S
2.0 Turbo	110	03/99→09/02					
2.0 Turbo	113	10/98→09/02	→			<b>24.0110-0226.1 410226</b>	Ø 286 10 8 + S
2.0 Turbo	136	02/98→09/02				<b>24.0310-0226.1 510226</b>	Ø 286 10 8 + S
2.0 Turbo	151	10/99→09/02					
2.2 TiD	85	02/98→11/00					
2.2 TiD	92	11/00→09/02					
2.3 i	110	02/98→09/02					
<b>SAAB - 9-3 (YS3F) 09/02→02/15</b>							
 <b>Bremsbelagsatz, Scheibenbremse</b>							
1,8t	110	09/02→02/15	←	→ 12/05; passend für Felgengröße [Zoll]: 16; für Bremssattel mit Kunststoffkolben		<b>13.0460-7172.2 607172</b> <b>13.0470-7172.2 LD7172</b>	ATE 23378 20,1 + WE / - WK ATE 23378 20,1 + WE / - WK Ceramic
			←	→ 12/05; passend für Felgengröße [Zoll]: 15; für Bremssattel mit Kunststoffkolben		<b>13.0460-7172.2 607172</b> <b>13.0470-7172.2 LD7172</b>	ATE 23378 20,1 + WE / - WK ATE 23378 20,1 + WE / - WK Ceramic
			←	→ 12/05; passend für Felgengröße [Zoll]: 16; für Bremssattel mit Stahlkolben		<b>13.0460-7212.2 607212</b>	ATE 23738 20,1 + WE / - WK
			←	→ 12/05; passend für Felgengröße [Zoll]: 15; für Bremssattel mit Stahlkolben		<b>13.0460-7212.2 607212</b>	ATE 23738 20,1 + WE / - WK
			→	→ 76001222		<b>13.0460-7194.2 607194</b> <b>13.0470-7194.2 LD7194</b>	ATE 23482 16,6 - WE / - WK ATE 23482 16,6 - WE / - WK Ceramic
			→	76001223→; → 06/12		<b>13.0460-7195.2 607195</b> <b>13.0470-7195.2 LD7195</b>	ATE 23482 16,6 - WE / - WK ATE 23482 16,6 - WE / - WK Ceramic
1,8t BioPower	110	01/07→02/15	←	→ 12/08; passend für Felgengröße [Zoll]: 16; für Bremssattel mit Kunststoffkolben		<b>13.0460-7172.2 607172</b> <b>13.0470-7172.2 LD7172</b>	ATE 23378 20,1 + WE / - WK ATE 23378 20,1 + WE / - WK Ceramic
1.9 TTiD	96	12/07→02/15					
1.9 TTiD	118	12/07→02/15					
1.9 TTiD	132	12/07→02/15					
2.0 t	120	01/07→02/15	←	→ 12/08; passend für Felgengröße [Zoll]: 16		<b>13.0460-7199.2 607199</b>	ATE 23404 20,6 + WE / - WK
2.0 t	154	09/02→02/15					
2.0 t BioPower	129	01/07→02/15	←	01/09→ 06/12; passend für Felgengröße [Zoll]: 17		<b>13.0460-7204.2 607204</b> <b>13.0470-7204.2 LD7204</b>	ATE 23801 18,8 - WE / - WK ATE 23801 18,8 - WE / - WK Ceramic
2.0 t BioPower	145	06/07→02/15					
2.0 t Bio Power	120	01/07→02/15					
2.0 t BioPower XWD	120	01/08→02/15					
2.0 t BioPower XWD	154	01/08→02/15	←	→ 12/08; passend für Felgengröße [Zoll]: 16; für Bremssattel mit Stahlkolben		<b>13.0460-7212.2 607212</b>	ATE 23738 20,1 + WE / - WK
2.0 t BioPower XWD	162	01/08→02/15					
2.0 Turbo XWD	154	01/08→02/15					
2.0 t XWD	120	01/07→02/15	→	→ 76001222		<b>13.0460-7194.2 607194</b> <b>13.0470-7194.2 LD7194</b>	ATE 23482 16,6 - WE / - WK ATE 23482 16,6 - WE / - WK Ceramic
2.0 t XWD	162	01/08→02/15					
2.8 Turbo V6	184	03/05→02/15					
2.8 Turbo V6	203	04/08→02/15					





















	kw			 	! #		
<b>SAAB - 9-3 (YS3F) 09/02→02/15</b>							
<b> Bremsbelagsatz, Scheibenbremse</b>							
2.8 Turbo V6 2.8 Turbo V6 XWD	206 206	05/08→02/15 05/08→02/15	➔	76001223→; → 06/12		<b>13.0460-7195.2 607195</b> <b>13.0470-7195.2 LD7195</b>	ATE 23482 16,6 - WE / - WK ATE 23482 16,6 - WE / - WK Ceramic
1.8 i	90	01/04→02/15	➔	→ 12/08; passend für Felgengröße [Zoll]: 16; für Bremssattel mit Kunststoffkolben		<b>13.0460-7172.2 607172</b> <b>13.0470-7172.2 LD7172</b>	ATE 23378 20,1 + WE / - WK ATE 23378 20,1 + WE / - WK Ceramic
			➔	01/06→ 12/08; passend für Felgengröße [Zoll]: 16; für Bremssattel mit Kunststoffkolben		<b>13.0460-7172.2 607172</b> <b>13.0470-7172.2 LD7172</b>	ATE 23378 20,1 + WE / - WK ATE 23378 20,1 + WE / - WK Ceramic
			➔	03/04→ 12/05; passend für Felgengröße [Zoll]: 15; für Bremssattel mit Kunststoffkolben		<b>13.0460-7172.2 607172</b> <b>13.0470-7172.2 LD7172</b>	ATE 23378 20,1 + WE / - WK ATE 23378 20,1 + WE / - WK Ceramic
			➔	03/04→ 12/05; passend für Felgengröße [Zoll]: 16; für Bremssattel mit Kunststoffkolben		<b>13.0460-7172.2 607172</b> <b>13.0470-7172.2 LD7172</b>	ATE 23378 20,1 + WE / - WK ATE 23378 20,1 + WE / - WK Ceramic
			➔	→ 12/08; passend für Felgengröße [Zoll]: 16		<b>13.0460-7199.2 607199</b>	ATE 23404 20,6 + WE / - WK
			➔	01/06→ 12/08; passend für Felgengröße [Zoll]: 16		<b>13.0460-7199.2 607199</b>	ATE 23404 20,6 + WE / - WK
			➔	01/09→ 06/12; passend für Felgengröße [Zoll]: 17		<b>13.0460-7204.2 607204</b> <b>13.0470-7204.2 LD7204</b>	ATE 23801 18,8 - WE / - WK ATE 23801 18,8 - WE / - WK Ceramic
			➔	→ 12/08; passend für Felgengröße [Zoll]: 16; für Bremssattel mit Stahlkolben		<b>13.0460-7212.2 607212</b>	ATE 23738 20,1 + WE / - WK
			➔	01/06→ 12/08; passend für Felgengröße [Zoll]: 16; für Bremssattel mit Stahlkolben		<b>13.0460-7212.2 607212</b>	ATE 23738 20,1 + WE / - WK
			➔	03/04→ 12/05; passend für Felgengröße [Zoll]: 16; für Bremssattel mit Stahlkolben		<b>13.0460-7212.2 607212</b>	ATE 23738 20,1 + WE / - WK
			➔	03/04→ 12/05; passend für Felgengröße [Zoll]: 15; für Bremssattel mit Stahlkolben		<b>13.0460-7212.2 607212</b>	ATE 23738 20,1 + WE / - WK
			➔	03/04→; → 76001222		<b>13.0460-7194.2 607194</b> <b>13.0470-7194.2 LD7194</b>	ATE 23482 16,6 - WE / - WK ATE 23482 16,6 - WE / - WK Ceramic
			➔	76001223→; → 06/12		<b>13.0460-7195.2 607195</b> <b>13.0470-7195.2 LD7195</b>	ATE 23482 16,6 - WE / - WK ATE 23482 16,6 - WE / - WK Ceramic
			1.9 TiD 1.9 TiD 2.0 t 2.2 TiD	88 110 129 92	09/04→02/15 09/04→02/15 09/02→02/15 09/02→02/15	➔	→ 12/05; passend für Felgengröße [Zoll]: 16; für Bremssattel mit Kunststoffkolben
➔	→ 12/05; passend für Felgengröße [Zoll]: 15; für Bremssattel mit Kunststoffkolben					<b>13.0460-7172.2 607172</b> <b>13.0470-7172.2 LD7172</b>	ATE 23378 20,1 + WE / - WK ATE 23378 20,1 + WE / - WK Ceramic
➔	01/06→ 12/08; passend für Felgengröße [Zoll]: 16; für Bremssattel mit Kunststoffkolben					<b>13.0460-7172.2 607172</b> <b>13.0470-7172.2 LD7172</b>	ATE 23378 20,1 + WE / - WK ATE 23378 20,1 + WE / - WK Ceramic
➔	→ 12/08; passend für Felgengröße [Zoll]: 16; für Bremssattel mit Kunststoffkolben					<b>13.0460-7172.2 607172</b> <b>13.0470-7172.2 LD7172</b>	ATE 23378 20,1 + WE / - WK ATE 23378 20,1 + WE / - WK Ceramic
➔	→ 12/08; passend für Felgengröße [Zoll]: 16					<b>13.0460-7199.2 607199</b>	ATE 23404 20,6 + WE / - WK
➔	01/06→ 12/08; passend für Felgengröße [Zoll]: 16					<b>13.0460-7199.2 607199</b>	ATE 23404 20,6 + WE / - WK
➔	01/09→ 06/12; passend für Felgengröße [Zoll]: 17					<b>13.0460-7204.2 607204</b> <b>13.0470-7204.2 LD7204</b>	ATE 23801 18,8 - WE / - WK ATE 23801 18,8 - WE / - WK Ceramic
➔	→ 12/05; passend für Felgengröße [Zoll]: 16; für Bremssattel mit Stahlkolben					<b>13.0460-7212.2 607212</b>	ATE 23738 20,1 + WE / - WK
➔	→ 12/05; passend für Felgengröße [Zoll]: 15; für Bremssattel mit Stahlkolben					<b>13.0460-7212.2 607212</b>	ATE 23738 20,1 + WE / - WK
➔	→ 12/08; passend für Felgengröße [Zoll]: 16; für Bremssattel mit Stahlkolben					<b>13.0460-7212.2 607212</b>	ATE 23738 20,1 + WE / - WK
➔	01/06→ 12/08; passend für Felgengröße [Zoll]: 16; für Bremssattel mit Stahlkolben					<b>13.0460-7212.2 607212</b>	ATE 23738 20,1 + WE / - WK











	kw			 	! #		
<b>SAAB - 9-3 (YS3F) 09/02→02/15</b>							
<b> Bremsbelagsatz, Scheibenbremse</b>							
1.9 TiD 1.9 TiD 2.0 t 2.2 TiD	88 110 129 92	09/04→02/15 09/04→02/15 09/02→02/15 09/02→02/15	→ → → →	→ 76001222  76001223→; → 06/12		<b>13.0460-7194.2 607194</b> <b>13.0470-7194.2 LD7194</b> <b>13.0460-7195.2 607195</b> <b>13.0470-7195.2 LD7195</b>	ATE 23482 16,6 - WE / - WK ATE 23482 16,6 - WE / - WK Ceramic ATE 23482 16,6 - WE / - WK ATE 23482 16,6 - WE / - WK Ceramic
2.0 t 2.0 t 2.0 t XWD	162 177 177	01/11→02/15 05/09→02/15 05/09→02/15	← → →	→ 06/12; passend für Felgenreöße [Zoll]: 17  → 76001222  76001223→; → 06/12		<b>13.0460-7204.2 607204</b> <b>13.0470-7204.2 LD7204</b> <b>13.0460-7194.2 607194</b> <b>13.0470-7194.2 LD7194</b> <b>13.0460-7195.2 607195</b> <b>13.0470-7195.2 LD7195</b>	ATE 23801 18,8 - WE / - WK ATE 23801 18,8 - WE / - WK Ceramic ATE 23482 16,6 - WE / - WK ATE 23482 16,6 - WE / - WK Ceramic ATE 23482 16,6 - WE / - WK ATE 23482 16,6 - WE / - WK Ceramic
2.0 Turbo Performance	185	04/04→02/15	← ← ← ← ← ← → →	→ 12/08; passend für Felgenreöße [Zoll]: 16; für Bremssattel mit Kunststoffkolben  → 12/05; passend für Felgenreöße [Zoll]: 15; für Bremssattel mit Kunststoffkolben  → 12/08; passend für Felgenreöße [Zoll]: 16  01/09→ 06/12; passend für Felgenreöße [Zoll]: 17  → 12/08; passend für Felgenreöße [Zoll]: 16; für Bremssattel mit Stahlkolben  → 12/05; passend für Felgenreöße [Zoll]: 15; für Bremssattel mit Stahlkolben  → 76001222  76001223→; → 06/12		<b>13.0460-7172.2 607172</b> <b>13.0470-7172.2 LD7172</b> <b>13.0460-7172.2 607172</b> <b>13.0470-7172.2 LD7172</b> <b>13.0460-7199.2 607199</b> <b>13.0460-7204.2 607204</b> <b>13.0470-7204.2 LD7204</b> <b>13.0460-7212.2 607212</b> <b>13.0460-7212.2 607212</b> <b>13.0460-7194.2 607194</b> <b>13.0470-7194.2 LD7194</b> <b>13.0460-7195.2 607195</b> <b>13.0470-7195.2 LD7195</b>	ATE 23378 20,1 + WE / - WK ATE 23378 20,1 + WE / - WK Ceramic ATE 23378 20,1 + WE / - WK ATE 23378 20,1 + WE / - WK Ceramic ATE 23404 20,6 + WE / - WK ATE 23801 18,8 - WE / - WK ATE 23801 18,8 - WE / - WK Ceramic ATE 23738 20,1 + WE / - WK ATE 23738 20,1 + WE / - WK ATE 23482 16,6 - WE / - WK ATE 23482 16,6 - WE / - WK Ceramic ATE 23482 16,6 - WE / - WK ATE 23482 16,6 - WE / - WK Ceramic
2.8 Turbo V6 2.8 Turbo V6	169 188	03/05→02/15 12/07→02/15	← ← ← ← → →	04/08→ 12/08; passend für Felgenreöße [Zoll]: 16; für Bremssattel mit Kunststoffkolben  04/08→ 12/08; passend für Felgenreöße [Zoll]: 16  01/09→ 06/12; passend für Felgenreöße [Zoll]: 17  04/08→ 12/08; passend für Felgenreöße [Zoll]: 16; für Bremssattel mit Stahlkolben  04/08→; → 76001222  76001223→; → 06/12		<b>13.0460-7172.2 607172</b> <b>13.0470-7172.2 LD7172</b> <b>13.0460-7199.2 607199</b> <b>13.0460-7204.2 607204</b> <b>13.0470-7204.2 LD7204</b> <b>13.0460-7212.2 607212</b> <b>13.0460-7194.2 607194</b> <b>13.0470-7194.2 LD7194</b> <b>13.0460-7195.2 607195</b> <b>13.0470-7195.2 LD7195</b>	ATE 23378 20,1 + WE / - WK ATE 23378 20,1 + WE / - WK Ceramic ATE 23404 20,6 + WE / - WK ATE 23801 18,8 - WE / - WK ATE 23801 18,8 - WE / - WK Ceramic ATE 23738 20,1 + WE / - WK ATE 23482 16,6 - WE / - WK ATE 23482 16,6 - WE / - WK Ceramic ATE 23482 16,6 - WE / - WK ATE 23482 16,6 - WE / - WK Ceramic
<b> Bremsscheibe</b>							
1,8t	110	09/02→02/15	← → → →	→ 06/12; passend für Felgenreöße [Zoll]: 15  → 06/12; passend für Felgenreöße [Zoll]: 15  → 06/12; passend für Felgenreöße [Zoll]: 16		<b>24.0125-0141.1 425141</b> <b>24.0325-0141.1 525141</b> <b>24.0112-0157.1 412157</b> <b>24.0312-0157.1 512157</b> <b>24.0120-0173.1 420173</b> <b>24.0320-0173.1 520173</b>	Ø 285 24,9 22 V + S Ø 285 24,9 22 V + S Ø 278 11,9 10 + S Ø 278 11,9 10 + S Ø 292 19,9 18 V + S Ø 292 19,9 18 V + S
1,8t BioPower 1.9 TiD 1.9 TiD 1.9 TTiD 1.9 TTiD 1.9 TTiD 2.0 t BioPower	110 88 110 96 118 132 129	01/07→02/15 09/04→02/15 09/04→02/15 12/07→02/15 12/07→02/15 12/07→02/15 01/07→02/15	← ← ← ← ← ←	→ 06/12; passend für Felgenreöße [Zoll]: 15  → 06/12; passend für Felgenreöße [Zoll]: 15  → 06/12; passend für Felgenreöße [Zoll]: 17		<b>24.0125-0141.1 425141</b> <b>24.0325-0141.1 525141</b> <b>24.0130-0189.1 430189</b>	Ø 285 24,9 22 V + S Ø 285 24,9 22 V + S Ø 345 29,9 27,5 V



















	kw			 	! #			
<b>SAAB - 9-3 (YS3F) 09/02→02/15</b>								
<b>Bremsscheibe</b>								
2.0 t BioPower 2.0 t Bio Power 2.2 TiD	145	06/07→02/15	→	→ 06/12;		24.0112-0157.1 412157	Ø 278 11,9 10 + S	
	120	01/07→02/15		passend für Felgengröße [Zoll]: 15		24.0312-0157.1 512157	Ø 278 11,9 10 + S	
	92	09/02→02/15	→	→ 06/12;		24.0120-0173.1 420173	Ø 292 19,9 18 V + S	
				passend für Felgengröße [Zoll]: 16		24.0320-0173.1 520173	Ø 292 19,9 18 V + S	
1.8 i	90	01/04→02/15	←	03/04→ 06/12;		24.0125-0141.1 425141	Ø 285 24,9 22 V + S	
				passend für Felgengröße [Zoll]: 15		24.0325-0141.1 525141	Ø 285 24,9 22 V + S	
			←	03/04→ 06/12;		24.0130-0189.1 430189	Ø 345 29,9 27,5 V	
				passend für Felgengröße [Zoll]: 17				
			→	03/04→ 06/12;		24.0112-0157.1 412157	Ø 278 11,9 10 + S	
			passend für Felgengröße [Zoll]: 15		24.0312-0157.1 512157	Ø 278 11,9 10 + S		
			→	03/04→ 06/12;		24.0120-0173.1 420173	Ø 292 19,9 18 V + S	
				passend für Felgengröße [Zoll]: 16		24.0320-0173.1 520173	Ø 292 19,9 18 V + S	
2.0 t 2.0 t	120	01/07→02/15	←	→ 06/12;		24.0130-0189.1 430189	Ø 345 29,9 27,5 V	
	162	01/11→02/15	→	→ 06/12;		24.0112-0157.1 412157	Ø 278 11,9 10 + S	
				passend für Felgengröße [Zoll]: 15		24.0312-0157.1 512157	Ø 278 11,9 10 + S	
			→	06/12;		24.0120-0173.1 420173	Ø 292 19,9 18 V + S	
				passend für Felgengröße [Zoll]: 16		24.0320-0173.1 520173	Ø 292 19,9 18 V + S	
2.0 t 2.0 t 2.0 Turbo Performance	129	09/02→02/15	←	→ 06/12;		24.0125-0141.1 425141	Ø 285 24,9 22 V + S	
	177	05/09→02/15		passend für Felgengröße [Zoll]: 15		24.0325-0141.1 525141	Ø 285 24,9 22 V + S	
	185	04/04→02/15	←	→ 06/12;		24.0128-0164.1 428164	Ø 314 28 25 V + S	
				passend für Felgengröße [Zoll]: 16				
				←	→ 06/12;		24.0130-0189.1 430189	Ø 345 29,9 27,5 V
					passend für Felgengröße [Zoll]: 17			
			→	06/12;		24.0112-0157.1 412157	Ø 278 11,9 10 + S	
				passend für Felgengröße [Zoll]: 15		24.0312-0157.1 512157	Ø 278 11,9 10 + S	
			→	06/12;		24.0120-0173.1 420173	Ø 292 19,9 18 V + S	
				passend für Felgengröße [Zoll]: 16		24.0320-0173.1 520173	Ø 292 19,9 18 V + S	
2.0 t 2.8 Turbo V6	154	09/02→02/15	←	→ 12/05;		24.0128-0137.1 428137	Ø 302 28 25 V + S	
	184	03/05→02/15		passend für Felgengröße [Zoll]: 16		24.0328-0137.1 528137	Ø 302 28 25 V + S	
			←	nicht für USA; → 06/12;		24.0128-0164.1 428164	Ø 314 28 25 V + S	
				passend für Felgengröße [Zoll]: 16				
			←	01/06→; für USA; → 06/12;		24.0128-0164.1 428164	Ø 314 28 25 V + S	
				passend für Felgengröße [Zoll]: 16				
			←	→ 06/12;		24.0130-0189.1 430189	Ø 345 29,9 27,5 V	
				passend für Felgengröße [Zoll]: 17				
			→	06/12;		24.0112-0157.1 412157	Ø 278 11,9 10 + S	
				passend für Felgengröße [Zoll]: 15		24.0312-0157.1 512157	Ø 278 11,9 10 + S	
			→	06/12;		24.0120-0173.1 420173	Ø 292 19,9 18 V + S	
				passend für Felgengröße [Zoll]: 16		24.0320-0173.1 520173	Ø 292 19,9 18 V + S	
2.0 t BioPower XWD 2.0 t BioPower XWD 2.0 t XWD 2.0 t XWD 2.0 t XWD 2.0 t XWD 2.8 Turbo V6 XWD	120	01/08→02/15	←	→ 06/12;		24.0128-0164.1 428164	Ø 314 28 25 V + S	
	154	01/08→02/15		passend für Felgengröße [Zoll]: 16				
	162	01/08→02/15	←	→ 06/12;		24.0130-0189.1 430189	Ø 345 29,9 27,5 V	
	120	01/07→02/15		passend für Felgengröße [Zoll]: 17				
	162	01/08→02/15	→	→ 06/12;		24.0120-0239.1 420239	Ø 292 20 18 V	
	177	05/09→02/15		passend für Felgengröße [Zoll]: 16				
	206	05/08→02/15						
2.0 Turbo XWD	154	01/08→02/15	←	→ 06/12;		24.0128-0164.1 428164	Ø 314 28 25 V + S	
				passend für Felgengröße [Zoll]: 16				
			→	→ 06/12;		24.0112-0157.1 412157	Ø 278 11,9 10 + S	
				passend für Felgengröße [Zoll]: 15		24.0312-0157.1 512157	Ø 278 11,9 10 + S	
			→	06/12;		24.0120-0173.1 420173	Ø 292 19,9 18 V + S	
			passend für Felgengröße [Zoll]: 16		24.0320-0173.1 520173	Ø 292 19,9 18 V + S		
			→	06/12;		24.0130-0189.1 430189	Ø 345 29,9 27,5 V	
				passend für Felgengröße [Zoll]: 17				
2.8 Turbo V6 2.8 Turbo V6	169	03/05→02/15	←	04/08→ 06/12;		24.0128-0164.1 428164	Ø 314 28 25 V + S	
	188	12/07→02/15		passend für Felgengröße [Zoll]: 16				
			←	04/08→ 06/12;		24.0130-0189.1 430189	Ø 345 29,9 27,5 V	
				passend für Felgengröße [Zoll]: 17				
			→	04/08→ 06/12;		24.0112-0157.1 412157	Ø 278 11,9 10 + S	
				passend für Felgengröße [Zoll]: 15		24.0312-0157.1 512157	Ø 278 11,9 10 + S	
			→	04/08→ 06/12;		24.0120-0173.1 420173	Ø 292 19,9 18 V + S	
				passend für Felgengröße [Zoll]: 16		24.0320-0173.1 520173	Ø 292 19,9 18 V + S	
2.8 Turbo V6	203	04/08→02/15	←	→ 06/12;		24.0128-0164.1 428164	Ø 314 28 25 V + S	
				passend für Felgengröße [Zoll]: 16				
			←	→ 06/12;		24.0130-0189.1 430189	Ø 345 29,9 27,5 V	
				passend für Felgengröße [Zoll]: 17				
↓								

	kw			 	! #		
<b>SAAB - 9-3 (YS3F) 09/02→02/15</b>							
 <b>Bremsscheibe</b>							
2.8 Turbo V6	203	04/08→02/15	➔	→ 06/12; passend für Felgengröße [Zoll]: 15		24.0112-0157.1 412157 24.0312-0157.1 512157	Ø 278 11,9 10 + S Ø 278 11,9 10 + S
			➔	→ 06/12; passend für Felgengröße [Zoll]: 16		24.0120-0173.1 420173 24.0320-0173.1 520173	Ø 292 19,9 18 V + S Ø 292 19,9 18 V + S
2.8 Turbo V6	206	05/08→02/15	➔	→ 06/12; passend für Felgengröße [Zoll]: 16		24.0128-0164.1 428164	Ø 314 28 25 V + S
			➔	→ 06/12; passend für Felgengröße [Zoll]: 17		24.0130-0189.1 430189	Ø 345 29,9 27,5 V
			➔	→ 06/12; passend für Felgengröße [Zoll]: 15		24.0112-0157.1 412157 24.0312-0157.1 512157	Ø 278 11,9 10 + S Ø 278 11,9 10 + S
			➔	→ 06/12; passend für Felgengröße [Zoll]: 16		24.0120-0173.1 420173 24.0120-0239.1 420239	Ø 292 19,9 18 V + S Ø 292 20 18 V
			➔			24.0320-0173.1 520173	Ø 292 19,9 18 V + S
<b>SAAB - 9-3 Cabriolet (YS3D) 02/98→08/03</b>							
 <b>Bremsbelagsatz, Scheibenbremse</b>							
2.0 i	96	02/98→08/03	➔	09/02→07/03; für Bremssattel mit Kunststoffkolben		13.0460-7172.2 607172 13.0470-7172.2 LD7172	ATE 23378 20,1 + WE / - WK ATE 23378 20,1 + WE / - WK Ceramic
2.0 SE Turbo	147	02/98→08/03	➔				
2.0 Turbo	110	01/01→08/03	➔				
2.0 Turbo	113	10/98→08/03	➔				
2.0 Turbo	136	02/98→08/03	➔	→ 08/02		13.0460-7173.2 607173	ATE 21829 20,3 - WK / + WK
2.0 Turbo	151	10/99→08/03	➔	09/02→07/03; für Bremssattel mit Stahlkolben		13.0460-7212.2 607212	ATE 23738 20,1 + WE / - WK
2.3 i	110	02/98→08/03	➔				
2.3 Turbo	165	10/99→08/03	➔	→ 08/02		13.0460-4040.2 604040	ATE 21050 15,8 - WE / - WK
			➔	09/02→07/03		13.0460-7194.2 607194 13.0470-7194.2 LD7194	ATE 23482 16,6 - WE / - WK ATE 23482 16,6 - WE / - WK Ceramic
2.3	169	09/99→01/02	➔	10/99→		13.0460-7173.2 607173	ATE 21829 20,3 - WK / + WK
			➔	10/99→		13.0460-4040.2 604040	ATE 21050 15,8 - WE / - WK
<b>Warnkontakt, Bremsbelagverschleiß</b>							
2.0 i	96	02/98→08/03	➔	→ 08/02	2	24.8190-0718.2 620718	L= 720
2.0 SE Turbo	147	02/98→08/03	➔				
2.0 Turbo	110	01/01→08/03	➔				
2.0 Turbo	113	10/98→08/03	➔				
2.0 Turbo	136	02/98→08/03	➔				
2.0 Turbo	151	10/99→08/03	➔				
2.3 i	110	02/98→08/03	➔				
2.3 Turbo	165	10/99→08/03	➔				
2.3	169	09/99→01/02	➔	10/99→	2	24.8190-0718.2 620718	L= 720
<b>Zubehörsatz, Scheibenbremsbelag</b>							
2.0 i	96	02/98→08/03	➔	→ 08/02		13.0460-0347.2 610347	
2.0 SE Turbo	147	02/98→08/03	➔				
2.0 Turbo	110	01/01→08/03	➔				
2.0 Turbo	113	10/98→08/03	➔				
2.0 Turbo	136	02/98→08/03	➔				
2.0 Turbo	151	10/99→08/03	➔				
2.3 i	110	02/98→08/03	➔				
2.3 Turbo	165	10/99→08/03	➔				
2.3	169	09/99→01/02	➔	10/99→		13.0460-0347.2 610347	
 <b>Bremsscheibe</b>							
2.0 i	96	02/98→08/03	➔	→ 07/03		24.0125-0119.1 425119 24.0325-0119.1 525119	Ø 288 25 22 V + S Ø 288 25 22 V + S
2.0 SE Turbo	147	02/98→08/03	➔				
2.0 Turbo	110	01/01→08/03	➔				
2.0 Turbo	113	10/98→08/03	➔	→ 07/03		24.0110-0226.1 410226 24.0310-0226.1 510226	Ø 286 10 8 + S Ø 286 10 8 + S
2.0 Turbo	136	02/98→08/03	➔				
2.0 Turbo	151	10/99→08/03	➔				
2.3 i	110	02/98→08/03	➔				
<b>SAAB - 9-3 Cabriolet (YS3F) 08/03→02/15</b>							
 <b>Bremsbelagsatz, Scheibenbremse</b>							
1,8t	110	08/03→02/15	➔	→ 06/12; passend für Felgengröße [Zoll]: 15 / 16; für Bremssattel mit Kunststoffkolben		13.0460-7172.2 607172 13.0470-7172.2 LD7172	ATE 23378 20,1 + WE / - WK ATE 23378 20,1 + WE / - WK Ceramic
1,8t BioPower	110	01/07→02/15	➔				
1.8 i	90	01/04→02/15	➔				
1.9 TiD	88	09/04→02/15	➔				
1.9 TiD	110	01/06→02/15	➔	→ 06/12; passend für Felgengröße [Zoll]: 15 / 16; für Bremssattel mit Stahlkolben		13.0460-7212.2 607212	ATE 23738 20,1 + WE / - WK
1.9 TTI	96	12/07→02/15	➔				
1.9 TTI	118	12/07→02/15	➔				
1.9 TTI	132	12/07→02/15	➔				
2.0 t	120	01/11→02/15	➔	→ 76001222		13.0460-7194.2 607194	ATE 23482 16,6 - WE / - WK











	kw			 	! #		
<b>SAAB - 9-3 Cabriolet (YS3F) 08/03→02/15</b>							
<b> Bremsbelagsatz, Scheibenbremse</b>							
2.0 t	129	08/03→02/15	➡	→ 76001222		13.0470-7194.2 LD7194	ATE 23482 16,6 - WE / - WK Ceramic
2.0 t	162	01/11→02/15					
2.0 t BioPower	120	01/11→02/15					
2.0 t BioPower	129	01/07→02/15	➡	76001223→; → 06/12		13.0460-7195.2 607195	ATE 23482 16,6 - WE / - WK Ceramic
2.0 t BioPower	162	01/11→02/15				13.0470-7195.2 LD7195	ATE 23482 16,6 - WE / - WK Ceramic
1,8t BioPower	129	01/07→02/15	⬅	07/07→ 06/12; passend für Felgengröße [Zoll]: 15 / 16; für Bremssattel mit Kunststoffkolben		13.0460-7172.2 607172	ATE 23378 20,1 + WE / - WK Ceramic
2.0 t BioPower	147	06/07→02/15				13.0470-7172.2 LD7172	ATE 23378 20,1 + WE / - WK Ceramic
			⬅	07/07→ 06/12; passend für Felgengröße [Zoll]: 15 / 16; für Bremssattel mit Stahlkolben		13.0460-7212.2 607212	ATE 23738 20,1 + WE / - WK Ceramic
			➡	07/07→; → 76001222		13.0460-7194.2 607194	ATE 23482 16,6 - WE / - WK Ceramic
			➡	76001223→; → 06/12		13.0460-7194.2 LD7194	ATE 23482 16,6 - WE / - WK Ceramic
			➡	76001223→; → 06/12		13.0460-7195.2 607195	ATE 23482 16,6 - WE / - WK Ceramic
			➡	76001223→; → 06/12		13.0470-7195.2 LD7195	ATE 23482 16,6 - WE / - WK Ceramic
2.0	143	04/06→09/07	⬅	passend für Felgengröße [Zoll]: 15 / 16; für Bremssattel mit Kunststoffkolben		13.0460-7172.2 607172	ATE 23378 20,1 + WE / - WK Ceramic
						13.0470-7172.2 LD7172	ATE 23378 20,1 + WE / - WK Ceramic
			⬅	passend für Felgengröße [Zoll]: 15 / 16; für Bremssattel mit Stahlkolben		13.0460-7212.2 607212	ATE 23738 20,1 + WE / - WK Ceramic
			➡	→ 76001222		13.0460-7194.2 607194	ATE 23482 16,6 - WE / - WK Ceramic
						13.0470-7194.2 LD7194	ATE 23482 16,6 - WE / - WK Ceramic
			➡	76001223→		13.0460-7195.2 607195	ATE 23482 16,6 - WE / - WK Ceramic
			➡	76001223→		13.0470-7195.2 LD7195	ATE 23482 16,6 - WE / - WK Ceramic
2.0 t	154	08/03→02/15	⬅	→ 06/12; passend für Felgengröße [Zoll]: 15 / 16; für Bremssattel mit Kunststoffkolben		13.0460-7172.2 607172	ATE 23378 20,1 + WE / - WK Ceramic
2.0 Turbo Performance	185	04/04→02/15				13.0470-7172.2 LD7172	ATE 23378 20,1 + WE / - WK Ceramic
			⬅	→ 06/12; passend für Felgengröße [Zoll]: 16; für Bremssattel mit Kunststoffkolben		13.0460-7172.2 607172	ATE 23378 20,1 + WE / - WK Ceramic
						13.0470-7172.2 LD7172	ATE 23378 20,1 + WE / - WK Ceramic
			⬅	→ 12/08; passend für Felgengröße [Zoll]: 16; + 16" plus Rad		13.0460-7199.2 607199	ATE 23404 20,6 + WE / - WK Ceramic
			⬅	01/09→ 06/12; passend für Felgengröße [Zoll]: 17		13.0460-7204.2 607204	ATE 23801 18,8 - WE / - WK Ceramic
						13.0470-7204.2 LD7204	ATE 23801 18,8 - WE / - WK Ceramic
			⬅	→ 06/12; passend für Felgengröße [Zoll]: 15 / 16; für Bremssattel mit Stahlkolben		13.0460-7212.2 607212	ATE 23738 20,1 + WE / - WK Ceramic
			⬅	→ 06/12; passend für Felgengröße [Zoll]: 16; für Bremssattel mit Stahlkolben		13.0460-7212.2 607212	ATE 23738 20,1 + WE / - WK Ceramic
			➡	→ 76001222		13.0460-7194.2 607194	ATE 23482 16,6 - WE / - WK Ceramic
						13.0470-7194.2 LD7194	ATE 23482 16,6 - WE / - WK Ceramic
			➡	76001223→; → 06/12		13.0460-7195.2 607195	ATE 23482 16,6 - WE / - WK Ceramic
						13.0470-7195.2 LD7195	ATE 23482 16,6 - WE / - WK Ceramic
2.8 Turbo V6	169	02/06→02/15	⬅	06/08→ 12/08; passend für Felgengröße [Zoll]: 16; + 16" plus Rad		13.0460-7199.2 607199	ATE 23404 20,6 + WE / - WK Ceramic
			⬅	01/09→ 06/12; passend für Felgengröße [Zoll]: 17		13.0460-7204.2 607204	ATE 23801 18,8 - WE / - WK Ceramic
						13.0470-7204.2 LD7204	ATE 23801 18,8 - WE / - WK Ceramic
			➡	06/08→; → 76001222		13.0460-7194.2 607194	ATE 23482 16,6 - WE / - WK Ceramic
						13.0470-7194.2 LD7194	ATE 23482 16,6 - WE / - WK Ceramic
			➡	76001223→; → 06/12		13.0460-7195.2 607195	ATE 23482 16,6 - WE / - WK Ceramic
						13.0470-7195.2 LD7195	ATE 23482 16,6 - WE / - WK Ceramic
2.8 Turbo V6	184	02/06→02/15	⬅	→ 12/08; passend für Felgengröße [Zoll]: 16; + 16" plus Rad		13.0460-7199.2 607199	ATE 23404 20,6 + WE / - WK Ceramic
2.8 Turbo V6	188	12/07→02/15				13.0470-7204.2 LD7204	ATE 23801 18,8 - WE / - WK Ceramic
			⬅	01/09→ 06/12; passend für Felgengröße [Zoll]: 17		13.0460-7204.2 607204	ATE 23801 18,8 - WE / - WK Ceramic
						13.0470-7204.2 LD7204	ATE 23801 18,8 - WE / - WK Ceramic







	kw			 	! #		
<b>SAAB - 9-3 Cabriolet (YS3F) 08/03→02/15</b>							
<b> Bremsbelagsatz, Scheibenbremse</b>							
2.8 Turbo V6 2.8 Turbo V6	184 188	02/06→02/15 12/07→02/15	➡	→ 76001222		13.0460-7194.2 607194 13.0470-7194.2 LD7194	ATE 23482 16,6 - WE / - WK ATE 23482 16,6 - WE / - WK Ceramic
			➡	76001223→; → 06/12		13.0460-7195.2 607195 13.0470-7195.2 LD7195	ATE 23482 16,6 - WE / - WK ATE 23482 16,6 - WE / - WK Ceramic
2.8 Turbo V6 2.8 Turbo V6	203 206	02/09→02/15 02/09→02/15	⬅	→ 06/12; passend für Felgenreöße [Zoll]: 17		13.0460-7204.2 607204 13.0470-7204.2 LD7204	ATE 23801 18,8 - WE / - WK ATE 23801 18,8 - WE / - WK Ceramic
			➡	→ 76001222		13.0460-7194.2 607194 13.0470-7194.2 LD7194	ATE 23482 16,6 - WE / - WK ATE 23482 16,6 - WE / - WK Ceramic
			➡	76001223→; → 06/12		13.0460-7195.2 607195 13.0470-7195.2 LD7195	ATE 23482 16,6 - WE / - WK ATE 23482 16,6 - WE / - WK Ceramic
<b> Bremsscheibe</b>							
1,8t	110	08/03→02/15	⬅	→ 06/12; passend für Felgenreöße [Zoll]: 15		24.0125-0141.1 425141 24.0325-0141.1 525141	Ø 285 24,9 22 V + S Ø 285 24,9 22 V + S
			⬅	→ 06/12; passend für Felgenreöße [Zoll]: 17		24.0130-0189.1 430189	Ø 345 29,9 27,5 V
			➡	→ 08/05		24.0112-0157.1 412157 24.0312-0157.1 512157	Ø 278 11,9 10 + S Ø 278 11,9 10 + S
			➡	09/05→ 06/12; passend für Felgenreöße [Zoll]: 15		24.0112-0157.1 412157 24.0312-0157.1 512157	Ø 278 11,9 10 + S Ø 278 11,9 10 + S
			➡	09/05→ 06/12; passend für Felgenreöße [Zoll]: 16		24.0120-0173.1 420173 24.0320-0173.1 520173	Ø 292 19,9 18 V + S Ø 292 19,9 18 V + S
1,8t BioPower 1.8 i 1.9 TiD 1.9 TiD 1.9 TTiD 1.9 TTiD 1.9 TTiD 2.0 t 2.0 t 2.0 t BioPower 2.0 t BioPower 2.0 t BioPower	110 90 88 110 96 118 132 120 162 120 129 162	01/07→02/15 01/04→02/15 09/04→02/15 01/06→02/15 12/07→02/15 12/07→02/15 12/07→02/15 01/11→02/15 01/11→02/15 01/11→02/15 01/07→02/15 01/11→02/15	⬅	→ 06/12; passend für Felgenreöße [Zoll]: 15		24.0125-0141.1 425141 24.0325-0141.1 525141	Ø 285 24,9 22 V + S Ø 285 24,9 22 V + S
			⬅	→ 06/12; passend für Felgenreöße [Zoll]: 17		24.0130-0189.1 430189	Ø 345 29,9 27,5 V
			➡	→ 06/12; passend für Felgenreöße [Zoll]: 15		24.0112-0157.1 412157 24.0312-0157.1 512157	Ø 278 11,9 10 + S Ø 278 11,9 10 + S
			➡	→ 06/12; passend für Felgenreöße [Zoll]: 16		24.0120-0173.1 420173 24.0320-0173.1 520173	Ø 292 19,9 18 V + S Ø 292 19,9 18 V + S
1,8t BioPower 2.0 t BioPower	129 147	01/07→02/15 06/07→02/15	⬅	07/07→ 06/12; passend für Felgenreöße [Zoll]: 15		24.0125-0141.1 425141 24.0325-0141.1 525141	Ø 285 24,9 22 V + S Ø 285 24,9 22 V + S
			⬅	07/07→ 06/12; passend für Felgenreöße [Zoll]: 17		24.0130-0189.1 430189	Ø 345 29,9 27,5 V
			➡	07/07→ 06/12; passend für Felgenreöße [Zoll]: 15		24.0112-0157.1 412157 24.0312-0157.1 512157	Ø 278 11,9 10 + S Ø 278 11,9 10 + S
			➡	07/07→ 06/12; passend für Felgenreöße [Zoll]: 16		24.0120-0173.1 420173 24.0320-0173.1 520173	Ø 292 19,9 18 V + S Ø 292 19,9 18 V + S
2.0	143	04/06→09/07	⬅	passend für Felgenreöße [Zoll]: 15		24.0125-0141.1 425141 24.0325-0141.1 525141	Ø 285 24,9 22 V + S Ø 285 24,9 22 V + S
			⬅	passend für Felgenreöße [Zoll]: 17		24.0130-0189.1 430189	Ø 345 29,9 27,5 V
			➡	passend für Felgenreöße [Zoll]: 15		24.0112-0157.1 412157 24.0312-0157.1 512157	Ø 278 11,9 10 + S Ø 278 11,9 10 + S
			➡	passend für Felgenreöße [Zoll]: 16		24.0120-0173.1 420173 24.0320-0173.1 520173	Ø 292 19,9 18 V + S Ø 292 19,9 18 V + S
2.0 t	129	08/03→02/15	⬅	→ 06/12; passend für Felgenreöße [Zoll]: 15		24.0125-0141.1 425141 24.0325-0141.1 525141	Ø 285 24,9 22 V + S Ø 285 24,9 22 V + S
			⬅	→ 06/12; passend für Felgenreöße [Zoll]: 16		24.0128-0137.1 428137 24.0328-0137.1 528137	Ø 302 28 25 V + S Ø 302 28 25 V + S
			⬅	→ 06/12; 16" plus Rad		24.0128-0164.1 428164	Ø 314 28 25 V + S
			⬅	→ 06/12; passend für Felgenreöße [Zoll]: 17		24.0130-0189.1 430189	Ø 345 29,9 27,5 V
			➡	09/05→ 06/12; passend für Felgenreöße [Zoll]: 15		24.0112-0157.1 412157 24.0312-0157.1 512157	Ø 278 11,9 10 + S Ø 278 11,9 10 + S
			➡	→ 08/05		24.0112-0157.1 412157 24.0120-0173.1 420173 24.0312-0157.1 512157 24.0320-0173.1 520173	Ø 278 11,9 10 + S Ø 292 19,9 18 V + S Ø 278 11,9 10 + S Ø 292 19,9 18 V + S











	kw			 	! #		
<b>SAAB - 9-3 Cabriolet (YS3F) 08/03→02/15</b>							
<b>Bremsscheibe</b>							
2.0 t	129	08/03→02/15	➔	09/05→06/12; passend für Felgengröße [Zoll]: 16		24.0120-0173.1 420173 24.0320-0173.1 520173	Ø 292 19,9 18 V + S Ø 292 19,9 18 V + S
2.0 t	154	08/03→02/15	➔	→ 06/12; passend für Felgengröße [Zoll]: 15		24.0125-0141.1 425141 24.0325-0141.1 525141	Ø 285 24,9 22 V + S Ø 285 24,9 22 V + S
			➔	→ 06/12; passend für Felgengröße [Zoll]: 16		24.0128-0137.1 428137 24.0328-0137.1 528137	Ø 302 28 25 V + S Ø 302 28 25 V + S
			➔	→ 06/12; 16" plus Rad		24.0128-0164.1 428164	Ø 314 28 25 V + S
			➔	→ 06/12; passend für Felgengröße [Zoll]: 17		24.0130-0189.1 430189	Ø 345 29,9 27,5 V
			➔	09/05→06/12; passend für Felgengröße [Zoll]: 15		24.0112-0157.1 412157 24.0312-0157.1 512157	Ø 278 11,9 10 + S Ø 278 11,9 10 + S
			➔	→ 08/05		24.0120-0173.1 420173 24.0320-0173.1 520173	Ø 292 19,9 18 V + S Ø 292 19,9 18 V + S
			➔	09/05→06/12; passend für Felgengröße [Zoll]: 16		24.0120-0173.1 420173 24.0320-0173.1 520173	Ø 292 19,9 18 V + S Ø 292 19,9 18 V + S
			2.0 Turbo Performance	185	04/04→02/15	➔	→ 06/12; passend für Felgengröße [Zoll]: 15
			➔	→ 06/12; passend für Felgengröße [Zoll]: 16		24.0128-0137.1 428137 24.0328-0137.1 528137	Ø 302 28 25 V + S Ø 302 28 25 V + S
			➔	→ 06/12; 16" plus Rad		24.0128-0164.1 428164	Ø 314 28 25 V + S
			➔	→ 06/12; passend für Felgengröße [Zoll]: 17		24.0130-0189.1 430189	Ø 345 29,9 27,5 V
			➔	→ 06/12; passend für Felgengröße [Zoll]: 15		24.0112-0157.1 412157 24.0312-0157.1 512157	Ø 278 11,9 10 + S Ø 278 11,9 10 + S
			➔	→ 06/12; passend für Felgengröße [Zoll]: 16		24.0120-0173.1 420173 24.0320-0173.1 520173	Ø 292 19,9 18 V + S Ø 292 19,9 18 V + S
			2.8 Turbo V6	169	02/06→02/15	➔	06/08→06/12; passend für Felgengröße [Zoll]: 16
			➔	06/08→06/12; 16" plus Rad		24.0128-0164.1 428164	Ø 314 28 25 V + S
			➔	06/08→06/12; passend für Felgengröße [Zoll]: 17		24.0130-0189.1 430189	Ø 345 29,9 27,5 V
			➔	06/08→06/12; passend für Felgengröße [Zoll]: 15		24.0112-0157.1 412157 24.0312-0157.1 512157	Ø 278 11,9 10 + S Ø 278 11,9 10 + S
			➔	06/08→06/12; passend für Felgengröße [Zoll]: 16		24.0120-0173.1 420173 24.0320-0173.1 520173	Ø 292 19,9 18 V + S Ø 292 19,9 18 V + S
			2.8 Turbo V6	184	02/06→02/15	➔	→ 06/12; passend für Felgengröße [Zoll]: 16
2.8 Turbo V6	188	12/07→02/15				24.0328-0137.1 528137	Ø 302 28 25 V + S
2.8 Turbo V6	203	02/09→02/15	➔	→ 06/12; 16" plus Rad		24.0128-0164.1 428164	Ø 314 28 25 V + S
2.8 Turbo V6	206	02/09→02/15	➔	→ 06/12; passend für Felgengröße [Zoll]: 17		24.0130-0189.1 430189	Ø 345 29,9 27,5 V
			➔	→ 06/12; passend für Felgengröße [Zoll]: 15		24.0112-0157.1 412157 24.0312-0157.1 512157	Ø 278 11,9 10 + S Ø 278 11,9 10 + S
			➔	→ 06/12; passend für Felgengröße [Zoll]: 16		24.0120-0173.1 420173 24.0320-0173.1 520173	Ø 292 19,9 18 V + S Ø 292 19,9 18 V + S
			<b>SAAB - 9-3 Kombi (YS3F) 03/05→02/15</b>				
<b>Bremsbelagsatz, Scheibenbremse</b>							
1.8 i	90	03/05→02/15	➔	→ 06/12; passend für Felgengröße [Zoll]: 15 / 16; für Bremssattel mit Kunststoffkolben		13.0460-7172.2 607172 13.0470-7172.2 LD7172	ATE 23378 20,1 + WE / - WK ATE 23378 20,1 + WE / - WK Ceramic
1.8t 2.0	110	03/05→02/15	➔	→ 06/12; passend für Felgengröße [Zoll]: 15 / 16; für Bremssattel mit Stahlkolben		13.0460-7212.2 607212	ATE 23738 20,1 + WE / - WK
1.9 TiD	88	03/05→02/15					
1.9 TiD	110	03/05→02/15					
2.0 t	110	03/05→02/15	➔	→ 06/12; passend für Felgengröße [Zoll]: 15 / 16; für Bremssattel mit Stahlkolben			
2.0 t	120	01/07→02/15					
2.0 t	129	03/05→02/15					
2.0 t BioPower	110	01/07→02/15	➔	→ 76001222		13.0460-7194.2 607194 13.0470-7194.2 LD7194	ATE 23482 16,6 - WE / - WK ATE 23482 16,6 - WE / - WK Ceramic
2.0 t BioPower	120	01/11→02/15					
2.0 t BioPower	129	01/07→02/15					
2.0 t BioPower	145	06/07→02/15	➔	76001223→; → 06/12		13.0460-7195.2 607195 13.0470-7195.2 LD7195	ATE 23482 16,6 - WE / - WK ATE 23482 16,6 - WE / - WK Ceramic
2.0 t BioPower	162	01/11→02/15					
2.0 t Bio Power	147	02/09→02/15					
2.0 t BioPower XWD	120	01/11→02/15					
2.0 t BioPower XWD	162	01/11→02/15					
2.0 t Bio Power XWD	154	06/08→02/15					
2.0 t XWD	120	01/07→02/15					
2.0 t XWD	162	01/11→02/15					
↓							









	kw			 	! #		
<b>SAAB - 9-3 Kombi (YS3F) 03/05→02/15</b>							
<b> Bremsbelagsatz, Scheibenbremse</b>							
1.9 TTiD 1.9 TTiD 1.9 TTiD	96 118 132	12/07→02/15 12/07→02/15 12/07→02/15	←	→ 06/12; passend für Felgenreöße [Zoll]: 15 / 16; für Bremssattel mit Kunststoffkolben	13.0460-7172.2 607172	ATE 23378 20,1 + WE / - WK	
			←	→ 12/08; + 16" plus Rad	13.0470-7172.2 LD7172	ATE 23378 20,1 + WE / - WK Ceramic	
			←	→ 06/12; passend für Felgenreöße [Zoll]: 15 / 16; für Bremssattel mit Stahlkolben	13.0460-7199.2 607199	ATE 23404 20,6 + WE / - WK	
			→	→ 06/12;	13.0460-7212.2 607212	ATE 23738 20,1 + WE / - WK	
			→	→ 76001222	13.0460-7194.2 607194	ATE 23482 16,6 - WE / - WK	
			→	76001223→; → 06/12	13.0470-7194.2 LD7194	ATE 23482 16,6 - WE / - WK Ceramic	
			→	76001223→; → 06/12	13.0460-7195.2 607195	ATE 23482 16,6 - WE / - WK	
			→	76001223→; → 06/12	13.0470-7195.2 LD7195	ATE 23482 16,6 - WE / - WK Ceramic	
2.0 t 2.0 t 2.0 t 2.0 t XWD	147 162 177 177	02/09→02/15 01/11→02/15 05/09→02/15 05/09→02/15	←	→ 06/12; passend für Felgenreöße [Zoll]: 17	13.0460-7204.2 607204	ATE 23801 18,8 - WE / - WK	
			←	→ 06/12; passend für Felgenreöße [Zoll]: 17	13.0470-7204.2 LD7204	ATE 23801 18,8 - WE / - WK Ceramic	
			→	→ 76001222	13.0460-7194.2 607194	ATE 23482 16,6 - WE / - WK	
			→	76001223→; → 06/12	13.0470-7194.2 LD7194	ATE 23482 16,6 - WE / - WK Ceramic	
			→	76001223→; → 06/12	13.0460-7195.2 607195	ATE 23482 16,6 - WE / - WK	
			→	76001223→; → 06/12	13.0470-7195.2 LD7195	ATE 23482 16,6 - WE / - WK Ceramic	
2.0 t 2.8 Turbo V6 2.8 Turbo V6 2.8 Turbo V6 2.8 Turbo V6 2.8 Turbo V6 2.8 Turbo V6 XWD	154 169 184 188 203 206 206	03/05→02/15 03/05→02/15 03/05→02/15 12/07→02/15 05/08→02/15 05/08→02/15 05/08→02/15	←	→ 12/08; + 16" plus Rad	13.0460-7199.2 607199	ATE 23404 20,6 + WE / - WK	
			←	01/09→ 06/12; passend für Felgenreöße [Zoll]: 17	13.0460-7204.2 607204	ATE 23801 18,8 - WE / - WK	
			←	01/09→ 06/12; passend für Felgenreöße [Zoll]: 17	13.0470-7204.2 LD7204	ATE 23801 18,8 - WE / - WK Ceramic	
			→	→ 76001222	13.0460-7194.2 607194	ATE 23482 16,6 - WE / - WK	
			→	→ 76001222	13.0470-7194.2 LD7194	ATE 23482 16,6 - WE / - WK Ceramic	
			→	76001223→; → 06/12	13.0460-7195.2 607195	ATE 23482 16,6 - WE / - WK	
			→	76001223→; → 06/12	13.0470-7195.2 LD7195	ATE 23482 16,6 - WE / - WK Ceramic	
2.0 t XWD	154	06/08→02/15	←	07/08→ 12/08; + 16" plus Rad	13.0460-7199.2 607199	ATE 23404 20,6 + WE / - WK	
			←	01/09→ 06/12; passend für Felgenreöße [Zoll]: 17	13.0460-7204.2 607204	ATE 23801 18,8 - WE / - WK	
			←	01/09→ 06/12; passend für Felgenreöße [Zoll]: 17	13.0470-7204.2 LD7204	ATE 23801 18,8 - WE / - WK Ceramic	
			→	07/08→; → 76001222	13.0460-7194.2 607194	ATE 23482 16,6 - WE / - WK	
			→	76001223→; → 06/12	13.0470-7194.2 LD7194	ATE 23482 16,6 - WE / - WK Ceramic	
			→	76001223→; → 06/12	13.0460-7195.2 607195	ATE 23482 16,6 - WE / - WK	
			→	76001223→; → 06/12	13.0470-7195.2 LD7195	ATE 23482 16,6 - WE / - WK Ceramic	
<b> Bremsscheibe</b>							
1.8 i 1.8t 2.0 1.9 TiD 1.9 TiD 2.0 t 2.0 t	90 110 88 110 110 129	03/05→02/15 03/05→02/15 03/05→02/15 03/05→02/15 03/05→02/15 03/05→02/15	←	→ 06/12; passend für Felgenreöße [Zoll]: 15	24.0125-0141.1 425141	Ø 285 24,9 22 V + S	
			←	→ 06/12; passend für Felgenreöße [Zoll]: 15	24.0325-0141.1 525141	Ø 285 24,9 22 V + S	
			←	→ 06/12; passend für Felgenreöße [Zoll]: 17	24.0130-0189.1 430189	Ø 345 29,9 27,5 V	
			→	→ 08/05	24.0112-0157.1 412157	Ø 278 11,9 10 + S	
			→	→ 08/05	24.0312-0157.1 512157	Ø 278 11,9 10 + S	
			→	09/05→ 06/12; passend für Felgenreöße [Zoll]: 15	24.0112-0157.1 412157	Ø 278 11,9 10 + S	
			→	09/05→ 06/12; passend für Felgenreöße [Zoll]: 15	24.0312-0157.1 512157	Ø 278 11,9 10 + S	
			→	09/05→ 06/12; passend für Felgenreöße [Zoll]: 16	24.0120-0173.1 420173	Ø 292 19,9 18 V + S	
			→	09/05→ 06/12; passend für Felgenreöße [Zoll]: 16	24.0320-0173.1 520173	Ø 292 19,9 18 V + S	
1.9 TTiD 1.9 TTiD 1.9 TTiD	96 118 132	12/07→02/15 12/07→02/15 12/07→02/15	←	→ 06/12; passend für Felgenreöße [Zoll]: 15	24.0125-0141.1 425141	Ø 285 24,9 22 V + S	
			←	→ 06/12; passend für Felgenreöße [Zoll]: 15	24.0325-0141.1 525141	Ø 285 24,9 22 V + S	
			←	→ 06/12; passend für Felgenreöße [Zoll]: 16	24.0128-0137.1 428137	Ø 302 28 25 V + S	
			←	→ 06/12; passend für Felgenreöße [Zoll]: 16	24.0128-0164.1 428164	Ø 314 28 25 V + S	
			←	→ 06/12; passend für Felgenreöße [Zoll]: 16	24.0328-0137.1 528137	Ø 302 28 25 V + S	
			←	→ 06/12; passend für Felgenreöße [Zoll]: 17	24.0130-0189.1 430189	Ø 345 29,9 27,5 V	
			→	→ 06/12; passend für Felgenreöße [Zoll]: 15	24.0112-0157.1 412157	Ø 278 11,9 10 + S	
			→	→ 06/12; passend für Felgenreöße [Zoll]: 15	24.0312-0157.1 512157	Ø 278 11,9 10 + S	
			→	→ 06/12; passend für Felgenreöße [Zoll]: 16	24.0120-0173.1 420173	Ø 292 19,9 18 V + S	
			→	→ 06/12; passend für Felgenreöße [Zoll]: 16	24.0320-0173.1 520173	Ø 292 19,9 18 V + S	
↓							









	kw			 	! #		
<b>SAAB - 9-3 Kombi (YS3F) 03/05→02/15</b>							
<b>Bremsscheibe</b>							
2.0 t	120	01/07→02/15	←	→ 06/12; passend für Felgengröße [Zoll]: 15		24.0125-0141.1 425141	Ø 285 24,9 22 V + S
2.0 t BioPower	110	01/07→02/15				24.0325-0141.1 525141	Ø 285 24,9 22 V + S
2.0 t BioPower	120	01/11→02/15					
2.0 t BioPower	129	01/07→02/15	←	→ 06/12;		24.0130-0189.1 430189	Ø 345 29,9 27,5 V
2.0 t BioPower	145	06/07→02/15		passend für Felgengröße [Zoll]: 17			
2.0 t Bio Power	147	02/09→02/15	→	→ 06/12;		24.0112-0157.1 412157	Ø 278 11,9 10 + S
2.0 t BioPower XWD	120	01/11→02/15		passend für Felgengröße [Zoll]: 15		24.0312-0157.1 512157	Ø 278 11,9 10 + S
2.0 t Bio Power XWD	154	06/08→02/15					
2.0 t XWD	120	01/07→02/15	→	→ 06/12;		24.0120-0173.1 420173	Ø 292 19,9 18 V + S
2.0 t XWD	162	01/11→02/15		passend für Felgengröße [Zoll]: 16		24.0320-0173.1 520173	Ø 292 19,9 18 V + S
2.0 t	147	02/09→02/15	←	→ 06/12;		24.0128-0137.1 428137	Ø 302 28 25 V + S
2.0 t	162	01/11→02/15		passend für Felgengröße [Zoll]: 16		24.0128-0164.1 428164	Ø 314 28 25 V + S
2.0 t	177	05/09→02/15					
2.0 t XWD	177	05/09→02/15				24.0328-0137.1 528137	Ø 302 28 25 V + S
2.8 Turbo V6	188	12/07→02/15	→	→ 06/12;		24.0112-0157.1 412157	Ø 278 11,9 10 + S
2.8 Turbo V6	203	05/08→02/15		passend für Felgengröße [Zoll]: 15		24.0312-0157.1 512157	Ø 278 11,9 10 + S
2.8 Turbo V6	206	05/08→02/15					
2.8 Turbo V6 XWD	206	05/08→02/15	→	→ 06/12;		24.0120-0173.1 420173	Ø 292 19,9 18 V + S
				passend für Felgengröße [Zoll]: 16		24.0320-0173.1 520173	Ø 292 19,9 18 V + S
2.0 t	154	03/05→02/15	←	→ 06/12;		24.0128-0137.1 428137	Ø 302 28 25 V + S
2.8 Turbo V6	184	03/05→02/15		passend für Felgengröße [Zoll]: 16		24.0128-0164.1 428164	Ø 314 28 25 V + S
						24.0328-0137.1 528137	Ø 302 28 25 V + S
			→	09/05→ 06/12;		24.0112-0157.1 412157	Ø 278 11,9 10 + S
				passend für Felgengröße [Zoll]: 15		24.0312-0157.1 512157	Ø 278 11,9 10 + S
			→	→ 08/05		24.0120-0173.1 420173	Ø 292 19,9 18 V + S
						24.0320-0173.1 520173	Ø 292 19,9 18 V + S
			→	09/05→ 06/12;		24.0120-0173.1 420173	Ø 292 19,9 18 V + S
				passend für Felgengröße [Zoll]: 16		24.0320-0173.1 520173	Ø 292 19,9 18 V + S
2.0 t BioPower	162	01/11→02/15	←	→ 06/12;		24.0125-0141.1 425141	Ø 285 24,9 22 V + S
				passend für Felgengröße [Zoll]: 15		24.0325-0141.1 525141	Ø 285 24,9 22 V + S
			→	→ 06/11;		24.0112-0157.1 412157	Ø 278 11,9 10 + S
				passend für Felgengröße [Zoll]: 15		24.0312-0157.1 512157	Ø 278 11,9 10 + S
			→	→ 06/11;		24.0120-0173.1 420173	Ø 292 19,9 18 V + S
				passend für Felgengröße [Zoll]: 16		24.0320-0173.1 520173	Ø 292 19,9 18 V + S
2.0 t BioPower XWD	162	01/11→02/15	←	→ 06/12;		24.0125-0141.1 425141	Ø 285 24,9 22 V + S
				passend für Felgengröße [Zoll]: 15		24.0325-0141.1 525141	Ø 285 24,9 22 V + S
			→	→ 06/12;		24.0112-0157.1 412157	Ø 278 11,9 10 + S
				passend für Felgengröße [Zoll]: 15		24.0312-0157.1 512157	Ø 278 11,9 10 + S
			→	→ 06/12;		24.0120-0173.1 420173	Ø 292 19,9 18 V + S
				passend für Felgengröße [Zoll]: 16		24.0320-0173.1 520173	Ø 292 19,9 18 V + S
2.0 t XWD	154	06/08→02/15	←	07/08→ 06/12;		24.0128-0137.1 428137	Ø 302 28 25 V + S
				passend für Felgengröße [Zoll]: 16		24.0128-0164.1 428164	Ø 314 28 25 V + S
						24.0328-0137.1 528137	Ø 302 28 25 V + S
			→	07/08→ 06/12;		24.0112-0157.1 412157	Ø 278 11,9 10 + S
				passend für Felgengröße [Zoll]: 15		24.0312-0157.1 512157	Ø 278 11,9 10 + S
			→	07/08→ 06/12;		24.0120-0173.1 420173	Ø 292 19,9 18 V + S
				passend für Felgengröße [Zoll]: 16		24.0320-0173.1 520173	Ø 292 19,9 18 V + S
2.8 Turbo V6	169	03/05→02/15	←	→ 06/12;		24.0128-0137.1 428137	Ø 302 28 25 V + S
				passend für Felgengröße [Zoll]: 16		24.0128-0164.1 428164	Ø 314 28 25 V + S
						24.0328-0137.1 528137	Ø 302 28 25 V + S
			→	→ 06/12;		24.0112-0157.1 412157	Ø 278 11,9 10 + S
				passend für Felgengröße [Zoll]: 15		24.0312-0157.1 512157	Ø 278 11,9 10 + S
			→	→ 06/12;		24.0120-0173.1 420173	Ø 292 19,9 18 V + S
				passend für Felgengröße [Zoll]: 16		24.0320-0173.1 520173	Ø 292 19,9 18 V + S
			→	→ 08/05		24.0120-0173.1 420173	Ø 292 19,9 18 V + S
						24.0320-0173.1 520173	Ø 292 19,9 18 V + S
<b>SAAB - 9-3X 02/09→12/12</b>							
<b>Bremsbelagsatz, Scheibenbremse</b>							
1.9 TTiD AWD	132	02/09→12/12	←	03/09→ 06/12;		13.0460-7172.2 607172	ATE 23378 20,1 + WE / - WK
2.0 t BioPower XWD	154	02/09→12/12		passend für Felgengröße [Zoll]: 15 / 16;		13.0470-7172.2 LD7172	ATE 23378 20,1 + WE / - WK
2.0 t XWD	154	02/09→12/12		für Bremssattel mit Kunststoffkolben			Ceramic
			←	03/09→ 06/12; + 16" plus Rad		13.0460-7199.2 607199	ATE 23404 20,6 + WE / - WK
			←	03/09→ 06/12;		13.0460-7204.2 607204	ATE 23801 18,8 - WE / - WK
				passend für Felgengröße [Zoll]: 17		13.0470-7204.2 LD7204	ATE 23801 18,8 - WE / - WK
							Ceramic
↓							









	kw			 	! #		
<b>SAAB - 9-3X 02/09→12/12</b>							
 <b>Bremsbelagsatz, Scheibenbremse</b>							
1.9 TTiD AWD 2.0 t BioPower XWD 2.0 t XWD	132 154 154	02/09→12/12 02/09→12/12 02/09→12/12	← →	03/09→ 06/12; passend für Felgengröße [Zoll]: 15 / 16; für Bremssattel mit Stahlkolben  03/09→ 06/12		13.0460-7212.2 607212  13.0460-7195.2 607195 13.0470-7195.2 LD7195	ATE 23738 20,1 + WE / - WK  ATE 23482 16,6 - WE / - WK ATE 23482 16,6 - WE / - WK Ceramic
2.0 t BioPower XWD	162	01/11→12/12	← ← ← ← →	→ 06/12; passend für Felgengröße [Zoll]: 15 / 16; für Bremssattel mit Kunststoffkolben  → 06/12; + 16" plus Rad  → 06/12; passend für Felgengröße [Zoll]: 17  → 06/12; passend für Felgengröße [Zoll]: 15 / 16; für Bremssattel mit Stahlkolben  → 06/12		13.0460-7172.2 607172 13.0470-7172.2 LD7172  13.0460-7199.2 607199  13.0460-7204.2 607204 13.0470-7204.2 LD7204  13.0460-7212.2 607212  13.0460-7195.2 607195 13.0470-7195.2 LD7195	ATE 23378 20,1 + WE / - WK ATE 23378 20,1 + WE / - WK Ceramic  ATE 23404 20,6 + WE / - WK  ATE 23801 18,8 - WE / - WK ATE 23801 18,8 - WE / - WK Ceramic  ATE 23738 20,1 + WE / - WK  ATE 23482 16,6 - WE / - WK ATE 23482 16,6 - WE / - WK Ceramic
 <b>Bremsscheibe</b>							
1.9 TTiD AWD 2.0 t BioPower XWD 2.0 t XWD	132 154 154	02/09→12/12 02/09→12/12 02/09→12/12	← ← ← ← → →	03/09→ 06/12; passend für Felgengröße [Zoll]: 15  03/09→ 06/12; passend für Felgengröße [Zoll]: 16  03/09→ 06/12; + 16" plus Rad  03/09→ 06/12; passend für Felgengröße [Zoll]: 17  03/09→ 06/12; passend für Felgengröße [Zoll]: 15  03/09→ 06/12; nicht für Felgengröße [Zoll]: 15		24.0125-0141.1 425141 24.0325-0141.1 525141  24.0128-0137.1 428137 24.0328-0137.1 528137  24.0128-0164.1 428164  24.0130-0189.1 430189  24.0112-0157.1 412157 24.0312-0157.1 512157  24.0120-0173.1 420173 24.0320-0173.1 520173	Ø 285 24,9 22 V + S Ø 285 24,9 22 V + S  Ø 302 28 25 V + S Ø 302 28 25 V + S  Ø 314 28 25 V + S  Ø 345 29,9 27,5 V  Ø 278 11,9 10 + S Ø 278 11,9 10 + S  Ø 292 19,9 18 V + S Ø 292 19,9 18 V + S
2.0 t BioPower XWD	162	01/11→12/12	← ← ← ← → →	→ 06/12; passend für Felgengröße [Zoll]: 15  → 06/12; passend für Felgengröße [Zoll]: 16  → 06/12; + 16" plus Rad  → 06/12; passend für Felgengröße [Zoll]: 17  → 06/12; passend für Felgengröße [Zoll]: 15  → 06/12; nicht für Felgengröße [Zoll]: 15		24.0125-0141.1 425141 24.0325-0141.1 525141  24.0128-0137.1 428137 24.0328-0137.1 528137  24.0128-0164.1 428164  24.0130-0189.1 430189  24.0112-0157.1 412157 24.0312-0157.1 512157  24.0120-0173.1 420173 24.0320-0173.1 520173	Ø 285 24,9 22 V + S Ø 285 24,9 22 V + S  Ø 302 28 25 V + S Ø 302 28 25 V + S  Ø 314 28 25 V + S  Ø 345 29,9 27,5 V  Ø 278 11,9 10 + S Ø 278 11,9 10 + S  Ø 292 19,9 18 V + S Ø 292 19,9 18 V + S
<b>SAAB - 9-5 (YS3E) 09/97→12/09</b>							
 <b>Bremsbelagsatz, Scheibenbremse</b>							
1.9 TiD 2.0 t 2.0 t BioPower 2.2 TiD 2.3 t 2.3 t BioPower 2.3 t BioPower 2.3 Turbo 2.3 Turbo 2.3 Turbo 2.3 Turbo 2.3 Turbo 3.0 TiD	110 136 110 88 136 136 152 134 162 184 188 191 130	01/06→12/09 07/00→12/09 01/05→12/09 03/02→12/09 01/01→12/09 01/07→12/09 11/06→12/09 04/08→12/09 07/03→12/09 09/01→12/09 04/08→12/09 11/05→12/09 07/01→12/09	← ← →	passend für Felgengröße [Zoll]: 16		13.0460-7091.2 607091 13.0460-7173.2 607173  13.0460-3605.2 603605 13.0470-3605.2 LD3605	ATE 21829 20,3 + WE / - WK ATE 21829 20,3 - WK / + WK  ATE 20180 17,3 + WE / - WK ATE 20180 17,3 + WE / - WK Ceramic
2.0 t 2.0 Turbo SE 2.3 t 3.0 V6t	110 141 125 147	09/97→12/09 10/98→07/00 09/97→12/09 01/98→12/09	← ← → →	passend für Felgengröße [Zoll]: 16  X3025752→  → X3025751		13.0460-7091.2 607091 13.0460-7173.2 607173  13.0460-3605.2 603605 13.0470-3605.2 LD3605  13.0460-4040.2 604040	ATE 21829 20,3 + WE / - WK ATE 21829 20,3 - WK / + WK  ATE 20180 17,3 + WE / - WK ATE 20180 17,3 + WE / - WK Ceramic  ATE 21050 15,8 - WE / - WK
2.0 t Biopower ↓	132	09/05→12/09	←	06/06→; passend für Felgengröße [Zoll]: 16		13.0460-7091.2 607091	ATE 21829 20,3 + WE / - WK









	kW			 	! #		
<b>SAAB - 9-5 (YS3E) 09/97→12/09</b>							
<b>Bremsbelagsatz, Scheibenbremse</b>							
2.0 t Biopower	132	09/05→12/09	←	06/06→		13.0460-7173.2 607173	ATE 21829 20,3 - WK / + WK
			→	06/06→		13.0460-3605.2 603605	ATE 20180 17,3 + WE / - WK
						13.0470-3605.2 LD3605	ATE 20180 17,3 + WE / - WK Ceramic
2.3 Turbo	169	10/99→09/01	←	01/00→; passend für Felgenreöße [Zoll]: 16		13.0460-7091.2 607091	ATE 21829 20,3 + WE / - WK
			←	01/00→		13.0460-7173.2 607173	ATE 21829 20,3 - WK / + WK
			→			13.0460-3605.2 603605	ATE 20180 17,3 + WE / - WK
						13.0470-3605.2 LD3605	ATE 20180 17,3 + WE / - WK Ceramic
2.3 Turbo	224	06/03→08/05	←	→ 03/04; passend für Felgenreöße [Zoll]: 16		13.0460-7091.2 607091	ATE 21829 20,3 + WE / - WK
			←	→ 03/04		13.0460-7173.2 607173	ATE 21829 20,3 - WK / + WK
			→	→ 03/04		13.0460-3605.2 603605	ATE 20180 17,3 + WE / - WK
						13.0470-3605.2 LD3605	ATE 20180 17,3 + WE / - WK Ceramic
<b>Warnkontakt, Bremsbelagverschleiß</b>							
1.9 TiD	110	01/06→12/09	←		2	24.8190-0718.2 620718	L= 720
2.0 t	110	09/97→12/09					
2.0 t	136	07/00→12/09					
2.0 t BioPower	110	01/05→12/09					
2.0 Turbo SE	141	10/98→07/00					
2.2 TiD	88	03/02→12/09					
2.3 t	125	09/97→12/09					
2.3 t	136	01/01→12/09					
2.3 t BioPower	136	01/07→12/09					
2.3 t BioPower	152	11/06→12/09					
2.3 Turbo	134	04/08→12/09					
2.3 Turbo	162	07/03→12/09					
2.3 Turbo	184	09/01→12/09					
2.3 Turbo	188	04/08→12/09					
2.3 Turbo	191	11/05→12/09					
3.0 TiD	130	07/01→12/09					
3.0 V6t	147	01/98→12/09					
2.0 t Biopower	132	09/05→12/09	←	06/06→	2	24.8190-0718.2 620718	L= 720
2.3 Turbo	169	10/99→09/01	←	01/00→	2	24.8190-0718.2 620718	L= 720
2.3 Turbo	224	06/03→08/05	←	→ 03/04	2	24.8190-0718.2 620718	L= 720
<b>Zubehörsatz, Scheibenbremsbelag</b>							
2.0 t	110	09/97→12/09	→	→ X3025751		13.0460-0347.2 610347	
2.0 Turbo SE	141	10/98→07/00					
2.3 t	125	09/97→12/09					
3.0 V6t	147	01/98→12/09					
<b>Bremsscheibe</b>							
1.9 TiD	110	01/06→12/09	←	passend für Felgenreöße [Zoll]: 15		24.0125-0119.1 425119	Ø 288 25 22 V + S
2.0 t	136	07/00→12/09				24.0325-0119.1 525119	Ø 288 25 22 V + S
2.0 t BioPower	110	01/05→12/09					
2.2 TiD	88	03/02→12/09	→			24.0110-0274.1 410274	Ø 286 10 8 + S
2.3 t	136	01/01→12/09					
2.3 t BioPower	136	01/07→12/09					
2.3 t BioPower	152	11/06→12/09					
2.3 Turbo	134	04/08→12/09					
2.0 t	110	09/97→12/09	←	passend für Felgenreöße [Zoll]: 15		24.0125-0119.1 425119	Ø 288 25 22 V + S
2.0 Turbo SE	141	10/98→07/00				24.0325-0119.1 525119	Ø 288 25 22 V + S
2.3 t	125	09/97→12/09	→	→ X3025751		24.0110-0226.1 410226	Ø 286 10 8 + S
						24.0310-0226.1 510226	Ø 286 10 8 + S
			→	X3025752→		24.0110-0274.1 410274	Ø 286 10 8 + S
2.0 t Biopower	132	09/05→12/09	←	06/06→; passend für Felgenreöße [Zoll]: 15		24.0125-0119.1 425119	Ø 288 25 22 V + S
			→	06/06→		24.0325-0119.1 525119	Ø 288 25 22 V + S
						24.0110-0274.1 410274	Ø 286 10 8 + S
2.3 Turbo	162	07/03→12/09	←	nicht für USA; passend für Felgenreöße [Zoll]: 15		24.0125-0119.1 425119	Ø 288 25 22 V + S
			←	43510123→; für USA; passend für Felgenreöße [Zoll]: 15		24.0325-0119.1 525119	Ø 288 25 22 V + S
			←	→ 43510122; für USA; passend für Felgenreöße [Zoll]: 16		24.0125-0142.1 425142	Ø 308 25 22 V + S
						24.0325-0142.1 525142	Ø 308 25 23 V + S
			→			24.0110-0274.1 410274	Ø 286 10 8 + S
↓							











	kw			 	! #		
<b>SAAB - 9-5 (YS3E) 09/97→12/09</b>							
<b>Bremsscheibe</b>							
2.3 Turbo	169	10/99→09/01	←	passend für Felgenreöße [Zoll]: 16		24.0125-0142.1 425142 24.0325-0142.1 525142	Ø 308 25 22 V + S Ø 308 25 23 V + S
			→			24.0110-0274.1 410274	Ø 286 10 8 + S
2.3 Turbo 3.0 TiD	184 130	09/01→12/09 07/01→12/09	←	passend für Felgenreöße [Zoll]: 16		24.0125-0142.1 425142 24.0325-0142.1 525142	Ø 308 25 22 V + S Ø 308 25 23 V + S
			→	→ 12/01		24.0110-0274.1 410274	Ø 286 10 8 + S
			→	01/02→		24.0120-0196.1 420196	Ø 300 20 18 V + S
2.3 Turbo 2.3 Turbo	188 191	04/08→12/09 11/05→12/09	←	passend für Felgenreöße [Zoll]: 16		24.0125-0142.1 425142 24.0325-0142.1 525142	Ø 308 25 22 V + S Ø 308 25 23 V + S
			→			24.0120-0196.1 420196	Ø 300 20 18 V + S
2.3 Turbo	224	06/03→08/05	←	→ 03/04; passend für Felgenreöße [Zoll]: 16		24.0125-0142.1 425142 24.0325-0142.1 525142	Ø 308 25 22 V + S Ø 308 25 23 V + S
			→	→ 03/04		24.0120-0196.1 420196	Ø 300 20 18 V + S
3.0 V6t	147	01/98→12/09	←	passend für Felgenreöße [Zoll]: 16		24.0125-0142.1 425142 24.0325-0142.1 525142	Ø 308 25 22 V + S Ø 308 25 23 V + S
			→	→ X3025751		24.0110-0226.1 410226 24.0310-0226.1 510226	Ø 286 10 8 + S Ø 286 10 8 + S
			→	→ 12/01; X3025752→		24.0110-0274.1 410274	Ø 286 10 8 + S
			→	01/02→		24.0120-0196.1 420196	Ø 300 20 18 V + S
<b>SAAB - 9-5 (YS3G) 01/10→01/12</b>							
<b>Bremsbelagsatz, Scheibenbremse</b>							
1.6 Turbo 2.0 t BioPower 2.0 t BioPower XWD 2.0 TiD 2.0 TTiD 2.0 TTiD XWD 2.0 Turbo 2.0 Turbo XWD 2.8 Turbo V6 XWD	132 162 162 118 140 140 162 162 221	05/10→01/12 05/10→01/12 05/10→01/12 05/10→01/12 05/10→01/12 05/10→01/12 05/10→01/12 05/10→01/12 05/10→01/12	←	+ 17plus" Rad		13.0460-2754.2 602754	TRW 24418 17,0 + WK + Zub
			←	passend für Felgenreöße [Zoll]: 16		13.0460-5611.2 605611 13.0470-5611.2 LD5611	MAN 24415 19,1 + WK + Zub MAN 24415 19,1 + WK + Zub Ceramic
			←	passend für Felgenreöße [Zoll]: 17		13.0460-5612.2 605612 13.0470-5612.2 LD5612	MAN 24412 19,0 + WK + Zub MAN 24412 19,0 + WK + Zub Ceramic
			→	passend für Felgenreöße [Zoll]: 16 / 17		13.0460-2755.2 602755 13.0470-2755.2 LD2755	TRW 24421 17,2 + WK + Zub TRW 24421 17,2 + WK + Zub Ceramic
<b>Bremsscheibe</b>							
1.6 Turbo 2.0 t BioPower 2.0 t BioPower XWD 2.0 TiD 2.0 TTiD 2.0 TTiD XWD 2.0 Turbo 2.0 Turbo XWD 2.8 Turbo V6 XWD	132 162 162 118 140 140 162 162 221	05/10→01/12 05/10→01/12 05/10→01/12 05/10→01/12 05/10→01/12 05/10→01/12 05/10→01/12 05/10→01/12 05/10→01/12	←	passend für Felgenreöße [Zoll]: 16		24.0130-0207.1 430207 24.0330-0207.1 530207	Ø 296 30 27 V + S Ø 296 30 27 V + S
			←	+ 17plus" Rad		24.0130-0208.1 430208	Ø 337 30 27 V + S
			←	passend für Felgenreöße [Zoll]: 17		24.0130-0209.1 430209 24.0330-0209.1 530209	Ø 321 30 27 V + S Ø 321 30 27 V + S
			→	passend für Felgenreöße [Zoll]: 16		24.0112-0187.1 412187 24.0312-0187.1 512187	Ø 292 12 10,5 + S Ø 292 12 10,5 + S
			→	passend für Felgenreöße [Zoll]: 17		24.0123-0114.1 423114 24.0323-0114.1 523114	Ø 315 22,9 21,5 V + S Ø 315 22,9 21,5 V + S
<b>SAAB - 9-5 Kombi (YS3E) 10/98→12/09</b>							
<b>Bremsbelagsatz, Scheibenbremse</b>							
1.9 TiD 1.9 TiD 2.2 TiD 2.3 Turbo 2.3 Turbo 2.3 Turbo 2.3 Turbo 2.3 Turbo 2.3 Turbo 3.0 TiD	110 129 88 162 169 184 188 191 224 130	01/06→12/09 01/07→12/09 03/02→12/09 07/03→12/09 10/99→09/01 09/01→12/09 04/08→12/09 01/06→12/09 06/03→08/05 07/01→12/09	←	passend für Felgenreöße [Zoll]: 16		13.0460-7091.2 607091 13.0460-7173.2 607173	ATE 21829 20,3 + WE / - WK ATE 21829 20,3 - WK / + WK
			→			13.0460-3605.2 603605 13.0470-3605.2 LD3605	ATE 20180 17,3 + WE / - WK ATE 20180 17,3 + WE / - WK Ceramic
2.0 t 2.0 t 2.0 t 2.0 t BioPower 2.3 t 2.3 t BioPower 2.3 t BioPower 3.0 V6t	110 136 141 110 125 136 152 147	10/98→12/09 07/00→07/01 10/98→07/00 01/06→12/09 10/98→12/09 01/07→12/09 11/06→12/09 10/98→12/09	←	passend für Felgenreöße [Zoll]: 16		13.0460-7091.2 607091 13.0460-7173.2 607173	ATE 21829 20,3 + WE / - WK ATE 21829 20,3 - WK / + WK
			→	X3025752→		13.0460-3605.2 603605 13.0470-3605.2 LD3605	ATE 20180 17,3 + WE / - WK ATE 20180 17,3 + WE / - WK Ceramic
			→	→ X3025751		13.0460-4040.2 604040	ATE 21050 15,8 - WE / - WK
↓							























	kW			 	! #			
<b>SAAB - 9-5 Kombi (YS3E) 10/98→12/09</b>								
<b> Bremsbelagsatz, Scheibenbremse</b>								
2.0 t Biopower	132	09/05→12/09	←	06/06→; passend für Felgenreöße [Zoll]: 16		<b>13.0460-7091.2</b>	<b>607091</b>	ATE 21829 20,3 + WE / - WK
			←	06/06→		<b>13.0460-7173.2</b>	<b>607173</b>	ATE 21829 20,3 - WK / + WK
			→	X3025752→		<b>13.0460-3605.2</b>	<b>603605</b>	ATE 20180 17,3 + WE / - WK
						<b>13.0470-3605.2</b>	<b>LD3605</b>	ATE 20180 17,3 + WE / - WK Ceramic
			→	06/06→; → X3025751		<b>13.0460-4040.2</b>	<b>604040</b>	ATE 21050 15,8 - WE / - WK
2.3 t	136	01/01→12/09	←	01/02→; passend für Felgenreöße [Zoll]: 16		<b>13.0460-7091.2</b>	<b>607091</b>	ATE 21829 20,3 + WE / - WK
			←	01/02→		<b>13.0460-7173.2</b>	<b>607173</b>	ATE 21829 20,3 - WK / + WK
			→			<b>13.0460-3605.2</b>	<b>603605</b>	ATE 20180 17,3 + WE / - WK
						<b>13.0470-3605.2</b>	<b>LD3605</b>	ATE 20180 17,3 + WE / - WK Ceramic
			→	06/06→; → X3025751		<b>13.0460-4040.2</b>	<b>604040</b>	ATE 21050 15,8 - WE / - WK
2.3 t BioPower	154	11/06→12/09	←	01/07→; passend für Felgenreöße [Zoll]: 16		<b>13.0460-7091.2</b>	<b>607091</b>	ATE 21829 20,3 + WE / - WK
			←	01/07→		<b>13.0460-7173.2</b>	<b>607173</b>	ATE 21829 20,3 - WK / + WK
			→	X3025752→		<b>13.0460-3605.2</b>	<b>603605</b>	ATE 20180 17,3 + WE / - WK
						<b>13.0470-3605.2</b>	<b>LD3605</b>	ATE 20180 17,3 + WE / - WK Ceramic
			→	01/07→; → X3025751		<b>13.0460-4040.2</b>	<b>604040</b>	ATE 21050 15,8 - WE / - WK
<b>Warnkontakt, Bremsbelagverschleiß</b>								
1.9 TiD	110	01/06→12/09	←		2	<b>24.8190-0718.2</b>	<b>620718</b>	L= 720
1.9 TiD	129	01/07→12/09						
2.0 t	110	10/98→12/09						
2.0 t	136	07/00→07/01						
2.0 t	141	10/98→07/00						
2.0 t BioPower	110	01/06→12/09						
2.2 TiD	88	03/02→12/09						
2.3 t	125	10/98→12/09						
2.3 t BioPower	136	01/07→12/09						
2.3 t BioPower	152	11/06→12/09						
2.3 Turbo	162	07/03→12/09						
2.3 Turbo	169	10/99→09/01						
2.3 Turbo	184	09/01→12/09						
2.3 Turbo	188	04/08→12/09						
2.3 Turbo	191	01/06→12/09						
2.3 Turbo	224	06/03→08/05						
3.0 TiD	130	07/01→12/09						
3.0 V6t	147	10/98→12/09						
2.0 t Biopower	132	09/05→12/09	←	06/06→	2	<b>24.8190-0718.2</b>	<b>620718</b>	L= 720
2.3 t	136	01/01→12/09	←	01/02→	2	<b>24.8190-0718.2</b>	<b>620718</b>	L= 720
2.3 t BioPower	154	11/06→12/09	←	01/07→	2	<b>24.8190-0718.2</b>	<b>620718</b>	L= 720
<b>Zubehörsatz, Scheibenbremsbelag</b>								
2.0 t	110	10/98→12/09	→	→ X3025751		<b>13.0460-0347.2</b>	<b>610347</b>	
2.0 t	136	07/00→07/01						
2.0 t	141	10/98→07/00						
2.0 t BioPower	110	01/06→12/09						
2.3 t	125	10/98→12/09						
2.3 t BioPower	136	01/07→12/09						
2.3 t BioPower	152	11/06→12/09						
3.0 V6t	147	10/98→12/09						
2.0 t Biopower	132	09/05→12/09	→	06/06→; → X3025751		<b>13.0460-0347.2</b>	<b>610347</b>	
2.3 t BioPower	154	11/06→12/09	→	01/07→; → X3025751		<b>13.0460-0347.2</b>	<b>610347</b>	
<b> Bremsscheibe</b>								
1.9 TiD	110	01/06→12/09	←	passend für Felgenreöße [Zoll]: 15		<b>24.0125-0119.1</b>	<b>425119</b>	Ø 288 25 22 V + S
1.9 TiD	129	01/07→12/09				<b>24.0325-0119.1</b>	<b>525119</b>	Ø 288 25 22 V + S
2.2 TiD	88	03/02→12/09						
2.3 t	136	01/01→12/09	→			<b>24.0110-0274.1</b>	<b>410274</b>	Ø 286 10 8 + S
2.0 t	110	10/98→12/09	←	passend für Felgenreöße [Zoll]: 15		<b>24.0125-0119.1</b>	<b>425119</b>	Ø 288 25 22 V + S
2.0 t	136	07/00→07/01				<b>24.0325-0119.1</b>	<b>525119</b>	Ø 288 25 22 V + S
2.0 t	141	10/98→07/00						
2.3 t	125	10/98→12/09	←	passend für Felgenreöße [Zoll]: 16		<b>24.0125-0142.1</b>	<b>425142</b>	Ø 308 25 22 V + S
2.3 t BioPower	136	01/07→12/09				<b>24.0325-0142.1</b>	<b>525142</b>	Ø 308 25 23 V + S
2.3 t BioPower	152	11/06→12/09	→	→ X3025751		<b>24.0110-0226.1</b>	<b>410226</b>	Ø 286 10 8 + S
			→			<b>24.0310-0226.1</b>	<b>510226</b>	Ø 286 10 8 + S
			→	X3025752→		<b>24.0110-0274.1</b>	<b>410274</b>	Ø 286 10 8 + S
2.0 t Biopower	132	09/05→12/09	←	06/06→; passend für Felgenreöße [Zoll]: 15		<b>24.0125-0119.1</b>	<b>425119</b>	Ø 288 25 22 V + S
						<b>24.0325-0119.1</b>	<b>525119</b>	Ø 288 25 22 V + S

	kW			 	! #		
<b>SAAB - 9-5 Kombi (YS3E) 10/98→12/09</b>							
<b>Bremsscheibe</b>							
2.0 t Biopower	132	09/05→12/09	➔	06/06→; → X3025751		24.0110-0226.1 410226 24.0310-0226.1 510226	Ø 286 10 8 + S Ø 286 10 8 + S
			➔	X3025752→		24.0110-0274.1 410274	Ø 286 10 8 + S
2.0 t BioPower	110	01/06→12/09	←	passend für Felgenreöße [Zoll]: 15		24.0125-0119.1 425119 24.0325-0119.1 525119	Ø 288 25 22 V + S Ø 288 25 22 V + S
			➔	→ X3025751		24.0110-0226.1 410226 24.0310-0226.1 510226	Ø 286 10 8 + S Ø 286 10 8 + S
			➔	X3025752→		24.0110-0274.1 410274	Ø 286 10 8 + S
2.3 t BioPower	154	11/06→12/09	←	01/07→; passend für Felgenreöße [Zoll]: 15		24.0125-0119.1 425119 24.0325-0119.1 525119	Ø 288 25 22 V + S Ø 288 25 22 V + S
			←	01/07→; passend für Felgenreöße [Zoll]: 16		24.0125-0142.1 425142 24.0325-0142.1 525142	Ø 308 25 22 V + S Ø 308 25 23 V + S
			➔	01/07→; → X3025751		24.0110-0226.1 410226 24.0310-0226.1 510226	Ø 286 10 8 + S Ø 286 10 8 + S
			➔	X3025752→		24.0110-0274.1 410274	Ø 286 10 8 + S
2.3 Turbo	162	07/03→12/09	←	43510123→; nur für USA; passend für Felgenreöße [Zoll]: 15		24.0125-0119.1 425119 24.0325-0119.1 525119	Ø 288 25 22 V + S Ø 288 25 22 V + S
			←	nicht für USA; passend für Felgenreöße [Zoll]: 15		24.0125-0119.1 425119 24.0325-0119.1 525119	Ø 288 25 22 V + S Ø 288 25 22 V + S
			←	→ 43510122; für USA; passend für Felgenreöße [Zoll]: 16		24.0125-0142.1 425142 24.0325-0142.1 525142	Ø 308 25 22 V + S Ø 308 25 23 V + S
			➔			24.0110-0274.1 410274	Ø 286 10 8 + S
2.3 Turbo	169	10/99→09/01	←	passend für Felgenreöße [Zoll]: 16		24.0125-0142.1 425142 24.0325-0142.1 525142	Ø 308 25 22 V + S Ø 308 25 23 V + S
			➔			24.0110-0274.1 410274	Ø 286 10 8 + S
2.3 Turbo 3.0 TiD	184 130	09/01→12/09 07/01→12/09	←	passend für Felgenreöße [Zoll]: 16		24.0125-0142.1 425142 24.0325-0142.1 525142	Ø 308 25 22 V + S Ø 308 25 23 V + S
			➔	→ 12/01		24.0110-0274.1 410274	Ø 286 10 8 + S
			➔	01/02→		24.0120-0196.1 420196	Ø 300 20 18 V + S
2.3 Turbo 2.3 Turbo 2.3 Turbo	188 191 224	04/08→12/09 01/06→12/09 06/03→08/05	←	passend für Felgenreöße [Zoll]: 16		24.0125-0142.1 425142 24.0325-0142.1 525142	Ø 308 25 22 V + S Ø 308 25 23 V + S
			➔			24.0120-0196.1 420196	Ø 300 20 18 V + S
3.0 V6t	147	10/98→12/09	←	passend für Felgenreöße [Zoll]: 15		24.0125-0119.1 425119 24.0325-0119.1 525119	Ø 288 25 22 V + S Ø 288 25 22 V + S
			←	passend für Felgenreöße [Zoll]: 16		24.0125-0142.1 425142 24.0325-0142.1 525142	Ø 308 25 22 V + S Ø 308 25 23 V + S
			➔	→ X3025751		24.0110-0226.1 410226 24.0310-0226.1 510226	Ø 286 10 8 + S Ø 286 10 8 + S
			➔	→ 12/01; X3025752→		24.0110-0274.1 410274	Ø 286 10 8 + S
			➔	01/02→		24.0120-0196.1 420196	Ø 300 20 18 V + S
<b>SAAB - 900 II 07/93→04/99</b>							
<b>Bremsbelagsatz, Scheibenbremse</b>							
2.0 -16 Turbo 2.3 -16 2.5 -24 V6	136 110 125	07/93→02/98 07/93→02/98 07/93→02/98	←	09/93→ 08/96		13.0460-7080.2 607080	ATE 21411 17,5 - WK
			←	09/96→		13.0460-7091.2 607091 13.0460-7173.2 607173	ATE 21829 20,3 + WE / - WK ATE 21829 20,3 - WK / + WK
			➔	09/96→		13.0460-4040.2 604040	ATE 21050 15,8 - WE / - WK
			➔	09/93→ 08/96		13.0460-4043.2 604043	ATE 21140 15,0 - WE / - WK
2.0 i	96	08/94→02/98	←	→ 08/96		13.0460-7080.2 607080	ATE 21411 17,5 - WK
			←	09/96→		13.0460-7091.2 607091 13.0460-7173.2 607173	ATE 21829 20,3 + WE / - WK ATE 21829 20,3 - WK / + WK
			➔	09/96→		13.0460-4040.2 604040	ATE 21050 15,8 - WE / - WK
			➔	→ 08/96		13.0460-4043.2 604043	ATE 21140 15,0 - WE / - WK
<b>Warnkontakt, Bremsbelagsverschleiß</b>							
2.0 -16 Turbo 2.0 i 2.3 -16 2.5 -24 V6 ↓	136 96 110 125	07/93→02/98 08/94→02/98 07/93→02/98 07/93→02/98	←	09/96→	2	24.8190-0718.2 620718	L= 720











	kW			 	! #		
<b>SAAB - 900 II 07/93→04/99</b>							
<b>Zubehörsatz, Scheibenbremsbelag</b>							
2.0 -16 Turbo	136	07/93→02/98	➡	09/93→ 08/96		13.0460-0217.2 610217	ATE
2.3 -16	110	07/93→02/98	➡	09/96→		13.0460-0347.2 610347	
2.5 -24 V6	125	07/93→02/98	➡				
2.0 i	96	08/94→02/98	➡	→ 08/96		13.0460-0217.2 610217	ATE
			➡	09/96→		13.0460-0347.2 610347	
<b> Bremsscheibe</b>							
2.0 -16 Turbo	136	07/93→02/98	⬅	09/93→ 08/96		24.0124-0133.1 424133	Ø 284 24 21 V
2.3 -16	110	07/93→02/98	⬅	09/96→		24.0125-0119.1 425119	Ø 288 25 22 V + S
2.5 -24 V6	125	07/93→02/98	⬅			24.0325-0119.1 525119	Ø 288 25 22 V + S
			➡	V7004690→		24.0110-0226.1 410226	Ø 286 10 8 + S
			➡	V2022962→		24.0310-0226.1 510226	Ø 286 10 8 + S
			➡	09/93→; → V2022961		24.0110-0226.1 410226	Ø 286 10 8 + S
			➡	09/93→; → V7004689		24.0110-0249.1 410249	Ø 260 10 8
2.0 i	96	08/94→02/98	⬅	→ 08/96		24.0124-0133.1 424133	Ø 284 24 21 V
			⬅	09/96→		24.0125-0119.1 425119	Ø 288 25 22 V + S
			⬅			24.0325-0119.1 525119	Ø 288 25 22 V + S
			➡	V2022962→		24.0110-0226.1 410226	Ø 286 10 8 + S
			➡			24.0310-0226.1 510226	Ø 286 10 8 + S
			➡	V7004690→		24.0110-0226.1 410226	Ø 286 10 8 + S
			➡			24.0310-0226.1 510226	Ø 286 10 8 + S
			➡	→ V7004689		24.0110-0249.1 410249	Ø 260 10 8
			➡	→ V2022961		24.0110-0249.1 410249	Ø 260 10 8
<b>SAAB - 900 II Cabriolet 09/93→04/99</b>							
<b> Bremsbelagsatz, Scheibenbremse</b>							
2.0 -16 Turbo	136	12/93→02/98	⬅	→ 08/96		13.0460-7080.2 607080	ATE 21411 17,5 - WK
2.0 i	96	12/93→02/98	⬅	09/96→		13.0460-7091.2 607091	ATE 21829 20,3 + WE / - WK
2.3 -16	110	12/93→02/98	⬅			13.0460-7173.2 607173	ATE 21829 20,3 - WK / + WK
2.5 -24 V6	125	12/93→02/98	⬅				
			➡	09/96→		13.0460-4040.2 604040	ATE 21050 15,8 - WE / - WK
			➡	→ 08/96		13.0460-4043.2 604043	ATE 21140 15,0 - WE / - WK
<b>Warnkontakt, Bremsbelagsverschleiß</b>							
2.0 -16 Turbo	136	12/93→02/98	⬅	09/96→	2	24.8190-0718.2 620718	L= 720
2.0 i	96	12/93→02/98	⬅				
2.3 -16	110	12/93→02/98	⬅				
2.5 -24 V6	125	12/93→02/98	⬅				
<b>Zubehörsatz, Scheibenbremsbelag</b>							
2.0 -16 Turbo	136	12/93→02/98	➡	→ 08/96		13.0460-0217.2 610217	ATE
2.0 i	96	12/93→02/98	➡	09/96→		13.0460-0347.2 610347	
2.3 -16	110	12/93→02/98	➡				
2.5 -24 V6	125	12/93→02/98	➡				
<b> Bremsscheibe</b>							
2.0 -16 Turbo	136	12/93→02/98	⬅	→ 08/96		24.0124-0133.1 424133	Ø 284 24 21 V
2.0 i	96	12/93→02/98	⬅	09/96→		24.0125-0119.1 425119	Ø 288 25 22 V + S
2.3 -16	110	12/93→02/98	⬅			24.0325-0119.1 525119	Ø 288 25 22 V + S
2.5 -24 V6	125	12/93→02/98	⬅				
			➡	V2022962→		24.0110-0226.1 410226	Ø 286 10 8 + S
			➡	V7004690→		24.0310-0226.1 510226	Ø 286 10 8 + S
			➡			24.0110-0226.1 410226	Ø 286 10 8 + S
			➡	→ V7004689		24.0310-0226.1 510226	Ø 286 10 8 + S
			➡	→ V2022961		24.0110-0249.1 410249	Ø 260 10 8
			➡			24.0110-0249.1 410249	Ø 260 10 8
<b>SAAB - 900 II Coupe 12/93→04/99</b>							
<b> Bremsbelagsatz, Scheibenbremse</b>							
2.0 -16 Turbo	136	12/93→02/98	⬅	→ 08/96		13.0460-7080.2 607080	ATE 21411 17,5 - WK
2.0 i	96	08/94→02/98	⬅	09/96→		13.0460-7091.2 607091	ATE 21829 20,3 + WE / - WK
2.3 -16	110	12/93→02/98	⬅			13.0460-7173.2 607173	ATE 21829 20,3 - WK / + WK
2.5 -24 V6	125	12/93→02/98	⬅				
↓							











	kW					! #		
<b>SAAB - 900 II Coupe 12/93→04/99</b>								
 <b>Bremsbelagsatz, Scheibenbremse</b>								
2.0 -16 Turbo	136	12/93→02/98	➡	09/96→			<b>13.0460-4040.2 604040</b>	ATE 21050 15,8 - WE / - WK
2.0 i	96	08/94→02/98						
2.3 -16	110	12/93→02/98	➡	→ 08/96			<b>13.0460-4043.2 604043</b>	ATE 21140 15,0 - WE / - WK
2.5 -24 V6	125	12/93→02/98						
<b>Warnkontakt, Bremsbelagverschleiß</b>								
2.0 -16 Turbo	136	12/93→02/98	⬅	09/96→	2		<b>24.8190-0718.2 620718</b>	L= 720
2.0 i	96	08/94→02/98						
2.3 -16	110	12/93→02/98						
2.5 -24 V6	125	12/93→02/98						
<b>Zubehörsatz, Scheibenbremsbelag</b>								
2.0 -16 Turbo	136	12/93→02/98	➡	→ 08/96			<b>13.0460-0217.2 610217</b>	ATE
2.0 i	96	08/94→02/98						
2.3 -16	110	12/93→02/98	➡	09/96→			<b>13.0460-0347.2 610347</b>	
2.5 -24 V6	125	12/93→02/98						
 <b>Bremsscheibe</b>								
2.0 -16 Turbo	136	12/93→02/98	⬅	→ 08/96			<b>24.0124-0133.1 424133</b>	Ø 284 24 21 V
2.0 i	96	08/94→02/98						
2.3 -16	110	12/93→02/98	⬅	09/96→			<b>24.0125-0119.1 425119</b>	Ø 288 25 22 V + S
2.5 -24 V6	125	12/93→02/98					<b>24.0325-0119.1 525119</b>	Ø 288 25 22 V + S
			➡	V2022962→			<b>24.0110-0226.1 410226</b>	Ø 286 10 8 + S
			➡	V7004690→			<b>24.0310-0226.1 510226</b>	Ø 286 10 8 + S
			➡	V7004689			<b>24.0110-0226.1 410226</b>	Ø 286 10 8 + S
			➡	→ V7004689			<b>24.0110-0249.1 410249</b>	Ø 260 10 8
			➡	→ V2022961			<b>24.0110-0249.1 410249</b>	Ø 260 10 8
<b>SAAB - 9000 04/85→12/98</b>								
 <b>Bremsbelagsatz, Scheibenbremse</b>								
2.0 -16 CD	96	09/93→12/98	⬅	→ 05/98			<b>13.0460-5703.2 605703</b>	ATE 21154 19,5 + WE / - WK
2.0 -16 CD	110	09/93→12/98						
2.3 -16 CDE	108	09/93→12/98	➡	→ 05/98			<b>13.0460-3306.2 603306</b>	ATE 21089 15,0 - WE / - WK
2.3 -16 CDE Eco-Power	125	09/93→12/98						
2.0 -16 Turbo CD	108	09/92→12/98	⬅	09/93→ 05/98			<b>13.0460-5703.2 605703</b>	ATE 21154 19,5 + WE / - WK
2.0 -16 Turbo CD	136	09/89→12/98	⬅	→ 08/93			<b>13.0460-5703.2 605703</b>	ATE 21154 19,5 + WE / - WK
			➡	09/93→ 05/98			<b>13.0460-3306.2 603306</b>	ATE 21089 15,0 - WE / - WK
			➡	→ 08/93			<b>13.0460-3306.2 603306</b>	ATE 21089 15,0 - WE / - WK
2.3 -16 CD	107	08/89→12/98	⬅	09/89→ 08/93			<b>13.0460-5703.2 605703</b>	ATE 21154 19,5 + WE / - WK
			➡	09/89→ 08/93			<b>13.0460-3306.2 603306</b>	ATE 21089 15,0 - WE / - WK
2.3 -16 CD Turbo	147	07/90→12/98	⬅	09/93→ 05/98			<b>13.0460-5703.2 605703</b>	ATE 21154 19,5 + WE / - WK
			➡	09/93→ 05/98			<b>13.0460-3306.2 603306</b>	ATE 21089 15,0 - WE / - WK
2.3 -16 Turbo	143	09/90→12/98	⬅				<b>13.0460-5703.2 605703</b>	ATE 21154 19,5 + WE / - WK
			➡				<b>13.0460-3306.2 603306</b>	ATE 21089 15,0 - WE / - WK
3.0 -24 V6 CD/CDE	155	07/94→12/98	⬅	09/94→ 05/98			<b>13.0460-5703.2 605703</b>	ATE 21154 19,5 + WE / - WK
			➡	09/94→ 05/98			<b>13.0460-3306.2 603306</b>	ATE 21089 15,0 - WE / - WK
 <b>Bremsscheibe</b>								
2.0 -16 CD	96	09/93→12/98	⬅	→ 05/98			<b>24.0125-0125.1 425125</b>	Ø 280 25 23 V
2.0 -16 CD	110	09/93→12/98						
2.3 -16 CDE	108	09/93→12/98	➡	→ 05/98			<b>24.0109-0130.1 409130</b>	Ø 258 9 7,5
2.3 -16 CDE Eco-Power	125	09/93→12/98						
2.0 -16 Turbo CD	108	09/92→12/98	⬅	09/93→ 05/98			<b>24.0125-0125.1 425125</b>	Ø 280 25 23 V
2.0 -16 Turbo CD	136	09/89→12/98	⬅	→ 08/93			<b>24.0125-0125.1 425125</b>	Ø 280 25 23 V
			➡	09/93→ 05/98			<b>24.0109-0130.1 409130</b>	Ø 258 9 7,5
			➡	→ 08/93			<b>24.0109-0130.1 409130</b>	Ø 258 9 7,5
2.3 -16 CD	107	08/89→12/98	⬅	09/89→ 08/93			<b>24.0125-0125.1 425125</b>	Ø 280 25 23 V
			➡	09/89→ 08/93			<b>24.0109-0130.1 409130</b>	Ø 258 9 7,5
2.3 -16 CD Turbo	147	07/90→12/98	⬅	09/93→ 05/98			<b>24.0125-0125.1 425125</b>	Ø 280 25 23 V
			➡	09/93→ 05/98			<b>24.0109-0130.1 409130</b>	Ø 258 9 7,5
2.3 -16 Turbo	143	09/90→12/98	⬅				<b>24.0125-0125.1 425125</b>	Ø 280 25 23 V
			➡				<b>24.0109-0130.1 409130</b>	Ø 258 9 7,5
3.0 -24 V6 CD/CDE	155	07/94→12/98	⬅	09/94→ 05/98			<b>24.0125-0125.1 425125</b>	Ø 280 25 23 V
↓								











	kw				! #		
<b>SAAB - 9000 04/85→12/98</b>							
 <b>Bremsscheibe</b>							
3.0 -24 V6 CD/CDE	155	07/94→12/98	➡	09/94→05/98		24.0109-0130.1 409130	Ø 258 9 7,5
<b>SAAB - 9000 Schrägheck 09/84→12/98</b>							
 <b>Bremsbelagsatz, Scheibenbremse</b>							
2.0 -16 CS	94	01/89→12/98	←	→ 08/89		13.0460-2811.2 602811	TRW 21068 17,0 - WK
			←	09/89→08/93		13.0460-5703.2 605703	ATE 21154 19,5 + WE / - WK
			➡	→ 08/93		13.0460-3306.2 603306	ATE 21089 15,0 - WE / - WK
2.0 -16 CS	96	09/93→12/98	←	→ 05/98		13.0460-5703.2 605703	ATE 21154 19,5 + WE / - WK
2.0 -16 ND Turbo	110	09/93→12/98	➡	→ 05/98		13.0460-3306.2 603306	ATE 21089 15,0 - WE / - WK
2.3 -16 CSE	108	09/93→12/98	➡	→ 05/98			
2.3 -16 CSE Eco Power	125	09/93→12/98					
2.3 -16 Turbo CSE	147	09/93→12/98					
2.0 -16 Turbo CS	136	09/88→12/98	←	09/93→05/98		13.0460-5703.2 605703	ATE 21154 19,5 + WE / - WK
			←	→ 08/93		13.0460-5703.2 605703	ATE 21154 19,5 + WE / - WK
			➡	09/93→05/98		13.0460-3306.2 603306	ATE 21089 15,0 - WE / - WK
			➡	→ 08/93		13.0460-3306.2 603306	ATE 21089 15,0 - WE / - WK
2.3 -16 Aero CS	162	02/93→12/98	←	09/93→05/98		13.0460-5703.2 605703	ATE 21154 19,5 + WE / - WK
2.3 -16 Aero CS	165	02/93→12/98	➡	09/93→05/98		13.0460-3306.2 603306	ATE 21089 15,0 - WE / - WK
2.3 -16 Turbo	143	09/90→12/98	➡	09/93→05/98			
2.3 -16 CS	107	09/89→12/98	←	→ 08/93		13.0460-5703.2 605703	ATE 21154 19,5 + WE / - WK
			➡	→ 08/93		13.0460-3306.2 603306	ATE 21089 15,0 - WE / - WK
3.0 -24 V6 CS/CSE	155	07/94→12/98	←	09/94→05/98		13.0460-5703.2 605703	ATE 21154 19,5 + WE / - WK
			➡	09/94→05/98		13.0460-3306.2 603306	ATE 21089 15,0 - WE / - WK
 <b>Bremsscheibe</b>							
2.0 -16 CS	94	01/89→12/98	←	→ 08/89		24.0123-0101.1 423101	Ø 280 23,4 21,5 V
			←	09/89→08/93		24.0125-0125.1 425125	Ø 280 25 23 V
			➡	→ 08/93		24.0109-0130.1 409130	Ø 258 9 7,5
2.0 -16 CS	96	09/93→12/98	←	→ 05/98		24.0125-0125.1 425125	Ø 280 25 23 V
2.0 -16 ND Turbo	110	09/93→12/98	➡	→ 05/98		24.0109-0130.1 409130	Ø 258 9 7,5
2.3 -16 CSE	108	09/93→12/98	➡	→ 05/98			
2.3 -16 CSE Eco Power	125	09/93→12/98					
2.3 -16 Turbo CSE	147	09/93→12/98					
2.0 -16 Turbo CS	136	09/88→12/98	←	09/93→05/98		24.0125-0125.1 425125	Ø 280 25 23 V
			←	→ 08/93		24.0125-0125.1 425125	Ø 280 25 23 V
			➡	09/93→05/98		24.0109-0130.1 409130	Ø 258 9 7,5
			➡	→ 08/93		24.0109-0130.1 409130	Ø 258 9 7,5
2.3 -16 Aero CS	162	02/93→12/98	←	09/93→05/98		24.0125-0125.1 425125	Ø 280 25 23 V
2.3 -16 Aero CS	165	02/93→12/98	➡	09/93→05/98		24.0109-0130.1 409130	Ø 258 9 7,5
2.3 -16 Turbo	143	09/90→12/98	➡	09/93→05/98			
2.3 -16 CS	107	09/89→12/98	←	→ 08/93		24.0125-0125.1 425125	Ø 280 25 23 V
			➡	→ 08/93		24.0109-0130.1 409130	Ø 258 9 7,5
3.0 -24 V6 CS/CSE	155	07/94→12/98	←	09/94→05/98		24.0125-0125.1 425125	Ø 280 25 23 V
			➡	09/94→05/98		24.0109-0130.1 409130	Ø 258 9 7,5
<b>SEAT - ALHAMBRA (7V8, 7V9) 04/96→03/10</b>							
 <b>Bremsbelagsatz, Scheibenbremse</b>							
1.8 T 20V	110	10/97→03/10	←	05/98→; → 7M-W-070000		13.0460-7076.2 607076	ATE 21848 19,8 - WE / - WK
			←	7M-X-000001→ 7M-1-530756		13.0460-7143.2 607143	ATE 21848 19,8 + WK
			←	7M-2-500001→		13.0460-7153.2 607153	ATE 23269 19,8 + WK
			➡	05/98→05/00		13.0460-2819.2 602819	TRW 20961 17,2 - WK
			➡	06/00→; → 7M-1-530756		13.0460-2859.2 602859	TRW 20961 17,0 + WK + Zub
			➡	7M-2-500001→		13.0460-2872.2 602872	TRW 23224 16,5 + WK + Zub
1.9 TDI	66	04/96→03/10	←	→ 7M-W-070000		13.0460-7076.2 607076	ATE 21848 19,8 - WE / - WK
2.0 i	85	04/96→03/10	←	7M-X-000001→ 7M-1-530756		13.0460-7143.2 607143	ATE 21848 19,8 + WK
			←	7M-2-500001→		13.0460-7154.2 607154	ATE 23034 18,8 + WK
			➡	→ 05/00		13.0460-2819.2 602819	TRW 20961 17,2 - WK
			➡	06/00→		13.0460-2859.2 602859	TRW 20961 17,0 + WK + Zub
↓							

























	kw			 	! #		
<b>SEAT - ALHAMBRA (7V8, 7V9) 04/96→03/10</b>							
<b> Bremsbelagsatz, Scheibenbremse</b>							
1.9 TDI	81	08/96→06/00	←	10/97→; → 7M-W-070000		<b>13.0460-7076.2 607076</b>	ATE 21848 19,8 - WE / - WK
			←	7M-X-000001→; → 05/00		<b>13.0460-7143.2 607143</b>	ATE 21848 19,8 + WK
			→	10/97→ 05/00		<b>13.0460-2819.2 602819</b>	TRW 20961 17,2 - WK
1.9 TDI	85	06/00→03/10	←	7M-X-000001→ 7M-1-530756		<b>13.0460-7143.2 607143</b>	ATE 21848 19,8 + WK
			←	7M-2-500001→		<b>13.0460-7154.2 607154</b>	ATE 23034 18,8 + WK
			→	→ 7M-1-530756		<b>13.0460-2859.2 602859</b>	TRW 20961 17,0 + WK + Zub
			→	7M-2-500001→		<b>13.0460-2872.2 602872</b>	TRW 23224 16,5 + WK + Zub
1.9 TDI	96	11/02→11/08	←			<b>13.0460-7154.2 607154</b>	ATE 23034 18,8 + WK
2.0 TDI	103	11/05→03/10	→			<b>13.0460-2859.2 602859</b>	TRW 20961 17,0 + WK + Zub
1.9 TDI	110	05/05→05/07	←			<b>13.0460-7153.2 607153</b>	ATE 23269 19,8 + WK
2.8 V6	150	06/00→03/10	→			<b>13.0460-2872.2 602872</b>	TRW 23224 16,5 + WK + Zub
1.9 TDI 4motion	85	06/00→03/10	←	02/01→		<b>13.0460-7153.2 607153</b>	ATE 23269 19,8 + WK
2.8 V6 4motion	150	06/00→03/10	→	02/01→		<b>13.0460-2872.2 602872</b>	TRW 23224 16,5 + WK + Zub
<b>Zubehörsatz, Scheibenbremsbelag</b>							
1.8 T 20V	110	10/97→03/10	→	05/98→ 05/00		<b>13.0460-0072.2 610072</b>	TRW
			→	7M-2-500001→		<b>13.0460-0225.2 610225</b>	
1.9 TDI	66	04/96→03/10	→	→ 05/00		<b>13.0460-0072.2 610072</b>	TRW
2.0 i	85	04/96→03/10					
1.9 TDI	81	08/96→06/00	→	10/97→ 05/00		<b>13.0460-0072.2 610072</b>	TRW
1.9 TDI	85	06/00→03/10	→	7M-2-500001→		<b>13.0460-0225.2 610225</b>	
1.9 TDI	110	05/05→05/07	→			<b>13.0460-0225.2 610225</b>	
2.8 V6	150	06/00→03/10					
1.9 TDI 4motion	85	06/00→03/10	→	02/01→		<b>13.0460-0225.2 610225</b>	
2.8 V6 4motion	150	06/00→03/10					
<b> Bremsscheibe</b>							
1.8 T 20V	110	10/97→03/10	←	05/98→; → 7M-1-530756		<b>24.0125-0114.1 425114</b>	Ø 288 25,1 21 V + S
						<b>24.0325-0114.1 525114</b>	Ø 288 25,1 21 V + S
			←	7M-2-500001→		<b>24.0126-0119.1 426119</b>	Ø 313 25,9 22 V
						<b>24.0326-0119.1 526119</b>	Ø 313 25,9 22 V
			→	05/98→; → 7M-1-530756		<b>24.0110-0223.1 410223</b>	Ø 268 10 8 + S
						<b>24.0310-0223.1 510223</b>	Ø 268 10 8 + S
			→	7M-2-500001→		<b>24.0113-0194.1 413194</b>	Ø 294 13,5 11,5
1.9 TDI	66	04/96→03/10	←	→ 7M-1-530756		<b>24.0125-0114.1 425114</b>	Ø 288 25,1 21 V + S
2.0 i	85	04/96→03/10				<b>24.0325-0114.1 525114</b>	Ø 288 25,1 21 V + S
			←	7M-2-500001→		<b>24.0126-0115.1 426115</b>	Ø 300 26 22 V
						<b>24.0326-0115.1 526115</b>	Ø 300 26 22 V
			→			<b>24.0110-0223.1 410223</b>	Ø 268 10 8 + S
						<b>24.0310-0223.1 510223</b>	Ø 268 10 8 + S
1.9 TDI	81	08/96→06/00	←	10/97→ 05/00		<b>24.0125-0114.1 425114</b>	Ø 288 25,1 21 V + S
						<b>24.0325-0114.1 525114</b>	Ø 288 25,1 21 V + S
			→	10/97→ 05/00		<b>24.0110-0223.1 410223</b>	Ø 268 10 8 + S
						<b>24.0310-0223.1 510223</b>	Ø 268 10 8 + S
1.9 TDI	85	06/00→03/10	←	→ 7M-1-530756		<b>24.0125-0114.1 425114</b>	Ø 288 25,1 21 V + S
						<b>24.0325-0114.1 525114</b>	Ø 288 25,1 21 V + S
			←	7M-2-500001→		<b>24.0126-0115.1 426115</b>	Ø 300 26 22 V
						<b>24.0326-0115.1 526115</b>	Ø 300 26 22 V
			→	→ 7M-1-530756		<b>24.0110-0223.1 410223</b>	Ø 268 10 8 + S
						<b>24.0310-0223.1 510223</b>	Ø 268 10 8 + S
			→	7M-2-500001→		<b>24.0113-0194.1 413194</b>	Ø 294 13,5 11,5
1.9 TDI	96	11/02→11/08	←			<b>24.0126-0115.1 426115</b>	Ø 300 26 22 V
2.0 TDI	103	11/05→03/10				<b>24.0326-0115.1 526115</b>	Ø 300 26 22 V
			→			<b>24.0110-0223.1 410223</b>	Ø 268 10 8 + S
						<b>24.0310-0223.1 510223</b>	Ø 268 10 8 + S
1.9 TDI	110	05/05→05/07	←			<b>24.0126-0119.1 426119</b>	Ø 313 25,9 22 V
2.8 V6	150	06/00→03/10				<b>24.0326-0119.1 526119</b>	Ø 313 25,9 22 V
			→			<b>24.0113-0194.1 413194</b>	Ø 294 13,5 11,5
1.9 TDI 4motion	85	06/00→03/10	←	02/01→		<b>24.0126-0119.1 426119</b>	Ø 313 25,9 22 V
↓							











	kw					! #		
<b>SEAT - ALHAMBRA (7V8, 7V9) 04/96→03/10</b>								
 <b>Bremsscheibe</b>								
2.8 V6 4motion	150	06/00→03/10	←	02/01→		24.0326-0119.1	526119	Ø 313 25,9 22 V
			→	02/01→		24.0113-0194.1	413194	Ø 294 13,5 11,5
<b>SEAT - ALHAMBRA (710, 711) 06/10→</b>								
 <b>Bremsbelagsatz, Scheibenbremse</b>								
1.4 TSI	110	06/10→	←	09/10→; +PR 1LW		13.0460-2764.2	602764	TRW 24738 20,0 + WK
2.0 TDI	100	06/10→05/11				13.0470-2764.2	LD2764	TRW 24738 20,0 + WK Ceramic
2.0 TDI	125	06/10→	←	09/10→; +PR 1LJ		13.0460-7242.2	607242	ATE 24332 19,8 + WK
						13.0470-7242.2	LD7242	ATE 24332 19,8 + WK Ceramic
			→	09/10→		13.0460-2749.2	602749	TRW 24483 16,9 - WE / - WK + Zub
						13.0460-2880.2	602880	TRW 23914 17,1 + WE / - WK + Zub
						13.0470-2749.2	LD2749	TRW 24483 16,9 - WE / - WK + Zub Ceramic
						13.0470-2880.2	LD2880	TRW 23914 17,1 + WE / - WK + Zub Ceramic
1.4 TSI	110	05/15→	←	+PR 1LW		13.0460-2764.2	602764	TRW 24738 20,0 + WK
1.8 TSI	118	11/12→				13.0470-2764.2	LD2764	TRW 24738 20,0 + WK Ceramic
2.0 TDI	85	05/11→	←	+PR 1LJ		13.0460-7242.2	607242	ATE 24332 19,8 + WK
2.0 TDI	103	06/10→				13.0470-7242.2	LD7242	ATE 24332 19,8 + WK Ceramic
2.0 TDI	130	11/12→						
2.0 TDI 4Drive	103	05/11→	→			13.0460-2749.2	602749	TRW 24483 16,9 - WE / - WK + Zub
2.0 TSI	147	11/10→				13.0460-2880.2	602880	TRW 23914 17,1 + WE / - WK + Zub
						13.0470-2749.2	LD2749	TRW 24483 16,9 - WE / - WK + Zub Ceramic
						13.0470-2880.2	LD2880	TRW 23914 17,1 + WE / - WK + Zub Ceramic
2.0 TDI	110	05/15→	←	+PR 1LW		13.0460-2764.2	602764	TRW 24738 20,0 + WK
2.0 TDI	135	05/15→				13.0470-2764.2	LD2764	TRW 24738 20,0 + WK Ceramic
2.0 TDI 4Drive	110	05/15→						
2.0 TDI 4Drive	135	05/16→	→	+ eFSB		13.0460-2790.2	602790	TRW 25110 17,5 - WE / - WK
2.0 TSI	162	05/15→				13.0470-2790.2	LD2790	TRW 25110 17,5 - WE / - WK Ceramic
 <b>Bremsscheibe</b>								
1.4 TSI	110	06/10→	←	09/10→; +PR 1LJ		24.0125-0158.1	425158	Ø 312 25 22 V + S
2.0 TDI	100	06/10→05/11				24.0325-0158.1	525158	Ø 312 25 22 V + S
2.0 TDI	125	06/10→	←	09/10→; +PR 1LW		24.0130-0220.1	430220	Ø 314 30 27 V + S
			→	09/10→		24.0112-0169.1	412169	Ø 282 12 10 + S
						24.0312-0169.1	512169	Ø 282 12 10 + S
1.4 TSI	110	05/15→	←	+PR 1LJ		24.0125-0158.1	425158	Ø 312 25 22 V + S
1.8 TSI	118	11/12→				24.0325-0158.1	525158	Ø 312 25 22 V + S
2.0 TDI	85	05/11→	←	+PR 1LW		24.0130-0220.1	430220	Ø 314 30 27 V + S
2.0 TDI	103	06/10→				24.0112-0169.1	412169	Ø 282 12 10 + S
2.0 TDI	130	11/12→	→			24.0312-0169.1	512169	Ø 282 12 10 + S
2.0 TDI 4Drive	103	05/11→						
2.0 TSI	147	11/10→						
2.0 TDI	110	05/15→	←	+PR 1LW		24.0130-0220.1	430220	Ø 314 30 27 V + S
2.0 TDI	135	05/15→				24.0112-0210.1	412210	Ø 300 12 10 + S
2.0 TDI 4Drive	110	05/15→	→	+ eFSB				
2.0 TDI 4Drive	135	05/16→						
2.0 TSI	162	05/15→						
<b>SEAT - ALTEA (5P1) 03/04→</b>								
 <b>Bremsbelagsatz, Scheibenbremse</b>								
1.2 TSI	77	04/10→	←	+PR 1ZF		13.0460-7117.2	607117	VW 23130 19,6 + WK
1.4 16V	63	05/06→				13.0470-7117.2	LD7117	VW 23130 19,6 + WK Ceramic
1.4 TSI	92	11/07→	←	+PR 1ZA,1ZE,1LJ		13.0460-7184.2	607184	ATE 23587 20,6 + WK
1.6	75	03/04→				13.0470-7184.2	LD7184	ATE 23587 20,6 + WK Ceramic
1.6 LPG	75	09/09→	→	+PR 1KF,1KJ		13.0460-2749.2	602749	TRW 24483 16,9 - WE / - WK + Zub
1.6 TDI	66	11/10→				13.0460-2880.2	602880	TRW 23914 17,1 + WE / - WK + Zub
1.6 TDI	77	10/09→				13.0470-2749.2	LD2749	TRW 24483 16,9 - WE / - WK + Zub
1.8 TFSI	118	01/07→						
1.9 TDI	66	08/09→						
1.9 TDI	77	04/04→						
2.0 FSI	110	05/04→03/09						
2.0 TDI	100	03/04→05/09						
2.0 TDI	103	11/05→						
2.0 TDI	125	03/06→						









	kw			 	! #		
<b>SEAT - ALTEA (5P1) 03/04→</b>							
 <b>Bremsbelagsatz, Scheibenbremse</b>							
2.0 TDI 16V 2.0 TFSI	103 147	03/04→ 04/06→05/09	➔	+PR 1KD,1KQ,1KZ		13.0460-2787.2 602787 13.0460-2820.2 602820 13.0470-2820.2 LD2820	TRW 23554 17,3 - WK / - WE TRW 20961 17,2 - WK TRW 20961 17,2 - WK Ceramic
			➔	+PR 1KS		13.0460-3858.2 603858 13.0470-3858.2 LD3858	BOS 24563 17,7 - WE / - WK + Zub BOS 24563 17,7 - WE / - WK + Zub Ceramic
 <b>Bremsscheibe</b>							
1.2 TSI 1.6 LPG 1.6 TDI 1.6 TDI	77 75 66 77	04/10→ 09/09→ 11/10→ 10/09→	←	+PR 1ZF		24.0122-0210.1 422210 24.0322-0210.1 522210	∅ 280 22 19 V + S ∅ 280 22 19 V + S
			←	+PR 1ZE		24.0125-0145.1 425145 24.0325-0145.1 525145	∅ 288 25 22 V + S ∅ 288 25 22 V + S
			←	+PR 1LJ,1ZA		24.0125-0158.1 425158 24.0325-0158.1 525158	∅ 312 25 22 V + S ∅ 312 25 22 V + S
			➔	+PR 1KD,1KQ		24.0110-0277.1 410277 24.0310-0277.1 510277	∅ 253 10 8 + S ∅ 253 10 8 + S
			➔	+PR 1KS		24.0110-0356.1 410356 24.0310-0356.1 510356	∅ 272 9,7 8 + S ∅ 272 9,7 8 + S
			➔	+PR 1KF		24.0112-0158.1 412158 24.0312-0158.1 512158	∅ 256 12 10 + S ∅ 256 12 10
			➔	+PR 1KJ,1KZ		24.0112-0169.1 412169 24.0312-0169.1 512169	∅ 282 12 10 + S ∅ 282 12 10 + S
1.4 16V 1.4 TSI 1.6 1.8 TFSI 1.9 TDI 1.9 TDI 2.0 FSI 2.0 TDI 2.0 TDI 2.0 TDI 16V 2.0 TFSI	63 92 75 118 66 77 110 100 103 125 103 147	05/06→ 11/07→ 03/04→ 01/07→ 08/09→ 04/04→ 05/04→03/09 03/04→05/09 11/05→ 03/06→ 03/04→ 04/06→05/09	←	+PR 1ZF		24.0122-0210.1 422210 24.0322-0210.1 522210	∅ 280 22 19 V + S ∅ 280 22 19 V + S
			←	+PR 1ZE		24.0125-0145.1 425145 24.0325-0145.1 525145	∅ 288 25 22 V + S ∅ 288 25 22 V + S
			←	+PR 1LJ,1ZA		24.0125-0158.1 425158 24.0325-0158.1 525158	∅ 312 25 22 V + S ∅ 312 25 22 V + S
			➔	+PR 1KD,1KQ		24.0110-0277.1 410277 24.0310-0277.1 510277	∅ 253 10 8 + S ∅ 253 10 8 + S
			➔	+PR 1KS		24.0110-0356.1 410356 24.0310-0356.1 510356	∅ 272 9,7 8 + S ∅ 272 9,7 8 + S
			➔	+PR 1KF		24.0112-0158.1 412158 24.0312-0158.1 512158	∅ 256 12 10 + S ∅ 256 12 10
			➔	+PR 1KJ,1KZ		24.0112-0169.1 412169 24.0312-0169.1 512169	∅ 282 12 10 + S ∅ 282 12 10 + S
<b>SEAT - ALTEA XL (5P5, 5P8) 10/06→</b>							
 <b>Bremsbelagsatz, Scheibenbremse</b>							
1.2 TSI 1.4 TSI 1.6 1.6 LPG 1.6 Multifuel 1.6 TDI 1.6 TDI 1.8 TFSI 1.9 TDI 1.9 TDI 1.9 TDI 4x4 2.0 FSI 2.0 TDI 2.0 TDI 2.0 TDI 16V 2.0 TDI 16V 4x4 2.0 TDI 4x4 2.0 TDI 4x4 2.0 TFSI 2.0 TFSI 4x4 2.0 TFSI 4x4	77 92 75 75 75 66 77 118 66 77 77 110 100 103 125 103 103 103 125 147 147 155	04/10→ 11/07→ 10/06→ 09/09→ 10/06→ 11/10→ 10/09→ 01/07→ 08/09→ 10/06→ 06/09→12/10 10/06→03/09 11/06→03/09 10/06→ 06/07→ 10/06→ 10/10→ 06/07→ 06/07→ 10/06→05/09 06/07→05/09 05/09→	←	+PR 1ZF		13.0460-7117.2 607117 13.0470-7117.2 LD7117	VW 23130 19,6 + WK VW 23130 19,6 + WK Ceramic
			←	+PR 1ZA,1ZE,1LJ		13.0460-7184.2 607184 13.0470-7184.2 LD7184	ATE 23587 20,6 + WK ATE 23587 20,6 + WK Ceramic
			➔	+PR 1KD,1KQ,1KZ		13.0460-2787.2 602787 13.0460-2820.2 602820 13.0470-2820.2 LD2820	TRW 23554 17,3 - WK / - WE TRW 20961 17,2 - WK TRW 20961 17,2 - WK Ceramic
			➔	+PR 1KS		13.0460-3858.2 603858 13.0470-3858.2 LD3858	BOS 24563 17,7 - WE / - WK + Zub BOS 24563 17,7 - WE / - WK + Zub Ceramic
1.4 16V	63	10/06→	←	05/08→; +PR 1ZF		13.0460-7117.2 607117 13.0470-7117.2 LD7117	VW 23130 19,6 + WK VW 23130 19,6 + WK Ceramic
			←	05/08→; +PR 1ZA,1ZE,1LJ		13.0460-7184.2 607184 13.0470-7184.2 LD7184	ATE 23587 20,6 + WK ATE 23587 20,6 + WK Ceramic
			➔	05/08→; +PR 1KD,1KQ,1KZ		13.0460-2787.2 602787 13.0460-2820.2 602820	TRW 23554 17,3 - WK / - WE TRW 20961 17,2 - WK









	kw			 	! #		
<b>SEAT - ALTEA XL (5P5, 5P8) 10/06→</b>							
 <b>Bremsbelagsatz, Scheibenbremse</b>							
1.4 16V	63	10/06→	➡	05/08→; +PR 1KD,1KQ,1KZ	13.0470-2820.2	LD2820	TRW 20961 17,2 - WK Ceramic
			➡	05/08→; +PR 1KS	13.0460-3858.2	603858	BOS 24563 17,7 - WE / - WK + Zub
					13.0470-3858.2	LD3858	BOS 24563 17,7 - WE / - WK + Zub Ceramic
 <b>Bremsscheibe</b>							
1.2 TSI	77	04/10→	←	+PR 1ZF	24.0122-0210.1	422210	Ø 280 22 19 V + S
1.6 LPG	75	09/09→			24.0322-0210.1	522210	Ø 280 22 19 V + S
1.9 TDI 4x4	77	06/09→12/10	←	+PR 1ZE	24.0125-0145.1	425145	Ø 288 25 22 V + S
					24.0325-0145.1	525145	Ø 288 25 22 V + S
			←	+PR 1LJ,1ZA	24.0125-0158.1	425158	Ø 312 25 22 V + S
					24.0325-0158.1	525158	Ø 312 25 22 V + S
			➡	+PR 1KD,1KQ	24.0110-0277.1	410277	Ø 253 10 8 + S
					24.0310-0277.1	510277	Ø 253 10 8 + S
			➡	+PR 1KS	24.0110-0356.1	410356	Ø 272 9,7 8 + S
					24.0310-0356.1	510356	Ø 272 9,7 8 + S
			➡	+PR 1KJ,1KZ	24.0112-0169.1	412169	Ø 282 12 10 + S
					24.0312-0169.1	512169	Ø 282 12 10 + S
1.4 16V	63	10/06→	←	05/08→; +PR 1ZF	24.0122-0210.1	422210	Ø 280 22 19 V + S
					24.0322-0210.1	522210	Ø 280 22 19 V + S
			←	05/08→; +PR 1ZE	24.0125-0145.1	425145	Ø 288 25 22 V + S
					24.0325-0145.1	525145	Ø 288 25 22 V + S
			←	05/08→; +PR 1LJ,1ZA	24.0125-0158.1	425158	Ø 312 25 22 V + S
					24.0325-0158.1	525158	Ø 312 25 22 V + S
			➡	05/08→; +PR 1KD;1KQ	24.0110-0277.1	410277	Ø 253 10 8 + S
					24.0310-0277.1	510277	Ø 253 10 8 + S
			➡	05/08→; +PR 1KS	24.0110-0356.1	410356	Ø 272 9,7 8 + S
					24.0310-0356.1	510356	Ø 272 9,7 8 + S
			➡	05/08→; +PR 1KJ,1KZ	24.0112-0169.1	412169	Ø 282 12 10 + S
					24.0312-0169.1	512169	Ø 282 12 10 + S
1.4 TSI	92	11/07→	←	+PR 1ZF	24.0122-0210.1	422210	Ø 280 22 19 V + S
1.6	75	10/06→			24.0322-0210.1	522210	Ø 280 22 19 V + S
1.6 Multifuel	75	10/06→					
1.8 TFSI	118	01/07→	←	+PR 1ZE	24.0125-0145.1	425145	Ø 288 25 22 V + S
1.9 TDI	66	08/09→			24.0325-0145.1	525145	Ø 288 25 22 V + S
1.9 TDI	77	10/06→					
2.0 FSI	110	10/06→03/09	←	+PR 1LJ,1ZA	24.0125-0158.1	425158	Ø 312 25 22 V + S
2.0 TDI	100	11/06→03/09			24.0325-0158.1	525158	Ø 312 25 22 V + S
2.0 TDI	103	10/06→	➡	+PR 1KD;1KQ	24.0110-0277.1	410277	Ø 253 10 8 + S
2.0 TDI	125	06/07→			24.0310-0277.1	510277	Ø 253 10 8 + S
2.0 TDI 16V	103	10/06→					
2.0 TDI 16V 4x4	103	10/10→	➡	+PR 1KS	24.0110-0356.1	410356	Ø 272 9,7 8 + S
2.0 TDI 4x4	103	06/07→			24.0310-0356.1	510356	Ø 272 9,7 8 + S
2.0 TDI 4x4	125	06/07→					
2.0 TFSI	147	10/06→05/09	➡	+PR 1KJ,1KZ	24.0112-0169.1	412169	Ø 282 12 10 + S
2.0 TFSI 4x4	147	06/07→05/09			24.0312-0169.1	512169	Ø 282 12 10 + S
2.0 TFSI 4x4	155	05/09→					
1.6 TDI	66	11/10→	←	+PR 1ZF	24.0122-0210.1	422210	Ø 280 22 19 V + S
1.6 TDI	77	10/09→			24.0322-0210.1	522210	Ø 280 22 19 V + S
			←	+PR 1ZE	24.0125-0145.1	425145	Ø 288 25 22 V + S
					24.0325-0145.1	525145	Ø 288 25 22 V + S
			←	+PR 1LJ,1ZA	24.0125-0158.1	425158	Ø 312 25 22 V + S
					24.0325-0158.1	525158	Ø 312 25 22 V + S
			➡	+PR 1KD, 1KQ	24.0110-0277.1	410277	Ø 253 10 8 + S
					24.0310-0277.1	510277	Ø 253 10 8 + S
			➡	+PR 1KS	24.0110-0356.1	410356	Ø 272 9,7 8 + S
					24.0310-0356.1	510356	Ø 272 9,7 8 + S
			➡	+PR 1KJ,1KZ	24.0112-0169.1	412169	Ø 282 12 10 + S
					24.0312-0169.1	512169	Ø 282 12 10 + S
<b>SEAT - ARONA (KJ7) 07/17→</b>							
 <b>Bremsbelagsatz, Scheibenbremse</b>							
1.0 TSI	70	07/17→	←	10/17→; +PR 1ZG	13.0460-7111.2	607111	VW 23130 19,6 - WE / - WK
1.0 TSI	85	07/17→			13.0470-7111.2	LD7111	VW 23130 19,6 - WE / - WK Ceramic
1.5 TSI	110	07/17→					
1.6 TDI	85	07/17→	➡	10/17→; +PR 1KD,1KV	13.0460-2820.2	602820	TRW 20961 17,2 - WK







	kW			 	! #		
<b>SEAT - ARONA (KJ7) 07/17→</b>							
 <b>Bremsbelagsatz, Scheibenbremse</b>							
1.0 TSI	70	07/17→	➔	10/17→; +PR 1KD,1KV		13.0470-2820.2 LD2820	TRW 20961 17,2 - WK Ceramic
1.0 TSI	85	07/17→					
1.5 TSI	110	07/17→					
1.6 TDI	85	07/17→					
1.6 TDI	70	11/17→	➔	+PR 1ZG		13.0460-7111.2 607111	VW 23130 19,6 - WE / - WK
						13.0470-7111.2 LD7111	VW 23130 19,6 - WE / - WK Ceramic
			➔	+PR 1KD,1KV		13.0460-2820.2 602820	TRW 20961 17,2 - WK
						13.0470-2820.2 LD2820	TRW 20961 17,2 - WK Ceramic
 <b>Bremsscheibe</b>							
1.0 TSI	70	07/17→	➔	+PR 1KD,1KV		24.0109-0123.1 409123	Ø 230 9 7 + S
1.0 TSI	85	07/17→				24.0309-0123.1 509123	Ø 230 9 7 + S
1.5 TSI	110	07/17→					
1.6 TDI	70	11/17→					
1.6 TDI	85	07/17→					
<b>SEAT - AROSA (6H) 05/97→06/04</b>							
 <b>Bremsbelagsatz, Scheibenbremse</b>							
1.0	37	05/97→06/04	➔			13.0460-7100.2 607100	VW 21866 17,2 - WE / - WK
1.0	37	10/98→01/01				13.0470-7100.2 LD7100	VW 21866 17,2 - WE / - WK Ceramic
1.4	44	05/97→06/04					
1.4 16V	74	01/00→06/04	➔			13.0460-2821.2 602821	TRW 21945 16,0 - WK
			➔			13.0460-2894.2 602894	TRW 20961 17,2 - WK + Zub
						13.0470-2894.2 LD2894	TRW 20961 17,2 - WK + Zub Ceramic
1.4 TDI	55	01/00→06/04	➔			13.0460-2821.2 602821	TRW 21945 16,0 - WK
1.7 SDI	44	08/97→06/04	➔	11/97→		13.0460-7100.2 607100	VW 21866 17,2 - WE / - WK
						13.0470-7100.2 LD7100	VW 21866 17,2 - WE / - WK Ceramic
<b>Zubehörsatz, Scheibenbremsbelag</b>							
1.4 16V	74	01/00→06/04	➔			13.0460-0072.2 610072	TRW
 <b>Bremsscheibe</b>							
1.0	37	05/97→06/04	➔			24.0110-0232.1 410232	Ø 239 9,9 8 + S
1.0	37	10/98→01/01				24.0118-0106.1 418106	Ø 239 18 16 V + S
						24.0318-0106.1 518106	Ø 239 18 16 V + S
1.4	44	05/97→06/04	➔			24.0118-0106.1 418106	Ø 239 18 16 V + S
						24.0318-0106.1 518106	Ø 239 18 16 V + S
1.4 16V	74	01/00→06/04	➔			24.0120-0128.1 420128	Ø 256 20 18 V + S
			➔			24.0320-0128.1 520128	Ø 256 20 18 V + S
			➔			24.0109-0124.1 409124	Ø 232 9 7
1.4 TDI	55	01/00→06/04	➔			24.0120-0128.1 420128	Ø 256 20 18 V + S
						24.0320-0128.1 520128	Ø 256 20 18 V + S
1.7 SDI	44	08/97→06/04	➔	11/97→		24.0118-0106.1 418106	Ø 239 18 16 V + S
						24.0318-0106.1 518106	Ø 239 18 16 V + S
<b>SEAT - ATECA (KH7) 04/16→</b>							
 <b>Bremsbelagsatz, Scheibenbremse</b>							
1.0 TSI	85	05/16→	➔	06/16→; +PR 1ZA		13.0460-2785.2 602785	TRW 25683 20,4 + WE / + WK
1.6 TDI	85	04/16→				13.0470-2785.2 LD2785	TRW 25683 20,4 + WE / + WK Ceramic
2.0 TDI	110	04/16→					
2.0 TDI 4Drive	110	04/16→	➔	06/16→; +PR 1KE; + eFSB		13.0460-7293.2 607293	ATE 25008 16,3 - WE / - WK
						13.0470-7293.2 LD7293	ATE 25008 16,3 - WE / - WK Ceramic
1.4 TSI	110	06/16→	➔	+PR 1ZA		13.0460-2785.2 602785	TRW 25683 20,4 + WE / + WK
1.4 TSI 4Drive	110	06/16→				13.0470-2785.2 LD2785	TRW 25683 20,4 + WE / + WK Ceramic
2.0 TDI	81	10/16→					
2.0 TDI	105	10/16→					
2.0 TDI 4Drive	140	06/16→	➔	+PR 1KE; + eFSB		13.0460-7293.2 607293	ATE 25008 16,3 - WE / - WK
2.0 TSI 4Drive	140	05/17→				13.0470-7293.2 LD7293	ATE 25008 16,3 - WE / - WK Ceramic
<b>Warnkontakt, Bremsbelagverschleiß</b>							
1.0 TSI	85	05/16→	➔	06/16→; +PR 1ZA	1	24.8190-0065.2 620065	L= 172
1.6 TDI	85	04/16→					
2.0 TDI	110	04/16→					
↓							









	kw			 	! #		
<b>SEAT - ATECA (KH7) 04/16→</b>							
<b>Warnkontakt, Bremsbelagverschleiß</b>							
2.0 TDI 4Drive	110	04/16→	←	06/16→; +PR 1ZA	1	24.8190-0065.2 620065	L= 172
1.4 TSI	110	06/16→	←	+PR 1ZA	1	24.8190-0065.2 620065	L= 172
1.4 TSI 4Drive	110	06/16→					
2.0 TDI	81	10/16→					
2.0 TDI	105	10/16→					
2.0 TDI 4Drive	140	06/16→					
2.0 TSI 4Drive	140	05/17→					
<b> Brems Scheibe</b>							
1.0 TSI	85	05/16→	←	06/16→; +PR 1ZA		24.0125-0158.1 425158	Ø 312 25 22 V + S
1.6 TDI	85	04/16→				24.0325-0158.1 525158	Ø 312 25 22 V + S
2.0 TDI	110	04/16→					
2.0 TDI 4Drive	110	04/16→	→	06/16→; +PR 1KE		24.0110-0356.1 410356	Ø 272 9,7 8 + S
						24.0310-0356.1 510356	Ø 272 9,7 8 + S
1.4 TSI	110	06/16→	←	+PR 1ZA		24.0125-0158.1 425158	Ø 312 25 22 V + S
1.4 TSI 4Drive	110	06/16→				24.0325-0158.1 525158	Ø 312 25 22 V + S
2.0 TDI	81	10/16→					
2.0 TDI	105	10/16→	→	+PR 1KE		24.0110-0356.1 410356	Ø 272 9,7 8 + S
2.0 TDI 4Drive	140	06/16→				24.0310-0356.1 510356	Ø 272 9,7 8 + S
2.0 TSI 4Drive	140	05/17→					
<b>SEAT - CORDOBA (6K1, 6K2) 02/93→12/02</b>							
<b> Bremsbelagsatz, Scheibenbremse</b>							
1.0 i	37	09/96→10/02	←	06/99→ 09/02		13.0460-7101.2 607101	VW 21866 15,3 - WE / - WK
1.4	40	12/97→04/99	←	+PR 1LY,1ZK		13.0460-2821.2 602821	TRW 21945 16,0 - WK
			←	+PR 1LV,1LW,1LD		13.0460-2958.2 602958	TRW 20168 19,3 - WK
			←	→ 6K-TR09920; - ABS		13.0460-7030.2 607030	VW 20889 17,3 - WE / - WK + Zub
			←	→ 6K-TR046558; + ABS		13.0460-7032.2 20887	VW 20887 19,7 - WE / - WK + Zub
			←	+PR 1LA		13.0460-7059.2 607059	VW 20887 17,3 - WE / - WK + Zub
			←	+PR 1LM		13.0460-7072.2 607072	VW 21866 19,7 - WE / - WK
			←	+PR 1LG		13.0460-7101.2 607101	VW 21866 15,3 - WE / - WK
1.4 16V	55	05/00→10/02	←	→ 09/02		13.0460-7101.2 607101	VW 21866 15,3 - WE / - WK
1.9 SDI	50	06/99→10/02					
1.4 i	44	06/94→10/02	←	01/97→ 05/99; +PR 1LY,1ZK		13.0460-2821.2 602821	TRW 21945 16,0 - WK
1.4 i 16V	74	09/96→10/02	←	01/97→ 05/99; +PR 1LV,1LW,1LD		13.0460-2958.2 602958	TRW 20168 19,3 - WK
			←	→ 6K-TR09920; - ABS		13.0460-7030.2 607030	VW 20889 17,3 - WE / - WK + Zub
			←	→ 6K-TR046558; + ABS		13.0460-7032.2 20887	VW 20887 19,7 - WE / - WK + Zub
			←	01/97→ 05/99; +PR 1LA		13.0460-7059.2 607059	VW 20887 17,3 - WE / - WK + Zub
			←	6K-TR09921→; → 12/96; - ABS		13.0460-7059.2 607059	VW 20887 17,3 - WE / - WK + Zub
			←	6K-TR046559→; → 12/96; + ABS		13.0460-7072.2 607072	VW 21866 19,7 - WE / - WK
			←	01/97→ 05/99; +PR 1LM		13.0460-7072.2 607072	VW 21866 19,7 - WE / - WK
			←	01/97→ 05/99; +PR 1LG		13.0460-7101.2 607101	VW 21866 15,3 - WE / - WK
			←	06/99→ 09/02		13.0460-7101.2 607101	VW 21866 15,3 - WE / - WK
1.6 i	55	02/93→10/02	←	01/97→ 05/99; +PR 1LY,1ZK		13.0460-2821.2 602821	TRW 21945 16,0 - WK
			←	01/97→ 05/99; +PR 1LV,1LW,1LD		13.0460-2958.2 602958	TRW 20168 19,3 - WK
			←	11/93→; → 6K-TR046558		13.0460-7032.2 20887	VW 20887 19,7 - WE / - WK + Zub
			←	11/93→ 12/96; V		13.0460-7033.2 20887	VW 20887 15,3 - WE / - WK
			←	01/97→ 05/99; +PR 1LA		13.0460-7059.2 607059	VW 20887 17,3 - WE / - WK + Zub
			←	6K-TR046559→; → 12/96		13.0460-7072.2 607072	VW 21866 19,7 - WE / - WK
			←	01/97→ 05/99; +PR 1LM		13.0460-7072.2 607072	VW 21866 19,7 - WE / - WK
			←	01/97→ 05/99; +PR 1LG		13.0460-7101.2 607101	VW 21866 15,3 - WE / - WK
			←	06/99→ 09/02		13.0460-7101.2 607101	VW 21866 15,3 - WE / - WK
1.6 i	55	05/94→06/99	←	→ 05/99; +PR 1LY,1ZK		13.0460-2821.2 602821	TRW 21945 16,0 - WK
			←	→ 05/99; +PR 1LV,1LW,1LD		13.0460-2958.2 602958	TRW 20168 19,3 - WK
			←	→ 05/99; +PR 1LA		13.0460-7059.2 607059	VW 20887 17,3 - WE / - WK + Zub

	kw			 	! #		
<b>SEAT - CORDOBA (6K1, 6K2) 02/93→12/02</b>							
<b> Bremsbelagsatz, Scheibenbremse</b>							
1.6 i	55	05/94→06/99	←	→ 05/99; +PR 1LM		<b>13.0460-7072.2 607072</b>	VW 21866 19,7 - WE / - WK
			←	→ 05/99; +PR 1LG		<b>13.0460-7101.2 607101</b>	VW 21866 15,3 - WE / - WK
1.6 i	74	07/96→10/02	←	06/99→ 09/02		<b>13.0460-2821.2 602821</b>	TRW 21945 16,0 - WK
			←	01/97→ 05/99; +PR 1LY,1ZK		<b>13.0460-2821.2 602821</b>	TRW 21945 16,0 - WK
			←	01/97→ 05/99; +PR 1LV,1LW,1LD		<b>13.0460-2958.2 602958</b>	TRW 20168 19,3 - WK
			←	→ 6K-TR046558		<b>13.0460-7032.2 20887</b>	VW 20887 19,7 - WE / - WK + Zub
			←	→ 12/96; V		<b>13.0460-7033.2 20887</b>	VW 20887 15,3 - WE / - WK
			←	01/97→ 05/99; +PR 1LA		<b>13.0460-7059.2 607059</b>	VW 20887 17,3 - WE / - WK + Zub
			←	01/97→ 05/99; +PR 1LM		<b>13.0460-7072.2 607072</b>	VW 21866 19,7 - WE / - WK
			←	6K-TR046559→; → 12/96		<b>13.0460-7072.2 607072</b>	VW 21866 19,7 - WE / - WK
			←	01/97→ 05/99; +PR 1LG		<b>13.0460-7101.2 607101</b>	VW 21866 15,3 - WE / - WK
1.8 i	66	02/93→09/02	←	01/97→ 05/99; +PR 1LY,1ZK		<b>13.0460-2821.2 602821</b>	TRW 21945 16,0 - WK
			←	01/97→ 05/99; +PR 1LV,1LW,1LD		<b>13.0460-2958.2 602958</b>	TRW 20168 19,3 - WK
			←	11/93→; → 6K-TR046558		<b>13.0460-7032.2 20887</b>	VW 20887 19,7 - WE / - WK + Zub
			←	11/93→ 12/96; V		<b>13.0460-7033.2 20887</b>	VW 20887 15,3 - WE / - WK
			←	01/97→ 05/99; +PR 1LA		<b>13.0460-7059.2 607059</b>	VW 20887 17,3 - WE / - WK + Zub
			←	01/97→ 05/99; +PR 1LM		<b>13.0460-7072.2 607072</b>	VW 21866 19,7 - WE / - WK
			←	6K-TR046559→; → 12/96		<b>13.0460-7072.2 607072</b>	VW 21866 19,7 - WE / - WK
			←	01/97→ 05/99; +PR 1LG		<b>13.0460-7101.2 607101</b>	VW 21866 15,3 - WE / - WK
1.8 i 16V	95	10/93→08/96	←	02/94→		<b>13.0460-2821.2 602821</b>	TRW 21945 16,0 - WK
			→	6K-X-290000→; +PR 1KE,1KK,1KQ		<b>13.0460-2894.2 602894</b> <b>13.0470-2894.2 LD2894</b>	TRW 20961 17,2 - WK + Zub TRW 20961 17,2 - WK + Zub Ceramic
			→	02/94→; → 6K-X-289999		<b>13.0460-2937.2 602937</b>	TRW 20961 15,2 - WK + Zub
1.8 T 20V Cupra	115	07/00→10/02	←	→ 09/02		<b>13.0460-2958.2 602958</b>	TRW 20168 19,3 - WK
			→	→ 09/02		<b>13.0460-2894.2 602894</b> <b>13.0470-2894.2 LD2894</b>	TRW 20961 17,2 - WK + Zub TRW 20961 17,2 - WK + Zub Ceramic
1.9 D	47	01/96→08/96	←	→ 6K-TR046558		<b>13.0460-7032.2 20887</b>	VW 20887 19,7 - WE / - WK + Zub
			←	V		<b>13.0460-7033.2 20887</b>	VW 20887 15,3 - WE / - WK
			←	6K-TR046559→		<b>13.0460-7072.2 607072</b>	VW 21866 19,7 - WE / - WK
1.9 D 1.9 TD	50 55	02/93→08/96 02/93→08/96	←	11/93→; → 6K-TR046558		<b>13.0460-7032.2 20887</b>	VW 20887 19,7 - WE / - WK + Zub
			←	11/93→; V		<b>13.0460-7033.2 20887</b>	VW 20887 15,3 - WE / - WK
			←	6K-TR046559→		<b>13.0460-7072.2 607072</b>	VW 21866 19,7 - WE / - WK
1.9 SDI	47	08/96→06/99	←	01/97→ 05/99; +PR 1LY,1ZK		<b>13.0460-2821.2 602821</b>	TRW 21945 16,0 - WK
			←	01/97→ 05/99; +PR 1LV,1LW,1LD		<b>13.0460-2958.2 602958</b>	TRW 20168 19,3 - WK
			←	→ 12/96; V		<b>13.0460-7033.2 20887</b>	VW 20887 15,3 - WE / - WK
			←	01/97→ 05/99; +PR 1LA		<b>13.0460-7059.2 607059</b>	VW 20887 17,3 - WE / - WK + Zub
			←	01/97→ 05/99; +PR 1LM		<b>13.0460-7072.2 607072</b>	VW 21866 19,7 - WE / - WK
			←	→ 12/96		<b>13.0460-7072.2 607072</b>	VW 21866 19,7 - WE / - WK
			←	01/97→ 05/99; +PR 1LG		<b>13.0460-7101.2 607101</b>	VW 21866 15,3 - WE / - WK
			←	06/99→ 09/02		<b>13.0460-2821.2 602821</b>	TRW 21945 16,0 - WK
1.9 TDI	66	08/96→10/02	←	01/97→ 05/99; +PR 1LY,1ZK		<b>13.0460-2821.2 602821</b>	TRW 21945 16,0 - WK
			←	01/97→ 05/99; +PR 1LV,1LW,1LD		<b>13.0460-2958.2 602958</b>	TRW 20168 19,3 - WK
			←	01/97→ 05/99; +PR 1LA		<b>13.0460-7059.2 607059</b>	VW 20887 17,3 - WE / - WK + Zub
			←	01/97→ 05/99; +PR 1LM		<b>13.0460-7072.2 607072</b>	VW 21866 19,7 - WE / - WK
			←	01/97→ 05/99; +PR 1LG		<b>13.0460-7101.2 607101</b>	VW 21866 15,3 - WE / - WK
1.9 TDI	81	03/97→10/02	←	→ 05/99; +PR 1LY,1ZK		<b>13.0460-2821.2 602821</b>	TRW 21945 16,0 - WK
			←	06/99→ 09/02		<b>13.0460-2958.2 602958</b>	TRW 20168 19,3 - WK
			←	→ 05/99; +PR 1LV,1LW,1LD		<b>13.0460-2958.2 602958</b>	TRW 20168 19,3 - WK









	kw			 	! #		
<b>SEAT - CORDOBA (6K1, 6K2) 02/93→12/02</b>							
<b> Bremsbelagsatz, Scheibenbremse</b>							
1.9 TDI	81	03/97→10/02	←	→ 05/99; +PR 1LA	13.0460-7059.2	607059	VW 20887 17,3 - WE / - WK + Zub
			←	→ 05/99; +PR 1LM	13.0460-7072.2	607072	VW 21866 19,7 - WE / - WK
			←	→ 05/99; +PR 1LG	13.0460-7101.2	607101	VW 21866 15,3 - WE / - WK
			→	6K-X-290000→; → 05/99; +PR 1KE,1KK,1KQ	13.0460-2894.2	602894	TRW 20961 17,2 - WK + Zub
			→	13.0470-2894.2	LD2894	TRW 20961 17,2 - WK + Zub Ceramic	
			→	06/99→ 09/02	13.0460-2894.2	602894	TRW 20961 17,2 - WK + Zub
→	13.0470-2894.2	LD2894	TRW 20961 17,2 - WK + Zub Ceramic				
→	→ 6K-X-289999	13.0460-2937.2	602937	TRW 20961 15,2 - WK + Zub			
2.0 i	85	02/93→06/99	←	01/97→ 05/99; +PR 1LY,1ZK	13.0460-2821.2	602821	TRW 21945 16,0 - WK
			←	11/93→ 12/96	13.0460-2821.2	602821	TRW 21945 16,0 - WK
			←	01/97→ 05/99; +PR 1LV,1LW,1LD	13.0460-2958.2	602958	TRW 20168 19,3 - WK
			←	01/97→ 05/99; +PR 1LA	13.0460-7059.2	607059	VW 20887 17,3 - WE / - WK + Zub
			←	01/97→ 05/99; +PR 1LM	13.0460-7072.2	607072	VW 21866 19,7 - WE / - WK
			←	01/97→ 05/99; +PR 1LG	13.0460-7101.2	607101	VW 21866 15,3 - WE / - WK
			→	6K-X-290000→; → 05/99; +PR 1KE,1KK,1KQ	13.0460-2894.2	602894	TRW 20961 17,2 - WK + Zub
			→	13.0470-2894.2	LD2894	TRW 20961 17,2 - WK + Zub Ceramic	
→	11/93→; → 6K-X-289999	13.0460-2937.2	602937	TRW 20961 15,2 - WK + Zub			
2.0 i 16V	110	08/96→06/99	←	→ 05/99	13.0460-2958.2	602958	TRW 20168 19,3 - WK
			→	6K-X-290000→; → 05/99; +PR 1KE,1KK,1KQ	13.0460-2894.2	602894	TRW 20961 17,2 - WK + Zub
			→	13.0470-2894.2	LD2894	TRW 20961 17,2 - WK + Zub Ceramic	
→	→ 6K-X-289999	13.0460-2984.2	602984	TRW 20961 17,2 - WK + Zub			
<b>Zubehörsatz, Scheibenbremsbelag</b>							
1.8 i 16V	95	10/93→08/96	→	02/94→; → 6K-X-289999	13.0460-0419.2	610419	TRW
1.8 T 20V Cupra	115	07/00→10/02	→	→ 09/02	13.0460-0072.2	610072	TRW
1.9 TDI	81	03/97→10/02	→	06/99→ 09/02	13.0460-0072.2	610072	TRW
			→	→ 6K-X-289999	13.0460-0419.2	610419	TRW
2.0 i	85	02/93→06/99	→	11/93→; → 6K-X-289999	13.0460-0419.2	610419	TRW
2.0 i 16V	110	08/96→06/99	→	→ 6K-X-289999	13.0460-0072.2	610072	TRW
<b> Bremsscheibe</b>							
1.0 i	37	09/96→10/02	←	06/99→ 09/02	24.0120-0123.1	420123	Ø 239 20 18 V + S
					24.0320-0123.1	520123	Ø 239 20 18 V + S
1.4	40	12/97→04/99	←	+PR 1LA	24.0110-0151.1	410151	Ø 239 10 8 + S
					24.0310-0151.1	510151	Ø 239 10 8 + S
			←	+PR 1LM	24.0112-0106.1	412106	Ø 239 12 10 + S
					24.0312-0106.1	512106	Ø 239 12 10 + S
			←	+PR 1LG	24.0120-0123.1	420123	Ø 239 20 18 V + S
					24.0320-0123.1	520123	Ø 239 20 18 V + S
←	+PR 1LY,1ZK	24.0120-0128.1	420128	Ø 256 20 18 V + S			
		24.0320-0128.1	520128	Ø 256 20 18 V + S			
←	+PR 1LV,1LW,1LD	24.0122-0101.1	422101	Ø 280 22 20 V			
1.4 16V	55	05/00→10/02	←	→ 09/02	24.0120-0123.1	420123	Ø 239 20 18 V + S
1.9 SDI	50	06/99→10/02	←		24.0320-0123.1	520123	Ø 239 20 18 V + S
1.4 i 1.4 i 16V	44	06/94→10/02	←	01/97→ 05/99; +PR 1LA	24.0110-0151.1	410151	Ø 239 10 8 + S
					24.0310-0151.1	510151	Ø 239 10 8 + S
			←	→ 12/96; - ABS	24.0110-0151.1	410151	Ø 239 10 8 + S
					24.0310-0151.1	510151	Ø 239 10 8 + S
	74	09/96→10/02	←	01/97→ 05/99; +PR 1LM	24.0112-0106.1	412106	Ø 239 12 10 + S
					24.0312-0106.1	512106	Ø 239 12 10 + S
			←	→ 12/96; + ABS	24.0112-0106.1	412106	Ø 239 12 10 + S
					24.0120-0123.1	420123	Ø 239 20 18 V + S
		24.0312-0106.1	512106	Ø 239 12 10 + S			
		24.0320-0123.1	520123	Ø 239 20 18 V + S			
↓							

	kw			 	! #		
<b>SEAT - CORDOBA (6K1, 6K2) 02/93→12/02</b>							
<b>Bremsscheibe</b>							
1.4 i 1.4 i 16V	44 74	06/94→10/02 09/96→10/02	←	01/97→ 05/99; +PR 1LG	24.0120-0123.1	420123	Ø 239 20 18 V + S
					24.0320-0123.1	520123	Ø 239 20 18 V + S
			←	06/99→ 09/02	24.0120-0123.1	420123	Ø 239 20 18 V + S
					24.0320-0123.1	520123	Ø 239 20 18 V + S
			←	01/97→ 05/99; +PR 1LY,1ZK	24.0120-0128.1	420128	Ø 256 20 18 V + S
		24.0320-0128.1	520128	Ø 256 20 18 V + S			
		←	01/97→ 05/99; +PR 1LV,1LW,1LD	24.0122-0101.1	422101	Ø 280 22 20 V	
1.6 i	55	02/93→10/02	←	01/97→ 05/99; +PR 1LA	24.0110-0151.1	410151	Ø 239 10 8 + S
					24.0310-0151.1	510151	Ø 239 10 8 + S
			←	11/93→ 12/96	24.0112-0106.1	412106	Ø 239 12 10 + S
					24.0120-0123.1	420123	Ø 239 20 18 V + S
					24.0312-0106.1	512106	Ø 239 12 10 + S
					24.0320-0123.1	520123	Ø 239 20 18 V + S
			←	01/97→ 05/99; +PR 1LM	24.0112-0106.1	412106	Ø 239 12 10 + S
					24.0312-0106.1	512106	Ø 239 12 10 + S
←	01/97→ 05/99; +PR 1LG	24.0120-0123.1	420123	Ø 239 20 18 V + S			
		24.0320-0123.1	520123	Ø 239 20 18 V + S			
←	06/99→ 09/02	24.0120-0123.1	420123	Ø 239 20 18 V + S			
		24.0320-0123.1	520123	Ø 239 20 18 V + S			
←	01/97→ 05/99; +PR 1LY,1ZK	24.0120-0128.1	420128	Ø 256 20 18 V + S			
		24.0320-0128.1	520128	Ø 256 20 18 V + S			
←	01/97→ 05/99; +PR 1LV,1LW,1LD	24.0122-0101.1	422101	Ø 280 22 20 V			
1.6 i	55	05/94→06/99	←	→ 05/99; +PR 1LA	24.0110-0151.1	410151	Ø 239 10 8 + S
					24.0310-0151.1	510151	Ø 239 10 8 + S
			←	→ 05/99; +PR 1LM	24.0112-0106.1	412106	Ø 239 12 10 + S
					24.0312-0106.1	512106	Ø 239 12 10 + S
			←	→ 05/99; +PR 1LG	24.0120-0123.1	420123	Ø 239 20 18 V + S
		24.0320-0123.1	520123	Ø 239 20 18 V + S			
←	→ 05/99; +PR 1LY,1ZK	24.0120-0128.1	420128	Ø 256 20 18 V + S			
		24.0320-0128.1	520128	Ø 256 20 18 V + S			
←	→ 05/99; +PR 1LV,1LW,1LD	24.0122-0101.1	422101	Ø 280 22 20 V			
1.6 i	74	07/96→10/02	←	01/97→ 05/99; +PR 1LA	24.0110-0151.1	410151	Ø 239 10 8 + S
					24.0310-0151.1	510151	Ø 239 10 8 + S
			←	→ 12/96	24.0112-0106.1	412106	Ø 239 12 10 + S
					24.0120-0123.1	420123	Ø 239 20 18 V + S
					24.0312-0106.1	512106	Ø 239 12 10 + S
					24.0320-0123.1	520123	Ø 239 20 18 V + S
			←	01/97→ 05/99; +PR 1LM	24.0112-0106.1	412106	Ø 239 12 10 + S
					24.0312-0106.1	512106	Ø 239 12 10 + S
←	01/97→ 05/99; +PR 1LG	24.0120-0123.1	420123	Ø 239 20 18 V + S			
		24.0320-0123.1	520123	Ø 239 20 18 V + S			
←	01/97→ 05/99; +PR 1LY,1ZK	24.0120-0128.1	420128	Ø 256 20 18 V + S			
		24.0320-0128.1	520128	Ø 256 20 18 V + S			
←	06/99→ 09/02	24.0120-0128.1	420128	Ø 256 20 18 V + S			
		24.0320-0128.1	520128	Ø 256 20 18 V + S			
←	01/97→ 05/99; +PR 1LV,1LW,1LD	24.0122-0101.1	422101	Ø 280 22 20 V			
1.8 i	66	02/93→09/02	←	01/97→ 05/99; +PR 1LA	24.0110-0151.1	410151	Ø 239 10 8 + S
					24.0310-0151.1	510151	Ø 239 10 8 + S
			←	11/93→ 12/96	24.0112-0106.1	412106	Ø 239 12 10 + S
					24.0120-0123.1	420123	Ø 239 20 18 V + S
					24.0312-0106.1	512106	Ø 239 12 10 + S
					24.0320-0123.1	520123	Ø 239 20 18 V + S
			←	01/97→ 05/99; +PR 1LM	24.0112-0106.1	412106	Ø 239 12 10 + S
		24.0312-0106.1	512106	Ø 239 12 10 + S			
←	01/97→ 05/99; +PR 1LG	24.0120-0123.1	420123	Ø 239 20 18 V + S			
		24.0320-0123.1	520123	Ø 239 20 18 V + S			
←	01/97→ 05/99; +PR 1LY,1ZK	24.0120-0128.1	420128	Ø 256 20 18 V + S			
		24.0320-0128.1	520128	Ø 256 20 18 V + S			
←	01/97→ 05/99; +PR 1LV,1LW,1LD	24.0122-0101.1	422101	Ø 280 22 20 V			
1.8 i 16V ↓	95	10/93→08/96	←	02/94→	24.0120-0128.1	420128	Ø 256 20 18 V + S











	kw			 	! #		
<b>SEAT - CORDOBA (6K1, 6K2) 02/93→12/02</b>							
<b>Bremsscheibe</b>							
1.8 i 16V	95	10/93→08/96	←	02/94→		24.0320-0128.1 520128	Ø 256 20 18 V + S
			→	6K-X-290000→; +PR 1KE,1KK,1KQ		24.0109-0124.1 409124	Ø 232 9 7
			→	02/94→; → 6K-X-289999		24.0110-0111.1 410111 24.0110-0275.2 410275	Ø 226 10 8 - ABS Ring / - RLG Ø 226 10 8 + ABS Ring / - RLG
1.8 T 20V Cupra	115	07/00→10/02	←	→ 09/02		24.0122-0101.1 422101	Ø 280 22 20 V
			→	→ 09/02		24.0109-0124.1 409124	Ø 232 9 7
1.9 D	47	01/96→08/96	←			24.0112-0106.1 412106 24.0120-0123.1 420123 24.0312-0106.1 512106 24.0320-0123.1 520123	Ø 239 12 10 + S Ø 239 20 18 V + S Ø 239 12 10 + S Ø 239 20 18 V + S
			←	11/93→		24.0112-0106.1 412106 24.0120-0123.1 420123 24.0312-0106.1 512106 24.0320-0123.1 520123	Ø 239 12 10 + S Ø 239 20 18 V + S Ø 239 12 10 + S Ø 239 20 18 V + S
			←	01/97→ 05/99; +PR 1LA		24.0110-0151.1 410151 24.0310-0151.1 510151	Ø 239 10 8 + S Ø 239 10 8 + S
			←	01/97→ 05/99; +PR 1LM		24.0112-0106.1 412106 24.0312-0106.1 512106	Ø 239 12 10 + S Ø 239 12 10 + S
1.9 SDI	47	08/96→06/99	←	→ 12/96		24.0112-0106.1 412106 24.0120-0123.1 420123 24.0312-0106.1 512106 24.0320-0123.1 520123	Ø 239 12 10 + S Ø 239 20 18 V + S Ø 239 12 10 + S Ø 239 20 18 V + S
			←	01/97→ 05/99; +PR 1LG		24.0120-0123.1 420123 24.0320-0123.1 520123	Ø 239 20 18 V + S Ø 239 20 18 V + S
			←	01/97→ 05/99; +PR 1LY,1ZK		24.0120-0128.1 420128 24.0320-0128.1 520128	Ø 256 20 18 V + S Ø 256 20 18 V + S
			←	01/97→ 05/99; +PR 1LV,1LW,1LD		24.0122-0101.1 422101	Ø 280 22 20 V
			←	01/97→ 05/99; +PR 1LA		24.0110-0151.1 410151 24.0310-0151.1 510151	Ø 239 10 8 + S Ø 239 10 8 + S
			←	01/97→ 05/99; +PR 1LM		24.0112-0106.1 412106 24.0312-0106.1 512106	Ø 239 12 10 + S Ø 239 12 10 + S
			←	01/97→ 05/99; +PR 1LG		24.0120-0123.1 420123 24.0320-0123.1 520123	Ø 239 20 18 V + S Ø 239 20 18 V + S
1.9 TDI	66	08/96→10/02	←	01/97→ 05/99; +PR 1LA		24.0110-0128.1 420128 24.0320-0128.1 520128	Ø 256 20 18 V + S Ø 256 20 18 V + S
			←	06/99→ 09/02		24.0120-0128.1 420128 24.0320-0128.1 520128	Ø 256 20 18 V + S Ø 256 20 18 V + S
			←	01/97→ 05/99; +PR 1LV,1LW,1LD		24.0122-0101.1 422101	Ø 280 22 20 V
			←	01/97→ 05/99; +PR 1LA		24.0110-0151.1 410151 24.0310-0151.1 510151	Ø 239 10 8 + S Ø 239 10 8 + S
			←	01/97→ 05/99; +PR 1LM		24.0112-0106.1 412106 24.0312-0106.1 512106	Ø 239 12 10 + S Ø 239 12 10 + S
			←	01/97→ 05/99; +PR 1LG		24.0120-0123.1 420123 24.0320-0123.1 520123	Ø 239 20 18 V + S Ø 239 20 18 V + S
1.9 TDI	81	03/97→10/02	←	→ 05/99; +PR 1LA		24.0110-0128.1 420128 24.0320-0128.1 520128	Ø 256 20 18 V + S Ø 256 20 18 V + S
			←	→ 05/99; +PR 1LY,1ZK		24.0120-0128.1 420128 24.0320-0128.1 520128	Ø 256 20 18 V + S Ø 256 20 18 V + S
			←	→ 05/99; +PR 1LV,1LW,1LD		24.0122-0101.1 422101	Ø 280 22 20 V
			←	06/99→ 09/02		24.0122-0101.1 422101	Ø 280 22 20 V
			→	06/99→ 09/02		24.0109-0124.1 409124	Ø 232 9 7
			→	6K-X-290000→; → 05/99; +PR 1KE,1KK,1KQ		24.0109-0124.1 409124	Ø 232 9 7
			→	→ 6K-X-289999		24.0110-0111.1 410111 24.0110-0275.2 410275	Ø 226 10 8 - ABS Ring / - RLG Ø 226 10 8 + ABS Ring / - RLG
			←	01/97→ 05/99; +PR 1LA		24.0110-0151.1 410151 24.0310-0151.1 510151	Ø 239 10 8 + S Ø 239 10 8 + S
			←	01/97→ 05/99; +PR 1LM		24.0112-0106.1 412106 24.0312-0106.1 512106	Ø 239 12 10 + S Ø 239 12 10 + S
2.0 i	85	02/93→06/99	←	01/97→ 05/99; +PR 1LA		24.0112-0123.1 420123 24.0320-0123.1 520123	Ø 239 20 18 V + S Ø 239 20 18 V + S
			←	01/97→ 05/99; +PR 1LY,1ZK		24.0120-0128.1 420128	Ø 256 20 18 V + S
			←	01/97→ 05/99; +PR 1LG		24.0120-0123.1 420123 24.0320-0123.1 520123	Ø 239 20 18 V + S Ø 239 20 18 V + S
			←	01/97→ 05/99; +PR 1LV,1LW,1LD		24.0122-0101.1 422101	Ø 280 22 20 V





















	kw			 	! #		
<b>SEAT - CORDOBA (6K1, 6K2) 02/93→12/02</b>							
 <b>Bremsscheibe</b>							
2.0 i	85	02/93→06/99	←	01/97→ 05/99; +PR 1LY,1ZK	24.0320-0128.1	520128	∅ 256 20 18 V + S
			←	11/93→ 12/96	24.0120-0128.1	420128	∅ 256 20 18 V + S
					24.0320-0128.1	520128	∅ 256 20 18 V + S
			←	01/97→ 05/99; +PR 1LV,1LW,1LD	24.0122-0101.1	422101	∅ 280 22 20 V
			→	6K-X-290000→; → 05/99; +PR 1KE,1KK,1KQ	24.0109-0124.1	409124	∅ 232 9 7
			→	11/93→; → 6K-X-289999	24.0110-0111.1	410111	∅ 226 10 8 - ABS Ring / - RLG
				24.0110-0275.2	410275	∅ 226 10 8 + ABS Ring / - RLG	
2.0 i 16V	110	08/96→06/99	←	→ 05/99	24.0122-0101.1	422101	∅ 280 22 20 V
			→	6K-X-290000→; → 05/99; +PR 1KE,1KK,1KQ	24.0109-0124.1	409124	∅ 232 9 7
			→	→ 6K-X-289999	24.0110-0111.1	410111	∅ 226 10 8 - ABS Ring / - RLG
					24.0110-0275.2	410275	∅ 226 10 8 + ABS Ring / - RLG
<b>SEAT - CORDOBA (6L2) 09/02→11/09</b>							
 <b>Bremsbelagsatz, Scheibenbremse</b>							
1.2 1.4 TDI	47 55	10/02→06/06 10/02→12/05	←	+PR 1LN;1ZH	13.0460-2883.2	602883	TRW 23581 18,8 - WE / - WK
					13.0460-2884.2	602884	TRW 23581 18,8 + WK
					13.0470-2884.2	LD2884	TRW 23581 18,8 + WK Ceramic
			←	+PR 1LQ;1ZF	13.0460-7111.2	607111	VW 23130 19,6 - WE / - WK
					13.0470-7111.2	LD7111	VW 23130 19,6 - WE / - WK Ceramic
			→		13.0460-2864.2	602864	TRW 20961 17,2 - WK
					13.0460-2877.2	602877	TRW 23554 17,2 + WK
					13.0460-2894.2	602894	TRW 20961 17,2 - WK + Zub
					13.0470-2877.2	LD2877	TRW 23554 17,2 + WK Ceramic
					13.0470-2894.2	LD2894	TRW 20961 17,2 - WK + Zub Ceramic
1.2 12V 1.4 16V 1.4 16V 1.4 TDI 1.4 TDI 1.6 1.6 16V 1.9 TDI	51 63 74 51 59 74 77 96	05/06→11/09 05/06→11/09 10/02→11/09 05/05→11/09 06/05→11/09 04/03→11/09 11/06→11/09 10/02→11/09	←	→ 06/09; +PR 1LN;1ZH	13.0460-2883.2	602883	TRW 23581 18,8 - WE / - WK
					13.0460-2884.2	602884	TRW 23581 18,8 + WK
					13.0470-2884.2	LD2884	TRW 23581 18,8 + WK Ceramic
			←	→ 06/09; +PR 1LQ;1ZF	13.0460-7111.2	607111	VW 23130 19,6 - WE / - WK
					13.0470-7111.2	LD7111	VW 23130 19,6 - WE / - WK Ceramic
			→	→ 06/09	13.0460-2864.2	602864	TRW 20961 17,2 - WK
					13.0460-2877.2	602877	TRW 23554 17,2 + WK
					13.0460-2894.2	602894	TRW 20961 17,2 - WK + Zub
					13.0470-2877.2	LD2877	TRW 23554 17,2 + WK Ceramic
					13.0470-2894.2	LD2894	TRW 20961 17,2 - WK + Zub Ceramic
1.4 16V	55	09/02→12/07	←	10/02→; +PR 1LN;1ZH	13.0460-2883.2	602883	TRW 23581 18,8 - WE / - WK
					13.0460-2884.2	602884	TRW 23581 18,8 + WK
					13.0470-2884.2	LD2884	TRW 23581 18,8 + WK Ceramic
			←	10/02→; +PR 1LQ;1ZF	13.0460-7111.2	607111	VW 23130 19,6 - WE / - WK
					13.0470-7111.2	LD7111	VW 23130 19,6 - WE / - WK Ceramic
			→	10/02→	13.0460-2864.2	602864	TRW 20961 17,2 - WK
				13.0460-2877.2	602877	TRW 23554 17,2 + WK	
				13.0460-2894.2	602894	TRW 20961 17,2 - WK + Zub	
				13.0470-2877.2	LD2877	TRW 23554 17,2 + WK Ceramic	
				13.0470-2894.2	LD2894	TRW 20961 17,2 - WK + Zub Ceramic	
1.9 SDI 1.9 TDI	47 74	09/02→11/09 09/02→11/09	←	10/02→ 06/09; +PR 1LN;1ZH	13.0460-2883.2	602883	TRW 23581 18,8 - WE / - WK
					13.0460-2884.2	602884	TRW 23581 18,8 + WK
					13.0470-2884.2	LD2884	TRW 23581 18,8 + WK Ceramic
			←	10/02→ 06/09; +PR 1LQ;1ZF	13.0460-7111.2	607111	VW 23130 19,6 - WE / - WK
				13.0470-7111.2	LD7111	VW 23130 19,6 - WE / - WK Ceramic	
→	10/02→ 06/09	13.0460-2864.2	602864	TRW 20961 17,2 - WK			
				13.0460-2877.2	602877	TRW 23554 17,2 + WK	
				13.0460-2894.2	602894	TRW 20961 17,2 - WK + Zub	
				13.0470-2877.2	LD2877	TRW 23554 17,2 + WK Ceramic	
				13.0470-2894.2	LD2894	TRW 20961 17,2 - WK + Zub Ceramic	
↓							









	kw			 	! #		
<b>SEAT - CORDOBA (6L2) 09/02→11/09</b>							
 <b>Bremsbelagsatz, Scheibenbremse</b>							
2.0	85	09/02→11/09	←	10/02→06/09; +PR 1LN,1ZH		13.0460-2883.2 602883 13.0460-2884.2 602884 13.0470-2884.2 LD2884	TRW 23581 18,8 - WE / - WK TRW 23581 18,8 + WK TRW 23581 18,8 + WK Ceramic
			←	10/02→06/09; +PR 1LQ,1ZF		13.0460-7111.2 607111 13.0470-7111.2 LD7111	VW 23130 19,6 - WE / - WK VW 23130 19,6 - WE / - WK Ceramic
			→	10/02→06/09		13.0460-2864.2 602864 13.0460-2877.2 602877 13.0460-2894.2 602894 13.0470-2877.2 LD2877 13.0470-2894.2 LD2894	TRW 20961 17,2 - WK TRW 23554 17,2 + WK TRW 20961 17,2 - WK + Zub TRW 23554 17,2 + WK Ceramic TRW 20961 17,2 - WK + Zub Ceramic
<b>Zubehörsatz, Scheibenbremsbelag</b>							
1.2	47	10/02→06/06	→			13.0460-0072.2 610072	TRW
1.4 TDI	55	10/02→12/05					
1.2 12V	51	05/06→11/09	→	→ 06/09		13.0460-0072.2 610072	TRW
1.4 16V	63	05/06→11/09					
1.4 16V	74	10/02→11/09					
1.4 TDI	51	05/05→11/09					
1.4 TDI	59	06/05→11/09					
1.6	74	04/03→11/09					
1.6 16V	77	11/06→11/09					
1.9 TDI	96	10/02→11/09					
1.4 16V	55	09/02→12/07	→	10/02→		13.0460-0072.2 610072	TRW
1.9 SDI	47	09/02→11/09	→	10/02→06/09		13.0460-0072.2 610072	TRW
1.9 TDI	74	09/02→11/09					
2.0	85	09/02→11/09					
 <b>Bremsscheibe</b>							
1.2	47	10/02→06/06	←	+PR 1LQ;1ZF		24.0122-0151.1 422151	Ø 256 22 19 V + S
1.4 TDI	55	10/02→12/05				24.0322-0151.1 522151	Ø 256 22 19 V + S
			←	+PR 1LN;1ZH		24.0125-0113.1 425113	Ø 288 25 22 V + S
						24.0325-0113.1 525113	Ø 288 25 22 V + S
			→			24.0109-0123.1 409123	Ø 230 9 7 + S
						24.0309-0123.1 509123	Ø 230 9 7 + S
1.2 12V	51	05/06→11/09	←	→ 06/09; +PR 1LQ;1ZF		24.0122-0151.1 422151	Ø 256 22 19 V + S
1.4 16V	63	05/06→11/09				24.0322-0151.1 522151	Ø 256 22 19 V + S
1.4 16V	74	10/02→11/09					
1.4 TDI	51	05/05→11/09	←	→ 06/09; +PR 1LN;1ZH		24.0125-0113.1 425113	Ø 288 25 22 V + S
1.4 TDI	59	06/05→11/09				24.0325-0113.1 525113	Ø 288 25 22 V + S
1.6	74	04/03→11/09					
1.6 16V	77	11/06→11/09	→	→ 06/09		24.0109-0123.1 409123	Ø 230 9 7 + S
1.9 TDI	96	10/02→11/09				24.0309-0123.1 509123	Ø 230 9 7 + S
1.4 16V	55	09/02→12/07	←	10/02→; +PR 1LQ;1ZF		24.0122-0151.1 422151	Ø 256 22 19 V + S
						24.0322-0151.1 522151	Ø 256 22 19 V + S
			←	10/02→; +PR 1LN;1ZH		24.0125-0113.1 425113	Ø 288 25 22 V + S
						24.0325-0113.1 525113	Ø 288 25 22 V + S
			→	10/02→		24.0109-0123.1 409123	Ø 230 9 7 + S
						24.0309-0123.1 509123	Ø 230 9 7 + S
1.9 SDI	47	09/02→11/09	←	10/02→06/09; +PR 1LQ;1ZF		24.0122-0151.1 422151	Ø 256 22 19 V + S
1.9 TDI	74	09/02→11/09				24.0322-0151.1 522151	Ø 256 22 19 V + S
			←	10/02→06/09; +PR 1LN;1ZH		24.0125-0113.1 425113	Ø 288 25 22 V + S
						24.0325-0113.1 525113	Ø 288 25 22 V + S
			→	10/02→06/09		24.0109-0123.1 409123	Ø 230 9 7 + S
						24.0309-0123.1 509123	Ø 230 9 7 + S
2.0	85	09/02→11/09	←	10/02→06/09; +PR 1LQ,1ZF		24.0122-0151.1 422151	Ø 256 22 19 V + S
						24.0322-0151.1 522151	Ø 256 22 19 V + S
			←	10/02→06/09; +PR 1LN,1ZH		24.0125-0113.1 425113	Ø 288 25 22 V + S
						24.0325-0113.1 525113	Ø 288 25 22 V + S
			→	10/02→06/09		24.0109-0123.1 409123	Ø 230 9 7 + S
						24.0309-0123.1 509123	Ø 230 9 7 + S
<b>SEAT - CORDOBA Vario (6K5) 07/96→12/02</b>							
 <b>Bremsbelagsatz, Scheibenbremse</b>							
1.4 16V	55	06/99→12/02	←	→ 09/02		13.0460-7101.2 607101	VW 21866 15,3 - WE / - WK
1.9 SDI	50	06/99→12/02					
1.4 i	44	09/96→12/02	←	01/97→05/99; +PR 1LY,1ZK		13.0460-2821.2 602821	TRW 21945 16,0 - WK
↓							









	kw			 	! #		
<b>SEAT - CORDOBA Vario (6K5) 07/96→12/02</b>							
<b> Bremsbelagsatz, Scheibenbremse</b>							
1.4 i	44	09/96→12/02	←	01/97→ 05/99; +PR 1LV,1LW,1LD	13.0460-2958.2	602958	TRW 20168 19,3 - WK
			←	→ 6K-TR09920; - ABS	13.0460-7030.2	607030	VW 20889 17,3 - WE / - WK + Zub
			←	→ 6K-TR046558; + ABS	13.0460-7032.2	20887	VW 20887 19,7 - WE / - WK + Zub
			←	01/97→ 05/99; +PR 1LA	13.0460-7059.2	607059	VW 20887 17,3 - WE / - WK + Zub
			←	6K-TR09921→; → 12/96; - ABS	13.0460-7059.2	607059	VW 20887 17,3 - WE / - WK + Zub
			←	6K-TR046559→; → 12/96; + ABS	13.0460-7072.2	607072	VW 21866 19,7 - WE / - WK
			←	01/97→ 05/99; +PR 1LM	13.0460-7072.2	607072	VW 21866 19,7 - WE / - WK
			←	01/97→ 05/99; +PR 1LG	13.0460-7101.2	607101	VW 21866 15,3 - WE / - WK
1.6 i	55	09/96→12/02	←	06/99→ 09/02	13.0460-7101.2	607101	VW 21866 15,3 - WE / - WK
			←	01/97→ 05/99; +PR 1LV,1LW,1LD	13.0460-2958.2	602958	TRW 20168 19,3 - WK
			←	→ 6K-TR046558	13.0460-7032.2	20887	VW 20887 19,7 - WE / - WK + Zub
			←	→ 12/96; V	13.0460-7033.2	20887	VW 20887 15,3 - WE / - WK
			←	01/97→ 05/99; +PR 1LA	13.0460-7059.2	607059	VW 20887 17,3 - WE / - WK + Zub
			←	01/97→ 05/99; +PR 1LM	13.0460-7072.2	607072	VW 21866 19,7 - WE / - WK
			←	6K-TR046559→; → 12/96	13.0460-7072.2	607072	VW 21866 19,7 - WE / - WK
			←	01/97→ 05/99; +PR 1LG	13.0460-7101.2	607101	VW 21866 15,3 - WE / - WK
1.6 i	55	05/97→06/99	←	06/99→ 09/02	13.0460-2821.2	602821	TRW 21945 16,0 - WK
			←	→ 05/99; +PR 1LY,1ZK	13.0460-2821.2	602821	TRW 21945 16,0 - WK
			←	→ 05/99; +PR 1LV,1LW,1LD	13.0460-2958.2	602958	TRW 20168 19,3 - WK
			←	→ 6K-TR046558	13.0460-7032.2	20887	VW 20887 19,7 - WE / - WK + Zub
			←	→ 05/99; +PR 1LA	13.0460-7059.2	607059	VW 20887 17,3 - WE / - WK + Zub
			←	→ 05/99; +PR 1LM	13.0460-7072.2	607072	VW 21866 19,7 - WE / - WK
1.6 i	74	09/96→12/02	←	→ 05/99; +PR 1LG	13.0460-7101.2	607101	VW 21866 15,3 - WE / - WK
			←	06/99→ 09/02	13.0460-2821.2	602821	TRW 21945 16,0 - WK
			←	01/97→ 05/99; +PR 1LY,1ZK	13.0460-2821.2	602821	TRW 21945 16,0 - WK
			←	01/97→ 05/99; +PR 1LV,1LW,1LD	13.0460-2958.2	602958	TRW 20168 19,3 - WK
			←	→ 6K-TR046558	13.0460-7032.2	20887	VW 20887 19,7 - WE / - WK + Zub
			←	→ 12/96; V	13.0460-7033.2	20887	VW 20887 15,3 - WE / - WK
			←	01/97→ 05/99; +PR 1LA	13.0460-7059.2	607059	VW 20887 17,3 - WE / - WK + Zub
			←	01/97→ 05/99; +PR 1LM	13.0460-7072.2	607072	VW 21866 19,7 - WE / - WK
1.9 SDI	47	09/96→06/99	←	6K-TR046559→; → 12/96	13.0460-7072.2	607072	VW 21866 19,7 - WE / - WK
			←	01/97→ 05/99; +PR 1LG	13.0460-7101.2	607101	VW 21866 15,3 - WE / - WK
			←	→ 12/96	13.0460-7072.2	607072	VW 21866 19,7 - WE / - WK
			←	01/97→ 05/99; +PR 1LM	13.0460-7072.2	607072	VW 21866 19,7 - WE / - WK
			←	01/97→ 05/99; +PR 1LA	13.0460-7059.2	607059	VW 20887 17,3 - WE / - WK + Zub
			←	→ 12/96; V	13.0460-7033.2	20887	VW 20887 15,3 - WE / - WK
			←	01/97→ 05/99; +PR 1LV,1LW,1LD	13.0460-2958.2	602958	TRW 20168 19,3 - WK
1.9 TDI	66	08/96→12/02	←	01/97→ 05/99; +PR 1LY,1ZK	13.0460-2821.2	602821	TRW 21945 16,0 - WK
			←	01/97→ 05/99; +PR 1LV,1LW,1LD	13.0460-2958.2	602958	TRW 20168 19,3 - WK
			←	01/97→ 05/99; +PR 1LA	13.0460-7059.2	607059	VW 20887 17,3 - WE / - WK + Zub
			←	01/97→ 05/99; +PR 1LM	13.0460-7072.2	607072	VW 21866 19,7 - WE / - WK
			←	01/97→ 05/99; +PR 1LG	13.0460-7101.2	607101	VW 21866 15,3 - WE / - WK
↓							





















	kw			 	! #		
<b>SEAT - CORDOBA Vario (6K5) 07/96→12/02</b>							
<b> Bremsbelagsatz, Scheibenbremse</b>							
1.9 TDI	81	07/97→12/02	←	→ 05/99; +PR 1LY,1ZK	13.0460-2821.2	602821	TRW 21945 16,0 - WK
			←	06/99→ 09/02	13.0460-2958.2	602958	TRW 20168 19,3 - WK
			←	→ 05/99; +PR 1LV,1LW,1LD	13.0460-2958.2	602958	TRW 20168 19,3 - WK
			←	→ 05/99; +PR 1LA	13.0460-7059.2	607059	VW 20887 17,3 - WE / - WK + Zub
			←	→ 05/99; +PR 1LM	13.0460-7072.2	607072	VW 21866 19,7 - WE / - WK
			←	→ 05/99; +PR 1LG	13.0460-7101.2	607101	VW 21866 15,3 - WE / - WK
			→	6K-X-290000→; → 05/99; +PR 1KE,1KK,1KQ	13.0460-2894.2	602894	TRW 20961 17,2 - WK + Zub
					13.0470-2894.2	LD2894	TRW 20961 17,2 - WK + Zub Ceramic
			→	06/99→ 09/02	13.0460-2894.2	602894	TRW 20961 17,2 - WK + Zub
		13.0470-2894.2	LD2894	TRW 20961 17,2 - WK + Zub Ceramic			
→	→ 6K-X-289999	13.0460-2937.2	602937	TRW 20961 15,2 - WK + Zub			
<b>Zubehörsatz, Scheibenbremsbelag</b>							
1.9 TDI	81	07/97→12/02	→	06/99→ 09/02	13.0460-0072.2	610072	TRW
			→	→ 6K-X-289999	13.0460-0419.2	610419	TRW
<b> Bremsscheibe</b>							
1.4 16V 1.9 SDI	55 50	06/99→12/02 06/99→12/02	←	→ 09/02	24.0120-0123.1	420123	Ø 239 20 18 V + S
					24.0320-0123.1	520123	Ø 239 20 18 V + S
1.4 i	44	09/96→12/02	←	01/97→ 05/99; +PR 1LA	24.0110-0151.1	410151	Ø 239 10 8 + S
					24.0310-0151.1	510151	Ø 239 10 8 + S
			←	→ 12/96; - ABS	24.0110-0151.1	410151	Ø 239 10 8 + S
					24.0310-0151.1	510151	Ø 239 10 8 + S
			←	01/97→ 05/99; +PR 1LM	24.0112-0106.1	412106	Ø 239 12 10 + S
					24.0312-0106.1	512106	Ø 239 12 10 + S
			←	→ 12/96; + ABS	24.0112-0106.1	412106	Ø 239 12 10 + S
					24.0120-0123.1	420123	Ø 239 20 18 V + S
					24.0312-0106.1	512106	Ø 239 12 10 + S
					24.0320-0123.1	520123	Ø 239 20 18 V + S
←	01/97→ 05/99; +PR 1LG	24.0120-0123.1	420123	Ø 239 20 18 V + S			
		24.0320-0123.1	520123	Ø 239 20 18 V + S			
←	06/99→ 09/02	24.0120-0123.1	420123	Ø 239 20 18 V + S			
		24.0320-0123.1	520123	Ø 239 20 18 V + S			
←	01/97→ 05/99; +PR 1LY,1ZK	24.0120-0128.1	420128	Ø 256 20 18 V + S			
		24.0320-0128.1	520128	Ø 256 20 18 V + S			
←	01/97→ 05/99; +PR 1LV,1LW,1LD	24.0122-0101.1	422101	Ø 280 22 20 V			
1.6 i	55	09/96→12/02	←	01/97→ 05/99; +PR 1LA	24.0110-0151.1	410151	Ø 239 10 8 + S
					24.0310-0151.1	510151	Ø 239 10 8 + S
			←	→ 12/96	24.0112-0106.1	412106	Ø 239 12 10 + S
					24.0120-0123.1	420123	Ø 239 20 18 V + S
					24.0312-0106.1	512106	Ø 239 12 10 + S
					24.0320-0123.1	520123	Ø 239 20 18 V + S
			←	01/97→ 05/99; +PR 1LM	24.0112-0106.1	412106	Ø 239 12 10 + S
					24.0312-0106.1	512106	Ø 239 12 10 + S
			←	01/97→ 05/99; +PR 1LG	24.0120-0123.1	420123	Ø 239 20 18 V + S
					24.0320-0123.1	520123	Ø 239 20 18 V + S
←	06/99→ 09/02	24.0120-0123.1	420123	Ø 239 20 18 V + S			
		24.0320-0123.1	520123	Ø 239 20 18 V + S			
←	01/97→ 05/99; +PR 1LY,1ZK	24.0120-0128.1	420128	Ø 256 20 18 V + S			
		24.0320-0128.1	520128	Ø 256 20 18 V + S			
←	01/97→ 05/99; +PR 1LV,1LW,1LD	24.0122-0101.1	422101	Ø 280 22 20 V			
1.6 i	55	05/97→06/99	←	→ 05/99; +PR 1LA	24.0110-0151.1	410151	Ø 239 10 8 + S
					24.0310-0151.1	510151	Ø 239 10 8 + S
			←	→ 05/99; +PR 1LM	24.0112-0106.1	412106	Ø 239 12 10 + S
					24.0312-0106.1	512106	Ø 239 12 10 + S
			←	→ 05/99; +PR 1LG	24.0120-0123.1	420123	Ø 239 20 18 V + S
		24.0320-0123.1	520123	Ø 239 20 18 V + S			
←	→ 05/99; +PR 1LY,1ZK	24.0120-0128.1	420128	Ø 256 20 18 V + S			









	kw			 	! #		
<b>SEAT - CORDOBA Vario (6K5) 07/96→12/02</b>							
<b>Bremsscheibe</b>							
1.6 i	55	05/97→06/99	←	→ 05/99; +PR 1LY,1ZK	24.0320-0128.1	520128	Ø 256 20 18 V + S
			←	→ 05/99; +PR 1LV,1LW,1LD	24.0122-0101.1	422101	Ø 280 22 20 V
1.6 i	74	09/96→12/02	←	01/97→ 05/99; +PR 1LA	24.0110-0151.1	410151	Ø 239 10 8 + S
					24.0310-0151.1	510151	Ø 239 10 8 + S
			←	→ 12/96	24.0112-0106.1	412106	Ø 239 12 10 + S
					24.0120-0123.1	420123	Ø 239 20 18 V + S
					24.0312-0106.1	512106	Ø 239 12 10 + S
					24.0320-0123.1	520123	Ø 239 20 18 V + S
			←	01/97→ 05/99; +PR 1LM	24.0112-0106.1	412106	Ø 239 12 10 + S
					24.0312-0106.1	512106	Ø 239 12 10 + S
			←	01/97→ 05/99; +PR 1LG	24.0120-0123.1	420123	Ø 239 20 18 V + S
		24.0320-0123.1	520123	Ø 239 20 18 V + S			
1.9 SDI	47	09/96→06/99	←	01/97→ 05/99; +PR 1LA	24.0110-0151.1	410151	Ø 239 10 8 + S
					24.0310-0151.1	510151	Ø 239 10 8 + S
			←	01/97→ 05/99; +PR 1LM	24.0112-0106.1	412106	Ø 239 12 10 + S
					24.0312-0106.1	512106	Ø 239 12 10 + S
			←	→ 12/96	24.0112-0106.1	412106	Ø 239 12 10 + S
					24.0120-0123.1	420123	Ø 239 20 18 V + S
					24.0312-0106.1	512106	Ø 239 12 10 + S
		24.0320-0123.1	520123	Ø 239 20 18 V + S			
1.9 TDI	66	08/96→12/02	←	01/97→ 05/99; +PR 1LG	24.0120-0123.1	420123	Ø 239 20 18 V + S
					24.0320-0123.1	520123	Ø 239 20 18 V + S
			←	01/97→ 05/99; +PR 1LY,1ZK	24.0120-0128.1	420128	Ø 256 20 18 V + S
					24.0320-0128.1	520128	Ø 256 20 18 V + S
			←	06/99→ 09/02	24.0120-0128.1	420128	Ø 256 20 18 V + S
					24.0320-0128.1	520128	Ø 256 20 18 V + S
1.9 TDI	81	07/97→12/02	←	→ 05/99; +PR 1LA	24.0110-0151.1	410151	Ø 239 10 8 + S
					24.0310-0151.1	510151	Ø 239 10 8 + S
			←	→ 05/99; +PR 1LM	24.0112-0106.1	412106	Ø 239 12 10 + S
					24.0312-0106.1	512106	Ø 239 12 10 + S
			←	→ 05/99; +PR 1LG	24.0120-0123.1	420123	Ø 239 20 18 V + S
					24.0320-0123.1	520123	Ø 239 20 18 V + S
			←	→ 05/99; +PR 1LY,1ZK	24.0120-0128.1	420128	Ø 256 20 18 V + S
					24.0320-0128.1	520128	Ø 256 20 18 V + S
SEAT - EXEO (3R2) 12/08→	75 110	03/09→09/10 12/08→05/10	←	04/09→; +PR 1LZ	13.0460-2837.2	602837	TRW 21945 19,6 + WK
			←	→ 05/99; +PR 1LA	24.0110-0151.1	410151	Ø 239 10 8 + S
					24.0310-0151.1	510151	Ø 239 10 8 + S
			←	→ 05/99; +PR 1LM	24.0112-0106.1	412106	Ø 239 12 10 + S
					24.0312-0106.1	512106	Ø 239 12 10 + S
			←	→ 05/99; +PR 1LG	24.0120-0123.1	420123	Ø 239 20 18 V + S
					24.0320-0123.1	520123	Ø 239 20 18 V + S
			←	→ 05/99; +PR 1LY,1ZK	24.0120-0128.1	420128	Ø 256 20 18 V + S
					24.0320-0128.1	520128	Ø 256 20 18 V + S
←	→ 05/99; +PR 1LV,1LW,1LD	24.0122-0101.1	422101	Ø 280 22 20 V			
←	06/99→ 09/02	24.0122-0101.1	422101	Ø 280 22 20 V			
→	06/99→ 09/02	24.0109-0124.1	409124	Ø 232 9 7			
→	6K-X-290000→; → 05/99; +PR 1KE,1KK,1KQ	24.0109-0124.1	409124	Ø 232 9 7			
→	→ 6K-X-289999	24.0110-0111.1	410111	Ø 226 10 8 - ABS Ring / - RLG			
		24.0110-0275.2	410275	Ø 226 10 8 + ABS Ring / - RLG			
<b>Bremsbelagsatz, Scheibenbremse</b>							
1.6 1.8 T ↓	75 110	03/09→09/10 12/08→05/10	←	04/09→; +PR 1LZ	13.0460-2837.2	602837	TRW 21945 19,6 + WK











	kw			 	! #		
<b>SEAT - EXEO (3R2) 12/08→</b>							
<b> Bremsbelagsatz, Scheibenbremse</b>							
1.6 1.8 T	75 110	03/09→09/10 12/08→05/10	←	04/09→; +PR 1LZ	13.0470-2837.2	LD2837	TRW 21945 19,6 + WK Ceramic
			←	04/09→; +PR 1LB,1LT	13.0460-7110.2	607110	ATE 20676 19,8 + WK ATE 20676 19,8 + WK Ceramic
			←	04/09→; +PR 1LA	13.0460-7201.2	607201	ATE 23763 20,3 + WK ATE 23763 20,3 + WK Ceramic
			→	04/09→; +PR 1KW	13.0460-2749.2	602749	TRW 24483 16,9 - WE / - WK + Zub
					13.0460-2880.2	602880	TRW 23914 17,1 + WE / - WK + Zub
					13.0470-2749.2	LD2749	TRW 24483 16,9 - WE / - WK + Zub Ceramic
			13.0470-2880.2	LD2880	TRW 23914 17,1 + WE / - WK + Zub Ceramic		
1.8 TSI 1.8 TSI 2.0 TFSI	88 118 155	09/10→ 05/10→ 05/10→	←	→ 06/13; +PR 1LZ	13.0460-2837.2	602837	TRW 21945 19,6 + WK TRW 21945 19,6 + WK Ceramic
			←	→ 06/13; +PR 1LB,1LT	13.0460-7110.2	607110	ATE 20676 19,8 + WK ATE 20676 19,8 + WK Ceramic
			←	→ 06/13; +PR 1LA	13.0460-7201.2	607201	ATE 23763 20,3 + WK ATE 23763 20,3 + WK Ceramic
			→	→ 06/13; +PR 1KW	13.0460-2749.2	602749	TRW 24483 16,9 - WE / - WK + Zub
					13.0460-2880.2	602880	TRW 23914 17,1 + WE / - WK + Zub
					13.0470-2749.2	LD2749	TRW 24483 16,9 - WE / - WK + Zub Ceramic
			13.0470-2880.2	LD2880	TRW 23914 17,1 + WE / - WK + Zub Ceramic		
2.0 TDI 2.0 TDI 2.0 TDI 2.0 TFSI	88 105 125 147	12/08→ 12/08→ 02/09→ 03/09→	←	04/09→ 06/13; +PR 1LZ	13.0460-2837.2	LD2837	TRW 21945 19,6 + WK TRW 21945 19,6 + WK Ceramic
			←	04/09→ 06/13; +PR 1LB,1LT	13.0460-7110.2	607110	ATE 20676 19,8 + WK ATE 20676 19,8 + WK Ceramic
			←	04/09→ 06/13; +PR 1LA	13.0460-7201.2	607201	ATE 23763 20,3 + WK ATE 23763 20,3 + WK Ceramic
			→	04/09→ 06/13; +PR 1KW	13.0460-2749.2	602749	TRW 24483 16,9 - WE / - WK + Zub
					13.0460-2880.2	602880	TRW 23914 17,1 + WE / - WK + Zub
					13.0470-2749.2	LD2749	TRW 24483 16,9 - WE / - WK + Zub Ceramic
			13.0470-2880.2	LD2880	TRW 23914 17,1 + WE / - WK + Zub Ceramic		
			13.0460-2886.2	602886	TRW 20961 16,0 - WK		
			13.0460-2937.2	602937	TRW 20961 15,2 - WK + Zub		
			13.0470-2886.2	LD2886	TRW 20961 16,0 - WK Ceramic		
<b> Bremsscheibe</b>							
1.6 1.8 T	75 110	03/09→09/10 12/08→05/10	←	04/09→; +PR 1LZ	24.0122-0152.1	422152	Ø 280 22 20 V + S
					24.0322-0152.1	522152	Ø 280 22 20 V + S
			←	04/09→; +PR 1LB	24.0125-0105.1	425105	Ø 288 25 23 V + S
					24.0325-0105.1	525105	Ø 288 25 23 V
			←	04/09→; +PR 1LT	24.0125-0137.1	425137	Ø 312 25 23 V + S
					24.0325-0137.1	525137	Ø 312 25 23 V
			←	04/09→; +PR 1LA	24.0130-0113.1	430113	Ø 320 30 28 V + S
					24.0330-0113.1	530113	Ø 320 30 28 V
→	04/09→; +PR 1KD	24.0110-0261.1	410261	Ø 245 10 8 + S			
		24.0310-0261.1	510261	Ø 245 10 8			
→	04/09→; +PR 1KP	24.0112-0148.1	412148	Ø 255 12 10			
		24.0312-0148.1	512148	Ø 255 12 10			
→	04/09→; +PR 1KW	24.0112-0166.1	412166	Ø 288 12 10			









	kw			 	! #		
<b>SEAT - EXEO (3R2) 12/08→</b>							
 <b>Bremsscheibe</b>							
1.6 1.8 T	75 110	03/09→09/10 12/08→05/10	➡	04/09→; +PR 1KW		24.0312-0166.1 512166	Ø 288 12 10
1.8 TSI 1.8 TSI 2.0 TFSI	88 118 155	09/10→ 05/10→ 05/10→	←	→ 06/13; +PR 1LZ		24.0122-0152.1 422152	Ø 280 22 20 V + S
					24.0322-0152.1 522152	Ø 280 22 20 V + S	
			←	→ 06/13; +PR 1LB		24.0125-0105.1 425105	Ø 288 25 23 V + S
					24.0325-0105.1 525105	Ø 288 25 23 V	
			←	→ 06/13; +PR 1LT		24.0125-0137.1 425137	Ø 312 25 23 V + S
					24.0325-0137.1 525137	Ø 312 25 23 V	
			←	→ 06/13; +PR 1LA		24.0130-0113.1 430113	Ø 320 30 28 V + S
					24.0330-0113.1 530113	Ø 320 30 28 V	
			➡	→ 06/13; +PR 1KD		24.0110-0261.1 410261	Ø 245 10 8 + S
					24.0310-0261.1 510261	Ø 245 10 8	
2.0 TDI 2.0 TDI 2.0 TDI 2.0 TFSI	88 105 125 147	12/08→ 12/08→ 02/09→ 03/09→	←	04/09→ 06/13; +PR 1LZ		24.0122-0152.1 422152	Ø 280 22 20 V + S
					24.0322-0152.1 522152	Ø 280 22 20 V + S	
			←	04/09→ 06/13; +PR 1LB		24.0125-0105.1 425105	Ø 288 25 23 V + S
					24.0325-0105.1 525105	Ø 288 25 23 V	
			←	04/09→ 06/13; +PR 1LT		24.0125-0137.1 425137	Ø 312 25 23 V + S
					24.0325-0137.1 525137	Ø 312 25 23 V	
			←	04/09→ 06/13; +PR 1LA		24.0130-0113.1 430113	Ø 320 30 28 V + S
					24.0330-0113.1 530113	Ø 320 30 28 V	
			➡	04/09→ 06/13; +PR 1KD		24.0110-0261.1 410261	Ø 245 10 8 + S
					24.0310-0261.1 510261	Ø 245 10 8	
1.6 1.8 T	75 110	06/09→09/10 06/09→05/10	←	+PR 1LZ		13.0460-2837.2 602837	TRW 21945 19,6 + WK
					13.0470-2837.2 LD2837	TRW 21945 19,6 + WK Ceramic	
			←	+PR 1LB,1LT		13.0460-7110.2 607110	ATE 20676 19,8 + WK
					13.0470-7110.2 LD7110	ATE 20676 19,8 + WK Ceramic	
			←	+PR 1LA		13.0460-7201.2 607201	ATE 23763 20,3 + WK
					13.0470-7201.2 LD7201	ATE 23763 20,3 + WK Ceramic	
			➡	+PR 1KW		13.0460-2749.2 602749	TRW 24483 16,9 - WE / - WK + Zub
					13.0460-2880.2 602880	TRW 23914 17,1 + WE / - WK + Zub	
					13.0470-2749.2 LD2749	TRW 24483 16,9 - WE / - WK + Zub Ceramic	
					13.0470-2880.2 LD2880	TRW 23914 17,1 + WE / - WK + Zub Ceramic	
1.8 TSI 1.8 TSI 2.0 TDI 2.0 TDI 2.0 TDI 2.0 TFSI 2.0 TFSI	88 118 88 105 125 147 155	09/10→ 05/10→ 07/09→ 05/09→ 05/09→ 06/09→ 05/10→	←	→ 06/13; +PR 1LZ		13.0460-2837.2 602837	TRW 21945 19,6 + WK
					13.0470-2837.2 LD2837	TRW 21945 19,6 + WK Ceramic	
			←	→ 06/13; +PR 1LB,1LT		13.0460-7110.2 607110	ATE 20676 19,8 + WK
					13.0470-7110.2 LD7110	ATE 20676 19,8 + WK Ceramic	
			←	→ 06/13; +PR 1LA		13.0460-7201.2 607201	ATE 23763 20,3 + WK
					13.0470-7201.2 LD7201	ATE 23763 20,3 + WK Ceramic	
			➡	→ 06/13; +PR 1KW		13.0460-2749.2 602749	TRW 24483 16,9 - WE / - WK + Zub
					13.0460-2880.2 602880	TRW 23914 17,1 + WE / - WK + Zub	
					13.0470-2749.2 LD2749	TRW 24483 16,9 - WE / - WK + Zub Ceramic	
					13.0470-2880.2 LD2880	TRW 23914 17,1 + WE / - WK + Zub Ceramic	
↓							









	kw			 	! #		
<b>SEAT - EXEO ST (3R5) 05/09→</b>							
 <b>Brembelagsatz, Scheibenbremse</b>							
1.8 TSI	88	09/10→	➔	→ 06/13; +PR 1KD,1KP		13.0460-2886.2 602886	TRW 20961 16,0 - WK
1.8 TSI	118	05/10→				13.0460-2937.2 602937	TRW 20961 15,2 - WK + Zub
2.0 TDI	88	07/09→				13.0470-2886.2 LD2886	TRW 20961 16,0 - WK Ceramic
2.0 TDI	105	05/09→					
2.0 TDI	125	05/09→					
2.0 TFSI	147	06/09→					
2.0 TFSI	155	05/10→					
 <b>Bremsscheibe</b>							
1.6	75	06/09→09/10	←	+PR 1LZ		24.0122-0152.1 422152	Ø 280 22 20 V + S
1.8 T	110	06/09→05/10				24.0322-0152.1 522152	Ø 280 22 20 V + S
			←	+PR 1LB		24.0125-0105.1 425105	Ø 288 25 23 V + S
						24.0325-0105.1 525105	Ø 288 25 23 V
			←	+PR 1LT		24.0125-0137.1 425137	Ø 312 25 23 V + S
						24.0325-0137.1 525137	Ø 312 25 23 V
			←	+PR 1LA		24.0130-0113.1 430113	Ø 320 30 28 V + S
						24.0330-0113.1 530113	Ø 320 30 28 V
			➔	+PR 1KD		24.0110-0261.1 410261	Ø 245 10 8 + S
						24.0310-0261.1 510261	Ø 245 10 8
			➔	+PR 1KP		24.0112-0148.1 412148	Ø 255 12 10
						24.0312-0148.1 512148	Ø 255 12 10
			➔	+PR 1KW		24.0112-0166.1 412166	Ø 288 12 10
						24.0312-0166.1 512166	Ø 288 12 10
1.8 TSI	88	09/10→	←	→ 06/13; +PR 1LZ		24.0122-0152.1 422152	Ø 280 22 20 V + S
1.8 TSI	118	05/10→				24.0322-0152.1 522152	Ø 280 22 20 V + S
2.0 TDI	88	07/09→					
2.0 TDI	105	05/09→	←	→ 06/13; +PR 1LB		24.0125-0105.1 425105	Ø 288 25 23 V + S
2.0 TDI	125	05/09→				24.0325-0105.1 525105	Ø 288 25 23 V
2.0 TFSI	147	06/09→	←	→ 06/13; +PR 1LT		24.0125-0137.1 425137	Ø 312 25 23 V + S
2.0 TFSI	155	05/10→				24.0325-0137.1 525137	Ø 312 25 23 V
			←	→ 06/13; +PR 1LA		24.0130-0113.1 430113	Ø 320 30 28 V + S
						24.0330-0113.1 530113	Ø 320 30 28 V
			➔	→ 06/13; +PR 1KD		24.0110-0261.1 410261	Ø 245 10 8 + S
						24.0310-0261.1 510261	Ø 245 10 8
			➔	→ 06/13; +PR 1KP		24.0112-0148.1 412148	Ø 255 12 10
						24.0312-0148.1 512148	Ø 255 12 10
			➔	→ 06/13; +PR 1KW		24.0112-0166.1 412166	Ø 288 12 10
						24.0312-0166.1 512166	Ø 288 12 10
<b>SEAT - IBIZA II (6K1) 03/93→02/02</b>							
 <b>Brembelagsatz, Scheibenbremse</b>							
1.0	33	03/93→09/96	←	- ABS		13.0460-7030.2 607030	VW 20889 17,3 - WE / - WK + Zub
			←	+ ABS		13.0460-7032.2 20887	VW 20887 19,7 - WE / - WK + Zub
			➔	+PR 1KK		13.0460-2894.2 602894	TRW 20961 17,2 - WK + Zub
						13.0470-2894.2 LD2894	TRW 20961 17,2 - WK + Zub Ceramic
1.0 16V	51	10/99→02/02	←	→ 01/02; +PR 1ZK		13.0460-2821.2 602821	TRW 21945 16,0 - WK
1.4 16V	55	05/00→02/02	←	→ 01/02; +PR 1LV,1LW		13.0460-2958.2 602958	TRW 20168 19,3 - WK
			←	→ 6K-W-000 500; +PR 1LA; - ABS		13.0460-7059.2 607059	VW 20887 17,3 - WE / - WK + Zub
			←	→ 01/02; +PR 1LG		13.0460-7101.2 607101	VW 21866 15,3 - WE / - WK
			➔	→ 01/02; +PR 1KE,1KK,1KQ		13.0460-2894.2 602894	TRW 20961 17,2 - WK + Zub
						13.0470-2894.2 LD2894	TRW 20961 17,2 - WK + Zub Ceramic
1.0 i	37	09/96→02/02	←	08/99→ 01/02; +PR 1ZK		13.0460-2821.2 602821	TRW 21945 16,0 - WK
			←	01/97→ 07/99; +PR 1LY,1ZK		13.0460-2821.2 602821	TRW 21945 16,0 - WK
			←	08/99→ 01/02; +PR 1LV,1LW		13.0460-2958.2 602958	TRW 20168 19,3 - WK
			←	01/97→ 07/99; +PR 1LD,1LV,1LW		13.0460-2958.2 602958	TRW 20168 19,3 - WK
			←	→ 12/96; - ABS		13.0460-7030.2 607030	VW 20889 17,3 - WE / - WK + Zub
			←	→ 12/96; + ABS		13.0460-7032.2 20887	VW 20887 19,7 - WE / - WK + Zub







	kw			 	! #		
<b>SEAT - IBIZA II (6K1) 03/93→02/02</b>							
<b> Bremsbelagsatz, Scheibenbremse</b>							
1.0 i	37	09/96→02/02	←	01/97→ 07/99; +PR 1LA		13.0460-7059.2 607059	VW 20887 17,3 - WE / - WK + Zub
			←	08/99→; → 6K-W-000 500; +PR 1LA; - ABS		13.0460-7059.2 607059	VW 20887 17,3 - WE / - WK + Zub
			←	01/97→ 07/99; +PR 1LM		13.0460-7072.2 607072	VW 21866 19,7 - WE / - WK
			←	08/99→ 01/02; +PR 1LG		13.0460-7101.2 607101	VW 21866 15,3 - WE / - WK
			←	01/97→ 07/99; +PR 1LG		13.0460-7101.2 607101	VW 21866 15,3 - WE / - WK
			→	08/99→ 01/02; +PR 1KE,1KK,1KQ		13.0460-2894.2 602894 13.0470-2894.2 LD2894	TRW 20961 17,2 - WK + Zub TRW 20961 17,2 - WK + Zub Ceramic
			→	→ 07/99; +PR 1KK		13.0460-2894.2 602894 13.0470-2894.2 LD2894	TRW 20961 17,2 - WK + Zub TRW 20961 17,2 - WK + Zub Ceramic
1.3 i	40	03/93→08/99	←	01/97→ 07/99; +PR 1LY,1ZK		13.0460-2821.2 602821	TRW 21945 16,0 - WK
			←	01/97→ 07/99; +PR 1LD,1LV,1LW		13.0460-2958.2 602958	TRW 20168 19,3 - WK
			←	→ 12/96; - ABS		13.0460-7030.2 607030	VW 20889 17,3 - WE / - WK + Zub
			←	→ 12/96; + ABS		13.0460-7032.2 20887	VW 20887 19,7 - WE / - WK + Zub
			←	01/97→ 07/99; +PR 1LA		13.0460-7059.2 607059	VW 20887 17,3 - WE / - WK + Zub
			←	01/97→ 07/99; +PR 1LM		13.0460-7072.2 607072	VW 21866 19,7 - WE / - WK
			←	01/97→ 07/99; +PR 1LG		13.0460-7101.2 607101	VW 21866 15,3 - WE / - WK
			→	→ 07/99; +PR 1KK		13.0460-2894.2 602894 13.0470-2894.2 LD2894	TRW 20961 17,2 - WK + Zub TRW 20961 17,2 - WK + Zub Ceramic
1.4	40	12/97→04/99	←	+PR 1LY,1ZK		13.0460-2821.2 602821	TRW 21945 16,0 - WK
			←	+PR 1LD,1LV,1LW		13.0460-2958.2 602958	TRW 20168 19,3 - WK
			←	+PR 1LA		13.0460-7059.2 607059	VW 20887 17,3 - WE / - WK + Zub
			←	+PR 1LM		13.0460-7072.2 607072	VW 21866 19,7 - WE / - WK
			←	+PR 1LG		13.0460-7101.2 607101	VW 21866 15,3 - WE / - WK
			→	+PR 1KK		13.0460-2894.2 602894 13.0470-2894.2 LD2894	TRW 20961 17,2 - WK + Zub TRW 20961 17,2 - WK + Zub Ceramic
1.4 i	44	09/93→02/02	←	08/99→ 01/02; +PR 1LM,1ZK		13.0460-2821.2 602821	TRW 21945 16,0 - WK
			←	01/97→ 07/99; +PR 1LY,1ZK		13.0460-2821.2 602821	TRW 21945 16,0 - WK
			←	08/99→ 01/02; +PR 1LV,1LW		13.0460-2958.2 602958	TRW 20168 19,3 - WK
			←	01/97→ 07/99; +PR 1LD,1LV,1LW		13.0460-2958.2 602958	TRW 20168 19,3 - WK
			←	→ 12/96; - ABS		13.0460-7030.2 607030	VW 20889 17,3 - WE / - WK + Zub
			←	→ 12/96; + ABS		13.0460-7032.2 20887	VW 20887 19,7 - WE / - WK + Zub
			←	01/97→ 07/99; +PR 1LA		13.0460-7059.2 607059	VW 20887 17,3 - WE / - WK + Zub
			←	08/99→; → 6K-W-000 500; +PR 1LA; - ABS		13.0460-7059.2 607059	VW 20887 17,3 - WE / - WK + Zub
			←	01/97→ 07/99; +PR 1LM		13.0460-7072.2 607072	VW 21866 19,7 - WE / - WK
			←	08/99→ 01/02; +PR 1LG		13.0460-7101.2 607101	VW 21866 15,3 - WE / - WK
			←	01/97→ 07/99; +PR 1LG		13.0460-7101.2 607101	VW 21866 15,3 - WE / - WK
			→	08/99→ 01/02; +PR 1KE,1KK,1KQ		13.0460-2894.2 602894 13.0470-2894.2 LD2894	TRW 20961 17,2 - WK + Zub TRW 20961 17,2 - WK + Zub Ceramic
			→	→ 07/99; +PR 1KK		13.0460-2894.2 602894 13.0470-2894.2 LD2894	TRW 20961 17,2 - WK + Zub TRW 20961 17,2 - WK + Zub Ceramic
1.4 i 16V 1.9 TDI	74 66	06/97→02/02 08/96→02/02	←	→ 07/99; +PR 1LY,1ZK		13.0460-2821.2 602821	TRW 21945 16,0 - WK
			←	08/99→ 01/02; +PR 1ZK		13.0460-2821.2 602821	TRW 21945 16,0 - WK
			←	→ 07/99; +PR 1LD,1LV,1LW		13.0460-2958.2 602958	TRW 20168 19,3 - WK
			←	08/99→ 01/02; +PR 1LV,1LW		13.0460-2958.2 602958	TRW 20168 19,3 - WK
			←	08/99→; → 6K-W-000 500; +PR 1LA; - ABS		13.0460-7059.2 607059	VW 20887 17,3 - WE / - WK + Zub







	kw			 	! #		
<b>SEAT - IBIZA II (6K1) 03/93→02/02</b>							
<b> Bremsbelagsatz, Scheibenbremse</b>							
1.4 i 16V 1.9 TDI	74 66	06/97→02/02 08/96→02/02	←	→ 07/99; +PR 1LA	13.0460-7059.2	607059	VW 20887 17,3 - WE / - WK + Zub
			←	→ 07/99; +PR 1LM	13.0460-7072.2	607072	VW 21866 19,7 - WE / - WK
			←	08/99→ 01/02; +PR 1LG	13.0460-7101.2	607101	VW 21866 15,3 - WE / - WK
			←	→ 07/99; +PR 1LG	13.0460-7101.2	607101	VW 21866 15,3 - WE / - WK
			→	08/99→ 01/02; +PR 1KE,1KK,1KQ	13.0460-2894.2	602894	TRW 20961 17,2 - WK + Zub
			→	→ 07/99; +PR 1KK	13.0460-2894.2	602894	TRW 20961 17,2 - WK + Zub
					13.0470-2894.2	LD2894	TRW 20961 17,2 - WK + Zub Ceramic
					13.0460-2894.2	602894	TRW 20961 17,2 - WK + Zub
					13.0470-2894.2	LD2894	TRW 20961 17,2 - WK + Zub Ceramic
1.6 i 1.6 i	55 74	03/93→02/02 04/96→02/02	←	01/97→ 07/99; +PR 1LY,1ZK	13.0460-2821.2	602821	TRW 21945 16,0 - WK
			←	08/99→ 01/02; +PR 1ZK	13.0460-2821.2	602821	TRW 21945 16,0 - WK
			←	→ 12/96	13.0460-2957.2	602957	TRW 20168 16,0 - WK
					13.0460-7032.2	20887	VW 20887 19,7 - WE / - WK + Zub
			←	08/99→ 01/02; +PR 1LV,1LW	13.0460-2958.2	602958	TRW 20168 19,3 - WK
			←	01/97→ 07/99; +PR 1LD,1LV,1LW	13.0460-2958.2	602958	TRW 20168 19,3 - WK
			←	08/99→; → 6K-W-000 500; +PR 1LA; - ABS	13.0460-7059.2	607059	VW 20887 17,3 - WE / - WK + Zub
			←	01/97→ 07/99; +PR 1LA	13.0460-7059.2	607059	VW 20887 17,3 - WE / - WK + Zub
			←	01/97→ 07/99; +PR 1LM	13.0460-7072.2	607072	VW 21866 19,7 - WE / - WK
			←	08/99→ 01/02; +PR 1LG	13.0460-7101.2	607101	VW 21866 15,3 - WE / - WK
			←	01/97→ 07/99; +PR 1LG	13.0460-7101.2	607101	VW 21866 15,3 - WE / - WK
					→ 07/99; +PR 1KK	13.0460-2894.2	602894
			13.0470-2894.2	LD2894	TRW 20961 17,2 - WK + Zub Ceramic		
			→ 07/99; +PR 1KK	13.0460-2894.2	602894	TRW 20961 17,2 - WK + Zub	
				13.0470-2894.2	LD2894	TRW 20961 17,2 - WK + Zub Ceramic	
1.6 i	55	09/94→06/99	←	01/97→; +PR 1LY,1ZK	13.0460-2821.2	602821	TRW 21945 16,0 - WK
			←	→ 12/96	13.0460-2957.2	602957	TRW 20168 16,0 - WK
					13.0460-7032.2	20887	VW 20887 19,7 - WE / - WK + Zub
			←	01/97→; +PR 1LD,1LV,1LW	13.0460-2958.2	602958	TRW 20168 19,3 - WK
			←	01/97→; +PR 1LA	13.0460-7059.2	607059	VW 20887 17,3 - WE / - WK + Zub
			←	01/97→; +PR 1LM	13.0460-7072.2	607072	VW 21866 19,7 - WE / - WK
			←	01/97→; +PR 1LG	13.0460-7101.2	607101	VW 21866 15,3 - WE / - WK
		+PR 1KK	13.0460-2894.2	602894	TRW 20961 17,2 - WK + Zub		
			13.0470-2894.2	LD2894	TRW 20961 17,2 - WK + Zub Ceramic		
1.8 i	66	03/93→08/99	←	01/97→ 07/99; +PR 1LY,1ZK	13.0460-2821.2	602821	TRW 21945 16,0 - WK
			←	→ 12/96	13.0460-2957.2	602957	TRW 20168 16,0 - WK
			←	01/97→ 07/99; +PR 1LD,1LV,1LW	13.0460-2958.2	602958	TRW 20168 19,3 - WK
			←	→ 6K-ZR003620	13.0460-7032.2	20887	VW 20887 19,7 - WE / - WK + Zub
			←	6K-ZR003621→; → 12/96	13.0460-7033.2	20887	VW 20887 15,3 - WE / - WK
					13.0460-7101.2	607101	VW 21866 15,3 - WE / - WK
			←	01/97→ 07/99; +PR 1LA	13.0460-7059.2	607059	VW 20887 17,3 - WE / - WK + Zub
			←	01/97→ 07/99; +PR 1LM	13.0460-7072.2	607072	VW 21866 19,7 - WE / - WK
			←	01/97→ 07/99; +PR 1LG	13.0460-7101.2	607101	VW 21866 15,3 - WE / - WK
		→ 07/99; +PR 1KK	13.0460-2894.2	602894	TRW 20961 17,2 - WK + Zub		
			13.0470-2894.2	LD2894	TRW 20961 17,2 - WK + Zub Ceramic		
1.8 i 16V	95	11/93→08/96	←	02/94→	13.0460-2957.2	602957	TRW 20168 16,0 - WK
			→	02/94→; +PR 1KK	13.0460-2894.2	602894	TRW 20961 17,2 - WK + Zub
					13.0470-2894.2	LD2894	TRW 20961 17,2 - WK + Zub Ceramic
			→ 02/94→	13.0460-2937.2	602937	TRW 20961 15,2 - WK + Zub	
↓							











	kw			 	! #			
<b>SEAT - IBIZA II (6K1) 03/93→02/02</b>								
<b> Bremsbelagsatz, Scheibenbremse</b>								
1.8 T 20V Cupra	115	07/00→02/02	←	→ 01/02		<b>13.0460-4964.2</b>	<b>604964</b>	BRE 21381 15,0 - WE / - WK
			→	→ 01/02; +PR 1KE,1KK,1KQ		<b>13.0460-2894.2</b>	<b>602894</b>	TRW 20961 17,2 - WK + Zub
						<b>13.0470-2894.2</b>	<b>LD2894</b>	TRW 20961 17,2 - WK + Zub Ceramic
1.9 D 1.9 D	47 50	04/93→08/96 10/94→08/96	←	→ 6K-ZR003611		<b>13.0460-7032.2</b>	<b>20887</b>	VW 20887 19,7 - WE / - WK + Zub
			←	6K-ZR003612→		<b>13.0460-7033.2</b>	<b>20887</b>	VW 20887 15,3 - WE / - WK
			→	+PR 1KK		<b>13.0460-2894.2</b>	<b>602894</b>	TRW 20961 17,2 - WK + Zub
						<b>13.0470-2894.2</b>	<b>LD2894</b>	TRW 20961 17,2 - WK + Zub Ceramic
1.9 SDI	47	08/96→08/99	←	→ 07/99; +PR 1LY,1ZK		<b>13.0460-2821.2</b>	<b>602821</b>	TRW 21945 16,0 - WK
			←	→ 07/99; +PR 1LD,1LV,1LW		<b>13.0460-2958.2</b>	<b>602958</b>	TRW 20168 19,3 - WK
			←	→ 07/99; +PR 1LA		<b>13.0460-7059.2</b>	<b>607059</b>	VW 20887 17,3 - WE / - WK + Zub
			←	→ 07/99; +PR 1LM		<b>13.0460-7072.2</b>	<b>607072</b>	VW 21866 19,7 - WE / - WK
			←	→ 07/99; +PR 1LG		<b>13.0460-7101.2</b>	<b>607101</b>	VW 21866 15,3 - WE / - WK
			→	→ 07/99; +PR 1KK		<b>13.0460-2894.2</b>	<b>602894</b>	TRW 20961 17,2 - WK + Zub
						<b>13.0470-2894.2</b>	<b>LD2894</b>	TRW 20961 17,2 - WK + Zub Ceramic
1.9 SDI	50	08/99→02/02	←	→ 01/02; +PR 1LM,1ZK		<b>13.0460-2821.2</b>	<b>602821</b>	TRW 21945 16,0 - WK
			←	→ 01/02; +PR 1LV,1LW		<b>13.0460-2958.2</b>	<b>602958</b>	TRW 20168 19,3 - WK
			←	→ 6K-W-000 500; +PR 1LA; - ABS		<b>13.0460-7059.2</b>	<b>607059</b>	VW 20887 17,3 - WE / - WK + Zub
			←	→ 01/02; +PR 1LG		<b>13.0460-7101.2</b>	<b>607101</b>	VW 21866 15,3 - WE / - WK
			→	→ 01/02; +PR 1KE,1KK,1KQ		<b>13.0460-2894.2</b>	<b>602894</b>	TRW 20961 17,2 - WK + Zub
						<b>13.0470-2894.2</b>	<b>LD2894</b>	TRW 20961 17,2 - WK + Zub Ceramic
1.9 TD	55	03/93→08/96	←	→ 6K-ZR003513		<b>13.0460-7032.2</b>	<b>20887</b>	VW 20887 19,7 - WE / - WK + Zub
			←	6K-ZR003514→		<b>13.0460-7033.2</b>	<b>20887</b>	VW 20887 15,3 - WE / - WK
						<b>13.0460-7101.2</b>	<b>607101</b>	VW 21866 15,3 - WE / - WK
			→	+PR 1KK		<b>13.0460-2894.2</b>	<b>602894</b>	TRW 20961 17,2 - WK + Zub
						<b>13.0470-2894.2</b>	<b>LD2894</b>	TRW 20961 17,2 - WK + Zub Ceramic
1.9 TDI	81	02/97→02/02	←	03/97→ 07/99; +PR 1LY,1ZK		<b>13.0460-2821.2</b>	<b>602821</b>	TRW 21945 16,0 - WK
			←	08/99→ 01/02; +PR 1ZK		<b>13.0460-2821.2</b>	<b>602821</b>	TRW 21945 16,0 - WK
			←	08/99→ 01/02; +PR 1LV,1LW		<b>13.0460-2958.2</b>	<b>602958</b>	TRW 20168 19,3 - WK
			←	03/97→ 07/99; +PR 1LD,1LV,1LW		<b>13.0460-2958.2</b>	<b>602958</b>	TRW 20168 19,3 - WK
			←	08/99→; → 6K-W-000 500; +PR 1LA; - ABS		<b>13.0460-7059.2</b>	<b>607059</b>	VW 20887 17,3 - WE / - WK + Zub
			←	03/97→ 07/99; +PR 1LA		<b>13.0460-7059.2</b>	<b>607059</b>	VW 20887 17,3 - WE / - WK + Zub
			←	03/97→ 07/99; +PR 1LM		<b>13.0460-7072.2</b>	<b>607072</b>	VW 21866 19,7 - WE / - WK
			←	03/97→ 07/99; +PR 1LG		<b>13.0460-7101.2</b>	<b>607101</b>	VW 21866 15,3 - WE / - WK
			←	08/99→ 01/02; +PR 1LG		<b>13.0460-7101.2</b>	<b>607101</b>	VW 21866 15,3 - WE / - WK
			→	03/97→ 07/99; +PR 1KK		<b>13.0460-2894.2</b>	<b>602894</b>	TRW 20961 17,2 - WK + Zub
						<b>13.0470-2894.2</b>	<b>LD2894</b>	TRW 20961 17,2 - WK + Zub Ceramic
						→	08/99→ 01/02; +PR 1KE,1KK,1KQ	
						<b>13.0470-2894.2</b>	<b>LD2894</b>	TRW 20961 17,2 - WK + Zub Ceramic
			→	03/97→ 07/99		<b>13.0460-2937.2</b>	<b>602937</b>	TRW 20961 15,2 - WK + Zub
2.0 i	85	03/93→08/99	←	01/97→ 07/99; +PR 1LY,1ZK		<b>13.0460-2821.2</b>	<b>602821</b>	TRW 21945 16,0 - WK
			←	→ 12/96		<b>13.0460-2957.2</b>	<b>602957</b>	TRW 20168 16,0 - WK
			←	01/97→ 07/99; +PR 1LD,1LV,1LW		<b>13.0460-2958.2</b>	<b>602958</b>	TRW 20168 19,3 - WK
			←	01/97→ 07/99; +PR 1LA		<b>13.0460-7059.2</b>	<b>607059</b>	VW 20887 17,3 - WE / - WK + Zub
			←	01/97→ 07/99; +PR 1LM		<b>13.0460-7072.2</b>	<b>607072</b>	VW 21866 19,7 - WE / - WK
			←	01/97→ 07/99; +PR 1LG		<b>13.0460-7101.2</b>	<b>607101</b>	VW 21866 15,3 - WE / - WK
			→	→ 07/99; +PR 1KK		<b>13.0460-2894.2</b>	<b>602894</b>	TRW 20961 17,2 - WK + Zub

	kw			 	! #		
<b>SEAT - IBIZA II (6K1) 03/93→02/02</b>							
<b> Bremsbelagsatz, Scheibenbremse</b>							
2.0 i	85	03/93→08/99	➡	→ 07/99; +PR 1KK		<b>13.0470-2894.2</b> <b>LD2894</b>	TRW 20961 17,2 - WK + Zub Ceramic
			➡	→ 07/99		<b>13.0460-2937.2</b> <b>602937</b>	TRW 20961 15,2 - WK + Zub
2.0 i 16V	110	08/96→08/99	⬅	01/97→ 07/99; +PR 1LY,1ZK		<b>13.0460-2821.2</b> <b>602821</b>	TRW 21945 16,0 - WK
			⬅	→ 12/96		<b>13.0460-2957.2</b> <b>602957</b>	TRW 20168 16,0 - WK
			⬅	01/97→ 07/99; +PR 1LD,1LV,1LW		<b>13.0460-2958.2</b> <b>602958</b>	TRW 20168 19,3 - WK
			⬅	01/97→ 07/99; +PR 1LA		<b>13.0460-7059.2</b> <b>607059</b>	VW 20887 17,3 - WE / - WK + Zub
			⬅	01/97→ 07/99; +PR 1LM		<b>13.0460-7072.2</b> <b>607072</b>	VW 21866 19,7 - WE / - WK
			⬅	01/97→ 07/99; +PR 1LG		<b>13.0460-7101.2</b> <b>607101</b>	VW 21866 15,3 - WE / - WK
			➡	→ 07/99; +PR 1KK		<b>13.0460-2894.2</b> <b>602894</b>	TRW 20961 17,2 - WK + Zub
			➡	→ 07/99		<b>13.0470-2894.2</b> <b>LD2894</b>	TRW 20961 17,2 - WK + Zub Ceramic
			➡	→ 07/99		<b>13.0460-2984.2</b> <b>602984</b>	TRW 20961 17,2 - WK + Zub
<b>Zubehörsatz, Scheibenbremsbelag</b>							
1.0 16V 1.4 16V 1.8 T 20V Cupra 1.9 SDI	51 55 115 50	10/99→02/02 05/00→02/02 07/00→02/02 08/99→02/02	➡	→ 01/02; +PR 1KE,1KK,1KQ		<b>13.0460-0072.2</b> <b>610072</b>	TRW
1.0 i 1.4 i 1.4 i 16V 1.6 i 1.6 i 1.9 TDI	37 44 74 55 74 66	09/96→02/02 09/93→02/02 06/97→02/02 03/93→02/02 04/96→02/02 08/96→02/02	➡	08/99→ 01/02; +PR 1KE,1KK,1KQ		<b>13.0460-0072.2</b> <b>610072</b>	TRW
1.8 i 16V	95	11/93→08/96	➡	02/94→		<b>13.0460-0419.2</b> <b>610419</b>	TRW
1.9 TDI	81	02/97→02/02	➡	08/99→ 01/02; +PR 1KE,1KK,1KQ		<b>13.0460-0072.2</b> <b>610072</b>	TRW
			➡	03/97→ 07/99		<b>13.0460-0419.2</b> <b>610419</b>	TRW
2.0 i	85	03/93→08/99	➡	→ 07/99		<b>13.0460-0419.2</b> <b>610419</b>	TRW
2.0 i 16V	110	08/96→08/99	➡	→ 07/99		<b>13.0460-0072.2</b> <b>610072</b>	TRW
<b> Bremsscheibe</b>							
1.0 1.9 D 1.9 D 1.9 TD	33 47 50 55	03/93→09/96 04/93→08/96 10/94→08/96 03/93→08/96	⬅	+PR 1LA		<b>24.0110-0151.1</b> <b>410151</b>	Ø 239 10 8 + S
			⬅	+PR 1LG		<b>24.0310-0151.1</b> <b>510151</b>	Ø 239 10 8 + S
			⬅	+PR 1KK		<b>24.0120-0123.1</b> <b>420123</b>	Ø 239 20 18 V + S
			➡	+PR 1KK		<b>24.0320-0123.1</b> <b>520123</b>	Ø 239 20 18 V + S
			➡	+PR 1KK		<b>24.0109-0124.1</b> <b>409124</b>	Ø 232 9 7
1.0 16V 1.4 16V	51 55	10/99→02/02 05/00→02/02	⬅	→ 6K-W-000 500; +PR 1LA; - ABS		<b>24.0110-0151.1</b> <b>410151</b>	Ø 239 10 8 + S
			⬅	→ 01/02; +PR 1LG		<b>24.0120-0123.1</b> <b>420123</b>	Ø 239 20 18 V + S
			⬅	→ 01/02; +PR 1ZK		<b>24.0320-0123.1</b> <b>520123</b>	Ø 239 20 18 V + S
			⬅	→ 01/02; +PR 1ZK		<b>24.0120-0128.1</b> <b>420128</b>	Ø 256 20 18 V + S
			⬅	→ 01/02; +PR 1LV,1LW		<b>24.0320-0128.1</b> <b>520128</b>	Ø 256 20 18 V + S
			⬅	→ 01/02; +PR 1LV,1LW		<b>24.0122-0101.1</b> <b>422101</b>	Ø 280 22 20 V
			⬅	→ 6K-W-000 500; +PR 1LA		<b>24.0310-0151.1</b> <b>510151</b>	Ø 239 10 8 + S
			➡	→ 01/02; +PR 1KE,1KK,1KQ		<b>24.0109-0124.1</b> <b>409124</b>	Ø 232 9 7
1.0 i 1.6 i 1.6 i	37 55 74	09/96→02/02 03/93→02/02 04/96→02/02	⬅	→ 07/99; +PR 1LA		<b>24.0110-0151.1</b> <b>410151</b>	Ø 239 10 8 + S
			⬅	→ 07/99; +PR 1LA		<b>24.0310-0151.1</b> <b>510151</b>	Ø 239 10 8 + S
			⬅	08/99→; → 6K-W-000 500; +PR 1LA; - ABS		<b>24.0110-0151.1</b> <b>410151</b>	Ø 239 10 8 + S
			⬅	01/97→ 07/99; +PR 1LM		<b>24.0112-0106.1</b> <b>412106</b>	Ø 239 12 10 + S
			⬅	01/97→ 07/99; +PR 1LM		<b>24.0312-0106.1</b> <b>512106</b>	Ø 239 12 10 + S
			⬅	08/99→ 01/02; +PR 1LG		<b>24.0120-0123.1</b> <b>420123</b>	Ø 239 20 18 V + S
			⬅	08/99→ 01/02; +PR 1LG		<b>24.0320-0123.1</b> <b>520123</b>	Ø 239 20 18 V + S
			⬅	→ 07/99; +PR 1LG		<b>24.0120-0123.1</b> <b>420123</b>	Ø 239 20 18 V + S
			⬅	→ 07/99; +PR 1LG		<b>24.0320-0123.1</b> <b>520123</b>	Ø 239 20 18 V + S
			⬅	08/99→ 01/02; +PR 1ZK		<b>24.0120-0128.1</b> <b>420128</b>	Ø 256 20 18 V + S
			⬅	08/99→ 01/02; +PR 1ZK		<b>24.0320-0128.1</b> <b>520128</b>	Ø 256 20 18 V + S
			⬅	01/97→ 07/99; +PR 1LY,1ZK		<b>24.0120-0128.1</b> <b>420128</b>	Ø 256 20 18 V + S
			⬅	01/97→ 07/99; +PR 1LY,1ZK		<b>24.0320-0128.1</b> <b>520128</b>	Ø 256 20 18 V + S
			⬅	08/99→ 01/02; +PR 1LV,1LW		<b>24.0122-0101.1</b> <b>422101</b>	Ø 280 22 20 V
			⬅	01/97→ 07/99; +PR 1LD,1LV,1LW		<b>24.0122-0101.1</b> <b>422101</b>	Ø 280 22 20 V











	kw			 	! #		
<b>SEAT - IBIZA II (6K1) 03/93→02/02</b>							
<b>Bremsscheibe</b>							
1.0 i	37	09/96→02/02	←	08/99→; → 6K-W-000 500; +PR 1LA		24.0310-0151.1 510151	Ø 239 10 8 + S
1.6 i	55	03/93→02/02	→	08/99→ 01/02; +PR 1KE,1KK,1KQ		24.0109-0124.1 409124	Ø 232 9 7
1.6 i	74	04/96→02/02	→	→ 07/99; +PR 1KK		24.0109-0124.1 409124	Ø 232 9 7
1.3 i	40	03/93→08/99	←	→ 07/99; +PR 1LA		24.0110-0151.1 410151	Ø 239 10 8 + S
1.8 i	66	03/93→08/99				24.0310-0151.1 510151	Ø 239 10 8 + S
2.0 i 16V	110	08/96→08/99	←	01/97→ 07/99; +PR 1LM		24.0112-0106.1 412106	Ø 239 12 10 + S
						24.0312-0106.1 512106	Ø 239 12 10 + S
			←	→ 07/99; +PR 1LG		24.0120-0123.1 420123	Ø 239 20 18 V + S
						24.0320-0123.1 520123	Ø 239 20 18 V + S
			←	01/97→ 07/99; +PR 1LY,1ZK		24.0120-0128.1 420128	Ø 256 20 18 V + S
						24.0320-0128.1 520128	Ø 256 20 18 V + S
			←	01/97→ 07/99; +PR 1LD,1LV,1LW		24.0122-0101.1 422101	Ø 280 22 20 V
			→	→ 07/99; +PR 1KK		24.0109-0124.1 409124	Ø 232 9 7
1.4	40	12/97→04/99	←	+PR 1LA		24.0110-0151.1 410151	Ø 239 10 8 + S
						24.0310-0151.1 510151	Ø 239 10 8 + S
			←	+PR 1LM		24.0112-0106.1 412106	Ø 239 12 10 + S
						24.0312-0106.1 512106	Ø 239 12 10 + S
			←	+PR 1LG		24.0120-0123.1 420123	Ø 239 20 18 V + S
						24.0320-0123.1 520123	Ø 239 20 18 V + S
			←	+PR 1LY,1ZK		24.0120-0128.1 420128	Ø 256 20 18 V + S
						24.0320-0128.1 520128	Ø 256 20 18 V + S
			←	+PR 1LD,1LV,1LW		24.0122-0101.1 422101	Ø 280 22 20 V
			→	+PR 1KK		24.0109-0124.1 409124	Ø 232 9 7
1.4 i	44	09/93→02/02	←	08/99→; → 6K-W-000 500; +PR 1LA; - ABS		24.0110-0151.1 410151	Ø 239 10 8 + S
			←	→ 07/99; +PR 1LA		24.0110-0151.1 410151	Ø 239 10 8 + S
						24.0310-0151.1 510151	Ø 239 10 8 + S
			←	08/99→ 01/02; +PR 1LM		24.0112-0106.1 412106	Ø 239 12 10 + S
						24.0312-0106.1 512106	Ø 239 12 10 + S
			←	01/97→ 07/99; +PR 1LM		24.0112-0106.1 412106	Ø 239 12 10 + S
						24.0312-0106.1 512106	Ø 239 12 10 + S
			←	→ 07/99; +PR 1LG		24.0120-0123.1 420123	Ø 239 20 18 V + S
						24.0320-0123.1 520123	Ø 239 20 18 V + S
			←	08/99→ 01/02; +PR 1LG		24.0120-0123.1 420123	Ø 239 20 18 V + S
						24.0320-0123.1 520123	Ø 239 20 18 V + S
			←	08/99→ 01/02; +PR 1ZK		24.0120-0128.1 420128	Ø 256 20 18 V + S
						24.0320-0128.1 520128	Ø 256 20 18 V + S
			←	01/97→ 07/99; +PR 1LY,1ZK		24.0120-0128.1 420128	Ø 256 20 18 V + S
						24.0320-0128.1 520128	Ø 256 20 18 V + S
			←	08/99→ 01/02; +PR 1LV,1LW		24.0122-0101.1 422101	Ø 280 22 20 V
			←	01/97→ 07/99; +PR 1LD,1LV,1LW		24.0122-0101.1 422101	Ø 280 22 20 V
			←	08/99→; → 6K-W-000 500; +PR 1LA		24.0310-0151.1 510151	Ø 239 10 8 + S
			→	08/99→ 01/02; +PR 1KE,1KK,1KQ		24.0109-0124.1 409124	Ø 232 9 7
			→	→ 07/99; +PR 1KK		24.0109-0124.1 409124	Ø 232 9 7
1.4 i 16V	74	06/97→02/02	←	→ 07/99; +PR 1LA		24.0110-0151.1 410151	Ø 239 10 8 + S
1.9 TDI	66	08/96→02/02				24.0310-0151.1 510151	Ø 239 10 8 + S
			←	08/99→; → 6K-W-000 500; +PR 1LA; - ABS		24.0110-0151.1 410151	Ø 239 10 8 + S
			←	→ 07/99; +PR 1LM		24.0112-0106.1 412106	Ø 239 12 10 + S
						24.0312-0106.1 512106	Ø 239 12 10 + S
			←	→ 07/99; +PR 1LG		24.0120-0123.1 420123	Ø 239 20 18 V + S
						24.0320-0123.1 520123	Ø 239 20 18 V + S
			←	08/99→ 01/02; +PR 1LG		24.0120-0123.1 420123	Ø 239 20 18 V + S
						24.0320-0123.1 520123	Ø 239 20 18 V + S
			←	08/99→ 01/02; +PR 1ZK		24.0120-0128.1 420128	Ø 256 20 18 V + S
						24.0320-0128.1 520128	Ø 256 20 18 V + S
			←	→ 07/99; +PR 1LY,1ZK		24.0120-0128.1 420128	Ø 256 20 18 V + S
						24.0320-0128.1 520128	Ø 256 20 18 V + S
			←	08/99→ 01/02; +PR 1LV,1LW		24.0122-0101.1 422101	Ø 280 22 20 V
			←	→ 07/99; +PR 1LD,1LV,1LW		24.0122-0101.1 422101	Ø 280 22 20 V









	kw			 	! #		
<b>SEAT - IBIZA II (6K1) 03/93→02/02</b>							
<b>Bremsscheibe</b>							
1.4 i 16V 1.9 TDI	74 66	06/97→02/02 08/96→02/02	←	08/99→; → 6K-W-000 500; +PR 1LA	24.0310-0151.1	510151	Ø 239 10 8 + S
			→	→ 07/99; +PR 1KK	24.0109-0124.1	409124	Ø 232 9 7
			→	08/99→ 01/02; +PR 1KE,1KK,1KQ	24.0109-0124.1	409124	Ø 232 9 7
1.6 i	55	09/94→06/99	←	+PR 1LA	24.0110-0151.1	410151	Ø 239 10 8 + S
					24.0310-0151.1	510151	Ø 239 10 8 + S
			←	01/97→; +PR 1LM	24.0112-0106.1	412106	Ø 239 12 10 + S
					24.0312-0106.1	512106	Ø 239 12 10 + S
			←	+PR 1LG	24.0120-0123.1	420123	Ø 239 20 18 V + S
					24.0320-0123.1	520123	Ø 239 20 18 V + S
			←	01/97→; +PR 1LY,1ZK	24.0120-0128.1	420128	Ø 256 20 18 V + S
		24.0320-0128.1	520128	Ø 256 20 18 V + S			
1.8 i 16V	95	11/93→08/96	←	02/94→; +PR 1LA	24.0110-0151.1	410151	Ø 239 10 8 + S
					24.0310-0151.1	510151	Ø 239 10 8 + S
			←	02/94→; +PR 1LG	24.0120-0123.1	420123	Ø 239 20 18 V + S
					24.0320-0123.1	520123	Ø 239 20 18 V + S
			→	02/94→; +PR 1KK	24.0109-0124.1	409124	Ø 232 9 7
1.8 T 20V Cupra	115	07/00→02/02	→	→ 01/02; +PR 1KE,1KK,1KQ	24.0109-0124.1	409124	Ø 232 9 7
1.9 SDI	47	08/96→08/99	←	→ 07/99; +PR 1LA	24.0110-0151.1	410151	Ø 239 10 8 + S
					24.0310-0151.1	510151	Ø 239 10 8 + S
			←	→ 07/99; +PR 1LM	24.0112-0106.1	412106	Ø 239 12 10 + S
					24.0312-0106.1	512106	Ø 239 12 10 + S
			←	→ 07/99; +PR 1LG	24.0120-0123.1	420123	Ø 239 20 18 V + S
					24.0320-0123.1	520123	Ø 239 20 18 V + S
1.9 SDI	50	08/99→02/02	←	→ 07/99; +PR 1LY,1ZK	24.0120-0128.1	420128	Ø 256 20 18 V + S
					24.0320-0128.1	520128	Ø 256 20 18 V + S
			←	→ 07/99; +PR 1LD,1LV,1LW	24.0122-0101.1	422101	Ø 280 22 20 V
			→	→ 07/99; +PR 1KK	24.0109-0124.1	409124	Ø 232 9 7
			←	→ 01/02; +PR 1LA	24.0110-0151.1	410151	Ø 239 10 8 + S
					24.0310-0151.1	510151	Ø 239 10 8 + S
1.9 TDI	81	02/97→02/02	←	→ 01/02; +PR 1LM	24.0112-0106.1	412106	Ø 239 12 10 + S
					24.0312-0106.1	512106	Ø 239 12 10 + S
			←	→ 01/02; +PR 1LG	24.0120-0123.1	420123	Ø 239 20 18 V + S
					24.0320-0123.1	520123	Ø 239 20 18 V + S
			←	→ 01/02; +PR 1ZK	24.0120-0128.1	420128	Ø 256 20 18 V + S
					24.0320-0128.1	520128	Ø 256 20 18 V + S
			←	→ 01/02; +PR 1LV,1LW	24.0122-0101.1	422101	Ø 280 22 20 V
			←	→ 6K-W-000 500; +PR 1LA	24.0310-0151.1	510151	Ø 239 10 8 + S
			→	→ 01/02; +PR 1KE,1KK,1KQ	24.0109-0124.1	409124	Ø 232 9 7
			←	08/99→; → 6K-W-000 500; +PR 1LA; - ABS	24.0110-0151.1	410151	Ø 239 10 8 + S
			←	03/97→ 07/99; +PR 1LA	24.0110-0151.1	410151	Ø 239 10 8 + S
		24.0310-0151.1	510151	Ø 239 10 8 + S			
←	03/97→ 07/99; +PR 1LM	24.0112-0106.1	412106	Ø 239 12 10 + S			
		24.0312-0106.1	512106	Ø 239 12 10 + S			
←	08/99→ 01/02; +PR 1LG	24.0120-0123.1	420123	Ø 239 20 18 V + S			
		24.0320-0123.1	520123	Ø 239 20 18 V + S			
←	03/97→ 07/99; +PR 1LG	24.0120-0123.1	420123	Ø 239 20 18 V + S			
		24.0320-0123.1	520123	Ø 239 20 18 V + S			
←	03/97→ 07/99; +PR 1LY,1ZK	24.0120-0128.1	420128	Ø 256 20 18 V + S			
		24.0320-0128.1	520128	Ø 256 20 18 V + S			
←	08/99→ 01/02; +PR 1ZK	24.0120-0128.1	420128	Ø 256 20 18 V + S			
		24.0320-0128.1	520128	Ø 256 20 18 V + S			
←	08/99→ 01/02; +PR 1LV,1LW	24.0122-0101.1	422101	Ø 280 22 20 V			
←	03/97→ 07/99; +PR 1LD,1LV,1LW	24.0122-0101.1	422101	Ø 280 22 20 V			
←	08/99→; → 6K-W-000 500; +PR 1LA	24.0310-0151.1	510151	Ø 239 10 8 + S			
→	03/97→ 07/99; +PR 1KK	24.0109-0124.1	409124	Ø 232 9 7			



















	kw			 	! #					
<b>SEAT - IBIZA II (6K1) 03/93—02/02</b>										
 <b>Bremsscheibe</b>										
1.9 TDI	81	02/97→02/02	➔	08/99→ 01/02; +PR 1KE,1KK,1KQ	24.0109-0124.1	409124	Ø 232 9 7			
			➔	03/97→ 07/99	24.0110-0111.1	410111	Ø 226 10 8 - ABS Ring / - RLG			
					24.0110-0275.2	410275	Ø 226 10 8 + ABS Ring / - RLG			
2.0 i	85	03/93→08/99	←	→ 07/99; +PR 1LA	24.0110-0151.1	410151	Ø 239 10 8 + S			
					24.0310-0151.1	510151	Ø 239 10 8 + S			
			←	01/97→ 07/99; +PR 1LM	24.0112-0106.1	412106	Ø 239 12 10 + S			
					24.0312-0106.1	512106	Ø 239 12 10 + S			
			←	→ 07/99; +PR 1LG	24.0120-0123.1	420123	Ø 239 20 18 V + S			
					24.0320-0123.1	520123	Ø 239 20 18 V + S			
			←	01/97→ 07/99; +PR 1LY,1ZK	24.0120-0128.1	420128	Ø 256 20 18 V + S			
					24.0320-0128.1	520128	Ø 256 20 18 V + S			
			←	01/97→ 07/99; +PR 1LD,1LV,1LW	24.0122-0101.1	422101	Ø 280 22 20 V			
<b>SEAT - IBIZA III (6L1) 02/02→11/09</b>										
 <b>Bremsbelagsatz, Scheibenbremse</b>										
1.2 1.8 T FR 2.0	44 110 85	06/07→05/08 12/03→05/08 04/02→11/09	←	+PR 1LN,1ZH	13.0460-2883.2	602883	TRW 23581 18,8 - WE / - WK			
					13.0460-2884.2	602884	TRW 23581 18,8 + WK			
					13.0470-2884.2	LD2884	TRW 23581 18,8 + WK Ceramic			
			←	+PR 1LQ,1LR,1ZF,1ZG	13.0460-7111.2	607111	VW 23130 19,6 - WE / - WK			
					13.0470-7111.2	LD7111	VW 23130 19,6 - WE / - WK Ceramic			
			➔		13.0460-2864.2	602864	TRW 20961 17,2 - WK			
					13.0460-2877.2	602877	TRW 23554 17,2 + WK			
					13.0460-2894.2	602894	TRW 20961 17,2 - WK + Zub			
					13.0470-2877.2	LD2877	TRW 23554 17,2 + WK Ceramic			
					13.0470-2894.2	LD2894	TRW 20961 17,2 - WK + Zub Ceramic			
1.2 1.2 12V 1.4 16V 1.4 16V 1.4 16V 1.4 TDI 1.4 TDI 1.4 TDI 1.6 1.6 16V 1.9 SDI 1.9 TDI 1.9 TDI	47 51 55 63 74 51 55 59 74 77 47 74 96	02/02→06/06 05/06→11/09 02/02→12/07 05/06→11/09 02/02→11/09 05/05→11/09 05/02→12/05 06/05→11/09 02/03→11/09 11/06→11/09 02/02→12/05 02/02→11/09 02/02→11/09	←	+PR 1LN;1ZH	13.0460-2883.2	602883	TRW 23581 18,8 - WE / - WK			
					13.0460-2884.2	602884	TRW 23581 18,8 + WK			
					13.0470-2884.2	LD2884	TRW 23581 18,8 + WK Ceramic			
			←	+PR 1LQ,1LR,1ZF,1ZG	13.0460-7111.2	607111	VW 23130 19,6 - WE / - WK			
					13.0470-7111.2	LD7111	VW 23130 19,6 - WE / - WK Ceramic			
			➔		13.0460-2864.2	602864	TRW 20961 17,2 - WK			
					13.0460-2877.2	602877	TRW 23554 17,2 + WK			
					13.0460-2894.2	602894	TRW 20961 17,2 - WK + Zub			
					13.0470-2877.2	LD2877	TRW 23554 17,2 + WK Ceramic			
					13.0470-2894.2	LD2894	TRW 20961 17,2 - WK + Zub Ceramic			
			1.8 T Cupra R	132	01/04→02/08	←		13.0460-7081.2	607081	ATE 20676 19,8 - WE / - WK
								13.0470-7081.2	LD7081	ATE 20676 19,8 - WE / - WK Ceramic
➔		13.0460-2864.2				602864	TRW 20961 17,2 - WK			
		13.0460-2877.2				602877	TRW 23554 17,2 + WK			
				13.0460-2894.2	602894	TRW 20961 17,2 - WK + Zub				
				13.0470-2877.2	LD2877	TRW 23554 17,2 + WK Ceramic				
				13.0470-2894.2	LD2894	TRW 20961 17,2 - WK + Zub Ceramic				
1.9 TDI Cupra R	118	03/04→02/08	←	+PR 1LN,1ZH	13.0460-2883.2	602883	TRW 23581 18,8 - WE / - WK			
					13.0460-2884.2	602884	TRW 23581 18,8 + WK			
					13.0470-2884.2	LD2884	TRW 23581 18,8 + WK Ceramic			
			←	+PR 1LT	13.0460-7081.2	607081	ATE 20676 19,8 - WE / - WK			
				13.0470-7081.2	LD7081	ATE 20676 19,8 - WE / - WK Ceramic				
			←	+PR 1LQ,1LR,1ZF,1ZG	13.0460-7111.2	607111	VW 23130 19,6 - WE / - WK			
					13.0470-7111.2	LD7111	VW 23130 19,6 - WE / - WK Ceramic			
			➔		13.0460-2864.2	602864	TRW 20961 17,2 - WK			
					13.0460-2877.2	602877	TRW 23554 17,2 + WK			
					13.0460-2894.2	602894	TRW 20961 17,2 - WK + Zub			











	kW			 	! #		
<b>SEAT - IBIZA III (6L1) 02/02→11/09</b>							
 <b>Bremsbelagsatz, Scheibenbremse</b>							
1.9 TDI Cupra R	118	03/04→02/08	➔			13.0470-2877.2 LD2877 13.0470-2894.2 LD2894	TRW 23554 17,2 + WK Ceramic TRW 20961 17,2 - WK + Zub Ceramic
<b>Zubehörsatz, Scheibenbremsbelag</b>							
1.2	44	06/07→05/08	➔			13.0460-0072.2 610072	TRW
1.2	47	02/02→06/06					
1.2 12V	51	05/06→11/09					
1.4 16V	55	02/02→12/07					
1.4 16V	63	05/06→11/09					
1.4 16V	74	02/02→11/09					
1.4 TDI	51	05/05→11/09					
1.4 TDI	55	05/02→12/05					
1.4 TDI	59	06/05→11/09					
1.6	74	02/03→11/09					
1.6 16V	77	11/06→11/09					
1.8 T Cupra R	132	01/04→02/08					
1.8 T FR	110	12/03→05/08					
1.9 SDI	47	02/02→12/05					
1.9 TDI	74	02/02→11/09					
1.9 TDI	96	02/02→11/09					
1.9 TDI Cupra R	118	03/04→02/08					
2.0	85	04/02→11/09					
 <b>Bremsscheibe</b>							
1.2	44	06/07→05/08	➔	+PR 1LQ,1LR,1ZF,1ZG		24.0122-0151.1 422151	Ø 256 22 19 V + S
1.8 T FR	110	12/03→05/08				24.0322-0151.1 522151	Ø 256 22 19 V + S
2.0	85	04/02→11/09	➔				
			➔	+PR 1LN,1ZH		24.0125-0113.1 425113	Ø 288 25 22 V + S
						24.0325-0113.1 525113	Ø 288 25 22 V + S
			➔			24.0109-0123.1 409123	Ø 230 9 7 + S
						24.0309-0123.1 509123	Ø 230 9 7 + S
1.2	47	02/02→06/06	➔	+PR 1LQ,1LR,1ZF,1ZG		24.0122-0151.1 422151	Ø 256 22 19 V + S
1.2 12V	51	05/06→11/09				24.0322-0151.1 522151	Ø 256 22 19 V + S
1.4 16V	55	02/02→12/07					
1.4 16V	63	05/06→11/09	➔	+PR 1LN;1ZH		24.0125-0113.1 425113	Ø 288 25 22 V + S
1.4 16V	74	02/02→11/09				24.0325-0113.1 525113	Ø 288 25 22 V + S
1.4 TDI	51	05/05→11/09					
1.4 TDI	55	05/02→12/05	➔			24.0109-0123.1 409123	Ø 230 9 7 + S
1.4 TDI	59	06/05→11/09				24.0309-0123.1 509123	Ø 230 9 7 + S
1.6	74	02/03→11/09					
1.6 16V	77	11/06→11/09					
1.9 SDI	47	02/02→12/05					
1.9 TDI	74	02/02→11/09					
1.9 TDI	96	02/02→11/09					
1.8 T Cupra R	132	01/04→02/08	➔			24.0125-0123.1 425123	Ø 310 25 22 V + S
						24.0325-0123.1 525123	Ø 310 25 22 V + S
			➔			24.0109-0123.1 409123	Ø 230 9 7 + S
						24.0309-0123.1 509123	Ø 230 9 7 + S
1.9 TDI Cupra R	118	03/04→02/08	➔	+PR 1LQ,1LR,1ZF,1ZG		24.0122-0151.1 422151	Ø 256 22 19 V + S
			➔	+PR 1LN,1ZH		24.0125-0113.1 425113	Ø 288 25 22 V + S
						24.0325-0113.1 525113	Ø 288 25 22 V + S
			➔	+PR 1LT		24.0125-0123.1 425123	Ø 310 25 22 V + S
						24.0325-0123.1 525123	Ø 310 25 22 V + S
			➔			24.0109-0123.1 409123	Ø 230 9 7 + S
						24.0309-0123.1 509123	Ø 230 9 7 + S
<b>SEAT - IBIZA IV (6J5, 6P1) 03/08→</b>							
 <b>Bremsbelagsatz, Scheibenbremse</b>							
1.0	55	05/15→	➔	+PR 1ZG		13.0460-7111.2 607111	VW 23130 19,6 - WE / - WK
1.0 TSI	70	05/15→				13.0470-7111.2 LD7111	VW 23130 19,6 - WE / - WK Ceramic
1.0 TSI	81	05/15→					
1.2 TSI	66	05/15→	➔	+PR 1ZC		13.0460-7184.2 607184	ATE 23587 20,6 + WK
						13.0470-7184.2 LD7184	ATE 23587 20,6 + WK Ceramic
			➔	+PR 1ZR,1ZS		13.0460-7285.2 607285	ATE 23587 20,6 - WE / - WK
						13.0470-7285.2 LD7285	ATE 23587 20,6 - WE / - WK Ceramic
			➔	+PR 1KV		13.0460-2787.2 602787	TRW 23554 17,3 - WK / - WE
						13.0460-2820.2 602820	TRW 20961 17,2 - WK
						13.0470-2820.2 LD2820	TRW 20961 17,2 - WK Ceramic
			➔	+PR 1KT		13.0460-2894.2 602894	TRW 20961 17,2 - WK + Zub

	kw			 	! #		
<b>SEAT - IBIZA IV (6J5, 6P1) 03/08→</b>							
<b> Bremsbelagsatz, Scheibenbremse</b>							
1.0 1.0 TSI 1.0 TSI 1.2 TSI	55 70 81 66	05/15→ 05/15→ 05/15→ 05/15→	➡	+PR 1KT		13.0470-2894.2 LD2894	TRW 20961 17,2 - WK + Zub Ceramic
1.2	44	07/09→	⬅	+PR 1LQ,1LR,1ZG		13.0460-7111.2 607111 13.0470-7111.2 LD7111	VW 23130 19,6 - WE / - WK Ceramic
			⬅	15"		13.0460-7184.2 607184 13.0470-7184.2 LD7184	ATE 23587 20,6 + WK ATE 23587 20,6 + WK Ceramic
			⬅	+PR 1ZR,1ZS		13.0460-7285.2 607285 13.0470-7285.2 LD7285	ATE 23587 20,6 - WE / - WK ATE 23587 20,6 - WE / - WK Ceramic
			➡	+PR 1KK,1KT		13.0460-2894.2 602894 13.0470-2894.2 LD2894	TRW 20961 17,2 - WK + Zub Ceramic
1.2	51	03/08→	⬅	07/08→; +PR 1LQ,1LR,1ZG		13.0460-7111.2 607111 13.0470-7111.2 LD7111	VW 23130 19,6 - WE / - WK Ceramic
			⬅	07/08→; 15"		13.0460-7184.2 607184 13.0470-7184.2 LD7184	ATE 23587 20,6 + WK ATE 23587 20,6 + WK Ceramic
			⬅	07/08→; +PR 1ZR,1ZS		13.0460-7285.2 607285 13.0470-7285.2 LD7285	ATE 23587 20,6 - WE / - WK ATE 23587 20,6 - WE / - WK Ceramic
			➡	07/08→; +PR 1KK,1KT		13.0460-2894.2 602894 13.0470-2894.2 LD2894	TRW 20961 17,2 - WK + Zub Ceramic
1.2 TDI 1.2 TSI 1.2 TSI 1.4 TDI 1.6 LPG 1.9 TDI 2.0 2.0 TDI	55 63 77 59 60 66 85 105	05/10→ 08/12→ 09/10→ 07/08→06/10 05/11→ 07/08→06/10 10/08→ 01/10→	⬅	+PR 1LQ,1LR,1ZG		13.0460-7111.2 607111 13.0470-7111.2 LD7111	VW 23130 19,6 - WE / - WK Ceramic
			⬅	+PR 1LN,1ZH; 15"		13.0460-7184.2 607184 13.0470-7184.2 LD7184	ATE 23587 20,6 + WK ATE 23587 20,6 + WK Ceramic
			⬅	+PR 1ZR,1ZS		13.0460-7285.2 607285 13.0470-7285.2 LD7285	ATE 23587 20,6 - WE / - WK ATE 23587 20,6 - WE / - WK Ceramic
			➡	+PR 1KK,1KT		13.0460-2894.2 602894 13.0470-2894.2 LD2894	TRW 20961 17,2 - WK + Zub Ceramic
1.2 TSI	81	09/15→	⬅	+PR 1LQ,1LR,1ZG		13.0460-7111.2 607111 13.0470-7111.2 LD7111	VW 23130 19,6 - WE / - WK Ceramic
			⬅	+PR 1ZC		13.0460-7184.2 607184 13.0470-7184.2 LD7184	ATE 23587 20,6 + WK ATE 23587 20,6 + WK Ceramic
			⬅	+PR 1ZR,1ZS		13.0460-7285.2 607285 13.0470-7285.2 LD7285	ATE 23587 20,6 - WE / - WK ATE 23587 20,6 - WE / - WK Ceramic
			➡	+PR 1KV		13.0460-2787.2 602787 13.0460-2820.2 602820 13.0470-2820.2 LD2820	TRW 23554 17,3 - WK / - WE TRW 20961 17,2 - WK TRW 20961 17,2 - WK Ceramic
			➡	+PR 1KK,1KT		13.0460-2894.2 602894 13.0470-2894.2 LD2894	TRW 20961 17,2 - WK + Zub Ceramic
1.4 1.6 1.9 TDI	63 77 77	03/08→ 05/08→ 03/08→06/10	⬅	07/08→; +PR 1LQ,1LR,1ZG		13.0460-7111.2 607111 13.0470-7111.2 LD7111	VW 23130 19,6 - WE / - WK Ceramic
			⬅	07/08→; +PR 1LN,1ZH; 15"		13.0460-7184.2 607184 13.0470-7184.2 LD7184	ATE 23587 20,6 + WK ATE 23587 20,6 + WK Ceramic
			⬅	07/08→; +PR 1ZR,1ZS		13.0460-7285.2 607285 13.0470-7285.2 LD7285	ATE 23587 20,6 - WE / - WK ATE 23587 20,6 - WE / - WK Ceramic
			➡	07/08→; +PR 1KK,1KT		13.0460-2894.2 602894 13.0470-2894.2 LD2894	TRW 20961 17,2 - WK + Zub Ceramic
1.4 TDI 1.4 TDI 1.4 TDI	55 66 77	05/15→ 05/15→ 05/15→	⬅	+PR 1ZG		13.0460-7111.2 607111 13.0470-7111.2 LD7111	VW 23130 19,6 - WE / - WK Ceramic
↓			⬅	+PR 1ZC		13.0460-7184.2 607184	ATE 23587 20,6 + WK







	kw			 	! #		
<b>SEAT - IBIZA IV (6J5, 6P1) 03/08→</b>							
<b> Bremsbelagsatz, Scheibenbremse</b>							
1.4 TDI	55	05/15→	←	+PR 1ZC	13.0470-7184.2	LD7184	ATE 23587 20,6 + WK Ceramic
1.4 TDI	66	05/15→	←	+PR 1ZR,1ZS	13.0460-7285.2	607285	ATE 23587 20,6 - WE / - WK
1.4 TDI	77	05/15→	←	+PR 1ZR,1ZS	13.0470-7285.2	LD7285	ATE 23587 20,6 - WE / - WK Ceramic
			→	+PR 1KV	13.0460-2787.2	602787	TRW 23554 17,3 - WK / - WE
			→	+PR 1KV	13.0460-2820.2	602820	TRW 20961 17,2 - WK
			→	+PR 1KV	13.0470-2820.2	LD2820	TRW 20961 17,2 - WK Ceramic
			→	+PR 1KK,1KT	13.0460-2894.2	602894	TRW 20961 17,2 - WK + Zub
			→	+PR 1KK,1KT	13.0470-2894.2	LD2894	TRW 20961 17,2 - WK + Zub Ceramic
1.4 TSI	103	10/13→	←	12/13→; +PR 1LQ,1LR,1ZG	13.0460-7111.2	607111	VW 23130 19,6 - WE / - WK
			←	12/13→; +PR 1LN,1ZH; 15"	13.0470-7111.2	LD7111	VW 23130 19,6 - WE / - WK Ceramic
			←	12/13→; +PR 1LN,1ZH; 15"	13.0460-7184.2	607184	ATE 23587 20,6 + WK
			←	12/13→; +PR 1LN,1ZH; 15"	13.0470-7184.2	LD7184	ATE 23587 20,6 + WK Ceramic
			←	12/13→; +PR 1ZR,1ZS	13.0460-7285.2	607285	ATE 23587 20,6 - WE / - WK
			←	12/13→; +PR 1ZR,1ZS	13.0470-7285.2	LD7285	ATE 23587 20,6 - WE / - WK Ceramic
			→	12/13→; +PR 1KD,1KS	13.0460-2864.2	602864	TRW 20961 17,2 - WK
1.4 TSI	110	06/09→	←	+PR 1LQ,1LR,1ZG	13.0460-7111.2	607111	VW 23130 19,6 - WE / - WK
1.4 TSI	110	11/15→	←	+PR 1LQ,1LR,1ZG	13.0470-7111.2	LD7111	VW 23130 19,6 - WE / - WK Ceramic
			←	+PR 1LN,1ZH; 15"	13.0460-7184.2	607184	ATE 23587 20,6 + WK
			←	+PR 1LN,1ZH; 15"	13.0470-7184.2	LD7184	ATE 23587 20,6 + WK Ceramic
			←	+PR 1ZR,1ZS	13.0460-7285.2	607285	ATE 23587 20,6 - WE / - WK
			←	+PR 1ZR,1ZS	13.0470-7285.2	LD7285	ATE 23587 20,6 - WE / - WK Ceramic
			→	+PR 1KD,1KS	13.0460-2864.2	602864	TRW 20961 17,2 - WK
1.6 TDI	66	05/09→	←	06/09→; +PR 1LQ,1LR,1ZG	13.0460-7111.2	607111	VW 23130 19,6 - WE / - WK
1.6 TDI	77	05/09→	←	06/09→; +PR 1LQ,1LR,1ZG	13.0470-7111.2	LD7111	VW 23130 19,6 - WE / - WK Ceramic
			←	06/09→; +PR 1LN,1ZH; 15"	13.0460-7184.2	607184	ATE 23587 20,6 + WK
			←	06/09→; +PR 1LN,1ZH; 15"	13.0470-7184.2	LD7184	ATE 23587 20,6 + WK Ceramic
			←	06/09→; +PR 1ZR,1ZS	13.0460-7285.2	607285	ATE 23587 20,6 - WE / - WK
			←	06/09→; +PR 1ZR,1ZS	13.0470-7285.2	LD7285	ATE 23587 20,6 - WE / - WK Ceramic
			→	06/09→; +PR 1KK,1KT	13.0460-2894.2	602894	TRW 20961 17,2 - WK + Zub
			→	06/09→; +PR 1KK,1KT	13.0470-2894.2	LD2894	TRW 20961 17,2 - WK + Zub Ceramic
<b>Zubehörsatz, Scheibenbremsbelag</b>							
1.0	55	05/15→		+PR 1KT	13.0460-0072.2	610072	TRW
1.0 TSI	70	05/15→					
1.0 TSI	81	05/15→					
1.2 TSI	66	05/15→					
1.2	44	07/09→		+PR 1KK,1KT	13.0460-0072.2	610072	TRW
1.2 TDI	55	05/10→					
1.2 TSI	63	08/12→					
1.2 TSI	77	09/10→					
1.2 TSI	81	09/15→					
1.4 TDI	55	05/15→					
1.4 TDI	59	07/08→06/10					
1.4 TDI	66	05/15→					
1.4 TDI	77	05/15→					
1.6 LPG	60	05/11→					
1.9 TDI	66	07/08→06/10					
2.0	85	10/08→					
2.0 TDI	105	01/10→					
1.2	51	03/08→		07/08→; +PR 1KK,1KT	13.0460-0072.2	610072	TRW
1.4	63	03/08→					
1.6	77	05/08→					
1.9 TDI	77	03/08→06/10					
1.6 TDI	66	05/09→		06/09→; +PR 1KK,1KT	13.0460-0072.2	610072	TRW
1.6 TDI	77	05/09→					
<b> Bremsscheibe</b>							
1.0	55	05/15→	←	+PR 1ZG	24.0122-0151.1	422151	Ø 256 22 19 V + S
1.0 TSI	70	05/15→			24.0322-0151.1	522151	Ø 256 22 19 V + S
1.0 TSI	81	05/15→	←	+PR 1ZC	24.0125-0113.1	425113	Ø 288 25 22 V + S
1.2 TSI	66	05/15→			24.0325-0113.1	525113	Ø 288 25 22 V + S
↓							

	kw			 	! #		
<b>SEAT - IBIZA IV (6J5, 6P1) 03/08→</b>							
<b>Bremsscheibe</b>							
1.0	55	05/15→	←	+PR 1ZR,1ZS		24.0125-0123.1 425123	Ø 310 25 22 V + S
1.0 TSI	70	05/15→				24.0325-0123.1 525123	Ø 310 25 22 V + S
1.0 TSI	81	05/15→					
1.2 TSI	66	05/15→	→	+PR 1KV,1KT		24.0109-0123.1 409123	Ø 230 9 7 + S
						24.0309-0123.1 509123	Ø 230 9 7 + S
1.2	44	07/09→	←	+PR 1LQ,1LR,1ZG		24.0122-0151.1 422151	Ø 256 22 19 V + S
1.2 TDI	55	05/10→				24.0322-0151.1 522151	Ø 256 22 19 V + S
1.2 TSI	63	08/12→					
1.2 TSI	77	09/10→	←	15"		24.0125-0113.1 425113	Ø 288 25 22 V + S
1.4 TDI	59	07/08→06/10				24.0325-0113.1 525113	Ø 288 25 22 V + S
1.6 LPG	60	05/11→	←	+PR 1ZR,1ZS		24.0125-0123.1 425123	Ø 310 25 22 V + S
2.0	85	10/08→				24.0325-0123.1 525123	Ø 310 25 22 V + S
2.0 TDI	105	01/10→	→	+PR 1KK,1KT		24.0109-0123.1 409123	Ø 230 9 7 + S
						24.0309-0123.1 509123	Ø 230 9 7 + S
1.2	51	03/08→	←	07/08→; +PR 1LQ,1LR,1ZG		24.0122-0151.1 422151	Ø 256 22 19 V + S
1.4	63	03/08→				24.0322-0151.1 522151	Ø 256 22 19 V + S
1.6	77	05/08→	←	07/08→; 15"		24.0125-0113.1 425113	Ø 288 25 22 V + S
1.9 TDI	77	03/08→06/10				24.0325-0113.1 525113	Ø 288 25 22 V + S
			←	07/08→; +PR 1ZR,1ZS		24.0125-0123.1 425123	Ø 310 25 22 V + S
						24.0325-0123.1 525123	Ø 310 25 22 V + S
			→	07/08→; +PR 1KK,1KT		24.0109-0123.1 409123	Ø 230 9 7 + S
						24.0309-0123.1 509123	Ø 230 9 7 + S
1.2 TSI	81	09/15→	←	+PR 1LQ,1LR,1ZG		24.0122-0151.1 422151	Ø 256 22 19 V + S
						24.0322-0151.1 522151	Ø 256 22 19 V + S
			←	+PR 1ZC		24.0125-0113.1 425113	Ø 288 25 22 V + S
						24.0325-0113.1 525113	Ø 288 25 22 V + S
			←	+PR 1ZR,1ZS		24.0125-0123.1 425123	Ø 310 25 22 V + S
						24.0325-0123.1 525123	Ø 310 25 22 V + S
			→	+PR 1KK,1KT		24.0109-0123.1 409123	Ø 230 9 7 + S
						24.0309-0123.1 509123	Ø 230 9 7 + S
1.4 TDI	55	05/15→	←	+PR 1ZG		24.0122-0151.1 422151	Ø 256 22 19 V + S
1.4 TDI	66	05/15→				24.0322-0151.1 522151	Ø 256 22 19 V + S
1.4 TDI	77	05/15→	←	+PR 1ZC		24.0125-0113.1 425113	Ø 288 25 22 V + S
						24.0325-0113.1 525113	Ø 288 25 22 V + S
			←	+PR 1ZR,1ZS		24.0125-0123.1 425123	Ø 310 25 22 V + S
						24.0325-0123.1 525123	Ø 310 25 22 V + S
			→	+PR 1KK,1KT		24.0109-0123.1 409123	Ø 230 9 7 + S
						24.0309-0123.1 509123	Ø 230 9 7 + S
1.4 TSI	103	10/13→	←	12/13→; +PR 1LQ,1LR,1ZG		24.0122-0151.1 422151	Ø 256 22 19 V + S
						24.0322-0151.1 522151	Ø 256 22 19 V + S
			←	12/13→; 15"		24.0125-0113.1 425113	Ø 288 25 22 V + S
						24.0325-0113.1 525113	Ø 288 25 22 V + S
			←	12/13→; +PR 1ZR,1ZS		24.0125-0123.1 425123	Ø 310 25 22 V + S
						24.0325-0123.1 525123	Ø 310 25 22 V + S
			→	12/13→; +PR 1KD,1KS		24.0109-0123.1 409123	Ø 230 9 7 + S
						24.0309-0123.1 509123	Ø 230 9 7 + S
1.4 TSI	110	06/09→	←	+PR 1LQ,1LR,1ZG		24.0122-0151.1 422151	Ø 256 22 19 V + S
1.4 TSI	110	11/15→				24.0322-0151.1 522151	Ø 256 22 19 V + S
			←	15"		24.0125-0113.1 425113	Ø 288 25 22 V + S
						24.0325-0113.1 525113	Ø 288 25 22 V + S
			←	+PR 1ZR,1ZS		24.0125-0123.1 425123	Ø 310 25 22 V + S
						24.0325-0123.1 525123	Ø 310 25 22 V + S
			→	+PR 1KD,1KS		24.0109-0123.1 409123	Ø 230 9 7 + S
						24.0309-0123.1 509123	Ø 230 9 7 + S
1.6 TDI	66	05/09→	←	06/09→; +PR 1LQ,1LR,1ZG		24.0122-0151.1 422151	Ø 256 22 19 V + S
1.6 TDI	77	05/09→				24.0322-0151.1 522151	Ø 256 22 19 V + S
			←	06/09→; 15"		24.0125-0113.1 425113	Ø 288 25 22 V + S
						24.0325-0113.1 525113	Ø 288 25 22 V + S
			←	06/09→; +PR 1ZR,1ZS		24.0125-0123.1 425123	Ø 310 25 22 V + S
						24.0325-0123.1 525123	Ø 310 25 22 V + S
			→	06/09→; +PR 1KK,1KT		24.0109-0123.1 409123	Ø 230 9 7 + S
						24.0309-0123.1 509123	Ø 230 9 7 + S
1.9 TDI	66	07/08→06/10	←	+PR 1LQ,1LR,1ZG		24.0122-0151.1 422151	Ø 256 22 19 V + S
↓							

















	kw			 	! #		
<b>SEAT - IBIZA IV (6J5, 6P1) 03/08→</b>							
 <b>Bremsscheibe</b>							
1.9 TDI	66	07/08→06/10	← +PR 1LQ,1LR,1ZG	24.0322-0151.1	522151	Ø 256 22 19 V + S	
			← 15"	24.0125-0113.1	425113	Ø 288 25 22 V + S	
				24.0325-0113.1	525113	Ø 288 25 22 V + S	
			← +PR 1ZR,1ZS	24.0125-0123.1	425123	Ø 310 25 22 V + S	
				24.0325-0123.1	525123	Ø 310 25 22 V + S	
			→ +PR 1KK,1KT	24.0109-0123.1	409123	Ø 230 9 7 + S	
			→ +PR 1KK,1KT	24.0309-0123.1	509123	Ø 230 9 7 + S	
<b>SEAT - IBIZA IV SPORTCOUPE (6J1, 6P5) 07/08→</b>							
 <b>Bremsbelagsatz, Scheibenbremse</b>							
1.0	55	05/15→	← +PR 1ZG	13.0460-7111.2	607111	VW 23130 19,6 - WE / - WK	
1.0 TSI	70	05/15→		13.0470-7111.2	LD7111	VW 23130 19,6 - WE / - WK Ceramic	
1.0 TSI	81	05/15→					
1.2 TSI	66	05/15→					
1.8 TSI Cupra	141	11/15→	← +PR 1ZC	13.0460-7184.2	607184	ATE 23587 20,6 + WK	
				13.0470-7184.2	LD7184	ATE 23587 20,6 + WK Ceramic	
			← +PR 1ZR,1ZS	13.0460-7285.2	607285	ATE 23587 20,6 - WE / - WK	
				13.0470-7285.2	LD7285	ATE 23587 20,6 - WE / - WK Ceramic	
			→ +PR 1KV	13.0460-2787.2	602787	TRW 23554 17,3 - WK / - WE	
				13.0460-2820.2	602820	TRW 20961 17,2 - WK	
				13.0470-2820.2	LD2820	TRW 20961 17,2 - WK Ceramic	
			→ +PR 1KT	13.0460-2894.2	602894	TRW 20961 17,2 - WK + Zub	
				13.0470-2894.2	LD2894	TRW 20961 17,2 - WK + Zub Ceramic	
1.2	44	07/09→	← +PR 1LQ,1LR,1ZG	13.0460-7111.2	607111	VW 23130 19,6 - WE / - WK	
1.2	51	07/08→		13.0470-7111.2	LD7111	VW 23130 19,6 - WE / - WK Ceramic	
			← 15"	13.0460-7184.2	607184	ATE 23587 20,6 + WK	
				13.0470-7184.2	LD7184	ATE 23587 20,6 + WK Ceramic	
			← +PR 1ZR,1ZS	13.0460-7285.2	607285	ATE 23587 20,6 - WE / - WK	
				13.0470-7285.2	LD7285	ATE 23587 20,6 - WE / - WK Ceramic	
			→ +PR 1KK,1KT	13.0460-2894.2	602894	TRW 20961 17,2 - WK + Zub	
				13.0470-2894.2	LD2894	TRW 20961 17,2 - WK + Zub Ceramic	
1.2 TDI	55	05/10→	← +PR 1LQ,1LR,1ZG	13.0460-7111.2	607111	VW 23130 19,6 - WE / - WK	
1.2 TSI	63	08/12→		13.0470-7111.2	LD7111	VW 23130 19,6 - WE / - WK Ceramic	
1.2 TSI	77	09/10→					
1.4	63	07/08→					
1.4 TDI	59	07/08→06/10	← +PR 1LN,1ZH; 15"	13.0460-7184.2	607184	ATE 23587 20,6 + WK	
1.6	77	07/08→		13.0470-7184.2	LD7184	ATE 23587 20,6 + WK Ceramic	
1.6 LPG	60	05/11→					
1.9 TDI	66	07/08→06/10	← +PR 1ZR,1ZS	13.0460-7285.2	607285	ATE 23587 20,6 - WE / - WK	
1.9 TDI	77	07/08→06/10		13.0470-7285.2	LD7285	ATE 23587 20,6 - WE / - WK Ceramic	
2.0	85	10/08→					
2.0 TDI	105	01/10→	→ +PR 1KK,1KT	13.0460-2894.2	602894	TRW 20961 17,2 - WK + Zub	
				13.0470-2894.2	LD2894	TRW 20961 17,2 - WK + Zub Ceramic	
1.2 TSI	81	09/15→	← +PR 1LQ,1LR,1ZG	13.0460-7111.2	607111	VW 23130 19,6 - WE / - WK	
				13.0470-7111.2	LD7111	VW 23130 19,6 - WE / - WK Ceramic	
			← +PR 1ZC	13.0460-7184.2	607184	ATE 23587 20,6 + WK	
				13.0470-7184.2	LD7184	ATE 23587 20,6 + WK Ceramic	
			← +PR 1ZR,1ZS	13.0460-7285.2	607285	ATE 23587 20,6 - WE / - WK	
				13.0470-7285.2	LD7285	ATE 23587 20,6 - WE / - WK Ceramic	
			→ +PR 1KV	13.0460-2787.2	602787	TRW 23554 17,3 - WK / - WE	
				13.0460-2820.2	602820	TRW 20961 17,2 - WK	
				13.0470-2820.2	LD2820	TRW 20961 17,2 - WK Ceramic	
			→ +PR 1KK,1KT	13.0460-2894.2	602894	TRW 20961 17,2 - WK + Zub	
				13.0470-2894.2	LD2894	TRW 20961 17,2 - WK + Zub Ceramic	
1.4 TDI	55	05/15→	← +PR 1ZG	13.0460-7111.2	607111	VW 23130 19,6 - WE / - WK	
1.4 TDI	66	05/15→		13.0470-7111.2	LD7111	VW 23130 19,6 - WE / - WK Ceramic	
1.4 TDI	77	05/15→					
			← +PR 1ZC	13.0460-7184.2	607184	ATE 23587 20,6 + WK	
				13.0470-7184.2	LD7184	ATE 23587 20,6 + WK Ceramic	





















	kw			 	! #		
<b>SEAT - IBIZA IV SPORTCOUPE (6J1, 6P5) 07/08→</b>							
<b>Bremsbelagsatz, Scheibenbremse</b>							
1.4 TDI 1.4 TDI 1.4 TDI	55 66 77	05/15→ 05/15→ 05/15→	←	+PR 1ZR,1ZS	13.0460-7285.2 13.0470-7285.2	607285 LD7285	ATE 23587 20,6 - WE / - WK ATE 23587 20,6 - WE / - WK Ceramic
			→	+PR 1KV	13.0460-2787.2 13.0460-2820.2 13.0470-2820.2	602787 602820 LD2820	TRW 23554 17,3 - WK / - WE TRW 20961 17,2 - WK TRW 20961 17,2 - WK Ceramic
			→	+PR 1KK,1KT	13.0460-2894.2 13.0470-2894.2	602894 LD2894	TRW 20961 17,2 - WK + Zub TRW 20961 17,2 - WK + Zub Ceramic
1.4 TSI	103	10/13→	←	12/13→; +PR 1LQ,1LR,1ZG	13.0460-7111.2 13.0470-7111.2	607111 LD7111	VW 23130 19,6 - WE / - WK VW 23130 19,6 - WE / - WK Ceramic
			←	12/13→; +PR 1LN,1ZH; 15"	13.0460-7184.2 13.0470-7184.2	607184 LD7184	ATE 23587 20,6 + WK ATE 23587 20,6 + WK Ceramic
			←	12/13→; +PR 1ZR,1ZS	13.0460-7285.2 13.0470-7285.2	607285 LD7285	ATE 23587 20,6 - WE / - WK ATE 23587 20,6 - WE / - WK Ceramic
			→	12/13→; +PR 1KD,1KS	13.0460-2864.2	602864	TRW 20961 17,2 - WK
1.4 TSI 1.4 TSI	110 110	06/09→ 11/15→	←	+PR 1LQ,1LR,1ZG	13.0460-7111.2 13.0470-7111.2	607111 LD7111	VW 23130 19,6 - WE / - WK VW 23130 19,6 - WE / - WK Ceramic
			←	+PR 1LN,1ZH; 15"	13.0460-7184.2 13.0470-7184.2	607184 LD7184	ATE 23587 20,6 + WK ATE 23587 20,6 + WK Ceramic
			←	+PR 1ZR,1ZS	13.0460-7285.2 13.0470-7285.2	607285 LD7285	ATE 23587 20,6 - WE / - WK ATE 23587 20,6 - WE / - WK Ceramic
			→	+PR 1KD,1KS	13.0460-2864.2	602864	TRW 20961 17,2 - WK
1.4 TSI Cupra	132	06/09→	←	+PR 1LV	13.0460-6921.2	606921	AP 24974 16,8 - WE / - WK
			←	15"	13.0460-7184.2 13.0470-7184.2	607184 LD7184	ATE 23587 20,6 + WK ATE 23587 20,6 + WK Ceramic
			→	+PR 1KP	13.0460-2787.2 13.0460-2820.2 13.0470-2820.2	602787 602820 LD2820	TRW 23554 17,3 - WK / - WE TRW 20961 17,2 - WK TRW 20961 17,2 - WK Ceramic
			→	+PR 1KK,1KT	13.0460-2894.2 13.0470-2894.2	602894 LD2894	TRW 20961 17,2 - WK + Zub TRW 20961 17,2 - WK + Zub Ceramic
1.6 TDI 1.6 TDI	66 77	05/09→ 05/09→	←	06/09→; +PR 1LQ,1LR,1ZG	13.0460-7111.2 13.0470-7111.2	607111 LD7111	VW 23130 19,6 - WE / - WK VW 23130 19,6 - WE / - WK Ceramic
			←	06/09→; +PR 1LN,1ZH; 15"	13.0460-7184.2 13.0470-7184.2	607184 LD7184	ATE 23587 20,6 + WK ATE 23587 20,6 + WK Ceramic
			←	06/09→; +PR 1ZR,1ZS	13.0460-7285.2 13.0470-7285.2	607285 LD7285	ATE 23587 20,6 - WE / - WK ATE 23587 20,6 - WE / - WK Ceramic
			→	06/09→; +PR 1KK,1KT	13.0460-2894.2 13.0470-2894.2	602894 LD2894	TRW 20961 17,2 - WK + Zub TRW 20961 17,2 - WK + Zub Ceramic
<b>Zubehörsatz, Scheibenbremsbelag</b>							
1.0 1.0 TSI 1.0 TSI 1.2 TSI 1.8 TSI Cupra	55 70 81 66 141	05/15→ 05/15→ 05/15→ 05/15→ 11/15→		+PR 1KT	13.0460-0072.2	610072	TRW
1.2 1.2 1.2 TDI 1.2 TSI 1.2 TSI 1.2 TSI 1.4 1.4 TDI 1.4 TDI 1.4 TDI 1.4 TDI 1.4 TSI Cupra 1.6 1.6 LPG 1.9 TDI ↓	44 51 55 63 77 81 63 55 59 66 77 132 77 60 66	07/09→ 07/08→ 05/10→ 08/12→ 09/10→ 09/15→ 07/08→ 05/15→ 07/08→06/10 05/15→ 05/15→ 06/09→ 07/08→ 05/11→ 07/08→06/10		+PR 1KK,1KT	13.0460-0072.2	610072	TRW



	kw			 	! #		
<b>SEAT - IBIZA IV SPORTCOUPE (6J1, 6P5) 07/08→</b>							
<b>Zubehörsatz, Scheibenbremsbelag</b>							
1.9 TDI 2.0 2.0 TDI	77 85 105	07/08→06/10 10/08→ 01/10→		+PR 1KK,1KT		13.0460-0072.2 610072	TRW
1.6 TDI 1.6 TDI	66 77	05/09→ 05/09→		06/09→; +PR 1KK,1KT		13.0460-0072.2 610072	TRW
<b> Bremsscheibe</b>							
1.0 1.0 TSI 1.0 TSI 1.2 TSI 1.8 TSI Cupra	55 70 81 66 141	05/15→ 05/15→ 05/15→ 05/15→ 11/15→	←	+PR 1ZG		24.0122-0151.1 422151 24.0322-0151.1 522151	Ø 256 22 19 V + S Ø 256 22 19 V + S
			←	+PR 1ZC		24.0125-0113.1 425113 24.0325-0113.1 525113	Ø 288 25 22 V + S Ø 288 25 22 V + S
			←	+PR 1ZR,1ZS		24.0125-0123.1 425123 24.0325-0123.1 525123	Ø 310 25 22 V + S Ø 310 25 22 V + S
			→	+PR 1KV,1KT		24.0109-0123.1 409123 24.0309-0123.1 509123	Ø 230 9 7 + S Ø 230 9 7 + S
1.2 1.2 TDI 1.2 TSI 1.2 TSI 1.4 TDI 1.6 LPG 2.0 2.0 TDI	44 55 63 77 59 60 85 105	07/09→ 05/10→ 08/12→ 09/10→ 07/08→06/10 05/11→ 10/08→ 01/10→	←	+PR 1LQ,1LR,1ZG		24.0122-0151.1 422151 24.0322-0151.1 522151	Ø 256 22 19 V + S Ø 256 22 19 V + S
			←	15"		24.0125-0113.1 425113 24.0325-0113.1 525113	Ø 288 25 22 V + S Ø 288 25 22 V + S
			←	+PR 1ZR,1ZS		24.0125-0123.1 425123 24.0325-0123.1 525123	Ø 310 25 22 V + S Ø 310 25 22 V + S
			→	+PR 1KK,1KT		24.0109-0123.1 409123 24.0309-0123.1 509123	Ø 230 9 7 + S Ø 230 9 7 + S
1.2 1.4 1.6 1.9 TDI 1.9 TDI	51 63 77 66 77	07/08→ 07/08→ 07/08→ 07/08→06/10 07/08→06/10	←	+PR 1LQ,1LR,1ZG		24.0122-0151.1 422151 24.0322-0151.1 522151	Ø 256 22 19 V + S Ø 256 22 19 V + S
			←	15"		24.0125-0113.1 425113 24.0325-0113.1 525113	Ø 288 25 22 V + S Ø 288 25 22 V + S
			←	+PR 1ZR,1ZS		24.0125-0123.1 425123 24.0325-0123.1 525123	Ø 310 25 22 V + S Ø 310 25 22 V + S
			→	+PR 1KK,1KT		24.0109-0123.1 409123 24.0309-0123.1 509123	Ø 230 9 7 + S Ø 230 9 7 + S
1.2 TSI	81	09/15→	←	+PR 1LQ,1LR,1ZG		24.0122-0151.1 422151 24.0322-0151.1 522151	Ø 256 22 19 V + S Ø 256 22 19 V + S
			←	+PR 1ZC		24.0125-0113.1 425113 24.0325-0113.1 525113	Ø 288 25 22 V + S Ø 288 25 22 V + S
			←	+PR 1ZR,1ZS		24.0125-0123.1 425123 24.0325-0123.1 525123	Ø 310 25 22 V + S Ø 310 25 22 V + S
			→	+PR 1KK,1KT		24.0109-0123.1 409123 24.0309-0123.1 509123	Ø 230 9 7 + S Ø 230 9 7 + S
1.4 TDI 1.4 TDI 1.4 TDI	55 66 77	05/15→ 05/15→ 05/15→	←	+PR 1ZG		24.0122-0151.1 422151 24.0322-0151.1 522151	Ø 256 22 19 V + S Ø 256 22 19 V + S
			←	+PR 1ZC		24.0125-0113.1 425113 24.0325-0113.1 525113	Ø 288 25 22 V + S Ø 288 25 22 V + S
			←	+PR 1ZR,1ZS		24.0125-0123.1 425123 24.0325-0123.1 525123	Ø 310 25 22 V + S Ø 310 25 22 V + S
			→	+PR 1KK,1KT		24.0109-0123.1 409123 24.0309-0123.1 509123	Ø 230 9 7 + S Ø 230 9 7 + S
1.4 TSI	103	10/13→	←	12/13→; +PR 1LQ,1LR,1ZG		24.0122-0151.1 422151 24.0322-0151.1 522151	Ø 256 22 19 V + S Ø 256 22 19 V + S
			←	12/13→; 15"		24.0125-0113.1 425113 24.0325-0113.1 525113	Ø 288 25 22 V + S Ø 288 25 22 V + S
			←	12/13→; +PR 1ZR,1ZS		24.0125-0123.1 425123 24.0325-0123.1 525123	Ø 310 25 22 V + S Ø 310 25 22 V + S
			→	12/13→; +PR 1KD,1KS		24.0109-0123.1 409123 24.0309-0123.1 509123	Ø 230 9 7 + S Ø 230 9 7 + S
1.4 TSI 1.4 TSI	110 110	06/09→ 11/15→	←	+PR 1LQ,1LR,1ZG		24.0122-0151.1 422151 24.0322-0151.1 522151	Ø 256 22 19 V + S Ø 256 22 19 V + S
			←	15"		24.0125-0113.1 425113 24.0325-0113.1 525113	Ø 288 25 22 V + S Ø 288 25 22 V + S
			←	+PR 1ZR,1ZS		24.0125-0123.1 425123 24.0325-0123.1 525123	Ø 310 25 22 V + S Ø 310 25 22 V + S
			→	+PR 1KD,1KS		24.0109-0123.1 409123 24.0309-0123.1 509123	Ø 230 9 7 + S Ø 230 9 7 + S
↓							











	kw			 	! #		
<b>SEAT - IBIZA IV SPORTCOUPE (6J1, 6P5) 07/08→</b>							
<b>Bremsscheibe</b>							
1.4 TSI Cupra	132	06/09→	←	15"	24.0125-0113.1	425113	Ø 288 25 22 V + S
			←	+PR 1LV	24.0325-0113.1	525113	Ø 288 25 22 V + S
			←	+PR 1KP	24.0125-0123.1	425123	Ø 310 25 22 V + S
			→	+PR 1KP	24.0325-0123.1	525123	Ø 310 25 22 V + S
1.6 TDI	66	05/09→	←	06/09→; +PR 1LQ,1LR,1ZG	24.0122-0151.1	422151	Ø 256 22 19 V + S
			←	06/09→; 15"	24.0322-0151.1	522151	Ø 256 22 19 V + S
1.6 TDI	77	05/09→	←	06/09→; +PR 1ZR,1ZS	24.0125-0113.1	425113	Ø 288 25 22 V + S
			←	06/09→; +PR 1ZR,1ZS	24.0325-0113.1	525113	Ø 288 25 22 V + S
			←	06/09→; +PR 1ZR,1ZS	24.0125-0123.1	425123	Ø 310 25 22 V + S
			→	06/09→; +PR 1ZR,1ZS	24.0325-0123.1	525123	Ø 310 25 22 V + S
			→	06/09→; +PR 1KK,1KT	24.0109-0123.1	409123	Ø 230 9 7 + S
			→	06/09→; +PR 1KK,1KT	24.0309-0123.1	509123	Ø 230 9 7 + S
<b>SEAT - IBIZA IV ST (6J8, 6P8) 03/10→</b>							
<b>Bremsbelagsatz, Scheibenbremse</b>							
1.0 1.0 TSI 1.0 TSI 1.2 TSI	55 70 81 66	05/15→ 05/15→ 05/15→ 05/15→	←	+PR 1ZG	13.0460-7111.2	607111	VW 23130 19,6 - WE / - WK
			←	+PR 1ZC	13.0470-7111.2	LD7111	VW 23130 19,6 - WE / - WK Ceramic
			←	+PR 1ZR,1ZS	13.0460-7184.2	607184	ATE 23587 20,6 + WK
			←	+PR 1ZR,1ZS	13.0470-7184.2	LD7184	ATE 23587 20,6 + WK Ceramic
			→	+PR 1KV	13.0460-7285.2	607285	ATE 23587 20,6 - WE / - WK
			→	+PR 1KV	13.0470-7285.2	LD7285	ATE 23587 20,6 - WE / - WK Ceramic
1.2 1.2	44 51	05/10→ 05/10→	←	+PR 1LQ,1LR,1ZG	13.0460-2894.2	602894	TRW 23554 17,3 - WK / - WE
			←	+PR 1LQ,1LR,1ZG	13.0470-2820.2	602820	TRW 20961 17,2 - WK
			←	+PR 1LQ,1LR,1ZG	13.0470-2820.2	LD2820	TRW 20961 17,2 - WK Ceramic
			→	+PR 1KT	13.0460-2894.2	602894	TRW 20961 17,2 - WK + Zub
→	+PR 1KT	13.0470-2894.2	LD2894	TRW 20961 17,2 - WK + Zub Ceramic			
1.2 TDI 1.2 TSI 1.2 TSI 1.4 1.6 TDI 1.6 TDI	55 63 77 63 66 77	04/10→ 09/12→ 09/10→ 03/10→ 03/10→ 03/10→	←	+PR 1LQ,1LR,1ZG	13.0460-7111.2	607111	VW 23130 19,6 - WE / - WK
			←	+PR 1LQ,1LR,1ZG	13.0470-7111.2	LD7111	VW 23130 19,6 - WE / - WK Ceramic
			←	+PR 1LN,1ZH; 15"	13.0460-7184.2	607184	ATE 23587 20,6 + WK
			←	+PR 1LN,1ZH; 15"	13.0470-7184.2	LD7184	ATE 23587 20,6 + WK Ceramic
			←	+PR 1ZR,1ZS	13.0460-7285.2	607285	ATE 23587 20,6 - WE / - WK
			←	+PR 1ZR,1ZS	13.0470-7285.2	LD7285	ATE 23587 20,6 - WE / - WK Ceramic
1.2 TSI	81	09/15→	→	+PR 1KK,1KT	13.0460-2894.2	602894	TRW 20961 17,2 - WK + Zub
			→	+PR 1KK,1KT	13.0470-2894.2	LD2894	TRW 20961 17,2 - WK + Zub Ceramic
			←	+PR 1LQ,1LR,1ZG	13.0460-7111.2	607111	VW 23130 19,6 - WE / - WK
			←	+PR 1LQ,1LR,1ZG	13.0470-7111.2	LD7111	VW 23130 19,6 - WE / - WK Ceramic
←	+PR 1ZC	13.0460-7184.2	607184	ATE 23587 20,6 + WK			
←	+PR 1ZC	13.0470-7184.2	LD7184	ATE 23587 20,6 + WK Ceramic			
←	+PR 1ZR,1ZS	13.0460-7285.2	607285	ATE 23587 20,6 - WE / - WK			
←	+PR 1ZR,1ZS	13.0470-7285.2	LD7285	ATE 23587 20,6 - WE / - WK Ceramic			
→	+PR 1KV	13.0460-2787.2	602787	TRW 23554 17,3 - WK / - WE			
→	+PR 1KV	13.0460-2820.2	602820	TRW 20961 17,2 - WK			
→	+PR 1KV	13.0470-2820.2	LD2820	TRW 20961 17,2 - WK Ceramic			

	kw			 	! #		
<b>SEAT - IBIZA IV ST (6J8, 6P8) 03/10→</b>							
<b> Bremsbelagsatz, Scheibenbremse</b>							
1.2 TSI	81	09/15→	➔	+PR 1KK,1KT		13.0460-2894.2 602894 13.0470-2894.2 LD2894	TRW 20961 17,2 - WK + Zub TRW 20961 17,2 - WK + Zub Ceramic
1.4 TDI	55	05/15→	➔	+PR 1ZG		13.0460-7111.2 607111 13.0470-7111.2 LD7111	VW 23130 19,6 - WE / - WK VW 23130 19,6 - WE / - WK Ceramic
1.4 TDI	66	05/15→	➔	+PR 1ZC		13.0460-7184.2 607184 13.0470-7184.2 LD7184	ATE 23587 20,6 + WK ATE 23587 20,6 + WK Ceramic
1.4 TDI	77	05/15→	➔	+PR 1ZR,1ZS		13.0460-7285.2 607285 13.0470-7285.2 LD7285	ATE 23587 20,6 - WE / - WK ATE 23587 20,6 - WE / - WK Ceramic
			➔	+PR 1KV		13.0460-2787.2 602787 13.0460-2820.2 602820 13.0470-2820.2 LD2820	TRW 23554 17,3 - WK / - WE TRW 20961 17,2 - WK TRW 20961 17,2 - WK Ceramic
			➔	+PR 1KK,1KT		13.0460-2894.2 602894 13.0470-2894.2 LD2894	TRW 20961 17,2 - WK + Zub TRW 20961 17,2 - WK + Zub Ceramic
1.4 TSI	103	10/13→	➔	12/13→; +PR 1LQ,1LR,1ZG		13.0460-7111.2 607111 13.0470-7111.2 LD7111	VW 23130 19,6 - WE / - WK VW 23130 19,6 - WE / - WK Ceramic
			➔	12/13→; +PR 1LN,1ZH; 15"		13.0460-7184.2 607184 13.0470-7184.2 LD7184	ATE 23587 20,6 + WK ATE 23587 20,6 + WK Ceramic
			➔	12/13→; +PR 1ZR,1ZS		13.0460-7285.2 607285 13.0470-7285.2 LD7285	ATE 23587 20,6 - WE / - WK ATE 23587 20,6 - WE / - WK Ceramic
			➔	12/13→; +PR 1KD,1KS		13.0460-2864.2 602864	TRW 20961 17,2 - WK
1.4 TSI	110	02/12→	➔	+PR 1LQ,1LR,1ZG		13.0460-7111.2 607111 13.0470-7111.2 LD7111	VW 23130 19,6 - WE / - WK VW 23130 19,6 - WE / - WK Ceramic
1.4 TSI	110	11/15→	➔	+PR 1LN,1ZH; 15"		13.0460-7184.2 607184 13.0470-7184.2 LD7184	ATE 23587 20,6 + WK ATE 23587 20,6 + WK Ceramic
			➔	+PR 1ZR,1ZS		13.0460-7285.2 607285 13.0470-7285.2 LD7285	ATE 23587 20,6 - WE / - WK ATE 23587 20,6 - WE / - WK Ceramic
			➔	+PR 1KD,1KS		13.0460-2864.2 602864	TRW 20961 17,2 - WK
<b>Zubehörsatz, Scheibenbremsbelag</b>							
1.0	55	05/15→		+PR 1KT		13.0460-0072.2 610072	TRW
1.0 TSI	70	05/15→					
1.0 TSI	81	05/15→					
1.2 TSI	66	05/15→					
1.2	44	05/10→		+PR 1KK,1KT		13.0460-0072.2 610072	TRW
1.2	51	05/10→					
1.2 TDI	55	04/10→					
1.2 TSI	63	09/12→					
1.2 TSI	77	09/10→					
1.2 TSI	81	09/15→					
1.4	63	03/10→					
1.4 TDI	55	05/15→					
1.4 TDI	66	05/15→					
1.4 TDI	77	05/15→					
1.6 TDI	66	03/10→					
1.6 TDI	77	03/10→					
<b> Bremsscheibe</b>							
1.0	55	05/15→	➔	+PR 1ZG		24.0122-0151.1 422151 24.0322-0151.1 522151	Ø 256 22 19 V + S Ø 256 22 19 V + S
1.0 TSI	70	05/15→	➔				
1.0 TSI	81	05/15→	➔				
1.2 TSI	66	05/15→	➔	+PR 1ZC		24.0125-0113.1 425113 24.0325-0113.1 525113	Ø 288 25 22 V + S Ø 288 25 22 V + S
			➔	+PR 1ZR,1ZS		24.0125-0123.1 425123 24.0325-0123.1 525123	Ø 310 25 22 V + S Ø 310 25 22 V + S
			➔	+PR 1KV,1KT		24.0109-0123.1 409123 24.0309-0123.1 509123	Ø 230 9 7 + S Ø 230 9 7 + S
1.2	44	05/10→	➔	+PR 1LQ,1LR,1ZG		24.0122-0151.1 422151 24.0322-0151.1 522151	Ø 256 22 19 V + S Ø 256 22 19 V + S
1.2 TDI	55	04/10→	➔				
1.2 TSI	63	09/12→	➔				
1.2 TSI	77	09/10→	➔	15"		24.0125-0113.1 425113 24.0325-0113.1 525113	Ø 288 25 22 V + S Ø 288 25 22 V + S
1.6 TDI	66	03/10→	➔				
1.6 TDI	77	03/10→	➔				









	kw			 	! #		
<b>SEAT - IBIZA IV ST (6J8, 6P8) 03/10→</b>							
 <b>Bremsscheibe</b>							
1.2	44	05/10→	←	+PR 1ZR,1ZS	24.0125-0123.1	425123	Ø 310 25 22 V + S
1.2 TDI	55	04/10→			24.0325-0123.1	525123	Ø 310 25 22 V + S
1.2 TSI	63	09/12→					
1.2 TSI	77	09/10→	→	+PR 1KK,1KT	24.0109-0123.1	409123	Ø 230 9 7 + S
1.6 TDI	66	03/10→			24.0309-0123.1	509123	Ø 230 9 7 + S
1.6 TDI	77	03/10→					
1.2	51	05/10→	←	+PR 1LQ,1LR,1ZG	24.0122-0151.1	422151	Ø 256 22 19 V + S
1.4	63	03/10→			24.0322-0151.1	522151	Ø 256 22 19 V + S
			←	15"	24.0125-0113.1	425113	Ø 288 25 22 V + S
					24.0325-0113.1	525113	Ø 288 25 22 V + S
			←	+PR 1ZR,1ZS	24.0125-0123.1	425123	Ø 310 25 22 V + S
					24.0325-0123.1	525123	Ø 310 25 22 V + S
			→	+PR 1KK;1KT	24.0109-0123.1	409123	Ø 230 9 7 + S
					24.0309-0123.1	509123	Ø 230 9 7 + S
1.2 TSI	81	09/15→	←	+PR 1LQ,1LR,1ZG	24.0122-0151.1	422151	Ø 256 22 19 V + S
					24.0322-0151.1	522151	Ø 256 22 19 V + S
			←	+PR 1ZC	24.0125-0113.1	425113	Ø 288 25 22 V + S
					24.0325-0113.1	525113	Ø 288 25 22 V + S
			←	+PR 1ZR,1ZS	24.0125-0123.1	425123	Ø 310 25 22 V + S
					24.0325-0123.1	525123	Ø 310 25 22 V + S
			→	+PR 1KK,1KT	24.0109-0123.1	409123	Ø 230 9 7 + S
					24.0309-0123.1	509123	Ø 230 9 7 + S
1.4 TDI	55	05/15→	←	+PR 1ZG	24.0122-0151.1	422151	Ø 256 22 19 V + S
1.4 TDI	66	05/15→			24.0322-0151.1	522151	Ø 256 22 19 V + S
1.4 TDI	77	05/15→					
			←	+PR 1ZC	24.0125-0113.1	425113	Ø 288 25 22 V + S
					24.0325-0113.1	525113	Ø 288 25 22 V + S
			←	+PR 1ZR,1ZS	24.0125-0123.1	425123	Ø 310 25 22 V + S
					24.0325-0123.1	525123	Ø 310 25 22 V + S
			→	+PR 1KK,1KT	24.0109-0123.1	409123	Ø 230 9 7 + S
					24.0309-0123.1	509123	Ø 230 9 7 + S
1.4 TSI	103	10/13→	←	12/13→; +PR 1LQ,1LR,1ZG	24.0122-0151.1	422151	Ø 256 22 19 V + S
					24.0322-0151.1	522151	Ø 256 22 19 V + S
			←	12/13→; 15"	24.0125-0113.1	425113	Ø 288 25 22 V + S
					24.0325-0113.1	525113	Ø 288 25 22 V + S
			←	12/13→; +PR 1ZR,1ZS	24.0125-0123.1	425123	Ø 310 25 22 V + S
					24.0325-0123.1	525123	Ø 310 25 22 V + S
			→	12/13→; +PR 1KD,1KS	24.0109-0123.1	409123	Ø 230 9 7 + S
					24.0309-0123.1	509123	Ø 230 9 7 + S
1.4 TSI	110	02/12→	←	+PR 1LQ,1LR,1ZG	24.0122-0151.1	422151	Ø 256 22 19 V + S
1.4 TSI	110	11/15→			24.0322-0151.1	522151	Ø 256 22 19 V + S
			←	15"	24.0125-0113.1	425113	Ø 288 25 22 V + S
					24.0325-0113.1	525113	Ø 288 25 22 V + S
			←	+PR 1ZR,1ZS	24.0125-0123.1	425123	Ø 310 25 22 V + S
					24.0325-0123.1	525123	Ø 310 25 22 V + S
			→	+PR 1KD,1KS	24.0109-0123.1	409123	Ø 230 9 7 + S
					24.0309-0123.1	509123	Ø 230 9 7 + S
<b>SEAT - IBIZA V (KJ1) 01/17→</b>							
 <b>Bremsbelagsatz, Scheibenbremse</b>							
1.0	48	07/17→	←	+PR 1ZG	13.0460-7111.2	607111	VW 23130 19,6 - WE / - WK
1.0	55	01/17→			13.0470-7111.2	LD7111	VW 23130 19,6 - WE / - WK Ceramic
1.0 TGI	66	11/17→					
1.0 TSI	70	01/17→					
1.0 TSI	85	01/17→	→	+PR 1KD,1KV	13.0460-2820.2	602820	TRW 20961 17,2 - WK
1.5 TSI	110	07/17→			13.0470-2820.2	LD2820	TRW 20961 17,2 - WK Ceramic
1.6 TDI	59	11/17→					
1.6 TDI	70	09/17→					
1.6 TDI	85	12/17→					
 <b>Bremsscheibe</b>							
1.0	48	07/17→	→	+PR 1KD,1KV	24.0109-0123.1	409123	Ø 230 9 7 + S
1.0	55	01/17→			24.0309-0123.1	509123	Ø 230 9 7 + S
1.0 TGI	66	11/17→					
1.0 TSI	70	01/17→					
1.0 TSI	85	01/17→					
1.5 TSI	110	07/17→					
1.6 TDI	59	11/17→					
↓							





















	kw			 	! #		
<b>SEAT - IBIZA V (KJ1) 01/17→</b>							
 <b>Bremsscheibe</b>							
1.6 TDI	70	09/17→	➔	+PR 1KD,1KV		24.0109-0123.1 409123	Ø 230 9 7 + S
1.6 TDI	85	12/17→				24.0309-0123.1 509123	Ø 230 9 7 + S
<b>SEAT - INCA (6K9) 11/95→11/03</b>							
 <b>Bremsbelagsatz, Scheibenbremse</b>							
1.4 16V	55	04/00→06/03	←			13.0460-2821.2 602821	TRW 21945 16,0 - WK
						13.0460-2958.2 602958	TRW 20168 19,3 - WK
1.4 i	44	11/95→06/03	←	9K-T-011101→		13.0460-2821.2 602821	TRW 21945 16,0 - WK
1.6 i	55	11/95→05/98					
1.6 i	55	06/97→09/00	←	→ 9K-T-011100		13.0460-2958.2 602958	TRW 20168 19,3 - WK
1.9 D	47	11/95→06/03					
1.9 SDI	47	11/95→06/03					
1.9 TDI	66	09/96→06/03					
1.7 D	42	09/96→06/03	←			13.0460-2821.2 602821	TRW 21945 16,0 - WK
 <b>Bremsscheibe</b>							
1.4 16V	55	04/00→06/03	←			24.0113-0178.1 413178	Ø 255,6 12,9 11 + S
						24.0313-0178.1 513178	Ø 255,6 12,9 11 + S
1.4 i	44	11/95→06/03	←	→ 9K-T-011100		24.0113-0178.1 413178	Ø 255,6 12,9 11 + S
1.6 i	55	11/95→05/98				24.0313-0178.1 513178	Ø 255,6 12,9 11 + S
1.6 i	55	06/97→09/00					
1.9 D	47	11/95→06/03	←	9K-T-011101→		24.0120-0128.1 420128	Ø 256 20 18 V + S
1.9 SDI	47	11/95→06/03				24.0320-0128.1 520128	Ø 256 20 18 V + S
1.9 TDI	66	09/96→06/03					
1.7 D	42	09/96→06/03	←			24.0120-0128.1 420128	Ø 256 20 18 V + S
						24.0320-0128.1 520128	Ø 256 20 18 V + S
<b>SEAT - LEON (1M1) 11/99→06/06</b>							
 <b>Bremsbelagsatz, Scheibenbremse</b>							
1.4 16V	55	11/99→06/06	←	→ 07/05; +PR 1LE		13.0460-7081.2 607081	ATE 20676 19,8 - WE / - WK
1.6	74	11/99→06/06				13.0470-7081.2 LD7081	ATE 20676 19,8 - WE / - WK Ceramic
1.6 16 V	77	09/00→06/06					
1.8 20V	92	11/99→06/06					
1.8 20V T	132	11/99→06/06	←	→ 07/05; +PR 1LQ		13.0460-7111.2 607111	VW 23130 19,6 - WE / - WK
1.8 20V T 4	132	11/99→06/06				13.0470-7111.2 LD7111	VW 23130 19,6 - WE / - WK Ceramic
1.9 SDI	50	11/99→06/06					
1.9 TDI	66	11/99→06/06	←	→ 07/05; +PR 1LS		13.0460-7117.2 607117	VW 23130 19,6 + WK
1.9 TDI	81	11/99→06/06				13.0470-7117.2 LD7117	VW 23130 19,6 + WK Ceramic
1.9 TDI	96	05/03→06/06					
1.9 TDI Syncro	110	05/02→06/06	←	→ 07/05; +PR 1LJ,1ZQ		13.0460-7122.2 607122	ATE 20676 19,8 + WK
						13.0470-7122.2 LD7122	ATE 20676 19,8 + WK Ceramic
			➔	→ 07/05; +PR 1KY,2EE		13.0460-2886.2 602886	TRW 20961 16,0 - WK
						13.0460-2937.2 602937	TRW 20961 15,2 - WK + Zub
			➔	→ 07/05; +PR 1KK,1KP,1KQ		13.0460-2886.2 LD2886	TRW 20961 16,0 - WK Ceramic
			➔	→ 07/05; +PR 1KK,1KP,1KQ		13.0460-2894.2 602894	TRW 20961 17,2 - WK + Zub
						13.0470-2894.2 LD2894	TRW 20961 17,2 - WK + Zub Ceramic
1.8 T Cupra R	154	02/02→06/06	←	05/02→ 07/05; passend für Felgenreöße [Zoll]: 18		13.0460-4801.2 604801	BRE 21381 15,0 + WK
			←	05/02→ 07/05; +PR 1LT		13.0460-7122.2 607122	ATE 20676 19,8 + WK
						13.0470-7122.2 LD7122	ATE 20676 19,8 + WK Ceramic
			➔	05/02→ 07/05; +PR 1KY,2EM		13.0460-2886.2 602886	TRW 20961 16,0 - WK
						13.0460-2937.2 602937	TRW 20961 15,2 - WK + Zub
						13.0470-2886.2 LD2886	TRW 20961 16,0 - WK Ceramic
1.8 T Cupra R	165	07/03→06/06	←	→ 07/05; passend für Felgenreöße [Zoll]: 18		13.0460-4801.2 604801	BRE 21381 15,0 + WK
2.8 Cupra 4	150	02/01→06/06	←	→ 07/05; +PR 1LT		13.0460-7122.2 607122	ATE 20676 19,8 + WK
						13.0470-7122.2 LD7122	ATE 20676 19,8 + WK Ceramic
			➔	→ 07/05; +PR 1KY,2EM		13.0460-2886.2 602886	TRW 20961 16,0 - WK
						13.0460-2937.2 602937	TRW 20961 15,2 - WK + Zub
						13.0470-2886.2 LD2886	TRW 20961 16,0 - WK Ceramic
1.9 TDI	110	09/00→06/06	←	02/01→ 07/05; +PR 1LE		13.0460-7081.2 607081	ATE 20676 19,8 - WE / - WK
						13.0470-7081.2 LD7081	ATE 20676 19,8 - WE / - WK Ceramic
			←	02/01→ 07/05; +PR 1LQ		13.0460-7111.2 607111	VW 23130 19,6 - WE / - WK
						13.0470-7111.2 LD7111	VW 23130 19,6 - WE / - WK Ceramic
			←	02/01→ 07/05; +PR 1LS		13.0460-7117.2 607117	VW 23130 19,6 + WK











	kw			 	! #		
<b>SEAT - LEON (1M1) 11/99→06/06</b>							
<b> Bremsbelagsatz, Scheibenbremse</b>							
1.9 TDI	110	09/00→06/06	←	02/01→ 07/05; +PR 1LS	13.0470-7117.2	LD7117	VW 23130 19,6 + WK Ceramic
			←	02/01→ 07/05; +PR 1LJ,1ZQ	13.0460-7122.2	607122	ATE 20676 19,8 + WK
			→	02/01→ 07/05; +PR 1KY,2EE	13.0470-7122.2	LD7122	ATE 20676 19,8 + WK Ceramic
			→	02/01→ 07/05; +PR 1KK,1KP,1KQ	13.0460-2886.2	602886	TRW 20961 16,0 - WK
2.8	150	05/02→06/04	←	+PR 1LE	13.0460-7081.2	607081	ATE 20676 19,8 - WE / - WK
			←	+PR 1LQ	13.0470-7081.2	LD7081	ATE 20676 19,8 - WE / - WK Ceramic
			←	+PR 1LS	13.0460-7111.2	607111	VW 23130 19,6 - WE / - WK
			←	+PR 1LJ,1ZQ	13.0470-7111.2	LD7111	VW 23130 19,6 - WE / - WK Ceramic
			→	+PR 1KY,2EE	13.0460-7117.2	607117	VW 23130 19,6 + WK
			→	+PR 1KK,1KP,1KQ	13.0470-7117.2	LD7117	VW 23130 19,6 + WK Ceramic
			→	+PR 1KY,2EE	13.0460-2886.2	602886	ATE 20676 19,8 + WK
<b>Zubehörsatz, Scheibenbremsbelag</b>							
1.4 16V	55	11/99→06/06	→	→ 07/05; +PR 1KK,1KP,1KQ	13.0460-0072.2	610072	TRW
1.6	74	11/99→06/06					
1.6 16 V	77	09/00→06/06					
1.8 20V	92	11/99→06/06					
1.8 20V T	132	11/99→06/06					
1.8 20V T 4	132	11/99→06/06					
1.9 SDI	50	11/99→06/06					
1.9 TDI	66	11/99→06/06					
1.9 TDI	81	11/99→06/06					
1.9 TDI	96	05/03→06/06					
1.9 TDI Syncro	110	05/02→06/06					
1.9 TDI	110	09/00→06/06	→	02/01→ 07/05; +PR 1KK,1KP,1KQ	13.0460-0072.2	610072	TRW
2.8	150	05/02→06/04	→	+PR 1KK,1KP,1KQ	13.0460-0072.2	610072	TRW
<b> Bremsscheibe</b>							
1.4 16V	55	11/99→06/06	←	→ 07/05; +PR 1LR,1LS	24.0122-0150.1	422150	Ø 280 22 19 V + S
1.6	74	11/99→06/06			24.0322-0150.1	522150	Ø 280 22 19 V + S
1.6 16 V	77	09/00→06/06					
1.8 20V	92	11/99→06/06	←	→ 07/05; +PR 1LQ	24.0122-0151.1	422151	Ø 256 22 19 V + S
1.8 20V T 4	132	11/99→06/06			24.0322-0151.1	522151	Ø 256 22 19 V + S
1.9 SDI	50	11/99→06/06	←	→ 07/05; +PR 1LE	24.0125-0113.1	425113	Ø 288 25 22 V + S
1.9 TDI	66	11/99→06/06			24.0325-0113.1	525113	Ø 288 25 22 V + S
1.9 TDI	81	11/99→06/06					
1.9 TDI	96	05/03→06/06	←	→ 07/05; +PR 1LJ,1ZQ	24.0125-0123.1	425123	Ø 310 25 22 V + S
1.9 TDI Syncro	110	05/02→06/06			24.0325-0123.1	525123	Ø 310 25 22 V + S
			→	→ 07/05; +PR 1KK,1KP,1KQ	24.0109-0123.1	409123	Ø 230 9 7 + S
			→	→ 07/05; +PR 1KY,2EE	24.0309-0123.1	509123	Ø 230 9 7 + S
			→	→ 07/05; +PR 1KY,2EE	24.0122-0163.1	422163	Ø 256 22 20 V
					24.0322-0163.1	522163	Ø 256 22 20 V
1.8 20V T	132	11/99→06/06	←	→ 07/05; +PR 1LR,1LS	24.0122-0150.1	422150	Ø 280 22 19 V + S
			←	→ 07/05; +PR 1LQ	24.0322-0150.1	522150	Ø 280 22 19 V + S
			←	→ 07/05; +PR 1LQ	24.0122-0151.1	422151	Ø 256 22 19 V + S
			←	→ 07/05; +PR 1LE	24.0322-0151.1	522151	Ø 256 22 19 V + S
			←	→ 07/05; +PR 1LE	24.0125-0113.1	425113	Ø 288 25 22 V + S
			←	→ 07/05; +PR 1LJ, 1ZQ	24.0325-0113.1	525113	Ø 288 25 22 V + S
			←	→ 07/05; +PR 1LJ, 1ZQ	24.0125-0123.1	425123	Ø 310 25 22 V + S
→	→ 07/05; +PR 1KK,1KP,1KQ	24.0325-0123.1	525123	Ø 310 25 22 V + S			
			→	→ 07/05; +PR 1KK,1KP,1KQ	24.0109-0123.1	409123	Ø 230 9 7 + S
			→	→ 07/05; +PR 1KY,2EE	24.0309-0123.1	509123	Ø 230 9 7 + S
			→	→ 07/05; +PR 1KY,2EE	24.0122-0163.1	422163	Ø 256 22 20 V









	kw			 	! #		
<b>SEAT - LEON (1M1) 11/99→06/06</b>							
 <b>Bremsscheibe</b>							
1.8 20V T	132	11/99→06/06	➔	→ 07/05; +PR 1KY,2EE		24.0322-0163.1 522163	Ø 256 22 20 V
1.8 T Cupra R	154	02/02→06/06	➔	05/02→ 07/05; +PR 1LT		24.0125-0123.1 425123	Ø 310 25 22 V + S
						24.0325-0123.1 525123	Ø 310 25 22 V + S
			➔	05/02→ 07/05; +PR 1KY,2EM		24.0122-0163.1 422163	Ø 256 22 20 V
			➔	→ 07/05; +PR 1KY,2EM		24.0322-0163.1 522163	Ø 256 22 20 V
1.8 T Cupra R 2.8 Cupra 4	165 150	07/03→06/06 02/01→06/06	➔	→ 07/05; +PR 1LT		24.0125-0123.1 425123	Ø 310 25 22 V + S
						24.0325-0123.1 525123	Ø 310 25 22 V + S
			➔	→ 07/05; +PR 1KY,2EM		24.0122-0163.1 422163	Ø 256 22 20 V
						24.0322-0163.1 522163	Ø 256 22 20 V
1.9 TDI	110	09/00→06/06	➔	02/01→ 07/05; +PR 1LR,1LS		24.0122-0150.1 422150	Ø 280 22 19 V + S
						24.0322-0150.1 522150	Ø 280 22 19 V + S
			➔	02/01→ 07/05; +PR 1LQ		24.0122-0151.1 422151	Ø 256 22 19 V + S
						24.0322-0151.1 522151	Ø 256 22 19 V + S
			➔	02/01→ 07/05; +PR 1LE		24.0125-0113.1 425113	Ø 288 25 22 V + S
						24.0325-0113.1 525113	Ø 288 25 22 V + S
			➔	02/01→ 07/05; +PR 1LJ,1ZQ		24.0125-0123.1 425123	Ø 310 25 22 V + S
						24.0325-0123.1 525123	Ø 310 25 22 V + S
			➔	02/01→ 07/05; +PR 1KK,1KP,1KQ		24.0109-0123.1 409123	Ø 230 9 7 + S
						24.0309-0123.1 509123	Ø 230 9 7 + S
			➔	02/01→ 07/05; +PR 1KY,2EE		24.0122-0163.1 422163	Ø 256 22 20 V
						24.0322-0163.1 522163	Ø 256 22 20 V
2.8	150	05/02→06/04	➔	+PR 1LR,1LS		24.0122-0150.1 422150	Ø 280 22 19 V + S
						24.0322-0150.1 522150	Ø 280 22 19 V + S
			➔	+PR 1LQ		24.0122-0151.1 422151	Ø 256 22 19 V + S
						24.0322-0151.1 522151	Ø 256 22 19 V + S
			➔	+PR 1LE		24.0125-0113.1 425113	Ø 288 25 22 V + S
						24.0325-0113.1 525113	Ø 288 25 22 V + S
			➔	+PR 1LJ,1ZQ		24.0125-0123.1 425123	Ø 310 25 22 V + S
						24.0325-0123.1 525123	Ø 310 25 22 V + S
			➔	+PR 1KK,1KP,1KQ		24.0109-0123.1 409123	Ø 230 9 7 + S
						24.0309-0123.1 509123	Ø 230 9 7 + S
			➔	+PR 1KY,2EE		24.0122-0163.1 422163	Ø 256 22 20 V
						24.0322-0163.1 522163	Ø 256 22 20 V
<b>SEAT - LEON (1P1) 05/05→12/13</b>							
 <b>Bremsbelagsatz, Scheibenbremse</b>							
1.2 TSI	77	02/10→12/12	➔	+PR 1ZF,1ZM; → 10/12		13.0460-7117.2 607117	VW 23130 19,6 + WK
1.6 LPG	75	12/09→12/12				13.0470-7117.2 LD7117	VW 23130 19,6 + WK Ceramic
1.6 MultiFuel	75	11/10→12/12					
1.6 TDI	66	11/10→12/12	➔	+PR 1ZE,1LJ; → 10/12		13.0460-7184.2 607184	ATE 23587 20,6 + WK
1.6 TDI	77	02/10→12/12				13.0470-7184.2 LD7184	ATE 23587 20,6 + WK Ceramic
2.0 Cupra R	195	09/09→12/12	➔	→ 10/12; +PR 1LU		13.0460-7200.2 607200	ATE 23801 20,3 + WK
						13.0470-7200.2 LD7200	ATE 23801 20,3 + WK Ceramic
			➔	→ 10/12; +PR 1LB		13.0460-7227.2 607227	ATE 23801 20,3 + WK
						13.0470-7227.2 LD7227	ATE 23801 20,4 + WK Ceramic
			➔	→ 10/12; +PR 1KY,1KZ		13.0460-2749.2 602749	TRW 24483 16,9 - WE / - WK + Zub
						13.0460-2880.2 602880	TRW 23914 17,1 + WE / - WK + Zub
						13.0470-2749.2 LD2749	TRW 24483 16,9 - WE / - WK + Zub Ceramic
			13.0470-2880.2 LD2880	TRW 23914 17,1 + WE / - WK + Zub Ceramic			
			➔	→ 10/12; +PR 1KD		13.0460-2787.2 602787	TRW 23554 17,3 - WK / - WE
						13.0460-2820.2 602820	TRW 20961 17,2 - WK
						13.0470-2820.2 LD2820	TRW 20961 17,2 - WK Ceramic
			➔	→ 10/12; +PR 1KS,1KT		13.0460-3858.2 603858	BOS 24563 17,7 - WE / - WK + Zub
						13.0470-3858.2 LD3858	BOS 24563 17,7 - WE / - WK + Zub Ceramic
1.4 16V	63	06/06→12/12	➔	→ 10/12; +PR 1ZF,1ZM		13.0460-7117.2 607117	VW 23130 19,6 + WK
1.4 TSI	92	11/07→12/12				13.0470-7117.2 LD7117	VW 23130 19,6 + WK Ceramic
1.8 TSI	118	06/07→12/12					
2.0 TDI	125	05/06→12/12	➔	→ 10/12; +PR 1ZE,1LJ		13.0460-7184.2 607184	ATE 23587 20,6 + WK
2.0 TFSI	155	06/09→12/12				13.0470-7184.2 LD7184	ATE 23587 20,6 + WK Ceramic
↓							

	kw			 	! #		
<b>SEAT - LEON (1P1) 05/05→12/13</b>							
<b> Bremsbelagsatz, Scheibenbremse</b>							
1.4 16V	63	06/06→12/12	←	→ 10/12; +PR 1LU		<b>13.0460-7200.2 607200</b>	ATE 23801 20,3 + WK
1.4 TSI	92	11/07→12/12				<b>13.0470-7200.2 LD7200</b>	ATE 23801 20,3 + WK Ceramic
1.8 TSI	118	06/07→12/12					
2.0 TDI	125	05/06→12/12	←	→ 10/12; +PR 1LB		<b>13.0460-7227.2 607227</b>	ATE 23801 20,3 + WK
2.0 TFSI	155	06/09→12/12				<b>13.0470-7227.2 LD7227</b>	ATE 23801 20,4 + WK Ceramic
			→	→ 10/12; +PR 1KY,1KZ		<b>13.0460-2749.2 602749</b>	TRW 24483 16,9 - WE / - WK + Zub
						<b>13.0460-2880.2 602880</b>	TRW 23914 17,1 + WE / - WK + Zub
						<b>13.0470-2749.2 LD2749</b>	TRW 24483 16,9 - WE / - WK + Zub Ceramic
						<b>13.0470-2880.2 LD2880</b>	TRW 23914 17,1 + WE / - WK + Zub Ceramic
			→	→ 10/12; +PR 1KD		<b>13.0460-2787.2 602787</b>	TRW 23554 17,3 - WK / - WE
						<b>13.0460-2820.2 602820</b>	TRW 20961 17,2 - WK
						<b>13.0470-2820.2 LD2820</b>	TRW 20961 17,2 - WK Ceramic
			→	→ 10/12; +PR 1KS,1KT		<b>13.0460-3858.2 603858</b>	BOS 24563 17,7 - WE / - WK + Zub
						<b>13.0470-3858.2 LD3858</b>	BOS 24563 17,7 - WE / - WK + Zub Ceramic
1.6	75	07/05→12/12	←	08/05→ 10/12; +PR 1ZF;1ZM		<b>13.0460-7117.2 607117</b>	VW 23130 19,6 + WK
2.0 TDI 16V	103	07/05→12/12				<b>13.0470-7117.2 LD7117</b>	VW 23130 19,6 + WK Ceramic
			←	08/05→ 10/12; +PR 1ZE;1LJ		<b>13.0460-7184.2 607184</b>	ATE 23587 20,6 + WK
						<b>13.0470-7184.2 LD7184</b>	ATE 23587 20,6 + WK Ceramic
			←	08/05→ 10/12; +PR 1LU		<b>13.0460-7200.2 607200</b>	ATE 23801 20,3 + WK
						<b>13.0470-7200.2 LD7200</b>	ATE 23801 20,3 + WK Ceramic
			←	08/05→ 10/12; +PR 1LB		<b>13.0460-7227.2 607227</b>	ATE 23801 20,3 + WK
						<b>13.0470-7227.2 LD7227</b>	ATE 23801 20,4 + WK Ceramic
			→	08/05→ 10/12; +PR 1KY,1KZ		<b>13.0460-2749.2 602749</b>	TRW 24483 16,9 - WE / - WK + Zub
						<b>13.0460-2880.2 602880</b>	TRW 23914 17,1 + WE / - WK + Zub
						<b>13.0470-2749.2 LD2749</b>	TRW 24483 16,9 - WE / - WK + Zub Ceramic
						<b>13.0470-2880.2 LD2880</b>	TRW 23914 17,1 + WE / - WK + Zub Ceramic
			→	08/05→ 10/12; +PR 1KD		<b>13.0460-2787.2 602787</b>	TRW 23554 17,3 - WK / - WE
						<b>13.0460-2820.2 602820</b>	TRW 20961 17,2 - WK
						<b>13.0470-2820.2 LD2820</b>	TRW 20961 17,2 - WK Ceramic
			→	08/05→ 10/12; +PR 1KS,1KT		<b>13.0460-3858.2 603858</b>	BOS 24563 17,7 - WE / - WK + Zub
						<b>13.0470-3858.2 LD3858</b>	BOS 24563 17,7 - WE / - WK + Zub Ceramic
1.9 TDI	66	06/07→12/10	←	+PR 1ZF;1ZM		<b>13.0460-7117.2 607117</b>	VW 23130 19,6 + WK
2.0 TDI	103	10/05→10/10				<b>13.0470-7117.2 LD7117</b>	VW 23130 19,6 + WK Ceramic
2.0 TFSI	136	09/05→05/06					
2.0 TFSI	177	11/06→05/11	←	+PR 1ZE;1LJ		<b>13.0460-7184.2 607184</b>	ATE 23587 20,6 + WK
						<b>13.0470-7184.2 LD7184</b>	ATE 23587 20,6 + WK Ceramic
			←	+PR 1LU		<b>13.0460-7200.2 607200</b>	ATE 23801 20,3 + WK
						<b>13.0470-7200.2 LD7200</b>	ATE 23801 20,3 + WK Ceramic
			←	+PR 1LB		<b>13.0460-7227.2 607227</b>	ATE 23801 20,3 + WK
						<b>13.0470-7227.2 LD7227</b>	ATE 23801 20,4 + WK Ceramic
			→	+PR 1KY,1KZ		<b>13.0460-2749.2 602749</b>	TRW 24483 16,9 - WE / - WK + Zub
						<b>13.0460-2880.2 602880</b>	TRW 23914 17,1 + WE / - WK + Zub
						<b>13.0470-2749.2 LD2749</b>	TRW 24483 16,9 - WE / - WK + Zub Ceramic
						<b>13.0470-2880.2 LD2880</b>	TRW 23914 17,1 + WE / - WK + Zub Ceramic
			→	+PR 1KD		<b>13.0460-2787.2 602787</b>	TRW 23554 17,3 - WK / - WE
						<b>13.0460-2820.2 602820</b>	TRW 20961 17,2 - WK
						<b>13.0470-2820.2 LD2820</b>	TRW 20961 17,2 - WK Ceramic
			→	+PR 1KS,1KT		<b>13.0460-3858.2 603858</b>	BOS 24563 17,7 - WE / - WK + Zub
						<b>13.0470-3858.2 LD3858</b>	BOS 24563 17,7 - WE / - WK + Zub Ceramic
1.9 TDI	77	07/05→12/10	←	08/05→; +PR 1ZF;1ZM		<b>13.0460-7117.2 607117</b>	VW 23130 19,6 + WK
2.0 FSI	110	07/05→05/10					
↓							









	kw			 	! #		
<b>SEAT - LEON (1P1) 05/05→12/13</b>							
<b> Bremsbelagsatz, Scheibenbremse</b>							
2.0 TDI 2.0 TFSI	100 147	07/05→05/10 05/05→03/09	←	08/05→; +PR 1ZF;1ZM	13.0470-7117.2	LD7117	VW 23130 19,6 + WK Ceramic
			←	08/05→; +PR 1ZE;1LJ	13.0460-7184.2	607184	ATE 23587 20,6 + WK
					13.0470-7184.2	LD7184	ATE 23587 20,6 + WK Ceramic
			←	08/05→; +PR 1LU	13.0460-7200.2	607200	ATE 23801 20,3 + WK
					13.0470-7200.2	LD7200	ATE 23801 20,3 + WK Ceramic
			←	08/05→; +PR 1LB	13.0460-7227.2	607227	ATE 23801 20,3 + WK
					13.0470-7227.2	LD7227	ATE 23801 20,4 + WK Ceramic
			→	08/05→; +PR 1KY,1KZ	13.0460-2749.2	602749	TRW 24483 16,9 - WE / - WK + Zub
		13.0460-2880.2	602880	TRW 23914 17,1 + WE / - WK + Zub			
		13.0470-2749.2	LD2749	TRW 24483 16,9 - WE / - WK + Zub Ceramic			
		13.0470-2880.2	LD2880	TRW 23914 17,1 + WE / - WK + Zub Ceramic			
		→	08/05→; +PR 1KD	13.0460-2787.2	602787	TRW 23554 17,3 - WK / - WE	
				13.0460-2820.2	602820	TRW 20961 17,2 - WK	
				13.0470-2820.2	LD2820	TRW 20961 17,2 - WK Ceramic	
			→	08/05→; +PR 1KS,1KT	13.0460-3858.2	603858	BOS 24563 17,7 - WE / - WK + Zub
				13.0470-3858.2	LD3858	BOS 24563 17,7 - WE / - WK + Zub Ceramic	
<b> Bremsscheibe</b>							
1.2 TSI 1.6 LPG 1.6 MultiFuel 1.6 TDI 1.6 TDI 2.0 Cupra R	77 75 75 66 77 195	02/10→12/12 12/09→12/12 11/10→12/12 11/10→12/12 02/10→12/12 09/09→12/12	←	+PR 1ZF,1ZM; → 10/12	24.0122-0210.1	422210	Ø 280 22 19 V + S
					24.0322-0210.1	522210	Ø 280 22 19 V + S
			←	→ 10/12; +PR 1ZE	24.0125-0145.1	425145	Ø 288 25 22 V + S
					24.0325-0145.1	525145	Ø 288 25 22 V + S
			←	→ 10/12; +PR 1LJ	24.0125-0158.1	425158	Ø 312 25 22 V + S
					24.0325-0158.1	525158	Ø 312 25 22 V + S
			←	→ 10/12; +PR 1LB,1LU	24.0130-0115.1	430115	Ø 345 30 27 V
					24.0330-0115.1	530115	Ø 345 30 27 V
		→	10/12; +PR 1KD	24.0110-0277.1	410277	Ø 253 10 8 + S	
				24.0310-0277.1	510277	Ø 253 10 8 + S	
			→	10/12; +PR 1KS,1KT	24.0110-0356.1	410356	Ø 272 9,7 8 + S
				24.0310-0356.1	510356	Ø 272 9,7 8 + S	
			→	10/12; +PR 1KY,1KZ	24.0112-0169.1	412169	Ø 282 12 10 + S
				24.0312-0169.1	512169	Ø 282 12 10 + S	
1.4 16V 1.4 TSI 1.8 TSI 2.0 TDI 2.0 TFSI	63 92 118 125 155	06/06→12/12 11/07→12/12 06/07→12/12 05/06→12/12 06/09→12/12	←	→ 10/12; +PR 1ZF;1ZM	24.0122-0210.1	422210	Ø 280 22 19 V + S
					24.0322-0210.1	522210	Ø 280 22 19 V + S
			←	→ 10/12; +PR 1ZE	24.0125-0145.1	425145	Ø 288 25 22 V + S
					24.0325-0145.1	525145	Ø 288 25 22 V + S
			←	→ 10/12; +PR 1LJ	24.0125-0158.1	425158	Ø 312 25 22 V + S
					24.0325-0158.1	525158	Ø 312 25 22 V + S
			←	→ 10/12; +PR 1LB,1LU	24.0130-0115.1	430115	Ø 345 30 27 V
					24.0330-0115.1	530115	Ø 345 30 27 V
		→	10/12; +PR 1KD	24.0110-0277.1	410277	Ø 253 10 8 + S	
				24.0310-0277.1	510277	Ø 253 10 8 + S	
			→	10/12; +PR 1KS,1KT	24.0110-0356.1	410356	Ø 272 9,7 8 + S
				24.0310-0356.1	510356	Ø 272 9,7 8 + S	
			→	10/12; +PR 1KY,1KZ	24.0112-0169.1	412169	Ø 282 12 10 + S
				24.0312-0169.1	512169	Ø 282 12 10 + S	
1.6 2.0 TDI 16V	75 103	07/05→12/12 07/05→12/12	←	08/05→ 10/12; +PR 1ZF;1ZM	24.0122-0210.1	422210	Ø 280 22 19 V + S
					24.0322-0210.1	522210	Ø 280 22 19 V + S
			←	08/05→ 10/12; +PR 1ZE	24.0125-0145.1	425145	Ø 288 25 22 V + S
					24.0325-0145.1	525145	Ø 288 25 22 V + S
			←	08/05→ 10/12; +PR 1LJ	24.0125-0158.1	425158	Ø 312 25 22 V + S
					24.0325-0158.1	525158	Ø 312 25 22 V + S
			←	08/05→ 10/12; +PR 1LB,1LU	24.0130-0115.1	430115	Ø 345 30 27 V
		24.0330-0115.1	530115	Ø 345 30 27 V			
		→	08/05→ 10/12; +PR 1KD	24.0110-0277.1	410277	Ø 253 10 8 + S	
				24.0310-0277.1	510277	Ø 253 10 8 + S	
			→	08/05→ 10/12; +PR 1KS,1KT	24.0110-0356.1	410356	Ø 272 9,7 8 + S























	kw			 	! #		
<b>SEAT - LEON (1P1) 05/05→12/13</b>							
<b>Bremsscheibe</b>							
1.6 2.0 TDI 16V	75 103	07/05→12/12 07/05→12/12	➡	08/05→ 10/12; +PR 1KS,1KT		24.0310-0356.1 510356	Ø 272 9,7 8 + S
			➡	08/05→ 10/12; +PR 1KY,1KZ		24.0112-0169.1 412169	Ø 282 12 10 + S
						24.0312-0169.1 512169	Ø 282 12 10 + S
1.9 TDI 2.0 TDI 2.0 TFSI	66 103 136	06/07→12/10 10/05→10/10 09/05→05/06	←	+PR 1ZF,1ZM		24.0122-0210.1 422210	Ø 280 22 19 V + S
2.0 TFSI	177	11/06→05/11	←	+PR 1ZE		24.0125-0145.1 425145	Ø 288 25 22 V + S
						24.0325-0145.1 525145	Ø 288 25 22 V + S
			←	+PR 1LJ		24.0125-0158.1 425158	Ø 312 25 22 V + S
						24.0325-0158.1 525158	Ø 312 25 22 V + S
			←	+PR 1LB,1LU		24.0130-0115.1 430115	Ø 345 30 27 V
						24.0330-0115.1 530115	Ø 345 30 27 V
			➡	+PR 1KD		24.0110-0277.1 410277	Ø 253 10 8 + S
						24.0310-0277.1 510277	Ø 253 10 8 + S
			➡	+PR 1KS,1KT		24.0110-0356.1 410356	Ø 272 9,7 8 + S
						24.0310-0356.1 510356	Ø 272 9,7 8 + S
			➡	+PR 1KY,1KZ		24.0112-0169.1 412169	Ø 282 12 10 + S
						24.0312-0169.1 512169	Ø 282 12 10 + S
1.9 TDI 2.0 FSI 2.0 TDI 2.0 TFSI	77 110 100 147	07/05→12/10 07/05→05/10 07/05→05/10 05/05→03/09	←	08/05→; +PR 1ZF,1ZM		24.0122-0210.1 422210	Ø 280 22 19 V + S
						24.0322-0210.1 522210	Ø 280 22 19 V + S
			←	08/05→; +PR 1ZE		24.0125-0145.1 425145	Ø 288 25 22 V + S
						24.0325-0145.1 525145	Ø 288 25 22 V + S
			←	08/05→; +PR 1LJ		24.0125-0158.1 425158	Ø 312 25 22 V + S
						24.0325-0158.1 525158	Ø 312 25 22 V + S
			←	08/05→; +PR 1LB,1LU		24.0130-0115.1 430115	Ø 345 30 27 V
						24.0330-0115.1 530115	Ø 345 30 27 V
			➡	08/05→; +PR 1KD		24.0110-0277.1 410277	Ø 253 10 8 + S
						24.0310-0277.1 510277	Ø 253 10 8 + S
			➡	08/05→; +PR 1KS,1KT		24.0110-0356.1 410356	Ø 272 9,7 8 + S
						24.0310-0356.1 510356	Ø 272 9,7 8 + S
			➡	08/05→; +PR 1KY,1KZ		24.0112-0169.1 412169	Ø 282 12 10 + S
						24.0312-0169.1 512169	Ø 282 12 10 + S
<b>SEAT - LEON (5F1) 09/12→</b>							
<b>Bremsbelagsatz, Scheibenbremse</b>							
1.0 TSI 1.2 TSI 1.2 TSI 1.4 TSI 1.4 TSI 1.4 TSI 1.4 TSI 1.4 TSI 1.6 TDI 1.6 TDI 1.6 TDI 1.8 TSI 2.0 TDI 2.0 TDI 2.0 TDI 2.0 TDI	85 63 77 81 90 92 103 110 66 77 81 132 81 105 110 135	05/15→ 12/12→ 01/13→ 04/14→ 11/12→ 05/14→ 09/12→ 05/14→ 11/12→ 11/12→ 09/13→ 02/13→ 05/13→ 05/13→ 10/12→ 09/12→	←	+PR 1ZA,1ZE		13.0460-2785.2 602785 13.0470-2785.2 LD2785	TRW 25683 20,4 + WE / + WK TRW 25683 20,4 + WE / + WK Ceramic
			←	+PR 1ZF,1ZH		13.0460-7303.2 607303 13.0470-7303.2 LD7303	ATE 22035 17,5 + WK ATE 22035 17,5 + WK Ceramic
			➡	+PR 1KF,1KW		13.0460-2749.2 602749	TRW 24483 16,9 - WE / - WK + Zub
						13.0460-2880.2 602880	TRW 23914 17,1 + WE / - WK + Zub
						13.0470-2749.2 LD2749	TRW 24483 16,9 - WE / - WK + Zub Ceramic
						13.0470-2880.2 LD2880	TRW 23914 17,1 + WE / - WK + Zub Ceramic
			➡	+PR 1KD		13.0460-2787.2 602787	TRW 23554 17,3 - WK / - WE
			➡	+PR 1KS		13.0460-2790.2 602790 13.0470-2790.2 LD2790	TRW 25110 17,5 - WE / - WK TRW 25110 17,5 - WE / - WK Ceramic
			➡	+PR 1KE		13.0460-7293.2 607293 13.0470-7293.2 LD7293	ATE 25008 16,3 - WE / - WK ATE 25008 16,3 - WE / - WK Ceramic
			➡	+PR 1KJ,1KY; + eFSB		13.0460-7294.2 607294 13.0470-7294.2 LD7294	ATE 25009 16,4 - WE / - WK ATE 25009 16,4 - WE / - WK Ceramic
1.4 TGI	81	02/13→	←	10/13→; +PR 1ZA,1ZE		13.0460-2785.2 602785 13.0470-2785.2 LD2785	TRW 25683 20,4 + WE / + WK TRW 25683 20,4 + WE / + WK Ceramic
			←	10/13→; +PR 1ZF,1ZH		13.0460-7303.2 607303 13.0470-7303.2 LD7303	ATE 22035 17,5 + WK ATE 22035 17,5 + WK Ceramic
			➡	10/13→; +PR 1KF,1KW		13.0460-2749.2 602749	TRW 24483 16,9 - WE / - WK + Zub











	kw			 	! #		
<b>SEAT - LEON (5F1) 09/12→</b>							
<b> Bremsbelagsatz, Scheibenbremse</b>							
1.4 TGI	81	02/13→	➡	10/13→; +PR 1KF,1KW	13.0460-2880.2	602880	TRW 23914 17,1 + WE / - WK + Zub
					13.0470-2749.2	LD2749	TRW 24483 16,9 - WE / - WK + Zub Ceramic
					13.0470-2880.2	LD2880	TRW 23914 17,1 + WE / - WK + Zub Ceramic
			➡	10/13→; +PR 1KD	13.0460-2787.2	602787	TRW 23554 17,3 - WK / - WE
			➡	10/13→; +PR 1KS	13.0460-2790.2	602790	TRW 25110 17,5 - WE / - WK
				13.0470-2790.2	LD2790	TRW 25110 17,5 - WE / - WK Ceramic	
			➡	10/13→; +PR 1KE	13.0460-7293.2	607293	ATE 25008 16,3 - WE / - WK
					13.0470-7293.2	LD7293	ATE 25008 16,3 - WE / - WK Ceramic
			➡	10/13→; +PR 1KJ,1KY; + eFSB	13.0460-7294.2	607294	ATE 25009 16,4 - WE / - WK
					13.0470-7294.2	LD7294	ATE 25009 16,4 - WE / - WK Ceramic
1.6 TDI	85	11/16→	←	01/17→; +PR 1ZA,1ZE	13.0460-2785.2	602785	TRW 25683 20,4 + WE / + WK
					13.0470-2785.2	LD2785	TRW 25683 20,4 + WE / + WK Ceramic
			←	01/17→; +PR 1ZF,1ZH	13.0460-7303.2	607303	ATE 22035 17,5 + WK
					13.0470-7303.2	LD7303	ATE 22035 17,5 + WK Ceramic
			➡	01/17→; +PR 1KD	13.0460-2787.2	602787	TRW 23554 17,3 - WK / - WE
			➡	01/17→; +PR 1KS	13.0460-2790.2	602790	TRW 25110 17,5 - WE / - WK
				13.0470-2790.2	LD2790	TRW 25110 17,5 - WE / - WK Ceramic	
			➡	01/17→; +PR 1KE	13.0460-7293.2	607293	ATE 25008 16,3 - WE / - WK
					13.0470-7293.2	LD7293	ATE 25008 16,3 - WE / - WK Ceramic
			➡	01/17→; +PR 1KJ,1KY; + eFSB	13.0460-7294.2	607294	ATE 25009 16,4 - WE / - WK
					13.0470-7294.2	LD7294	ATE 25009 16,4 - WE / - WK Ceramic
2.0 Cupra 2.0 Cupra 2.0 Cupra	195 206 213	10/13→ 10/13→ 10/15→	←	+PR 1ZA,1ZE	13.0460-2785.2	602785	TRW 25683 20,4 + WE / + WK
					13.0470-2785.2	LD2785	TRW 25683 20,4 + WE / + WK Ceramic
			←	+ Performance Pack	13.0460-4833.2	604833	BRE 24098 17,1 + WE / - WK
					13.0470-4833.2	LD4833	BRE 24098 17,1 + WE / - WK Ceramic
			←	+PR 1ZF,1ZH	13.0460-7303.2	607303	ATE 22035 17,5 + WK
					13.0470-7303.2	LD7303	ATE 22035 17,5 + WK Ceramic
			➡	+PR 1KF,1KW	13.0460-2749.2	602749	TRW 24483 16,9 - WE / - WK + Zub
					13.0460-2880.2	602880	TRW 23914 17,1 + WE / - WK + Zub
					13.0470-2749.2	LD2749	TRW 24483 16,9 - WE / - WK + Zub Ceramic
				13.0470-2880.2	LD2880	TRW 23914 17,1 + WE / - WK + Zub Ceramic	
➡	+PR 1KD	13.0460-2787.2	602787	TRW 23554 17,3 - WK / - WE			
➡	+PR 1KS	13.0460-2790.2	602790	TRW 25110 17,5 - WE / - WK			
				13.0470-2790.2	LD2790	TRW 25110 17,5 - WE / - WK Ceramic	
➡	+PR 1KE	13.0460-7293.2	607293	ATE 25008 16,3 - WE / - WK			
				13.0470-7293.2	LD7293	ATE 25008 16,3 - WE / - WK Ceramic	
➡	+PR 1KJ,1KY; + eFSB	13.0460-7294.2	607294	ATE 25009 16,4 - WE / - WK			
				13.0470-7294.2	LD7294	ATE 25009 16,4 - WE / - WK Ceramic	
2.0 Cupra	221	01/17→	←	+PR 1ZA,1ZE	13.0460-2785.2	602785	TRW 25683 20,4 + WE / + WK
					13.0470-2785.2	LD2785	TRW 25683 20,4 + WE / + WK Ceramic
			←	+ Performance Pack	13.0460-4833.2	604833	BRE 24098 17,1 + WE / - WK
					13.0470-4833.2	LD4833	BRE 24098 17,1 + WE / - WK Ceramic
			←	+PR 1ZF,1ZH	13.0460-7303.2	607303	ATE 22035 17,5 + WK
				13.0470-7303.2	LD7303	ATE 22035 17,5 + WK Ceramic	
➡	+PR 1KD	13.0460-2787.2	602787	TRW 23554 17,3 - WK / - WE			
↓							

	kw			 	! #		
<b>SEAT - LEON (5F1) 09/12→</b>							
<b> Bremsbelagsatz, Scheibenbremse</b>							
2.0 Cupra	221	01/17→	➔	+PR 1KS		13.0460-2790.2 602790 13.0470-2790.2 LD2790	TRW 25110 17,5 - WE / - WK TRW 25110 17,5 - WE / - WK Ceramic
			➔	+PR 1KE		13.0460-7293.2 607293 13.0470-7293.2 LD7293	ATE 25008 16,3 - WE / - WK ATE 25008 16,3 - WE / - WK Ceramic
			➔	+PR 1KJ,1KY; + eFSB		13.0460-7294.2 607294 13.0470-7294.2 LD7294	ATE 25009 16,4 - WE / - WK ATE 25009 16,4 - WE / - WK Ceramic
2.0 Cupra R	228	11/17→	➔	+PR 1ZA,1ZE		13.0460-2785.2 602785	TRW 25683 20,4 + WE / + WK
			➔	+ Performance Pack		13.0460-4833.2 604833	BRE 24098 17,1 + WE / - WK
			➔	+PR 1ZF,1ZH		13.0460-7303.2 607303	ATE 22035 17,5 + WK
			➔	+PR 1KD		13.0460-2787.2 602787	TRW 23554 17,3 - WK / - WE
			➔	+PR 1KS		13.0460-2790.2 602790 13.0470-2790.2 LD2790	TRW 25110 17,5 - WE / - WK TRW 25110 17,5 - WE / - WK Ceramic
			➔	+PR 1KE		13.0460-7293.2 607293 13.0470-7293.2 LD7293	ATE 25008 16,3 - WE / - WK ATE 25008 16,3 - WE / - WK Ceramic
			➔	+PR 1KJ,1KY; + eFSB		13.0460-7294.2 607294 13.0470-7294.2 LD7294	ATE 25009 16,4 - WE / - WK ATE 25009 16,4 - WE / - WK Ceramic
<b>Warnkontakt, Bremsbelagverschleiß</b>							
1.0 TSI	85	05/15→	➔	+PR 1ZA,1ZE	1	24.8190-0065.2 620065	L= 172
1.2 TSI	63	12/12→					
1.2 TSI	77	01/13→					
1.2 TSI	81	04/14→					
1.4 TSI	90	11/12→					
1.4 TSI	92	05/14→					
1.4 TSI	103	09/12→					
1.4 TSI	110	05/14→					
1.6 TDI	66	11/12→					
1.6 TDI	77	11/12→					
1.6 TDI	81	09/13→					
1.8 TSI	132	02/13→					
2.0 TDI	81	05/13→					
2.0 TDI	105	05/13→					
2.0 TDI	110	10/12→					
2.0 TDI	135	09/12→					
1.4 TGI	81	02/13→	➔	10/13→; +PR 1ZA,1ZE	1	24.8190-0065.2 620065	L= 172
1.6 TDI	85	11/16→	➔	01/17→; +PR 1ZA,1ZE	1	24.8190-0065.2 620065	L= 172
2.0 Cupra	195	10/13→	➔	+PR 1ZA,1ZE	1	24.8190-0065.2 620065	L= 172
2.0 Cupra	206	10/13→					
2.0 Cupra	213	10/15→	➔	+ Performance Pack	1	24.8190-0302.2 620302	L= 367,4
2.0 Cupra	221	01/17→					
2.0 Cupra R	228	11/17→					
<b> Bremsscheibe</b>							
1.0 TSI	85	05/15→	➔	+PR 1ZF,1ZH		24.0124-0258.1 424258	Ø 276 24 21 V + S
1.2 TSI	63	12/12→					
1.2 TSI	81	04/14→	➔	+PR 1ZE		24.0125-0145.1 425145	Ø 288 25 22 V + S
1.4 TSI	90	11/12→				24.0325-0145.1 525145	Ø 288 25 22 V + S
1.4 TSI	92	05/14→					
1.4 TSI	103	09/12→	➔	+PR 1ZA		24.0125-0158.1 425158	Ø 312 25 22 V + S
1.4 TSI	110	05/14→				24.0325-0158.1 525158	Ø 312 25 22 V + S
1.6 TDI	66	11/12→	➔	+PR 1LG		24.0130-0225.1 430225	Ø 340 30 27 V + S
1.6 TDI	77	11/12→					
1.6 TDI	81	09/13→	➔	+PR 1KD		24.0110-0277.1 410277	Ø 253 10 8 + S
1.8 TSI	132	02/13→				24.0310-0277.1 510277	Ø 253 10 8 + S
2.0 TDI	81	05/13→	➔	+PR 1KS,1KE		24.0110-0356.1 410356	Ø 272 9,7 8 + S
2.0 TDI	105	05/13→				24.0310-0356.1 510356	Ø 272 9,7 8 + S
2.0 TDI	110	10/12→					
2.0 TDI	135	09/12→	➔	+PR 1KF,1KJ,1KW,1KY; + eFSB		24.0122-0219.1 422219	Ø 310 22 20 V
1.2 TSI	77	01/13→	➔	+PR 1ZF,1ZH		24.0124-0258.1 424258	Ø 276 24 21 V + S
			➔	+PR 1ZE		24.0125-0145.1 425145	Ø 288 25 22 V + S
						24.0325-0145.1 525145	Ø 288 25 22 V + S
			➔	+PR 1ZA		24.0125-0158.1 425158	Ø 312 25 22 V + S
						24.0325-0158.1 525158	Ø 312 25 22 V + S
			➔	+PR 1LJ,1LG		24.0130-0225.1 430225	Ø 340 30 27 V + S
			➔	+PR 1KD		24.0110-0277.1 410277	Ø 253 10 8 + S



	kw			 	! #		
<b>SEAT - LEON (5F1) 09/12→</b>							
 <b>Bremsscheibe</b>							
1.2 TSI	77	01/13→	➡	+PR 1KD	24.0310-0277.1	510277	Ø 253 10 8 + S
			➡	+PR 1KS,1KE	24.0110-0356.1	410356	Ø 272 9,7 8 + S
			➡	+PR 1KF,1KJ,1KW,1KY; + eFSB	24.0310-0356.1	510356	Ø 272 9,7 8 + S
1.4 TGI	81	02/13→	⬅	10/13→; +PR 1ZF,1ZH	24.0124-0258.1	424258	Ø 276 24 21 V + S
			⬅	10/13→; +PR 1ZE	24.0125-0145.1	425145	Ø 288 25 22 V + S
			⬅	10/13→; +PR 1ZA	24.0325-0145.1	525145	Ø 288 25 22 V + S
			⬅	10/13→; +PR 1ZA	24.0125-0158.1	425158	Ø 312 25 22 V + S
			⬅	10/13→; +PR 1ZA	24.0325-0158.1	525158	Ø 312 25 22 V + S
			⬅	10/13→; +PR 1LG	24.0130-0225.1	430225	Ø 340 30 27 V + S
			➡	10/13→	24.0110-0277.1	410277	Ø 253 10 8 + S
			➡	10/13→	24.0310-0277.1	510277	Ø 253 10 8 + S
1.6 TDI	85	11/16→	➡	10/13→; +PR 1KS,1KE	24.0110-0356.1	410356	Ø 272 9,7 8 + S
			➡	10/13→; +PR 1KS,1KE	24.0310-0356.1	510356	Ø 272 9,7 8 + S
			➡	10/13→; +PR 1KF,1KJ,1KW,1KY; + eFSB	24.0122-0219.1	422219	Ø 310 22 20 V
			⬅	01/17→; +PR 1ZF,1ZH	24.0124-0258.1	424258	Ø 276 24 21 V + S
			⬅	01/17→; +PR 1ZE	24.0125-0145.1	425145	Ø 288 25 22 V + S
			⬅	01/17→; +PR 1ZE	24.0325-0145.1	525145	Ø 288 25 22 V + S
			⬅	01/17→; +PR 1ZA	24.0125-0158.1	425158	Ø 312 25 22 V + S
			⬅	01/17→; +PR 1ZA	24.0325-0158.1	525158	Ø 312 25 22 V + S
2.0 Cupra 2.0 Cupra 2.0 Cupra	195 206 213	10/13→ 10/13→ 10/15→	➡	01/17→; +PR 1KD	24.0110-0277.1	410277	Ø 253 10 8 + S
			➡	01/17→; +PR 1KD	24.0310-0277.1	510277	Ø 253 10 8 + S
			➡	+PR 1KS,1KE	24.0110-0356.1	410356	Ø 272 9,7 8 + S
			➡	+PR 1KS,1KE	24.0310-0356.1	510356	Ø 272 9,7 8 + S
			➡	01/17→; +PR 1KF,1KJ,1KW,1KY; + eFSB	24.0122-0219.1	422219	Ø 310 22 20 V
			⬅	+PR 1ZF,1ZH	24.0124-0258.1	424258	Ø 276 24 21 V + S
			⬅	+PR 1ZE	24.0125-0145.1	425145	Ø 288 25 22 V + S
			⬅	+PR 1ZE	24.0325-0145.1	525145	Ø 288 25 22 V + S
2.0 Cupra 2.0 Cupra R	221 228	01/17→ 11/17→	⬅	+PR 1ZA	24.0125-0158.1	425158	Ø 312 25 22 V + S
			⬅	+PR 1ZA	24.0325-0158.1	525158	Ø 312 25 22 V + S
			⬅	+PR 1LJ	24.0130-0225.1	430225	Ø 340 30 27 V + S
			➡	+PR 1KD	24.0110-0277.1	410277	Ø 253 10 8 + S
			➡	+PR 1KS,1KE	24.0110-0356.1	410356	Ø 272 9,7 8 + S
			➡	+PR 1KS,1KE	24.0310-0356.1	510356	Ø 272 9,7 8 + S
			➡	+PR 1KF,1KJ,1KW,1KY; + eFSB	24.0122-0219.1	422219	Ø 310 22 20 V
			➡	+PR 1KF,1KJ,1KW,1KY; + eFSB	24.0122-0219.1	422219	Ø 310 22 20 V
<b>SEAT - LEON Kasten/Schrägheck (5F1) 09/12→</b>							
 <b>Bremsbelagsatz, Scheibenbremse</b>							
1.0 TSI	85	05/15→	⬅	+PR 1ZA,1ZE	13.0460-2785.2	602785	TRW 25683 20,4 + WE / + WK
1.2 TSI	63	01/13→			13.0470-2785.2	LD2785	TRW 25683 20,4 + WE / + WK
1.2 TSI	81	04/14→					Ceramic
1.4 TSI	90	09/12→10/16			13.0460-7303.2	607303	ATE 22035 17,5 + WK
1.4 TSI	103	09/12→10/16	⬅	+PR 1ZF,1ZH	13.0470-7303.2	LD7303	ATE 22035 17,5 + WK Ceramic
1.4 TSI	110	05/14→					
1.6 TDI	66	11/12→10/16			13.0460-2749.2	602749	TRW 24483 16,9 - WE / - WK
1.6 TDI	77	09/12→10/16	➡	+PR 1KF,1KW			+ Zub
1.6 TDI	81	09/13→10/16			13.0460-2880.2	602880	TRW 23914 17,1 + WE / - WK
1.8 TFSI	132	02/13→					+ Zub
2.0 TDI	110	10/12→			13.0470-2749.2	LD2749	TRW 24483 16,9 - WE / - WK
2.0 TDI	135	02/13→					+ Zub Ceramic
↓							

	kw			 	! #		
<b>SEAT - LEON Kasten/Schrägheck (5F1) 09/12→</b>							
<b> Bremsbelagsatz, Scheibenbremse</b>							
1.0 TSI	85	05/15→	➡	+PR 1KF,1KW		13.0470-2880.2 LD2880	TRW 23914 17,1 + WE / - WK + Zub Ceramic
1.2 TSI	63	01/13→					
1.2 TSI	81	04/14→					
1.4 TSI	90	09/12→10/16	➡	+PR 1KD		13.0460-2787.2 602787	TRW 23554 17,3 - WK / - WE
1.4 TSI	103	09/12→10/16	➡	+PR 1KS		13.0460-2790.2 602790	TRW 25110 17,5 - WE / - WK
1.4 TSI	110	05/14→				13.0470-2790.2 LD2790	TRW 25110 17,5 - WE / - WK Ceramic
1.6 TDI	66	11/12→10/16					
1.6 TDI	77	09/12→10/16					
1.6 TDI	81	09/13→10/16	➡	+PR 1KE		13.0460-7293.2 607293	ATE 25008 16,3 - WE / - WK
1.8 TFSI	132	02/13→				13.0470-7293.2 LD7293	ATE 25008 16,3 - WE / - WK Ceramic
2.0 TDI	110	10/12→					
2.0 TDI	135	02/13→	➡	+PR 1KJ,1KY; + eFSB		13.0460-7294.2 607294	ATE 25009 16,4 - WE / - WK Ceramic
						13.0470-7294.2 LD7294	ATE 25009 16,4 - WE / - WK Ceramic
1.6 TDI	85	11/16→	⬅	01/17→; +PR 1ZA,1ZE		13.0460-2785.2 602785	TRW 25683 20,4 + WE / + WK
						13.0470-2785.2 LD2785	TRW 25683 20,4 + WE / + WK Ceramic
			⬅	01/17→; +PR 1ZF,1ZH		13.0460-7303.2 607303	ATE 22035 17,5 + WK
						13.0470-7303.2 LD7303	ATE 22035 17,5 + WK Ceramic
			➡	01/17→; +PR 1KD		13.0460-2787.2 602787	TRW 23554 17,3 - WK / - WE
			➡	01/17→; +PR 1KS		13.0460-2790.2 602790	TRW 25110 17,5 - WE / - WK
						13.0470-2790.2 LD2790	TRW 25110 17,5 - WE / - WK Ceramic
			➡	01/17→; +PR 1KE		13.0460-7293.2 607293	ATE 25008 16,3 - WE / - WK
						13.0470-7293.2 LD7293	ATE 25008 16,3 - WE / - WK Ceramic
			➡	01/17→; +PR 1KJ,1KY; + eFSB		13.0460-7294.2 607294	ATE 25009 16,4 - WE / - WK
						13.0470-7294.2 LD7294	ATE 25009 16,4 - WE / - WK Ceramic
2.0 Cupra	213	09/15→10/16	⬅	+PR 1ZA,1ZE		13.0460-2785.2 602785	TRW 25683 20,4 + WE / + WK
2.0 Cupra	221	01/17→				13.0470-2785.2 LD2785	TRW 25683 20,4 + WE / + WK Ceramic
			⬅	+ Performance Pack		13.0460-4833.2 604833	BRE 24098 17,1 + WE / - WK
						13.0470-4833.2 LD4833	BRE 24098 17,1 + WE / - WK Ceramic
			⬅	+PR 1ZF,1ZH		13.0460-7303.2 607303	ATE 22035 17,5 + WK
						13.0470-7303.2 LD7303	ATE 22035 17,5 + WK Ceramic
			➡	+PR 1KF,1KW		13.0460-2749.2 602749	TRW 24483 16,9 - WE / - WK + Zub
						13.0460-2880.2 602880	TRW 23914 17,1 + WE / - WK + Zub
						13.0470-2749.2 LD2749	TRW 24483 16,9 - WE / - WK + Zub Ceramic
						13.0470-2880.2 LD2880	TRW 23914 17,1 + WE / - WK + Zub Ceramic
			➡	+PR 1KD		13.0460-2787.2 602787	TRW 23554 17,3 - WK / - WE
			➡	+PR 1KS		13.0460-2790.2 602790	TRW 25110 17,5 - WE / - WK
						13.0470-2790.2 LD2790	TRW 25110 17,5 - WE / - WK Ceramic
			➡	+PR 1KE		13.0460-7293.2 607293	ATE 25008 16,3 - WE / - WK
						13.0470-7293.2 LD7293	ATE 25008 16,3 - WE / - WK Ceramic
			➡	+PR 1KJ,1KY; + eFSB		13.0460-7294.2 607294	ATE 25009 16,4 - WE / - WK
						13.0470-7294.2 LD7294	ATE 25009 16,4 - WE / - WK Ceramic
<b>Warnkontakt, Bremsbelagverschleiß</b>							
1.0 TSI	85	05/15→	⬅	+PR 1ZA,1ZE	1	24.8190-0065.2 620065	L= 172
1.2 TSI	63	01/13→					
1.2 TSI	81	04/14→					
1.4 TSI	90	09/12→10/16					
1.4 TSI	103	09/12→10/16					
1.4 TSI	110	05/14→					
1.6 TDI	66	11/12→10/16					
1.6 TDI	77	09/12→10/16					
1.6 TDI	81	09/13→10/16					
1.8 TFSI	132	02/13→					
2.0 TDI	110	10/12→					
2.0 TDI	135	02/13→					
1.6 TDI	85	11/16→	⬅	01/17→; +PR 1ZA,1ZE	1	24.8190-0065.2 620065	L= 172
↓							



**SEAT - LEON Kasten/Schrägheck (5F1) 09/12→**

**Warnkontakt, Bremsbelagverschleiß**

2.0 Cupra	213	09/15→10/16	←	+PR 1ZA,1ZE	1	24.8190-0065.2	620065	L= 172
2.0 Cupra	221	01/17→	←	+ Performance Pack	1	24.8190-0302.2	620302	L= 367,4

**Bremsscheibe**









1.0 TSI	85	05/15→	←	+PR 1ZF,1ZH		24.0124-0258.1	424258	Ø 276 24 21 V + S
1.2 TSI	63	01/13→	←	+PR 1ZE		24.0125-0145.1	425145	Ø 288 25 22 V + S
1.2 TSI	81	04/14→	←			24.0325-0145.1	525145	Ø 288 25 22 V + S
1.4 TSI	90	09/12→10/16	←	+PR 1ZA		24.0125-0158.1	425158	Ø 312 25 22 V + S
1.4 TSI	103	09/12→10/16	←			24.0325-0158.1	525158	Ø 312 25 22 V + S
1.4 TSI	110	05/14→	←			24.0130-0225.1	430225	Ø 340 30 27 V + S
1.6 TDI	66	11/12→10/16	←	+PR 1LG		24.0110-0277.1	410277	Ø 253 10 8 + S
1.6 TDI	77	09/12→10/16	←			24.0310-0277.1	510277	Ø 253 10 8 + S
1.6 TDI	81	09/13→10/16	→	+PR 1KD		24.0110-0356.1	410356	Ø 272 9,7 8 + S
1.8 TFSI	132	02/13→	→			24.0310-0356.1	510356	Ø 272 9,7 8 + S
2.0 TDI	110	10/12→	→	+PR 1KS,1KE		24.0122-0219.1	422219	Ø 310 22 20 V
2.0 TDI	135	02/13→	→			24.0110-0356.1	410356	Ø 272 9,7 8 + S
			→	+PR 1KF,1KJ,1KW,1KY; + eFSB		24.0122-0219.1	422219	Ø 310 22 20 V
1.6 TDI	85	11/16→	←	01/17→; +PR 1ZF,1ZH		24.0125-0145.1	425145	Ø 288 25 22 V + S
			←	01/17→; +PR 1ZE		24.0325-0145.1	525145	Ø 288 25 22 V + S
			←	01/17→; +PR 1ZA		24.0125-0158.1	425158	Ø 312 25 22 V + S
			←			24.0325-0158.1	525158	Ø 312 25 22 V + S
			→	01/17→; +PR 1KD		24.0110-0277.1	410277	Ø 253 10 8 + S
			→			24.0310-0277.1	510277	Ø 253 10 8 + S
			→	+PR 1KS,1KE		24.0110-0356.1	410356	Ø 272 9,7 8 + S
			→			24.0310-0356.1	510356	Ø 272 9,7 8 + S
			→	01/17→; +PR 1KF,1KJ,1KW,1KY; + eFSB		24.0122-0219.1	422219	Ø 310 22 20 V
2.0 Cupra	213	09/15→10/16	←	+PR 1ZF,1ZH		24.0124-0258.1	424258	Ø 276 24 21 V + S
2.0 Cupra	221	01/17→	←	+PR 1ZE		24.0125-0145.1	425145	Ø 288 25 22 V + S
			←			24.0325-0145.1	525145	Ø 288 25 22 V + S
			←	+PR 1ZA		24.0125-0158.1	425158	Ø 312 25 22 V + S
			←			24.0325-0158.1	525158	Ø 312 25 22 V + S
			←	+PR 1LJ		24.0130-0225.1	430225	Ø 340 30 27 V + S
			→	+PR 1KD		24.0110-0277.1	410277	Ø 253 10 8 + S
			→	+PR 1KS,1KE		24.0110-0356.1	410356	Ø 272 9,7 8 + S
			→			24.0310-0356.1	510356	Ø 272 9,7 8 + S
			→	+PR 1KF,1KJ,1KW,1KY; + eFSB		24.0122-0219.1	422219	Ø 310 22 20 V









**SEAT - LEON SC (5F5) 01/13→**

**Bremsbelagsatz, Scheibenbremse**

1.0 TSI	85	05/15→	←	+PR 1ZA,1ZE		13.0460-2785.2	602785	TRW 25683 20,4 + WE / + WK
1.2 TSI	63	01/13→	←			13.0470-2785.2	LD2785	TRW 25683 20,4 + WE / + WK Ceramic
1.2 TSI	77	02/13→	←	+PR 1ZF,1ZH		13.0460-7303.2	607303	ATE 22035 17,5 + WK
1.2 TSI	81	05/14→	←			13.0470-7303.2	LD7303	ATE 22035 17,5 + WK Ceramic
1.4 TSI	90	02/13→	←			13.0460-2749.2	602749	TRW 24483 16,9 - WE / - WK + Zub
1.4 TSI	92	05/14→	←			13.0460-2880.2	602880	TRW 23914 17,1 + WE / - WK + Zub
1.4 TSI	103	02/13→	→	+PR 1KF,1KW		13.0470-2749.2	LD2749	TRW 24483 16,9 - WE / - WK + Zub Ceramic
1.4 TSI	110	05/14→	→			13.0470-2880.2	LD2880	TRW 23914 17,1 + WE / - WK + Zub Ceramic
1.6 TDI	66	02/13→	→			13.0460-2787.2	602787	TRW 23554 17,3 - WK / - WE
1.6 TDI	77	02/13→	→	+PR 1KS		13.0460-2790.2	602790	TRW 25110 17,5 - WE / - WK Ceramic
1.6 TDI	81	09/13→	→			13.0470-2790.2	LD2790	TRW 25110 17,5 - WE / - WK Ceramic
1.8 TSI	132	02/13→	→	+PR 1KE		13.0460-7293.2	607293	ATE 25008 16,3 - WE / - WK Ceramic
2.0 TDI	105	05/13→	→			13.0470-7293.2	LD7293	ATE 25008 16,3 - WE / - WK Ceramic
2.0 TDI	110	02/13→	→			13.0460-7294.2	607294	ATE 25009 16,4 - WE / - WK Ceramic
2.0 TDI	135	03/13→	→	+PR 1KJ,1KY; + eFSB		13.0470-7294.2	LD7294	ATE 25009 16,4 - WE / - WK Ceramic

↓

	kw			 	! #		
<b>SEAT - LEON SC (5F5) 01/13→</b>							
<b> Bremsbelagsatz, Scheibenbremse</b>							
1.6 TDI	85	11/16→	←	01/17→; +PR 1ZA,1ZE	13.0460-2785.2	602785	TRW 25683 20,4 + WE / + WK
					13.0470-2785.2	LD2785	TRW 25683 20,4 + WE / + WK Ceramic
			←	01/17→; +PR 1ZF,1ZH	13.0460-7303.2	607303	ATE 22035 17,5 + WK
					13.0470-7303.2	LD7303	ATE 22035 17,5 + WK Ceramic
			→	01/17→; +PR 1KD	13.0460-2787.2	602787	TRW 23554 17,3 - WK / - WE
					13.0460-2790.2	602790	TRW 25110 17,5 - WE / - WK
		13.0470-2790.2	LD2790	TRW 25110 17,5 - WE / - WK Ceramic			
		→	01/17→; +PR 1KS	13.0460-2790.2	602790	TRW 25110 17,5 - WE / - WK	
				13.0470-2790.2	LD2790	TRW 25110 17,5 - WE / - WK Ceramic	
		→	01/17→; +PR 1KE	13.0460-7293.2	607293	ATE 25008 16,3 - WE / - WK	
				13.0470-7293.2	LD7293	ATE 25008 16,3 - WE / - WK Ceramic	
		→	01/17→; +PR 1KJ,1KY; + eFSB	13.0460-7294.2	607294	ATE 25009 16,4 - WE / - WK	
				13.0470-7294.2	LD7294	ATE 25009 16,4 - WE / - WK Ceramic	
2.0 Cupra 2.0 Cupra 2.0 Cupra	195 206 213	10/13→ 10/13→ 10/15→	←	+PR 1ZA,1ZE	13.0460-2785.2	602785	TRW 25683 20,4 + WE / + WK
					13.0470-2785.2	LD2785	TRW 25683 20,4 + WE / + WK Ceramic
			←	+ Performance Pack	13.0460-4833.2	604833	BRE 24098 17,1 + WE / - WK
					13.0470-4833.2	LD4833	BRE 24098 17,1 + WE / - WK Ceramic
			←	+PR 1ZF,1ZH	13.0460-7303.2	607303	ATE 22035 17,5 + WK
					13.0470-7303.2	LD7303	ATE 22035 17,5 + WK Ceramic
			→	+PR 1KF,1KW	13.0460-2749.2	602749	TRW 24483 16,9 - WE / - WK + Zub
					13.0460-2880.2	602880	TRW 23914 17,1 + WE / - WK + Zub
		13.0470-2749.2	LD2749	TRW 24483 16,9 - WE / - WK + Zub Ceramic			
		13.0470-2880.2	LD2880	TRW 23914 17,1 + WE / - WK + Zub Ceramic			
		→	+PR 1KD	13.0460-2787.2	602787	TRW 23554 17,3 - WK / - WE	
		→	+PR 1KS	13.0460-2790.2	602790	TRW 25110 17,5 - WE / - WK	
				13.0470-2790.2	LD2790	TRW 25110 17,5 - WE / - WK Ceramic	
		→	+PR 1KE	13.0460-7293.2	607293	ATE 25008 16,3 - WE / - WK	
				13.0470-7293.2	LD7293	ATE 25008 16,3 - WE / - WK Ceramic	
		→	+PR 1KJ,1KY; + eFSB	13.0460-7294.2	607294	ATE 25009 16,4 - WE / - WK	
				13.0470-7294.2	LD7294	ATE 25009 16,4 - WE / - WK Ceramic	
2.0 Cupra	221	01/17→	←	+PR 1ZA,1ZE	13.0460-2785.2	602785	TRW 25683 20,4 + WE / + WK
					13.0470-2785.2	LD2785	TRW 25683 20,4 + WE / + WK Ceramic
			←	+ Performance Pack	13.0460-4833.2	604833	BRE 24098 17,1 + WE / - WK
					13.0470-4833.2	LD4833	BRE 24098 17,1 + WE / - WK Ceramic
			←	+PR 1ZF,1ZH	13.0460-7303.2	607303	ATE 22035 17,5 + WK
					13.0470-7303.2	LD7303	ATE 22035 17,5 + WK Ceramic
			→	+PR 1KD	13.0460-2787.2	602787	TRW 23554 17,3 - WK / - WE
		→	+PR 1KS	13.0460-2790.2	602790	TRW 25110 17,5 - WE / - WK	
				13.0470-2790.2	LD2790	TRW 25110 17,5 - WE / - WK Ceramic	
		→	+PR 1KE	13.0460-7293.2	607293	ATE 25008 16,3 - WE / - WK	
				13.0470-7293.2	LD7293	ATE 25008 16,3 - WE / - WK Ceramic	
		→	+PR 1KJ,1KY; + eFSB	13.0460-7294.2	607294	ATE 25009 16,4 - WE / - WK	
				13.0470-7294.2	LD7294	ATE 25009 16,4 - WE / - WK Ceramic	
2.0 TDI	81	02/13→	←	05/13→; +PR 1ZA,1ZE	13.0460-2785.2	602785	TRW 25683 20,4 + WE / + WK
					13.0470-2785.2	LD2785	TRW 25683 20,4 + WE / + WK Ceramic
			←	05/13→; +PR 1ZF,1ZH	13.0460-7303.2	607303	ATE 22035 17,5 + WK
				13.0470-7303.2	LD7303	ATE 22035 17,5 + WK Ceramic	
		→	05/13→; +PR 1KF,1KW	13.0460-2749.2	602749	TRW 24483 16,9 - WE / - WK + Zub	

	kw			 	! #		
<b>SEAT - LEON SC (5F5) 01/13→</b>							
<b> Bremsbelagsatz, Scheibenbremse</b>							
2.0 TDI	81	02/13→	➡	05/13→; +PR 1KF,1KW		13.0460-2880.2 602880 13.0470-2749.2 LD2749 13.0470-2880.2 LD2880	TRW 23914 17,1 + WE / - WK + Zub TRW 24483 16,9 - WE / - WK + Zub Ceramic TRW 23914 17,1 + WE / - WK + Zub Ceramic
			➡	05/13→; +PR 1KD		13.0460-2787.2 602787	TRW 23554 17,3 - WK / - WE
			➡	05/13→; +PR 1KS		13.0460-2790.2 602790 13.0470-2790.2 LD2790	TRW 25110 17,5 - WE / - WK TRW 25110 17,5 - WE / - WK Ceramic
			➡	05/13→; +PR 1KE		13.0460-7293.2 607293 13.0470-7293.2 LD7293	ATE 25008 16,3 - WE / - WK ATE 25008 16,3 - WE / - WK Ceramic
			➡	05/13→; +PR 1KJ,1KY; + eFSB		13.0460-7294.2 607294 13.0470-7294.2 LD7294	ATE 25009 16,4 - WE / - WK ATE 25009 16,4 - WE / - WK Ceramic
<b>Warnkontakt, Bremsbelagverschleiß</b>							
1.0 TSI	85	05/15→	←	+PR 1ZA,1ZE	1	24.8190-0065.2 620065	L= 172
1.2 TSI	63	01/13→					
1.2 TSI	77	02/13→					
1.2 TSI	81	05/14→					
1.4 TSI	90	02/13→					
1.4 TSI	92	05/14→					
1.4 TSI	103	02/13→					
1.4 TSI	110	05/14→					
1.6 TDI	66	02/13→					
1.6 TDI	77	02/13→					
1.6 TDI	81	09/13→					
1.8 TSI	132	02/13→					
2.0 TDI	105	05/13→					
2.0 TDI	110	02/13→					
2.0 TDI	135	03/13→					
1.6 TDI	85	11/16→	←	01/17→; +PR 1ZA,1ZE	1	24.8190-0065.2 620065	L= 172
2.0 Cupra	195	10/13→	←	+PR 1ZA,1ZE	1	24.8190-0065.2 620065	L= 172
2.0 Cupra	206	10/13→					
2.0 Cupra	213	10/15→	←	+ Performance Pack	1	24.8190-0302.2 620302	L= 367,4
2.0 Cupra	221	01/17→					
2.0 TDI	81	02/13→	←	05/13→; +PR 1ZA,1ZE	1	24.8190-0065.2 620065	L= 172
<b> Bremsscheibe</b>							
1.0 TSI	85	05/15→	←	+PR 1ZF,1ZH		24.0124-0258.1 424258	Ø 276 24 21 V + S
1.2 TSI	63	01/13→					
1.2 TSI	81	05/14→	←	+PR 1ZE		24.0125-0145.1 425145	Ø 288 25 22 V + S
1.4 TSI	90	02/13→				24.0325-0145.1 525145	Ø 288 25 22 V + S
1.4 TSI	92	05/14→					
1.4 TSI	103	02/13→	←	+PR 1ZA		24.0125-0158.1 425158	Ø 312 25 22 V + S
1.4 TSI	110	05/14→				24.0325-0158.1 525158	Ø 312 25 22 V + S
1.6 TDI	66	02/13→	←	+PR 1LG		24.0130-0225.1 430225	Ø 340 30 27 V + S
1.6 TDI	77	02/13→					
1.6 TDI	81	09/13→	➡	+PR 1KD		24.0110-0277.1 410277	Ø 253 10 8 + S
1.8 TSI	132	02/13→				24.0310-0277.1 510277	Ø 253 10 8 + S
2.0 TDI	105	05/13→	➡	+PR 1KS,1KE		24.0110-0356.1 410356	Ø 272 9,7 8 + S
2.0 TDI	110	02/13→				24.0310-0356.1 510356	Ø 272 9,7 8 + S
2.0 TDI	135	03/13→	➡	+PR 1KF,1KJ,1KW,1KY; + eFSB		24.0122-0219.1 422219	Ø 310 22 20 V
1.2 TSI	77	02/13→	←	+PR 1ZF,1ZH		24.0124-0258.1 424258	Ø 276 24 21 V + S
			←	+PR 1ZE		24.0125-0145.1 425145	Ø 288 25 22 V + S
						24.0325-0145.1 525145	Ø 288 25 22 V + S
			←	+PR 1ZA		24.0125-0158.1 425158	Ø 312 25 22 V + S
						24.0325-0158.1 525158	Ø 312 25 22 V + S
			←	+PR 1LJ,1LG		24.0130-0225.1 430225	Ø 340 30 27 V + S
			➡	+PR 1KD		24.0110-0277.1 410277	Ø 253 10 8 + S
						24.0310-0277.1 510277	Ø 253 10 8 + S
			➡	+PR 1KS,1KE		24.0110-0356.1 410356	Ø 272 9,7 8 + S
						24.0310-0356.1 510356	Ø 272 9,7 8 + S
			➡	+PR 1KF,1KJ,1KW,1KY; + eFSB		24.0122-0219.1 422219	Ø 310 22 20 V
1.6 TDI	85	11/16→	←	01/17→; +PR 1ZF,1ZH		24.0124-0258.1 424258	Ø 276 24 21 V + S
			←	01/17→; +PR 1ZE		24.0125-0145.1 425145	Ø 288 25 22 V + S
						24.0325-0145.1 525145	Ø 288 25 22 V + S

**SEAT - LEON SC (5F5) 01/13→**









**Bremsscheibe**

1.6 TDI	85	11/16→	←	01/17→; +PR 1ZA	24.0125-0158.1 425158	Ø 312 25 22 V + S
					24.0325-0158.1 525158	Ø 312 25 22 V + S
			→	01/17→; +PR 1KD	24.0110-0277.1 410277	Ø 253 10 8 + S
					24.0310-0277.1 510277	Ø 253 10 8 + S
			→	01/17→; +PR 1KS,1KE	24.0110-0356.1 410356	Ø 272 9,7 8 + S
					24.0310-0356.1 510356	Ø 272 9,7 8 + S
			→	01/17→; +PR 1KF,1KJ,1KW,1KY; + eFSB	24.0122-0219.1 422219	Ø 310 22 20 V
2.0 Cupra 2.0 Cupra 2.0 Cupra	195 206 213	10/13→ 10/13→ 10/15→	←	+PR 1ZF,1ZH	24.0124-0258.1 424258	Ø 276 24 21 V + S
			←	+PR 1ZE	24.0125-0145.1 425145	Ø 288 25 22 V + S
					24.0325-0145.1 525145	Ø 288 25 22 V + S
			←	+PR 1ZA	24.0125-0158.1 425158	Ø 312 25 22 V + S
					24.0325-0158.1 525158	Ø 312 25 22 V + S
			←	+PR 1LJ	24.0130-0225.1 430225	Ø 340 30 27 V + S
			→	+PR 1KD	24.0110-0277.1 410277	Ø 253 10 8 + S
			→	+PR 1KS,1KE	24.0110-0356.1 410356	Ø 272 9,7 8 + S
					24.0310-0356.1 510356	Ø 272 9,7 8 + S
			→	+PR 1KF,1KJ,1KW,1KY; + eFSB	24.0122-0219.1 422219	Ø 310 22 20 V
			←	+PR 1ZF,1ZH	24.0124-0258.1 424258	Ø 276 24 21 V + S
			←	+PR 1ZE	24.0125-0145.1 425145	Ø 288 25 22 V + S
					24.0325-0145.1 525145	Ø 288 25 22 V + S
			←	+PR 1ZA	24.0125-0158.1 425158	Ø 312 25 22 V + S
					24.0325-0158.1 525158	Ø 312 25 22 V + S
			→	+PR 1KD	24.0110-0277.1 410277	Ø 253 10 8 + S
2.0 Cupra	221	01/17→	→	+PR 1KS,1KE	24.0110-0356.1 410356	Ø 272 9,7 8 + S
					24.0310-0356.1 510356	Ø 272 9,7 8 + S
			→	+PR 1KF,1KJ,1KW,1KY; + eFSB	24.0122-0219.1 422219	Ø 310 22 20 V
			←	+PR 1ZF,1ZH	24.0124-0258.1 424258	Ø 276 24 21 V + S
			←	+PR 1ZE	24.0125-0145.1 425145	Ø 288 25 22 V + S
					24.0325-0145.1 525145	Ø 288 25 22 V + S
			←	+PR 1ZA	24.0125-0158.1 425158	Ø 312 25 22 V + S
					24.0325-0158.1 525158	Ø 312 25 22 V + S
2.0 TDI	81	02/13→	→	+PR 1KD	24.0110-0277.1 410277	Ø 253 10 8 + S
					24.0310-0277.1 510277	Ø 253 10 8 + S
			→	+PR 1KS,1KE	24.0110-0356.1 410356	Ø 272 9,7 8 + S
					24.0310-0356.1 510356	Ø 272 9,7 8 + S
			→	+PR 1KF,1KJ,1KW,1KY; + eFSB	24.0122-0219.1 422219	Ø 310 22 20 V
			←	05/13→; +PR 1ZF,1ZH	24.0124-0258.1 424258	Ø 276 24 21 V + S
			←	05/13→; +PR 1ZE	24.0125-0145.1 425145	Ø 288 25 22 V + S
					24.0325-0145.1 525145	Ø 288 25 22 V + S
			←	05/13→; +PR 1ZA	24.0125-0158.1 425158	Ø 312 25 22 V + S
					24.0325-0158.1 525158	Ø 312 25 22 V + S
			←	05/13→; +PR 1LG	24.0130-0225.1 430225	Ø 340 30 27 V + S
			→	05/13→; +PR 1KD	24.0110-0277.1 410277	Ø 253 10 8 + S
					24.0310-0277.1 510277	Ø 253 10 8 + S
			→	05/13→; +PR 1KS,1KE	24.0110-0356.1 410356	Ø 272 9,7 8 + S
					24.0310-0356.1 510356	Ø 272 9,7 8 + S
			→	05/13→; +PR 1KF,1KJ,1KW,1KY; + eFSB	24.0122-0219.1 422219	Ø 310 22 20 V

**SEAT - LEON ST (5F8) 08/13→**









**Bremsbelagsatz, Scheibenbremse**

1.0 TSI	85	05/15→	←	+PR 1ZA,1ZE	13.0460-2785.2 602785	TRW 25683 20,4 + WE / + WK
1.2 TSI	63	11/13→			13.0470-2785.2 LD2785	TRW 25683 20,4 + WE / + WK Ceramic
1.2 TSI	77	08/13→				
1.2 TSI	81	05/14→	←	+PR 1ZF,1ZH	13.0460-7303.2 607303	ATE 22035 17,5 + WK
1.4 TGI	81	10/13→			13.0470-7303.2 LD7303	ATE 22035 17,5 + WK Ceramic
1.4 TSI	90	10/13→	→	+PR 1KF,1KW	13.0460-2749.2 602749	TRW 24483 16,9 - WE / - WK + Zub
1.4 TSI	92	05/14→				
1.4 TSI	103	10/13→				
1.4 TSI	110	05/14→				
1.6 TDI	66	11/13→			13.0460-2880.2 602880	TRW 23914 17,1 + WE / - WK + Zub
1.6 TDI	77	10/13→				
1.6 TDI	81	09/13→			13.0470-2749.2 LD2749	TRW 24483 16,9 - WE / - WK + Zub Ceramic
1.6 TDI 4Drive	77	04/14→				
1.6 TDI 4Drive	81	11/14→			13.0470-2880.2 LD2880	TRW 23914 17,1 + WE / - WK + Zub Ceramic
1.8 TSI	132	10/13→				
1.8 TSI 4Drive	132	11/14→				
2.0 TDI	81	11/13→	→	+PR 1KD	13.0460-2787.2 602787	TRW 23554 17,3 - WK / - WE
2.0 TDI	105	10/13→				
2.0 TDI	110	10/13→	→	+PR 1KS	13.0460-2790.2 602790	TRW 25110 17,5 - WE / - WK
2.0 TDI	135	08/13→			13.0470-2790.2 LD2790	TRW 25110 17,5 - WE / - WK Ceramic
2.0 TDI 4Drive	110	04/14→				
2.0 TDI 4Drive	135	11/14→	→	+PR 1KE	13.0460-7293.2 607293	ATE 25008 16,3 - WE / - WK
					13.0470-7293.2 LD7293	ATE 25008 16,3 - WE / - WK Ceramic







	kw			 	! #		
<b>SEAT - LEON ST (5F8) 08/13→</b>							
<b> Bremsbelagsatz, Scheibenbremse</b>							
1.0 TSI	85	05/15→	➔	+PR 1KJ,1KY; + eFSB		<b>13.0460-7294.2 607294</b>	ATE 25009 16,4 - WE / - WK
1.2 TSI	63	11/13→				<b>13.0470-7294.2 LD7294</b>	ATE 25009 16,4 - WE / - WK
1.2 TSI	77	08/13→					Ceramic
1.2 TSI	81	05/14→					
1.4 TGI	81	10/13→					
1.4 TSI	90	10/13→					
1.4 TSI	92	05/14→					
1.4 TSI	103	10/13→					
1.4 TSI	110	05/14→					
1.6 TDI	66	11/13→					
1.6 TDI	77	10/13→					
1.6 TDI	81	09/13→					
1.6 TDI 4Drive	77	04/14→					
1.6 TDI 4Drive	81	11/14→					
1.8 TSI	132	10/13→					
1.8 TSI 4Drive	132	11/14→					
2.0 TDI	81	11/13→					
2.0 TDI	105	10/13→					
2.0 TDI	110	10/13→					
2.0 TDI	135	08/13→					
2.0 TDI 4Drive	110	04/14→					
2.0 TDI 4Drive	135	11/14→					
1.6 TDI	85	11/16→	➔	01/17→; +PR 1ZA,1ZE		<b>13.0460-2785.2 602785</b>	TRW 25683 20,4 + WE / + WK
						<b>13.0470-2785.2 LD2785</b>	TRW 25683 20,4 + WE / + WK
							Ceramic
			➔	01/17→; +PR 1ZF,1ZH		<b>13.0460-7303.2 607303</b>	ATE 22035 17,5 + WK
						<b>13.0470-7303.2 LD7303</b>	ATE 22035 17,5 + WK Ceramic
			➔	01/17→; +PR 1KD		<b>13.0460-2787.2 602787</b>	TRW 23554 17,3 - WK / - WE
			➔	01/17→; +PR 1KS		<b>13.0460-2790.2 602790</b>	TRW 25110 17,5 - WE / - WK
						<b>13.0470-2790.2 LD2790</b>	TRW 25110 17,5 - WE / - WK
							Ceramic
			➔	01/17→; +PR 1KE		<b>13.0460-7293.2 607293</b>	ATE 25008 16,3 - WE / - WK
						<b>13.0470-7293.2 LD7293</b>	ATE 25008 16,3 - WE / - WK
							Ceramic
			➔	01/17→; +PR 1KJ,1KY; + eFSB		<b>13.0460-7294.2 607294</b>	ATE 25009 16,4 - WE / - WK
						<b>13.0470-7294.2 LD7294</b>	ATE 25009 16,4 - WE / - WK
							Ceramic
2.0 Cupra	195	10/13→	➔	+PR 1ZA,1ZE		<b>13.0460-2785.2 602785</b>	TRW 25683 20,4 + WE / + WK
2.0 Cupra	206	10/13→				<b>13.0470-2785.2 LD2785</b>	TRW 25683 20,4 + WE / + WK
2.0 Cupra	213	10/15→					Ceramic
			➔	+ Performance Pack		<b>13.0460-4833.2 604833</b>	BRE 24098 17,1 + WE / - WK
						<b>13.0470-4833.2 LD4833</b>	BRE 24098 17,1 + WE / - WK
							Ceramic
			➔	+PR 1ZF,1ZH		<b>13.0460-7303.2 607303</b>	ATE 22035 17,5 + WK
						<b>13.0470-7303.2 LD7303</b>	ATE 22035 17,5 + WK Ceramic
			➔	+PR 1KF,1KW		<b>13.0460-2749.2 602749</b>	TRW 24483 16,9 - WE / - WK
						<b>13.0460-2880.2 602880</b>	TRW 23914 17,1 + WE / - WK
							+ Zub
						<b>13.0470-2749.2 LD2749</b>	TRW 24483 16,9 - WE / - WK
						<b>13.0470-2880.2 LD2880</b>	TRW 23914 17,1 + WE / - WK
							+ Zub Ceramic
			➔	+PR 1KD		<b>13.0460-2787.2 602787</b>	TRW 23554 17,3 - WK / - WE
			➔	+PR 1KS		<b>13.0460-2790.2 602790</b>	TRW 25110 17,5 - WE / - WK
						<b>13.0470-2790.2 LD2790</b>	TRW 25110 17,5 - WE / - WK
							Ceramic
			➔	+PR 1KE		<b>13.0460-7293.2 607293</b>	ATE 25008 16,3 - WE / - WK
						<b>13.0470-7293.2 LD7293</b>	ATE 25008 16,3 - WE / - WK
							Ceramic
			➔	+PR 1KJ,1KY; + eFSB		<b>13.0460-7294.2 607294</b>	ATE 25009 16,4 - WE / - WK
						<b>13.0470-7294.2 LD7294</b>	ATE 25009 16,4 - WE / - WK
							Ceramic
2.0 Cupra	221	11/16→	➔	+PR 1ZA,1ZE		<b>13.0460-2785.2 602785</b>	TRW 25683 20,4 + WE / + WK
2.0 Cupra 4Drive	221	11/16→				<b>13.0470-2785.2 LD2785</b>	TRW 25683 20,4 + WE / + WK
							Ceramic
			➔	+ Performance Pack		<b>13.0460-4833.2 604833</b>	BRE 24098 17,1 + WE / - WK
						<b>13.0470-4833.2 LD4833</b>	BRE 24098 17,1 + WE / - WK
							Ceramic
			➔	+PR 1ZF,1ZH		<b>13.0460-7303.2 607303</b>	ATE 22035 17,5 + WK
						<b>13.0470-7303.2 LD7303</b>	ATE 22035 17,5 + WK Ceramic





































	kw			 	! #		
<b>SEAT - LEON ST (5F8) 08/13→</b>							
<b> Bremsbelagsatz, Scheibenbremse</b>							
2.0 Cupra	221	11/16→	➡	+PR 1KD		13.0460-2787.2 602787	TRW 23554 17,3 - WK / - WE
2.0 Cupra 4Drive	221	11/16→	➡	+PR 1KS		13.0460-2790.2 602790 13.0470-2790.2 LD2790	TRW 25110 17,5 - WE / - WK TRW 25110 17,5 - WE / - WK Ceramic
			➡	+PR 1KE		13.0460-7293.2 607293 13.0470-7293.2 LD7293	ATE 25008 16,3 - WE / - WK ATE 25008 16,3 - WE / - WK Ceramic
			➡	+PR 1KJ,1KY; + eFSB		13.0460-7294.2 607294 13.0470-7294.2 LD7294	ATE 25009 16,4 - WE / - WK ATE 25009 16,4 - WE / - WK Ceramic
<b>Warnkontakt, Bremsbelagverschleiß</b>							
1.0 TSI	85	05/15→	←	+PR 1ZA,1ZE	1	24.8190-0065.2 620065	L= 172
1.2 TSI	63	11/13→					
1.2 TSI	77	08/13→					
1.2 TSI	81	05/14→					
1.4 TGI	81	10/13→					
1.4 TSI	90	10/13→					
1.4 TSI	92	05/14→					
1.4 TSI	103	10/13→					
1.4 TSI	110	05/14→					
1.6 TDI	66	11/13→					
1.6 TDI	77	10/13→					
1.6 TDI	81	09/13→					
1.6 TDI 4Drive	77	04/14→					
1.6 TDI 4Drive	81	11/14→					
1.8 TSI	132	10/13→					
1.8 TSI 4Drive	132	11/14→					
2.0 TDI	81	11/13→					
2.0 TDI	105	10/13→					
2.0 TDI	110	10/13→					
2.0 TDI	135	08/13→					
2.0 TDI 4Drive	110	04/14→					
2.0 TDI 4Drive	135	11/14→					
1.6 TDI	85	11/16→	←	01/17→; +PR 1ZA,1ZE	1	24.8190-0065.2 620065	L= 172
2.0 Cupra	195	10/13→	←	+PR 1ZA,1ZE	1	24.8190-0065.2 620065	L= 172
2.0 Cupra	206	10/13→					
2.0 Cupra	213	10/15→	←	+ Performance Pack	1	24.8190-0302.2 620302	L= 367,4
2.0 Cupra	221	11/16→					
2.0 Cupra 4Drive	221	11/16→					
<b> Bremsscheibe</b>							
1.0 TSI	85	05/15→	←	+PR 1ZF,1ZH		24.0124-0258.1 424258	Ø 276 24 21 V + S
1.2 TSI	63	11/13→					
1.2 TSI	81	05/14→	←	+PR 1ZE		24.0125-0145.1 425145	Ø 288 25 22 V + S
1.4 TSI	90	10/13→				24.0325-0145.1 525145	Ø 288 25 22 V + S
1.4 TSI	92	05/14→					
1.4 TSI	103	10/13→	←	+PR 1ZA		24.0125-0158.1 425158	Ø 312 25 22 V + S
1.4 TSI	110	05/14→				24.0325-0158.1 525158	Ø 312 25 22 V + S
1.6 TDI	66	11/13→	←	+PR 1LG		24.0130-0225.1 430225	Ø 340 30 27 V + S
1.6 TDI	77	10/13→					
1.6 TDI	81	09/13→	➡	+PR 1KD		24.0110-0277.1 410277	Ø 253 10 8 + S
1.6 TDI 4Drive	77	04/14→				24.0310-0277.1 510277	Ø 253 10 8 + S
1.6 TDI 4Drive	81	11/14→					
1.8 TSI	132	10/13→	➡	+PR 1KS,1KE		24.0110-0356.1 410356	Ø 272 9,7 8 + S
1.8 TSI 4Drive	132	11/14→				24.0310-0356.1 510356	Ø 272 9,7 8 + S
2.0 TDI	81	11/13→	➡	+PR 1KF,1KJ,1KW,1KY; + eFSB		24.0122-0219.1 422219	Ø 310 22 20 V
2.0 TDI	105	10/13→					
2.0 TDI	110	10/13→					
2.0 TDI	135	08/13→					
2.0 TDI 4Drive	110	04/14→					
2.0 TDI 4Drive	135	11/14→					
1.2 TSI	77	08/13→	←	+PR 1ZF,1ZH		24.0124-0258.1 424258	Ø 276 24 21 V + S
			←	+PR 1ZE		24.0125-0145.1 425145	Ø 288 25 22 V + S
						24.0325-0145.1 525145	Ø 288 25 22 V + S
			←	+PR 1ZA		24.0125-0158.1 425158	Ø 312 25 22 V + S
						24.0325-0158.1 525158	Ø 312 25 22 V + S
			←	+PR 1LJ,1LG		24.0130-0225.1 430225	Ø 340 30 27 V + S
			➡	+PR 1KD		24.0110-0277.1 410277	Ø 253 10 8 + S
						24.0310-0277.1 510277	Ø 253 10 8 + S
			➡	+PR 1KS,1KE		24.0110-0356.1 410356	Ø 272 9,7 8 + S
						24.0310-0356.1 510356	Ø 272 9,7 8 + S
			➡	+PR 1KF,1KJ,1KW,1KY; + eFSB		24.0122-0219.1 422219	Ø 310 22 20 V
1.4 TGI	81	10/13→	←	+PR 1ZF,1ZH		24.0124-0258.1 424258	Ø 276 24 21 V + S
↓							











	kw			 	! #		
<b>SEAT - LEON ST (5F8) 08/13→</b>							
<b>Bremsscheibe</b>							
1.4 TGI	81	10/13→	←	+PR 1ZE	24.0125-0145.1 425145	∅ 288 25 22 V + S	
			←	+PR 1ZA	24.0125-0158.1 425158	∅ 312 25 22 V + S	
			←	+PR 1LG	24.0130-0225.1 430225	∅ 340 30 27 V + S	
			→		24.0110-0277.1 410277	∅ 253 10 8 + S	
			→	+PR 1KS,1KE	24.0110-0356.1 410356	∅ 272 9,7 8 + S	
			→	+PR 1KF,1KJ,1KW,1KY; + eFSB	24.0122-0219.1 422219	∅ 310 22 20 V	
			→		24.0310-0277.1 510277	∅ 253 10 8 + S	
1.6 TDI	85	11/16→	←	01/17→; +PR 1ZF,1ZH	24.0124-0258.1 424258	∅ 276 24 21 V + S	
			←	01/17→; +PR 1ZE	24.0125-0145.1 425145	∅ 288 25 22 V + S	
			←	01/17→; +PR 1ZA	24.0125-0158.1 425158	∅ 312 25 22 V + S	
			→	01/17→; +PR 1KD	24.0110-0277.1 410277	∅ 253 10 8 + S	
			→	01/17→; +PR 1KS,1KE	24.0110-0356.1 410356	∅ 272 9,7 8 + S	
			→	01/17→; +PR 1KF,1KJ,1KW,1KY; + eFSB	24.0122-0219.1 422219	∅ 310 22 20 V	
			→		24.0310-0356.1 510356	∅ 272 9,7 8 + S	
2.0 Cupra 2.0 Cupra 2.0 Cupra	195 206 213	10/13→ 10/13→ 10/15→	←	+PR 1ZF,1ZH	24.0124-0258.1 424258	∅ 276 24 21 V + S	
			←	+PR 1ZE	24.0125-0145.1 425145	∅ 288 25 22 V + S	
			←	+PR 1ZA	24.0125-0158.1 425158	∅ 312 25 22 V + S	
			←	+PR 1LJ	24.0130-0225.1 430225	∅ 340 30 27 V + S	
			→	+PR 1KD	24.0110-0277.1 410277	∅ 253 10 8 + S	
			→	+PR 1KS,1KE	24.0110-0356.1 410356	∅ 272 9,7 8 + S	
			→	+PR 1KF,1KJ,1KW,1KY; + eFSB	24.0122-0219.1 422219	∅ 310 22 20 V	
2.0 Cupra 2.0 Cupra 4Drive	221 221	11/16→ 11/16→	←	+PR 1ZF,1ZH	24.0124-0258.1 424258	∅ 276 24 21 V + S	
			←	+PR 1ZE	24.0125-0145.1 425145	∅ 288 25 22 V + S	
			←	+PR 1ZA	24.0125-0158.1 425158	∅ 312 25 22 V + S	
			→	+PR 1KD	24.0110-0277.1 410277	∅ 253 10 8 + S	
			→	+PR 1KS,1KE	24.0110-0356.1 410356	∅ 272 9,7 8 + S	
			→	+PR 1KF,1KJ,1KW,1KY; + eFSB	24.0122-0219.1 422219	∅ 310 22 20 V	
			→		24.0310-0356.1 510356	∅ 272 9,7 8 + S	
<b>SEAT - LEON ST Kasten/Kombi (5F8) 08/13→</b>							
<b>Bremsbelagsatz, Scheibenbremse</b>							
1.0 TSI	85	05/15→	←	+PR 1ZA,1ZE	13.0460-2785.2 602785	TRW 25683 20,4 + WE / + WK	
1.2 TSI	63	01/13→			13.0470-2785.2 LD2785	TRW 25683 20,4 + WE / + WK	
1.2 TSI	81	05/14→				Ceramic	
1.4 TSI	110	05/14→					
1.6 TDI	81	09/13→	←	+PR 1ZF,1ZH	13.0460-7303.2 607303	ATE 22035 17,5 + WK	
1.8 TFSI	132	10/13→			13.0470-7303.2 LD7303	ATE 22035 17,5 + WK Ceramic	
2.0 TDI	110	04/13→	→	+PR 1KF,1KW	13.0460-2749.2 602749	TRW 24483 16,9 - WE / - WK + Zub	
2.0 TDI	135	08/13→					
2.0 TDI 4Drive	110	09/14→			13.0460-2880.2 602880	TRW 23914 17,1 + WE / - WK + Zub	
2.0 TDI 4Drive	135	10/14→			13.0470-2749.2 LD2749	TRW 24483 16,9 - WE / - WK + Zub Ceramic	
					13.0470-2880.2 LD2880	TRW 23914 17,1 + WE / - WK + Zub Ceramic	
			→	+PR 1KD	13.0460-2787.2 602787	TRW 23554 17,3 - WK / - WE	
			→	+PR 1KS	13.0460-2790.2 602790	TRW 25110 17,5 - WE / - WK	
					13.0470-2790.2 LD2790	TRW 25110 17,5 - WE / - WK Ceramic	
			→	+PR 1KE	13.0460-7293.2 607293	ATE 25008 16,3 - WE / - WK	
↓							









	kw			 	! #			
<b>SEAT - LEON ST Kasten/Kombi (5F8) 08/13→</b>								
<b> Bremsbelagsatz, Scheibenbremse</b>								
1.0 TSI 1.2 TSI 1.2 TSI 1.4 TSI 1.6 TDI 1.8 TFSI 2.0 TDI 2.0 TDI 2.0 TDI 4Drive 2.0 TDI 4Drive	85 63 81 110 81 132 110 135 110 135	05/15→ 01/13→ 05/14→ 05/14→ 09/13→ 10/13→ 04/13→ 08/13→ 09/14→ 10/14→	➡ ➡	+PR 1KE +PR 1KJ,1KY; + eFSB		13.0470-7293.2 13.0460-7294.2 13.0470-7294.2	LD7293 607294 LD7294	ATE 25008 16,3 - WE / - WK Ceramic ATE 25009 16,4 - WE / - WK ATE 25009 16,4 - WE / - WK Ceramic
1.6 TDI	85	11/16→	⬅ ⬅ ➡ ➡ ➡ ➡	01/17→; +PR 1ZA,1ZE 01/17→; +PR 1ZF,1ZH 01/17→; +PR 1KD 01/17→; +PR 1KS 01/17→; +PR 1KE 01/17→; +PR 1KJ,1KY; + eFSB		13.0460-2785.2 13.0470-2785.2 13.0460-7303.2 13.0470-7303.2 13.0460-2787.2 13.0460-2790.2 13.0470-2790.2 13.0460-7293.2 13.0470-7293.2 13.0460-7294.2 13.0470-7294.2	602785 LD2785 607303 LD7303 602787 602790 LD2790 607293 LD7293 607294 LD7294	TRW 25683 20,4 + WE / + WK TRW 25683 20,4 + WE / + WK Ceramic ATE 22035 17,5 + WK ATE 22035 17,5 + WK Ceramic TRW 23554 17,3 - WK / - WE TRW 25110 17,5 - WE / - WK TRW 25110 17,5 - WE / - WK Ceramic ATE 25008 16,3 - WE / - WK ATE 25008 16,3 - WE / - WK Ceramic ATE 25009 16,4 - WE / - WK ATE 25009 16,4 - WE / - WK Ceramic
2.0 Cupra	206	10/13→	⬅ ⬅ ⬅ ➡ ➡ ➡ ➡ ➡ ➡ ➡	+PR 1ZA,1ZE + Performance Pack +PR 1ZF,1ZH +PR 1KF,1KW +PR 1KD +PR 1KS +PR 1KE +PR 1KJ,1KY; + eFSB		13.0460-2785.2 13.0470-2785.2 13.0460-4833.2 13.0470-4833.2 13.0460-7303.2 13.0470-7303.2 13.0460-2749.2 13.0460-2880.2 13.0470-2749.2 13.0470-2880.2 13.0460-2787.2 13.0460-2790.2 13.0470-2790.2 13.0460-7293.2 13.0470-7293.2 13.0460-7294.2 13.0470-7294.2	602785 LD2785 604833 LD4833 607303 LD7303 602749 602880 LD2749 LD2880 602787 602790 LD2790 607293 LD7293 607294 LD7294	TRW 25683 20,4 + WE / + WK TRW 25683 20,4 + WE / + WK Ceramic BRE 24098 17,1 + WE / - WK BRE 24098 17,1 + WE / - WK Ceramic ATE 22035 17,5 + WK ATE 22035 17,5 + WK Ceramic TRW 24483 16,9 - WE / - WK + Zub TRW 23914 17,1 + WE / - WK + Zub TRW 24483 16,9 - WE / - WK + Zub Ceramic TRW 23914 17,1 + WE / - WK + Zub Ceramic TRW 23554 17,3 - WK / - WE TRW 25110 17,5 - WE / - WK TRW 25110 17,5 - WE / - WK Ceramic ATE 25008 16,3 - WE / - WK ATE 25008 16,3 - WE / - WK Ceramic ATE 25009 16,4 - WE / - WK ATE 25009 16,4 - WE / - WK Ceramic
2.0 Cupra 2.0 Cupra 4Drive	221 221	11/16→ 11/16→	⬅ ⬅ ⬅ ➡ ➡ ➡ ➡	+PR 1ZA,1ZE + Performance Pack +PR 1ZF,1ZH +PR 1KD +PR 1KS +PR 1KE +PR 1KJ,1KY; + eFSB		13.0460-2785.2 13.0470-2785.2 13.0460-4833.2 13.0470-4833.2 13.0460-7303.2 13.0470-7303.2 13.0460-2787.2 13.0460-2790.2 13.0470-2790.2 13.0460-7293.2 13.0470-7293.2 13.0460-7294.2 13.0470-7294.2	602785 LD2785 604833 LD4833 607303 LD7303 602787 602790 LD2790 607293 LD7293 607294 LD7294	TRW 25683 20,4 + WE / + WK TRW 25683 20,4 + WE / + WK Ceramic BRE 24098 17,1 + WE / - WK BRE 24098 17,1 + WE / - WK Ceramic ATE 22035 17,5 + WK ATE 22035 17,5 + WK Ceramic TRW 23554 17,3 - WK / - WE TRW 25110 17,5 - WE / - WK TRW 25110 17,5 - WE / - WK Ceramic ATE 25008 16,3 - WE / - WK ATE 25008 16,3 - WE / - WK Ceramic ATE 25009 16,4 - WE / - WK ATE 25009 16,4 - WE / - WK Ceramic
↓								







	kw			 	! #		
<b>SEAT - LEON ST Kasten/Kombi (5F8) 08/13→</b>							
<b> Bremsbelagsatz, Scheibenbremse</b>							
2.0 Cupra 2.0 Cupra 4Drive	221 221	11/16→ 11/16→	➡	+PR 1KJ,1KY; + eFSB		13.0470-7294.2 LD7294	ATE 25009 16,4 - WE / - WK Ceramic
<b>Warnkontakt, Bremsbelagverschleiß</b>							
1.0 TSI 1.2 TSI 1.2 TSI 1.4 TSI 1.6 TDI 1.8 TFSI 2.0 TDI 2.0 TDI 2.0 TDI 4Drive 2.0 TDI 4Drive	85 63 81 110 81 132 110 135 110 135	05/15→ 01/13→ 05/14→ 05/14→ 09/13→ 10/13→ 04/13→ 08/13→ 09/14→ 10/14→	←	+PR 1ZA,1ZE	1	24.8190-0065.2 620065	L= 172
1.6 TDI	85	11/16→	←	01/17→; +PR 1ZA,1ZE	1	24.8190-0065.2 620065	L= 172
2.0 Cupra 2.0 Cupra 2.0 Cupra 4Drive	206 221 221	10/13→ 11/16→ 11/16→	←	+PR 1ZA,1ZE	1	24.8190-0065.2 620065	L= 172
			←	+ Performance Pack	1	24.8190-0302.2 620302	L= 367,4
<b> Bremsscheibe</b>							
1.0 TSI 1.2 TSI 1.4 TSI 1.6 TDI 1.8 TFSI 2.0 TDI 2.0 TDI 2.0 TDI 4Drive 2.0 TDI 4Drive	85 81 110 81 132 110 135 110 135	05/15→ 05/14→ 05/14→ 09/13→ 10/13→ 04/13→ 08/13→ 09/14→ 10/14→	←	+PR 1ZF,1ZH		24.0124-0258.1 424258	∅ 276 24 21 V + S
			←	+PR 1ZE		24.0125-0145.1 425145	∅ 288 25 22 V + S
			←	+PR 1ZA		24.0125-0158.1 425158	∅ 312 25 22 V + S
			←	+PR 1LJ,1LG		24.0130-0225.1 430225	∅ 340 30 27 V + S
			➡	+PR 1KD		24.0110-0277.1 410277	∅ 253 10 8 + S
			➡	+PR 1KS,1KE		24.0110-0356.1 410356	∅ 272 9,7 8 + S
			➡	+PR 1KF,1KJ,1KW,1KY; + eFSB		24.0122-0219.1 422219	∅ 310 22 20 V
1.2 TSI	63	01/13→	←	+PR 1ZF,1ZH		24.0124-0258.1 424258	∅ 276 24 21 V + S
			←	+PR 1ZE		24.0125-0145.1 425145	∅ 288 25 22 V + S
			←	+PR 1ZA		24.0125-0158.1 425158	∅ 312 25 22 V + S
			←	+PR 1LJ,1LG		24.0130-0225.1 430225	∅ 340 30 27 V + S
			➡	+PR 1KD		24.0110-0277.1 410277	∅ 253 10 8 + S
			➡	+PR 1KS,1KE		24.0110-0356.1 410356	∅ 272 9,7 8 + S
			➡	+PR 1KF,1KJ,1KW,1KY; + eFSB		24.0122-0219.1 422219	∅ 310 22 20 V
1.6 TDI	85	11/16→	←	01/17→; +PR 1ZF,1ZH		24.0124-0258.1 424258	∅ 276 24 21 V + S
			←	01/17→; +PR 1ZE		24.0125-0145.1 425145	∅ 288 25 22 V + S
			←	01/17→; +PR 1ZA		24.0125-0158.1 425158	∅ 312 25 22 V + S
			➡	01/17→; +PR 1KD		24.0110-0277.1 410277	∅ 253 10 8 + S
			➡	01/17→; +PR 1KS,1KE		24.0110-0356.1 410356	∅ 272 9,7 8 + S
			➡	01/17→; +PR 1KF,1KJ,1KW,1KY; + eFSB		24.0122-0219.1 422219	∅ 310 22 20 V
2.0 Cupra	206	10/13→	←	+PR 1ZF,1ZH		24.0124-0258.1 424258	∅ 276 24 21 V + S
			←	+PR 1ZE		24.0125-0145.1 425145	∅ 288 25 22 V + S
			←	+PR 1ZA		24.0125-0158.1 425158	∅ 312 25 22 V + S
			←	+PR 1LJ		24.0130-0225.1 430225	∅ 340 30 27 V + S
			➡	+PR 1KD		24.0110-0277.1 410277	∅ 253 10 8 + S
			➡	+PR 1KS,1KE		24.0110-0356.1 410356	∅ 272 9,7 8 + S
			➡	+PR 1KF,1KJ,1KW,1KY; + eFSB		24.0122-0219.1 422219	∅ 310 22 20 V
↓							







	kw			 	! #		
<b>SEAT - LEON ST Kasten/Kombi (5F8) 08/13→</b>							
 <b>Bremsscheibe</b>							
2.0 Cupra	221	11/16→	←	+PR 1ZF,1ZH		24.0124-0258.1 424258	Ø 276 24 21 V + S
2.0 Cupra 4Drive	221	11/16→	←	+PR 1ZE		24.0125-0145.1 425145	Ø 288 25 22 V + S
						24.0325-0145.1 525145	Ø 288 25 22 V + S
			←	+PR 1ZA		24.0125-0158.1 425158	Ø 312 25 22 V + S
						24.0325-0158.1 525158	Ø 312 25 22 V + S
			→	+PR 1KD		24.0110-0277.1 410277	Ø 253 10 8 + S
			→	+PR 1KS,1KE		24.0110-0356.1 410356	Ø 272 9,7 8 + S
						24.0310-0356.1 510356	Ø 272 9,7 8 + S
			→	+PR 1KF,1KJ,1KW,1KY; + eFSB		24.0122-0219.1 422219	Ø 310 22 20 V
<b>SEAT - MARBELLA (28) 08/86→05/99</b>							
 <b>Bremsbelagsatz, Scheibenbremse</b>							
0.9	32	07/97→10/98	←			13.0460-3939.2 603939	BDX 20775 18,0 + WE / - WK
0.9 Cat	29	01/90→11/96					
0.9 Cat	30	11/96→10/98					
<b>Zubehörsatz, Scheibenbremsbelag</b>							
0.9	32	07/97→10/98	←			13.0460-0410.2 610410	BDX
0.9 Cat	29	01/90→11/96					
0.9 Cat	30	11/96→10/98					
 <b>Bremsscheibe</b>							
0.9	32	07/97→10/98	←			24.0111-0130.1 411130	Ø 227 10,8 9
0.9 Cat	29	01/90→11/96					
0.9 Cat	30	11/96→10/98					
<b>SEAT - Mii (KF1) 10/11→</b>							
 <b>Bremsbelagsatz, Scheibenbremse</b>							
1.0	44	10/11→	←	05/12→		13.0460-7111.2 607111	VW 23130 19,6 - WE / - WK
1.0	55	10/11→				13.0470-7111.2 LD7111	VW 23130 19,6 - WE / - WK Ceramic
1.0 EcoFuel	50	11/12→	←			13.0460-7111.2 607111	VW 23130 19,6 - WE / - WK
						13.0470-7111.2 LD7111	VW 23130 19,6 - WE / - WK Ceramic
 <b>Bremsscheibe</b>							
1.0	44	10/11→	←	05/12→		24.0122-0281.1 422281	Ø 256 22 19 V + S
1.0	55	10/11→					
1.0 EcoFuel	50	11/12→	←			24.0122-0281.1 422281	Ø 256 22 19 V + S
<b>SEAT - TERRA (24) 01/87→12/96</b>							
 <b>Bremsbelagsatz, Scheibenbremse</b>							
0.9	29	02/87→12/96	←	03/87→		13.0460-3939.2 603939	BDX 20775 18,0 + WE / - WK
<b>Zubehörsatz, Scheibenbremsbelag</b>							
0.9	29	02/87→12/96	←	03/87→		13.0460-0410.2 610410	BDX
 <b>Bremsscheibe</b>							
0.9	29	02/87→12/96	←	03/87→		24.0111-0130.1 411130	Ø 227 10,8 9
<b>SEAT - TOLEDO I (1L) 01/91→10/99</b>							
 <b>Bremsbelagsatz, Scheibenbremse</b>							
1.6 i	54	05/91→03/99	←	09/96→ 09/98; +PR 1LY,1ZK		13.0460-2821.2 602821	TRW 21945 16,0 - WK
			←	09/96→ 09/98; +PR 1LD,1LV		13.0460-2958.2 602958	TRW 20168 19,3 - WK
			←	09/91→ 08/96		13.0460-7032.2 20887	VW 20887 19,7 - WE / - WK + Zub
			←	09/96→ 09/98; +PR 1LK,1LM		13.0460-7072.2 607072	VW 21866 19,7 - WE / - WK
			←	09/96→ 09/98; +PR 1LG		13.0460-7101.2 607101	VW 21866 15,3 - WE / - WK
			→	09/96→ 09/98; +PR 1KD,1KK		13.0460-2984.2 602984	TRW 20961 17,2 - WK + Zub
1.6 i	55	01/93→03/99	←	09/96→ 09/98; +PR 1LY,1ZK		13.0460-2821.2 602821	TRW 21945 16,0 - WK
			←	09/96→ 09/98; +PR 1LD,1LV		13.0460-2958.2 602958	TRW 20168 19,3 - WK
			←	→ 08/96		13.0460-7032.2 20887	VW 20887 19,7 - WE / - WK + Zub
			←	09/96→ 09/98; +PR 1LK,1LM		13.0460-7072.2 607072	VW 21866 19,7 - WE / - WK
↓							











	kw			 	! #		
<b>SEAT - TOLEDO I (1L) 01/91→10/99</b>							
<b> Bremsbelagsatz, Scheibenbremse</b>							
1.6 i	55	01/93→03/99	←	09/96→ 09/98; +PR 1LG		<b>13.0460-7101.2 607101</b>	VW 21866 15,3 - WE / - WK
			→	09/96→ 09/98; +PR 1KD,1KK		<b>13.0460-2984.2 602984</b>	TRW 20961 17,2 - WK + Zub
1.6 i	74	11/96→03/99	←	→ 09/98; +PR 1LY,1ZK		<b>13.0460-2821.2 602821</b>	TRW 21945 16,0 - WK
			←	→ 09/98; +PR 1LD,1LV		<b>13.0460-2958.2 602958</b>	TRW 20168 19,3 - WK
			←	→ 09/98; +PR 1LK,1LM		<b>13.0460-7072.2 607072</b>	VW 21866 19,7 - WE / - WK
			←	→ 09/98; +PR 1LG		<b>13.0460-7101.2 607101</b>	VW 21866 15,3 - WE / - WK
			→	→ 09/98; +PR 1KD,1KK		<b>13.0460-2984.2 602984</b>	TRW 20961 17,2 - WK + Zub
1.8 16V 1.8 16V	92	05/91→03/99	←	09/91→ 03/94		<b>13.0460-2821.2 602821</b>	TRW 21945 16,0 - WK
	98	05/91→03/99	→	09/91→ 03/94		<b>13.0460-2937.2 602937</b>	TRW 20961 15,2 - WK + Zub
1.8 i	65	05/91→12/96	←	09/96→; +PR 1LY,1ZK		<b>13.0460-2821.2 602821</b>	TRW 21945 16,0 - WK
			←	09/96→; +PR 1LD,1LV		<b>13.0460-2958.2 602958</b>	TRW 20168 19,3 - WK
			←	09/91→ 08/96		<b>13.0460-7032.2 20887</b>	VW 20887 19,7 - WE / - WK + Zub
			←	09/96→; +PR 1LG,1LK,1LM		<b>13.0460-7072.2 607072</b>	VW 21866 19,7 - WE / - WK
			←	09/96→; +PR 1LG		<b>13.0460-7101.2 607101</b>	VW 21866 15,3 - WE / - WK
			→	09/96→; +PR 1KD,1KK		<b>13.0460-2984.2 602984</b>	TRW 20961 17,2 - WK + Zub
1.8 i	66	11/93→12/96	←	09/96→; +PR 1LY,1ZK		<b>13.0460-2821.2 602821</b>	TRW 21945 16,0 - WK
			←	09/96→; +PR 1LD,1LV		<b>13.0460-2958.2 602958</b>	TRW 20168 19,3 - WK
			←	→ 08/96		<b>13.0460-7032.2 20887</b>	VW 20887 19,7 - WE / - WK + Zub
			←	09/96→; +PR 1LG,1LK,1LM		<b>13.0460-7072.2 607072</b>	VW 21866 19,7 - WE / - WK
			←	09/96→; +PR 1LG		<b>13.0460-7101.2 607101</b>	VW 21866 15,3 - WE / - WK
			→	09/96→; +PR 1KD,1KK		<b>13.0460-2984.2 602984</b>	TRW 20961 17,2 - WK + Zub
1.9 D	47	12/95→03/99	←	09/96→ 09/98; +PR 1LY,1ZK		<b>13.0460-2821.2 602821</b>	TRW 21945 16,0 - WK
			←	09/96→ 09/98; +PR 1LD,1LV		<b>13.0460-2958.2 602958</b>	TRW 20168 19,3 - WK
			←	→ 08/96		<b>13.0460-7032.2 20887</b>	VW 20887 19,7 - WE / - WK + Zub
			←	09/96→ 09/98; +PR 1LG,1LK,1LM		<b>13.0460-7072.2 607072</b>	VW 21866 19,7 - WE / - WK
			←	09/96→ 09/98; +PR 1LG		<b>13.0460-7101.2 607101</b>	VW 21866 15,3 - WE / - WK
			→	09/96→ 09/98; +PR 1KD,1KK		<b>13.0460-2984.2 602984</b>	TRW 20961 17,2 - WK + Zub
1.9 D 1.9 TD	50	05/91→03/99	←	09/96→ 09/98; +PR 1LY,1ZK		<b>13.0460-2821.2 602821</b>	TRW 21945 16,0 - WK
	55	05/91→03/99	←	09/96→ 09/98; +PR 1LD,1LV		<b>13.0460-2958.2 602958</b>	TRW 20168 19,3 - WK
			←	09/91→ 08/96		<b>13.0460-7032.2 20887</b>	VW 20887 19,7 - WE / - WK + Zub
			←	09/96→ 09/98; +PR 1LG,1LK,1LM		<b>13.0460-7072.2 607072</b>	VW 21866 19,7 - WE / - WK
			←	09/96→ 09/98; +PR 1LG		<b>13.0460-7101.2 607101</b>	VW 21866 15,3 - WE / - WK
			→	09/96→ 09/98; +PR 1KD,1KK		<b>13.0460-2984.2 602984</b>	TRW 20961 17,2 - WK + Zub
1.9 TDI	66	08/95→03/99	←	1L-TR017000→; → 08/96		<b>13.0460-2821.2 602821</b>	TRW 21945 16,0 - WK
			←	09/96→ 09/98; +PR 1LY,1ZK		<b>13.0460-2821.2 602821</b>	TRW 21945 16,0 - WK
			←	09/96→ 09/98; +PR 1LD,1LV		<b>13.0460-2958.2 602958</b>	TRW 20168 19,3 - WK
			←	→ 1L-TR016999		<b>13.0460-2958.2 602958</b>	TRW 20168 19,3 - WK
			←	09/96→ 09/98; +PR 1LG,1LK,1LM		<b>13.0460-7072.2 607072</b>	VW 21866 19,7 - WE / - WK
			←	09/96→ 09/98; +PR 1LG		<b>13.0460-7101.2 607101</b>	VW 21866 15,3 - WE / - WK
			→	09/96→ 09/98; +PR 1KD,1KK		<b>13.0460-2984.2 602984</b>	TRW 20961 17,2 - WK + Zub
1.9 TDI	81	11/96→03/99	←	→ 09/98; +PR 1LY,1ZK		<b>13.0460-2821.2 602821</b>	TRW 21945 16,0 - WK
			←	→ 09/98; +PR 1LD,1LV		<b>13.0460-2958.2 602958</b>	TRW 20168 19,3 - WK
			←	→ 1L-TR016999		<b>13.0460-2958.2 602958</b>	TRW 20168 19,3 - WK
			←	→ 09/98; +PR 1LG,1LK,1LM		<b>13.0460-7072.2 607072</b>	VW 21866 19,7 - WE / - WK
			←	→ 09/98; +PR 1LG		<b>13.0460-7101.2 607101</b>	VW 21866 15,3 - WE / - WK
			→	→ 09/98; +PR 1KD,1KK		<b>13.0460-2984.2 602984</b>	TRW 20961 17,2 - WK + Zub
2.0 i	85	05/91→03/99	←	09/91→ 08/96		<b>13.0460-2821.2 602821</b>	TRW 21945 16,0 - WK
			←	09/96→ 09/98; +PR 1LY,1ZK		<b>13.0460-2821.2 602821</b>	TRW 21945 16,0 - WK
			←	09/96→ 09/98; +PR 1LD,1LV		<b>13.0460-2958.2 602958</b>	TRW 20168 19,3 - WK
			←	09/96→ 09/98; +PR 1LG,1LK,1LM		<b>13.0460-7072.2 607072</b>	VW 21866 19,7 - WE / - WK
↓							









	kw			 	! #				
<b>SEAT - TOLEDO I (1L) 01/91→10/99</b>									
<b> Bremsbelagsatz, Scheibenbremse</b>									
2.0 i	85	05/91→03/99	←	09/96→ 09/98; +PR 1LG	13.0460-7101.2	607101	VW 21866 15,3 - WE / - WK		
			→	09/91→; → 1L-ZD328000	13.0460-2937.2	602937	TRW 20961 15,2 - WK + Zub		
			→	09/96→ 09/98; +PR 1KD,1KK	13.0460-2984.2	602984	TRW 20961 17,2 - WK + Zub		
2.0 i 16V	110	11/93→03/99	←	09/96→ 09/98; +PR 1LY,1ZK	13.0460-2821.2	602821	TRW 21945 16,0 - WK		
			←	09/96→ 09/98; +PR 1LD,1LV	13.0460-2958.2	602958	TRW 20168 19,3 - WK		
			←	03/94→ 08/96	13.0460-2958.2	602958	TRW 20168 19,3 - WK		
			←	09/96→ 09/98; +PR 1LG,1LK,1LM	13.0460-7072.2	607072	VW 21866 19,7 - WE / - WK		
			←	09/96→ 09/98; +PR 1LG	13.0460-7101.2	607101	VW 21866 15,3 - WE / - WK		
			→	09/96→ 09/98; +PR 1KD,1KK	13.0460-2984.2	602984	TRW 20961 17,2 - WK + Zub		
<b>Zubehörsatz, Scheibenbremsbelag</b>									
1.6 i	54	05/91→03/99	→	09/96→ 09/98; +PR 1KD,1KK	13.0460-0072.2	610072	TRW		
1.6 i	55	01/93→03/99							
1.9 D	47	12/95→03/99							
1.9 D	50	05/91→03/99							
1.9 TD	55	05/91→03/99							
1.6 i	74	11/96→03/99	→	→ 09/98; +PR 1KD,1KK	13.0460-0072.2	610072	TRW		
1.9 TDI	81	11/96→03/99							
1.8 16V	92	05/91→03/99	→	09/91→ 03/94	13.0460-0419.2	610419	TRW		
1.8 16V	98	05/91→03/99							
1.8 i	65	05/91→12/96	→	09/96→; +PR 1KD,1KK	13.0460-0072.2	610072	TRW		
1.8 i	66	11/93→12/96							
1.9 TDI	66	08/95→03/99	→	→ 08/96	13.0460-0072.2	610072	TRW		
			→	09/96→ 09/98; +PR 1KD,1KK	13.0460-0072.2	610072	TRW		
2.0 i	85	05/91→03/99	→	→ 08/96; 1L-ZD328001→	13.0460-0072.2	610072	TRW		
			→	09/96→ 09/98; +PR 1KD,1KK	13.0460-0072.2	610072	TRW		
			→	09/91→; → 1L-ZD328000	13.0460-0419.2	610419	TRW		
2.0 i 16V	110	11/93→03/99	→	09/96→ 09/98; +PR 1KD,1KK	13.0460-0072.2	610072	TRW		
			→	03/94→ 08/96	13.0460-0072.2	610072	TRW		
<b> Bremsscheibe</b>									
1.6 i	54	05/91→03/99	←	09/91→ 08/96	24.0112-0106.1	412106	Ø 239 12 10 + S		
					24.0312-0106.1	512106	Ø 239 12 10 + S		
			←	09/96→ 09/98; +PR 1LK,1LM	24.0112-0106.1	412106	Ø 239 12 10 + S		
					24.0312-0106.1	512106	Ø 239 12 10 + S		
			←	09/96→ 09/98; +PR 1LG	24.0120-0123.1	420123	Ø 239 20 18 V + S		
					24.0320-0123.1	520123	Ø 239 20 18 V + S		
			←	09/96→ 09/98; +PR 1LY,1ZK	24.0120-0128.1	420128	Ø 256 20 18 V + S		
					24.0320-0128.1	520128	Ø 256 20 18 V + S		
1.6 i	55	01/93→03/99	←	→ 08/96	24.0112-0106.1	412106	Ø 239 12 10 + S		
					24.0312-0106.1	512106	Ø 239 12 10 + S		
			←	09/96→ 09/98; +PR 1LK,1LM	24.0112-0106.1	412106	Ø 239 12 10 + S		
					24.0312-0106.1	512106	Ø 239 12 10 + S		
			←	09/96→ 09/98; +PR 1LG	24.0120-0123.1	420123	Ø 239 20 18 V + S		
					24.0320-0123.1	520123	Ø 239 20 18 V + S		
			←	09/96→ 09/98; +PR 1LY,1ZK	24.0120-0128.1	420128	Ø 256 20 18 V + S		
					24.0320-0128.1	520128	Ø 256 20 18 V + S		
1.6 i	74	11/96→03/99	←	→ 09/98; +PR 1LK,1LM	24.0112-0106.1	412106	Ø 239 12 10 + S		
					24.0312-0106.1	512106	Ø 239 12 10 + S		
↓									







	kw			 	! #		
<b>SEAT - TOLEDO I (1L) 01/91→10/99</b>							
<b>Bremsscheibe</b>							
1.6 i	74	11/96→03/99	←	→ 09/98; +PR 1LG	24.0120-0123.1	420123	Ø 239 20 18 V + S
					24.0320-0123.1	520123	Ø 239 20 18 V + S
			←	→ 09/98; +PR 1LY,1ZK	24.0120-0128.1	420128	Ø 256 20 18 V + S
					24.0320-0128.1	520128	Ø 256 20 18 V + S
			←	→ 09/98; +PR 1LD	24.0122-0100.1	422100	Ø 280 22 20 V
					24.0322-0100.1	522100	Ø 280 22 20 V
1.8 16V 1.8 16V	92 98	05/91→03/99 05/91→03/99	←	09/91→ 03/94	24.0120-0128.1	420128	Ø 256 20 18 V + S
					24.0320-0128.1	520128	Ø 256 20 18 V + S
			→	09/91→ 03/94	24.0110-0111.1	410111	Ø 226 10 8 - ABS Ring / - RLG
					24.0110-0275.2	410275	Ø 226 10 8 + ABS Ring / - RLG
			→	09/98; +PR 1KD	24.0110-0203.1	410203	Ø 226 10 8 - ABS Ring
					24.0110-0276.2	410276	Ø 226 10 8 + ABS Ring
1.8 i	65	05/91→12/96	←	09/96→; +PR 1LG,1LK,1LM	24.0112-0106.1	412106	Ø 239 12 10 + S
					24.0312-0106.1	512106	Ø 239 12 10 + S
			←	09/91→ 08/96	24.0112-0106.1	412106	Ø 239 12 10 + S
					24.0120-0128.1	420128	Ø 256 20 18 V + S
					24.0312-0106.1	512106	Ø 239 12 10 + S
					24.0320-0128.1	520128	Ø 256 20 18 V + S
			←	09/96→; +PR 1LG	24.0120-0123.1	420123	Ø 239 20 18 V + S
					24.0320-0123.1	520123	Ø 239 20 18 V + S
			←	09/96→; +PR 1LY,1ZK	24.0120-0128.1	420128	Ø 256 20 18 V + S
					24.0320-0128.1	520128	Ø 256 20 18 V + S
1.8 i	66	11/93→12/96	←	→ 08/96	24.0112-0106.1	412106	Ø 239 12 10 + S
					24.0120-0128.1	420128	Ø 256 20 18 V + S
					24.0312-0106.1	512106	Ø 239 12 10 + S
					24.0320-0128.1	520128	Ø 256 20 18 V + S
			←	09/96→; +PR 1LG,1LK,1LM	24.0112-0106.1	412106	Ø 239 12 10 + S
					24.0312-0106.1	512106	Ø 239 12 10 + S
			←	09/96→; +PR 1LG	24.0120-0123.1	420123	Ø 239 20 18 V + S
					24.0320-0123.1	520123	Ø 239 20 18 V + S
			←	09/96→; +PR 1LY,1ZK	24.0120-0128.1	420128	Ø 256 20 18 V + S
					24.0320-0128.1	520128	Ø 256 20 18 V + S
1.9 D	47	12/95→03/99	←	09/96→ 09/98; +PR 1LG,1LK,1LM	24.0112-0106.1	412106	Ø 239 12 10 + S
					24.0312-0106.1	512106	Ø 239 12 10 + S
			←	→ 08/96	24.0112-0106.1	412106	Ø 239 12 10 + S
					24.0312-0106.1	512106	Ø 239 12 10 + S
			←	09/96→ 09/98; +PR 1LG	24.0120-0123.1	420123	Ø 239 20 18 V + S
					24.0320-0123.1	520123	Ø 239 20 18 V + S
			←	09/96→ 09/98; +PR 1LY,1ZK	24.0120-0128.1	420128	Ø 256 20 18 V + S
					24.0320-0128.1	520128	Ø 256 20 18 V + S
1.9 D 1.9 TD ↓	50 55	05/91→03/99 05/91→03/99	←	09/91→ 08/96	24.0112-0106.1	412106	Ø 239 12 10 + S











	kw			 	! #		
<b>SEAT - TOLEDO I (1L) 01/91→10/99</b>							
<b>Bremsscheibe</b>							
1.9 D 1.9 TD	50	05/91→03/99 05/91→03/99	←	09/91→ 08/96	24.0312-0106.1	512106	Ø 239 12 10 + S
	55		←	09/96→ 09/98; +PR 1LG,1LK,1LM	24.0112-0106.1	412106	Ø 239 12 10 + S
					24.0312-0106.1	512106	Ø 239 12 10 + S
			←	09/96→ 09/98; +PR 1LG	24.0120-0123.1	420123	Ø 239 20 18 V + S
					24.0320-0123.1	520123	Ø 239 20 18 V + S
			←	09/96→ 09/98; +PR 1LY,1ZK	24.0120-0128.1	420128	Ø 256 20 18 V + S
					24.0320-0128.1	520128	Ø 256 20 18 V + S
			←	09/96→ 09/98; +PR 1LD	24.0122-0100.1	422100	Ø 280 22 20 V
		24.0322-0100.1	522100	Ø 280 22 20 V			
		→	09/96→ 09/98; +PR 1KD	24.0110-0111.1	410111	Ø 226 10 8 - ABS Ring / - RLG	
				24.0110-0275.2	410275	Ø 226 10 8 + ABS Ring / - RLG	
		→	09/96→ 09/98; +PR 1KK	24.0110-0203.1	410203	Ø 226 10 8 - ABS Ring	
				24.0110-0276.2	410276	Ø 226 10 8 + ABS Ring	
1.9 TDI	66	08/95→03/99	←	09/96→ 09/98; +PR 1LG,1LK,1LM	24.0112-0106.1	412106	Ø 239 12 10 + S
					24.0312-0106.1	512106	Ø 239 12 10 + S
			←	→ 1L-TR016999	24.0113-0178.1	413178	Ø 255,6 12,9 11 + S
					24.0313-0178.1	513178	Ø 255,6 12,9 11 + S
			←	09/96→ 09/98; +PR 1LG	24.0120-0123.1	420123	Ø 239 20 18 V + S
					24.0320-0123.1	520123	Ø 239 20 18 V + S
			←	1L-TR017000→; → 08/96	24.0120-0128.1	420128	Ø 256 20 18 V + S
					24.0320-0128.1	520128	Ø 256 20 18 V + S
			←	09/96→ 09/98; +PR 1LY,1ZK	24.0120-0128.1	420128	Ø 256 20 18 V + S
					24.0320-0128.1	520128	Ø 256 20 18 V + S
←	09/96→ 09/98; +PR 1LD	24.0122-0100.1	422100	Ø 280 22 20 V			
			24.0322-0100.1	522100	Ø 280 22 20 V		
→	09/96→ 09/98; +PR 1KD	24.0110-0111.1	410111	Ø 226 10 8 - ABS Ring / - RLG			
			24.0110-0275.2	410275	Ø 226 10 8 + ABS Ring / - RLG		
→	11/95→ 08/96	24.0110-0111.1	410111	Ø 226 10 8 - ABS Ring / - RLG			
			24.0110-0275.2	410275	Ø 226 10 8 + ABS Ring / - RLG		
→	09/96→ 09/98; +PR 1KK	24.0110-0203.1	410203	Ø 226 10 8 - ABS Ring			
			24.0110-0276.2	410276	Ø 226 10 8 + ABS Ring		
1.9 TDI	81	11/96→03/99	←	→ 09/98; +PR 1LG,1LK,1LM	24.0112-0106.1	412106	Ø 239 12 10 + S
					24.0312-0106.1	512106	Ø 239 12 10 + S
			←	→ 1L-TR016999	24.0113-0178.1	413178	Ø 255,6 12,9 11 + S
					24.0313-0178.1	513178	Ø 255,6 12,9 11 + S
			←	→ 09/98; +PR 1LG	24.0120-0123.1	420123	Ø 239 20 18 V + S
					24.0320-0123.1	520123	Ø 239 20 18 V + S
			←	→ 09/98; +PR 1LY,1ZK	24.0120-0128.1	420128	Ø 256 20 18 V + S
					24.0320-0128.1	520128	Ø 256 20 18 V + S
←	→ 09/98; +PR 1LD	24.0122-0100.1	422100	Ø 280 22 20 V			
			24.0322-0100.1	522100	Ø 280 22 20 V		
→	→ 09/98; +PR 1KD	24.0110-0111.1	410111	Ø 226 10 8 - ABS Ring / - RLG			
			24.0110-0275.2	410275	Ø 226 10 8 + ABS Ring / - RLG		
→	→ 09/98; +PR 1KK	24.0110-0203.1	410203	Ø 226 10 8 - ABS Ring			
			24.0110-0276.2	410276	Ø 226 10 8 + ABS Ring		
2.0 i	85	05/91→03/99	←	09/96→ 09/98; +PR 1LG,1LK,1LM	24.0112-0106.1	412106	Ø 239 12 10 + S
					24.0312-0106.1	512106	Ø 239 12 10 + S
			←	09/96→ 09/98; +PR 1LG	24.0120-0123.1	420123	Ø 239 20 18 V + S
					24.0320-0123.1	520123	Ø 239 20 18 V + S
			←	09/91→ 08/96	24.0120-0128.1	420128	Ø 256 20 18 V + S
					24.0320-0128.1	520128	Ø 256 20 18 V + S
			←	09/96→ 09/98; +PR 1LY,1ZK	24.0120-0128.1	420128	Ø 256 20 18 V + S
					24.0320-0128.1	520128	Ø 256 20 18 V + S
			←	09/96→ 09/98; +PR 1LD	24.0122-0100.1	422100	Ø 280 22 20 V
						24.0322-0100.1	522100
→	09/91→ 08/96	24.0110-0111.1	410111	Ø 226 10 8 - ABS Ring / - RLG			
			24.0110-0275.2	410275	Ø 226 10 8 + ABS Ring / - RLG		
→	09/96→ 09/98; +PR 1KD	24.0110-0111.1	410111	Ø 226 10 8 - ABS Ring / - RLG			
			24.0110-0275.2	410275	Ø 226 10 8 + ABS Ring / - RLG		
→	09/96→ 09/98; +PR 1KK	24.0110-0203.1	410203	Ø 226 10 8 - ABS Ring			
			24.0110-0276.2	410276	Ø 226 10 8 + ABS Ring		
↓							

	kw			 	! #		
<b>SEAT - TOLEDO I (1L) 01/91→10/99</b>							
<b> Bremsscheibe</b>							
2.0 i 16V	110	11/93→03/99	←	09/96→ 09/98; +PR 1LG,1LK,1LM	24.0112-0106.1 412106	Ø 239 12 10 + S	
					24.0312-0106.1 512106	Ø 239 12 10 + S	
			←	09/96→ 09/98; +PR 1LG	24.0120-0123.1 420123	Ø 239 20 18 V + S	
					24.0320-0123.1 520123	Ø 239 20 18 V + S	
			←	09/96→ 09/98; +PR 1LY,1ZK	24.0120-0128.1 420128	Ø 256 20 18 V + S	
					24.0320-0128.1 520128	Ø 256 20 18 V + S	
			←	03/94→ 08/96	24.0122-0100.1 422100	Ø 280 22 20 V	
					24.0322-0100.1 522100	Ø 280 22 20 V	
			←	09/96→ 09/98; +PR 1LD	24.0122-0100.1 422100	Ø 280 22 20 V	
		24.0322-0100.1 522100	Ø 280 22 20 V				
			→	09/96→ 09/98; +PR 1KD	24.0110-0111.1 410111	Ø 226 10 8 - ABS Ring / - RLG	
					24.0110-0275.2 410275	Ø 226 10 8 + ABS Ring / - RLG	
			→	09/96→ 09/98; +PR 1KK	24.0110-0203.1 410203	Ø 226 10 8 - ABS Ring	
					24.0110-0276.2 410276	Ø 226 10 8 + ABS Ring	
			→	03/94→ 08/96	24.0110-0203.1 410203	Ø 226 10 8 - ABS Ring	
					24.0110-0276.2 410276	Ø 226 10 8 + ABS Ring	
<b>SEAT - TOLEDO II (1M2) 10/98→05/06</b>							
<b> Bremsbelagsatz, Scheibenbremse</b>							
1.4 16V 1.6 1.8 20V 1.9 TDI 1.9 TDI 2.3 V5 2.3 V5 20V	55 74 92 81 110 110 125	01/00→05/02 10/98→07/04 10/98→07/04 10/98→07/04 10/00→07/04 10/98→11/00 09/00→11/03	←	→ X-800 000; +PR 1LN,1LE,1ZE,1ZH	13.0460-7081.2 607081	ATE 20676 19,8 - WE / - WK	
					13.0470-7081.2 LD7081	ATE 20676 19,8 - WE / - WK Ceramic	
			←	+PR 1LQ	13.0460-7111.2 607111	VW 23130 19,6 - WE / - WK	
					13.0470-7111.2 LD7111	VW 23130 19,6 - WE / - WK Ceramic	
			←	+PR 1LR,1LS	13.0460-7117.2 607117	VW 23130 19,6 + WK	
					13.0470-7117.2 LD7117	VW 23130 19,6 + WK Ceramic	
			←	+PR 1LJ,1ZQ	13.0460-7122.2 607122	ATE 20676 19,8 + WK	
					13.0470-7122.2 LD7122	ATE 20676 19,8 + WK Ceramic	
			←	Y-000 001→; +PR 1LN,1LE,1ZE,1ZH	13.0460-7122.2 607122	ATE 20676 19,8 + WK	
					13.0470-7122.2 LD7122	ATE 20676 19,8 + WK Ceramic	
			→	+PR 1KY,2EE	13.0460-2886.2 602886	TRW 20961 16,0 - WK	
					13.0460-2937.2 602937	TRW 20961 15,2 - WK + Zub	
					13.0470-2886.2 LD2886	TRW 20961 16,0 - WK Ceramic	
			→	+PR 1KK,1KP,1KQ	13.0460-2894.2 602894	TRW 20961 17,2 - WK + Zub	
					13.0470-2894.2 LD2894	TRW 20961 17,2 - WK + Zub Ceramic	
1.6	75	08/05→05/06	←	→ X-800 000; +PR 1LN,1LE,1ZE,1ZH	13.0460-7081.2 607081	ATE 20676 19,8 - WE / - WK	
					13.0470-7081.2 LD7081	ATE 20676 19,8 - WE / - WK Ceramic	
1.6 16V 1.9 TDI	77 96	06/00→05/06 05/03→05/06	←	→ X-800 000; +PR 1LN,1LE,1ZE,1ZH	13.0460-7081.2 607081	ATE 20676 19,8 - WE / - WK	
					13.0470-7081.2 LD7081	ATE 20676 19,8 - WE / - WK Ceramic	
			←	→ 09/04; +PR 1LQ	13.0460-7111.2 607111	VW 23130 19,6 - WE / - WK	
					13.0470-7111.2 LD7111	VW 23130 19,6 - WE / - WK Ceramic	
			←	→ 09/04; +PR 1LR,1LS	13.0460-7117.2 607117	VW 23130 19,6 + WK	
					13.0470-7117.2 LD7117	VW 23130 19,6 + WK Ceramic	
			←	Y-000 001→; → 09/04; +PR 1LN,1LE,1ZE,1ZH	13.0460-7122.2 607122	ATE 20676 19,8 + WK	
					13.0470-7122.2 LD7122	ATE 20676 19,8 + WK Ceramic	
			←	→ 09/04; +PR 1LJ,1ZQ	13.0460-7122.2 607122	ATE 20676 19,8 + WK	
					13.0470-7122.2 LD7122	ATE 20676 19,8 + WK Ceramic	
			→	→ 09/04; +PR 1KY,2EE	13.0460-2886.2 602886	TRW 20961 16,0 - WK	
					13.0460-2937.2 602937	TRW 20961 15,2 - WK + Zub	
					13.0470-2886.2 LD2886	TRW 20961 16,0 - WK Ceramic	
			→	→ 09/04; +PR 1KK,1KP,1KQ	13.0460-2894.2 602894	TRW 20961 17,2 - WK + Zub	
					13.0470-2894.2 LD2894	TRW 20961 17,2 - WK + Zub Ceramic	
1.8 20VT	132	09/00→07/04	←	05/01→; → X-800 000; +PR 1LN,1LE,1ZE,1ZH	13.0460-7081.2 607081	ATE 20676 19,8 - WE / - WK	
					13.0470-7081.2 LD7081	ATE 20676 19,8 - WE / - WK Ceramic	
			←	05/01→; +PR 1LQ	13.0460-7111.2 607111	VW 23130 19,6 - WE / - WK	
					13.0470-7111.2 LD7111	VW 23130 19,6 - WE / - WK Ceramic	





















	kw			 	! #		
<b>SEAT - TOLEDO II (1M2) 10/98→05/06</b>							
<b> Bremsbelagsatz, Scheibenbremse</b>							
1.8 20VT	132	09/00→07/04	←	05/01→; +PR 1LR,1LS	13.0460-7117.2 607117	VW 23130 19,6 + WK	
			←	Y-000 001→; +PR 1LN,1LE,1ZE,1ZH	13.0460-7117.2 LD7117	VW 23130 19,6 + WK Ceramic	
			←	05/01→; +PR 1LJ,1ZQ	13.0460-7122.2 607122	ATE 20676 19,8 + WK	
			←	05/01→; +PR 1KY,2EE	13.0460-7122.2 LD7122	ATE 20676 19,8 + WK Ceramic	
			→	05/01→; +PR 1KK,1KP,1KQ	13.0460-2886.2 602886	TRW 20961 16,0 - WK	
					13.0460-2937.2 602937	TRW 20961 15,2 - WK + Zub	
					13.0470-2886.2 LD2886	TRW 20961 16,0 - WK Ceramic	
					13.0460-2894.2 602894	TRW 20961 17,2 - WK + Zub	
					13.0470-2894.2 LD2894	TRW 20961 17,2 - WK + Zub Ceramic	
1.9 TDI	66	03/99→07/04	←	→ X-800 000; +PR 1LN,1LE,1ZE,1ZH	13.0460-7081.2 607081	ATE 20676 19,8 - WE / - WK	
			←	+PR 1LQ	13.0460-7081.2 LD7081	ATE 20676 19,8 - WE / - WK Ceramic	
			←	+PR 1LR,1LS	13.0460-7111.2 607111	VW 23130 19,6 - WE / - WK	
			←	04/99→; +PR 1LJ,1ZQ	13.0460-7111.2 LD7111	VW 23130 19,6 - WE / - WK Ceramic	
			←	+PR 1LR,1LS	13.0460-7122.2 607122	ATE 20676 19,8 + WK	
			←	Y-000 001→; +PR 1LN,1LE,1ZE,1ZH	13.0460-7122.2 LD7122	ATE 20676 19,8 + WK Ceramic	
			→	+PR 1KY,2EE	13.0460-7122.2 LD7122	ATE 20676 19,8 + WK Ceramic	
					13.0460-2886.2 602886	TRW 20961 16,0 - WK	
					13.0460-2937.2 602937	TRW 20961 15,2 - WK + Zub	
					13.0470-2886.2 LD2886	TRW 20961 16,0 - WK Ceramic	
					13.0460-2894.2 602894	TRW 20961 17,2 - WK + Zub	
					13.0470-2894.2 LD2894	TRW 20961 17,2 - WK + Zub Ceramic	
<b>Zubehörsatz, Scheibenbremsbelag</b>							
1.4 16V	55	01/00→05/02	→	+PR 1KY,2EE	13.0460-0072.2 610072	TRW	
1.6	74	10/98→07/04	→	+PR 1KK,1KP,1KQ	13.0460-0072.2 610072	TRW	
1.8 20V	92	10/98→07/04	→	+PR 1KK,1KP,1KQ	13.0460-0072.2 610072	TRW	
1.9 TDI	66	03/99→07/04	→	+PR 1KK,1KP,1KQ	13.0460-0072.2 610072	TRW	
1.9 TDI	81	10/98→07/04	→	+PR 1KK,1KP,1KQ	13.0460-0072.2 610072	TRW	
1.9 TDI	110	10/00→07/04	→	+PR 1KK,1KP,1KQ	13.0460-0072.2 610072	TRW	
2.3 V5	110	10/98→11/00	→	+PR 1KK,1KP,1KQ	13.0460-0072.2 610072	TRW	
2.3 V5 20V	125	09/00→11/03	→	+PR 1KK,1KP,1KQ	13.0460-0072.2 610072	TRW	
1.6 16V	77	06/00→05/06	→	→ 09/04; +PR 1KY,2EE	13.0460-0072.2 610072	TRW	
1.9 TDI	96	05/03→05/06	→	→ 09/04; +PR 1KK,1KP,1KQ	13.0460-0072.2 610072	TRW	
1.8 20VT	132	09/00→07/04	→	05/01→; +PR 1KY,2EE	13.0460-0072.2 610072	TRW	
			→	05/01→; +PR 1KK,1KP,1KQ	13.0460-0072.2 610072	TRW	
<b> Bremsscheibe</b>							
1.4 16V	55	01/00→05/02	←	+PR 1LR,1LS	24.0122-0150.1 422150	Ø 280 22 19 V + S	
1.6	74	10/98→07/04	←	+PR 1LQ	24.0122-0151.1 422151	Ø 256 22 19 V + S	
1.8 20V	92	10/98→07/04	←	+PR 1LQ	24.0122-0151.1 422151	Ø 256 22 19 V + S	
1.9 TDI	81	10/98→07/04	←	+PR 1LQ	24.0322-0151.1 522151	Ø 256 22 19 V + S	
1.9 TDI	110	10/00→07/04	←	+PR 1LN,1LE,1ZE,1ZH	24.0125-0113.1 425113	Ø 288 25 22 V + S	
2.3 V5	110	10/98→11/00	←	+PR 1LN,1LE,1ZE,1ZH	24.0325-0113.1 525113	Ø 288 25 22 V + S	
2.3 V5 20V	125	09/00→11/03	←	+PR 1LJ,1ZQ	24.0125-0123.1 425123	Ø 310 25 22 V + S	
			→	+PR 1KK,1KP,1KQ	24.0109-0123.1 409123	Ø 230 9 7 + S	
			→	+PR 1KK,1KP,1KQ	24.0309-0123.1 509123	Ø 230 9 7 + S	
			→	+PR 1KY,2EE	24.0122-0163.1 422163	Ø 256 22 20 V	
			→	+PR 1KY,2EE	24.0322-0163.1 522163	Ø 256 22 20 V	
1.6 16V	77	06/00→05/06	←	→ 09/04; +PR 1LR,1LS	24.0122-0150.1 422150	Ø 280 22 19 V + S	
1.9 TDI	96	05/03→05/06	←	→ 09/04; +PR 1LQ	24.0122-0151.1 422151	Ø 256 22 19 V + S	
			←	→ 09/04; +PR 1LQ	24.0322-0151.1 522151	Ø 256 22 19 V + S	
			←	→ 09/04; +PR 1LN,1LE,1ZE,1ZH	24.0125-0113.1 425113	Ø 288 25 22 V + S	
			←	→ 09/04; +PR 1LN,1LE,1ZE,1ZH	24.0325-0113.1 525113	Ø 288 25 22 V + S	
			←	→ 09/04; +PR 1LJ,1ZQ	24.0125-0123.1 425123	Ø 310 25 22 V + S	
			→	→ 09/04; +PR 1KK,1KP,1KQ	24.0109-0123.1 409123	Ø 230 9 7 + S	
			→	→ 09/04; +PR 1KK,1KP,1KQ	24.0309-0123.1 509123	Ø 230 9 7 + S	

	kw			 	! #		
<b>SEAT - TOLEDO II (1M2) 10/98→05/06</b>							
<b>Bremsscheibe</b>							
1.6 16V 1.9 TDI	77 96	06/00→05/06 05/03→05/06	➔	→ 09/04; +PR 1KY,2EE		24.0122-0163.1 422163 24.0322-0163.1 522163	Ø 256 22 20 V Ø 256 22 20 V
1.8 20VT	132	09/00→07/04	➔	05/01→; +PR 1LR,1LS		24.0122-0150.1 422150	Ø 280 22 19 V + S
			➔	05/01→; +PR 1LQ		24.0122-0151.1 422151 24.0322-0151.1 522151	Ø 256 22 19 V + S Ø 256 22 19 V + S
			➔	05/01→; +PR 1LN,1LE,1ZE,1ZH		24.0125-0113.1 425113 24.0325-0113.1 525113	Ø 288 25 22 V + S Ø 288 25 22 V + S
			➔	05/01→; +PR 1LJ,1ZQ		24.0125-0123.1 425123	Ø 310 25 22 V + S
			➔	05/01→; +PR 1KK,1KP,1KQ		24.0109-0123.1 409123 24.0309-0123.1 509123	Ø 230 9 7 + S Ø 230 9 7 + S
			➔	05/01→; +PR 1KY,2EE		24.0122-0163.1 422163 24.0322-0163.1 522163	Ø 256 22 20 V Ø 256 22 20 V
			➔	05/01→; +PR 1KY,2EE		24.0122-0163.1 422163 24.0322-0163.1 522163	Ø 256 22 20 V Ø 256 22 20 V
1.9 TDI	66	03/99→07/04	➔	+PR 1LR,1LS		24.0122-0150.1 422150	Ø 280 22 19 V + S
			➔	+PR 1LQ		24.0122-0151.1 422151 24.0322-0151.1 522151	Ø 256 22 19 V + S Ø 256 22 19 V + S
			➔	04/99→; +PR 1LN,1LE,1ZE,1ZH		24.0125-0113.1 425113 24.0325-0113.1 525113	Ø 288 25 22 V + S Ø 288 25 22 V + S
			➔	04/99→; +PR 1LJ,1ZQ		24.0125-0123.1 425123	Ø 310 25 22 V + S
			➔	+PR 1KK,1KP,1KQ		24.0109-0123.1 409123 24.0309-0123.1 509123	Ø 230 9 7 + S Ø 230 9 7 + S
			➔	+PR 1KY,2EE		24.0122-0163.1 422163 24.0322-0163.1 522163	Ø 256 22 20 V Ø 256 22 20 V
			➔	+PR 1KY,2EE		24.0122-0163.1 422163 24.0322-0163.1 522163	Ø 256 22 20 V Ø 256 22 20 V
<b>SEAT - TOLEDO III (5P2) 04/04→05/09</b>							
<b>Bremsbelagsatz, Scheibenbremse</b>							
1.4 16V 1.4 TSI 1.6 1.8 TFSI 1.9 TDI 2.0 FSI 2.0 TDI 2.0 TDI 2.0 TFSI	63 92 75 118 77 110 103 125 147	05/06→05/09 11/07→05/09 10/04→05/09 01/07→05/09 10/04→05/09 10/04→05/09 11/05→05/09 01/06→05/09 11/05→05/09	➔	→ 03/09; +PR 1ZF		13.0460-7117.2 607117 13.0470-7117.2 LD7117	VW 23130 19,6 + WK VW 23130 19,6 + WK Ceramic
			➔	→ 03/09; +PR 1ZE		13.0460-7184.2 607184 13.0470-7184.2 LD7184	ATE 23587 20,6 + WK ATE 23587 20,6 + WK Ceramic
			➔	→ 03/09; +PR 1KF,1KJ,1KZ		13.0460-2749.2 602749 13.0460-2880.2 602880 13.0470-2749.2 LD2749 13.0470-2880.2 LD2880	TRW 24483 16,9 - WE / - WK + Zub TRW 23914 17,1 + WE / - WK + Zub TRW 24483 16,9 - WE / - WK + Zub Ceramic TRW 23914 17,1 + WE / - WK + Zub Ceramic
			➔	→ 03/09; +PR 1KD		13.0460-2787.2 602787 13.0460-2820.2 602820 13.0470-2820.2 LD2820	TRW 23554 17,3 - WK / - WE TRW 20961 17,2 - WK TRW 20961 17,2 - WK Ceramic
			➔	10/04→ 03/09; +PR 1ZF		13.0460-7117.2 607117 13.0470-7117.2 LD7117	VW 23130 19,6 + WK VW 23130 19,6 + WK Ceramic
			➔	10/04→ 03/09; +PR 1ZE		13.0460-7184.2 607184 13.0470-7184.2 LD7184	ATE 23587 20,6 + WK ATE 23587 20,6 + WK Ceramic
			➔	10/04→ 03/09; +PR 1KF,1KJ,1KZ		13.0460-2749.2 602749 13.0460-2880.2 602880 13.0470-2749.2 LD2749 13.0470-2880.2 LD2880	TRW 24483 16,9 - WE / - WK + Zub TRW 23914 17,1 + WE / - WK + Zub TRW 24483 16,9 - WE / - WK + Zub Ceramic TRW 23914 17,1 + WE / - WK + Zub Ceramic
			➔	10/04→ 03/09; +PR 1KD		13.0460-2787.2 602787 13.0460-2820.2 602820 13.0470-2820.2 LD2820	TRW 23554 17,3 - WK / - WE TRW 20961 17,2 - WK TRW 20961 17,2 - WK Ceramic
			➔	10/04→ 03/09; +PR 1ZF		13.0460-7117.2 607117 13.0470-7117.2 LD7117	VW 23130 19,6 + WK VW 23130 19,6 + WK Ceramic
			➔	10/04→ 03/09; +PR 1ZE		13.0460-7184.2 607184 13.0470-7184.2 LD7184	ATE 23587 20,6 + WK ATE 23587 20,6 + WK Ceramic
➔	10/04→ 03/09; +PR 1KF,1KJ,1KZ		13.0460-2749.2 602749 13.0460-2880.2 602880 13.0470-2749.2 LD2749 13.0470-2880.2 LD2880	TRW 24483 16,9 - WE / - WK + Zub TRW 23914 17,1 + WE / - WK + Zub TRW 24483 16,9 - WE / - WK + Zub Ceramic TRW 23914 17,1 + WE / - WK + Zub Ceramic			
➔	10/04→ 03/09; +PR 1KD		13.0460-2787.2 602787 13.0460-2820.2 602820 13.0470-2820.2 LD2820	TRW 23554 17,3 - WK / - WE TRW 20961 17,2 - WK TRW 20961 17,2 - WK Ceramic			
<b>Zubehörsatz, Scheibenbremsbelag</b>							
1.4 16V 1.4 TSI 1.6 1.8 TFSI 1.9 TDI 2.0 FSI 2.0 TDI 2.0 TDI ↓	63 92 75 118 77 110 103 125	05/06→05/09 11/07→05/09 10/04→05/09 01/07→05/09 10/04→05/09 10/04→05/09 11/05→05/09 01/06→05/09	➔	→ 03/09; +PR 1KF,1KJ,1KZ		13.0460-0259.2 610259	







	kW			 	! #		
<b>SEAT - TOLEDO III (5P2) 04/04→05/09</b>							
<b>Zubehörsatz, Scheibenbremsbelag</b>							
2.0 TFSI	147	11/05→05/09	➡	→ 03/09; +PR 1KF,1KJ,1KZ		13.0460-0259.2 610259	
2.0 TDI	100	09/04→05/09	➡	10/04→ 03/09; +PR 1KF,1KJ,1KZ		13.0460-0259.2 610259	
2.0 TDI 16V	103	04/04→05/09					
<b> Bremsscheibe</b>							
1.4 16V	63	05/06→05/09	←	→ 03/09; +PR 1ZF		24.0122-0210.1 422210	Ø 280 22 19 V + S
1.4 TSI	92	11/07→05/09				24.0322-0210.1 522210	Ø 280 22 19 V + S
1.6	75	10/04→05/09					
1.8 TFSI	118	01/07→05/09	←	→ 03/09; +PR 1ZE		24.0125-0145.1 425145	Ø 288 25 22 V + S
1.9 TDI	77	10/04→05/09				24.0325-0145.1 525145	Ø 288 25 22 V + S
2.0 FSI	110	10/04→05/09					
2.0 TDI	103	11/05→05/09	➡	→ 03/09; +PR 1KD		24.0110-0277.1 410277	Ø 253 10 8 + S
2.0 TDI	125	01/06→05/09				24.0310-0277.1 510277	Ø 253 10 8 + S
2.0 TFSI	147	11/05→05/09	➡	→ 03/09; +PR 1KF		24.0112-0158.1 412158	Ø 256 12 10 + S
						24.0312-0158.1 512158	Ø 256 12 10
			➡	→ 03/09; +PR 1KJ,1KZ		24.0112-0169.1 412169	Ø 282 12 10 + S
						24.0312-0169.1 512169	Ø 282 12 10 + S
2.0 TDI	100	09/04→05/09	←	10/04→ 03/09; +PR 1ZF		24.0122-0210.1 422210	Ø 280 22 19 V + S
2.0 TDI 16V	103	04/04→05/09				24.0322-0210.1 522210	Ø 280 22 19 V + S
			←	10/04→ 03/09; +PR 1ZE		24.0125-0145.1 425145	Ø 288 25 22 V + S
						24.0325-0145.1 525145	Ø 288 25 22 V + S
			➡	10/04→ 03/09; +PR 1KD		24.0110-0277.1 410277	Ø 253 10 8 + S
						24.0310-0277.1 510277	Ø 253 10 8 + S
			➡	10/04→ 03/09; +PR 1KF		24.0112-0158.1 412158	Ø 256 12 10 + S
						24.0312-0158.1 512158	Ø 256 12 10
			➡	10/04→ 03/09; +PR 1KJ,1KZ		24.0112-0169.1 412169	Ø 282 12 10 + S
						24.0312-0169.1 512169	Ø 282 12 10 + S
<b>SEAT - TOLEDO IV (KG3) 07/12→</b>							
<b> Bremsbelagsatz, Scheibenbremse</b>							
1.0 TSI	70	05/17→	←	+PR 1ZG		13.0460-7111.2 607111	VW 23130 19,6 - WE / - WK
1.0 TSI	81	05/17→				13.0470-7111.2 LD7111	VW 23130 19,6 - WE / - WK Ceramic
1.2 TSI	66	05/15→					
1.2 TSI	81	05/15→					
1.4 TDI	66	05/15→	←	+PR 1ZC		13.0460-7184.2 607184	ATE 23587 20,6 + WK
1.4 TSI	92	05/15→				13.0470-7184.2 LD7184	ATE 23587 20,6 + WK Ceramic
1.6 TDI	85	05/15→	➡			13.0460-2787.2 602787	TRW 23554 17,3 - WK / - WE
						13.0460-2820.2 602820	TRW 20961 17,2 - WK
						13.0470-2820.2 LD2820	TRW 20961 17,2 - WK Ceramic
1.2	55	07/12→	←	+PR 1ZG		13.0460-7111.2 607111	VW 23130 19,6 - WE / - WK
1.2 TSI	63	07/12→				13.0470-7111.2 LD7111	VW 23130 19,6 - WE / - WK Ceramic
1.2 TSI	77	07/12→					
1.4 TSI	90	07/12→					
1.6	77	07/13→	←	für Bremsscheibendurchmesser [mm]: 288		13.0460-7184.2 607184	ATE 23587 20,6 + WK
1.6 TDI	66	06/13→				13.0470-7184.2 LD7184	ATE 23587 20,6 + WK Ceramic
1.6 TDI	77	07/12→	➡			13.0460-2787.2 602787	TRW 23554 17,3 - WK / - WE
						13.0460-2820.2 602820	TRW 20961 17,2 - WK
						13.0470-2820.2 LD2820	TRW 20961 17,2 - WK Ceramic
<b> Bremsscheibe</b>							
1.0 TSI	70	05/17→	←	+PR 1ZG		24.0122-0151.1 422151	Ø 256 22 19 V + S
1.0 TSI	81	05/17→				24.0322-0151.1 522151	Ø 256 22 19 V + S
1.2 TSI	66	05/15→					
1.2 TSI	81	05/15→	←	+PR 1ZC		24.0125-0113.1 425113	Ø 288 25 22 V + S
1.4 TDI	66	05/15→				24.0325-0113.1 525113	Ø 288 25 22 V + S
1.4 TSI	92	05/15→					
1.6 TDI	85	05/15→	➡			24.0109-0123.1 409123	Ø 230 9 7 + S
						24.0309-0123.1 509123	Ø 230 9 7 + S
1.2	55	07/12→	←	+PR 1ZG		24.0122-0151.1 422151	Ø 256 22 19 V + S
1.2 TSI	63	07/12→				24.0322-0151.1 522151	Ø 256 22 19 V + S
1.2 TSI	77	07/12→					
1.4 TSI	90	07/12→	←	für Bremsscheibendurchmesser [mm]: 288		24.0125-0113.1 425113	Ø 288 25 22 V + S
1.6	77	07/13→				24.0325-0113.1 525113	Ø 288 25 22 V + S
1.6 TDI	66	06/13→					
1.6 TDI	77	07/12→	➡			24.0109-0123.1 409123	Ø 230 9 7 + S
						24.0309-0123.1 509123	Ø 230 9 7 + S
<b>SKODA - CITIGO 10/11→</b>							
<b> Bremsbelagsatz, Scheibenbremse</b>							
1.0	44	10/11→	←	05/12→		13.0460-7111.2 607111	VW 23130 19,6 - WE / - WK
1.0	55	10/11→					
↓							























	kw			 	! #		
<b>SKODA - CITIGO 10/11→</b>							
 <b>Bremsbelagsatz, Scheibenbremse</b>							
1.0 LPG	55	10/11→	←	05/12→		13.0470-7111.2 LD7111	VW 23130 19,6 - WE / - WK Ceramic
1.0 CNG	50	11/12→	←			13.0460-7111.2 607111 13.0470-7111.2 LD7111	VW 23130 19,6 - WE / - WK VW 23130 19,6 - WE / - WK Ceramic
 <b>Bremsscheibe</b>							
1.0	44	10/11→	←	05/12→		24.0122-0281.1 422281	Ø 256 22 19 V + S
1.0	55	10/11→					
1.0 LPG	55	10/11→					
1.0 CNG	50	11/12→	←			24.0122-0281.1 422281	Ø 256 22 19 V + S
<b>SKODA - FABIA I (6Y2) 08/99→03/08</b>							
 <b>Bremsbelagsatz, Scheibenbremse</b>							
1.0	37	12/99→08/02	←	02/00→; +PR 1LN;1LP		13.0460-2883.2 602883	TRW 23581 18,8 - WE / - WK
1.4	50	08/99→05/03				13.0460-2884.2 602884	TRW 23581 18,8 + WK
						13.0470-2884.2 LD2884	TRW 23581 18,8 + WK Ceramic
			←	02/00→; +PR 1LB;1LM		13.0460-7100.2 607100	VW 21866 17,2 - WE / - WK
						13.0460-7164.2 607164	VW 21866 17,2 + WK
						13.0470-7100.2 LD7100	VW 21866 17,2 - WE / - WK Ceramic
			←	02/00→; +PR 1LQ;1LR		13.0460-7111.2 607111	VW 23130 19,6 - WE / - WK
						13.0460-7117.2 607117	VW 23130 19,6 + WK
						13.0470-7111.2 LD7111	VW 23130 19,6 - WE / - WK Ceramic
						13.0470-7117.2 LD7117	VW 23130 19,6 + WK Ceramic
1.2	40	07/01→04/07	←	08/02→; +PR 1LN;1LP		13.0460-2883.2 602883	TRW 23581 18,8 - WE / - WK
						13.0460-2884.2 602884	TRW 23581 18,8 + WK
						13.0470-2884.2 LD2884	TRW 23581 18,8 + WK Ceramic
			←	08/02→; +PR 1LB;1LM		13.0460-7100.2 607100	VW 21866 17,2 - WE / - WK
						13.0460-7164.2 607164	VW 21866 17,2 + WK
						13.0470-7100.2 LD7100	VW 21866 17,2 - WE / - WK Ceramic
			←	08/02→; +PR 1LQ;1LR		13.0460-7111.2 607111	VW 23130 19,6 - WE / - WK
						13.0460-7117.2 607117	VW 23130 19,6 + WK
						13.0470-7111.2 LD7111	VW 23130 19,6 - WE / - WK Ceramic
						13.0470-7117.2 LD7117	VW 23130 19,6 + WK Ceramic
1.2	47	01/03→03/08	←	→ 12/07; +PR 1LN;1LP		13.0460-2883.2 602883	TRW 23581 18,8 - WE / - WK
1.9 SDI	47	12/99→03/08				13.0460-2884.2 602884	TRW 23581 18,8 + WK
						13.0470-2884.2 LD2884	TRW 23581 18,8 + WK Ceramic
			←	→ 12/07; +PR 1LB;1LM		13.0460-7100.2 607100	VW 21866 17,2 - WE / - WK
						13.0460-7164.2 607164	VW 21866 17,2 + WK
						13.0470-7100.2 LD7100	VW 21866 17,2 - WE / - WK Ceramic
			←	→ 12/07; +PR 1LQ;1LR		13.0460-7111.2 607111	VW 23130 19,6 - WE / - WK
						13.0460-7117.2 607117	VW 23130 19,6 + WK
						13.0470-7111.2 LD7111	VW 23130 19,6 - WE / - WK Ceramic
						13.0470-7117.2 LD7117	VW 23130 19,6 + WK Ceramic
1.4	44	08/00→08/02	←	+PR 1LN;1LP		13.0460-2883.2 602883	TRW 23581 18,8 - WE / - WK
						13.0460-2884.2 602884	TRW 23581 18,8 + WK
						13.0470-2884.2 LD2884	TRW 23581 18,8 + WK Ceramic
			←	+PR 1LB;1LM		13.0460-7100.2 607100	VW 21866 17,2 - WE / - WK
						13.0460-7164.2 607164	VW 21866 17,2 + WK
						13.0470-7100.2 LD7100	VW 21866 17,2 - WE / - WK Ceramic
			←	+PR 1LQ;1LR		13.0460-7111.2 607111	VW 23130 19,6 - WE / - WK
						13.0460-7117.2 607117	VW 23130 19,6 + WK
						13.0470-7111.2 LD7111	VW 23130 19,6 - WE / - WK Ceramic
						13.0470-7117.2 LD7117	VW 23130 19,6 + WK Ceramic
1.4 16V	55	12/99→03/08	←	→ 12/07; +PR 1LN;1LP		13.0460-2883.2 602883	TRW 23581 18,8 - WE / - WK
1.4 16V	74	12/99→03/08				13.0460-2884.2 602884	TRW 23581 18,8 + WK
1.4 TDI	51	10/05→03/08				13.0470-2884.2 LD2884	TRW 23581 18,8 + WK Ceramic
1.4 TDI	55	04/03→03/08					
↓							









	kw			 	! #		
<b>SKODA - FABIA I (6Y2) 08/99→03/08</b>							
<b> Bremsbelagsatz, Scheibenbremse</b>							
1.4 TDI 2.0	59 85	10/05→03/08 12/99→03/08	←	→ 12/07; +PR 1LB;1LM	13.0460-7100.2 607100	VW 21866 17,2 - WE / - WK	
					13.0460-7164.2 607164	VW 21866 17,2 + WK	
					13.0470-7100.2 LD7100	VW 21866 17,2 - WE / - WK Ceramic	
			←	→ 12/07; +PR 1LQ;1LR	13.0460-7111.2 607111	VW 23130 19,6 - WE / - WK	
					13.0460-7117.2 607117	VW 23130 19,6 + WK	
					13.0470-7111.2 LD7111	VW 23130 19,6 - WE / - WK Ceramic	
					13.0470-7117.2 LD7117	VW 23130 19,6 + WK Ceramic	
			→	→ 12/07; +PR 1KK,1KP	13.0460-2894.2 602894	TRW 20961 17,2 - WK + Zub	
					13.0470-2894.2 LD2894	TRW 20961 17,2 - WK + Zub Ceramic	
1.9 TDI	74	01/00→03/08	←	02/00→ 12/07; +PR 1LN;1LP	13.0460-2883.2 602883	TRW 23581 18,8 - WE / - WK	
					13.0460-2884.2 602884	TRW 23581 18,8 + WK	
					13.0470-2884.2 LD2884	TRW 23581 18,8 + WK Ceramic	
						←	02/00→ 12/07; +PR 1LB;1LM
					13.0460-7164.2 607164	VW 21866 17,2 + WK	
					13.0470-7100.2 LD7100	VW 21866 17,2 - WE / - WK Ceramic	
			←	02/00→ 12/07; +PR 1LQ;1LR	13.0460-7111.2 607111	VW 23130 19,6 - WE / - WK	
					13.0460-7117.2 607117	VW 23130 19,6 + WK	
					13.0470-7111.2 LD7111	VW 23130 19,6 - WE / - WK Ceramic	
					13.0470-7117.2 LD7117	VW 23130 19,6 + WK Ceramic	
			→	02/00→ 12/07; +PR 1KK,1KP	13.0460-2894.2 602894	TRW 20961 17,2 - WK + Zub	
					13.0470-2894.2 LD2894	TRW 20961 17,2 - WK + Zub Ceramic	
1.9 TDI RS	96	06/03→03/08	←	09/03→ 12/07; +PR 1LN;1LP	13.0460-2883.2 602883	TRW 23581 18,8 - WE / - WK	
					13.0460-2884.2 602884	TRW 23581 18,8 + WK	
					13.0470-2884.2 LD2884	TRW 23581 18,8 + WK Ceramic	
						←	09/03→ 12/07; +PR 1LB;1LM
					13.0460-7164.2 607164	VW 21866 17,2 + WK	
					13.0470-7100.2 LD7100	VW 21866 17,2 - WE / - WK Ceramic	
			←	09/03→ 12/07; +PR 1LQ;1LR	13.0460-7111.2 607111	VW 23130 19,6 - WE / - WK	
					13.0460-7117.2 607117	VW 23130 19,6 + WK	
					13.0470-7111.2 LD7111	VW 23130 19,6 - WE / - WK Ceramic	
					13.0470-7117.2 LD7117	VW 23130 19,6 + WK Ceramic	
			→	09/03→ 12/07; +PR 1KK,1KP	13.0460-2894.2 602894	TRW 20961 17,2 - WK + Zub	
					13.0470-2894.2 LD2894	TRW 20961 17,2 - WK + Zub Ceramic	
<b> Bremsscheibe</b>							
1.0 1.4	37 50	12/99→08/02 08/99→05/03	←	02/00→; +PR 1LB;1LM	24.0118-0137.1 418137	Ø 239 18 16 V + S	
					24.0318-0137.1 518137	Ø 239 18 16 V + S	
						←	02/00→; +PR 1LQ;1LR
					24.0322-0151.1 522151	Ø 256 22 19 V + S	
			←	02/00→; +PR 1LN;1LP	24.0125-0113.1 425113	Ø 288 25 22 V + S	
					24.0325-0113.1 525113	Ø 288 25 22 V + S	
1.2	40	07/01→04/07	←	08/02→; +PR 1LB;1LM	24.0118-0137.1 418137	Ø 239 18 16 V + S	
					24.0318-0137.1 518137	Ø 239 18 16 V + S	
						←	08/02→; +PR 1LQ;1LR
					24.0322-0151.1 522151	Ø 256 22 19 V + S	
			←	08/02→; +PR 1LN;1LP	24.0125-0113.1 425113	Ø 288 25 22 V + S	
					24.0325-0113.1 525113	Ø 288 25 22 V + S	
1.2 1.9 SDI	47 47	01/03→03/08 12/99→03/08	←	→ 12/07; +PR 1LB;1LM	24.0118-0137.1 418137	Ø 239 18 16 V + S	
					24.0318-0137.1 518137	Ø 239 18 16 V + S	
						←	→ 12/07; +PR 1LQ;1LR
					24.0322-0151.1 522151	Ø 256 22 19 V + S	
			←	→ 12/07; +PR 1LN;1LP	24.0125-0113.1 425113	Ø 288 25 22 V + S	
					24.0325-0113.1 525113	Ø 288 25 22 V + S	
1.4	44	08/00→08/02	←	+PR 1LB;1LM	24.0118-0137.1 418137	Ø 239 18 16 V + S	
					24.0318-0137.1 518137	Ø 239 18 16 V + S	
↓							











	kw			 	! #		
<b>SKODA - FABIA I (6Y2) 08/99→03/08</b>							
<b>Bremsscheibe</b>							
1.4	44	08/00→08/02	←	+PR 1LQ;1LR		24.0122-0151.1 422151 24.0322-0151.1 522151	Ø 256 22 19 V + S Ø 256 22 19 V + S
			←	+PR 1LN;1LP		24.0125-0113.1 425113 24.0325-0113.1 525113	Ø 288 25 22 V + S Ø 288 25 22 V + S
1.4 16V	55	12/99→03/08	←	→ 12/07; +PR 1LB;1LM		24.0118-0137.1 418137	Ø 239 18 16 V + S
1.4 16V	74	12/99→03/08				24.0318-0137.1 518137	Ø 239 18 16 V + S
1.4 TDI	51	10/05→03/08					
1.4 TDI	55	04/03→03/08	←	→ 12/07; +PR 1LQ;1LR		24.0122-0151.1 422151	Ø 256 22 19 V + S
1.4 TDI	59	10/05→03/08				24.0322-0151.1 522151	Ø 256 22 19 V + S
2.0	85	12/99→03/08	←	→ 12/07; +PR 1LN;1LP		24.0125-0113.1 425113 24.0325-0113.1 525113	Ø 288 25 22 V + S Ø 288 25 22 V + S
			→	→ 12/07; +PR 1KK,1KP		24.0109-0123.1 409123 24.0309-0123.1 509123	Ø 230 9 7 + S Ø 230 9 7 + S
1.9 TDI	74	01/00→03/08	←	02/00→ 12/07; +PR 1LB;1LM		24.0118-0137.1 418137 24.0318-0137.1 518137	Ø 239 18 16 V + S Ø 239 18 16 V + S
			←	02/00→ 12/07; +PR 1LQ;1LR		24.0122-0151.1 422151 24.0322-0151.1 522151	Ø 256 22 19 V + S Ø 256 22 19 V + S
			←	02/00→ 12/07; +PR 1LN;1LP		24.0125-0113.1 425113 24.0325-0113.1 525113	Ø 288 25 22 V + S Ø 288 25 22 V + S
			→	02/00→ 12/07; +PR 1KK,1KP		24.0109-0123.1 409123 24.0309-0123.1 509123	Ø 230 9 7 + S Ø 230 9 7 + S
1.9 TDI RS	96	06/03→03/08	←	09/03→ 12/07; +PR 1LB;1LM		24.0118-0137.1 418137 24.0318-0137.1 518137	Ø 239 18 16 V + S Ø 239 18 16 V + S
			←	09/03→ 12/07; +PR 1LQ;1LR		24.0122-0151.1 422151 24.0322-0151.1 522151	Ø 256 22 19 V + S Ø 256 22 19 V + S
			←	09/03→ 12/07; +PR 1LN;1LP		24.0125-0113.1 425113 24.0325-0113.1 525113	Ø 288 25 22 V + S Ø 288 25 22 V + S
			→	09/03→ 12/07; +PR 1KK,1KP		24.0109-0123.1 409123 24.0309-0123.1 509123	Ø 230 9 7 + S Ø 230 9 7 + S
<b>SKODA - FABIA I Combi (6Y5) 04/00→12/07</b>							
<b>Bremsbelagsatz, Scheibenbremse</b>							
1.2	40	07/01→12/07	←	08/02→; +PR 1LN;1LP		13.0460-2883.2 602883 13.0460-2884.2 602884 13.0470-2884.2 LD2884	TRW 23581 18,8 - WE / - WK TRW 23581 18,8 + WK TRW 23581 18,8 + WK Ceramic
			←	08/02→; +PR 1LB;1LM		13.0460-7100.2 607100 13.0460-7164.2 607164 13.0470-7100.2 LD7100	VW 21866 17,2 - WE / - WK VW 21866 17,2 + WK VW 21866 17,2 - WE / - WK Ceramic
			←	08/02→; +PR 1LQ;1LR		13.0460-7111.2 607111 13.0460-7117.2 607117 13.0470-7111.2 LD7111 13.0470-7117.2 LD7117	VW 23130 19,6 - WE / - WK VW 23130 19,6 + WK VW 23130 19,6 - WE / - WK Ceramic VW 23130 19,6 + WK Ceramic
1.2	47	01/03→12/07	←	+PR 1LN;1LP		13.0460-2883.2 602883	TRW 23581 18,8 - WE / - WK
1.4	44	04/00→03/03				13.0460-2884.2 602884	TRW 23581 18,8 + WK
1.4	50	04/00→05/03				13.0470-2884.2 LD2884	TRW 23581 18,8 + WK Ceramic
1.9 SDI	47	04/00→12/07	←	+PR 1LB;1LM		13.0460-7100.2 607100 13.0460-7164.2 607164 13.0470-7100.2 LD7100	VW 21866 17,2 - WE / - WK VW 21866 17,2 + WK VW 21866 17,2 - WE / - WK Ceramic
			←	+PR 1LQ;1LR		13.0460-7111.2 607111 13.0460-7117.2 607117 13.0470-7111.2 LD7111 13.0470-7117.2 LD7117	VW 23130 19,6 - WE / - WK VW 23130 19,6 + WK VW 23130 19,6 - WE / - WK Ceramic VW 23130 19,6 + WK Ceramic
1.4 16V	55	05/00→12/07	←	+PR 1LN;1LP		13.0460-2883.2 602883	TRW 23581 18,8 - WE / - WK
1.4 16V	59	04/06→12/07				13.0460-2884.2 602884	TRW 23581 18,8 + WK
1.4 16V	74	04/00→12/07				13.0470-2884.2 LD2884	TRW 23581 18,8 + WK Ceramic
1.4 TDI	51	10/05→12/07					
1.4 TDI	55	04/03→12/07	←	+PR 1LB;1LM		13.0460-7100.2 607100	VW 21866 17,2 - WE / - WK
1.4 TDI	59	10/05→12/07				13.0460-7164.2 607164	VW 21866 17,2 + WK
1.9 TDI	74	04/00→12/07				13.0470-7100.2 LD7100	VW 21866 17,2 - WE / - WK Ceramic
2.0	85	04/00→12/07	←	+PR 1LQ;1LR		13.0460-7111.2 607111	VW 23130 19,6 - WE / - WK
↓							









	kw			 	! #		
<b>SKODA - FABIA I Combi (6Y5) 04/00→12/07</b>							
 <b>Bremsbelagsatz, Scheibenbremse</b>							
1.4 16V	55	05/00→12/07	←	+PR 1LQ;1LR		13.0460-7117.2 607117	VW 23130 19,6 + WK
1.4 16V	59	04/06→12/07				13.0470-7111.2 LD7111	VW 23130 19,6 - WE / - WK Ceramic
1.4 16V	74	04/00→12/07					
1.4 TDI	51	10/05→12/07				13.0470-7117.2 LD7117	VW 23130 19,6 + WK Ceramic
1.4 TDI	55	04/03→12/07					
1.4 TDI	59	10/05→12/07	→	+PR 1KK,1KP		13.0460-2894.2 602894	TRW 20961 17,2 - WK + Zub
1.9 TDI	74	04/00→12/07				13.0470-2894.2 LD2894	TRW 20961 17,2 - WK + Zub Ceramic
2.0	85	04/00→12/07					
 <b>Bremsscheibe</b>							
1.2	40	07/01→12/07	←	08/02→; +PR 1LB;1LM		24.0118-0137.1 418137	Ø 239 18 16 V + S
						24.0318-0137.1 518137	Ø 239 18 16 V + S
			←	08/02→; +PR 1LQ;1LR		24.0122-0151.1 422151	Ø 256 22 19 V + S
						24.0322-0151.1 522151	Ø 256 22 19 V + S
			←	08/02→; +PR 1LN;1LP		24.0125-0113.1 425113	Ø 288 25 22 V + S
						24.0325-0113.1 525113	Ø 288 25 22 V + S
1.2	47	01/03→12/07	←	+PR 1LB;1LM		24.0118-0137.1 418137	Ø 239 18 16 V + S
1.4	44	04/00→03/03				24.0318-0137.1 518137	Ø 239 18 16 V + S
1.4	50	04/00→05/03	←	+PR 1LQ;1LR		24.0122-0151.1 422151	Ø 256 22 19 V + S
1.9 SDI	47	04/00→12/07				24.0322-0151.1 522151	Ø 256 22 19 V + S
			←	+PR 1LN;1LP		24.0125-0113.1 425113	Ø 288 25 22 V + S
						24.0325-0113.1 525113	Ø 288 25 22 V + S
1.4 16V	55	05/00→12/07	←	+PR 1LB;1LM		24.0118-0137.1 418137	Ø 239 18 16 V + S
1.4 16V	59	04/06→12/07				24.0318-0137.1 518137	Ø 239 18 16 V + S
1.4 16V	74	04/00→12/07					
1.4 TDI	51	10/05→12/07	←	+PR 1LQ;1LR		24.0122-0151.1 422151	Ø 256 22 19 V + S
1.4 TDI	55	04/03→12/07				24.0322-0151.1 522151	Ø 256 22 19 V + S
1.4 TDI	59	10/05→12/07	←	+PR 1LN;1LP		24.0125-0113.1 425113	Ø 288 25 22 V + S
1.9 TDI	74	04/00→12/07				24.0325-0113.1 525113	Ø 288 25 22 V + S
2.0	85	04/00→12/07	→	+PR 1KK,1KP		24.0109-0123.1 409123	Ø 230 9 7 + S
						24.0309-0123.1 509123	Ø 230 9 7 + S
<b>SKODA - FABIA I Praktik (6Y5) 07/01→12/07</b>							
 <b>Bremsbelagsatz, Scheibenbremse</b>							
1.2	40	07/01→12/07	←	08/02→; +PR 1LN;1LP		13.0460-2883.2 602883	TRW 23581 18,8 - WE / - WK
						13.0460-2884.2 602884	TRW 23581 18,8 + WK
						13.0470-2884.2 LD2884	TRW 23581 18,8 + WK Ceramic
			←	08/02→; +PR 1LB;1LM		13.0460-7100.2 607100	VW 21866 17,2 - WE / - WK
						13.0460-7164.2 607164	VW 21866 17,2 + WK
						13.0470-7100.2 LD7100	VW 21866 17,2 - WE / - WK Ceramic
			←	08/02→; +PR 1LQ;1LR		13.0460-7111.2 607111	VW 23130 19,6 - WE / - WK
						13.0460-7117.2 607117	VW 23130 19,6 + WK
						13.0470-7111.2 LD7111	VW 23130 19,6 - WE / - WK Ceramic
						13.0470-7117.2 LD7117	VW 23130 19,6 + WK Ceramic
1.2	47	01/03→12/07	←	+PR 1LN;1LP		13.0460-2883.2 602883	TRW 23581 18,8 - WE / - WK
1.4	50	07/01→05/03				13.0460-2884.2 602884	TRW 23581 18,8 + WK
1.9 SDI	47	07/01→12/07				13.0470-2884.2 LD2884	TRW 23581 18,8 + WK Ceramic
			←	+PR 1LB;1LM		13.0460-7100.2 607100	VW 21866 17,2 - WE / - WK
						13.0460-7164.2 607164	VW 21866 17,2 + WK
						13.0470-7100.2 LD7100	VW 21866 17,2 - WE / - WK Ceramic
			←	+PR 1LQ;1LR		13.0460-7111.2 607111	VW 23130 19,6 - WE / - WK
						13.0460-7117.2 607117	VW 23130 19,6 + WK
						13.0470-7111.2 LD7111	VW 23130 19,6 - WE / - WK Ceramic
						13.0470-7117.2 LD7117	VW 23130 19,6 + WK Ceramic
1.4 TDI	51	10/05→12/07	←	+PR 1LN;1LP		13.0460-2883.2 602883	TRW 23581 18,8 - WE / - WK
						13.0460-2884.2 602884	TRW 23581 18,8 + WK
						13.0470-2884.2 LD2884	TRW 23581 18,8 + WK Ceramic
			←	+PR 1LB;1LM		13.0460-7100.2 607100	VW 21866 17,2 - WE / - WK
						13.0460-7164.2 607164	VW 21866 17,2 + WK
						13.0470-7100.2 LD7100	VW 21866 17,2 - WE / - WK Ceramic
↓							







	kw			 	! #		
<b>SKODA - FABIA I Praktik (6Y5) 07/01→12/07</b>							
 <b>Bremsbelagsatz, Scheibenbremse</b>							
1.4 TDI	51	10/05→12/07	←	+PR 1LQ;1LR		13.0460-7111.2 607111 13.0460-7117.2 607117 13.0470-7111.2 LD7111 13.0470-7117.2 LD7117	VW 23130 19,6 - WE / - WK VW 23130 19,6 + WK VW 23130 19,6 - WE / - WK Ceramic VW 23130 19,6 + WK Ceramic
			→	+PR 1KK,1KP		13.0460-2894.2 602894 13.0470-2894.2 LD2894	TRW 20961 17,2 - WK + Zub TRW 20961 17,2 - WK + Zub Ceramic
 <b>Bremsscheibe</b>							
1.2	40	07/01→12/07	←	08/02→; +PR 1LB;1LM		24.0118-0137.1 418137 24.0318-0137.1 518137	Ø 239 18 16 V + S Ø 239 18 16 V + S
			←	08/02→; +PR 1LQ;1LR		24.0122-0151.1 422151 24.0322-0151.1 522151	Ø 256 22 19 V + S Ø 256 22 19 V + S
			←	08/02→; +PR 1LN;1LP		24.0125-0113.1 425113 24.0325-0113.1 525113	Ø 288 25 22 V + S Ø 288 25 22 V + S
1.2 1.4 1.9 SDI	47 50 47	01/03→12/07 07/01→05/03 07/01→12/07	←	+PR 1LB;1LM		24.0118-0137.1 418137 24.0318-0137.1 518137	Ø 239 18 16 V + S Ø 239 18 16 V + S
			←	+PR 1LQ;1LR		24.0122-0151.1 422151 24.0322-0151.1 522151	Ø 256 22 19 V + S Ø 256 22 19 V + S
			←	+PR 1LN;1LP		24.0125-0113.1 425113 24.0325-0113.1 525113	Ø 288 25 22 V + S Ø 288 25 22 V + S
1.4 TDI	51	10/05→12/07	←	+PR 1LB;1LM		24.0118-0137.1 418137 24.0318-0137.1 518137	Ø 239 18 16 V + S Ø 239 18 16 V + S
			←	+PR 1LQ;1LR		24.0122-0151.1 422151 24.0322-0151.1 522151	Ø 256 22 19 V + S Ø 256 22 19 V + S
			←	+PR 1LN;1LP		24.0125-0113.1 425113 24.0325-0113.1 525113	Ø 288 25 22 V + S Ø 288 25 22 V + S
			→	+PR 1KK,1KP		24.0109-0123.1 409123 24.0309-0123.1 509123	Ø 230 9 7 + S Ø 230 9 7 + S
<b>SKODA - FABIA I Stufenheck (6Y3) 10/99→12/07</b>							
 <b>Bremsbelagsatz, Scheibenbremse</b>							
1.2	40	07/01→12/07	←	08/02→; +PR 1LN;1LP		13.0460-2883.2 602883 13.0460-2884.2 602884 13.0470-2884.2 LD2884	TRW 23581 18,8 - WE / - WK TRW 23581 18,8 + WK TRW 23581 18,8 + WK Ceramic
			←	08/02→; +PR 1LB;1LM		13.0460-7100.2 607100 13.0460-7164.2 607164 13.0470-7100.2 LD7100	VW 21866 17,2 - WE / - WK VW 21866 17,2 + WK VW 21866 17,2 - WE / - WK Ceramic
			←	08/02→; +PR 1LQ;1LR		13.0460-7111.2 607111 13.0460-7117.2 607117 13.0470-7111.2 LD7111 13.0470-7117.2 LD7117	VW 23130 19,6 - WE / - WK VW 23130 19,6 + WK VW 23130 19,6 - WE / - WK Ceramic VW 23130 19,6 + WK Ceramic
1.2 1.4 1.4	47 44 50	01/03→12/07 04/00→08/02 07/01→05/03	←	+PR 1LN;1LP		13.0460-2883.2 602883 13.0460-2884.2 602884 13.0470-2884.2 LD2884	TRW 23581 18,8 - WE / - WK TRW 23581 18,8 + WK TRW 23581 18,8 + WK Ceramic
			←	+PR 1LB;1LM		13.0460-7100.2 607100 13.0460-7164.2 607164 13.0470-7100.2 LD7100	VW 21866 17,2 - WE / - WK VW 21866 17,2 + WK VW 21866 17,2 - WE / - WK Ceramic
			←	+PR 1LQ;1LR		13.0460-7111.2 607111 13.0460-7117.2 607117 13.0470-7111.2 LD7111 13.0470-7117.2 LD7117	VW 23130 19,6 - WE / - WK VW 23130 19,6 + WK VW 23130 19,6 - WE / - WK Ceramic VW 23130 19,6 + WK Ceramic
1.4 16V 1.4 16V 1.4 16V 1.4 TDI 1.4 TDI 1.4 TDI 2.0 ↓	55 59 74 51 55 59 85	10/99→12/07 04/06→12/07 12/99→12/07 10/05→12/07 04/03→12/07 10/05→12/07 12/99→12/07	←	+PR 1LN;1LP		13.0460-2883.2 602883 13.0460-2884.2 602884 13.0470-2884.2 LD2884	TRW 23581 18,8 - WE / - WK TRW 23581 18,8 + WK TRW 23581 18,8 + WK Ceramic
			←	+PR 1LB;1LM		13.0460-7100.2 607100 13.0460-7164.2 607164	VW 21866 17,2 - WE / - WK VW 21866 17,2 + WK







	kw			 	! #		
<b>SKODA - FABIA I Stufenheck (6Y3) 10/99→12/07</b>							
<b> Bremsbelagsatz, Scheibenbremse</b>							
1.4 16V	55	10/99→12/07	←	+PR 1LB;1LM		13.0470-7100.2 LD7100	VW 21866 17,2 - WE / - WK Ceramic
1.4 16V	59	04/06→12/07					
1.4 16V	74	12/99→12/07					
1.4 TDI	51	10/05→12/07	←	+PR 1LQ;1LR		13.0460-7111.2 607111	VW 23130 19,6 - WE / - WK
1.4 TDI	55	04/03→12/07				13.0460-7117.2 607117	VW 23130 19,6 + WK
1.4 TDI	59	10/05→12/07				13.0470-7111.2 LD7111	VW 23130 19,6 - WE / - WK Ceramic
2.0	85	12/99→12/07				13.0470-7117.2 LD7117	VW 23130 19,6 + WK Ceramic
			→	+PR 1KK,1KP		13.0460-2894.2 602894	TRW 20961 17,2 - WK + Zub
						13.0470-2894.2 LD2894	TRW 20961 17,2 - WK + Zub Ceramic
1.9 SDI	47	11/99→12/07	←	12/99→; +PR 1LN;1LP		13.0460-2883.2 602883	TRW 23581 18,8 - WE / - WK
						13.0460-2884.2 602884	TRW 23581 18,8 + WK
						13.0470-2884.2 LD2884	TRW 23581 18,8 + WK Ceramic
			←	12/99→; +PR 1LB;1LM		13.0460-7100.2 607100	VW 21866 17,2 - WE / - WK
						13.0460-7164.2 607164	VW 21866 17,2 + WK
						13.0470-7100.2 LD7100	VW 21866 17,2 - WE / - WK Ceramic
			←	12/99→; +PR 1LQ;1LR		13.0460-7111.2 607111	VW 23130 19,6 - WE / - WK
						13.0460-7117.2 607117	VW 23130 19,6 + WK
						13.0470-7111.2 LD7111	VW 23130 19,6 - WE / - WK Ceramic
						13.0470-7117.2 LD7117	VW 23130 19,6 + WK Ceramic
1.9 TDI	74	01/00→12/07	←	02/00→; +PR 1LN;1LP		13.0460-2883.2 602883	TRW 23581 18,8 - WE / - WK
						13.0460-2884.2 602884	TRW 23581 18,8 + WK
						13.0470-2884.2 LD2884	TRW 23581 18,8 + WK Ceramic
			←	02/00→; +PR 1LB;1LM		13.0460-7100.2 607100	VW 21866 17,2 - WE / - WK
						13.0460-7164.2 607164	VW 21866 17,2 + WK
						13.0470-7100.2 LD7100	VW 21866 17,2 - WE / - WK Ceramic
			←	02/00→; +PR 1LQ;1LR		13.0460-7111.2 607111	VW 23130 19,6 - WE / - WK
						13.0460-7117.2 607117	VW 23130 19,6 + WK
						13.0470-7111.2 LD7111	VW 23130 19,6 - WE / - WK Ceramic
						13.0470-7117.2 LD7117	VW 23130 19,6 + WK Ceramic
			→	02/00→; +PR 1KK,1KP		13.0460-2894.2 602894	TRW 20961 17,2 - WK + Zub
						13.0470-2894.2 LD2894	TRW 20961 17,2 - WK + Zub Ceramic
<b> Bremsscheibe</b>							
1.2	40	07/01→12/07	←	08/02→; +PR 1LB;1LM		24.0118-0137.1 418137	Ø 239 18 16 V + S
						24.0318-0137.1 518137	Ø 239 18 16 V + S
			←	08/02→; +PR 1LQ;1LR		24.0122-0151.1 422151	Ø 256 22 19 V + S
						24.0322-0151.1 522151	Ø 256 22 19 V + S
			←	08/02→; +PR 1LN;1LP		24.0125-0113.1 425113	Ø 288 25 22 V + S
						24.0325-0113.1 525113	Ø 288 25 22 V + S
1.2	47	01/03→12/07	←	+PR 1LB;1LM		24.0118-0137.1 418137	Ø 239 18 16 V + S
1.4	44	04/00→08/02				24.0318-0137.1 518137	Ø 239 18 16 V + S
1.4	50	07/01→05/03	←	+PR 1LQ;1LR		24.0122-0151.1 422151	Ø 256 22 19 V + S
						24.0322-0151.1 522151	Ø 256 22 19 V + S
			←	+PR 1LN;1LP		24.0125-0113.1 425113	Ø 288 25 22 V + S
						24.0325-0113.1 525113	Ø 288 25 22 V + S
1.4 16V	55	10/99→12/07	←	+PR 1LB;1LM		24.0118-0137.1 418137	Ø 239 18 16 V + S
1.4 16V	59	04/06→12/07				24.0318-0137.1 518137	Ø 239 18 16 V + S
1.4 16V	74	12/99→12/07					
1.4 TDI	51	10/05→12/07	←	+PR 1LQ;1LR		24.0122-0151.1 422151	Ø 256 22 19 V + S
1.4 TDI	55	04/03→12/07				24.0322-0151.1 522151	Ø 256 22 19 V + S
1.4 TDI	59	10/05→12/07	←	+PR 1LN;1LP		24.0125-0113.1 425113	Ø 288 25 22 V + S
2.0	85	12/99→12/07				24.0325-0113.1 525113	Ø 288 25 22 V + S
			→	+PR 1KK,1KP		24.0109-0123.1 409123	Ø 230 9 7 + S
						24.0309-0123.1 509123	Ø 230 9 7 + S
1.9 SDI	47	11/99→12/07	←	12/99→; +PR 1LB;1LM		24.0118-0137.1 418137	Ø 239 18 16 V + S
						24.0318-0137.1 518137	Ø 239 18 16 V + S
			←	12/99→; +PR 1LQ;1LR		24.0122-0151.1 422151	Ø 256 22 19 V + S
						24.0322-0151.1 522151	Ø 256 22 19 V + S
			←	12/99→; +PR 1LN;1LP		24.0125-0113.1 425113	Ø 288 25 22 V + S

	kw			 	! #		
<b>SKODA - FABIA I Stufenheck (6Y3) 10/99→12/07</b>							
 <b>Bremsscheibe</b>							
1.9 SDI	47	11/99→12/07	←	12/99→; +PR 1LN;1LP		24.0325-0113.1 525113	Ø 288 25 22 V + S
1.9 TDI	74	01/00→12/07	←	02/00→; +PR 1LB;1LM		24.0118-0137.1 418137	Ø 239 18 16 V + S
					24.0318-0137.1 518137	Ø 239 18 16 V + S	
			←	02/00→; +PR 1LQ;1LR		24.0122-0151.1 422151	Ø 256 22 19 V + S
					24.0322-0151.1 522151	Ø 256 22 19 V + S	
			←	02/00→; +PR 1LN;1LP		24.0125-0113.1 425113	Ø 288 25 22 V + S
					24.0325-0113.1 525113	Ø 288 25 22 V + S	
			→	02/00→; +PR 1KK,1KP		24.0109-0123.1 409123	Ø 230 9 7 + S
						24.0309-0123.1 509123	Ø 230 9 7 + S
<b>SKODA - FABIA II (542) 12/06→12/14</b>							
 <b>Bremsbelagsatz, Scheibenbremse</b>							
1.2 1.2 1.4	44 51 63	12/06→12/14 01/07→12/14 01/07→12/14	←	03/07→ 06/14; +PR 1ZE		13.0460-2612.2 602612	TRW 25681 17,7 - WE / - WK + Zub
			←	03/07→ 06/14; +PR 1LN,1ZH		13.0460-2883.2 602883	TRW 23581 18,8 - WE / - WK
					13.0460-2884.2 602884	TRW 23581 18,8 + WK	
					13.0470-2884.2 LD2884	TRW 23581 18,8 + WK Ceramic	
			←	03/07→ 06/14; +PR 1LB;1LM		13.0460-7100.2 607100	VW 21866 17,2 - WE / - WK
					13.0460-7164.2 607164	VW 21866 17,2 + WK	
					13.0470-7100.2 LD7100	VW 21866 17,2 - WE / - WK Ceramic	
			←	03/07→ 06/14; +PR 1LQ,1LR,1ZG		13.0460-7111.2 607111	VW 23130 19,6 - WE / - WK
					13.0460-7117.2 607117	VW 23130 19,6 + WK	
					13.0470-7111.2 LD7111	VW 23130 19,6 - WE / - WK Ceramic	
			13.0470-7117.2 LD7117	VW 23130 19,6 + WK Ceramic			
			←	03/07→ 06/14; +PR 1ZC		13.0460-7184.2 607184	ATE 23587 20,6 + WK
						13.0470-7184.2 LD7184	ATE 23587 20,6 + WK Ceramic
			→	03/07→ 06/14; +PR 1KT,1KV		13.0460-2787.2 602787	TRW 23554 17,3 - WK / - WE
						13.0460-2820.2 602820	TRW 20961 17,2 - WK
						13.0470-2820.2 LD2820	TRW 20961 17,2 - WK Ceramic
			→	03/07→ 06/14; +PR 1KK		13.0460-2894.2 602894	TRW 20961 17,2 - WK + Zub
						13.0470-2894.2 LD2894	TRW 20961 17,2 - WK + Zub Ceramic
1.2 12V 1.6	44 77	11/11→12/14 04/07→12/14	←	→ 06/14; +PR 1ZE		13.0460-2612.2 602612	TRW 25681 17,7 - WE / - WK + Zub
			←	→ 06/14; +PR 1LN,1ZH		13.0460-2883.2 602883	TRW 23581 18,8 - WE / - WK
					13.0460-2884.2 602884	TRW 23581 18,8 + WK	
					13.0470-2884.2 LD2884	TRW 23581 18,8 + WK Ceramic	
			←	→ 06/14; +PR 1LB;1LM		13.0460-7100.2 607100	VW 21866 17,2 - WE / - WK
					13.0460-7164.2 607164	VW 21866 17,2 + WK	
					13.0470-7100.2 LD7100	VW 21866 17,2 - WE / - WK Ceramic	
			←	→ 06/14; +PR 1LQ,1LR,1ZG		13.0460-7111.2 607111	VW 23130 19,6 - WE / - WK
					13.0460-7117.2 607117	VW 23130 19,6 + WK	
					13.0470-7111.2 LD7111	VW 23130 19,6 - WE / - WK Ceramic	
			13.0470-7117.2 LD7117	VW 23130 19,6 + WK Ceramic			
			←	→ 06/14; +PR 1ZC		13.0460-7184.2 607184	ATE 23587 20,6 + WK
						13.0470-7184.2 LD7184	ATE 23587 20,6 + WK Ceramic
			→	→ 06/14; +PR 1KT,1KV		13.0460-2787.2 602787	TRW 23554 17,3 - WK / - WE
						13.0460-2820.2 602820	TRW 20961 17,2 - WK
						13.0470-2820.2 LD2820	TRW 20961 17,2 - WK Ceramic
			→	→ 06/14; +PR 1KK		13.0460-2894.2 602894	TRW 20961 17,2 - WK + Zub
						13.0470-2894.2 LD2894	TRW 20961 17,2 - WK + Zub Ceramic
1.2 TDI 1.2 TSI 1.2 TSI 1.4 TSI RS 1.6 TDI 1.6 TDI 1.6 TDI	55 63 77 132 55 66 77	05/10→12/14 03/10→12/14 03/10→12/14 05/10→12/14 04/10→12/14 03/10→12/14 03/10→12/14	←	→ 06/14; +PR 1ZE		13.0460-2612.2 602612	TRW 25681 17,7 - WE / - WK + Zub
			←	→ 06/14; +PR 1LN,1ZH		13.0460-2883.2 602883	TRW 23581 18,8 - WE / - WK
					13.0460-2884.2 602884	TRW 23581 18,8 + WK	
					13.0470-2884.2 LD2884	TRW 23581 18,8 + WK Ceramic	
			←	→ 06/14; +PR 1LB,1LM		13.0460-7100.2 607100	VW 21866 17,2 - WE / - WK
						13.0460-7164.2 607164	VW 21866 17,2 + WK































	kw			 	! #		
<b>SKODA - FABIA II (542) 12/06—12/14</b>							
<b> Bremsbelagsatz, Scheibenbremse</b>							
1.2 TDI	55	05/10→12/14	←	→ 06/14; +PR 1LB,1LM		13.0470-7100.2 LD7100	VW 21866 17,2 - WE / - WK Ceramic
1.2 TSI	63	03/10→12/14					
1.2 TSI	77	03/10→12/14					
1.4 TSI RS	132	05/10→12/14	←	→ 06/14; +PR 1LQ,1LR,1ZG		13.0460-7111.2 607111	VW 23130 19,6 - WE / - WK
1.6 TDI	55	04/10→12/14				13.0460-7117.2 607117	VW 23130 19,6 + WK
1.6 TDI	66	03/10→12/14				13.0470-7111.2 LD7111	VW 23130 19,6 - WE / - WK Ceramic
1.6 TDI	77	03/10→12/14				13.0470-7117.2 LD7117	VW 23130 19,6 + WK Ceramic
			←	→ 06/14; +PR 1ZC		13.0460-7184.2 607184	ATE 23587 20,6 + WK
						13.0470-7184.2 LD7184	ATE 23587 20,6 + WK Ceramic
			→	→ 06/14; +PR 1KT,1KV		13.0460-2787.2 602787	TRW 23554 17,3 - WK / - WE
						13.0460-2820.2 602820	TRW 20961 17,2 - WK
						13.0470-2820.2 LD2820	TRW 20961 17,2 - WK Ceramic
			→	→ 06/14; +PR 1KK		13.0460-2894.2 602894	TRW 20961 17,2 - WK + Zub
						13.0470-2894.2 LD2894	TRW 20961 17,2 - WK + Zub Ceramic
1.4 TDI	51	02/07→03/10	←	03/07→; +PR 1ZE		13.0460-2612.2 602612	TRW 25681 17,7 - WE / - WK + Zub
1.4 TDI	59	01/07→03/10	←	03/07→; +PR 1LN,1ZH		13.0460-2883.2 602883	TRW 23581 18,8 - WE / - WK
						13.0460-2884.2 602884	TRW 23581 18,8 + WK
						13.0470-2884.2 LD2884	TRW 23581 18,8 + WK Ceramic
			←	03/07→; +PR 1LB;1LM		13.0460-7100.2 607100	VW 21866 17,2 - WE / - WK
						13.0460-7164.2 607164	VW 21866 17,2 + WK
						13.0470-7100.2 LD7100	VW 21866 17,2 - WE / - WK Ceramic
			←	03/07→; +PR 1LQ,1LR,1ZG		13.0460-7111.2 607111	VW 23130 19,6 - WE / - WK
						13.0460-7117.2 607117	VW 23130 19,6 + WK
						13.0470-7111.2 LD7111	VW 23130 19,6 - WE / - WK Ceramic
						13.0470-7117.2 LD7117	VW 23130 19,6 + WK Ceramic
			←	03/07→; +PR 1ZC		13.0460-7184.2 607184	ATE 23587 20,6 + WK
						13.0470-7184.2 LD7184	ATE 23587 20,6 + WK Ceramic
			→	03/07→; +PR 1KT,1KV		13.0460-2787.2 602787	TRW 23554 17,3 - WK / - WE
						13.0460-2820.2 602820	TRW 20961 17,2 - WK
						13.0470-2820.2 LD2820	TRW 20961 17,2 - WK Ceramic
			→	03/07→; +PR 1KK		13.0460-2894.2 602894	TRW 20961 17,2 - WK + Zub
						13.0470-2894.2 LD2894	TRW 20961 17,2 - WK + Zub Ceramic
1.9 TDI	77	04/07→03/10	←	+PR 1ZE		13.0460-2612.2 602612	TRW 25681 17,7 - WE / - WK + Zub
			←	+PR 1LN,1ZH		13.0460-2883.2 602883	TRW 23581 18,8 - WE / - WK
						13.0460-2884.2 602884	TRW 23581 18,8 + WK
						13.0470-2884.2 LD2884	TRW 23581 18,8 + WK Ceramic
			←	+PR 1LB;1LM		13.0460-7100.2 607100	VW 21866 17,2 - WE / - WK
						13.0460-7164.2 607164	VW 21866 17,2 + WK
						13.0470-7100.2 LD7100	VW 21866 17,2 - WE / - WK Ceramic
			←	+PR 1LQ,1LR,1ZG		13.0460-7111.2 607111	VW 23130 19,6 - WE / - WK
						13.0460-7117.2 607117	VW 23130 19,6 + WK
						13.0470-7111.2 LD7111	VW 23130 19,6 - WE / - WK Ceramic
						13.0470-7117.2 LD7117	VW 23130 19,6 + WK Ceramic
			←	+PR 1ZC		13.0460-7184.2 607184	ATE 23587 20,6 + WK
						13.0470-7184.2 LD7184	ATE 23587 20,6 + WK Ceramic
			→	+PR 1KT,1KV		13.0460-2787.2 602787	TRW 23554 17,3 - WK / - WE
						13.0460-2820.2 602820	TRW 20961 17,2 - WK
						13.0470-2820.2 LD2820	TRW 20961 17,2 - WK Ceramic
			→	+PR 1KK		13.0460-2894.2 602894	TRW 20961 17,2 - WK + Zub
						13.0470-2894.2 LD2894	TRW 20961 17,2 - WK + Zub Ceramic
<b> Bremsscheibe</b>							
1.2	44	12/06→12/14	←	03/07→ 06/14; +PR 1LB;1LM		24.0118-0137.1 418137	Ø 239 18 16 V + S
1.2	51	01/07→12/14				24.0318-0137.1 518137	Ø 239 18 16 V + S
1.4	63	01/07→12/14	←	03/07→ 06/14; +PR 1LQ,1LR,1ZE,1ZG		24.0122-0151.1 422151	Ø 256 22 19 V + S
						24.0322-0151.1 522151	Ø 256 22 19 V + S
↓							

	kw			 	! #		
<b>SKODA - FABIA II (542) 12/06→12/14</b>							
<b>Bremsscheibe</b>							
1.2	44	12/06→12/14	←	03/07→ 06/14; +PR 1LN,1ZC,1ZH		24.0125-0113.1 425113	Ø 288 25 22 V + S
1.2	51	01/07→12/14				24.0325-0113.1 525113	Ø 288 25 22 V + S
1.4	63	01/07→12/14	→	03/07→ 06/14; +PR 1KT,2EJ,1KK,1KV		24.0109-0123.1 409123	Ø 230 9 7 + S
1.2 12V	44	11/11→12/14	←	→ 06/14; +PR 1LB;1LM		24.0118-0137.1 418137	Ø 239 18 16 V + S
1.6	77	04/07→12/14				24.0318-0137.1 518137	Ø 239 18 16 V + S
			←	→ 06/14; +PR 1LQ,1LR,1ZE,1ZG		24.0122-0151.1 422151	Ø 256 22 19 V + S
						24.0322-0151.1 522151	Ø 256 22 19 V + S
			←	→ 06/14; +PR 1LN,1ZC,1ZH		24.0125-0113.1 425113	Ø 288 25 22 V + S
						24.0325-0113.1 525113	Ø 288 25 22 V + S
			→	→ 06/14; +PR 1KT,2EJ,1KK,1KV		24.0109-0123.1 409123	Ø 230 9 7 + S
1.2 TDI	55	05/10→12/14	←	→ 06/14; +PR 1LB,1LM		24.0118-0137.1 418137	Ø 239 18 16 V + S
1.2 TSI	63	03/10→12/14				24.0318-0137.1 518137	Ø 239 18 16 V + S
1.2 TSI	77	03/10→12/14					
1.4 TSI RS	132	05/10→12/14	←	→ 06/14; +PR 1LQ,1LR,1ZE,1ZG		24.0122-0151.1 422151	Ø 256 22 19 V + S
1.6 TDI	55	04/10→12/14				24.0322-0151.1 522151	Ø 256 22 19 V + S
1.6 TDI	66	03/10→12/14					
1.6 TDI	77	03/10→12/14	←	→ 06/14; +PR 1LN,1ZC,1ZH		24.0125-0113.1 425113	Ø 288 25 22 V + S
						24.0325-0113.1 525113	Ø 288 25 22 V + S
			→	→ 06/14; +PR 1KT,1KV,2EJ		24.0109-0123.1 409123	Ø 230 9 7 + S
1.4 TDI	51	02/07→03/10	←	03/07→; +PR 1LB;1LM		24.0118-0137.1 418137	Ø 239 18 16 V + S
1.4 TDI	59	01/07→03/10				24.0318-0137.1 518137	Ø 239 18 16 V + S
			←	03/07→; +PR 1LQ,1LR,1ZE,1ZG		24.0122-0151.1 422151	Ø 256 22 19 V + S
						24.0322-0151.1 522151	Ø 256 22 19 V + S
			←	03/07→; +PR 1LN,1ZC,1ZH		24.0125-0113.1 425113	Ø 288 25 22 V + S
						24.0325-0113.1 525113	Ø 288 25 22 V + S
			→	03/07→; +PR 1KT,2EJ,1KK,1KV		24.0109-0123.1 409123	Ø 230 9 7 + S
1.9 TDI	77	04/07→03/10	←	+PR 1LB;1LM		24.0118-0137.1 418137	Ø 239 18 16 V + S
						24.0318-0137.1 518137	Ø 239 18 16 V + S
			←	+PR 1LQ,1LR,1ZE,1ZG		24.0122-0151.1 422151	Ø 256 22 19 V + S
						24.0322-0151.1 522151	Ø 256 22 19 V + S
			←	+PR 1LN,1ZC,1ZH		24.0125-0113.1 425113	Ø 288 25 22 V + S
						24.0325-0113.1 525113	Ø 288 25 22 V + S
			→	06/09→; +PR 1KT,2EJ,1KK,1KV		24.0109-0123.1 409123	Ø 230 9 7 + S
<b>SKODA - FABIA II Combi (545) 10/07→12/14</b>							
<b>Bremsbelagsatz, Scheibenbremse</b>							
1.2	44	10/07→11/14	←	→ 06/14; +PR 1ZE		13.0460-2612.2 602612	TRW 25681 17,7 - WE / - WK + Zub
1.2	51	10/07→12/14					
1.2 12V	44	11/11→12/14	←	→ 06/14; +PR 1LN,1ZH		13.0460-2883.2 602883	TRW 23581 18,8 - WE / - WK
1.4	63	10/07→12/14				13.0460-2884.2 602884	TRW 23581 18,8 + WK
1.6	77	10/07→12/14				13.0470-2884.2 LD2884	TRW 23581 18,8 + WK Ceramic
			←	→ 06/14; +PR 1LB;1LM		13.0460-7100.2 607100	VW 21866 17,2 - WE / - WK
						13.0460-7164.2 607164	VW 21866 17,2 + WK
						13.0470-7100.2 LD7100	VW 21866 17,2 - WE / - WK Ceramic
			←	→ 06/14; +PR 1LQ,1LR,1ZG		13.0460-7111.2 607111	VW 23130 19,6 - WE / - WK
						13.0460-7117.2 607117	VW 23130 19,6 + WK
						13.0470-7111.2 LD7111	VW 23130 19,6 - WE / - WK Ceramic
						13.0470-7117.2 LD7117	VW 23130 19,6 + WK Ceramic
			←	→ 06/14; +PR 1ZC		13.0460-7184.2 607184	ATE 23587 20,6 + WK
						13.0470-7184.2 LD7184	ATE 23587 20,6 + WK Ceramic
			→	→ 06/14; +PR 1KT,1KV		13.0460-2787.2 602787	TRW 23554 17,3 - WK / - WE
						13.0460-2820.2 602820	TRW 20961 17,2 - WK
						13.0470-2820.2 LD2820	TRW 20961 17,2 - WK Ceramic
			→	→ 06/14; +PR 1KK		13.0460-2894.2 602894	TRW 20961 17,2 - WK + Zub
						13.0470-2894.2 LD2894	TRW 20961 17,2 - WK + Zub Ceramic
1.2 TDI	55	05/10→12/14	←	→ 06/14; +PR 1ZE		13.0460-2612.2 602612	TRW 25681 17,7 - WE / - WK + Zub
1.2 TSI	63	03/10→12/14					
1.2 TSI	77	03/10→12/14					
1.4 TSI RS	132	05/10→12/14	←	→ 06/14; +PR 1LN,1ZH		13.0460-2883.2 602883	TRW 23581 18,8 - WE / - WK
1.6 TDI	55	04/10→12/14				13.0460-2884.2 602884	TRW 23581 18,8 + WK
1.6 TDI	66	03/10→12/14				13.0470-2884.2 LD2884	TRW 23581 18,8 + WK Ceramic
1.6 TDI	77	03/10→12/14	←	→ 06/14; +PR 1LB,1LM		13.0460-7100.2 607100	VW 21866 17,2 - WE / - WK

















	kw			 	! #		
<b>SKODA - FABIA II Combi (545) 10/07→12/14</b>							
<b>Bremsbelagsatz, Scheibenbremse</b>							
1.2 TDI	55	05/10→12/14	←	→ 06/14; +PR 1LB,1LM		13.0460-7164.2 607164	VW 21866 17,2 + WK
1.2 TSI	63	03/10→12/14				13.0470-7100.2 LD7100	VW 21866 17,2 - WE / - WK
1.2 TSI	77	03/10→12/14					Ceramic
1.4 TSI RS	132	05/10→12/14					
1.6 TDI	55	04/10→12/14	←	→ 06/14; +PR 1LQ,1LR,1ZG		13.0460-7111.2 607111	VW 23130 19,6 - WE / - WK
1.6 TDI	66	03/10→12/14				13.0460-7117.2 607117	VW 23130 19,6 + WK
1.6 TDI	77	03/10→12/14				13.0470-7111.2 LD7111	VW 23130 19,6 - WE / - WK
							Ceramic
						13.0470-7117.2 LD7117	VW 23130 19,6 + WK Ceramic
			←	→ 06/14; +PR 1ZC		13.0460-7184.2 607184	ATE 23587 20,6 + WK
						13.0470-7184.2 LD7184	ATE 23587 20,6 + WK Ceramic
			→	→ 06/14; +PR 1KT,1KV		13.0460-2787.2 602787	TRW 23554 17,3 - WK / - WE
						13.0460-2820.2 602820	TRW 20961 17,2 - WK
						13.0470-2820.2 LD2820	TRW 20961 17,2 - WK Ceramic
			→	→ 06/14; +PR 1KK		13.0460-2894.2 602894	TRW 20961 17,2 - WK + Zub
						13.0470-2894.2 LD2894	TRW 20961 17,2 - WK + Zub
							Ceramic
1.4 TDI	51	10/07→03/10	←	+PR 1ZE		13.0460-2612.2 602612	TRW 25681 17,7 - WE / - WK
1.4 TDI	59	10/07→03/10					+ Zub
1.9 TDI	77	10/07→03/10	←	+PR 1LN,1ZH		13.0460-2883.2 602883	TRW 23581 18,8 - WE / - WK
						13.0460-2884.2 602884	TRW 23581 18,8 + WK
						13.0470-2884.2 LD2884	TRW 23581 18,8 + WK Ceramic
			←	+PR 1LB;1LM		13.0460-7100.2 607100	VW 21866 17,2 - WE / - WK
						13.0460-7164.2 607164	VW 21866 17,2 + WK
						13.0470-7100.2 LD7100	VW 21866 17,2 - WE / - WK
							Ceramic
			←	+PR 1LQ,1LR,1ZG		13.0460-7111.2 607111	VW 23130 19,6 - WE / - WK
						13.0460-7117.2 607117	VW 23130 19,6 + WK
						13.0470-7111.2 LD7111	VW 23130 19,6 - WE / - WK
							Ceramic
						13.0470-7117.2 LD7117	VW 23130 19,6 + WK Ceramic
			←	+PR 1ZC		13.0460-7184.2 607184	ATE 23587 20,6 + WK
						13.0470-7184.2 LD7184	ATE 23587 20,6 + WK Ceramic
			→	+PR 1KT,1KV		13.0460-2787.2 602787	TRW 23554 17,3 - WK / - WE
						13.0460-2820.2 602820	TRW 20961 17,2 - WK
						13.0470-2820.2 LD2820	TRW 20961 17,2 - WK Ceramic
			→	+PR 1KK		13.0460-2894.2 602894	TRW 20961 17,2 - WK + Zub
						13.0470-2894.2 LD2894	TRW 20961 17,2 - WK + Zub
							Ceramic
<b>Bremsscheibe</b>							
1.2	44	10/07→11/14	←	→ 06/14; +PR 1LB;1LM		24.0118-0137.1 418137	Ø 239 18 16 V + S
1.2	51	10/07→12/14				24.0318-0137.1 518137	Ø 239 18 16 V + S
1.2 12V	44	11/11→12/14					
1.4	63	10/07→12/14	←	→ 06/14; +PR 1LQ,1LR,1ZE,1ZG		24.0122-0151.1 422151	Ø 256 22 19 V + S
1.6	77	10/07→12/14				24.0322-0151.1 522151	Ø 256 22 19 V + S
			←	→ 06/14; +PR 1LN,1ZC,1ZH		24.0125-0113.1 425113	Ø 288 25 22 V + S
						24.0325-0113.1 525113	Ø 288 25 22 V + S
			→	→ 06/14; +PR 1KT,2EJ,1KK,1KV		24.0109-0123.1 409123	Ø 230 9 7 + S
1.2 TDI	55	05/10→12/14	←	→ 06/14; +PR 1LB,1LM		24.0118-0137.1 418137	Ø 239 18 16 V + S
1.2 TSI	63	03/10→12/14				24.0318-0137.1 518137	Ø 239 18 16 V + S
1.2 TSI	77	03/10→12/14					
1.4 TSI RS	132	05/10→12/14	←	→ 06/14; +PR 1LQ,1LR,1ZE,1ZG		24.0122-0151.1 422151	Ø 256 22 19 V + S
1.6 TDI	55	04/10→12/14				24.0322-0151.1 522151	Ø 256 22 19 V + S
1.6 TDI	66	03/10→12/14	←	→ 06/14; +PR 1LN,1ZC,1ZH		24.0125-0113.1 425113	Ø 288 25 22 V + S
1.6 TDI	77	03/10→12/14				24.0325-0113.1 525113	Ø 288 25 22 V + S
			→	→ 06/14; +PR 1KT,1KV,2EJ		24.0109-0123.1 409123	Ø 230 9 7 + S
1.4 TDI	51	10/07→03/10	←	+PR 1LB;1LM		24.0118-0137.1 418137	Ø 239 18 16 V + S
1.4 TDI	59	10/07→03/10				24.0318-0137.1 518137	Ø 239 18 16 V + S
			←	+PR 1LQ,1LR,1ZE,1ZG		24.0122-0151.1 422151	Ø 256 22 19 V + S
						24.0322-0151.1 522151	Ø 256 22 19 V + S
			←	+PR 1LN,1ZC,1ZH		24.0125-0113.1 425113	Ø 288 25 22 V + S
						24.0325-0113.1 525113	Ø 288 25 22 V + S
			→	+PR 1KT,2EJ,1KK,1KV		24.0109-0123.1 409123	Ø 230 9 7 + S
1.9 TDI	77	10/07→03/10	←	+PR 1LB;1LM		24.0118-0137.1 418137	Ø 239 18 16 V + S
						24.0318-0137.1 518137	Ø 239 18 16 V + S
↓							











	kw			 	! #		
<b>SKODA - FABIA II Combi (545) 10/07→12/14</b>							
 <b>Bremsscheibe</b>							
1.9 TDI	77	10/07→03/10	←	+PR 1LQ,1LR,1ZE,1ZG		24.0122-0151.1 422151 24.0322-0151.1 522151	Ø 256 22 19 V + S Ø 256 22 19 V + S
			←	+PR 1LN,1ZC,1ZH		24.0125-0113.1 425113 24.0325-0113.1 525113	Ø 288 25 22 V + S Ø 288 25 22 V + S
			→	06/09→; +PR 1KT,2EJ,1KK,1KV		24.0109-0123.1 409123	Ø 230 9 7 + S
<b>SKODA - FABIA III (NJ3) 08/14→</b>							
 <b>Bremsbelagsatz, Scheibenbremse</b>							
1.0	44	08/14→	←	+PR 1ZG		13.0460-7111.2 607111 13.0470-7111.2 LD7111	VW 23130 19,6 - WE / - WK VW 23130 19,6 - WE / - WK Ceramic
1.0	55	08/14→					
1.0 LPG	44	08/14→					
1.0 LPG	55	08/14→	←	+PR 1ZC		13.0460-7184.2 607184 13.0470-7184.2 LD7184	ATE 23587 20,6 + WK ATE 23587 20,6 + WK Ceramic
1.0 TSI	70	05/17→					
1.0 TSI	81	05/17→	→	+PR 1KK,1KT,2EJ		13.0460-2787.2 602787 13.0460-2820.2 602820 13.0470-2820.2 LD2820	TRW 23554 17,3 - WK / - WE TRW 20961 17,2 - WK TRW 20961 17,2 - WK Ceramic
1.2 TSI	66	08/14→					
1.2 TSI	81	08/14→					
1.4 TDI	66	08/14→					
1.4 TDI	77	08/14→					
1.4 TSI R5	92	02/18→					
1.4 TDI	55	05/15→	←	+PR 1ZG		13.0460-7111.2 607111 13.0470-7111.2 LD7111	VW 23130 19,6 - WE / - WK VW 23130 19,6 - WE / - WK Ceramic
1.6	81	01/15→	←	+PR 1ZC		13.0460-7184.2 607184 13.0470-7184.2 LD7184	ATE 23587 20,6 + WK ATE 23587 20,6 + WK Ceramic
			→	+PR 1KT		13.0460-2787.2 602787 13.0460-2820.2 602820 13.0470-2820.2 LD2820	TRW 23554 17,3 - WK / - WE TRW 20961 17,2 - WK TRW 20961 17,2 - WK Ceramic
 <b>Bremsscheibe</b>							
1.0	44	08/14→	←	+PR 1ZG		24.0122-0151.1 422151 24.0322-0151.1 522151	Ø 256 22 19 V + S Ø 256 22 19 V + S
1.0	55	08/14→					
1.0 LPG	44	08/14→	←	+PR 1ZC		24.0125-0113.1 425113 24.0325-0113.1 525113	Ø 288 25 22 V + S Ø 288 25 22 V + S
1.0 LPG	55	08/14→					
1.0 TSI	70	05/17→					
1.0 TSI	81	05/17→	→	+PR 1KK,1KT,2EJ		24.0109-0123.1 409123	Ø 230 9 7 + S
1.2 TSI	66	08/14→					
1.2 TSI	81	08/14→					
1.4 TDI	66	08/14→					
1.4 TDI	77	08/14→					
1.4 TSI R5	92	02/18→					
1.4 TDI	55	05/15→	←	+PR 1ZG		24.0122-0151.1 422151 24.0322-0151.1 522151	Ø 256 22 19 V + S Ø 256 22 19 V + S
1.6	81	01/15→	←	+PR 1ZC		24.0125-0113.1 425113 24.0325-0113.1 525113	Ø 288 25 22 V + S Ø 288 25 22 V + S
			→	+PR 1KT		24.0109-0123.1 409123	Ø 230 9 7 + S
<b>SKODA - FABIA III Kombi (NJ5) 10/14→</b>							
 <b>Bremsbelagsatz, Scheibenbremse</b>							
1.0	44	10/14→	←	+PR 1ZG		13.0460-7111.2 607111 13.0470-7111.2 LD7111	VW 23130 19,6 - WE / - WK VW 23130 19,6 - WE / - WK Ceramic
1.0	55	10/14→					
1.0 LPG	55	10/14→					
1.0 TSI	70	05/17→	←	+PR 1ZC		13.0460-7184.2 607184 13.0470-7184.2 LD7184	ATE 23587 20,6 + WK ATE 23587 20,6 + WK Ceramic
1.0 TSI	81	05/17→					
1.2 TSI	66	10/14→					
1.2 TSI	81	10/14→	→	+PR 1KK,1KT,2EJ		13.0460-2787.2 602787 13.0460-2820.2 602820 13.0470-2820.2 LD2820	TRW 23554 17,3 - WK / - WE TRW 20961 17,2 - WK TRW 20961 17,2 - WK Ceramic
1.4 TDI	66	10/14→					
1.4 TDI	77	10/14→					
1.4 TDI	55	05/15→	←	+PR 1ZG		13.0460-7111.2 607111 13.0470-7111.2 LD7111	VW 23130 19,6 - WE / - WK VW 23130 19,6 - WE / - WK Ceramic
1.6	81	01/15→	←	+PR 1ZC		13.0460-7184.2 607184 13.0470-7184.2 LD7184	ATE 23587 20,6 + WK ATE 23587 20,6 + WK Ceramic
			→	+PR 1KT		13.0460-2787.2 602787 13.0460-2820.2 602820 13.0470-2820.2 LD2820	TRW 23554 17,3 - WK / - WE TRW 20961 17,2 - WK TRW 20961 17,2 - WK Ceramic
 <b>Bremsscheibe</b>							
1.0	44	10/14→	←	+PR 1ZG		24.0122-0151.1 422151 24.0322-0151.1 522151	Ø 256 22 19 V + S Ø 256 22 19 V + S
1.0	55	10/14→					
↓							









	kw			 	! #		
<b>SKODA - FABIA III Kombi (NJ5) 10/14→</b>							
 <b>Bremsscheibe</b>							
1.0 LPG	55	10/14→	←	+PR 1ZC		24.0125-0113.1 425113	Ø 288 25 22 V + S
1.0 TSI	70	05/17→				24.0325-0113.1 525113	Ø 288 25 22 V + S
1.0 TSI	81	05/17→					
1.2 TSI	66	10/14→	→	+PR 1KK,1KT,2EJ		24.0109-0123.1 409123	Ø 230 9 7 + S
1.2 TSI	81	10/14→					
1.4 TDI	66	10/14→					
1.4 TDI	77	10/14→					
1.4 TDI	55	05/15→	←	+PR 1ZG		24.0122-0151.1 422151	Ø 256 22 19 V + S
1.6	81	01/15→				24.0322-0151.1 522151	Ø 256 22 19 V + S
			←	+PR 1ZC		24.0125-0113.1 425113	Ø 288 25 22 V + S
						24.0325-0113.1 525113	Ø 288 25 22 V + S
			→	+PR 1KT		24.0109-0123.1 409123	Ø 230 9 7 + S
<b>SKODA - FAVORIT Pick-up (787) 06/92→06/97</b>							
 <b>Bremsbelagsatz, Scheibenbremse</b>							
1.3	40	12/92→06/97	←	→ 12/95		13.0460-2964.2 602964	TRW 20861 17,5 - WK
1.3	42	12/92→06/97					
1.3	50	12/92→06/97					
 <b>Bremsscheibe</b>							
1.3	40	12/92→06/97	←	04/94→ 12/95		24.0113-0182.1 413182	Ø 236 12,8 11,4
1.3	42	12/92→06/97					
1.3	50	12/92→06/97					
<b>SKODA - FELICIA I (6U1) 10/94→03/98</b>							
 <b>Bremsbelagsatz, Scheibenbremse</b>							
1.3	40	10/94→03/98	←	→ 02/98		13.0460-2964.2 602964	TRW 20861 17,5 - WK
1.3	43	10/94→03/98					
1.3	50	10/94→03/98					
1.6 LX	55	08/95→03/98					
1.9 D	47	10/95→03/98	←	10/96→ 02/98		13.0460-2964.2 602964	TRW 20861 17,5 - WK
 <b>Bremsscheibe</b>							
1.3	40	10/94→03/98	←	→ 02/98		24.0113-0182.1 413182	Ø 236 12,8 11,4
1.3	43	10/94→03/98					
1.3	50	10/94→03/98					
1.6 LX	55	08/95→03/98					
1.9 D	47	10/95→03/98	←	10/96→ 02/98		24.0113-0182.1 413182	Ø 236 12,8 11,4
<b>SKODA - FELICIA I Kombi (6U5) 07/95→03/98</b>							
 <b>Bremsbelagsatz, Scheibenbremse</b>							
1.3	43	08/95→03/98	←	→ 02/98		13.0460-2964.2 602964	TRW 20861 17,5 - WK
1.3 LX	40	08/95→03/98					
1.3 LXI	50	08/95→03/98					
1.6 GLX	55	08/95→03/98					
1.9 D	47	10/95→03/98	←	10/96→ 02/98		13.0460-2964.2 602964	TRW 20861 17,5 - WK
 <b>Bremsscheibe</b>							
1.3	43	08/95→03/98	←	→ 02/98		24.0113-0182.1 413182	Ø 236 12,8 11,4
1.3 LX	40	08/95→03/98					
1.3 LXI	50	08/95→03/98					
1.6 GLX	55	08/95→03/98					
1.9 D	47	10/95→03/98	←	10/96→ 02/98		24.0113-0182.1 413182	Ø 236 12,8 11,4
<b>SKODA - FELICIA I Pick-up (6UF, 6U7) 10/95→04/02</b>							
 <b>Bremsbelagsatz, Scheibenbremse</b>							
1.3	40	06/97→04/02	←	→ 12/00		13.0460-2964.2 602964	TRW 20861 17,5 - WK
1.3	50	06/97→04/02					
1.9 D	47	06/97→04/02					
1.3	43	10/95→04/02	←	06/97→ 12/00		13.0460-2964.2 602964	TRW 20861 17,5 - WK
1.6	55	06/97→04/02	←	→ 12/99		13.0460-2964.2 602964	TRW 20861 17,5 - WK
 <b>Bremsscheibe</b>							
1.3	40	06/97→04/02	←	→ 12/00		24.0113-0182.1 413182	Ø 236 12,8 11,4
1.3	50	06/97→04/02					
1.9 D	47	06/97→04/02					
1.3	43	10/95→04/02	←	06/97→ 12/00		24.0113-0182.1 413182	Ø 236 12,8 11,4
1.6	55	06/97→04/02	←	→ 12/99		24.0113-0182.1 413182	Ø 236 12,8 11,4





















	kw			 	! #		
<b>SKODA - FELICIA II (6U1) 01/98→06/01</b>							
 <b>Bremsbelagsatz, Scheibenbremse</b>							
1.3	40	01/98→06/01	←	03/98→		13.0460-2964.2 602964	TRW 20861 17,5 - WK
1.3	43	01/98→06/01					
1.3	50	01/98→06/01					
1.6	55	01/98→06/01					
1.9 D	47	01/98→06/01					
 <b>Bremsscheibe</b>							
1.3	40	01/98→06/01	←	03/98→		24.0113-0182.1 413182	Ø 236 12,8 11,4
1.3	43	01/98→06/01					
1.3	50	01/98→06/01					
1.6	55	01/98→06/01					
1.9 D	47	01/98→06/01					
<b>SKODA - FELICIA II Kombi (6U5) 01/98→06/01</b>							
 <b>Bremsbelagsatz, Scheibenbremse</b>							
1.3	50	01/98→06/01	←	03/98→		13.0460-2964.2 602964	TRW 20861 17,5 - WK
1.6	55	01/98→06/01					
1.9 D	47	01/98→06/01					
 <b>Bremsscheibe</b>							
1.3	50	01/98→06/01	←	03/98→		24.0113-0182.1 413182	Ø 236 12,8 11,4
1.6	55	01/98→06/01					
1.9 D	47	01/98→06/01					
<b>SKODA - FELICIA Cube Van (6U5) 03/97→12/01</b>							
 <b>Bremsbelagsatz, Scheibenbremse</b>							
1.3	50	03/97→06/98	←			13.0460-2964.2 602964	TRW 20861 17,5 - WK
1.6	55	06/98→12/01					
1.9 D	47	03/97→12/01	←	03/98→		13.0460-2964.2 602964	TRW 20861 17,5 - WK
 <b>Bremsscheibe</b>							
1.3	50	03/97→06/98	←			24.0113-0182.1 413182	Ø 236 12,8 11,4
1.6	55	06/98→12/01					
1.9 D	47	03/97→12/01	←	03/98→		24.0113-0182.1 413182	Ø 236 12,8 11,4
<b>SKODA - KAROQ (NU7) 07/17→</b>							
 <b>Bremsbelagsatz, Scheibenbremse</b>							
1.0 TSI	85	07/17→	→	+PR 1KE; + eFSB		13.0460-7293.2 607293	ATE 25008 16,3 - WE / - WK
1.5 TSI	110	07/17→					
1.6 TDI	85	07/17→				13.0470-7293.2 LD7293	ATE 25008 16,3 - WE / - WK Ceramic
2.0 TDI 4x4	110	07/17→					
2.0 TDI 4x4	140	07/17→					
<b>Warnkontakt, Bremsbelagverschleiß</b>							
1.0 TSI	85	07/17→	←	+PR 1ZA	1	24.8190-0065.2 620065	L= 172
1.5 TSI	110	07/17→					
1.6 TDI	85	07/17→					
2.0 TDI 4x4	110	07/17→					
2.0 TDI 4x4	140	07/17→					
 <b>Bremsscheibe</b>							
1.0 TSI	85	07/17→	←	+PR 1ZA		24.0125-0158.1 425158	Ø 312 25 22 V + S
1.5 TSI	110	07/17→				24.0325-0158.1 525158	Ø 312 25 22 V + S
1.6 TDI	85	07/17→					
2.0 TDI 4x4	110	07/17→	→	+PR 1KE		24.0110-0356.1 410356	Ø 272 9,7 8 + S
2.0 TDI 4x4	140	07/17→				24.0310-0356.1 510356	Ø 272 9,7 8 + S
<b>SKODA - KODIAQ (NS7) 10/16→</b>							
 <b>Bremsbelagsatz, Scheibenbremse</b>							
1.4 TSI	92	10/16→	→	03/17→; +PR 1KU; + eFSB		13.0460-7294.2 607294	ATE 25009 16,4 - WE / - WK
1.4 TSI	110	10/16→					
1.4 TSI 4x4	110	10/16→				13.0470-7294.2 LD7294	ATE 25009 16,4 - WE / - WK Ceramic
2.0 TDI	110	10/16→					
2.0 TDI 4x4	110	10/16→					
2.0 TDI 4x4	140	10/16→					
2.0 TSI 4x4	132	10/16→					
<b>Warnkontakt, Bremsbelagverschleiß</b>							
1.4 TSI	92	10/16→	←	03/17→; +PR 1LA,1LW	1	24.8190-0065.2 620065	L= 172
1.4 TSI	110	10/16→					
1.4 TSI 4x4	110	10/16→	←	03/17→; +PR 1ZA	1	24.8190-0065.2 620065	L= 172
2.0 TDI	110	10/16→					
2.0 TDI 4x4	110	10/16→					
2.0 TDI 4x4	140	10/16→					

	kw			 	! #		
<b>SKODA - KODIAQ (NS7) 10/16→</b>							
<b>Warnkontakt, Bremsbelagverschleiß</b>							
2.0 TSI 4x4	132	10/16→	←	03/17→; +PR 1LA,1LW	1	24.8190-0065.2 620065	L= 172
			←	03/17→; +PR 1ZA	1	24.8190-0065.2 620065	L= 172
<b> Bremsscheibe</b>							
1.4 TSI	92	10/16→	←	03/17→; +PR 1ZA		24.0125-0158.1 425158	Ø 312 25 22 V + S
1.4 TSI	110	10/16→				24.0325-0158.1 525158	Ø 312 25 22 V + S
1.4 TSI 4x4	110	10/16→					
2.0 TDI	110	10/16→	←	03/17→; +PR 1LW		24.0130-0220.1 430220	Ø 314 30 27 V + S
2.0 TDI 4x4	110	10/16→	←	03/17→; +PR 1LA		24.0130-0225.1 430225	Ø 340 30 27 V + S
2.0 TDI 4x4	140	10/16→					
2.0 TSI 4x4	132	10/16→	→	03/17→; +PR 1KU; + eFSB		24.0112-0210.1 412210	Ø 300 12 10 + S
<b>SKODA - OCTAVIA I (1U2) 09/96→12/10</b>							
<b> Bremsbelagsatz, Scheibenbremse</b>							
1.4	44	04/99→03/01	←	+PR 1LN,1LE,1ZD,1ZE / 1ZH		13.0460-7081.2 607081	ATE 20676 19,8 - WE / - WK
						13.0460-7122.2 607122	ATE 20676 19,8 + WK
						13.0470-7081.2 LD7081	ATE 20676 19,8 - WE / - WK Ceramic
						13.0470-7122.2 LD7122	ATE 20676 19,8 + WK Ceramic
			←	→ 1U-X-415000; +PR 1LQ,1LR,1LS,1ZM		13.0460-7111.2 607111	VW 23130 19,6 - WE / - WK
						13.0470-7111.2 LD7111	VW 23130 19,6 - WE / - WK Ceramic
			←	1U-Y-000001→; +PR 1LQ,1LR,1LS,1ZM		13.0460-7117.2 607117	VW 23130 19,6 + WK
						13.0470-7117.2 LD7117	VW 23130 19,6 + WK Ceramic
1.4 16V	55	09/00→12/10	←	→ 06/10; +PR 1LN,1LE,1ZD,1ZE / 1ZH		13.0460-7081.2 607081	ATE 20676 19,8 - WE / - WK
						13.0460-7122.2 607122	ATE 20676 19,8 + WK
						13.0470-7081.2 LD7081	ATE 20676 19,8 - WE / - WK Ceramic
						13.0470-7122.2 LD7122	ATE 20676 19,8 + WK Ceramic
			←	→ 1U-X-415000; +PR 1LQ,1LR,1LS,1ZM		13.0460-7111.2 607111	VW 23130 19,6 - WE / - WK
						13.0470-7111.2 LD7111	VW 23130 19,6 - WE / - WK Ceramic
			←	1U-Y-000001→; → 06/10; +PR 1LQ,1LR,1LS,1ZM		13.0460-7117.2 607117	VW 23130 19,6 + WK
						13.0470-7117.2 LD7117	VW 23130 19,6 + WK Ceramic
1.6 1.8	55 92	09/96→09/04 09/96→07/00	←	10/96→; +PR 1LN,1LE,1ZD,1ZE / 1ZH		13.0460-7081.2 607081	ATE 20676 19,8 - WE / - WK
						13.0460-7122.2 607122	ATE 20676 19,8 + WK
						13.0470-7081.2 LD7081	ATE 20676 19,8 - WE / - WK Ceramic
						13.0470-7122.2 LD7122	ATE 20676 19,8 + WK Ceramic
			←	10/96→; +PR 1LQ,1LR,1LS,1ZM; → 1U-X-415000		13.0460-7111.2 607111	VW 23130 19,6 - WE / - WK
						13.0470-7111.2 LD7111	VW 23130 19,6 - WE / - WK Ceramic
			←	1U-Y-000001→; +PR 1LQ,1LR,1LS,1ZM		13.0460-7117.2 607117	VW 23130 19,6 + WK
						13.0470-7117.2 LD7117	VW 23130 19,6 + WK Ceramic
			→	10/96→; +PR 1KK,1KS,1KP		13.0460-2894.2 602894	TRW 20961 17,2 - WK + Zub
						13.0470-2894.2 LD2894	TRW 20961 17,2 - WK + Zub Ceramic
1.6 1.9 SDI 1.9 TDI 2.0	74 50 81 85	02/97→12/07 06/97→12/03 08/97→01/06 04/99→05/07	←	+PR 1LN,1LE,1ZD,1ZE / 1ZH		13.0460-7081.2 607081	ATE 20676 19,8 - WE / - WK
						13.0460-7122.2 607122	ATE 20676 19,8 + WK
						13.0470-7081.2 LD7081	ATE 20676 19,8 - WE / - WK Ceramic
						13.0470-7122.2 LD7122	ATE 20676 19,8 + WK Ceramic
			←	→ 1U-X-415000; +PR 1LQ,1LR,1LS,1ZM		13.0460-7111.2 607111	VW 23130 19,6 - WE / - WK
						13.0470-7111.2 LD7111	VW 23130 19,6 - WE / - WK Ceramic
			←	1U-Y-000001→; +PR 1LQ,1LR,1LS,1ZM		13.0460-7117.2 607117	VW 23130 19,6 + WK
						13.0470-7117.2 LD7117	VW 23130 19,6 + WK Ceramic
			→	+PR 1KK,1KS,1KP		13.0460-2894.2 602894	TRW 20961 17,2 - WK + Zub
						13.0470-2894.2 LD2894	TRW 20961 17,2 - WK + Zub Ceramic
1.6	75	11/00→12/10	←	→ 06/10; +PR 1LN,1LE,1ZD,1ZE / 1ZH		13.0460-7081.2 607081	ATE 20676 19,8 - WE / - WK
						13.0460-7122.2 607122	ATE 20676 19,8 + WK
						13.0470-7081.2 LD7081	ATE 20676 19,8 - WE / - WK Ceramic
						13.0470-7122.2 LD7122	ATE 20676 19,8 + WK Ceramic
↓							

















	kw			 	! #		
<b>SKODA - OCTAVIA I (1U2) 09/96→12/10</b>							
<b> Bremsbelagsatz, Scheibenbremse</b>							
1.6	75	11/00→12/10	←	→ 1U-X-415000; +PR 1LQ,1LR,1LS,1ZM	13.0460-7111.2	607111	VW 23130 19,6 - WE / - WK
					13.0470-7111.2	LD7111	VW 23130 19,6 - WE / - WK Ceramic
			←	1U-Y-000001→; → 06/10; +PR 1LQ,1LR,1LS,1ZM	13.0460-7117.2	607117	VW 23130 19,6 + WK
				13.0470-7117.2	LD7117	VW 23130 19,6 + WK Ceramic	
			→	→ 06/10; +PR 1KK,1KS,1KP	13.0460-2894.2	602894	TRW 20961 17,2 - WK + Zub
					13.0470-2894.2	LD2894	TRW 20961 17,2 - WK + Zub Ceramic
1.8 T	110	08/97→12/10	←	03/98→ 06/10; +PR 1LN,1LE,1ZD,1ZE / 1ZH	13.0460-7081.2	607081	ATE 20676 19,8 - WE / - WK
					13.0460-7122.2	607122	ATE 20676 19,8 + WK
					13.0470-7081.2	LD7081	ATE 20676 19,8 - WE / - WK Ceramic
					13.0470-7122.2	LD7122	ATE 20676 19,8 + WK Ceramic
			←	03/98→; → 1U-X-415000; +PR 1LQ,1LR,1LS,1ZM	13.0460-7111.2	607111	VW 23130 19,6 - WE / - WK
					13.0470-7111.2	LD7111	VW 23130 19,6 - WE / - WK Ceramic
			←	1U-Y-000001→; → 06/10; +PR 1LQ,1LR,1LS,1ZM	13.0460-7117.2	607117	VW 23130 19,6 + WK
					13.0470-7117.2	LD7117	VW 23130 19,6 + WK Ceramic
			→	03/98→ 06/10; +PR 1KK,1KS,1KP	13.0460-2894.2	602894	TRW 20961 17,2 - WK + Zub
					13.0470-2894.2	LD2894	TRW 20961 17,2 - WK + Zub Ceramic
1.8 T 4x4	110	05/01→05/06	←	+PR 1LN,1LE,1ZD,1ZE / 1ZH	13.0460-7081.2	607081	ATE 20676 19,8 - WE / - WK
					13.0460-7122.2	607122	ATE 20676 19,8 + WK
					13.0470-7081.2	LD7081	ATE 20676 19,8 - WE / - WK Ceramic
					13.0470-7122.2	LD7122	ATE 20676 19,8 + WK Ceramic
			←	+PR 1LQ,1LR,1LS,1ZM	13.0460-7117.2	607117	VW 23130 19,6 + WK
					13.0470-7117.2	LD7117	VW 23130 19,6 + WK Ceramic
			→	+PR 1KE	13.0460-2894.2	602894	TRW 20961 17,2 - WK + Zub
					13.0470-2894.2	LD2894	TRW 20961 17,2 - WK + Zub Ceramic
1.9 TDI	66	09/96→03/10	←	10/96→; +PR 1LN,1LE,1ZD,1ZE / 1ZH	13.0460-7081.2	607081	ATE 20676 19,8 - WE / - WK
					13.0460-7122.2	607122	ATE 20676 19,8 + WK
					13.0470-7081.2	LD7081	ATE 20676 19,8 - WE / - WK Ceramic
					13.0470-7122.2	LD7122	ATE 20676 19,8 + WK Ceramic
			←	10/96→; +PR 1LQ,1LR,1LS,1ZM; → 1U-X-415000	13.0460-7111.2	607111	VW 23130 19,6 - WE / - WK
					13.0470-7111.2	LD7111	VW 23130 19,6 - WE / - WK Ceramic
			←	1U-Y-000001→; +PR 1LQ,1LR,1LS,1ZM	13.0460-7117.2	607117	VW 23130 19,6 + WK
					13.0470-7117.2	LD7117	VW 23130 19,6 + WK Ceramic
			→	08/97→; +PR 1KK,1KS,1KP	13.0460-2894.2	602894	TRW 20961 17,2 - WK + Zub
					13.0470-2894.2	LD2894	TRW 20961 17,2 - WK + Zub Ceramic
1.9 TDI	74	10/05→12/10	←	→ 06/10; +PR 1LN,1LE,1ZD,1ZE / 1ZH	13.0460-7081.2	607081	ATE 20676 19,8 - WE / - WK
					13.0460-7122.2	607122	ATE 20676 19,8 + WK
					13.0470-7081.2	LD7081	ATE 20676 19,8 - WE / - WK Ceramic
					13.0470-7122.2	LD7122	ATE 20676 19,8 + WK Ceramic
			←	→ 06/10; +PR 1LQ,1LR,1LS,1ZM	13.0460-7117.2	607117	VW 23130 19,6 + WK
					13.0470-7117.2	LD7117	VW 23130 19,6 + WK Ceramic
			→	→ 06/10; +PR 1KK,1KS,1KP	13.0460-2894.2	602894	TRW 20961 17,2 - WK + Zub
					13.0470-2894.2	LD2894	TRW 20961 17,2 - WK + Zub Ceramic
1.9 TDI	96	09/02→09/04	←	01/03→; +PR 1LN,1LE,1ZD,1ZE / 1ZH	13.0460-7081.2	607081	ATE 20676 19,8 - WE / - WK
					13.0460-7122.2	607122	ATE 20676 19,8 + WK
					13.0470-7081.2	LD7081	ATE 20676 19,8 - WE / - WK Ceramic
					13.0470-7122.2	LD7122	ATE 20676 19,8 + WK Ceramic
			←	01/03→; +PR 1LQ,1LR,1LS,1ZM	13.0460-7117.2	607117	VW 23130 19,6 + WK
					13.0470-7117.2	LD7117	VW 23130 19,6 + WK Ceramic
			→	01/03→; +PR 1KK,1KS,1KP	13.0460-2894.2	602894	TRW 20961 17,2 - WK + Zub
					13.0470-2894.2	LD2894	TRW 20961 17,2 - WK + Zub Ceramic
RS 1.8 T ↓	132	05/01→01/06	←	+PR 1ZN	13.0460-7081.2	607081	ATE 20676 19,8 - WE / - WK







	kw			 	! #		
<b>SKODA - OCTAVIA I (1U2) 09/96→12/10</b>							
<b> Bremsbelagsatz, Scheibenbremse</b>							
RS 1.8 T	132	05/01→01/06	←	+PR 1ZN		13.0460-7122.2 607122 13.0470-7081.2 LD7081 13.0470-7122.2 LD7122	ATE 20676 19,8 + WK ATE 20676 19,8 - WE / - WK Ceramic ATE 20676 19,8 + WK Ceramic
			→	01/03→; +PR 2ED		13.0460-2886.2 602886 13.0460-2937.2 602937 13.0470-2886.2 LD2886	TRW 20961 16,0 - WK TRW 20961 15,2 - WK + Zub TRW 20961 16,0 - WK Ceramic
<b>Zubehörsatz, Scheibenbremsbelag</b>							
1.6 1.8	55 92	09/96→09/04 09/96→07/00	→	10/96→; +PR 1KK,1KS,1KP		13.0460-0072.2 610072	TRW
1.6 1.9 SDI 1.9 TDI 2.0	74 50 81 85	02/97→12/07 06/97→12/03 08/97→01/06 04/99→05/07	→	+PR 1KK,1KS,1KP		13.0460-0072.2 610072	TRW
1.6 1.9 TDI	75 74	11/00→12/10 10/05→12/10	→	→ 06/10; +PR 1KK,1KS,1KP		13.0460-0072.2 610072	TRW
1.8 T	110	08/97→12/10	→	03/98→ 06/10; +PR 1KK,1KS,1KP		13.0460-0072.2 610072	TRW
1.8 T 4x4	110	05/01→05/06	→	+PR 1KE		13.0460-0072.2 610072	TRW
1.9 TDI	66	09/96→03/10	→	08/97→; +PR 1KK,1KS,1KP		13.0460-0072.2 610072	TRW
1.9 TDI	96	09/02→09/04	→	01/03→; +PR 1KK,1KS,1KP		13.0460-0072.2 610072	TRW
<b> Bremsscheibe</b>							
1.4	44	04/99→03/01	←	+PR 1LR,1LS,1ZM		24.0122-0150.1 422150 24.0322-0150.1 522150	Ø 280 22 19 V + S Ø 280 22 19 V + S
			←	+PR 1LQ		24.0122-0151.1 422151 24.0322-0151.1 522151	Ø 256 22 19 V + S Ø 256 22 19 V + S
			←	+PR 1LE,1LN,1ZE,1ZH		24.0125-0113.1 425113 24.0325-0113.1 525113	Ø 288 25 22 V + S Ø 288 25 22 V + S
1.4 16V	55	09/00→12/10	←	→ 06/10; +PR 1LR,1LS,1ZM		24.0122-0150.1 422150 24.0322-0150.1 522150	Ø 280 22 19 V + S Ø 280 22 19 V + S
			←	→ 06/10; +PR 1LQ		24.0122-0151.1 422151 24.0322-0151.1 522151	Ø 256 22 19 V + S Ø 256 22 19 V + S
			←	→ 06/10; +PR 1LE,1LN,1ZE,1ZH		24.0125-0113.1 425113 24.0325-0113.1 525113	Ø 288 25 22 V + S Ø 288 25 22 V + S
1.6 1.8 1.9 TDI	55 92 66	09/96→09/04 09/96→07/00 09/96→03/10	←	10/96→; +PR 1LR,1LS,1ZM		24.0122-0150.1 422150 24.0322-0150.1 522150	Ø 280 22 19 V + S Ø 280 22 19 V + S
			←	10/96→; +PR 1LQ		24.0122-0151.1 422151 24.0322-0151.1 522151	Ø 256 22 19 V + S Ø 256 22 19 V + S
			←	10/96→; +PR 1LE,1LN,1ZE,1ZH		24.0125-0113.1 425113 24.0325-0113.1 525113	Ø 288 25 22 V + S Ø 288 25 22 V + S
			→	10/96→; +PR 1KK,1KS,1KP		24.0109-0123.1 409123 24.0309-0123.1 509123	Ø 230 9 7 + S Ø 230 9 7 + S
1.6 1.9 SDI 1.9 TDI 2.0	74 50 81 85	02/97→12/07 06/97→12/03 08/97→01/06 04/99→05/07	←	+PR 1LR,1LS,1ZM		24.0122-0150.1 422150 24.0322-0150.1 522150	Ø 280 22 19 V + S Ø 280 22 19 V + S
			←	+PR 1LQ		24.0122-0151.1 422151 24.0322-0151.1 522151	Ø 256 22 19 V + S Ø 256 22 19 V + S
			←	+PR 1LE,1LN,1ZE,1ZH		24.0125-0113.1 425113 24.0325-0113.1 525113	Ø 288 25 22 V + S Ø 288 25 22 V + S
			→	+PR 1KK,1KS,1KP		24.0109-0123.1 409123 24.0309-0123.1 509123	Ø 230 9 7 + S Ø 230 9 7 + S
1.6 1.9 TDI	75 74	11/00→12/10 10/05→12/10	←	→ 06/10; +PR 1LR,1LS,1ZM		24.0122-0150.1 422150 24.0322-0150.1 522150	Ø 280 22 19 V + S Ø 280 22 19 V + S
			←	→ 06/10; +PR 1LQ		24.0122-0151.1 422151 24.0322-0151.1 522151	Ø 256 22 19 V + S Ø 256 22 19 V + S
			←	→ 06/10; +PR 1LE,1LN,1ZE,1ZH		24.0125-0113.1 425113 24.0325-0113.1 525113	Ø 288 25 22 V + S Ø 288 25 22 V + S
			→	→ 06/10; +PR 1KK,1KS,1KP		24.0109-0123.1 409123 24.0309-0123.1 509123	Ø 230 9 7 + S Ø 230 9 7 + S
1.8 T	110	08/97→12/10	←	03/98→ 06/10; +PR 1LR,1LS,1ZM		24.0122-0150.1 422150 24.0322-0150.1 522150	Ø 280 22 19 V + S Ø 280 22 19 V + S
			←	03/98→ 06/10; +PR 1LQ		24.0122-0151.1 422151 24.0322-0151.1 522151	Ø 256 22 19 V + S Ø 256 22 19 V + S
↓							









	kw			 	! #		
<b>SKODA - OCTAVIA I (1U2) 09/96→12/10</b>							
 <b>Bremsscheibe</b>							
1.8 T	110	08/97→12/10	←	03/98→ 06/10; +PR 1LE,1LN,1ZE,1ZH	24.0125-0113.1 425113	Ø 288 25 22 V + S	
			→	03/98→ 06/10; +PR 1KK,1KS,1KP	24.0109-0123.1 409123	Ø 230 9 7 + S	
1.8 T 4x4	110	05/01→05/06	←	+PR 1LR,1LS,1ZM	24.0122-0150.1 422150	Ø 280 22 19 V + S	
			←	+PR 1LQ	24.0122-0151.1 422151	Ø 256 22 19 V + S	
			←	+PR 1LE,1LN,1ZE,1ZH	24.0125-0113.1 425113	Ø 288 25 22 V + S	
			→	+PR 1KE	24.0109-0133.1 409133	Ø 239 8,9 7 + S	
			→		24.0309-0123.1 509123	Ø 230 9 7 + S	
1.9 TDI	96	09/02→09/04	←	01/03→; +PR 1LR,1LS,1ZM	24.0122-0150.1 422150	Ø 280 22 19 V + S	
			←	01/03→; +PR 1LQ	24.0122-0151.1 422151	Ø 256 22 19 V + S	
			←	01/03→; +PR 1LE,1LN,1ZE,1ZH	24.0125-0113.1 425113	Ø 288 25 22 V + S	
			→	01/03→; +PR 1KK,1KS,1KP	24.0109-0123.1 409123	Ø 230 9 7 + S	
RS 1.8 T	132	05/01→01/06	←	+PR 1ZN	24.0125-0123.1 425123	Ø 310 25 22 V + S	
			→	01/03→; +PR 2ED	24.0122-0163.1 422163	Ø 256 22 20 V	
<b>SKODA - OCTAVIA I Combi (1U5) 07/98→12/10</b>							
 <b>Bremsbelagsatz, Scheibenbremse</b>							
1.4 16V	55	08/00→12/10	←	→ 06/10; +PR 1LN,1LE,1ZD,1ZE / 1ZH	13.0460-7081.2 607081	ATE 20676 19,8 - WE / - WK	
			←	→ 1U-X-415000; +PR 1LQ,1LR,1LS,1ZM	13.0460-7111.2 607111	VW 23130 19,6 - WE / - WK Ceramic	
			←	1U-Y-000001→; → 06/10; +PR 1LQ,1LR,1LS,1ZM	13.0460-7117.2 607117	VW 23130 19,6 + WK Ceramic	
1.6 1.6 1.8 20V 1.9 SDI 1.9 TDI 1.9 TDI 2.0	55 74 92 50 66 81 85	07/98→09/04 07/98→12/07 07/98→07/00 07/98→12/03 07/98→03/10 07/98→01/06 04/99→05/07	←	+PR 1LN,1LE,1ZD,1ZE / 1ZH	13.0460-7081.2 607081	ATE 20676 19,8 - WE / - WK	
			←	→ 1U-X-415000; +PR 1LQ,1LR,1LS,1ZM	13.0460-7111.2 607111	VW 23130 19,6 - WE / - WK Ceramic	
			←	1U-Y-000001→; +PR 1LQ,1LR,1LS,1ZM	13.0460-7117.2 607117	VW 23130 19,6 + WK Ceramic	
			→	+PR 1KK,1KS,1KP	13.0460-2894.2 602894	TRW 20961 17,2 - WK + Zub Ceramic	
			←	→ 06/10; +PR 1LN,1LE,1ZD,1ZE / 1ZH	13.0460-7081.2 607081	ATE 20676 19,8 - WE / - WK Ceramic	
1.6 1.8 T	75 110	09/00→12/10 07/98→12/10	←	→ 06/10; +PR 1LN,1LE,1ZD,1ZE / 1ZH	13.0460-7122.2 607122	ATE 20676 19,8 + WK	
			←	→ 1U-X-415000; +PR 1LQ,1LR,1LS,1ZM	13.0460-7111.2 607111	VW 23130 19,6 - WE / - WK Ceramic	
			←	1U-Y-000001→; → 06/10; +PR 1LQ,1LR,1LS,1ZM	13.0460-7117.2 607117	VW 23130 19,6 + WK Ceramic	
			→	→ 06/10; +PR 1KK,1KS,1KP	13.0460-2894.2 602894	TRW 20961 17,2 - WK + Zub Ceramic	
↓							











	kw			 	! #		
<b>SKODA - OCTAVIA I Combi (1U5) 07/98→12/10</b>							
<b>Bremsbelagsatz, Scheibenbremse</b>							
1.8 T 4x4 1.9 TDI 4x4 1.9 TDI 4x4	110 66 74	05/01→05/06 11/99→02/06 09/00→01/06	←	+PR 1LN,1LE,1ZD,1ZE / 1ZH		13.0460-7081.2 607081 13.0460-7122.2 607122 13.0470-7081.2 LD7081 13.0470-7122.2 LD7122	ATE 20676 19,8 - WE / - WK ATE 20676 19,8 + WK ATE 20676 19,8 - WE / - WK Ceramic ATE 20676 19,8 + WK Ceramic
			←	+PR 1LQ,1LR,1LS,1ZM		13.0460-7117.2 607117 13.0470-7117.2 LD7117	VW 23130 19,6 + WK VW 23130 19,6 + WK Ceramic
			→	+PR 1KE		13.0460-2894.2 602894 13.0470-2894.2 LD2894	TRW 20961 17,2 - WK + Zub TRW 20961 17,2 - WK + Zub Ceramic
1.9 TDI	74	08/00→12/10	←	→ 06/10; +PR 1LN,1LE,1ZD,1ZE / 1ZH		13.0460-7081.2 607081 13.0460-7122.2 607122 13.0470-7081.2 LD7081 13.0470-7122.2 LD7122	ATE 20676 19,8 - WE / - WK ATE 20676 19,8 + WK ATE 20676 19,8 - WE / - WK Ceramic ATE 20676 19,8 + WK Ceramic
			←	→ 06/10; +PR 1LQ,1LR,1LS,1ZM		13.0460-7117.2 607117 13.0470-7117.2 LD7117	VW 23130 19,6 + WK VW 23130 19,6 + WK Ceramic
			→	→ 06/10; +PR 1KK,1KS,1KP		13.0460-2894.2 602894 13.0470-2894.2 LD2894	TRW 20961 17,2 - WK + Zub TRW 20961 17,2 - WK + Zub Ceramic
1.9 TDI	96	09/02→09/04	←	01/03→; +PR 1LN,1LE,1ZD,1ZE / 1ZH		13.0460-7081.2 607081 13.0460-7122.2 607122 13.0470-7081.2 LD7081 13.0470-7122.2 LD7122	ATE 20676 19,8 - WE / - WK ATE 20676 19,8 + WK ATE 20676 19,8 - WE / - WK Ceramic ATE 20676 19,8 + WK Ceramic
			←	01/03→; +PR 1LQ,1LR,1LS,1ZM		13.0460-7117.2 607117 13.0470-7117.2 LD7117	VW 23130 19,6 + WK VW 23130 19,6 + WK Ceramic
			→	01/03→; +PR 1KK,1KS,1KP		13.0460-2894.2 602894 13.0470-2894.2 LD2894	TRW 20961 17,2 - WK + Zub TRW 20961 17,2 - WK + Zub Ceramic
2.0 4x4	85	08/00→09/04	←	05/01→; +PR 1LN,1LE,1ZD,1ZE / 1ZH		13.0460-7081.2 607081 13.0460-7122.2 607122 13.0470-7081.2 LD7081 13.0470-7122.2 LD7122	ATE 20676 19,8 - WE / - WK ATE 20676 19,8 + WK ATE 20676 19,8 - WE / - WK Ceramic ATE 20676 19,8 + WK Ceramic
			←	05/01→; +PR 1LQ,1LR,1LS,1ZM		13.0460-7117.2 607117 13.0470-7117.2 LD7117	VW 23130 19,6 + WK VW 23130 19,6 + WK Ceramic
			→	05/01→; +PR 1KE		13.0460-2894.2 602894 13.0470-2894.2 LD2894	TRW 20961 17,2 - WK + Zub TRW 20961 17,2 - WK + Zub Ceramic
2.0 4x4	88	01/00→12/10	←	→ 06/10; +PR 1LN,1LE,1ZD,1ZE / 1ZH		13.0460-7081.2 607081 13.0460-7122.2 607122 13.0470-7081.2 LD7081 13.0470-7122.2 LD7122	ATE 20676 19,8 - WE / - WK ATE 20676 19,8 + WK ATE 20676 19,8 - WE / - WK Ceramic ATE 20676 19,8 + WK Ceramic
			←	→ 06/10; +PR 1LQ,1LR,1LS,1ZM		13.0460-7117.2 607117 13.0470-7117.2 LD7117	VW 23130 19,6 + WK VW 23130 19,6 + WK Ceramic
			→	→ 06/10; +PR 1KE		13.0460-2894.2 602894 13.0470-2894.2 LD2894	TRW 20961 17,2 - WK + Zub TRW 20961 17,2 - WK + Zub Ceramic
RS 1.8 T	132	08/02→01/06	←	+PR 1ZN		13.0460-7081.2 607081 13.0460-7122.2 607122 13.0470-7081.2 LD7081 13.0470-7122.2 LD7122	ATE 20676 19,8 - WE / - WK ATE 20676 19,8 + WK ATE 20676 19,8 - WE / - WK Ceramic ATE 20676 19,8 + WK Ceramic
			→	01/03→; +PR 2ED		13.0460-2886.2 602886 13.0460-2937.2 602937 13.0470-2886.2 LD2886	TRW 20961 16,0 - WK TRW 20961 15,2 - WK + Zub TRW 20961 16,0 - WK Ceramic
<b>Zubehörsatz, Scheibenbremsbelag</b>							
1.6 1.6 1.8 20V 1.9 SDI 1.9 TDI 1.9 TDI 2.0	55 74 92 50 66 81 85	07/98→09/04 07/98→12/07 07/98→07/00 07/98→12/03 07/98→03/10 07/98→01/06 04/99→05/07	→	+PR 1KK,1KS,1KP		13.0460-0072.2 610072	TRW
↓							







	kW			 	! #		
<b>SKODA - OCTAVIA I Combi (1U5) 07/98→12/10</b>							
<b>Zubehörsatz, Scheibenbremsbelag</b>							
1.6 1.8 T 1.9 TDI	75 110 74	09/00→12/10 07/98→12/10 08/00→12/10	➡	→ 06/10; +PR 1KK,1KS,1KP		13.0460-0072.2 610072	TRW
1.8 T 4x4 1.9 TDI 4x4 1.9 TDI 4x4	110 66 74	05/01→05/06 11/99→02/06 09/00→01/06	➡	+PR 1KE		13.0460-0072.2 610072	TRW
1.9 TDI	96	09/02→09/04	➡	01/03→; +PR 1KK,1KS,1KP		13.0460-0072.2 610072	TRW
2.0 4x4	85	08/00→09/04	➡	05/01→; +PR 1KE		13.0460-0072.2 610072	TRW
2.0 4x4	88	01/00→12/10	➡	→ 06/10; +PR 1KE		13.0460-0072.2 610072	TRW
<b> Bremsscheibe</b>							
1.4 16V	55	08/00→12/10	⬅	→ 06/10; +PR 1LR,1LS,1ZM		24.0122-0150.1 422150 24.0322-0150.1 522150	Ø 280 22 19 V + S Ø 280 22 19 V + S
			⬅	→ 06/10; +PR 1LQ		24.0122-0151.1 422151 24.0322-0151.1 522151	Ø 256 22 19 V + S Ø 256 22 19 V + S
			⬅	→ 06/10; +PR 1LE,1LN,1ZE,1ZH		24.0125-0113.1 425113 24.0325-0113.1 525113	Ø 288 25 22 V + S Ø 288 25 22 V + S
1.6 1.6 1.8 20V 1.9 SDI 1.9 TDI 1.9 TDI 2.0	55 74 92 50 66 81 85	07/98→09/04 07/98→12/07 07/98→07/00 07/98→12/03 07/98→03/10 07/98→01/06 04/99→05/07	⬅	+PR 1LR,1LS,1ZM		24.0122-0150.1 422150 24.0322-0150.1 522150	Ø 280 22 19 V + S Ø 280 22 19 V + S
			⬅	+PR 1LQ		24.0122-0151.1 422151 24.0322-0151.1 522151	Ø 256 22 19 V + S Ø 256 22 19 V + S
			⬅	+PR 1LE,1LN,1ZE,1ZH		24.0125-0113.1 425113 24.0325-0113.1 525113	Ø 288 25 22 V + S Ø 288 25 22 V + S
			➡	+PR 1KK,1KS,1KP		24.0109-0123.1 409123 24.0309-0123.1 509123	Ø 230 9 7 + S Ø 230 9 7 + S
1.6 1.8 T 1.9 TDI	75 110 74	09/00→12/10 07/98→12/10 08/00→12/10	⬅	→ 06/10; +PR 1LR,1LS,1ZM		24.0122-0150.1 422150 24.0322-0150.1 522150	Ø 280 22 19 V + S Ø 280 22 19 V + S
			⬅	→ 06/10; +PR 1LQ		24.0122-0151.1 422151 24.0322-0151.1 522151	Ø 256 22 19 V + S Ø 256 22 19 V + S
			⬅	→ 06/10; +PR 1LE,1LN,1ZE,1ZH		24.0125-0113.1 425113 24.0325-0113.1 525113	Ø 288 25 22 V + S Ø 288 25 22 V + S
			➡	→ 06/10; +PR 1KK,1KS,1KP		24.0109-0123.1 409123 24.0309-0123.1 509123	Ø 230 9 7 + S Ø 230 9 7 + S
1.8 T 4x4 1.9 TDI 4x4 1.9 TDI 4x4	110 66 74	05/01→05/06 11/99→02/06 09/00→01/06	⬅	+PR 1LR,1LS,1ZM		24.0122-0150.1 422150 24.0322-0150.1 522150	Ø 280 22 19 V + S Ø 280 22 19 V + S
			⬅	+PR 1LQ		24.0122-0151.1 422151 24.0322-0151.1 522151	Ø 256 22 19 V + S Ø 256 22 19 V + S
			⬅	+PR 1LE,1LN,1ZE,1ZH		24.0125-0113.1 425113 24.0325-0113.1 525113	Ø 288 25 22 V + S Ø 288 25 22 V + S
			➡	+PR 1KE		24.0109-0133.1 409133 24.0309-0133.1 509133	Ø 239 8,9 7 + S Ø 239 8,9 7 + S
1.9 TDI	96	09/02→09/04	⬅	01/03→; +PR 1LR,1LS,1ZM		24.0122-0150.1 422150 24.0322-0150.1 522150	Ø 280 22 19 V + S Ø 280 22 19 V + S
			⬅	01/03→; +PR 1LQ		24.0122-0151.1 422151 24.0322-0151.1 522151	Ø 256 22 19 V + S Ø 256 22 19 V + S
			⬅	01/03→; +PR 1LE,1LN,1ZE,1ZH		24.0125-0113.1 425113 24.0325-0113.1 525113	Ø 288 25 22 V + S Ø 288 25 22 V + S
			➡	01/03→; +PR 1KK,1KS,1KP		24.0109-0123.1 409123 24.0309-0123.1 509123	Ø 230 9 7 + S Ø 230 9 7 + S
2.0 4x4	85	08/00→09/04	⬅	05/01→; +PR 1LR,1LS,1ZM		24.0122-0150.1 422150 24.0322-0150.1 522150	Ø 280 22 19 V + S Ø 280 22 19 V + S
			⬅	05/01→; +PR 1LQ		24.0122-0151.1 422151 24.0322-0151.1 522151	Ø 256 22 19 V + S Ø 256 22 19 V + S
			⬅	05/01→; +PR 1LE,1LN,1ZE,1ZH		24.0125-0113.1 425113 24.0325-0113.1 525113	Ø 288 25 22 V + S Ø 288 25 22 V + S
			➡	05/01→; +PR 1KE		24.0109-0133.1 409133 24.0309-0133.1 509133	Ø 239 8,9 7 + S Ø 239 8,9 7 + S
2.0 4x4	88	01/00→12/10	⬅	→ 06/10; +PR 1LR,1LS,1ZM		24.0122-0150.1 422150 24.0322-0150.1 522150	Ø 280 22 19 V + S Ø 280 22 19 V + S
			⬅	→ 06/10; +PR 1LQ		24.0122-0151.1 422151 24.0322-0151.1 522151	Ø 256 22 19 V + S Ø 256 22 19 V + S
			⬅	→ 06/10; +PR 1LE,1LN,1ZE,1ZH		24.0125-0113.1 425113	Ø 288 25 22 V + S
↓							









	kw			 	! #		
<b>SKODA - OCTAVIA I Combi (1U5) 07/98→12/10</b>							
<b>Bremsscheibe</b>							
2.0 4x4	88	01/00→12/10	←	→ 06/10; +PR 1LE,1LN,1ZE,1ZH	24.0325-0113.1	525113	∅ 288 25 22 V + S
			→	→ 06/10; +PR 1KE	24.0109-0133.1	409133	∅ 239 8,9 7 + S
					24.0309-0133.1	509133	∅ 239 8,9 7 + S
RS 1.8 T	132	08/02→01/06	←	+PR 1ZN	24.0125-0123.1	425123	∅ 310 25 22 V + S
					24.0325-0123.1	525123	∅ 310 25 22 V + S
			→	01/03→; +PR 2ED	24.0122-0163.1	422163	∅ 256 22 20 V
				24.0322-0163.1	522163	∅ 256 22 20 V	
<b>SKODA - OCTAVIA II (1Z3) 02/04→06/13</b>							
<b>Bremsbelagsatz, Scheibenbremse</b>							
1.2 TSI 1.4 1.4 TSI 1.6 1.6 TDI 1.8 TSI 1.8 TSI 2.0 TDI	77 59 90 75 77 112 118 81	02/10→06/13 06/04→04/13 11/08→06/13 06/04→06/13 06/09→04/13 03/09→06/13 06/07→04/13 03/10→06/13	←	→ 01/13; +PR 1ZF,1ZM,1ZC	13.0460-7117.2	607117	VW 23130 19,6 + WK
					13.0470-7117.2	LD7117	VW 23130 19,6 + WK Ceramic
			←	→ 01/13; +PR 1ZE	13.0460-7184.2	607184	ATE 23587 20,6 + WK
					13.0470-7184.2	LD7184	ATE 23587 20,6 + WK Ceramic
			→	→ 01/13; +PR 1KF	13.0460-2749.2	602749	TRW 24483 16,9 - WE / - WK + Zub
					13.0460-2880.2	602880	TRW 23914 17,1 + WE / - WK + Zub
					13.0470-2749.2	LD2749	TRW 24483 16,9 - WE / - WK + Zub Ceramic
					13.0470-2880.2	LD2880	TRW 23914 17,1 + WE / - WK + Zub Ceramic
			→	→ 01/13; +PR 1KD	13.0460-2787.2	602787	TRW 23554 17,3 - WK / - WE
					13.0460-2820.2	602820	TRW 20961 17,2 - WK
		13.0470-2820.2	LD2820	TRW 20961 17,2 - WK Ceramic			
		→ 01/13; +PR 1KS,1KT	13.0460-3858.2	603858	BOS 24563 17,7 - WE / - WK + Zub		
			13.0470-3858.2	LD3858	BOS 24563 17,7 - WE / - WK + Zub Ceramic		
1.4 1.6 FSI 2.0 TDI	55 85 100	05/04→05/06 02/04→10/08 02/04→05/10	←	06/04→; +PR 1ZF,1ZM,1ZC	13.0460-7117.2	607117	VW 23130 19,6 + WK
					13.0470-7117.2	LD7117	VW 23130 19,6 + WK Ceramic
			←	06/04→; +PR 1ZE	13.0460-7184.2	607184	ATE 23587 20,6 + WK
					13.0470-7184.2	LD7184	ATE 23587 20,6 + WK Ceramic
			→	06/04→; +PR 1KF	13.0460-2749.2	602749	TRW 24483 16,9 - WE / - WK + Zub
					13.0460-2880.2	602880	TRW 23914 17,1 + WE / - WK + Zub
					13.0470-2749.2	LD2749	TRW 24483 16,9 - WE / - WK + Zub Ceramic
					13.0470-2880.2	LD2880	TRW 23914 17,1 + WE / - WK + Zub Ceramic
			→	06/04→; +PR 1KD	13.0460-2787.2	602787	TRW 23554 17,3 - WK / - WE
					13.0460-2820.2	602820	TRW 20961 17,2 - WK
		13.0470-2820.2	LD2820	TRW 20961 17,2 - WK Ceramic			
		→ 06/04→; +PR 1KS,1KT	13.0460-3858.2	603858	BOS 24563 17,7 - WE / - WK + Zub		
			13.0470-3858.2	LD3858	BOS 24563 17,7 - WE / - WK + Zub Ceramic		
1.6 LPG	75	08/09→11/12	←	09/09→; +PR 1ZF,1ZM,1ZC	13.0460-7117.2	607117	VW 23130 19,6 + WK
					13.0470-7117.2	LD7117	VW 23130 19,6 + WK Ceramic
			←	09/09→; +PR 1ZE	13.0460-7184.2	607184	ATE 23587 20,6 + WK
					13.0470-7184.2	LD7184	ATE 23587 20,6 + WK Ceramic
			→	09/09→; +PR 1KF	13.0460-2749.2	602749	TRW 24483 16,9 - WE / - WK + Zub
					13.0460-2880.2	602880	TRW 23914 17,1 + WE / - WK + Zub
					13.0470-2749.2	LD2749	TRW 24483 16,9 - WE / - WK + Zub Ceramic
		13.0470-2880.2	LD2880	TRW 23914 17,1 + WE / - WK + Zub Ceramic			
→	09/09→; +PR 1KD	13.0460-2787.2	602787	TRW 23554 17,3 - WK / - WE			
		13.0460-2820.2	602820	TRW 20961 17,2 - WK			
		13.0470-2820.2	LD2820	TRW 20961 17,2 - WK Ceramic			
		→ 09/09→; +PR 1KS,1KT	13.0460-3858.2	603858	BOS 24563 17,7 - WE / - WK + Zub		









	kw			 	! #		
<b>SKODA - OCTAVIA II (1Z3) 02/04→06/13</b>							
<b> Bremsbelagsatz, Scheibenbremse</b>							
1.6 LPG	75	08/09→11/12	➡	09/09→; +PR 1KS,1KT		<b>13.0470-3858.2 LD3858</b>	BOS 24563 17,7 - WE / - WK + Zub Ceramic
1.6 MultiFuel	75	01/08→06/13	←	09/09→; +PR 1ZF,1ZM,1ZC; → 01/13		<b>13.0460-7117.2 607117</b> <b>13.0470-7117.2 LD7117</b>	VW 23130 19,6 + WK VW 23130 19,6 + WK Ceramic
			←	09/09→; +PR 1ZE; → 01/13		<b>13.0460-7184.2 607184</b> <b>13.0470-7184.2 LD7184</b>	ATE 23587 20,6 + WK ATE 23587 20,6 + WK Ceramic
			➡	09/09→; +PR 1KF; → 01/13		<b>13.0460-2749.2 602749</b> <b>13.0460-2880.2 602880</b> <b>13.0470-2749.2 LD2749</b> <b>13.0470-2880.2 LD2880</b>	TRW 24483 16,9 - WE / - WK + Zub TRW 23914 17,1 + WE / - WK + Zub TRW 24483 16,9 - WE / - WK + Zub Ceramic TRW 23914 17,1 + WE / - WK + Zub Ceramic
			➡	09/09→; +PR 1KD; → 01/13		<b>13.0460-2787.2 602787</b> <b>13.0460-2820.2 602820</b> <b>13.0470-2820.2 LD2820</b>	TRW 23554 17,3 - WK / - WE TRW 20961 17,2 - WK TRW 20961 17,2 - WK Ceramic
			➡	09/09→; +PR 1KS,1KT; → 01/13		<b>13.0460-3858.2 603858</b> <b>13.0470-3858.2 LD3858</b>	BOS 24563 17,7 - WE / - WK + Zub BOS 24563 17,7 - WE / - WK + Zub Ceramic
			←	+PR 1ZF,1ZM,1ZC		<b>13.0460-7117.2 607117</b> <b>13.0470-7117.2 LD7117</b>	VW 23130 19,6 + WK VW 23130 19,6 + WK Ceramic
			←	+PR 1ZE		<b>13.0460-7184.2 607184</b> <b>13.0470-7184.2 LD7184</b>	ATE 23587 20,6 + WK ATE 23587 20,6 + WK Ceramic
1.9 TDI 2.0 FSI 2.0 TDI	77 110 103	06/04→12/10 11/04→10/08 11/05→05/10	➡	+PR 1KF		<b>13.0460-2749.2 602749</b> <b>13.0460-2880.2 602880</b> <b>13.0470-2749.2 LD2749</b> <b>13.0470-2880.2 LD2880</b>	TRW 24483 16,9 - WE / - WK + Zub TRW 23914 17,1 + WE / - WK + Zub TRW 24483 16,9 - WE / - WK + Zub Ceramic TRW 23914 17,1 + WE / - WK + Zub Ceramic
			➡	+PR 1KD		<b>13.0460-2787.2 602787</b> <b>13.0460-2820.2 602820</b> <b>13.0470-2820.2 LD2820</b>	TRW 23554 17,3 - WK / - WE TRW 20961 17,2 - WK TRW 20961 17,2 - WK Ceramic
			➡	+PR 1KS,1KT		<b>13.0460-3858.2 603858</b> <b>13.0470-3858.2 LD3858</b>	BOS 24563 17,7 - WE / - WK + Zub BOS 24563 17,7 - WE / - WK + Zub Ceramic
			←	+PR 1LL,1LP,1ZB; → 01/13		<b>13.0460-7184.2 607184</b> <b>13.0470-7184.2 LD7184</b>	ATE 23587 20,6 + WK ATE 23587 20,6 + WK Ceramic
			➡	+PR 1KP; → 01/13		<b>13.0460-2749.2 602749</b> <b>13.0460-2880.2 602880</b> <b>13.0470-2749.2 LD2749</b> <b>13.0470-2880.2 LD2880</b>	TRW 24483 16,9 - WE / - WK + Zub TRW 23914 17,1 + WE / - WK + Zub TRW 24483 16,9 - WE / - WK + Zub Ceramic TRW 23914 17,1 + WE / - WK + Zub Ceramic
			➡	→ 01/13; +PR 1KS,1KT		<b>13.0460-3858.2 603858</b> <b>13.0470-3858.2 LD3858</b>	BOS 24563 17,7 - WE / - WK + Zub BOS 24563 17,7 - WE / - WK + Zub Ceramic
2.0 RS 2.0 TDI RS	147 125	10/05→02/13 04/06→02/13	➡	→ 01/13; +PR 1KS,1KT		<b>13.0460-3858.2 603858</b> <b>13.0470-3858.2 LD3858</b>	BOS 24563 17,7 - WE / - WK + Zub BOS 24563 17,7 - WE / - WK + Zub Ceramic
			←	06/04→ 01/13; +PR 1ZF,1ZM,1ZC		<b>13.0460-7117.2 607117</b> <b>13.0470-7117.2 LD7117</b>	VW 23130 19,6 + WK VW 23130 19,6 + WK Ceramic
			←	06/04→ 01/13; +PR 1ZE		<b>13.0460-7184.2 607184</b> <b>13.0470-7184.2 LD7184</b>	ATE 23587 20,6 + WK ATE 23587 20,6 + WK Ceramic
			➡	06/04→ 01/13; +PR 1KF		<b>13.0460-2749.2 602749</b> <b>13.0460-2880.2 602880</b> <b>13.0470-2749.2 LD2749</b> <b>13.0470-2880.2 LD2880</b>	TRW 24483 16,9 - WE / - WK + Zub TRW 23914 17,1 + WE / - WK + Zub TRW 24483 16,9 - WE / - WK + Zub Ceramic TRW 23914 17,1 + WE / - WK + Zub Ceramic
			➡	06/04→ 01/13; +PR 1KD		<b>13.0460-2787.2 602787</b> <b>13.0460-2820.2 602820</b>	TRW 23554 17,3 - WK / - WE TRW 20961 17,2 - WK
2.0 TDI 16V	103	02/04→04/13	←	06/04→ 01/13; +PR 1ZF,1ZM,1ZC		<b>13.0460-7117.2 607117</b> <b>13.0470-7117.2 LD7117</b>	VW 23130 19,6 + WK VW 23130 19,6 + WK Ceramic
			←	06/04→ 01/13; +PR 1ZE		<b>13.0460-7184.2 607184</b> <b>13.0470-7184.2 LD7184</b>	ATE 23587 20,6 + WK ATE 23587 20,6 + WK Ceramic
			➡	06/04→ 01/13; +PR 1KF		<b>13.0460-2749.2 602749</b> <b>13.0460-2880.2 602880</b> <b>13.0470-2749.2 LD2749</b> <b>13.0470-2880.2 LD2880</b>	TRW 24483 16,9 - WE / - WK + Zub TRW 23914 17,1 + WE / - WK + Zub TRW 24483 16,9 - WE / - WK + Zub Ceramic TRW 23914 17,1 + WE / - WK + Zub Ceramic
			➡	06/04→ 01/13; +PR 1KD		<b>13.0460-2787.2 602787</b> <b>13.0460-2820.2 602820</b>	TRW 23554 17,3 - WK / - WE TRW 20961 17,2 - WK







	kw			 	! #		
<b>SKODA - OCTAVIA II (1Z3) 02/04→06/13</b>							
<b> Bremsbelagsatz, Scheibenbremse</b>							
2.0 TDI 16V	103	02/04→04/13	➡	06/04→ 01/13; +PR 1KD		13.0470-2820.2 LD2820	TRW 20961 17,2 - WK Ceramic
			➡	06/04→ 01/13; +PR 1KS,1KT		13.0460-3858.2 603858	BOS 24563 17,7 - WE / - WK + Zub
						13.0470-3858.2 LD3858	BOS 24563 17,7 - WE / - WK + Zub Ceramic
<b> Bremsscheibe</b>							
1.2 TSI	77	02/10→06/13	←	+PR 1ZF,1ZM; → 01/13		24.0122-0210.1 422210	Ø 280 22 19 V + S
1.4 TSI	90	11/08→06/13				24.0322-0210.1 522210	Ø 280 22 19 V + S
1.6 TDI	77	06/09→04/13	←	→ 01/13; +PR 1ZE		24.0125-0145.1 425145	Ø 288 25 22 V + S
2.0 TDI	81	03/10→06/13	←			24.0325-0145.1 525145	Ø 288 25 22 V + S
			➡	→ 01/13; +PR 1KD		24.0110-0277.1 410277	Ø 253 10 8 + S
			➡			24.0310-0277.1 510277	Ø 253 10 8 + S
			➡	→ 01/13; +PR 1KS,1KT		24.0110-0356.1 410356	Ø 272 9,7 8 + S
			➡			24.0310-0356.1 510356	Ø 272 9,7 8 + S
			➡	→ 01/13; +PR 1KF		24.0112-0158.1 412158	Ø 256 12 10 + S
						24.0312-0158.1 512158	Ø 256 12 10
1.4	55	05/04→05/06	←	06/04→; +PR 1ZF;1ZM		24.0122-0210.1 422210	Ø 280 22 19 V + S
1.6 FSI	85	02/04→10/08				24.0322-0210.1 522210	Ø 280 22 19 V + S
2.0 TDI	100	02/04→05/10	←	06/04→; +PR 1ZE		24.0125-0145.1 425145	Ø 288 25 22 V + S
						24.0325-0145.1 525145	Ø 288 25 22 V + S
			➡	06/04→; +PR 1KD		24.0110-0277.1 410277	Ø 253 10 8 + S
			➡			24.0310-0277.1 510277	Ø 253 10 8 + S
			➡	06/04→; +PR 1KS,1KT		24.0110-0356.1 410356	Ø 272 9,7 8 + S
			➡			24.0310-0356.1 510356	Ø 272 9,7 8 + S
			➡	06/04→; +PR 1KF		24.0112-0158.1 412158	Ø 256 12 10 + S
						24.0312-0158.1 512158	Ø 256 12 10
1.4	59	06/04→04/13	←	→ 01/13; +PR 1ZF;1ZM		24.0122-0210.1 422210	Ø 280 22 19 V + S
1.6	75	06/04→06/13				24.0322-0210.1 522210	Ø 280 22 19 V + S
1.8 TSI	112	03/09→06/13	←	→ 01/13; +PR 1ZE		24.0125-0145.1 425145	Ø 288 25 22 V + S
1.8 TSI	118	06/07→04/13	←			24.0325-0145.1 525145	Ø 288 25 22 V + S
			➡	→ 01/13; +PR 1KD		24.0110-0277.1 410277	Ø 253 10 8 + S
			➡			24.0310-0277.1 510277	Ø 253 10 8 + S
			➡	→ 01/13; +PR 1KS,1KT		24.0110-0356.1 410356	Ø 272 9,7 8 + S
			➡			24.0310-0356.1 510356	Ø 272 9,7 8 + S
			➡	→ 01/13; +PR 1KF		24.0112-0158.1 412158	Ø 256 12 10 + S
						24.0312-0158.1 512158	Ø 256 12 10
1.6 LPG	75	08/09→11/12	←	09/09→; +PR 1ZF,1ZM		24.0122-0210.1 422210	Ø 280 22 19 V + S
			←			24.0322-0210.1 522210	Ø 280 22 19 V + S
			←	09/09→; +PR 1ZE		24.0125-0145.1 425145	Ø 288 25 22 V + S
						24.0325-0145.1 525145	Ø 288 25 22 V + S
			➡	09/09→; +PR 1KD		24.0110-0277.1 410277	Ø 253 10 8 + S
			➡			24.0310-0277.1 510277	Ø 253 10 8 + S
			➡	09/09→; +PR 1KS,1KT		24.0110-0356.1 410356	Ø 272 9,7 8 + S
			➡			24.0310-0356.1 510356	Ø 272 9,7 8 + S
			➡	09/09→; +PR 1KF		24.0112-0158.1 412158	Ø 256 12 10 + S
						24.0312-0158.1 512158	Ø 256 12 10
1.6 MultiFuel	75	01/08→06/13	←	09/09→; +PR 1ZF,1ZM; → 01/13		24.0122-0210.1 422210	Ø 280 22 19 V + S
						24.0322-0210.1 522210	Ø 280 22 19 V + S
			←	09/09→; +PR 1ZE; → 01/13		24.0125-0145.1 425145	Ø 288 25 22 V + S
						24.0325-0145.1 525145	Ø 288 25 22 V + S
			➡	09/09→; +PR 1KD; → 01/13		24.0110-0277.1 410277	Ø 253 10 8 + S
			➡			24.0310-0277.1 510277	Ø 253 10 8 + S
			➡	09/09→; +PR 1KS,1KT; → 01/13		24.0110-0356.1 410356	Ø 272 9,7 8 + S
			➡			24.0310-0356.1 510356	Ø 272 9,7 8 + S
			➡	09/09→; +PR 1KF; → 01/13		24.0112-0158.1 412158	Ø 256 12 10 + S
						24.0312-0158.1 512158	Ø 256 12 10
1.9 TDI	77	06/04→12/10	←	+PR 1ZF;1ZM		24.0122-0210.1 422210	Ø 280 22 19 V + S
2.0 FSI	110	11/04→10/08				24.0322-0210.1 522210	Ø 280 22 19 V + S
2.0 TDI	103	11/05→05/10	←	+PR 1ZE		24.0125-0145.1 425145	Ø 288 25 22 V + S
						24.0325-0145.1 525145	Ø 288 25 22 V + S
			➡	+PR 1KD		24.0110-0277.1 410277	Ø 253 10 8 + S









	kw			 	! #		
<b>SKODA - OCTAVIA II (1Z3) 02/04→06/13</b>							
<b>Bremsscheibe</b>							
1.9 TDI	77	06/04→12/10	➡	+PR 1KD		24.0310-0277.1 510277	Ø 253 10 8 + S
2.0 FSI	110	11/04→10/08	➡	+PR 1KS,1KT		24.0110-0356.1 410356	Ø 272 9,7 8 + S
2.0 TDI	103	11/05→05/10	➡	+PR 1KF		24.0310-0356.1 510356	Ø 272 9,7 8 + S
			➡	+PR 1KF		24.0112-0158.1 412158	Ø 256 12 10 + S
						24.0312-0158.1 512158	Ø 256 12 10
2.0 RS	147	10/05→02/13	⬅	→ 01/13; +PR 1LL,1LP,1ZB		24.0125-0158.1 425158	Ø 312 25 22 V + S
2.0 TDI RS	125	04/06→02/13	➡	→ 01/13; +PR 1KS,1KT		24.0110-0356.1 410356	Ø 272 9,7 8 + S
			➡	→ 01/13; +PR 1KP		24.0112-0169.1 412169	Ø 282 12 10 + S
						24.0312-0169.1 512169	Ø 282 12 10 + S
2.0 TDI 16V	103	02/04→04/13	⬅	06/04→ 01/13; +PR 1ZF;1ZM		24.0122-0210.1 422210	Ø 280 22 19 V + S
			⬅	06/04→ 01/13; +PR 1ZE		24.0322-0210.1 522210	Ø 280 22 19 V + S
			➡	06/04→ 01/13; +PR 1KD		24.0125-0145.1 425145	Ø 288 25 22 V + S
						24.0325-0145.1 525145	Ø 288 25 22 V + S
			➡	06/04→ 01/13; +PR 1KD		24.0110-0277.1 410277	Ø 253 10 8 + S
						24.0310-0277.1 510277	Ø 253 10 8 + S
			➡	06/04→ 01/13; +PR 1KS,1KT		24.0110-0356.1 410356	Ø 272 9,7 8 + S
						24.0310-0356.1 510356	Ø 272 9,7 8 + S
			➡	06/04→ 01/13; +PR 1KF		24.0112-0158.1 412158	Ø 256 12 10 + S
						24.0312-0158.1 512158	Ø 256 12 10
<b>SKODA - OCTAVIA II Combi (1Z5) 02/04→06/13</b>							
<b>Bremsbelagsatz, Scheibenbremse</b>							
1.2 TSI	77	02/10→04/13	⬅	→ 01/13; +PR 1ZF,1ZM,1ZC		13.0460-7117.2 607117	VW 23130 19,6 + WK
1.4	59	05/06→06/13				13.0470-7117.2 LD7117	VW 23130 19,6 + WK Ceramic
1.4 TSI	90	11/08→06/13					
1.6	75	09/04→06/13	⬅	→ 01/13; +PR 1ZE		13.0460-7184.2 607184	ATE 23587 20,6 + WK
1.6 TDI	77	06/09→04/13				13.0470-7184.2 LD7184	ATE 23587 20,6 + WK Ceramic
1.8 TSI	112	03/09→06/13	➡	→ 01/13; +PR 1KF		13.0460-2749.2 602749	TRW 24483 16,9 - WE / - WK + Zub
1.8 TSI	118	06/07→04/13					
2.0 TDI	81	03/10→06/13					
2.0 TDI 4x4	81	05/11→02/13				13.0460-2880.2 602880	TRW 23914 17,1 + WE / - WK + Zub
						13.0470-2749.2 LD2749	TRW 24483 16,9 - WE / - WK + Zub Ceramic
						13.0470-2880.2 LD2880	TRW 23914 17,1 + WE / - WK + Zub Ceramic
			➡	→ 01/13; +PR 1KD		13.0460-2787.2 602787	TRW 23554 17,3 - WK / - WE
						13.0460-2820.2 602820	TRW 20961 17,2 - WK
						13.0470-2820.2 LD2820	TRW 20961 17,2 - WK Ceramic
			➡	→ 01/13; +PR 1KS,1KT		13.0460-3858.2 603858	BOS 24563 17,7 - WE / - WK + Zub
						13.0470-3858.2 LD3858	BOS 24563 17,7 - WE / - WK + Zub Ceramic
1.4	55	05/04→05/06	⬅	06/04→; +PR 1ZF,1ZM,1ZC		13.0460-7117.2 607117	VW 23130 19,6 + WK
1.6 FSI	85	02/04→10/08				13.0470-7117.2 LD7117	VW 23130 19,6 + WK Ceramic
2.0 TDI 16V	100	02/04→05/10	⬅	06/04→; +PR 1ZE		13.0460-7184.2 607184	ATE 23587 20,6 + WK
						13.0470-7184.2 LD7184	ATE 23587 20,6 + WK Ceramic
			➡	06/04→; +PR 1KF		13.0460-2749.2 602749	TRW 24483 16,9 - WE / - WK + Zub
						13.0460-2880.2 602880	TRW 23914 17,1 + WE / - WK + Zub
						13.0470-2749.2 LD2749	TRW 24483 16,9 - WE / - WK + Zub Ceramic
			➡	06/04→; +PR 1KD		13.0460-2787.2 602787	TRW 23554 17,3 - WK / - WE
						13.0460-2820.2 602820	TRW 20961 17,2 - WK
						13.0470-2820.2 LD2820	TRW 20961 17,2 - WK Ceramic
			➡	06/04→; +PR 1KS,1KT		13.0460-3858.2 603858	BOS 24563 17,7 - WE / - WK + Zub
						13.0470-3858.2 LD3858	BOS 24563 17,7 - WE / - WK + Zub Ceramic
1.6 LPG	75	08/09→11/12	⬅	09/09→; +PR 1ZF,1ZM,1ZC		13.0460-7117.2 607117	VW 23130 19,6 + WK
						13.0470-7117.2 LD7117	VW 23130 19,6 + WK Ceramic
↓							

	kw			 	! #		
<b>SKODA - OCTAVIA II Combi (1Z5) 02/04→06/13</b>							
<b> Bremsbelagsatz, Scheibenbremse</b>							
1.6 LPG	75	08/09→11/12	←	09/09→; +PR 1ZE	13.0460-7184.2	607184	ATE 23587 20,6 + WK
					13.0470-7184.2	LD7184	ATE 23587 20,6 + WK Ceramic
			→	09/09→; +PR 1KF	13.0460-2749.2	602749	TRW 24483 16,9 - WE / - WK + Zub
					13.0460-2880.2	602880	TRW 23914 17,1 + WE / - WK + Zub
					13.0470-2749.2	LD2749	TRW 24483 16,9 - WE / - WK + Zub Ceramic
				13.0470-2880.2	LD2880	TRW 23914 17,1 + WE / - WK + Zub Ceramic	
			→	09/09→; +PR 1KD	13.0460-2787.2	602787	TRW 23554 17,3 - WK / - WE
					13.0460-2820.2	602820	TRW 20961 17,2 - WK
					13.0470-2820.2	LD2820	TRW 20961 17,2 - WK Ceramic
			→	09/09→; +PR 1KS,1KT	13.0460-3858.2	603858	BOS 24563 17,7 - WE / - WK + Zub
					13.0470-3858.2	LD3858	BOS 24563 17,7 - WE / - WK + Zub Ceramic
1.6 MultiFuel	75	01/08→06/13	←	09/09→; +PR 1ZF,1ZM,1ZC; → 01/13	13.0460-7117.2	607117	VW 23130 19,6 + WK
					13.0470-7117.2	LD7117	VW 23130 19,6 + WK Ceramic
			←	09/09→; +PR 1ZE; → 01/13	13.0460-7184.2	607184	ATE 23587 20,6 + WK
					13.0470-7184.2	LD7184	ATE 23587 20,6 + WK Ceramic
			→	09/09→; +PR 1KF; → 01/13	13.0460-2749.2	602749	TRW 24483 16,9 - WE / - WK + Zub
					13.0460-2880.2	602880	TRW 23914 17,1 + WE / - WK + Zub
					13.0470-2749.2	LD2749	TRW 24483 16,9 - WE / - WK + Zub Ceramic
				13.0470-2880.2	LD2880	TRW 23914 17,1 + WE / - WK + Zub Ceramic	
			→	09/09→; +PR 1KD; → 01/13	13.0460-2787.2	602787	TRW 23554 17,3 - WK / - WE
					13.0460-2820.2	602820	TRW 20961 17,2 - WK
					13.0470-2820.2	LD2820	TRW 20961 17,2 - WK Ceramic
			→	09/09→; +PR 1KS,1KT; → 01/13	13.0460-3858.2	603858	BOS 24563 17,7 - WE / - WK + Zub
					13.0470-3858.2	LD3858	BOS 24563 17,7 - WE / - WK + Zub Ceramic
1.6 TDI 4x4 1.8 TSI 4x4 1.8 TSI 4x4 2.0 TDI 16V 4x4	77 112 118 103	06/09→02/13 03/09→02/13 11/08→02/13 05/10→02/13	←	→ 01/13; +PR 1ZF,1ZM,1ZC	13.0460-7117.2	607117	VW 23130 19,6 + WK
					13.0470-7117.2	LD7117	VW 23130 19,6 + WK Ceramic
			←	→ 01/13; +PR 1ZE	13.0460-7184.2	607184	ATE 23587 20,6 + WK
					13.0470-7184.2	LD7184	ATE 23587 20,6 + WK Ceramic
			→	→ 01/13; +PR 1KF	13.0460-2749.2	602749	TRW 24483 16,9 - WE / - WK + Zub
				13.0460-2880.2	602880	TRW 23914 17,1 + WE / - WK + Zub	
					13.0470-2749.2	LD2749	TRW 24483 16,9 - WE / - WK + Zub Ceramic
					13.0470-2880.2	LD2880	TRW 23914 17,1 + WE / - WK + Zub Ceramic
			→	→ 01/13; +PR 1KS,1KT	13.0460-3858.2	603858	BOS 24563 17,7 - WE / - WK + Zub
					13.0470-3858.2	LD3858	BOS 24563 17,7 - WE / - WK + Zub Ceramic
1.9 TDI 2.0 FSI 2.0 TDI	77 110 103	09/04→12/10 11/04→10/08 11/05→05/10	←	+PR 1ZF,1ZM,1ZC	13.0460-7117.2	607117	VW 23130 19,6 + WK
					13.0470-7117.2	LD7117	VW 23130 19,6 + WK Ceramic
			←	+PR 1ZE	13.0460-7184.2	607184	ATE 23587 20,6 + WK
					13.0470-7184.2	LD7184	ATE 23587 20,6 + WK Ceramic
			→	+PR 1KF	13.0460-2749.2	602749	TRW 24483 16,9 - WE / - WK + Zub
				13.0460-2880.2	602880	TRW 23914 17,1 + WE / - WK + Zub	
					13.0470-2749.2	LD2749	TRW 24483 16,9 - WE / - WK + Zub Ceramic
					13.0470-2880.2	LD2880	TRW 23914 17,1 + WE / - WK + Zub Ceramic
			→	+PR 1KD	13.0460-2787.2	602787	TRW 23554 17,3 - WK / - WE
					13.0460-2820.2	602820	TRW 20961 17,2 - WK
					13.0470-2820.2	LD2820	TRW 20961 17,2 - WK Ceramic

	kw			 	! #		
<b>SKODA - OCTAVIA II Combi (1Z5) 02/04→06/13</b>							
<b> Bremsbelagsatz, Scheibenbremse</b>							
1.9 TDI 2.0 FSI 2.0 TDI	77 110 103	09/04→12/10 11/04→10/08 11/05→05/10	➡	+PR 1KS,1KT		13.0460-3858.2 603858 13.0470-3858.2 LD3858	BOS 24563 17,7 - WE / - WK + Zub BOS 24563 17,7 - WE / - WK + Zub Ceramic
1.9 TDI 4x4 2.0 FSI 4x4 2.0 TDI 4x4	77 110 103	11/04→12/10 11/04→10/08 07/06→05/10	⬅	+PR 1ZF,1ZM,1ZC		13.0460-7117.2 607117 13.0470-7117.2 LD7117	VW 23130 19,6 + WK VW 23130 19,6 + WK Ceramic
			⬅	+PR 1ZE		13.0460-7184.2 607184 13.0470-7184.2 LD7184	ATE 23587 20,6 + WK ATE 23587 20,6 + WK Ceramic
			➡	+PR 1KF		13.0460-2749.2 602749 13.0460-2880.2 602880 13.0470-2749.2 LD2749 13.0470-2880.2 LD2880	TRW 24483 16,9 - WE / - WK + Zub TRW 23914 17,1 + WE / - WK + Zub TRW 24483 16,9 - WE / - WK + Zub Ceramic TRW 23914 17,1 + WE / - WK + Zub Ceramic
			➡	+PR 1KS,1KT		13.0460-3858.2 603858 13.0470-3858.2 LD3858	BOS 24563 17,7 - WE / - WK + Zub BOS 24563 17,7 - WE / - WK + Zub Ceramic
2.0 RS 2.0 TDI RS	147 125	10/05→02/13 04/06→02/13	⬅	+PR 1LL,1LP,1ZB; → 01/13		13.0460-7184.2 607184 13.0470-7184.2 LD7184	ATE 23587 20,6 + WK ATE 23587 20,6 + WK Ceramic
			➡	+PR 1KP; → 01/13		13.0460-2749.2 602749 13.0460-2880.2 602880 13.0470-2749.2 LD2749 13.0470-2880.2 LD2880	TRW 24483 16,9 - WE / - WK + Zub TRW 23914 17,1 + WE / - WK + Zub TRW 24483 16,9 - WE / - WK + Zub Ceramic TRW 23914 17,1 + WE / - WK + Zub Ceramic
			➡	→ 01/13; +PR 1KS,1KT		13.0460-3858.2 603858 13.0470-3858.2 LD3858	BOS 24563 17,7 - WE / - WK + Zub BOS 24563 17,7 - WE / - WK + Zub Ceramic
2.0 TDI 16V	103	02/04→05/13	⬅	06/04→ 01/13; +PR 1ZF,1ZM,1ZC		13.0460-7117.2 607117 13.0470-7117.2 LD7117	VW 23130 19,6 + WK VW 23130 19,6 + WK Ceramic
			⬅	06/04→ 01/13; +PR 1ZE		13.0460-7184.2 607184 13.0470-7184.2 LD7184	ATE 23587 20,6 + WK ATE 23587 20,6 + WK Ceramic
			➡	06/04→ 01/13; +PR 1KF		13.0460-2749.2 602749 13.0460-2880.2 602880 13.0470-2749.2 LD2749 13.0470-2880.2 LD2880	TRW 24483 16,9 - WE / - WK + Zub TRW 23914 17,1 + WE / - WK + Zub TRW 24483 16,9 - WE / - WK + Zub Ceramic TRW 23914 17,1 + WE / - WK + Zub Ceramic
			➡	06/04→ 01/13; +PR 1KD		13.0460-2787.2 602787 13.0460-2820.2 602820 13.0470-2820.2 LD2820	TRW 23554 17,3 - WK / - WE TRW 20961 17,2 - WK TRW 20961 17,2 - WK Ceramic
			➡	06/04→ 01/13; +PR 1KS,1KT		13.0460-3858.2 603858 13.0470-3858.2 LD3858	BOS 24563 17,7 - WE / - WK + Zub BOS 24563 17,7 - WE / - WK + Zub Ceramic
<b> Bremsscheibe</b>							
1.2 TSI 1.4 TSI 1.6 TDI 2.0 TDI 2.0 TDI 4x4	77 90 77 81 81	02/10→04/13 11/08→06/13 06/09→04/13 03/10→06/13 05/11→02/13	⬅	+PR 1ZF,1ZM; → 01/13		24.0122-0210.1 422210 24.0322-0210.1 522210	Ø 280 22 19 V + S Ø 280 22 19 V + S
			⬅	→ 01/13; +PR 1ZE		24.0125-0145.1 425145 24.0325-0145.1 525145	Ø 288 25 22 V + S Ø 288 25 22 V + S
			➡	→ 01/13; +PR 1KD		24.0110-0277.1 410277 24.0310-0277.1 510277	Ø 253 10 8 + S Ø 253 10 8 + S
			➡	→ 01/13; +PR 1KS,1KT		24.0110-0356.1 410356 24.0310-0356.1 510356	Ø 272 9,7 8 + S Ø 272 9,7 8 + S
			➡	→ 01/13; +PR 1KF		24.0112-0158.1 412158 24.0312-0158.1 512158	Ø 256 12 10 + S Ø 256 12 10
1.4 1.6 FSI 2.0 TDI 16V	55 85 100	05/04→05/06 02/04→10/08 02/04→05/10	⬅	06/04→; +PR 1ZF,1ZM		24.0122-0210.1 422210 24.0322-0210.1 522210	Ø 280 22 19 V + S Ø 280 22 19 V + S
↓							











	kw			 	! #		
<b>SKODA - OCTAVIA II Combi (1Z5) 02/04→06/13</b>							
<b>Bremsscheibe</b>							
1.4 1.6 FSI 2.0 TDI 16V	55 85 100	05/04→05/06 02/04→10/08 02/04→05/10	←	06/04→; +PR 1ZE	24.0125-0145.1	425145	Ø 288 25 22 V + S
					24.0325-0145.1	525145	Ø 288 25 22 V + S
			→	06/04→; +PR 1KD	24.0110-0277.1	410277	Ø 253 10 8 + S
					24.0310-0277.1	510277	Ø 253 10 8 + S
			→	06/04→; +PR 1KS,1KT	24.0110-0356.1	410356	Ø 272 9,7 8 + S
		24.0310-0356.1	510356	Ø 272 9,7 8 + S			
			→	06/04→; +PR 1KF	24.0112-0158.1	412158	Ø 256 12 10 + S
					24.0312-0158.1	512158	Ø 256 12 10
1.4 1.6 1.8 TSI 1.8 TSI	59 75 112 118	05/06→06/13 09/04→06/13 03/09→06/13 06/07→04/13	←	→ 01/13; +PR 1ZF,1ZM	24.0122-0210.1	422210	Ø 280 22 19 V + S
					24.0322-0210.1	522210	Ø 280 22 19 V + S
			←	→ 01/13; +PR 1ZE	24.0125-0145.1	425145	Ø 288 25 22 V + S
					24.0325-0145.1	525145	Ø 288 25 22 V + S
			→	→ 01/13; +PR 1KD	24.0110-0277.1	410277	Ø 253 10 8 + S
		24.0310-0277.1	510277	Ø 253 10 8 + S			
			→	→ 01/13; +PR 1KS,1KT	24.0110-0356.1	410356	Ø 272 9,7 8 + S
					24.0310-0356.1	510356	Ø 272 9,7 8 + S
			→	→ 01/13; +PR 1KF	24.0112-0158.1	412158	Ø 256 12 10 + S
					24.0312-0158.1	512158	Ø 256 12 10
1.6 LPG	75	08/09→11/12	←	09/09→; +PR 1ZF,1ZM	24.0122-0210.1	422210	Ø 280 22 19 V + S
					24.0322-0210.1	522210	Ø 280 22 19 V + S
			←	09/09→; +PR 1ZE	24.0125-0145.1	425145	Ø 288 25 22 V + S
					24.0325-0145.1	525145	Ø 288 25 22 V + S
			→	09/09→; +PR 1KD	24.0110-0277.1	410277	Ø 253 10 8 + S
		24.0310-0277.1	510277	Ø 253 10 8 + S			
			→	09/09→; +PR 1KS,1KT	24.0110-0356.1	410356	Ø 272 9,7 8 + S
					24.0310-0356.1	510356	Ø 272 9,7 8 + S
			→	09/09→; +PR 1KF	24.0112-0158.1	412158	Ø 256 12 10 + S
					24.0312-0158.1	512158	Ø 256 12 10
1.6 MultiFuel	75	01/08→06/13	←	09/09→; +PR 1ZF,1ZM; → 01/13	24.0122-0210.1	422210	Ø 280 22 19 V + S
					24.0322-0210.1	522210	Ø 280 22 19 V + S
			←	09/09→; +PR 1ZE; → 01/13	24.0125-0145.1	425145	Ø 288 25 22 V + S
					24.0325-0145.1	525145	Ø 288 25 22 V + S
			→	09/09→; +PR 1KD; → 01/13	24.0110-0277.1	410277	Ø 253 10 8 + S
		24.0310-0277.1	510277	Ø 253 10 8 + S			
			→	09/09→; +PR 1KS,1KT; → 01/13	24.0110-0356.1	410356	Ø 272 9,7 8 + S
					24.0310-0356.1	510356	Ø 272 9,7 8 + S
			→	09/09→; +PR 1KF; → 01/13	24.0112-0158.1	412158	Ø 256 12 10 + S
					24.0312-0158.1	512158	Ø 256 12 10
1.6 TDI 4x4 1.8 TSI 4x4 1.8 TSI 4x4 2.0 TDI 16V 4x4	77 112 118 103	06/09→02/13 03/09→02/13 11/08→02/13 05/10→02/13	←	+PR 1ZF,1ZM; → 01/13	24.0122-0210.1	422210	Ø 280 22 19 V + S
					24.0322-0210.1	522210	Ø 280 22 19 V + S
			←	→ 01/13; +PR 1ZE	24.0125-0145.1	425145	Ø 288 25 22 V + S
					24.0325-0145.1	525145	Ø 288 25 22 V + S
			→	→ 01/13; +PR 1KS,1KT	24.0110-0356.1	410356	Ø 272 9,7 8 + S
		24.0310-0356.1	510356	Ø 272 9,7 8 + S			
			→	→ 01/13; +PR 1KF	24.0112-0158.1	412158	Ø 256 12 10 + S
					24.0312-0158.1	512158	Ø 256 12 10
1.9 TDI 2.0 FSI 2.0 TDI	77 110 103	09/04→12/10 11/04→10/08 11/05→05/10	←	+PR 1ZF,1ZM	24.0122-0210.1	422210	Ø 280 22 19 V + S
					24.0322-0210.1	522210	Ø 280 22 19 V + S
			←	+PR 1ZE	24.0125-0145.1	425145	Ø 288 25 22 V + S
					24.0325-0145.1	525145	Ø 288 25 22 V + S
			→	+PR 1KD	24.0110-0277.1	410277	Ø 253 10 8 + S
		24.0310-0277.1	510277	Ø 253 10 8 + S			
			→	+PR 1KS,1KT	24.0110-0356.1	410356	Ø 272 9,7 8 + S
					24.0310-0356.1	510356	Ø 272 9,7 8 + S
			→	+PR 1KF	24.0112-0158.1	412158	Ø 256 12 10 + S
					24.0312-0158.1	512158	Ø 256 12 10
1.9 TDI 4x4 2.0 FSI 4x4 2.0 TDI 4x4	77 110 103	11/04→12/10 11/04→10/08 07/06→05/10	←	+PR 1ZF,1ZM	24.0122-0210.1	422210	Ø 280 22 19 V + S
					24.0322-0210.1	522210	Ø 280 22 19 V + S
			←	+PR 1ZE	24.0125-0145.1	425145	Ø 288 25 22 V + S
				24.0325-0145.1	525145	Ø 288 25 22 V + S	
			→	+PR 1KS,1KT	24.0110-0356.1	410356	Ø 272 9,7 8 + S











	kw			 	! #				
<b>SKODA - OCTAVIA II Combi (1Z5) 02/04→06/13</b>									
<b>Bremsscheibe</b>									
1.9 TDI 4x4	77	11/04→12/10	➡	+PR 1KS,1KT		24.0310-0356.1 510356	Ø 272 9,7 8 + S		
2.0 FSI 4x4	110	11/04→10/08	➡	+PR 1KF		24.0112-0158.1 412158	Ø 256 12 10 + S		
2.0 TDI 4x4	103	07/06→05/10					24.0312-0158.1 512158	Ø 256 12 10	
2.0 RS	147	10/05→02/13	➡	→ 01/13; +PR 1LL,1LP,1ZB		24.0125-0158.1 425158	Ø 312 25 22 V + S		
2.0 TDI RS	125	04/06→02/13					24.0325-0158.1 525158	Ø 312 25 22 V + S	
						→ 01/13; +PR 1KS,1KT		24.0110-0356.1 410356	Ø 272 9,7 8 + S
						→ 01/13; +PR 1KP		24.0112-0169.1 412169	Ø 282 12 10 + S
						24.0312-0169.1 512169	Ø 282 12 10 + S		
2.0 TDI 16V	103	02/04→05/13	➡	06/04→ 01/13; +PR 1ZF;1ZM		24.0122-0210.1 422210	Ø 280 22 19 V + S		
					06/04→ 01/13; +PR 1ZE		24.0125-0145.1 425145	Ø 288 25 22 V + S	
							24.0325-0145.1 525145	Ø 288 25 22 V + S	
					06/04→ 01/13; +PR 1KD		24.0110-0277.1 410277	Ø 253 10 8 + S	
							24.0310-0277.1 510277	Ø 253 10 8 + S	
					06/04→ 01/13; +PR 1KS,1KT		24.0110-0356.1 410356	Ø 272 9,7 8 + S	
						24.0310-0356.1 510356	Ø 272 9,7 8 + S		
				06/04→ 01/13; +PR 1KF		24.0112-0158.1 412158	Ø 256 12 10 + S		
						24.0312-0158.1 512158	Ø 256 12 10		
<b>SKODA - OCTAVIA III (5E3, NL3, NR3) 11/12→</b>									
<b>Bremsbelagsatz, Scheibenbremse</b>									
1.0 TSI	85	05/16→	➡	+PR 1ZA,1ZB,1ZE		13.0460-2785.2 602785	TRW 25683 20,4 + WE / + WK		
1.2 TSI	81	05/15→					13.0470-2785.2 LD2785	TRW 25683 20,4 + WE / + WK Ceramic	
1.4 TSI	103	11/12→	➡	+PR 1ZF		13.0460-7303.2 607303	ATE 22035 17,5 + WK		
1.4 TSI G-TEC	81	11/13→					13.0470-7303.2 LD7303	ATE 22035 17,5 + WK Ceramic	
1.5 TSI	110	02/17→	➡	+PR 1KW		13.0460-2621.2 602621	TRW 24483 16,9 - WE / - WK + Zub		
1.6	81	01/14→					13.0460-2887.2 602887	TRW 23914 17,1 + WE / - WK + Zub	
1.6 TDI	81	05/13→	➡			13.0460-2621.2 LD2621	TRW 24483 16,9 - WE / - WK + Zub Ceramic		
1.6 TDI	85	02/17→					13.0470-2887.2 LD2887	TRW 23914 17,1 + WE / - WK + Zub Ceramic	
1.6 TDI 4x4	77	09/14→	➡	+PR 1KD		13.0460-2787.2 602787	TRW 23554 17,3 - WK / - WE		
1.6 TDI 4x4	81	05/15→					13.0460-2790.2 602790	TRW 25110 17,5 - WE / - WK Ceramic	
1.8 TSI	132	11/12→	➡	+PR 1KS,1KT		13.0460-2790.2 LD2790	TRW 25110 17,5 - WE / - WK Ceramic		
1.8 TSI 4x4	132	09/14→					13.0470-2790.2 LD2790	TRW 25110 17,5 - WE / - WK Ceramic	
2.0 TDI	105	11/12→	➡			13.0460-2785.2 602785	TRW 25683 20,4 + WE / + WK		
2.0 TDI / TDI RS 4x4	135	09/14→					13.0470-2785.2 LD2785	TRW 25683 20,4 + WE / + WK Ceramic	
2.0 TDI 4x4	110	09/14→	➡	02/13→; +PR 1ZF		13.0460-7303.2 607303	ATE 22035 17,5 + WK		
2.0 TDI RS	135	05/13→					13.0470-7303.2 LD7303	ATE 22035 17,5 + WK Ceramic	
2.0 TSI RS	162	05/13→	➡	02/13→; +PR 1KW		13.0460-2621.2 602621	TRW 24483 16,9 - WE / - WK + Zub		
2.0 TSI RS	169	05/15→					13.0460-2887.2 602887	TRW 23914 17,1 + WE / - WK + Zub	
2.0 TSI RS	180	02/17→			13.0470-2621.2 LD2621	TRW 24483 16,9 - WE / - WK + Zub Ceramic			
					13.0470-2887.2 LD2887	TRW 23914 17,1 + WE / - WK + Zub Ceramic			
				02/13→; +PR 1KD		13.0460-2787.2 602787	TRW 23554 17,3 - WK / - WE		
				02/13→; +PR 1KS,1KT		13.0460-2790.2 602790	TRW 25110 17,5 - WE / - WK Ceramic		
						13.0470-2790.2 LD2790	TRW 25110 17,5 - WE / - WK Ceramic		
1.4 TSI	110	08/14→	➡	05/15→; +PR 1ZA,1ZB,1ZE		13.0460-2785.2 602785	TRW 25683 20,4 + WE / + WK		
							13.0470-2785.2 LD2785	TRW 25683 20,4 + WE / + WK Ceramic	
					05/15→; +PR 1ZF		13.0460-7303.2 607303	ATE 22035 17,5 + WK	
						13.0470-7303.2 LD7303	ATE 22035 17,5 + WK Ceramic		
				05/15→; +PR 1KW		13.0460-2621.2 602621	TRW 24483 16,9 - WE / - WK + Zub		
						13.0460-2887.2 602887	TRW 23914 17,1 + WE / - WK + Zub		





	kw					! #		
<b>SKODA - OCTAVIA III (5E3, NL3, NR3) 11/12→</b>								
 <b>Bremsbelagsatz, Scheibenbremse</b>								
1.4 TSI	110	08/14→	➡	05/15→; +PR 1KW			<b>13.0470-2621.2 LD2621</b>	TRW 24483 16,9 - WE / - WK + Zub Ceramic
							<b>13.0470-2887.2 LD2887</b>	TRW 23914 17,1 + WE / - WK + Zub Ceramic
			➡	05/15→; +PR 1KD			<b>13.0460-2787.2 602787</b>	TRW 23554 17,3 - WK / - WE
			➡	05/15→; +PR 1KS,1KT			<b>13.0460-2790.2 602790</b>	TRW 25110 17,5 - WE / - WK
							<b>13.0470-2790.2 LD2790</b>	TRW 25110 17,5 - WE / - WK Ceramic
 <b>Bremsscheibe</b>								
1.0 TSI	85	05/16→	←	+PR 1ZF			<b>24.0124-0258.1 424258</b>	Ø 276 24 21 V + S
1.2 TSI	81	05/15→	←	+PR 1ZE			<b>24.0125-0145.1 425145</b>	Ø 288 25 22 V + S
1.4 TSI	103	11/12→	←	+PR 1ZE			<b>24.0125-0145.1 425145</b>	Ø 288 25 22 V + S
1.4 TSI G-TEC	81	11/13→	←	+PR 1ZA,1ZB			<b>24.0125-0158.1 425158</b>	Ø 312 25 22 V + S
1.5 TSI	110	02/17→	←	+PR 1ZA,1ZB			<b>24.0125-0158.1 425158</b>	Ø 312 25 22 V + S
1.6	81	01/14→	←	+PR 1ZA,1ZB			<b>24.0125-0158.1 425158</b>	Ø 312 25 22 V + S
1.6 TDI	81	05/13→	←	+PR 1LG			<b>24.0130-0225.1 430225</b>	Ø 340 30 27 V + S
1.6 TDI	85	02/17→	←	+PR 1LG			<b>24.0130-0225.1 430225</b>	Ø 340 30 27 V + S
1.6 TDI 4x4	77	09/14→	➡	+PR 1KD			<b>24.0110-0277.1 410277</b>	Ø 253 10 8 + S
1.6 TDI 4x4	81	05/15→	➡	+PR 1KD			<b>24.0110-0277.1 410277</b>	Ø 253 10 8 + S
1.8 TSI	132	11/12→	➡	+PR 1KS,1KT			<b>24.0110-0356.1 410356</b>	Ø 272 9,7 8 + S
1.8 TSI 4x4	132	09/14→	➡	+PR 1KS,1KT			<b>24.0110-0356.1 410356</b>	Ø 272 9,7 8 + S
2.0 TDI	105	11/12→	➡	+PR 1KW			<b>24.0122-0219.1 422219</b>	Ø 310 22 20 V
2.0 TDI / TDI RS 4x4	135	09/14→	➡	+PR 1KW			<b>24.0122-0219.1 422219</b>	Ø 310 22 20 V
2.0 TDI 4x4	110	09/14→	➡	+PR 1KW			<b>24.0122-0219.1 422219</b>	Ø 310 22 20 V
2.0 TDI RS	135	05/13→	➡	+PR 1KW			<b>24.0122-0219.1 422219</b>	Ø 310 22 20 V
2.0 TSI RS	162	05/13→	➡	+PR 1KW			<b>24.0122-0219.1 422219</b>	Ø 310 22 20 V
2.0 TSI RS	169	05/15→	➡	+PR 1KW			<b>24.0122-0219.1 422219</b>	Ø 310 22 20 V
2.0 TSI RS	180	02/17→	➡	+PR 1KW			<b>24.0122-0219.1 422219</b>	Ø 310 22 20 V
1.2 TSI	63	11/12→	←	02/13→; +PR 1ZF			<b>24.0124-0258.1 424258</b>	Ø 276 24 21 V + S
1.2 TSI	77	11/12→	←	02/13→; +PR 1ZE			<b>24.0125-0145.1 425145</b>	Ø 288 25 22 V + S
1.6 TDI	66	11/12→	←	02/13→; +PR 1ZE			<b>24.0125-0145.1 425145</b>	Ø 288 25 22 V + S
1.6 TDI	77	11/12→	←	02/13→; +PR 1ZA,1ZB			<b>24.0125-0158.1 425158</b>	Ø 312 25 22 V + S
2.0 TDI	110	11/12→	←	02/13→; +PR 1ZA,1ZB			<b>24.0125-0158.1 425158</b>	Ø 312 25 22 V + S
			←	02/13→; +PR 1LG			<b>24.0130-0225.1 430225</b>	Ø 340 30 27 V + S
			➡	02/13→; +PR 1KD			<b>24.0110-0277.1 410277</b>	Ø 253 10 8 + S
			➡	02/13→; +PR 1KS,1KT			<b>24.0110-0356.1 410356</b>	Ø 272 9,7 8 + S
			➡	02/13→; +PR 1KW			<b>24.0122-0219.1 422219</b>	Ø 310 22 20 V
1.4 TSI	110	08/14→	←	05/15→; +PR 1ZF			<b>24.0124-0258.1 424258</b>	Ø 276 24 21 V + S
			←	05/15→; +PR 1ZE			<b>24.0125-0145.1 425145</b>	Ø 288 25 22 V + S
			←	05/15→; +PR 1ZA,1ZB			<b>24.0125-0158.1 425158</b>	Ø 312 25 22 V + S
			←	05/15→; +PR 1LG			<b>24.0130-0225.1 430225</b>	Ø 340 30 27 V + S
			➡	05/15→; +PR 1KD			<b>24.0110-0277.1 410277</b>	Ø 253 10 8 + S
			➡	05/15→; +PR 1KS,1KT			<b>24.0110-0356.1 410356</b>	Ø 272 9,7 8 + S
			➡	05/15→; +PR 1KW			<b>24.0122-0219.1 422219</b>	Ø 310 22 20 V
			➡	05/15→; +PR 1KW			<b>24.0122-0219.1 422219</b>	Ø 310 22 20 V
<b>SKODA - OCTAVIA III Combi (5E5) 11/12→</b>								
 <b>Bremsbelagsatz, Scheibenbremse</b>								
1.0 TSI	85	05/16→	←	+PR 1ZA,1ZB,1ZE			<b>13.0460-2785.2 602785</b>	TRW 25683 20,4 + WE / + WK
1.2 TSI	81	05/15→	←	+PR 1ZF			<b>13.0470-2785.2 LD2785</b>	TRW 25683 20,4 + WE / + WK Ceramic
1.4 TSI	103	11/12→	←	+PR 1ZF			<b>13.0470-2785.2 LD2785</b>	TRW 25683 20,4 + WE / + WK Ceramic
1.4 TSI G-TEC	81	11/13→	←	+PR 1ZF			<b>13.0460-7303.2 607303</b>	ATE 22035 17,5 + WK
1.5 TSI	110	02/17→	←	+PR 1ZF			<b>13.0470-7303.2 LD7303</b>	ATE 22035 17,5 + WK Ceramic
1.6	81	01/14→	➡	+PR 1KW			<b>13.0460-2621.2 602621</b>	TRW 24483 16,9 - WE / - WK + Zub
1.6 TDI	81	05/13→	➡	+PR 1KW			<b>13.0460-2621.2 602621</b>	TRW 24483 16,9 - WE / - WK + Zub
1.6 TDI	85	02/17→	➡	+PR 1KW			<b>13.0460-2621.2 602621</b>	TRW 24483 16,9 - WE / - WK + Zub
1.6 TDI 4x4	77	11/12→	➡	+PR 1KW			<b>13.0460-2621.2 602621</b>	TRW 24483 16,9 - WE / - WK + Zub
1.6 TDI 4x4	81	05/15→	➡	+PR 1KW			<b>13.0460-2887.2 602887</b>	TRW 23914 17,1 + WE / - WK + Zub
1.8 TSI	132	11/12→	➡	+PR 1KW			<b>13.0470-2621.2 LD2621</b>	TRW 24483 16,9 - WE / - WK + Zub Ceramic
1.8 TSI 4x4	132	11/12→	➡	+PR 1KW			<b>13.0470-2621.2 LD2621</b>	TRW 24483 16,9 - WE / - WK + Zub Ceramic
2.0 TDI	105	11/12→	➡	+PR 1KW			<b>13.0470-2887.2 LD2887</b>	TRW 23914 17,1 + WE / - WK + Zub Ceramic
2.0 TDI / TDI RS 4x4	135	09/14→	➡	+PR 1KW			<b>13.0470-2887.2 LD2887</b>	TRW 23914 17,1 + WE / - WK + Zub Ceramic
2.0 TDI 4x4	110	11/12→	➡	+PR 1KW			<b>13.0470-2887.2 LD2887</b>	TRW 23914 17,1 + WE / - WK + Zub Ceramic
2.0 TDI RS	135	05/13→	➡	+PR 1KW			<b>13.0470-2887.2 LD2887</b>	TRW 23914 17,1 + WE / - WK + Zub Ceramic
↓								



	kw			 	! #		
<b>SKODA - OCTAVIA III Combi (5E5) 11/12→</b>							
<b> Bremsbelagsatz, Scheibenbremse</b>							
2.0 TSI RS 2.0 TSI RS	169 180	05/15→ 02/17→	➡	+PR 1KD		<b>13.0460-2787.2 602787</b>	TRW 23554 17,3 - WK / - WE
			➡	+PR 1KS,1KT		<b>13.0460-2790.2 602790</b> <b>13.0470-2790.2 LD2790</b>	TRW 25110 17,5 - WE / - WK TRW 25110 17,5 - WE / - WK Ceramic
1.2 TSI 1.2 TSI 1.6 TDI 1.6 TDI 2.0 TDI	63 77 66 77 110	11/12→ 11/12→ 11/12→ 11/12→ 11/12→	⬅	02/13→; +PR 1ZA,1ZB,1ZE		<b>13.0460-2785.2 602785</b> <b>13.0470-2785.2 LD2785</b>	TRW 25683 20,4 + WE / + WK TRW 25683 20,4 + WE / + WK Ceramic
			⬅	02/13→; +PR 1ZF		<b>13.0460-7303.2 607303</b> <b>13.0470-7303.2 LD7303</b>	ATE 22035 17,5 + WK ATE 22035 17,5 + WK Ceramic
			➡	02/13→; +PR 1KW		<b>13.0460-2621.2 602621</b> <b>13.0460-2887.2 602887</b> <b>13.0470-2621.2 LD2621</b> <b>13.0470-2887.2 LD2887</b>	TRW 24483 16,9 - WE / - WK + Zub TRW 23914 17,1 + WE / - WK + Zub TRW 24483 16,9 - WE / - WK + Zub Ceramic TRW 23914 17,1 + WE / - WK + Zub Ceramic
			➡	02/13→; +PR 1KD		<b>13.0460-2787.2 602787</b>	TRW 23554 17,3 - WK / - WE
			➡	02/13→; +PR 1KS,1KT		<b>13.0460-2790.2 602790</b> <b>13.0470-2790.2 LD2790</b>	TRW 25110 17,5 - WE / - WK TRW 25110 17,5 - WE / - WK Ceramic
1.4 TSI	110	08/14→	⬅	05/15→; +PR 1ZA,1ZB,1ZE		<b>13.0460-2785.2 602785</b> <b>13.0470-2785.2 LD2785</b>	TRW 25683 20,4 + WE / + WK TRW 25683 20,4 + WE / + WK Ceramic
			⬅	05/15→; +PR 1ZF		<b>13.0460-7303.2 607303</b> <b>13.0470-7303.2 LD7303</b>	ATE 22035 17,5 + WK ATE 22035 17,5 + WK Ceramic
			➡	05/15→; +PR 1KW		<b>13.0460-2621.2 602621</b> <b>13.0460-2887.2 602887</b> <b>13.0470-2621.2 LD2621</b> <b>13.0470-2887.2 LD2887</b>	TRW 24483 16,9 - WE / - WK + Zub TRW 23914 17,1 + WE / - WK + Zub TRW 24483 16,9 - WE / - WK + Zub Ceramic TRW 23914 17,1 + WE / - WK + Zub Ceramic
			➡	05/15→; +PR 1KD		<b>13.0460-2787.2 602787</b>	TRW 23554 17,3 - WK / - WE
			➡	05/15→; +PR 1KS,1KT		<b>13.0460-2790.2 602790</b> <b>13.0470-2790.2 LD2790</b>	TRW 25110 17,5 - WE / - WK TRW 25110 17,5 - WE / - WK Ceramic
2.0 TSI RS	162	11/12→	⬅	05/13→; +PR 1ZA,1ZB,1ZE		<b>13.0460-2785.2 602785</b> <b>13.0470-2785.2 LD2785</b>	TRW 25683 20,4 + WE / + WK TRW 25683 20,4 + WE / + WK Ceramic
			⬅	05/13→; +PR 1ZF		<b>13.0460-7303.2 607303</b> <b>13.0470-7303.2 LD7303</b>	ATE 22035 17,5 + WK ATE 22035 17,5 + WK Ceramic
			➡	05/13→; +PR 1KW		<b>13.0460-2621.2 602621</b> <b>13.0460-2887.2 602887</b> <b>13.0470-2621.2 LD2621</b> <b>13.0470-2887.2 LD2887</b>	TRW 24483 16,9 - WE / - WK + Zub TRW 23914 17,1 + WE / - WK + Zub TRW 24483 16,9 - WE / - WK + Zub Ceramic TRW 23914 17,1 + WE / - WK + Zub Ceramic
			➡	05/13→; +PR 1KD		<b>13.0460-2787.2 602787</b>	TRW 23554 17,3 - WK / - WE
			➡	05/13→; +PR 1KS,1KT		<b>13.0460-2790.2 602790</b> <b>13.0470-2790.2 LD2790</b>	TRW 25110 17,5 - WE / - WK TRW 25110 17,5 - WE / - WK Ceramic
<b> Bremsscheibe</b>							
1.0 TSI 1.2 TSI 1.4 TSI 1.4 TSI G-TEC 1.5 TSI 1.6 1.6 TDI 1.6 TDI 1.6 TDI 4x4 1.6 TDI 4x4 1.8 TSI 1.8 TSI 4x4	85 81 103 81 110 81 81 85 77 81 132 132	05/16→ 05/15→ 11/12→ 11/13→ 02/17→ 01/14→ 05/13→ 02/17→ 11/12→ 05/15→ 11/12→ 11/12→	⬅	+PR 1ZF		<b>24.0124-0258.1 424258</b>	∅ 276 24 21 V + S
			⬅	+PR 1ZE		<b>24.0125-0145.1 425145</b> <b>24.0325-0145.1 525145</b>	∅ 288 25 22 V + S ∅ 288 25 22 V + S
			⬅	+PR 1ZA,1ZB		<b>24.0125-0158.1 425158</b> <b>24.0325-0158.1 525158</b>	∅ 312 25 22 V + S ∅ 312 25 22 V + S
			⬅	+PR 1LG		<b>24.0130-0225.1 430225</b>	∅ 340 30 27 V + S
			➡	+PR 1KD		<b>24.0110-0277.1 410277</b> <b>24.0310-0277.1 510277</b>	∅ 253 10 8 + S ∅ 253 10 8 + S
			➡	+PR 1KS,1KT		<b>24.0110-0356.1 410356</b>	∅ 272 9,7 8 + S

**SKODA - OCTAVIA III Combi (5E5) 11/12→**











**Bremsscheibe**











2.0 TDI	105	11/12→	➡	+PR 1KS,1KT		24.0310-0356.1	510356	Ø 272 9,7 8 + S
2.0 TDI / TDI RS 4x4	135	09/14→	➡	+PR 1KW		24.0122-0219.1	422219	Ø 310 22 20 V
2.0 TDI 4x4	110	11/12→						
2.0 TDI RS	135	05/13→						
2.0 TSI RS	169	05/15→						
2.0 TSI RS	180	02/17→						
1.2 TSI	63	11/12→	←	02/13→; +PR 1ZF		24.0124-0258.1	424258	Ø 276 24 21 V + S
1.2 TSI	77	11/12→	←	02/13→; +PR 1ZE		24.0125-0145.1	425145	Ø 288 25 22 V + S
1.6 TDI	66	11/12→	←	02/13→; +PR 1ZE		24.0325-0145.1	525145	Ø 288 25 22 V + S
1.6 TDI	77	11/12→	←	02/13→; +PR 1ZA,1ZB		24.0125-0158.1	425158	Ø 312 25 22 V + S
2.0 TDI	110	11/12→	←	02/13→; +PR 1ZA,1ZB		24.0325-0158.1	525158	Ø 312 25 22 V + S
			←	02/13→; +PR 1LG		24.0130-0225.1	430225	Ø 340 30 27 V + S
			➡	02/13→; +PR 1KD		24.0110-0277.1	410277	Ø 253 10 8 + S
						24.0310-0277.1	510277	Ø 253 10 8 + S
			➡	02/13→; +PR 1KS,1KT		24.0110-0356.1	410356	Ø 272 9,7 8 + S
						24.0310-0356.1	510356	Ø 272 9,7 8 + S
			➡	02/13→; +PR 1KW		24.0122-0219.1	422219	Ø 310 22 20 V
1.4 TSI	110	08/14→	←	05/15→; +PR 1ZF		24.0124-0258.1	424258	Ø 276 24 21 V + S
			←	05/15→; +PR 1ZE		24.0125-0145.1	425145	Ø 288 25 22 V + S
						24.0325-0145.1	525145	Ø 288 25 22 V + S
			←	05/15→; +PR 1ZA,1ZB		24.0125-0158.1	425158	Ø 312 25 22 V + S
						24.0325-0158.1	525158	Ø 312 25 22 V + S
			←	05/15→; +PR 1LG		24.0130-0225.1	430225	Ø 340 30 27 V + S
			➡	05/15→; +PR 1KD		24.0110-0277.1	410277	Ø 253 10 8 + S
						24.0310-0277.1	510277	Ø 253 10 8 + S
			➡	05/15→; +PR 1KS,1KT		24.0110-0356.1	410356	Ø 272 9,7 8 + S
						24.0310-0356.1	510356	Ø 272 9,7 8 + S
			➡	05/15→; +PR 1KW		24.0122-0219.1	422219	Ø 310 22 20 V
2.0 TSI RS	162	11/12→	←	05/13→; +PR 1ZF		24.0124-0258.1	424258	Ø 276 24 21 V + S
			←	05/13→; +PR 1ZE		24.0125-0145.1	425145	Ø 288 25 22 V + S
						24.0325-0145.1	525145	Ø 288 25 22 V + S
			←	05/13→; +PR 1ZA,1ZB		24.0125-0158.1	425158	Ø 312 25 22 V + S
						24.0325-0158.1	525158	Ø 312 25 22 V + S
			←	05/13→; +PR 1LG		24.0130-0225.1	430225	Ø 340 30 27 V + S
			➡	05/13→; +PR 1KD		24.0110-0277.1	410277	Ø 253 10 8 + S
						24.0310-0277.1	510277	Ø 253 10 8 + S
			➡	05/13→; +PR 1KS,1KT		24.0110-0356.1	410356	Ø 272 9,7 8 + S
						24.0310-0356.1	510356	Ø 272 9,7 8 + S
			➡	05/13→; +PR 1KW		24.0122-0219.1	422219	Ø 310 22 20 V

**SKODA - RAPID (NH3) 07/12→**

**Bremsbelagsatz, Scheibenbremse**

1.0 TSI	70	06/17→	←	+PR 1ZG		13.0460-7111.2	607111	VW 23130 19,6 - WE / - WK
1.0 TSI	81	06/17→				13.0470-7111.2	LD7111	VW 23130 19,6 - WE / - WK Ceramic
1.2 TSI	66	05/15→						
1.2 TSI	81	05/15→	←	+PR 1ZC		13.0460-7184.2	607184	ATE 23587 20,6 + WK
1.4 TDI	66	05/15→				13.0470-7184.2	LD7184	ATE 23587 20,6 + WK Ceramic
1.4 TSI	92	05/15→						
1.6	81	05/15→	➡	+PR 1KT		13.0460-2787.2	602787	TRW 23554 17,3 - WK / - WE
1.6 TDI	66	08/13→				13.0460-2820.2	602820	TRW 20961 17,2 - WK
1.6 TDI	85	05/15→				13.0470-2820.2	LD2820	TRW 20961 17,2 - WK Ceramic
1.2	55	07/12→	←	10/12→; +PR 1ZG		13.0460-7111.2	607111	VW 23130 19,6 - WE / - WK
1.2 TSI	63	07/12→				13.0470-7111.2	LD7111	VW 23130 19,6 - WE / - WK Ceramic
1.2 TSI	77	07/12→						
1.4 TSI	90	07/12→						
1.6 TDI	77	07/12→	←	10/12→; +PR 1ZC		13.0460-7184.2	607184	ATE 23587 20,6 + WK
						13.0470-7184.2	LD7184	ATE 23587 20,6 + WK Ceramic
			➡	10/12→; +PR 1KT		13.0460-2787.2	602787	TRW 23554 17,3 - WK / - WE
						13.0460-2820.2	602820	TRW 20961 17,2 - WK
						13.0470-2820.2	LD2820	TRW 20961 17,2 - WK Ceramic
1.6	77	07/12→	←	07/13→; +PR 1ZG		13.0460-7111.2	607111	VW 23130 19,6 - WE / - WK
						13.0470-7111.2	LD7111	VW 23130 19,6 - WE / - WK Ceramic
			←	07/13→; +PR 1ZC		13.0460-7184.2	607184	ATE 23587 20,6 + WK

	kw			 	! #		
<b>SKODA - RAPID (NH3) 07/12→</b>							
 <b>Bremsbelagsatz, Scheibenbremse</b>							
1.6	77	07/12→	←	07/13→; +PR 1ZC	13.0470-7184.2	LD7184	ATE 23587 20,6 + WK Ceramic
			→	07/13→; +PR 1KT	13.0460-2787.2	602787	TRW 23554 17,3 - WK / - WE
					13.0460-2820.2	602820	TRW 20961 17,2 - WK
					13.0470-2820.2	LD2820	TRW 20961 17,2 - WK Ceramic
 <b>Bremsscheibe</b>							
1.0 TSI	70	06/17→	←	+PR 1ZG	24.0122-0151.1	422151	Ø 256 22 19 V + S
1.0 TSI	81	06/17→			24.0322-0151.1	522151	Ø 256 22 19 V + S
1.2 TSI	66	05/15→					
1.2 TSI	81	05/15→	←	+PR 1ZC	24.0125-0113.1	425113	Ø 288 25 22 V + S
1.4 TDI	66	05/15→			24.0325-0113.1	525113	Ø 288 25 22 V + S
1.4 TSI	92	05/15→					
1.6	81	05/15→	→	+PR 1KT	24.0109-0123.1	409123	Ø 230 9 7 + S
1.6 TDI	66	08/13→			24.0309-0123.1	509123	Ø 230 9 7 + S
1.6 TDI	85	05/15→					
1.2	55	07/12→	←	10/12→; +PR 1ZG	24.0122-0151.1	422151	Ø 256 22 19 V + S
1.2 TSI	63	07/12→			24.0322-0151.1	522151	Ø 256 22 19 V + S
1.2 TSI	77	07/12→					
1.4 TSI	90	07/12→	←	10/12→; +PR 1ZC	24.0125-0113.1	425113	Ø 288 25 22 V + S
1.6 TDI	77	07/12→			24.0325-0113.1	525113	Ø 288 25 22 V + S
			→	10/12→; +PR 1KT	24.0109-0123.1	409123	Ø 230 9 7 + S
					24.0309-0123.1	509123	Ø 230 9 7 + S
1.6	77	07/12→	←	07/13→; +PR 1ZG	24.0122-0151.1	422151	Ø 256 22 19 V + S
					24.0322-0151.1	522151	Ø 256 22 19 V + S
			←	07/13→; +PR 1ZC	24.0125-0113.1	425113	Ø 288 25 22 V + S
					24.0325-0113.1	525113	Ø 288 25 22 V + S
			→	07/13→; +PR 1KT	24.0109-0123.1	409123	Ø 230 9 7 + S
					24.0309-0123.1	509123	Ø 230 9 7 + S
<b>SKODA - RAPID Spaceback (NH1) 07/12→</b>							
 <b>Bremsbelagsatz, Scheibenbremse</b>							
1.0 TSI	70	06/17→	←	+PR 1ZG	13.0460-7111.2	607111	VW 23130 19,6 - WE / - WK
1.0 TSI	81	06/17→			13.0470-7111.2	LD7111	VW 23130 19,6 - WE / - WK Ceramic
1.2 TSI	66	05/15→					
1.2 TSI	81	05/15→	←	+PR 1ZC	13.0460-7184.2	607184	ATE 23587 20,6 + WK
1.4 TDI	66	05/15→			13.0470-7184.2	LD7184	ATE 23587 20,6 + WK Ceramic
1.4 TSI	92	05/15→					
1.6 TDI	66	08/13→	→	+PR 1KT	13.0460-2787.2	602787	TRW 23554 17,3 - WK / - WE
1.6 TDI	85	05/15→			13.0460-2820.2	602820	TRW 20961 17,2 - WK
					13.0470-2820.2	LD2820	TRW 20961 17,2 - WK Ceramic
1.2	55	07/12→	←	10/12→; +PR 1ZG	13.0460-7111.2	607111	VW 23130 19,6 - WE / - WK
1.2 TSI	63	07/12→			13.0470-7111.2	LD7111	VW 23130 19,6 - WE / - WK Ceramic
1.2 TSI	77	07/12→					
1.4 TSI	90	07/12→	←	10/12→; +PR 1ZC	13.0460-7184.2	607184	ATE 23587 20,6 + WK
1.6 TDI	77	07/12→			13.0470-7184.2	LD7184	ATE 23587 20,6 + WK Ceramic
			→	10/12→; +PR 1KT	13.0460-2787.2	602787	TRW 23554 17,3 - WK / - WE
					13.0460-2820.2	602820	TRW 20961 17,2 - WK
					13.0470-2820.2	LD2820	TRW 20961 17,2 - WK Ceramic
1.6	77	07/12→	←	07/13→; +PR 1ZG	13.0460-7111.2	607111	VW 23130 19,6 - WE / - WK
					13.0470-7111.2	LD7111	VW 23130 19,6 - WE / - WK Ceramic
			←	07/13→; +PR 1ZC	13.0460-7184.2	607184	ATE 23587 20,6 + WK
					13.0470-7184.2	LD7184	ATE 23587 20,6 + WK Ceramic
			→	07/13→; +PR 1KT	13.0460-2787.2	602787	TRW 23554 17,3 - WK / - WE
					13.0460-2820.2	602820	TRW 20961 17,2 - WK
					13.0470-2820.2	LD2820	TRW 20961 17,2 - WK Ceramic
 <b>Bremsscheibe</b>							
1.0 TSI	70	06/17→	←	+PR 1ZG	24.0122-0151.1	422151	Ø 256 22 19 V + S
1.0 TSI	81	06/17→			24.0322-0151.1	522151	Ø 256 22 19 V + S
1.2 TSI	66	05/15→					
1.2 TSI	81	05/15→	←	+PR 1ZC	24.0125-0113.1	425113	Ø 288 25 22 V + S
1.4 TDI	66	05/15→			24.0325-0113.1	525113	Ø 288 25 22 V + S
1.4 TSI	92	05/15→					
1.6 TDI	66	08/13→	→	+PR 1KT	24.0109-0123.1	409123	Ø 230 9 7 + S
1.6 TDI	85	05/15→			24.0309-0123.1	509123	Ø 230 9 7 + S
1.2	55	07/12→	←	10/12→; +PR 1ZG	24.0122-0151.1	422151	Ø 256 22 19 V + S
1.2 TSI	63	07/12→			24.0322-0151.1	522151	Ø 256 22 19 V + S
1.2 TSI	77	07/12→					
1.4 TSI	90	07/12→	←	10/12→; +PR 1ZC	24.0125-0113.1	425113	Ø 288 25 22 V + S

	kw			 	! #		
<b>SKODA - RAPID Spaceback (NH1) 07/12→</b>							
 <b>Bremsscheibe</b>							
1.6 TDI	77	07/12→	←	10/12→; +PR 1ZC	24.0325-0113.1	525113	∅ 288 25 22 V + S
			→	10/12→; +PR 1KT	24.0109-0123.1	409123	∅ 230 9 7 + S
					24.0309-0123.1	509123	∅ 230 9 7 + S
1.6	77	07/12→	←	07/13→; +PR 1ZG	24.0122-0151.1	422151	∅ 256 22 19 V + S
					24.0322-0151.1	522151	∅ 256 22 19 V + S
			←	07/13→; +PR 1ZC	24.0125-0113.1	425113	∅ 288 25 22 V + S
			→	07/13→; +PR 1KT	24.0109-0123.1	409123	∅ 230 9 7 + S
				24.0309-0123.1	509123	∅ 230 9 7 + S	
<b>SKODA - ROOMSTER (5J) 03/06→05/15</b>							
 <b>Bremsbelagsatz, Scheibenbremse</b>							
1.2	47	05/06→01/07	←	07/06→; +PR 1LN,1ZH	13.0460-2883.2	602883	TRW 23581 18,8 - WE / - WK
					13.0460-2884.2	602884	TRW 23581 18,8 + WK
					13.0470-2884.2	LD2884	TRW 23581 18,8 + WK Ceramic
			←	07/06→; +PR 1LQ,1LR,1ZG	13.0460-7111.2	607111	VW 23130 19,6 - WE / - WK
					13.0460-7117.2	607117	VW 23130 19,6 + WK
					13.0470-7111.2	LD7111	VW 23130 19,6 - WE / - WK Ceramic
				13.0470-7117.2	LD7117	VW 23130 19,6 + WK Ceramic	
			←	07/06→; +PR 1ZC	13.0460-7184.2	607184	ATE 23587 20,6 + WK
					13.0470-7184.2	LD7184	ATE 23587 20,6 + WK Ceramic
			→	07/06→; +PR 1KT	13.0460-2787.2	602787	TRW 23554 17,3 - WK / - WE
					13.0460-2820.2	602820	TRW 20961 17,2 - WK
					13.0470-2820.2	LD2820	TRW 20961 17,2 - WK Ceramic
			→	07/06→; +PR 1KK	13.0460-2894.2	602894	TRW 20961 17,2 - WK + Zub
					13.0470-2894.2	LD2894	TRW 20961 17,2 - WK + Zub Ceramic
1.2	51	01/07→05/15	←	→ 04/15; +PR 1LN,1ZH	13.0460-2883.2	602883	TRW 23581 18,8 - WE / - WK
1.2 TDI	55	03/10→05/15			13.0460-2884.2	602884	TRW 23581 18,8 + WK
1.2 TSI	63	03/10→05/15			13.0470-2884.2	LD2884	TRW 23581 18,8 + WK Ceramic
1.2 TSI	77	03/10→05/15					
1.4	63	09/06→05/15	←	→ 04/15; +PR 1LQ,1LR,1ZG	13.0460-7111.2	607111	VW 23130 19,6 - WE / - WK
1.6	77	09/06→05/15			13.0460-7117.2	607117	VW 23130 19,6 + WK
1.6 TDI	66	03/10→05/15			13.0470-7111.2	LD7111	VW 23130 19,6 - WE / - WK Ceramic
1.6 TDI	77	03/10→05/15					
					13.0470-7117.2	LD7117	VW 23130 19,6 + WK Ceramic
			←	→ 04/15; +PR 1ZC	13.0460-7184.2	607184	ATE 23587 20,6 + WK
					13.0470-7184.2	LD7184	ATE 23587 20,6 + WK Ceramic
			→	→ 04/15; +PR 1KT	13.0460-2787.2	602787	TRW 23554 17,3 - WK / - WE
					13.0460-2820.2	602820	TRW 20961 17,2 - WK
					13.0470-2820.2	LD2820	TRW 20961 17,2 - WK Ceramic
			→	→ 04/15; +PR 1KK	13.0460-2894.2	602894	TRW 20961 17,2 - WK + Zub
					13.0470-2894.2	LD2894	TRW 20961 17,2 - WK + Zub Ceramic
1.4 TDI	51	07/06→03/10	←	+PR 1LN,1ZH	13.0460-2883.2	602883	TRW 23581 18,8 - WE / - WK
1.4 TDI	59	09/06→03/10			13.0460-2884.2	602884	TRW 23581 18,8 + WK
1.9 TDI	77	09/06→03/10			13.0470-2884.2	LD2884	TRW 23581 18,8 + WK Ceramic
			←	+PR 1LQ,1LR,1ZG	13.0460-7111.2	607111	VW 23130 19,6 - WE / - WK
					13.0460-7117.2	607117	VW 23130 19,6 + WK
					13.0470-7111.2	LD7111	VW 23130 19,6 - WE / - WK Ceramic
					13.0470-7117.2	LD7117	VW 23130 19,6 + WK Ceramic
			←	+PR 1ZC	13.0460-7184.2	607184	ATE 23587 20,6 + WK
					13.0470-7184.2	LD7184	ATE 23587 20,6 + WK Ceramic
			→	+PR 1KT	13.0460-2787.2	602787	TRW 23554 17,3 - WK / - WE
					13.0460-2820.2	602820	TRW 20961 17,2 - WK
					13.0470-2820.2	LD2820	TRW 20961 17,2 - WK Ceramic
			→	+PR 1KK	13.0460-2894.2	602894	TRW 20961 17,2 - WK + Zub
					13.0470-2894.2	LD2894	TRW 20961 17,2 - WK + Zub Ceramic
 <b>Bremsscheibe</b>							
1.2	47	05/06→01/07	←	07/06→; +PR 1LQ,1LR,1ZG	24.0122-0151.1	422151	∅ 256 22 19 V + S
↓							









**SKODA - ROOMSTER (5J) 03/06→05/15**







<b>Bremsscheibe</b>							
1.2	47	05/06→01/07	←	07/06→; +PR 1LQ,1LR,1ZG	24.0322-0151.1	522151	Ø 256 22 19 V + S
			←	07/06→; +PR 1LN,1ZC,1ZH	24.0125-0113.1	425113	Ø 288 25 22 V + S
					24.0325-0113.1	525113	Ø 288 25 22 V + S
			→	07/06→; +PR 1KK,1KT	24.0109-0123.1	409123	Ø 230 9 7 + S
				24.0309-0123.1	509123	Ø 230 9 7 + S	
1.2	51	01/07→05/15	←	→ 04/15; +PR 1LQ,1LR,1ZG	24.0122-0151.1	422151	Ø 256 22 19 V + S
1.2 TDI	55	03/10→05/15			24.0322-0151.1	522151	Ø 256 22 19 V + S
1.2 TSI	63	03/10→05/15					
1.2 TSI	77	03/10→05/15	←	→ 04/15; +PR 1LN,1ZC,1ZH	24.0125-0113.1	425113	Ø 288 25 22 V + S
1.4	63	09/06→05/15			24.0325-0113.1	525113	Ø 288 25 22 V + S
1.6	77	09/06→05/15					
1.6 TDI	66	03/10→05/15	→	→ 04/15; +PR 1KK,1KT	24.0109-0123.1	409123	Ø 230 9 7 + S
1.6 TDI	77	03/10→05/15			24.0309-0123.1	509123	Ø 230 9 7 + S
1.4 TDI	51	07/06→03/10	←	+PR 1LQ,1LR,1ZG	24.0122-0151.1	422151	Ø 256 22 19 V + S
1.4 TDI	59	09/06→03/10			24.0322-0151.1	522151	Ø 256 22 19 V + S
1.9 TDI	77	09/06→03/10	←	+PR 1LN,1ZC,1ZH	24.0125-0113.1	425113	Ø 288 25 22 V + S
					24.0325-0113.1	525113	Ø 288 25 22 V + S
			→	+PR 1KK,1KT	24.0109-0123.1	409123	Ø 230 9 7 + S
					24.0309-0123.1	509123	Ø 230 9 7 + S









**SKODA - ROOMSTER Praktik (5J) 03/07→05/15**

<b>Bremsbelagsatz, Scheibenbremse</b>							
1.2	51	03/07→05/15	←	→ 04/15; +PR 1LN,1ZH	13.0460-2883.2	602883	TRW 23581 18,8 - WE / - WK
					13.0460-2884.2	602884	TRW 23581 18,8 + WK
					13.0470-2884.2	LD2884	TRW 23581 18,8 + WK Ceramic
1.2 TDI	55	03/10→05/15					
1.2 TSI	63	03/10→05/15					
1.4	63	03/07→05/15					
1.6 TDI	66	03/10→05/15	←	→ 04/15; +PR 1LQ,1LR,1ZG	13.0460-7111.2	607111	VW 23130 19,6 - WE / - WK
					13.0460-7117.2	607117	VW 23130 19,6 + WK
					13.0470-7111.2	LD7111	VW 23130 19,6 - WE / - WK Ceramic
					13.0470-7117.2	LD7117	VW 23130 19,6 + WK Ceramic
			←	→ 04/15; +PR 1ZC	13.0460-7184.2	607184	ATE 23587 20,6 + WK
					13.0470-7184.2	LD7184	ATE 23587 20,6 + WK Ceramic
			→	→ 04/15; +PR 1KT	13.0460-2787.2	602787	TRW 23554 17,3 - WK / - WE
					13.0460-2820.2	602820	TRW 20961 17,2 - WK
					13.0470-2820.2	LD2820	TRW 20961 17,2 - WK Ceramic
			→	→ 04/15; +PR 1KK	13.0460-2894.2	602894	TRW 20961 17,2 - WK + Zub
					13.0470-2894.2	LD2894	TRW 20961 17,2 - WK + Zub Ceramic
1.4 TDI	51	03/07→03/10	←	+PR 1LN,1ZH	13.0460-2883.2	602883	TRW 23581 18,8 - WE / - WK
1.4 TDI	59	03/07→03/10			13.0460-2884.2	602884	TRW 23581 18,8 + WK
					13.0470-2884.2	LD2884	TRW 23581 18,8 + WK Ceramic
			←	+PR 1LQ,1LR,1ZG	13.0460-7111.2	607111	VW 23130 19,6 - WE / - WK
					13.0460-7117.2	607117	VW 23130 19,6 + WK
					13.0470-7111.2	LD7111	VW 23130 19,6 - WE / - WK Ceramic
					13.0470-7117.2	LD7117	VW 23130 19,6 + WK Ceramic
			←	+PR 1ZC	13.0460-7184.2	607184	ATE 23587 20,6 + WK
					13.0470-7184.2	LD7184	ATE 23587 20,6 + WK Ceramic
			→	+PR 1KT	13.0460-2787.2	602787	TRW 23554 17,3 - WK / - WE
					13.0460-2820.2	602820	TRW 20961 17,2 - WK
					13.0470-2820.2	LD2820	TRW 20961 17,2 - WK Ceramic
			→	+PR 1KK	13.0460-2894.2	602894	TRW 20961 17,2 - WK + Zub
					13.0470-2894.2	LD2894	TRW 20961 17,2 - WK + Zub Ceramic







<b>Bremsscheibe</b>									
1.2	51	03/07→05/15	←	→ 04/15; +PR 1LQ,1LR,1ZG	24.0122-0151.1	422151	Ø 256 22 19 V + S		
					24.0322-0151.1	522151	Ø 256 22 19 V + S		
			←	→ 04/15; +PR 1LN,1ZC,1ZH	24.0125-0113.1	425113	Ø 288 25 22 V + S		
1.2 TDI	55	03/10→05/15			24.0325-0113.1	525113	Ø 288 25 22 V + S		
1.2 TSI	63	03/10→05/15							
1.4	63	03/07→05/15							
1.6 TDI	66	03/10→05/15	→	→ 04/15; +PR 1KK,1KT	24.0109-0123.1	409123	Ø 230 9 7 + S		
					24.0309-0123.1	509123	Ø 230 9 7 + S		
1.4 TDI	51	03/07→03/10	←	+PR 1LQ,1LR,1ZG	24.0122-0151.1	422151	Ø 256 22 19 V + S		
1.4 TDI	59	03/07→03/10			24.0322-0151.1	522151	Ø 256 22 19 V + S		
			←	+PR 1LN,1ZC,1ZH	24.0125-0113.1	425113	Ø 288 25 22 V + S		

	kw			 	! #		
<b>SKODA - ROOMSTER Praktik (5J) 03/07→05/15</b>							
<b>Bremsscheibe</b>							
1.4 TDI	51	03/07→03/10	←	+PR 1LN,1ZC,1ZH		24.0325-0113.1 525113	Ø 288 25 22 V + S
1.4 TDI	59	03/07→03/10	→	+PR 1KK,1KT		24.0109-0123.1 409123	Ø 230 9 7 + S
						24.0309-0123.1 509123	Ø 230 9 7 + S
<b>SKODA - SUPERB I (3U4) 12/01→03/08</b>							
<b>Bremsbelagsatz, Scheibenbremse</b>							
1.8 T	110	12/01→03/08	←	→ 02/08		13.0460-7110.2 607110	ATE 20676 19,8 + WK
2.0	85	12/01→03/08	→	→ 02/08		13.0470-7110.2 LD7110	ATE 20676 19,8 + WK Ceramic
			←			13.0460-2787.2 602787	TRW 23554 17,3 - WK / - WE
			→			13.0460-2820.2 602820	TRW 20961 17,2 - WK
						13.0470-2820.2 LD2820	TRW 20961 17,2 - WK Ceramic
1.9 TDI	74	08/02→10/05	←			13.0460-7110.2 607110	ATE 20676 19,8 + WK
1.9 TDI	77	10/05→05/07	→			13.0470-7110.2 LD7110	ATE 20676 19,8 + WK Ceramic
2.5 TDI	114	12/01→08/03	←			13.0460-2787.2 602787	TRW 23554 17,3 - WK / - WE
			→			13.0460-2820.2 602820	TRW 20961 17,2 - WK
						13.0470-2820.2 LD2820	TRW 20961 17,2 - WK Ceramic
1.9 TDI	85	01/07→03/08	←	→ 12/07		13.0460-7110.2 607110	ATE 20676 19,8 + WK
1.9 TDI	96	12/01→03/08	→	→ 12/07		13.0470-7110.2 LD7110	ATE 20676 19,8 + WK Ceramic
2.0 TDI	103	10/05→03/08	←			13.0460-2787.2 602787	TRW 23554 17,3 - WK / - WE
2.5 TDI	120	06/03→03/08	→			13.0460-2820.2 602820	TRW 20961 17,2 - WK
2.8 V6	140	06/02→03/08				13.0470-2820.2 LD2820	TRW 20961 17,2 - WK Ceramic
2.8 V6	142	12/01→03/08					
<b>Bremsscheibe</b>							
1.8 T	110	12/01→03/08	←	→ 3U-39046708		24.0125-0105.1 425105	Ø 288 25 23 V + S
2.0	85	12/01→03/08	←	3U-69101370→; → 02/08		24.0325-0105.1 525105	Ø 288 25 23 V
			←			24.0125-0145.1 425145	Ø 288 25 22 V + S
			←			24.0325-0145.1 525145	Ø 288 25 22 V + S
			←	3U-39046709→ 3U-69101369		24.0125-0171.1 425171	Ø 288 25 23 V
			←			24.0325-0171.1 525171	Ø 288 25 23 V
			→	→ 02/08		24.0110-0201.1 410201	Ø 245 10 8
						24.0310-0201.1 510201	Ø 245 10 8
1.9 TDI	74	08/02→10/05	←	→ 3U-39046708		24.0125-0105.1 425105	Ø 288 25 23 V + S
			←	3U-69101370→		24.0325-0105.1 525105	Ø 288 25 23 V
			←			24.0125-0145.1 425145	Ø 288 25 22 V + S
			←			24.0325-0145.1 525145	Ø 288 25 22 V + S
			←	3U-39046709→ 3U-69101369		24.0125-0171.1 425171	Ø 288 25 23 V
			←			24.0325-0171.1 525171	Ø 288 25 23 V
			→			24.0110-0201.1 410201	Ø 245 10 8
						24.0310-0201.1 510201	Ø 245 10 8
1.9 TDI	77	10/05→05/07	←	3U-69101370→		24.0125-0145.1 425145	Ø 288 25 22 V + S
			←	→ 3U-69101369		24.0325-0145.1 525145	Ø 288 25 22 V + S
			←			24.0125-0171.1 425171	Ø 288 25 23 V
			←			24.0325-0171.1 525171	Ø 288 25 23 V
			→			24.0110-0201.1 410201	Ø 245 10 8
						24.0310-0201.1 510201	Ø 245 10 8
1.9 TDI	85	01/07→03/08	←	→ 12/07		24.0125-0145.1 425145	Ø 288 25 22 V + S
			→	→ 12/07		24.0325-0145.1 525145	Ø 288 25 22 V + S
			→			24.0110-0201.1 410201	Ø 245 10 8
						24.0310-0201.1 510201	Ø 245 10 8
1.9 TDI	96	12/01→03/08	←	→ 3U-39046708		24.0125-0105.1 425105	Ø 288 25 23 V + S
			←	3U-69101370→; → 12/07		24.0325-0105.1 525105	Ø 288 25 23 V
			←			24.0125-0145.1 425145	Ø 288 25 22 V + S
			←			24.0325-0145.1 525145	Ø 288 25 22 V + S
			←	3U-39046709→ 3U-69101369		24.0125-0171.1 425171	Ø 288 25 23 V
			←			24.0325-0171.1 525171	Ø 288 25 23 V
			→	→ 12/07		24.0110-0201.1 410201	Ø 245 10 8
						24.0310-0201.1 510201	Ø 245 10 8
2.0 TDI	103	10/05→03/08	←	→ 3U-39043704		24.0125-0137.1 425137	Ø 312 25 23 V + S
2.5 TDI	120	06/03→03/08	←	3U-69100011→; → 12/07		24.0325-0137.1 525137	Ø 312 25 23 V
			←			24.0125-0158.1 425158	Ø 312 25 22 V + S
						24.0325-0158.1 525158	Ø 312 25 22 V + S
↓							









	kW			 	! #		
<b>SKODA - SUPERB I (3U4) 12/01→03/08</b>							
<b>Bremsscheibe</b>							
2.0 TDI 2.5 TDI	103 120	10/05→03/08 06/03→03/08	←	3U-39043705→ 3U-69100010	24.0125-0172.1 425172	Ø 312 25 23 V	
			→	→ 12/07	24.0325-0172.1 525172	Ø 312 25 23 V	
2.5 TDI	114	12/01→08/03	←	→ 3U-39043704	24.0110-0201.1 410201	Ø 245 10 8	
			→		24.0310-0201.1 510201	Ø 245 10 8	
			←	→ 3U-39043704	24.0125-0137.1 425137	Ø 312 25 23 V + S	
			←	3U-69100011→	24.0325-0137.1 525137	Ø 312 25 23 V	
			←	3U-69100011→	24.0125-0158.1 425158	Ø 312 25 22 V + S	
2.8 V6 2.8 V6	140 142	06/02→03/08 12/01→03/08	←	→ 3U-39043704	24.0325-0158.1 525158	Ø 312 25 22 V + S	
			←	3U-39043705→ 3U-69100010	24.0325-0158.1 525158	Ø 312 25 22 V + S	
			←	→ 3U-39043704	24.0125-0172.1 425172	Ø 312 25 23 V	
			←	3U-69100011→; → 12/07	24.0125-0172.1 425172	Ø 312 25 23 V	
			←	3U-39043705→ 3U-69100010	24.0125-0172.1 425172	Ø 312 25 23 V	
			→	→ 12/07	24.0110-0201.1 410201	Ø 245 10 8	
			→	→ 12/07	24.0310-0201.1 510201	Ø 245 10 8	
<b>SKODA - SUPERB II (3T4) 03/08→05/15</b>							
<b>Bremsbelagsatz, Scheibenbremse</b>							
1.4 TSI 1.8 TSI 2.0 TDI	92 118 125	07/08→05/15 03/08→05/15 07/08→05/15	←	08/08→ 02/15; +PR 1ZE,1LJ,1ZA	13.0460-7184.2 607184	ATE 23587 20,6 + WK	
			←	08/08→ 02/15; +PR 1LJ,1ZA	13.0470-7184.2 LD7184	ATE 23587 20,6 + WK Ceramic	
			←	08/08→ 02/15; +PR 1LK	13.0460-7200.2 607200	ATE 23801 20,3 + WK	
			←	08/08→ 02/15; +PR 1LK	13.0470-7200.2 LD7200	ATE 23801 20,3 + WK Ceramic	
			→	08/08→ 02/15; +PR 1KF,1KJ	13.0460-2749.2 602749	TRW 24483 16,9 - WE / - WK + Zub	
1.6 TDI 1.8 TSI 2.0 TDI 16V 2.0 TSI	77 112 103 147	09/10→05/15 03/09→05/15 01/09→05/15 05/10→05/15	←	→ 02/15; +PR 1ZE,1LJ,1ZA	13.0460-2880.2 602880	TRW 23914 17,1 + WE / - WK + Zub	
			←	→ 02/15; +PR 1LJ,1ZA	13.0470-2749.2 LD2749	TRW 24483 16,9 - WE / - WK + Zub Ceramic	
			←	→ 02/15; +PR 1LK	13.0470-2880.2 LD2880	TRW 23914 17,1 + WE / - WK + Zub Ceramic	
			→	→ 02/15; +PR 1KF,1KJ	13.0460-2749.2 602749	TRW 24483 16,9 - WE / - WK + Zub	
			→	→ 02/15; +PR 1KF,1KJ	13.0460-2880.2 602880	TRW 23914 17,1 + WE / - WK + Zub	
1.8 TSI 4x4 1.8 TSI 4x4 2.0 TDI 16V 4x4 3.6 FSI 4x4	112 118 103 191	03/09→05/15 11/08→05/15 11/10→05/15 11/08→05/15	←	→ 02/15; +PR 1KF,1KJ	13.0470-2880.2 LD2880	TRW 23914 17,1 + WE / - WK + Zub Ceramic	
			←	→ 02/15; +PR 1KS	13.0460-3858.2 603858	BOS 24563 17,7 - WE / - WK + Zub	
			←	→ 02/15; +PR 1KS	13.0470-3858.2 LD3858	BOS 24563 17,7 - WE / - WK + Zub Ceramic	
			←	→ 02/15; +PR 1ZE,1LJ,1ZA	13.0460-7184.2 607184	ATE 23587 20,6 + WK	
			←	→ 02/15; +PR 1LJ,1ZA	13.0470-7184.2 LD7184	ATE 23587 20,6 + WK Ceramic	
			←	→ 02/15; +PR 1LK	13.0460-7200.2 607200	ATE 23801 20,3 + WK	
			←	→ 02/15; +PR 1LK	13.0470-7200.2 LD7200	ATE 23801 20,3 + WK Ceramic	
			→	→ 02/15; +PR 2EA	13.0460-2749.2 602749	TRW 24483 16,9 - WE / - WK + Zub	
			→	→ 02/15; +PR 2EA	13.0460-2880.2 602880	TRW 23914 17,1 + WE / - WK + Zub	
			→	→ 02/15; +PR 2EA	13.0470-2749.2 LD2749	TRW 24483 16,9 - WE / - WK + Zub Ceramic	









	kw			 	! #		
<b>SKODA - SUPERB II (3T4) 03/08→05/15</b>							
<b> Bremsbelagsatz, Scheibenbremse</b>							
1.8 TSI 4x4 1.8 TSI 4x4 2.0 TDI 16V 4x4 3.6 FSI 4x4	112 118 103 191	03/09→05/15 11/08→05/15 11/10→05/15 11/08→05/15	→ → →	→ 02/15; +PR 2EA  → 02/15; +PR 1KS		13.0470-2880.2 LD2880 13.0460-3858.2 603858 13.0470-3858.2 LD3858	TRW 23914 17,1 + WE / - WK + Zub Ceramic BOS 24563 17,7 - WE / - WK + Zub BOS 24563 17,7 - WE / - WK + Zub Ceramic
1.9 TDI 2.0 TDI	77 103	03/08→11/10 03/08→05/10	← ← → → →	08/08→; +PR 1ZE,1LJ,1ZA  08/08→; +PR 1LK  08/08→; +PR 1KF,1KJ  08/08→; +PR 1KS		13.0460-7184.2 607184 13.0470-7184.2 LD7184 13.0460-7200.2 607200 13.0470-7200.2 LD7200 13.0460-2749.2 602749 13.0460-2880.2 602880 13.0470-2749.2 LD2749 13.0470-2880.2 LD2880 13.0460-3858.2 603858 13.0470-3858.2 LD3858	ATE 23587 20,6 + WK ATE 23587 20,6 + WK Ceramic ATE 23801 20,3 + WK ATE 23801 20,3 + WK Ceramic TRW 24483 16,9 - WE / - WK + Zub TRW 23914 17,1 + WE / - WK + Zub TRW 24483 16,9 - WE / - WK + Zub Ceramic TRW 23914 17,1 + WE / - WK + Zub Ceramic BOS 24563 17,7 - WE / - WK + Zub BOS 24563 17,7 - WE / - WK + Zub Ceramic
2.0 TDI 4x4	125	09/08→05/15	← ← → → →	10/08→ 02/15; +PR 1ZE,1LJ,1ZA  10/08→ 02/15; +PR 1LK  10/08→ 02/15; +PR 2EA  10/08→ 02/15; +PR 1KS		13.0460-7184.2 607184 13.0470-7184.2 LD7184 13.0460-7200.2 607200 13.0470-7200.2 LD7200 13.0460-2749.2 602749 13.0460-2880.2 602880 13.0470-2749.2 LD2749 13.0470-2880.2 LD2880 13.0460-3858.2 603858 13.0470-3858.2 LD3858	ATE 23587 20,6 + WK ATE 23587 20,6 + WK Ceramic ATE 23801 20,3 + WK ATE 23801 20,3 + WK Ceramic TRW 24483 16,9 - WE / - WK + Zub TRW 23914 17,1 + WE / - WK + Zub TRW 24483 16,9 - WE / - WK + Zub Ceramic TRW 23914 17,1 + WE / - WK + Zub Ceramic BOS 24563 17,7 - WE / - WK + Zub BOS 24563 17,7 - WE / - WK + Zub Ceramic
<b> Bremsscheibe</b>							
1.4 TSI 1.8 TSI 2.0 TDI	92 118 125	07/08→05/15 03/08→05/15 07/08→05/15	← ← ← → → → →	08/08→ 02/15; +PR 1ZE  08/08→ 02/15; +PR 1LJ,1ZA  08/08→ 02/15; +PR 1LK  08/08→ 02/15; +PR 1KS  08/08→ 02/15; +PR 1KF  08/08→ 02/15; +PR 1KJ		24.0125-0145.1 425145 24.0325-0145.1 525145 24.0125-0158.1 425158 24.0325-0158.1 525158 24.0130-0115.1 430115 24.0330-0115.1 530115 24.0110-0356.1 410356 24.0310-0356.1 510356 24.0112-0158.1 412158 24.0312-0158.1 512158 24.0112-0169.1 412169 24.0312-0169.1 512169	Ø 288 25 22 V + S Ø 288 25 22 V + S Ø 312 25 22 V + S Ø 312 25 22 V + S Ø 345 30 27 V Ø 345 30 27 V Ø 272 9,7 8 + S Ø 272 9,7 8 + S Ø 256 12 10 + S Ø 256 12 10 Ø 282 12 10 + S Ø 282 12 10 + S
1.6 TDI 1.8 TSI 2.0 TDI 16V 2.0 TSI	77 112 103 147	09/10→05/15 03/09→05/15 01/09→05/15 05/10→05/15	← ← ← → → → →	→ 02/15; +PR 1ZE  → 02/15; +PR 1LJ,1ZA  → 02/15; +PR 1LK  → 02/15; +PR 1KS  → 02/15; +PR 1KF  → 02/15; +PR 1KJ		24.0125-0145.1 425145 24.0325-0145.1 525145 24.0125-0158.1 425158 24.0325-0158.1 525158 24.0130-0115.1 430115 24.0330-0115.1 530115 24.0110-0356.1 410356 24.0310-0356.1 510356 24.0112-0158.1 412158 24.0312-0158.1 512158 24.0112-0169.1 412169 24.0312-0169.1 512169	Ø 288 25 22 V + S Ø 288 25 22 V + S Ø 312 25 22 V + S Ø 312 25 22 V + S Ø 345 30 27 V Ø 345 30 27 V Ø 272 9,7 8 + S Ø 272 9,7 8 + S Ø 256 12 10 + S Ø 256 12 10 Ø 282 12 10 + S Ø 282 12 10 + S
1.8 TSI 4x4 1.8 TSI 4x4 ↓	112 118	03/09→05/15 11/08→05/15	←	→ 02/15; +PR 1ZE		24.0125-0145.1 425145	Ø 288 25 22 V + S





















	kw			 	! #		
<b>SKODA - SUPERB II (3T4) 03/08→05/15</b>							
<b>Bremsscheibe</b>							
2.0 TDI 16V 4x4 3.6 FSI 4x4	103 191	11/10→05/15 11/08→05/15	←	→ 02/15; +PR 1ZE	24.0325-0145.1	525145	Ø 288 25 22 V + S
			←	→ 02/15; +PR 1LJ,1ZA	24.0125-0158.1	425158	Ø 312 25 22 V + S
					24.0325-0158.1	525158	Ø 312 25 22 V + S
			←	→ 02/15; +PR 1LK	24.0130-0115.1	430115	Ø 345 30 27 V
					24.0330-0115.1	530115	Ø 345 30 27 V
			→	→ 02/15; +PR 1KS	24.0110-0356.1	410356	Ø 272 9,7 8 + S
		24.0310-0356.1	510356	Ø 272 9,7 8 + S			
			→ 02/15; +PR 2EA	24.0122-0219.1	422219	Ø 310 22 20 V	
1.9 TDI 2.0 TDI	77 103	03/08→11/10 03/08→05/10	←	08/08→; +PR 1ZE	24.0125-0145.1	425145	Ø 288 25 22 V + S
					24.0325-0145.1	525145	Ø 288 25 22 V + S
			←	08/08→; +PR 1LJ,1ZA	24.0125-0158.1	425158	Ø 312 25 22 V + S
					24.0325-0158.1	525158	Ø 312 25 22 V + S
			←	08/08→; +PR 1LK	24.0130-0115.1	430115	Ø 345 30 27 V
					24.0330-0115.1	530115	Ø 345 30 27 V
			→	08/08→; +PR 1KS	24.0110-0356.1	410356	Ø 272 9,7 8 + S
		24.0310-0356.1	510356	Ø 272 9,7 8 + S			
			08/08→; +PR 1KF	24.0112-0158.1	412158	Ø 256 12 10 + S	
				24.0312-0158.1	512158	Ø 256 12 10	
			08/08→; +PR 1KJ	24.0112-0169.1	412169	Ø 282 12 10 + S	
				24.0312-0169.1	512169	Ø 282 12 10 + S	
2.0 TDI 4x4	125	09/08→05/15	←	10/08→ 02/15; +PR 1ZE	24.0125-0145.1	425145	Ø 288 25 22 V + S
					24.0325-0145.1	525145	Ø 288 25 22 V + S
			←	10/08→ 02/15; +PR 1LJ,1ZA	24.0125-0158.1	425158	Ø 312 25 22 V + S
					24.0325-0158.1	525158	Ø 312 25 22 V + S
			←	10/08→ 02/15; +PR 1LK	24.0130-0115.1	430115	Ø 345 30 27 V
					24.0330-0115.1	530115	Ø 345 30 27 V
			10/08→ 02/15; +PR 1KS	24.0110-0356.1	410356	Ø 272 9,7 8 + S	
				24.0310-0356.1	510356	Ø 272 9,7 8 + S	
			10/08→ 02/15; +PR 2EA	24.0122-0219.1	422219	Ø 310 22 20 V	
<b>SKODA - SUPERB II Kombi (3T5) 10/09→05/15</b>							
<b>Bremsbelagsatz, Scheibenbremse</b>							
1.4 TSI 1.8 TSI 1.8 TSI 2.0 TDI 2.0 TDI 16V	92 112 118 125 103	10/09→05/15 10/09→05/15 10/09→05/15 10/09→05/15 10/09→05/15	←	11/09→ 02/15; +PR 1LJ,1ZA,1ZE	13.0460-7184.2	607184	ATE 23587 20,6 + WK
					13.0470-7184.2	LD7184	ATE 23587 20,6 + WK Ceramic
			←	11/09→ 02/15; +PR 1LK	13.0460-7200.2	607200	ATE 23801 20,3 + WK
					13.0470-7200.2	LD7200	ATE 23801 20,3 + WK Ceramic
			→	11/09→ 02/15; +PR 1KF,1KJ	13.0460-2749.2	602749	TRW 24483 16,9 - WE / - WK + Zub
					13.0460-2880.2	602880	TRW 23914 17,1 + WE / - WK + Zub
					13.0470-2749.2	LD2749	TRW 24483 16,9 - WE / - WK + Zub Ceramic
				13.0470-2880.2	LD2880	TRW 23914 17,1 + WE / - WK + Zub Ceramic	
			11/09→ 02/15; +PR 1KS	13.0460-3858.2	603858	BOS 24563 17,7 - WE / - WK + Zub	
				13.0470-3858.2	LD3858	BOS 24563 17,7 - WE / - WK + Zub Ceramic	
1.6 TDI 2.0 TSI	77 147	09/10→05/15 05/10→05/15	←	→ 02/15; +PR 1LJ,1ZA,1ZE	13.0460-7184.2	607184	ATE 23587 20,6 + WK
					13.0470-7184.2	LD7184	ATE 23587 20,6 + WK Ceramic
			←	→ 02/15; +PR 1LK	13.0460-7200.2	607200	ATE 23801 20,3 + WK
					13.0470-7200.2	LD7200	ATE 23801 20,3 + WK Ceramic
			→	→ 02/15; +PR 1KF,1KJ	13.0460-2749.2	602749	TRW 24483 16,9 - WE / - WK + Zub
					13.0460-2880.2	602880	TRW 23914 17,1 + WE / - WK + Zub
				13.0470-2749.2	LD2749	TRW 24483 16,9 - WE / - WK + Zub Ceramic	
				13.0470-2880.2	LD2880	TRW 23914 17,1 + WE / - WK + Zub Ceramic	
			→ 02/15; +PR 1KS	13.0460-3858.2	603858	BOS 24563 17,7 - WE / - WK + Zub	
				13.0470-3858.2	LD3858	BOS 24563 17,7 - WE / - WK + Zub Ceramic	
↓							











	kw			 	! #		
<b>SKODA - SUPERB II Kombi (3T5) 10/09→05/15</b>							
<b> Bremsbelagsatz, Scheibenbremse</b>							
1.8 TSI 4x4 1.8 TSI 4x4 2.0 TDI 4x4 3.6 V6 4x4	112 118 125 191	10/09→05/15 10/09→05/15 10/09→05/15 10/09→05/15	←	11/09→ 02/15; +PR 1LJ,1ZA,1ZE	13.0460-7184.2 607184	ATE 23587 20,6 + WK	
					13.0470-7184.2 LD7184	ATE 23587 20,6 + WK Ceramic	
			←	11/09→ 02/15; +PR 1LK	13.0460-7200.2 607200	ATE 23801 20,3 + WK	
					13.0470-7200.2 LD7200	ATE 23801 20,3 + WK Ceramic	
			→	11/09→ 02/15; +PR 2EA	13.0460-2749.2 602749	TRW 24483 16,9 - WE / - WK + Zub	
					13.0460-2880.2 602880	TRW 23914 17,1 + WE / - WK + Zub	
					13.0470-2749.2 LD2749	TRW 24483 16,9 - WE / - WK + Zub Ceramic	
					13.0470-2880.2 LD2880	TRW 23914 17,1 + WE / - WK + Zub Ceramic	
			→	11/09→ 02/15; +PR 1KF,1KJ	13.0460-2749.2 602749	TRW 24483 16,9 - WE / - WK + Zub	
					13.0460-2880.2 602880	TRW 23914 17,1 + WE / - WK + Zub	
					13.0470-2749.2 LD2749	TRW 24483 16,9 - WE / - WK + Zub Ceramic	
					13.0470-2880.2 LD2880	TRW 23914 17,1 + WE / - WK + Zub Ceramic	
1.9 TDI	77	10/09→11/10	←	+PR 1LJ,1ZA,1ZE	13.0460-7184.2 607184	ATE 23587 20,6 + WK	
					13.0470-7184.2 LD7184	ATE 23587 20,6 + WK Ceramic	
			←	+PR 1LK	13.0460-7200.2 607200	ATE 23801 20,3 + WK	
					13.0470-7200.2 LD7200	ATE 23801 20,3 + WK Ceramic	
			→	+PR 1KF,1KJ	13.0460-2749.2 602749	TRW 24483 16,9 - WE / - WK + Zub	
		13.0460-2880.2 602880	TRW 23914 17,1 + WE / - WK + Zub				
		13.0470-2749.2 LD2749	TRW 24483 16,9 - WE / - WK + Zub Ceramic				
		13.0470-2880.2 LD2880	TRW 23914 17,1 + WE / - WK + Zub Ceramic				
→	+PR 1KS	13.0460-3858.2 603858	BOS 24563 17,7 - WE / - WK + Zub				
		13.0470-3858.2 LD3858	BOS 24563 17,7 - WE / - WK + Zub Ceramic				
2.0 TDI	103	10/09→03/10	←	11/09→; +PR 1LJ,1ZA,1ZE	13.0460-7184.2 607184	ATE 23587 20,6 + WK	
					13.0470-7184.2 LD7184	ATE 23587 20,6 + WK Ceramic	
			←	11/09→; +PR 1LK	13.0460-7200.2 607200	ATE 23801 20,3 + WK	
					13.0470-7200.2 LD7200	ATE 23801 20,3 + WK Ceramic	
			→	11/09→; +PR 1KF,1KJ	13.0460-2749.2 602749	TRW 24483 16,9 - WE / - WK + Zub	
		13.0460-2880.2 602880	TRW 23914 17,1 + WE / - WK + Zub				
		13.0470-2749.2 LD2749	TRW 24483 16,9 - WE / - WK + Zub Ceramic				
		13.0470-2880.2 LD2880	TRW 23914 17,1 + WE / - WK + Zub Ceramic				
→	11/09→; +PR 1KS	13.0460-3858.2 603858	BOS 24563 17,7 - WE / - WK + Zub				
		13.0470-3858.2 LD3858	BOS 24563 17,7 - WE / - WK + Zub Ceramic				
2.0 TDI 16V 4x4	103	11/10→05/15	←	→ 02/15; +PR 1LJ,1ZA,1ZE	13.0460-7184.2 607184	ATE 23587 20,6 + WK	
					13.0470-7184.2 LD7184	ATE 23587 20,6 + WK Ceramic	
			←	→ 02/15; +PR 1LK	13.0460-7200.2 607200	ATE 23801 20,3 + WK	
					13.0470-7200.2 LD7200	ATE 23801 20,3 + WK Ceramic	
→	→ 02/15; +PR 2EA	13.0460-2749.2 602749	TRW 24483 16,9 - WE / - WK + Zub				
		13.0460-2880.2 602880	TRW 23914 17,1 + WE / - WK + Zub				
		13.0470-2749.2 LD2749	TRW 24483 16,9 - WE / - WK + Zub Ceramic				
		13.0470-2880.2 LD2880	TRW 23914 17,1 + WE / - WK + Zub Ceramic				
↓							







	kw			 	! #		
<b>SKODA - SUPERB II Kombi (3T5) 10/09→05/15</b>							
<b> Bremsbelagsatz, Scheibenbremse</b>							
2.0 TDI 16V 4x4	103	11/10→05/15	➔	→ 02/15; +PR 1KF,1KJ		13.0460-2749.2 602749 13.0460-2880.2 602880 13.0470-2749.2 LD2749 13.0470-2880.2 LD2880	TRW 24483 16,9 - WE / - WK + Zub TRW 23914 17,1 + WE / - WK + Zub TRW 24483 16,9 - WE / - WK + Zub Ceramic TRW 23914 17,1 + WE / - WK + Zub Ceramic
			➔	→ 02/15; +PR 1KS		13.0460-3858.2 603858 13.0470-3858.2 LD3858	BOS 24563 17,7 - WE / - WK + Zub BOS 24563 17,7 - WE / - WK + Zub Ceramic
<b> Bremsscheibe</b>							
1.4 TSI	92	10/09→05/15	➔	11/09→ 02/15; +PR 1ZE		24.0125-0145.1 425145	Ø 288 25 22 V + S
1.8 TSI	112	10/09→05/15	➔	11/09→ 02/15; +PR 1LJ,1ZA		24.0125-0158.1 425158	Ø 312 25 22 V + S
1.8 TSI	118	10/09→05/15	➔	11/09→ 02/15; +PR 1LJ,1ZA		24.0325-0158.1 525158	Ø 312 25 22 V + S
2.0 TDI	125	10/09→05/15	➔	11/09→ 02/15; +PR 1LJ,1ZA		24.0325-0158.1 525158	Ø 312 25 22 V + S
2.0 TDI 16V	103	10/09→05/15	➔	11/09→ 02/15; +PR 1LK		24.0130-0115.1 430115 24.0330-0115.1 530115	Ø 345 30 27 V Ø 345 30 27 V
			➔	11/09→ 02/15; +PR 1KS		24.0110-0356.1 410356 24.0310-0356.1 510356	Ø 272 9,7 8 + S Ø 272 9,7 8 + S
			➔	11/09→ 02/15; +PR 1KF		24.0112-0158.1 412158 24.0312-0158.1 512158	Ø 256 12 10 + S Ø 256 12 10
			➔	11/09→ 02/15; +PR 1KJ		24.0112-0169.1 412169 24.0312-0169.1 512169	Ø 282 12 10 + S Ø 282 12 10 + S
1.6 TDI	77	09/10→05/15	➔	→ 02/15; +PR 1ZE		24.0125-0145.1 425145	Ø 288 25 22 V + S
2.0 TSI	147	05/10→05/15	➔	→ 02/15; +PR 1LJ,1ZA		24.0125-0158.1 425158 24.0325-0158.1 525158	Ø 312 25 22 V + S Ø 312 25 22 V + S
			➔	→ 02/15; +PR 1LK		24.0130-0115.1 430115 24.0330-0115.1 530115	Ø 345 30 27 V Ø 345 30 27 V
			➔	→ 02/15; +PR 1KS		24.0110-0356.1 410356 24.0310-0356.1 510356	Ø 272 9,7 8 + S Ø 272 9,7 8 + S
			➔	→ 02/15; +PR 1KF		24.0112-0158.1 412158 24.0312-0158.1 512158	Ø 256 12 10 + S Ø 256 12 10
			➔	→ 02/15; +PR 1KJ		24.0112-0169.1 412169 24.0312-0169.1 512169	Ø 282 12 10 + S Ø 282 12 10 + S
1.8 TSI 4x4	112	10/09→05/15	➔	11/09→ 02/15; +PR 1ZE		24.0125-0145.1 425145	Ø 288 25 22 V + S
1.8 TSI 4x4	118	10/09→05/15	➔	11/09→ 02/15; +PR 1LJ,1ZA		24.0125-0158.1 425158	Ø 312 25 22 V + S
2.0 TDI 4x4	125	10/09→05/15	➔	11/09→ 02/15; +PR 1LJ,1ZA		24.0325-0158.1 525158	Ø 312 25 22 V + S
			➔	11/09→ 02/15; +PR 1LK		24.0130-0115.1 430115 24.0330-0115.1 530115	Ø 345 30 27 V Ø 345 30 27 V
			➔	11/09→ 02/15; +PR 1KS		24.0110-0356.1 410356 24.0310-0356.1 510356	Ø 272 9,7 8 + S Ø 272 9,7 8 + S
			➔	11/09→ 02/15; +PR 1KF		24.0112-0158.1 412158 24.0312-0158.1 512158	Ø 256 12 10 + S Ø 256 12 10
			➔	11/09→ 02/15; +PR 1KJ		24.0112-0169.1 412169 24.0312-0169.1 512169	Ø 282 12 10 + S Ø 282 12 10 + S
			➔	11/09→ 02/15; +PR 2EA		24.0122-0219.1 422219	Ø 310 22 20 V
1.9 TDI	77	10/09→11/10	➔	+PR 1ZE		24.0125-0145.1 425145	Ø 288 25 22 V + S
			➔	+PR 1LJ,1ZA		24.0125-0158.1 425158 24.0325-0158.1 525158	Ø 312 25 22 V + S Ø 312 25 22 V + S
			➔	+PR 1LK		24.0130-0115.1 430115 24.0330-0115.1 530115	Ø 345 30 27 V Ø 345 30 27 V
			➔	+PR 1KS		24.0110-0356.1 410356 24.0310-0356.1 510356	Ø 272 9,7 8 + S Ø 272 9,7 8 + S
			➔	+PR 1KF		24.0112-0158.1 412158 24.0312-0158.1 512158	Ø 256 12 10 + S Ø 256 12 10
			➔	+PR 1KJ		24.0112-0169.1 412169 24.0312-0169.1 512169	Ø 282 12 10 + S Ø 282 12 10 + S
2.0 TDI	103	10/09→03/10	➔	11/09→; +PR 1ZE		24.0125-0145.1 425145	Ø 288 25 22 V + S
			➔	11/09→; +PR 1LJ,1ZA		24.0125-0158.1 425158 24.0325-0158.1 525158	Ø 312 25 22 V + S Ø 312 25 22 V + S
↓							













	kw				! #			
<b>SKODA - SUPERB II Kombi (3T5) 10/09→05/15</b>								
<b> Bremsscheibe</b>								
2.0 TDI	103	10/09→03/10	←	11/09→; +PR 1LK	24.0130-0115.1	430115	Ø 345 30 27 V	
			→	11/09→; +PR 1KS	24.0330-0115.1	530115	Ø 345 30 27 V	
			→	11/09→; +PR 1KF	24.0110-0356.1	410356	Ø 272 9,7 8 + S	
			→	11/09→; +PR 1KJ	24.0310-0356.1	510356	Ø 272 9,7 8 + S	
2.0 TDI 16V 4x4	103	11/10→05/15	←	→ 02/15; +PR 1ZE	24.0112-0158.1	412158	Ø 256 12 10 + S	
			←	→ 02/15; +PR 1LJ,1ZA	24.0312-0158.1	512158	Ø 256 12 10	
			←	→ 02/15; +PR 1LK	24.0125-0145.1	425145	Ø 288 25 22 V + S	
			→	→ 02/15; +PR 1KS	24.0125-0158.1	425158	Ø 312 25 22 V + S	
			→	→ 02/15; +PR 1KF	24.0325-0158.1	525158	Ø 312 25 22 V + S	
			→	→ 02/15; +PR 1KJ	24.0130-0115.1	430115	Ø 345 30 27 V	
			→	→ 02/15; +PR 1KJ	24.0330-0115.1	530115	Ø 345 30 27 V	
			→	→ 02/15; +PR 2EA	24.0110-0356.1	410356	Ø 272 9,7 8 + S	
3.6 V6 4x4	191	10/09→05/15	←	11/09→ 02/15; +PR 1ZE	24.0310-0356.1	510356	Ø 272 9,7 8 + S	
			←	11/09→ 02/15; +PR 1LJ,1ZA	24.0112-0158.1	412158	Ø 256 12 10 + S	
			←	11/09→ 02/15; +PR 1LK	24.0312-0158.1	512158	Ø 256 12 10	
			→	11/09→ 02/15; +PR 1KS	24.0112-0169.1	412169	Ø 282 12 10 + S	
			→	11/09→ 02/15; +PR 1KJ	24.0312-0169.1	512169	Ø 282 12 10 + S	
			→	11/09→ 02/15; +PR 2EA	24.0122-0219.1	422219	Ø 310 22 20 V	
<b>SKODA - SUPERB III (3V3) 03/15→</b>								
<b> Bremsbelagsatz, Scheibenbremse</b>								
1.4 TSI	92	03/15→	←	+PR 1ZA	13.0460-2785.2	602785	TRW 25683 20,4 + WE / + WK	
1.4 TSI	110	03/15→			13.0470-2785.2	LD2785	TRW 25683 20,4 + WE / + WK	
1.4 TSI 4x4	110	03/15→					Ceramic	
1.6 TDI	88	03/15→						
1.8 TSI	132	03/15→	→	+PR 1KU,1KZ; + eFSB	13.0460-7294.2	607294	ATE 25009 16,4 - WE / - WK	
2.0 TDI	110	03/15→			13.0470-7294.2	LD7294	ATE 25009 16,4 - WE / - WK	
2.0 TDI	140	03/15→					Ceramic	
2.0 TDI 4x4	110	03/15→						
2.0 TDI 4x4	140	03/15→						
2.0 TSI	162	03/15→						
2.0 TSI 4x4	206	03/15→						
<b>Warnkontakt, Bremsbelagverschleiß</b>								
1.4 TSI	92	03/15→	←	+PR 1LA	1	24.8190-0065.2	620065	L= 172
1.4 TSI	110	03/15→						
1.4 TSI 4x4	110	03/15→	←	+PR 1ZA	1	24.8190-0065.2	620065	L= 172
1.6 TDI	88	03/15→						
1.8 TSI	132	03/15→						
2.0 TDI	110	03/15→						
2.0 TDI	140	03/15→						
2.0 TDI 4x4	110	03/15→						
2.0 TDI 4x4	140	03/15→						
2.0 TSI	162	03/15→						
2.0 TSI 4x4	206	03/15→						
<b> Bremsscheibe</b>								
1.4 TSI	92	03/15→	←	+PR 1ZA	24.0125-0158.1	425158	Ø 312 25 22 V + S	
1.4 TSI	110	03/15→			24.0325-0158.1	525158	Ø 312 25 22 V + S	
1.4 TSI 4x4	110	03/15→						
1.6 TDI	88	03/15→	←	+PR 1LA	24.0130-0225.1	430225	Ø 340 30 27 V + S	
1.8 TSI	132	03/15→	→	+PR 1KU; + eFSB	24.0112-0210.1	412210	Ø 300 12 10 + S	
2.0 TDI	110	03/15→						
2.0 TDI	140	03/15→	→	+PR 1KZ	24.0122-0219.1	422219	Ø 310 22 20 V	
2.0 TDI 4x4	110	03/15→						
2.0 TDI 4x4	140	03/15→						
2.0 TSI	162	03/15→						
2.0 TSI 4x4	206	03/15→						

	kw			 	! #		
<b>SKODA - SUPERB III Kombi (3V5) 03/15→</b>							
 <b>Bremsbelagsatz, Scheibenbremse</b>							
1.4 TSI	92	03/15→	←	+PR 1ZA		13.0460-2785.2 602785	TRW 25683 20,4 + WE / + WK
1.4 TSI	110	03/15→				13.0470-2785.2 LD2785	TRW 25683 20,4 + WE / + WK Ceramic
1.4 TSI 4x4	110	03/15→					
1.6 TDI	88	03/15→					
1.8 TSI	132	03/15→	→	+PR 1KU,1KZ; + eFSB		13.0460-7294.2 607294	ATE 25009 16,4 - WE / - WK
2.0 TDI	110	03/15→				13.0470-7294.2 LD7294	ATE 25009 16,4 - WE / - WK Ceramic
2.0 TDI	140	03/15→					
2.0 TDI 4x4	110	03/15→					
2.0 TDI 4x4	140	03/15→					
2.0 TSI	162	03/15→					
2.0 TSI 4x4	206	03/15→					
<b>Warnkontakt, Bremsbelagverschleiß</b>							
1.4 TSI	92	03/15→	←	+PR 1LA	1	24.8190-0065.2 620065	L= 172
1.4 TSI	110	03/15→					
1.4 TSI 4x4	110	03/15→	←	+PR 1ZA	1	24.8190-0065.2 620065	L= 172
1.6 TDI	88	03/15→					
1.8 TSI	132	03/15→					
2.0 TDI	110	03/15→					
2.0 TDI	140	03/15→					
2.0 TDI 4x4	110	03/15→					
2.0 TDI 4x4	140	03/15→					
2.0 TSI	162	03/15→					
2.0 TSI 4x4	206	03/15→					
<b>Bremsscheibe</b>							
1.4 TSI	92	03/15→	←	+PR 1ZA		24.0125-0158.1 425158	∅ 312 25 22 V + S
1.4 TSI	110	03/15→				24.0325-0158.1 525158	∅ 312 25 22 V + S
1.4 TSI 4x4	110	03/15→					
1.6 TDI	88	03/15→	←	+PR 1LA		24.0130-0225.1 430225	∅ 340 30 27 V + S
1.8 TSI	132	03/15→					
2.0 TDI	110	03/15→	→	+PR 1KU,1KZ; + eFSB		24.0112-0210.1 412210	∅ 300 12 10 + S
2.0 TDI	140	03/15→					
2.0 TDI 4x4	110	03/15→					
2.0 TDI 4x4	140	03/15→					
2.0 TSI	162	03/15→					
2.0 TSI 4x4	206	03/15→					
<b>SKODA - YETI (5L) 05/09→12/17</b>							
 <b>Bremsbelagsatz, Scheibenbremse</b>							
1.2 TSI	77	09/09→05/15	←	+PR 1ZF		13.0460-7117.2 607117	VW 23130 19,6 + WK
						13.0470-7117.2 LD7117	VW 23130 19,6 + WK Ceramic
			←	+PR 1ZA,1ZE		13.0460-7184.2 607184	ATE 23587 20,6 + WK
						13.0470-7184.2 LD7184	ATE 23587 20,6 + WK Ceramic
			→	+PR 1KJ		13.0460-2749.2 602749	TRW 24483 16,9 - WE / - WK + Zub
						13.0460-2880.2 602880	TRW 23914 17,1 + WE / - WK + Zub
						13.0470-2749.2 LD2749	TRW 24483 16,9 - WE / - WK + Zub Ceramic
						13.0470-2880.2 LD2880	TRW 23914 17,1 + WE / - WK + Zub Ceramic
			→	+PR 1KD		13.0460-2787.2 602787	TRW 23554 17,3 - WK / - WE
						13.0460-2820.2 602820	TRW 20961 17,2 - WK
						13.0470-2820.2 LD2820	TRW 20961 17,2 - WK Ceramic
			→	11/09→; +PR 1KS		13.0460-3858.2 603858	BOS 24563 17,7 - WE / - WK + Zub
						13.0470-3858.2 LD3858	BOS 24563 17,7 - WE / - WK + Zub Ceramic
1.2 TSI	81	05/15→12/17	←	+PR 1ZF		13.0460-7117.2 607117	VW 23130 19,6 + WK
1.4 TSI	92	05/15→12/17				13.0470-7117.2 LD7117	VW 23130 19,6 + WK Ceramic
1.6	81	04/14→12/17					
2.0 TDI	103	11/11→12/17	←	+PR 1ZA,1ZE		13.0460-7184.2 607184	ATE 23587 20,6 + WK
2.0 TDI	110	05/15→12/17				13.0470-7184.2 LD7184	ATE 23587 20,6 + WK Ceramic
			→	+PR 1KD		13.0460-2787.2 602787	TRW 23554 17,3 - WK / - WE
						13.0460-2820.2 602820	TRW 20961 17,2 - WK
						13.0470-2820.2 LD2820	TRW 20961 17,2 - WK Ceramic
			→	+PR 1KS		13.0460-3858.2 603858	BOS 24563 17,7 - WE / - WK + Zub
						13.0470-3858.2 LD3858	BOS 24563 17,7 - WE / - WK + Zub Ceramic
1.4 TSI	90	06/10→05/15	←	+PR 1ZF		13.0460-7117.2 607117	VW 23130 19,6 + WK
1.6 TDI	77	11/10→05/15				13.0470-7117.2 LD7117	VW 23130 19,6 + WK Ceramic
2.0 TDI	81	11/09→12/17					
↓							















	kw			 	! #		
<b>SKODA - YETI (5L) 05/09→12/17</b>							
<b> Bremsbelagsatz, Scheibenbremse</b>							
1.4 TSI 1.6 TDI 2.0 TDI	90	06/10→05/15	←	+PR 1ZA,1ZE		13.0460-7184.2 607184	ATE 23587 20,6 + WK
	77	11/10→05/15				13.0470-7184.2 LD7184	ATE 23587 20,6 + WK Ceramic
	81	11/09→12/17	→	+PR 1KJ		13.0460-2749.2 602749	TRW 24483 16,9 - WE / - WK + Zub
						13.0460-2880.2 602880	TRW 23914 17,1 + WE / - WK + Zub
						13.0470-2749.2 LD2749	TRW 24483 16,9 - WE / - WK + Zub Ceramic
			→	+PR 1KD		13.0460-2880.2 LD2880	TRW 23914 17,1 + WE / - WK + Zub Ceramic
			→	+PR 1KS		13.0460-2787.2 602787	TRW 23554 17,3 - WK / - WE
						13.0460-2820.2 602820	TRW 20961 17,2 - WK
						13.0470-2820.2 LD2820	TRW 20961 17,2 - WK Ceramic
			→	+PR 1KS		13.0460-3858.2 603858	BOS 24563 17,7 - WE / - WK + Zub
						13.0470-3858.2 LD3858	BOS 24563 17,7 - WE / - WK + Zub Ceramic
1.4 TSI 4x4	110	05/15→12/17	←	+PR 1ZF		13.0460-7117.2 607117	VW 23130 19,6 + WK
						13.0470-7117.2 LD7117	VW 23130 19,6 + WK Ceramic
			←	+PR 1ZA,1ZE		13.0460-7184.2 607184	ATE 23587 20,6 + WK
					13.0470-7184.2 LD7184	ATE 23587 20,6 + WK Ceramic	
			→	+PR 1KS		13.0460-3858.2 603858	BOS 24563 17,7 - WE / - WK + Zub
						13.0470-3858.2 LD3858	BOS 24563 17,7 - WE / - WK + Zub Ceramic
1.8 TSI 4x4 2.0 TDI 4x4 2.0 TDI 4x4	112 81 125	11/09→12/17 11/09→12/17 11/09→05/15	←	+PR 1ZF		13.0460-7117.2 607117	VW 23130 19,6 + WK
						13.0470-7117.2 LD7117	VW 23130 19,6 + WK Ceramic
			←	+PR 1ZA,1ZE		13.0460-7184.2 607184	ATE 23587 20,6 + WK
						13.0470-7184.2 LD7184	ATE 23587 20,6 + WK Ceramic
			→	+PR 1KJ		13.0460-2749.2 602749	TRW 24483 16,9 - WE / - WK + Zub
					13.0460-2880.2 602880	TRW 23914 17,1 + WE / - WK + Zub	
					13.0470-2749.2 LD2749	TRW 24483 16,9 - WE / - WK + Zub Ceramic	
					13.0470-2880.2 LD2880	TRW 23914 17,1 + WE / - WK + Zub Ceramic	
			→	+PR 1KS		13.0460-3858.2 603858	BOS 24563 17,7 - WE / - WK + Zub
						13.0470-3858.2 LD3858	BOS 24563 17,7 - WE / - WK + Zub Ceramic
1.8 TSI 4x4 2.0 TDI 4x4	118 103	05/09→12/17 05/09→12/17	←	+PR 1ZF		13.0460-7117.2 607117	VW 23130 19,6 + WK
						13.0470-7117.2 LD7117	VW 23130 19,6 + WK Ceramic
			←	+PR 1ZA,1ZE		13.0460-7184.2 607184	ATE 23587 20,6 + WK
						13.0470-7184.2 LD7184	ATE 23587 20,6 + WK Ceramic
			→	+PR 1KJ		13.0460-2749.2 602749	TRW 24483 16,9 - WE / - WK + Zub
					13.0460-2880.2 602880	TRW 23914 17,1 + WE / - WK + Zub	
					13.0470-2749.2 LD2749	TRW 24483 16,9 - WE / - WK + Zub Ceramic	
					13.0470-2880.2 LD2880	TRW 23914 17,1 + WE / - WK + Zub Ceramic	
			→	11/09→; +PR 1KS		13.0460-3858.2 603858	BOS 24563 17,7 - WE / - WK + Zub
						13.0470-3858.2 LD3858	BOS 24563 17,7 - WE / - WK + Zub Ceramic
2.0 TDI 4x4	110	05/15→12/17	←	+PR 1ZF		13.0460-7117.2 607117	VW 23130 19,6 + WK
						13.0470-7117.2 LD7117	VW 23130 19,6 + WK Ceramic
			→	+PR 1KS		13.0460-3858.2 603858	BOS 24563 17,7 - WE / - WK + Zub
						13.0470-3858.2 LD3858	BOS 24563 17,7 - WE / - WK + Zub Ceramic
<b> Bremsscheibe</b>							
1.2 TSI	77	09/09→05/15	←	+PR 1ZF		24.0122-0210.1 422210	Ø 280 22 19 V + S
↓						24.0322-0210.1 522210	Ø 280 22 19 V + S

















	kw			 	! #		
<b>SKODA - YETI (5L) 05/09→12/17</b>							
<b>Bremsscheibe</b>							
1.2 TSI	77	09/09→05/15	←	+PR 1ZE	24.0125-0145.1	425145	Ø 288 25 22 V + S
					24.0325-0145.1	525145	Ø 288 25 22 V + S
			←	+PR 1ZA	24.0125-0158.1	425158	Ø 312 25 22 V + S
					24.0325-0158.1	525158	Ø 312 25 22 V + S
			→	+PR 1KD	24.0110-0277.1	410277	Ø 253 10 8 + S
					24.0310-0277.1	510277	Ø 253 10 8 + S
1.2 TSI	81	05/15→12/17	←	+PR 1ZF	24.0122-0210.1	422210	Ø 280 22 19 V + S
					24.0322-0210.1	522210	Ø 280 22 19 V + S
			←	+PR 1ZE	24.0125-0145.1	425145	Ø 288 25 22 V + S
					24.0325-0145.1	525145	Ø 288 25 22 V + S
			←	+PR 1ZA	24.0125-0158.1	425158	Ø 312 25 22 V + S
					24.0325-0158.1	525158	Ø 312 25 22 V + S
1.4 TSI 1.4 TSI 1.6 2.0 TDI 2.0 TDI	103	05/15→12/17	→	+PR 1KD	24.0110-0277.1	410277	Ø 253 10 8 + S
					24.0310-0277.1	510277	Ø 253 10 8 + S
			→	11/09→; +PR 1KS	24.0110-0356.1	410356	Ø 272 9,7 8 + S
					24.0310-0356.1	510356	Ø 272 9,7 8 + S
			→	+PR 1KJ	24.0112-0169.1	412169	Ø 282 12 10 + S
					24.0312-0169.1	512169	Ø 282 12 10 + S
1.4 TSI 1.6 TDI 2.0 TDI	81	11/09→12/17	←	+PR 1ZE	24.0125-0145.1	425145	Ø 288 25 22 V + S
					24.0325-0145.1	525145	Ø 288 25 22 V + S
			←	+PR 1ZA	24.0125-0158.1	425158	Ø 312 25 22 V + S
					24.0325-0158.1	525158	Ø 312 25 22 V + S
			→	+PR 1KD	24.0110-0277.1	410277	Ø 253 10 8 + S
					24.0310-0277.1	510277	Ø 253 10 8 + S
1.4 TSI 4x4	110	05/15→12/17	→	+PR 1KS	24.0110-0356.1	410356	Ø 272 9,7 8 + S
					24.0310-0356.1	510356	Ø 272 9,7 8 + S
			→	+PR 1KJ	24.0112-0169.1	412169	Ø 282 12 10 + S
					24.0312-0169.1	512169	Ø 282 12 10 + S
			←	+PR 1ZE	24.0125-0145.1	425145	Ø 288 25 22 V + S
					24.0325-0145.1	525145	Ø 288 25 22 V + S
1.8 TSI 4x4 2.0 TDI 4x4 2.0 TDI 4x4	125	11/09→05/15	←	+PR 1ZA	24.0125-0158.1	425158	Ø 312 25 22 V + S
					24.0325-0158.1	525158	Ø 312 25 22 V + S
			→	+PR 1KS	24.0110-0356.1	410356	Ø 272 9,7 8 + S
					24.0310-0356.1	510356	Ø 272 9,7 8 + S
			→	+PR 1KJ	24.0112-0169.1	412169	Ø 282 12 10 + S
					24.0312-0169.1	512169	Ø 282 12 10 + S
1.8 TSI 4x4	118	05/09→12/17	←	+PR 1ZE	24.0125-0145.1	425145	Ø 288 25 22 V + S
					24.0325-0145.1	525145	Ø 288 25 22 V + S
			←	+PR 1ZA	24.0125-0158.1	425158	Ø 312 25 22 V + S
					24.0325-0158.1	525158	Ø 312 25 22 V + S
			→	11/09→; +PR 1KS	24.0110-0356.1	410356	Ø 272 9,7 8 + S
					24.0310-0356.1	510356	Ø 272 9,7 8 + S
2.0 TDI 4x4 ↓	103	05/09→12/17	→	+PR 1KJ	24.0112-0169.1	412169	Ø 282 12 10 + S
					24.0312-0169.1	512169	Ø 282 12 10 + S
			←	+PR 1ZF	24.0122-0210.1	422210	Ø 280 22 19 V + S
					24.0322-0210.1	522210	Ø 280 22 19 V + S
			←	+PR 1ZE	24.0125-0145.1	425145	Ø 288 25 22 V + S
					24.0325-0145.1	525145	Ø 288 25 22 V + S















	kw			 	! #		
<b>SKODA - YETI (5L) 05/09→12/17</b>							
 <b>Bremsscheibe</b>							
2.0 TDI 4x4	103	05/09→12/17	←	+PR 1ZF	24.0322-0210.1	522210	Ø 280 22 19 V + S
			←	+PR 1ZE	24.0125-0145.1	425145	Ø 288 25 22 V + S
					24.0325-0145.1	525145	Ø 288 25 22 V + S
			←	+PR 1ZA	24.0125-0158.1	425158	Ø 312 25 22 V + S
					24.0325-0158.1	525158	Ø 312 25 22 V + S
			←	05/15→; +PR 1ZA	24.0125-0158.1	425158	Ø 312 25 22 V + S
					24.0325-0158.1	525158	Ø 312 25 22 V + S
		→	11/09→; +PR 1KS	24.0110-0356.1	410356	Ø 272 9,7 8 + S	
				24.0310-0356.1	510356	Ø 272 9,7 8 + S	
			→	+PR 1KJ	24.0112-0169.1	412169	Ø 282 12 10 + S
					24.0312-0169.1	512169	Ø 282 12 10 + S
2.0 TDI 4x4	110	05/15→12/17	←	+PR 1ZF	24.0122-0210.1	422210	Ø 280 22 19 V + S
					24.0322-0210.1	522210	Ø 280 22 19 V + S
			←	+PR 1ZE	24.0125-0145.1	425145	Ø 288 25 22 V + S
					24.0325-0145.1	525145	Ø 288 25 22 V + S
			→	+PR 1KS	24.0110-0356.1	410356	Ø 272 9,7 8 + S
					24.0310-0356.1	510356	Ø 272 9,7 8 + S
<b>SMART - CABRIO (450) 03/00→01/04</b>							
 <b>Bremselagsatz, Scheibenbremse</b>							
0.6 (450.432)	52	06/02→01/04	←		13.0460-3979.2	603979	BOS 21999 15,8 + WK - Zub
0.6 (S1OLA1, 450.441, 450.442, 450.443)	40	03/00→01/04					
0.6 (S1OLD2, 450.452)	45	01/01→01/04					
0.7 (450.433)	55	01/03→01/04					
0.7 (450.452, 450.432)	45	01/03→01/04					
0.8 CDI (S1OLC1, 450.401, 450.402, 450.403, 450.400)	30	03/01→01/04					
 <b>Bremsscheibe</b>							
0.6 (450.432)	52	06/02→01/04	←		24.0110-0331.1	410331	Ø 280 9,6 8 + S
0.6 (S1OLA1, 450.441, 450.442, 450.443)	40	03/00→01/04					
0.6 (S1OLD2, 450.452)	45	01/01→01/04					
0.7 (450.433)	55	01/03→01/04					
0.7 (450.452, 450.432)	45	01/03→01/04					
0.8 CDI (S1OLC1, 450.401, 450.402, 450.403, 450.400)	30	03/01→01/04					
<b>SMART - CITY-COUPE (450) 07/98→01/04</b>							
 <b>Bremselagsatz, Scheibenbremse</b>							
0.6 (450.330, 450.332)	52	06/02→01/04	←		13.0460-3979.2	603979	BOS 21999 15,8 + WK - Zub
0.6 (450.352, 450.353)	45	01/01→01/04					
0.6 (S1CLA1, 450.341)	40	07/98→01/04					
0.6 (S1CLB1, 450.331, 450.336)	33	07/98→01/04					
0.7 (450.330)	37	01/03→01/04					
0.7 (450.333)	55	01/03→01/04					
0.7 (450.352, 450.353)	45	01/03→01/04					
0.8 CDI (S1CLC1, 450.300, 450.301, 450.302, 450.303,...)	30	11/99→01/04					
 <b>Bremsscheibe</b>							
0.6 (450.330, 450.332)	52	06/02→01/04	←		24.0110-0331.1	410331	Ø 280 9,6 8 + S
0.6 (450.352, 450.353)	45	01/01→01/04					
0.6 (S1CLA1, 450.341)	40	07/98→01/04					
0.6 (S1CLB1, 450.331, 450.336)	33	07/98→01/04					
0.7 (450.330)	37	01/03→01/04					
0.7 (450.333)	55	01/03→01/04					
0.7 (450.352, 450.353)	45	01/03→01/04					
0.8 CDI (S1CLC1, 450.300, 450.301, 450.302, 450.303,...)	30	11/99→01/04					
<b>SMART - CROSSBLADE (450) 06/02→12/03</b>							
 <b>Bremselagsatz, Scheibenbremse</b>							
0.6 (450.418)	52	06/02→12/03	←		13.0460-3979.2	603979	BOS 21999 15,8 + WK - Zub
↓							



















	kW			 	! #		
<b>SMART - CROSSBLADE (450) 06/02→12/03</b>							
 <b>Bremsscheibe</b>							
0.6 (450.418)	52	06/02→12/03	←			24.0110-0331.1 410331	Ø 280 9,6 8 + S
<b>SMART - FORFOUR (454) 01/04→06/06</b>							
 <b>Bremsbelagsatz, Scheibenbremse</b>							
1.1 (454.030)	55	01/04→06/06	←	03/04→		13.0460-2896.2 602896	TRW 21920 16,6 + WK + Zub
1.3 (454.031)	70	01/04→06/06	→	03/04→		13.0460-2897.2 602897	TRW 21861 15,2 + WK
1.5 (454.032)	80	01/04→06/06					
1.1 (454.033)	47	02/05→06/06	←			13.0460-2896.2 602896	TRW 21920 16,6 + WK + Zub
1.5 CDI (454.000)	50	09/04→06/06	→			13.0460-2897.2 602897	TRW 21861 15,2 + WK
1.5 CDI (454.001)	70	09/04→06/06					
1.5 (454.032)	90	01/04→06/06	←	11/04→		13.0460-2896.2 602896	TRW 21920 16,6 + WK + Zub
			→	11/04→		13.0460-2897.2 602897	TRW 21861 15,2 + WK
1.5 BRABUS (454.034)	130	05/05→06/06	←			13.0460-2619.2 602619	TRW + WK
			→			13.0460-2897.2 602897	TRW 21861 15,2 + WK
 <b>Bremsscheibe</b>							
1.1 (454.030)	55	01/04→06/06	←	03/04→		24.0124-0192.1 424192	Ø 256 24 21,5 V
1.3 (454.031)	70	01/04→06/06	→	03/04→		24.0110-0304.1 410304	Ø 250 10 8
1.5 (454.032)	80	01/04→06/06					
1.1 (454.033)	47	02/05→06/06	←			24.0124-0192.1 424192	Ø 256 24 21,5 V
1.5 CDI (454.000)	50	09/04→06/06	→			24.0110-0304.1 410304	Ø 250 10 8
1.5 CDI (454.001)	70	09/04→06/06					
1.5 (454.032)	90	01/04→06/06	←	11/04→		24.0124-0192.1 424192	Ø 256 24 21,5 V
			→	11/04→		24.0110-0304.1 410304	Ø 250 10 8
1.5 BRABUS (454.034)	130	05/05→06/06	→			24.0110-0304.1 410304	Ø 250 10 8
<b>SMART - FORFOUR Schrägheck (453) 07/14→</b>							
 <b>Bremsbelagsatz, Scheibenbremse</b>							
0.9 (453.044, 453.053)	66	11/14→	←			13.0460-7298.2 607298	ATE 25702 18,2 - WE / - WK
0.9 Brabus (453.062)	80	07/16→				13.0470-7298.2 LD7298	ATE 25702 18,2 - WE / - WK Ceramic
1.0 (453.041)	45	11/14→	←	01/15→		13.0460-7298.2 607298	ATE 25702 18,2 - WE / - WK
1.0 (453.042, 453.043)	52	07/14→	←	11/14→		13.0470-7298.2 LD7298	ATE 25702 18,2 - WE / - WK Ceramic
						13.0460-7298.2 607298	ATE 25702 18,2 - WE / - WK
 <b>Bremsscheibe</b>							
0.9 (453.044, 453.053)	66	11/14→	←			24.0112-0171.1 412171	Ø 259 12 10,6 + S
0.9 Brabus (453.062)	80	07/16→				24.0122-0289.1 422289	Ø 258 22 19,8 V + S
1.0 (453.041)	45	11/14→	←	01/15→		24.0112-0171.1 412171	Ø 259 12 10,6 + S
1.0 (453.042, 453.043)	52	07/14→	←	11/14→		24.0122-0289.1 422289	Ø 258 22 19,8 V + S
						24.0112-0171.1 412171	Ø 259 12 10,6 + S
						24.0122-0289.1 422289	Ø 258 22 19,8 V + S
<b>SMART - FORTWO Cabrio (450) 01/04→01/07</b>							
 <b>Bremsbelagsatz, Scheibenbremse</b>							
0.6 Brabus (450.433)	55	01/04→12/06	←			13.0460-3979.2 603979	BOS 21999 15,8 + WK - Zub
0.7 (450.433)	55	01/04→01/07					
0.7 (450.452)	45	01/04→01/07					
0.8 CDI (450.401, 450.402, 450.403, 450.400)	30	01/04→01/07					
 <b>Bremsscheibe</b>							
0.6 Brabus (450.433)	55	01/04→12/06	←			24.0110-0331.1 410331	Ø 280 9,6 8 + S
0.7 (450.433)	55	01/04→01/07					
0.7 (450.452)	45	01/04→01/07					
0.8 CDI (450.401, 450.402, 450.403, 450.400)	30	01/04→01/07					
<b>SMART - FORTWO Cabrio (451) 01/07→</b>							
 <b>Bremsbelagsatz, Scheibenbremse</b>							
0.8 CDi (451.400)	33	01/07→	←	04/07→		13.0460-3979.2 603979	BOS 21999 15,8 + WK - Zub
1.0 (451.431, 451.480)	52	01/07→					
1.0 Turbo (451.432)	62	01/07→					
↓							

















	kW			 	! #		
<b>SMART - FORTWO Cabrio (451) 01/07→</b>							
 <b>Bremsbelagsatz, Scheibenbremse</b>							
0.8 CDi (451.401)	40	08/09→	←			13.0460-3979.2 603979	BOS 21999 15,8 + WK - Zub
1.0 Brabus	88	04/12→					
1.0 Brabus (451.433)	72	01/08→					
1.0 Turbo Brabus (451.433)	75	07/10→					
electric drive (451.490, 451.491)	20	12/10→12/12					
electric drive (451.490, 451.491)	55	01/13→					
electric drive (451.490)	35	12/11→12/12					
electric drive (451.491)	30	11/09→12/11					
electric drive Brabus (451.492)	60	01/13→					
 <b>Bremsscheibe</b>							
0.8 CDi (451.400)	33	01/07→	←	04/07→		24.0110-0331.1 410331	Ø 280 9,6 8 + S
1.0 (451.431, 451.480)	52	01/07→					
1.0 Turbo (451.432)	62	01/07→					
0.8 CDi (451.401)	40	08/09→	←			24.0110-0331.1 410331	Ø 280 9,6 8 + S
1.0 Brabus	88	04/12→					
1.0 Brabus (451.433)	72	01/08→					
1.0 Turbo Brabus (451.433)	75	07/10→					
electric drive (451.490, 451.491)	20	12/10→12/12					
electric drive (451.490, 451.491)	55	01/13→					
electric drive (451.490)	35	12/11→12/12					
electric drive (451.491)	30	11/09→12/11					
electric drive Brabus (451.492)	60	01/13→					
<b>SMART - FORTWO Cabriolet (453) 09/15→</b>							
 <b>Bremsbelagsatz, Scheibenbremse</b>							
0.9 (453.444, 453.453)	66	09/15→	←			13.0460-7298.2 607298	ATE 25702 18,2 - WE / - WK
0.9 Brabus (453.462)	80	07/16→				13.0470-7298.2 LD7298	ATE 25702 18,2 - WE / - WK Ceramic
1.0 (453.442, 453.443)	52	09/15→					
 <b>Bremsscheibe</b>							
0.9 (453.444, 453.453)	66	09/15→	←			24.0112-0171.1 412171	Ø 259 12 10,6 + S
0.9 Brabus (453.462)	80	07/16→				24.0122-0289.1 422289	Ø 258 22 19,8 V + S
1.0 (453.442, 453.443)	52	09/15→					
<b>SMART - FORTWO Coupe (450) 01/04→02/07</b>							
 <b>Bremsbelagsatz, Scheibenbremse</b>							
0.6 (450.332)	45	01/04→02/07	←			13.0460-3979.2 603979	BOS 21999 15,8 + WK - Zub
0.7 (450.330)	37	01/04→01/07					
0.7 (450.333)	55	01/04→01/07					
0.7 (450.335)	40	01/04→01/07					
0.7 (450.352, 450.332)	45	01/04→01/07					
0.8 CDI (450.300, 450.301, 450.302, 450.303, 450.306)	30	01/04→01/07					
 <b>Bremsscheibe</b>							
0.6 (450.332)	45	01/04→02/07	←			24.0110-0331.1 410331	Ø 280 9,6 8 + S
0.7 (450.330)	37	01/04→01/07					
0.7 (450.333)	55	01/04→01/07					
0.7 (450.335)	40	01/04→01/07					
0.7 (450.352, 450.332)	45	01/04→01/07					
0.8 CDI (450.300, 450.301, 450.302, 450.303, 450.306)	30	01/04→01/07					
<b>SMART - FORTWO Coupe (451) 01/07→</b>							
 <b>Bremsbelagsatz, Scheibenbremse</b>							
0.8 CDi (451.300)	33	01/07→	←	04/07→		13.0460-3979.2 603979	BOS 21999 15,8 + WK - Zub
1.0 (451.330, 451.334)	45	01/07→					
1.0 (451.331, 451.380)	52	01/07→					
1.0 Turbo (451.332)	62	01/07→					
0.8 CDi (451.301)	40	08/09→	←			13.0460-3979.2 603979	BOS 21999 15,8 + WK - Zub
1.0 Brabus (451.333)	72	01/08→					
1.0 Turbo Brabus (451.333)	75	07/10→					
electric drive (451.390, 451.391)	55	01/13→					
electric drive (451.390)	35	12/11→12/12					
↓							





























	kW			 	! #		
<b>SMART - FORTWO Coupe (451) 01/07→</b>							
 <b>Bremsbelagsatz, Scheibenbremse</b>							
electric drive (451.391, 451.390)	20	12/10→12/12	←			<b>13.0460-3979.2 603979</b>	BOS 21999 15,8 + WK - Zub
electric drive (451.391)	30	11/09→12/11					
electric drive Brabus (451.392)	60	01/13→					
 <b>Bremsscheibe</b>							
0.8 CDi (451.300)	33	01/07→	←	04/07→		<b>24.0110-0331.1 410331</b>	Ø 280 9,6 8 + S
1.0 (451.330, 451.334)	45	01/07→					
1.0 (451.331, 451.380)	52	01/07→					
1.0 Turbo (451.332)	62	01/07→					
0.8 CDi (451.301)	40	08/09→	←			<b>24.0110-0331.1 410331</b>	Ø 280 9,6 8 + S
1.0 Brabus (451.333)	72	01/08→					
1.0 Turbo Brabus (451.333)	75	07/10→					
electric drive (451.390, 451.391)	55	01/13→					
electric drive (451.390)	35	12/11→12/12					
electric drive (451.391, 451.390)	20	12/10→12/12					
electric drive (451.391)	30	11/09→12/11					
electric drive Brabus (451.392)	60	01/13→					
<b>SMART - FORTWO Coupe (453) 07/14→</b>							
 <b>Bremsbelagsatz, Scheibenbremse</b>							
0.9 (453.344, 453.353)	66	09/14→	←	11/14→		<b>13.0460-7298.2 607298</b>	ATE 25702 18,2 - WE / - WK
1.0 (453.342, 453.343)	52	07/14→				<b>13.0470-7298.2 LD7298</b>	ATE 25702 18,2 - WE / - WK Ceramic
0.9 Brabus (453.362)	80	07/16→	←			<b>13.0460-7298.2 607298</b>	ATE 25702 18,2 - WE / - WK
						<b>13.0470-7298.2 LD7298</b>	ATE 25702 18,2 - WE / - WK Ceramic
1.0 (453.341)	45	11/14→	←	01/15→		<b>13.0460-7298.2 607298</b>	ATE 25702 18,2 - WE / - WK
						<b>13.0470-7298.2 LD7298</b>	ATE 25702 18,2 - WE / - WK Ceramic
 <b>Bremsscheibe</b>							
0.9 (453.344, 453.353)	66	09/14→	←	11/14→		<b>24.0112-0171.1 412171</b>	Ø 259 12 10,6 + S
1.0 (453.342, 453.343)	52	07/14→				<b>24.0122-0289.1 422289</b>	Ø 258 22 19,8 V + S
0.9 Brabus (453.362)	80	07/16→	←			<b>24.0112-0171.1 412171</b>	Ø 259 12 10,6 + S
						<b>24.0122-0289.1 422289</b>	Ø 258 22 19,8 V + S
1.0 (453.341)	45	11/14→	←	01/15→		<b>24.0112-0171.1 412171</b>	Ø 259 12 10,6 + S
						<b>24.0122-0289.1 422289</b>	Ø 258 22 19,8 V + S
<b>SMART - ROADSTER (452) 04/03→11/05</b>							
 <b>Bremsbelagsatz, Scheibenbremse</b>							
0.7 (452.432)	45	04/03→11/05	←			<b>13.0460-3979.2 603979</b>	BOS 21999 15,8 + WK - Zub
0.7 (452.434)	60	04/03→11/05					
0.7 Brabus (452.437)	74	12/03→11/05	←	03/04→		<b>13.0460-3979.2 603979</b>	BOS 21999 15,8 + WK - Zub
 <b>Bremsscheibe</b>							
0.7 (452.432)	45	04/03→11/05	←			<b>24.0110-0331.1 410331</b>	Ø 280 9,6 8 + S
0.7 (452.434)	60	04/03→11/05					
0.7 Brabus (452.437)	74	12/03→11/05	←	03/04→		<b>24.0110-0331.1 410331</b>	Ø 280 9,6 8 + S
<b>SMART - ROADSTER Coupe (452) 04/03→11/05</b>							
 <b>Bremsbelagsatz, Scheibenbremse</b>							
0.7 (452.332)	45	06/03→11/05	←	04/05→		<b>13.0460-3979.2 603979</b>	BOS 21999 15,8 + WK - Zub
0.7 (452.334)	60	04/03→11/05	←			<b>13.0460-3979.2 603979</b>	BOS 21999 15,8 + WK - Zub
0.7 Brabus (452.337)	74	12/03→11/05	←	03/04→		<b>13.0460-3979.2 603979</b>	BOS 21999 15,8 + WK - Zub
 <b>Bremsscheibe</b>							
0.7 (452.332)	45	06/03→11/05	←	04/05→		<b>24.0110-0331.1 410331</b>	Ø 280 9,6 8 + S
0.7 (452.334)	60	04/03→11/05	←			<b>24.0110-0331.1 410331</b>	Ø 280 9,6 8 + S
0.7 Brabus (452.337)	74	12/03→11/05	←	03/04→		<b>24.0110-0331.1 410331</b>	Ø 280 9,6 8 + S









	kw			 	! #		
<b>SSANGYONG - ACTYON I 11/05→</b>							
 <b>Bremsbelagsatz, Scheibenbremse</b>							
2.0 Xdi	100	07/07→	➔	+ ABS		13.0460-5623.2 605623	MAN 23673 15,9 + WK
2.0 Xdi	104	11/05→					
2.3	110	11/06→					
2.3 4x4	110	11/06→					
200 Xdi 4WD	100	07/07→					
200 Xdi 4WD	104	10/06→					
<b>SSANGYONG - ACTYON SPORTS I (QJ) 11/05→</b>							
 <b>Bremsbelagsatz, Scheibenbremse</b>							
2.0 Xdi	104	04/07→	➔	+ ABS		13.0460-5623.2 605623	MAN 23673 15,9 + WK
2.0 Xdi 4WD	104	04/07→					
2.3 4WD	110	09/11→					
<b>SSANGYONG - ACTYON SPORTS II 10/12→</b>							
 <b>Bremsbelagsatz, Scheibenbremse</b>							
2.2 Xdi	131	07/15→	➔			13.0460-5623.2 605623	MAN 23673 15,9 + WK
2.2 Xdi 4WD	131	07/15→					
<b>SSANGYONG - KORANDO (KJ) 12/96→11/06</b>							
 <b>Bremsscheibe</b>							
2.3	103	05/97→02/00	➔	→ 01/99		24.0110-0352.1 410352	Ø 299 10,4 8,5
2.3	105	01/99→11/06					
2.3 TDiC 4x4	74	07/98→11/06					
2.9 D	73	06/97→10/00					
2.9 D (KJ)	72	12/96→10/00					
2.9 TD	88	04/98→11/06					
3.2	156	01/99→02/00					
3.2	162	06/97→11/06					
3.2 (KJ)	154	12/96→11/02					
2.3 D (KJ)	58	12/96→06/98	➔			24.0110-0352.1 410352	Ø 299 10,4 8,5
<b>SSANGYONG - KORANDO Cabrio (KJ) 12/96→11/06</b>							
 <b>Bremsscheibe</b>							
2.3	103	11/97→02/00	➔	→ 01/99		24.0110-0352.1 410352	Ø 299 10,4 8,5
2.9 D	72	11/97→10/00					
2.9 TD	88	04/98→02/00					
3.2	156	01/99→11/02					
3.2	162	06/97→11/06					
<b>SSANGYONG - KYRON 05/05→</b>							
 <b>Bremsbelagsatz, Scheibenbremse</b>							
2.0 Xdi	100	01/10→	➔	+ ABS		13.0460-5623.2 605623	MAN 23673 15,9 + WK
2.0 Xdi	104	05/05→					
2.0 Xdi 4x4	100	01/10→					
2.0 Xdi 4x4	101	05/05→					
2.0 Xdi 4x4	104	05/05→					
2.3	110	01/10→					
2.7 Xdi	120	03/06→					
2.7 Xdi	121	05/05→					
2.3 4x4	110	11/06→	➔			13.0460-5623.2 605623	MAN 23673 15,9 + WK
<b>SSANGYONG - MUSSO (FJ) 01/93→09/07</b>							
 <b>Bremsscheibe</b>							
2.0	93	10/96→05/05	➔	01/99→		24.0110-0352.1 410352	Ø 299 10,4 8,5
2.3	103	10/96→11/02					
2.3 D	59	10/95→04/99					
3.2	162	06/96→09/04					
2.3	110	04/03→08/06	➔	→ 11/05		24.0110-0352.1 410352	Ø 299 10,4 8,5
2.9 TD	88	04/98→09/07	➔	01/99→ 11/05		24.0110-0352.1 410352	Ø 299 10,4 8,5
<b>SSANGYONG - MUSSO SPORTS 08/04→</b>							
 <b>Bremsscheibe</b>							
2.9 D	88	08/04→09/07	➔	→ 11/05		24.0110-0352.1 410352	Ø 299 10,4 8,5
2.9 D 4x4	88	08/04→					
<b>SSANGYONG - REXTON (GAB_) 04/02→</b>							
 <b>Bremsbelagsatz, Scheibenbremse</b>							
2.3 RX230 4x4	110	05/02→	➔	→ 08/06		13.0460-5623.2 605623	MAN 23673 15,9 + WK
2.9 TD	88	04/02→					
2.7 D 4x4	137	05/06→	➔			13.0460-5623.2 605623	MAN 23673 15,9 + WK
2.7 Xdi	121	03/05→08/06					
↓							











	kw					! #		
<b>SSANGYONG - REXTON (GAB_) 04/02→</b>								
 <b>Bremsbelagsatz, Scheibenbremse</b>								
2.7 Xdi Turbo 4x4	132	03/11→	➡				<b>13.0460-5623.2 605623</b>	MAN 23673 15,9 + WK
2.7 Xdi	120	08/04→	➡	→ 08/06			<b>13.0460-5623.2 605623</b>	MAN 23673 15,9 + WK
			➡	09/06→			<b>13.0460-5623.2 605623</b>	MAN 23673 15,9 + WK
2.7 Xdi 4x4	118	03/11→	➡	nicht für Multi-link Achse			<b>13.0460-5623.2 605623</b>	MAN 23673 15,9 + WK
2.7 Xdi 4x4	121	03/06→05/12	➡	01/07→; nicht für Multi-link Achse			<b>13.0460-5623.2 605623</b>	MAN 23673 15,9 + WK
3.2 4x4	162	04/02→	➡	09/06→; + ABS			<b>13.0460-5623.2 605623</b>	MAN 23673 15,9 + WK
			➡	→ 08/06			<b>13.0460-5623.2 605623</b>	MAN 23673 15,9 + WK
 <b>Bremsscheibe</b>								
2.3 RX230 4x4	110	05/02→	➡	→ 02/06			<b>24.0110-0352.1 410352</b>	Ø 299 10,4 8,5
2.7 Xdi	120	08/04→						
2.7 Xdi	121	03/05→08/06						
2.9 TD	88	04/02→						
3.2 4x4	162	04/02→						
<b>SSANGYONG - REXTON W 07/12→</b>								
 <b>Bremsbelagsatz, Scheibenbremse</b>								
2.0 Xdi	114	07/12→	➡	nicht für Multi-link Achse			<b>13.0460-5623.2 605623</b>	MAN 23673 15,9 + WK
2.0 Xdi Allrad	114	07/12→						
2.2 Xdi	131	07/15→						
2.2 Xdi Allrad	131	07/15→						
2.7 Xdi Allrad	121	07/12→						
2.7 Xdi Allrad	137	10/12→	➡	02/14→; nicht für Multi-link Achse			<b>13.0460-5623.2 605623</b>	MAN 23673 15,9 + WK
<b>SSANGYONG - RODIUS 05/05→</b>								
 <b>Bremsbelagsatz, Scheibenbremse</b>								
2.7 Xdi	120	05/05→	⬅				<b>13.0460-5622.2 605622</b>	MAN 23726 16,5 + WK + Zub
2.7 Xdi	121	05/05→						
2.7 Xdi 4WD	120	05/05→						
2.7 Xdi 4WD	121	05/05→						
3.2	162	05/05→						
3.2 4WD	162	07/07→						
<b>SSANGYONG - RODIUS II 07/13→</b>								
 <b>Bremsbelagsatz, Scheibenbremse</b>								
2.0 Xdi	114	07/13→	⬅				<b>13.0460-5622.2 605622</b>	MAN 23726 16,5 + WK + Zub
2.0 Xdi 4WD	114	07/13→						
2.2 Xdi	131	07/15→						
2.2 Xdi 4WD	131	07/15→						
3.2 4WD	162	07/13→						
<b>SUBARU - BRZ 06/12→</b>								
 <b>Bremsbelagsatz, Scheibenbremse</b>								
2.0	147	06/12→	⬅	Low-Type			<b>13.0460-5787.2 605787</b>	TOK 23865 16,9 + WK + Zub
 <b>Bremsscheibe</b>								
2.0	147	06/12→	⬅	Low-Type			<b>24.0124-0145.1 424145</b>	Ø 277 24 22 V
			⬅	High-Type			<b>24.0124-0196.1 424196</b>	Ø 293,5 24 22 V
			➡	Low-Type			<b>24.0110-0366.1 410366</b>	Ø 286 10 8,5
<b>SUBARU - FORESTER (SF_) 03/97→09/02</b>								
 <b>Bremsbelagsatz, Scheibenbremse</b>								
2.0 AWD (SF5)	90	08/97→09/02	⬅				<b>13.0460-5851.2 605851</b>	AKE 21915 17,2 + WK
2.0 AWD (SF5)	92	06/98→09/02	⬅	07/98→			<b>13.0460-5851.2 605851</b>	AKE 21915 17,2 + WK
2.0 S Turbo AWD (SF5)	125	06/98→04/01						
2.0 S Turbo AWD (SF5)	130	04/01→09/02	⬅	09/02→			<b>13.0460-5787.2 605787</b>	TOK 23865 16,9 + WK + Zub
 <b>Bremsscheibe</b>								
2.0 AWD (SF5)	90	08/97→09/02	⬅				<b>24.0124-0145.1 424145</b>	Ø 277 24 22 V
2.0 AWD (SF5)	92	06/98→09/02	⬅	07/98→			<b>24.0124-0145.1 424145</b>	Ø 277 24 22 V
2.0 S Turbo AWD (SF5)	125	06/98→04/01	⬅	07/98→			<b>24.0124-0145.1 424145</b>	Ø 277 24 22 V
			➡	07/98→			<b>24.0110-0237.1 410237</b>	Ø 266 10 8,5
2.0 S Turbo AWD (SF5)	130	04/01→09/02	⬅	09/02→			<b>24.0124-0196.1 424196</b>	Ø 293,5 24 22 V
			➡	09/02→			<b>24.0110-0237.1 410237</b>	Ø 266 10 8,5









	kw			 	! #		
<b>SUBARU - FORESTER (SG_) 06/02→12/12</b>							
 <b>Bremsbelagsatz, Scheibenbremse</b>							
2.0 AWD	92	06/02→05/05	←	09/02→		13.0460-5787.2 605787	TOK 23865 16,9 + WK + Zub
2.0 S Turbo AWD	130	09/02→05/05	←			13.0460-5787.2 605787	TOK 23865 16,9 + WK + Zub
			→	06/03→		13.0460-5628.2 605628	24331 13,8 + WK
2.0 X AWD	116	06/05→05/08	←			13.0460-5787.2 605787	TOK 23865 16,9 + WK + Zub
			→			13.0460-5628.2 605628	24331 13,8 + WK
2.5 AWD (SG9)	155	12/03→05/05	←				
2.5 Prodrive Performance Pack AWD	188	05/05→09/05	→				
2.5 RX Nato AWD (SG9)	115	11/02→12/08	←				
2.5 AWD	171	01/04→12/09	←	07/05→ 05/08		13.0460-5787.2 605787	TOK 23865 16,9 + WK + Zub
			→	07/05→ 05/08		13.0460-5628.2 605628	24331 13,8 + WK
2.5 AWD (SG9)	121	06/05→05/08	←	07/05→		13.0460-5787.2 605787	TOK 23865 16,9 + WK + Zub
			→	07/05→		13.0460-5628.2 605628	24331 13,8 + WK
2.5 XT AWD (SG9)	169	06/05→05/08	←	09/05→		13.0460-5787.2 605787	TOK 23865 16,9 + WK + Zub
			→	09/05→		13.0460-5628.2 605628	24331 13,8 + WK
 <b>Bremsscheibe</b>							
2.0 AWD	92	06/02→05/05	←	09/02→		24.0124-0145.1 424145	Ø 277 24 22 V
2.0 S Turbo AWD	130	09/02→05/05	←			24.0124-0196.1 424196	Ø 293,5 24 22 V
			→			24.0110-0237.1 410237	Ø 266 10 8,5
2.5 AWD (SG9)	155	12/03→05/05	←				
2.5 Prodrive Performance Pack AWD	188	05/05→09/05	→				
2.5 RX Nato AWD (SG9)	115	11/02→12/08	←				
2.0 X AWD	116	06/05→05/08	←			24.0124-0145.1 424145	Ø 277 24 22 V
			→			24.0110-0237.1 410237	Ø 266 10 8,5
2.5 AWD	171	01/04→12/09	←	07/05→ 05/08		24.0124-0196.1 424196	Ø 293,5 24 22 V
			→	07/05→ 05/08		24.0110-0237.1 410237	Ø 266 10 8,5
2.5 AWD (SG9)	121	06/05→05/08	←	07/05→		24.0124-0196.1 424196	Ø 293,5 24 22 V
			→	07/05→		24.0110-0237.1 410237	Ø 266 10 8,5
2.5 XT AWD (SG9)	169	06/05→05/08	←	09/05→		24.0124-0196.1 424196	Ø 293,5 24 22 V
			→	09/05→		24.0110-0237.1 410237	Ø 266 10 8,5
<b>SUBARU - FORESTER (SH_) 12/07→</b>							
 <b>Bremsbelagsatz, Scheibenbremse</b>							
2.0 AWD	110	01/08→09/13	←	01/10→ 02/13		13.0460-5787.2 605787	TOK 23865 16,9 + WK + Zub
2.0 AWD	110	01/10→	←	04/10→ 02/13		13.0460-5787.2 605787	TOK 23865 16,9 + WK + Zub
			→				
2.0 D AWD (SHH)	108	09/08→09/13	←				
2.5	126	01/08→	←	→ 02/13		13.0460-5787.2 605787	TOK 23865 16,9 + WK + Zub
2.5 AWD (SH9)	126	01/09→09/13	←				
2.5 AWD	126	03/11→09/13	←			13.0460-5787.2 605787	TOK 23865 16,9 + WK + Zub
 <b>Bremsscheibe</b>							
2.0 AWD	110	01/08→09/13	←	→ 02/13		24.0124-0145.1 424145	Ø 277 24 22 V
2.0 AWD	110	01/10→	←			24.0110-0366.1 410366	Ø 286 10 8,5
			→	→ 02/13		24.0110-0366.1 410366	Ø 286 10 8,5
2.0 D AWD (SHH)	108	09/08→09/13	←	→ 02/13		24.0124-0196.1 424196	Ø 293,5 24 22 V
2.5	126	01/08→	←	→ 02/13		24.0110-0366.1 410366	Ø 286 10 8,5
2.5 AWD (SH9)	126	01/09→09/13	←				
2.5 AWD (SH9)	169	06/08→09/13	←				
2.5 AWD	126	03/11→09/13	←			24.0124-0196.1 424196	Ø 293,5 24 22 V
			→			24.0110-0366.1 410366	Ø 286 10 8,5
<b>SUBARU - FORESTER (SJ_) 11/12→</b>							
 <b>Bremsbelagsatz, Scheibenbremse</b>							
2.0 D AWD	108	03/13→	←	Baumuster: IC+HL+ISC		13.0460-5787.2 605787	TOK 23865 16,9 + WK + Zub
			←	Baumuster: XTC+DS,XTC+DL		13.0460-5797.2 605797	AKE 24222 16,9 + WK + Zub
2.0 i AWD	110	03/13→	←			13.0460-5787.2 605787	TOK 23865 16,9 + WK + Zub
2.0 XT AWD (SJG)	177	03/13→	←			13.0460-5797.2 605797	AKE 24222 16,9 + WK + Zub
 <b>Bremsscheibe</b>							
2.0 D AWD	108	03/13→	←	für Fahrzeuge ohne PCS (Pre-Crash Safety System)		24.0124-0196.1 424196	Ø 293,5 24 22 V
			←	für Fahrzeuge mit PCS (Pre-Crash Safety System)		24.0130-0204.1 430204	Ø 316 30 28 V
↓							













	kw			 	! #		
<b>SUBARU - FORESTER (SJ_) 11/12→</b>							
 <b>Bremsscheibe</b>							
2.0 D AWD	108	03/13→	→			24.0110-0384.1 410384 24.0118-0160.1 418160	Ø 273,8 10 8,5 Ø 278 18 16 V
2.0 i AWD	110	03/13→	←			24.0124-0196.1 424196	Ø 293,5 24 22 V
			→			24.0110-0384.1 410384	Ø 273,8 10 8,5
2.0 XT AWD (SJG)	177	03/13→	←			24.0130-0204.1 430204	Ø 316 30 28 V
			→			24.0118-0160.1 418160	Ø 278 18 16 V
<b>SUBARU - IMPREZA Coupe (GFC) 01/93→12/00</b>							
 <b>Bremsbelagsatz, Scheibenbremse</b>							
1.6	66	12/96→12/00	→			13.0460-5850.2 605850	SUM 21703 15,0 + WK
1.6 AWD	66	12/96→12/00	←			13.0460-5978.2 605978	21495 17,0 + WK
			→			13.0460-5850.2 605850	SUM 21703 15,0 + WK
2.0 AWD	85	12/95→12/00	←	09/96→		13.0460-5895.2 605895	23780 16,7 + WK + Zub
			←	→ 08/96		13.0460-5978.2 605978	21495 17,0 + WK
			→			13.0460-5850.2 605850	SUM 21703 15,0 + WK
2.0 AWD	92	03/99→12/00	←			13.0460-5895.2 605895	23780 16,7 + WK + Zub
			←			13.0460-5978.2 605978	21495 17,0 + WK
			→			13.0460-5850.2 605850	SUM 21703 15,0 + WK
2.0 Turbo AWD	155	12/96→12/00	←			13.0460-5851.2 605851	AKE 21915 17,2 + WK
			→			13.0460-5850.2 605850	SUM 21703 15,0 + WK
<b>Zubehörsatz, Scheibenbremsbelag</b>							
1.6	66	12/96→12/00	→			13.0460-0143.2 610143	
1.6 AWD	66	12/96→12/00					
2.0 AWD	85	12/95→12/00					
2.0 AWD	92	03/99→12/00					
2.0 Turbo AWD	155	12/96→12/00					
 <b>Bremsscheibe</b>							
1.6	66	12/96→12/00	←	- ABS		24.0118-0125.1 418125	Ø 242 18 16 V
1.6 AWD	66	12/96→12/00	←	+ ABS		24.0124-0141.1 424141	Ø 260 24 22 V
2.0 AWD	92	03/99→12/00	→			24.0110-0237.1 410237	Ø 266 10 8,5
2.0 AWD	85	12/95→12/00	←	→ 08/96; - ABS		24.0118-0125.1 418125	Ø 242 18 16 V
			←	09/96→; + ABS		24.0124-0141.1 424141	Ø 260 24 22 V
			→			24.0110-0237.1 410237	Ø 266 10 8,5
2.0 Turbo AWD	155	12/96→12/00	→	→ 07/98		24.0110-0237.1 410237	Ø 266 10 8,5
<b>SUBARU - IMPREZA Schrägheck (GP) 10/11→</b>							
 <b>Bremsbelagsatz, Scheibenbremse</b>							
1.6 i (GP2)	84	06/12→09/16	←			13.0460-5787.2 605787	TOK 23865 16,9 + WK + Zub
1.6 i AWD	84	06/12→					
1.6 i AWD (GP3)	85	12/11→10/16	←	06/12→		13.0460-5787.2 605787	TOK 23865 16,9 + WK + Zub
 <b>Bremsscheibe</b>							
1.6 i (GP2)	84	06/12→09/16	←			24.0124-0145.1 424145	Ø 277 24 22 V
1.6 i AWD	84	06/12→	→				
1.6 i AWD (GP3)	85	12/11→10/16	→			24.0110-0384.1 410384	Ø 273,8 10 8,5
2.0 AWD (GP7)	110	01/12→	←			24.0124-0196.1 424196	Ø 293,5 24 22 V
			→			24.0110-0384.1 410384	Ø 273,8 10 8,5
<b>SUBARU - IMPREZA Schrägheck (GR, GH, G3) 03/07→05/14</b>							
 <b>Bremsbelagsatz, Scheibenbremse</b>							
1.5 AWD	79	02/08→03/12	←	→ 12/11		13.0460-5787.2 605787	TOK 23865 16,9 + WK + Zub
1.5 F	79	02/08→03/12					
2.0 D AWD	110	01/09→03/12					
2.0 D AWD	80	01/11→12/11	←			13.0460-5787.2 605787	TOK 23865 16,9 + WK + Zub
2.0 R AWD (GH7)	110	01/08→03/12	←	02/08→ 12/11		13.0460-5787.2 605787	TOK 23865 16,9 + WK + Zub
 <b>Bremsscheibe</b>							
1.5 AWD	79	02/08→03/12	←	→ 12/11; - ESP		24.0124-0141.1 424141	Ø 260 24 22 V
1.5 F	79	02/08→03/12	←	→ 12/11; + ESP		24.0124-0145.1 424145	Ø 277 24 22 V
↓							















	kW					! #		
<b>SUBARU - IMPREZA Schrägheck (GR, GH, G3) 03/07→05/14</b>								
<b>Bremsscheibe</b>								
2.0 D AWD	80	01/11→12/11	←				24.0124-0196.1 424196	Ø 293,5 24 22 V
			→				24.0110-0366.1 410366	Ø 286 10 8,5
2.0 D AWD	110	01/09→03/12	←	→ 12/11			24.0124-0196.1 424196	Ø 293,5 24 22 V
			→	→ 12/11			24.0110-0366.1 410366	Ø 286 10 8,5
2.0 R AWD (GH7)	110	01/08→03/12	←	02/08→ 12/11			24.0124-0145.1 424145	Ø 277 24 22 V
			→	02/08→ 12/11			24.0110-0366.1 410366	Ø 286 10 8,5
2.5 AWD (GHE)	169	01/08→09/11	←	02/08→			24.0124-0196.1 424196	Ø 293,5 24 22 V
			→	02/08→			24.0110-0366.1 410366	Ø 286 10 8,5
2.5 STI CS400 AWD	294	04/10→08/13	←	→ 12/11			24.0130-0203.1 430203	Ø 326 30 28 V
2.5 WRX S AWD	188	02/09→12/10	←				24.0130-0203.1 430203	Ø 326 30 28 V
2.5 WRX SE AWD	195	09/08→09/11						
2.5 WRX STI 330S AWD	243	05/09→12/10						
2.5 WRX STI AWD (GRF)	221	01/08→08/13	←	02/08→ 12/11			24.0130-0203.1 430203	Ø 326 30 28 V
<b>SUBARU - IMPREZA Station Wagon (GF) 08/92→12/00</b>								
<b>Bremsbelagsatz, Scheibenbremse</b>								
1.6	66	01/93→08/98	←	09/96→			13.0460-5895.2 605895	23780 16,7 + WK + Zub
2.0 i AWD (GF8)	85	12/95→12/00	←	→ 08/96			13.0460-5978.2 605978	21495 17,0 + WK
			→				13.0460-5850.2 605850	SUM 21703 15,0 + WK
1.6 i (GF3)	70	06/98→12/00	←				13.0460-5895.2 605895	23780 16,7 + WK + Zub
1.6 i AWD	70	06/98→12/00	→				13.0460-5850.2 605850	SUM 21703 15,0 + WK
2.0 i	92	09/98→09/00						
2.0 i 16V AWD	92	06/98→12/00						
1.6 i AWD	66	08/92→12/00	←	09/96→			13.0460-5895.2 605895	23780 16,7 + WK + Zub
			←	01/93→ 08/96			13.0460-5978.2 605978	21495 17,0 + WK
			→	01/93→			13.0460-5850.2 605850	SUM 21703 15,0 + WK
1.8 i (GF5)	76	11/95→06/96	←				13.0460-5978.2 605978	21495 17,0 + WK
			→				13.0460-5850.2 605850	SUM 21703 15,0 + WK
1.8 i AWD (GF6)	76	08/92→12/00	←	01/93→ 06/96			13.0460-5978.2 605978	21495 17,0 + WK
			→	01/93→ 06/96			13.0460-5850.2 605850	SUM 21703 15,0 + WK
2.0 i Turbo AWD (GF8)	155	03/94→12/00	→				13.0460-5850.2 605850	SUM 21703 15,0 + WK
2.0 Turbo GT AWD (GF8)	160	06/98→12/00	←				13.0460-5640.2 605640	21854 15,0 + WK
							13.0460-5851.2 605851	AKE 21915 17,2 + WK
<b>Zubehörsatz, Scheibenbremsbelag</b>								
1.6	66	01/93→08/98	→				13.0460-0143.2 610143	
1.6 i (GF3)	70	06/98→12/00						
1.6 i AWD	70	06/98→12/00						
1.8 i (GF5)	76	11/95→06/96						
2.0 i	92	09/98→09/00						
2.0 i 16V AWD	92	06/98→12/00						
2.0 i AWD (GF8)	85	12/95→12/00						
2.0 i Turbo AWD (GF8)	155	03/94→12/00						
1.6 i AWD	66	08/92→12/00	→	01/93→			13.0460-0143.2 610143	
1.8 i AWD (GF6)	76	08/92→12/00	→	01/93→ 06/96			13.0460-0143.2 610143	
<b>Bremsscheibe</b>								
1.6	66	01/93→08/98	←	- ABS			24.0118-0125.1 418125	Ø 242 18 16 V
1.6 i (GF3)	70	06/98→12/00	←	+ ABS			24.0124-0141.1 424141	Ø 260 24 22 V
1.6 i AWD	70	06/98→12/00						
1.8 i (GF5)	76	11/95→06/96	→				24.0110-0237.1 410237	Ø 266 10 8,5
1.6 i AWD	66	08/92→12/00	←	01/93→; - ABS			24.0118-0125.1 418125	Ø 242 18 16 V
			←	01/93→; + ABS			24.0124-0141.1 424141	Ø 260 24 22 V
			→	01/93→			24.0110-0237.1 410237	Ø 266 10 8,5
1.8 i AWD (GF6)	76	08/92→12/00	←	01/93→ 06/96; - ABS			24.0118-0125.1 418125	Ø 242 18 16 V
			←	01/93→ 06/96; + ABS			24.0124-0141.1 424141	Ø 260 24 22 V
			→	01/93→ 06/96			24.0110-0237.1 410237	Ø 266 10 8,5
2.0 i	92	09/98→09/00	←	+ ABS			24.0124-0141.1 424141	Ø 260 24 22 V
2.0 i 16V AWD	92	06/98→12/00	→				24.0110-0237.1 410237	Ø 266 10 8,5
2.0 i AWD (GF8)	85	12/95→12/00	←	→ 08/96; - ABS			24.0118-0125.1 418125	Ø 242 18 16 V
↓								















	kW			 	! #		
<b>SUBARU - IMPREZA Station Wagon (GF) 08/92→12/00</b>							
 <b>Bremsscheibe</b>							
2.0 i AWD (GF8)	85	12/95→12/00	←	09/96→; + ABS		24.0124-0141.1 424141	Ø 260 24 22 V
			→			24.0110-0237.1 410237	Ø 266 10 8,5
2.0 i Turbo AWD (GF8)	155	03/94→12/00	←	→ 07/96		24.0124-0145.1 424145	Ø 277 24 22 V
			→			24.0110-0237.1 410237	Ø 266 10 8,5
2.0 Turbo GT AWD (GF8)	160	06/98→12/00	←			24.0124-0196.1 424196	Ø 293,5 24 22 V
<b>SUBARU - IMPREZA Station Wagon (GG) 10/00→12/08</b>							
 <b>Bremsbelagsatz, Scheibenbremse</b>							
1.5 AWD	77	05/06→03/07	←			13.0460-5793.2 605793	AKE 24372 17,3 + WK + Zub
1.6 AWD	70	12/00→09/06	←	07/02→		13.0460-5793.2 605793	AKE 24372 17,3 + WK + Zub
			←	→ 09/05; + EU		13.0460-5851.2 605851	AKE 21915 17,2 + WK
			←	→ 09/05; Europa		13.0460-5895.2 605895	23780 16,7 + WK + Zub
2.0 AWD	92	12/00→12/07	←	11/02→ 09/05		13.0460-5787.2 605787	TOK 23865 16,9 + WK + Zub
			←	→ 10/02		13.0460-5851.2 605851	AKE 21915 17,2 + WK
			→	11/02→ 09/05		13.0460-5628.2 605628	24331 13,8 + WK
2.0 i R AWD (GG9)	118	09/05→06/07	←	10/05→		13.0460-5787.2 605787	TOK 23865 16,9 + WK + Zub
			→	10/05→		13.0460-5628.2 605628	24331 13,8 + WK
2.0 Turbo AWD (GGA)	160	12/00→12/05	←	→ 09/05		13.0460-5640.2 605640	21854 15,0 + WK
2.0 WRX Turbo AWD	165	12/02→09/06	←				
2.0 WRX STi AWD	206	10/05→12/08	←	→ 08/07		13.0460-4973.2 604973	BRE 23092 16,0 + WK
			→	→ 08/07		13.0460-4974.2 604974	BRE 21580 14,6 + WK
2.5 AWD	221	10/05→03/07	←			13.0460-4973.2 604973	BRE 23092 16,0 + WK
			→			13.0460-4974.2 604974	BRE 21580 14,6 + WK
2.5 GB270 AWD	198	07/07→12/07	←			13.0460-5640.2 605640	21854 15,0 + WK
2.5 WRX AWD (GGG)	169	09/05→12/08	←	10/05→ 08/07		13.0460-5640.2 605640	21854 15,0 + WK
 <b>Bremsscheibe</b>							
1.5 AWD	77	05/06→03/07	←			24.0124-0141.1 424141	Ø 260 24 22 V
1.6 AWD	70	12/00→09/06	←	→ 09/05		24.0124-0141.1 424141	Ø 260 24 22 V
2.0 AWD	92	12/00→12/07	←	→ 09/05		24.0124-0145.1 424145	Ø 277 24 22 V
			→	→ 09/05		24.0110-0237.1 410237	Ø 266 10 8,5
2.0 i R AWD (GG9)	118	09/05→06/07	←	10/05→		24.0124-0145.1 424145	Ø 277 24 22 V
			→	10/05→		24.0110-0237.1 410237	Ø 266 10 8,5
2.0 Turbo AWD (GGA)	160	12/00→12/05	←	→ 09/05		24.0124-0196.1 424196	Ø 293,5 24 22 V
2.0 WRX Turbo AWD	165	12/02→09/06	→	→ 09/05		24.0118-0725.1 418725	Ø 290 18 16 V
2.0 WRX STi AWD	206	10/05→12/08	←	→ 08/07		24.0130-0203.1 430203	Ø 326 30 28 V
2.5 AWD	221	10/05→03/07	←			24.0130-0203.1 430203	Ø 326 30 28 V
2.5 GB270 AWD	198	07/07→12/07	←			24.0124-0196.1 424196	Ø 293,5 24 22 V
			→			24.0118-0725.1 418725	Ø 290 18 16 V
2.5 WRX AWD (GGG)	169	09/05→12/08	←	10/05→ 08/07		24.0124-0196.1 424196	Ø 293,5 24 22 V
			→	10/05→ 08/07		24.0118-0725.1 418725	Ø 290 18 16 V
<b>SUBARU - IMPREZA Stufenheck (GC) 08/92→09/01</b>							
 <b>Bremsbelagsatz, Scheibenbremse</b>							
1.6 i (GC3)	66	08/92→12/00	←	01/93→ 08/96		13.0460-5978.2 605978	21495 17,0 + WK
			→	01/93→		13.0460-5850.2 605850	SUM 21703 15,0 + WK
1.6 i (GC3)	70	06/98→12/00	→			13.0460-5850.2 605850	SUM 21703 15,0 + WK
1.6 i AWD	66	08/92→12/00	←	01/93→		13.0460-5978.2 605978	21495 17,0 + WK
			→	01/93→		13.0460-5850.2 605850	SUM 21703 15,0 + WK
1.6 i AWD	70	06/98→12/00	←			13.0460-5978.2 605978	21495 17,0 + WK
			→			13.0460-5850.2 605850	SUM 21703 15,0 + WK
1.8 i AWD (GC6)	76	08/92→12/00	←	01/93→ 06/96		13.0460-5978.2 605978	21495 17,0 + WK
			→	01/93→ 06/96		13.0460-5850.2 605850	SUM 21703 15,0 + WK
2.0 AWD (GC8)	206	09/98→09/00	←			13.0460-5895.2 605895	23780 16,7 + WK + Zub
2.0 i AWD (GC8)	92	06/98→12/00					















	kw				! #		
<b>SUBARU - IMPREZA Stufenheck (GC) 08/92→09/01</b>							
<b> Bremsbelagsatz, Scheibenbremse</b>							
2.0 AWD (GC8)	206	09/98→09/00	➡			13.0460-5850.2 605850	SUM 21703 15,0 + WK
2.0 i AWD (GC8)	92	06/98→12/00	➡				
2.0 i (GC7)	85	07/96→08/98	⬅	08/96→		13.0460-5978.2 605978	21495 17,0 + WK
			➡	08/96→		13.0460-5850.2 605850	SUM 21703 15,0 + WK
2.0 i AWD (GC7)	85	10/95→12/00	⬅	09/96→		13.0460-5895.2 605895	23780 16,7 + WK + Zub
			⬅	→ 08/96		13.0460-5978.2 605978	21495 17,0 + WK
			➡			13.0460-5850.2 605850	SUM 21703 15,0 + WK
2.0 Turbo GT AWD (GC8)	155	03/94→12/00	⬅	08/96→		13.0460-5851.2 605851	AKE 21915 17,2 + WK
			➡			13.0460-5850.2 605850	SUM 21703 15,0 + WK
2.0 Turbo GT AWD (GC8)	160	06/98→12/00	⬅			13.0460-5640.2 605640	21854 15,0 + WK
<b>Zubehörsatz, Scheibenbremsbelag</b>							
1.6 i (GC3)	66	08/92→12/00	➡	01/93→		13.0460-0143.2 610143	
1.6 i AWD	66	08/92→12/00	➡				
1.6 i (GC3)	70	06/98→12/00	➡			13.0460-0143.2 610143	
1.6 i AWD	70	06/98→12/00	➡				
2.0 AWD (GC8)	206	09/98→09/00	➡				
2.0 i AWD (GC7)	85	10/95→12/00	➡				
2.0 i AWD (GC8)	92	06/98→12/00	➡				
2.0 Turbo GT AWD (GC8)	155	03/94→12/00	➡				
1.8 i AWD (GC6)	76	08/92→12/00	➡	01/93→ 06/96		13.0460-0143.2 610143	
2.0 i (GC7)	85	07/96→08/98	➡	08/96→		13.0460-0143.2 610143	
<b> Bremsscheibe</b>							
1.6 i (GC3)	66	08/92→12/00	⬅	01/93→; - ABS		24.0118-0125.1 418125	Ø 242 18 16 V
1.6 i AWD	66	08/92→12/00	⬅	01/93→; + ABS		24.0124-0141.1 424141	Ø 260 24 22 V
			➡	01/93→		24.0110-0237.1 410237	Ø 266 10 8,5
1.6 i (GC3)	70	06/98→12/00	⬅	- ABS		24.0118-0125.1 418125	Ø 242 18 16 V
1.6 i AWD	70	06/98→12/00	⬅	+ ABS		24.0124-0141.1 424141	Ø 260 24 22 V
			➡			24.0110-0237.1 410237	Ø 266 10 8,5
1.8 i AWD (GC6)	76	08/92→12/00	⬅	01/93→ 06/96; - ABS		24.0118-0125.1 418125	Ø 242 18 16 V
			⬅	01/93→ 06/96; + ABS		24.0124-0141.1 424141	Ø 260 24 22 V
			➡	01/93→ 06/96		24.0110-0237.1 410237	Ø 266 10 8,5
2.0 AWD (GC8)	206	09/98→09/00	⬅	+ ABS		24.0124-0141.1 424141	Ø 260 24 22 V
2.0 i AWD (GC8)	92	06/98→12/00	➡			24.0110-0237.1 410237	Ø 266 10 8,5
2.0 i (GC7)	85	07/96→08/98	⬅	08/96→; + ABS		24.0124-0141.1 424141	Ø 260 24 22 V
			➡	08/96→		24.0110-0237.1 410237	Ø 266 10 8,5
2.0 i AWD (GC7)	85	10/95→12/00	⬅	→ 08/96; - ABS		24.0118-0125.1 418125	Ø 242 18 16 V
			⬅	09/96→; + ABS		24.0124-0141.1 424141	Ø 260 24 22 V
			➡			24.0110-0237.1 410237	Ø 266 10 8,5
2.0 Turbo GT AWD (GC8)	155	03/94→12/00	⬅	→ 07/96		24.0124-0145.1 424145	Ø 277 24 22 V
			➡	→ 07/98		24.0110-0237.1 410237	Ø 266 10 8,5
2.0 Turbo GT AWD (GC8)	160	06/98→12/00	⬅			24.0124-0196.1 424196	Ø 293,5 24 22 V
<b>SUBARU - IMPREZA Stufenheck (GD) 09/99→06/09</b>							
<b> Bremsbelagsatz, Scheibenbremse</b>							
1.5	74	06/01→09/05	⬅			13.0460-5793.2 605793	AKE 24372 17,3 + WK + Zub
1.5	81	10/05→03/07					
1.5 AWD	77	05/06→03/07					
1.6	70	06/01→09/06	⬅	→ 09/05		13.0460-5851.2 605851	AKE 21915 17,2 + WK
1.6 AWD	70	12/00→06/09				13.0460-5895.2 605895	23780 16,7 + WK + Zub
2.0 i AWD (GD9)	92	12/00→06/09	⬅	11/02→ 09/05		13.0460-5787.2 605787	TOK 23865 16,9 + WK + Zub
			⬅	→ 10/02		13.0460-5851.2 605851	AKE 21915 17,2 + WK
2.0 i R AWD (GD9)	118	09/05→03/07	⬅	10/05→		13.0460-5787.2 605787	TOK 23865 16,9 + WK + Zub
			➡	10/05→		13.0460-5628.2 605628	24331 13,8 + WK
2.0 i WRX AWD (GDA)	168	12/02→09/05	⬅			13.0460-5640.2 605640	21854 15,0 + WK
2.0 WRX STi AWD (GDB)	195	11/01→07/05	⬅	11/02→		13.0460-4973.2 604973	BRE 23092 16,0 + WK
↓							

















	kw			 	! #		
<b>SUBARU - IMPREZA Stufenheck (GD) 09/99→06/09</b>							
 <b>Bremsbelagsatz, Scheibenbremse</b>							
2.0 WRX Turbo AWD 2.0 WRX Turbo AWD (GDA)	165 160	12/02→03/07 12/00→12/05	←	→ 09/05		13.0460-5640.2 605640	21854 15,0 + WK
2.5 AWD	130	03/01→09/05	←			13.0460-5851.2 605851	AKE 21915 17,2 + WK
2.5 AWD	221	10/05→03/07	←			13.0460-4973.2 604973	BRE 23092 16,0 + WK
			→			13.0460-4974.2 604974	BRE 21580 14,6 + WK
2.5 i WRX AWD (GDG) 2.5 WRX STi AWD (GDF)	169 206	09/05→12/08 09/05→12/07	←	10/05→ 08/07		13.0460-5640.2 605640	21854 15,0 + WK
 <b>Bremsscheibe</b>							
1.5 1.5 1.5 AWD	74 81 77	06/01→09/05 10/05→03/07 05/06→03/07	←			24.0124-0141.1 424141	Ø 260 24 22 V
1.6 1.6 AWD	70 70	06/01→09/06 12/00→06/09	←	→ 09/05		24.0124-0141.1 424141	Ø 260 24 22 V
2.0 AWD 2.0 i WRX AWD (GDA)	184 168	10/05→03/07 12/02→09/05	←			24.0124-0196.1 424196	Ø 293,5 24 22 V
			→			24.0118-0725.1 418725	Ø 290 18 16 V
2.0 i AWD (GD9)	92	12/00→06/09	←	→ 09/05		24.0124-0145.1 424145	Ø 277 24 22 V
			→	→ 09/05		24.0110-0237.1 410237	Ø 266 10 8,5
2.0 i R AWD (GD9)	118	09/05→03/07	←	10/05→		24.0124-0145.1 424145	Ø 277 24 22 V
			→	10/05→		24.0110-0237.1 410237	Ø 266 10 8,5
2.0 WRX Turbo AWD 2.0 WRX Turbo AWD (GDA)	165 160	12/02→03/07 12/00→12/05	←	→ 09/05		24.0124-0196.1 424196	Ø 293,5 24 22 V
			→	→ 09/05		24.0118-0725.1 418725	Ø 290 18 16 V
2.5 AWD	130	03/01→09/05	←			24.0124-0145.1 424145	Ø 277 24 22 V
			→			24.0110-0237.1 410237	Ø 266 10 8,5
2.5 AWD	221	10/05→03/07	←			24.0130-0203.1 430203	Ø 326 30 28 V
2.5 i WRX AWD (GDG) 2.5 WRX STi AWD (GDF)	169 206	09/05→12/08 09/05→12/07	←	10/05→ 08/07		24.0124-0196.1 424196	Ø 293,5 24 22 V
			→	10/05→ 08/07		24.0118-0725.1 418725	Ø 290 18 16 V
<b>SUBARU - IMPREZA Stufenheck (GJ) 07/11→</b>							
 <b>Bremsbelagsatz, Scheibenbremse</b>							
1.6 AWD	85	01/15→	←			13.0460-5787.2 605787	TOK 23865 16,9 + WK + Zub
 <b>Bremsscheibe</b>							
1.6 AWD	85	01/15→	←			24.0124-0145.1 424145	Ø 277 24 22 V
			→			24.0110-0384.1 410384	Ø 273,8 10 8,5
<b>SUBARU - IMPREZA Stufenheck (GR) 01/07→</b>							
 <b>Bremsbelagsatz, Scheibenbremse</b>							
1.5 1.5 AWD 2.0 i AWD	79 79 110	02/08→ 02/08→ 01/11→	←	→ 12/11		13.0460-5787.2 605787	TOK 23865 16,9 + WK + Zub
2.5 AWD 2.5 AWD	199 200	07/07→ 01/07→12/07	←			13.0460-5640.2 605640	21854 15,0 + WK
2.5 AWD	235	02/07→12/07	←			13.0460-4973.2 604973	BRE 23092 16,0 + WK
			→			13.0460-4974.2 604974	BRE 21580 14,6 + WK
 <b>Bremsscheibe</b>							
1.5 1.5 AWD	79 79	02/08→ 02/08→	←	→ 12/11; - ESP		24.0124-0141.1 424141	Ø 260 24 22 V
			←	→ 12/11; + ESP		24.0124-0145.1 424145	Ø 277 24 22 V
2.0 i AWD	110	01/11→	←	→ 12/11		24.0124-0145.1 424145	Ø 277 24 22 V
			→	→ 12/11		24.0110-0366.1 410366	Ø 286 10 8,5
2.5 AWD	169	01/10→	←	→ 12/11		24.0124-0196.1 424196	Ø 293,5 24 22 V
			→	→ 12/11		24.0110-0366.1 410366	Ø 286 10 8,5
2.5 AWD 2.5 AWD	199 200	07/07→ 01/07→12/07	←			24.0124-0196.1 424196	Ø 293,5 24 22 V
			→			24.0118-0725.1 418725	Ø 290 18 16 V
2.5 AWD	235	02/07→12/07	←			24.0130-0203.1 430203	Ø 326 30 28 V
2.5 WRX SE AWD 2.5 WRX STi AWD	195 221	01/11→ 01/11→	←	→ 12/11		24.0130-0203.1 430203	Ø 326 30 28 V

















	kw			 	! #		
<b>SUBARU - JUSTY II (JMA, MS) 10/95→11/03</b>							
 <b>Bremsbelagsatz, Scheibenbremse</b>							
1.3 4x4	63	04/01→11/03	←			<b>13.0460-5837.2 605837</b>	BOS 23296 14,5 + WK
1.3 GX 4x4	50	10/95→11/03	←	07/98→ 09/00		<b>13.0460-5837.2 605837</b>	BOS 23296 14,5 + WK
			←	→ 06/98		<b>13.0460-5985.2 605985</b>	TOK 21333 15,0 + WK
 <b>Bremsscheibe</b>							
1.3 4x4	63	04/01→11/03	←			<b>24.0117-0103.1 417103</b>	Ø 231,2 17 15 V
1.3 GX 4x4	50	10/95→11/03	←	→ 09/00		<b>24.0117-0103.1 417103</b>	Ø 231,2 17 15 V
<b>SUBARU - JUSTY III (G3X) 09/03→</b>							
 <b>Bremsbelagsatz, Scheibenbremse</b>							
1.3 AWD	69	09/03→	←	→ 08/07		<b>13.0460-3995.2 603995</b>	BOS 23605 15,7 + WK + Zub
1.5 AWD	73	09/03→					
 <b>Bremsscheibe</b>							
1.3 AWD	69	09/03→	←	→ 08/07		<b>24.0117-0106.1 417106</b>	Ø 253 17 15 V
1.5 AWD	73	09/03→					
<b>SUBARU - JUSTY IV 01/07→</b>							
 <b>Bremsbelagsatz, Scheibenbremse</b>							
1.0	51	01/07→	←	09/07→ 05/11; passend für Felgenreöße [Zoll]: 14; Schaltgetriebe		<b>13.0460-5794.2 605794</b>	TRW 24283 15,5 + WK + Zub
			←	09/07→ 05/11; passend für Felgenreöße [Zoll]: 14; Vollautomatik		<b>13.0460-5887.2 605887</b>	SUM 23507 15,2 + WK
1.3 AWD	67	03/08→	←	→ 05/11		<b>13.0460-5613.2 605613</b>	25262 15,0 + WK + Zub
			←	→ 05/11; passend für Felgenreöße [Zoll]: 14; Schaltgetriebe		<b>13.0460-5794.2 605794</b>	TRW 24283 15,5 + WK + Zub
			←	→ 05/11; passend für Felgenreöße [Zoll]: 14; Vollautomatik		<b>13.0460-5887.2 605887</b>	SUM 23507 15,2 + WK
 <b>Bremsscheibe</b>							
1.0	51	01/07→	←	09/07→ 05/11; passend für Felgenreöße [Zoll]: 13		<b>24.0116-0130.1 416130</b>	Ø 234 16 15 V
			←	09/07→ 05/11; passend für Felgenreöße [Zoll]: 14; Vollautomatik		<b>24.0117-0107.1 417107</b>	Ø 246 17 16 V
			←	09/07→ 05/11; passend für Felgenreöße [Zoll]: 14; Schaltgetriebe		<b>24.0122-0263.1 422263</b>	Ø 254 22 20 V
1.3 AWD	67	03/08→	←	→ 05/11; passend für Felgenreöße [Zoll]: 13		<b>24.0116-0130.1 416130</b>	Ø 234 16 15 V
			←	→ 05/11; passend für Felgenreöße [Zoll]: 14; Vollautomatik		<b>24.0117-0107.1 417107</b>	Ø 246 17 16 V
			←	→ 05/11; passend für Felgenreöße [Zoll]: 14; Schaltgetriebe		<b>24.0122-0263.1 422263</b>	Ø 254 22 20 V
<b>SUBARU - LEGACY II (BD) 01/94→10/99</b>							
 <b>Bremsbelagsatz, Scheibenbremse</b>							
2.0 i	85	09/94→03/99	←	02/96→		<b>13.0460-5895.2 605895</b>	23780 16,7 + WK + Zub
2.0 i 4WD	85	09/94→03/99					
2.2 (BD6)	94	07/94→11/98	←	→ 01/96		<b>13.0460-5978.2 605978</b>	21495 17,0 + WK
2.2 i 4WD (BD7)	94	09/94→03/99	→			<b>13.0460-5850.2 605850</b>	SUM 21703 15,0 + WK
2.2 i 4WD	96	06/96→03/99	←			<b>13.0460-5895.2 605895</b>	23780 16,7 + WK + Zub
			→			<b>13.0460-5850.2 605850</b>	SUM 21703 15,0 + WK
2.5 i 4WD	110	06/96→03/99	←			<b>13.0460-5851.2 605851</b>	AKE 21915 17,2 + WK
			→			<b>13.0460-5850.2 605850</b>	SUM 21703 15,0 + WK
<b>Zubehörsatz, Scheibenbremsbelag</b>							
2.0 i	85	09/94→03/99	→			<b>13.0460-0143.2 610143</b>	
2.0 i 4WD	85	09/94→03/99					
2.2 (BD6)	94	07/94→11/98					
2.2 i 4WD	96	06/96→03/99					
2.2 i 4WD (BD7)	94	09/94→03/99					
2.5 i 4WD	110	06/96→03/99					
↓							



















	kw			 	! #		
<b>SUBARU - LEGACY II (BD) 01/94→10/99</b>							
 <b>Bremsscheibe</b>							
2.0 i	85	09/94→03/99	←			24.0124-0141.1 424141	Ø 260 24 22 V
2.0 i 4WD	85	09/94→03/99	→			24.0110-0237.1 410237	Ø 266 10 8,5
2.2 (BD6)	94	07/94→11/98					
2.2 i 4WD	96	06/96→03/99					
2.2 i 4WD (BD7)	94	09/94→03/99					
2.5 i 4WD	110	06/96→03/99	←			24.0124-0145.1 424145	Ø 277 24 22 V
			→			24.0110-0237.1 410237	Ø 266 10 8,5
<b>SUBARU - LEGACY II Station Wagon (BG) 02/94→12/99</b>							
 <b>Bremsbelagsatz, Scheibenbremse</b>							
2.0 i	85	09/94→11/98	←	02/96→		13.0460-5895.2 605895	23780 16,7 + WK + Zub
2.0 i 4WD	85	09/94→11/98	←	→ 01/96		13.0460-5978.2 605978	21495 17,0 + WK
			→			13.0460-5850.2 605850	SUM 21703 15,0 + WK
2.2 i 4WD	96	06/96→11/98	←			13.0460-5895.2 605895	23780 16,7 + WK + Zub
			→			13.0460-5850.2 605850	SUM 21703 15,0 + WK
2.2 i 4WD (BG7)	94	02/94→12/98	←	02/96→ 11/98		13.0460-5895.2 605895	23780 16,7 + WK + Zub
			←	→ 01/96		13.0460-5978.2 605978	21495 17,0 + WK
			→	→ 11/98		13.0460-5850.2 605850	SUM 21703 15,0 + WK
2.5 i 4WD	110	06/96→11/98	←			13.0460-5851.2 605851	AKE 21915 17,2 + WK
			→			13.0460-5850.2 605850	SUM 21703 15,0 + WK
<b>Zubehörsatz, Scheibenbremsbelag</b>							
2.0 i	85	09/94→11/98	→			13.0460-0143.2 610143	
2.0 i 4WD	85	09/94→11/98					
2.2 i 4WD	96	06/96→11/98					
2.5 i 4WD	110	06/96→11/98					
2.2 i 4WD (BG7)	94	02/94→12/98	→	→ 11/98		13.0460-0143.2 610143	
 <b>Bremsscheibe</b>							
2.0 i	85	09/94→11/98	←			24.0124-0141.1 424141	Ø 260 24 22 V
2.0 i 4WD	85	09/94→11/98	→			24.0110-0237.1 410237	Ø 266 10 8,5
2.2 i 4WD	96	06/96→11/98					
2.2 i 4WD (BG7)	94	02/94→12/98	←	→ 11/98		24.0124-0141.1 424141	Ø 260 24 22 V
			→	→ 11/98		24.0110-0237.1 410237	Ø 266 10 8,5
2.5 i 4WD	110	06/96→11/98	←			24.0124-0145.1 424145	Ø 277 24 22 V
			→			24.0110-0237.1 410237	Ø 266 10 8,5
<b>SUBARU - LEGACY III (BE) 10/98→08/03</b>							
 <b>Bremsbelagsatz, Scheibenbremse</b>							
2.0 AWD (BE5)	92	04/99→08/03	←	08/00→		13.0460-5851.2 605851	AKE 21915 17,2 + WK
			←	→ 07/00		13.0460-5895.2 605895	23780 16,7 + WK + Zub
2.5 AWD (BE9)	115	10/98→08/03	←			13.0460-5851.2 605851	AKE 21915 17,2 + WK
<b>Zubehörsatz, Scheibenbremsbelag</b>							
2.0 AWD (BE5)	92	04/99→08/03	→	+ ABS		13.0460-0143.2 610143	
2.5 AWD (BE9)	115	10/98→08/03	→			13.0460-0143.2 610143	
 <b>Bremsscheibe</b>							
2.0 AWD (BE5)	92	04/99→08/03	←	→ 07/00		24.0124-0141.1 424141	Ø 260 24 22 V
			←	08/00→		24.0124-0145.1 424145	Ø 277 24 22 V
2.5 AWD (BE9)	115	10/98→08/03	←			24.0124-0145.1 424145	Ø 277 24 22 V
<b>SUBARU - LEGACY III Station Wagon (BH) 10/98→08/03</b>							
 <b>Bremsbelagsatz, Scheibenbremse</b>							
2.0 AWD (BH5)	92	12/98→08/03	←	08/00→		13.0460-5851.2 605851	AKE 21915 17,2 + WK
			←	04/99→ 07/00		13.0460-5895.2 605895	23780 16,7 + WK + Zub
2.5 AWD (BH9)	115	12/98→08/03	←			13.0460-5851.2 605851	AKE 21915 17,2 + WK
<b>Zubehörsatz, Scheibenbremsbelag</b>							
2.0 AWD (BH5)	92	12/98→08/03	→	04/99→; + ABS		13.0460-0143.2 610143	
2.5 AWD (BH9)	115	12/98→08/03	→			13.0460-0143.2 610143	
↓							















	kw					! #		
<b>SUBARU - LEGACY III Station Wagon (BH) 10/98→08/03</b>								
 <b>Bremsscheibe</b>								
2.0 AWD (BH5)	92	12/98→08/03	←	04/99→ 07/00		24.0124-0141.1	424141	Ø 260 24 22 V
			←	08/00→		24.0124-0145.1	424145	Ø 277 24 22 V
2.5 AWD (BH9)	115	12/98→08/03	←			24.0124-0145.1	424145	Ø 277 24 22 V
<b>SUBARU - LEGACY IV (BL) 09/03→12/15</b>								
 <b>Bremsbelagsatz, Scheibenbremse</b>								
2.0 AWD	121	06/05→04/09	←			13.0460-5797.2	605797	AKE 24222 16,9 + WK + Zub
2.0 AWD (BL5)	101	09/03→10/05	←			13.0460-5787.2	605787	TOK 23865 16,9 + WK + Zub
2.0 D AWD	110	02/08→12/09	←	→ 04/09		13.0460-5787.2	605787	TOK 23865 16,9 + WK + Zub
2.0 R AWD	110	09/07→12/09						
2.5 i AWD (BL9)	127	09/07→12/09						
2.5 AWD (BL9)	121	09/03→04/09	←			13.0460-5787.2	605787	TOK 23865 16,9 + WK + Zub
						13.0460-5797.2	605797	AKE 24222 16,9 + WK + Zub
3.0 R AWD (BLE)	180	09/03→06/09	←	→ 04/09		13.0460-5797.2	605797	AKE 24222 16,9 + WK + Zub
 <b>Bremsscheibe</b>								
2.0 AWD	121	06/05→04/09	←			24.0130-0204.1	430204	Ø 316 30 28 V
3.0 R AWD (BLE)	180	09/03→06/09	→			24.0118-0725.1	418725	Ø 290 18 16 V
2.0 AWD (BL5)	101	09/03→10/05	←			24.0124-0145.1	424145	Ø 277 24 22 V
2.5 AWD (BL9)	121	09/03→04/09	→			24.0110-0728.1	410728	Ø 273,8 10 8,5
2.0 D AWD	110	02/08→12/09	←	→ 04/09		24.0124-0196.1	424196	Ø 293,5 24 22 V
			→	→ 04/09		24.0110-0728.1	410728	Ø 273,8 10 8,5
2.0 R AWD	110	09/07→12/09	←	→ 04/09		24.0124-0145.1	424145	Ø 277 24 22 V
2.5 i AWD (BL9)	127	09/07→12/09	→	→ 04/09		24.0110-0728.1	410728	Ø 273,8 10 8,5
<b>SUBARU - LEGACY IV Station Wagon (BP) 09/03→12/09</b>								
 <b>Bremsbelagsatz, Scheibenbremse</b>								
2.0 AWD (BP5)	101	09/03→10/05	←			13.0460-5787.2	605787	TOK 23865 16,9 + WK + Zub
2.0 AWD (BP5)	121	06/05→04/09	←			13.0460-5797.2	605797	AKE 24222 16,9 + WK + Zub
3.0 R AWD (BPE)	180	09/03→04/09						
2.0 D AWD	110	02/08→12/09	←	→ 04/09		13.0460-5787.2	605787	TOK 23865 16,9 + WK + Zub
2.0 R AWD	110	09/07→12/09						
2.5 i AWD	127	01/08→12/09						
2.5 AWD (BP9)	121	09/03→04/09	←			13.0460-5787.2	605787	TOK 23865 16,9 + WK + Zub
						13.0460-5797.2	605797	AKE 24222 16,9 + WK + Zub
 <b>Bremsscheibe</b>								
2.0 AWD (BP5)	101	09/03→10/05	←			24.0124-0145.1	424145	Ø 277 24 22 V
2.5 AWD (BP9)	121	09/03→04/09	→			24.0110-0728.1	410728	Ø 273,8 10 8,5
2.0 AWD (BP5)	121	06/05→04/09	←			24.0130-0204.1	430204	Ø 316 30 28 V
			→			24.0110-0728.1	410728	Ø 273,8 10 8,5
						24.0118-0725.1	418725	Ø 290 18 16 V
2.0 D AWD	110	02/08→12/09	←	→ 04/09		24.0124-0196.1	424196	Ø 293,5 24 22 V
			→	→ 04/09		24.0110-0728.1	410728	Ø 273,8 10 8,5
2.0 R AWD	110	09/07→12/09	←	→ 04/09		24.0124-0145.1	424145	Ø 277 24 22 V
2.5 i AWD	127	01/08→12/09	→	→ 04/09		24.0110-0728.1	410728	Ø 273,8 10 8,5
3.0 R AWD (BPE)	180	09/03→04/09	←			24.0130-0204.1	430204	Ø 316 30 28 V
			→			24.0118-0725.1	418725	Ø 290 18 16 V
<b>SUBARU - LEGACY V (BM) 05/09→</b>								
 <b>Bremsbelagsatz, Scheibenbremse</b>								
2.0 D AWD	110	09/09→12/14	←			13.0460-5787.2	605787	TOK 23865 16,9 + WK + Zub
2.0 i AWD	110	09/09→12/14						
2.0 i LPG AWD	108	09/09→12/11						
2.5 i AWD (BM9)	123	09/09→12/14	←			13.0460-5793.2	605793	AKE 24372 17,3 + WK + Zub
 <b>Bremsscheibe</b>								
2.0 D AWD	110	09/09→12/14	←			24.0124-0196.1	424196	Ø 293,5 24 22 V
			→			24.0110-0366.1	410366	Ø 286 10 8,5
2.0 i AWD	110	09/09→12/14	←			24.0124-0145.1	424145	Ø 277 24 22 V
↓								

	kw					! #		
<b>SUBARU - LEGACY V (BM) 05/09→</b>								
 <b>Bremsscheibe</b>								
2.0 i LPG AWD	108	09/09→12/11	→				24.0110-0366.1 410366	Ø 286 10 8,5
2.5 i AWD (BM9)	123	09/09→12/14						
2.5 GT AWD (BM9)	195	07/10→12/14	←				24.0130-0204.1 430204	Ø 316 30 28 V
<b>SUBARU - LEGACY V Station Wagon (BR) 06/08→12/14</b>								
 <b>Bremsbelagsatz, Scheibenbremse</b>								
2.0 D AWD	108	01/13→12/14	←				13.0460-5787.2 605787	TOK 23865 16,9 + WK + Zub
2.0 D AWD	110	09/09→12/14						
2.0 i AWD	110	09/09→12/14						
2.0 i AWD	110	06/12→12/14						
2.0 i LPG AWD	108	09/09→12/11						
2.5 i AWD (BR9)	123	09/09→12/14	←				13.0460-5793.2 605793	AKE 24372 17,3 + WK + Zub
2.5 i AWD (BRM)	127	07/12→12/14						
 <b>Bremsscheibe</b>								
2.0 D AWD	108	01/13→12/14	←				24.0124-0196.1 424196	Ø 293,5 24 22 V
2.0 D AWD	110	09/09→12/14					24.0110-0366.1 410366	Ø 286 10 8,5
2.0 i AWD	110	09/09→12/14	←				24.0124-0145.1 424145	Ø 277 24 22 V
2.0 i AWD	110	06/12→12/14						
2.0 i LPG AWD	108	09/09→12/11	→				24.0110-0366.1 410366	Ø 286 10 8,5
2.5 i AWD (BR9)	123	09/09→12/14						
2.5 i AWD (BRM)	127	07/12→12/14						
2.5 GT AWD (BR9)	195	07/10→12/14	←				24.0130-0204.1 430204	Ø 316 30 28 V
<b>SUBARU - LEGACY OUTBACK (BG) 01/96→12/99</b>								
 <b>Bremsbelagsatz, Scheibenbremse</b>								
2.5 (BG9)	110	01/96→12/99	←	06/96→ 11/98			13.0460-5851.2 605851	AKE 21915 17,2 + WK
			→	06/96→ 11/98			13.0460-5850.2 605850	SUM 21703 15,0 + WK
<b>Zubehörsatz, Scheibenbremsbelag</b>								
2.5 (BG9)	110	01/96→12/99	→	06/96→ 11/98			13.0460-0143.2 610143	
 <b>Bremsscheibe</b>								
2.5 (BG9)	110	01/96→12/99	←	06/96→ 11/98			24.0124-0145.1 424145	Ø 277 24 22 V
			→	06/96→ 11/98			24.0110-0237.1 410237	Ø 266 10 8,5
<b>SUBARU - OUTBACK (BE, BH) 10/98→08/03</b>								
 <b>Bremsbelagsatz, Scheibenbremse</b>								
2.5 AWD (BH9)	115	10/00→08/03	←				13.0460-5851.2 605851	AKE 21915 17,2 + WK
3.0 H6 AWD (BHE)	154	10/00→08/03						
 <b>Bremsscheibe</b>								
2.5 AWD (BH9)	115	10/00→08/03	←				24.0124-0196.1 424196	Ø 293,5 24 22 V
3.0 H6 AWD (BHE)	154	10/00→08/03						
<b>SUBARU - OUTBACK (BL, BP) 09/03→06/10</b>								
 <b>Bremsbelagsatz, Scheibenbremse</b>								
2.0 D AWD	110	09/08→09/09	←	→ 04/09			13.0460-5787.2 605787	TOK 23865 16,9 + WK + Zub
2.5 AWD (BP9)	121	11/03→09/09					13.0460-5797.2 605797	AKE 24222 16,9 + WK + Zub
2.5 AWD	127	09/08→09/09	←	→ 06/09			13.0460-5787.2 605787	TOK 23865 16,9 + WK + Zub
3.0 AWD (BPE)	180	11/03→09/09					13.0460-5797.2 605797	AKE 24222 16,9 + WK + Zub
 <b>Bremsscheibe</b>								
2.0 D AWD	110	09/08→09/09	←	→ 04/09			24.0124-0196.1 424196	Ø 293,5 24 22 V
			→	→ 04/09			24.0110-0728.1 410728	Ø 273,8 10 8,5
2.5 AWD	127	09/08→09/09	←	→ 06/09			24.0124-0196.1 424196	Ø 293,5 24 22 V
			→	→ 06/09			24.0110-0728.1 410728	Ø 273,8 10 8,5
2.5 AWD (BP9)	121	11/03→09/09	←	→ 04/09			24.0124-0196.1 424196	Ø 293,5 24 22 V
			→	→ 04/09			24.0110-0728.1 410728	Ø 273,8 10 8,5
							24.0118-0725.1 418725	Ø 290 18 16 V
3.0 AWD (BPE)	180	11/03→09/09	←	→ 06/09			24.0124-0196.1 424196	Ø 293,5 24 22 V
			→	→ 06/09			24.0110-0728.1 410728	Ø 273,8 10 8,5
							24.0118-0725.1 418725	Ø 290 18 16 V











	kw			 	! #		
<b>SUBARU - OUTBACK (BR) 09/09→</b>							
 <b>Bremsbelagsatz, Scheibenbremse</b>							
2.0 D AWD	108	01/13→	←			13.0460-5787.2 605787	TOK 23865 16,9 + WK + Zub
2.0 D AWD (BRD)	110	09/09→					
2.5 i AWD (BR9)	123	09/09→					
2.5 i AWD	127	01/13→	←			13.0460-5793.2 605793	AKE 24372 17,3 + WK + Zub
3.6 AWD	182	06/11→	←	→ 12/14		13.0460-5797.2 605797	AKE 24222 16,9 + WK + Zub
3.6 R AWD (BRF)	191	09/09→	←			13.0460-5797.2 605797	AKE 24222 16,9 + WK + Zub
 <b>Bremsscheibe</b>							
2.0 D AWD	108	01/13→	←			24.0124-0196.1 424196	Ø 293,5 24 22 V
2.0 D AWD (BRD)	110	09/09→				24.0110-0366.1 410366	Ø 286 10 8,5
2.5 i AWD (BR9)	123	09/09→	→				
2.5 i AWD	127	01/13→	←			24.0124-0145.1 424145	Ø 277 24 22 V
			→			24.0110-0366.1 410366	Ø 286 10 8,5
3.6 AWD	182	06/11→	←	→ 12/14		24.0130-0204.1 430204	Ø 316 30 28 V
3.6 R AWD (BRF)	191	09/09→	←			24.0130-0204.1 430204	Ø 316 30 28 V
			→			24.0110-0366.1 410366	Ø 286 10 8,5
<b>SUBARU - OUTBACK (BS) 10/14→</b>							
 <b>Bremsbelagsatz, Scheibenbremse</b>							
2.0 D AWD (BSD)	110	03/15→	←			13.0460-5797.2 605797	AKE 24222 16,9 + WK + Zub
2.5 AWD (BS9)	129	03/15→					
<b>SUBARU - TREZIA 11/10→</b>							
 <b>Bremsbelagsatz, Scheibenbremse</b>							
1.3 (NSP120X)	73	03/11→	←			13.0460-5767.2 605767	AKE 24336 17,5 - WE / - WK
1.4 D	66	03/11→	→			13.0460-5769.2 605769	24610 15,0 + WK
 <b>Bremsscheibe</b>							
1.3 (NSP120X)	73	03/11→	←			24.0122-0276.1 422276	Ø 275 22 19 V
1.4 D	66	03/11→	→			24.0109-0163.1 409163	Ø 259 9 7,5
<b>SUBARU - TRIBECA (B9) 01/05→</b>							
 <b>Bremsbelagsatz, Scheibenbremse</b>							
3.0	180	10/06→	←	→ 11/07		13.0460-5797.2 605797	AKE 24222 16,9 + WK + Zub
3.0	184	01/05→	←	→ 09/06		13.0460-5797.2 605797	AKE 24222 16,9 + WK + Zub
3.6	188	09/09→	←	→ 10/10		13.0460-5797.2 605797	AKE 24222 16,9 + WK + Zub
3.6	190	09/07→	←	12/07→ 10/10		13.0460-5797.2 605797	AKE 24222 16,9 + WK + Zub
<b>SUBARU - XV (GP) 12/11→</b>							
 <b>Bremsbelagsatz, Scheibenbremse</b>							
1.6 i AWD (GP3)	84	03/12→	←			13.0460-5787.2 605787	TOK 23865 16,9 + WK + Zub
2.0 D AWD	80	03/12→					
2.0 D AWD (GPD)	108	03/12→					
2.0 Hybrid AWD	110	07/14→					
2.0 i AWD (GP7)	110	03/12→					
 <b>Bremsscheibe</b>							
1.6 i AWD (GP3)	84	03/12→	←			24.0124-0196.1 424196	Ø 293,5 24 22 V
2.0 D AWD	80	03/12→				24.0110-0384.1 410384	Ø 273,8 10 8,5
2.0 D AWD (GPD)	108	03/12→	→				
2.0 Hybrid AWD	110	07/14→					
2.0 i AWD (GP7)	110	03/12→					
<b>SUBARU - XV (GT) 04/17→</b>							
 <b>Bremsbelagsatz, Scheibenbremse</b>							
2.0 i AWD (GT7)	115	03/17→	←			13.0460-5787.2 605787	TOK 23865 16,9 + WK + Zub
 <b>Bremsscheibe</b>							
2.0 i AWD (GT7)	115	03/17→	←			24.0124-0196.1 424196	Ø 293,5 24 22 V
			→			24.0110-0384.1 410384	Ø 273,8 10 8,5















	kW					! #		
<b>SUZUKI - ALTO (EF) 10/93→09/98</b>								
 <b>Bremsbelagsatz, Scheibenbremse</b>								
0.8	25	11/93→06/96	←			13.0460-5916.2	605916	AKE 20731 15,3 - WE / - WK
0.8	29	11/94→06/96	←					
1.0 (SH410)	39	09/94→09/98	←			13.0460-5985.2	605985	TOK 21333 15,0 + WK
 <b>Bremsscheibe</b>								
0.8	25	11/93→06/96	←			24.0110-0136.1	410136	Ø 215 10 8
0.8	29	11/94→06/96	←					
1.0 (SH410)	39	09/94→09/98	←			24.0117-0103.1	417103	Ø 231,2 17 15 V
<b>SUZUKI - ALTO (FF) 09/04→12/09</b>								
 <b>Bremsbelagsatz, Scheibenbremse</b>								
1.1 (RF410)	46	09/04→12/08	←			13.0460-5621.2	605621	24423 14,6 + WK
 <b>Bremsscheibe</b>								
1.1 (RF410)	46	09/04→12/08	←			24.0117-0105.1	417105	Ø 231 17 15 V
<b>SUZUKI - ALTO (GF) 01/09→</b>								
 <b>Bremsbelagsatz, Scheibenbremse</b>								
1.0 (AMF310)	50	01/09→	←			13.0460-5887.2	605887	SUM 23507 15,2 + WK
 <b>Bremsscheibe</b>								
1.0 (AMF310)	50	01/09→	←			24.0120-0225.1	420225	Ø 231 20 18 V
<b>SUZUKI - ALTO (HA12, HA23) 10/97→09/04</b>								
 <b>Bremsbelagsatz, Scheibenbremse</b>								
1.0	43	01/00→06/02	←			13.0460-5985.2	605985	TOK 21333 15,0 + WK
 <b>Bremsscheibe</b>								
1.0	43	01/00→06/02	←			24.0117-0103.1	417103	Ø 231,2 17 15 V
<b>SUZUKI - BALENO (EG) 03/95→12/09</b>								
 <b>Bremsbelagsatz, Scheibenbremse</b>								
1.3 (SY413)	52	09/96→05/02	←	→ 01/99		13.0460-5838.2	605838	AIS 23400 15,5 + WK
			←	02/99→		13.0460-5839.2	605839	AIS 23795 15,0 + WK
1.3 i 16V (SY413)	63	07/95→05/02	←	→ 01/97		13.0460-5838.2	605838	AIS 23400 15,5 + WK
1.6 i 16V (SY416)	72	07/95→05/02	←					
1.6 i 16V 4x4 (SY416)	72	07/95→05/02	←	02/97→		13.0460-5839.2	605839	AIS 23795 15,0 + WK
1.8 GTX (SY418)	89	03/96→05/02	←	→ 01/97		13.0460-5838.2	605838	AIS 23400 15,5 + WK
1.8 i 4x4 (SY418)	89	03/96→05/02	←	02/97→		13.0460-5839.2	605839	AIS 23795 15,0 + WK
			→			13.0460-5972.2	605972	21559 11,5 - WE / - WK
1.9 TD (SY419)	55	04/98→05/02	←	→ 01/99		13.0460-5838.2	605838	AIS 23400 15,5 + WK
			←	02/99→		13.0460-5839.2	605839	AIS 23795 15,0 + WK
			→			13.0460-5972.2	605972	21559 11,5 - WE / - WK
<b>Zubehörsatz, Scheibenbremsbelag</b>								
1.3 (SY413)	52	09/96→05/02	←	→ 01/99		13.0460-0265.2	610265	
1.9 TD (SY419)	55	04/98→05/02	←					
1.3 i 16V (SY413)	63	07/95→05/02	←	→ 01/97		13.0460-0265.2	610265	
1.6 i 16V (SY416)	72	07/95→05/02	←					
1.6 i 16V 4x4 (SY416)	72	07/95→05/02	←					
1.8 GTX (SY418)	89	03/96→05/02	←					
1.8 i 4x4 (SY418)	89	03/96→05/02	←					
 <b>Bremsscheibe</b>								
1.3 (SY413)	52	09/96→05/02	←			24.0120-0163.1	420163	Ø 235 20 18 V
1.3 i 16V (SY413)	63	07/95→05/02	←					
1.6 i 16V (SY416)	72	07/95→05/02	←					
1.6 i 16V 4x4 (SY416)	72	07/95→05/02	←					
1.8 GTX (SY418)	89	03/96→05/02	←			24.0120-0197.1	420197	Ø 246 20 18 V
1.8 i 4x4 (SY418)	89	03/96→05/02	←					
1.9 TD (SY419)	55	04/98→05/02	←					
<b>SUZUKI - BALENO (FW, EW) 02/16→</b>								
 <b>Bremsbelagsatz, Scheibenbremse</b>								
1.0 (A1K310)	82	02/16→	←			13.0460-5794.2	605794	TRW 24283 15,5 + WK + Zub















	kw			 	! #		
<b>SUZUKI - BALENO (FW, EW) 02/16→</b>							
 <b>Bremsbelagsatz, Scheibenbremse</b>							
1.2 (A1K412)	66	02/16→	→			13.0460-5683.2 605683	AKE 25258 14,4 + WK
1.2 Hybrid (A1K412)	66	02/16→					
<b>SUZUKI - BALENO Kombi (EG) 04/95→04/05</b>							
 <b>Bremsbelagsatz, Scheibenbremse</b>							
1.3 16V (SY413)	63	03/97→05/02	←			13.0460-5839.2 605839	AIS 23795 15,0 + WK
1.6 i 16V (SY416)	72	08/96→05/02	←	→ 01/97		13.0460-5838.2 605838	AIS 23400 15,5 + WK
1.6 i 16V (SY416)	73	08/96→05/02					
1.6 i 16V 4x4 (SY416)	72	08/96→05/02	←	02/97→		13.0460-5839.2 605839	AIS 23795 15,0 + WK
1.6 i 16V 4x4 (SY416)	73	08/96→05/02					
1.8 i 16V (SY418)	89	08/96→05/02	←	→ 01/97		13.0460-5838.2 605838	AIS 23400 15,5 + WK
1.8 i 16V 4x4 (SY418)	89	08/96→05/02	←	02/97→		13.0460-5839.2 605839	AIS 23795 15,0 + WK
			→			13.0460-5972.2 605972	21559 11,5 - WE / - WK
1.9 TD (SY419)	55	04/98→05/02	←	→ 01/99		13.0460-5838.2 605838	AIS 23400 15,5 + WK
			←	02/99→		13.0460-5839.2 605839	AIS 23795 15,0 + WK
			→			13.0460-5972.2 605972	21559 11,5 - WE / - WK
<b>Zubehörsatz, Scheibenbremsbelag</b>							
1.6 i 16V (SY416)	72	08/96→05/02	←	→ 01/97		13.0460-0265.2 610265	
1.6 i 16V (SY416)	73	08/96→05/02					
1.6 i 16V 4x4 (SY416)	72	08/96→05/02					
1.6 i 16V 4x4 (SY416)	73	08/96→05/02					
1.8 i 16V (SY418)	89	08/96→05/02					
1.8 i 16V 4x4 (SY418)	89	08/96→05/02					
1.9 TD (SY419)	55	04/98→05/02	←	→ 01/99		13.0460-0265.2 610265	
 <b>Bremsscheibe</b>							
1.3 16V (SY413)	63	03/97→05/02	←			24.0120-0163.1 420163	Ø 235 20 18 V
1.6 i 16V (SY416)	72	08/96→05/02					
1.6 i 16V (SY416)	73	08/96→05/02					
1.6 i 16V 4x4 (SY416)	72	08/96→05/02					
1.6 i 16V 4x4 (SY416)	73	08/96→05/02					
1.8 i 16V (SY418)	89	08/96→05/02	←			24.0120-0197.1 420197	Ø 246 20 18 V
1.8 i 16V 4x4 (SY418)	89	08/96→05/02					
1.9 TD (SY419)	55	04/98→05/02					
<b>SUZUKI - BALENO Schrägheck (EG) 03/95→05/02</b>							
 <b>Bremsbelagsatz, Scheibenbremse</b>							
1.3 (SY413)	52	09/96→05/02	←	→ 01/99		13.0460-5838.2 605838	AIS 23400 15,5 + WK
			←	02/99→		13.0460-5839.2 605839	AIS 23795 15,0 + WK
1.3 i 16V (SY413)	63	07/95→05/02	←	→ 01/97		13.0460-5838.2 605838	AIS 23400 15,5 + WK
1.6 i 16V (SY416)	72	07/95→05/02					
1.6 i 16V 4x4 (SY416)	72	07/95→05/02	←	02/97→		13.0460-5839.2 605839	AIS 23795 15,0 + WK
1.8 GTX (SY418)	89	03/96→05/02	←	→ 01/97		13.0460-5838.2 605838	AIS 23400 15,5 + WK
1.8 i 4x4 (SY418)	89	03/96→05/02	←	02/97→		13.0460-5839.2 605839	AIS 23795 15,0 + WK
			→			13.0460-5972.2 605972	21559 11,5 - WE / - WK
1.9 TD (SY419)	55	04/98→05/02	←	→ 01/99		13.0460-5838.2 605838	AIS 23400 15,5 + WK
			←	02/99→		13.0460-5839.2 605839	AIS 23795 15,0 + WK
			→			13.0460-5972.2 605972	21559 11,5 - WE / - WK
<b>Zubehörsatz, Scheibenbremsbelag</b>							
1.3 (SY413)	52	09/96→05/02	←	→ 01/99		13.0460-0265.2 610265	
1.9 TD (SY419)	55	04/98→05/02					
1.3 i 16V (SY413)	63	07/95→05/02	←	→ 01/97		13.0460-0265.2 610265	
1.6 i 16V (SY416)	72	07/95→05/02					
1.6 i 16V 4x4 (SY416)	72	07/95→05/02					
1.8 GTX (SY418)	89	03/96→05/02					
1.8 i 4x4 (SY418)	89	03/96→05/02					
 <b>Bremsscheibe</b>							
1.3 (SY413)	52	09/96→05/02	←			24.0120-0163.1 420163	Ø 235 20 18 V
1.3 i 16V (SY413)	63	07/95→05/02					
1.6 i 16V (SY416)	72	07/95→05/02					
1.6 i 16V 4x4 (SY416)	72	07/95→05/02					
1.8 GTX (SY418)	89	03/96→05/02	←			24.0120-0197.1 420197	Ø 246 20 18 V
1.8 i 4x4 (SY418)	89	03/96→05/02					
1.9 TD (SY419)	55	04/98→05/02					

































	kw			 	! #		
<b>SUZUKI - GRAND VITARA I (FT, HT) 03/98→08/06</b>							
 <b>Bremsbelagsatz, Scheibenbremse</b>							
1.6 4x4 (SQ 416)	69	03/98→07/03	←			<b>13.0460-5864.2 605864</b>	21907 15,5 + WK
1.6 4x4 (SQ 416)	71	09/03→09/05					
1.6 4x4 (SQ 416)	73	02/00→09/02					
2.0 4x4 (SQ 420)	97	08/98→12/00	←			<b>13.0460-5857.2 605857</b>	SUM 23314 15,0 + WK
2.0 4x4 (SQ 420)	103	04/98→08/05					
2.0 TD 4x4 (SQ 420D)	64	03/98→07/03					
2.5 V6 24V 4x4 (SQ 625)	116	04/01→07/03					
2.7 4x4 (JA 627)	127	09/01→07/03					
2.0 4x4 (TA52, TL52, SQ 420)	94	03/98→07/03	←	2S2GTA52C00470001→		<b>13.0460-5609.2 605609</b>	24346 16,4 + WK
			←			<b>13.0460-5857.2 605857</b>	SUM 23314 15,0 + WK
						<b>13.0460-5864.2 605864</b>	21907 15,5 + WK
2.0 HDI 110 16V 4x4 (SQ 420D)	80	07/01→09/05	←	Baumuster: SQ420		<b>13.0460-5857.2 605857</b>	SUM 23314 15,0 + WK
2.0 HDI 110 4x4 (SQ 420D)	80	07/01→09/05					
2.0 TD 4x4 (SQ 420D)	63	04/00→09/05	←			<b>13.0460-5857.2 605857</b>	SUM 23314 15,0 + WK
						<b>13.0460-5864.2 605864</b>	21907 15,5 + WK
2.5 V6 24V 4x4 (TD62, SQ 625)	106	04/98→07/03	←	→ 09/00		<b>13.0460-5857.2 605857</b>	SUM 23314 15,0 + WK
2.7 (JA 627)	127	06/01→08/03	←	09/01→		<b>13.0460-5857.2 605857</b>	SUM 23314 15,0 + WK
2.7 (JA 627)	135	09/03→08/06	←	→ 09/05		<b>13.0460-5609.2 605609</b>	24346 16,4 + WK
						<b>13.0460-5857.2 605857</b>	SUM 23314 15,0 + WK
2.7 4x4 (TX92, JA 627)	135	04/03→07/03	←			<b>13.0460-5609.2 605609</b>	24346 16,4 + WK
						<b>13.0460-5857.2 605857</b>	SUM 23314 15,0 + WK
 <b>Bremsscheibe</b>							
1.6 4x4 (SQ 416)	69	03/98→07/03	←			<b>24.0117-0109.1 417109</b>	Ø 287 17 15 V
			←	08/98→		<b>24.0122-0200.1 422200</b>	Ø 310 22 20 V
1.6 4x4 (SQ 416)	71	09/03→09/05	←	→ 11/04; Baumuster: Grand Vitara		<b>24.0117-0109.1 417109</b>	Ø 287 17 15 V
			←	Baumuster: Grand Escudo		<b>24.0122-0200.1 422200</b>	Ø 310 22 20 V
1.6 4x4 (SQ 416)	73	02/00→09/02	←			<b>24.0117-0109.1 417109</b>	Ø 287 17 15 V
2.0 4x4 (SQ 420)	97	08/98→12/00	←			<b>24.0122-0200.1 422200</b>	Ø 310 22 20 V
2.0 4x4 (SQ 420)	103	04/98→08/05					
2.0 HDI 110 16V 4x4 (SQ 420D)	80	07/01→09/05					
2.0 HDI 110 4x4 (SQ 420D)	80	07/01→09/05					
2.0 TD 4x4 (SQ 420D)	63	04/00→09/05					
2.0 TD 4x4 (SQ 420D)	64	03/98→07/03					
2.5 V6 24V 4x4 (SQ 625)	116	04/01→07/03					
2.7 4x4 (JA 627)	127	09/01→07/03					
2.7 4x4 (TX92, JA 627)	135	04/03→07/03					
2.0 4x4 (TA52, TL52, SQ 420)	94	03/98→07/03	←			<b>24.0117-0109.1 417109</b>	Ø 287 17 15 V
						<b>24.0122-0200.1 422200</b>	Ø 310 22 20 V
2.5 V6 24V 4x4 (TD62, SQ 625)	106	04/98→07/03	←	→ 09/00		<b>24.0122-0200.1 422200</b>	Ø 310 22 20 V
2.7 (JA 627)	127	06/01→08/03	←	09/01→		<b>24.0122-0200.1 422200</b>	Ø 310 22 20 V
2.7 (JA 627)	135	09/03→08/06	←	→ 09/05		<b>24.0122-0200.1 422200</b>	Ø 310 22 20 V
<b>SUZUKI - GRAND VITARA I Cabriolet (GT) 03/98→09/05</b>							
 <b>Bremsbelagsatz, Scheibenbremse</b>							
1.6 4x4 (SQ 416)	69	03/98→07/03	←			<b>13.0460-5864.2 605864</b>	21907 15,5 + WK
2.0 4x4 (SQ 420)	94	03/98→07/03	←	2S2GTA52C00470001→		<b>13.0460-5609.2 605609</b>	24346 16,4 + WK
			←			<b>13.0460-5857.2 605857</b>	SUM 23314 15,0 + WK
						<b>13.0460-5864.2 605864</b>	21907 15,5 + WK
 <b>Bremsscheibe</b>							
1.6 4x4 (SQ 416)	69	03/98→07/03	←			<b>24.0117-0109.1 417109</b>	Ø 287 17 15 V
			←	08/98→		<b>24.0122-0200.1 422200</b>	Ø 310 22 20 V
2.0 4x4 (SQ 420)	94	03/98→07/03	←			<b>24.0117-0109.1 417109</b>	Ø 287 17 15 V
						<b>24.0122-0200.1 422200</b>	Ø 310 22 20 V

	kw					! #		
<b>SUZUKI - GRAND VITARA II (JT, TE, TD) 04/05→02/15</b>								
 <b>Bremsbelagsatz, Scheibenbremse</b>								
1.6 (JB416)	78	10/05→02/15	←	→ 02/15			<b>13.0460-5609.2 605609</b>	24346 16,4 + WK
1.6 Allrad (JB416)	78	04/05→02/15	←				<b>13.0460-5609.2 605609</b>	24346 16,4 + WK
1.9 DDiS (JB419WD, JB419XD)	95	03/06→08/08						
1.9 DDiS Allrad (JT419, TD44, JB419WD, JB419XD)	95	10/05→02/15						
2.0 Allrad (TD54, JB420)	103	10/05→02/15						
2.7 Allrad (JB627)	136	01/07→12/08						
2.0 (JB420)	103	10/05→02/15	←	→ 12/11			<b>13.0460-5609.2 605609</b>	24346 16,4 + WK
2.7 (JB627)	138	09/05→12/08	←	10/05→ 08/08			<b>13.0460-5609.2 605609</b>	24346 16,4 + WK
2.7 Allrad (JB627)	138	04/05→08/08	←	10/05→			<b>13.0460-5609.2 605609</b>	24346 16,4 + WK
 <b>Bremsscheibe</b>								
1.6 (JB416)	78	10/05→02/15	←	→ 02/15			<b>24.0125-0190.1 425190</b>	Ø 294,5 25 23 V
1.6 Allrad (JB416)	78	04/05→02/15	←				<b>24.0125-0190.1 425190</b>	Ø 294,5 25 23 V
1.9 DDiS (JB419WD, JB419XD)	95	03/06→08/08						
1.9 DDiS Allrad (JT419, TD44, JB419WD, JB419XD)	95	10/05→02/15						
2.0 Allrad (TD54, JB420)	103	10/05→02/15						
2.4 (JB424)	124	09/09→02/15						
2.4 Allrad (JB424)	124	01/09→02/15						
2.4 Allrad (JT424, JB424)	122	01/09→02/15						
2.7 Allrad (JB627)	136	01/07→12/08						
3.2 Allrad (JB632)	165	06/08→02/15						
3.2 Allrad (TDB4, JT632, JB632)	171	01/09→02/15						
2.0 (JB420)	103	10/05→02/15	←	→ 12/11			<b>24.0125-0190.1 425190</b>	Ø 294,5 25 23 V
2.7 (JB627)	138	09/05→12/08	←	10/05→ 08/08			<b>24.0125-0190.1 425190</b>	Ø 294,5 25 23 V
2.7 Allrad (JB627)	138	04/05→08/08	←	10/05→			<b>24.0125-0190.1 425190</b>	Ø 294,5 25 23 V
<b>SUZUKI - IGNIS I (FH) 10/00→12/05</b>								
 <b>Bremsbelagsatz, Scheibenbremse</b>								
1.3 (HV51, HX51, RG413)	61	10/00→09/03	←	→ 08/03			<b>13.0460-5887.2 605887</b>	SUM 23507 15,2 + WK
1.3 4WD (RG413)	61	10/00→09/03						
 <b>Bremsscheibe</b>								
1.3 (HV51, HX51, RG413)	61	10/00→09/03	←	→ 08/03			<b>24.0117-0108.1 417108</b>	Ø 257 17 15 V
1.3 4WD (RG413)	61	10/00→09/03						
<b>SUZUKI - IGNIS II (MH) 09/03→</b>								
 <b>Bremsbelagsatz, Scheibenbremse</b>								
1.3 (RM413)	69	09/03→	←	→ 12/12			<b>13.0460-3995.2 603995</b>	BOS 23605 15,7 + WK + Zub
1.3 4x4 (RM413)	69	09/03→						
1.3 DDiS (RM413D)	51	09/03→						
1.5 (RM415)	73	09/03→						
1.5 4x4 (RM415)	73	09/03→						
1.5 Sport (RM415)	80	12/03→	←	→ 12/12			<b>13.0460-5887.2 605887</b>	SUM 23507 15,2 + WK
			→	→ 12/12; für Fahrzeuge mit Sportfahrwerk			<b>13.0460-5856.2 605856</b>	24039 14,4 + WK
 <b>Bremsscheibe</b>								
1.3 (RM413)	69	09/03→	←	→ 12/12			<b>24.0117-0106.1 417106</b>	Ø 253 17 15 V
1.3 4x4 (RM413)	69	09/03→						
1.3 DDiS (RM413D)	51	09/03→						
1.5 (RM415)	73	09/03→						
1.5 4x4 (RM415)	73	09/03→						
1.5 Sport (RM415)	80	12/03→	←	→ 12/12			<b>24.0117-0108.1 417108</b>	Ø 257 17 15 V
<b>SUZUKI - JIMNY Geländewagen geschlossen (SN) 07/98→</b>								
 <b>Bremsbelagsatz, Scheibenbremse</b>								
1.3 (SN413)	63	08/04→	←				<b>13.0460-5966.2 605966</b>	SUM 21142 15,0 - WE / - WK
1.3 16V (SN413)	59	09/98→						
1.3 16V (SN413)	60	02/01→						
1.3 16V 4WD (SN413)	59	09/98→						
1.3 16V 4WD (SN413)	60	02/01→						
1.3 16V 4x4 (SN413)	63	08/05→						













	kw					! #		
<b>SUZUKI - JIMNY Geländewagen geschlossen (SN) 07/98→</b>								
 <b>Bremsbelagsatz, Scheibenbremse</b>								
1.3 4WD (SN413)	62	05/14→	←				13.0460-5966.2 605966	SUM 21142 15,0 - WE / - WK
1.3 4x4 (SN413)	63	09/98→08/00	←					
1.5 DDiS 4WD (SN415D)	48	12/03→	←				13.0460-5864.2 605864	21907 15,5 + WK
1.5 DDiS 4x4	63	08/05→	←					
 <b>Bremsscheibe</b>								
1.3 (SN413)	63	08/04→	←	→ 00203804			24.0110-0242.1 410242	Ø 290 10 8
1.3 16V (SN413)	59	09/98→	←	00203805→			24.0110-0355.1 410355	Ø 290 10 8
1.3 16V (SN413)	60	02/01→	←					
1.3 16V 4WD (SN413)	59	09/98→	←					
1.3 16V 4WD (SN413)	60	02/01→	←					
1.3 16V 4x4 (SN413)	63	08/05→	←					
1.3 4WD (SN413)	62	05/14→	←					
1.3 4x4 (SN413)	63	09/98→08/00	←					
1.5 DDiS 4WD (SN415D)	48	12/03→	←	→ 00201861			24.0117-0104.1 417104	Ø 287 17 15 V
1.5 DDiS 4x4	63	08/05→	←					
<b>SUZUKI - JIMNY Geländewagen offen (SN) 01/98→</b>								
 <b>Bremsbelagsatz, Scheibenbremse</b>								
1.3 (SN413)	63	08/04→	←				13.0460-5966.2 605966	SUM 21142 15,0 - WE / - WK
1.3 16V 4WD (SN413)	59	09/98→	←					
1.3 4WD (SN413)	63	03/13→	←					
 <b>Bremsscheibe</b>								
1.3 (SN413)	63	08/04→	←	→ JSAFJB43V00203804			24.0110-0242.1 410242	Ø 290 10 8
			←	JSAFJB43V00203805→			24.0110-0355.1 410355	Ø 290 10 8
1.3 16V 4WD (SN413)	59	09/98→	←				24.0110-0242.1 410242	Ø 290 10 8
1.3 4WD (SN413)	63	03/13→	←				24.0110-0355.1 410355	Ø 290 10 8
<b>SUZUKI - KIZASHI (FR) 10/10→</b>								
 <b>Bremsscheibe</b>								
2.4 (A6B 424)	131	10/10→	←				24.0126-0172.1 426172	Ø 300 26 24 V
2.4 4x4 (A6B 424)	131	10/10→	→				24.0112-0195.1 412195	Ø 278 12 11
<b>SUZUKI - LIANA (ER, RH_) 10/01→</b>								
 <b>Bremsbelagsatz, Scheibenbremse</b>								
1.3 (RH 413)	66	03/02→	←	→ 12/07			13.0460-5774.2 605774	24830 15,5 + WK
1.4 DDiS (RH 414D)	66	04/04→	←				13.0460-5888.2 605888	23817 16,6 + WK
1.6 (RH 416)	76	03/02→	←					
1.6 (RH 416)	79	01/05→	←					
1.6 4WD (RH 416)	76	03/02→	←					
1.6 4WD (RH 416)	78	04/02→	←					
1.6 i (RH416)	78	04/02→	←					
1.5 (RH415)	81	04/04→11/07	←	01/05→			13.0460-5774.2 605774	24830 15,5 + WK
			←				13.0460-5888.2 605888	23817 16,6 + WK
1.6 4WD (RH 416)	79	01/05→12/07	←				13.0460-5774.2 605774	24830 15,5 + WK
			←				13.0460-5888.2 605888	23817 16,6 + WK
 <b>Bremsscheibe</b>								
1.3 (RH 413)	66	03/02→	←	→ 12/07			24.0120-0197.1 420197	Ø 246 20 18 V
1.4 DDiS (RH 414D)	66	04/04→	←					
1.6 (RH 416)	76	03/02→	←					
1.6 (RH 416)	79	01/05→	←					
1.6 4WD (RH 416)	76	03/02→	←					
1.6 4WD (RH 416)	78	04/02→	←					
1.6 i (RH416)	78	04/02→	←					
1.5 (RH415)	81	04/04→11/07	←	01/05→			24.0120-0197.1 420197	Ø 246 20 18 V
1.6 4WD (RH 416)	79	01/05→12/07	←				24.0120-0197.1 420197	Ø 246 20 18 V
<b>SUZUKI - LIANA Schrägheck 06/01→</b>								
 <b>Bremsbelagsatz, Scheibenbremse</b>								
1.3	66	07/01→12/07	←				13.0460-5774.2 605774	24830 15,5 + WK
1.4 DDiS	66	04/04→12/07	←				13.0460-5888.2 605888	23817 16,6 + WK
1.6	76	07/01→12/07	←					
1.6	79	01/05→12/07	←					
1.6 4WD	76	07/01→12/07	←					
1.6 4WD	78	04/02→12/07	←					
1.6 4WD	79	01/05→12/07	←					
1.6 i (RH416)	78	04/02→12/07	←					















	kw			 	! #		
<b>SUZUKI - LIANA Schrägheck 06/01→</b>							
 <b>Bremsscheibe</b>							
1.3	66	07/01→12/07	←			24.0120-0197.1 420197	Ø 246 20 18 V
1.3 DDiS	66	04/04→12/07					
1.6	76	07/01→12/07					
1.6	79	01/05→12/07					
1.6 4WD	76	07/01→12/07					
1.6 4WD	78	04/02→12/07					
1.6 4WD	79	01/05→12/07					
1.6 i (RH416)	78	04/02→12/07					
<b>SUZUKI - SAMURAI Geländewagen geschlossen (SJ) 11/88→12/04</b>							
 <b>Bremsbelagsatz, Scheibenbremse</b>							
1.0 Allrad (SJ 410)	33	11/88→12/04	←	→ 12/92		13.0460-2997.2 602997	TRW 20708 15,8 + WE / - WK
1.3 Allrad (SJ 413)	44	11/88→12/04				13.0460-5966.2 605966	SUM 21142 15,0 - WE / - WK
1.3 Allrad (SJ 413)	47	11/88→12/04					
1.3 Allrad (SJ 413)	51	11/88→12/04					
1.3 Allrad (SJ 413)	59	01/00→12/04	←	09/00→		13.0460-5966.2 605966	SUM 21142 15,0 - WE / - WK
1.9 D	46	09/00→12/04	←			13.0460-5720.2 605720	TRW 20708 14,5 - WE / - WK
1.9 D Allrad	47	11/98→12/04					
1.9 TD Allrad (SJ 419TD)	46	11/98→12/04					
 <b>Bremsscheibe</b>							
1.0 Allrad (SJ 410)	33	11/88→12/04	←	→ 12/92		24.0110-0192.1 410192	Ø 289,8 10 9
1.3 Allrad (SJ 413)	44	11/88→12/04					
1.3 Allrad (SJ 413)	47	11/88→12/04					
1.3 Allrad (SJ 413)	51	11/88→12/04	←	11/98→		24.0110-0192.1 410192	Ø 289,8 10 9
			←	→ 12/92		24.0110-0192.1 410192	Ø 289,8 10 9
1.3 Allrad (SJ 413)	59	01/00→12/04	←	09/00→		24.0110-0192.1 410192	Ø 289,8 10 9
						24.0110-0242.1 410242	Ø 290 10 8
1.9 D	46	09/00→12/04	←			24.0110-0242.1 410242	Ø 290 10 8
1.9 D Allrad	47	11/98→12/04					
1.9 TD Allrad (SJ 419TD)	46	11/98→12/04					
<b>SUZUKI - SPLASH (EX) 01/08→</b>							
 <b>Bremsbelagsatz, Scheibenbremse</b>							
1.0 (A5B 310)	48	01/08→	←			13.0460-5700.2 605700	TRW 23973 17,0 + WK
1.0 (A5B 310)	50	06/11→					
1.2 (A5B 412)	63	01/08→					
1.2 VVT (A5B 412)	66	06/11→					
1.2 VVT (A5B 412)	67	08/12→					
1.2 VVT (A5B 412)	69	09/10→					
1.3 CDTI (A5B 413D)	55	01/08→					
 <b>Bremsscheibe</b>							
1.0 (A5B 310)	48	01/08→	←			24.0120-0211.1 420211	Ø 252 20 18 V + S
1.0 (A5B 310)	50	06/11→					
1.2 (A5B 412)	63	01/08→					
1.2 VVT (A5B 412)	66	06/11→					
1.2 VVT (A5B 412)	67	08/12→					
1.2 VVT (A5B 412)	69	09/10→					
1.3 CDTI (A5B 413D)	55	01/08→					
<b>SUZUKI - SUPER CARRY Bus (ED) 07/85→03/99</b>							
 <b>Bremsbelagsatz, Scheibenbremse</b>							
1.0 (SK410)	33	10/85→03/99	←	→ 02/88		13.0460-5916.2 605916	AKE 20731 15,3 - WE / - WK
 <b>Bremsscheibe</b>							
1.0 (SK410)	33	10/85→03/99	←	→ 02/88		24.0110-0136.1 410136	Ø 215 10 8
						24.0110-0192.1 410192	Ø 289,8 10 9
<b>SUZUKI - SWIFT II Schrägheck (EA, MA) 03/89→12/05</b>							
 <b>Bremsbelagsatz, Scheibenbremse</b>							
1.0 (SF310, AA44)	37	03/89→05/01	←	320340→; → 10/96		13.0460-5837.2 605837	BOS 23296 14,5 + WK
			←	08/92→; → 320339		13.0460-5985.2 605985	TOK 21333 15,0 + WK
1.0 i (SF310, AA44)	39	01/95→12/05	←	11/96→ 12/04; - ABS		13.0460-5763.2 605763	21730 14,0 + WK
			←	320340→; → 10/96		13.0460-5837.2 605837	BOS 23296 14,5 + WK
			←	→ 320339		13.0460-5985.2 605985	TOK 21333 15,0 + WK
			←	11/96→ 12/04; + ABS		13.0460-5985.2 605985	TOK 21333 15,0 + WK
↓							



















	kw					! #		
<b>SUZUKI - SWIFT II Schrägheck (EA, MA) 03/89→12/05</b>								
 <b>Bremsbelagsatz, Scheibenbremse</b>								
1.3 (SF413, AB35)	50	03/89→05/01	←	11/96→			<b>13.0460-5763.2 605763</b>	21730 14,0 + WK
1.3 (SF 413)	51	03/89→10/96	←	320340→			<b>13.0460-5837.2 605837</b>	BOS 23296 14,5 + WK
			←	04/89→; → 320339			<b>13.0460-5985.2 605985</b>	TOK 21333 15,0 + WK
1.3 (SF 413)	63	06/01→12/03	←				<b>13.0460-5763.2 605763</b>	21730 14,0 + WK
1.3 4WD (SF413, AA35)	50	03/89→05/01	←	11/96→			<b>13.0460-5985.2 605985</b>	TOK 21333 15,0 + WK
 <b>Bremsscheibe</b>								
1.0 (SF310, AA44)	37	03/89→05/01	←	08/91→ 10/96			<b>24.0117-0103.1 417103</b>	Ø 231,2 17 15 V
1.0 i (SF310, AA44)	39	01/95→12/05	←	11/96→ 12/04; - ABS			<b>24.0112-0173.1 412173</b>	Ø 232 12 9,5
			←	11/96→ 12/04; + ABS			<b>24.0117-0103.1 417103</b>	Ø 231,2 17 15 V
			←	→ 10/96			<b>24.0117-0103.1 417103</b>	Ø 231,2 17 15 V
1.3 (SF413, AB35)	50	03/89→05/01	←	11/96→			<b>24.0112-0173.1 412173</b>	Ø 232 12 9,5
1.3 (SF 413)	51	03/89→10/96	←	04/89→			<b>24.0117-0103.1 417103</b>	Ø 231,2 17 15 V
1.3 (SF 413)	63	06/01→12/03	←				<b>24.0112-0173.1 412173</b>	Ø 232 12 9,5
1.3 4WD (SF413, AA35)	50	03/89→05/01	←	11/96→			<b>24.0117-0103.1 417103</b>	Ø 231,2 17 15 V
<b>SUZUKI - SWIFT III (MZ, EZ) 02/05→</b>								
 <b>Bremsbelagsatz, Scheibenbremse</b>								
1.2	66	04/08→12/10	←				<b>13.0460-5700.2 605700</b>	TRW 23973 17,0 + WK
1.3 (RS 413)	67	02/05→06/15	←	→ 09/10			<b>13.0460-5700.2 605700</b>	TRW 23973 17,0 + WK
1.3 (RS 413)	68	02/05→						
1.3 4x4 (RS 413)	66	01/06→						
1.3 4x4 (RS 413)	68	02/05→						
1.3 DDiS (RS 413D)	55	08/05→						
1.5 (RS 415)	75	02/05→						
1.5 4x4 (RS 415)	74	02/05→						
1.3 DDiS (RS 413D)	51	08/05→	←	→ 09/07			<b>13.0460-5700.2 605700</b>	TRW 23973 17,0 + WK
1.6 (RS 416)	92	05/06→	←	→ 09/10			<b>13.0460-5700.2 605700</b>	TRW 23973 17,0 + WK
			→	→ 09/10			<b>13.0460-5929.2 605929</b>	AKE 21719 15,0 + WK
 <b>Bremsscheibe</b>								
1.2	66	04/08→12/10	←				<b>24.0120-0211.1 420211</b>	Ø 252 20 18 V + S
1.3 (RS 413)	67	02/05→06/15	←	→ 09/10			<b>24.0120-0211.1 420211</b>	Ø 252 20 18 V + S
1.3 (RS 413)	68	02/05→						
1.3 4x4 (RS 413)	66	01/06→						
1.3 4x4 (RS 413)	68	02/05→						
1.3 DDiS (RS 413D)	55	08/05→						
1.5 (RS 415)	75	02/05→						
1.5 4x4 (RS 415)	74	02/05→						
1.3 DDiS (RS 413D)	51	08/05→	←	→ 09/07			<b>24.0120-0211.1 420211</b>	Ø 252 20 18 V + S
1.6 (RS 416)	92	05/06→	←	→ 09/10			<b>24.0120-0216.1 420216</b>	Ø 276 20 18 V
			→	→ 09/10			<b>24.0109-0160.1 409160</b>	Ø 278 9 8
<b>SUZUKI - SWIFT IV (FZ, NZ) 10/10→</b>								
 <b>Bremsbelagsatz, Scheibenbremse</b>								
1.2 (AZG 412)	66	10/10→	←	für Geschwindigkeitsregelanlage			<b>13.0460-5794.2 605794</b>	TRW 24283 15,5 + WK + Zub
1.2 (AZH 412, AZG 412)	67	08/12→						
1.2 (AZH 412)	69	10/10→	→				<b>13.0460-5655.2 605655</b>	AKE 25258 14,4 + WK + Zub
1.2 4WD (AZH 412, AZG 412)	67	08/12→						
1.2 4x4 (AZG 412)	66	10/10→						
1.2 4x4 (AZH 412)	69	10/10→						
1.3 DDiS (AZG 413D)	55	10/10→						
1.6 (AZG 416, AZH 416, RS416)	100	01/12→	→				<b>13.0460-5655.2 605655</b>	AKE 25258 14,4 + WK + Zub
 <b>Bremsscheibe</b>								
1.2 (AZG 412)	66	10/10→	←				<b>24.0122-0280.1 422280</b>	Ø 256 22 20 V
1.2 (AZH 412, AZG 412)	67	08/12→						
1.2 (AZH 412)	69	10/10→	←	für Geschwindigkeitsregelanlage			<b>24.0122-0282.1 422282</b>	Ø 272 22 20 V
1.2 4WD (AZH 412, AZG 412)	67	08/12→	→				<b>24.0109-0175.1 409175</b>	Ø 259 9 8
1.2 4x4 (AZG 412)	66	10/10→						
1.2 4x4 (AZH 412)	69	10/10→						
1.3 DDiS (AZG 413D)	55	10/10→						





























	kW			 	! #		
<b>SUZUKI - SX4 (EY, GY) 06/06→</b>							
 <b>Bremsbelagsatz, Scheibenbremse</b>							
1.5 (RW 415)	73	06/06→07/10	←	Made in Ungarn		<b>13.0460-2715.2 602715</b>	TRW 24391 16,6 + WK + Zub
1.5 VVTi	81	07/07→12/15	←	Made in Japan		<b>13.0460-5716.2 605716</b>	21561 17,0 + WK
1.6 VVT	82	11/10→12/15	←				
1.6 VVT (RW 416)	79	06/06→	→	+ ABS		<b>13.0460-5929.2 605929</b>	AKE 21719 15,0 + WK
1.6 VVT (RW 416)	88	07/09→					
1.6 VVT 4x4 (RW 416)	79	06/06→					
1.6 VVT 4x4 (RW 416)	82	07/09→					
1.6 VVT 4x4 (RW 416)	88	07/09→					
1.5 VVT (RW 415)	82	07/10→	←			<b>13.0460-2715.2 602715</b>	TRW 24391 16,6 + WK + Zub
1.5 VVT 4x4 (RW 415)	82	07/10→	←				
1.6 DDiS (RW 416D)	66	04/07→	→	+ ABS		<b>13.0460-5929.2 605929</b>	AKE 21719 15,0 + WK
1.9 DDiS (RW 419D)	88	06/06→					
1.9 DDiS 4x4 (RW 419D)	88	06/06→					
2.0 DDiS (RW 420D)	99	07/09→					
2.0 DDiS 4x4 (RW 420D)	99	07/09→					
 <b>Bremsscheibe</b>							
1.5 (RW 415)	73	06/06→07/10	←			<b>24.0122-0252.1 422252</b>	Ø 280 22 20 V
1.5 VVT (RW 415)	82	07/10→	←				
1.5 VVT 4x4 (RW 415)	82	07/10→	→			<b>24.0109-0167.1 409167</b>	Ø 278 9 8
1.5 VVTi	81	07/07→12/15					
1.6 DDiS (RW 416D)	66	04/07→					
1.6 VVT	82	11/10→12/15					
1.6 VVT (RW 416)	79	06/06→					
1.6 VVT (RW 416)	88	07/09→					
1.6 VVT 4x4 (RW 416)	79	06/06→					
1.6 VVT 4x4 (RW 416)	82	07/09→					
1.6 VVT 4x4 (RW 416)	88	07/09→					
1.9 DDiS (RW 419D)	88	06/06→					
1.9 DDiS 4x4 (RW 419D)	88	06/06→					
2.0 DDiS (RW 420D)	99	07/09→					
2.0 DDiS 4x4 (RW 420D)	99	07/09→					
<b>SUZUKI - SX4 S-Cross (JY) 08/13→</b>							
 <b>Bremsbelagsatz, Scheibenbremse</b>							
1.0	82	08/16→	→			<b>13.0460-5655.2 605655</b>	AKE 25258 14,4 + WK + Zub
1.0 AllGrip	82	08/16→					
1.4 T (AKK 414)	103	08/16→					
1.4 T AllGrip	103	08/16→					
1.6 (AKK416)	85	12/13→	←			<b>13.0460-5656.2 605656</b>	AKE 25979 16,0 + WK + Zub
1.6 (AKK 416)	86	12/13→	←				
1.6 (AKK 416)	88	08/13→	→			<b>13.0460-5655.2 605655</b>	AKE 25258 14,4 + WK + Zub
1.6 AllGrip (AKK416)	85	12/13→					
1.6 AllGrip	86	12/13→					
1.6 AllGrip	88	08/13→					
1.6 DDiS (AKK 416D)	88	08/13→					
1.6 DDiS AllGrip	88	08/13→					
 <b>Bremsscheibe</b>							
1.0	82	08/16→	←			<b>24.0122-0290.1 422290</b>	Ø 280 22 20 V
1.0 AllGrip	82	08/16→	←				
1.4 T (AKK 414)	103	08/16→	→			<b>24.0109-0182.1 409182</b>	Ø 259,4 9 8
1.4 T AllGrip	103	08/16→					
1.6 (AKK416)	85	12/13→					
1.6 (AKK 416)	86	12/13→					
1.6 (AKK 416)	88	08/13→					
1.6 AllGrip (AKK416)	85	12/13→					
1.6 AllGrip	86	12/13→					
1.6 AllGrip	88	08/13→					
1.6 DDiS (AKK 416D)	88	08/13→					
1.6 DDiS AllGrip	88	08/13→					
<b>SUZUKI - SX4 Stufenheck (GY) 10/07→</b>							
 <b>Bremsbelagsatz, Scheibenbremse</b>							
1.6 (RW 416)	79	10/07→	←	Made in Ungarn		<b>13.0460-2715.2 602715</b>	TRW 24391 16,6 + WK + Zub
1.6 (RW 416)	88	10/07→	←	Made in Japan		<b>13.0460-5716.2 605716</b>	21561 17,0 + WK
1.6 AWD (RW 416)	79	10/07→12/11	←				
1.6 AWD (RW 416)	88	10/07→	→	+ ABS		<b>13.0460-5929.2 605929</b>	AKE 21719 15,0 + WK
 <b>Bremsscheibe</b>							
1.6 (RW 416)	79	10/07→	←			<b>24.0122-0252.1 422252</b>	Ø 280 22 20 V
1.6 (RW 416)	88	10/07→	←				
1.6 AWD (RW 416)	79	10/07→12/11	→			<b>24.0109-0167.1 409167</b>	Ø 278 9 8
1.6 AWD (RW 416)	88	10/07→					

	kw			 	! #		
<b>SUZUKI - VITARA (ET, TA) 07/88→08/99</b>							
 <b>Bremsbelagsatz, Scheibenbremse</b>							
1.6 Allrad (TA, TA01, SE416)	59	07/88→03/98	←	01/89→01/95		<b>13.0460-2997.2 602997</b> <b>13.0460-5967.2 605967</b>	TRW 20708 15,8 + WE / - WK AKE 21500 15,0 + WK
1.9 D Allrad (SE 419TD)	50	01/95→03/98	←			<b>13.0460-5857.2 605857</b>	SUM 23314 15,0 + WK
1.9 D Allrad (SE 419TD)	55	08/96→03/98					
2.0 16V Allrad (SV420)	97	12/96→03/98					
2.0 TD Allrad (SV 420D)	52	12/94→03/98					
2.0 TD Intercooler Allrad (SV 420D)	64	12/95→03/98					
2.0 V6 24V Allrad (SV620)	100	12/94→03/98					
<b>Zubehörsatz, Scheibenbremsbelag</b>							
1.6 Allrad (TA, TA01, SE416)	59	07/88→03/98	←	01/89→01/95		<b>13.0460-0449.2 610449</b>	AKE
 <b>Bremsscheibe</b>							
1.6 Allrad (TA, TA01, SE416)	59	07/88→03/98	←	01/89→01/95		<b>24.0110-0242.1 410242</b>	Ø 290 10 8
1.6 i 16V Allrad (ET, TA02, SE416)	71	07/90→03/98	←	02/91→12/94		<b>24.0117-0104.1 417104</b>	Ø 287 17 15 V
<b>SUZUKI - VITARA (LY) 02/15→</b>							
 <b>Bremsbelagsatz, Scheibenbremse</b>							
1.4 T (APK 414)	103	09/15→	→			<b>13.0460-5655.2 605655</b>	AKE 25258 14,4 + WK + Zub
1.4 T AllGrip	103	09/15→					
1.6 (APK 416)	86	05/15→					
1.6 (APK 416)	88	02/15→	←			<b>13.0460-5656.2 605656</b>	AKE 25979 16,0 + WK + Zub
1.6 AllGrip	86	05/15→					
1.6 AllGrip	88	02/15→	→			<b>13.0460-5655.2 605655</b>	AKE 25258 14,4 + WK + Zub
1.6 DDiS (APK 416D)	88	02/15→					
1.6 DDiS AllGrip	88	02/15→					
1.6 VVT AllGrip	93	08/16→					
 <b>Bremsscheibe</b>							
1.4 T (APK 414)	103	09/15→	←			<b>24.0122-0290.1 422290</b>	Ø 280 22 20 V
1.4 T AllGrip	103	09/15→					
1.6 (APK 416)	86	05/15→	→			<b>24.0109-0182.1 409182</b>	Ø 259,4 9 8
1.6 (APK 416)	88	02/15→					
1.6 AllGrip	86	05/15→					
1.6 AllGrip	88	02/15→					
1.6 DDiS (APK 416D)	88	02/15→					
1.6 DDiS AllGrip	88	02/15→					
1.6 VVT AllGrip	93	08/16→					
<b>SUZUKI - VITARA Cabrio (ET, TA) 07/88→10/02</b>							
 <b>Bremsbelagsatz, Scheibenbremse</b>							
1.6 i 16V (TA02, SE416)	71	07/90→03/99	←	→ 01/95		<b>13.0460-2997.2 602997</b> <b>13.0460-5967.2 605967</b>	TRW 20708 15,8 + WE / - WK AKE 21500 15,0 + WK
1.9 D (SE 419TD)	50	01/95→03/98	←			<b>13.0460-5857.2 605857</b>	SUM 23314 15,0 + WK
1.9 D (SE 419TD)	55	08/96→03/99	←	→ 03/98		<b>13.0460-5857.2 605857</b>	SUM 23314 15,0 + WK
2.0 16V (TA51, SV420)	97	12/96→03/99					
<b>Zubehörsatz, Scheibenbremsbelag</b>							
1.6 i 16V (TA02, SE416)	71	07/90→03/99	←	→ 01/95		<b>13.0460-0449.2 610449</b>	AKE
 <b>Bremsscheibe</b>							
1.6 i 16V (TA02, SE416)	71	07/90→03/99	←	→ 01/95		<b>24.0110-0242.1 410242</b>	Ø 290 10 8
<b>SUZUKI - WAGON R Schrägheck 07/03→12/12</b>							
 <b>Bremsbelagsatz, Scheibenbremse</b>							
1.0	39	07/03→08/05	←			<b>13.0460-5836.2 605836</b>	23662 15,0 + WK + Zub
1.0	44	06/04→08/05	←			<b>13.0460-3995.2 603995</b>	BOS 23605 15,7 + WK + Zub
1.2	59	06/04→08/05					
1.3 (RB413)	65	09/03→12/10					
<b>Zubehörsatz, Scheibenbremsbelag</b>							
1.0	39	07/03→08/05	←			<b>13.0460-0141.2 610141</b>	
 <b>Bremsscheibe</b>							
1.0	39	07/03→08/05	←			<b>24.0117-0105.1 417105</b>	Ø 231 17 15 V
1.0	44	06/04→08/05	←			<b>24.0117-0106.1 417106</b>	Ø 253 17 15 V
↓							

	kw					! #		
<b>SUZUKI - WAGON R Schrägheck 07/03→12/12</b>								
 <b>Bremsscheibe</b>								
1.2	59	06/04→08/05	←			24.0117-0106.1	417106	Ø 253 17 15 V
1.3 (RB413)	65	09/03→12/10	←	→ TSM53S00210000		24.0112-0153.1	412153	Ø 247 12 10,5
			←	TSM53S00210001→		24.0117-0106.1	417106	Ø 253 17 15 V
<b>SUZUKI - WAGON R+ Schrägheck (EM) 10/97→10/00</b>								
 <b>Bremsbelagsatz, Scheibenbremse</b>								
1.0 (RC410, SR410, SR412)	48	02/98→05/00	←	→ 04/00		13.0460-5836.2	605836	23662 15,0 + WK + Zub
1.2 (SR412)	51	02/98→05/00						
1.2 4WD (SR412)	51	02/98→05/00						
<b>Zubehörsatz, Scheibenbremsbelag</b>								
1.0 (RC410, SR410, SR412)	48	02/98→05/00	←	→ 04/00		13.0460-0141.2	610141	
1.2 (SR412)	51	02/98→05/00						
1.2 4WD (SR412)	51	02/98→05/00						
 <b>Bremsscheibe</b>								
1.0 (RC410, SR410, SR412)	48	02/98→05/00	←	→ 04/00		24.0117-0105.1	417105	Ø 231 17 15 V
1.2 (SR412)	51	02/98→05/00						
1.2 4WD (SR412)	51	02/98→05/00						
<b>SUZUKI - WAGON R+ Schrägheck (MM) 05/00→</b>								
 <b>Bremsbelagsatz, Scheibenbremse</b>								
1.0 XT Plus	74	08/00→07/01	←			13.0460-5836.2	605836	23662 15,0 + WK + Zub
1.3 (RB 413)	56	05/00→12/04	←			13.0460-3995.2	603995	BOS 23605 15,7 + WK + Zub
1.3 (RB 413)	69	09/03→	←	→ 04/08		13.0460-3995.2	603995	BOS 23605 15,7 + WK + Zub
			←					
1.3 4WD (RB 413)	69	09/03→						
1.3 DDiS (RB 413D)	51	09/03→						
1.3 4WD (RB 413)	56	10/01→	←	→ 12/04		13.0460-3995.2	603995	BOS 23605 15,7 + WK + Zub
<b>Zubehörsatz, Scheibenbremsbelag</b>								
1.0 XT Plus	74	08/00→07/01	←			13.0460-0141.2	610141	
 <b>Bremsscheibe</b>								
1.0 XT Plus	74	08/00→07/01	←			24.0117-0105.1	417105	Ø 231 17 15 V
1.3 (RB 413)	56	05/00→12/04	←	→ 210000		24.0112-0153.1	412153	Ø 247 12 10,5
			←	210001→		24.0117-0106.1	417106	Ø 253 17 15 V
1.3 (RB 413)	69	09/03→	←	→ 04/08		24.0117-0106.1	417106	Ø 253 17 15 V
			←					
1.3 4WD (RB 413)	69	09/03→						
1.3 DDiS (RB 413D)	51	09/03→						
1.3 4WD (RB 413)	56	10/01→	←	→ 210000		24.0112-0153.1	412153	Ø 247 12 10,5
			←	210001→; → 12/04		24.0117-0106.1	417106	Ø 253 17 15 V
<b>SUZUKI - X-90 (EL) 09/95→12/97</b>								
 <b>Bremsbelagsatz, Scheibenbremse</b>								
1.6 i 16V (SZ 416)	71	09/95→12/97	←	→ 10/97		13.0460-5967.2	605967	AKE 21500 15,0 + WK
1.6 i 16V 4x4 (SZ416)	71	09/95→12/97						
 <b>Bremsscheibe</b>								
1.6 i 16V (SZ 416)	71	09/95→12/97	←	→ 10/97		24.0110-0242.1	410242	Ø 290 10 8
1.6 i 16V 4x4 (SZ416)	71	09/95→12/97						
<b>TOYOTA - 4 RUNNER (_N1_) 08/87→03/96</b>								
 <b>Bremsscheibe</b>								
3.0 Turbo-D (KZN130_)	92	10/93→03/96	←			24.0125-0135.1	425135	Ø 291 25 23 V
<b>TOYOTA - 4 RUNNER (_N18_) 11/95→11/02</b>								
 <b>Bremsscheibe</b>								
2.7	112	11/95→07/02	←	→ 06/99;		24.0122-0185.1	422185	Ø 319 22 20 V
3.4	136	11/95→07/02		passend für Felgengröße [Zoll]: 16		24.0122-0253.1	422253	Ø 297 22 20 V
2.7 4WD (RZN185_)	112	11/95→08/02	←			24.0122-0185.1	422185	Ø 319 22 20 V
3.0 Turbo-D	92	11/95→11/02	←	→ 03/96		24.0125-0135.1	425135	Ø 291 25 23 V
3.4 4WD	136	09/98→11/02	←	→ 08/02		24.0122-0185.1	422185	Ø 319 22 20 V

























	kw					! #		
<b>TOYOTA - ALPHARD / VELLFIRE (_H2_) 04/08→12/14</b>								
 <b>Bremsbelagsatz, Scheibenbremse</b>								
3.5 (GGH20W)	202	04/08→12/14	←				<b>13.0460-5614.2 605614</b>	24601 18,0 - WE / - WK
			→				<b>13.0460-5814.2 605814</b>	BOS 23620 16,4 + WK
 <b>Bremsscheibe</b>								
3.5 (GGH20W)	202	04/08→12/14	←				<b>24.0128-0232.1 428232</b>	Ø 296 28 25 V
<b>TOYOTA - ALTEZZA (_E1_) 01/99→11/05</b>								
 <b>Bremsbelagsatz, Scheibenbremse</b>								
2.0	114	01/99→07/05	→				<b>13.0460-5748.2 605748</b>	23429 15,5 + WK
2.0 VVTi	118	01/99→07/05						
3.0	157	07/01→07/05						
 <b>Bremsscheibe</b>								
2.0	114	01/99→07/05	←				<b>24.0132-0701.1 432701</b>	Ø 296 32 30 V
2.0 VVTi	118	01/99→07/05						
3.0	157	07/01→07/05	→				<b>24.0112-0703.1 412703</b>	Ø 306,6 12 10,5
<b>TOYOTA - ALTEZZA GITA Kombi (_XE1_) 10/98→06/05</b>								
 <b>Bremsbelagsatz, Scheibenbremse</b>								
2.0	114	01/99→06/01	→				<b>13.0460-5748.2 605748</b>	23429 15,5 + WK
3.0	157	07/01→06/05						
 <b>Bremsscheibe</b>								
2.0	114	01/99→06/01	←				<b>24.0132-0701.1 432701</b>	Ø 296 32 30 V
3.0	157	07/01→06/05	→				<b>24.0112-0703.1 412703</b>	Ø 306,6 12 10,5
<b>TOYOTA - AURIS (_E15_) 10/06→09/12</b>								
 <b>Bremsbelagsatz, Scheibenbremse</b>								
1.33 Dual-VVTi (NRE150_)	73	01/10→09/12	←	Made in Großbritannien			<b>13.0460-5602.2 605602</b>	24122 19,0 + WK + Zub
1.33 Dual-VVTi (NRE150_)	74	05/09→09/12	←	Made in Japan			<b>13.0460-5767.2 605767</b>	AKE 24336 17,5 - WE / - WK
			→	Made in Großbritannien			<b>13.0460-5604.2 605604</b>	24664 15,2 + WK + Zub
1.4 (ZZE150_)	71	03/07→09/12						
1.5 (NZE151_)	81	09/09→09/12	→	Made in Japan			<b>13.0460-5769.2 605769</b>	24610 15,0 + WK
1.5 4WD (NZE154_)	77	09/09→09/12						
1.6 (ZRE151_)	91	03/07→09/12						
1.6 (ZRE151_)	97	05/09→09/12						
1.8 (ZRE152_, ZZE122)	100	10/06→09/12						
1.8 (ZRE152_)	106	02/09→09/12						
1.8 (ZRE152_)	108	02/09→09/12						
1.8 4WD (ZRE154_)	100	02/09→09/12						
1.4 D-4D (NDE150_)	66	03/07→09/12	←				<b>13.0460-5602.2 605602</b>	24122 19,0 + WK + Zub
			→	Made in Großbritannien			<b>13.0460-5604.2 605604</b>	24664 15,2 + WK + Zub
1.8 Hybrid (ZWE150_)	73	09/10→09/12	←				<b>13.0460-5602.2 605602</b>	24122 19,0 + WK + Zub
							<b>13.0460-5766.2 605766</b>	24337 17,5 - WK
			→				<b>13.0460-5769.2 605769</b>	24610 15,0 + WK
2.0 D-4D (ADE150_)	93	03/07→09/12	←				<b>13.0460-5603.2 605603</b>	24204 19,2 + WK + Zub
			→	Made in Großbritannien			<b>13.0460-5604.2 605604</b>	24664 15,2 + WK + Zub
2.2 D (ADE157_, ADE151_)	130	11/06→09/12	←				<b>13.0460-5603.2 605603</b>	24204 19,2 + WK + Zub
			→				<b>13.0460-5604.2 605604</b>	24664 15,2 + WK + Zub
 <b>Bremsscheibe</b>								
1.33 Dual-VVTi (NRE150_)	73	01/10→09/12	←	Made in Japan			<b>24.0122-0256.1 422256</b>	Ø 275 22 19 V
1.33 Dual-VVTi (NRE150_)	74	05/09→09/12	←	Made in Großbritannien			<b>24.0126-0148.1 426148</b>	Ø 273 26 23 V
			→	Made in Japan			<b>24.0109-0155.1 409155</b>	Ø 259 9 7,5
1.4 (ZZE150_)	71	03/07→09/12						
1.5 (NZE151_)	81	09/09→09/12	→	Made in Großbritannien			<b>24.0110-0337.1 410337</b>	Ø 270 9,9 8
1.5 4WD (NZE154_)	77	09/09→09/12						
1.6 (ZRE151_)	91	03/07→09/12						
1.6 (ZRE151_)	97	05/09→09/12						
1.8 (ZRE152_, ZZE122)	100	10/06→09/12						
1.8 (ZRE152_)	106	02/09→09/12						
1.8 (ZRE152_)	108	02/09→09/12						
1.8 4WD (ZRE154_)	100	02/09→09/12						
1.4 D-4D (NDE150_)	66	03/07→09/12	←				<b>24.0126-0148.1 426148</b>	Ø 273 26 23 V
			→				<b>24.0110-0337.1 410337</b>	Ø 270 9,9 8
1.8 Hybrid (ZWE150_)	73	09/10→09/12	←				<b>24.0126-0148.1 426148</b>	Ø 273 26 23 V

	kw			 	! #		
<b>TOYOTA - AURIS (E15) 10/06→09/12</b>							
 <b>Bremsscheibe</b>							
1.8 Hybrid (ZWE150_)	73	09/10→09/12	←			24.0128-0159.1 428159	Ø 296 28 25 V
			→			24.0109-0155.1 409155	Ø 259 9 7,5
2.0 D-4D (ADE150_)	93	03/07→09/12	←			24.0126-0156.1 426156	Ø 295 26 23 V
2.2 D (ADE157_)	130	11/06→09/12	→			24.0110-0337.1 410337	Ø 270 9,9 8
ADE151_)							
<b>TOYOTA - AURIS (E18) 10/12→</b>							
 <b>Bremsbelagsatz, Scheibenbremse</b>							
1.2 (NRE185_)	85	03/15→	←			13.0460-3868.2 603868	BOS 25698 18,7 + WK + Zub
1.3 (NRE180_)	73	10/12→	→			13.0460-5604.2 605604	24664 15,2 + WK + Zub
1.4 D-4D (NDE180_)	66	10/12→					
1.6 (ZRE181_)	97	10/12→					
ZRE185_)							
1.6 D4-D (WWE185_)	82	04/15→					
1.8 (ZRE182)	103	10/12→	←			13.0460-5766.2 605766	24337 17,5 - WK
			→			13.0460-5604.2 605604	24664 15,2 + WK + Zub
1.8 Hybrid (ZWE186_)	73	10/12→	←	für Fahrzeuge ohne Panorama-Sonnendach		13.0460-3868.2 603868	BOS 25698 18,7 + WK + Zub
			←	für Fahrzeuge mit Panorama-Sonnendach		13.0460-5766.2 605766	24337 17,5 - WK
			→			13.0460-5604.2 605604	24664 15,2 + WK + Zub
2.0 D-4D (ADE186_)	91	10/12→	←			13.0460-5603.2 605603	24204 19,2 + WK + Zub
			→			13.0460-5604.2 605604	24664 15,2 + WK + Zub
 <b>Bremsscheibe</b>							
1.2 (NRE185_)	85	03/15→	←			24.0126-0184.1 426184	Ø 277 26 23 V
1.3 (NRE180_)	73	10/12→	→			24.0110-0337.1 410337	Ø 270 9,9 8
1.4 D-4D (NDE180_)	66	10/12→					
1.6 (ZRE181_)	97	10/12→					
ZRE185_)							
1.6 D4-D (WWE185_)	82	04/15→					
1.8 (ZRE182)	103	10/12→	←			24.0128-0159.1 428159	Ø 296 28 25 V
			→			24.0110-0337.1 410337	Ø 270 9,9 8
1.8 Hybrid (ZWE186_)	73	10/12→	←	für Fahrzeuge ohne Panorama-Sonnendach		24.0126-0184.1 426184	Ø 277 26 23 V
			←	für Fahrzeuge mit Panorama-Sonnendach		24.0128-0159.1 428159	Ø 296 28 25 V
			→			24.0110-0337.1 410337	Ø 270 9,9 8
2.0 D-4D (ADE186_)	91	10/12→	←			24.0126-0156.1 426156	Ø 295 26 23 V
			→			24.0110-0337.1 410337	Ø 270 9,9 8
<b>TOYOTA - AURIS TOURING SPORTS Kombi (E18) 07/13→</b>							
 <b>Bremsbelagsatz, Scheibenbremse</b>							
1.2 (NRE185_)	85	03/15→	←			13.0460-3868.2 603868	BOS 25698 18,7 + WK + Zub
1.3 (NRE180_)	73	07/13→	→			13.0460-5604.2 605604	24664 15,2 + WK + Zub
1.4 D-4D (NDE180_)	66	07/13→					
1.6 (ZRE185_)	97	07/13→					
1.6 D4-D (WWE185_)	82	04/15→					
1.8 Hybrid (ZWE186_)	73	07/13→	←	für Fahrzeuge ohne Panorama-Sonnendach		13.0460-3868.2 603868	BOS 25698 18,7 + WK + Zub
			←	für Fahrzeuge mit Panorama-Sonnendach		13.0460-5766.2 605766	24337 17,5 - WK
			→			13.0460-5604.2 605604	24664 15,2 + WK + Zub
2.0 D-4D (ADE186_)	91	07/13→	←			13.0460-5603.2 605603	24204 19,2 + WK + Zub
			→			13.0460-5604.2 605604	24664 15,2 + WK + Zub
 <b>Bremsscheibe</b>							
1.2 (NRE185_)	85	03/15→	←			24.0126-0184.1 426184	Ø 277 26 23 V
1.3 (NRE180_)	73	07/13→	→			24.0110-0337.1 410337	Ø 270 9,9 8
1.4 D-4D (NDE180_)	66	07/13→					
1.6 (ZRE185_)	97	07/13→					
1.6 D4-D (WWE185_)	82	04/15→					
1.8 Hybrid (ZWE186_)	73	07/13→	←	für Fahrzeuge ohne Panorama-Sonnendach		24.0126-0184.1 426184	Ø 277 26 23 V
			←	für Fahrzeuge mit Panorama-Sonnendach		24.0128-0159.1 428159	Ø 296 28 25 V
			→			24.0110-0337.1 410337	Ø 270 9,9 8
2.0 D-4D (ADE186_)	91	07/13→	←			24.0126-0156.1 426156	Ø 295 26 23 V
			→			24.0110-0337.1 410337	Ø 270 9,9 8

























	kw					! #		
<b>TOYOTA - AURIS VAN Kasten ( E18_ ) 03/13→</b>								
 <b>Bremsbelagsatz, Scheibenbremse</b>								
1.4 D-4D (NDE180_)	66	03/13→	←			13.0460-3868.2	603868	BOS 25698 18,7 + WK + Zub
			→			13.0460-5604.2	605604	24664 15,2 + WK + Zub
 <b>Bremsscheibe</b>								
1.4 D-4D (NDE180_)	66	03/13→	←			24.0126-0184.1	426184	Ø 277 26 23 V
			→			24.0110-0337.1	410337	Ø 270 9,9 8
<b>TOYOTA - AVENSIS ( T22_ ) 09/97→02/03</b>								
 <b>Bremsbelagsatz, Scheibenbremse</b>								
1.6 (AT220_)	74	09/97→10/00	←	→ 09/00;	für Fahrzeuge mit Trommelbremse an der Hinterachse	13.0460-5809.2	605809	ATE 21975 18,2 + WK
1.8 (AT221_)	81	09/97→10/00						
1.6 (AT220_)	81	10/97→06/00	←		für Fahrzeuge mit Trommelbremse an der Hinterachse	13.0460-5809.2	605809	ATE 21975 18,2 + WK
2.0 D (CT220_)	61	10/97→05/98						
1.6 VVT-i (ZZT220_)	81	10/00→02/03	←	07/01→;	für Fahrzeuge mit Scheibenbremse an der Hinterachse	13.0460-5844.2	605844	ATE 23996 17,5 + WK
1.8 VVT-i (ZZT221_)	95	10/00→02/03						
2.0 VVT-i (AZT220_)	110	10/00→02/03	←	→ 06/01;	für Fahrzeuge mit Scheibenbremse an der Hinterachse	13.0460-5845.2	605845	AKE 21961 15,5 + WK
			→			13.0460-5840.2	605840	AKE 21833 15,0 + WK
			→	07/01→		13.0460-5869.2	605869	TRW 24013 14,9 + WK
2.0 (ST220_)	94	09/97→10/00	←	→ 09/00;	für Fahrzeuge mit Trommelbremse an der Hinterachse	13.0460-5809.2	605809	ATE 21975 18,2 + WK
			←	10/00→;	für Fahrzeuge mit Scheibenbremse an der Hinterachse	13.0460-5845.2	605845	AKE 21961 15,5 + WK
			→	10/00→		13.0460-5840.2	605840	AKE 21833 15,0 + WK
2.0 D-4D (CDT220_)	81	10/99→02/03	←	für Fahrzeuge mit Trommelbremse an der Hinterachse		13.0460-5809.2	605809	ATE 21975 18,2 + WK
2.0 TD (CT220_)	66	09/97→02/03	←	07/01→;	für Fahrzeuge mit Scheibenbremse an der Hinterachse	13.0460-5844.2	605844	ATE 23996 17,5 + WK
			←	→ 06/01;	für Fahrzeuge mit Scheibenbremse an der Hinterachse	13.0460-5845.2	605845	AKE 21961 15,5 + WK
			→			13.0460-5840.2	605840	AKE 21833 15,0 + WK
			→	07/01→		13.0460-5869.2	605869	TRW 24013 14,9 + WK
 <b>Bremsscheibe</b>								
1.6 (AT220_)	74	09/97→10/00	←	→ 09/00;	für Fahrzeuge mit Trommelbremse an der Hinterachse	24.0125-0140.1	425140	Ø 260 25 23 V
1.8 (AT221_)	81	09/97→10/00						
1.6 (AT220_)	81	10/97→06/00	←		für Fahrzeuge mit Trommelbremse an der Hinterachse	24.0125-0140.1	425140	Ø 260 25 23 V
2.0 D (CT220_)	61	10/97→05/98						
1.6 VVT-i (ZZT220_)	81	10/00→02/03	←	07/01→;	für Fahrzeuge mit Scheibenbremse an der Hinterachse	24.0125-0156.1	425156	Ø 276 25 23 V
1.8 VVT-i (ZZT221_)	95	10/00→02/03						
2.0 VVT-i (AZT220_)	110	10/00→02/03	←	→ 06/01;	für Fahrzeuge mit Scheibenbremse an der Hinterachse	24.0128-0183.1	428183	Ø 275 28 26 V
			→			24.0110-0284.1	410284	Ø 271 10 9
			→	06/01		24.0110-0305.1	410305	Ø 288 10 8,5
2.0 (ST220_)	94	09/97→10/00	←	→ 09/00;	für Fahrzeuge mit Trommelbremse an der Hinterachse	24.0125-0140.1	425140	Ø 260 25 23 V
			←	10/00→;	für Fahrzeuge mit Scheibenbremse an der Hinterachse	24.0128-0183.1	428183	Ø 275 28 26 V
			→	10/00→		24.0110-0305.1	410305	Ø 288 10 8,5
2.0 D-4D (CDT220_)	81	10/99→02/03	←	für Fahrzeuge mit Trommelbremse an der Hinterachse		24.0125-0140.1	425140	Ø 260 25 23 V
2.0 TD (CT220_)	66	09/97→02/03	←	07/01→;	für Fahrzeuge mit Scheibenbremse an der Hinterachse	24.0125-0156.1	425156	Ø 276 25 23 V
			←	→ 06/01;	für Fahrzeuge mit Scheibenbremse an der Hinterachse	24.0128-0183.1	428183	Ø 275 28 26 V
			→			24.0110-0284.1	410284	Ø 271 10 9











	kW					! #		
<b>TOYOTA - AVENSIS ( T22 ) 09/97→02/03</b>								
 <b>Bremsscheibe</b>								
2.0 D-4D (CDT220_)	81	10/99→02/03	➡	→ 06/01			24.0110-0305.1 410305	Ø 288 10 8,5
2.0 TD (CT220_)	66	09/97→02/03						
<b>TOYOTA - AVENSIS ( T25 ) 03/03→11/08</b>								
 <b>Bremsbelagsatz, Scheibenbremse</b>								
1.6 VVT-i (ZZT250_)	81	04/03→11/08	←	01/08→			13.0460-5813.2 605813	BOS 23480 19,3 + WK
1.8 (ZZT251_)	95	03/03→10/08						
2.0 (AZT250_)	108	03/03→11/08	←	→ 12/07			13.0460-5813.2 605813	BOS 23480 19,3 + WK
2.0 D-4D (ADT250_)	93	03/06→11/08						
2.0 D-4D (CDT250_)	85	04/03→11/08	➡				13.0460-5814.2 605814	BOS 23620 16,4 + WK
2.2 D-4D (ADT251_)	110	10/05→11/08						
2.2 D-CAT (ADT251_)	130	07/05→11/08						
2.4 (AZT251_)	120	10/03→10/08						
2.4 (AZT251_)	125	09/03→11/08						
<b>Zubehörsatz, Scheibenbremsbelag</b>								
1.6 VVT-i (ZZT250_)	81	04/03→11/08	←	→ 12/07			13.0460-0454.2 610454	BOS
1.8 (ZZT251_)	95	03/03→10/08						
2.0 (AZT250_)	108	03/03→11/08	➡				13.0460-0256.2 610256	BOS
2.0 D-4D (ADT250_)	93	03/06→11/08						
2.0 D-4D (CDT250_)	85	04/03→11/08						
2.2 D-4D (ADT251_)	110	10/05→11/08						
2.2 D-CAT (ADT251_)	130	07/05→11/08						
2.4 (AZT251_)	120	10/03→10/08						
2.4 (AZT251_)	125	09/03→11/08						
 <b>Bremsscheibe</b>								
1.6 VVT-i (ZZT250_)	81	04/03→11/08	←				24.0126-0139.1 426139	Ø 277 26 24 V
1.8 (ZZT251_)	95	03/03→10/08	➡				24.0110-0311.1 410311	Ø 280 10 9
2.0 (AZT250_)	108	03/03→11/08	←				24.0126-0141.1 426141	Ø 295 26 24 V
2.0 D-4D (ADT250_)	93	03/06→11/08						
2.0 D-4D (CDT250_)	85	04/03→11/08	➡				24.0110-0311.1 410311	Ø 280 10 9
2.4 (AZT251_)	120	10/03→10/08						
2.4 (AZT251_)	125	09/03→11/08						
2.2 D-4D (ADT251_)	110	10/05→11/08	←				24.0126-0138.1 426138	Ø 295 26 24 V
2.2 D-CAT (ADT251_)	130	07/05→11/08	➡				24.0110-0333.1 410333	Ø 280 10 8,5
<b>TOYOTA - AVENSIS Combi ( T25 ) 04/03→11/08</b>								
 <b>Bremsbelagsatz, Scheibenbremse</b>								
1.6 VVT-i (ZZT250_)	81	04/03→11/08	←	01/08→			13.0460-5813.2 605813	BOS 23480 19,3 + WK
1.8 (ZZT251_)	95	04/03→11/08						
2.0 (AZT250_)	108	04/03→11/08	←	→ 12/07			13.0460-5813.2 605813	BOS 23480 19,3 + WK
2.0 D-4D (ADT250_)	93	03/06→11/08						
2.0 D-4D (CDT250_)	85	04/03→11/08	➡				13.0460-5814.2 605814	BOS 23620 16,4 + WK
2.0 VVTi (AZT250_)	114	04/03→11/08						
2.2 D-4D (ADT251_)	110	10/05→11/08						
2.2 D-CAT (ADT251_)	130	07/05→11/08						
2.4 (AZT251_)	120	10/03→10/08						
2.4 (AZT251_)	125	09/03→11/08						
<b>Zubehörsatz, Scheibenbremsbelag</b>								
1.6 VVT-i (ZZT250_)	81	04/03→11/08	←	→ 12/07			13.0460-0454.2 610454	BOS
1.8 (ZZT251_)	95	04/03→11/08						
2.0 (AZT250_)	108	04/03→11/08	➡				13.0460-0256.2 610256	BOS
2.0 D-4D (ADT250_)	93	03/06→11/08						
2.0 D-4D (CDT250_)	85	04/03→11/08						
2.0 VVTi (AZT250_)	114	04/03→11/08						
2.2 D-4D (ADT251_)	110	10/05→11/08						
2.2 D-CAT (ADT251_)	130	07/05→11/08						
2.4 (AZT251_)	120	10/03→10/08						
2.4 (AZT251_)	125	09/03→11/08						
 <b>Bremsscheibe</b>								
1.6 VVT-i (ZZT250_)	81	04/03→11/08	←				24.0126-0139.1 426139	Ø 277 26 24 V
1.8 (ZZT251_)	95	04/03→11/08	➡				24.0110-0311.1 410311	Ø 280 10 9
2.0 VVTi (AZT250_)	114	04/03→11/08						
2.0 (AZT250_)	108	04/03→11/08	←				24.0126-0141.1 426141	Ø 295 26 24 V
2.0 D-4D (ADT250_)	93	03/06→11/08						
2.0 D-4D (CDT250_)	85	04/03→11/08	➡				24.0110-0311.1 410311	Ø 280 10 9
2.4 (AZT251_)	120	10/03→10/08						
2.4 (AZT251_)	125	09/03→11/08						
2.2 D-4D (ADT251_)	110	10/05→11/08	←				24.0126-0138.1 426138	Ø 295 26 24 V
2.2 D-CAT (ADT251_)	130	07/05→11/08	➡				24.0110-0333.1 410333	Ø 280 10 8,5

















	kw			 	! #		
<b>TOYOTA - AVENSIS Kombi ( _T22_) 09/97→02/03</b>							
<b> Bremsbelagsatz, Scheibenbremse</b>							
1.6 (AT220_, ZZT220_) 1.6 (AT220_) 1.8 (AT221_)	81 74 81	09/97→10/00 09/97→10/00 09/97→10/00	←	→ 09/00; für Fahrzeuge mit Trommelbremse an der Hinterachse		13.0460-5809.2 605809	ATE 21975 18,2 + WK
1.6 (ZZT220_)	81	07/00→02/03	←	07/01→; für Fahrzeuge mit Scheibenbremse an der Hinterachse		13.0460-5844.2 605844	ATE 23996 17,5 + WK
			←	10/00→ 06/01; für Fahrzeuge mit Scheibenbremse an der Hinterachse		13.0460-5845.2 605845	AKE 21961 15,5 + WK
			→	10/00→ 06/01		13.0460-5840.2 605840	AKE 21833 15,0 + WK
			→	07/01→		13.0460-5869.2 605869	TRW 24013 14,9 + WK
1.8 (ZZT221_) 2.0 (AZT220_)	95 110	10/00→02/03 10/00→02/03	←	07/01→; für Fahrzeuge mit Scheibenbremse an der Hinterachse		13.0460-5844.2 605844	ATE 23996 17,5 + WK
			←	→ 06/01; für Fahrzeuge mit Scheibenbremse an der Hinterachse		13.0460-5845.2 605845	AKE 21961 15,5 + WK
			→	→ 06/01		13.0460-5840.2 605840	AKE 21833 15,0 + WK
			→	07/01→		13.0460-5869.2 605869	TRW 24013 14,9 + WK
2.0 (ST220_)	94	09/97→10/00	←	→ 09/00; für Fahrzeuge mit Trommelbremse an der Hinterachse		13.0460-5809.2 605809	ATE 21975 18,2 + WK
			←	10/00→; für Fahrzeuge mit Scheibenbremse an der Hinterachse		13.0460-5845.2 605845	AKE 21961 15,5 + WK
			→	10/00→		13.0460-5840.2 605840	AKE 21833 15,0 + WK
2.0 D (CDT220_)	85	09/02→02/03	←	für Fahrzeuge mit Scheibenbremse an der Hinterachse		13.0460-5844.2 605844	ATE 23996 17,5 + WK
			→			13.0460-5869.2 605869	TRW 24013 14,9 + WK
2.0 D (CT220_)	61	10/97→05/98	←	für Fahrzeuge mit Trommelbremse an der Hinterachse		13.0460-5809.2 605809	ATE 21975 18,2 + WK
2.0 D-4D (CDT220_) 2.0 TD (CT220_)	81 66	10/99→02/03 09/97→02/03	←	für Fahrzeuge mit Trommelbremse an der Hinterachse		13.0460-5809.2 605809	ATE 21975 18,2 + WK
			←	07/01→; für Fahrzeuge mit Scheibenbremse an der Hinterachse		13.0460-5844.2 605844	ATE 23996 17,5 + WK
			←	→ 06/01; für Fahrzeuge mit Scheibenbremse an der Hinterachse		13.0460-5845.2 605845	AKE 21961 15,5 + WK
			→	→ 06/01		13.0460-5840.2 605840	AKE 21833 15,0 + WK
→	07/01→		13.0460-5869.2 605869	TRW 24013 14,9 + WK			
<b> Bremsscheibe</b>							
1.6 (AT220_, ZZT220_) 1.6 (AT220_) 1.8 (AT221_)	81 74 81	09/97→10/00 09/97→10/00 09/97→10/00	←	→ 09/00; für Fahrzeuge mit Trommelbremse an der Hinterachse		24.0125-0140.1 425140	Ø 260 25 23 V
1.6 (ZZT220_)	81	07/00→02/03	←	07/01→; für Fahrzeuge mit Scheibenbremse an der Hinterachse		24.0125-0156.1 425156	Ø 276 25 23 V
			←	10/00→ 06/01; für Fahrzeuge mit Scheibenbremse an der Hinterachse		24.0128-0183.1 428183	Ø 275 28 26 V
			→	07/01→		24.0110-0284.1 410284	Ø 271 10 9
			→	10/00→ 06/01		24.0110-0305.1 410305	Ø 288 10 8,5
1.8 (ZZT221_) 2.0 (AZT220_)	95 110	10/00→02/03 10/00→02/03	←	07/01→; für Fahrzeuge mit Scheibenbremse an der Hinterachse		24.0125-0156.1 425156	Ø 276 25 23 V
			←	→ 06/01; für Fahrzeuge mit Scheibenbremse an der Hinterachse		24.0128-0183.1 428183	Ø 275 28 26 V
			→	07/01→		24.0110-0284.1 410284	Ø 271 10 9
			→	→ 06/01		24.0110-0305.1 410305	Ø 288 10 8,5
2.0 (ST220_)	94	09/97→10/00	←	→ 09/00; für Fahrzeuge mit Trommelbremse an der Hinterachse		24.0125-0140.1 425140	Ø 260 25 23 V
			←	10/00→; für Fahrzeuge mit Scheibenbremse an der Hinterachse		24.0128-0183.1 428183	Ø 275 28 26 V
			→	10/00→		24.0110-0305.1 410305	Ø 288 10 8,5
2.0 D (CDT220_)	85	09/02→02/03	←	für Fahrzeuge mit Scheibenbremse an der Hinterachse		24.0125-0156.1 425156	Ø 276 25 23 V
↓							



















	kw					! #		
<b>TOYOTA - AVENSIS Kombi ( _T22_) 09/97→02/03</b>								
 <b>Bremsscheibe</b>								
2.0 D (CDT220_)	85	09/02→02/03	➔				<b>24.0110-0284.1 410284</b>	Ø 271 10 9
2.0 D (CT220_)	61	10/97→05/98	➔	für Fahrzeuge mit Trommelbremse an der Hinterachse			<b>24.0125-0140.1 425140</b>	Ø 260 25 23 V
2.0 D-4D (CDT220_)	81	10/99→02/03	➔	für Fahrzeuge mit Trommelbremse an der Hinterachse			<b>24.0125-0140.1 425140</b>	Ø 260 25 23 V
2.0 TD (CT220_)	66	09/97→02/03	➔	07/01→; für Fahrzeuge mit Scheibenbremse an der Hinterachse			<b>24.0125-0156.1 425156</b>	Ø 276 25 23 V
			➔	→ 06/01; für Fahrzeuge mit Scheibenbremse an der Hinterachse			<b>24.0128-0183.1 428183</b>	Ø 275 28 26 V
			➔	07/01→			<b>24.0110-0284.1 410284</b>	Ø 271 10 9
			➔	→ 06/01			<b>24.0110-0305.1 410305</b>	Ø 288 10 8,5
<b>TOYOTA - AVENSIS Kombi ( _T27_) 02/09→</b>								
 <b>Bremsbelagsatz, Scheibenbremse</b>								
1.6 (ZRT270_)	97	02/09→	➔				<b>13.0460-5603.2 605603</b>	24204 19,2 + WK + Zub
1.8 (ZRT271_)	108	02/09→	➔				<b>13.0460-3853.2 603853</b>	BOS 24885 16,8 + WK + Zub
2.0 (ZRT272_)	112	02/09→	➔					
2.0 D-4D (ADT270_)	91	11/11→	➔					
2.0 D-4D (ADT270_)	93	02/09→	➔					
1.6 D4-D (WWT270_)	82	04/15→	➔	→ 06/15			<b>13.0460-5603.2 605603</b>	24204 19,2 + WK + Zub
			➔	→ 06/15			<b>13.0460-3853.2 603853</b>	BOS 24885 16,8 + WK + Zub
2.0 D-4D (WWT271_)	105	04/15→	➔	→ 06/15			<b>13.0460-3874.2 603874</b>	BOS 25006 18,8 + WK + Zub
			➔	→ 06/15; Kasten/Kombi			<b>13.0460-5603.2 605603</b>	24204 19,2 + WK + Zub
			➔	→ 06/15			<b>13.0460-3853.2 603853</b>	BOS 24885 16,8 + WK + Zub
2.2 D-4D (ADT271_)	110	02/09→	➔	12/10→			<b>13.0460-3874.2 603874</b>	BOS 25006 18,8 + WK + Zub
2.2 D-4D (ADT271_)	130	02/09→	➔	→ 11/10			<b>13.0460-5615.2 605615</b>	BOS 24946 19,0 + WK + Zub
			➔				<b>13.0460-3853.2 603853</b>	BOS 24885 16,8 + WK + Zub
 <b>Bremsscheibe</b>								
1.6 (ZRT270_)	97	02/09→	➔				<b>24.0126-0156.1 426156</b>	Ø 295 26 23 V
1.6 D4-D (WWT270_)	82	04/15→	➔				<b>24.0111-0169.1 411169</b>	Ø 290 11 9
1.8 (ZRT271_)	108	02/09→	➔					
2.0 (ZRT272_)	112	02/09→	➔					
2.0 D-4D (ADT270_)	91	11/11→	➔					
2.0 D-4D (ADT270_)	93	02/09→	➔					
2.0 D-4D (WWT271_)	105	04/15→	➔				<b>24.0126-0160.1 426160</b>	Ø 320 26 23 V
2.2 D-4D (ADT271_)	110	02/09→	➔				<b>24.0111-0169.1 411169</b>	Ø 290 11 9
2.2 D-4D (ADT271_)	130	02/09→	➔					
<b>TOYOTA - AVENSIS Liftback ( _T22_) 09/97→02/03</b>								
 <b>Bremsbelagsatz, Scheibenbremse</b>								
1.6 (AT220_)	74	09/97→10/00	➔	→ 09/00;			<b>13.0460-5809.2 605809</b>	ATE 21975 18,2 + WK
1.6 (AT220_)	81	09/97→10/00	➔	für Fahrzeuge mit Trommelbremse an der Hinterachse				
1.8 (AT221_)	81	09/97→10/00	➔					
1.6 (ZZT220_)	81	10/00→02/03	➔	07/01→;			<b>13.0460-5844.2 605844</b>	ATE 23996 17,5 + WK
1.8 (ZZT221_)	95	10/00→02/03	➔	für Fahrzeuge mit Scheibenbremse an der Hinterachse				
2.0 (AZT220_)	110	10/00→02/03	➔	→ 06/01; für Fahrzeuge mit Scheibenbremse an der Hinterachse			<b>13.0460-5845.2 605845</b>	AKE 21961 15,5 + WK
			➔	→ 06/01			<b>13.0460-5840.2 605840</b>	AKE 21833 15,0 + WK
			➔	07/01→			<b>13.0460-5869.2 605869</b>	TRW 24013 14,9 + WK
2.0 (ST220_)	94	09/97→10/00	➔	→ 09/00;			<b>13.0460-5809.2 605809</b>	ATE 21975 18,2 + WK
			➔	für Fahrzeuge mit Trommelbremse an der Hinterachse				
			➔	10/00→;			<b>13.0460-5845.2 605845</b>	AKE 21961 15,5 + WK
			➔	für Fahrzeuge mit Scheibenbremse an der Hinterachse				
			➔	10/00→			<b>13.0460-5840.2 605840</b>	AKE 21833 15,0 + WK
2.0 D (CDT220_)	85	09/02→02/03	➔	für Fahrzeuge mit Scheibenbremse an der Hinterachse			<b>13.0460-5844.2 605844</b>	ATE 23996 17,5 + WK
			➔				<b>13.0460-5869.2 605869</b>	TRW 24013 14,9 + WK
2.0 D-4D (CDT220_)	81	10/99→02/03	➔	für Fahrzeuge mit Trommelbremse an der Hinterachse			<b>13.0460-5809.2 605809</b>	ATE 21975 18,2 + WK
2.0 TD (CT220_)	66	09/97→02/03	➔	07/01→;			<b>13.0460-5844.2 605844</b>	ATE 23996 17,5 + WK
			➔	für Fahrzeuge mit Scheibenbremse an der Hinterachse				





























	kw					! #		
<b>TOYOTA - AVENSIS Liftback (_T22_) 09/97→02/03</b>								
 <b>Bremsbelagsatz, Scheibenbremse</b>								
2.0 D-4D (CDT220_) 2.0 TD (CT220_)	81 66	10/99→02/03 09/97→02/03	←	→ 06/01; für Fahrzeuge mit Scheibenbremse an der Hinterachse			<b>13.0460-5845.2 605845</b>	AKE 21961 15,5 + WK
			→	→ 06/01			<b>13.0460-5840.2 605840</b>	AKE 21833 15,0 + WK
			→	07/01→			<b>13.0460-5869.2 605869</b>	TRW 24013 14,9 + WK
 <b>Bremsscheibe</b>								
1.6 (AT220_) 1.6 (AT220_) 1.8 (AT221_)	74 81 81	09/97→10/00 09/97→10/00 09/97→10/00	←	→ 09/00; für Fahrzeuge mit Trommelbremse an der Hinterachse			<b>24.0125-0140.1 425140</b>	Ø 260 25 23 V
1.6 (ZZT220_) 1.8 (ZZT221_) 2.0 (AZT220_)	81 95 110	10/00→02/03 10/00→02/03 10/00→02/03	←	07/01→; für Fahrzeuge mit Scheibenbremse an der Hinterachse			<b>24.0125-0156.1 425156</b>	Ø 276 25 23 V
			←	→ 06/01; für Fahrzeuge mit Scheibenbremse an der Hinterachse			<b>24.0128-0183.1 428183</b>	Ø 275 28 26 V
			→	07/01→			<b>24.0110-0284.1 410284</b>	Ø 271 10 9
			→	→ 06/01			<b>24.0110-0305.1 410305</b>	Ø 288 10 8,5
2.0 (ST220_)	94	09/97→10/00	←	→ 09/00; für Fahrzeuge mit Trommelbremse an der Hinterachse			<b>24.0125-0140.1 425140</b>	Ø 260 25 23 V
			←	10/00→; für Fahrzeuge mit Scheibenbremse an der Hinterachse			<b>24.0128-0183.1 428183</b>	Ø 275 28 26 V
			→	10/00→			<b>24.0110-0305.1 410305</b>	Ø 288 10 8,5
2.0 D (CDT220_)	85	09/02→02/03	←	für Fahrzeuge mit Scheibenbremse an der Hinterachse			<b>24.0125-0156.1 425156</b>	Ø 276 25 23 V
			→				<b>24.0110-0284.1 410284</b>	Ø 271 10 9
2.0 D-4D (CDT220_) 2.0 TD (CT220_)	81 66	10/99→02/03 09/97→02/03	←	für Fahrzeuge mit Trommelbremse an der Hinterachse			<b>24.0125-0140.1 425140</b>	Ø 260 25 23 V
			←	07/01→; für Fahrzeuge mit Scheibenbremse an der Hinterachse			<b>24.0125-0156.1 425156</b>	Ø 276 25 23 V
			←	→ 06/01; für Fahrzeuge mit Scheibenbremse an der Hinterachse			<b>24.0128-0183.1 428183</b>	Ø 275 28 26 V
			→	07/01→			<b>24.0110-0284.1 410284</b>	Ø 271 10 9
			→	→ 06/01			<b>24.0110-0305.1 410305</b>	Ø 288 10 8,5
<b>TOYOTA - AVENSIS Stufenheck (_T25_) 04/03→11/08</b>								
 <b>Bremsbelagsatz, Scheibenbremse</b>								
1.6 VVT-i (ZZT250_) 1.8 (ZZT251_) 2.0 (AZT250_)	81 95 108	04/03→11/08 04/03→11/08 04/03→11/08	←	01/08→			<b>13.0460-5813.2 605813</b>	BOS 23480 19,3 + WK
2.0 D-4D (ADT250_) 2.0 D-4D (CDT250_) 2.0 VVTi (AZT250_) 2.2 D-4D (ADT251_) 2.2 D-CAT (ADT251_) 2.4 (AZT251_) 2.4 (AZT251_)	93 85 114 110 130 120 125	03/06→10/08 04/03→11/08 04/03→11/08 10/05→11/08 07/05→11/08 10/03→10/08 09/03→11/08	←	→ 12/07			<b>13.0460-5813.2 605813</b>	BOS 23480 19,3 + WK
			→				<b>13.0460-5814.2 605814</b>	BOS 23620 16,4 + WK
<b>Zubehörsatz, Scheibenbremsbelag</b>								
1.6 VVT-i (ZZT250_) 1.8 (ZZT251_) 2.0 (AZT250_)	81 95 108	04/03→11/08 04/03→11/08 04/03→11/08	←	→ 12/07			<b>13.0460-0454.2 610454</b>	BOS
2.0 D-4D (ADT250_) 2.0 D-4D (CDT250_) 2.0 VVTi (AZT250_) 2.2 D-4D (ADT251_) 2.2 D-CAT (ADT251_) 2.4 (AZT251_) 2.4 (AZT251_)	93 85 114 110 130 120 125	03/06→10/08 04/03→11/08 04/03→11/08 10/05→11/08 07/05→11/08 10/03→10/08 09/03→11/08	→				<b>13.0460-0256.2 610256</b>	BOS
 <b>Bremsscheibe</b>								
1.6 VVT-i (ZZT250_) 1.8 (ZZT251_) 2.0 VVTi (AZT250_)	81 95 114	04/03→11/08 04/03→11/08 04/03→11/08	←				<b>24.0126-0139.1 426139</b>	Ø 277 26 24 V
2.0 (AZT250_) 2.0 D-4D (ADT250_) 2.0 D-4D (CDT250_) 2.4 (AZT251_) 2.4 (AZT251_)	108 93 85 120 125	04/03→11/08 03/06→10/08 04/03→11/08 10/03→10/08 09/03→11/08	→				<b>24.0110-0311.1 410311</b>	Ø 280 10 9
			←				<b>24.0126-0141.1 426141</b>	Ø 295 26 24 V
			→				<b>24.0110-0311.1 410311</b>	Ø 280 10 9
			↓					



	kW					! #			
<b>TOYOTA - AVENSIS Stufenheck (_T25_) 04/03→11/08</b>									
 <b>Bremsscheibe</b>									
2.2 D-4D (ADT251_)	110	10/05→11/08	←				<b>24.0126-0138.1</b>	<b>426138</b>	Ø 295 26 24 V
2.2 D-CAT (ADT251_)	130	07/05→11/08	→				<b>24.0110-0333.1</b>	<b>410333</b>	Ø 280 10 8,5
<b>TOYOTA - AVENSIS Stufenheck (_T27_) 11/08→</b>									
 <b>Bremsbelagsatz, Scheibenbremse</b>									
1.6 (ZRT270_)	97	11/08→	←	02/09→			<b>13.0460-5603.2</b>	<b>605603</b>	24204 19,2 + WK + Zub
1.8 (ZRT271_)	108	11/08→	→	02/09→			<b>13.0460-3853.2</b>	<b>603853</b>	BOS 24885 16,8 + WK + Zub
2.0 (AZT270_)	100	11/08→04/11							
2.0 (ZRT272_)	112	11/08→							
2.0 D-4D (ADT270_)	93	11/08→							
1.6 D4-D (WWT270_)	82	04/15→	←	→ 06/15			<b>13.0460-5603.2</b>	<b>605603</b>	24204 19,2 + WK + Zub
			→	→ 06/15			<b>13.0460-3853.2</b>	<b>603853</b>	BOS 24885 16,8 + WK + Zub
2.0 D-4D (ADT270_)	91	11/11→	←				<b>13.0460-5603.2</b>	<b>605603</b>	24204 19,2 + WK + Zub
			→				<b>13.0460-3853.2</b>	<b>603853</b>	BOS 24885 16,8 + WK + Zub
2.0 D-4D (WWT271_)	105	04/15→	←	→ 06/15			<b>13.0460-3874.2</b>	<b>603874</b>	BOS 25006 18,8 + WK + Zub
			←	→ 06/15; Kasten/Kombi			<b>13.0460-5603.2</b>	<b>605603</b>	24204 19,2 + WK + Zub
			→	→ 06/15			<b>13.0460-3853.2</b>	<b>603853</b>	BOS 24885 16,8 + WK + Zub
2.2 D-4D (ADT271_)	110	11/08→	←	12/10→			<b>13.0460-3874.2</b>	<b>603874</b>	BOS 25006 18,8 + WK + Zub
2.2 D-4D (ADT271_)	130	11/08→	←	02/09→ 11/10			<b>13.0460-5615.2</b>	<b>605615</b>	BOS 24946 19,0 + WK + Zub
			→	02/09→			<b>13.0460-3853.2</b>	<b>603853</b>	BOS 24885 16,8 + WK + Zub
 <b>Bremsscheibe</b>									
1.6 (ZRT270_)	97	11/08→	←	02/09→			<b>24.0126-0156.1</b>	<b>426156</b>	Ø 295 26 23 V
1.8 (ZRT271_)	108	11/08→	→	02/09→					
2.0 (AZT270_)	100	11/08→04/11					<b>24.0111-0169.1</b>	<b>411169</b>	Ø 290 11 9
2.0 (ZRT272_)	112	11/08→							
2.0 D-4D (ADT270_)	93	11/08→							
1.6 D4-D (WWT270_)	82	04/15→	←				<b>24.0126-0156.1</b>	<b>426156</b>	Ø 295 26 23 V
2.0 D-4D (ADT270_)	91	11/11→	→				<b>24.0111-0169.1</b>	<b>411169</b>	Ø 290 11 9
2.0 D-4D (WWT271_)	105	04/15→	←				<b>24.0126-0160.1</b>	<b>426160</b>	Ø 320 26 23 V
			→				<b>24.0111-0169.1</b>	<b>411169</b>	Ø 290 11 9
2.2 D-4D (ADT271_)	110	11/08→	←	02/09→			<b>24.0126-0160.1</b>	<b>426160</b>	Ø 320 26 23 V
2.2 D-4D (ADT271_)	130	11/08→	→	02/09→			<b>24.0111-0169.1</b>	<b>411169</b>	Ø 290 11 9
<b>TOYOTA - AVENSIS VERSO (_M2_) 05/01→12/11</b>									
 <b>Bremsbelagsatz, Scheibenbremse</b>									
2.0 (ACM20_)	110	08/01→11/09	←				<b>13.0460-5846.2</b>	<b>605846</b>	AKE 23836 17,0 - WK
2.0 D (CLM20_)	85	08/01→08/05	→						
2.4 (ACM21_)	118	05/01→12/11					<b>13.0460-5847.2</b>	<b>605847</b>	SUM 23646 16,5 + WK
2.4 (ACM21)	115	08/01→08/07							
2.4 4WD (ACM21_)	115	11/03→08/06							
 <b>Bremsscheibe</b>									
2.0 (ACM20_)	110	08/01→11/09	←				<b>24.0128-0115.1</b>	<b>428115</b>	Ø 275 28 26 V
2.0 D (CLM20_)	85	08/01→08/05	→						
2.4 (ACM21_)	118	05/01→12/11					<b>24.0112-0164.1</b>	<b>412164</b>	Ø 291 12 10,5
2.4 (ACM21)	115	08/01→08/07							
2.4 4WD (ACM21_)	115	11/03→08/06							
<b>TOYOTA - AYGO (_B1_) 02/05→</b>									
 <b>Bremsbelagsatz, Scheibenbremse</b>									
1.0 (KGB10_)	50	07/05→	←	→ 06/14			<b>13.0460-3829.2</b>	<b>603829</b>	BOS 23959 17,0 - WE / - WK + Zub
1.0 GPL (KGB10_)	50	07/05→							
1.4 HDi (WNB10_)	40	07/05→08/10	←				<b>13.0460-3829.2</b>	<b>603829</b>	BOS 23959 17,0 - WE / - WK + Zub
 <b>Bremsscheibe</b>									
1.0 (KGB10_)	50	07/05→	←	→ 06/14			<b>24.0120-0180.1</b>	<b>420180</b>	Ø 247 20 18 V + S
1.0 GPL (KGB10_)	50	07/05→							
1.4 HDi (WNB10_)	40	07/05→08/10	←				<b>24.0120-0180.1</b>	<b>420180</b>	Ø 247 20 18 V + S
<b>TOYOTA - AYGO (_B4_) 05/14→</b>									
 <b>Bremsbelagsatz, Scheibenbremse</b>									
1.0 (KGB40_)	51	05/14→	←				<b>13.0460-3829.2</b>	<b>603829</b>	BOS 23959 17,0 - WE / - WK + Zub
1.2 (PAB40_)	60	05/14→							

	kw			 	! #			
<b>TOYOTA - AYGO (_B4_) 05/14→</b>								
 <b>Bremsscheibe</b>								
1.0 (KGB40_)	51	05/14→	←			24.0120-0180.1	420180	Ø 247 20 18 V + S
1.2 (PAB40_)	60	05/14→						
<b>TOYOTA - CAMRY (_V1_) 06/91→06/98</b>								
 <b>Bremsbelagsatz, Scheibenbremse</b>								
2.2 (SXV10_)	100	06/91→07/96	→	+ ABS		13.0460-5835.2	605835	AKE 20076 15,5 + WK
3.0 (MCV10_)	135	09/93→07/96	→			13.0460-5835.2	605835	AKE 20076 15,5 + WK
3.0 (VCV10_)	138	06/91→08/96						
 <b>Bremsscheibe</b>								
2.2 (SXV10_)	100	06/91→07/96	←	→ 07/93		24.0128-0114.1	428114	Ø 255 28 26 V
			←	08/93→		24.0128-0115.1	428115	Ø 275 28 26 V
			→	+ ABS		24.0110-0700.1	410700	Ø 269 10 9
3.0 (MCV10_)	135	09/93→07/96	←			24.0128-0115.1	428115	Ø 275 28 26 V
3.0 (VCV10_)	138	06/91→08/96						
<b>TOYOTA - CAMRY (_V2_) 08/96→09/02</b>								
 <b>Bremsbelagsatz, Scheibenbremse</b>								
2.2 (SXV20_)	96	08/96→11/01	→	→ 07/99		13.0460-5835.2	605835	AKE 20076 15,5 + WK
3.0 24V (MCV20_)	140	08/96→11/01						
3.0 V6 (MCV20_)	135	08/96→11/01						
 <b>Bremsscheibe</b>								
2.2 (SXV20_)	93	08/97→09/02	←			24.0128-0115.1	428115	Ø 275 28 26 V
2.2 (SXV20_)	96	08/96→11/01						
3.0 24V (MCV20_)	140	08/96→11/01	→	passend für Felgenreife [Zoll]: 14		24.0110-0700.1	410700	Ø 269 10 9
3.0 V6 (MCV20_)	135	08/96→11/01						
<b>TOYOTA - CAMRY Kombi (_V1_) 06/91→08/97</b>								
 <b>Bremsbelagsatz, Scheibenbremse</b>								
2.2 (SXV10_)	100	09/91→07/96	→	+ ABS		13.0460-5835.2	605835	AKE 20076 15,5 + WK
3.0 (VCV10_)	136	09/91→07/96	→			13.0460-5835.2	605835	AKE 20076 15,5 + WK
3.0 (VCV10_)	138	09/91→07/96						
 <b>Bremsscheibe</b>								
2.2 (SXV10_)	100	09/91→07/96	←	→ 07/93		24.0128-0114.1	428114	Ø 255 28 26 V
			←	08/93→		24.0128-0115.1	428115	Ø 275 28 26 V
			→	+ ABS		24.0110-0700.1	410700	Ø 269 10 9
3.0 (VCV10_)	136	09/91→07/96	←			24.0128-0115.1	428115	Ø 275 28 26 V
3.0 (VCV10_)	138	09/91→07/96						
<b>TOYOTA - CAMRY Stufenheck (_V3_) 08/01→11/06</b>								
 <b>Bremsbelagsatz, Scheibenbremse</b>								
2.0 (ACV31_)	110	08/01→11/06	←	12/01→ 12/05		13.0460-5743.2	605743	23928 17,3 - WK
2.4 (ACV30_, ACV36)	112	11/01→11/06						
3.0 (MCV30_)	137	08/01→11/06	→	12/01→ 12/05		13.0460-5738.2	605738	23702 15,1 - WE / - WK
 <b>Bremsscheibe</b>								
2.0 (ACV31_)	110	08/01→11/06	←	12/01→ 12/05; für Linkslenker		24.0128-0190.1	428190	Ø 296 28 26 V
2.4 (ACV30_, ACV36)	112	11/01→11/06						
3.0 (MCV30_)	137	08/01→11/06	←	12/01→ 12/05; für Rechtslenker		24.0128-0212.1	428212	Ø 296 28 26 V
<b>TOYOTA - CAMRY Stufenheck (_V4_) 01/06→12/14</b>								
 <b>Bremsbelagsatz, Scheibenbremse</b>								
2.0 (ACV41_)	108	01/06→09/11	←	→ 08/11		13.0460-5764.2	605764	AKE 24350 17,3 - WE / - WK + Zub
2.4 (ACV40_)	123	01/06→09/11						
2.4 (ACV40_)	127	10/06→09/11	→	→ 08/11		13.0460-5765.2	605765	AKE 24338 15,5 - WE / - WK
2.4 (ACV40_)	116	01/06→09/11						
2.4 Hybrid (AHV40_)	110	01/06→09/11						
2.5 (ASV40_)	129	01/10→09/11						
3.5 (GSV40_)	204	01/08→09/11						
2.4 Hybrid (AHV40_)	105	01/06→07/11	←			13.0460-5764.2	605764	AKE 24350 17,3 - WE / - WK + Zub
3.5 (GSV40_)	200	01/06→12/11	→			13.0460-5765.2	605765	AKE 24338 15,5 - WE / - WK
 <b>Bremsscheibe</b>								
2.0 (ACV41_)	108	01/06→09/11	←	→ 08/11		24.0128-0159.1	428159	Ø 296 28 25 V
2.4 (ACV40_)	123	01/06→09/11						
2.4 (ACV40_)	127	10/06→09/11						

	kw			 	! #			
<b>TOYOTA - CAMRY Stufenheck (_V4_) 01/06→12/14</b>								
<b> Bremsscheibe</b>								
2.4 (ACV40)	116	01/06→09/11	←	→ 08/11		24.0128-0159.1	428159	Ø 296 28 25 V
2.4 Hybrid (AHV40_)	110	01/06→09/11						
2.5 (ASV40_)	129	01/10→09/11						
3.5 (GSV40_)	204	01/08→09/11						
2.4 Hybrid (AHV40_)	105	01/06→07/11	←			24.0128-0159.1	428159	Ø 296 28 25 V
3.5 (GSV40_)	200	01/06→12/11						
<b>TOYOTA - CAMRY Stufenheck (_V5_) 09/11→</b>								
<b> Bremsbelagsatz, Scheibenbremse</b>								
2.0 (ACV51_)	109	09/11→	←			13.0460-5764.2	605764	AKE 24350 17,3 - WE / - WK + Zub
2.0 (ASV51_)	110	01/15→						
2.0 (ASV51_)	123	01/15→	→			13.0460-5765.2	605765	AKE 24338 15,5 - WE / - WK
2.5 (ASV50_)	131	10/11→	←	Made in Japan		13.0460-5764.2	605764	AKE 24350 17,3 - WE / - WK + Zub
2.5 (ASV50_)	133	09/11→						
2.5 (ASV50_)	135	01/12→	←	Made in USA		13.0460-5765.2	605765	AKE 24338 15,5 - WE / - WK
3.5 (GSV50_)	183	12/12→	→	Made in USA				
3.5 (GSV50_)	204	09/11→	→	Made in Japan		13.0460-5765.2	605765	AKE 24338 15,5 - WE / - WK
<b> Bremsscheibe</b>								
2.0 (ACV51_)	109	09/11→	←			24.0128-0159.1	428159	Ø 296 28 25 V
2.0 (ASV51_)	110	01/15→						
2.0 (ASV51_)	123	01/15→						
2.5 (ASV50_)	131	10/11→	←	Made in Japan		24.0128-0159.1	428159	Ø 296 28 25 V
2.5 (ASV50_)	133	09/11→						
2.5 (ASV50_)	135	01/12→	←	Made in USA		24.0128-0274.1	428274	Ø 296 28 25 V
3.5 (GSV50_)	183	12/12→	→	Made in USA				
3.5 (GSV50_)	204	09/11→	→	Made in USA		24.0110-0374.1	410374	Ø 281 10 8,5
<b>TOYOTA - CARINA E (_T19_) 04/92→09/97</b>								
<b> Bremsbelagsatz, Scheibenbremse</b>								
1.6 (AT190)	73	12/93→09/97	←			13.0460-5951.2	605951	SUM 21601 17,5 + WK
1.6 (AT190)	85	12/93→09/97						
1.6 16V (AT190_)	78	10/95→09/97						
1.6 GLI (AT190)	79	04/92→09/97						
1.8 (AT191)	79	01/95→09/97						
2.0 D (CT190)	54	04/92→01/96						
2.0 GLI (ST191)	98	04/92→09/97						
2.0 i (ST191)	93	12/93→09/97						
2.0 TD (CT190)	61	01/96→09/97						
<b>Zubehörsatz, Scheibenbremsbelag</b>								
1.6 (AT190)	73	12/93→09/97	←			13.0460-0441.2	610441	SUM
1.6 (AT190)	85	12/93→09/97						
1.6 16V (AT190_)	78	10/95→09/97						
1.6 GLI (AT190)	79	04/92→09/97						
1.8 (AT191)	79	01/95→09/97						
2.0 D (CT190)	54	04/92→01/96						
2.0 GLI (ST191)	98	04/92→09/97						
2.0 i (ST191)	93	12/93→09/97						
2.0 TD (CT190)	61	01/96→09/97						
<b> Bremsscheibe</b>								
1.6 (AT190)	73	12/93→09/97	←			24.0125-0124.1	425124	Ø 255 24,9 24 V
1.6 (AT190)	85	12/93→09/97						
1.6 16V (AT190_)	78	10/95→09/97						
1.6 GLI (AT190)	79	04/92→09/97						
2.0 D (CT190)	54	04/92→01/96						
2.0 TD (CT190)	61	01/96→09/97						
1.8 (AT191)	79	01/95→09/97	←			24.0128-0113.1	428113	Ø 255 28 26 V
2.0 GLI (ST191)	98	04/92→09/97	←			24.0128-0116.1	428116	Ø 255 28 26 V
2.0 i (ST191)	93	12/93→09/97						
<b>TOYOTA - CARINA E Station Wagon (_T19_) 02/92→09/97</b>								
<b> Bremsbelagsatz, Scheibenbremse</b>								
1.6	85	04/92→09/97	←			13.0460-5951.2	605951	SUM 21601 17,5 + WK
1.6 GLI (AT190_)	79	01/93→09/97						
1.6 i (AT190_)	73	02/95→09/97						
1.8 i (AT191_)	79	02/95→09/97						
2.0 D (CT190_)	54	01/93→01/96						
2.0 GLI (ST191_)	98	01/93→09/97						
2.0 i (ST191_)	93	05/95→09/97						
2.0 TD (CT190_)	61	01/96→09/97						
<b>Zubehörsatz, Scheibenbremsbelag</b>								
1.6	85	04/92→09/97	←			13.0460-0441.2	610441	SUM
1.6 GLI (AT190_)	79	01/93→09/97						
↓								

	kW					! #		
<b>TOYOTA - CARINA E Station Wagon (_T19_) 02/92→09/97</b>								
<b>Zubehörsatz, Scheibenbremsbelag</b>								
1.6 i (AT190_)	73	02/95→09/97	←			13.0460-0441.2	610441	SUM
1.8 i (AT191_)	79	02/95→09/97						
2.0 D (CT190_)	54	01/93→01/96						
2.0 GLI (ST191_)	98	01/93→09/97						
2.0 i (ST191_)	93	05/95→09/97						
2.0 TD (CT190_)	61	01/96→09/97						
<b> Bremsscheibe</b>								
1.6	85	04/92→09/97	←			24.0125-0124.1	425124	Ø 255 24,9 24 V
1.6 GLI (AT190_)	79	01/93→09/97						
1.6 i (AT190_)	73	02/95→09/97						
2.0 D (CT190_)	54	01/93→01/96						
2.0 TD (CT190_)	61	01/96→09/97						
1.8 i (AT191_)	79	02/95→09/97	←			24.0128-0113.1	428113	Ø 255 28 26 V
2.0 GLI (ST191_)	98	01/93→09/97	←			24.0128-0116.1	428116	Ø 255 28 26 V
2.0 i (ST191_)	93	05/95→09/97						
<b>TOYOTA - CARINA E Stufenheck (_T19_) 04/92→09/97</b>								
<b> Bremsbelagsatz, Scheibenbremse</b>								
1.6 (AT190)	73	01/95→09/97	←			13.0460-5951.2	605951	SUM 21601 17,5 + WK
1.6 (AT190)	78	10/95→09/97						
1.6 (AT190)	79	01/93→09/97						
1.6 16V (AT190_)	85	12/94→09/97						
1.8 i 16V (AT191)	79	01/95→09/97						
2.0 (ST191)	98	01/93→09/97						
2.0 D (CT190)	54	08/92→01/96						
2.0 i (ST191)	93	12/92→09/97						
2.0 TD (CT190_)	61	01/96→09/97						
<b>Zubehörsatz, Scheibenbremsbelag</b>								
1.6 (AT190)	73	01/95→09/97	←			13.0460-0441.2	610441	SUM
1.6 (AT190)	78	10/95→09/97						
1.6 (AT190)	79	01/93→09/97						
1.6 16V (AT190_)	85	12/94→09/97						
1.8 i 16V (AT191)	79	01/95→09/97						
2.0 (ST191)	98	01/93→09/97						
2.0 D (CT190)	54	08/92→01/96						
2.0 i (ST191)	93	12/92→09/97						
2.0 TD (CT190_)	61	01/96→09/97						
<b> Bremsscheibe</b>								
1.6 (AT190)	73	01/95→09/97	←			24.0125-0124.1	425124	Ø 255 24,9 24 V
1.6 (AT190)	78	10/95→09/97						
1.6 (AT190)	79	01/93→09/97						
1.6 16V (AT190_)	85	12/94→09/97						
2.0 D (CT190)	54	08/92→01/96						
2.0 TD (CT190_)	61	01/96→09/97						
1.8 i 16V (AT191)	79	01/95→09/97	←			24.0128-0113.1	428113	Ø 255 28 26 V
2.0 (ST191)	98	01/93→09/97	←			24.0128-0116.1	428116	Ø 255 28 26 V
2.0 i (ST191)	93	12/92→09/97						
<b>TOYOTA - CELICA Cabriolet (_T20_) 11/93→08/99</b>								
<b> Bremsbelagsatz, Scheibenbremse</b>								
2.0 GTi (ST202)	129	08/94→08/99	→			13.0460-5835.2	605835	AKE 20076 15,5 + WK
2.0 i 16V (ST202)	125	11/93→08/99						
<b> Bremsscheibe</b>								
2.0 GTi (ST202)	129	08/94→08/99	→			24.0109-0148.1	409148	Ø 269 9 8
2.0 i 16V (ST202)	125	11/93→08/99						
<b>TOYOTA - CELICA Coupe (_T20_) 09/93→11/99</b>								
<b> Bremsbelagsatz, Scheibenbremse</b>								
1.8 i 16V (AT200/ST)	85	11/93→11/99	←			13.0460-5951.2	605951	SUM 21601 17,5 + WK
			→			13.0460-5835.2	605835	AKE 20076 15,5 + WK
2.0 i 16V (ST202_)	125	04/96→11/99	→			13.0460-5835.2	605835	AKE 20076 15,5 + WK
2.0 i 16V (ST202/GT)	129	11/93→11/99						
<b>Zubehörsatz, Scheibenbremsbelag</b>								
1.8 i 16V (AT200/ST)	85	11/93→11/99	←			13.0460-0441.2	610441	SUM
<b> Bremsscheibe</b>								
1.8 i 16V (AT200/ST)	85	11/93→11/99	←			24.0125-0124.1	425124	Ø 255 24,9 24 V
			→	09/95→		24.0109-0148.1	409148	Ø 269 9 8
↓								

	kw					! #		
<b>TOYOTA - CELICA Coupe (_T20_) 09/93→11/99</b>								
<b>Bremsscheibe</b>								
1.8 i 16V (AT200/ST)	85	11/93→11/99	➔	→ 08/95		24.0110-0350.1	410350	Ø 269 10 9
2.0 i 16V (ST202_)	125	04/96→11/99	➔			24.0109-0148.1	409148	Ø 269 9 8
2.0 i 16V (ST202/GT)	129	11/93→11/99						
<b>TOYOTA - CELICA Coupe (_T23_) 08/99→03/06</b>								
<b>Bremsbelagsatz, Scheibenbremse</b>								
1.8 16V TS (ZZT231_)	141	08/99→09/05	←	11/99→ 07/02		13.0460-5817.2	605817	AKE 23526 17,5 + WE / - WK
			←	08/02→		13.0460-5817.2	605817	AKE 23526 17,5 + WE / - WK
			➔	11/99→		13.0460-5812.2	605812	SUM 23521 14,0 + WK
1.8 16V VT-i (ZZT230_)	105	08/99→07/05	←	11/99→ 07/02		13.0460-5810.2	605810	AKE 23510 16,5 + WK
			←	08/02→		13.0460-5817.2	605817	AKE 23526 17,5 + WE / - WK
			➔	11/99→		13.0460-5812.2	605812	SUM 23521 14,0 + WK
<b>Zubehörsatz, Scheibenbremsbelag</b>								
1.8 16V TS (ZZT231_)	141	08/99→09/05	➔	11/99→		13.0460-0136.2	610136	SUM
1.8 16V VT-i (ZZT230_)	105	08/99→07/05						
<b>Bremsscheibe</b>								
1.8 16V TS (ZZT231_)	141	08/99→09/05	←	11/99→		24.0125-0700.1	425700	Ø 275 25 23 V
			➔	11/99→		24.0109-0711.1	409711	Ø 269 9 7,5
1.8 16V VT-i (ZZT230_)	105	08/99→07/05	←	11/99→ 07/02		24.0125-0124.1	425124	Ø 255 24,9 24 V
			←	08/02→		24.0125-0700.1	425700	Ø 275 25 23 V
			➔	11/99→		24.0109-0711.1	409711	Ø 269 9 7,5
<b>TOYOTA - COROLLA (_E10_) 06/91→11/99</b>								
<b>Bremsbelagsatz, Scheibenbremse</b>								
1.3 12V (EE100_)	53	07/92→04/97	←	→ 05/95		13.0460-5976.2	605976	AKE 20870 15,0 - WE / - WK
1.3 XLI (EE101_)	55	09/95→04/97	←			13.0460-5951.2	605951	SUM 21601 17,5 + WK
1.6 (AE101_)	85	05/92→04/97				13.0460-5976.2	605976	AKE 20870 15,0 - WE / - WK
1.6 Si (AE101_)	84	09/95→04/97						
2.0 D (CE100_)	53	07/92→04/97						
<b>Zubehörsatz, Scheibenbremsbelag</b>								
1.3 12V (EE100_)	53	07/92→04/97	←	→ 05/95		13.0460-0325.2	610325	AKE
1.3 XLI (EE101_)	55	09/95→04/97	←			13.0460-0325.2	610325	AKE
1.6 (AE101_)	85	05/92→04/97				13.0460-0441.2	610441	SUM
1.6 Si (AE101_)	84	09/95→04/97						
2.0 D (CE100_)	53	07/92→04/97						
<b>Bremsscheibe</b>								
1.3 12V (EE100_)	53	07/92→04/97	←	→ 05/95		24.0118-0110.1	418110	Ø 238 18 17 V
1.3 XLI (EE101_)	55	09/95→04/97	←			24.0122-0158.1	422158	Ø 255 22 20 V
1.6 (AE101_)	85	05/92→04/97						
1.6 Si (AE101_)	84	09/95→04/97						
2.0 D (CE100_)	53	07/92→04/97						
<b>TOYOTA - COROLLA (_E11_) 04/97→06/02</b>								
<b>Bremsbelagsatz, Scheibenbremse</b>								
1.3	55	05/97→10/01	←	Made in Japan		13.0460-5976.2	605976	AKE 20870 15,0 - WE / - WK
1.4 (EE111_)	63	05/97→09/99	←	für Fahrzeuge ohne Schlechtwegeausführung; Made in Japan		13.0460-5951.2	605951	SUM 21601 17,5 + WK
			←	für Fahrzeuge mit Schlechtwegeausführung; Made in Japan		13.0460-5976.2	605976	AKE 20870 15,0 - WE / - WK
			➔			13.0460-5835.2	605835	AKE 20076 15,5 + WK
1.4 16V (ZZE111_)	71	02/00→11/01	←	für Fahrzeuge ohne Schlechtwegeausführung; Made in Japan		13.0460-5951.2	605951	SUM 21601 17,5 + WK
1.6 16V (ZZE112_)	81	10/99→10/01	←	für Fahrzeuge mit Schlechtwegeausführung; Made in Japan		13.0460-5976.2	605976	AKE 20870 15,0 - WE / - WK
			➔	Made in Japan		13.0460-5835.2	605835	AKE 20076 15,5 + WK
			➔	Made in Großbritannien		13.0460-5869.2	605869	TRW 24013 14,9 + WK
1.6 (AE111)	81	04/97→02/00	←	05/97→ 01/00; für Fahrzeuge ohne Schlechtwegeausführung; Made in Japan		13.0460-5951.2	605951	SUM 21601 17,5 + WK
1.6 Aut. (AE111_)	79	04/97→02/00	←	05/97→ 01/00; für Fahrzeuge mit Schlechtwegeausführung; Made in Japan		13.0460-5976.2	605976	AKE 20870 15,0 - WE / - WK
↓								



**TOYOTA - COROLLA (E11\_) 04/97→06/02**

 **Bremsbelagsatz, Scheibenbremse**

1.6 (AE111) 1.6 Aut. (AE111_)	81 79	04/97→02/00 04/97→02/00	➡	08/98→ 09/99		<b>13.0460-5835.2</b>	<b>605835</b>	AKE 20076 15,5 + WK
1.9 D (WZE110_)	51	02/00→11/01	←	Made in Japan		<b>13.0460-5951.2</b>	<b>605951</b>	SUM 21601 17,5 + WK
			➡	Made in Japan		<b>13.0460-5835.2</b>	<b>605835</b>	AKE 20076 15,5 + WK
			➡	Made in Großbritannien		<b>13.0460-5869.2</b>	<b>605869</b>	TRW 24013 14,9 + WK
2.0 D (CE110_)	53	04/97→02/00	←	05/97→ 01/00; Made in Japan		<b>13.0460-5951.2</b>	<b>605951</b>	SUM 21601 17,5 + WK
			➡	08/98→ 09/99		<b>13.0460-5835.2</b>	<b>605835</b>	AKE 20076 15,5 + WK
2.0 D-4D (CDE110_)	66	09/00→11/01	←	Made in Japan		<b>13.0460-5951.2</b>	<b>605951</b>	SUM 21601 17,5 + WK
			➡			<b>13.0460-5835.2</b>	<b>605835</b>	AKE 20076 15,5 + WK

**Zubehörsatz, Scheibenbremsbelag**

1.4 (EE111_)	63	05/97→09/99	←	für Fahrzeuge ohne Schlechtwegeausführung		<b>13.0460-0074.2</b>	<b>610074</b>	
1.4 16V (ZZE111_)	71	02/00→11/01						
1.6 16V (ZZE112_)	81	10/99→10/01						
1.6 (AE111) 1.6 Aut. (AE111_)	81 79	04/97→02/00 04/97→02/00	←	05/97→ 01/00; für Fahrzeuge ohne Schlechtwegeausführung		<b>13.0460-0074.2</b>	<b>610074</b>	
1.9 D (WZE110_)	51	02/00→11/01	←			<b>13.0460-0074.2</b>	<b>610074</b>	
2.0 D-4D (CDE110_)	66	09/00→11/01						
2.0 D (CE110_)	53	04/97→02/00	←	05/97→ 01/00		<b>13.0460-0074.2</b>	<b>610074</b>	









 **Bremsscheibe**

1.3	55	05/97→10/01	←			<b>24.0118-0110.1</b>	<b>418110</b>	Ø 238 18 17 V
1.4 (EE111_)	63	05/97→09/99	←	für Fahrzeuge ohne Schlechtwegeausführung		<b>24.0122-0158.1</b>	<b>422158</b>	Ø 255 22 20 V
			➡			<b>24.0109-0159.1</b>	<b>409159</b>	Ø 266 9 8
1.4 16V (ZZE111_)	71	02/00→11/01	←	für Fahrzeuge ohne Schlechtwegeausführung		<b>24.0122-0158.1</b>	<b>422158</b>	Ø 255 22 20 V
			➡	Made in Japan		<b>24.0109-0159.1</b>	<b>409159</b>	Ø 266 9 8
1.6 (AE111) 1.6 Aut. (AE111_)	81 79	04/97→02/00 04/97→02/00	←	05/97→ 01/00; für Fahrzeuge ohne Schlechtwegeausführung		<b>24.0122-0158.1</b>	<b>422158</b>	Ø 255 22 20 V
			➡	08/98→ 01/00		<b>24.0109-0159.1</b>	<b>409159</b>	Ø 266 9 8
1.9 D (WZE110_)	51	02/00→11/01	←			<b>24.0122-0158.1</b>	<b>422158</b>	Ø 255 22 20 V
			➡	Made in Japan		<b>24.0109-0159.1</b>	<b>409159</b>	Ø 266 9 8
2.0 D (CE110_)	53	04/97→02/00	←	05/97→ 01/00		<b>24.0122-0158.1</b>	<b>422158</b>	Ø 255 22 20 V
			➡	08/98→ 01/00		<b>24.0109-0159.1</b>	<b>409159</b>	Ø 266 9 8
2.0 D-4D (CDE110_)	66	09/00→11/01	←			<b>24.0122-0158.1</b>	<b>422158</b>	Ø 255 22 20 V
			➡			<b>24.0109-0159.1</b>	<b>409159</b>	Ø 266 9 8











**TOYOTA - COROLLA (E12\_) 01/01→12/07**











 **Bremsbelagsatz, Scheibenbremse**

1.4 D (NDE120_)	66	07/04→02/07	←	→ 10/06		<b>13.0460-5815.2</b>	<b>605815</b>	TRW 23766 17,8 + WK
			➡	→ 12/06		<b>13.0460-5819.2</b>	<b>605819</b>	TRW 23816 16,0 + WK
1.4 VVT-i (ZZE120_)	71	01/02→12/06	←	→ 05/04; Made in Japan		<b>13.0460-5810.2</b>	<b>605810</b>	AKE 23510 16,5 + WK
			←	02/02→ 05/04; Made in Großbritannien		<b>13.0460-5815.2</b>	<b>605815</b>	TRW 23766 17,8 + WK
			←	06/04→ 10/06		<b>13.0460-5815.2</b>	<b>605815</b>	TRW 23766 17,8 + WK
			➡	→ 05/04; Made in Japan		<b>13.0460-5812.2</b>	<b>605812</b>	SUM 23521 14,0 + WK
			➡	06/04→ 10/06		<b>13.0460-5819.2</b>	<b>605819</b>	TRW 23816 16,0 + WK
			➡	02/02→ 05/04; Made in Großbritannien		<b>13.0460-5819.2</b>	<b>605819</b>	TRW 23816 16,0 + WK
1.6 VVT-i (ZZE121_)	81	01/02→12/06	←	→ 05/04; Made in Japan		<b>13.0460-5810.2</b>	<b>605810</b>	AKE 23510 16,5 + WK
			←	08/02→ 05/04; Made in Großbritannien		<b>13.0460-5815.2</b>	<b>605815</b>	TRW 23766 17,8 + WK
			←	06/04→ 10/06		<b>13.0460-5815.2</b>	<b>605815</b>	TRW 23766 17,8 + WK
			➡	→ 05/04; Made in Japan		<b>13.0460-5812.2</b>	<b>605812</b>	SUM 23521 14,0 + WK
			➡	06/04→ 10/06		<b>13.0460-5819.2</b>	<b>605819</b>	TRW 23816 16,0 + WK
			➡	08/02→ 05/04; Made in Großbritannien		<b>13.0460-5819.2</b>	<b>605819</b>	TRW 23816 16,0 + WK
1.8 4WD	100	12/01→02/07	←	→ 12/01; Made in Japan		<b>13.0460-5951.2</b>	<b>605951</b>	SUM 21601 17,5 + WK
1.8 VVTL-i TS	140	01/01→09/06	←	→ 05/04; Made in Großbritannien		<b>13.0460-5815.2</b>	<b>605815</b>	TRW 23766 17,8 + WK
1.8 VVTL-i TS (ZZE123)	141	01/02→02/07						
2.0 D-4D (CDE120R_)	81	01/02→12/06	➡	→ 05/04; Made in Großbritannien		<b>13.0460-5819.2</b>	<b>605819</b>	TRW 23816 16,0 + WK
↓								









	kW			 	! #		
<b>TOYOTA - COROLLA (_E12_) 01/01→12/07</b>							
<b> Bremsbelagsatz, Scheibenbremse</b>							
1.8 VVTL-i TS (ZZE123_)	160	10/05→12/06	←	→ 10/06		13.0460-5815.2 605815	TRW 23766 17,8 + WK
1.8 VVTL-i TS (ZZE123_)	165	02/05→02/07	→	→ 10/06		13.0460-5819.2 605819	TRW 23816 16,0 + WK
2.0 D-4D (CDE120_)	66	01/02→12/06	←	08/02→ 05/04; Made in Großbritannien		13.0460-5815.2 605815	TRW 23766 17,8 + WK
			←	→ 05/04; Made in Japan		13.0460-5817.2 605817	AKE 23526 17,5 + WE / - WK
			→	→ 05/04; Made in Japan		13.0460-5812.2 605812	SUM 23521 14,0 + WK
			→	08/02→ 05/04; Made in Großbritannien		13.0460-5819.2 605819	TRW 23816 16,0 + WK
2.0 D-4D (CDE120R_, CDE120L_)	85	05/03→02/07	←	06/04→ 10/06		13.0460-5815.2 605815	TRW 23766 17,8 + WK
			←	→ 05/04; Made in Großbritannien		13.0460-5815.2 605815	TRW 23766 17,8 + WK
			→	→ 05/04; Made in Großbritannien		13.0460-5819.2 605819	TRW 23816 16,0 + WK
			→	06/04→ 10/06		13.0460-5819.2 605819	TRW 23816 16,0 + WK
<b>Zubehörsatz, Scheibenbremsbelag</b>							
1.4 D (NDE120_)	66	07/04→02/07	←	→ 10/06		13.0460-0138.2 610138	TRW
1.8 VVTL-i TS (ZZE123_)	160	10/05→12/06					
1.8 VVTL-i TS (ZZE123_)	165	02/05→02/07					
1.4 VVT-i (ZZE120_)	71	01/02→12/06	←	02/02→ 05/04; Made in Großbritannien		13.0460-0138.2 610138	TRW
			←	06/04→ 10/06		13.0460-0138.2 610138	TRW
			→	→ 05/04; Made in Japan		13.0460-0136.2 610136	SUM
1.6 VVT-i (ZZE121_)	81	01/02→12/06	←	08/02→ 05/04; Made in Großbritannien		13.0460-0138.2 610138	TRW
			←	06/04→ 10/06		13.0460-0138.2 610138	TRW
			→	→ 05/04; Made in Japan		13.0460-0136.2 610136	SUM
1.8 4WD	100	12/01→02/07	←	→ 12/01		13.0460-0074.2 610074	
1.8 VVTL-i TS	140	01/01→09/06	←	→ 05/04; Made in Großbritannien		13.0460-0138.2 610138	TRW
1.8 VVTL-i TS (ZZE123)	141	01/02→02/07					
2.0 D-4D (CDE120R_, CDE120L_)	81	01/02→12/06					
2.0 D-4D (CDE120_)	66	01/02→12/06	←	08/02→ 05/04; Made in Großbritannien		13.0460-0138.2 610138	TRW
			→	→ 05/04; Made in Japan		13.0460-0136.2 610136	SUM
2.0 D-4D (CDE120R_, CDE120L_)	85	05/03→02/07	←	→ 05/04; Made in Großbritannien		13.0460-0138.2 610138	TRW
			←	06/04→ 10/06		13.0460-0138.2 610138	TRW
<b> Bremsscheibe</b>							
1.4 D (NDE120_)	66	07/04→02/07	←	→ 10/06		24.0125-0157.1 425157	Ø 275 25 23 V
1.8 VVTL-i TS (ZZE123_)	160	10/05→12/06	→	→ 10/06		24.0109-0140.1 409140	Ø 279 9 8
1.8 VVTL-i TS (ZZE123_)	165	02/05→02/07					
1.4 VVT-i (ZZE120_)	71	01/02→12/06	←	→ 05/04		24.0125-0155.1 425155	Ø 255 25 23 V
			←	06/04→ 10/06		24.0125-0155.1 425155	Ø 255 25 23 V
			→	02/02→ 05/04; Made in Großbritannien		24.0109-0138.1 409138	Ø 258 9 8
			→	06/04→ 10/06		24.0109-0138.1 409138	Ø 258 9 8
			→	→ 05/04; Made in Japan		24.0109-0139.1 409139	Ø 269 9 8
1.6 VVT-i (ZZE121_)	81	01/02→12/06	←	06/04→ 10/06		24.0125-0155.1 425155	Ø 255 25 23 V
			←	→ 05/04		24.0125-0155.1 425155	Ø 255 25 23 V
			→	08/02→ 05/04; Made in Großbritannien		24.0109-0138.1 409138	Ø 258 9 8
			→	06/04→ 10/06		24.0109-0138.1 409138	Ø 258 9 8
			→	→ 05/04; Made in Japan		24.0109-0139.1 409139	Ø 269 9 8
1.8 4WD	100	12/01→02/07	←	→ 12/01		24.0122-0158.1 422158	Ø 255 22 20 V
1.8 VVTL-i TS	140	01/01→09/06	←	→ 05/04; Made in Großbritannien		24.0125-0157.1 425157	Ø 275 25 23 V
1.8 VVTL-i TS (ZZE123)	141	01/02→02/07					
2.0 D-4D (CDE120R_, CDE120L_)	81	01/02→12/06	→	→ 05/04; Made in Großbritannien		24.0109-0140.1 409140	Ø 279 9 8
2.0 D-4D (CDE120_)	66	01/02→12/06	←	08/02→ 05/04; Made in Großbritannien		24.0125-0157.1 425157	Ø 275 25 23 V
			←	→ 05/04; Made in Japan		24.0125-0168.1 425168	Ø 275 25 23 V
			→	→ 05/04; Made in Japan		24.0109-0139.1 409139	Ø 269 9 8
			→	08/02→ 05/04; Made in Großbritannien		24.0109-0140.1 409140	Ø 279 9 8
2.0 D-4D (CDE120R_, CDE120L_)	85	05/03→02/07	←	→ 05/04; Made in Großbritannien		24.0125-0157.1 425157	Ø 275 25 23 V
↓							

	kw			 	! #		
<b>TOYOTA - COROLLA (_E12_) 01/01→12/07</b>							
 <b>Bremsscheibe</b>							
2.0 D-4D (CDE120R_, CDE120L_)	85	05/03→02/07	←	06/04→ 10/06	24.0125-0157.1	425157	Ø 275 25 23 V
			→	06/04→ 10/06	24.0109-0140.1	409140	Ø 279 9 8
			→	→ 05/04; Made in Großbritannien	24.0109-0140.1	409140	Ø 279 9 8
<b>TOYOTA - COROLLA Combi (_E12_) 03/01→12/08</b>							
 <b>Bremsbelagsatz, Scheibenbremse</b>							
1.4 D4-D (NDE120_)	66	06/04→10/07	←	→ 10/06	13.0460-5815.2	605815	TRW 23766 17,8 + WK
			→	→ 12/06	13.0460-5819.2	605819	TRW 23816 16,0 + WK
1.4 VVT-i (ZZE120_)	71	01/02→02/07	←	→ 05/04; Made in Japan	13.0460-5810.2	605810	AKE 23510 16,5 + WK
			←	02/02→ 05/04; Made in Großbritannien	13.0460-5815.2	605815	TRW 23766 17,8 + WK
			←	06/04→ 10/06	13.0460-5815.2	605815	TRW 23766 17,8 + WK
			→	→ 05/04; Made in Japan	13.0460-5812.2	605812	SUM 23521 14,0 + WK
			→	06/04→ 10/06	13.0460-5819.2	605819	TRW 23816 16,0 + WK
			→	02/02→ 05/04; Made in Großbritannien	13.0460-5819.2	605819	TRW 23816 16,0 + WK
1.6 VVT-i (ZZE121_)	81	01/02→08/07	←	→ 05/04; Made in Japan	13.0460-5810.2	605810	AKE 23510 16,5 + WK
			←	08/02→ 05/04; Made in Großbritannien	13.0460-5815.2	605815	TRW 23766 17,8 + WK
			←	06/04→ 10/06	13.0460-5815.2	605815	TRW 23766 17,8 + WK
			→	→ 05/04; Made in Japan	13.0460-5812.2	605812	SUM 23521 14,0 + WK
			→	06/04→ 10/06	13.0460-5819.2	605819	TRW 23816 16,0 + WK
1.8 (ZZE122)	100	06/04→02/07	←	→ 10/06	13.0460-5815.2	605815	TRW 23766 17,8 + WK
			→	→ 10/06	13.0460-5819.2	605819	TRW 23816 16,0 + WK
2.0 D-4D (CDE120_)	66	01/02→02/07	←	08/02→ 05/04; Made in Großbritannien	13.0460-5815.2	605815	TRW 23766 17,8 + WK
			←	→ 05/04; Made in Japan	13.0460-5817.2	605817	AKE 23526 17,5 + WE / - WK
			→	→ 05/04; Made in Japan	13.0460-5812.2	605812	SUM 23521 14,0 + WK
			→	08/02→ 05/04; Made in Großbritannien	13.0460-5819.2	605819	TRW 23816 16,0 + WK
2.0 D-4D (CDE120_)	85	04/04→02/07	←	06/04→ 10/06	13.0460-5815.2	605815	TRW 23766 17,8 + WK
			←	→ 05/04; Made in Großbritannien	13.0460-5815.2	605815	TRW 23766 17,8 + WK
			→	→ 05/04; Made in Großbritannien	13.0460-5819.2	605819	TRW 23816 16,0 + WK
			→	06/04→ 10/06	13.0460-5819.2	605819	TRW 23816 16,0 + WK
<b>Zubehörsatz, Scheibenbremsbelag</b>							
1.4 D4-D (NDE120_)	66	06/04→10/07	←	→ 10/06	13.0460-0138.2	610138	TRW
			→	→ 10/06	13.0460-0138.2	610138	TRW
1.8 (ZZE122)	100	06/04→02/07	←	02/02→ 05/04; Made in Großbritannien	13.0460-0138.2	610138	TRW
			←	06/04→ 10/06	13.0460-0138.2	610138	TRW
			→	→ 05/04; Made in Japan	13.0460-0136.2	610136	SUM
1.4 VVT-i (ZZE120_)	71	01/02→02/07	←	02/02→ 05/04; Made in Großbritannien	13.0460-0138.2	610138	TRW
			←	06/04→ 10/06	13.0460-0138.2	610138	TRW
			→	→ 05/04; Made in Japan	13.0460-0136.2	610136	SUM
1.6 VVT-i (ZZE121_)	81	01/02→08/07	←	08/02→ 05/04; Made in Großbritannien	13.0460-0138.2	610138	TRW
			←	06/04→ 10/06	13.0460-0138.2	610138	TRW
			→	→ 05/04; Made in Japan	13.0460-0136.2	610136	SUM
2.0 D-4D (CDE120_)	66	01/02→02/07	←	08/02→ 05/04; Made in Großbritannien	13.0460-0138.2	610138	TRW
			→	→ 05/04; Made in Japan	13.0460-0136.2	610136	SUM
2.0 D-4D (CDE120_)	85	04/04→02/07	←	→ 05/04; Made in Großbritannien	13.0460-0138.2	610138	TRW
			←	06/04→ 10/06	13.0460-0138.2	610138	TRW
 <b>Bremsscheibe</b>							
1.4 D4-D (NDE120_)	66	06/04→10/07	←	→ 10/06	24.0125-0157.1	425157	Ø 275 25 23 V
			→	→ 10/06	24.0109-0140.1	409140	Ø 279 9 8
1.8 (ZZE122)	100	06/04→02/07	←	→ 05/04	24.0125-0155.1	425155	Ø 255 25 23 V
			←	06/04→ 10/06	24.0125-0155.1	425155	Ø 255 25 23 V
			→	02/02→ 05/04; Made in Großbritannien	24.0109-0138.1	409138	Ø 258 9 8
			→	06/04→ 10/06	24.0109-0138.1	409138	Ø 258 9 8
			→	→ 05/04; Made in Japan	24.0109-0139.1	409139	Ø 269 9 8
			→	→ 05/04; Made in Japan	24.0109-0139.1	409139	Ø 269 9 8
1.4 VVT-i (ZZE120_)	71	01/02→02/07	←	→ 05/04	24.0125-0155.1	425155	Ø 255 25 23 V
			←	06/04→ 10/06	24.0125-0155.1	425155	Ø 255 25 23 V
1.6 VVT-i (ZZE121_)	81	01/02→08/07	←	06/04→ 10/06	24.0125-0155.1	425155	Ø 255 25 23 V
			←	→ 05/04	24.0125-0155.1	425155	Ø 255 25 23 V













	kW			 	! #		
<b>TOYOTA - COROLLA Combi ( _E12_ ) 03/01→12/08</b>							
 <b>Bremsscheibe</b>							
1.6 VVT-i (ZZE121_)	81	01/02→08/07	➔	08/02→ 05/04; Made in Großbritannien	24.0109-0138.1	409138	Ø 258 9 8
			➔	06/04→ 10/06	24.0109-0138.1	409138	Ø 258 9 8
			➔	→ 05/04; Made in Japan	24.0109-0139.1	409139	Ø 269 9 8
2.0 D-4D (CDE120_)	66	01/02→02/07	➔	08/02→ 05/04; Made in Großbritannien	24.0125-0157.1	425157	Ø 275 25 23 V
			➔	→ 05/04; Made in Japan	24.0125-0168.1	425168	Ø 275 25 23 V
			➔	→ 05/04; Made in Japan	24.0109-0139.1	409139	Ø 269 9 8
			➔	08/02→ 05/04; Made in Großbritannien	24.0109-0140.1	409140	Ø 279 9 8
2.0 D-4D (CDE120_)	85	04/04→02/07	➔	→ 05/04; Made in Großbritannien	24.0125-0157.1	425157	Ø 275 25 23 V
			➔	06/04→ 10/06	24.0125-0157.1	425157	Ø 275 25 23 V
			➔	06/04→ 10/06	24.0109-0140.1	409140	Ø 279 9 8
			➔	→ 05/04; Made in Großbritannien	24.0109-0140.1	409140	Ø 279 9 8
<b>TOYOTA - COROLLA Compact ( _E10_ ) 05/92→11/99</b>							
 <b>Bremsbelagsatz, Scheibenbremse</b>							
1.3 XLI (EE101_)	55	08/95→04/97	➔		13.0460-5951.2	605951	SUM 21601 17,5 + WK
1.6 Si (AE101_)	84	07/92→04/97	➔		13.0460-5976.2	605976	AKE 20870 15,0 - WE / - WK
2.0 D (CE100_)	53	07/92→04/97	➔				
1.6 i (AE101)	78	09/94→11/99	➔	→ 04/97	13.0460-5951.2	605951	SUM 21601 17,5 + WK
					13.0460-5976.2	605976	AKE 20870 15,0 - WE / - WK
<b>Zubehörsatz, Scheibenbremsbelag</b>							
1.3 XLI (EE101_)	55	08/95→04/97	➔		13.0460-0325.2	610325	AKE
1.6 Si (AE101_)	84	07/92→04/97	➔		13.0460-0441.2	610441	SUM
2.0 D (CE100_)	53	07/92→04/97	➔				
1.6 i (AE101)	78	09/94→11/99	➔	→ 04/97	13.0460-0325.2	610325	AKE
					13.0460-0441.2	610441	SUM
 <b>Bremsscheibe</b>							
1.3 XLI (EE101_)	55	08/95→04/97	➔		24.0122-0158.1	422158	Ø 255 22 20 V
1.6 Si (AE101_)	84	07/92→04/97	➔				
2.0 D (CE100_)	53	07/92→04/97	➔				
1.6 i (AE101)	78	09/94→11/99	➔	→ 04/97	24.0122-0158.1	422158	Ø 255 22 20 V
<b>TOYOTA - COROLLA Compact ( _E11_ ) 04/97→01/02</b>							
 <b>Bremsbelagsatz, Scheibenbremse</b>							
1.4 (EE111_)	63	05/97→09/99	➔	für Fahrzeuge ohne Schlechtwegeausführung; Made in Japan	13.0460-5951.2	605951	SUM 21601 17,5 + WK
			➔	für Fahrzeuge mit Schlechtwegeausführung; Made in Japan	13.0460-5976.2	605976	AKE 20870 15,0 - WE / - WK
			➔		13.0460-5835.2	605835	AKE 20076 15,5 + WK
1.4 (ZZE111_)	71	02/00→01/02	➔	→ 12/01; für Fahrzeuge ohne Schlechtwegeausführung; Made in Japan	13.0460-5951.2	605951	SUM 21601 17,5 + WK
			➔	→ 12/01; für Fahrzeuge mit Schlechtwegeausführung; Made in Japan	13.0460-5976.2	605976	AKE 20870 15,0 - WE / - WK
			➔	→ 12/01; Made in Japan	13.0460-5835.2	605835	AKE 20076 15,5 + WK
			➔	→ 12/01; Made in Großbritannien	13.0460-5869.2	605869	TRW 24013 14,9 + WK
1.6 (AE111_)	81	04/97→02/00	➔	05/97→ 01/00; für Fahrzeuge ohne Schlechtwegeausführung; Made in Japan	13.0460-5951.2	605951	SUM 21601 17,5 + WK
1.6 Aut. (AE111_)	79	04/97→02/00	➔	05/97→ 01/00; für Fahrzeuge mit Schlechtwegeausführung; Made in Japan	13.0460-5976.2	605976	AKE 20870 15,0 - WE / - WK
			➔	08/98→ 09/99	13.0460-5835.2	605835	AKE 20076 15,5 + WK
1.6 (ZZE112_)	81	10/99→10/01	➔	für Fahrzeuge ohne Schlechtwegeausführung; Made in Japan	13.0460-5951.2	605951	SUM 21601 17,5 + WK
			➔	für Fahrzeuge mit Schlechtwegeausführung; Made in Japan	13.0460-5976.2	605976	AKE 20870 15,0 - WE / - WK
			➔	Made in Japan	13.0460-5835.2	605835	AKE 20076 15,5 + WK
			➔	Made in Großbritannien	13.0460-5869.2	605869	TRW 24013 14,9 + WK
1.9 D (WZE110_)	51	02/00→01/02	➔	→ 12/01; Made in Japan	13.0460-5951.2	605951	SUM 21601 17,5 + WK
			➔	→ 12/01; Made in Japan	13.0460-5835.2	605835	AKE 20076 15,5 + WK
			➔	→ 12/01; Made in Großbritannien	13.0460-5869.2	605869	TRW 24013 14,9 + WK
↓							







	kw			 	! #		
<b>TOYOTA - COROLLA Compact ( _E11_ ) 04/97→01/02</b>							
 <b>Bremsbelagsatz, Scheibenbremse</b>							
2.0 D (CE110_)	53	04/97→02/00	←	05/97→ 01/00; Made in Japan		<b>13.0460-5951.2 605951</b>	SUM 21601 17,5 + WK
			→	08/98→ 09/99		<b>13.0460-5835.2 605835</b>	AKE 20076 15,5 + WK
2.0 D-4D (CDE110_)	66	09/00→01/02	←	→ 12/01; Made in Japan		<b>13.0460-5951.2 605951</b>	SUM 21601 17,5 + WK
			→	→ 12/01		<b>13.0460-5835.2 605835</b>	AKE 20076 15,5 + WK
<b>Zubehörsatz, Scheibenbremsbelag</b>							
1.4 (EE111_)	63	05/97→09/99	←	für Fahrzeuge ohne Schlechtwegeausführung		<b>13.0460-0074.2 610074</b>	
1.6 (ZZE112_)	81	10/99→10/01					
1.4 (ZZE111_)	71	02/00→01/02	←	→ 12/01; für Fahrzeuge ohne Schlechtwegeausführung		<b>13.0460-0074.2 610074</b>	
1.6 (AE111_)	81	04/97→02/00	←	05/97→ 01/00; für Fahrzeuge ohne Schlechtwegeausführung		<b>13.0460-0074.2 610074</b>	
1.6 Aut. (AE111_)	79	04/97→02/00					
1.9 D (WZE110_)	51	02/00→01/02	←	→ 12/01		<b>13.0460-0074.2 610074</b>	
2.0 D-4D (CDE110_)	66	09/00→01/02					
2.0 D (CE110_)	53	04/97→02/00	←	05/97→ 01/00		<b>13.0460-0074.2 610074</b>	
 <b>Bremsscheibe</b>							
1.4 (EE111_)	63	05/97→09/99	←	für Fahrzeuge ohne Schlechtwegeausführung		<b>24.0122-0158.1 422158</b>	Ø 255 22 20 V
			→			<b>24.0109-0159.1 409159</b>	Ø 266 9 8
1.4 (ZZE111_)	71	02/00→01/02	←	→ 12/01; für Fahrzeuge ohne Schlechtwegeausführung		<b>24.0122-0158.1 422158</b>	Ø 255 22 20 V
			→	→ 12/01; Made in Japan		<b>24.0109-0159.1 409159</b>	Ø 266 9 8
1.6 (AE111_)	81	04/97→02/00	←	05/97→ 01/00; für Fahrzeuge ohne Schlechtwegeausführung		<b>24.0122-0158.1 422158</b>	Ø 255 22 20 V
1.6 Aut. (AE111_)	79	04/97→02/00					
			→	08/98→ 01/00		<b>24.0109-0159.1 409159</b>	Ø 266 9 8
1.6 (ZZE112_)	81	10/99→10/01	←	für Fahrzeuge ohne Schlechtwegeausführung		<b>24.0122-0158.1 422158</b>	Ø 255 22 20 V
			→	Made in Japan		<b>24.0109-0159.1 409159</b>	Ø 266 9 8
1.9 D (WZE110_)	51	02/00→01/02	←	→ 12/01		<b>24.0122-0158.1 422158</b>	Ø 255 22 20 V
			→	→ 12/01; Made in Japan		<b>24.0109-0159.1 409159</b>	Ø 266 9 8
2.0 D (CE110_)	53	04/97→02/00	←	05/97→ 01/00		<b>24.0122-0158.1 422158</b>	Ø 255 22 20 V
			→	08/98→ 01/00		<b>24.0109-0159.1 409159</b>	Ø 266 9 8
2.0 D-4D (CDE110_)	66	09/00→01/02	←	→ 12/01		<b>24.0122-0158.1 422158</b>	Ø 255 22 20 V
			→	→ 12/01		<b>24.0109-0159.1 409159</b>	Ø 266 9 8
<b>TOYOTA - COROLLA Kombi ( _E10_ ) 05/92→04/97</b>							
 <b>Bremsbelagsatz, Scheibenbremse</b>							
1.3 XLI (EE101_)	55	09/95→04/97	←			<b>13.0460-5951.2 605951</b>	SUM 21601 17,5 + WK
1.6 Si (AE101_)	84	07/92→04/97				<b>13.0460-5976.2 605976</b>	AKE 20870 15,0 - WE / - WK
2.0 D (CE100_)	53	07/92→04/97					
1.8	81	09/92→04/97	←	→ 05/95		<b>13.0460-5951.2 605951</b>	SUM 21601 17,5 + WK
						<b>13.0460-5976.2 605976</b>	AKE 20870 15,0 - WE / - WK
1.8 16V 4WD (AE103_)	81	09/95→04/97	←			<b>13.0460-5951.2 605951</b>	SUM 21601 17,5 + WK
<b>Zubehörsatz, Scheibenbremsbelag</b>							
1.3 XLI (EE101_)	55	09/95→04/97	←			<b>13.0460-0325.2 610325</b>	AKE
1.6 Si (AE101_)	84	07/92→04/97				<b>13.0460-0441.2 610441</b>	SUM
2.0 D (CE100_)	53	07/92→04/97					
1.8	81	09/92→04/97	←	→ 05/95		<b>13.0460-0325.2 610325</b>	AKE
						<b>13.0460-0441.2 610441</b>	SUM
1.8 16V 4WD (AE103_)	81	09/95→04/97	←			<b>13.0460-0441.2 610441</b>	SUM
 <b>Bremsscheibe</b>							
1.3 XLI (EE101_)	55	09/95→04/97	←			<b>24.0122-0158.1 422158</b>	Ø 255 22 20 V
1.6 Si (AE101_)	84	07/92→04/97					
1.8 16V 4WD (AE103_)	81	09/95→04/97					
2.0 D (CE100_)	53	07/92→04/97					
1.8	81	09/92→04/97	←	→ 05/95		<b>24.0122-0158.1 422158</b>	Ø 255 22 20 V
			→	→ 05/95		<b>24.0109-0159.1 409159</b>	Ø 266 9 8











	kw			 	! #		
<b>TOYOTA - COROLLA Kombi ( E11 ) 04/97→10/01</b>							
<b> Bremsbelagsatz, Scheibenbremse</b>							
1.4 (EE111_)	63	04/97→02/00	←	05/97→ 01/00; für Fahrzeuge ohne Schlechtwegeausführung; Made in Japan	13.0460-5951.2	605951	SUM 21601 17,5 + WK
			←	05/97→ 01/00; für Fahrzeuge mit Schlechtwegeausführung; Made in Japan	13.0460-5976.2	605976	AKE 20870 15,0 - WE / - WK
			→	05/97→ 09/99	13.0460-5835.2	605835	AKE 20076 15,5 + WK
1.4 16V (ZZE111_) 1.6 16V (ZZE112_)	71	02/00→10/01	←	für Fahrzeuge ohne Schlechtwegeausführung; Made in Japan	13.0460-5951.2	605951	SUM 21601 17,5 + WK
	81	02/00→10/01	←	für Fahrzeuge mit Schlechtwegeausführung; Made in Japan	13.0460-5976.2	605976	AKE 20870 15,0 - WE / - WK
			→	Made in Japan	13.0460-5835.2	605835	AKE 20076 15,5 + WK
			→	Made in Großbritannien	13.0460-5869.2	605869	TRW 24013 14,9 + WK
1.6 (AE111_) 1.6 Aut. (AE111_)	81	04/97→02/00	←	05/97→ 01/00; für Fahrzeuge ohne Schlechtwegeausführung; Made in Japan	13.0460-5951.2	605951	SUM 21601 17,5 + WK
	79	04/97→02/00	←	05/97→ 01/00; für Fahrzeuge mit Schlechtwegeausführung; Made in Japan	13.0460-5976.2	605976	AKE 20870 15,0 - WE / - WK
			→	08/98→ 09/99	13.0460-5835.2	605835	AKE 20076 15,5 + WK
1.8	81	10/97→10/01	←	Made in Japan	13.0460-5951.2	605951	SUM 21601 17,5 + WK
1.8 4WD (AE115_)	81	04/97→10/01	←	05/97→; Made in Japan	13.0460-5951.2	605951	SUM 21601 17,5 + WK
1.9 D (WZE110_)	51	02/00→10/01	←	Made in Japan	13.0460-5951.2	605951	SUM 21601 17,5 + WK
			→	Made in Japan	13.0460-5835.2	605835	AKE 20076 15,5 + WK
			→	Made in Großbritannien	13.0460-5869.2	605869	TRW 24013 14,9 + WK
2.0 D (CE110_)	53	04/97→02/00	←	05/97→ 01/00; Made in Japan	13.0460-5951.2	605951	SUM 21601 17,5 + WK
			→	08/98→ 09/99	13.0460-5835.2	605835	AKE 20076 15,5 + WK
2.0 D-4D (CDE110_)	66	09/00→10/01	←	Made in Japan	13.0460-5951.2	605951	SUM 21601 17,5 + WK
			→		13.0460-5835.2	605835	AKE 20076 15,5 + WK
<b>Zubehörsatz, Scheibenbremsbelag</b>							
1.4 (EE111_) 1.6 (AE111_) 1.6 Aut. (AE111_)	63	04/97→02/00	←	05/97→ 01/00; für Fahrzeuge ohne Schlechtwegeausführung	13.0460-0074.2	610074	
	81	04/97→02/00	←	für Fahrzeuge ohne Schlechtwegeausführung	13.0460-0074.2	610074	
	79	04/97→02/00	←		13.0460-0074.2	610074	
1.4 16V (ZZE111_) 1.6 16V (ZZE112_)	71	02/00→10/01	←	für Fahrzeuge ohne Schlechtwegeausführung	13.0460-0074.2	610074	
	81	02/00→10/01	←		13.0460-0074.2	610074	
1.8	81	10/97→10/01	←		13.0460-0074.2	610074	
1.9 D (WZE110_)	51	02/00→10/01	←		13.0460-0074.2	610074	
2.0 D-4D (CDE110_)	66	09/00→10/01	←		13.0460-0074.2	610074	
1.8 4WD (AE115_)	81	04/97→10/01	←	05/97→	13.0460-0074.2	610074	
2.0 D (CE110_)	53	04/97→02/00	←	05/97→ 01/00	13.0460-0074.2	610074	
<b> Bremsscheibe</b>							
1.4 (EE111_)	63	04/97→02/00	←	05/97→ 01/00; für Fahrzeuge ohne Schlechtwegeausführung	24.0122-0158.1	422158	Ø 255 22 20 V
			→	05/97→ 01/00	24.0109-0159.1	409159	Ø 266 9 8
1.4 16V (ZZE111_) 1.6 16V (ZZE112_)	71	02/00→10/01	←	für Fahrzeuge ohne Schlechtwegeausführung	24.0122-0158.1	422158	Ø 255 22 20 V
	81	02/00→10/01	→	Made in Japan	24.0109-0159.1	409159	Ø 266 9 8
1.6 (AE111_) 1.6 Aut. (AE111_)	81	04/97→02/00	←	05/97→ 01/00; für Fahrzeuge ohne Schlechtwegeausführung	24.0122-0158.1	422158	Ø 255 22 20 V
	79	04/97→02/00	→	08/98→ 01/00	24.0109-0159.1	409159	Ø 266 9 8
1.8	81	10/97→10/01	←		24.0122-0158.1	422158	Ø 255 22 20 V
1.8 4WD (AE115_)	81	04/97→10/01	←	05/97→	24.0122-0158.1	422158	Ø 255 22 20 V
1.9 D (WZE110_)	51	02/00→10/01	←		24.0122-0158.1	422158	Ø 255 22 20 V
			→	Made in Japan	24.0109-0159.1	409159	Ø 266 9 8
2.0 D (CE110_)	53	04/97→02/00	←	05/97→ 01/00	24.0122-0158.1	422158	Ø 255 22 20 V
			→	08/98→ 01/00	24.0109-0159.1	409159	Ø 266 9 8
2.0 D-4D (CDE110_)	66	09/00→10/01	←		24.0122-0158.1	422158	Ø 255 22 20 V
			→		24.0109-0159.1	409159	Ø 266 9 8















	kW			 	! #		
<b>TOYOTA - COROLLA LEVIN Coupe ( _E10_ ) 06/91→08/97</b>							
 <b>Bremsbelagsatz, Scheibenbremse</b>							
1.6 GT	85	06/91→08/97	←	05/92→ 05/95		13.0460-5976.2 605976	AKE 20870 15,0 - WE / - WK
<b>Zubehörsatz, Scheibenbremsbelag</b>							
1.6 GT	85	06/91→08/97	←	05/92→ 05/95		13.0460-0325.2 610325	AKE
 <b>Bremsscheibe</b>							
1.6 GT	85	06/91→08/97	→	05/92→ 05/95		24.0109-0159.1 409159	Ø 266 9 8
<b>TOYOTA - COROLLA Liftback ( _E10_ ) 05/92→04/97</b>							
 <b>Bremsbelagsatz, Scheibenbremse</b>							
1.3 XLI (EE101_)	65	07/92→04/97	←			13.0460-5951.2 605951	SUM 21601 17,5 + WK
1.6 GLI (AE101_)	84	07/92→04/97				13.0460-5976.2 605976	AKE 20870 15,0 - WE / - WK
2.0 D (CE100_)	53	07/92→04/97					
<b>Zubehörsatz, Scheibenbremsbelag</b>							
1.3 XLI (EE101_)	65	07/92→04/97	←			13.0460-0325.2 610325	AKE
1.6 GLI (AE101_)	84	07/92→04/97				13.0460-0441.2 610441	SUM
2.0 D (CE100_)	53	07/92→04/97					
 <b>Bremsscheibe</b>							
1.3 XLI (EE101_)	65	07/92→04/97	←			24.0122-0158.1 422158	Ø 255 22 20 V
1.6 GLI (AE101_)	84	07/92→04/97					
2.0 D (CE100_)	53	07/92→04/97					
<b>TOYOTA - COROLLA Liftback ( _E11_ ) 04/97→01/02</b>							
 <b>Bremsbelagsatz, Scheibenbremse</b>							
1.4 (EE111_)	63	04/97→02/00	←	05/97→ 01/00; für Fahrzeuge ohne Schlechtwegeausführung; Made in Japan		13.0460-5951.2 605951	SUM 21601 17,5 + WK
			←	05/97→ 01/00; für Fahrzeuge mit Schlechtwegeausführung; Made in Japan		13.0460-5976.2 605976	AKE 20870 15,0 - WE / - WK
			→	05/97→ 09/99		13.0460-5835.2 605835	AKE 20076 15,5 + WK
1.4 (ZZE111_)	71	02/00→01/02	←	→ 12/01; für Fahrzeuge ohne Schlechtwegeausführung; Made in Japan		13.0460-5951.2 605951	SUM 21601 17,5 + WK
1.6 (ZZE112_)	81	02/00→01/02	←	→ 12/01; für Fahrzeuge mit Schlechtwegeausführung; Made in Japan		13.0460-5976.2 605976	AKE 20870 15,0 - WE / - WK
			→	→ 12/01; Made in Japan		13.0460-5835.2 605835	AKE 20076 15,5 + WK
			→	→ 12/01; Made in Großbritannien		13.0460-5869.2 605869	TRW 24013 14,9 + WK
1.6 (AE111_)	81	04/97→02/00	←	05/97→ 01/00; für Fahrzeuge ohne Schlechtwegeausführung; Made in Japan		13.0460-5951.2 605951	SUM 21601 17,5 + WK
1.6 Aut. (AE111_)	79	04/97→02/00	←	05/97→ 01/00; für Fahrzeuge mit Schlechtwegeausführung; Made in Japan		13.0460-5976.2 605976	AKE 20870 15,0 - WE / - WK
			→	08/98→ 09/99		13.0460-5835.2 605835	AKE 20076 15,5 + WK
1.9 D (WZE110_)	51	02/00→01/02	←	→ 12/01; Made in Japan		13.0460-5951.2 605951	SUM 21601 17,5 + WK
			→	→ 12/01; Made in Japan		13.0460-5835.2 605835	AKE 20076 15,5 + WK
			→	→ 12/01; Made in Großbritannien		13.0460-5869.2 605869	TRW 24013 14,9 + WK
2.0 D (CE110)	53	04/97→02/00	←	05/97→ 01/00; Made in Japan		13.0460-5951.2 605951	SUM 21601 17,5 + WK
			→	08/98→ 09/99		13.0460-5835.2 605835	AKE 20076 15,5 + WK
2.0 D-4D (CDE110_)	66	09/00→01/02	←	→ 12/01; Made in Japan		13.0460-5951.2 605951	SUM 21601 17,5 + WK
			→	→ 12/01		13.0460-5835.2 605835	AKE 20076 15,5 + WK
<b>Zubehörsatz, Scheibenbremsbelag</b>							
1.4 (EE111_)	63	04/97→02/00	←	05/97→ 01/00; für Fahrzeuge ohne Schlechtwegeausführung		13.0460-0074.2 610074	
1.6 (AE111_)	81	04/97→02/00	←				
1.6 Aut. (AE111_)	79	04/97→02/00	←				
1.4 (ZZE111_)	71	02/00→01/02	←	→ 12/01; für Fahrzeuge ohne Schlechtwegeausführung		13.0460-0074.2 610074	
1.6 (ZZE112_)	81	02/00→01/02	←				
1.9 D (WZE110_)	51	02/00→01/02	←	→ 12/01		13.0460-0074.2 610074	
2.0 D-4D (CDE110_)	66	09/00→01/02	←				
2.0 D (CE110)	53	04/97→02/00	←	05/97→ 01/00		13.0460-0074.2 610074	
↓							













	kw			 	! #		
<b>TOYOTA - COROLLA Liftback ( _E11_ ) 04/97→01/02</b>							
<b>Bremsscheibe</b>							
1.4 (EE111_)	63	04/97→02/00	←	05/97→ 01/00; für Fahrzeuge ohne Schlechtwegeausführung		24.0122-0158.1 422158	Ø 255 22 20 V
			→	05/97→ 01/00		24.0109-0159.1 409159	Ø 266 9 8
1.4 (ZZE111_) 1.6 (ZZE112_)	71 81	02/00→01/02 02/00→01/02	←	→ 12/01; für Fahrzeuge ohne Schlechtwegeausführung		24.0122-0158.1 422158	Ø 255 22 20 V
			→	→ 12/01; Made in Japan		24.0109-0159.1 409159	Ø 266 9 8
1.6 (AE111_) 1.6 Aut. (AE111_)	81 79	04/97→02/00 04/97→02/00	←	05/97→ 01/00; für Fahrzeuge ohne Schlechtwegeausführung		24.0122-0158.1 422158	Ø 255 22 20 V
			→	08/98→ 01/00		24.0109-0159.1 409159	Ø 266 9 8
1.9 D (WZE110_)	51	02/00→01/02	←	→ 12/01		24.0122-0158.1 422158	Ø 255 22 20 V
			→	→ 12/01; Made in Japan		24.0109-0159.1 409159	Ø 266 9 8
2.0 D (CE110)	53	04/97→02/00	←	05/97→ 01/00		24.0122-0158.1 422158	Ø 255 22 20 V
			→	08/98→ 01/00		24.0109-0159.1 409159	Ø 266 9 8
2.0 D-4D (CDE110_)	66	09/00→01/02	←	→ 12/01		24.0122-0158.1 422158	Ø 255 22 20 V
			→	→ 12/01		24.0109-0159.1 409159	Ø 266 9 8
<b>TOYOTA - COROLLA Stufenheck ( _E12_ ) 08/00→03/08</b>							
<b>Bremsbelagsatz, Scheibenbremse</b>							
1.4 D-4D (NDE120_)	66	06/04→10/06	←			13.0460-5815.2 605815	TRW 23766 17,8 + WK
			→			13.0460-5819.2 605819	TRW 23816 16,0 + WK
1.4 VVT-i (ZZE120_)	71	10/01→10/06	←	→ 05/04; Made in Japan		13.0460-5810.2 605810	AKE 23510 16,5 + WK
			←	06/04→		13.0460-5815.2 605815	TRW 23766 17,8 + WK
			←	→ 05/04; Made in Großbritannien		13.0460-5815.2 605815	TRW 23766 17,8 + WK
			→	→ 05/04; Made in Japan		13.0460-5812.2 605812	SUM 23521 14,0 + WK
			→	→ 05/04; Made in Großbritannien		13.0460-5819.2 605819	TRW 23816 16,0 + WK
			→	06/04→		13.0460-5819.2 605819	TRW 23816 16,0 + WK
1.5 (ZZA120_, ZZE123_)	80	11/01→07/07	←	→ 05/04; Made in Japan		13.0460-5810.2 605810	AKE 23510 16,5 + WK
			←	08/02→ 05/04; Made in Großbritannien		13.0460-5815.2 605815	TRW 23766 17,8 + WK
			←	06/04→ 10/06		13.0460-5815.2 605815	TRW 23766 17,8 + WK
			→	→ 05/04; Made in Japan		13.0460-5812.2 605812	SUM 23521 14,0 + WK
			→	06/04→ 10/06		13.0460-5819.2 605819	TRW 23816 16,0 + WK
			→	08/02→ 05/04; Made in Großbritannien		13.0460-5819.2 605819	TRW 23816 16,0 + WK
1.6 VVT-i (ZZE121_)	81	10/01→07/07	←	01/02→ 05/04; Made in Japan		13.0460-5810.2 605810	AKE 23510 16,5 + WK
			←	08/02→ 05/04; Made in Großbritannien		13.0460-5815.2 605815	TRW 23766 17,8 + WK
			←	06/04→ 10/06		13.0460-5815.2 605815	TRW 23766 17,8 + WK
			→	01/02→ 05/04; Made in Japan		13.0460-5812.2 605812	SUM 23521 14,0 + WK
			→	08/02→ 05/04; Made in Großbritannien		13.0460-5819.2 605819	TRW 23816 16,0 + WK
			→	06/04→ 10/06		13.0460-5819.2 605819	TRW 23816 16,0 + WK
2.0 D-4D (CDE120_)	66	01/02→12/06	←	→ 05/04; Made in Großbritannien		13.0460-5815.2 605815	TRW 23766 17,8 + WK
			←	05/03→ 05/04; Made in Großbritannien		13.0460-5815.2 605815	TRW 23766 17,8 + WK
			←	→ 05/04; Made in Japan		13.0460-5817.2 605817	AKE 23526 17,5 + WE / - WK
			→	→ 05/04; Made in Japan		13.0460-5812.2 605812	SUM 23521 14,0 + WK
			→	→ 05/04; Made in Großbritannien		13.0460-5819.2 605819	TRW 23816 16,0 + WK
			→	05/03→ 05/04; Made in Großbritannien		13.0460-5819.2 605819	TRW 23816 16,0 + WK
2.0 D-4D (CDE120_)	85	06/04→07/07	←	→ 10/06		13.0460-5815.2 605815	TRW 23766 17,8 + WK
			→	→ 10/06		13.0460-5819.2 605819	TRW 23816 16,0 + WK
<b>Zubehörsatz, Scheibenbremsbelag</b>							
1.4 D-4D (NDE120_)	66	06/04→10/06	←			13.0460-0138.2 610138	TRW
1.4 VVT-i (ZZE120_)	71	10/01→10/06	←	→ 05/04; Made in Großbritannien		13.0460-0138.2 610138	TRW
			←	06/04→		13.0460-0138.2 610138	TRW
			→	→ 05/04; Made in Japan		13.0460-0136.2 610136	SUM
1.5 (ZZA120_, ZZE123_)	80	11/01→07/07	←	08/02→ 05/04; Made in Großbritannien		13.0460-0138.2 610138	TRW
↓							





























	kw				! #		
<b>TOYOTA - COROLLA Stufenheck (_E12_) 08/00→03/08</b>							
<b>Zubehörsatz, Scheibenbremsbelag</b>							
1.5 (ZZA120_, ZZE123_)	80	11/01→07/07	←	06/04→ 10/06		13.0460-0138.2 610138	TRW
			→	→ 05/04; Made in Japan		13.0460-0136.2 610136	SUM
1.6 VVT-i (ZZE121_)	81	10/01→07/07	←	08/02→ 05/04; Made in Großbritannien		13.0460-0138.2 610138	TRW
			←	06/04→ 10/06		13.0460-0138.2 610138	TRW
			→	01/02→ 05/04; Made in Japan		13.0460-0136.2 610136	SUM
2.0 D-4D (CDE120_)	66	01/02→12/06	←	→ 05/04; Made in Großbritannien		13.0460-0138.2 610138	TRW
			←	05/03→ 05/04; Made in Großbritannien		13.0460-0138.2 610138	TRW
			→	→ 05/04; Made in Japan		13.0460-0136.2 610136	SUM
2.0 D-4D (CDE120_)	85	06/04→07/07	←	→ 10/06		13.0460-0138.2 610138	TRW
<b> Bremsscheibe</b>							
1.4 D-4D (NDE120_)	66	06/04→10/06	←			24.0125-0157.1 425157	Ø 275 25 23 V
			→			24.0109-0140.1 409140	Ø 279 9 8
1.4 VVT-i (ZZE120_)	71	10/01→10/06	←	06/04→		24.0125-0155.1 425155	Ø 255 25 23 V
			←	→ 05/04		24.0125-0155.1 425155	Ø 255 25 23 V
			→	06/04→		24.0109-0138.1 409138	Ø 258 9 8
			→	→ 05/04; Made in Großbritannien		24.0109-0138.1 409138	Ø 258 9 8
			→	→ 05/04; Made in Japan		24.0109-0139.1 409139	Ø 269 9 8
1.5 (ZZA120_, ZZE123_)	80	11/01→07/07	←	06/04→ 10/06		24.0125-0155.1 425155	Ø 255 25 23 V
			←	→ 05/04		24.0125-0155.1 425155	Ø 255 25 23 V
			→	08/02→ 05/04; Made in Großbritannien		24.0109-0138.1 409138	Ø 258 9 8
			→	06/04→ 10/06		24.0109-0138.1 409138	Ø 258 9 8
			→	→ 05/04; Made in Japan		24.0109-0139.1 409139	Ø 269 9 8
1.6 VVT-i (ZZE121_)	81	10/01→07/07	←	01/02→ 05/04		24.0125-0155.1 425155	Ø 255 25 23 V
			←	06/04→ 10/06		24.0125-0155.1 425155	Ø 255 25 23 V
			→	08/02→ 05/04; Made in Großbritannien		24.0109-0138.1 409138	Ø 258 9 8
			→	06/04→ 10/06		24.0109-0138.1 409138	Ø 258 9 8
			→	01/02→ 05/04; Made in Japan		24.0109-0139.1 409139	Ø 269 9 8
2.0 D-4D (CDE120_)	66	01/02→12/06	←	05/03→ 05/04; Made in Großbritannien		24.0125-0157.1 425157	Ø 275 25 23 V
			←	→ 05/04; Made in Großbritannien		24.0125-0157.1 425157	Ø 275 25 23 V
			←	→ 05/04; Made in Japan		24.0125-0168.1 425168	Ø 275 25 23 V
			→	→ 05/04; Made in Japan		24.0109-0139.1 409139	Ø 269 9 8
			→	05/03→ 05/04; Made in Großbritannien		24.0109-0140.1 409140	Ø 279 9 8
			→	→ 05/04; Made in Großbritannien		24.0109-0140.1 409140	Ø 279 9 8
2.0 D-4D (CDE120_)	85	06/04→07/07	←	→ 10/06		24.0125-0157.1 425157	Ø 275 25 23 V
			→	→ 10/06		24.0109-0140.1 409140	Ø 279 9 8
<b>TOYOTA - COROLLA Stufenheck (_E15_) 10/06→</b>							
<b> Bremsbelagsatz, Scheibenbremse</b>							
1.33	74	01/07→	←	10/08→ 05/13		13.0460-5767.2 605767	AKE 24336 17,5 - WE / - WK
			→	10/08→ 05/13		13.0460-5769.2 605769	24610 15,0 + WK
1.4 D-4D	66	10/06→	←	01/09→ 05/13		13.0460-5602.2 605602	24122 19,0 + WK + Zub
			→	01/09→ 05/13		13.0460-5604.2 605604	24664 15,2 + WK + Zub
1.4 VVT-i (ZZE150_)	71	11/06→11/13	←	→ 12/08		13.0460-5767.2 605767	AKE 24336 17,5 - WE / - WK
1.6 Dual VVTi (ZRE141)	91	01/07→	→	→ 12/08		13.0460-5769.2 605769	24610 15,0 + WK
1.6 VVT-i (ZZE141_)	81	08/07→06/13	→	→ 12/08		13.0460-5769.2 605769	24610 15,0 + WK
1.6	97	01/09→	←	→ 05/13		13.0460-5767.2 605767	AKE 24336 17,5 - WE / - WK
			→	→ 05/13		13.0460-5769.2 605769	24610 15,0 + WK
2.0 D-4D	93	01/07→	←	→ 05/13		13.0460-5603.2 605603	24204 19,2 + WK + Zub
			→	→ 05/13		13.0460-5604.2 605604	24664 15,2 + WK + Zub
<b> Bremsscheibe</b>							
1.33	74	01/07→	←	10/08→ 05/13		24.0122-0256.1 422256	Ø 275 22 19 V
			→	10/08→ 05/13		24.0109-0155.1 409155	Ø 259 9 7,5
1.4 D-4D	66	10/06→	←	01/09→ 05/13		24.0126-0148.1 426148	Ø 273 26 23 V
↓							













	kw					! #		
<b>TOYOTA - COROLLA Stufenheck ( _E15_ ) 10/06→</b>								
 <b>Bremsscheibe</b>								
1.4 D-4D	66	10/06→	➔	01/09→05/13		24.0110-0337.1	410337	Ø 270 9,9 8
1.4 VVT-i (ZZE150_)	71	11/06→11/13	➔	→ 12/08		24.0122-0256.1	422256	Ø 275 22 19 V
1.6 Dual VVTi (ZRE141)	91	01/07→	➔	→ 12/08		24.0109-0155.1	409155	Ø 259 9 7,5
1.6 VVT-i (ZZE141_)	81	08/07→06/13	➔					
1.6	97	01/09→	➔	→ 05/13		24.0122-0256.1	422256	Ø 275 22 19 V
			➔	→ 05/13		24.0109-0155.1	409155	Ø 259 9 7,5
2.0 D-4D	93	01/07→	➔	→ 05/13		24.0126-0156.1	426156	Ø 295 26 23 V
			➔	→ 05/13		24.0110-0337.1	410337	Ø 270 9,9 8
<b>TOYOTA - COROLLA Stufenheck ( _E18_, ZRE1_ ) 06/13→</b>								
 <b>Bremsbelagsatz, Scheibenbremse</b>								
1.3 (NRE180_)	73	06/13→	➔			13.0460-3868.2	603868	BOS 25698 18,7 + WK + Zub
			➔			13.0460-5767.2	605767	AKE 24336 17,5 - WE / - WK
1.4 D-4D (NDE180_)	66	06/13→	➔			13.0460-5604.2	605604	24664 15,2 + WK + Zub
			➔			13.0460-3868.2	603868	BOS 25698 18,7 + WK + Zub
			➔	für Fahrzeuge mit Bremsassistent		13.0460-5769.2	605769	24610 15,0 + WK
1.6 (ZRE181_)	97	06/13→	➔			13.0460-3868.2	603868	BOS 25698 18,7 + WK + Zub
			➔			13.0460-5767.2	605767	AKE 24336 17,5 - WE / - WK
			➔	für Fahrzeuge ohne Bremsassistent		13.0460-5604.2	605604	24664 15,2 + WK + Zub
1.8 VVTi (ZRE172)	103	06/13→	➔	für Fahrzeuge mit Bremsassistent		13.0460-5769.2	605769	24610 15,0 + WK
 <b>Bremsscheibe</b>								
1.3 (NRE180_)	73	06/13→	➔			24.0126-0184.1	426184	Ø 277 26 23 V
1.4 D-4D (NDE180_)	66	06/13→	➔			24.0110-0337.1	410337	Ø 270 9,9 8
1.6 (ZRE181_)	97	06/13→	➔	für Fahrzeuge mit Bremsassistent		24.0122-0256.1	422256	Ø 275 22 19 V
			➔	für Fahrzeuge ohne Bremsassistent		24.0126-0184.1	426184	Ø 277 26 23 V
			➔	für Fahrzeuge mit Bremsassistent		24.0109-0155.1	409155	Ø 259 9 7,5
			➔	für Fahrzeuge ohne Bremsassistent		24.0110-0337.1	410337	Ø 270 9,9 8
1.8 VVTi (ZRE172)	103	06/13→	➔					
<b>TOYOTA - COROLLA Verso ( _E12_ ) 07/01→07/04</b>								
 <b>Bremsbelagsatz, Scheibenbremse</b>								
1.6 VVT-i (ZZE121_)	81	08/01→05/04	➔			13.0460-5810.2	605810	AKE 23510 16,5 + WK
			➔			13.0460-5812.2	605812	SUM 23521 14,0 + WK
1.8 VVT-i (ZZE122_)	99	12/01→05/04	➔			13.0460-5817.2	605817	AKE 23526 17,5 + WE / - WK
2.0 D-4D (CDE120_)	66	01/02→05/04	➔			13.0460-5812.2	605812	SUM 23521 14,0 + WK
<b>Zubehörsatz, Scheibenbremsbelag</b>								
1.6 VVT-i (ZZE121_)	81	08/01→05/04	➔			13.0460-0136.2	610136	SUM
1.8 VVT-i (ZZE122_)	99	12/01→05/04						
2.0 D-4D (CDE120_)	66	01/02→05/04						
 <b>Bremsscheibe</b>								
1.6 VVT-i (ZZE121_)	81	08/01→05/04	➔			24.0125-0155.1	425155	Ø 255 25 23 V
			➔			24.0109-0139.1	409139	Ø 269 9 8
1.8 VVT-i (ZZE122_)	99	12/01→05/04	➔			24.0125-0168.1	425168	Ø 275 25 23 V
2.0 D-4D (CDE120_)	66	01/02→05/04	➔			24.0109-0139.1	409139	Ø 269 9 8
<b>TOYOTA - COROLLA Verso ( ZER_, ZZE12_, R1_ ) 03/04→04/09</b>								
 <b>Bremsbelagsatz, Scheibenbremse</b>								
1.3 VVTi	64	03/04→03/09	➔	05/04→		13.0460-5813.2	605813	BOS 23480 19,3 + WK
1.6 (ZNR10_)	81	04/04→03/09	➔					
1.8 (ZNR11_)	95	04/04→03/09	➔	05/04→		13.0460-5814.2	605814	BOS 23620 16,4 + WK
2.0 D-4D (CUR10_)	85	04/04→03/09						
2.2 D-4D (AUR10_)	100	10/05→03/09	➔			13.0460-5813.2	605813	BOS 23480 19,3 + WK
2.2 D-4D (AUR10_)	130	10/05→03/09	➔			13.0460-5814.2	605814	BOS 23620 16,4 + WK
<b>Zubehörsatz, Scheibenbremsbelag</b>								
1.3 VVTi	64	03/04→03/09	➔	05/04→		13.0460-0454.2	610454	BOS
1.6 (ZNR10_)	81	04/04→03/09						
↓								

















	kw					! #		
<b>TOYOTA - COROLLA Verso (ZER_, ZZE12_, R1_) 03/04→04/09</b>								
<b>Zubehörsatz, Scheibenbremsbelag</b>								
1.8 (ZNR11_) 2.0 D-4D (CUR10_)	95 85	04/04→03/09 04/04→03/09	➡	05/04→			13.0460-0256.2 610256	BOS
2.2 D-4D (AUR10_) 2.2 D-4D (AUR10_)	100 130	10/05→03/09 10/05→03/09	←				13.0460-0454.2 610454	BOS
			➡				13.0460-0256.2 610256	BOS
<b> Bremsscheibe</b>								
1.3 VVTi 1.6 (ZNR10_)	64 81	03/04→03/09 04/04→03/09	←				24.0125-0155.1 425155	Ø 255 25 23 V
			←	05/04→			24.0126-0138.1 426138	Ø 295 26 24 V
			➡	05/04→			24.0110-0320.1 410320	Ø 290 10 8,5
1.8 (ZNR11_) 2.0 D-4D (CUR10_)	95 85	04/04→03/09 04/04→03/09	←	05/04→			24.0126-0138.1 426138	Ø 295 26 24 V
			➡	05/04→			24.0110-0320.1 410320	Ø 290 10 8,5
2.2 D-4D (AUR10_) 2.2 D-4D (AUR10_)	100 130	10/05→03/09 10/05→03/09	←				24.0126-0138.1 426138	Ø 295 26 24 V
			➡				24.0110-0320.1 410320	Ø 290 10 8,5
<b>TOYOTA - DYNA Pritsche/Fahrgestell (KD_, LY_, _Y2_, _U3_, _U4_) 08/01→</b>								
<b> Bremsbelagsatz, Scheibenbremse</b>								
2.5 D4d	75	08/01→	←				13.0460-5938.2 605938	AKE 21158 15,5 - WE / - WK
			←	→ 08/06			13.0460-5938.2 605938	AKE 21158 15,5 - WE / - WK
2.5 D4d (KDY220_, KDY230_)	65	08/01→	←	→ 08/06			13.0460-5938.2 605938	AKE 21158 15,5 - WE / - WK
3.0 D4d 3.0 D4d (KDY22_, KDY23_, KDY25_, KDY26_) 3.0 D4d (KDY261_, KDY251_, KDY231_, KDY221_)	100 106 80	10/09→ 09/06→ 09/06→	←				13.0460-5938.2 605938	AKE 21158 15,5 - WE / - WK
<b>TOYOTA - FJ CRUISER (GSJ1_) 01/06→</b>								
<b> Bremsbelagsatz, Scheibenbremse</b>								
4.0 (GSJ10_) 4.0 4WD (GSJ15_)	178 178	01/06→10/10 01/06→10/10	←				13.0460-5747.2 605747	24024 17,0 + WK
			➡				13.0460-5744.2 605744	21947 15,4 - WE / - WK
4.0 4WD (GSJ15_)	193	11/10→	←	12/10→ 06/14			13.0460-5747.2 605747	24024 17,0 + WK
			➡	12/10→ 06/14			13.0460-5744.2 605744	21947 15,4 - WE / - WK
4.0 4WD (GSJ15_) 4.0 4WD (GSJ15_)	200 203	12/10→ 01/11→	←	→ 06/14			13.0460-5747.2 605747	24024 17,0 + WK
			➡	→ 06/14			13.0460-5744.2 605744	21947 15,4 - WE / - WK
<b>TOYOTA - HARRIER (_U3_) 02/03→12/13</b>								
<b> Bremsbelagsatz, Scheibenbremse</b>								
2.4 (ACU30_)	118	02/03→06/12	←	10/03→			13.0460-5750.2 605750	23734 16,8 - WK
			➡	10/03→			13.0460-5734.2 605734	SUM 23967 15,1
2.4 4WD (ACU35_) 3.3 Hybrid 4WD (MHU38_) 3.5 (GSU30_) 3.5 4WD (GSU35_, GSU36_)	118 155 206 206	10/03→06/12 04/05→05/12 04/05→12/08 04/05→12/08	←				13.0460-5750.2 605750	23734 16,8 - WK
			➡				13.0460-5734.2 605734	SUM 23967 15,1
<b> Bremsscheibe</b>								
2.4 (ACU30_)	118	02/03→06/12	←	10/03→			24.0128-0753.1 428753	Ø 319 28 26 V
			➡	10/03→			24.0110-0316.1 410316	Ø 288 10 8,5
2.4 4WD (ACU35_) 3.3 Hybrid 4WD (MHU38_) 3.5 (GSU30_) 3.5 4WD (GSU35_, GSU36_)	118 155 206 206	10/03→06/12 04/05→05/12 04/05→12/08 04/05→12/08	←				24.0128-0753.1 428753	Ø 319 28 26 V
			➡				24.0110-0316.1 410316	Ø 288 10 8,5
<b>TOYOTA - HIACE / COMMUTER V (TRH2_, KDH2_) 08/04→</b>								
<b> Bremsbelagsatz, Scheibenbremse</b>								
2.5 D-4D	75	09/06→	←				13.0460-5722.2 605722	21468 15,5 - WK
2.5 D-4D 4WD ↓	94	01/05→	←	09/06→			13.0460-5722.2 605722	21468 15,5 - WK















	kw					! #		
<b>TOYOTA - HIACE / COMMUTER V (TRH2_, KDH2_) 08/04→</b>								
 <b>Bremsscheibe</b>								
2.5 D-4D	75	09/06→	←			24.0128-0189.1	428189	∅ 285 28 26 V
<b>TOYOTA - HIACE III Wagon (_H1_) 08/87→12/04</b>								
 <b>Bremsbelagsatz, Scheibenbremse</b>								
2.0 (RZH102, RZH112)	74	08/89→04/98	←	08/95→; - ABS		13.0460-5722.2	605722	21468 15,5 - WK
			←	02/90→ 08/95		13.0460-5892.2	605892	21689 15,5 - WE / - WK
2.4 D (LH5_, LH6_, LH7_, LH10_, LH11_)	57	08/89→12/04	←	→ 08/95		13.0460-5892.2	605892	21689 15,5 - WE / - WK
 <b>Bremsscheibe</b>								
2.0 (RZH102, RZH112)	74	08/89→04/98	←	08/95→		24.0128-0189.1	428189	∅ 285 28 26 V
<b>TOYOTA - HIACE IV Bus (_H1_, _H2_) 08/95→</b>								
 <b>Bremsbelagsatz, Scheibenbremse</b>								
2.4 (RCH12_, RCH22_) 2.4 4WD (RCH18_)	85 85	08/95→04/98 08/95→04/98	←	- ABS		13.0460-5722.2	605722	21468 15,5 - WK
2.4 D	61	08/95→08/06	←	→ 08/01; - ABS		13.0460-5722.2	605722	21468 15,5 - WK
2.4 D (LXH12_, LXH22_) 2.4 TD (LXH12_, LXH22_)	58 66	08/95→08/06 08/95→08/06	←	07/99→ 08/01; + ABS		13.0460-5722.2	605722	21468 15,5 - WK
2.4 D (LXH12_)	55	08/95→08/01	←	+ ABS		13.0460-5722.2	605722	21468 15,5 - WK
			←	- ABS		13.0460-5722.2	605722	21468 15,5 - WK
2.4 TD 4WD (LXH18_, LXH28_)	66	08/95→08/06	←	→ 08/01; - ABS		13.0460-5722.2	605722	21468 15,5 - WK
2.5 D-4D (KLH12_, KLH22_) 2.5 D-4D (KLH12_, KLH22_) 2.5 D-4D (KLH12_) 2.5 D-4D 4WD (KLH18_)	70 75 65 86	09/06→12/12 11/01→08/06 11/01→08/06 09/06→	←			13.0460-5722.2	605722	21468 15,5 - WK
2.5 D-4D (KLH12_, KLH22_)	86	08/06→12/12	←	09/06→		13.0460-5722.2	605722	21468 15,5 - WK
2.5 D-4D 4WD (KLH18_)	75	08/01→07/06	←	11/01→		13.0460-5722.2	605722	21468 15,5 - WK
2.7 (RCH13_, RCH23_)	105	04/98→11/01	←	07/99→; + ABS		13.0460-5722.2	605722	21468 15,5 - WK
			←	- ABS		13.0460-5722.2	605722	21468 15,5 - WK
2.7 (RCH13_, RCH23_)	106	11/01→12/06	←	→ 06/06; - ABS		13.0460-5722.2	605722	21468 15,5 - WK
			←	→ 06/06; + ABS		13.0460-5722.2	605722	21468 15,5 - WK
2.7 4WD (RCH19_) 2.7 4WD (RCH19_)	105 106	04/98→08/06 07/99→	←	→ 06/06; - ABS		13.0460-5722.2	605722	21468 15,5 - WK
 <b>Bremsscheibe</b>								
2.4 (RCH12_, RCH22_) 2.4 D (LXH12_) 2.5 D-4D (KLH12_, KLH22_) 2.5 D-4D (KLH12_, KLH22_) 2.5 D-4D (KLH12_) 2.7 (RCH13_, RCH23_)	85 55 70 75 65 105	08/95→04/98 08/95→08/01 09/06→12/12 11/01→08/06 11/01→08/06 04/98→11/01	←			24.0128-0189.1	428189	∅ 285 28 26 V
2.4 D 2.4 D (LXH12_, LXH22_) 2.4 TD (LXH12_, LXH22_)	61 58 66	08/95→08/06 08/95→08/06 08/95→08/06	←	→ 08/01		24.0128-0189.1	428189	∅ 285 28 26 V
2.5 D-4D (KLH12_, KLH22_) 2.5 D-4D 4WD (KLH18_)	86 75	08/06→12/12 08/01→07/06	←	09/06→ 11/01→		24.0128-0189.1	428189	∅ 285 28 26 V ∅ 285 28 26 V
2.7 (RCH13_, RCH23_)	106	11/01→12/06	←	→ 06/06		24.0128-0189.1	428189	∅ 285 28 26 V
<b>TOYOTA - HIACE IV Kasten (LXH1_, RZH1_, LH1_) 08/95→</b>								
 <b>Bremsbelagsatz, Scheibenbremse</b>								
2.4 (RCH12_, RCH22_) 2.4 i (RZH10)	85 88	08/95→11/03 08/95→08/04	←	→ 04/98; - ABS		13.0460-5722.2	605722	21468 15,5 - WK
2.4 4WD (RCH18_, RCH28_)	85	08/95→04/98	←	- ABS		13.0460-5722.2	605722	21468 15,5 - WK
2.4 D (LXH12_, LXH22_) 2.4 D (LXH12_, LXH22_)	55 61	09/95→08/01 08/95→07/01	←	07/99→; + ABS - ABS		13.0460-5722.2	605722	21468 15,5 - WK 21468 15,5 - WK
2.4 D (LXH12_, LXH22_) 2.4 TD (LXH12_, LXH22_)	58 66	08/95→12/01 08/95→08/06	←	→ 08/01; - ABS 07/99→ 08/01; + ABS		13.0460-5722.2	605722	21468 15,5 - WK 21468 15,5 - WK

	kw					! #		
<b>TOYOTA - HIACE IV Kasten (LXH1_, RZH1_, LH1_) 08/95→</b>								
 <b>Bremsbelagsatz, Scheibenbremse</b>								
2.4 TD 4WD (LXH18_, LXH28_)	66	08/95→08/06	←	→ 08/01; - ABS			13.0460-5722.2 605722	21468 15,5 - WK
2.5 D-4D (KLH12_, KLH22_)	65	11/01→08/06	←				13.0460-5722.2 605722	21468 15,5 - WK
2.5 D-4D (KLH12_, KLH22_)	70	09/06→						
2.5 D-4D (KLH12_, KLH22_)	75	11/01→08/06						
2.5 D-4D (KLH12_, KLH22_)	86	09/06→						
2.5 D-4D 4WD (KLH18_, KLH28_)	75	11/01→08/06						
2.5 D-4D 4WD (KLH28_, KLH18_)	86	09/06→12/12						
2.5 D-4D 4WD (KLH18_, KLH28_)	65	08/01→07/06	←	→ 08/04			13.0460-5722.2 605722	21468 15,5 - WK
2.7 (RCH13_, RCH23_)	105	04/98→08/06	←	07/99→ 06/06; + ABS			13.0460-5722.2 605722	21468 15,5 - WK
			←	→ 06/06; - ABS			13.0460-5722.2 605722	21468 15,5 - WK
2.7 4WD (RCH19_, RCH29_)	106	04/98→	←	→ 06/06; - ABS			13.0460-5722.2 605722	21468 15,5 - WK
 <b>Bremsscheibe</b>								
2.4 (RCH12_, RCH22_)	85	08/95→11/03	←	→ 04/98			24.0128-0189.1 428189	Ø 285 28 26 V
2.4 i (RZH10)	88	08/95→08/04						
2.4 D (LXH12_, LXH22_)	55	09/95→08/01	←				24.0128-0189.1 428189	Ø 285 28 26 V
2.4 D (LXH12_, LXH22_)	61	08/95→07/01						
2.5 D-4D (KLH12_, KLH22_)	65	11/01→08/06						
2.5 D-4D (KLH12_, KLH22_)	70	09/06→						
2.5 D-4D (KLH12_, KLH22_)	75	11/01→08/06						
2.5 D-4D (KLH12_, KLH22_)	86	09/06→						
2.4 D (LXH12_, LXH22_)	58	08/95→12/01	←	→ 08/01			24.0128-0189.1 428189	Ø 285 28 26 V
2.4 TD (LXH12_, LXH22_)	66	08/95→08/06						
2.7 (RCH13_, RCH23_)	105	04/98→08/06	←	→ 06/06			24.0128-0189.1 428189	Ø 285 28 26 V
<b>TOYOTA - HIACE V Kasten (TRH2_, KDH2_) 06/04→</b>								
 <b>Bremsbelagsatz, Scheibenbremse</b>								
2.5 D-4D	70	09/06→	←				13.0460-5722.2 605722	21468 15,5 - WK
2.5 D-4D (KDH20_, KDH21_, KDH22_)	75	06/04→						
2.5 D-4D (KDH200_, KDH202_, KDH212_, KDH222_)	86	09/06→						
 <b>Bremsscheibe</b>								
2.5 D-4D	70	09/06→	←				24.0128-0189.1 428189	Ø 285 28 26 V
2.5 D-4D (KDH20_, KDH21_, KDH22_)	75	06/04→						
2.5 D-4D (KDH200_, KDH202_, KDH212_, KDH222_)	86	09/06→						
<b>TOYOTA - HILUX V Pick-up (_N_, KZN1_, VZN1_) 09/88→01/99</b>								
 <b>Bremsbelagsatz, Scheibenbremse</b>								
1.8 (YN5_, YN8_, YN85)	61	09/88→06/98	←	→ 07/97			13.0460-5938.2 605938	AKE 21158 15,5 - WE / - WK
2.4 D (LN85_, LN110, Ln90)	61	09/88→08/97						
2.4 D (LN90_)	58	03/95→08/97						
2.4 D 4WD (LN110_)	58	01/94→12/97						
2.4 D (LN5_, LN85, LN90)	55	10/88→07/97	←				13.0460-5938.2 605938	AKE 21158 15,5 - WE / - WK
2.4 D 4WD (LN1_)	61	09/88→08/97	←	→ 07/97			13.0460-5992.2 605992	21679 15,0 + WK
2.4 D 4WD (LN11_)	73	08/91→07/97	←				13.0460-5992.2 605992	21679 15,0 + WK
2.4 i 4WD (RN106_, RN110_)	84	01/89→07/97						
 <b>Bremsscheibe</b>								
1.8 (YN5_, YN8_, YN85)	61	09/88→06/98	←	→ 07/97			24.0125-0118.1 425118	Ø 257 25 23 V
2.4 D (LN85_, LN110, Ln90)	61	09/88→08/97						
2.4 D (LN90_)	58	03/95→08/97						
2.4 D 4WD (LN110_)	58	01/94→12/97						
↓								















	kw					! #		
<b>TOYOTA - HILUX V Pick-up (_N_, KZN1_, VZN1_) 09/88→01/99</b>								
 <b>Bremsscheibe</b>								
2.4 D (LN5_, LN85, LN90)	55	10/88→07/97	←				24.0125-0118.1 425118	Ø 257 25 23 V
2.4 D 4WD (LN1_)	61	09/88→08/97	←	→ 07/97			24.0120-0168.1 420168	Ø 289 20 18 V
2.4 D 4WD (LN11_) 2.4 i 4WD (RN106_, RN110_)	73 84	08/91→07/97 01/89→07/97	←				24.0120-0168.1 420168	Ø 289 20 18 V
<b>TOYOTA - HILUX VI Pick-up (_N1_) 06/97→03/06</b>								
 <b>Bremsbelagsatz, Scheibenbremse</b>								
2.4 2.4 i 4WD (RZN14_, RZN16_, RZN19_)	107 103	08/97→07/05 08/97→10/05	←	→ 07/01			13.0460-5992.2 605992	21679 15,0 + WK
2.4 D 2.4 D (LN150, LN145)	58 55	08/97→07/05 08/97→04/05	←	→ 01/02			13.0460-5892.2 605892	21689 15,5 - WE / - WK
2.4 TD (LN190)	66	08/98→01/02	←	→ 08/01			13.0460-5892.2 605892	21689 15,5 - WE / - WK
2.4 TD 4WD (LN165_, LN170_, LN190_) 2.5 D-4D 4WD (KDN165_, KDN170_, KDN190_) 2.8 D 4WD (LN5_, LN8_)	66 75 65	08/98→01/02 11/01→07/05 08/97→07/05	←				13.0460-5992.2 605992	21679 15,0 + WK
2.5 D-4D (KDN14_, KDN15_, KDN16_, KDN19_)	65	11/01→07/05	←				13.0460-5892.2 605892	21689 15,5 - WE / - WK
 <b>Bremsscheibe</b>								
2.4 2.4 i 4WD (RZN14_, RZN16_, RZN19_)	107 103	08/97→07/05 08/97→10/05	←	→ 07/01			24.0120-0168.1 420168	Ø 289 20 18 V
2.4 D 2.4 D (LN150, LN145)	58 55	08/97→07/05 08/97→04/05	←	→ 01/02			24.0125-0118.1 425118	Ø 257 25 23 V
2.4 TD (LN190)	66	08/98→01/02	←	→ 08/01			24.0125-0118.1 425118	Ø 257 25 23 V
2.4 TD 4WD (LN165_, LN170_, LN190_) 2.5 D-4D 4WD (KDN165_, KDN170_, KDN190_) 2.8 D 4WD (LN5_, LN8_)	66 75 65	08/98→01/02 11/01→07/05 08/97→07/05	←				24.0120-0168.1 420168	Ø 289 20 18 V
2.5 D-4D (KDN14_, KDN15_, KDN16_, KDN19_)	65	11/01→07/05	←				24.0125-0118.1 425118	Ø 257 25 23 V
<b>TOYOTA - HILUX VII Pick-up (_N1_, _N2_, _N3_) 08/04→</b>								
 <b>Bremsbelagsatz, Scheibenbremse</b>								
2.5 D-4D (KUN15_, KDN1_) 2.5 D-4D (KUN15_)	65 88	08/05→10/06 12/07→	←	kurzer Radstand			13.0460-5616.2 605616	24567 16,0 - WE / - WK
2.5 D-4D (KUN15_, KUN25_, KUN35_)	75	10/05→	←	06/06→; kurzer Radstand			13.0460-5616.2 605616	24567 16,0 - WE / - WK
2.5 D-4D 4WD (KUN25_)	94	11/04→12/05	←				13.0460-5616.2 605616	24567 16,0 - WE / - WK
3.0 D-4D 4WD	145	05/08→12/08	←	Brems-/Fahr dyn. Artikelbezug: für ESP			13.0460-5747.2 605747	24024 17,0 + WK
 <b>Bremsscheibe</b>								
2.5 D-4D	106	01/10→	←	→ 05/15; Brems-/Fahr dyn. Artikelbezug: für ESP			24.0125-0192.1 425192	Ø 297 24,9 23,5 V
			←	→ 05/15; kurzer Radstand; Baumuster: KUN15			24.0128-0249.1 428249	Ø 258 28 26 V
2.5 D-4D (KUN15_, KDN1_) 2.5 D-4D 4WD (KUN25_)	65 94	08/05→10/06 11/04→12/05	←				24.0128-0249.1 428249	Ø 258 28 26 V
2.5 D-4D (KUN15_, KUN25_, KUN35_) 2.5 D-4D (KUN15_)	75 88	10/05→ 12/07→	←	06/06→ 10/08 → 10/08			24.0128-0249.1 428249	Ø 258 28 26 V
2.5 D-4D 4WD 2.5 D 4WD (KUN25_) 3.0 D-4D 4WD (KUN26)	106 88 75 126	09/09→ 12/07→ 10/05→ 12/07→	←				24.0125-0192.1 425192	Ø 297 24,9 23,5 V
2.7 4WD (TGN26) 3.0 D (KUN16, KUN26) 3.0 D 4WD (KUN26_)	118 126 120	08/05→05/15 10/06→ 08/05→05/15	←	12/07→			24.0125-0192.1 425192	Ø 297 24,9 23,5 V
↓								













	kw					! #		
<b>TOYOTA - HILUX VII Pick-up ( _N1_, _N2_, _N3_ ) 08/04→</b>								
 <b>Bremsscheibe</b>								
3.0 D-4D 4WD	145	05/08→12/08	←	→ 10/08		24.0125-0192.1	425192	Ø 297 24,9 23,5 V
<b>TOYOTA - HILUX Geländewagen geschlossen (LN_, KZN1_, VZN1_ ) 08/88→11/98</b>								
 <b>Bremsbelagsatz, Scheibenbremse</b>								
2.4 TD 4WD (LN130_)	92	08/88→08/97	←	→ 07/97		13.0460-5992.2	605992	21679 15,0 + WK
 <b>Bremsscheibe</b>								
2.4 TD 4WD (LN130_)	92	08/88→08/97	←	→ 07/97		24.0120-0168.1	420168	Ø 289 20 18 V
<b>TOYOTA - HILUX Pritsche/Fahrgestell ( _N1_, _N2_ ) 02/05→</b>								
 <b>Bremsscheibe</b>								
3.0 D 4WD (KUN26_)	126	02/05→	←	12/07→		24.0125-0192.1	425192	Ø 297 24,9 23,5 V
<b>TOYOTA - IQ ( _J1_ ) 11/08→</b>								
 <b>Bremsbelagsatz, Scheibenbremse</b>								
1.0 (KGJ10_)	50	01/09→	←			13.0460-5810.2	605810	AKE 23510 16,5 + WK
1.33 (NGJ10_)	72	01/09→	→					
1.4 D-4D (NUJ10_)	66	01/09→	→	+ ABS		13.0460-5769.2	605769	24610 15,0 + WK
 <b>Bremsscheibe</b>								
1.0 (KGJ10_)	50	01/09→	←			24.0120-0219.1	420219	Ø 255 20 18 V
1.33 (NGJ10_)	72	01/09→	→					
1.4 D-4D (NUJ10_)	66	01/09→	→	+ ABS		24.0109-0156.1	409156	Ø 259 9 7,5
<b>TOYOTA - LAND CRUISER ( _J7_ ) 03/84→</b>								
 <b>Bremsbelagsatz, Scheibenbremse</b>								
2.4 (RJ70_V, RJ73_V)	84	12/88→12/96	←	01/90→; für Fahrzeuge mit Scheibenbremse an der Hinterachse		13.0460-5992.2	605992	21679 15,0 + WK
			→	01/90→		13.0460-5744.2	605744	21947 15,4 - WE / - WK
3.0 TD (KZJ70_, KZJ73_, KZJ77_)	92	05/93→05/96	←			13.0460-5992.2	605992	21679 15,0 + WK
3.4 D (BJ70_V, BJ73_)	70	11/84→12/96	←	→ 12/89		13.0460-5935.2	605935	SUM 20852 15,5 - WE / - WK
			←	01/90→		13.0460-5992.2	605992	21679 15,0 + WK
4.2 D (HZJ7_)	96	01/90→12/99	←	01/97→		13.0460-5746.2	605746	23524 17,4 + WK
			←	→ 12/96		13.0460-5992.2	605992	21679 15,0 + WK
			→	→ 12/96		13.0460-5744.2	605744	21947 15,4 - WE / - WK
4.2 D 4x4 (HZJ74, HZJ78, HZJ75)	123	08/90→08/01	←	→ 12/96		13.0460-5992.2	605992	21679 15,0 + WK
			→	→ 12/96		13.0460-5744.2	605744	21947 15,4 - WE / - WK
4.2 TDi 4x4	150	09/01→06/06	←	11/01→		13.0460-5746.2	605746	23524 17,4 + WK
			→			13.0460-5749.2	605749	23539 17,3 - WE / - WK
4.5 4x4 (FZJ75)	158	11/92→11/99	←	→ 12/97		13.0460-5745.2	605745	21775 15,0 + WK
			→	→ 12/97		13.0460-5744.2	605744	21947 15,4 - WE / - WK
4.5 TD 24V 4x4 (VDJ76, VDJ78, VDJ79_)	151	03/07→	←	08/07→		13.0460-5618.2	605618	24386 17,9 + WK
			→	08/07→		13.0460-5619.2	605619	24653 17,3 - WE / - WK
<b>Zubehörsatz, Scheibenbremsbelag</b>								
3.4 D (BJ70_V, BJ73_)	70	11/84→12/96	←	→ 12/89		13.0460-0327.2	610327	SUM
 <b>Bremsscheibe</b>								
2.4 (RJ70_V, RJ73_V)	84	12/88→12/96	←	01/90→; für Fahrzeuge mit Trommelbremse an der Hinterachse		24.0113-0105.1	413105	Ø 302 12,5 11,5
			←	01/90→; für Fahrzeuge mit Scheibenbremse an der Hinterachse		24.0120-0153.1	420153	Ø 302 20 19 V
3.0 TD (KZJ70_, KZJ73_, KZJ77_)	92	05/93→05/96	←			24.0120-0153.1	420153	Ø 302 20 19 V
3.4 D (BJ70_V, BJ73_)	70	11/84→12/96	←	→ 12/89		24.0120-0153.1	420153	Ø 302 20 19 V
			←	01/90→		24.0120-0153.1	420153	Ø 302 20 19 V
4.2 D (HZJ7_)	96	01/90→12/99	←	→ 12/96		24.0120-0153.1	420153	Ø 302 20 19 V
4.2 D 4x4 (HZJ74, HZJ78, HZJ75)	123	08/90→08/01	←					
↓								





















	kw					! #		
<b>TOYOTA - LAND CRUISER (_J7_) 03/84→</b>								
 <b>Bremsscheibe</b>								
4.2 TDi 4x4	150	09/01→06/06	←			24.0132-0148.1	432148	Ø 313 32 30 V
			→			24.0118-0143.1	418143	Ø 329,2 18 16 V
4.5 4x4 (FZJ75)	158	11/92→11/99	←	→ 12/97		24.0132-0111.1	432111	Ø 311 32 30 V
<b>TOYOTA - LAND CRUISER 100 (_J1_) 01/98→07/08</b>								
 <b>Bremsbelagsatz, Scheibenbremse</b>								
4.2 D (HZJ105)	96	03/98→08/07	←	→ 11/99		13.0460-5744.2	605744	21947 15,4 - WE / - WK
4.2 TD (HDJ100_)	150	01/98→08/07	←	11/01→		13.0460-5746.2	605746	23524 17,4 + WK
			→			13.0460-5749.2	605749	23539 17,3 - WE / - WK
4.7 (UZJ100_)	173	01/98→08/07	←	→ 11/99		13.0460-5744.2	605744	21947 15,4 - WE / - WK
			←	11/01→ 04/02		13.0460-5746.2	605746	23524 17,4 + WK
			→	→ 04/02		13.0460-5749.2	605749	23539 17,3 - WE / - WK
4.7 (UZJ100)	175	02/02→08/07	←	05/02→		13.0460-5746.2	605746	23524 17,4 + WK
			→	05/02→		13.0460-5749.2	605749	23539 17,3 - WE / - WK
 <b>Bremsscheibe</b>								
4.2 D (HZJ105)	96	03/98→08/07	←			24.0132-0148.1	432148	Ø 313 32 30 V
4.2 TD (HDJ100_)	150	01/98→08/07	→			24.0118-0143.1	418143	Ø 329,2 18 16 V
4.7 (UZJ100_)	173	01/98→08/07	←	→ 04/02		24.0132-0148.1	432148	Ø 313 32 30 V
			→	→ 04/02		24.0118-0143.1	418143	Ø 329,2 18 16 V
4.7 (UZJ100)	175	02/02→08/07	←	05/02→		24.0132-0148.1	432148	Ø 313 32 30 V
			→	05/02→		24.0118-0143.1	418143	Ø 329,2 18 16 V
<b>TOYOTA - LAND CRUISER 200 (_J2_) 08/07→</b>								
 <b>Bremsbelagsatz, Scheibenbremse</b>								
4.0 (GRJ200_)	176	01/10→	←			13.0460-5747.2	605747	24024 17,0 + WK
			→			13.0460-5744.2	605744	21947 15,4 - WE / - WK
4.5 D4-D (VDJ200_)	183	08/15→	←			13.0460-5618.2	605618	24386 17,9 + WK
4.5 D4-D (VDJ200)	173	08/07→	←			13.0460-5618.2	605618	24386 17,9 + WK
4.5 D4-D (VDJ200)	200	01/12→	→			13.0460-5619.2	605619	24653 17,3 - WE / - WK
4.5 D-4D (VDJ200)	195	01/08→	→					
4.5 D V8 (VDJ200)	210	01/08→						
4.6 V8 (_URJ202W_)	234	01/12→						
4.6 V8 (URJ202)	227	09/10→						
4.7 V8 (UZJ200)	202	08/07→						
4.7 V8 (UZJ200)	212	01/08→						
 <b>Bremsscheibe</b>								
4.0 (GRJ200_)	176	01/10→	←			24.0132-0187.1	432187	Ø 338 32 29 V
<b>TOYOTA - LAND CRUISER 80 (_J8_) 01/90→11/99</b>								
 <b>Bremsbelagsatz, Scheibenbremse</b>								
4.2 D (HZJ80_)	99	01/90→12/97	←			13.0460-5745.2	605745	21775 15,0 + WK
4.2 TD (HDJ80)	118	10/92→12/97	→			13.0460-5744.2	605744	21947 15,4 - WE / - WK
4.2 TD (HDJ80)	123	01/90→12/97	→					
4.2 TD 24V (HDJ80_)	125	03/95→12/97						
4.5 24V (FZJ80_)	151	08/92→12/97						
 <b>Bremsscheibe</b>								
4.5 24V (FZJ80_)	151	08/92→12/97	←			24.0132-0111.1	432111	Ø 311 32 30 V
<b>TOYOTA - LAND CRUISER 90 (_J9_) 04/95→</b>								
 <b>Bremsbelagsatz, Scheibenbremse</b>								
2.7 (RZJ95)	110	04/95→07/02	←	04/96→ 07/00		13.0460-5992.2	605992	21679 15,0 + WK
			→	04/96→ 07/00		13.0460-5744.2	605744	21947 15,4 - WE / - WK
3.0 D-4D 4WD (KDJ90_, KDJ95_)	120	08/00→08/02	←			13.0460-5992.2	605992	21679 15,0 + WK
			→			13.0460-5744.2	605744	21947 15,4 - WE / - WK
3.0 TD	103	04/95→07/00	←	04/96→		13.0460-5992.2	605992	21679 15,0 + WK
			→	04/96→		13.0460-5744.2	605744	21947 15,4 - WE / - WK
3.0 TD (KZJ90_, KZJ95_)	92	04/96→12/02	←	→ 07/00		13.0460-5992.2	605992	21679 15,0 + WK
↓								





















	kw					! #		
<b>TOYOTA - LAND CRUISER 90 (_J9_) 04/95→</b>								
 <b>Bremsbelagsatz, Scheibenbremse</b>								
3.0 TD (KZJ90_, KZJ95_)	92	04/96→12/02	➡	→ 07/00			13.0460-5744.2 605744	21947 15,4 - WE / - WK
3.4 i 24V (VZJ90_, VZJ95_)	131	03/96→12/02	⬅	04/96→ 08/02			13.0460-5992.2 605992	21679 15,0 + WK
			➡	04/96→ 08/02			13.0460-5744.2 605744	21947 15,4 - WE / - WK
4.7	175	08/02→	⬅	→ 07/08			13.0460-5746.2 605746	23524 17,4 + WK
			➡	→ 07/08			13.0460-5749.2 605749	23539 17,3 - WE / - WK
 <b>Bremsscheibe</b>								
2.7 (RZJ95)	110	04/95→07/02	⬅	04/96→ 07/00			24.0122-0185.1 422185	Ø 319 22 20 V
			➡	04/96→ 07/00			24.0118-0709.1 418709	Ø 312 18 16 V
3.0 D-4D 4WD (KDJ90_, KDJ95_)	120	08/00→08/02	⬅				24.0122-0185.1 422185	Ø 319 22 20 V
			➡				24.0118-0709.1 418709	Ø 312 18 16 V
3.0 TD	103	04/95→07/00	⬅	04/96→			24.0122-0185.1 422185	Ø 319 22 20 V
			➡	04/96→			24.0118-0709.1 418709	Ø 312 18 16 V
3.0 TD (KZJ90_, KZJ95_)	92	04/96→12/02	⬅	→ 07/00			24.0122-0185.1 422185	Ø 319 22 20 V
			➡	→ 07/00			24.0118-0709.1 418709	Ø 312 18 16 V
3.4 i 24V (VZJ90_, VZJ95_)	131	03/96→12/02	⬅	04/96→ 08/02			24.0122-0185.1 422185	Ø 319 22 20 V
			➡	04/96→ 08/02			24.0118-0709.1 418709	Ø 312 18 16 V
4.7	175	08/02→	⬅	→ 07/08			24.0132-0148.1 432148	Ø 313 32 30 V
			➡	→ 07/08			24.0118-0143.1 418143	Ø 329,2 18 16 V
<b>TOYOTA - LAND CRUISER Hardtop (_J7_) 01/90→05/96</b>								
 <b>Bremsbelagsatz, Scheibenbremse</b>								
2.4 TD (LJ70_)	66	07/90→05/96	⬅	für Fahrzeuge mit Scheibenbremse an der Hinterachse			13.0460-5992.2 605992	21679 15,0 + WK
			➡				13.0460-5744.2 605744	21947 15,4 - WE / - WK
3.0 TD (KZJ70_)	92	05/93→05/96	⬅				13.0460-5992.2 605992	21679 15,0 + WK
 <b>Bremsscheibe</b>								
2.4 TD (LJ70_)	66	07/90→05/96	⬅	für Fahrzeuge mit Trommelbremse an der Hinterachse			24.0113-0105.1 413105	Ø 302 12,5 11,5
			⬅	für Fahrzeuge mit Scheibenbremse an der Hinterachse			24.0120-0153.1 420153	Ø 302 20 19 V
3.0 TD (KZJ70_)	92	05/93→05/96	⬅				24.0120-0153.1 420153	Ø 302 20 19 V
<b>TOYOTA - LAND CRUISER Pick-up (_J7_) 11/84→</b>								
 <b>Bremsbelagsatz, Scheibenbremse</b>								
4.0 4x4	170	03/07→	⬅				13.0460-5747.2 605747	24024 17,0 + WK
			➡				13.0460-5744.2 605744	21947 15,4 - WE / - WK
4.2 D 4x4 (HZJ7__V)	96	01/90→02/07	⬅	→ 12/96			13.0460-5992.2 605992	21679 15,0 + WK
			➡	→ 12/96			13.0460-5744.2 605744	21947 15,4 - WE / - WK
 <b>Bremsscheibe</b>								
4.0 4x4	170	03/07→	⬅				24.0128-0194.1 428194	Ø 338 28 26 V
			➡				24.0118-0709.1 418709	Ø 312 18 16 V
4.2 D 4x4 (HZJ7__V)	96	01/90→02/07	⬅	→ 12/96			24.0120-0153.1 420153	Ø 302 20 19 V
<b>TOYOTA - LAND CRUISER PRADO (_J12_) 09/02→12/10</b>								
 <b>Bremsbelagsatz, Scheibenbremse</b>								
3.0 D	70	09/02→07/09	⬅	01/03→			13.0460-5747.2 605747	24024 17,0 + WK
3.0 D-4D (KDJ120, KDJ150, KDJ125)	120	09/02→07/09	➡	01/03→			13.0460-5744.2 605744	21947 15,4 - WE / - WK
3.0 D-4D (KZJ12)	92	09/02→07/09						
3.0 D-4D (KDJ120_)	150	08/04→07/09	⬅				13.0460-5747.2 605747	24024 17,0 + WK
4.0 (GRJ12)	179	09/02→08/10	➡				13.0460-5744.2 605744	21947 15,4 - WE / - WK
4.0 (GRJ120_)	183	12/02→12/09						
4.0 (GRJ120)	203	08/05→07/09						
4.0 V6 VVT-i	207	01/03→07/09						
3.0 D-4D (KDJ120, KDJ125)	122	07/04→08/09	⬅	01/05→ 10/06			13.0460-5747.2 605747	24024 17,0 + WK
			➡	01/05→ 10/06			13.0460-5744.2 605744	21947 15,4 - WE / - WK
↓								



















	kW				! #		
<b>TOYOTA - LAND CRUISER PRADO (_J12_) 09/02→12/10</b>							
 <b>Bremsbelagsatz, Scheibenbremse</b>							
3.0 D-4D (KDJ120, KDJ125)	127	09/02→12/10	←	11/06→		13.0460-5747.2 605747	24024 17,0 + WK
			→	11/06→		13.0460-5744.2 605744	21947 15,4 - WE / - WK
 <b>Bremsscheibe</b>							
3.0 D	70	09/02→07/09	←	01/03→		24.0128-0194.1 428194	Ø 338 28 26 V
3.0 D-4D (KDJ120, KDJ150, KDJ125)	120	09/02→07/09	→	01/03→		24.0118-0709.1 418709	Ø 312 18 16 V
3.0 D-4D (KZJ12)	92	09/02→07/09					
3.0 D-4D (KDJ120_)	150	08/04→07/09	←			24.0128-0194.1 428194	Ø 338 28 26 V
4.0 (GRJ12)	179	09/02→08/10	→			24.0118-0709.1 418709	Ø 312 18 16 V
4.0 (GRJ120_)	183	12/02→12/09					
4.0 (GRJ120)	203	08/05→07/09					
4.0 V6 VVT-i	207	01/03→07/09					
3.0 D-4D (KDJ120, KDJ125)	122	07/04→08/09	←	01/05→ 10/06		24.0128-0194.1 428194	Ø 338 28 26 V
			→	01/05→ 10/06		24.0118-0709.1 418709	Ø 312 18 16 V
3.0 D-4D (KDJ120, KDJ125)	127	09/02→12/10	←	11/06→		24.0128-0194.1 428194	Ø 338 28 26 V
			→	11/06→		24.0118-0709.1 418709	Ø 312 18 16 V
<b>TOYOTA - LAND CRUISER PRADO (_J15_) 07/09→</b>							
 <b>Bremsbelagsatz, Scheibenbremse</b>							
2.7 (TRJ150_, TRJ155_)	120	08/09→	←	01/10→		13.0460-5747.2 605747	24024 17,0 + WK
4.0 V6 Dual VVTi (GRJ150_)	205	08/09→	→	01/10→		13.0460-5744.2 605744	21947 15,4 - WE / - WK
4.0 V6 VVT-i (GRJ150_, GRJ125_)	207	08/09→					
4.0 V6 VVTi (GRJ150)	202	08/09→					
2.8 D-4D (GDJ150_, GDJ155_)	130	06/15→	←			13.0460-5747.2 605747	24024 17,0 + WK
3.0 D (LJ150_)	70	07/09→	→			13.0460-5744.2 605744	21947 15,4 - WE / - WK
3.0 D-4D (KDJ155_, KDJ150_)	140	10/10→					
3.0 TDi (KDJ150_)	120	08/09→					
3.5 (GRJ152_)	206	09/15→					
4.0 V6 VVTi (GRJ150_)	183	01/10→					
4.0 V6 VVTi (GRJ150_)	203	01/10→					
3.0 D-4D (KDJ150_)	127	08/09→	←	03/10→		13.0460-5747.2 605747	24024 17,0 + WK
			→	03/10→		13.0460-5744.2 605744	21947 15,4 - WE / - WK
 <b>Bremsscheibe</b>							
2.7 (TRJ150_, TRJ155_)	120	08/09→	←	01/10→		24.0132-0187.1 432187	Ø 338 32 29 V
4.0 V6 Dual VVTi (GRJ150_)	205	08/09→					
4.0 V6 VVT-i (GRJ150_, GRJ125_)	207	08/09→					
4.0 V6 VVTi (GRJ150)	202	08/09→					
2.8 D-4D (GDJ150_, GDJ155_)	130	06/15→	←			24.0132-0187.1 432187	Ø 338 32 29 V
3.0 D (LJ150_)	70	07/09→					
3.0 D-4D (KDJ155_, KDJ150_)	140	10/10→					
3.0 TDi (KDJ150_)	120	08/09→					
3.5 (GRJ152_)	206	09/15→					
4.0 V6 VVTi (GRJ150_)	203	01/10→					
3.0 D-4D (KDJ150_)	127	08/09→	←	03/10→		24.0132-0187.1 432187	Ø 338 32 29 V
4.0 V6 VVTi (GRJ150_)	183	01/10→	←			24.0128-0194.1 428194	Ø 338 28 26 V
			→			24.0132-0187.1 432187	Ø 338 32 29 V
			→			24.0118-0709.1 418709	Ø 312 18 16 V
<b>TOYOTA - MATRIX (_E13_) 01/02→12/07</b>							
 <b>Bremsbelagsatz, Scheibenbremse</b>							
1.8 VVTi	96	01/02→02/04	←	02/02→		13.0460-5817.2 605817	AKE 23526 17,5 + WE / - WK
			→	02/02→		13.0460-5812.2 605812	SUM 23521 14,0 + WK
 <b>Bremsscheibe</b>							
1.8 VVTi	96	01/02→02/04	←	02/02→		24.0125-0168.1 425168	Ø 275 25 23 V
			→	02/02→		24.0109-0139.1 409139	Ø 269 9 8































	kw					! #		
<b>TOYOTA - MIRAI (JPD1_) 10/14→</b>								
 <b>Bremsbelagsatz, Scheibenbremse</b>								
FCV (JPD10_)	113	10/14→	←	01/15→; Herstellereinschränkung Advics-Ohio		13.0460-5766.2	605766	24337 17,5 - WK
 <b>Bremsscheibe</b>								
FCV (JPD10_)	113	10/14→	←	01/15→		24.0128-0159.1	428159	Ø 296 28 25 V
<b>TOYOTA - MR 2 II (SW2_) 12/89→05/00</b>								
 <b>Bremsscheibe</b>								
2.0 16V (SW20_)	115	12/89→09/99	←	→ 11/91		24.0125-0129.1	425129	Ø 258 25 24 V
2.0 16V (SW20_)	125	12/89→05/00						
2.0 16V (SW20_)	129	12/89→07/99						
2.0 Turbo (SW20_)	167	12/89→07/99						
2.0 Turbo (SW20_)	180	12/89→07/99						
<b>TOYOTA - MR 2 III (ZZW3_) 10/99→06/07</b>								
 <b>Bremsbelagsatz, Scheibenbremse</b>								
1.8 16V VT-i (ZZW30)	103	10/99→06/07	←	01/00→		13.0460-5810.2	605810	AKE 23510 16,5 + WK
 <b>Bremsscheibe</b>								
1.8 16V VT-i (ZZW30)	103	10/99→06/07	←	01/00→		24.0120-0175.1	420175	Ø 255 20 18 V
						24.0320-0175.1	520175	Ø 255 20 18 V
<b>TOYOTA - PASEO Cabriolet (EL54_) 10/96→01/98</b>								
 <b>Bremsbelagsatz, Scheibenbremse</b>								
1.5 (EL54_)	66	10/96→01/98	←			13.0460-5976.2	605976	AKE 20870 15,0 - WE / - WK
<b>TOYOTA - PASEO Coupe (EL54_) 08/95→12/99</b>								
 <b>Bremsbelagsatz, Scheibenbremse</b>								
1.5 (EL54_)	66	08/95→06/99	←			13.0460-5976.2	605976	AKE 20870 15,0 - WE / - WK
<b>TOYOTA - PICNIC (_XM1_) 05/96→12/01</b>								
 <b>Bremsbelagsatz, Scheibenbremse</b>								
2.0	99	09/96→05/01	←			13.0460-5951.2	605951	SUM 21601 17,5 + WK
2.0 (SXM10_)	90	01/01→12/01						
2.0 (SXM10_)	100	05/96→04/01						
2.0 16V (SXM10_)	94	08/96→09/00						
2.0 4WD	99	09/96→05/01						
2.2 D (CMX10_)	66	08/97→12/01	←	09/97→		13.0460-5951.2	605951	SUM 21601 17,5 + WK
<b>Zubehörsatz, Scheibenbremsbelag</b>								
2.0	99	09/96→05/01	←			13.0460-0441.2	610441	SUM
2.0 (SXM10_)	90	01/01→12/01						
2.0 (SXM10_)	100	05/96→04/01						
2.0 16V (SXM10_)	94	08/96→09/00						
2.0 4WD	99	09/96→05/01						
2.2 D (CMX10_)	66	08/97→12/01	←	09/97→		13.0460-0441.2	610441	SUM
 <b>Bremsscheibe</b>								
2.0	99	09/96→05/01	←			24.0128-0114.1	428114	Ø 255 28 26 V
2.0 (SXM10_)	90	01/01→12/01						
2.0 (SXM10_)	100	05/96→04/01						
2.0 16V (SXM10_)	94	08/96→09/00						
2.0 4WD	99	09/96→05/01						
2.2 D (CMX10_)	66	08/97→12/01	←	09/97→		24.0128-0114.1	428114	Ø 255 28 26 V
<b>TOYOTA - PREVIA (_R1_, _R2_) 01/90→08/00</b>								
 <b>Bremsbelagsatz, Scheibenbremse</b>								
2.4 (TCR11_, TCR10_)	97	05/90→08/00	←	- ABS		13.0460-5968.2	605968	21369 15,5 + WK
2.4 4WD (TCR21_, TCR20_)	97	01/90→08/00	→	+ ABS		13.0460-5862.2	605862	21688 15,3 - WE / - WK
<b>Zubehörsatz, Scheibenbremsbelag</b>								
2.4 (TCR11_, TCR10_)	97	05/90→08/00	←	- ABS		13.0460-0450.2	610450	
2.4 4WD (TCR21_, TCR20_)	97	01/90→08/00	→	+ ABS		13.0460-0325.2	610325	AKE
 <b>Bremsscheibe</b>								
2.4 (TCR11_, TCR10_)	97	05/90→08/00	←	- ABS		24.0125-0116.1	425116	Ø 255 25 23 V
↓								















	kw			 	! #		
<b>TOYOTA - PREVIA (_R1_, _R2_) 01/90→08/00</b>							
 <b>Bremsscheibe</b>							
2.4 (TCR11_, TCR10_)	97	05/90→08/00	←	10/90→; + ABS		24.0125-0126.1 425126	Ø 271 25 23 V
2.4 4WD (TCR21_, TCR20_)	97	01/90→08/00	←	- ABS		24.0122-0183.1 422183	Ø 279 22 20 V
			←	+ ABS		24.0125-0126.1 425126	Ø 271 25 23 V
<b>TOYOTA - PREVIA (_R3_) 02/00→02/06</b>							
 <b>Bremsbelagsatz, Scheibenbremse</b>							
2.0 D-4D (CLR30_)	85	03/01→01/06	←	→ 03/03		13.0460-5891.2 605891	AKE 23513 17,0 - WE / - WK
2.4 (ACR30)	115	02/00→02/06	←	04/03→ 12/05		13.0460-5894.2 605894	23759 17,0 - WK
			→	→ 12/05		13.0460-5847.2 605847	SUM 23646 16,5 + WK
 <b>Bremsscheibe</b>							
2.0 D-4D (CLR30_)	85	03/01→01/06	←	→ 03/03		24.0128-0115.1 428115	Ø 275 28 26 V
2.4 (ACR30)	115	02/00→02/06	←	04/03→ 12/05		24.0128-0190.1 428190	Ø 296 28 26 V
			→	→ 12/05		24.0112-0164.1 412164	Ø 291 12 10,5
<b>TOYOTA - PREVIA III (_R2_, _R5_) 10/05→</b>							
 <b>Bremsbelagsatz, Scheibenbremse</b>							
2.4 (ACR50_)	125	10/05→	←			13.0460-5614.2 605614	24601 18,0 - WE / - WK
2.4 4WD (ACR55W)	125	01/06→	←			13.0460-5814.2 605814	BOS 23620 16,4 + WK
3.5 (GSR50_)	202	01/06→	→				
 <b>Bremsscheibe</b>							
2.4 (ACR50_)	125	10/05→	←			24.0128-0232.1 428232	Ø 296 28 25 V
2.4 4WD (ACR55W)	125	01/06→	←			24.0110-0346.1 410346	Ø 298 10 8,5
3.5 (GSR50_)	202	01/06→	→				
<b>TOYOTA - PRIUS (_W3_) 06/08→</b>							
 <b>Bremsbelagsatz, Scheibenbremse</b>							
1.8 Hybrid (ZVW3_)	73	04/09→	←			13.0460-5617.2 605617	24451 15,6 - WE / - WK
			→	→ 05/11		13.0460-5769.2 605769	24610 15,0 + WK
1.8 Plug-in Hybrid (ZVW35)	73	01/12→	←			13.0460-5617.2 605617	24451 15,6 - WE / - WK
			→			13.0460-5769.2 605769	24610 15,0 + WK
 <b>Bremsscheibe</b>							
1.8 Hybrid (ZVW3_)	73	04/09→	←			24.0125-0196.1 425196	Ø 255 25 22 V
1.8 Plug-in Hybrid (ZVW35)	73	01/12→	→			24.0109-0163.1 409163	Ø 259 9 7,5
<b>TOYOTA - PRIUS (_W5_) 09/15→</b>							
 <b>Bremsbelagsatz, Scheibenbremse</b>							
1.8 Hybrid (ZVW50_, ZVW51_)	72	09/15→	←	MARK AK NS380H		13.0460-5617.2 605617	24451 15,6 - WE / - WK
			→			13.0460-5769.2 605769	24610 15,0 + WK
 <b>Bremsscheibe</b>							
1.8 Hybrid (ZVW50_, ZVW51_)	72	09/15→	→			24.0109-0163.1 409163	Ø 259 9 7,5
<b>TOYOTA - PRIUS C (NHP10_) 09/11→</b>							
 <b>Bremsbelagsatz, Scheibenbremse</b>							
1.5 Hybrid (NHP10)	54	12/11→	←	03/12→		13.0460-5766.2 605766	24337 17,5 - WK
			→	03/12→		13.0460-5635.2 605635	AKE 24918 15,0 - WK
			→			13.0470-5635.2 LD5635	AKE 24918 15,0 - WK Ceramic
 <b>Bremsscheibe</b>							
1.5 Hybrid (NHP10)	54	12/11→	←	03/12→		24.0128-0159.1 428159	Ø 296 28 25 V
			→	03/12→		24.0112-0203.1 412203	Ø 290 12 10,5
<b>TOYOTA - PRIUS Liftback (_W2_) 09/03→12/09</b>							
 <b>Bremsbelagsatz, Scheibenbremse</b>							
1.5 (NHW20_)	57	09/03→12/09	←			13.0460-5810.2 605810	AKE 23510 16,5 + WK
			→	→ 07/04		13.0460-5812.2 605812	SUM 23521 14,0 + WK
↓							









	kw			 	! #		
<b>TOYOTA - PRIUS Liftback (_W2_) 09/03→12/09</b>							
<b>Zubehörsatz, Scheibenbremsbelag</b>							
1.5 (NHW20_)	57	09/03→12/09	➡	→ 07/04		13.0460-0136.2 610136	SUM
<b> Bremsscheibe</b>							
1.5 (NHW20_)	57	09/03→12/09	←			24.0122-0258.1 422258	Ø 255 22 20 V
			➡			24.0109-0711.1 409711	Ø 269 9 7,5
<b>TOYOTA - PRIUS PHV (_W52_) 01/16→</b>							
<b> Bremsbelagsatz, Scheibenbremse</b>							
1.8 Plug-in Hybrid (ZVW52_)	72	01/16→	➡			13.0460-5769.2 605769	24610 15,0 + WK
<b> Bremsscheibe</b>							
1.8 Plug-in Hybrid (ZVW52_)	72	01/16→	➡			24.0109-0163.1 409163	Ø 259 9 7,5
<b>TOYOTA - PRIUS PLUS (_W4_) 05/11→</b>							
<b> Bremsbelagsatz, Scheibenbremse</b>							
1.8 Hybrid (ZVW4_)	73	05/11→	←	03/12→		13.0460-5766.2 605766	24337 17,5 - WK
			➡	03/12→		13.0460-5635.2 605635	AKE 24918 15,0 - WK
						13.0470-5635.2 LD5635	AKE 24918 15,0 - WK Ceramic
<b> Bremsscheibe</b>							
1.8 Hybrid (ZVW4_)	73	05/11→	←	03/12→		24.0128-0159.1 428159	Ø 296 28 25 V
			➡	03/12→		24.0112-0203.1 412203	Ø 290 12 10,5
<b>TOYOTA - PRIUS Stufenheck (_W1_) 05/00→01/04</b>							
<b> Bremsbelagsatz, Scheibenbremse</b>							
1.5 Hybrid (NHW1_)	53	05/00→01/04	←	→ 07/03		13.0460-5810.2 605810	AKE 23510 16,5 + WK
			➡	→ 07/03		13.0460-5812.2 605812	SUM 23521 14,0 + WK
<b>Zubehörsatz, Scheibenbremsbelag</b>							
1.5 Hybrid (NHW1_)	53	05/00→01/04	➡	→ 07/03		13.0460-0136.2 610136	SUM
<b> Bremsscheibe</b>							
1.5 Hybrid (NHW1_)	53	05/00→01/04	←	→ 07/03		24.0125-0155.1 425155	Ø 255 25 23 V
			➡	→ 07/03		24.0109-0139.1 409139	Ø 269 9 8
<b>TOYOTA - PROACE Bus (MPY_) 02/16→</b>							
<b> Bremsscheibe</b>							
1.6 D (MPY2_)	85	02/16→	➡			24.0112-0212.1 412212	Ø 290 12 10 + S
1.6 D (MPY9_)	70	02/16→					
2.0 D (MPY4_)	110	02/16→					
2.0 D (MPY6_)	130	02/16→					
<b>TOYOTA - PROACE Kasten/Kombi (MDX_) 06/13→03/16</b>							
<b> Bremsscheibe</b>							
1.6 D (MDX9_)	66	06/13→03/16	←	passend für Felgenreöße [Zoll]: 15		24.0128-0214.1 428214	Ø 280 28 26 V + S
2.0 D (MDX3_)	94	06/13→03/16	←	passend für Felgenreöße [Zoll]: 16		24.0128-0216.1 428216	Ø 304 28 26 V + S
2.0 D (MDX6_)	120	06/13→03/16	➡			24.0114-0116.1 414116	Ø 290 14 12 + S
<b>TOYOTA - PROACE Kasten (MDZ_) 02/16→</b>							
<b> Bremsscheibe</b>							
1.6 D (MDZ2_)	85	02/16→	➡			24.0112-0212.1 412212	Ø 290 12 10 + S
1.6 D (MDZ9_)	70	02/16→					
2.0 D (MDZ3_)	90	02/16→					
2.0 D (MDZ4_)	110	02/16→					
2.0 D (MDZ6_)	130	02/16→					
<b>TOYOTA - PROACE Pritsche/Fahrgestell (MDZ_) 02/16→</b>							
<b> Bremsscheibe</b>							
2.0 D (MDZ4_)	110	02/16→	➡			24.0112-0212.1 412212	Ø 290 12 10 + S

	kw			 	! #		
<b>TOYOTA - PROACE VERSO (MPY_) 02/16→</b>							
 <b>Bremsscheibe</b>							
1.6 D (MPY2_)	85	02/16→	→			24.0112-0212.1 412212	Ø 290 12 10 + S
1.6 D (MPY9_)	70	02/16→					
2.0 D (MPY4_)	110	02/16→					
2.0 D (MPY6_)	130	02/16→					
2.0 D 4x4 (MPY4_)	110	04/18→					
<b>TOYOTA - RAV 4 I (_A1_) 01/94→09/00</b>							
 <b>Bremsbelagsatz, Scheibenbremse</b>							
2.0	95	09/97→09/00	←			13.0460-5951.2 605951	SUM 21601 17,5 + WK
2.0 4WD (SXA10_)	94	07/96→06/00					
2.0 4WD (SXA10)	95	06/94→06/00					
2.0 4WD	99	01/94→09/99	←	04/94→		13.0460-5951.2 605951	SUM 21601 17,5 + WK
<b>Zubehörsatz, Scheibenbremsbelag</b>							
2.0	95	09/97→09/00	←			13.0460-0441.2 610441	SUM
2.0 4WD (SXA10_)	94	07/96→06/00					
2.0 4WD (SXA10)	95	06/94→06/00					
2.0 4WD	99	01/94→09/99	←	04/94→		13.0460-0441.2 610441	SUM
 <b>Bremsscheibe</b>							
2.0	95	09/97→09/00	←			24.0118-0129.1 418129	Ø 302 18 16 V
2.0 4WD (SXA10_)	94	07/96→06/00					
2.0 4WD (SXA10)	95	06/94→06/00					
2.0 4WD	99	01/94→09/99	←	04/94→		24.0118-0129.1 418129	Ø 302 18 16 V
<b>TOYOTA - RAV 4 I Cabrio (_A1_) 12/97→06/00</b>							
 <b>Bremsbelagsatz, Scheibenbremse</b>							
2.0 4WD (SXA11)	94	12/97→06/00	←			13.0460-5951.2 605951	SUM 21601 17,5 + WK
<b>Zubehörsatz, Scheibenbremsbelag</b>							
2.0 4WD (SXA11)	94	12/97→06/00	←			13.0460-0441.2 610441	SUM
 <b>Bremsscheibe</b>							
2.0 4WD (SXA11)	94	12/97→06/00	←			24.0118-0129.1 418129	Ø 302 18 16 V
<b>TOYOTA - RAV 4 II (_A2_) 06/00→11/05</b>							
 <b>Bremsbelagsatz, Scheibenbremse</b>							
1.8 (ZCA25_, ZCA26_)	92	08/00→11/05	←	02/01→		13.0460-5848.2 605848	AKE 23585 17,4 - WK
			→	02/01→; + ABS		13.0460-5849.2 605849	AKE 23656 14,0 + WK
2.0 4WD (ACA21, ACA20)	110	06/00→11/05	←			13.0460-5848.2 605848	AKE 23585 17,4 - WK
			→	+ ABS		13.0460-5849.2 605849	AKE 23656 14,0 + WK
2.0 D 4WD (CLA20_, CLA21_)	85	05/01→11/05	←	09/01→		13.0460-5848.2 605848	AKE 23585 17,4 - WK
			→	09/01→; + ABS		13.0460-5849.2 605849	AKE 23656 14,0 + WK
 <b>Bremsscheibe</b>							
1.8 (ZCA25_, ZCA26_)	92	08/00→11/05	←	02/01→		24.0125-0143.1 425143	Ø 275 25 23 V
			→	02/01→; + ABS		24.0109-0152.1 409152	Ø 303 9 8
2.0 4WD (ACA21, ACA20)	110	06/00→11/05	←			24.0125-0143.1 425143	Ø 275 25 23 V
			→	+ ABS		24.0109-0152.1 409152	Ø 303 9 8
2.0 D 4WD (CLA20_, CLA21_)	85	05/01→11/05	←	09/01→		24.0125-0143.1 425143	Ø 275 25 23 V
			→	09/01→; + ABS		24.0109-0152.1 409152	Ø 303 9 8
<b>TOYOTA - RAV 4 III (_A3_) 06/05→</b>							
 <b>Bremsbelagsatz, Scheibenbremse</b>							
2.0	109	03/09→	←			13.0460-5766.2 605766	24337 17,5 - WK
2.0 (ZSA35_)	116	12/08→	→				
2.0 4WD	109	03/09→				13.0460-5765.2 605765	AKE 24338 15,5 - WE / - WK
2.0 4WD (ACA30_)	112	03/06→					
2.0 4WD (ZSA30_)	116	12/08→					
2.2 D (ALA35_)	110	12/08→12/13					
2.2 D 4WD (ALA30_)	100	02/06→12/12					
2.2 D 4WD (ALA30_)	110	12/08→12/13					
2.2 D 4WD (ALA30_)	130	03/06→					
2.4 (ACA33)	125	11/05→					
2.4 4WD (ACR38)	125	11/05→					
3.5 4WD	198	11/05→	←			13.0460-5767.2 605767	AKE 24336 17,5 - WE / - WK
↓							

	kw					! #		
<b>TOYOTA - RAV 4 III (_A3_) 06/05→</b>								
 <b>Bremsbelagsatz, Scheibenbremse</b>								
3.5 4WD (GSA33)	201	11/05→	→				13.0460-5765.2 605765	AKE 24338 15,5 - WE / - WK
 <b>Bremsscheibe</b>								
2.0	109	03/09→	←				24.0128-0159.1 428159	Ø 296 28 25 V
2.0 (ZSA35_)	116	12/08→	→				24.0112-0714.1 412714	Ø 281 12 10,5
2.0 4WD	109	03/09→	→					
2.0 4WD (ACA30_)	112	03/06→	→					
2.0 4WD (ZSA30_)	116	12/08→	→					
2.2 D (ALA35_)	110	12/08→12/13	→					
2.2 D 4WD (ALA30_)	100	02/06→12/12	→					
2.2 D 4WD (ALA30_)	110	12/08→12/13	→					
2.2 D 4WD (ALA30_)	130	03/06→	→					
2.4 (ACA33)	125	11/05→	→					
2.4 4WD (ACR38)	125	11/05→	→					
3.5 4WD	198	11/05→	←				24.0125-0178.1 425178	Ø 275 25 22 V
3.5 4WD (GSA33)	201	11/05→	→				24.0112-0714.1 412714	Ø 281 12 10,5
<b>TOYOTA - RAV 4 IV (_A4_) 12/12→</b>								
 <b>Bremsbelagsatz, Scheibenbremse</b>								
2.0 (ZSA42)	107	12/12→	←				13.0460-5766.2 605766	24337 17,5 - WK
2.0 4WD (ZSA44_)	111	12/12→	→				13.0460-5765.2 605765	AKE 24338 15,5 - WE / - WK
2.0 4WD (ZSA44_)	112	04/15→	→					
2.5 4WD (ASA44)	132	12/12→	→					
2.5 Hybrid (AVA42_, AVA44_)	114	10/15→	→					
2.5 Hybrid 4WD (AVA44_)	114	10/15→	→					
2.0 D (ALA40_)	91	12/12→	←				13.0460-5634.2 605634	ADV 24452 17,5 - WK + Zub
2.0 D (WWA42_)	105	10/15→	→				13.0470-5634.2 LD5634	ADV 24452 17,5 - WK + Zub Ceramic
2.5 Hybrid (AVA42_)	145	11/15→	→				13.0460-5765.2 605765	AKE 24338 15,5 - WE / - WK
2.0 D 4WD (ALA41_)	91	01/13→	←	11/13→			13.0460-5634.2 605634	ADV 24452 17,5 - WK + Zub
			→	11/13→			13.0470-5634.2 LD5634	ADV 24452 17,5 - WK + Zub Ceramic
			→	11/13→			13.0460-5765.2 605765	AKE 24338 15,5 - WE / - WK
2.2 D 4WD (ALA49)	110	12/12→	←				13.0460-5634.2 605634	ADV 24452 17,5 - WK + Zub
			→				13.0460-5766.2 605766	24337 17,5 - WK
			→				13.0470-5634.2 LD5634	ADV 24452 17,5 - WK + Zub Ceramic
			→				13.0460-5765.2 605765	AKE 24338 15,5 - WE / - WK
 <b>Bremsscheibe</b>								
2.0 (ZSA42)	107	12/12→	←				24.0128-0159.1 428159	Ø 296 28 25 V
2.0 4WD (ZSA44_)	111	12/12→	←	16"			24.0128-0159.1 428159	Ø 296 28 25 V
2.2 D 4WD (ALA49)	110	12/12→	←	16"			24.0112-0714.1 412714	Ø 281 12 10,5
2.5 4WD (ASA44)	132	12/12→	→				24.0112-0714.1 412714	Ø 281 12 10,5
2.0 4WD (ZSA44_)	112	04/15→	→				24.0112-0714.1 412714	Ø 281 12 10,5
2.0 D (WWA42_)	105	10/15→	→					
2.5 Hybrid (AVA42_)	145	11/15→	→					
2.0 D (ALA40_)	91	12/12→	←	16"			24.0128-0159.1 428159	Ø 296 28 25 V
2.5 Hybrid (AVA42_, AVA44_)	114	10/15→	→				24.0112-0714.1 412714	Ø 281 12 10,5
2.5 Hybrid 4WD (AVA44_)	114	10/15→	→					
2.0 D 4WD (ALA41_)	91	01/13→	←	12/13→; 16"			24.0128-0159.1 428159	Ø 296 28 25 V
			→	11/13→			24.0112-0714.1 412714	Ø 281 12 10,5
<b>TOYOTA - STARLET (_P8_) 12/89→03/96</b>								
 <b>Bremsbelagsatz, Scheibenbremse</b>								
1.3 12V Cat (EP81)	55	12/89→03/96	←	- ABS			13.0460-5969.2 605969	SUM 21948 13,5 - WE / - WK
			←	→ 11/90; + ABS			13.0460-5976.2 605976	AKE 20870 15,0 - WE / - WK
1.5 D (NP80_)	40	12/89→03/96	←				13.0460-5969.2 605969	SUM 21948 13,5 - WE / - WK
<b>Zubehörsatz, Scheibenbremsbelag</b>								
1.3 12V Cat (EP81)	55	12/89→03/96	←	→ 11/90; + ABS			13.0460-0325.2 610325	AKE
 <b>Bremsscheibe</b>								
1.3 12V Cat (EP81)	55	12/89→03/96	←	01/92→; + ABS			24.0118-0124.1 418124	Ø 238 18 17 V

	kw			 	! #		
<b>TOYOTA - STARLET (_P9_) 01/96→10/99</b>							
 <b>Bremsbelagsatz, Scheibenbremse</b>							
1.3 (EP91_)	55	01/96→10/99	←	→ 04/96		13.0460-5969.2 605969	SUM 21948 13,5 - WE / - WK
			←	05/96→ 07/99		13.0460-5976.2 605976	AKE 20870 15,0 - WE / - WK
<b>Zubehörsatz, Scheibenbremsbelag</b>							
1.3 (EP91_)	55	01/96→10/99	←	+ ABS		13.0460-0325.2 610325	AKE
 <b>Bremsscheibe</b>							
1.3 (EP91_)	55	01/96→10/99	←	05/96→ 07/99		24.0118-0124.1 418124	Ø 238 18 17 V
<b>TOYOTA - URBAN CRUISER (_P1_) 07/07→</b>							
 <b>Bremsbelagsatz, Scheibenbremse</b>							
1.33 (NSP110_)	73	01/09→	←	04/10→		13.0460-5767.2 605767	AKE 24336 17,5 - WE / - WK
			→	04/10→		13.0460-5769.2 605769	24610 15,0 + WK
1.33 (NSP110_)	74	04/09→	←			13.0460-5767.2 605767	AKE 24336 17,5 - WE / - WK
			→			13.0460-5769.2 605769	24610 15,0 + WK
1.4 D-4D (NLP110_)	66	01/09→04/14	←	04/09→		13.0460-5767.2 605767	AKE 24336 17,5 - WE / - WK
			→	04/09→		13.0460-5769.2 605769	24610 15,0 + WK
1.4 D-4D 4WD (NLP115_)	66	01/09→04/14	←	04/09→		13.0460-5767.2 605767	AKE 24336 17,5 - WE / - WK
 <b>Bremsscheibe</b>							
1.33 (NSP110_)	73	01/09→	←	04/10→		24.0122-0276.1 422276	Ø 275 22 19 V
			→	04/10→		24.0109-0170.1 409170	Ø 259 9 7,5
1.33 (NSP110_)	74	04/09→	←			24.0122-0276.1 422276	Ø 275 22 19 V
			→			24.0109-0170.1 409170	Ø 259 9 7,5
1.4 D-4D (NLP110_)	66	01/09→04/14	←	04/09→		24.0122-0276.1 422276	Ø 275 22 19 V
			→	04/09→		24.0109-0170.1 409170	Ø 259 9 7,5
1.4 D-4D 4WD (NLP115_)	66	01/09→04/14	←	04/09→		24.0122-0276.1 422276	Ø 275 22 19 V
			→	04/09→		24.0110-0364.1 410364	Ø 279 10 8,5
<b>TOYOTA - VERSO (_R2_) 04/09→</b>							
 <b>Bremsbelagsatz, Scheibenbremse</b>							
1.6 (ZGR20_)	97	04/09→	←			13.0460-5603.2 605603	24204 19,2 + WK + Zub
1.6 D4-D (WAR20_)	82	11/13→	→			13.0460-3854.2 603854	BOS 24926 16,5 + WK + Zub
1.8 (ZGR21_)	108	04/09→	→				
2.0 D-4D (AUR20_)	91	11/12→					
2.0 D-4D (AUR20_)	93	04/09→					
2.2 D-4D (AUR21_)	110	04/09→	←	11/10→		13.0460-3874.2 603874	BOS 25006 18,8 + WK + Zub
2.2 D-CAT (AUR21_)	130	04/09→	←	→ 10/10		13.0460-5615.2 605615	BOS 24946 19,0 + WK + Zub
			→			13.0460-3854.2 603854	BOS 24926 16,5 + WK + Zub
 <b>Bremsscheibe</b>							
1.6 (ZGR20_)	97	04/09→	←			24.0126-0156.1 426156	Ø 295 26 23 V
1.6 D4-D (WAR20_)	82	11/13→	→			24.0111-0168.1 411168	Ø 297 11 9
1.8 (ZGR21_)	108	04/09→	→				
2.0 D-4D (AUR20_)	91	11/12→					
2.0 D-4D (AUR20_)	93	04/09→					
2.2 D-4D (AUR21_)	110	04/09→	←			24.0126-0160.1 426160	Ø 320 26 23 V
2.2 D-CAT (AUR21_)	130	04/09→	→			24.0111-0168.1 411168	Ø 297 11 9
<b>TOYOTA - VERSO S (_P12_) 11/10→10/16</b>							
 <b>Bremsbelagsatz, Scheibenbremse</b>							
1.33 (NSP120_)	73	11/10→10/16	←			13.0460-5767.2 605767	AKE 24336 17,5 - WE / - WK
1.4 D4-D (NLP121_)	66	11/10→10/16	→			13.0460-5769.2 605769	24610 15,0 + WK
 <b>Bremsscheibe</b>							
1.33 (NSP120_)	73	11/10→10/16	←			24.0122-0276.1 422276	Ø 275 22 19 V
1.4 D4-D (NLP121_)	66	11/10→10/16	→			24.0109-0163.1 409163	Ø 259 9 7,5

	kw				! #		
<b>TOYOTA - YARIS / VIOS Stufenheck (_P9_) 08/05→</b>							
<b>Bremsscheibe</b>							
1.0 (KSP90_) 1.3 4WD (NCP92_)	52 64	08/07→ 08/07→	←	→ 12/12		24.0122-0246.1 422246	Ø 255 22 19 V
1.3 (NCP92_, SCP92_) 1.3 (NCP92_)	64 63	09/05→04/14 08/05→04/13	←	01/06→ 12/12		24.0122-0246.1 422246	Ø 255 22 19 V
<b>TOYOTA - YARIS (_P1_) 01/99→12/05</b>							
<b>Bremsbelagsatz, Scheibenbremse</b>							
1.0 (SCP10_)	48	03/03→09/05	←	04/03→ 08/05; für Fahrzeuge mit Trommelbremse an der Hinterachse		13.0460-5800.2 605800	BOS 23340 17,0 + WK
			←	04/03→ 08/05; für Fahrzeuge mit Scheibenbremse an der Hinterachse		13.0460-5810.2 605810	AKE 23510 16,5 + WK
			→	04/03→ 08/05; + ABS		13.0460-5812.2 605812	SUM 23521 14,0 + WK
1.0 (SCP10_)	50	04/99→09/05	←	08/99→ 03/03		13.0460-5800.2 605800	BOS 23340 17,0 + WK
			←	→ 07/99		13.0460-5811.2 605811	AKE 23510 16,5 + WK
			→	→ 03/03; + ABS		13.0460-5812.2 605812	SUM 23521 14,0 + WK
1.3 (NCP10_, SCP12_)	63	11/99→10/05	←	→ 10/04; für Fahrzeuge mit Scheibenbremse an der Hinterachse		13.0460-5810.2 605810	AKE 23510 16,5 + WK
			←	→ 10/04; für Fahrzeuge mit Trommelbremse an der Hinterachse		13.0460-5811.2 605811	23348 16,5 + WK
			→	→ 10/04; + ABS		13.0460-5812.2 605812	SUM 23521 14,0 + WK
1.3 (SCP12_, NCP10_, SCP13_)	64	04/02→09/05	←	→ 08/05; für Fahrzeuge mit Trommelbremse an der Hinterachse		13.0460-5800.2 605800	BOS 23340 17,0 + WK
			←	→ 03/03; für Fahrzeuge mit Scheibenbremse an der Hinterachse		13.0460-5810.2 605810	AKE 23510 16,5 + WK
			→	→ 08/05; + ABS		13.0460-5812.2 605812	SUM 23521 14,0 + WK
1.4 D-4D (NLP10_)	55	10/01→09/05	←	04/03→ 08/05; für Fahrzeuge mit Trommelbremse an der Hinterachse		13.0460-5800.2 605800	BOS 23340 17,0 + WK
			←	12/01→ 08/05; für Fahrzeuge mit Scheibenbremse an der Hinterachse		13.0460-5810.2 605810	AKE 23510 16,5 + WK
			←	12/01→ 03/03; für Fahrzeuge mit Trommelbremse an der Hinterachse		13.0460-5811.2 605811	23348 16,5 + WK
			→	12/01→ 08/05; + ABS		13.0460-5812.2 605812	SUM 23521 14,0 + WK
1.5 (NCP13_)	77	01/03→11/05	←	→ 08/05; für Fahrzeuge mit Scheibenbremse an der Hinterachse		13.0460-5810.2 605810	AKE 23510 16,5 + WK
			→	→ 08/05		13.0460-5812.2 605812	SUM 23521 14,0 + WK
1.5 (NCP13_)	78	04/01→09/05	←	→ 03/03; für Fahrzeuge mit Scheibenbremse an der Hinterachse		13.0460-5810.2 605810	AKE 23510 16,5 + WK
			→	→ 03/03		13.0460-5812.2 605812	SUM 23521 14,0 + WK
1.5 (NCP13_)	110	03/00→07/05	←	04/03→ 10/04; für Fahrzeuge mit Scheibenbremse an der Hinterachse		13.0460-5810.2 605810	AKE 23510 16,5 + WK
			→	04/03→ 10/04		13.0460-5812.2 605812	SUM 23521 14,0 + WK
<b>Zubehörsatz, Scheibenbremsbelag</b>							
1.0 (SCP10_)	48	03/03→09/05	→	04/03→ 08/05; + ABS		13.0460-0136.2 610136	SUM
1.0 (SCP10_)	50	04/99→09/05	→	→ 03/03; + ABS		13.0460-0136.2 610136	SUM
1.3 (NCP10_, SCP12_)	63	11/99→10/05	→	→ 10/04; + ABS		13.0460-0136.2 610136	SUM
1.3 (SCP12_, NCP10_, SCP13_)	64	04/02→09/05	→	→ 08/05; + ABS		13.0460-0136.2 610136	SUM
1.4 D-4D (NLP10_)	55	10/01→09/05	→	12/01→ 08/05; + ABS		13.0460-0136.2 610136	SUM
1.5 (NCP13_)	77	01/03→11/05	→	→ 08/05		13.0460-0136.2 610136	SUM
1.5 (NCP13_)	78	04/01→09/05	→	→ 03/03		13.0460-0136.2 610136	SUM
1.5 (NCP13_)	110	03/00→07/05	→	04/03→ 10/04		13.0460-0136.2 610136	SUM
↓							



**TOYOTA - YARIS (P1) 01/99→12/05**

**Bremsscheibe**

1.0 (SCP10_)	48	03/03→09/05	←	04/03→ 08/05; für Fahrzeuge mit Trommelbremse an der Hinterachse	24.0118-0131.1	418131	Ø 235 17,9 16 V
			←	04/03→ 08/05; für Fahrzeuge mit Scheibenbremse an der Hinterachse	24.0120-0175.1	420175	Ø 255 20 18 V
			→	04/03→ 08/05; + ABS	24.0320-0175.1	520175	Ø 255 20 18 V
1.0 (SCP10_)	50	04/99→09/05	←	→ 07/99	24.0118-0131.1	418131	Ø 235 17,9 16 V
			←	08/99→ 03/03	24.0120-0175.1	420175	Ø 255 20 18 V
			→	→ 03/03; + ABS	24.0320-0175.1	520175	Ø 255 20 18 V
1.3 (NCP10_, SCP12_)	63	11/99→10/05	←	→ 10/04; für Fahrzeuge mit Trommelbremse an der Hinterachse	24.0118-0131.1	418131	Ø 235 17,9 16 V
			←	→ 10/04; für Fahrzeuge mit Scheibenbremse an der Hinterachse	24.0120-0175.1	420175	Ø 255 20 18 V
			→	→ 10/04; + ABS	24.0320-0175.1	520175	Ø 255 20 18 V
1.3 (SCP12_, NCP10_, SCP13_)	64	04/02→09/05	←	→ 08/05; für Fahrzeuge mit Trommelbremse an der Hinterachse	24.0118-0131.1	418131	Ø 235 17,9 16 V
			←	→ 08/05; für Fahrzeuge mit Scheibenbremse an der Hinterachse	24.0120-0175.1	420175	Ø 255 20 18 V
			→	→ 08/05; + ABS	24.0320-0175.1	520175	Ø 255 20 18 V
1.4 D-4D (NLP10_)	55	10/01→09/05	←	12/01→ 08/05; für Fahrzeuge mit Trommelbremse an der Hinterachse	24.0118-0131.1	418131	Ø 235 17,9 16 V
			←	12/01→ 08/05; für Fahrzeuge mit Scheibenbremse an der Hinterachse	24.0120-0175.1	420175	Ø 255 20 18 V
			→	12/01→ 08/05; + ABS	24.0320-0175.1	520175	Ø 255 20 18 V
1.5 (NCP13_)	77	01/03→11/05	←	→ 08/05; für Fahrzeuge mit Scheibenbremse an der Hinterachse	24.0118-0131.1	418131	Ø 235 17,9 16 V
			→	→ 08/05	24.0120-0175.1	420175	Ø 255 20 18 V
1.5 (NCP13_)	78	04/01→09/05	←	→ 03/03; für Fahrzeuge mit Scheibenbremse an der Hinterachse	24.0120-0175.1	420175	Ø 255 20 18 V
			→	→ 03/03	24.0320-0175.1	520175	Ø 255 20 18 V
1.5 (NCP13_)	110	03/00→07/05	←	04/03→ 10/04; für Fahrzeuge mit Scheibenbremse an der Hinterachse	24.0109-0139.1	409139	Ø 269 9 8
			→	04/03→ 10/04	24.0120-0175.1	420175	Ø 255 20 18 V

**TOYOTA - YARIS (P9) 01/05→**

**Bremsbelagsatz, Scheibenbremse**

1.0 GPL (KSP90_)	51	01/06→	←	→ 08/11; + ABS; Made in Japan	13.0460-5768.2	605768	AKE 24347 17,5 - WK
			←	→ 08/11; Made in Frankreich	13.0460-7213.2	607213	ATE 23202 17,8 + WK
			→	→ 08/11; Made in Japan	13.0460-5769.2	605769	24610 15,0 + WK
			→	→ 08/11; Made in Frankreich	13.0460-7214.2	607214	ATE 24574 15,0 + WK
1.0 VVT-i (KSP90_)	51	01/05→11/11	←	01/06→ 08/11; + ABS; Made in Japan	13.0460-5768.2	605768	AKE 24347 17,5 - WK
			←	01/06→ 08/11; Made in Frankreich	13.0460-7213.2	607213	ATE 23202 17,8 + WK
			→	01/06→ 08/11; Made in Japan	13.0460-5769.2	605769	24610 15,0 + WK
			→	01/06→ 08/11; Made in Frankreich	13.0460-7214.2	607214	ATE 24574 15,0 + WK
1.33 VVT-i (NSP90_)	73	07/10→	←	→ 08/11; Made in Frankreich	13.0460-7213.2	607213	ATE 23202 17,8 + WK
			→	→ 08/11; Made in Frankreich	13.0460-7214.2	607214	ATE 24574 15,0 + WK
1.33 VVT-i (NSP90_)	74	11/08→	←	03/09→ 08/11; Made in Frankreich	13.0460-7213.2	607213	ATE 23202 17,8 + WK
			→	03/09→ 08/11; Made in Frankreich	13.0460-7214.2	607214	ATE 24574 15,0 + WK
1.3 4WD (NCP92_)	64	08/07→	←	+ ABS; Made in Japan	13.0460-5768.2	605768	AKE 24347 17,5 - WK
			←	Made in Frankreich	13.0460-7213.2	607213	ATE 23202 17,8 + WK
			→	Made in Japan	13.0460-5769.2	605769	24610 15,0 + WK
			→	Made in Frankreich	13.0460-7214.2	607214	ATE 24574 15,0 + WK
1.3 VVT-i (NCP90_)	63	01/05→	←	01/06→ 08/11; Made in Frankreich	13.0460-7213.2	607213	ATE 23202 17,8 + WK



**TOYOTA - YARIS (\_P9\_) 01/05→**

**Bremsbelagsatz, Scheibenbremse**

1.3 VVT-i (SCP90_) 1.4 D-4D (NLP90_)	64 66	08/05→ 08/05→	→	01/06→ 08/11; Made in Frankreich	13.0460-7214.2	607214	ATE 24574 15,0 + WK
1.8 VVTi (ZSP90_)	98	01/07→12/11	←	→ 08/11; Made in Japan	13.0460-5768.2	605768	AKE 24347 17,5 - WK
			→	→ 08/11; Made in Japan	13.0460-5769.2	605769	24610 15,0 + WK

**Bremsscheibe**

1.0 GPL (KSP90_)	51	01/06→	←	→ 08/11; Made in Frankreich	24.0122-0240.1	422240	∅ 258 22 20 V
			←	→ 08/11; - ABS; Made in Japan	24.0122-0246.1	422246	∅ 255 22 19 V
			←	→ 08/11; + ABS; Made in Japan	24.0122-0254.1	422254	∅ 275 22 19 V
			→	→ 08/11; Made in Frankreich	24.0109-0142.1	409142	∅ 278 9 7
			→	→ 08/11; Made in Japan	24.0109-0156.1	409156	∅ 259 9 7,5
1.0 VVT-i (KSP90_)	51	01/05→11/11	←	01/06→ 08/11; Made in Frankreich	24.0122-0240.1	422240	∅ 258 22 20 V
			←	01/06→ 08/11; - ABS; Made in Japan	24.0122-0246.1	422246	∅ 255 22 19 V
			←	01/06→ 08/11; + ABS; Made in Japan	24.0122-0254.1	422254	∅ 275 22 19 V
			→	01/06→ 08/11; Made in Frankreich	24.0109-0142.1	409142	∅ 278 9 7
			→	01/06→ 08/11; Made in Japan	24.0109-0156.1	409156	∅ 259 9 7,5
1.33 VVT-i (NSP90_)	73	07/10→	←	→ 08/11; Made in Frankreich	24.0122-0240.1	422240	∅ 258 22 20 V
			→	→ 08/11; Made in Frankreich	24.0109-0142.1	409142	∅ 278 9 7
1.33 VVT-i (NSP90_)	74	11/08→	←	03/09→ 08/11; Made in Frankreich	24.0122-0240.1	422240	∅ 258 22 20 V
			→	03/09→ 08/11; Made in Frankreich	24.0109-0142.1	409142	∅ 278 9 7
1.3 4WD (NCP92_)	64	08/07→	←	Made in Frankreich	24.0122-0240.1	422240	∅ 258 22 20 V
			←	- ABS; Made in Japan	24.0122-0246.1	422246	∅ 255 22 19 V
			←	+ ABS; Made in Japan	24.0122-0254.1	422254	∅ 275 22 19 V
			→	Made in Frankreich	24.0109-0142.1	409142	∅ 278 9 7
			→	Made in Japan	24.0109-0156.1	409156	∅ 259 9 7,5
1.3 VVT-i (NCP90_) 1.3 VVT-i (SCP90_) 1.4 D-4D (NLP90_)	63 64 66	01/05→ 08/05→ 08/05→	←	01/06→ 08/11; Made in Frankreich	24.0122-0240.1	422240	∅ 258 22 20 V
			→	01/06→ 08/11; Made in Frankreich	24.0109-0142.1	409142	∅ 278 9 7
			←	→ 08/11; Made in Japan	24.0122-0254.1	422254	∅ 275 22 19 V
1.8 VVTi (ZSP90_)	98	01/07→12/11	→	→ 08/11; Made in Japan	24.0109-0156.1	409156	∅ 259 9 7,5











**TOYOTA - YARIS (\_P13\_) 12/10→**

**Bremsbelagsatz, Scheibenbremse**













1.0 (KSP130_)	51	12/10→	←	09/11→; Made in Frankreich	13.0460-7213.2	607213	ATE 23202 17,8 + WK
			→	09/11→; Made in Frankreich; + ESP	13.0460-7214.2	607214	ATE 24574 15,0 + WK
1.3 (NCP130_) 1.3 (NSP130_)	63 73	08/11→ 09/11→	←	Made in Japan	13.0460-5768.2	605768	AKE 24347 17,5 - WK
			←	Made in Frankreich	13.0460-7213.2	607213	ATE 23202 17,8 + WK
1.3 4WD (NSP135_)	70	12/10→	←	09/11→; Made in Japan	13.0460-5768.2	605768	AKE 24347 17,5 - WK
			←	09/11→; Made in Frankreich	13.0460-7213.2	607213	ATE 23202 17,8 + WK
			→	09/11→; Made in Frankreich; + ESP	13.0460-7214.2	607214	ATE 24574 15,0 + WK
1.4 D (NLP130_)	66	09/11→	←		13.0460-7213.2	607213	ATE 23202 17,8 + WK
			→	+ ESP	13.0460-7214.2	607214	ATE 24574 15,0 + WK
1.5 (NSP131_)	82	02/17→	←		13.0460-7213.2	607213	ATE 23202 17,8 + WK
			→		13.0460-7214.2	607214	ATE 24574 15,0 + WK
1.5 Hybrid (NHP130_)	54	04/15→	←		13.0460-5767.2	605767	AKE 24336 17,5 - WE / - WK
			→	+ ESP	13.0460-7214.2	607214	ATE 24574 15,0 + WK
1.5 Hybrid (NHP130_)	55	03/12→	←	→ 02/13	13.0460-5767.2	605767	AKE 24336 17,5 - WE / - WK
			←	03/13→	13.0460-7213.2	607213	ATE 23202 17,8 + WK
			→	+ ESP	13.0460-7214.2	607214	ATE 24574 15,0 + WK
1.8 GRMN (NSP131_)	156	09/17→	→		13.0460-7214.2	607214	ATE 24574 15,0 + WK











**Bremsscheibe**

1.0 (KSP130_) ↓	51	12/10→	←	09/11→; Made in Frankreich	24.0122-0240.1	422240	∅ 258 22 20 V
			←	09/11→; Made in Japan	24.0122-0246.1	422246	∅ 255 22 19 V

	kw			 	! #		
<b>TOYOTA - YARIS (_P13_) 12/10→</b>							
 <b>Bremsscheibe</b>							
1.0 (KSP130_)	51	12/10→	➔	09/11→; Made in Frankreich; + ESP		24.0109-0142.1 409142	Ø 278 9 7
1.3 (NCP130_)	63	08/11→	➔	Made in Frankreich		24.0122-0240.1 422240	Ø 258 22 20 V
1.3 (NSP130_)	73	09/11→	➔	Made in Japan		24.0122-0254.1 422254	Ø 275 22 19 V
			➔	Made in Frankreich; + ESP		24.0109-0142.1 409142	Ø 278 9 7
1.3 4WD (NSP135_)	70	12/10→	➔	09/11→; Made in Frankreich		24.0122-0240.1 422240	Ø 258 22 20 V
			➔	09/11→; Made in Japan		24.0122-0254.1 422254	Ø 275 22 19 V
			➔	09/11→; Made in Frankreich; + ESP		24.0109-0142.1 409142	Ø 278 9 7
1.4 D (NLP130_)	66	09/11→	➔			24.0122-0240.1 422240	Ø 258 22 20 V
			➔	+ ESP		24.0109-0142.1 409142	Ø 278 9 7
1.5 (NSP131_)	82	02/17→	➔			24.0109-0142.1 409142	Ø 278 9 7
1.8 GRMN (NSP131_)	156	09/17→	➔				
1.5 Hybrid (NHP130_)	54	04/15→	➔			24.0122-0254.1 422254	Ø 275 22 19 V
			➔	+ ESP		24.0109-0142.1 409142	Ø 278 9 7
1.5 Hybrid (NHP130_)	55	03/12→	➔	→ 02/13		24.0122-0254.1 422254	Ø 275 22 19 V
			➔	+ ESP		24.0109-0142.1 409142	Ø 278 9 7
<b>TOYOTA - YARIS VERSO (_P2_) 08/99→09/05</b>							
 <b>Bremsbelagsatz, Scheibenbremse</b>							
1.3 (NCP20_, NCP22_)	62	11/02→09/05	➔	01/03→		13.0460-5800.2 605800	BOS 23340 17,0 + WK
			➔	01/03→; + ABS		13.0460-5810.2 605810	AKE 23510 16,5 + WK
			➔	01/03→; + ABS		13.0460-5812.2 605812	SUM 23521 14,0 + WK
1.3 (NCP20_, NCP22_)	63	08/99→10/02	➔	11/99→		13.0460-5800.2 605800	BOS 23340 17,0 + WK
			➔	11/99→; + ABS		13.0460-5810.2 605810	AKE 23510 16,5 + WK
			➔	11/99→; + ABS		13.0460-5812.2 605812	SUM 23521 14,0 + WK
1.4 D-4D (NLP20_, NLP22_)	55	12/01→09/05	➔			13.0460-5800.2 605800	BOS 23340 17,0 + WK
1.5 (NCP21_)	77	03/00→09/05	➔			13.0460-5810.2 605810	AKE 23510 16,5 + WK
1.5 4WD (NCP21_)	78	03/00→09/05	➔	+ ABS		13.0460-5812.2 605812	SUM 23521 14,0 + WK
1.5 (NCP21_)	78	03/00→09/05	➔	→ 03/03		13.0460-5800.2 605800	BOS 23340 17,0 + WK
			➔	→ 03/03; + ABS		13.0460-5810.2 605810	AKE 23510 16,5 + WK
			➔	→ 03/03; + ABS		13.0460-5812.2 605812	SUM 23521 14,0 + WK
<b>Zubehörsatz, Scheibenbremsbelag</b>							
1.3 (NCP20_, NCP22_)	62	11/02→09/05	➔	01/03→; + ABS		13.0460-0136.2 610136	SUM
1.3 (NCP20_, NCP22_)	63	08/99→10/02	➔	11/99→; + ABS		13.0460-0136.2 610136	SUM
1.4 D-4D (NLP20_, NLP22_)	55	12/01→09/05	➔	+ ABS		13.0460-0136.2 610136	SUM
1.5 (NCP21_)	77	03/00→09/05	➔				
1.5 4WD (NCP21_)	78	03/00→09/05	➔				
1.5 (NCP21_)	78	03/00→09/05	➔	→ 03/03; + ABS		13.0460-0136.2 610136	SUM
 <b>Bremsscheibe</b>							
1.3 (NCP20_, NCP22_)	62	11/02→09/05	➔	01/03→		24.0120-0175.1 420175	Ø 255 20 18 V
			➔	01/03→; + ABS		24.0320-0175.1 520175	Ø 255 20 18 V
			➔	01/03→; + ABS		24.0109-0139.1 409139	Ø 269 9 8
1.3 (NCP20_, NCP22_)	63	08/99→10/02	➔	11/99→		24.0120-0175.1 420175	Ø 255 20 18 V
			➔	11/99→; + ABS		24.0320-0175.1 520175	Ø 255 20 18 V
			➔	11/99→; + ABS		24.0109-0139.1 409139	Ø 269 9 8
1.4 D-4D (NLP20_, NLP22_)	55	12/01→09/05	➔			24.0120-0175.1 420175	Ø 255 20 18 V
1.5 (NCP21_)	77	03/00→09/05	➔			24.0320-0175.1 520175	Ø 255 20 18 V
1.5 4WD (NCP21_)	78	03/00→09/05	➔	+ ABS		24.0109-0139.1 409139	Ø 269 9 8
1.5 (NCP21_)	78	03/00→09/05	➔	→ 03/03		24.0120-0175.1 420175	Ø 255 20 18 V
			➔	→ 03/03; + ABS		24.0320-0175.1 520175	Ø 255 20 18 V
			➔	→ 03/03; + ABS		24.0109-0139.1 409139	Ø 269 9 8
<b>VAUXHALL - ADAM (M13) 10/12→</b>							
 <b>Bremsbelagsatz, Scheibenbremse</b>							
1.0	85	07/14→	➔	für Bremsscheibendurchmesser [mm]:		13.0460-3839.2 603839	BOS 23707 17,9 + WK + Zub
1.4 S	110	11/14→	➔	257		13.0470-3839.2 LD3839	BOS 23707 17,9 + WK + Zub Ceramic
↓							























	kw			 	! #		
<b>VAUXHALL - ADAM (M13) 10/12→</b>							
 <b>Bremsbelagsatz, Scheibenbremse</b>							
1.0 1.4 S	85 110	07/14→ 11/14→	←	für Bremsscheibendurchmesser [mm]: 308		<b>13.0460-7179.2 607179</b> <b>13.0470-7179.2 LD7179</b>	ATE 23832 20,2 - WK / + WK ATE 23832 20,2 - WK / + WK Ceramic
			←	für Bremsscheibendurchmesser [mm]: 284		<b>13.0460-7308.2 607308</b>	ATE 22123 18,2 + WK + Zub
			→			<b>13.0460-2793.2 602793</b>	TRW 25973 17,2 + WK + Zub
1.2 1.4 1.4	51 64 74	10/12→ 10/12→ 10/12→	←	01/13→; für Bremsscheibendurchmesser [mm]: 257		<b>13.0460-3839.2 603839</b> <b>13.0470-3839.2 LD3839</b>	BOS 23707 17,9 + WK + Zub BOS 23707 17,9 + WK + Zub Ceramic
			←	01/13→; für Bremsscheibendurchmesser [mm]: 308		<b>13.0460-7179.2 607179</b> <b>13.0470-7179.2 LD7179</b>	ATE 23832 20,2 - WK / + WK ATE 23832 20,2 - WK / + WK Ceramic
			←	01/13→; für Bremsscheibendurchmesser [mm]: 284		<b>13.0460-7308.2 607308</b>	ATE 22123 18,2 + WK + Zub
			→	01/13→		<b>13.0460-2793.2 602793</b>	TRW 25973 17,2 + WK + Zub
 <b>Bremsscheibe</b>							
1.0 1.4 S	85 110	07/14→ 11/14→	←			<b>24.0122-0231.1 422231</b> <b>24.0122-0241.1 422241</b> <b>24.0125-0142.1 425142</b> <b>24.0322-0231.1 522231</b> <b>24.0325-0142.1 525142</b>	Ø 257 22 20 V + S Ø 284 22 20 V + S Ø 308 25 22 V + S Ø 257 22 20 V + S Ø 308 25 23 V + S
			→			<b>24.0110-0323.1 410323</b> <b>24.0110-0347.1 410347</b>	Ø 264 10 8 Ø 264 10 8
1.2 1.4 1.4	51 64 74	10/12→ 10/12→ 10/12→	←	01/13→		<b>24.0122-0231.1 422231</b> <b>24.0122-0241.1 422241</b> <b>24.0125-0142.1 425142</b> <b>24.0322-0231.1 522231</b> <b>24.0325-0142.1 525142</b>	Ø 257 22 20 V + S Ø 284 22 20 V + S Ø 308 25 22 V + S Ø 257 22 20 V + S Ø 308 25 23 V + S
			→	01/13→		<b>24.0110-0323.1 410323</b> <b>24.0110-0347.1 410347</b>	Ø 264 10 8 Ø 264 10 8
<b>VAUXHALL - AGILA Mk I (A) (H00) 02/00→03/08</b>							
 <b>Bremsbelagsatz, Scheibenbremse</b>							
1.0 12V 1.2 16V Twinport	43 59	09/00→08/05 07/04→11/06	←			<b>13.0460-3995.2 603995</b>	BOS 23605 15,7 + WK + Zub
1.0 12V	44	02/00→11/06	←	09/00→		<b>13.0460-3995.2 603995</b>	BOS 23605 15,7 + WK + Zub
1.2 16V	55	09/00→03/08	←	→ 07/07		<b>13.0460-3995.2 603995</b>	BOS 23605 15,7 + WK + Zub
 <b>Bremsscheibe</b>							
1.0 12V 1.2 16V Twinport	43 59	09/00→08/05 07/04→11/06	←	→ 3G002367		<b>24.0112-0153.1 412153</b>	Ø 247 12 10,5
			←	3G002368→		<b>24.0117-0106.1 417106</b>	Ø 253 17 15 V
1.0 12V	44	02/00→11/06	←	09/00→; → 3G002367		<b>24.0112-0153.1 412153</b>	Ø 247 12 10,5
			←	3G002368→		<b>24.0117-0106.1 417106</b>	Ø 253 17 15 V
1.2 16V	55	09/00→03/08	←	→ 3G002367		<b>24.0112-0153.1 412153</b>	Ø 247 12 10,5
			←	3G002368→; → 07/07		<b>24.0117-0106.1 417106</b>	Ø 253 17 15 V
<b>VAUXHALL - AGILA Mk II (B) (H08) 01/08→11/14</b>							
 <b>Bremsbelagsatz, Scheibenbremse</b>							
1.0 12V 1.0 i 1.2 i 16V 1.2 i 16V 1.3 CDTI	48 50 63 69 55	01/08→11/14 08/11→11/14 01/08→11/14 01/08→11/14 01/08→11/14	←			<b>13.0460-5700.2 605700</b>	TRW 23973 17,0 + WK
 <b>Bremsscheibe</b>							
1.0 12V 1.0 i 1.2 i 16V 1.2 i 16V 1.3 CDTI	48 50 63 69 55	01/08→11/14 08/11→11/14 01/08→11/14 01/08→11/14 01/08→11/14	←			<b>24.0120-0211.1 420211</b>	Ø 252 20 18 V + S

	kw			 	! #		
<b>VAUXHALL - AMPERA (R12) 03/12→</b>							
 <b>Bremsbelagsatz, Scheibenbremse</b>							
EV 150 (D1JOI)	111	03/12→	←			<b>13.0460-7263.2 607263</b>	24034 19,1 + WK + Zub
			→	+ eFSB		<b>13.0470-7263.2 LD7263</b>	24034 19,1 + WK + Zub Ceramic
			←			<b>13.0460-7264.2 607264</b>	ATE 25096 17,0 + WK + Zub
			→			<b>13.0470-7264.2 LD7264</b>	ATE 25096 17,0 + WK + Zub Ceramic
 <b>Bremsscheibe</b>							
EV 150 (D1JOI)	111	03/12→	←			<b>24.0126-0166.1 426166</b>	Ø 300 26 23 V + S
			→	+ eFSB		<b>24.0326-0166.1 526166</b>	Ø 300 26 23 V + S
			←			<b>24.0112-0189.1 412189</b>	Ø 292 12 10 + S
			→			<b>24.0312-0189.1 512189</b>	Ø 292 12 10 + S
<b>VAUXHALL - ANTARA (L07) 08/06→</b>							
 <b>Bremsbelagsatz, Scheibenbremse</b>							
2.0 CDTi	93	08/06→04/15	←	09/08→		<b>13.0460-5785.2 605785</b>	24510 17,0 + WK
			→	09/08→		<b>13.0460-5788.2 605788</b>	24498 14,7 + WK
2.0 CDTi	110	08/06→04/15	←			<b>13.0460-5785.2 605785</b>	24510 17,0 + WK
2.0 CDTi 4x4	110	08/06→04/15	→			<b>13.0460-5788.2 605788</b>	24498 14,7 + WK
2.2 CDTi 4x4	120	12/10→					
2.2 CDTi 4x4	135	12/10→					
2.2 CDTi FWD	120	12/10→					
2.4	103	08/06→04/15					
2.4	123	12/10→04/15					
2.4 4x4	123	12/10→04/15					
2.0 CDTi 4x4	93	08/06→04/15	←	03/07→		<b>13.0460-5785.2 605785</b>	24510 17,0 + WK
			→	03/07→		<b>13.0460-5788.2 605788</b>	24498 14,7 + WK
2.4	126	11/10→04/15	←	12/10→		<b>13.0460-5785.2 605785</b>	24510 17,0 + WK
2.4 4x4	126	11/10→04/15	→	12/10→		<b>13.0460-5788.2 605788</b>	24498 14,7 + WK
3.0 4x4	188	11/10→04/15					
2.4 4x4	103	08/06→04/15	←	01/07→		<b>13.0460-5785.2 605785</b>	24510 17,0 + WK
2.4 LPG 4x4	103	08/06→	→	01/07→		<b>13.0460-5788.2 605788</b>	24498 14,7 + WK
<b>Zubehörsatz, Scheibenbremsbelag</b>							
2.0 CDTi	93	08/06→04/15	→	09/08→		<b>13.0460-0135.2 610135</b>	
2.0 CDTi	110	08/06→04/15	→			<b>13.0460-0135.2 610135</b>	
2.0 CDTi 4x4	110	08/06→04/15					
2.2 CDTi 4x4	120	12/10→					
2.2 CDTi 4x4	135	12/10→					
2.2 CDTi FWD	120	12/10→					
2.4	103	08/06→04/15					
2.4	123	12/10→04/15					
2.4 4x4	123	12/10→04/15					
2.0 CDTi 4x4	93	08/06→04/15	→	03/07→		<b>13.0460-0135.2 610135</b>	
2.4	126	11/10→04/15	→	12/10→		<b>13.0460-0135.2 610135</b>	
2.4 4x4	126	11/10→04/15					
3.0 4x4	188	11/10→04/15					
2.4 4x4	103	08/06→04/15	→	01/07→		<b>13.0460-0135.2 610135</b>	
2.4 LPG 4x4	103	08/06→					
 <b>Bremsscheibe</b>							
2.0 CDTi	93	08/06→04/15	←	09/08→		<b>24.0129-0101.1 429101</b>	Ø 296 29 27,5 V
			→	09/08→		<b>24.0120-0209.1 420209</b>	Ø 303 20 18,4 V
2.0 CDTi	110	08/06→04/15	←			<b>24.0129-0101.1 429101</b>	Ø 296 29 27,5 V
2.0 CDTi 4x4	110	08/06→04/15	→			<b>24.0120-0209.1 420209</b>	Ø 303 20 18,4 V
2.2 CDTi 4x4	120	12/10→					
2.2 CDTi 4x4	135	12/10→					
2.2 CDTi FWD	120	12/10→					
2.4	103	08/06→04/15					
2.4	123	12/10→04/15					
2.4 4x4	123	12/10→04/15					
2.0 CDTi 4x4	93	08/06→04/15	←	03/07→		<b>24.0129-0101.1 429101</b>	Ø 296 29 27,5 V
			→	03/07→		<b>24.0120-0209.1 420209</b>	Ø 303 20 18,4 V
2.4	126	11/10→04/15	←	12/10→		<b>24.0129-0101.1 429101</b>	Ø 296 29 27,5 V
2.4 4x4	126	11/10→04/15	→	12/10→		<b>24.0120-0209.1 420209</b>	Ø 303 20 18,4 V
3.0 4x4	188	11/10→04/15					
2.4 4x4	103	08/06→04/15	←	01/07→		<b>24.0129-0101.1 429101</b>	Ø 296 29 27,5 V
2.4 LPG 4x4	103	08/06→	→	01/07→		<b>24.0120-0209.1 420209</b>	Ø 303 20 18,4 V





	kw					! #		
<b>VAUXHALL - ARENA Combi (A97) 01/97→08/01</b>								
 <b>Bremsbelagsatz, Scheibenbremse</b>								
1.9 D 2.5 D	44 55	03/98→08/01 03/98→08/01	←				13.0460-3969.2 603969	BDX 20926 18,5 + WK
 <b>Bremsscheibe</b>								
1.9 D 2.5 D	44 55	03/98→08/01 03/98→08/01	←				24.0124-0103.1 424103	Ø 252,5 24 22 V
<b>VAUXHALL - ARENA Van (A97) 01/97→08/01</b>								
 <b>Bremsbelagsatz, Scheibenbremse</b>								
1.9 D 2.5 D	44 55	03/98→08/01 03/98→08/01	←				13.0460-3969.2 603969	BDX 20926 18,5 + WK
 <b>Bremsscheibe</b>								
1.9 D 2.5 D	44 55	03/98→08/01 03/98→08/01	←				24.0124-0103.1 424103	Ø 252,5 24 22 V
<b>VAUXHALL - ASTRA Mk III (F) Cabriolet (T92) 03/93→03/01</b>								
 <b>Bremsbelagsatz, Scheibenbremse</b>								
1.4 i 1.4 i 16V	60 66	05/93→03/01 01/96→03/01	←				13.0460-7051.2 607051	ATE 20547 16,5 + WE / - WK
1.6 i	52	03/93→08/96	←				13.0460-7051.2 607051	ATE 20547 16,5 + WE / - WK
			←	Motorcode: C16NZ / X16SZR		13.0460-7051.2 607051	ATE 20547 16,5 + WE / - WK	
			←	nicht für Motorcode: C16NZ / X16SZR		13.0460-7052.2 607052	ATE 21190 17,5 + WE / - WK	
1.6 i	55	01/96→03/01	←				13.0460-7051.2 607051	ATE 20547 16,5 + WE / - WK
			←	→ 09/98; Motorcode: C16NZ / X16SZR		13.0460-7051.2 607051	ATE 20547 16,5 + WE / - WK	
			←	→ 09/98; nicht für Motorcode: C16NZ / X16SZR		13.0460-7052.2 607052	ATE 21190 17,5 + WE / - WK	
1.8	92	09/94→08/96	←				13.0460-7052.2 607052	ATE 21190 17,5 + WE / - WK
			→			13.0460-4043.2 604043	ATE 21140 15,0 - WE / - WK	
1.8 16V	85	11/94→03/01	←	→ 09/98			13.0460-7051.2 607051	ATE 20547 16,5 + WE / - WK
			←			13.0460-7052.2 607052	ATE 21190 17,5 + WE / - WK	
2.0 i 16V	100	01/94→02/98	←	→ 10/94			13.0460-7052.2 607052	ATE 21190 17,5 + WE / - WK
<b>Warnkontakt, Bremsbelagverschleiß</b>								
1.4 i 1.4 i 16V	60 66	05/93→03/01 01/96→03/01	←			2	24.8190-0707.2 620707	L= 685
1.6 i	52	03/93→08/96	←	nicht für Motorcode: C16NZ / X16SZR		2	24.8190-0705.2 620705	L= 670
			←			2	24.8190-0707.2 620707	L= 685
			←	Motorcode: C16NZ / X16SZR		2	24.8190-0707.2 620707	L= 685
1.6 i	55	01/96→03/01	←	→ 09/98; nicht für Motorcode: C16NZ / X16SZR		2	24.8190-0705.2 620705	L= 670
			←	→ 09/98; Motorcode: C16NZ / X16SZR		2	24.8190-0707.2 620707	L= 685
			←			2	24.8190-0707.2 620707	L= 685
1.8	92	09/94→08/96	←			2	24.8190-0705.2 620705	L= 670
1.8 16V	85	11/94→03/01	←			2	24.8190-0705.2 620705	L= 670
			←	→ 09/98		2	24.8190-0707.2 620707	L= 685
2.0 i 16V	100	01/94→02/98	←	→ 10/94		2	24.8190-0705.2 620705	L= 670
<b>Zubehörsatz, Scheibenbremsbelag</b>								
1.8	92	09/94→08/96	→				13.0460-0217.2 610217	ATE
 <b>Bremsscheibe</b>								
1.4 i 1.4 i 16V	60 66	05/93→03/01 01/96→03/01	←				24.0120-0115.1 420115	Ø 236 20 17 V + S
1.6 i	52	03/93→08/96	←				24.0120-0115.1 420115	Ø 236 20 17 V + S
			←			24.0124-0115.1 424115	Ø 256 24 21 V + S	
			←			24.0320-0115.1 520115	Ø 236 20 17 V + S	
			←			24.0324-0115.1 524115	Ø 256 24 21 V + S	
1.6 i	55	01/96→03/01	←				24.0120-0115.1 420115	Ø 236 20 17 V + S
			←			24.0320-0115.1 520115	Ø 236 20 17 V + S	
			←	→ 09/98		24.0124-0115.1 424115	Ø 256 24 21 V + S	
1.8	92	09/94→08/96	←				24.0324-0115.1 524115	Ø 256 24 21 V + S
			←			24.0124-0115.1 424115	Ø 256 24 21 V + S	

	kw			 	! #		
<b>VAUXHALL - ASTRA Mk III (F) Cabriolet (T92) 03/93→03/01</b>							
<b>Bremsscheibe</b>							
1.8	92	09/94→08/96	←			24.0324-0115.1 524115	Ø 256 24 21 V + S
			→			24.0110-0204.1 410204	Ø 260 10 8
1.8 16V	85	11/94→03/01	←			24.0124-0115.1 424115	Ø 256 24 21 V + S
						24.0324-0115.1 524115	Ø 256 24 21 V + S
2.0 i 16V	100	01/94→02/98	←	→ 10/94		24.0124-0115.1 424115	Ø 256 24 21 V + S
						24.0324-0115.1 524115	Ø 256 24 21 V + S
<b>VAUXHALL - ASTRA Mk III (F) CC (T92) 09/91→02/98</b>							
<b>Bremsbelagsatz, Scheibenbremse</b>							
1.4 i	44	09/91→02/98	←	10/91→		13.0460-7051.2 607051	ATE 20547 16,5 + WE / - WK
1.4 S	55	09/91→02/98					
1.8 i	66	09/91→02/98					
1.4 i	60	03/92→02/98	←	nicht für Fahrzeuge mit verstärkter Bremse		13.0460-7051.2 607051	ATE 20547 16,5 + WE / - WK
1.4 i 16V	66	02/96→02/98					
1.7 D	42	12/91→02/98	←	für Fahrzeuge mit verstärkter Bremse		13.0460-7052.2 607052	ATE 21190 17,5 + WE / - WK
1.7 TD	50	08/94→02/98					
1.7 TD	60	12/91→02/98					
1.6 i	52	02/93→12/96	←	Motorcode: C16NZ / X16SZR		13.0460-7051.2 607051	ATE 20547 16,5 + WE / - WK
			←	nicht für Motorcode: C16NZ / X16SZR		13.0460-7052.2 607052	ATE 21190 17,5 + WE / - WK
1.6 i	55	09/91→02/98	←	10/91→; Motorcode: C16NZ / X16SZR		13.0460-7051.2 607051	ATE 20547 16,5 + WE / - WK
			←	10/91→; nicht für Motorcode: C16NZ / X16SZR		13.0460-7052.2 607052	ATE 21190 17,5 + WE / - WK
1.6 i	74	03/92→02/98	←			13.0460-7052.2 607052	ATE 21190 17,5 + WE / - WK
1.6 i 16V	74	01/94→02/98	←	nicht für Motorcode: C16NZ / X16SZR		13.0460-7052.2 607052	ATE 21190 17,5 + WE / - WK
1.8 i 16V	85	09/94→02/98	←			13.0460-7051.2 607051	ATE 20547 16,5 + WE / - WK
1.8 i 16V	92	09/94→02/98	←			13.0460-7051.2 607051	ATE 20547 16,5 + WE / - WK
			→			13.0460-4043.2 604043	ATE 21140 15,0 - WE / - WK
2.0 i	85	09/91→02/98	←	10/91→		13.0460-7052.2 607052	ATE 21190 17,5 + WE / - WK
2.0 i 16V	100	01/94→02/98	←			13.0460-7052.2 607052	ATE 21190 17,5 + WE / - WK
2.0 i 16V	110	09/91→02/98	←	10/91→		13.0460-7052.2 607052	ATE 21190 17,5 + WE / - WK
			→	10/91→		13.0460-4043.2 604043	ATE 21140 15,0 - WE / - WK
<b>Warnkontakt, Bremsbelagsverschleiß</b>							
1.4 i	44	09/91→02/98	←	10/91→	2	24.8190-0707.2 620707	L= 685
1.4 S	55	09/91→02/98					
1.8 i	66	09/91→02/98					
1.4 i	60	03/92→02/98	←	für Fahrzeuge mit verstärkter Bremse	2	24.8190-0705.2 620705	L= 670
1.4 i 16V	66	02/96→02/98					
1.7 D	42	12/91→02/98	←	nicht für Fahrzeuge mit verstärkter Bremse	2	24.8190-0707.2 620707	L= 685
1.7 TD	50	08/94→02/98					
1.7 TD	60	12/91→02/98					
1.6 i	52	02/93→12/96	←	nicht für Motorcode: C16NZ / X16SZR	2	24.8190-0705.2 620705	L= 670
			←	Motorcode: C16NZ / X16SZR	2	24.8190-0707.2 620707	L= 685
1.6 i	55	09/91→02/98	←	10/91→; nicht für Motorcode: C16NZ / X16SZR	2	24.8190-0705.2 620705	L= 670
			←	10/91→; Motorcode: C16NZ / X16SZR	2	24.8190-0707.2 620707	L= 685
1.6 i	74	03/92→02/98	←	nicht für Motorcode: C16NZ / X16SZR	2	24.8190-0705.2 620705	L= 670
1.6 i 16V	74	01/94→02/98	←		2	24.8190-0705.2 620705	L= 670
1.8 i 16V	85	09/94→02/98	←		2	24.8190-0707.2 620707	L= 685
1.8 i 16V	92	09/94→02/98	←		2	24.8190-0705.2 620705	L= 670
						24.8190-0707.2 620707	L= 685
2.0 i	85	09/91→02/98	←	10/91→	2	24.8190-0705.2 620705	L= 670
2.0 i 16V	110	09/91→02/98					
2.0 i 16V	100	01/94→02/98	←		2	24.8190-0705.2 620705	L= 670
<b>Zubehörsatz, Scheibenbremsbelag</b>							
1.8 i 16V	92	09/94→02/98	→			13.0460-0217.2 610217	ATE
2.0 i 16V	110	09/91→02/98	→	10/91→		13.0460-0217.2 610217	ATE
<b>Bremsscheibe</b>							
1.4 i	44	09/91→02/98	←	10/91→		24.0113-0161.1 413161	Ø 236 12,7 9,7 + S
1.4 S	55	09/91→02/98				24.0313-0161.1 513161	Ø 236 12,7 9,7 + S
↓							



**VAUXHALL - ASTRA Mk III (F) CC (T92) 09/91→02/98**











**Bremsscheibe**









1.4 i	60	03/92→02/98	←	Schaltgetriebe; nicht für Fahrzeuge mit verstärkter Bremsen	24.0113-0161.1 413161	Ø 236 12,7 9,7 + S
			←	Vollautomatik; nicht für Fahrzeuge mit verstärkter Bremsen	24.0120-0115.1 420115	Ø 236 20 17 V + S
			←	für Fahrzeuge mit verstärkter Bremsen	24.0320-0115.1 520115	Ø 236 20 17 V + S
1.4 i 16V 1.6 i 1.6 i 16V	66 74 74	02/96→02/98 03/92→02/98 01/94→02/98	←		24.0120-0115.1 420115	Ø 236 20 17 V + S
			←		24.0124-0115.1 424115	Ø 256 24 21 V + S
			←		24.0320-0115.1 520115	Ø 236 20 17 V + S
			←		24.0324-0115.1 524115	Ø 256 24 21 V + S
1.6 i	52	02/93→12/96	←	→ T5000073; Schaltgetriebe	24.0113-0161.1 413161	Ø 236 12,7 9,7 + S
			←	Vollautomatik	24.0120-0115.1 420115	Ø 236 20 17 V + S
			←	T5000074→; Schaltgetriebe	24.0120-0115.1 420115	Ø 236 20 17 V + S
			←		24.0320-0115.1 520115	Ø 236 20 17 V + S
1.6 i	55	09/91→02/98	←	10/91→; → T5000073; Schaltgetriebe	24.0113-0161.1 413161	Ø 236 12,7 9,7 + S
			←	10/91→; Vollautomatik	24.0120-0115.1 420115	Ø 236 20 17 V + S
			←	T5000074→; Schaltgetriebe	24.0120-0115.1 420115	Ø 236 20 17 V + S
			←	10/91→	24.0124-0115.1 424115	Ø 256 24 21 V + S
1.7 D 1.7 TD 1.7 TD	42 50 60	12/91→02/98 08/94→02/98 12/91→02/98	←	nicht für Fahrzeuge mit verstärkter Bremsen	24.0120-0115.1 420115	Ø 236 20 17 V + S
			←	für Fahrzeuge mit verstärkter Bremsen	24.0320-0115.1 520115	Ø 236 20 17 V + S
1.8 i	66	09/91→02/98	←	10/91→	24.0124-0115.1 424115	Ø 256 24 21 V + S
1.8 i 16V	92	09/94→02/98	←		24.0324-0115.1 524115	Ø 256 24 21 V + S
			→		24.0110-0204.1 410204	Ø 260 10 8
2.0 i	85	09/91→02/98	←	10/91→	24.0124-0115.1 424115	Ø 256 24 21 V + S
2.0 i 16V	100	01/94→02/98	←		24.0324-0115.1 524115	Ø 256 24 21 V + S
			←		24.0124-0115.1 424115	Ø 256 24 21 V + S
2.0 i 16V	110	09/91→02/98	←	10/91→	24.0124-0115.1 424115	Ø 256 24 21 V + S
			→	10/91→	24.0324-0115.1 524115	Ø 256 24 21 V + S

**VAUXHALL - ASTRA Mk III (F) Kombi (T92) 03/91→12/98**









**Bremsbelagsatz, Scheibenbremse**









1.4 i	44	09/91→02/98	←	10/91→	13.0460-7051.2 607051	ATE 20547 16,5 + WE / - WK
1.8 i	66	09/91→02/98	←	10/91→	13.0460-7051.2 607051	ATE 20547 16,5 + WE / - WK
1.4 i	60	03/91→02/98	←	10/91→; nicht für Fahrzeuge mit verstärkter Bremsen	13.0460-7051.2 607051	ATE 20547 16,5 + WE / - WK
			←	10/91→; für Fahrzeuge mit verstärkter Bremsen	13.0460-7052.2 607052	ATE 21190 17,5 + WE / - WK
1.4 i 16V	66	02/96→01/98	←	nicht für Fahrzeuge mit verstärkter Bremsen	13.0460-7051.2 607051	ATE 20547 16,5 + WE / - WK
1.7 D	42	12/91→02/98	←		13.0460-7052.2 607052	ATE 21190 17,5 + WE / - WK
1.7 TD	50	01/94→02/98	←	für Fahrzeuge mit verstärkter Bremsen	13.0460-7052.2 607052	ATE 21190 17,5 + WE / - WK
1.7 TD	60	12/91→02/98	←		13.0460-7051.2 607051	ATE 20547 16,5 + WE / - WK
1.6 i	52	07/94→02/98	←		13.0460-7051.2 607051	ATE 20547 16,5 + WE / - WK
			←	Motorcode: C16NZ / X16SZR	13.0460-7051.2 607051	ATE 20547 16,5 + WE / - WK
			←	nicht für Motorcode: C16NZ / X16SZR	13.0460-7052.2 607052	ATE 21190 17,5 + WE / - WK
1.6 i	55	09/91→12/98	←	10/91→ 09/98; Motorcode: C16NZ / X16SZR	13.0460-7051.2 607051	ATE 20547 16,5 + WE / - WK
			←	10/91→ 09/98	13.0460-7051.2 607051	ATE 20547 16,5 + WE / - WK
↓						









	kw			 	! #		
<b>VAUXHALL - ASTRA Mk III (F) Kombi (T92) 03/91→12/98</b>							
<b> Bremsbelagsatz, Scheibenbremse</b>							
1.6 i	55	09/91→12/98	←	10/91→ 09/98; nicht für Motorcode: C16NZ / X16SZR		13.0460-7052.2 607052	ATE 21190 17,5 + WE / - WK
1.6 i 16V 2.0 i 16V	74 100	01/94→02/98 01/94→02/98	←			13.0460-7052.2 607052	ATE 21190 17,5 + WE / - WK
1.8 i 16V 1.8 i 16V	85 92	09/94→02/98 09/94→02/98	←			13.0460-7051.2 607051	ATE 20547 16,5 + WE / - WK
2.0 i	85	09/91→02/98	←	10/91→		13.0460-7052.2 607052	ATE 21190 17,5 + WE / - WK
<b>Warnkontakt, Bremsbelagverschleiß</b>							
1.4 i 1.8 i	44 66	09/91→02/98 09/91→02/98	←	10/91→	2	24.8190-0707.2 620707	L= 685
1.4 i	60	03/91→02/98	←	10/91→; für Fahrzeuge mit verstärkter Bremse	2	24.8190-0705.2 620705	L= 670
			←	10/91→; nicht für Fahrzeuge mit verstärkter Bremse	2	24.8190-0707.2 620707	L= 685
1.4 i 16V 1.7 D 1.7 TD 1.7 TD	66 42 50 60	02/96→01/98 12/91→02/98 01/94→02/98 12/91→02/98	←	für Fahrzeuge mit verstärkter Bremse nicht für Fahrzeuge mit verstärkter Bremse	2	24.8190-0705.2 620705	L= 670 L= 685
1.6 i	52	07/94→02/98	←	nicht für Motorcode: C16NZ / X16SZR	2	24.8190-0705.2 620705	L= 670
			←		2	24.8190-0707.2 620707	L= 685
			←	Motorcode: C16NZ / X16SZR	2	24.8190-0707.2 620707	L= 685
1.6 i	55	09/91→12/98	←	10/91→ 09/98; nicht für Motorcode: C16NZ / X16SZR	2	24.8190-0705.2 620705	L= 670
			←	10/91→ 09/98	2	24.8190-0707.2 620707	L= 685
			←	10/91→ 09/98; Motorcode: C16NZ / X16SZR	2	24.8190-0707.2 620707	L= 685
1.6 i 16V 2.0 i 16V	74 100	01/94→02/98 01/94→02/98	←		2	24.8190-0705.2 620705	L= 670
1.8 i 16V 1.8 i 16V	85 92	09/94→02/98 09/94→02/98	←		2	24.8190-0707.2 620707	L= 685
2.0 i	85	09/91→02/98	←	10/91→	2	24.8190-0705.2 620705	L= 670
<b> Bremsscheibe</b>							
1.4 i	44	09/91→02/98	←	10/91→		24.0113-0161.1 413161 24.0313-0161.1 513161	Ø 236 12,7 9,7 + S Ø 236 12,7 9,7 + S
1.4 i	60	03/91→02/98	←	10/91→; Schaltgetriebe; nicht für Fahrzeuge mit verstärkter Bremse		24.0113-0161.1 413161 24.0313-0161.1 513161	Ø 236 12,7 9,7 + S Ø 236 12,7 9,7 + S
			←	10/91→; Vollautomatik; nicht für Fahrzeuge mit verstärkter Bremse		24.0120-0115.1 420115 24.0320-0115.1 520115	Ø 236 20 17 V + S Ø 236 20 17 V + S
			←	10/91→; für Fahrzeuge mit verstärkter Bremse		24.0124-0115.1 424115 24.0324-0115.1 524115	Ø 256 24 21 V + S Ø 256 24 21 V + S
1.4 i 16V 1.6 i	66 52	02/96→01/98 07/94→02/98	←			24.0120-0115.1 420115 24.0124-0115.1 424115 24.0320-0115.1 520115 24.0324-0115.1 524115	Ø 236 20 17 V + S Ø 256 24 21 V + S Ø 236 20 17 V + S Ø 256 24 21 V + S
1.6 i	55	09/91→12/98	←	10/91→ 09/98		24.0120-0115.1 420115 24.0124-0115.1 424115 24.0320-0115.1 520115 24.0324-0115.1 524115	Ø 236 20 17 V + S Ø 256 24 21 V + S Ø 236 20 17 V + S Ø 256 24 21 V + S
1.6 i 16V 2.0 i 16V	74 100	01/94→02/98 01/94→02/98	←			24.0124-0115.1 424115 24.0324-0115.1 524115	Ø 256 24 21 V + S Ø 256 24 21 V + S
1.7 D 1.7 TD 1.7 TD	42 50 60	12/91→02/98 01/94→02/98 12/91→02/98	←	nicht für Fahrzeuge mit verstärkter Bremse für Fahrzeuge mit verstärkter Bremse		24.0120-0115.1 420115 24.0320-0115.1 520115 24.0124-0115.1 424115 24.0324-0115.1 524115	Ø 236 20 17 V + S Ø 236 20 17 V + S Ø 256 24 21 V + S Ø 256 24 21 V + S
1.8 i	66	09/91→02/98	←	10/91→		24.0120-0140.1 420140	Ø 256 20 17 V + S
2.0 i	85	09/91→02/98	←	10/91→		24.0124-0115.1 424115 24.0324-0115.1 524115	Ø 256 24 21 V + S Ø 256 24 21 V + S
<b>VAUXHALL - ASTRA Mk III (F) Stufenheck (T92) 09/91→09/98</b>							
<b> Bremsbelagsatz, Scheibenbremse</b>							
1.4 i 1.8 i	44 66	04/92→09/98 03/92→09/98	←			13.0460-7051.2 607051	ATE 20547 16,5 + WE / - WK
↓							

	kW			 	! #		
<b>VAUXHALL - ASTRA Mk III (F) Stufenheck (T92) 09/91→09/98</b>							
<b> Bremsbelagsatz, Scheibenbremse</b>							
1.4 i	60	04/92→09/98	←	nicht für Fahrzeuge mit verstärkter Bremse		13.0460-7051.2 607051	ATE 20547 16,5 + WE / - WK
1.4 i 16V	66	02/96→09/98					
1.7 D	44	07/92→09/98	←	für Fahrzeuge mit verstärkter Bremse		13.0460-7052.2 607052	ATE 21190 17,5 + WE / - WK
1.7 TD	50	08/94→09/98					
1.7 TD	60	12/91→09/98					
1.6 i	52	08/94→07/96	←	Motorcode: C16NZ / X16SZR		13.0460-7051.2 607051	ATE 20547 16,5 + WE / - WK
1.6 i	55	03/92→09/98	←	nicht für Motorcode: C16NZ / X16SZR		13.0460-7052.2 607052	ATE 21190 17,5 + WE / - WK
1.6 i 16V	74	08/94→09/98	←			13.0460-7052.2 607052	ATE 21190 17,5 + WE / - WK
			←	nicht für Motorcode: C16NZ / X16SZR		13.0460-7052.2 607052	ATE 21190 17,5 + WE / - WK
1.8 i 16V	82	09/95→02/98	←			13.0460-7052.2 607052	ATE 21190 17,5 + WE / - WK
1.8 i 16V	85	01/94→12/96					
2.0 i 16V	100	02/95→09/98	→			13.0460-4043.2 604043	ATE 21140 15,0 - WE / - WK
2.0 i	85	03/92→09/98	←			13.0460-7052.2 607052	ATE 21190 17,5 + WE / - WK
<b>Warnkontakt, Bremsbelagsverschleiß</b>							
1.4 i	44	04/92→09/98	←		2	24.8190-0707.2 620707	L= 685
1.8 i	66	03/92→09/98					
1.4 i	60	04/92→09/98	←	für Fahrzeuge mit verstärkter Bremse	2	24.8190-0705.2 620705	L= 670
1.4 i 16V	66	02/96→09/98					
1.7 D	44	07/92→09/98	←	nicht für Fahrzeuge mit verstärkter Bremse	2	24.8190-0707.2 620707	L= 685
1.7 TD	50	08/94→09/98					
1.7 TD	60	12/91→09/98					
1.6 i	52	08/94→07/96	←	nicht für Motorcode: C16NZ / X16SZR	2	24.8190-0705.2 620705	L= 670
1.6 i	55	03/92→09/98	←	Motorcode: C16NZ / X16SZR	2	24.8190-0707.2 620707	L= 685
1.6 i 16V	74	08/94→09/98	←	nicht für Motorcode: C16NZ / X16SZR	2	24.8190-0705.2 620705	L= 670
			←		2	24.8190-0705.2 620705	L= 670
1.8 i 16V	82	09/95→02/98	←		2	24.8190-0705.2 620705	L= 670
1.8 i 16V	85	01/94→12/96					
2.0 i	85	03/92→09/98					
2.0 i 16V	100	02/95→09/98					
<b>Zubehörsatz, Scheibenbremsbelag</b>							
1.8 i 16V	82	09/95→02/98	→			13.0460-0217.2 610217	ATE
1.8 i 16V	85	01/94→12/96					
2.0 i 16V	100	02/95→09/98					
<b> Bremsscheibe</b>							
1.4 i	44	04/92→09/98	←			24.0113-0161.1 413161	Ø 236 12,7 9,7 + S
						24.0313-0161.1 513161	Ø 236 12,7 9,7 + S
1.4 i	60	04/92→09/98	←			24.0120-0115.1 420115	Ø 236 20 17 V + S
1.4 i 16V	66	02/96→09/98				24.0124-0115.1 424115	Ø 256 24 21 V + S
						24.0320-0115.1 520115	Ø 236 20 17 V + S
						24.0324-0115.1 524115	Ø 256 24 21 V + S
1.6 i	52	08/94→07/96	←	→ T5000073; Schaltgetriebe		24.0113-0161.1 413161	Ø 236 12,7 9,7 + S
1.6 i	55	03/92→09/98	←	Vollautomatik		24.0120-0115.1 420115	Ø 236 20 17 V + S
			←			24.0320-0115.1 520115	Ø 236 20 17 V + S
			←	T5000074→; Schaltgetriebe		24.0120-0115.1 420115	Ø 236 20 17 V + S
			←			24.0320-0115.1 520115	Ø 236 20 17 V + S
			←			24.0124-0115.1 424115	Ø 256 24 21 V + S
			←			24.0324-0115.1 524115	Ø 256 24 21 V + S
1.6 i 16V	74	08/94→09/98	←			24.0124-0115.1 424115	Ø 256 24 21 V + S
2.0 i	85	03/92→09/98				24.0324-0115.1 524115	Ø 256 24 21 V + S
1.7 D	44	07/92→09/98	←	nicht für Fahrzeuge mit verstärkter Bremse		24.0120-0115.1 420115	Ø 236 20 17 V + S
1.7 TD	50	08/94→09/98				24.0320-0115.1 520115	Ø 236 20 17 V + S
1.7 TD	60	12/91→09/98					
			←	für Fahrzeuge mit verstärkter Bremse		24.0124-0115.1 424115	Ø 256 24 21 V + S
						24.0324-0115.1 524115	Ø 256 24 21 V + S
1.8 i	66	03/92→09/98	←			24.0120-0140.1 420140	Ø 256 20 17 V + S
1.8 i 16V	82	09/95→02/98	←			24.0124-0115.1 424115	Ø 256 24 21 V + S
1.8 i 16V	85	01/94→12/96				24.0324-0115.1 524115	Ø 256 24 21 V + S
2.0 i 16V	100	02/95→09/98	→			24.0110-0204.1 410204	Ø 260 10 8



	kw					! #		
<b>VAUXHALL - ASTRA Mk IV (G) Cabriolet (T98) 03/01→10/05</b>								
<b> Bremsbelagsatz, Scheibenbremse</b>								
1.6 16V 1.6 16V	74 76	03/01→10/05 03/03→10/05	←				13.0460-7115.2 607115 13.0470-7115.2 LD7115	ATE 23063 17,5 ohne integrierten Verschleiß- sensor / + WK ATE 23063 17,5 - WK / + WK Ceramic
			→				13.0460-2868.2 602868 13.0460-3976.2 603976 13.0470-2868.2 LD2868	TRW 23417 15,3 + WK + Zub BOS 23258 16,5 + WK + Zub TRW 23417 15,3 + WK + Zub Ceramic
1.8 16V	92	03/01→10/05	←	- ABS			13.0460-7115.2 607115 13.0470-7115.2 LD7115	ATE 23063 17,5 ohne integrierten Verschleiß- sensor / + WK ATE 23063 17,5 - WK / + WK Ceramic
			←	+ ABS			13.0460-7116.2 607116 13.0470-7116.2 LD7116	ATE 23057 20,2 - WK / + WK ATE 23057 20,2 - WK / + WK Ceramic
			→				13.0460-2868.2 602868 13.0460-3976.2 603976 13.0470-2868.2 LD2868	TRW 23417 15,3 + WK + Zub BOS 23258 16,5 + WK + Zub TRW 23417 15,3 + WK + Zub Ceramic
2.0 2.0 Turbo	147 141	09/02→10/05 03/02→10/05	←				13.0460-7173.2 607173	ATE 21829 20,3 - WK / + WK
			→				13.0460-2868.2 602868 13.0460-3976.2 603976 13.0470-2868.2 LD2868	TRW 23417 15,3 + WK + Zub BOS 23258 16,5 + WK + Zub TRW 23417 15,3 + WK + Zub Ceramic
2.2 16V	108	03/01→10/05	←				13.0460-7116.2 607116 13.0470-7116.2 LD7116	ATE 23057 20,2 - WK / + WK ATE 23057 20,2 - WK / + WK Ceramic
			→				13.0460-2868.2 602868 13.0460-3976.2 603976 13.0470-2868.2 LD2868	TRW 23417 15,3 + WK + Zub BOS 23258 16,5 + WK + Zub TRW 23417 15,3 + WK + Zub Ceramic
<b>Warnkontakt, Bremsbelagverschleiß</b>								
1.6 16V 1.6 16V 1.8 16V 2.0 2.0 Turbo 2.2 16V	74 76 92 147 141 108	03/01→10/05 03/03→10/05 03/01→10/05 09/02→10/05 03/02→10/05 03/01→10/05	←	42187759→ → 42187758		2 2	24.8190-0018.2 620018 24.8190-0718.2 620718	L= 755 L= 720
<b> Bremsscheibe</b>								
1.6 16V 1.6 16V	74 76	03/01→10/05 03/03→10/05	←	Felge Lochzahl: 4			24.0124-0152.1 424152 24.0324-0152.1 524152	Ø 256 23,8 21 V + S Ø 256 23,8 21 V + S
			→	Felge Lochzahl: 4			24.0110-0251.1 410251 24.0310-0251.1 510251	Ø 240 9,8 8 + S Ø 240 9,8 8 + S
1.8 16V	92	03/01→10/05	←	- ABS; Felge Lochzahl: 4			24.0124-0152.1 424152 24.0324-0152.1 524152	Ø 256 23,8 21 V + S Ø 256 23,8 21 V + S
			←	+ ABS; Felge Lochzahl: 5			24.0125-0131.1 425131 24.0325-0131.1 525131	Ø 280 24,8 22 V + S Ø 280 24,8 22 V + S
			→	+ ABS; Felge Lochzahl: 5			24.0110-0250.1 410250 24.0310-0250.1 510250	Ø 264 9,8 8 + S Ø 264 9,8 8 + S
			→	- ABS; Felge Lochzahl: 4			24.0110-0251.1 410251 24.0310-0251.1 510251	Ø 240 9,8 8 + S Ø 240 9,8 8 + S
2.0 2.0 Turbo	147 141	09/02→10/05 03/02→10/05	←				24.0125-0142.1 425142 24.0325-0142.1 525142	Ø 308 25 22 V + S Ø 308 25 23 V + S
			→	Felge Lochzahl: 5			24.0110-0250.1 410250 24.0310-0250.1 510250	Ø 264 9,8 8 + S Ø 264 9,8 8 + S
2.2 16V	108	03/01→10/05	←	Felge Lochzahl: 5			24.0125-0131.1 425131 24.0325-0131.1 525131	Ø 280 24,8 22 V + S Ø 280 24,8 22 V + S
			→	Felge Lochzahl: 5			24.0110-0250.1 410250 24.0310-0250.1 510250	Ø 264 9,8 8 + S Ø 264 9,8 8 + S

	kw			 	! #		
<b>VAUXHALL - ASTRA Mk IV (G) CC (T98) 02/98→05/05</b>							
<b> Bremsbelagsatz, Scheibenbremse</b>							
1.2 16V (F08, F48) 1.6 (F08, F48) 1.6 (F08, F48) 1.6 Dualfuel (F08, F48) 1.6 Dualfuel (F08) 1.7 CDTI 16V (F08, F48) 1.7 DTI 16V (F08, F48)	55 62 76 63 62 59 55	09/00→05/05 09/00→05/05 12/02→05/05 09/02→05/05 07/00→05/05 04/03→05/05 02/00→05/05	←     →			13.0460-7115.2 607115   13.0470-7115.2 LD7115   13.0460-2868.2 602868 13.0460-3976.2 603976 13.0470-2868.2 LD2868	ATE 23063 17,5 ohne integrierten Verschleiß- sensor / + WK ATE 23063 17,5 - WK / + WK Ceramic TRW 23417 15,3 + WK + Zub BOS 23258 16,5 + WK + Zub TRW 23417 15,3 + WK + Zub Ceramic
1.4 16V (F08, F48) 1.6 (F08, F48) 1.6 16V (F08, F48) 1.7 TD (F08, F48)	66 55 74 50	02/98→05/05 02/98→09/00 02/98→05/05 02/98→08/00	←  →	04/98→  04/98→		13.0460-7115.2 607115   13.0470-7115.2 LD7115   13.0460-2868.2 602868 13.0460-3976.2 603976 13.0470-2868.2 LD2868	ATE 23063 17,5 ohne integrierten Verschleiß- sensor / + WK ATE 23063 17,5 - WK / + WK Ceramic TRW 23417 15,3 + WK + Zub BOS 23258 16,5 + WK + Zub TRW 23417 15,3 + WK + Zub Ceramic
1.8 16V (F08, F48)	85	02/98→09/00	←  →	04/98→; - ABS  04/98→; + ABS  04/98→		13.0460-7115.2 607115   13.0470-7115.2 LD7115   13.0460-7116.2 607116 13.0470-7116.2 LD7116   13.0460-2868.2 602868 13.0460-3976.2 603976 13.0470-2868.2 LD2868	ATE 23063 17,5 ohne integrierten Verschleiß- sensor / + WK ATE 23063 17,5 - WK / + WK Ceramic ATE 23057 20,2 - WK / + WK ATE 23057 20,2 - WK / + WK Ceramic TRW 23417 15,3 + WK + Zub BOS 23258 16,5 + WK + Zub TRW 23417 15,3 + WK + Zub Ceramic
1.8 16V (F08, F48) 1.8 16V Dualfuel (F08, F48)	92 87	09/00→05/05 09/02→05/05	←  →	- ABS  + ABS		13.0460-7115.2 607115   13.0470-7115.2 LD7115   13.0460-7116.2 607116 13.0470-7116.2 LD7116   13.0460-2868.2 602868 13.0460-3976.2 603976 13.0470-2868.2 LD2868	ATE 23063 17,5 ohne integrierten Verschleiß- sensor / + WK ATE 23063 17,5 - WK / + WK Ceramic ATE 23057 20,2 - WK / + WK ATE 23057 20,2 - WK / + WK Ceramic TRW 23417 15,3 + WK + Zub BOS 23258 16,5 + WK + Zub TRW 23417 15,3 + WK + Zub Ceramic
2.0 16V (F08)	100	02/98→05/05	←  →	04/98→  04/98→		13.0460-7116.2 607116 13.0470-7116.2 LD7116   13.0460-2868.2 602868 13.0460-3976.2 603976 13.0470-2868.2 LD2868	ATE 23057 20,2 - WK / + WK ATE 23057 20,2 - WK / + WK Ceramic TRW 23417 15,3 + WK + Zub BOS 23258 16,5 + WK + Zub TRW 23417 15,3 + WK + Zub Ceramic
2.0 DI (F48)	60	02/98→05/05	←  →	04/98→  04/98→; + ABS  04/98→		13.0460-7115.2 607115   13.0470-7115.2 LD7115   13.0460-7116.2 607116 13.0470-7116.2 LD7116   13.0460-2868.2 602868 13.0460-3976.2 603976 13.0470-2868.2 LD2868	ATE 23063 17,5 ohne integrierten Verschleiß- sensor / + WK ATE 23063 17,5 - WK / + WK Ceramic ATE 23057 20,2 - WK / + WK ATE 23057 20,2 - WK / + WK Ceramic TRW 23417 15,3 + WK + Zub BOS 23258 16,5 + WK + Zub TRW 23417 15,3 + WK + Zub Ceramic
2.0 DTI 16V (F48) 2.2 16V (F08, F48)	74 108	08/99→05/05 03/01→05/05	←  →			13.0460-7116.2 607116 13.0470-7116.2 LD7116   13.0460-2868.2 602868 13.0460-3976.2 603976 13.0470-2868.2 LD2868	ATE 23057 20,2 - WK / + WK ATE 23057 20,2 - WK / + WK Ceramic TRW 23417 15,3 + WK + Zub BOS 23258 16,5 + WK + Zub TRW 23417 15,3 + WK + Zub Ceramic
↓							

	kw					! #		
<b>VAUXHALL - ASTRA Mk IV (G) CC (T98) 02/98→05/05</b>								
<b> Bremsbelagsatz, Scheibenbremse</b>								
2.0 SRI Turbo (F08)	141	11/01→05/05	←				<b>13.0460-7173.2 607173</b>	ATE 21829 20,3 - WK / + WK
			→				<b>13.0460-2868.2 602868</b>	TRW 23417 15,3 + WK + Zub
							<b>13.0460-3976.2 603976</b>	BOS 23258 16,5 + WK + Zub
							<b>13.0470-2868.2 LD2868</b>	TRW 23417 15,3 + WK + Zub Ceramic
<b>Warnkontakt, Bremsbelagverschleiß</b>								
1.2 16V (F08, F48)	55	09/00→05/05	←	42187759→	2	<b>24.8190-0018.2 620018</b>		L= 755
1.6 (F08, F48)	62	09/00→05/05						
1.6 (F08, F48)	76	12/02→05/05	←	→ 42187758	2	<b>24.8190-0718.2 620718</b>		L= 720
1.6 Dualfuel (F08, F48)	63	09/02→05/05						
1.6 Dualfuel (F08)	62	07/00→05/05						
1.7 CDTI 16V (F08, F48)	59	04/03→05/05						
1.7 DTI 16V (F08, F48)	55	02/00→05/05						
1.8 16V (F08, F48)	92	09/00→05/05						
1.8 16V Dualfuel (F08, F48)	87	09/02→05/05						
2.0 DTI 16V (F48)	74	08/99→05/05						
2.0 SRI Turbo (F08)	141	11/01→05/05						
2.2 16V (F08, F48)	108	03/01→05/05						
1.4 16V (F08, F48)	66	02/98→05/05	←	04/98→; 42187759→	2	<b>24.8190-0018.2 620018</b>		L= 755
1.6 (F08, F48)	55	02/98→09/00						
1.6 16V (F08, F48)	74	02/98→05/05	←	04/98→; → 42187758	2	<b>24.8190-0718.2 620718</b>		L= 720
1.7 TD (F08, F48)	50	02/98→08/00						
1.8 16V (F08, F48)	85	02/98→09/00						
2.0 16V (F08)	100	02/98→05/05						
2.0 DI (F48)	60	02/98→05/05	←	04/98→; 42187759→	2	<b>24.8190-0018.2 620018</b>		L= 755
			←	04/98→; + ABS; 42187759→	2	<b>24.8190-0018.2 620018</b>		L= 755
			←	04/98→; + ABS; → 42187758	2	<b>24.8190-0718.2 620718</b>		L= 720
			←	04/98→; → 42187758	2	<b>24.8190-0718.2 620718</b>		L= 720
<b> Bremsscheibe</b>								
1.2 16V (F08, F48)	55	09/00→05/05	←	→ 18999999; für Fahrzeuge mit Trommelbremse an der Hinterachse		<b>24.0111-0141.1 411141</b>		Ø 256 10,8 8
						<b>24.0311-0141.1 511141</b>		Ø 256 10,8 8
			←	22000001→; Felge Lochzahl: 4		<b>24.0124-0152.1 424152</b>		Ø 256 23,8 21 V + S
						<b>24.0324-0152.1 524152</b>		Ø 256 23,8 21 V + S
			←	→ 18999999; für Fahrzeuge mit Scheibenbremse an der Hinterachse; Felge Lochzahl: 4		<b>24.0124-0152.1 424152</b>		Ø 256 23,8 21 V + S
						<b>24.0324-0152.1 524152</b>		Ø 256 23,8 21 V + S
			→	Felge Lochzahl: 4		<b>24.0110-0251.1 410251</b>		Ø 240 9,8 8 + S
						<b>24.0310-0251.1 510251</b>		Ø 240 9,8 8 + S
1.4 16V (F08, F48)	66	02/98→05/05	←	04/98→; Felge Lochzahl: 4		<b>24.0124-0152.1 424152</b>		Ø 256 23,8 21 V + S
1.7 TD (F08, F48)	50	02/98→08/00				<b>24.0324-0152.1 524152</b>		Ø 256 23,8 21 V + S
			→	04/98→; Felge Lochzahl: 4		<b>24.0110-0251.1 410251</b>		Ø 240 9,8 8 + S
						<b>24.0310-0251.1 510251</b>		Ø 240 9,8 8 + S
1.6 (F08, F48)	55	02/98→09/00	←	04/98→; Felge Lochzahl: 4		<b>24.0124-0152.1 424152</b>		Ø 256 23,8 21 V + S
						<b>24.0324-0152.1 524152</b>		Ø 256 23,8 21 V + S
			←	04/98→; Felge Lochzahl: 5		<b>24.0125-0131.1 425131</b>		Ø 280 24,8 22 V + S
						<b>24.0325-0131.1 525131</b>		Ø 280 24,8 22 V + S
			→	04/98→; Felge Lochzahl: 4		<b>24.0110-0251.1 410251</b>		Ø 240 9,8 8 + S
						<b>24.0310-0251.1 510251</b>		Ø 240 9,8 8 + S
1.6 (F08, F48)	62	09/00→05/05	←	Felge Lochzahl: 4		<b>24.0124-0152.1 424152</b>		Ø 256 23,8 21 V + S
1.6 Dualfuel (F08)	62	07/00→05/05				<b>24.0324-0152.1 524152</b>		Ø 256 23,8 21 V + S
			←	Felge Lochzahl: 5		<b>24.0125-0131.1 425131</b>		Ø 280 24,8 22 V + S
						<b>24.0325-0131.1 525131</b>		Ø 280 24,8 22 V + S
			→	Felge Lochzahl: 4		<b>24.0110-0251.1 410251</b>		Ø 240 9,8 8 + S
						<b>24.0310-0251.1 510251</b>		Ø 240 9,8 8 + S
1.6 (F08, F48)	76	12/02→05/05	←	Felge Lochzahl: 4		<b>24.0124-0152.1 424152</b>		Ø 256 23,8 21 V + S
1.7 CDTI 16V (F08, F48)	59	04/03→05/05				<b>24.0324-0152.1 524152</b>		Ø 256 23,8 21 V + S
1.7 DTI 16V (F08, F48)	55	02/00→05/05				<b>24.0110-0251.1 410251</b>		Ø 240 9,8 8 + S
			→	Felge Lochzahl: 4		<b>24.0310-0251.1 510251</b>		Ø 240 9,8 8 + S
1.6 16V (F08, F48)	74	02/98→05/05	←	04/98→; Felge Lochzahl: 4		<b>24.0124-0152.1 424152</b>		Ø 256 23,8 21 V + S
						<b>24.0324-0152.1 524152</b>		Ø 256 23,8 21 V + S
			←	04/98→; Felge Lochzahl: 5		<b>24.0125-0131.1 425131</b>		Ø 280 24,8 22 V + S
						<b>24.0325-0131.1 525131</b>		Ø 280 24,8 22 V + S
			→	04/98→; Felge Lochzahl: 5		<b>24.0110-0250.1 410250</b>		Ø 264 9,8 8 + S

**VAUXHALL - ASTRA Mk IV (G) CC (T98) 02/98→05/05**









**Bremsscheibe**

1.6 16V (F08, F48)	74	02/98→05/05	➡	04/98→; Felge Lochzahl: 5	24.0310-0250.1	510250	Ø 264 9,8 8 + S
			➡	04/98→; Felge Lochzahl: 4	24.0110-0251.1	410251	Ø 240 9,8 8 + S
1.6 Dualfuel (F08, F48)	63	09/02→05/05	←	Felge Lochzahl: 4	24.0124-0152.1	424152	Ø 256 23,8 21 V + S
			←	Felge Lochzahl: 5	24.0324-0152.1	524152	Ø 256 23,8 21 V + S
			←	Felge Lochzahl: 5	24.0125-0131.1	425131	Ø 280 24,8 22 V + S
			←	Felge Lochzahl: 5	24.0325-0131.1	525131	Ø 280 24,8 22 V + S
			➡	Felge Lochzahl: 5	24.0110-0250.1	410250	Ø 264 9,8 8 + S
			➡	Felge Lochzahl: 4	24.0310-0250.1	510250	Ø 264 9,8 8 + S
1.8 16V (F08, F48) 2.0 DI (F48)	85 60	02/98→09/00 02/98→05/05	←	04/98→; - ABS; Felge Lochzahl: 4	24.0124-0152.1	424152	Ø 256 23,8 21 V + S
			←	04/98→; + ABS; Felge Lochzahl: 5	24.0324-0152.1	524152	Ø 256 23,8 21 V + S
			←	04/98→; + ABS; Felge Lochzahl: 5	24.0125-0131.1	425131	Ø 280 24,8 22 V + S
			←	04/98→; + ABS; Felge Lochzahl: 5	24.0325-0131.1	525131	Ø 280 24,8 22 V + S
			➡	04/98→; - ABS; Felge Lochzahl: 4	24.0110-0250.1	410250	Ø 264 9,8 8 + S
1.8 16V (F08, F48) 1.8 16V Dualfuel (F08, F48)	92 87	09/00→05/05 09/02→05/05	←	- ABS; Felge Lochzahl: 4	24.0310-0250.1	510250	Ø 264 9,8 8 + S
			←	+ ABS; Felge Lochzahl: 5	24.0124-0152.1	424152	Ø 256 23,8 21 V + S
			←	+ ABS; Felge Lochzahl: 5	24.0324-0152.1	524152	Ø 256 23,8 21 V + S
			➡	+ ABS; Felge Lochzahl: 5	24.0125-0131.1	425131	Ø 280 24,8 22 V + S
			➡	- ABS; Felge Lochzahl: 4	24.0325-0131.1	525131	Ø 280 24,8 22 V + S
2.0 16V (F08)	100	02/98→05/05	←	04/98→; Felge Lochzahl: 5	24.0110-0250.1	410250	Ø 264 9,8 8 + S
			←	04/98→; Felge Lochzahl: 5	24.0310-0250.1	510250	Ø 264 9,8 8 + S
			➡	04/98→; Felge Lochzahl: 5	24.0125-0131.1	425131	Ø 280 24,8 22 V + S
2.0 DTI 16V (F48) 2.2 16V (F08, F48)	74 108	08/99→05/05 03/01→05/05	←	Felge Lochzahl: 5	24.0325-0131.1	525131	Ø 280 24,8 22 V + S
			➡	Felge Lochzahl: 5	24.0110-0250.1	410250	Ø 264 9,8 8 + S
2.0 SRI Turbo (F08)	141	11/01→05/05	←		24.0310-0250.1	510250	Ø 264 9,8 8 + S
			←		24.0125-0142.1	425142	Ø 308 25 22 V + S
			➡	Felge Lochzahl: 5	24.0325-0142.1	525142	Ø 308 25 23 V + S
					24.0110-0250.1	410250	Ø 264 9,8 8 + S
					24.0310-0250.1	510250	Ø 264 9,8 8 + S







**VAUXHALL - ASTRA Mk IV (G) Coupe (T98) 03/00→08/05**







**Brembelagsatz, Scheibenbremse**

1.6 16V	76	03/00→08/05	←		13.0460-7115.2	607115	ATE 23063 17,5 ohne integrierten Verschleißsensor / + WK
			←		13.0470-7115.2	LD7115	ATE 23063 17,5 - WK / + WK Ceramic
			➡		13.0460-2868.2	602868	TRW 23417 15,3 + WK + Zub
1.8 16V 1.8 16V 1.8 16V Dualfuel	85 92 87	03/00→08/05 09/00→08/05 09/02→08/05	←		13.0460-3976.2	603976	BOS 23258 16,5 + WK + Zub
			←		13.0470-2868.2	LD2868	TRW 23417 15,3 + WK + Zub Ceramic
			➡		13.0460-2868.2	602868	TRW 23417 15,3 + WK + Zub
2.0 16V Turbo	140	09/00→08/05	←		13.0460-3976.2	603976	BOS 23258 16,5 + WK + Zub
			←		13.0470-2868.2	LD2868	TRW 23417 15,3 + WK + Zub Ceramic
			➡		13.0460-2868.2	602868	TRW 23417 15,3 + WK + Zub
					13.0460-7173.2	607173	ATE 21829 20,3 - WK / + WK
					13.0460-2868.2	602868	TRW 23417 15,3 + WK + Zub
					13.0460-3976.2	603976	BOS 23258 16,5 + WK + Zub
					13.0470-2868.2	LD2868	TRW 23417 15,3 + WK + Zub Ceramic

	kw				! #		
<b>VAUXHALL - ASTRA Mk IV (G) Coupe (T98) 03/00→08/05</b>							
<b> Bremsbelagsatz, Scheibenbremse</b>							
2.2 16V	108	03/00→08/05	←	09/00→		13.0460-7116.2 607116 13.0470-7116.2 LD7116	ATE 23057 20,2 - WK / + WK ATE 23057 20,2 - WK / + WK Ceramic
			→	09/00→		13.0460-2868.2 602868 13.0460-3976.2 603976 13.0470-2868.2 LD2868	TRW 23417 15,3 + WK + Zub BOS 23258 16,5 + WK + Zub TRW 23417 15,3 + WK + Zub Ceramic
<b>Warnkontakt, Bremsbelagverschleiß</b>							
1.6 16V	76	03/00→08/05	←	42187759→	2	24.8190-0018.2 620018	L= 755
1.8 16V	85	03/00→08/05	←	→ 42187758	2	24.8190-0718.2 620718	L= 720
1.8 16V	92	09/00→08/05	←				
1.8 16V Dualfuel	87	09/02→08/05	←				
2.0 16V Turbo	140	09/00→08/05	←				
2.2 16V	108	03/00→08/05	←	09/00→; 42187759→	2	24.8190-0018.2 620018	L= 755
			←	09/00→; → 42187758	2	24.8190-0718.2 620718	L= 720
<b> Bremsscheibe</b>							
1.6 16V	76	03/00→08/05	←	Felge Lochzahl: 4		24.0124-0152.1 424152 24.0324-0152.1 524152	Ø 256 23,8 21 V + S Ø 256 23,8 21 V + S
			←	Felge Lochzahl: 5		24.0125-0131.1 425131 24.0325-0131.1 525131	Ø 280 24,8 22 V + S Ø 280 24,8 22 V + S
			→	Felge Lochzahl: 5		24.0110-0250.1 410250 24.0310-0250.1 510250	Ø 264 9,8 8 + S Ø 264 9,8 8 + S
			→	Felge Lochzahl: 4		24.0110-0251.1 410251 24.0310-0251.1 510251	Ø 240 9,8 8 + S Ø 240 9,8 8 + S
1.8 16V	85	03/00→08/05	←	Felge Lochzahl: 5		24.0125-0131.1 425131	Ø 280 24,8 22 V + S
1.8 16V	92	09/00→08/05	←			24.0325-0131.1 525131	Ø 280 24,8 22 V + S
1.8 16V Dualfuel	87	09/02→08/05	→	Felge Lochzahl: 5		24.0110-0250.1 410250 24.0310-0250.1 510250	Ø 264 9,8 8 + S Ø 264 9,8 8 + S
2.0 16V Turbo	140	09/00→08/05	←			24.0125-0142.1 425142 24.0325-0142.1 525142	Ø 308 25 22 V + S Ø 308 25 23 V + S
			→	Felge Lochzahl: 5		24.0110-0250.1 410250 24.0310-0250.1 510250	Ø 264 9,8 8 + S Ø 264 9,8 8 + S
2.2 16V	108	03/00→08/05	←	09/00→; Felge Lochzahl: 5		24.0125-0131.1 425131 24.0325-0131.1 525131	Ø 280 24,8 22 V + S Ø 280 24,8 22 V + S
			→	09/00→; Felge Lochzahl: 5		24.0110-0250.1 410250 24.0310-0250.1 510250	Ø 264 9,8 8 + S Ø 264 9,8 8 + S
<b>VAUXHALL - ASTRA Mk IV (G) Kombi (T98) 02/98→05/05</b>							
<b> Bremsbelagsatz, Scheibenbremse</b>							
1.2 16V	55	09/00→05/05	←			13.0460-7115.2 607115	ATE 23063 17,5 ohne integrierten Verschleiß- sensor / + WK
1.6	76	12/02→05/05	←			13.0470-7115.2 LD7115	ATE 23063 17,5 - WK / + WK Ceramic
1.6 Dualfuel	62	07/00→05/05	←				
1.7 CDTI 16V	59	04/03→05/05	←				
1.7 DTI 16V	55	02/00→05/05	←				
			→			13.0460-2868.2 602868 13.0460-3976.2 603976 13.0470-2868.2 LD2868	TRW 23417 15,3 + WK + Zub BOS 23258 16,5 + WK + Zub TRW 23417 15,3 + WK + Zub Ceramic
1.4 16V	66	02/98→05/05	←	04/98→		13.0460-7115.2 607115	ATE 23063 17,5 ohne integrierten Verschleiß- sensor / + WK
1.6	55	03/98→04/04	←			13.0470-7115.2 LD7115	ATE 23063 17,5 - WK / + WK Ceramic
1.6	62	03/98→04/04	←				
1.6 16V	74	03/98→04/04	←				
1.6 Dualfuel	63	03/98→04/04	←				
1.7 TD	50	02/98→08/00	→	04/98→		13.0460-2868.2 602868 13.0460-3976.2 603976 13.0470-2868.2 LD2868	TRW 23417 15,3 + WK + Zub BOS 23258 16,5 + WK + Zub TRW 23417 15,3 + WK + Zub Ceramic
1.8 16V	85	02/98→08/00	←	04/98→; - ABS		13.0460-7115.2 607115 13.0470-7115.2 LD7115	ATE 23063 17,5 ohne integrierten Verschleiß- sensor / + WK ATE 23063 17,5 - WK / + WK Ceramic
			←	04/98→; + ABS		13.0460-7116.2 607116	ATE 23057 20,2 - WK / + WK



	kw			 	! #			
<b>VAUXHALL - ASTRA Mk IV (G) Kombi (T98) 02/98→05/05</b>								
<b>Bremsbelagsatz, Scheibenbremse</b>								
1.8 16V	85	02/98→08/00	←	04/98→; + ABS		13.0470-7116.2	LD7116	ATE 23057 20,2 - WK / + WK Ceramic
			→	04/98→		13.0460-2868.2	602868	TRW 23417 15,3 + WK + Zub
						13.0460-3976.2	603976	BOS 23258 16,5 + WK + Zub
						13.0470-2868.2	LD2868	TRW 23417 15,3 + WK + Zub Ceramic
1.8 16V 1.8 16V Dualfuel	92 87	09/00→05/05 09/02→05/05	←	- ABS		13.0460-7115.2	607115	ATE 23063 17,5 ohne integrierten Verschleißsensor / + WK
						13.0470-7115.2	LD7115	ATE 23063 17,5 - WK / + WK Ceramic
			←	+ ABS		13.0460-7116.2	607116	ATE 23057 20,2 - WK / + WK Ceramic
						13.0470-7116.2	LD7116	ATE 23057 20,2 - WK / + WK Ceramic
			→			13.0460-2868.2	602868	TRW 23417 15,3 + WK + Zub
						13.0460-3976.2	603976	BOS 23258 16,5 + WK + Zub
						13.0470-2868.2	LD2868	TRW 23417 15,3 + WK + Zub Ceramic
2.0 DI	60	03/98→04/04	←	04/98→		13.0460-7115.2	607115	ATE 23063 17,5 ohne integrierten Verschleißsensor / + WK
						13.0470-7115.2	LD7115	ATE 23063 17,5 - WK / + WK Ceramic
			←	04/98→; + ABS		13.0460-7116.2	607116	ATE 23057 20,2 - WK / + WK Ceramic
						13.0470-7116.2	LD7116	ATE 23057 20,2 - WK / + WK Ceramic
			→	04/98→		13.0460-2868.2	602868	TRW 23417 15,3 + WK + Zub
						13.0460-3976.2	603976	BOS 23258 16,5 + WK + Zub
						13.0470-2868.2	LD2868	TRW 23417 15,3 + WK + Zub Ceramic
2.0 DTI 16V	74	03/98→04/04	←	08/99→		13.0460-7116.2	607116	ATE 23057 20,2 - WK / + WK Ceramic
						13.0470-7116.2	LD7116	ATE 23057 20,2 - WK / + WK Ceramic
			→	08/99→		13.0460-2868.2	602868	TRW 23417 15,3 + WK + Zub
						13.0460-3976.2	603976	BOS 23258 16,5 + WK + Zub
						13.0470-2868.2	LD2868	TRW 23417 15,3 + WK + Zub Ceramic
2.2 16V	108	03/01→05/05	←			13.0460-7116.2	607116	ATE 23057 20,2 - WK / + WK Ceramic
						13.0470-7116.2	LD7116	ATE 23057 20,2 - WK / + WK Ceramic
			→			13.0460-2868.2	602868	TRW 23417 15,3 + WK + Zub
						13.0460-3976.2	603976	BOS 23258 16,5 + WK + Zub
						13.0470-2868.2	LD2868	TRW 23417 15,3 + WK + Zub Ceramic
<b>Warnkontakt, Bremsbelagverschleiß</b>								
1.2 16V	55	09/00→05/05	←	42187759→	2	24.8190-0018.2	620018	L= 755
1.6	76	12/02→05/05						
1.6 Dualfuel	62	07/00→05/05	←	→ 42187758	2	24.8190-0718.2	620718	L= 720
1.7 CDTI 16V	59	04/03→05/05						
1.7 DTI 16V	55	02/00→05/05						
1.8 16V	92	09/00→05/05						
1.8 16V Dualfuel	87	09/02→05/05						
2.2 16V	108	03/01→05/05						
1.4 16V	66	02/98→05/05	←	04/98→; 42187759→	2	24.8190-0018.2	620018	L= 755
			←	04/98→; → 42187758	2	24.8190-0718.2	620718	L= 720
1.6	55	03/98→04/04						
1.6	62	03/98→04/04	←					
1.6 16V	74	03/98→04/04						
1.6 Dualfuel	63	03/98→04/04						
1.7 TD	50	02/98→08/00						
1.8 16V	85	02/98→08/00						
2.0 DI	60	03/98→04/04	←	04/98→; 42187759→	2	24.8190-0018.2	620018	L= 755
			←	04/98→; + ABS; 42187759→	2	24.8190-0018.2	620018	L= 755
			←	04/98→; + ABS; → 42187758	2	24.8190-0718.2	620718	L= 720
			←	04/98→; → 42187758	2	24.8190-0718.2	620718	L= 720
2.0 DTI 16V	74	03/98→04/04	←	08/99→; 42187759→	2	24.8190-0018.2	620018	L= 755
			←	08/99→; → 42187758	2	24.8190-0718.2	620718	L= 720
↓								

	kw			 	! #		
<b>VAUXHALL - ASTRA Mk IV (G) Kombi (T98) 02/98→05/05</b>							
<b>Bremsscheibe</b>							
1.2 16V	55	09/00→05/05	←	→ 189999999; für Fahrzeuge mit Trommelbremse an der Hinterachse	24.0111-0141.1	411141	Ø 256 10,8 8
					24.0311-0141.1	511141	Ø 256 10,8 8
			←	22000001→; Felge Lochzahl: 4	24.0124-0152.1	424152	Ø 256 23,8 21 V + S
					24.0324-0152.1	524152	Ø 256 23,8 21 V + S
1.4 16V 1.7 TD	66 50	02/98→05/05 02/98→08/00	←	04/98→; Felge Lochzahl: 4	24.0124-0152.1	424152	Ø 256 23,8 21 V + S
					24.0324-0152.1	524152	Ø 256 23,8 21 V + S
			→	04/98→; Felge Lochzahl: 4	24.0110-0251.1	410251	Ø 240 9,8 8 + S
					24.0310-0251.1	510251	Ø 240 9,8 8 + S
1.6 1.6 1.6 Dualfuel	55 62 63	03/98→04/04 03/98→04/04 03/98→04/04	←	04/98→; Felge Lochzahl: 4	24.0124-0152.1	424152	Ø 256 23,8 21 V + S
					24.0324-0152.1	524152	Ø 256 23,8 21 V + S
			←	04/98→; Felge Lochzahl: 5	24.0125-0131.1	425131	Ø 280 24,8 22 V + S
					24.0325-0131.1	525131	Ø 280 24,8 22 V + S
1.6 1.6 Dualfuel	76 62	12/02→05/05 07/00→05/05	←	Felge Lochzahl: 4	24.0124-0152.1	424152	Ø 256 23,8 21 V + S
					24.0324-0152.1	524152	Ø 256 23,8 21 V + S
			←	Felge Lochzahl: 5	24.0125-0131.1	425131	Ø 280 24,8 22 V + S
					24.0325-0131.1	525131	Ø 280 24,8 22 V + S
1.6 16V	74	03/98→04/04	←	04/98→; Felge Lochzahl: 4	24.0124-0152.1	424152	Ø 256 23,8 21 V + S
					24.0324-0152.1	524152	Ø 256 23,8 21 V + S
			←	04/98→; Felge Lochzahl: 5	24.0125-0131.1	425131	Ø 280 24,8 22 V + S
					24.0325-0131.1	525131	Ø 280 24,8 22 V + S
1.7 CDTI 16V 1.7 DTI 16V	59 55	04/03→05/05 02/00→05/05	←	Felge Lochzahl: 4	24.0124-0152.1	424152	Ø 256 23,8 21 V + S
					24.0324-0152.1	524152	Ø 256 23,8 21 V + S
			→	Felge Lochzahl: 4	24.0110-0251.1	410251	Ø 240 9,8 8 + S
					24.0310-0251.1	510251	Ø 240 9,8 8 + S
1.8 16V 2.0 DI	85 60	02/98→08/00 03/98→04/04	←	04/98→; - ABS; Felge Lochzahl: 4	24.0124-0152.1	424152	Ø 256 23,8 21 V + S
					24.0324-0152.1	524152	Ø 256 23,8 21 V + S
			←	04/98→; + ABS; Felge Lochzahl: 5	24.0125-0131.1	425131	Ø 280 24,8 22 V + S
					24.0325-0131.1	525131	Ø 280 24,8 22 V + S
1.8 16V 1.8 16V Dualfuel	92 87	09/00→05/05 09/02→05/05	→	04/98→; + ABS; Felge Lochzahl: 5	24.0110-0250.1	410250	Ø 264 9,8 8 + S
					24.0310-0250.1	510250	Ø 264 9,8 8 + S
			→	- ABS; Felge Lochzahl: 4	24.0110-0251.1	410251	Ø 240 9,8 8 + S
					24.0310-0251.1	510251	Ø 240 9,8 8 + S
2.0 DTI 16V	74	03/98→04/04	←	08/99→; Felge Lochzahl: 5	24.0125-0131.1	425131	Ø 280 24,8 22 V + S
					24.0325-0131.1	525131	Ø 280 24,8 22 V + S
			→	08/99→; Felge Lochzahl: 5	24.0110-0250.1	410250	Ø 264 9,8 8 + S
					24.0310-0250.1	510250	Ø 264 9,8 8 + S
2.2 16V	108	03/01→05/05	←	Felge Lochzahl: 5	24.0125-0131.1	425131	Ø 280 24,8 22 V + S
					24.0325-0131.1	525131	Ø 280 24,8 22 V + S
			→	Felge Lochzahl: 5	24.0110-0250.1	410250	Ø 264 9,8 8 + S
					24.0310-0250.1	510250	Ø 264 9,8 8 + S









**VAUXHALL - ASTRA Mk IV (G) Stufenheck (T98) 02/98→05/05**









**Bremsbelagsatz, Scheibenbremse**

1.2 16V 1.4 16V 1.6 1.6 1.6 16V 1.6 Dualfuel 1.6 Dualfuel 1.7 CDTI 16V 1.7 DTI 16V 1.7 TD	55 66 55 62 74 62 63 59 55 50	09/00→05/05 09/98→05/05 09/98→09/00 09/00→05/05 09/98→05/05 07/00→05/05 09/02→05/05 04/03→05/05 02/00→05/05 09/98→08/00	←					13.0460-7115.2 607115  13.0470-7115.2 LD7115	ATE 23063 17,5 ohne integrierten Verschleiß- sensor / + WK ATE 23063 17,5 - WK / + WK Ceramic
1.8 16V 1.8 16V 1.8 16V Dualfuel	85 92 87	02/98→07/04 02/98→07/04 02/98→07/04	←	04/98→; - ABS				13.0460-7115.2 607115  13.0470-7115.2 LD7115	ATE 23063 17,5 ohne integrierten Verschleiß- sensor / + WK ATE 23063 17,5 - WK / + WK Ceramic
			←	04/98→; + ABS				13.0460-7116.2 607116 13.0470-7116.2 LD7116	ATE 23057 20,2 - WK / + WK ATE 23057 20,2 - WK / + WK Ceramic
			→	04/98→				13.0460-2868.2 602868 13.0460-3976.2 603976 13.0470-2868.2 LD2868	TRW 23417 15,3 + WK + Zub BOS 23258 16,5 + WK + Zub TRW 23417 15,3 + WK + Zub Ceramic
2.0 16V 2.2 16V 2.2 DTI	100 108 92	09/98→05/05 03/01→05/05 09/02→05/05	←					13.0460-7116.2 607116 13.0470-7116.2 LD7116	ATE 23057 20,2 - WK / + WK ATE 23057 20,2 - WK / + WK Ceramic
			→					13.0460-2868.2 602868 13.0460-3976.2 603976 13.0470-2868.2 LD2868	TRW 23417 15,3 + WK + Zub BOS 23258 16,5 + WK + Zub TRW 23417 15,3 + WK + Zub Ceramic
			←	04/98→				13.0460-7115.2 607115  13.0470-7115.2 LD7115	ATE 23063 17,5 ohne integrierten Verschleiß- sensor / + WK ATE 23063 17,5 - WK / + WK Ceramic
2.0 DI	60	02/98→07/04	←	04/98→				13.0460-7116.2 607116 13.0470-7116.2 LD7116	ATE 23057 20,2 - WK / + WK ATE 23057 20,2 - WK / + WK Ceramic
			←	04/98→; + ABS				13.0460-7116.2 607116 13.0470-7116.2 LD7116	ATE 23057 20,2 - WK / + WK ATE 23057 20,2 - WK / + WK Ceramic
			→	04/98→				13.0460-2868.2 602868 13.0460-3976.2 603976 13.0470-2868.2 LD2868	TRW 23417 15,3 + WK + Zub BOS 23258 16,5 + WK + Zub TRW 23417 15,3 + WK + Zub Ceramic
2.0 DTI 16V	74	02/98→07/04	←	08/99→				13.0460-7116.2 607116 13.0470-7116.2 LD7116	ATE 23057 20,2 - WK / + WK ATE 23057 20,2 - WK / + WK Ceramic
			→	08/99→				13.0460-2868.2 602868 13.0460-3976.2 603976 13.0470-2868.2 LD2868	TRW 23417 15,3 + WK + Zub BOS 23258 16,5 + WK + Zub TRW 23417 15,3 + WK + Zub Ceramic







**Warnkontakt, Bremsbelagsverschleiß**









1.2 16V 1.4 16V 1.6 1.6 1.6 16V 1.6 Dualfuel 1.6 Dualfuel 1.7 CDTI 16V 1.7 DTI 16V 1.7 TD 2.0 16V 2.2 16V 2.2 DTI	55 66 55 62 74 62 63 59 55 50 100 108 92	09/00→05/05 09/98→05/05 09/98→09/00 09/00→05/05 09/98→05/05 07/00→05/05 09/02→05/05 04/03→05/05 02/00→05/05 09/98→08/00 09/98→05/05 03/01→05/05 09/02→05/05	←	42187759→	2	24.8190-0018.2 620018	L= 755
1.8 16V 1.8 16V 1.8 16V Dualfuel 2.0 DI 2.0 DI 2.0 DI 2.0 DI 2.0 DI 2.0 DI 2.0 DTI 16V	85 92 87 60 60 60 60 60 60 60 60 60 60	02/98→07/04 02/98→07/04 02/98→07/04 02/98→07/04 02/98→07/04 02/98→07/04 02/98→07/04 02/98→07/04 02/98→07/04 02/98→07/04 02/98→07/04 02/98→07/04 02/98→07/04	←	→ 42187758	2	24.8190-0718.2 620718	L= 720
			←	04/98→; 42187759→	2	24.8190-0018.2 620018	L= 755
			←	04/98→; → 42187758	2	24.8190-0718.2 620718	L= 720
			←	04/98→; 42187759→	2	24.8190-0018.2 620018	L= 755
			←	04/98→; + ABS; 42187759→	2	24.8190-0018.2 620018	L= 755
			←	04/98→; + ABS; → 42187758	2	24.8190-0718.2 620718	L= 720
			←	04/98→; → 42187758	2	24.8190-0718.2 620718	L= 720
			←	08/99→; 42187759→	2	24.8190-0018.2 620018	L= 755
			↓				







	kw				! #		
<b>VAUXHALL - ASTRA Mk IV (G) Stufenheck (T98) 02/98→05/05</b>							
<b>Warnkontakt, Bremsbelagverschleiß</b>							
2.0 DTI 16V	74	02/98→07/04	←	08/99→; → 42187758	2	24.8190-0718.2 620718	L= 720
<b> Brems Scheibe</b>							
1.2 16V	55	09/00→05/05	←	→ 18999999; für Fahrzeuge mit Trommelbremse an der Hinterachse	24.0111-0141.1 411141	∅ 256 10,8 8	
			←	22000001→; Felge Lochzahl: 4	24.0124-0152.1 424152 24.0324-0152.1 524152	∅ 256 23,8 21 V + S ∅ 256 23,8 21 V + S	
			←	→ 18999999; für Fahrzeuge mit Scheibenbremse an der Hinterachse; Felge Lochzahl: 4	24.0124-0152.1 424152 24.0324-0152.1 524152	∅ 256 23,8 21 V + S ∅ 256 23,8 21 V + S	
			→	Felge Lochzahl: 4	24.0110-0251.1 410251 24.0310-0251.1 510251	∅ 240 9,8 8 + S ∅ 240 9,8 8 + S	
1.4 16V 1.7 CDTI 16V 1.7 DTI 16V 1.7 TD	66 59 55 50	09/98→05/05 04/03→05/05 02/00→05/05 09/98→08/00	←	Felge Lochzahl: 4	24.0124-0152.1 424152 24.0324-0152.1 524152	∅ 256 23,8 21 V + S ∅ 256 23,8 21 V + S	
			→	Felge Lochzahl: 4	24.0110-0251.1 410251 24.0310-0251.1 510251	∅ 240 9,8 8 + S ∅ 240 9,8 8 + S	
1.6 1.6 1.6 Dualfuel 1.6 Dualfuel	55 62 62 63	09/98→09/00 09/00→05/05 07/00→05/05 09/02→05/05	←	Felge Lochzahl: 4	24.0124-0152.1 424152 24.0324-0152.1 524152	∅ 256 23,8 21 V + S ∅ 256 23,8 21 V + S	
			←	Felge Lochzahl: 5	24.0125-0131.1 425131 24.0325-0131.1 525131	∅ 280 24,8 22 V + S ∅ 280 24,8 22 V + S	
			→	Felge Lochzahl: 4	24.0110-0251.1 410251 24.0310-0251.1 510251	∅ 240 9,8 8 + S ∅ 240 9,8 8 + S	
			←	Felge Lochzahl: 4	24.0124-0152.1 424152 24.0324-0152.1 524152	∅ 256 23,8 21 V + S ∅ 256 23,8 21 V + S	
1.6 16V	74	09/98→05/05	←	Felge Lochzahl: 4	24.0124-0152.1 424152 24.0324-0152.1 524152	∅ 256 23,8 21 V + S ∅ 256 23,8 21 V + S	
			←	Felge Lochzahl: 5	24.0125-0131.1 425131 24.0325-0131.1 525131	∅ 280 24,8 22 V + S ∅ 280 24,8 22 V + S	
			→	Felge Lochzahl: 5	24.0110-0250.1 410250 24.0310-0250.1 510250	∅ 264 9,8 8 + S ∅ 264 9,8 8 + S	
			→	Felge Lochzahl: 4	24.0110-0251.1 410251 24.0310-0251.1 510251	∅ 240 9,8 8 + S ∅ 240 9,8 8 + S	
1.8 16V 1.8 16V 1.8 16V Dualfuel 2.0 DI	85 92 87 60	02/98→07/04 02/98→07/04 02/98→07/04 02/98→07/04	←	04/98→; - ABS; Felge Lochzahl: 4	24.0124-0152.1 424152 24.0324-0152.1 524152	∅ 256 23,8 21 V + S ∅ 256 23,8 21 V + S	
			←	04/98→; + ABS; Felge Lochzahl: 5	24.0125-0131.1 425131 24.0325-0131.1 525131	∅ 280 24,8 22 V + S ∅ 280 24,8 22 V + S	
			→	04/98→; + ABS; Felge Lochzahl: 5	24.0110-0250.1 410250 24.0310-0250.1 510250	∅ 264 9,8 8 + S ∅ 264 9,8 8 + S	
			→	04/98→; - ABS; Felge Lochzahl: 4	24.0110-0251.1 410251 24.0310-0251.1 510251	∅ 240 9,8 8 + S ∅ 240 9,8 8 + S	
2.0 16V 2.2 16V 2.2 DTI	100 108 92	09/98→05/05 03/01→05/05 09/02→05/05	←	Felge Lochzahl: 5	24.0125-0131.1 425131 24.0325-0131.1 525131	∅ 280 24,8 22 V + S ∅ 280 24,8 22 V + S	
			→	Felge Lochzahl: 5	24.0110-0250.1 410250 24.0310-0250.1 510250	∅ 264 9,8 8 + S ∅ 264 9,8 8 + S	
2.0 DTI 16V	74	02/98→07/04	←	08/99→; Felge Lochzahl: 5	24.0125-0131.1 425131 24.0325-0131.1 525131	∅ 280 24,8 22 V + S ∅ 280 24,8 22 V + S	
			→	08/99→; Felge Lochzahl: 5	24.0110-0250.1 410250 24.0310-0250.1 510250	∅ 264 9,8 8 + S ∅ 264 9,8 8 + S	
<b>VAUXHALL - ASTRA Mk V (H) CC (A04) 01/04→09/09</b>							
<b> Bremsbelagsatz, Scheibenbremse</b>							
1.3 CDTI (L48)	66	01/04→05/09	←	08/05→	13.0460-7179.2 607179 13.0470-7179.2 LD7179	ATE 23832 20,2 - WK / + WK ATE 23832 20,2 - WK / + WK Ceramic	
			→	08/05→	13.0460-2868.2 602868 13.0470-2868.2 LD2868	TRW 23417 15,3 + WK + Zub TRW 23417 15,3 + WK + Zub Ceramic	
1.4 (L48) 1.6 (L48) 1.7 CDTI (L48) 1.7 CDTI (L48) 1.8 (L48) 2.0 Turbo (L48)	66 77 59 74 92 125	01/04→05/09 01/04→05/09 01/04→05/09 01/04→05/09 01/04→05/09 01/04→05/09	←		13.0460-7179.2 607179 13.0470-7179.2 LD7179	ATE 23832 20,2 - WK / + WK ATE 23832 20,2 - WK / + WK Ceramic	
			→		13.0460-2868.2 602868 13.0470-2868.2 LD2868	TRW 23417 15,3 + WK + Zub TRW 23417 15,3 + WK + Zub Ceramic	
			←		13.0460-7179.2 607179 13.0470-7179.2 LD7179	ATE 23832 20,2 - WK / + WK ATE 23832 20,2 - WK / + WK Ceramic	
			→		13.0460-2868.2 602868 13.0470-2868.2 LD2868	TRW 23417 15,3 + WK + Zub TRW 23417 15,3 + WK + Zub Ceramic	
1.6 (L48) 1.6 Turbo (L48) ↓	85 132	01/04→05/09 09/06→09/09	←	01/07→	13.0460-7179.2 607179	ATE 23832 20,2 - WK / + WK	









	kw			 	! #		
<b>VAUXHALL - ASTRA Mk V (H) CC (A04) 01/04→09/09</b>							
<b> Bremsbelagsatz, Scheibenbremse</b>							
1.6 (L48) 1.6 Turbo (L48)	85 132	01/04→05/09 09/06→09/09	←	01/07→		13.0470-7179.2 LD7179	ATE 23832 20,2 - WK / + WK Ceramic
			→	01/07→		13.0460-2868.2 602868 13.0470-2868.2 LD2868	TRW 23417 15,3 + WK + Zub Ceramic
1.7 CDTi (L48)	81	01/04→05/09	←	04/07→		13.0460-7179.2 607179 13.0470-7179.2 LD7179	ATE 23832 20,2 - WK / + WK Ceramic
			→	04/07→		13.0460-2868.2 602868 13.0470-2868.2 LD2868	TRW 23417 15,3 + WK + Zub Ceramic
1.8 (L48)	103	01/04→05/09	←	01/06→		13.0460-7179.2 607179 13.0470-7179.2 LD7179	ATE 23832 20,2 - WK / + WK Ceramic
			→	01/06→		13.0460-2868.2 602868 13.0470-2868.2 LD2868	TRW 23417 15,3 + WK + Zub Ceramic
1.9 CDTi (L48) 1.9 CDTi (L48) 1.9 CDTi 16V (L48) 2.0 Turbo (L48)	88 110 88 147	01/04→05/09 01/04→05/09 01/04→05/09 01/04→05/09	←	09/04→		13.0460-7179.2 607179 13.0470-7179.2 LD7179	ATE 23832 20,2 - WK / + WK Ceramic
			→	09/04→		13.0460-2868.2 602868 13.0470-2868.2 LD2868	TRW 23417 15,3 + WK + Zub Ceramic
2.0 Turbo (L48)	177	01/04→05/09	←	03/05→; für Bremssattel mit Kunststoffkolben		13.0460-7172.2 607172 13.0470-7172.2 LD7172	ATE 23378 20,1 + WE / - WK Ceramic
			←	03/05→; für Bremssattel mit Stahlkolben		13.0460-7212.2 607212	ATE 23738 20,1 + WE / - WK
			→	03/05→		13.0460-2868.2 602868 13.0470-2868.2 LD2868	TRW 23417 15,3 + WK + Zub Ceramic
<b>Warnkontakt, Bremsbelagverschleiß</b>							
1.3 CDTi (L48)	66	01/04→05/09	←	08/05→	1	24.8190-0720.2 620720	L= 287
1.4 (L48) 1.6 (L48) 1.7 CDTi (L48) 1.7 CDTi (L48) 1.8 (L48) 2.0 Turbo (L48)	66 77 59 74 92 125	01/04→05/09 01/04→05/09 01/04→05/09 01/04→05/09 01/04→05/09 01/04→05/09	←		1	24.8190-0720.2 620720	L= 287
1.6 (L48) 1.6 Turbo (L48)	85 132	01/04→05/09 09/06→09/09	←	01/07→	1	24.8190-0720.2 620720	L= 287
1.7 CDTi (L48)	81	01/04→05/09	←	04/07→	1	24.8190-0720.2 620720	L= 287
1.8 (L48)	103	01/04→05/09	←	01/06→	1	24.8190-0720.2 620720	L= 287
1.9 CDTi (L48) 1.9 CDTi (L48) 1.9 CDTi 16V (L48) 2.0 Turbo (L48)	88 110 88 147	01/04→05/09 01/04→05/09 01/04→05/09 01/04→05/09	←	09/04→	1	24.8190-0720.2 620720	L= 287
2.0 Turbo (L48)	177	01/04→05/09	←	03/05→	1	24.8190-0720.2 620720	L= 287
<b> Bremsscheibe</b>							
1.3 CDTi (L48)	66	01/04→05/09	←	08/05→; Felge Lochzahl: 5		24.0125-0131.1 425131 24.0325-0131.1 525131	Ø 280 24,8 22 V + S
			←	08/05→; Felge Lochzahl: 4		24.0125-0198.1 425198 24.0325-0198.1 525198	Ø 280 25 22 V + S
			→	08/05→; Felge Lochzahl: 5		24.0110-0250.1 410250 24.0310-0250.1 510250	Ø 264 9,8 8 + S
			→	08/05→; Felge Lochzahl: 4		24.0110-0251.1 410251 24.0310-0251.1 510251	Ø 240 9,8 8 + S
1.4 (L48) 1.6 (L48) 1.7 CDTi (L48) 1.7 CDTi (L48) 1.8 (L48)	66 77 59 74 92	01/04→05/09 01/04→05/09 01/04→05/09 01/04→05/09 01/04→05/09	←	Felge Lochzahl: 5		24.0125-0131.1 425131 24.0325-0131.1 525131	Ø 280 24,8 22 V + S
			←	Felge Lochzahl: 4		24.0125-0198.1 425198 24.0325-0198.1 525198	Ø 280 25 22 V + S
			→	Felge Lochzahl: 5		24.0110-0250.1 410250 24.0310-0250.1 510250	Ø 264 9,8 8 + S
			→	Felge Lochzahl: 4		24.0110-0251.1 410251 24.0310-0251.1 510251	Ø 240 9,8 8 + S
↓							









	kw			 	! #		
<b>VAUXHALL - ASTRA Mk V (H) CC (A04) 01/04→09/09</b>							
<b>Bremsscheibe</b>							
1.6 (L48)	85	01/04→05/09	←	01/07→; Felge Lochzahl: 5	24.0125-0131.1	425131	Ø 280 24,8 22 V + S
					24.0325-0131.1	525131	Ø 280 24,8 22 V + S
			←	01/07→; Felge Lochzahl: 4	24.0125-0198.1	425198	Ø 280 25 22 V + S
					24.0325-0198.1	525198	Ø 280 25 22 V + S
1.6 Turbo (L48)	132	09/06→09/09	→	01/07→; Felge Lochzahl: 5	24.0110-0250.1	410250	Ø 264 9,8 8 + S
					24.0310-0250.1	510250	Ø 264 9,8 8 + S
			→	01/07→; Felge Lochzahl: 4	24.0110-0251.1	410251	Ø 240 9,8 8 + S
					24.0310-0251.1	510251	Ø 240 9,8 8 + S
1.7 CDTi (L48)	81	01/04→05/09	←	04/07→; Felge Lochzahl: 5	24.0125-0131.1	425131	Ø 280 24,8 22 V + S
					24.0325-0131.1	525131	Ø 280 24,8 22 V + S
			←	04/07→; Felge Lochzahl: 4	24.0125-0198.1	425198	Ø 280 25 22 V + S
					24.0325-0198.1	525198	Ø 280 25 22 V + S
1.8 (L48)	103	01/04→05/09	→	04/07→; Felge Lochzahl: 5	24.0110-0250.1	410250	Ø 264 9,8 8 + S
					24.0310-0250.1	510250	Ø 264 9,8 8 + S
			→	04/07→; Felge Lochzahl: 4	24.0110-0251.1	410251	Ø 240 9,8 8 + S
					24.0310-0251.1	510251	Ø 240 9,8 8 + S
1.9 CDTi (L48) 1.9 CDTi (L48) 1.9 CDTi 16V (L48) 2.0 Turbo (L48)	88 110 88 147	01/04→05/09	←	01/06→; Felge Lochzahl: 5	24.0125-0131.1	425131	Ø 280 24,8 22 V + S
					24.0325-0131.1	525131	Ø 280 24,8 22 V + S
			←	01/06→; Felge Lochzahl: 4	24.0125-0198.1	425198	Ø 280 25 22 V + S
					24.0325-0198.1	525198	Ø 280 25 22 V + S
2.0 Turbo (L48)	125	01/04→05/09	→	01/06→; Felge Lochzahl: 5	24.0110-0250.1	410250	Ø 264 9,8 8 + S
					24.0310-0250.1	510250	Ø 264 9,8 8 + S
			→	01/06→; Felge Lochzahl: 4	24.0110-0251.1	410251	Ø 240 9,8 8 + S
					24.0310-0251.1	510251	Ø 240 9,8 8 + S
2.0 Turbo (L48)	177	01/04→05/09	←	09/04→; Felge Lochzahl: 5	24.0125-0142.1	425142	Ø 308 25 22 V + S
					24.0325-0142.1	525142	Ø 308 25 23 V + S
			←	09/04→; Felge Lochzahl: 4	24.0125-0198.1	425198	Ø 280 25 22 V + S
					24.0325-0198.1	525198	Ø 280 25 22 V + S
2.0 Turbo (L48)	125	01/04→05/09	→	09/04→; Felge Lochzahl: 5	24.0110-0250.1	410250	Ø 264 9,8 8 + S
					24.0310-0250.1	510250	Ø 264 9,8 8 + S
			→	09/04→; Felge Lochzahl: 4	24.0110-0251.1	410251	Ø 240 9,8 8 + S
					24.0310-0251.1	510251	Ø 240 9,8 8 + S
2.0 Turbo (L48)	125	01/04→05/09	←	Felge Lochzahl: 5	24.0125-0142.1	425142	Ø 308 25 22 V + S
					24.0325-0142.1	525142	Ø 308 25 23 V + S
			←	Felge Lochzahl: 4	24.0125-0198.1	425198	Ø 280 25 22 V + S
					24.0325-0198.1	525198	Ø 280 25 22 V + S
2.0 Turbo (L48)	125	01/04→05/09	→	Felge Lochzahl: 5	24.0110-0250.1	410250	Ø 264 9,8 8 + S
					24.0310-0250.1	510250	Ø 264 9,8 8 + S
			→	Felge Lochzahl: 4	24.0110-0251.1	410251	Ø 240 9,8 8 + S
					24.0310-0251.1	510251	Ø 240 9,8 8 + S
2.0 Turbo (L48)	177	01/04→05/09	←	03/05→; Felge Lochzahl: 5	24.0128-0201.1	428201	Ø 321 28 25 V
					24.0110-0339.1	410339	Ø 278 10 8 + S
<b>VAUXHALL - ASTRA Mk V (H) CC (A04) 02/05→11/10</b>							
<b>Brembelagsatz, Scheibenbremse</b>							
1.3 CDTi (L08)	66	04/05→11/10	←	08/05→	13.0460-7179.2	607179	ATE 23832 20,2 - WK / + WK
					13.0470-7179.2	LD7179	ATE 23832 20,2 - WK / + WK Ceramic
1.4 i 16V (L08) 1.6 (L08) 1.7 CDTi (L08)	66 77 74	03/05→11/10 02/05→11/10 02/05→11/10	→	08/05→	13.0460-2868.2	602868	TRW 23417 15,3 + WK + Zub
					13.0470-2868.2	LD2868	TRW 23417 15,3 + WK + Zub Ceramic
↓			←		13.0460-7179.2	607179	ATE 23832 20,2 - WK / + WK
					13.0470-7179.2	LD7179	ATE 23832 20,2 - WK / + WK Ceramic

	kw			 	! #		
<b>VAUXHALL - ASTRA Mk V (H) CC (A04) 02/05→11/10</b>							
<b> Bremsbelagsatz, Scheibenbremse</b>							
1.8 (L08) 1.8 i 16V (L08) 1.9 CDTi (L08) 1.9 CDTi (L08) 2.0 Turbo (L08)	92 103 88 110 125	02/05→11/10 03/07→11/10 02/05→11/10 02/05→11/10 02/05→11/10	➔			13.0460-2868.2 602868 13.0470-2868.2 LD2868	TRW 23417 15,3 + WK + Zub TRW 23417 15,3 + WK + Zub Ceramic
1.6 (L08) 1.6 i 16V (L08)	132 85	10/06→11/10 12/06→11/10	➔	01/07→		13.0460-7179.2 607179 13.0470-7179.2 LD7179	ATE 23832 20,2 - WK / + WK ATE 23832 20,2 - WK / + WK Ceramic
			➔	01/07→		13.0460-2868.2 602868 13.0470-2868.2 LD2868	TRW 23417 15,3 + WK + Zub TRW 23417 15,3 + WK + Zub Ceramic
1.7 CDTi (L08)	81	02/07→11/10	➔	04/07→		13.0460-7179.2 607179 13.0470-7179.2 LD7179	ATE 23832 20,2 - WK / + WK ATE 23832 20,2 - WK / + WK Ceramic
			➔	04/07→		13.0460-2868.2 602868 13.0470-2868.2 LD2868	TRW 23417 15,3 + WK + Zub TRW 23417 15,3 + WK + Zub Ceramic
1.9 CDTi (L08)	74	08/05→11/10	➔	09/05→		13.0460-7179.2 607179 13.0470-7179.2 LD7179	ATE 23832 20,2 - WK / + WK ATE 23832 20,2 - WK / + WK Ceramic
			➔	09/05→		13.0460-2868.2 602868 13.0470-2868.2 LD2868	TRW 23417 15,3 + WK + Zub TRW 23417 15,3 + WK + Zub Ceramic
2.0 VXR (L08)	176	02/09→11/10	➔	für Bremssattel mit Kunststoffkolben		13.0460-7172.2 607172 13.0470-7172.2 LD7172	ATE 23378 20,1 + WE / - WK ATE 23378 20,1 + WE / - WK Ceramic
			➔	für Bremssattel mit Stahlkolben		13.0460-7212.2 607212	ATE 23738 20,1 + WE / - WK
			➔			13.0460-2868.2 602868 13.0470-2868.2 LD2868	TRW 23417 15,3 + WK + Zub TRW 23417 15,3 + WK + Zub Ceramic
<b>Warnkontakt, Bremsbelagverschleiß</b>							
1.3 CDTi (L08)	66	04/05→11/10	➔	08/05→	1	24.8190-0720.2 620720	L= 287
1.4 i 16V (L08) 1.6 (L08) 1.7 CDTi (L08) 1.8 (L08) 1.8 i 16V (L08) 1.9 CDTi (L08) 1.9 CDTi (L08) 2.0 Turbo (L08) 2.0 VXR (L08)	66 77 74 92 103 88 110 125 176	03/05→11/10 02/05→11/10 02/05→11/10 02/05→11/10 03/07→11/10 02/05→11/10 02/05→11/10 02/05→11/10 02/09→11/10	➔		1	24.8190-0720.2 620720	L= 287
1.6 (L08) 1.6 i 16V (L08)	132 85	10/06→11/10 12/06→11/10	➔	01/07→	1	24.8190-0720.2 620720	L= 287
1.7 CDTi (L08)	81	02/07→11/10	➔	04/07→	1	24.8190-0720.2 620720	L= 287
1.9 CDTi (L08)	74	08/05→11/10	➔	09/05→	1	24.8190-0720.2 620720	L= 287
<b> Bremsscheibe</b>							
1.3 CDTi (L08)	66	04/05→11/10	➔	08/05→; Felge Lochzahl: 5		24.0125-0131.1 425131 24.0325-0131.1 525131	Ø 280 24,8 22 V + S Ø 280 24,8 22 V + S
			➔	08/05→; Felge Lochzahl: 4		24.0125-0198.1 425198 24.0325-0198.1 525198	Ø 280 25 22 V + S Ø 280 25 22 V + S
			➔	08/05→; Felge Lochzahl: 5		24.0110-0250.1 410250 24.0310-0250.1 510250	Ø 264 9,8 8 + S Ø 264 9,8 8 + S
			➔	08/05→; Felge Lochzahl: 4		24.0110-0251.1 410251 24.0310-0251.1 510251	Ø 240 9,8 8 + S Ø 240 9,8 8 + S
1.4 i 16V (L08) 1.6 (L08) 1.7 CDTi (L08) 1.8 (L08) 1.8 i 16V (L08)	66 77 74 92 103	03/05→11/10 02/05→11/10 02/05→11/10 02/05→11/10 03/07→11/10	➔	Felge Lochzahl: 5		24.0125-0131.1 425131 24.0325-0131.1 525131	Ø 280 24,8 22 V + S Ø 280 24,8 22 V + S
			➔	Felge Lochzahl: 4		24.0125-0198.1 425198 24.0325-0198.1 525198	Ø 280 25 22 V + S Ø 280 25 22 V + S
			➔	Felge Lochzahl: 5		24.0110-0250.1 410250 24.0310-0250.1 510250	Ø 264 9,8 8 + S Ø 264 9,8 8 + S
			➔	Felge Lochzahl: 4		24.0110-0251.1 410251 24.0310-0251.1 510251	Ø 240 9,8 8 + S Ø 240 9,8 8 + S
1.6 (L08)	132	10/06→11/10	➔	01/07→; Felge Lochzahl: 5		24.0125-0142.1 425142 24.0325-0142.1 525142	Ø 308 25 22 V + S Ø 308 25 23 V + S
↓			➔	01/07→; Felge Lochzahl: 4		24.0125-0198.1 425198	Ø 280 25 22 V + S







	kW					! #		
<b>VAUXHALL - ASTRA Mk V (H) CC (A04) 02/05→11/10</b>								
<b>Bremsscheibe</b>								
1.6 (L08)	132	10/06→11/10	←	01/07→; Felge Lochzahl: 4	24.0325-0198.1	525198	Ø 280 25 22 V + S	
			→	01/07→; Felge Lochzahl: 5	24.0110-0250.1	410250	Ø 264 9,8 8 + S	
					24.0310-0250.1	510250	Ø 264 9,8 8 + S	
			→	01/07→; Felge Lochzahl: 4	24.0110-0251.1	410251	Ø 240 9,8 8 + S	
				24.0310-0251.1	510251	Ø 240 9,8 8 + S		
1.6 i 16V (L08)	85	12/06→11/10	←	01/07→; Felge Lochzahl: 5	24.0125-0131.1	425131	Ø 280 24,8 22 V + S	
					24.0325-0131.1	525131	Ø 280 24,8 22 V + S	
			←	01/07→; Felge Lochzahl: 4	24.0125-0198.1	425198	Ø 280 25 22 V + S	
					24.0325-0198.1	525198	Ø 280 25 22 V + S	
			→	01/07→; Felge Lochzahl: 5	24.0110-0250.1	410250	Ø 264 9,8 8 + S	
					24.0310-0250.1	510250	Ø 264 9,8 8 + S	
			→	01/07→; Felge Lochzahl: 4	24.0110-0251.1	410251	Ø 240 9,8 8 + S	
				24.0310-0251.1	510251	Ø 240 9,8 8 + S		
1.7 CDTi (L08)	81	02/07→11/10	←	04/07→; Felge Lochzahl: 5	24.0125-0131.1	425131	Ø 280 24,8 22 V + S	
					24.0325-0131.1	525131	Ø 280 24,8 22 V + S	
			←	04/07→; Felge Lochzahl: 4	24.0125-0198.1	425198	Ø 280 25 22 V + S	
					24.0325-0198.1	525198	Ø 280 25 22 V + S	
			→	04/07→; Felge Lochzahl: 5	24.0110-0250.1	410250	Ø 264 9,8 8 + S	
					24.0310-0250.1	510250	Ø 264 9,8 8 + S	
			→	04/07→; Felge Lochzahl: 4	24.0110-0251.1	410251	Ø 240 9,8 8 + S	
				24.0310-0251.1	510251	Ø 240 9,8 8 + S		
1.9 CDTi (L08)	74	08/05→11/10	←	09/05→; Felge Lochzahl: 5	24.0125-0142.1	425142	Ø 308 25 22 V + S	
					24.0325-0142.1	525142	Ø 308 25 23 V + S	
			←	09/05→; Felge Lochzahl: 4	24.0125-0198.1	425198	Ø 280 25 22 V + S	
					24.0325-0198.1	525198	Ø 280 25 22 V + S	
			→	09/05→; Felge Lochzahl: 5	24.0110-0250.1	410250	Ø 264 9,8 8 + S	
					24.0310-0250.1	510250	Ø 264 9,8 8 + S	
			→	09/05→; Felge Lochzahl: 4	24.0110-0251.1	410251	Ø 240 9,8 8 + S	
				24.0310-0251.1	510251	Ø 240 9,8 8 + S		
1.9 CDTi (L08) 1.9 CDTi (L08) 2.0 Turbo (L08)	88 110 125	02/05→11/10 02/05→11/10 02/05→11/10	←	Felge Lochzahl: 5	24.0125-0142.1	425142	Ø 308 25 22 V + S	
					24.0325-0142.1	525142	Ø 308 25 23 V + S	
			←	Felge Lochzahl: 4	24.0125-0198.1	425198	Ø 280 25 22 V + S	
					24.0325-0198.1	525198	Ø 280 25 22 V + S	
			→	Felge Lochzahl: 5	24.0110-0250.1	410250	Ø 264 9,8 8 + S	
					24.0310-0250.1	510250	Ø 264 9,8 8 + S	
			→	Felge Lochzahl: 4	24.0110-0251.1	410251	Ø 240 9,8 8 + S	
				24.0310-0251.1	510251	Ø 240 9,8 8 + S		
2.0 VXR (L08)	176	02/09→11/10	←	Felge Lochzahl: 5	24.0128-0201.1	428201	Ø 321 28 25 V	
			→		24.0110-0339.1	410339	Ø 278 10 8 + S	
<b>VAUXHALL - ASTRA Mk V (H) Convertible (A04) 09/05→08/11</b>								
<b>Bremsbelagsatz, Scheibenbremse</b>								
1.6 (L67) 1.9 CDTi (L67) 2.0 (L67) 2.0 Turbo (L67)	77 110 125 147	09/05→11/10 01/06→11/10 02/06→11/10 01/06→11/10	←	03/06→	13.0460-7179.2	607179	ATE 23832 20,2 - WK / + WK	
					13.0470-7179.2	LD7179	ATE 23832 20,2 - WK / + WK Ceramic	
			→	03/06→	13.0460-2868.2	602868	TRW 23417 15,3 + WK + Zub	
					13.0470-2868.2	LD2868	TRW 23417 15,3 + WK + Zub Ceramic	
1.6 i 16V (L67)	85	10/06→08/11	←	12/06→	13.0460-7179.2	607179	ATE 23832 20,2 - WK / + WK	
					13.0470-7179.2	LD7179	ATE 23832 20,2 - WK / + WK Ceramic	
			→	12/06→	13.0460-2868.2	602868	TRW 23417 15,3 + WK + Zub	
					13.0470-2868.2	LD2868	TRW 23417 15,3 + WK + Zub Ceramic	
1.8 (L67)	103	05/08→11/10	←		13.0460-7179.2	607179	ATE 23832 20,2 - WK / + WK	
					13.0470-7179.2	LD7179	ATE 23832 20,2 - WK / + WK Ceramic	
			→		13.0460-2868.2	602868	TRW 23417 15,3 + WK + Zub	
					13.0470-2868.2	LD2868	TRW 23417 15,3 + WK + Zub Ceramic	
<b>Warnkontakt, Bremsbelagverschleiß</b>								
1.6 (L67) ↓	77	09/05→11/10	←	03/06→	1	24.8190-0720.2	620720	L= 287











	kw			 	! #		
<b>VAUXHALL - ASTRA Mk V (H) Convertible (A04) 09/05→08/11</b>							
<b>Warnkontakt, Bremsbelagverschleiß</b>							
1.9 CDTi (L67) 2.0 (L67) 2.0 Turbo (L67)	110 125 147	01/06→11/10 02/06→11/10 01/06→11/10	←	03/06→	1	24.8190-0720.2 620720	L= 287
1.6 i 16V (L67)	85	10/06→08/11	←	12/06→	1	24.8190-0720.2 620720	L= 287
1.8 (L67)	103	05/08→11/10	←		1	24.8190-0720.2 620720	L= 287
<b> Bremsscheibe</b>							
1.6 (L67)	77	09/05→11/10	←	03/06→; Felge Lochzahl: 5		24.0125-0131.1 425131 24.0325-0131.1 525131	Ø 280 24,8 22 V + S Ø 280 24,8 22 V + S
			←	03/06→; Felge Lochzahl: 4		24.0125-0198.1 425198 24.0325-0198.1 525198	Ø 280 25 22 V + S Ø 280 25 22 V + S
			→	03/06→; Felge Lochzahl: 5		24.0110-0250.1 410250	Ø 264 9,8 8 + S
			→	03/06→; Felge Lochzahl: 4		24.0110-0291.1 410291 24.0310-0291.1 510291	Ø 264 10 8 + S Ø 264 10 8 + S
1.6 i 16V (L67)	85	10/06→08/11	←	12/06→; Felge Lochzahl: 5		24.0125-0131.1 425131 24.0325-0131.1 525131	Ø 280 24,8 22 V + S Ø 280 24,8 22 V + S
			←	12/06→; Felge Lochzahl: 4		24.0125-0198.1 425198 24.0325-0198.1 525198	Ø 280 25 22 V + S Ø 280 25 22 V + S
			→	12/06→; Felge Lochzahl: 5		24.0110-0250.1 410250	Ø 264 9,8 8 + S
			→	12/06→; Felge Lochzahl: 4		24.0110-0291.1 410291 24.0310-0291.1 510291	Ø 264 10 8 + S Ø 264 10 8 + S
1.8 (L67)	103	05/08→11/10	←	Felge Lochzahl: 5		24.0125-0131.1 425131 24.0325-0131.1 525131	Ø 280 24,8 22 V + S Ø 280 24,8 22 V + S
			←	Felge Lochzahl: 4		24.0125-0198.1 425198 24.0325-0198.1 525198	Ø 280 25 22 V + S Ø 280 25 22 V + S
			→	Felge Lochzahl: 5		24.0110-0250.1 410250	Ø 264 9,8 8 + S
			→	Felge Lochzahl: 4		24.0110-0291.1 410291 24.0310-0291.1 510291	Ø 264 10 8 + S Ø 264 10 8 + S
1.9 CDTi (L67) 2.0 (L67) 2.0 Turbo (L67)	110 125 147	01/06→11/10 02/06→11/10 01/06→11/10	←	03/06→; Felge Lochzahl: 5		24.0125-0142.1 425142	Ø 308 25 22 V + S
			←	03/06→; Felge Lochzahl: 4		24.0125-0198.1 425198 24.0325-0198.1 525198	Ø 280 25 22 V + S Ø 280 25 22 V + S
			←	03/06→		24.0325-0142.1 525142	Ø 308 25 23 V + S
			→	03/06→; Felge Lochzahl: 5		24.0110-0250.1 410250	Ø 264 9,8 8 + S
			→	03/06→; Felge Lochzahl: 4		24.0110-0291.1 410291 24.0310-0291.1 510291	Ø 264 10 8 + S Ø 264 10 8 + S
<b>VAUXHALL - ASTRA Mk V (H) Kombi (A04) 08/04→10/12</b>							
<b> Bremsbelagsatz, Scheibenbremse</b>							
1.3 CDTi (L35)	66	08/04→03/09	←	08/05→		13.0460-7179.2 607179 13.0470-7179.2 LD7179	ATE 23832 20,2 - WK / + WK ATE 23832 20,2 - WK / + WK Ceramic
			→	08/05→		13.0460-2868.2 602868 13.0470-2868.2 LD2868	TRW 23417 15,3 + WK + Zub TRW 23417 15,3 + WK + Zub Ceramic
1.4 (L35) 1.4 (L35) 1.6 (L35) 1.7 CDTi (L35) 1.7 CDTi (L35) 1.8 (L35) 1.8 (L35) 1.9 CDTi (L35) 2.0 Turbo (L35)	55 66 77 74 59 92 103 88 125	08/04→10/10 08/04→03/09 08/04→03/09 08/04→03/09 08/04→05/09 10/04→03/09 12/05→10/10 08/04→03/09 08/04→10/10	←			13.0460-7179.2 607179 13.0470-7179.2 LD7179	ATE 23832 20,2 - WK / + WK ATE 23832 20,2 - WK / + WK Ceramic
			→			13.0460-2868.2 602868 13.0470-2868.2 LD2868	TRW 23417 15,3 + WK + Zub TRW 23417 15,3 + WK + Zub Ceramic
			←	01/07→		13.0460-7179.2 607179 13.0470-7179.2 LD7179	ATE 23832 20,2 - WK / + WK ATE 23832 20,2 - WK / + WK Ceramic
			→	01/07→		13.0460-2868.2 602868 13.0470-2868.2 LD2868	TRW 23417 15,3 + WK + Zub TRW 23417 15,3 + WK + Zub Ceramic
			←	04/07→ 11/10		13.0460-7179.2 607179 13.0470-7179.2 LD7179	ATE 23832 20,2 - WK / + WK ATE 23832 20,2 - WK / + WK Ceramic
			→	04/07→ 11/10		13.0460-2868.2 602868 13.0470-2868.2 LD2868	TRW 23417 15,3 + WK + Zub TRW 23417 15,3 + WK + Zub Ceramic
			↓				











	kW				! #		
<b>VAUXHALL - ASTRA Mk V (H) Kombi (A04) 08/04→10/12</b>							
<b>Bremsbelagsatz, Scheibenbremse</b>							
1.9 CDTi (L35) 2.0 Turbo (L35)	110 147	08/04→03/09 08/04→10/10	← →	09/04→ 09/04→		13.0460-7179.2 607179 13.0470-7179.2 LD7179	ATE 23832 20,2 - WK / + WK ATE 23832 20,2 - WK / + WK Ceramic
						13.0460-2868.2 602868 13.0470-2868.2 LD2868	TRW 23417 15,3 + WK + Zub TRW 23417 15,3 + WK + Zub Ceramic
<b>Warnkontakt, Bremsbelagverschleiß</b>							
1.3 CDTi (L35)	66	08/04→03/09	←	08/05→	1	24.8190-0720.2 620720	L= 287
1.4 (L35) 1.4 (L35) 1.6 (L35) 1.7 CDTi (L35) 1.7 CDTi (L35) 1.8 (L35) 1.8 (L35) 1.9 CDTi (L35) 2.0 Turbo (L35)	55 66 77 74 59 92 103 88 125	08/04→10/10 08/04→03/09 08/04→03/09 08/04→03/09 08/04→05/09 10/04→03/09 12/05→10/10 08/04→03/09 08/04→10/10	←		1	24.8190-0720.2 620720	L= 287
1.6 (L35) 1.6 (L35)	85 132	08/04→03/09 08/04→03/09	←	01/07→	1	24.8190-0720.2 620720	L= 287
1.7 CDTi (L35)	81	08/04→10/12	←	04/07→ 11/10	1	24.8190-0720.2 620720	L= 287
1.9 CDTi (L35) 2.0 Turbo (L35)	110 147	08/04→03/09 08/04→10/10	←	09/04→	1	24.8190-0720.2 620720	L= 287
<b>Bremsscheibe</b>							
1.3 CDTi (L35)	66	08/04→03/09	←	08/05→; Felge Lochzahl: 5		24.0125-0131.1 425131	Ø 280 24,8 22 V + S
			←	08/05→; Felge Lochzahl: 4		24.0125-0198.1 425198	Ø 280 25 22 V + S
						24.0325-0198.1 525198	Ø 280 25 22 V + S
			→	08/05→; Felge Lochzahl: 5		24.0110-0250.1 410250	Ø 264 9,8 8 + S
						24.0310-0250.1 510250	Ø 264 9,8 8 + S
			→	08/05→; Felge Lochzahl: 4		24.0110-0251.1 410251	Ø 240 9,8 8 + S
						24.0310-0251.1 510251	Ø 240 9,8 8 + S
1.4 (L35) 1.4 (L35) 1.6 (L35) 1.7 CDTi (L35) 1.7 CDTi (L35) 1.8 (L35)	55 66 77 74 59 103	08/04→10/10 08/04→03/09 08/04→03/09 08/04→03/09 08/04→05/09 12/05→10/10	←	Felge Lochzahl: 5		24.0125-0131.1 425131	Ø 280 24,8 22 V + S
			←	Felge Lochzahl: 4		24.0125-0198.1 425198	Ø 280 25 22 V + S
						24.0325-0198.1 525198	Ø 280 25 22 V + S
			→	Felge Lochzahl: 5		24.0110-0250.1 410250	Ø 264 9,8 8 + S
						24.0310-0250.1 510250	Ø 264 9,8 8 + S
			→	Felge Lochzahl: 4		24.0110-0251.1 410251	Ø 240 9,8 8 + S
						24.0310-0251.1 510251	Ø 240 9,8 8 + S
1.6 (L35)	85	08/04→03/09	←	01/07→; Felge Lochzahl: 5		24.0125-0131.1 425131	Ø 280 24,8 22 V + S
			←	01/07→; Felge Lochzahl: 4		24.0125-0198.1 425198	Ø 280 25 22 V + S
						24.0325-0198.1 525198	Ø 280 25 22 V + S
			→	01/07→; Felge Lochzahl: 5		24.0110-0250.1 410250	Ø 264 9,8 8 + S
						24.0310-0250.1 510250	Ø 264 9,8 8 + S
			→	01/07→; Felge Lochzahl: 4		24.0110-0251.1 410251	Ø 240 9,8 8 + S
						24.0310-0251.1 510251	Ø 240 9,8 8 + S
1.6 (L35)	132	08/04→03/09	←	01/07→; Felge Lochzahl: 5		24.0125-0142.1 425142	Ø 308 25 22 V + S
			←	01/07→; Felge Lochzahl: 4		24.0125-0198.1 425198	Ø 280 25 22 V + S
						24.0325-0198.1 525198	Ø 280 25 22 V + S
			→	01/07→; Felge Lochzahl: 5		24.0110-0250.1 410250	Ø 264 9,8 8 + S
						24.0310-0250.1 510250	Ø 264 9,8 8 + S
			→	01/07→; Felge Lochzahl: 4		24.0110-0251.1 410251	Ø 240 9,8 8 + S
						24.0310-0251.1 510251	Ø 240 9,8 8 + S
1.7 CDTi (L35)	81	08/04→10/12	←	04/07→ 11/10; Felge Lochzahl: 5		24.0125-0131.1 425131	Ø 280 24,8 22 V + S
			←	04/07→ 11/10; Felge Lochzahl: 4		24.0125-0198.1 425198	Ø 280 25 22 V + S
						24.0325-0198.1 525198	Ø 280 25 22 V + S
			→	04/07→ 11/10; Felge Lochzahl: 5		24.0110-0250.1 410250	Ø 264 9,8 8 + S
						24.0310-0250.1 510250	Ø 264 9,8 8 + S
			→	04/07→ 11/10; Felge Lochzahl: 4		24.0110-0251.1 410251	Ø 240 9,8 8 + S
						24.0310-0251.1 510251	Ø 240 9,8 8 + S
1.8 (L35)	92	10/04→03/09	←	Felge Lochzahl: 5		24.0125-0131.1 425131	Ø 280 24,8 22 V + S
						24.0325-0131.1 525131	Ø 280 24,8 22 V + S
			←	Felge Lochzahl: 4		24.0125-0198.1 425198	Ø 280 25 22 V + S



























	kW				! #					
<b>VAUXHALL - ASTRA Mk V (H) Kombi (A04) 08/04→10/12</b>										
<b>Bremsscheibe</b>										
1.8 (L35)	92	10/04→03/09	←	Felge Lochzahl: 4	24.0325-0198.1	525198	Ø 280 25 22 V + S			
			→	Felge Lochzahl: 5	24.0110-0250.1	410250	Ø 264 9,8 8 + S			
					24.0310-0250.1	510250	Ø 264 9,8 8 + S			
			→	Felge Lochzahl: 4	24.0110-0251.1	410251	Ø 240 9,8 8 + S			
			→		24.0310-0251.1	510251	Ø 240 9,8 8 + S			
1.9 CDTi (L35) 2.0 Turbo (L35)	88 125	08/04→03/09 08/04→10/10	←	Felge Lochzahl: 5	24.0125-0142.1	425142	Ø 308 25 22 V + S			
					24.0325-0142.1	525142	Ø 308 25 23 V + S			
			←	Felge Lochzahl: 4	24.0125-0198.1	425198	Ø 280 25 22 V + S			
					24.0325-0198.1	525198	Ø 280 25 22 V + S			
			→	Felge Lochzahl: 5	24.0110-0250.1	410250	Ø 264 9,8 8 + S			
					24.0310-0250.1	510250	Ø 264 9,8 8 + S			
			→	Felge Lochzahl: 4	24.0110-0251.1	410251	Ø 240 9,8 8 + S			
					24.0310-0251.1	510251	Ø 240 9,8 8 + S			
1.9 CDTi (L35) 2.0 Turbo (L35)	110 147	08/04→03/09 08/04→10/10	←	09/04→; Felge Lochzahl: 5	24.0125-0142.1	425142	Ø 308 25 22 V + S			
					24.0325-0142.1	525142	Ø 308 25 23 V + S			
			←	09/04→; Felge Lochzahl: 4	24.0125-0198.1	425198	Ø 280 25 22 V + S			
					24.0325-0198.1	525198	Ø 280 25 22 V + S			
			→	09/04→; Felge Lochzahl: 5	24.0110-0250.1	410250	Ø 264 9,8 8 + S			
					24.0310-0250.1	510250	Ø 264 9,8 8 + S			
			→	09/04→; Felge Lochzahl: 4	24.0110-0251.1	410251	Ø 240 9,8 8 + S			
					24.0310-0251.1	510251	Ø 240 9,8 8 + S			
<b>VAUXHALL - ASTRA Mk VI (J) (P10) 12/09→</b>										
<b>Bremsbelagsatz, Scheibenbremse</b>										
1.3 CDTi 1.4 1.4 1.4 Turbo 1.4 Turbo 1.6 1.6 Turbo 1.7 CDTi 1.7 CDTi 1.7 CDTi 2.0 BiTurbo CDTi 2.0 CDTi 2.0 CDTi	70 64 74 88 103 85 132 81 92 96 143 118 121	12/09→ 12/09→ 12/09→12/16 08/11→ 12/09→ 12/09→ 12/09→ 12/09→ 12/09→ 06/11→ 12/12→ 12/09→ 08/11→	←	für Bremsscheibendurchmesser [mm]: 321	13.0460-5612.2	605612	MAN 24412 19,0 + WK + Zub			
					13.0470-5612.2	LD5612	MAN 24412 19,0 + WK + Zub Ceramic			
			←	für Bremsscheibendurchmesser [mm]: 276	13.0460-7262.2	607262	25031 19,1 + WK + Zub			
					13.0470-7262.2	LD7262	25031 19,1 + WK + Zub Ceramic			
			←	für Bremsscheibendurchmesser [mm]: 300	13.0460-7263.2	607263	24034 19,1 + WK + Zub			
					13.0470-7263.2	LD7263	24034 19,1 + WK + Zub Ceramic			
			→		13.0460-7264.2	607264	ATE 25096 17,0 + WK + Zub			
					13.0470-7264.2	LD7264	ATE 25096 17,0 + WK + Zub Ceramic			
			1.6 CDTi	81	11/13→	←	02/14→; für Bremsscheibendurchmesser [mm]: 321	13.0460-5612.2	605612	MAN 24412 19,0 + WK + Zub
								13.0470-5612.2	LD5612	MAN 24412 19,0 + WK + Zub Ceramic
						←	02/14→; für Bremsscheibendurchmesser [mm]: 276	13.0460-7262.2	607262	25031 19,1 + WK + Zub
								13.0470-7262.2	LD7262	25031 19,1 + WK + Zub Ceramic
			←	02/14→; für Bremsscheibendurchmesser [mm]: 300	13.0460-7263.2	607263	24034 19,1 + WK + Zub			
					13.0470-7263.2	LD7263	24034 19,1 + WK + Zub Ceramic			
			→	02/14→	13.0460-7264.2	607264	ATE 25096 17,0 + WK + Zub			
					13.0470-7264.2	LD7264	ATE 25096 17,0 + WK + Zub Ceramic			
1.6 CDTi	100	11/13→	←	01/14→; für Bremsscheibendurchmesser [mm]: 321	13.0460-5612.2	605612	MAN 24412 19,0 + WK + Zub			
					13.0470-5612.2	LD5612	MAN 24412 19,0 + WK + Zub Ceramic			
			←	01/14→; für Bremsscheibendurchmesser [mm]: 276	13.0460-7262.2	607262	25031 19,1 + WK + Zub			
					13.0470-7262.2	LD7262	25031 19,1 + WK + Zub Ceramic			
			←	01/14→; für Bremsscheibendurchmesser [mm]: 300	13.0460-7263.2	607263	24034 19,1 + WK + Zub			
					13.0470-7263.2	LD7263	24034 19,1 + WK + Zub Ceramic			
			→	01/14→	13.0460-7264.2	607264	ATE 25096 17,0 + WK + Zub			
					13.0470-7264.2	LD7264	ATE 25096 17,0 + WK + Zub Ceramic			
<b>Bremsscheibe</b>										
1.3 CDTi 1.4 1.4 1.4 Turbo 1.4 Turbo 1.6 1.6 Turbo ↓	70 64 74 88 103 85 132	12/09→ 12/09→ 12/09→12/16 08/11→ 12/09→ 12/09→ 12/09→	←		24.0126-0165.1	426165	Ø 276 26 23 V + S			
					24.0126-0166.1	426166	Ø 300 26 23 V + S			
					24.0130-0224.1	430224	Ø 321 30 27 V + S			
					24.0326-0165.1	526165	Ø 276 26 23 V + S			
					24.0326-0166.1	526166	Ø 300 26 23 V + S			











	kw			 	! #		
<b>VAUXHALL - ASTRA Mk VI (J) (P10) 12/09→</b>							
 <b>Bremsscheibe</b>							
1.7 CDTi	81	12/09→	→			24.0112-0188.1 412188	Ø 268 12 10 + S
1.7 CDTi	92	12/09→				24.0112-0189.1 412189	Ø 292 12 10 + S
1.7 CDTi	96	06/11→				24.0312-0188.1 512188	Ø 268 12 10 + S
2.0 BiTurbo CDTI	143	12/12→				24.0312-0189.1 512189	Ø 292 12 10 + S
2.0 CDTi	118	12/09→					
2.0 CDTi	121	08/11→					
1.6 CDTi	81	11/13→	←	02/14→		24.0126-0165.1 426165	Ø 276 26 23 V + S
						24.0126-0166.1 426166	Ø 300 26 23 V + S
						24.0130-0224.1 430224	Ø 321 30 27 V + S
						24.0326-0165.1 526165	Ø 276 26 23 V + S
						24.0326-0166.1 526166	Ø 300 26 23 V + S
			→	02/14→		24.0112-0188.1 412188	Ø 268 12 10 + S
						24.0112-0189.1 412189	Ø 292 12 10 + S
						24.0312-0188.1 512188	Ø 268 12 10 + S
						24.0312-0189.1 512189	Ø 292 12 10 + S
1.6 CDTi	100	11/13→	←	01/14→		24.0126-0165.1 426165	Ø 276 26 23 V + S
						24.0126-0166.1 426166	Ø 300 26 23 V + S
						24.0130-0224.1 430224	Ø 321 30 27 V + S
						24.0326-0165.1 526165	Ø 276 26 23 V + S
						24.0326-0166.1 526166	Ø 300 26 23 V + S
			→	01/14→		24.0112-0188.1 412188	Ø 268 12 10 + S
						24.0112-0189.1 412189	Ø 292 12 10 + S
						24.0312-0188.1 512188	Ø 268 12 10 + S
						24.0312-0189.1 512189	Ø 292 12 10 + S
<b>VAUXHALL - ASTRA Mk VI (J) CC (P10) 10/11→</b>							
 <b>Bremsbelagsatz, Scheibenbremse</b>							
1.4	74	10/11→	←	für Bremsscheibendurchmesser [mm]:		13.0460-5612.2 605612	MAN 24412 19,0 + WK + Zub
1.4	88	10/11→		321		13.0470-5612.2 LD5612	MAN 24412 19,0 + WK + Zub Ceramic
1.4	103	10/11→					
1.6	132	10/11→					
1.6 CDTi	81	07/14→	←	für Bremsscheibendurchmesser [mm]:		13.0460-7262.2 607262	25031 19,1 + WK + Zub
1.6 CDTi	100	07/14→		276		13.0470-7262.2 LD7262	25031 19,1 + WK + Zub Ceramic
1.6 SIDI	147	09/13→					
1.7 CDTi	81	10/11→	←	für Bremsscheibendurchmesser [mm]:		13.0460-7263.2 607263	24034 19,1 + WK + Zub
1.7 CDTi	96	10/11→		300		13.0470-7263.2 LD7263	24034 19,1 + WK + Zub Ceramic
2.0 BiTurbo CDTI	143	12/12→					
2.0 CDTi	121	10/11→	→			13.0460-7264.2 607264	ATE 25096 17,0 + WK + Zub
						13.0470-7264.2 LD7264	ATE 25096 17,0 + WK + Zub Ceramic
2.0 VXR	206	04/12→	←	06/12→		13.0460-4855.2 604855	BRE 23325 16,4 + WK
			→	F0000001→		13.0460-7309.2 607309	ATE 25096 16,7 + WK + Zub
						13.0470-7309.2 LD7309	ATE 25096 16,7 + WK + Zub Ceramic
 <b>Bremsscheibe</b>							
1.4	74	10/11→	←			24.0126-0165.1 426165	Ø 276 26 23 V + S
1.4	88	10/11→				24.0126-0166.1 426166	Ø 300 26 23 V + S
1.4	103	10/11→				24.0130-0224.1 430224	Ø 321 30 27 V + S
1.6	132	10/11→				24.0326-0165.1 526165	Ø 276 26 23 V + S
1.6 CDTi	81	07/14→				24.0326-0166.1 526166	Ø 300 26 23 V + S
1.6 CDTi	100	07/14→					
1.6 SIDI	147	09/13→					
1.7 CDTi	81	10/11→	→			24.0112-0188.1 412188	Ø 268 12 10 + S
1.7 CDTi	96	10/11→				24.0112-0189.1 412189	Ø 292 12 10 + S
2.0 BiTurbo CDTI	143	12/12→				24.0312-0188.1 512188	Ø 268 12 10 + S
2.0 CDTi	121	10/11→				24.0312-0189.1 512189	Ø 292 12 10 + S
<b>VAUXHALL - ASTRA Mk VI (J) Kombi (P10) 10/10→</b>							
 <b>Bremsbelagsatz, Scheibenbremse</b>							
1.3 CDTi	70	10/10→	←	11/10→;		13.0460-5612.2 605612	MAN 24412 19,0 + WK + Zub
1.4	64	10/10→		für Bremsscheibendurchmesser [mm]:		13.0470-5612.2 LD5612	MAN 24412 19,0 + WK + Zub Ceramic
1.4	74	10/10→12/16		321			
1.4 Turbo	88	10/10→					
1.4 Turbo	103	10/10→	←	11/10→;		13.0460-7262.2 607262	25031 19,1 + WK + Zub
1.6	85	10/10→		für Bremsscheibendurchmesser [mm]:		13.0470-7262.2 LD7262	25031 19,1 + WK + Zub Ceramic
1.6 Turbo	132	10/10→		276			
1.7 CDTi	81	10/10→	←	11/10→;		13.0460-7263.2 607263	24034 19,1 + WK + Zub
1.7 CDTi	92	10/10→		für Bremsscheibendurchmesser [mm]:		13.0470-7263.2 LD7263	24034 19,1 + WK + Zub Ceramic
2.0 CDTi	118	10/10→	→	300		13.0460-7264.2 607264	ATE 25096 17,0 + WK + Zub
↓				11/10→			

	kw			 	! #		
<b>VAUXHALL - ASTRA Mk VI (J) Kombi (P10) 10/10→</b>							
 <b>Bremsbelagsatz, Scheibenbremse</b>							
1.3 CDTi 1.4 1.4 Turbo 1.4 Turbo 1.6 1.6 Turbo 1.7 CDTi 1.7 CDTi 2.0 CDTi	70 64 74 88 103 85 132 81 92 118	10/10→ 10/10→ 10/10→12/16 10/10→ 10/10→ 10/10→ 10/10→ 10/10→ 10/10→ 10/10→	➡	11/10→		<b>13.0470-7264.2</b> <b>LD7264</b>	ATE 25096 17,0 + WK + Zub Ceramic
1.6 CDTi	81	01/14→	⬅	02/14→; für Bremsscheibendurchmesser [mm]: 321	<b>13.0460-5612.2</b> <b>605612</b> <b>13.0470-5612.2</b> <b>LD5612</b>	MAN 24412 19,0 + WK + Zub MAN 24412 19,0 + WK + Zub Ceramic	
			⬅	02/14→; für Bremsscheibendurchmesser [mm]: 276	<b>13.0460-7262.2</b> <b>607262</b> <b>13.0470-7262.2</b> <b>LD7262</b>	25031 19,1 + WK + Zub 25031 19,1 + WK + Zub Ceramic	
			⬅	02/14→; für Bremsscheibendurchmesser [mm]: 300	<b>13.0460-7263.2</b> <b>607263</b> <b>13.0470-7263.2</b> <b>LD7263</b>	24034 19,1 + WK + Zub 24034 19,1 + WK + Zub Ceramic	
			➡	02/14→	<b>13.0460-7264.2</b> <b>607264</b> <b>13.0470-7264.2</b> <b>LD7264</b>	ATE 25096 17,0 + WK + Zub ATE 25096 17,0 + WK + Zub Ceramic	
1.6 CDTi 1.7 CDTi 2.0 BiTurbo CDTi 2.0 CDTi	100 96 143 121	01/14→ 06/11→05/14 12/12→ 08/11→	⬅	für Bremsscheibendurchmesser [mm]: 321	<b>13.0460-5612.2</b> <b>605612</b> <b>13.0470-5612.2</b> <b>LD5612</b>	MAN 24412 19,0 + WK + Zub MAN 24412 19,0 + WK + Zub Ceramic	
			⬅	für Bremsscheibendurchmesser [mm]: 276	<b>13.0460-7262.2</b> <b>607262</b> <b>13.0470-7262.2</b> <b>LD7262</b>	25031 19,1 + WK + Zub 25031 19,1 + WK + Zub Ceramic	
			⬅	für Bremsscheibendurchmesser [mm]: 300	<b>13.0460-7263.2</b> <b>607263</b> <b>13.0470-7263.2</b> <b>LD7263</b>	24034 19,1 + WK + Zub 24034 19,1 + WK + Zub Ceramic	
			➡		<b>13.0460-7264.2</b> <b>607264</b> <b>13.0470-7264.2</b> <b>LD7264</b>	ATE 25096 17,0 + WK + Zub ATE 25096 17,0 + WK + Zub Ceramic	
 <b>Bremsscheibe</b>							
1.3 CDTi 1.4 1.4 Turbo 1.4 Turbo 1.6 1.6 Turbo 1.7 CDTi 1.7 CDTi 2.0 CDTi	70 64 74 88 103 85 132 81 92 118	10/10→ 10/10→ 10/10→12/16 10/10→ 10/10→ 10/10→ 10/10→ 10/10→ 10/10→ 10/10→	⬅	11/10→	<b>24.0126-0165.1</b> <b>426165</b> <b>24.0126-0166.1</b> <b>426166</b> <b>24.0130-0224.1</b> <b>430224</b> <b>24.0326-0165.1</b> <b>526165</b> <b>24.0326-0166.1</b> <b>526166</b>	Ø 276 26 23 V + S Ø 300 26 23 V + S Ø 321 30 27 V + S Ø 276 26 23 V + S Ø 300 26 23 V + S	
1.6 CDTi	81	01/14→	⬅	02/14→	<b>24.0126-0165.1</b> <b>426165</b> <b>24.0126-0166.1</b> <b>426166</b> <b>24.0130-0224.1</b> <b>430224</b> <b>24.0326-0165.1</b> <b>526165</b> <b>24.0326-0166.1</b> <b>526166</b>	Ø 276 26 23 V + S Ø 300 26 23 V + S Ø 321 30 27 V + S Ø 276 26 23 V + S Ø 300 26 23 V + S	
			➡	02/14→	<b>24.0112-0188.1</b> <b>412188</b> <b>24.0112-0189.1</b> <b>412189</b> <b>24.0312-0188.1</b> <b>512188</b> <b>24.0312-0189.1</b> <b>512189</b>	Ø 268 12 10 + S Ø 292 12 10 + S Ø 268 12 10 + S Ø 292 12 10 + S	
			⬅		<b>24.0126-0165.1</b> <b>426165</b> <b>24.0126-0166.1</b> <b>426166</b> <b>24.0130-0224.1</b> <b>430224</b> <b>24.0326-0165.1</b> <b>526165</b> <b>24.0326-0166.1</b> <b>526166</b>	Ø 276 26 23 V + S Ø 300 26 23 V + S Ø 321 30 27 V + S Ø 276 26 23 V + S Ø 300 26 23 V + S	
			➡		<b>24.0112-0188.1</b> <b>412188</b> <b>24.0112-0189.1</b> <b>412189</b> <b>24.0312-0188.1</b> <b>512188</b> <b>24.0312-0189.1</b> <b>512189</b>	Ø 268 12 10 + S Ø 292 12 10 + S Ø 268 12 10 + S Ø 292 12 10 + S	
1.6 CDTi 1.7 CDTi 2.0 BiTurbo CDTi 2.0 CDTi	100 96 143 121	01/14→ 06/11→05/14 12/12→ 08/11→	⬅		<b>24.0126-0165.1</b> <b>426165</b> <b>24.0126-0166.1</b> <b>426166</b> <b>24.0130-0224.1</b> <b>430224</b> <b>24.0326-0165.1</b> <b>526165</b> <b>24.0326-0166.1</b> <b>526166</b>	Ø 276 26 23 V + S Ø 300 26 23 V + S Ø 321 30 27 V + S Ø 276 26 23 V + S Ø 300 26 23 V + S	
			⬅		<b>24.0126-0165.1</b> <b>426165</b> <b>24.0126-0166.1</b> <b>426166</b> <b>24.0130-0224.1</b> <b>430224</b> <b>24.0326-0165.1</b> <b>526165</b> <b>24.0326-0166.1</b> <b>526166</b>	Ø 276 26 23 V + S Ø 300 26 23 V + S Ø 321 30 27 V + S Ø 276 26 23 V + S Ø 300 26 23 V + S	
			➡		<b>24.0112-0188.1</b> <b>412188</b> <b>24.0112-0189.1</b> <b>412189</b> <b>24.0312-0188.1</b> <b>512188</b> <b>24.0312-0189.1</b> <b>512189</b>	Ø 268 12 10 + S Ø 292 12 10 + S Ø 268 12 10 + S Ø 292 12 10 + S	
			⬅		<b>24.0126-0165.1</b> <b>426165</b> <b>24.0126-0166.1</b> <b>426166</b> <b>24.0130-0224.1</b> <b>430224</b> <b>24.0326-0165.1</b> <b>526165</b> <b>24.0326-0166.1</b> <b>526166</b>	Ø 276 26 23 V + S Ø 300 26 23 V + S Ø 321 30 27 V + S Ø 276 26 23 V + S Ø 300 26 23 V + S	
			➡		<b>24.0112-0188.1</b> <b>412188</b> <b>24.0112-0189.1</b> <b>412189</b> <b>24.0312-0188.1</b> <b>512188</b> <b>24.0312-0189.1</b> <b>512189</b>	Ø 268 12 10 + S Ø 292 12 10 + S Ø 268 12 10 + S Ø 292 12 10 + S	
<b>VAUXHALL - ASTRA Mk VI (J) Stufenheck (P10) 06/12→</b>							
 <b>Bremsbelagsatz, Scheibenbremse</b>							
1.3 CDTi 1.4 1.4 Turbo 1.6 ↓	70 74 103 85	06/12→ 06/12→ 06/12→ 06/12→	⬅	für Bremsscheibendurchmesser [mm]: 321	<b>13.0460-5612.2</b> <b>605612</b> <b>13.0470-5612.2</b> <b>LD5612</b>	MAN 24412 19,0 + WK + Zub MAN 24412 19,0 + WK + Zub Ceramic	







	kw			 	! #			
<b>VAUXHALL - ASTRA Mk VI (J) Stufenheck (P10) 06/12→</b>								
 <b>Bremsbelagsatz, Scheibenbremse</b>								
1.6 Turbo	132	06/12→	←	für Bremsscheibendurchmesser [mm]:	13.0460-7262.2	607262	25031 19,1 + WK + Zub	
1.7 CDTI	81	06/12→		276			13.0470-7262.2	LD7262
1.7 CDTI	96	06/12→		←	für Bremsscheibendurchmesser [mm]:	13.0460-7263.2	607263	24034 19,1 + WK + Zub
			300		13.0470-7263.2			LD7263
			→		13.0460-7264.2	607264	ATE 25096 17,0 + WK + Zub	
					13.0470-7264.2	LD7264	ATE 25096 17,0 + WK + Zub Ceramic	
 <b>Bremsscheibe</b>								
1.3 CDTI	70	06/12→	←		24.0126-0165.1	426165	Ø 276 26 23 V + S	
1.4	74	06/12→				24.0126-0166.1	426166	Ø 300 26 23 V + S
1.4 Turbo	103	06/12→				24.0130-0224.1	430224	Ø 321 30 27 V + S
1.6	85	06/12→				24.0326-0165.1	526165	Ø 276 26 23 V + S
1.6 Turbo	132	06/12→				24.0326-0166.1	526166	Ø 300 26 23 V + S
1.7 CDTI	81	06/12→				24.0312-0188.1	512188	Ø 268 12 10 + S
1.7 CDTI	96	06/12→	→		24.0112-0188.1	412188	Ø 292 12 10 + S	
						24.0112-0189.1	412189	Ø 292 12 10 + S
						24.0312-0188.1	512188	Ø 268 12 10 + S
						24.0312-0189.1	512189	Ø 292 12 10 + S
<b>VAUXHALL - ASTRA Mk VII (K) (B16) 07/15→</b>								
 <b>Bremsbelagsatz, Scheibenbremse</b>								
1.0	77	07/15→	←	für Bremsscheibendurchmesser [mm]:	13.0460-7324.2	607324	ATE 22345 19,7 + WK	
1.4	74	07/15→		300			13.0470-7324.2	LD7324
1.4 Turbo	92	07/15→	←	für Bremsscheibendurchmesser [mm]:	13.0460-7325.2	607325	ATE 22342 19,8 + WK	
1.4 Turbo	110	07/15→		276			13.0470-7325.2	LD7325
1.6 CDTi	70	07/15→	→		13.0460-2615.2	602615	TRW 22129 17,4 + WK + Zub	
1.6 CDTi	81	07/15→			13.0470-2615.2	LD2615	TRW + WK + Zub Ceramic	
1.6 CDTi	100	07/15→						
1.6 CDTi	118	11/15→						
1.6 Turbo	147	11/15→						
 <b>Bremsscheibe</b>								
1.0	77	07/15→	←		24.0126-0187.1	426187	Ø 276 26 23 V + S	
1.4	74	07/15→				24.0126-0188.1	426188	Ø 300 26 23 V + S
1.4 Turbo	92	07/15→	→		24.0110-0404.1	410404	Ø 264 10 8 + S	
1.4 Turbo	110	07/15→						
1.6 CDTi	70	07/15→						
1.6 CDTi	81	07/15→						
1.6 CDTi	100	07/15→						
1.6 CDTi	118	11/15→						
1.6 Turbo	147	11/15→						
<b>VAUXHALL - ASTRA Mk VII (K) Kombi (B16) 11/15→</b>								
 <b>Bremsbelagsatz, Scheibenbremse</b>								
1.0	77	11/15→	←	für Bremsscheibendurchmesser [mm]:	13.0460-7324.2	607324	ATE 22345 19,7 + WK	
1.4	74	11/15→		300			13.0470-7324.2	LD7324
1.4 Turbo	92	11/15→	←	für Bremsscheibendurchmesser [mm]:	13.0460-7325.2	607325	ATE 22342 19,8 + WK	
1.4 Turbo	110	11/15→		276			13.0470-7325.2	LD7325
1.6 CDTi	70	11/15→	→		13.0460-2615.2	602615	TRW 22129 17,4 + WK + Zub	
1.6 CDTi	81	11/15→			13.0470-2615.2	LD2615	TRW + WK + Zub Ceramic	
1.6 CDTi	100	11/15→						
1.6 CDTi	118	11/15→						
1.6 Turbo	147	11/15→						
 <b>Bremsscheibe</b>								
1.0	77	11/15→	←		24.0126-0187.1	426187	Ø 276 26 23 V + S	
1.4	74	11/15→				24.0126-0188.1	426188	Ø 300 26 23 V + S
1.4 Turbo	92	11/15→	→		24.0110-0404.1	410404	Ø 264 10 8 + S	
1.4 Turbo	110	11/15→						
1.6 CDTi	70	11/15→						
1.6 CDTi	81	11/15→						
1.6 CDTi	100	11/15→						
1.6 CDTi	118	11/15→						
1.6 Turbo	147	11/15→						
<b>VAUXHALL - ASTRVAN Mk III (F) (T92) 01/91→08/98</b>								
 <b>Bremsbelagsatz, Scheibenbremse</b>								
1.6 i	52	02/94→10/96	←		13.0460-7052.2	607052	ATE 21190 17,5 + WE / - WK	
				nicht für Motorcode: C16NZ / X16SZR			13.0460-7052.2	607052
1.6 i	55	01/91→08/98	←	10/91→	13.0460-7052.2	607052	ATE 21190 17,5 + WE / - WK	
↓								













	kw				! #		
<b>VAUXHALL - ASTRAVAN Mk III (F) (T92) 01/91→08/98</b>							
<b> Bremsbelagsatz, Scheibenbremse</b>							
1.6 i	55	01/91→08/98	←	10/91→; nicht für Motorcode: C16NZ / X16SZR		13.0460-7052.2 607052	ATE 21190 17,5 + WE / - WK
1.7 TD	50	01/94→08/98	←	nicht für Fahrzeuge mit verstärkter Brems		13.0460-7051.2 607051	ATE 20547 16,5 + WE / - WK
			←	für Fahrzeuge mit verstärkter Bremse		13.0460-7052.2 607052	ATE 21190 17,5 + WE / - WK
<b>Warnkontakt, Bremsbelagverschleiß</b>							
1.6 i	52	02/94→10/96	←	nicht für Motorcode: C16NZ / X16SZR	2	24.8190-0705.2 620705	L= 670
			←		2	24.8190-0705.2 620705	L= 670
1.6 i	55	01/91→08/98	←	10/91→; nicht für Motorcode: C16NZ / X16SZR	2	24.8190-0705.2 620705	L= 670
			←	10/91→	2	24.8190-0705.2 620705	L= 670
1.7 TD	50	01/94→08/98	←	für Fahrzeuge mit verstärkter Bremse	2	24.8190-0705.2 620705	L= 670
			←	nicht für Fahrzeuge mit verstärkter Bremse	2	24.8190-0707.2 620707	L= 685
<b> Bremsscheibe</b>							
1.6 i	52	02/94→10/96	←			24.0120-0115.1 420115	∅ 236 20 17 V + S
						24.0124-0115.1 424115	∅ 256 24 21 V + S
						24.0320-0115.1 520115	∅ 236 20 17 V + S
						24.0324-0115.1 524115	∅ 256 24 21 V + S
1.6 i	55	01/91→08/98	←	10/91→		24.0120-0115.1 420115	∅ 236 20 17 V + S
						24.0124-0115.1 424115	∅ 256 24 21 V + S
						24.0320-0115.1 520115	∅ 236 20 17 V + S
						24.0324-0115.1 524115	∅ 256 24 21 V + S
1.7 TD	50	01/94→08/98	←	nicht für Fahrzeuge mit verstärkter Bremse		24.0120-0115.1 420115	∅ 236 20 17 V + S
			←	für Fahrzeuge mit verstärkter Bremse		24.0124-0115.1 424115	∅ 256 24 21 V + S
						24.0320-0115.1 520115	∅ 236 20 17 V + S
						24.0324-0115.1 524115	∅ 256 24 21 V + S
<b>VAUXHALL - ASTRAVAN Mk IV (G) (T98) 08/98→08/06</b>							
<b> Bremsbelagsatz, Scheibenbremse</b>							
1.6 i	55	08/98→09/00	←			13.0460-7115.2 607115	ATE 23063 17,5 ohne integrierten Verschleiß- sensor / + WK
1.6 i	62	09/00→08/06	←				
1.7 CDTI	59	04/04→08/06	←			13.0470-7115.2 LD7115	ATE 23063 17,5 - WK / + WK Ceramic
1.7 DTI 16V	55	04/01→08/06	←				
1.7 TD	50	08/98→08/06	←				
			→			13.0460-2868.2 602868	TRW 23417 15,3 + WK + Zub
			→			13.0460-3976.2 603976	BOS 23258 16,5 + WK + Zub
			→			13.0470-2868.2 LD2868	TRW 23417 15,3 + WK + Zub Ceramic
2.0 DI	60	08/98→08/06	←			13.0460-7115.2 607115	ATE 23063 17,5 ohne integrierten Verschleiß- sensor / + WK
						13.0470-7115.2 LD7115	ATE 23063 17,5 - WK / + WK Ceramic
			←	+ ABS		13.0460-7116.2 607116	ATE 23057 20,2 - WK / + WK
			←			13.0470-7116.2 LD7116	ATE 23057 20,2 - WK / + WK Ceramic
			→			13.0460-2868.2 602868	TRW 23417 15,3 + WK + Zub
			→			13.0460-3976.2 603976	BOS 23258 16,5 + WK + Zub
			→			13.0470-2868.2 LD2868	TRW 23417 15,3 + WK + Zub Ceramic
2.0 DTI	74	04/04→08/06	←			13.0460-7116.2 607116	ATE 23057 20,2 - WK / + WK
						13.0470-7116.2 LD7116	ATE 23057 20,2 - WK / + WK Ceramic
			→			13.0460-2868.2 602868	TRW 23417 15,3 + WK + Zub
			→			13.0460-3976.2 603976	BOS 23258 16,5 + WK + Zub
			→			13.0470-2868.2 LD2868	TRW 23417 15,3 + WK + Zub Ceramic
<b>Warnkontakt, Bremsbelagverschleiß</b>							
1.6 i	55	08/98→09/00	←	42187759→	2	24.8190-0018.2 620018	L= 755
1.6 i	62	09/00→08/06	←				
1.7 CDTI	59	04/04→08/06	←	→ 42187758	2	24.8190-0718.2 620718	L= 720
1.7 DTI 16V	55	04/01→08/06	←				
1.7 TD	50	08/98→08/06	←				
↓							

















	kW					! #		
<b>VAUXHALL - ASTRAVAN Mk IV (G) (T98) 08/98→08/06</b>								
<b>Warnkontakt, Bremsbelagverschleiß</b>								
2.0 DTI	74	04/04→08/06	←	42187759→	2	24.8190-0018.2	620018	L= 755
			←	→ 42187758	2	24.8190-0718.2	620718	L= 720
2.0 DI	60	08/98→08/06	←	+ ABS; 42187759→	2	24.8190-0018.2	620018	L= 755
			←	42187759→	2	24.8190-0018.2	620018	L= 755
			←	→ 42187758	2	24.8190-0718.2	620718	L= 720
			←	+ ABS; → 42187758	2	24.8190-0718.2	620718	L= 720
<b> Bremsscheibe</b>								
1.6 i	55	08/98→09/00	←	Felge Lochzahl: 4		24.0124-0152.1	424152	Ø 256 23,8 21 V + S
1.6 i	62	09/00→08/06	←	Felge Lochzahl: 5		24.0324-0152.1	524152	Ø 256 23,8 21 V + S
			←	Felge Lochzahl: 5		24.0125-0131.1	425131	Ø 280 24,8 22 V + S
			←	Felge Lochzahl: 5		24.0325-0131.1	525131	Ø 280 24,8 22 V + S
			→	Felge Lochzahl: 4		24.0110-0251.1	410251	Ø 240 9,8 8 + S
			→	Felge Lochzahl: 4		24.0310-0251.1	510251	Ø 240 9,8 8 + S
1.7 CDTi	59	04/04→08/06	←	Felge Lochzahl: 4		24.0124-0152.1	424152	Ø 256 23,8 21 V + S
1.7 DTi 16V	55	04/01→08/06	←	Felge Lochzahl: 4		24.0324-0152.1	524152	Ø 256 23,8 21 V + S
1.7 TD	50	08/98→08/06	→	Felge Lochzahl: 4		24.0110-0251.1	410251	Ø 240 9,8 8 + S
			→	Felge Lochzahl: 4		24.0310-0251.1	510251	Ø 240 9,8 8 + S
2.0 DI	60	08/98→08/06	←	- ABS; Felge Lochzahl: 4		24.0124-0152.1	424152	Ø 256 23,8 21 V + S
			←	+ ABS; Felge Lochzahl: 5		24.0125-0131.1	425131	Ø 280 24,8 22 V + S
			←	+ ABS; Felge Lochzahl: 5		24.0325-0131.1	525131	Ø 280 24,8 22 V + S
			→	+ ABS; Felge Lochzahl: 5		24.0110-0250.1	410250	Ø 264 9,8 8 + S
			→	+ ABS; Felge Lochzahl: 5		24.0310-0250.1	510250	Ø 264 9,8 8 + S
			→	- ABS; Felge Lochzahl: 4		24.0110-0251.1	410251	Ø 240 9,8 8 + S
			→	- ABS; Felge Lochzahl: 4		24.0310-0251.1	510251	Ø 240 9,8 8 + S
2.0 DTI	74	04/04→08/06	←	Felge Lochzahl: 5		24.0125-0131.1	425131	Ø 280 24,8 22 V + S
			←	Felge Lochzahl: 5		24.0325-0131.1	525131	Ø 280 24,8 22 V + S
			→	Felge Lochzahl: 5		24.0110-0250.1	410250	Ø 264 9,8 8 + S
			→	Felge Lochzahl: 5		24.0310-0250.1	510250	Ø 264 9,8 8 + S
<b>VAUXHALL - ASTRAVAN Mk V (H) (A04) 03/05→</b>								
<b> Bremsbelagsatz, Scheibenbremse</b>								
1.3 CDTi	66	08/05→	←	→ 11/10		13.0460-7179.2	607179	ATE 23832 20,2 - WK / + WK
1.4 i	66	03/05→	←			13.0470-7179.2	LD7179	ATE 23832 20,2 - WK / + WK
1.6	76	03/05→	←					Ceramic
1.7 CDTi	74	03/05→11/11	←					
1.9 CDTi	88	03/05→11/11	→	→ 11/10		13.0460-2868.2	602868	TRW 23417 15,3 + WK + Zub
1.9 CDTi	110	03/05→11/11	→			13.0470-2868.2	LD2868	TRW 23417 15,3 + WK + Zub
								Ceramic
1.7 CDTi	59	03/05→07/06	←			13.0460-7179.2	607179	ATE 23832 20,2 - WK / + WK
			←			13.0470-7179.2	LD7179	ATE 23832 20,2 - WK / + WK
			→			13.0460-2868.2	602868	TRW 23417 15,3 + WK + Zub
			→			13.0470-2868.2	LD2868	TRW 23417 15,3 + WK + Zub
								Ceramic
<b>Warnkontakt, Bremsbelagverschleiß</b>								
1.3 CDTi	66	08/05→	←	→ 11/10	1	24.8190-0720.2	620720	L= 287
1.4 i	66	03/05→	←					
1.6	76	03/05→	←					
1.7 CDTi	74	03/05→11/11	←					
1.9 CDTi	88	03/05→11/11	←					
1.9 CDTi	110	03/05→11/11	←					
1.7 CDTi	59	03/05→07/06	←		1	24.8190-0720.2	620720	L= 287
<b> Bremsscheibe</b>								
1.3 CDTi	66	08/05→	←	→ 11/10; Felge Lochzahl: 5		24.0125-0131.1	425131	Ø 280 24,8 22 V + S
1.4 i	66	03/05→	←	→ 11/10; Felge Lochzahl: 4		24.0125-0198.1	425198	Ø 280 25 22 V + S
1.6	76	03/05→	←	→ 11/10; Felge Lochzahl: 4		24.0325-0198.1	525198	Ø 280 25 22 V + S
1.7 CDTi	74	03/05→11/11	→	→ 11/10; Felge Lochzahl: 5		24.0110-0250.1	410250	Ø 264 9,8 8 + S
			→	→ 11/10; Felge Lochzahl: 5		24.0310-0250.1	510250	Ø 264 9,8 8 + S
			→	→ 11/10; Felge Lochzahl: 4		24.0110-0251.1	410251	Ø 240 9,8 8 + S
			→	→ 11/10; Felge Lochzahl: 4		24.0310-0251.1	510251	Ø 240 9,8 8 + S
↓								



	kw				! #		
<b>VAUXHALL - ASTRAVAN Mk V (H) (A04) 03/05→</b>							
<b>Bremsscheibe</b>							
1.7 CDTi	59	03/05→07/06	←	Felge Lochzahl: 5		24.0125-0131.1 425131	∅ 280 24,8 22 V + S
			←	Felge Lochzahl: 4		24.0125-0198.1 425198	∅ 280 25 22 V + S
			→	Felge Lochzahl: 5		24.0110-0250.1 410250	∅ 264 9,8 8 + S
			→	Felge Lochzahl: 4		24.0110-0251.1 410251	∅ 240 9,8 8 + S
1.9 CDTi 1.9 CDTi	88 110	03/05→11/11 03/05→11/11	←	→ 11/10; Felge Lochzahl: 5		24.0125-0142.1 425142	∅ 308 25 22 V + S
			←	→ 11/10; Felge Lochzahl: 4		24.0125-0198.1 425198	∅ 280 25 22 V + S
			→	→ 11/10; Felge Lochzahl: 5		24.0110-0250.1 410250	∅ 264 9,8 8 + S
			→	→ 11/10; Felge Lochzahl: 4		24.0110-0251.1 410251	∅ 240 9,8 8 + S
<b>VAUXHALL - BRAVA Pick-up (TF0, TF1) 12/88→12/02</b>							
<b>Bremsbelagsatz, Scheibenbremse</b>							
2.2 D (TFR52)	39	12/88→09/96	←	01/92→ 08/96		13.0460-5942.2 605942	AKE 21543 16,5 + WK
2.2 D 4x4 (TFS52)	39	12/88→09/96	←	09/90→ 08/96		13.0460-5942.2 605942	AKE 21543 16,5 + WK
2.3 (TFR16) 2.3 4x4 (TFS16) 2.5 TD (TFR54) 2.5 TD 4x4 (TFS54)	72 72 56 56	08/94→09/96 08/94→09/96 07/94→12/02 07/94→12/02	←	→ 08/96		13.0460-5942.2 605942	AKE 21543 16,5 + WK
2.5 DTI 2.5 DTI 4x4	74 74	08/01→12/02 08/01→12/02	←			13.0460-5942.2 605942	AKE 21543 16,5 + WK
<b>Zubehörsatz, Scheibenbremsbelag</b>							
2.2 D (TFR52)	39	12/88→09/96	←	01/92→ 08/96		13.0460-0337.2 610337	AKE
2.2 D 4x4 (TFS52)	39	12/88→09/96	←	09/90→ 08/96		13.0460-0337.2 610337	AKE
2.3 (TFR16) 2.3 4x4 (TFS16) 2.5 TD (TFR54) 2.5 TD 4x4 (TFS54)	72 72 56 56	08/94→09/96 08/94→09/96 07/94→12/02 07/94→12/02	←	→ 08/96		13.0460-0337.2 610337	AKE
2.5 DTI 2.5 DTI 4x4	74 74	08/01→12/02 08/01→12/02	←			13.0460-0337.2 610337	AKE
<b>Bremsscheibe</b>							
2.2 D (TFR52)	39	12/88→09/96	←	01/92→ 08/96		24.0122-0156.1 422156	∅ 257 22 20,6 V
2.2 D 4x4 (TFS52)	39	12/88→09/96	←	09/90→ 08/96		24.0122-0156.1 422156	∅ 257 22 20,6 V
2.3 (TFR16) 2.3 4x4 (TFS16) 2.5 TD (TFR54) 2.5 TD 4x4 (TFS54)	72 72 56 56	08/94→09/96 08/94→09/96 07/94→12/02 07/94→12/02	←	→ 08/96		24.0122-0156.1 422156	∅ 257 22 20,6 V
2.5 DTI 2.5 DTI 4x4	74 74	08/01→12/02 08/01→12/02	←			24.0122-0156.1 422156	∅ 257 22 20,6 V
<b>VAUXHALL - CALIBRA (C89) 06/90→07/97</b>							
<b>Bremsbelagsatz, Scheibenbremse</b>							
2.0 i 2.0 i 16V 2.0 i 16V 4x4 2.0 i 4x4	85 100 100 85	06/90→07/97 06/90→07/97 02/94→07/97 06/90→07/97	← →			13.0460-7052.2 607052	ATE 21190 17,5 + WE / - WK
2.0 i 4x4 2.0 i Turbo 4x4	85 150	06/90→07/97 03/92→07/97	←	→ S9999999		13.0460-4043.2 604043	ATE 21140 15,0 - WE / - WK
2.0 i Turbo 4x4	150	03/92→07/97	←	T1000001→		13.0460-7080.2 607080	ATE 21411 17,5 - WK
			←	T1000001→		13.0460-7091.2 607091	ATE 21829 20,3 + WE / - WK
			→			13.0460-4043.2 604043	ATE 21140 15,0 - WE / - WK
2.5 i V6	125	04/93→07/97	←	→ S9999999		13.0460-7080.2 607080	ATE 21411 17,5 - WK
			←	T1000001→		13.0460-7091.2 607091	ATE 21829 20,3 + WE / - WK
			→	T1000001→		13.0460-4040.2 604040	ATE 21050 15,8 - WE / - WK
			→	→ S9999999		13.0460-4043.2 604043	ATE 21140 15,0 - WE / - WK
<b>Warnkontakt, Bremsbelagverschleiß</b>							
2.0 i 2.0 i 16V 2.0 i 16V 4x4 2.0 i 4x4	85 100 100 85	06/90→07/97 06/90→07/97 02/94→07/97 06/90→07/97	←		2	24.8190-0705.2 620705	L= 670
↓							











	kw				! #		
<b>VAUXHALL - CALIBRA (C89) 06/90→07/97</b>							
<b>Warnkontakt, Bremsbelagverschleiß</b>							
2.0 i Turbo 4x4	150	03/92→07/97	←	→ S9999999	2	24.8190-0707.2 620707	L= 685
2.5 i V6	125	04/93→07/97	←	T1000001→	2	24.8190-0713.2 620713	L= 685
<b>Zubehörsatz, Scheibenbremsbelag</b>							
2.0 i	85	06/90→07/97	→			13.0460-0217.2 610217	ATE
2.0 i 16V	100	06/90→07/97					
2.0 i 16V 4x4	100	02/94→07/97					
2.0 i 4x4	85	06/90→07/97					
2.0 i Turbo 4x4	150	03/92→07/97					
2.5 i V6	125	04/93→07/97	→	→ S9999999		13.0460-0217.2 610217	ATE
			→	T1000001→		13.0460-0347.2 610347	
<b> Bremsscheibe</b>							
2.0 i	85	06/90→07/97	←			24.0124-0115.1 424115	Ø 256 24 21 V + S
2.0 i 16V	100	06/90→07/97				24.0324-0115.1 524115	Ø 256 24 21 V + S
2.0 i 16V 4x4	100	02/94→07/97					
2.0 i 4x4	85	06/90→07/97	→			24.0110-0205.1 410205	Ø 270 9,9 8
2.0 i Turbo 4x4	150	03/92→07/97	←	→ S9999999		24.0124-0133.1 424133	Ø 284 24 21 V
2.5 i V6	125	04/93→07/97	←	T1000001→		24.0125-0119.1 425119	Ø 288 25 22 V + S
			→			24.0325-0119.1 525119	Ø 288 25 22 V + S
			→			24.0110-0253.1 410253	Ø 270 10 8
<b>VAUXHALL - CASCADA Cabriolet (W13) 02/13→</b>							
<b> Bremsbelagsatz, Scheibenbremse</b>							
1.4	103	02/13→	←			13.0460-5612.2 605612	MAN 24412 19,0 + WK + Zub
1.6	125	02/13→				13.0470-5612.2 LD5612	MAN 24412 19,0 + WK + Zub
1.6	147	11/13→					Ceramic
2.0 CDTI	121	02/13→	→				
2.0 CDTI	125	07/15→	→			13.0460-7264.2 607264	ATE 25096 17,0 + WK + Zub
2.0 CDTI	143	02/13→				13.0470-7264.2 LD7264	ATE 25096 17,0 + WK + Zub
							Ceramic
<b> Bremsscheibe</b>							
1.4	103	02/13→	←			24.0130-0224.1 430224	Ø 321 30 27 V + S
1.6	125	02/13→					
1.6	147	11/13→	→			24.0112-0189.1 412189	Ø 292 12 10 + S
2.0 CDTI	121	02/13→				24.0312-0189.1 512189	Ø 292 12 10 + S
2.0 CDTI	125	07/15→					
2.0 CDTI	143	02/13→					
<b>VAUXHALL - COMBO Mk I (B) (S93) 07/94→10/01</b>							
<b> Bremsbelagsatz, Scheibenbremse</b>							
1.4	44	07/94→10/01	←	→ 09/00		13.0460-7051.2 607051	ATE 20547 16,5 + WE / - WK
1.4 16V	66	08/99→10/01					
1.7 D	44	07/94→10/01					
<b> Bremsscheibe</b>							
1.4	44	07/94→10/01	←	→ 09/00		24.0120-0115.1 420115	Ø 236 20 17 V + S
1.4 16V	66	08/99→10/01				24.0320-0115.1 520115	Ø 236 20 17 V + S
1.7 D	44	07/94→10/01					
<b>VAUXHALL - COMBO Mk II (C) Kasten/Kombi (F25) 09/01→02/12</b>							
<b> Bremsbelagsatz, Scheibenbremse</b>							
1.3 CDTI 16V	51	09/04→02/12	←	→ 43033898, 53000000; für erhöhte Nutzlast		13.0460-2857.2 602857	TRW 23225 17,0 + WK + Zub
1.3 CDTI 16V	55	10/05→11/11				13.0470-2857.2 LD2857	TRW 23225 17,0 + WK + Zub
1.4 i 16V	66	01/04→11/11					Ceramic
1.6	64	10/01→11/11	←	→ 10/11; nicht für erhöhte Nutzlast		13.0460-2857.2 602857	TRW 23225 17,0 + WK + Zub
1.7 DTI 16V	55	10/01→11/11	←			13.0470-2857.2 LD2857	TRW 23225 17,0 + WK + Zub
							Ceramic
			←	43033899, 53000001→; → 10/11; für erhöhte Nutzlast		13.0460-7179.2 607179	ATE 23832 20,2 - WK / + WK
						13.0470-7179.2 LD7179	ATE 23832 20,2 - WK / + WK
			→	→ 10/11		13.0460-2868.2 602868	TRW 23417 15,3 + WK + Zub
						13.0470-2868.2 LD2868	TRW 23417 15,3 + WK + Zub
							Ceramic
1.4 16V	66	10/01→05/07	←	nicht für erhöhte Nutzlast		13.0460-2857.2 602857	TRW 23225 17,0 + WK + Zub
						13.0470-2857.2 LD2857	TRW 23225 17,0 + WK + Zub
			←	→ 43033898, 53000000; für erhöhte Nutzlast		13.0460-2857.2 602857	TRW 23225 17,0 + WK + Zub











	kw			 	! #		
<b>VAUXHALL - COMBO Mk II (C) Kasten/Kombi (F25) 09/01→02/12</b>							
<b>Bremsbelagsatz, Scheibenbremse</b>							
1.4 16V	66	10/01→05/07	←	→ 43033898, 53000000; für erhöhte Nutzlast	13.0470-2857.2	LD2857	TRW 23225 17,0 + WK + Zub Ceramic
			←	43033899, 53000001→; für erhöhte Nutzlast	13.0460-7179.2	607179	ATE 23832 20,2 - WK / + WK
			→		13.0470-7179.2	LD7179	ATE 23832 20,2 - WK / + WK Ceramic
1.6	62	09/01→10/04	←	10/01→; → 43033898, 53000000; für erhöhte Nutzlast	13.0460-2857.2	602857	TRW 23417 15,3 + WK + Zub
			←	10/01→; nicht für erhöhte Nutzlast	13.0470-2857.2	LD2857	TRW 23225 17,0 + WK + Zub Ceramic
			←	43033899, 53000001→; für erhöhte Nutzlast	13.0460-2857.2	602857	TRW 23225 17,0 + WK + Zub Ceramic
			→	10/01→	13.0470-2857.2	LD2857	ATE 23832 20,2 - WK / + WK Ceramic
1.6 CNG 16V 1.6 CNG 16V 1.7 CDTI 16V	69 71 74	06/06→02/12 04/05→02/12 12/04→11/11	←	→ 10/11	13.0460-7179.2	607179	ATE 23832 20,2 - WK / + WK
			←		13.0470-7179.2	LD7179	ATE 23832 20,2 - WK / + WK Ceramic
			→	→ 10/11	13.0460-2868.2	602868	TRW 23417 15,3 + WK + Zub
			→		13.0470-2868.2	LD2868	TRW 23417 15,3 + WK + Zub Ceramic
1.7 DI 16V	48	09/01→11/11	←	10/01→ 10/11; nicht für erhöhte Nutzlast	13.0460-2857.2	602857	TRW 23225 17,0 + WK + Zub
			←	10/01→; → 43033898, 53000000; für erhöhte Nutzlast	13.0470-2857.2	LD2857	TRW 23225 17,0 + WK + Zub Ceramic
			←	43033899, 53000001→; → 10/11; für erhöhte Nutzlast	13.0460-2857.2	602857	TRW 23225 17,0 + WK + Zub Ceramic
			→	10/01→ 10/11	13.0470-2857.2	LD2857	ATE 23832 20,2 - WK / + WK Ceramic
			←	→ 10/11	13.0460-2868.2	602868	TRW 23417 15,3 + WK + Zub
			←		13.0470-2868.2	LD2868	TRW 23417 15,3 + WK + Zub Ceramic
			→	→ 10/11	13.0460-2868.2	602868	TRW 23417 15,3 + WK + Zub
			→		13.0470-2868.2	LD2868	TRW 23417 15,3 + WK + Zub Ceramic
<b>Bremsscheibe</b>							
1.3 CDTI 16V 1.3 CDTI 16V 1.4 i 16V 1.6 1.7 DTI 16V	51 55 66 64 55	09/04→02/12 10/05→11/11 01/04→11/11 10/01→11/11 10/01→11/11	←	→ 10/11; nicht für erhöhte Nutzlast	24.0124-0166.1	424166	Ø 260 24 21 V + S
			←		24.0324-0166.1	524166	Ø 260 24 21 V
			←	→ 43033898, 53000000; für erhöhte Nutzlast	24.0124-0166.1	424166	Ø 260 24 21 V + S
			←		24.0324-0166.1	524166	Ø 260 24 21 V
			←	43033899, 53000001→; → 10/11; für erhöhte Nutzlast	24.0125-0148.1	425148	Ø 280 25 22 V + S
			←		24.0325-0148.1	525148	Ø 280 25 22 V + S
			→	→ 10/11	24.0110-0291.1	410291	Ø 264 10 8 + S
			→		24.0310-0291.1	510291	Ø 264 10 8 + S
1.4 16V	66	10/01→05/07	←	nicht für erhöhte Nutzlast	24.0124-0166.1	424166	Ø 260 24 21 V + S
			←	→ 43033898, 53000000; für erhöhte Nutzlast	24.0324-0166.1	524166	Ø 260 24 21 V
			←	43033899, 53000001→; für erhöhte Nutzlast	24.0124-0166.1	424166	Ø 260 24 21 V + S
			←		24.0324-0166.1	524166	Ø 260 24 21 V
1.6	62	09/01→10/04	←	10/01→; → 43033898, 53000000; für erhöhte Nutzlast	24.0125-0148.1	425148	Ø 280 25 22 V + S
			←		24.0325-0148.1	525148	Ø 280 25 22 V + S
			←	10/01→; nicht für erhöhte Nutzlast	24.0110-0291.1	410291	Ø 264 10 8 + S
			←		24.0310-0291.1	510291	Ø 264 10 8 + S
			←	43033899, 53000001→; für erhöhte Nutzlast	24.0124-0166.1	424166	Ø 260 24 21 V + S
			←		24.0324-0166.1	524166	Ø 260 24 21 V
			←	10/01→	24.0124-0166.1	424166	Ø 260 24 21 V + S
			←		24.0324-0166.1	524166	Ø 260 24 21 V
1.6 CNG 16V ↓	69	06/06→02/12	←	→ 10/11	24.0125-0148.1	425148	Ø 280 25 22 V + S
			←		24.0325-0148.1	525148	Ø 280 25 22 V + S
			←		24.0110-0291.1	410291	Ø 264 10 8 + S
			←		24.0310-0291.1	510291	Ø 264 10 8 + S

	kw					! #		
<b>VAUXHALL - COMBO Mk II (C) Kasten/Kombi (F25) 09/01→02/12</b>								
<b>Bremsscheibe</b>								
1.6 CNG 16V	71	04/05→02/12	←	→ 10/11		24.0325-0148.1	525148	Ø 280 25 22 V + S
			→	→ 10/11		24.0110-0291.1	410291	Ø 264 10 8 + S
						24.0310-0291.1	510291	Ø 264 10 8 + S
1.7 CDTi 16V	74	12/04→11/11	←	→ 10/11		24.0125-0131.1	425131	Ø 280 24,8 22 V + S
						24.0325-0131.1	525131	Ø 280 24,8 22 V + S
			→	→ 10/11		24.0110-0250.1	410250	Ø 264 9,8 8 + S
1.7 DI 16V	48	09/01→11/11	←	10/01→; → 43033898, 53000000; für erhöhte Nutzlast		24.0124-0166.1	424166	Ø 260 24 21 V + S
						24.0324-0166.1	524166	Ø 260 24 21 V
			←	10/01→ 10/11; nicht für erhöhte Nutzlast		24.0124-0166.1	424166	Ø 260 24 21 V + S
						24.0324-0166.1	524166	Ø 260 24 21 V
			←	43033899, 53000001→; → 10/11; für erhöhte Nutzlast		24.0125-0148.1	425148	Ø 280 25 22 V + S
						24.0325-0148.1	525148	Ø 280 25 22 V + S
			→	10/01→ 10/11		24.0110-0291.1	410291	Ø 264 10 8 + S
						24.0310-0291.1	510291	Ø 264 10 8 + S
<b>VAUXHALL - COMBO Mk III (D) Kasten/Kombi (X12) 11/11→</b>								
<b>Bremsbelagsatz, Scheibenbremse</b>								
1.3 CDTi	66	11/11→	←	für Bremsscheibendurchmesser [mm]: 284		13.0460-3827.2	603827	BOS 23709 19,6 + WK + Zub
1.3 CDTi	70	03/16→				13.0470-3827.2	LD3827	BOS 23709 19,6 + WK + Zub Ceramic
1.4	70	11/11→						
1.6 CDTi	66	11/11→						
1.6 CDTi	74	11/11→	←	für Bremsscheibendurchmesser [mm]: 305		13.0460-7265.2	607265	ATE 24727 20,7 + WK
1.6 CDTi	77	11/11→						
2.0 CDTi	99	11/11→						
<b>Bremsscheibe</b>								
1.3 CDTi	66	11/11→	←			24.0122-0145.1	422145	Ø 284 22 20,2 V
1.3 CDTi	70	03/16→				24.0128-0253.1	428253	Ø 305 28 26 V
1.4	70	11/11→						
1.6 CDTi	66	11/11→						
1.6 CDTi	74	11/11→						
1.6 CDTi	77	11/11→						
2.0 CDTi	99	11/11→						
<b>VAUXHALL - COMBO TOUR Mk II (C) (F25) 09/01→02/12</b>								
<b>Bremsbelagsatz, Scheibenbremse</b>								
1.3 CDTi 16V	51	09/04→09/06	←	nicht für erhöhte Nutzlast		13.0460-2857.2	602857	TRW 23225 17,0 + WK + Zub
1.4	66	10/04→09/10				13.0470-2857.2	LD2857	TRW 23225 17,0 + WK + Zub Ceramic
1.6	64	10/01→06/04						
			←	→ 43033898, 53000000; für erhöhte Nutzlast		13.0460-2857.2	602857	TRW 23225 17,0 + WK + Zub
						13.0470-2857.2	LD2857	TRW 23225 17,0 + WK + Zub Ceramic
			←	43033899, 53000001→; für erhöhte Nutzlast		13.0460-7179.2	607179	ATE 23832 20,2 - WK / + WK
						13.0470-7179.2	LD7179	ATE 23832 20,2 - WK / + WK Ceramic
			→			13.0460-2868.2	602868	TRW 23417 15,3 + WK + Zub
						13.0470-2868.2	LD2868	TRW 23417 15,3 + WK + Zub Ceramic
1.3 CDTi 16V	55	07/06→02/12	←	→ 43033898, 53000000; für erhöhte Nutzlast		13.0460-2857.2	602857	TRW 23225 17,0 + WK + Zub
1.7 DTi 16V	55	10/01→02/12				13.0470-2857.2	LD2857	TRW 23225 17,0 + WK + Zub Ceramic
			←	→ 10/11; nicht für erhöhte Nutzlast		13.0460-2857.2	602857	TRW 23225 17,0 + WK + Zub
						13.0470-2857.2	LD2857	TRW 23225 17,0 + WK + Zub Ceramic
			←	43033899, 53000001→; → 10/11; für erhöhte Nutzlast		13.0460-7179.2	607179	ATE 23832 20,2 - WK / + WK
						13.0470-7179.2	LD7179	ATE 23832 20,2 - WK / + WK Ceramic
			→	→ 10/11		13.0460-2868.2	602868	TRW 23417 15,3 + WK + Zub
						13.0470-2868.2	LD2868	TRW 23417 15,3 + WK + Zub Ceramic
1.6 CNG	69	06/06→09/10	←			13.0460-7179.2	607179	ATE 23832 20,2 - WK / + WK
1.7 CDTi 16V	74	12/04→09/10				13.0470-7179.2	LD7179	ATE 23832 20,2 - WK / + WK Ceramic
			→			13.0460-2868.2	602868	TRW 23417 15,3 + WK + Zub
						13.0470-2868.2	LD2868	TRW 23417 15,3 + WK + Zub Ceramic
1.6 CNG	71	04/05→02/12	←	→ 10/11		13.0460-7179.2	607179	ATE 23832 20,2 - WK / + WK
↓								



































	kw			 	! #			
<b>VAUXHALL - COMBO TOUR Mk II (C) (F25) 09/01→02/12</b>								
 <b>Bremsbelagsatz, Scheibenbremse</b>								
1.6 CNG	71	04/05→02/12	←	→ 10/11		13.0470-7179.2	LD7179	ATE 23832 20,2 - WK / + WK Ceramic
			→	→ 10/11		13.0460-2868.2	602868	TRW 23417 15,3 + WK + Zub
						13.0470-2868.2	LD2868	TRW 23417 15,3 + WK + Zub Ceramic
1.7 DI 16V	48	09/01→06/04	←	10/01→; → 43033898, 53000000; für erhöhte Nutzlast		13.0460-2857.2	602857	TRW 23225 17,0 + WK + Zub
						13.0470-2857.2	LD2857	TRW 23225 17,0 + WK + Zub Ceramic
			←	10/01→; nicht für erhöhte Nutzlast		13.0460-2857.2	602857	TRW 23225 17,0 + WK + Zub
						13.0470-2857.2	LD2857	TRW 23225 17,0 + WK + Zub Ceramic
			←	43033899, 53000001→; für erhöhte Nutzlast		13.0460-7179.2	607179	ATE 23832 20,2 - WK / + WK
					13.0470-7179.2	LD7179	ATE 23832 20,2 - WK / + WK Ceramic	
			→	10/01→		13.0460-2868.2	602868	TRW 23417 15,3 + WK + Zub
						13.0470-2868.2	LD2868	TRW 23417 15,3 + WK + Zub Ceramic
 <b>Bremsscheibe</b>								
1.3 CDTI 16V 1.4 1.6	51 66 64	09/04→09/06 10/04→09/10 10/01→06/04	←	nicht für erhöhte Nutzlast		24.0124-0166.1	424166	Ø 260 24 21 V + S
						24.0324-0166.1	524166	Ø 260 24 21 V
			←	→ 43033898, 53000000; für erhöhte Nutzlast		24.0124-0166.1	424166	Ø 260 24 21 V + S
						24.0324-0166.1	524166	Ø 260 24 21 V
			←	43033899, 53000001→; für erhöhte Nutzlast		24.0125-0148.1	425148	Ø 280 25 22 V + S
					24.0325-0148.1	525148	Ø 280 25 22 V + S	
			→			24.0110-0291.1	410291	Ø 264 10 8 + S
						24.0310-0291.1	510291	Ø 264 10 8 + S
1.3 CDTI 16V 1.7 DTI 16V	55 55	07/06→02/12 10/01→02/12	←	→ 10/11; nicht für erhöhte Nutzlast		24.0124-0166.1	424166	Ø 260 24 21 V + S
						24.0324-0166.1	524166	Ø 260 24 21 V
			←	→ 43033898, 53000000; für erhöhte Nutzlast		24.0124-0166.1	424166	Ø 260 24 21 V + S
						24.0324-0166.1	524166	Ø 260 24 21 V
			←	43033899, 53000001→; → 10/11; für erhöhte Nutzlast		24.0125-0148.1	425148	Ø 280 25 22 V + S
					24.0325-0148.1	525148	Ø 280 25 22 V + S	
			→	→ 10/11		24.0110-0291.1	410291	Ø 264 10 8 + S
						24.0310-0291.1	510291	Ø 264 10 8 + S
1.6 CNG	69	06/06→09/10	←			24.0125-0148.1	425148	Ø 280 25 22 V + S
						24.0325-0148.1	525148	Ø 280 25 22 V + S
			→			24.0110-0291.1	410291	Ø 264 10 8 + S
						24.0310-0291.1	510291	Ø 264 10 8 + S
1.6 CNG	71	04/05→02/12	←	→ 10/11		24.0125-0148.1	425148	Ø 280 25 22 V + S
						24.0325-0148.1	525148	Ø 280 25 22 V + S
			→	→ 10/11		24.0110-0291.1	410291	Ø 264 10 8 + S
						24.0310-0291.1	510291	Ø 264 10 8 + S
1.7 CDTI 16V	74	12/04→09/10	←			24.0125-0131.1	425131	Ø 280 24,8 22 V + S
						24.0325-0131.1	525131	Ø 280 24,8 22 V + S
			→			24.0110-0250.1	410250	Ø 264 9,8 8 + S
1.7 DI 16V	48	09/01→06/04	←	10/01→; → 43033898, 53000000; für erhöhte Nutzlast		24.0124-0166.1	424166	Ø 260 24 21 V + S
						24.0324-0166.1	524166	Ø 260 24 21 V
			←	10/01→; nicht für erhöhte Nutzlast		24.0124-0166.1	424166	Ø 260 24 21 V + S
						24.0324-0166.1	524166	Ø 260 24 21 V
			←	43033899, 53000001→; für erhöhte Nutzlast		24.0125-0148.1	425148	Ø 280 25 22 V + S
					24.0325-0148.1	525148	Ø 280 25 22 V + S	
			→	10/01→		24.0110-0291.1	410291	Ø 264 10 8 + S
						24.0310-0291.1	510291	Ø 264 10 8 + S
<b>VAUXHALL - CORSA Mk I (B) (S93) 12/92→09/00</b>								
 <b>Bremsbelagsatz, Scheibenbremse</b>								
1.0 i 12V	40	11/96→09/00	←			13.0460-7051.2	607051	ATE 20547 16,5 + WE / - WK
1.4 i	44	03/93→09/00						
1.4 i 16V	66	09/94→09/00						
1.4 i S	60	03/93→09/00						
1.5 TD	49	03/93→10/96						
1.6 i 16V	78	09/94→09/00						
1.7 D	44	02/96→09/00						
↓								

	kw			 	! #		
<b>VAUXHALL - CORSA Mk I (B) (S93) 12/92→09/00</b>							
 <b>Bremsbelagsatz, Scheibenbremse</b>							
1.2 i	33	03/93→09/00	←			<b>13.0460-7051.2 607051</b>	ATE 20547 16,5 + WE / - WK
			←	04/98→		<b>13.0460-7051.2 607051</b>	ATE 20547 16,5 + WE / - WK
1.2 i 16V	48	03/98→09/00	←	04/98→		<b>13.0460-7051.2 607051</b>	ATE 20547 16,5 + WE / - WK
1.5 D	37	12/92→12/96	←	03/93→		<b>13.0460-7051.2 607051</b>	ATE 20547 16,5 + WE / - WK
1.6 GSI 16V	80	03/93→09/00	←	09/93→		<b>13.0460-7051.2 607051</b>	ATE 20547 16,5 + WE / - WK
 <b>Bremsscheibe</b>							
1.0 i 12V	40	11/96→09/00	←			<b>24.0113-0161.1 413161</b>	Ø 236 12,7 9,7 + S
1.5 TD	49	03/93→10/96				<b>24.0313-0161.1 513161</b>	Ø 236 12,7 9,7 + S
1.7 D	44	02/96→09/00					
1.2 i	33	03/93→09/00	←	04/98→; für Schaltgetriebe		<b>24.0113-0161.1 413161</b>	Ø 236 12,7 9,7 + S
						<b>24.0313-0161.1 513161</b>	Ø 236 12,7 9,7 + S
			←			<b>24.0113-0161.1 413161</b>	Ø 236 12,7 9,7 + S
						<b>24.0313-0161.1 513161</b>	Ø 236 12,7 9,7 + S
			←	04/98→; für Fahrzeuge ohne Klimaanlage; für Automatikgetriebe		<b>24.0113-0161.1 413161</b>	Ø 236 12,7 9,7 + S
						<b>24.0313-0161.1 513161</b>	Ø 236 12,7 9,7 + S
1.2 i 16V	48	03/98→09/00	←	04/98→; für Fahrzeuge ohne Klimaanlage; für Automatikgetriebe		<b>24.0113-0161.1 413161</b>	Ø 236 12,7 9,7 + S
						<b>24.0313-0161.1 513161</b>	Ø 236 12,7 9,7 + S
			←	04/98→; für Schaltgetriebe		<b>24.0113-0161.1 413161</b>	Ø 236 12,7 9,7 + S
						<b>24.0313-0161.1 513161</b>	Ø 236 12,7 9,7 + S
			←	04/98→; für Fahrzeuge mit Klimaanlage; für Automatikgetriebe		<b>24.0120-0115.1 420115</b>	Ø 236 20 17 V + S
						<b>24.0320-0115.1 520115</b>	Ø 236 20 17 V + S
1.4 i	44	03/93→09/00	←	04/98→		<b>24.0120-0115.1 420115</b>	Ø 236 20 17 V + S
						<b>24.0320-0115.1 520115</b>	Ø 236 20 17 V + S
			←	für Automatikgetriebe; für Fahrzeuge ohne Klimaanlage		<b>24.0113-0161.1 413161</b>	Ø 236 12,7 9,7 + S
						<b>24.0313-0161.1 513161</b>	Ø 236 12,7 9,7 + S
			←	für Schaltgetriebe		<b>24.0113-0161.1 413161</b>	Ø 236 12,7 9,7 + S
						<b>24.0313-0161.1 513161</b>	Ø 236 12,7 9,7 + S
1.4 i 16V	66	09/94→09/00	←			<b>24.0120-0115.1 420115</b>	Ø 236 20 17 V + S
						<b>24.0320-0115.1 520115</b>	Ø 236 20 17 V + S
1.4 i S	60	03/93→09/00	←			<b>24.0120-0115.1 420115</b>	Ø 236 20 17 V + S
						<b>24.0320-0115.1 520115</b>	Ø 236 20 17 V + S
1.5 D	37	12/92→12/96	←	03/93→		<b>24.0113-0161.1 413161</b>	Ø 236 12,7 9,7 + S
						<b>24.0313-0161.1 513161</b>	Ø 236 12,7 9,7 + S
1.6 GSI 16V	80	03/93→09/00	←	09/93→		<b>24.0120-0140.1 420140</b>	Ø 256 20 17 V + S
1.6 i 16V	78	09/94→09/00	←			<b>24.0120-0140.1 420140</b>	Ø 256 20 17 V + S
<b>VAUXHALL - CORSA Mk II (C) (X01) 08/00→10/06</b>							
 <b>Bremsbelagsatz, Scheibenbremse</b>							
1.0 12V (F08, F68)	43	09/00→10/03	←			<b>13.0460-2857.2 602857</b>	TRW 23225 17,0 + WK + Zub
						<b>13.0470-2857.2 LD2857</b>	TRW 23225 17,0 + WK + Zub Ceramic
1.0 12V (F08, F68)	44	11/03→10/06	←	→ 09/06		<b>13.0460-2857.2 602857</b>	TRW 23225 17,0 + WK + Zub
1.2 16V (F08, F68)	55	09/00→10/06				<b>13.0470-2857.2 LD2857</b>	TRW 23225 17,0 + WK + Zub
1.2 16V Dualfuel (F08)	55	08/01→10/06					TRW 23225 17,0 + WK + Zub Ceramic
1.2 Twinport (F08, F68)	59	07/04→10/06					
1.3 CDTI 16V (F08, F68)	52	08/00→09/06	←	06/03→		<b>13.0460-2857.2 602857</b>	TRW 23225 17,0 + WK + Zub
						<b>13.0470-2857.2 LD2857</b>	TRW 23225 17,0 + WK + Zub Ceramic
			→	06/03→		<b>13.0460-2858.2 602858</b>	TRW 23284 14,0 + WK
						<b>13.0470-2858.2 LD2858</b>	TRW 23284 14,0 + WK Ceramic
1.4 16V (F08, F68)	66	09/00→10/06	←	→ 09/06		<b>13.0460-2857.2 602857</b>	TRW 23225 17,0 + WK + Zub
1.4 Twinport (F08, F68)	66	06/03→10/06				<b>13.0470-2857.2 LD2857</b>	TRW 23225 17,0 + WK + Zub Ceramic
			→	→ 09/06		<b>13.0460-2858.2 602858</b>	TRW 23284 14,0 + WK
						<b>13.0470-2858.2 LD2858</b>	TRW 23284 14,0 + WK Ceramic
↓							

























	kw			 	! #		
<b>VAUXHALL - CORSA Mk II (C) (X01) 08/00→10/06</b>							
 <b>Bremsbelagsatz, Scheibenbremse</b>							
1.7 CDTI 16V (F08, F68)	74	08/00→09/06	←	06/03→		<b>13.0460-7179.2 607179</b> <b>13.0470-7179.2 LD7179</b>	ATE 23832 20,2 - WK / + WK ATE 23832 20,2 - WK / + WK Ceramic
			→	06/03→		<b>13.0460-2858.2 602858</b> <b>13.0470-2858.2 LD2858</b>	TRW 23284 14,0 + WK TRW 23284 14,0 + WK Ceramic
1.7 DI 16V (F08, F68)	48	08/00→09/06	←	09/00→		<b>13.0460-2857.2 602857</b>	TRW 23225 17,0 + WK + Zub
1.7 DTI 16V (F08, F68)	55	08/00→09/06				<b>13.0470-2857.2 LD2857</b>	TRW 23225 17,0 + WK + Zub Ceramic
1.8 16V (F08, F68)	92	08/00→09/06	→	09/00→		<b>13.0460-2858.2 602858</b> <b>13.0470-2858.2 LD2858</b>	TRW 23284 14,0 + WK TRW 23284 14,0 + WK Ceramic
 <b>Bremsscheibe</b>							
1.0 12V (F08, F68)	43	09/00→10/03	←	- ABS		<b>24.0111-0152.1 411152</b>	Ø 240 11 8
			←	+ ABS		<b>24.0120-0174.1 420174</b>	Ø 240 20 17 V + S
1.0 12V (F08, F68)	44	11/03→10/06	←	- ABS; → 09/06		<b>24.0111-0152.1 411152</b>	Ø 240 11 8
1.2 16V (F08, F68)	55	09/00→10/06				<b>24.0120-0174.1 420174</b>	Ø 240 20 17 V + S
1.2 16V Dualfuel (F08)	55	08/01→10/06	←	+ ABS; → 09/06			
1.2 Twinport (F08, F68)	59	07/04→10/06					
1.3 CDTI 16V (F08, F68)	52	08/00→09/06	←	06/03→		<b>24.0124-0166.1 424166</b> <b>24.0324-0166.1 524166</b>	Ø 260 24 21 V + S Ø 260 24 21 V
			→	06/03→		<b>24.0110-0268.1 410268</b> <b>24.0110-0291.1 410291</b> <b>24.0310-0291.1 510291</b>	Ø 240 10,2 8,2 Ø 264 10 8 + S Ø 264 10 8 + S
1.4 16V (F08, F68)	66	09/00→10/06	←	→ 09/06		<b>24.0124-0166.1 424166</b> <b>24.0324-0166.1 524166</b>	Ø 260 24 21 V + S Ø 260 24 21 V
1.4 Twinport (F08, F68)	66	06/03→10/06	→	→ 09/06		<b>24.0110-0268.1 410268</b> <b>24.0110-0291.1 410291</b> <b>24.0310-0291.1 510291</b>	Ø 240 10,2 8,2 Ø 264 10 8 + S Ø 264 10 8 + S
1.7 CDTI 16V (F08, F68)	74	08/00→09/06	←	06/03→		<b>24.0125-0131.1 425131</b> <b>24.0325-0131.1 525131</b>	Ø 280 24,8 22 V + S Ø 280 24,8 22 V + S
			→	06/03→		<b>24.0110-0250.1 410250</b> <b>24.0310-0250.1 510250</b>	Ø 264 9,8 8 + S Ø 264 9,8 8 + S
1.7 DI 16V (F08, F68)	48	08/00→09/06	←	09/00→		<b>24.0120-0174.1 420174</b>	Ø 240 20 17 V + S
			→	09/00→		<b>24.0110-0268.1 410268</b> <b>24.0110-0291.1 410291</b> <b>24.0310-0291.1 510291</b>	Ø 240 10,2 8,2 Ø 264 10 8 + S Ø 264 10 8 + S
1.7 DTI 16V (F08, F68)	55	08/00→09/06	←	09/00→		<b>24.0124-0166.1 424166</b> <b>24.0324-0166.1 524166</b>	Ø 260 24 21 V + S Ø 260 24 21 V
1.8 16V (F08, F68)	92	08/00→09/06	→	09/00→		<b>24.0110-0268.1 410268</b> <b>24.0110-0291.1 410291</b> <b>24.0310-0291.1 510291</b>	Ø 240 10,2 8,2 Ø 264 10 8 + S Ø 264 10 8 + S
<b>VAUXHALL - CORSA Mk III (D) (S07) 07/06→08/14</b>							
 <b>Bremsbelagsatz, Scheibenbremse</b>							
1.0	44	11/06→08/14	←	V		<b>13.0460-3839.2 603839</b> <b>13.0470-3839.2 LD3839</b>	BOS 23707 17,9 + WK + Zub BOS 23707 17,9 + WK + Zub Ceramic
1.0 i 12V	48	06/10→08/14	←			<b>13.0460-3839.2 603839</b> <b>13.0470-3839.2 LD3839</b>	BOS 23707 17,9 + WK + Zub BOS 23707 17,9 + WK + Zub Ceramic
1.2	51	06/10→08/14	←			<b>13.0460-3839.2 603839</b> <b>13.0470-3839.2 LD3839</b>	BOS 23707 17,9 + WK + Zub BOS 23707 17,9 + WK + Zub Ceramic
1.2	59	11/06→08/14					
1.2 LPG	59	09/09→08/14					
1.2 LPG	63	08/11→08/14					
1.4	64	09/09→08/14					
1.4	74	07/10→08/14					
1.4 LPG	64	09/09→08/14					
1.2 i 16V	63	11/06→08/14	←	06/10→		<b>13.0460-3839.2 603839</b> <b>13.0470-3839.2 LD3839</b>	BOS 23707 17,9 + WK + Zub BOS 23707 17,9 + WK + Zub Ceramic
1.3 CDTI	55	07/06→08/14	←	10/06→; für Bremsscheibendurchmesser [mm]: 257		<b>13.0460-3839.2 603839</b> <b>13.0470-3839.2 LD3839</b>	BOS 23707 17,9 + WK + Zub BOS 23707 17,9 + WK + Zub Ceramic
			←	10/06→; für Bremsscheibendurchmesser [mm]: 284		<b>13.0460-3840.2 603840</b> <b>13.0470-3840.2 LD3840</b>	BOS 23981 19,6 + WK + Zub BOS 23981 19,6 + WK + Zub Ceramic
↓							













	kw				! #		
<b>VAUXHALL - CORSA Mk III (D) (S07) 07/06→08/14</b>							
<b> Bremsbelagsatz, Scheibenbremse</b>							
1.3 CDTI	66	07/06→08/14	←	10/06→		<b>13.0460-3840.2 603840</b> <b>13.0470-3840.2 LD3840</b>	BOS 23981 19,6 + WK + Zub Ceramic
1.3 CDTI	70	06/10→08/14	←	für Bremsscheibendurchmesser [mm]: 257		<b>13.0460-3839.2 603839</b> <b>13.0470-3839.2 LD3839</b>	BOS 23707 17,9 + WK + Zub Ceramic
			←	für Bremsscheibendurchmesser [mm]: 284		<b>13.0460-3840.2 603840</b> <b>13.0470-3840.2 LD3840</b>	BOS 23981 19,6 + WK + Zub Ceramic
1.4 1.4 LPG	66 66	07/06→08/14 07/06→08/14	←	10/06→		<b>13.0460-3839.2 603839</b> <b>13.0470-3839.2 LD3839</b>	BOS 23707 17,9 + WK + Zub Ceramic
1.4 1.7 CDTI	88 92	07/12→08/14 11/06→08/14	←			<b>13.0460-3841.2 603841</b>	BOS 24550 19,5 + WK + Zub
			→			<b>13.0460-3848.2 603848</b>	BOS 24349 17,6 - WE / - WK + Zub
1.6 SRi	110	05/07→08/14	←	06/07→		<b>13.0460-7179.2 607179</b> <b>13.0470-7179.2 LD7179</b>	ATE 23832 20,2 - WK / + WK Ceramic
			→	06/07→		<b>13.0460-3848.2 603848</b>	BOS 24349 17,6 - WE / - WK + Zub
1.6 VXR 1.6 VXR	141 150	12/13→08/14 06/11→08/14	←			<b>13.0460-7179.2 607179</b> <b>13.0470-7179.2 LD7179</b>	ATE 23832 20,2 - WK / + WK Ceramic
			→			<b>13.0460-3848.2 603848</b>	BOS 24349 17,6 - WE / - WK + Zub
1.7 CDTI	96	11/06→08/14	←	06/10→		<b>13.0460-3841.2 603841</b>	BOS 24550 19,5 + WK + Zub
			→	06/10→		<b>13.0460-3848.2 603848</b>	BOS 24349 17,6 - WE / - WK + Zub
<b> Bremsscheibe</b>							
1.0 1.0 i 12V	44 48	11/06→08/14 06/10→08/14	←			<b>24.0112-0184.1 412184</b> <b>24.0122-0231.1 422231</b> <b>24.0322-0231.1 522231</b>	∅ 257 12 10 + S ∅ 257 22 20 V + S ∅ 257 22 20 V + S
			←			<b>24.0122-0231.1 422231</b> <b>24.0322-0231.1 522231</b>	∅ 257 22 20 V + S ∅ 257 22 20 V + S
			←			<b>24.0122-0231.1 422231</b> <b>24.0322-0231.1 522231</b>	∅ 257 22 20 V + S ∅ 257 22 20 V + S
1.2 1.2 1.2 LPG 1.2 LPG 1.4 1.4 LPG	51 59 59 63 64 64	06/10→08/14 11/06→08/14 09/09→08/14 08/11→08/14 09/09→08/14 09/09→08/14	←			<b>24.0122-0231.1 422231</b> <b>24.0322-0231.1 522231</b>	∅ 257 22 20 V + S ∅ 257 22 20 V + S
			←			<b>24.0122-0231.1 422231</b> <b>24.0322-0231.1 522231</b>	∅ 257 22 20 V + S ∅ 257 22 20 V + S
1.2 i 16V	63	11/06→08/14	←	06/10→		<b>24.0122-0231.1 422231</b> <b>24.0322-0231.1 522231</b>	∅ 257 22 20 V + S ∅ 257 22 20 V + S
1.3 CDTI	55	07/06→08/14	←	10/06→; für Bremsscheibendurchmesser [mm]: 257		<b>24.0122-0231.1 422231</b> <b>24.0322-0231.1 522231</b>	∅ 257 22 20 V + S ∅ 257 22 20 V + S
			←	10/06→; für Bremsscheibendurchmesser [mm]: 284		<b>24.0122-0241.1 422241</b>	∅ 284 22 20 V + S
1.3 CDTI	66	07/06→08/14	←	10/06→		<b>24.0122-0241.1 422241</b>	∅ 284 22 20 V + S
1.3 CDTI	70	06/10→08/14	←	für Bremsscheibendurchmesser [mm]: 257		<b>24.0122-0231.1 422231</b> <b>24.0322-0231.1 522231</b>	∅ 257 22 20 V + S ∅ 257 22 20 V + S
			←	für Bremsscheibendurchmesser [mm]: 284		<b>24.0122-0241.1 422241</b>	∅ 284 22 20 V + S
1.4 1.4 LPG	66 66	07/06→08/14 07/06→08/14	←	10/06→		<b>24.0122-0231.1 422231</b> <b>24.0322-0231.1 522231</b>	∅ 257 22 20 V + S ∅ 257 22 20 V + S
1.4	74	07/10→08/14	←	für Bremsscheibendurchmesser [mm]: 257		<b>24.0122-0231.1 422231</b> <b>24.0322-0231.1 522231</b>	∅ 257 22 20 V + S ∅ 257 22 20 V + S
			←			<b>24.0126-0146.1 426146</b> <b>24.0110-0347.1 410347</b>	∅ 278 26 23 V ∅ 264 10 8
1.4 1.7 CDTI	88 92	07/12→08/14 11/06→08/14	←			<b>24.0126-0146.1 426146</b> <b>24.0110-0347.1 410347</b>	∅ 278 26 23 V ∅ 264 10 8
1.6 SRi	110	05/07→08/14	←	06/07→		<b>24.0125-0142.1 425142</b> <b>24.0325-0142.1 525142</b>	∅ 308 25 22 V + S ∅ 308 25 23 V + S
			→	06/07→		<b>24.0110-0347.1 410347</b>	∅ 264 10 8
1.6 VXR 1.6 VXR	141 150	12/13→08/14 06/11→08/14	←	nicht für Ausstattungsvariante: Nuerburg- ring Edit.		<b>24.0125-0142.1 425142</b> <b>24.0325-0142.1 525142</b>	∅ 308 25 22 V + S ∅ 308 25 23 V + S
			→			<b>24.0110-0347.1 410347</b>	∅ 264 10 8
1.7 CDTI	96	11/06→08/14	←	06/10→		<b>24.0126-0146.1 426146</b> <b>24.0110-0347.1 410347</b>	∅ 278 26 23 V ∅ 264 10 8
			→	06/10→		<b>24.0126-0146.1 426146</b> <b>24.0110-0347.1 410347</b>	∅ 278 26 23 V ∅ 264 10 8









	kW			 	! #		
<b>VAUXHALL - CORSA Mk IV (E) (X15) 08/14→</b>							
 <b>Bremsbelagsatz, Scheibenbremse</b>							
1.0	66	08/14→	←	11/14→; für Bremsscheibendurchmesser [mm]: 308	13.0460-7179.2	607179	ATE 23832 20,2 - WK / + WK
1.0	85	08/14→			13.0470-7179.2	LD7179	ATE 23832 20,2 - WK / + WK Ceramic
1.2	51	08/14→					
1.3 CDTi	55	08/14→	←	11/14→; für Bremsscheibendurchmesser [mm]: 284	13.0460-7308.2	607308	ATE 22123 18,2 + WK + Zub
1.3 CDTi	70	08/14→					
1.4	55	09/14→					
1.4	66	08/14→	←	11/14→; für Bremsscheibendurchmesser [mm]: 257	13.0460-7310.2	607310	ATE 22143 17,5 + WK + Zub
1.4	74	08/14→	→	11/14→	13.0460-2793.2	602793	TRW 25973 17,2 + WK + Zub
1.4	110	07/15→	←	für Bremsscheibendurchmesser [mm]: 308	13.0460-7179.2	607179	ATE 23832 20,2 - WK / + WK
					13.0470-7179.2	LD7179	ATE 23832 20,2 - WK / + WK Ceramic
			←	für Bremsscheibendurchmesser [mm]: 284	13.0460-7308.2	607308	ATE 22123 18,2 + WK + Zub
			←	für Bremsscheibendurchmesser [mm]: 257	13.0460-7310.2	607310	ATE 22143 17,5 + WK + Zub
			→		13.0460-2793.2	602793	TRW 25973 17,2 + WK + Zub
1.6 VXR	151	04/15→	→		13.0460-2793.2	602793	TRW 25973 17,2 + WK + Zub
 <b>Bremsscheibe</b>							
1.0	66	08/14→	←	11/14→	24.0122-0231.1	422231	Ø 257 22 20 V + S
1.0	85	08/14→			24.0122-0241.1	422241	Ø 284 22 20 V + S
1.2	51	08/14→			24.0125-0142.1	425142	Ø 308 25 22 V + S
1.3 CDTi	55	08/14→			24.0322-0231.1	522231	Ø 257 22 20 V + S
1.3 CDTi	70	08/14→			24.0325-0142.1	525142	Ø 308 25 23 V + S
1.4	55	09/14→					
1.4	66	08/14→	→	11/14→; +POC J67	24.0110-0323.1	410323	Ø 264 10 8
1.4	74	08/14→	→	11/14→; +POC J7A	24.0110-0347.1	410347	Ø 264 10 8
1.4	110	07/15→	←		24.0122-0231.1	422231	Ø 257 22 20 V + S
					24.0122-0241.1	422241	Ø 284 22 20 V + S
					24.0125-0142.1	425142	Ø 308 25 22 V + S
					24.0322-0231.1	522231	Ø 257 22 20 V + S
					24.0325-0142.1	525142	Ø 308 25 23 V + S
			→	+POC J67	24.0110-0323.1	410323	Ø 264 10 8
			→	+POC J7A	24.0110-0347.1	410347	Ø 264 10 8
1.6 VXR	151	04/15→	→		24.0110-0347.1	410347	Ø 264 10 8
<b>VAUXHALL - CORSAVAN Mk I (B) (S93) 01/94→09/00</b>							
 <b>Bremsbelagsatz, Scheibenbremse</b>							
1.4 i	44	01/94→09/00	←		13.0460-7051.2	607051	ATE 20547 16,5 + WE / - WK
1.7 D	44	01/94→09/00					
 <b>Bremsscheibe</b>							
1.4 i	44	01/94→09/00	←	für Automatikgetriebe; für Fahrzeuge ohne Klimaanlage	24.0113-0161.1	413161	Ø 236 12,7 9,7 + S
					24.0313-0161.1	513161	Ø 236 12,7 9,7 + S
			←	für Schaltgetriebe	24.0113-0161.1	413161	Ø 236 12,7 9,7 + S
					24.0313-0161.1	513161	Ø 236 12,7 9,7 + S
			←		24.0120-0115.1	420115	Ø 236 20 17 V + S
					24.0320-0115.1	520115	Ø 236 20 17 V + S
			←	für Fahrzeuge mit Klimaanlage; für Automatikgetriebe	24.0120-0115.1	420115	Ø 236 20 17 V + S
					24.0320-0115.1	520115	Ø 236 20 17 V + S
1.7 D	44	01/94→09/00	←		24.0113-0161.1	413161	Ø 236 12,7 9,7 + S
					24.0313-0161.1	513161	Ø 236 12,7 9,7 + S
<b>VAUXHALL - CORSAVAN Mk II (C) (X01) 09/00→06/06</b>							
 <b>Bremsbelagsatz, Scheibenbremse</b>							
1.2 16V (F08)	55	09/00→06/06	←		13.0460-2857.2	602857	TRW 23225 17,0 + WK + Zub
1.2 16V Dualfuel (F08)	55	08/01→06/06			13.0470-2857.2	LD2857	TRW 23225 17,0 + WK + Zub Ceramic
1.3 CDTI 16V (F08)	52	04/04→06/06	←		13.0460-2857.2	602857	TRW 23225 17,0 + WK + Zub
1.4 (F08)	66	11/03→06/06			13.0470-2857.2	LD2857	TRW 23225 17,0 + WK + Zub Ceramic
1.7 DI 16V (F08)	48	09/00→06/06					
1.7 DTI 16V (F08)	55	09/00→06/06	→		13.0460-2858.2	602858	TRW 23284 14,0 + WK
					13.0470-2858.2	LD2858	TRW 23284 14,0 + WK Ceramic



	kw					! #		
<b>VAUXHALL - CORSAVAN Mk II (C) (X01) 09/00→06/06</b>								
 <b>Bremsscheibe</b>								
1.2 16V (F08)	55	09/00→06/06	←	- ABS		24.0111-0152.1	411152	Ø 240 11 8
1.2 16V Dualfuel (F08)	55	08/01→06/06	←	+ ABS		24.0120-0174.1	420174	Ø 240 20 17 V + S
1.3 CDTI 16V (F08)	52	04/04→06/06	←			24.0124-0166.1	424166	Ø 260 24 21 V + S
1.4 (F08)	66	11/03→06/06				24.0324-0166.1	524166	Ø 260 24 21 V
1.7 DTI 16V (F08)	55	09/00→06/06	→			24.0110-0268.1	410268	Ø 240 10,2 8,2
						24.0110-0291.1	410291	Ø 264 10 8 + S
						24.0310-0291.1	510291	Ø 264 10 8 + S
1.7 DI 16V (F08)	48	09/00→06/06	←			24.0120-0174.1	420174	Ø 240 20 17 V + S
			→			24.0110-0268.1	410268	Ø 240 10,2 8,2
						24.0110-0291.1	410291	Ø 264 10 8 + S
						24.0310-0291.1	510291	Ø 264 10 8 + S
<b>VAUXHALL - CORSAVAN Mk III (D) (S07) 07/06→</b>								
 <b>Bremsbelagsatz, Scheibenbremse</b>								
1.2	51	01/10→	←	06/10→		13.0460-3839.2	603839	BOS 23707 17,9 + WK + Zub
						13.0470-3839.2	LD3839	BOS 23707 17,9 + WK + Zub Ceramic
1.2	59	07/09→	←			13.0460-3839.2	603839	BOS 23707 17,9 + WK + Zub
						13.0470-3839.2	LD3839	BOS 23707 17,9 + WK + Zub Ceramic
1.3 CDTI	55	07/06→	←	10/06→; für Bremsscheibendurchmesser [mm]: 257		13.0460-3839.2	603839	BOS 23707 17,9 + WK + Zub
						13.0470-3839.2	LD3839	BOS 23707 17,9 + WK + Zub Ceramic
			←	10/06→; für Bremsscheibendurchmesser [mm]: 284		13.0460-3840.2	603840	BOS 23981 19,6 + WK + Zub
						13.0470-3840.2	LD3840	BOS 23981 19,6 + WK + Zub Ceramic
1.3 CDTI	66	07/06→	←	10/06→		13.0460-3840.2	603840	BOS 23981 19,6 + WK + Zub
						13.0470-3840.2	LD3840	BOS 23981 19,6 + WK + Zub Ceramic
1.3 CDTI	70	07/06→	←	06/10→; für Bremsscheibendurchmesser [mm]: 257		13.0460-3839.2	603839	BOS 23707 17,9 + WK + Zub
						13.0470-3839.2	LD3839	BOS 23707 17,9 + WK + Zub Ceramic
			←	06/10→; für Bremsscheibendurchmesser [mm]: 284		13.0460-3840.2	603840	BOS 23981 19,6 + WK + Zub
						13.0470-3840.2	LD3840	BOS 23981 19,6 + WK + Zub Ceramic
 <b>Bremsscheibe</b>								
1.2	51	01/10→	←	06/10→		24.0122-0231.1	422231	Ø 257 22 20 V + S
						24.0322-0231.1	522231	Ø 257 22 20 V + S
1.2	59	07/09→	←			24.0122-0231.1	422231	Ø 257 22 20 V + S
						24.0322-0231.1	522231	Ø 257 22 20 V + S
1.3 CDTI	55	07/06→	←	10/06→; für Bremsscheibendurchmesser [mm]: 257		24.0122-0231.1	422231	Ø 257 22 20 V + S
						24.0322-0231.1	522231	Ø 257 22 20 V + S
			←	10/06→; für Bremsscheibendurchmesser [mm]: 284		24.0122-0241.1	422241	Ø 284 22 20 V + S
1.3 CDTI	66	07/06→	←	10/06→		24.0122-0241.1	422241	Ø 284 22 20 V + S
1.3 CDTI	70	07/06→	←	06/10→; für Bremsscheibendurchmesser [mm]: 257		24.0122-0231.1	422231	Ø 257 22 20 V + S
						24.0322-0231.1	522231	Ø 257 22 20 V + S
			←	06/10→; für Bremsscheibendurchmesser [mm]: 284		24.0122-0241.1	422241	Ø 284 22 20 V + S
<b>VAUXHALL - CORSAVAN Mk IV (E) (X15) 10/14→</b>								
 <b>Bremsbelagsatz, Scheibenbremse</b>								
1.2	51	10/14→	←	11/14→; für Bremsscheibendurchmesser [mm]: 308		13.0460-7179.2	607179	ATE 23832 20,2 - WK / + WK
1.3 CDTi	55	10/14→				13.0470-7179.2	LD7179	ATE 23832 20,2 - WK / + WK Ceramic
1.3 CDTi	70	10/14→	←	11/14→; für Bremsscheibendurchmesser [mm]: 284		13.0460-7308.2	607308	ATE 22123 18,2 + WK + Zub
			←	11/14→; für Bremsscheibendurchmesser [mm]: 257		13.0460-7310.2	607310	ATE 22143 17,5 + WK + Zub
			→	11/14→		13.0460-2793.2	602793	TRW 25973 17,2 + WK + Zub

	kw					! #		
<b>VAUXHALL - CORSAVAN Mk IV (E) (X15) 10/14→</b>								
 <b>Bremsscheibe</b>								
1.2	51	10/14→	←	11/14→		24.0122-0231.1	422231	Ø 257 22 20 V + S
1.3 CDTi	55	10/14→	←			24.0122-0241.1	422241	Ø 284 22 20 V + S
1.3 CDTi	70	10/14→	←			24.0125-0142.1	425142	Ø 308 25 22 V + S
			←			24.0322-0231.1	522231	Ø 257 22 20 V + S
			←			24.0325-0142.1	525142	Ø 308 25 23 V + S
			→	11/14→; +POC J67		24.0110-0323.1	410323	Ø 264 10 8
			→	11/14→; +POC J7A		24.0110-0347.1	410347	Ø 264 10 8
<b>VAUXHALL - CROSSLAND X (P17) 03/17→</b>								
 <b>Bremsscheibe</b>								
1.2 (75)	60	03/17→	←	RPO Nummer: JAC; 14"		24.0122-0194.1	422194	Ø 266 22 20 V + S
1.2 (75)	81	03/17→	←	RPO Nummer: JAB; 15"		24.0126-0120.1	426120	Ø 283 26 24 V + S
1.2 (75)	96	03/17→	←					
1.2 LPG (75)	55	03/17→	→	→ 03122017		24.0109-0100.2	409100	Ø 249 9 7 + LG / + ABS Ring
1.6 Turbo D (75)	73	03/17→						
1.6 Turbo D (75)	85	06/17→						
1.6 Turbo D (75)	88	03/17→						
<b>VAUXHALL - FRONTERA Mk I (A) (U92) 09/91→10/98</b>								
 <b>Bremsbelagsatz, Scheibenbremse</b>								
2.0	85	04/95→08/98	←	SV720103→		13.0460-5926.2	605926	AKE 21845 16,5 + WK
2.2 i	100	03/95→10/98	←	→ SV720102		13.0460-5942.2	605942	AKE 21543 16,5 + WK
2.4 i	92	03/92→10/98	←					
			→	SV720103→		13.0460-5927.2	605927	AKE 21875 16,0 + WK
2.3 TD	74	09/91→06/98	←	SV720103→		13.0460-5926.2	605926	AKE 21845 16,5 + WK
			←	03/92→; → SV720102		13.0460-5942.2	605942	AKE 21543 16,5 + WK
			→	SV720103→		13.0460-5927.2	605927	AKE 21875 16,0 + WK
2.5 TDS	85	11/91→06/98	←	SV720103→		13.0460-5926.2	605926	AKE 21845 16,5 + WK
			←	09/96→; → SV720102		13.0460-5942.2	605942	AKE 21543 16,5 + WK
			→	SV720103→		13.0460-5927.2	605927	AKE 21875 16,0 + WK
2.8 TD	83	01/95→12/96	←	SV720103→		13.0460-5926.2	605926	AKE 21845 16,5 + WK
			←	03/95→; → SV720102		13.0460-5942.2	605942	AKE 21543 16,5 + WK
			→	SV720103→		13.0460-5927.2	605927	AKE 21875 16,0 + WK
<b>Zubehörsatz, Scheibenbremsbelag</b>								
2.0	85	04/95→08/98	←	→ SV720102		13.0460-0337.2	610337	AKE
2.2 i	100	03/95→10/98	←	SV720103→		13.0460-0446.2	610446	AKE
2.4 i	92	03/92→10/98	←					
			→	SV720103→		13.0460-0447.2	610447	AKE
2.3 TD	74	09/91→06/98	←	03/92→; → SV720102		13.0460-0337.2	610337	AKE
			←	SV720103→		13.0460-0446.2	610446	AKE
			→	SV720103→		13.0460-0447.2	610447	AKE
2.5 TDS	85	11/91→06/98	←	09/96→; → SV720102		13.0460-0337.2	610337	AKE
			←	SV720103→		13.0460-0446.2	610446	AKE
			→	SV720103→		13.0460-0447.2	610447	AKE
2.8 TD	83	01/95→12/96	←	03/95→; → SV720102		13.0460-0337.2	610337	AKE
			←	SV720103→		13.0460-0446.2	610446	AKE
			→	SV720103→		13.0460-0447.2	610447	AKE
 <b>Bremsscheibe</b>								
2.0	85	04/95→08/98	←	→ SV720102		24.0122-0156.1	422156	Ø 257 22 20,6 V
2.2 i	100	03/95→10/98	←	SV720103→		24.0126-0111.1	426111	Ø 280 26 24,6 V
2.4 i	92	03/92→10/98	←					
			→	SV720103→		24.0118-0122.1	418122	Ø 313,5 18 16,6 V
2.3 TD	74	09/91→06/98	←	03/92→; → SV720102		24.0122-0156.1	422156	Ø 257 22 20,6 V
			←	SV720103→		24.0126-0111.1	426111	Ø 280 26 24,6 V
			→	SV720103→		24.0118-0122.1	418122	Ø 313,5 18 16,6 V
2.5 TDS	85	11/91→06/98	←	09/96→; → SV720102		24.0122-0156.1	422156	Ø 257 22 20,6 V
			←	SV720103→		24.0126-0111.1	426111	Ø 280 26 24,6 V
			→	SV720103→		24.0118-0122.1	418122	Ø 313,5 18 16,6 V
2.8 TD	83	01/95→12/96	←	03/95→; → SV720102		24.0122-0156.1	422156	Ø 257 22 20,6 V
↓								

	kw			 	! #		
<b>VAUXHALL - FRONTERA Mk I (A) (U92) 09/91→10/98</b>							
 <b>Bremsscheibe</b>							
2.8 TD	83	01/95→12/96	←	SV720103→		24.0126-0111.1 426111	Ø 280 26 24,6 V
			→	SV720103→		24.0118-0122.1 418122	Ø 313,5 18 16,6 V
<b>VAUXHALL - FRONTERA Mk I (A) Sport (U92) 03/92→10/98</b>							
 <b>Bremsbelagsatz, Scheibenbremse</b>							
2.0 i	85	03/92→10/98	←	SV720103→		13.0460-5926.2 605926	AKE 21845 16,5 + WK
2.5 TDS	85	09/96→10/98	←	→ SV720102		13.0460-5942.2 605942	AKE 21543 16,5 + WK
			→	SV720103→		13.0460-5927.2 605927	AKE 21875 16,0 + WK
2.8 TD	83	01/95→12/96	←	SV720103→		13.0460-5926.2 605926	AKE 21845 16,5 + WK
			←	03/95→; → SV720102		13.0460-5942.2 605942	AKE 21543 16,5 + WK
			→	SV720103→		13.0460-5927.2 605927	AKE 21875 16,0 + WK
<b>Zubehörsatz, Scheibenbremsbelag</b>							
2.0 i	85	03/92→10/98	←	→ SV720102		13.0460-0337.2 610337	AKE
2.5 TDS	85	09/96→10/98	←	SV720103→		13.0460-0446.2 610446	AKE
			→	SV720103→		13.0460-0447.2 610447	AKE
2.8 TD	83	01/95→12/96	←	03/95→; → SV720102		13.0460-0337.2 610337	AKE
			←	SV720103→		13.0460-0446.2 610446	AKE
			→	SV720103→		13.0460-0447.2 610447	AKE
 <b>Bremsscheibe</b>							
2.0 i	85	03/92→10/98	←	→ SV720102		24.0122-0156.1 422156	Ø 257 22 20,6 V
2.5 TDS	85	09/96→10/98	←	SV720103→		24.0126-0111.1 426111	Ø 280 26 24,6 V
			→	SV720103→		24.0118-0122.1 418122	Ø 313,5 18 16,6 V
2.8 TD	83	01/95→12/96	←	03/95→; → SV720102		24.0122-0156.1 422156	Ø 257 22 20,6 V
			←	SV720103→		24.0126-0111.1 426111	Ø 280 26 24,6 V
			→	SV720103→		24.0118-0122.1 418122	Ø 313,5 18 16,6 V
<b>VAUXHALL - FRONTERA Mk II (B) (U99) 10/98→10/04</b>							
 <b>Bremsbelagsatz, Scheibenbremse</b>							
2.2 DTI	85	10/98→09/04	←	→ 02/04; für Fahrzeuge ohne Bordcomputer		13.0460-5926.2 605926	AKE 21845 16,5 + WK
2.2 i	100	10/98→10/04					
3.2 i	151	10/98→10/04	→	→ 02/04		13.0460-5927.2 605927	AKE 21875 16,0 + WK
<b>Zubehörsatz, Scheibenbremsbelag</b>							
2.2 DTI	85	10/98→09/04	→	→ 02/04		13.0460-0447.2 610447	AKE
2.2 i	100	10/98→10/04					
3.2 i	151	10/98→10/04					
 <b>Bremsscheibe</b>							
2.2 DTI	85	10/98→09/04	←	→ 02/04		24.0126-0111.1 426111	Ø 280 26 24,6 V
2.2 i	100	10/98→10/04					
3.2 i	151	10/98→10/04	→	→ 02/04		24.0118-0122.1 418122	Ø 313,5 18 16,6 V
<b>VAUXHALL - INSIGNIA Mk I (A) Estate 07/08→05/17</b>							
 <b>Bremsbelagsatz, Scheibenbremse</b>							
1.4 (35)	103	04/11→05/17	←	06/11→; für Bremsscheibendurchmesser [mm]: 337		13.0460-2754.2 602754	TRW 24418 17,0 + WK + Zub
			←	06/11→; für Bremsscheibendurchmesser [mm]: 296		13.0460-5611.2 605611 13.0470-5611.2 LD5611	MAN 24415 19,1 + WK + Zub MAN 24415 19,1 + WK + Zub Ceramic
			←	06/11→; für Bremsscheibendurchmesser [mm]: 321		13.0460-5612.2 605612 13.0470-5612.2 LD5612	MAN 24412 19,0 + WK + Zub MAN 24412 19,0 + WK + Zub Ceramic
			→	06/11→; für Bremsscheibendurchmesser [mm]: 315		13.0460-2755.2 602755 13.0470-2755.2 LD2755	TRW 24421 17,2 + WK + Zub TRW 24421 17,2 + WK + Zub Ceramic
			→	06/11→; für Bremsscheibendurchmesser [mm]: 292		13.0460-2758.2 602758 13.0470-2758.2 LD2758	TRW 24421 17,2 + WK + Zub TRW 24421 17,2 + WK + Zub Ceramic
1.4 LPG (35) 1.6 CDTI (35)	103 100	07/12→05/17 07/15→05/17	←	für Bremsscheibendurchmesser [mm]: 337		13.0460-2754.2 602754	TRW 24418 17,0 + WK + Zub

	kw			 	! #		
<b>VAUXHALL - INSIGNIA Mk I (A) Estate 07/08→05/17</b>							
<b> Bremsbelagsatz, Scheibenbremse</b>							
1.6 Turbo (35)	125	07/13→05/17	←	für Bremsscheibendurchmesser [mm]:		<b>13.0460-5611.2 605611</b>	MAN 24415 19,1 + WK + Zub
1.6 Turbo (35)	132	01/09→05/17		296		<b>13.0470-5611.2 LD5611</b>	MAN 24415 19,1 + WK + Zub
1.8 (35)	103	07/08→05/17					Ceramic
2.0 Biturbo CDTI (35)	143	03/12→05/17	←	für Bremsscheibendurchmesser [mm]:		<b>13.0460-5612.2 605612</b>	MAN 24412 19,0 + WK + Zub
2.0 Biturbo CDTI 4x4 (35)	143	03/12→05/17		321		<b>13.0470-5612.2 LD5612</b>	MAN 24412 19,0 + WK + Zub
2.0 CDTI (35)	81	07/08→05/17					Ceramic
2.0 CDTI (35)	96	07/08→12/14	→	für Bremsscheibendurchmesser [mm]:		<b>13.0460-2755.2 602755</b>	TRW 24421 17,2 + WK + Zub
2.0 CDTI (35)	103	07/13→05/17		315		<b>13.0470-2755.2 LD2755</b>	TRW 24421 17,2 + WK + Zub
2.0 CDTI (35)	118	07/08→05/17					Ceramic
2.0 CDTI (35)	120	07/13→05/17	→	für Bremsscheibendurchmesser [mm]:		<b>13.0460-2758.2 602758</b>	TRW 24421 17,2 + WK + Zub
2.0 CDTI (35)	125	11/14→05/17		292		<b>13.0470-2758.2 LD2758</b>	TRW 24421 17,2 + WK + Zub
2.0 CDTI (35)	140	11/08→05/17					Ceramic
2.0 CDTI 4x4 (35)	125	11/14→05/17					
2.0 CDTI 4x4 (35)	140	05/09→05/17					
2.0 Turbo (35)	162	07/08→05/17					
2.0 Turbo (35)	184	04/14→05/17					
2.0 Turbo 4x4 (35)	162	07/08→05/17					
2.0 Turbo 4x4 (35)	184	09/11→05/17					
2.0 CDTI (35)	88	03/12→03/16	←	03/13→;		<b>13.0460-2754.2 602754</b>	TRW 24418 17,0 + WK + Zub
			←	für Bremsscheibendurchmesser [mm]:		<b>13.0460-5611.2 605611</b>	MAN 24415 19,1 + WK + Zub
				296		<b>13.0470-5611.2 LD5611</b>	MAN 24415 19,1 + WK + Zub
			←	03/13→;		<b>13.0460-5612.2 605612</b>	MAN 24412 19,0 + WK + Zub
				für Bremsscheibendurchmesser [mm]:		<b>13.0470-5612.2 LD5612</b>	MAN 24412 19,0 + WK + Zub
			→	321			Ceramic
			→	03/13→;		<b>13.0460-2755.2 602755</b>	TRW 24421 17,2 + WK + Zub
				für Bremsscheibendurchmesser [mm]:		<b>13.0470-2755.2 LD2755</b>	TRW 24421 17,2 + WK + Zub
			→	315			Ceramic
			→	03/13→;		<b>13.0460-2758.2 602758</b>	TRW 24421 17,2 + WK + Zub
				für Bremsscheibendurchmesser [mm]:		<b>13.0470-2758.2 LD2758</b>	TRW 24421 17,2 + WK + Zub
				292			Ceramic
2.0 CDTI 4x4 (35)	118	07/08→05/17	←	06/10→;		<b>13.0460-2754.2 602754</b>	TRW 24418 17,0 + WK + Zub
			←	für Bremsscheibendurchmesser [mm]:		<b>13.0460-5611.2 605611</b>	MAN 24415 19,1 + WK + Zub
				337		<b>13.0470-5611.2 LD5611</b>	MAN 24415 19,1 + WK + Zub
			←	06/10→;		<b>13.0460-5612.2 605612</b>	MAN 24412 19,0 + WK + Zub
				für Bremsscheibendurchmesser [mm]:		<b>13.0470-5612.2 LD5612</b>	MAN 24412 19,0 + WK + Zub
			→	296			Ceramic
			→	06/10→;		<b>13.0460-2755.2 602755</b>	TRW 24421 17,2 + WK + Zub
				für Bremsscheibendurchmesser [mm]:		<b>13.0470-2755.2 LD2755</b>	TRW 24421 17,2 + WK + Zub
			→	315			Ceramic
			→	06/10→;		<b>13.0460-2758.2 602758</b>	TRW 24421 17,2 + WK + Zub
				für Bremsscheibendurchmesser [mm]:		<b>13.0470-2758.2 LD2758</b>	TRW 24421 17,2 + WK + Zub
				292			Ceramic
2.8 V6 Turbo (35)	191	08/08→05/17	←	für Bremsscheibendurchmesser [mm]:		<b>13.0460-2754.2 602754</b>	TRW 24418 17,0 + WK + Zub
			→	337		<b>13.0460-2755.2 602755</b>	TRW 24421 17,2 + WK + Zub
						<b>13.0470-2755.2 LD2755</b>	TRW 24421 17,2 + WK + Zub
							Ceramic
2.8 VXR (35)	239	07/09→05/17	←			<b>13.0460-4855.2 604855</b>	BRE 23325 16,4 + WK
			→			<b>13.0460-2755.2 602755</b>	TRW 24421 17,2 + WK + Zub
						<b>13.0470-2755.2 LD2755</b>	TRW 24421 17,2 + WK + Zub
							Ceramic
<b> Bremsscheibe</b>							
1.4 (35)	103	04/11→05/17	←	06/11→		<b>24.0130-0207.1 430207</b>	Ø 296 30 27 V + S
						<b>24.0130-0208.1 430208</b>	Ø 337 30 27 V + S
						<b>24.0130-0209.1 430209</b>	Ø 321 30 27 V + S
						<b>24.0330-0207.1 530207</b>	Ø 296 30 27 V + S
						<b>24.0330-0209.1 530209</b>	Ø 321 30 27 V + S
			→	06/11→		<b>24.0112-0187.1 412187</b>	Ø 292 12 10,5 + S
						<b>24.0123-0114.1 423114</b>	Ø 315 22,9 21,5 V + S
						<b>24.0312-0187.1 512187</b>	Ø 292 12 10,5 + S
						<b>24.0323-0114.1 523114</b>	Ø 315 22,9 21,5 V + S
1.4 LPG (35)	103	07/12→05/17	←			<b>24.0130-0207.1 430207</b>	Ø 296 30 27 V + S
1.6 CDTI (35)	100	07/15→05/17				<b>24.0130-0208.1 430208</b>	Ø 337 30 27 V + S
↓							

**VAUXHALL - INSIGNIA Mk I (A) Estate 07/08→05/17**

**Bremsscheibe**









1.6 Turbo (35)	125	07/13→05/17	←			24.0130-0209.1	430209	Ø 321 30 27 V + S
1.6 Turbo (35)	132	01/09→05/17				24.0330-0207.1	530207	Ø 296 30 27 V + S
1.8 (35)	103	07/08→05/17				24.0330-0209.1	530209	Ø 321 30 27 V + S
2.0 Biturbo CDTI (35)	143	03/12→05/17				24.0112-0187.1	412187	Ø 292 12 10,5 + S
2.0 Biturbo CDTI 4x4 (35)	143	03/12→05/17	→			24.0123-0114.1	423114	Ø 315 22,9 21,5 V + S
2.0 CDTI (35)	81	07/08→05/17				24.0312-0187.1	512187	Ø 292 12 10,5 + S
2.0 CDTI (35)	96	07/08→12/14				24.0323-0114.1	523114	Ø 315 22,9 21,5 V + S
2.0 CDTI (35)	103	07/13→05/17						
2.0 CDTI (35)	118	07/08→05/17						
2.0 CDTI (35)	120	07/13→05/17						
2.0 CDTI (35)	125	11/14→05/17						
2.0 CDTI (35)	140	11/08→05/17						
2.0 CDTI 4x4 (35)	125	11/14→05/17						
2.0 CDTI 4x4 (35)	140	05/09→05/17						
2.0 Turbo (35)	162	07/08→05/17						
2.0 Turbo (35)	184	04/14→05/17						
2.0 Turbo 4x4 (35)	162	07/08→05/17						
2.0 Turbo 4x4 (35)	184	09/11→05/17						
2.0 CDTI (35)	88	03/12→03/16	←	03/13→		24.0130-0207.1	430207	Ø 296 30 27 V + S
						24.0130-0208.1	430208	Ø 337 30 27 V + S
						24.0130-0209.1	430209	Ø 321 30 27 V + S
						24.0330-0207.1	530207	Ø 296 30 27 V + S
						24.0330-0209.1	530209	Ø 321 30 27 V + S
			→	03/13→		24.0112-0187.1	412187	Ø 292 12 10,5 + S
						24.0123-0114.1	423114	Ø 315 22,9 21,5 V + S
						24.0312-0187.1	512187	Ø 292 12 10,5 + S
						24.0323-0114.1	523114	Ø 315 22,9 21,5 V + S
2.0 CDTI 4x4 (35)	118	07/08→05/17	←	06/10→		24.0130-0207.1	430207	Ø 296 30 27 V + S
						24.0130-0208.1	430208	Ø 337 30 27 V + S
						24.0130-0209.1	430209	Ø 321 30 27 V + S
						24.0330-0207.1	530207	Ø 296 30 27 V + S
						24.0330-0209.1	530209	Ø 321 30 27 V + S
			→	06/10→		24.0112-0187.1	412187	Ø 292 12 10,5 + S
						24.0123-0114.1	423114	Ø 315 22,9 21,5 V + S
						24.0312-0187.1	512187	Ø 292 12 10,5 + S
						24.0323-0114.1	523114	Ø 315 22,9 21,5 V + S
2.8 V6 Turbo (35)	191	08/08→05/17	←			24.0130-0208.1	430208	Ø 337 30 27 V + S
			→			24.0123-0114.1	423114	Ø 315 22,9 21,5 V + S
						24.0323-0114.1	523114	Ø 315 22,9 21,5 V + S
2.8 VXR (35)	239	07/09→05/17	→			24.0123-0114.1	423114	Ø 315 22,9 21,5 V + S
						24.0323-0114.1	523114	Ø 315 22,9 21,5 V + S

**VAUXHALL - INSIGNIA Mk I (A) Schrägheck (G09) 07/08→05/17**

**Bremselagsatz, Scheibenbremse**

1.4 (68)	103	04/11→05/17	←	06/11→; für Bremsscheibendurchmesser [mm]: 337		13.0460-2754.2	602754	TRW 24418 17,0 + WK + Zub
			←	06/11→; für Bremsscheibendurchmesser [mm]: 296		13.0460-5611.2	605611	MAN 24415 19,1 + WK + Zub
						13.0470-5611.2	LD5611	MAN 24415 19,1 + WK + Zub Ceramic
			←	06/11→; für Bremsscheibendurchmesser [mm]: 321		13.0460-5612.2	605612	MAN 24412 19,0 + WK + Zub
						13.0470-5612.2	LD5612	MAN 24412 19,0 + WK + Zub Ceramic
			→	06/11→; für Bremsscheibendurchmesser [mm]: 315		13.0460-2755.2	602755	TRW 24421 17,2 + WK + Zub
						13.0470-2755.2	LD2755	TRW 24421 17,2 + WK + Zub Ceramic
			→	06/11→; für Bremsscheibendurchmesser [mm]: 292		13.0460-2758.2	602758	TRW 24421 17,2 + WK + Zub
						13.0470-2758.2	LD2758	TRW 24421 17,2 + WK + Zub Ceramic
1.4 LPG (68)	103	07/12→05/17	←	für Bremsscheibendurchmesser [mm]: 337		13.0460-2754.2	602754	TRW 24418 17,0 + WK + Zub
1.6 CDTI (68)	100	07/15→05/17						
1.6 Turbo (68)	125	07/13→05/17						
1.6 Turbo (68)	132	01/09→05/17	←	für Bremsscheibendurchmesser [mm]: 296		13.0460-5611.2	605611	MAN 24415 19,1 + WK + Zub
1.8 (68)	103	07/08→05/17				13.0470-5611.2	LD5611	MAN 24415 19,1 + WK + Zub Ceramic
2.0 Biturbo CDTI (68)	143	03/12→05/17						
2.0 Biturbo CDTI 4x4 (68)	143	03/12→05/17	←	für Bremsscheibendurchmesser [mm]: 321		13.0460-5612.2	605612	MAN 24412 19,0 + WK + Zub
2.0 CDTI (68)	81	07/08→05/17				13.0470-5612.2	LD5612	MAN 24412 19,0 + WK + Zub Ceramic
2.0 CDTI (68)	96	07/08→12/14						
2.0 CDTI (68)	103	07/13→05/17						



	kW			 	! #		
<b>VAUXHALL - INSIGNIA Mk I (A) Schrägheck (G09) 07/08→05/17</b>							
<b> Bremsbelagsatz, Scheibenbremse</b>							
2.0 CDTI (68)	118	07/08→05/17	➔	für Bremsscheibendurchmesser [mm]:		<b>13.0460-2755.2 602755</b>	TRW 24421 17,2 + WK + Zub
2.0 CDTI (68)	120	07/13→05/17		315		<b>13.0470-2755.2 LD2755</b>	TRW 24421 17,2 + WK + Zub
2.0 CDTI (68)	125	11/14→05/17					Ceramic
2.0 CDTI (68)	140	10/08→05/17	➔	für Bremsscheibendurchmesser [mm]:		<b>13.0460-2758.2 602758</b>	TRW 24421 17,2 + WK + Zub
2.0 CDTI 4x4 (68)	125	11/14→05/17		292		<b>13.0470-2758.2 LD2758</b>	TRW 24421 17,2 + WK + Zub
2.0 CDTI 4x4 (68)	140	05/09→05/17					Ceramic
2.0 Turbo (68)	162	07/08→05/17					
2.0 Turbo (68)	184	04/14→05/17					
2.0 Turbo 4x4 (68)	162	07/08→05/17					
2.0 Turbo 4x4 (68)	184	09/11→05/17					
2.0 CDTI (68)	88	03/12→03/16	⬅	03/13→;		<b>13.0460-2754.2 602754</b>	TRW 24418 17,0 + WK + Zub
				für Bremsscheibendurchmesser [mm]:			
				337			
			⬅	03/13→;		<b>13.0460-5611.2 605611</b>	MAN 24415 19,1 + WK + Zub
				für Bremsscheibendurchmesser [mm]:		<b>13.0470-5611.2 LD5611</b>	MAN 24415 19,1 + WK + Zub
				296			Ceramic
			⬅	03/13→;		<b>13.0460-5612.2 605612</b>	MAN 24412 19,0 + WK + Zub
				für Bremsscheibendurchmesser [mm]:		<b>13.0470-5612.2 LD5612</b>	MAN 24412 19,0 + WK + Zub
				321			Ceramic
			➔	03/13→;		<b>13.0460-2755.2 602755</b>	TRW 24421 17,2 + WK + Zub
				für Bremsscheibendurchmesser [mm]:		<b>13.0470-2755.2 LD2755</b>	TRW 24421 17,2 + WK + Zub
				315			Ceramic
			➔	03/13→;		<b>13.0460-2758.2 602758</b>	TRW 24421 17,2 + WK + Zub
				für Bremsscheibendurchmesser [mm]:		<b>13.0470-2758.2 LD2758</b>	TRW 24421 17,2 + WK + Zub
				292			Ceramic
2.0 CDTI 4x4 (68)	118	07/08→05/17	⬅	06/10→;		<b>13.0460-2754.2 602754</b>	TRW 24418 17,0 + WK + Zub
				für Bremsscheibendurchmesser [mm]:			
				337			
			⬅	06/10→;		<b>13.0460-5611.2 605611</b>	MAN 24415 19,1 + WK + Zub
				für Bremsscheibendurchmesser [mm]:		<b>13.0470-5611.2 LD5611</b>	MAN 24415 19,1 + WK + Zub
				296			Ceramic
			⬅	06/10→;		<b>13.0460-5612.2 605612</b>	MAN 24412 19,0 + WK + Zub
				für Bremsscheibendurchmesser [mm]:		<b>13.0470-5612.2 LD5612</b>	MAN 24412 19,0 + WK + Zub
				321			Ceramic
			➔	06/10→;		<b>13.0460-2755.2 602755</b>	TRW 24421 17,2 + WK + Zub
				für Bremsscheibendurchmesser [mm]:		<b>13.0470-2755.2 LD2755</b>	TRW 24421 17,2 + WK + Zub
				315			Ceramic
			➔	06/10→;		<b>13.0460-2758.2 602758</b>	TRW 24421 17,2 + WK + Zub
				für Bremsscheibendurchmesser [mm]:		<b>13.0470-2758.2 LD2758</b>	TRW 24421 17,2 + WK + Zub
				292			Ceramic
2.8 V6 Turbo 4x4 (68)	191	07/08→05/17	⬅	für Bremsscheibendurchmesser [mm]:		<b>13.0460-2754.2 602754</b>	TRW 24418 17,0 + WK + Zub
				337			
			➔			<b>13.0460-2755.2 602755</b>	TRW 24421 17,2 + WK + Zub
2.8 VXR (68)	239	07/09→05/17	⬅			<b>13.0460-4855.2 604855</b>	BRE 23325 16,4 + WK
			➔			<b>13.0460-2755.2 602755</b>	TRW 24421 17,2 + WK + Zub
<b> Bremsscheibe</b>							
1.4 (68)	103	04/11→05/17	⬅	06/11→		<b>24.0130-0207.1 430207</b>	Ø 296 30 27 V + S
						<b>24.0130-0208.1 430208</b>	Ø 337 30 27 V + S
						<b>24.0130-0209.1 430209</b>	Ø 321 30 27 V + S
						<b>24.0330-0207.1 530207</b>	Ø 296 30 27 V + S
						<b>24.0330-0209.1 530209</b>	Ø 321 30 27 V + S
			➔	06/11→		<b>24.0112-0187.1 412187</b>	Ø 292 12 10,5 + S
						<b>24.0123-0114.1 423114</b>	Ø 315 22,9 21,5 V + S
						<b>24.0312-0187.1 512187</b>	Ø 292 12 10,5 + S
						<b>24.0323-0114.1 523114</b>	Ø 315 22,9 21,5 V + S
1.4 LPG (68)	103	07/12→05/17	⬅			<b>24.0130-0207.1 430207</b>	Ø 296 30 27 V + S
1.6 CDTI (68)	100	07/15→05/17				<b>24.0130-0208.1 430208</b>	Ø 337 30 27 V + S
1.6 Turbo (68)	125	07/13→05/17				<b>24.0130-0209.1 430209</b>	Ø 321 30 27 V + S
1.6 Turbo (68)	132	01/09→05/17				<b>24.0330-0207.1 530207</b>	Ø 296 30 27 V + S
1.8 (68)	103	07/08→05/17				<b>24.0330-0209.1 530209</b>	Ø 321 30 27 V + S
2.0 Biturbo CDTI (68)	143	03/12→05/17					
2.0 Biturbo CDTI 4x4 (68)	143	03/12→05/17	➔			<b>24.0112-0187.1 412187</b>	Ø 292 12 10,5 + S
2.0 CDTI (68)	81	07/08→05/17				<b>24.0123-0114.1 423114</b>	Ø 315 22,9 21,5 V + S
2.0 CDTI (68)	96	07/08→12/14				<b>24.0312-0187.1 512187</b>	Ø 292 12 10,5 + S
2.0 CDTI (68)	103	07/13→05/17				<b>24.0323-0114.1 523114</b>	Ø 315 22,9 21,5 V + S
2.0 CDTI (68)	118	07/08→05/17					
2.0 CDTI (68)	120	07/13→05/17					
2.0 CDTI (68)	125	11/14→05/17					
2.0 CDTI (68)	140	10/08→05/17					
2.0 CDTI 4x4 (68)	125	11/14→05/17	↓				

**VAUXHALL - INSIGNIA Mk I (A) Schrägheck (G09) 07/08→05/17**









**Bremsscheibe**

2.0 CDTI 4x4 (68) 2.0 Turbo (68) 2.0 Turbo (68) 2.0 Turbo 4x4 (68) 2.0 Turbo 4x4 (68)	140 162 184 162 184	05/09→05/17 07/08→05/17 04/14→05/17 07/08→05/17 09/11→05/17	←		24.0130-0207.1 430207	Ø 296 30 27 V + S
					24.0130-0208.1 430208	Ø 337 30 27 V + S
					24.0130-0209.1 430209	Ø 321 30 27 V + S
					24.0330-0207.1 530207	Ø 296 30 27 V + S
					24.0330-0209.1 530209	Ø 321 30 27 V + S
			→		24.0112-0187.1 412187	Ø 292 12 10,5 + S
					24.0123-0114.1 423114	Ø 315 22,9 21,5 V + S
					24.0312-0187.1 512187	Ø 292 12 10,5 + S
					24.0323-0114.1 523114	Ø 315 22,9 21,5 V + S
2.0 CDTI (68)	88	03/12→03/16	←	03/13→	24.0130-0207.1 430207	Ø 296 30 27 V + S
					24.0130-0208.1 430208	Ø 337 30 27 V + S
					24.0130-0209.1 430209	Ø 321 30 27 V + S
					24.0330-0207.1 530207	Ø 296 30 27 V + S
					24.0330-0209.1 530209	Ø 321 30 27 V + S
			→	03/13→	24.0112-0187.1 412187	Ø 292 12 10,5 + S
					24.0123-0114.1 423114	Ø 315 22,9 21,5 V + S
					24.0312-0187.1 512187	Ø 292 12 10,5 + S
					24.0323-0114.1 523114	Ø 315 22,9 21,5 V + S
2.0 CDTI 4x4 (68)	118	07/08→05/17	←	06/10→	24.0130-0207.1 430207	Ø 296 30 27 V + S
					24.0130-0208.1 430208	Ø 337 30 27 V + S
					24.0130-0209.1 430209	Ø 321 30 27 V + S
					24.0330-0207.1 530207	Ø 296 30 27 V + S
					24.0330-0209.1 530209	Ø 321 30 27 V + S
			→	06/10→	24.0112-0187.1 412187	Ø 292 12 10,5 + S
					24.0123-0114.1 423114	Ø 315 22,9 21,5 V + S
					24.0312-0187.1 512187	Ø 292 12 10,5 + S
					24.0323-0114.1 523114	Ø 315 22,9 21,5 V + S
2.8 V6 Turbo 4x4 (68)	191	07/08→05/17	←		24.0130-0208.1 430208	Ø 337 30 27 V + S
					24.0123-0114.1 423114	Ø 315 22,9 21,5 V + S
					24.0323-0114.1 523114	Ø 315 22,9 21,5 V + S
2.8 VXR (68)	239	07/09→05/17	→		24.0123-0114.1 423114	Ø 315 22,9 21,5 V + S
					24.0323-0114.1 523114	Ø 315 22,9 21,5 V + S

**VAUXHALL - INSIGNIA Mk I (A) Stufenheck (G09) 07/08→05/17**

**Bremsbelagsatz, Scheibenbremse**

1.4 (69)	103	04/11→05/17	←	06/11→; für Bremsscheibendurchmesser [mm]: 337	13.0460-2754.2 602754	TRW 24418 17,0 + WK + Zub		
					13.0460-5611.2 605611 13.0470-5611.2 LD5611	MAN 24415 19,1 + WK + Zub MAN 24415 19,1 + WK + Zub Ceramic		
						13.0460-5612.2 605612 13.0470-5612.2 LD5612	MAN 24412 19,0 + WK + Zub MAN 24412 19,0 + WK + Zub Ceramic	
					→		06/11→; für Bremsscheibendurchmesser [mm]: 315	13.0460-2755.2 602755 13.0470-2755.2 LD2755
						13.0460-2758.2 602758 13.0470-2758.2 LD2758		TRW 24421 17,2 + WK + Zub TRW 24421 17,2 + WK + Zub Ceramic
1.4 LPG (69) 1.6 Turbo (69) 1.8 (69) 2.0 Biturbo CDTI (69) 2.0 Biturbo CDTI 4x4 (69) 2.0 CDTI (69) 2.0 CDTI (69) 2.0 CDTI (69) 2.0 CDTI (69) 2.0 CDTI (69) 2.0 CDTI (69) 2.0 CDTI 4x4 (69) 2.0 CDTI 4x4 (69) 2.0 Turbo (69) 2.0 Turbo 4x4 (69) 2.0 Turbo 4x4 (69)	103 132 103 143 143 81 96 103 118 120 125 140 125 140 162 162 184	07/12→05/17 01/09→05/17 07/08→05/17 03/12→05/17 03/12→05/17 07/08→05/17 07/08→12/14 07/13→05/17 07/08→05/17 07/13→05/17 11/14→05/17 11/08→05/17 11/14→05/17 05/09→05/17 07/08→05/17 07/08→05/17 09/11→05/17	←	für Bremsscheibendurchmesser [mm]: 337 für Bremsscheibendurchmesser [mm]: 296 für Bremsscheibendurchmesser [mm]: 321 für Bremsscheibendurchmesser [mm]: 315 für Bremsscheibendurchmesser [mm]: 292	13.0460-2754.2 602754	TRW 24418 17,0 + WK + Zub		
					13.0460-5611.2 605611 13.0470-5611.2 LD5611	MAN 24415 19,1 + WK + Zub MAN 24415 19,1 + WK + Zub Ceramic		
						13.0460-5612.2 605612 13.0470-5612.2 LD5612	MAN 24412 19,0 + WK + Zub MAN 24412 19,0 + WK + Zub Ceramic	
					→		für Bremsscheibendurchmesser [mm]: 315	13.0460-2755.2 602755 13.0470-2755.2 LD2755
						13.0460-2758.2 602758 13.0470-2758.2 LD2758		TRW 24421 17,2 + WK + Zub TRW 24421 17,2 + WK + Zub Ceramic
					→	für Bremsscheibendurchmesser [mm]: 292	13.0460-2758.2 602758 13.0470-2758.2 LD2758	TRW 24421 17,2 + WK + Zub TRW 24421 17,2 + WK + Zub Ceramic

	kw			 	! #		
<b>VAUXHALL - INSIGNIA Mk I (A) Stufenheck (G09) 07/08→05/17</b>							
<b> Bremsbelagsatz, Scheibenbremse</b>							
2.0 CDTI (69)	88	03/12→12/14	←	03/13→; für Bremsscheibendurchmesser [mm]: 337	13.0460-2754.2	602754	TRW 24418 17,0 + WK + Zub
			←	03/13→; für Bremsscheibendurchmesser [mm]: 296	13.0460-5611.2 13.0470-5611.2	605611 LD5611	MAN 24415 19,1 + WK + Zub MAN 24415 19,1 + WK + Zub Ceramic
			←	03/13→; für Bremsscheibendurchmesser [mm]: 321	13.0460-5612.2 13.0470-5612.2	605612 LD5612	MAN 24412 19,0 + WK + Zub MAN 24412 19,0 + WK + Zub Ceramic
			→	03/13→; für Bremsscheibendurchmesser [mm]: 315	13.0460-2755.2 13.0470-2755.2	602755 LD2755	TRW 24421 17,2 + WK + Zub TRW 24421 17,2 + WK + Zub Ceramic
			→	03/13→; für Bremsscheibendurchmesser [mm]: 292	13.0460-2758.2 13.0470-2758.2	602758 LD2758	TRW 24421 17,2 + WK + Zub TRW 24421 17,2 + WK + Zub Ceramic
2.0 CDTI 4x4 (69)	118	07/08→05/17	←	06/10→; für Bremsscheibendurchmesser [mm]: 337	13.0460-2754.2	602754	TRW 24418 17,0 + WK + Zub
			←	06/10→; für Bremsscheibendurchmesser [mm]: 296	13.0460-5611.2 13.0470-5611.2	605611 LD5611	MAN 24415 19,1 + WK + Zub MAN 24415 19,1 + WK + Zub Ceramic
			←	06/10→; für Bremsscheibendurchmesser [mm]: 321	13.0460-5612.2 13.0470-5612.2	605612 LD5612	MAN 24412 19,0 + WK + Zub MAN 24412 19,0 + WK + Zub Ceramic
			→	06/10→; für Bremsscheibendurchmesser [mm]: 315	13.0460-2755.2 13.0470-2755.2	602755 LD2755	TRW 24421 17,2 + WK + Zub TRW 24421 17,2 + WK + Zub Ceramic
			→	06/10→; für Bremsscheibendurchmesser [mm]: 292	13.0460-2758.2 13.0470-2758.2	602758 LD2758	TRW 24421 17,2 + WK + Zub TRW 24421 17,2 + WK + Zub Ceramic
2.0 Turbo (69)	184	09/11→05/17	←	04/14→; für Bremsscheibendurchmesser [mm]: 337	13.0460-2754.2	602754	TRW 24418 17,0 + WK + Zub
			←	04/14→; für Bremsscheibendurchmesser [mm]: 296	13.0460-5611.2 13.0470-5611.2	605611 LD5611	MAN 24415 19,1 + WK + Zub MAN 24415 19,1 + WK + Zub Ceramic
			←	04/14→; für Bremsscheibendurchmesser [mm]: 321	13.0460-5612.2 13.0470-5612.2	605612 LD5612	MAN 24412 19,0 + WK + Zub MAN 24412 19,0 + WK + Zub Ceramic
			→	04/14→; für Bremsscheibendurchmesser [mm]: 315	13.0460-2755.2 13.0470-2755.2	602755 LD2755	TRW 24421 17,2 + WK + Zub TRW 24421 17,2 + WK + Zub Ceramic
			→	04/14→; für Bremsscheibendurchmesser [mm]: 292	13.0460-2758.2 13.0470-2758.2	602758 LD2758	TRW 24421 17,2 + WK + Zub TRW 24421 17,2 + WK + Zub Ceramic
2.8 V6 Turbo 4x4 (69)	191	07/08→05/17	←	für Bremsscheibendurchmesser [mm]: 337	13.0460-2754.2	602754	TRW 24418 17,0 + WK + Zub
			→		13.0460-2755.2	602755	TRW 24421 17,2 + WK + Zub
2.8 VXR (69)	239	07/09→05/17	←		13.0460-4855.2	604855	BRE 23325 16,4 + WK
			→		13.0460-2755.2	602755	TRW 24421 17,2 + WK + Zub
<b> Bremsscheibe</b>							
1.4 (69)	103	04/11→05/17	←	06/11→	24.0130-0207.1 24.0130-0208.1 24.0130-0209.1 24.0330-0207.1 24.0330-0209.1	430207 430208 430209 530207 530209	Ø 296 30 27 V + S Ø 337 30 27 V + S Ø 321 30 27 V + S Ø 296 30 27 V + S Ø 321 30 27 V + S
			→	06/11→	24.0112-0187.1 24.0123-0114.1 24.0312-0187.1 24.0323-0114.1	412187 423114 512187 523114	Ø 292 12 10,5 + S Ø 315 22,9 21,5 V + S Ø 292 12 10,5 + S Ø 315 22,9 21,5 V + S
1.4 LPG (69)	103	07/12→05/17	←		24.0130-0207.1	430207	Ø 296 30 27 V + S
1.6 Turbo (69)	132	01/09→05/17	←		24.0130-0208.1	430208	Ø 337 30 27 V + S
1.8 (69)	103	07/08→05/17	←		24.0130-0209.1	430209	Ø 321 30 27 V + S
2.0 Biturbo CDTI (69)	143	03/12→05/17	←		24.0130-0209.1	430209	Ø 321 30 27 V + S
2.0 Biturbo CDTI 4x4 (69)	143	03/12→05/17	←		24.0330-0207.1	530207	Ø 296 30 27 V + S
2.0 CDTI (69)	81	07/08→05/17	←		24.0330-0209.1	530209	Ø 321 30 27 V + S
2.0 CDTI (69)	96	07/08→12/14	←				

**VAUXHALL - INSIGNIA Mk I (A) Stufenheck (G09) 07/08→05/17**









**Bremsscheibe**

2.0 CDTi (69)	103	07/13→05/17	➔			24.0112-0187.1	412187	Ø 292 12 10,5 + S
2.0 CDTi (69)	118	07/08→05/17				24.0123-0114.1	423114	Ø 315 22,9 21,5 V + S
2.0 CDTi (69)	120	07/13→05/17				24.0312-0187.1	512187	Ø 292 12 10,5 + S
2.0 CDTi (69)	125	11/14→05/17				24.0323-0114.1	523114	Ø 315 22,9 21,5 V + S
2.0 CDTi (69)	140	11/08→05/17						
2.0 CDTi 4x4 (69)	125	11/14→05/17						
2.0 CDTi 4x4 (69)	140	05/09→05/17						
2.0 Turbo (69)	162	07/08→05/17						
2.0 Turbo 4x4 (69)	162	07/08→05/17						
2.0 Turbo 4x4 (69)	184	09/11→05/17						
2.0 CDTi (69)	88	03/12→12/14	➔	03/13→		24.0130-0207.1	430207	Ø 296 30 27 V + S
						24.0130-0208.1	430208	Ø 337 30 27 V + S
						24.0130-0209.1	430209	Ø 321 30 27 V + S
						24.0330-0207.1	530207	Ø 296 30 27 V + S
						24.0330-0209.1	530209	Ø 321 30 27 V + S
			➔	03/13→		24.0112-0187.1	412187	Ø 292 12 10,5 + S
						24.0123-0114.1	423114	Ø 315 22,9 21,5 V + S
						24.0312-0187.1	512187	Ø 292 12 10,5 + S
						24.0323-0114.1	523114	Ø 315 22,9 21,5 V + S
2.0 CDTi 4x4 (69)	118	07/08→05/17	➔	06/10→		24.0130-0207.1	430207	Ø 296 30 27 V + S
						24.0130-0208.1	430208	Ø 337 30 27 V + S
						24.0130-0209.1	430209	Ø 321 30 27 V + S
						24.0330-0207.1	530207	Ø 296 30 27 V + S
						24.0330-0209.1	530209	Ø 321 30 27 V + S
			➔	06/10→		24.0112-0187.1	412187	Ø 292 12 10,5 + S
						24.0123-0114.1	423114	Ø 315 22,9 21,5 V + S
						24.0312-0187.1	512187	Ø 292 12 10,5 + S
						24.0323-0114.1	523114	Ø 315 22,9 21,5 V + S
2.0 Turbo (69)	184	09/11→05/17	➔	04/14→		24.0130-0207.1	430207	Ø 296 30 27 V + S
						24.0130-0208.1	430208	Ø 337 30 27 V + S
						24.0130-0209.1	430209	Ø 321 30 27 V + S
						24.0330-0207.1	530207	Ø 296 30 27 V + S
						24.0330-0209.1	530209	Ø 321 30 27 V + S
			➔	04/14→		24.0112-0187.1	412187	Ø 292 12 10,5 + S
						24.0123-0114.1	423114	Ø 315 22,9 21,5 V + S
						24.0312-0187.1	512187	Ø 292 12 10,5 + S
						24.0323-0114.1	523114	Ø 315 22,9 21,5 V + S
2.8 V6 Turbo 4x4 (69)	191	07/08→05/17	➔			24.0130-0208.1	430208	Ø 337 30 27 V + S
						24.0123-0114.1	423114	Ø 315 22,9 21,5 V + S
						24.0323-0114.1	523114	Ø 315 22,9 21,5 V + S
2.8 VXR (69)	239	07/09→05/17	➔			24.0123-0114.1	423114	Ø 315 22,9 21,5 V + S
						24.0323-0114.1	523114	Ø 315 22,9 21,5 V + S











**VAUXHALL - MERIVA Mk I (A) (X03) 01/03→06/10**















**Bremsbelagsatz, Scheibenbremse**









1.3 CDTi	51	04/05→06/10	➔	→ 05/10		13.0460-7179.2	607179	ATE 23832 20,2 - WK / + WK
1.6 Turbo	132	05/06→06/10				13.0470-7179.2	LD7179	ATE 23832 20,2 - WK / + WK
1.7 CDTi	74	09/03→06/10						Ceramic
1.7 DTi	55	06/03→06/10						
1.8 i 16V	92	05/03→06/10	➔	→ 05/10		13.0460-2868.2	602868	TRW 23417 15,3 + WK + Zub
						13.0470-2868.2	LD2868	TRW 23417 15,3 + WK + Zub
								Ceramic
1.3 CDTi	55	01/03→10/09	➔	09/03→		13.0460-7179.2	607179	ATE 23832 20,2 - WK / + WK
						13.0470-7179.2	LD7179	ATE 23832 20,2 - WK / + WK
								Ceramic
			➔	09/03→		13.0460-2868.2	602868	TRW 23417 15,3 + WK + Zub
						13.0470-2868.2	LD2868	TRW 23417 15,3 + WK + Zub
								Ceramic
1.4 16V Twinport	66	01/03→06/10	➔	07/04→ 05/10; Felge Lochzahl: 4		13.0460-2857.2	602857	TRW 23225 17,0 + WK + Zub
						13.0470-2857.2	LD2857	TRW 23225 17,0 + WK + Zub
								Ceramic
			➔	07/04→ 05/10; Felge Lochzahl: 5		13.0460-7179.2	607179	ATE 23832 20,2 - WK / + WK
						13.0470-7179.2	LD7179	ATE 23832 20,2 - WK / + WK
								Ceramic
			➔	07/04→ 05/10		13.0460-2868.2	602868	TRW 23417 15,3 + WK + Zub
						13.0470-2868.2	LD2868	TRW 23417 15,3 + WK + Zub
								Ceramic

	kw			 	! #		
<b>VAUXHALL - MERIVA Mk I (A) (X03) 01/03→06/10</b>							
<b> Bremsbelagsatz, Scheibenbremse</b>							
1.6 i	64	01/03→06/10	←	05/03→ 05/10	13.0460-2857.2	602857	TRW 23225 17,0 + WK + Zub
			→	05/03→ 05/10	13.0470-2857.2	LD2857	TRW 23225 17,0 + WK + Zub Ceramic
1.6 i 16V	74	01/03→09/05	←	05/03→	13.0460-7179.2	607179	ATE 23832 20,2 - WK / + WK
			→	05/03→	13.0470-7179.2	LD7179	ATE 23832 20,2 - WK / + WK Ceramic
1.6 i 16V Twinport	77	05/03→06/10	←	01/06→ 05/10	13.0460-7179.2	607179	ATE 23832 20,2 - WK / + WK
			→	01/06→ 05/10	13.0470-7179.2	LD7179	ATE 23832 20,2 - WK / + WK Ceramic
1.7 CDTI	92	08/06→05/10	←	09/06→	13.0460-7179.2	607179	ATE 23832 20,2 - WK / + WK
			→	09/06→	13.0470-7179.2	LD7179	ATE 23832 20,2 - WK / + WK Ceramic
			←	09/06→	13.0460-2868.2	602868	TRW 23417 15,3 + WK + Zub
			→	09/06→	13.0470-2868.2	LD2868	TRW 23417 15,3 + WK + Zub Ceramic
<b> Bremsscheibe</b>							
1.3 CDTI 1.7 DTI 1.8 i 16V	51 55 92	04/05→06/10 06/03→06/10 05/03→06/10	←	→ 05/10; Felge Lochzahl: 5	24.0125-0131.1	425131	Ø 280 24,8 22 V + S
			←	→ 05/10; Felge Lochzahl: 4	24.0325-0131.1	525131	Ø 280 24,8 22 V + S
			→	→ 05/10; Felge Lochzahl: 5	24.0125-0148.1	425148	Ø 280 25 22 V + S
			→	→ 05/10; Felge Lochzahl: 4	24.0325-0148.1	525148	Ø 280 25 22 V + S
1.3 CDTI	55	01/03→10/09	←	09/03→; Felge Lochzahl: 5	24.0110-0250.1	410250	Ø 264 9,8 8 + S
			←	09/03→; Felge Lochzahl: 4	24.0310-0250.1	510250	Ø 264 9,8 8 + S
			→	09/03→; Felge Lochzahl: 5	24.0110-0291.1	410291	Ø 264 10 8 + S
			→	09/03→; Felge Lochzahl: 4	24.0310-0291.1	510291	Ø 264 10 8 + S
1.4 16V Twinport	66	01/03→06/10	←	07/04→ 05/10; Felge Lochzahl: 4	24.0125-0131.1	425131	Ø 280 24,8 22 V + S
			←	07/04→ 05/10; Felge Lochzahl: 5	24.0324-0166.1	524166	Ø 260 24 21 V + S
			→	07/04→ 05/10; Felge Lochzahl: 5	24.0125-0131.1	425131	Ø 280 24,8 22 V + S
			→	07/04→ 05/10; Felge Lochzahl: 4	24.0325-0131.1	525131	Ø 280 24,8 22 V + S
1.6 i	64	01/03→06/10	←	05/03→ 05/10; Felge Lochzahl: 4	24.0110-0250.1	410250	Ø 264 9,8 8 + S
			←	05/03→ 05/10; Felge Lochzahl: 5	24.0310-0250.1	510250	Ø 264 9,8 8 + S
			→	05/03→ 05/10; Felge Lochzahl: 5	24.0110-0251.1	410251	Ø 240 9,8 8 + S
			→	05/03→ 05/10; Felge Lochzahl: 4	24.0310-0251.1	510251	Ø 240 9,8 8 + S
1.6 i 16V	74	01/03→09/05	←	05/03→; Felge Lochzahl: 5	24.0125-0131.1	425131	Ø 280 24,8 22 V + S
			←	05/03→; Felge Lochzahl: 4	24.0325-0131.1	525131	Ø 280 24,8 22 V + S
			→	05/03→; Felge Lochzahl: 5	24.0125-0148.1	425148	Ø 280 25 22 V + S
			→	05/03→; Felge Lochzahl: 4	24.0325-0148.1	525148	Ø 280 25 22 V + S
			→	05/03→; Felge Lochzahl: 5	24.0110-0250.1	410250	Ø 264 9,8 8 + S























	kw				! #		
<b>VAUXHALL - MERIVA Mk I (A) (X03) 01/03→06/10</b>							
 <b>Bremsscheibe</b>							
1.6 i 16V	74	01/03→09/05	→	05/03→; Felge Lochzahl: 5		24.0310-0250.1 510250	Ø 264 9,8 8 + S
			→	05/03→; Felge Lochzahl: 4		24.0110-0291.1 410291	Ø 264 10 8 + S
1.6 i 16V Twinport	77	05/03→06/10	←	01/06→ 05/10; Felge Lochzahl: 5		24.0125-0131.1 425131	Ø 280 24,8 22 V + S
			←	01/06→ 05/10; Felge Lochzahl: 4		24.0325-0131.1 525131	Ø 280 24,8 22 V + S
			→	01/06→ 05/10; Felge Lochzahl: 5		24.0110-0250.1 410250	Ø 264 9,8 8 + S
			→	01/06→ 05/10; Felge Lochzahl: 4		24.0310-0250.1 510250	Ø 264 9,8 8 + S
			→	01/06→ 05/10; Felge Lochzahl: 5		24.0110-0291.1 410291	Ø 264 10 8 + S
1.6 Turbo	132	05/06→06/10	←	→ 05/10		24.0125-0142.1 425142	Ø 308 25 22 V + S
			→	→ 05/10; Felge Lochzahl: 5		24.0325-0142.1 525142	Ø 308 25 23 V + S
1.7 CDTi	74	09/03→06/10	←	→ 05/10; Felge Lochzahl: 5		24.0110-0250.1 410250	Ø 264 9,8 8 + S
			→	→ 05/10; Felge Lochzahl: 5		24.0310-0250.1 510250	Ø 264 9,8 8 + S
			←	→ 05/10; Felge Lochzahl: 5		24.0125-0131.1 425131	Ø 280 24,8 22 V + S
1.7 CDTI	92	08/06→05/10	←	09/06→; Felge Lochzahl: 5		24.0325-0131.1 525131	Ø 280 24,8 22 V + S
			→	09/06→; Felge Lochzahl: 5		24.0110-0250.1 410250	Ø 264 9,8 8 + S
						24.0310-0250.1 510250	Ø 264 9,8 8 + S
<b>VAUXHALL - MERIVA Mk II (B) (S10) 06/10→</b>							
 <b>Bremsbelagsatz, Scheibenbremse</b>							
1.3 CDTi	70	06/10→	←			13.0460-7179.2 607179	ATE 23832 20,2 - WK / + WK
1.3 CDTi	55	06/10→				13.0470-7179.2 LD7179	ATE 23832 20,2 - WK / + WK Ceramic
1.4	74	06/10→					
1.4	88	06/10→					
1.4	103	06/10→	→			13.0460-2868.2 602868	TRW 23417 15,3 + WK + Zub
1.4 LPG	88	06/11→				13.0470-2868.2 LD2868	TRW 23417 15,3 + WK + Zub Ceramic
1.6 CDTi	81	07/14→					
1.6 CDTi	100	08/13→					
1.7 CDTi	81	06/10→					
1.7 CDTi	96	06/10→					
1.7 CDTi	74	06/10→					
1.6 CDTI	70	01/14→	←	03/14→		13.0460-7179.2 607179	ATE 23832 20,2 - WK / + WK
			→	03/14→		13.0470-7179.2 LD7179	ATE 23832 20,2 - WK / + WK Ceramic
						13.0460-2868.2 602868	TRW 23417 15,3 + WK + Zub
						13.0470-2868.2 LD2868	TRW 23417 15,3 + WK + Zub Ceramic
 <b>Bremsscheibe</b>							
1.3 CDTi	70	06/10→	←			24.0125-0131.1 425131	Ø 280 24,8 22 V + S
1.3 CDTi	55	06/10→				24.0325-0131.1 525131	Ø 280 24,8 22 V + S
1.4	74	06/10→	→			24.0110-0250.1 410250	Ø 264 9,8 8 + S
						24.0310-0250.1 510250	Ø 264 9,8 8 + S
1.4	88	06/10→	←			24.0125-0131.1 425131	Ø 280 24,8 22 V + S
1.4 LPG	88	06/11→				24.0125-0142.1 425142	Ø 308 25 22 V + S
1.7 CDTi	81	06/10→				24.0325-0131.1 525131	Ø 280 24,8 22 V + S
1.7 CDTi	96	06/10→					
1.7 CDTi	74	06/10→	→			24.0110-0250.1 410250	Ø 264 9,8 8 + S
						24.0310-0250.1 510250	Ø 264 9,8 8 + S
1.4	103	06/10→	←			24.0125-0142.1 425142	Ø 308 25 22 V + S
1.6 CDTi	81	07/14→				24.0110-0250.1 410250	Ø 264 9,8 8 + S
1.6 CDTi	100	08/13→	→			24.0310-0250.1 510250	Ø 264 9,8 8 + S
1.6 CDTI	70	01/14→	←	03/14→		24.0125-0142.1 425142	Ø 308 25 22 V + S
			→	03/14→		24.0110-0250.1 410250	Ø 264 9,8 8 + S
						24.0310-0250.1 510250	Ø 264 9,8 8 + S
<b>VAUXHALL - MOKKA / MOKKA X (J13) 06/12→</b>							
 <b>Bremsbelagsatz, Scheibenbremse</b>							
1.4	103	04/13→	←			13.0460-7263.2 607263	24034 19,1 + WK + Zub
1.4 4x4	103	06/12→					
↓							

	kw			 	! #		
<b>VAUXHALL - MOKKA / MOKKA X (J13) 06/12→</b>							
 <b>Bremsbelagsatz, Scheibenbremse</b>							
1.4 4x4	112	06/16→	←			13.0470-7263.2 LD7263	24034 19,1 + WK + Zub Ceramic
1.6	85	06/12→	→			13.0460-7264.2 607264	ATE 25096 17,0 + WK + Zub
1.6 CDTi	100	01/15→					13.0470-7264.2 LD7264
1.6 CDTi	81	06/15→					
1.6 CDTi 4x4	100	01/15→					
1.7 CDTi	96	06/12→					
1.7 CDTi 4x4	96	06/12→					
 <b>Bremsscheibe</b>							
1.4	103	04/13→	←			24.0126-0182.1 426182	Ø 300 26 23 V + S
1.4 4x4	103	06/12→	→			24.0112-0188.1 412188	Ø 268 12 10 + S
1.4 4x4	112	06/16→					24.0312-0188.1 512188
1.6	85	06/12→					
1.6 CDTi	100	01/15→					
1.6 CDTi	81	06/15→					
1.6 CDTi 4x4	100	01/15→					
1.7 CDTi	96	06/12→					
1.7 CDTi 4x4	96	06/12→					
<b>VAUXHALL - MONTEREY (M92) 09/91→07/98</b>							
 <b>Bremsbelagsatz, Scheibenbremse</b>							
3.1 TD	84	09/91→07/98	←			13.0460-5926.2 605926	AKE 21845 16,5 + WK
3.2	130	06/92→07/98	→			13.0460-5927.2 605927	AKE 21875 16,0 + WK
<b>Zubehörsatz, Scheibenbremsbelag</b>							
3.1 TD	84	09/91→07/98	←			13.0460-0446.2 610446	AKE
3.2	130	06/92→07/98	→			13.0460-0447.2 610447	AKE
 <b>Bremsscheibe</b>							
3.1 TD	84	09/91→07/98	←			24.0126-0111.1 426111	Ø 280 26 24,6 V
3.2	130	06/92→07/98	→			24.0118-0122.1 418122	Ø 313,5 18 16,6 V
<b>VAUXHALL - MONTEREY Mk II (M98) 07/98→08/99</b>							
 <b>Bremsbelagsatz, Scheibenbremse</b>							
3.0 DTI	117	07/98→08/99	←			13.0460-5926.2 605926	AKE 21845 16,5 + WK
3.5 V6 24V	158	07/98→08/99	→			13.0460-5927.2 605927	AKE 21875 16,0 + WK
<b>Zubehörsatz, Scheibenbremsbelag</b>							
3.0 DTI	117	07/98→08/99	←			13.0460-0446.2 610446	AKE
3.5 V6 24V	158	07/98→08/99	→			13.0460-0447.2 610447	AKE
 <b>Bremsscheibe</b>							
3.0 DTI	117	07/98→08/99	←			24.0126-0111.1 426111	Ø 280 26 24,6 V
3.5 V6 24V	158	07/98→08/99	→			24.0118-0122.1 418122	Ø 313,5 18 16,6 V
<b>VAUXHALL - MOVANO Mk I (A) Chassis/Cab (X70) 10/98→12/10</b>							
 <b>Bremsbelagsatz, Scheibenbremse</b>							
2.2 DTI (UD0)	66	09/00→05/10	←	→ 01/10;		13.0460-3800.2 603800	BOS 23613 17,7 - WE / - WK
2.5 CDTi (UD0, ED)	74	10/06→12/10	←	passend für Felgengröße [Zoll]: 16		13.0460-3946.2 603946	BDX 23302 18,0 + WE / - WK
3.0 DTi (ED)	100	10/03→05/10		←	→ 01/10;		13.0460-3806.2 603806
			→	passend für Felgengröße [Zoll]: 15			
			→	→ 01/10			
2.5 CDTi (ED, UD0)	88	08/06→05/10	←	09/06→ 01/10;		13.0460-3800.2 603800	BOS 23613 17,7 - WE / - WK
2.5 CDTi (ED, UD0)	107	08/06→05/10	←	passend für Felgengröße [Zoll]: 16		13.0460-3946.2 603946	BDX 23302 18,0 + WE / - WK
			←	09/06→ 01/10;		13.0460-3806.2 603806	BOS 23669 16,8 - WE / - WK
			→	passend für Felgengröße [Zoll]: 15			
			→	09/06→ 01/10			
2.5 D (UD0)	59	10/98→08/02	←	→ 09/00;		13.0460-3800.2 603800	BOS 23613 17,7 - WE / - WK
			←	passend für Felgengröße [Zoll]: 16		13.0460-3946.2 603946	BDX 23302 18,0 + WE / - WK
			←	→ 09/00;		13.0460-3806.2 603806	BOS 23669 16,8 - WE / - WK
			→	passend für Felgengröße [Zoll]: 15			
			→	→ 09/00			
2.5 DTI (ED, UD0)	84	01/01→12/06	←	passend für Felgengröße [Zoll]: 16		13.0460-3800.2 603800	BOS 23613 17,7 - WE / - WK
2.8 DTI (UD0, ED, HD)	84	10/98→10/01	←	passend für Felgengröße [Zoll]: 15		13.0460-3946.2 603946	BDX 23302 18,0 + WE / - WK
			→			13.0460-3806.2 603806	BOS 23669 16,8 - WE / - WK
↓							









	kw				! #			
<b>VAUXHALL - MOVANO Mk I (A) Chassis/Cab (X70) 10/98→12/10</b>								
<b>Zubehörsatz, Scheibenbremsbelag</b>								
2.2 DTi (UD0)	66	09/00→05/10	←	→ 01/10;		13.0460-0344.2	610344	
2.5 CDTi (UD0, ED)	74	10/06→12/10		passend für Felgengröße [Zoll]: 16				
3.0 DTi (ED)	100	10/03→05/10						
2.5 CDTi (ED, UD0)	88	08/06→05/10	←	09/06→ 01/10;		13.0460-0344.2	610344	
2.5 CDTi (ED, UD0)	107	08/06→05/10		passend für Felgengröße [Zoll]: 16				
2.5 D (UD0)	59	10/98→08/02	←	→ 09/00;		13.0460-0344.2	610344	
				passend für Felgengröße [Zoll]: 16				
2.5 DTi (ED, UD0)	84	01/01→12/06	←	passend für Felgengröße [Zoll]: 16		13.0460-0344.2	610344	
2.8 DTi (UD0, ED, HD)	84	10/98→10/01						
<b> Bremsscheibe</b>								
2.2 DTi (UD0)	66	09/00→05/10	←	→ 01/10;		24.0124-0162.1	424162	Ø 280 24 21 V
2.5 CDTi (UD0, ED)	74	10/06→12/10		passend für Felgengröße [Zoll]: 15				
3.0 DTi (ED)	100	10/03→05/10	←	→ 01/10;		24.0128-0129.1	428129	Ø 305,5 28 25 V + S
				passend für Felgengröße [Zoll]: 16		24.0328-0129.1	528129	Ø 305,5 28 25 V + S
			→	→ 01/10		24.0112-0155.1	412155	Ø 305 12 10,5 + S
2.5 CDTi (ED, UD0)	88	08/06→05/10	←	09/06→ 01/10;		24.0124-0162.1	424162	Ø 280 24 21 V
2.5 CDTi (ED, UD0)	107	08/06→05/10	←	passend für Felgengröße [Zoll]: 15				
			←	09/06→ 01/10;		24.0128-0129.1	428129	Ø 305,5 28 25 V + S
				passend für Felgengröße [Zoll]: 16		24.0328-0129.1	528129	Ø 305,5 28 25 V + S
			→	09/06→ 01/10		24.0112-0155.1	412155	Ø 305 12 10,5 + S
2.5 D (UD0)	59	10/98→08/02	←	→ 09/00;		24.0124-0162.1	424162	Ø 280 24 21 V
				passend für Felgengröße [Zoll]: 15				
			←	→ 09/00;		24.0128-0129.1	428129	Ø 305,5 28 25 V + S
				passend für Felgengröße [Zoll]: 16		24.0328-0129.1	528129	Ø 305,5 28 25 V + S
			→	→ 09/00		24.0112-0155.1	412155	Ø 305 12 10,5 + S
2.5 DTi (ED, UD0)	84	01/01→12/06	←	passend für Felgengröße [Zoll]: 15		24.0124-0162.1	424162	Ø 280 24 21 V
2.8 DTi (UD0, ED, HD)	84	10/98→10/01	←	passend für Felgengröße [Zoll]: 16		24.0128-0129.1	428129	Ø 305,5 28 25 V + S
						24.0328-0129.1	528129	Ø 305,5 28 25 V + S
			→			24.0112-0155.1	412155	Ø 305 12 10,5 + S
<b>VAUXHALL - MOVANO Mk I (A) Combi (X70) 10/98→05/10</b>								
<b> Bremsbelagsatz, Scheibenbremse</b>								
1.9 DTi (JD)	59	09/00→10/01	←	passend für Felgengröße [Zoll]: 16		13.0460-3800.2	603800	BOS 23613 17,7 - WE / - WK
2.5 D (JD)	59	10/98→09/00	←	passend für Felgengröße [Zoll]: 15		13.0460-3946.2	603946	BDX 23302 18,0 + WE / - WK
2.5 DTi (JD)	84	10/01→08/09						
2.8 DTi (JD)	84	10/98→10/01	→			13.0460-3806.2	603806	BOS 23669 16,8 - WE / - WK
1.9 DTi (JD)	60	10/01→05/10	←	→ 01/10;		13.0460-3800.2	603800	BOS 23613 17,7 - WE / - WK
2.2 DTi (JD)	66	09/00→05/10		passend für Felgengröße [Zoll]: 16				
3.0 DTi (JD)	100	10/03→05/10	←	→ 01/10;		13.0460-3946.2	603946	BDX 23302 18,0 + WE / - WK
				passend für Felgengröße [Zoll]: 15				
			→	→ 01/10		13.0460-3806.2	603806	BOS 23669 16,8 - WE / - WK
2.5 CDTi (JD)	74	10/01→08/09	←	09/06→;		13.0460-3800.2	603800	BOS 23613 17,7 - WE / - WK
2.5 CDTi (JD)	88	02/03→08/09	←	passend für Felgengröße [Zoll]: 16				
			←	09/06→;		13.0460-3946.2	603946	BDX 23302 18,0 + WE / - WK
				passend für Felgengröße [Zoll]: 15				
			→	09/06→		13.0460-3806.2	603806	BOS 23669 16,8 - WE / - WK
2.5 CDTi (JD)	107	08/06→05/10	←	09/06→ 01/10;		13.0460-3800.2	603800	BOS 23613 17,7 - WE / - WK
				passend für Felgengröße [Zoll]: 16				
			←	09/06→ 01/10;		13.0460-3946.2	603946	BDX 23302 18,0 + WE / - WK
				passend für Felgengröße [Zoll]: 15				
			→	09/06→ 01/10		13.0460-3806.2	603806	BOS 23669 16,8 - WE / - WK
<b>Zubehörsatz, Scheibenbremsbelag</b>								
1.9 DTi (JD)	59	09/00→10/01	←	passend für Felgengröße [Zoll]: 16		13.0460-0344.2	610344	
2.5 D (JD)	59	10/98→09/00						
2.5 DTi (JD)	84	10/01→08/09						
2.8 DTi (JD)	84	10/98→10/01						
1.9 DTi (JD)	60	10/01→05/10	←	→ 01/10;		13.0460-0344.2	610344	
2.2 DTi (JD)	66	09/00→05/10		passend für Felgengröße [Zoll]: 16				
3.0 DTi (JD)	100	10/03→05/10						
2.5 CDTi (JD)	74	10/01→08/09	←	09/06→;		13.0460-0344.2	610344	
2.5 CDTi (JD)	88	02/03→08/09		passend für Felgengröße [Zoll]: 16				
2.5 CDTi (JD)	107	08/06→05/10	←	09/06→ 01/10;		13.0460-0344.2	610344	
				passend für Felgengröße [Zoll]: 16				
<b> Bremsscheibe</b>								
1.9 DTi (JD)	59	09/00→10/01	←	passend für Felgengröße [Zoll]: 15		24.0124-0162.1	424162	Ø 280 24 21 V
2.5 D (JD)	59	10/98→09/00						
2.5 DTi (JD)	84	10/01→08/09	←	passend für Felgengröße [Zoll]: 16		24.0128-0129.1	428129	Ø 305,5 28 25 V + S
↓								



	kw				! #		
<b>VAUXHALL - MOVANO Mk I (A) Combi (X70) 10/98→05/10</b>							
 <b>Bremsscheibe</b>							
2.8 DTI (JD)	84	10/98→10/01	←	passend für Felgengröße [Zoll]: 16		24.0328-0129.1 528129	Ø 305,5 28 25 V + S
			→			24.0112-0155.1 412155	Ø 305 12 10,5 + S
1.9 DTI (JD)	60	10/01→05/10	←	→ 01/10;		24.0124-0162.1 424162	Ø 280 24 21 V
2.2 DTI (JD)	66	09/00→05/10		passend für Felgengröße [Zoll]: 15			
3.0 DTi (JD)	100	10/03→05/10	←	→ 01/10;		24.0128-0129.1 428129	Ø 305,5 28 25 V + S
				passend für Felgengröße [Zoll]: 16		24.0328-0129.1 528129	Ø 305,5 28 25 V + S
			→	→ 01/10		24.0112-0155.1 412155	Ø 305 12 10,5 + S
2.5 CDTI (JD)	74	10/01→08/09	←	09/06→;		24.0124-0162.1 424162	Ø 280 24 21 V
2.5 CDTI (JD)	88	02/03→08/09		passend für Felgengröße [Zoll]: 15			
			←	09/06→;		24.0128-0129.1 428129	Ø 305,5 28 25 V + S
				passend für Felgengröße [Zoll]: 16		24.0328-0129.1 528129	Ø 305,5 28 25 V + S
			→	09/06→		24.0112-0155.1 412155	Ø 305 12 10,5 + S
2.5 CDTI (JD)	107	08/06→05/10	←	09/06→ 01/10;		24.0124-0162.1 424162	Ø 280 24 21 V
				passend für Felgengröße [Zoll]: 15			
			←	09/06→ 01/10;		24.0128-0129.1 428129	Ø 305,5 28 25 V + S
				passend für Felgengröße [Zoll]: 16		24.0328-0129.1 528129	Ø 305,5 28 25 V + S
			→	09/06→ 01/10		24.0112-0155.1 412155	Ø 305 12 10,5 + S
<b>VAUXHALL - MOVANO Mk I (A) Van (X70) 10/98→12/10</b>							
 <b>Bremsbelagsatz, Scheibenbremse</b>							
1.9 DTI (FD)	59	09/00→10/01	←	passend für Felgengröße [Zoll]: 16		13.0460-3800.2 603800	BOS 23613 17,7 - WE / - WK
2.5 D (FD)	59	10/98→09/00					
2.8 TDI (FD)	84	10/98→10/01	←	passend für Felgengröße [Zoll]: 15		13.0460-3946.2 603946	BDX 23302 18,0 + WE / - WK
			→			13.0460-3806.2 603806	BOS 23669 16,8 - WE / - WK
1.9 DTI (FD)	60	10/01→05/10	←	→ 01/10;		13.0460-3800.2 603800	BOS 23613 17,7 - WE / - WK
2.2 DTI (FD)	66	09/00→05/10		passend für Felgengröße [Zoll]: 16			
2.5 CDTI (FD)	74	10/06→12/10	←	→ 01/10;		13.0460-3946.2 603946	BDX 23302 18,0 + WE / - WK
2.5 DTI (FD)	84	10/01→05/10		passend für Felgengröße [Zoll]: 15			
3.0 DTi (FD)	100	10/03→05/10	→	→ 01/10		13.0460-3806.2 603806	BOS 23669 16,8 - WE / - WK
2.5 CDTI (FD)	88	08/06→05/10	←	09/06→ 01/10;		13.0460-3800.2 603800	BOS 23613 17,7 - WE / - WK
2.5 CDTI (FD)	107	08/06→05/10		passend für Felgengröße [Zoll]: 16			
			←	09/06→ 01/10;		13.0460-3946.2 603946	BDX 23302 18,0 + WE / - WK
				passend für Felgengröße [Zoll]: 15			
			→	09/06→ 01/10		13.0460-3806.2 603806	BOS 23669 16,8 - WE / - WK
<b>Zubehörsatz, Scheibenbremsbelag</b>							
1.9 DTI (FD)	59	09/00→10/01	←	passend für Felgengröße [Zoll]: 16		13.0460-0344.2 610344	
2.5 D (FD)	59	10/98→09/00					
2.8 TDI (FD)	84	10/98→10/01					
1.9 DTI (FD)	60	10/01→05/10	←	→ 01/10;		13.0460-0344.2 610344	
2.2 DTI (FD)	66	09/00→05/10		passend für Felgengröße [Zoll]: 16			
2.5 CDTI (FD)	74	10/06→12/10					
2.5 DTI (FD)	84	10/01→05/10					
3.0 DTi (FD)	100	10/03→05/10					
2.5 CDTI (FD)	88	08/06→05/10	←	09/06→ 01/10;		13.0460-0344.2 610344	
2.5 CDTI (FD)	107	08/06→05/10		passend für Felgengröße [Zoll]: 16			
 <b>Bremsscheibe</b>							
1.9 DTI (FD)	59	09/00→10/01	←	passend für Felgengröße [Zoll]: 15		24.0124-0162.1 424162	Ø 280 24 21 V
2.5 D (FD)	59	10/98→09/00					
2.8 TDI (FD)	84	10/98→10/01	←	passend für Felgengröße [Zoll]: 16		24.0128-0129.1 428129	Ø 305,5 28 25 V + S
			→			24.0328-0129.1 528129	Ø 305,5 28 25 V + S
						24.0112-0155.1 412155	Ø 305 12 10,5 + S
1.9 DTI (FD)	60	10/01→05/10	←	→ 01/10;		24.0124-0162.1 424162	Ø 280 24 21 V
2.2 DTI (FD)	66	09/00→05/10		passend für Felgengröße [Zoll]: 15			
2.5 CDTI (FD)	74	10/06→12/10	←	→ 01/10;		24.0128-0129.1 428129	Ø 305,5 28 25 V + S
2.5 DTI (FD)	84	10/01→05/10		passend für Felgengröße [Zoll]: 16		24.0328-0129.1 528129	Ø 305,5 28 25 V + S
3.0 DTi (FD)	100	10/03→05/10	→	→ 01/10		24.0112-0155.1 412155	Ø 305 12 10,5 + S
2.5 CDTI (FD)	88	08/06→05/10	←	09/06→ 01/10;		24.0124-0162.1 424162	Ø 280 24 21 V
2.5 CDTI (FD)	107	08/06→05/10		passend für Felgengröße [Zoll]: 15			
			←	09/06→ 01/10;		24.0128-0129.1 428129	Ø 305,5 28 25 V + S
				passend für Felgengröße [Zoll]: 16		24.0328-0129.1 528129	Ø 305,5 28 25 V + S
			→	09/06→ 01/10		24.0112-0155.1 412155	Ø 305 12 10,5 + S
<b>VAUXHALL - MOVANO Mk II (B) Chassis/Cab (X62) 05/10→</b>							
 <b>Bremsbelagsatz, Scheibenbremse</b>							
2.3 CDTI FWD (UV, EV)	81	05/14→	←			13.0460-4856.2 604856	BRE 25147 18,4 + WK
↓							

	kw				! #		
<b>VAUXHALL - MOVANO Mk II (B) Chassis/Cab (X62) 05/10→</b>							
 <b>Bremsbelagsatz, Scheibenbremse</b>							
2.3 CDTI FWD (UV, HV, EV)	92	05/10→	➔	für Doppelbereifung		<b>13.0460-4857.2 604857</b>	BRE 25172 18,4 + WK
2.3 CDTI FWD (UV, HV, EV)	107	05/10→	➔	für Einfachbereifung		<b>13.0460-4858.2 604858</b>	BRE 25112 18,4 + WK
2.3 CDTI FWD (UV, HV)	74	05/10→					
2.3 CDTI FWD (UV, HV)	100	05/14→					
2.3 CDTI FWD (UV, HV)	125	11/16→					
2.3 CDTI RWD (UV, HV, EV)	92	07/10→					
2.3 CDTI RWD (UV, HV, EV)	107	07/10→					
2.3 CDTI RWD (UV, HV)	74	07/10→					
2.3 CDTI RWD (UV, HV)	100	05/14→					
2.3 CDTI RWD (UV, HV)	120	05/14→					
2.3 CDTI FWD (UV, HV, EV)	96	10/16→	➔	11/16→		<b>13.0460-4856.2 604856</b>	BRE 25147 18,4 + WK
2.3 CDTI RWD (UV, HV)	96	10/16→	➔	11/16→; für Doppelbereifung		<b>13.0460-4857.2 604857</b>	BRE 25172 18,4 + WK
			➔	11/16→; für Einfachbereifung		<b>13.0460-4858.2 604858</b>	BRE 25112 18,4 + WK
 <b>Bremsscheibe</b>							
2.3 CDTI FWD (UV, EV)	81	05/14→	➔			<b>24.0128-0252.1 428252</b>	Ø 302 28 24,5 V + S
2.3 CDTI FWD (UV, HV, EV)	92	05/10→	➔			<b>24.0112-0191.1 412191</b>	Ø 305 12 10 + S
2.3 CDTI FWD (UV, HV, EV)	107	05/10→					
2.3 CDTI FWD (UV, HV)	74	05/10→					
2.3 CDTI FWD (UV, HV)	100	05/14→					
2.3 CDTI FWD (UV, HV)	125	11/16→					
2.3 CDTI RWD (UV, HV)	120	05/14→					
2.3 CDTI FWD (UV, HV, EV)	96	10/16→	➔	11/16→		<b>24.0128-0252.1 428252</b>	Ø 302 28 24,5 V + S
			➔	11/16→		<b>24.0112-0191.1 412191</b>	Ø 305 12 10 + S
2.3 CDTI RWD (UV, HV, EV)	92	07/10→	➔			<b>24.0128-0252.1 428252</b>	Ø 302 28 24,5 V + S
2.3 CDTI RWD (UV, HV, EV)	107	07/10→	➔	für Einfachbereifung		<b>24.0112-0190.1 412190</b>	Ø 305 12 10 + S
2.3 CDTI RWD (UV, HV)	74	07/10→	➔	für Doppelbereifung		<b>24.0118-0153.1 418153</b>	Ø 302 18 15
2.3 CDTI RWD (UV, HV)	100	05/14→					
2.3 CDTI RWD (UV, HV)	96	10/16→	➔	11/16→		<b>24.0128-0252.1 428252</b>	Ø 302 28 24,5 V + S
			➔	11/16→; für Einfachbereifung		<b>24.0112-0190.1 412190</b>	Ø 305 12 10 + S
			➔	11/16→; für Doppelbereifung		<b>24.0118-0153.1 418153</b>	Ø 302 18 15
<b>VAUXHALL - MOVANO Mk II (B) Combi (X62) 05/10→</b>							
 <b>Bremsbelagsatz, Scheibenbremse</b>							
2.3 CDTI FWD (JV)	74	05/10→	➔			<b>13.0460-4856.2 604856</b>	BRE 25147 18,4 + WK
2.3 CDTI FWD (JV)	81	05/14→					
2.3 CDTI FWD (JV)	92	05/10→	➔	für Doppelbereifung		<b>13.0460-4857.2 604857</b>	BRE 25172 18,4 + WK
2.3 CDTI FWD (JV)	100	05/14→	➔	für Einfachbereifung		<b>13.0460-4858.2 604858</b>	BRE 25112 18,4 + WK
2.3 CDTI FWD (JV)	107	05/10→					
2.3 CDTI FWD (JV)	120	05/14→					
2.3 CDTI FWD (JV)	125	07/15→					
 <b>Bremsscheibe</b>							
2.3 CDTI FWD (JV)	74	05/10→	➔			<b>24.0128-0252.1 428252</b>	Ø 302 28 24,5 V + S
2.3 CDTI FWD (JV)	81	05/14→					
2.3 CDTI FWD (JV)	92	05/10→	➔			<b>24.0112-0191.1 412191</b>	Ø 305 12 10 + S
2.3 CDTI FWD (JV)	100	05/14→					
2.3 CDTI FWD (JV)	107	05/10→					
2.3 CDTI FWD (JV)	120	05/14→					
2.3 CDTI FWD (JV)	125	07/15→					
<b>VAUXHALL - MOVANO Mk II (B) VAN (X62) 05/10→</b>							
 <b>Bremsbelagsatz, Scheibenbremse</b>							
2.3 CDTI FWD (FV)	74	05/10→	➔			<b>13.0460-4856.2 604856</b>	BRE 25147 18,4 + WK
2.3 CDTI FWD (FV)	92	05/10→					
2.3 CDTI FWD (FV)	100	05/14→	➔	für Doppelbereifung		<b>13.0460-4857.2 604857</b>	BRE 25172 18,4 + WK
2.3 CDTI FWD (FV)	107	05/10→	➔	für Einfachbereifung		<b>13.0460-4858.2 604858</b>	BRE 25112 18,4 + WK
2.3 CDTI FWD (FV)	120	05/14→					
2.3 CDTI FWD (FV)	125	11/16→					
2.3 CDTI RWD (FV)	74	05/10→					
2.3 CDTI RWD (FV)	92	05/10→					
2.3 CDTI RWD (FV)	100	05/14→					
2.3 CDTI RWD (FV)	107	05/10→					
2.3 CDTI RWD (FV)	120	05/14→					
2.3 CDTI FWD (FV)	81	02/12→	➔	05/14→		<b>13.0460-4856.2 604856</b>	BRE 25147 18,4 + WK
			➔	05/14→; für Doppelbereifung		<b>13.0460-4857.2 604857</b>	BRE 25172 18,4 + WK



	kw				! #		
<b>VAUXHALL - MOVANO Mk II (B) VAN (X62) 05/10→</b>							
 <b>Bremsbelagsatz, Scheibenbremse</b>							
2.3 CDTI FWD (FV)	81	02/12→	➔	05/14→; für Einfachbereifung		13.0460-4858.2 604858	BRE 25112 18,4 + WK
2.3 CDTI FWD (FV)	96	10/16→	➔	11/16→		13.0460-4856.2 604856	BRE 25147 18,4 + WK
2.3 CDTI RWD (FV)	96	10/16→	➔	11/16→; für Doppelbereifung		13.0460-4857.2 604857	BRE 25172 18,4 + WK
			➔	11/16→; für Einfachbereifung		13.0460-4858.2 604858	BRE 25112 18,4 + WK
 <b>Bremsscheibe</b>							
2.3 CDTI FWD (FV)	74	05/10→	➔			24.0128-0252.1 428252	Ø 302 28 24,5 V + S
2.3 CDTI FWD (FV)	92	05/10→	➔			24.0112-0191.1 412191	Ø 305 12 10 + S
2.3 CDTI FWD (FV)	100	05/14→	➔				
2.3 CDTI FWD (FV)	107	05/10→	➔				
2.3 CDTI FWD (FV)	120	05/14→	➔				
2.3 CDTI FWD (FV)	125	11/16→	➔				
2.3 CDTI FWD (FV)	81	02/12→	➔	05/14→		24.0128-0252.1 428252	Ø 302 28 24,5 V + S
			➔	05/14→		24.0112-0191.1 412191	Ø 305 12 10 + S
2.3 CDTI FWD (FV)	96	10/16→	➔	11/16→		24.0128-0252.1 428252	Ø 302 28 24,5 V + S
			➔	11/16→		24.0112-0191.1 412191	Ø 305 12 10 + S
2.3 CDTI RWD (FV)	74	05/10→	➔			24.0128-0252.1 428252	Ø 302 28 24,5 V + S
2.3 CDTI RWD (FV)	92	05/10→	➔			24.0112-0190.1 412190	Ø 305 12 10 + S
2.3 CDTI RWD (FV)	100	05/14→	➔	für Einfachbereifung		24.0112-0190.1 412190	Ø 305 12 10 + S
2.3 CDTI RWD (FV)	107	05/10→	➔	für Doppelbereifung		24.0118-0153.1 418153	Ø 302 18 15
2.3 CDTI RWD (FV)	120	05/14→	➔				
2.3 CDTI RWD (FV)	96	10/16→	➔	11/16→		24.0128-0252.1 428252	Ø 302 28 24,5 V + S
			➔	11/16→; für Einfachbereifung		24.0112-0190.1 412190	Ø 305 12 10 + S
			➔	11/16→; für Doppelbereifung		24.0118-0153.1 418153	Ø 302 18 15
<b>VAUXHALL - OMEGA (B) Kombi (V94) 12/93→06/03</b>							
 <b>Bremsbelagsatz, Scheibenbremse</b>							
2.0	85	03/94→09/99	➔	W1000001→		13.0460-2815.2 602815	TRW 21368 18,3 - WK
			➔	→ V1999999; nicht für Sonderfahrzeuge / nicht für Polizei- fahrzeuge		13.0460-7080.2 607080	ATE 21411 17,5 - WK
			➔			13.0460-4040.2 604040	ATE 21050 15,8 - WE / - WK
2.0 16V	100	03/94→07/01	➔	W1000001→; → 09/99		13.0460-2815.2 602815	TRW 21368 18,3 - WK
			➔	→ V1999999; nicht für Sonderfahrzeuge / nicht für Polizei- fahrzeuge		13.0460-7080.2 607080	ATE 21411 17,5 - WK
			➔	→ 09/99		13.0460-4040.2 604040	ATE 21050 15,8 - WE / - WK
2.0 DTI 16V	74	01/98→09/00	➔	→ 08/00		13.0460-2815.2 602815	TRW 21368 18,3 - WK
			➔	→ 08/00		13.0460-4040.2 604040	ATE 21050 15,8 - WE / - WK
2.2 16V	106	02/94→06/03	➔	10/99→		13.0460-2815.2 602815	TRW 21368 18,3 - WK
			➔	10/99→		13.0460-4040.2 604040	ATE 21050 15,8 - WE / - WK
2.2 DTI 16V	88	08/00→06/03	➔	09/00→		13.0460-2815.2 602815	TRW 21368 18,3 - WK
2.6 V6	132	08/00→06/03	➔	09/00→		13.0460-4040.2 604040	ATE 21050 15,8 - WE / - WK
2.5 DTI 24V	110	09/01→06/03	➔			13.0460-2815.2 602815	TRW 21368 18,3 - WK
2.5 TD	96	04/94→07/01	➔			13.0460-4040.2 604040	ATE 21050 15,8 - WE / - WK
2.5 V6	125	03/94→09/00	➔				
3.0 V6	155	07/94→07/00	➔				
3.2 V6	160	02/01→06/03	➔				
<b>Warnkontakt, Bremsbelagverschleiß</b>							
2.0	85	03/94→09/99	➔	→ V1999999; nicht für Sonderfahrzeuge / nicht für Polizei- fahrzeuge	2	24.8190-0710.2 620710	L= 730
			➔	W1000001→	2	24.8190-0711.2 620711	L= 730
2.0 16V	100	03/94→07/01	➔	→ V1999999; nicht für Sonderfahrzeuge / nicht für Polizei- fahrzeuge	2	24.8190-0710.2 620710	L= 730
			➔	W1000001→; → 09/99	2	24.8190-0711.2 620711	L= 730
2.0 DTI 16V	74	01/98→09/00	➔	→ 08/00	2	24.8190-0711.2 620711	L= 730
2.2 16V	106	02/94→06/03	➔	10/99→	2	24.8190-0711.2 620711	L= 730
2.2 DTI 16V	88	08/00→06/03	➔	09/00→	2	24.8190-0711.2 620711	L= 730
2.6 V6	132	08/00→06/03	➔				
2.5 DTI 24V	110	09/01→06/03	➔		2	24.8190-0711.2 620711	L= 730
2.5 TD	96	04/94→07/01	➔				
2.5 V6	125	03/94→09/00	➔				
3.0 V6	155	07/94→07/00	➔				

**VAUXHALL - OMEGA (B) Kombi (V94) 12/93→06/03**

**Warnkontakt, Bremsbelagverschleiß**

3.2 V6	160	02/01→06/03	←		2	24.8190-0711.2	620711	L= 730
--------	-----	-------------	---	--	---	----------------	--------	--------

**Zubehörsatz, Scheibenbremsbelag**

2.0	85	03/94→09/99	→			13.0460-0246.2	610246	
2.5 DTI 24V	110	09/01→06/03						
2.5 TD	96	04/94→07/01						
2.5 V6	125	03/94→09/00						
3.0 V6	155	07/94→07/00						
3.2 V6	160	02/01→06/03						
2.0 16V	100	03/94→07/01	→	→ 09/99		13.0460-0246.2	610246	
2.0 DTI 16V	74	01/98→09/00	→	→ 08/00		13.0460-0246.2	610246	
2.2 16V	106	02/94→06/03	→	10/99→		13.0460-0246.2	610246	
2.2 DTI 16V	88	08/00→06/03	→	09/00→		13.0460-0246.2	610246	
2.6 V6	132	08/00→06/03						







**Bremsscheibe**







2.0	85	03/94→09/99	←	→ V1999999; nicht für Sonderfahrzeuge / nicht für Polizei-fahrzeuge		24.0124-0119.1	424119	Ø 286 24 21 V
			←	W1000001→		24.0128-0104.1	428104	Ø 296 28 25 V + S
			→			24.0112-0131.1	412131	Ø 286 12 10
						24.0120-0171.1	420171	Ø 286 20 18 V
2.0 16V	100	03/94→07/01	←	→ V1999999; nicht für Sonderfahrzeuge / nicht für Polizei-fahrzeuge		24.0124-0119.1	424119	Ø 286 24 21 V
			←	W1000001→; → 09/99		24.0128-0104.1	428104	Ø 296 28 25 V + S
			→	→ 09/99		24.0112-0131.1	412131	Ø 286 12 10
						24.0120-0171.1	420171	Ø 286 20 18 V
2.0 DTI 16V	74	01/98→09/00	←	→ 08/00		24.0128-0104.1	428104	Ø 296 28 25 V + S
			→	→ 08/00		24.0112-0131.1	412131	Ø 286 12 10
						24.0120-0171.1	420171	Ø 286 20 18 V
2.2 16V	106	02/94→06/03	←	10/99→		24.0128-0104.1	428104	Ø 296 28 25 V + S
			→	10/99→		24.0112-0131.1	412131	Ø 286 12 10
						24.0120-0171.1	420171	Ø 286 20 18 V
2.2 DTI 16V	88	08/00→06/03	←	09/00→		24.0128-0104.1	428104	Ø 296 28 25 V + S
2.6 V6	132	08/00→06/03	→	09/00→		24.0112-0131.1	412131	Ø 286 12 10
						24.0120-0171.1	420171	Ø 286 20 18 V
2.5 DTI 24V	110	09/01→06/03	←			24.0128-0104.1	428104	Ø 296 28 25 V + S
2.5 TD	96	04/94→07/01						
2.5 V6	125	03/94→09/00	→			24.0112-0131.1	412131	Ø 286 12 10
3.0 V6	155	07/94→07/00				24.0120-0171.1	420171	Ø 286 20 18 V
3.2 V6	160	02/01→06/03						

**VAUXHALL - OMEGA (B) Stufenheck (V94) 12/93→07/03**









**Bremsbelagsatz, Scheibenbremse**

2.0	85	03/94→09/99	←	W1000001→		13.0460-2815.2	602815	TRW 21368 18,3 - WK
2.0	85	09/95→09/96	←	→ V1999999; nicht für Sonderfahrzeuge / nicht für Polizei-fahrzeuge		13.0460-7080.2	607080	ATE 21411 17,5 - WK
			→			13.0460-4040.2	604040	ATE 21050 15,8 - WE / - WK
2.0 16V	100	03/94→07/01	←	W1000001→; → 09/99		13.0460-2815.2	602815	TRW 21368 18,3 - WK
			←	→ V1999999; nicht für Sonderfahrzeuge / nicht für Polizei-fahrzeuge		13.0460-7080.2	607080	ATE 21411 17,5 - WK
			→	→ 09/99		13.0460-4040.2	604040	ATE 21050 15,8 - WE / - WK
2.0 DTI 16V	74	01/98→09/00	←	→ 08/00		13.0460-2815.2	602815	TRW 21368 18,3 - WK
			→	→ 08/00		13.0460-4040.2	604040	ATE 21050 15,8 - WE / - WK
2.2 16V	106	01/94→06/03	←	10/99→		13.0460-2815.2	602815	TRW 21368 18,3 - WK
			→	10/99→		13.0460-4040.2	604040	ATE 21050 15,8 - WE / - WK
2.2 DTI 16V	88	08/00→07/03	←	09/00→		13.0460-2815.2	602815	TRW 21368 18,3 - WK
2.6 V6	132	08/00→07/03	→	09/00→		13.0460-4040.2	604040	ATE 21050 15,8 - WE / - WK
2.5 DTI 24V	110	09/01→07/03	←			13.0460-2815.2	602815	TRW 21368 18,3 - WK
2.5 TD	96	04/94→07/01						
2.5 V6	125	03/94→09/00	→			13.0460-4040.2	604040	ATE 21050 15,8 - WE / - WK
3.0 V6	155	04/94→07/00						
3.2 V6	160	02/01→07/03						















	kw			 	! #		
<b>VAUXHALL - OMEGA (B) Stufenheck (V94) 12/93→07/03</b>							
<b>Warnkontakt, Bremsbelagverschleiß</b>							
2.0 2.0	85 85	03/94→09/99 09/95→09/96	←	→ V1999999; nicht für Sonderfahrzeuge / nicht für Polizei-fahrzeuge	2	24.8190-0710.2 620710	L= 730
			←	W1000001→	2	24.8190-0711.2 620711	L= 730
2.0 16V	100	03/94→07/01	←	→ V1999999; nicht für Sonderfahrzeuge / nicht für Polizei-fahrzeuge	2	24.8190-0710.2 620710	L= 730
			←	W1000001→; → 09/99	2	24.8190-0711.2 620711	L= 730
2.0 DTI 16V	74	01/98→09/00	←	→ 08/00	2	24.8190-0711.2 620711	L= 730
2.2 16V	106	01/94→06/03	←	10/99→	2	24.8190-0711.2 620711	L= 730
2.2 DTI 16V 2.6 V6	88 132	08/00→07/03 08/00→07/03	←	09/00→	2	24.8190-0711.2 620711	L= 730
2.5 DTI 24V 2.5 TD 2.5 V6 3.0 V6 3.2 V6	110 96 125 155 160	09/01→07/03 04/94→07/01 03/94→09/00 04/94→07/00 02/01→07/03	←		2	24.8190-0711.2 620711	L= 730
<b>Zubehörsatz, Scheibenbremsbelag</b>							
2.0 2.0 2.5 DTI 24V 2.5 TD 2.5 V6 3.0 V6 3.2 V6	85 85 110 96 125 155 160	03/94→09/99 09/95→09/96 09/01→07/03 04/94→07/01 03/94→09/00 04/94→07/00 02/01→07/03	→			13.0460-0246.2 610246	
2.0 16V	100	03/94→07/01	→	→ 09/99		13.0460-0246.2 610246	
2.0 DTI 16V	74	01/98→09/00	→	→ 08/00		13.0460-0246.2 610246	
2.2 16V	106	01/94→06/03	→	10/99→		13.0460-0246.2 610246	
2.2 DTI 16V 2.6 V6	88 132	08/00→07/03 08/00→07/03	→	09/00→		13.0460-0246.2 610246	
<b>Bremsscheibe</b>							
2.0 2.0	85 85	03/94→09/99 09/95→09/96	←	→ V1999999; nicht für Sonderfahrzeuge / nicht für Polizei-fahrzeuge		24.0124-0119.1 424119	Ø 286 24 21 V
			←	W1000001→		24.0128-0104.1 428104	Ø 296 28 25 V + S
			→			24.0112-0131.1 412131	Ø 286 12 10
			→			24.0120-0171.1 420171	Ø 286 20 18 V
2.0 16V	100	03/94→07/01	←	→ V1999999; nicht für Sonderfahrzeuge / nicht für Polizei-fahrzeuge		24.0124-0119.1 424119	Ø 286 24 21 V
			←	W1000001→; → 09/99		24.0128-0104.1 428104	Ø 296 28 25 V + S
			→	→ 09/99		24.0112-0131.1 412131	Ø 286 12 10
			→			24.0120-0171.1 420171	Ø 286 20 18 V
2.0 DTI 16V	74	01/98→09/00	←	→ 08/00		24.0128-0104.1 428104	Ø 296 28 25 V + S
			→	→ 08/00		24.0112-0131.1 412131	Ø 286 12 10
			→			24.0120-0171.1 420171	Ø 286 20 18 V
2.2 16V	106	01/94→06/03	←	10/99→		24.0128-0104.1 428104	Ø 296 28 25 V + S
			→	10/99→		24.0112-0131.1 412131	Ø 286 12 10
			→			24.0120-0171.1 420171	Ø 286 20 18 V
2.2 DTI 16V 2.6 V6	88 132	08/00→07/03 08/00→07/03	←	09/00→		24.0128-0104.1 428104	Ø 296 28 25 V + S
			→	09/00→		24.0112-0131.1 412131	Ø 286 12 10
			→			24.0120-0171.1 420171	Ø 286 20 18 V
2.5 DTI 24V 2.5 TD 2.5 V6 3.0 V6 3.2 V6	110 96 125 155 160	09/01→07/03 04/94→07/01 03/94→09/00 04/94→07/00 02/01→07/03	←			24.0128-0104.1 428104	Ø 296 28 25 V + S
			→			24.0112-0131.1 412131	Ø 286 12 10
			→			24.0120-0171.1 420171	Ø 286 20 18 V
<b>VAUXHALL - SIGNUM (Z03) 03/03→10/08</b>							
<b>Bremsbelagsatz, Scheibenbremse</b>							
1.8 1.9 CDTI 1.9 CDTI 16V 1.9 Turbo	90 88 110 74	06/03→07/05 04/04→03/08 04/04→03/08 01/05→05/08	←	für Bremssattel mit Kunststoffkolben		13.0460-7172.2 607172 13.0470-7172.2 LD7172	ATE 23378 20,1 + WE / - WK ATE 23378 20,1 + WE / - WK Ceramic
2.0 DTI 2.2 DTI	74 92	05/03→05/08 05/03→05/08	←	für Bremssattel mit Stahlkolben		13.0460-7212.2 607212	ATE 23738 20,1 + WE / - WK
2.2 i ↓	114	05/03→05/08	→	→ 41096248 / 48091178		13.0460-7194.2 607194	ATE 23482 16,6 - WE / - WK









	kW			 	! #			
<b>VAUXHALL - SIGNUM (Z03) 03/03→10/08</b>								
<b>Bremsbelagsatz, Scheibenbremse</b>								
1.8 1.9 CDTi 1.9 CDTi 16V 1.9 Turbo 2.0 DTi 2.2 DTi 2.2 i	90 88 110 74 74 92 114	06/03→07/05 04/04→03/08 04/04→03/08 01/05→05/08 05/03→05/08 05/03→05/08 05/03→05/08	→ → →	→ 41096248 / 48091178 41096249 / 48091179→		13.0470-7194.2 13.0460-7195.2 13.0470-7195.2	LD7194 607195 LD7195	ATE 23482 16,6 - WE / - WK Ceramic ATE 23482 16,6 - WE / - WK ATE 23482 16,6 - WE / - WK Ceramic
1.8	103	08/05→05/08	← ← →	09/05→; für Bremssattel mit Kunststoffkolben 09/05→; für Bremssattel mit Stahlkolben 09/05→		13.0460-7172.2 13.0470-7172.2 13.0460-7194.2 13.0460-7195.2 13.0470-7194.2 13.0470-7195.2	607172 LD7172 607194 607195 LD7194 LD7195	ATE 23378 20,1 + WE / - WK Ceramic ATE 23378 20,1 + WE / - WK ATE 23482 16,6 - WE / - WK ATE 23482 16,6 - WE / - WK ATE 23482 16,6 - WE / - WK Ceramic ATE 23482 16,6 - WE / - WK Ceramic
2.0 i Turbo	129	03/03→10/08	← ← → →	05/03→ 05/08; für Bremssattel mit Kunststoffkolben 05/03→ 05/08; für Bremssattel mit Stahlkolben 05/03→; → 41096248 / 48091178 41096249 / 48091179→; → 05/08		13.0460-7172.2 13.0470-7172.2 13.0460-7212.2 13.0460-7194.2 13.0470-7194.2 13.0460-7195.2 13.0470-7195.2	607172 LD7172 607212 607194 LD7194 607195 LD7195	ATE 23378 20,1 + WE / - WK Ceramic ATE 23738 20,1 + WE / - WK ATE 23482 16,6 - WE / - WK ATE 23482 16,6 - WE / - WK ATE 23482 16,6 - WE / - WK Ceramic ATE 23482 16,6 - WE / - WK Ceramic
2.8 V6 Turbo	169	07/05→05/08	← →	61000001→ 09/05→		13.0460-7199.2 13.0460-7194.2 13.0460-7195.2 13.0470-7194.2 13.0470-7195.2	607199 607194 607195 LD7194 LD7195	ATE 23404 20,6 + WE / - WK ATE 23482 16,6 - WE / - WK ATE 23482 16,6 - WE / - WK ATE 23482 16,6 - WE / - WK Ceramic ATE 23482 16,6 - WE / - WK Ceramic
2.8 V6 Turbo	184	05/07→10/08	← →	→ 05/08 → 05/08		13.0460-7199.2 13.0460-7194.2 13.0460-7195.2 13.0470-7194.2 13.0470-7195.2	607199 607194 607195 LD7194 LD7195	ATE 23404 20,6 + WE / - WK ATE 23482 16,6 - WE / - WK ATE 23482 16,6 - WE / - WK ATE 23482 16,6 - WE / - WK Ceramic ATE 23482 16,6 - WE / - WK Ceramic
3.0 CDTi 3.2 V6	130 155	05/03→05/08 05/03→05/08	← ← ← → →	→ 31068238; für Bremssattel mit Kunststoffkolben 31068239→ → 31068238; für Bremssattel mit Stahlkolben → 41096248 / 48091178 41096249 / 48091179→		13.0460-7172.2 13.0470-7172.2 13.0460-7199.2 13.0460-7212.2 13.0460-7194.2 13.0470-7194.2 13.0460-7195.2 13.0470-7195.2	607172 LD7172 607199 607212 607194 LD7194 607195 LD7195	ATE 23378 20,1 + WE / - WK Ceramic ATE 23404 20,6 + WE / - WK ATE 23738 20,1 + WE / - WK ATE 23482 16,6 - WE / - WK ATE 23482 16,6 - WE / - WK Ceramic ATE 23482 16,6 - WE / - WK Ceramic
3.0 V6 CDTi	135	07/05→06/08	← →	61000001→; → 05/08 09/05→ 05/08		13.0460-7199.2 13.0460-7194.2 13.0460-7195.2 13.0470-7194.2 13.0470-7195.2	607199 607194 607195 LD7194 LD7195	ATE 23404 20,6 + WE / - WK ATE 23482 16,6 - WE / - WK ATE 23482 16,6 - WE / - WK ATE 23482 16,6 - WE / - WK Ceramic ATE 23482 16,6 - WE / - WK Ceramic
<b>Warnkontakt, Bremsbelagverschleiß</b>								
1.8 1.9 CDTi 1.9 CDTi 16V 1.9 Turbo 2.0 DTi 2.2 DTi ↓	90 88 110 74 74 92	06/03→07/05 04/04→03/08 04/04→03/08 01/05→05/08 05/03→05/08 05/03→05/08	← ←	bis Bj. 08.2004 ab Bj. 09.2004	1 1	24.8190-0719.2 24.8190-0720.2	620719 620720	L= 685,5 L= 287



















	kW			 	! #		
<b>VAUXHALL - SIGNUM (Z03) 03/03→10/08</b>							
<b>Warnkontakt, Bremsbelagverschleiß</b>							
2.2 i	114	05/03→05/08	←	bis Bj. 08.2004	1	24.8190-0719.2 620719	L= 685,5
			←	ab Bj. 09.2004	1	24.8190-0720.2 620720	L= 287
1.8	103	08/05→05/08	←	09/05→; bis Bj. 08.2004	1	24.8190-0719.2 620719	L= 685,5
			←	09/05→; ab Bj. 09.2004	1	24.8190-0720.2 620720	L= 287
2.0 i Turbo	129	03/03→10/08	←	05/03→ 05/08; bis Bj. 08.2004	1	24.8190-0719.2 620719	L= 685,5
			←	05/03→ 05/08; ab Bj. 09.2004	1	24.8190-0720.2 620720	L= 287
2.8 V6 Turbo	169	07/05→05/08	←	61000001→; bis ChNr. 41048790	1	24.8190-0721.2 620721	L= 700
			←	61000001→; ab ChNr. 41048791	1	24.8190-0722.2 620722	L= 302
2.8 V6 Turbo	184	05/07→10/08	←	→ 05/08; bis ChNr. 41048790	1	24.8190-0721.2 620721	L= 700
			←	→ 05/08; ab ChNr. 41048791	1	24.8190-0722.2 620722	L= 302
3.0 CDTi	130	05/03→05/08	←	→ 31068238; bis Bj. 08.2004	1	24.8190-0719.2 620719	L= 685,5
3.2 V6	155	05/03→05/08	←	→ 31068238; ab Bj. 09.2004	1	24.8190-0720.2 620720	L= 287
			←	31068239→; bis ChNr. 41048790	1	24.8190-0721.2 620721	L= 700
			←	31068239→; ab ChNr. 41048791	1	24.8190-0722.2 620722	L= 302
3.0 V6 CDTi	135	07/05→06/08	←	61000001→; → 05/08; bis ChNr. 41048790	1	24.8190-0721.2 620721	L= 700
			←	61000001→; → 05/08; ab ChNr. 41048791	1	24.8190-0722.2 620722	L= 302
<b> Brems Scheibe</b>							
1.8	90	06/03→07/05	←	für Fahrzeuge ohne Sportfahrwerk		24.0125-0141.1 425141	Ø 285 24,9 22 V + S
1.9 CDTi	88	04/04→03/08				24.0325-0141.1 525141	Ø 285 24,9 22 V + S
1.9 CDTi 16V	110	04/04→03/08					
1.9 Turbo	74	01/05→05/08	←	für Fahrzeuge mit Sportfahrwerk		24.0128-0137.1 428137	Ø 302 28 25 V + S
2.0 DTi	74	05/03→05/08				24.0328-0137.1 528137	Ø 302 28 25 V + S
2.2 DTi	92	05/03→05/08	→			24.0112-0157.1 412157	Ø 278 11,9 10 + S
2.2 i	114	05/03→05/08	→			24.0120-0173.1 420173	Ø 292 19,9 18 V + S
						24.0312-0157.1 512157	Ø 278 11,9 10 + S
						24.0320-0173.1 520173	Ø 292 19,9 18 V + S
1.8	103	08/05→05/08	←	09/05→; nicht für Polizeifahrzeuge; für Fahrzeuge mit Sportfahrwerk		24.0125-0141.1 425141	Ø 285 24,9 22 V + S
						24.0325-0141.1 525141	Ø 285 24,9 22 V + S
			←	09/05→; für Polizeifahrzeuge; für Fahrzeuge mit Sportfahrwerk		24.0128-0137.1 428137	Ø 302 28 25 V + S
						24.0328-0137.1 528137	Ø 302 28 25 V + S
			→	09/05→		24.0112-0157.1 412157	Ø 278 11,9 10 + S
						24.0120-0173.1 420173	Ø 292 19,9 18 V + S
						24.0312-0157.1 512157	Ø 278 11,9 10 + S
						24.0320-0173.1 520173	Ø 292 19,9 18 V + S
2.0 i Turbo	129	03/03→10/08	←	05/03→ 05/08		24.0128-0137.1 428137	Ø 302 28 25 V + S
						24.0328-0137.1 528137	Ø 302 28 25 V + S
			→	05/03→ 05/08		24.0120-0173.1 420173	Ø 292 19,9 18 V + S
						24.0320-0173.1 520173	Ø 292 19,9 18 V + S
2.8 V6 Turbo	169	07/05→05/08	←	61000001→		24.0128-0164.1 428164	Ø 314 28 25 V + S
			→	09/05→		24.0112-0157.1 412157	Ø 278 11,9 10 + S
						24.0120-0173.1 420173	Ø 292 19,9 18 V + S
						24.0312-0157.1 512157	Ø 278 11,9 10 + S
						24.0320-0173.1 520173	Ø 292 19,9 18 V + S
2.8 V6 Turbo	184	05/07→10/08	←	→ 05/08		24.0128-0164.1 428164	Ø 314 28 25 V + S
			→	→ 05/08		24.0112-0157.1 412157	Ø 278 11,9 10 + S
						24.0120-0173.1 420173	Ø 292 19,9 18 V + S
						24.0312-0157.1 512157	Ø 278 11,9 10 + S
						24.0320-0173.1 520173	Ø 292 19,9 18 V + S
3.0 CDTi	130	05/03→05/08	←	→ 31068238		24.0128-0137.1 428137	Ø 302 28 25 V + S
3.2 V6	155	05/03→05/08				24.0328-0137.1 528137	Ø 302 28 25 V + S
			←	31068239→		24.0128-0164.1 428164	Ø 314 28 25 V + S
			→			24.0120-0173.1 420173	Ø 292 19,9 18 V + S
						24.0320-0173.1 520173	Ø 292 19,9 18 V + S
3.0 V6 CDTi	135	07/05→06/08	←	61000001→; → 05/08		24.0128-0164.1 428164	Ø 314 28 25 V + S
			→	09/05→ 05/08		24.0112-0157.1 412157	Ø 278 11,9 10 + S
						24.0120-0173.1 420173	Ø 292 19,9 18 V + S
						24.0312-0157.1 512157	Ø 278 11,9 10 + S
						24.0320-0173.1 520173	Ø 292 19,9 18 V + S











	kw			 	! #		
<b>VAUXHALL - SINTRA (APV) 09/96→04/99</b>							
 <b>Bremsbelagsatz, Scheibenbremse</b>							
2.2 DTI	85	07/97→04/99	←			13.0460-8002.2 608002	23358 18,0 + WK
2.2 i 16 V	104	11/96→04/99					
3.0 i 24V	148	11/96→04/99	→			13.0460-8011.2 608011	23361 14,2 + WK
 <b>Bremsscheibe</b>							
2.2 DTI	85	07/97→04/99	←			24.0132-0110.1 432110	Ø 278 32,2 30,7 V
2.2 i 16 V	104	11/96→04/99					
3.0 i 24V	148	11/96→04/99	→			24.0111-0133.1 411133	Ø 278 11 9
<b>VAUXHALL - SPEEDSTER (E01) 03/01→09/06</b>							
 <b>Bremsscheibe</b>							
2.2	108	03/01→09/06	←	→ 09/05		24.0125-0119.1 425119	Ø 288 25 22 V + S
						24.0325-0119.1 525119	Ø 288 25 22 V + S
			→	→ 09/05		24.0125-0119.1 425119	Ø 288 25 22 V + S
						24.0325-0119.1 525119	Ø 288 25 22 V + S
<b>VAUXHALL - TIGRA Convertible (X04) 06/04→08/09</b>							
 <b>Bremsbelagsatz, Scheibenbremse</b>							
1.3 CDTI	51	06/04→08/09	←			13.0460-2857.2 602857	TRW 23225 17,0 + WK + Zub
1.4	66	06/04→08/09				13.0470-2857.2 LD2857	TRW 23225 17,0 + WK + Zub Ceramic
1.8	92	06/04→08/09					
			→	Orga 7E000001→		13.0460-2858.2 602858	TRW 23284 14,0 + WK
						13.0470-2858.2 LD2858	TRW 23284 14,0 + WK Ceramic
			→	→Orga 6E999999		13.0460-2858.2 602858	TRW 23284 14,0 + WK
						13.0470-2858.2 LD2858	TRW 23284 14,0 + WK Ceramic
 <b>Bremsscheibe</b>							
1.3 CDTI	51	06/04→08/09	←			24.0124-0166.1 424166	Ø 260 24 21 V + S
1.4	66	06/04→08/09				24.0324-0166.1 524166	Ø 260 24 21 V
1.8	92	06/04→08/09					
			→			24.0110-0268.1 410268	Ø 240 10,2 8,2
<b>VAUXHALL - TIGRA Mk I (S93) 07/94→12/00</b>							
 <b>Bremsbelagsatz, Scheibenbremse</b>							
1.4 16V	66	07/94→12/00	←			13.0460-7051.2 607051	ATE 20547 16,5 + WE / - WK
1.6 16V	78	07/94→12/00	←	→ 08/98		13.0460-7051.2 607051	ATE 20547 16,5 + WE / - WK
 <b>Bremsscheibe</b>							
1.4 16V	66	07/94→12/00	←			24.0120-0140.1 420140	Ø 256 20 17 V + S
1.6 16V	78	07/94→12/00	←	→ 08/98		24.0120-0140.1 420140	Ø 256 20 17 V + S
<b>VAUXHALL - VECTRA (B) CC (J96) 08/95→07/03</b>							
 <b>Bremsbelagsatz, Scheibenbremse</b>							
1.6 i (F68)	55	08/95→10/01	←	09/95→; → W7999999		13.0460-7052.2 607052	ATE 21190 17,5 + WE / - WK
			←	X1000001→		13.0460-7091.2 607091	ATE 21829 20,3 + WE / - WK
1.6 i 16V (F68)	74	08/95→10/01	←	09/95→; → W7999999		13.0460-7052.2 607052	ATE 21190 17,5 + WE / - WK
			←	X1000001→		13.0460-7091.2 607091	ATE 21829 20,3 + WE / - WK
			→	09/95→		13.0460-4040.2 604040	ATE 21050 15,8 - WE / - WK
1.7 TD (F68)	60	10/95→11/96	←			13.0460-7052.2 607052	ATE 21190 17,5 + WE / - WK
			→			13.0460-4040.2 604040	ATE 21050 15,8 - WE / - WK
1.8 Dualfuel (F68)	92	09/00→07/03	←	→ W7999999		13.0460-7052.2 607052	ATE 21190 17,5 + WE / - WK
1.8 i 16V (F68)	92	09/00→07/03	←	X1000001→; → 04/02		13.0460-7091.2 607091	ATE 21829 20,3 + WE / - WK
			→	→ 04/02		13.0460-4040.2 604040	ATE 21050 15,8 - WE / - WK
1.8 i 16V (F68)	85	10/95→09/00	←	→ W7999999		13.0460-7052.2 607052	ATE 21190 17,5 + WE / - WK
2.0 DTi 16V (F68)	74	06/97→10/01	←	X1000001→		13.0460-7091.2 607091	ATE 21829 20,3 + WE / - WK
			→			13.0460-4040.2 604040	ATE 21050 15,8 - WE / - WK
2.0 Di 16V (F68)	60	08/95→10/01	←	11/96→; → W7999999		13.0460-7052.2 607052	ATE 21190 17,5 + WE / - WK
			←	X1000001→		13.0460-7091.2 607091	ATE 21829 20,3 + WE / - WK
2.0 i 16V (F68)	100	10/95→01/01	←			13.0460-7091.2 607091	ATE 21829 20,3 + WE / - WK
2.5 i GSi (F68)	143	03/98→07/00					
2.5 i V6 (F68)	125	09/95→08/00	→			13.0460-4040.2 604040	ATE 21050 15,8 - WE / - WK
2.2 DTi 16V (F68)	92	08/95→10/01	←	09/00→		13.0460-7091.2 607091	ATE 21829 20,3 + WE / - WK







	kw			 	! #		
<b>VAUXHALL - VECTRA (B) CC (J96) 08/95→07/03</b>							
<b> Bremsbelagsatz, Scheibenbremse</b>							
2.2 DTi 16V (F68)	92	08/95→10/01	➡	09/00→		<b>13.0460-4040.2 604040</b>	ATE 21050 15,8 - WE / - WK
2.2 i 16V (F68)	108	09/00→07/03	←	→ 04/02		<b>13.0460-7091.2 607091</b>	ATE 21829 20,3 + WE / - WK
2.6 i V6 (F68)	125	09/00→07/03	➡	→ 04/02		<b>13.0460-4040.2 604040</b>	ATE 21050 15,8 - WE / - WK
<b>Warnkontakt, Bremsbelagverschleiß</b>							
1.6 i (F68)	55	08/95→10/01	←	X1000001→	2	<b>24.8190-0714.2 620714</b>	L= 660
1.6 i 16V (F68)	74	08/95→10/01	←	09/95→; → W7999999	2	<b>24.8190-0715.2 620715</b>	L= 660
1.7 TD (F68)	60	10/95→11/96	←		2	<b>24.8190-0715.2 620715</b>	L= 660
1.8 Dualfuel (F68)	92	09/00→07/03	←	X1000001→; → 04/02	2	<b>24.8190-0714.2 620714</b>	L= 660
1.8 i 16V (F68)	92	09/00→07/03	←	→ W7999999	2	<b>24.8190-0715.2 620715</b>	L= 660
1.8 i 16V (F68)	85	10/95→09/00	←	X1000001→	2	<b>24.8190-0714.2 620714</b>	L= 660
2.0 DTi 16V (F68)	74	06/97→10/01	←	→ W7999999	2	<b>24.8190-0715.2 620715</b>	L= 660
2.0 Di 16V (F68)	60	08/95→10/01	←	X1000001→	2	<b>24.8190-0714.2 620714</b>	L= 660
			←	11/96→; → W7999999	2	<b>24.8190-0715.2 620715</b>	L= 660
2.0 i 16V (F68)	100	10/95→01/01	←		2	<b>24.8190-0714.2 620714</b>	L= 660
2.5 i GSi (F68)	143	03/98→07/00					
2.5 i V6 (F68)	125	09/95→08/00					
2.2 DTi 16V (F68)	92	08/95→10/01	←	09/00→	2	<b>24.8190-0714.2 620714</b>	L= 660
2.2 i 16V (F68)	108	09/00→07/03	←	→ 04/02	2	<b>24.8190-0714.2 620714</b>	L= 660
2.6 i V6 (F68)	125	09/00→07/03					
<b>Zubehörsatz, Scheibenbremsbelag</b>							
1.6 i 16V (F68)	74	08/95→10/01	➡	09/95→		<b>13.0460-0347.2 610347</b>	
1.7 TD (F68)	60	10/95→11/96	➡			<b>13.0460-0347.2 610347</b>	
1.8 i 16V (F68)	85	10/95→09/00					
2.0 DTi 16V (F68)	74	06/97→10/01					
2.0 i 16V (F68)	100	10/95→01/01					
2.5 i GSi (F68)	143	03/98→07/00					
2.5 i V6 (F68)	125	09/95→08/00					
1.8 Dualfuel (F68)	92	09/00→07/03	➡	→ 04/02		<b>13.0460-0347.2 610347</b>	
1.8 i 16V (F68)	92	09/00→07/03					
2.2 i 16V (F68)	108	09/00→07/03					
2.6 i V6 (F68)	125	09/00→07/03					
2.2 DTi 16V (F68)	92	08/95→10/01	➡	09/00→		<b>13.0460-0347.2 610347</b>	
<b> Bremsscheibe</b>							
1.6 i (F68)	55	08/95→10/01	←	09/95→; → W7999999		<b>24.0124-0115.1 424115</b>	Ø 256 24 21 V + S
			←	X1000001→		<b>24.0324-0115.1 524115</b>	Ø 256 24 21 V + S
			←	X1000001→		<b>24.0125-0119.1 425119</b>	Ø 288 25 22 V + S
			←	X1000001→		<b>24.0325-0119.1 525119</b>	Ø 288 25 22 V + S
1.6 i 16V (F68)	74	08/95→10/01	←	09/95→; → W7999999		<b>24.0124-0115.1 424115</b>	Ø 256 24 21 V + S
			←	X1000001→		<b>24.0324-0115.1 524115</b>	Ø 256 24 21 V + S
			←	X1000001→		<b>24.0125-0119.1 425119</b>	Ø 288 25 22 V + S
			←	X1000001→		<b>24.0325-0119.1 525119</b>	Ø 288 25 22 V + S
			➡	09/95→; → W7999999		<b>24.0110-0225.1 410225</b>	Ø 270 10 8 + S
			➡	→ W7999999		<b>24.0310-0225.1 510225</b>	Ø 270 10 8 + S
			➡	X1000001→		<b>24.0110-0226.1 410226</b>	Ø 286 10 8 + S
			➡	→ W7999999		<b>24.0310-0226.1 510226</b>	Ø 286 10 8 + S
1.7 TD (F68)	60	10/95→11/96	←			<b>24.0124-0115.1 424115</b>	Ø 256 24 21 V + S
			➡			<b>24.0324-0115.1 524115</b>	Ø 256 24 21 V + S
			➡			<b>24.0110-0225.1 410225</b>	Ø 270 10 8 + S
			➡			<b>24.0310-0225.1 510225</b>	Ø 270 10 8 + S
1.8 Dualfuel (F68)	92	09/00→07/03	←	→ W7999999		<b>24.0124-0115.1 424115</b>	Ø 256 24 21 V + S
1.8 i 16V (F68)	92	09/00→07/03	←	→ W7999999		<b>24.0324-0115.1 524115</b>	Ø 256 24 21 V + S
			←	X1000001→; → 04/02		<b>24.0125-0119.1 425119</b>	Ø 288 25 22 V + S
			←	X1000001→; → 04/02		<b>24.0325-0119.1 525119</b>	Ø 288 25 22 V + S
			➡	→ W7999999		<b>24.0110-0225.1 410225</b>	Ø 270 10 8 + S
			➡	→ W7999999		<b>24.0310-0225.1 510225</b>	Ø 270 10 8 + S
			➡	X1000001→; → 04/02		<b>24.0110-0226.1 410226</b>	Ø 286 10 8 + S
			➡	X1000001→; → 04/02		<b>24.0310-0226.1 510226</b>	Ø 286 10 8 + S
1.8 i 16V (F68)	85	10/95→09/00	←	→ W7999999		<b>24.0124-0115.1 424115</b>	Ø 256 24 21 V + S
2.0 DTi 16V (F68)	74	06/97→10/01	←	→ W7999999		<b>24.0324-0115.1 524115</b>	Ø 256 24 21 V + S
			←	X1000001→		<b>24.0125-0119.1 425119</b>	Ø 288 25 22 V + S
↓							

	kw			 	! #		
<b>VAUXHALL - VECTRA (B) CC (J96) 08/95→07/03</b>							
<b>Bremsscheibe</b>							
1.8 i 16V (F68) 2.0 DTi 16V (F68)	85 74	10/95→09/00 06/97→10/01	← X1000001→ → W7999999 → X1000001→			24.0325-0119.1 525119 24.0110-0225.1 410225 24.0310-0225.1 510225 24.0110-0226.1 410226 24.0310-0226.1 510226	Ø 288 25 22 V + S Ø 270 10 8 + S Ø 270 10 8 + S Ø 286 10 8 + S Ø 286 10 8 + S
2.0 Di 16V (F68)	60	08/95→10/01	← 11/96→; → W7999999 ← X1000001→			24.0124-0115.1 424115 24.0324-0115.1 524115 24.0125-0119.1 425119 24.0325-0119.1 525119	Ø 256 24 21 V + S Ø 256 24 21 V + S Ø 288 25 22 V + S Ø 288 25 22 V + S
2.0 i 16V (F68) 2.5 i GSi (F68) 2.5 i V6 (F68)	100 143 125	10/95→01/01 03/98→07/00 09/95→08/00	← →			24.0125-0119.1 425119 24.0325-0119.1 525119 24.0110-0226.1 410226 24.0310-0226.1 510226	Ø 288 25 22 V + S Ø 288 25 22 V + S Ø 286 10 8 + S Ø 286 10 8 + S
2.2 DTi 16V (F68)	92	08/95→10/01	← 09/00→ → 09/00→			24.0125-0119.1 425119 24.0325-0119.1 525119 24.0110-0226.1 410226 24.0310-0226.1 510226	Ø 288 25 22 V + S Ø 288 25 22 V + S Ø 286 10 8 + S Ø 286 10 8 + S
2.2 i 16V (F68) 2.6 i V6 (F68)	108 125	09/00→07/03 09/00→07/03	← → 04/02 → 04/02			24.0125-0119.1 425119 24.0325-0119.1 525119 24.0110-0226.1 410226 24.0310-0226.1 510226	Ø 288 25 22 V + S Ø 288 25 22 V + S Ø 286 10 8 + S Ø 286 10 8 + S
<b>VAUXHALL - VECTRA (B) Kombi (J96) 08/95→03/02</b>							
<b>Bremsbelagsatz, Scheibenbremse</b>							
1.8 Dualfuel (F35) 1.8 i 16V (F35) 1.8 i 16V (F35)	92 85 92	09/00→03/02 11/96→09/00 09/00→03/02	← → W7999999 ← X1000001→ →			13.0460-7052.2 607052 13.0460-7091.2 607091 13.0460-4040.2 604040	ATE 21190 17,5 + WE / - WK ATE 21829 20,3 + WE / - WK ATE 21050 15,8 - WE / - WK
2.0 DI 16V (F35)	60	08/95→10/01	← 11/96→; → W7999999 ← X1000001→ → 11/96→			13.0460-7052.2 607052 13.0460-7091.2 607091 13.0460-4040.2 604040	ATE 21190 17,5 + WE / - WK ATE 21829 20,3 + WE / - WK ATE 21050 15,8 - WE / - WK
2.0 DTi 16V (F35)	74	08/95→10/01	← 06/97→; → W7999999 ← X1000001→ → 06/97→			13.0460-7052.2 607052 13.0460-7091.2 607091 13.0460-4040.2 604040	ATE 21190 17,5 + WE / - WK ATE 21829 20,3 + WE / - WK ATE 21050 15,8 - WE / - WK
2.0 i 16V (F35) 2.5 i GSi (F35) 2.5 i V6 (F35) 2.6 i V6 (F35)	100 143 125 125	10/95→01/01 05/98→09/99 11/96→08/00 09/00→03/02	← →			13.0460-7091.2 607091 13.0460-4040.2 604040	ATE 21829 20,3 + WE / - WK ATE 21050 15,8 - WE / - WK
2.2 DTi 16V (F35) 2.2 i 16V (F35)	92 108	08/95→10/01 08/95→10/01	← 09/00→ → 09/00→			13.0460-7091.2 607091 13.0460-4040.2 604040	ATE 21829 20,3 + WE / - WK ATE 21050 15,8 - WE / - WK
<b>Warnkontakt, Bremsbelagverschleiß</b>							
1.8 Dualfuel (F35) 1.8 i 16V (F35) 1.8 i 16V (F35)	92 85 92	09/00→03/02 11/96→09/00 09/00→03/02	← X1000001→ ← → W7999999	2	24.8190-0714.2 620714 24.8190-0715.2 620715	L= 660 L= 660	
2.0 DI 16V (F35)	60	08/95→10/01	← X1000001→ ← 11/96→; → W7999999	2	24.8190-0714.2 620714 24.8190-0715.2 620715	L= 660 L= 660	
2.0 DTi 16V (F35)	74	08/95→10/01	← X1000001→ ← 06/97→; → W7999999	2	24.8190-0714.2 620714 24.8190-0715.2 620715	L= 660 L= 660	
2.0 i 16V (F35) 2.5 i GSi (F35) 2.5 i V6 (F35) 2.6 i V6 (F35)	100 143 125 125	10/95→01/01 05/98→09/99 11/96→08/00 09/00→03/02	←	2	24.8190-0714.2 620714	L= 660	
2.2 DTi 16V (F35) 2.2 i 16V (F35)	92 108	08/95→10/01 08/95→10/01	← 09/00→	2	24.8190-0714.2 620714	L= 660	
<b>Zubehörsatz, Scheibenbremsbelag</b>							
1.8 Dualfuel (F35) 1.8 i 16V (F35) 1.8 i 16V (F35) 2.0 i 16V (F35) 2.5 i GSi (F35) 2.5 i V6 (F35) 2.6 i V6 (F35)	92 85 92 100 143 125 125	09/00→03/02 11/96→09/00 09/00→03/02 10/95→01/01 05/98→09/99 11/96→08/00 09/00→03/02	→			13.0460-0347.2 610347	
2.0 DI 16V (F35)	60	08/95→10/01	→ 11/96→			13.0460-0347.2 610347	
↓							







	kw					! #		
<b>VAUXHALL - VECTRA (B) Kombi (J96) 08/95→03/02</b>								
<b>Zubehörsatz, Scheibenbremsbelag</b>								
2.0 DTI 16V (F35)	74	08/95→10/01	➡	06/97→			13.0460-0347.2 610347	
2.2 DTI 16V (F35) 2.2 i 16V (F35)	92 108	08/95→10/01 08/95→10/01	➡	09/00→			13.0460-0347.2 610347	
<b> Bremsscheibe</b>								
1.8 Dualfuel (F35) 1.8 i 16V (F35) 1.8 i 16V (F35)	92 85 92	09/00→03/02 11/96→09/00 09/00→03/02	←	→ W7999999			24.0124-0115.1 424115 24.0324-0115.1 524115	Ø 256 24 21 V + S Ø 256 24 21 V + S
			←	X1000001→			24.0125-0119.1 425119 24.0325-0119.1 525119	Ø 288 25 22 V + S Ø 288 25 22 V + S
			➡	→ W7999999			24.0110-0225.1 410225 24.0310-0225.1 510225	Ø 270 10 8 + S Ø 270 10 8 + S
			➡	X1000001→			24.0110-0226.1 410226 24.0310-0226.1 510226	Ø 286 10 8 + S Ø 286 10 8 + S
2.0 DI 16V (F35)	60	08/95→10/01	←	11/96→; → W7999999			24.0124-0115.1 424115 24.0324-0115.1 524115	Ø 256 24 21 V + S Ø 256 24 21 V + S
			←	X1000001→			24.0125-0119.1 425119 24.0325-0119.1 525119	Ø 288 25 22 V + S Ø 288 25 22 V + S
			➡	11/96→; → W7999999			24.0110-0225.1 410225 24.0310-0225.1 510225	Ø 270 10 8 + S Ø 270 10 8 + S
			➡	X1000001→			24.0110-0226.1 410226 24.0310-0226.1 510226	Ø 286 10 8 + S Ø 286 10 8 + S
2.0 DTI 16V (F35)	74	08/95→10/01	←	06/97→; → W7999999			24.0124-0115.1 424115 24.0324-0115.1 524115	Ø 256 24 21 V + S Ø 256 24 21 V + S
			←	X1000001→			24.0125-0119.1 425119 24.0325-0119.1 525119	Ø 288 25 22 V + S Ø 288 25 22 V + S
			➡	06/97→; → W7999999			24.0110-0225.1 410225 24.0310-0225.1 510225	Ø 270 10 8 + S Ø 270 10 8 + S
			➡	X1000001→			24.0110-0226.1 410226 24.0310-0226.1 510226	Ø 286 10 8 + S Ø 286 10 8 + S
2.0 i 16V (F35) 2.5 i GSi (F35) 2.5 i V6 (F35) 2.6 i V6 (F35)	100 143 125 125	10/95→01/01 05/98→09/99 11/96→08/00 09/00→03/02	←				24.0125-0119.1 425119 24.0325-0119.1 525119	Ø 288 25 22 V + S Ø 288 25 22 V + S
			➡				24.0110-0226.1 410226 24.0310-0226.1 510226	Ø 286 10 8 + S Ø 286 10 8 + S
2.2 DTI 16V (F35) 2.2 i 16V (F35)	92 108	08/95→10/01 08/95→10/01	←	09/00→			24.0125-0119.1 425119 24.0325-0119.1 525119	Ø 288 25 22 V + S Ø 288 25 22 V + S
			➡	09/00→			24.0110-0226.1 410226 24.0310-0226.1 510226	Ø 286 10 8 + S Ø 286 10 8 + S
<b>VAUXHALL - VECTRA (B) Stufenheck (J96) 08/95→03/02</b>								
<b> Bremsbelagsatz, Scheibenbremse</b>								
1.6 i (F19)	55	08/95→10/01	←	09/95→; → W7999999			13.0460-7052.2 607052	ATE 21190 17,5 + WE / - WK
			←	X1000001→			13.0460-7091.2 607091	ATE 21829 20,3 + WE / - WK
1.6 i 16V (F19)	74	08/95→10/01	←	09/95→; → W7999999			13.0460-7052.2 607052	ATE 21190 17,5 + WE / - WK
			←	X1000001→			13.0460-7091.2 607091	ATE 21829 20,3 + WE / - WK
			➡	09/95→			13.0460-4040.2 604040	ATE 21050 15,8 - WE / - WK
1.7 TD (F19)	60	10/95→11/96	←				13.0460-7052.2 607052	ATE 21190 17,5 + WE / - WK
			➡				13.0460-4040.2 604040	ATE 21050 15,8 - WE / - WK
1.8 Dualfuel (F19) 1.8 i 16V (F19) 1.8 i 16V (F19)	92 85 92	09/00→03/02 10/95→09/00 09/00→03/02	←	→ W7999999			13.0460-7052.2 607052	ATE 21190 17,5 + WE / - WK
			←	X1000001→			13.0460-7091.2 607091	ATE 21829 20,3 + WE / - WK
			➡				13.0460-4040.2 604040	ATE 21050 15,8 - WE / - WK
2.0 DI 16V (F19)	60	08/95→10/01	←	11/96→; → W7999999			13.0460-7052.2 607052	ATE 21190 17,5 + WE / - WK
			←	X1000001→			13.0460-7091.2 607091	ATE 21829 20,3 + WE / - WK
2.0 DTI 16V (F19)	74	08/95→10/01	←	06/97→; → W7999999			13.0460-7052.2 607052	ATE 21190 17,5 + WE / - WK
			←	X1000001→			13.0460-7091.2 607091	ATE 21829 20,3 + WE / - WK
			➡	06/97→			13.0460-4040.2 604040	ATE 21050 15,8 - WE / - WK
2.0 i 16V (F19) 2.5 i GSi (F19) 2.5 i V6 (F19) 2.6 i V6 (F19)	100 143 125 125	10/95→01/01 03/98→07/00 09/95→08/00 09/00→03/02	←				13.0460-7091.2 607091	ATE 21829 20,3 + WE / - WK
			➡				13.0460-4040.2 604040	ATE 21050 15,8 - WE / - WK
2.2 DTI 16V (F19) 2.2 i 16V (F19)	92 108	08/95→10/01 08/95→10/01	←	09/00→			13.0460-7091.2 607091	ATE 21829 20,3 + WE / - WK

	kW				! #		
<b>VAUXHALL - VECTRA (B) Stufenheck (J96) 08/95→03/02</b>							
<b> Bremsbelagsatz, Scheibenbremse</b>							
2.2 DTI 16V (F19)	92	08/95→10/01	➡	09/00→		13.0460-4040.2 604040	ATE 21050 15,8 - WE / - WK
2.2 i 16V (F19)	108	08/95→10/01					
<b>Warnkontakt, Bremsbelagverschleiß</b>							
1.6 i (F19)	55	08/95→10/01	←	X1000001→	2	24.8190-0714.2 620714	L= 660
1.6 i 16V (F19)	74	08/95→10/01	←	09/95→; → W7999999	2	24.8190-0715.2 620715	L= 660
1.7 TD (F19)	60	10/95→11/96	←		2	24.8190-0715.2 620715	L= 660
1.8 Dualfuel (F19)	92	09/00→03/02	←	X1000001→	2	24.8190-0714.2 620714	L= 660
1.8 i 16V (F19)	85	10/95→09/00					
1.8 i 16V (F19)	92	09/00→03/02	←	→ W7999999	2	24.8190-0715.2 620715	L= 660
2.0 DI 16V (F19)	60	08/95→10/01	←	X1000001→	2	24.8190-0714.2 620714	L= 660
			←	11/96→; → W7999999	2	24.8190-0715.2 620715	L= 660
2.0 DTI 16V (F19)	74	08/95→10/01	←	X1000001→	2	24.8190-0714.2 620714	L= 660
			←	06/97→; → W7999999	2	24.8190-0715.2 620715	L= 660
2.0 i 16V (F19)	100	10/95→01/01	←		2	24.8190-0714.2 620714	L= 660
2.5 i GSi (F19)	143	03/98→07/00					
2.5 i V6 (F19)	125	09/95→08/00					
2.6 i V6 (F19)	125	09/00→03/02					
2.2 DTI 16V (F19)	92	08/95→10/01	←	09/00→	2	24.8190-0714.2 620714	L= 660
2.2 i 16V (F19)	108	08/95→10/01					
<b>Zubehörsatz, Scheibenbremsbelag</b>							
1.6 i 16V (F19)	74	08/95→10/01	➡	09/95→		13.0460-0347.2 610347	
1.7 TD (F19)	60	10/95→11/96	➡			13.0460-0347.2 610347	
1.8 Dualfuel (F19)	92	09/00→03/02					
1.8 i 16V (F19)	85	10/95→09/00					
1.8 i 16V (F19)	92	09/00→03/02					
2.0 i 16V (F19)	100	10/95→01/01					
2.5 i GSi (F19)	143	03/98→07/00					
2.5 i V6 (F19)	125	09/95→08/00					
2.6 i V6 (F19)	125	09/00→03/02					
2.0 DTI 16V (F19)	74	08/95→10/01	➡	06/97→		13.0460-0347.2 610347	
2.2 DTI 16V (F19)	92	08/95→10/01	➡	09/00→		13.0460-0347.2 610347	
2.2 i 16V (F19)	108	08/95→10/01					
<b> Bremsscheibe</b>							
1.6 i (F19)	55	08/95→10/01	←	09/95→; → W7999999		24.0124-0115.1 424115 24.0324-0115.1 524115	Ø 256 24 21 V + S Ø 256 24 21 V + S
			←	X1000001→		24.0125-0119.1 425119 24.0325-0119.1 525119	Ø 288 25 22 V + S Ø 288 25 22 V + S
1.6 i 16V (F19)	74	08/95→10/01	←	09/95→; → W7999999		24.0124-0115.1 424115 24.0324-0115.1 524115	Ø 256 24 21 V + S Ø 256 24 21 V + S
			←	X1000001→		24.0125-0119.1 425119 24.0325-0119.1 525119	Ø 288 25 22 V + S Ø 288 25 22 V + S
			➡	09/95→; → W7999999		24.0110-0225.1 410225 24.0310-0225.1 510225	Ø 270 10 8 + S Ø 270 10 8 + S
			➡	X1000001→		24.0110-0226.1 410226 24.0310-0226.1 510226	Ø 286 10 8 + S Ø 286 10 8 + S
1.7 TD (F19)	60	10/95→11/96	←			24.0124-0115.1 424115 24.0324-0115.1 524115	Ø 256 24 21 V + S Ø 256 24 21 V + S
			➡			24.0110-0225.1 410225 24.0310-0225.1 510225	Ø 270 10 8 + S Ø 270 10 8 + S
1.8 Dualfuel (F19)	92	09/00→03/02	←	→ W7999999		24.0124-0115.1 424115 24.0324-0115.1 524115	Ø 256 24 21 V + S Ø 256 24 21 V + S
1.8 i 16V (F19)	85	10/95→09/00					
1.8 i 16V (F19)	92	09/00→03/02	←	X1000001→		24.0125-0119.1 425119 24.0325-0119.1 525119	Ø 288 25 22 V + S Ø 288 25 22 V + S
			➡	→ W7999999		24.0110-0225.1 410225 24.0310-0225.1 510225	Ø 270 10 8 + S Ø 270 10 8 + S
			➡	X1000001→		24.0110-0226.1 410226 24.0310-0226.1 510226	Ø 286 10 8 + S Ø 286 10 8 + S
2.0 DI 16V (F19)	60	08/95→10/01	←	11/96→; → W7999999		24.0124-0115.1 424115 24.0324-0115.1 524115	Ø 256 24 21 V + S Ø 256 24 21 V + S
			←	X1000001→		24.0125-0119.1 425119 24.0325-0119.1 525119	Ø 288 25 22 V + S Ø 288 25 22 V + S
2.0 DTI 16V (F19)	74	08/95→10/01	←	06/97→; → W7999999		24.0124-0115.1 424115 24.0324-0115.1 524115	Ø 256 24 21 V + S Ø 256 24 21 V + S

















	kW			 	! #			
<b>VAUXHALL - VECTRA (B) Stufenheck (J96) 08/95→03/02</b>								
<b>Bremsscheibe</b>								
2.0 DTI 16V (F19)	74	08/95→10/01	←	X1000001→		24.0125-0119.1 425119	∅ 288 25 22 V + S	
						24.0325-0119.1 525119	∅ 288 25 22 V + S	
			→	06/97→; → W7999999		24.0110-0225.1 410225	∅ 270 10 8 + S	
						24.0310-0225.1 510225	∅ 270 10 8 + S	
			→	X1000001→		24.0110-0226.1 410226	∅ 286 10 8 + S	
						24.0310-0226.1 510226	∅ 286 10 8 + S	
2.0 i 16V (F19) 2.5 i GSi (F19) 2.5 i V6 (F19) 2.6 i V6 (F19)	100 143 125 125	10/95→01/01 03/98→07/00	←			24.0125-0119.1 425119	∅ 288 25 22 V + S	
						24.0325-0119.1 525119	∅ 288 25 22 V + S	
		09/95→08/00 09/00→03/02	→				24.0110-0226.1 410226	∅ 286 10 8 + S
							24.0310-0226.1 510226	∅ 286 10 8 + S
2.2 DTI 16V (F19) 2.2 i 16V (F19)	92 108	08/95→10/01 08/95→10/01	←	09/00→		24.0125-0119.1 425119	∅ 288 25 22 V + S	
						24.0325-0119.1 525119	∅ 288 25 22 V + S	
			→	09/00→		24.0110-0226.1 410226	∅ 286 10 8 + S	
						24.0310-0226.1 510226	∅ 286 10 8 + S	
<b>VAUXHALL - VECTRA Mk II (C) (Z02) 01/00→10/08</b>								
<b>Bremsbelagsatz, Scheibenbremse</b>								
1.8	103	01/06→07/08	←	für Bremssattel mit Kunststoffkolben		13.0460-7172.2 607172	ATE 23378 20,1 + WE / - WK	
						13.0470-7172.2 LD7172	ATE 23378 20,1 + WE / - WK Ceramic	
			←	für Bremssattel mit Stahlkolben		13.0460-7212.2 607212	ATE 23738 20,1 + WE / - WK	
			→			13.0460-7194.2 607194	ATE 23482 16,6 - WE / - WK	
						13.0460-7195.2 607195	ATE 23482 16,6 - WE / - WK	
						13.0470-7194.2 LD7194	ATE 23482 16,6 - WE / - WK Ceramic	
						13.0470-7195.2 LD7195	ATE 23482 16,6 - WE / - WK Ceramic	
1.8 16V 1.8 16V Dualfuel 1.9 CDTI 16V 2.0 DTI 16V 2.2 DTI 16V	90 90 110 74 92	04/02→07/08 04/02→07/08 04/04→08/08 04/02→10/08	←	für Bremssattel mit Kunststoffkolben		13.0460-7172.2 607172	ATE 23378 20,1 + WE / - WK	
						13.0470-7172.2 LD7172	ATE 23378 20,1 + WE / - WK Ceramic	
		04/02→10/08	←	für Bremssattel mit Stahlkolben		13.0460-7212.2 607212	ATE 23738 20,1 + WE / - WK	
				→ 41096248 / 48091178		13.0460-7194.2 607194	ATE 23482 16,6 - WE / - WK	
						13.0470-7194.2 LD7194	ATE 23482 16,6 - WE / - WK Ceramic	
			→	41096249 / 48091179→		13.0460-7195.2 607195	ATE 23482 16,6 - WE / - WK	
						13.0470-7195.2 LD7195	ATE 23482 16,6 - WE / - WK Ceramic	
1.9 CDTI	88	04/02→09/08	←	04/04→; für Bremssattel mit Kunststoffkolben		13.0460-7172.2 607172	ATE 23378 20,1 + WE / - WK	
						13.0470-7172.2 LD7172	ATE 23378 20,1 + WE / - WK Ceramic	
			←	04/04→; für Bremssattel mit Stahlkolben		13.0460-7212.2 607212	ATE 23738 20,1 + WE / - WK	
			→	04/04→; → 41096248 / 48091178		13.0460-7194.2 607194	ATE 23482 16,6 - WE / - WK	
						13.0470-7194.2 LD7194	ATE 23482 16,6 - WE / - WK Ceramic	
			→	41096249 / 48091179→		13.0460-7195.2 607195	ATE 23482 16,6 - WE / - WK	
						13.0470-7195.2 LD7195	ATE 23482 16,6 - WE / - WK Ceramic	
2.0 16V Turbo	129	01/00→10/08	←	03/03→; für Bremssattel mit Kunststoffkolben		13.0460-7172.2 607172	ATE 23378 20,1 + WE / - WK	
						13.0470-7172.2 LD7172	ATE 23378 20,1 + WE / - WK Ceramic	
			←	03/03→; für Bremssattel mit Stahlkolben		13.0460-7212.2 607212	ATE 23738 20,1 + WE / - WK	
			→	03/03→; → 41096248 / 48091178		13.0460-7194.2 607194	ATE 23482 16,6 - WE / - WK	
						13.0470-7194.2 LD7194	ATE 23482 16,6 - WE / - WK Ceramic	
			→	41096249 / 48091179→		13.0460-7195.2 607195	ATE 23482 16,6 - WE / - WK	
						13.0470-7195.2 LD7195	ATE 23482 16,6 - WE / - WK Ceramic	
2.2 16V	108	01/02→10/08	←	04/02→; für Bremssattel mit Kunststoffkolben		13.0460-7172.2 607172	ATE 23378 20,1 + WE / - WK	
						13.0470-7172.2 LD7172	ATE 23378 20,1 + WE / - WK Ceramic	
			←	04/02→; für Bremssattel mit Stahlkolben		13.0460-7212.2 607212	ATE 23738 20,1 + WE / - WK	
			→	04/02→; → 41096248 / 48091178		13.0460-7194.2 607194	ATE 23482 16,6 - WE / - WK	
						13.0470-7194.2 LD7194	ATE 23482 16,6 - WE / - WK Ceramic	









	kw				! #		
<b>VAUXHALL - VECTRA Mk II (C) (Z02) 01/00→10/08</b>							
<b>Bremsbelagsatz, Scheibenbremse</b>							
2.2 16V	108	01/02→10/08	➡	41096249 / 48091179→		<b>13.0460-7195.2 607195</b> <b>13.0470-7195.2 LD7195</b>	ATE 23482 16,6 - WE / - WK ATE 23482 16,6 - WE / - WK Ceramic
2.2 direct	114	01/02→10/08	←	10/03→; für Bremssattel mit Kunststoffkolben		<b>13.0460-7172.2 607172</b> <b>13.0470-7172.2 LD7172</b>	ATE 23378 20,1 + WE / - WK ATE 23378 20,1 + WE / - WK Ceramic
			←	10/03→; für Bremssattel mit Stahlkolben		<b>13.0460-7212.2 607212</b>	ATE 23738 20,1 + WE / - WK
			➡	10/03→; → 41096248 / 48091178		<b>13.0460-7194.2 607194</b> <b>13.0470-7194.2 LD7194</b>	ATE 23482 16,6 - WE / - WK ATE 23482 16,6 - WE / - WK Ceramic
			➡	41096249 / 48091179→		<b>13.0460-7195.2 607195</b> <b>13.0470-7195.2 LD7195</b>	ATE 23482 16,6 - WE / - WK ATE 23482 16,6 - WE / - WK Ceramic
3.0 CDTi	135	08/05→07/08	←			<b>13.0460-7199.2 607199</b>	ATE 23404 20,6 + WE / - WK
			➡			<b>13.0460-7194.2 607194</b> <b>13.0460-7195.2 607195</b> <b>13.0470-7194.2 LD7194</b>	ATE 23482 16,6 - WE / - WK ATE 23482 16,6 - WE / - WK ATE 23482 16,6 - WE / - WK Ceramic
			➡			<b>13.0470-7195.2 LD7195</b>	ATE 23482 16,6 - WE / - WK Ceramic
3.0 V6 CDTI	130	06/03→08/05	←			<b>13.0460-7199.2 607199</b>	ATE 23404 20,6 + WE / - WK
			➡	→ 41096248 / 48091178		<b>13.0460-7194.2 607194</b> <b>13.0470-7194.2 LD7194</b>	ATE 23482 16,6 - WE / - WK ATE 23482 16,6 - WE / - WK Ceramic
			➡	41096249 / 48091179→		<b>13.0460-7195.2 607195</b> <b>13.0470-7195.2 LD7195</b>	ATE 23482 16,6 - WE / - WK ATE 23482 16,6 - WE / - WK Ceramic
3.2 V6	155	06/03→07/08	←	→ 31070293 / 38047797; für Bremssattel mit Kunststoffkolben		<b>13.0460-7172.2 607172</b> <b>13.0470-7172.2 LD7172</b>	ATE 23378 20,1 + WE / - WK ATE 23378 20,1 + WE / - WK Ceramic
			←	31070294 / 38047798→ 48045597		<b>13.0460-7199.2 607199</b>	ATE 23404 20,6 + WE / - WK
			←	48045598→		<b>13.0460-7199.2 607199</b>	ATE 23404 20,6 + WE / - WK
			←	→ 31070293 / 38047797; für Bremssattel mit Stahlkolben		<b>13.0460-7212.2 607212</b>	ATE 23738 20,1 + WE / - WK
			➡	→ 41096248 / 48091178		<b>13.0460-7194.2 607194</b> <b>13.0470-7194.2 LD7194</b>	ATE 23482 16,6 - WE / - WK ATE 23482 16,6 - WE / - WK Ceramic
			➡	41096249 / 48091179→		<b>13.0460-7195.2 607195</b> <b>13.0470-7195.2 LD7195</b>	ATE 23482 16,6 - WE / - WK ATE 23482 16,6 - WE / - WK Ceramic
<b>Warnkontakt, Bremsbelagverschleiß</b>							
1.8	103	01/06→07/08	←	→ 48045597	1	<b>24.8190-0719.2 620719</b>	L= 685,5
1.8 16V	90	04/02→07/08	←	48045598→	1	<b>24.8190-0720.2 620720</b>	L= 287
1.8 16V Dualfuel	90	04/02→07/08					
1.9 CDTI 16V	110	04/04→08/08	←		1	<b>24.8190-0719.2 620719</b>	L= 685,5
2.0 DTI 16V	74	04/02→10/08					
2.2 DTI 16V	92	04/02→10/08					
1.9 CDTI	88	04/02→09/08	←	04/04→; → 48045597	1	<b>24.8190-0719.2 620719</b>	L= 685,5
			←	04/04→; 48045598→	1	<b>24.8190-0720.2 620720</b>	L= 287
2.0 16V Turbo	129	01/00→10/08	←	03/03→; → 48045597	1	<b>24.8190-0719.2 620719</b>	L= 685,5
			←	03/03→; 48045598→	1	<b>24.8190-0720.2 620720</b>	L= 287
2.2 16V	108	01/02→10/08	←	04/02→; → 48045597	1	<b>24.8190-0719.2 620719</b>	L= 685,5
			←	04/02→; 48045598→	1	<b>24.8190-0720.2 620720</b>	L= 287
2.2 direct	114	01/02→10/08	←	10/03→; → 48045597	1	<b>24.8190-0719.2 620719</b>	L= 685,5
			←	10/03→; 48045598→	1	<b>24.8190-0720.2 620720</b>	L= 287
3.0 CDTi	135	08/05→07/08	←	→ 48045597	1	<b>24.8190-0721.2 620721</b>	L= 700
3.0 V6 CDTI	130	06/03→08/05	←	48045598→	1	<b>24.8190-0722.2 620722</b>	L= 302
3.2 V6	155	06/03→07/08	←	→ 31070293 / 38047797	1	<b>24.8190-0719.2 620719</b>	L= 685,5
			←	31070294 / 38047798→ 48045597	1	<b>24.8190-0721.2 620721</b>	L= 700
			←	48045598→	1	<b>24.8190-0722.2 620722</b>	L= 302
↓							

















	kw			 	! #		
<b>VAUXHALL - VECTRA Mk II (C) (Z02) 01/00→10/08</b>							
<b>Bremsscheibe</b>							
1.8	103	01/06→07/08	←	für Fahrzeuge mit Sportfahrwerk; nicht für Polizeifahrzeuge	24.0125-0141.1 425141	Ø 285 24,9 22 V + S	
			←	für Fahrzeuge mit Sportfahrwerk; für Polizeifahrzeuge	24.0128-0137.1 428137	Ø 302 28 25 V + S	
			→		24.0112-0157.1 412157	Ø 278 11,9 10 + S	
1.8 16V 1.8 16V Dualfuel 2.2 DTI 16V	90 90 92	04/02→07/08 04/02→07/08 04/02→10/08	←	für Fahrzeuge ohne Sportfahrwerk	24.0125-0141.1 425141	Ø 285 24,9 22 V + S	
			←	für Fahrzeuge mit Sportfahrwerk	24.0128-0137.1 428137	Ø 302 28 25 V + S	
			→		24.0112-0157.1 412157	Ø 278 11,9 10 + S	
1.9 CDTI	88	04/02→09/08	←	04/04→	24.0125-0141.1 425141	Ø 285 24,9 22 V + S	
			→	04/04→	24.0112-0157.1 412157	Ø 278 11,9 10 + S	
					24.0120-0173.1 420173	Ø 292 19,9 18 V + S	
1.9 CDTI 16V 2.0 DTI 16V	110 74	04/04→08/08 04/02→10/08	←		24.0125-0141.1 425141	Ø 285 24,9 22 V + S	
			→		24.0112-0157.1 412157	Ø 278 11,9 10 + S	
					24.0120-0173.1 420173	Ø 292 19,9 18 V + S	
2.0 16V Turbo	129	01/00→10/08	←	03/03→	24.0128-0137.1 428137	Ø 302 28 25 V + S	
			→	03/03→	24.0112-0157.1 412157	Ø 278 11,9 10 + S	
					24.0120-0173.1 420173	Ø 292 19,9 18 V + S	
2.2 16V	108	01/02→10/08	←	04/02→; für Fahrzeuge ohne Sportfahrwerk	24.0125-0141.1 425141	Ø 285 24,9 22 V + S	
			←	04/02→; für Fahrzeuge mit Sportfahrwerk	24.0128-0137.1 428137	Ø 302 28 25 V + S	
			→	04/02→	24.0112-0157.1 412157	Ø 278 11,9 10 + S	
2.2 direct	114	01/02→10/08	←	10/03→; für Fahrzeuge ohne Sportfahrwerk	24.0125-0141.1 425141	Ø 285 24,9 22 V + S	
			←	10/03→; für Fahrzeuge mit Sportfahrwerk	24.0128-0137.1 428137	Ø 302 28 25 V + S	
			→	10/03→	24.0112-0157.1 412157	Ø 278 11,9 10 + S	
3.0 CDTi	135	08/05→07/08	←	61000001→	24.0128-0164.1 428164	Ø 314 28 25 V + S	
			→		24.0112-0157.1 412157	Ø 278 11,9 10 + S	
					24.0120-0173.1 420173	Ø 292 19,9 18 V + S	
3.0 V6 CDTI 3.2 V6	130 155	06/03→08/05 06/03→07/08	←	→ 31070293	24.0128-0137.1 428137	Ø 302 28 25 V + S	
			←	31070294→	24.0328-0137.1 528137	Ø 302 28 25 V + S	
			→		24.0128-0164.1 428164	Ø 314 28 25 V + S	
↓					24.0112-0157.1 412157	Ø 278 11,9 10 + S	
					24.0120-0173.1 420173	Ø 292 19,9 18 V + S	
					24.0312-0157.1 512157	Ø 278 11,9 10 + S	













	kw			 	! #		
<b>VAUXHALL - VECTRA Mk II (C) (Z02) 01/00→10/08</b>							
<b>Bremsscheibe</b>							
3.0 V6 CDTi 3.2 V6	130 155	06/03→08/05 06/03→07/08	➡			24.0320-0173.1 520173	Ø 292 19,9 18 V + S
<b>VAUXHALL - VECTRA Mk II (C) CC (Z02) 08/02→07/08</b>							
<b>Bremsbelagsatz, Scheibenbremse</b>							
1.8	103	01/06→07/08	←	für Bremssattel mit Kunststoffkolben		13.0460-7172.2 607172 13.0470-7172.2 LD7172	ATE 23378 20,1 + WE / - WK ATE 23378 20,1 + WE / - WK Ceramic
			←	für Bremssattel mit Stahlkolben		13.0460-7212.2 607212	ATE 23738 20,1 + WE / - WK
			➡			13.0460-7194.2 607194 13.0460-7195.2 607195 13.0470-7194.2 LD7194 13.0470-7195.2 LD7195	ATE 23482 16,6 - WE / - WK ATE 23482 16,6 - WE / - WK ATE 23482 16,6 - WE / - WK Ceramic ATE 23482 16,6 - WE / - WK Ceramic
1.8 16V 1.8 16V Dualfuel 1.9 CDTi 16V 2.0 16V Turbo 2.0 DTi 16V 2.2 16V 2.2 direct 2.2 DTi 16V	90 90 110 129 74 108 114 92	08/02→07/08 08/02→07/08 04/04→07/08 03/03→07/08 08/02→07/08 08/02→07/08 10/03→08/05 08/02→07/08	←	für Bremssattel mit Kunststoffkolben		13.0460-7172.2 607172 13.0470-7172.2 LD7172	ATE 23378 20,1 + WE / - WK ATE 23378 20,1 + WE / - WK Ceramic
			←	für Bremssattel mit Stahlkolben		13.0460-7212.2 607212	ATE 23738 20,1 + WE / - WK
			➡	→ 41096248 / 48091178		13.0460-7194.2 607194 13.0470-7194.2 LD7194	ATE 23482 16,6 - WE / - WK ATE 23482 16,6 - WE / - WK Ceramic
			➡	41096249 / 48091179→		13.0460-7195.2 607195 13.0470-7195.2 LD7195	ATE 23482 16,6 - WE / - WK ATE 23482 16,6 - WE / - WK Ceramic
1.9 CDTi	88	08/02→07/08	←	04/04→; für Bremssattel mit Kunststoffkolben		13.0460-7172.2 607172 13.0470-7172.2 LD7172	ATE 23378 20,1 + WE / - WK ATE 23378 20,1 + WE / - WK Ceramic
			←	04/04→; für Bremssattel mit Stahlkolben		13.0460-7212.2 607212	ATE 23738 20,1 + WE / - WK
			➡	04/04→; → 41096248 / 48091178		13.0460-7194.2 607194 13.0470-7194.2 LD7194	ATE 23482 16,6 - WE / - WK ATE 23482 16,6 - WE / - WK Ceramic
			➡	41096249 / 48091179→		13.0460-7195.2 607195 13.0470-7195.2 LD7195	ATE 23482 16,6 - WE / - WK ATE 23482 16,6 - WE / - WK Ceramic
2.8 V6 Turbo 2.8 V6 Turbo 3.0 CDTi	169 184 135	08/05→07/08 08/06→07/08 08/05→07/08	←			13.0460-7199.2 607199	ATE 23404 20,6 + WE / - WK
			➡			13.0460-7194.2 607194 13.0460-7195.2 607195 13.0470-7194.2 LD7194 13.0470-7195.2 LD7195	ATE 23482 16,6 - WE / - WK ATE 23482 16,6 - WE / - WK ATE 23482 16,6 - WE / - WK Ceramic ATE 23482 16,6 - WE / - WK Ceramic
2.8 V6 Turbo 2.8 V6 Turbo	188 206	08/05→07/08 08/06→07/08	➡			13.0460-7194.2 607194 13.0460-7195.2 607195 13.0470-7194.2 LD7194 13.0470-7195.2 LD7195	ATE 23482 16,6 - WE / - WK ATE 23482 16,6 - WE / - WK ATE 23482 16,6 - WE / - WK Ceramic ATE 23482 16,6 - WE / - WK Ceramic
3.0 V6 CDTi	130	06/03→08/05	←			13.0460-7199.2 607199	ATE 23404 20,6 + WE / - WK
			➡	→ 41096248 / 48091178		13.0460-7194.2 607194 13.0470-7194.2 LD7194	ATE 23482 16,6 - WE / - WK ATE 23482 16,6 - WE / - WK Ceramic
			➡	41096249 / 48091179→		13.0460-7195.2 607195 13.0470-7195.2 LD7195	ATE 23482 16,6 - WE / - WK ATE 23482 16,6 - WE / - WK Ceramic
3.2 V6	155	08/02→07/08	←	→ 31070293 / 38047797; für Bremssattel mit Kunststoffkolben		13.0460-7172.2 607172 13.0470-7172.2 LD7172	ATE 23378 20,1 + WE / - WK ATE 23378 20,1 + WE / - WK Ceramic
			←	31070294 / 38047798→ 48045597		13.0460-7199.2 607199	ATE 23404 20,6 + WE / - WK
			←	48045598→		13.0460-7199.2 607199	ATE 23404 20,6 + WE / - WK
			←	→ 31070293 / 38047797; für Bremssattel mit Stahlkolben		13.0460-7212.2 607212	ATE 23738 20,1 + WE / - WK
			➡	→ 41096248 / 48091178		13.0460-7194.2 607194 13.0470-7194.2 LD7194	ATE 23482 16,6 - WE / - WK ATE 23482 16,6 - WE / - WK Ceramic

	kw			 	! #		
<b>VAUXHALL - VECTRA Mk II (C) CC (Z02) 08/02→07/08</b>							
<b>Bremsbelagsatz, Scheibenbremse</b>							
3.2 V6	155	08/02→07/08	➔	41096249 / 48091179→		13.0460-7195.2 607195 13.0470-7195.2 LD7195	ATE 23482 16,6 - WE / - WK ATE 23482 16,6 - WE / - WK Ceramic
<b>Warnkontakt, Bremsbelagverschleiß</b>							
1.8	103	01/06→07/08	←	→ 48045597	1	24.8190-0719.2 620719	L= 685,5
1.8 16V	90	08/02→07/08					
1.8 16V Dualfuel	90	08/02→07/08	←	48045598→	1	24.8190-0720.2 620720	L= 287
1.9 CDTi 16V	110	04/04→07/08					
2.0 16V Turbo	129	03/03→07/08					
2.0 DTI 16V	74	08/02→07/08					
2.2 16V	108	08/02→07/08					
2.2 direct	114	10/03→08/05					
2.2 DTI 16V	92	08/02→07/08					
1.9 CDTi	88	08/02→07/08	←	04/04→; → 48045597	1	24.8190-0719.2 620719	L= 685,5
			←	04/04→; 48045598→	1	24.8190-0720.2 620720	L= 287
2.8 V6 Turbo	169	08/05→07/08	←	→ 48045597	1	24.8190-0721.2 620721	L= 700
2.8 V6 Turbo	184	08/06→07/08					
3.0 CDTi	135	08/05→07/08	←	48045598→	1	24.8190-0722.2 620722	L= 302
3.0 V6 CDTi	130	06/03→08/05					
2.8 V6 Turbo	188	08/05→07/08	←		1	24.8190-0722.2 620722	L= 302
2.8 V6 Turbo	206	08/06→07/08					
3.2 V6	155	08/02→07/08	←	→ 31070293 / 38047797	1	24.8190-0719.2 620719	L= 685,5
			←	31070294 / 38047798→ 48045597	1	24.8190-0721.2 620721	L= 700
			←	48045598→	1	24.8190-0722.2 620722	L= 302
<b>Bremsscheibe</b>							
1.8	103	01/06→07/08	←	für Fahrzeuge mit Sportfahrwerk; nicht für Polizeifahrzeuge		24.0125-0141.1 425141 24.0325-0141.1 525141	Ø 285 24,9 22 V + S Ø 285 24,9 22 V + S
			←	für Fahrzeuge mit Sportfahrwerk; für Polizeifahrzeuge		24.0128-0137.1 428137 24.0328-0137.1 528137	Ø 302 28 25 V + S Ø 302 28 25 V + S
			➔			24.0112-0157.1 412157 24.0120-0173.1 420173 24.0312-0157.1 512157 24.0320-0173.1 520173	Ø 278 11,9 10 + S Ø 292 19,9 18 V + S Ø 278 11,9 10 + S Ø 292 19,9 18 V + S
1.8 16V	90	08/02→07/08	←	für Fahrzeuge ohne Sportfahrwerk		24.0125-0141.1 425141 24.0325-0141.1 525141	Ø 285 24,9 22 V + S Ø 285 24,9 22 V + S
1.8 16V Dualfuel	90	08/02→07/08					
2.2 16V	108	08/02→07/08					
2.2 direct	114	10/03→08/05	←	für Fahrzeuge mit Sportfahrwerk		24.0128-0137.1 428137 24.0328-0137.1 528137	Ø 302 28 25 V + S Ø 302 28 25 V + S
2.2 DTI 16V	92	08/02→07/08				24.0112-0157.1 412157 24.0120-0173.1 420173 24.0312-0157.1 512157 24.0320-0173.1 520173	Ø 278 11,9 10 + S Ø 292 19,9 18 V + S Ø 278 11,9 10 + S Ø 292 19,9 18 V + S
1.9 CDTi	88	08/02→07/08	←	04/04→		24.0125-0141.1 425141 24.0325-0141.1 525141	Ø 285 24,9 22 V + S Ø 285 24,9 22 V + S
			➔	04/04→		24.0112-0157.1 412157 24.0120-0173.1 420173 24.0312-0157.1 512157 24.0320-0173.1 520173	Ø 278 11,9 10 + S Ø 292 19,9 18 V + S Ø 278 11,9 10 + S Ø 292 19,9 18 V + S
1.9 CDTi 16V	110	04/04→07/08	←			24.0125-0141.1 425141 24.0325-0141.1 525141	Ø 285 24,9 22 V + S Ø 285 24,9 22 V + S
2.0 DTI 16V	74	08/02→07/08				24.0112-0157.1 412157 24.0120-0173.1 420173 24.0312-0157.1 512157 24.0320-0173.1 520173	Ø 278 11,9 10 + S Ø 292 19,9 18 V + S Ø 278 11,9 10 + S Ø 292 19,9 18 V + S
2.0 16V Turbo	129	03/03→07/08	←			24.0128-0137.1 428137 24.0328-0137.1 528137	Ø 302 28 25 V + S Ø 302 28 25 V + S
			➔			24.0112-0157.1 412157 24.0120-0173.1 420173 24.0312-0157.1 512157 24.0320-0173.1 520173	Ø 278 11,9 10 + S Ø 292 19,9 18 V + S Ø 278 11,9 10 + S Ø 292 19,9 18 V + S
2.8 V6 Turbo	169	08/05→07/08	←	61000001→		24.0128-0164.1 428164	Ø 314 28 25 V + S
3.0 CDTi	135	08/05→07/08	➔			24.0112-0157.1 412157 24.0120-0173.1 420173 24.0312-0157.1 512157	Ø 278 11,9 10 + S Ø 292 19,9 18 V + S Ø 278 11,9 10 + S



























	kw					! #		
<b>VAUXHALL - VECTRA Mk II (C) CC (Z02) 08/02→07/08</b>								
<b>Bremsscheibe</b>								
2.8 V6 Turbo 3.0 CDTi	169 135	08/05→07/08 08/05→07/08	→				24.0320-0173.1 520173	Ø 292 19,9 18 V + S
2.8 V6 Turbo	184	08/06→07/08	←				24.0128-0164.1 428164	Ø 314 28 25 V + S
			→				24.0112-0157.1 412157	Ø 278 11,9 10 + S
							24.0120-0173.1 420173	Ø 292 19,9 18 V + S
							24.0312-0157.1 512157	Ø 278 11,9 10 + S
							24.0320-0173.1 520173	Ø 292 19,9 18 V + S
2.8 V6 Turbo 2.8 V6 Turbo	188 206	08/05→07/08 08/06→07/08	←	61000001→			24.0130-0189.1 430189	Ø 345 29,9 27,5 V
			→				24.0112-0157.1 412157	Ø 278 11,9 10 + S
							24.0120-0173.1 420173	Ø 292 19,9 18 V + S
							24.0312-0157.1 512157	Ø 278 11,9 10 + S
							24.0320-0173.1 520173	Ø 292 19,9 18 V + S
3.0 V6 CDTi 3.2 V6	130 155	06/03→08/05 08/02→07/08	←	→ 31070293			24.0128-0137.1 428137	Ø 302 28 25 V + S
							24.0328-0137.1 528137	Ø 302 28 25 V + S
			←	31070294→			24.0128-0164.1 428164	Ø 314 28 25 V + S
			→				24.0112-0157.1 412157	Ø 278 11,9 10 + S
							24.0120-0173.1 420173	Ø 292 19,9 18 V + S
							24.0312-0157.1 512157	Ø 278 11,9 10 + S
							24.0320-0173.1 520173	Ø 292 19,9 18 V + S
<b>VAUXHALL - VECTRA Mk II (C) Kombi (Z02) 10/03→05/09</b>								
<b>Bremsbelagsatz, Scheibenbremse</b>								
1.8 1.8 16V 1.9 CDTi 2.0 16V Turbo 2.0 DTI 16V 2.2 direct 2.2 DTI 16V	103 90 88 129 74 114 92	01/06→07/08 10/03→08/05 04/04→07/08 10/03→07/08 10/03→07/08 10/03→07/08 10/03→07/08	←	für Bremssattel mit Kunststoffkolben			13.0460-7172.2 607172	ATE 23378 20,1 + WE / - WK
							13.0470-7172.2 LD7172	ATE 23378 20,1 + WE / - WK Ceramic
			←	für Bremssattel mit Stahlkolben			13.0460-7212.2 607212	ATE 23738 20,1 + WE / - WK
			→	→ 41096248 / 48091178			13.0460-7194.2 607194	ATE 23482 16,6 - WE / - WK
							13.0470-7194.2 LD7194	ATE 23482 16,6 - WE / - WK Ceramic
			→	41096249 / 48091179→			13.0460-7195.2 607195	ATE 23482 16,6 - WE / - WK
							13.0470-7195.2 LD7195	ATE 23482 16,6 - WE / - WK Ceramic
1.9 CDTi 16V	110	04/04→05/09	←	→ 10/08; für Bremssattel mit Kunststoffkolben			13.0460-7172.2 607172	ATE 23378 20,1 + WE / - WK
							13.0470-7172.2 LD7172	ATE 23378 20,1 + WE / - WK Ceramic
			←	→ 10/08; für Bremssattel mit Stahlkolben			13.0460-7212.2 607212	ATE 23738 20,1 + WE / - WK
			→	→ 41096248 / 48091178			13.0460-7194.2 607194	ATE 23482 16,6 - WE / - WK
							13.0470-7194.2 LD7194	ATE 23482 16,6 - WE / - WK Ceramic
			→	41096249 / 48091179→; → 10/08			13.0460-7195.2 607195	ATE 23482 16,6 - WE / - WK
							13.0470-7195.2 LD7195	ATE 23482 16,6 - WE / - WK Ceramic
2.8 V6 Turbo 3.0 CDTi 3.0 V6 CDTi 3.2 V6	169 135 130 155	08/05→07/08 08/05→07/08 10/03→08/05 10/03→08/05	←				13.0460-7199.2 607199	ATE 23404 20,6 + WE / - WK
			→	→ 41096248 / 48091178			13.0460-7194.2 607194	ATE 23482 16,6 - WE / - WK
							13.0470-7194.2 LD7194	ATE 23482 16,6 - WE / - WK Ceramic
			→	41096249 / 48091179→			13.0460-7195.2 607195	ATE 23482 16,6 - WE / - WK
							13.0470-7195.2 LD7195	ATE 23482 16,6 - WE / - WK Ceramic
2.8 V6 Turbo 2.8 V6 Turbo	188 206	08/06→07/08 10/06→07/08	→	→ 41096248 / 48091178			13.0460-7194.2 607194	ATE 23482 16,6 - WE / - WK
							13.0470-7194.2 LD7194	ATE 23482 16,6 - WE / - WK Ceramic
			→	41096249 / 48091179→			13.0460-7195.2 607195	ATE 23482 16,6 - WE / - WK
							13.0470-7195.2 LD7195	ATE 23482 16,6 - WE / - WK Ceramic
<b>Warnkontakt, Bremsbelagsverschleiß</b>								
1.8 1.8 16V 1.9 CDTi 2.0 16V Turbo 2.0 DTI 16V 2.2 direct 2.2 DTI 16V	103 90 88 129 74 114 92	01/06→07/08 10/03→08/05 04/04→07/08 10/03→07/08 10/03→07/08 10/03→07/08 10/03→07/08	←	→ 48045597	1	24.8190-0719.2 620719		L= 685,5
			←	48045598→	1	24.8190-0720.2 620720		L= 287
1.9 CDTi 16V	110	04/04→05/09	←	→ 10/08; → 48045597	1	24.8190-0719.2 620719		L= 685,5
↓								

	kw			 	! #		
<b>VAUXHALL - VECTRA Mk II (C) Kombi (Z02) 10/03→05/09</b>							
<b>Warnkontakt, Bremsbelagverschleiß</b>							
1.9 CDTi 16V	110	04/04→05/09	←	→ 10/08; 48045598→	1	24.8190-0720.2 620720	L= 287
2.8 V6 Turbo	169	08/05→07/08	←	→ 48045597	1	24.8190-0721.2 620721	L= 700
3.0 CDTi	135	08/05→07/08	←	48045598→	1	24.8190-0722.2 620722	L= 302
3.0 V6 CDTi	130	10/03→08/05					
3.2 V6	155	10/03→08/05					
2.8 V6 Turbo	188	08/06→07/08	←		1	24.8190-0722.2 620722	L= 302
2.8 V6 Turbo	206	10/06→07/08	←				
<b> Bremsscheibe</b>							
1.8	103	01/06→07/08	←	für Fahrzeuge mit Sportfahrwerk; nicht für Polizeifahrzeuge		24.0125-0141.1 425141 24.0325-0141.1 525141	Ø 285 24,9 22 V + S Ø 285 24,9 22 V + S
			←	für Fahrzeuge mit Sportfahrwerk; für Polizeifahrzeuge		24.0128-0137.1 428137 24.0328-0137.1 528137	Ø 302 28 25 V + S Ø 302 28 25 V + S
			→			24.0112-0157.1 412157 24.0120-0173.1 420173 24.0312-0157.1 512157 24.0320-0173.1 520173	Ø 278 11,9 10 + S Ø 292 19,9 18 V + S Ø 278 11,9 10 + S Ø 292 19,9 18 V + S
			→				
1.8 16V 2.2 direct 2.2 DTi 16V	90 114 92	10/03→08/05 10/03→07/08 10/03→07/08	←	für Fahrzeuge ohne Sportfahrwerk		24.0125-0141.1 425141 24.0325-0141.1 525141	Ø 285 24,9 22 V + S Ø 285 24,9 22 V + S
			←	für Fahrzeuge mit Sportfahrwerk		24.0128-0137.1 428137 24.0328-0137.1 528137	Ø 302 28 25 V + S Ø 302 28 25 V + S
			→			24.0112-0157.1 412157 24.0120-0173.1 420173 24.0312-0157.1 512157 24.0320-0173.1 520173	Ø 278 11,9 10 + S Ø 292 19,9 18 V + S Ø 278 11,9 10 + S Ø 292 19,9 18 V + S
			→				
1.9 CDTi	88	04/04→07/08	←	für Fahrzeuge ohne Sportfahrwerk; nicht für Polizeifahrzeuge		24.0125-0141.1 425141 24.0325-0141.1 525141	Ø 285 24,9 22 V + S Ø 285 24,9 22 V + S
			←	für Fahrzeuge mit Sportfahrwerk; für Polizeifahrzeuge		24.0128-0137.1 428137 24.0328-0137.1 528137	Ø 302 28 25 V + S Ø 302 28 25 V + S
			→			24.0112-0157.1 412157 24.0120-0173.1 420173 24.0312-0157.1 512157 24.0320-0173.1 520173	Ø 278 11,9 10 + S Ø 292 19,9 18 V + S Ø 278 11,9 10 + S Ø 292 19,9 18 V + S
			→				
1.9 CDTi 16V	110	04/04→05/09	←	für Fahrzeuge ohne Sportfahrwerk; → 10/08		24.0125-0141.1 425141 24.0325-0141.1 525141	Ø 285 24,9 22 V + S Ø 285 24,9 22 V + S
			←	für Fahrzeuge mit Sportfahrwerk; → 10/08		24.0128-0137.1 428137 24.0328-0137.1 528137	Ø 302 28 25 V + S Ø 302 28 25 V + S
			→	→ 10/08		24.0112-0157.1 412157 24.0120-0173.1 420173 24.0312-0157.1 512157 24.0320-0173.1 520173	Ø 278 11,9 10 + S Ø 292 19,9 18 V + S Ø 278 11,9 10 + S Ø 292 19,9 18 V + S
			→				
2.0 16V Turbo	129	10/03→07/08	←			24.0128-0137.1 428137 24.0328-0137.1 528137	Ø 302 28 25 V + S Ø 302 28 25 V + S
			→			24.0112-0157.1 412157 24.0120-0173.1 420173 24.0312-0157.1 512157 24.0320-0173.1 520173	Ø 278 11,9 10 + S Ø 292 19,9 18 V + S Ø 278 11,9 10 + S Ø 292 19,9 18 V + S
			→				
			→				
2.0 DTi 16V	74	10/03→07/08	←			24.0125-0141.1 425141 24.0325-0141.1 525141	Ø 285 24,9 22 V + S Ø 285 24,9 22 V + S
			→			24.0112-0157.1 412157 24.0120-0173.1 420173 24.0312-0157.1 512157 24.0320-0173.1 520173	Ø 278 11,9 10 + S Ø 292 19,9 18 V + S Ø 278 11,9 10 + S Ø 292 19,9 18 V + S
			→				
			→				
2.8 V6 Turbo	169	08/05→07/08	←	61000001→		24.0128-0164.1 428164	Ø 314 28 25 V + S
			→			24.0112-0157.1 412157 24.0120-0173.1 420173 24.0312-0157.1 512157 24.0320-0173.1 520173	Ø 278 11,9 10 + S Ø 292 19,9 18 V + S Ø 278 11,9 10 + S Ø 292 19,9 18 V + S
			→				
			→				
2.8 V6 Turbo	188	08/06→07/08	←	61000001→		24.0130-0189.1 430189	Ø 345 29,9 27,5 V
			→			24.0112-0157.1 412157 24.0120-0173.1 420173 24.0312-0157.1 512157 24.0320-0173.1 520173	Ø 278 11,9 10 + S Ø 292 19,9 18 V + S Ø 278 11,9 10 + S Ø 292 19,9 18 V + S
			→				
			→				
↓							

	kw					! #		
<b>VAUXHALL - VECTRA Mk II (C) Kombi (Z02) 10/03→05/09</b>								
 <b>Bremsscheibe</b>								
2.8 V6 Turbo	206	10/06→07/08	←			24.0130-0189.1	430189	Ø 345 29,9 27,5 V
			→			24.0112-0157.1	412157	Ø 278 11,9 10 + S
						24.0120-0173.1	420173	Ø 292 19,9 18 V + S
						24.0312-0157.1	512157	Ø 278 11,9 10 + S
						24.0320-0173.1	520173	Ø 292 19,9 18 V + S
3.0 CDTi	135	08/05→07/08	←			24.0128-0164.1	428164	Ø 314 28 25 V + S
			→			24.0112-0157.1	412157	Ø 278 11,9 10 + S
						24.0120-0173.1	420173	Ø 292 19,9 18 V + S
						24.0312-0157.1	512157	Ø 278 11,9 10 + S
						24.0320-0173.1	520173	Ø 292 19,9 18 V + S
3.0 V6 CDTi 3.2 V6	130 155	10/03→08/05 10/03→08/05	←	→ 31070293		24.0128-0137.1	428137	Ø 302 28 25 V + S
						24.0328-0137.1	528137	Ø 302 28 25 V + S
			←	31070294 →		24.0128-0164.1	428164	Ø 314 28 25 V + S
			→			24.0112-0157.1	412157	Ø 278 11,9 10 + S
						24.0120-0173.1	420173	Ø 292 19,9 18 V + S
						24.0312-0157.1	512157	Ø 278 11,9 10 + S
						24.0320-0173.1	520173	Ø 292 19,9 18 V + S
<b>VAUXHALL - VIVA (C16) 01/15→</b>								
 <b>Bremsbelagsatz, Scheibenbremse</b>								
1.0	55	01/15→	←			13.0460-5673.2	605673	AKE 22326 18,0 + WK + Zub
1.0 LPG	54	06/15→						
 <b>Bremsscheibe</b>								
1.0	55	01/15→	←			24.0120-0249.1	420249	Ø 236 20 18 V
1.0 LPG	54	06/15→						
<b>VAUXHALL - VIVARO Combi (X82) 05/14→</b>								
 <b>Bremsbelagsatz, Scheibenbremse</b>								
1.6 CDTi	66	05/14→	→	07/14→		13.0460-2840.2	602840	TRW 23980 16,5 + WE / - WK
1.6 CDTi	85	05/14→						
1.6 CDTi	88	05/14→						
1.6 CDTi	103	06/14→						
1.6 CDTi	70	08/16→	→			13.0460-2840.2	602840	TRW 23980 16,5 + WE / - WK
1.6 CDTi	92	08/16→						
 <b>Bremsscheibe</b>								
1.6 CDTi	66	05/14→	←	07/14→		24.0128-0287.1	428287	Ø 296 28 23,4 V + S
1.6 CDTi	85	05/14→						
1.6 CDTi	88	05/14→	→	07/14→		24.0112-0217.2	412217	Ø 280 12 10 + LG / + ABS Ring
1.6 CDTi	103	06/14→						
1.6 CDTi	70	08/16→	←			24.0128-0287.1	428287	Ø 296 28 23,4 V + S
1.6 CDTi	92	08/16→	→			24.0112-0217.2	412217	Ø 280 12 10 + LG / + ABS Ring
<b>VAUXHALL - VIVARO Combi (X83) 08/01→07/14</b>								
 <b>Bremsbelagsatz, Scheibenbremse</b>								
1.9 DI	59	08/01→12/06	←			13.0460-2870.2	602870	TRW 23099 18,4 - WK
1.9 DTI	74	08/01→12/06						
2.0 16V	88	08/01→12/06	→			13.0460-2840.2	602840	TRW 23980 16,5 + WE / - WK
2.0 CDTi	66	01/06→07/14	←	08/06→ 06/14		13.0460-2870.2	602870	TRW 23099 18,4 - WK
2.5 CDTi	107	01/06→07/14	→	08/06→ 06/14		13.0460-2840.2	602840	TRW 23980 16,5 + WE / - WK
2.0 CDTi	84	08/06→07/14	←	→ 06/14		13.0460-2870.2	602870	TRW 23099 18,4 - WK
2.0 ECOTEC	86	08/06→07/14						
2.5 CDTi	84	08/06→07/14	→	→ 06/14		13.0460-2840.2	602840	TRW 23980 16,5 + WE / - WK
2.5 DTI	99	07/03→07/14						
<b>Zubehörsatz, Scheibenbremsbelag</b>								
1.9 DI	59	08/01→12/06	→			13.0460-0072.2	610072	TRW
1.9 DTI	74	08/01→12/06						
2.0 16V	88	08/01→12/06						
2.0 CDTi	66	01/06→07/14	→	08/06→ 06/14		13.0460-0072.2	610072	TRW
2.5 CDTi	107	01/06→07/14						
2.0 CDTi	84	08/06→07/14	→	→ 06/14		13.0460-0072.2	610072	TRW
2.0 ECOTEC	86	08/06→07/14						
2.5 CDTi	84	08/06→07/14						
2.5 DTI	99	07/03→07/14						
↓								



















	kw					! #		
<b>VAUXHALL - VIVARO Combi (X83) 08/01→07/14</b>								
 <b>Bremsscheibe</b>								
1.9 DI	59	08/01→12/06	←			24.0128-0132.1	428132	∅ 305 28 24 V + S
1.9 DTI	74	08/01→12/06	→			24.0112-0177.2	412177	∅ 280 12 10 + LG / + ABS Ring
2.0 16V	88	08/01→12/06	→					
2.0 CDTI	66	01/06→07/14	←	08/06→06/14		24.0128-0132.1	428132	∅ 305 28 24 V + S
2.5 CDTI	107	01/06→07/14	→	08/06→06/14		24.0112-0177.2	412177	∅ 280 12 10 + LG / + ABS Ring
2.0 CDTI	84	08/06→07/14	←	→06/14		24.0128-0132.1	428132	∅ 305 28 24 V + S
2.0 ECOTEC	86	08/06→07/14	→	→06/14		24.0112-0177.2	412177	∅ 280 12 10 + LG / + ABS Ring
2.5 CDTI	84	08/06→07/14	→	→06/14				
2.5 DTI	99	07/03→07/14	→					
<b>VAUXHALL - VIVARO Kasten (X82) 05/14→</b>								
 <b>Bremsbelagsatz, Scheibenbremse</b>								
1.6 CDTi	66	05/14→	→	07/14→		13.0460-2840.2	602840	TRW 23980 16,5 + WE / - WK
1.6 CDTi	85	05/14→	→					
1.6 CDTi	88	05/14→	→					
1.6 CDTi	103	05/14→	→					
1.6 CDTi	70	08/16→	→			13.0460-2840.2	602840	TRW 23980 16,5 + WE / - WK
1.6 CDTi	92	08/16→	→					
1.6 CDTi	107	08/16→	→					
 <b>Bremsscheibe</b>								
1.6 CDTi	66	05/14→	←	07/14→		24.0128-0287.1	428287	∅ 296 28 23,4 V + S
1.6 CDTi	85	05/14→	→	07/14→		24.0112-0217.2	412217	∅ 280 12 10 + LG / + ABS Ring
1.6 CDTi	88	05/14→	→					
1.6 CDTi	103	05/14→	→					
1.6 CDTi	70	08/16→	←			24.0128-0287.1	428287	∅ 296 28 23,4 V + S
1.6 CDTi	92	08/16→	→			24.0112-0217.2	412217	∅ 280 12 10 + LG / + ABS Ring
1.6 CDTi	107	08/16→	→					
<b>VAUXHALL - VIVARO Kasten (X83) 08/01→07/14</b>								
 <b>Bremsbelagsatz, Scheibenbremse</b>								
1.9 DI	59	08/01→12/06	←			13.0460-2870.2	602870	TRW 23099 18,4 - WK
1.9 DTI	74	08/01→12/06	→			13.0460-2840.2	602840	TRW 23980 16,5 + WE / - WK
2.0 16V	88	08/01→12/06	→					
2.5 CDTI	84	08/06→08/08	→					
2.0 CDTI	66	01/06→07/14	←	08/06→06/14		13.0460-2870.2	602870	TRW 23099 18,4 - WK
			→	08/06→06/14		13.0460-2840.2	602840	TRW 23980 16,5 + WE / - WK
2.0 CDTI	84	08/06→07/14	←	→06/14		13.0460-2870.2	602870	TRW 23099 18,4 - WK
2.0 ECOTEC	86	08/06→07/14	→	→06/14		13.0460-2840.2	602840	TRW 23980 16,5 + WE / - WK
2.5 CDTI	107	08/06→07/14	→					
2.5 DTI	99	07/03→07/14	→					
<b>Zubehörsatz, Scheibenbremsbelag</b>								
1.9 DI	59	08/01→12/06	→			13.0460-0072.2	610072	TRW
1.9 DTI	74	08/01→12/06	→					
2.0 16V	88	08/01→12/06	→					
2.5 CDTI	84	08/06→08/08	→					
2.0 CDTI	66	01/06→07/14	→	08/06→06/14		13.0460-0072.2	610072	TRW
2.0 CDTI	84	08/06→07/14	→	→06/14		13.0460-0072.2	610072	TRW
2.0 ECOTEC	86	08/06→07/14	→					
2.5 CDTI	107	08/06→07/14	→					
2.5 DTI	99	07/03→07/14	→					
 <b>Bremsscheibe</b>								
1.9 DI	59	08/01→12/06	←			24.0128-0132.1	428132	∅ 305 28 24 V + S
1.9 DTI	74	08/01→12/06	→			24.0112-0177.2	412177	∅ 280 12 10 + LG / + ABS Ring
2.0 16V	88	08/01→12/06	→					
2.5 CDTI	84	08/06→08/08	→					
2.0 CDTI	66	01/06→07/14	←	08/06→06/14		24.0128-0132.1	428132	∅ 305 28 24 V + S
			→	08/06→06/14		24.0112-0177.2	412177	∅ 280 12 10 + LG / + ABS Ring
2.0 CDTI	84	08/06→07/14	←	→06/14		24.0128-0132.1	428132	∅ 305 28 24 V + S
2.0 ECOTEC	86	08/06→07/14	→	→06/14		24.0112-0177.2	412177	∅ 280 12 10 + LG / + ABS Ring
2.5 CDTI	107	08/06→07/14	→					
2.5 DTI	99	07/03→07/14	→					
<b>VAUXHALL - VIVARO Pritsche/Fahrgestell (X82) 05/14→</b>								
 <b>Bremsbelagsatz, Scheibenbremse</b>								
1.6 CDTi	85	05/14→	→	07/14→		13.0460-2840.2	602840	TRW 23980 16,5 + WE / - WK
1.6 CDTi	88	05/14→	→					
1.6 CDTi	103	05/14→	→					
1.6 CDTi	107	08/16→	→			13.0460-2840.2	602840	TRW 23980 16,5 + WE / - WK
1.6 CDTi	92	08/16→	→					
↓								

	kw			 	! #		
<b>VAUXHALL - VIVARO Pritsche/Fahrgestell (X82) 05/14 →</b>							
 <b>Bremsscheibe</b>							
1.6 CDTi	85	05/14 →	←	07/14 →		24.0128-0287.1 428287	Ø 296 28 23,4 V + S
1.6 CDTi	88	05/14 →	→	07/14 →		24.0112-0217.2 412217	Ø 280 12 10 + LG / + ABS Ring
1.6 CDTi	103	05/14 →					
1.6 CDTi	107	08/16 →	←			24.0128-0287.1 428287	Ø 296 28 23,4 V + S
1.6 CDTi	92	08/16 →	→			24.0112-0217.2 412217	Ø 280 12 10 + LG / + ABS Ring
<b>VAUXHALL - VIVARO Pritsche/Fahrgestell (X83) 04/03 → 07/14</b>							
 <b>Bremsbelagsatz, Scheibenbremse</b>							
1.9 DI	59	04/03 → 07/14	←	→ 06/14		13.0460-2870.2 602870	TRW 23099 18,4 - WK
2.0 16V	88	04/03 → 07/14	→	→ 06/14		13.0460-2840.2 602840	TRW 23980 16,5 + WE / - WK
2.0 CDTI	84	08/06 → 07/14					
2.0 ECOTEC	86	08/06 → 07/14					
2.5 CDTI	84	08/06 → 07/14					
2.5 CDTI	107	08/06 → 07/14					
2.0 CDTI	66	01/06 → 07/14	←	08/06 → 06/14		13.0460-2870.2 602870	TRW 23099 18,4 - WK
			→	08/06 → 06/14		13.0460-2840.2 602840	TRW 23980 16,5 + WE / - WK
2.5 CDTI	99	04/03 → 07/06	←	05/03 →		13.0460-2870.2 602870	TRW 23099 18,4 - WK
			→	05/03 →		13.0460-2840.2 602840	TRW 23980 16,5 + WE / - WK
<b>Zubehörsatz, Scheibenbremsbelag</b>							
1.9 DI	59	04/03 → 07/14	→	→ 06/14		13.0460-0072.2 610072	TRW
2.0 16V	88	04/03 → 07/14	→	→ 06/14		13.0460-0072.2 610072	TRW
2.0 CDTI	84	08/06 → 07/14					
2.0 ECOTEC	86	08/06 → 07/14					
2.5 CDTI	84	08/06 → 07/14					
2.5 CDTI	107	08/06 → 07/14					
2.0 CDTI	66	01/06 → 07/14	→	08/06 → 06/14		13.0460-0072.2 610072	TRW
2.5 CDTI	99	04/03 → 07/06	→	05/03 →		13.0460-0072.2 610072	TRW
 <b>Bremsscheibe</b>							
1.9 DI	59	04/03 → 07/14	←	→ 06/14		24.0128-0132.1 428132	Ø 305 28 24 V + S
2.0 16V	88	04/03 → 07/14	→	→ 06/14		24.0112-0177.2 412177	Ø 280 12 10 + LG / + ABS Ring
2.0 CDTI	84	08/06 → 07/14					
2.0 ECOTEC	86	08/06 → 07/14					
2.5 CDTI	84	08/06 → 07/14					
2.5 CDTI	107	08/06 → 07/14					
2.0 CDTI	66	01/06 → 07/14	←	08/06 → 06/14		24.0128-0132.1 428132	Ø 305 28 24 V + S
			→	08/06 → 06/14		24.0112-0177.2 412177	Ø 280 12 10 + LG / + ABS Ring
2.5 CDTI	99	04/03 → 07/06	←	05/03 →		24.0128-0132.1 428132	Ø 305 28 24 V + S
			→	05/03 →		24.0112-0177.2 412177	Ø 280 12 10 + LG / + ABS Ring
<b>VAUXHALL - VX220 Cabriolet (E01) 09/00 → 07/05</b>							
 <b>Bremsscheibe</b>							
2.0 i Turbo	147	03/01 → 07/05	←	04/03 →		24.0125-0119.1 425119	Ø 288 25 22 V + S
			→	04/03 →		24.0325-0119.1 525119	Ø 288 25 22 V + S
2.2 i	108	09/00 → 07/05	←			24.0125-0119.1 425119	Ø 288 25 22 V + S
			→			24.0325-0119.1 525119	Ø 288 25 22 V + S
<b>VAUXHALL - ZAFIRA Mk I (A) (T98) 11/98 → 08/05</b>							
 <b>Bremsbelagsatz, Scheibenbremse</b>							
1.6 16V	74	04/99 → 08/05	←	→ 06/05; - ABS		13.0460-7115.2 607115	ATE 23063 17,5 ohne integrierten Verschleißsensor / + WK
1.8 16V	92	09/00 → 08/05	→	→ 06/05; + ABS		13.0470-7115.2 LD7115	ATE 23063 17,5 - WK / + WK Ceramic
1.8 Dualfuel	92	09/00 → 08/05					
2.0 DI 16V	60	10/99 → 08/05					
			←	→ 06/05; + ABS		13.0460-7116.2 607116	ATE 23057 20,2 - WK / + WK
			→	→ 06/05		13.0470-7116.2 LD7116	ATE 23057 20,2 - WK / + WK Ceramic
			→	→ 06/05		13.0460-2868.2 602868	TRW 23417 15,3 + WK + Zub
			→	→ 06/05		13.0460-3976.2 603976	BOS 23258 16,5 + WK + Zub
			→	→ 06/05		13.0470-2868.2 LD2868	TRW 23417 15,3 + WK + Zub Ceramic
↓							

























	kW			 	! #		
<b>VAUXHALL - ZAFIRA Mk I (A) (T98) 11/98→08/05</b>							
<b> Bremsbelagsatz, Scheibenbremse</b>							
1.6 CNG 1.8 16V	71 85	09/01→06/05 05/99→08/00	←	- ABS		13.0460-7115.2 607115	ATE 23063 17,5 ohne integrierten Verschleiß- sensor / + WK
						13.0470-7115.2 LD7115	ATE 23063 17,5 - WK / + WK Ceramic
			←	+ ABS		13.0460-7116.2 607116	ATE 23057 20,2 - WK / + WK
						13.0470-7116.2 LD7116	ATE 23057 20,2 - WK / + WK Ceramic
			→			13.0460-2868.2 602868	TRW 23417 15,3 + WK + Zub
						13.0460-3976.2 603976	BOS 23258 16,5 + WK + Zub
						13.0470-2868.2 LD2868	TRW 23417 15,3 + WK + Zub Ceramic
1.6 Dualfuel	74	11/98→08/05	←	04/99→ 06/05; - ABS		13.0460-7115.2 607115	ATE 23063 17,5 ohne integrierten Verschleiß- sensor / + WK
						13.0470-7115.2 LD7115	ATE 23063 17,5 - WK / + WK Ceramic
			←	04/99→ 06/05; + ABS		13.0460-7116.2 607116	ATE 23057 20,2 - WK / + WK
						13.0470-7116.2 LD7116	ATE 23057 20,2 - WK / + WK Ceramic
			→	04/99→ 06/05		13.0460-2868.2 602868	TRW 23417 15,3 + WK + Zub
						13.0460-3976.2 603976	BOS 23258 16,5 + WK + Zub
						13.0470-2868.2 LD2868	TRW 23417 15,3 + WK + Zub Ceramic
2.0 2.0 GSI Turbo	147 141	06/02→06/05 09/01→06/05	←			13.0460-7173.2 607173	ATE 21829 20,3 - WK / + WK
			→			13.0460-2868.2 602868	TRW 23417 15,3 + WK + Zub
						13.0460-3976.2 603976	BOS 23258 16,5 + WK + Zub
						13.0470-2868.2 LD2868	TRW 23417 15,3 + WK + Zub Ceramic
2.0 DTI 16V	74	04/99→08/05	←	06/00→ 06/05; - ABS		13.0460-7115.2 607115	ATE 23063 17,5 ohne integrierten Verschleiß- sensor / + WK
						13.0470-7115.2 LD7115	ATE 23063 17,5 - WK / + WK Ceramic
			←	06/00→ 06/05; + ABS		13.0460-7116.2 607116	ATE 23057 20,2 - WK / + WK
						13.0470-7116.2 LD7116	ATE 23057 20,2 - WK / + WK Ceramic
			→	06/00→ 06/05		13.0460-2868.2 602868	TRW 23417 15,3 + WK + Zub
						13.0460-3976.2 603976	BOS 23258 16,5 + WK + Zub
						13.0470-2868.2 LD2868	TRW 23417 15,3 + WK + Zub Ceramic
2.2 16V	108	11/98→08/04	←	09/00→		13.0460-7116.2 607116	ATE 23057 20,2 - WK / + WK
						13.0470-7116.2 LD7116	ATE 23057 20,2 - WK / + WK Ceramic
			→	09/00→		13.0460-2868.2 602868	TRW 23417 15,3 + WK + Zub
						13.0460-3976.2 603976	BOS 23258 16,5 + WK + Zub
						13.0470-2868.2 LD2868	TRW 23417 15,3 + WK + Zub Ceramic
2.2 D	92	06/01→06/05	←	01/02→		13.0460-7116.2 607116	ATE 23057 20,2 - WK / + WK
						13.0470-7116.2 LD7116	ATE 23057 20,2 - WK / + WK Ceramic
			→	01/02→		13.0460-2868.2 602868	TRW 23417 15,3 + WK + Zub
						13.0460-3976.2 603976	BOS 23258 16,5 + WK + Zub
						13.0470-2868.2 LD2868	TRW 23417 15,3 + WK + Zub Ceramic
<b>Warnkontakt, Bremsbelagverschleiß</b>							
1.6 16V	74	04/99→08/05	←	→ 06/05; 42187759→	2	24.8190-0018.2 620018	L= 755
1.8 16V	92	09/00→08/05	←	→ 06/05; → 42187758	2	24.8190-0718.2 620718	L= 720
1.8 Dualfuel	92	09/00→08/05	←				
2.0 DI 16V	60	10/99→08/05	←				
1.6 CNG	71	09/01→06/05	←	42187759→	2	24.8190-0018.2 620018	L= 755
1.8 16V	85	05/99→08/00	←				
2.0	147	06/02→06/05	←	→ 42187758	2	24.8190-0718.2 620718	L= 720
2.0 GSI Turbo	141	09/01→06/05	←				
1.6 Dualfuel	74	11/98→08/05	←	04/99→ 06/05; 42187759→	2	24.8190-0018.2 620018	L= 755
			←	04/99→ 06/05; → 42187758	2	24.8190-0718.2 620718	L= 720
2.0 DTI 16V	74	04/99→08/05	←	06/00→ 06/05; 42187759→	2	24.8190-0018.2 620018	L= 755
↓							













	kw			 	! #		
<b>VAUXHALL - ZAFIRA Mk I (A) (T98) 11/98→08/05</b>							
<b>Warnkontakt, Bremsbelagverschleiß</b>							
2.0 DTI 16V	74	04/99→08/05	←	06/00→ 06/05; → 42187758	2	24.8190-0718.2 620718	L= 720
2.2 16V	108	11/98→08/04	←	09/00→	2	24.8190-0718.2 620718	L= 720
2.2 D	92	06/01→06/05	←	01/02→	2	24.8190-0718.2 620718	L= 720
<b> Bremsscheibe</b>							
1.6 16V	74	04/99→08/05	←	→ 06/05		24.0125-0131.1 425131	Ø 280 24,8 22 V + S
1.8 16V	92	09/00→08/05				24.0325-0131.1 525131	Ø 280 24,8 22 V + S
1.8 Dualfuel	92	09/00→08/05					
2.0 DI 16V	60	10/99→08/05	→	→ 06/05		24.0110-0250.1 410250	Ø 264 9,8 8 + S
						24.0310-0250.1 510250	Ø 264 9,8 8 + S
1.6 CNG	71	09/01→06/05	←			24.0125-0131.1 425131	Ø 280 24,8 22 V + S
1.8 16V	85	05/99→08/00				24.0325-0131.1 525131	Ø 280 24,8 22 V + S
			→			24.0110-0250.1 410250	Ø 264 9,8 8 + S
						24.0310-0250.1 510250	Ø 264 9,8 8 + S
1.6 Dualfuel	74	11/98→08/05	←	04/99→ 06/05		24.0125-0131.1 425131	Ø 280 24,8 22 V + S
						24.0325-0131.1 525131	Ø 280 24,8 22 V + S
			→	04/99→ 06/05		24.0110-0250.1 410250	Ø 264 9,8 8 + S
						24.0310-0250.1 510250	Ø 264 9,8 8 + S
2.0	147	06/02→06/05	←			24.0125-0142.1 425142	Ø 308 25 22 V + S
2.0 GSI Turbo	141	09/01→06/05				24.0325-0142.1 525142	Ø 308 25 23 V + S
			→			24.0110-0250.1 410250	Ø 264 9,8 8 + S
						24.0310-0250.1 510250	Ø 264 9,8 8 + S
2.0 DTI 16V	74	04/99→08/05	←	06/00→ 06/05		24.0125-0131.1 425131	Ø 280 24,8 22 V + S
						24.0325-0131.1 525131	Ø 280 24,8 22 V + S
			→	06/00→ 06/05		24.0110-0250.1 410250	Ø 264 9,8 8 + S
						24.0310-0250.1 510250	Ø 264 9,8 8 + S
2.2 16V	108	11/98→08/04	←	09/00→		24.0125-0131.1 425131	Ø 280 24,8 22 V + S
						24.0325-0131.1 525131	Ø 280 24,8 22 V + S
			→	09/00→		24.0110-0250.1 410250	Ø 264 9,8 8 + S
						24.0310-0250.1 510250	Ø 264 9,8 8 + S
2.2 D	92	06/01→06/05	←	01/02→		24.0125-0131.1 425131	Ø 280 24,8 22 V + S
						24.0325-0131.1 525131	Ø 280 24,8 22 V + S
			→	01/02→		24.0110-0250.1 410250	Ø 264 9,8 8 + S
						24.0310-0250.1 510250	Ø 264 9,8 8 + S
<b>VAUXHALL - ZAFIRA Mk II (B) (A05) 04/05→11/14</b>							
<b> Bremsbelagsatz, Scheibenbremse</b>							
1.6	77	07/05→11/14	←			13.0460-7179.2 607179	ATE 23832 20,2 - WK / + WK
1.6	85	12/07→11/14				13.0470-7179.2 LD7179	ATE 23832 20,2 - WK / + WK Ceramic
1.6 CNG Turbo	110	02/09→11/14					
1.7 CDTI	81	04/09→11/14					
1.7 CDTI	92	01/08→11/14	→			13.0460-2868.2 602868	TRW 23417 15,3 + WK + Zub
1.9 CDTI	74	07/05→11/14				13.0470-2868.2 LD2868	TRW 23417 15,3 + WK + Zub Ceramic
1.9 CDTI	88	07/05→11/14					
1.9 CDTI	110	07/05→11/14					
2.0	147	07/05→11/14					
2.2	110	07/05→11/14					
1.6 CNG	69	07/05→11/14	←	01/06→		13.0460-7179.2 607179	ATE 23832 20,2 - WK / + WK
						13.0470-7179.2 LD7179	ATE 23832 20,2 - WK / + WK Ceramic
			→	01/06→		13.0460-2868.2 602868	TRW 23417 15,3 + WK + Zub
						13.0470-2868.2 LD2868	TRW 23417 15,3 + WK + Zub Ceramic
1.8	88	04/13→11/14	←	06/13→		13.0460-7179.2 607179	ATE 23832 20,2 - WK / + WK
						13.0470-7179.2 LD7179	ATE 23832 20,2 - WK / + WK Ceramic
			→	06/13→		13.0460-2868.2 602868	TRW 23417 15,3 + WK + Zub
						13.0470-2868.2 LD2868	TRW 23417 15,3 + WK + Zub Ceramic
1.8	103	04/05→11/14	←	07/05→		13.0460-7179.2 607179	ATE 23832 20,2 - WK / + WK
						13.0470-7179.2 LD7179	ATE 23832 20,2 - WK / + WK Ceramic
			→	07/05→		13.0460-2868.2 602868	TRW 23417 15,3 + WK + Zub
						13.0470-2868.2 LD2868	TRW 23417 15,3 + WK + Zub Ceramic
2.0	176	01/06→11/14	←	für Bremssattel mit Kunststoffkolben		13.0460-7172.2 607172	ATE 23378 20,1 + WE / - WK
↓							













	kw			 	! #		
<b>VAUXHALL - ZAFIRA Mk II (B) (A05) 04/05→11/14</b>							
<b> Bremsbelagsatz, Scheibenbremse</b>							
2.0	176	01/06→11/14	←	für Bremssattel mit Kunststoffkolben		13.0470-7172.2 LD7172	ATE 23378 20,1 + WE / - WK Ceramic
			←	für Bremssattel mit Stahlkolben		13.0460-7212.2 607212	ATE 23738 20,1 + WE / - WK
			→			13.0460-2868.2 602868	TRW 23417 15,3 + WK + Zub
						13.0470-2868.2 LD2868	TRW 23417 15,3 + WK + Zub Ceramic
<b>Warnkontakt, Bremsbelagverschleiß</b>							
1.6	77	07/05→11/14	←		1	24.8190-0720.2 620720	L= 287
1.6	85	12/07→11/14					
1.6 CNG Turbo	110	02/09→11/14					
1.7 CDTI	81	04/09→11/14					
1.7 CDTI	92	01/08→11/14					
1.9 CDTI	74	07/05→11/14					
1.9 CDTI	88	07/05→11/14					
1.9 CDTI	110	07/05→11/14					
2.0	147	07/05→11/14					
2.0	176	01/06→11/14					
2.2	110	07/05→11/14					
1.6 CNG	69	07/05→11/14	←	01/06→	1	24.8190-0720.2 620720	L= 287
1.8	88	04/13→11/14	←	06/13→	1	24.8190-0720.2 620720	L= 287
1.8	103	04/05→11/14	←	07/05→	1	24.8190-0720.2 620720	L= 287
<b> Bremsscheibe</b>							
1.6	77	07/05→11/14	←			24.0125-0131.1 425131	Ø 280 24,8 22 V + S
1.6	85	12/07→11/14				24.0325-0131.1 525131	Ø 280 24,8 22 V + S
			→			24.0110-0250.1 410250	Ø 264 9,8 8 + S
						24.0310-0250.1 510250	Ø 264 9,8 8 + S
1.6 CNG	69	07/05→11/14	←	01/06→		24.0125-0142.1 425142	Ø 308 25 22 V + S
						24.0325-0142.1 525142	Ø 308 25 23 V + S
1.6 CNG Turbo	110	02/09→11/14	←			24.0125-0142.1 425142	Ø 308 25 22 V + S
						24.0325-0142.1 525142	Ø 308 25 23 V + S
1.7 CDTI	81	04/09→11/14	←			24.0125-0131.1 425131	Ø 280 24,8 22 V + S
1.7 CDTI	92	01/08→11/14				24.0125-0142.1 425142	Ø 308 25 22 V + S
						24.0325-0131.1 525131	Ø 280 24,8 22 V + S
						24.0325-0142.1 525142	Ø 308 25 23 V + S
			→	nicht für Fahrzeuge mit verstärkter Bremse		24.0110-0250.1 410250	Ø 264 9,8 8 + S
						24.0310-0250.1 510250	Ø 264 9,8 8 + S
			→	für Fahrzeuge mit verstärkter Bremse		24.0110-0339.1 410339	Ø 278 10 8 + S
1.8	88	04/13→11/14	←	06/13→		24.0125-0131.1 425131	Ø 280 24,8 22 V + S
						24.0125-0142.1 425142	Ø 308 25 22 V + S
						24.0325-0131.1 525131	Ø 280 24,8 22 V + S
						24.0325-0142.1 525142	Ø 308 25 23 V + S
			→	06/13→; nicht für Fahrzeuge mit verstärkter Bremse		24.0110-0250.1 410250	Ø 264 9,8 8 + S
						24.0310-0250.1 510250	Ø 264 9,8 8 + S
			→	06/13→; für Fahrzeuge mit verstärkter Bremse		24.0110-0339.1 410339	Ø 278 10 8 + S
1.8	103	04/05→11/14	←	07/05→		24.0125-0131.1 425131	Ø 280 24,8 22 V + S
						24.0125-0142.1 425142	Ø 308 25 22 V + S
						24.0325-0131.1 525131	Ø 280 24,8 22 V + S
						24.0325-0142.1 525142	Ø 308 25 23 V + S
			→	07/05→; nicht für Fahrzeuge mit verstärkter Bremse		24.0110-0250.1 410250	Ø 264 9,8 8 + S
						24.0310-0250.1 510250	Ø 264 9,8 8 + S
			→	07/05→; für Fahrzeuge mit verstärkter Bremse		24.0110-0339.1 410339	Ø 278 10 8 + S
1.9 CDTI	74	07/05→11/14	←			24.0125-0142.1 425142	Ø 308 25 22 V + S
1.9 CDTI	88	07/05→11/14				24.0325-0142.1 525142	Ø 308 25 23 V + S
1.9 CDTI	110	07/05→11/14					
2.2	110	07/05→11/14	→	nicht für Fahrzeuge mit verstärkter Bremse		24.0110-0250.1 410250	Ø 264 9,8 8 + S
						24.0310-0250.1 510250	Ø 264 9,8 8 + S
			→	für Fahrzeuge mit verstärkter Bremse		24.0110-0339.1 410339	Ø 278 10 8 + S
2.0	147	07/05→11/14	←			24.0125-0142.1 425142	Ø 308 25 22 V + S
						24.0325-0142.1 525142	Ø 308 25 23 V + S
			→	→ 52999999		24.0110-0250.1 410250	Ø 264 9,8 8 + S
						24.0310-0250.1 510250	Ø 264 9,8 8 + S
↓							

	kw					! #		
<b>VAUXHALL - ZAFIRA Mk II (B) (A05) 04/05→11/14</b>								
 <b>Bremsscheibe</b>								
2.0	147	07/05→11/14	➔	62000001→			24.0110-0339.1 410339	Ø 278 10 8 + S
2.0	176	01/06→11/14	➔				24.0128-0201.1 428201	Ø 321 28 25 V
			➔				24.0110-0339.1 410339	Ø 278 10 8 + S
<b>VAUXHALL - ZAFIRA Mk III (P12) 10/11→</b>								
 <b>Bremsbelagsatz, Scheibenbremse</b>								
1.4	88	10/11→	➔	11/11→; für Bremsscheibendurchmesser [mm]: 321			13.0460-5612.2 605612	MAN 24412 19,0 + WK + Zub
1.4	103	10/11→	➔				13.0470-5612.2 LD5612	MAN 24412 19,0 + WK + Zub
1.4 LPG	103	10/11→	➔					Ceramic
1.6 CNG	110	10/11→	➔					
1.8	85	10/11→	➔	11/11→; für Bremsscheibendurchmesser [mm]: 300			13.0460-7263.2 607263	24034 19,1 + WK + Zub
1.8	103	10/11→	➔				13.0470-7263.2 LD7263	24034 19,1 + WK + Zub Ceramic
2.0 CDTi	81	10/11→	➔	F0000001→; für Bremsscheibendurchmesser [mm]: 292			13.0460-7264.2 607264	ATE 25096 17,0 + WK + Zub
2.0 CDTi	96	10/11→	➔				13.0470-7264.2 LD7264	ATE 25096 17,0 + WK + Zub Ceramic
2.0 CDTi	121	10/11→	➔	11/11→; für Bremsscheibendurchmesser [mm]: 292; → E9999999			13.0460-7264.2 607264	ATE 25096 17,0 + WK + Zub
			➔				13.0470-7264.2 LD7264	ATE 25096 17,0 + WK + Zub Ceramic
			➔	F0000001→; für Bremsscheibendurchmesser [mm]: 315			13.0460-7309.2 607309	ATE 25096 16,7 + WK + Zub
			➔				13.0470-7309.2 LD7309	ATE 25096 16,7 + WK + Zub Ceramic
1.6 CDTi	99	10/16→	➔	für Bremsscheibendurchmesser [mm]: 321			13.0460-5612.2 605612	MAN 24412 19,0 + WK + Zub
1.6 CDTi	100	03/13→	➔				13.0470-5612.2 LD5612	MAN 24412 19,0 + WK + Zub Ceramic
2.0 BiTurbo CDTi	143	01/13→	➔	für Bremsscheibendurchmesser [mm]: 300			13.0460-7263.2 607263	24034 19,1 + WK + Zub
			➔				13.0470-7263.2 LD7263	24034 19,1 + WK + Zub Ceramic
			➔	für Bremsscheibendurchmesser [mm]: 292; → E9999999			13.0460-7264.2 607264	ATE 25096 17,0 + WK + Zub
			➔				13.0470-7264.2 LD7264	ATE 25096 17,0 + WK + Zub Ceramic
			➔	F0000001→; für Bremsscheibendurchmesser [mm]: 292			13.0460-7264.2 607264	ATE 25096 17,0 + WK + Zub
			➔				13.0470-7264.2 LD7264	ATE 25096 17,0 + WK + Zub Ceramic
			➔	F0000001→; für Bremsscheibendurchmesser [mm]: 315			13.0460-7309.2 607309	ATE 25096 16,7 + WK + Zub
			➔				13.0470-7309.2 LD7309	ATE 25096 16,7 + WK + Zub Ceramic
2.0 CDTi	125	01/15→	➔	für Bremsscheibendurchmesser [mm]: 321			13.0460-5612.2 605612	MAN 24412 19,0 + WK + Zub
			➔				13.0470-5612.2 LD5612	MAN 24412 19,0 + WK + Zub Ceramic
			➔	für Bremsscheibendurchmesser [mm]: 300			13.0460-7263.2 607263	24034 19,1 + WK + Zub
			➔				13.0470-7263.2 LD7263	24034 19,1 + WK + Zub Ceramic
			➔	für Bremsscheibendurchmesser [mm]: 292			13.0460-7264.2 607264	ATE 25096 17,0 + WK + Zub
			➔				13.0470-7264.2 LD7264	ATE 25096 17,0 + WK + Zub Ceramic
			➔	für Bremsscheibendurchmesser [mm]: 315			13.0460-7309.2 607309	ATE 25096 16,7 + WK + Zub
			➔				13.0470-7309.2 LD7309	ATE 25096 16,7 + WK + Zub Ceramic
 <b>Bremsscheibe</b>								
1.4	88	10/11→	➔	11/11→			24.0126-0166.1 426166	Ø 300 26 23 V + S
1.4	103	10/11→	➔				24.0130-0224.1 430224	Ø 321 30 27 V + S
1.4 LPG	103	10/11→	➔				24.0326-0166.1 526166	Ø 300 26 23 V + S
1.6 CNG	110	10/11→	➔					
1.8	85	10/11→	➔	11/11→			24.0112-0189.1 412189	Ø 292 12 10 + S
1.8	103	10/11→	➔				24.0123-0116.1 423116	Ø 315 23 20 V + S
2.0 CDTi	81	10/11→	➔				24.0312-0189.1 512189	Ø 292 12 10 + S
2.0 CDTi	96	10/11→	➔					
2.0 CDTi	121	10/11→	➔					
1.6 CDTi	99	10/16→	➔				24.0126-0166.1 426166	Ø 300 26 23 V + S
1.6 CDTi	100	03/13→	➔				24.0130-0224.1 430224	Ø 321 30 27 V + S
2.0 BiTurbo CDTi	143	01/13→	➔				24.0326-0166.1 526166	Ø 300 26 23 V + S
2.0 CDTi	125	01/15→	➔				24.0112-0189.1 412189	Ø 292 12 10 + S
			➔				24.0123-0116.1 423116	Ø 315 23 20 V + S
			➔				24.0312-0189.1 512189	Ø 292 12 10 + S
<b>VOLVO - 440 K (445) 08/88→12/96</b>								
 <b>Bremsbelagsatz, Scheibenbremse</b>								
1.6	61	09/88→12/96	➔	EKC 006387→			13.0460-2812.2 602812	TRW 21217 18,0 - WK
↓								



























	kw			 	! #		
<b>VOLVO - 440 K (445) 08/88→12/96</b>							
 <b>Bremsbelagsatz, Scheibenbremse</b>							
1.7	75	08/89→12/96	←	→ EKC 006386		13.0460-2846.2 602846	TRW 21010 15,8 - WK
1.7	78	09/88→12/96	→			13.0460-3306.2 603306	ATE 21089 15,0 - WE / - WK
1.7	64	09/88→12/96	←	EKC 006387→		13.0460-2812.2 602812	TRW 21217 18,0 - WK
			←	→ EKC 006386		13.0460-2846.2 602846	TRW 21010 15,8 - WK
1.7 Turbo	88	08/88→07/96	←			13.0460-7146.2 607146	ATE 20147 17,0 - WE / - WK
1.7 Turbo	90	01/91→12/96	→			13.0460-3306.2 603306	ATE 21089 15,0 - WE / - WK
1.8	66	08/91→07/96	←			13.0460-2812.2 602812	TRW 21217 18,0 - WK
1.8	66	09/95→12/96	→			13.0460-3306.2 603306	ATE 21089 15,0 - WE / - WK
1.9 Turbo-Diesel	66	07/94→12/96	→			13.0460-3306.2 603306	ATE 21089 15,0 - WE / - WK
2.0	80	08/93→07/96	←	EKC 006387→		13.0460-2812.2 602812	TRW 21217 18,0 - WK
			←			13.0460-7146.2 607146	ATE 20147 17,0 - WE / - WK
 <b>Bremsscheibe</b>							
1.6	61	09/88→12/96	←			24.0112-0135.1 412135	Ø 260 12 10,8
1.7	75	08/89→12/96	→			24.0109-0125.1 409125	Ø 228 9 8
1.7	78	09/88→12/96	→			24.0109-0125.1 409125	Ø 228 9 8
1.8	66	08/91→07/96	←			24.0112-0135.1 412135	Ø 260 12 10,8
1.8	66	09/95→12/96	→			24.0109-0125.1 409125	Ø 228 9 8
1.9 Turbo-Diesel	66	07/94→12/96	→			24.0109-0125.1 409125	Ø 228 9 8
1.7	64	09/88→12/96	←			24.0112-0135.1 412135	Ø 260 12 10,8
1.7 Turbo	88	08/88→07/96	→			24.0109-0125.1 409125	Ø 228 9 8
1.7 Turbo	90	01/91→12/96	→			24.0109-0125.1 409125	Ø 228 9 8
2.0	80	08/93→07/96	←	EKC 006387→		24.0112-0135.1 412135	Ø 260 12 10,8
<b>VOLVO - 460 L (464) 09/88→12/96</b>							
 <b>Bremsbelagsatz, Scheibenbremse</b>							
1.6	61	07/92→07/96	←			13.0460-2812.2 602812	TRW 21217 18,0 - WK
1.7	64	09/88→07/96	←	EKC 006387→		13.0460-2812.2 602812	TRW 21217 18,0 - WK
1.7	66	09/90→07/96	←	→ EKC 006386		13.0460-2846.2 602846	TRW 21010 15,8 - WK
1.7 Turbo	88	08/89→07/96	←			13.0460-7146.2 607146	ATE 20147 17,0 - WE / - WK
1.7 Turbo	90	01/91→07/96	→			13.0460-3306.2 603306	ATE 21089 15,0 - WE / - WK
1.8	66	08/91→07/96	←			13.0460-2812.2 602812	TRW 21217 18,0 - WK
1.9 Turbo-Diesel	66	07/94→07/96	→			13.0460-3306.2 603306	ATE 21089 15,0 - WE / - WK
2.0	80	08/93→07/96	←	EKC 006387→		13.0460-2812.2 602812	TRW 21217 18,0 - WK
			←			13.0460-7146.2 607146	ATE 20147 17,0 - WE / - WK
 <b>Bremsscheibe</b>							
1.6	61	07/92→07/96	←	Herstellereinschränkung TRW		24.0112-0135.1 412135	Ø 260 12 10,8
1.7	64	09/88→07/96	←			24.0109-0125.1 409125	Ø 228 9 8
1.7	66	09/90→07/96	←			24.0109-0125.1 409125	Ø 228 9 8
1.7 Turbo	88	08/89→07/96	→			24.0112-0135.1 412135	Ø 260 12 10,8
1.7 Turbo	90	01/91→07/96	→			24.0109-0125.1 409125	Ø 228 9 8
1.8	66	08/91→07/96	←	Herstellereinschränkung TRW		24.0112-0135.1 412135	Ø 260 12 10,8
1.9 Turbo-Diesel	66	07/94→07/96	→			24.0109-0125.1 409125	Ø 228 9 8
2.0	80	08/93→07/96	←	EKC 006387→; Herstellereinschränkung TRW		24.0112-0135.1 412135	Ø 260 12 10,8
<b>VOLVO - 480 E (482) 04/86→07/96</b>							
 <b>Bremsbelagsatz, Scheibenbremse</b>							
1.7	75	08/89→07/96	←			13.0460-2812.2 602812	TRW 21217 18,0 - WK
			→			13.0460-3306.2 603306	ATE 21089 15,0 - WE / - WK
1.7 Turbo	88	08/87→07/96	←			13.0460-7146.2 607146	ATE 20147 17,0 - WE / - WK
1.7 Turbo	90	01/91→07/96	→			13.0460-3306.2 603306	ATE 21089 15,0 - WE / - WK
 <b>Bremsscheibe</b>							
1.7	75	08/89→07/96	←			24.0112-0135.1 412135	Ø 260 12 10,8
1.7 Turbo	88	08/87→07/96	→			24.0109-0125.1 409125	Ø 228 9 8
1.7 Turbo	90	01/91→07/96	→			24.0109-0125.1 409125	Ø 228 9 8



	kW			 	! #		
<b>VOLVO - 850 (854) 06/91→10/97</b>							
<b> Bremsbelagsatz, Scheibenbremse</b>							
2.0	93	08/94→12/96	←			<b>13.0460-7053.2 607053</b>	ATE 21273 19,5 + WE / - WK
2.0	105	06/91→12/96				<b>13.0470-7053.2 LD7053</b>	ATE 21273 19,5 + WE / - WK Ceramic
2.0 Turbo	132	09/93→10/96					
2.0 Turbo	155	08/93→12/96					
2.4	106	08/94→12/96	→			<b>13.0460-3403.2 603403</b>	ATE 20755 14,4 - WE / - WK
2.4	125	08/91→12/96					
2.5 TDI	103	08/95→12/96					
2.3 T5	166	08/93→07/96	←			<b>13.0460-7053.2 607053</b>	ATE 21273 19,5 + WE / - WK
2.3 T5 R	176	04/96→10/96					
2.3 T5-R	184	08/95→12/96	→			<b>13.0460-3403.2 603403</b>	ATE 20755 14,4 - WE / - WK
2.3 Turbo R	177	06/95→10/96	←	08/95→		<b>13.0460-7053.2 607053</b>	ATE 21273 19,5 + WE / - WK
			→	08/95→		<b>13.0460-3403.2 603403</b>	ATE 20755 14,4 - WE / - WK
2.3 Turbo R	179	09/94→10/97	←	08/95→ 12/96		<b>13.0460-7053.2 607053</b>	ATE 21273 19,5 + WE / - WK
			→	08/95→ 12/96		<b>13.0460-3403.2 603403</b>	ATE 20755 14,4 - WE / - WK
<b>Zubehörsatz, Scheibenbremsbelag</b>							
2.0	93	08/94→12/96	→			<b>13.0460-0088.2 610088</b>	ATE
2.0	105	06/91→12/96					
2.0 Turbo	132	09/93→10/96					
2.0 Turbo	155	08/93→12/96					
2.3 T5	166	08/93→07/96					
2.3 T5 R	176	04/96→10/96					
2.3 T5-R	184	08/95→12/96					
2.4	106	08/94→12/96					
2.4	125	08/91→12/96					
2.5 TDI	103	08/95→12/96					
2.3 Turbo R	177	06/95→10/96	→	08/95→		<b>13.0460-0088.2 610088</b>	ATE
2.3 Turbo R	179	09/94→10/97	→	08/95→ 12/96		<b>13.0460-0088.2 610088</b>	ATE
<b> Bremsscheibe</b>							
2.0	93	08/94→12/96	←			<b>24.0126-0102.1 426102</b>	Ø 280,3 26 23 V
2.0	105	06/91→12/96					
2.0 Turbo	132	09/93→10/96	→			<b>24.0110-0214.1 410214</b>	Ø 295 9,6 8,4
2.0 Turbo	155	08/93→12/96					
2.3 T5	166	08/93→07/96					
2.3 T5 R	176	04/96→10/96					
2.3 T5-R	184	08/95→12/96					
2.4	106	08/94→12/96					
2.5 TDI	103	08/95→12/96					
2.3 Turbo R	177	06/95→10/96	←	08/95→		<b>24.0126-0102.1 426102</b>	Ø 280,3 26 23 V
			→	08/95→		<b>24.0110-0214.1 410214</b>	Ø 295 9,6 8,4
2.3 Turbo R	179	09/94→10/97	←	08/95→ 12/96		<b>24.0126-0102.1 426102</b>	Ø 280,3 26 23 V
			→	08/95→ 12/96		<b>24.0110-0214.1 410214</b>	Ø 295 9,6 8,4
2.4	125	08/91→12/96	←	→ 08/93		<b>24.0126-0101.1 426101</b>	Ø 280,3 26 23 V
			←	09/93→		<b>24.0126-0102.1 426102</b>	Ø 280,3 26 23 V
			→	09/93→		<b>24.0110-0214.1 410214</b>	Ø 295 9,6 8,4
			→	→ 08/93		<b>24.0110-0216.1 410216</b>	Ø 295 9,6 8,4
<b>VOLVO - 850 Kombi (855) 04/92→10/97</b>							
<b> Bremsbelagsatz, Scheibenbremse</b>							
2.0	93	08/94→12/96	←			<b>13.0460-7053.2 607053</b>	ATE 21273 19,5 + WE / - WK
2.0	105	02/93→12/96				<b>13.0470-7053.2 LD7053</b>	ATE 21273 19,5 + WE / - WK Ceramic
2.0 Turbo	155	02/93→12/96					
2.4	106	08/94→12/96					
2.4	125	09/92→12/96	→			<b>13.0460-3403.2 603403</b>	ATE 20755 14,4 - WE / - WK
2.5 TDI	103	08/95→12/96					
2.0 Turbo	132	09/93→10/97	←	→ 12/96		<b>13.0460-7053.2 607053</b>	ATE 21273 19,5 + WE / - WK
			→	→ 12/96		<b>13.0470-7053.2 LD7053</b>	ATE 21273 19,5 + WE / - WK Ceramic
			→	→ 12/96		<b>13.0460-3403.2 603403</b>	ATE 20755 14,4 - WE / - WK
2.3 T5	166	02/93→12/96	←			<b>13.0460-7053.2 607053</b>	ATE 21273 19,5 + WE / - WK
2.3 T5 R	176	04/96→10/96					
2.3 T5-R	184	08/95→12/96	→			<b>13.0460-3403.2 603403</b>	ATE 20755 14,4 - WE / - WK
2.3 Turbo R	177	06/95→10/97	←	08/95→ 12/96		<b>13.0460-7053.2 607053</b>	ATE 21273 19,5 + WE / - WK
			→	08/95→ 12/96		<b>13.0460-3403.2 603403</b>	ATE 20755 14,4 - WE / - WK
2.4 AWD	142	04/96→12/96	←			<b>13.0460-7053.2 607053</b>	ATE 21273 19,5 + WE / - WK
						<b>13.0470-7053.2 LD7053</b>	ATE 21273 19,5 + WE / - WK Ceramic
			→			<b>13.0460-2935.2 602935</b>	TRW 21385 13,8 - WK



	kw			 	! #		
<b>VOLVO - 850 Kombi (855) 04/92→10/97</b>							
<b>Zubehörsatz, Scheibenbremsbelag</b>							
2.0	93	08/94→12/96	➔			13.0460-0088.2 610088	ATE
2.0	105	02/93→12/96					
2.0 Turbo	155	02/93→12/96					
2.3 T5	166	02/93→12/96					
2.3 T5 R	176	04/96→10/96					
2.3 T5-R	184	08/95→12/96					
2.4	106	08/94→12/96					
2.4	125	09/92→12/96					
2.5 TDI	103	08/95→12/96					
2.0 Turbo	132	09/93→10/97	➔	→ 12/96		13.0460-0088.2 610088	ATE
2.3 Turbo R	177	06/95→10/97	➔	08/95→ 12/96		13.0460-0088.2 610088	ATE
<b> Bremsscheibe</b>							
2.0	93	08/94→12/96	➔			24.0126-0102.1 426102	Ø 280,3 26 23 V
2.0	105	02/93→12/96					
2.0 Turbo	155	02/93→12/96	➔			24.0110-0214.1 410214	Ø 295 9,6 8,4
2.3 T5	166	02/93→12/96					
2.3 T5 R	176	04/96→10/96					
2.3 T5-R	184	08/95→12/96					
2.4	106	08/94→12/96					
2.5 TDI	103	08/95→12/96					
2.0 Turbo	132	09/93→10/97	➔	→ 12/96		24.0126-0102.1 426102	Ø 280,3 26 23 V
			➔	→ 12/96		24.0110-0214.1 410214	Ø 295 9,6 8,4
2.3 Turbo R	177	06/95→10/97	➔	08/95→ 12/96		24.0126-0102.1 426102	Ø 280,3 26 23 V
			➔	08/95→ 12/96		24.0110-0214.1 410214	Ø 295 9,6 8,4
2.4	125	09/92→12/96	➔	→ 08/93		24.0126-0101.1 426101	Ø 280,3 26 23 V
			➔	08/93→		24.0126-0102.1 426102	Ø 280,3 26 23 V
			➔	09/93→		24.0110-0214.1 410214	Ø 295 9,6 8,4
			➔	→ 08/93		24.0110-0216.1 410216	Ø 295 9,6 8,4
2.4 AWD	142	04/96→12/96	➔			24.0126-0102.1 426102	Ø 280,3 26 23 V
			➔	Allrad		24.0110-0292.1 410292	Ø 283 10 8
<b>VOLVO - 940 II (944) 08/94→12/98</b>							
<b> Bremsbelagsatz, Scheibenbremse</b>							
2.0 Turbo	114	04/96→10/98	➔			13.0460-2985.2 602985	TRW 20164 18,2 - WK
2.3	96	08/94→10/98				13.0460-3914.2 603914	BDX 21233 16,7 - WE / - WK
2.3 ti	99	01/95→10/98	➔	Multi-link Achse		13.0460-2935.2 602935	TRW 21385 13,8 - WK
2.3 Turbo	121	08/94→10/98	➔	nicht für Multi-link Achse		13.0460-3401.2 603401	ATE 20755 14,4 - WE / - WK
2.4 TD Interc.	90	08/94→10/98	➔				
2.3 Turbo	126	01/95→12/98	➔	→ 10/98		13.0460-2985.2 602985	TRW 20164 18,2 - WK
			➔	→ 10/98; Multi-link Achse		13.0460-3914.2 603914	BDX 21233 16,7 - WE / - WK
			➔	→ 10/98; nicht für Multi-link Achse		13.0460-3401.2 603401	ATE 20755 14,4 - WE / - WK
<b>Zubehörsatz, Scheibenbremsbelag</b>							
2.0 Turbo	114	04/96→10/98	➔			13.0460-0429.2 610429	BDX
2.3	96	08/94→10/98					
2.3 ti	99	01/95→10/98	➔	nicht für Multi-link Achse		13.0460-0088.2 610088	ATE
2.3 Turbo	121	08/94→10/98					
2.4 TD Interc.	90	08/94→10/98					
2.3 Turbo	126	01/95→12/98	➔	→ 10/98		13.0460-0429.2 610429	BDX
			➔	→ 10/98; nicht für Multi-link Achse		13.0460-0088.2 610088	ATE
<b> Bremsscheibe</b>							
2.0 Turbo	114	04/96→10/98	➔			24.0126-0105.1 426105	Ø 280 26 23 V
2.3	96	08/94→10/98					
2.3 ti	99	01/95→10/98	➔	nicht für Multi-link Achse		24.0110-0189.1 410189	Ø 281 9,6 8,4
2.3 Turbo	121	08/94→10/98	➔	Multi-link Achse		24.0110-0206.1 410206	Ø 265 10 8
2.4 TD Interc.	90	08/94→10/98					
2.3 Turbo	126	01/95→12/98	➔	→ 10/98		24.0126-0105.1 426105	Ø 280 26 23 V
			➔	→ 10/98; nicht für Multi-link Achse		24.0110-0189.1 410189	Ø 281 9,6 8,4
			➔	→ 10/98; Multi-link Achse		24.0110-0206.1 410206	Ø 265 10 8
<b>VOLVO - 940 II Kombi (945) 08/94→10/98</b>							
<b> Bremsbelagsatz, Scheibenbremse</b>							
2.0 Turbo	114	04/96→10/98	➔			13.0460-2985.2 602985	TRW 20164 18,2 - WK
2.3	96	08/94→10/98					
↓							

	kW					! #		
<b>VOLVO - 940 II Kombi (945) 08/94→10/98</b>								
 <b>Bremsbelagsatz, Scheibenbremse</b>								
2.3 ti	99	01/95→10/98	←			13.0460-3914.2	603914	BDX 21233 16,7 - WE / - WK
2.3 Turbo	121	08/94→10/98	→	Multi-link Achse		13.0460-2935.2	602935	TRW 21385 13,8 - WK
2.3 Turbo	126	08/95→10/98	→					
2.4 TD Interc.	90	08/94→10/98	→	nicht für Multi-link Achse		13.0460-3401.2	603401	ATE 20755 14,4 - WE / - WK
<b>Zubehörsatz, Scheibenbremsbelag</b>								
2.0 Turbo	114	04/96→10/98	←			13.0460-0429.2	610429	BDX
2.3	96	08/94→10/98	→	nicht für Multi-link Achse		13.0460-0088.2	610088	ATE
2.3 ti	99	01/95→10/98	→					
2.3 Turbo	121	08/94→10/98	→					
2.3 Turbo	126	08/95→10/98	→					
2.4 TD Interc.	90	08/94→10/98	→					
 <b>Bremsscheibe</b>								
2.0 Turbo	114	04/96→10/98	←			24.0126-0105.1	426105	Ø 280 26 23 V
2.3	96	08/94→10/98	→	nicht für Multi-link Achse		24.0110-0189.1	410189	Ø 281 9,6 8,4
2.3 ti	99	01/95→10/98	→					
2.3 Turbo	121	08/94→10/98	→	Multi-link Achse		24.0110-0206.1	410206	Ø 265 10 8
2.3 Turbo	126	08/95→10/98	→					
2.4 TD Interc.	90	08/94→10/98	→					
<b>VOLVO - 960 II (964) 07/94→12/96</b>								
 <b>Bremsbelagsatz, Scheibenbremse</b>								
2.5	125	07/94→12/96	←	08/94→		13.0460-2985.2	602985	TRW 20164 18,2 - WK
2.9	150	07/94→12/96	→	08/94→; Multi-link Achse		13.0460-2935.2	602935	TRW 21385 13,8 - WK
			→	08/94→; nicht für Multi-link Achse		13.0460-3401.2	603401	ATE 20755 14,4 - WE / - WK
<b>Zubehörsatz, Scheibenbremsbelag</b>								
2.5	125	07/94→12/96	→	08/94→; nicht für Multi-link Achse		13.0460-0088.2	610088	ATE
2.9	150	07/94→12/96	→					
 <b>Bremsscheibe</b>								
2.5	125	07/94→12/96	←	08/94→		24.0126-0102.1	426102	Ø 280,3 26 23 V
			→	08/94→; nicht für Multi-link Achse		24.0110-0189.1	410189	Ø 281 9,6 8,4
			→	08/94→; Multi-link Achse		24.0110-0289.1	410289	Ø 265 10 8
2.9	150	07/94→12/96	←	01/95→		24.0126-0102.1	426102	Ø 280,3 26 23 V
			←	08/94→ 12/94		24.0126-0105.1	426105	Ø 280 26 23 V
			→	08/94→; nicht für Multi-link Achse		24.0110-0189.1	410189	Ø 281 9,6 8,4
			→	08/94→; Multi-link Achse		24.0110-0206.1	410206	Ø 265 10 8
<b>VOLVO - 960 II Kombi (965) 07/94→12/96</b>								
 <b>Bremsbelagsatz, Scheibenbremse</b>								
2.5	125	08/94→12/96	←			13.0460-2985.2	602985	TRW 20164 18,2 - WK
2.9	150	09/94→12/96	→	Multi-link Achse		13.0460-2935.2	602935	TRW 21385 13,8 - WK
			→	nicht für Multi-link Achse		13.0460-3401.2	603401	ATE 20755 14,4 - WE / - WK
<b>Zubehörsatz, Scheibenbremsbelag</b>								
2.5	125	08/94→12/96	→	nicht für Multi-link Achse		13.0460-0088.2	610088	ATE
2.9	150	09/94→12/96	→					
 <b>Bremsscheibe</b>								
2.5	125	08/94→12/96	←			24.0126-0102.1	426102	Ø 280,3 26 23 V
			→	nicht für Multi-link Achse		24.0110-0189.1	410189	Ø 281 9,6 8,4
			→	Multi-link Achse		24.0110-0289.1	410289	Ø 265 10 8
2.9	150	09/94→12/96	←	01/95→		24.0126-0102.1	426102	Ø 280,3 26 23 V
			←	→ 12/94		24.0126-0105.1	426105	Ø 280 26 23 V
			→	nicht für Multi-link Achse		24.0110-0189.1	410189	Ø 281 9,6 8,4
			→	Multi-link Achse		24.0110-0206.1	410206	Ø 265 10 8
<b>VOLVO - C30 (533) 09/06→12/13</b>								
 <b>Bremsbelagsatz, Scheibenbremse</b>								
1.6	74	10/06→12/12	←	passend für Felgenreöße [Zoll]: 15 / 16		13.0460-7193.2	607193	ATE 23723 18,1 - WE / - WK
1.6 D	80	10/06→12/12	←			13.0470-7193.2	LD7193	ATE 23723 18,1 - WE / - WK
1.6 D2	84	10/10→12/12	←					Ceramic
1.8	92	10/06→12/12	←					
↓								



**VOLVO - C30 (533) 09/06→12/13**

**Bremsbelagsatz, Scheibenbremse**

2.0	107	10/06→12/12	→			<b>13.0460-7195.2</b>	<b>607195</b>	ATE 23482 16,6 - WE / - WK
2.0 D	100	10/06→12/12				<b>13.0470-7195.2</b>	<b>LD7195</b>	ATE 23482 16,6 - WE / - WK
2.0 FlexFuel	107	01/10→12/12						Ceramic
2.4 i	125	10/06→12/12						
D3	110	10/10→12/12						
D4	130	10/10→12/12						
D5	120	10/06→12/12						
D5	132	10/06→12/12						
T5	162	10/06→12/12						
T5	169	03/07→12/12						
1.8 FlexFuel	92	01/07→12/12	←	04/07→; passend für Felgenreöße [Zoll]: 15 / 16		<b>13.0460-7193.2</b>	<b>607193</b>	ATE 23723 18,1 - WE / - WK
			→	04/07→		<b>13.0470-7193.2</b>	<b>LD7193</b>	ATE 23723 18,1 - WE / - WK
								Ceramic
Electric	82	12/10→12/12	←	passend für Felgenreöße [Zoll]: 15 / 16		<b>13.0460-7193.2</b>	<b>607193</b>	ATE 23723 18,1 - WE / - WK
Electric	89	12/10→12/12				<b>13.0470-7193.2</b>	<b>LD7193</b>	ATE 23723 18,1 - WE / - WK
								Ceramic

**Bremsscheibe**

1.6	74	10/06→12/12	←	passend für Felgenreöße [Zoll]: 15		<b>24.0125-0117.1</b>	<b>425117</b>	Ø 278 25 23 V
1.6 D	80	10/06→12/12				<b>24.0325-0117.1</b>	<b>525117</b>	Ø 278 25 23 V
1.6 D2	84	10/10→12/12						
1.8	92	10/06→12/12	←	passend für Felgenreöße [Zoll]: 16		<b>24.0125-0162.1</b>	<b>425162</b>	Ø 300 25 23 V
2.0	107	10/06→12/12				<b>24.0325-0162.1</b>	<b>525162</b>	Ø 300 25 23 V
2.0 D	100	10/06→12/12	→			<b>24.0111-0158.1</b>	<b>411158</b>	Ø 280 11 9 + S
2.0 FlexFuel	107	01/10→12/12				<b>24.0311-0158.1</b>	<b>511158</b>	Ø 280 11 9 + S
2.4 i	125	10/06→12/12						
D3	110	10/10→12/12						
D4	130	10/10→12/12						
D5	120	10/06→12/12						
D5	132	10/06→12/12						
T5	162	10/06→12/12						
T5	169	03/07→12/12						
1.8 FlexFuel	92	01/07→12/12	←	04/07→; passend für Felgenreöße [Zoll]: 15		<b>24.0125-0117.1</b>	<b>425117</b>	Ø 278 25 23 V
			←	04/07→; passend für Felgenreöße [Zoll]: 16		<b>24.0325-0117.1</b>	<b>525117</b>	Ø 278 25 23 V
			←	04/07→; passend für Felgenreöße [Zoll]: 16		<b>24.0125-0162.1</b>	<b>425162</b>	Ø 300 25 23 V
			→	04/07→		<b>24.0325-0162.1</b>	<b>525162</b>	Ø 300 25 23 V
						<b>24.0111-0158.1</b>	<b>411158</b>	Ø 280 11 9 + S
						<b>24.0311-0158.1</b>	<b>511158</b>	Ø 280 11 9 + S
Electric	82	12/10→12/12	←	passend für Felgenreöße [Zoll]: 15		<b>24.0125-0117.1</b>	<b>425117</b>	Ø 278 25 23 V
Electric	89	12/10→12/12				<b>24.0325-0117.1</b>	<b>525117</b>	Ø 278 25 23 V
			←	passend für Felgenreöße [Zoll]: 16		<b>24.0125-0162.1</b>	<b>425162</b>	Ø 300 25 23 V
						<b>24.0325-0162.1</b>	<b>525162</b>	Ø 300 25 23 V











**VOLVO - C70 I Cabriolet (873) 03/98→10/05**

**Bremsbelagsatz, Scheibenbremse**

2.0	132	03/98→10/05	←			<b>13.0460-7053.2</b>	<b>607053</b>	ATE 21273 19,5 + WE / - WK
2.0 T	120	03/00→10/05				<b>13.0470-7053.2</b>	<b>LD7053</b>	ATE 21273 19,5 + WE / - WK
2.4	125	06/98→10/05						Ceramic
2.4 T	142	03/98→10/05	→			<b>13.0460-4044.2</b>	<b>604044</b>	ATE 20755 15,1 - WE / - WK
2.4 T	147	07/02→10/05				<b>13.0470-4044.2</b>	<b>LD4044</b>	ATE 20755 15,1 - WE / - WK
								Ceramic
2.0 T	166	03/98→10/05	←			<b>13.0460-7053.2</b>	<b>607053</b>	ATE 21273 19,5 + WE / - WK
2.3 T5	176	03/98→10/05	→			<b>13.0460-4044.2</b>	<b>604044</b>	ATE 20755 15,1 - WE / - WK
2.3 T5	180	07/02→10/05				<b>13.0470-4044.2</b>	<b>LD4044</b>	ATE 20755 15,1 - WE / - WK
								Ceramic

**Bremsscheibe**

2.0	132	03/98→10/05	←	passend für Felgenreöße [Zoll]: 15		<b>24.0126-0102.1</b>	<b>426102</b>	Ø 280,3 26 23 V
2.0 T	120	03/00→10/05	←	passend für Felgenreöße [Zoll]: 16		<b>24.0126-0107.1</b>	<b>426107</b>	Ø 302 26 23 V
2.0 T	166	03/98→10/05				<b>24.0326-0107.1</b>	<b>526107</b>	Ø 302 26 23 V
2.3 T5	176	03/98→10/05						
2.3 T5	180	07/02→10/05	→			<b>24.0110-0214.1</b>	<b>410214</b>	Ø 295 9,6 8,4
2.4	125	06/98→10/05						
2.4 T	142	03/98→10/05						
2.4 T	147	07/02→10/05						

	kw			 	! #		
<b>VOLVO - C70 I Coupe (872) 03/97→09/02</b>							
 <b>Bremsbelagsatz, Scheibenbremse</b>							
2.0 2.0 T 2.4 T	132 166 142	03/97→09/02 03/97→09/02 03/97→09/02	←	01/99→; passend für Felgengröße [Zoll]: 15 / 16		<b>13.0460-7053.2 607053</b> <b>13.0470-7053.2 LD7053</b>	ATE 21273 19,5 + WE / - WK ATE 21273 19,5 + WE / - WK Ceramic
			←	→ 12/98; passend für Felgengröße [Zoll]: 15 / 16		<b>13.0460-7193.2 607193</b> <b>13.0470-7193.2 LD7193</b>	ATE 23723 18,1 - WE / - WK ATE 23723 18,1 - WE / - WK Ceramic
			→			<b>13.0460-4044.2 604044</b> <b>13.0470-4044.2 LD4044</b>	ATE 20755 15,1 - WE / - WK ATE 20755 15,1 - WE / - WK Ceramic
2.0 T	120	03/00→09/02	←	passend für Felgengröße [Zoll]: 15 / 16		<b>13.0460-7053.2 607053</b> <b>13.0470-7053.2 LD7053</b>	ATE 21273 19,5 + WE / - WK ATE 21273 19,5 + WE / - WK Ceramic
			→			<b>13.0460-4044.2 604044</b> <b>13.0470-4044.2 LD4044</b>	ATE 20755 15,1 - WE / - WK ATE 20755 15,1 - WE / - WK Ceramic
2.3 T-5	176	03/97→09/02	←	01/99→; passend für Felgengröße [Zoll]: 15 / 16		<b>13.0460-7053.2 607053</b>	ATE 21273 19,5 + WE / - WK
			←	→ 12/98; passend für Felgengröße [Zoll]: 15 / 16		<b>13.0460-7193.2 607193</b>	ATE 23723 18,1 - WE / - WK
			→			<b>13.0460-4044.2 604044</b> <b>13.0470-4044.2 LD4044</b>	ATE 20755 15,1 - WE / - WK ATE 20755 15,1 - WE / - WK Ceramic
2.4	121	03/99→09/02	←	09/99→; passend für Felgengröße [Zoll]: 15 / 16		<b>13.0460-7053.2 607053</b> <b>13.0470-7053.2 LD7053</b>	ATE 21273 19,5 + WE / - WK ATE 21273 19,5 + WE / - WK Ceramic
			→			<b>13.0460-4044.2 604044</b> <b>13.0470-4044.2 LD4044</b>	ATE 20755 15,1 - WE / - WK ATE 20755 15,1 - WE / - WK Ceramic
2.4	125	05/99→09/02	←	11/99→; passend für Felgengröße [Zoll]: 15 / 16		<b>13.0460-7053.2 607053</b> <b>13.0470-7053.2 LD7053</b>	ATE 21273 19,5 + WE / - WK ATE 21273 19,5 + WE / - WK Ceramic
			→	11/99→		<b>13.0460-4044.2 604044</b> <b>13.0470-4044.2 LD4044</b>	ATE 20755 15,1 - WE / - WK ATE 20755 15,1 - WE / - WK Ceramic
 <b>Bremsscheibe</b>							
2.0 2.0 T 2.0 T 2.3 T-5 2.4 2.4 T	132 120 166 176 121 142	03/97→09/02 03/00→09/02 03/97→09/02 03/97→09/02 03/99→09/02 03/97→09/02	←	passend für Felgengröße [Zoll]: 15		<b>24.0126-0102.1 426102</b>	Ø 280,3 26 23 V
			←	passend für Felgengröße [Zoll]: 16		<b>24.0126-0107.1 426107</b>	Ø 302 26 23 V
			→			<b>24.0326-0107.1 526107</b>	Ø 302 26 23 V
			→			<b>24.0110-0214.1 410214</b>	Ø 295 9,6 8,4
2.4	125	05/99→09/02	←	11/99→; passend für Felgengröße [Zoll]: 15		<b>24.0126-0102.1 426102</b>	Ø 280,3 26 23 V
			←	11/99→; passend für Felgengröße [Zoll]: 16		<b>24.0126-0107.1 426107</b> <b>24.0326-0107.1 526107</b>	Ø 302 26 23 V Ø 302 26 23 V
			→	11/99→		<b>24.0110-0214.1 410214</b>	Ø 295 9,6 8,4
<b>VOLVO - C70 II Cabriolet (542) 03/06→12/13</b>							
 <b>Bremsbelagsatz, Scheibenbremse</b>							
2.0 D	100	01/08→10/09	←	06/08→; nicht für Felgengröße [Zoll]: 17		<b>13.0460-7193.2 607193</b> <b>13.0470-7193.2 LD7193</b>	ATE 23723 18,1 - WE / - WK ATE 23723 18,1 - WE / - WK Ceramic
			←	06/08→; passend für Felgengröße [Zoll]: 17		<b>13.0460-7204.2 607204</b> <b>13.0470-7204.2 LD7204</b>	ATE 23801 18,8 - WE / - WK ATE 23801 18,8 - WE / - WK Ceramic
			→	06/08→		<b>13.0460-7195.2 607195</b> <b>13.0470-7195.2 LD7195</b>	ATE 23482 16,6 - WE / - WK ATE 23482 16,6 - WE / - WK Ceramic
2.4 2.4 D 2.4 i D3 D4 D5 T5 T5	103 120 125 110 130 132 162 169	03/06→10/09 03/07→06/13 03/06→10/09 10/10→06/13 10/10→06/13 03/06→06/13 03/06→02/07 03/07→10/09	←	nicht für Felgengröße [Zoll]: 17		<b>13.0460-7193.2 607193</b> <b>13.0470-7193.2 LD7193</b>	ATE 23723 18,1 - WE / - WK ATE 23723 18,1 - WE / - WK Ceramic
			←	passend für Felgengröße [Zoll]: 17		<b>13.0460-7204.2 607204</b> <b>13.0470-7204.2 LD7204</b>	ATE 23801 18,8 - WE / - WK ATE 23801 18,8 - WE / - WK Ceramic
			→			<b>13.0460-7195.2 607195</b> <b>13.0470-7195.2 LD7195</b>	ATE 23482 16,6 - WE / - WK ATE 23482 16,6 - WE / - WK Ceramic
↓							





**VOLVO - C70 II Cabriolet (542) 03/06→12/13**

**Bremsscheibe**

2.0 D	100	01/08→10/09	←	06/08→; passend für Felgengröße [Zoll]: 15	24.0125-0117.1 425117	Ø 278 25 23 V
					24.0325-0117.1 525117	Ø 278 25 23 V
			←	06/08→; passend für Felgengröße [Zoll]: 16	24.0125-0162.1 425162	Ø 300 25 23 V
					24.0325-0162.1 525162	Ø 300 25 23 V
			←	06/08→; passend für Felgengröße [Zoll]: 17	24.0125-0197.1 425197	Ø 320 25 23 V
					24.0325-0197.1 525197	Ø 320 25 23 V
			→	06/08→	24.0111-0158.1 411158	Ø 280 11 9 + S
					24.0311-0158.1 511158	Ø 280 11 9 + S
2.4	103	03/06→10/09	←	passend für Felgengröße [Zoll]: 15	24.0125-0117.1 425117	Ø 278 25 23 V
2.4 D	120	03/07→06/13			24.0325-0117.1 525117	Ø 278 25 23 V
2.4 i	125	03/06→10/09				
D3	110	10/10→06/13	←	passend für Felgengröße [Zoll]: 16	24.0125-0162.1 425162	Ø 300 25 23 V
D4	130	10/10→06/13			24.0325-0162.1 525162	Ø 300 25 23 V
D5	132	03/06→06/13				
T5	162	03/06→02/07	←	passend für Felgengröße [Zoll]: 17	24.0125-0197.1 425197	Ø 320 25 23 V
T5	169	03/07→10/09			24.0325-0197.1 525197	Ø 320 25 23 V
			→		24.0111-0158.1 411158	Ø 280 11 9 + S
					24.0311-0158.1 511158	Ø 280 11 9 + S

**VOLVO - S40 I (644) 07/95→12/04**

**Bremsbelagsatz, Scheibenbremse**

1.6	77	09/95→08/99	←	→ 08/97	13.0460-2830.2 602830	TRW 21920 14,6 + WK + Zub
1.8	85	07/95→08/99	←	09/97→	13.0460-2853.2 602853	TRW 21983 17,2 + WK
1.9 T4	147	05/97→07/00				
1.9 TD	66	07/95→08/99	→		13.0460-2831.2 602831	TRW 21861 15,2 + WK
2.0	100	07/95→12/03				
2.0	103	07/95→08/99				
1.6	80	03/99→12/03	←		13.0460-2853.2 602853	TRW 21983 17,2 + WK
1.8	90	03/99→12/03				
1.8 i	90	06/01→12/03	→		13.0460-2831.2 602831	TRW 21861 15,2 + WK
1.8 i	92	03/98→12/03				
1.9 DI	70	03/99→07/00				
1.9 DI	75	07/00→12/03				
1.9 DI	85	07/00→12/03				
2.0 T	120	06/01→12/03				
2.0 T	121	07/00→06/01				
2.0 T4	147	07/00→12/03				
2.0 T	118	10/97→12/03	←	→ 07/00	13.0460-2853.2 602853	TRW 21983 17,2 + WK
			→	→ 07/00	13.0460-2831.2 602831	TRW 21861 15,2 + WK











**Bremsscheibe**









1.6	77	09/95→08/99	←	→ 08/97	24.0124-0136.1 424136	Ø 256 24 21,5 V
1.8	85	07/95→08/99	←	09/97→	24.0124-0159.1 424159	Ø 281 23,9 21,5 V
1.9 T4	147	05/97→07/00			24.0324-0159.1 524159	Ø 281 23,9 21,5 V
1.9 TD	66	07/95→08/99				
2.0	100	07/95→12/03	→		24.0110-0229.1 410229	Ø 260 10 8,4
2.0	103	07/95→08/99				
1.6	80	03/99→12/03	←		24.0124-0159.1 424159	Ø 281 23,9 21,5 V
1.8	90	03/99→12/03			24.0324-0159.1 524159	Ø 281 23,9 21,5 V
1.8 i	90	06/01→12/03	→		24.0110-0229.1 410229	Ø 260 10 8,4
1.8 i	92	03/98→12/03				
1.9 DI	70	03/99→07/00				
1.9 DI	75	07/00→12/03				
1.9 DI	85	07/00→12/03				
2.0 T	120	06/01→12/03				
2.0 T	121	07/00→06/01				
2.0 T4	147	07/00→12/03				
2.0 T	118	10/97→12/03	←	→ 07/00	24.0124-0159.1 424159	Ø 281 23,9 21,5 V
					24.0324-0159.1 524159	Ø 281 23,9 21,5 V
			→	→ 07/00	24.0110-0229.1 410229	Ø 260 10 8,4









**VOLVO - S40 II (544) 12/03→12/12**







**Bremsbelagsatz, Scheibenbremse**

1.6	74	01/05→12/12	←	→ 05/12; nicht für Felgengröße [Zoll]: 17	13.0460-7193.2 607193	ATE 23723 18,1 - WE / - WK
1.6 D	81	01/05→12/12			13.0470-7193.2 LD7193	ATE 23723 18,1 - WE / - WK
1.6 D2	84	10/10→12/12				Ceramic
2.0	107	10/06→12/12				
2.0 F	107	10/09→12/12	←	→ 05/12;	13.0460-7204.2 607204	ATE 23801 18,8 - WE / - WK
2.4 AWD	125	08/06→12/12		passend für Felgengröße [Zoll]: 17	13.0470-7204.2 LD7204	ATE 23801 18,8 - WE / - WK
D3	110	10/10→12/12				Ceramic
D4	130	10/10→12/12				
T5	169	03/07→12/12	→	→ 05/12	13.0460-7195.2 607195	ATE 23482 16,6 - WE / - WK
					13.0470-7195.2 LD7195	ATE 23482 16,6 - WE / - WK
						Ceramic









	kw			 	! #		
<b>VOLVO - S40 II (544) 12/03→12/12</b>							
 <b>Bremsbelagsatz, Scheibenbremse</b>							
1.8 2.0 D 2.4 2.4 2.4 D5 T5 T5 AWD T5 AWD	92 100 103 125 132 162 162 169	04/04→12/10 01/04→12/10 01/04→12/10 01/04→12/12 03/06→12/10 01/04→12/07 04/04→12/07 03/07→12/10	← ← ← →	nicht für Felgengröße [Zoll]: 17 passend für Felgengröße [Zoll]: 17	13.0460-7193.2 13.0470-7193.2	607193 LD7193	ATE 23723 18,1 - WE / - WK ATE 23723 18,1 - WE / - WK Ceramic ATE 23801 18,8 - WE / - WK ATE 23801 18,8 - WE / - WK Ceramic ATE 23482 16,6 - WE / - WK ATE 23482 16,6 - WE / - WK Ceramic
1.8 FlexFuel	92	01/06→12/10	← ← →	04/07→; nicht für Felgengröße [Zoll]: 17 04/07→; passend für Felgengröße [Zoll]: 17 04/07→	13.0460-7193.2 13.0470-7193.2 13.0460-7204.2 13.0470-7204.2 13.0460-7195.2 13.0470-7195.2	607193 LD7193 607204 LD7204 607195 LD7195	ATE 23723 18,1 - WE / - WK ATE 23723 18,1 - WE / - WK Ceramic ATE 23801 18,8 - WE / - WK ATE 23801 18,8 - WE / - WK Ceramic ATE 23482 16,6 - WE / - WK ATE 23482 16,6 - WE / - WK Ceramic
 <b>Bremsscheibe</b>							
1.6 1.6 D 1.6 D2 2.0 2.0 F 2.4 AWD D3 D4 T5	74 81 84 107 107 125 110 130 169	01/05→12/12 01/05→12/12 10/10→12/12 10/06→12/12 10/09→12/12 08/06→12/12 10/10→12/12 10/10→12/12 03/07→12/12	← ← ← ← →	→ 05/12; passend für Felgengröße [Zoll]: 15 → 05/12; passend für Felgengröße [Zoll]: 16 → 05/12; passend für Felgengröße [Zoll]: 17 → 05/12	24.0125-0117.1 24.0325-0117.1 24.0125-0162.1 24.0325-0162.1 24.0125-0197.1 24.0325-0197.1 24.0111-0158.1 24.0311-0158.1	425117 525117 425162 525162 425197 525197 411158 511158	Ø 278 25 23 V Ø 278 25 23 V Ø 300 25 23 V Ø 300 25 23 V Ø 320 25 23 V Ø 320 25 23 V Ø 280 11 9 + S Ø 280 11 9 + S
1.8 2.0 D 2.4 2.4 2.4 D5 T5 T5 AWD T5 AWD	92 100 103 125 132 162 162 169	04/04→12/10 01/04→12/10 01/04→12/10 01/04→12/12 03/06→12/10 01/04→12/07 04/04→12/07 03/07→12/10	← ← ← ← →	passend für Felgengröße [Zoll]: 15 passend für Felgengröße [Zoll]: 16 passend für Felgengröße [Zoll]: 17	24.0125-0117.1 24.0325-0117.1 24.0125-0162.1 24.0325-0162.1 24.0125-0197.1 24.0325-0197.1 24.0111-0158.1 24.0311-0158.1	425117 525117 425162 525162 425197 525197 411158 511158	Ø 278 25 23 V Ø 278 25 23 V Ø 300 25 23 V Ø 300 25 23 V Ø 320 25 23 V Ø 320 25 23 V Ø 280 11 9 + S Ø 280 11 9 + S
1.8 FlexFuel	92	01/06→12/10	← ← ← →	04/07→; passend für Felgengröße [Zoll]: 15 04/07→; passend für Felgengröße [Zoll]: 16 04/07→; passend für Felgengröße [Zoll]: 17 04/07→	24.0125-0117.1 24.0325-0117.1 24.0125-0162.1 24.0325-0162.1 24.0125-0197.1 24.0325-0197.1 24.0111-0158.1 24.0311-0158.1	425117 525117 425162 525162 425197 525197 411158 511158	Ø 278 25 23 V Ø 278 25 23 V Ø 300 25 23 V Ø 300 25 23 V Ø 320 25 23 V Ø 320 25 23 V Ø 280 11 9 + S Ø 280 11 9 + S
<b>VOLVO - S60 I (384) 07/00→04/10</b>							
 <b>Bremsbelagsatz, Scheibenbremse</b>							
2.0 T	132	07/00→04/10	← ← →	09/01→ 01/09; nicht für Felgengröße [Zoll]: 17 09/01→ 01/09; passend für Felgengröße [Zoll]: 17 09/01→ 01/09	13.0460-7145.2 13.0470-7145.2 13.0460-7187.2 13.0470-7187.2 13.0460-7135.2 13.0470-7135.2	607145 LD7145 607187 LD7187 607135 LD7135	ATE 23073 18,8 - WE / - WK ATE 23073 18,8 - WE / - WK Ceramic ATE 23590 19,5 - WE / - WK ATE 23590 19,5 - WE / - WK Ceramic ATE 23076 17,5 - WE / - WK ATE 23076 17,5 - WE / - WK Ceramic
2.3 T5 2.4 2.4 D	195 132 90	07/00→09/02 01/05→10/06 05/05→12/06	← ← →	nicht für Felgengröße [Zoll]: 17 passend für Felgengröße [Zoll]: 17	13.0460-7145.2 13.0470-7145.2 13.0460-7187.2 13.0470-7187.2 13.0460-7135.2 13.0470-7135.2	607145 LD7145 607187 LD7187 607135 LD7135	ATE 23073 18,8 - WE / - WK ATE 23073 18,8 - WE / - WK Ceramic ATE 23590 19,5 - WE / - WK ATE 23590 19,5 - WE / - WK Ceramic ATE 23076 17,5 - WE / - WK ATE 23076 17,5 - WE / - WK Ceramic
↓							

	kw			 	! #		
<b>VOLVO - S60 I (384) 07/00→04/10</b>							
<b> Bremsbelagsatz, Scheibenbremse</b>							
2.4 2.4 T	103 147	07/00→04/10 07/00→04/10	←	11/00→ 01/09; nicht für Felgengröße [Zoll]: 17	13.0460-7145.2	607145	ATE 23073 18,8 - WE / - WK
					13.0470-7145.2	LD7145	ATE 23073 18,8 - WE / - WK Ceramic
			←	11/00→ 01/09; passend für Felgengröße [Zoll]: 17	13.0460-7187.2	607187	ATE 23590 19,5 - WE / - WK
			→	11/00→ 01/09	13.0470-7187.2	LD7187	ATE 23590 19,5 - WE / - WK Ceramic
			→	11/00→ 01/09	13.0460-7135.2	607135	ATE 23076 17,5 - WE / - WK
					13.0470-7135.2	LD7135	ATE 23076 17,5 - WE / - WK Ceramic
2.4 2.4 D 2.4 T5	125 120 191	11/00→04/10 07/05→12/09 04/04→04/10	←	→ 01/09; nicht für Felgengröße [Zoll]: 17	13.0460-7145.2	607145	ATE 23073 18,8 - WE / - WK
					13.0470-7145.2	LD7145	ATE 23073 18,8 - WE / - WK Ceramic
			←	→ 01/09; passend für Felgengröße [Zoll]: 17	13.0460-7187.2	607187	ATE 23590 19,5 - WE / - WK
			→	01/09	13.0470-7187.2	LD7187	ATE 23590 19,5 - WE / - WK Ceramic
			→	01/09	13.0460-7135.2	607135	ATE 23076 17,5 - WE / - WK
					13.0470-7135.2	LD7135	ATE 23076 17,5 - WE / - WK Ceramic
2.4 Bifuel (CNG) 2.4 Bifuel (LPG)	103 103	07/01→04/10 07/01→04/10	←	06/02→ 01/09; nicht für Felgengröße [Zoll]: 17	13.0460-7145.2	607145	ATE 23073 18,8 - WE / - WK
					13.0470-7145.2	LD7145	ATE 23073 18,8 - WE / - WK Ceramic
			←	06/02→ 01/09; passend für Felgengröße [Zoll]: 17	13.0460-7187.2	607187	ATE 23590 19,5 - WE / - WK
			→	06/02→ 01/09	13.0470-7187.2	LD7187	ATE 23590 19,5 - WE / - WK Ceramic
			→	06/02→ 01/09	13.0460-7135.2	607135	ATE 23076 17,5 - WE / - WK
					13.0470-7135.2	LD7135	ATE 23076 17,5 - WE / - WK Ceramic
2.4 D 2.4 D5	93 136	03/05→04/10 03/05→04/10	←	09/05→ 01/09; nicht für Felgengröße [Zoll]: 17	13.0460-7145.2	607145	ATE 23073 18,8 - WE / - WK
					13.0470-7145.2	LD7145	ATE 23073 18,8 - WE / - WK Ceramic
			←	09/05→ 01/09; passend für Felgengröße [Zoll]: 17	13.0460-7187.2	607187	ATE 23590 19,5 - WE / - WK
			→	09/05→ 01/09	13.0470-7187.2	LD7187	ATE 23590 19,5 - WE / - WK Ceramic
			→	09/05→ 01/09	13.0460-7135.2	607135	ATE 23076 17,5 - WE / - WK
					13.0470-7135.2	LD7135	ATE 23076 17,5 - WE / - WK Ceramic
2.4 D	96	05/01→04/10	←	12/01→ 01/09; nicht für Felgengröße [Zoll]: 17	13.0460-7145.2	607145	ATE 23073 18,8 - WE / - WK
					13.0470-7145.2	LD7145	ATE 23073 18,8 - WE / - WK Ceramic
			←	12/01→ 01/09; passend für Felgengröße [Zoll]: 17	13.0460-7187.2	607187	ATE 23590 19,5 - WE / - WK
			→	12/01→ 01/09	13.0470-7187.2	LD7187	ATE 23590 19,5 - WE / - WK Ceramic
			→	12/01→ 01/09	13.0460-7135.2	607135	ATE 23076 17,5 - WE / - WK
					13.0470-7135.2	LD7135	ATE 23076 17,5 - WE / - WK Ceramic
2.4 D5	120	01/01→04/10	←	07/01→ 01/09; nicht für Felgengröße [Zoll]: 17	13.0460-7145.2	607145	ATE 23073 18,8 - WE / - WK
					13.0470-7145.2	LD7145	ATE 23073 18,8 - WE / - WK Ceramic
			←	07/01→ 01/09; passend für Felgengröße [Zoll]: 17	13.0460-7187.2	607187	ATE 23590 19,5 - WE / - WK
			→	07/01→ 01/09	13.0470-7187.2	LD7187	ATE 23590 19,5 - WE / - WK Ceramic
			→	07/01→ 01/09	13.0460-7135.2	607135	ATE 23076 17,5 - WE / - WK
					13.0470-7135.2	LD7135	ATE 23076 17,5 - WE / - WK Ceramic
2.4 T AWD	147	06/01→04/10	←	11/01→ 01/09; nicht für Felgengröße [Zoll]: 17	13.0460-7145.2	607145	ATE 23073 18,8 - WE / - WK
					13.0470-7145.2	LD7145	ATE 23073 18,8 - WE / - WK Ceramic
			←	11/01→ 01/09; passend für Felgengröße [Zoll]: 17	13.0460-7187.2	607187	ATE 23590 19,5 - WE / - WK
			→	11/01→ 01/09	13.0470-7187.2	LD7187	ATE 23590 19,5 - WE / - WK Ceramic
			→	11/01→ 01/09	13.0460-7135.2	607135	ATE 23076 17,5 - WE / - WK
					13.0470-7135.2	LD7135	ATE 23076 17,5 - WE / - WK Ceramic
2.5 T	154	01/03→04/10	←	02/04→ 01/09; nicht für Felgengröße [Zoll]: 17	13.0460-7145.2	607145	ATE 23073 18,8 - WE / - WK
					13.0470-7145.2	LD7145	ATE 23073 18,8 - WE / - WK Ceramic
↓							

	kw			 	! #		
<b>VOLVO - S60 I (384) 07/00→04/10</b>							
<b> Bremsbelagsatz, Scheibenbremse</b>							
2.5 T	154	01/03→04/10	←	02/04→ 01/09; passend für Felgengröße [Zoll]: 17	13.0460-7187.2	607187	ATE 23590 19,5 - WE / - WK
			→	02/04→ 01/09	13.0470-7187.2	LD7187	ATE 23590 19,5 - WE / - WK Ceramic
2.5 T AWD	154	07/02→04/10	←	04/04→ 01/09; nicht für Felgengröße [Zoll]: 17	13.0460-7145.2	607145	ATE 23073 18,8 - WE / - WK
			←	04/04→ 01/09; passend für Felgengröße [Zoll]: 17	13.0470-7145.2	LD7145	ATE 23073 18,8 - WE / - WK Ceramic
			→	04/04→ 01/09	13.0460-7187.2	607187	ATE 23590 19,5 - WE / - WK
R 2,5 T AWD	221	01/03→04/10	←	03/03→ 01/09	13.0460-7135.2	607135	ATE 23076 17,5 - WE / - WK
			→	03/03→ 01/09	13.0470-7135.2	LD7135	ATE 23076 17,5 - WE / - WK Ceramic
T5	184	07/00→04/10	←	08/00→ 04/04; nicht für Felgengröße [Zoll]: 17	13.0460-4804.2	604804	BRE 23092 15,6 - WE / - WK
			←	08/00→ 04/04; passend für Felgengröße [Zoll]: 17	13.0460-4964.2	604964	BRE 21381 15,0 - WE / - WK
			→	08/00→ 04/04	13.0460-7145.2	607145	ATE 23073 18,8 - WE / - WK
T5	184	07/00→04/10	←	08/00→ 04/04; passend für Felgengröße [Zoll]: 17	13.0470-7145.2	LD7145	ATE 23073 18,8 - WE / - WK Ceramic
			→	08/00→ 04/04	13.0460-7187.2	607187	ATE 23590 19,5 - WE / - WK
T5	184	07/00→04/10	←	08/00→ 04/04; passend für Felgengröße [Zoll]: 17	13.0470-7187.2	LD7187	ATE 23590 19,5 - WE / - WK Ceramic
			→	08/00→ 04/04	13.0460-7135.2	607135	ATE 23076 17,5 - WE / - WK
T5	184	07/00→04/10	←	08/00→ 04/04	13.0470-7135.2	LD7135	ATE 23076 17,5 - WE / - WK Ceramic
			→	08/00→ 04/04	13.0460-7135.2	LD7135	ATE 23076 17,5 - WE / - WK Ceramic
<b> Bremsscheibe</b>							
2.0 T	132	07/00→04/10	←	09/01→ 01/09; passend für Felgengröße [Zoll]: 15	24.0126-0122.1	426122	Ø 285,5 26 23 V
			←	09/01→ 01/09; passend für Felgengröße [Zoll]: 16	24.0128-0123.1	428123	Ø 305 27,9 25 V
			←	09/01→ 01/09; passend für Felgengröße [Zoll]: 17	24.0328-0123.1	528123	Ø 305 27,9 25 V
			←	09/01→ 01/09; passend für Felgengröße [Zoll]: 17	24.0128-0144.1	428144	Ø 316 28 25 V
			→	09/01→ 01/09	24.0128-0184.1	428184	Ø 320 28 25 V
2.3 T5 2.4 2.4 D	195 132 90	07/00→09/02 01/05→10/06 05/05→12/06	←	09/01→ 01/09	24.0112-0151.1	412151	Ø 288 11,9 10
			←	09/01→ 01/09	24.0312-0151.1	512151	Ø 288 11,9 10
			←	passend für Felgengröße [Zoll]: 15	24.0126-0122.1	426122	Ø 285,5 26 23 V
			←	passend für Felgengröße [Zoll]: 16	24.0128-0123.1	428123	Ø 305 27,9 25 V
			←	passend für Felgengröße [Zoll]: 17	24.0328-0123.1	528123	Ø 305 27,9 25 V
2.4 2.4 T	103 147	07/00→04/10 07/00→04/10	←	passend für Felgengröße [Zoll]: 17	24.0128-0144.1	428144	Ø 316 28 25 V
			←	passend für Felgengröße [Zoll]: 17	24.0128-0184.1	428184	Ø 320 28 25 V
			→		24.0112-0151.1	412151	Ø 288 11,9 10
			→		24.0312-0151.1	512151	Ø 288 11,9 10
			←	11/00→ 01/09; passend für Felgengröße [Zoll]: 15	24.0126-0122.1	426122	Ø 285,5 26 23 V
2.4 2.4 T	103 147	07/00→04/10 07/00→04/10	←	11/00→ 01/09; passend für Felgengröße [Zoll]: 16	24.0128-0123.1	428123	Ø 305 27,9 25 V
			←	11/00→ 01/09; passend für Felgengröße [Zoll]: 16	24.0328-0123.1	528123	Ø 305 27,9 25 V
			←	11/00→ 01/09; passend für Felgengröße [Zoll]: 17	24.0128-0144.1	428144	Ø 316 28 25 V
			←	11/00→ 01/09; passend für Felgengröße [Zoll]: 17	24.0128-0184.1	428184	Ø 320 28 25 V
			→	11/00→ 01/09	24.0112-0151.1	412151	Ø 288 11,9 10
2.4 2.4 D 2.4 T5	125 120 191	11/00→04/10 07/05→12/09 04/04→04/10	←	11/00→ 01/09	24.0312-0151.1	512151	Ø 288 11,9 10
			←	→ 01/09; passend für Felgengröße [Zoll]: 15	24.0126-0122.1	426122	Ø 285,5 26 23 V
			←	→ 01/09; passend für Felgengröße [Zoll]: 16	24.0128-0123.1	428123	Ø 305 27,9 25 V
			←	→ 01/09; passend für Felgengröße [Zoll]: 16	24.0328-0123.1	528123	Ø 305 27,9 25 V
			←	→ 01/09; passend für Felgengröße [Zoll]: 17	24.0128-0144.1	428144	Ø 316 28 25 V
2.4 Bifuel (CNG) 2.4 Bifuel (LPG)	103 103	07/01→04/10 07/01→04/10	←	→ 01/09	24.0128-0184.1	428184	Ø 320 28 25 V
			←	→ 01/09	24.0112-0151.1	412151	Ø 288 11,9 10
			←	→ 01/09	24.0312-0151.1	512151	Ø 288 11,9 10
			←	06/02→ 01/09; passend für Felgengröße [Zoll]: 15	24.0126-0122.1	426122	Ø 285,5 26 23 V
			←	06/02→ 01/09; passend für Felgengröße [Zoll]: 16	24.0128-0123.1	428123	Ø 305 27,9 25 V
↓			←	06/02→ 01/09; passend für Felgengröße [Zoll]: 17	24.0328-0123.1	528123	Ø 305 27,9 25 V
			←	06/02→ 01/09; passend für Felgengröße [Zoll]: 17	24.0128-0144.1	428144	Ø 316 28 25 V











	kw			 	! #		
<b>VOLVO - S60 I (384) 07/00→04/10</b>							
<b>Bremsscheibe</b>							
2.4 Bifuel (CNG) 2.4 Bifuel (LPG)	103 103	07/01→04/10 07/01→04/10	← →	06/02→ 01/09; passend für Felgengröße [Zoll]: 17  06/02→ 01/09		24.0128-0184.1 428184 24.0112-0151.1 412151 24.0312-0151.1 512151	Ø 320 28 25 V Ø 288 11,9 10 Ø 288 11,9 10
2.4 D 2.4 D5	93 136	03/05→04/10 03/05→04/10	← ← ← →	09/05→ 01/09; passend für Felgengröße [Zoll]: 15  09/05→ 01/09; passend für Felgengröße [Zoll]: 16  09/05→ 01/09; passend für Felgengröße [Zoll]: 17  09/05→ 01/09		24.0126-0122.1 426122 24.0128-0123.1 428123 24.0328-0123.1 528123 24.0128-0123.1 428123 24.0328-0123.1 528123 24.0128-0144.1 428144 24.0128-0184.1 428184 24.0128-0184.1 428184 24.0112-0151.1 412151 24.0312-0151.1 512151	Ø 285,5 26 23 V Ø 305 27,9 25 V Ø 305 27,9 25 V Ø 316 28 25 V Ø 320 28 25 V Ø 288 11,9 10 Ø 288 11,9 10
2.4 D	96	05/01→04/10	← ← ← →	12/01→ 01/09; passend für Felgengröße [Zoll]: 15  12/01→ 01/09; passend für Felgengröße [Zoll]: 16  12/01→ 01/09; passend für Felgengröße [Zoll]: 17  12/01→ 01/09		24.0126-0122.1 426122 24.0128-0123.1 428123 24.0328-0123.1 528123 24.0128-0144.1 428144 24.0128-0184.1 428184 24.0112-0151.1 412151 24.0312-0151.1 512151	Ø 285,5 26 23 V Ø 305 27,9 25 V Ø 305 27,9 25 V Ø 316 28 25 V Ø 320 28 25 V Ø 288 11,9 10 Ø 288 11,9 10
2.4 D5	120	01/01→04/10	← ← ← →	07/01→ 01/09; passend für Felgengröße [Zoll]: 15  07/01→ 01/09; passend für Felgengröße [Zoll]: 16  07/01→ 01/09; passend für Felgengröße [Zoll]: 17  07/01→ 01/09		24.0126-0122.1 426122 24.0128-0123.1 428123 24.0328-0123.1 528123 24.0128-0144.1 428144 24.0128-0184.1 428184 24.0112-0151.1 412151 24.0312-0151.1 512151	Ø 285,5 26 23 V Ø 305 27,9 25 V Ø 305 27,9 25 V Ø 316 28 25 V Ø 320 28 25 V Ø 288 11,9 10 Ø 288 11,9 10
2.4 T AWD	147	06/01→04/10	← ← ← →	11/01→ 01/09; passend für Felgengröße [Zoll]: 15  11/01→ 01/09; passend für Felgengröße [Zoll]: 16  11/01→ 01/09; passend für Felgengröße [Zoll]: 17  11/01→ 01/09		24.0126-0122.1 426122 24.0128-0123.1 428123 24.0328-0123.1 528123 24.0128-0144.1 428144 24.0128-0184.1 428184 24.0112-0151.1 412151 24.0312-0151.1 512151	Ø 285,5 26 23 V Ø 305 27,9 25 V Ø 305 27,9 25 V Ø 316 28 25 V Ø 320 28 25 V Ø 288 11,9 10 Ø 288 11,9 10
2.5 T	154	01/03→04/10	← ← ← →	02/04→ 01/09; passend für Felgengröße [Zoll]: 15  02/04→ 01/09; passend für Felgengröße [Zoll]: 16  02/04→ 01/09; passend für Felgengröße [Zoll]: 17  02/04→ 01/09		24.0126-0122.1 426122 24.0128-0123.1 428123 24.0328-0123.1 528123 24.0128-0144.1 428144 24.0128-0184.1 428184 24.0112-0151.1 412151 24.0312-0151.1 512151	Ø 285,5 26 23 V Ø 305 27,9 25 V Ø 305 27,9 25 V Ø 316 28 25 V Ø 320 28 25 V Ø 288 11,9 10 Ø 288 11,9 10
2.5 T AWD	154	07/02→04/10	← ← ← →	04/04→ 01/09; passend für Felgengröße [Zoll]: 15  04/04→ 01/09; passend für Felgengröße [Zoll]: 16  04/04→ 01/09; passend für Felgengröße [Zoll]: 17  04/04→ 01/09		24.0126-0122.1 426122 24.0128-0123.1 428123 24.0328-0123.1 528123 24.0128-0144.1 428144 24.0128-0184.1 428184 24.0112-0151.1 412151 24.0312-0151.1 512151	Ø 285,5 26 23 V Ø 305 27,9 25 V Ø 305 27,9 25 V Ø 316 28 25 V Ø 320 28 25 V Ø 288 11,9 10 Ø 288 11,9 10
T5	184	07/00→04/10	← ← ← →	08/00→ 04/04; passend für Felgengröße [Zoll]: 15  08/00→ 04/04; passend für Felgengröße [Zoll]: 16  08/00→ 04/04; passend für Felgengröße [Zoll]: 17  08/00→ 04/04		24.0126-0122.1 426122 24.0128-0123.1 428123 24.0328-0123.1 528123 24.0128-0144.1 428144 24.0128-0184.1 428184 24.0112-0151.1 412151 24.0312-0151.1 512151	Ø 285,5 26 23 V Ø 305 27,9 25 V Ø 305 27,9 25 V Ø 316 28 25 V Ø 320 28 25 V Ø 288 11,9 10 Ø 288 11,9 10
<b>VOLVO - S60 II (134) 04/10→</b>							
<b>Bremsbelagsatz, Scheibenbremse</b>							
1.5 T2 1.5 T3 ↓	90 112	10/15→ 03/15→	←	für Bremsscheibendurchmesser [mm]: 300		13.0460-7228.2 607228	ATE 24123 20,3 - WE / - WK









	kw			 	! #		
<b>VOLVO - S60 II (134) 04/10→</b>							
<b> Bremsbelagsatz, Scheibenbremse</b>							
2.0 D2	88	03/15→	←	für Bremsscheibendurchmesser [mm]: 300		<b>13.0470-7228.2</b> <b>LD7228</b>	ATE 24123 20,3 - WE / - WK Ceramic
2.0 D3	110	03/15→					
2.0 D4	140	03/15→					
2.0 D5	165	03/15→	←	für Bremsscheibendurchmesser [mm]: 316 / 336		<b>13.0460-7243.2</b> <b>607243</b>	ATE 24142 20,6 - WE / - WK
2.0 T	149	04/10→12/11				<b>13.0470-7243.2</b> <b>LD7243</b>	ATE 24142 20,6 - WE / - WK Ceramic
2.0 T3	112	03/15→					
2.4 D4 AWD	140	03/15→	→			<b>13.0460-2722.2</b> <b>602722</b>	TRW 24496 17,3 - WE / - WK + Zub
2.5 T5	186	09/11→				<b>13.0470-2722.2</b> <b>LD2722</b>	TRW 24496 17,3 - WE / - WK + Zub Ceramic
2.5 T5 AWD	186	09/12→					
D3	100	05/12→12/15					
D3	120	04/10→12/14	→	V		<b>13.0460-2736.2</b> <b>602736</b>	TRW 24496 17,3 - WE / - WK + Zub
D4	133	09/13→12/15				<b>13.0470-2736.2</b> <b>LD2736</b>	TRW 24496 17,3 - WE / - WK + Zub Ceramic
D5	151	04/10→12/11					
D5	169	04/14→12/15					
D5 AWD	151	04/10→12/11					
D5 AWD	169	04/14→12/15					
DRIVE / D2	84	01/11→12/15					
T3	110	04/10→12/15					
T4	132	04/10→12/15					
T4F	132	04/11→12/15					
T5	177	04/10→12/14					
T5	180	09/13→					
T5 AWD	180	07/14→					
T5 AWD	187	08/15→					
2.0 T	132	05/12→12/15	←	12/13→; für Bremsscheibendurchmesser [mm]: 300		<b>13.0460-7228.2</b> <b>607228</b>	ATE 24123 20,3 - WE / - WK
						<b>13.0470-7228.2</b> <b>LD7228</b>	ATE 24123 20,3 - WE / - WK Ceramic
			←	12/13→; für Bremsscheibendurchmesser [mm]: 316 / 336		<b>13.0460-7243.2</b> <b>607243</b>	ATE 24142 20,6 - WE / - WK
						<b>13.0470-7243.2</b> <b>LD7243</b>	ATE 24142 20,6 - WE / - WK Ceramic
2.0 T4	140	03/15→	←	05/15→; für Bremsscheibendurchmesser [mm]: 300		<b>13.0460-7228.2</b> <b>607228</b>	ATE 24123 20,3 - WE / - WK
						<b>13.0470-7228.2</b> <b>LD7228</b>	ATE 24123 20,3 - WE / - WK Ceramic
			←	05/15→; für Bremsscheibendurchmesser [mm]: 316 / 336		<b>13.0460-7243.2</b> <b>607243</b>	ATE 24142 20,6 - WE / - WK
						<b>13.0470-7243.2</b> <b>LD7243</b>	ATE 24142 20,6 - WE / - WK Ceramic
			→	05/15→		<b>13.0460-2722.2</b> <b>602722</b>	TRW 24496 17,3 - WE / - WK + Zub
						<b>13.0470-2722.2</b> <b>LD2722</b>	TRW 24496 17,3 - WE / - WK + Zub Ceramic
			→	05/15→; V		<b>13.0460-2736.2</b> <b>602736</b>	TRW 24496 17,3 - WE / - WK + Zub
						<b>13.0470-2736.2</b> <b>LD2736</b>	TRW 24496 17,3 - WE / - WK + Zub Ceramic
D4	120	04/10→12/14	←	05/12→; für Bremsscheibendurchmesser [mm]: 300		<b>13.0460-7228.2</b> <b>607228</b>	ATE 24123 20,3 - WE / - WK
						<b>13.0470-7228.2</b> <b>LD7228</b>	ATE 24123 20,3 - WE / - WK Ceramic
			←	05/12→; für Bremsscheibendurchmesser [mm]: 316 / 336		<b>13.0460-7243.2</b> <b>607243</b>	ATE 24142 20,6 - WE / - WK
						<b>13.0470-7243.2</b> <b>LD7243</b>	ATE 24142 20,6 - WE / - WK Ceramic
			→	05/12→		<b>13.0460-2722.2</b> <b>602722</b>	TRW 24496 17,3 - WE / - WK + Zub
						<b>13.0470-2722.2</b> <b>LD2722</b>	TRW 24496 17,3 - WE / - WK + Zub Ceramic
			→	05/12→; V		<b>13.0460-2736.2</b> <b>602736</b>	TRW 24496 17,3 - WE / - WK + Zub
						<b>13.0470-2736.2</b> <b>LD2736</b>	TRW 24496 17,3 - WE / - WK + Zub Ceramic
D5	158	04/11→12/15	←	06/11→; für Bremsscheibendurchmesser [mm]: 300		<b>13.0460-7228.2</b> <b>607228</b>	ATE 24123 20,3 - WE / - WK
D5 AWD	158	04/11→12/15				<b>13.0470-7228.2</b> <b>LD7228</b>	ATE 24123 20,3 - WE / - WK Ceramic
			←	06/11→; für Bremsscheibendurchmesser [mm]: 316 / 336		<b>13.0460-7243.2</b> <b>607243</b>	ATE 24142 20,6 - WE / - WK
						<b>13.0470-7243.2</b> <b>LD7243</b>	ATE 24142 20,6 - WE / - WK Ceramic
			→	06/11→		<b>13.0460-2722.2</b> <b>602722</b>	TRW 24496 17,3 - WE / - WK + Zub
						<b>13.0470-2722.2</b> <b>LD2722</b>	TRW 24496 17,3 - WE / - WK + Zub Ceramic
			→	06/11→; V		<b>13.0460-2736.2</b> <b>602736</b>	TRW 24496 17,3 - WE / - WK + Zub
						<b>13.0470-2736.2</b> <b>LD2736</b>	TRW 24496 17,3 - WE / - WK + Zub Ceramic
↓							













	kW				! #		
<b>VOLVO - S60 II (134) 04/10→</b>							
<b> Bremsbelagsatz, Scheibenbremse</b>							
T5	225	08/13→	←	für Bremsscheibendurchmesser [mm]:	13.0460-7228.2	607228	ATE 24123 20,3 - WE / - WK
T6	225	09/13→		300			
T6 AWD	225	09/15→	←	für Bremsscheibendurchmesser [mm]:	13.0460-7243.2	607243	ATE 24142 20,6 - WE / - WK
T6 AWD	242	04/14→12/15		316 / 336			
			→		13.0460-2722.2	602722	TRW 24496 17,3 - WE / - WK + Zub
					13.0470-2722.2	LD2722	TRW 24496 17,3 - WE / - WK + Zub Ceramic
			→	V	13.0460-2736.2	602736	TRW 24496 17,3 - WE / - WK + Zub
					13.0470-2736.2	LD2736	TRW 24496 17,3 - WE / - WK + Zub Ceramic
T6 AWD	224	04/10→12/15	←	für Bremsscheibendurchmesser [mm]:	13.0460-7228.2	607228	ATE 24123 20,3 - WE / - WK
				300			
			←	für Bremsscheibendurchmesser [mm]:	13.0460-7243.2	607243	ATE 24142 20,6 - WE / - WK
				316 / 336	13.0470-7243.2	LD7243	ATE 24142 20,6 - WE / - WK Ceramic
			→		13.0460-2722.2	602722	TRW 24496 17,3 - WE / - WK + Zub
					13.0470-2722.2	LD2722	TRW 24496 17,3 - WE / - WK + Zub Ceramic
			→	V	13.0460-2736.2	602736	TRW 24496 17,3 - WE / - WK + Zub
					13.0470-2736.2	LD2736	TRW 24496 17,3 - WE / - WK + Zub Ceramic
<b> Bremsscheibe</b>							
1.5 T2	90	10/15→	←		24.0128-0154.1	428154	Ø 300 28 26 V + S
1.5 T3	112	03/15→			24.0128-0162.1	428162	Ø 316 28 26 V + S
2.0 D2	88	03/15→			24.0128-0210.1	428210	Ø 336 28 26 V + S
2.0 D3	110	03/15→			24.0328-0154.1	528154	Ø 300 28 26 V + S
2.0 D4	140	03/15→			24.0328-0162.1	528162	Ø 316 28 26 V + S
2.0 D5	165	03/15→					
2.0 T	149	04/10→12/11					
2.0 T3	112	03/15→	→		24.0111-0147.1	411147	Ø 302 11 9 + S
2.4 D4 AWD	140	03/15→			24.0122-0259.1	422259	Ø 302 22 20 V + S
2.5 T5	186	09/11→					
2.5 T5 AWD	186	09/12→					
D3	100	05/12→12/15					
D3	120	04/10→12/14					
D4	133	09/13→12/15					
D5	151	04/10→12/11					
D5 AWD	151	04/10→12/11					
DRIVE / D2	84	01/11→12/15					
T3	110	04/10→12/15					
T4	132	04/10→12/15					
T4F	132	04/11→12/15					
T5	177	04/10→12/14					
T5	180	09/13→					
T5	225	08/13→					
T5 AWD	180	07/14→					
T5 AWD	187	08/15→					
T6	225	09/13→					
T6 AWD	225	09/15→					
T6 AWD	224	04/10→12/15					
T6 AWD	242	04/14→12/15					
2.0 T	132	05/12→12/15	←	12/13→	24.0128-0154.1	428154	Ø 300 28 26 V + S
					24.0328-0154.1	528154	Ø 300 28 26 V + S
2.0 T4	140	03/15→	←	05/15→	24.0128-0154.1	428154	Ø 300 28 26 V + S
					24.0128-0162.1	428162	Ø 316 28 26 V + S
					24.0128-0210.1	428210	Ø 336 28 26 V + S
					24.0328-0154.1	528154	Ø 300 28 26 V + S
					24.0328-0162.1	528162	Ø 316 28 26 V + S
			→	05/15→	24.0111-0147.1	411147	Ø 302 11 9 + S
					24.0122-0259.1	422259	Ø 302 22 20 V + S
D4	120	04/10→12/14	←	05/12→	24.0128-0154.1	428154	Ø 300 28 26 V + S
					24.0128-0162.1	428162	Ø 316 28 26 V + S
					24.0128-0210.1	428210	Ø 336 28 26 V + S
					24.0328-0154.1	528154	Ø 300 28 26 V + S
					24.0328-0162.1	528162	Ø 316 28 26 V + S
			→	05/12→	24.0111-0147.1	411147	Ø 302 11 9 + S
					24.0122-0259.1	422259	Ø 302 22 20 V + S
D5	158	04/11→12/15	←	06/11→	24.0128-0154.1	428154	Ø 300 28 26 V + S
↓							











	kW					! #		
<b>VOLVO - S60 II (134) 04/10→</b>								
<b>Bremsscheibe</b>								
D5 AWD	158	04/11→12/15	←	06/11→			24.0128-0162.1 428162 24.0128-0210.1 428210 24.0328-0154.1 528154 24.0328-0162.1 528162	Ø 316 28 26 V + S Ø 336 28 26 V + S Ø 300 28 26 V + S Ø 316 28 26 V + S
			→	06/11→			24.0111-0147.1 411147 24.0122-0259.1 422259	Ø 302 11 9 + S Ø 302 22 20 V + S
D5	169	04/14→12/15	←				24.0128-0154.1 428154	Ø 300 28 26 V + S
D5 AWD	169	04/14→12/15	←				24.0128-0162.1 428162 24.0128-0210.1 428210 24.0328-0154.1 528154 24.0328-0162.1 528162	Ø 316 28 26 V + S Ø 336 28 26 V + S Ø 300 28 26 V + S Ø 316 28 26 V + S
			→				24.0111-0147.1 411147	Ø 302 11 9 + S
<b>VOLVO - S70 (874) 11/96→11/00</b>								
<b>Bremsbelagsatz, Scheibenbremse</b>								
2.0	93	01/97→11/00	←				13.0460-7053.2 607053	ATE 21273 19,5 + WE / - WK
2.0	105	01/97→11/00	←				13.0470-7053.2 LD7053	ATE 21273 19,5 + WE / - WK Ceramic
2.0	120	01/97→11/00	←					
2.0	132	01/97→11/00	←					
2.0 Turbo	155	01/97→11/00	→				13.0460-4044.2 604044	ATE 20755 15,1 - WE / - WK
2.0 Turbo	166	01/97→11/00	→				13.0470-4044.2 LD4044	ATE 20755 15,1 - WE / - WK Ceramic
2.3	195	04/99→09/00	→					
2.4	103	08/99→11/00	→					
2.4	106	01/97→11/00	→					
2.4	121	06/98→11/00	→					
2.4	125	01/97→11/00	→					
2.4 AWD	103	04/99→09/00	→					
2.4 AWD	106	11/96→05/99	→					
2.4 AWD	121	10/98→05/99	→					
2.4 Bifuel	103	07/99→11/00	→					
2.4 Bifuel	106	10/98→11/00	→					
2.4 Blu-Fuel	103	07/97→09/00	→					
2.4 T5 AWD	142	11/96→04/99	→					
2.4 Turbo	142	01/97→11/00	→					
2.5 TDI	103	01/97→11/00	→					
2.5 TDi AWD	103	10/99→09/00	→					
2.3	177	11/96→11/00	←	01/97→			13.0460-7053.2 607053	ATE 21273 19,5 + WE / - WK
			→	01/97→			13.0460-4044.2 604044 13.0470-4044.2 LD4044	ATE 20755 15,1 - WE / - WK ATE 20755 15,1 - WE / - WK Ceramic
2.3 T-5	176	01/97→11/00	←				13.0460-7053.2 607053	ATE 21273 19,5 + WE / - WK
2.3 Turbo	184	01/97→11/00	←				13.0460-4044.2 604044 13.0470-4044.2 LD4044	ATE 20755 15,1 - WE / - WK ATE 20755 15,1 - WE / - WK Ceramic
2.4 AWD	125	04/99→09/00	←	→ 05/99			13.0460-7053.2 607053 13.0470-7053.2 LD7053	ATE 21273 19,5 + WE / - WK ATE 21273 19,5 + WE / - WK Ceramic
			→	→ 05/99			13.0460-4044.2 604044 13.0470-4044.2 LD4044	ATE 20755 15,1 - WE / - WK ATE 20755 15,1 - WE / - WK Ceramic
<b>Bremsscheibe</b>								
2.0	93	01/97→11/00	←	passend für Felgengröße [Zoll]: 15			24.0126-0102.1 426102	Ø 280,3 26 23 V
2.0	105	01/97→11/00	←	passend für Felgengröße [Zoll]: 16			24.0126-0107.1 426107	Ø 302 26 23 V
2.0	120	01/97→11/00	←				24.0326-0107.1 526107	Ø 302 26 23 V
2.0	132	01/97→11/00	←					
2.0 Turbo	155	01/97→11/00	→				24.0110-0214.1 410214	Ø 295 9,6 8,4
2.0 Turbo	166	01/97→11/00	→					
2.3	195	04/99→09/00	→					
2.3 T-5	176	01/97→11/00	→					
2.3 Turbo	184	01/97→11/00	→					
2.4	103	08/99→11/00	→					
2.4	106	01/97→11/00	→					
2.4	121	06/98→11/00	→					
2.4	125	01/97→11/00	→					
2.4 AWD	103	04/99→09/00	→					
2.4 AWD	106	11/96→05/99	→					
2.4 AWD	121	10/98→05/99	→					
2.4 Bifuel	103	07/99→11/00	→					
2.4 Bifuel	106	10/98→11/00	→					
2.4 Blu-Fuel	103	07/97→09/00	→					
2.4 T5 AWD	142	11/96→04/99	→					
2.4 Turbo	142	01/97→11/00	→					
↓								

	kw			 	! #					
<b>VOLVO - S70 (874) 11/96→11/00</b>										
 <b>Bremsscheibe</b>										
2.5 TDI 2.5 TDi AWD	103 103	01/97→11/00 10/99→09/00	←	passend für Felgengröße [Zoll]: 15	24.0126-0102.1	426102	Ø 280,3 26 23 V			
			←	passend für Felgengröße [Zoll]: 16	24.0126-0107.1	426107	Ø 302 26 23 V			
					24.0326-0107.1	526107	Ø 302 26 23 V			
			→		24.0110-0214.1	410214	Ø 295 9,6 8,4			
2.3	177	11/96→11/00	←	01/97→; passend für Felgengröße [Zoll]: 15	24.0126-0102.1	426102	Ø 280,3 26 23 V			
			←	01/97→; passend für Felgengröße [Zoll]: 16	24.0126-0107.1	426107	Ø 302 26 23 V			
					24.0326-0107.1	526107	Ø 302 26 23 V			
			→	01/97→	24.0110-0214.1	410214	Ø 295 9,6 8,4			
2.4 AWD	125	04/99→09/00	←	→ 05/99; passend für Felgengröße [Zoll]: 15	24.0126-0102.1	426102	Ø 280,3 26 23 V			
			←	→ 05/99; passend für Felgengröße [Zoll]: 16	24.0126-0107.1	426107	Ø 302 26 23 V			
				→ 05/99	24.0326-0107.1	526107	Ø 302 26 23 V			
			→	05/99	24.0110-0214.1	410214	Ø 295 9,6 8,4			
<b>VOLVO - S80 I (184) 05/98→02/08</b>										
 <b>Bremsbelagsatz, Scheibenbremse</b>										
2.0 2.0 T 2.0 T 2.4 2.4 2.4 Bifuel (CNG) 2.4 Bifuel (LPG) 2.4 D 2.4 D5 2.4 T 2.5 T AWD 2.5 TDI 2.9 2.9 3.0	120 132 166 103 125 103 103 96 120 147 154 103 147 150 144	06/98→07/06 12/99→07/06 06/98→07/06 01/99→07/06 01/99→07/06 09/01→07/06 09/01→07/06 10/01→07/06 08/01→07/06 06/00→07/06 07/03→07/06 01/99→07/06 03/99→07/06 05/98→07/06 06/01→07/06	←	→ 02/06; nicht für Felgengröße [Zoll]: 17	13.0460-7145.2	607145	ATE 23073 18,8 - WE / - WK			
					13.0470-7145.2	LD7145	ATE 23073 18,8 - WE / - WK Ceramic			
			←	→ 02/06; passend für Felgengröße [Zoll]: 17	13.0460-7187.2	607187	ATE 23590 19,5 - WE / - WK			
					13.0470-7187.2	LD7187	ATE 23590 19,5 - WE / - WK Ceramic			
			→	→ 02/06	13.0460-7135.2	607135	ATE 23076 17,5 - WE / - WK			
					13.0470-7135.2	LD7135	ATE 23076 17,5 - WE / - WK Ceramic			
			2.4 T5 AWD	147	04/00→09/03	←	06/00→; nicht für Felgengröße [Zoll]: 17	13.0460-7145.2	607145	ATE 23073 18,8 - WE / - WK
								13.0470-7145.2	LD7145	ATE 23073 18,8 - WE / - WK Ceramic
						←	06/00→; passend für Felgengröße [Zoll]: 17	13.0460-7187.2	607187	ATE 23590 19,5 - WE / - WK
						→	06/00→	13.0470-7187.2	LD7187	ATE 23590 19,5 - WE / - WK Ceramic
			→	06/00→	13.0460-7135.2	607135	ATE 23076 17,5 - WE / - WK			
					13.0470-7135.2	LD7135	ATE 23076 17,5 - WE / - WK Ceramic			
2.5 T	154	03/03→07/06	←	07/03→ 02/06; nicht für Felgengröße [Zoll]: 17	13.0460-7145.2	607145	ATE 23073 18,8 - WE / - WK			
					13.0470-7145.2	LD7145	ATE 23073 18,8 - WE / - WK Ceramic			
			←	07/03→ 02/06; passend für Felgengröße [Zoll]: 17	13.0460-7187.2	607187	ATE 23590 19,5 - WE / - WK			
			→	07/03→ 02/06	13.0470-7187.2	LD7187	ATE 23590 19,5 - WE / - WK Ceramic			
			→	07/03→ 02/06	13.0460-7135.2	607135	ATE 23076 17,5 - WE / - WK			
					13.0470-7135.2	LD7135	ATE 23076 17,5 - WE / - WK Ceramic			
2.8 T6 3.0 T6	200 200	05/98→07/06 06/01→07/06	←	→ 02/06; nicht für Felgengröße [Zoll]: 17	13.0460-7145.2	607145	ATE 23073 18,8 - WE / - WK			
			←	→ 02/06; passend für Felgengröße [Zoll]: 17	13.0460-7187.2	607187	ATE 23590 19,5 - WE / - WK			
			←	→ 02/06	13.0470-7187.2	LD7187	ATE 23590 19,5 - WE / - WK Ceramic			
			→	→ 02/06	13.0460-7135.2	607135	ATE 23076 17,5 - WE / - WK			
					13.0470-7135.2	LD7135	ATE 23076 17,5 - WE / - WK Ceramic			
 <b>Bremsscheibe</b>										
2.0 2.0 T 2.0 T 2.4 2.4 2.4 Bifuel (CNG) 2.4 Bifuel (LPG) 2.4 D 2.4 D5 2.4 T 2.5 T AWD	120 132 166 103 125 103 103 96 120 147 154	06/98→07/06 12/99→07/06 06/98→07/06 01/99→07/06 01/99→07/06 09/01→07/06 09/01→07/06 10/01→07/06 08/01→07/06 06/00→07/06 07/03→07/06	←	→ 02/06; passend für Felgengröße [Zoll]: 15	24.0126-0122.1	426122	Ø 285,5 26 23 V			
			←	→ 02/06; passend für Felgengröße [Zoll]: 16	24.0128-0123.1	428123	Ø 305 27,9 25 V			
					24.0328-0123.1	528123	Ø 305 27,9 25 V			
			←	→ 02/06; passend für Felgengröße [Zoll]: 17	24.0128-0184.1	428184	Ø 320 28 25 V			
			→	→ 02/06	24.0112-0151.1	412151	Ø 288 11,9 10			
					24.0312-0151.1	512151	Ø 288 11,9 10			
			↓							









	kw			 	! #			
<b>VOLVO - S80 I (184) 05/98→02/08</b>								
<b>Bremsscheibe</b>								
2.5 TDI	103	01/99→07/06	←	→ 02/06;		24.0126-0122.1	426122	Ø 285,5 26 23 V
2.8 T6	200	05/98→07/06		passend für Felgengröße [Zoll]: 15				
2.9	147	03/99→07/06	←	→ 02/06;		24.0128-0123.1	428123	Ø 305 27,9 25 V
2.9	150	05/98→07/06		passend für Felgengröße [Zoll]: 16		24.0328-0123.1	528123	Ø 305 27,9 25 V
3.0	144	06/01→07/06	←	→ 02/06;		24.0128-0184.1	428184	Ø 320 28 25 V
3.0 T6	200	06/01→07/06	→	→ 02/06		24.0112-0151.1	412151	Ø 288 11,9 10
						24.0312-0151.1	512151	Ø 288 11,9 10
2.4 T5 AWD	147	04/00→09/03	←	06/00→;		24.0126-0122.1	426122	Ø 285,5 26 23 V
			←	passend für Felgengröße [Zoll]: 15				
			←	06/00→;		24.0128-0123.1	428123	Ø 305 27,9 25 V
				passend für Felgengröße [Zoll]: 16		24.0328-0123.1	528123	Ø 305 27,9 25 V
			←	06/00→;		24.0128-0184.1	428184	Ø 320 28 25 V
			→	passend für Felgengröße [Zoll]: 17				
			→	06/00→		24.0112-0151.1	412151	Ø 288 11,9 10
						24.0312-0151.1	512151	Ø 288 11,9 10
2.5 T	154	03/03→07/06	←	07/03→ 02/06;		24.0126-0122.1	426122	Ø 285,5 26 23 V
			←	passend für Felgengröße [Zoll]: 15				
			←	07/03→ 02/06;		24.0128-0123.1	428123	Ø 305 27,9 25 V
				passend für Felgengröße [Zoll]: 16		24.0328-0123.1	528123	Ø 305 27,9 25 V
			←	07/03→ 02/06;		24.0128-0184.1	428184	Ø 320 28 25 V
			→	passend für Felgengröße [Zoll]: 17				
			→	07/03→ 02/06		24.0112-0151.1	412151	Ø 288 11,9 10
						24.0312-0151.1	512151	Ø 288 11,9 10
<b>VOLVO - S80 II (124) 03/06→</b>								
<b>Bremsbelagsatz, Scheibenbremse</b>								
1.6 D DRiVe	80	01/10→12/11	←	passend für Felgengröße [Zoll]: 16		13.0460-7228.2	607228	ATE 24123 20,3 - WE / - WK
1.6 DRiVe	84	06/11→				13.0470-7228.2	LD7228	ATE 24123 20,3 - WE / - WK
2.0	107	01/08→09/12						Ceramic
2.0 Drive- E	180	12/14→	←	passend für Felgengröße [Zoll]: 17 / 18		13.0460-7243.2	607243	ATE 24142 20,6 - WE / - WK
2.0 FlexFuel	107	01/08→12/11				13.0470-7243.2	LD7243	ATE 24142 20,6 - WE / - WK
2.0 T	149	01/10→						Ceramic
2.0 TDi	100	02/08→03/11	→	+ eFSB		13.0460-2722.2	602722	TRW 24496 17,3 - WE / - WK
2.4 D	120	03/06→				13.0470-2722.2	LD2722	TRW 24496 17,3 - WE / - WK
2.4 D	129	01/10→03/11	→	V; + eFSB		13.0460-2736.2	602736	TRW 24496 17,3 - WE / - WK
2.5 T	147	03/06→12/11				13.0470-2736.2	LD2736	TRW 24496 17,3 - WE / - WK
2.5 T	170	01/10→12/12						+ Zub Ceramic
2.5 T	183	09/12→	→	- eFSB		13.0460-2737.2	602737	TRW 24537 15,8 - WE / - WK
2.5 T	187	01/12→						+ Zub
2.5 T AWD	147	10/06→04/09						
2.5 T FlexFuel	147	05/08→12/11						
2.5 T FlexFuel	170	01/10→12/11						
3.2	175	03/06→						
3.2	179	01/10→	→	- eFSB				
3.2 AWD	175	01/07→12/10						
3.2 AWD	179	01/10→12/12						
D3	100	05/12→						
D3 / D4	120	01/10→						
D4	133	09/13→						
D5	136	03/06→						
D5	151	01/10→						
D5	158	06/11→						
D5 AWD	136	01/07→						
D5 AWD	151	01/10→						
D5 AWD	158	06/11→						
T4	132	10/10→						
T4F	132	05/11→						
T5	177	10/10→						
T5	180	09/13→						
T6 AWD	210	01/07→12/10						
4.4 V8 AWD	232	03/06→03/12	←	passend für Felgengröße [Zoll]: 16		13.0460-7228.2	607228	ATE 24123 20,3 - WE / - WK
T6 AWD	224	10/10→12/16	←	passend für Felgengröße [Zoll]: 17 / 18		13.0460-7243.2	607243	ATE 24142 20,6 - WE / - WK
			→	+ eFSB		13.0460-2722.2	602722	TRW 24496 17,3 - WE / - WK
						13.0470-2722.2	LD2722	TRW 24496 17,3 - WE / - WK
								+ Zub Ceramic
			→	V; + eFSB		13.0460-2736.2	602736	TRW 24496 17,3 - WE / - WK
						13.0470-2736.2	LD2736	TRW 24496 17,3 - WE / - WK
								+ Zub Ceramic
			→	- eFSB		13.0460-2737.2	602737	TRW 24537 15,8 - WE / - WK
								+ Zub













	kw			 	! #		
<b>VOLVO - S80 II (124) 03/06→</b>							
 <b>Bremsscheibe</b>							
1.6 D DRIVE	80	01/10→12/11	←	passend für Felgengröße [Zoll]: 16		24.0128-0154.1 428154	Ø 300 28 26 V + S
1.6 DRIVe	84	06/11→				24.0328-0154.1 528154	Ø 300 28 26 V + S
2.0	107	01/08→09/12					
2.0 Drive- E	180	12/14→	←	passend für Felgengröße [Zoll]: 17		24.0128-0162.1 428162	Ø 316 28 26 V + S
2.0 FlexFuel	107	01/08→12/11				24.0328-0162.1 528162	Ø 316 28 26 V + S
2.0 T	149	01/10→					
2.0 TDi	100	02/08→03/11	←	passend für Felgengröße [Zoll]: 18		24.0128-0210.1 428210	Ø 336 28 26 V + S
2.4 D	120	03/06→	→	+ eFSB		24.0111-0147.1 411147	Ø 302 11 9 + S
2.4 D	129	01/10→03/11				24.0122-0259.1 422259	Ø 302 22 20 V + S
2.5 T	147	03/06→12/11					
2.5 T	170	01/10→12/12	→	- eFSB		24.0112-0180.1 412180	Ø 302 12 10 + S
2.5 T	183	09/12→					
2.5 T	187	01/12→					
2.5 T AWD	147	10/06→04/09					
2.5 T FlexFuel	147	05/08→12/11					
2.5 T FlexFuel	170	01/10→12/11					
3.2	175	03/06→					
3.2	179	01/10→					
3.2 AWD	175	01/07→12/10					
3.2 AWD	179	01/10→12/12					
4.4 V8 AWD	232	03/06→03/12					
D3	100	05/12→					
D3 / D4	120	01/10→					
D4	133	09/13→					
D5	136	03/06→					
D5	151	01/10→					
D5	158	06/11→					
D5 AWD	136	01/07→					
D5 AWD	151	01/10→					
D5 AWD	158	06/11→					
T5	177	10/10→					
T5	180	09/13→					
T6 AWD	210	01/07→12/10					
T6 AWD	224	10/10→12/16					
T4	132	10/10→	←	passend für Felgengröße [Zoll]: 16		24.0128-0154.1 428154	Ø 300 28 26 V + S
T4F	132	05/11→				24.0328-0154.1 528154	Ø 300 28 26 V + S
			←	passend für Felgengröße [Zoll]: 17		24.0128-0162.1 428162	Ø 316 28 26 V + S
						24.0328-0162.1 528162	Ø 316 28 26 V + S
			→	+ eFSB		24.0111-0147.1 411147	Ø 302 11 9 + S
						24.0122-0259.1 422259	Ø 302 22 20 V + S
			→	- eFSB		24.0112-0180.1 412180	Ø 302 12 10 + S
<b>VOLVO - S90 (964) 11/96→12/98</b>							
 <b>Bremsbelagsatz, Scheibenbremse</b>							
2.5	125	11/96→10/98	←			13.0460-2985.2 602985	TRW 20164 18,2 - WK
2.5	132	11/96→10/97					
2.9	132	01/97→05/98	→			13.0460-2935.2 602935	TRW 21385 13,8 - WK
2.9	150	01/97→05/98					
 <b>Bremsscheibe</b>							
2.5	125	11/96→10/98	←			24.0126-0102.1 426102	Ø 280,3 26 23 V
2.5	132	11/96→10/97					
2.9	132	01/97→05/98	→			24.0112-0150.1 412150	Ø 277 11,9 10
2.9	150	01/97→05/98					
<b>VOLVO - S90 II (234) 03/16→</b>							
 <b>Bremsbelagsatz, Scheibenbremse</b>							
2.0	183	03/16→	←	passend für Felgengröße [Zoll]: 18		13.0460-7328.2 607328	ATE 22317 18,8 + WE / - WK
2.0 D4	140	03/16→	←	passend für Felgengröße [Zoll]: 18		13.0460-7328.2 607328	ATE 22317 18,8 + WE / - WK
2.0 D5 AWD	173	03/16→					
2.0 T5	187	03/16→	→	passend für Felgengröße [Zoll]: 17		13.0460-7326.2 607326	ATE 22141 15,5 + WE / - WK
2.0 T6 AWD	235	03/16→					
 <b>Bremsscheibe</b>							
2.0	183	03/16→	←	passend für Felgengröße [Zoll]: 18		24.0130-0243.1 430243	Ø 345 30 27,5 V + S
2.0 D4	140	03/16→	←	passend für Felgengröße [Zoll]: 18		24.0130-0243.1 430243	Ø 345 30 27,5 V + S
2.0 D5 AWD	173	03/16→					
2.0 T5	187	03/16→	→	passend für Felgengröße [Zoll]: 17		24.0120-0246.1 420246	Ø 320 20 17,5 V + S
2.0 T6 AWD	235	03/16→					
<b>VOLVO - V40 Kombi (645) 07/95→06/04</b>							
 <b>Bremsbelagsatz, Scheibenbremse</b>							
1.6	77	12/95→08/99	←	→ 08/97		13.0460-2830.2 602830	TRW 21920 14,6 + WK + Zub
1.8	85	07/95→08/99					
1.9 TD	66	07/95→08/99	←	09/97→		13.0460-2853.2 602853	TRW 21983 17,2 + WK
↓							









	kw			 	! #		
<b>VOLVO - V40 Kombi (645) 07/95→06/04</b>							
 <b>Bremsbelagsatz, Scheibenbremse</b>							
2.0	100	07/95→06/04	→			<b>13.0460-2831.2 602831</b>	TRW 21861 15,2 + WK
2.0	103	07/95→08/99	→				
1.6	80	03/99→06/04	←			<b>13.0460-2853.2 602853</b>	TRW 21983 17,2 + WK
1.8	90	03/99→06/04	←				
1.8 i	90	06/01→06/04	→			<b>13.0460-2831.2 602831</b>	TRW 21861 15,2 + WK
1.8 i	92	03/98→06/04	→				
1.9 DI	70	03/99→07/00	→				
1.9 DI	75	07/00→06/04	→				
1.9 DI	85	07/00→06/04	→				
2.0 T	118	10/97→07/00	→				
2.0 T	120	06/01→06/04	→				
1.9 T4	147	05/97→07/00	←	→ 08/97; + ABS		<b>13.0460-2830.2 602830</b>	TRW 21920 14,6 + WK + Zub
			←	09/97→		<b>13.0460-2853.2 602853</b>	TRW 21983 17,2 + WK
			→			<b>13.0460-2831.2 602831</b>	TRW 21861 15,2 + WK
2.0 T	121	07/99→06/04	←	07/00→ 06/01		<b>13.0460-2853.2 602853</b>	TRW 21983 17,2 + WK
			→	07/00→ 06/01		<b>13.0460-2831.2 602831</b>	TRW 21861 15,2 + WK
2.0 T4	147	07/00→06/04	←	→ 04/04		<b>13.0460-2853.2 602853</b>	TRW 21983 17,2 + WK
			→	→ 04/04		<b>13.0460-2831.2 602831</b>	TRW 21861 15,2 + WK
 <b>Bremsscheibe</b>							
1.6	77	12/95→08/99	←	→ 08/97		<b>24.0124-0136.1 424136</b>	Ø 256 24 21,5 V
1.8	85	07/95→08/99	←	09/97→		<b>24.0124-0159.1 424159</b>	Ø 281 23,9 21,5 V
1.9 TD	66	07/95→08/99	←	09/97→		<b>24.0324-0159.1 524159</b>	Ø 281 23,9 21,5 V
2.0	100	07/95→06/04	→			<b>24.0110-0229.1 410229</b>	Ø 260 10 8,4
2.0	103	07/95→08/99	→				
1.6	80	03/99→06/04	←			<b>24.0124-0159.1 424159</b>	Ø 281 23,9 21,5 V
1.8	90	03/99→06/04	←			<b>24.0324-0159.1 524159</b>	Ø 281 23,9 21,5 V
1.8 i	90	06/01→06/04	→			<b>24.0110-0229.1 410229</b>	Ø 260 10 8,4
1.8 i	92	03/98→06/04	→				
1.9 DI	70	03/99→07/00	→				
1.9 DI	75	07/00→06/04	→				
1.9 DI	85	07/00→06/04	→				
2.0 T	118	10/97→07/00	→				
2.0 T	120	06/01→06/04	→				
1.9 T4	147	05/97→07/00	←	→ 08/97; + ABS		<b>24.0124-0136.1 424136</b>	Ø 256 24 21,5 V
			←	09/97→		<b>24.0124-0159.1 424159</b>	Ø 281 23,9 21,5 V
			←			<b>24.0324-0159.1 524159</b>	Ø 281 23,9 21,5 V
			→			<b>24.0110-0229.1 410229</b>	Ø 260 10 8,4
2.0 T	121	07/99→06/04	←	07/00→ 06/01		<b>24.0124-0159.1 424159</b>	Ø 281 23,9 21,5 V
			←			<b>24.0324-0159.1 524159</b>	Ø 281 23,9 21,5 V
			→	07/00→ 06/01		<b>24.0110-0229.1 410229</b>	Ø 260 10 8,4
2.0 T4	147	07/00→06/04	←	→ 04/04		<b>24.0124-0159.1 424159</b>	Ø 281 23,9 21,5 V
			←			<b>24.0324-0159.1 524159</b>	Ø 281 23,9 21,5 V
			→	→ 04/04		<b>24.0110-0229.1 410229</b>	Ø 260 10 8,4
<b>VOLVO - V40 Schrägheck (525, 526) 03/12→</b>							
 <b>Bremsbelagsatz, Scheibenbremse</b>							
D2	84	03/12→	←	09/12→; passend für Felgenreöße [Zoll]: 15 / 16		<b>13.0460-7193.2 607193</b> <b>13.0470-7193.2 LD7193</b>	ATE 23723 18,1 - WE / - WK ATE 23723 18,1 - WE / - WK Ceramic
			←	09/12→; passend für Felgenreöße [Zoll]: 17		<b>13.0460-7204.2 607204</b> <b>13.0470-7204.2 LD7204</b>	ATE 23801 18,8 - WE / - WK ATE 23801 18,8 - WE / - WK Ceramic
			→	09/12→; - ALU Bremsscheibe		<b>13.0460-7195.2 607195</b> <b>13.0470-7195.2 LD7195</b>	ATE 23482 16,6 - WE / - WK ATE 23482 16,6 - WE / - WK Ceramic
D2	88	02/15→	←	passend für Felgenreöße [Zoll]: 15 / 16		<b>13.0460-7193.2 607193</b>	ATE 23723 18,1 - WE / - WK
D3	110	04/15→	←			<b>13.0470-7193.2 LD7193</b>	ATE 23723 18,1 - WE / - WK Ceramic
D4	140	05/14→	←				
T2	90	02/15→	←				
T2 GTDi	88	03/13→12/15	←	passend für Felgenreöße [Zoll]: 17		<b>13.0460-7204.2 607204</b>	ATE 23801 18,8 - WE / - WK
T3	112	02/15→	←			<b>13.0470-7204.2 LD7204</b>	ATE 23801 18,8 - WE / - WK Ceramic
T4	147	04/14→	←				
T4	132	07/13→	←				
T4	140	08/15→	→			<b>13.0460-7195.2 607195</b>	ATE 23482 16,6 - WE / - WK
T5	157	03/13→	→			<b>13.0470-7195.2 LD7195</b>	ATE 23482 16,6 - WE / - WK Ceramic
T5	180	05/14→	→				
T5 AWD	157	03/13→	→				
T5 AWD	180	05/14→	→				
↓							











	kw			 	! #		
<b>VOLVO - V40 Schrägheck (525, 526) 03/12→</b>							
<b> Bremsbelagsatz, Scheibenbremse</b>							
D3 D4 T3 GTDi T4 GTDi	110 130 110 132	03/12→03/15 03/12→ 03/12→ 03/12→	← ← →	09/12→; passend für Felgengröße [Zoll]: 15 / 16  09/12→; passend für Felgengröße [Zoll]: 17  09/12→	   	   	ATE 23723 18,1 - WE / - WK ATE 23723 18,1 - WE / - WK Ceramic  ATE 23801 18,8 - WE / - WK ATE 23801 18,8 - WE / - WK Ceramic  ATE 23482 16,6 - WE / - WK ATE 23482 16,6 - WE / - WK Ceramic
T4 AWD T4 AWD T5 T5 AWD	132 140 187 187	07/13→ 05/14→ 12/12→ 01/13→	← →	passend für Felgengröße [Zoll]: 17   	   	   	ATE 23801 18,8 - WE / - WK ATE 23801 18,8 - WE / - WK Ceramic  ATE 23482 16,6 - WE / - WK ATE 23482 16,6 - WE / - WK Ceramic
T5	183	01/14→	← ← →	05/14→; passend für Felgengröße [Zoll]: 15 / 16  05/14→; passend für Felgengröße [Zoll]: 17  05/14→	   	   	ATE 23723 18,1 - WE / - WK ATE 23723 18,1 - WE / - WK Ceramic  ATE 23801 18,8 - WE / - WK ATE 23801 18,8 - WE / - WK Ceramic  ATE 23482 16,6 - WE / - WK ATE 23482 16,6 - WE / - WK Ceramic
<b> Bremsscheibe</b>							
D2	84	03/12→	← ← ← →	09/12→; passend für Felgengröße [Zoll]: 16  09/12→; passend für Felgengröße [Zoll]: 17  09/12→; passend für Felgengröße [Zoll]: 15  09/12→; nicht für Ausstattungsvariante: ALU Bremsscheibe	   	   	Ø 300 25 23 V  Ø 320 25 23 V Ø 320 25 23 V  Ø 278 25 23 V  Ø 280 11 9 + S
D2 D3 D4 T2 T3 T4 T5 T5 T5 AWD T5 AWD	88 110 140 90 112 140 157 180 157 180	02/15→ 04/15→ 05/14→ 02/15→ 02/15→ 08/15→ 03/13→ 05/14→ 03/13→ 05/14→	← ← ← ← →	passend für Felgengröße [Zoll]: 16  passend für Felgengröße [Zoll]: 17  passend für Felgengröße [Zoll]: 15   	   	   	Ø 300 25 23 V  Ø 320 25 23 V Ø 320 25 23 V  Ø 278 25 23 V  Ø 280 11 9 + S
D3 D4 T3 GTDi T4 GTDi	110 130 110 132	03/12→03/15 03/12→ 03/12→ 03/12→	← ← ← →	09/12→; passend für Felgengröße [Zoll]: 16  09/12→; passend für Felgengröße [Zoll]: 17  09/12→; passend für Felgengröße [Zoll]: 15  09/12→	   	   	Ø 300 25 23 V  Ø 320 25 23 V Ø 320 25 23 V  Ø 278 25 23 V  Ø 280 11 9 + S
T2 GTDi T4 AWD T4 AWD T5 T5 AWD	88 132 140 187 187	03/13→12/15 07/13→ 05/14→ 12/12→ 01/13→	← →	passend für Felgengröße [Zoll]: 17   	   	   	Ø 320 25 23 V Ø 320 25 23 V  Ø 280 11 9 + S
T4 T4	147 132	04/14→ 07/13→	← ← →	passend für Felgengröße [Zoll]: 16  passend für Felgengröße [Zoll]: 17  	   	   	Ø 300 25 23 V  Ø 320 25 23 V Ø 320 25 23 V  Ø 280 11 9 + S
T5	183	01/14→	← ← ← →	05/14→; passend für Felgengröße [Zoll]: 16  05/14→; passend für Felgengröße [Zoll]: 17  05/14→; passend für Felgengröße [Zoll]: 15  05/14→	   	   	Ø 300 25 23 V  Ø 320 25 23 V Ø 320 25 23 V  Ø 278 25 23 V  Ø 280 11 9 + S









	kw			 	! #		
<b>VOLVO - V50 (545) 12/03→12/12</b>							
 <b>Bremsbelagsatz, Scheibenbremse</b>							
1.6	74	01/05→12/12	←	→ 05/12; nicht für Felgengröße [Zoll]: 17		<b>13.0460-7193.2</b> <b>607193</b>	ATE 23723 18,1 - WE / - WK
1.6 D	80	03/05→				<b>13.0470-7193.2</b> <b>LD7193</b>	ATE 23723 18,1 - WE / - WK
1.6 D2	84	01/10→12/12					Ceramic
2.0	107	10/06→12/12	←	→ 05/12;		<b>13.0460-7204.2</b> <b>607204</b>	ATE 23801 18,8 - WE / - WK
2.0 FlexFuel	107	01/10→12/12		passend für Felgengröße [Zoll]: 17		<b>13.0470-7204.2</b> <b>LD7204</b>	ATE 23801 18,8 - WE / - WK
D3	110	10/10→12/12					Ceramic
D4	130	10/10→12/12					
T5	169	03/07→12/12	→	→ 05/12		<b>13.0460-7195.2</b> <b>607195</b>	ATE 23482 16,6 - WE / - WK
						<b>13.0470-7195.2</b> <b>LD7195</b>	ATE 23482 16,6 - WE / - WK
							Ceramic
1.6 D	81	01/05→12/11	←	nicht für Felgengröße [Zoll]: 17		<b>13.0460-7193.2</b> <b>607193</b>	ATE 23723 18,1 - WE / - WK
1.8	92	04/04→12/10				<b>13.0470-7193.2</b> <b>LD7193</b>	ATE 23723 18,1 - WE / - WK
2.0 D	100	04/04→12/10					Ceramic
2.4	103	04/04→12/10	←	passend für Felgengröße [Zoll]: 17		<b>13.0460-7204.2</b> <b>607204</b>	ATE 23801 18,8 - WE / - WK
2.4 AWD	125	04/04→12/10				<b>13.0470-7204.2</b> <b>LD7204</b>	ATE 23801 18,8 - WE / - WK
2.4 D5	125	08/06→12/09					Ceramic
2.4 D5	132	03/06→12/10					
2.4 Tdi	120	05/07→12/10	→			<b>13.0460-7195.2</b> <b>607195</b>	ATE 23482 16,6 - WE / - WK
T5	162	04/04→12/07				<b>13.0470-7195.2</b> <b>LD7195</b>	ATE 23482 16,6 - WE / - WK
T5 AWD	162	04/04→12/07					Ceramic
T5 AWD	169	03/07→12/10					
1.8 FlexFuel	92	01/05→12/10	←	04/07→; nicht für Felgengröße [Zoll]: 17		<b>13.0460-7193.2</b> <b>607193</b>	ATE 23723 18,1 - WE / - WK
						<b>13.0470-7193.2</b> <b>LD7193</b>	ATE 23723 18,1 - WE / - WK
			←	04/07→;		<b>13.0460-7204.2</b> <b>607204</b>	ATE 23801 18,8 - WE / - WK
				passend für Felgengröße [Zoll]: 17		<b>13.0470-7204.2</b> <b>LD7204</b>	ATE 23801 18,8 - WE / - WK
							Ceramic
			→	04/07→		<b>13.0460-7195.2</b> <b>607195</b>	ATE 23482 16,6 - WE / - WK
						<b>13.0470-7195.2</b> <b>LD7195</b>	ATE 23482 16,6 - WE / - WK
							Ceramic
 <b>Bremsscheibe</b>							
1.6	74	01/05→12/12	←	→ 05/12;		<b>24.0125-0117.1</b> <b>425117</b>	Ø 278 25 23 V
1.6 D	80	03/05→		passend für Felgengröße [Zoll]: 15		<b>24.0325-0117.1</b> <b>525117</b>	Ø 278 25 23 V
1.6 D2	84	01/10→12/12	←	→ 05/12;		<b>24.0125-0162.1</b> <b>425162</b>	Ø 300 25 23 V
2.0	107	10/06→12/12		passend für Felgengröße [Zoll]: 16		<b>24.0325-0162.1</b> <b>525162</b>	Ø 300 25 23 V
2.0 FlexFuel	107	01/10→12/12	←	→ 05/12;		<b>24.0125-0197.1</b> <b>425197</b>	Ø 320 25 23 V
D3	110	10/10→12/12		passend für Felgengröße [Zoll]: 17		<b>24.0325-0197.1</b> <b>525197</b>	Ø 320 25 23 V
D4	130	10/10→12/12					
T5	169	03/07→12/12	→	→ 05/12		<b>24.0111-0158.1</b> <b>411158</b>	Ø 280 11 9 + S
						<b>24.0311-0158.1</b> <b>511158</b>	Ø 280 11 9 + S
1.6 D	81	01/05→12/11	←	passend für Felgengröße [Zoll]: 15		<b>24.0125-0117.1</b> <b>425117</b>	Ø 278 25 23 V
1.8	92	04/04→12/10				<b>24.0325-0117.1</b> <b>525117</b>	Ø 278 25 23 V
2.0 D	100	04/04→12/10	←	passend für Felgengröße [Zoll]: 16		<b>24.0125-0162.1</b> <b>425162</b>	Ø 300 25 23 V
2.4	103	04/04→12/10				<b>24.0325-0162.1</b> <b>525162</b>	Ø 300 25 23 V
2.4 AWD	125	04/04→12/10	←	passend für Felgengröße [Zoll]: 17		<b>24.0125-0197.1</b> <b>425197</b>	Ø 320 25 23 V
2.4 D5	125	08/06→12/09				<b>24.0325-0197.1</b> <b>525197</b>	Ø 320 25 23 V
2.4 D5	132	03/06→12/10					
2.4 Tdi	120	05/07→12/10	→			<b>24.0111-0158.1</b> <b>411158</b>	Ø 280 11 9 + S
T5	162	04/04→12/07				<b>24.0311-0158.1</b> <b>511158</b>	Ø 280 11 9 + S
T5 AWD	162	04/04→12/07					
T5 AWD	169	03/07→12/10					
1.8 FlexFuel	92	01/05→12/10	←	04/07→;		<b>24.0125-0117.1</b> <b>425117</b>	Ø 278 25 23 V
				passend für Felgengröße [Zoll]: 15		<b>24.0325-0117.1</b> <b>525117</b>	Ø 278 25 23 V
			←	04/07→;		<b>24.0125-0162.1</b> <b>425162</b>	Ø 300 25 23 V
				passend für Felgengröße [Zoll]: 16		<b>24.0325-0162.1</b> <b>525162</b>	Ø 300 25 23 V
			←	04/07→;		<b>24.0125-0197.1</b> <b>425197</b>	Ø 320 25 23 V
				passend für Felgengröße [Zoll]: 17		<b>24.0325-0197.1</b> <b>525197</b>	Ø 320 25 23 V
			→	04/07→		<b>24.0111-0158.1</b> <b>411158</b>	Ø 280 11 9 + S
						<b>24.0311-0158.1</b> <b>511158</b>	Ø 280 11 9 + S
<b>VOLVO - V60 (155, 157) 07/10→</b>							
 <b>Bremsbelagsatz, Scheibenbremse</b>							
1.5 T2	90	10/15→	←	01/16→;		<b>13.0460-7228.2</b> <b>607228</b>	ATE 24123 20,3 - WE / - WK
				für Bremsscheibendurchmesser [mm]: 300		<b>13.0470-7228.2</b> <b>LD7228</b>	ATE 24123 20,3 - WE / - WK
			←	01/16→;		<b>13.0460-7243.2</b> <b>607243</b>	ATE 24142 20,6 - WE / - WK
				für Bremsscheibendurchmesser [mm]: 316 / 336		<b>13.0470-7243.2</b> <b>LD7243</b>	ATE 24142 20,6 - WE / - WK
							Ceramic
			→	01/16→; - CDN / - USA		<b>13.0460-2722.2</b> <b>602722</b>	TRW 24496 17,3 - WE / - WK
							+ Zub
↓							











	kw			 	! #		
<b>VOLVO - V60 (155, 157) 07/10→</b>							
<b> Bremsbelagsatz, Scheibenbremse</b>							
1.5 T2	90	10/15→	➡	01/16→; - CDN / - USA		<b>13.0470-2722.2</b> <b>LD2722</b>	TRW 24496 17,3 - WE / - WK + Zub Ceramic
			➡	01/16→; V		<b>13.0460-2736.2</b> <b>602736</b>	TRW 24496 17,3 - WE / - WK + Zub
1.6 DRIVe 2.4 D5 2.4 D5 AWD	84 158 158	02/11→12/15 04/11→12/15 04/11→12/15	⬅	06/11→; für Bremsscheibendurchmesser [mm]: 300		<b>13.0460-7228.2</b> <b>607228</b>	ATE 24123 20,3 - WE / - WK
			⬅	06/11→; für Bremsscheibendurchmesser [mm]: 316 / 336		<b>13.0470-7228.2</b> <b>LD7228</b>	ATE 24123 20,3 - WE / - WK Ceramic
			➡	06/11→; - CDN / - USA		<b>13.0460-7243.2</b> <b>607243</b>	ATE 24142 20,6 - WE / - WK
			➡	06/11→; V		<b>13.0470-7243.2</b> <b>LD7243</b>	ATE 24142 20,6 - WE / - WK Ceramic
2.0 D2 2.0 D3 2.0 D4 2.4 D5 Hybrid AWD D4 D4 AWD D4 AWD D5 D5 D5 AWD D6 Hybrid AWD T3 T4F T5 T5	88 110 140 120 133 140 165 169 169 162 112 132 176 180	03/15→ 03/15→ 03/15→ 03/15→ 10/13→12/15 10/13→12/15 03/15→ 03/15→ 04/14→12/15 04/14→12/15 03/15→ 03/15→ 04/11→12/15 08/12→ 10/13→	⬅	für Bremsscheibendurchmesser [mm]: 300		<b>13.0460-7228.2</b> <b>607228</b>	ATE 24123 20,3 - WE / - WK
			⬅	für Bremsscheibendurchmesser [mm]: 316 / 336		<b>13.0470-7228.2</b> <b>LD7228</b>	ATE 24123 20,3 - WE / - WK Ceramic
			➡	- CDN / - USA		<b>13.0460-7243.2</b> <b>607243</b>	ATE 24142 20,6 - WE / - WK
			➡	V		<b>13.0470-7243.2</b> <b>LD7243</b>	ATE 24142 20,6 - WE / - WK Ceramic
2.0 T D3 / D4 D5 D5 AWD T3 T4 T5	149 120 151 151 110 132 177	07/10→12/12 07/10→12/14 07/10→12/11 07/10→12/11 09/10→12/15 09/10→12/15 09/10→12/14	⬅	11/10→; für Bremsscheibendurchmesser [mm]: 300		<b>13.0460-7228.2</b> <b>607228</b>	ATE 24123 20,3 - WE / - WK
			⬅	11/10→; für Bremsscheibendurchmesser [mm]: 316 / 336		<b>13.0470-7228.2</b> <b>LD7228</b>	ATE 24123 20,3 - WE / - WK Ceramic
			➡	11/10→; - CDN / - USA		<b>13.0460-7243.2</b> <b>607243</b>	ATE 24142 20,6 - WE / - WK
			➡	11/10→; V		<b>13.0470-7243.2</b> <b>LD7243</b>	ATE 24142 20,6 - WE / - WK Ceramic
2.0 T4	140	03/15→	⬅	05/15→; für Bremsscheibendurchmesser [mm]: 300		<b>13.0460-7228.2</b> <b>607228</b>	ATE 24123 20,3 - WE / - WK
			⬅	05/15→; für Bremsscheibendurchmesser [mm]: 316 / 336		<b>13.0470-7228.2</b> <b>LD7228</b>	ATE 24123 20,3 - WE / - WK Ceramic
			➡	05/15→; - CDN / - USA		<b>13.0460-7243.2</b> <b>607243</b>	ATE 24142 20,6 - WE / - WK
			➡	05/15→; V		<b>13.0470-7243.2</b> <b>LD7243</b>	ATE 24142 20,6 - WE / - WK Ceramic
2.4 Hybrid D6 AWD	158	06/12→12/15	⬅	11/12→; für Bremsscheibendurchmesser [mm]: 300		<b>13.0460-7228.2</b> <b>607228</b>	ATE 24123 20,3 - WE / - WK
			⬅	11/12→; für Bremsscheibendurchmesser [mm]: 316 / 336		<b>13.0470-7228.2</b> <b>LD7228</b>	ATE 24123 20,3 - WE / - WK Ceramic
↓							



















	kw			 	! #		
<b>VOLVO - V60 (155, 157) 07/10→</b>							
<b> Bremsbelagsatz, Scheibenbremse</b>							
2.4 Hybrid D6 AWD	158	06/12→12/15	➡	11/12→; - CDN / - USA	13.0460-2722.2	602722	TRW 24496 17,3 - WE / - WK + Zub
			➡	11/12→; V	13.0470-2722.2	LD2722	TRW 24496 17,3 - WE / - WK + Zub Ceramic
			➡	11/12→; - CDN / - USA	13.0460-2736.2	602736	TRW 24496 17,3 - WE / - WK + Zub
			➡	11/12→; V	13.0470-2736.2	LD2736	TRW 24496 17,3 - WE / - WK + Zub Ceramic
3.0 T AWD	258	04/14→	➡	05/14→; - CDN / - USA	13.0460-2722.2	602722	TRW 24496 17,3 - WE / - WK + Zub
			➡	05/14→; V	13.0470-2722.2	LD2722	TRW 24496 17,3 - WE / - WK + Zub Ceramic
			➡	05/14→; - CDN / - USA	13.0460-2736.2	602736	TRW 24496 17,3 - WE / - WK + Zub
			➡	05/14→; V	13.0470-2736.2	LD2736	TRW 24496 17,3 - WE / - WK + Zub Ceramic
D3	100	05/12→12/15	←	10/12→; für Bremsscheibendurchmesser [mm]: 300	13.0460-7228.2	607228	ATE 24123 20,3 - WE / - WK Ceramic
			←	11/12→; für Bremsscheibendurchmesser [mm]: 316 / 336	13.0470-7228.2	LD7228	ATE 24123 20,3 - WE / - WK Ceramic
			➡	10/12→; - CDN / - USA	13.0460-7243.2	607243	ATE 24142 20,6 - WE / - WK Ceramic
			➡	10/12→; V	13.0470-7243.2	LD7243	ATE 24142 20,6 - WE / - WK Ceramic
D4 AWD	120	05/12→	➡	10/12→; - CDN / - USA	13.0460-2722.2	602722	TRW 24496 17,3 - WE / - WK + Zub
			➡	10/12→; V	13.0470-2722.2	LD2722	TRW 24496 17,3 - WE / - WK + Zub Ceramic
			➡	10/12→; V	13.0460-2736.2	602736	TRW 24496 17,3 - WE / - WK + Zub
			➡	10/12→; V	13.0470-2736.2	LD2736	TRW 24496 17,3 - WE / - WK + Zub Ceramic
D4 AWD	120	05/12→	←	12/12→; für Bremsscheibendurchmesser [mm]: 300	13.0460-7228.2	607228	ATE 24123 20,3 - WE / - WK Ceramic
			←	12/12→; für Bremsscheibendurchmesser [mm]: 316 / 336	13.0470-7228.2	LD7228	ATE 24123 20,3 - WE / - WK Ceramic
			➡	12/12→; - CDN / - USA	13.0460-7243.2	607243	ATE 24142 20,6 - WE / - WK Ceramic
			➡	12/12→; V	13.0470-7243.2	LD7243	ATE 24142 20,6 - WE / - WK Ceramic
T5	157	10/13→	➡	12/12→; V	13.0460-2736.2	602736	TRW 24496 17,3 - WE / - WK + Zub
			➡	12/12→; V	13.0470-2736.2	LD2736	TRW 24496 17,3 - WE / - WK + Zub Ceramic
			←	04/14→; für Bremsscheibendurchmesser [mm]: 300	13.0460-2722.2	602722	TRW 24496 17,3 - WE / - WK + Zub
			←	04/14→; für Bremsscheibendurchmesser [mm]: 316 / 336	13.0470-2722.2	LD2722	TRW 24496 17,3 - WE / - WK + Zub Ceramic
T5	157	10/13→	➡	04/14→; - CDN / - USA	13.0460-2722.2	602722	TRW 24496 17,3 - WE / - WK + Zub
			➡	04/14→; V	13.0470-2722.2	LD2722	TRW 24496 17,3 - WE / - WK + Zub Ceramic
			➡	04/14→; - CDN / - USA	13.0460-2736.2	602736	TRW 24496 17,3 - WE / - WK + Zub
			➡	04/14→; V	13.0470-2736.2	LD2736	TRW 24496 17,3 - WE / - WK + Zub Ceramic
T6 T6 AWD T6 AWD	225 225 242	10/13→ 10/13→ 04/14→12/15	←	für Bremsscheibendurchmesser [mm]: 300	13.0460-7228.2	607228	ATE 24123 20,3 - WE / - WK
			←	für Bremsscheibendurchmesser [mm]: 316 / 336	13.0470-7228.2	LD7228	ATE 24123 20,3 - WE / - WK Ceramic
			➡	- CDN / - USA	13.0460-7243.2	607243	ATE 24142 20,6 - WE / - WK Ceramic
			➡	V	13.0470-7243.2	LD7243	ATE 24142 20,6 - WE / - WK Ceramic
			➡	- CDN / - USA	13.0460-2722.2	602722	TRW 24496 17,3 - WE / - WK + Zub
			➡	V	13.0470-2722.2	LD2722	TRW 24496 17,3 - WE / - WK + Zub Ceramic
			➡	V	13.0460-2736.2	602736	TRW 24496 17,3 - WE / - WK + Zub
			➡	V	13.0470-2736.2	LD2736	TRW 24496 17,3 - WE / - WK + Zub Ceramic
↓							

	kW			 	! #		
<b>VOLVO - V60 (155, 157) 07/10→</b>							
<b> Bremsbelagsatz, Scheibenbremse</b>							
T6 AWD	224	07/10→12/15	←	11/10→; für Bremsscheibendurchmesser [mm]: 300	13.0460-7228.2	607228	ATE 24123 20,3 - WE / - WK
			←	11/10→; für Bremsscheibendurchmesser [mm]: 316 / 336	13.0460-7243.2	607243	ATE 24142 20,6 - WE / - WK
			→	11/10→; - CDN / - USA	13.0460-2722.2	602722	TRW 24496 17,3 - WE / - WK + Zub
			→	11/10→; V	13.0460-2736.2	602736	TRW 24496 17,3 - WE / - WK + Zub
					13.0470-2722.2	LD2722	TRW 24496 17,3 - WE / - WK + Zub Ceramic
					13.0470-2736.2	LD2736	TRW 24496 17,3 - WE / - WK + Zub Ceramic
<b> Bremsscheibe</b>							
1.5 T2	90	10/15→	←	01/16→	24.0128-0154.1	428154	Ø 300 28 26 V + S
			→	01/16→	24.0122-0259.1	422259	Ø 302 22 20 V + S
1.6 DRIVe 2.4 D5 2.4 D5 AWD	84 158 158	02/11→12/15 04/11→12/15 04/11→12/15	←	06/11→	24.0128-0154.1	428154	Ø 300 28 26 V + S
			→	06/11→	24.0111-0147.1	411147	Ø 302 11 9 + S
					24.0128-0162.1	428162	Ø 316 28 26 V + S
					24.0128-0210.1	428210	Ø 336 28 26 V + S
					24.0328-0154.1	528154	Ø 300 28 26 V + S
					24.0328-0162.1	528162	Ø 316 28 26 V + S
2.0 D2 2.0 D3 2.0 D4 2.4 D5 Hybrid AWD D4 D4 AWD D4 AWD D5 D5 D5 AWD D6 Hybrid AWD T3 T4F T5 T5 T6 T6 AWD T6 AWD	88 110 140 120 133 133 140 165 169 169 162 112 132 176 180 225 225 242	03/15→ 03/15→ 03/15→ 03/15→ 10/13→12/15 10/13→12/15 03/15→ 03/15→ 04/14→12/15 04/14→12/15 03/15→ 03/15→ 04/11→12/15 08/12→ 10/13→ 10/13→ 10/13→ 04/14→12/15	←		24.0128-0154.1	428154	Ø 300 28 26 V + S
			←		24.0128-0162.1	428162	Ø 316 28 26 V + S
			←		24.0128-0210.1	428210	Ø 336 28 26 V + S
			←		24.0328-0154.1	528154	Ø 300 28 26 V + S
			←		24.0328-0162.1	528162	Ø 316 28 26 V + S
			→		24.0111-0147.1	411147	Ø 302 11 9 + S
			→		24.0122-0259.1	422259	Ø 302 22 20 V + S
			→				
			→				
			→				
			→				
			→				
			→				
			→				
2.0 T D3 / D4 D5 D5 AWD T3 T4 T5 T6 AWD	149 120 151 151 110 132 177 224	07/10→12/12 07/10→12/14 07/10→12/11 07/10→12/11 09/10→12/15 09/10→12/15 09/10→12/14 07/10→12/15	←	11/10→	24.0128-0154.1	428154	Ø 300 28 26 V + S
			→	11/10→	24.0111-0147.1	411147	Ø 302 11 9 + S
					24.0128-0162.1	428162	Ø 316 28 26 V + S
					24.0128-0210.1	428210	Ø 336 28 26 V + S
					24.0328-0154.1	528154	Ø 300 28 26 V + S
					24.0328-0162.1	528162	Ø 316 28 26 V + S
2.0 T4	140	03/15→	←	05/15→	24.0128-0154.1	428154	Ø 300 28 26 V + S
			→	05/15→	24.0111-0147.1	411147	Ø 302 11 9 + S
					24.0128-0162.1	428162	Ø 316 28 26 V + S
					24.0128-0210.1	428210	Ø 336 28 26 V + S
					24.0328-0154.1	528154	Ø 300 28 26 V + S
					24.0328-0162.1	528162	Ø 316 28 26 V + S
2.4 Hybrid D6 AWD	158	06/12→12/15	←	11/12→	24.0128-0154.1	428154	Ø 300 28 26 V + S
			→	11/12→	24.0111-0147.1	411147	Ø 302 11 9 + S
					24.0128-0162.1	428162	Ø 316 28 26 V + S
					24.0128-0210.1	428210	Ø 336 28 26 V + S
					24.0328-0154.1	528154	Ø 300 28 26 V + S
					24.0328-0162.1	528162	Ø 316 28 26 V + S
↓					24.0122-0259.1	422259	Ø 302 22 20 V + S

	kw			 	! #		
<b>VOLVO - V60 (155, 157) 07/10→</b>							
<b> Bremsscheibe</b>							
3.0 T AWD	258	04/14→	➔	05/14→		24.0111-0147.1 411147 24.0122-0259.1 422259	Ø 302 11 9 + S Ø 302 22 20 V + S
D3	100	05/12→12/15	➔	10/12→		24.0128-0154.1 428154 24.0128-0162.1 428162 24.0128-0210.1 428210 24.0328-0154.1 528154 24.0328-0162.1 528162	Ø 300 28 26 V + S Ø 316 28 26 V + S Ø 336 28 26 V + S Ø 300 28 26 V + S Ø 316 28 26 V + S
				10/12→		24.0111-0147.1 411147 24.0122-0259.1 422259	Ø 302 11 9 + S Ø 302 22 20 V + S
D4 AWD	120	05/12→	➔	12/12→		24.0128-0154.1 428154 24.0128-0162.1 428162 24.0128-0210.1 428210 24.0328-0154.1 528154 24.0328-0162.1 528162	Ø 300 28 26 V + S Ø 316 28 26 V + S Ø 336 28 26 V + S Ø 300 28 26 V + S Ø 316 28 26 V + S
				12/12→		24.0111-0147.1 411147 24.0122-0259.1 422259	Ø 302 11 9 + S Ø 302 22 20 V + S
T5	157	10/13→	➔	04/14→		24.0128-0154.1 428154 24.0128-0162.1 428162 24.0128-0210.1 428210 24.0328-0154.1 528154 24.0328-0162.1 528162	Ø 300 28 26 V + S Ø 316 28 26 V + S Ø 336 28 26 V + S Ø 300 28 26 V + S Ø 316 28 26 V + S
				04/14→		24.0111-0147.1 411147 24.0122-0259.1 422259	Ø 302 11 9 + S Ø 302 22 20 V + S
<b>VOLVO - V70 I (875, 876) 12/95→12/00</b>							
<b> Bremsbelagsatz, Scheibenbremse</b>							
2.0 2.0 2.0 Turbo 2.0 Turbo 2.4 2.5 TDi AWD	93 105 132 155 106 103	12/95→03/00 12/95→03/00 11/96→03/00 12/95→03/00 12/95→03/00 11/96→02/00	➔	01/97→		13.0460-7053.2 607053 13.0470-7053.2 LD7053	ATE 21273 19,5 + WE / - WK ATE 21273 19,5 + WE / - WK Ceramic
				01/97→ 12/99		13.0460-4044.2 604044 13.0470-4044.2 LD4044	ATE 20755 15,1 - WE / - WK ATE 20755 15,1 - WE / - WK Ceramic
				01/00→		13.0460-7135.2 607135 13.0470-7135.2 LD7135	ATE 23076 17,5 - WE / - WK ATE 23076 17,5 - WE / - WK Ceramic
2.0 2.4 Bifuel	120 103	01/97→12/00 08/99→12/00	➔	→ 03/00		13.0460-7053.2 607053 13.0470-7053.2 LD7053	ATE 21273 19,5 + WE / - WK ATE 21273 19,5 + WE / - WK Ceramic
				→ 12/99		13.0460-4044.2 604044 13.0470-4044.2 LD4044	ATE 20755 15,1 - WE / - WK ATE 20755 15,1 - WE / - WK Ceramic
				01/00→ 03/00		13.0460-7135.2 607135 13.0470-7135.2 LD7135	ATE 23076 17,5 - WE / - WK ATE 23076 17,5 - WE / - WK Ceramic
2.0 Turbo 2.3 2.3 T-5	166 177 176	11/96→12/00 11/96→11/00 11/96→12/00	➔	01/97→ 03/00		13.0460-7053.2 607053	ATE 21273 19,5 + WE / - WK
				01/97→ 12/99		13.0460-4044.2 604044 13.0470-4044.2 LD4044	ATE 20755 15,1 - WE / - WK ATE 20755 15,1 - WE / - WK Ceramic
				01/00→ 03/00		13.0460-7135.2 607135 13.0470-7135.2 LD7135	ATE 23076 17,5 - WE / - WK ATE 23076 17,5 - WE / - WK Ceramic
2.0 Turbo AWD	166	11/96→12/00	➔	01/97→ 03/00		13.0460-7053.2 607053	ATE 21273 19,5 + WE / - WK
				01/97→ 12/99		13.0460-2935.2 602935	TRW 21385 13,8 - WK
				01/00→ 03/00		13.0460-7135.2 607135 13.0470-7135.2 LD7135	ATE 23076 17,5 - WE / - WK ATE 23076 17,5 - WE / - WK Ceramic
2.3 AWD 2.4	177 121	04/97→09/98 06/98→12/99	➔	→ 03/00		13.0460-7053.2 607053 13.0470-7053.2 LD7053	ATE 21273 19,5 + WE / - WK ATE 21273 19,5 + WE / - WK Ceramic
						13.0460-4044.2 604044 13.0470-4044.2 LD4044	ATE 20755 15,1 - WE / - WK ATE 20755 15,1 - WE / - WK Ceramic
2.3 T-5 AWD ↓	176	01/97→12/00	➔	→ 03/00		13.0460-7053.2 607053	ATE 21273 19,5 + WE / - WK



















	kw			 	! #			
<b>VOLVO - V70 I (875, 876) 12/95→12/00</b>								
<b> Bremsbelagsatz, Scheibenbremse</b>								
2.3 T-5 AWD	176	01/97→12/00	←	→ 03/00		<b>13.0470-7053.2</b>	<b>LD7053</b>	ATE 21273 19,5 + WE / - WK Ceramic
			→	→ 12/99		<b>13.0460-2935.2</b>	<b>602935</b>	TRW 21385 13,8 - WK
			→	01/00→ 03/00		<b>13.0460-7135.2</b>	<b>607135</b>	ATE 23076 17,5 - WE / - WK
2.3 T AWD	184	04/97→03/00	←			<b>13.0460-7053.2</b>	<b>607053</b>	ATE 21273 19,5 + WE / - WK
			→	→ 12/99		<b>13.0460-2935.2</b>	<b>602935</b>	TRW 21385 13,8 - WK
			→	01/00→		<b>13.0460-7135.2</b>	<b>607135</b>	ATE 23076 17,5 - WE / - WK
2.3 Turbo	184	12/95→03/00	←	01/97→		<b>13.0460-7053.2</b>	<b>607053</b>	ATE 21273 19,5 + WE / - WK
			→	01/97→ 12/99		<b>13.0460-4044.2</b>	<b>604044</b>	ATE 20755 15,1 - WE / - WK
			→	01/00→		<b>13.0460-7135.2</b>	<b>607135</b>	ATE 23076 17,5 - WE / - WK
2.4	103	03/99→12/00	←	08/99→ 03/00		<b>13.0460-7053.2</b>	<b>607053</b>	ATE 21273 19,5 + WE / - WK
			→	08/99→ 12/99		<b>13.0460-4044.2</b>	<b>604044</b>	ATE 20755 15,1 - WE / - WK
			→	01/00→ 03/00		<b>13.0460-7135.2</b>	<b>607135</b>	ATE 23076 17,5 - WE / - WK
2.4 2.4 Turbo 2.5 TDI	125 142 103	12/95→05/00 04/96→12/00 12/95→12/00	←	01/97→ 03/00		<b>13.0460-7053.2</b>	<b>607053</b>	ATE 21273 19,5 + WE / - WK
			→	01/97→ 12/99		<b>13.0460-4044.2</b>	<b>604044</b>	ATE 20755 15,1 - WE / - WK
			→	01/00→ 03/00		<b>13.0460-7135.2</b>	<b>607135</b>	ATE 23076 17,5 - WE / - WK
2.4 AWD	121	06/98→12/99	←	10/98→ 05/99		<b>13.0460-7053.2</b>	<b>607053</b>	ATE 21273 19,5 + WE / - WK
			→	10/98→ 05/99		<b>13.0460-4044.2</b>	<b>604044</b>	ATE 20755 15,1 - WE / - WK
2.4 Bifuel	106	05/98→12/99	←	10/98→ 08/99		<b>13.0460-7053.2</b>	<b>607053</b>	ATE 21273 19,5 + WE / - WK
			→	10/98→ 08/99		<b>13.0460-4044.2</b>	<b>604044</b>	ATE 20755 15,1 - WE / - WK
2.4 Turbo AWD	142	04/96→12/00	←	01/97→ 03/00		<b>13.0460-7053.2</b>	<b>607053</b>	ATE 21273 19,5 + WE / - WK
			→	01/97→ 12/99		<b>13.0460-2935.2</b>	<b>602935</b>	TRW 21385 13,8 - WK
			→	01/00→ 03/00		<b>13.0460-7135.2</b>	<b>607135</b>	ATE 23076 17,5 - WE / - WK
2.4 Turbo AWD	195	03/99→12/00	←	→ 03/00		<b>13.0460-7053.2</b>	<b>607053</b>	ATE 21273 19,5 + WE / - WK
			→	→ 12/99		<b>13.0460-2935.2</b>	<b>602935</b>	TRW 21385 13,8 - WK
			→	01/00→ 03/00		<b>13.0460-7135.2</b>	<b>607135</b>	ATE 23076 17,5 - WE / - WK
<b> Bremsscheibe</b>								
2.0	93	12/95→03/00	←	01/97→;		<b>24.0126-0102.1</b>	<b>426102</b>	Ø 280,3 26 23 V
2.0	105	12/95→03/00	←	passend für Felgenreöße [Zoll]: 15				
2.0	132	11/96→03/00	←	01/97→;		<b>24.0126-0107.1</b>	<b>426107</b>	Ø 302 26 23 V
2.0 Turbo	155	12/95→03/00	←	passend für Felgenreöße [Zoll]: 16				
↓								







	kw			 	! #		
<b>VOLVO - V70 I (875, 876) 12/95→12/00</b>							
<b>Bremsscheibe</b>							
2.3 Turbo 2.4 2.5 TDi AWD	184 106 103	12/95→03/00 12/95→03/00 11/96→02/00	← ← →	01/97→; passend für Felgengröße [Zoll]: 16 01/97→		24.0326-0107.1 526107 24.0110-0214.1 410214	Ø 302 26 23 V Ø 295 9,6 8,4
2.0 2.4 Bifuel	120 103	01/97→12/00 08/99→12/00	← ← ← →	→ 03/00; passend für Felgengröße [Zoll]: 15 → 03/00; passend für Felgengröße [Zoll]: 16 → 03/00		24.0126-0102.1 426102 24.0126-0107.1 426107 24.0326-0107.1 526107 24.0110-0214.1 410214	Ø 280,3 26 23 V Ø 302 26 23 V Ø 302 26 23 V Ø 295 9,6 8,4
2.0 Turbo 2.3 2.3 T-5 2.4 2.4 Turbo 2.5 TDI	166 177 176 125 142 103	11/96→12/00 11/96→11/00 11/96→12/00 12/95→05/00 04/96→12/00 12/95→12/00	← ← ← ← →	01/97→ 03/00; passend für Felgengröße [Zoll]: 15 01/97→ 03/00; passend für Felgengröße [Zoll]: 16 01/97→ 03/00		24.0126-0102.1 426102 24.0126-0107.1 426107 24.0326-0107.1 526107 24.0110-0214.1 410214	Ø 280,3 26 23 V Ø 302 26 23 V Ø 302 26 23 V Ø 295 9,6 8,4
2.0 Turbo AWD 2.4 Turbo AWD	166 142	11/96→12/00 04/96→12/00	← ← ← → → →	01/97→ 03/00; passend für Felgengröße [Zoll]: 15 01/97→ 03/00; passend für Felgengröße [Zoll]: 16 01/97→ 03/00 01/97→; → 587043 → 03/00; 587044→		24.0126-0102.1 426102 24.0126-0107.1 426107 24.0326-0107.1 526107 24.0110-0214.1 410214 24.0110-0292.1 410292 24.0112-0165.1 412165	Ø 280,3 26 23 V Ø 302 26 23 V Ø 302 26 23 V Ø 295 9,6 8,4 Ø 283 10 8 Ø 288 12 10
2.3 AWD 2.4	177 121	04/97→09/98 06/98→12/99	← ← →	passend für Felgengröße [Zoll]: 15 passend für Felgengröße [Zoll]: 16		24.0126-0102.1 426102 24.0126-0107.1 426107 24.0326-0107.1 526107 24.0110-0214.1 410214	Ø 280,3 26 23 V Ø 302 26 23 V Ø 302 26 23 V Ø 295 9,6 8,4
2.3 T-5 AWD	176	01/97→12/00	← ← ← → → →	→ 03/00; passend für Felgengröße [Zoll]: 15 → 03/00; passend für Felgengröße [Zoll]: 16 → 03/00 → 587043 → 03/00; 587044→		24.0126-0102.1 426102 24.0126-0107.1 426107 24.0326-0107.1 526107 24.0110-0214.1 410214 24.0110-0292.1 410292 24.0112-0165.1 412165	Ø 280,3 26 23 V Ø 302 26 23 V Ø 302 26 23 V Ø 295 9,6 8,4 Ø 283 10 8 Ø 288 12 10
2.3 T AWD	184	04/97→03/00	← ← → → →	passend für Felgengröße [Zoll]: 15 passend für Felgengröße [Zoll]: 16 → 587043 587044→		24.0126-0102.1 426102 24.0126-0107.1 426107 24.0326-0107.1 526107 24.0110-0214.1 410214 24.0110-0292.1 410292 24.0112-0165.1 412165	Ø 280,3 26 23 V Ø 302 26 23 V Ø 302 26 23 V Ø 295 9,6 8,4 Ø 283 10 8 Ø 288 12 10
2.4	103	03/99→12/00	← ← →	08/99→ 03/00; passend für Felgengröße [Zoll]: 15 08/99→ 03/00; passend für Felgengröße [Zoll]: 16 08/99→ 03/00		24.0126-0102.1 426102 24.0126-0107.1 426107 24.0326-0107.1 526107 24.0110-0214.1 410214	Ø 280,3 26 23 V Ø 302 26 23 V Ø 302 26 23 V Ø 295 9,6 8,4
2.4 AWD	121	06/98→12/99	← ← →	10/98→ 05/99; passend für Felgengröße [Zoll]: 15 10/98→ 05/99; passend für Felgengröße [Zoll]: 16 10/98→ 05/99		24.0126-0102.1 426102 24.0126-0107.1 426107 24.0326-0107.1 526107 24.0110-0214.1 410214	Ø 280,3 26 23 V Ø 302 26 23 V Ø 302 26 23 V Ø 295 9,6 8,4
2.4 Bifuel	106	05/98→12/99	← ← →	10/98→ 08/99; passend für Felgengröße [Zoll]: 15 10/98→ 08/99; passend für Felgengröße [Zoll]: 16 10/98→ 08/99		24.0126-0102.1 426102 24.0126-0107.1 426107 24.0326-0107.1 526107 24.0110-0214.1 410214	Ø 280,3 26 23 V Ø 302 26 23 V Ø 302 26 23 V Ø 295 9,6 8,4
2.4 Turbo AWD	195	03/99→12/00	← ← →	→ 03/00; passend für Felgengröße [Zoll]: 15 → 03/00; passend für Felgengröße [Zoll]: 16 → 03/00		24.0126-0102.1 426102 24.0126-0107.1 426107 24.0326-0107.1 526107 24.0110-0214.1 410214 24.0112-0165.1 412165	Ø 280,3 26 23 V Ø 302 26 23 V Ø 302 26 23 V Ø 295 9,6 8,4 Ø 288 12 10



















	kw			 	! #		
<b>VOLVO - V70 II (285) 11/99→12/08</b>							
<b> Bremsbelagsatz, Scheibenbremse</b>							
2.0 T	132	11/99→08/07	←	07/01→ 07/07; nicht für Felgengröße [Zoll]: 17	13.0460-7145.2	607145	ATE 23073 18,8 - WE / - WK
					13.0470-7145.2	LD7145	ATE 23073 18,8 - WE / - WK Ceramic
			←	07/01→ 07/07; passend für Felgengröße [Zoll]: 17	13.0460-7187.2	607187	ATE 23590 19,5 - WE / - WK
				13.0470-7187.2	LD7187	ATE 23590 19,5 - WE / - WK Ceramic	
			→	07/01→ 07/07	13.0460-7135.2	607135	ATE 23076 17,5 - WE / - WK
					13.0470-7135.2	LD7135	ATE 23076 17,5 - WE / - WK Ceramic
2.3 2.4 T AWD 2.5 AWD	195 147 155	10/00→09/04 09/01→08/02 09/02→12/04	←	nicht für Felgengröße [Zoll]: 17	13.0460-7145.2	607145	ATE 23073 18,8 - WE / - WK
					13.0470-7145.2	LD7145	ATE 23073 18,8 - WE / - WK Ceramic
			←	passend für Felgengröße [Zoll]: 17	13.0460-7187.2	607187	ATE 23590 19,5 - WE / - WK
					13.0470-7187.2	LD7187	ATE 23590 19,5 - WE / - WK Ceramic
			→		13.0460-7135.2	607135	ATE 23076 17,5 - WE / - WK
					13.0470-7135.2	LD7135	ATE 23076 17,5 - WE / - WK Ceramic
2.3 T5	184	11/99→12/04	←	03/00→; nicht für Felgengröße [Zoll]: 17	13.0460-7145.2	607145	ATE 23073 18,8 - WE / - WK
					13.0470-7145.2	LD7145	ATE 23073 18,8 - WE / - WK Ceramic
			←	03/00→; passend für Felgengröße [Zoll]: 17	13.0460-7187.2	607187	ATE 23590 19,5 - WE / - WK
					13.0470-7187.2	LD7187	ATE 23590 19,5 - WE / - WK Ceramic
			→	03/00→	13.0460-7135.2	607135	ATE 23076 17,5 - WE / - WK
					13.0470-7135.2	LD7135	ATE 23076 17,5 - WE / - WK Ceramic
2.4 2.4 2.4 Bifuel (CNG) 2.4 Bifuel (LPG)	103 125 103 103	03/00→08/07 03/00→08/07 09/01→08/07 09/01→08/07	←	→ 07/07; nicht für Felgengröße [Zoll]: 17	13.0460-7145.2	607145	ATE 23073 18,8 - WE / - WK
					13.0470-7145.2	LD7145	ATE 23073 18,8 - WE / - WK Ceramic
			←	→ 07/07; passend für Felgengröße [Zoll]: 17	13.0460-7187.2	607187	ATE 23590 19,5 - WE / - WK
					13.0470-7187.2	LD7187	ATE 23590 19,5 - WE / - WK Ceramic
			→	→ 07/07	13.0460-7135.2	607135	ATE 23076 17,5 - WE / - WK
					13.0470-7135.2	LD7135	ATE 23076 17,5 - WE / - WK Ceramic
2.4 D	93	04/05→12/08	←	05/05→ 07/07; nicht für Felgengröße [Zoll]: 17	13.0460-7145.2	607145	ATE 23073 18,8 - WE / - WK
					13.0470-7145.2	LD7145	ATE 23073 18,8 - WE / - WK Ceramic
			←	05/05→ 07/07; passend für Felgengröße [Zoll]: 17	13.0460-7187.2	607187	ATE 23590 19,5 - WE / - WK
					13.0470-7187.2	LD7187	ATE 23590 19,5 - WE / - WK Ceramic
			→	05/05→ 07/07	13.0460-7135.2	607135	ATE 23076 17,5 - WE / - WK
					13.0470-7135.2	LD7135	ATE 23076 17,5 - WE / - WK Ceramic
2.4 D	96	07/01→08/07	←	12/01→ 07/07; nicht für Felgengröße [Zoll]: 17	13.0460-7145.2	607145	ATE 23073 18,8 - WE / - WK
					13.0470-7145.2	LD7145	ATE 23073 18,8 - WE / - WK Ceramic
			←	12/01→ 07/07; passend für Felgengröße [Zoll]: 17	13.0460-7187.2	607187	ATE 23590 19,5 - WE / - WK
					13.0470-7187.2	LD7187	ATE 23590 19,5 - WE / - WK Ceramic
			→	12/01→ 07/07	13.0460-7135.2	607135	ATE 23076 17,5 - WE / - WK
					13.0470-7135.2	LD7135	ATE 23076 17,5 - WE / - WK Ceramic
2.4 D5	120	01/01→12/08	←	08/01→ 07/07; nicht für Felgengröße [Zoll]: 17	13.0460-7145.2	607145	ATE 23073 18,8 - WE / - WK
					13.0470-7145.2	LD7145	ATE 23073 18,8 - WE / - WK Ceramic
			←	08/01→ 07/07; passend für Felgengröße [Zoll]: 17	13.0460-7187.2	607187	ATE 23590 19,5 - WE / - WK
					13.0470-7187.2	LD7187	ATE 23590 19,5 - WE / - WK Ceramic
			→	08/01→ 07/07	13.0460-7135.2	607135	ATE 23076 17,5 - WE / - WK
					13.0470-7135.2	LD7135	ATE 23076 17,5 - WE / - WK Ceramic
2.4 D5 2.4 D5 AWD	136 136	04/05→12/08 05/05→08/07	←	12/05→ 07/07; nicht für Felgengröße [Zoll]: 17	13.0460-7145.2	607145	ATE 23073 18,8 - WE / - WK
					13.0470-7145.2	LD7145	ATE 23073 18,8 - WE / - WK Ceramic
			←	12/05→ 07/07; passend für Felgengröße [Zoll]: 17	13.0460-7187.2	607187	ATE 23590 19,5 - WE / - WK
					13.0470-7187.2	LD7187	ATE 23590 19,5 - WE / - WK Ceramic
↓							

	kw			 	! #		
<b>VOLVO - V70 II (285) 11/99→12/08</b>							
<b> Bremsbelagsatz, Scheibenbremse</b>							
2.4 D5 2.4 D5 AWD	136 136	04/05→12/08 05/05→08/07	➡	12/05→ 07/07		<b>13.0460-7135.2 607135</b> <b>13.0470-7135.2 LD7135</b>	ATE 23076 17,5 - WE / - WK ATE 23076 17,5 - WE / - WK Ceramic
2.4 D5 AWD	120	07/02→08/07	⬅	03/03→ 07/07; nicht für Felgenreöße [Zoll]: 17		<b>13.0460-7145.2 607145</b> <b>13.0470-7145.2 LD7145</b>	ATE 23073 18,8 - WE / - WK ATE 23073 18,8 - WE / - WK Ceramic
			⬅	03/03→ 07/07; passend für Felgenreöße [Zoll]: 17		<b>13.0460-7187.2 607187</b> <b>13.0470-7187.2 LD7187</b>	ATE 23590 19,5 - WE / - WK ATE 23590 19,5 - WE / - WK Ceramic
			➡	03/03→ 07/07		<b>13.0460-7135.2 607135</b> <b>13.0470-7135.2 LD7135</b>	ATE 23076 17,5 - WE / - WK ATE 23076 17,5 - WE / - WK Ceramic
2.4 T	147	11/99→08/03	⬅	03/00→; nicht für Felgenreöße [Zoll]: 17		<b>13.0460-7145.2 607145</b> <b>13.0470-7145.2 LD7145</b>	ATE 23073 18,8 - WE / - WK ATE 23073 18,8 - WE / - WK Ceramic
			⬅	03/00→; passend für Felgenreöße [Zoll]: 17		<b>13.0460-7187.2 607187</b> <b>13.0470-7187.2 LD7187</b>	ATE 23590 19,5 - WE / - WK ATE 23590 19,5 - WE / - WK Ceramic
			➡	03/00→		<b>13.0460-7135.2 607135</b> <b>13.0470-7135.2 LD7135</b>	ATE 23076 17,5 - WE / - WK ATE 23076 17,5 - WE / - WK Ceramic
2.4 T5	191	04/04→08/07	⬅	→ 07/07; nicht für Felgenreöße [Zoll]: 17		<b>13.0460-7145.2 607145</b>	ATE 23073 18,8 - WE / - WK
			⬅	→ 07/07; passend für Felgenreöße [Zoll]: 17		<b>13.0460-7187.2 607187</b> <b>13.0470-7187.2 LD7187</b>	ATE 23590 19,5 - WE / - WK ATE 23590 19,5 - WE / - WK Ceramic
			➡	→ 07/07		<b>13.0460-7135.2 607135</b> <b>13.0470-7135.2 LD7135</b>	ATE 23076 17,5 - WE / - WK ATE 23076 17,5 - WE / - WK Ceramic
2.5 R Sport	221	12/02→08/07	⬅			<b>13.0460-4804.2 604804</b>	BRE 23092 15,6 - WE / - WK
			➡			<b>13.0460-4964.2 604964</b>	BRE 21381 15,0 - WE / - WK
2.5 T	154	07/01→08/07	⬅	04/04→ 07/07; nicht für Felgenreöße [Zoll]: 17		<b>13.0460-7145.2 607145</b> <b>13.0470-7145.2 LD7145</b>	ATE 23073 18,8 - WE / - WK ATE 23073 18,8 - WE / - WK Ceramic
			⬅	04/04→ 07/07; passend für Felgenreöße [Zoll]: 17		<b>13.0460-7187.2 607187</b> <b>13.0470-7187.2 LD7187</b>	ATE 23590 19,5 - WE / - WK ATE 23590 19,5 - WE / - WK Ceramic
			➡	04/04→ 07/07		<b>13.0460-7135.2 607135</b> <b>13.0470-7135.2 LD7135</b>	ATE 23076 17,5 - WE / - WK ATE 23076 17,5 - WE / - WK Ceramic
2.5 T AWD	154	07/02→08/07	⬅	09/02→ 07/07; nicht für Felgenreöße [Zoll]: 17		<b>13.0460-7145.2 607145</b> <b>13.0470-7145.2 LD7145</b>	ATE 23073 18,8 - WE / - WK ATE 23073 18,8 - WE / - WK Ceramic
			⬅	09/02→ 07/07; passend für Felgenreöße [Zoll]: 17		<b>13.0460-7187.2 607187</b> <b>13.0470-7187.2 LD7187</b>	ATE 23590 19,5 - WE / - WK ATE 23590 19,5 - WE / - WK Ceramic
			➡	09/02→ 07/07		<b>13.0460-7135.2 607135</b> <b>13.0470-7135.2 LD7135</b>	ATE 23076 17,5 - WE / - WK ATE 23076 17,5 - WE / - WK Ceramic
2.5 TDI	103	11/99→08/07	⬅	03/00→ 07/07; nicht für Felgenreöße [Zoll]: 17		<b>13.0460-7145.2 607145</b> <b>13.0470-7145.2 LD7145</b>	ATE 23073 18,8 - WE / - WK ATE 23073 18,8 - WE / - WK Ceramic
			⬅	03/00→ 07/07; passend für Felgenreöße [Zoll]: 17		<b>13.0460-7187.2 607187</b> <b>13.0470-7187.2 LD7187</b>	ATE 23590 19,5 - WE / - WK ATE 23590 19,5 - WE / - WK Ceramic
			➡	03/00→ 07/07		<b>13.0460-7135.2 607135</b> <b>13.0470-7135.2 LD7135</b>	ATE 23076 17,5 - WE / - WK ATE 23076 17,5 - WE / - WK Ceramic
R 2,5 T AWD	221	03/03→08/07	⬅	→ 07/07		<b>13.0460-4804.2 604804</b>	BRE 23092 15,6 - WE / - WK
			➡	→ 07/07		<b>13.0460-4964.2 604964</b>	BRE 21381 15,0 - WE / - WK
<b> Bremsscheibe</b>							
2.0 T  ↓	132	11/99→08/07	⬅	07/01→ 07/07; passend für Felgenreöße [Zoll]: 15		<b>24.0126-0122.1 426122</b>	Ø 285,5 26 23 V
			⬅	07/01→ 07/07; passend für Felgenreöße [Zoll]: 16		<b>24.0128-0123.1 428123</b> <b>24.0328-0123.1 528123</b>	Ø 305 27,9 25 V Ø 305 27,9 25 V









	kw			 	! #		
<b>VOLVO - V70 II (285) 11/99→12/08</b>							
<b>Bremsscheibe</b>							
2.0 T	132	11/99→08/07	←	07/01→ 07/07; passend für Felgengröße [Zoll]: 17		24.0128-0184.1 428184	Ø 320 28 25 V
			→	07/01→ 07/07		24.0112-0151.1 412151 24.0312-0151.1 512151	Ø 288 11,9 10 Ø 288 11,9 10
2.3 2.4 T AWD 2.5 AWD	195 147 155	10/00→09/04 09/01→08/02 09/02→12/04	←	passend für Felgengröße [Zoll]: 15		24.0126-0122.1 426122	Ø 285,5 26 23 V
			←	passend für Felgengröße [Zoll]: 16		24.0128-0123.1 428123 24.0328-0123.1 528123	Ø 305 27,9 25 V Ø 305 27,9 25 V
			←	passend für Felgengröße [Zoll]: 17		24.0128-0184.1 428184	Ø 320 28 25 V
			→			24.0112-0151.1 412151 24.0312-0151.1 512151	Ø 288 11,9 10 Ø 288 11,9 10
2.3 T5 2.4 T	184 147	11/99→12/04 11/99→08/03	←	03/00→; passend für Felgengröße [Zoll]: 15		24.0126-0122.1 426122	Ø 285,5 26 23 V
			←	03/00→; passend für Felgengröße [Zoll]: 16		24.0128-0123.1 428123 24.0328-0123.1 528123	Ø 305 27,9 25 V Ø 305 27,9 25 V
			←	03/00→; passend für Felgengröße [Zoll]: 17		24.0128-0184.1 428184	Ø 320 28 25 V
			→	03/00→		24.0112-0151.1 412151 24.0312-0151.1 512151	Ø 288 11,9 10 Ø 288 11,9 10
2.4 2.4 2.4 Bifuel (CNG) 2.4 Bifuel (LPG) 2.4 T5	103 125 103 103 191	03/00→08/07 03/00→08/07 09/01→08/07 09/01→08/07 04/04→08/07	←	→ 07/07; passend für Felgengröße [Zoll]: 15		24.0126-0122.1 426122	Ø 285,5 26 23 V
			←	→ 07/07; passend für Felgengröße [Zoll]: 16		24.0128-0123.1 428123 24.0328-0123.1 528123	Ø 305 27,9 25 V Ø 305 27,9 25 V
			←	→ 07/07; passend für Felgengröße [Zoll]: 17		24.0128-0184.1 428184	Ø 320 28 25 V
			→	→ 07/07		24.0112-0151.1 412151 24.0312-0151.1 512151	Ø 288 11,9 10 Ø 288 11,9 10
2.4 D	93	04/05→12/08	←	05/05→ 07/07; passend für Felgengröße [Zoll]: 15		24.0126-0122.1 426122	Ø 285,5 26 23 V
			←	05/05→ 07/07; passend für Felgengröße [Zoll]: 16		24.0128-0123.1 428123 24.0328-0123.1 528123	Ø 305 27,9 25 V Ø 305 27,9 25 V
			←	05/05→ 07/07; passend für Felgengröße [Zoll]: 17		24.0128-0184.1 428184	Ø 320 28 25 V
			→	05/05→ 07/07		24.0112-0151.1 412151 24.0312-0151.1 512151	Ø 288 11,9 10 Ø 288 11,9 10
2.4 D	96	07/01→08/07	←	12/01→ 07/07; passend für Felgengröße [Zoll]: 15		24.0126-0122.1 426122	Ø 285,5 26 23 V
			←	12/01→ 07/07; passend für Felgengröße [Zoll]: 16		24.0128-0123.1 428123 24.0328-0123.1 528123	Ø 305 27,9 25 V Ø 305 27,9 25 V
			←	12/01→ 07/07; passend für Felgengröße [Zoll]: 17		24.0128-0184.1 428184	Ø 320 28 25 V
			→	12/01→ 07/07		24.0112-0151.1 412151 24.0312-0151.1 512151	Ø 288 11,9 10 Ø 288 11,9 10
2.4 D5	120	01/01→12/08	←	08/01→ 07/07; passend für Felgengröße [Zoll]: 15		24.0126-0122.1 426122	Ø 285,5 26 23 V
			←	08/01→ 07/07; passend für Felgengröße [Zoll]: 16		24.0128-0123.1 428123 24.0328-0123.1 528123	Ø 305 27,9 25 V Ø 305 27,9 25 V
			←	08/01→ 07/07; passend für Felgengröße [Zoll]: 17		24.0128-0184.1 428184	Ø 320 28 25 V
			→	08/01→ 07/07		24.0112-0151.1 412151 24.0312-0151.1 512151	Ø 288 11,9 10 Ø 288 11,9 10
2.4 D5 2.4 D5 AWD	136 136	04/05→12/08 05/05→08/07	←	12/05→ 07/07; passend für Felgengröße [Zoll]: 15		24.0126-0122.1 426122	Ø 285,5 26 23 V
			←	12/05→ 07/07; passend für Felgengröße [Zoll]: 16		24.0128-0123.1 428123 24.0328-0123.1 528123	Ø 305 27,9 25 V Ø 305 27,9 25 V
			←	12/05→ 07/07; passend für Felgengröße [Zoll]: 17		24.0128-0184.1 428184	Ø 320 28 25 V
			→	12/05→ 07/07		24.0112-0151.1 412151 24.0312-0151.1 512151	Ø 288 11,9 10 Ø 288 11,9 10
2.4 D5 AWD	120	07/02→08/07	←	03/03→ 07/07; passend für Felgengröße [Zoll]: 15		24.0126-0122.1 426122	Ø 285,5 26 23 V
			←	03/03→ 07/07; passend für Felgengröße [Zoll]: 16		24.0128-0123.1 428123 24.0328-0123.1 528123	Ø 305 27,9 25 V Ø 305 27,9 25 V
			←	03/03→ 07/07; passend für Felgengröße [Zoll]: 17		24.0128-0184.1 428184	Ø 320 28 25 V
			→	03/03→ 07/07		24.0112-0151.1 412151 24.0312-0151.1 512151	Ø 288 11,9 10 Ø 288 11,9 10
↓							









	kw			 	! #		
<b>VOLVO - V70 II (285) 11/99→12/08</b>							
<b>Bremsscheibe</b>							
2.5 T	154	07/01→08/07	←	04/04→ 07/07; passend für Felgengröße [Zoll]: 15	24.0126-0122.1	426122	Ø 285,5 26 23 V
			←	04/04→ 07/07; passend für Felgengröße [Zoll]: 16	24.0128-0123.1	428123	Ø 305 27,9 25 V
			←	04/04→ 07/07; passend für Felgengröße [Zoll]: 16	24.0328-0123.1	528123	Ø 305 27,9 25 V
			←	04/04→ 07/07; passend für Felgengröße [Zoll]: 17	24.0128-0184.1	428184	Ø 320 28 25 V
			→	04/04→ 07/07	24.0112-0151.1	412151	Ø 288 11,9 10
2.5 T AWD	154	07/02→08/07	←	09/02→ 07/07; passend für Felgengröße [Zoll]: 15	24.0126-0122.1	426122	Ø 285,5 26 23 V
			←	09/02→ 07/07; passend für Felgengröße [Zoll]: 16	24.0128-0123.1	428123	Ø 305 27,9 25 V
			←	09/02→ 07/07; passend für Felgengröße [Zoll]: 16	24.0328-0123.1	528123	Ø 305 27,9 25 V
			←	09/02→ 07/07; passend für Felgengröße [Zoll]: 17	24.0128-0184.1	428184	Ø 320 28 25 V
			→	09/02→ 07/07	24.0112-0151.1	412151	Ø 288 11,9 10
2.5 TDI	103	11/99→08/07	←	03/00→ 07/07; passend für Felgengröße [Zoll]: 15	24.0126-0122.1	426122	Ø 285,5 26 23 V
			←	03/00→ 07/07; passend für Felgengröße [Zoll]: 16	24.0128-0123.1	428123	Ø 305 27,9 25 V
			←	03/00→ 07/07; passend für Felgengröße [Zoll]: 16	24.0328-0123.1	528123	Ø 305 27,9 25 V
			←	03/00→ 07/07; passend für Felgengröße [Zoll]: 17	24.0128-0184.1	428184	Ø 320 28 25 V
			→	03/00→ 07/07	24.0112-0151.1	412151	Ø 288 11,9 10
					24.0312-0151.1	512151	Ø 288 11,9 10
<b>VOLVO - V70 III (135) 04/07→</b>							
<b>Bremsbelagsatz, Scheibenbremse</b>							
1.6 D 2.0 T	80 149	07/09→12/11 09/09→12/11	←	01/10→; für Bremsscheibendurchmesser [mm]: 300	13.0460-7228.2	607228	ATE 24123 20,3 - WE / - WK
					13.0470-7228.2	LD7228	ATE 24123 20,3 - WE / - WK Ceramic
			←	01/10→; für Bremsscheibendurchmesser [mm]: 316 / 336	13.0460-7243.2	607243	ATE 24142 20,6 - WE / - WK
					13.0470-7243.2	LD7243	ATE 24142 20,6 - WE / - WK Ceramic
			→	01/10→; + eFSB	13.0460-2722.2	602722	TRW 24496 17,3 - WE / - WK + Zub
				13.0470-2722.2	LD2722	TRW 24496 17,3 - WE / - WK + Zub Ceramic	
			→	01/10→; V; + eFSB	13.0460-2736.2	602736	TRW 24496 17,3 - WE / - WK + Zub
					13.0470-2736.2	LD2736	TRW 24496 17,3 - WE / - WK + Zub Ceramic
			→	01/10→; - eFSB	13.0460-2737.2	602737	TRW 24537 15,8 - WE / - WK + Zub
1.6 DRiVe / D2 1.6 T4F 2.0 2.0 BiFuel 2.0 D 2.0 FlexiFuel 2.5 T 2.5 T FlexiFuel D2 D3 D3 / D4 D4 D4 AWD D5 AWD T4 T4 T5 T5	84 132 107 157 100 107 147 147 88 110 120 133 133 151 132 140 177 180	04/11→12/15 01/11→12/15 10/07→12/11 03/13→12/15 10/07→12/15 01/08→12/11 08/07→12/09 05/08→12/09 03/15→ 03/15→ 03/10→12/15 10/13→ 10/13→ 12/09→12/11 10/10→12/15 03/15→ 01/10→12/14 10/13→	←	für Bremsscheibendurchmesser [mm]: 300	13.0460-7228.2	607228	ATE 24123 20,3 - WE / - WK
					13.0470-7228.2	LD7228	ATE 24123 20,3 - WE / - WK Ceramic
			←	für Bremsscheibendurchmesser [mm]: 316 / 336	13.0460-7243.2	607243	ATE 24142 20,6 - WE / - WK
					13.0470-7243.2	LD7243	ATE 24142 20,6 - WE / - WK Ceramic
			→	+ eFSB	13.0460-2722.2	602722	TRW 24496 17,3 - WE / - WK + Zub
					13.0470-2722.2	LD2722	TRW 24496 17,3 - WE / - WK + Zub Ceramic
			→	V; + eFSB	13.0460-2736.2	602736	TRW 24496 17,3 - WE / - WK + Zub
					13.0470-2736.2	LD2736	TRW 24496 17,3 - WE / - WK + Zub Ceramic
			→	- eFSB	13.0460-2737.2	602737	TRW 24537 15,8 - WE / - WK + Zub
2.0 GDI	157	04/12→12/15	←	03/13→; für Bremsscheibendurchmesser [mm]: 300	13.0460-7228.2	607228	ATE 24123 20,3 - WE / - WK
					13.0470-7228.2	LD7228	ATE 24123 20,3 - WE / - WK Ceramic
			←	03/13→; für Bremsscheibendurchmesser [mm]: 316 / 336	13.0460-7243.2	607243	ATE 24142 20,6 - WE / - WK
				13.0470-7243.2	LD7243	ATE 24142 20,6 - WE / - WK Ceramic	
			→	03/13→; + eFSB	13.0460-2722.2	602722	TRW 24496 17,3 - WE / - WK + Zub
↓							







	kw			 	! #		
<b>VOLVO - V70 III (135) 04/07→</b>							
<b> Bremsbelagsatz, Scheibenbremse</b>							
2.0 GDI	157	04/12→12/15	➡	03/13→; + eFSB	13.0470-2722.2	LD2722	TRW 24496 17,3 - WE / - WK + Zub Ceramic
			➡	03/13→; V; + eFSB	13.0460-2736.2	602736	TRW 24496 17,3 - WE / - WK + Zub
			➡	03/13→; - eFSB	13.0470-2736.2	LD2736	TRW 24496 17,3 - WE / - WK + Zub Ceramic
2.4 D D5	120 136	04/07→12/10 04/07→12/09	←	08/07→; für Bremsscheibendurchmesser [mm]: 300	13.0460-7228.2	607228	ATE 24123 20,3 - WE / - WK
			←	08/07→; für Bremsscheibendurchmesser [mm]: 316 / 336	13.0470-7228.2	LD7228	ATE 24123 20,3 - WE / - WK Ceramic
			➡	08/07→; + eFSB	13.0460-7243.2	607243	ATE 24142 20,6 - WE / - WK
			➡	08/07→; V; + eFSB	13.0470-7243.2	LD7243	ATE 24142 20,6 - WE / - WK Ceramic
			➡	08/07→; - eFSB	13.0460-2722.2	602722	TRW 24496 17,3 - WE / - WK + Zub
2.4 D 2.5 T 2.5 T FlexiFuel	129 170 170	04/09→12/10 04/09→12/12 04/09→12/11	←	10/09→; für Bremsscheibendurchmesser [mm]: 300	13.0460-2737.2	602737	TRW 24537 15,8 - WE / - WK + Zub
			←	10/09→; für Bremsscheibendurchmesser [mm]: 316 / 336	13.0460-2736.2	602736	TRW 24496 17,3 - WE / - WK + Zub
			➡	10/09→; + eFSB	13.0470-2722.2	LD2722	TRW 24496 17,3 - WE / - WK + Zub Ceramic
			➡	10/09→; V; + eFSB	13.0460-2722.2	602722	TRW 24496 17,3 - WE / - WK + Zub
			➡	10/09→; - eFSB	13.0470-2736.2	LD2736	TRW 24496 17,3 - WE / - WK + Zub Ceramic
3.2 3.2 3.2 AWD T6 AWD	175 179 179 210	08/07→12/10 04/10→12/14 04/10→12/15 08/07→12/10	←	für Bremsscheibendurchmesser [mm]: 300	13.0460-2737.2	602737	TRW 24537 15,8 - WE / - WK + Zub
			←	für Bremsscheibendurchmesser [mm]: 316 / 336	13.0460-7228.2	607228	ATE 24123 20,3 - WE / - WK
			←	für Bremsscheibendurchmesser [mm]: 316 / 336	13.0470-7228.2	LD7228	ATE 24123 20,3 - WE / - WK Ceramic
			➡	+ eFSB	13.0460-7243.2	607243	ATE 24142 20,6 - WE / - WK
			➡	V; + eFSB	13.0470-7243.2	LD7243	ATE 24142 20,6 - WE / - WK Ceramic
			➡	- eFSB	13.0460-2722.2	602722	TRW 24496 17,3 - WE / - WK + Zub
3.2 AWD	175	04/07→12/10	←	08/07→; für Bremsscheibendurchmesser [mm]: 300	13.0460-2722.2	602722	TRW 24496 17,3 - WE / - WK + Zub Ceramic
			←	08/07→; für Bremsscheibendurchmesser [mm]: 316 / 336	13.0460-7228.2	607228	ATE 24123 20,3 - WE / - WK
			←	08/07→; für Bremsscheibendurchmesser [mm]: 336	13.0470-7228.2	LD7228	ATE 24123 20,3 - WE / - WK Ceramic
			➡	08/07→; + eFSB	13.0460-7243.2	607243	ATE 24142 20,6 - WE / - WK















↓











	kw			 	! #		
<b>VOLVO - V70 III (135) 04/07→</b>							
<b> Bremsbelagsatz, Scheibenbremse</b>							
3.2 AWD	175	04/07→12/10	➔	08/07→; + eFSB	13.0470-2722.2	LD2722	TRW 24496 17,3 - WE / - WK + Zub Ceramic
			➔	08/07→; V; + eFSB	13.0460-2736.2	602736	TRW 24496 17,3 - WE / - WK + Zub
			➔	08/07→; - eFSB	13.0470-2736.2	LD2736	TRW 24496 17,3 - WE / - WK + Zub Ceramic
D3	100	10/07→12/15	➔	08/07→; - eFSB	13.0460-2737.2	602737	TRW 24537 15,8 - WE / - WK + Zub
			➔	05/12→; für Bremsscheibendurchmesser [mm]: 300	13.0460-7228.2	607228	ATE 24123 20,3 - WE / - WK
			➔	05/12→; für Bremsscheibendurchmesser [mm]: 316 / 336	13.0470-7228.2	LD7228	ATE 24123 20,3 - WE / - WK Ceramic
			➔	05/12→; + eFSB	13.0460-7243.2	607243	ATE 24142 20,6 - WE / - WK
			➔	05/12→; + eFSB	13.0470-7243.2	LD7243	ATE 24142 20,6 - WE / - WK Ceramic
D4 AWD	120	10/07→12/15	➔	05/12→; V; + eFSB	13.0460-2722.2	602722	TRW 24496 17,3 - WE / - WK + Zub
			➔	05/12→; V; + eFSB	13.0470-2722.2	LD2722	TRW 24496 17,3 - WE / - WK + Zub Ceramic
			➔	05/12→; V; + eFSB	13.0460-2736.2	602736	TRW 24496 17,3 - WE / - WK + Zub
			➔	05/12→; V; + eFSB	13.0470-2736.2	LD2736	TRW 24496 17,3 - WE / - WK + Zub Ceramic
			➔	05/12→; - eFSB	13.0460-2737.2	602737	TRW 24537 15,8 - WE / - WK + Zub
D5	151	10/08→12/11	➔	01/13→; für Bremsscheibendurchmesser [mm]: 300	13.0460-7228.2	607228	ATE 24123 20,3 - WE / - WK
			➔	01/13→; für Bremsscheibendurchmesser [mm]: 316 / 336	13.0470-7228.2	LD7228	ATE 24123 20,3 - WE / - WK Ceramic
			➔	01/13→; + eFSB	13.0460-7243.2	607243	ATE 24142 20,6 - WE / - WK
			➔	01/13→; + eFSB	13.0470-7243.2	LD7243	ATE 24142 20,6 - WE / - WK Ceramic
			➔	01/13→; + eFSB	13.0460-2722.2	602722	TRW 24496 17,3 - WE / - WK + Zub
D5 D5 AWD	158 158	04/11→12/15 04/11→12/15	➔	01/13→; V; + eFSB	13.0470-2722.2	LD2722	TRW 24496 17,3 - WE / - WK + Zub Ceramic
			➔	01/13→; V; + eFSB	13.0460-2736.2	602736	TRW 24496 17,3 - WE / - WK + Zub
			➔	01/13→; - eFSB	13.0470-2736.2	LD2736	TRW 24496 17,3 - WE / - WK + Zub Ceramic
			➔	01/13→; - eFSB	13.0460-2737.2	602737	TRW 24537 15,8 - WE / - WK + Zub
			➔	06/11→; für Bremsscheibendurchmesser [mm]: 300	13.0460-7228.2	607228	ATE 24123 20,3 - WE / - WK
↓			➔	06/11→; für Bremsscheibendurchmesser [mm]: 316 / 336	13.0470-7228.2	LD7228	ATE 24123 20,3 - WE / - WK Ceramic
			➔	06/11→; + eFSB	13.0460-7243.2	607243	ATE 24142 20,6 - WE / - WK
			➔	06/11→; + eFSB	13.0470-7243.2	LD7243	ATE 24142 20,6 - WE / - WK Ceramic
			➔	06/11→; + eFSB	13.0460-2722.2	602722	TRW 24496 17,3 - WE / - WK + Zub
			➔	06/11→; V; + eFSB	13.0470-2722.2	LD2722	TRW 24496 17,3 - WE / - WK + Zub Ceramic
			➔	06/11→; V; + eFSB	13.0460-2736.2	602736	TRW 24496 17,3 - WE / - WK + Zub

	kw			 	! #		
<b>VOLVO - V70 III (135) 04/07→</b>							
<b> Bremsbelagsatz, Scheibenbremse</b>							
D5 D5 AWD	158 158	04/11→12/15 04/11→12/15	→	06/11→; V; + eFSB		13.0470-2736.2 LD2736	TRW 24496 17,3 - WE / - WK + Zub Ceramic
			→	06/11→; - eFSB		13.0460-2737.2 602737	TRW 24537 15,8 - WE / - WK + Zub
D5 AWD	136	04/07→12/09	←	10/07→; für Bremsscheibendurchmesser [mm]: 300		13.0460-7228.2 607228 13.0470-7228.2 LD7228	ATE 24123 20,3 - WE / - WK ATE 24123 20,3 - WE / - WK Ceramic
			←	10/07→; für Bremsscheibendurchmesser [mm]: 316 / 336		13.0460-7243.2 607243 13.0470-7243.2 LD7243	ATE 24142 20,6 - WE / - WK ATE 24142 20,6 - WE / - WK Ceramic
			→	10/07→; + eFSB		13.0460-2722.2 602722 13.0470-2722.2 LD2722	TRW 24496 17,3 - WE / - WK + Zub TRW 24496 17,3 - WE / - WK + Zub Ceramic
			→	10/07→; V; + eFSB		13.0460-2736.2 602736 13.0470-2736.2 LD2736	TRW 24496 17,3 - WE / - WK + Zub TRW 24496 17,3 - WE / - WK + Zub Ceramic
			→	10/07→; - eFSB		13.0460-2737.2 602737	TRW 24537 15,8 - WE / - WK + Zub
T6 AWD	224	01/10→12/15	←	04/11→; für Bremsscheibendurchmesser [mm]: 300		13.0460-7228.2 607228 13.0470-7228.2 LD7228	ATE 24123 20,3 - WE / - WK ATE 24123 20,3 - WE / - WK Ceramic
			←	04/11→; für Bremsscheibendurchmesser [mm]: 316 / 336		13.0460-7243.2 607243 13.0470-7243.2 LD7243	ATE 24142 20,6 - WE / - WK ATE 24142 20,6 - WE / - WK Ceramic
			→	04/11→; + eFSB		13.0460-2722.2 602722 13.0470-2722.2 LD2722	TRW 24496 17,3 - WE / - WK + Zub TRW 24496 17,3 - WE / - WK + Zub Ceramic
			→	04/11→; V; + eFSB		13.0460-2736.2 602736 13.0470-2736.2 LD2736	TRW 24496 17,3 - WE / - WK + Zub TRW 24496 17,3 - WE / - WK + Zub Ceramic
			→	04/11→; - eFSB		13.0460-2737.2 602737	TRW 24537 15,8 - WE / - WK + Zub
<b> Bremsscheibe</b>							
1.6 D 2.0 T	80 149	07/09→12/11 09/09→12/11	←	01/10→		24.0128-0154.1 428154 24.0128-0162.1 428162 24.0128-0210.1 428210 24.0328-0154.1 528154 24.0328-0162.1 528162	Ø 300 28 26 V + S Ø 316 28 26 V + S Ø 336 28 26 V + S Ø 300 28 26 V + S Ø 316 28 26 V + S
			→	01/10→; + eFSB		24.0111-0147.1 411147 24.0122-0259.1 422259	Ø 302 11 9 + S Ø 302 22 20 V + S
			→	01/10→; - eFSB		24.0112-0180.1 412180	Ø 302 12 10 + S
1.6 DRIVe / D2 1.6 T4F 2.0 2.0 BiFuel 2.0 D 2.0 FlexiFuel 2.5 T 2.5 T FlexiFuel 3.2 3.2 3.2 AWD D3 / D4 D4 D4 AWD D5 AWD T4 T5 T5 T6 AWD	84 132 107 157 100 107 147 147 175 179 179 120 133 133 151 132 177 180 210	04/11→12/15 01/11→12/15 10/07→12/11 03/13→12/15 10/07→12/15 01/08→12/11 08/07→12/09 05/08→12/09 08/07→12/10 04/10→12/14 04/10→12/15 03/10→12/15 10/13→ 10/13→ 12/09→12/11 10/10→12/15 01/10→12/14 10/13→ 08/07→12/10	←			24.0128-0154.1 428154 24.0128-0162.1 428162 24.0128-0210.1 428210 24.0328-0154.1 528154 24.0328-0162.1 528162	Ø 300 28 26 V + S Ø 316 28 26 V + S Ø 336 28 26 V + S Ø 300 28 26 V + S Ø 316 28 26 V + S
			→	+ eFSB		24.0111-0147.1 411147 24.0122-0259.1 422259	Ø 302 11 9 + S Ø 302 22 20 V + S
			→	- eFSB		24.0112-0180.1 412180	Ø 302 12 10 + S
2.0 GDI	157	04/12→12/15	←	03/13→		24.0128-0154.1 428154 24.0128-0162.1 428162 24.0128-0210.1 428210 24.0328-0154.1 528154 24.0328-0162.1 528162	Ø 300 28 26 V + S Ø 316 28 26 V + S Ø 336 28 26 V + S Ø 300 28 26 V + S Ø 316 28 26 V + S
↓							











	kw			 	! #		
<b>VOLVO - V70 III (135) 04/07→</b>							
<b>Bremsscheibe</b>							
2.0 GDI	157	04/12→12/15	➔	03/13→; + eFSB	24.0111-0147.1	411147	Ø 302 11 9 + S
			➔	03/13→; - eFSB	24.0122-0259.1	422259	Ø 302 22 20 V + S
2.4 D 3.2 AWD D5	120 175 136	04/07→12/10 04/07→12/10 04/07→12/09	➔	08/07→	24.0128-0154.1	428154	Ø 300 28 26 V + S
					24.0128-0162.1	428162	Ø 316 28 26 V + S
					24.0128-0210.1	428210	Ø 336 28 26 V + S
					24.0328-0154.1	528154	Ø 300 28 26 V + S
					24.0328-0162.1	528162	Ø 316 28 26 V + S
			➔	08/07→; + eFSB	24.0111-0147.1	411147	Ø 302 11 9 + S
		24.0122-0259.1	422259	Ø 302 22 20 V + S			
			➔	08/07→; - eFSB	24.0112-0180.1	412180	Ø 302 12 10 + S
2.4 D 2.5 T 2.5 T FlexiFuel	129 170 170	04/09→12/10 04/09→12/12 04/09→12/11	➔	10/09→	24.0128-0154.1	428154	Ø 300 28 26 V + S
					24.0128-0162.1	428162	Ø 316 28 26 V + S
					24.0128-0210.1	428210	Ø 336 28 26 V + S
					24.0328-0154.1	528154	Ø 300 28 26 V + S
					24.0328-0162.1	528162	Ø 316 28 26 V + S
			➔	10/09→; + eFSB	24.0111-0147.1	411147	Ø 302 11 9 + S
		24.0122-0259.1	422259	Ø 302 22 20 V + S			
			➔	10/09→; - eFSB	24.0112-0180.1	412180	Ø 302 12 10 + S
D2 D3 T4	88 110 140	03/15→ 03/15→ 03/15→	➔	für Bremsscheibendurchmesser [mm]: 300	24.0128-0154.1	428154	Ø 300 28 26 V + S
					24.0328-0154.1	528154	Ø 300 28 26 V + S
			➔	für Bremsscheibendurchmesser [mm]: 316	24.0128-0162.1	428162	Ø 316 28 26 V + S
					24.0328-0162.1	528162	Ø 316 28 26 V + S
			➔	für Bremsscheibendurchmesser [mm]: 336	24.0128-0210.1	428210	Ø 336 28 26 V + S
			➔	+ eFSB	24.0111-0147.1	411147	Ø 302 11 9 + S
		24.0122-0259.1	422259	Ø 302 22 20 V + S			
			➔	- eFSB	24.0112-0180.1	412180	Ø 302 12 10 + S
D3	100	10/07→12/15	➔	05/12→	24.0128-0154.1	428154	Ø 300 28 26 V + S
					24.0128-0162.1	428162	Ø 316 28 26 V + S
					24.0128-0210.1	428210	Ø 336 28 26 V + S
					24.0328-0154.1	528154	Ø 300 28 26 V + S
			➔	05/12→; + eFSB	24.0111-0147.1	411147	Ø 302 11 9 + S
				24.0122-0259.1	422259	Ø 302 22 20 V + S	
			➔	05/12→; - eFSB	24.0112-0180.1	412180	Ø 302 12 10 + S
D4 AWD	120	10/07→12/15	➔	01/13→	24.0128-0154.1	428154	Ø 300 28 26 V + S
					24.0128-0162.1	428162	Ø 316 28 26 V + S
					24.0128-0210.1	428210	Ø 336 28 26 V + S
					24.0328-0154.1	528154	Ø 300 28 26 V + S
			➔	01/13→; + eFSB	24.0111-0147.1	411147	Ø 302 11 9 + S
				24.0122-0259.1	422259	Ø 302 22 20 V + S	
			➔	01/13→; - eFSB	24.0112-0180.1	412180	Ø 302 12 10 + S
D5	151	10/08→12/11	➔	12/09→	24.0128-0154.1	428154	Ø 300 28 26 V + S
					24.0128-0162.1	428162	Ø 316 28 26 V + S
					24.0128-0210.1	428210	Ø 336 28 26 V + S
					24.0328-0154.1	528154	Ø 300 28 26 V + S
			➔	12/09→; + eFSB	24.0111-0147.1	411147	Ø 302 11 9 + S
				24.0122-0259.1	422259	Ø 302 22 20 V + S	
			➔	12/09→; - eFSB	24.0112-0180.1	412180	Ø 302 12 10 + S
D5 D5 AWD	158 158	04/11→12/15 04/11→12/15	➔	06/11→	24.0128-0154.1	428154	Ø 300 28 26 V + S
					24.0128-0162.1	428162	Ø 316 28 26 V + S
					24.0128-0210.1	428210	Ø 336 28 26 V + S
					24.0328-0154.1	528154	Ø 300 28 26 V + S
			➔	06/11→; + eFSB	24.0111-0147.1	411147	Ø 302 11 9 + S
				24.0122-0259.1	422259	Ø 302 22 20 V + S	
			➔	06/11→; - eFSB	24.0112-0180.1	412180	Ø 302 12 10 + S
↓							









	kw			 	! #		
<b>VOLVO - V70 III (135) 04/07→</b>							
 <b>Bremsscheibe</b>							
D5 AWD	136	04/07→12/09	←	10/07→	24.0128-0154.1	428154	∅ 300 28 26 V + S
					24.0128-0162.1	428162	∅ 316 28 26 V + S
					24.0128-0210.1	428210	∅ 336 28 26 V + S
					24.0328-0154.1	528154	∅ 300 28 26 V + S
			→	10/07→; + eFSB	24.0111-0147.1	411147	∅ 302 11 9 + S
			→	10/07→; - eFSB	24.0122-0259.1	422259	∅ 302 22 20 V + S
			→	10/07→; - eFSB	24.0112-0180.1	412180	∅ 302 12 10 + S
T6 AWD	224	01/10→12/15	←	04/11→	24.0128-0154.1	428154	∅ 300 28 26 V + S
					24.0128-0162.1	428162	∅ 316 28 26 V + S
					24.0128-0210.1	428210	∅ 336 28 26 V + S
					24.0328-0154.1	528154	∅ 300 28 26 V + S
					24.0328-0162.1	528162	∅ 316 28 26 V + S
						→	04/11→; + eFSB
			→	04/11→; - eFSB	24.0122-0259.1	422259	∅ 302 22 20 V + S
			→	04/11→; - eFSB	24.0112-0180.1	412180	∅ 302 12 10 + S
<b>VOLVO - V90 II Kombi (235, 236) 03/16→</b>							
 <b>Brembelagsatz, Scheibenbremse</b>							
2.0 D3	110	03/16→	←	passend für Felgengröße [Zoll]: 18	13.0460-7328.2	607328	ATE 22317 18,8 + WE / - WK
2.0 D3 AWD	110	03/16→					
2.0 D4	140	03/16→	→	passend für Felgengröße [Zoll]: 17	13.0460-7326.2	607326	ATE 22141 15,5 + WE / - WK
2.0 D4 AWD	140	03/16→					
2.0 D5 AWD	173	03/16→					
2.0 T5	187	03/16→					
2.0 T5 AWD	187	03/16→					
2.0 T6 AWD	235	03/16→					
2.0 Hybrid AWD	235	03/16→	←	passend für Felgengröße [Zoll]: 18	13.0460-7328.2	607328	ATE 22317 18,8 + WE / - WK
 <b>Bremsscheibe</b>							
2.0 D3	110	03/16→	←	passend für Felgengröße [Zoll]: 18	24.0130-0243.1	430243	∅ 345 30 27,5 V + S
2.0 D3 AWD	110	03/16→					
2.0 D4	140	03/16→					
2.0 D4 AWD	140	03/16→					
2.0 D5 AWD	173	03/16→					
2.0 Hybrid AWD	235	03/16→					
2.0 T5	187	03/16→					
2.0 T5 AWD	187	03/16→					
2.0 T6 AWD	235	03/16→					
<b>VOLVO - V90 Kombi (965) 11/96→12/98</b>							
 <b>Brembelagsatz, Scheibenbremse</b>							
2.5	125	11/96→10/98	←		13.0460-2985.2	602985	TRW 20164 18,2 - WK
2.5	132	11/96→10/97					
2.9	132	01/97→12/98	→		13.0460-2935.2	602935	TRW 21385 13,8 - WK
2.9	150	01/97→12/98					
 <b>Bremsscheibe</b>							
2.5	125	11/96→10/98	←		24.0126-0102.1	426102	∅ 280,3 26 23 V
2.5	132	11/96→10/97					
2.9	132	01/97→12/98	→		24.0112-0150.1	412150	∅ 277 11,9 10
2.9	150	01/97→12/98					
<b>VOLVO - XC40 (536) 10/17→</b>							
 <b>Brembelagsatz, Scheibenbremse</b>							
1.5 T3	115	05/18→	←	18"; für Individualausstattungs-ID: RC02	13.0460-7328.2	607328	ATE 22317 18,8 + WE / - WK
2.0 D3	110	10/17→	←	18"	13.0460-7328.2	607328	ATE 22317 18,8 + WE / - WK
2.0 D4 AWD	140	10/17→					
2.0 T4	140	05/18→					
2.0 T4 AWD	140	05/18→					
T5 AWD	182	10/17→					
 <b>Bremsscheibe</b>							
1.5 T3	115	05/18→	←	18"	24.0130-0243.1	430243	∅ 345 30 27,5 V + S
2.0 D3	110	10/17→					
2.0 D4 AWD	140	10/17→					
2.0 T4	140	05/18→					
2.0 T4 AWD	140	05/18→					
T5 AWD	182	10/17→					









	kw			 	! #			
<b>VOLVO - XC60 (156) 05/08 →</b>								
<b> Bremsbelagsatz, Scheibenbremse</b>								
2.0 T	149	12/09 → 12/12	←	03/10 →		<b>13.0460-7272.2</b>	<b>607272</b>	ATE 24399 20,4 + WE / - WK
			→	03/10 →		<b>13.0460-2736.2</b>	<b>602736</b>	TRW 24496 17,3 - WE / - WK + Zub
						<b>13.0470-2736.2</b>	<b>LD2736</b>	TRW 24496 17,3 - WE / - WK + Zub Ceramic
2.4 D	129	04/09 → 12/10	←			<b>13.0460-7272.2</b>	<b>607272</b>	ATE 24399 20,4 + WE / - WK
2.4 D AWD	129	06/09 → 12/10	→			<b>13.0460-2736.2</b>	<b>602736</b>	TRW 24496 17,3 - WE / - WK + Zub
3.2 AWD	175	07/09 → 12/10				<b>13.0470-2736.2</b>	<b>LD2736</b>	TRW 24496 17,3 - WE / - WK + Zub Ceramic
3.2 AWD	179	03/10 → 12/15						
D3	100	04/12 → 12/15						
D3 / D4	120	03/10 → 12/14						
D4	133	10/13 → 12/15						
D4 AWD	133	10/13 → 12/15						
D5	158	06/11 → 02/17						
D5 AWD	151	07/09 → 06/11						
T5	177	09/10 → 12/14						
T5	180	10/13 →						
T5 AWD	180	10/15 → 02/17						
T5 AWD	187	04/14 → 02/17						
T6	225	10/13 →						
T6 AWD	225	10/13 →						
T6 AWD	224	03/10 → 12/15						
2.4 D / D3 / D4 AWD	120	05/08 → 02/17	←	09/08 →		<b>13.0460-7272.2</b>	<b>607272</b>	ATE 24399 20,4 + WE / - WK
D5 AWD	136	05/08 → 12/09	→	09/08 →		<b>13.0460-2736.2</b>	<b>602736</b>	TRW 24496 17,3 - WE / - WK + Zub
T6 AWD	210	05/08 → 12/10				<b>13.0470-2736.2</b>	<b>LD2736</b>	TRW 24496 17,3 - WE / - WK + Zub Ceramic
D3	110	03/15 → 02/17	←			<b>13.0460-7327.2</b>	<b>607327</b>	ATE 22386 19,0 + WE / - WK
D4	140	03/15 → 02/17				<b>13.0470-7327.2</b>	<b>LD7327</b>	ATE 22386 19,0 + WE / - WK Ceramic
D4 AWD	140	03/15 → 02/17	→	→ 789937		<b>13.0460-2736.2</b>	<b>602736</b>	TRW 24496 17,3 - WE / - WK + Zub
D5 AWD	162	03/15 → 02/17				<b>13.0470-2736.2</b>	<b>LD2736</b>	TRW 24496 17,3 - WE / - WK + Zub Ceramic
			→	789938 →		<b>13.0460-2736.2</b>	<b>602736</b>	TRW 24496 17,3 - WE / - WK + Zub
						<b>13.0470-2736.2</b>	<b>LD2736</b>	TRW 24496 17,3 - WE / - WK + Zub Ceramic
D5 AWD	158	04/11 → 12/15	←	06/11 →		<b>13.0460-7272.2</b>	<b>607272</b>	ATE 24399 20,4 + WE / - WK
			→	06/11 →		<b>13.0460-2736.2</b>	<b>602736</b>	TRW 24496 17,3 - WE / - WK + Zub
						<b>13.0470-2736.2</b>	<b>LD2736</b>	TRW 24496 17,3 - WE / - WK + Zub Ceramic
D5 AWD	169	04/14 → 12/15	←	→ 775000		<b>13.0460-7272.2</b>	<b>607272</b>	ATE 24399 20,4 + WE / - WK
			←	775001 →		<b>13.0460-7327.2</b>	<b>607327</b>	ATE 22386 19,0 + WE / - WK
						<b>13.0470-7327.2</b>	<b>LD7327</b>	ATE 22386 19,0 + WE / - WK Ceramic
			→	→ 789937		<b>13.0460-2736.2</b>	<b>602736</b>	TRW 24496 17,3 - WE / - WK + Zub
						<b>13.0470-2736.2</b>	<b>LD2736</b>	TRW 24496 17,3 - WE / - WK + Zub Ceramic
			→	789938 →		<b>13.0460-2736.2</b>	<b>602736</b>	TRW 24496 17,3 - WE / - WK + Zub
						<b>13.0470-2736.2</b>	<b>LD2736</b>	TRW 24496 17,3 - WE / - WK + Zub Ceramic
T6 AWD	242	04/14 → 12/15	←	→ 775000		<b>13.0460-7272.2</b>	<b>607272</b>	ATE 24399 20,4 + WE / - WK
			←	775001 →		<b>13.0460-7327.2</b>	<b>607327</b>	ATE 22386 19,0 + WE / - WK
			→	789938 →		<b>13.0460-2736.2</b>	<b>602736</b>	TRW 24496 17,3 - WE / - WK + Zub
						<b>13.0470-2736.2</b>	<b>LD2736</b>	TRW 24496 17,3 - WE / - WK + Zub Ceramic
			→	→ 789937		<b>13.0460-2736.2</b>	<b>602736</b>	TRW 24496 17,3 - WE / - WK + Zub
						<b>13.0470-2736.2</b>	<b>LD2736</b>	TRW 24496 17,3 - WE / - WK + Zub Ceramic
<b> Bremsscheibe</b>								
2.0 T	149	12/09 → 12/12	←	03/10 →		<b>24.0130-0212.1</b>	<b>430212</b>	Ø 328 30 28 V
			→	03/10 →		<b>24.0122-0261.1</b>	<b>422261</b>	Ø 302 22 20 V
2.4 D	129	04/09 → 12/10	←			<b>24.0130-0212.1</b>	<b>430212</b>	Ø 328 30 28 V
↓								



























	kw			 	! #		
<b>VOLVO - XC60 (156) 05/08 →</b>							
 <b>Bremsscheibe</b>							
2.4 D AWD	129	06/09 → 12/10	→			24.0122-0261.1 422261	Ø 302 22 20 V
3.2 AWD	175	07/09 → 12/10					
3.2 AWD	179	03/10 → 12/15					
D3	100	04/12 → 12/15					
D3 / D4	120	03/10 → 12/14					
D4	133	10/13 → 12/15					
D4 AWD	133	10/13 → 12/15					
D5	158	06/11 → 02/17					
D5 AWD	151	07/09 → 06/11					
D5 AWD	169	04/14 → 12/15					
T5	177	09/10 → 12/14					
T5	180	10/13 →					
T5 AWD	180	10/15 → 02/17					
T5 AWD	187	04/14 → 02/17					
T6	225	10/13 →					
T6 AWD	225	10/13 →					
T6 AWD	224	03/10 → 12/15					
T6 AWD	242	04/14 → 12/15					
2.4 D / D3 / D4 AWD	120	05/08 → 02/17	←	09/08 →		24.0130-0212.1 430212	Ø 328 30 28 V
D5 AWD	136	05/08 → 12/09					
T6 AWD	210	05/08 → 12/10	→	09/08 →		24.0122-0261.1 422261	Ø 302 22 20 V
D3	110	03/15 → 02/17	→			24.0122-0261.1 422261	Ø 302 22 20 V
D4	140	03/15 → 02/17					
D4 AWD	140	03/15 → 02/17					
D5 AWD	162	03/15 → 02/17					
D5 AWD	158	04/11 → 12/15	←	06/11 →		24.0130-0212.1 430212	Ø 328 30 28 V
			→	06/11 →		24.0122-0261.1 422261	Ø 302 22 20 V
<b>VOLVO - XC60 II (246) 03/17 →</b>							
 <b>Bremsbelagsatz, Scheibenbremse</b>							
2.0 D3	110	03/17 →	←	passend für Felgenreöße [Zoll]: 18 / 19		13.0460-7328.2 607328	ATE 22317 18,8 + WE / - WK
2.0 D4	140	03/17 →					
2.0 T5	184	10/17 →	→	passend für Felgenreöße [Zoll]: 17; für Individualausstattungs-ID: RC01,RK02 / RK03,RK05		13.0460-7326.2 607326	ATE 22141 15,5 + WE / - WK
2.0 T5	187	03/17 →					
2.0 T5 AWD	183	10/17 →					
2.0 T5 AWD	184	10/17 →					
2.0 T6 AWD	228	10/17 →					
2.0 T8 Hybrid AWD	223	02/18 →					
2.0 D4 AWD	140	03/17 →	←	passend für Felgenreöße [Zoll]: 18		13.0460-7328.2 607328	ATE 22317 18,8 + WE / - WK
2.0 D5 AWD	173	03/17 →					
2.0 T5 AWD	187	03/17 →					
2.0 T6 AWD	235	03/17 →					
2.0 T8 Hybrid AWD	235	03/17 →					
 <b>Bremsscheibe</b>							
2.0 D3	110	03/17 →	←	passend für Felgenreöße [Zoll]: 19		24.0130-0242.1 430242	Ø 366 30 27,5 V + S
2.0 D4	140	03/17 →					
2.0 T5	184	10/17 →	←	passend für Felgenreöße [Zoll]: 18		24.0130-0243.1 430243	Ø 345 30 27,5 V + S
2.0 T5	187	03/17 →					
2.0 T5 AWD	183	10/17 →					
2.0 T5 AWD	184	10/17 →					
2.0 T6 AWD	228	10/17 →					
2.0 T8 Hybrid AWD	223	02/18 →					
2.0 D4 AWD	140	03/17 →	←	passend für Felgenreöße [Zoll]: 18		24.0130-0243.1 430243	Ø 345 30 27,5 V + S
2.0 D5 AWD	173	03/17 →					
2.0 T5 AWD	187	03/17 →					
2.0 T6 AWD	235	03/17 →					
2.0 T8 Hybrid AWD	235	03/17 →					
<b>VOLVO - XC70 II (136) 04/07 →</b>							
 <b>Bremsbelagsatz, Scheibenbremse</b>							
2.4 D	129	06/09 → 12/10	←	01/10 →; passend für Felgenreöße [Zoll]: 16		13.0460-7228.2 607228 13.0470-7228.2 LD7228	ATE 24123 20,3 - WE / - WK ATE 24123 20,3 - WE / - WK Ceramic
			←	01/10 →; passend für Felgenreöße [Zoll]: 17 / 18		13.0460-7243.2 607243 13.0470-7243.2 LD7243	ATE 24142 20,6 - WE / - WK ATE 24142 20,6 - WE / - WK Ceramic
			→	01/10 →; + eFSB		13.0460-2722.2 602722 13.0470-2722.2 LD2722	TRW 24496 17,3 - WE / - WK + Zub TRW 24496 17,3 - WE / - WK + Zub Ceramic
			→	01/10 →; V; + eFSB		13.0460-2736.2 602736 13.0470-2736.2 LD2736	TRW 24496 17,3 - WE / - WK + Zub TRW 24496 17,3 - WE / - WK + Zub Ceramic
↓							

	kw			 	! #		
<b>VOLVO - XC70 II (136) 04/07→</b>							
<b> Bremsbelagsatz, Scheibenbremse</b>							
2.4 D	129	06/09→12/10	➡	01/10→; - eFSB		<b>13.0460-2737.2 602737</b>	TRW 24537 15,8 - WE / - WK + Zub
2.4 D / D4 AWD	120	08/07→	⬅	passend für Felgengröße [Zoll]: 16		<b>13.0460-7228.2 607228</b>	ATE 24123 20,3 - WE / - WK
3.2 AWD	175	08/07→12/11				<b>13.0470-7228.2 LD7228</b>	ATE 24123 20,3 - WE / - WK Ceramic
3.2 AWD	179	05/10→					
D4	133	10/13→					
D4 AWD	133	10/13→	⬅	passend für Felgengröße [Zoll]: 17 / 18		<b>13.0460-7243.2 607243</b>	ATE 24142 20,6 - WE / - WK
D5 AWD	162	03/15→				<b>13.0470-7243.2 LD7243</b>	ATE 24142 20,6 - WE / - WK Ceramic
T5	180	10/13→					
T5 AWD	187	08/15→	➡	+ eFSB		<b>13.0460-2722.2 602722</b>	TRW 24496 17,3 - WE / - WK + Zub
T6 AWD	210	01/08→					
T6 AWD	224	01/10→				<b>13.0470-2722.2 LD2722</b>	TRW 24496 17,3 - WE / - WK + Zub Ceramic
			➡	V; + eFSB		<b>13.0460-2736.2 602736</b>	TRW 24496 17,3 - WE / - WK + Zub
						<b>13.0470-2736.2 LD2736</b>	TRW 24496 17,3 - WE / - WK + Zub Ceramic
			➡	- eFSB		<b>13.0460-2737.2 602737</b>	TRW 24537 15,8 - WE / - WK + Zub
D3	120	04/10→12/15	⬅	08/11→; passend für Felgengröße [Zoll]: 16		<b>13.0460-7228.2 607228</b>	ATE 24123 20,3 - WE / - WK
						<b>13.0470-7228.2 LD7228</b>	ATE 24123 20,3 - WE / - WK Ceramic
			⬅	08/11→; passend für Felgengröße [Zoll]: 17 / 18		<b>13.0460-7243.2 607243</b>	ATE 24142 20,6 - WE / - WK
						<b>13.0470-7243.2 LD7243</b>	ATE 24142 20,6 - WE / - WK Ceramic
			➡	08/11→; + eFSB		<b>13.0460-2722.2 602722</b>	TRW 24496 17,3 - WE / - WK + Zub
						<b>13.0470-2722.2 LD2722</b>	TRW 24496 17,3 - WE / - WK + Zub Ceramic
			➡	08/11→; V; + eFSB		<b>13.0460-2736.2 602736</b>	TRW 24496 17,3 - WE / - WK + Zub
						<b>13.0470-2736.2 LD2736</b>	TRW 24496 17,3 - WE / - WK + Zub Ceramic
			➡	08/11→; - eFSB		<b>13.0460-2737.2 602737</b>	TRW 24537 15,8 - WE / - WK + Zub
D5 AWD	136	04/07→12/09	⬅	08/07→; passend für Felgengröße [Zoll]: 16		<b>13.0460-7228.2 607228</b>	ATE 24123 20,3 - WE / - WK
						<b>13.0470-7228.2 LD7228</b>	ATE 24123 20,3 - WE / - WK Ceramic
			⬅	08/07→; passend für Felgengröße [Zoll]: 17 / 18		<b>13.0460-7243.2 607243</b>	ATE 24142 20,6 - WE / - WK
						<b>13.0470-7243.2 LD7243</b>	ATE 24142 20,6 - WE / - WK Ceramic
			➡	08/07→; + eFSB		<b>13.0460-2722.2 602722</b>	TRW 24496 17,3 - WE / - WK + Zub
						<b>13.0470-2722.2 LD2722</b>	TRW 24496 17,3 - WE / - WK + Zub Ceramic
			➡	08/07→; V; + eFSB		<b>13.0460-2736.2 602736</b>	TRW 24496 17,3 - WE / - WK + Zub
						<b>13.0470-2736.2 LD2736</b>	TRW 24496 17,3 - WE / - WK + Zub Ceramic
			➡	08/07→; - eFSB		<b>13.0460-2737.2 602737</b>	TRW 24537 15,8 - WE / - WK + Zub
D5 AWD	151	04/09→12/11	⬅	12/09→; passend für Felgengröße [Zoll]: 16		<b>13.0460-7228.2 607228</b>	ATE 24123 20,3 - WE / - WK
						<b>13.0470-7228.2 LD7228</b>	ATE 24123 20,3 - WE / - WK Ceramic
			⬅	12/09→; passend für Felgengröße [Zoll]: 17 / 18		<b>13.0460-7243.2 607243</b>	ATE 24142 20,6 - WE / - WK
						<b>13.0470-7243.2 LD7243</b>	ATE 24142 20,6 - WE / - WK Ceramic
			➡	12/09→; + eFSB		<b>13.0460-2722.2 602722</b>	TRW 24496 17,3 - WE / - WK + Zub
						<b>13.0470-2722.2 LD2722</b>	TRW 24496 17,3 - WE / - WK + Zub Ceramic
			➡	12/09→; V; + eFSB		<b>13.0460-2736.2 602736</b>	TRW 24496 17,3 - WE / - WK + Zub
						<b>13.0470-2736.2 LD2736</b>	TRW 24496 17,3 - WE / - WK + Zub Ceramic
			➡	12/09→; - eFSB		<b>13.0460-2737.2 602737</b>	TRW 24537 15,8 - WE / - WK + Zub
D5 AWD	158	04/11→12/15	⬅	06/11→; passend für Felgengröße [Zoll]: 16		<b>13.0460-7228.2 607228</b>	ATE 24123 20,3 - WE / - WK
						<b>13.0470-7228.2 LD7228</b>	ATE 24123 20,3 - WE / - WK Ceramic
↓							













	kw				! #		
<b>VOLVO - XC70 II (136) 04/07→</b>							
<b> Bremsbelagsatz, Scheibenbremse</b>							
D5 AWD	158	04/11→12/15	←	06/11→; passend für Felgengröße [Zoll]: 17 / 18	13.0460-7243.2 13.0470-7243.2	607243 LD7243	ATE 24142 20,6 - WE / - WK ATE 24142 20,6 - WE / - WK Ceramic
			→	06/11→; + eFSB	13.0460-2722.2 13.0470-2722.2	602722 LD2722	TRW 24496 17,3 - WE / - WK + Zub TRW 24496 17,3 - WE / - WK + Zub Ceramic
			→	06/11→; V; + eFSB	13.0460-2736.2 13.0470-2736.2	602736 LD2736	TRW 24496 17,3 - WE / - WK + Zub TRW 24496 17,3 - WE / - WK + Zub Ceramic
			→	06/11→; - eFSB	13.0460-2737.2	602737	TRW 24537 15,8 - WE / - WK + Zub
<b> Bremsscheibe</b>							
2.4 D	129	06/09→12/10	←	01/10→; passend für Felgengröße [Zoll]: 16	24.0128-0154.1 24.0328-0154.1	428154 528154	Ø 300 28 26 V + S Ø 300 28 26 V + S
			←	01/10→; passend für Felgengröße [Zoll]: 17	24.0128-0162.1 24.0328-0162.1	428162 528162	Ø 316 28 26 V + S Ø 316 28 26 V + S
			←	01/10→; passend für Felgengröße [Zoll]: 18	24.0128-0210.1	428210	Ø 336 28 26 V + S
			→	01/10→; + eFSB	24.0111-0147.1 24.0122-0259.1	411147 422259	Ø 302 11 9 + S Ø 302 22 20 V + S
			→	01/10→; - eFSB	24.0112-0180.1	412180	Ø 302 12 10 + S
2.4 D / D4 AWD 3.2 AWD 3.2 AWD D4 D4 AWD D5 AWD T5 T5 AWD T6 AWD T6 AWD	120 175 179 133 133 162 180 187 210 224	08/07→ 08/07→12/11 05/10→ 10/13→ 10/13→ 03/15→ 10/13→ 08/15→ 01/08→ 01/10→	←	passend für Felgengröße [Zoll]: 16	24.0128-0154.1 24.0328-0154.1	428154 528154	Ø 300 28 26 V + S Ø 300 28 26 V + S
			←	passend für Felgengröße [Zoll]: 17	24.0128-0162.1 24.0328-0162.1	428162 528162	Ø 316 28 26 V + S Ø 316 28 26 V + S
			←	passend für Felgengröße [Zoll]: 18	24.0128-0210.1	428210	Ø 336 28 26 V + S
			→	+ eFSB	24.0111-0147.1 24.0122-0259.1	411147 422259	Ø 302 11 9 + S Ø 302 22 20 V + S
			→	- eFSB	24.0112-0180.1	412180	Ø 302 12 10 + S
D3	120	04/10→12/15	←	08/11→; passend für Felgengröße [Zoll]: 16	24.0128-0154.1 24.0328-0154.1	428154 528154	Ø 300 28 26 V + S Ø 300 28 26 V + S
			←	08/11→; passend für Felgengröße [Zoll]: 17	24.0128-0162.1 24.0328-0162.1	428162 528162	Ø 316 28 26 V + S Ø 316 28 26 V + S
			←	08/11→; passend für Felgengröße [Zoll]: 18	24.0128-0210.1	428210	Ø 336 28 26 V + S
			→	08/11→; + eFSB	24.0111-0147.1 24.0122-0259.1	411147 422259	Ø 302 11 9 + S Ø 302 22 20 V + S
			→	08/11→; - eFSB	24.0112-0180.1	412180	Ø 302 12 10 + S
D5 AWD	136	04/07→12/09	←	08/07→; passend für Felgengröße [Zoll]: 16	24.0128-0154.1 24.0328-0154.1	428154 528154	Ø 300 28 26 V + S Ø 300 28 26 V + S
			←	08/07→; passend für Felgengröße [Zoll]: 17	24.0128-0162.1 24.0328-0162.1	428162 528162	Ø 316 28 26 V + S Ø 316 28 26 V + S
			←	08/07→; passend für Felgengröße [Zoll]: 18	24.0128-0210.1	428210	Ø 336 28 26 V + S
			→	08/07→; + eFSB	24.0111-0147.1 24.0122-0259.1	411147 422259	Ø 302 11 9 + S Ø 302 22 20 V + S
			→	08/07→; - eFSB	24.0112-0180.1	412180	Ø 302 12 10 + S
D5 AWD	151	04/09→12/11	←	12/09→; passend für Felgengröße [Zoll]: 16	24.0128-0154.1 24.0328-0154.1	428154 528154	Ø 300 28 26 V + S Ø 300 28 26 V + S
			←	12/09→; passend für Felgengröße [Zoll]: 17	24.0128-0162.1 24.0328-0162.1	428162 528162	Ø 316 28 26 V + S Ø 316 28 26 V + S
			←	12/09→; passend für Felgengröße [Zoll]: 18	24.0128-0210.1	428210	Ø 336 28 26 V + S
			→	12/09→; + eFSB	24.0111-0147.1 24.0122-0259.1	411147 422259	Ø 302 11 9 + S Ø 302 22 20 V + S
			→	12/09→; - eFSB	24.0112-0180.1	412180	Ø 302 12 10 + S
D5 AWD	158	04/11→12/15	←	06/11→; passend für Felgengröße [Zoll]: 16	24.0128-0154.1 24.0328-0154.1	428154 528154	Ø 300 28 26 V + S Ø 300 28 26 V + S
			←	06/11→; passend für Felgengröße [Zoll]: 17	24.0128-0162.1 24.0328-0162.1	428162 528162	Ø 316 28 26 V + S Ø 316 28 26 V + S
↓							









	kw			 	! #		
<b>VOLVO - XC70 II (136) 04/07→</b>							
 <b>Bremsscheibe</b>							
D5 AWD	158	04/11→12/15	←	06/11→; passend für Felgenreöße [Zoll]: 18	24.0128-0210.1	428210	Ø 336 28 26 V + S
			→	06/11→; + eFSB	24.0111-0147.1	411147	Ø 302 11 9 + S
					24.0122-0259.1	422259	Ø 302 22 20 V + S
			→	06/11→; - eFSB	24.0112-0180.1	412180	Ø 302 12 10 + S
<b>VOLVO - XC70 CROSS COUNTRY (295) 10/97→10/07</b>							
 <b>Bremsbelagsatz, Scheibenbremse</b>							
2.4 D5 AWD 2.4 D5 XC AWD 2.5 T XC AWD	136 120 154	12/05→08/07 09/02→08/07 09/02→08/07	←	→ 07/07	13.0460-7145.2	607145	ATE 23073 18,8 - WE / - WK
					13.0470-7145.2	LD7145	ATE 23073 18,8 - WE / - WK Ceramic
			→	→ 07/07	13.0460-7135.2	607135	ATE 23076 17,5 - WE / - WK
					13.0470-7135.2	LD7135	ATE 23076 17,5 - WE / - WK Ceramic
2.4 T XC AWD	142	11/97→09/02	←	passend für Felgenreöße [Zoll]: 15; für Bremsscheibendurchmesser [mm]: 280	13.0460-7053.2	607053	ATE 21273 19,5 + WE / - WK
			←		13.0460-7145.2	607145	ATE 23073 18,8 - WE / - WK
					13.0470-7145.2	LD7145	ATE 23073 18,8 - WE / - WK Ceramic
			→		13.0460-7135.2	607135	ATE 23076 17,5 - WE / - WK
					13.0470-7135.2	LD7135	ATE 23076 17,5 - WE / - WK Ceramic
2.4 T XC AWD	147	03/00→09/02	←		13.0460-7145.2	607145	ATE 23073 18,8 - WE / - WK
					13.0470-7145.2	LD7145	ATE 23073 18,8 - WE / - WK Ceramic
			→		13.0460-7135.2	607135	ATE 23076 17,5 - WE / - WK
					13.0470-7135.2	LD7135	ATE 23076 17,5 - WE / - WK Ceramic
 <b>Bremsscheibe</b>							
2.4 D5 AWD 2.4 D5 XC AWD 2.5 T XC AWD	136 120 154	12/05→08/07 09/02→08/07 09/02→08/07	←	→ 07/07; passend für Felgenreöße [Zoll]: 15	24.0126-0122.1	426122	Ø 285,5 26 23 V
			←	→ 07/07; passend für Felgenreöße [Zoll]: 16	24.0128-0123.1	428123	Ø 305 27,9 25 V
					24.0328-0123.1	528123	Ø 305 27,9 25 V
			←	→ 07/07; passend für Felgenreöße [Zoll]: 17	24.0128-0184.1	428184	Ø 320 28 25 V
			→	→ 07/07	24.0112-0151.1	412151	Ø 288 11,9 10
					24.0312-0151.1	512151	Ø 288 11,9 10
2.4 T XC AWD	142	11/97→09/02	←	passend für Felgenreöße [Zoll]: 15	24.0126-0102.1	426102	Ø 280,3 26 23 V
					24.0126-0122.1	426122	Ø 285,5 26 23 V
			←	passend für Felgenreöße [Zoll]: 16	24.0128-0123.1	428123	Ø 305 27,9 25 V
					24.0328-0123.1	528123	Ø 305 27,9 25 V
			←	passend für Felgenreöße [Zoll]: 17	24.0128-0184.1	428184	Ø 320 28 25 V
			→	587442→	24.0112-0151.1	412151	Ø 288 11,9 10
					24.0312-0151.1	512151	Ø 288 11,9 10
2.4 T XC AWD	147	03/00→09/02	←	passend für Felgenreöße [Zoll]: 15	24.0126-0122.1	426122	Ø 285,5 26 23 V
			←	passend für Felgenreöße [Zoll]: 16	24.0128-0123.1	428123	Ø 305 27,9 25 V
					24.0328-0123.1	528123	Ø 305 27,9 25 V
			←	passend für Felgenreöße [Zoll]: 17	24.0128-0184.1	428184	Ø 320 28 25 V
			→		24.0112-0151.1	412151	Ø 288 11,9 10
					24.0312-0151.1	512151	Ø 288 11,9 10
<b>VOLVO - XC90 I (275) 06/02→01/15</b>							
 <b>Bremsbelagsatz, Scheibenbremse</b>							
2.5 T AWD 2.5 T AWD	154 154	10/02→09/14 10/12→09/14	←	passend für Felgenreöße [Zoll]: 16	13.0460-7187.2	607187	ATE 23590 19,5 - WE / - WK
					13.0470-7187.2	LD7187	ATE 23590 19,5 - WE / - WK Ceramic
3.2 AWD D3 / D5	179 120	04/10→12/12 04/09→12/14	←	+ 17,5" Rad	13.0460-7188.2	607188	ATE 24141 19,1 - WE / - WK
					13.0470-7188.2	LD7188	ATE 24141 19,1 - WE / - WK Ceramic
D5 AWD D5 AWD D5 AWD T6 AWD	120 120 147 200	10/02→12/06 10/07→12/10 01/11→12/14 10/02→12/06	←	passend für Felgenreöße [Zoll]: 17	13.0460-7272.2	607272	ATE 24399 20,4 + WE / - WK
			→		13.0460-7189.2	607189	ATE 24011 18,7 - WE / - WK
3.2 AWD D5 AWD	175 136	03/06→12/10 04/05→12/10	←	05/06→; passend für Felgenreöße [Zoll]: 16	13.0460-7187.2	607187	ATE 23590 19,5 - WE / - WK
			↓				











	kw			 	! #		
<b>VOLVO - XC90 I (275) 06/02 → 01/15</b>							
 <b>Bremsbelagsatz, Scheibenbremse</b>							
3.2 AWD D5 AWD	175 136	03/06 → 12/10 04/05 → 12/10	←	05/06 →; passend für Felgengröße [Zoll]: 16	13.0470-7187.2	LD7187	ATE 23590 19,5 - WE / - WK Ceramic
			←	05/06 →; + 17,5" Rad	13.0460-7188.2	607188	ATE 24141 19,1 - WE / - WK
			←	05/06 →; passend für Felgengröße [Zoll]: 17	13.0460-7188.2	LD7188	ATE 24141 19,1 - WE / - WK Ceramic
			←	05/06 →; passend für Felgengröße [Zoll]: 17	13.0460-7272.2	607272	ATE 24399 20,4 + WE / - WK
			→	05/06 →	13.0460-7189.2	607189	ATE 24011 18,7 - WE / - WK
V8 AWD	232	01/05 → 12/10	←	passend für Felgengröße [Zoll]: 16	13.0460-7187.2	607187	ATE 23590 19,5 - WE / - WK
			←	passend für Felgengröße [Zoll]: 17,5	13.0460-7188.2	607188	ATE 24141 19,1 - WE / - WK
			←	passend für Felgengröße [Zoll]: 17	13.0460-7272.2	607272	ATE 24399 20,4 + WE / - WK
			→		13.0460-7189.2	607189	ATE 24011 18,7 - WE / - WK
 <b>Bremsscheibe</b>							
2.5 T AWD	154	10/02 → 09/14	←	passend für Felgengröße [Zoll]: 16	24.0128-0144.1	428144	Ø 316 28 25 V
2.5 T AWD	154	10/12 → 09/14	←	+ 17,5" Rad	24.0130-0116.1	430116	Ø 336 30 27 V
3.2 AWD	179	04/10 → 12/12	←	+ 17,5" Rad	24.0130-0116.1	430116	Ø 336 30 27 V
D3 / D5	120	04/09 → 12/14	←	passend für Felgengröße [Zoll]: 17	24.0130-0240.1	430240	Ø 327,5 30 27 V
D5 AWD	120	10/02 → 12/06	→		24.0120-0122.1	420122	Ø 308 20 18 V
D5 AWD	120	10/07 → 12/10	→		24.0120-0122.1	420122	Ø 308 20 18 V
D5 AWD	147	01/11 → 12/14	→		24.0120-0122.1	420122	Ø 308 20 18 V
T6 AWD	200	10/02 → 12/06	→		24.0120-0122.1	420122	Ø 308 20 18 V
V8 AWD	232	01/05 → 12/10	→		24.0120-0122.1	420122	Ø 308 20 18 V
3.2 AWD D5 AWD	175 136	03/06 → 12/10 04/05 → 12/10	←	05/06 →; passend für Felgengröße [Zoll]: 16	24.0128-0144.1	428144	Ø 316 28 25 V
			←	05/06 →; + 17,5" Rad	24.0130-0116.1	430116	Ø 336 30 27 V
			←	05/06 →; passend für Felgengröße [Zoll]: 17	24.0130-0240.1	430240	Ø 327,5 30 27 V
			→	05/06 →	24.0120-0122.1	420122	Ø 308 20 18 V
<b>VOLVO - XC90 II (256) 09/14 →</b>							
 <b>Bremsbelagsatz, Scheibenbremse</b>							
2.0 T5 AWD	183	06/15 →	←	Variant code RC02	13.0460-7328.2	607328	ATE 22317 18,8 + WE / - WK
D5 AWD	165	09/14 →	←	135578 →; Variant code RC01	13.0460-7328.2	607328	ATE 22317 18,8 + WE / - WK
D5 AWD	173	09/14 →	←	135578 →; Variant code RC01	13.0460-7328.2	607328	ATE 22317 18,8 + WE / - WK
T5 AWD	187	06/15 →	→	+ eFSB	13.0460-7326.2	607326	ATE 22141 15,5 + WE / - WK
T6 AWD	235	09/14 →	→	+ eFSB	13.0460-7326.2	607326	ATE 22141 15,5 + WE / - WK
T8 Hybrid AWD	235	06/15 →	→	+ eFSB	13.0460-7326.2	607326	ATE 22141 15,5 + WE / - WK
T8 Hybrid AWD	298	06/15 →	→	+ eFSB	13.0460-7326.2	607326	ATE 22141 15,5 + WE / - WK
2.0 T5 AWD 2.0 T6 AWD D4 D4 AWD	184 228 140 140	10/17 → 10/17 → 06/15 → 06/15 →	←	18"; für Individualausstattungs-ID: RC01	13.0460-7328.2	607328	ATE 22317 18,8 + WE / - WK
			←	135578 →; 19"; für Individualausstattungs-ID: RC01	13.0460-7328.2	607328	ATE 22317 18,8 + WE / - WK
			←	→ 85192; 19"; für Individualausstattungs-ID: RC01	13.0460-7328.2	607328	ATE 22317 18,8 + WE / - WK
			←	18" / 19"; für Individualausstattungs-ID: RC02	13.0460-7328.2	607328	ATE 22317 18,8 + WE / - WK
			→	17" / 18"; für Individualausstattungs-ID: RC01	13.0460-7326.2	607326	ATE 22141 15,5 + WE / - WK
			→	17" / 18"; für Individualausstattungs-ID: RC01	13.0460-7326.2	607326	ATE 22141 15,5 + WE / - WK
2.0 T8 Hybrid AWD	223	04/18 →	←	18"; für Individualausstattungs-ID: RC01	13.0460-7328.2	607328	ATE 22317 18,8 + WE / - WK
			←	135578 →; 19"; für Individualausstattungs-ID: RC01	13.0460-7328.2	607328	ATE 22317 18,8 + WE / - WK
			←	→ 85192; 19"; für Individualausstattungs-ID: RC01	13.0460-7328.2	607328	ATE 22317 18,8 + WE / - WK
			←	18" / 19"; für Individualausstattungs-ID: RC02	13.0460-7328.2	607328	ATE 22317 18,8 + WE / - WK
			→	17" / 18"; für Individualausstattungs-ID: RC01	13.0460-7326.2	607326	ATE 22141 15,5 + WE / - WK
 <b>Bremsscheibe</b>							
2.0 T5 AWD	183	06/15 →	←	passend für Felgengröße [Zoll]: 19	24.0130-0242.1	430242	Ø 366 30 27,5 V + S
D5 AWD	165	09/14 →	←	passend für Felgengröße [Zoll]: 18	24.0130-0243.1	430243	Ø 345 30 27,5 V + S
D5 AWD	173	09/14 →	←	passend für Felgengröße [Zoll]: 18	24.0130-0243.1	430243	Ø 345 30 27,5 V + S
T5 AWD	187	06/15 →	→	passend für Felgengröße [Zoll]: 17	24.0120-0246.1	420246	Ø 320 20 17,5 V + S
T6 AWD	235	09/14 →	→	passend für Felgengröße [Zoll]: 17	24.0120-0246.1	420246	Ø 320 20 17,5 V + S
T8 Hybrid AWD	235	06/15 →	→	passend für Felgengröße [Zoll]: 18	24.0120-0247.1	420247	Ø 340 20 17,5 V + S
T8 Hybrid AWD	298	06/15 →	→	passend für Felgengröße [Zoll]: 18	24.0120-0247.1	420247	Ø 340 20 17,5 V + S
2.0 T5 AWD	184	10/17 →	←	19"	24.0130-0242.1	430242	Ø 366 30 27,5 V + S
2.0 T6 AWD	228	10/17 →	←	18"	24.0130-0243.1	430243	Ø 345 30 27,5 V + S
2.0 T8 Hybrid AWD	223	04/18 →	←	18"	24.0130-0243.1	430243	Ø 345 30 27,5 V + S
D4	140	06/15 →	←	18"	24.0130-0243.1	430243	Ø 345 30 27,5 V + S
D4 AWD	140	06/15 →	←	passend für Felgengröße [Zoll]: 19	24.0130-0242.1	430242	Ø 366 30 27,5 V + S
			←	passend für Felgengröße [Zoll]: 18	24.0130-0243.1	430243	Ø 345 30 27,5 V + S





















	kw					! #		
<b>VW - AMAROK (2HA, 2HB, S1B, S6B, S7A, S7B) 09/10→</b>								
 <b>Bremsbelagsatz, Scheibenbremse</b>								
2.0 BiTDI	120	09/10→	←	+PR 2E3			13.0460-3860.2 603860	BOS 24484 18,8 + WE / - WK + Zub
2.0 BiTDI	132	11/11→						
2.0 BiTDI 4motion	120	09/10→	←	+PR 2E4			13.0460-3877.2 603877	BOS 24484 18,8 + WE / - WK + Zub Ceramic
2.0 BiTDI 4motion	132	11/11→						
2.0 TDI	90	09/10→	←	+PR 2E3			13.0460-3860.2 603860	BOS 24484 18,8 + WE / - WK + Zub
2.0 TDI	103	07/12→						
2.0 TDI 4motion	90	09/10→	←	+PR 2E4			13.0460-3877.2 603877	BOS 24484 18,8 + WE / - WK + Zub Ceramic
2.0 TDI 4motion	103	06/12→						
2.0 TSI	118	12/10→	←	+PR 2E3			13.0460-3860.2 603860	BOS 24484 18,8 + WE / - WK + Zub
3.0 TDI	120	06/16→						
3.0 TDI 4motion	150	06/16→	←	+PR 2E4			13.0460-3877.2 603877	BOS 24484 18,8 + WE / - WK + Zub Ceramic
3.0 TDI 4motion	165	06/16→						
 <b>Bremsscheibe</b>								
2.0 BiTDI	120	09/10→	←	+PR 2E3			24.0128-0251.1 428251	Ø 303 28 26 V
2.0 BiTDI	132	11/11→						
2.0 BiTDI 4motion	120	09/10→	←	+PR 2E4			24.0128-0251.1 428251	Ø 303 28 26 V
2.0 BiTDI 4motion	132	11/11→						
2.0 TDI	90	09/10→	←	+PR 2E3			24.0128-0251.1 428251	Ø 303 28 26 V
2.0 TDI	103	07/12→						
2.0 TDI 4motion	90	09/10→	←	+PR 2E4			24.0128-0251.1 428251	Ø 303 28 26 V
2.0 TDI 4motion	103	06/12→						
2.0 TSI	118	12/10→	←	+PR 2E3			24.0128-0251.1 428251	Ø 303 28 26 V
3.0 TDI	120	06/16→						
3.0 TDI 4motion	150	06/16→	←	+PR 2E4			24.0128-0251.1 428251	Ø 303 28 26 V
3.0 TDI 4motion	165	06/16→						
<b>VW - AMAROK Pritsche/Fahrgestell (S1B) 09/11→</b>								
 <b>Bremsbelagsatz, Scheibenbremse</b>								
2.0 TDI	103	09/11→	←	07/12→; +PR 2E3			13.0460-3860.2 603860	BOS 24484 18,8 + WE / - WK + Zub
			←	07/12→; +PR 2E4			13.0460-3877.2 603877	BOS 24484 18,8 + WE / - WK + Zub Ceramic
2.0 TDI	132	09/11→	←	11/11→; +PR 2E3			13.0460-3860.2 603860	BOS 24484 18,8 + WE / - WK + Zub
			←	11/11→; +PR 2E4			13.0460-3877.2 603877	BOS 24484 18,8 + WE / - WK + Zub Ceramic
2.0 TDI 4motion	103	09/11→	←	06/12→; +PR 2E3			13.0460-3860.2 603860	BOS 24484 18,8 + WE / - WK + Zub
			←	06/12→; +PR 2E4			13.0460-3877.2 603877	BOS 24484 18,8 + WE / - WK + Zub Ceramic
 <b>Bremsscheibe</b>								
2.0 TDI	103	09/11→	←	07/12→; +PR 2E3			24.0128-0251.1 428251	Ø 303 28 26 V
2.0 TDI	132	09/11→	←	11/11→; +PR 2E3			24.0128-0251.1 428251	Ø 303 28 26 V
2.0 TDI 4motion	103	09/11→	←	06/12→; +PR 2E3			24.0128-0251.1 428251	Ø 303 28 26 V
<b>VW - ARTEON (3H7) 04/17→</b>								
 <b>Bremsbelagsatz, Scheibenbremse</b>								
1.5 TSi	110	11/17→	←	+PR 1ZD			13.0460-2785.2 602785	TRW 25683 20,4 + WE / + WK
2.0 TDI	110	04/17→						
2.0 TDI	140	05/17→	→	+PR 1KU,1KZ			13.0460-7294.2 607294	TRW 25683 20,4 + WE / + WK Ceramic
2.0 TDI 4motion	140	05/17→						
2.0 TDI 4motion	176	04/17→	→	+PR 1ZA			13.0460-7294.2 607294	ATE 25009 16,4 - WE / - WK
2.0 TSI	140	05/17→						
2.0 TSI 4motion	206	04/17→	→	+PR 1LA			13.0460-7294.2 607294	ATE 25009 16,4 - WE / - WK Ceramic
<b>Warnkontakt, Bremsbelagverschleiß</b>								
1.5 TSi	110	11/17→	←	+PR 1LB	1	24.8190-0065.2 620065	L= 172	
2.0 TDI	110	04/17→	←	+PR 1ZD	1	24.8190-0065.2 620065	L= 172	
2.0 TDI	140	05/17→	←	+PR 1ZA	1	24.8190-0065.2 620065	L= 172	
2.0 TDI 4motion	140	05/17→	←	+PR 1LA	1	24.8190-0065.2 620065	L= 172	
2.0 TDI 4motion	176	04/17→	←					
2.0 TSI	140	05/17→	←					
↓								

	kW			 	! #		
<b>VW - ARTEON (3H7) 04/17→</b>							
<b>Warnkontakt, Bremsbelagverschleiß</b>							
2.0 TSI 4motion	206	04/17→	←	+PR 1LB	1	24.8190-0065.2 620065	L= 172
			←	+PR 1ZD	1	24.8190-0065.2 620065	L= 172
			←	+PR 1ZA	1	24.8190-0065.2 620065	L= 172
			←	+PR 1LA	1	24.8190-0065.2 620065	L= 172
<b> Brems Scheibe</b>							
1.5 TSi 2.0 TDI 2.0 TDI 4motion 2.0 TSI 4motion	110 110 176 206	11/17→ 04/17→ 04/17→ 04/17→	←	+PR 1ZA,1ZD		24.0125-0158.1 425158	Ø 312 25 22 V + S
						24.0325-0158.1 525158	Ø 312 25 22 V + S
			←	+PR 1LA,1LB		24.0130-0225.1 430225	Ø 340 30 27 V + S
			→	+PR 1KU		24.0112-0210.1 412210	Ø 300 12 10 + S
			→	+PR 1KZ		24.0122-0219.1 422219	Ø 310 22 20 V
2.0 TDI 2.0 TDI 4motion	140 140	05/17→ 05/17→	←	+PR 1ZA,1ZD		24.0125-0158.1 425158	Ø 312 25 22 V + S
						24.0325-0158.1 525158	Ø 312 25 22 V + S
			←	+PR 1LA,1LB		24.0130-0225.1 430225	Ø 340 30 27 V + S
			→	10/17→; +PR 1KU		24.0112-0210.1 412210	Ø 300 12 10 + S
			→	10/17→; +PR 1KZ		24.0122-0219.1 422219	Ø 310 22 20 V
2.0 TSI	140	05/17→	←	+PR 1ZA,1ZD		24.0125-0158.1 425158	Ø 312 25 22 V + S
						24.0325-0158.1 525158	Ø 312 25 22 V + S
			←	+PR 1LA,1LB		24.0130-0225.1 430225	Ø 340 30 27 V + S
			→	08/17→; +PR 1KU		24.0112-0210.1 412210	Ø 300 12 10 + S
			→	08/17→; +PR 1KZ		24.0122-0219.1 422219	Ø 310 22 20 V
<b>VW - BEETLE (5C1, 5C2) 04/11→</b>							
<b> Bremsbelagsatz, Scheibenbremse</b>							
1.2 TSI 2.0 TDI 2.0 TSI	77 103 147	07/11→ 04/11→ 04/11→	←	+PR 1ZQ		13.0460-7111.2 607111	VW 23130 19,6 - WE / - WK
						13.0470-7111.2 LD7111	VW 23130 19,6 - WE / - WK Ceramic
			←	+PR 1LV,1ZD,1ZM,1ZP		13.0460-7117.2 607117	VW 23130 19,6 + WK
						13.0470-7117.2 LD7117	VW 23130 19,6 + WK Ceramic
			←	10/11→; +PR 1ZA,1ZB,1ZE		13.0460-7184.2 607184	ATE 23587 20,6 + WK
						13.0470-7184.2 LD7184	ATE 23587 20,6 + WK Ceramic
			→	+PR 1KD,1KU		13.0460-2787.2 602787	TRW 23554 17,3 - WK / - WE
			13.0460-2820.2 602820	TRW 20961 17,2 - WK			
			13.0470-2820.2 LD2820	TRW 20961 17,2 - WK Ceramic			
			→	+PR 1KS,1KT		13.0460-3858.2 603858	BOS 24563 17,7 - WE / - WK + Zub
						13.0470-3858.2 LD3858	BOS 24563 17,7 - WE / - WK + Zub Ceramic
1.2 TSI 16V 1.4 TSI 1.4 TSI 1.6 TDI 2.0 TSI 2.5	77 110 118 77 162 125	12/14→ 12/14→ 10/11→ 10/11→ 12/14→ 04/11→	←	+PR 1ZQ		13.0460-7111.2 607111	VW 23130 19,6 - WE / - WK
						13.0470-7111.2 LD7111	VW 23130 19,6 - WE / - WK Ceramic
			←	+PR 1LV,1ZD,1ZM,1ZP		13.0460-7117.2 607117	VW 23130 19,6 + WK
						13.0470-7117.2 LD7117	VW 23130 19,6 + WK Ceramic
			←	+PR 1ZA,1ZB,1ZE		13.0460-7184.2 607184	ATE 23587 20,6 + WK
						13.0470-7184.2 LD7184	ATE 23587 20,6 + WK Ceramic
			→	+PR 1KD,1KU		13.0460-2787.2 602787	TRW 23554 17,3 - WK / - WE
			13.0460-2820.2 602820	TRW 20961 17,2 - WK			
			13.0470-2820.2 LD2820	TRW 20961 17,2 - WK Ceramic			
			→	+PR 1KS,1KT		13.0460-3858.2 603858	BOS 24563 17,7 - WE / - WK + Zub
						13.0470-3858.2 LD3858	BOS 24563 17,7 - WE / - WK + Zub Ceramic
2.0 TDI	81	06/14→	←	12/14→; +PR 1LV,1ZD,1ZM,1ZP		13.0460-7117.2 607117	VW 23130 19,6 + WK
						13.0470-7117.2 LD7117	VW 23130 19,6 + WK Ceramic
			←	12/14→; +PR 1ZA,1ZB,1ZE		13.0460-7184.2 607184	ATE 23587 20,6 + WK
						13.0470-7184.2 LD7184	ATE 23587 20,6 + WK Ceramic
			→	12/14→; +PR 1KD,1KU		13.0460-2787.2 602787	TRW 23554 17,3 - WK / - WE
			13.0460-2820.2 602820	TRW 20961 17,2 - WK			
			13.0470-2820.2 LD2820	TRW 20961 17,2 - WK Ceramic			
			→	12/14→; +PR 1KS,1KT		13.0460-3858.2 603858	BOS 24563 17,7 - WE / - WK + Zub







	kw			 	! #		
<b>VW - BEETLE (5C1, 5C2) 04/11→</b>							
<b> Bremsbelagsatz, Scheibenbremse</b>							
2.0 TDI	81	06/14→	➔	12/14→; +PR 1KS,1KT		13.0470-3858.2 LD3858	BOS 24563 17,7 - WE / - WK + Zub Ceramic
2.0 TDI	110	07/14→	➔	09/14→; +PR 1ZQ		13.0460-7111.2 607111 13.0470-7111.2 LD7111	VW 23130 19,6 - WE / - WK VW 23130 19,6 - WE / - WK Ceramic
			➔	09/14→; +PR 1LV,1ZD,1ZM,1ZP		13.0460-7117.2 607117 13.0470-7117.2 LD7117	VW 23130 19,6 + WK VW 23130 19,6 + WK Ceramic
			➔	09/14→; +PR 1ZA,1ZB,1ZE		13.0460-7184.2 607184 13.0470-7184.2 LD7184	ATE 23587 20,6 + WK ATE 23587 20,6 + WK Ceramic
			➔	09/14→; +PR 1KD,1KU		13.0460-2787.2 602787 13.0460-2820.2 602820 13.0470-2820.2 LD2820	TRW 23554 17,3 - WK / - WE TRW 20961 17,2 - WK TRW 20961 17,2 - WK Ceramic
			➔	09/14→; +PR 1KS,1KT		13.0460-3858.2 603858 13.0470-3858.2 LD3858	BOS 24563 17,7 - WE / - WK + Zub BOS 24563 17,7 - WE / - WK + Zub Ceramic
			➔	09/14→; +PR 1ZQ		13.0460-7111.2 607111 13.0470-7111.2 LD7111	VW 23130 19,6 - WE / - WK VW 23130 19,6 - WE / - WK Ceramic
2.0 TSI	155	12/12→	➔	05/13→; +PR 1ZQ		13.0460-7111.2 607111 13.0470-7111.2 LD7111	VW 23130 19,6 - WE / - WK VW 23130 19,6 - WE / - WK Ceramic
			➔	05/13→; +PR 1LV,1ZD,1ZM,1ZP		13.0460-7117.2 607117 13.0470-7117.2 LD7117	VW 23130 19,6 + WK VW 23130 19,6 + WK Ceramic
			➔	05/13→; +PR 1ZA,1ZB,1ZE		13.0460-7184.2 607184 13.0470-7184.2 LD7184	ATE 23587 20,6 + WK ATE 23587 20,6 + WK Ceramic
			➔	05/13→; +PR 1KD,1KU		13.0460-2787.2 602787 13.0460-2820.2 602820 13.0470-2820.2 LD2820	TRW 23554 17,3 - WK / - WE TRW 20961 17,2 - WK TRW 20961 17,2 - WK Ceramic
			➔	05/13→; +PR 1KS,1KT		13.0460-3858.2 603858 13.0470-3858.2 LD3858	BOS 24563 17,7 - WE / - WK + Zub BOS 24563 17,7 - WE / - WK + Zub Ceramic
			➔	05/13→; +PR 1ZQ		24.0122-0210.1 422210 24.0322-0210.1 522210	Ø 280 22 19 V + S Ø 280 22 19 V + S
1.2 TSI 1.2 TSI 16V 1.4 TSI 1.4 TSI 1.6 TDI 2.0 TDI 2.0 TSI 2.0 TSI 2.5	77 77 110 118 77 103 147 162 125	07/11→ 12/14→ 12/14→ 10/11→ 10/11→ 04/11→ 04/11→ 12/14→ 04/11→	➔	+PR 1ZM,1ZQ		24.0122-0210.1 422210 24.0322-0210.1 522210	Ø 280 22 19 V + S Ø 280 22 19 V + S
			➔	+PR 1ZE,1ZP		24.0125-0145.1 425145 24.0325-0145.1 525145	Ø 288 25 22 V + S Ø 288 25 22 V + S
			➔	+PR 1ZA,1ZB,1ZD,1LV		24.0125-0158.1 425158 24.0325-0158.1 525158	Ø 312 25 22 V + S Ø 312 25 22 V + S
			➔	+PR 1KD,1KU		24.0110-0277.1 410277	Ø 253 10 8 + S
			➔	+PR 1KS,1KT		24.0110-0356.1 410356 24.0310-0356.1 510356	Ø 272 9,7 8 + S Ø 272 9,7 8 + S
			➔	12/14→; +PR 1ZM,1ZQ		24.0122-0210.1 422210 24.0322-0210.1 522210	Ø 280 22 19 V + S Ø 280 22 19 V + S
			➔	12/14→; +PR 1ZE,1ZP		24.0125-0145.1 425145 24.0325-0145.1 525145	Ø 288 25 22 V + S Ø 288 25 22 V + S
			➔	12/14→; +PR 1ZA,1ZB,1ZD,1LV		24.0125-0158.1 425158 24.0325-0158.1 525158	Ø 312 25 22 V + S Ø 312 25 22 V + S
2.0 TDI	81	06/14→	➔	12/14→; +PR 1ZM,1ZQ		24.0122-0210.1 422210 24.0322-0210.1 522210	Ø 280 22 19 V + S Ø 280 22 19 V + S
			➔	12/14→; +PR 1ZE,1ZP		24.0125-0145.1 425145 24.0325-0145.1 525145	Ø 288 25 22 V + S Ø 288 25 22 V + S
			➔	12/14→; +PR 1ZA,1ZB,1ZD,1LV		24.0125-0158.1 425158 24.0325-0158.1 525158	Ø 312 25 22 V + S Ø 312 25 22 V + S
			➔	12/14→; +PR 1KD,1KU		24.0110-0277.1 410277	Ø 253 10 8 + S
			➔	12/14→; +PR 1KS,1KT		24.0110-0356.1 410356 24.0310-0356.1 510356	Ø 272 9,7 8 + S Ø 272 9,7 8 + S
			➔	09/14→; +PR 1ZM,1ZQ		24.0122-0210.1 422210 24.0322-0210.1 522210	Ø 280 22 19 V + S Ø 280 22 19 V + S
2.0 TDI	110	07/14→	➔	09/14→; +PR 1ZE,1ZP		24.0125-0145.1 425145 24.0325-0145.1 525145	Ø 288 25 22 V + S Ø 288 25 22 V + S
			➔	09/14→; +PR 1ZA,1ZB,1ZD,1LV		24.0125-0158.1 425158 24.0325-0158.1 525158	Ø 312 25 22 V + S Ø 312 25 22 V + S
			➔	09/14→; +PR 1KD,1KU		24.0110-0277.1 410277	Ø 253 10 8 + S
			➔	09/14→; +PR 1KS,1KT		24.0110-0356.1 410356 24.0310-0356.1 510356	Ø 272 9,7 8 + S Ø 272 9,7 8 + S
			➔	05/13→; +PR 1ZM,1ZQ		24.0122-0210.1 422210 24.0322-0210.1 522210	Ø 280 22 19 V + S Ø 280 22 19 V + S
			➔	05/13→; +PR 1ZE,1ZP		24.0125-0145.1 425145 24.0325-0145.1 525145	Ø 288 25 22 V + S Ø 288 25 22 V + S
2.0 TSI	155	12/12→	➔	05/13→; +PR 1ZM,1ZQ		24.0122-0210.1 422210 24.0322-0210.1 522210	Ø 280 22 19 V + S Ø 280 22 19 V + S
			➔	05/13→; +PR 1ZE,1ZP		24.0125-0145.1 425145 24.0325-0145.1 525145	Ø 288 25 22 V + S Ø 288 25 22 V + S
			➔	05/13→; +PR 1ZM,1ZQ		24.0122-0210.1 422210 24.0322-0210.1 522210	Ø 280 22 19 V + S Ø 280 22 19 V + S











	kw			 	! #		
<b>VW - BEETLE (5C1, 5C2) 04/11→</b>							
 <b>Bremsscheibe</b>							
2.0 TSI	155	12/12→	←	05/13→; +PR 1ZA,1ZB,1ZD,1LV	24.0125-0158.1	425158	∅ 312 25 22 V + S
					24.0325-0158.1	525158	∅ 312 25 22 V + S
			→	05/13→; +PR 1KD,1KU	24.0110-0277.1	410277	∅ 253 10 8 + S
			→	05/13→; +PR 1KS,1KT	24.0110-0356.1	410356	∅ 272 9,7 8 + S
				24.0310-0356.1	510356	∅ 272 9,7 8 + S	
<b>VW - BEETLE Cabriolet (5C7, 5C8) 12/11→</b>							
 <b>Bremsbelagsatz, Scheibenbremse</b>							
1.2 TSI 1.4 TSI 1.6 TDI 2.0 TDI 2.0 TSI	77 118 77 103 147	12/11→ 12/11→ 12/11→ 04/12→ 12/11→	←	11/12→; +PR 1ZQ	13.0460-7111.2	607111	VW 23130 19,6 - WE / - WK
					13.0470-7111.2	LD7111	VW 23130 19,6 - WE / - WK Ceramic
			←	11/12→; +PR 1ZM	13.0460-7117.2	607117	VW 23130 19,6 + WK
					13.0470-7117.2	LD7117	VW 23130 19,6 + WK Ceramic
			←	11/12→; +PR 1ZA,1ZB,1ZE	13.0460-7184.2	607184	ATE 23587 20,6 + WK
					13.0470-7184.2	LD7184	ATE 23587 20,6 + WK Ceramic
			←	11/12→; +PR 1LV,1ZP	13.0460-7285.2	607285	ATE 23587 20,6 - WE / - WK
		13.0470-7285.2	LD7285	ATE 23587 20,6 - WE / - WK Ceramic			
			→	11/12→; +PR 1KD,1KU	13.0460-2787.2	602787	TRW 23554 17,3 - WK / - WE
					13.0460-2820.2	602820	TRW 20961 17,2 - WK
					13.0470-2820.2	LD2820	TRW 20961 17,2 - WK Ceramic
			→	11/12→; +PR 1KS,1KT	13.0460-3858.2	603858	BOS 24563 17,7 - WE / - WK + Zub
					13.0470-3858.2	LD3858	BOS 24563 17,7 - WE / - WK + Zub Ceramic
1.2 TSI 16V 1.4 TSI 2.0 TDI 2.0 TSI	77 110 110 162	12/14→ 12/14→ 09/14→ 12/14→	←	+PR 1ZQ	13.0460-7111.2	607111	VW 23130 19,6 - WE / - WK
					13.0470-7111.2	LD7111	VW 23130 19,6 - WE / - WK Ceramic
			←	+PR 1ZM	13.0460-7117.2	607117	VW 23130 19,6 + WK
					13.0470-7117.2	LD7117	VW 23130 19,6 + WK Ceramic
			←	+PR 1ZA,1ZB,1ZE	13.0460-7184.2	607184	ATE 23587 20,6 + WK
					13.0470-7184.2	LD7184	ATE 23587 20,6 + WK Ceramic
			←	+PR 1LV,1ZP	13.0460-7285.2	607285	ATE 23587 20,6 - WE / - WK
		13.0470-7285.2	LD7285	ATE 23587 20,6 - WE / - WK Ceramic			
			→	+PR 1KD,1KU	13.0460-2787.2	602787	TRW 23554 17,3 - WK / - WE
					13.0460-2820.2	602820	TRW 20961 17,2 - WK
					13.0470-2820.2	LD2820	TRW 20961 17,2 - WK Ceramic
			→	+PR 1KS,1KT	13.0460-3858.2	603858	BOS 24563 17,7 - WE / - WK + Zub
					13.0470-3858.2	LD3858	BOS 24563 17,7 - WE / - WK + Zub Ceramic
2.0 TDI	81	06/14→	←	12/14→; +PR 1ZQ	13.0460-7111.2	607111	VW 23130 19,6 - WE / - WK
					13.0470-7111.2	LD7111	VW 23130 19,6 - WE / - WK Ceramic
			←	12/14→; +PR 1ZM	13.0460-7117.2	607117	VW 23130 19,6 + WK
					13.0470-7117.2	LD7117	VW 23130 19,6 + WK Ceramic
			←	12/14→; +PR 1ZA,1ZB,1ZE	13.0460-7184.2	607184	ATE 23587 20,6 + WK
					13.0470-7184.2	LD7184	ATE 23587 20,6 + WK Ceramic
			←	12/14→; +PR 1LV,1ZP	13.0460-7285.2	607285	ATE 23587 20,6 - WE / - WK
		13.0470-7285.2	LD7285	ATE 23587 20,6 - WE / - WK Ceramic			
			→	12/14→; +PR 1KD,1KU	13.0460-2787.2	602787	TRW 23554 17,3 - WK / - WE
					13.0460-2820.2	602820	TRW 20961 17,2 - WK
					13.0470-2820.2	LD2820	TRW 20961 17,2 - WK Ceramic
			→	12/14→; +PR 1KS,1KT	13.0460-3858.2	603858	BOS 24563 17,7 - WE / - WK + Zub
					13.0470-3858.2	LD3858	BOS 24563 17,7 - WE / - WK + Zub Ceramic
2.0 TSI	155	12/12→	←	05/13→; +PR 1ZQ	13.0460-7111.2	607111	VW 23130 19,6 - WE / - WK
					13.0470-7111.2	LD7111	VW 23130 19,6 - WE / - WK Ceramic
			←	05/13→; +PR 1ZM	13.0460-7117.2	607117	VW 23130 19,6 + WK
					13.0470-7117.2	LD7117	VW 23130 19,6 + WK Ceramic
			←	05/13→; +PR 1ZA,1ZB,1ZE	13.0460-7184.2	607184	ATE 23587 20,6 + WK









	kw			 	! #		
<b>VW - BEETLE Cabriolet (5C7, 5C8) 12/11→</b>							
<b> Bremsbelagsatz, Scheibenbremse</b>							
2.0 TSI	155	12/12→	←	05/13→; +PR 1ZA,1ZB,1ZE	13.0470-7184.2	LD7184	ATE 23587 20,6 + WK Ceramic
			←	05/13→; +PR 1LV,1ZP	13.0460-7285.2	607285	ATE 23587 20,6 - WE / - WK
			→	05/13→; +PR 1KD,1KU	13.0460-2787.2	602787	TRW 23554 17,3 - WK / - WE
			→	05/13→; +PR 1KS,1KT	13.0460-3858.2	603858	BOS 24563 17,7 - WE / - WK + Zub
2.5	125	12/11→	←	12/12→; +PR 1ZQ	13.0460-7111.2	607111	VW 23130 19,6 - WE / - WK
			←	12/12→; +PR 1ZM	13.0460-7117.2	607117	VW 23130 19,6 + WK
			←	12/12→; +PR 1ZA,1ZB,1ZE	13.0460-7184.2	607184	ATE 23587 20,6 + WK
			←	12/12→; +PR 1LV,1ZP	13.0460-7285.2	607285	ATE 23587 20,6 - WE / - WK
			→	12/12→; +PR 1KD,1KU	13.0460-2787.2	602787	TRW 23554 17,3 - WK / - WE
			→	12/12→; +PR 1KS,1KT	13.0460-3858.2	603858	BOS 24563 17,7 - WE / - WK + Zub
<b> Bremsscheibe</b>							
1.2 TSI 1.4 TSI 1.6 TDI 2.0 TDI 2.0 TSI	77 118 77 103 147	12/11→ 12/11→ 12/11→ 04/12→ 12/11→	←	11/12→; +PR 1ZM,1ZQ	24.0122-0210.1	422210	Ø 280 22 19 V + S
			←	11/12→; +PR 1ZE,1ZP	24.0125-0145.1	425145	Ø 288 25 22 V + S
			←	11/12→; +PR 1ZA,1ZB,1LV	24.0125-0158.1	425158	Ø 312 25 22 V + S
			→	11/12→; +PR 1KD,1KU	24.0110-0277.1	410277	Ø 253 10 8 + S
			→	11/12→; +PR 1KS,1KT	24.0110-0356.1	410356	Ø 272 9,7 8 + S
			→	11/12→; +PR 1KS,1KT	24.0310-0356.1	510356	Ø 272 9,7 8 + S
1.2 TSI 16V 1.4 TSI 2.0 TDI 2.0 TSI	77 110 110 162	12/14→ 12/14→ 09/14→ 12/14→	←	+PR 1ZM,1ZQ	24.0122-0210.1	422210	Ø 280 22 19 V + S
			←	+PR 1ZE,1ZP	24.0125-0145.1	425145	Ø 288 25 22 V + S
			←	+PR 1ZA,1ZB,1LV	24.0125-0158.1	425158	Ø 312 25 22 V + S
			→	+PR 1KD,1KU	24.0110-0277.1	410277	Ø 253 10 8 + S
			→	+PR 1KS,1KT	24.0110-0356.1	410356	Ø 272 9,7 8 + S
			→	+PR 1KS,1KT	24.0310-0356.1	510356	Ø 272 9,7 8 + S
2.0 TDI	81	06/14→	←	12/14→; +PR 1ZM,1ZQ	24.0122-0210.1	422210	Ø 280 22 19 V + S
			←	12/14→; +PR 1ZE,1ZP	24.0125-0145.1	425145	Ø 288 25 22 V + S
			←	12/14→; +PR 1ZA,1ZB,1LV	24.0125-0158.1	425158	Ø 312 25 22 V + S
			→	12/14→; +PR 1KD,1KU	24.0110-0277.1	410277	Ø 253 10 8 + S
			→	12/14→; +PR 1KS,1KT	24.0110-0356.1	410356	Ø 272 9,7 8 + S
2.0 TSI	155	12/12→	←	05/13→; +PR 1ZM,1ZQ	24.0122-0210.1	422210	Ø 280 22 19 V + S
			←	05/13→; +PR 1ZE,1ZP	24.0125-0145.1	425145	Ø 288 25 22 V + S
			←	05/13→; +PR 1ZA,1ZB,1LV	24.0125-0158.1	425158	Ø 312 25 22 V + S
			←	05/13→; +PR 1ZA,1ZB,1LV	24.0325-0158.1	525158	Ø 312 25 22 V + S









	kw			 	! #		
<b>VW - BEETLE Cabriolet (5C7, 5C8) 12/11→</b>							
<b>Bremsscheibe</b>							
2.0 TSI	155	12/12→	➔	05/13→; +PR 1KD,1KU	24.0110-0277.1	410277	Ø 253 10 8 + S
			➔	05/13→; +PR 1KS,1KT	24.0110-0356.1	410356	Ø 272 9,7 8 + S
					24.0310-0356.1	510356	Ø 272 9,7 8 + S
2.5	125	12/11→	←	12/12→; +PR 1ZM,1ZQ	24.0122-0210.1	422210	Ø 280 22 19 V + S
					24.0322-0210.1	522210	Ø 280 22 19 V + S
			←	12/12→; +PR 1ZE,1ZP	24.0125-0145.1	425145	Ø 288 25 22 V + S
					24.0325-0145.1	525145	Ø 288 25 22 V + S
			←	12/12→; +PR 1ZA,1ZB,1LV	24.0125-0158.1	425158	Ø 312 25 22 V + S
					24.0325-0158.1	525158	Ø 312 25 22 V + S
			➔	12/12→; +PR 1KD,1KU	24.0110-0277.1	410277	Ø 253 10 8 + S
➔	12/12→; +PR 1KS,1KT	24.0110-0356.1	410356	Ø 272 9,7 8 + S			
				24.0310-0356.1	510356	Ø 272 9,7 8 + S	
<b>VW - BORA (1J2) 10/98→12/13</b>							
<b>Bremsbelagsatz, Scheibenbremse</b>							
1.4 16V	55	03/00→05/05	←	→ 1J-X-800000; +PR 1LR,1LS,1LQ,1ZM	13.0460-7111.2	607111	VW 23130 19,6 - WE / - WK
1.6	74	10/98→05/05			13.0470-7111.2	LD7111	VW 23130 19,6 - WE / - WK Ceramic
1.6	75	08/00→05/05					
1.8	92	10/98→05/05					
1.8 4motion	92	02/99→05/05	←	1J-Y-000001→; → 12/04; +PR 1LS,1LQ,1ZP,1ZM	13.0460-7117.2	607117	VW 23130 19,6 + WK
1.9 SDI	50	10/98→05/05			13.0470-7117.2	LD7117	VW 23130 19,6 + WK Ceramic
2.0	85	10/98→05/05	←	→ 12/04; +PR 1LN,1ZD,1ZE,1ZH	13.0460-7122.2	607122	ATE 20676 19,8 + WK
2.3 V5	125	10/00→05/05			13.0470-7122.2	LD7122	ATE 20676 19,8 + WK Ceramic
2.3 V5 4motion	125	10/00→05/05	➔	→ 12/04; +PR 1KU,2EE	13.0460-2787.2	602787	TRW 23554 17,3 - WK / - WE
					13.0460-2820.2	602820	TRW 20961 17,2 - WK
					13.0470-2820.2	LD2820	TRW 20961 17,2 - WK Ceramic
			➔	→ 12/04; +PR 1KY	13.0460-2886.2	602886	TRW 20961 16,0 - WK
					13.0460-2937.2	602937	TRW 20961 15,2 - WK + Zub
					13.0470-2886.2	LD2886	TRW 20961 16,0 - WK Ceramic
			➔	→ 12/04; +PR 1KE,1KP,1KT	13.0460-2894.2	602894	TRW 20961 17,2 - WK + Zub
					13.0470-2894.2	LD2894	TRW 20961 17,2 - WK + Zub Ceramic
1.6 16V	77	05/00→05/05	←	→ 12/04; +PR 1LS,1LQ,1ZP,1ZM	13.0460-7117.2	607117	VW 23130 19,6 + WK
1.6 FSI	81	01/02→05/05			13.0470-7117.2	LD7117	VW 23130 19,6 + WK Ceramic
1.9 TDI	74	09/00→05/05	←	→ 12/04; +PR 1LN,1ZD,1ZE,1ZH	13.0460-7122.2	607122	ATE 20676 19,8 + WK
1.9 TDI 4motion	74	09/00→05/05			13.0470-7122.2	LD7122	ATE 20676 19,8 + WK Ceramic
2.0 4motion	85	04/00→05/05	➔	→ 12/04; +PR 1KU,2EE	13.0460-2787.2	602787	TRW 23554 17,3 - WK / - WE
					13.0460-2820.2	602820	TRW 20961 17,2 - WK
					13.0470-2820.2	LD2820	TRW 20961 17,2 - WK Ceramic
			➔	→ 12/04; +PR 1KY	13.0460-2886.2	602886	TRW 20961 16,0 - WK
					13.0460-2937.2	602937	TRW 20961 15,2 - WK + Zub
					13.0470-2886.2	LD2886	TRW 20961 16,0 - WK Ceramic
			➔	→ 12/04; +PR 1KE,1KP,1KT	13.0460-2894.2	602894	TRW 20961 17,2 - WK + Zub
					13.0470-2894.2	LD2894	TRW 20961 17,2 - WK + Zub Ceramic
1.8 T	110	05/00→05/05	←	09/00→ 12/04; +PR 1LS,1LQ,1ZP,1ZM	13.0460-7117.2	607117	VW 23130 19,6 + WK
					13.0470-7117.2	LD7117	VW 23130 19,6 + WK Ceramic
			←	09/00→ 12/04; +PR 1LN,1ZD,1ZE,1ZH	13.0460-7122.2	607122	ATE 20676 19,8 + WK
					13.0470-7122.2	LD7122	ATE 20676 19,8 + WK Ceramic
			➔	09/00→ 12/04; +PR 1KU,2EE	13.0460-2787.2	602787	TRW 23554 17,3 - WK / - WE
					13.0460-2820.2	602820	TRW 20961 17,2 - WK
					13.0470-2820.2	LD2820	TRW 20961 17,2 - WK Ceramic
			➔	09/00→ 12/04; +PR 1KY	13.0460-2886.2	602886	TRW 20961 16,0 - WK
					13.0460-2937.2	602937	TRW 20961 15,2 - WK + Zub
					13.0470-2886.2	LD2886	TRW 20961 16,0 - WK Ceramic
			➔	09/00→ 12/04; +PR 1KE,1KP,1KT	13.0460-2894.2	602894	TRW 20961 17,2 - WK + Zub
					13.0470-2894.2	LD2894	TRW 20961 17,2 - WK + Zub Ceramic
1.8 T	132	03/02→05/05	←	05/02→ 12/04; +PR 1LS,1LQ,1ZP,1ZM	13.0460-7117.2	607117	VW 23130 19,6 + WK
					13.0470-7117.2	LD7117	VW 23130 19,6 + WK Ceramic
			←	05/02→ 12/04; +PR 1LN,1ZD,1ZE,1ZH	13.0460-7122.2	607122	ATE 20676 19,8 + WK
					13.0470-7122.2	LD7122	ATE 20676 19,8 + WK Ceramic
			➔	05/02→ 12/04; +PR 1KU,2EE	13.0460-2787.2	602787	TRW 23554 17,3 - WK / - WE







	kw			 	! #		
<b>VW - BORA (1J2) 10/98→12/13</b>							
<b> Bremsbelagsatz, Scheibenbremse</b>							
1.8 T	132	03/02→05/05	➡	05/02→ 12/04; +PR 1KU,2EE	13.0460-2820.2	602820	TRW 20961 17,2 - WK
					13.0470-2820.2	LD2820	TRW 20961 17,2 - WK Ceramic
			➡	05/02→ 12/04; +PR 1KY	13.0460-2886.2	602886	TRW 20961 16,0 - WK
				13.0460-2937.2	602937	TRW 20961 15,2 - WK + Zub	
				13.0470-2886.2	LD2886	TRW 20961 16,0 - WK Ceramic	
			➡	05/02→ 12/04; +PR 1KE,1KP,1KT	13.0460-2894.2	602894	TRW 20961 17,2 - WK + Zub
					13.0470-2894.2	LD2894	TRW 20961 17,2 - WK + Zub Ceramic
1.9 TDI	66	10/98→05/05	←	→ 1J-X-800000; +PR 1LR,1LS,1LQ,1ZM	13.0460-7111.2	607111	VW 23130 19,6 - WE / - WK
					13.0470-7111.2	LD7111	VW 23130 19,6 - WE / - WK Ceramic
			←	1J-Y-000001→; → 06/01; +PR 1LS,1LQ,1ZP,1ZM	13.0460-7117.2	607117	VW 23130 19,6 + WK
					13.0470-7117.2	LD7117	VW 23130 19,6 + WK Ceramic
			←	→ 06/01; +PR 1LN,1ZD,1ZE,1ZH	13.0460-7122.2	607122	ATE 20676 19,8 + WK
					13.0470-7122.2	LD7122	ATE 20676 19,8 + WK Ceramic
			➡	→ 06/01; +PR 1KU,2EE	13.0460-2787.2	602787	TRW 23554 17,3 - WK / - WE
		13.0460-2820.2	602820	TRW 20961 17,2 - WK			
				13.0470-2820.2	LD2820	TRW 20961 17,2 - WK Ceramic	
			➡	→ 06/01; +PR 1KY	13.0460-2886.2	602886	TRW 20961 16,0 - WK
				13.0460-2937.2	602937	TRW 20961 15,2 - WK + Zub	
				13.0470-2886.2	LD2886	TRW 20961 16,0 - WK Ceramic	
			➡	→ 06/01; +PR 1KE,1KP,1KT	13.0460-2894.2	602894	TRW 20961 17,2 - WK + Zub
					13.0470-2894.2	LD2894	TRW 20961 17,2 - WK + Zub Ceramic
1.9 TDI 1.9 TDI 4motion 2.3 V5	81 85 110	10/98→06/01 02/99→06/01 10/98→10/00	←	→ 1J-X-800000; +PR 1LR,1LS,1LQ,1ZM	13.0460-7111.2	607111	VW 23130 19,6 - WE / - WK
					13.0470-7111.2	LD7111	VW 23130 19,6 - WE / - WK Ceramic
			←	1J-Y-000001→; +PR 1LS,1LQ,1ZP,1ZM	13.0460-7117.2	607117	VW 23130 19,6 + WK
					13.0470-7117.2	LD7117	VW 23130 19,6 + WK Ceramic
			←	+PR 1LN,1ZD,1ZE,1ZH	13.0460-7122.2	607122	ATE 20676 19,8 + WK
					13.0470-7122.2	LD7122	ATE 20676 19,8 + WK Ceramic
			➡	+PR 1KU,2EE	13.0460-2787.2	602787	TRW 23554 17,3 - WK / - WE
		13.0460-2820.2	602820	TRW 20961 17,2 - WK			
				13.0470-2820.2	LD2820	TRW 20961 17,2 - WK Ceramic	
			➡	+PR 1KY	13.0460-2886.2	602886	TRW 20961 16,0 - WK
				13.0460-2937.2	602937	TRW 20961 15,2 - WK + Zub	
				13.0470-2886.2	LD2886	TRW 20961 16,0 - WK Ceramic	
			➡	+PR 1KE,1KP,1KT	13.0460-2894.2	602894	TRW 20961 17,2 - WK + Zub
					13.0470-2894.2	LD2894	TRW 20961 17,2 - WK + Zub Ceramic
1.9 TDI 1.9 TDI 4motion	85 66	12/98→01/02 11/98→04/02	←	02/99→; → 1J-X-800000; +PR 1LR,1LS,1LQ,1ZM	13.0460-7111.2	607111	VW 23130 19,6 - WE / - WK
					13.0470-7111.2	LD7111	VW 23130 19,6 - WE / - WK Ceramic
			←	1J-Y-000001→; → 06/01; +PR 1LS,1LQ,1ZP,1ZM	13.0460-7117.2	607117	VW 23130 19,6 + WK
					13.0470-7117.2	LD7117	VW 23130 19,6 + WK Ceramic
			←	02/99→ 06/01; +PR 1LN,1ZD,1ZE,1ZH	13.0460-7122.2	607122	ATE 20676 19,8 + WK
					13.0470-7122.2	LD7122	ATE 20676 19,8 + WK Ceramic
			➡	02/99→ 06/01; +PR 1KU,2EE	13.0460-2787.2	602787	TRW 23554 17,3 - WK / - WE
		13.0460-2820.2	602820	TRW 20961 17,2 - WK			
				13.0470-2820.2	LD2820	TRW 20961 17,2 - WK Ceramic	
			➡	02/99→ 06/01; +PR 1KY	13.0460-2886.2	602886	TRW 20961 16,0 - WK
				13.0460-2937.2	602937	TRW 20961 15,2 - WK + Zub	
				13.0470-2886.2	LD2886	TRW 20961 16,0 - WK Ceramic	
			➡	02/99→ 06/01; +PR 1KE,1KP,1KT	13.0460-2894.2	602894	TRW 20961 17,2 - WK + Zub
					13.0470-2894.2	LD2894	TRW 20961 17,2 - WK + Zub Ceramic
1.9 TDI 1.9 TDI 4motion	96 96	11/00→05/05 11/00→05/05	←	04/01→ 12/04; +PR 1LS,1LQ,1ZP,1ZM	13.0460-7117.2	607117	VW 23130 19,6 + WK
					13.0470-7117.2	LD7117	VW 23130 19,6 + WK Ceramic
			←	04/01→ 12/04; +PR 1LN,1ZD,1ZE,1ZH	13.0460-7122.2	607122	ATE 20676 19,8 + WK
					13.0470-7122.2	LD7122	ATE 20676 19,8 + WK Ceramic
			➡	04/01→ 12/04; +PR 1KU,2EE	13.0460-2787.2	602787	TRW 23554 17,3 - WK / - WE
				13.0460-2820.2	602820	TRW 20961 17,2 - WK	
					13.0470-2820.2	LD2820	TRW 20961 17,2 - WK Ceramic









	kw			 	! #		
<b>VW - BORA (1J2) 10/98→12/13</b>							
<b> Bremsbelagsatz, Scheibenbremse</b>							
1.9 TDI 1.9 TDI 4motion	96 96	11/00→05/05 11/00→05/05	➡	04/01→ 12/04; +PR 1KY		13.0460-2886.2 602886 13.0460-2937.2 602937 13.0470-2886.2 LD2886	TRW 20961 16,0 - WK TRW 20961 15,2 - WK + Zub TRW 20961 16,0 - WK Ceramic
			➡	04/01→ 12/04; +PR 1KE,1KP,1KT		13.0460-2894.2 602894 13.0470-2894.2 LD2894	TRW 20961 17,2 - WK + Zub TRW 20961 17,2 - WK + Zub Ceramic
1.9 TDI 1.9 TDI 4motion	110 110	05/00→05/05 05/00→05/05	⬅	10/00→ 12/04; +PR 1LS,1LQ,1ZP,1ZM		13.0460-7117.2 607117 13.0470-7117.2 LD7117	VW 23130 19,6 + WK VW 23130 19,6 + WK Ceramic
			⬅	10/00→ 12/04; +PR 1LN,1ZD,1ZE,1ZH		13.0460-7122.2 607122 13.0470-7122.2 LD7122	ATE 20676 19,8 + WK ATE 20676 19,8 + WK Ceramic
			➡	10/00→ 12/04; +PR 1KU,2EE		13.0460-2787.2 602787 13.0460-2820.2 602820 13.0470-2820.2 LD2820	TRW 23554 17,3 - WK / - WE TRW 20961 17,2 - WK TRW 20961 17,2 - WK Ceramic
			➡	10/00→ 12/04; +PR 1KY		13.0460-2886.2 602886 13.0460-2937.2 602937 13.0470-2886.2 LD2886	TRW 20961 16,0 - WK TRW 20961 15,2 - WK + Zub TRW 20961 16,0 - WK Ceramic
			➡	10/00→ 12/04; +PR 1KE,1KP,1KT		13.0460-2894.2 602894 13.0470-2894.2 LD2894	TRW 20961 17,2 - WK + Zub TRW 20961 17,2 - WK + Zub Ceramic
2.3 V5 4motion	110	12/98→10/00	⬅	02/99→; → 1J-X-800000; +PR 1LR,1LS,1LQ,1ZM		13.0460-7111.2 607111 13.0470-7111.2 LD7111	VW 23130 19,6 - WE / - WK VW 23130 19,6 - WE / - WK Ceramic
			⬅	1J-Y-000001→; +PR 1LS,1LQ,1ZP,1ZM		13.0460-7117.2 607117 13.0470-7117.2 LD7117	VW 23130 19,6 + WK VW 23130 19,6 + WK Ceramic
			⬅	02/99→; +PR 1LN,1ZD,1ZE,1ZH		13.0460-7122.2 607122 13.0470-7122.2 LD7122	ATE 20676 19,8 + WK ATE 20676 19,8 + WK Ceramic
			➡	02/99→; +PR 1KU,2EE		13.0460-2787.2 602787 13.0460-2820.2 602820 13.0470-2820.2 LD2820	TRW 23554 17,3 - WK / - WE TRW 20961 17,2 - WK TRW 20961 17,2 - WK Ceramic
			➡	02/99→; +PR 1KY		13.0460-2886.2 602886 13.0460-2937.2 602937 13.0470-2886.2 LD2886	TRW 20961 16,0 - WK TRW 20961 15,2 - WK + Zub TRW 20961 16,0 - WK Ceramic
			➡	02/99→; +PR 1KE,1KP,1KT		13.0460-2894.2 602894 13.0470-2894.2 LD2894	TRW 20961 17,2 - WK + Zub TRW 20961 17,2 - WK + Zub Ceramic
2.8 V6 4motion	150	03/99→05/05	⬅	05/99→ 12/04; +PR 1LS,1LQ,1ZP,1ZM		13.0460-7117.2 607117 13.0470-7117.2 LD7117	VW 23130 19,6 + WK VW 23130 19,6 + WK Ceramic
			⬅	05/99→ 12/04; +PR 1LN,1ZD,1ZE,1ZH		13.0460-7122.2 607122 13.0470-7122.2 LD7122	ATE 20676 19,8 + WK ATE 20676 19,8 + WK Ceramic
			➡	05/99→ 12/04; +PR 1KU,2EE		13.0460-2787.2 602787 13.0460-2820.2 602820 13.0470-2820.2 LD2820	TRW 23554 17,3 - WK / - WE TRW 20961 17,2 - WK TRW 20961 17,2 - WK Ceramic
			➡	05/99→ 12/04; +PR 1KY		13.0460-2886.2 602886 13.0460-2937.2 602937 13.0470-2886.2 LD2886	TRW 20961 16,0 - WK TRW 20961 15,2 - WK + Zub TRW 20961 16,0 - WK Ceramic
			➡	05/99→ 12/04; +PR 1KE,1KP,1KT		13.0460-2894.2 602894 13.0470-2894.2 LD2894	TRW 20961 17,2 - WK + Zub TRW 20961 17,2 - WK + Zub Ceramic
<b> Bremsscheibe</b>							
1.4 16V	55	03/00→05/05	⬅	→ 12/04; +PR 1LR,1LS,1ZP,1ZM		24.0122-0150.1 422150 24.0322-0150.1 522150	Ø 280 22 19 V + S Ø 280 22 19 V + S
1.6	74	10/98→05/05					
1.6	75	08/00→05/05					
1.6 16V	77	05/00→05/05	⬅	→ 12/04; +PR 1LQ		24.0122-0151.1 422151 24.0322-0151.1 522151	Ø 256 22 19 V + S Ø 256 22 19 V + S
1.6 FSI	81	01/02→05/05					
1.8	92	10/98→05/05					
1.8 4motion	92	02/99→05/05	⬅	→ 12/04; +PR 1LN,1ZD,1ZE,1ZH		24.0125-0113.1 425113 24.0325-0113.1 525113	Ø 288 25 22 V + S Ø 288 25 22 V + S
1.9 SDI	50	10/98→05/05					
1.9 TDI	74	09/00→05/05	⬅	→ 12/04; +PR 1LJ,1ZQ		24.0125-0123.1 425123 24.0325-0123.1 525123	Ø 310 25 22 V + S Ø 310 25 22 V + S
1.9 TDI 4motion	74	09/00→05/05					
2.0	85	10/98→05/05					
2.0 4motion	85	04/00→05/05	➡	→ 12/04; +PR 1KP,1KT		24.0109-0123.1 409123 24.0309-0123.1 509123	Ø 230 9 7 + S Ø 230 9 7 + S
2.3 V5	125	10/00→05/05					
2.3 V5 4motion	125	10/00→05/05	➡	→ 12/04; +PR 1KE		24.0109-0133.1 409133 24.0309-0133.1 509133	Ø 239 8,9 7 + S Ø 239 8,9 7 + S
			➡	→ 12/04; +PR 1KU;1KY;2EE		24.0122-0163.1 422163	Ø 256 22 20 V









	kw			 	! #		
<b>VW - BORA (1J2) 10/98→12/13</b>							
<b>Bremsscheibe</b>							
1.4 16V	55	03/00→05/05	➔	→ 12/04; +PR 1KU;1KY;2EE		24.0322-0163.1 522163	Ø 256 22 20 V
1.6	74	10/98→05/05					
1.6	75	08/00→05/05					
1.6 16V	77	05/00→05/05					
1.6 FSI	81	01/02→05/05					
1.8	92	10/98→05/05					
1.8 4motion	92	02/99→05/05					
1.9 SDI	50	10/98→05/05					
1.9 TDI	74	09/00→05/05					
1.9 TDI 4motion	74	09/00→05/05					
2.0	85	10/98→05/05					
2.0 4motion	85	04/00→05/05					
2.3 V5	125	10/00→05/05					
2.3 V5 4motion	125	10/00→05/05					
1.8 T	110	05/00→05/05	➔	09/00→ 12/04; +PR 1LR,1LS,1ZP,1ZM		24.0122-0150.1 422150	Ø 280 22 19 V + S
			➔	09/00→ 12/04; +PR 1LQ		24.0322-0150.1 522150	Ø 280 22 19 V + S
			➔	09/00→ 12/04; +PR 1LN,1ZD,1ZE,1ZH		24.0122-0151.1 422151	Ø 256 22 19 V + S
			➔	09/00→ 12/04; +PR 1LQ		24.0322-0151.1 522151	Ø 256 22 19 V + S
			➔	09/00→ 12/04; +PR 1LN,1ZD,1ZE,1ZH		24.0125-0113.1 425113	Ø 288 25 22 V + S
			➔	09/00→ 12/04; +PR 1LN,1ZD,1ZE,1ZH		24.0325-0113.1 525113	Ø 288 25 22 V + S
			➔	09/00→ 12/04; +PR 1LJ,1ZQ		24.0125-0123.1 425123	Ø 310 25 22 V + S
			➔	09/00→ 12/04; +PR 1LJ,1ZQ		24.0325-0123.1 525123	Ø 310 25 22 V + S
1.8 T	132	03/02→05/05	➔	09/00→ 12/04; +PR 1KP,1KT		24.0109-0123.1 409123	Ø 230 9 7 + S
			➔	09/00→ 12/04; +PR 1KP,1KT		24.0309-0123.1 509123	Ø 230 9 7 + S
			➔	09/00→ 12/04; +PR 1KE		24.0109-0133.1 409133	Ø 239 8,9 7 + S
			➔	09/00→ 12/04; +PR 1KE		24.0309-0133.1 509133	Ø 239 8,9 7 + S
			➔	09/00→ 12/04; +PR 1KU;1KY;2EE		24.0122-0163.1 422163	Ø 256 22 20 V
			➔	09/00→ 12/04; +PR 1KU;1KY;2EE		24.0322-0163.1 522163	Ø 256 22 20 V
			➔	05/02→ 12/04; +PR 1LR,1LS,1ZP,1ZM		24.0122-0150.1 422150	Ø 280 22 19 V + S
			➔	05/02→ 12/04; +PR 1LR,1LS,1ZP,1ZM		24.0322-0150.1 522150	Ø 280 22 19 V + S
1.8 T	132	03/02→05/05	➔	05/02→ 12/04; +PR 1LQ		24.0122-0151.1 422151	Ø 256 22 19 V + S
			➔	05/02→ 12/04; +PR 1LQ		24.0322-0151.1 522151	Ø 256 22 19 V + S
			➔	05/02→ 12/04; +PR 1LN,1ZD,1ZE,1ZH		24.0125-0113.1 425113	Ø 288 25 22 V + S
			➔	05/02→ 12/04; +PR 1LN,1ZD,1ZE,1ZH		24.0325-0113.1 525113	Ø 288 25 22 V + S
			➔	05/02→ 12/04; +PR 1LJ,1ZQ		24.0125-0123.1 425123	Ø 310 25 22 V + S
			➔	05/02→ 12/04; +PR 1LJ,1ZQ		24.0325-0123.1 525123	Ø 310 25 22 V + S
			➔	05/02→ 12/04; +PR 1KP,1KT		24.0109-0123.1 409123	Ø 230 9 7 + S
			➔	05/02→ 12/04; +PR 1KP,1KT		24.0309-0123.1 509123	Ø 230 9 7 + S
1.9 TDI	66	10/98→05/05	➔	05/02→ 12/04; +PR 1KE		24.0109-0133.1 409133	Ø 239 8,9 7 + S
			➔	05/02→ 12/04; +PR 1KE		24.0309-0133.1 509133	Ø 239 8,9 7 + S
			➔	05/02→ 12/04; +PR 1KU;1KY;2EE		24.0122-0163.1 422163	Ø 256 22 20 V
			➔	05/02→ 12/04; +PR 1KU;1KY;2EE		24.0322-0163.1 522163	Ø 256 22 20 V
			➔	→ 06/01; +PR 1LR,1LS,1ZP,1ZM		24.0122-0150.1 422150	Ø 280 22 19 V + S
			➔	→ 06/01; +PR 1LR,1LS,1ZP,1ZM		24.0322-0150.1 522150	Ø 280 22 19 V + S
			➔	→ 06/01; +PR 1LQ		24.0122-0151.1 422151	Ø 256 22 19 V + S
			➔	→ 06/01; +PR 1LQ		24.0322-0151.1 522151	Ø 256 22 19 V + S
1.9 TDI	66	10/98→05/05	➔	→ 06/01; +PR 1LN,1ZD,1ZE,1ZH		24.0125-0113.1 425113	Ø 288 25 22 V + S
			➔	→ 06/01; +PR 1LN,1ZD,1ZE,1ZH		24.0325-0113.1 525113	Ø 288 25 22 V + S
			➔	→ 06/01; +PR 1LJ,1ZQ		24.0125-0123.1 425123	Ø 310 25 22 V + S
			➔	→ 06/01; +PR 1LJ,1ZQ		24.0325-0123.1 525123	Ø 310 25 22 V + S
			➔	→ 06/01; +PR 1KP,1KT		24.0109-0123.1 409123	Ø 230 9 7 + S
			➔	→ 06/01; +PR 1KP,1KT		24.0309-0123.1 509123	Ø 230 9 7 + S
			➔	→ 06/01; +PR 1KE		24.0109-0133.1 409133	Ø 239 8,9 7 + S
			➔	→ 06/01; +PR 1KE		24.0309-0133.1 509133	Ø 239 8,9 7 + S
1.9 TDI 1.9 TDI 4motion 2.3 V5	81 85 110	10/98→06/01 02/99→06/01 10/98→10/00	➔	→ 06/01; +PR 1KU;1KY;2EE		24.0122-0163.1 422163	Ø 256 22 20 V
			➔	→ 06/01; +PR 1KU;1KY;2EE		24.0322-0163.1 522163	Ø 256 22 20 V
			➔	+PR 1LR,1LS,1ZP,1ZM		24.0122-0150.1 422150	Ø 280 22 19 V + S
			➔	+PR 1LR,1LS,1ZP,1ZM		24.0322-0150.1 522150	Ø 280 22 19 V + S
			➔	+PR 1LQ		24.0122-0151.1 422151	Ø 256 22 19 V + S
			➔	+PR 1LQ		24.0322-0151.1 522151	Ø 256 22 19 V + S
			➔	+PR 1LN,1ZD,1ZE,1ZH		24.0125-0113.1 425113	Ø 288 25 22 V + S
➔	+PR 1LN,1ZD,1ZE,1ZH		24.0325-0113.1 525113	Ø 288 25 22 V + S			
↓			➔	+PR 1LJ,1ZQ		24.0125-0123.1 425123	Ø 310 25 22 V + S
			➔	+PR 1LJ,1ZQ		24.0325-0123.1 525123	Ø 310 25 22 V + S
			➔	+PR 1KP,1KT		24.0109-0123.1 409123	Ø 230 9 7 + S









	kw			 	! #			
<b>VW - BORA (1J2) 10/98→12/13</b>								
<b>Bremsscheibe</b>								
1.9 TDI 1.9 TDI 4motion 2.3 V5	81	10/98→06/01	➔	+PR 1KP,1KT		24.0309-0123.1 509123	Ø 230 9 7 + S	
	85	02/99→06/01	➔	+PR 1KE		24.0109-0133.1 409133	Ø 239 8,9 7 + S	
	110	10/98→10/00	➔	+PR 1KU;1KY;2EE		24.0309-0133.1 509133	Ø 239 8,9 7 + S	
			➔			24.0122-0163.1 422163	Ø 256 22 20 V	
						24.0322-0163.1 522163	Ø 256 22 20 V	
1.9 TDI 1.9 TDI 4motion	85	12/98→01/02	➔	02/99→ 06/01; +PR 1LR,1LS,1ZP,1ZM		24.0122-0150.1 422150	Ø 280 22 19 V + S	
	66	11/98→04/02	➔			24.0322-0150.1 522150	Ø 280 22 19 V + S	
			➔	02/99→ 06/01; +PR 1LQ		24.0122-0151.1 422151	Ø 256 22 19 V + S	
						24.0322-0151.1 522151	Ø 256 22 19 V + S	
				➔	02/99→ 06/01; +PR 1LN,1ZD,1ZE,1ZH		24.0125-0113.1 425113	Ø 288 25 22 V + S
				➔			24.0325-0113.1 525113	Ø 288 25 22 V + S
				➔	02/99→ 06/01; +PR 1LJ,1ZQ		24.0125-0123.1 425123	Ø 310 25 22 V + S
				➔			24.0325-0123.1 525123	Ø 310 25 22 V + S
			➔	02/99→ 06/01; +PR 1KP,1KT		24.0109-0123.1 409123	Ø 230 9 7 + S	
			➔			24.0309-0123.1 509123	Ø 230 9 7 + S	
			➔	02/99→ 06/01; +PR 1KE		24.0109-0133.1 409133	Ø 239 8,9 7 + S	
			➔			24.0309-0133.1 509133	Ø 239 8,9 7 + S	
			➔	02/99→ 06/01; +PR 1KU;1KY;2EE		24.0122-0163.1 422163	Ø 256 22 20 V	
			➔			24.0322-0163.1 522163	Ø 256 22 20 V	
1.9 TDI 1.9 TDI 4motion	96	11/00→05/05	➔	04/01→ 12/04; +PR 1LR,1LS,1ZP,1ZM		24.0122-0150.1 422150	Ø 280 22 19 V + S	
	96	11/00→05/05	➔			24.0322-0150.1 522150	Ø 280 22 19 V + S	
			➔	04/01→ 12/04; +PR 1LQ		24.0122-0151.1 422151	Ø 256 22 19 V + S	
				➔			24.0322-0151.1 522151	Ø 256 22 19 V + S
				➔	04/01→ 12/04; +PR 1LN,1ZD,1ZE,1ZH		24.0125-0113.1 425113	Ø 288 25 22 V + S
				➔			24.0325-0113.1 525113	Ø 288 25 22 V + S
				➔	04/01→ 12/04; +PR 1LJ,1ZQ		24.0125-0123.1 425123	Ø 310 25 22 V + S
				➔			24.0325-0123.1 525123	Ø 310 25 22 V + S
			➔	04/01→ 12/04; +PR 1KP,1KT		24.0109-0123.1 409123	Ø 230 9 7 + S	
			➔			24.0309-0123.1 509123	Ø 230 9 7 + S	
			➔	04/01→ 12/04; +PR 1KE		24.0109-0133.1 409133	Ø 239 8,9 7 + S	
			➔			24.0309-0133.1 509133	Ø 239 8,9 7 + S	
			➔	04/01→ 12/04; +PR 1KU;1KY;2EE		24.0122-0163.1 422163	Ø 256 22 20 V	
			➔			24.0322-0163.1 522163	Ø 256 22 20 V	
1.9 TDI 1.9 TDI 4motion	110	05/00→05/05	➔	10/00→ 12/04; +PR 1LR,1LS,1ZP,1ZM		24.0122-0150.1 422150	Ø 280 22 19 V + S	
	110	05/00→05/05	➔			24.0322-0150.1 522150	Ø 280 22 19 V + S	
			➔	10/00→ 12/04; +PR 1LQ		24.0122-0151.1 422151	Ø 256 22 19 V + S	
				➔			24.0322-0151.1 522151	Ø 256 22 19 V + S
				➔	10/00→ 12/04; +PR 1LN,1ZD,1ZE,1ZH		24.0125-0113.1 425113	Ø 288 25 22 V + S
				➔			24.0325-0113.1 525113	Ø 288 25 22 V + S
				➔	10/00→ 12/04; +PR 1LJ,1ZQ		24.0125-0123.1 425123	Ø 310 25 22 V + S
				➔			24.0325-0123.1 525123	Ø 310 25 22 V + S
			➔	10/00→ 12/04; +PR 1KP,1KT		24.0109-0123.1 409123	Ø 230 9 7 + S	
			➔			24.0309-0123.1 509123	Ø 230 9 7 + S	
			➔	10/00→ 12/04; +PR 1KE		24.0109-0133.1 409133	Ø 239 8,9 7 + S	
			➔			24.0309-0133.1 509133	Ø 239 8,9 7 + S	
			➔	10/00→ 12/04; +PR 1KU;1KY;2EE		24.0122-0163.1 422163	Ø 256 22 20 V	
			➔			24.0322-0163.1 522163	Ø 256 22 20 V	
2.3 V5 4motion	110	12/98→10/00	➔	02/99→; +PR 1LR,1LS,1ZP,1ZM		24.0122-0150.1 422150	Ø 280 22 19 V + S	
			➔			24.0322-0150.1 522150	Ø 280 22 19 V + S	
			➔	02/99→; +PR 1LQ		24.0122-0151.1 422151	Ø 256 22 19 V + S	
			➔			24.0322-0151.1 522151	Ø 256 22 19 V + S	
			➔	02/99→; +PR 1LN,1ZD,1ZE,1ZH		24.0125-0113.1 425113	Ø 288 25 22 V + S	
			➔			24.0325-0113.1 525113	Ø 288 25 22 V + S	
			➔	02/99→; +PR 1LJ,1ZQ		24.0125-0123.1 425123	Ø 310 25 22 V + S	
			➔			24.0325-0123.1 525123	Ø 310 25 22 V + S	
			➔	02/99→; +PR 1KP,1KT		24.0109-0123.1 409123	Ø 230 9 7 + S	
			➔			24.0309-0123.1 509123	Ø 230 9 7 + S	
			➔	02/99→; +PR 1KE		24.0109-0133.1 409133	Ø 239 8,9 7 + S	
			➔			24.0309-0133.1 509133	Ø 239 8,9 7 + S	
			➔	02/99→; +PR 1KU;1KY;2EE		24.0122-0163.1 422163	Ø 256 22 20 V	
			➔			24.0322-0163.1 522163	Ø 256 22 20 V	
↓								

























	kw			 	! #		
<b>VW - BORA (1J2) 10/98→12/13</b>							
<b>Bremsscheibe</b>							
2.8 V6 4motion	150	03/99→05/05	←	05/99→ 12/04; +PR 1LR,1LS,1ZP,1ZM	24.0122-0150.1 422150	Ø 280 22 19 V + S	
					24.0322-0150.1 522150	Ø 280 22 19 V + S	
			←	05/99→ 12/04; +PR 1LQ	24.0122-0151.1 422151	Ø 256 22 19 V + S	
					24.0322-0151.1 522151	Ø 256 22 19 V + S	
			←	05/99→ 12/04; +PR 1LN,1ZD,1ZE,1ZH	24.0125-0113.1 425113	Ø 288 25 22 V + S	
					24.0325-0113.1 525113	Ø 288 25 22 V + S	
			←	05/99→ 12/04; +PR 1LJ,1ZQ	24.0125-0123.1 425123	Ø 310 25 22 V + S	
					24.0325-0123.1 525123	Ø 310 25 22 V + S	
VW - BORA Variant (1J6) 05/99→05/05	<b>Bremsbelagsatz, Scheibenbremse</b>						
	1.4 16V 1.6 1.6 1.8 4motion 2.0 2.3 V5 2.3 V5 4motion	55 74 75 92 85 125 125	09/01→05/05 05/99→05/05 08/00→05/05 05/99→05/05 05/99→05/05 10/00→05/05 10/00→05/05	←	→ 1J-X-800000; +PR 1LR,1LS,1LQ,1ZM	13.0460-7111.2 607111	VW 23130 19,6 - WE / - WK
						13.0470-7111.2 LD7111	VW 23130 19,6 - WE / - WK Ceramic
				←	1J-Y-000001→; → 12/04; +PR 1LS,1LQ,1ZP,1ZM	13.0460-7117.2 607117	VW 23130 19,6 + WK
						13.0470-7117.2 LD7117	VW 23130 19,6 + WK Ceramic
				←	→ 12/04; +PR 1LN,1ZD,1ZE,1ZH	13.0460-7122.2 607122	ATE 20676 19,8 + WK
						13.0470-7122.2 LD7122	ATE 20676 19,8 + WK Ceramic
				→	→ 12/04; +PR 1KU,2EE	13.0460-2787.2 602787	TRW 23554 17,3 - WK / - WE
					13.0460-2820.2 602820	TRW 20961 17,2 - WK	
1.6 16V 1.6 FSI 1.8 T 1.9 TDI 1.9 TDI 1.9 TDI 4motion 1.9 TDI 4motion 2.0 4motion 2.8 V6 4motion	77 81 132 74 110 74 110 85 150	02/00→05/05 01/02→05/05 05/02→05/05 09/00→05/05 05/01→05/05 09/00→05/05 05/01→05/05 04/00→05/05 05/99→05/05	←	→ 12/04; +PR 1LS,1LQ,1ZP,1ZM	13.0460-7117.2 607117	VW 23130 19,6 + WK	
					13.0470-7117.2 LD7117	VW 23130 19,6 + WK Ceramic	
			←	→ 12/04; +PR 1LN,1ZD,1ZE,1ZH	13.0460-7122.2 607122	ATE 20676 19,8 + WK	
					13.0470-7122.2 LD7122	ATE 20676 19,8 + WK Ceramic	
			→	→ 12/04; +PR 1KU,2EE	13.0460-2787.2 602787	TRW 23554 17,3 - WK / - WE	
					13.0460-2820.2 602820	TRW 20961 17,2 - WK	
			→	→ 12/04; +PR 1KY	13.0460-2886.2 602886	TRW 20961 16,0 - WK	
					13.0460-2937.2 602937	TRW 20961 15,2 - WK + Zub	
1.8 T	110	05/00→05/05	←	09/00→ 12/04; +PR 1LS,1LQ,1ZP,1ZM	13.0460-7117.2 607117	VW 23130 19,6 + WK	
					13.0470-7117.2 LD7117	VW 23130 19,6 + WK Ceramic	
			←	09/00→ 12/04; +PR 1LN,1ZD,1ZE,1ZH	13.0460-7122.2 607122	ATE 20676 19,8 + WK	
					13.0470-7122.2 LD7122	ATE 20676 19,8 + WK Ceramic	
			→	09/00→ 12/04; +PR 1KU,2EE	13.0460-2787.2 602787	TRW 23554 17,3 - WK / - WE	
					13.0460-2820.2 602820	TRW 20961 17,2 - WK	
			→	09/00→ 12/04; +PR 1KY	13.0460-2886.2 602886	TRW 20961 16,0 - WK	
					13.0460-2937.2 602937	TRW 20961 15,2 - WK + Zub	
1.9 TDI	66	07/04→05/05	←	→ 1J-X-800000; +PR 1LR,1LS,1LQ,1ZM	13.0460-7111.2 607111	VW 23130 19,6 - WE / - WK	
					13.0470-7111.2 LD7111	VW 23130 19,6 - WE / - WK Ceramic	
			←	09/00→ 12/04; +PR 1KE,1KP,1KT	13.0460-2894.2 602894	TRW 20961 17,2 - WK + Zub	
					13.0470-2894.2 LD2894	TRW 20961 17,2 - WK + Zub Ceramic	
			→	09/00→ 12/04; +PR 1KE,1KP,1KT	13.0460-2894.2 602894	TRW 20961 17,2 - WK + Zub	
					13.0470-2894.2 LD2894	TRW 20961 17,2 - WK + Zub Ceramic	
			→	09/00→ 12/04; +PR 1KE,1KP,1KT	13.0460-2894.2 602894	TRW 20961 17,2 - WK + Zub	
					13.0470-2894.2 LD2894	TRW 20961 17,2 - WK + Zub Ceramic	
1.9 TDI	81	05/99→06/01	←	→ 1J-X-800000; +PR 1LR,1LS,1LQ,1ZM	13.0460-7111.2 607111	VW 23130 19,6 - WE / - WK	

	kw			 	! #		
<b>VW - BORA Variant (1J6) 05/99→05/05</b>							
<b> Bremsbelagsatz, Scheibenbremse</b>							
1.9 TDI 1.9 TDI 4motion 2.3 V5 2.3 V5 4motion	85 85 110 110	05/99→06/01 05/99→06/01 05/99→10/00 05/99→10/00	←	→ 1J-X-800000; +PR 1LR,1LS,1LQ,1ZM		13.0470-7111.2 LD7111	VW 23130 19,6 - WE / - WK Ceramic
			←	1J-Y-000001→; +PR 1LS,1LQ,1ZP,1ZM		13.0460-7117.2 607117 13.0470-7117.2 LD7117	VW 23130 19,6 + WK VW 23130 19,6 + WK Ceramic
			←	+PR 1LN,1ZD,1ZE,1ZH		13.0460-7122.2 607122 13.0470-7122.2 LD7122	ATE 20676 19,8 + WK ATE 20676 19,8 + WK Ceramic
			→	+PR 1KU,2EE		13.0460-2787.2 602787 13.0460-2820.2 602820 13.0470-2820.2 LD2820	TRW 23554 17,3 - WK / - WE TRW 20961 17,2 - WK TRW 20961 17,2 - WK Ceramic
			→	+PR 1KY		13.0460-2886.2 602886 13.0460-2937.2 602937 13.0470-2886.2 LD2886	TRW 20961 16,0 - WK TRW 20961 15,2 - WK + Zub TRW 20961 16,0 - WK Ceramic
			→	+PR 1KE,1KP,1KT		13.0460-2894.2 602894 13.0470-2894.2 LD2894	TRW 20961 17,2 - WK + Zub TRW 20961 17,2 - WK + Zub Ceramic
1.9 TDI 1.9 TDI 4motion	96 96	11/00→05/05 11/00→05/05	←	04/01→ 12/04; +PR 1LS,1LQ,1ZP,1ZM		13.0460-7117.2 607117 13.0470-7117.2 LD7117	VW 23130 19,6 + WK VW 23130 19,6 + WK Ceramic
			←	04/01→ 12/04; +PR 1LN,1ZD,1ZE,1ZH		13.0460-7122.2 607122 13.0470-7122.2 LD7122	ATE 20676 19,8 + WK ATE 20676 19,8 + WK Ceramic
			→	04/01→ 12/04; +PR 1KU,2EE		13.0460-2787.2 602787 13.0460-2820.2 602820 13.0470-2820.2 LD2820	TRW 23554 17,3 - WK / - WE TRW 20961 17,2 - WK TRW 20961 17,2 - WK Ceramic
			→	04/01→ 12/04; +PR 1KY		13.0460-2886.2 602886 13.0460-2937.2 602937 13.0470-2886.2 LD2886	TRW 20961 16,0 - WK TRW 20961 15,2 - WK + Zub TRW 20961 16,0 - WK Ceramic
			→	04/01→ 12/04; +PR 1KE,1KP,1KT		13.0460-2894.2 602894 13.0470-2894.2 LD2894	TRW 20961 17,2 - WK + Zub TRW 20961 17,2 - WK + Zub Ceramic
2.0 4motion	88	12/99→05/03	←	04/00→; +PR 1LS,1LQ,1ZP,1ZM		13.0460-7117.2 607117 13.0470-7117.2 LD7117	VW 23130 19,6 + WK VW 23130 19,6 + WK Ceramic
			←	04/00→; +PR 1LN,1ZD,1ZE,1ZH		13.0460-7122.2 607122 13.0470-7122.2 LD7122	ATE 20676 19,8 + WK ATE 20676 19,8 + WK Ceramic
			→	04/00→; +PR 1KU,2EE		13.0460-2787.2 602787 13.0460-2820.2 602820 13.0470-2820.2 LD2820	TRW 23554 17,3 - WK / - WE TRW 20961 17,2 - WK TRW 20961 17,2 - WK Ceramic
			→	04/00→; +PR 1KY		13.0460-2886.2 602886 13.0460-2937.2 602937 13.0470-2886.2 LD2886	TRW 20961 16,0 - WK TRW 20961 15,2 - WK + Zub TRW 20961 16,0 - WK Ceramic
			→	04/00→; +PR 1KE,1KP,1KT		13.0460-2894.2 602894 13.0470-2894.2 LD2894	TRW 20961 17,2 - WK + Zub TRW 20961 17,2 - WK + Zub Ceramic
2.8 VR6	150	03/00→05/00	←	+PR 1LS,1LQ,1ZP,1ZM		13.0460-7117.2 607117 13.0470-7117.2 LD7117	VW 23130 19,6 + WK VW 23130 19,6 + WK Ceramic
			←	+PR 1LN,1ZD,1ZE,1ZH		13.0460-7122.2 607122 13.0470-7122.2 LD7122	ATE 20676 19,8 + WK ATE 20676 19,8 + WK Ceramic
			→	+PR 1KU,2EE		13.0460-2787.2 602787 13.0460-2820.2 602820 13.0470-2820.2 LD2820	TRW 23554 17,3 - WK / - WE TRW 20961 17,2 - WK TRW 20961 17,2 - WK Ceramic
			→	+PR 1KY		13.0460-2886.2 602886 13.0460-2937.2 602937 13.0470-2886.2 LD2886	TRW 20961 16,0 - WK TRW 20961 15,2 - WK + Zub TRW 20961 16,0 - WK Ceramic
			→	+PR 1KE,1KP,1KT		13.0460-2894.2 602894 13.0470-2894.2 LD2894	TRW 20961 17,2 - WK + Zub TRW 20961 17,2 - WK + Zub Ceramic
<b> Bremsscheibe</b>							
1.4 16V 1.6 1.6	55 74 75	09/01→05/05 05/99→05/05 08/00→05/05	←	→ 12/04; +PR 1LR,1LS,1ZP,1ZM		24.0122-0150.1 422150 24.0322-0150.1 522150	∅ 280 22 19 V + S ∅ 280 22 19 V + S
1.6 16V 1.6 FSI 1.8 4motion 1.8 T 1.9 TDI 1.9 TDI	77 81 92 132 74 110	02/00→05/05 01/02→05/05 05/99→05/05 05/02→05/05 09/00→05/05 05/01→05/05	←	→ 12/04; +PR 1LQ		24.0122-0151.1 422151 24.0322-0151.1 522151	∅ 256 22 19 V + S ∅ 256 22 19 V + S
			←	→ 12/04; +PR 1LN,1ZD,1ZE,1ZH		24.0125-0113.1 425113 24.0325-0113.1 525113	∅ 288 25 22 V + S ∅ 288 25 22 V + S
			←	→ 12/04; +PR 1LJ,1ZQ		24.0125-0123.1 425123	∅ 310 25 22 V + S









	kw			 	! #		
<b>VW - BORA Variant (1J6) 05/99—05/05</b>							
<b>Bremsscheibe</b>							
1.9 TDI 4motion	74	09/00→05/05	←	→ 12/04; +PR 1LJ,1ZQ		24.0325-0123.1 525123	Ø 310 25 22 V + S
1.9 TDI 4motion	110	05/01→05/05	→	→ 12/04; +PR 1KP,1KT		24.0109-0123.1 409123	Ø 230 9 7 + S
2.0 4motion	85	05/99→05/05					
2.0 4motion	85	04/00→05/05				24.0309-0123.1 509123	Ø 230 9 7 + S
2.3 V5	125	10/00→05/05	→	→ 12/04; +PR 1KE		24.0109-0133.1 409133	Ø 239 8,9 7 + S
2.3 V5 4motion	125	10/00→05/05				24.0309-0133.1 509133	Ø 239 8,9 7 + S
2.8 V6 4motion	150	05/99→05/05	→	→ 12/04; +PR 1KU;1KY;2EE		24.0122-0163.1 422163	Ø 256 22 20 V
						24.0322-0163.1 522163	Ø 256 22 20 V
1.8 T	110	05/00→05/05	←	09/00→ 12/04; +PR 1LR,1LS,1ZP,1ZM		24.0122-0150.1 422150	Ø 280 22 19 V + S
					24.0322-0150.1 522150	Ø 280 22 19 V + S	
			←	09/00→ 12/04; +PR 1LQ		24.0122-0151.1 422151	Ø 256 22 19 V + S
					24.0322-0151.1 522151	Ø 256 22 19 V + S	
			←	09/00→ 12/04; +PR 1LN,1ZD,1ZE,1ZH		24.0125-0113.1 425113	Ø 288 25 22 V + S
					24.0325-0113.1 525113	Ø 288 25 22 V + S	
			←	09/00→ 12/04; +PR 1LJ,1ZQ		24.0125-0123.1 425123	Ø 310 25 22 V + S
					24.0325-0123.1 525123	Ø 310 25 22 V + S	
			→	09/00→ 12/04; +PR 1KP,1KT		24.0109-0123.1 409123	Ø 230 9 7 + S
						24.0309-0123.1 509123	Ø 230 9 7 + S
			→	09/00→ 12/04; +PR 1KE		24.0109-0133.1 409133	Ø 239 8,9 7 + S
						24.0309-0133.1 509133	Ø 239 8,9 7 + S
			→	09/00→ 12/04; +PR 1KU;1KY;2EE		24.0122-0163.1 422163	Ø 256 22 20 V
						24.0322-0163.1 522163	Ø 256 22 20 V
1.9 TDI 1.9 TDI 1.9 TDI 4motion 2.3 V5 2.3 V5 4motion 2.8 VR6	81 85 85 110 110 150	05/99→06/01 05/99→06/01 05/99→06/01 05/99→10/00 05/99→10/00 03/00→05/00	←	+PR 1LR,1LS,1ZP,1ZM		24.0122-0150.1 422150	Ø 280 22 19 V + S
					24.0322-0150.1 522150	Ø 280 22 19 V + S	
			←	+PR 1LQ		24.0122-0151.1 422151	Ø 256 22 19 V + S
					24.0322-0151.1 522151	Ø 256 22 19 V + S	
			←	+PR 1LN,1ZD,1ZE,1ZH		24.0125-0113.1 425113	Ø 288 25 22 V + S
					24.0325-0113.1 525113	Ø 288 25 22 V + S	
			←	+PR 1LJ,1ZQ		24.0125-0123.1 425123	Ø 310 25 22 V + S
					24.0325-0123.1 525123	Ø 310 25 22 V + S	
			→	+PR 1KP,1KT		24.0109-0123.1 409123	Ø 230 9 7 + S
						24.0309-0123.1 509123	Ø 230 9 7 + S
			→	+PR 1KE		24.0109-0133.1 409133	Ø 239 8,9 7 + S
						24.0309-0133.1 509133	Ø 239 8,9 7 + S
			→	+PR 1KU;1KY;2EE		24.0122-0163.1 422163	Ø 256 22 20 V
						24.0322-0163.1 522163	Ø 256 22 20 V
1.9 TDI 1.9 TDI 4motion	96 96	11/00→05/05 11/00→05/05	←	04/01→ 12/04; +PR 1LR,1LS,1ZP,1ZM		24.0122-0150.1 422150	Ø 280 22 19 V + S
					24.0322-0150.1 522150	Ø 280 22 19 V + S	
			←	04/01→ 12/04; +PR 1LQ		24.0122-0151.1 422151	Ø 256 22 19 V + S
					24.0322-0151.1 522151	Ø 256 22 19 V + S	
			←	04/01→ 12/04; +PR 1LN,1ZD,1ZE,1ZH		24.0125-0113.1 425113	Ø 288 25 22 V + S
					24.0325-0113.1 525113	Ø 288 25 22 V + S	
			←	04/01→ 12/04; +PR 1LJ,1ZQ		24.0125-0123.1 425123	Ø 310 25 22 V + S
					24.0325-0123.1 525123	Ø 310 25 22 V + S	
			→	04/01→ 12/04; +PR 1KP,1KT		24.0109-0123.1 409123	Ø 230 9 7 + S
						24.0309-0123.1 509123	Ø 230 9 7 + S
			→	04/01→ 12/04; +PR 1KE		24.0109-0133.1 409133	Ø 239 8,9 7 + S
						24.0309-0133.1 509133	Ø 239 8,9 7 + S
			→	04/01→ 12/04; +PR 1KU;1KY;2EE		24.0122-0163.1 422163	Ø 256 22 20 V
						24.0322-0163.1 522163	Ø 256 22 20 V
2.0 4motion	88	12/99→05/03	←	04/00→; +PR 1LR,1LS,1ZP,1ZM		24.0122-0150.1 422150	Ø 280 22 19 V + S
					24.0322-0150.1 522150	Ø 280 22 19 V + S	
			←	04/00→; +PR 1LQ		24.0122-0151.1 422151	Ø 256 22 19 V + S
					24.0322-0151.1 522151	Ø 256 22 19 V + S	
			←	04/00→; +PR 1LN,1ZD,1ZE,1ZH		24.0125-0113.1 425113	Ø 288 25 22 V + S
					24.0325-0113.1 525113	Ø 288 25 22 V + S	
			←	04/00→; +PR 1LJ,1ZQ		24.0125-0123.1 425123	Ø 310 25 22 V + S
		24.0325-0123.1 525123	Ø 310 25 22 V + S				
			→	04/00→; +PR 1KP,1KT		24.0109-0123.1 409123	Ø 230 9 7 + S
						24.0309-0123.1 509123	Ø 230 9 7 + S
			→	04/00→; +PR 1KE		24.0109-0133.1 409133	Ø 239 8,9 7 + S
						24.0309-0133.1 509133	Ø 239 8,9 7 + S









	kW			 	! #		
<b>VW - BORA Variant (1J6) 05/99→05/05</b>							
 <b>Bremsscheibe</b>							
2.0 4motion	88	12/99→05/03	➔	04/00→; +PR 1KU;1KY;2EE		24.0122-0163.1 422163 24.0322-0163.1 522163	Ø 256 22 20 V Ø 256 22 20 V
<b>VW - CADDY II Kasten (9K9A) 11/95→01/04</b>							
 <b>Bremsbelagsatz, Scheibenbremse</b>							
1.4	55	08/00→01/04	←	9K-T-514501→		13.0460-2821.2 602821	TRW 21945 16,0 - WK
1.9 D	47	11/95→01/04	←	→ 9K-T-514500		13.0460-2958.2 602958	TRW 20168 19,3 - WK
1.9 SDI	47	11/95→01/04	←				
60 1.4	44	11/95→01/04	←				
75 1.6	55	11/95→05/97	←				
75 1.6	55	11/95→09/00	←				
1.7 SDI	42	07/96→09/00	←			13.0460-2821.2 602821	TRW 21945 16,0 - WK
1.9 TDI	66	09/96→01/04	←				
 <b>Bremsscheibe</b>							
1.4	55	08/00→01/04	←	→ 9K-T-514500		24.0113-0178.1 413178	Ø 255,6 12,9 11 + S
1.9 D	47	11/95→01/04	←			24.0313-0178.1 513178	Ø 255,6 12,9 11 + S
1.9 SDI	47	11/95→01/04	←				
60 1.4	44	11/95→01/04	←	9K-T-514501→		24.0120-0128.1 420128	Ø 256 20 18 V + S
75 1.6	55	11/95→05/97	←			24.0320-0128.1 520128	Ø 256 20 18 V + S
75 1.6	55	11/95→09/00	←				
1.7 SDI	42	07/96→09/00	←			24.0120-0128.1 420128	Ø 256 20 18 V + S
1.9 TDI	66	09/96→01/04	←			24.0320-0128.1 520128	Ø 256 20 18 V + S
<b>VW - CADDY II Kombi (9K9B) 11/95→01/04</b>							
 <b>Bremsbelagsatz, Scheibenbremse</b>							
1.4	44	11/95→01/04	←	9K-T-514501→		13.0460-2821.2 602821	TRW 21945 16,0 - WK
1.4 16V	55	08/00→01/04	←				
1.6	55	11/95→05/97	←	→ 9K-T-514500		13.0460-2958.2 602958	TRW 20168 19,3 - WK
1.6	55	06/97→09/00	←				
1.9 D	47	11/95→01/04	←				
1.9 SDI	47	11/95→01/04	←				
1.7 SDI	42	07/96→09/00	←			13.0460-2821.2 602821	TRW 21945 16,0 - WK
1.9 TDI	66	10/96→01/04	←				
 <b>Bremsscheibe</b>							
1.4	44	11/95→01/04	←	→ 9K-T-514500		24.0113-0178.1 413178	Ø 255,6 12,9 11 + S
1.4 16V	55	08/00→01/04	←			24.0313-0178.1 513178	Ø 255,6 12,9 11 + S
1.6	55	11/95→05/97	←				
1.6	55	06/97→09/00	←	9K-T-514501→		24.0120-0128.1 420128	Ø 256 20 18 V + S
1.9 D	47	11/95→01/04	←			24.0320-0128.1 520128	Ø 256 20 18 V + S
1.9 SDI	47	11/95→01/04	←				
1.7 SDI	42	07/96→09/00	←			24.0120-0128.1 420128	Ø 256 20 18 V + S
1.9 TDI	66	10/96→01/04	←			24.0320-0128.1 520128	Ø 256 20 18 V + S
<b>VW - CADDY II Pick-up (9U7) 06/96→12/00</b>							
 <b>Bremsbelagsatz, Scheibenbremse</b>							
1.6	55	06/96→12/00	←	10/97→		13.0460-2964.2 602964	TRW 20861 17,5 - WK
1.9 D	47	06/96→12/00	←				
 <b>Bremsscheibe</b>							
1.6	55	06/96→12/00	←	10/97→		24.0113-0182.1 413182	Ø 236 12,8 11,4
1.9 D	47	06/96→12/00	←				
<b>VW - CADDY III Kasten (2KA, 2KH, 2CA, 2CH) 03/04→05/15</b>							
 <b>Bremsbelagsatz, Scheibenbremse</b>							
1.2 TSI	63	09/10→05/15	←	+PR 1ZF,1ZM		13.0460-7117.2 607117	VW 23130 19,6 + WK
1.2 TSI	77	09/10→05/15	←			13.0470-7117.2 LD7117	VW 23130 19,6 + WK Ceramic
1.6 TDI	55	08/10→05/15	←				
1.6 TDI	75	08/10→05/15	←	+PR 1ZE,1LJ,1ZA		13.0460-7184.2 607184	ATE 23587 20,6 + WK
1.9 TDI 4motion	77	11/08→08/10	←			13.0470-7184.2 LD7184	ATE 23587 20,6 + WK Ceramic
2.0 TDI 4motion	62	12/10→05/15	➔	+PR 1ZE,1LJ; → 2K-B-200 000		13.0460-2749.2 602749	TRW 24483 16,9 - WE / - WK + Zub
						13.0460-2880.2 602880	TRW 23914 17,1 + WE / - WK + Zub
						13.0470-2749.2 LD2749	TRW 24483 16,9 - WE / - WK + Zub Ceramic
						13.0470-2880.2 LD2880	TRW 23914 17,1 + WE / - WK + Zub Ceramic
			➔	+PR 1ZF,2E2		13.0460-2787.2 602787	TRW 23554 17,3 - WK / - WE
						13.0460-2860.2 602860	TRW 23554 16,4 - WK / + WE









	kw			 	! #		
<b>VW - CADDY III Kasten (2KA, 2KH, 2CA, 2CH) 03/04→05/15</b>							
<b> Bremsbelagsatz, Scheibenbremse</b>							
1.2 TSI 1.2 TSI 1.6 TDI 1.6 TDI 1.9 TDI 4motion 2.0 TDI 4motion	63 77 55 75 77 62	09/10→05/15 09/10→05/15 08/10→05/15 08/10→05/15 11/08→08/10 12/10→05/15	➡	+PR 1ZF,2E2		13.0470-2860.2 LD2860	TRW 23554 16,4 - WK / + WE Ceramic
			➡	2K-B-200 001→; +PR 1ZA,1ZE,1ZF,2E3		13.0460-3858.2 603858 13.0470-3858.2 LD3858	BOS 24563 17,7 - WE / - WK + Zub BOS 24563 17,7 - WE / - WK + Zub Ceramic
1.4	55	03/04→05/06	⬅	+PR 1ZF;1ZM		13.0460-7117.2 607117 13.0470-7117.2 LD7117	VW 23130 19,6 + WK VW 23130 19,6 + WK Ceramic
			⬅	+PR 1ZE,1LJ,1ZA		13.0460-7184.2 607184 13.0470-7184.2 LD7184	ATE 23587 20,6 + WK ATE 23587 20,6 + WK Ceramic
			➡			13.0460-2749.2 602749 13.0460-2880.2 602880 13.0470-2749.2 LD2749 13.0470-2880.2 LD2880	TRW 24483 16,9 - WE / - WK + Zub TRW 23914 17,1 + WE / - WK + Zub TRW 24483 16,9 - WE / - WK + Zub Ceramic TRW 23914 17,1 + WE / - WK + Zub Ceramic
			➡	2K-B-200 001→; +PR 1ZA,1ZE,1ZF,2E3		13.0460-3858.2 603858 13.0470-3858.2 LD3858	BOS 24563 17,7 - WE / - WK + Zub BOS 24563 17,7 - WE / - WK + Zub Ceramic
1.4 1.6 1.9 TDI 1.9 TDI 2.0 EcoFuel 2.0 SDI 2.0 TDI	59 75 55 77 80 51 103	05/06→08/10 04/04→05/15 09/05→08/10 04/04→08/10 04/06→05/15 03/04→08/10 09/07→08/10	⬅	+PR 1ZF;1ZM		13.0460-7117.2 607117 13.0470-7117.2 LD7117	VW 23130 19,6 + WK VW 23130 19,6 + WK Ceramic
			⬅	+PR 1ZE,1LJ,1ZA		13.0460-7184.2 607184 13.0470-7184.2 LD7184	ATE 23587 20,6 + WK ATE 23587 20,6 + WK Ceramic
			➡	→ 11/07		13.0460-2749.2 602749 13.0460-2880.2 602880 13.0470-2749.2 LD2749 13.0470-2880.2 LD2880	TRW 24483 16,9 - WE / - WK + Zub TRW 23914 17,1 + WE / - WK + Zub TRW 24483 16,9 - WE / - WK + Zub Ceramic TRW 23914 17,1 + WE / - WK + Zub Ceramic
			➡	12/07→; +PR 1ZE,1LJ; → 2K-B-200 000		13.0460-2749.2 602749 13.0460-2880.2 602880 13.0470-2749.2 LD2749 13.0470-2880.2 LD2880	TRW 24483 16,9 - WE / - WK + Zub TRW 23914 17,1 + WE / - WK + Zub TRW 24483 16,9 - WE / - WK + Zub Ceramic TRW 23914 17,1 + WE / - WK + Zub Ceramic
			➡	12/07→; +PR 1ZF,2E2		13.0460-2787.2 602787 13.0460-2860.2 602860 13.0470-2860.2 LD2860	TRW 23554 17,3 - WK / - WE TRW 23554 16,4 - WK / + WE TRW 23554 16,4 - WK / + WE Ceramic
			➡	2K-B-200 001→; +PR 1ZA,1ZE,1ZF,2E3		13.0460-3858.2 603858 13.0470-3858.2 LD3858	BOS 24563 17,7 - WE / - WK + Zub BOS 24563 17,7 - WE / - WK + Zub Ceramic
1.6 BiFuel 2.0 TDI 2.0 TDI 16V 2.0 TDI 16V 4motion	75 62 103 103	05/11→05/15 11/10→05/15 11/10→05/15 11/10→05/15	⬅	+PR 1ZF;1ZM		13.0460-7117.2 607117 13.0470-7117.2 LD7117	VW 23130 19,6 + WK VW 23130 19,6 + WK Ceramic
			⬅	+PR 1ZE,1LJ,1ZA		13.0460-7184.2 607184 13.0470-7184.2 LD7184	ATE 23587 20,6 + WK ATE 23587 20,6 + WK Ceramic
			➡	+PR 1ZE,1LJ; → 2K-B-200 000		13.0460-2749.2 602749 13.0460-2880.2 602880 13.0470-2749.2 LD2749 13.0470-2880.2 LD2880	TRW 24483 16,9 - WE / - WK + Zub TRW 23914 17,1 + WE / - WK + Zub TRW 24483 16,9 - WE / - WK + Zub Ceramic TRW 23914 17,1 + WE / - WK + Zub Ceramic
			➡	+PR 1ZF,2E2		13.0460-2787.2 602787 13.0460-2860.2 602860 13.0470-2860.2 LD2860	TRW 23554 17,3 - WK / - WE TRW 23554 16,4 - WK / + WE TRW 23554 16,4 - WK / + WE Ceramic
			➡	2K-B-200 001→; +PR 1ZA,1ZE,1ZF,2E3		13.0460-3858.2 603858	BOS 24563 17,7 - WE / - WK + Zub
↓							









	kw			 	! #		
<b>VW - CADDY III Kasten (2KA, 2KH, 2CA, 2CH) 03/04→05/15</b>							
<b> Bremsbelagsatz, Scheibenbremse</b>							
1.6 BiFuel 2.0 TDI 2.0 TDI 16V 2.0 TDI 16V 4motion	75 62 103 103	05/11→05/15 11/10→05/15 11/10→05/15 11/10→05/15	➡	2K-B-200 001→; +PR 1ZA,1ZE,1ZF,2E3		13.0470-3858.2 LD3858	BOS 24563 17,7 - WE / - WK + Zub Ceramic
2.0 TDI 2.0 TDI 4motion	81 81	08/10→05/15 08/10→05/15	←	10/10→; +PR 1ZF,1ZM		13.0460-7117.2 607117	VW 23130 19,6 + WK
					13.0470-7117.2 LD7117	VW 23130 19,6 + WK Ceramic	
			←	10/10→; +PR 1ZE,1LJ,1ZA		13.0460-7184.2 607184	ATE 23587 20,6 + WK
					13.0470-7184.2 LD7184	ATE 23587 20,6 + WK Ceramic	
			➡	10/10→; +PR 1ZE,1LJ; → 2K-B-200 000		13.0460-2749.2 602749	TRW 24483 16,9 - WE / - WK + Zub
					13.0460-2880.2 602880	TRW 23914 17,1 + WE / - WK + Zub	
					13.0470-2749.2 LD2749	TRW 24483 16,9 - WE / - WK + Zub Ceramic	
		13.0470-2880.2 LD2880	TRW 23914 17,1 + WE / - WK + Zub Ceramic				
			➡	10/10→; +PR 1ZF,2E2		13.0460-2787.2 602787	TRW 23554 17,3 - WK / - WE
						13.0460-2860.2 602860	TRW 23554 16,4 - WK / + WE
						13.0470-2860.2 LD2860	TRW 23554 16,4 - WK / + WE Ceramic
			➡	2K-B-200 001→; +PR 1ZA,1ZE,1ZF,2E3		13.0460-3858.2 603858	BOS 24563 17,7 - WE / - WK + Zub
						13.0470-3858.2 LD3858	BOS 24563 17,7 - WE / - WK + Zub Ceramic
2.0 TDI	125	05/12→05/15	←	+PR 1ZF,1ZM		13.0460-7117.2 607117	VW 23130 19,6 + WK
					13.0470-7117.2 LD7117	VW 23130 19,6 + WK Ceramic	
			←	+PR 1ZE,1LJ,1ZA		13.0460-7184.2 607184	ATE 23587 20,6 + WK
					13.0470-7184.2 LD7184	ATE 23587 20,6 + WK Ceramic	
			➡	+PR 1ZF,2E2		13.0460-2787.2 602787	TRW 23554 17,3 - WK / - WE
						13.0460-2860.2 602860	TRW 23554 16,4 - WK / + WE
						13.0470-2860.2 LD2860	TRW 23554 16,4 - WK / + WE Ceramic
			➡	+PR 1ZA,1ZE,1ZF,2E3		13.0460-3858.2 603858	BOS 24563 17,7 - WE / - WK + Zub
						13.0470-3858.2 LD3858	BOS 24563 17,7 - WE / - WK + Zub Ceramic
<b>Zubehörsatz, Scheibenbremsbelag</b>							
1.2 TSI 1.2 TSI 1.6 BiFuel 1.6 TDI 1.6 TDI 1.9 TDI 4motion 2.0 TDI 2.0 TDI 16V 2.0 TDI 16V 4motion 2.0 TDI 4motion	63 77 75 55 75 77 62 103 103 62	09/10→05/15 09/10→05/15 05/11→05/15 08/10→05/15 08/10→05/15 11/08→08/10 11/10→05/15 11/10→05/15 11/10→05/15 12/10→05/15	➡	+PR 1ZF,2E2		13.0460-0259.2 610259	
			➡	+PR 1ZE,1LJ; → 2K-B-200 000		13.0460-0259.2 610259	
1.4	55	03/04→05/06	➡			13.0460-0259.2 610259	
1.4 1.6 1.9 TDI 1.9 TDI 2.0 EcoFuel 2.0 SDI 2.0 TDI	59 75 55 77 80 51 103	05/06→08/10 04/04→05/15 09/05→08/10 04/04→08/10 04/06→05/15 03/04→08/10 09/07→08/10	➡	12/07→; +PR 1ZE,1LJ; → 2K-B-200 000		13.0460-0259.2 610259	
			➡	→ 11/07		13.0460-0259.2 610259	
			➡	12/07→; +PR 1ZF,2E2		13.0460-0259.2 610259	
2.0 TDI 2.0 TDI 4motion	81 81	08/10→05/15 08/10→05/15	➡	10/10→; +PR 1ZE,1LJ; → 2K-B-200 000		13.0460-0259.2 610259	
			➡	10/10→; +PR 1ZF,2E2		13.0460-0259.2 610259	
2.0 TDI	125	05/12→05/15	➡	+PR 1ZF,2E2		13.0460-0259.2 610259	
<b> Bremsscheibe</b>							
1.2 TSI 1.2 TSI 1.6 TDI 1.6 TDI 1.9 TDI 4motion 2.0 TDI 4motion	63 77 55 75 77 62	09/10→05/15 09/10→05/15 08/10→05/15 08/10→05/15 11/08→08/10 12/10→05/15	←	+PR 1ZF,1ZM		24.0122-0210.1 422210	Ø 280 22 19 V + S
			←			24.0322-0210.1 522210	Ø 280 22 19 V + S
			←	+PR 1ZE		24.0125-0145.1 425145	Ø 288 25 22 V + S
			←			24.0325-0145.1 525145	Ø 288 25 22 V + S
			←	+PR 1LJ,1ZA		24.0125-0158.1 425158	Ø 312 25 22 V + S
			←			24.0325-0158.1 525158	Ø 312 25 22 V + S
			➡	+PR 1ZF,2E2		24.0110-0277.1 410277	Ø 253 10 8 + S
						24.0310-0277.1 510277	Ø 253 10 8 + S









	kw			 	! #		
<b>VW - CADDY III Kasten (2KA, 2KH, 2CA, 2CH) 03/04→05/15</b>							
<b>Bremsscheibe</b>							
1.2 TSI	63	09/10→05/15	➔	2K-B-200 001→; +PR 1ZA,1ZE,1ZF,2E3	24.0110-0356.1	410356	Ø 272 9,7 8 + S
1.2 TSI	77	09/10→05/15			24.0310-0356.1	510356	Ø 272 9,7 8 + S
1.6 TDI	55	08/10→05/15					
1.6 TDI	75	08/10→05/15	➔	+PR 1ZE,1LJ; → 2K-B-200 000	24.0112-0158.1	412158	Ø 256 12 10 + S
1.9 TDI 4motion	77	11/08→08/10			24.0312-0158.1	512158	Ø 256 12 10
2.0 TDI 4motion	62	12/10→05/15					
1.4	55	03/04→05/06	←	+PR 1ZF;1ZM	24.0122-0210.1	422210	Ø 280 22 19 V + S
					24.0322-0210.1	522210	Ø 280 22 19 V + S
			←	+PR 1ZE	24.0125-0145.1	425145	Ø 288 25 22 V + S
					24.0325-0145.1	525145	Ø 288 25 22 V + S
			←	+PR 1LJ,1ZA	24.0125-0158.1	425158	Ø 312 25 22 V + S
					24.0325-0158.1	525158	Ø 312 25 22 V + S
			➔	2K-B-200 001→; +PR 1ZA,1ZE,1ZF,2E3	24.0110-0356.1	410356	Ø 272 9,7 8 + S
					24.0310-0356.1	510356	Ø 272 9,7 8 + S
			➔		24.0112-0158.1	412158	Ø 256 12 10 + S
					24.0312-0158.1	512158	Ø 256 12 10
1.4	59	05/06→08/10	←	+PR 1ZF;1ZM	24.0122-0210.1	422210	Ø 280 22 19 V + S
1.6	75	04/04→05/15			24.0322-0210.1	522210	Ø 280 22 19 V + S
1.9 TDI	55	09/05→08/10					
1.9 TDI	77	04/04→08/10	←	+PR 1ZE	24.0125-0145.1	425145	Ø 288 25 22 V + S
2.0 EcoFuel	80	04/06→05/15			24.0325-0145.1	525145	Ø 288 25 22 V + S
2.0 SDI	51	03/04→08/10					
2.0 TDI	103	09/07→08/10	←	+PR 1LJ,1ZA	24.0125-0158.1	425158	Ø 312 25 22 V + S
					24.0325-0158.1	525158	Ø 312 25 22 V + S
			➔	12/07→; +PR 1ZF,2E2	24.0110-0277.1	410277	Ø 253 10 8 + S
					24.0310-0277.1	510277	Ø 253 10 8 + S
			➔	2K-B-200 001→; +PR 1ZA,1ZE,1ZF,2E3	24.0110-0356.1	410356	Ø 272 9,7 8 + S
					24.0310-0356.1	510356	Ø 272 9,7 8 + S
			➔	12/07→; +PR 1ZE,1LJ; → 2K-B-200 000	24.0112-0158.1	412158	Ø 256 12 10 + S
					24.0312-0158.1	512158	Ø 256 12 10
			➔	→ 11/07	24.0112-0158.1	412158	Ø 256 12 10 + S
					24.0312-0158.1	512158	Ø 256 12 10
1.6 BiFuel	75	05/11→05/15	←	+PR 1ZF;1ZM	24.0122-0210.1	422210	Ø 280 22 19 V + S
2.0 TDI	62	11/10→05/15			24.0322-0210.1	522210	Ø 280 22 19 V + S
2.0 TDI 16V	103	11/10→05/15					
2.0 TDI 16V 4motion	103	11/10→05/15	←	+PR 1ZE	24.0125-0145.1	425145	Ø 288 25 22 V + S
					24.0325-0145.1	525145	Ø 288 25 22 V + S
			←	+PR 1LJ,1ZA	24.0125-0158.1	425158	Ø 312 25 22 V + S
					24.0325-0158.1	525158	Ø 312 25 22 V + S
			➔	+PR 1ZF,2E2	24.0110-0277.1	410277	Ø 253 10 8 + S
					24.0310-0277.1	510277	Ø 253 10 8 + S
			➔	2K-B-200 001→; +PR 1ZA,1ZE,1ZF,2E3	24.0110-0356.1	410356	Ø 272 9,7 8 + S
					24.0310-0356.1	510356	Ø 272 9,7 8 + S
			➔	+PR 1ZE,1LJ; → 2K-B-200 000	24.0112-0158.1	412158	Ø 256 12 10 + S
					24.0312-0158.1	512158	Ø 256 12 10
2.0 TDI	81	08/10→05/15	←	10/10→; +PR 1ZF,1ZM	24.0122-0210.1	422210	Ø 280 22 19 V + S
2.0 TDI 4motion	81	08/10→05/15			24.0322-0210.1	522210	Ø 280 22 19 V + S
			←	10/10→; +PR 1ZE	24.0125-0145.1	425145	Ø 288 25 22 V + S
					24.0325-0145.1	525145	Ø 288 25 22 V + S
			←	10/10→; +PR 1LJ,1ZA	24.0125-0158.1	425158	Ø 312 25 22 V + S
					24.0325-0158.1	525158	Ø 312 25 22 V + S
			➔	10/10→; +PR 1ZF,2E2	24.0110-0277.1	410277	Ø 253 10 8 + S
					24.0310-0277.1	510277	Ø 253 10 8 + S
			➔	2K-B-200 001→; +PR 1ZA,1ZE,1ZF,2E3	24.0110-0356.1	410356	Ø 272 9,7 8 + S
					24.0310-0356.1	510356	Ø 272 9,7 8 + S
			➔	10/10→; +PR 1ZE,1LJ; → 2K-B-200 000	24.0112-0158.1	412158	Ø 256 12 10 + S
					24.0312-0158.1	512158	Ø 256 12 10
2.0 TDI	125	05/12→05/15	←	+PR 1ZF,1ZM	24.0122-0210.1	422210	Ø 280 22 19 V + S
					24.0322-0210.1	522210	Ø 280 22 19 V + S
			←	+PR 1ZE	24.0125-0145.1	425145	Ø 288 25 22 V + S
					24.0325-0145.1	525145	Ø 288 25 22 V + S
			←	+PR 1LJ,1ZA	24.0125-0158.1	425158	Ø 312 25 22 V + S
					24.0325-0158.1	525158	Ø 312 25 22 V + S
			➔	+PR 1ZF,2E2	24.0110-0277.1	410277	Ø 253 10 8 + S
					24.0310-0277.1	510277	Ø 253 10 8 + S













	kw			 	! #		
<b>VW - CADDY III Kasten (2KA, 2KH, 2CA, 2CH) 03/04→05/15</b>							
 <b>Bremsscheibe</b>							
2.0 TDI	125	05/12→05/15	➡	+PR 1ZA,1ZE,1ZF,2E3		24.0110-0356.1 410356 24.0310-0356.1 510356	Ø 272 9,7 8 + S Ø 272 9,7 8 + S
<b>VW - CADDY III Kombi (2KB, 2KJ, 2CB, 2CJ) 03/04→05/15</b>							
 <b>Bremsbelagsatz, Scheibenbremse</b>							
1.2 TSI	63	09/10→05/15	←	+PR 1ZF,1ZM		13.0460-7117.2 607117	VW 23130 19,6 + WK
1.2 TSI	77	09/10→05/15				13.0470-7117.2 LD7117	VW 23130 19,6 + WK Ceramic
1.6 TDI	55	08/10→05/15					
1.6 TDI	75	08/10→05/15	←	+PR 1ZE,1LJ,1ZA		13.0460-7184.2 607184	ATE 23587 20,6 + WK
1.9 TDI 4motion	77	05/08→08/10				13.0470-7184.2 LD7184	ATE 23587 20,6 + WK Ceramic
2.0 TDI 16V 4motion	103	11/10→05/15	➡	+PR 1ZE,1LJ; → 2K-B-200 000		13.0460-2749.2 602749	TRW 24483 16,9 - WE / - WK + Zub
						13.0460-2880.2 602880	TRW 23914 17,1 + WE / - WK + Zub
						13.0470-2749.2 LD2749	TRW 24483 16,9 - WE / - WK + Zub Ceramic
						13.0470-2880.2 LD2880	TRW 23914 17,1 + WE / - WK + Zub Ceramic
			➡	+PR 1ZF,2E2		13.0460-2787.2 602787	TRW 23554 17,3 - WK / - WE
						13.0460-2860.2 602860	TRW 23554 16,4 - WK / + WE
						13.0470-2860.2 LD2860	TRW 23554 16,4 - WK / + WE Ceramic
			➡	2K-B-200 001→; +PR 1ZA,1ZE,1ZF,2E3		13.0460-3858.2 603858	BOS 24563 17,7 - WE / - WK + Zub
						13.0470-3858.2 LD3858	BOS 24563 17,7 - WE / - WK + Zub Ceramic
1.4	55	03/04→05/06	←	+PR 1ZF;1ZM		13.0460-7117.2 607117	VW 23130 19,6 + WK
						13.0470-7117.2 LD7117	VW 23130 19,6 + WK Ceramic
			←	+PR 1ZE,1LJ,1ZA		13.0460-7184.2 607184	ATE 23587 20,6 + WK
						13.0470-7184.2 LD7184	ATE 23587 20,6 + WK Ceramic
			➡			13.0460-2749.2 602749	TRW 24483 16,9 - WE / - WK + Zub
						13.0460-2880.2 602880	TRW 23914 17,1 + WE / - WK + Zub
						13.0470-2749.2 LD2749	TRW 24483 16,9 - WE / - WK + Zub Ceramic
						13.0470-2880.2 LD2880	TRW 23914 17,1 + WE / - WK + Zub Ceramic
			➡	2K-B-200 001→; +PR 1ZA,1ZE,1ZF,2E3		13.0460-3858.2 603858	BOS 24563 17,7 - WE / - WK + Zub
						13.0470-3858.2 LD3858	BOS 24563 17,7 - WE / - WK + Zub Ceramic
1.4	59	05/06→08/10	←	+PR 1ZF;1ZM		13.0460-7117.2 607117	VW 23130 19,6 + WK
1.6	74	03/05→05/15				13.0470-7117.2 LD7117	VW 23130 19,6 + WK Ceramic
1.6	75	04/04→05/15					
1.9 TDI	55	09/05→08/10	←	+PR 1ZE,1LJ,1ZA		13.0460-7184.2 607184	ATE 23587 20,6 + WK
1.9 TDI	77	04/04→08/10				13.0470-7184.2 LD7184	ATE 23587 20,6 + WK Ceramic
2.0 EcoFuel	80	04/06→05/15					
2.0 SDI	51	03/04→08/10	➡	→ 11/07		13.0460-2749.2 602749	TRW 24483 16,9 - WE / - WK + Zub
2.0 TDI	103	09/07→08/10				13.0460-2880.2 602880	TRW 23914 17,1 + WE / - WK + Zub
						13.0470-2749.2 LD2749	TRW 24483 16,9 - WE / - WK + Zub Ceramic
						13.0470-2880.2 LD2880	TRW 23914 17,1 + WE / - WK + Zub Ceramic
			➡	12/07→; +PR 1ZE,1LJ; → 2K-B-200 000		13.0460-2749.2 602749	TRW 24483 16,9 - WE / - WK + Zub
						13.0460-2880.2 602880	TRW 23914 17,1 + WE / - WK + Zub
						13.0470-2749.2 LD2749	TRW 24483 16,9 - WE / - WK + Zub Ceramic
						13.0470-2880.2 LD2880	TRW 23914 17,1 + WE / - WK + Zub Ceramic
			➡	12/07→; +PR 1ZF,2E2		13.0460-2787.2 602787	TRW 23554 17,3 - WK / - WE
						13.0460-2860.2 602860	TRW 23554 16,4 - WK / + WE
						13.0470-2860.2 LD2860	TRW 23554 16,4 - WK / + WE Ceramic
			➡	2K-B-200 001→; +PR 1ZA,1ZE,1ZF,2E3		13.0460-3858.2 603858	BOS 24563 17,7 - WE / - WK + Zub

















	kw			 	! #		
<b>VW - CADDY III Kombi (2KB, 2KJ, 2CB, 2CJ) 03/04→05/15</b>							
<b>Bremsbelagsatz, Scheibenbremse</b>							
1.4 1.6 1.6 1.9 TDI 1.9 TDI 2.0 EcoFuel 2.0 SDI 2.0 TDI	59 74 75 55 77 80 51 103	05/06→08/10 03/05→05/15 04/04→05/15 09/05→08/10 04/04→08/10 04/06→05/15 03/04→08/10 09/07→08/10	➡	2K-B-200 001→; +PR 1ZA,1ZE,1ZF,2E3		13.0470-3858.2 LD3858	BOS 24563 17,7 - WE / - WK + Zub Ceramic
1.6 BiFuel 2.0 TDI 16V	75 103	05/11→05/15 11/10→05/15	←	+PR 1ZF;1ZM		13.0460-7117.2 607117	VW 23130 19,6 + WK
					13.0470-7117.2 LD7117	VW 23130 19,6 + WK Ceramic	
			←	+PR 1ZE,1LJ,1ZA		13.0460-7184.2 607184	ATE 23587 20,6 + WK
					13.0470-7184.2 LD7184	ATE 23587 20,6 + WK Ceramic	
			➡	+PR 1ZE,1LJ; → 2K-B-200 000		13.0460-2749.2 602749	TRW 24483 16,9 - WE / - WK + Zub
					13.0460-2880.2 602880	TRW 23914 17,1 + WE / - WK + Zub	
					13.0470-2749.2 LD2749	TRW 24483 16,9 - WE / - WK + Zub Ceramic	
		13.0470-2880.2 LD2880	TRW 23914 17,1 + WE / - WK + Zub Ceramic				
			➡	+PR 1ZF,2E2		13.0460-2787.2 602787	TRW 23554 17,3 - WK / - WE
						13.0460-2860.2 602860	TRW 23554 16,4 - WK / + WE
						13.0470-2860.2 LD2860	TRW 23554 16,4 - WK / + WE Ceramic
			➡	2K-B-200 001→; +PR 1ZA,1ZE,1ZF,2E3		13.0460-3858.2 603858	BOS 24563 17,7 - WE / - WK + Zub
						13.0470-3858.2 LD3858	BOS 24563 17,7 - WE / - WK + Zub Ceramic
2.0 TDI 2.0 TDI 4motion	81 81	08/10→05/15 08/10→05/15	←	10/10→; +PR 1ZF,1ZM		13.0460-7117.2 607117	VW 23130 19,6 + WK
					13.0470-7117.2 LD7117	VW 23130 19,6 + WK Ceramic	
			←	10/10→; +PR 1ZE,1LJ,1ZA		13.0460-7184.2 607184	ATE 23587 20,6 + WK
					13.0470-7184.2 LD7184	ATE 23587 20,6 + WK Ceramic	
			➡	10/10→; +PR 1ZE,1LJ; → 2K-B-200 000		13.0460-2749.2 602749	TRW 24483 16,9 - WE / - WK + Zub
					13.0460-2880.2 602880	TRW 23914 17,1 + WE / - WK + Zub	
					13.0470-2749.2 LD2749	TRW 24483 16,9 - WE / - WK + Zub Ceramic	
		13.0470-2880.2 LD2880	TRW 23914 17,1 + WE / - WK + Zub Ceramic				
			➡	10/10→; +PR 1ZF,2E2		13.0460-2787.2 602787	TRW 23554 17,3 - WK / - WE
						13.0460-2860.2 602860	TRW 23554 16,4 - WK / + WE
						13.0470-2860.2 LD2860	TRW 23554 16,4 - WK / + WE Ceramic
			➡	2K-B-200 001→; +PR 1ZA,1ZE,1ZF,2E3		13.0460-3858.2 603858	BOS 24563 17,7 - WE / - WK + Zub
						13.0470-3858.2 LD3858	BOS 24563 17,7 - WE / - WK + Zub Ceramic
2.0 TDI	125	05/12→05/15	←	+PR 1ZF,1ZM		13.0460-7117.2 607117	VW 23130 19,6 + WK
					13.0470-7117.2 LD7117	VW 23130 19,6 + WK Ceramic	
			←	+PR 1ZE,1LJ,1ZA		13.0460-7184.2 607184	ATE 23587 20,6 + WK
					13.0470-7184.2 LD7184	ATE 23587 20,6 + WK Ceramic	
			➡	+PR 1ZF,2E2		13.0460-2787.2 602787	TRW 23554 17,3 - WK / - WE
						13.0460-2860.2 602860	TRW 23554 16,4 - WK / + WE
						13.0470-2860.2 LD2860	TRW 23554 16,4 - WK / + WE Ceramic
			➡	+PR 1ZA,1ZE,1ZF,2E3		13.0460-3858.2 603858	BOS 24563 17,7 - WE / - WK + Zub
						13.0470-3858.2 LD3858	BOS 24563 17,7 - WE / - WK + Zub Ceramic
<b>Zubehörsatz, Scheibenbremsbelag</b>							
1.2 TSI 1.2 TSI 1.6 BiFuel 1.6 TDI 1.6 TDI 1.9 TDI 4motion 2.0 TDI 16V 2.0 TDI 16V 4motion	63 77 75 55 75 77 103 103	09/10→05/15 09/10→05/15 05/11→05/15 08/10→05/15 08/10→05/15 05/08→08/10 11/10→05/15 11/10→05/15	➡	+PR 1ZF,2E2		13.0460-0259.2 610259	
			➡	+PR 1ZE,1LJ; → 2K-B-200 000		13.0460-0259.2 610259	
↓							











	kW			 	! #					
<b>VW - CADDY III Kombi (2KB, 2KJ, 2CB, 2CJ) 03/04→05/15</b>										
<b>Zubehörsatz, Scheibenbremsbelag</b>										
1.4	55	03/04→05/06	➡			13.0460-0259.2 610259				
1.4	59	05/06→08/10	➡	12/07→; +PR 1ZE,1LJ; → 2K-B-200 000		13.0460-0259.2 610259				
1.6	74	03/05→05/15	➡	→ 11/07		13.0460-0259.2 610259				
1.6	75	04/04→05/15								
1.9 TDI	55	09/05→08/10	➡	12/07→; +PR 1ZF,2E2		13.0460-0259.2 610259				
1.9 TDI	77	04/04→08/10								
2.0 EcoFuel	80	04/06→05/15								
2.0 SDI	51	03/04→08/10								
2.0 TDI	103	09/07→08/10								
2.0 TDI	81	08/10→05/15	➡	10/10→; +PR 1ZE,1LJ; → 2K-B-200 000		13.0460-0259.2 610259				
2.0 TDI 4motion	81	08/10→05/15	➡	10/10→; +PR 1ZF,2E2		13.0460-0259.2 610259				
2.0 TDI	125	05/12→05/15	➡	+PR 1ZF,2E2		13.0460-0259.2 610259				
<b> Bremsscheibe</b>										
1.2 TSI	63	09/10→05/15	←	+PR 1ZF,1ZM		24.0122-0210.1 422210	Ø 280 22 19 V + S			
1.2 TSI	77	09/10→05/15	←			24.0322-0210.1 522210	Ø 280 22 19 V + S			
1.6 TDI	55	08/10→05/15								
1.6 TDI	75	08/10→05/15	←	+PR 1ZE		24.0125-0145.1 425145	Ø 288 25 22 V + S			
1.9 TDI 4motion	77	05/08→08/10	←	+PR 1LJ,1ZA		24.0325-0145.1 525145	Ø 288 25 22 V + S			
2.0 TDI 16V 4motion	103	11/10→05/15								
						➡	+PR 1ZF,2E2		24.0125-0158.1 425158	Ø 312 25 22 V + S
						➡			24.0325-0158.1 525158	Ø 312 25 22 V + S
						➡	+PR 1ZF,2E2		24.0110-0277.1 410277	Ø 253 10 8 + S
						➡			24.0310-0277.1 510277	Ø 253 10 8 + S
						➡	2K-B-200 001→; +PR 1ZA,1ZE,1ZF,2E3		24.0110-0356.1 410356	Ø 272 9,7 8 + S
						➡			24.0310-0356.1 510356	Ø 272 9,7 8 + S
			➡	+PR 1ZE,1LJ; → 2K-B-200 000		24.0112-0158.1 412158	Ø 256 12 10 + S			
			➡			24.0312-0158.1 512158	Ø 256 12 10			
1.4	55	03/04→05/06	←	+PR 1ZF;1ZM		24.0122-0210.1 422210	Ø 280 22 19 V + S			
			←	+PR 1ZE		24.0322-0210.1 522210	Ø 280 22 19 V + S			
			←	+PR 1LJ,1ZA		24.0125-0145.1 425145	Ø 288 25 22 V + S			
			←	+PR 1LJ,1ZA		24.0325-0145.1 525145	Ø 288 25 22 V + S			
			➡	2K-B-200 001→; +PR 1ZA,1ZE,1ZF,2E3		24.0125-0158.1 425158	Ø 312 25 22 V + S			
			➡			24.0325-0158.1 525158	Ø 312 25 22 V + S			
			➡			24.0110-0356.1 410356	Ø 272 9,7 8 + S			
			➡			24.0310-0356.1 510356	Ø 272 9,7 8 + S			
			➡			24.0112-0158.1 412158	Ø 256 12 10 + S			
			➡			24.0312-0158.1 512158	Ø 256 12 10			
1.4	59	05/06→08/10	←	+PR 1ZF;1ZM		24.0122-0210.1 422210	Ø 280 22 19 V + S			
1.6	74	03/05→05/15	←			24.0322-0210.1 522210	Ø 280 22 19 V + S			
1.6	75	04/04→05/15								
1.9 TDI	55	09/05→08/10	←	+PR 1ZE		24.0125-0145.1 425145	Ø 288 25 22 V + S			
1.9 TDI	77	04/04→08/10	←	+PR 1LJ,1ZA		24.0325-0145.1 525145	Ø 288 25 22 V + S			
2.0 EcoFuel	80	04/06→05/15								
2.0 SDI	51	03/04→08/10								
2.0 TDI	103	09/07→08/10								
			➡	12/07→; +PR 1ZF,2E2		24.0125-0158.1 425158	Ø 312 25 22 V + S			
			➡			24.0110-0277.1 410277	Ø 253 10 8 + S			
			➡	2K-B-200 001→; +PR 1ZA,1ZE,1ZF,2E3		24.0310-0277.1 510277	Ø 253 10 8 + S			
			➡			24.0110-0356.1 410356	Ø 272 9,7 8 + S			
			➡			24.0310-0356.1 510356	Ø 272 9,7 8 + S			
			➡	12/07→; +PR 1ZE,1LJ; → 2K-B-200 000		24.0112-0158.1 412158	Ø 256 12 10 + S			
			➡			24.0312-0158.1 512158	Ø 256 12 10			
			➡	→ 11/07		24.0112-0158.1 412158	Ø 256 12 10 + S			
			➡			24.0312-0158.1 512158	Ø 256 12 10			
1.6 BiFuel	75	05/11→05/15	←	+PR 1ZF;1ZM		24.0122-0210.1 422210	Ø 280 22 19 V + S			
2.0 TDI 16V	103	11/10→05/15	←	+PR 1ZE		24.0322-0210.1 522210	Ø 280 22 19 V + S			
			←	+PR 1LJ,1ZA		24.0125-0145.1 425145	Ø 288 25 22 V + S			
			←	+PR 1LJ,1ZA		24.0325-0145.1 525145	Ø 288 25 22 V + S			
			➡	+PR 1ZF,2E2		24.0125-0158.1 425158	Ø 312 25 22 V + S			
			➡			24.0325-0158.1 525158	Ø 312 25 22 V + S			
			➡			24.0110-0277.1 410277	Ø 253 10 8 + S			
			➡			24.0310-0277.1 510277	Ø 253 10 8 + S			
			➡	2K-B-200 001→; +PR 1ZA,1ZE,1ZF,2E3		24.0110-0356.1 410356	Ø 272 9,7 8 + S			
			➡			24.0310-0356.1 510356	Ø 272 9,7 8 + S			
			➡	+PR 1ZE,1LJ; → 2K-B-200 000		24.0112-0158.1 412158	Ø 256 12 10 + S			
			➡			24.0312-0158.1 512158	Ø 256 12 10			
2.0 TDI	81	08/10→05/15	←	10/10→; +PR 1ZF,1ZM		24.0122-0210.1 422210	Ø 280 22 19 V + S			
↓										













	kw					! #		
<b>VW - CADDY III Kombi (2KB, 2KJ, 2CB, 2CJ) 03/04→05/15</b>								
 <b>Bremsscheibe</b>								
2.0 TDI 4motion	81	08/10→05/15	←	10/10→; +PR 1ZF,1ZM	24.0322-0210.1	522210	Ø 280 22 19 V + S	
			←	10/10→; +PR 1ZE	24.0125-0145.1	425145	Ø 288 25 22 V + S	
					24.0325-0145.1	525145	Ø 288 25 22 V + S	
			←	10/10→; +PR 1LJ,1ZA	24.0125-0158.1	425158	Ø 312 25 22 V + S	
					24.0325-0158.1	525158	Ø 312 25 22 V + S	
			→	10/10→; +PR 1ZF,2E2	24.0110-0277.1	410277	Ø 253 10 8 + S	
					24.0310-0277.1	510277	Ø 253 10 8 + S	
			→	2K-B-200 001→; +PR 1ZA,1ZE,1ZF,2E3	24.0110-0356.1	410356	Ø 272 9,7 8 + S	
					24.0310-0356.1	510356	Ø 272 9,7 8 + S	
			→	10/10→; +PR 1ZE,1LJ; → 2K-B-200 000	24.0112-0158.1	412158	Ø 256 12 10 + S	
					24.0312-0158.1	512158	Ø 256 12 10	
2.0 TDI	125	05/12→05/15	←	+PR 1ZF,1ZM	24.0122-0210.1	422210	Ø 280 22 19 V + S	
					24.0322-0210.1	522210	Ø 280 22 19 V + S	
			←	+PR 1ZE	24.0125-0145.1	425145	Ø 288 25 22 V + S	
					24.0325-0145.1	525145	Ø 288 25 22 V + S	
			←	+PR 1LJ,1ZA	24.0125-0158.1	425158	Ø 312 25 22 V + S	
					24.0325-0158.1	525158	Ø 312 25 22 V + S	
			→	+PR 1ZF,2E2	24.0110-0277.1	410277	Ø 253 10 8 + S	
					24.0310-0277.1	510277	Ø 253 10 8 + S	
			→	+PR 1ZA,1ZE,1ZF,2E3	24.0110-0356.1	410356	Ø 272 9,7 8 + S	
					24.0310-0356.1	510356	Ø 272 9,7 8 + S	
<b>VW - CADDY IV Kasten (SAA, SAH) 05/15→</b>								
 <b>Bremsbelagsatz, Scheibenbremse</b>								
1.0 TSI	75	11/15→	←	+PR 1ZE	13.0460-2609.2	602609	TRW 25683 20,4 + WE / - WK	
1.2 TSI	62	06/15→						
1.4 TGI CNG	81	06/15→	←	+PR 1ZA	13.0460-2609.2	602609	TRW 25683 20,4 + WE / - WK	
1.4 TSI	92	05/15→						
1.6	81	11/15→	→		13.0460-2790.2	602790	TRW 25110 17,5 - WE / - WK	
1.6 TDI	55	05/15→			13.0470-2790.2	LD2790	TRW 25110 17,5 - WE / - WK	
1.6 TDI	75	05/15→					Ceramic	
2.0 TDI	55	05/15→						
2.0 TDI	75	05/15→						
2.0 TDI	103	05/15→						
2.0 TDI	110	05/15→						
2.0 TDI 4motion	55	11/15→						
2.0 TDI 4motion	81	05/15→						
2.0 TDI 4motion	90	05/15→						
2.0 TDI 4motion	103	05/15→						
2.0 TDI 4motion	110	11/15→						
<b>VW - CADDY IV Kombi (SAB, SAJ) 05/15→</b>								
 <b>Bremsbelagsatz, Scheibenbremse</b>								
1.0 TSI	75	11/15→	←	+PR 1ZE	13.0460-2609.2	602609	TRW 25683 20,4 + WE / - WK	
1.2 TSI	62	06/15→						
1.4 TGI CNG	81	06/15→	←	+PR 1ZA	13.0460-2609.2	602609	TRW 25683 20,4 + WE / - WK	
1.4 TSI	92	05/15→						
1.6	81	11/15→	→		13.0460-2790.2	602790	TRW 25110 17,5 - WE / - WK	
1.6 TDI	55	05/15→			13.0470-2790.2	LD2790	TRW 25110 17,5 - WE / - WK	
1.6 TDI	75	05/15→					Ceramic	
2.0 TDI	55	05/15→						
2.0 TDI	75	05/15→						
2.0 TDI	103	05/15→						
2.0 TDI	110	05/15→						
2.0 TDI 4motion	81	05/15→						













	kw			 	! #		
<b>VW - CADDY IV Kombi (SAB, SAJ) 05/15→</b>							
 <b>Bremsbelagsatz, Scheibenbremse</b>							
2.0 TDI 4motion	90	05/15→	←	+PR 1ZE		13.0460-2609.2 602609	TRW 25683 20,4 + WE / - WK
2.0 TDI 4motion	103	05/15→	←	+PR 1ZA		13.0460-2609.2 602609	TRW 25683 20,4 + WE / - WK
2.0 TDI 4motion	110	11/15→	→			13.0460-2790.2 602790 13.0470-2790.2 LD2790	TRW 25110 17,5 - WE / - WK TRW 25110 17,5 - WE / - WK Ceramic
 <b>Bremsscheibe</b>							
1.0 TSI	75	11/15→	←	+PR 1ZE		24.0125-0145.1 425145	Ø 288 25 22 V + S
1.2 TSI	62	06/15→				24.0325-0145.1 525145	Ø 288 25 22 V + S
1.4 TGI CNG	81	06/15→	←	+PR 1ZA		24.0125-0158.1 425158	Ø 312 25 22 V + S
1.4 TSI	92	05/15→	←	+PR 1ZA		24.0325-0158.1 525158	Ø 312 25 22 V + S
1.6	81	11/15→					
1.6 TDI	55	05/15→	→			24.0110-0356.1 410356	Ø 272 9,7 8 + S
1.6 TDI	75	05/15→	→			24.0310-0356.1 510356	Ø 272 9,7 8 + S
2.0 TDI	55	05/15→					
2.0 TDI	75	05/15→					
2.0 TDI	103	05/15→					
2.0 TDI	110	05/15→					
2.0 TDI 4motion	81	05/15→					
2.0 TDI 4motion	90	05/15→					
2.0 TDI 4motion	103	05/15→					
2.0 TDI 4motion	110	11/15→					
<b>VW - CADDY ALLTRACK Kasten (SAA) 05/15→</b>							
 <b>Bremsbelagsatz, Scheibenbremse</b>							
1.0 TSI	75	11/15→	←	+PR 1ZE		13.0460-2609.2 602609	TRW 25683 20,4 + WE / - WK
1.2 TSI	62	06/15→	←	+PR 1ZA		13.0460-2609.2 602609	TRW 25683 20,4 + WE / - WK
1.4 TGI CNG	81	06/15→	←	+PR 1ZA			
1.4 TSI	92	05/15→	→			13.0460-2790.2 602790	TRW 25110 17,5 - WE / - WK
2.0 TDI	55	05/15→	→			13.0470-2790.2 LD2790	TRW 25110 17,5 - WE / - WK Ceramic
2.0 TDI	75	05/15→					
2.0 TDI	110	05/15→					
2.0 TDI 4motion	90	05/15→					
2.0 TDI 4motion	110	11/15→					
 <b>Bremsscheibe</b>							
1.0 TSI	75	11/15→	←	+PR 1ZE		24.0125-0145.1 425145	Ø 288 25 22 V + S
1.2 TSI	62	06/15→				24.0325-0145.1 525145	Ø 288 25 22 V + S
1.4 TGI CNG	81	06/15→	←	+PR 1ZA		24.0125-0158.1 425158	Ø 312 25 22 V + S
1.4 TSI	92	05/15→	←	+PR 1ZA		24.0325-0158.1 525158	Ø 312 25 22 V + S
2.0 TDI	55	05/15→	→			24.0110-0356.1 410356	Ø 272 9,7 8 + S
2.0 TDI	75	05/15→	→			24.0310-0356.1 510356	Ø 272 9,7 8 + S
2.0 TDI	110	05/15→					
2.0 TDI 4motion	90	05/15→					
2.0 TDI 4motion	110	11/15→					
<b>VW - CADDY ALLTRACK Kombi (SAB) 05/15→</b>							
 <b>Bremsbelagsatz, Scheibenbremse</b>							
1.0 TSI	75	11/15→	←	+PR 1ZE		13.0460-2609.2 602609	TRW 25683 20,4 + WE / - WK
1.2 TSI	62	06/15→	←	+PR 1ZA		13.0460-2609.2 602609	TRW 25683 20,4 + WE / - WK
1.4 TGI CNG	81	06/15→	←	+PR 1ZA			
1.4 TSI	92	05/15→	→			13.0460-2790.2 602790	TRW 25110 17,5 - WE / - WK
2.0 TDI	55	05/15→	→			13.0470-2790.2 LD2790	TRW 25110 17,5 - WE / - WK Ceramic
2.0 TDI	75	05/15→					
2.0 TDI	110	05/15→					
2.0 TDI 4motion	90	05/15→					
2.0 TDI 4motion	110	11/15→					
 <b>Bremsscheibe</b>							
1.0 TSI	75	11/15→	←	+PR 1ZE		24.0125-0145.1 425145	Ø 288 25 22 V + S
1.2 TSI	62	06/15→				24.0325-0145.1 525145	Ø 288 25 22 V + S
1.4 TGI CNG	81	06/15→	←	+PR 1ZA		24.0125-0158.1 425158	Ø 312 25 22 V + S
1.4 TSI	92	05/15→	←	+PR 1ZA		24.0325-0158.1 525158	Ø 312 25 22 V + S
2.0 TDI	55	05/15→	→			24.0110-0356.1 410356	Ø 272 9,7 8 + S
2.0 TDI	75	05/15→	→			24.0310-0356.1 510356	Ø 272 9,7 8 + S
2.0 TDI	110	05/15→					
2.0 TDI 4motion	90	05/15→					
2.0 TDI 4motion	110	11/15→					
<b>VW - CC (358) 11/11→12/16</b>							
 <b>Bremsbelagsatz, Scheibenbremse</b>							
1.4 TSI	110	05/15→12/16	←	+PR 1LA,1LB		13.0460-2764.2 602764	TRW 24738 20,0 + WK
1.4 TSI	118	11/11→12/16				13.0470-2764.2 LD2764	TRW 24738 20,0 + WK Ceramic
1.4 TSI MultiFuel	118	11/11→12/16	←	+PR 1ZM,1ZG		13.0460-7184.2 607184	ATE 23587 20,6 + WK
1.8 TSI	112	11/11→12/16	←	+PR 1ZM,1ZG		13.0470-7184.2 LD7184	ATE 23587 20,6 + WK Ceramic
1.8 TSI	118	11/11→12/16					

	kw			 	! #		
<b>VW - CC (358) 11/11→12/16</b>							
 <b>Bremsbelagsatz, Scheibenbremse</b>							
2.0 TDI	100	11/11→12/16	➔	+PR 2EA		13.0460-2621.2 602621	TRW 24483 16,9 - WE / - WK + Zub
2.0 TDI	103	11/11→12/16					
2.0 TDI	110	05/15→12/16				13.0460-2887.2 602887	TRW 23914 17,1 + WE / - WK + Zub
2.0 TDI	125	11/11→12/16					
2.0 TDI	130	12/12→12/16					
2.0 TDI	135	05/15→12/16				13.0470-2621.2 LD2621	TRW 24483 16,9 - WE / - WK + Zub Ceramic
2.0 TDI 4motion	103	11/11→12/16					
2.0 TDI 4motion	125	11/11→01/13				13.0470-2887.2 LD2887	TRW 23914 17,1 + WE / - WK + Zub Ceramic
2.0 TDI 4motion	130	12/12→12/16					
2.0 TSI	147	11/11→12/16					
2.0 TSI	155	11/11→12/16	➔	+PR 1KW		13.0460-2749.2 602749	TRW 24483 16,9 - WE / - WK + Zub
3.6 FSI 4motion	220	11/11→12/16					
						13.0460-2880.2 602880	TRW 23914 17,1 + WE / - WK + Zub
						13.0470-2749.2 LD2749	TRW 24483 16,9 - WE / - WK + Zub Ceramic
						13.0470-2880.2 LD2880	TRW 23914 17,1 + WE / - WK + Zub Ceramic
 <b>Bremsscheibe</b>							
1.4 TSI	110	05/15→12/16	➔	+PR 1ZM,1ZG		24.0125-0158.1 425158	Ø 312 25 22 V + S
1.4 TSI	118	11/11→12/16				24.0325-0158.1 525158	Ø 312 25 22 V + S
1.4 TSI MultiFuel	118	11/11→12/16					
1.8 TSI	112	11/11→12/16	➔	+PR 1LA,1LB		24.0130-0225.1 430225	Ø 340 30 27 V + S
1.8 TSI	118	11/11→12/16					
2.0 TDI	100	11/11→12/16	➔	+PR 1KW		24.0112-0169.1 412169	Ø 282 12 10 + S
2.0 TDI	103	11/11→12/16				24.0312-0169.1 512169	Ø 282 12 10 + S
2.0 TDI	110	05/15→12/16	➔	+PR 2EA		24.0122-0219.1 422219	Ø 310 22 20 V
2.0 TDI	125	11/11→12/16					
2.0 TDI	130	12/12→12/16					
2.0 TDI	135	05/15→12/16					
2.0 TDI 4motion	103	11/11→12/16					
2.0 TDI 4motion	125	11/11→01/13					
2.0 TDI 4motion	130	12/12→12/16					
2.0 TSI	147	11/11→12/16					
2.0 TSI	155	11/11→12/16					
3.6 FSI 4motion	220	11/11→12/16					
<b>VW - CRAFTER 30-35 Bus (2E_) 04/06→12/16</b>							
 <b>Bremsbelagsatz, Scheibenbremse</b>							
2.0 TDI	80	05/11→12/16	➔	07/11→; +PR 0WC, 0WL		13.0460-4826.2 604826	BRE 29192 20,7 + WE / - WK + Zub
2.0 TDI	100	05/11→12/16				13.0460-4877.2 604877	BRE 29192 20,3 + WE / - WK + Zub
			➔	07/11→; +PR 0WF		13.0460-4827.2 604827	BRE 29200 21,0 + WE / - WK + Zub
			➔	07/11→; +PR 0WC, 0WL		13.0460-3832.2 603832	BOS 29190 20,2 + WE / - WK
			➔	07/11→; +PR 0WF		13.0460-3842.2 603842	BOS 29217 20,5 + WE / - WK
2.0 TDI	84	11/13→12/16	➔	+PR 0WC, 0WL		13.0460-4826.2 604826	BRE 29192 20,7 + WE / - WK + Zub
2.0 TDI	105	10/11→12/16				13.0460-4877.2 604877	BRE 29192 20,3 + WE / - WK + Zub
2.0 TDI	120	07/11→12/16					
			➔	+PR 0WF		13.0460-4827.2 604827	BRE 29200 21,0 + WE / - WK + Zub
			➔	+PR 0WC, 0WL		13.0460-3832.2 603832	BOS 29190 20,2 + WE / - WK
			➔	+PR 0WF		13.0460-3842.2 603842	BOS 29217 20,5 + WE / - WK
2.0 TDI 4motion	120	11/11→12/16	➔	+PR 0WC,0WL		13.0460-4826.2 604826	BRE 29192 20,7 + WE / - WK + Zub
						13.0460-4877.2 604877	BRE 29192 20,3 + WE / - WK + Zub
			➔	+PR 0WF		13.0460-4827.2 604827	BRE 29200 21,0 + WE / - WK + Zub
			➔	+PR 0WC,0WL		13.0460-3832.2 603832	BOS 29190 20,2 + WE / - WK
			➔	+PR 0WF		13.0460-3842.2 603842	BOS 29217 20,5 + WE / - WK
2.5 TDI	65	04/06→07/11	➔	+PR 0WC, 0WL		13.0460-4826.2 604826	BRE 29192 20,7 + WE / - WK + Zub
2.5 TDI	80	04/06→05/13				13.0460-4877.2 604877	BRE 29192 20,3 + WE / - WK + Zub
2.5 TDI	100	04/06→05/13					
2.5 TDI	120	04/06→07/11					
			➔	→ 06/11; +PR 0WF		13.0460-4827.2 604827	BRE 29200 21,0 + WE / - WK + Zub
			➔	07/11→; +PR 0WF		13.0460-4827.2 604827	BRE 29200 21,0 + WE / - WK + Zub
↓							









	kw			 	! #		
<b>VW - CRAFTER 30-35 Bus (2E_) 04/06→12/16</b>							
 <b>Bremsbelagsatz, Scheibenbremse</b>							
2.5 TDI	65	04/06→07/11	➡	+PR 0WC, 0WL		13.0460-3832.2 603832	BOS 29190 20,2 + WE / - WK
2.5 TDI	80	04/06→05/13	➡	+PR 0WF		13.0460-3842.2 603842	BOS 29217 20,5 + WE / - WK
2.5 TDI	100	04/06→05/13					
2.5 TDI	120	04/06→07/11					
<b>Warnkontakt, Bremsbelagverschleiß</b>							
2.0 TDI	80	05/11→12/16	⬅	07/11→; +PR 0WF	2	24.8190-0424.2 620424	L= 103,2
2.0 TDI	100	05/11→12/16	⬅	07/11→; +PR 0WC, 0WL	2	24.8190-0424.2 620424	L= 103,2
			➡	07/11→; +PR 0WF	2	24.8190-0005.2 620005	L= 84
			➡	07/11→; +PR 0WC, 0WL	2	24.8190-0418.2 620418	L= 95
2.0 TDI	84	11/13→12/16	⬅	+PR 0WF	2	24.8190-0424.2 620424	L= 103,2
2.0 TDI	105	10/11→12/16	⬅	+PR 0WC, 0WL	2	24.8190-0424.2 620424	L= 103,2
2.0 TDI	120	07/11→12/16					
			➡	+PR 0WF	2	24.8190-0005.2 620005	L= 84
			➡	+PR 0WC, 0WL	2	24.8190-0418.2 620418	L= 95
2.0 TDI 4motion	120	11/11→12/16	⬅	+PR 0WC,0WL	2	24.8190-0005.2 620005	L= 84
			⬅	+PR 0WF	2	24.8190-0005.2 620005	L= 84
			➡	+PR 0WF	2	24.8190-0005.2 620005	L= 84
			➡	+PR 0WC,0WL	2	24.8190-0418.2 620418	L= 95
2.5 TDI	65	04/06→07/11	⬅	07/11→; +PR 0WF	2	24.8190-0424.2 620424	L= 103,2
2.5 TDI	80	04/06→05/13	⬅	→ 06/11; +PR 0WF	2	24.8190-0424.2 620424	L= 103,2
2.5 TDI	100	04/06→05/13					
2.5 TDI	120	04/06→07/11					
			⬅	+PR 0WC, 0WL	2	24.8190-0424.2 620424	L= 103,2
			➡	+PR 0WF	2	24.8190-0005.2 620005	L= 84
			➡	+PR 0WC, 0WL	2	24.8190-0418.2 620418	L= 95
 <b>Bremsscheibe</b>							
2.0 TDI	80	05/11→12/16	⬅	07/11→; +PR 0WC, 0WF, 0WL		24.0128-0203.1 428203	Ø 300 28 25 V + S
2.0 TDI	100	05/11→12/16	➡	07/11→; +PR 0WC, 0WL		24.0116-0121.1 416121	Ø 298 16 14 + S
			➡	07/11→; +PR 0WF		24.0128-0202.1 428202	Ø 303 28 25 V
2.0 TDI	84	11/13→12/16	⬅	+PR 0WC, 0WF, 0WL		24.0128-0203.1 428203	Ø 300 28 25 V + S
2.0 TDI	105	10/11→12/16	➡	+PR 0WC, 0WL		24.0116-0121.1 416121	Ø 298 16 14 + S
2.5 TDI	65	04/06→07/11					
2.5 TDI	80	04/06→05/13					
2.5 TDI	100	04/06→05/13	➡	+PR 0WF		24.0128-0202.1 428202	Ø 303 28 25 V
2.5 TDI	120	04/06→07/11					
2.0 TDI	120	07/11→12/16	⬅	+PR 0WC,0WF,0WL		24.0128-0203.1 428203	Ø 300 28 25 V + S
2.0 TDI 4motion	120	11/11→12/16	➡	+PR 0WC, 0WL		24.0116-0121.1 416121	Ø 298 16 14 + S
			➡	+PR 0WF		24.0128-0202.1 428202	Ø 303 28 25 V
<b>VW - CRAFTER 30-50 Kasten (2E_) 04/06→12/16</b>							
 <b>Bremsbelagsatz, Scheibenbremse</b>							
2.0 TDI	80	05/11→12/16	⬅	07/11→; +PR 0WC, 0WL		13.0460-4826.2 604826	BRE 29192 20,7 + WE / - WK + Zub
2.0 TDI	100	05/11→12/16	⬅	07/11→; +PR 0WF		13.0460-4877.2 604877	BRE 29192 20,3 + WE / - WK + Zub
			➡	07/11→; +PR 0WC, 0WL		13.0460-3832.2 603832	BOS 29190 20,2 + WE / - WK
			➡	07/11→; +PR 0WF		13.0460-3842.2 603842	BOS 29217 20,5 + WE / - WK
2.0 TDI	84	11/13→12/16	⬅	+PR 0WC, 0WL		13.0460-4826.2 604826	BRE 29192 20,7 + WE / - WK + Zub
2.0 TDI	105	10/11→12/16	⬅	+PR 0WF		13.0460-4877.2 604877	BRE 29192 20,3 + WE / - WK + Zub
2.0 TDI	120	07/11→12/16					
			⬅	+PR 0WF		13.0460-4827.2 604827	BRE 29200 21,0 + WE / - WK + Zub
			➡	+PR 0WC, 0WL		13.0460-3832.2 603832	BOS 29190 20,2 + WE / - WK
			➡	+PR 0WF		13.0460-3842.2 603842	BOS 29217 20,5 + WE / - WK
2.0 TDI	103	11/15→12/16	⬅	+PR 0WC,0WL		13.0460-4826.2 604826	BRE 29192 20,7 + WE / - WK + Zub
2.0 TDI 4motion	120	11/11→12/16	⬅	+PR 0WF		13.0460-4877.2 604877	BRE 29192 20,3 + WE / - WK + Zub
			⬅	+PR 0WF		13.0460-4827.2 604827	BRE 29200 21,0 + WE / - WK + Zub





















	kW			 	! #		
<b>VW - CRAFTER 30-50 Kasten (2E_) 04/06→12/16</b>							
<b> Bremsbelagsatz, Scheibenbremse</b>							
2.0 TDI	103	11/15→12/16	➡	+PR 0WC,0WL		13.0460-3832.2 603832	BOS 29190 20,2 + WE / - WK
2.0 TDI 4motion	120	11/11→12/16	➡	+PR 0WF		13.0460-3842.2 603842	BOS 29217 20,5 + WE / - WK
2.5 TDI	65	04/06→07/11	⬅	+PR 0WC, 0WL		13.0460-4826.2 604826	BRE 29192 20,7 + WE / - WK + Zub
2.5 TDI	80	04/06→05/13					
2.5 TDI	100	04/06→05/13				13.0460-4877.2 604877	BRE 29192 20,3 + WE / - WK + Zub
2.5 TDI	120	04/06→07/11	⬅	→ 06/11; +PR 0WF		13.0460-4827.2 604827	BRE 29200 21,0 + WE / - WK + Zub
			⬅	07/11→; +PR 0WF		13.0460-4827.2 604827	BRE 29200 21,0 + WE / - WK + Zub
			➡	+PR 0WC, 0WL		13.0460-3832.2 603832	BOS 29190 20,2 + WE / - WK
			➡	+PR 0WF		13.0460-3842.2 603842	BOS 29217 20,5 + WE / - WK
<b>Warnkontakt, Bremsbelagverschleiß</b>							
2.0 TDI	80	05/11→12/16	⬅	07/11→; +PR 0WF	2	24.8190-0424.2 620424	L= 103,2
2.0 TDI	100	05/11→12/16	⬅	07/11→; +PR 0WC, 0WL	2	24.8190-0424.2 620424	L= 103,2
			➡	07/11→; +PR 0WF	2	24.8190-0005.2 620005	L= 84
			➡	07/11→; +PR 0WC, 0WL	2	24.8190-0418.2 620418	L= 95
2.0 TDI	84	11/13→12/16	⬅	+PR 0WF	2	24.8190-0424.2 620424	L= 103,2
2.0 TDI	105	10/11→12/16	⬅	+PR 0WC, 0WL	2	24.8190-0424.2 620424	L= 103,2
2.0 TDI	120	07/11→12/16	➡	+PR 0WF	2	24.8190-0005.2 620005	L= 84
			➡	+PR 0WC, 0WL	2	24.8190-0418.2 620418	L= 95
2.0 TDI	103	11/15→12/16	⬅	+PR 0WF	2	24.8190-0424.2 620424	L= 103,2
			⬅	+PR 0WC,0WL	2	24.8190-0424.2 620424	L= 103,2
			➡	+PR 0WF	2	24.8190-0005.2 620005	L= 84
			➡	+PR 0WC,0WL	2	24.8190-0418.2 620418	L= 95
2.0 TDI 4motion	120	11/11→12/16	⬅	+PR 0WC,0WL	2	24.8190-0005.2 620005	L= 84
			⬅	+PR 0WF	2	24.8190-0005.2 620005	L= 84
			➡	+PR 0WF	2	24.8190-0005.2 620005	L= 84
			➡	+PR 0WC,0WL	2	24.8190-0418.2 620418	L= 95
2.5 TDI	65	04/06→07/11	⬅	07/11→; +PR 0WF	2	24.8190-0424.2 620424	L= 103,2
2.5 TDI	80	04/06→05/13					
2.5 TDI	100	04/06→05/13	⬅	→ 06/11; +PR 0WF	2	24.8190-0424.2 620424	L= 103,2
2.5 TDI	120	04/06→07/11	⬅	+PR 0WC, 0WL	2	24.8190-0424.2 620424	L= 103,2
			➡	+PR 0WF	2	24.8190-0005.2 620005	L= 84
			➡	+PR 0WC, 0WL	2	24.8190-0418.2 620418	L= 95
<b> Bremsscheibe</b>							
2.0 TDI	80	05/11→12/16	⬅	07/11→; +PR 0WC, 0WF, 0WL		24.0128-0203.1 428203	Ø 300 28 25 V + S
2.0 TDI	100	05/11→12/16	➡	07/11→; +PR 0WC, 0WL		24.0116-0121.1 416121	Ø 298 16 14 + S
			➡	07/11→; +PR 0WF		24.0128-0202.1 428202	Ø 303 28 25 V
2.0 TDI	84	11/13→12/16	⬅	+PR 0WC, 0WF, 0WL		24.0128-0203.1 428203	Ø 300 28 25 V + S
2.5 TDI	65	04/06→07/11	➡	+PR 0WC, 0WL		24.0116-0121.1 416121	Ø 298 16 14 + S
2.5 TDI	80	04/06→05/13	➡	+PR 0WF		24.0128-0202.1 428202	Ø 303 28 25 V
2.5 TDI	100	04/06→05/13	➡	+PR 0WF		24.0128-0202.1 428202	Ø 303 28 25 V
2.5 TDI	120	04/06→07/11	➡	+PR 0WF		24.0128-0202.1 428202	Ø 303 28 25 V
2.0 TDI	103	11/15→12/16	⬅	+PR 0WC, 0WF, 0WL		24.0128-0203.1 428203	Ø 300 28 25 V + S
			➡	+PR 0WC,0WL		24.0116-0121.1 416121	Ø 298 16 14 + S
			➡	+PR 0WF		24.0128-0202.1 428202	Ø 303 28 25 V
2.0 TDI	105	10/11→12/16	⬅	+PR 0WC,0WF,0WL		24.0128-0203.1 428203	Ø 300 28 25 V + S
2.0 TDI	120	07/11→12/16	➡	+PR 0WC, 0WL		24.0116-0121.1 416121	Ø 298 16 14 + S
2.0 TDI 4motion	120	11/11→12/16	➡	+PR 0WF		24.0128-0202.1 428202	Ø 303 28 25 V
<b>VW - CRAFTER 30-50 Pritsche/Fahrgestell (2F_) 04/06→12/16</b>							
<b> Bremsbelagsatz, Scheibenbremse</b>							
2.0 TDI	80	05/11→12/16	⬅	07/11→; +PR 0WC, 0WL		13.0460-4826.2 604826	BRE 29192 20,7 + WE / - WK + Zub
2.0 TDI	100	05/11→12/16				13.0460-4877.2 604877	BRE 29192 20,3 + WE / - WK + Zub
↓							





















	kw			 	! #		
<b>VW - CRAFTER 30-50 Pritsche/Fahrgestell (2F_) 04/06→12/16</b>							
<b> Bremsbelagsatz, Scheibenbremse</b>							
2.0 TDI	80	05/11→12/16	←	07/11→; +PR 0WF		13.0460-4827.2 604827	BRE 29200 21,0 + WE / - WK + Zub
2.0 TDI	100	05/11→12/16	→	07/11→; +PR 0WC, 0WL		13.0460-3832.2 603832	BOS 29190 20,2 + WE / - WK
			→	07/11→; +PR 0WF		13.0460-3842.2 603842	BOS 29217 20,5 + WE / - WK
2.0 TDI	84	11/13→12/16	←	+PR 0WC, 0WL		13.0460-4826.2 604826	BRE 29192 20,7 + WE / - WK + Zub
2.0 TDI	105	10/11→12/16					
2.0 TDI	120	07/11→12/16				13.0460-4877.2 604877	BRE 29192 20,3 + WE / - WK + Zub
			←	+PR 0WF		13.0460-4827.2 604827	BRE 29200 21,0 + WE / - WK + Zub
			→	+PR 0WC, 0WL		13.0460-3832.2 603832	BOS 29190 20,2 + WE / - WK
			→	+PR 0WF		13.0460-3842.2 603842	BOS 29217 20,5 + WE / - WK
2.0 TDI	103	11/15→12/16	←	+PR 0WC,0WL		13.0460-4826.2 604826	BRE 29192 20,7 + WE / - WK + Zub
2.0 TDI 4motion	120	11/11→12/16				13.0460-4877.2 604877	BRE 29192 20,3 + WE / - WK + Zub
			←	+PR 0WF		13.0460-4827.2 604827	BRE 29200 21,0 + WE / - WK + Zub
			→	+PR 0WC,0WL		13.0460-3832.2 603832	BOS 29190 20,2 + WE / - WK
			→	+PR 0WF		13.0460-3842.2 603842	BOS 29217 20,5 + WE / - WK
2.5 TDI	65	04/06→07/11	←	+PR 0WC, 0WL		13.0460-4826.2 604826	BRE 29192 20,7 + WE / - WK + Zub
2.5 TDI	80	04/06→05/13					
2.5 TDI	100	04/06→05/13				13.0460-4877.2 604877	BRE 29192 20,3 + WE / - WK + Zub
2.5 TDI	120	04/06→07/11					
			←	→ 06/11; +PR 0WF		13.0460-4827.2 604827	BRE 29200 21,0 + WE / - WK + Zub
			←	07/11→; +PR 0WF		13.0460-4827.2 604827	BRE 29200 21,0 + WE / - WK + Zub
			→	+PR 0WC, 0WL		13.0460-3832.2 603832	BOS 29190 20,2 + WE / - WK
			→	+PR 0WF		13.0460-3842.2 603842	BOS 29217 20,5 + WE / - WK
<b>Warnkontakt, Bremsbelagverschleiß</b>							
2.0 TDI	80	05/11→12/16	←	07/11→; +PR 0WF	2	24.8190-0424.2 620424	L= 103,2
2.0 TDI	100	05/11→12/16	←	07/11→; +PR 0WC, 0WL	2	24.8190-0424.2 620424	L= 103,2
			→	07/11→; +PR 0WF	2	24.8190-0005.2 620005	L= 84
			→	07/11→; +PR 0WC, 0WL	2	24.8190-0418.2 620418	L= 95
2.0 TDI	84	11/13→12/16	←	+PR 0WF	2	24.8190-0424.2 620424	L= 103,2
2.0 TDI	105	10/11→12/16	←	+PR 0WC, 0WL	2	24.8190-0424.2 620424	L= 103,2
2.0 TDI	120	07/11→12/16	→	+PR 0WF	2	24.8190-0005.2 620005	L= 84
			→	+PR 0WC, 0WL	2	24.8190-0418.2 620418	L= 95
2.0 TDI	103	11/15→12/16	←	+PR 0WF	2	24.8190-0424.2 620424	L= 103,2
			←	+PR 0WC,0WL	2	24.8190-0424.2 620424	L= 103,2
			→	+PR 0WF	2	24.8190-0005.2 620005	L= 84
			→	+PR 0WC,0WL	2	24.8190-0418.2 620418	L= 95
2.0 TDI 4motion	120	11/11→12/16	←	+PR 0WC,0WL	2	24.8190-0005.2 620005	L= 84
			←	+PR 0WF	2	24.8190-0005.2 620005	L= 84
			→	+PR 0WF	2	24.8190-0005.2 620005	L= 84
			→	+PR 0WC,0WL	2	24.8190-0418.2 620418	L= 95
2.5 TDI	65	04/06→07/11	←	07/11→; +PR 0WF	2	24.8190-0424.2 620424	L= 103,2
2.5 TDI	80	04/06→05/13					
2.5 TDI	100	04/06→05/13	←	→ 06/11; +PR 0WF	2	24.8190-0424.2 620424	L= 103,2
2.5 TDI	120	04/06→07/11	←	+PR 0WC, 0WL	2	24.8190-0424.2 620424	L= 103,2
			→	+PR 0WF	2	24.8190-0005.2 620005	L= 84
			→	+PR 0WC, 0WL	2	24.8190-0418.2 620418	L= 95
<b> Bremsscheibe</b>							
2.0 TDI	80	05/11→12/16	←	07/11→; +PR 0WC, 0WF, 0WL		24.0128-0203.1 428203	Ø 300 28 25 V + S
2.0 TDI	100	05/11→12/16	→	07/11→; +PR 0WC, 0WL		24.0116-0121.1 416121	Ø 298 16 14 + S
			→	07/11→; +PR 0WF		24.0128-0202.1 428202	Ø 303 28 25 V
2.0 TDI	84	11/13→12/16	←	+PR 0WC, 0WF, 0WL		24.0128-0203.1 428203	Ø 300 28 25 V + S
2.0 TDI	105	10/11→12/16					
↓							

	kw			 	! #		
<b>VW - CRAFTER 30-50 Pritsche/Fahrgestell (2F_) 04/06→12/16</b>							
<b>Bremsscheibe</b>							
2.5 TDI	65	04/06→07/11	➡	+PR 0WC, 0WL		24.0116-0121.1 416121	Ø 298 16 14 + S
2.5 TDI	80	04/06→05/13	➡	+PR 0WF		24.0128-0202.1 428202	Ø 303 28 25 V
2.5 TDI	100	04/06→05/13					
2.5 TDI	120	04/06→07/11					
2.0 TDI	103	11/15→12/16	⬅	+PR 0WC, 0WF, 0WL		24.0128-0203.1 428203	Ø 300 28 25 V + S
			➡	+PR 0WC,0WL		24.0116-0121.1 416121	Ø 298 16 14 + S
			➡	+PR 0WF		24.0128-0202.1 428202	Ø 303 28 25 V
2.0 TDI	120	07/11→12/16	⬅	+PR 0WC,0WF,0WL		24.0128-0203.1 428203	Ø 300 28 25 V + S
2.0 TDI 4motion	120	11/11→12/16	➡	+PR 0WC, 0WL		24.0116-0121.1 416121	Ø 298 16 14 + S
			➡	+PR 0WF		24.0128-0202.1 428202	Ø 303 28 25 V
<b>VW - EOS (1F7, 1F8) 03/06→08/15</b>							
<b>Bremsbelagsatz, Scheibenbremse</b>							
1.4 TSI	90	11/07→08/15	⬅	+PR 1LJ,1ZA,1ZD,1ZE		13.0460-7184.2 607184	ATE 23587 20,6 + WK
1.4 TSI	118	05/08→08/15				13.0470-7184.2 LD7184	ATE 23587 20,6 + WK Ceramic
1.6 FSI	85	06/06→05/08	⬅	+PR 1LK		13.0460-7200.2 607200	ATE 23801 20,3 + WK
2.0 TDI	100	11/10→08/15					
2.0 TDI	103	06/06→05/08				13.0470-7200.2 LD7200	ATE 23801 20,3 + WK Ceramic
2.0 TDI 16V	103	05/08→08/15	➡	+PR 2EA		13.0460-2749.2 602749	TRW 24483 16,9 - WE / - WK + Zub
2.0 TSI	155	11/09→08/15				13.0460-2880.2 602880	TRW 23914 17,1 + WE / - WK + Zub
3.2 V6	184	06/06→05/09				13.0470-2749.2 LD2749	TRW 24483 16,9 - WE / - WK + Zub Ceramic
3.6 V6	191	05/09→11/10				13.0470-2880.2 LD2880	TRW 23914 17,1 + WE / - WK + Zub Ceramic
						13.0460-2749.2 602749	TRW 24483 16,9 - WE / - WK + Zub
						13.0460-2880.2 602880	TRW 23914 17,1 + WE / - WK + Zub
						13.0470-2749.2 LD2749	TRW 24483 16,9 - WE / - WK + Zub Ceramic
						13.0470-2880.2 LD2880	TRW 23914 17,1 + WE / - WK + Zub Ceramic
						13.0460-2860.2 602860	TRW 23554 16,4 - WK / + WE
						13.0470-2860.2 LD2860	TRW 23554 16,4 - WK / + WE Ceramic
			➡	+PR 1KJ,1KZ		13.0460-2749.2 602749	TRW 24483 16,9 - WE / - WK + Zub
						13.0460-2880.2 602880	TRW 23914 17,1 + WE / - WK + Zub
						13.0470-2749.2 LD2749	TRW 24483 16,9 - WE / - WK + Zub Ceramic
						13.0470-2880.2 LD2880	TRW 23914 17,1 + WE / - WK + Zub Ceramic
			➡	+PR 1KD		13.0460-2860.2 602860	TRW 23554 16,4 - WK / + WE
						13.0470-2860.2 LD2860	TRW 23554 16,4 - WK / + WE Ceramic
			➡	+PR 1KS		13.0460-3858.2 603858	BOS 24563 17,7 - WE / - WK + Zub
						13.0470-3858.2 LD3858	BOS 24563 17,7 - WE / - WK + Zub Ceramic
2.0 FSI	110	03/06→05/08	⬅	05/06→; +PR 1LJ,1ZA,1ZD,1ZE		13.0460-7184.2 607184	ATE 23587 20,6 + WK
2.0 TFSI	147	03/06→08/15				13.0470-7184.2 LD7184	ATE 23587 20,6 + WK Ceramic
						13.0460-7200.2 607200	ATE 23801 20,3 + WK
						13.0470-7200.2 LD7200	ATE 23801 20,3 + WK Ceramic
						13.0460-2749.2 602749	TRW 24483 16,9 - WE / - WK + Zub
						13.0460-2880.2 602880	TRW 23914 17,1 + WE / - WK + Zub
						13.0470-2749.2 LD2749	TRW 24483 16,9 - WE / - WK + Zub Ceramic
						13.0470-2880.2 LD2880	TRW 23914 17,1 + WE / - WK + Zub Ceramic
						13.0460-2749.2 602749	TRW 24483 16,9 - WE / - WK + Zub
						13.0460-2880.2 602880	TRW 23914 17,1 + WE / - WK + Zub
						13.0470-2749.2 LD2749	TRW 24483 16,9 - WE / - WK + Zub Ceramic
						13.0470-2880.2 LD2880	TRW 23914 17,1 + WE / - WK + Zub Ceramic
			➡	05/06→; +PR 2EA		13.0460-2749.2 602749	TRW 24483 16,9 - WE / - WK + Zub
						13.0460-2880.2 602880	TRW 23914 17,1 + WE / - WK + Zub
						13.0470-2749.2 LD2749	TRW 24483 16,9 - WE / - WK + Zub Ceramic
						13.0470-2880.2 LD2880	TRW 23914 17,1 + WE / - WK + Zub Ceramic
			➡	05/06→; +PR 1KD		13.0460-2860.2 602860	TRW 23554 16,4 - WK / + WE
						13.0470-2860.2 LD2860	TRW 23554 16,4 - WK / + WE Ceramic
			➡	05/06→; +PR 1KS		13.0460-3858.2 603858	BOS 24563 17,7 - WE / - WK + Zub
						13.0470-3858.2 LD3858	BOS 24563 17,7 - WE / - WK + Zub Ceramic







	kw					! #		
<b>VW - EOS (1F7, 1F8) 03/06→08/15</b>								
<b>Zubehörsatz, Scheibenbremsbelag</b>								
1.4 TSI	90	11/07→08/15	➡	+PR 2EA			13.0460-0035.2	610035
1.4 TSI	118	05/08→08/15	➡	+PR 1KD			13.0460-0259.2	610259
1.6 FSI	85	06/06→05/08	➡					
2.0 TDI	100	11/10→08/15	➡	+PR 1KJ,1KZ			13.0460-0259.2	610259
2.0 TDI	103	06/06→05/08						
2.0 TDI 16V	103	05/08→08/15						
2.0 TSI	155	11/09→08/15						
3.2 V6	184	06/06→05/09						
3.6 V6	191	05/09→11/10						
2.0 FSI	110	03/06→05/08	➡	05/06→; +PR 2EA			13.0460-0035.2	610035
2.0 TFSI	147	03/06→08/15	➡	05/06→; +PR 1KD			13.0460-0259.2	610259
			➡	05/06→; +PR 1KJ,1KZ			13.0460-0259.2	610259
<b> Bremsscheibe</b>								
1.4 TSI	90	11/07→08/15	←	+PR 1ZE			24.0125-0145.1	425145 Ø 288 25 22 V + S
1.4 TSI	118	05/08→08/15	←				24.0325-0145.1	525145 Ø 288 25 22 V + S
1.6 FSI	85	06/06→05/08	←	+PR 1LJ,1ZA,1ZD			24.0125-0158.1	425158 Ø 312 25 22 V + S
2.0 TDI	100	11/10→08/15	←				24.0325-0158.1	525158 Ø 312 25 22 V + S
2.0 TDI	103	06/06→05/08	←	+PR 1LK			24.0130-0115.1	430115 Ø 345 30 27 V
2.0 TDI 16V	103	05/08→08/15	←				24.0330-0115.1	530115 Ø 345 30 27 V
2.0 TSI	155	11/09→08/15	←					
3.2 V6	184	06/06→05/09	➡	+PR 1KD			24.0110-0277.1	410277 Ø 253 10 8 + S
3.6 V6	191	05/09→11/10	➡				24.0310-0277.1	510277 Ø 253 10 8 + S
			➡	+PR 1KS			24.0110-0356.1	410356 Ø 272 9,7 8 + S
			➡				24.0310-0356.1	510356 Ø 272 9,7 8 + S
			➡	+PR 1KJ,1KZ			24.0112-0169.1	412169 Ø 282 12 10 + S
			➡				24.0312-0169.1	512169 Ø 282 12 10 + S
			➡	+PR 2EA			24.0122-0219.1	422219 Ø 310 22 20 V
2.0 FSI	110	03/06→05/08	←	05/06→; +PR 1ZE			24.0125-0145.1	425145 Ø 288 25 22 V + S
2.0 TFSI	147	03/06→08/15	←				24.0325-0145.1	525145 Ø 288 25 22 V + S
			←	05/06→; +PR 1LJ,1ZA,1ZD			24.0125-0158.1	425158 Ø 312 25 22 V + S
			←				24.0325-0158.1	525158 Ø 312 25 22 V + S
			←	05/06→; +PR 1LK			24.0130-0115.1	430115 Ø 345 30 27 V
			←				24.0330-0115.1	530115 Ø 345 30 27 V
			➡	05/06→; +PR 1KD			24.0110-0277.1	410277 Ø 253 10 8 + S
			➡				24.0310-0277.1	510277 Ø 253 10 8 + S
			➡	05/06→; +PR 1KS			24.0110-0356.1	410356 Ø 272 9,7 8 + S
			➡				24.0310-0356.1	510356 Ø 272 9,7 8 + S
			➡	05/06→; +PR 1KJ,1KZ			24.0112-0169.1	412169 Ø 282 12 10 + S
			➡				24.0312-0169.1	512169 Ø 282 12 10 + S
			➡	05/06→; +PR 2EA			24.0122-0219.1	422219 Ø 310 22 20 V
<b>VW - FOX (5Z1, 5Z3) 10/03→</b>								
<b> Bremsbelagsatz, Scheibenbremse</b>								
1.2	40	04/05→	←	→ 08/11; +PR 1ZN			13.0460-7100.2	607100 VW 21866 17,2 - WE / - WK
1.2	44	09/10→					13.0470-7100.2	LD7100 VW 21866 17,2 - WE / - WK
1.4	55	04/05→						Ceramic
1.4 TDI	51	04/05→	←	→ 08/11; +PR 1ZF			13.0460-7111.2	607111 VW 23130 19,6 - WE / - WK
1.6	74	10/03→					13.0470-7111.2	LD7111 VW 23130 19,6 - WE / - WK
1.6 Total Flex	74	10/03→						Ceramic
<b> Bremsscheibe</b>								
1.2	40	04/05→	←	→ 08/11; +PR 1ZN			24.0118-0137.1	418137 Ø 239 18 16 V + S
1.2	44	09/10→					24.0318-0137.1	518137 Ø 239 18 16 V + S
1.4	55	04/05→	←	→ 08/11; +PR 1ZF			24.0122-0151.1	422151 Ø 256 22 19 V + S
1.4 TDI	51	04/05→					24.0322-0151.1	522151 Ø 256 22 19 V + S
1.6	74	10/03→						
1.6 Total Flex	74	10/03→						
<b>VW - GOLF III (1H1) 08/91→07/98</b>								
<b> Bremsbelagsatz, Scheibenbremse</b>								
1.4	40	11/91→08/97	←	05/96→ 09/96; + ABS			13.0460-2821.2	602821 TRW 21945 16,0 - WK
1.6	55	09/92→08/97	←	→ 1H-T-028354			13.0460-7032.2	20887 VW 20887 19,7 - WE / - WK
1.9 SDI	47	07/95→08/97						+ Zub
1.9 TD,GTD	55	11/91→08/97	←	1H-T-028355→; - ABS			13.0460-7072.2	607072 VW 21866 19,7 - WE / - WK
			←	10/96→; + ABS			13.0460-7101.2	607101 VW 21866 15,3 - WE / - WK
↓								











	kw			 	! #		
<b>VW - GOLF III (1H1) 08/91→07/98</b>							
<b> Bremsbelagsatz, Scheibenbremse</b>							
1.4	44	10/91→08/97	←	05/96→ 09/96; + ABS		<b>13.0460-2821.2 602821</b>	TRW 21945 16,0 - WK
			←	11/91→; → 1H-T-028354		<b>13.0460-7032.2 20887</b>	VW 20887 19,7 - WE / - WK + Zub
			←	1H-T-028355→; - ABS		<b>13.0460-7072.2 607072</b>	VW 21866 19,7 - WE / - WK
			←	10/96→; + ABS		<b>13.0460-7101.2 607101</b>	VW 21866 15,3 - WE / - WK
1.6	74	07/95→08/97	←			<b>13.0460-2821.2 602821</b>	TRW 21945 16,0 - WK
			←	- ABS		<b>13.0460-2958.2 602958</b>	TRW 20168 19,3 - WK
			→			<b>13.0460-2984.2 602984</b>	TRW 20961 17,2 - WK + Zub
1.8 1.8	55 66	11/91→08/97 11/91→08/97	←	05/96→; + ABS		<b>13.0460-2821.2 602821</b>	TRW 21945 16,0 - WK
			←			<b>13.0460-2821.2 602821</b>	TRW 21945 16,0 - WK
			←	1H-S-246941→; - ABS		<b>13.0460-2958.2 602958</b>	TRW 20168 19,3 - WK
			←	→ 1H-S-246940; Vollautomatik		<b>13.0460-7032.2 20887</b>	VW 20887 19,7 - WE / - WK + Zub
			←	→ 1H-T-028354; Schaltgetriebe		<b>13.0460-7032.2 20887</b>	VW 20887 19,7 - WE / - WK + Zub
			←	1H-T-028355→; Schaltgetriebe; - ABS		<b>13.0460-7072.2 607072</b>	VW 21866 19,7 - WE / - WK
			→			<b>13.0460-2937.2 602937</b>	TRW 20961 15,2 - WK + Zub
1.8 Syncro (1HX1)	66	01/93→08/97	←	+ ABS		<b>13.0460-2821.2 602821</b>	TRW 21945 16,0 - WK
			←	1H-S-089451→; - ABS		<b>13.0460-2958.2 602958</b>	TRW 20168 19,3 - WK
			←	→ 1H-S-089450; - ABS		<b>13.0460-7032.2 20887</b>	VW 20887 19,7 - WE / - WK + Zub
1.9 D	47	11/91→08/97	←	1H-S-246941→; → 07/95		<b>13.0460-2821.2 602821</b>	TRW 21945 16,0 - WK
			←	05/96→ 09/96; + ABS		<b>13.0460-2821.2 602821</b>	TRW 21945 16,0 - WK
			←	08/93→; → 1H-S-246940		<b>13.0460-7032.2 20887</b>	VW 20887 19,7 - WE / - WK + Zub
			←	→ 1H-T-028354		<b>13.0460-7032.2 20887</b>	VW 20887 19,7 - WE / - WK + Zub
			←	1H-T-028355→; - ABS		<b>13.0460-7072.2 607072</b>	VW 21866 19,7 - WE / - WK
			←	10/96→; + ABS		<b>13.0460-7101.2 607101</b>	VW 21866 15,3 - WE / - WK
1.9 TDI	66	09/93→08/97	←	05/96→		<b>13.0460-2821.2 602821</b>	TRW 21945 16,0 - WK
			←	10/93→ 04/96		<b>13.0460-2958.2 602958</b>	TRW 20168 19,3 - WK
1.9 TDI	81	04/96→08/97	←	nicht für Bremssattelfarbe: rot		<b>13.0460-2821.2 602821</b>	TRW 21945 16,0 - WK
			←	→ 04/96; Bremssattelfarbe: rot		<b>13.0460-2958.2 602958</b>	TRW 20168 19,3 - WK
			←	05/96→; Bremssattelfarbe: rot		<b>13.0460-7081.2 607081</b> <b>13.0470-7081.2 LD7081</b>	ATE 20676 19,8 - WE / - WK ATE 20676 19,8 - WE / - WK Ceramic
			→			<b>13.0460-2984.2 602984</b>	TRW 20961 17,2 - WK + Zub
1.9 TDI Syncro (1HX1)	66	08/95→08/97	←	05/96→		<b>13.0460-2821.2 602821</b>	TRW 21945 16,0 - WK
			←	→ 04/96		<b>13.0460-2958.2 602958</b>	TRW 20168 19,3 - WK
2.0	85	11/91→08/97	←	→ 1H-S-560000		<b>13.0460-2806.2 602806</b>	TRW 20168 19,3 + WK
			←	1H-S-560001→; → 04/96		<b>13.0460-2958.2 602958</b>	TRW 20168 19,3 - WK
			←	05/96→		<b>13.0460-7081.2 607081</b> <b>13.0470-7081.2 LD7081</b>	ATE 20676 19,8 - WE / - WK ATE 20676 19,8 - WE / - WK Ceramic
			→			<b>13.0460-2937.2 602937</b>	TRW 20961 15,2 - WK + Zub
			→	1H-P-240001→		<b>13.0460-2984.2 602984</b>	TRW 20961 17,2 - WK + Zub
2.0 GL	79	08/95→09/97	←	→ 08/97		<b>13.0460-2821.2 602821</b>	TRW 21945 16,0 - WK
2.0 GTI 16V	110	08/92→08/97	←	→ 1H-S-560000		<b>13.0460-2806.2 602806</b>	TRW 20168 19,3 + WK
			←	1H-S-560001→; → 04/96		<b>13.0460-2958.2 602958</b>	TRW 20168 19,3 - WK
			←	05/96→		<b>13.0460-7081.2 607081</b> <b>13.0470-7081.2 LD7081</b>	ATE 20676 19,8 - WE / - WK ATE 20676 19,8 - WE / - WK Ceramic
			→	→ 1H-P-240000		<b>13.0460-2937.2 602937</b>	TRW 20961 15,2 - WK + Zub
			→	1H-P-240001→		<b>13.0460-2984.2 602984</b>	TRW 20961 17,2 - WK + Zub
2.0 Syncro (1HX1)	85	08/95→08/97	←			<b>13.0460-2821.2 602821</b>	TRW 21945 16,0 - WK
2.8 VR6	120	08/95→09/97	←	→ 1H-S-399999		<b>13.0460-2806.2 602806</b>	TRW 20168 19,3 + WK
			←	1H-S-400001→; → 08/97		<b>13.0460-7081.2 607081</b>	ATE 20676 19,8 - WE / - WK
↓							













	kw			 	! #		
<b>VW - GOLF III (1H1) 08/91→07/98</b>							
<b> Bremsbelagsatz, Scheibenbremse</b>							
2.8 VR6	120	08/95→09/97	←	1H-S-400001→; → 08/97		<b>13.0470-7081.2</b> <b>LD7081</b>	ATE 20676 19,8 - WE / - WK Ceramic
			→	→ 1H-P-240000		<b>13.0460-2937.2</b> <b>602937</b>	TRW 20961 15,2 - WK + Zub
			→	1H-P-240001→; → 08/97		<b>13.0460-2984.2</b> <b>602984</b>	TRW 20961 17,2 - WK + Zub
2.8 VR6	128	01/92→08/97	←	→ 1H-S-399999		<b>13.0460-2806.2</b> <b>602806</b>	TRW 20168 19,3 + WK
			←	1H-S-400001→		<b>13.0460-7081.2</b> <b>607081</b>	ATE 20676 19,8 - WE / - WK
						<b>13.0470-7081.2</b> <b>LD7081</b>	ATE 20676 19,8 - WE / - WK Ceramic
			→	→ 1H-P-240000		<b>13.0460-2937.2</b> <b>602937</b>	TRW 20961 15,2 - WK + Zub
			→	1H-P-240001→		<b>13.0460-2984.2</b> <b>602984</b>	TRW 20961 17,2 - WK + Zub
2.9 VR6 Syncro (1HX1)	140	10/94→08/97	←			<b>13.0460-7081.2</b> <b>607081</b>	ATE 20676 19,8 - WE / - WK
						<b>13.0470-7081.2</b> <b>LD7081</b>	ATE 20676 19,8 - WE / - WK Ceramic
			→			<b>13.0460-2984.2</b> <b>602984</b>	TRW 20961 17,2 - WK + Zub
<b>Zubehörsatz, Scheibenbremsbelag</b>							
1.6	74	07/95→08/97	→			<b>13.0460-0072.2</b> <b>610072</b>	TRW
1.9 TDI	81	04/96→08/97					
2.9 VR6 Syncro (1HX1)	140	10/94→08/97					
1.8	55	11/91→08/97	→			<b>13.0460-0419.2</b> <b>610419</b>	TRW
1.8	66	11/91→08/97					
2.0	85	11/91→08/97	→	1H-P-240001→		<b>13.0460-0072.2</b> <b>610072</b>	TRW
			→			<b>13.0460-0419.2</b> <b>610419</b>	TRW
2.0 GTI 16V	110	08/92→08/97	→	1H-P-240001→		<b>13.0460-0072.2</b> <b>610072</b>	TRW
2.8 VR6	128	01/92→08/97	→	→ 1H-P-240000		<b>13.0460-0419.2</b> <b>610419</b>	TRW
2.8 VR6	120	08/95→09/97	→	1H-P-240001→; → 08/97		<b>13.0460-0072.2</b> <b>610072</b>	TRW
			→	→ 1H-P-240000		<b>13.0460-0419.2</b> <b>610419</b>	TRW
<b> Bremsscheibe</b>							
1.4	40	11/91→08/97	←	- ABS		<b>24.0112-0106.1</b> <b>412106</b>	Ø 239 12 10 + S
1.6	55	09/92→08/97				<b>24.0312-0106.1</b> <b>512106</b>	Ø 239 12 10 + S
1.9 SDI	47	07/95→08/97	←	10/96→; + ABS		<b>24.0120-0123.1</b> <b>420123</b>	Ø 239 20 18 V + S
1.9 TD,GTD	55	11/91→08/97				<b>24.0320-0123.1</b> <b>520123</b>	Ø 239 20 18 V + S
			←	05/96→ 09/96; + ABS; Felge Lochzahl: 4		<b>24.0120-0128.1</b> <b>420128</b>	Ø 256 20 18 V + S
						<b>24.0320-0128.1</b> <b>520128</b>	Ø 256 20 18 V + S
1.4	44	10/91→08/97	←	11/91→; - ABS		<b>24.0112-0106.1</b> <b>412106</b>	Ø 239 12 10 + S
			←	10/96→; + ABS		<b>24.0312-0106.1</b> <b>512106</b>	Ø 239 12 10 + S
			←	10/96→; + ABS		<b>24.0120-0123.1</b> <b>420123</b>	Ø 239 20 18 V + S
			←	05/96→ 09/96; + ABS; Felge Lochzahl: 4		<b>24.0320-0123.1</b> <b>520123</b>	Ø 239 20 18 V + S
			←	05/96→ 09/96; + ABS; Felge Lochzahl: 4		<b>24.0120-0128.1</b> <b>420128</b>	Ø 256 20 18 V + S
						<b>24.0320-0128.1</b> <b>520128</b>	Ø 256 20 18 V + S
1.6	74	07/95→08/97	←	- ABS / - ESP		<b>24.0113-0178.1</b> <b>413178</b>	Ø 255,6 12,9 11 + S
			←	Felge Lochzahl: 4		<b>24.0120-0128.1</b> <b>420128</b>	Ø 256 20 18 V + S
						<b>24.0320-0128.1</b> <b>520128</b>	Ø 256 20 18 V + S
			←	- ABS		<b>24.0313-0178.1</b> <b>513178</b>	Ø 255,6 12,9 11 + S
			→	Felge Lochzahl: 4		<b>24.0110-0111.1</b> <b>410111</b>	Ø 226 10 8 - ABS Ring / - RLG
			→			<b>24.0110-0275.2</b> <b>410275</b>	Ø 226 10 8 + ABS Ring / - RLG
1.8	55	11/91→08/97	←	Schaltgetriebe; - ABS		<b>24.0112-0106.1</b> <b>412106</b>	Ø 239 12 10 + S
1.8	66	11/91→08/97				<b>24.0312-0106.1</b> <b>512106</b>	Ø 239 12 10 + S
			←	→ 1H-S-246940; Vollautomatik; - ABS		<b>24.0112-0106.1</b> <b>412106</b>	Ø 239 12 10 + S
						<b>24.0312-0106.1</b> <b>512106</b>	Ø 239 12 10 + S
			←	1H-S-246941→; Vollautomatik; - ABS / - ESP		<b>24.0113-0178.1</b> <b>413178</b>	Ø 255,6 12,9 11 + S
			←	Felge Lochzahl: 4		<b>24.0120-0128.1</b> <b>420128</b>	Ø 256 20 18 V + S
						<b>24.0320-0128.1</b> <b>520128</b>	Ø 256 20 18 V + S
			←	05/96→; + ABS; Felge Lochzahl: 4		<b>24.0120-0128.1</b> <b>420128</b>	Ø 256 20 18 V + S
						<b>24.0320-0128.1</b> <b>520128</b>	Ø 256 20 18 V + S
			←	1H-S-246941→; Vollautomatik; - ABS		<b>24.0313-0178.1</b> <b>513178</b>	Ø 255,6 12,9 11 + S
			→	Felge Lochzahl: 4		<b>24.0110-0111.1</b> <b>410111</b>	Ø 226 10 8 - ABS Ring / - RLG
			→			<b>24.0110-0275.2</b> <b>410275</b>	Ø 226 10 8 + ABS Ring / - RLG
1.8 Syncro (1HX1) ↓	66	01/93→08/97	←	→ 1H-S-089450; - ABS		<b>24.0112-0106.1</b> <b>412106</b>	Ø 239 12 10 + S



















	kw			 	! #		
<b>VW - GOLF III (1H1) 08/91→07/98</b>							
<b>Bremsscheibe</b>							
1.8 Syncro (1HX1)	66	01/93→08/97	←	→ 1H-S-089450; - ABS	24.0312-0106.1	512106	Ø 239 12 10 + S
			←	1H-S-089451→; - ESP	24.0113-0178.1	413178	Ø 255,6 12,9 11 + S
			←	+ ABS; Felge Lochzahl: 4	24.0120-0128.1	420128	Ø 256 20 18 V + S
			←	24.0320-0128.1	520128	Ø 256 20 18 V + S	
1.9 D	47	11/91→08/97	←	1H-S-089451→	24.0313-0178.1	513178	Ø 255,6 12,9 11 + S
			←	→ 1H-S-246940	24.0112-0106.1	412106	Ø 239 12 10 + S
			←	24.0312-0106.1	512106	Ø 239 12 10 + S	
			←	- ABS	24.0112-0106.1	412106	Ø 239 12 10 + S
			←	24.0312-0106.1	512106	Ø 239 12 10 + S	
			←	10/96→; + ABS	24.0120-0123.1	420123	Ø 239 20 18 V + S
1.9 TDI	66	09/93→08/97	←	24.0320-0123.1	520123	Ø 239 20 18 V + S	
			←	05/96→ 09/96; + ABS; Felge Lochzahl: 4	24.0120-0128.1	420128	Ø 256 20 18 V + S
			←	24.0320-0128.1	520128	Ø 256 20 18 V + S	
			←	1H-S-246941→; → 07/95; Felge Lochzahl: 4	24.0120-0128.1	420128	Ø 256 20 18 V + S
			←	24.0320-0128.1	520128	Ø 256 20 18 V + S	
			←	10/93→ 04/96; - ESP	24.0113-0178.1	413178	Ø 255,6 12,9 11 + S
1.9 TDI	81	04/96→08/97	←	05/96→; Felge Lochzahl: 4	24.0120-0128.1	420128	Ø 256 20 18 V + S
			←	24.0320-0128.1	520128	Ø 256 20 18 V + S	
			←	10/93→ 04/96	24.0313-0178.1	513178	Ø 255,6 12,9 11 + S
			←	nicht für Bremssattelfarbe: rot; Felge Lochzahl: 4	24.0120-0128.1	420128	Ø 256 20 18 V + S
			←	24.0320-0128.1	520128	Ø 256 20 18 V + S	
			←	→ 04/96; Bremssattelfarbe: rot; Felge Lochzahl: 5	24.0122-0100.1	422100	Ø 280 22 20 V
			←	24.0322-0100.1	522100	Ø 280 22 20 V	
1.9 TDI Syncro (1HX1)	66	08/95→08/97	←	05/96→; Bremssattelfarbe: rot	24.0125-0108.1	425108	Ø 288 25 23 V
			→	nicht für Bremssattelfarbe: rot; Felge Lochzahl: 4	24.0110-0111.1	410111	Ø 226 10 8 - ABS Ring / - RLG
			→	Bremssattelfarbe: rot; Felge Lochzahl: 5	24.0110-0203.1	410203	Ø 226 10 8 - ABS Ring
			→	nicht für Bremssattelfarbe: rot	24.0110-0275.2	410275	Ø 226 10 8 + ABS Ring / - RLG
			→	Bremssattelfarbe: rot	24.0110-0276.2	410276	Ø 226 10 8 + ABS Ring
			→	→ 04/96; - ESP	24.0113-0178.1	413178	Ø 255,6 12,9 11 + S
2.0 2.0 GTI 16V	85 110	11/91→08/97 08/92→08/97	←	05/96→; Felge Lochzahl: 4	24.0120-0128.1	420128	Ø 256 20 18 V + S
			←	24.0320-0128.1	520128	Ø 256 20 18 V + S	
			←	→ 04/96	24.0313-0178.1	513178	Ø 255,6 12,9 11 + S
			←	→ 04/96; Felge Lochzahl: 5	24.0122-0100.1	422100	Ø 280 22 20 V
2.0 GL	79	08/95→09/97	←	24.0322-0100.1	522100	Ø 280 22 20 V	
			←	05/96→	24.0125-0108.1	425108	Ø 288 25 23 V
			→	Felge Lochzahl: 5	24.0110-0203.1	410203	Ø 226 10 8 - ABS Ring
			→		24.0110-0276.2	410276	Ø 226 10 8 + ABS Ring
2.0 Syncro (1HX1)	85	08/95→08/97	←	→ 08/97; Felge Lochzahl: 4	24.0120-0128.1	420128	Ø 256 20 18 V + S
			←	24.0320-0128.1	520128	Ø 256 20 18 V + S	
			→	→ 08/97; Felge Lochzahl: 4	24.0110-0111.1	410111	Ø 226 10 8 - ABS Ring / - RLG
2.8 VR6	120	08/95→09/97	→	→ 08/97	24.0110-0275.2	410275	Ø 226 10 8 + ABS Ring / - RLG
			←	Felge Lochzahl: 4	24.0120-0128.1	420128	Ø 256 20 18 V + S
			←	24.0320-0128.1	520128	Ø 256 20 18 V + S	
			←	→ 08/97; Felge Lochzahl: 5	24.0122-0100.1	422100	Ø 280 22 20 V
2.8 VR6	128	01/92→08/97	←	24.0322-0100.1	522100	Ø 280 22 20 V	
			←	1H-S-399999; Felge Lochzahl: 5	24.0122-0100.1	422100	Ø 280 22 20 V
			←	24.0322-0100.1	522100	Ø 280 22 20 V	
			←	1H-S-400001→; → 08/97	24.0125-0108.1	425108	Ø 288 25 23 V
2.9 VR6 Syncro (1HX1)	140	10/94→08/97	→	→ 08/97; Felge Lochzahl: 5	24.0110-0203.1	410203	Ø 226 10 8 - ABS Ring
			→	→ 08/97	24.0110-0276.2	410276	Ø 226 10 8 + ABS Ring
			←	→ 1H-S-399999; Felge Lochzahl: 5	24.0122-0100.1	422100	Ø 280 22 20 V
			←	24.0322-0100.1	522100	Ø 280 22 20 V	
			←	1H-S-400001→	24.0125-0108.1	425108	Ø 288 25 23 V
			→	Felge Lochzahl: 5	24.0110-0203.1	410203	Ø 226 10 8 - ABS Ring
			→		24.0110-0276.2	410276	Ø 226 10 8 + ABS Ring
			←		24.0125-0108.1	425108	Ø 288 25 23 V

	kw			 	! #		
<b>VW - GOLF III Cabriolet (1E7) 07/93→05/98</b>							
<b> Bremsbelagsatz, Scheibenbremse</b>							
1.6	74	10/94→05/98	←	1E-V-000001→		13.0460-2821.2 602821	TRW 21945 16,0 - WK
			←	→ 1E-T-030000		13.0460-2958.2 602958	TRW 20168 19,3 - WK
			→	04/98→; → 1E-X-014000		13.0460-2937.2 602937	TRW 20961 15,2 - WK + Zub
			→	1E-X-014001→		13.0460-2984.2 602984	TRW 20961 17,2 - WK + Zub
1.8 1.8	55 66	07/93→05/98 07/93→05/98	←	1E-V-000001→		13.0460-2821.2 602821	TRW 21945 16,0 - WK
			←	09/93→; → 1E-T-030000		13.0460-2958.2 602958	TRW 20168 19,3 - WK
			→	04/98→; → 1E-X-014000		13.0460-2937.2 602937	TRW 20961 15,2 - WK + Zub
			→	1E-X-014001→		13.0460-2984.2 602984	TRW 20961 17,2 - WK + Zub
1.9 TDI	66	08/95→05/98	←	1E-V-000001→		13.0460-2821.2 602821	TRW 21945 16,0 - WK
			←	→ 1E-T-030000		13.0460-2958.2 602958	TRW 20168 19,3 - WK
			→	1E-X-014001→; - ABS		13.0460-2937.2 602937	TRW 20961 15,2 - WK + Zub
			→	04/98→; → 1E-X-014000		13.0460-2937.2 602937	TRW 20961 15,2 - WK + Zub
			→	1E-X-014001→; + ABS		13.0460-2984.2 602984	TRW 20961 17,2 - WK + Zub
1.9 TDI	81	07/96→05/98	←	09/96→		13.0460-2821.2 602821	TRW 21945 16,0 - WK
			→	09/96→; → 1E-X-014000		13.0460-2937.2 602937	TRW 20961 15,2 - WK + Zub
			→	1E-X-014001→; - ABS		13.0460-2937.2 602937	TRW 20961 15,2 - WK + Zub
			→	1E-X-014001→; + ABS		13.0460-2984.2 602984	TRW 20961 17,2 - WK + Zub
2.0	85	07/93→05/98	←	1E-V-000001→		13.0460-2821.2 602821	TRW 21945 16,0 - WK
			←	09/93→; → 1E-T-030000		13.0460-2958.2 602958	TRW 20168 19,3 - WK
			→	1E-2-800 001→		13.0460-2894.2 602894	TRW 20961 17,2 - WK + Zub
						13.0470-2894.2 LD2894	TRW 20961 17,2 - WK + Zub Ceramic
			→	04/98→; → 1E-X-014000		13.0460-2937.2 602937	TRW 20961 15,2 - WK + Zub
			→	1E-X-014001→ 1E-2-015 000		13.0460-2984.2 602984	TRW 20961 17,2 - WK + Zub
<b>Zubehörsatz, Scheibenbremsbelag</b>							
1.6 1.8 1.8	74 55 66	10/94→05/98 07/93→05/98 07/93→05/98	→	1E-X-014001→		13.0460-0072.2 610072	TRW
			→	04/98→; → 1E-X-014000		13.0460-0419.2 610419	TRW
1.9 TDI	66	08/95→05/98	→	1E-X-014001→; + ABS		13.0460-0072.2 610072	TRW
			→	04/98→; → 1E-X-014000		13.0460-0419.2 610419	TRW
1.9 TDI	81	07/96→05/98	→	1E-X-014001→; + ABS		13.0460-0072.2 610072	TRW
			→	09/96→; → 1E-X-014000		13.0460-0419.2 610419	TRW
2.0	85	07/93→05/98	→	1E-X-014001→ 1E-2-015 000		13.0460-0072.2 610072	TRW
			→	04/98→; → 1E-X-014000		13.0460-0419.2 610419	TRW
<b> Brems Scheibe</b>							
1.6 1.9 TDI	74 66	10/94→05/98 08/95→05/98	←	→ 1E-T-030000		24.0113-0178.1 413178	Ø 255,6 12,9 11 + S
						24.0313-0178.1 513178	Ø 255,6 12,9 11 + S
			←	1E-V-000001→		24.0120-0128.1 420128	Ø 256 20 18 V + S
						24.0320-0128.1 520128	Ø 256 20 18 V + S
			→	04/98→		24.0110-0111.1 410111	Ø 226 10 8 - ABS Ring / - RLG
						24.0110-0275.2 410275	Ø 226 10 8 + ABS Ring / - RLG
1.8 1.8 2.0	55 66 85	07/93→05/98 07/93→05/98 07/93→05/98	←	09/93→; → 1E-T-030000		24.0113-0178.1 413178	Ø 255,6 12,9 11 + S
						24.0313-0178.1 513178	Ø 255,6 12,9 11 + S
			←	1E-V-000001→		24.0120-0128.1 420128	Ø 256 20 18 V + S
						24.0320-0128.1 520128	Ø 256 20 18 V + S
			→	04/98→		24.0110-0111.1 410111	Ø 226 10 8 - ABS Ring / - RLG
						24.0110-0275.2 410275	Ø 226 10 8 + ABS Ring / - RLG
1.9 TDI	81	07/96→05/98	←	09/96→		24.0120-0128.1 420128	Ø 256 20 18 V + S
						24.0320-0128.1 520128	Ø 256 20 18 V + S
			→	09/96→		24.0110-0111.1 410111	Ø 226 10 8 - ABS Ring / - RLG
						24.0110-0275.2 410275	Ø 226 10 8 + ABS Ring / - RLG
<b>VW - GOLF III Van (1H1) 08/91→12/97</b>							
<b> Bremsbelagsatz, Scheibenbremse</b>							
1.8 ↓	66	08/91→12/97	←	05/96→ 08/97; + ABS		13.0460-2821.2 602821	TRW 21945 16,0 - WK









	kw			 	! #		
<b>VW - GOLF III Van (1H1) 08/91→12/97</b>							
 <b>Bremsscheibe</b>							
1.8	66	08/91→12/97	←	11/91→ 08/97; Schaltgetriebe; - ABS	24.0112-0106.1 412106	Ø 239 12 10 + S	
					24.0312-0106.1 512106	Ø 239 12 10 + S	
			←	11/91→; → 1H-S-246940; Vollautomatik; - ABS	24.0112-0106.1 412106	Ø 239 12 10 + S	
					24.0312-0106.1 512106	Ø 239 12 10 + S	
			←	1H-S-246941→; → 08/97; Vollautomatik; - ABS / - ESP	24.0113-0178.1 413178	Ø 255,6 12,9 11 + S	
			←	05/96→ 08/97; + ABS; Felge Lochzahl: 4	24.0120-0128.1 420128	Ø 256 20 18 V + S	
					24.0320-0128.1 520128	Ø 256 20 18 V + S	
			←	1H-S-246941→; → 08/97; Vollautomatik; - ABS	24.0313-0178.1 513178	Ø 255,6 12,9 11 + S	
<b>VW - GOLF III Variant (1H5) 07/93→04/99</b>							
 <b>Bremsbelagsatz, Scheibenbremse</b>							
1.4	40	07/93→04/99	←	05/96→ 09/96; + ABS	13.0460-2821.2 602821	TRW 21945 16,0 - WK	
1.4	44	07/93→04/99	←	→ 1H-TB015953	13.0460-7032.2 20887	VW 20887 19,7 - WE / - WK + Zub	
			←	1H-TB015954→; → 04/96	13.0460-7072.2 607072	VW 21866 19,7 - WE / - WK	
			←	05/96→; - ABS	13.0460-7072.2 607072	VW 21866 19,7 - WE / - WK	
			←	10/96→; + ABS	13.0460-7101.2 607101	VW 21866 15,3 - WE / - WK	
1.6	74	07/94→04/99	←	05/96→ 09/96	13.0460-2821.2 602821	TRW 21945 16,0 - WK	
			←	→ 04/96	13.0460-2958.2 602958	TRW 20168 19,3 - WK	
1.8	55	07/93→04/99	←	05/96→; + ABS	13.0460-2821.2 602821	TRW 21945 16,0 - WK	
1.8	66	07/93→04/99	←	05/96→; - ABS	13.0460-2958.2 602958	TRW 20168 19,3 - WK	
1.9 TDI	66	03/94→04/99	←	→ 04/96	13.0460-2958.2 602958	TRW 20168 19,3 - WK	
1.8 Syncro	66	10/94→04/99	←	1H-TD365210→	13.0460-2821.2 602821	TRW 21945 16,0 - WK	
			←	1H-SW369001→ 1H-TD365209	13.0460-2958.2 602958	TRW 20168 19,3 - WK	
			←	→ 1H-SW369000	13.0460-7032.2 20887	VW 20887 19,7 - WE / - WK + Zub	
1.9 D	47	07/93→04/99	←	05/96→ 09/96; + ABS	13.0460-2821.2 602821	TRW 21945 16,0 - WK	
1.9 SDI	47	07/95→04/99	←	05/96→; - ABS	13.0460-2958.2 602958	TRW 20168 19,3 - WK	
1.9 TD	55	07/93→04/99	←	→ 04/96	13.0460-2958.2 602958	TRW 20168 19,3 - WK	
			←	10/96→; + ABS	13.0460-7101.2 607101	VW 21866 15,3 - WE / - WK	
1.9 TDI	81	04/96→04/99	←		13.0460-2821.2 602821	TRW 21945 16,0 - WK	
1.9 TDI Syncro	66	07/95→04/99					
2.0	79	08/95→04/96					
2.0	85	07/93→04/99					
2.0 Syncro	85	08/95→04/99					
2.9 VR6 Syncro	140	10/94→04/99	←	07/95→	13.0460-7081.2 607081	ATE 20676 19,8 - WE / - WK	
					13.0470-7081.2 LD7081	ATE 20676 19,8 - WE / - WK Ceramic	
			→	07/95→	13.0460-2984.2 602984	TRW 20961 17,2 - WK + Zub	
<b>Zubehörsatz, Scheibenbremsbelag</b>							
2.9 VR6 Syncro	140	10/94→04/99	→	07/95→	13.0460-0072.2 610072	TRW	
 <b>Bremsscheibe</b>							
1.4	40	07/93→04/99	←	05/96→; - ABS	24.0112-0106.1 412106	Ø 239 12 10 + S	
1.4	44	07/93→04/99			24.0312-0106.1 512106	Ø 239 12 10 + S	
			←	→ 04/96	24.0112-0106.1 412106	Ø 239 12 10 + S	
			←	10/96→; + ABS	24.0312-0106.1 512106	Ø 239 12 10 + S	
			←	05/96→ 09/96; + ABS	24.0120-0123.1 420123	Ø 239 20 18 V + S	
					24.0320-0123.1 520123	Ø 239 20 18 V + S	
1.6	74	07/94→04/99	←	→ 04/96	24.0113-0178.1 413178	Ø 255,6 12,9 11 + S	
					24.0313-0178.1 513178	Ø 255,6 12,9 11 + S	
			←	05/96→	24.0120-0128.1 420128	Ø 256 20 18 V + S	
					24.0320-0128.1 520128	Ø 256 20 18 V + S	
1.8	55	07/93→04/99	←	05/96→; - ABS	24.0113-0178.1 413178	Ø 255,6 12,9 11 + S	
1.8	66	07/93→04/99			24.0313-0178.1 513178	Ø 255,6 12,9 11 + S	
1.9 TDI	66	03/94→04/99	←	→ 04/96	24.0113-0178.1 413178	Ø 255,6 12,9 11 + S	
					24.0313-0178.1 513178	Ø 255,6 12,9 11 + S	

















	kw			 	! #		
<b>VW - GOLF III Variant (1H5) 07/93→04/99</b>							
<b> Bremsscheibe</b>							
1.8	55	07/93→04/99	←	05/96→; + ABS		24.0120-0128.1 420128	Ø 256 20 18 V + S
1.8	66	07/93→04/99	←			24.0320-0128.1 520128	Ø 256 20 18 V + S
1.9 TDI	66	03/94→04/99	←				
1.8 Syncro	66	10/94→04/99	←	→ 1H-SW369000		24.0112-0106.1 412106	Ø 239 12 10 + S
			←	1H-SW369001→ 1H-TD365209		24.0312-0106.1 512106	Ø 239 12 10 + S
			←	1H-TD365210→		24.0113-0178.1 413178	Ø 255,6 12,9 11 + S
			←			24.0313-0178.1 513178	Ø 255,6 12,9 11 + S
1.9 D	47	07/93→04/99	←	05/96→; - ABS		24.0120-0128.1 420128	Ø 256 20 18 V + S
1.9 SDI	47	07/95→04/99	←			24.0320-0128.1 520128	Ø 256 20 18 V + S
1.9 TD	55	07/93→04/99	←	→ 04/96		24.0113-0178.1 413178	Ø 255,6 12,9 11 + S
			←			24.0313-0178.1 513178	Ø 255,6 12,9 11 + S
			←	10/96→; + ABS		24.0120-0123.1 420123	Ø 239 20 18 V + S
			←			24.0320-0123.1 520123	Ø 239 20 18 V + S
			←	05/96→ 09/96; + ABS		24.0120-0128.1 420128	Ø 256 20 18 V + S
			←			24.0320-0128.1 520128	Ø 256 20 18 V + S
1.9 TDI	81	04/96→04/99	←			24.0120-0128.1 420128	Ø 256 20 18 V + S
1.9 TDI Syncro	66	07/95→04/99	←			24.0320-0128.1 520128	Ø 256 20 18 V + S
2.0	79	08/95→04/96	←				
2.0	85	07/93→04/99	←				
2.0 Syncro	85	08/95→04/99	←				
2.9 VR6 Syncro	140	10/94→04/99	←	07/95→		24.0125-0108.1 425108	Ø 288 25 23 V
<b>VW - GOLF IV (1J1) 08/97→03/07</b>							
<b> Bremsbelagsatz, Scheibenbremse</b>							
1.4 16V	55	08/97→06/05	←	10/97→; → 1J-X-800000; +PR 1LR,1LS,1LQ,1ZF / 1ZM		13.0460-7111.2 607111	VW 23130 19,6 - WE / - WK
1.6	74	08/97→05/04	←			13.0470-7111.2 LD7111	VW 23130 19,6 - WE / - WK Ceramic
1.9 SDI	50	08/97→06/05	←				
1.9 TDI	81	08/97→05/04	←	1J-Y-000001→; → 10/03; +PR 1LS,1LQ,1ZF,1ZM		13.0460-7117.2 607117	VW 23130 19,6 + WK
			→	10/97→ 10/03; +PR 1KY		13.0470-7117.2 LD7117	VW 23130 19,6 + WK Ceramic
			→			13.0460-2886.2 602886	TRW 20961 16,0 - WK
			→			13.0460-2937.2 602937	TRW 20961 15,2 - WK + Zub
			→			13.0470-2886.2 LD2886	TRW 20961 16,0 - WK Ceramic
			→	10/97→ 10/03; +PR 1KK,1KS,1KV / 1KQ,1KW		13.0460-2894.2 602894	TRW 20961 17,2 - WK + Zub
			→			13.0470-2894.2 LD2894	TRW 20961 17,2 - WK + Zub Ceramic
1.6	74	02/01→06/01	←	→ 1J-X-800000; +PR 1LR,1LS,1LQ,1ZF / 1ZM		13.0460-7111.2 607111	VW 23130 19,6 - WE / - WK
1.9 TDI	74	09/00→06/05	←			13.0470-7111.2 LD7111	VW 23130 19,6 - WE / - WK Ceramic
			←	1J-Y-000001→; +PR 1LS,1LQ,1ZF,1ZM		13.0460-7117.2 607117	VW 23130 19,6 + WK
			→	+PR 1KY		13.0470-7117.2 LD7117	VW 23130 19,6 + WK Ceramic
			→			13.0460-2886.2 602886	TRW 20961 16,0 - WK
			→			13.0460-2937.2 602937	TRW 20961 15,2 - WK + Zub
			→			13.0470-2886.2 LD2886	TRW 20961 16,0 - WK Ceramic
			→	+PR 1KK,1KS,1KV / 1KQ,1KW		13.0460-2894.2 602894	TRW 20961 17,2 - WK + Zub
			→			13.0470-2894.2 LD2894	TRW 20961 17,2 - WK + Zub Ceramic
1.6	75	08/00→06/05	←	→ 1J-X-800000; +PR 1LR,1LS,1LQ,1ZF / 1ZM		13.0460-7111.2 607111	VW 23130 19,6 - WE / - WK
1.6	78	08/03→06/05	←			13.0470-7111.2 LD7111	VW 23130 19,6 - WE / - WK Ceramic
1.6 16V	77	02/00→06/05	←				
			←	1J-Y-000001→; → 10/03; +PR 1LS,1LQ,1ZF,1ZM		13.0460-7117.2 607117	VW 23130 19,6 + WK
			→	→ 10/03; +PR 1KY		13.0470-7117.2 LD7117	VW 23130 19,6 + WK Ceramic
			→			13.0460-2886.2 602886	TRW 20961 16,0 - WK
			→			13.0460-2937.2 602937	TRW 20961 15,2 - WK + Zub
			→			13.0470-2886.2 LD2886	TRW 20961 16,0 - WK Ceramic
			→	→ 10/03; +PR 1KK,1KS,1KV / 1KQ,1KW		13.0460-2894.2 602894	TRW 20961 17,2 - WK + Zub
			→			13.0470-2894.2 LD2894	TRW 20961 17,2 - WK + Zub Ceramic
1.6 FSI	81	01/02→06/05	←	→ 10/03; +PR 1LS,1LQ,1ZF,1ZM		13.0460-7117.2 607117	VW 23130 19,6 + WK
			→	→ 10/03; +PR 1KY		13.0470-7117.2 LD7117	VW 23130 19,6 + WK Ceramic
			→			13.0460-2886.2 602886	TRW 20961 16,0 - WK
			→			13.0460-2937.2 602937	TRW 20961 15,2 - WK + Zub
			→			13.0470-2886.2 LD2886	TRW 20961 16,0 - WK Ceramic
			→	→ 10/03; +PR 1KK,1KS,1KV / 1KQ,1KW		13.0460-2894.2 602894	TRW 20961 17,2 - WK + Zub







	kw			 	! #		
<b>VW - GOLF IV (1J1) 08/97→03/07</b>							
<b> Bremsbelagsatz, Scheibenbremse</b>							
1.6 FSI	81	01/02→06/05	➡	→ 10/03; +PR 1KK,1KS,1KV / 1KQ,1KW		<b>13.0470-2894.2</b> <b>LD2894</b>	TRW 20961 17,2 - WK + Zub Ceramic
1.8 1.8 T	92 110	08/97→06/05 08/97→06/05	←	10/97→; → 1J-X-800000; +PR 1LR,1LS,1LQ,1ZF / 1ZM		<b>13.0460-7111.2</b> <b>607111</b> <b>13.0470-7111.2</b> <b>LD7111</b>	VW 23130 19,6 - WE / - WK VW 23130 19,6 - WE / - WK Ceramic
			←	1J-Y-000001→; → 10/03; +PR 1LS,1LQ,1ZF,1ZM		<b>13.0460-7117.2</b> <b>607117</b> <b>13.0470-7117.2</b> <b>LD7117</b>	VW 23130 19,6 + WK VW 23130 19,6 + WK Ceramic
			←	10/97→ 10/03; +PR 1LE,1LJ,1LN,1ZE / 1ZH,1ZQ		<b>13.0460-7122.2</b> <b>607122</b> <b>13.0470-7122.2</b> <b>LD7122</b>	ATE 20676 19,8 + WK ATE 20676 19,8 + WK Ceramic
			➡	10/97→ 10/03; +PR 1KY		<b>13.0460-2886.2</b> <b>602886</b> <b>13.0460-2937.2</b> <b>602937</b> <b>13.0470-2886.2</b> <b>LD2886</b>	TRW 20961 16,0 - WK TRW 20961 15,2 - WK + Zub TRW 20961 16,0 - WK Ceramic
			➡	10/97→ 10/03; +PR 1KK,1KS,1KV / 1KQ,1KW		<b>13.0460-2894.2</b> <b>602894</b> <b>13.0470-2894.2</b> <b>LD2894</b>	TRW 20961 17,2 - WK + Zub TRW 20961 17,2 - WK + Zub Ceramic
			➡	10/97→ 10/03; +PR 1KE		<b>13.0460-2886.2</b> <b>602886</b> <b>13.0460-2937.2</b> <b>602937</b> <b>13.0470-2886.2</b> <b>LD2886</b>	TRW 20961 16,0 - WK TRW 20961 15,2 - WK + Zub TRW 20961 16,0 - WK Ceramic
1.8 4motion	92	05/98→06/05	←	07/98→ 10/03; +PR 1LS,1LQ,1ZF,1ZM		<b>13.0460-7117.2</b> <b>607117</b> <b>13.0470-7117.2</b> <b>LD7117</b>	VW 23130 19,6 + WK VW 23130 19,6 + WK Ceramic
			←	07/98→ 10/03; +PR 1LE,1LJ,1LN,1ZE / 1ZH,1ZQ		<b>13.0460-7122.2</b> <b>607122</b> <b>13.0470-7122.2</b> <b>LD7122</b>	ATE 20676 19,8 + WK ATE 20676 19,8 + WK Ceramic
			➡	07/98→ 10/03; +PR 1KU,2EE,2EL		<b>13.0460-2787.2</b> <b>602787</b> <b>13.0460-2820.2</b> <b>602820</b> <b>13.0470-2820.2</b> <b>LD2820</b>	TRW 23554 17,3 - WK / - WE TRW 20961 17,2 - WK TRW 20961 17,2 - WK Ceramic
			➡	07/98→ 10/03; +PR 1KE		<b>13.0460-2894.2</b> <b>602894</b> <b>13.0470-2894.2</b> <b>LD2894</b>	TRW 20961 17,2 - WK + Zub TRW 20961 17,2 - WK + Zub Ceramic
1.8 T GTI	132	08/01→06/05	←	→ 10/03		<b>13.0460-7081.2</b> <b>607081</b> <b>13.0470-7081.2</b> <b>LD7081</b>	ATE 20676 19,8 - WE / - WK ATE 20676 19,8 - WE / - WK Ceramic
			➡	→ 10/03		<b>13.0460-2886.2</b> <b>602886</b> <b>13.0460-2937.2</b> <b>602937</b> <b>13.0470-2886.2</b> <b>LD2886</b>	TRW 20961 16,0 - WK TRW 20961 15,2 - WK + Zub TRW 20961 16,0 - WK Ceramic
1.9 TDI	66	10/97→05/04	←	→ 1J-X-800000; +PR 1LR,1LS,1LQ,1ZF / 1ZM		<b>13.0460-7111.2</b> <b>607111</b> <b>13.0470-7111.2</b> <b>LD7111</b>	VW 23130 19,6 - WE / - WK VW 23130 19,6 - WE / - WK Ceramic
			←	1J-Y-000001→; → 06/01; +PR 1LS,1LQ,1ZF,1ZM		<b>13.0460-7117.2</b> <b>607117</b> <b>13.0470-7117.2</b> <b>LD7117</b>	VW 23130 19,6 + WK VW 23130 19,6 + WK Ceramic
			➡	→ 06/01; +PR 1KY		<b>13.0460-2886.2</b> <b>602886</b> <b>13.0460-2937.2</b> <b>602937</b> <b>13.0470-2886.2</b> <b>LD2886</b>	TRW 20961 16,0 - WK TRW 20961 15,2 - WK + Zub TRW 20961 16,0 - WK Ceramic
			➡	→ 06/01; +PR 1KK,1KS,1KV / 1KQ,1KW		<b>13.0460-2894.2</b> <b>602894</b> <b>13.0470-2894.2</b> <b>LD2894</b>	TRW 20961 17,2 - WK + Zub TRW 20961 17,2 - WK + Zub Ceramic
1.9 TDI	85	12/98→06/01	←	05/99→; → 1J-X-800000; +PR 1LR,1LS,1LQ,1ZF / 1ZM		<b>13.0460-7111.2</b> <b>607111</b> <b>13.0470-7111.2</b> <b>LD7111</b>	VW 23130 19,6 - WE / - WK VW 23130 19,6 - WE / - WK Ceramic
			←	1J-Y-000001→; +PR 1LS,1LQ,1ZF,1ZM		<b>13.0460-7117.2</b> <b>607117</b> <b>13.0470-7117.2</b> <b>LD7117</b>	VW 23130 19,6 + WK VW 23130 19,6 + WK Ceramic
			➡	05/99→; +PR 1KY		<b>13.0460-2886.2</b> <b>602886</b> <b>13.0460-2937.2</b> <b>602937</b> <b>13.0470-2886.2</b> <b>LD2886</b>	TRW 20961 16,0 - WK TRW 20961 15,2 - WK + Zub TRW 20961 16,0 - WK Ceramic
			➡	05/99→; +PR 1KK,1KS,1KV / 1KQ,1KW		<b>13.0460-2894.2</b> <b>602894</b> <b>13.0470-2894.2</b> <b>LD2894</b>	TRW 20961 17,2 - WK + Zub TRW 20961 17,2 - WK + Zub Ceramic
1.9 TDI	96	11/00→06/05	←	04/01→ 10/03; +PR 1LE,1LJ,1LN,1ZE / 1ZH,1ZQ		<b>13.0460-7122.2</b> <b>607122</b> <b>13.0470-7122.2</b> <b>LD7122</b>	ATE 20676 19,8 + WK ATE 20676 19,8 + WK Ceramic
			➡	04/01→ 10/03; +PR 1KY		<b>13.0460-2886.2</b> <b>602886</b> <b>13.0460-2937.2</b> <b>602937</b> <b>13.0470-2886.2</b> <b>LD2886</b>	TRW 20961 16,0 - WK TRW 20961 15,2 - WK + Zub TRW 20961 16,0 - WK Ceramic
			➡	04/01→ 10/03; +PR 1KK,1KS,1KV / 1KQ,1KW		<b>13.0460-2894.2</b> <b>602894</b> <b>13.0470-2894.2</b> <b>LD2894</b>	TRW 20961 17,2 - WK + Zub TRW 20961 17,2 - WK + Zub Ceramic
1.9 TDI	110	05/00→06/05	←	09/00→ 10/03; +PR 1LE,1LJ,1LN,1ZE / 1ZH,1ZQ		<b>13.0460-7122.2</b> <b>607122</b> <b>13.0470-7122.2</b> <b>LD7122</b>	ATE 20676 19,8 + WK ATE 20676 19,8 + WK Ceramic
			➡	09/00→ 10/03; +PR 1KY		<b>13.0460-2886.2</b> <b>602886</b>	TRW 20961 16,0 - WK









	kw			 	! #		
<b>VW - GOLF IV (1J1) 08/97→03/07</b>							
<b> Bremsbelagsatz, Scheibenbremse</b>							
1.9 TDI	110	05/00→06/05	➡	09/00→ 10/03; +PR 1KY	13.0460-2937.2	602937	TRW 20961 15,2 - WK + Zub
			➡	09/00→ 10/03; +PR 1KK,1KS,1KV / 1KQ,1KW	13.0470-2886.2	LD2886	TRW 20961 16,0 - WK Ceramic
1.9 TDI 4motion	66	07/98→04/02	➡	09/00→ 10/03; +PR 1KK,1KS,1KV / 1KQ,1KW	13.0460-2894.2	602894	TRW 20961 17,2 - WK + Zub
			➡	09/00→ 10/03; +PR 1KK,1KS,1KV / 1KQ,1KW	13.0470-2894.2	LD2894	TRW 20961 17,2 - WK + Zub Ceramic
			➡	→ 06/01; +PR 1LS,1LQ,1ZF,1ZM	13.0460-7117.2	607117	VW 23130 19,6 + WK
1.9 TDI 4motion	66	07/98→04/02	➡	→ 06/01; +PR 1LS,1LQ,1ZF,1ZM	13.0470-7117.2	LD7117	VW 23130 19,6 + WK Ceramic
			➡	→ 06/01; +PR 1KU,2EE,2EL	13.0460-2787.2	602787	TRW 23554 17,3 - WK / - WE
			➡	→ 06/01; +PR 1KE	13.0460-2820.2	602820	TRW 20961 17,2 - WK
1.9 TDI 4motion	74	09/00→06/05	➡	→ 06/01; +PR 1KE	13.0470-2820.2	LD2820	TRW 20961 17,2 - WK Ceramic
			➡	+PR 1KE	13.0460-2894.2	602894	TRW 20961 17,2 - WK + Zub
			➡	+PR 1KE	13.0470-2894.2	LD2894	TRW 20961 17,2 - WK + Zub Ceramic
1.9 TDI 4motion	74	09/00→06/05	➡	+PR 1LS,1LQ,1ZF,1ZM	13.0460-7117.2	607117	VW 23130 19,6 + WK
			➡	+PR 1LS,1LQ,1ZF,1ZM	13.0470-7117.2	LD7117	VW 23130 19,6 + WK Ceramic
			➡	+PR 1KU,2EE,2EL	13.0460-2787.2	602787	TRW 23554 17,3 - WK / - WE
1.9 TDI 4motion	85	09/99→06/01	➡	+PR 1KU,2EE,2EL	13.0460-2820.2	602820	TRW 20961 17,2 - WK
			➡	+PR 1KE	13.0470-2820.2	LD2820	TRW 20961 17,2 - WK Ceramic
			➡	+PR 1KE	13.0460-2894.2	602894	TRW 20961 17,2 - WK + Zub
1.9 TDI 4motion	85	09/99→06/01	➡	+PR 1KE	13.0470-2894.2	LD2894	TRW 20961 17,2 - WK + Zub Ceramic
			➡	11/99→; +PR 1LS,1LQ,1ZF,1ZM	13.0460-7117.2	607117	VW 23130 19,6 + WK
			➡	11/99→; +PR 1LS,1LQ,1ZF,1ZM	13.0470-7117.2	LD7117	VW 23130 19,6 + WK Ceramic
1.9 TDI 4motion	96	11/00→06/05	➡	11/99→; +PR 1KU,2EE,2EL	13.0460-2787.2	602787	TRW 23554 17,3 - WK / - WE
			➡	11/99→; +PR 1KE	13.0460-2820.2	602820	TRW 20961 17,2 - WK
			➡	11/99→; +PR 1KE	13.0470-2820.2	LD2820	TRW 20961 17,2 - WK Ceramic
1.9 TDI 4motion	96	11/00→06/05	➡	11/99→; +PR 1KE	13.0460-2894.2	602894	TRW 20961 17,2 - WK + Zub
			➡	04/01→ 10/03; +PR 1LE,1LJ,1LN,1ZE / 1ZH,1ZQ	13.0470-2894.2	LD2894	TRW 20961 17,2 - WK + Zub Ceramic
			➡	04/01→ 10/03; +PR 1KE	13.0460-7122.2	607122	ATE 20676 19,8 + WK
1.9 TDI 4motion	110	02/00→06/05	➡	04/01→ 10/03; +PR 1KE	13.0470-7122.2	LD7122	ATE 20676 19,8 + WK Ceramic
			➡	04/01→ 10/03; +PR 1KE	13.0460-2787.2	602787	TRW 23554 17,3 - WK / - WE
			➡	04/01→ 10/03; +PR 1KE	13.0460-2820.2	602820	TRW 20961 17,2 - WK
1.9 TDI 4motion	110	02/00→06/05	➡	04/01→ 10/03; +PR 1KE	13.0470-2820.2	LD2820	TRW 20961 17,2 - WK Ceramic
			➡	09/00→ 10/03; +PR 1KE	13.0460-2894.2	602894	TRW 20961 17,2 - WK + Zub
			➡	09/00→ 10/03; +PR 1KE	13.0470-2894.2	LD2894	TRW 20961 17,2 - WK + Zub Ceramic
2.0	85	07/98→05/04	➡	09/00→ 10/03; +PR 1LE,1LJ,1LN,1ZE / 1ZH,1ZQ	13.0460-7122.2	607122	ATE 20676 19,8 + WK
			➡	09/00→ 10/03; +PR 1KE	13.0470-7122.2	LD7122	ATE 20676 19,8 + WK Ceramic
			➡	09/00→ 10/03; +PR 1KE	13.0460-2787.2	602787	TRW 23554 17,3 - WK / - WE
2.0	85	07/98→05/04	➡	09/00→ 10/03; +PR 1KE	13.0460-2820.2	602820	TRW 20961 17,2 - WK
			➡	09/00→ 10/03; +PR 1KE	13.0470-2820.2	LD2820	TRW 20961 17,2 - WK Ceramic
			➡	08/98→ 10/03; +PR 1KE	13.0460-2894.2	602894	TRW 20961 17,2 - WK + Zub
2.0	85	07/98→05/04	➡	08/98→ 10/03; +PR 1KE	13.0470-2894.2	LD2894	TRW 20961 17,2 - WK + Zub Ceramic
			➡	08/98→ 10/03; +PR 1KY	13.0460-2886.2	602886	TRW 20961 16,0 - WK
			➡	08/98→ 10/03; +PR 1KY	13.0460-2937.2	602937	TRW 20961 15,2 - WK + Zub
2.0	85	07/98→05/04	➡	08/98→ 10/03; +PR 1KY	13.0470-2886.2	LD2886	TRW 20961 16,0 - WK Ceramic
			➡	08/98→ 10/03; +PR 1KK,1KS,1KV / 1KQ,1KW	13.0460-2894.2	602894	TRW 20961 17,2 - WK + Zub
			➡	08/98→ 10/03; +PR 1KK,1KS,1KV / 1KQ,1KW	13.0470-2894.2	LD2894	TRW 20961 17,2 - WK + Zub Ceramic
2.0 4motion	85	10/00→06/05	➡	08/98→ 10/03; +PR 1KY	13.0460-2894.2	602894	TRW 20961 17,2 - WK + Zub
			➡	→ 10/03; +PR 1LS,1LQ,1ZF,1ZM	13.0470-2894.2	LD2894	TRW 20961 17,2 - WK + Zub Ceramic
			➡	→ 10/03; +PR 1LS,1LQ,1ZF,1ZM	13.0460-7117.2	607117	VW 23130 19,6 + WK
2.0 4motion	85	10/00→06/05	➡	→ 10/03; +PR 1LS,1LQ,1ZF,1ZM	13.0470-7117.2	LD7117	VW 23130 19,6 + WK Ceramic
			➡	→ 10/03; +PR 1KU,2EE,2EL	13.0460-2787.2	602787	TRW 23554 17,3 - WK / - WE
			➡	→ 10/03; +PR 1KE	13.0460-2820.2	602820	TRW 20961 17,2 - WK
2.0 4motion	85	10/00→06/05	➡	→ 10/03; +PR 1KE	13.0470-2820.2	LD2820	TRW 20961 17,2 - WK Ceramic
			➡	→ 10/03; +PR 1KE	13.0460-2894.2	602894	TRW 20961 17,2 - WK + Zub
			➡	→ 10/03; +PR 1KE	13.0470-2894.2	LD2894	TRW 20961 17,2 - WK + Zub Ceramic
2.3 V5	110	08/97→10/00	➡	10/97→; → 1J-X-800000; +PR 1LE,1LN,1ZE,1ZH	13.0460-7081.2	607081	ATE 20676 19,8 - WE / - WK
			➡	10/97→; → 1J-X-800000; +PR 1LE,1LN,1ZE,1ZH	13.0470-7081.2	LD7081	ATE 20676 19,8 - WE / - WK Ceramic
↓							

	kw			 	! #			
<b>VW - GOLF IV (1J1) 08/97→03/07</b>								
<b>Bremsbelagsatz, Scheibenbremse</b>								
2.3 V5	110	08/97→10/00	←	1J-Y-000001→; +PR 1LJ,1ZE,1ZQ	13.0460-7122.2	607122	ATE 20676 19,8 + WK	
					13.0470-7122.2	LD7122	ATE 20676 19,8 + WK Ceramic	
			→	10/97→; +PR 1KY	13.0460-2886.2	602886	TRW 20961 16,0 - WK	
					13.0460-2937.2	602937	TRW 20961 15,2 - WK + Zub	
				13.0470-2886.2	LD2886	TRW 20961 16,0 - WK Ceramic		
			→	10/97→; +PR 1KK,1KS,1KV / 1KQ,1KW	13.0460-2894.2	602894	TRW 20961 17,2 - WK + Zub	
					13.0470-2894.2	LD2894	TRW 20961 17,2 - WK + Zub Ceramic	
2.3 V5	125	10/00→06/05	←	→ 1J-X-800000; +PR 1LE,1LN,1ZE,1ZH	13.0460-7081.2	607081	ATE 20676 19,8 - WE / - WK	
					13.0470-7081.2	LD7081	ATE 20676 19,8 - WE / - WK Ceramic	
			←	1J-Y-000001→; → 10/03; +PR 1LJ,1ZE,1ZQ	13.0460-7122.2	607122	ATE 20676 19,8 + WK	
					13.0470-7122.2	LD7122	ATE 20676 19,8 + WK Ceramic	
			→	10/03; +PR 1KY	13.0460-2886.2	602886	TRW 20961 16,0 - WK	
					13.0460-2937.2	602937	TRW 20961 15,2 - WK + Zub	
					13.0470-2886.2	LD2886	TRW 20961 16,0 - WK Ceramic	
			→	10/03; +PR 1KK,1KS,1KV / 1KQ,1KW	13.0460-2894.2	602894	TRW 20961 17,2 - WK + Zub	
					13.0470-2894.2	LD2894	TRW 20961 17,2 - WK + Zub Ceramic	
2.3 V5 4motion	110	12/98→10/00	←	→ 1J-X-800000; +PR 1LE,1LN,1ZE,1ZH	13.0460-7081.2	607081	ATE 20676 19,8 - WE / - WK	
					13.0470-7081.2	LD7081	ATE 20676 19,8 - WE / - WK Ceramic	
			←	1J-Y-000001→; +PR 1LJ,1ZE,1ZQ	13.0460-7122.2	607122	ATE 20676 19,8 + WK	
					13.0470-7122.2	LD7122	ATE 20676 19,8 + WK Ceramic	
			→	+PR 1KU,2EE,2EL	13.0460-2787.2	602787	TRW 23554 17,3 - WK / - WE	
					13.0460-2820.2	602820	TRW 20961 17,2 - WK	
					13.0470-2820.2	LD2820	TRW 20961 17,2 - WK Ceramic	
			→	+PR 1KE	13.0460-2894.2	602894	TRW 20961 17,2 - WK + Zub	
					13.0470-2894.2	LD2894	TRW 20961 17,2 - WK + Zub Ceramic	
2.3 V5 4motion 2.8 V6 4motion	125 150	10/00→06/05 03/99→06/05	←	→ 1J-X-800000; +PR 1LE,1LN,1ZE,1ZH	13.0460-7081.2	607081	ATE 20676 19,8 - WE / - WK	
					13.0470-7081.2	LD7081	ATE 20676 19,8 - WE / - WK Ceramic	
			←	1J-Y-000001→; → 10/03; +PR 1LJ,1ZE,1ZQ	13.0460-7122.2	607122	ATE 20676 19,8 + WK	
					13.0470-7122.2	LD7122	ATE 20676 19,8 + WK Ceramic	
			→	10/03; +PR 1KU,2EE,2EL	13.0460-2787.2	602787	TRW 23554 17,3 - WK / - WE	
					13.0460-2820.2	602820	TRW 20961 17,2 - WK	
					13.0470-2820.2	LD2820	TRW 20961 17,2 - WK Ceramic	
			→	10/03; +PR 1KE	13.0460-2894.2	602894	TRW 20961 17,2 - WK + Zub	
					13.0470-2894.2	LD2894	TRW 20961 17,2 - WK + Zub Ceramic	
3.2 R32 4motion	177	09/02→06/05	←	→ 10/03; +PR 1ZT	13.0460-7183.2	607183	ATE 21484 20,5 + WE / - WK	
			→	→ 10/03; +PR 1KU,2EE,2EL	13.0460-2787.2	602787	TRW 23554 17,3 - WK / - WE	
					13.0460-2820.2	602820	TRW 20961 17,2 - WK	
					13.0470-2820.2	LD2820	TRW 20961 17,2 - WK Ceramic	
			→	10/03; +PR 1KE	13.0460-2894.2	602894	TRW 20961 17,2 - WK + Zub	
					13.0470-2894.2	LD2894	TRW 20961 17,2 - WK + Zub Ceramic	
<b>Warnkontakt, Bremsbelagverschleiß</b>								
3.2 R32 4motion	177	09/02→06/05	←	→ 10/03; +PR 1ZT	1	24.8190-0106.2	620106	L= 270
<b>Zubehörsatz, Scheibenbremsbelag</b>								
1.4 16V	55	08/97→06/05	→	10/97→ 10/03; +PR 1KY	13.0460-0072.2	610072	TRW	
1.6	74	08/97→05/04	→	10/97→ 10/03;	13.0460-0072.2	610072	TRW	
1.8	92	08/97→06/05	→	+PR 1KK,1KS,1KV / 1KQ,1KW				
1.8 T	110	08/97→06/05						
1.9 SDI	50	08/97→06/05						
1.9 TDI	81	08/97→05/04						
1.6	74	02/01→06/01	→	+PR 1KK,1KS,1KV / 1KQ,1KW	13.0460-0072.2	610072	TRW	
1.9 TDI	74	09/00→06/05	→	+PR 1KY	13.0460-0072.2	610072	TRW	
1.6	75	08/00→06/05	→	→ 10/03; +PR 1KY	13.0460-0072.2	610072	TRW	
1.6	78	08/03→06/05						
1.6 16V	77	02/00→06/05	→	→ 10/03; +PR 1KK,1KS,1KV / 1KQ,1KW	13.0460-0072.2	610072	TRW	
1.6 FSI	81	01/02→06/05						
2.3 V5	125	10/00→06/05						
↓								









	kw			 	! #		
<b>VW - GOLF IV (1J1) 08/97→03/07</b>							
<b>Zubehörsatz, Scheibenbremsbelag</b>							
1.8 4motion	92	05/98→06/05	➡	07/98→ 10/03; +PR 1KE		13.0460-0072.2 610072	TRW
			➡	07/98→ 10/03; +PR 1KU,2EE,2EL		13.0460-0072.2 610072	TRW
1.8 T GTI	132	08/01→06/05	➡	→ 10/03		13.0460-0072.2 610072	TRW
1.9 TDI	66	10/97→05/04	➡	→ 06/01; +PR 1KY		13.0460-0072.2 610072	TRW
			➡	→ 06/01; +PR 1KK,1KS,1KV / 1KQ,1KW		13.0460-0072.2 610072	TRW
1.9 TDI	85	12/98→06/01	➡	05/99→; +PR 1KY		13.0460-0072.2 610072	TRW
			➡	05/99→; +PR 1KK,1KS,1KV / 1KQ,1KW		13.0460-0072.2 610072	TRW
1.9 TDI	96	11/00→06/05	➡	04/01→ 10/03; +PR 1KY		13.0460-0072.2 610072	TRW
			➡	04/01→ 10/03; +PR 1KK,1KS,1KV / 1KQ,1KW		13.0460-0072.2 610072	TRW
1.9 TDI	110	05/00→06/05	➡	09/00→ 10/03; +PR 1KK,1KS,1KV / 1KQ,1KW		13.0460-0072.2 610072	TRW
			➡	09/00→ 10/03; +PR 1KY		13.0460-0072.2 610072	TRW
1.9 TDI 4motion	66	07/98→04/02	➡	→ 06/01; +PR 1KU,2EE,2EL		13.0460-0072.2 610072	TRW
			➡	→ 06/01; +PR 1KE		13.0460-0072.2 610072	TRW
1.9 TDI 4motion 2.3 V5 4motion	74 110	09/00→06/05 12/98→10/00	➡	+PR 1KE		13.0460-0072.2 610072	TRW
			➡	+PR 1KU,2EE,2EL		13.0460-0072.2 610072	TRW
1.9 TDI 4motion	85	09/99→06/01	➡	11/99→; +PR 1KU,2EE,2EL		13.0460-0072.2 610072	TRW
			➡	11/99→; +PR 1KE		13.0460-0072.2 610072	TRW
1.9 TDI 4motion	96	11/00→06/05	➡	04/01→ 10/03; +PR 1KU,2EE,2EL		13.0460-0072.2 610072	TRW
			➡	04/01→ 10/03; +PR 1KE		13.0460-0072.2 610072	TRW
1.9 TDI 4motion	110	02/00→06/05	➡	09/00→ 10/03; +PR 1KU,2EE,2EL		13.0460-0072.2 610072	TRW
			➡	09/00→ 10/03; +PR 1KE		13.0460-0072.2 610072	TRW
2.0	85	07/98→05/04	➡	08/98→ 10/03; +PR 1KY		13.0460-0072.2 610072	TRW
			➡	08/98→ 10/03; +PR 1KK,1KS,1KV / 1KQ,1KW		13.0460-0072.2 610072	TRW
2.0 4motion 2.3 V5 4motion	85 125	10/00→06/05	➡	→ 10/03; +PR 1KE		13.0460-0072.2 610072	TRW
2.8 V6 4motion 3.2 R32 4motion	150 177	03/99→06/05 09/02→06/05	➡	→ 10/03; +PR 1KU,2EE,2EL		13.0460-0072.2 610072	TRW
2.3 V5	110	08/97→10/00	➡	10/97→; +PR 1KY		13.0460-0072.2 610072	TRW
			➡	10/97→; +PR 1KK,1KS,1KV / 1KQ,1KW		13.0460-0072.2 610072	TRW
<b> Bremsscheibe</b>							
1.4 16V 1.6 1.8 1.8 T 1.9 SDI 1.9 TDI	55 74 92 110 50 81	08/97→06/05 08/97→05/04 08/97→06/05 08/97→06/05 08/97→06/05 08/97→05/04	←	10/97→ 10/03; +PR 1LR,1LS,1ZM		24.0122-0150.1 422150 24.0322-0150.1 522150	Ø 280 22 19 V + S Ø 280 22 19 V + S
			←	10/97→ 10/03; +PR 1LQ,1ZF		24.0122-0151.1 422151 24.0322-0151.1 522151	Ø 256 22 19 V + S Ø 256 22 19 V + S
			←	10/97→ 10/03; +PR 1LE,1LN,1ZE,1ZH		24.0125-0113.1 425113 24.0325-0113.1 525113	Ø 288 25 22 V + S Ø 288 25 22 V + S
			➡	10/97→ 10/03; +PR 1KK,1KS,1KV / 1KQ,1KW		24.0109-0123.1 409123 24.0309-0123.1 509123	Ø 230 9 7 + S Ø 230 9 7 + S
			➡	10/97→ 10/03; +PR 1KY		24.0122-0163.1 422163 24.0322-0163.1 522163	Ø 256 22 20 V Ø 256 22 20 V
1.6 1.9 TDI	74 74	02/01→06/01 09/00→06/05	←	+PR 1LR,1LS,1ZM		24.0122-0150.1 422150 24.0322-0150.1 522150	Ø 280 22 19 V + S Ø 280 22 19 V + S
			←	+PR 1LQ,1ZF		24.0122-0151.1 422151 24.0322-0151.1 522151	Ø 256 22 19 V + S Ø 256 22 19 V + S
			←	+PR 1LE,1LN,1ZE,1ZH		24.0125-0113.1 425113 24.0325-0113.1 525113	Ø 288 25 22 V + S Ø 288 25 22 V + S
			➡	+PR 1KK,1KS,1KV / 1KQ,1KW		24.0109-0123.1 409123 24.0309-0123.1 509123	Ø 230 9 7 + S Ø 230 9 7 + S
			➡	+PR 1KY		24.0122-0163.1 422163 24.0322-0163.1 522163	Ø 256 22 20 V Ø 256 22 20 V
1.6 1.6 1.6 16V 1.6 FSI	75 78 77 81	08/00→06/05 08/03→06/05 02/00→06/05 01/02→06/05	←	→ 10/03; +PR 1LR,1LS,1ZM		24.0122-0150.1 422150 24.0322-0150.1 522150	Ø 280 22 19 V + S Ø 280 22 19 V + S
			←	→ 10/03; +PR 1LQ,1ZF		24.0122-0151.1 422151 24.0322-0151.1 522151	Ø 256 22 19 V + S Ø 256 22 19 V + S
			←	→ 10/03; +PR 1LE,1LN,1ZE,1ZH		24.0125-0113.1 425113 24.0325-0113.1 525113	Ø 288 25 22 V + S Ø 288 25 22 V + S
↓							

	kw			 	! #		
<b>VW - GOLF IV (1J1) 08/97→03/07</b>							
<b>Bremsscheibe</b>							
1.6	75	08/00→06/05	➔	→ 10/03; +PR 1KK,1KS,1KV / 1KQ,1KW	24.0109-0123.1	409123	Ø 230 9 7 + S
1.6	78	08/03→06/05			24.0309-0123.1	509123	Ø 230 9 7 + S
1.6 16V	77	02/00→06/05					
1.6 FSI	81	01/02→06/05	➔	→ 10/03; +PR 1KY	24.0122-0163.1	422163	Ø 256 22 20 V
					24.0322-0163.1	522163	Ø 256 22 20 V
1.8 4motion	92	05/98→06/05	➔	07/98→ 10/03; +PR 1LR,1LS,1ZM	24.0122-0150.1	422150	Ø 280 22 19 V + S
					24.0322-0150.1	522150	Ø 280 22 19 V + S
			➔	07/98→ 10/03; +PR 1LQ,1ZF	24.0122-0151.1	422151	Ø 256 22 19 V + S
					24.0322-0151.1	522151	Ø 256 22 19 V + S
			➔	→ 06/01; +PR 1LE,1LN,1ZE,1ZH	24.0125-0113.1	425113	Ø 288 25 22 V + S
				24.0325-0113.1	525113	Ø 288 25 22 V + S	
			➔	07/98→ 10/03; +PR 1KE	24.0109-0133.1	409133	Ø 239 8,9 7 + S
					24.0309-0133.1	509133	Ø 239 8,9 7 + S
1.8 T GTI	132	08/01→06/05	➔	→ 10/03	24.0125-0123.1	425123	Ø 310 25 22 V + S
					24.0325-0123.1	525123	Ø 310 25 22 V + S
			➔	→ 10/03	24.0122-0163.1	422163	Ø 256 22 20 V
					24.0322-0163.1	522163	Ø 256 22 20 V
1.9 TDI	66	10/97→05/04	➔	→ 06/01; +PR 1LR,1LS,1ZM	24.0122-0150.1	422150	Ø 280 22 19 V + S
					24.0322-0150.1	522150	Ø 280 22 19 V + S
			➔	→ 06/01; +PR 1LQ,1ZF	24.0122-0151.1	422151	Ø 256 22 19 V + S
					24.0322-0151.1	522151	Ø 256 22 19 V + S
			➔	→ 06/01; +PR 1LE,1LN,1ZE,1ZH	24.0125-0113.1	425113	Ø 288 25 22 V + S
					24.0325-0113.1	525113	Ø 288 25 22 V + S
			➔	→ 06/01; +PR 1KK,1KS,1KV / 1KQ,1KW	24.0109-0123.1	409123	Ø 230 9 7 + S
					24.0309-0123.1	509123	Ø 230 9 7 + S
			➔	→ 06/01; +PR 1KY	24.0122-0163.1	422163	Ø 256 22 20 V
					24.0322-0163.1	522163	Ø 256 22 20 V
1.9 TDI	85	12/98→06/01	➔	05/99→; +PR 1LR,1LS,1ZM	24.0122-0150.1	422150	Ø 280 22 19 V + S
					24.0322-0150.1	522150	Ø 280 22 19 V + S
			➔	05/99→; +PR 1LQ,1ZF	24.0122-0151.1	422151	Ø 256 22 19 V + S
					24.0322-0151.1	522151	Ø 256 22 19 V + S
			➔	05/99→; +PR 1LE,1LN,1ZE,1ZH	24.0125-0113.1	425113	Ø 288 25 22 V + S
					24.0325-0113.1	525113	Ø 288 25 22 V + S
			➔	05/99→; +PR 1KK,1KS,1KV / 1KQ,1KW	24.0109-0123.1	409123	Ø 230 9 7 + S
					24.0309-0123.1	509123	Ø 230 9 7 + S
			➔	05/99→; +PR 1KY	24.0122-0163.1	422163	Ø 256 22 20 V
					24.0322-0163.1	522163	Ø 256 22 20 V
1.9 TDI	96	11/00→06/05	➔	04/01→ 10/03; +PR 1LR,1LS,1ZM	24.0122-0150.1	422150	Ø 280 22 19 V + S
					24.0322-0150.1	522150	Ø 280 22 19 V + S
			➔	04/01→ 10/03; +PR 1LQ,1ZF	24.0122-0151.1	422151	Ø 256 22 19 V + S
					24.0322-0151.1	522151	Ø 256 22 19 V + S
			➔	04/01→ 10/03; +PR 1LE,1LN,1ZE,1ZH	24.0125-0113.1	425113	Ø 288 25 22 V + S
					24.0325-0113.1	525113	Ø 288 25 22 V + S
			➔	04/01→ 10/03; +PR 1KK,1KS,1KV / 1KQ,1KW	24.0109-0123.1	409123	Ø 230 9 7 + S
					24.0309-0123.1	509123	Ø 230 9 7 + S
			➔	04/01→ 10/03; +PR 1KY	24.0122-0163.1	422163	Ø 256 22 20 V
					24.0322-0163.1	522163	Ø 256 22 20 V
1.9 TDI	110	05/00→06/05	➔	09/00→ 10/03; +PR 1LR,1LS,1ZM	24.0122-0150.1	422150	Ø 280 22 19 V + S
					24.0322-0150.1	522150	Ø 280 22 19 V + S
			➔	09/00→ 10/03; +PR 1LQ,1ZF	24.0122-0151.1	422151	Ø 256 22 19 V + S
					24.0322-0151.1	522151	Ø 256 22 19 V + S
			➔	09/00→ 10/03; +PR 1LE,1LN,1ZE,1ZH	24.0125-0113.1	425113	Ø 288 25 22 V + S
					24.0325-0113.1	525113	Ø 288 25 22 V + S
			➔	09/00→ 10/03; +PR 1KK,1KS,1KV / 1KQ,1KW	24.0109-0123.1	409123	Ø 230 9 7 + S
					24.0309-0123.1	509123	Ø 230 9 7 + S
			➔	09/00→ 10/03; +PR 1KY	24.0122-0163.1	422163	Ø 256 22 20 V
					24.0322-0163.1	522163	Ø 256 22 20 V
1.9 TDI 4motion	66	07/98→04/02	➔	→ 06/01; +PR 1LR,1LS,1ZM	24.0122-0150.1	422150	Ø 280 22 19 V + S
					24.0322-0150.1	522150	Ø 280 22 19 V + S
			➔	→ 06/01; +PR 1LQ,1ZF	24.0122-0151.1	422151	Ø 256 22 19 V + S
					24.0322-0151.1	522151	Ø 256 22 19 V + S
			➔	→ 06/01; +PR 1LE,1LN,1ZE,1ZH	24.0125-0113.1	425113	Ø 288 25 22 V + S











	kw			 	! #		
<b>VW - GOLF IV (1J1) 08/97→03/07</b>							
<b>Bremsscheibe</b>							
1.9 TDI 4motion	66	07/98→04/02	←	→ 06/01; +PR 1LE,1LN,1ZE,1ZH	24.0325-0113.1	525113	Ø 288 25 22 V + S
			→	→ 06/01; +PR 1KE	24.0109-0133.1	409133	Ø 239 8,9 7 + S
1.9 TDI 4motion	74	09/00→06/05	←	+PR 1LR,1LS,1ZM	24.0122-0150.1	422150	Ø 280 22 19 V + S
					24.0322-0150.1	522150	Ø 280 22 19 V + S
			←	+PR 1LQ,1ZF	24.0122-0151.1	422151	Ø 256 22 19 V + S
					24.0322-0151.1	522151	Ø 256 22 19 V + S
			←	+PR 1LE,1LN,1ZE,1ZH	24.0125-0113.1	425113	Ø 288 25 22 V + S
					24.0325-0113.1	525113	Ø 288 25 22 V + S
1.9 TDI 4motion	85	09/99→06/01	←	11/99→; +PR 1LR,1LS,1ZM	24.0122-0150.1	422150	Ø 280 22 19 V + S
					24.0322-0150.1	522150	Ø 280 22 19 V + S
1.9 TDI 4motion	96	11/00→06/05	←	04/01→ 10/03; +PR 1LR,1LS,1ZM	24.0122-0150.1	422150	Ø 280 22 19 V + S
					24.0322-0150.1	522150	Ø 280 22 19 V + S
			←	04/01→ 10/03; +PR 1LQ,1ZF	24.0122-0151.1	422151	Ø 256 22 19 V + S
					24.0322-0151.1	522151	Ø 256 22 19 V + S
			←	04/01→ 10/03; +PR 1LE,1LN,1ZE,1ZH	24.0125-0113.1	425113	Ø 288 25 22 V + S
					24.0325-0113.1	525113	Ø 288 25 22 V + S
1.9 TDI 4motion	110	02/00→06/05	←	09/00→ 10/03; +PR 1LR,1LS,1ZM	24.0122-0150.1	422150	Ø 280 22 19 V + S
					24.0322-0150.1	522150	Ø 280 22 19 V + S
2.0	85	07/98→05/04	←	08/98→ 10/03; +PR 1LR,1LS,1ZM	24.0122-0150.1	422150	Ø 280 22 19 V + S
					24.0322-0150.1	522150	Ø 280 22 19 V + S
			←	08/98→ 10/03; +PR 1LQ,1ZF	24.0122-0151.1	422151	Ø 256 22 19 V + S
					24.0322-0151.1	522151	Ø 256 22 19 V + S
			←	08/98→ 10/03; +PR 1LE,1LN,1ZE,1ZH	24.0125-0113.1	425113	Ø 288 25 22 V + S
					24.0325-0113.1	525113	Ø 288 25 22 V + S
2.0 4motion	85	10/00→06/05	←	→ 10/03; +PR 1LR,1LS,1ZM	24.0122-0150.1	422150	Ø 280 22 19 V + S
					24.0322-0150.1	522150	Ø 280 22 19 V + S
2.3 V5	110	08/97→10/00	←	→ 10/03; +PR 1LQ,1ZF	24.0122-0151.1	422151	Ø 256 22 19 V + S
					24.0322-0151.1	522151	Ø 256 22 19 V + S
			←	→ 10/03; +PR 1LE,1LN,1ZE,1ZH	24.0125-0113.1	425113	Ø 288 25 22 V + S
					24.0325-0113.1	525113	Ø 288 25 22 V + S
			←	→ 10/03; +PR 1KE	24.0109-0133.1	409133	Ø 239 8,9 7 + S
					24.0309-0133.1	509133	Ø 239 8,9 7 + S
2.3 V5	110	08/97→10/00	←	10/97→; +PR 1LR,1LS,1ZM	24.0122-0150.1	422150	Ø 280 22 19 V + S
					24.0322-0150.1	522150	Ø 280 22 19 V + S
			←	10/97→; +PR 1LQ,1ZF	24.0122-0151.1	422151	Ø 256 22 19 V + S
					24.0322-0151.1	522151	Ø 256 22 19 V + S
2.3 V5	110	08/97→10/00	←	10/97→; +PR 1LE,1LN,1ZE,1ZH	24.0125-0113.1	425113	Ø 288 25 22 V + S
					24.0325-0113.1	525113	Ø 288 25 22 V + S
2.3 V5	110	08/97→10/00	←	10/97→; +PR 1LJ,1ZQ	24.0125-0123.1	425123	Ø 310 25 22 V + S
					24.0325-0123.1	525123	Ø 310 25 22 V + S























	kw			 	! #		
<b>VW - GOLF IV (1J1) 08/97→03/07</b>							
<b> Bremsscheibe</b>							
2.3 V5	110	08/97→10/00	➔	10/97→; +PR 1KK,1KS,1KV / 1KQ,1KW	24.0109-0123.1 409123	Ø 230 9 7 + S	
			➔	10/97→; +PR 1KY	24.0309-0123.1 509123	Ø 230 9 7 + S	
			➔	10/97→; +PR 1KY	24.0122-0163.1 422163	Ø 256 22 20 V	
2.3 V5	125	10/00→06/05	➔	10/03; +PR 1LR,1LS,1ZM	24.0122-0150.1 422150	Ø 280 22 19 V + S	
			➔	10/03; +PR 1LQ,1ZF	24.0322-0150.1 522150	Ø 280 22 19 V + S	
			➔	10/03; +PR 1LQ,1ZF	24.0122-0151.1 422151	Ø 256 22 19 V + S	
			➔	10/03; +PR 1LQ,1ZF	24.0322-0151.1 522151	Ø 256 22 19 V + S	
			➔	10/03; +PR 1LE,1LN,1ZE,1ZH	24.0125-0113.1 425113	Ø 288 25 22 V + S	
			➔	10/03; +PR 1LE,1LN,1ZE,1ZH	24.0325-0113.1 525113	Ø 288 25 22 V + S	
			➔	10/03; +PR 1LJ,1ZQ	24.0125-0123.1 425123	Ø 310 25 22 V + S	
2.3 V5 4motion	110	12/98→10/00	➔	10/03; +PR 1KK,1KS,1KV / 1KQ,1KW	24.0109-0123.1 409123	Ø 230 9 7 + S	
			➔	10/03; +PR 1KY	24.0309-0123.1 509123	Ø 230 9 7 + S	
			➔	10/03; +PR 1KY	24.0122-0163.1 422163	Ø 256 22 20 V	
			➔	10/03; +PR 1KY	24.0322-0163.1 522163	Ø 256 22 20 V	
			➔	10/03; +PR 1LR,1LS,1ZM	24.0122-0150.1 422150	Ø 280 22 19 V + S	
			➔	10/03; +PR 1LR,1LS,1ZM	24.0322-0150.1 522150	Ø 280 22 19 V + S	
			➔	10/03; +PR 1LQ,1ZF	24.0122-0151.1 422151	Ø 256 22 19 V + S	
2.3 V5 4motion	125	10/00→06/05	➔	10/03; +PR 1LQ,1ZF	24.0322-0151.1 522151	Ø 256 22 19 V + S	
			➔	10/03; +PR 1LQ,1ZF	24.0122-0151.1 422151	Ø 256 22 19 V + S	
			➔	10/03; +PR 1LQ,1ZF	24.0322-0151.1 522151	Ø 256 22 19 V + S	
			➔	10/03; +PR 1LE,1LN,1ZE,1ZH	24.0125-0113.1 425113	Ø 288 25 22 V + S	
			➔	10/03; +PR 1LE,1LN,1ZE,1ZH	24.0325-0113.1 525113	Ø 288 25 22 V + S	
			➔	10/03; +PR 1LJ,1ZQ	24.0125-0123.1 425123	Ø 310 25 22 V + S	
			➔	10/03; +PR 1LJ,1ZQ	24.0325-0123.1 525123	Ø 310 25 22 V + S	
2.8 V6 4motion	150	03/99→06/05	➔	+PR 1KE	24.0109-0133.1 409133	Ø 239 8,9 7 + S	
			➔	+PR 1KE	24.0309-0133.1 509133	Ø 239 8,9 7 + S	
			➔	+PR 1KE	24.0122-0163.1 422163	Ø 256 22 20 V	
			➔	+PR 1KE	24.0322-0163.1 522163	Ø 256 22 20 V	
			➔	+PR 1KU,2EE,2EL	24.0122-0163.1 422163	Ø 256 22 20 V	
			➔	+PR 1KU,2EE,2EL	24.0322-0163.1 522163	Ø 256 22 20 V	
			➔	+PR 1KU,2EE,2EL	24.0122-0163.1 422163	Ø 256 22 20 V	
3.2 R32 4motion	177	09/02→06/05	➔	+PR 1KU,2EE,2EL	24.0122-0163.1 422163	Ø 256 22 20 V	
			➔	+PR 1KU,2EE,2EL	24.0322-0163.1 522163	Ø 256 22 20 V	
			➔	+PR 1KU,2EE,2EL	24.0122-0163.1 422163	Ø 256 22 20 V	
<b>VW - GOLF IV Cabriolet (1E7) 06/98→06/02</b>							
<b> Bremsbelagsatz, Scheibenbremse</b>							
1.6 1.8 1.8	74 55 66	06/98→06/02	➔	1E-V-000001→; → 02/02	13.0460-2821.2 602821	TRW 21945 16,0 - WK	
			➔	1E-T-030000	13.0460-2958.2 602958	TRW 20168 19,3 - WK	
			➔	1E-X-014000	13.0460-2937.2 602937	TRW 20961 15,2 - WK + Zub	
			➔	1E-X-014001→; → 02/02	13.0460-2984.2 602984	TRW 20961 17,2 - WK + Zub	
1.9 TDI	66	06/98→06/02	➔	1E-V-000001→; → 02/02	13.0460-2821.2 602821	TRW 21945 16,0 - WK	
			➔	1E-T-030000	13.0460-2958.2 602958	TRW 20168 19,3 - WK	
			➔	1E-X-014001→; → 02/02; - ABS	13.0460-2937.2 602937	TRW 20961 15,2 - WK + Zub	
↓							











	kw			 	! #		
<b>VW - GOLF IV Cabriolet (1E7) 06/98→06/02</b>							
 <b>Bremsbelagsatz, Scheibenbremse</b>							
1.9 TDI	66	06/98→06/02	➡	→ 1E-X-014000		<b>13.0460-2937.2 602937</b>	TRW 20961 15,2 - WK + Zub
			➡	1E-X-014001→; + ABS; → 02/02		<b>13.0460-2984.2 602984</b>	TRW 20961 17,2 - WK + Zub
1.9 TDI	81	06/98→06/02	⬅	→ 02/02		<b>13.0460-2821.2 602821</b>	TRW 21945 16,0 - WK
			➡	→ 1E-X-014000		<b>13.0460-2937.2 602937</b>	TRW 20961 15,2 - WK + Zub
			➡	1E-X-014001→; → 02/02; - ABS		<b>13.0460-2937.2 602937</b>	TRW 20961 15,2 - WK + Zub
2.0	85	06/98→06/02	➡	1E-X-014001→; + ABS; → 02/02		<b>13.0460-2984.2 602984</b>	TRW 20961 17,2 - WK + Zub
			⬅	1E-V-000001→; → 02/02		<b>13.0460-2821.2 602821</b>	TRW 21945 16,0 - WK
			⬅	→ 1E-T-030000		<b>13.0460-2958.2 602958</b>	TRW 20168 19,3 - WK
2.0	85	06/98→06/02	➡	1E-2-800 001→; → 02/02		<b>13.0460-2894.2 602894</b>	TRW 20961 17,2 - WK + Zub
						<b>13.0470-2894.2 LD2894</b>	TRW 20961 17,2 - WK + Zub Ceramic
			➡	→ 1E-X-014000		<b>13.0460-2937.2 602937</b>	TRW 20961 15,2 - WK + Zub
			➡	1E-X-014001→ 1E-2-015 000		<b>13.0460-2984.2 602984</b>	TRW 20961 17,2 - WK + Zub
<b>Zubehörsatz, Scheibenbremsbelag</b>							
1.6	74	06/98→06/02	➡	1E-X-014001→; → 02/02		<b>13.0460-0072.2 610072</b>	TRW
1.8	55	06/98→06/02	➡	→ 1E-X-014000		<b>13.0460-0419.2 610419</b>	TRW
1.8	66	06/98→06/02	➡	→ 1E-X-014000		<b>13.0460-0419.2 610419</b>	TRW
1.9 TDI	66	06/98→06/02	➡	1E-X-014001→; + ABS; → 02/02		<b>13.0460-0072.2 610072</b>	TRW
1.9 TDI	81	06/98→06/02	➡	→ 1E-X-014000		<b>13.0460-0419.2 610419</b>	TRW
2.0	85	06/98→06/02	➡	1E-X-014001→ 1E-2-015 000		<b>13.0460-0072.2 610072</b>	TRW
			➡	→ 1E-X-014000		<b>13.0460-0419.2 610419</b>	TRW
 <b>Bremsscheibe</b>							
1.6	74	06/98→06/02	⬅	→ 1E-T-030000		<b>24.0113-0178.1 413178</b>	Ø 255,6 12,9 11 + S
1.8	55	06/98→06/02	⬅	→ 1E-T-030000		<b>24.0313-0178.1 513178</b>	Ø 255,6 12,9 11 + S
1.8	66	06/98→06/02	⬅	→ 1E-T-030000		<b>24.0313-0178.1 513178</b>	Ø 255,6 12,9 11 + S
1.9 TDI	66	06/98→06/02	⬅	1E-V-000001→; → 02/02		<b>24.0120-0128.1 420128</b>	Ø 256 20 18 V + S
2.0	85	06/98→06/02	⬅	1E-V-000001→; → 02/02		<b>24.0320-0128.1 520128</b>	Ø 256 20 18 V + S
1.9 TDI	81	06/98→06/02	➡	→ 02/02		<b>24.0110-0111.1 410111</b>	Ø 226 10 8 - ABS Ring / - RLG
			➡	→ 02/02		<b>24.0110-0275.2 410275</b>	Ø 226 10 8 + ABS Ring / - RLG
1.9 TDI	81	06/98→06/02	⬅	→ 02/02		<b>24.0120-0128.1 420128</b>	Ø 256 20 18 V + S
			⬅	→ 02/02		<b>24.0320-0128.1 520128</b>	Ø 256 20 18 V + S
1.9 TDI	81	06/98→06/02	⬅	→ 02/02		<b>24.0110-0111.1 410111</b>	Ø 226 10 8 - ABS Ring / - RLG
			⬅	→ 02/02		<b>24.0110-0275.2 410275</b>	Ø 226 10 8 + ABS Ring / - RLG
<b>VW - GOLF IV Van (1J1) 05/00→05/04</b>							
 <b>Bremsbelagsatz, Scheibenbremse</b>							
1.9 TDI	66	05/00→09/02	⬅	→ 1J-X-800000; +PR 1LR,1LS,1LQ,1ZF / 1ZM		<b>13.0460-7111.2 607111</b>	VW 23130 19,6 - WE / - WK
						<b>13.0470-7111.2 LD7111</b>	VW 23130 19,6 - WE / - WK Ceramic
			⬅	1J-Y-000001→; → 06/01; +PR 1LS,1LQ,1ZF,1ZM		<b>13.0460-7117.2 607117</b>	VW 23130 19,6 + WK
						<b>13.0470-7117.2 LD7117</b>	VW 23130 19,6 + WK Ceramic
1.9 TDI	96	04/01→05/04	➡	→ 06/01; +PR 1KY		<b>13.0460-2886.2 602886</b>	TRW 20961 16,0 - WK
						<b>13.0460-2937.2 602937</b>	TRW 20961 15,2 - WK + Zub
						<b>13.0470-2886.2 LD2886</b>	TRW 20961 16,0 - WK Ceramic
			➡	→ 06/01; +PR 1KK,1KS,1KV / 1KQ,1KW		<b>13.0460-2894.2 602894</b>	TRW 20961 17,2 - WK + Zub
			➡	→ 06/01; +PR 1KK,1KS,1KV / 1KQ,1KW		<b>13.0470-2894.2 LD2894</b>	TRW 20961 17,2 - WK + Zub Ceramic
1.9 TDI	96	04/01→05/04	⬅	→ 1J-X-800000; +PR 1LR,1LS,1LQ,1ZF / 1ZM		<b>13.0460-7111.2 607111</b>	VW 23130 19,6 - WE / - WK
						<b>13.0470-7111.2 LD7111</b>	VW 23130 19,6 - WE / - WK Ceramic
			⬅	1J-Y-000001→; → 06/01; +PR 1LS,1LQ,1ZF,1ZM		<b>13.0460-7117.2 607117</b>	VW 23130 19,6 + WK
						<b>13.0470-7117.2 LD7117</b>	VW 23130 19,6 + WK Ceramic
			⬅	→ 10/03; +PR 1LE,1LJ,1LN,1ZE / 1ZH,1ZQ		<b>13.0460-7122.2 607122</b>	ATE 20676 19,8 + WK
						<b>13.0470-7122.2 LD7122</b>	ATE 20676 19,8 + WK Ceramic
↓			➡	→ 06/01; +PR 1KY		<b>13.0460-2886.2 602886</b>	TRW 20961 16,0 - WK
						<b>13.0460-2937.2 602937</b>	TRW 20961 15,2 - WK + Zub
						<b>13.0470-2886.2 LD2886</b>	TRW 20961 16,0 - WK Ceramic
			➡	→ 10/03; +PR 1KY		<b>13.0460-2886.2 602886</b>	TRW 20961 16,0 - WK
						<b>13.0460-2937.2 602937</b>	TRW 20961 15,2 - WK + Zub
						<b>13.0470-2886.2 LD2886</b>	TRW 20961 16,0 - WK Ceramic

	kw			 	! #		
<b>VW - GOLF IV Van (1J1) 05/00→05/04</b>							
 <b>Bremsbelagsatz, Scheibenbremse</b>							
1.9 TDI	96	04/01→05/04	➡	→ 10/03; +PR 1KK,1KS,1KV / 1KQ,1KW	13.0460-2894.2	602894	TRW 20961 17,2 - WK + Zub
					13.0470-2894.2	LD2894	TRW 20961 17,2 - WK + Zub Ceramic
			➡	→ 06/01; +PR 1KK,1KS,1KV / 1KQ,1KW	13.0460-2894.2	602894	TRW 20961 17,2 - WK + Zub
					13.0470-2894.2	LD2894	TRW 20961 17,2 - WK + Zub Ceramic
<b>Zubehörsatz, Scheibenbremsbelag</b>							
1.9 TDI	66	05/00→09/02	➡	→ 06/01; +PR 1KY	13.0460-0072.2	610072	TRW
			➡	→ 06/01; +PR 1KK,1KS,1KV / 1KQ,1KW	13.0460-0072.2	610072	TRW
1.9 TDI	96	04/01→05/04	➡	→ 06/01; +PR 1KY	13.0460-0072.2	610072	TRW
			➡	→ 10/03; +PR 1KY	13.0460-0072.2	610072	TRW
			➡	→ 06/01; +PR 1KK,1KS,1KV / 1KQ,1KW	13.0460-0072.2	610072	TRW
			➡	→ 10/03; +PR 1KK,1KS,1KV / 1KQ,1KW	13.0460-0072.2	610072	TRW
 <b>Bremsscheibe</b>							
1.9 TDI	66	05/00→09/02	⬅	→ 06/01; +PR 1LR,1LS,1ZM	24.0122-0150.1	422150	Ø 280 22 19 V + S
					24.0322-0150.1	522150	Ø 280 22 19 V + S
			⬅	→ 06/01; +PR 1LQ,1ZF	24.0122-0151.1	422151	Ø 256 22 19 V + S
					24.0322-0151.1	522151	Ø 256 22 19 V + S
			⬅	→ 06/01; +PR 1LE,1LN,1ZE,1ZH	24.0125-0113.1	425113	Ø 288 25 22 V + S
					24.0325-0113.1	525113	Ø 288 25 22 V + S
			➡	→ 06/01; +PR 1KK,1KS,1KV / 1KQ,1KW	24.0109-0123.1	409123	Ø 230 9 7 + S
					24.0309-0123.1	509123	Ø 230 9 7 + S
			➡	→ 06/01; +PR 1KY	24.0122-0163.1	422163	Ø 256 22 20 V
					24.0322-0163.1	522163	Ø 256 22 20 V
1.9 TDI	96	04/01→05/04	⬅	→ 10/03; +PR 1LR,1LS,1ZM	24.0122-0150.1	422150	Ø 280 22 19 V + S
					24.0322-0150.1	522150	Ø 280 22 19 V + S
			⬅	→ 06/01; +PR 1LR,1LS,1ZM	24.0122-0150.1	422150	Ø 280 22 19 V + S
					24.0322-0150.1	522150	Ø 280 22 19 V + S
			⬅	→ 06/01; +PR 1LQ,1ZF	24.0122-0151.1	422151	Ø 256 22 19 V + S
					24.0322-0151.1	522151	Ø 256 22 19 V + S
			⬅	→ 10/03; +PR 1LQ,1ZF	24.0122-0151.1	422151	Ø 256 22 19 V + S
					24.0322-0151.1	522151	Ø 256 22 19 V + S
			⬅	→ 06/01; +PR 1LE,1LN,1ZE,1ZH	24.0125-0113.1	425113	Ø 288 25 22 V + S
					24.0325-0113.1	525113	Ø 288 25 22 V + S
			⬅	→ 10/03; +PR 1LE,1LN,1ZE,1ZH	24.0125-0113.1	425113	Ø 288 25 22 V + S
					24.0325-0113.1	525113	Ø 288 25 22 V + S
			➡	→ 10/03; +PR 1KK,1KS,1KV / 1KQ,1KW	24.0109-0123.1	409123	Ø 230 9 7 + S
					24.0309-0123.1	509123	Ø 230 9 7 + S
			➡	→ 06/01; +PR 1KK,1KS,1KV / 1KQ,1KW	24.0109-0123.1	409123	Ø 230 9 7 + S
					24.0309-0123.1	509123	Ø 230 9 7 + S
			➡	→ 10/03; +PR 1KY	24.0122-0163.1	422163	Ø 256 22 20 V
					24.0322-0163.1	522163	Ø 256 22 20 V
			➡	→ 06/01; +PR 1KY	24.0122-0163.1	422163	Ø 256 22 20 V
					24.0322-0163.1	522163	Ø 256 22 20 V
<b>VW - GOLF IV Variant (1J5) 05/99→06/06</b>							
 <b>Bremsbelagsatz, Scheibenbremse</b>							
1.4 16V	55	05/99→06/06	⬅	+PR 1LR,1LS,1ZF,1ZP / 1ZM	13.0460-7117.2	607117	VW 23130 19,6 + WK
1.6	74	05/99→04/02			13.0470-7117.2	LD7117	VW 23130 19,6 + WK Ceramic
1.6	75	08/00→06/06					
1.6 16V	77	02/00→06/06	➡	+PR 1KE,1KP,1KT	13.0460-2894.2	602894	TRW 20961 17,2 - WK + Zub
1.6 FSI	81	01/02→06/06			13.0470-2894.2	LD2894	TRW 20961 17,2 - WK + Zub Ceramic
1.9 SDI	50	05/99→06/06					
1.9 TDI	66	05/99→05/06					
1.9 TDI	74	09/00→06/06					
1.9 TDI	81	05/99→06/01					
1.9 TDI	85	08/99→06/01					
2.0	85	05/99→06/06					
2.0 Bi-Fuel	85	02/02→06/06					
1.8 4motion	92	05/99→06/06	⬅	+PR 1LR,1LS,1ZF,1ZP / 1ZM	13.0460-7117.2	607117	VW 23130 19,6 + WK
1.9 TDI 4motion	66	05/99→04/02			13.0470-7117.2	LD7117	VW 23130 19,6 + WK Ceramic
1.9 TDI 4motion	74	09/00→06/06					
2.0 4motion	85	10/00→06/06	➡	+PR 2EE,2EL	13.0460-2787.2	602787	TRW 23554 17,3 - WK / - WE
↓							



















	kw			 	! #		
<b>VW - GOLF IV Variant (1J5) 05/99→06/06</b>							
<b> Bremsbelagsatz, Scheibenbremse</b>							
1.8 4motion	92	05/99→06/06	➡	+PR 2EE,2EL		<b>13.0460-2820.2 602820</b>	TRW 20961 17,2 - WK
1.9 TDI 4motion	66	05/99→04/02				<b>13.0470-2820.2 LD2820</b>	TRW 20961 17,2 - WK Ceramic
1.9 TDI 4motion	74	09/00→06/06					
2.0 4motion	85	10/00→06/06	➡	+PR 1KE		<b>13.0460-2894.2 602894</b>	TRW 20961 17,2 - WK + Zub
						<b>13.0470-2894.2 LD2894</b>	TRW 20961 17,2 - WK + Zub Ceramic
1.8 T	110	05/00→06/06	⬅	+PR 1ZD;1ZE / 1ZE		<b>13.0460-7122.2 607122</b>	ATE 20676 19,8 + WK
			⬅	+PR 1ZD;1ZE		<b>13.0470-7122.2 LD7122</b>	ATE 20676 19,8 + WK Ceramic
			➡	+PR 1KE,1KP,1KT		<b>13.0460-2894.2 602894</b>	TRW 20961 17,2 - WK + Zub
						<b>13.0470-2894.2 LD2894</b>	TRW 20961 17,2 - WK + Zub Ceramic
1.9 TDI	96	11/00→06/06	⬅	04/01→; +PR 1LR,1LS,1ZF,1ZP / 1ZM		<b>13.0460-7117.2 607117</b>	VW 23130 19,6 + WK
						<b>13.0470-7117.2 LD7117</b>	VW 23130 19,6 + WK Ceramic
			⬅	04/01→; +PR 1ZD;1ZE / 1ZE		<b>13.0460-7122.2 607122</b>	ATE 20676 19,8 + WK
			⬅	04/01→; +PR 1ZD;1ZE		<b>13.0470-7122.2 LD7122</b>	ATE 20676 19,8 + WK Ceramic
			➡	04/01→; +PR 1KE,1KP,1KT		<b>13.0460-2894.2 602894</b>	TRW 20961 17,2 - WK + Zub
						<b>13.0470-2894.2 LD2894</b>	TRW 20961 17,2 - WK + Zub Ceramic
1.9 TDI	110	06/01→06/06	⬅	+PR 1LR,1LS,1ZF,1ZP / 1ZM		<b>13.0460-7117.2 607117</b>	VW 23130 19,6 + WK
						<b>13.0470-7117.2 LD7117</b>	VW 23130 19,6 + WK Ceramic
			⬅	+PR 1ZD;1ZE / 1ZE		<b>13.0460-7122.2 607122</b>	ATE 20676 19,8 + WK
			⬅	+PR 1ZD;1ZE		<b>13.0470-7122.2 LD7122</b>	ATE 20676 19,8 + WK Ceramic
			➡	+PR 1KE,1KP,1KT		<b>13.0460-2894.2 602894</b>	TRW 20961 17,2 - WK + Zub
						<b>13.0470-2894.2 LD2894</b>	TRW 20961 17,2 - WK + Zub Ceramic
1.9 TDI 4motion	85	05/99→06/01	⬅	11/99→; +PR 1LR,1LS,1ZF,1ZP / 1ZM		<b>13.0460-7117.2 607117</b>	VW 23130 19,6 + WK
						<b>13.0470-7117.2 LD7117</b>	VW 23130 19,6 + WK Ceramic
			➡	11/99→; +PR 2EE,2EL		<b>13.0460-2787.2 602787</b>	TRW 23554 17,3 - WK / - WE
						<b>13.0460-2820.2 602820</b>	TRW 20961 17,2 - WK
						<b>13.0470-2820.2 LD2820</b>	TRW 20961 17,2 - WK Ceramic
			➡	11/99→; +PR 1KE		<b>13.0460-2894.2 602894</b>	TRW 20961 17,2 - WK + Zub
						<b>13.0470-2894.2 LD2894</b>	TRW 20961 17,2 - WK + Zub Ceramic
1.9 TDI 4motion	96	11/00→06/06	⬅	04/01→; +PR 1ZD;1ZE / 1ZE		<b>13.0460-7122.2 607122</b>	ATE 20676 19,8 + WK
			⬅	04/01→; +PR 1ZD;1ZE		<b>13.0470-7122.2 LD7122</b>	ATE 20676 19,8 + WK Ceramic
			➡	04/01→; +PR 2EE,2EL		<b>13.0460-2787.2 602787</b>	TRW 23554 17,3 - WK / - WE
						<b>13.0460-2820.2 602820</b>	TRW 20961 17,2 - WK
						<b>13.0470-2820.2 LD2820</b>	TRW 20961 17,2 - WK Ceramic
			➡	04/01→; +PR 1KE		<b>13.0460-2894.2 602894</b>	TRW 20961 17,2 - WK + Zub
						<b>13.0470-2894.2 LD2894</b>	TRW 20961 17,2 - WK + Zub Ceramic
1.9 TDI 4motion	110	05/02→06/05	⬅	+PR 1ZD;1ZE / 1ZE		<b>13.0460-7122.2 607122</b>	ATE 20676 19,8 + WK
			⬅	+PR 1ZD;1ZE		<b>13.0470-7122.2 LD7122</b>	ATE 20676 19,8 + WK Ceramic
			➡	+PR 2EE,2EL		<b>13.0460-2787.2 602787</b>	TRW 23554 17,3 - WK / - WE
						<b>13.0460-2820.2 602820</b>	TRW 20961 17,2 - WK
						<b>13.0470-2820.2 LD2820</b>	TRW 20961 17,2 - WK Ceramic
			➡	+PR 1KE		<b>13.0460-2894.2 602894</b>	TRW 20961 17,2 - WK + Zub
						<b>13.0470-2894.2 LD2894</b>	TRW 20961 17,2 - WK + Zub Ceramic
2.0 4motion	88	12/99→06/06	⬅	04/00→; +PR 1LR,1LS,1ZF,1ZP / 1ZM		<b>13.0460-7117.2 607117</b>	VW 23130 19,6 + WK
						<b>13.0470-7117.2 LD7117</b>	VW 23130 19,6 + WK Ceramic
			➡	04/00→; +PR 2EE,2EL		<b>13.0460-2787.2 602787</b>	TRW 23554 17,3 - WK / - WE
						<b>13.0460-2820.2 602820</b>	TRW 20961 17,2 - WK
						<b>13.0470-2820.2 LD2820</b>	TRW 20961 17,2 - WK Ceramic
			➡	04/00→; +PR 1KE		<b>13.0460-2894.2 602894</b>	TRW 20961 17,2 - WK + Zub
						<b>13.0470-2894.2 LD2894</b>	TRW 20961 17,2 - WK + Zub Ceramic
2.3 V5	110	05/99→06/06	⬅	→ 1J-X-800000; +PR 1ZE		<b>13.0460-7081.2 607081</b>	ATE 20676 19,8 - WE / - WK
2.3 V5	125	10/00→06/06				<b>13.0470-7081.2 LD7081</b>	ATE 20676 19,8 - WE / - WK Ceramic
			⬅	1J-Y-000001→; +PR 1ZD;1ZE / 1ZE		<b>13.0460-7122.2 607122</b>	ATE 20676 19,8 + WK
			⬅	1J-Y-000001→; +PR 1ZD;1ZE		<b>13.0470-7122.2 LD7122</b>	ATE 20676 19,8 + WK Ceramic
			➡	+PR 1KE,1KP,1KT		<b>13.0460-2894.2 602894</b>	TRW 20961 17,2 - WK + Zub



	kw			 	! #		
<b>VW - GOLF IV Variant (1J5) 05/99→06/06</b>							
<b> Bremsbelagsatz, Scheibenbremse</b>							
2.3 V5 2.3 V5	110 125	05/99→06/06 10/00→06/06	➡	+PR 1KE,1KP,1KT		13.0470-2894.2 LD2894	TRW 20961 17,2 - WK + Zub Ceramic
2.3 V5 4motion 2.3 V5 4motion	110 125	05/99→06/06 10/00→06/06	←	→ 1J-X-800000; +PR 1ZE		13.0460-7081.2 607081 13.0470-7081.2 LD7081	ATE 20676 19,8 - WE / - WK ATE 20676 19,8 - WE / - WK Ceramic
			←	1J-Y-000001→; +PR 1ZD;1ZE / 1ZE		13.0460-7122.2 607122	ATE 20676 19,8 + WK
			←	1J-Y-000001→; +PR 1ZD;1ZE		13.0470-7122.2 LD7122	ATE 20676 19,8 + WK Ceramic
			➡	+PR 2EE,2EL		13.0460-2787.2 602787 13.0460-2820.2 602820 13.0470-2820.2 LD2820	TRW 23554 17,3 - WK / - WE TRW 20961 17,2 - WK TRW 20961 17,2 - WK Ceramic
			➡	+PR 1KE		13.0460-2894.2 602894 13.0470-2894.2 LD2894	TRW 20961 17,2 - WK + Zub TRW 20961 17,2 - WK + Zub Ceramic
2.8 V6 4motion	150	05/99→06/06	←			13.0460-7081.2 607081 13.0470-7081.2 LD7081	ATE 20676 19,8 - WE / - WK ATE 20676 19,8 - WE / - WK Ceramic
			➡	+PR 2EE,2EL		13.0460-2787.2 602787 13.0460-2820.2 602820 13.0470-2820.2 LD2820	TRW 23554 17,3 - WK / - WE TRW 20961 17,2 - WK TRW 20961 17,2 - WK Ceramic
			➡	+PR 1KE		13.0460-2894.2 602894 13.0470-2894.2 LD2894	TRW 20961 17,2 - WK + Zub TRW 20961 17,2 - WK + Zub Ceramic
<b>Zubehörsatz, Scheibenbremsbelag</b>							
1.4 16V 1.6 1.6 1.6 16V 1.6 FSI 1.8 T 1.9 SDI 1.9 TDI 1.9 TDI 1.9 TDI 1.9 TDI 1.9 TDI 2.0 2.0 Bi-Fuel 2.3 V5 2.3 V5	55 74 75 77 81 110 50 66 74 81 85 110 85 85 110 125	05/99→06/06 05/99→04/02 08/00→06/06 02/00→06/06 01/02→06/06 05/00→06/06 05/99→06/06 05/99→05/06 09/00→06/06 05/99→06/01 08/99→06/01 06/01→06/06 05/99→06/06 02/02→06/06 05/99→06/06 10/00→06/06	➡	+PR 1KE,1KP,1KT		13.0460-0072.2 610072	TRW
1.8 4motion 1.9 TDI 4motion 1.9 TDI 4motion 1.9 TDI 4motion 2.0 4motion 2.3 V5 4motion 2.3 V5 4motion 2.8 V6 4motion	92 66 74 110 85 110 125 150	05/99→06/06 05/99→04/02 09/00→06/06 05/02→06/05 10/00→06/06 05/99→06/06 10/00→06/06 05/99→06/06	➡	+PR 1KE		13.0460-0072.2 610072	TRW
1.9 TDI 1.9 TDI 4motion 1.9 TDI 4motion 2.0 4motion	96 85 96 88	11/00→06/06 05/99→06/01 11/00→06/06 12/99→06/06	➡	04/01→; +PR 1KE,1KP,1KT 11/99→; +PR 1KE 04/01→; +PR 1KE 04/00→; +PR 1KE		13.0460-0072.2 610072 13.0460-0072.2 610072 13.0460-0072.2 610072 13.0460-0072.2 610072	TRW TRW TRW TRW
<b> Bremsscheibe</b>							
1.4 16V 1.6 1.6 1.6 16V 1.6 FSI 1.9 SDI 1.9 TDI 1.9 TDI 1.9 TDI 1.9 TDI 2.0 2.0 Bi-Fuel	55 74 75 77 81 50 66 74 81 85 85 85	05/99→06/06 05/99→04/02 08/00→06/06 02/00→06/06 01/02→06/06 05/99→06/06 05/99→05/06 09/00→06/06 05/99→06/01 08/99→06/01 05/99→06/06 02/02→06/06	←	+PR 1LR,1LS,1ZF,1ZP / 1ZM		24.0122-0150.1 422150 24.0322-0150.1 522150	Ø 280 22 19 V + S Ø 280 22 19 V + S
1.6 16V 1.6 FSI 1.9 SDI 1.9 TDI 1.9 TDI 1.9 TDI 2.0 2.0 Bi-Fuel	77 81 50 66 74 81 85 85	02/00→06/06 01/02→06/06 05/99→06/06 05/99→05/06 09/00→06/06 05/99→06/01 08/99→06/01 05/99→06/06	➡	+PR 1KP,1KT		24.0109-0123.1 409123 24.0309-0123.1 509123	Ø 230 9 7 + S Ø 230 9 7 + S
1.8 4motion 1.9 TDI 4motion 1.9 TDI 4motion 2.0 4motion	92 66 74 85	05/99→06/06 05/99→04/02 09/00→06/06 10/00→06/06	←	+PR 1LR,1LS,1ZF,1ZP / 1ZM		24.0122-0150.1 422150 24.0322-0150.1 522150	Ø 280 22 19 V + S Ø 280 22 19 V + S
			➡	+PR 1KE		24.0109-0133.1 409133 24.0309-0133.1 509133	Ø 239 8,9 7 + S Ø 239 8,9 7 + S
			➡	+PR 2EE,2EL		24.0122-0163.1 422163	Ø 256 22 20 V
↓							



















	kw			 	! #		
<b>VW - GOLF IV Variant (1J5) 05/99→06/06</b>							
<b> Bremsscheibe</b>							
1.8 4motion 1.9 TDI 4motion 1.9 TDI 4motion 2.0 4motion	92 66 74 85	05/99→06/06 05/99→04/02 09/00→06/06 10/00→06/06	➡	+PR 2EE,2EL		24.0322-0163.1 522163	Ø 256 22 20 V
1.8 T 2.3 V5 2.3 V5	110 110 125	05/00→06/06 05/99→06/06 10/00→06/06	⬅	+PR 1ZD,1ZE		24.0125-0113.1 425113 24.0325-0113.1 525113	Ø 288 25 22 V + S Ø 288 25 22 V + S
			➡	+PR 1KP,1KT		24.0109-0123.1 409123 24.0309-0123.1 509123	Ø 230 9 7 + S Ø 230 9 7 + S
1.9 TDI	96	11/00→06/06	⬅	04/01→; +PR 1LR,1LS,1ZF,1ZP / 1ZM		24.0122-0150.1 422150 24.0322-0150.1 522150	Ø 280 22 19 V + S Ø 280 22 19 V + S
			⬅	04/01→; +PR 1ZD,1ZE		24.0125-0113.1 425113 24.0325-0113.1 525113	Ø 288 25 22 V + S Ø 288 25 22 V + S
			➡	04/01→; +PR 1KP,1KT		24.0109-0123.1 409123 24.0309-0123.1 509123	Ø 230 9 7 + S Ø 230 9 7 + S
1.9 TDI	110	06/01→06/06	⬅	+PR 1LR,1LS,1ZF,1ZP / 1ZM		24.0122-0150.1 422150 24.0322-0150.1 522150	Ø 280 22 19 V + S Ø 280 22 19 V + S
			⬅	+PR 1ZD,1ZE		24.0125-0113.1 425113 24.0325-0113.1 525113	Ø 288 25 22 V + S Ø 288 25 22 V + S
			➡	+PR 1KP,1KT		24.0109-0123.1 409123 24.0309-0123.1 509123	Ø 230 9 7 + S Ø 230 9 7 + S
1.9 TDI 4motion	85	05/99→06/01	⬅	11/99→; +PR 1LR,1LS,1ZF,1ZP / 1ZM		24.0122-0150.1 422150 24.0322-0150.1 522150	Ø 280 22 19 V + S Ø 280 22 19 V + S
			➡	11/99→; +PR 1KE		24.0109-0133.1 409133 24.0309-0133.1 509133	Ø 239 8,9 7 + S Ø 239 8,9 7 + S
			➡	11/99→; +PR 2EE,2EL		24.0122-0163.1 422163 24.0322-0163.1 522163	Ø 256 22 20 V Ø 256 22 20 V
1.9 TDI 4motion	96	11/00→06/06	⬅	04/01→; +PR 1ZD,1ZE		24.0125-0113.1 425113 24.0325-0113.1 525113	Ø 288 25 22 V + S Ø 288 25 22 V + S
			➡	04/01→; +PR 1KE		24.0109-0133.1 409133 24.0309-0133.1 509133	Ø 239 8,9 7 + S Ø 239 8,9 7 + S
			➡	04/01→; +PR 2EE,2EL		24.0122-0163.1 422163 24.0322-0163.1 522163	Ø 256 22 20 V Ø 256 22 20 V
1.9 TDI 4motion 2.3 V5 4motion 2.3 V5 4motion	110 110 125	05/02→06/05 05/99→06/06 10/00→06/06	⬅	+PR 1ZD,1ZE		24.0125-0113.1 425113 24.0325-0113.1 525113	Ø 288 25 22 V + S Ø 288 25 22 V + S
			➡	+PR 1KE		24.0109-0133.1 409133 24.0309-0133.1 509133	Ø 239 8,9 7 + S Ø 239 8,9 7 + S
			➡	+PR 2EE,2EL		24.0122-0163.1 422163 24.0322-0163.1 522163	Ø 256 22 20 V Ø 256 22 20 V
2.0 4motion	88	12/99→06/06	⬅	04/00→; +PR 1LR,1LS,1ZF,1ZP / 1ZM		24.0122-0150.1 422150 24.0322-0150.1 522150	Ø 280 22 19 V + S Ø 280 22 19 V + S
			➡	04/00→; +PR 1KE		24.0109-0133.1 409133 24.0309-0133.1 509133	Ø 239 8,9 7 + S Ø 239 8,9 7 + S
			➡	04/00→; +PR 2EE,2EL		24.0122-0163.1 422163 24.0322-0163.1 522163	Ø 256 22 20 V Ø 256 22 20 V
2.8 V6 4motion	150	05/99→06/06	⬅			24.0125-0123.1 425123 24.0325-0123.1 525123	Ø 310 25 22 V + S Ø 310 25 22 V + S
			➡	+PR 1KE		24.0109-0133.1 409133 24.0309-0133.1 509133	Ø 239 8,9 7 + S Ø 239 8,9 7 + S
			➡	+PR 2EE,2EL		24.0122-0163.1 422163 24.0322-0163.1 522163	Ø 256 22 20 V Ø 256 22 20 V
<b>VW - GOLF V (1K1) 10/03→02/09</b>							
<b> Bremsbelagsatz, Scheibenbremse</b>							
1.4 16V 1.4 FSI 1.6 FSI	55 66 85	10/03→05/06 10/03→07/06 10/03→07/08	⬅	+PR 1ZF;1ZM;1ZC		13.0460-7117.2 607117 13.0470-7117.2 LD7117	VW 23130 19,6 + WK VW 23130 19,6 + WK Ceramic
			⬅	+PR 1ZE;1ZP / 1LJ,1LL,1LV,1ZD		13.0460-7184.2 607184 13.0470-7184.2 LD7184	ATE 23587 20,6 + WK ATE 23587 20,6 + WK Ceramic
			⬅	+PR 1LK;1LM		13.0460-7200.2 607200 13.0470-7200.2 LD7200	ATE 23801 20,3 + WK ATE 23801 20,3 + WK Ceramic
			➡	+PR 1KY,1KZ,1KF,2EL / 1KE		13.0460-2748.2 602748 13.0460-2880.2 602880	TRW 24606 17,4 - WE / - WK + Zub TRW 23914 17,1 + WE / - WK + Zub
↓							







	kw			 	! #		
<b>VW - GOLF V (1K1) 10/03—02/09</b>							
<b> Bremsbelagsatz, Scheibenbremse</b>							
1.4 16V 1.4 FSI 1.6 FSI	55 66 85	10/03→05/06 10/03→07/06 10/03→07/08	➡	+PR 1KY,1KZ,1KF,2EL / 1KE		13.0470-2748.2 LD2748 13.0470-2880.2 LD2880	TRW 24606 17,4 - WE / - WK + Zub Ceramic TRW 23914 17,1 + WE / - WK + Zub Ceramic
			➡	+PR 1KV		13.0460-2749.2 602749 13.0460-2880.2 602880 13.0470-2749.2 LD2749 13.0470-2880.2 LD2880	TRW 24483 16,9 - WE / - WK + Zub TRW 23914 17,1 + WE / - WK + Zub TRW 24483 16,9 - WE / - WK + Zub Ceramic TRW 23914 17,1 + WE / - WK + Zub Ceramic
			➡	+PR 1KD;1KQ		13.0460-2787.2 602787 13.0460-2860.2 602860 13.0470-2860.2 LD2860	TRW 23554 17,3 - WK / - WE TRW 23554 16,4 - WK / + WE TRW 23554 16,4 - WK / + WE Ceramic
1.4 16V 1.6 1.6 MultiFuel 1.9 TDI 1.9 TDI 2.0 FSI 2.0 GTI 2.0 SDI 2.0 TDI 2.0 TDI 2.0 TDI 16V 2.5	59 75 75 66 77 110 147 55 100 103 103 110	05/06→11/08 01/04→11/08 10/07→11/08 05/04→11/08 10/03→11/08 01/04→11/08 10/04→02/09 01/04→11/08 10/03→11/08 12/04→11/08 10/03→11/08 06/05→11/08	⬅	+PR 1ZF;1ZM;1ZC; → 09/08		13.0460-7117.2 607117 13.0470-7117.2 LD7117	VW 23130 19,6 + WK VW 23130 19,6 + WK Ceramic
			⬅	→ 09/08; +PR 1ZE;1ZP / 1LJ,1LL,1LV,1ZD		13.0460-7184.2 607184 13.0470-7184.2 LD7184	ATE 23587 20,6 + WK ATE 23587 20,6 + WK Ceramic
			⬅	+PR 1LK;1LM; → 09/08		13.0460-7200.2 607200 13.0470-7200.2 LD7200	ATE 23801 20,3 + WK ATE 23801 20,3 + WK Ceramic
			➡	→ 09/08; +PR 1KY,1KZ,1KF,2EL / 1KE		13.0460-2748.2 602748 13.0460-2880.2 602880 13.0470-2748.2 LD2748 13.0470-2880.2 LD2880	TRW 24606 17,4 - WE / - WK + Zub TRW 23914 17,1 + WE / - WK + Zub TRW 24606 17,4 - WE / - WK + Zub Ceramic TRW 23914 17,1 + WE / - WK + Zub Ceramic
			➡	→ 09/08; +PR 1KV		13.0460-2749.2 602749 13.0460-2880.2 602880 13.0470-2749.2 LD2749 13.0470-2880.2 LD2880	TRW 24483 16,9 - WE / - WK + Zub TRW 23914 17,1 + WE / - WK + Zub TRW 24483 16,9 - WE / - WK + Zub Ceramic TRW 23914 17,1 + WE / - WK + Zub Ceramic
			➡	+PR 1KD;1KQ; → 09/08		13.0460-2787.2 602787 13.0460-2860.2 602860 13.0470-2860.2 LD2860	TRW 23554 17,3 - WK / - WE TRW 23554 16,4 - WK / + WE TRW 23554 16,4 - WK / + WE Ceramic
1.4 TSI 2.0 GTI	90 169	05/07→11/08 09/06→12/08	⬅	+PR 1ZF;1ZM;1ZC; → 09/08		13.0460-7117.2 607117 13.0470-7117.2 LD7117	VW 23130 19,6 + WK VW 23130 19,6 + WK Ceramic
			⬅	→ 09/08; +PR 1ZE;1ZP / 1LJ,1LL,1LV,1ZD		13.0460-7184.2 607184 13.0470-7184.2 LD7184	ATE 23587 20,6 + WK ATE 23587 20,6 + WK Ceramic
			⬅	+PR 1LK;1LM; → 09/08		13.0460-7200.2 607200 13.0470-7200.2 LD7200	ATE 23801 20,3 + WK ATE 23801 20,3 + WK Ceramic
			➡	→ 09/08; +PR 1KY,1KZ,1KF,2EL / 1KE		13.0460-2748.2 602748 13.0460-2880.2 602880 13.0470-2748.2 LD2748 13.0470-2880.2 LD2880	TRW 24606 17,4 - WE / - WK + Zub TRW 23914 17,1 + WE / - WK + Zub TRW 24606 17,4 - WE / - WK + Zub Ceramic TRW 23914 17,1 + WE / - WK + Zub Ceramic
			➡	→ 09/08; +PR 1KV		13.0460-2749.2 602749 13.0460-2880.2 602880 13.0470-2749.2 LD2749 13.0470-2880.2 LD2880	TRW 24483 16,9 - WE / - WK + Zub TRW 23914 17,1 + WE / - WK + Zub TRW 24483 16,9 - WE / - WK + Zub Ceramic TRW 23914 17,1 + WE / - WK + Zub Ceramic
			➡	+PR 1KD;1KQ; → 09/08		13.0460-2787.2 602787 13.0460-2820.2 602820 13.0460-2860.2 602860 13.0470-2820.2 LD2820	TRW 23554 17,3 - WK / - WE TRW 20961 17,2 - WK TRW 23554 16,4 - WK / + WE TRW 20961 17,2 - WK Ceramic

↓









	kw			 	! #		
<b>VW - GOLF V (1K1) 10/03—02/09</b>							
<b> Bremsbelagsatz, Scheibenbremse</b>							
1.4 TSI 2.0 GTI	90 169	05/07→11/08 09/06→12/08	➡	+PR 1KD;1KQ; → 09/08		13.0470-2860.2 LD2860	TRW 23554 16,4 - WK / + WE Ceramic
1.4 TSI	103	05/06→11/08	←	+PR 1ZF;1ZM;1ZC; → 09/08		13.0460-7117.2 607117 13.0470-7117.2 LD7117	VW 23130 19,6 + WK VW 23130 19,6 + WK Ceramic
			←	→ 09/08; +PR 1ZE,1ZP / 1LJ,1LL,1LV,1ZD		13.0460-7184.2 607184 13.0470-7184.2 LD7184	ATE 23587 20,6 + WK ATE 23587 20,6 + WK Ceramic
			←	+PR 1LK;1LM; → 09/08		13.0460-7200.2 607200 13.0470-7200.2 LD7200	ATE 23801 20,3 + WK ATE 23801 20,3 + WK Ceramic
			➡	→ 09/08; +PR 1KY,1KZ,1KF,2EL / 1KE		13.0460-2748.2 602748 13.0460-2880.2 602880 13.0470-2748.2 LD2748 13.0470-2880.2 LD2880	TRW 24606 17,4 - WE / - WK + Zub TRW 23914 17,1 + WE / - WK + Zub TRW 24606 17,4 - WE / - WK + Zub Ceramic TRW 23914 17,1 + WE / - WK + Zub Ceramic
			➡	→ 09/08; +PR 1KV		13.0460-2749.2 602749 13.0460-2880.2 602880 13.0470-2749.2 LD2749 13.0470-2880.2 LD2880	TRW 24483 16,9 - WE / - WK + Zub TRW 23914 17,1 + WE / - WK + Zub TRW 24483 16,9 - WE / - WK + Zub Ceramic TRW 23914 17,1 + WE / - WK + Zub Ceramic
			➡	+PR 1KD;1KQ; → 09/08		13.0460-2787.2 602787 13.0460-2860.2 602860 13.0470-2860.2 LD2860	TRW 23554 17,3 - WK / - WE TRW 23554 16,4 - WK / + WE TRW 23554 16,4 - WK / + WE Ceramic
			←	+PR 1ZF;1ZM;1ZC; → 09/08		13.0460-7117.2 607117 13.0470-7117.2 LD7117	VW 23130 19,6 + WK VW 23130 19,6 + WK Ceramic
			←	→ 09/08; +PR 1LJ,1LL,1LV,1ZD / 1ZE;1ZP		13.0460-7184.2 607184 13.0470-7184.2 LD7184	ATE 23587 20,6 + WK ATE 23587 20,6 + WK Ceramic
1.4 TSI	125	11/05→11/08	←	+PR 1LK;1LM; → 09/08		13.0460-7200.2 607200 13.0470-7200.2 LD7200	ATE 23801 20,3 + WK ATE 23801 20,3 + WK Ceramic
			➡	→ 09/08; +PR 1KY,1KZ,1KF,2EL / 1KE		13.0460-2748.2 602748 13.0460-2880.2 602880 13.0470-2748.2 LD2748 13.0470-2880.2 LD2880	TRW 24606 17,4 - WE / - WK + Zub TRW 23914 17,1 + WE / - WK + Zub TRW 24606 17,4 - WE / - WK + Zub Ceramic TRW 23914 17,1 + WE / - WK + Zub Ceramic
			➡	→ 09/08; +PR 1KV		13.0460-2749.2 602749 13.0460-2880.2 602880 13.0470-2749.2 LD2749 13.0470-2880.2 LD2880	TRW 24483 16,9 - WE / - WK + Zub TRW 23914 17,1 + WE / - WK + Zub TRW 24483 16,9 - WE / - WK + Zub Ceramic TRW 23914 17,1 + WE / - WK + Zub Ceramic
			➡	+PR 1KD;1KQ; → 09/08		13.0460-2787.2 602787 13.0460-2860.2 602860 13.0470-2860.2 LD2860	TRW 23554 17,3 - WK / - WE TRW 23554 16,4 - WK / + WE TRW 23554 16,4 - WK / + WE Ceramic
			←	→ 09/08; +PR 1ZF,1ZM,1ZC		13.0460-7117.2 607117 13.0470-7117.2 LD7117	VW 23130 19,6 + WK VW 23130 19,6 + WK Ceramic
1.8 GTI 2.0	132 85	08/06→11/08 08/06→11/08	←	→ 09/08; +PR 1LJ,1LL,1LV,1ZD / 1ZP,1ZE		13.0460-7184.2 607184 13.0470-7184.2 LD7184	ATE 23587 20,6 + WK ATE 23587 20,6 + WK Ceramic
			←	→ 09/08; +PR 1LK,1LM		13.0460-7200.2 607200 13.0470-7200.2 LD7200	ATE 23801 20,3 + WK ATE 23801 20,3 + WK Ceramic
			➡	→ 09/08; +PR 1KY,1KZ,1KF,1KE / 2EL		13.0460-2748.2 602748 13.0460-2880.2 602880 13.0470-2748.2 LD2748 13.0470-2880.2 LD2880	TRW 24606 17,4 - WE / - WK + Zub TRW 23914 17,1 + WE / - WK + Zub TRW 24606 17,4 - WE / - WK + Zub Ceramic TRW 23914 17,1 + WE / - WK + Zub Ceramic
			↓				









	kw			 	! #		
<b>VW - GOLF V (1K1) 10/03—02/09</b>							
<b> Bremsbelagsatz, Scheibenbremse</b>							
1.8 GTI 2.0	132 85	08/06→11/08 08/06→11/08	➡	→ 09/08; +PR 1KV	13.0460-2749.2	602749	TRW 24483 16,9 - WE / - WK + Zub
					13.0460-2880.2	602880	TRW 23914 17,1 + WE / - WK + Zub
					13.0470-2749.2	LD2749	TRW 24483 16,9 - WE / - WK + Zub Ceramic
					13.0470-2880.2	LD2880	TRW 23914 17,1 + WE / - WK + Zub Ceramic
			➡	→ 09/08; +PR 1KD,1KQ	13.0460-2787.2	602787	TRW 23554 17,3 - WK / - WE
					13.0460-2860.2	602860	TRW 23554 16,4 - WK / + WE
					13.0470-2860.2	LD2860	TRW 23554 16,4 - WK / + WE Ceramic
1.9 TDI 4motion	77	08/04→11/08	←	+PR 1ZF;1ZM;1ZC; → 09/08	13.0460-7117.2	607117	VW 23130 19,6 + WK
					13.0470-7117.2	LD7117	VW 23130 19,6 + WK Ceramic
			←	→ 09/08; +PR 1LJ,1LL,1LV,1ZD / 1ZE;1ZP	13.0460-7184.2	607184	ATE 23587 20,6 + WK
					13.0470-7184.2	LD7184	ATE 23587 20,6 + WK Ceramic
			←	+PR 1LK;1LM; → 09/08	13.0460-7200.2	607200	ATE 23801 20,3 + WK
					13.0470-7200.2	LD7200	ATE 23801 20,3 + WK Ceramic
			➡	→ 09/08; +PR 1KY,1KZ,1KF,2EL / 1KE	13.0460-2748.2	602748	TRW 24606 17,4 - WE / - WK + Zub
				13.0460-2880.2	602880	TRW 23914 17,1 + WE / - WK + Zub	
					13.0470-2748.2	LD2748	TRW 24606 17,4 - WE / - WK + Zub Ceramic
					13.0470-2880.2	LD2880	TRW 23914 17,1 + WE / - WK + Zub Ceramic
			➡	08/06→ 09/08; +PR 1KY,1KZ,1KF,1KE / 2EL	13.0460-2748.2	602748	TRW 24606 17,4 - WE / - WK + Zub
					13.0460-2880.2	602880	TRW 23914 17,1 + WE / - WK + Zub
					13.0470-2748.2	LD2748	TRW 24606 17,4 - WE / - WK + Zub Ceramic
					13.0470-2880.2	LD2880	TRW 23914 17,1 + WE / - WK + Zub Ceramic
			➡	→ 09/08; +PR 1KV	13.0460-2749.2	602749	TRW 24483 16,9 - WE / - WK + Zub
					13.0460-2880.2	602880	TRW 23914 17,1 + WE / - WK + Zub
					13.0470-2749.2	LD2749	TRW 24483 16,9 - WE / - WK + Zub Ceramic
					13.0470-2880.2	LD2880	TRW 23914 17,1 + WE / - WK + Zub Ceramic
2.0 FSI 4motion 2.0 TDI 16V 4motion 2.0 TDI 4motion	110 103 103	08/04→11/08 08/04→11/08 08/04→11/08	←	+PR 1ZF;1ZM;1ZC; → 09/08	13.0460-7117.2	607117	VW 23130 19,6 + WK
					13.0470-7117.2	LD7117	VW 23130 19,6 + WK Ceramic
			←	→ 09/08; +PR 1LJ,1LL,1LV,1ZD / 1ZE;1ZP	13.0460-7184.2	607184	ATE 23587 20,6 + WK
					13.0470-7184.2	LD7184	ATE 23587 20,6 + WK Ceramic
			←	+PR 1LK;1LM; → 09/08	13.0460-7200.2	607200	ATE 23801 20,3 + WK
		13.0470-7200.2	LD7200	ATE 23801 20,3 + WK Ceramic			
			➡	→ 09/08; +PR 1KY,1KZ,1KF,2EL / 1KE	13.0460-2748.2	602748	TRW 24606 17,4 - WE / - WK + Zub
					13.0460-2880.2	602880	TRW 23914 17,1 + WE / - WK + Zub
					13.0470-2748.2	LD2748	TRW 24606 17,4 - WE / - WK + Zub Ceramic
					13.0470-2880.2	LD2880	TRW 23914 17,1 + WE / - WK + Zub Ceramic
			➡	→ 09/08; +PR 1KV	13.0460-2749.2	602749	TRW 24483 16,9 - WE / - WK + Zub
					13.0460-2880.2	602880	TRW 23914 17,1 + WE / - WK + Zub
					13.0470-2749.2	LD2749	TRW 24483 16,9 - WE / - WK + Zub Ceramic
					13.0470-2880.2	LD2880	TRW 23914 17,1 + WE / - WK + Zub Ceramic
2.0 TDI	125	11/05→11/08	←	+PR 1ZF;1ZM;1ZC; → 09/08	13.0460-7117.2	607117	VW 23130 19,6 + WK
					13.0470-7117.2	LD7117	VW 23130 19,6 + WK Ceramic
			←	→ 09/08; +PR 1LJ,1LL,1LV,1ZD / 1ZE;1ZP	13.0460-7184.2	607184	ATE 23587 20,6 + WK
				13.0470-7184.2	LD7184	ATE 23587 20,6 + WK Ceramic	
↓							











	kw			 	! #		
<b>VW - GOLF V (1K1) 10/03→02/09</b>							
<b>Bremsbelagsatz, Scheibenbremse</b>							
2.0 TDI	125	11/05→11/08	←	+PR 1LK;1LM; → 09/08	13.0460-7200.2 607200	ATE 23801 20,3 + WK	
			→	+PR 1KD;1KQ; → 09/08	13.0470-7200.2 LD7200	ATE 23801 20,3 + WK Ceramic	
3.2	184	09/05→11/08	←	11/05→ 09/08; +PR 1ZF;1ZM;1ZC	13.0460-7117.2 607117	VW 23130 19,6 + WK	
			←	11/05→ 09/08; +PR 1ZE;1ZP / 1LJ,1LL,1LV,1ZD	13.0460-7184.2 607184	ATE 23587 20,6 + WK	
			←	11/05→ 09/08; +PR 1LK;1LM	13.0460-7200.2 607200	ATE 23801 20,3 + WK	
			→	11/05→ 09/08; +PR 1KY,1KZ,1KF,2EL / 1KE	13.0460-2748.2 602748	TRW 24606 17,4 - WE / - WK + Zub	
			→	11/05→ 09/08; +PR 1KV	13.0460-2880.2 602880	TRW 23914 17,1 + WE / - WK + Zub	
			→	11/05→ 09/08; +PR 1KV	13.0470-2748.2 LD2748	TRW 24606 17,4 - WE / - WK + Zub Ceramic	
			→	11/05→ 09/08; +PR 1KV	13.0470-2880.2 LD2880	TRW 23914 17,1 + WE / - WK + Zub Ceramic	
			→	11/05→ 09/08; +PR 1KV	13.0460-2749.2 602749	TRW 24483 16,9 - WE / - WK + Zub	
			→	11/05→ 09/08; +PR 1KV	13.0460-2880.2 602880	TRW 23914 17,1 + WE / - WK + Zub	
			→	11/05→ 09/08; +PR 1KV	13.0470-2749.2 LD2749	TRW 24483 16,9 - WE / - WK + Zub Ceramic	
3.2 R32 4motion	184	11/05→11/08	←	+PR 1ZF;1ZM;1ZC; → 09/08	13.0460-7117.2 607117	VW 23130 19,6 + WK	
			←	→ 09/08; +PR 1ZE;1ZP / 1LJ,1LL,1LV,1ZD	13.0460-7184.2 607184	ATE 23587 20,6 + WK	
			←	+PR 1LK;1LM; → 09/08	13.0460-7200.2 607200	ATE 23801 20,3 + WK	
			→	→ 09/08; +PR 1KY,1KZ,1KF,2EL / 1KE	13.0460-2748.2 602748	TRW 24606 17,4 - WE / - WK + Zub	
			→	→ 09/08; +PR 1KV	13.0460-2880.2 602880	TRW 23914 17,1 + WE / - WK + Zub	
			→	→ 09/08; +PR 1KV	13.0470-2748.2 LD2748	TRW 24606 17,4 - WE / - WK + Zub Ceramic	
			→	→ 09/08; +PR 1KV	13.0470-2880.2 LD2880	TRW 23914 17,1 + WE / - WK + Zub Ceramic	
			→	→ 09/08; +PR 1KV	13.0460-2749.2 602749	TRW 24483 16,9 - WE / - WK + Zub	
			→	→ 09/08; +PR 1KV	13.0460-2880.2 602880	TRW 23914 17,1 + WE / - WK + Zub	
			→	→ 09/08; +PR 1KV	13.0470-2749.2 LD2749	TRW 24483 16,9 - WE / - WK + Zub Ceramic	
<b>Zubehörsatz, Scheibenbremsbelag</b>							
1.4 16V	55	10/03→05/06	→	+PR 1KD;1KQ	13.0460-0072.2 610072	TRW	
1.4 FSI	66	10/03→07/06	→	+PR 1KV	13.0460-0259.2 610259		
1.6 FSI	85	10/03→07/08	→	+PR 1KY,1KZ,1KF,2EL / 1KE	13.0460-0259.2 610259		
1.4 16V	59	05/06→11/08	→	+PR 1KD;1KQ; → 09/08	13.0460-0072.2 610072	TRW	
1.4 TSI	90	05/07→11/08	→	→ 09/08; +PR 1KY,1KZ,1KF,2EL / 1KE	13.0460-0259.2 610259		
1.4 TSI	103	05/06→11/08	→	→ 09/08; +PR 1KV	13.0460-0259.2 610259		
1.4 TSI	125	11/05→11/08	→	→ 09/08; +PR 1KV	13.0460-0259.2 610259		
1.6	75	01/04→11/08					
1.6 MultiFuel	75	10/07→11/08					
1.9 TDI	66	05/04→11/08					
1.9 TDI	77	10/03→11/08					
2.0 FSI	110	01/04→11/08					
2.0 GTI	147	10/04→02/09					
2.0 GTI	169	09/06→12/08					
2.0 SDI	55	01/04→11/08					
2.0 TDI	100	10/03→11/08					
2.0 TDI	103	12/04→11/08					
2.0 TDI 16V	103	10/03→11/08					











	kw			 	! #		
<b>VW - GOLF V (1K1) 10/03—02/09</b>							
<b>Zubehörsatz, Scheibenbremsbelag</b>							
2.5	110	06/05→11/08	➡	+PR 1KD;1KQ; → 09/08		13.0460-0072.2 610072	TRW
			➡	→ 09/08; +PR 1KY,1KZ,1KF,2EL / 1KE		13.0460-0259.2 610259	
			➡	→ 09/08; +PR 1KV		13.0460-0259.2 610259	
1.8 GTI 2.0	132 85	08/06→11/08 08/06→11/08	➡	→ 09/08; +PR 1KD,1KQ		13.0460-0072.2 610072	TRW
			➡	→ 09/08; +PR 1KY,1KZ,1KF,1KE / 2EL		13.0460-0259.2 610259	
			➡	→ 09/08; +PR 1KV		13.0460-0259.2 610259	
1.9 TDI 4motion	77	08/04→11/08	➡	08/06→ 09/08; +PR 1KY,1KZ,1KF,1KE / 2EL		13.0460-0259.2 610259	
			➡	→ 09/08; +PR 1KY,1KZ,1KF,2EL / 1KE		13.0460-0259.2 610259	
			➡	→ 09/08; +PR 1KV		13.0460-0259.2 610259	
2.0 FSI 4motion 2.0 TDI 16V 4motion 2.0 TDI 4motion 3.2 R32 4motion 2.0 TDI	110 103 103 184 125	08/04→11/08 08/04→11/08 08/04→11/08 11/05→11/08 11/05→11/08	➡	→ 09/08; +PR 1KY,1KZ,1KF,2EL / 1KE		13.0460-0259.2 610259	
			➡	→ 09/08; +PR 1KV		13.0460-0259.2 610259	
			➡	+PR 1KD;1KQ; → 09/08		13.0460-0072.2 610072	TRW
3.2	184	09/05→11/08	➡	11/05→ 09/08; +PR 1KV		13.0460-0259.2 610259	
			➡	11/05→ 09/08; +PR 1KY,1KZ,1KF,2EL / 1KE		13.0460-0259.2 610259	
<b>Bremsscheibe</b>							
1.4 16V 1.4 FSI 1.6 FSI	55 66 85	10/03→05/06 10/03→07/06 10/03→07/08	←	+PR 1ZF;1ZM;1ZC		24.0122-0210.1 422210	Ø 280 22 19 V + S
			←	+PR 1ZE;1ZP		24.0322-0210.1 522210	Ø 280 22 19 V + S
			←	+PR 1LJ;1LL;1LV;1ZD		24.0125-0145.1 425145	Ø 288 25 22 V + S
			←	+PR 1LJ;1LL;1LV;1ZD		24.0325-0145.1 525145	Ø 288 25 22 V + S
			←	+PR 1LJ;1LL;1LV;1ZD		24.0125-0158.1 425158	Ø 312 25 22 V + S
			←	+PR 1LJ;1LL;1LV;1ZD		24.0325-0158.1 525158	Ø 312 25 22 V + S
			←	+PR 1LK;1LM		24.0130-0115.1 430115	Ø 345 30 27 V
			←	+PR 1LK;1LM		24.0330-0115.1 530115	Ø 345 30 27 V
			➡	+PR 1KD;1KQ		24.0110-0277.1 410277	Ø 253 10 8 + S
			➡	+PR 1KD;1KQ		24.0310-0277.1 510277	Ø 253 10 8 + S
			➡	+PR 1KE;1KF		24.0112-0158.1 412158	Ø 256 12 10 + S
			➡	+PR 1KE;1KF		24.0312-0158.1 512158	Ø 256 12 10
			➡	+PR 1KY;1KZ;1KV		24.0112-0169.1 412169	Ø 282 12 10 + S
			➡	+PR 1KY;1KZ;1KV		24.0312-0169.1 512169	Ø 282 12 10 + S
1.4 16V 1.4 TSI 1.4 TSI 1.4 TSI 1.6 1.6 MultiFuel 1.9 TDI 1.9 TDI 2.0 FSI 2.0 GTI 2.0 GTI 2.0 SDI 2.0 TDI 2.0 TDI 2.0 TDI 2.0 TDI 2.0 TDI 16V 2.5	59 90 103 125 75 75 66 77 110 147 169 55 100 103 125 103 110	05/06→11/08 05/07→11/08 05/06→11/08 11/05→11/08 01/04→11/08 10/07→11/08 05/04→11/08 10/03→11/08 01/04→11/08 10/04→02/09 09/06→12/08 01/04→11/08 10/03→11/08 12/04→11/08 11/05→11/08 10/03→11/08 06/05→11/08	←	+PR 1ZF;1ZM;1ZC; → 09/08		24.0122-0210.1 422210	Ø 280 22 19 V + S
			←	+PR 1ZF;1ZM;1ZC; → 09/08		24.0322-0210.1 522210	Ø 280 22 19 V + S
			←	+PR 1ZE;1ZP; → 09/08		24.0125-0145.1 425145	Ø 288 25 22 V + S
			←	+PR 1ZE;1ZP; → 09/08		24.0325-0145.1 525145	Ø 288 25 22 V + S
			←	+PR 1LJ;1LL;1LV;1ZD; → 09/08		24.0125-0158.1 425158	Ø 312 25 22 V + S
			←	+PR 1LJ;1LL;1LV;1ZD; → 09/08		24.0325-0158.1 525158	Ø 312 25 22 V + S
			←	+PR 1LK;1LM; → 09/08		24.0130-0115.1 430115	Ø 345 30 27 V
			➡	+PR 1LK;1LM; → 09/08		24.0330-0115.1 530115	Ø 345 30 27 V
			➡	+PR 1KD;1KQ; → 09/08		24.0110-0277.1 410277	Ø 253 10 8 + S
			➡	+PR 1KD;1KQ; → 09/08		24.0310-0277.1 510277	Ø 253 10 8 + S
			➡	+PR 1KE;1KF; → 09/08		24.0112-0158.1 412158	Ø 256 12 10 + S
			➡	+PR 1KE;1KF; → 09/08		24.0312-0158.1 512158	Ø 256 12 10
			➡	+PR 1KY;1KZ;1KV; → 09/08		24.0112-0169.1 412169	Ø 282 12 10 + S
			➡	+PR 1KY;1KZ;1KV; → 09/08		24.0312-0169.1 512169	Ø 282 12 10 + S
1.8 GTI 2.0	132 85	08/06→11/08 08/06→11/08	←	→ 09/08; +PR 1ZF,1ZM,1ZC		24.0122-0210.1 422210	Ø 280 22 19 V + S
			←	→ 09/08; +PR 1ZE,1ZP		24.0322-0210.1 522210	Ø 280 22 19 V + S
			←	→ 09/08; +PR 1ZE,1ZP		24.0125-0145.1 425145	Ø 288 25 22 V + S
			←	→ 09/08; +PR 1ZE,1ZP		24.0325-0145.1 525145	Ø 288 25 22 V + S
			←	→ 09/08; +PR 1LJ,1LL,1LV,1ZD		24.0125-0158.1 425158	Ø 312 25 22 V + S
			←	→ 09/08; +PR 1LJ,1LL,1LV,1ZD		24.0325-0158.1 525158	Ø 312 25 22 V + S
			←	→ 09/08; +PR 1LK,1LM		24.0130-0115.1 430115	Ø 345 30 27 V
			←	→ 09/08; +PR 1LK,1LM		24.0330-0115.1 530115	Ø 345 30 27 V
			➡	→ 09/08; +PR 1KD,1KQ		24.0110-0277.1 410277	Ø 253 10 8 + S
			➡	→ 09/08; +PR 1KD,1KQ		24.0310-0277.1 510277	Ø 253 10 8 + S
			➡	→ 09/08; +PR 1KE,1KF		24.0112-0158.1 412158	Ø 256 12 10 + S
			➡	→ 09/08; +PR 1KE,1KF		24.0312-0158.1 512158	Ø 256 12 10
			➡	→ 09/08; +PR 1KY,1KZ,1KV		24.0112-0169.1 412169	Ø 282 12 10 + S
			➡	→ 09/08; +PR 1KY,1KZ,1KV		24.0312-0169.1 512169	Ø 282 12 10 + S









	kw			 	! #		
<b>VW - GOLF V (1K1) 10/03→02/09</b>							
<b> Bremsscheibe</b>							
1.9 TDI 4motion	77	08/04→11/08	←	+PR 1ZF;1ZM;1ZC; → 09/08		24.0122-0210.1 422210	Ø 280 22 19 V + S
2.0 FSI 4motion	110	08/04→11/08				24.0322-0210.1 522210	Ø 280 22 19 V + S
2.0 TDI 16V 4motion	103	08/04→11/08	←	+PR 1ZE;1ZP; → 09/08		24.0125-0145.1 425145	Ø 288 25 22 V + S
2.0 TDI 4motion	103	08/04→11/08	←	+PR 1LJ;1LL;1LV;1ZD; → 09/08		24.0325-0145.1 525145	Ø 288 25 22 V + S
			←	+PR 1LJ;1LL;1LV;1ZD; → 09/08		24.0125-0158.1 425158	Ø 312 25 22 V + S
			←	+PR 1LJ;1LL;1LV;1ZD; → 09/08		24.0325-0158.1 525158	Ø 312 25 22 V + S
			←	+PR 1LK;1LM; → 09/08		24.0130-0115.1 430115	Ø 345 30 27 V
			←	+PR 1LK;1LM; → 09/08		24.0330-0115.1 530115	Ø 345 30 27 V
			→	+PR 1KE;1KF; → 09/08		24.0112-0158.1 412158	Ø 256 12 10 + S
			→	+PR 1KE;1KF; → 09/08		24.0312-0158.1 512158	Ø 256 12 10
			→	+PR 2EL; → 09/08		24.0122-0219.1 422219	Ø 310 22 20 V
3.2	184	09/05→11/08	←	11/05→ 09/08; +PR 1ZF;1ZM;1ZC		24.0122-0210.1 422210	Ø 280 22 19 V + S
			←	11/05→ 09/08; +PR 1ZE;1ZP		24.0322-0210.1 522210	Ø 280 22 19 V + S
			←	11/05→ 09/08; +PR 1LJ;1LL;1LV;1ZD		24.0125-0158.1 425158	Ø 312 25 22 V + S
			←	11/05→ 09/08; +PR 1LJ;1LL;1LV;1ZD		24.0325-0158.1 525158	Ø 312 25 22 V + S
			←	11/05→ 09/08; +PR 1LK;1LM		24.0130-0115.1 430115	Ø 345 30 27 V
			←	11/05→ 09/08; +PR 1LK;1LM		24.0330-0115.1 530115	Ø 345 30 27 V
			→	11/05→ 09/08; +PR 1KE;1KF		24.0112-0158.1 412158	Ø 256 12 10 + S
			→	11/05→ 09/08; +PR 1KE;1KF		24.0312-0158.1 512158	Ø 256 12 10
			→	11/05→ 09/08; +PR 2EL		24.0122-0219.1 422219	Ø 310 22 20 V
3.2 R32 4motion	184	11/05→11/08	←	+PR 1ZF;1ZM;1ZC; → 09/08		24.0122-0210.1 422210	Ø 280 22 19 V + S
			←	+PR 1ZF;1ZM;1ZC; → 09/08		24.0322-0210.1 522210	Ø 280 22 19 V + S
			←	+PR 1ZE;1ZP; → 09/08		24.0125-0145.1 425145	Ø 288 25 22 V + S
			←	+PR 1LJ;1LL;1LV;1ZD; → 09/08		24.0125-0158.1 425158	Ø 312 25 22 V + S
			←	+PR 1LJ;1LL;1LV;1ZD; → 09/08		24.0325-0158.1 525158	Ø 312 25 22 V + S
			←	+PR 1LK;1LM; → 09/08		24.0130-0115.1 430115	Ø 345 30 27 V
			←	+PR 1LK;1LM; → 09/08		24.0330-0115.1 530115	Ø 345 30 27 V
			→	+PR 1KE;1KF; → 09/08		24.0112-0158.1 412158	Ø 256 12 10 + S
			→	+PR 1KE;1KF; → 09/08		24.0312-0158.1 512158	Ø 256 12 10
			→	+PR 2EL; → 09/08		24.0122-0219.1 422219	Ø 310 22 20 V
<b>VW - GOLF V Variant (1K5) 01/07→07/09</b>							
<b> Bremsbelagsatz, Scheibenbremse</b>							
1.4	59	06/07→07/09	←	→ 06/09; +PR 1ZM		13.0460-7117.2 607117	VW 23130 19,6 + WK
1.4 TSI	90	06/07→07/09				13.0470-7117.2 LD7117	VW 23130 19,6 + WK Ceramic
1.4 TSI	103	06/07→07/09					
1.4 TSI	125	06/07→07/09	←	→ 06/09; +PR 1LJ;1ZD;1ZE;1ZP		13.0460-7184.2 607184	ATE 23587 20,6 + WK
1.6	75	06/07→07/09				13.0470-7184.2 LD7184	ATE 23587 20,6 + WK Ceramic
1.6 MultiFuel	75	11/07→07/09					
1.9 TDI	77	06/07→07/09	→	→ 06/09; +PR 1KE,1KF,1KJ		13.0460-2749.2 602749	TRW 24483 16,9 - WE / - WK + Zub
1.9 TDI 4motion	77	01/08→07/09					
2.0	147	06/07→07/09				13.0460-2880.2 602880	TRW 23914 17,1 + WE / - WK + Zub
2.0 TDI	100	06/07→07/09					
2.0 TDI	103	06/07→07/09				13.0470-2749.2 LD2749	TRW 24483 16,9 - WE / - WK + Zub Ceramic
2.0 TDI 16V	103	06/07→07/09				13.0470-2880.2 LD2880	TRW 23914 17,1 + WE / - WK + Zub Ceramic
			→	→ 06/09; +PR 1KV		13.0460-2749.2 602749	TRW 24483 16,9 - WE / - WK + Zub
						13.0460-2880.2 602880	TRW 23914 17,1 + WE / - WK + Zub
						13.0470-2749.2 LD2749	TRW 24483 16,9 - WE / - WK + Zub Ceramic
						13.0470-2880.2 LD2880	TRW 23914 17,1 + WE / - WK + Zub Ceramic
1.4 TSI	118	07/08→07/09	←	→ 06/09; +PR 1ZM		13.0460-7117.2 607117	VW 23130 19,6 + WK
						13.0470-7117.2 LD7117	VW 23130 19,6 + WK Ceramic
			←	→ 06/09; +PR 1LJ;1ZD;1ZE;1ZP		13.0460-7184.2 607184	ATE 23587 20,6 + WK
						13.0470-7184.2 LD7184	ATE 23587 20,6 + WK Ceramic
			→	→ 06/09; +PR 1KE,1KF,1KJ		13.0460-2749.2 602749	TRW 24483 16,9 - WE / - WK + Zub
						13.0460-2880.2 602880	TRW 23914 17,1 + WE / - WK + Zub











	kw			 	! #		
<b>VW - GOLF V Variant (1K5) 01/07→07/09</b>							
<b> Bremsbelagsatz, Scheibenbremse</b>							
1.4 TSI	118	07/08→07/09	➡	→ 06/09; +PR 1KE,1KF,1KJ		13.0470-2749.2 LD2749	TRW 24483 16,9 - WE / - WK + Zub Ceramic
						13.0470-2880.2 LD2880	TRW 23914 17,1 + WE / - WK + Zub Ceramic
			➡	→ 06/09; +PR 1KV		13.0460-2749.2 602749	TRW 24483 16,9 - WE / - WK + Zub
						13.0460-2880.2 602880	TRW 23914 17,1 + WE / - WK + Zub
						13.0470-2749.2 LD2749	TRW 24483 16,9 - WE / - WK + Zub Ceramic
						13.0470-2880.2 LD2880	TRW 23914 17,1 + WE / - WK + Zub Ceramic
<b>Zubehörsatz, Scheibenbremsbelag</b>							
1.4	59	06/07→07/09	➡	→ 06/09; +PR 1KE,1KF,1KJ		13.0460-0259.2 610259	
1.4 TSI	90	06/07→07/09					
1.4 TSI	103	06/07→07/09	➡	→ 06/09; +PR 1KV		13.0460-0259.2 610259	
1.4 TSI	118	07/08→07/09					
1.4 TSI	125	06/07→07/09					
1.6	75	06/07→07/09					
1.6 MultiFuel	75	11/07→07/09					
1.9 TDI	77	06/07→07/09					
1.9 TDI 4motion	77	01/08→07/09					
2.0	147	06/07→07/09					
2.0 TDI	100	06/07→07/09					
2.0 TDI	103	06/07→07/09					
2.0 TDI 16V	103	06/07→07/09					
<b> Bremsscheibe</b>							
1.4	59	06/07→07/09	⬅	→ 06/09; +PR 1ZM		24.0122-0210.1 422210	Ø 280 22 19 V + S
1.4 TSI	90	06/07→07/09				24.0322-0210.1 522210	Ø 280 22 19 V + S
1.4 TSI	103	06/07→07/09					
1.4 TSI	125	06/07→07/09	⬅	→ 06/09; +PR 1ZE,1ZP		24.0125-0145.1 425145	Ø 288 25 22 V + S
1.6	75	06/07→07/09				24.0325-0145.1 525145	Ø 288 25 22 V + S
1.6 MultiFuel	75	11/07→07/09					
1.9 TDI	77	06/07→07/09	⬅	→ 06/09; +PR 1LJ;1ZD		24.0125-0158.1 425158	Ø 312 25 22 V + S
1.9 TDI 4motion	77	01/08→07/09				24.0325-0158.1 525158	Ø 312 25 22 V + S
2.0	147	06/07→07/09	➡	→ 06/09; +PR 1KE;1KF		24.0112-0158.1 412158	Ø 256 12 10 + S
2.0 TDI	100	06/07→07/09				24.0312-0158.1 512158	Ø 256 12 10
2.0 TDI	103	06/07→07/09					
2.0 TDI 16V	103	06/07→07/09	➡	→ 06/09; +PR 1KJ,1KV		24.0112-0169.1 412169	Ø 282 12 10 + S
						24.0312-0169.1 512169	Ø 282 12 10 + S
1.4 TSI	118	07/08→07/09	⬅	→ 06/09; +PR 1ZM		24.0122-0210.1 422210	Ø 280 22 19 V + S
						24.0322-0210.1 522210	Ø 280 22 19 V + S
			⬅	→ 06/09; +PR 1ZE,1ZP		24.0125-0145.1 425145	Ø 288 25 22 V + S
						24.0325-0145.1 525145	Ø 288 25 22 V + S
			⬅	→ 06/09; +PR 1LJ;1ZD		24.0125-0158.1 425158	Ø 312 25 22 V + S
						24.0325-0158.1 525158	Ø 312 25 22 V + S
			➡	→ 06/09; +PR 1KE;1KF		24.0112-0158.1 412158	Ø 256 12 10 + S
						24.0312-0158.1 512158	Ø 256 12 10
			➡	→ 06/09; +PR 1KJ,1KV		24.0112-0169.1 412169	Ø 282 12 10 + S
						24.0312-0169.1 512169	Ø 282 12 10 + S
<b>VW - GOLF VI (5K1) 10/08→11/13</b>							
<b> Bremsbelagsatz, Scheibenbremse</b>							
1.2 TSI	63	05/10→11/12	⬅	+PR 1ZF		13.0460-7117.2 607117	VW 23130 19,6 + WK
1.4	59	10/08→11/12				13.0470-7117.2 LD7117	VW 23130 19,6 + WK Ceramic
1.4 TSI	90	10/08→11/12					
1.4 TSI	118	10/08→11/12	⬅	+PR 1ZA,1ZB,1ZD,1ZE / 1ZP,1LJ,1LL		13.0460-7184.2 607184	ATE 23587 20,6 + WK
1.6	75	10/08→11/12				13.0470-7184.2 LD7184	ATE 23587 20,6 + WK Ceramic
1.6 BiFuel	75	03/09→11/12					
1.6 MultiFuel	75	10/08→11/12	⬅	+PR 1LM		13.0460-7200.2 607200	ATE 23801 20,3 + WK
1.6 TDI	66	02/09→11/12				13.0470-7200.2 LD7200	ATE 23801 20,3 + WK Ceramic
1.6 TDI	77	02/09→11/12	⬅	+PR 1ZK		13.0460-7227.2 607227	ATE 23801 20,3 + WK
1.8 TSI	118	06/09→01/11				13.0470-7227.2 LD7227	ATE 23801 20,4 + WK Ceramic
2.0 GTi	147	06/09→11/13					
2.0 GTi	155	04/09→11/12	➡	+PR 1KF,1KY,1KZ,1KE / 1KV		13.0460-2749.2 602749	TRW 24483 16,9 - WE / - WK + Zub
2.0 GTi	173	05/11→11/12					
2.0 TDI	81	10/08→11/12				13.0460-2880.2 602880	TRW 23914 17,1 + WE / - WK + Zub
2.0 TDI	100	10/08→11/12					
2.0 TDI	103	10/08→05/13				13.0470-2749.2 LD2749	TRW 24483 16,9 - WE / - WK + Zub Ceramic
2.0 TDI	125	04/09→11/12				13.0470-2880.2 LD2880	TRW 23914 17,1 + WE / - WK + Zub Ceramic
↓							



	kw					! #		
<b>VW - GOLF VI (5K1) 10/08→11/13</b>								
<b> Bremsbelagsatz, Scheibenbremse</b>								
1.2 TSI 1.4 1.4 TSI 1.4 TSI 1.6 1.6 BiFuel 1.6 MultiFuel 1.6 TDI 1.6 TDI 1.8 TSI 2.0 GTi 2.0 GTi 2.0 GTi 2.0 TDI 2.0 TDI 2.0 TDI 2.0 TDI	63 59 90 118 75 75 75 66 77 118 147 155 173 81 100 103 125	05/10→11/12 10/08→11/12 10/08→11/12 10/08→11/12 10/08→11/12 03/09→11/12 10/08→11/12 02/09→11/12 02/09→11/12 06/09→01/11 06/09→11/13 04/09→11/12 05/11→11/12 10/08→11/12 10/08→11/12 10/08→05/13 04/09→11/12	➔	+PR 1KD			13.0460-2787.2 602787 13.0460-2860.2 602860 13.0470-2860.2 LD2860	TRW 23554 17,3 - WK / - WE TRW 23554 16,4 - WK / + WE TRW 23554 16,4 - WK / + WE Ceramic BOS 24563 17,7 - WE / - WK + Zub BOS 24563 17,7 - WE / - WK + Zub Ceramic
1.2 TSI	77	11/08→11/12	➔	05/09→; +PR 1ZF			13.0460-7117.2 607117 13.0470-7117.2 LD7117	VW 23130 19,6 + WK VW 23130 19,6 + WK Ceramic
			➔	05/09→; +PR 1ZA,1ZB,1ZD,1ZE / 1ZP,1LJ,1LL			13.0460-7184.2 607184 13.0470-7184.2 LD7184	ATE 23587 20,6 + WK ATE 23587 20,6 + WK Ceramic
			➔	05/09→; +PR 1LM			13.0460-7200.2 607200 13.0470-7200.2 LD7200	ATE 23801 20,3 + WK ATE 23801 20,3 + WK Ceramic
			➔	05/09→; +PR 1ZK			13.0460-7227.2 607227 13.0470-7227.2 LD7227	ATE 23801 20,3 + WK ATE 23801 20,4 + WK Ceramic
			➔	05/09→; +PR 1KF,1KY,1KZ,1KE / 1KV			13.0460-2749.2 602749 13.0460-2880.2 602880 13.0470-2749.2 LD2749 13.0470-2880.2 LD2880	TRW 24483 16,9 - WE / - WK + Zub TRW 23914 17,1 + WE / - WK + Zub TRW 24483 16,9 - WE / - WK + Zub Ceramic TRW 23914 17,1 + WE / - WK + Zub Ceramic
			➔	05/09→; +PR 1KD			13.0460-2787.2 602787 13.0460-2860.2 602860 13.0470-2860.2 LD2860	TRW 23554 17,3 - WK / - WE TRW 23554 16,4 - WK / + WE TRW 23554 16,4 - WK / + WE Ceramic
			➔	05/09→; +PR 1KS,1KT			13.0460-3858.2 603858 13.0470-3858.2 LD3858	BOS 24563 17,7 - WE / - WK + Zub BOS 24563 17,7 - WE / - WK + Zub Ceramic
2.0 R 4motion 2.0 R 4motion 2.0 R 4motion 2.0 TDI 4motion	188 195 199 103	11/09→11/13 11/09→05/11 11/09→11/12 05/09→11/12	➔	+PR 1ZF			13.0460-7117.2 607117 13.0470-7117.2 LD7117	VW 23130 19,6 + WK VW 23130 19,6 + WK Ceramic
			➔	+PR 1ZA,1ZB,1ZD,1ZE / 1ZP,1LJ,1LL			13.0460-7184.2 607184 13.0470-7184.2 LD7184	ATE 23587 20,6 + WK ATE 23587 20,6 + WK Ceramic
			➔	+PR 1LM			13.0460-7200.2 607200 13.0470-7200.2 LD7200	ATE 23801 20,3 + WK ATE 23801 20,3 + WK Ceramic
			➔	+PR 1ZK			13.0460-7227.2 607227 13.0470-7227.2 LD7227	ATE 23801 20,3 + WK ATE 23801 20,4 + WK Ceramic
			➔	+PR 1KF,1KY,1KZ,1KE / 1KV,1KW,2EL			13.0460-2749.2 602749 13.0460-2880.2 602880 13.0470-2749.2 LD2749 13.0470-2880.2 LD2880	TRW 24483 16,9 - WE / - WK + Zub TRW 23914 17,1 + WE / - WK + Zub TRW 24483 16,9 - WE / - WK + Zub Ceramic TRW 23914 17,1 + WE / - WK + Zub Ceramic
			➔	+PR 1KS,1KT			13.0460-3858.2 603858 13.0470-3858.2 LD3858	BOS 24563 17,7 - WE / - WK + Zub BOS 24563 17,7 - WE / - WK + Zub Ceramic
<b> Bremsscheibe</b>								
1.2 TSI 1.4 1.4 TSI 1.4 TSI 1.6 1.6 BiFuel 1.6 MultiFuel 1.6 TDI 1.6 TDI ↓	63 59 90 118 75 75 75 66 77	05/10→11/12 10/08→11/12 10/08→11/12 10/08→11/12 10/08→11/12 03/09→11/12 10/08→11/12 02/09→11/12 02/09→11/12	➔	+PR 1ZF			24.0122-0210.1 422210 24.0322-0210.1 522210	∅ 280 22 19 V + S ∅ 280 22 19 V + S
			➔	+PR 1ZE,1ZP			24.0125-0145.1 425145 24.0325-0145.1 525145	∅ 288 25 22 V + S ∅ 288 25 22 V + S
			➔	+PR 1LJ,1LL,1LV,1ZA / 1ZB,1ZD			24.0125-0158.1 425158 24.0325-0158.1 525158	∅ 312 25 22 V + S ∅ 312 25 22 V + S

	kw			 	! #		
<b>VW - GOLF VI (5K1) 10/08→11/13</b>							
<b>Bremsscheibe</b>							
1.8 TSI	118	06/09→01/11	←	+PR 1LM,1ZK		24.0130-0115.1 430115	Ø 345 30 27 V
2.0 GTI	147	06/09→11/13				24.0330-0115.1 530115	Ø 345 30 27 V
2.0 GTI	155	04/09→11/12					
2.0 GTI	173	05/11→11/12	→	+PR 1KD		24.0110-0277.1 410277	Ø 253 10 8 + S
2.0 TDI	81	10/08→11/12				24.0310-0277.1 510277	Ø 253 10 8 + S
2.0 TDI	100	10/08→11/12					
2.0 TDI	103	10/08→05/13	→	+PR 1KS,1KT		24.0110-0356.1 410356	Ø 272 9,7 8 + S
2.0 TDI	125	04/09→11/12				24.0310-0356.1 510356	Ø 272 9,7 8 + S
			→	+PR 1KE,1KF		24.0112-0158.1 412158	Ø 256 12 10 + S
						24.0312-0158.1 512158	Ø 256 12 10
			→	+PR 1KV,1KY,1KZ		24.0112-0169.1 412169	Ø 282 12 10 + S
						24.0312-0169.1 512169	Ø 282 12 10 + S
1.2 TSI	77	11/08→11/12	←	05/09→; +PR 1ZF		24.0122-0210.1 422210	Ø 280 22 19 V + S
						24.0322-0210.1 522210	Ø 280 22 19 V + S
			←	05/09→; +PR 1ZE,1ZP		24.0125-0145.1 425145	Ø 288 25 22 V + S
						24.0325-0145.1 525145	Ø 288 25 22 V + S
			←	05/09→; +PR 1LJ,1LL,1LV,1ZA / 1ZB,1ZD		24.0125-0158.1 425158	Ø 312 25 22 V + S
						24.0325-0158.1 525158	Ø 312 25 22 V + S
			←	05/09→; +PR 1LM,1ZK		24.0130-0115.1 430115	Ø 345 30 27 V
						24.0330-0115.1 530115	Ø 345 30 27 V
			→	05/09→; +PR 1KD		24.0110-0277.1 410277	Ø 253 10 8 + S
						24.0310-0277.1 510277	Ø 253 10 8 + S
			→	05/09→; +PR 1KS,1KT		24.0110-0356.1 410356	Ø 272 9,7 8 + S
						24.0310-0356.1 510356	Ø 272 9,7 8 + S
			→	05/09→; +PR 1KE,1KF		24.0112-0158.1 412158	Ø 256 12 10 + S
						24.0312-0158.1 512158	Ø 256 12 10
			→	05/09→; +PR 1KV,1KY,1KZ		24.0112-0169.1 412169	Ø 282 12 10 + S
						24.0312-0169.1 512169	Ø 282 12 10 + S
2.0 R 4motion	188	11/09→11/13	←	+PR 1ZF		24.0122-0210.1 422210	Ø 280 22 19 V + S
2.0 R 4motion	195	11/09→05/11				24.0322-0210.1 522210	Ø 280 22 19 V + S
2.0 R 4motion	199	11/09→11/12					
2.0 TDI 4motion	103	05/09→11/12	←	+PR 1ZE,1ZP		24.0125-0145.1 425145	Ø 288 25 22 V + S
						24.0325-0145.1 525145	Ø 288 25 22 V + S
			←	+PR 1LJ,1LL,1LV,1ZA / 1ZB,1ZD		24.0125-0158.1 425158	Ø 312 25 22 V + S
						24.0325-0158.1 525158	Ø 312 25 22 V + S
			←	+PR 1LM,1ZK		24.0130-0115.1 430115	Ø 345 30 27 V
						24.0330-0115.1 530115	Ø 345 30 27 V
			→	+PR 1KS,1KT		24.0110-0356.1 410356	Ø 272 9,7 8 + S
						24.0310-0356.1 510356	Ø 272 9,7 8 + S
			→	+PR 1KE,1KF		24.0112-0158.1 412158	Ø 256 12 10 + S
						24.0312-0158.1 512158	Ø 256 12 10
			→	+PR 1KW,2EL		24.0122-0219.1 422219	Ø 310 22 20 V
<b>VW - GOLF VI Cabriolet (517) 03/11→</b>							
<b>Bremsbelagsatz, Scheibenbremse</b>							
1.2 TSI	77	03/11→11/13	←	06/11→; +PR 1ZE,1ZD,1ZP,1ZA / 1ZB		13.0460-7184.2 607184	ATE 23587 20,6 + WK
1.4 TSI	118	03/11→				13.0470-7184.2 LD7184	ATE 23587 20,6 + WK Ceramic
1.6 TDI	77	03/11→	←	06/11→; +PR 1ZK		13.0460-7227.2 607227	ATE 23801 20,3 + WK
						13.0470-7227.2 LD7227	ATE 23801 20,4 + WK Ceramic
			→	06/11→; +PR 1KW		13.0460-2749.2 602749	TRW 24483 16,9 - WE / - WK + Zub
						13.0460-2880.2 602880	TRW 23914 17,1 + WE / - WK + Zub
						13.0470-2749.2 LD2749	TRW 24483 16,9 - WE / - WK + Zub Ceramic
						13.0470-2880.2 LD2880	TRW 23914 17,1 + WE / - WK + Zub Ceramic
			→	06/11→; +PR 1KD		13.0460-2787.2 602787	TRW 23554 17,3 - WK / - WE
						13.0460-2860.2 602860	TRW 23554 16,4 - WK / + WE
						13.0470-2860.2 LD2860	TRW 23554 16,4 - WK / + WE Ceramic
			→	06/11→; +PR 1KS,1KT		13.0460-3858.2 603858	BOS 24563 17,7 - WE / - WK + Zub
						13.0470-3858.2 LD3858	BOS 24563 17,7 - WE / - WK + Zub Ceramic
1.2 TSI 16V	77	11/13→	←	+PR 1ZE,1ZD,1ZP,1ZA / 1ZB		13.0460-7184.2 607184	ATE 23587 20,6 + WK
↓							



	kw			 	! #		
<b>VW - GOLF VI Cabriolet (517) 03/11→</b>							
 <b>Bremsbelagsatz, Scheibenbremse</b>							
1.4 TSI	90	11/11→	←	+PR 1ZE,1ZD,1ZP,1ZA / 1ZB		13.0470-7184.2 LD7184	ATE 23587 20,6 + WK Ceramic
1.4 TSI	92	11/13→	←	+PR 1ZK		13.0460-7227.2 607227	ATE 23801 20,3 + WK
1.4 TSI	110	11/13→	←			13.0470-7227.2 LD7227	ATE 23801 20,4 + WK Ceramic
2.0 GTI	155	11/11→	→	+PR 1KW		13.0460-2749.2 602749	TRW 24483 16,9 - WE / - WK + Zub
2.0 R	195	01/13→	→			13.0460-2880.2 602880	TRW 23914 17,1 + WE / - WK + Zub
2.0 TDI	81	11/13→	→			13.0470-2749.2 LD2749	TRW 24483 16,9 - WE / - WK + Zub Ceramic
2.0 TDI	103	11/11→	→			13.0470-2880.2 LD2880	TRW 23914 17,1 + WE / - WK + Zub Ceramic
2.0 TDI	110	11/13→	→				
2.0 TSI	162	11/13→	→	+PR 1KD		13.0460-2787.2 602787	TRW 23554 17,3 - WK / - WE
			→			13.0460-2860.2 602860	TRW 23554 16,4 - WK / + WE
			→			13.0470-2860.2 LD2860	TRW 23554 16,4 - WK / + WE Ceramic
			→	+PR 1KS,1KT		13.0460-3858.2 603858	BOS 24563 17,7 - WE / - WK + Zub
			→			13.0470-3858.2 LD3858	BOS 24563 17,7 - WE / - WK + Zub Ceramic
 <b>Bremsscheibe</b>							
1.2 TSI	77	03/11→11/13	←	06/11→; +PR 1ZE,1ZP		24.0125-0145.1 425145	Ø 288 25 22 V + S
1.4 TSI	118	03/11→	←			24.0325-0145.1 525145	Ø 288 25 22 V + S
1.6 TDI	77	03/11→	←	06/11→; +PR 1ZA,1ZD,1ZB		24.0125-0158.1 425158	Ø 312 25 22 V + S
			←			24.0325-0158.1 525158	Ø 312 25 22 V + S
			←	06/11→; +PR 1ZK		24.0130-0115.1 430115	Ø 345 30 27 V
			→	06/11→; +PR 1KD		24.0110-0277.1 410277	Ø 253 10 8 + S
			→			24.0310-0277.1 510277	Ø 253 10 8 + S
			→	06/11→; +PR 1KS,1KT		24.0110-0356.1 410356	Ø 272 9,7 8 + S
			→			24.0310-0356.1 510356	Ø 272 9,7 8 + S
			→	06/11→; +PR 1KW		24.0122-0219.1 422219	Ø 310 22 20 V
1.2 TSI 16V	77	11/13→	←	+PR 1ZE,1ZP		24.0125-0145.1 425145	Ø 288 25 22 V + S
1.4 TSI	90	11/11→	←			24.0325-0145.1 525145	Ø 288 25 22 V + S
1.4 TSI	92	11/13→	←				
1.4 TSI	110	11/13→	←	+PR 1ZA,1ZD,1ZB		24.0125-0158.1 425158	Ø 312 25 22 V + S
2.0 GTI	155	11/11→	←			24.0325-0158.1 525158	Ø 312 25 22 V + S
2.0 R	195	01/13→	←				
2.0 TDI	81	11/13→	←	+PR 1ZK		24.0130-0115.1 430115	Ø 345 30 27 V
2.0 TDI	103	11/11→	→	+PR 1KD		24.0110-0277.1 410277	Ø 253 10 8 + S
2.0 TDI	110	11/13→	→			24.0310-0277.1 510277	Ø 253 10 8 + S
2.0 TSI	162	11/13→	→	+PR 1KS,1KT		24.0110-0356.1 410356	Ø 272 9,7 8 + S
			→			24.0310-0356.1 510356	Ø 272 9,7 8 + S
			→	+PR 1KW		24.0122-0219.1 422219	Ø 310 22 20 V
<b>VW - GOLF VI Variant (AJ5) 07/09→07/13</b>							
 <b>Bremsbelagsatz, Scheibenbremse</b>							
1.2 TSI	63	07/10→07/13	←	+PR 1ZM		13.0460-7117.2 607117	VW 23130 19,6 + WK
1.4	59	07/09→07/13	←			13.0470-7117.2 LD7117	VW 23130 19,6 + WK Ceramic
1.4 TSI	90	07/09→07/13	←				
1.4 TSI	118	07/09→07/13	←	+PR 1ZA,1ZD,1ZE,1ZP / 1LJ		13.0460-7184.2 607184	ATE 23587 20,6 + WK
1.6	75	07/09→07/13	←			13.0470-7184.2 LD7184	ATE 23587 20,6 + WK Ceramic
1.6 MultiFuel	75	07/10→07/13	→	+PR 1KE,1KF,1KJ		13.0460-2749.2 602749	TRW 24483 16,9 - WE / - WK + Zub
1.6 TDI	66	12/09→07/13	→				
1.6 TDI	77	07/09→07/13	→			13.0460-2880.2 602880	TRW 23914 17,1 + WE / - WK + Zub
1.6 TDI 4motion	77	07/09→07/13	→			13.0470-2749.2 LD2749	TRW 24483 16,9 - WE / - WK + Zub Ceramic
2.0 TDI	81	01/10→07/13	→			13.0470-2880.2 LD2880	TRW 23914 17,1 + WE / - WK + Zub Ceramic
2.0 TDI	100	07/09→07/13	→				
2.0 TDI	103	07/09→07/13	→				
2.0 TSI	147	07/09→07/13	→	+PR 1KS		13.0460-3858.2 603858	BOS 24563 17,7 - WE / - WK + Zub
			→			13.0470-3858.2 LD3858	BOS 24563 17,7 - WE / - WK + Zub Ceramic
1.2 TSI	77	07/09→07/13	←	08/09→; +PR 1ZM		13.0460-7117.2 607117	VW 23130 19,6 + WK
			←			13.0470-7117.2 LD7117	VW 23130 19,6 + WK Ceramic
			←	08/09→; +PR 1ZA,1ZD,1ZE,1ZP / 1LJ		13.0460-7184.2 607184	ATE 23587 20,6 + WK
			←			13.0470-7184.2 LD7184	ATE 23587 20,6 + WK Ceramic
↓							

**VW - GOLF VI Variant (AJ5) 07/09→07/13**

**Bremsbelagsatz, Scheibenbremse**

1.2 TSI	77	07/09→07/13	➡	08/09→; +PR 1KE,1KF,1KJ			TRW 24483 16,9 - WE / - WK + Zub
					13.0460-2749.2	602749	TRW 23914 17,1 + WE / - WK + Zub
					13.0470-2749.2	LD2749	TRW 24483 16,9 - WE / - WK + Zub Ceramic
					13.0470-2880.2	LD2880	TRW 23914 17,1 + WE / - WK + Zub Ceramic
			➡	08/09→; +PR 1KS			BOS 24563 17,7 - WE / - WK + Zub
					13.0460-3858.2	603858	BOS 24563 17,7 - WE / - WK + Zub Ceramic

**Bremsscheibe**









1.2 TSI	63	07/10→07/13	←	+PR 1ZM			Ø 280 22 19 V + S					
					24.0122-0210.1	422210	Ø 280 22 19 V + S					
					24.0322-0210.1	522210	Ø 280 22 19 V + S					
					1.4 TSI	90	07/09→07/13	←	+PR 1ZE,1ZP			Ø 288 25 22 V + S
										24.0125-0145.1	425145	Ø 288 25 22 V + S
					24.0325-0145.1	525145	Ø 288 25 22 V + S					
					1.6 TDI	66	12/09→07/13	←	+PR 1LJ,1ZA,1ZD			Ø 312 25 22 V + S
										24.0125-0158.1	425158	Ø 312 25 22 V + S
					24.0325-0158.1	525158	Ø 312 25 22 V + S					
					1.6 TDI 4motion	77	07/09→07/13	➡	+PR 1KS			Ø 272 9,7 8 + S
24.0110-0356.1	410356	Ø 272 9,7 8 + S										
24.0310-0356.1	510356	Ø 272 9,7 8 + S										
2.0 TDI	100	07/09→07/13	➡	+PR 1KE,1KF			Ø 256 12 10 + S					
					24.0112-0158.1	412158	Ø 256 12 10 + S					
24.0312-0158.1	512158	Ø 256 12 10										
2.0 TSI	147	07/09→07/13	➡	+PR 1KJ			Ø 282 12 10 + S					
					24.0112-0169.1	412169	Ø 282 12 10 + S					
24.0312-0169.1	512169	Ø 282 12 10 + S										
1.2 TSI	77	07/09→07/13	←	08/09→; +PR 1ZM			Ø 280 22 19 V + S					
					24.0122-0210.1	422210	Ø 280 22 19 V + S					
				24.0322-0210.1	522210	Ø 280 22 19 V + S						
				08/09→; +PR 1ZE,1ZP			←				Ø 288 25 22 V + S	
									24.0125-0145.1	425145	Ø 288 25 22 V + S	
				24.0325-0145.1	525145	Ø 288 25 22 V + S						
				08/09→; +PR 1LJ,1ZA,1ZD			←				Ø 312 25 22 V + S	
									24.0125-0158.1	425158	Ø 312 25 22 V + S	
24.0325-0158.1	525158	Ø 312 25 22 V + S										
08/09→; +PR 1KS			➡				Ø 272 9,7 8 + S					
					24.0110-0356.1	410356	Ø 272 9,7 8 + S					
24.0310-0356.1	510356	Ø 272 9,7 8 + S										
08/09→; +PR 1KE,1KF			➡				Ø 256 12 10 + S					
					24.0112-0158.1	412158	Ø 256 12 10 + S					
24.0312-0158.1	512158	Ø 256 12 10										
08/09→; +PR 1KJ			➡				Ø 282 12 10 + S					
					24.0112-0169.1	412169	Ø 282 12 10 + S					
24.0312-0169.1	512169	Ø 282 12 10 + S										







**VW - GOLF VII (5G1, BQ1, BE1, BE2) 08/12→**







**Bremsbelagsatz, Scheibenbremse**

1.0 TSI	63	01/17→	←	+PR 1ZA,1ZB,1ZD,1ZE / 1ZP,1LV,1ZC,1ZG			TRW 25683 20,4 + WE / + WK
					13.0460-2785.2	602785	TRW 25683 20,4 + WE / + WK
1.0 TSI	81	11/16→			13.0470-2785.2	LD2785	Ceramic
1.0 TSI	85	05/15→					
1.2 TSI	77	11/12→					
1.2 TSI	81	04/14→	←	+PR 1ZF	13.0460-7303.2	607303	ATE 22035 17,5 + WK
1.4 GTE Hybrid	110	05/14→			13.0470-7303.2	LD7303	ATE 22035 17,5 + WK Ceramic
1.4 TSI	90	11/12→					
1.4 TSI	92	05/14→	➡	+PR 1KE,1KK; + eFSB	13.0460-7293.2	607293	ATE 25008 16,3 - WE / - WK
1.4 TSI	110	05/14→			13.0470-7293.2	LD7293	ATE 25008 16,3 - WE / - WK Ceramic
1.4 TSI MultiFuel	90	04/13→					
1.4 TSI MultiFuel	92	12/13→	➡	+PR 1KJ,1KV,1KY; + eFSB	13.0460-7294.2	607294	ATE 25009 16,4 - WE / - WK
1.5 TSI	96	07/17→			13.0470-7294.2	LD7294	ATE 25009 16,4 - WE / - WK Ceramic
1.5 TSI	110	04/17→					
1.6	81	05/14→					
1.6 TDI	66	04/13→					
1.6 TDI	85	11/16→					
1.6 TDI 4motion	77	11/12→					
1.6 TDI 4motion	81	01/13→					
2.0 GTD	135	04/13→					
2.0 GTI	155	11/13→					
2.0 GTI	162	04/13→					
2.0 GTI	169	04/13→					
2.0 GTI	180	03/17→					
2.0 GTI Clubsport	195	02/16→					
2.0 R 4motion	206	11/13→					
2.0 R 4motion	213	12/16→					
2.0 R 4motion	221	11/13→					
2.0 TDI	81	11/12→					
2.0 TDI	105	08/12→					
2.0 TDI	110	11/12→					























	kw			 	! #		
<b>VW - GOLF VII (5G1, BQ1, BE1, BE2) 08/12→</b>							
<b> Bremsbelagsatz, Scheibenbremse</b>							
2.0 TDI 4motion	110	11/12→	←	+PR 1ZA,1ZB,1ZD,1ZE / 1ZP,1LV,1ZC,1ZG	13.0460-2785.2	602785	TRW 25683 20,4 + WE / + WK
			←	+PR 1ZF	13.0460-7303.2	607303	TRW 25683 20,4 + WE / + WK Ceramic
			→	+PR 1KE,1KK; + eFSB	13.0460-7293.2	607293	ATE 22035 17,5 + WK
			→	+PR 1KJ,1KV,1KY; + eFSB	13.0460-7294.2	607294	ATE 22035 17,5 + WK Ceramic
1.2 TSI 1.4 TSI 1.6 TDI	63 103 77	08/12→ 08/12→ 08/12→	←	11/12→; +PR 1ZA,1ZB,1ZD,1ZE / 1ZP,1LV,1ZC,1ZG	13.0460-2785.2	602785	ATE 25008 16,3 - WE / - WK
			←	11/12→; +PR 1ZF	13.0460-7303.2	607303	ATE 25008 16,3 - WE / - WK Ceramic
			→	11/12→; +PR 1KE,1KK; + eFSB	13.0460-7293.2	607293	ATE 25009 16,4 - WE / - WK
			→	11/12→; +PR 1KJ,1KV,1KY; + eFSB	13.0460-7294.2	607294	ATE 25009 16,4 - WE / - WK Ceramic
1.4 TGI CNG	81	06/13→	←	08/13→; +PR 1ZA,1ZB,1ZD,1ZE / 1ZP,1LV,1ZC,1ZG	13.0460-2785.2	602785	ATE 25008 16,3 - WE / - WK
			←	08/13→; +PR 1ZF	13.0460-7303.2	607303	ATE 25008 16,3 - WE / - WK Ceramic
			→	08/13→; +PR 1KE,1KK; + eFSB	13.0460-7293.2	607293	ATE 25009 16,4 - WE / - WK
			→	08/13→; +PR 1KJ,1KV,1KY; + eFSB	13.0460-7294.2	607294	ATE 25009 16,4 - WE / - WK Ceramic
1.6 TDI	81	01/13→	←	06/13→; +PR 1ZA,1ZB,1ZD,1ZE / 1ZP,1LV,1ZC,1ZG	13.0460-2785.2	602785	ATE 25008 16,3 - WE / - WK
			←	06/13→; +PR 1ZF	13.0460-7303.2	607303	ATE 25008 16,3 - WE / - WK Ceramic
			→	06/13→; +PR 1KE,1KK; + eFSB	13.0460-7293.2	607293	ATE 25009 16,4 - WE / - WK
			→	06/13→; +PR 1KJ,1KV,1KY; + eFSB	13.0460-7294.2	607294	ATE 25009 16,4 - WE / - WK Ceramic
2.0 GTI Clubsport S 2.0 R 360S 4motion 2.0 R 4motion	228 265 228	09/16→ 09/16→ 12/16→	←	+PR 1ZA,1ZB,1ZD,1ZE / 1ZP,1LV,1ZC,1ZG	13.0460-2785.2	602785	ATE 25008 16,3 - WE / - WK
			←	+PR 1ZF	13.0460-7303.2	607303	ATE 25008 16,3 - WE / - WK Ceramic
			→	+PR 1KE,1KK; + eFSB	13.0460-7293.2	607293	ATE 25009 16,4 - WE / - WK
			→	+PR 1KJ,1KV,1KY; + eFSB	13.0460-7294.2	607294	ATE 25009 16,4 - WE / - WK Ceramic
e-Golf	85	03/14→02/17	←	08/14→; +PR 1ZE,1ZP	13.0460-2785.2	602785	ATE 25008 16,3 - WE / - WK
			→	08/14→; +PR 1KE,1KR; + eFSB	13.0460-7293.2	607293	ATE 25008 16,3 - WE / - WK Ceramic
e-Golf	100	12/16→	←	+PR 1ZE,1ZP	13.0460-2785.2	602785	ATE 25008 16,3 - WE / - WK
			→	+PR 1KE,1KR; + eFSB	13.0460-7293.2	607293	ATE 25008 16,3 - WE / - WK Ceramic
↓							









	kw			 	! #		
<b>VW - GOLF VII (5G1, BQ1, BE1, BE2) 08/12→</b>							
<b>Warnkontakt, Bremsbelagverschleiß</b>							
1.0 TSI	63	01/17→	←	+PR 1LJ,1LM	1	24.8190-0065.2 620065	L= 172
1.0 TSI	81	11/16→					
1.0 TSI	85	05/15→					
1.2 TSI	77	11/12→					
1.2 TSI	81	04/14→					
1.4 GTE Hybrid	110	05/14→					
1.4 TSI	90	11/12→					
1.4 TSI	92	05/14→					
1.4 TSI	110	05/14→					
1.4 TSI MultiFuel	90	04/13→					
1.4 TSI MultiFuel	92	12/13→					
1.5 TSI	96	07/17→					
1.5 TSI	110	04/17→					
1.6	81	05/14→					
1.6 TDI	66	04/13→					
1.6 TDI	85	11/16→					
1.6 TDI 4motion	77	11/12→					
1.6 TDI 4motion	81	01/13→					
2.0 GTD	135	04/13→					
2.0 GTI	155	11/13→					
2.0 GTI	162	04/13→					
2.0 GTI	169	04/13→					
2.0 GTI	180	03/17→					
2.0 GTI Clubsport	195	02/16→					
2.0 GTI Clubsport S	228	09/16→					
2.0 R 360S 4motion	265	09/16→					
2.0 R 4motion	206	11/13→					
2.0 R 4motion	213	12/16→					
2.0 R 4motion	221	11/13→					
2.0 R 4motion	228	12/16→					
2.0 TDI	81	11/12→					
2.0 TDI	105	08/12→					
2.0 TDI	110	11/12→					
2.0 TDI 4motion	110	11/12→					
1.2 TSI	63	08/12→	←	11/12→; +PR 1LJ,1LM	1	24.8190-0065.2 620065	L= 172
1.4 TSI	103	08/12→					
1.6 TDI	77	08/12→					
1.4 TGI CNG	81	06/13→	←	08/13→; +PR 1LJ,1LM	1	24.8190-0065.2 620065	L= 172
1.6 TDI	81	01/13→	←	06/13→; +PR 1LJ,1LM	1	24.8190-0065.2 620065	L= 172
<b>Bremsscheibe</b>							
1.0 TSI	63	01/17→	←	+PR 1ZF		24.0124-0258.1 424258	Ø 276 24 21 V + S
1.0 TSI	81	11/16→					
1.0 TSI	85	05/15→	←	+PR 1ZE,1ZP		24.0125-0145.1 425145	Ø 288 25 22 V + S
1.2 TSI	77	11/12→				24.0325-0145.1 525145	Ø 288 25 22 V + S
1.2 TSI	81	04/14→					
1.4 GTE Hybrid	110	05/14→	←	+PR 1ZA,1ZB,1ZD / 1LV,1ZC,1ZG		24.0125-0158.1 425158	Ø 312 25 22 V + S
1.4 TSI	90	11/12→				24.0325-0158.1 525158	Ø 312 25 22 V + S
1.4 TSI	92	05/14→	←	+PR 1LJ,1LM		24.0130-0225.1 430225	Ø 340 30 27 V + S
1.4 TSI	110	05/14→					
1.4 TSI MultiFuel	90	04/13→	→	+PR 1KE,1KK; + eFSB		24.0110-0356.1 410356	Ø 272 9,7 8 + S
1.4 TSI MultiFuel	92	12/13→				24.0310-0356.1 510356	Ø 272 9,7 8 + S
1.5 TSI	96	07/17→					
1.5 TSI	110	04/17→	→	+PR 1KV; + eFSB		24.0112-0210.1 412210	Ø 300 12 10 + S
1.6	81	05/14→	→	+PR 1KJ,1KY; + eFSB		24.0122-0219.1 422219	Ø 310 22 20 V
1.6 TDI	66	04/13→					
1.6 TDI	85	11/16→					
1.6 TDI 4motion	77	11/12→					
1.6 TDI 4motion	81	01/13→					
2.0 GTD	135	04/13→					
2.0 GTI	155	11/13→					
2.0 GTI	162	04/13→					
2.0 GTI	169	04/13→					
2.0 GTI	180	03/17→					
2.0 GTI Clubsport	195	02/16→					
2.0 GTI Clubsport S	228	09/16→					
2.0 R 360S 4motion	265	09/16→					
2.0 R 4motion	206	11/13→					
2.0 R 4motion	213	12/16→					
2.0 R 4motion	221	11/13→					
2.0 R 4motion	228	12/16→					
2.0 TDI	81	11/12→					
2.0 TDI	105	08/12→					
2.0 TDI	110	11/12→					
2.0 TDI 4motion	110	11/12→					
1.2 TSI	63	08/12→	←	11/12→; +PR 1ZF		24.0124-0258.1 424258	Ø 276 24 21 V + S
1.4 TSI	103	08/12→					
1.6 TDI	77	08/12→	←	11/12→; +PR 1ZE,1ZP		24.0125-0145.1 425145	Ø 288 25 22 V + S
						24.0325-0145.1 525145	Ø 288 25 22 V + S
			←	11/12→; +PR 1ZA,1ZB,1ZD / 1LV,1ZC,1ZG		24.0125-0158.1 425158	Ø 312 25 22 V + S
						24.0325-0158.1 525158	Ø 312 25 22 V + S







	kw			 	! #		
<b>VW - GOLF VII (5G1, BQ1, BE1, BE2) 08/12→</b>							
<b>Bremsscheibe</b>							
1.2 TSI 1.4 TSI 1.6 TDI	63	08/12→	←	11/12→; +PR 1LJ,1LM	24.0130-0225.1	430225	Ø 340 30 27 V + S
	103	08/12→	→	11/12→; +PR 1KE,1KK; + eFSB	24.0110-0356.1	410356	Ø 272 9,7 8 + S
	77	08/12→	→	11/12→; +PR 1KV; + eFSB	24.0310-0356.1	510356	Ø 272 9,7 8 + S
			→	11/12→; +PR 1KJ,1KY; + eFSB	24.0112-0210.1	412210	Ø 300 12 10 + S
			→	11/12→; +PR 1KE,1KK; + eFSB	24.0122-0219.1	422219	Ø 310 22 20 V
1.4 TGI CNG	81	06/13→	←	08/13→; +PR 1ZF	24.0124-0258.1	424258	Ø 276 24 21 V + S
			←	08/13→; +PR 1ZE,1ZP	24.0125-0145.1	425145	Ø 288 25 22 V + S
					24.0325-0145.1	525145	Ø 288 25 22 V + S
			←	08/13→; +PR 1ZA,1ZB,1ZD / 1LV,1ZC,1ZG	24.0125-0158.1	425158	Ø 312 25 22 V + S
					24.0325-0158.1	525158	Ø 312 25 22 V + S
			←	08/13→; +PR 1LJ,1LM	24.0130-0225.1	430225	Ø 340 30 27 V + S
			→	08/13→; +PR 1KE,1KK; + eFSB	24.0110-0356.1	410356	Ø 272 9,7 8 + S
					24.0310-0356.1	510356	Ø 272 9,7 8 + S
1.6 TDI	81	01/13→	←	06/13→; +PR 1ZF	24.0124-0258.1	424258	Ø 276 24 21 V + S
			←	06/13→; +PR 1ZE,1ZP	24.0125-0145.1	425145	Ø 288 25 22 V + S
					24.0325-0145.1	525145	Ø 288 25 22 V + S
			←	06/13→; +PR 1ZA,1ZB,1ZD / 1LV,1ZC,1ZG	24.0125-0158.1	425158	Ø 312 25 22 V + S
					24.0325-0158.1	525158	Ø 312 25 22 V + S
			←	06/13→; +PR 1LJ,1LM	24.0130-0225.1	430225	Ø 340 30 27 V + S
			→	06/13→; +PR 1KE,1KK; + eFSB	24.0110-0356.1	410356	Ø 272 9,7 8 + S
					24.0310-0356.1	510356	Ø 272 9,7 8 + S
e-Golf	85	03/14→02/17	←	08/14→; +PR 1ZE,1ZP	24.0125-0145.1	425145	Ø 288 25 22 V + S
					24.0325-0145.1	525145	Ø 288 25 22 V + S
			→	08/14→; +PR 1KE,1KR; + eFSB	24.0110-0356.1	410356	Ø 272 9,7 8 + S
					24.0310-0356.1	510356	Ø 272 9,7 8 + S
			←	+PR 1ZE,1ZP	24.0125-0145.1	425145	Ø 288 25 22 V + S
					24.0325-0145.1	525145	Ø 288 25 22 V + S
			→	+PR 1KE,1KR; + eFSB	24.0110-0356.1	410356	Ø 272 9,7 8 + S
		24.0310-0356.1	510356	Ø 272 9,7 8 + S			
<b>VW - GOLF VII Variant (BA5, BV5) 04/13→</b>							
<b>Bremsbelagsatz, Scheibenbremse</b>							
1.0 TSI	63	01/17→	←	+PR 1ZA,1ZB,1ZD,1ZE / 1ZP,1LV	13.0460-2785.2	602785	TRW 25683 20,4 + WE / + WK
	81	11/16→			13.0470-2785.2	LD2785	TRW 25683 20,4 + WE / + WK Ceramic
1.0 TSI	85	05/15→					
1.2 TSI	81	04/14→	←	+PR 1ZF	13.0460-7303.2	607303	ATE 22035 17,5 + WK
1.4 TGI CNG	81	09/13→					
1.4 TSI	92	05/14→			13.0470-7303.2	LD7303	ATE 22035 17,5 + WK Ceramic
1.4 TSI	110	05/14→	→	+PR 1KE; + eFSB	13.0460-7293.2	607293	ATE 25008 16,3 - WE / - WK
1.4 TSI MultiFuel	90	04/13→			13.0470-7293.2	LD7293	ATE 25008 16,3 - WE / - WK Ceramic
1.4 TSI MultiFuel	92	05/14→					
1.5 TSI	96	07/17→					
1.5 TSI	110	04/17→	→	+PR 1KV,1KY; + eFSB	13.0460-7294.2	607294	ATE 25009 16,4 - WE / - WK
1.6	81	05/14→			13.0470-7294.2	LD7294	ATE 25009 16,4 - WE / - WK Ceramic
1.6 TDI	85	11/16→					
1.8 TSI 4motion	132	11/16→					
2.0 GTD	130	11/16→					
2.0 GTD	135	01/15→					
2.0 R 4motion	206	03/15→					
2.0 R 4motion	213	12/16→					
2.0 R 4motion	221	03/15→					
1.2 TSI	63	05/13→	←	07/13→; +PR 1ZA,1ZB,1ZD,1ZE / 1ZP,1LV	13.0460-2785.2	602785	TRW 25683 20,4 + WE / + WK
	77	05/13→			13.0470-2785.2	LD2785	TRW 25683 20,4 + WE / + WK Ceramic
1.4 TSI	90	05/13→					
1.4 TSI	103	05/13→	←	07/13→; +PR 1ZF	13.0460-7303.2	607303	ATE 22035 17,5 + WK
1.6 TDI	66	05/13→			13.0470-7303.2	LD7303	ATE 22035 17,5 + WK Ceramic
1.6 TDI	77	05/13→					
1.6 TDI	81	05/13→	→	07/13→; +PR 1KE; + eFSB	13.0460-7293.2	607293	ATE 25008 16,3 - WE / - WK
1.6 TDI 4motion	77	05/13→			13.0470-7293.2	LD7293	ATE 25008 16,3 - WE / - WK Ceramic
1.6 TDI 4motion	81	05/13→					
2.0 TDI	81	05/13→	→	07/13→; +PR 1KV,1KY; + eFSB	13.0460-7294.2	607294	ATE 25009 16,4 - WE / - WK
2.0 TDI	110	04/13→					
2.0 TDI 4motion	110	04/13→					









	kw			 	! #		
<b>VW - GOLF VII Variant (BA5, BV5) 04/13→</b>							
<b> Bremsbelagsatz, Scheibenbremse</b>							
1.2 TSI 1.2 TSI 1.4 TSI 1.4 TSI 1.6 TDI 1.6 TDI 1.6 TDI 1.6 TDI 4motion 1.6 TDI 4motion 2.0 TDI 2.0 TDI 2.0 TDI 4motion	63 77 90 103 66 77 81 77 81 81 110 110	05/13→ 05/13→ 05/13→ 05/13→ 05/13→ 05/13→ 05/13→ 05/13→ 05/13→ 05/13→ 04/13→ 04/13→	➡	07/13→; +PR 1KV,1KY; + eFSB		13.0470-7294.2 LD7294	ATE 25009 16,4 - WE / - WK Ceramic
2.0 R 360S 4motion 2.0 R 4motion	265 228	09/16→ 12/16→	←	+PR 1ZA,1ZB,1ZD,1ZE / 1ZP,1LV		13.0460-2785.2 602785	TRW 25683 20,4 + WE / + WK
			←	+PR 1ZF		13.0460-7303.2 607303	ATE 22035 17,5 + WK
			➡	+PR 1KE; + eFSB		13.0460-7293.2 607293	ATE 25008 16,3 - WE / - WK
						13.0470-7293.2 LD7293	ATE 25008 16,3 - WE / - WK Ceramic
			➡	+PR 1KV,1KY; + eFSB		13.0460-7294.2 607294	ATE 25009 16,4 - WE / - WK
						13.0470-7294.2 LD7294	ATE 25009 16,4 - WE / - WK Ceramic
<b>Warnkontakt, Bremsbelagverschleiß</b>							
1.0 TSI 1.0 TSI 1.0 TSI 1.2 TSI 1.4 TGI CNG 1.4 TSI 1.4 TSI 1.4 TSI MultiFuel 1.4 TSI MultiFuel 1.5 TSI 1.5 TSI 1.6 1.6 TDI 1.8 TSI 4motion 2.0 GTD 2.0 GTD 2.0 R 360S 4motion 2.0 R 4motion 2.0 R 4motion 2.0 R 4motion 2.0 R 4motion	63 81 85 81 81 92 110 90 92 96 110 81 85 132 130 135 265 206 213 221 228	01/17→ 11/16→ 05/15→ 04/14→ 09/13→ 05/14→ 05/14→ 04/13→ 05/14→ 07/17→ 04/17→ 05/14→ 11/16→ 11/16→ 11/16→ 01/15→ 09/16→ 03/15→ 12/16→ 03/15→ 12/16→	←	+PR 1LM	1	24.8190-0065.2 620065	L= 172
			←	+PR 1ZA,1ZB,1ZD,1ZE / 1ZP,1LV	1	24.8190-0065.2 620065	L= 172
1.2 TSI 1.2 TSI 1.4 TSI 1.4 TSI 1.6 TDI 1.6 TDI 1.6 TDI 1.6 TDI 4motion 1.6 TDI 4motion 2.0 TDI 2.0 TDI 2.0 TDI 4motion	63 77 90 103 66 77 81 77 81 81 110 110	05/13→ 05/13→ 05/13→ 05/13→ 05/13→ 05/13→ 05/13→ 05/13→ 05/13→ 05/13→ 04/13→ 04/13→	←	07/13→; +PR 1ZA,1ZB,1ZD,1ZE / 1ZP,1LV	1	24.8190-0065.2 620065	L= 172
			←	07/13→; +PR 1LM	1	24.8190-0065.2 620065	L= 172
<b> Bremsscheibe</b>							
1.0 TSI 1.0 TSI 1.0 TSI 1.2 TSI 1.4 TGI CNG 1.4 TSI 1.4 TSI 1.4 TSI MultiFuel 1.4 TSI MultiFuel 1.5 TSI 1.5 TSI 1.6 1.6 TDI 1.8 TSI 4motion 2.0 GTD 2.0 R 360S 4motion 2.0 R 4motion 2.0 R 4motion 2.0 R 4motion 2.0 R 4motion	63 81 85 81 81 92 110 90 92 96 110 81 85 132 130 265 206 213 221 228	01/17→ 11/16→ 05/15→ 04/14→ 09/13→ 05/14→ 05/14→ 04/13→ 05/14→ 07/17→ 04/17→ 05/14→ 11/16→ 11/16→ 09/16→ 03/15→ 12/16→ 03/15→ 12/16→	←	+PR 1ZF		24.0124-0258.1 424258	Ø 276 24 21 V + S
			←	+PR 1ZE,1ZP		24.0125-0145.1 425145	Ø 288 25 22 V + S
			←	+PR 1ZA,1ZB,1ZD,1LV		24.0125-0158.1 425158	Ø 312 25 22 V + S
						24.0325-0158.1 525158	Ø 312 25 22 V + S
			←	+PR 1LM		24.0130-0225.1 430225	Ø 340 30 27 V + S
			➡	+PR 1KE		24.0110-0356.1 410356	Ø 272 9,7 8 + S
						24.0310-0356.1 510356	Ø 272 9,7 8 + S
			➡	+PR 1KV; + eFSB		24.0112-0210.1 412210	Ø 300 12 10 + S
			➡	+PR 1KY		24.0122-0219.1 422219	Ø 310 22 20 V
1.2 TSI 1.2 TSI 1.4 TSI	63 77 90	05/13→ 05/13→ 05/13→	←	07/13→; +PR 1ZF		24.0124-0258.1 424258	Ø 276 24 21 V + S
			←	07/13→; +PR 1ZE,1ZP		24.0125-0145.1 425145	Ø 288 25 22 V + S
↓							

	kw			 	! #		
<b>VW - GOLF VII Variant (BA5, BV5) 04/13→</b>							
<b> Bremsscheibe</b>							
1.4 TSI	103	05/13→	←	07/13→; +PR 1ZA,1ZB,1ZD,1LV		24.0125-0158.1 425158	Ø 312 25 22 V + S
1.6 TDI	66	05/13→				24.0325-0158.1 525158	Ø 312 25 22 V + S
1.6 TDI	77	05/13→					
1.6 TDI	81	05/13→	←	07/13→; +PR 1LM		24.0130-0225.1 430225	Ø 340 30 27 V + S
1.6 TDI 4motion	77	05/13→					
1.6 TDI 4motion	81	05/13→	→	07/13→; +PR 1KE		24.0110-0356.1 410356	Ø 272 9,7 8 + S
2.0 TDI	81	05/13→				24.0310-0356.1 510356	Ø 272 9,7 8 + S
2.0 TDI	110	04/13→	→	07/13→; +PR 1KV; + eFSB		24.0112-0210.1 412210	Ø 300 12 10 + S
2.0 TDI 4motion	110	04/13→	→	07/13→; +PR 1KY		24.0122-0219.1 422219	Ø 310 22 20 V
2.0 GTD	135	01/15→	←	+PR 1ZF		24.0124-0258.1 424258	Ø 276 24 21 V + S
			←	+PR 1ZE,1ZP		24.0125-0145.1 425145	Ø 288 25 22 V + S
			←	+PR 1ZA,1ZB,1ZD,1LV		24.0125-0158.1 425158	Ø 312 25 22 V + S
						24.0325-0158.1 525158	Ø 312 25 22 V + S
			←	03/15→; +PR 1LM		24.0130-0225.1 430225	Ø 340 30 27 V + S
			→	+PR 1KE		24.0110-0356.1 410356	Ø 272 9,7 8 + S
						24.0310-0356.1 510356	Ø 272 9,7 8 + S
			→	+PR 1KV; + eFSB		24.0112-0210.1 412210	Ø 300 12 10 + S
			→	+PR 1KY		24.0122-0219.1 422219	Ø 310 22 20 V
<b>VW - GOLF ALLTRACK (BA5, BV5) 12/14→</b>							
<b> Bremsbelagsatz, Scheibenbremse</b>							
1.6 TDI 4motion	81	12/14→	←	+PR 1ZA,1ZB,1ZD,1ZE / 1ZP,1LV		13.0460-2785.2 602785	TRW 25683 20,4 + WE / + WK
1.8 TSI 4motion	132	12/14→				13.0470-2785.2 LD2785	TRW 25683 20,4 + WE / + WK Ceramic
2.0 TDI 4motion	110	12/14→					
2.0 TDI 4motion	135	12/14→	←	+PR 1ZF		13.0460-7303.2 607303	ATE 22035 17,5 + WK
						13.0470-7303.2 LD7303	ATE 22035 17,5 + WK Ceramic
			→	+PR 1KE; + eFSB		13.0460-7293.2 607293	ATE 25008 16,3 - WE / - WK
						13.0470-7293.2 LD7293	ATE 25008 16,3 - WE / - WK Ceramic
			→	+PR 1KV,1KY; + eFSB		13.0460-7294.2 607294	ATE 25009 16,4 - WE / - WK
						13.0470-7294.2 LD7294	ATE 25009 16,4 - WE / - WK Ceramic
<b> Bremsscheibe</b>							
1.6 TDI 4motion	81	12/14→	←	+PR 1ZF		24.0124-0258.1 424258	Ø 276 24 21 V + S
1.8 TSI 4motion	132	12/14→				24.0125-0145.1 425145	Ø 288 25 22 V + S
2.0 TDI 4motion	110	12/14→	←	+PR 1ZE,1ZP		24.0125-0145.1 425145	Ø 288 25 22 V + S
2.0 TDI 4motion	135	12/14→	←	+PR 1ZA,1ZB,1ZD,1LV		24.0125-0158.1 425158	Ø 312 25 22 V + S
						24.0325-0158.1 525158	Ø 312 25 22 V + S
			←	+PR 1LM		24.0130-0225.1 430225	Ø 340 30 27 V + S
			→	+PR 1KE		24.0110-0356.1 410356	Ø 272 9,7 8 + S
						24.0310-0356.1 510356	Ø 272 9,7 8 + S
			→	+PR 1KV; + eFSB		24.0112-0210.1 412210	Ø 300 12 10 + S
			→	+PR 1KY		24.0122-0219.1 422219	Ø 310 22 20 V
<b>VW - GOLF PLUS (5M1, 521) 12/04→12/13</b>							
<b> Bremsbelagsatz, Scheibenbremse</b>							
1.2 TSI	63	05/10→12/13	←	+PR 1ZF,1ZM		13.0460-7117.2 607117	VW 23130 19,6 + WK
1.2 TSI	77	11/09→12/13				13.0470-7117.2 LD7117	VW 23130 19,6 + WK Ceramic
1.6 BiFuel	75	05/09→12/13					
1.6 TDI	66	02/09→12/13	←	+PR 1ZA,1ZP,1ZE,1LJ		13.0460-7184.2 607184	ATE 23587 20,6 + WK
1.6 TDI	77	03/09→12/13				13.0470-7184.2 LD7184	ATE 23587 20,6 + WK Ceramic
			→	+PR 1KE,1KZ		13.0460-2749.2 602749	TRW 24483 16,9 - WE / - WK + Zub
						13.0460-2880.2 602880	TRW 23914 17,1 + WE / - WK + Zub
						13.0470-2749.2 LD2749	TRW 24483 16,9 - WE / - WK + Zub Ceramic
						13.0470-2880.2 LD2880	TRW 23914 17,1 + WE / - WK + Zub Ceramic
			→	+PR 1KD		13.0460-2787.2 602787	TRW 23554 17,3 - WK / - WE
						13.0460-2860.2 602860	TRW 23554 16,4 - WK / + WE
						13.0470-2860.2 LD2860	TRW 23554 16,4 - WK / + WE Ceramic
1.4 16V	55	01/05→11/06	←	+PR 1ZF;1ZM		13.0460-7117.2 607117	VW 23130 19,6 + WK

	kW			 	! #		
<b>VW - GOLF PLUS (5M1, 521) 12/04→12/13</b>							
<b> Bremsbelagsatz, Scheibenbremse</b>							
1.4 16V	59	05/06→12/13	←	+PR 1ZF;1ZM		13.0470-7117.2 LD7117	VW 23130 19,6 + WK Ceramic
1.4 TSI	90	06/07→12/13	←	+PR 1ZA,1ZP,1ZE,1LJ		13.0460-7184.2 607184	ATE 23587 20,6 + WK
1.4 TSI	103	05/06→06/08	←			13.0470-7184.2 LD7184	ATE 23587 20,6 + WK Ceramic
1.4 TSI	118	06/08→12/13	→	+PR 1KE,1KZ		13.0460-2749.2 602749	TRW 24483 16,9 - WE / - WK + Zub
1.4 TSI	125	05/06→06/08	→			13.0460-2880.2 602880	TRW 23914 17,1 + WE / - WK + Zub
1.6	75	05/05→12/13				13.0470-2749.2 LD2749	TRW 24483 16,9 - WE / - WK + Zub Ceramic
1.6 FSI	85	12/04→05/08				13.0470-2880.2 LD2880	TRW 23914 17,1 + WE / - WK + Zub Ceramic
1.6 MultiFuel	75	11/07→12/13					
1.9 TDI	66	05/05→12/08					
1.9 TDI	77	01/05→01/09					
2.0 FSI	110	05/05→06/08					
2.0 TDI	81	01/09→12/13					
2.0 TDI	96	05/05→05/07					
2.0 TDI	100	05/05→12/13	→	+PR 1KD		13.0460-2787.2 602787	TRW 23554 17,3 - WK / - WE
2.0 TDI	103	12/05→05/11				13.0460-2860.2 602860	TRW 23554 16,4 - WK / + WE
2.0 TDI 16V	103	01/05→12/13				13.0470-2860.2 LD2860	TRW 23554 16,4 - WK / + WE Ceramic
1.4 FSI	66	07/05→11/06	←	+PR 1ZF,1ZM		13.0460-7117.2 607117	VW 23130 19,6 + WK
			←	+PR 1ZA,1ZP,1ZE,1LJ		13.0470-7117.2 LD7117	VW 23130 19,6 + WK Ceramic
			←			13.0460-7184.2 607184	ATE 23587 20,6 + WK
			←			13.0470-7184.2 LD7184	ATE 23587 20,6 + WK Ceramic
			→	+PR 1KE;1KZ		13.0460-2749.2 602749	TRW 24483 16,9 - WE / - WK + Zub
						13.0460-2880.2 602880	TRW 23914 17,1 + WE / - WK + Zub
						13.0470-2749.2 LD2749	TRW 24483 16,9 - WE / - WK + Zub Ceramic
						13.0470-2880.2 LD2880	TRW 23914 17,1 + WE / - WK + Zub Ceramic
			→	+PR 1KD		13.0460-2787.2 602787	TRW 23554 17,3 - WK / - WE
						13.0460-2860.2 602860	TRW 23554 16,4 - WK / + WE
						13.0470-2860.2 LD2860	TRW 23554 16,4 - WK / + WE Ceramic
<b>Zubehörsatz, Scheibenbremsbelag</b>							
1.2 TSI	63	05/10→12/13	→	+PR 1KD		13.0460-0259.2 610259	
1.2 TSI	77	11/09→12/13	→				
1.4 16V	55	01/05→11/06	→	+PR 1KE,1KZ		13.0460-0259.2 610259	
1.4 16V	59	05/06→12/13					
1.4 TSI	90	06/07→12/13					
1.4 TSI	103	05/06→06/08					
1.4 TSI	118	06/08→12/13					
1.4 TSI	125	05/06→06/08					
1.6	75	05/05→12/13					
1.6 BiFuel	75	05/09→12/13					
1.6 FSI	85	12/04→05/08					
1.6 MultiFuel	75	11/07→12/13					
1.6 TDI	66	02/09→12/13					
1.6 TDI	77	03/09→12/13					
1.9 TDI	66	05/05→12/08					
1.9 TDI	77	01/05→01/09					
2.0 FSI	110	05/05→06/08					
2.0 TDI	81	01/09→12/13					
2.0 TDI	96	05/05→05/07					
2.0 TDI	100	05/05→12/13					
2.0 TDI	103	12/05→05/11					
2.0 TDI 16V	103	01/05→12/13					
1.4 FSI	66	07/05→11/06	→	+PR 1KD		13.0460-0259.2 610259	
			→	+PR 1KE;1KZ		13.0460-0259.2 610259	
<b> Bremsscheibe</b>							
1.2 TSI	63	05/10→12/13	←	+PR 1ZF,1ZM		24.0122-0210.1 422210	Ø 280 22 19 V + S
1.2 TSI	77	11/09→12/13				24.0322-0210.1 522210	Ø 280 22 19 V + S
1.6 BiFuel	75	05/09→12/13					
1.6 TDI	66	02/09→12/13	←	+PR 1ZE,1ZP		24.0125-0145.1 425145	Ø 288 25 22 V + S
1.6 TDI	77	03/09→12/13				24.0325-0145.1 525145	Ø 288 25 22 V + S
			←	+PR 1LJ,1ZA		24.0125-0158.1 425158	Ø 312 25 22 V + S
						24.0325-0158.1 525158	Ø 312 25 22 V + S
			→	+PR 1KD		24.0110-0277.1 410277	Ø 253 10 8 + S
						24.0310-0277.1 510277	Ø 253 10 8 + S
			→	+PR 1KE		24.0112-0158.1 412158	Ø 256 12 10 + S
						24.0312-0158.1 512158	Ø 256 12 10
			→	+PR 1KZ		24.0112-0169.1 412169	Ø 282 12 10 + S

	kw					! #		
<b>VW - GOLF PLUS (5M1, 521) 12/04→12/13</b>								
<b>Bremsscheibe</b>								
1.2 TSI	63	05/10→12/13	➡	+PR 1KZ		24.0312-0169.1	512169	Ø 282 12 10 + S
1.2 TSI	77	11/09→12/13						
1.6 BiFuel	75	05/09→12/13						
1.6 TDI	66	02/09→12/13						
1.6 TDI	77	03/09→12/13						
1.4 16V	55	01/05→11/06	⬅	+PR 1ZF;1ZM		24.0122-0210.1	422210	Ø 280 22 19 V + S
1.4 16V	59	05/06→12/13				24.0322-0210.1	522210	Ø 280 22 19 V + S
1.4 TSI	90	06/07→12/13						
1.4 TSI	103	05/06→06/08	⬅	+PR 1ZE;1ZP		24.0125-0145.1	425145	Ø 288 25 22 V + S
1.4 TSI	118	06/08→12/13				24.0325-0145.1	525145	Ø 288 25 22 V + S
1.4 TSI	125	05/06→06/08						
1.6	75	05/05→12/13	⬅	+PR 1LJ,1ZA		24.0125-0158.1	425158	Ø 312 25 22 V + S
1.6 FSI	85	12/04→05/08				24.0325-0158.1	525158	Ø 312 25 22 V + S
1.6 MultiFuel	75	11/07→12/13	➡	+PR 1KD		24.0110-0277.1	410277	Ø 253 10 8 + S
1.9 TDI	66	05/05→12/08				24.0310-0277.1	510277	Ø 253 10 8 + S
1.9 TDI	77	01/05→01/09						
2.0 FSI	110	05/05→06/08	➡	+PR 1KE		24.0112-0158.1	412158	Ø 256 12 10 + S
2.0 TDI	81	01/09→12/13				24.0312-0158.1	512158	Ø 256 12 10
2.0 TDI	96	05/05→05/07						
2.0 TDI	100	05/05→12/13	➡	+PR 1KZ		24.0112-0169.1	412169	Ø 282 12 10 + S
2.0 TDI	103	12/05→05/11				24.0312-0169.1	512169	Ø 282 12 10 + S
2.0 TDI 16V	103	01/05→12/13						
1.4 FSI	66	07/05→11/06	⬅	+PR 1ZF;1ZM		24.0122-0210.1	422210	Ø 280 22 19 V + S
						24.0322-0210.1	522210	Ø 280 22 19 V + S
			⬅	+PR 1ZE;1ZP		24.0125-0145.1	425145	Ø 288 25 22 V + S
						24.0325-0145.1	525145	Ø 288 25 22 V + S
			⬅	+PR 1LJ,1ZA		24.0125-0158.1	425158	Ø 312 25 22 V + S
						24.0325-0158.1	525158	Ø 312 25 22 V + S
			➡	+PR 1KD		24.0110-0277.1	410277	Ø 253 10 8 + S
						24.0310-0277.1	510277	Ø 253 10 8 + S
			➡	+PR 1KE		24.0112-0158.1	412158	Ø 256 12 10 + S
						24.0312-0158.1	512158	Ø 256 12 10
			➡			24.0112-0169.1	412169	Ø 282 12 10 + S
						24.0312-0169.1	512169	Ø 282 12 10 + S
<b>VW - GOLF SPORTSVAN (AM1) 02/14→</b>								
<b>Bremsbelagsatz, Scheibenbremse</b>								
1.0 TSI	63	05/17→	⬅	+PR 1ZA,1ZE,1ZP		13.0460-2785.2	602785	TRW 25683 20,4 + WE / + WK
1.0 TSI	81	05/17→				13.0470-2785.2	LD2785	TRW 25683 20,4 + WE / + WK Ceramic
1.0 TSI	85	05/15→						
1.2 TSI	63	05/14→						
1.2 TSI	81	04/14→	⬅	+PR 1ZF		13.0460-7303.2	607303	ATE 22035 17,5 + WK
1.4 TSI	92	04/14→				13.0470-7303.2	LD7303	ATE 22035 17,5 + WK Ceramic
1.4 TSI MultiFuel	92	04/14→						
1.5 TSI	96	05/17→	➡	+PR 1KE; + eFSB		13.0460-7293.2	607293	ATE 25008 16,3 - WE / - WK
1.5 TSI	110	05/17→				13.0470-7293.2	LD7293	ATE 25008 16,3 - WE / - WK Ceramic
1.6	81	05/14→						
1.6 TDI	66	02/14→						
2.0 TDI	81	05/14→						
1.4 TSI	110	02/14→	⬅	05/14→; +PR 1ZA,1ZE,1ZP		13.0460-2785.2	602785	TRW 25683 20,4 + WE / + WK
1.6 TDI	81	02/14→				13.0470-2785.2	LD2785	TRW 25683 20,4 + WE / + WK Ceramic
2.0 TDI	110	02/14→						
			⬅	05/14→; +PR 1ZF		13.0460-7303.2	607303	ATE 22035 17,5 + WK
						13.0470-7303.2	LD7303	ATE 22035 17,5 + WK Ceramic
			➡	05/14→; +PR 1KE; + eFSB		13.0460-7293.2	607293	ATE 25008 16,3 - WE / - WK
						13.0470-7293.2	LD7293	ATE 25008 16,3 - WE / - WK Ceramic
1.6 TDI	85	11/16→	⬅	+PR 1ZA,1ZE		13.0460-2785.2	602785	TRW 25683 20,4 + WE / + WK
						13.0470-2785.2	LD2785	TRW 25683 20,4 + WE / + WK Ceramic
			⬅	+PR 1ZF		13.0460-7303.2	607303	ATE 22035 17,5 + WK
						13.0470-7303.2	LD7303	ATE 22035 17,5 + WK Ceramic
			➡	+ eFSB		13.0460-7293.2	607293	ATE 25008 16,3 - WE / - WK
						13.0470-7293.2	LD7293	ATE 25008 16,3 - WE / - WK Ceramic
<b>Bremsscheibe</b>								
1.0 TSI	63	05/17→	⬅	+PR 1ZF		24.0124-0258.1	424258	Ø 276 24 21 V + S
1.0 TSI	81	05/17→						
1.0 TSI	85	05/15→	⬅	+PR 1ZE,1ZP		24.0125-0145.1	425145	Ø 288 25 22 V + S
1.2 TSI	63	05/14→				24.0325-0145.1	525145	Ø 288 25 22 V + S
1.2 TSI	81	04/14→						
1.4 TSI	92	04/14→	⬅	+PR 1ZA		24.0125-0158.1	425158	Ø 312 25 22 V + S

	kw			 	! #		
<b>VW - GOLF SPORTSVAN (AM1) 02/14→</b>							
<b>Bremsscheibe</b>							
1.4 TSI MultiFuel	92	04/14→	←	+PR 1ZA		24.0325-0158.1 525158	Ø 312 25 22 V + S
1.5 TSI	96	05/17→	→	+PR 1KE		24.0110-0356.1 410356	Ø 272 9,7 8 + S
1.5 TSI	110	05/17→					
1.6	81	05/14→				24.0310-0356.1 510356	Ø 272 9,7 8 + S
1.6 TDI	66	02/14→					
2.0 TDI	81	05/14→					
1.4 TSI	110	02/14→	←	05/14→; +PR 1ZF		24.0124-0258.1 424258	Ø 276 24 21 V + S
1.6 TDI	81	02/14→	←	05/14→; +PR 1ZE,1ZP		24.0125-0145.1 425145	Ø 288 25 22 V + S
2.0 TDI	110	02/14→				24.0325-0145.1 525145	Ø 288 25 22 V + S
			←	05/14→; +PR 1ZA		24.0125-0158.1 425158	Ø 312 25 22 V + S
						24.0325-0158.1 525158	Ø 312 25 22 V + S
			→	05/14→; +PR 1KE		24.0110-0356.1 410356	Ø 272 9,7 8 + S
						24.0310-0356.1 510356	Ø 272 9,7 8 + S
1.6 TDI	85	11/16→	←	+PR 1ZF		24.0124-0258.1 424258	Ø 276 24 21 V + S
			←	+PR 1ZE		24.0125-0145.1 425145	Ø 288 25 22 V + S
						24.0325-0145.1 525145	Ø 288 25 22 V + S
			←	+PR 1ZA		24.0125-0158.1 425158	Ø 312 25 22 V + S
						24.0325-0158.1 525158	Ø 312 25 22 V + S
			→	+PR 1KE		24.0110-0356.1 410356	Ø 272 9,7 8 + S
						24.0310-0356.1 510356	Ø 272 9,7 8 + S
<b>VW - JETTA III (1K2) 09/04→10/10</b>							
<b>Bremsbelagsatz, Scheibenbremse</b>							
1.4 TSI	90	05/07→10/10	←	+PR 1ZM		13.0460-7117.2 607117	VW 23130 19,6 + WK
1.4 TSI	103	07/06→10/10				13.0470-7117.2 LD7117	VW 23130 19,6 + WK Ceramic
1.4 TSI	118	07/08→10/10					
1.4 TSI	125	07/06→10/10	←	+PR 1ZE;1ZP;1ZD;1LJ		13.0460-7184.2 607184	ATE 23587 20,6 + WK
1.6	75	10/05→10/10				13.0470-7184.2 LD7184	ATE 23587 20,6 + WK Ceramic
1.6 FSI	85	09/05→10/10					
1.6 MultiFuel	75	01/08→10/10	→	+PR 1KE,1KF,1KJ,1KV		13.0460-2749.2 602749	TRW 24483 16,9 - WE / - WK + Zub
1.9 TDI	77	08/05→10/10					
2.0 FSI	110	08/05→10/10				13.0460-2880.2 602880	TRW 23914 17,1 + WE / - WK + Zub
2.0 TDI	100	09/05→10/10					
2.0 TDI	103	10/05→10/10				13.0470-2749.2 LD2749	TRW 24483 16,9 - WE / - WK + Zub Ceramic
2.0 TDI	125	10/06→10/10					
2.0 TDI 16V	103	08/05→10/10				13.0470-2880.2 LD2880	TRW 23914 17,1 + WE / - WK + Zub Ceramic
2.0 TFSI	147	10/05→10/10					
2.5	125	07/08→10/10					
1.6 TDI	66	12/09→10/10	←	+PR 1ZM		13.0460-7117.2 607117	VW 23130 19,6 + WK
1.6 TDI	77	06/09→10/10				13.0470-7117.2 LD7117	VW 23130 19,6 + WK Ceramic
			←	+PR 1ZE,1ZP,1ZD,1LJ		13.0460-7184.2 607184	ATE 23587 20,6 + WK
						13.0470-7184.2 LD7184	ATE 23587 20,6 + WK Ceramic
			→	+PR 1KE,1KF,1KJ,1KV		13.0460-2749.2 602749	TRW 24483 16,9 - WE / - WK + Zub
						13.0460-2880.2 602880	TRW 23914 17,1 + WE / - WK + Zub
						13.0470-2749.2 LD2749	TRW 24483 16,9 - WE / - WK + Zub Ceramic
						13.0470-2880.2 LD2880	TRW 23914 17,1 + WE / - WK + Zub Ceramic
2.5	110	01/06→10/10	←	07/08→; +PR 1ZM		13.0460-7117.2 607117	VW 23130 19,6 + WK
						13.0470-7117.2 LD7117	VW 23130 19,6 + WK Ceramic
			←	07/08→; +PR 1ZE;1ZP;1ZD;1LJ		13.0460-7184.2 607184	ATE 23587 20,6 + WK
						13.0470-7184.2 LD7184	ATE 23587 20,6 + WK Ceramic
			→	07/08→; +PR 1KE,1KF,1KJ,1KV		13.0460-2749.2 602749	TRW 24483 16,9 - WE / - WK + Zub
						13.0460-2880.2 602880	TRW 23914 17,1 + WE / - WK + Zub
						13.0470-2749.2 LD2749	TRW 24483 16,9 - WE / - WK + Zub Ceramic
						13.0470-2880.2 LD2880	TRW 23914 17,1 + WE / - WK + Zub Ceramic
<b>Zubehörsatz, Scheibenbremsbelag</b>							
1.4 TSI	90	05/07→10/10	→	+PR 1KE,1KF,1KJ,1KV		13.0460-0259.2 610259	
1.4 TSI	103	07/06→10/10					
1.4 TSI	118	07/08→10/10					
1.4 TSI	125	07/06→10/10					
1.6	75	10/05→10/10					
1.6 FSI	85	09/05→10/10					
1.6 MultiFuel	75	01/08→10/10					





### VW - JETTA III (1K2) 09/04→10/10

#### Zubehörsatz, Scheibenbremsbelag

1.6 TDI	66	12/09→10/10	➔	+PR 1KE,1KF,1KJ,1KV	13.0460-0259.2	610259	
1.6 TDI	77	06/09→10/10					
1.9 TDI	77	08/05→10/10					
2.0 FSI	110	08/05→10/10					
2.0 TDI	100	09/05→10/10					
2.0 TDI	103	10/05→10/10					
2.0 TDI	125	10/06→10/10					
2.0 TDI 16V	103	08/05→10/10					
2.0 TFSI	147	10/05→10/10					
2.5	125	07/08→10/10					
2.5	110	01/06→10/10	➔	07/08→; +PR 1KE,1KF,1KJ,1KV	13.0460-0259.2	610259	











#### Bremsscheibe

1.4 TSI	90	05/07→10/10	←	+PR 1ZM	24.0122-0210.1	422210	Ø 280 22 19 V + S
1.4 TSI	103	07/06→10/10			24.0322-0210.1	522210	Ø 280 22 19 V + S
1.4 TSI	118	07/08→10/10					
1.4 TSI	125	07/06→10/10	←	+PR 1ZE;1ZP	24.0125-0145.1	425145	Ø 288 25 22 V + S
1.6	75	10/05→10/10			24.0325-0145.1	525145	Ø 288 25 22 V + S
1.6 FSI	85	09/05→10/10					
1.6 MultiFuel	75	01/08→10/10	←	+PR 1LJ;1ZD	24.0125-0158.1	425158	Ø 312 25 22 V + S
1.9 TDI	77	08/05→10/10			24.0325-0158.1	525158	Ø 312 25 22 V + S
2.0 FSI	110	08/05→10/10	➔	+PR 1KE;1KF	24.0112-0158.1	412158	Ø 256 12 10 + S
2.0 TDI	100	09/05→10/10			24.0312-0158.1	512158	Ø 256 12 10
2.0 TDI	103	10/05→10/10					
2.0 TDI	125	10/06→10/10	➔	+PR 1KJ,1KV	24.0112-0169.1	412169	Ø 282 12 10 + S
2.0 TDI 16V	103	08/05→10/10			24.0312-0169.1	512169	Ø 282 12 10 + S
2.0 TFSI	147	10/05→10/10					
2.5	125	07/08→10/10					
1.6 TDI	66	12/09→10/10	←	+PR 1ZM	24.0122-0210.1	422210	Ø 280 22 19 V + S
1.6 TDI	77	06/09→10/10			24.0322-0210.1	522210	Ø 280 22 19 V + S
			←	+PR 1ZE,1ZP	24.0125-0145.1	425145	Ø 288 25 22 V + S
					24.0325-0145.1	525145	Ø 288 25 22 V + S
			←	+PR 1LJ,1ZD	24.0125-0158.1	425158	Ø 312 25 22 V + S
					24.0325-0158.1	525158	Ø 312 25 22 V + S
			➔	+PR 1KE,1KF	24.0112-0158.1	412158	Ø 256 12 10 + S
					24.0312-0158.1	512158	Ø 256 12 10
			➔	+PR 1KJ,1KV	24.0112-0169.1	412169	Ø 282 12 10 + S
					24.0312-0169.1	512169	Ø 282 12 10 + S
2.5	110	01/06→10/10	←	07/08→; +PR 1ZM	24.0122-0210.1	422210	Ø 280 22 19 V + S
					24.0322-0210.1	522210	Ø 280 22 19 V + S
			←	07/08→; +PR 1ZE;1ZP	24.0125-0145.1	425145	Ø 288 25 22 V + S
					24.0325-0145.1	525145	Ø 288 25 22 V + S
			←	07/08→; +PR 1LJ;1ZD	24.0125-0158.1	425158	Ø 312 25 22 V + S
					24.0325-0158.1	525158	Ø 312 25 22 V + S
			➔	07/08→; +PR 1KE;1KF	24.0112-0158.1	412158	Ø 256 12 10 + S
					24.0312-0158.1	512158	Ø 256 12 10
			➔	07/08→; +PR 1KJ,1KV	24.0112-0169.1	412169	Ø 282 12 10 + S
					24.0312-0169.1	512169	Ø 282 12 10 + S















### VW - JETTA IV (162, 163) 09/09→







#### Bremsbelagsatz, Scheibenbremse

1.2 TSI	77	10/10→	←	04/11→; +PR 1ZQ	13.0460-7111.2	607111	VW 23130 19,6 - WE / - WK
1.6 TDI	77	04/10→07/14			13.0470-7111.2	LD7111	VW 23130 19,6 - WE / - WK Ceramic
2.0 TDI	103	02/11→					
2.0 TSI	147	12/10→					
2.5	125	04/10→	←	04/11→; +PR 1ZM	13.0460-7117.2	607117	VW 23130 19,6 + WK
					13.0470-7117.2	LD7117	VW 23130 19,6 + WK Ceramic
			←	04/11→; +PR 1ZA,1ZB,1ZE	13.0460-7184.2	607184	ATE 23587 20,6 + WK
					13.0470-7184.2	LD7184	ATE 23587 20,6 + WK Ceramic
			←	04/11→; +PR 1LV,1ZP	13.0460-7285.2	607285	ATE 23587 20,6 - WE / - WK
					13.0470-7285.2	LD7285	ATE 23587 20,6 - WE / - WK Ceramic
			➔	04/11→; +PR 1KD,1KU	13.0460-2787.2	602787	TRW 23554 17,3 - WK / - WE
					13.0460-2820.2	602820	TRW 20961 17,2 - WK
					13.0470-2820.2	LD2820	TRW 20961 17,2 - WK Ceramic
			➔	04/11→; +PR 1KS,1KT	13.0460-3858.2	603858	BOS 24563 17,7 - WE / - WK + Zub
					13.0470-3858.2	LD3858	BOS 24563 17,7 - WE / - WK + Zub Ceramic
1.2 TSI 16V	77	08/14→	←	+PR 1ZQ	13.0460-7111.2	607111	VW 23130 19,6 - WE / - WK
↓							







	kw			 	! #		
<b>VW - JETTA IV (162, 163) 09/09→</b>							
 <b>Bremsbelagsatz, Scheibenbremse</b>							
1.4 TSI	90	05/11→	←	+PR 1ZQ		13.0470-7111.2 LD7111	VW 23130 19,6 - WE / - WK Ceramic
1.4 TSI	110	04/11→07/14					
1.4 TSI	118	04/11→	←	+PR 1ZM		13.0460-7117.2 607117	VW 23130 19,6 + WK
1.4 TSI Hybrid	110	04/11→				13.0470-7117.2 LD7117	VW 23130 19,6 + WK Ceramic
1.6	63	03/13→					
1.6	77	12/11→	←	+PR 1ZA,1ZB,1ZE		13.0460-7184.2 607184	ATE 23587 20,6 + WK
1.6	81	09/15→				13.0470-7184.2 LD7184	ATE 23587 20,6 + WK Ceramic
2.0	85	06/10→					
2.0 TDI	81	10/10→	←	+PR 1LV,1ZP		13.0460-7285.2 607285	ATE 23587 20,6 - WE / - WK
2.0 TSI	155	12/12→				13.0470-7285.2 LD7285	ATE 23587 20,6 - WE / - WK Ceramic
			→	+PR 1KD,1KU		13.0460-2787.2 602787	TRW 23554 17,3 - WK / - WE
						13.0460-2820.2 602820	TRW 20961 17,2 - WK
						13.0470-2820.2 LD2820	TRW 20961 17,2 - WK Ceramic
			→	+PR 1KS,1KT		13.0460-3858.2 603858	BOS 24563 17,7 - WE / - WK + Zub
						13.0470-3858.2 LD3858	BOS 24563 17,7 - WE / - WK + Zub Ceramic
1.4 TSI	92	08/14→	←	+PR 1ZQ		13.0460-7111.2 607111	VW 23130 19,6 - WE / - WK
1.4 TSI	110	08/14→				13.0470-7111.2 LD7111	VW 23130 19,6 - WE / - WK Ceramic
1.8 TSI	125	07/14→					
2.0 TDI	110	08/14→	←	+PR 1ZM		13.0460-7117.2 607117	VW 23130 19,6 + WK
						13.0470-7117.2 LD7117	VW 23130 19,6 + WK Ceramic
			←	+PR 1ZA,1ZB,1ZE		13.0460-7184.2 607184	ATE 23587 20,6 + WK
						13.0470-7184.2 LD7184	ATE 23587 20,6 + WK Ceramic
			←	+PR 1LV,1ZP		13.0460-7285.2 607285	ATE 23587 20,6 - WE / - WK
						13.0470-7285.2 LD7285	ATE 23587 20,6 - WE / - WK Ceramic
			→	+PR 1KD,1KU		13.0460-2787.2 602787	TRW 23554 17,3 - WK / - WE
						13.0460-2820.2 602820	TRW 20961 17,2 - WK
						13.0470-2820.2 LD2820	TRW 20961 17,2 - WK Ceramic
 <b>Bremsscheibe</b>							
1.2 TSI	77	10/10→	←	04/11→; +PR 1ZM,1ZQ		24.0122-0210.1 422210	Ø 280 22 19 V + S
1.6 TDI	77	04/10→07/14				24.0322-0210.1 522210	Ø 280 22 19 V + S
2.0 TDI	103	02/11→					
2.0 TSI	147	12/10→	←	04/11→; +PR 1ZE,1ZP		24.0125-0145.1 425145	Ø 288 25 22 V + S
2.5	125	04/10→				24.0325-0158.1 525158	Ø 312 25 22 V + S
			←	04/11→; +PR 1ZA,1ZB,1LV		24.0125-0158.1 425158	Ø 312 25 22 V + S
						24.0325-0145.1 525145	Ø 288 25 22 V + S
			→	04/11→; +PR 1KD,1KU		24.0110-0277.1 410277	Ø 253 10 8 + S
						24.0310-0277.1 510277	Ø 253 10 8 + S
			→	04/11→; +PR 1KS,1KT		24.0110-0356.1 410356	Ø 272 9,7 8 + S
						24.0310-0356.1 510356	Ø 272 9,7 8 + S
1.2 TSI 16V	77	08/14→	←	+PR 1ZM,1ZQ		24.0122-0210.1 422210	Ø 280 22 19 V + S
1.4 TSI	90	05/11→				24.0322-0210.1 522210	Ø 280 22 19 V + S
1.4 TSI	110	04/11→07/14					
1.4 TSI	118	04/11→	←	+PR 1ZE,1ZP		24.0125-0145.1 425145	Ø 288 25 22 V + S
1.4 TSI Hybrid	110	04/11→				24.0325-0158.1 525158	Ø 312 25 22 V + S
1.6	63	03/13→					
1.6	77	12/11→	←	+PR 1ZA,1ZB,1LV		24.0125-0158.1 425158	Ø 312 25 22 V + S
1.6	81	09/15→				24.0325-0145.1 525145	Ø 288 25 22 V + S
2.0	85	06/10→	→	+PR 1KD,1KU		24.0110-0277.1 410277	Ø 253 10 8 + S
2.0 TDI	81	10/10→				24.0310-0277.1 510277	Ø 253 10 8 + S
2.0 TSI	155	12/12→	→	+PR 1KS,1KT		24.0110-0356.1 410356	Ø 272 9,7 8 + S
						24.0310-0356.1 510356	Ø 272 9,7 8 + S
1.4 TSI	92	08/14→	←	+PR 1ZM,1ZQ		24.0122-0210.1 422210	Ø 280 22 19 V + S
1.4 TSI	110	08/14→				24.0322-0210.1 522210	Ø 280 22 19 V + S
1.8 TSI	125	07/14→					
2.0 TDI	110	08/14→	←	+PR 1ZE,1ZP		24.0125-0145.1 425145	Ø 288 25 22 V + S
						24.0325-0158.1 525158	Ø 312 25 22 V + S
			←	+PR 1ZA,1ZB,1LV		24.0125-0158.1 425158	Ø 312 25 22 V + S
						24.0325-0145.1 525145	Ø 288 25 22 V + S
			→	+PR 1KD,1KU		24.0110-0277.1 410277	Ø 253 10 8 + S
						24.0310-0277.1 510277	Ø 253 10 8 + S
<b>VW - LOAD UP (121, 122, BL1, BL2) 12/14→</b>							
 <b>Bremsbelagsatz, Scheibenbremse</b>							
1.0	44	12/14→	←	+PR 1ZE; 05/16→		13.0460-2609.2 602609	TRW 25683 20,4 + WE / - WK
↓							













	kw			 	! #		
<b>VW - LOAD UP (121, 122, BL1, BL2) 12/14→</b>							
 <b>Bremsbelagsatz, Scheibenbremse</b>							
1.0 EcoFuel	50	12/14→	←	+PR 1LA,1ZQ		13.0460-7111.2 607111 13.0470-7111.2 LD7111	VW 23130 19,6 - WE / - WK VW 23130 19,6 - WE / - WK Ceramic
e-Load Up	60	12/14→	←	+PR 1ZE; 05/16→		13.0460-2609.2 602609	TRW 25683 20,4 + WE / - WK
			←	+PR 1ZQ		13.0460-7111.2 607111 13.0470-7111.2 LD7111	VW 23130 19,6 - WE / - WK VW 23130 19,6 - WE / - WK Ceramic
 <b>Bremsscheibe</b>							
1.0 1.0 EcoFuel e-Load Up	44 50 60	12/14→ 12/14→ 12/14→	←	+PR 1LA,1ZQ		24.0122-0281.1 422281	Ø 256 22 19 V + S
<b>VW - LT 28-35 I Bus (281-363) 04/75→06/96</b>							
 <b>Bremsbelagsatz, Scheibenbremse</b>							
2.4 D 2.4 i 2.4 TD	51 69 70	08/89→06/96 08/89→06/96 09/92→06/96	←			13.0460-5701.2 605701	ATE 20392 18,5 + WE / - WK
<b>Zubehörsatz, Scheibenbremsbelag</b>							
2.4 D 2.4 i 2.4 TD	51 69 70	08/89→06/96 08/89→06/96 09/92→06/96	←			13.0460-0091.2 610091	ATE
 <b>Bremsscheibe</b>							
2.4 D 2.4 i 2.4 TD	51 69 70	08/89→06/96 08/89→06/96 09/92→06/96	←	28-B-019163→ 28-D-007273; für Rechtslenker		24.0120-0114.2 420114	Ø 281 19,9 18
			←	28-B-018541→ 28-D-007273; für Linkslenker		24.0120-0114.2 420114	Ø 281 19,9 18
			←	28-D-007274→		24.0120-0114.2 420114	Ø 281 19,9 18
<b>VW - LT 28-35 I Kasten (281-363) 04/75→06/96</b>							
 <b>Bremsbelagsatz, Scheibenbremse</b>							
2.4 D 2.4 i 2.4 TD 2.4 TD Syncro	51 69 70 70	07/90→05/96 08/89→06/96 06/92→05/96 08/92→04/96	←			13.0460-5701.2 605701	ATE 20392 18,5 + WE / - WK
<b>Zubehörsatz, Scheibenbremsbelag</b>							
2.4 D 2.4 i 2.4 TD 2.4 TD Syncro	51 69 70 70	07/90→05/96 08/89→06/96 06/92→05/96 08/92→04/96	←			13.0460-0091.2 610091	ATE
 <b>Bremsscheibe</b>							
2.4 D 2.4 i 2.4 TD 2.4 TD Syncro	51 69 70 70	07/90→05/96 08/89→06/96 06/92→05/96 08/92→04/96	←	28-B-018541→ 28-D-007273; für Linkslenker		24.0120-0114.2 420114	Ø 281 19,9 18
			←	28-B-019163→ 28-D-007273; für Rechtslenker		24.0120-0114.2 420114	Ø 281 19,9 18
			←	28-B-012411→		24.0120-0114.2 420114	Ø 281 19,9 18
			←	28-D-007274→		24.0120-0114.2 420114	Ø 281 19,9 18
<b>VW - LT 28-35 I Pritsche/Fahrgestell (281-363) 04/75→06/96</b>							
 <b>Bremsbelagsatz, Scheibenbremse</b>							
2.4 D 2.4 i 2.4 TD 2.4 TD Syncro	51 69 70 70	08/90→06/96 03/94→06/96 08/92→06/96 08/92→04/96	←			13.0460-5701.2 605701	ATE 20392 18,5 + WE / - WK
<b>Zubehörsatz, Scheibenbremsbelag</b>							
2.4 D 2.4 i 2.4 TD 2.4 TD Syncro	51 69 70 70	08/90→06/96 03/94→06/96 08/92→06/96 08/92→04/96	←			13.0460-0091.2 610091	ATE
 <b>Bremsscheibe</b>							
2.4 D 2.4 i 2.4 TD 2.4 TD Syncro	51 69 70 70	08/90→06/96 03/94→06/96 08/92→06/96 08/92→04/96	←	28-B-018541→ 28-D-007273; für Linkslenker		24.0120-0114.2 420114	Ø 281 19,9 18
			←	28-B-019163→ 28-D-007273; für Rechtslenker		24.0120-0114.2 420114	Ø 281 19,9 18
			←	28-B-012411→		24.0120-0114.2 420114	Ø 281 19,9 18
			←	28-D-007274→		24.0120-0114.2 420114	Ø 281 19,9 18













	kw			 	! #			
<b>VW - LT 28-35 II Bus (2DB, 2DE, 2DK) 04/96→07/06</b>								
<b>Bremsbelagsatz, Scheibenbremse</b>								
2.3 2.5 SDI	105 55	05/96→07/06 07/96→07/06	←	Baumuster: LT 35		<b>13.0460-7196.2</b>	<b>607196</b>	ATE 21576 20,7 + WE / - WK
			←	Baumuster: LT 28		<b>13.0460-7196.2</b>	<b>607196</b>	ATE 21576 20,7 + WE / - WK
			←	Baumuster: LT 46		<b>13.0460-7909.2</b>	<b>607909</b>	PER 29153 20,0 + WE / - WK + Zub
			→	→ 12/03; Baumuster: LT 35		<b>13.0460-3990.2</b>	<b>603990</b>	BOS 23021 18,9 + WE / - WK
			→	Baumuster: LT 28		<b>13.0460-7083.2</b>	<b>607083</b>	ATE 21621 17,3 + WE / - WK
			→	Baumuster: LT 35		<b>13.0460-7084.2</b>	<b>607084</b>	ATE 21592 18,8 + WE / - WK
			→	Baumuster: LT 46		<b>13.0460-7909.2</b>	<b>607909</b>	PER 29153 20,0 + WE / - WK + Zub
2.5 TDI 2.5 TDI 2.5 TDI 2.5 TDI	61 66 70 80	05/01→07/06 05/99→07/06 05/01→07/06 05/99→07/06	←	Baumuster: LT 35		<b>13.0460-7196.2</b>	<b>607196</b>	ATE 21576 20,7 + WE / - WK
			←	Baumuster: LT 28		<b>13.0460-7196.2</b>	<b>607196</b>	ATE 21576 20,7 + WE / - WK
			→	→ 12/03; Baumuster: LT 35		<b>13.0460-3990.2</b>	<b>603990</b>	BOS 23021 18,9 + WE / - WK
			→	Baumuster: LT 28		<b>13.0460-7083.2</b>	<b>607083</b>	ATE 21621 17,3 + WE / - WK
			→	Baumuster: LT 35		<b>13.0460-7084.2</b>	<b>607084</b>	ATE 21592 18,8 + WE / - WK
2.5 TDI	75	05/96→08/99	←	Baumuster: LT 35		<b>13.0460-7196.2</b>	<b>607196</b>	ATE 21576 20,7 + WE / - WK
			←	Baumuster: LT 28		<b>13.0460-7196.2</b>	<b>607196</b>	ATE 21576 20,7 + WE / - WK
			←	Baumuster: LT 46		<b>13.0460-7909.2</b>	<b>607909</b>	PER 29153 20,0 + WE / - WK + Zub
			→	Baumuster: LT 35		<b>13.0460-3990.2</b>	<b>603990</b>	BOS 23021 18,9 + WE / - WK
			→	Baumuster: LT 28		<b>13.0460-7083.2</b>	<b>607083</b>	ATE 21621 17,3 + WE / - WK
			→	Baumuster: LT 46		<b>13.0460-7909.2</b>	<b>607909</b>	PER 29153 20,0 + WE / - WK + Zub
			→	Baumuster: LT 28		<b>13.0460-7083.2</b>	<b>607083</b>	ATE 21621 17,3 + WE / - WK
2.8 TDI 2.8 TDI	96 116	01/99→01/02 05/01→06/06	←	Baumuster: LT 28		<b>13.0460-7196.2</b>	<b>607196</b>	ATE 21576 20,7 + WE / - WK
			→	Baumuster: LT 28		<b>13.0460-7083.2</b>	<b>607083</b>	ATE 21621 17,3 + WE / - WK
<b>Warnkontakt, Bremsbelagverschleiß</b>								
2.3 2.5 SDI 2.5 TDI	105 55 75	05/96→07/06 07/96→07/06 05/96→08/99	←	Baumuster: LT 35	2	<b>24.8190-0417.2</b>	<b>620417</b>	L= 99 L= 167
			←	Baumuster: LT 46	2	<b>24.8190-0417.2</b>	<b>620417</b>	L= 99 L= 167
			←	Baumuster: LT 28	2	<b>24.8190-0417.2</b>	<b>620417</b>	L= 99 L= 167
			→	Baumuster: LT 28; nur in Verbindung mit: 13.0460-7083.2	2	<b>24.8190-0407.2</b>	<b>620407</b>	L= 115 L= 185
			→	Baumuster: LT 35; nur in Verbindung mit: 13.0460-7084.2	2	<b>24.8190-0407.2</b>	<b>620407</b>	L= 115 L= 185
			→	Baumuster: LT 46	2	<b>24.8190-0417.2</b>	<b>620417</b>	L= 99 L= 167
2.5 TDI 2.5 TDI 2.5 TDI 2.5 TDI	61 66 70 80	05/01→07/06 05/99→07/06 05/01→07/06 05/99→07/06	←	Baumuster: LT 35	2	<b>24.8190-0417.2</b>	<b>620417</b>	L= 99 L= 167
			←	Baumuster: LT 28	2	<b>24.8190-0417.2</b>	<b>620417</b>	L= 99 L= 167
			→	Baumuster: LT 28; nur in Verbindung mit: 13.0460-7083.2	2	<b>24.8190-0407.2</b>	<b>620407</b>	L= 115 L= 185
			→	Baumuster: LT 35; nur in Verbindung mit: 13.0460-7084.2	2	<b>24.8190-0407.2</b>	<b>620407</b>	L= 115 L= 185
2.8 TDI 2.8 TDI	96 116	01/99→01/02 05/01→06/06	←	Baumuster: LT 28	2	<b>24.8190-0417.2</b>	<b>620417</b>	L= 99 L= 167
			→	Baumuster: LT 28; nur in Verbindung mit: 13.0460-7083.2	2	<b>24.8190-0407.2</b>	<b>620407</b>	L= 115 L= 185
<b>Zubehörsatz, Scheibenbremsbelag</b>								
2.3 2.5 SDI	105 55	05/96→07/06 07/96→07/06	←	Baumuster: LT 46; nur in Verbindung mit: 13.0460-7904.2		<b>13.0460-0281.2</b>	<b>610281</b>	PER
			→	→ 12/03; Baumuster: LT 35; nur in Verbindung mit: 13.0460-3990.2		<b>13.0460-0250.2</b>	<b>610250</b>	BOS
			→	Baumuster: LT 46; nur in Verbindung mit: 13.0460-7904.2		<b>13.0460-0281.2</b>	<b>610281</b>	PER
2.5 TDI 2.5 TDI 2.5 TDI 2.5 TDI	61 66 70 80	05/01→07/06 05/99→07/06 05/01→07/06 05/99→07/06	→	→ 12/03; Baumuster: LT 35; nur in Verbindung mit: 13.0460-3990.2		<b>13.0460-0250.2</b>	<b>610250</b>	BOS
			←	Baumuster: LT 46; nur in Verbindung mit: 13.0460-7904.2		<b>13.0460-0281.2</b>	<b>610281</b>	PER
			→	Baumuster: LT 35; nur in Verbindung mit: 13.0460-3990.2		<b>13.0460-0250.2</b>	<b>610250</b>	BOS
2.5 TDI	75	05/96→08/99	←	Baumuster: LT 46; nur in Verbindung mit: 13.0460-7904.2		<b>13.0460-0281.2</b>	<b>610281</b>	PER
			→	Baumuster: LT 35; nur in Verbindung mit: 13.0460-3990.2		<b>13.0460-0250.2</b>	<b>610250</b>	BOS
			→	Baumuster: LT 46; nur in Verbindung mit: 13.0460-7904.2		<b>13.0460-0281.2</b>	<b>610281</b>	PER
↓								



	kw					! #		
<b>VW - LT 28-35 II Bus (2DB, 2DE, 2DK) 04/96→07/06</b>								
<b>Bremsscheibe</b>								
2.3	105	05/96→07/06	←				24.0122-0161.1 422161	Ø 276 22 19 V + S
2.5 SDI	55	07/96→07/06					24.0322-0161.1 522161	Ø 276 22 19 V + S
2.5 TDI	75	05/96→08/99	→	Baumuster: LT 28			24.0112-0142.1 412142	Ø 258 12 10 + S
			→	Baumuster: LT 35			24.0116-0110.1 416110	Ø 272 16 14 + S
			→	Baumuster: LT 46			24.0122-0196.1 422196	Ø 285 21,9 19 V
2.5 TDI	61	05/01→07/06	←				24.0122-0161.1 422161	Ø 276 22 19 V + S
2.5 TDI	66	05/99→07/06					24.0322-0161.1 522161	Ø 276 22 19 V + S
2.5 TDI	70	05/01→07/06	→	Baumuster: LT 28			24.0112-0142.1 412142	Ø 258 12 10 + S
2.5 TDI	80	05/99→07/06	→	Baumuster: LT 35			24.0116-0110.1 416110	Ø 272 16 14 + S
2.8 TDI	92	07/97→05/03	←	28-B-019163→ 28-D-007273; für Rechtslenker			24.0120-0114.2 420114	Ø 281 19,9 18
			←	28-B-018541→ 28-D-007273; für Linkslenker			24.0120-0114.2 420114	Ø 281 19,9 18
2.8 TDI	96	01/99→01/02	←				24.0122-0161.1 422161	Ø 276 22 19 V + S
2.8 TDI	116	05/01→06/06					24.0322-0161.1 522161	Ø 276 22 19 V + S
			→	Baumuster: LT 28			24.0112-0142.1 412142	Ø 258 12 10 + S
<b>VW - LT 28-46 II Kasten (2DA, 2DD, 2DH) 04/96→07/06</b>								
<b>Bremsbelagsatz, Scheibenbremse</b>								
2.3	105	05/96→07/06	←	Baumuster: LT 35			13.0460-7196.2 607196	ATE 21576 20,7 + WE / - WK
2.5 SDI	55	09/96→07/06	←	Baumuster: LT 28			13.0460-7196.2 607196	ATE 21576 20,7 + WE / - WK
2.5 TDI	61	05/01→07/06	←	Baumuster: LT 46			13.0460-7909.2 607909	PER 29153 20,0 + WE / - WK + Zub
2.5 TDI	66	05/99→07/06	←	Baumuster: LT 46			13.0460-7909.2 607909	PER 29153 20,0 + WE / - WK + Zub
2.5 TDI	70	05/01→07/06	→	→ 12/03; Baumuster: LT 35			13.0460-3990.2 603990	BOS 23021 18,9 + WE / - WK
2.5 TDI	80	05/99→07/06	→	Baumuster: LT 28			13.0460-7083.2 607083	ATE 21621 17,3 + WE / - WK
2.8 TDI	96	01/99→07/06	→	Baumuster: LT 35			13.0460-7084.2 607084	ATE 21592 18,8 + WE / - WK
2.8 TDI	116	04/02→07/06	→	Baumuster: LT 46			13.0460-7909.2 607909	PER 29153 20,0 + WE / - WK + Zub
2.5 TDI	75	05/96→08/99	←	Baumuster: LT 35			13.0460-7196.2 607196	ATE 21576 20,7 + WE / - WK
2.8 TDI	92	07/97→01/02	←	Baumuster: LT 28			13.0460-7196.2 607196	ATE 21576 20,7 + WE / - WK
			←	Baumuster: LT 46			13.0460-7909.2 607909	PER 29153 20,0 + WE / - WK + Zub
			→	Baumuster: LT 35			13.0460-3990.2 603990	BOS 23021 18,9 + WE / - WK
			→	Baumuster: LT 28			13.0460-7083.2 607083	ATE 21621 17,3 + WE / - WK
			→	Baumuster: LT 46			13.0460-7909.2 607909	PER 29153 20,0 + WE / - WK + Zub
<b>Warnkontakt, Bremsbelagverschleiß</b>								
2.3	105	05/96→07/06	←	Baumuster: LT 35	2	24.8190-0417.2 620417	L= 99 L= 167	
2.5 SDI	55	09/96→07/06	←	Baumuster: LT 46	2	24.8190-0417.2 620417	L= 99 L= 167	
2.5 TDI	61	05/01→07/06	←	Baumuster: LT 28	2	24.8190-0417.2 620417	L= 99 L= 167	
2.5 TDI	66	05/99→07/06	←	Baumuster: LT 28	2	24.8190-0417.2 620417	L= 99 L= 167	
2.5 TDI	70	05/01→07/06	→	Baumuster: LT 28;	2	24.8190-0407.2 620407	L= 115 L= 185	
2.5 TDI	75	05/96→08/99	→	nur in Verbindung mit: 13.0460-7083.2	2	24.8190-0407.2 620407	L= 115 L= 185	
2.5 TDI	80	05/99→07/06	→	Baumuster: LT 35;	2	24.8190-0407.2 620407	L= 115 L= 185	
2.5 TDI	92	07/97→01/02	→	nur in Verbindung mit: 13.0460-7084.2	2	24.8190-0407.2 620407	L= 115 L= 185	
2.8 TDI	96	01/99→07/06	→	Baumuster: LT 35;	2	24.8190-0407.2 620407	L= 115 L= 185	
2.8 TDI	116	04/02→07/06	→	nur in Verbindung mit: 13.0460-7084.2	2	24.8190-0407.2 620407	L= 115 L= 185	
			→	Baumuster: LT 46	2	24.8190-0417.2 620417	L= 99 L= 167	
<b>Zubehörsatz, Scheibenbremsbelag</b>								
2.3	105	05/96→07/06	←	Baumuster: LT 46;		13.0460-0281.2 610281	PER	
2.5 SDI	55	09/96→07/06		nur in Verbindung mit: 13.0460-7904.2		13.0460-0281.2 610281	PER	
2.5 TDI	61	05/01→07/06	→	→ 12/03; Baumuster: LT 35;		13.0460-0250.2 610250	BOS	
2.5 TDI	66	05/99→07/06	→	nur in Verbindung mit: 13.0460-3990.2		13.0460-0250.2 610250	BOS	
2.5 TDI	70	05/01→07/06	→	Baumuster: LT 46;		13.0460-0281.2 610281	PER	
2.5 TDI	80	05/99→07/06	→	nur in Verbindung mit: 13.0460-7904.2		13.0460-0281.2 610281	PER	
2.8 TDI	96	01/99→07/06	→	Baumuster: LT 46;		13.0460-0281.2 610281	PER	
2.8 TDI	116	04/02→07/06	→	nur in Verbindung mit: 13.0460-7904.2		13.0460-0281.2 610281	PER	
2.5 TDI	75	05/96→08/99	←	Baumuster: LT 46;		13.0460-0281.2 610281	PER	
2.8 TDI	92	07/97→01/02	←	nur in Verbindung mit: 13.0460-7904.2		13.0460-0281.2 610281	PER	
			→	Baumuster: LT 35;		13.0460-0250.2 610250	BOS	
			→	nur in Verbindung mit: 13.0460-3990.2		13.0460-0250.2 610250	BOS	
			→	Baumuster: LT 46;		13.0460-0281.2 610281	PER	
			→	nur in Verbindung mit: 13.0460-7904.2		13.0460-0281.2 610281	PER	





















	kw			 	! #		
<b>VW - LT 28-46 II Kasten (2DA, 2DD, 2DH) 04/96→07/06</b>							
 <b>Bremsscheibe</b>							
2.3	105	05/96→07/06	←			24.0122-0161.1 422161	Ø 276 22 19 V + S
2.5 SDI	55	09/96→07/06				24.0322-0161.1 522161	Ø 276 22 19 V + S
2.5 TDI	61	05/01→07/06					
2.5 TDI	66	05/99→07/06	→	Baumuster: LT 28		24.0112-0142.1 412142	Ø 258 12 10 + S
2.5 TDI	70	05/01→07/06	→	Baumuster: LT 35		24.0116-0110.1 416110	Ø 272 16 14 + S
2.5 TDI	75	05/96→08/99					
2.5 TDI	80	05/99→07/06	→	Baumuster: LT 46		24.0122-0196.1 422196	Ø 285 21,9 19 V
2.8 TDI	92	07/97→01/02					
2.8 TDI	96	01/99→07/06					
2.8 TDI	116	04/02→07/06					
<b>VW - LT 28-46 II Pritsche/Fahrgestell (2DC, 2DF, 2DG, 2DL, 2DM) 04/96→07/06</b>							
 <b>Bremsbelagsatz, Scheibenbremse</b>							
2.3	105	06/96→07/06	←	Baumuster: LT 35		13.0460-7196.2 607196	ATE 21576 20,7 + WE / - WK
2.5 SDI	55	09/96→07/06					
2.5 TDI	61	05/01→07/06	←	Baumuster: LT 28		13.0460-7196.2 607196	ATE 21576 20,7 + WE / - WK
2.5 TDI	66	05/99→07/06	←	Baumuster: LT 46		13.0460-7909.2 607909	PER 29153 20,0 + WE / - WK + Zub
2.5 TDI	70	05/01→07/06					
2.5 TDI	80	05/99→07/06	→	→ 12/03; Baumuster: LT 35		13.0460-3990.2 603990	BOS 23021 18,9 + WE / - WK
2.8 TDI	96	01/99→07/06	→	Baumuster: LT 28		13.0460-7083.2 607083	ATE 21621 17,3 + WE / - WK
2.8 TDI	116	04/02→07/06	→	Baumuster: LT 35		13.0460-7084.2 607084	ATE 21592 18,8 + WE / - WK
			→	Baumuster: LT 46		13.0460-7909.2 607909	PER 29153 20,0 + WE / - WK + Zub
2.5 TDI	75	06/96→08/99	←	Baumuster: LT 35		13.0460-7196.2 607196	ATE 21576 20,7 + WE / - WK
2.8 TDI	92	07/97→01/02	←	Baumuster: LT 28		13.0460-7196.2 607196	ATE 21576 20,7 + WE / - WK
			←	Baumuster: LT 46		13.0460-7909.2 607909	PER 29153 20,0 + WE / - WK + Zub
			→	Baumuster: LT 35		13.0460-3990.2 603990	BOS 23021 18,9 + WE / - WK
			→	Baumuster: LT 28		13.0460-7083.2 607083	ATE 21621 17,3 + WE / - WK
			→	Baumuster: LT 46		13.0460-7909.2 607909	PER 29153 20,0 + WE / - WK + Zub
<b>Warnkontakt, Bremsbelagverschleiß</b>							
2.3	105	06/96→07/06	←	Baumuster: LT 35	2	24.8190-0417.2 620417	L= 99 L= 167
2.5 SDI	55	09/96→07/06					
2.5 TDI	61	05/01→07/06	←	Baumuster: LT 46	2	24.8190-0417.2 620417	L= 99 L= 167
2.5 TDI	66	05/99→07/06	←	Baumuster: LT 28	2	24.8190-0417.2 620417	L= 99 L= 167
2.5 TDI	70	05/01→07/06					
2.5 TDI	75	06/96→08/99	→	Baumuster: LT 28;	2	24.8190-0407.2 620407	L= 115 L= 185
2.5 TDI	80	05/99→07/06		nur in Verbindung mit: 13.0460-7083.2			
2.8 TDI	92	07/97→01/02	→	Baumuster: LT 35;	2	24.8190-0407.2 620407	L= 115 L= 185
2.8 TDI	96	01/99→07/06		nur in Verbindung mit: 13.0460-7084.2			
2.8 TDI	116	04/02→07/06	→	Baumuster: LT 46	2	24.8190-0417.2 620417	L= 99 L= 167
<b>Zubehörsatz, Scheibenbremsbelag</b>							
2.3	105	06/96→07/06	←	Baumuster: LT 46;		13.0460-0281.2 610281	PER
2.5 SDI	55	09/96→07/06		nur in Verbindung mit: 13.0460-7904.2			
2.5 TDI	61	05/01→07/06	→	→ 12/03; Baumuster: LT 35;		13.0460-0250.2 610250	BOS
2.5 TDI	66	05/99→07/06		nur in Verbindung mit: 13.0460-3990.2			
2.5 TDI	70	05/01→07/06	→	Baumuster: LT 46;		13.0460-0281.2 610281	PER
2.5 TDI	80	05/99→07/06		nur in Verbindung mit: 13.0460-7904.2			
2.8 TDI	96	01/99→07/06					
2.8 TDI	116	04/02→07/06					
2.5 TDI	75	06/96→08/99	←	Baumuster: LT 46;		13.0460-0281.2 610281	PER
2.8 TDI	92	07/97→01/02		nur in Verbindung mit: 13.0460-7904.2			
			→	Baumuster: LT 35;		13.0460-0250.2 610250	BOS
				nur in Verbindung mit: 13.0460-3990.2			
			→	Baumuster: LT 46;		13.0460-0281.2 610281	PER
				nur in Verbindung mit: 13.0460-7904.2			
 <b>Bremsscheibe</b>							
2.3	105	06/96→07/06	←			24.0122-0161.1 422161	Ø 276 22 19 V + S
2.5 SDI	55	09/96→07/06				24.0322-0161.1 522161	Ø 276 22 19 V + S
2.5 TDI	61	05/01→07/06					
2.5 TDI	66	05/99→07/06	→	Baumuster: LT 28		24.0112-0142.1 412142	Ø 258 12 10 + S
2.5 TDI	70	05/01→07/06	→	Baumuster: LT 35		24.0116-0110.1 416110	Ø 272 16 14 + S
2.5 TDI	75	06/96→08/99					
2.5 TDI	80	05/99→07/06	→	Baumuster: LT 46		24.0122-0196.1 422196	Ø 285 21,9 19 V
2.8 TDI	92	07/97→01/02					
2.8 TDI	96	01/99→07/06					
2.8 TDI	116	04/02→07/06					

	kw			 	! #		
<b>VW - LT 40-55 I Kasten (291-512) 04/75→06/96</b>							
 <b>Bremsbelagsatz, Scheibenbremse</b>							
2.4 D 2.4 i 2.4 TD	51 69 70	07/90→05/96 01/93→06/96 06/92→05/96	←			13.0460-5701.2 605701	ATE 20392 18,5 + WE / - WK
<b>Zubehörsatz, Scheibenbremsbelag</b>							
2.4 D 2.4 i 2.4 TD	51 69 70	07/90→05/96 01/93→06/96 06/92→05/96	←			13.0460-0091.2 610091	ATE
 <b>Bremsscheibe</b>							
2.4 D 2.4 i 2.4 TD	51 69 70	07/90→05/96 01/93→06/96 06/92→05/96	←			24.0120-0114.2 420114	Ø 281 19,9 18
			←	28-B-012411→		24.0120-0114.2 420114	Ø 281 19,9 18
<b>VW - LT 40-55 I Pritsche/Fahrgestell (293-909) 04/75→06/96</b>							
 <b>Bremsbelagsatz, Scheibenbremse</b>							
2.4 D 2.4 i 2.4 TD	51 69 70	08/90→06/96 03/94→06/96 08/92→06/96	←			13.0460-5701.2 605701	ATE 20392 18,5 + WE / - WK
<b>Zubehörsatz, Scheibenbremsbelag</b>							
2.4 D 2.4 i 2.4 TD	51 69 70	08/90→06/96 03/94→06/96 08/92→06/96	←			13.0460-0091.2 610091	ATE
 <b>Bremsscheibe</b>							
2.4 D 2.4 i	51 69	08/90→06/96 03/94→06/96	←			24.0120-0114.2 420114	Ø 281 19,9 18
			←	28-B-012411→		24.0120-0114.2 420114	Ø 281 19,9 18
2.4 TD	70	08/92→06/96	←			24.0120-0114.2 420114	Ø 281 19,9 18
<b>VW - LUPO (6X1, 6E1) 09/98→07/05</b>							
 <b>Bremsbelagsatz, Scheibenbremse</b>							
1.0 1.0 1.4 1.4 TDI 1.7 SDI	37 37 44 55 44	09/98→07/05 10/98→05/00 10/00→07/05 01/99→07/05 09/98→07/05	←	+PR 1ZE,1ZJ,1ZK,1LX		13.0460-2821.2 602821	TRW 21945 16,0 - WK
			←	+PR 1LM,1ZN,1LB,1ZC		13.0460-7100.2 607100	VW 21866 17,2 - WE / - WK
						13.0470-7100.2 LD7100	VW 21866 17,2 - WE / - WK Ceramic
1.2 TDI 3L	45	07/99→07/05	←	+PR 1ZB		13.0460-7177.2 607177	VW 23394 13,7 - WE / - WK
1.4 16V	55	09/98→07/05	←	10/98→; +PR 1ZE,1ZJ,1ZK,1LX		13.0460-2821.2 602821	TRW 21945 16,0 - WK
			←	10/98→; +PR 1LM,1ZN,1LB,1ZC		13.0460-7100.2 607100	VW 21866 17,2 - WE / - WK
						13.0470-7100.2 LD7100	VW 21866 17,2 - WE / - WK Ceramic
1.4 16V 1.4 FSI 1.6 GTI	74 77 92	08/99→07/05 02/01→07/05 09/00→07/05	←	+PR 1ZE,1ZJ,1ZK,1LX		13.0460-2821.2 602821	TRW 21945 16,0 - WK
			←	+PR 1LM,1ZN,1LB,1ZC		13.0460-7100.2 607100	VW 21866 17,2 - WE / - WK
						13.0470-7100.2 LD7100	VW 21866 17,2 - WE / - WK Ceramic
			→			13.0460-2864.2 602864	TRW 20961 17,2 - WK
						13.0460-2877.2 602877	TRW 23554 17,2 + WK
						13.0470-2877.2 LD2877	TRW 23554 17,2 + WK Ceramic
 <b>Bremsscheibe</b>							
1.0 1.0 1.4 1.4 TDI 1.7 SDI	37 37 44 55 44	09/98→07/05 10/98→05/00 10/00→07/05 01/99→07/05 09/98→07/05	←	+PR 1LM,1ZN,1LB,1ZC		24.0118-0106.1 418106	Ø 239 18 16 V + S
			←	+PR 1ZE,1ZJ,1ZK		24.0120-0128.1 420128	Ø 256 20 18 V + S
						24.0320-0128.1 520128	Ø 256 20 18 V + S
			←	+PR 1LX		24.0125-0136.1 425136	Ø 256 25 23 V
			←	+PR 1LM,1ZN,1LB,1ZC / 1LM,1ZN		24.0318-0106.1 518106	Ø 239 18 16 V + S
1.2 TDI 3L	45	07/99→07/05	←	+PR 1ZB		24.0115-0109.1 415109	Ø 239 15 13 V
1.4 16V	55	09/98→07/05	←	10/98→; +PR 1LM,1ZN,1LB,1ZC		24.0118-0106.1 418106	Ø 239 18 16 V + S
			←	10/98→; +PR 1ZE,1ZJ,1ZK		24.0120-0128.1 420128	Ø 256 20 18 V + S
						24.0320-0128.1 520128	Ø 256 20 18 V + S
			←	10/98→; +PR 1LX		24.0125-0136.1 425136	Ø 256 25 23 V
			←	10/98→; +PR 1LM,1ZN,1LB,1ZC / 1LM,1ZN		24.0318-0106.1 518106	Ø 239 18 16 V + S
1.4 16V 1.4 FSI 1.6 GTI	74 77 92	08/99→07/05 02/01→07/05 09/00→07/05	←	+PR 1LM,1ZN,1LB,1ZC		24.0118-0106.1 418106	Ø 239 18 16 V + S
			←	+PR 1ZE,1ZJ,1ZK		24.0120-0128.1 420128	Ø 256 20 18 V + S
						24.0320-0128.1 520128	Ø 256 20 18 V + S









	kw			 	! #		
<b>VW - LUPO (6X1, 6E1) 09/98→07/05</b>							
<b>Bremsscheibe</b>							
1.4 16V	74	08/99→07/05	←	+PR 1LX		24.0125-0136.1 425136	Ø 256 25 23 V
1.4 FSI	77	02/01→07/05	←	+PR 1LM,1ZN,1LB,1ZC / 1LM,1ZN		24.0318-0106.1 518106	Ø 239 18 16 V + S
1.6 GTI	92	09/00→07/05	→				
<b>VW - MULTIVAN T5 (7HM, 7HN, 7HF, 7EF, 7EM, 7EN) 04/03→08/15</b>							
<b>Bremsbelagsatz, Scheibenbremse</b>							
1.9 TDI	62	01/06→11/09	←	+PR 2E3		13.0460-7236.2 607236	ATE 23746 19,7 + WK
1.9 TDI	75	06/06→11/09	←	+PR 2E4; → 7H-A-050000		13.0460-7240.2 607240	ATE 23746 18,1 + WK
			←	7H-A-200001→; +PR 2E4		13.0460-7286.2 607286	ATE 24623 18,2 + WK
			→	7H-A-200001→		13.0460-2882.2 602882	TRW 23326 17,4 + WK + Zub
			→	7H-8-028000→; +PR 0WR; → 7H-8-200000		13.0460-2882.2 602882	TRW 23326 17,4 + WK + Zub
			→	7H-6-000001→; +PR 2E3,2E4; → 7H-A-050000		13.0460-2882.2 602882	TRW 23326 17,4 + WK + Zub
			→	+PR 0WR; → 7H-8-027999		13.0460-7218.2 607218	ATE 24367 19,1 + WK
1.9 TDI	63	04/03→11/09	←	+PR 2E3		13.0460-7236.2 607236	ATE 23746 19,7 + WK
1.9 TDI	77	04/03→11/09	←	+PR 2E4; → 7H-A-050000		13.0460-7240.2 607240	ATE 23746 18,1 + WK
2.0	85	11/03→08/15	←	7H-A-200001→; +PR 2E4		13.0460-7286.2 607286	ATE 24623 18,2 + WK
2.5 TDI	96	04/03→11/09	←	7H-8-028000→; +PR 0WR; → 7H-8-200000		13.0460-2882.2 602882	TRW 23326 17,4 + WK + Zub
2.5 TDI	120	11/03→11/09	→	7H-A-200001→		13.0460-2882.2 602882	TRW 23326 17,4 + WK + Zub
2.5 TDI	128	04/03→11/09	→	7H-6-000001→; +PR 2E3,2E4; → 7H-A-050000		13.0460-2882.2 602882	TRW 23326 17,4 + WK + Zub
2.5 TDI 4motion	96	07/04→11/09	→	+PR 0WL,0WN / 0WM,0WP,0WQ; → 7H-5-120000		13.0460-2882.2 602882	TRW 23326 17,4 + WK + Zub
2.5 TDI 4motion	128	07/04→11/09	→	+PR 0WR; → 7H-8-027999		13.0460-7218.2 607218	ATE 24367 19,1 + WK
3.2 V6	170	02/04→06/04	→	+PR 2E3		13.0460-7236.2 607236	ATE 23746 19,7 + WK
3.2 V6	173	02/04→11/09	→	+PR 2E4; → 7H-A-050000		13.0460-7240.2 607240	ATE 23746 18,1 + WK
3.2 V6 4motion	173	07/04→11/09	→	7H-A-200001→; +PR 2E4		13.0460-7286.2 607286	ATE 24623 18,2 + WK
			→	7H-6-000001→; +PR 2E3,2E4; → 7H-A-050000		13.0460-2882.2 602882	TRW 23326 17,4 + WK + Zub
			→	+PR 0WL,0WN / 0WM,0WP,0WQ; → 7H-5-120000		13.0460-2882.2 602882	TRW 23326 17,4 + WK + Zub
			→	+PR 0WR; → 7H-8-027999		13.0460-7218.2 607218	ATE 24367 19,1 + WK
2.0 BiTDI	132	09/09→08/15	←	+PR 2E3		13.0460-7236.2 607236	ATE 23746 19,7 + WK
2.0 BiTDI 4motion	132	09/09→08/15	←	+PR 2E4; → 7H-A-050000		13.0460-7240.2 607240	ATE 23746 18,1 + WK
2.0 TDI	62	09/09→08/15	←	7H-A-200001→; +PR 2E4		13.0460-7286.2 607286	ATE 24623 18,2 + WK
2.0 TDI	75	09/09→08/15	←	7H-A-200001→		13.0460-2882.2 602882	TRW 23326 17,4 + WK + Zub
2.0 TDI	103	09/09→08/15	→	7H-6-000001→; +PR 2E3,2E4; → 7H-A-050000		13.0460-2882.2 602882	TRW 23326 17,4 + WK + Zub
2.0 TDI 4motion	103	09/09→08/15	→	+PR 0WR; → 7H-8-027999		13.0460-7218.2 607218	ATE 24367 19,1 + WK
2.0 TDI	84	05/11→08/15	←	+PR 2E3		13.0460-7236.2 607236	ATE 23746 19,7 + WK
2.0 TSI	110	07/12→08/15	←	+PR 2E4		13.0460-7286.2 607286	ATE 24623 18,2 + WK
2.0 TSI	150	05/11→08/15	→			13.0460-2882.2 602882	TRW 23326 17,4 + WK + Zub
2.0 TSI 4motion	150	07/11→08/15	→			13.0460-2882.2 602882	TRW 23326 17,4 + WK + Zub
2.0 TDI	100	05/10→08/15	←	+PR 2E3		13.0460-7236.2 607236	ATE 23746 19,7 + WK
2.0 TDI 4motion	100	05/10→08/15	←	7H-A-200001→; +PR 2E4		13.0460-7286.2 607286	ATE 24623 18,2 + WK
			→	7H-A-200001→		13.0460-2882.2 602882	TRW 23326 17,4 + WK + Zub
<b>Zubehörsatz, Scheibenbremsbelag</b>							
1.9 TDI	62	01/06→11/09	→	7H-8-028000→; +PR 0WR; → 7H-8-200000		13.0460-0023.2 610023	
1.9 TDI	75	06/06→11/09	→	7H-A-200001→		13.0460-0023.2 610023	
			→	7H-6-000001→; +PR 2E3,2E4; → 7H-A-050000		13.0460-0023.2 610023	
1.9 TDI	63	04/03→11/09	→	7H-8-028000→; +PR 0WR; → 7H-8-200000		13.0460-0023.2 610023	
1.9 TDI	77	04/03→11/09	→	+PR 0WL,0WN / 0WM,0WP,0WQ; → 7H-5-120000		13.0460-0023.2 610023	
2.0	85	11/03→08/15	→	7H-6-000001→; +PR 2E3,2E4; → 7H-A-050000		13.0460-0023.2 610023	
2.5 TDI	96	04/03→11/09	→	7H-A-200001→		13.0460-0023.2 610023	
2.5 TDI	120	11/03→11/09	→			13.0460-0023.2 610023	
2.5 TDI	128	04/03→11/09	→			13.0460-0023.2 610023	
2.5 TDI 4motion	96	07/04→11/09	→			13.0460-0023.2 610023	
2.5 TDI 4motion	128	07/04→11/09	→			13.0460-0023.2 610023	
3.2 V6	170	02/04→06/04	→			13.0460-0023.2 610023	
3.2 V6	173	02/04→11/09	→			13.0460-0023.2 610023	
3.2 V6 4motion	173	07/04→11/09	→			13.0460-0023.2 610023	
2.0 BiTDI	132	09/09→08/15	→	7H-A-200001→		13.0460-0023.2 610023	
2.0 BiTDI 4motion	132	09/09→08/15	→			13.0460-0023.2 610023	
2.0 TDI	62	09/09→08/15	→			13.0460-0023.2 610023	
2.0 TDI	75	09/09→08/15	→			13.0460-0023.2 610023	
2.0 TDI	103	09/09→08/15	→			13.0460-0023.2 610023	
2.0 TDI 4motion	103	09/09→08/15	→			13.0460-0023.2 610023	
2.0 TDI	84	05/11→08/15	→			13.0460-0023.2 610023	
2.0 TSI	110	07/12→08/15	→			13.0460-0023.2 610023	
2.0 TSI	150	05/11→08/15	→			13.0460-0023.2 610023	
2.0 TSI 4motion	150	07/11→08/15	→			13.0460-0023.2 610023	





















	kw			 	! #		
<b>VW - MULTIVAN T5 (7HM, 7HN, 7HF, 7EF, 7EM, 7EN) 04/03→08/15</b>							
<b>Zubehörsatz, Scheibenbremsbelag</b>							
2.0 TDI	100	05/10→08/15	➡	7H-A-200001→		13.0460-0023.2	610023
2.0 TDI 4motion	100	05/10→08/15					
<b> Bremsscheibe</b>							
1.9 TDI	62	01/06→11/09	←	+PR 2E3		24.0130-0114.1	430114 Ø 308 29,5 25,5 V
1.9 TDI	75	06/06→11/09	←	→ 7H-A-050000; +PR 2E4		24.0132-0116.1	432116 Ø 333 32,5 28,5 V + S
			←	7H-A-200001→; +PR 2E4		24.0133-0100.1	433100 Ø 340 32,6 29,5 V + S
			➡	7H-A-200001→		24.0122-0211.1	422211 Ø 294 21,9 19,5 V + S
			➡	7H-8-028000→; +PR 0WR; → 7H-8-200000		24.0122-0211.1	422211 Ø 294 21,9 19,5 V + S
			➡	7H-6-000001→; +PR 2E3,2E4; → 7H-A-050000		24.0122-0211.1	422211 Ø 294 21,9 19,5 V + S
			➡	+PR 0WR; → 7H-8-027999		24.0122-0215.1	422215 Ø 314 22 18 V + S
1.9 TDI	63	04/03→11/09	←	+PR 2E3		24.0130-0114.1	430114 Ø 308 29,5 25,5 V
1.9 TDI	77	04/03→11/09	←	→ 7H-A-050000; +PR 2E4		24.0132-0116.1	432116 Ø 333 32,5 28,5 V + S
2.0 TDI	85	11/03→08/15	←	7H-A-200001→; +PR 2E4		24.0133-0100.1	433100 Ø 340 32,6 29,5 V + S
2.5 TDI	96	04/03→11/09	←	7H-8-028000→; +PR 0WR; → 7H-8-200000		24.0122-0211.1	422211 Ø 294 21,9 19,5 V + S
2.5 TDI	120	11/03→11/09	➡	7H-A-200001→		24.0122-0211.1	422211 Ø 294 21,9 19,5 V + S
2.5 TDI	128	04/03→11/09	➡	7H-6-000001→; +PR 2E3,2E4; → 7H-A-050000		24.0122-0211.1	422211 Ø 294 21,9 19,5 V + S
2.5 TDI 4motion	96	07/04→11/09	➡	+PR 0WL,0WN / 0WM,0WP,0WQ; → 7H-5-120000		24.0122-0211.1	422211 Ø 294 21,9 19,5 V + S
2.5 TDI 4motion	128	07/04→11/09	➡	+PR 0WR; → 7H-8-027999		24.0122-0215.1	422215 Ø 314 22 18 V + S
3.2 V6	170	02/04→06/04					
3.2 V6	173	02/04→11/09	←	+PR 2E3		24.0130-0114.1	430114 Ø 308 29,5 25,5 V
3.2 V6 4motion	173	07/04→11/09	←	→ 7H-A-050000; +PR 2E4		24.0132-0116.1	432116 Ø 333 32,5 28,5 V + S
			←	7H-A-200001→; +PR 2E4		24.0133-0100.1	433100 Ø 340 32,6 29,5 V + S
			➡	7H-A-200001→		24.0122-0211.1	422211 Ø 294 21,9 19,5 V + S
			➡	7H-6-000001→; +PR 2E3,2E4; → 7H-A-050000		24.0122-0211.1	422211 Ø 294 21,9 19,5 V + S
2.0 BiTDI	132	09/09→08/15	←	+PR 2E3		24.0130-0114.1	430114 Ø 308 29,5 25,5 V
2.0 BiTDI 4motion	132	09/09→08/15	←	→ 7H-A-050000; +PR 2E4		24.0132-0116.1	432116 Ø 333 32,5 28,5 V + S
2.0 TDI	62	09/09→08/15	←	7H-A-200001→; +PR 2E4		24.0133-0100.1	433100 Ø 340 32,6 29,5 V + S
2.0 TDI	75	09/09→08/15	←	7H-A-200001→		24.0122-0211.1	422211 Ø 294 21,9 19,5 V + S
2.0 TDI	103	09/09→08/15	←	7H-6-000001→; +PR 2E3,2E4; → 7H-A-050000		24.0122-0211.1	422211 Ø 294 21,9 19,5 V + S
2.0 TDI 4motion	103	09/09→08/15	➡	+PR 0WR; → 7H-8-027999		24.0122-0215.1	422215 Ø 314 22 18 V + S
2.0 TDI	84	05/11→08/15	←	+PR 2E3		24.0130-0114.1	430114 Ø 308 29,5 25,5 V
2.0 TSI	110	07/12→08/15	←	+PR 2E4		24.0133-0100.1	433100 Ø 340 32,6 29,5 V + S
2.0 TSI	150	05/11→08/15	←			24.0122-0211.1	422211 Ø 294 21,9 19,5 V + S
2.0 TSI 4motion	150	07/11→08/15	➡			24.0122-0211.1	422211 Ø 294 21,9 19,5 V + S
2.0 TDI	100	05/10→08/15	←	+PR 2E3		24.0130-0114.1	430114 Ø 308 29,5 25,5 V
2.0 TDI 4motion	100	05/10→08/15	←	7H-A-200001→; +PR 2E4		24.0133-0100.1	433100 Ø 340 32,6 29,5 V + S
			➡	7H-A-200001→		24.0122-0211.1	422211 Ø 294 21,9 19,5 V + S
<b>VW - MULTIVAN T6 (SGF, SGM, SGN) 04/15→</b>							
<b> Bremsbelagsatz, Scheibenbremse</b>							
2.0 TDI	62	04/15→	←	passend für Felgenreöße [Zoll]: 16		13.0460-7236.2	607236 ATE 23746 19,7 + WK
2.0 TDI	75	04/15→	←	passend für Felgenreöße [Zoll]: 17		13.0460-7286.2	607286 ATE 24623 18,2 + WK
2.0 TDI	84	05/16→	←				
2.0 TDI	103	04/15→	➡			13.0460-2882.2	602882 TRW 23326 17,4 + WK + Zub
2.0 TDI	110	04/15→					
2.0 TDI	132	04/15→					
2.0 TDI	150	06/15→					
2.0 TDI 4motion	103	06/15→					
2.0 TDI 4motion	110	08/15→					
2.0 TDI 4motion	132	06/15→					
2.0 TDI 4motion	150	06/15→					
2.0 TSI	110	04/15→					
2.0 TSI	150	04/15→					
2.0 TSI 4motion	150	06/15→					
<b> Bremsscheibe</b>							
2.0 TDI	62	04/15→	←	passend für Felgenreöße [Zoll]: 16		24.0130-0114.1	430114 Ø 308 29,5 25,5 V
2.0 TDI	75	04/15→	←	passend für Felgenreöße [Zoll]: 17		24.0133-0100.1	433100 Ø 340 32,6 29,5 V + S
2.0 TDI	84	05/16→	←				
2.0 TDI	103	04/15→	➡			24.0122-0211.1	422211 Ø 294 21,9 19,5 V + S
2.0 TDI	110	04/15→					
2.0 TDI	132	04/15→					
2.0 TDI	150	06/15→					
2.0 TDI 4motion	103	06/15→					
2.0 TDI 4motion	110	08/15→					
2.0 TDI 4motion	132	06/15→					
2.0 TDI 4motion	150	06/15→					
2.0 TSI	110	04/15→					
2.0 TSI	150	04/15→					
2.0 TSI 4motion	150	06/15→					









	kw			 	! #		
<b>VW - NEW BEETLE (9C1, 1C1) 01/98—11/10</b>							
<b> Bremsbelagsatz, Scheibenbremse</b>							
1.4 1.6 1.8 T 1.9 TDI 1.9 TDI	55 75 110 74 77	11/01→09/10 06/00→09/10 10/99→09/10 02/01→09/10 07/05→09/10	← ← ← →	→ 05/10; +PR 1ZP;1ZM  → 05/10; +PR 1ZD;1ZE  → 05/10; +PR 1KS,1KV		13.0460-7117.2 607117 13.0470-7117.2 LD7117 13.0460-7122.2 607122 13.0470-7122.2 LD7122 13.0460-2894.2 602894 13.0470-2894.2 LD2894	VW 23130 19,6 + WK VW 23130 19,6 + WK Ceramic ATE 20676 19,8 + WK ATE 20676 19,8 + WK Ceramic TRW 20961 17,2 - WK + Zub TRW 20961 17,2 - WK + Zub Ceramic
1.6	74	10/99→09/00	← ← →	11/99→; +PR 1ZP;1ZM  11/99→; +PR 1ZD;1ZE  11/99→; +PR 1KS,1KV		13.0460-7117.2 607117 13.0470-7117.2 LD7117 13.0460-7122.2 607122 13.0470-7122.2 LD7122 13.0460-2894.2 602894 13.0470-2894.2 LD2894	VW 23130 19,6 + WK VW 23130 19,6 + WK Ceramic ATE 20676 19,8 + WK ATE 20676 19,8 + WK Ceramic TRW 20961 17,2 - WK + Zub TRW 20961 17,2 - WK + Zub Ceramic
1.8 T	132	11/01→06/05	← ← → →	+PR 1ZP;1ZM  +PR 1ZD;1ZE  +PR 1KY  +PR 1KS,1KV		13.0460-7117.2 607117 13.0470-7117.2 LD7117 13.0460-7122.2 607122 13.0470-7122.2 LD7122 13.0460-2886.2 602886 13.0460-2937.2 602937 13.0470-2886.2 LD2886 13.0460-2894.2 602894 13.0470-2894.2 LD2894	VW 23130 19,6 + WK VW 23130 19,6 + WK Ceramic ATE 20676 19,8 + WK ATE 20676 19,8 + WK Ceramic TRW 20961 16,0 - WK TRW 20961 15,2 - WK + Zub TRW 20961 16,0 - WK Ceramic TRW 20961 17,2 - WK + Zub TRW 20961 17,2 - WK + Zub Ceramic
1.9 TDI	66	01/98→06/04	← ← ← ← →	→ 9C-X-699000; +PR 1ZE;1ZH  → 9C-X-999000; +PR 1ZM  9C-Y-600001→; → 02/01; +PR 1ZP;1ZM  9C-Y-600001→; → 02/01; +PR 1ZD;1ZE  → 02/01; +PR 1KS,1KV		13.0460-7081.2 607081 13.0470-7081.2 LD7081 13.0460-7111.2 607111 13.0470-7111.2 LD7111 13.0460-7117.2 607117 13.0470-7117.2 LD7117 13.0460-7122.2 607122 13.0470-7122.2 LD7122 13.0460-2894.2 602894 13.0470-2894.2 LD2894	ATE 20676 19,8 - WE / - WK ATE 20676 19,8 - WE / - WK Ceramic VW 23130 19,6 - WE / - WK VW 23130 19,6 - WE / - WK Ceramic VW 23130 19,6 + WK VW 23130 19,6 + WK Ceramic ATE 20676 19,8 + WK ATE 20676 19,8 + WK Ceramic TRW 20961 17,2 - WK + Zub TRW 20961 17,2 - WK + Zub Ceramic
2.0 2.5	85 110	01/98→09/10 07/05→09/10	← ← ← ← →	→ 9C-X-699000; +PR 1ZE;1ZH  → 9C-X-999000; +PR 1ZM  9C-Y-600001→; → 05/10; +PR 1ZP;1ZM  9C-Y-600001→; → 05/10; +PR 1ZD;1ZE  → 05/10; +PR 1KS,1KV		13.0460-7081.2 607081 13.0470-7081.2 LD7081 13.0460-7111.2 607111 13.0470-7111.2 LD7111 13.0460-7117.2 607117 13.0470-7117.2 LD7117 13.0460-7122.2 607122 13.0470-7122.2 LD7122 13.0460-2894.2 602894 13.0470-2894.2 LD2894	ATE 20676 19,8 - WE / - WK ATE 20676 19,8 - WE / - WK Ceramic VW 23130 19,6 - WE / - WK VW 23130 19,6 - WE / - WK Ceramic VW 23130 19,6 + WK VW 23130 19,6 + WK Ceramic ATE 20676 19,8 + WK ATE 20676 19,8 + WK Ceramic TRW 20961 17,2 - WK + Zub TRW 20961 17,2 - WK + Zub Ceramic
2.3 V5	125	10/00→09/10	← → →	→ 05/05  → 05/05; +PR 1KY  → 05/05; +PR 1KS,1KV		13.0460-7122.2 607122 13.0470-7122.2 LD7122 13.0460-2886.2 602886 13.0460-2937.2 602937 13.0470-2886.2 LD2886 13.0460-2894.2 602894 13.0470-2894.2 LD2894	ATE 20676 19,8 + WK ATE 20676 19,8 + WK Ceramic TRW 20961 16,0 - WK TRW 20961 15,2 - WK + Zub TRW 20961 16,0 - WK Ceramic TRW 20961 17,2 - WK + Zub TRW 20961 17,2 - WK + Zub Ceramic
RSI 3.2 4motion (1C9)	165	04/00→05/01	← →			13.0460-7122.2 607122 13.0470-7122.2 LD7122 13.0460-2787.2 602787 13.0460-2820.2 602820 13.0470-2820.2 LD2820	ATE 20676 19,8 + WK ATE 20676 19,8 + WK Ceramic TRW 23554 17,3 - WK / - WE TRW 20961 17,2 - WK TRW 20961 17,2 - WK Ceramic
↓							











	kw			 	! #		
<b>VW - NEW BEETLE (9C1, 1C1) 01/98→11/10</b>							
<b>Zubehörsatz, Scheibenbremsbelag</b>							
1.4 1.6 1.8 T 1.9 TDI 1.9 TDI 2.0 2.5	55 75 110 74 77 85 110	11/01→09/10 06/00→09/10 10/99→09/10 02/01→09/10 07/05→09/10 01/98→09/10 07/05→09/10	➡	→ 05/10; +PR 1KS,1KV		13.0460-0072.2 610072	TRW
1.6	74	10/99→09/00	➡	11/99→; +PR 1KS,1KV		13.0460-0072.2 610072	TRW
1.8 T	132	11/01→06/05	➡	+PR 1KY		13.0460-0072.2 610072	TRW
			➡	+PR 1KS,1KV		13.0460-0072.2 610072	TRW
1.9 TDI	66	01/98→06/04	➡	→ 02/01; +PR 1KS,1KV		13.0460-0072.2 610072	TRW
2.3 V5	125	10/00→09/10	➡	→ 05/05; +PR 1KY		13.0460-0072.2 610072	TRW
			➡	→ 05/05; +PR 1KS,1KV		13.0460-0072.2 610072	TRW
<b> Bremsscheibe</b>							
1.4 1.6 1.8 T 1.9 TDI 1.9 TDI 2.0 2.5	55 75 110 74 77 85 110	11/01→09/10 06/00→09/10 10/99→09/10 02/01→09/10 07/05→09/10 01/98→09/10 07/05→09/10	⬅	→ 05/10; +PR 1ZP;1ZM		24.0122-0150.1 422150 24.0322-0150.1 522150	Ø 280 22 19 V + S
			⬅	→ 05/10; +PR 1ZD;1ZE		24.0125-0113.1 425113 24.0325-0113.1 525113	Ø 288 25 22 V + S
			➡	→ 05/10; +PR 1KS,1KV		24.0109-0123.1 409123 24.0309-0123.1 509123	Ø 230 9 7 + S
1.6	74	10/99→09/00	⬅	11/99→; +PR 1ZP;1ZM		24.0122-0150.1 422150 24.0322-0150.1 522150	Ø 280 22 19 V + S
			⬅	11/99→; +PR 1ZD;1ZE		24.0125-0113.1 425113 24.0325-0113.1 525113	Ø 288 25 22 V + S
			➡	11/99→; +PR 1KS,1KV		24.0109-0123.1 409123 24.0309-0123.1 509123	Ø 230 9 7 + S
1.8 T	132	11/01→06/05	⬅	+PR 1ZP;1ZM		24.0122-0150.1 422150 24.0322-0150.1 522150	Ø 280 22 19 V + S
			⬅	+PR 1ZD;1ZE		24.0125-0113.1 425113 24.0325-0113.1 525113	Ø 288 25 22 V + S
			➡	+PR 1KS,1KV		24.0109-0123.1 409123 24.0309-0123.1 509123	Ø 230 9 7 + S
			➡	+PR 1KY		24.0122-0163.1 422163 24.0322-0163.1 522163	Ø 256 22 20 V
1.9 TDI	66	01/98→06/04	⬅	→ 02/01; +PR 1ZP;1ZM		24.0122-0150.1 422150 24.0322-0150.1 522150	Ø 280 22 19 V + S
			⬅	→ 02/01; +PR 1ZD;1ZE		24.0125-0113.1 425113 24.0325-0113.1 525113	Ø 288 25 22 V + S
			➡	→ 02/01; +PR 1KS,1KV		24.0109-0123.1 409123 24.0309-0123.1 509123	Ø 230 9 7 + S
2.3 V5	125	10/00→09/10	⬅	→ 12/05		24.0125-0123.1 425123 24.0325-0123.1 525123	Ø 310 25 22 V + S
			➡	→ 05/05; +PR 1KY		24.0122-0163.1 422163 24.0322-0163.1 522163	Ø 256 22 20 V
RSI 3.2 4motion (1C9)	165	04/00→05/01	⬅			24.0125-0123.1 425123 24.0325-0123.1 525123	Ø 310 25 22 V + S
			➡			24.0122-0163.1 422163 24.0322-0163.1 522163	Ø 256 22 20 V
<b>VW - NEW BEETLE Cabriolet (1Y7) 09/02→12/11</b>							
<b> Bremsbelagsatz, Scheibenbremse</b>							
1.4 1.6 1.9 TDI 2.5	55 75 77 110	01/03→09/10 01/03→09/10 07/05→09/10 07/05→09/10	⬅	→ 05/10; +PR 1ZP;1ZM		13.0460-7117.2 607117 13.0470-7117.2 LD7117	VW 23130 19,6 + WK VW 23130 19,6 + WK Ceramic
			⬅	→ 05/10; +PR 1ZD;1ZE		13.0460-7122.2 607122 13.0470-7122.2 LD7122	ATE 20676 19,8 + WK ATE 20676 19,8 + WK Ceramic
			➡	→ 05/10; +PR 1KS,1KV		13.0460-2894.2 602894 13.0470-2894.2 LD2894	TRW 20961 17,2 - WK + Zub TRW 20961 17,2 - WK + Zub Ceramic
1.8 T	110	01/03→09/10	⬅	12/03→ 05/10; +PR 1ZP;1ZM		13.0460-7117.2 607117 13.0470-7117.2 LD7117	VW 23130 19,6 + WK VW 23130 19,6 + WK Ceramic
			⬅	12/03→ 05/10; +PR 1ZD;1ZE		13.0460-7122.2 607122 13.0470-7122.2 LD7122	ATE 20676 19,8 + WK ATE 20676 19,8 + WK Ceramic
↓							









	kw			 	! #		
<b>VW - NEW BEETLE Cabriolet (1Y7) 09/02→12/11</b>							
<b> Bremsbelagsatz, Scheibenbremse</b>							
1.8 T	110	01/03→09/10	➡	12/03→ 05/10; +PR 1KS,1KV		13.0460-2894.2 602894 13.0470-2894.2 LD2894	TRW 20961 17,2 - WK + Zub TRW 20961 17,2 - WK + Zub Ceramic
1.9 TDI	74	06/03→09/10	←	07/03→ 05/10; +PR 1ZP;1ZM		13.0460-7117.2 607117 13.0470-7117.2 LD7117	VW 23130 19,6 + WK VW 23130 19,6 + WK Ceramic
			←	07/03→ 05/10; +PR 1ZD;1ZE		13.0460-7122.2 607122 13.0470-7122.2 LD7122	ATE 20676 19,8 + WK ATE 20676 19,8 + WK Ceramic
			➡	07/03→ 05/10; +PR 1KS,1KV		13.0460-2894.2 602894 13.0470-2894.2 LD2894	TRW 20961 17,2 - WK + Zub TRW 20961 17,2 - WK + Zub Ceramic
2.0	85	09/02→10/10	←	01/03→ 05/10; +PR 1ZP;1ZM		13.0460-7117.2 607117 13.0470-7117.2 LD7117	VW 23130 19,6 + WK VW 23130 19,6 + WK Ceramic
			←	01/03→ 05/10; +PR 1ZD;1ZE		13.0460-7122.2 607122 13.0470-7122.2 LD7122	ATE 20676 19,8 + WK ATE 20676 19,8 + WK Ceramic
			➡	01/03→ 05/10; +PR 1KS,1KV		13.0460-2894.2 602894 13.0470-2894.2 LD2894	TRW 20961 17,2 - WK + Zub TRW 20961 17,2 - WK + Zub Ceramic
<b>Zubehörsatz, Scheibenbremsbelag</b>							
1.4 1.6 1.9 TDI 2.5	55 75 77 110	01/03→09/10 01/03→09/10 07/05→09/10 07/05→09/10	➡	→ 05/10; +PR 1KS,1KV		13.0460-0072.2 610072	TRW
1.8 T	110	01/03→09/10	➡	12/03→ 05/10; +PR 1KS,1KV		13.0460-0072.2 610072	TRW
1.9 TDI	74	06/03→09/10	➡	07/03→ 05/10; +PR 1KS,1KV		13.0460-0072.2 610072	TRW
2.0	85	09/02→10/10	➡	01/03→ 05/10; +PR 1KS,1KV		13.0460-0072.2 610072	TRW
<b> Bremsscheibe</b>							
1.4 1.6 1.9 TDI 2.5	55 75 77 110	01/03→09/10 01/03→09/10 07/05→09/10 07/05→09/10	←	→ 05/10; +PR 1ZP;1ZM		24.0122-0150.1 422150 24.0322-0150.1 522150	Ø 280 22 19 V + S Ø 280 22 19 V + S
1.8 T	110	01/03→09/10	←	12/03→ 05/10; +PR 1ZP;1ZM		24.0122-0150.1 422150 24.0322-0150.1 522150	Ø 280 22 19 V + S Ø 280 22 19 V + S
			←	12/03→ 05/10; +PR 1ZD;1ZE		24.0125-0113.1 425113 24.0325-0113.1 525113	Ø 288 25 22 V + S Ø 288 25 22 V + S
			➡	12/03→ 05/10; +PR 1KS,1KV		24.0109-0123.1 409123 24.0309-0123.1 509123	Ø 230 9 7 + S Ø 230 9 7 + S
1.9 TDI	74	06/03→09/10	←	07/03→ 05/10; +PR 1ZP;1ZM		24.0122-0150.1 422150 24.0322-0150.1 522150	Ø 280 22 19 V + S Ø 280 22 19 V + S
			←	07/03→ 05/10; +PR 1ZD;1ZE		24.0125-0113.1 425113 24.0325-0113.1 525113	Ø 288 25 22 V + S Ø 288 25 22 V + S
			➡	07/03→ 05/10; +PR 1KS,1KV		24.0109-0123.1 409123 24.0309-0123.1 509123	Ø 230 9 7 + S Ø 230 9 7 + S
2.0	85	09/02→10/10	←	01/03→ 05/10; +PR 1ZP;1ZM		24.0122-0150.1 422150 24.0322-0150.1 522150	Ø 280 22 19 V + S Ø 280 22 19 V + S
			←	01/03→ 05/10; +PR 1ZD;1ZE		24.0125-0113.1 425113 24.0325-0113.1 525113	Ø 288 25 22 V + S Ø 288 25 22 V + S
			➡	01/03→ 05/10; +PR 1KS,1KV		24.0109-0123.1 409123 24.0309-0123.1 509123	Ø 230 9 7 + S Ø 230 9 7 + S
<b>VW - PASSAT (3A2, 35I) 02/88→12/97</b>							
<b> Bremsbelagsatz, Scheibenbremse</b>							
1.6	74	10/94→08/96	←	3A-T-130757→		13.0460-2957.2 602957	TRW 20168 16,0 - WK
1.8 1.9 TD	55 55	08/90→08/96 03/91→08/96	←	→ 3A-T-130756		13.0460-2958.2 602958	TRW 20168 19,3 - WK
			←	→ 10/93		13.0460-2958.2 602958	TRW 20168 19,3 - WK
1.8	66	02/88→08/96	←	10/93→		13.0460-2958.2 602958	TRW 20168 19,3 - WK
			←	04/88→ 10/93		13.0460-2958.2 602958	TRW 20168 19,3 - WK
1.8 G60 Syncro	118	08/88→08/96	←	→ 10/93		13.0460-2958.2 602958	TRW 20168 19,3 - WK
↓							

	kw			 	! #		
<b>VW - PASSAT (3A2, 35I) 02/88→12/97</b>							
<b> Bremsbelagsatz, Scheibenbremse</b>							
1.8 G60 Syncro	118	08/88→08/96	➔	→ 31-P-080000		<b>13.0460-2937.2 602937</b>	TRW 20961 15,2 - WK + Zub
			➔	31-P-080001→; → 10/93		<b>13.0460-2984.2 602984</b>	TRW 20961 17,2 - WK + Zub
1.9 TDI	66	10/93→08/96	←	3A-T-000001→		<b>13.0460-2957.2 602957</b>	TRW 20168 16,0 - WK
			←	→ 3A-S-300000		<b>13.0460-2958.2 602958</b>	TRW 20168 19,3 - WK
			➔	3A-T-000001→		<b>13.0460-2984.2 602984</b>	TRW 20961 17,2 - WK + Zub
1.9 TDI	81	03/96→08/96	←			<b>13.0460-2958.2 602958</b>	TRW 20168 19,3 - WK
			➔			<b>13.0460-2984.2 602984</b>	TRW 20961 17,2 - WK + Zub
2.0	79	03/95→08/96	←			<b>13.0460-2957.2 602957</b>	TRW 20168 16,0 - WK
			➔			<b>13.0460-2984.2 602984</b>	TRW 20961 17,2 - WK + Zub
2.0	85	02/90→08/96	←	03/90→ 10/93		<b>13.0460-2957.2 602957</b>	TRW 20168 16,0 - WK
			←	10/93→		<b>13.0460-2957.2 602957</b>	TRW 20168 16,0 - WK
			➔	03/90→; → 31-PB080000		<b>13.0460-2937.2 602937</b>	TRW 20961 15,2 - WK + Zub
			➔	03/90→; → 31-PE080000		<b>13.0460-2937.2 602937</b>	TRW 20961 15,2 - WK + Zub
			➔	31-PB080001→; → 10/93		<b>13.0460-2984.2 602984</b>	TRW 20961 17,2 - WK + Zub
			➔	31-PE080001→; → 10/93		<b>13.0460-2984.2 602984</b>	TRW 20961 17,2 - WK + Zub
			➔	10/93→		<b>13.0460-2984.2 602984</b>	TRW 20961 17,2 - WK + Zub
			➔				
2.0 16V	110	01/94→08/96	←			<b>13.0460-7081.2 607081</b>	ATE 20676 19,8 - WE / - WK
						<b>13.0470-7081.2 LD7081</b>	ATE 20676 19,8 - WE / - WK Ceramic
			➔			<b>13.0460-2984.2 602984</b>	TRW 20961 17,2 - WK + Zub
2.0 Syncro	85	10/90→08/96	←	→ 10/93		<b>13.0460-2957.2 602957</b>	TRW 20168 16,0 - WK
			←	01/94→		<b>13.0460-2957.2 602957</b>	TRW 20168 16,0 - WK
			➔	→ 31-P-080000		<b>13.0460-2937.2 602937</b>	TRW 20961 15,2 - WK + Zub
			➔	31-P-080001→; → 10/93		<b>13.0460-2984.2 602984</b>	TRW 20961 17,2 - WK + Zub
			➔	01/94→		<b>13.0460-2984.2 602984</b>	TRW 20961 17,2 - WK + Zub
2.8 VR6	128	06/91→08/96	←	→ 10/93		<b>13.0460-2958.2 602958</b>	TRW 20168 19,3 - WK
			←	10/93→		<b>13.0460-7081.2 607081</b>	ATE 20676 19,8 - WE / - WK
						<b>13.0470-7081.2 LD7081</b>	ATE 20676 19,8 - WE / - WK Ceramic
			➔	→ 31-PE080000		<b>13.0460-2937.2 602937</b>	TRW 20961 15,2 - WK + Zub
			➔	→ 31-PB080000		<b>13.0460-2937.2 602937</b>	TRW 20961 15,2 - WK + Zub
			➔	31-PB080001→; → 10/93		<b>13.0460-2984.2 602984</b>	TRW 20961 17,2 - WK + Zub
			➔	10/93→		<b>13.0460-2984.2 602984</b>	TRW 20961 17,2 - WK + Zub
➔	31-PE080001→; → 10/93		<b>13.0460-2984.2 602984</b>	TRW 20961 17,2 - WK + Zub			
<b>Zubehörsatz, Scheibenbremsbelag</b>							
1.8 G60 Syncro	118	08/88→08/96	➔	31-P-080001→; → 10/93		<b>13.0460-0072.2 610072</b>	TRW
			➔	→ 31-P-080000		<b>13.0460-0419.2 610419</b>	TRW
1.9 TDI	66	10/93→08/96	➔	3A-T-000001→		<b>13.0460-0072.2 610072</b>	TRW
1.9 TDI	81	03/96→08/96	➔			<b>13.0460-0072.2 610072</b>	TRW
2.0	79	03/95→08/96	➔			<b>13.0460-0072.2 610072</b>	TRW
2.0 16V	110	01/94→08/96	➔			<b>13.0460-0072.2 610072</b>	TRW
2.0	85	02/90→08/96	➔	31-PB080001→; → 10/93		<b>13.0460-0072.2 610072</b>	TRW
			➔	31-PE080001→; → 10/93		<b>13.0460-0072.2 610072</b>	TRW
			➔	10/93→		<b>13.0460-0072.2 610072</b>	TRW
			➔	03/90→; → 31-PB080000		<b>13.0460-0419.2 610419</b>	TRW
			➔	03/90→; → 31-PE080000		<b>13.0460-0419.2 610419</b>	TRW
			➔				
2.0 Syncro	85	10/90→08/96	➔	01/94→		<b>13.0460-0072.2 610072</b>	TRW
			➔	31-P-080001→; → 10/93		<b>13.0460-0072.2 610072</b>	TRW
			➔	→ 31-P-080000		<b>13.0460-0419.2 610419</b>	TRW
2.8 VR6	128	06/91→08/96	➔	31-PB080001→; → 10/93		<b>13.0460-0072.2 610072</b>	TRW
			➔	31-PE080001→; → 10/93		<b>13.0460-0072.2 610072</b>	TRW
			➔	10/93→		<b>13.0460-0072.2 610072</b>	TRW
			➔	→ 31-PB080000		<b>13.0460-0419.2 610419</b>	TRW
			➔	→ 31-PE080000		<b>13.0460-0419.2 610419</b>	TRW
↓							







	kW			 	! #		
<b>VW - PASSAT (3A2, 35I) 02/88→12/97</b>							
<b> Bremsscheibe</b>							
1.6	74	10/94→08/96	←	→ 3A-T-130756		24.0113-0178.1 413178 24.0313-0178.1 513178	∅ 255,6 12,9 11 + S ∅ 255,6 12,9 11 + S
			←	3A-T-130757→		24.0120-0128.1 420128 24.0320-0128.1 520128	∅ 256 20 18 V + S ∅ 256 20 18 V + S
1.8 1.9 TD	55 55	08/90→08/96 03/91→08/96	←	→ 10/93		24.0113-0178.1 413178 24.0313-0178.1 513178	∅ 255,6 12,9 11 + S ∅ 255,6 12,9 11 + S
			←	10/93→		24.0113-0178.1 413178 24.0313-0178.1 513178	∅ 255,6 12,9 11 + S ∅ 255,6 12,9 11 + S
1.8	66	02/88→08/96	←	10/93→		24.0113-0178.1 413178 24.0313-0178.1 513178	∅ 255,6 12,9 11 + S ∅ 255,6 12,9 11 + S
			←	04/88→ 10/93		24.0113-0178.1 413178 24.0313-0178.1 513178	∅ 255,6 12,9 11 + S ∅ 255,6 12,9 11 + S
1.8 G60 Syncro	118	08/88→08/96	←	→ 10/93		24.0122-0101.1 422101	∅ 280 22 20 V
			→	→ 10/93		24.0110-0151.1 410151	∅ 239 10 8 + S
1.9 TDI	66	10/93→08/96	←	→ 3A-S-300000		24.0113-0178.1 413178 24.0313-0178.1 513178	∅ 255,6 12,9 11 + S ∅ 255,6 12,9 11 + S
			←	3A-T-000001→		24.0120-0128.1 420128 24.0320-0128.1 520128	∅ 256 20 18 V + S ∅ 256 20 18 V + S
			→	3A-T-000001→		24.0110-0111.1 410111 24.0110-0275.2 410275	∅ 226 10 8 - ABS Ring / - RLG ∅ 226 10 8 + ABS Ring / - RLG
1.9 TDI	81	03/96→08/96	←			24.0122-0100.1 422100 24.0322-0100.1 522100	∅ 280 22 20 V ∅ 280 22 20 V
			→			24.0110-0203.1 410203 24.0110-0276.2 410276	∅ 226 10 8 - ABS Ring ∅ 226 10 8 + ABS Ring
2.0	79	03/95→08/96	←			24.0120-0128.1 420128 24.0320-0128.1 520128	∅ 256 20 18 V + S ∅ 256 20 18 V + S
			→			24.0110-0111.1 410111 24.0110-0275.2 410275	∅ 226 10 8 - ABS Ring / - RLG ∅ 226 10 8 + ABS Ring / - RLG
2.0	85	02/90→08/96	←	03/90→ 10/93		24.0120-0128.1 420128 24.0320-0128.1 520128	∅ 256 20 18 V + S ∅ 256 20 18 V + S
			←	10/93→		24.0120-0128.1 420128 24.0320-0128.1 520128	∅ 256 20 18 V + S ∅ 256 20 18 V + S
			→	10/93→		24.0110-0111.1 410111 24.0110-0275.2 410275	∅ 226 10 8 - ABS Ring / - RLG ∅ 226 10 8 + ABS Ring / - RLG
			→	03/90→ 10/93		24.0110-0111.1 410111 24.0110-0275.2 410275	∅ 226 10 8 - ABS Ring / - RLG ∅ 226 10 8 + ABS Ring / - RLG
			→			24.0125-0108.1 425108 24.0110-0203.1 410203 24.0110-0276.2 410276	∅ 288 25 23 V ∅ 226 10 8 - ABS Ring ∅ 226 10 8 + ABS Ring
2.0 16V	110	01/94→08/96	←			24.0125-0108.1 425108 24.0110-0203.1 410203 24.0110-0276.2 410276	∅ 288 25 23 V ∅ 226 10 8 - ABS Ring ∅ 226 10 8 + ABS Ring
			→			24.0125-0108.1 425108 24.0110-0203.1 410203 24.0110-0276.2 410276	∅ 288 25 23 V ∅ 226 10 8 - ABS Ring ∅ 226 10 8 + ABS Ring
			←	01/94→		24.0120-0128.1 420128 24.0320-0128.1 520128	∅ 256 20 18 V + S ∅ 256 20 18 V + S
			←	→ 10/93		24.0120-0128.1 420128 24.0320-0128.1 520128	∅ 256 20 18 V + S ∅ 256 20 18 V + S
			→	→ 10/93		24.0110-0151.1 410151	∅ 239 10 8 + S
2.0 Syncro	85	10/90→08/96	←	→ 10/93		24.0110-0151.1 410151	∅ 239 10 8 + S
			→	01/94→		24.0110-0151.1 410151	∅ 239 10 8 + S
			←	→ 10/93		24.0122-0100.1 422100 24.0322-0100.1 522100	∅ 280 22 20 V ∅ 280 22 20 V
2.8 VR6	128	06/91→08/96	←	→ 10/93; 31-N-255990→		24.0122-0100.1 422100 24.0322-0100.1 522100	∅ 280 22 20 V ∅ 280 22 20 V
			←	10/93→		24.0125-0108.1 425108	∅ 288 25 23 V
			→	10/93→		24.0110-0203.1 410203 24.0110-0276.2 410276	∅ 226 10 8 - ABS Ring ∅ 226 10 8 + ABS Ring
			→	→ 10/93		24.0110-0203.1 410203 24.0110-0276.2 410276	∅ 226 10 8 - ABS Ring ∅ 226 10 8 + ABS Ring
			→			24.0110-0203.1 410203 24.0110-0276.2 410276	∅ 226 10 8 - ABS Ring ∅ 226 10 8 + ABS Ring
<b>VW - PASSAT (3B2) 08/96→12/01</b>							
<b> Bremsbelagsatz, Scheibenbremse</b>							
1.6	74	10/96→11/00	←	→ 3B-X-600000; +PR 1LZ,1ZJ		13.0460-2822.2 602822	TRW 21945 19,6 - WK
			←	3B-Y-000001→; → 09/00; +PR 1LZ,1ZJ		13.0460-2837.2 602837 13.0470-2837.2 LD2837	TRW 21945 19,6 + WK TRW 21945 19,6 + WK Ceramic
			←	→ 3B-X-600000; +PR 1LB,1ZC		13.0460-7077.2 607077	ATE 20676 19,8 - WE / - WK
			←	3B-Y-000001→; +PR 1LB,1ZC		13.0460-7110.2 607110	ATE 20676 19,8 + WK
↓							









	kw			 	! #		
<b>VW - PASSAT (3B2) 08/96→12/01</b>							
<b> Bremsbelagsatz, Scheibenbremse</b>							
1.6	74	10/96→11/00	←	3B-Y-000001→; +PR 1LB,1ZC	13.0470-7110.2	LD7110	ATE 20676 19,8 + WK Ceramic
			←	3B-Y-000001→; +PR 1LE, 1LT	13.0460-7110.2	607110	ATE 20676 19,8 + WK
			→	+PR 1KD,1KE,1KF,1KW	13.0460-2787.2	602787	TRW 23554 17,3 - WK / - WE
1.8	85	01/97→11/00	←	→ 3B-X-600000	13.0460-2822.2	602822	TRW 21945 19,6 - WK
			←	3B-Y-000001→; → 09/00	13.0460-2837.2	602837	TRW 21945 19,6 + WK
			→	→ 09/00	13.0460-2787.2	602787	TRW 23554 17,3 - WK / - WE
			→	→ 09/00; China	13.0460-2820.2	602820	TRW 20961 17,2 - WK
1.8	92	10/96→11/00	←	→ 3B-X-600000; +PR 1LZ,1ZJ	13.0460-2822.2	602822	TRW 21945 19,6 - WK
			←	3B-Y-000001→; → 09/00; +PR 1LZ,1ZJ	13.0460-2837.2	602837	TRW 21945 19,6 + WK
			←	→ 3B-X-600000; +PR 1LB,1ZC	13.0470-2837.2	LD2837	TRW 21945 19,6 + WK Ceramic
			←	→ 3B-X-600000; +PR 1LB,1ZC	13.0460-7077.2	607077	ATE 20676 19,8 - WE / - WK
			←	3B-Y-000001→; +PR 1LE, 1LT	13.0460-7110.2	607110	ATE 20676 19,8 + WK
			←	3B-Y-000001→; +PR 1LB,1ZC	13.0470-7110.2	LD7110	ATE 20676 19,8 + WK Ceramic
			→	→ 09/00; +PR 1KD,1KE,1KF,1KW	13.0460-7110.2	LD7110	ATE 20676 19,8 + WK Ceramic
1.8 Syncro/4motion 1.9 TDI	92 66	10/96→11/00 10/96→11/00	←	→ 3B-X-600000; +PR 1LZ,1ZJ	13.0460-2787.2	602787	TRW 23554 17,3 - WK / - WE
			←	3B-Y-000001→; → 09/00; +PR 1LZ,1ZJ	13.0460-2820.2	602820	TRW 20961 17,2 - WK
			←	→ 3B-X-600000; +PR 1LB,1ZC	13.0470-2820.2	LD2820	TRW 20961 17,2 - WK Ceramic
			←	→ 3B-X-600000; +PR 1LB,1ZC	13.0460-7077.2	607077	ATE 20676 19,8 - WE / - WK
			←	3B-Y-000001→; +PR 1LE,1LT	13.0460-2837.2	602837	TRW 21945 19,6 + WK
			←	3B-Y-000001→; +PR 1LB,1ZC	13.0470-2837.2	LD2837	TRW 21945 19,6 + WK Ceramic
			←	3B-Y-000001→; +PR 1LB,1ZC	13.0460-7110.2	607110	ATE 20676 19,8 + WK
1.8 T 1.8 T Syncro 1.9 TDI 1.9 TDI 1.9 TDI 4motion 1.9 TDI Syncro/4motion 2.3 VR5 2.3 VR5 Syncro/4motion 2.5 TDI Syncro/4motion 2.8 Syncro 2.8 V6 2.8 V6 2.8 V6 4motion 2.8 V6 Syncro/4motion	110 110 81 85 85 81 110 110 110 132 140 142 140 142	10/96→11/00 11/96→08/00 10/96→11/00 08/98→11/00 08/99→11/00 10/96→11/00 10/96→11/00 10/97→11/00 12/98→11/00 05/97→09/99 09/99→11/00 08/96→11/00 09/99→11/00 10/96→11/00	←	→ 3B-X-600000; +PR 1LB,1ZC	13.0460-7110.2	607110	ATE 20676 19,8 + WK
			←	3B-Y-000001→; +PR 1LE, 1LT	13.0470-7110.2	LD7110	ATE 20676 19,8 + WK Ceramic
			←	→ 3B-X-600000; +PR 1LB,1ZC	13.0460-7077.2	607077	ATE 20676 19,8 - WE / - WK
			←	3B-Y-000001→; +PR 1LE, 1LT	13.0460-7110.2	607110	ATE 20676 19,8 + WK
			←	3B-Y-000001→; +PR 1LB,1ZC	13.0470-7110.2	LD7110	ATE 20676 19,8 + WK Ceramic
			→	+PR 1KD,1KE,1KF,1KW	13.0460-7110.2	LD7110	ATE 20676 19,8 + WK Ceramic
			→	+PR 1KD,1KE,1KF,1KW	13.0460-2787.2	602787	TRW 23554 17,3 - WK / - WE
			→	+PR 1KD,1KE,1KF,1KW	13.0460-2820.2	602820	TRW 20961 17,2 - WK
			→	+PR 1KD,1KE,1KF,1KW	13.0470-2820.2	LD2820	TRW 20961 17,2 - WK Ceramic
			→	+PR 1KD,1KE,1KF,1KW	13.0460-2820.2	602820	TRW 20961 17,2 - WK
			→	+PR 1KD,1KE,1KF,1KW	13.0470-2820.2	LD2820	TRW 20961 17,2 - WK Ceramic
			→	+PR 1KD,1KE,1KF,1KW	13.0460-2787.2	602787	TRW 23554 17,3 - WK / - WE
			→	+PR 1KD,1KE,1KF,1KW	13.0460-2820.2	602820	TRW 20961 17,2 - WK
1.9 TDI 2.0 2.0 4motion	74 88 88	02/00→11/00 04/00→11/00 04/00→11/00	←	10/00→; +PR 1LE, 1LT	13.0460-7110.2	607110	ATE 20676 19,8 + WK
			←	10/00→; +PR 1LB,1ZC	13.0470-7110.2	LD7110	ATE 20676 19,8 + WK Ceramic
			←	10/00→; +PR 1LB,1ZC	13.0460-7110.2	607110	ATE 20676 19,8 + WK
			→	10/00→; +PR 1KD,1KE,1KF,1KW	13.0470-7110.2	LD7110	ATE 20676 19,8 + WK Ceramic
2.5 TDI	110	07/98→11/00	←	08/98→; → 3B-X-600000; +PR 1LB,1ZC	13.0460-2787.2	602787	TRW 23554 17,3 - WK / - WE
			←	3B-Y-000001→; +PR 1LE, 1LT	13.0460-2820.2	602820	TRW 20961 17,2 - WK
			←	3B-Y-000001→; +PR 1LB,1ZC	13.0470-2820.2	LD2820	TRW 20961 17,2 - WK Ceramic
			←	3B-Y-000001→; +PR 1LB,1ZC	13.0460-7077.2	607077	ATE 20676 19,8 - WE / - WK
			→	08/98→; +PR 1KD,1KE,1KF,1KW	13.0460-7110.2	607110	ATE 20676 19,8 + WK
→	08/98→; +PR 1KD,1KE,1KF,1KW	13.0470-7110.2	LD7110	ATE 20676 19,8 + WK Ceramic			
→	08/98→; +PR 1KD,1KE,1KF,1KW	13.0460-7110.2	607110	ATE 20676 19,8 + WK			
→	08/98→; +PR 1KD,1KE,1KF,1KW	13.0470-7110.2	LD7110	ATE 20676 19,8 + WK Ceramic			
→	08/98→; +PR 1KD,1KE,1KF,1KW	13.0460-2787.2	602787	TRW 23554 17,3 - WK / - WE			
→	08/98→; +PR 1KD,1KE,1KF,1KW	13.0460-2820.2	602820	TRW 20961 17,2 - WK			
→	08/98→; +PR 1KD,1KE,1KF,1KW	13.0470-2820.2	LD2820	TRW 20961 17,2 - WK Ceramic			











	kw			 	! #		
<b>VW - PASSAT (3B2) 08/96→12/01</b>							
<b> Bremsbelagsatz, Scheibenbremse</b>							
2.8 V6	132	05/97→09/99	←	→ 3B-X-600000		<b>13.0460-7077.2 607077</b>	ATE 20676 19,8 - WE / - WK
			←	3B-Y-000001→		<b>13.0460-7110.2 607110</b>	ATE 20676 19,8 + WK
						<b>13.0470-7110.2 LD7110</b>	ATE 20676 19,8 + WK Ceramic
			→			<b>13.0460-2787.2 602787</b>	TRW 23554 17,3 - WK / - WE
						<b>13.0460-2820.2 602820</b>	TRW 20961 17,2 - WK
						<b>13.0470-2820.2 LD2820</b>	TRW 20961 17,2 - WK Ceramic
<b>Zubehörsatz, Scheibenbremsbelag</b>							
1.6	74	10/96→11/00	→	+PR 1KD,1KE,1KF,1KW		<b>13.0460-0072.2 610072</b>	TRW
1.8 T	110	10/96→11/00					
1.8 T Syncro	110	11/96→08/00					
1.9 TDI	81	10/96→11/00					
1.9 TDI	85	08/98→11/00					
1.9 TDI 4motion	85	08/99→11/00					
1.9 TDI Syncro/4motion	81	10/96→11/00					
2.3 VR5	110	10/96→11/00					
2.3 VR5 Syncro/4motion	110	10/97→11/00					
2.5 TDI Syncro/4motion	110	12/98→11/00					
2.8 Syncro	132	05/97→09/99					
2.8 V6	140	09/99→11/00					
2.8 V6	142	08/96→11/00					
2.8 V6 4motion	140	09/99→11/00					
2.8 V6 Syncro/4motion	142	10/96→11/00					
1.8	85	01/97→11/00	→	→ 09/00		<b>13.0460-0072.2 610072</b>	TRW
1.8	92	10/96→11/00	→	→ 09/00; +PR 1KD,1KE,1KF,1KW		<b>13.0460-0072.2 610072</b>	TRW
1.8 Syncro/4motion	92	10/96→11/00					
1.9 TDI	66	10/96→11/00					
1.9 TDI	74	02/00→11/00	→	10/00→; +PR 1KD,1KE,1KF,1KW		<b>13.0460-0072.2 610072</b>	TRW
2.0	88	04/00→11/00					
2.0 4motion	88	04/00→11/00					
2.5 TDI	110	07/98→11/00	→	08/98→; +PR 1KD,1KE,1KF,1KW		<b>13.0460-0072.2 610072</b>	TRW
2.8 V6	132	05/97→09/99	→			<b>13.0460-0072.2 610072</b>	TRW
<b> Bremsscheibe</b>							
1.6	74	10/96→11/00	←	→ 09/00; +PR 1LZ,1ZJ		<b>24.0122-0152.1 422152</b>	Ø 280 22 20 V + S
						<b>24.0322-0152.1 522152</b>	Ø 280 22 20 V + S
			←	→ 3B-X-124107; +PR 1LB,1ZC		<b>24.0125-0115.1 425115</b>	Ø 282,5 25 23 V
						<b>24.0325-0115.1 525115</b>	Ø 282,5 25 23 V
			←	3B-X-124108→; +PR 1LB,1LE,1ZC		<b>24.0125-0171.1 425171</b>	Ø 288 25 23 V
						<b>24.0325-0171.1 525171</b>	Ø 288 25 23 V
			→	+PR 1KD,1KE,1KF,1KW		<b>24.0110-0201.1 410201</b>	Ø 245 10 8
						<b>24.0310-0201.1 510201</b>	Ø 245 10 8
1.8	85	01/97→11/00	←	→ 09/00; für Canada/GUS		<b>24.0122-0152.1 422152</b>	Ø 280 22 20 V + S
						<b>24.0322-0152.1 522152</b>	Ø 280 22 20 V + S
			→	→ 09/00; nicht China/GUS		<b>24.0110-0201.1 410201</b>	Ø 245 10 8
						<b>24.0310-0201.1 510201</b>	Ø 245 10 8
1.8	92	10/96→11/00	←	→ 09/00; +PR 1LZ,1ZJ		<b>24.0122-0152.1 422152</b>	Ø 280 22 20 V + S
1.9 TDI	66	10/96→11/00				<b>24.0322-0152.1 522152</b>	Ø 280 22 20 V + S
			←	→ 3B-X-124107; +PR 1LB,1ZC		<b>24.0125-0115.1 425115</b>	Ø 282,5 25 23 V
						<b>24.0325-0115.1 525115</b>	Ø 282,5 25 23 V
			←	3B-X-124108→; +PR 1LB,1LE,1ZC		<b>24.0125-0171.1 425171</b>	Ø 288 25 23 V
						<b>24.0325-0171.1 525171</b>	Ø 288 25 23 V
			→	→ 09/00; +PR 1KD,1KE,1KF,1KW		<b>24.0110-0201.1 410201</b>	Ø 245 10 8
						<b>24.0310-0201.1 510201</b>	Ø 245 10 8
1.8 Syncro/4motion	92	10/96→11/00	←	→ 09/00; +PR 1LZ,1ZJ		<b>24.0122-0152.1 422152</b>	Ø 280 22 20 V + S
						<b>24.0322-0152.1 522152</b>	Ø 280 22 20 V + S
			←	→ 3B-X-124107; +PR 1LB,1ZC		<b>24.0125-0115.1 425115</b>	Ø 282,5 25 23 V
						<b>24.0325-0115.1 525115</b>	Ø 282,5 25 23 V
			←	3B-X-124108→; +PR 1LB,1LE,1ZC		<b>24.0125-0171.1 425171</b>	Ø 288 25 23 V
						<b>24.0325-0171.1 525171</b>	Ø 288 25 23 V
			→	+PR 1KD;1KF		<b>24.0110-0224.1 410224</b>	Ø 245 10 8
						<b>24.0310-0224.1 510224</b>	Ø 245 10 8
			→	+PR 1KE		<b>24.0122-0221.1 422221</b>	Ø 256 22 20 V
			→	+PR 1KW		<b>24.0122-0222.1 422222</b>	Ø 269 22 20 V
1.8 T	110	10/96→11/00	←	→ 3B-X-124107; +PR 1LB,1ZC		<b>24.0125-0115.1 425115</b>	Ø 282,5 25 23 V
1.8 T Syncro	110	11/96→08/00					
1.9 TDI	81	10/96→11/00				<b>24.0325-0115.1 525115</b>	Ø 282,5 25 23 V
↓							









	kw			 	! #		
<b>VW - PASSAT (3B2) 08/96→12/01</b>							
<b>Bremsscheibe</b>							
1.9 TDI	85	08/98→11/00	←	3B-X-124108→; +PR 1LB,1LE,1ZC	24.0125-0171.1 425171	Ø 288 25 23 V	
			→	+PR 1KD,1KE,1KF,1KW	24.0325-0171.1 525171	Ø 288 25 23 V	
1.9 TDI 2.0	74 88	02/00→11/00 04/00→11/00	←	10/00→; +PR 1LB,1LE,1ZC	24.0125-0171.1 425171	Ø 288 25 23 V	
			→	10/00→; +PR 1KD,1KE,1KF,1KW	24.0325-0171.1 525171	Ø 288 25 23 V	
1.9 TDI 4motion 1.9 TDI Syncro/4motion	85 81	08/99→11/00 10/96→11/00	←	→ 3B-X-124107; +PR 1LB,1ZC	24.0125-0115.1 425115	Ø 282,5 25 23 V	
			←	3B-X-124108→; +PR 1LB,1LE,1ZC	24.0325-0115.1 525115	Ø 282,5 25 23 V	
			→	+PR 1KD;1KF	24.0125-0171.1 425171	Ø 288 25 23 V	
			→	+PR 1KE	24.0110-0224.1 410224	Ø 245 10 8	
			→	+PR 1KW	24.0310-0224.1 510224	Ø 245 10 8	
			→	+PR 1KE	24.0122-0221.1 422221	Ø 256 22 20 V	
			→	+PR 1KW	24.0122-0222.1 422222	Ø 269 22 20 V	
			→	+PR 1KW	24.0122-0222.1 422222	Ø 269 22 20 V	
2.0 4motion	88	04/00→11/00	←	10/00→; +PR 1LB,1LE,1ZC	24.0125-0171.1 425171	Ø 288 25 23 V	
			→	10/00→; +PR 1KD;1KF	24.0325-0171.1 525171	Ø 288 25 23 V	
			→	+PR 1KD;1KF	24.0110-0224.1 410224	Ø 245 10 8	
			→	+PR 1KE	24.0310-0224.1 510224	Ø 245 10 8	
			→	+PR 1KE	24.0122-0221.1 422221	Ø 256 22 20 V	
			→	+PR 1KW	24.0122-0222.1 422222	Ø 269 22 20 V	
2.3 VR5	110	10/96→11/00	←	→ 3B-X-124107; +PR 1LB,1ZC	24.0125-0115.1 425115	Ø 282,5 25 23 V	
			←	3B-X-124108→; → 09/00; +PR 1LB,1LE,1ZC	24.0325-0115.1 525115	Ø 282,5 25 23 V	
			←	10/00→; +PR 1LT	24.0125-0171.1 425171	Ø 288 25 23 V	
			→	+PR 1KD,1KE,1KF,1KW	24.0125-0172.1 425172	Ø 312 25 23 V	
			→	+PR 1KD,1KE,1KF,1KW	24.0110-0201.1 410201	Ø 245 10 8	
			→	+PR 1KW	24.0310-0201.1 510201	Ø 245 10 8	
2.3 VR5 Syncro/4motion	110	10/97→11/00	←	→ 3B-X-124107; +PR 1LB,1ZC	24.0125-0115.1 425115	Ø 282,5 25 23 V	
			←	3B-X-124108→; → 09/00; +PR 1LB,1LE,1ZC	24.0325-0115.1 525115	Ø 282,5 25 23 V	
			←	10/00→; +PR 1LT	24.0125-0171.1 425171	Ø 288 25 23 V	
			→	+PR 1KD;1KF	24.0125-0172.1 425172	Ø 312 25 23 V	
			→	+PR 1KD;1KF	24.0110-0224.1 410224	Ø 245 10 8	
			→	+PR 1KE	24.0310-0224.1 510224	Ø 245 10 8	
			→	+PR 1KE	24.0122-0221.1 422221	Ø 256 22 20 V	
			→	+PR 1KW	24.0122-0222.1 422222	Ø 269 22 20 V	
2.5 TDI	110	07/98→11/00	←	08/98→ 09/00; +PR 1LB,1LE,1ZC	24.0125-0171.1 425171	Ø 288 25 23 V	
			←	10/00→; +PR 1LT	24.0325-0171.1 525171	Ø 288 25 23 V	
			←	10/00→; +PR 1LT	24.0125-0172.1 425172	Ø 312 25 23 V	
			→	08/98→; +PR 1KD,1KE,1KF,1KW	24.0325-0172.1 525172	Ø 312 25 23 V	
			→	+PR 1KD,1KE,1KF,1KW	24.0110-0201.1 410201	Ø 245 10 8	
			→	+PR 1KW	24.0310-0201.1 510201	Ø 245 10 8	
2.5 TDI Syncro/4motion	110	12/98→11/00	←	→ 09/00; +PR 1LB,1LE,1ZC	24.0125-0171.1 425171	Ø 288 25 23 V	
			←	10/00→; +PR 1LT	24.0325-0171.1 525171	Ø 288 25 23 V	
			←	10/00→; +PR 1LT	24.0125-0172.1 425172	Ø 312 25 23 V	
			→	+PR 1KD;1KF	24.0325-0172.1 525172	Ø 312 25 23 V	
			→	+PR 1KD;1KF	24.0110-0224.1 410224	Ø 245 10 8	
			→	+PR 1KE	24.0310-0224.1 510224	Ø 245 10 8	
			→	+PR 1KE	24.0122-0221.1 422221	Ø 256 22 20 V	
			→	+PR 1KW	24.0122-0222.1 422222	Ø 269 22 20 V	
2.8 Syncro	132	05/97→09/99	←	→ 3B-X-124107; +PR 1LB,1ZC	24.0125-0115.1 425115	Ø 282,5 25 23 V	
			←	3B-X-124108→; +PR 1LB,1LE,1ZC	24.0325-0115.1 525115	Ø 282,5 25 23 V	
			→	+PR 1KD;1KF	24.0125-0171.1 425171	Ø 288 25 23 V	
			→	+PR 1KD;1KF	24.0110-0224.1 410224	Ø 245 10 8	
			→	+PR 1KE	24.0310-0224.1 510224	Ø 245 10 8	
			→	+PR 1KE	24.0122-0221.1 422221	Ø 256 22 20 V	
			→	+PR 1KW	24.0122-0222.1 422222	Ø 269 22 20 V	
			→	+PR 1KW	24.0122-0222.1 422222	Ø 269 22 20 V	
↓							

	kw			 	! #					
<b>VW - PASSAT (3B2) 08/96→12/01</b>										
 <b>Bremsscheibe</b>										
2.8 V6	132	05/97→09/99	←	→ 3B-X-124107; für Canada/GUS	24.0125-0115.1	425115	Ø 282,5 25 23 V			
					24.0325-0115.1	525115	Ø 282,5 25 23 V			
			←	3B-X-124108→; für Canada/GUS	24.0125-0171.1	425171	Ø 288 25 23 V			
			→	nicht China/GUS	24.0110-0201.1	410201	Ø 245 10 8			
				24.0310-0201.1	510201	Ø 245 10 8				
2.8 V6 2.8 V6	140 142	09/99→11/00 08/96→11/00	←	→ 3B-X-124107; +PR 1LB,1ZC	24.0125-0115.1	425115	Ø 282,5 25 23 V			
					24.0325-0115.1	525115	Ø 282,5 25 23 V			
			←	3B-X-124108→; → 09/00; +PR 1LB,1LE,1ZC	24.0125-0171.1	425171	Ø 288 25 23 V			
			←	10/00→; +PR 1LT	24.0125-0172.1	425172	Ø 312 25 23 V			
			→	+PR 1KD,1KE,1KF,1KW	24.0110-0201.1	410201	Ø 245 10 8			
				24.0310-0201.1	510201	Ø 245 10 8				
2.8 V6 4motion 2.8 V6 Syncro/4motion	140 142	09/99→11/00 10/96→11/00	←	→ 3B-X-124107; +PR 1LB,1ZC	24.0125-0115.1	425115	Ø 282,5 25 23 V			
					24.0325-0115.1	525115	Ø 282,5 25 23 V			
			←	3B-X-124108→; → 09/00; +PR 1LB,1LE,1ZC	24.0125-0171.1	425171	Ø 288 25 23 V			
			←	10/00→; +PR 1LT	24.0125-0172.1	425172	Ø 312 25 23 V			
			→	+PR 1KD;1KF	24.0110-0224.1	410224	Ø 245 10 8			
					24.0310-0224.1	510224	Ø 245 10 8			
			→	+PR 1KE	24.0122-0221.1	422221	Ø 256 22 20 V			
				24.0122-0222.1	422222	Ø 269 22 20 V				
<b>VW - PASSAT (3B3) 10/00→12/05</b>										
 <b>Bremsbelagsatz, Scheibenbremse</b>										
1.6	75	11/00→05/05	←	→ 3B-X-600000; +PR 1LZ,1ZJ	13.0460-2822.2	602822	TRW 21945 19,6 - WK			
			←	→ 3B-X-600000; +PR 1LB,1ZC	13.0460-7077.2	607077	ATE 20676 19,8 - WE / - WK			
			←	3B-Y-000001→; +PR 1LB,1ZC	13.0460-7110.2	607110	ATE 20676 19,8 + WK			
					13.0470-7110.2	LD7110	ATE 20676 19,8 + WK Ceramic			
			←	3B-Y-000001→; +PR 1LE, 1LT	13.0460-7110.2	607110	ATE 20676 19,8 + WK			
					13.0470-7110.2	LD7110	ATE 20676 19,8 + WK Ceramic			
			→	+PR 1KD,1KE,1KF,1KW	13.0460-2787.2	602787	TRW 23554 17,3 - WK / - WE			
					13.0460-2820.2	602820	TRW 20961 17,2 - WK			
					13.0470-2820.2	LD2820	TRW 20961 17,2 - WK Ceramic			
1.8 T 1.8 T 20V 2.3 V5 2.3 V5 4motion 2.5 TDI 2.5 TDI 2.5 TDI 4motion 2.5 TDI 4motion 2.8 2.8 2.8 4motion 2.8 4motion	125 110 125 125 110 120 110 132 140 142 140 142	02/01→05/05 11/00→05/05 11/00→05/05 11/00→05/05 11/00→05/05 05/03→05/05 11/00→05/05 01/03→05/05 10/00→05/05 05/02→05/03 10/00→05/05 11/00→05/05	←	→ 3B-X-600000; +PR 1LB,1ZC	13.0460-7077.2	607077	ATE 20676 19,8 - WE / - WK			
			←	3B-Y-000001→; +PR 1LB,1ZC	13.0460-7110.2	607110	ATE 20676 19,8 + WK			
					13.0470-7110.2	LD7110	ATE 20676 19,8 + WK Ceramic			
			←	3B-Y-000001→; +PR 1LE, 1LT	13.0460-7110.2	607110	ATE 20676 19,8 + WK			
					13.0470-7110.2	LD7110	ATE 20676 19,8 + WK Ceramic			
			→	+PR 1KD,1KE,1KF,1KW	13.0460-2787.2	602787	TRW 23554 17,3 - WK / - WE			
					13.0460-2820.2	602820	TRW 20961 17,2 - WK			
					13.0470-2820.2	LD2820	TRW 20961 17,2 - WK Ceramic			
			1.8 T 4motion	125	03/01→05/05	←	→ 3B-X-600000; +PR 1LZ,1ZJ	13.0460-2822.2	602822	TRW 21945 19,6 - WK
						←	→ 3B-X-600000; +PR 1LB,1ZC	13.0460-7077.2	607077	ATE 20676 19,8 - WE / - WK
						←	3B-Y-000001→; +PR 1LE,1LT	13.0460-7110.2	607110	ATE 20676 19,8 + WK
		13.0470-7110.2				LD7110	ATE 20676 19,8 + WK Ceramic			
			←	3B-Y-000001→; +PR 1LB,1ZC	13.0460-7110.2	607110	ATE 20676 19,8 + WK			
					13.0470-7110.2	LD7110	ATE 20676 19,8 + WK Ceramic			
1.9 TDI 1.9 TDI 1.9 TDI 4motion 2.0 2.0 4motion 2.0 TDI	74 96 96 85 85 100	11/00→05/05 11/00→05/05 11/00→05/05 11/00→05/05 11/00→05/05 12/03→05/05	←	+PR 1LE, 1LT	13.0460-7110.2	607110	ATE 20676 19,8 + WK			
					13.0470-7110.2	LD7110	ATE 20676 19,8 + WK Ceramic			
			←	+PR 1LB,1ZC	13.0460-7110.2	607110	ATE 20676 19,8 + WK			
					13.0470-7110.2	LD7110	ATE 20676 19,8 + WK Ceramic			
			→	+PR 1KD,1KE,1KF,1KW	13.0460-2787.2	602787	TRW 23554 17,3 - WK / - WE			
					13.0460-2820.2	602820	TRW 20961 17,2 - WK			
					13.0470-2820.2	LD2820	TRW 20961 17,2 - WK Ceramic			
2.0	96	11/01→05/05	←	05/02→; +PR 1LE, 1LT	13.0460-7110.2	607110	ATE 20676 19,8 + WK			
					13.0470-7110.2	LD7110	ATE 20676 19,8 + WK Ceramic			
			←	05/02→; +PR 1LB,1ZC	13.0460-7110.2	607110	ATE 20676 19,8 + WK			
					13.0470-7110.2	LD7110	ATE 20676 19,8 + WK Ceramic			
			→	05/02→; +PR 1KD,1KE,1KF,1KW	13.0460-2787.2	602787	TRW 23554 17,3 - WK / - WE			
					13.0460-2820.2	602820	TRW 20961 17,2 - WK			



	kw			 	! #		
<b>VW - PASSAT (3B3) 10/00→12/05</b>							
<b> Bremsbelagsatz, Scheibenbremse</b>							
2.0	96	11/01→05/05	➡	05/02→; +PR 1KD,1KE,1KF,1KW		<b>13.0470-2820.2 LD2820</b>	TRW 20961 17,2 - WK Ceramic
4.0 W8 4motion	202	09/01→09/04	⬅	+PR 1ZF,1ZG; für gepanzerte Fahrzeuge		<b>13.0460-2875.2 602875</b>	TRW 23119 17,5 + WK
			⬅	+PR 1ZF,1ZG; nicht für gepanzerte Fahrzeuge		<b>13.0460-7183.2 607183</b>	ATE 21484 20,5 + WE / - WK
			➡	+PR 1KD,1KE,1KF,1KW		<b>13.0460-2787.2 602787</b> <b>13.0460-2820.2 602820</b> <b>13.0470-2820.2 LD2820</b>	TRW 23554 17,3 - WK / - WE TRW 20961 17,2 - WK TRW 20961 17,2 - WK Ceramic
<b>Warnkontakt, Bremsbelagverschleiß</b>							
4.0 W8 4motion	202	09/01→09/04	⬅	+PR 1ZF,1ZG; nicht für gepanzerte Fahrzeuge	1	<b>24.8190-0107.2 620107</b>	L= 235
<b>Zubehörsatz, Scheibenbremsbelag</b>							
1.6	75	11/00→05/05	➡	+PR 1KD,1KE,1KF,1KW		<b>13.0460-0072.2 610072</b>	TRW
1.8 T	125	02/01→05/05					
1.8 T 20V	110	11/00→05/05					
1.9 TDI	74	11/00→05/05					
1.9 TDI	96	11/00→05/05					
1.9 TDI 4motion	96	11/00→05/05					
2.0	85	11/00→05/05					
2.0 4motion	85	11/00→05/05					
2.0 TDI	100	12/03→05/05					
2.3 V5	125	11/00→05/05					
2.3 V5 4motion	125	11/00→05/05					
2.5 TDI	110	11/00→05/05					
2.5 TDI	120	05/03→05/05					
2.5 TDI 4motion	110	11/00→05/05					
2.5 TDI 4motion	132	01/03→05/05					
2.8	140	10/00→05/05					
2.8	142	05/02→05/03					
2.8 4motion	140	10/00→05/05					
2.8 4motion	142	11/00→05/05					
4.0 W8 4motion	202	09/01→09/04					
2.0	96	11/01→05/05	➡	05/02→; +PR 1KD,1KE,1KF,1KW		<b>13.0460-0072.2 610072</b>	TRW
<b> Bremsscheibe</b>							
1.6	75	11/00→05/05	⬅	→ 3B-X-124107; +PR 1LB,1ZC		<b>24.0125-0115.1 425115</b>	Ø 282,5 25 23 V
1.8 T	125	02/01→05/05				<b>24.0325-0115.1 525115</b>	Ø 282,5 25 23 V
1.8 T 20V	110	11/00→05/05	⬅	3B-X-124108→; +PR 1LB,1LE,1ZC		<b>24.0125-0171.1 425171</b> <b>24.0325-0171.1 525171</b>	Ø 288 25 23 V Ø 288 25 23 V
			➡	+PR 1KD,1KE,1KF,1KW		<b>24.0110-0201.1 410201</b> <b>24.0310-0201.1 510201</b>	Ø 245 10 8 Ø 245 10 8
1.8 T 4motion	125	03/01→05/05	⬅	→ 3B-X-124107; +PR 1LB,1ZC		<b>24.0125-0115.1 425115</b> <b>24.0325-0115.1 525115</b>	Ø 282,5 25 23 V Ø 282,5 25 23 V
			⬅	3B-X-124108→; +PR 1LB,1LE,1ZC		<b>24.0125-0171.1 425171</b> <b>24.0325-0171.1 525171</b>	Ø 288 25 23 V Ø 288 25 23 V
			➡	+PR 1KD;1KF		<b>24.0110-0224.1 410224</b> <b>24.0310-0224.1 510224</b>	Ø 245 10 8 Ø 245 10 8
			➡	+PR 1KE		<b>24.0122-0221.1 422221</b>	Ø 256 22 20 V
			➡	+PR 1KW		<b>24.0122-0222.1 422222</b>	Ø 269 22 20 V
1.9 TDI	74	11/00→05/05	⬅	+PR 1LB,1LE,1ZC		<b>24.0125-0171.1 425171</b>	Ø 288 25 23 V
1.9 TDI	96	11/00→05/05				<b>24.0325-0171.1 525171</b>	Ø 288 25 23 V
2.0	85	11/00→05/05	➡	+PR 1KD,1KE,1KF,1KW		<b>24.0110-0201.1 410201</b> <b>24.0310-0201.1 510201</b>	Ø 245 10 8 Ø 245 10 8
1.9 TDI 4motion 2.0 4motion	96 85	11/00→05/05 11/00→05/05	⬅	+PR 1LB,1LE,1ZC		<b>24.0125-0171.1 425171</b> <b>24.0325-0171.1 525171</b>	Ø 288 25 23 V Ø 288 25 23 V
			➡	+PR 1KD;1KF		<b>24.0110-0224.1 410224</b> <b>24.0310-0224.1 510224</b>	Ø 245 10 8 Ø 245 10 8
			➡	+PR 1KE		<b>24.0122-0221.1 422221</b>	Ø 256 22 20 V
			➡	+PR 1KW		<b>24.0122-0222.1 422222</b>	Ø 269 22 20 V
2.0	96	11/01→05/05	⬅	05/02→; +PR 1LB,1LE,1ZC		<b>24.0125-0171.1 425171</b> <b>24.0325-0171.1 525171</b>	Ø 288 25 23 V Ø 288 25 23 V
			➡	05/02→; +PR 1KD,1KE,1KF,1KW		<b>24.0110-0201.1 410201</b> <b>24.0310-0201.1 510201</b>	Ø 245 10 8 Ø 245 10 8
2.0 TDI	100	12/03→05/05	⬅	+PR 1LB,1LE,1ZC		<b>24.0125-0171.1 425171</b> <b>24.0325-0171.1 525171</b>	Ø 288 25 23 V Ø 288 25 23 V
			⬅	+PR 1LT		<b>24.0125-0172.1 425172</b>	Ø 312 25 23 V
↓							









	kw			 	! #		
<b>VW - PASSAT (3B3) 10/00→12/05</b>							
<b>Bremsscheibe</b>							
2.0 TDI	100	12/03→05/05	←	+PR 1LT	24.0325-0172.1	525172	Ø 312 25 23 V
			→	+PR 1KD,1KE,1KF,1KW	24.0110-0201.1	410201	Ø 245 10 8
2.3 V5 2.8 2.8	125 140 142	11/00→05/05 10/00→05/05 05/02→05/03	←	→ 3B-X-124107; +PR 1LB,1ZC	24.0125-0115.1	425115	Ø 282,5 25 23 V
			←	+PR 1LT	24.0325-0115.1	525115	Ø 282,5 25 23 V
			→	+PR 1KD,1KE,1KF,1KW	24.0110-0201.1	410201	Ø 245 10 8
			→	+PR 1KE	24.0310-0201.1	510201	Ø 245 10 8
2.3 V5 4motion 2.8 4motion 2.8 4motion	125 140 142	11/00→05/05 10/00→05/05 11/00→05/05	←	→ 3B-X-124107; +PR 1LB,1ZC	24.0125-0115.1	425115	Ø 282,5 25 23 V
			←	+PR 1LT	24.0325-0115.1	525115	Ø 282,5 25 23 V
			→	+PR 1KD;1KF	24.0110-0224.1	410224	Ø 245 10 8
			→	+PR 1KE	24.0310-0224.1	510224	Ø 245 10 8
			→	+PR 1KE	24.0122-0221.1	422221	Ø 256 22 20 V
			→	+PR 1KW	24.0122-0222.1	422222	Ø 269 22 20 V
2.5 TDI 2.5 TDI	110 120	11/00→05/05 05/03→05/05	←	+PR 1LT	24.0125-0172.1	425172	Ø 312 25 23 V
			→	+PR 1KD,1KE,1KF,1KW	24.0325-0172.1	525172	Ø 312 25 23 V
			→	+PR 1KD,1KE,1KF,1KW	24.0110-0201.1	410201	Ø 245 10 8
2.5 TDI 4motion 2.5 TDI 4motion	110 132	11/00→05/05 01/03→05/05	←	+PR 1LT	24.0310-0201.1	510201	Ø 245 10 8
			←	+PR 1LT	24.0125-0172.1	425172	Ø 312 25 23 V
			→	+PR 1KD;1KF	24.0325-0172.1	525172	Ø 312 25 23 V
			→	+PR 1KD;1KF	24.0110-0224.1	410224	Ø 245 10 8
4.0 W8 4motion	202	09/01→09/04	→	+PR 1KE	24.0310-0224.1	510224	Ø 245 10 8
			→	+PR 1KE	24.0122-0221.1	422221	Ø 256 22 20 V
			→	+PR 1KW	24.0122-0222.1	422222	Ø 269 22 20 V
			→	+PR 1KW	24.0122-0222.1	422222	Ø 269 22 20 V







**VW - PASSAT (3C2) 03/05→12/10**

**Bremsbelagsatz, Scheibenbremse**









1.4 TSI 1.8 TSI	90 118	05/07→07/10 05/07→07/10	←	10/07→; +PR 1LJ,1LH,1ZG,1ZM	13.0460-7184.2	607184	ATE 23587 20,6 + WK
			←	10/07→; +PR 1LK,1LM	13.0470-7184.2	LD7184	ATE 23587 20,6 + WK Ceramic
			→	10/07→; +PR 2EA,2EL	13.0460-7200.2	607200	ATE 23801 20,3 + WK
			→	10/07→; +PR 2EA,2EL	13.0470-7200.2	LD7200	ATE 23801 20,3 + WK Ceramic
			→	10/07→; +PR 2EA,2EL	13.0460-2621.2	602621	TRW 24483 16,9 - WE / - WK + Zub
			→	10/07→; +PR 2EA,2EL	13.0460-2887.2	602887	TRW 23914 17,1 + WE / - WK + Zub
1.4 TSI EcoFuel 1.6 1.6 FSI 1.6 TDI 1.8 TSI 1.9 TDI 2.0 FSI 2.0 FSI 2.0 FSI 2.0 FSI 4motion 2.0 TDI 2.0 TDI 2.0 TDI	110 75 85 77 112 77 110 125 147 110 81 88 90 103	01/09→07/10 05/05→07/10 03/05→06/08 08/09→07/10 11/09→07/10 03/05→07/10 03/05→07/10 08/07→07/10 07/05→07/10 09/05→07/10 11/08→07/10 11/05→05/07 08/05→07/06 03/05→05/09	←	+PR 1LJ,1LH,1ZG,1ZM	13.0460-2621.2	LD2621	TRW 24483 16,9 - WE / - WK + Zub Ceramic
			←	+PR 1LJ,1LH,1ZG,1ZM	13.0460-2887.2	602887	TRW 23914 17,1 + WE / - WK + Zub
			←	+PR 1LK,1LM	13.0470-2621.2	LD2621	TRW 24483 16,9 - WE / - WK + Zub Ceramic
			←	+PR 1LK,1LM	13.0470-2887.2	LD2887	TRW 23914 17,1 + WE / - WK + Zub Ceramic
			→	+PR 1KU,1KW	13.0460-2749.2	602749	TRW 24483 16,9 - WE / - WK + Zub
			→	+PR 1KU,1KW	13.0460-2880.2	602880	TRW 23914 17,1 + WE / - WK + Zub
			→	+PR 1KU,1KW	13.0470-2749.2	LD2749	TRW 24483 16,9 - WE / - WK + Zub Ceramic
			→	+PR 1KU,1KW	13.0470-2880.2	LD2880	TRW 23914 17,1 + WE / - WK + Zub Ceramic
			→	+PR 1LJ,1LH,1ZG,1ZM	13.0460-7184.2	607184	ATE 23587 20,6 + WK
			→	+PR 1LJ,1LH,1ZG,1ZM	13.0470-7184.2	LD7184	ATE 23587 20,6 + WK Ceramic























	kw			 	! #		
<b>VW - PASSAT (3C2) 03/05→12/10</b>							
<b> Bremsbelagsatz, Scheibenbremse</b>							
2.0 TDI	120	08/05→05/09	➡	+PR 2EA,2EL		13.0470-2887.2 LD2887	TRW 23914 17,1 + WE / - WK + Zub Ceramic
2.0 TDI	125	08/05→07/10					
2.0 TDI 16V	103	03/05→07/10					
2.0 TDI 4motion	103	03/05→05/09	➡	+PR 1KU,1KW		13.0460-2749.2 602749	TRW 24483 16,9 - WE / - WK + Zub
2.0 TDI 4motion	125	05/09→07/10					
3.2 FSI 4motion	184	11/05→07/10				13.0460-2880.2 602880	TRW 23914 17,1 + WE / - WK + Zub
3.6 R36 4motion	220	04/07→07/10				13.0470-2749.2 LD2749	TRW 24483 16,9 - WE / - WK + Zub Ceramic
						13.0470-2880.2 LD2880	TRW 23914 17,1 + WE / - WK + Zub Ceramic
2.0 BlueTDI	105	01/09→11/10	⬅	+PR 1LJ,1LH,1ZG,1ZM; → 07/10		13.0460-7184.2 607184	ATE 23587 20,6 + WK
2.0 TDI	100	03/05→11/10				13.0470-7184.2 LD7184	ATE 23587 20,6 + WK Ceramic
2.0 TDI 16V 4motion	103	03/05→08/10					
			⬅	+PR 1LK,1LM; → 07/10		13.0460-7200.2 607200	ATE 23801 20,3 + WK
						13.0470-7200.2 LD7200	ATE 23801 20,3 + WK Ceramic
			➡	→ 07/10; +PR 2EA,2EL		13.0460-2621.2 602621	TRW 24483 16,9 - WE / - WK + Zub
						13.0460-2887.2 602887	TRW 23914 17,1 + WE / - WK + Zub
						13.0470-2621.2 LD2621	TRW 24483 16,9 - WE / - WK + Zub Ceramic
						13.0470-2887.2 LD2887	TRW 23914 17,1 + WE / - WK + Zub Ceramic
			➡	→ 07/10; +PR 1KU,1KW		13.0460-2749.2 602749	TRW 24483 16,9 - WE / - WK + Zub
						13.0460-2880.2 602880	TRW 23914 17,1 + WE / - WK + Zub
						13.0470-2749.2 LD2749	TRW 24483 16,9 - WE / - WK + Zub Ceramic
						13.0470-2880.2 LD2880	TRW 23914 17,1 + WE / - WK + Zub Ceramic
<b>Zubehörsatz, Scheibenbremsbelag</b>							
1.4 TSI	90	05/07→07/10	➡	10/07→; +PR 2EA,2EL		13.0460-0035.2 610035	
1.8 TSI	118	05/07→07/10	➡	10/07→; +PR 1KU,1KW		13.0460-0259.2 610259	
1.4 TSI EcoFuel	110	01/09→07/10	➡	+PR 2EA,2EL		13.0460-0035.2 610035	
1.6	75	05/05→07/10					
1.6 FSI	85	03/05→06/08	➡	+PR 1KU,1KW		13.0460-0259.2 610259	
1.6 TDI	77	08/09→07/10					
1.8 TSI	112	11/09→07/10					
1.9 TDI	77	03/05→07/10					
2.0 FSI	110	03/05→07/10					
2.0 FSI	125	08/07→07/10					
2.0 FSI	147	07/05→07/10					
2.0 FSI 4motion	110	09/05→07/10					
2.0 TDI	81	11/08→07/10					
2.0 TDI	88	11/05→05/07					
2.0 TDI	90	08/05→07/06					
2.0 TDI	103	03/05→05/09					
2.0 TDI	120	08/05→05/09					
2.0 TDI	125	08/05→07/10					
2.0 TDI 16V	103	03/05→07/10					
2.0 TDI 4motion	103	03/05→05/09					
2.0 TDI 4motion	125	05/09→07/10					
3.2 FSI 4motion	184	11/05→07/10					
3.6 R36 4motion	220	04/07→07/10					
2.0 BlueTDI	105	01/09→11/10	➡	→ 07/10; +PR 2EA,2EL		13.0460-0035.2 610035	
2.0 TDI	100	03/05→11/10					
2.0 TDI 16V 4motion	103	03/05→08/10	➡	→ 07/10; +PR 1KU,1KW		13.0460-0259.2 610259	
<b> Bremsscheibe</b>							
1.4 TSI	90	05/07→07/10	⬅	10/07→; +PR 1LJ,1LH,1ZG,1ZM		24.0125-0158.1 425158	Ø 312 25 22 V + S
1.8 TSI	118	05/07→07/10				24.0325-0158.1 525158	Ø 312 25 22 V + S
			⬅	10/07→; +PR 1LK,1LM		24.0130-0115.1 430115	Ø 345 30 27 V
						24.0330-0115.1 530115	Ø 345 30 27 V
			➡	10/07→; +PR 1KU,1KW		24.0112-0169.1 412169	Ø 282 12 10 + S
						24.0312-0169.1 512169	Ø 282 12 10 + S
			➡	10/07→; +PR 2EA,2EL; + eFSB		24.0122-0219.1 422219	Ø 310 22 20 V
1.4 TSI EcoFuel	110	01/09→07/10	⬅	+PR 1LJ,1LH,1ZG,1ZM		24.0125-0158.1 425158	Ø 312 25 22 V + S
1.6	75	05/05→07/10				24.0325-0158.1 525158	Ø 312 25 22 V + S
1.6 FSI	85	03/05→06/08					
1.6 TDI	77	08/09→07/10	⬅	+PR 1LK,1LM		24.0130-0115.1 430115	Ø 345 30 27 V
1.8 TSI	112	11/09→07/10				24.0330-0115.1 530115	Ø 345 30 27 V
1.9 TDI	77	03/05→07/10					

	kw			 	! #		
<b>VW - PASSAT (3C2) 03/05→12/10</b>							
<b>Bremsscheibe</b>							
2.0 FSI	110	03/05→07/10	➔	+PR 1KU,1KW		24.0112-0169.1 412169	Ø 282 12 10 + S
2.0 FSI	125	08/07→07/10				24.0312-0169.1 512169	Ø 282 12 10 + S
2.0 FSI	147	07/05→07/10					
2.0 FSI 4motion	110	09/05→07/10	➔	+PR 2EA,2EL; + eFSB		24.0122-0219.1 422219	Ø 310 22 20 V
2.0 TDI	81	11/08→07/10					
2.0 TDI	88	11/05→05/07					
2.0 TDI	90	08/05→07/06					
2.0 TDI	103	03/05→05/09					
2.0 TDI	120	08/05→05/09					
2.0 TDI	125	08/05→07/10					
2.0 TDI 16V	103	03/05→07/10					
2.0 TDI 4motion	103	03/05→05/09					
2.0 TDI 4motion	125	05/09→07/10					
3.2 FSI 4motion	184	11/05→07/10					
3.6 R36 4motion	220	04/07→07/10					
2.0 BlueTDI	105	01/09→11/10	➔	→ 07/10; +PR 1LJ,1LH,1ZG,1ZM		24.0125-0158.1 425158	Ø 312 25 22 V + S
2.0 TDI	100	03/05→11/10				24.0325-0158.1 525158	Ø 312 25 22 V + S
2.0 TDI 16V 4motion	103	03/05→08/10	➔	→ 07/10; +PR 1LK,1LM		24.0130-0115.1 430115	Ø 345 30 27 V
			➔	→ 07/10; +PR 1LK,1LM		24.0330-0115.1 530115	Ø 345 30 27 V
			➔	→ 07/10; +PR 1KU,1KW		24.0112-0169.1 412169	Ø 282 12 10 + S
			➔	→ 07/10; +PR 1KU,1KW		24.0312-0169.1 512169	Ø 282 12 10 + S
			➔	→ 07/10; +PR 2EA,2EL; + eFSB		24.0122-0219.1 422219	Ø 310 22 20 V
<b>VW - PASSAT (3G2) 08/14→</b>							
<b>Brembelagsatz, Scheibenbremse</b>							
1.4 GTE Hybrid	115	06/15→	➔	+PR 1ZA,1ZC,1ZD,1ZG / 1ZK,1ZL		13.0460-2785.2 602785	TRW 25683 20,4 + WE / + WK
1.4 TSI	92	11/14→				13.0470-2785.2 LD2785	TRW 25683 20,4 + WE / + WK Ceramic
1.4 TSI	110	11/14→					
1.4 TSI 4motion	110	02/15→	➔	+PR 1KU,1KZ,2EA; + eFSB		13.0460-7294.2 607294	ATE 25009 16,4 - WE / - WK
1.8 TSI	132	02/15→				13.0470-7294.2 LD7294	ATE 25009 16,4 - WE / - WK Ceramic
2.0 TDI	81	01/16→					
2.0 TDI	110	11/14→					
2.0 TDI	135	07/15→					
2.0 TDI	140	11/14→					
2.0 TDI 4motion	110	02/15→					
2.0 TDI 4motion	140	11/14→					
2.0 TSI 4motion	206	05/15→					
1.6 TDI	88	08/14→	➔	11/14→; +PR 1ZA,1ZC,1ZD,1ZG / 1ZK,1ZL		13.0460-2785.2 602785	TRW 25683 20,4 + WE / + WK
2.0 TDI 4motion	176	08/14→				13.0470-2785.2 LD2785	TRW 25683 20,4 + WE / + WK Ceramic
			➔	11/14→; +PR 1KU,1KZ,2EA; + eFSB		13.0460-7294.2 607294	ATE 25009 16,4 - WE / - WK
						13.0470-7294.2 LD7294	ATE 25009 16,4 - WE / - WK Ceramic
2.0 TSI	162	02/15→	➔	05/15→; +PR 1ZA,1ZC,1ZD,1ZG / 1ZK,1ZL		13.0460-2785.2 602785	TRW 25683 20,4 + WE / + WK
						13.0470-2785.2 LD2785	TRW 25683 20,4 + WE / + WK Ceramic
			➔	05/15→; +PR 1KU,1KZ,2EA; + eFSB		13.0460-7294.2 607294	ATE 25009 16,4 - WE / - WK
						13.0470-7294.2 LD7294	ATE 25009 16,4 - WE / - WK Ceramic
<b>Warnkontakt, Bremsbelagsverschleiß</b>							
1.4 GTE Hybrid	115	06/15→	➔	+PR 1ZA,1ZC,1ZD,1ZG / 1ZK,1ZL	1	24.8190-0065.2 620065	L= 172
1.4 TSI	92	11/14→	➔	+PR 1LA	1	24.8190-0065.2 620065	L= 172
1.4 TSI	110	11/14→					
1.4 TSI 4motion	110	02/15→					
1.8 TSI	132	02/15→					
2.0 TDI	81	01/16→					
2.0 TDI	110	11/14→					
2.0 TDI	135	07/15→					
2.0 TDI	140	11/14→					
2.0 TDI 4motion	110	02/15→					
2.0 TDI 4motion	140	11/14→					
2.0 TSI 4motion	206	05/15→					
1.6 TDI	88	08/14→	➔	11/14→; +PR 1LA	1	24.8190-0065.2 620065	L= 172
2.0 TDI 4motion	176	08/14→	➔	11/14→; +PR 1ZA,1ZC,1ZD,1ZG / 1ZK,1ZL	1	24.8190-0065.2 620065	L= 172
2.0 TSI	162	02/15→	➔	05/15→; +PR 1LA	1	24.8190-0065.2 620065	L= 172
			➔	05/15→; +PR 1ZA,1ZC,1ZD,1ZG / 1ZK,1ZL	1	24.8190-0065.2 620065	L= 172
<b>Bremsscheibe</b>							
1.4 GTE Hybrid	115	06/15→	➔	+PR 1ZA,1ZC,1ZD,1ZG / 1ZK,1ZL		24.0125-0158.1 425158	Ø 312 25 22 V + S
1.4 TSI	92	11/14→				24.0325-0158.1 525158	Ø 312 25 22 V + S
1.4 TSI	110	11/14→					
↓							



	kw			 	! #		
<b>VW - PASSAT (3G2) 08/14→</b>							
 <b>Bremsscheibe</b>							
1.4 TSI 4motion	110	02/15→	←	+PR 1LA		24.0130-0225.1 430225	Ø 340 30 27 V + S
1.8 TSI	132	02/15→	→	+PR 1KU,2EA; + eFSB		24.0112-0210.1 412210	Ø 300 12 10 + S
2.0 TDI	81	01/16→	→	+PR 1KZ		24.0122-0219.1 422219	Ø 310 22 20 V
2.0 TDI	110	11/14→					
2.0 TDI	135	07/15→					
2.0 TDI	140	11/14→					
2.0 TDI 4motion	110	02/15→					
2.0 TDI 4motion	140	11/14→					
2.0 TSI 4motion	206	05/15→					
1.6 TDI	88	08/14→	←	11/14→; +PR 1ZA,1ZC,1ZD,1ZG / 1ZK,1ZL		24.0125-0158.1 425158	Ø 312 25 22 V + S
2.0 TDI 4motion	176	08/14→	←	11/14→; +PR 1LA		24.0130-0225.1 430225	Ø 340 30 27 V + S
			→	11/14→; +PR 1KU,2EA; + eFSB		24.0112-0210.1 412210	Ø 300 12 10 + S
			→	11/14→; +PR 1KZ		24.0122-0219.1 422219	Ø 310 22 20 V
2.0 TSI	162	02/15→	←	05/15→; +PR 1ZA,1ZC,1ZD,1ZG / 1ZK,1ZL		24.0125-0158.1 425158	Ø 312 25 22 V + S
			←	05/15→; +PR 1LA		24.0130-0225.1 430225	Ø 340 30 27 V + S
			→	05/15→; +PR 1KU,2EA; + eFSB		24.0112-0210.1 412210	Ø 300 12 10 + S
			→	05/15→; +PR 1KZ		24.0122-0219.1 422219	Ø 310 22 20 V
<b>VW - PASSAT (362) 08/10→12/14</b>							
 <b>Bremsbelagsatz, Scheibenbremse</b>							
1.4 TSI	90	08/10→12/14	←	→ 10/14; +PR 1LA,1LB		13.0460-2764.2 602764	TRW 24738 20,0 + WK
1.4 TSI EcoFuel	110	08/10→12/14				13.0470-2764.2 LD2764	TRW 24738 20,0 + WK Ceramic
1.4 TSI MultiFuel	118	11/10→12/14	←	→ 10/14; +PR 1ZM,1ZG		13.0460-7184.2 607184	ATE 23587 20,6 + WK
1.6 TDI	77	08/10→12/14				13.0470-7184.2 LD7184	ATE 23587 20,6 + WK Ceramic
1.8 TSI	112	02/11→12/14					
1.8 TSI	118	08/10→12/14	→	→ 10/14; +PR 2EA		13.0460-2621.2 602621	TRW 24483 16,9 - WE / - WK + Zub
2.0 TDI	100	08/10→12/14				13.0460-2887.2 602887	TRW 23914 17,1 + WE / - WK + Zub
2.0 TDI	103	08/10→12/14				13.0470-2621.2 LD2621	TRW 24483 16,9 - WE / - WK + Zub Ceramic
2.0 TDI	125	08/10→12/14				13.0470-2887.2 LD2887	TRW 23914 17,1 + WE / - WK + Zub Ceramic
2.0 TDI	130	12/12→12/14					
2.0 TDI 4motion	103	08/10→12/14					
2.0 TDI 4motion	130	01/13→12/14					
2.0 TSI	155	11/10→12/14					
3.6 FSI 4motion	220	01/11→12/14	→	→ 10/14; +PR 1KW		13.0460-2749.2 602749	TRW 24483 16,9 - WE / - WK + Zub
						13.0460-2880.2 602880	TRW 23914 17,1 + WE / - WK + Zub
						13.0470-2749.2 LD2749	TRW 24483 16,9 - WE / - WK + Zub Ceramic
						13.0470-2880.2 LD2880	TRW 23914 17,1 + WE / - WK + Zub Ceramic
1.4 TSI	118	11/12→12/14	←	→ 10/14; +PR 1LA,1LB		13.0460-2764.2 602764	TRW 24738 20,0 + WK
			←	→ 10/14; +PR 1ZM,1ZG		13.0460-7184.2 607184	ATE 23587 20,6 + WK
						13.0470-7184.2 LD7184	ATE 23587 20,6 + WK Ceramic
			→	→ 10/14		13.0460-2621.2 602621	TRW 24483 16,9 - WE / - WK + Zub
						13.0460-2887.2 602887	TRW 23914 17,1 + WE / - WK + Zub
						13.0470-2621.2 LD2621	TRW 24483 16,9 - WE / - WK + Zub Ceramic
						13.0470-2887.2 LD2887	TRW 23914 17,1 + WE / - WK + Zub Ceramic
			→	→ 10/14; +PR 1KW		13.0460-2749.2 602749	TRW 24483 16,9 - WE / - WK + Zub
						13.0460-2880.2 602880	TRW 23914 17,1 + WE / - WK + Zub
						13.0470-2749.2 LD2749	TRW 24483 16,9 - WE / - WK + Zub Ceramic
						13.0470-2880.2 LD2880	TRW 23914 17,1 + WE / - WK + Zub Ceramic
2.0 TDI 4motion	125	08/10→01/13	←	+PR 1LA,1LB		13.0460-2764.2 602764	TRW 24738 20,0 + WK
			←	+PR 1ZM,1ZG		13.0460-7184.2 607184	ATE 23587 20,6 + WK
						13.0470-7184.2 LD7184	ATE 23587 20,6 + WK Ceramic
↓							

	kw			 	! #		
<b>VW - PASSAT (362) 08/10→12/14</b>							
 <b>Bremsbelagsatz, Scheibenbremse</b>							
2.0 TDI 4motion	125	08/10→01/13	➡	+PR 2EA		13.0460-2621.2 602621 13.0460-2887.2 602887 13.0470-2621.2 LD2621 13.0470-2887.2 LD2887	TRW 24483 16,9 - WE / - WK + Zub TRW 23914 17,1 + WE / - WK + Zub TRW 24483 16,9 - WE / - WK + Zub Ceramic TRW 23914 17,1 + WE / - WK + Zub Ceramic
			➡	+PR 1KW		13.0460-2749.2 602749 13.0460-2880.2 602880 13.0470-2749.2 LD2749 13.0470-2880.2 LD2880	TRW 24483 16,9 - WE / - WK + Zub TRW 23914 17,1 + WE / - WK + Zub TRW 24483 16,9 - WE / - WK + Zub Ceramic TRW 23914 17,1 + WE / - WK + Zub Ceramic
 <b>Bremsscheibe</b>							
1.4 TSI	90	08/10→12/14	←	→ 10/14; +PR 1ZM,1ZG		24.0125-0158.1 425158	Ø 312 25 22 V + S
1.4 TSI	118	11/12→12/14				24.0325-0158.1 525158	Ø 312 25 22 V + S
1.4 TSI EcoFuel	110	08/10→12/14					
1.4 TSI MultiFuel	118	11/10→12/14	←	→ 10/14; +PR 1LA,1LB		24.0130-0225.1 430225	Ø 340 30 27 V + S
1.6 TDI	77	08/10→12/14	➡	→ 10/14; +PR 1KW		24.0112-0169.1 412169	Ø 282 12 10 + S
1.8 TSI	112	02/11→12/14				24.0312-0169.1 512169	Ø 282 12 10 + S
1.8 TSI	118	08/10→12/14					
2.0 TDI	100	08/10→12/14	➡	→ 10/14; +PR 2EA; + eFSB		24.0122-0219.1 422219	Ø 310 22 20 V
2.0 TDI	103	08/10→12/14					
2.0 TDI	125	08/10→12/14					
2.0 TDI	130	12/12→12/14					
2.0 TDI 4motion	103	08/10→12/14					
2.0 TDI 4motion	130	01/13→12/14					
2.0 TSI	155	11/10→12/14					
3.6 FSI 4motion	220	01/11→12/14					
2.0 TDI 4motion	125	08/10→01/13	←	+PR 1ZM,1ZG		24.0125-0158.1 425158 24.0325-0158.1 525158	Ø 312 25 22 V + S Ø 312 25 22 V + S
			←	+PR 1LA,1LB		24.0130-0225.1 430225	Ø 340 30 27 V + S
			➡	+PR 1KW		24.0112-0169.1 412169 24.0312-0169.1 512169	Ø 282 12 10 + S Ø 282 12 10 + S
			➡	+PR 2EA; + eFSB		24.0122-0219.1 422219	Ø 310 22 20 V
<b>VW - PASSAT ALLTRACK (3G5) 05/15→</b>							
 <b>Bremsbelagsatz, Scheibenbremse</b>							
1.4 TSI 4motion	110	05/15→	←	+PR 1ZA,1ZC,1ZD,1ZG / 1ZK,1ZL		13.0460-2785.2 602785 13.0470-2785.2 LD2785	TRW 25683 20,4 + WE / + WK TRW 25683 20,4 + WE / + WK Ceramic
2.0 TDI 4motion	110	05/15→					
2.0 TDI 4motion	135	07/15→					
2.0 TDI 4motion	140	05/15→	➡	+PR 1KU,1KZ,2EA; + eFSB		13.0460-7294.2 607294 13.0470-7294.2 LD7294	ATE 25009 16,4 - WE / - WK ATE 25009 16,4 - WE / - WK Ceramic
2.0 TDI 4motion	176	05/15→					
2.0 TSI 4motion	162	07/15→					
<b>Warnkontakt, Bremsbelagverschleiß</b>							
1.4 TSI 4motion	110	05/15→	←	+PR 1ZA,1ZC,1ZD,1ZG / 1ZK,1ZL	1	24.8190-0065.2 620065	L= 172
2.0 TDI 4motion	110	05/15→					
2.0 TDI 4motion	135	07/15→	←	+PR 1LA	1	24.8190-0065.2 620065	L= 172
2.0 TDI 4motion	140	05/15→					
2.0 TDI 4motion	176	05/15→					
2.0 TSI 4motion	162	07/15→					
 <b>Bremsscheibe</b>							
1.4 TSI 4motion	110	05/15→	←	+PR 1ZA,1ZC,1ZD,1ZG / 1ZK,1ZL		24.0125-0158.1 425158 24.0325-0158.1 525158	Ø 312 25 22 V + S Ø 312 25 22 V + S
2.0 TDI 4motion	110	05/15→					
2.0 TDI 4motion	135	07/15→					
2.0 TDI 4motion	140	05/15→	←	+PR 1LA		24.0130-0225.1 430225	Ø 340 30 27 V + S
2.0 TDI 4motion	176	05/15→	➡	+PR 1KU,2EA; + eFSB		24.0112-0210.1 412210	Ø 300 12 10 + S
2.0 TSI 4motion	162	07/15→	➡	+PR 1KZ		24.0122-0219.1 422219	Ø 310 22 20 V
<b>VW - PASSAT ALLTRACK (365) 01/12→12/14</b>							
 <b>Bremsbelagsatz, Scheibenbremse</b>							
1.8 TSI	112	01/12→12/14	←	+PR 1LA,1LB		13.0460-2764.2 602764 13.0470-2764.2 LD2764	TRW 24738 20,0 + WK TRW 24738 20,0 + WK Ceramic
1.8 TSI	118	01/12→12/14					
2.0 TDI	103	01/12→12/14					
2.0 TDI 4motion	103	01/12→12/14	←	+PR 1ZM,1ZG		13.0460-7184.2 607184	ATE 23587 20,6 + WK
2.0 TDI 4motion	125	01/12→12/14					

	kw			 	! #		
<b>VW - PASSAT ALLTRACK (365) 01/12→12/14</b>							
 <b>Bremsbelagsatz, Scheibenbremse</b>							
2.0 TDI 4motion	130	01/13→12/14	←	+PR 1ZM,1ZG		13.0470-7184.2 LD7184	ATE 23587 20,6 + WK Ceramic
2.0 TSI 4motion	155	01/12→12/14	→	+PR 2EA		13.0460-2621.2 602621	TRW 24483 16,9 - WE / - WK + Zub
						13.0460-2887.2 602887	TRW 23914 17,1 + WE / - WK + Zub
						13.0470-2621.2 LD2621	TRW 24483 16,9 - WE / - WK + Zub Ceramic
						13.0470-2887.2 LD2887	TRW 23914 17,1 + WE / - WK + Zub Ceramic
			→	+PR 1KW		13.0460-2749.2 602749	TRW 24483 16,9 - WE / - WK + Zub
						13.0460-2880.2 602880	TRW 23914 17,1 + WE / - WK + Zub
						13.0470-2749.2 LD2749	TRW 24483 16,9 - WE / - WK + Zub Ceramic
						13.0470-2880.2 LD2880	TRW 23914 17,1 + WE / - WK + Zub Ceramic
<b>Bremsscheibe</b>							
1.8 TSI	112	01/12→12/14	←	+PR 1ZM,1ZG		24.0125-0158.1 425158	Ø 312 25 22 V + S
1.8 TSI	118	01/12→12/14				24.0325-0158.1 525158	Ø 312 25 22 V + S
2.0 TDI	103	01/12→12/14					
2.0 TDI 4motion	103	01/12→12/14	←	+PR 1LA,1LB		24.0130-0225.1 430225	Ø 340 30 27 V + S
2.0 TDI 4motion	125	01/12→12/14	→	+PR 1KW		24.0112-0169.1 412169	Ø 282 12 10 + S
2.0 TDI 4motion	130	01/13→12/14				24.0312-0169.1 512169	Ø 282 12 10 + S
2.0 TSI 4motion	155	01/12→12/14	→	+PR 2EA; + eFSB		24.0122-0219.1 422219	Ø 310 22 20 V
<b>VW - PASSAT CC (357) 05/08→01/12</b>							
 <b>Bremsbelagsatz, Scheibenbremse</b>							
1.4 TSI MultiFuel	118	01/11→01/12	←	→ 09/11; +PR 1LA,1LB		13.0460-2764.2 602764	TRW 24738 20,0 + WK
1.8 TSI	118	06/08→01/12				13.0470-2764.2 LD2764	TRW 24738 20,0 + WK Ceramic
2.0 TDI	103	06/08→01/12					
2.0 TDI	125	06/08→01/12	←	→ 09/11; +PR 1LH,1ZM,1ZG		13.0460-7184.2 607184	ATE 23587 20,6 + WK
2.0 TDI 4motion	103	08/09→01/12				13.0470-7184.2 LD7184	ATE 23587 20,6 + WK Ceramic
2.0 TDI 4motion	125	11/09→01/12	←	→ 09/11; +PR 1LK		13.0460-7200.2 607200	ATE 23801 20,3 + WK
2.0 TSI	147	06/08→01/12				13.0470-7200.2 LD7200	ATE 23801 20,3 + WK Ceramic
2.0 TSI	155	11/10→01/12					
3.6 FSI 4motion	206	06/08→01/12	→	→ 09/11; +PR 2EA		13.0460-2621.2 602621	TRW 24483 16,9 - WE / - WK + Zub
						13.0460-2887.2 602887	TRW 23914 17,1 + WE / - WK + Zub
						13.0470-2621.2 LD2621	TRW 24483 16,9 - WE / - WK + Zub Ceramic
						13.0470-2887.2 LD2887	TRW 23914 17,1 + WE / - WK + Zub Ceramic
			→	→ 09/11; +PR 1KU,1KW		13.0460-2749.2 602749	TRW 24483 16,9 - WE / - WK + Zub
						13.0460-2880.2 602880	TRW 23914 17,1 + WE / - WK + Zub
						13.0470-2749.2 LD2749	TRW 24483 16,9 - WE / - WK + Zub Ceramic
						13.0470-2880.2 LD2880	TRW 23914 17,1 + WE / - WK + Zub Ceramic
1.8 TSI	112	11/08→05/10	←	+PR 1LA,1LB		13.0460-2764.2 602764	TRW 24738 20,0 + WK
2.0 BlueTDI	105	05/09→11/10				13.0470-2764.2 LD2764	TRW 24738 20,0 + WK Ceramic
2.0 TDI	100	06/08→05/11					
2.0 TDI	120	05/08→05/11	←	+PR 1LH,1ZM,1ZG		13.0460-7184.2 607184	ATE 23587 20,6 + WK
3.6 FSI 4motion	220	06/08→05/10				13.0470-7184.2 LD7184	ATE 23587 20,6 + WK Ceramic
			←	+PR 1LK		13.0460-7200.2 607200	ATE 23801 20,3 + WK
						13.0470-7200.2 LD7200	ATE 23801 20,3 + WK Ceramic
			→	+PR 2EA		13.0460-2621.2 602621	TRW 24483 16,9 - WE / - WK + Zub
						13.0460-2887.2 602887	TRW 23914 17,1 + WE / - WK + Zub
						13.0470-2621.2 LD2621	TRW 24483 16,9 - WE / - WK + Zub Ceramic
						13.0470-2887.2 LD2887	TRW 23914 17,1 + WE / - WK + Zub Ceramic
			→	+PR 1KU,1KW		13.0460-2749.2 602749	TRW 24483 16,9 - WE / - WK + Zub



**VW - PASSAT CC (357) 05/08→01/12**

**Bremsbelagsatz, Scheibenbremse**

1.8 TSI	112	11/08→05/10	➡	+PR 1KU,1KW		<b>13.0460-2880.2</b>	<b>602880</b>	TRW 23914 17,1 + WE / - WK + Zub
2.0 BlueTDI	105	05/09→11/10						
2.0 TDI	100	06/08→05/11				<b>13.0470-2749.2</b>	<b>LD2749</b>	TRW 24483 16,9 - WE / - WK + Zub Ceramic
2.0 TDI	120	05/08→05/11						
3.6 FSI 4motion	220	06/08→05/10				<b>13.0470-2880.2</b>	<b>LD2880</b>	TRW 23914 17,1 + WE / - WK + Zub Ceramic

**Zubehörsatz, Scheibenbremsbelag**

1.4 TSI MultiFuel	118	01/11→01/12	➡	→ 09/11; +PR 1KU,1KW		<b>13.0460-0259.2</b>	<b>610259</b>	
1.8 TSI	118	06/08→01/12						
2.0 TDI	103	06/08→01/12						
2.0 TDI	125	06/08→01/12						
2.0 TDI 4motion	103	08/09→01/12						
2.0 TDI 4motion	125	11/09→01/12						
2.0 TSI	147	06/08→01/12						
2.0 TSI	155	11/10→01/12						
3.6 FSI 4motion	206	06/08→01/12						
1.8 TSI	112	11/08→05/10	➡	+PR 1KU,1KW		<b>13.0460-0259.2</b>	<b>610259</b>	
2.0 BlueTDI	105	05/09→11/10						
2.0 TDI	100	06/08→05/11						
2.0 TDI	120	05/08→05/11						
3.6 FSI 4motion	220	06/08→05/10						









**Bremsscheibe**







1.4 TSI MultiFuel	118	01/11→01/12	←	→ 09/11; +PR 1LH,1ZM,1ZG		<b>24.0125-0158.1</b>	<b>425158</b>	Ø 312 25 22 V + S
1.8 TSI	118	06/08→01/12				<b>24.0325-0158.1</b>	<b>525158</b>	Ø 312 25 22 V + S
2.0 TDI	103	06/08→01/12						
2.0 TDI	125	06/08→01/12	←	→ 09/11; +PR 1LK		<b>24.0130-0115.1</b>	<b>430115</b>	Ø 345 30 27 V
2.0 TDI 4motion	103	08/09→01/12	←	→ 09/11; +PR 1LA,1LB		<b>24.0130-0225.1</b>	<b>430225</b>	Ø 340 30 27 V + S
2.0 TDI 4motion	125	11/09→01/12						
2.0 TSI	147	06/08→01/12	➡	→ 09/11; +PR 1KU,1KW		<b>24.0112-0169.1</b>	<b>412169</b>	Ø 282 12 10 + S
2.0 TSI	155	11/10→01/12				<b>24.0312-0169.1</b>	<b>512169</b>	Ø 282 12 10 + S
3.6 FSI 4motion	206	06/08→01/12	➡	→ 09/11; +PR 2EA; + eFSB		<b>24.0122-0219.1</b>	<b>422219</b>	Ø 310 22 20 V
1.8 TSI	112	11/08→05/10	←	+PR 1LH,1ZM,1ZG		<b>24.0125-0158.1</b>	<b>425158</b>	Ø 312 25 22 V + S
2.0 BlueTDI	105	05/09→11/10				<b>24.0325-0158.1</b>	<b>525158</b>	Ø 312 25 22 V + S
2.0 TDI	100	06/08→05/11						
2.0 TDI	120	05/08→05/11	←	+PR 1LK		<b>24.0130-0115.1</b>	<b>430115</b>	Ø 345 30 27 V
3.6 FSI 4motion	220	06/08→05/10	←	+PR 1LA,1LB		<b>24.0130-0225.1</b>	<b>430225</b>	Ø 340 30 27 V + S
			➡	+PR 1KU,1KW		<b>24.0112-0169.1</b>	<b>412169</b>	Ø 282 12 10 + S
						<b>24.0312-0169.1</b>	<b>512169</b>	Ø 282 12 10 + S
			➡	+PR 2EA; + eFSB		<b>24.0122-0219.1</b>	<b>422219</b>	Ø 310 22 20 V







**VW - PASSAT Variant (3A5, 35I) 02/88→06/97**









**Bremsbelagsatz, Scheibenbremse**

1.8	55	08/90→05/97	←	10/93→ 12/96		<b>13.0460-2958.2</b>	<b>602958</b>	TRW 20168 19,3 - WK
1.9 TD	55	03/91→05/97	←	→ 10/93		<b>13.0460-2958.2</b>	<b>602958</b>	TRW 20168 19,3 - WK
1.8	66	02/88→05/97	←	10/93→ 12/96		<b>13.0460-2958.2</b>	<b>602958</b>	TRW 20168 19,3 - WK
			←	04/88→ 10/93		<b>13.0460-2958.2</b>	<b>602958</b>	TRW 20168 19,3 - WK
1.8 G60 Syncro	118	08/88→05/97	←	→ 10/93		<b>13.0460-2958.2</b>	<b>602958</b>	TRW 20168 19,3 - WK
			➡	→ 31-P-080000		<b>13.0460-2937.2</b>	<b>602937</b>	TRW 20961 15,2 - WK + Zub
			➡	31-P-080001→; → 10/93		<b>13.0460-2984.2</b>	<b>602984</b>	TRW 20961 17,2 - WK + Zub
1.9 TDI	66	10/93→05/97	←	3A-T-000001→; → 12/96		<b>13.0460-2957.2</b>	<b>602957</b>	TRW 20168 16,0 - WK
			←	→ 3A-S-300000		<b>13.0460-2958.2</b>	<b>602958</b>	TRW 20168 19,3 - WK
			➡	3A-T-000001→; → 12/96		<b>13.0460-2984.2</b>	<b>602984</b>	TRW 20961 17,2 - WK + Zub
1.9 TDI	81	03/96→05/97	←	→ 12/96		<b>13.0460-2958.2</b>	<b>602958</b>	TRW 20168 19,3 - WK
			➡	→ 12/96		<b>13.0460-2984.2</b>	<b>602984</b>	TRW 20961 17,2 - WK + Zub
2.0	79	03/95→08/96	←			<b>13.0460-2957.2</b>	<b>602957</b>	TRW 20168 16,0 - WK
2.0	85	10/93→10/96	➡			<b>13.0460-2984.2</b>	<b>602984</b>	TRW 20961 17,2 - WK + Zub
2.0	85	02/90→05/97	←	03/90→ 10/93		<b>13.0460-2957.2</b>	<b>602957</b>	TRW 20168 16,0 - WK
			←	10/93→ 12/96		<b>13.0460-2957.2</b>	<b>602957</b>	TRW 20168 16,0 - WK
			➡	03/90→; → 31-PE080000		<b>13.0460-2937.2</b>	<b>602937</b>	TRW 20961 15,2 - WK + Zub
			➡	03/90→; → 31-PB080000		<b>13.0460-2937.2</b>	<b>602937</b>	TRW 20961 15,2 - WK + Zub
			➡	31-PB080001→; → 10/93		<b>13.0460-2984.2</b>	<b>602984</b>	TRW 20961 17,2 - WK + Zub
			➡	10/93→ 12/96		<b>13.0460-2984.2</b>	<b>602984</b>	TRW 20961 17,2 - WK + Zub
			➡	31-PE080001→; → 10/93		<b>13.0460-2984.2</b>	<b>602984</b>	TRW 20961 17,2 - WK + Zub







	kw			 	! #		
<b>VW - PASSAT Variant (3A5, 35I) 02/88→06/97</b>							
<b> Bremsbelagsatz, Scheibenbremse</b>							
2.0 16V	110	01/94→05/97	←	→ 12/96		<b>13.0460-7081.2 607081</b>	ATE 20676 19,8 - WE / - WK
						<b>13.0470-7081.2 LD7081</b>	ATE 20676 19,8 - WE / - WK Ceramic
2.0 Syncro	85	10/90→05/97	→	→ 12/96		<b>13.0460-2984.2 602984</b>	TRW 20961 17,2 - WK + Zub
			←	01/94→ 12/96		<b>13.0460-2957.2 602957</b>	TRW 20168 16,0 - WK
			←	→ 10/93		<b>13.0460-2957.2 602957</b>	TRW 20168 16,0 - WK
			→	→ 31-P-080000		<b>13.0460-2937.2 602937</b>	TRW 20961 15,2 - WK + Zub
			→	31-P-080001→; → 10/93		<b>13.0460-2984.2 602984</b>	TRW 20961 17,2 - WK + Zub
			→	01/94→ 12/96		<b>13.0460-2984.2 602984</b>	TRW 20961 17,2 - WK + Zub
2.8 VR6	128	06/91→05/97	←	→ 10/93		<b>13.0460-2958.2 602958</b>	TRW 20168 19,3 - WK
			←	10/93→ 12/96		<b>13.0460-7081.2 607081</b>	ATE 20676 19,8 - WE / - WK
						<b>13.0470-7081.2 LD7081</b>	ATE 20676 19,8 - WE / - WK Ceramic
			→	→ 31-PE080000		<b>13.0460-2937.2 602937</b>	TRW 20961 15,2 - WK + Zub
			→	→ 31-PB080000		<b>13.0460-2937.2 602937</b>	TRW 20961 15,2 - WK + Zub
			→	31-PB080001→; → 10/93		<b>13.0460-2984.2 602984</b>	TRW 20961 17,2 - WK + Zub
			→	31-PE080001→; → 10/93		<b>13.0460-2984.2 602984</b>	TRW 20961 17,2 - WK + Zub
			→	10/93→ 12/96		<b>13.0460-2984.2 602984</b>	TRW 20961 17,2 - WK + Zub
2.9 VR6 Syncro	135	01/94→05/97	←	10/94→ 12/96		<b>13.0460-7081.2 607081</b>	ATE 20676 19,8 - WE / - WK
						<b>13.0470-7081.2 LD7081</b>	ATE 20676 19,8 - WE / - WK Ceramic
			→	10/94→ 12/96		<b>13.0460-2984.2 602984</b>	TRW 20961 17,2 - WK + Zub
<b>Zubehörsatz, Scheibenbremsbelag</b>							
1.8 G60 Syncro	118	08/88→05/97	→	31-P-080001→; → 10/93		<b>13.0460-0072.2 610072</b>	TRW
			→	→ 31-P-080000		<b>13.0460-0419.2 610419</b>	TRW
1.9 TDI	66	10/93→05/97	→	3A-T-000001→; → 12/96		<b>13.0460-0072.2 610072</b>	TRW
1.9 TDI	81	03/96→05/97	→	→ 12/96		<b>13.0460-0072.2 610072</b>	TRW
2.0 16V	110	01/94→05/97				<b>13.0460-0072.2 610072</b>	TRW
2.0	79	03/95→08/96	→			<b>13.0460-0072.2 610072</b>	TRW
2.0	85	10/93→10/96				<b>13.0460-0072.2 610072</b>	TRW
2.0	85	02/90→05/97	→	31-PB080001→; → 10/93		<b>13.0460-0072.2 610072</b>	TRW
			→	10/93→ 12/96		<b>13.0460-0072.2 610072</b>	TRW
			→	31-PE080001→; → 10/93		<b>13.0460-0072.2 610072</b>	TRW
			→	03/90→; → 31-PB080000		<b>13.0460-0419.2 610419</b>	TRW
			→	03/90→; → 31-PE080000		<b>13.0460-0419.2 610419</b>	TRW
2.0 Syncro	85	10/90→05/97	→	01/94→ 12/96		<b>13.0460-0072.2 610072</b>	TRW
			→	31-P-080001→; → 10/93		<b>13.0460-0072.2 610072</b>	TRW
			→	→ 31-P-080000		<b>13.0460-0419.2 610419</b>	TRW
2.8 VR6	128	06/91→05/97	→	31-PB080001→; → 10/93		<b>13.0460-0072.2 610072</b>	TRW
			→	10/93→ 12/96		<b>13.0460-0072.2 610072</b>	TRW
			→	31-PE080001→; → 10/93		<b>13.0460-0072.2 610072</b>	TRW
			→	→ 31-PB080000		<b>13.0460-0419.2 610419</b>	TRW
			→	→ 31-PE080000		<b>13.0460-0419.2 610419</b>	TRW
2.9 VR6 Syncro	135	01/94→05/97	→	10/94→ 12/96		<b>13.0460-0072.2 610072</b>	TRW
<b> Bremsscheibe</b>							
1.8 1.9 TD	55 55	08/90→05/97 03/91→05/97	←	10/93→ 12/96		<b>24.0113-0178.1 413178</b>	Ø 255,6 12,9 11 + S
						<b>24.0313-0178.1 513178</b>	Ø 255,6 12,9 11 + S
			←	→ 10/93		<b>24.0113-0178.1 413178</b>	Ø 255,6 12,9 11 + S
						<b>24.0313-0178.1 513178</b>	Ø 255,6 12,9 11 + S
1.8	66	02/88→05/97	←	10/93→ 12/96		<b>24.0113-0178.1 413178</b>	Ø 255,6 12,9 11 + S
						<b>24.0313-0178.1 513178</b>	Ø 255,6 12,9 11 + S
			←	04/88→ 10/93		<b>24.0113-0178.1 413178</b>	Ø 255,6 12,9 11 + S
						<b>24.0313-0178.1 513178</b>	Ø 255,6 12,9 11 + S
1.8 G60 Syncro	118	08/88→05/97	←	→ 10/93		<b>24.0122-0101.1 422101</b>	Ø 280 22 20 V
			→	→ 10/93		<b>24.0110-0151.1 410151</b>	Ø 239 10 8 + S
1.9 TDI ↓	66	10/93→05/97	←	→ 3A-S-300000		<b>24.0113-0178.1 413178</b>	Ø 255,6 12,9 11 + S







	kw			 	! #		
<b>VW - PASSAT Variant (3A5, 35I) 02/88→06/97</b>							
<b>Bremsscheibe</b>							
1.9 TDI	66	10/93→05/97	←	→ 3A-S-300000		24.0313-0178.1 513178	Ø 255,6 12,9 11 + S
			←	3A-T-000001→; → 12/96		24.0120-0128.1 420128	Ø 256 20 18 V + S
			→	3A-T-000001→; → 12/96		24.0320-0128.1 520128	Ø 256 20 18 V + S
1.9 TDI	81	03/96→05/97	←	→ 12/96		24.0110-0111.1 410111	Ø 226 10 8 - ABS Ring / - RLG
			←	→ 12/96		24.0110-0275.2 410275	Ø 226 10 8 + ABS Ring / - RLG
			→	→ 12/96		24.0122-0100.1 422100	Ø 280 22 20 V
2.0	79 85	03/95→08/96 10/93→10/96	←			24.0322-0100.1 522100	Ø 280 22 20 V
			→			24.0110-0203.1 410203	Ø 226 10 8 - ABS Ring
			→			24.0110-0276.2 410276	Ø 226 10 8 + ABS Ring
2.0	85	02/90→05/97	←	10/93→ 12/96		24.0120-0128.1 420128	Ø 256 20 18 V + S
			←	03/90→ 10/93		24.0320-0128.1 520128	Ø 256 20 18 V + S
			→	03/90→ 10/93		24.0120-0128.1 420128	Ø 256 20 18 V + S
			→	03/90→ 10/93		24.0320-0128.1 520128	Ø 256 20 18 V + S
			→	10/93→ 12/96		24.0110-0111.1 410111	Ø 226 10 8 - ABS Ring / - RLG
2.0 16V	110	01/94→05/97	←	→ 12/96		24.0110-0111.1 410111	Ø 226 10 8 - ABS Ring / - RLG
			→	→ 12/96		24.0110-0275.2 410275	Ø 226 10 8 + ABS Ring / - RLG
			→	→ 12/96		24.0125-0108.1 425108	Ø 288 25 23 V
2.0 Syncro	85	10/90→05/97	←	→ 10/93		24.0110-0203.1 410203	Ø 226 10 8 - ABS Ring
			←	01/94→ 12/96		24.0110-0276.2 410276	Ø 226 10 8 + ABS Ring
			←	→ 10/93		24.0120-0128.1 420128	Ø 256 20 18 V + S
			→	01/94→ 12/96		24.0320-0128.1 520128	Ø 256 20 18 V + S
			→	01/94→ 12/96		24.0110-0151.1 410151	Ø 239 10 8 + S
2.8 VR6	128	06/91→05/97	←	→ 10/93; 31-N-255990→		24.0110-0151.1 410151	Ø 239 10 8 + S
			←	10/93→ 12/96		24.0122-0100.1 422100	Ø 280 22 20 V
			→	→ 10/93		24.0322-0100.1 522100	Ø 280 22 20 V
			→	10/93→ 12/96		24.0125-0108.1 425108	Ø 288 25 23 V
			→	10/93→ 12/96		24.0110-0203.1 410203	Ø 226 10 8 - ABS Ring
2.9 VR6 Syncro	135	01/94→05/97	←	10/94→ 12/96		24.0110-0276.2 410276	Ø 226 10 8 + ABS Ring
			←	10/94→ 12/96		24.0125-0108.1 425108	Ø 288 25 23 V
			←	10/94→ 12/96			
<b>VW - PASSAT Variant (3B5) 05/97→12/01</b>							
<b>Bremsbelagsatz, Scheibenbremse</b>							
1.6	74	06/97→11/00	←	→ 3B-X-600000; +PR 1LZ,1ZJ		13.0460-2822.2 602822	TRW 21945 19,6 - WK
			←	3B-Y-000001→; → 09/00; +PR 1LZ,1ZJ		13.0460-2837.2 602837	TRW 21945 19,6 + WK
			←	→ 3B-X-600000; +PR 1LB,1ZC		13.0470-2837.2 LD2837	TRW 21945 19,6 + WK Ceramic
			←	3B-Y-000001→; +PR 1LB,1ZC		13.0460-7077.2 607077	ATE 20676 19,8 - WE / - WK
			←	3B-Y-000001→; +PR 1LE, 1LT		13.0460-7110.2 607110	ATE 20676 19,8 + WK
			→	+PR 1KD,1KE,1KF,1KW		13.0470-7110.2 LD7110	ATE 20676 19,8 + WK Ceramic
			→			13.0460-2787.2 602787	TRW 23554 17,3 - WK / - WE
1.8	85	06/97→11/00	←	→ 3B-X-600000		13.0460-2820.2 602820	TRW 20961 17,2 - WK
			←	3B-Y-000001→; → 09/00		13.0470-2820.2 LD2820	TRW 20961 17,2 - WK Ceramic
			→	→ 09/00; China		13.0460-2837.2 602837	TRW 21945 19,6 + WK
			→	→ 09/00		13.0460-2787.2 602787	TRW 23554 17,3 - WK / - WE
			→			13.0460-2820.2 602820	TRW 20961 17,2 - WK
1.8	92	06/97→11/00	←	→ 3B-X-600000; +PR 1LZ,1ZJ		13.0470-2820.2 LD2820	TRW 20961 17,2 - WK Ceramic
			←			13.0460-2822.2 602822	TRW 21945 19,6 - WK

	kW			 	! #		
<b>VW - PASSAT Variant (3B5) 05/97→12/01</b>							
<b>Bremsbelagsatz, Scheibenbremse</b>							
1.8	92	06/97→11/00	←	3B-Y-000001→; → 09/00; +PR 1LZ,1ZJ		<b>13.0460-2837.2 602837</b>	TRW 21945 19,6 + WK
			←	→ 3B-X-600000; +PR 1LB,1ZC		<b>13.0470-2837.2 LD2837</b>	TRW 21945 19,6 + WK Ceramic
			←	→ 3B-X-600000; +PR 1LB,1ZC		<b>13.0460-7077.2 607077</b>	ATE 20676 19,8 - WE / - WK
			←	3B-Y-000001→; +PR 1LE, 1LT		<b>13.0460-7110.2 607110</b>	ATE 20676 19,8 + WK
			←	3B-Y-000001→; +PR 1LE, 1LT		<b>13.0470-7110.2 LD7110</b>	ATE 20676 19,8 + WK Ceramic
			←	3B-Y-000001→; +PR 1LB,1ZC		<b>13.0460-7110.2 607110</b>	ATE 20676 19,8 + WK
			←	3B-Y-000001→; +PR 1LB,1ZC		<b>13.0470-7110.2 LD7110</b>	ATE 20676 19,8 + WK Ceramic
			→	→ 09/00; +PR 1KD,1KE,1KF,1KW		<b>13.0460-2787.2 602787</b>	TRW 23554 17,3 - WK / - WE
						<b>13.0460-2820.2 602820</b>	TRW 20961 17,2 - WK
						<b>13.0470-2820.2 LD2820</b>	TRW 20961 17,2 - WK Ceramic
1.8	112	01/00→12/01	←	→ 3B-X-600000; +PR 1LB,1ZC		<b>13.0460-7077.2 607077</b>	ATE 20676 19,8 - WE / - WK
1.8 T	110	06/97→11/00	←	→ 3B-X-600000; +PR 1LB,1ZC		<b>13.0460-7110.2 607110</b>	ATE 20676 19,8 + WK
1.9 TDI	81	06/97→11/00	←	3B-Y-000001→; +PR 1LB,1ZC		<b>13.0460-7110.2 607110</b>	ATE 20676 19,8 + WK
1.9 TDI	85	08/98→11/00	←	→ 3B-X-600000; +PR 1LB,1ZC		<b>13.0470-7110.2 LD7110</b>	ATE 20676 19,8 + WK Ceramic
1.9 TDI 4motion	85	08/99→11/00	←	3B-Y-000001→; +PR 1LE, 1LT		<b>13.0460-7110.2 607110</b>	ATE 20676 19,8 + WK
1.9 TDI Syncro/4motion	81	06/97→11/00	←	3B-Y-000001→; +PR 1LE, 1LT		<b>13.0470-7110.2 LD7110</b>	ATE 20676 19,8 + WK Ceramic
2.3 VR5	110	06/97→11/00	→	+PR 1KD,1KE,1KF,1KW		<b>13.0460-2787.2 602787</b>	TRW 23554 17,3 - WK / - WE
2.3 VR5 Syncro/4motion	110	10/97→11/00	→	+PR 1KD,1KE,1KF,1KW		<b>13.0460-2820.2 602820</b>	TRW 20961 17,2 - WK
2.5 TDI Syncro/4motion	110	12/98→11/00	→	+PR 1KD,1KE,1KF,1KW		<b>13.0470-2820.2 LD2820</b>	TRW 20961 17,2 - WK Ceramic
2.8 V6	140	09/99→11/00					
2.8 V6	142	06/97→11/00					
2.8 V6 4motion	140	09/99→11/00					
2.8 V6 Syncro/4motion	142	06/97→11/00					
1.8 Syncro/4motion	92	06/97→11/00	←	→ 3B-X-600000; +PR 1LZ,1ZJ		<b>13.0460-2822.2 602822</b>	TRW 21945 19,6 - WK
1.9 TDI	66	06/97→11/00	←	3B-Y-000001→; → 09/00; +PR 1LZ,1ZJ		<b>13.0460-2837.2 602837</b>	TRW 21945 19,6 + WK
			←	→ 3B-X-600000; +PR 1LB,1ZC		<b>13.0470-2837.2 LD2837</b>	TRW 21945 19,6 + WK Ceramic
			←	→ 3B-X-600000; +PR 1LB,1ZC		<b>13.0460-7077.2 607077</b>	ATE 20676 19,8 - WE / - WK
			←	3B-Y-000001→; +PR 1LE,1LT		<b>13.0460-7110.2 607110</b>	ATE 20676 19,8 + WK
			←	3B-Y-000001→; +PR 1LE,1LT		<b>13.0470-7110.2 LD7110</b>	ATE 20676 19,8 + WK Ceramic
			←	3B-Y-000001→; +PR 1LB,1ZC		<b>13.0460-7110.2 607110</b>	ATE 20676 19,8 + WK
			←	3B-Y-000001→; +PR 1LB,1ZC		<b>13.0470-7110.2 LD7110</b>	ATE 20676 19,8 + WK Ceramic
			→	→ 09/00; +PR 1KD,1KE,1KF,1KW		<b>13.0460-2787.2 602787</b>	TRW 23554 17,3 - WK / - WE
						<b>13.0460-2820.2 602820</b>	TRW 20961 17,2 - WK
						<b>13.0470-2820.2 LD2820</b>	TRW 20961 17,2 - WK Ceramic
1.9 TDI	74	02/00→11/00	←	10/00→; +PR 1LE, 1LT		<b>13.0460-7110.2 607110</b>	ATE 20676 19,8 + WK
2.0	88	04/00→11/00	←	10/00→; +PR 1LE, 1LT		<b>13.0470-7110.2 LD7110</b>	ATE 20676 19,8 + WK Ceramic
2.0 4motion	88	04/00→11/00	←	10/00→; +PR 1LB,1ZC		<b>13.0460-7110.2 607110</b>	ATE 20676 19,8 + WK
			←	10/00→; +PR 1LB,1ZC		<b>13.0470-7110.2 LD7110</b>	ATE 20676 19,8 + WK Ceramic
			→	10/00→; +PR 1KD,1KE,1KF,1KW		<b>13.0460-2787.2 602787</b>	TRW 23554 17,3 - WK / - WE
						<b>13.0460-2820.2 602820</b>	TRW 20961 17,2 - WK
						<b>13.0470-2820.2 LD2820</b>	TRW 20961 17,2 - WK Ceramic
2.5 TDI	110	07/98→11/00	←	08/98→; → 3B-X-600000; +PR 1LB,1ZC		<b>13.0460-7077.2 607077</b>	ATE 20676 19,8 - WE / - WK
			←	3B-Y-000001→; +PR 1LE, 1LT		<b>13.0460-7110.2 607110</b>	ATE 20676 19,8 + WK
			←	3B-Y-000001→; +PR 1LE, 1LT		<b>13.0470-7110.2 LD7110</b>	ATE 20676 19,8 + WK Ceramic
			←	3B-Y-000001→; +PR 1LB,1ZC		<b>13.0460-7110.2 607110</b>	ATE 20676 19,8 + WK
			←	3B-Y-000001→; +PR 1LB,1ZC		<b>13.0470-7110.2 LD7110</b>	ATE 20676 19,8 + WK Ceramic
			→	08/98→; +PR 1KD,1KE,1KF,1KW		<b>13.0460-2787.2 602787</b>	TRW 23554 17,3 - WK / - WE
						<b>13.0460-2820.2 602820</b>	TRW 20961 17,2 - WK
						<b>13.0470-2820.2 LD2820</b>	TRW 20961 17,2 - WK Ceramic
2.8 V6	132	09/97→09/99	←	→ 3B-X-600000		<b>13.0460-7077.2 607077</b>	ATE 20676 19,8 - WE / - WK
			←	3B-Y-000001→		<b>13.0460-7110.2 607110</b>	ATE 20676 19,8 + WK
						<b>13.0470-7110.2 LD7110</b>	ATE 20676 19,8 + WK Ceramic
			→	China		<b>13.0460-2787.2 602787</b>	TRW 23554 17,3 - WK / - WE
			→			<b>13.0460-2820.2 602820</b>	TRW 20961 17,2 - WK
						<b>13.0470-2820.2 LD2820</b>	TRW 20961 17,2 - WK Ceramic
<b>Zubehörsatz, Scheibenbremsbelag</b>							
1.6	74	06/97→11/00	→	+PR 1KD,1KE,1KF,1KW		<b>13.0460-0072.2 610072</b>	TRW
1.8	112	01/00→12/01					
1.8 T	110	06/97→11/00					
1.9 TDI	81	06/97→11/00					
1.9 TDI	85	08/98→11/00					
1.9 TDI 4motion	85	08/99→11/00					
1.9 TDI Syncro/4motion	81	06/97→11/00					
2.3 VR5	110	06/97→11/00					
2.3 VR5 Syncro/4motion	110	10/97→11/00					
2.5 TDI Syncro/4motion	110	12/98→11/00					
↓							









	kW			 	! #		
<b>VW - PASSAT Variant (3B5) 05/97→12/01</b>							
<b>Zubehörsatz, Scheibenbremsbelag</b>							
2.8 V6	140	09/99→11/00	➡	+PR 1KD,1KE,1KF,1KW		13.0460-0072.2 610072	TRW
2.8 V6	142	06/97→11/00					
2.8 V6 4motion	140	09/99→11/00					
2.8 V6 Syncro/4motion	142	06/97→11/00					
1.8	85	06/97→11/00	➡	→ 09/00		13.0460-0072.2 610072	TRW
1.8	92	06/97→11/00	➡	→ 09/00; +PR 1KD,1KE,1KF,1KW		13.0460-0072.2 610072	TRW
1.8 Syncro/4motion	92	06/97→11/00					
1.9 TDI	66	06/97→11/00					
1.9 TDI	74	02/00→11/00	➡	10/00→; +PR 1KD,1KE,1KF,1KW		13.0460-0072.2 610072	TRW
2.0	88	04/00→11/00					
2.0 4motion	88	04/00→11/00					
2.5 TDI	110	07/98→11/00	➡	08/98→; +PR 1KD,1KE,1KF,1KW		13.0460-0072.2 610072	TRW
2.8 V6	132	09/97→09/99	➡			13.0460-0072.2 610072	TRW
<b> Bremsscheibe</b>							
1.6	74	06/97→11/00	←	→ 09/00; +PR 1LZ,1ZJ	24.0122-0152.1 422152	Ø 280 22 20 V + S	
					24.0322-0152.1 522152	Ø 280 22 20 V + S	
			←	→ 3B-X-124107; +PR 1LB,1ZC	24.0125-0115.1 425115	Ø 282,5 25 23 V	
					24.0325-0115.1 525115	Ø 282,5 25 23 V	
			←	3B-X-124108→; +PR 1LB,1LE,1ZC	24.0125-0171.1 425171	Ø 288 25 23 V	
		24.0325-0171.1 525171	Ø 288 25 23 V				
		➡	+PR 1KD,1KE,1KF,1KW	24.0110-0201.1 410201	Ø 245 10 8		
				24.0310-0201.1 510201	Ø 245 10 8		
1.8	85	06/97→11/00	←	→ 09/00; für Canada/GUS	24.0122-0152.1 422152	Ø 280 22 20 V + S	
					24.0322-0152.1 522152	Ø 280 22 20 V + S	
			➡	→ 09/00; nicht China/GUS	24.0110-0201.1 410201	Ø 245 10 8	
					24.0310-0201.1 510201	Ø 245 10 8	
1.8 1.9 TDI	92 66	06/97→11/00 06/97→11/00	←	→ 09/00; +PR 1LZ,1ZJ	24.0122-0152.1 422152	Ø 280 22 20 V + S	
					24.0322-0152.1 522152	Ø 280 22 20 V + S	
			←	→ 3B-X-124107; +PR 1LB,1ZC	24.0125-0115.1 425115	Ø 282,5 25 23 V	
					24.0325-0115.1 525115	Ø 282,5 25 23 V	
			←	3B-X-124108→; +PR 1LB,1LE,1ZC	24.0125-0171.1 425171	Ø 288 25 23 V	
		24.0325-0171.1 525171	Ø 288 25 23 V				
		➡	→ 09/00; +PR 1KD,1KE,1KF,1KW	24.0110-0201.1 410201	Ø 245 10 8		
				24.0310-0201.1 510201	Ø 245 10 8		
1.8 1.8 T 1.9 TDI 1.9 TDI	112 110 81 85	01/00→12/01 06/97→11/00 06/97→11/00 08/98→11/00	←	→ 3B-X-124107; +PR 1LB,1ZC	24.0125-0115.1 425115	Ø 282,5 25 23 V	
					24.0325-0115.1 525115	Ø 282,5 25 23 V	
			←	3B-X-124108→; +PR 1LB,1LE,1ZC	24.0125-0171.1 425171	Ø 288 25 23 V	
					24.0325-0171.1 525171	Ø 288 25 23 V	
			➡	+PR 1KD,1KE,1KF,1KW	24.0110-0201.1 410201	Ø 245 10 8	
				24.0310-0201.1 510201	Ø 245 10 8		
1.8 Syncro/4motion	92	06/97→11/00	←	→ 09/00; +PR 1LZ,1ZJ	24.0122-0152.1 422152	Ø 280 22 20 V + S	
					24.0322-0152.1 522152	Ø 280 22 20 V + S	
			←	→ 3B-X-124107; +PR 1LB,1ZC	24.0125-0115.1 425115	Ø 282,5 25 23 V	
					24.0325-0115.1 525115	Ø 282,5 25 23 V	
			←	3B-X-124108→; +PR 1LB,1LE,1ZC	24.0125-0171.1 425171	Ø 288 25 23 V	
					24.0325-0171.1 525171	Ø 288 25 23 V	
			➡	+PR 1KD;1KF	24.0110-0224.1 410224	Ø 245 10 8	
					24.0310-0224.1 510224	Ø 245 10 8	
		➡	+PR 1KE	24.0122-0221.1 422221	Ø 256 22 20 V		
				24.0122-0222.1 422222	Ø 269 22 20 V		
			➡	+PR 1KW	24.0122-0222.1 422222	Ø 269 22 20 V	
1.9 TDI 2.0	74 88	02/00→11/00 04/00→11/00	←	10/00→; +PR 1LB,1LE,1ZC	24.0125-0171.1 425171	Ø 288 25 23 V	
					24.0325-0171.1 525171	Ø 288 25 23 V	
			➡	10/00→; +PR 1KD,1KE,1KF,1KW	24.0110-0201.1 410201	Ø 245 10 8	
				24.0310-0201.1 510201	Ø 245 10 8		
1.9 TDI 4motion 1.9 TDI Syncro/4motion	85 81	08/99→11/00 06/97→11/00	←	→ 3B-X-124107; +PR 1LB,1ZC	24.0125-0115.1 425115	Ø 282,5 25 23 V	
					24.0325-0115.1 525115	Ø 282,5 25 23 V	
			←	3B-X-124108→; +PR 1LB,1LE,1ZC	24.0125-0171.1 425171	Ø 288 25 23 V	
					24.0325-0171.1 525171	Ø 288 25 23 V	
			➡	+PR 1KD;1KF	24.0110-0224.1 410224	Ø 245 10 8	
					24.0310-0224.1 510224	Ø 245 10 8	
		➡	+PR 1KE	24.0122-0221.1 422221	Ø 256 22 20 V		
				24.0122-0222.1 422222	Ø 269 22 20 V		
			➡	+PR 1KW	24.0122-0222.1 422222	Ø 269 22 20 V	
↓							

















	kw			 	! #		
<b>VW - PASSAT Variant (3B5) 05/97→12/01</b>							
<b>Bremsscheibe</b>							
2.0 4motion	88	04/00→11/00	←	10/00→; +PR 1LB,1LE,1ZC	24.0125-0171.1 425171	Ø 288 25 23 V	
			→	10/00→; +PR 1KD;1KF	24.0325-0171.1 525171	Ø 288 25 23 V	
			→	10/00→; +PR 1KE	24.0110-0224.1 410224	Ø 245 10 8	
			→	10/00→; +PR 1KW	24.0310-0224.1 510224	Ø 245 10 8	
2.3 VR5	110	06/97→11/00	←	→ 3B-X-124107; +PR 1LB,1ZC	24.0125-0115.1 425115	Ø 282,5 25 23 V	
			←	3B-X-124108→; → 09/00; +PR 1LB,1LE,1ZC	24.0325-0115.1 525115	Ø 282,5 25 23 V	
			←	10/00→; +PR 1LT	24.0125-0171.1 425171	Ø 288 25 23 V	
			→	+PR 1KE,1KF,1KW	24.0125-0172.1 425172	Ø 312 25 23 V	
2.3 VR5 Syncro/4motion	110	10/97→11/00	←	→ 3B-X-124107; +PR 1LB,1ZC	24.0110-0201.1 410201	Ø 245 10 8	
			←	3B-X-124108→; → 09/00; +PR 1KD,1KE,1KF,1KW	24.0310-0201.1 510201	Ø 245 10 8	
			←	10/00→; +PR 1LT	24.0125-0115.1 425115	Ø 282,5 25 23 V	
			→	+PR 1KE	24.0325-0115.1 525115	Ø 282,5 25 23 V	
2.5 TDI	110	07/98→11/00	←	08/98→ 09/00; +PR 1LB,1LE,1ZC	24.0125-0171.1 425171	Ø 288 25 23 V	
			←	10/00→; +PR 1LT	24.0325-0171.1 525171	Ø 288 25 23 V	
			→	08/98→; +PR 1KD,1KE,1KF,1KW	24.0125-0172.1 425172	Ø 312 25 23 V	
			→	+PR 1KE	24.0325-0172.1 525172	Ø 312 25 23 V	
2.5 TDI Syncro/4motion	110	12/98→11/00	←	→ 09/00; +PR 1KD,1KF	24.0110-0201.1 410201	Ø 245 10 8	
			←	10/00→; +PR 1LT	24.0310-0201.1 510201	Ø 245 10 8	
			→	+PR 1KE	24.0125-0171.1 425171	Ø 288 25 23 V	
			→	+PR 1KW	24.0325-0171.1 525171	Ø 288 25 23 V	
2.8 V6	132	09/97→09/99	←	→ 3B-X-124107; für Canada/GUS	24.0125-0115.1 425115	Ø 282,5 25 23 V	
			←	3B-X-124108→; für Canada/GUS	24.0325-0115.1 525115	Ø 282,5 25 23 V	
			→	nicht China/GUS	24.0125-0171.1 425171	Ø 288 25 23 V	
2.8 V6 2.8 V6	140 142	09/99→11/00 06/97→11/00	←	→ 3B-X-124107; +PR 1LB,1ZC	24.0110-0201.1 410201	Ø 245 10 8	
			←	3B-X-124108→; → 09/00; +PR 1KD,1KE,1KF,1KW	24.0310-0201.1 510201	Ø 245 10 8	
			←	10/00→; +PR 1LT	24.0125-0115.1 425115	Ø 282,5 25 23 V	
			→	+PR 1KE	24.0325-0115.1 525115	Ø 282,5 25 23 V	
2.8 V6 4motion 2.8 V6 Syncro/4motion	140 142	09/99→11/00 06/97→11/00	←	→ 3B-X-124107; +PR 1LB,1ZC	24.0125-0171.1 425171	Ø 288 25 23 V	
			←	3B-X-124108→; → 09/00; +PR 1LB,1LE,1ZC	24.0325-0171.1 525171	Ø 288 25 23 V	
			←	10/00→; +PR 1LT	24.0125-0115.1 425115	Ø 282,5 25 23 V	
			→	+PR 1KE,1KF,1KW	24.0125-0172.1 425172	Ø 312 25 23 V	
			→	+PR 1KD;1KF	24.0110-0201.1 410201	Ø 245 10 8	
			→	+PR 1KE	24.0310-0201.1 510201	Ø 245 10 8	

	kw			 	! #		
<b>VW - PASSAT Variant (3B6) 09/00→08/05</b>							
<b>Bremsbelagsatz, Scheibenbremse</b>							
1.6	75	11/00→05/05	←	→ 3B-X-600000; +PR 1LZ,1ZJ		<b>13.0460-2822.2 602822</b>	TRW 21945 19,6 - WK
			←	→ 3B-X-600000; +PR 1LB,1ZC		<b>13.0460-7077.2 607077</b>	ATE 20676 19,8 - WE / - WK
			←	3B-Y-000001→; +PR 1LB,1ZC		<b>13.0460-7110.2 607110</b>	ATE 20676 19,8 + WK
						<b>13.0470-7110.2 LD7110</b>	ATE 20676 19,8 + WK Ceramic
			←	3B-Y-000001→; +PR 1LE, 1LT		<b>13.0460-7110.2 607110</b>	ATE 20676 19,8 + WK
						<b>13.0470-7110.2 LD7110</b>	ATE 20676 19,8 + WK Ceramic
			→	+PR 1KD,1KE,1KF,1KW		<b>13.0460-2787.2 602787</b>	TRW 23554 17,3 - WK / - WE
						<b>13.0460-2820.2 602820</b>	TRW 20961 17,2 - WK
						<b>13.0470-2820.2 LD2820</b>	TRW 20961 17,2 - WK Ceramic
1.8 4motion	125	03/01→05/05	←	+PR 1LE, 1LT		<b>13.0460-7110.2 607110</b>	ATE 20676 19,8 + WK
1.9 TDI	74	11/00→05/05				<b>13.0470-7110.2 LD7110</b>	ATE 20676 19,8 + WK Ceramic
1.9 TDI	96	11/00→05/05					
1.9 TDI 4motion	96	11/00→05/05	←	+PR 1LB,1ZC		<b>13.0460-7110.2 607110</b>	ATE 20676 19,8 + WK
2.0	85	11/00→05/05				<b>13.0470-7110.2 LD7110</b>	ATE 20676 19,8 + WK Ceramic
2.0 4motion	85	11/00→05/05					
2.0 TDI	100	12/03→05/05	→	+PR 1KD,1KE,1KF,1KW		<b>13.0460-2787.2 602787</b>	TRW 23554 17,3 - WK / - WE
						<b>13.0460-2820.2 602820</b>	TRW 20961 17,2 - WK
						<b>13.0470-2820.2 LD2820</b>	TRW 20961 17,2 - WK Ceramic
1.8 T	125	05/02→08/05	←	→ 3B-X-600000; +PR 1LB,1ZC		<b>13.0460-7077.2 607077</b>	ATE 20676 19,8 - WE / - WK
2.8	142	10/00→08/05	←	3B-Y-000001→; → 06/05; +PR 1LB,1ZC		<b>13.0460-7110.2 607110</b>	ATE 20676 19,8 + WK
						<b>13.0470-7110.2 LD7110</b>	ATE 20676 19,8 + WK Ceramic
			←	3B-Y-000001→; → 06/05; +PR 1LE, 1LT		<b>13.0460-7110.2 607110</b>	ATE 20676 19,8 + WK
						<b>13.0470-7110.2 LD7110</b>	ATE 20676 19,8 + WK Ceramic
			→	→ 06/05; +PR 1KD,1KE,1KF,1KW		<b>13.0460-2787.2 602787</b>	TRW 23554 17,3 - WK / - WE
						<b>13.0460-2820.2 602820</b>	TRW 20961 17,2 - WK
						<b>13.0470-2820.2 LD2820</b>	TRW 20961 17,2 - WK Ceramic
1.8 T 20V	110	11/00→05/05	←	→ 3B-X-600000; +PR 1LB,1ZC		<b>13.0460-7077.2 607077</b>	ATE 20676 19,8 - WE / - WK
2.3 VR5	125	11/00→05/05					
2.3 VR5 4motion	125	11/00→05/05	←	3B-Y-000001→; +PR 1LB,1ZC		<b>13.0460-7110.2 607110</b>	ATE 20676 19,8 + WK
2.5 TDI	110	11/00→05/05				<b>13.0470-7110.2 LD7110</b>	ATE 20676 19,8 + WK Ceramic
2.5 TDI	120	05/03→05/05					
2.5 TDI 4motion	110	11/00→05/05	←	3B-Y-000001→; +PR 1LE, 1LT		<b>13.0460-7110.2 607110</b>	ATE 20676 19,8 + WK
2.5 TDI 4motion	132	01/03→05/05				<b>13.0470-7110.2 LD7110</b>	ATE 20676 19,8 + WK Ceramic
2.8 4motion	140	10/00→05/05					
2.8 4motion	142	11/00→05/05	→	+PR 1KD,1KE,1KF,1KW		<b>13.0460-2787.2 602787</b>	TRW 23554 17,3 - WK / - WE
						<b>13.0460-2820.2 602820</b>	TRW 20961 17,2 - WK
						<b>13.0470-2820.2 LD2820</b>	TRW 20961 17,2 - WK Ceramic
2.0	96	11/01→05/05	←	05/02→; +PR 1LE, 1LT		<b>13.0460-7110.2 607110</b>	ATE 20676 19,8 + WK
						<b>13.0470-7110.2 LD7110</b>	ATE 20676 19,8 + WK Ceramic
			←	05/02→; +PR 1LB,1ZC		<b>13.0460-7110.2 607110</b>	ATE 20676 19,8 + WK
						<b>13.0470-7110.2 LD7110</b>	ATE 20676 19,8 + WK Ceramic
			→	05/02→; +PR 1KD,1KE,1KF,1KW		<b>13.0460-2787.2 602787</b>	TRW 23554 17,3 - WK / - WE
						<b>13.0460-2820.2 602820</b>	TRW 20961 17,2 - WK
						<b>13.0470-2820.2 LD2820</b>	TRW 20961 17,2 - WK Ceramic
4.0 W8 4motion	202	09/01→09/04	←	+PR 1ZF,1ZG; für gepanzerte Fahrzeuge		<b>13.0460-2875.2 602875</b>	TRW 23119 17,5 + WK
			←	+PR 1ZF,1ZG; nicht für gepanzerte Fahrzeuge		<b>13.0460-7183.2 607183</b>	ATE 21484 20,5 + WE / - WK
			→	+PR 1KD,1KE,1KF,1KW		<b>13.0460-2787.2 602787</b>	TRW 23554 17,3 - WK / - WE
						<b>13.0460-2820.2 602820</b>	TRW 20961 17,2 - WK
						<b>13.0470-2820.2 LD2820</b>	TRW 20961 17,2 - WK Ceramic
<b>Warnkontakt, Bremsbelagsverschleiß</b>							
4.0 W8 4motion	202	09/01→09/04	←	+PR 1ZF,1ZG; nicht für gepanzerte Fahrzeuge	1	<b>24.8190-0107.2 620107</b>	L= 235
<b>Zubehörsatz, Scheibenbremsbelag</b>							
1.6	75	11/00→05/05	→	+PR 1KD,1KE,1KF,1KW		<b>13.0460-0072.2 610072</b>	TRW
1.8 4motion	125	03/01→05/05					
1.8 T 20V	110	11/00→05/05					
1.9 TDI	74	11/00→05/05					
1.9 TDI	96	11/00→05/05					
1.9 TDI 4motion	96	11/00→05/05					
2.0	85	11/00→05/05					
2.0 4motion	85	11/00→05/05					
2.0 TDI	100	12/03→05/05					
2.3 VR5	125	11/00→05/05					
2.3 VR5 4motion	125	11/00→05/05					
2.5 TDI	110	11/00→05/05					
2.5 TDI	120	05/03→05/05					
2.5 TDI 4motion	110	11/00→05/05					
2.5 TDI 4motion	132	01/03→05/05					
↓							











	kW			 	! #		
<b>VW - PASSAT Variant (3B6) 09/00→08/05</b>							
<b>Zubehörsatz, Scheibenbremsbelag</b>							
2.8 4motion 2.8 4motion 4.0 W8 4motion	140 142 202	10/00→05/05 11/00→05/05 09/01→09/04	➡	+PR 1KD,1KE,1KF,1KW		13.0460-0072.2 610072	TRW
1.8 T 2.8	125 142	05/02→08/05 10/00→08/05	➡	→ 06/05; +PR 1KD,1KE,1KF,1KW		13.0460-0072.2 610072	TRW
2.0	96	11/01→05/05	➡	05/02→; +PR 1KD,1KE,1KF,1KW		13.0460-0072.2 610072	TRW
<b> Bremsscheibe</b>							
1.6 1.8 T 20V	75 110	11/00→05/05 11/00→05/05	←	→ 3B-X-124107; +PR 1LB,1ZC		24.0125-0115.1 425115	Ø 282,5 25 23 V
			←	3B-X-124108→; +PR 1LB,1LE,1ZC		24.0125-0171.1 425171 24.0325-0171.1 525171	Ø 288 25 23 V Ø 288 25 23 V
			➡	+PR 1KD,1KE,1KF,1KW		24.0110-0201.1 410201 24.0310-0201.1 510201	Ø 245 10 8 Ø 245 10 8
1.8 4motion 1.9 TDI 4motion 2.0 4motion	125 96 85	03/01→05/05 11/00→05/05 11/00→05/05	←	+PR 1LB,1LE,1ZC		24.0125-0171.1 425171 24.0325-0171.1 525171	Ø 288 25 23 V Ø 288 25 23 V
			➡	+PR 1KD;1KF		24.0110-0224.1 410224 24.0310-0224.1 510224	Ø 245 10 8 Ø 245 10 8
			➡	+PR 1KE		24.0122-0221.1 422221	Ø 256 22 20 V
			➡	+PR 1KW		24.0122-0222.1 422222	Ø 269 22 20 V
1.8 T	125	05/02→08/05	←	→ 3B-X-124107; +PR 1LB,1ZC		24.0125-0115.1 425115 24.0325-0115.1 525115	Ø 282,5 25 23 V Ø 282,5 25 23 V
			←	3B-X-124108→; → 06/05; +PR 1LB,1LE,1ZC		24.0125-0171.1 425171 24.0325-0171.1 525171	Ø 288 25 23 V Ø 288 25 23 V
			➡	→ 06/05; +PR 1KD,1KE,1KF,1KW		24.0110-0201.1 410201 24.0310-0201.1 510201	Ø 245 10 8 Ø 245 10 8
1.9 TDI 1.9 TDI 2.0	74 96 85	11/00→05/05 11/00→05/05 11/00→05/05	←	+PR 1LB,1LE,1ZC		24.0125-0171.1 425171 24.0325-0171.1 525171	Ø 288 25 23 V Ø 288 25 23 V
			➡	+PR 1KD,1KE,1KF,1KW		24.0110-0201.1 410201 24.0310-0201.1 510201	Ø 245 10 8 Ø 245 10 8
2.0	96	11/01→05/05	←	05/02→; +PR 1LB,1LE,1ZC		24.0125-0171.1 425171 24.0325-0171.1 525171	Ø 288 25 23 V Ø 288 25 23 V
			➡	05/02→; +PR 1KD,1KE,1KF,1KW		24.0110-0201.1 410201 24.0310-0201.1 510201	Ø 245 10 8 Ø 245 10 8
2.0 TDI	100	12/03→05/05	←	+PR 1LB,1LE,1ZC		24.0125-0171.1 425171 24.0325-0171.1 525171	Ø 288 25 23 V Ø 288 25 23 V
			←	+PR 1LT		24.0125-0172.1 425172 24.0325-0172.1 525172	Ø 312 25 23 V Ø 312 25 23 V
			➡	+PR 1KD,1KE,1KF,1KW		24.0110-0201.1 410201 24.0310-0201.1 510201	Ø 245 10 8 Ø 245 10 8
2.3 VR5	125	11/00→05/05	←	→ 3B-X-124107; +PR 1LB,1ZC		24.0125-0115.1 425115 24.0325-0115.1 525115	Ø 282,5 25 23 V Ø 282,5 25 23 V
			←	+PR 1LT		24.0125-0172.1 425172	Ø 312 25 23 V
			➡	+PR 1KD,1KE,1KF,1KW		24.0110-0201.1 410201 24.0310-0201.1 510201	Ø 245 10 8 Ø 245 10 8
2.3 VR5 4motion 2.8 4motion 2.8 4motion	125 140 142	11/00→05/05 10/00→05/05 11/00→05/05	←	→ 3B-X-124107; +PR 1LB,1ZC		24.0125-0115.1 425115 24.0325-0115.1 525115	Ø 282,5 25 23 V Ø 282,5 25 23 V
			←	+PR 1LT		24.0125-0172.1 425172	Ø 312 25 23 V
			➡	+PR 1KD;1KF		24.0110-0224.1 410224 24.0310-0224.1 510224	Ø 245 10 8 Ø 245 10 8
			➡	+PR 1KE		24.0122-0221.1 422221	Ø 256 22 20 V
			➡	+PR 1KW		24.0122-0222.1 422222	Ø 269 22 20 V
2.5 TDI 2.5 TDI	110 120	11/00→05/05 05/03→05/05	←	+PR 1LT		24.0125-0172.1 425172 24.0325-0172.1 525172	Ø 312 25 23 V Ø 312 25 23 V
			➡	+PR 1KD,1KE,1KF,1KW		24.0110-0201.1 410201 24.0310-0201.1 510201	Ø 245 10 8 Ø 245 10 8
2.5 TDI 4motion 2.5 TDI 4motion	110 132	11/00→05/05 01/03→05/05	←	+PR 1LT		24.0125-0172.1 425172 24.0325-0172.1 525172	Ø 312 25 23 V Ø 312 25 23 V
			➡	+PR 1KD;1KF		24.0110-0224.1 410224 24.0310-0224.1 510224	Ø 245 10 8 Ø 245 10 8
			➡	+PR 1KE		24.0122-0221.1 422221	Ø 256 22 20 V
↓							









	kw			 	! #					
<b>VW - PASSAT Variant (3B6) 09/00→08/05</b>										
<b>Bremsscheibe</b>										
2.5 TDI 4motion	110	11/00→05/05	➔	+PR 1KW		24.0122-0222.1 422222	Ø 269 22 20 V			
2.5 TDI 4motion	132	01/03→05/05								
2.8	142	10/00→08/05	➔	→ 3B-X-124107; +PR 1LB,1ZC		24.0125-0115.1 425115	Ø 282,5 25 23 V			
						24.0325-0115.1 525115	Ø 282,5 25 23 V			
			➔	→ 06/05; +PR 1LT		24.0125-0172.1 425172	Ø 312 25 23 V			
			➔	→ 06/05; +PR 1KD,1KE,1KF,1KW		24.0110-0201.1 410201	Ø 245 10 8			
4.0 W8 4motion	202	09/01→09/04	➔	+PR 1KD;1KF		24.0110-0224.1 410224	Ø 245 10 8			
						24.0310-0201.1 510201	Ø 245 10 8			
			➔	+PR 1KE		24.0122-0221.1 422221	Ø 256 22 20 V			
			➔	+PR 1KW		24.0122-0222.1 422222	Ø 269 22 20 V			
<b>VW - PASSAT Variant (3C5) 08/05→11/11</b>										
<b>Bremsbelagsatz, Scheibenbremse</b>										
1.4 TSI 1.8 TSI	90 118	05/07→11/10 05/07→10/11	➔	10/07→ 07/10; +PR 1LJ,1LH,1ZG,1ZM		13.0460-7184.2 607184	ATE 23587 20,6 + WK			
						13.0470-7184.2 LD7184	ATE 23587 20,6 + WK Ceramic			
			➔	10/07→ 07/10; +PR 1LK,1LM		13.0460-7200.2 607200	ATE 23801 20,3 + WK			
						13.0470-7200.2 LD7200	ATE 23801 20,3 + WK Ceramic			
			➔	10/07→ 07/10; +PR 2EA,2EL		13.0460-2621.2 602621	TRW 24483 16,9 - WE / - WK + Zub			
			➔	10/07→ 07/10; +PR 1KU,1KW		13.0460-2887.2 602887	TRW 23914 17,1 + WE / - WK + Zub			
						13.0470-2621.2 LD2621	TRW 24483 16,9 - WE / - WK + Zub Ceramic			
						13.0470-2887.2 LD2887	TRW 23914 17,1 + WE / - WK + Zub Ceramic			
			➔	10/07→ 07/10; +PR 1KU,1KW		13.0460-2749.2 602749	TRW 24483 16,9 - WE / - WK + Zub			
						13.0460-2880.2 602880	TRW 23914 17,1 + WE / - WK + Zub			
						13.0470-2749.2 LD2749	TRW 24483 16,9 - WE / - WK + Zub Ceramic			
						13.0470-2880.2 LD2880	TRW 23914 17,1 + WE / - WK + Zub Ceramic			
1.4 TSI EcoFuel 1.6 1.6 TDI 1.8 TSI 2.0 BlueTDI 2.0 FSI 2.0 FSI 2.0 FSI 4motion 2.0 TDI 2.0 TDI 2.0 TDI 2.0 TDI 16V 2.0 TDI 4motion 3.2 FSI 4motion 3.6 R36 4motion	110 75 77 112 105 110 147 110 81 100 125 103 125 184 220	01/09→11/10 08/05→11/10 08/09→11/10 11/09→11/10 01/09→11/10 08/05→11/10 08/05→11/10 09/05→11/10 11/08→11/10 08/05→11/10 08/05→11/10 08/05→11/10 08/05→11/10 05/09→11/10 11/05→11/10 04/07→11/10	➔	→ 07/10; +PR 1LJ,1LH,1ZG,1ZM		13.0460-7184.2 607184	ATE 23587 20,6 + WK			
								13.0470-7184.2 LD7184	ATE 23587 20,6 + WK Ceramic	
			➔	→ 07/10; +PR 1LK,1LM		13.0460-7200.2 607200	ATE 23801 20,3 + WK			
								13.0470-7200.2 LD7200	ATE 23801 20,3 + WK Ceramic	
			➔	→ 07/10; +PR 2EA,2EL		13.0460-2621.2 602621	TRW 24483 16,9 - WE / - WK + Zub			
						➔	→ 07/10; +PR 1KU,1KW		13.0460-2887.2 602887	TRW 23914 17,1 + WE / - WK + Zub
									13.0470-2621.2 LD2621	TRW 24483 16,9 - WE / - WK + Zub Ceramic
									13.0470-2887.2 LD2887	TRW 23914 17,1 + WE / - WK + Zub Ceramic
						➔	→ 07/10; +PR 1KU,1KW		13.0460-2749.2 602749	TRW 24483 16,9 - WE / - WK + Zub
									13.0460-2880.2 602880	TRW 23914 17,1 + WE / - WK + Zub
									13.0470-2749.2 LD2749	TRW 24483 16,9 - WE / - WK + Zub Ceramic
									13.0470-2880.2 LD2880	TRW 23914 17,1 + WE / - WK + Zub Ceramic
			1.6 FSI 1.9 TDI 2.0 TDI 2.0 TDI 2.0 TDI 2.0 TDI	85 77 88 90 103 120	08/05→06/08 08/05→11/10 11/05→05/07 08/05→02/06 08/05→05/09 08/05→05/09	➔	+PR 1LJ,1LH,1ZG,1ZM		13.0460-7184.2 607184	ATE 23587 20,6 + WK
									13.0470-7184.2 LD7184	ATE 23587 20,6 + WK Ceramic
						➔	+PR 1LK,1LM		13.0460-7200.2 607200	ATE 23801 20,3 + WK
						13.0470-7200.2 LD7200	ATE 23801 20,3 + WK Ceramic			
➔	+PR 2EA,2EL					13.0460-2621.2 602621	TRW 24483 16,9 - WE / - WK + Zub			
			➔	→ 07/10; +PR 1KU,1KW		13.0460-2887.2 602887	TRW 23914 17,1 + WE / - WK + Zub			
						13.0470-2621.2 LD2621	TRW 24483 16,9 - WE / - WK + Zub Ceramic			
						13.0470-2887.2 LD2887	TRW 23914 17,1 + WE / - WK + Zub Ceramic			
						13.0470-2887.2 LD2887	TRW 23914 17,1 + WE / - WK + Zub Ceramic			









	kw			 	! #		
<b>VW - PASSAT Variant (3C5) 08/05→11/11</b>							
<b>Bremsbelagsatz, Scheibenbremse</b>							
1.6 FSI 1.9 TDI 2.0 TDI 2.0 TDI 2.0 TDI 2.0 TDI	85 77 88 90 103 120	08/05→06/08 08/05→11/10 11/05→05/07 08/05→02/06 08/05→05/09 08/05→05/09	➔	+PR 1KU,1KW		13.0460-2749.2 602749 13.0460-2880.2 602880 13.0470-2749.2 LD2749 13.0470-2880.2 LD2880	TRW 24483 16,9 - WE / - WK + Zub TRW 23914 17,1 + WE / - WK + Zub TRW 24483 16,9 - WE / - WK + Zub Ceramic TRW 23914 17,1 + WE / - WK + Zub Ceramic
2.0 TDI 16V 4motion	103	08/05→11/10	➔	09/05→ 07/10; +PR 1LJ,1LH,1ZG,1ZM		13.0460-7184.2 607184 13.0470-7184.2 LD7184	ATE 23587 20,6 + WK ATE 23587 20,6 + WK Ceramic
			➔	09/05→ 07/10; +PR 1LK,1LM		13.0460-7200.2 607200 13.0470-7200.2 LD7200	ATE 23801 20,3 + WK ATE 23801 20,3 + WK Ceramic
			➔	09/05→ 07/10; +PR 2EA,2EL		13.0460-2621.2 602621 13.0460-2887.2 602887 13.0470-2621.2 LD2621 13.0470-2887.2 LD2887	TRW 24483 16,9 - WE / - WK + Zub TRW 23914 17,1 + WE / - WK + Zub TRW 24483 16,9 - WE / - WK + Zub Ceramic TRW 23914 17,1 + WE / - WK + Zub Ceramic
			➔	09/05→ 07/10; +PR 1KU,1KW		13.0460-2749.2 602749 13.0460-2880.2 602880 13.0470-2749.2 LD2749 13.0470-2880.2 LD2880	TRW 24483 16,9 - WE / - WK + Zub TRW 23914 17,1 + WE / - WK + Zub TRW 24483 16,9 - WE / - WK + Zub Ceramic TRW 23914 17,1 + WE / - WK + Zub Ceramic
			➔	09/05→ 07/10; +PR 1LJ,1LH,1ZG,1ZM		13.0460-7184.2 607184 13.0470-7184.2 LD7184 13.0460-7200.2 607200 13.0470-7200.2 LD7200 13.0460-2621.2 602621 13.0460-2887.2 602887 13.0470-2621.2 LD2621 13.0470-2887.2 LD2887	ATE 23587 20,6 + WK ATE 23587 20,6 + WK Ceramic ATE 23801 20,3 + WK ATE 23801 20,3 + WK Ceramic TRW 24483 16,9 - WE / - WK + Zub TRW 23914 17,1 + WE / - WK + Zub TRW 24483 16,9 - WE / - WK + Zub Ceramic TRW 23914 17,1 + WE / - WK + Zub Ceramic
2.0 TDI 4motion	103	08/05→05/09	➔	09/05→; +PR 1LJ,1LH,1ZG,1ZM		13.0460-7184.2 607184 13.0470-7184.2 LD7184 13.0460-7200.2 607200 13.0470-7200.2 LD7200 13.0460-2621.2 602621 13.0460-2887.2 602887 13.0470-2621.2 LD2621 13.0470-2887.2 LD2887	ATE 23587 20,6 + WK ATE 23587 20,6 + WK Ceramic ATE 23801 20,3 + WK ATE 23801 20,3 + WK Ceramic TRW 24483 16,9 - WE / - WK + Zub TRW 23914 17,1 + WE / - WK + Zub TRW 24483 16,9 - WE / - WK + Zub Ceramic TRW 23914 17,1 + WE / - WK + Zub Ceramic
			➔	09/05→; +PR 1LK,1LM		13.0460-2749.2 602749 13.0460-2880.2 602880 13.0470-2749.2 LD2749 13.0470-2880.2 LD2880	TRW 24483 16,9 - WE / - WK + Zub TRW 23914 17,1 + WE / - WK + Zub TRW 24483 16,9 - WE / - WK + Zub Ceramic TRW 23914 17,1 + WE / - WK + Zub Ceramic
			➔	09/05→; +PR 2EA,2EL		13.0460-2749.2 602749 13.0460-2880.2 602880 13.0470-2749.2 LD2749 13.0470-2880.2 LD2880	TRW 24483 16,9 - WE / - WK + Zub TRW 23914 17,1 + WE / - WK + Zub TRW 24483 16,9 - WE / - WK + Zub Ceramic TRW 23914 17,1 + WE / - WK + Zub Ceramic
			➔	09/05→; +PR 1KU,1KW		13.0460-2749.2 602749 13.0460-2880.2 602880 13.0470-2749.2 LD2749 13.0470-2880.2 LD2880	TRW 24483 16,9 - WE / - WK + Zub TRW 23914 17,1 + WE / - WK + Zub TRW 24483 16,9 - WE / - WK + Zub Ceramic TRW 23914 17,1 + WE / - WK + Zub Ceramic
<b>Zubehörsatz, Scheibenbremsbelag</b>							
1.4 TSI 1.8 TSI	90 118	05/07→11/10 05/07→10/11	➔	10/07→ 07/10; +PR 2EA,2EL		13.0460-0035.2 610035	
			➔	10/07→ 07/10; +PR 1KU,1KW		13.0460-0259.2 610259	
1.4 TSI EcoFuel 1.6 1.6 TDI 1.8 TSI 2.0 BlueTDI 2.0 FSI 2.0 FSI 2.0 FSI 4motion 2.0 TDI 2.0 TDI 2.0 TDI 16V 2.0 TDI 4motion 3.2 FSI 4motion 3.6 R36 4motion	110 75 77 112 105 110 147 110 81 100 125 103 125 184 220	01/09→11/10 08/05→11/10 08/09→11/10 11/09→11/10 01/09→11/10 08/05→11/10 08/05→11/10 09/05→11/10 11/08→11/10 08/05→11/10 08/05→11/10 08/05→11/10 05/09→11/10 11/05→11/10 04/07→11/10	➔	→ 07/10; +PR 2EA,2EL		13.0460-0035.2 610035	
			➔	→ 07/10; +PR 1KU,1KW		13.0460-0259.2 610259	
1.6 FSI 1.9 TDI 2.0 TDI 2.0 TDI 2.0 TDI ↓	85 77 88 90 103	08/05→06/08 08/05→11/10 11/05→05/07 08/05→02/06 08/05→05/09	➔	+PR 2EA,2EL		13.0460-0035.2 610035	
			➔	+PR 1KU,1KW		13.0460-0259.2 610259	













	kw			 	! #		
<b>VW - PASSAT Variant (3C5) 08/05→11/11</b>							
<b>Zubehörsatz, Scheibenbremsbelag</b>							
2.0 TDI	120	08/05→05/09	➡	+PR 2EA,2EL		13.0460-0035.2 610035	
			➡	+PR 1KU,1KW		13.0460-0259.2 610259	
2.0 TDI 16V 4motion	103	08/05→11/10	➡	09/05→ 07/10; +PR 2EA,2EL		13.0460-0035.2 610035	
			➡	09/05→ 07/10; +PR 1KU,1KW		13.0460-0259.2 610259	
2.0 TDI 4motion	103	08/05→05/09	➡	09/05→; +PR 2EA,2EL		13.0460-0035.2 610035	
			➡	09/05→; +PR 1KU,1KW		13.0460-0259.2 610259	
<b> Bremsscheibe</b>							
1.4 TSI	90	05/07→11/10	←	10/07→ 07/10; +PR 1LJ,1LH,1ZG,1ZM		24.0125-0158.1 425158	Ø 312 25 22 V + S
1.8 TSI	118	05/07→10/11	←	10/07→ 07/10; +PR 1LK,1LM		24.0325-0158.1 525158	Ø 312 25 22 V + S
			←	10/07→ 07/10; +PR 1LK,1LM		24.0130-0115.1 430115	Ø 345 30 27 V
			←	10/07→ 07/10; +PR 1LK,1LM		24.0330-0115.1 530115	Ø 345 30 27 V
			➡	10/07→ 07/10; +PR 1KU,1KW		24.0112-0169.1 412169	Ø 282 12 10 + S
			➡	10/07→ 07/10; +PR 1KU,1KW		24.0312-0169.1 512169	Ø 282 12 10 + S
			➡	10/07→ 07/10; +PR 2EA,2EL		24.0122-0219.1 422219	Ø 310 22 20 V
1.4 TSI EcoFuel	110	01/09→11/10	←	→ 07/10; +PR 1LJ,1LH,1ZG,1ZM		24.0125-0158.1 425158	Ø 312 25 22 V + S
1.6	75	08/05→11/10	←	→ 07/10; +PR 1LJ,1LH,1ZG,1ZM		24.0325-0158.1 525158	Ø 312 25 22 V + S
1.6 TDI	77	08/09→11/10	←	→ 07/10; +PR 1LK,1LM		24.0130-0115.1 430115	Ø 345 30 27 V
1.8 TSI	112	11/09→11/10	←	→ 07/10; +PR 1LK,1LM		24.0330-0115.1 530115	Ø 345 30 27 V
2.0 BlueTDI	105	01/09→11/10	←	→ 07/10; +PR 1LK,1LM		24.0330-0115.1 530115	Ø 345 30 27 V
2.0 FSI	110	08/05→11/10	➡	→ 07/10; +PR 1KU,1KW		24.0112-0169.1 412169	Ø 282 12 10 + S
2.0 FSI	147	08/05→11/10	➡	→ 07/10; +PR 1KU,1KW		24.0312-0169.1 512169	Ø 282 12 10 + S
2.0 FSI 4motion	110	09/05→11/10	➡	→ 07/10; +PR 1KU,1KW		24.0312-0169.1 512169	Ø 282 12 10 + S
2.0 TDI	81	11/08→11/10	➡	→ 07/10; +PR 2EA,2EL		24.0122-0219.1 422219	Ø 310 22 20 V
2.0 TDI	100	08/05→11/10	➡	→ 07/10; +PR 2EA,2EL		24.0122-0219.1 422219	Ø 310 22 20 V
2.0 TDI	125	08/05→11/10	➡	→ 07/10; +PR 2EA,2EL		24.0122-0219.1 422219	Ø 310 22 20 V
2.0 TDI 16V	103	08/05→11/10	➡	→ 07/10; +PR 2EA,2EL		24.0122-0219.1 422219	Ø 310 22 20 V
2.0 TDI 4motion	125	05/09→11/10	➡	→ 07/10; +PR 2EA,2EL		24.0122-0219.1 422219	Ø 310 22 20 V
3.2 FSI 4motion	184	11/05→11/10	➡	→ 07/10; +PR 2EA,2EL		24.0122-0219.1 422219	Ø 310 22 20 V
3.6 R36 4motion	220	04/07→11/10	➡	→ 07/10; +PR 2EA,2EL		24.0122-0219.1 422219	Ø 310 22 20 V
1.6 FSI	85	08/05→06/08	←	+PR 1LJ,1LH,1ZG,1ZM		24.0125-0158.1 425158	Ø 312 25 22 V + S
1.9 TDI	77	08/05→11/10	←	+PR 1LJ,1LH,1ZG,1ZM		24.0325-0158.1 525158	Ø 312 25 22 V + S
2.0 TDI	88	11/05→05/07	←	+PR 1LK,1LM		24.0130-0115.1 430115	Ø 345 30 27 V
2.0 TDI	90	08/05→02/06	←	+PR 1LK,1LM		24.0330-0115.1 530115	Ø 345 30 27 V
2.0 TDI	103	08/05→05/09	➡	+PR 1KU,1KW		24.0112-0169.1 412169	Ø 282 12 10 + S
2.0 TDI	120	08/05→05/09	➡	+PR 1KU,1KW		24.0312-0169.1 512169	Ø 282 12 10 + S
			➡	+PR 2EA,2EL		24.0122-0219.1 422219	Ø 310 22 20 V
2.0 TDI 16V 4motion	103	08/05→11/10	←	09/05→ 07/10; +PR 1LJ,1LH,1ZG,1ZM		24.0125-0158.1 425158	Ø 312 25 22 V + S
			←	09/05→ 07/10; +PR 1LJ,1LH,1ZG,1ZM		24.0325-0158.1 525158	Ø 312 25 22 V + S
			←	09/05→ 07/10; +PR 1LK,1LM		24.0130-0115.1 430115	Ø 345 30 27 V
			←	09/05→ 07/10; +PR 1LK,1LM		24.0330-0115.1 530115	Ø 345 30 27 V
			➡	09/05→ 07/10; +PR 1KU,1KW		24.0112-0169.1 412169	Ø 282 12 10 + S
			➡	09/05→ 07/10; +PR 1KU,1KW		24.0312-0169.1 512169	Ø 282 12 10 + S
			➡	09/05→ 07/10; +PR 2EA,2EL		24.0122-0219.1 422219	Ø 310 22 20 V
2.0 TDI 4motion	103	08/05→05/09	←	09/05→; +PR 1LJ,1LH,1ZG,1ZM		24.0125-0158.1 425158	Ø 312 25 22 V + S
			←	09/05→; +PR 1LJ,1LH,1ZG,1ZM		24.0325-0158.1 525158	Ø 312 25 22 V + S
			←	09/05→; +PR 1LK,1LM		24.0130-0115.1 430115	Ø 345 30 27 V
			←	09/05→; +PR 1LK,1LM		24.0330-0115.1 530115	Ø 345 30 27 V
			➡	09/05→; +PR 1KU,1KW		24.0112-0169.1 412169	Ø 282 12 10 + S
			➡	09/05→; +PR 1KU,1KW		24.0312-0169.1 512169	Ø 282 12 10 + S
			➡	09/05→; +PR 2EA,2EL		24.0122-0219.1 422219	Ø 310 22 20 V
<b>VW - PASSAT Variant (3G5) 08/14→</b>							
<b> Bremsbelagsatz, Scheibenbremse</b>							
1.4 GTE Hybrid	115	06/15→	←	+PR 1ZA,1ZC,1ZD,1ZG / 1ZK,1ZL		13.0460-2785.2 602785	TRW 25683 20,4 + WE / + WK
1.4 TSI	92	11/14→	←	+PR 1ZA,1ZC,1ZD,1ZG / 1ZK,1ZL		13.0470-2785.2 LD2785	TRW 25683 20,4 + WE / + WK Ceramic
1.4 TSI	110	11/14→	←	+PR 1ZA,1ZC,1ZD,1ZG / 1ZK,1ZL		13.0470-2785.2 LD2785	TRW 25683 20,4 + WE / + WK Ceramic
1.4 TSI 4motion	110	02/15→	➡	+PR 1KU,1KZ,2EA; + eFSB		13.0460-7294.2 607294	ATE 25009 16,4 - WE / - WK
1.8 TSI	132	02/15→	➡	+PR 1KU,1KZ,2EA; + eFSB		13.0470-7294.2 LD7294	ATE 25009 16,4 - WE / - WK Ceramic
2.0 TDI	110	11/14→	➡	+PR 1KU,1KZ,2EA; + eFSB		13.0460-7294.2 607294	ATE 25009 16,4 - WE / - WK
2.0 TDI	135	07/15→	➡	+PR 1KU,1KZ,2EA; + eFSB		13.0470-7294.2 LD7294	ATE 25009 16,4 - WE / - WK Ceramic
2.0 TDI	140	11/14→	➡	+PR 1KU,1KZ,2EA; + eFSB		13.0460-7294.2 607294	ATE 25009 16,4 - WE / - WK
2.0 TDI 4motion	110	02/15→	➡	+PR 1KU,1KZ,2EA; + eFSB		13.0460-7294.2 607294	ATE 25009 16,4 - WE / - WK
2.0 TDI 4motion	140	11/14→	➡	+PR 1KU,1KZ,2EA; + eFSB		13.0470-7294.2 LD7294	ATE 25009 16,4 - WE / - WK
2.0 TSI 4motion	206	05/15→	➡	+PR 1KU,1KZ,2EA; + eFSB		13.0460-7294.2 607294	ATE 25009 16,4 - WE / - WK
1.6 TDI	88	08/14→	←	11/14→; +PR 1ZA,1ZC,1ZD,1ZG / 1ZK,1ZL		13.0460-2785.2 602785	TRW 25683 20,4 + WE / + WK
2.0 TDI 4motion	176	08/14→	←	11/14→; +PR 1ZA,1ZC,1ZD,1ZG / 1ZK,1ZL		13.0460-2785.2 602785	TRW 25683 20,4 + WE / + WK











	kw				! #		
<b>VW - PASSAT Variant (3G5) 08/14→</b>							
<b> Bremsbelagsatz, Scheibenbremse</b>							
1.6 TDI 2.0 TDI 4motion	88 176	08/14→ 08/14→	← →	11/14→; +PR 1ZA,1ZC,1ZD,1ZG / 1ZK,1ZL  11/14→; +PR 1KU,1KZ,2EA; + eFSB		13.0470-2785.2 LD2785  13.0460-7294.2 607294 13.0470-7294.2 LD7294	TRW 25683 20,4 + WE / + WK Ceramic  ATE 25009 16,4 - WE / - WK ATE 25009 16,4 - WE / - WK Ceramic
2.0 TSI	162	02/15→	← →	05/15→; +PR 1ZA,1ZC,1ZD,1ZG / 1ZK,1ZL  05/15→; +PR 1KU,1KZ,2EA; + eFSB		13.0460-2785.2 602785 13.0470-2785.2 LD2785  13.0460-7294.2 607294 13.0470-7294.2 LD7294	TRW 25683 20,4 + WE / + WK TRW 25683 20,4 + WE / + WK Ceramic  ATE 25009 16,4 - WE / - WK ATE 25009 16,4 - WE / - WK Ceramic
<b>Warnkontakt, Bremsbelagverschleiß</b>							
1.4 GTE Hybrid 1.4 TSI 1.4 TSI 1.4 TSI 4motion 1.8 TSI 2.0 TDI 2.0 TDI 2.0 TDI 2.0 TDI 4motion 2.0 TDI 4motion 2.0 TDI 4motion 2.0 TSI 4motion	115 92 110 110 132 110 135 140 110 140 110 140 206	06/15→ 11/14→ 11/14→ 02/15→ 02/15→ 11/14→ 07/15→ 11/14→ 02/15→ 11/14→ 05/15→	← ←	+PR 1ZA,1ZC,1ZD,1ZG / 1ZK,1ZL  +PR 1LA	1 1	24.8190-0065.2 620065  24.8190-0065.2 620065	L= 172  L= 172
1.6 TDI 2.0 TDI 4motion	88 176	08/14→ 08/14→	← ←	11/14→; +PR 1LA  11/14→; +PR 1ZA,1ZC,1ZD,1ZG / 1ZK,1ZL	1 1	24.8190-0065.2 620065 24.8190-0065.2 620065	L= 172 L= 172
2.0 TSI	162	02/15→	← ←	05/15→; +PR 1LA  05/15→; +PR 1ZA,1ZC,1ZD,1ZG / 1ZK,1ZL	1 1	24.8190-0065.2 620065 24.8190-0065.2 620065	L= 172 L= 172
<b> Bremsscheibe</b>							
1.4 GTE Hybrid 1.4 TSI 1.4 TSI 1.4 TSI 4motion 1.8 TSI 2.0 TDI 2.0 TDI 2.0 TDI 2.0 TDI 4motion 2.0 TDI 4motion 2.0 TDI 4motion 2.0 TSI 4motion	115 92 110 110 132 110 135 140 110 140 110 140 206	06/15→ 11/14→ 11/14→ 02/15→ 02/15→ 11/14→ 07/15→ 11/14→ 02/15→ 11/14→ 05/15→	← ← ← → →	+PR 1ZA,1ZC,1ZD,1ZG / 1ZK,1ZL  +PR 1LA  +PR 1KU,2EA; + eFSB  +PR 1KZ		24.0125-0158.1 425158 24.0325-0158.1 525158 24.0130-0225.1 430225 24.0112-0210.1 412210 24.0122-0219.1 422219	∅ 312 25 22 V + S ∅ 312 25 22 V + S ∅ 340 30 27 V + S ∅ 300 12 10 + S ∅ 310 22 20 V
1.6 TDI 2.0 TDI 4motion	88 176	08/14→ 08/14→	← ← → →	11/14→; +PR 1ZA,1ZC,1ZD,1ZG / 1ZK,1ZL  11/14→; +PR 1LA  11/14→; +PR 1KU,2EA; + eFSB  11/14→; +PR 1KZ		24.0125-0158.1 425158 24.0325-0158.1 525158 24.0130-0225.1 430225 24.0112-0210.1 412210 24.0122-0219.1 422219	∅ 312 25 22 V + S ∅ 312 25 22 V + S ∅ 340 30 27 V + S ∅ 300 12 10 + S ∅ 310 22 20 V
2.0 TSI	162	02/15→	← ← → →	05/15→; +PR 1ZA,1ZC,1ZD,1ZG / 1ZK,1ZL  05/15→; +PR 1LA  05/15→; +PR 1KU,2EA; + eFSB  05/15→; +PR 1KZ		24.0125-0158.1 425158 24.0325-0158.1 525158 24.0130-0225.1 430225 24.0112-0210.1 412210 24.0122-0219.1 422219	∅ 312 25 22 V + S ∅ 312 25 22 V + S ∅ 340 30 27 V + S ∅ 300 12 10 + S ∅ 310 22 20 V
<b>VW - PASSAT Variant (365) 08/10→12/14</b>							
<b> Bremsbelagsatz, Scheibenbremse</b>							
1.4 TSI 1.4 TSI EcoFuel 1.4 TSI MultiFuel 1.6 TDI 1.8 TSI 1.8 TSI 2.0 TDI 2.0 TDI 2.0 TDI 2.0 TDI 2.0 TDI 4motion 2.0 TDI 4motion 2.0 TSI 3.6 FSI 4motion	90 110 118 77 112 118 100 103 125 130 103 130 155 220	08/10→12/14 08/10→12/14 11/10→12/14 08/10→12/14 02/11→12/14 08/10→12/14 08/10→12/14 08/10→12/14 12/12→12/14 08/10→12/14 01/13→12/14 11/10→12/14 01/11→12/14	← ← ← →	→ 10/14; +PR 1LA,1LB  → 10/14; +PR 1ZM,1ZG  → 10/14; +PR 2EA		13.0460-2764.2 602764 13.0470-2764.2 LD2764 13.0460-7184.2 607184 13.0470-7184.2 LD7184 13.0460-2621.2 602621 13.0460-2887.2 602887 13.0470-2621.2 LD2621 13.0470-2887.2 LD2887	TRW 24738 20,0 + WK TRW 24738 20,0 + WK Ceramic ATE 23587 20,6 + WK ATE 23587 20,6 + WK Ceramic TRW 24483 16,9 - WE / - WK + Zub TRW 23914 17,1 + WE / - WK + Zub TRW 24483 16,9 - WE / - WK + Zub Ceramic TRW 23914 17,1 + WE / - WK + Zub Ceramic
↓							

	kw			 	! #		
<b>VW - PASSAT Variant (365) 08/10→12/14</b>							
<b> Bremsbelagsatz, Scheibenbremse</b>							
1.4 TSI	90	08/10→12/14	➔	→ 10/14; +PR 1KW		<b>13.0460-2749.2 602749</b>	TRW 24483 16,9 - WE / - WK + Zub
1.4 TSI EcoFuel	110	08/10→12/14					
1.4 TSI MultiFuel	118	11/10→12/14				<b>13.0460-2880.2 602880</b>	TRW 23914 17,1 + WE / - WK + Zub
1.6 TDI	77	08/10→12/14					
1.8 TSI	112	02/11→12/14				<b>13.0470-2749.2 LD2749</b>	TRW 24483 16,9 - WE / - WK + Zub Ceramic
1.8 TSI	118	08/10→12/14					
2.0 TDI	100	08/10→12/14				<b>13.0470-2880.2 LD2880</b>	TRW 23914 17,1 + WE / - WK + Zub Ceramic
2.0 TDI	103	08/10→12/14					
2.0 TDI	125	08/10→12/14					
2.0 TDI	130	12/12→12/14					
2.0 TDI 4motion	103	08/10→12/14					
2.0 TDI 4motion	130	01/13→12/14					
2.0 TSI	155	11/10→12/14					
3.6 FSI 4motion	220	01/11→12/14					
1.4 TSI	118	11/12→12/14	➔	→ 10/14; +PR 1LA,1LB		<b>13.0460-2764.2 602764</b>	TRW 24738 20,0 + WK
						<b>13.0470-2764.2 LD2764</b>	TRW 24738 20,0 + WK Ceramic
			➔	→ 10/14; +PR 1ZM,1ZG		<b>13.0460-7184.2 607184</b>	ATE 23587 20,6 + WK
						<b>13.0470-7184.2 LD7184</b>	ATE 23587 20,6 + WK Ceramic
			➔	→ 10/14		<b>13.0460-2621.2 602621</b>	TRW 24483 16,9 - WE / - WK + Zub
						<b>13.0460-2887.2 602887</b>	TRW 23914 17,1 + WE / - WK + Zub
						<b>13.0470-2621.2 LD2621</b>	TRW 24483 16,9 - WE / - WK + Zub Ceramic
						<b>13.0470-2887.2 LD2887</b>	TRW 23914 17,1 + WE / - WK + Zub Ceramic
			➔	→ 10/14; +PR 1KW		<b>13.0460-2749.2 602749</b>	TRW 24483 16,9 - WE / - WK + Zub
						<b>13.0460-2880.2 602880</b>	TRW 23914 17,1 + WE / - WK + Zub
						<b>13.0470-2749.2 LD2749</b>	TRW 24483 16,9 - WE / - WK + Zub Ceramic
						<b>13.0470-2880.2 LD2880</b>	TRW 23914 17,1 + WE / - WK + Zub Ceramic
2.0 TDI 4motion	125	08/10→01/13	➔	+PR 1LA,1LB		<b>13.0460-2764.2 602764</b>	TRW 24738 20,0 + WK
						<b>13.0470-2764.2 LD2764</b>	TRW 24738 20,0 + WK Ceramic
			➔	+PR 1ZM,1ZG		<b>13.0460-7184.2 607184</b>	ATE 23587 20,6 + WK
						<b>13.0470-7184.2 LD7184</b>	ATE 23587 20,6 + WK Ceramic
			➔	+PR 2EA		<b>13.0460-2621.2 602621</b>	TRW 24483 16,9 - WE / - WK + Zub
						<b>13.0460-2887.2 602887</b>	TRW 23914 17,1 + WE / - WK + Zub
						<b>13.0470-2621.2 LD2621</b>	TRW 24483 16,9 - WE / - WK + Zub Ceramic
						<b>13.0470-2887.2 LD2887</b>	TRW 23914 17,1 + WE / - WK + Zub Ceramic
			➔	+PR 1KW		<b>13.0460-2749.2 602749</b>	TRW 24483 16,9 - WE / - WK + Zub
						<b>13.0460-2880.2 602880</b>	TRW 23914 17,1 + WE / - WK + Zub
						<b>13.0470-2749.2 LD2749</b>	TRW 24483 16,9 - WE / - WK + Zub Ceramic
						<b>13.0470-2880.2 LD2880</b>	TRW 23914 17,1 + WE / - WK + Zub Ceramic
<b> Bremsscheibe</b>							
1.4 TSI	90	08/10→12/14	➔	→ 10/14; +PR 1ZM,1ZG		<b>24.0125-0158.1 425158</b>	Ø 312 25 22 V + S
1.4 TSI	118	11/12→12/14				<b>24.0325-0158.1 525158</b>	Ø 312 25 22 V + S
1.4 TSI EcoFuel	110	08/10→12/14					
1.4 TSI MultiFuel	118	11/10→12/14	➔	→ 10/14; +PR 1LA,1LB		<b>24.0130-0225.1 430225</b>	Ø 340 30 27 V + S
1.6 TDI	77	08/10→12/14					
1.8 TSI	112	02/11→12/14	➔	→ 10/14; +PR 1KW		<b>24.0112-0169.1 412169</b>	Ø 282 12 10 + S
1.8 TSI	118	08/10→12/14				<b>24.0312-0169.1 512169</b>	Ø 282 12 10 + S
2.0 TDI	100	08/10→12/14	➔	→ 10/14; +PR 2EA; + eFSB		<b>24.0122-0219.1 422219</b>	Ø 310 22 20 V
2.0 TDI	103	08/10→12/14					
2.0 TDI	125	08/10→12/14					
2.0 TDI	130	12/12→12/14					
2.0 TDI 4motion	103	08/10→12/14					
2.0 TDI 4motion	130	01/13→12/14					
2.0 TSI	155	11/10→12/14					
3.6 FSI 4motion	220	01/11→12/14					
2.0 TDI 4motion	125	08/10→01/13	➔	+PR 1ZM,1ZG		<b>24.0125-0158.1 425158</b>	Ø 312 25 22 V + S
						<b>24.0325-0158.1 525158</b>	Ø 312 25 22 V + S
↓							



















	kw			 	! #		
<b>VW - PASSAT Variant (365) 08/10→12/14</b>							
 <b>Bremsscheibe</b>							
2.0 TDI 4motion	125	08/10→01/13	←	+PR 1LA,1LB	24.0130-0225.1	430225	Ø 340 30 27 V + S
			→	+PR 1KW	24.0112-0169.1	412169	Ø 282 12 10 + S
					24.0312-0169.1	512169	Ø 282 12 10 + S
			→	+PR 2EA; + eFSB	24.0122-0219.1	422219	Ø 310 22 20 V
<b>VW - PHAETON (3D1, 3D2, 3D3, 3D4, 3D6, 3D7, 3D8, 3D9) 04/02→03/16</b>							
 <b>Bremsbelagsatz, Scheibenbremse</b>							
3.0 V6 TDI 4motion	165	09/04→05/07	←	+PR 1LC	13.0460-4800.2	604800	BRE 23751 17,0 + WK
3.0 V6 TDI 4motion	176	11/08→03/16					
3.0 V6 TDI 4motion	180	11/13→03/16	←	+PR 1ZK;1ZL	13.0460-7182.2	607182	ATE 23896 20,6 + WK
4.2 V8 4motion	246	05/03→03/16	→	+PR 1KD,1KP,1KY	13.0460-2890.2	602890	TRW 23326 17,4 + WK
5.0 V10 TDI 4motion	230	11/02→10/06					
6.0 W12 4motion	309	04/02→12/05					
6.0 W12 4motion	331	05/05→03/16					
3.0 V6 TDI 4motion	171	06/07→11/08	←	04/08→; +PR 1LC	13.0460-4800.2	604800	BRE 23751 17,0 + WK
			←	04/08→; +PR 1ZK;1ZL	13.0460-7182.2	607182	ATE 23896 20,6 + WK
			→	04/08→; +PR 1KD,1KP,1KY	13.0460-2890.2	602890	TRW 23326 17,4 + WK
3.2 V6	177	04/02→05/05	←	+PR 1LX	13.0460-2875.2	602875	TRW 23119 17,5 + WK
			←	+PR 1LC	13.0460-4800.2	604800	BRE 23751 17,0 + WK
			←	+PR 1ZK;1ZL	13.0460-7182.2	607182	ATE 23896 20,6 + WK
			→	+PR 1KD,1KP,1KY	13.0460-2890.2	602890	TRW 23326 17,4 + WK
3.2 V6 4motion 3.6 V6 4motion	177 206	02/04→11/08 11/08→03/16	←	+PR 1LC	13.0460-4800.2	604800	BRE 23751 17,0 + WK
			←	+PR 1ZK,1ZL	13.0460-7182.2	607182	ATE 23896 20,6 + WK
			→	+PR 1KD,1KP,1KY	13.0460-2890.2	602890	TRW 23326 17,4 + WK
<b>Zubehörsatz, Scheibenbremsbelag</b>							
3.0 V6 TDI 4motion	165	09/04→05/07	→	+PR 1KD,1KP,1KY	13.0460-0023.2	610023	
3.0 V6 TDI 4motion	176	11/08→03/16					
3.0 V6 TDI 4motion	180	11/13→03/16					
3.2 V6	177	04/02→05/05					
3.2 V6 4motion	177	02/04→11/08					
3.6 V6 4motion	206	11/08→03/16					
4.2 V8 4motion	246	05/03→03/16					
5.0 V10 TDI 4motion	230	11/02→10/06					
6.0 W12 4motion	309	04/02→12/05					
6.0 W12 4motion	331	05/05→03/16					
3.0 V6 TDI 4motion	171	06/07→11/08	→	04/08→; +PR 1KD,1KP,1KY	13.0460-0023.2	610023	
 <b>Bremsscheibe</b>							
3.0 V6 TDI 4motion	165	09/04→05/07	←	+PR 1ZK;1ZL	24.0134-0100.1	434100	Ø 360 34 31 V
3.0 V6 TDI 4motion	176	11/08→03/16					
3.0 V6 TDI 4motion	180	11/13→03/16	→	+PR 1KD	24.0122-0202.1	422202	Ø 280 22 20 V
4.2 V8 4motion	246	05/03→03/16	→	+PR 1KP	24.0122-0212.1	422212	Ø 310 22 20 V
5.0 V10 TDI 4motion	230	11/02→10/06					
6.0 W12 4motion	309	04/02→12/05	→	+PR 1KY	24.0122-0214.1	422214	Ø 335 22 20 V
6.0 W12 4motion	331	05/05→03/16					
3.0 V6 TDI 4motion	171	06/07→11/08	←	04/08→; +PR 1ZK;1ZL	24.0134-0100.1	434100	Ø 360 34 31 V
			→	04/08→; +PR 1KD	24.0122-0202.1	422202	Ø 280 22 20 V
			→	04/08→; +PR 1KP	24.0122-0212.1	422212	Ø 310 22 20 V
			→	04/08→; +PR 1KY	24.0122-0214.1	422214	Ø 335 22 20 V
3.2 V6	177	04/02→05/05	←	+PR 1LX	24.0130-0183.1	430183	Ø 323 30 28 V
			←	+PR 1ZK;1ZL	24.0134-0100.1	434100	Ø 360 34 31 V
			→	+PR 1KD	24.0122-0202.1	422202	Ø 280 22 20 V
			→	+PR 1KP	24.0122-0212.1	422212	Ø 310 22 20 V
			→	+PR 1KY	24.0122-0214.1	422214	Ø 335 22 20 V
3.2 V6 4motion 3.6 V6 4motion	177 206	02/04→11/08 11/08→03/16	←	+PR 1ZK,1ZL	24.0134-0100.1	434100	Ø 360 34 31 V
			→	+PR 1KD	24.0122-0202.1	422202	Ø 280 22 20 V
			→	+PR 1KP	24.0122-0212.1	422212	Ø 310 22 20 V
			→	+PR 1KY	24.0122-0214.1	422214	Ø 335 22 20 V
<b>VW - POLO (6N1) 10/94→10/99</b>							
 <b>Bremsbelagsatz, Scheibenbremse</b>							
1.7 SDI ↓	42	04/97→10/99	←	05/97→	13.0460-7100.2	607100	VW 21866 17,2 - WE / - WK









	kw			 	! #		
<b>VW - POLO (6N1) 10/94→10/99</b>							
<b> Bremsbelagsatz, Scheibenbremse</b>							
1.7 SDI	42	04/97→10/99	←	05/97→		13.0470-7100.2 LD7100	VW 21866 17,2 - WE / - WK Ceramic
100 1.4 16V	74	04/96→10/99	←			13.0460-2821.2 602821	TRW 21945 16,0 - WK
			→	10/99→; nur für Deutschland		13.0460-2886.2 602886	TRW 20961 16,0 - WK
						13.0460-2894.2 602894	TRW 20961 17,2 - WK + Zub
						13.0460-2937.2 602937	TRW 20961 15,2 - WK + Zub
			→	→ 09/99; nur für Deutschland		13.0470-2886.2 LD2886	TRW 20961 16,0 - WK Ceramic
			→	→ 09/99; nur für Deutschland		13.0470-2894.2 LD2894	TRW 20961 17,2 - WK + Zub Ceramic
120 1.6 16V GTI	88	09/98→10/99	←			13.0460-2821.2 602821	TRW 21945 16,0 - WK
			→	10/99→		13.0460-2886.2 602886	TRW 20961 16,0 - WK
						13.0460-2894.2 602894	TRW 20961 17,2 - WK + Zub
						13.0460-2937.2 602937	TRW 20961 15,2 - WK + Zub
			→	→ 09/99		13.0470-2886.2 LD2886	TRW 20961 16,0 - WK Ceramic
			→	→ 09/99		13.0470-2894.2 LD2894	TRW 20961 17,2 - WK + Zub Ceramic
45 1.0 55 1.4 60 1.4 64 1.9 D 64 1.9 SDI 75 1.6 4motion	33 40 44 47 47 55	10/94→09/96 08/95→10/99 07/95→10/99 10/94→10/99 07/96→10/99 08/95→10/99	←	→ 6N-TW082000		13.0460-7059.2 607059	VW 20887 17,3 - WE / - WK + Zub
			←	→ 6N-TY140000		13.0460-7059.2 607059	VW 20887 17,3 - WE / - WK + Zub
			←	6N-TY140001→		13.0460-7100.2 607100	VW 21866 17,2 - WE / - WK
						13.0470-7100.2 LD7100	VW 21866 17,2 - WE / - WK Ceramic
			←	6N-TW082001→		13.0460-7100.2 607100	VW 21866 17,2 - WE / - WK
			←	→ 09/99		13.0470-7100.2 LD7100	VW 21866 17,2 - WE / - WK Ceramic
50 1.0 60 1.7 SDI	37 44	09/96→10/99 08/97→10/99	←			13.0460-7100.2 607100	VW 21866 17,2 - WE / - WK
						13.0470-7100.2 LD7100	VW 21866 17,2 - WE / - WK Ceramic
75 1.6	55	10/94→10/99	←	→ 6N-TW082000		13.0460-7059.2 607059	VW 20887 17,3 - WE / - WK + Zub
			←	→ 6N-TY140000		13.0460-7059.2 607059	VW 20887 17,3 - WE / - WK + Zub
			←	6N-TW082001→; → 09/99		13.0460-7100.2 607100	VW 21866 17,2 - WE / - WK
						13.0470-7100.2 LD7100	VW 21866 17,2 - WE / - WK Ceramic
			←	6N-TY140001→; → 09/99		13.0460-7100.2 607100	VW 21866 17,2 - WE / - WK
						13.0470-7100.2 LD7100	VW 21866 17,2 - WE / - WK Ceramic
<b>Zubehörsatz, Scheibenbremsbelag</b>							
100 1.4 16V	74	04/96→10/99	→	10/99→; nur für Deutschland		13.0460-0072.2 610072	TRW
			→	→ 09/99; nur für Deutschland		13.0460-0072.2 610072	TRW
120 1.6 16V GTI	88	09/98→10/99	→	10/99→		13.0460-0072.2 610072	TRW
			→	→ 09/99		13.0460-0072.2 610072	TRW
<b> Bremsscheibe</b>							
1.7 SDI	42	04/97→10/99	←	05/97→		24.0118-0106.1 418106	Ø 239 18 16 V + S
100 1.4 16V	74	04/96→10/99	←			24.0318-0106.1 518106	Ø 239 18 16 V + S
						24.0120-0128.1 420128	Ø 256 20 18 V + S
			→	10/99→		24.0320-0128.1 520128	Ø 256 20 18 V + S
			→	→ 09/99; für Deutschland		24.0109-0124.1 409124	Ø 232 9 7
			→	→ 09/99; für Deutschland		24.0110-0111.1 410111	Ø 226 10 8 - ABS Ring / - RLG
						24.0110-0275.2 410275	Ø 226 10 8 + ABS Ring / - RLG
120 1.6 16V GTI	88	09/98→10/99	←			24.0125-0136.1 425136	Ø 256 25 23 V
			→	10/99→		24.0109-0124.1 409124	Ø 232 9 7
			→	→ 09/99		24.0110-0111.1 410111	Ø 226 10 8 - ABS Ring / - RLG
						24.0110-0275.2 410275	Ø 226 10 8 + ABS Ring / - RLG
45 1.0 64 1.9 D 64 1.9 SDI 75 1.6 4motion	33 47 47 55	10/94→09/96 10/94→10/99 07/96→10/99 08/95→10/99	←	→ 6N-SY087410		24.0110-0232.1 410232	Ø 239 9,9 8 + S
			←	→ 6N-SW008500		24.0110-0232.1 410232	Ø 239 9,9 8 + S
			←	6N-SW008501→		24.0118-0106.1 418106	Ø 239 18 16 V + S





















	kw			 	! #		
<b>VW - POLO (6N1) 10/94→10/99</b>							
<b>Bremsscheibe</b>							
45 1.0	33	10/94→09/96	←	6N-SW008501→		24.0318-0106.1 518106	Ø 239 18 16 V + S
64 1.9 D	47	10/94→10/99	←	6N-SY087411→		24.0118-0106.1 418106	Ø 239 18 16 V + S
64 1.9 SDI	47	07/96→10/99	←			24.0318-0106.1 518106	Ø 239 18 16 V + S
75 1.6 4motion	55	08/95→10/99	←			24.0318-0106.1 518106	Ø 239 18 16 V + S
50 1.0	37	09/96→10/99	←			24.0118-0106.1 418106	Ø 239 18 16 V + S
55 1.4	40	08/95→10/99	←			24.0318-0106.1 518106	Ø 239 18 16 V + S
60 1.4	44	07/95→10/99	←			24.0318-0106.1 518106	Ø 239 18 16 V + S
60 1.7 SDI	44	08/97→10/99	←			24.0318-0106.1 518106	Ø 239 18 16 V + S
75 1.6	55	10/94→10/99	←	→ 6N-SY087410		24.0110-0232.1 410232	Ø 239 9,9 8 + S
			←	→ 6N-SW008500		24.0110-0232.1 410232	Ø 239 9,9 8 + S
			←	6N-SW008501→; → 09/99		24.0118-0106.1 418106	Ø 239 18 16 V + S
			←			24.0318-0106.1 518106	Ø 239 18 16 V + S
			←	6N-SY087411→; → 09/99		24.0118-0106.1 418106	Ø 239 18 16 V + S
			←			24.0318-0106.1 518106	Ø 239 18 16 V + S
<b>VW - POLO (6N2) 10/99→10/01</b>							
<b>Bremsbelagsatz, Scheibenbremse</b>							
1.0	37	10/99→09/01	←			13.0460-7100.2 607100	VW 21866 17,2 - WE / - WK
1.7 SDI	44	10/99→09/01	←			13.0470-7100.2 LD7100	VW 21866 17,2 - WE / - WK Ceramic
1.4	40	10/99→09/01	←	→ 6N-TW082000		13.0460-7059.2 607059	VW 20887 17,3 - WE / - WK + Zub
1.4	44	10/99→09/01	←			13.0460-7059.2 607059	VW 20887 17,3 - WE / - WK + Zub
1.9 D	47	10/99→09/01	←	→ 6N-TY140000		13.0460-7059.2 607059	VW 20887 17,3 - WE / - WK + Zub
1.9 SDI	47	10/99→09/01	←			13.0460-7100.2 607100	VW 21866 17,2 - WE / - WK
			←	6N-TY140001→		13.0470-7100.2 LD7100	VW 21866 17,2 - WE / - WK Ceramic
			←			13.0460-7100.2 607100	VW 21866 17,2 - WE / - WK
			←	6N-TW082001→		13.0470-7100.2 LD7100	VW 21866 17,2 - WE / - WK Ceramic
1.4 16V	55	10/99→09/01	←	+ ABS		13.0460-2821.2 602821	TRW 21945 16,0 - WK
			←	- ABS		13.0460-7100.2 607100	VW 21866 17,2 - WE / - WK
			←			13.0470-7100.2 LD7100	VW 21866 17,2 - WE / - WK Ceramic
			→	+ ABS		13.0460-2886.2 602886	TRW 20961 16,0 - WK
			→			13.0460-2894.2 602894	TRW 20961 17,2 - WK + Zub
			→			13.0460-2937.2 602937	TRW 20961 15,2 - WK + Zub
			→			13.0470-2886.2 LD2886	TRW 20961 16,0 - WK Ceramic
			→			13.0470-2894.2 LD2894	TRW 20961 17,2 - WK + Zub Ceramic
1.4 16V	74	10/99→09/01	←			13.0460-2821.2 602821	TRW 21945 16,0 - WK
			→	nur für Deutschland		13.0460-2886.2 602886	TRW 20961 16,0 - WK
			→			13.0460-2894.2 602894	TRW 20961 17,2 - WK + Zub
			→			13.0460-2937.2 602937	TRW 20961 15,2 - WK + Zub
			→			13.0470-2886.2 LD2886	TRW 20961 16,0 - WK Ceramic
			→			13.0470-2894.2 LD2894	TRW 20961 17,2 - WK + Zub Ceramic
1.4 TDI	55	10/99→09/01	←			13.0460-2821.2 602821	TRW 21945 16,0 - WK
			→	+ ABS		13.0460-2886.2 602886	TRW 20961 16,0 - WK
			→			13.0460-2894.2 602894	TRW 20961 17,2 - WK + Zub
			→			13.0460-2937.2 602937	TRW 20961 15,2 - WK + Zub
			→			13.0470-2886.2 LD2886	TRW 20961 16,0 - WK Ceramic
			→			13.0470-2894.2 LD2894	TRW 20961 17,2 - WK + Zub Ceramic
1.6 16V GTI	92	10/99→09/01	←			13.0460-2821.2 602821	TRW 21945 16,0 - WK
			→			13.0460-2886.2 602886	TRW 20961 16,0 - WK
			→			13.0460-2894.2 602894	TRW 20961 17,2 - WK + Zub
			→			13.0460-2937.2 602937	TRW 20961 15,2 - WK + Zub
			→			13.0470-2886.2 LD2886	TRW 20961 16,0 - WK Ceramic
			→			13.0470-2894.2 LD2894	TRW 20961 17,2 - WK + Zub Ceramic
<b>Zubehörsatz, Scheibenbremsbelag</b>							
1.4 16V	55	10/99→09/01	→	+ ABS		13.0460-0072.2 610072	TRW
1.4 TDI	55	10/99→09/01	→			13.0460-0072.2 610072	TRW
1.4 16V	74	10/99→09/01	→	nur für Deutschland		13.0460-0072.2 610072	TRW
↓							









	kw			 	! #		
<b>VW - POLO (6N2) 10/99→10/01</b>							
<b>Zubehörsatz, Scheibenbremsbelag</b>							
1.6 16V GTI	92	10/99→09/01	➡			13.0460-0072.2 610072	TRW
<b> Bremsscheibe</b>							
1.0	37	10/99→09/01	←			24.0118-0106.1 418106	Ø 239 18 16 V + S
1.4	40	10/99→09/01	←			24.0318-0106.1 518106	Ø 239 18 16 V + S
1.4	44	10/99→09/01	←				
1.7 SDI	44	10/99→09/01	←				
1.4 16V	55	10/99→09/01	←	- ABS		24.0118-0106.1 418106	Ø 239 18 16 V + S
			←	+ ABS		24.0120-0128.1 420128	Ø 256 20 18 V + S
			➡	+ ABS		24.0320-0128.1 520128	Ø 256 20 18 V + S
1.4 16V	74	10/99→09/01	←			24.0109-0124.1 409124	Ø 232 9 7
			➡			24.0120-0128.1 420128	Ø 256 20 18 V + S
1.4 16V	74	10/99→09/01	←			24.0320-0128.1 520128	Ø 256 20 18 V + S
			➡			24.0109-0124.1 409124	Ø 232 9 7
1.4 TDI	55	10/99→09/01	←			24.0120-0128.1 420128	Ø 256 20 18 V + S
			➡	+ ABS		24.0320-0128.1 520128	Ø 256 20 18 V + S
1.6 16V GTI	92	10/99→09/01	←			24.0109-0124.1 409124	Ø 232 9 7
			➡			24.0125-0136.1 425136	Ø 256 25 23 V
1.9 D	47	10/99→09/01	←	→ 6N-SY087410		24.0110-0232.1 410232	Ø 239 9,9 8 + S
1.9 SDI	47	10/99→09/01	←	→ 6N-SW008500		24.0110-0232.1 410232	Ø 239 9,9 8 + S
			←	6N-SW008501→		24.0118-0106.1 418106	Ø 239 18 16 V + S
			←			24.0318-0106.1 518106	Ø 239 18 16 V + S
			←	6N-SY087411→		24.0118-0106.1 418106	Ø 239 18 16 V + S
						24.0318-0106.1 518106	Ø 239 18 16 V + S
<b>VW - POLO (6R1, 6C1) 03/09→</b>							
<b> Bremsbelagsatz, Scheibenbremse</b>							
1.0	44	01/14→	←	+PR 1ZG,1LR,1ZJ		13.0460-7111.2 607111	VW 23130 19,6 - WE / - WK
1.0	55	01/14→	←			13.0470-7111.2 LD7111	VW 23130 19,6 - WE / - WK Ceramic
1.0 TSI	70	11/14→	←				
1.0 TSI	81	11/14→	←				
1.4 TDI	55	03/14→	←	+PR 1LN,1ZC		13.0460-7184.2 607184	ATE 23587 20,6 + WK
1.4 TDI	66	02/14→	←			13.0470-7184.2 LD7184	ATE 23587 20,6 + WK Ceramic
1.4 TDI	77	05/14→	➡	+PR 1KD,1KK,1KT,2EJ		13.0460-2787.2 602787	TRW 23554 17,3 - WK / - WE
1.4 TSI	110	05/14→	➡	+PR 1KK,1KT,2EJ		13.0460-2820.2 602820	TRW 20961 17,2 - WK
			➡			13.0470-2820.2 LD2820	TRW 20961 17,2 - WK Ceramic
			➡	+PR 2EJ		13.0460-2894.2 602894	TRW 20961 17,2 - WK + Zub
			➡			13.0470-2894.2 LD2894	TRW 20961 17,2 - WK + Zub Ceramic
1.2	44	06/09→	←	+PR 1ZG,1LR,1ZJ		13.0460-7111.2 607111	VW 23130 19,6 - WE / - WK
1.2	51	06/09→	←			13.0470-7111.2 LD7111	VW 23130 19,6 - WE / - WK Ceramic
1.2 TDI	55	10/09→	←				
1.2 TSI	66	05/11→05/14	←	+PR 1LN,1ZC,1ZD		13.0460-7184.2 607184	ATE 23587 20,6 + WK
1.2 TSI	77	11/09→	←			13.0470-7184.2 LD7184	ATE 23587 20,6 + WK Ceramic
1.4 (6R1)	63	03/09→05/14	←				
1.4 BiFuel	60	03/10→01/11	←	+PR 1ZP,1ZR		13.0460-7285.2 607285	ATE 23587 20,6 - WE / - WK
1.4 GTI	132	05/10→	←			13.0470-7285.2 LD7285	ATE 23587 20,6 - WE / - WK Ceramic
1.4 TSI	103	10/12→	←				
1.6 BiFuel	60	01/11→	➡	+PR 1KK,1KT,1KV		13.0460-2787.2 602787	TRW 23554 17,3 - WK / - WE
1.6 TDI	55	06/09→	➡			13.0460-2820.2 602820	TRW 20961 17,2 - WK
1.6 TDI	66	06/09→	➡			13.0470-2820.2 LD2820	TRW 20961 17,2 - WK Ceramic
1.6 TDI	77	06/09→	➡	+PR 2EJ		13.0460-2894.2 602894	TRW 20961 17,2 - WK + Zub
			➡			13.0470-2894.2 LD2894	TRW 20961 17,2 - WK + Zub Ceramic
1.2 TSI	81	01/14→	←	+PR 1ZG,1LR,1ZJ		13.0460-7111.2 607111	VW 23130 19,6 - WE / - WK
			←			13.0470-7111.2 LD7111	VW 23130 19,6 - WE / - WK Ceramic
			←	+PR 1LN,1ZC		13.0460-7184.2 607184	ATE 23587 20,6 + WK
			←			13.0470-7184.2 LD7184	ATE 23587 20,6 + WK Ceramic
			←	+PR 1ZP,1ZR		13.0460-7285.2 607285	ATE 23587 20,6 - WE / - WK
			←			13.0470-7285.2 LD7285	ATE 23587 20,6 - WE / - WK Ceramic
			➡	+PR 1KD,1KK,1KT,2EJ		13.0460-2787.2 602787	TRW 23554 17,3 - WK / - WE

	kw			 	! #		
<b>VW - POLO (6R1, 6C1) 03/09→</b>							
<b> Bremsbelagsatz, Scheibenbremse</b>							
1.2 TSI	81	01/14→	➔	+PR 1KK,1KT,2EJ	13.0460-2820.2 602820	TRW 20961 17,2 - WK	
			➔	+PR 2EJ	13.0470-2820.2 LD2820	TRW 20961 17,2 - WK Ceramic	
			➔	+PR 2EJ	13.0460-2894.2 602894	TRW 20961 17,2 - WK + Zub	
1.2 TSI 16V	66	02/14→	➔	+PR 1ZG,1LR,1ZJ	13.0460-2894.2 LD2894	TRW 20961 17,2 - WK + Zub Ceramic	
			➔	+PR 1ZG,1LR,1ZJ	13.0460-7111.2 607111	VW 23130 19,6 - WE / - WK	
			➔	+PR 1ZG,1LR,1ZJ	13.0470-7111.2 LD7111	VW 23130 19,6 - WE / - WK Ceramic	
			➔	+PR 1LN,1ZC,1ZD	13.0460-7184.2 607184	ATE 23587 20,6 + WK	
			➔	+PR 1LN,1ZC,1ZD	13.0470-7184.2 LD7184	ATE 23587 20,6 + WK Ceramic	
			➔	+PR 1ZP,1ZR	13.0460-7285.2 607285	ATE 23587 20,6 - WE / - WK	
			➔	+PR 1ZP,1ZR	13.0470-7285.2 LD7285	ATE 23587 20,6 - WE / - WK Ceramic	
1.6 1.6	66 81	07/14→ 07/14→	➔	+PR 1KD,1KK,1KT,1KV	13.0460-2787.2 602787	TRW 23554 17,3 - WK / - WE	
			➔	+PR 1KK,1KT,1KV	13.0460-2820.2 602820	TRW 20961 17,2 - WK	
			➔	+PR 1KK,1KT,1KV	13.0470-2820.2 LD2820	TRW 20961 17,2 - WK Ceramic	
			➔	+PR 2EJ	13.0460-2894.2 602894	TRW 20961 17,2 - WK + Zub	
			➔	+PR 2EJ	13.0470-2894.2 LD2894	TRW 20961 17,2 - WK + Zub Ceramic	
			➔	+PR 1ZG,1LR,1ZJ	13.0460-7111.2 607111	VW 23130 19,6 - WE / - WK	
			➔	+PR 1ZG,1LR,1ZJ	13.0470-7111.2 LD7111	VW 23130 19,6 - WE / - WK Ceramic	
1.6	77	01/10→	➔	+PR 1LN,1ZC	13.0460-7184.2 607184	ATE 23587 20,6 + WK	
			➔	+PR 1LN,1ZC	13.0470-7184.2 LD7184	ATE 23587 20,6 + WK Ceramic	
			➔	+PR 1ZP,1ZR	13.0460-7285.2 607285	ATE 23587 20,6 - WE / - WK	
			➔	+PR 1ZP,1ZR	13.0470-7285.2 LD7285	ATE 23587 20,6 - WE / - WK Ceramic	
			➔	+PR 1KD,1KK,1KT,1KV	13.0460-2787.2 602787	TRW 23554 17,3 - WK / - WE	
			➔	+PR 1KK,1KT,1KV	13.0460-2820.2 602820	TRW 20961 17,2 - WK	
			➔	+PR 1KK,1KT,1KV	13.0470-2820.2 LD2820	TRW 20961 17,2 - WK Ceramic	
1.8 GTI	141	11/14→	➔	+PR 2EJ	13.0460-2894.2 602894	TRW 20961 17,2 - WK + Zub	
			➔	+PR 2EJ	13.0470-2894.2 LD2894	TRW 20961 17,2 - WK + Zub Ceramic	
			➔	07/14→; +PR 1ZG,1LR,1ZJ	13.0460-7111.2 607111	VW 23130 19,6 - WE / - WK	
			➔	07/14→; +PR 1ZG,1LR,1ZJ	13.0470-7111.2 LD7111	VW 23130 19,6 - WE / - WK Ceramic	
			➔	07/14→; +PR 1LN,1ZC	13.0460-7184.2 607184	ATE 23587 20,6 + WK	
1.8 GTI 230	169	04/16→	➔	07/14→; +PR 1LN,1ZC	13.0470-7184.2 LD7184	ATE 23587 20,6 + WK Ceramic	
			➔	07/14→; +PR 1ZP,1ZR	13.0460-7285.2 607285	ATE 23587 20,6 - WE / - WK	
			➔	07/14→; +PR 1ZP,1ZR	13.0470-7285.2 LD7285	ATE 23587 20,6 - WE / - WK Ceramic	
			➔	07/14→; +PR 1KK,1KT,1KV	13.0460-2787.2 602787	TRW 23554 17,3 - WK / - WE	
			➔	07/14→; +PR 1KK,1KT,1KV	13.0460-2820.2 602820	TRW 20961 17,2 - WK	
			➔	07/14→; +PR 1KK,1KT,1KV	13.0470-2820.2 LD2820	TRW 20961 17,2 - WK Ceramic	
			➔	07/14→; +PR 2EJ	13.0460-2894.2 602894	TRW 20961 17,2 - WK + Zub	
➔	07/14→; +PR 2EJ	13.0470-2894.2 LD2894	TRW 20961 17,2 - WK + Zub Ceramic				
1.8 GTI	141	11/14→	➔	+PR 1LN,1ZC	13.0460-7184.2 607184	ATE 23587 20,6 + WK	
			➔	+PR 1LN,1ZC	13.0470-7184.2 LD7184	ATE 23587 20,6 + WK Ceramic	
			➔	+PR 1ZP,1ZR	13.0460-7285.2 607285	ATE 23587 20,6 - WE / - WK	
			➔	+PR 1ZP,1ZR	13.0470-7285.2 LD7285	ATE 23587 20,6 - WE / - WK Ceramic	
1.8 GTI 230	169	04/16→	➔	+PR 1KD,1KK,1KT,2EJ	13.0460-2787.2 602787	TRW 23554 17,3 - WK / - WE	
			➔	+PR 1KK,1KT,2EJ	13.0460-2820.2 602820	TRW 20961 17,2 - WK	
			➔	+PR 1KK,1KT,2EJ	13.0470-2820.2 LD2820	TRW 20961 17,2 - WK Ceramic	
			➔		13.0460-2894.2 602894	TRW 20961 17,2 - WK + Zub	
			➔		13.0470-2894.2 LD2894	TRW 20961 17,2 - WK + Zub Ceramic	
			➔	+PR 1ZG,1LR,1ZJ	13.0460-7111.2 607111	VW 23130 19,6 - WE / - WK	
			➔	+PR 1ZG,1LR,1ZJ	13.0470-7111.2 LD7111	VW 23130 19,6 - WE / - WK Ceramic	
↓							









	kw			 	! #		
<b>VW - POLO (6R1, 6C1) 03/09→</b>							
<b> Bremsbelagsatz, Scheibenbremse</b>							
1.8 GTI 230	169	04/16→	←	+PR 1LN,1ZC	13.0460-7184.2	607184	ATE 23587 20,6 + WK
			←	+PR 1ZP,1ZR	13.0470-7184.2	LD7184	ATE 23587 20,6 + WK Ceramic
			→	+PR 1KK,1KT,2EJ	13.0460-7285.2	607285	ATE 23587 20,6 - WE / - WK
			→		13.0470-7285.2	LD7285	ATE 23587 20,6 - WE / - WK Ceramic
2.0 R WRC	162	08/13→	←	+PR 1ZG,1LR,1ZJ	13.0460-2787.2	602787	TRW 23554 17,3 - WK / - WE
			←	+PR 1LN,1ZC,1ZD	13.0460-2820.2	602820	TRW 20961 17,2 - WK
			←	+PR 1ZP,1ZR	13.0470-2820.2	LD2820	TRW 20961 17,2 - WK Ceramic
			→	+PR 1KD	13.0460-2894.2	602894	TRW 20961 17,2 - WK + Zub
			→	+PR 1KK,1KT,1KV	13.0470-2894.2	LD2894	TRW 20961 17,2 - WK + Zub Ceramic
			→	+PR 2EJ			
<b> Bremsscheibe</b>							
1.0 1.0 1.0 TSI 1.0 TSI 1.4 TDI 1.4 TDI 1.4 TDI 1.4 TSI	44 55 70 81 55 66 77 110	01/14→ 01/14→ 11/14→ 11/14→ 03/14→ 02/14→ 05/14→ 05/14→	←	+PR 1LR,1ZG,1ZJ	24.0122-0151.1	422151	∅ 256 22 19 V + S
			←	+PR 1LN,1ZC	24.0322-0151.1	522151	∅ 256 22 19 V + S
			←	+PR 1KK,1KT,2EJ	24.0125-0113.1	425113	∅ 288 25 22 V + S
			→		24.0325-0113.1	525113	∅ 288 25 22 V + S
			→		24.0109-0123.1	409123	∅ 230 9 7 + S
			→		24.0309-0123.1	509123	∅ 230 9 7 + S
			→				
1.2 1.2 1.2 TDI 1.2 TSI 1.2 TSI 1.2 TSI 16V 1.4 (6R1) 1.4 BiFuel 1.4 GTI 1.4 TSI 1.6 BiFuel 1.6 TDI 1.6 TDI 1.6 TDI	44 51 55 66 77 66 63 60 132 103 60 55 66 77	06/09→ 06/09→ 10/09→ 05/11→05/14 11/09→ 02/14→ 03/09→05/14 03/10→01/11 05/10→ 10/12→ 01/11→ 06/09→ 06/09→ 06/09→	←	+PR 1LR,1ZG,1ZJ	24.0122-0151.1	422151	∅ 256 22 19 V + S
			←	+PR 1LN,1ZC,1ZD	24.0322-0151.1	522151	∅ 256 22 19 V + S
			←	+PR 1ZP,1ZR	24.0125-0113.1	425113	∅ 288 25 22 V + S
			←		24.0325-0113.1	525113	∅ 288 25 22 V + S
			←	+PR 1KK,1KT,1KV,2EJ	24.0125-0123.1	425123	∅ 310 25 22 V + S
			←		24.0325-0123.1	525123	∅ 310 25 22 V + S
			→		24.0109-0123.1	409123	∅ 230 9 7 + S
			→		24.0309-0123.1	509123	∅ 230 9 7 + S
			→				
			→				
			→				
1.6 1.6	66 81	07/14→ 07/14→	←	+PR 1LR,1ZG,1ZJ	24.0122-0151.1	422151	∅ 256 22 19 V + S
			←		24.0322-0151.1	522151	∅ 256 22 19 V + S
			←		24.0125-0113.1	425113	∅ 288 25 22 V + S
			←	+PR 1ZP,1ZR	24.0325-0113.1	525113	∅ 288 25 22 V + S
			→	+PR 1KK,1KT,1KV,2EJ	24.0125-0123.1	425123	∅ 310 25 22 V + S
1.6	77	01/10→	←	07/14→; +PR 1LR,1ZG,1ZJ	24.0125-0123.1	409123	∅ 230 9 7 + S
			←		24.0309-0123.1	509123	∅ 230 9 7 + S
			←	07/14→; +PR 1LR,1ZG,1ZJ	24.0122-0151.1	422151	∅ 256 22 19 V + S
↓			←	07/14→	24.0322-0151.1	522151	∅ 256 22 19 V + S
			←		24.0125-0113.1	425113	∅ 288 25 22 V + S







	kw			 	! #		
<b>VW - POLO (6R1, 6C1) 03/09→</b>							
<b>Bremsscheibe</b>							
1.6	77	01/10→	←	07/14→		24.0325-0113.1 525113	Ø 288 25 22 V + S
			←	07/14→; +PR 1ZP,1ZR		24.0125-0123.1 425123	Ø 310 25 22 V + S
						24.0325-0123.1 525123	Ø 310 25 22 V + S
			→	07/14→; +PR 1KK,1KT,1KV,2EJ		24.0109-0123.1 409123	Ø 230 9 7 + S
						24.0309-0123.1 509123	Ø 230 9 7 + S
2.0 R WRC	162	08/13→	←	+PR 1LN,1ZC,1ZD		24.0125-0113.1 425113	Ø 288 25 22 V + S
						24.0325-0113.1 525113	Ø 288 25 22 V + S
			←	+PR 1ZP,1ZR		24.0125-0123.1 425123	Ø 310 25 22 V + S
						24.0325-0123.1 525123	Ø 310 25 22 V + S
			→	+PR 1KK,1KT,1KV,2EJ		24.0109-0123.1 409123	Ø 230 9 7 + S
<b>VW - POLO (9N_) 10/01→01/12</b>							
<b>Bremsbelagsatz, Scheibenbremse</b>							
1.2	40	01/02→05/07	←	+PR 1LN;1ZD;1ZH		13.0460-2883.2 602883	TRW 23581 18,8 - WE / - WK
1.4 FSI	63	02/02→07/06				13.0460-2884.2 602884	TRW 23581 18,8 + WK
						13.0470-2884.2 LD2884	TRW 23581 18,8 + WK Ceramic
			←	+PR 1LM;1ZN		13.0460-7100.2 607100	VW 21866 17,2 - WE / - WK
						13.0460-7164.2 607164	VW 21866 17,2 + WK
						13.0470-7100.2 LD7100	VW 21866 17,2 - WE / - WK Ceramic
			←	+PR 1ZF		13.0460-7111.2 607111	VW 23130 19,6 - WE / - WK
						13.0470-7111.2 LD7111	VW 23130 19,6 - WE / - WK Ceramic
			←	+PR 1LQ;1LR;1ZG		13.0460-7117.2 607117	VW 23130 19,6 + WK
						13.0470-7117.2 LD7117	VW 23130 19,6 + WK Ceramic
			←	+PR 1LJ		13.0460-7122.2 607122	ATE 20676 19,8 + WK
						13.0470-7122.2 LD7122	ATE 20676 19,8 + WK Ceramic
			→	+PR 1KK,1KT		13.0460-2787.2 602787	TRW 23554 17,3 - WK / - WE
						13.0460-2860.2 602860	TRW 23554 16,4 - WK / + WE
						13.0460-2894.2 602894	TRW 20961 17,2 - WK + Zub
						13.0470-2860.2 LD2860	TRW 23554 16,4 - WK / + WE Ceramic
						13.0470-2894.2 LD2894	TRW 20961 17,2 - WK + Zub Ceramic
			→	+PR 1KD,1KS,1KV		13.0460-2864.2 602864	TRW 20961 17,2 - WK
						13.0460-2877.2 602877	TRW 23554 17,2 + WK
						13.0470-2877.2 LD2877	TRW 23554 17,2 + WK Ceramic
1.2	44	05/07→11/09	←	→ 05/09; +PR 1LN;1ZD;1ZH		13.0460-2883.2 602883	TRW 23581 18,8 - WE / - WK
1.2 12V	51	05/07→11/09				13.0460-2884.2 602884	TRW 23581 18,8 + WK
1.4 16V	59	05/06→11/09				13.0470-2884.2 LD2884	TRW 23581 18,8 + WK Ceramic
1.4 TDI	51	04/05→11/09					
1.4 TDI	59	04/05→11/09	←	→ 05/09; +PR 1LM;1ZN		13.0460-7100.2 607100	VW 21866 17,2 - WE / - WK
1.6 16V	77	05/06→11/09				13.0460-7164.2 607164	VW 21866 17,2 + WK
1.8 GTI	110	09/05→11/09				13.0470-7100.2 LD7100	VW 21866 17,2 - WE / - WK Ceramic
1.9 TDI	96	11/03→11/09					
			←	→ 05/09; +PR 1ZF		13.0460-7111.2 607111	VW 23130 19,6 - WE / - WK
						13.0470-7111.2 LD7111	VW 23130 19,6 - WE / - WK Ceramic
			←	→ 05/09; +PR 1LQ;1LR;1ZG		13.0460-7117.2 607117	VW 23130 19,6 + WK
						13.0470-7117.2 LD7117	VW 23130 19,6 + WK Ceramic
			←	→ 05/09; +PR 1LJ		13.0460-7122.2 607122	ATE 20676 19,8 + WK
						13.0470-7122.2 LD7122	ATE 20676 19,8 + WK Ceramic
			→	→ 05/09; +PR 1KK,1KT		13.0460-2787.2 602787	TRW 23554 17,3 - WK / - WE
						13.0460-2860.2 602860	TRW 23554 16,4 - WK / + WE
						13.0460-2894.2 602894	TRW 20961 17,2 - WK + Zub
						13.0470-2860.2 LD2860	TRW 23554 16,4 - WK / + WE Ceramic
						13.0470-2894.2 LD2894	TRW 20961 17,2 - WK + Zub Ceramic
			→	→ 05/09; +PR 1KD,1KS,1KV		13.0460-2864.2 602864	TRW 20961 17,2 - WK
						13.0460-2877.2 602877	TRW 23554 17,2 + WK
						13.0470-2877.2 LD2877	TRW 23554 17,2 + WK Ceramic
1.2 12V	47	10/01→07/07	←	11/01→; +PR 1LN;1ZD;1ZH		13.0460-2883.2 602883	TRW 23581 18,8 - WE / - WK
1.4 16V	55	10/01→05/08				13.0460-2884.2 602884	TRW 23581 18,8 + WK
1.4 16V	74	10/01→05/08					



















	kw			 	! #		
<b>VW - POLO (9N_) 10/01→01/12</b>							
<b> Bremsbelagsatz, Scheibenbremse</b>							
1.4 TDI	55	10/01→06/05	←	11/01→; +PR 1LN;1ZD;1ZH	13.0470-2884.2	LD2884	TRW 23581 18,8 + WK Ceramic
			←	11/01→; +PR 1LM;1ZN	13.0460-7100.2	607100	VW 21866 17,2 - WE / - WK
					13.0460-7164.2	607164	VW 21866 17,2 + WK
					13.0470-7100.2	LD7100	VW 21866 17,2 - WE / - WK Ceramic
			←	11/01→; +PR 1ZF	13.0460-7111.2	607111	VW 23130 19,6 - WE / - WK
					13.0470-7111.2	LD7111	VW 23130 19,6 - WE / - WK Ceramic
			←	11/01→; +PR 1LQ;1LR;1ZG	13.0460-7117.2	607117	VW 23130 19,6 + WK
		13.0470-7117.2	LD7117	VW 23130 19,6 + WK Ceramic			
		←	11/01→; +PR 1LJ	13.0460-7122.2	607122	ATE 20676 19,8 + WK	
				13.0470-7122.2	LD7122	ATE 20676 19,8 + WK Ceramic	
			→	11/01→; +PR 1KK,1KT	13.0460-2787.2	602787	TRW 23554 17,3 - WK / - WE
					13.0460-2860.2	602860	TRW 23554 16,4 - WK / + WE
					13.0460-2894.2	602894	TRW 20961 17,2 - WK + Zub
					13.0470-2860.2	LD2860	TRW 23554 16,4 - WK / + WE Ceramic
					13.0470-2894.2	LD2894	TRW 20961 17,2 - WK + Zub Ceramic
			→	11/01→; +PR 1KD,1KS,1KV	13.0460-2864.2	602864	TRW 20961 17,2 - WK
					13.0460-2877.2	602877	TRW 23554 17,2 + WK
					13.0470-2877.2	LD2877	TRW 23554 17,2 + WK Ceramic
1.4	61	08/02→11/09	←	05/06→ 05/09; +PR 1LN;1ZD;1ZH	13.0460-2883.2	602883	TRW 23581 18,8 - WE / - WK
					13.0460-2884.2	602884	TRW 23581 18,8 + WK
					13.0470-2884.2	LD2884	TRW 23581 18,8 + WK Ceramic
			←	05/06→ 05/09; +PR 1LM;1ZN	13.0460-7100.2	607100	VW 21866 17,2 - WE / - WK
					13.0460-7164.2	607164	VW 21866 17,2 + WK
					13.0470-7100.2	LD7100	VW 21866 17,2 - WE / - WK Ceramic
			←	05/06→ 05/09; +PR 1ZF	13.0460-7111.2	607111	VW 23130 19,6 - WE / - WK
		13.0470-7111.2	LD7111	VW 23130 19,6 - WE / - WK Ceramic			
		←	05/06→ 05/09; +PR 1LQ;1LR;1ZG	13.0460-7117.2	607117	VW 23130 19,6 + WK	
				13.0470-7117.2	LD7117	VW 23130 19,6 + WK Ceramic	
			←	05/06→ 05/09; +PR 1LJ	13.0460-7122.2	607122	ATE 20676 19,8 + WK
					13.0470-7122.2	LD7122	ATE 20676 19,8 + WK Ceramic
			→	05/06→ 05/09; +PR 1KK,1KT	13.0460-2787.2	602787	TRW 23554 17,3 - WK / - WE
					13.0460-2860.2	602860	TRW 23554 16,4 - WK / + WE
					13.0460-2894.2	602894	TRW 20961 17,2 - WK + Zub
					13.0470-2860.2	LD2860	TRW 23554 16,4 - WK / + WE Ceramic
					13.0470-2894.2	LD2894	TRW 20961 17,2 - WK + Zub Ceramic
			→	05/06→ 05/09; +PR 1KD,1KS,1KV	13.0460-2864.2	602864	TRW 20961 17,2 - WK
					13.0460-2877.2	602877	TRW 23554 17,2 + WK
					13.0470-2877.2	LD2877	TRW 23554 17,2 + WK Ceramic
1.8 GTi Cup Edition	132	05/06→11/09	←	06/06→ 05/09; +PR 1LN;1ZD;1ZH	13.0460-2883.2	602883	TRW 23581 18,8 - WE / - WK
					13.0460-2884.2	602884	TRW 23581 18,8 + WK
					13.0470-2884.2	LD2884	TRW 23581 18,8 + WK Ceramic
			←	06/06→ 05/09; +PR 1LM;1ZN	13.0460-7100.2	607100	VW 21866 17,2 - WE / - WK
					13.0460-7164.2	607164	VW 21866 17,2 + WK
					13.0470-7100.2	LD7100	VW 21866 17,2 - WE / - WK Ceramic
←	06/06→ 05/09; +PR 1ZF	13.0460-7111.2	607111	VW 23130 19,6 - WE / - WK			
		13.0470-7111.2	LD7111	VW 23130 19,6 - WE / - WK Ceramic			
		←	06/06→ 05/09; +PR 1LQ;1LR;1ZG	13.0460-7117.2	607117	VW 23130 19,6 + WK	
				13.0470-7117.2	LD7117	VW 23130 19,6 + WK Ceramic	
			←	06/06→ 05/09; +PR 1LJ	13.0460-7122.2	607122	ATE 20676 19,8 + WK
					13.0470-7122.2	LD7122	ATE 20676 19,8 + WK Ceramic
			→	06/06→ 05/09; +PR 1KK,1KT	13.0460-2787.2	602787	TRW 23554 17,3 - WK / - WE
					13.0460-2860.2	602860	TRW 23554 16,4 - WK / + WE
					13.0460-2894.2	602894	TRW 20961 17,2 - WK + Zub

↓











	kW			 	! #		
<b>VW - POLO (9N_) 10/01→01/12</b>							
<b> Bremsbelagsatz, Scheibenbremse</b>							
1.8 GTI Cup Edition	132	05/06→11/09	➡	06/06→ 05/09; +PR 1KK,1KT		<b>13.0470-2860.2</b> <b>LD2860</b>	TRW 23554 16,4 - WK / + WE Ceramic
						<b>13.0470-2894.2</b> <b>LD2894</b>	TRW 20961 17,2 - WK + Zub Ceramic
			➡	06/06→ 05/09; +PR 1KD,1KS,1KV		<b>13.0460-2864.2</b> <b>602864</b>	TRW 20961 17,2 - WK
						<b>13.0460-2877.2</b> <b>602877</b>	TRW 23554 17,2 + WK
						<b>13.0470-2877.2</b> <b>LD2877</b>	TRW 23554 17,2 + WK Ceramic
1.9 SDI 1.9 TDI	47 74	10/01→11/09 10/01→11/09	⬅	11/01→ 05/09; +PR 1LN;1ZD;1ZH		<b>13.0460-2883.2</b> <b>602883</b>	TRW 23581 18,8 - WE / - WK
						<b>13.0460-2884.2</b> <b>602884</b>	TRW 23581 18,8 + WK
						<b>13.0470-2884.2</b> <b>LD2884</b>	TRW 23581 18,8 + WK Ceramic
			⬅	11/01→ 05/09; +PR 1LM;1ZN		<b>13.0460-7100.2</b> <b>607100</b>	VW 21866 17,2 - WE / - WK
						<b>13.0460-7164.2</b> <b>607164</b>	VW 21866 17,2 + WK
						<b>13.0470-7100.2</b> <b>LD7100</b>	VW 21866 17,2 - WE / - WK Ceramic
			⬅	11/01→ 05/09; +PR 1ZF		<b>13.0460-7111.2</b> <b>607111</b>	VW 23130 19,6 - WE / - WK
						<b>13.0470-7111.2</b> <b>LD7111</b>	VW 23130 19,6 - WE / - WK Ceramic
			⬅	11/01→ 05/09; +PR 1LQ;1LR;1ZG		<b>13.0460-7117.2</b> <b>607117</b>	VW 23130 19,6 + WK
						<b>13.0470-7117.2</b> <b>LD7117</b>	VW 23130 19,6 + WK Ceramic
			⬅	11/01→ 05/09; +PR 1LJ		<b>13.0460-7122.2</b> <b>607122</b>	ATE 20676 19,8 + WK
						<b>13.0470-7122.2</b> <b>LD7122</b>	ATE 20676 19,8 + WK Ceramic
			➡	11/01→ 05/09; +PR 1KK,1KT		<b>13.0460-2787.2</b> <b>602787</b>	TRW 23554 17,3 - WK / - WE
						<b>13.0460-2860.2</b> <b>602860</b>	TRW 23554 16,4 - WK / + WE
						<b>13.0460-2894.2</b> <b>602894</b>	TRW 20961 17,2 - WK + Zub
						<b>13.0470-2860.2</b> <b>LD2860</b>	TRW 23554 16,4 - WK / + WE Ceramic
						<b>13.0470-2894.2</b> <b>LD2894</b>	TRW 20961 17,2 - WK + Zub Ceramic
			➡	11/01→ 05/09; +PR 1KD,1KS,1KV		<b>13.0460-2864.2</b> <b>602864</b>	TRW 20961 17,2 - WK
						<b>13.0460-2877.2</b> <b>602877</b>	TRW 23554 17,2 + WK
						<b>13.0470-2877.2</b> <b>LD2877</b>	TRW 23554 17,2 + WK Ceramic
<b>Zubehörsatz, Scheibenbremsbelag</b>							
1.2 1.4 FSI	40 63	01/02→05/07 02/02→07/06	➡	+PR 1KD,1KS,1KV		<b>13.0460-0072.2</b> <b>610072</b>	TRW
			➡	+PR 1KK,1KT		<b>13.0460-0072.2</b> <b>610072</b>	TRW
1.2 1.2 12V 1.4 16V 1.4 TDI 1.4 TDI 1.6 16V 1.8 GTI 1.9 TDI	44 51 59 51 59 77 110 96	05/07→11/09 05/07→11/09 05/06→11/09 04/05→11/09 04/05→11/09 05/06→11/09 09/05→11/09 11/03→11/09	➡	→ 05/09; +PR 1KK,1KT		<b>13.0460-0072.2</b> <b>610072</b>	TRW
			➡	→ 05/09; +PR 1KD,1KS,1KV		<b>13.0460-0072.2</b> <b>610072</b>	TRW
1.2 12V 1.4 16V 1.4 16V 1.4 TDI	47 55 74 55	10/01→07/07 10/01→05/08 10/01→05/08 10/01→06/05	➡	11/01→; +PR 1KK,1KT		<b>13.0460-0072.2</b> <b>610072</b>	TRW
			➡	11/01→; +PR 1KD,1KS,1KV		<b>13.0460-0072.2</b> <b>610072</b>	TRW
1.4	61	08/02→11/09	➡	05/06→ 05/09; +PR 1KK,1KT		<b>13.0460-0072.2</b> <b>610072</b>	TRW
			➡	05/06→ 05/09; +PR 1KD,1KS,1KV		<b>13.0460-0072.2</b> <b>610072</b>	TRW
1.8 GTI Cup Edition	132	05/06→11/09	➡	06/06→ 05/09; +PR 1KK,1KT		<b>13.0460-0072.2</b> <b>610072</b>	TRW
			➡	06/06→ 05/09; +PR 1KD,1KS,1KV		<b>13.0460-0072.2</b> <b>610072</b>	TRW
1.9 SDI 1.9 TDI	47 74	10/01→11/09 10/01→11/09	➡	11/01→ 05/09; +PR 1KD,1KS,1KV		<b>13.0460-0072.2</b> <b>610072</b>	TRW
			➡	11/01→ 05/09; +PR 1KK,1KT		<b>13.0460-0072.2</b> <b>610072</b>	TRW
<b> Bremsscheibe</b>							
1.2 1.4 FSI	40 63	01/02→05/07 02/02→07/06	⬅	+PR 1LM;1ZN		<b>24.0118-0137.1</b> <b>418137</b>	Ø 239 18 16 V + S
						<b>24.0318-0137.1</b> <b>518137</b>	Ø 239 18 16 V + S
			⬅	+PR 1LQ;1LR;1ZF;1ZG		<b>24.0122-0151.1</b> <b>422151</b>	Ø 256 22 19 V + S
						<b>24.0322-0151.1</b> <b>522151</b>	Ø 256 22 19 V + S
			⬅	+PR 1LN;1ZD;1ZH		<b>24.0125-0113.1</b> <b>425113</b>	Ø 288 25 22 V + S
						<b>24.0325-0113.1</b> <b>525113</b>	Ø 288 25 22 V + S
			⬅	+PR 1LJ		<b>24.0125-0123.1</b> <b>425123</b>	Ø 310 25 22 V + S
						<b>24.0325-0123.1</b> <b>525123</b>	Ø 310 25 22 V + S
			➡	+PR 1KD,1KS,1KT,1KV		<b>24.0109-0123.1</b> <b>409123</b>	Ø 230 9 7 + S
						<b>24.0309-0123.1</b> <b>509123</b>	Ø 230 9 7 + S
↓							











	kW			 	! #		
<b>VW - POLO (9N_) 10/01→01/12</b>							
<b>Bremsscheibe</b>							
1.2 1.4 FSI	40 63	01/02→05/07 02/02→07/06	➔	+PR 1KK		24.0109-0174.1 409174	Ø 232 9 7 + S
1.2 1.2 12V 1.4 16V 1.4 TDI	44 51 59 51	05/07→11/09 05/07→11/09 05/06→11/09 04/05→11/09	➔	→ 05/09; +PR 1LM;1ZN		24.0118-0137.1 418137 24.0318-0137.1 518137	Ø 239 18 16 V + S Ø 239 18 16 V + S
1.4 TDI 1.6 16V 1.8 GTI 1.9 TDI	59 77 110 96	04/05→11/09 05/06→11/09 09/05→11/09 11/03→11/09	➔	→ 05/09; +PR 1LQ;1LR;1ZF;1ZG		24.0122-0151.1 422151 24.0322-0151.1 522151	Ø 256 22 19 V + S Ø 256 22 19 V + S
			➔	→ 05/09; +PR 1LN;1ZD;1ZH		24.0125-0113.1 425113 24.0325-0113.1 525113	Ø 288 25 22 V + S Ø 288 25 22 V + S
			➔	→ 05/09; +PR 1LJ		24.0125-0123.1 425123 24.0325-0123.1 525123	Ø 310 25 22 V + S Ø 310 25 22 V + S
			➔	→ 05/09; +PR 1KD,1KS,1KT,1KV		24.0109-0123.1 409123 24.0309-0123.1 509123	Ø 230 9 7 + S Ø 230 9 7 + S
			➔	→ 05/09; +PR 1KK		24.0109-0174.1 409174	Ø 232 9 7 + S
1.2 12V 1.4 16V 1.4 16V 1.4 TDI	47 55 74 55	10/01→07/07 10/01→05/08 10/01→05/08 10/01→06/05	➔	11/01→; +PR 1LM;1ZN		24.0118-0137.1 418137 24.0318-0137.1 518137	Ø 239 18 16 V + S Ø 239 18 16 V + S
			➔	11/01→; +PR 1LQ;1LR;1ZF;1ZG		24.0122-0151.1 422151 24.0322-0151.1 522151	Ø 256 22 19 V + S Ø 256 22 19 V + S
			➔	11/01→; +PR 1LN;1ZD;1ZH		24.0125-0113.1 425113 24.0325-0113.1 525113	Ø 288 25 22 V + S Ø 288 25 22 V + S
			➔	11/01→; +PR 1LJ		24.0125-0123.1 425123 24.0325-0123.1 525123	Ø 310 25 22 V + S Ø 310 25 22 V + S
			➔	11/01→; +PR 1KD,1KS,1KT,1KV		24.0109-0123.1 409123 24.0309-0123.1 509123	Ø 230 9 7 + S Ø 230 9 7 + S
			➔	11/01→; +PR 1KK		24.0109-0174.1 409174	Ø 232 9 7 + S
1.4	61	08/02→11/09	➔	05/06→ 05/09; +PR 1LM;1ZN		24.0118-0137.1 418137 24.0318-0137.1 518137	Ø 239 18 16 V + S Ø 239 18 16 V + S
			➔	05/06→ 05/09; +PR 1LQ;1LR;1ZF;1ZG		24.0122-0151.1 422151 24.0322-0151.1 522151	Ø 256 22 19 V + S Ø 256 22 19 V + S
			➔	05/06→ 05/09; +PR 1LN;1ZD;1ZH		24.0125-0113.1 425113 24.0325-0113.1 525113	Ø 288 25 22 V + S Ø 288 25 22 V + S
			➔	05/06→ 05/09; +PR 1LJ		24.0125-0123.1 425123 24.0325-0123.1 525123	Ø 310 25 22 V + S Ø 310 25 22 V + S
			➔	05/06→ 05/09; +PR 1KD,1KS,1KT,1KV		24.0109-0123.1 409123 24.0309-0123.1 509123	Ø 230 9 7 + S Ø 230 9 7 + S
			➔	05/06→ 05/09; +PR 1KK		24.0109-0174.1 409174	Ø 232 9 7 + S
1.8 GTI Cup Edition	132	05/06→11/09	➔	06/06→ 05/09; +PR 1LM;1ZN		24.0118-0137.1 418137 24.0318-0137.1 518137	Ø 239 18 16 V + S Ø 239 18 16 V + S
			➔	06/06→ 05/09; +PR 1LQ;1LR;1ZF;1ZG		24.0122-0151.1 422151 24.0322-0151.1 522151	Ø 256 22 19 V + S Ø 256 22 19 V + S
			➔	06/06→ 05/09; +PR 1LN;1ZD;1ZH		24.0125-0113.1 425113 24.0325-0113.1 525113	Ø 288 25 22 V + S Ø 288 25 22 V + S
			➔	06/06→ 05/09; +PR 1LJ		24.0125-0123.1 425123 24.0325-0123.1 525123	Ø 310 25 22 V + S Ø 310 25 22 V + S
			➔	06/06→ 05/09; +PR 1KD,1KS,1KT,1KV		24.0109-0123.1 409123 24.0309-0123.1 509123	Ø 230 9 7 + S Ø 230 9 7 + S
			➔	06/06→ 05/09; +PR 1KK		24.0109-0174.1 409174	Ø 232 9 7 + S
1.9 SDI 1.9 TDI	47 74	10/01→11/09 10/01→11/09	➔	11/01→ 05/09; +PR 1LM;1ZN		24.0118-0137.1 418137 24.0318-0137.1 518137	Ø 239 18 16 V + S Ø 239 18 16 V + S
			➔	11/01→ 05/09; +PR 1LQ;1LR;1ZF;1ZG		24.0122-0151.1 422151 24.0322-0151.1 522151	Ø 256 22 19 V + S Ø 256 22 19 V + S
			➔	11/01→ 05/09; +PR 1LN;1ZD;1ZH		24.0125-0113.1 425113 24.0325-0113.1 525113	Ø 288 25 22 V + S Ø 288 25 22 V + S
			➔	11/01→ 05/09; +PR 1LJ		24.0125-0123.1 425123 24.0325-0123.1 525123	Ø 310 25 22 V + S Ø 310 25 22 V + S
			➔	11/01→ 05/09; +PR 1KD,1KS,1KT,1KV		24.0109-0123.1 409123 24.0309-0123.1 509123	Ø 230 9 7 + S Ø 230 9 7 + S
			➔	11/01→ 05/09; +PR 1KK		24.0109-0174.1 409174	Ø 232 9 7 + S
<b>VW - POLO (AW1, BZ1) 06/17→</b>							
<b>Bremsbelagsatz, Scheibenbremse</b>							
1.0 ↓	48	08/17→	➔	09/17→; +PR 1ZG		13.0460-7111.2 607111	VW 23130 19,6 - WE / - WK











	kw			 	! #		
<b>VW - POLO (AW1, BZ1) 06/17→</b>							
 <b>Bremsbelagsatz, Scheibenbremse</b>							
1.0 1.0 TSI	55 70	06/17→ 06/17→	←	09/17→; +PR 1ZG		13.0470-7111.2 LD7111	VW 23130 19,6 - WE / - WK Ceramic
1.0 TGI 1.0 TSI 1.6 TDI 1.6 TDI 2.0 GTI	66 85 59 70 147	09/17→ 09/17→ 11/17→ 11/17→ 11/17→	←	+PR 1ZG		13.0460-7111.2 607111 13.0470-7111.2 LD7111	VW 23130 19,6 - WE / - WK VW 23130 19,6 - WE / - WK Ceramic
<b>VW - POLO CLASSIC (6V2) 11/95→11/09</b>							
 <b>Bremsbelagsatz, Scheibenbremse</b>							
1.9 SDI 57 1.7 SDI 64 1.9 SDI	48 42 47	06/96→09/01 07/97→09/01 12/95→08/99	←	→ 6K-V-022628 6K-V-022629→		13.0460-7072.2 607072 13.0460-7101.2 607101	VW 21866 19,7 - WE / - WK VW 21866 15,3 - WE / - WK
1.9 TDI 90 1.9 TDI 100 1.6	67 66 74	01/97→08/99 09/96→09/01 12/95→09/01	←			13.0460-2821.2 602821 13.0460-2821.2 602821	TRW 21945 16,0 - WK TRW 21945 16,0 - WK
110 1.9 TDI	81	06/98→01/02	←	→ 09/01 10/99→ 09/01		13.0460-2821.2 602821 13.0460-2886.2 602886 13.0460-2894.2 602894 13.0460-2937.2 602937 13.0470-2886.2 LD2886 13.0470-2894.2 LD2894	TRW 21945 16,0 - WK TRW 20961 16,0 - WK TRW 20961 17,2 - WK + Zub TRW 20961 15,2 - WK + Zub TRW 20961 16,0 - WK Ceramic TRW 20961 17,2 - WK + Zub
			→	→ 09/99; - ABS		13.0460-2937.2 602937	TRW 20961 15,2 - WK + Zub
			→	→ 09/99; + ABS		13.0460-2984.2 602984	TRW 20961 17,2 - WK + Zub
54 1.4 60 1.4 75 1.4 16V	40 44 55	01/98→08/99 12/95→09/01 10/99→09/01	←	→ 6K-V-022628; - ABS → 6K-V-022628; + ABS 6K-V-022629→		13.0460-7059.2 607059 13.0460-7072.2 607072 13.0460-7101.2 607101	VW 20887 17,3 - WE / - WK + Zub VW 21866 19,7 - WE / - WK VW 21866 15,3 - WE / - WK
64 1,9 D	47	01/96→10/96	←	→ 6N-TW082000 → 6N-TY140000 6N-TY140001→ 6N-TW082001→		13.0460-7059.2 607059 13.0460-7059.2 607059 13.0460-7100.2 607100 13.0470-7100.2 LD7100 13.0460-7100.2 607100 13.0470-7100.2 LD7100	VW 20887 17,3 - WE / - WK + Zub VW 20887 17,3 - WE / - WK + Zub VW 21866 17,2 - WE / - WK VW 21866 17,2 - WE / - WK Ceramic VW 21866 17,2 - WE / - WK VW 21866 17,2 - WE / - WK Ceramic
68 1.9 SDI	50	08/99→01/02	←	→ 6K-V-022628 6K-V-022629→; → 09/01		13.0460-7072.2 607072 13.0460-7101.2 607101	VW 21866 19,7 - WE / - WK VW 21866 15,3 - WE / - WK
75 1.6 75 1.6	55 55	11/95→09/97 11/95→09/01	←	05/96→ 05/96→; → 6K-V-022628 6K-V-022629→		13.0460-2821.2 602821 13.0460-7072.2 607072 13.0460-7101.2 607101	TRW 21945 16,0 - WK VW 21866 19,7 - WE / - WK VW 21866 15,3 - WE / - WK
90 1.8	66	01/97→09/01	←	03/98→		13.0460-2821.2 602821	TRW 21945 16,0 - WK
<b>Zubehörsatz, Scheibenbremsbelag</b>							
110 1.9 TDI	81	06/98→01/02	→	→ 09/99; + ABS 10/99→ 09/01		13.0460-0072.2 610072 13.0460-0072.2 610072	TRW TRW
 <b>Bremsscheibe</b>							
1.9 SDI 57 1.7 SDI 64 1.9 SDI	48 42 47	06/96→09/01 07/97→09/01 12/95→08/99	←	→ 6K-V-022628 6K-V-022629→		24.0112-0106.1 412106 24.0312-0106.1 512106 24.0120-0123.1 420123 24.0320-0123.1 520123	∅ 239 12 10 + S ∅ 239 12 10 + S ∅ 239 20 18 V + S ∅ 239 20 18 V + S
1.9 TDI 90 1.9 TDI	67 66	01/97→08/99 09/96→09/01	←			24.0120-0128.1 420128 24.0320-0128.1 520128	∅ 256 20 18 V + S ∅ 256 20 18 V + S
100 1.6	74	12/95→09/01	←	05/96→		24.0120-0128.1 420128 24.0320-0128.1 520128	∅ 256 20 18 V + S ∅ 256 20 18 V + S
110 1.9 TDI	81	06/98→01/02	←	→ 09/01 10/99→ 09/01 → 09/99		24.0120-0128.1 420128 24.0320-0128.1 520128 24.0109-0124.1 409124 24.0110-0111.1 410111	∅ 256 20 18 V + S ∅ 256 20 18 V + S ∅ 232 9 7 ∅ 226 10 8 - ABS Ring / - RLG
↓							











	kw			 	! #		
<b>VW - POLO CLASSIC (6V2) 11/95→11/09</b>							
<b>Bremsscheibe</b>							
110 1.9 TDI	81	06/98→01/02	→	→ 09/99		<b>24.0110-0275.2 410275</b>	Ø 226 10 8 + ABS Ring / - RLG
54 1.4	40	01/98→08/99	←	→ 6K-V-022628; - ABS		<b>24.0110-0151.1 410151</b>	Ø 239 10 8 + S
60 1.4	44	12/95→09/01				<b>24.0310-0151.1 510151</b>	Ø 239 10 8 + S
75 1.4 16V	55	10/99→09/01	←	→ 6K-V-022628; + ABS		<b>24.0112-0106.1 412106</b>	Ø 239 12 10 + S
						<b>24.0312-0106.1 512106</b>	Ø 239 12 10 + S
			←	6K-V-022629→		<b>24.0120-0123.1 420123</b>	Ø 239 20 18 V + S
						<b>24.0320-0123.1 520123</b>	Ø 239 20 18 V + S
64 1,9 D	47	01/96→10/96	←	→ 6N-SY087410		<b>24.0110-0232.1 410232</b>	Ø 239 9,9 8 + S
			←	→ 6N-SW008500		<b>24.0110-0232.1 410232</b>	Ø 239 9,9 8 + S
			←	6N-SW008501→		<b>24.0118-0106.1 418106</b>	Ø 239 18 16 V + S
						<b>24.0318-0106.1 518106</b>	Ø 239 18 16 V + S
			←	6N-SY087411→		<b>24.0118-0106.1 418106</b>	Ø 239 18 16 V + S
						<b>24.0318-0106.1 518106</b>	Ø 239 18 16 V + S
68 1.9 SDI	50	08/99→01/02	←	→ 6K-V-022628		<b>24.0112-0106.1 412106</b>	Ø 239 12 10 + S
			←	6K-V-022629→; → 09/01		<b>24.0120-0123.1 420123</b>	Ø 239 20 18 V + S
						<b>24.0320-0123.1 520123</b>	Ø 239 20 18 V + S
75 1.6	55	11/95→09/97	←	05/96→; → 6K-V-022628		<b>24.0112-0106.1 412106</b>	Ø 239 12 10 + S
75 1.6	55	11/95→09/01	←	6K-V-022629→		<b>24.0120-0123.1 420123</b>	Ø 239 20 18 V + S
						<b>24.0320-0123.1 520123</b>	Ø 239 20 18 V + S
			←	05/96→		<b>24.0120-0128.1 420128</b>	Ø 256 20 18 V + S
						<b>24.0320-0128.1 520128</b>	Ø 256 20 18 V + S
90 1.8	66	01/97→09/01	←	03/98→; für Mexico		<b>24.0120-0128.1 420128</b>	Ø 256 20 18 V + S
						<b>24.0320-0128.1 520128</b>	Ø 256 20 18 V + S
<b>VW - POLO Stufenheck (9A4, 9A2, 9N2) 09/02→</b>							
<b>Bremsbelagsatz, Scheibenbremse</b>							
1.4	55	07/06→04/12	←	→ 05/09; +PR 1LN;1ZD;1ZH		<b>13.0460-2883.2 602883</b>	TRW 23581 18,8 - WE / - WK
1.4	74	11/03→				<b>13.0460-2884.2 602884</b>	TRW 23581 18,8 + WK
1.4 TDI	55	07/03→				<b>13.0470-2884.2 LD2884</b>	TRW 23581 18,8 + WK Ceramic
1.9 SDI	47	09/02→	←	→ 05/09; +PR 1LM;1ZN		<b>13.0460-7100.2 607100</b>	VW 21866 17,2 - WE / - WK
1.9 TDi	74	09/02→				<b>13.0460-7164.2 607164</b>	VW 21866 17,2 + WK
						<b>13.0470-7100.2 LD7100</b>	VW 21866 17,2 - WE / - WK Ceramic
			←	→ 05/09; +PR 1ZF		<b>13.0460-7111.2 607111</b>	VW 23130 19,6 - WE / - WK
						<b>13.0470-7111.2 LD7111</b>	VW 23130 19,6 - WE / - WK Ceramic
			←	→ 05/09; +PR 1LQ;1LR;1ZG		<b>13.0460-7117.2 607117</b>	VW 23130 19,6 + WK
						<b>13.0470-7117.2 LD7117</b>	VW 23130 19,6 + WK Ceramic
			←	→ 05/09; +PR 1LJ		<b>13.0460-7122.2 607122</b>	ATE 20676 19,8 + WK
						<b>13.0470-7122.2 LD7122</b>	ATE 20676 19,8 + WK Ceramic
			→	→ 05/09; +PR 1KK,1KT		<b>13.0460-2787.2 602787</b>	TRW 23554 17,3 - WK / - WE
						<b>13.0460-2860.2 602860</b>	TRW 23554 16,4 - WK / + WE
						<b>13.0460-2894.2 602894</b>	TRW 20961 17,2 - WK + Zub
						<b>13.0470-2860.2 LD2860</b>	TRW 23554 16,4 - WK / + WE Ceramic
						<b>13.0470-2894.2 LD2894</b>	TRW 20961 17,2 - WK + Zub Ceramic
			→	→ 05/09; +PR 1KD,1KS,1KV		<b>13.0460-2864.2 602864</b>	TRW 20961 17,2 - WK
						<b>13.0460-2877.2 602877</b>	TRW 23554 17,2 + WK
						<b>13.0470-2877.2 LD2877</b>	TRW 23554 17,2 + WK Ceramic
1.6	74	09/02→	←	05/06→ 05/09; +PR 1LN;1ZD;1ZH		<b>13.0460-2883.2 602883</b>	TRW 23581 18,8 - WE / - WK
						<b>13.0460-2884.2 602884</b>	TRW 23581 18,8 + WK
						<b>13.0470-2884.2 LD2884</b>	TRW 23581 18,8 + WK Ceramic
			←	05/06→ 05/09; +PR 1LM;1ZN		<b>13.0460-7100.2 607100</b>	VW 21866 17,2 - WE / - WK
						<b>13.0460-7164.2 607164</b>	VW 21866 17,2 + WK
						<b>13.0470-7100.2 LD7100</b>	VW 21866 17,2 - WE / - WK Ceramic
			←	05/06→ 05/09; +PR 1ZF		<b>13.0460-7111.2 607111</b>	VW 23130 19,6 - WE / - WK
						<b>13.0470-7111.2 LD7111</b>	VW 23130 19,6 - WE / - WK Ceramic
			←	05/06→ 05/09; +PR 1LQ;1LR;1ZG		<b>13.0460-7117.2 607117</b>	VW 23130 19,6 + WK











	kw			 	! #		
<b>VW - POLO Stufenheck (9A4, 9A2, 9N2) 09/02→</b>							
 <b>Bremsbelagsatz, Scheibenbremse</b>							
1.6	74	09/02→	←	05/06→ 05/09; +PR 1LQ;1LR;1ZG	13.0470-7117.2	LD7117	VW 23130 19,6 + WK Ceramic
			←	05/06→ 05/09; +PR 1LJ	13.0460-7122.2	607122	ATE 20676 19,8 + WK
					13.0470-7122.2	LD7122	ATE 20676 19,8 + WK Ceramic
			→	05/06→ 05/09; +PR 1KK,1KT	13.0460-2787.2	602787	TRW 23554 17,3 - WK / - WE
					13.0460-2860.2	602860	TRW 23554 16,4 - WK / + WE
					13.0460-2894.2	602894	TRW 20961 17,2 - WK + Zub
					13.0470-2860.2	LD2860	TRW 23554 16,4 - WK / + WE Ceramic
					13.0470-2894.2	LD2894	TRW 20961 17,2 - WK + Zub Ceramic
			→	05/06→ 05/09; +PR 1KD,1KS,1KV	13.0460-2864.2	602864	TRW 20961 17,2 - WK
					13.0460-2877.2	602877	TRW 23554 17,2 + WK
					13.0470-2877.2	LD2877	TRW 23554 17,2 + WK Ceramic
<b>Zubehörsatz, Scheibenbremsbelag</b>							
1.4	55	07/06→04/12	→	→ 05/09; +PR 1KK,1KT	13.0460-0072.2	610072	TRW
1.4	74	11/03→					
1.4 TDI	55	07/03→	→	→ 05/09; +PR 1KD,1KS,1KV	13.0460-0072.2	610072	TRW
1.9 SDI	47	09/02→					
1.9 TDi	74	09/02→					
1.6	74	09/02→	→	05/06→ 05/09; +PR 1KK,1KT	13.0460-0072.2	610072	TRW
			→	05/06→ 05/09; +PR 1KD,1KS,1KV	13.0460-0072.2	610072	TRW
 <b>Bremsscheibe</b>							
1.4	55	07/06→04/12	←	→ 05/09; +PR 1LM;1ZN	24.0118-0137.1	418137	Ø 239 18 16 V + S
1.4	74	11/03→			24.0318-0137.1	518137	Ø 239 18 16 V + S
1.4 TDI	55	07/03→					
1.9 SDI	47	09/02→	←	→ 05/09; +PR 1LQ;1LR;1ZF;1ZG	24.0122-0151.1	422151	Ø 256 22 19 V + S
1.9 TDi	74	09/02→			24.0322-0151.1	522151	Ø 256 22 19 V + S
			←	→ 05/09; +PR 1LN;1ZD;1ZH	24.0125-0113.1	425113	Ø 288 25 22 V + S
					24.0325-0113.1	525113	Ø 288 25 22 V + S
			←	→ 05/09; +PR 1LJ	24.0125-0123.1	425123	Ø 310 25 22 V + S
					24.0325-0123.1	525123	Ø 310 25 22 V + S
			→	→ 05/09; +PR 1KD,1KS,1KT,1KV	24.0109-0123.1	409123	Ø 230 9 7 + S
					24.0309-0123.1	509123	Ø 230 9 7 + S
			→	→ 05/09; +PR 1KK	24.0109-0174.1	409174	Ø 232 9 7 + S
1.6	74	09/02→	←	05/06→ 05/09; +PR 1LM;1ZN	24.0118-0137.1	418137	Ø 239 18 16 V + S
					24.0318-0137.1	518137	Ø 239 18 16 V + S
			←	05/06→ 05/09; +PR 1LQ;1LR;1ZF;1ZG	24.0122-0151.1	422151	Ø 256 22 19 V + S
					24.0322-0151.1	522151	Ø 256 22 19 V + S
			←	05/06→ 05/09; +PR 1LN;1ZD;1ZH	24.0125-0113.1	425113	Ø 288 25 22 V + S
					24.0325-0113.1	525113	Ø 288 25 22 V + S
			←	05/06→ 05/09; +PR 1LJ	24.0125-0123.1	425123	Ø 310 25 22 V + S
					24.0325-0123.1	525123	Ø 310 25 22 V + S
			→	05/06→ 05/09; +PR 1KD,1KS,1KT,1KV	24.0109-0123.1	409123	Ø 230 9 7 + S
					24.0309-0123.1	509123	Ø 230 9 7 + S
			→	05/06→ 05/09; +PR 1KK	24.0109-0174.1	409174	Ø 232 9 7 + S
<b>VW - POLO Stufenheck (602, 604, 612, 614) 05/09→</b>							
 <b>Bremsbelagsatz, Scheibenbremse</b>							
1.6	63	11/10→	←	07/14→; +PR 1ZG,1LR,1ZJ	13.0460-7111.2	607111	VW 23130 19,6 - WE / - WK
1.6	77	05/10→			13.0470-7111.2	LD7111	VW 23130 19,6 - WE / - WK Ceramic
			←	07/14→; +PR 1LN,1ZC	13.0460-7184.2	607184	ATE 23587 20,6 + WK
					13.0470-7184.2	LD7184	ATE 23587 20,6 + WK Ceramic
			←	07/14→; +PR 1ZP,1ZR	13.0460-7285.2	607285	ATE 23587 20,6 - WE / - WK
					13.0470-7285.2	LD7285	ATE 23587 20,6 - WE / - WK Ceramic
			→	07/14→; +PR 1KK,1KT,1KV	13.0460-2787.2	602787	TRW 23554 17,3 - WK / - WE
					13.0460-2820.2	602820	TRW 20961 17,2 - WK
					13.0470-2820.2	LD2820	TRW 20961 17,2 - WK Ceramic
			→	07/14→; +PR 2EJ	13.0460-2894.2	602894	TRW 20961 17,2 - WK + Zub
					13.0470-2894.2	LD2894	TRW 20961 17,2 - WK + Zub Ceramic
1.6	81	05/15→	←	+PR 1ZG,1LR,1ZJ	13.0460-7111.2	607111	VW 23130 19,6 - WE / - WK
↓							

	kw			 	! #		
<b>VW - POLO Stufenheck (602, 604, 612, 614) 05/09→</b>							
 <b>Bremsbelagsatz, Scheibenbremse</b>							
1.6	81	05/15→	←	+PR 1ZG,1LR,1ZJ	13.0470-7111.2	LD7111	VW 23130 19,6 - WE / - WK Ceramic
			←	+PR 1LN,1ZC	13.0460-7184.2	607184	ATE 23587 20,6 + WK
					13.0470-7184.2	LD7184	ATE 23587 20,6 + WK Ceramic
			←	+PR 1ZP,1ZR	13.0460-7285.2	607285	ATE 23587 20,6 - WE / - WK
					13.0470-7285.2	LD7285	ATE 23587 20,6 - WE / - WK Ceramic
			→	+PR 1KK,1KT,1KV	13.0460-2787.2	602787	TRW 23554 17,3 - WK / - WE
		13.0460-2820.2	602820	TRW 20961 17,2 - WK			
		13.0470-2820.2	LD2820	TRW 20961 17,2 - WK Ceramic			
		→	+PR 2EJ	13.0460-2894.2	602894	TRW 20961 17,2 - WK + Zub	
				13.0470-2894.2	LD2894	TRW 20961 17,2 - WK + Zub Ceramic	
 <b>Bremsscheibe</b>							
1.6	63	11/10→	←	07/14→; +PR 1LR,1ZG,1ZJ	24.0122-0151.1	422151	Ø 256 22 19 V + S
1.6	77	05/10→	←	07/14→	24.0322-0151.1	522151	Ø 256 22 19 V + S
			←	07/14→	24.0125-0113.1	425113	Ø 288 25 22 V + S
					24.0325-0113.1	525113	Ø 288 25 22 V + S
			←	07/14→; +PR 1ZP,1ZR	24.0125-0123.1	425123	Ø 310 25 22 V + S
					24.0325-0123.1	525123	Ø 310 25 22 V + S
			→	07/14→; +PR 1KK,1KT,1KV,2EJ	24.0109-0123.1	409123	Ø 230 9 7 + S
					24.0309-0123.1	509123	Ø 230 9 7 + S
1.6	81	05/15→	←	+PR 1LR,1ZG,1ZJ	24.0122-0151.1	422151	Ø 256 22 19 V + S
			←		24.0322-0151.1	522151	Ø 256 22 19 V + S
			←		24.0125-0113.1	425113	Ø 288 25 22 V + S
					24.0325-0113.1	525113	Ø 288 25 22 V + S
			←	+PR 1ZP,1ZR	24.0125-0123.1	425123	Ø 310 25 22 V + S
					24.0325-0123.1	525123	Ø 310 25 22 V + S
			→	+PR 1KK,1KT,1KV,2EJ	24.0109-0123.1	409123	Ø 230 9 7 + S
					24.0309-0123.1	509123	Ø 230 9 7 + S
<b>VW - POLO Van (6R) 01/14→</b>							
 <b>Bremsbelagsatz, Scheibenbremse</b>							
1.0	44	01/14→	←	+PR 1ZG,1LR,1ZJ	13.0460-7111.2	607111	VW 23130 19,6 - WE / - WK
1.0	55	01/14→			13.0470-7111.2	LD7111	VW 23130 19,6 - WE / - WK Ceramic
1.0 TSI	70	11/14→					
1.4 TDI	55	03/14→	←	+PR 1LN,1ZC	13.0460-7184.2	607184	ATE 23587 20,6 + WK
1.4 TDI	66	02/14→			13.0470-7184.2	LD7184	ATE 23587 20,6 + WK Ceramic
1.4 TSI	110	05/14→	→	+PR 1KD,1KK,1KT,2EJ	13.0460-2787.2	602787	TRW 23554 17,3 - WK / - WE
			→	+PR 1KK,1KT,2EJ	13.0460-2820.2	602820	TRW 20961 17,2 - WK
					13.0470-2820.2	LD2820	TRW 20961 17,2 - WK Ceramic
			→	+PR 2EJ	13.0460-2894.2	602894	TRW 20961 17,2 - WK + Zub
					13.0470-2894.2	LD2894	TRW 20961 17,2 - WK + Zub Ceramic
1.2 TSI	66	02/14→	←	+PR 1ZG,1LR,1ZJ	13.0460-7111.2	607111	VW 23130 19,6 - WE / - WK
					13.0470-7111.2	LD7111	VW 23130 19,6 - WE / - WK Ceramic
			←	+PR 1LN,1ZC,1ZD	13.0460-7184.2	607184	ATE 23587 20,6 + WK
					13.0470-7184.2	LD7184	ATE 23587 20,6 + WK Ceramic
			←	+PR 1ZP,1ZR	13.0460-7285.2	607285	ATE 23587 20,6 - WE / - WK
					13.0470-7285.2	LD7285	ATE 23587 20,6 - WE / - WK Ceramic
			→	+PR 1KD,1KK,1KT,1KV	13.0460-2787.2	602787	TRW 23554 17,3 - WK / - WE
			→	+PR 1KK,1KT,1KV	13.0460-2820.2	602820	TRW 20961 17,2 - WK
					13.0470-2820.2	LD2820	TRW 20961 17,2 - WK Ceramic
			→	+PR 2EJ	13.0460-2894.2	602894	TRW 20961 17,2 - WK + Zub
					13.0470-2894.2	LD2894	TRW 20961 17,2 - WK + Zub Ceramic
1.2 TSI	81	01/14→	←	+PR 1ZG,1LR,1ZJ	13.0460-7111.2	607111	VW 23130 19,6 - WE / - WK
					13.0470-7111.2	LD7111	VW 23130 19,6 - WE / - WK Ceramic
			←	+PR 1LN,1ZC	13.0460-7184.2	607184	ATE 23587 20,6 + WK
↓							







	kw			 	! #		
<b>VW - POLO Van (6R) 01/14→</b>							
 <b>Bremsbelagsatz, Scheibenbremse</b>							
1.2 TSI	81	01/14→	←	+PR 1LN,1ZC	13.0470-7184.2	LD7184	ATE 23587 20,6 + WK Ceramic
			←	+PR 1ZP,1ZR	13.0460-7285.2	607285	ATE 23587 20,6 - WE / - WK
					13.0470-7285.2	LD7285	ATE 23587 20,6 - WE / - WK Ceramic
			→	+PR 1KD,1KK,1KT,2EJ	13.0460-2787.2	602787	TRW 23554 17,3 - WK / - WE
			→	+PR 1KK,1KT,2EJ	13.0460-2820.2	602820	TRW 20961 17,2 - WK
		13.0470-2820.2	LD2820	TRW 20961 17,2 - WK Ceramic			
		→	+PR 2EJ	13.0460-2894.2	602894	TRW 20961 17,2 - WK + Zub	
				13.0470-2894.2	LD2894	TRW 20961 17,2 - WK + Zub Ceramic	
 <b>Bremsscheibe</b>							
1.0	44	01/14→	←	+PR 1LR,1ZG,1ZJ	24.0122-0151.1	422151	Ø 256 22 19 V + S
1.0	55	01/14→			24.0322-0151.1	522151	Ø 256 22 19 V + S
1.0 TSI	70	11/14→					
1.4 TDI	55	03/14→	←	+PR 1LN,1ZC	24.0125-0113.1	425113	Ø 288 25 22 V + S
1.4 TDI	66	02/14→			24.0325-0113.1	525113	Ø 288 25 22 V + S
1.4 TSI	110	05/14→	→	+PR 1KK,1KT,2EJ	24.0109-0123.1	409123	Ø 230 9 7 + S
					24.0309-0123.1	509123	Ø 230 9 7 + S
1.2 TSI	66	02/14→	←	+PR 1LR,1ZG,1ZJ	24.0122-0151.1	422151	Ø 256 22 19 V + S
					24.0322-0151.1	522151	Ø 256 22 19 V + S
			←	+PR 1LN,1ZC,1ZD	24.0125-0113.1	425113	Ø 288 25 22 V + S
					24.0325-0113.1	525113	Ø 288 25 22 V + S
			←	+PR 1ZP,1ZR	24.0125-0123.1	425123	Ø 310 25 22 V + S
		→	+PR 1KK,1KT,1KV,2EJ	24.0109-0123.1	409123	Ø 230 9 7 + S	
				24.0309-0123.1	509123	Ø 230 9 7 + S	
1.2 TSI	81	01/14→	←	+PR 1LR,1ZG,1ZJ	24.0122-0151.1	422151	Ø 256 22 19 V + S
					24.0322-0151.1	522151	Ø 256 22 19 V + S
			←	+PR 1LN,1ZC	24.0125-0113.1	425113	Ø 288 25 22 V + S
					24.0325-0113.1	525113	Ø 288 25 22 V + S
			←	+PR 1ZP,1ZR	24.0125-0123.1	425123	Ø 310 25 22 V + S
		→	+PR 1KK,1KT,2EJ	24.0109-0123.1	409123	Ø 230 9 7 + S	
				24.0309-0123.1	509123	Ø 230 9 7 + S	
<b>VW - POLO Van Kasten/Schrägheck (6N1) 09/94→12/99</b>							
 <b>Bremsbelagsatz, Scheibenbremse</b>							
1.0	33	10/94→12/99	←	→ 6N-TW082000	13.0460-7059.2	607059	VW 20887 17,3 - WE / - WK + Zub
			←	→ 6N-TY140000	13.0460-7059.2	607059	VW 20887 17,3 - WE / - WK + Zub
			←	6N-TW082001→; → 09/96	13.0460-7100.2	607100	VW 21866 17,2 - WE / - WK
					13.0470-7100.2	LD7100	VW 21866 17,2 - WE / - WK Ceramic
		←	6N-TY140001→; → 09/96	13.0460-7100.2	607100	VW 21866 17,2 - WE / - WK	
				13.0470-7100.2	LD7100	VW 21866 17,2 - WE / - WK Ceramic	
1.4 1.9 D	44 47	05/98→12/99 10/94→12/99	←	→ 6N-TW082000	13.0460-7059.2	607059	VW 20887 17,3 - WE / - WK + Zub
			←	→ 6N-TY140000	13.0460-7059.2	607059	VW 20887 17,3 - WE / - WK + Zub
			←	6N-TY140001→	13.0460-7100.2	607100	VW 21866 17,2 - WE / - WK
					13.0470-7100.2	LD7100	VW 21866 17,2 - WE / - WK Ceramic
		←	6N-TW082001→	13.0460-7100.2	607100	VW 21866 17,2 - WE / - WK	
				13.0470-7100.2	LD7100	VW 21866 17,2 - WE / - WK Ceramic	
1.7 SDI	44	08/97→12/99	←		13.0460-7100.2	607100	VW 21866 17,2 - WE / - WK
					13.0470-7100.2	LD7100	VW 21866 17,2 - WE / - WK Ceramic
1.9 SDI	47	07/96→12/99	←	03/97→; → 6K-V-022628	13.0460-7072.2	607072	VW 21866 19,7 - WE / - WK
			←	6K-V-022629→	13.0460-7101.2	607101	VW 21866 15,3 - WE / - WK
↓							









	kw					! #		
<b>VW - POLO Van Kasten/Schrägheck (6N1) 09/94→12/99</b>								
 <b>Bremsscheibe</b>								
1.0	33	10/94→12/99	←	→ 6N-SY087410		24.0110-0232.1	410232	∅ 239 9,9 8 + S
			←	→ 6N-SW008500		24.0110-0232.1	410232	∅ 239 9,9 8 + S
			←	6N-SY087411→; → 09/96		24.0118-0106.1	418106	∅ 239 18 16 V + S
			←	6N-SW008501→; → 09/96		24.0318-0106.1	518106	∅ 239 18 16 V + S
1.4 1.7 SDI	44	05/98→12/99	←			24.0118-0106.1	418106	∅ 239 18 16 V + S
	44	08/97→12/99				24.0318-0106.1	518106	∅ 239 18 16 V + S
1.9 D	47	10/94→12/99	←	→ 6N-SY087410		24.0110-0232.1	410232	∅ 239 9,9 8 + S
			←	→ 6N-SW008500		24.0110-0232.1	410232	∅ 239 9,9 8 + S
			←	6N-SW008501→		24.0118-0106.1	418106	∅ 239 18 16 V + S
			←	6N-SY087411→		24.0318-0106.1	518106	∅ 239 18 16 V + S
1.9 SDI	47	07/96→12/99	←	03/97→; → 6K-V-022628		24.0112-0106.1	412106	∅ 239 12 10 + S
						24.0312-0106.1	512106	∅ 239 12 10 + S
			←	6K-V-022629→		24.0120-0123.1	420123	∅ 239 20 18 V + S
					24.0320-0123.1	520123	∅ 239 20 18 V + S	
<b>VW - POLO Variant (6V5) 04/97→09/01</b>								
 <b>Bremsbelagsatz, Scheibenbremse</b>								
1.4 1.4 1.4 16V	40	12/98→09/01	←	→ 6K-V-022628; - ABS		13.0460-7059.2	607059	VW 20887 17,3 - WE / - WK + Zub
	44	05/97→09/01	←	→ 6K-V-022628; + ABS		13.0460-7072.2	607072	VW 21866 19,7 - WE / - WK
	55	10/99→09/01	←	6K-V-022629→		13.0460-7101.2	607101	VW 21866 15,3 - WE / - WK
1.6 1.7 SDI	55	05/97→09/01	←	→ 6K-V-022628		13.0460-7072.2	607072	VW 21866 19,7 - WE / - WK
	42	08/97→09/01						
1.9 SDI	47	06/97→09/01	←	6K-V-022629→		13.0460-7101.2	607101	VW 21866 15,3 - WE / - WK
1.9 SDI	50	08/99→09/01						
1.6	74	05/97→09/01	←			13.0460-2821.2	602821	TRW 21945 16,0 - WK
1.8	66	05/97→09/01						
1.9 TDI	66	05/97→09/01						
1.9 TDI	81	06/98→09/01	←			13.0460-2821.2	602821	TRW 21945 16,0 - WK
			→			13.0460-2886.2	602886	TRW 20961 16,0 - WK
						13.0460-2894.2	602894	TRW 20961 17,2 - WK + Zub
						13.0460-2937.2	602937	TRW 20961 15,2 - WK + Zub
						13.0470-2886.2	LD2886	TRW 20961 16,0 - WK Ceramic
					13.0470-2894.2	LD2894	TRW 20961 17,2 - WK + Zub Ceramic	
<b>Zubehörsatz, Scheibenbremsbelag</b>								
1.9 TDI	81	06/98→09/01	→			13.0460-0072.2	610072	TRW
 <b>Bremsscheibe</b>								
1.4 1.4 1.4 16V	40 44 55	12/98→09/01 05/97→09/01 10/99→09/01	←	→ 6K-V-022628; - ABS		24.0110-0151.1	410151	∅ 239 10 8 + S
			←	→ 6K-V-022628; + ABS		24.0310-0151.1	510151	∅ 239 10 8 + S
			←	6K-V-022629→		24.0112-0106.1	412106	∅ 239 12 10 + S
1.6 1.7 SDI	55 42	05/97→09/01 08/97→09/01	←	→ 6K-V-022628		24.0112-0106.1	412106	∅ 239 12 10 + S
						24.0312-0106.1	512106	∅ 239 12 10 + S
1.9 SDI	47	06/97→09/01	←	6K-V-022629→		24.0120-0123.1	420123	∅ 239 20 18 V + S
1.9 SDI	50	08/99→09/01				24.0320-0123.1	520123	∅ 239 20 18 V + S
1.6 1.8	74 66	05/97→09/01 05/97→09/01	←			24.0120-0128.1	420128	∅ 256 20 18 V + S
						24.0320-0128.1	520128	∅ 256 20 18 V + S
1.9 TDI	66	05/97→09/01						
1.9 TDI	81	06/98→09/01	←			24.0120-0128.1	420128	∅ 256 20 18 V + S
			→			24.0109-0124.1	409124	∅ 232 9 7







	kw			 	! #		
<b>VW - SCIROCCO (137, 138) 05/08→11/17</b>							
<b> Bremsbelagsatz, Scheibenbremse</b>							
1.4 TSI	90	08/08→11/17	←	09/08→; +PR 1LJ,1ZA,1ZB,1ZD / 1ZE,1ZP	13.0460-7184.2 607184	ATE 23587 20,6 + WK	
					13.0470-7184.2 LD7184	ATE 23587 20,6 + WK Ceramic	
			←	09/08→; +PR 1ZK	13.0460-7227.2 607227	ATE 23801 20,3 + WK	
					13.0470-7227.2 LD7227	ATE 23801 20,4 + WK Ceramic	
			→	09/08→; +PR 1KE,1KW	13.0460-2749.2 602749	TRW 24483 16,9 - WE / - WK + Zub	
					13.0460-2880.2 602880	TRW 23914 17,1 + WE / - WK + Zub	
					13.0470-2749.2 LD2749	TRW 24483 16,9 - WE / - WK + Zub Ceramic	
					13.0470-2880.2 LD2880	TRW 23914 17,1 + WE / - WK + Zub Ceramic	
		→	09/08→; +PR 1KD	13.0460-2787.2 602787	TRW 23554 17,3 - WK / - WE		
				13.0460-2860.2 602860	TRW 23554 16,4 - WK / + WE		
				13.0470-2860.2 LD2860	TRW 23554 16,4 - WK / + WE Ceramic		
			→	09/08→; +PR 1KT	13.0460-3858.2 603858	BOS 24563 17,7 - WE / - WK + Zub	
				13.0470-3858.2 LD3858	BOS 24563 17,7 - WE / - WK + Zub Ceramic		
			→	09/08→; +PR 1KS	13.0460-3858.2 603858	BOS 24563 17,7 - WE / - WK + Zub	
				13.0470-3858.2 LD3858	BOS 24563 17,7 - WE / - WK + Zub Ceramic		
1.4 TSI	92	11/13→11/17	←	+PR 1LJ,1ZA,1ZB,1ZD / 1ZE,1ZP	13.0460-7184.2 607184	ATE 23587 20,6 + WK	
1.4 TSI	110	07/15→11/17			13.0470-7184.2 LD7184	ATE 23587 20,6 + WK Ceramic	
2.0 R	188	11/09→11/17	←	+PR 1ZK	13.0460-7227.2 607227	ATE 23801 20,3 + WK	
2.0 R	195	11/09→11/17			13.0470-7227.2 LD7227	ATE 23801 20,4 + WK Ceramic	
2.0 TDI	100	11/10→11/17	→	+PR 1KE,1KW	13.0460-2749.2 602749	TRW 24483 16,9 - WE / - WK + Zub	
2.0 TDI	110	11/13→11/17			13.0460-2880.2 602880	TRW 23914 17,1 + WE / - WK + Zub	
2.0 TDI	125	05/09→11/17			13.0470-2749.2 LD2749	TRW 24483 16,9 - WE / - WK + Zub Ceramic	
2.0 TDI	130	01/13→11/17			13.0470-2880.2 LD2880	TRW 23914 17,1 + WE / - WK + Zub Ceramic	
2.0 TDI	135	05/14→11/17					
2.0 TSI	132	11/13→11/17					
2.0 TSI	155	11/09→11/17					
2.0 TSI	162	11/13→11/17					
			→	+PR 1KD	13.0460-2787.2 602787	TRW 23554 17,3 - WK / - WE	
					13.0460-2860.2 602860	TRW 23554 16,4 - WK / + WE	
					13.0470-2860.2 LD2860	TRW 23554 16,4 - WK / + WE Ceramic	
			→	+PR 1KS	13.0460-3858.2 603858	BOS 24563 17,7 - WE / - WK + Zub	
					13.0470-3858.2 LD3858	BOS 24563 17,7 - WE / - WK + Zub Ceramic	
			→	+PR 1KT	13.0460-3858.2 603858	BOS 24563 17,7 - WE / - WK + Zub	
					13.0470-3858.2 LD3858	BOS 24563 17,7 - WE / - WK + Zub Ceramic	
1.4 TSI	118	05/08→11/17	←	08/08→; +PR 1LJ,1ZA,1ZB,1ZD / 1ZE,1ZP	13.0460-7184.2 607184	ATE 23587 20,6 + WK	
2.0 TSI	147	05/08→11/09			13.0470-7184.2 LD7184	ATE 23587 20,6 + WK Ceramic	
			←	08/08→; +PR 1ZK	13.0460-7227.2 607227	ATE 23801 20,3 + WK	
					13.0470-7227.2 LD7227	ATE 23801 20,4 + WK Ceramic	
			→	08/08→; +PR 1KE,1KW	13.0460-2749.2 602749	TRW 24483 16,9 - WE / - WK + Zub	
					13.0460-2880.2 602880	TRW 23914 17,1 + WE / - WK + Zub	
					13.0470-2749.2 LD2749	TRW 24483 16,9 - WE / - WK + Zub Ceramic	
					13.0470-2880.2 LD2880	TRW 23914 17,1 + WE / - WK + Zub Ceramic	
			→	08/08→; +PR 1KD	13.0460-2787.2 602787	TRW 23554 17,3 - WK / - WE	
					13.0460-2860.2 602860	TRW 23554 16,4 - WK / + WE	
					13.0470-2860.2 LD2860	TRW 23554 16,4 - WK / + WE Ceramic	
			→	08/08→; +PR 1KT	13.0460-3858.2 603858	BOS 24563 17,7 - WE / - WK + Zub	
					13.0470-3858.2 LD3858	BOS 24563 17,7 - WE / - WK + Zub Ceramic	



















	kw			 	! #		
<b>VW - SCIROCCO (137, 138) 05/08→11/17</b>							
<b>Bremsbelagsatz, Scheibenbremse</b>							
1.4 TSI 2.0 TSI	118 147	05/08→11/17 05/08→11/09	➡	08/08→; +PR 1KS		13.0460-3858.2 603858 13.0470-3858.2 LD3858	BOS 24563 17,7 - WE / - WK + Zub BOS 24563 17,7 - WE / - WK + Zub Ceramic
2.0 R	206	05/14→11/17	←	08/14→; +PR 1LJ,1ZA,1ZB,1ZD / 1ZE,1ZP		13.0460-7184.2 607184 13.0470-7184.2 LD7184	ATE 23587 20,6 + WK ATE 23587 20,6 + WK Ceramic
			←	08/14→; +PR 1ZK		13.0460-7227.2 607227 13.0470-7227.2 LD7227	ATE 23801 20,3 + WK ATE 23801 20,4 + WK Ceramic
			➡	08/14→; +PR 1KE,1KW		13.0460-2749.2 602749 13.0460-2880.2 602880 13.0470-2749.2 LD2749 13.0470-2880.2 LD2880	TRW 24483 16,9 - WE / - WK + Zub TRW 23914 17,1 + WE / - WK + Zub TRW 24483 16,9 - WE / - WK + Zub Ceramic TRW 23914 17,1 + WE / - WK + Zub Ceramic
			➡	08/14→; +PR 1KD		13.0460-2787.2 602787 13.0460-2860.2 602860 13.0470-2860.2 LD2860	TRW 23554 17,3 - WK / - WE TRW 23554 16,4 - WK / + WE TRW 23554 16,4 - WK / + WE Ceramic
			➡	08/14→; +PR 1KS		13.0460-3858.2 603858 13.0470-3858.2 LD3858	BOS 24563 17,7 - WE / - WK + Zub BOS 24563 17,7 - WE / - WK + Zub Ceramic
			➡	08/14→; +PR 1KT		13.0460-3858.2 603858 13.0470-3858.2 LD3858	BOS 24563 17,7 - WE / - WK + Zub BOS 24563 17,7 - WE / - WK + Zub Ceramic
			➡	08/14→; +PR 1KS		13.0460-3858.2 603858 13.0470-3858.2 LD3858	BOS 24563 17,7 - WE / - WK + Zub BOS 24563 17,7 - WE / - WK + Zub Ceramic
2.0 TDI	103	08/08→11/17	←	10/08→; +PR 1LJ,1ZA,1ZB,1ZD / 1ZE,1ZP		13.0460-7184.2 607184 13.0470-7184.2 LD7184	ATE 23587 20,6 + WK ATE 23587 20,6 + WK Ceramic
			←	10/08→; +PR 1ZK		13.0460-7227.2 607227 13.0470-7227.2 LD7227	ATE 23801 20,3 + WK ATE 23801 20,4 + WK Ceramic
			➡	10/08→; +PR 1KE,1KW		13.0460-2749.2 602749 13.0460-2880.2 602880 13.0470-2749.2 LD2749 13.0470-2880.2 LD2880	TRW 24483 16,9 - WE / - WK + Zub TRW 23914 17,1 + WE / - WK + Zub TRW 24483 16,9 - WE / - WK + Zub Ceramic TRW 23914 17,1 + WE / - WK + Zub Ceramic
			➡	10/08→; +PR 1KD		13.0460-2787.2 602787 13.0460-2860.2 602860 13.0470-2860.2 LD2860	TRW 23554 17,3 - WK / - WE TRW 23554 16,4 - WK / + WE TRW 23554 16,4 - WK / + WE Ceramic
			➡	10/08→; +PR 1KT		13.0460-3858.2 603858 13.0470-3858.2 LD3858	BOS 24563 17,7 - WE / - WK + Zub BOS 24563 17,7 - WE / - WK + Zub Ceramic
			➡	10/08→; +PR 1KS		13.0460-3858.2 603858 13.0470-3858.2 LD3858	BOS 24563 17,7 - WE / - WK + Zub BOS 24563 17,7 - WE / - WK + Zub Ceramic
			➡	10/08→; +PR 1KS		13.0460-3858.2 603858 13.0470-3858.2 LD3858	BOS 24563 17,7 - WE / - WK + Zub BOS 24563 17,7 - WE / - WK + Zub Ceramic
<b>Zubehörsatz, Scheibenbremsbelag</b>							
1.4 TSI	90	08/08→11/17	➡	09/08→; +PR 1KD		13.0460-0259.2 610259	
			➡	09/08→; +PR 1KE,1KW		13.0460-0259.2 610259	
1.4 TSI	92	11/13→11/17	➡	+PR 1KD		13.0460-0259.2 610259	
1.4 TSI	110	07/15→11/17	➡	+PR 1KE,1KW		13.0460-0259.2 610259	
2.0 R	188	11/09→11/17	➡				
2.0 R	195	11/09→11/17	➡				
2.0 TDI	100	11/10→11/17	➡				
2.0 TDI	110	11/13→11/17	➡				
2.0 TDI	125	05/09→11/17	➡				
2.0 TDI	130	01/13→11/17	➡				
2.0 TDI	135	05/14→11/17	➡				
2.0 TSI	132	11/13→11/17	➡				
2.0 TSI	155	11/09→11/17	➡				
2.0 TSI	162	11/13→11/17	➡				
1.4 TSI 2.0 TSI ↓	118 147	05/08→11/17 05/08→11/09	➡	08/08→; +PR 1KD		13.0460-0259.2 610259	













	kw			 	! #		
<b>VW - SCIROCCO (137, 138) 05/08→11/17</b>							
<b>Zubehörsatz, Scheibenbremsbelag</b>							
1.4 TSI	118	05/08→11/17	➡	08/08→; +PR 1KE,1KW		13.0460-0259.2 610259	
2.0 TSI	147	05/08→11/09					
2.0 R	206	05/14→11/17	➡	08/14→; +PR 1KD		13.0460-0259.2 610259	
			➡	08/14→; +PR 1KE,1KW		13.0460-0259.2 610259	
2.0 TDI	103	08/08→11/17	➡	10/08→; +PR 1KE,1KW		13.0460-0259.2 610259	
			➡	10/08→; +PR 1KD		13.0460-0259.2 610259	
<b> Bremsscheibe</b>							
1.4 TSI	90	08/08→11/17	⬅	09/08→; +PR 1ZE,1ZP		24.0125-0145.1 425145 Ø 288 25 22 V + S 24.0325-0145.1 525145 Ø 288 25 22 V + S	
			⬅	09/08→; +PR 1LJ,1ZA,1ZB,1ZD		24.0125-0158.1 425158 Ø 312 25 22 V + S 24.0325-0158.1 525158 Ø 312 25 22 V + S	
			⬅	09/08→; +PR 1ZK		24.0130-0115.1 430115 Ø 345 30 27 V 24.0330-0115.1 530115 Ø 345 30 27 V	
			➡	09/08→; +PR 1KD		24.0110-0277.1 410277 Ø 253 10 8 + S 24.0310-0277.1 510277 Ø 253 10 8 + S	
			➡	09/08→; +PR 1KS,1KT		24.0110-0356.1 410356 Ø 272 9,7 8 + S 24.0310-0356.1 510356 Ø 272 9,7 8 + S	
			➡	09/08→; +PR 1KE		24.0112-0158.1 412158 Ø 256 12 10 + S 24.0312-0158.1 512158 Ø 256 12 10	
			➡	09/08→; +PR 1KW		24.0122-0219.1 422219 Ø 310 22 20 V	
1.4 TSI	92	11/13→11/17	⬅	+PR 1ZE,1ZP		24.0125-0145.1 425145 Ø 288 25 22 V + S	
1.4 TSI	110	07/15→11/17				24.0325-0145.1 525145 Ø 288 25 22 V + S	
2.0 R	188	11/09→11/17					
2.0 R	195	11/09→11/17	⬅	+PR 1LJ,1ZA,1ZB,1ZD		24.0125-0158.1 425158 Ø 312 25 22 V + S	
2.0 TDI	100	11/10→11/17				24.0325-0158.1 525158 Ø 312 25 22 V + S	
2.0 TDI	110	11/13→11/17	⬅	+PR 1ZK		24.0130-0115.1 430115 Ø 345 30 27 V	
2.0 TDI	125	05/09→11/17				24.0330-0115.1 530115 Ø 345 30 27 V	
2.0 TDI	130	01/13→11/17					
2.0 TDI	135	05/14→11/17	➡	+PR 1KD		24.0110-0277.1 410277 Ø 253 10 8 + S	
2.0 TSI	132	11/13→11/17	➡	+PR 1KS,1KT		24.0110-0356.1 410356 Ø 272 9,7 8 + S 24.0310-0356.1 510356 Ø 272 9,7 8 + S	
			➡	+PR 1KE		24.0112-0158.1 412158 Ø 256 12 10 + S 24.0312-0158.1 512158 Ø 256 12 10	
			➡	+PR 1KW		24.0122-0219.1 422219 Ø 310 22 20 V	
1.4 TSI	118	05/08→11/17	⬅	08/08→; +PR 1ZE,1ZP		24.0125-0145.1 425145 Ø 288 25 22 V + S	
2.0 TSI	147	05/08→11/09	⬅	08/08→; +PR 1LJ,1ZA,1ZB,1ZD		24.0325-0145.1 525145 Ø 288 25 22 V + S 24.0125-0158.1 425158 Ø 312 25 22 V + S 24.0325-0158.1 525158 Ø 312 25 22 V + S	
			⬅	08/08→; +PR 1ZK		24.0130-0115.1 430115 Ø 345 30 27 V 24.0330-0115.1 530115 Ø 345 30 27 V	
			➡	08/08→; +PR 1KD		24.0110-0277.1 410277 Ø 253 10 8 + S 24.0310-0277.1 510277 Ø 253 10 8 + S	
			➡	08/08→; +PR 1KS,1KT		24.0110-0356.1 410356 Ø 272 9,7 8 + S 24.0310-0356.1 510356 Ø 272 9,7 8 + S	
			➡	08/08→; +PR 1KE		24.0112-0158.1 412158 Ø 256 12 10 + S 24.0312-0158.1 512158 Ø 256 12 10	
			➡	08/08→; +PR 1KW		24.0122-0219.1 422219 Ø 310 22 20 V	
2.0 R	206	05/14→11/17	⬅	08/14→; +PR 1ZE,1ZP		24.0125-0145.1 425145 Ø 288 25 22 V + S 24.0325-0145.1 525145 Ø 288 25 22 V + S	
			⬅	08/14→; +PR 1LJ,1ZA,1ZB,1ZD		24.0125-0158.1 425158 Ø 312 25 22 V + S 24.0325-0158.1 525158 Ø 312 25 22 V + S	
			⬅	08/14→; +PR 1ZK		24.0130-0115.1 430115 Ø 345 30 27 V 24.0330-0115.1 530115 Ø 345 30 27 V	
			➡	08/14→; +PR 1KD		24.0110-0277.1 410277 Ø 253 10 8 + S 24.0310-0277.1 510277 Ø 253 10 8 + S	
			➡	08/14→; +PR 1KS,1KT		24.0110-0356.1 410356 Ø 272 9,7 8 + S 24.0310-0356.1 510356 Ø 272 9,7 8 + S	
			➡	08/14→; +PR 1KE		24.0112-0158.1 412158 Ø 256 12 10 + S 24.0312-0158.1 512158 Ø 256 12 10	
			➡	08/14→; +PR 1KW		24.0122-0219.1 422219 Ø 310 22 20 V	
↓							

	kw			 	! #		
<b>VW - SCIROCCO (137, 138) 05/08→11/17</b>							
<b>Bremsscheibe</b>							
2.0 TDI	103	08/08→11/17	←	10/08→; +PR 1ZE,1ZP	24.0125-0145.1 425145	Ø 288 25 22 V + S	
			←	10/08→; +PR 1LJ,1ZA,1ZB,1ZD	24.0125-0158.1 425158	Ø 312 25 22 V + S	
			←	10/08→; +PR 1ZK	24.0130-0115.1 430115	Ø 345 30 27 V	
			→	10/08→; +PR 1KD	24.0110-0277.1 410277	Ø 253 10 8 + S	
			→	10/08→; +PR 1KS,1KT	24.0110-0356.1 410356	Ø 272 9,7 8 + S	
			→	10/08→; +PR 1KE	24.0112-0158.1 412158	Ø 256 12 10 + S	
			→	10/08→; +PR 1KW	24.0122-0219.1 422219	Ø 310 22 20 V	
2.0 TSI	155	11/09→11/17	←	+PR 1ZE,1ZP	24.0125-0145.1 425145	Ø 288 25 22 V + S	
			←	+PR 1LJ,1ZA,1ZB,1ZD	24.0125-0158.1 425158	Ø 312 25 22 V + S	
			←	+PR 1ZK	24.0130-0115.1 430115	Ø 345 30 27 V	
			→	+PR 1KD	24.0110-0277.1 410277	Ø 253 10 8 + S	
			→	+PR 1KS,1KT	24.0110-0356.1 410356	Ø 272 9,7 8 + S	
			→	+PR 1KE	24.0112-0158.1 412158	Ø 256 12 10 + S	
			→	11/13→; +PR 1KE	24.0112-0158.1 412158	Ø 256 12 10 + S	
2.0 TSI	162	11/13→11/17	←	+PR 1ZE,1ZP	24.0125-0145.1 425145	Ø 288 25 22 V + S	
			←	+PR 1LJ,1ZA,1ZB,1ZD	24.0125-0158.1 425158	Ø 312 25 22 V + S	
			←	+PR 1ZK	24.0130-0115.1 430115	Ø 345 30 27 V	
			→	+PR 1KD	24.0110-0277.1 410277	Ø 253 10 8 + S	
			→	+PR 1KS,1KT	24.0110-0356.1 410356	Ø 272 9,7 8 + S	
			→	+PR 1KE	24.0112-0158.1 412158	Ø 256 12 10 + S	
			→	+PR 1KW	24.0122-0219.1 422219	Ø 310 22 20 V	
<b>VW - SHARAN (7M8, 7M9, 7M6) 05/95→03/10</b>							
<b>Bremsbelagsatz, Scheibenbremse</b>							
1.8 T 20V	110	09/97→03/10	←	→ 7M-W-070000	13.0460-7076.2 607076	ATE 21848 19,8 - WE / - WK	
			←	7M-X-000001→ 7M-1-070000	13.0460-7143.2 607143	ATE 21848 19,8 + WK	
			←	7M-2-000001→	13.0460-7153.2 607153	ATE 23269 19,8 + WK	
			→	→ 04/00	13.0460-2819.2 602819	TRW 20961 17,2 - WK	
			→	05/00→; → 7M-1-070000	13.0460-2859.2 602859	TRW 20961 17,0 + WK + Zub	
			→	7M-2-000001→	13.0460-2872.2 602872	TRW 23224 16,5 + WK + Zub	
1.9 TDI 2.0	66 85	09/95→03/10 09/95→03/10	←	→ 7M-W-070000	13.0460-7076.2 607076	ATE 21848 19,8 - WE / - WK	
			←	7M-X-000001→ 7M-1-070000	13.0460-7143.2 607143	ATE 21848 19,8 + WK	
			←	7M-2-000001→	13.0460-7154.2 607154	ATE 23034 18,8 + WK	
			→	→ 04/00	13.0460-2819.2 602819	TRW 20961 17,2 - WK	
			→	05/00→	13.0460-2859.2 602859	TRW 20961 17,0 + WK + Zub	
			→				
1.9 TDI	81	09/96→04/00	←	→ 7M-W-070000	13.0460-7076.2 607076	ATE 21848 19,8 - WE / - WK	
			←	7M-X-000001→ 7M-1-070000	13.0460-7143.2 607143	ATE 21848 19,8 + WK	
			→		13.0460-2819.2 602819	TRW 20961 17,2 - WK	
↓							











	kw					! #			
<b>VW - SHARAN (7M8, 7M9, 7M6) 05/95→03/10</b>									
<b>Bremsbelagsatz, Scheibenbremse</b>									
1.9 TDI	85	04/00→03/10	←	05/00→; → 7M-1-070000			<b>13.0460-7143.2</b>	<b>607143</b>	ATE 21848 19,8 + WK
			←	7M-2-000001→			<b>13.0460-7154.2</b>	<b>607154</b>	ATE 23034 18,8 + WK
			→	05/00→			<b>13.0460-2859.2</b>	<b>602859</b>	TRW 20961 17,0 + WK + Zub
1.9 TDI	96	11/02→03/10	←				<b>13.0460-7154.2</b>	<b>607154</b>	ATE 23034 18,8 + WK
			→				<b>13.0460-2859.2</b>	<b>602859</b>	TRW 20961 17,0 + WK + Zub
1.9 TDI 2.8 V6 24V	110 150	06/05→03/10 04/00→03/10	←				<b>13.0460-7153.2</b>	<b>607153</b>	ATE 23269 19,8 + WK
			→				<b>13.0460-2872.2</b>	<b>602872</b>	TRW 23224 16,5 + WK + Zub
2.8 V6 24V 4motion	150	04/00→03/10	←				<b>13.0460-2872.2</b>	<b>602872</b>	TRW 23224 16,5 + WK + Zub
			→				<b>13.0460-2872.2</b>	<b>602872</b>	TRW 23224 16,5 + WK + Zub
1.9 TDI 4motion	85	04/00→03/10	←	05/00→			<b>13.0460-7153.2</b>	<b>607153</b>	ATE 23269 19,8 + WK
			→	05/00→			<b>13.0460-2872.2</b>	<b>602872</b>	TRW 23224 16,5 + WK + Zub
2.0 16V	110	09/95→02/00	←	→ 7M-W-070000			<b>13.0460-7076.2</b>	<b>607076</b>	ATE 21848 19,8 - WE / - WK
			←	7M-X-000001→ 7M-1-070000			<b>13.0460-7143.2</b>	<b>607143</b>	ATE 21848 19,8 + WK
			←	7M-2-000001→			<b>13.0460-7154.2</b>	<b>607154</b>	ATE 23034 18,8 + WK
			→				<b>13.0460-2819.2</b>	<b>602819</b>	TRW 20961 17,2 - WK
2.0 LPG	85	04/06→03/10	←	→ 7M-W-070000			<b>13.0460-7076.2</b>	<b>607076</b>	ATE 21848 19,8 - WE / - WK
			←	7M-X-000001→ 7M-1-070000			<b>13.0460-7143.2</b>	<b>607143</b>	ATE 21848 19,8 + WK
			←	7M-2-000001→			<b>13.0460-7154.2</b>	<b>607154</b>	ATE 23034 18,8 + WK
			→				<b>13.0460-2859.2</b>	<b>602859</b>	TRW 20961 17,0 + WK + Zub
2.0 TDI	100 103	11/05→03/10 11/05→03/10	←	→ 7M-1-070000			<b>13.0460-7143.2</b>	<b>607143</b>	ATE 21848 19,8 + WK
			←	7M-2-000001→			<b>13.0460-7154.2</b>	<b>607154</b>	ATE 23034 18,8 + WK
2.8 VR6 2.8 VR6 Syncro	128 128	09/95→04/00 11/96→04/00	←	→ 7M-W-070000			<b>13.0460-7076.2</b>	<b>607076</b>	ATE 21848 19,8 - WE / - WK
			←	7M-X-000001→ 7M-Y-050000			<b>13.0460-7143.2</b>	<b>607143</b>	ATE 21848 19,8 + WK
			←	7M-1-000001→			<b>13.0460-7153.2</b>	<b>607153</b>	ATE 23269 19,8 + WK
			→				<b>13.0460-2819.2</b>	<b>602819</b>	TRW 20961 17,2 - WK
<b>Zubehörsatz, Scheibenbremsbelag</b>									
1.8 T 20V	110	09/97→03/10	→	→ 04/00			<b>13.0460-0072.2</b>	<b>610072</b>	TRW
			→	7M-2-000001→			<b>13.0460-0225.2</b>	<b>610225</b>	
1.9 TDI 2.0	66 85	09/95→03/10 09/95→03/10	→	→ 04/00			<b>13.0460-0072.2</b>	<b>610072</b>	TRW
			→				<b>13.0460-0072.2</b>	<b>610072</b>	TRW
1.9 TDI 2.0 16V	81 110	09/96→04/00 09/95→02/00	→				<b>13.0460-0072.2</b>	<b>610072</b>	TRW
			→				<b>13.0460-0072.2</b>	<b>610072</b>	TRW
2.8 VR6 2.8 VR6 Syncro	128 128	09/95→04/00 11/96→04/00	→				<b>13.0460-0072.2</b>	<b>610072</b>	TRW
			→				<b>13.0460-0072.2</b>	<b>610072</b>	TRW
1.9 TDI 2.8 V6 24V	110 150	06/05→03/10 04/00→03/10	→				<b>13.0460-0225.2</b>	<b>610225</b>	
			→				<b>13.0460-0225.2</b>	<b>610225</b>	
2.8 V6 24V 4motion 1.9 TDI 4motion	150 85	04/00→03/10 04/00→03/10	→	05/00→			<b>13.0460-0225.2</b>	<b>610225</b>	
			→	05/00→			<b>13.0460-0225.2</b>	<b>610225</b>	
<b>Bremsscheibe</b>									
1.8 T 20V	110	09/97→03/10	←	→ 7M-1-070000			<b>24.0125-0114.1</b>	<b>425114</b>	Ø 288 25,1 21 V + S
			←	7M-2-000001→			<b>24.0325-0114.1</b>	<b>525114</b>	Ø 288 25,1 21 V + S
			←	7M-2-000001→			<b>24.0126-0119.1</b>	<b>426119</b>	Ø 313 25,9 22 V
			←	7M-2-000001→			<b>24.0326-0119.1</b>	<b>526119</b>	Ø 313 25,9 22 V
			→	→ 7M-1-070000			<b>24.0110-0223.1</b>	<b>410223</b>	Ø 268 10 8 + S
1.9 TDI 2.0 2.0 16V 2.0 LPG	66 85 110 85	09/95→03/10 09/95→03/10 09/95→02/00 04/06→03/10	←	→ 7M-1-070000			<b>24.0125-0114.1</b>	<b>425114</b>	Ø 288 25,1 21 V + S
			←	→ 7M-1-070000			<b>24.0325-0114.1</b>	<b>525114</b>	Ø 288 25,1 21 V + S
			←	7M-2-000001→			<b>24.0126-0115.1</b>	<b>426115</b>	Ø 300 26 22 V
			←	7M-2-000001→			<b>24.0326-0115.1</b>	<b>526115</b>	Ø 300 26 22 V
			→				<b>24.0110-0223.1</b>	<b>410223</b>	Ø 268 10 8 + S
1.9 TDI 2.8 VR6 2.8 VR6 Syncro	81 128 128	09/96→04/00 09/95→04/00 11/96→04/00	←				<b>24.0110-0223.1</b>	<b>410223</b>	Ø 268 10 8 + S
			←				<b>24.0310-0223.1</b>	<b>510223</b>	Ø 268 10 8 + S
			←				<b>24.0125-0114.1</b>	<b>425114</b>	Ø 288 25,1 21 V + S
			←				<b>24.0325-0114.1</b>	<b>525114</b>	Ø 288 25,1 21 V + S
			→				<b>24.0110-0223.1</b>	<b>410223</b>	Ø 268 10 8 + S
↓			→				<b>24.0310-0223.1</b>	<b>510223</b>	Ø 268 10 8 + S
			→				<b>24.0310-0223.1</b>	<b>510223</b>	Ø 268 10 8 + S









	kw			 	! #		
<b>VW - SHARAN (7M8, 7M9, 7M6) 05/95→03/10</b>							
<b>Bremsscheibe</b>							
1.9 TDI	85	04/00→03/10	←	05/00→; → 7M-1-070000	24.0125-0114.1 425114	Ø 288 25,1 21 V + S	
					24.0325-0114.1 525114	Ø 288 25,1 21 V + S	
			←	7M-2-000001→	24.0126-0115.1 426115	Ø 300 26 22 V	
					24.0326-0115.1 526115	Ø 300 26 22 V	
			→	05/00→	24.0110-0223.1 410223	Ø 268 10 8 + S	
					24.0310-0223.1 510223	Ø 268 10 8 + S	
1.9 TDI 2.0 TDI 2.0 TDI	96 100 103	11/02→03/10 11/05→03/10 11/05→03/10	←		24.0126-0115.1 426115	Ø 300 26 22 V	
					24.0326-0115.1 526115	Ø 300 26 22 V	
			→		24.0110-0223.1 410223	Ø 268 10 8 + S	
					24.0310-0223.1 510223	Ø 268 10 8 + S	
1.9 TDI 2.8 V6 24V 2.8 V6 24V 4motion	110 150 150	06/05→03/10 04/00→03/10 04/00→03/10	←		24.0126-0119.1 426119	Ø 313 25,9 22 V	
					24.0326-0119.1 526119	Ø 313 25,9 22 V	
			→		24.0113-0194.1 413194	Ø 294 13,5 11,5	
1.9 TDI 4motion	85	04/00→03/10	←	05/00→	24.0126-0119.1 426119	Ø 313 25,9 22 V	
					24.0326-0119.1 526119	Ø 313 25,9 22 V	
			→	05/00→	24.0113-0194.1 413194	Ø 294 13,5 11,5	
<b>VW - SHARAN (7N1, 7N2) 05/10→</b>							
<b>Bremsbelagsatz, Scheibenbremse</b>							
1.4 TSI 2.0 TDI 2.0 TDI	110 100 103	05/10→ 05/10→ 05/10→	←	07/10→; +PR 1LW	13.0460-2764.2 602764	TRW 24738 20,0 + WK	
					13.0470-2764.2 LD2764	TRW 24738 20,0 + WK Ceramic	
			←	07/12→; +PR 1LX	13.0460-2764.2 602764	TRW 24738 20,0 + WK	
					13.0470-2764.2 LD2764	TRW 24738 20,0 + WK Ceramic	
			←	07/10→; +PR 1LJ	13.0460-7242.2 607242	ATE 24332 19,8 + WK	
				13.0470-7242.2 LD7242	ATE 24332 19,8 + WK Ceramic		
			→	07/10→	13.0460-2749.2 602749	TRW 24483 16,9 - WE / - WK + Zub	
					13.0460-2880.2 602880	TRW 23914 17,1 + WE / - WK + Zub	
					13.0470-2749.2 LD2749	TRW 24483 16,9 - WE / - WK + Zub Ceramic	
					13.0470-2880.2 LD2880	TRW 23914 17,1 + WE / - WK + Zub Ceramic	
1.4 TSI 2.0 TDI 2.0 TDI 2.0 TDI 4motion 2.0 TDI 4motion 2.0 TSI	110 110 135 110 135 162	05/15→ 05/15→ 05/15→ 05/15→ 05/16→ 05/15→	←		13.0460-2764.2 602764	TRW 24738 20,0 + WK	
					13.0470-2764.2 LD2764	TRW 24738 20,0 + WK Ceramic	
			→	+ eFSB	13.0460-2790.2 602790	TRW 25110 17,5 - WE / - WK	
					13.0470-2790.2 LD2790	TRW 25110 17,5 - WE / - WK Ceramic	
2.0 TDI 2.0 TDI 2.0 TDI 4motion 2.0 TSI	85 125 103 147	05/11→ 08/10→ 05/11→ 12/10→	←	+PR 1LW	13.0460-2764.2 602764	TRW 24738 20,0 + WK	
					13.0470-2764.2 LD2764	TRW 24738 20,0 + WK Ceramic	
			←	07/12→; +PR 1LX	13.0460-2764.2 602764	TRW 24738 20,0 + WK	
					13.0470-2764.2 LD2764	TRW 24738 20,0 + WK Ceramic	
			←	+PR 1LJ	13.0460-7242.2 607242	ATE 24332 19,8 + WK	
				13.0470-7242.2 LD7242	ATE 24332 19,8 + WK Ceramic		
			→		13.0460-2749.2 602749	TRW 24483 16,9 - WE / - WK + Zub	
					13.0460-2880.2 602880	TRW 23914 17,1 + WE / - WK + Zub	
					13.0470-2749.2 LD2749	TRW 24483 16,9 - WE / - WK + Zub Ceramic	
					13.0470-2880.2 LD2880	TRW 23914 17,1 + WE / - WK + Zub Ceramic	
2.0 TDI	130	01/13→	←	+PR 1LW	13.0460-2764.2 602764	TRW 24738 20,0 + WK	
					13.0470-2764.2 LD2764	TRW 24738 20,0 + WK Ceramic	
			←	+PR 1LX	13.0460-2764.2 602764	TRW 24738 20,0 + WK	
					13.0470-2764.2 LD2764	TRW 24738 20,0 + WK Ceramic	
			←	+PR 1LJ	13.0460-7242.2 607242	ATE 24332 19,8 + WK	
				13.0470-7242.2 LD7242	ATE 24332 19,8 + WK Ceramic		
			→		13.0460-2749.2 602749	TRW 24483 16,9 - WE / - WK + Zub	
					13.0460-2880.2 602880	TRW 23914 17,1 + WE / - WK + Zub	
					13.0470-2749.2 LD2749	TRW 24483 16,9 - WE / - WK + Zub Ceramic	











	kw					! #		
<b>VW - SHARAN (7N1, 7N2) 05/10→</b>								
 <b>Bremsbelagsatz, Scheibenbremse</b>								
2.0 TDI	130	01/13→	→				<b>13.0470-2880.2 LD2880</b>	TRW 23914 17,1 + WE / - WK + Zub Ceramic
 <b>Bremsscheibe</b>								
1.4 TSI	110	05/10→	←	07/10→; +PR 1LJ			<b>24.0125-0158.1 425158</b>	Ø 312 25 22 V + S
2.0 TDI	100	05/10→					<b>24.0325-0158.1 525158</b>	Ø 312 25 22 V + S
2.0 TDI	103	05/10→	←	07/10→; +PR 1LW,1LX			<b>24.0130-0220.1 430220</b>	Ø 314 30 27 V + S
			→	07/10→			<b>24.0112-0169.1 412169</b>	Ø 282 12 10 + S
							<b>24.0312-0169.1 512169</b>	Ø 282 12 10 + S
1.4 TSI	110	05/15→	←				<b>24.0130-0220.1 430220</b>	Ø 314 30 27 V + S
2.0 TDI	110	05/15→	→	+ eFSB			<b>24.0112-0210.1 412210</b>	Ø 300 12 10 + S
2.0 TDI	135	05/15→						
2.0 TDI 4motion	110	05/15→						
2.0 TDI 4motion	135	05/16→						
2.0 TSI	162	05/15→						
2.0 TDI	85	05/11→	←	+PR 1LJ			<b>24.0125-0158.1 425158</b>	Ø 312 25 22 V + S
2.0 TDI	125	08/10→					<b>24.0325-0158.1 525158</b>	Ø 312 25 22 V + S
2.0 TDI	130	01/13→						
2.0 TDI 4motion	103	05/11→	←	+PR 1LW,1LX			<b>24.0130-0220.1 430220</b>	Ø 314 30 27 V + S
2.0 TSI	147	12/10→	→				<b>24.0112-0169.1 412169</b>	Ø 282 12 10 + S
							<b>24.0312-0169.1 512169</b>	Ø 282 12 10 + S
<b>VW - TARO 04/89→03/97</b>								
 <b>Bremsbelagsatz, Scheibenbremse</b>								
2.4 D	58	07/94→03/97	←				<b>13.0460-5938.2 605938</b>	AKE 21158 15,5 - WE / - WK
2.4 D	61	06/89→03/97						
 <b>Bremsscheibe</b>								
2.4 D	58	07/94→03/97	←				<b>24.0125-0118.1 425118</b>	Ø 257 25 23 V
2.4 D	61	06/89→03/97						
2.4 D 4x4	58	07/94→03/97	←	Einzelradaufhängung			<b>24.0120-0168.1 420168</b>	Ø 289 20 18 V
2.4 i 4x4	84	06/89→03/97						
2.4 D 4x4	61	04/89→03/97	←	07/94→; Einzelradaufhängung			<b>24.0120-0168.1 420168</b>	Ø 289 20 18 V
<b>VW - TIGUAN (5N_) 09/07→</b>								
 <b>Bremsbelagsatz, Scheibenbremse</b>								
1.4 TSI	90	08/10→	←				<b>13.0460-7242.2 607242</b>	ATE 24332 19,8 + WK
1.4 TSI	92	05/15→					<b>13.0470-7242.2 LD7242</b>	ATE 24332 19,8 + WK Ceramic
1.4 TSI	110	05/08→	→					
1.4 TSI	110	05/15→					<b>13.0460-2749.2 602749</b>	TRW 24483 16,9 - WE / - WK + Zub
1.4 TSI	118	05/11→						
1.4 TSI 4motion	110	09/07→					<b>13.0460-2880.2 602880</b>	TRW 23914 17,1 + WE / - WK + Zub
1.4 TSI 4motion	118	05/11→						
2.0 TDI	81	05/10→					<b>13.0470-2749.2 LD2749</b>	TRW 24483 16,9 - WE / - WK + Zub Ceramic
2.0 TDI	103	03/08→						
2.0 TDI	110	05/15→					<b>13.0470-2880.2 LD2880</b>	TRW 23914 17,1 + WE / - WK + Zub Ceramic
2.0 TDI 4motion	100	11/07→						
2.0 TDI 4motion	110	05/15→						
2.0 TDI 4motion	120	02/08→08/09						
2.0 TDI 4motion	130	11/12→						
2.0 TDI 4motion	135	05/15→						
2.0 TSI 4motion	132	05/11→						
2.0 TSI 4motion	155	05/11→						
2.0 TDI 4motion	103	09/07→	←	11/07→			<b>13.0460-7242.2 607242</b>	ATE 24332 19,8 + WK
							<b>13.0470-7242.2 LD7242</b>	ATE 24332 19,8 + WK Ceramic
			→	11/07→			<b>13.0460-2749.2 602749</b>	TRW 24483 16,9 - WE / - WK + Zub
							<b>13.0460-2880.2 602880</b>	TRW 23914 17,1 + WE / - WK + Zub
							<b>13.0470-2749.2 LD2749</b>	TRW 24483 16,9 - WE / - WK + Zub Ceramic
							<b>13.0470-2880.2 LD2880</b>	TRW 23914 17,1 + WE / - WK + Zub Ceramic
2.0 TDI 4motion	125	09/07→	←	01/08→			<b>13.0460-7242.2 607242</b>	ATE 24332 19,8 + WK
							<b>13.0470-7242.2 LD7242</b>	ATE 24332 19,8 + WK Ceramic
			→	01/08→			<b>13.0460-2749.2 602749</b>	TRW 24483 16,9 - WE / - WK + Zub
							<b>13.0460-2880.2 602880</b>	TRW 23914 17,1 + WE / - WK + Zub
							<b>13.0470-2749.2 LD2749</b>	TRW 24483 16,9 - WE / - WK + Zub Ceramic











	kW			 	! #		
<b>VW - TIGUAN (5N_) 09/07→</b>							
 <b>Bremsbelagsatz, Scheibenbremse</b>							
2.0 TDI 4motion	125	09/07→	→	01/08→		13.0470-2880.2 LD2880	TRW 23914 17,1 + WE / - WK + Zub Ceramic
2.0 TFSI 4motion	125	09/07→	←	02/08→		13.0460-7242.2 607242	ATE 24332 19,8 + WK
2.0 TFSI 4motion	147	09/07→	→	02/08→		13.0470-7242.2 LD7242	ATE 24332 19,8 + WK Ceramic
						13.0460-2749.2 602749	TRW 24483 16,9 - WE / - WK + Zub
						13.0460-2880.2 602880	TRW 23914 17,1 + WE / - WK + Zub
						13.0470-2749.2 LD2749	TRW 24483 16,9 - WE / - WK + Zub Ceramic
						13.0470-2880.2 LD2880	TRW 23914 17,1 + WE / - WK + Zub Ceramic
<b>Zubehörsatz, Scheibenbremsbelag</b>							
1.4 TSI	90	08/10→	→			13.0460-0259.2 610259	
1.4 TSI	92	05/15→					
1.4 TSI	110	05/08→					
1.4 TSI	110	05/15→					
1.4 TSI	118	05/11→					
1.4 TSI 4motion	110	09/07→					
1.4 TSI 4motion	118	05/11→					
2.0 TDI	81	05/10→					
2.0 TDI	103	03/08→					
2.0 TDI	110	05/15→					
2.0 TDI 4motion	100	11/07→					
2.0 TDI 4motion	110	05/15→					
2.0 TDI 4motion	120	02/08→08/09					
2.0 TDI 4motion	130	11/12→					
2.0 TDI 4motion	135	05/15→					
2.0 TSI 4motion	132	05/11→					
2.0 TSI 4motion	155	05/11→					
2.0 TDI 4motion	103	09/07→	→	11/07→		13.0460-0259.2 610259	
2.0 TDI 4motion	125	09/07→	→	01/08→		13.0460-0259.2 610259	
2.0 TFSI 4motion	125	09/07→	→	02/08→		13.0460-0259.2 610259	
2.0 TFSI 4motion	147	09/07→					
 <b>Bremsscheibe</b>							
1.4 TSI	90	08/10→	←			24.0125-0158.1 425158	Ø 312 25 22 V + S
1.4 TSI	92	05/15→				24.0325-0158.1 525158	Ø 312 25 22 V + S
1.4 TSI	110	05/08→	→			24.0112-0169.1 412169	Ø 282 12 10 + S
1.4 TSI	110	05/15→				24.0312-0169.1 512169	Ø 282 12 10 + S
1.4 TSI	118	05/11→					
1.4 TSI 4motion	110	09/07→					
1.4 TSI 4motion	118	05/11→					
2.0 TDI	81	05/10→					
2.0 TDI	103	03/08→					
2.0 TDI	110	05/15→					
2.0 TDI 4motion	100	11/07→					
2.0 TDI 4motion	110	05/15→					
2.0 TDI 4motion	120	02/08→08/09					
2.0 TDI 4motion	130	11/12→					
2.0 TDI 4motion	135	05/15→					
2.0 TSI 4motion	132	05/11→					
2.0 TSI 4motion	155	05/11→					
2.0 TDI 4motion	103	09/07→	←	11/07→		24.0125-0158.1 425158	Ø 312 25 22 V + S
			→	11/07→		24.0325-0158.1 525158	Ø 312 25 22 V + S
			→	11/07→		24.0112-0169.1 412169	Ø 282 12 10 + S
			→	11/07→		24.0312-0169.1 512169	Ø 282 12 10 + S
2.0 TDI 4motion	125	09/07→	←	01/08→		24.0125-0158.1 425158	Ø 312 25 22 V + S
			→	01/08→		24.0325-0158.1 525158	Ø 312 25 22 V + S
			→	01/08→		24.0112-0169.1 412169	Ø 282 12 10 + S
			→	01/08→		24.0312-0169.1 512169	Ø 282 12 10 + S
2.0 TFSI 4motion	125	09/07→	←	02/08→		24.0125-0158.1 425158	Ø 312 25 22 V + S
2.0 TFSI 4motion	147	09/07→	→	02/08→		24.0325-0158.1 525158	Ø 312 25 22 V + S
			→	02/08→		24.0112-0169.1 412169	Ø 282 12 10 + S
			→	02/08→		24.0312-0169.1 512169	Ø 282 12 10 + S
<b>VW - TIGUAN (AD1) 01/16→</b>							
 <b>Bremsbelagsatz, Scheibenbremse</b>							
1.4 TSI	92	01/16→	←	+PR 1ZA,1ZD		13.0460-2785.2 602785	TRW 25683 20,4 + WE / + WK
1.4 TSI	110	05/16→				13.0470-2785.2 LD2785	TRW 25683 20,4 + WE / + WK Ceramic
1.4 TSI 4motion	110	05/16→					
1.6 TDI	85	05/16→					
↓							

	kw				! #		
<b>VW - TIGUAN (AD1) 01/16→</b>							
 <b>Bremsbelagsatz, Scheibenbremse</b>							
2.0 TDI	81	08/16→	➔	+PR 1KU,1KZ; + eFSB		13.0460-7294.2 607294	ATE 25009 16,4 - WE / - WK
2.0 TDI	85	05/16→				13.0470-7294.2 LD7294	ATE 25009 16,4 - WE / - WK
2.0 TDI 4motion	140	04/16→					Ceramic
2.0 TDI 4motion	176	05/16→					
2.0 TSI 4motion	162	06/16→					
2.0 TDI	110	01/16→	➔	02/16→; +PR 1ZA,1ZD		13.0460-2785.2 602785	TRW 25683 20,4 + WE / + WK
2.0 TDI 4motion	110	01/16→				13.0470-2785.2 LD2785	TRW 25683 20,4 + WE / + WK
2.0 TSI 4motion	132	01/16→					Ceramic
			➔	02/16→; +PR 1KU,1KZ; + eFSB		13.0460-7294.2 607294	ATE 25009 16,4 - WE / - WK
						13.0470-7294.2 LD7294	ATE 25009 16,4 - WE / - WK
							Ceramic
<b>Warnkontakt, Bremsbelagverschleiß</b>							
1.4 TSI	92	01/16→	➔	+PR 1ZA,1ZD	1	24.8190-0065.2 620065	L= 172
1.4 TSI	110	05/16→					
1.4 TSI 4motion	110	05/16→	➔	+PR 1LA,1LW	1	24.8190-0065.2 620065	L= 172
1.6 TDI	85	05/16→					
2.0 TDI	81	08/16→					
2.0 TDI	85	05/16→					
2.0 TDI 4motion	140	04/16→					
2.0 TDI 4motion	176	05/16→					
2.0 TSI 4motion	162	06/16→					
2.0 TDI	110	01/16→	➔	02/16→; +PR 1ZA,1ZD	1	24.8190-0065.2 620065	L= 172
2.0 TDI 4motion	110	01/16→					
2.0 TSI 4motion	132	01/16→	➔	02/16→; +PR 1LA,1LW	1	24.8190-0065.2 620065	L= 172
<b>Bremsscheibe</b>							
1.4 TSI	92	01/16→	➔	+PR 1ZA,1ZD		24.0125-0158.1 425158	Ø 312 25 22 V + S
1.4 TSI	110	05/16→				24.0325-0158.1 525158	Ø 312 25 22 V + S
1.4 TSI 4motion	110	05/16→	➔	+PR 1LW		24.0130-0220.1 430220	Ø 314 30 27 V + S
1.6 TDI	85	05/16→					
2.0 TDI	81	08/16→	➔	+PR 1LA		24.0130-0225.1 430225	Ø 340 30 27 V + S
2.0 TDI	85	05/16→					
2.0 TDI 4motion	140	04/16→	➔	+PR 1KU; + eFSB		24.0112-0210.1 412210	Ø 300 12 10 + S
2.0 TDI 4motion	176	05/16→	➔	+PR 1KZ; + eFSB		24.0122-0219.1 422219	Ø 310 22 20 V
2.0 TSI 4motion	162	06/16→					
2.0 TDI	110	01/16→	➔	02/16→; +PR 1ZA,1ZD		24.0125-0158.1 425158	Ø 312 25 22 V + S
2.0 TDI 4motion	110	01/16→				24.0325-0158.1 525158	Ø 312 25 22 V + S
2.0 TSI 4motion	132	01/16→	➔	02/16→; +PR 1LW		24.0130-0220.1 430220	Ø 314 30 27 V + S
			➔	02/16→; +PR 1LA		24.0130-0225.1 430225	Ø 340 30 27 V + S
			➔	02/16→; +PR 1KU; + eFSB		24.0112-0210.1 412210	Ø 300 12 10 + S
			➔	02/16→; +PR 1KZ; + eFSB		24.0122-0219.1 422219	Ø 310 22 20 V
<b>VW - TIGUAN ALLSPACE (BW2) 03/17→</b>							
 <b>Bremsbelagsatz, Scheibenbremse</b>							
1.4 TSI	110	04/17→	➔	+PR 1KU		13.0460-7294.2 607294	ATE 25009 16,4 - WE / - WK
1.4 TSI E100	110	07/17→				13.0470-7294.2 LD7294	ATE 25009 16,4 - WE / - WK
2.0 TDI	110	06/17→					Ceramic
2.0 TDI 4motion	110	06/17→					
2.0 TDI 4motion	140	06/17→					
2.0 TDI 4motion	176	06/17→					
2.0 TSI	137	04/17→					
2.0 TSI 4motion	132	03/17→					
2.0 TSI 4motion	137	04/17→					
2.0 TSI 4motion	162	07/17→					
<b>Warnkontakt, Bremsbelagverschleiß</b>							
1.4 TSI	110	04/17→	➔		1	24.8190-0065.2 620065	L= 172
1.4 TSI E100	110	07/17→					
2.0 TDI	110	06/17→					
2.0 TDI 4motion	110	06/17→					
2.0 TDI 4motion	140	06/17→					
2.0 TDI 4motion	176	06/17→					
2.0 TSI	137	04/17→					
2.0 TSI 4motion	132	03/17→					
2.0 TSI 4motion	137	04/17→					
2.0 TSI 4motion	162	07/17→					
<b>Bremsscheibe</b>							
1.4 TSI	110	04/17→	➔	+PR 1LA,1LB		24.0130-0225.1 430225	Ø 340 30 27 V + S
1.4 TSI E100	110	07/17→					
2.0 TDI	110	06/17→	➔	+PR 1KU		24.0112-0210.1 412210	Ø 300 12 10 + S
2.0 TDI 4motion	110	06/17→	➔	+PR 1KZ		24.0122-0219.1 422219	Ø 310 22 20 V
2.0 TDI 4motion	140	06/17→					
2.0 TDI 4motion	176	06/17→					
2.0 TSI	137	04/17→					









	kw			 	! #		
<b>VW - TIGUAN ALLSPACE (BW2) 03/17→</b>							
 <b>Bremsscheibe</b>							
2.0 TSI 4motion	132	03/17→	←	+PR 1LA,1LB		24.0130-0225.1 430225	Ø 340 30 27 V + S
2.0 TSI 4motion	137	04/17→	→	+PR 1KU		24.0112-0210.1 412210	Ø 300 12 10 + S
2.0 TSI 4motion	162	07/17→	→	+PR 1KZ		24.0122-0219.1 422219	Ø 310 22 20 V
<b>VW - TOUAREG (7LA, 7L6, 7L7) 10/02→01/13</b>							
 <b>Bremsbelagsatz, Scheibenbremse</b>							
2.5 R5 TDI	120	08/03→05/10	←	01/06→; +PR 1LE; → 03/10		13.0460-4833.2 604833	BRE 24098 17,1 + WE / - WK
2.5 R5 TDI	128	01/03→05/10				13.0470-4833.2 LD4833	BRE 24098 17,1 + WE / - WK Ceramic
3.0 V6 TDI	165	11/04→05/10	←	+PR 1LT;1LU; → 03/10		13.0460-4852.2 604852	BRE 24553 15,8 + WE / - WK + Zub
			←	+PR 1LC; → 03/10		13.0460-4992.2 604992	BRE 23692 16,6 + WE / - WK Ceramic
						13.0470-4992.2 LD4992	BRE 23692 16,6 + WE / - WK Ceramic
			←	+PR 1LF; → 03/10		13.0460-4993.2 604993	BRE 23693 16,6 + WE / - WK Ceramic
						13.0470-4993.2 LD4993	BRE 23693 16,6 + WE / - WK Ceramic
			←	+PR 1LB; → 03/10		13.0460-7191.2 607191	ATE 23749 19,1 + WK
						13.0460-7245.2 607245	ATE 23747 19,6 + WK
						13.0470-7191.2 LD7191	ATE 23749 19,1 + WK Ceramic
			→	01/06→; +PR 1KQ; → 03/10		13.0460-4834.2 604834	BRE 24097 17,1 + WE / - WK Ceramic
						13.0470-4834.2 LD4834	BRE 24097 17,1 + WE / - WK Ceramic
			→	+PR 1KD;2ED; → 03/10		13.0460-4850.2 604850	BRE 24296 15,5 + WE / - WK Ceramic
						13.0470-4850.2 LD4850	BRE 24296 15,5 + WE / - WK Ceramic
			→	+PR 1KF; → 03/10		13.0460-4976.2 604976	BRE 23694 16,7 + WE / - WK Ceramic
						13.0470-4976.2 LD4976	BRE 23694 16,4 + WE / - WK Ceramic
			→	+PR 1KE; → 03/10		13.0460-7190.2 607190	ATE 24367 19,1 + WK
						13.0470-7190.2 LD7190	ATE 24367 19,1 + WK Ceramic
3.0 TDI	155	04/06→05/10	←	→ 03/10; +PR 1LE		13.0460-4833.2 604833	BRE 24098 17,1 + WE / - WK Ceramic
						13.0470-4833.2 LD4833	BRE 24098 17,1 + WE / - WK Ceramic
			←	+PR 1LT;1LU; → 03/10		13.0460-4852.2 604852	BRE 24553 15,8 + WE / - WK + Zub
			←	+PR 1LC; → 03/10		13.0460-4992.2 604992	BRE 23692 16,6 + WE / - WK Ceramic
						13.0470-4992.2 LD4992	BRE 23692 16,6 + WE / - WK Ceramic
			←	+PR 1LF; → 03/10		13.0460-4993.2 604993	BRE 23693 16,6 + WE / - WK Ceramic
						13.0470-4993.2 LD4993	BRE 23693 16,6 + WE / - WK Ceramic
			←	+PR 1LB; → 03/10		13.0460-7191.2 607191	ATE 23749 19,1 + WK
						13.0460-7245.2 607245	ATE 23747 19,6 + WK
						13.0470-7191.2 LD7191	ATE 23749 19,1 + WK Ceramic
			→	→ 03/10; +PR 1KQ		13.0460-4834.2 604834	BRE 24097 17,1 + WE / - WK Ceramic
						13.0470-4834.2 LD4834	BRE 24097 17,1 + WE / - WK Ceramic
			→	+PR 1KD;2ED; → 03/10		13.0460-4850.2 604850	BRE 24296 15,5 + WE / - WK Ceramic
						13.0470-4850.2 LD4850	BRE 24296 15,5 + WE / - WK Ceramic
			→	+PR 1KF; → 03/10		13.0460-4976.2 604976	BRE 23694 16,7 + WE / - WK Ceramic
						13.0470-4976.2 LD4976	BRE 23694 16,4 + WE / - WK Ceramic
			→	+PR 1KE; → 03/10		13.0460-7190.2 607190	ATE 24367 19,1 + WK
						13.0470-7190.2 LD7190	ATE 24367 19,1 + WK Ceramic
3.0 V6 TDI	176	11/07→05/10	←	→ 03/10; +PR 1LE		13.0460-4833.2 604833	BRE 24098 17,1 + WE / - WK Ceramic
						13.0470-4833.2 LD4833	BRE 24098 17,1 + WE / - WK Ceramic
			←	+PR 1LT;1LU; → 03/10		13.0460-4852.2 604852	BRE 24553 15,8 + WE / - WK + Zub
			←	+PR 1LF; → 03/10		13.0460-4993.2 604993	BRE 23693 16,6 + WE / - WK Ceramic
						13.0470-4993.2 LD4993	BRE 23693 16,6 + WE / - WK Ceramic
			←	+PR 1LB; → 03/10		13.0460-7191.2 607191	ATE 23749 19,1 + WK

















	kw			 	! #		
<b>VW - TOUAREG (7LA, 7L6, 7L7) 10/02—01/13</b>							
<b> Bremsbelagsatz, Scheibenbremse</b>							
3.0 V6 TDI	176	11/07→05/10	←	+PR 1LB; → 03/10	13.0460-7245.2	607245	ATE 23747 19,6 + WK
					13.0470-7191.2	LD7191	ATE 23749 19,1 + WK Ceramic
			→	→ 03/10; +PR 1KQ	13.0460-4834.2	604834	BRE 24097 17,1 + WE / - WK
					13.0470-4834.2	LD4834	BRE 24097 17,1 + WE / - WK Ceramic
			→	+PR 1KD;2ED; → 03/10	13.0460-4850.2	604850	BRE 24296 15,5 + WE / - WK
		13.0470-4850.2	LD4850	BRE 24296 15,5 + WE / - WK Ceramic			
			→	+PR 1KF; → 03/10	13.0460-4976.2	604976	BRE 23694 16,7 + WE / - WK
					13.0470-4976.2	LD4976	BRE 23694 16,4 + WE / - WK Ceramic
			→	+PR 1KE; → 03/10	13.0460-7190.2	607190	ATE 24367 19,1 + WK
					13.0470-7190.2	LD7190	ATE 24367 19,1 + WK Ceramic
3.2 V6	162	10/02→11/06	←	11/02→ 12/05; +PR 1LE	13.0460-4833.2	604833	BRE 24098 17,1 + WE / - WK
					13.0470-4833.2	LD4833	BRE 24098 17,1 + WE / - WK Ceramic
			←	11/02→; +PR 1LC; → 12/05	13.0460-4992.2	604992	BRE 23692 16,6 + WE / - WK
					13.0470-4992.2	LD4992	BRE 23692 16,6 + WE / - WK Ceramic
			←	11/02→; +PR 1LF; → 12/05	13.0460-4993.2	604993	BRE 23693 16,6 + WE / - WK
					13.0470-4993.2	LD4993	BRE 23693 16,6 + WE / - WK Ceramic
			←	11/02→; +PR 1LB; → 12/05	13.0460-7191.2	607191	ATE 23749 19,1 + WK
					13.0460-7245.2	607245	ATE 23747 19,6 + WK
		13.0470-7191.2	LD7191	ATE 23749 19,1 + WK Ceramic			
			→	11/02→ 12/05; +PR 1KQ	13.0460-4834.2	604834	BRE 24097 17,1 + WE / - WK
					13.0470-4834.2	LD4834	BRE 24097 17,1 + WE / - WK Ceramic
			→	11/02→; +PR 1KF; → 12/05	13.0460-4976.2	604976	BRE 23694 16,7 + WE / - WK
					13.0470-4976.2	LD4976	BRE 23694 16,4 + WE / - WK Ceramic
			→	11/02→; +PR 1KE; → 12/05	13.0460-7190.2	607190	ATE 24367 19,1 + WK
					13.0470-7190.2	LD7190	ATE 24367 19,1 + WK Ceramic
3.2 V6	177	11/04→11/06	←	→ 12/05; +PR 1LE	13.0460-4833.2	604833	BRE 24098 17,1 + WE / - WK
					13.0470-4833.2	LD4833	BRE 24098 17,1 + WE / - WK Ceramic
			←	+PR 1LC; → 12/05	13.0460-4992.2	604992	BRE 23692 16,6 + WE / - WK
					13.0470-4992.2	LD4992	BRE 23692 16,6 + WE / - WK Ceramic
			←	+PR 1LF; → 12/05	13.0460-4993.2	604993	BRE 23693 16,6 + WE / - WK
					13.0470-4993.2	LD4993	BRE 23693 16,6 + WE / - WK Ceramic
			←	+PR 1LB; → 12/05	13.0460-7191.2	607191	ATE 23749 19,1 + WK
					13.0460-7245.2	607245	ATE 23747 19,6 + WK
		13.0470-7191.2	LD7191	ATE 23749 19,1 + WK Ceramic			
			→	→ 12/05; +PR 1KQ	13.0460-4834.2	604834	BRE 24097 17,1 + WE / - WK
					13.0470-4834.2	LD4834	BRE 24097 17,1 + WE / - WK Ceramic
			→	+PR 1KF; → 12/05	13.0460-4976.2	604976	BRE 23694 16,7 + WE / - WK
					13.0470-4976.2	LD4976	BRE 23694 16,4 + WE / - WK Ceramic
			→	+PR 1KE; → 12/05	13.0460-7190.2	607190	ATE 24367 19,1 + WK
					13.0470-7190.2	LD7190	ATE 24367 19,1 + WK Ceramic
3.6 V6 FSI	206	10/05→05/10	←	01/06→; +PR 1LE; → 03/10	13.0460-4833.2	604833	BRE 24098 17,1 + WE / - WK
					13.0470-4833.2	LD4833	BRE 24098 17,1 + WE / - WK Ceramic
			←	01/06→ 03/10; +PR 1LT;1LU	13.0460-4852.2	604852	BRE 24553 15,8 + WE / - WK + Zub
			←	01/06→ 03/10; +PR 1LC	13.0460-4992.2	604992	BRE 23692 16,6 + WE / - WK
					13.0470-4992.2	LD4992	BRE 23692 16,6 + WE / - WK Ceramic
←	01/06→ 03/10; +PR 1LF	13.0460-4993.2	604993	BRE 23693 16,6 + WE / - WK			
		13.0470-4993.2	LD4993	BRE 23693 16,6 + WE / - WK Ceramic			
←	01/06→ 03/10; +PR 1LB	13.0460-7191.2	607191	ATE 23749 19,1 + WK			
		13.0460-7245.2	607245	ATE 23747 19,6 + WK			



















	kw			 	! #		
<b>VW - TOUAREG (7LA, 7L6, 7L7) 10/02—01/13</b>							
<b> Bremsbelagsatz, Scheibenbremse</b>							
3.6 V6 FSI	206	10/05→05/10	←	01/06→ 03/10; +PR 1LB	13.0470-7191.2	LD7191	ATE 23749 19,1 + WK Ceramic
			→	01/06→; +PR 1KQ; → 03/10	13.0460-4834.2	604834	BRE 24097 17,1 + WE / - WK
					13.0470-4834.2	LD4834	BRE 24097 17,1 + WE / - WK Ceramic
			→	01/06→ 03/10; +PR 1KD;2ED	13.0460-4850.2	604850	BRE 24296 15,5 + WE / - WK
					13.0470-4850.2	LD4850	BRE 24296 15,5 + WE / - WK Ceramic
4.2 V8	228	12/02→11/06	←	01/06→; +PR 1LE	13.0460-4833.2	604833	BRE 24098 17,1 + WE / - WK
			←	+PR 1LC	13.0460-4992.2	604992	BRE 23692 16,6 + WE / - WK
			←	+PR 1LF	13.0460-4993.2	604993	BRE 23693 16,6 + WE / - WK
			←	+PR 1LB	13.0460-7191.2	607191	ATE 23749 19,1 + WK
					13.0460-7245.2	607245	ATE 23747 19,6 + WK
4.2 V8 FSI	228	12/02→11/06	→	01/06→; +PR 1KQ	13.0460-4834.2	604834	BRE 24097 17,1 + WE / - WK
					13.0470-4834.2	LD4834	BRE 24097 17,1 + WE / - WK Ceramic
			→	+PR 1KF	13.0460-4976.2	604976	BRE 23694 16,7 + WE / - WK
					13.0470-4976.2	LD4976	BRE 23694 16,4 + WE / - WK Ceramic
			→	+PR 1KE	13.0460-7190.2	607190	ATE 24367 19,1 + WK
		13.0470-7190.2	LD7190	ATE 24367 19,1 + WK Ceramic			
4.2 V8 FSI	257	06/06→05/10	←	12/06→ 03/10; +PR 1LE	13.0460-4833.2	604833	BRE 24098 17,1 + WE / - WK
			←	12/06→ 03/10; +PR 1LT;1LU	13.0460-4852.2	604852	BRE 24553 15,8 + WE / - WK + Zub
			←	12/06→ 03/10; +PR 1LC	13.0460-4992.2	604992	BRE 23692 16,6 + WE / - WK
			←	12/06→ 03/10; +PR 1LF	13.0460-4993.2	604993	BRE 23693 16,6 + WE / - WK
			←	12/06→ 03/10; +PR 1LB	13.0460-7191.2	607191	ATE 23749 19,1 + WK
					13.0460-7245.2	607245	ATE 23747 19,6 + WK
			→	12/06→ 03/10; +PR 1KQ	13.0460-4834.2	604834	BRE 24097 17,1 + WE / - WK
					13.0470-4834.2	LD4834	BRE 24097 17,1 + WE / - WK Ceramic
			→	12/06→ 03/10; +PR 1KD;2ED	13.0460-4850.2	604850	BRE 24296 15,5 + WE / - WK
		13.0470-4850.2	LD4850	BRE 24296 15,5 + WE / - WK Ceramic			
5.0 R50 TDI	257	08/07→05/10	→	12/06→ 03/10; +PR 1KF	13.0460-4976.2	604976	BRE 23694 16,7 + WE / - WK
					13.0470-4976.2	LD4976	BRE 23694 16,4 + WE / - WK Ceramic
			→	12/06→ 03/10; +PR 1KE	13.0460-7190.2	607190	ATE 24367 19,1 + WK
					13.0470-7190.2	LD7190	ATE 24367 19,1 + WK Ceramic
			←	01/08→ 03/10; +PR 1LE	13.0460-4833.2	604833	BRE 24098 17,1 + WE / - WK
			←	01/08→ 03/10; +PR 1LT;1LU	13.0460-4852.2	604852	BRE 24553 15,8 + WE / - WK + Zub
			←	01/08→ 03/10; +PR 1LF	13.0460-4993.2	604993	BRE 23693 16,6 + WE / - WK
			←	01/08→ 03/10; +PR 1LB	13.0460-7191.2	607191	ATE 23749 19,1 + WK
					13.0460-7245.2	607245	ATE 23747 19,6 + WK
5.0 V10 TDI	230	10/02→05/10	→	01/08→ 03/10; +PR 1KQ	13.0460-4834.2	604834	BRE 24097 17,1 + WE / - WK
					13.0470-4834.2	LD4834	BRE 24097 17,1 + WE / - WK Ceramic
			→	01/08→ 03/10; +PR 1KD;2ED	13.0460-4850.2	604850	BRE 24296 15,5 + WE / - WK
					13.0470-4850.2	LD4850	BRE 24296 15,5 + WE / - WK Ceramic
			→	01/08→ 03/10; +PR 1KF	13.0460-4976.2	604976	BRE 23694 16,7 + WE / - WK
					13.0470-4976.2	LD4976	BRE 23694 16,4 + WE / - WK Ceramic
			→	01/08→ 03/10; +PR 1KE	13.0460-7190.2	607190	ATE 24367 19,1 + WK
					13.0470-7190.2	LD7190	ATE 24367 19,1 + WK Ceramic
			←	01/06→; +PR 1LE; → 03/10	13.0460-4833.2	604833	BRE 24098 17,1 + WE / - WK
←	11/02→; +PR 1LT;1LU; → 03/10	13.0460-4852.2	604852	BRE 24553 15,8 + WE / - WK + Zub			
↓							

	kw			 	! #		
<b>VW - TOUAREG (7LA, 7L6, 7L7) 10/02→01/13</b>							
<b>Bremsbelagsatz, Scheibenbremse</b>							
5.0 V10 TDI	230	10/02→05/10	←	11/02→; +PR 1LC; → 03/10		13.0460-4992.2 604992	BRE 23692 16,6 + WE / - WK
			←	11/02→; +PR 1LF; → 03/10		13.0460-4993.2 604993	BRE 23693 16,6 + WE / - WK
			←	11/02→; +PR 1LB; → 03/10		13.0460-7191.2 607191	ATE 23749 19,1 + WK
						13.0460-7245.2 607245	ATE 23747 19,6 + WK
			→	01/06→; +PR 1KQ; → 03/10		13.0460-4834.2 604834	BRE 24097 17,1 + WE / - WK
						13.0470-4834.2 LD4834	BRE 24097 17,1 + WE / - WK Ceramic
			→	11/02→; +PR 1KD;2ED; → 03/10		13.0460-4850.2 604850	BRE 24296 15,5 + WE / - WK
			13.0470-4850.2 LD4850	BRE 24296 15,5 + WE / - WK Ceramic			
			→	11/02→; +PR 1KF; → 03/10		13.0460-4976.2 604976	BRE 23694 16,7 + WE / - WK
						13.0470-4976.2 LD4976	BRE 23694 16,4 + WE / - WK Ceramic
			→	11/02→; +PR 1KE; → 03/10		13.0460-7190.2 607190	ATE 24367 19,1 + WK
						13.0470-7190.2 LD7190	ATE 24367 19,1 + WK Ceramic
6.0 W12	331	08/04→05/10	←	01/06→; +PR 1LE; → 11/06		13.0460-4833.2 604833	BRE 24098 17,1 + WE / - WK
			←	+PR 1LC; → 11/06		13.0460-4992.2 604992	BRE 23692 16,6 + WE / - WK
			←	+PR 1LF; → 11/06		13.0460-4993.2 604993	BRE 23693 16,6 + WE / - WK
			←	+PR 1LB; → 11/06		13.0460-7191.2 607191	ATE 23749 19,1 + WK
						13.0460-7245.2 607245	ATE 23747 19,6 + WK
			→	01/06→; +PR 1KQ; → 11/06		13.0460-4834.2 604834	BRE 24097 17,1 + WE / - WK
						13.0470-4834.2 LD4834	BRE 24097 17,1 + WE / - WK Ceramic
			→	+PR 1KF; → 11/06		13.0460-4976.2 604976	BRE 23694 16,7 + WE / - WK
						13.0470-4976.2 LD4976	BRE 23694 16,4 + WE / - WK Ceramic
			→	+PR 1KE; → 11/06		13.0460-7190.2 607190	ATE 24367 19,1 + WK
						13.0470-7190.2 LD7190	ATE 24367 19,1 + WK Ceramic
<b>Warnkontakt, Bremsbelagverschleiß</b>							
2.5 R5 TDI 2.5 R5 TDI 3.0 V6 TDI	120 128 165	08/03→05/10 01/03→05/10 11/04→05/10	←	01/06→; +PR 1LE; → 03/10	2	24.8190-0929.2 620929	L= 417,4
			←	+PR 1LC; → 03/10	2	24.8190-0929.2 620929	L= 417,4
			←	+PR 1LF; → 03/10	2	24.8190-0929.2 620929	L= 417,4
			←	+PR 1LT;1LU; → 03/10	2	24.8190-0936.2 620936	L= 367,4
			→	+PR 1KF; → 03/10	2	24.8190-0930.2 620930	L= 252,4
			→	01/06→; +PR 1KQ; → 03/10	2	24.8190-0930.2 620930	L= 252,4
			→	+PR 1KD;2ED; → 03/10	2	24.8190-0930.2 620930	L= 252,4
3.0 TDI	155	04/06→05/10	←	+PR 1LC; → 03/10	2	24.8190-0929.2 620929	L= 417,4
			←	+PR 1LF; → 03/10	2	24.8190-0929.2 620929	L= 417,4
			←	→ 03/10; +PR 1LE	2	24.8190-0929.2 620929	L= 417,4
			←	+PR 1LT;1LU; → 03/10	2	24.8190-0936.2 620936	L= 367,4
			→	+PR 1KF; → 03/10	2	24.8190-0930.2 620930	L= 252,4
			→	→ 03/10; +PR 1KQ	2	24.8190-0930.2 620930	L= 252,4
			→	+PR 1KD;2ED; → 03/10	2	24.8190-0930.2 620930	L= 252,4
3.0 V6 TDI	176	11/07→05/10	←	+PR 1LF; → 03/10	2	24.8190-0929.2 620929	L= 417,4
			←	→ 03/10; +PR 1LE	2	24.8190-0929.2 620929	L= 417,4
			←	+PR 1LT;1LU; → 03/10	2	24.8190-0936.2 620936	L= 367,4
			→	+PR 1KF; → 03/10	2	24.8190-0930.2 620930	L= 252,4
			→	+PR 1KD;2ED; → 03/10	2	24.8190-0930.2 620930	L= 252,4
			→	→ 03/10; +PR 1KQ	2	24.8190-0930.2 620930	L= 252,4
3.2 V6	162	10/02→11/06	←	11/02→ 12/05; +PR 1LE	2	24.8190-0929.2 620929	L= 417,4
			←	11/02→; +PR 1LC; → 12/05	2	24.8190-0929.2 620929	L= 417,4
			←	11/02→; +PR 1LF; → 12/05	2	24.8190-0929.2 620929	L= 417,4
			→	11/02→ 12/05; +PR 1KQ	2	24.8190-0930.2 620930	L= 252,4
			→	11/02→; +PR 1KF; → 12/05	2	24.8190-0930.2 620930	L= 252,4
3.2 V6	177	11/04→11/06	←	+PR 1LC; → 12/05	2	24.8190-0929.2 620929	L= 417,4
			←	+PR 1LF; → 12/05	2	24.8190-0929.2 620929	L= 417,4
↓							

	kw			 	! #		
<b>VW - TOUAREG (7LA, 7L6, 7L7) 10/02→01/13</b>							
<b>Warnkontakt, Bremsbelagverschleiß</b>							
3.2 V6	177	11/04→11/06	←	→ 12/05; +PR 1LE	2	24.8190-0929.2 620929	L= 417,4
			→	+PR 1KF; → 12/05	2	24.8190-0930.2 620930	L= 252,4
			→	→ 12/05; +PR 1KQ	2	24.8190-0930.2 620930	L= 252,4
3.6 V6 FSI	206	10/05→05/10	←	01/06→; +PR 1LE; → 03/10	2	24.8190-0929.2 620929	L= 417,4
			←	01/06→ 03/10; +PR 1LF	2	24.8190-0929.2 620929	L= 417,4
			←	01/06→ 03/10; +PR 1LC	2	24.8190-0929.2 620929	L= 417,4
			←	01/06→ 03/10; +PR 1LT;1LU	2	24.8190-0936.2 620936	L= 367,4
			→	01/06→ 03/10; +PR 1KD;2ED	2	24.8190-0930.2 620930	L= 252,4
			→	01/06→; +PR 1KQ; → 03/10	2	24.8190-0930.2 620930	L= 252,4
			→	01/06→ 03/10; +PR 1KF	2	24.8190-0930.2 620930	L= 252,4
4.2 V8	228	12/02→11/06	←	+PR 1LC	2	24.8190-0929.2 620929	L= 417,4
			←	01/06→; +PR 1LE	2	24.8190-0929.2 620929	L= 417,4
			←	+PR 1LF	2	24.8190-0929.2 620929	L= 417,4
			→	+PR 1KF	2	24.8190-0930.2 620930	L= 252,4
			→	01/06→; +PR 1KQ	2	24.8190-0930.2 620930	L= 252,4
4.2 V8 FSI	257	06/06→05/10	←	12/06→ 03/10; +PR 1LC	2	24.8190-0929.2 620929	L= 417,4
			←	12/06→ 03/10; +PR 1LE	2	24.8190-0929.2 620929	L= 417,4
			←	12/06→ 03/10; +PR 1LF	2	24.8190-0929.2 620929	L= 417,4
			←	12/06→ 03/10; +PR 1LT;1LU	2	24.8190-0936.2 620936	L= 367,4
			→	12/06→ 03/10; +PR 1KD;2ED	2	24.8190-0930.2 620930	L= 252,4
			→	12/06→ 03/10; +PR 1KF	2	24.8190-0930.2 620930	L= 252,4
			→	12/06→ 03/10; +PR 1KQ	2	24.8190-0930.2 620930	L= 252,4
5.0 R50 TDI	257	08/07→05/10	←	01/08→ 03/10; +PR 1LE	2	24.8190-0929.2 620929	L= 417,4
			←	01/08→ 03/10; +PR 1LF	2	24.8190-0929.2 620929	L= 417,4
			←	01/08→ 03/10; +PR 1LT;1LU	2	24.8190-0936.2 620936	L= 367,4
			→	01/08→ 03/10; +PR 1KQ	2	24.8190-0930.2 620930	L= 252,4
			→	01/08→ 03/10; +PR 1KD;2ED	2	24.8190-0930.2 620930	L= 252,4
			→	01/08→ 03/10; +PR 1KF	2	24.8190-0930.2 620930	L= 252,4
5.0 V10 TDI	230	10/02→05/10	←	01/06→; +PR 1LE; → 03/10	2	24.8190-0929.2 620929	L= 417,4
			←	11/02→; +PR 1LC; → 03/10	2	24.8190-0929.2 620929	L= 417,4
			←	11/02→; +PR 1LF; → 03/10	2	24.8190-0929.2 620929	L= 417,4
			←	11/02→; +PR 1LT;1LU; → 03/10	2	24.8190-0936.2 620936	L= 367,4
			→	11/02→; +PR 1KD;2ED; → 03/10	2	24.8190-0930.2 620930	L= 252,4
			→	11/02→; +PR 1KF; → 03/10	2	24.8190-0930.2 620930	L= 252,4
			→	01/06→; +PR 1KQ; → 03/10	2	24.8190-0930.2 620930	L= 252,4
6.0 W12	331	08/04→05/10	←	01/06→; +PR 1LE; → 11/06	2	24.8190-0929.2 620929	L= 417,4
			←	+PR 1LF; → 11/06	2	24.8190-0929.2 620929	L= 417,4
			←	+PR 1LC; → 11/06	2	24.8190-0929.2 620929	L= 417,4
			→	01/06→; +PR 1KQ; → 11/06	2	24.8190-0930.2 620930	L= 252,4
			→	+PR 1KF; → 11/06	2	24.8190-0930.2 620930	L= 252,4
<b>Zubehörsatz, Scheibenbremsbelag</b>							
2.5 R5 TDI	120	08/03→05/10	←	+PR 1LC; → 03/10		13.0460-0279.2 610279	
2.5 R5 TDI	128	01/03→05/10	←	+PR 1LF; → 03/10		13.0460-0279.2 610279	
3.0 TDI	155	04/06→05/10	←	+PR 1LC; → 03/10		13.0460-0279.2 610279	
3.0 V6 TDI	165	11/04→05/10	→	+PR 1KF; → 03/10		13.0460-0280.2 610280	
3.0 V6 TDI	176	11/07→05/10	←	+PR 1LF; → 03/10		13.0460-0279.2 610279	
			→	+PR 1KF; → 03/10		13.0460-0280.2 610280	
3.2 V6	162	10/02→11/06	←	11/02→; +PR 1LF; → 12/05		13.0460-0279.2 610279	
			←	11/02→; +PR 1LC; → 12/05		13.0460-0279.2 610279	
			→	11/02→; +PR 1KF; → 12/05		13.0460-0280.2 610280	
3.2 V6	177	11/04→11/06	←	+PR 1LF; → 12/05		13.0460-0279.2 610279	
			←	+PR 1LC; → 12/05		13.0460-0279.2 610279	
			→	+PR 1KF; → 12/05		13.0460-0280.2 610280	
↓							

















	kw			 	! #			
<b>VW - TOUAREG (7LA, 7L6, 7L7) 10/02→01/13</b>								
<b>Zubehörsatz, Scheibenbremsbelag</b>								
3.6 V6 FSI	206	10/05→05/10	←	01/06→ 03/10; +PR 1LC		13.0460-0279.2	610279	
			←	01/06→ 03/10; +PR 1LF		13.0460-0279.2	610279	
			→	01/06→ 03/10; +PR 1KF		13.0460-0280.2	610280	
4.2 V8	228	12/02→11/06	←	+PR 1LF		13.0460-0279.2	610279	
			←	+PR 1LC		13.0460-0279.2	610279	
			→	+PR 1KF		13.0460-0280.2	610280	
4.2 V8 FSI	257	06/06→05/10	←	12/06→ 03/10; +PR 1LF		13.0460-0279.2	610279	
			←	12/06→ 03/10; +PR 1LC		13.0460-0279.2	610279	
			→	12/06→ 03/10; +PR 1KF		13.0460-0280.2	610280	
5.0 R50 TDI	257	08/07→05/10	←	01/08→ 03/10; +PR 1LF		13.0460-0279.2	610279	
			→	01/08→ 03/10; +PR 1KF		13.0460-0280.2	610280	
5.0 V10 TDI	230	10/02→05/10	←	11/02→; +PR 1LF; → 03/10		13.0460-0279.2	610279	
			←	11/02→; +PR 1LC; → 03/10		13.0460-0279.2	610279	
			→	11/02→; +PR 1KF; → 03/10		13.0460-0280.2	610280	
6.0 W12	331	08/04→05/10	←	+PR 1LC; → 11/06		13.0460-0279.2	610279	
			←	+PR 1LF; → 11/06		13.0460-0279.2	610279	
			→	+PR 1KF; → 11/06		13.0460-0280.2	610280	
<b>Bremsscheibe</b>								
2.5 R5 TDI 128 2.5 R5 TDI 155 3.0 TDI 165 3.0 V6 TDI 176	120 128 155 165 176	08/03→05/10 01/03→05/10 04/06→05/10 11/04→05/10 11/07→05/10	←	+PR 1LB; → 03/10		24.0130-0114.1	430114	Ø 308 29,5 25,5 V
			←	☐; +PR 1LC;1LE; → 03/10		24.0132-0117.1	432117	Ø 330 32 30 V + S
			←	☐; +PR 1LC;1LE; → 03/10		24.0132-0118.1	432118	Ø 330 32 30 V + S
			←	☐; +PR 1LF; → 03/10		24.0134-0123.1	434123	Ø 350 34 32 V
			←	☐; +PR 1LF; → 03/10		24.0134-0124.1	434124	Ø 350 34 32 V
			←	+PR 1LT;1LU; → 03/10		24.0136-0111.1	436111	Ø 368 36 34 V
			→	+PR 1KE; → 03/10		24.0122-0215.1	422215	Ø 314 22 18 V + S
			→	+PR 1KF;1KQ; → 03/10		24.0128-0149.1	428149	Ø 330 28 26 V + S
			→	+PR 1KD;2ED; → 03/10		24.0128-0169.1	428169	Ø 358 28 26 V
			3.2 V6	162	10/02→11/06	←	11/02→; +PR 1LB; → 12/05	
←	☐; 11/02→; +PR 1LC;1LE; → 12/05					24.0132-0117.1	432117	Ø 330 32 30 V + S
←	☐; 11/02→; +PR 1LC;1LE; → 12/05					24.0132-0118.1	432118	Ø 330 32 30 V + S
←	☐; 11/02→; +PR 1LF; → 12/05					24.0134-0123.1	434123	Ø 350 34 32 V
←	☐; 11/02→; +PR 1LF; → 12/05					24.0134-0124.1	434124	Ø 350 34 32 V
→	11/02→; +PR 1KE; → 12/05					24.0122-0215.1	422215	Ø 314 22 18 V + S
→	11/02→; +PR 1KF;1KQ; → 12/05					24.0128-0149.1	428149	Ø 330 28 26 V + S
3.2 V6	177	11/04→11/06	←	+PR 1LB; → 12/05		24.0130-0114.1	430114	Ø 308 29,5 25,5 V
			←	☐; +PR 1LC;1LE; → 12/05		24.0132-0117.1	432117	Ø 330 32 30 V + S
			←	☐; +PR 1LC;1LE; → 12/05		24.0132-0118.1	432118	Ø 330 32 30 V + S
			←	☐; +PR 1LF; → 12/05		24.0134-0123.1	434123	Ø 350 34 32 V
			←	☐; +PR 1LF; → 12/05		24.0134-0124.1	434124	Ø 350 34 32 V
			→	+PR 1KE; → 12/05		24.0122-0215.1	422215	Ø 314 22 18 V + S
			→	+PR 1KF;1KQ; → 12/05		24.0128-0149.1	428149	Ø 330 28 26 V + S
3.6 V6 FSI	206	10/05→05/10	←	01/06→ 03/10; +PR 1LB		24.0130-0114.1	430114	Ø 308 29,5 25,5 V
			←	☐; 01/06→ 03/10; +PR 1LC;1LE		24.0132-0117.1	432117	Ø 330 32 30 V + S
			←	☐; 01/06→ 03/10; +PR 1LC;1LE		24.0132-0118.1	432118	Ø 330 32 30 V + S
			←	☐; 01/06→ 03/10; +PR 1LF		24.0134-0123.1	434123	Ø 350 34 32 V
			←	☐; 01/06→ 03/10; +PR 1LF		24.0134-0124.1	434124	Ø 350 34 32 V
			←	01/06→ 03/10; +PR 1LT;1LU		24.0136-0111.1	436111	Ø 368 36 34 V
			→	01/06→ 03/10; +PR 1KE		24.0122-0215.1	422215	Ø 314 22 18 V + S
			→	01/06→ 03/10; +PR 1KF;1KQ		24.0128-0149.1	428149	Ø 330 28 26 V + S
			→	01/06→ 03/10; +PR 1KD;2ED		24.0128-0169.1	428169	Ø 358 28 26 V
4.2 V8	228	12/02→11/06	←	+PR 1LB		24.0130-0114.1	430114	Ø 308 29,5 25,5 V
			←	☐; +PR 1LC;1LE		24.0132-0117.1	432117	Ø 330 32 30 V + S
↓								









	kw			 	! #		
<b>VW - TOUAREG (7LA, 7L6, 7L7) 10/02→01/13</b>							
<b>Bremsscheibe</b>							
4.2 V8	228	12/02→11/06	←	☐; +PR 1LC;1LE	24.0132-0118.1	432118	Ø 330 32 30 V + S
			←	☐; +PR 1LF	24.0134-0123.1	434123	Ø 350 34 32 V
			←	☐; +PR 1LF	24.0134-0124.1	434124	Ø 350 34 32 V
			→	+PR 1KE	24.0122-0215.1	422215	Ø 314 22 18 V + S
			→	+PR 1KF;1KQ	24.0128-0149.1	428149	Ø 330 28 26 V + S
4.2 V8 FSI	257	06/06→05/10	←	12/06→ 03/10; +PR 1LB	24.0130-0114.1	430114	Ø 308 29,5 25,5 V
			←	☐; 12/06→ 03/10; +PR 1LC;1LE	24.0132-0117.1	432117	Ø 330 32 30 V + S
			←	☐; 12/06→ 03/10; +PR 1LC;1LE	24.0132-0118.1	432118	Ø 330 32 30 V + S
			←	☐; 12/06→ 03/10; +PR 1LF	24.0134-0123.1	434123	Ø 350 34 32 V
			←	☐; 12/06→ 03/10; +PR 1LF	24.0134-0124.1	434124	Ø 350 34 32 V
			←	12/06→ 03/10; +PR 1LT;1LU	24.0136-0111.1	436111	Ø 368 36 34 V
			→	12/06→ 03/10; +PR 1KE	24.0122-0215.1	422215	Ø 314 22 18 V + S
			→	12/06→ 03/10; +PR 1KF;1KQ	24.0128-0149.1	428149	Ø 330 28 26 V + S
			→	12/06→ 03/10; +PR 1KD;2ED	24.0128-0169.1	428169	Ø 358 28 26 V
5.0 R50 TDI	257	08/07→05/10	←	01/08→ 03/10; +PR 1LB	24.0130-0114.1	430114	Ø 308 29,5 25,5 V
			←	☐; 01/08→ 03/10; +PR 1LC;1LE	24.0132-0117.1	432117	Ø 330 32 30 V + S
			←	☐; 01/08→ 03/10; +PR 1LC;1LE	24.0132-0118.1	432118	Ø 330 32 30 V + S
			←	☐; 01/08→ 03/10; +PR 1LF	24.0134-0123.1	434123	Ø 350 34 32 V
			←	☐; 01/08→ 03/10; +PR 1LF	24.0134-0124.1	434124	Ø 350 34 32 V
			←	01/08→ 03/10; +PR 1LT;1LU	24.0136-0111.1	436111	Ø 368 36 34 V
			→	01/08→ 03/10; +PR 1KE	24.0122-0215.1	422215	Ø 314 22 18 V + S
			→	01/08→ 03/10; +PR 1KF;1KQ	24.0128-0149.1	428149	Ø 330 28 26 V + S
			→	01/08→ 03/10; +PR 1KD;2ED	24.0128-0169.1	428169	Ø 358 28 26 V
5.0 V10 TDI	230	10/02→05/10	←	11/02→; +PR 1LB; → 03/10	24.0130-0114.1	430114	Ø 308 29,5 25,5 V
			←	☐; 11/02→; +PR 1LC;1LE; → 03/10	24.0132-0117.1	432117	Ø 330 32 30 V + S
			←	☐; 11/02→; +PR 1LC;1LE; → 03/10	24.0132-0118.1	432118	Ø 330 32 30 V + S
			←	☐; 11/02→; +PR 1LF; → 03/10	24.0134-0123.1	434123	Ø 350 34 32 V
			←	☐; 11/02→; +PR 1LF; → 03/10	24.0134-0124.1	434124	Ø 350 34 32 V
			←	11/02→; +PR 1LT;1LU; → 03/10	24.0136-0111.1	436111	Ø 368 36 34 V
			→	11/02→; +PR 1KE; → 03/10	24.0122-0215.1	422215	Ø 314 22 18 V + S
			→	11/02→; +PR 1KF;1KQ; → 03/10	24.0128-0149.1	428149	Ø 330 28 26 V + S
			→	11/02→; +PR 1KD;2ED; → 03/10	24.0128-0169.1	428169	Ø 358 28 26 V
6.0 W12	331	08/04→05/10	←	+PR 1LB; → 11/06	24.0130-0114.1	430114	Ø 308 29,5 25,5 V
			←	☐; +PR 1LC;1LE; → 11/06	24.0132-0117.1	432117	Ø 330 32 30 V + S
			←	☐; +PR 1LC;1LE; → 11/06	24.0132-0118.1	432118	Ø 330 32 30 V + S
			←	☐; +PR 1LF; → 11/06	24.0134-0123.1	434123	Ø 350 34 32 V
			←	☐; +PR 1LF; → 11/06	24.0134-0124.1	434124	Ø 350 34 32 V
			→	+PR 1KE; → 11/06	24.0122-0215.1	422215	Ø 314 22 18 V + S
			→	+PR 1KF;1KQ; → 11/06	24.0128-0149.1	428149	Ø 330 28 26 V + S
<b>VW - TOUAREG (7P5, 7P6) 01/10→03/18</b>							
<b>Bremsbelagsatz, Scheibenbremse</b>							
3.0 V6 TDI	150	01/10→	←	04/10→; +PR 1LC,1LE	13.0460-4833.2	604833	BRE 24098 17,1 + WE / - WK
					13.0470-4833.2	LD4833	BRE 24098 17,1 + WE / - WK Ceramic
			←	04/10→; +PR 1LG,1LW	13.0460-4852.2	604852	BRE 24553 15,8 + WE / - WK + Zub
			←	04/10→; +PR 1LJ	13.0460-4852.2	604852	BRE 24553 15,8 + WE / - WK + Zub
			→	04/10→; +PR 1KJ,1KQ,2EG	13.0460-4872.2	604872	BRE + WE / - WK
					13.0470-4872.2	LD4872	BRE + WE / - WK Ceramic
3.0 V6 TDI 3.0 V6 TDI 3.6 V6 FSI 3.6 V6 FSI	165 180 183 206	06/10→ 05/11→ 08/10→ 04/10→	←	+PR 1LC,1LE	13.0460-4833.2	604833	BRE 24098 17,1 + WE / - WK
					13.0470-4833.2	LD4833	BRE 24098 17,1 + WE / - WK Ceramic
			←	+PR 1LJ	13.0460-4852.2	604852	BRE 24553 15,8 + WE / - WK + Zub
↓							























	kw			 	! #		
<b>VW - TOUAREG (7P5, 7P6) 01/10→03/18</b>							
<b> Bremsbelagsatz, Scheibenbremse</b>							
3.0 V6 TDI 3.0 V6 TDI 3.6 V6 FSI 3.6 V6 FSI	165 180 183 206	06/10→ 05/11→ 08/10→ 04/10→	← →	+PR 1LG,1LW +PR 1KJ,1KQ,2EG		13.0460-4852.2 604852 13.0460-4872.2 604872 13.0470-4872.2 LD4872	BRE 24553 15,8 + WE / - WK + Zub BRE + WE / - WK BRE + WE / - WK Ceramic
3.0 V6 TDI	176	01/10→	← ← ← →	04/10→; +PR 1LC,1LE 04/10→; +PR 1LG,1LW 04/10→; +PR 1LJ 04/11→; +PR 1KJ,1KQ,2EG		13.0460-4833.2 604833 13.0470-4833.2 LD4833 13.0460-4852.2 604852 13.0460-4852.2 604852 13.0460-4872.2 604872 13.0470-4872.2 LD4872	BRE 24098 17,1 + WE / - WK BRE 24098 17,1 + WE / - WK Ceramic BRE 24553 15,8 + WE / - WK + Zub BRE 24553 15,8 + WE / - WK + Zub BRE + WE / - WK BRE + WE / - WK Ceramic
3.0 V6 TDI	193	09/14→	← ← ← →	+PR 1LC,1LE +PR 1LJ +PR 1LG,1LW +PR 1KQ,2EG		13.0460-4833.2 604833 13.0470-4833.2 LD4833 13.0460-4852.2 604852 13.0460-4852.2 604852 13.0460-4872.2 604872 13.0470-4872.2 LD4872	BRE 24098 17,1 + WE / - WK BRE 24098 17,1 + WE / - WK Ceramic BRE 24553 15,8 + WE / - WK + Zub BRE 24553 15,8 + WE / - WK + Zub BRE + WE / - WK BRE + WE / - WK Ceramic
3.0 V6 TSI 3.0 V6 TSI Hybrid 4.2 V8 FSI	213 245 265	08/10→ 04/10→ 01/11→	← ← ← →	+PR 1LC,1LE +PR 1LJ +PR 1LG,1LW +PR 1KJ,1KQ,2EG		13.0460-4833.2 604833 13.0460-4852.2 604852 13.0460-4852.2 604852 13.0460-4872.2 604872 13.0470-4872.2 LD4872	BRE 24098 17,1 + WE / - WK BRE 24553 15,8 + WE / - WK + Zub BRE 24553 15,8 + WE / - WK + Zub BRE + WE / - WK BRE + WE / - WK Ceramic
4.2 V8 TDI	250	01/10→	← ← ← →	04/10→; +PR 1LC,1LE 04/10→; +PR 1LG,1LW 04/10→; +PR 1LJ 04/10→; +PR 1KJ,1KQ,2EG		13.0460-4833.2 604833 13.0460-4852.2 604852 13.0460-4852.2 604852 13.0460-4872.2 604872 13.0470-4872.2 LD4872	BRE 24098 17,1 + WE / - WK BRE 24553 15,8 + WE / - WK + Zub BRE 24553 15,8 + WE / - WK + Zub BRE + WE / - WK BRE + WE / - WK Ceramic
<b>Warnkontakt, Bremsbelagverschleiß</b>							
3.0 V6 TDI 4.2 V8 TDI	150 250	01/10→ 01/10→	← ← ← →	04/10→; +PR 1LC,1LE 04/10→; +PR 1LJ 04/10→; +PR 1LG,1LW 04/10→; +PR 1KJ,1KQ,2EG	2	24.8190-0013.2 620013 24.8190-0014.2 620014 24.8190-0014.2 620014 24.8190-0015.2 620015	L= 323 L= 296 L= 296 L= 138
3.0 V6 TDI 3.0 V6 TDI 3.0 V6 TSI 3.0 V6 TSI Hybrid 3.6 V6 FSI 3.6 V6 FSI 4.2 V8 FSI	165 180 213 245 183 206 265	06/10→ 05/11→ 08/10→ 04/10→ 08/10→ 04/10→ 01/11→	← ← ← ← →	+PR 1LC,1LE +PR 1LJ +PR 1LG,1LW +PR 1KJ,1KQ,2EG	2	24.8190-0013.2 620013 24.8190-0014.2 620014 24.8190-0014.2 620014 24.8190-0015.2 620015	L= 323 L= 296 L= 296 L= 138
3.0 V6 TDI	176	01/10→	← ← ← →	04/10→; +PR 1LC,1LE 04/10→; +PR 1LJ 04/10→; +PR 1LG,1LW 04/11→; +PR 1KJ,1KQ,2EG	2	24.8190-0013.2 620013 24.8190-0014.2 620014 24.8190-0014.2 620014 24.8190-0015.2 620015	L= 323 L= 296 L= 296 L= 138
3.0 V6 TDI	193	09/14→	← ← ← →	+PR 1LC,1LE +PR 1LG,1LW +PR 1LJ +PR 1KQ,2EG	2	24.8190-0013.2 620013 24.8190-0014.2 620014 24.8190-0014.2 620014 24.8190-0015.2 620015	L= 323 L= 296 L= 296 L= 138
<b> Bremsscheibe</b>							
3.0 V6 TDI 3.0 V6 TDI 4.2 V8 TDI	150 176 250	01/10→ 01/10→ 01/10→	← ← ← ←	□; 04/10→; +PR 1LC,1LE □; 04/10→; +PR 1LC,1LE □; 04/10→; +PR 1LG,1LJ,1LW □; 04/10→; +PR 1LG,1LJ,1LW		24.0132-0117.1 432117 24.0132-0118.1 432118 24.0136-0123.1 436123 24.0136-0124.1 436124	∅ 330 32 30 V + S ∅ 330 32 30 V + S ∅ 360 36 34 V + S ∅ 360 36 34 V + S
↓							









	kw				! #		
<b>VW - TOUAREG (7P5, 7P6) 01/10→03/18</b>							
<b>Bremsscheibe</b>							
3.0 V6 TDI	150	01/10→	➔	04/10→; +PR 1KJ,1KQ,2EG; + eFSB		24.0128-0149.1 428149	Ø 330 28 26 V + S
3.0 V6 TDI	176	01/10→					
4.2 V8 TDI	250	01/10→					
3.0 V6 TDI	165	06/10→	➔	☐; +PR 1LC,1LE		24.0132-0117.1 432117	Ø 330 32 30 V + S
3.0 V6 TDI	180	05/11→					
3.0 V6 TSI	213	08/10→	➔	☐; +PR 1LC,1LE		24.0132-0118.1 432118	Ø 330 32 30 V + S
3.0 V6 TSI Hybrid	245	04/10→	➔	☐; +PR 1LG,1LJ,1LW		24.0136-0123.1 436123	Ø 360 36 34 V + S
3.6 V6 FSI	183	08/10→					
3.6 V6 FSI	206	04/10→	➔	☐; +PR 1LG,1LJ,1LW		24.0136-0124.1 436124	Ø 360 36 34 V + S
4.2 V8 FSI	265	01/11→	➔	+PR 1KJ,1KQ,2EG; + eFSB		24.0128-0149.1 428149	Ø 330 28 26 V + S
3.0 V6 TDI	193	09/14→	➔	☐; +PR 1LC,1LE		24.0132-0117.1 432117	Ø 330 32 30 V + S
			➔	☐; +PR 1LC,1LE		24.0132-0118.1 432118	Ø 330 32 30 V + S
			➔	☐; +PR 1LJ,1LW		24.0136-0123.1 436123	Ø 360 36 34 V + S
			➔	☐; +PR 1LJ,1LW		24.0136-0124.1 436124	Ø 360 36 34 V + S
			➔	+PR 1KQ,2EG; + eFSB		24.0128-0149.1 428149	Ø 330 28 26 V + S
<b>VW - TOUAREG (CR7) 11/17→</b>							
<b>Warnkontakt, Bremsbelagverschleiß</b>							
3.0 TDI	210	11/17→	➔	+PR 1LV	2	24.8190-0976.2 620976	L= 422
3.0 TDI AWD	170	05/18→	➔	+PR 2ED,2EE,1KQ,1KU	2	24.8190-0964.2 620964	L= 379
<b>Bremsscheibe</b>							
3.0 TDI	210	11/17→	➔	+PR 2ED,2EE		24.0122-0272.1 422272	Ø 330 21,9 20 V + S
3.0 TDI AWD	170	05/18→					
<b>VW - TOURAN (1T1, 1T2) 02/03→05/10</b>							
<b>Bremsbelagsatz, Scheibenbremse</b>							
1.4 FSI	125	11/06→05/10	➔	+PR 1ZD,1ZE,1ZP / 1ZA,1LJ		13.0460-7184.2 607184	ATE 23587 20,6 + WK
1.4 TSI EcoFuel	110	05/09→05/10				13.0470-7184.2 LD7184	ATE 23587 20,6 + WK Ceramic
1.6	75	07/03→05/10					
1.6 FSI	85	02/03→01/07	➔	+PR 1KE,1KF,1KJ		13.0460-2749.2 602749	TRW 24483 16,9 - WE / - WK + Zub
1.9 TDI	66	11/04→05/10					
1.9 TDI	74	02/03→05/04				13.0460-2880.2 602880	TRW 23914 17,1 + WE / - WK + Zub
1.9 TDI	77	08/03→05/10					
2.0 EcoFuel	80	02/06→05/09				13.0470-2749.2 LD2749	TRW 24483 16,9 - WE / - WK + Zub Ceramic
2.0 FSI	110	10/03→01/07					
2.0 TDI	103	12/05→05/10				13.0470-2880.2 LD2880	TRW 23914 17,1 + WE / - WK + Zub Ceramic
2.0 TDI 16V	103	08/03→05/10					
			➔	+PR 1KS		13.0460-3858.2 603858	BOS 24563 17,7 - WE / - WK + Zub
						13.0470-3858.2 LD3858	BOS 24563 17,7 - WE / - WK + Zub Ceramic
1.4 TSI	103	02/06→05/10	➔	09/06→; +PR 1ZD,1ZE,1ZP / 1ZA,1LJ		13.0460-7184.2 607184	ATE 23587 20,6 + WK
						13.0470-7184.2 LD7184	ATE 23587 20,6 + WK Ceramic
			➔	09/06→; +PR 1KE,1KF,1KJ		13.0460-2749.2 602749	TRW 24483 16,9 - WE / - WK + Zub
						13.0460-2880.2 602880	TRW 23914 17,1 + WE / - WK + Zub
						13.0470-2749.2 LD2749	TRW 24483 16,9 - WE / - WK + Zub Ceramic
						13.0470-2880.2 LD2880	TRW 23914 17,1 + WE / - WK + Zub Ceramic
			➔	09/06→; +PR 1KS		13.0460-3858.2 603858	BOS 24563 17,7 - WE / - WK + Zub
						13.0470-3858.2 LD3858	BOS 24563 17,7 - WE / - WK + Zub Ceramic
2.0 TDI	100	02/03→05/10	➔	08/03→; +PR 1ZD,1ZE,1ZP / 1ZA,1LJ		13.0460-7184.2 607184	ATE 23587 20,6 + WK
						13.0470-7184.2 LD7184	ATE 23587 20,6 + WK Ceramic
			➔	08/03→; +PR 1KE,1KF,1KJ		13.0460-2749.2 602749	TRW 24483 16,9 - WE / - WK + Zub
						13.0460-2880.2 602880	TRW 23914 17,1 + WE / - WK + Zub
						13.0470-2749.2 LD2749	TRW 24483 16,9 - WE / - WK + Zub Ceramic
						13.0470-2880.2 LD2880	TRW 23914 17,1 + WE / - WK + Zub Ceramic
			➔	08/03→; +PR 1KS		13.0460-3858.2 603858	BOS 24563 17,7 - WE / - WK + Zub

	kw			 	! #		
<b>VW - TOURAN (1T1, 1T2) 02/03→05/10</b>							
<b> Bremsbelagsatz, Scheibenbremse</b>							
2.0 TDI	100	02/03→05/10	➡	08/03→; +PR 1KS		<b>13.0470-3858.2 LD3858</b>	BOS 24563 17,7 - WE / - WK + Zub Ceramic
2.0 TDI	125	12/05→05/10	←	02/06→; +PR 1ZA,1ZD,1ZE / 1ZP,1LJ		<b>13.0460-7184.2 607184</b> <b>13.0470-7184.2 LD7184</b>	ATE 23587 20,6 + WK ATE 23587 20,6 + WK Ceramic
				➡	02/06→; +PR 1KE,1KF,1KJ		<b>13.0460-2749.2 602749</b> <b>13.0460-2880.2 602880</b> <b>13.0470-2749.2 LD2749</b> <b>13.0470-2880.2 LD2880</b>
			➡	02/06→; +PR 1KS		<b>13.0460-3858.2 603858</b> <b>13.0470-3858.2 LD3858</b>	BOS 24563 17,7 - WE / - WK + Zub BOS 24563 17,7 - WE / - WK + Zub Ceramic
			<b>Zubehörsatz, Scheibenbremsbelag</b>				
1.4 FSI	125	11/06→05/10	➡	+PR 1KE,1KF,1KJ		<b>13.0460-0259.2 610259</b>	
1.4 TSI EcoFuel	110	05/09→05/10					
1.6	75	07/03→05/10					
1.6 FSI	85	02/03→01/07					
1.9 TDI	66	11/04→05/10					
1.9 TDI	74	02/03→05/04					
1.9 TDI	77	08/03→05/10					
2.0 EcoFuel	80	02/06→05/09					
2.0 FSI	110	10/03→01/07					
2.0 TDI	103	12/05→05/10					
2.0 TDI 16V	103	08/03→05/10					
1.4 TSI	103	02/06→05/10	➡	09/06→; +PR 1KE,1KF,1KJ		<b>13.0460-0259.2 610259</b>	
2.0 TDI	100	02/03→05/10	➡	08/03→; +PR 1KE,1KF,1KJ		<b>13.0460-0259.2 610259</b>	
2.0 TDI	125	12/05→05/10	➡	02/06→; +PR 1KE,1KF,1KJ		<b>13.0460-0259.2 610259</b>	
<b> Bremsscheibe</b>							
1.4 FSI	125	11/06→05/10	←	+PR 1ZE,1ZP		<b>24.0125-0145.1 425145</b>	Ø 288 25 22 V + S
1.6	75	07/03→05/10				<b>24.0325-0145.1 525145</b>	Ø 288 25 22 V + S
1.6 FSI	85	02/03→01/07					
1.9 TDI	66	11/04→05/10	←	+PR 1LJ,1ZA,1ZD		<b>24.0125-0158.1 425158</b>	Ø 312 25 22 V + S
1.9 TDI	74	02/03→05/04				<b>24.0325-0158.1 525158</b>	Ø 312 25 22 V + S
1.9 TDI	77	08/03→05/10					
2.0 EcoFuel	80	02/06→05/09	➡	+PR 1KS		<b>24.0110-0356.1 410356</b>	Ø 272 9,7 8 + S
2.0 FSI	110	10/03→01/07				<b>24.0310-0356.1 510356</b>	Ø 272 9,7 8 + S
2.0 TDI	103	12/05→05/10	➡	+PR 1KE;1KF		<b>24.0112-0158.1 412158</b> <b>24.0312-0158.1 512158</b>	Ø 256 12 10 + S Ø 256 12 10
2.0 TDI 16V	103	08/03→05/10	➡	+PR 1KJ		<b>24.0112-0169.1 412169</b> <b>24.0312-0169.1 512169</b>	Ø 282 12 10 + S Ø 282 12 10 + S
1.4 TSI	103	02/06→05/10	←	09/06→; +PR 1ZE,1ZP		<b>24.0125-0145.1 425145</b> <b>24.0325-0145.1 525145</b>	Ø 288 25 22 V + S Ø 288 25 22 V + S
				09/06→; +PR 1LJ,1ZA,1ZD		<b>24.0125-0158.1 425158</b> <b>24.0325-0158.1 525158</b>	Ø 312 25 22 V + S Ø 312 25 22 V + S
			➡	09/06→; +PR 1KS		<b>24.0110-0356.1 410356</b> <b>24.0310-0356.1 510356</b>	Ø 272 9,7 8 + S Ø 272 9,7 8 + S
			➡	09/06→; +PR 1KE;1KF		<b>24.0112-0158.1 412158</b> <b>24.0312-0158.1 512158</b>	Ø 256 12 10 + S Ø 256 12 10
			➡	09/06→; +PR 1KJ		<b>24.0112-0169.1 412169</b> <b>24.0312-0169.1 512169</b>	Ø 282 12 10 + S Ø 282 12 10 + S
1.4 TSI EcoFuel	110	05/09→05/10	←	+PR 1ZE,1ZP		<b>24.0125-0145.1 425145</b> <b>24.0325-0145.1 525145</b>	Ø 288 25 22 V + S Ø 288 25 22 V + S
				+PR 1LJ,1ZA,1ZD		<b>24.0125-0158.1 425158</b> <b>24.0325-0158.1 525158</b>	Ø 312 25 22 V + S Ø 312 25 22 V + S
			➡	+PR 1KS		<b>24.0110-0356.1 410356</b> <b>24.0310-0356.1 510356</b>	Ø 272 9,7 8 + S Ø 272 9,7 8 + S
			➡	+PR 1KE,1KF		<b>24.0112-0158.1 412158</b> <b>24.0312-0158.1 512158</b>	Ø 256 12 10 + S Ø 256 12 10
			➡	+PR 1KJ		<b>24.0112-0169.1 412169</b> <b>24.0312-0169.1 512169</b>	Ø 282 12 10 + S Ø 282 12 10 + S
2.0 TDI	100	02/03→05/10	←	08/03→; +PR 1ZE,1ZP		<b>24.0125-0145.1 425145</b> <b>24.0325-0145.1 525145</b>	Ø 288 25 22 V + S Ø 288 25 22 V + S
↓							







	kw			 	! #				
<b>VW - TOURAN (1T1, 1T2) 02/03→05/10</b>									
<b> Bremsscheibe</b>									
2.0 TDI	100	02/03→05/10	←	08/03→; +PR 1LJ,1ZA,1ZD	24.0125-0158.1 425158	Ø 312 25 22 V + S			
					24.0325-0158.1 525158	Ø 312 25 22 V + S			
			→	08/03→; +PR 1KS	24.0110-0356.1 410356	Ø 272 9,7 8 + S			
					24.0310-0356.1 510356	Ø 272 9,7 8 + S			
			→	08/03→; +PR 1KE;1KF	24.0112-0158.1 412158	Ø 256 12 10 + S			
		24.0312-0158.1 512158	Ø 256 12 10						
		→	08/03→; +PR 1KJ	24.0112-0169.1 412169	Ø 282 12 10 + S				
				24.0312-0169.1 512169	Ø 282 12 10 + S				
2.0 TDI	125	12/05→05/10	←	02/06→; +PR 1ZE,1ZP	24.0125-0145.1 425145	Ø 288 25 22 V + S			
					24.0325-0145.1 525145	Ø 288 25 22 V + S			
			←	02/06→; +PR 1LJ,1ZA,1ZD	24.0125-0158.1 425158	Ø 312 25 22 V + S			
					24.0325-0158.1 525158	Ø 312 25 22 V + S			
			→	02/06→; +PR 1KS	24.0110-0356.1 410356	Ø 272 9,7 8 + S			
		24.0310-0356.1 510356	Ø 272 9,7 8 + S						
		→	02/06→; +PR 1KE;1KF	24.0112-0158.1 412158	Ø 256 12 10 + S				
				24.0312-0158.1 512158	Ø 256 12 10				
		→	02/06→; +PR 1KJ	24.0112-0169.1 412169	Ø 282 12 10 + S				
				24.0312-0169.1 512169	Ø 282 12 10 + S				
<b>VW - TOURAN (1T3) 05/10→05/15</b>									
<b> Bremsbelagsatz, Scheibenbremse</b>									
1.2 TSI 1.4 TSI 1.4 TSI 1.4 TSI EcoFuel 1.6 TDI 1.6 TDI 2.0 TDI 2.0 TDI	77 103 125 110 66 77 81 103	05/10→05/15 05/10→05/15 05/10→05/15 05/10→05/15 05/10→05/15 05/10→05/15 11/10→05/15 05/10→05/15	←	+PR 1ZD,1ZE,1ZP / 1ZA,1LJ	13.0460-7184.2 607184	ATE 23587 20,6 + WK			
					13.0470-7184.2 LD7184	ATE 23587 20,6 + WK Ceramic			
			→	+PR 1KE,1KF,1KJ	13.0460-2749.2 602749	TRW 24483 16,9 - WE / - WK + Zub			
					13.0460-2880.2 602880	TRW 23914 17,1 + WE / - WK + Zub			
					13.0470-2749.2 LD2749	TRW 24483 16,9 - WE / - WK + Zub Ceramic			
					13.0470-2880.2 LD2880	TRW 23914 17,1 + WE / - WK + Zub Ceramic			
			→	+PR 1KS	13.0460-3858.2 603858	BOS 24563 17,7 - WE / - WK + Zub			
					13.0470-3858.2 LD3858	BOS 24563 17,7 - WE / - WK + Zub Ceramic			
			2.0 TDI	125	05/10→01/13	←	+PR 1ZA,1ZD,1ZE / 1ZP,1LJ	13.0460-7184.2 607184	ATE 23587 20,6 + WK
								13.0470-7184.2 LD7184	ATE 23587 20,6 + WK Ceramic
→	+PR 1KE,1KF,1KJ	13.0460-2749.2 602749				TRW 24483 16,9 - WE / - WK + Zub			
		13.0460-2880.2 602880				TRW 23914 17,1 + WE / - WK + Zub			
		13.0470-2749.2 LD2749				TRW 24483 16,9 - WE / - WK + Zub Ceramic			
		→	+PR 1KS	13.0460-3858.2 603858	BOS 24563 17,7 - WE / - WK + Zub				
				13.0470-3858.2 LD3858	BOS 24563 17,7 - WE / - WK + Zub Ceramic				
2.0 TDI	130	01/13→05/15	←	+PR 1ZA,1ZD,1ZE,1ZP / 1LJ	13.0460-7184.2 607184	ATE 23587 20,6 + WK			
					13.0470-7184.2 LD7184	ATE 23587 20,6 + WK Ceramic			
			→		13.0460-3858.2 603858	BOS 24563 17,7 - WE / - WK + Zub			
				13.0470-3858.2 LD3858	BOS 24563 17,7 - WE / - WK + Zub Ceramic				
<b>Zubehörsatz, Scheibenbremsbelag</b>									
1.2 TSI 1.4 TSI 1.4 TSI 1.4 TSI EcoFuel 1.6 TDI 1.6 TDI 2.0 TDI 2.0 TDI 2.0 TDI ↓	77 103 125 110 66 77 81 103 125	05/10→05/15 05/10→05/15 05/10→05/15 05/10→05/15 05/10→05/15 05/10→05/15 11/10→05/15 05/10→05/15 05/10→01/13	→	+PR 1KE,1KF,1KJ	13.0460-0259.2 610259				







	kw			 	! #		
<b>VW - TOURAN (1T3) 05/10→05/15</b>							
 <b>Bremsscheibe</b>							
1.2 TSI	77	05/10→05/15	←	+PR 1ZE,1ZP		24.0125-0145.1 425145	Ø 288 25 22 V + S
1.4 TSI EcoFuel	110	05/10→05/15				24.0325-0145.1 525145	Ø 288 25 22 V + S
1.6 TDI	66	05/10→05/15	←	+PR 1LJ,1ZA,1ZD		24.0125-0158.1 425158	Ø 312 25 22 V + S
1.6 TDI	77	05/10→05/15				24.0325-0158.1 525158	Ø 312 25 22 V + S
			→	+PR 1KS		24.0110-0356.1 410356	Ø 272 9,7 8 + S
			→	+PR 1KE,1KF		24.0310-0356.1 510356	Ø 272 9,7 8 + S
			→	+PR 1KJ		24.0112-0158.1 412158	Ø 256 12 10 + S
			→			24.0312-0158.1 512158	Ø 256 12 10
			→			24.0112-0169.1 412169	Ø 282 12 10 + S
			→			24.0312-0169.1 512169	Ø 282 12 10 + S
1.4 TSI	103	05/10→05/15	←	+PR 1ZE,1ZP		24.0125-0145.1 425145	Ø 288 25 22 V + S
1.4 TSI	125	05/10→05/15				24.0325-0145.1 525145	Ø 288 25 22 V + S
2.0 TDI	81	11/10→05/15	←	+PR 1LJ,1ZA,1ZD		24.0125-0158.1 425158	Ø 312 25 22 V + S
2.0 TDI	103	05/10→05/15				24.0325-0158.1 525158	Ø 312 25 22 V + S
2.0 TDI	125	05/10→01/13	→	+PR 1KS		24.0110-0356.1 410356	Ø 272 9,7 8 + S
			→	+PR 1KE,1KF		24.0310-0356.1 510356	Ø 272 9,7 8 + S
			→	+PR 1KJ		24.0112-0158.1 412158	Ø 256 12 10 + S
			→			24.0312-0158.1 512158	Ø 256 12 10
			→			24.0112-0169.1 412169	Ø 282 12 10 + S
			→			24.0312-0169.1 512169	Ø 282 12 10 + S
2.0 TDI	130	01/13→05/15	←	+PR 1ZE,1ZP		24.0125-0145.1 425145	Ø 288 25 22 V + S
						24.0325-0145.1 525145	Ø 288 25 22 V + S
			←	+PR 1LJ,1ZA,1ZD		24.0125-0158.1 425158	Ø 312 25 22 V + S
						24.0325-0158.1 525158	Ø 312 25 22 V + S
			→			24.0110-0356.1 410356	Ø 272 9,7 8 + S
						24.0310-0356.1 510356	Ø 272 9,7 8 + S
<b>VW - TOURAN (5T1) 05/15→</b>							
 <b>Bremsbelagsatz, Scheibenbremse</b>							
1.2 TSI	81	05/15→	←	09/15→; +PR 1ZA,1ZD		13.0460-2785.2 602785	TRW 25683 20,4 + WE / + WK
1.4 TSI	110	05/15→				13.0470-2785.2 LD2785	TRW 25683 20,4 + WE / + WK Ceramic
1.6 TDI	81	05/15→05/16	→	09/15→; +PR 1KE; + eFSB		13.0460-7293.2 607293	ATE 25008 16,3 - WE / - WK
2.0 TDI	110	05/15→				13.0470-7293.2 LD7293	ATE 25008 16,3 - WE / - WK Ceramic
			→	09/15→; +PR 1KU; + eFSB		13.0460-7294.2 607294	ATE 25009 16,4 - WE / - WK
						13.0470-7294.2 LD7294	ATE 25009 16,4 - WE / - WK Ceramic
1.6 TDI	85	05/16→	←	+PR 1ZA,1ZD		13.0460-2785.2 602785	TRW 25683 20,4 + WE / + WK
1.8 TSI	132	11/15→				13.0470-2785.2 LD2785	TRW 25683 20,4 + WE / + WK Ceramic
2.0 TDI	81	11/15→	→	+PR 1KE; + eFSB		13.0460-7293.2 607293	ATE 25008 16,3 - WE / - WK
2.0 TDI	140	11/15→				13.0470-7293.2 LD7293	ATE 25008 16,3 - WE / - WK Ceramic
			→	+PR 1KU; + eFSB		13.0460-7294.2 607294	ATE 25009 16,4 - WE / - WK
						13.0470-7294.2 LD7294	ATE 25009 16,4 - WE / - WK Ceramic
<b>Warnkontakt, Bremsbelagsverschleiß</b>							
1.2 TSI	81	05/15→	←	☐; 09/15→; +PR 1ZA,1ZD	1	24.8190-0065.2 620065	L= 172
1.4 TSI	110	05/15→					
1.6 TDI	81	05/15→05/16					
2.0 TDI	110	05/15→					
1.6 TDI	85	05/16→	←	☐; +PR 1ZA,1ZD	1	24.8190-0065.2 620065	L= 172
1.8 TSI	132	11/15→					
2.0 TDI	81	11/15→					
2.0 TDI	140	11/15→					
 <b>Bremsscheibe</b>							
1.2 TSI	81	05/15→	←	09/15→; +PR 1ZA,1ZD		24.0125-0158.1 425158	Ø 312 25 22 V + S
1.4 TSI	110	05/15→				24.0325-0158.1 525158	Ø 312 25 22 V + S
1.6 TDI	81	05/15→05/16	→	09/15→; +PR 1KE		24.0110-0356.1 410356	Ø 272 9,7 8 + S
2.0 TDI	110	05/15→				24.0310-0356.1 510356	Ø 272 9,7 8 + S
			→	09/15→; +PR 1KU; + eFSB		24.0112-0210.1 412210	Ø 300 12 10 + S
1.6 TDI	85	05/16→	←	+PR 1ZA,1ZD		24.0125-0158.1 425158	Ø 312 25 22 V + S
1.8 TSI	132	11/15→					









	kw			 	! #		
<b>VW - TOURAN (5T1) 05/15→</b>							
 <b>Bremsscheibe</b>							
2.0 TDI	81	11/15→	←	+PR 1ZA,1ZD	24.0325-0158.1	525158	Ø 312 25 22 V + S
2.0 TDI	140	11/15→	→	+PR 1KE	24.0110-0356.1	410356	Ø 272 9,7 8 + S
			→	+PR 1KU; + eFSB	24.0310-0356.1	510356	Ø 272 9,7 8 + S
			→	+PR 1KU; + eFSB	24.0112-0210.1	412210	Ø 300 12 10 + S
<b>VW - TRANSPORTER T4 Bus (70B, 70C, 7DB, 7DK, 70J, 70K, 7DC, 7DJ) 09/90→06/03</b>							
 <b>Bremsbelagsatz, Scheibenbremse</b>							
1.9 TD	50	10/92→04/03	←	70-Y-000001→; +PR 1LP	13.0460-2838.2	602838	TRW 21479 19,2 + WK
2.0	62	09/90→04/03	←	70-Y-000001→; +PR 1LE	13.0460-2839.2	602839	TRW 20651 18,3 + WK
2.4 D	57	09/90→04/98	←	→ 04/96; +PR 1LA	13.0460-2972.2	602972	TRW 20124 18,9 - WK
2.5	81	11/90→06/03	←	→ 70-X-250000; +PR 1LE	13.0460-2973.2	602973	TRW 20651 18,0 - WE / - WK
			←	70-P-160001→ 70-X-250000; +PR 1LP	13.0460-2982.2	602982	TRW 21479 19,2 - WK
			←	05/96→; → 70-X-250000; +PR 1LU	13.0460-7102.2	607102	ATE 21883 19,8 - WE / - WK
			←	05/97→; → 70-1-000954; +PR 1LB	13.0460-7123.2	607123	ATE 23034 18,8 + WK
			←	70-Y-000001→; +PR 1LU	13.0460-7124.2	607124	ATE 21883 19,8 + WK
			←	70-1-000955→; +PR 1LB	13.0460-7153.2	607153	ATE 23269 19,8 + WK
			→	05/97→; +PR 2E3	13.0460-2872.2	602872	TRW 23224 16,5 + WK + Zub
			→	70-T-200000→; +PR 2E2	13.0460-2874.2	602874	TRW 23224 16,5 + WK + Zub
2.4 D	55	08/97→04/03	←	70-Y-000001→; +PR 1LP	13.0460-2838.2	602838	TRW 21479 19,2 + WK
			←	70-Y-000001→; +PR 1LE	13.0460-2839.2	602839	TRW 20651 18,3 + WK
			←	→ 70-X-250000; +PR 1LE	13.0460-2973.2	602973	TRW 20651 18,0 - WE / - WK
			←	70-P-160001→ 70-X-250000; +PR 1LP	13.0460-2982.2	602982	TRW 21479 19,2 - WK
			←	→ 70-X-250000; +PR 1LU	13.0460-7102.2	607102	ATE 21883 19,8 - WE / - WK
			←	→ 70-1-000954; +PR 1LB	13.0460-7123.2	607123	ATE 23034 18,8 + WK
			←	70-Y-000001→; +PR 1LU	13.0460-7124.2	607124	ATE 21883 19,8 + WK
			←	70-1-000955→; +PR 1LB	13.0460-7153.2	607153	ATE 23269 19,8 + WK
			→	+PR 2E3	13.0460-2872.2	602872	TRW 23224 16,5 + WK + Zub
			→	70-T-200000→; +PR 2E2	13.0460-2874.2	602874	TRW 23224 16,5 + WK + Zub
2.4 D Syncro	57	10/92→09/98	←	70-Y-000001→; +PR 1LP	13.0460-2838.2	602838	TRW 21479 19,2 + WK
			←	70-Y-000001→; +PR 1LE	13.0460-2839.2	602839	TRW 20651 18,3 + WK
			←	11/92→; → 70-X-250000; +PR 1LE	13.0460-2973.2	602973	TRW 20651 18,0 - WE / - WK
			←	11/92→; → 70-X-250000; +PR 1LP	13.0460-2982.2	602982	TRW 21479 19,2 - WK
			←	07/95→; → 70-X-250000; +PR 1LU	13.0460-7102.2	607102	ATE 21883 19,8 - WE / - WK
			←	70-Y-000001→; +PR 1LU	13.0460-7124.2	607124	ATE 21883 19,8 + WK
			←	07/95→; +PR 1LB	13.0460-7153.2	607153	ATE 23269 19,8 + WK
			→	05/97→; +PR 2E3	13.0460-2872.2	602872	TRW 23224 16,5 + WK + Zub
			→	70-T-200000→; +PR 2E2	13.0460-2874.2	602874	TRW 23224 16,5 + WK + Zub
2.5	85	08/96→04/03	←	70-Y-000001→; +PR 1LP	13.0460-2838.2	602838	TRW 21479 19,2 + WK
			←	70-Y-000001→; +PR 1LE	13.0460-2839.2	602839	TRW 20651 18,3 + WK
			←	→ 70-X-250000; +PR 1LE	13.0460-2973.2	602973	TRW 20651 18,0 - WE / - WK
			←	70-P-160001→ 70-X-250000; +PR 1LP	13.0460-2982.2	602982	TRW 21479 19,2 - WK
			←	→ 70-X-250000; +PR 1LU	13.0460-7102.2	607102	ATE 21883 19,8 - WE / - WK
			←	05/97→; → 70-1-000954; +PR 1LB	13.0460-7123.2	607123	ATE 23034 18,8 + WK
			←	70-Y-000001→; +PR 1LU	13.0460-7124.2	607124	ATE 21883 19,8 + WK
			←	70-1-000955→; +PR 1LB	13.0460-7153.2	607153	ATE 23269 19,8 + WK
			→	05/97→; +PR 2E3	13.0460-2872.2	602872	TRW 23224 16,5 + WK + Zub
			→	70-T-200000→; +PR 2E2	13.0460-2874.2	602874	TRW 23224 16,5 + WK + Zub
2.5 Syncro	81	11/92→04/03	←	70-Y-000001→; +PR 1LP	13.0460-2838.2	602838	TRW 21479 19,2 + WK
			←	70-Y-000001→; +PR 1LE	13.0460-2839.2	602839	TRW 20651 18,3 + WK
			←	→ 70-X-250000; +PR 1LE	13.0460-2973.2	602973	TRW 20651 18,0 - WE / - WK
			←	→ 70-X-250000; +PR 1LP	13.0460-2982.2	602982	TRW 21479 19,2 - WK
			←	07/95→; → 70-X-250000; +PR 1LU	13.0460-7102.2	607102	ATE 21883 19,8 - WE / - WK
			←	70-Y-000001→; +PR 1LU	13.0460-7124.2	607124	ATE 21883 19,8 + WK









	kw					! #		
<b>VW - TRANSPORTER T4 Bus (70B, 70C, 7DB, 7DK, 70J, 70K, 7DC, 7DJ) 09/90→06/03</b>								
<b>Bremsbelagsatz, Scheibenbremse</b>								
2.5 Syncro	81	11/92→04/03	←	07/95→; +PR 1LB		13.0460-7153.2	607153	ATE 23269 19,8 + WK
			→	05/97→; +PR 2E3		13.0460-2872.2	602872	TRW 23224 16,5 + WK + Zub
			→	70-T-200000→; +PR 2E2		13.0460-2874.2	602874	TRW 23224 16,5 + WK + Zub
2.5 Syncro 2.5 TDI Syncro	85 75	07/96→04/03 01/96→04/03	←	70-Y-000001→; +PR 1LP		13.0460-2838.2	602838	TRW 21479 19,2 + WK
			←	70-Y-000001→; +PR 1LE		13.0460-2839.2	602839	TRW 20651 18,3 + WK
			←	→ 70-X-250000; +PR 1LE		13.0460-2973.2	602973	TRW 20651 18,0 - WE / - WK
			←	→ 70-X-250000; +PR 1LP		13.0460-2982.2	602982	TRW 21479 19,2 - WK
			←	→ 70-X-250000; +PR 1LU		13.0460-7102.2	607102	ATE 21883 19,8 - WE / - WK
			←	70-Y-000001→; +PR 1LU		13.0460-7124.2	607124	ATE 21883 19,8 + WK
			←	+PR 1LB		13.0460-7153.2	607153	ATE 23269 19,8 + WK
			→	05/97→; +PR 2E3		13.0460-2872.2	602872	TRW 23224 16,5 + WK + Zub
			→	70-T-200000→; +PR 2E2		13.0460-2874.2	602874	TRW 23224 16,5 + WK + Zub
2.5 TDI 2.5 TDI 2.8 VR6	65 111 150	05/98→04/03 05/98→04/03 04/00→04/03	←	70-Y-000001→; +PR 1LP		13.0460-2838.2	602838	TRW 21479 19,2 + WK
			←	70-Y-000001→; +PR 1LE		13.0460-2839.2	602839	TRW 20651 18,3 + WK
			←	→ 70-X-250000; +PR 1LE		13.0460-2973.2	602973	TRW 20651 18,0 - WE / - WK
			←	→ 70-X-250000; +PR 1LP		13.0460-2982.2	602982	TRW 21479 19,2 - WK
			←	→ 70-X-250000; +PR 1LU		13.0460-7102.2	607102	ATE 21883 19,8 - WE / - WK
			←	→ 70-1-000954; +PR 1LB		13.0460-7123.2	607123	ATE 23034 18,8 + WK
			←	70-Y-000001→; +PR 1LU		13.0460-7124.2	607124	ATE 21883 19,8 + WK
			←	70-1-000955→; +PR 1LB		13.0460-7153.2	607153	ATE 23269 19,8 + WK
			→	+PR 2E3		13.0460-2872.2	602872	TRW 23224 16,5 + WK + Zub
			→	70-T-200000→; +PR 2E2		13.0460-2874.2	602874	TRW 23224 16,5 + WK + Zub
2.5 TDI	75	09/95→04/03	←	70-Y-000001→; +PR 1LP		13.0460-2838.2	602838	TRW 21479 19,2 + WK
			←	70-Y-000001→; +PR 1LE		13.0460-2839.2	602839	TRW 20651 18,3 + WK
			←	→ 04/96; +PR 1LA		13.0460-2972.2	602972	TRW 20124 18,9 - WK
			←	→ 70-X-250000; +PR 1LE		13.0460-2973.2	602973	TRW 20651 18,0 - WE / - WK
			←	→ 70-X-250000; +PR 1LP		13.0460-2982.2	602982	TRW 21479 19,2 - WK
			←	05/96→; → 70-X-250000; +PR 1LU		13.0460-7102.2	607102	ATE 21883 19,8 - WE / - WK
			←	05/97→; → 70-1-000954; +PR 1LB		13.0460-7123.2	607123	ATE 23034 18,8 + WK
			←	70-Y-000001→; +PR 1LU		13.0460-7124.2	607124	ATE 21883 19,8 + WK
			←	70-1-000955→; +PR 1LB		13.0460-7153.2	607153	ATE 23269 19,8 + WK
			→	05/97→; +PR 2E3		13.0460-2872.2	602872	TRW 23224 16,5 + WK + Zub
			→	70-T-200000→; +PR 2E2		13.0460-2874.2	602874	TRW 23224 16,5 + WK + Zub
2.8 VR 6	103	11/95→04/00	←	70-Y-000001→; +PR 1LP		13.0460-2838.2	602838	TRW 21479 19,2 + WK
			←	70-Y-000001→; +PR 1LE		13.0460-2839.2	602839	TRW 20651 18,3 + WK
			←	→ 70-X-250000; +PR 1LE		13.0460-2973.2	602973	TRW 20651 18,0 - WE / - WK
			←	→ 70-X-250000; +PR 1LP		13.0460-2982.2	602982	TRW 21479 19,2 - WK
			←	→ 70-X-250000; +PR 1LU		13.0460-7102.2	607102	ATE 21883 19,8 - WE / - WK
			←	05/97→; → 70-1-000954; +PR 1LB		13.0460-7123.2	607123	ATE 23034 18,8 + WK
			←	70-Y-000001→; +PR 1LU		13.0460-7124.2	607124	ATE 21883 19,8 + WK
			←	70-1-000955→; +PR 1LB		13.0460-7153.2	607153	ATE 23269 19,8 + WK
			→	05/97→; +PR 2E3		13.0460-2872.2	602872	TRW 23224 16,5 + WK + Zub
			→	70-T-200000→; +PR 2E2		13.0460-2874.2	602874	TRW 23224 16,5 + WK + Zub
<b>Zubehörsatz, Scheibenbremsbelag</b>								
1.9 TD	50	10/92→04/03	←	70-Y-000001→; +PR 1LE		13.0460-0286.2	610286	
2.0	62	09/90→04/03	←	→ 70-X-250000; +PR 1LE		13.0460-0286.2	610286	
2.4 D	57	09/90→04/98	←					
2.5	81	11/90→06/03	→	70-T-200000→; +PR 2E2		13.0460-0225.2	610225	
2.5	85	08/96→04/03	→					
2.5 Syncro	81	11/92→04/03	→	05/97→; +PR 2E3		13.0460-0225.2	610225	
2.5 Syncro	85	07/96→04/03						
2.5 TDI	75	09/95→04/03						
2.5 TDI Syncro	75	01/96→04/03						
2.8 VR 6	103	11/95→04/00						
2.4 D	55	08/97→04/03	←	70-Y-000001→; +PR 1LE		13.0460-0286.2	610286	
2.5 TDI	65	05/98→04/03	←	→ 70-X-250000; +PR 1LE		13.0460-0286.2	610286	
2.5 TDI	111	05/98→04/03	←					
↓								

	kw				! #		
<b>VW - TRANSPORTER T4 Bus (70B, 70C, 7DB, 7DK, 70J, 70K, 7DC, 7DJ) 09/90→06/03</b>							
<b>Zubehörsatz, Scheibenbremsbelag</b>							
2.8 VR6	150	04/00→04/03	➡	+PR 2E3		13.0460-0225.2 610225	
			➡	70-T-200000→; +PR 2E2		13.0460-0225.2 610225	
2.4 D Syncro	57	10/92→09/98	⬅	70-Y-000001→; +PR 1LE		13.0460-0286.2 610286	
			⬅	11/92→; → 70-X-250000; +PR 1LE		13.0460-0286.2 610286	
			➡	70-T-200000→; +PR 2E2		13.0460-0225.2 610225	
			➡	05/97→; +PR 2E3		13.0460-0225.2 610225	
<b> Bremsscheibe</b>							
1.9 TD	50	10/92→04/03	⬅	→ 04/96; +PR 1LA		24.0116-0108.1 416108	Ø 260 16 13
2.0	62	09/90→04/03	⬅	70-P-160001→; → 04/96; +PR 1LP		24.0118-0105.1 418105	Ø 282 18 15
2.4 D	57	09/90→04/98	⬅	05/96→; +PR 1LP		24.0118-0111.1 418111	Ø 282 18 15 + S
2.5	81	11/90→06/03	⬅	→ 04/96; +PR 1LE,1LU		24.0124-0118.1 424118	Ø 280 24 20 V
			⬅	05/96→; +PR 1LE,1LU		24.0124-0128.1 424128	Ø 280 24 20 V + S
			⬅	05/97→; → 70-1-000954; +PR 1LB		24.0126-0115.1 426115	Ø 300 26 22 V
						24.0326-0115.1 526115	Ø 300 26 22 V
			⬅	70-1-000955→; +PR 1LB		24.0126-0119.1 426119	Ø 313 25,9 22 V
						24.0326-0119.1 526119	Ø 313 25,9 22 V
			➡	70-T-200000→; +PR 2E2		24.0112-0138.1 412138	Ø 280 12 10 + S
			➡	05/97→; +PR 2E3		24.0113-0194.1 413194	Ø 294 13,5 11,5
2.4 D	55	08/97→04/03	⬅	+PR 1LP		24.0118-0111.1 418111	Ø 282 18 15 + S
2.5 TDI	65	05/98→04/03	⬅	+PR 1LE,1LU		24.0124-0128.1 424128	Ø 280 24 20 V + S
2.5 TDI	111	05/98→04/03	⬅	→ 70-1-000954; +PR 1LB		24.0126-0115.1 426115	Ø 300 26 22 V
2.8 VR6	150	04/00→04/03	⬅			24.0326-0115.1 526115	Ø 300 26 22 V
			⬅	70-1-000955→; +PR 1LB		24.0126-0119.1 426119	Ø 313 25,9 22 V
						24.0326-0119.1 526119	Ø 313 25,9 22 V
			➡	70-T-200000→; +PR 2E2		24.0112-0138.1 412138	Ø 280 12 10 + S
			➡	+PR 2E3		24.0113-0194.1 413194	Ø 294 13,5 11,5
2.4 D Syncro	57	10/92→09/98	⬅	11/92→ 04/96; +PR 1LP		24.0118-0105.1 418105	Ø 282 18 15
			⬅	05/96→; +PR 1LP		24.0118-0111.1 418111	Ø 282 18 15 + S
			⬅	11/92→ 06/95; +PR 1LE,1LU		24.0124-0118.1 424118	Ø 280 24 20 V
			⬅	07/95→; +PR 1LE,1LU		24.0124-0128.1 424128	Ø 280 24 20 V + S
			⬅	07/95→; +PR 1LB		24.0126-0119.1 426119	Ø 313 25,9 22 V
						24.0326-0119.1 526119	Ø 313 25,9 22 V
			➡	05/96→; +PR 2E2		24.0112-0138.1 412138	Ø 280 12 10 + S
			➡	05/97→; +PR 2E3		24.0113-0194.1 413194	Ø 294 13,5 11,5
2.5	85	08/96→04/03	⬅	+PR 1LP		24.0118-0111.1 418111	Ø 282 18 15 + S
2.8 VR 6	103	11/95→04/00	⬅	+PR 1LE,1LU		24.0124-0128.1 424128	Ø 280 24 20 V + S
			⬅	05/97→; → 70-1-000954; +PR 1LB		24.0126-0115.1 426115	Ø 300 26 22 V
						24.0326-0115.1 526115	Ø 300 26 22 V
			⬅	70-1-000955→; +PR 1LB		24.0126-0119.1 426119	Ø 313 25,9 22 V
						24.0326-0119.1 526119	Ø 313 25,9 22 V
			➡	70-T-200000→; +PR 2E2		24.0112-0138.1 412138	Ø 280 12 10 + S
			➡	05/97→; +PR 2E3		24.0113-0194.1 413194	Ø 294 13,5 11,5
2.5 Syncro	81	11/92→04/03	⬅	→ 04/96; +PR 1LP		24.0118-0105.1 418105	Ø 282 18 15
			⬅	05/96→; +PR 1LP		24.0118-0111.1 418111	Ø 282 18 15 + S
			⬅	→ 06/95; +PR 1LE,1LU		24.0124-0118.1 424118	Ø 280 24 20 V
			⬅	07/95→; +PR 1LE,1LU		24.0124-0128.1 424128	Ø 280 24 20 V + S
			⬅	07/95→; +PR 1LB		24.0126-0119.1 426119	Ø 313 25,9 22 V
						24.0326-0119.1 526119	Ø 313 25,9 22 V
			➡	05/96→; +PR 2E2		24.0112-0138.1 412138	Ø 280 12 10 + S
			➡	05/97→; +PR 2E3		24.0113-0194.1 413194	Ø 294 13,5 11,5
2.5 Syncro	85	07/96→04/03	⬅	+PR 1LP		24.0118-0111.1 418111	Ø 282 18 15 + S
			⬅	+PR 1LE,1LU		24.0124-0128.1 424128	Ø 280 24 20 V + S
			⬅	+PR 1LB		24.0126-0119.1 426119	Ø 313 25,9 22 V
						24.0326-0119.1 526119	Ø 313 25,9 22 V
			➡	+PR 2E2		24.0112-0138.1 412138	Ø 280 12 10 + S









	kw			 	! #		
<b>VW - TRANSPORTER T4 Bus (70B, 70C, 7DB, 7DK, 70J, 70K, 7DC, 7DJ) 09/90→06/03</b>							
<b>Bremsscheibe</b>							
2.5 Syncro	85	07/96→04/03	➔	05/97→; +PR 2E3		24.0113-0194.1 413194	Ø 294 13,5 11,5
2.5 TDI	75	09/95→04/03	➔	→ 04/96; +PR 1LA		24.0116-0108.1 416108	Ø 260 16 13
			➔	→ 04/96; +PR 1LP		24.0118-0105.1 418105	Ø 282 18 15
			➔	05/96→; +PR 1LP		24.0118-0111.1 418111	Ø 282 18 15 + S
			➔	→ 04/96; +PR 1LE,1LU		24.0124-0118.1 424118	Ø 280 24 20 V
			➔	05/96→; +PR 1LE,1LU		24.0124-0128.1 424128	Ø 280 24 20 V + S
			➔	05/97→; → 70-1-000954; +PR 1LB		24.0126-0115.1 426115	Ø 300 26 22 V
						24.0326-0115.1 526115	Ø 300 26 22 V
			➔	70-1-000955→; +PR 1LB		24.0126-0119.1 426119	Ø 313 25,9 22 V
						24.0326-0119.1 526119	Ø 313 25,9 22 V
			➔	70-T-200000→; +PR 2E2		24.0112-0138.1 412138	Ø 280 12 10 + S
2.5 TDI Syncro	75	01/96→04/03	➔	→ 04/96; +PR 1LP		24.0118-0105.1 418105	Ø 282 18 15
			➔	05/96→; +PR 1LP		24.0118-0111.1 418111	Ø 282 18 15 + S
			➔	+PR 1LE,1LU		24.0124-0128.1 424128	Ø 280 24 20 V + S
			➔	+PR 1LB		24.0126-0119.1 426119	Ø 313 25,9 22 V
						24.0326-0119.1 526119	Ø 313 25,9 22 V
			➔	05/96→; +PR 2E2		24.0112-0138.1 412138	Ø 280 12 10 + S
			➔	05/97→; +PR 2E3		24.0113-0194.1 413194	Ø 294 13,5 11,5
<b>VW - TRANSPORTER T4 Kasten (70A, 70H, 7DA, 7DH) 07/90→04/03</b>							
<b>Bremsbelagsatz, Scheibenbremse</b>							
1.9 TD 2.0 2.4 D 2.5	50 62 57 81	10/92→04/03 07/90→04/03 07/90→04/98 11/90→04/03	➔	70-Y-000001→; +PR 1LP		13.0460-2838.2 602838	TRW 21479 19,2 + WK
			➔	70-Y-000001→; +PR 1LE		13.0460-2839.2 602839	TRW 20651 18,3 + WK
			➔	→ 04/96; +PR 1LA		13.0460-2972.2 602972	TRW 20124 18,9 - WK
			➔	→ 70-X-250000; +PR 1LE		13.0460-2973.2 602973	TRW 20651 18,0 - WE / - WK
			➔	70-P-160001→ 70-X-250000; +PR 1LP		13.0460-2982.2 602982	TRW 21479 19,2 - WK
			➔	05/96→; → 70-X-250000; +PR 1LU		13.0460-7102.2 607102	ATE 21883 19,8 - WE / - WK
			➔	05/97→; → 70-1-000954; +PR 1LB		13.0460-7123.2 607123	ATE 23034 18,8 + WK
			➔	70-Y-000001→; +PR 1LU		13.0460-7124.2 607124	ATE 21883 19,8 + WK
			➔	70-1-000955→; +PR 1LB		13.0460-7153.2 607153	ATE 23269 19,8 + WK
			➔	05/97→; +PR 2E3		13.0460-2872.2 602872	TRW 23224 16,5 + WK + Zub
			➔	70-T-200000→; +PR 2E2		13.0460-2874.2 602874	TRW 23224 16,5 + WK + Zub
			2.4 D	55	08/97→04/03	➔	70-Y-000001→; +PR 1LP
➔	70-Y-000001→; +PR 1LE					13.0460-2839.2 602839	TRW 20651 18,3 + WK
➔	→ 70-X-250000; +PR 1LE					13.0460-2973.2 602973	TRW 20651 18,0 - WE / - WK
➔	70-P-160001→ 70-X-250000; +PR 1LP					13.0460-2982.2 602982	TRW 21479 19,2 - WK
➔	→ 70-X-250000; +PR 1LU					13.0460-7102.2 607102	ATE 21883 19,8 - WE / - WK
➔	→ 70-1-000954; +PR 1LB					13.0460-7123.2 607123	ATE 23034 18,8 + WK
➔	70-Y-000001→; +PR 1LU					13.0460-7124.2 607124	ATE 21883 19,8 + WK
➔	70-1-000955→; +PR 1LB					13.0460-7153.2 607153	ATE 23269 19,8 + WK
➔	+PR 2E3					13.0460-2872.2 602872	TRW 23224 16,5 + WK + Zub
➔	70-T-200000→; +PR 2E2					13.0460-2874.2 602874	TRW 23224 16,5 + WK + Zub
2.4 D Syncro 2.5 Syncro	57 81	10/92→09/98 10/92→04/03	➔	70-Y-000001→; +PR 1LP		13.0460-2838.2 602838	TRW 21479 19,2 + WK
			➔	70-Y-000001→; +PR 1LE		13.0460-2839.2 602839	TRW 20651 18,3 + WK
			➔	11/92→; → 70-X-250000; +PR 1LE		13.0460-2973.2 602973	TRW 20651 18,0 - WE / - WK
			➔	11/92→; → 70-X-250000; +PR 1LP		13.0460-2982.2 602982	TRW 21479 19,2 - WK
			➔	07/95→; → 70-X-250000; +PR 1LU		13.0460-7102.2 607102	ATE 21883 19,8 - WE / - WK
			➔	70-Y-000001→; +PR 1LU		13.0460-7124.2 607124	ATE 21883 19,8 + WK
			➔	07/95→; +PR 1LB		13.0460-7153.2 607153	ATE 23269 19,8 + WK
			➔	05/97→; +PR 2E3		13.0460-2872.2 602872	TRW 23224 16,5 + WK + Zub
			➔	70-T-200000→; +PR 2E2		13.0460-2874.2 602874	TRW 23224 16,5 + WK + Zub
2.5	85	08/96→04/03	➔	70-Y-000001→; +PR 1LP		13.0460-2838.2 602838	TRW 21479 19,2 + WK
			➔	70-Y-000001→; +PR 1LE		13.0460-2839.2 602839	TRW 20651 18,3 + WK
↓							







	kw			 	! #		
<b>VW - TRANSPORTER T4 Kasten (70A, 70H, 7DA, 7DH) 07/90→04/03</b>							
<b>Bremsbelagsatz, Scheibenbremse</b>							
2.5	85	08/96→04/03	←	→ 70-X-250000; +PR 1LE	13.0460-2973.2	602973	TRW 20651 18,0 - WE / - WK
			←	70-P-160001→ 70-X-250000; +PR 1LP	13.0460-2982.2	602982	TRW 21479 19,2 - WK
			←	→ 70-X-250000; +PR 1LU	13.0460-7102.2	607102	ATE 21883 19,8 - WE / - WK
			←	05/97→; → 70-1-000954; +PR 1LB	13.0460-7123.2	607123	ATE 23034 18,8 + WK
			←	70-Y-000001→; +PR 1LU	13.0460-7124.2	607124	ATE 21883 19,8 + WK
			←	70-1-000955→; +PR 1LB	13.0460-7153.2	607153	ATE 23269 19,8 + WK
			→	05/97→; +PR 2E3	13.0460-2872.2	602872	TRW 23224 16,5 + WK + Zub
			→	70-T-200000→; +PR 2E2	13.0460-2874.2	602874	TRW 23224 16,5 + WK + Zub
2.5 Syncro 2.5 TDI Syncro	85 75	08/96→04/03 09/95→04/03	←	70-Y-000001→; +PR 1LP	13.0460-2838.2	602838	TRW 21479 19,2 + WK
			←	70-Y-000001→; +PR 1LE	13.0460-2839.2	602839	TRW 20651 18,3 + WK
			←	→ 70-X-250000; +PR 1LE	13.0460-2973.2	602973	TRW 20651 18,0 - WE / - WK
			←	→ 70-X-250000; +PR 1LP	13.0460-2982.2	602982	TRW 21479 19,2 - WK
			←	→ 70-X-250000; +PR 1LU	13.0460-7102.2	607102	ATE 21883 19,8 - WE / - WK
			←	70-Y-000001→; +PR 1LU	13.0460-7124.2	607124	ATE 21883 19,8 + WK
			←	+PR 1LB	13.0460-7153.2	607153	ATE 23269 19,8 + WK
			→	05/97→; +PR 2E3	13.0460-2872.2	602872	TRW 23224 16,5 + WK + Zub
2.5 TDI 2.5 TDI 2.8 VR6	65 111 150	12/98→04/03 09/00→04/03 06/00→04/03	←	70-Y-000001→; +PR 1LP	13.0460-2838.2	602838	TRW 21479 19,2 + WK
			←	70-Y-000001→; +PR 1LE	13.0460-2839.2	602839	TRW 20651 18,3 + WK
			←	→ 70-X-250000; +PR 1LE	13.0460-2973.2	602973	TRW 20651 18,0 - WE / - WK
			←	→ 70-X-250000; +PR 1LP	13.0460-2982.2	602982	TRW 21479 19,2 - WK
			←	→ 70-X-250000; +PR 1LU	13.0460-7102.2	607102	ATE 21883 19,8 - WE / - WK
			←	→ 70-1-000954; +PR 1LB	13.0460-7123.2	607123	ATE 23034 18,8 + WK
			←	70-Y-000001→; +PR 1LU	13.0460-7124.2	607124	ATE 21883 19,8 + WK
			←	70-1-000955→; +PR 1LB	13.0460-7153.2	607153	ATE 23269 19,8 + WK
2.5 TDI	75	09/95→04/03	←	70-Y-000001→; +PR 1LP	13.0460-2838.2	602838	TRW 21479 19,2 + WK
			←	70-Y-000001→; +PR 1LE	13.0460-2839.2	602839	TRW 20651 18,3 + WK
			←	→ 04/96; +PR 1LA	13.0460-2972.2	602972	TRW 20124 18,9 - WK
			←	→ 70-X-250000; +PR 1LE	13.0460-2973.2	602973	TRW 20651 18,0 - WE / - WK
			←	→ 70-X-250000; +PR 1LP	13.0460-2982.2	602982	TRW 21479 19,2 - WK
			←	05/96→; → 70-X-250000; +PR 1LU	13.0460-7102.2	607102	ATE 21883 19,8 - WE / - WK
			←	05/97→; → 70-1-000954; +PR 1LB	13.0460-7123.2	607123	ATE 23034 18,8 + WK
			←	70-Y-000001→; +PR 1LU	13.0460-7124.2	607124	ATE 21883 19,8 + WK
2.8 VR6	103	05/96→05/00	←	70-Y-000001→; +PR 1LP	13.0460-2838.2	602838	TRW 21479 19,2 + WK
			←	70-Y-000001→; +PR 1LE	13.0460-2839.2	602839	TRW 20651 18,3 + WK
			←	→ 70-X-250000; +PR 1LE	13.0460-2973.2	602973	TRW 20651 18,0 - WE / - WK
			←	→ 70-X-250000; +PR 1LP	13.0460-2982.2	602982	TRW 21479 19,2 - WK
			←	→ 70-X-250000; +PR 1LU	13.0460-7102.2	607102	ATE 21883 19,8 - WE / - WK
			←	05/97→; → 70-1-000954; +PR 1LB	13.0460-7123.2	607123	ATE 23034 18,8 + WK
			←	70-Y-000001→; +PR 1LU	13.0460-7124.2	607124	ATE 21883 19,8 + WK
			←	70-1-000955→; +PR 1LB	13.0460-7153.2	607153	ATE 23269 19,8 + WK
<b>Zubehörsatz, Scheibenbremsbelag</b>							
1.9 TD 2.0 2.4 D 2.5 2.5 ↓	50 62 57 81 85	10/92→04/03 07/90→04/03 07/90→04/98 11/90→04/03 08/96→04/03	←	70-Y-000001→; +PR 1LE	13.0460-0286.2	610286	
			←	→ 70-X-250000; +PR 1LE	13.0460-0286.2	610286	
			→	70-T-200000→; +PR 2E2	13.0460-0225.2	610225	



















	kw				! #		
<b>VW - TRANSPORTER T4 Kasten (70A, 70H, 7DA, 7DH) 07/90→04/03</b>							
<b>Zubehörsatz, Scheibenbremsbelag</b>							
2.5 Syncro 2.5 TDI 2.5 TDI Syncro 2.8 VR6	85 75 75 103	08/96→04/03 09/95→04/03 09/95→04/03 05/96→05/00	➡	05/97→; +PR 2E3		13.0460-0225.2 610225	
2.4 D 2.5 TDI 2.5 TDI 2.8 VR6	55 65 111 150	08/97→04/03 12/98→04/03 09/00→04/03 06/00→04/03	←	70-Y-000001→; +PR 1LE		13.0460-0286.2 610286	
			←	→ 70-X-250000; +PR 1LE		13.0460-0286.2 610286	
			➡	+PR 2E3		13.0460-0225.2 610225	
			➡	70-T-200000→; +PR 2E2		13.0460-0225.2 610225	
2.4 D Syncro 2.5 Syncro	57 81	10/92→09/98 10/92→04/03	←	70-Y-000001→; +PR 1LE		13.0460-0286.2 610286	
			←	11/92→; → 70-X-250000; +PR 1LE		13.0460-0286.2 610286	
			➡	70-T-200000→; +PR 2E2		13.0460-0225.2 610225	
			➡	05/97→; +PR 2E3		13.0460-0225.2 610225	
<b> Bremsscheibe</b>							
1.9 TD 2.0 2.4 D 2.5	50 62 57 81	10/92→04/03 07/90→04/03 07/90→04/98 11/90→04/03	←	→ 04/96; +PR 1LA		24.0116-0108.1 416108	∅ 260 16 13
			←	70-P-160001→; → 04/96; +PR 1LP		24.0118-0105.1 418105	∅ 282 18 15
			←	05/96→; +PR 1LP		24.0118-0111.1 418111	∅ 282 18 15 + S
			←	→ 04/96; +PR 1LE,1LU		24.0124-0118.1 424118	∅ 280 24 20 V
			←	05/96→; +PR 1LE,1LU		24.0124-0128.1 424128	∅ 280 24 20 V + S
			←	05/97→; → 70-1-000954; +PR 1LB		24.0126-0115.1 426115	∅ 300 26 22 V
						24.0326-0115.1 526115	∅ 300 26 22 V
			←	70-1-000955→; +PR 1LB		24.0126-0119.1 426119	∅ 313 25,9 22 V
						24.0326-0119.1 526119	∅ 313 25,9 22 V
			➡	70-T-200000→; +PR 2E2		24.0112-0138.1 412138	∅ 280 12 10 + S
			➡	05/97→; +PR 2E3		24.0113-0194.1 413194	∅ 294 13,5 11,5
2.4 D 2.5 TDI 2.5 TDI 2.8 VR6	55 65 111 150	08/97→04/03 12/98→04/03 09/00→04/03 06/00→04/03	←	+PR 1LP		24.0118-0111.1 418111	∅ 282 18 15 + S
			←	+PR 1LE,1LU		24.0124-0128.1 424128	∅ 280 24 20 V + S
			←	→ 70-1-000954; +PR 1LB		24.0126-0115.1 426115	∅ 300 26 22 V
						24.0326-0115.1 526115	∅ 300 26 22 V
			←	70-1-000955→; +PR 1LB		24.0126-0119.1 426119	∅ 313 25,9 22 V
						24.0326-0119.1 526119	∅ 313 25,9 22 V
			➡	70-T-200000→; +PR 2E2		24.0112-0138.1 412138	∅ 280 12 10 + S
			➡	+PR 2E3		24.0113-0194.1 413194	∅ 294 13,5 11,5
2.4 D Syncro 2.5 Syncro	57 81	10/92→09/98 10/92→04/03	←	11/92→ 04/96; +PR 1LP		24.0118-0105.1 418105	∅ 282 18 15
			←	05/96→; +PR 1LP		24.0118-0111.1 418111	∅ 282 18 15 + S
			←	11/92→ 06/95; +PR 1LE,1LU		24.0124-0118.1 424118	∅ 280 24 20 V
			←	07/95→; +PR 1LE,1LU		24.0124-0128.1 424128	∅ 280 24 20 V + S
			←	07/95→; +PR 1LB		24.0126-0119.1 426119	∅ 313 25,9 22 V
						24.0326-0119.1 526119	∅ 313 25,9 22 V
			➡	05/96→; +PR 2E2		24.0112-0138.1 412138	∅ 280 12 10 + S
			➡	05/97→; +PR 2E3		24.0113-0194.1 413194	∅ 294 13,5 11,5
2.5 2.8 VR6	85 103	08/96→04/03 05/96→05/00	←	+PR 1LP		24.0118-0111.1 418111	∅ 282 18 15 + S
			←	+PR 1LE,1LU		24.0124-0128.1 424128	∅ 280 24 20 V + S
			←	05/97→; → 70-1-000954; +PR 1LB		24.0126-0115.1 426115	∅ 300 26 22 V
						24.0326-0115.1 526115	∅ 300 26 22 V
			←	70-1-000955→; +PR 1LB		24.0126-0119.1 426119	∅ 313 25,9 22 V
						24.0326-0119.1 526119	∅ 313 25,9 22 V
			➡	70-T-200000→; +PR 2E2		24.0112-0138.1 412138	∅ 280 12 10 + S
			➡	05/97→; +PR 2E3		24.0113-0194.1 413194	∅ 294 13,5 11,5
2.5 Syncro	85	08/96→04/03	←	+PR 1LP		24.0118-0111.1 418111	∅ 282 18 15 + S
			←	+PR 1LE,1LU		24.0124-0128.1 424128	∅ 280 24 20 V + S
			←	+PR 1LB		24.0126-0119.1 426119	∅ 313 25,9 22 V
						24.0326-0119.1 526119	∅ 313 25,9 22 V
			➡	+PR 2E2		24.0112-0138.1 412138	∅ 280 12 10 + S
			➡	05/97→; +PR 2E3		24.0113-0194.1 413194	∅ 294 13,5 11,5
2.5 TDI	75	09/95→04/03	←	→ 04/96; +PR 1LA		24.0116-0108.1 416108	∅ 260 16 13
			←	→ 04/96; +PR 1LP		24.0118-0105.1 418105	∅ 282 18 15









	kw					! #		
<b>VW - TRANSPORTER T4 Kasten (70A, 70H, 7DA, 7DH) 07/90→04/03</b>								
<b>Bremsscheibe</b>								
2.5 TDI	75	09/95→04/03	←	05/96→; +PR 1LP	24.0118-0111.1	418111	Ø 282 18 15 + S	
			←	→ 04/96; +PR 1LE,1LU	24.0124-0118.1	424118	Ø 280 24 20 V	
			←	05/96→; +PR 1LE,1LU	24.0124-0128.1	424128	Ø 280 24 20 V + S	
			←	05/97→; → 70-1-000954; +PR 1LB	24.0126-0115.1	426115	Ø 300 26 22 V	
					24.0326-0115.1	526115	Ø 300 26 22 V	
			←	70-1-000955→; +PR 1LB	24.0126-0119.1	426119	Ø 313 25,9 22 V	
					24.0326-0119.1	526119	Ø 313 25,9 22 V	
			→	70-T-200000→; +PR 2E2	24.0112-0138.1	412138	Ø 280 12 10 + S	
			→	05/97→; +PR 2E3	24.0113-0194.1	413194	Ø 294 13,5 11,5	
2.5 TDI Syncro	75	09/95→04/03	←	→ 04/96; +PR 1LP	24.0118-0105.1	418105	Ø 282 18 15	
			←	05/96→; +PR 1LP	24.0118-0111.1	418111	Ø 282 18 15 + S	
			←	+PR 1LE,1LU	24.0124-0128.1	424128	Ø 280 24 20 V + S	
			←	+PR 1LB	24.0126-0119.1	426119	Ø 313 25,9 22 V	
					24.0326-0119.1	526119	Ø 313 25,9 22 V	
			→	05/96→; +PR 2E2	24.0112-0138.1	412138	Ø 280 12 10 + S	
			→	05/97→; +PR 2E3	24.0113-0194.1	413194	Ø 294 13,5 11,5	
<b>VW - TRANSPORTER T4 Pritsche/Fahrgestell (70E, 70L, 70M, 7DE, 7DL 07/90→04/03</b>								
<b>Bremsbelagsatz, Scheibenbremse</b>								
1.9 TD 2.0 2.4 D 2.5	50 62 57 81	10/92→04/03 07/90→04/03 09/90→04/98 11/90→04/03	←	70-Y-000001→; +PR 1LP	13.0460-2838.2	602838	TRW 21479 19,2 + WK	
			←	70-Y-000001→; +PR 1LE	13.0460-2839.2	602839	TRW 20651 18,3 + WK	
			←	→ 04/96; +PR 1LA	13.0460-2972.2	602972	TRW 20124 18,9 - WK	
			←	→ 70-X-250000; +PR 1LE	13.0460-2973.2	602973	TRW 20651 18,0 - WE / - WK	
			←	70-P-160001→ 70-X-250000; +PR 1LP	13.0460-2982.2	602982	TRW 21479 19,2 - WK	
			←	05/96→; → 70-X-250000; +PR 1LU	13.0460-7102.2	607102	ATE 21883 19,8 - WE / - WK	
			←	05/97→; → 70-1-000954; +PR 1LB	13.0460-7123.2	607123	ATE 23034 18,8 + WK	
			←	70-Y-000001→; +PR 1LU	13.0460-7124.2	607124	ATE 21883 19,8 + WK	
			←	70-1-000955→; +PR 1LB	13.0460-7153.2	607153	ATE 23269 19,8 + WK	
			→	05/97→; +PR 2E3	13.0460-2872.2	602872	TRW 23224 16,5 + WK + Zub	
			→	70-T-200000→; +PR 2E2	13.0460-2874.2	602874	TRW 23224 16,5 + WK + Zub	
			2.4 D	55	08/97→04/03	←	70-Y-000001→; +PR 1LP	13.0460-2838.2
←	70-Y-000001→; +PR 1LE	13.0460-2839.2				602839	TRW 20651 18,3 + WK	
←	→ 70-X-250000; +PR 1LE	13.0460-2973.2				602973	TRW 20651 18,0 - WE / - WK	
←	70-P-160001→ 70-X-250000; +PR 1LP	13.0460-2982.2				602982	TRW 21479 19,2 - WK	
←	→ 70-X-250000; +PR 1LU	13.0460-7102.2				607102	ATE 21883 19,8 - WE / - WK	
←	→ 70-1-000954; +PR 1LB	13.0460-7123.2				607123	ATE 23034 18,8 + WK	
←	70-Y-000001→; +PR 1LU	13.0460-7124.2				607124	ATE 21883 19,8 + WK	
←	70-1-000955→; +PR 1LB	13.0460-7153.2				607153	ATE 23269 19,8 + WK	
→	+PR 2E3	13.0460-2872.2				602872	TRW 23224 16,5 + WK + Zub	
→	70-T-200000→; +PR 2E2	13.0460-2874.2				602874	TRW 23224 16,5 + WK + Zub	
2.4 D Syncro 2.5 Syncro	57 81	10/92→09/98 10/92→04/03				←	70-Y-000001→; +PR 1LP	13.0460-2838.2
			←	70-Y-000001→; +PR 1LE	13.0460-2839.2	602839	TRW 20651 18,3 + WK	
			←	11/92→; → 70-X-250000; +PR 1LE	13.0460-2973.2	602973	TRW 20651 18,0 - WE / - WK	
			←	11/92→; → 70-X-250000; +PR 1LP	13.0460-2982.2	602982	TRW 21479 19,2 - WK	
			←	07/95→; → 70-X-250000; +PR 1LU	13.0460-7102.2	607102	ATE 21883 19,8 - WE / - WK	
			←	70-Y-000001→; +PR 1LU	13.0460-7124.2	607124	ATE 21883 19,8 + WK	
			←	07/95→; +PR 1LB	13.0460-7153.2	607153	ATE 23269 19,8 + WK	
			→	05/97→; +PR 2E3	13.0460-2872.2	602872	TRW 23224 16,5 + WK + Zub	
			→	70-T-200000→; +PR 2E2	13.0460-2874.2	602874	TRW 23224 16,5 + WK + Zub	
			2.5	85	08/96→04/03	←	70-Y-000001→; +PR 1LP	13.0460-2838.2
←	70-Y-000001→; +PR 1LE	13.0460-2839.2				602839	TRW 20651 18,3 + WK	
←	→ 70-X-250000; +PR 1LE	13.0460-2973.2				602973	TRW 20651 18,0 - WE / - WK	
←	70-P-160001→ 70-X-250000; +PR 1LP	13.0460-2982.2				602982	TRW 21479 19,2 - WK	
←	→ 70-X-250000; +PR 1LU	13.0460-7102.2				607102	ATE 21883 19,8 - WE / - WK	







	kw			 	! #		
<b>VW - TRANSPORTER T4 Pritsche/Fahrgestell (70E, 70L, 70M, 7DE, 7DL 07/90→04/03</b>							
<b>Bremsbelagsatz, Scheibenbremse</b>							
2.5	85	08/96→04/03	←	05/97→; → 70-1-000954; +PR 1LB		13.0460-7123.2 607123	ATE 23034 18,8 + WK
			←	70-Y-000001→; +PR 1LU		13.0460-7124.2 607124	ATE 21883 19,8 + WK
			←	70-1-000955→; +PR 1LB		13.0460-7153.2 607153	ATE 23269 19,8 + WK
			→	05/97→; +PR 2E3		13.0460-2872.2 602872	TRW 23224 16,5 + WK + Zub
			→	70-T-200000→; +PR 2E2		13.0460-2874.2 602874	TRW 23224 16,5 + WK + Zub
2.5 Syncro	85	08/96→04/03	←	70-Y-000001→; +PR 1LP		13.0460-2838.2 602838	TRW 21479 19,2 + WK
			←	70-Y-000001→; +PR 1LE		13.0460-2839.2 602839	TRW 20651 18,3 + WK
			←	→ 70-X-250000; +PR 1LE		13.0460-2973.2 602973	TRW 20651 18,0 - WE / - WK
			←	→ 70-X-250000; +PR 1LP		13.0460-2982.2 602982	TRW 21479 19,2 - WK
			←	→ 70-X-250000; +PR 1LU		13.0460-7102.2 607102	ATE 21883 19,8 - WE / - WK
			←	70-Y-000001→; +PR 1LU		13.0460-7124.2 607124	ATE 21883 19,8 + WK
			←	+PR 1LB		13.0460-7153.2 607153	ATE 23269 19,8 + WK
			→	05/97→; +PR 2E3		13.0460-2872.2 602872	TRW 23224 16,5 + WK + Zub
			→	70-T-200000→; +PR 2E2		13.0460-2874.2 602874	TRW 23224 16,5 + WK + Zub
2.5 TDI	65	05/98→04/03	←	70-Y-000001→; +PR 1LP		13.0460-2838.2 602838	TRW 21479 19,2 + WK
			←	70-Y-000001→; +PR 1LE		13.0460-2839.2 602839	TRW 20651 18,3 + WK
			←	→ 70-X-250000; +PR 1LE		13.0460-2973.2 602973	TRW 20651 18,0 - WE / - WK
			←	→ 70-X-250000; +PR 1LP		13.0460-2982.2 602982	TRW 21479 19,2 - WK
			←	→ 70-X-250000; +PR 1LU		13.0460-7102.2 607102	ATE 21883 19,8 - WE / - WK
			←	→ 70-1-000954; +PR 1LB		13.0460-7123.2 607123	ATE 23034 18,8 + WK
			←	70-Y-000001→; +PR 1LU		13.0460-7124.2 607124	ATE 21883 19,8 + WK
			←	70-1-000955→; +PR 1LB		13.0460-7153.2 607153	ATE 23269 19,8 + WK
			→	+PR 2E3		13.0460-2872.2 602872	TRW 23224 16,5 + WK + Zub
			→	70-T-200000→; +PR 2E2		13.0460-2874.2 602874	TRW 23224 16,5 + WK + Zub
2.5 TDI	75	09/95→04/03	←	70-Y-000001→; +PR 1LP		13.0460-2838.2 602838	TRW 21479 19,2 + WK
			←	70-Y-000001→; +PR 1LE		13.0460-2839.2 602839	TRW 20651 18,3 + WK
			←	→ 04/96; +PR 1LA		13.0460-2972.2 602972	TRW 20124 18,9 - WK
			←	→ 70-X-250000; +PR 1LE		13.0460-2973.2 602973	TRW 20651 18,0 - WE / - WK
			←	→ 70-X-250000; +PR 1LP		13.0460-2982.2 602982	TRW 21479 19,2 - WK
			←	05/96→; → 70-X-250000; +PR 1LU		13.0460-7102.2 607102	ATE 21883 19,8 - WE / - WK
			←	05/97→; → 70-1-000954; +PR 1LB		13.0460-7123.2 607123	ATE 23034 18,8 + WK
			←	70-Y-000001→; +PR 1LU		13.0460-7124.2 607124	ATE 21883 19,8 + WK
			←	70-1-000955→; +PR 1LB		13.0460-7153.2 607153	ATE 23269 19,8 + WK
			→	05/97→; +PR 2E3		13.0460-2872.2 602872	TRW 23224 16,5 + WK + Zub
			→	70-T-200000→; +PR 2E2		13.0460-2874.2 602874	TRW 23224 16,5 + WK + Zub
2.5 TDI Syncro	75	05/98→04/03	←	70-Y-000001→; +PR 1LP		13.0460-2838.2 602838	TRW 21479 19,2 + WK
			←	70-Y-000001→; +PR 1LE		13.0460-2839.2 602839	TRW 20651 18,3 + WK
			←	→ 70-X-250000; +PR 1LE		13.0460-2973.2 602973	TRW 20651 18,0 - WE / - WK
			←	→ 70-X-250000; +PR 1LP		13.0460-2982.2 602982	TRW 21479 19,2 - WK
			←	→ 70-X-250000; +PR 1LU		13.0460-7102.2 607102	ATE 21883 19,8 - WE / - WK
			←	70-Y-000001→; +PR 1LU		13.0460-7124.2 607124	ATE 21883 19,8 + WK
			←	+PR 1LB		13.0460-7153.2 607153	ATE 23269 19,8 + WK
			→	+PR 2E3		13.0460-2872.2 602872	TRW 23224 16,5 + WK + Zub
			→	70-T-200000→; +PR 2E2		13.0460-2874.2 602874	TRW 23224 16,5 + WK + Zub
<b>Zubehörsatz, Scheibenbremsbelag</b>							
1.9 TD	50	10/92→04/03	←	70-Y-000001→; +PR 1LE		13.0460-0286.2 610286	
2.0	62	07/90→04/03					
2.4 D	57	09/90→04/98	←	→ 70-X-250000; +PR 1LE		13.0460-0286.2 610286	
2.5	81	11/90→04/03	→	70-T-200000→; +PR 2E2		13.0460-0225.2 610225	
2.5	85	08/96→04/03					
2.5 Syncro	85	08/96→04/03	→	05/97→; +PR 2E3		13.0460-0225.2 610225	
2.5 TDI	75	09/95→04/03					
2.4 D	55	08/97→04/03	←	70-Y-000001→; +PR 1LE		13.0460-0286.2 610286	
2.5 TDI	65	05/98→04/03	←	→ 70-X-250000; +PR 1LE		13.0460-0286.2 610286	
2.5 TDI Syncro	75	05/98→04/03	→	+PR 2E3		13.0460-0225.2 610225	
↓							







	kw			 	! #		
<b>VW - TRANSPORTER T4 Pritsche/Fahrgestell (70E, 70L, 70M, 7DE, 7DL 07/90→04/03)</b>							
<b>Zubehörsatz, Scheibenbremsbelag</b>							
2.4 D 2.5 TDI 2.5 TDI Syncro	55 65 75	08/97→04/03 05/98→04/03 05/98→04/03	➡	70-T-200000→; +PR 2E2		13.0460-0225.2 610225	
2.4 D Syncro 2.5 Syncro	57 81	10/92→09/98 10/92→04/03	⬅	70-Y-000001→; +PR 1LE		13.0460-0286.2 610286	
			⬅	11/92→; → 70-X-250000; +PR 1LE		13.0460-0286.2 610286	
			➡	70-T-200000→; +PR 2E2		13.0460-0225.2 610225	
			➡	05/97→; +PR 2E3		13.0460-0225.2 610225	
<b> Bremsscheibe</b>							
1.9 TD 2.0 2.4 D 2.5	50 62 57 81	10/92→04/03 07/90→04/03 09/90→04/98 11/90→04/03	⬅	→ 04/96; +PR 1LA		24.0116-0108.1 416108	Ø 260 16 13
			⬅	70-P-160001→; → 04/96; +PR 1LP		24.0118-0105.1 418105	Ø 282 18 15
			⬅	05/96→; +PR 1LP		24.0118-0111.1 418111	Ø 282 18 15 + S
			⬅	→ 04/96; +PR 1LE,1LU		24.0124-0118.1 424118	Ø 280 24 20 V
			⬅	05/96→; +PR 1LE,1LU		24.0124-0128.1 424128	Ø 280 24 20 V + S
			⬅	05/97→; → 70-1-000954; +PR 1LB		24.0126-0115.1 426115	Ø 300 26 22 V
						24.0326-0115.1 526115	Ø 300 26 22 V
			⬅	70-1-000955→; +PR 1LB		24.0126-0119.1 426119	Ø 313 25,9 22 V
						24.0326-0119.1 526119	Ø 313 25,9 22 V
			➡	70-T-200000→; +PR 2E2		24.0112-0138.1 412138	Ø 280 12 10 + S
			➡	05/97→; +PR 2E3		24.0113-0194.1 413194	Ø 294 13,5 11,5
2.4 D 2.5 TDI	55 65	08/97→04/03 05/98→04/03	⬅	+PR 1LP		24.0118-0111.1 418111	Ø 282 18 15 + S
			⬅	+PR 1LE,1LU		24.0124-0128.1 424128	Ø 280 24 20 V + S
			⬅	→ 70-1-000954; +PR 1LB		24.0126-0115.1 426115	Ø 300 26 22 V
						24.0326-0115.1 526115	Ø 300 26 22 V
			⬅	70-1-000955→; +PR 1LB		24.0126-0119.1 426119	Ø 313 25,9 22 V
						24.0326-0119.1 526119	Ø 313 25,9 22 V
			➡	70-T-200000→; +PR 2E2		24.0112-0138.1 412138	Ø 280 12 10 + S
			➡	+PR 2E3		24.0113-0194.1 413194	Ø 294 13,5 11,5
2.4 D Syncro 2.5 Syncro	57 81	10/92→09/98 10/92→04/03	⬅	11/92→ 04/96; +PR 1LP		24.0118-0105.1 418105	Ø 282 18 15
			⬅	05/96→; +PR 1LP		24.0118-0111.1 418111	Ø 282 18 15 + S
			⬅	11/92→ 06/95; +PR 1LE,1LU		24.0124-0118.1 424118	Ø 280 24 20 V
			⬅	07/95→; +PR 1LE,1LU		24.0124-0128.1 424128	Ø 280 24 20 V + S
			⬅	07/95→; +PR 1LB		24.0126-0119.1 426119	Ø 313 25,9 22 V
						24.0326-0119.1 526119	Ø 313 25,9 22 V
			➡	05/96→; +PR 2E2		24.0112-0138.1 412138	Ø 280 12 10 + S
			➡	05/97→; +PR 2E3		24.0113-0194.1 413194	Ø 294 13,5 11,5
2.5	85	08/96→04/03	⬅	+PR 1LP		24.0118-0111.1 418111	Ø 282 18 15 + S
			⬅	+PR 1LE,1LU		24.0124-0128.1 424128	Ø 280 24 20 V + S
			⬅	05/97→; → 70-1-000954; +PR 1LB		24.0126-0115.1 426115	Ø 300 26 22 V
						24.0326-0115.1 526115	Ø 300 26 22 V
			⬅	70-1-000955→; +PR 1LB		24.0126-0119.1 426119	Ø 313 25,9 22 V
						24.0326-0119.1 526119	Ø 313 25,9 22 V
			➡	70-T-200000→; +PR 2E2		24.0112-0138.1 412138	Ø 280 12 10 + S
			➡	05/97→; +PR 2E3		24.0113-0194.1 413194	Ø 294 13,5 11,5
2.5 Syncro	85	08/96→04/03	⬅	+PR 1LP		24.0118-0111.1 418111	Ø 282 18 15 + S
			⬅	+PR 1LE,1LU		24.0124-0128.1 424128	Ø 280 24 20 V + S
			⬅	+PR 1LB		24.0126-0119.1 426119	Ø 313 25,9 22 V
						24.0326-0119.1 526119	Ø 313 25,9 22 V
			➡	+PR 2E2		24.0112-0138.1 412138	Ø 280 12 10 + S
			➡	05/97→; +PR 2E3		24.0113-0194.1 413194	Ø 294 13,5 11,5
2.5 TDI	75	09/95→04/03	⬅	→ 04/96; +PR 1LA		24.0116-0108.1 416108	Ø 260 16 13
			⬅	→ 04/96; +PR 1LP		24.0118-0105.1 418105	Ø 282 18 15
			⬅	05/96→; +PR 1LP		24.0118-0111.1 418111	Ø 282 18 15 + S
			⬅	→ 04/96; +PR 1LE,1LU		24.0124-0118.1 424118	Ø 280 24 20 V
			⬅	05/96→; +PR 1LE,1LU		24.0124-0128.1 424128	Ø 280 24 20 V + S
			⬅	05/97→; → 70-1-000954; +PR 1LB		24.0126-0115.1 426115	Ø 300 26 22 V
						24.0326-0115.1 526115	Ø 300 26 22 V









	kw					! #		
<b>VW - TRANSPORTER T4 Pritsche/Fahrgestell (70E, 70L, 70M, 7DE, 7DL 07/90→04/03</b>								
<b>Bremsscheibe</b>								
2.5 TDI	75	09/95→04/03	←	70-1-000955→; +PR 1LB	24.0126-0119.1	426119	∅ 313 25,9 22 V	
			→	70-T-200000→; +PR 2E2	24.0326-0119.1	526119	∅ 313 25,9 22 V	
			→	05/97→; +PR 2E3	24.0112-0138.1	412138	∅ 280 12 10 + S	
2.5 TDI Syncro	75	05/98→04/03	←	+PR 1LP	24.0113-0194.1	413194	∅ 294 13,5 11,5	
			←	+PR 1LE,1LU	24.0118-0111.1	418111	∅ 282 18 15 + S	
			←	+PR 1LB	24.0124-0128.1	424128	∅ 280 24 20 V + S	
			←	+PR 1LB	24.0126-0119.1	426119	∅ 313 25,9 22 V	
			→	+PR 2E2	24.0326-0119.1	526119	∅ 313 25,9 22 V	
			→	+PR 2E3	24.0112-0138.1	412138	∅ 280 12 10 + S	
<b>VW - TRANSPORTER T5 Bus (7HB, 7HJ, 7EB, 7EJ, 7EF, 7EG, 7HF, 7EC) 04/03→08/15</b>								
<b>Bremsbelagsatz, Scheibenbremse</b>								
1.9 TDI	62	01/06→11/09	←	+PR 2E3	13.0460-7236.2	607236	ATE 23746 19,7 + WK	
1.9 TDI	75	06/06→11/09	←	+PR 2E4; → 7H-A-050000	13.0460-7240.2	607240	ATE 23746 18,1 + WK	
			←	7H-A-200001→; +PR 2E4	13.0460-7286.2	607286	ATE 24623 18,2 + WK	
			→	7H-A-200001→	13.0460-2882.2	602882	TRW 23326 17,4 + WK + Zub	
			→	7H-8-028000→; +PR 0WR; → 7H-8-200000	13.0460-2882.2	602882	TRW 23326 17,4 + WK + Zub	
			→	7H-6-000001→; +PR 2E3,2E4; → 7H-A-050000	13.0460-2882.2	602882	TRW 23326 17,4 + WK + Zub	
			→	+PR 0WR; → 7H-8-027999	13.0460-7218.2	607218	ATE 24367 19,1 + WK	
1.9 TDI	63	04/03→11/09	←	+PR 2E3	13.0460-7236.2	607236	ATE 23746 19,7 + WK	
1.9 TDI	77	04/03→11/09	←	+PR 2E4; → 7H-A-050000	13.0460-7240.2	607240	ATE 23746 18,1 + WK	
2.0	85	11/03→08/15	←	+PR 2E4; → 7H-A-050000	13.0460-7240.2	607240	ATE 23746 18,1 + WK	
2.5 TDi	120	11/03→11/09	←	7H-A-200001→; +PR 2E4	13.0460-7286.2	607286	ATE 24623 18,2 + WK	
2.5 TDI	96	04/03→11/09	←	7H-A-200001→; +PR 2E4	13.0460-7286.2	607286	ATE 24623 18,2 + WK	
2.5 TDI	128	04/03→11/09	→	7H-8-028000→; +PR 0WR; → 7H-8-200000	13.0460-2882.2	602882	TRW 23326 17,4 + WK + Zub	
2.5 TDI 4motion	96	07/04→11/09	→	7H-A-200001→	13.0460-2882.2	602882	TRW 23326 17,4 + WK + Zub	
2.5 TDI 4motion	128	07/04→11/09	→	7H-A-200001→	13.0460-2882.2	602882	TRW 23326 17,4 + WK + Zub	
3.2 V6	170	02/04→06/04	→	7H-6-000001→; +PR 2E3,2E4; → 7H-A-050000	13.0460-2882.2	602882	TRW 23326 17,4 + WK + Zub	
3.2 V6	173	02/04→11/09	→	+PR 0WL,0WN / 0WM,0WP,0WQ; → 7H-5-120000	13.0460-2882.2	602882	TRW 23326 17,4 + WK + Zub	
			→	+PR 0WR; → 7H-8-027999	13.0460-7218.2	607218	ATE 24367 19,1 + WK	
2.0 BiTDI	132	09/09→08/15	←	+PR 2E3	13.0460-7236.2	607236	ATE 23746 19,7 + WK	
2.0 BiTDI 4motion	132	09/09→08/15	←	+PR 2E4; → 7H-A-050000	13.0460-7240.2	607240	ATE 23746 18,1 + WK	
2.0 TDI	62	09/09→08/15	←	+PR 2E4; → 7H-A-050000	13.0460-7240.2	607240	ATE 23746 18,1 + WK	
2.0 TDI	75	09/09→08/15	←	7H-A-200001→; +PR 2E4	13.0460-7286.2	607286	ATE 24623 18,2 + WK	
2.0 TDI	103	09/09→08/15	←	7H-A-200001→; +PR 2E4	13.0460-7286.2	607286	ATE 24623 18,2 + WK	
2.0 TDI 4motion	103	09/09→08/15	→	7H-A-200001→	13.0460-2882.2	602882	TRW 23326 17,4 + WK + Zub	
			→	7H-6-000001→; +PR 2E3,2E4; → 7H-A-050000	13.0460-2882.2	602882	TRW 23326 17,4 + WK + Zub	
2.0 TDI	84	05/11→08/15	←	+PR 2E3	13.0460-7236.2	607236	ATE 23746 19,7 + WK	
2.0 TSI	110	07/12→08/15	←	+PR 2E4	13.0460-7286.2	607286	ATE 24623 18,2 + WK	
2.0 TSI	150	05/11→08/15	←	+PR 2E4	13.0460-7286.2	607286	ATE 24623 18,2 + WK	
2.0 TSI 4motion	150	07/11→08/15	→		13.0460-2882.2	602882	TRW 23326 17,4 + WK + Zub	
2.0 TDI	100	05/10→08/15	←	+PR 2E3	13.0460-7236.2	607236	ATE 23746 19,7 + WK	
2.0 TDI 4motion	100	05/10→08/15	←	7H-A-200001→; +PR 2E4	13.0460-7286.2	607286	ATE 24623 18,2 + WK	
			→	7H-A-200001→	13.0460-2882.2	602882	TRW 23326 17,4 + WK + Zub	
3.2 V6 4motion	173	11/03→11/09	←	07/04→; +PR 2E3	13.0460-7236.2	607236	ATE 23746 19,7 + WK	
			←	07/04→; +PR 2E4; → 7H-A-050000	13.0460-7240.2	607240	ATE 23746 18,1 + WK	
			←	7H-A-200001→; +PR 2E4	13.0460-7286.2	607286	ATE 24623 18,2 + WK	
			→	7H-8-028000→; +PR 0WR; → 7H-8-200000	13.0460-2882.2	602882	TRW 23326 17,4 + WK + Zub	
			→	07/04→; +PR 0WL,0WN / 0WM,0WP,0WQ; → 7H-5-120000	13.0460-2882.2	602882	TRW 23326 17,4 + WK + Zub	
			→	7H-A-200001→	13.0460-2882.2	602882	TRW 23326 17,4 + WK + Zub	
			→	7H-6-000001→; +PR 2E3,2E4; → 7H-A-050000	13.0460-2882.2	602882	TRW 23326 17,4 + WK + Zub	
			→	07/04→; +PR 0WR; → 7H-8-027999	13.0460-7218.2	607218	ATE 24367 19,1 + WK	



	kw			 	! #		
<b>VW - TRANSPORTER T5 Bus (7HB, 7HJ, 7EB, 7EJ, 7EF, 7EG, 7HF, 7EC) 04/03→08/15</b>							
<b>Zubehörsatz, Scheibenbremsbelag</b>							
1.9 TDI 1.9 TDI	62 75	01/06→11/09 06/06→11/09	➡	7H-8-028000→; +PR 0WR; → 7H-8-200000		13.0460-0023.2 610023	
			➡	7H-A-200001→		13.0460-0023.2 610023	
			➡	7H-6-000001→; +PR 2E3,2E4; → 7H-A-050000		13.0460-0023.2 610023	
1.9 TDI 1.9 TDI 2.0 2.5 TDi 2.5 TDI 2.5 TDI 2.5 TDI 4motion 2.5 TDI 4motion 3.2 V6 3.2 V6	63 77 85 120 96 128 96 128 170 173	04/03→11/09 04/03→11/09 11/03→08/15 11/03→11/09 04/03→11/09 04/03→11/09 07/04→11/09 07/04→11/09 02/04→06/04 02/04→11/09	➡	7H-8-028000→; +PR 0WR; → 7H-8-200000		13.0460-0023.2 610023	
			➡	+PR OWL,OWN / OWM,OWP,OWQ; → 7H-5-120000		13.0460-0023.2 610023	
			➡	7H-6-000001→; +PR 2E3,2E4; → 7H-A-050000		13.0460-0023.2 610023	
			➡	7H-A-200001→		13.0460-0023.2 610023	
2.0 BiTDI 2.0 BiTDI 4motion 2.0 TDI 2.0 TDI 2.0 TDI 2.0 TDI 4motion	132 132 62 75 103 103	09/09→08/15 09/09→08/15 09/09→08/15 09/09→08/15 09/09→08/15 09/09→08/15	➡	7H-A-200001→		13.0460-0023.2 610023	
			➡	7H-6-000001→; +PR 2E3,2E4; → 7H-A-050000		13.0460-0023.2 610023	
2.0 TDI 2.0 TSI 2.0 TSI 2.0 TSI 4motion	84 110 150 150	05/11→08/15 07/12→08/15 05/11→08/15 07/11→08/15	➡			13.0460-0023.2 610023	
2.0 TDI 2.0 TDI 4motion	100 100	05/10→08/15 05/10→08/15	➡	7H-A-200001→		13.0460-0023.2 610023	
3.2 V6 4motion	173	11/03→11/09	➡	7H-A-200001→		13.0460-0023.2 610023	
			➡	7H-8-028000→; +PR 0WR; → 7H-8-200000		13.0460-0023.2 610023	
			➡	7H-6-000001→; +PR 2E3,2E4; → 7H-A-050000		13.0460-0023.2 610023	
			➡	07/04→; +PR OWL,OWN / OWM,OWP,OWQ; → 7H-5-120000		13.0460-0023.2 610023	
<b>Bremsscheibe</b>							
1.9 TDI 1.9 TDI	62 75	01/06→11/09 06/06→11/09	←	+PR 2E3		24.0130-0114.1 430114	Ø 308 29,5 25,5 V
			←	→ 7H-A-050000; +PR 2E4		24.0132-0116.1 432116	Ø 333 32,5 28,5 V + S
			←	7H-A-200001→; +PR 2E4		24.0133-0100.1 433100	Ø 340 32,6 29,5 V + S
			➡	7H-A-200001→		24.0122-0211.1 422211	Ø 294 21,9 19,5 V + S
			➡	7H-8-028000→; +PR 0WR; → 7H-8-200000		24.0122-0211.1 422211	Ø 294 21,9 19,5 V + S
			➡	7H-6-000001→; +PR 2E3,2E4; → 7H-A-050000		24.0122-0211.1 422211	Ø 294 21,9 19,5 V + S
			➡	+PR 0WR; → 7H-8-027999		24.0122-0215.1 422215	Ø 314 22 18 V + S
1.9 TDI 1.9 TDI 2.0 2.5 TDi 2.5 TDI 2.5 TDI 2.5 TDI 4motion 2.5 TDI 4motion 3.2 V6 3.2 V6	63 77 85 120 96 128 96 128 170 173	04/03→11/09 04/03→11/09 11/03→08/15 11/03→11/09 04/03→11/09 04/03→11/09 07/04→11/09 07/04→11/09 02/04→06/04 02/04→11/09	←	+PR 2E3		24.0130-0114.1 430114	Ø 308 29,5 25,5 V
			←	→ 7H-A-050000; +PR 2E4		24.0132-0116.1 432116	Ø 333 32,5 28,5 V + S
			←	7H-A-200001→; +PR 2E4		24.0133-0100.1 433100	Ø 340 32,6 29,5 V + S
			➡	7H-8-028000→; +PR 0WR; → 7H-8-200000		24.0122-0211.1 422211	Ø 294 21,9 19,5 V + S
			➡	7H-A-200001→		24.0122-0211.1 422211	Ø 294 21,9 19,5 V + S
			➡	7H-6-000001→; +PR 2E3,2E4; → 7H-A-050000		24.0122-0211.1 422211	Ø 294 21,9 19,5 V + S
			➡	+PR OWL,OWN / OWM,OWP,OWQ; → 7H-5-120000		24.0122-0211.1 422211	Ø 294 21,9 19,5 V + S
			➡	+PR 0WR; → 7H-8-027999		24.0122-0215.1 422215	Ø 314 22 18 V + S
2.0 BiTDI 2.0 BiTDI 4motion 2.0 TDI 2.0 TDI 2.0 TDI 4motion	132 132 62 75 103 103	09/09→08/15 09/09→08/15 09/09→08/15 09/09→08/15 09/09→08/15	←	+PR 2E3		24.0130-0114.1 430114	Ø 308 29,5 25,5 V
			←	→ 7H-A-050000; +PR 2E4		24.0132-0116.1 432116	Ø 333 32,5 28,5 V + S
			←	7H-A-200001→; +PR 2E4		24.0133-0100.1 433100	Ø 340 32,6 29,5 V + S
			➡	7H-A-200001→		24.0122-0211.1 422211	Ø 294 21,9 19,5 V + S
			➡	7H-6-000001→; +PR 2E3,2E4; → 7H-A-050000		24.0122-0211.1 422211	Ø 294 21,9 19,5 V + S
2.0 TDI 2.0 TSI 2.0 TSI 2.0 TSI 4motion	84 110 150 150	05/11→08/15 07/12→08/15 05/11→08/15 07/11→08/15	←	+PR 2E3		24.0130-0114.1 430114	Ø 308 29,5 25,5 V
			←	+PR 2E4		24.0133-0100.1 433100	Ø 340 32,6 29,5 V + S
			➡			24.0122-0211.1 422211	Ø 294 21,9 19,5 V + S
2.0 TDI 2.0 TDI 4motion	100 100	05/10→08/15 05/10→08/15	←	+PR 2E3		24.0130-0114.1 430114	Ø 308 29,5 25,5 V
			←	7H-A-200001→; +PR 2E4		24.0133-0100.1 433100	Ø 340 32,6 29,5 V + S
↓							

	kw					! #		
<b>VW - TRANSPORTER T5 Bus (7HB, 7HJ, 7EB, 7EJ, 7EF, 7EG, 7HF, 7EC) 04/03→08/15</b>								
<b>Bremsscheibe</b>								
2.0 TDI	100	05/10→08/15	➔	7H-A-200001→		24.0122-0211.1	422211	Ø 294 21,9 19,5 V + S
2.0 TDI 4motion	100	05/10→08/15						
3.2 V6 4motion	173	11/03→11/09	➔	07/04→; +PR 2E3		24.0130-0114.1	430114	Ø 308 29,5 25,5 V
			➔	07/04→; → 7H-A-050000; +PR 2E4		24.0132-0116.1	432116	Ø 333 32,5 28,5 V + S
			➔	7H-A-200001→; +PR 2E4		24.0133-0100.1	433100	Ø 340 32,6 29,5 V + S
			➔	7H-8-028000→; +PR 0WR; → 7H-8-200000		24.0122-0211.1	422211	Ø 294 21,9 19,5 V + S
			➔	07/04→; +PR 0WL,0WN / 0WM,0WP,0WQ; → 7H-5-120000		24.0122-0211.1	422211	Ø 294 21,9 19,5 V + S
			➔	7H-A-200001→		24.0122-0211.1	422211	Ø 294 21,9 19,5 V + S
			➔	7H-6-000001→; +PR 2E3,2E4; → 7H-A-050000		24.0122-0211.1	422211	Ø 294 21,9 19,5 V + S
			➔	07/04→; +PR 0WR; → 7H-8-027999		24.0122-0215.1	422215	Ø 314 22 18 V + S
<b>VW - TRANSPORTER T5 Kasten (7HA, 7HH, 7EA, 7EH) 04/03→08/15</b>								
<b>Bremsbelagsatz, Scheibenbremse</b>								
1.9 TDI	62	01/06→11/09	➔	+PR 2E3		13.0460-7236.2	607236	ATE 23746 19,7 + WK
1.9 TDI	75	06/06→11/09	➔	+PR 2E4; → 7H-A-050000		13.0460-7240.2	607240	ATE 23746 18,1 + WK
			➔	7H-A-200001→; +PR 2E4		13.0460-7286.2	607286	ATE 24623 18,2 + WK
			➔	7H-A-200001→		13.0460-2882.2	602882	TRW 23326 17,4 + WK + Zub
			➔	7H-8-028000→; +PR 0WR; → 7H-8-200000		13.0460-2882.2	602882	TRW 23326 17,4 + WK + Zub
			➔	7H-6-000001→; +PR 2E3,2E4; → 7H-A-050000		13.0460-2882.2	602882	TRW 23326 17,4 + WK + Zub
			➔	+PR 0WR; → 7H-8-027999		13.0460-7218.2	607218	ATE 24367 19,1 + WK
			➔	+PR 2E3		13.0460-7236.2	607236	ATE 23746 19,7 + WK
			➔	+PR 2E4; → 7H-A-050000		13.0460-7240.2	607240	ATE 23746 18,1 + WK
			➔	7H-A-200001→; +PR 2E4		13.0460-7286.2	607286	ATE 24623 18,2 + WK
1.9 TDI 1.9 TDI 2.0 2.0 BiFuel 2.5 TDI 2.5 TDI 2.5 TDI 4motion 2.5 TDI 4motion 3.2 V6 3.2 V6	63 77 85 85 96 128 96 128 170 173	04/03→11/09 04/03→11/09 11/03→08/15 05/11→08/15 04/03→11/09 04/03→11/09 07/04→11/09 07/04→11/09 04/03→06/04 02/04→11/09	➔	7H-A-200001→		13.0460-2882.2	602882	TRW 23326 17,4 + WK + Zub
			➔	7H-8-028000→; +PR 0WR; → 7H-8-200000		13.0460-2882.2	602882	TRW 23326 17,4 + WK + Zub
			➔	7H-6-000001→; +PR 2E3,2E4; → 7H-A-050000		13.0460-2882.2	602882	TRW 23326 17,4 + WK + Zub
			➔	+PR 0WR; → 7H-8-027999		13.0460-7218.2	607218	ATE 24367 19,1 + WK
			➔	+PR 2E3		13.0460-7236.2	607236	ATE 23746 19,7 + WK
			➔	+PR 2E4; → 7H-A-050000		13.0460-7240.2	607240	ATE 23746 18,1 + WK
			➔	7H-A-200001→; +PR 2E4		13.0460-7286.2	607286	ATE 24623 18,2 + WK
			➔	7H-A-200001→		13.0460-2882.2	602882	TRW 23326 17,4 + WK + Zub
2.0 BiTDI 2.0 BiTDI 4motion 2.0 TDI 2.0 TDI 2.0 TDI 2.0 TDI 4motion	132 132 62 75 103 103	09/09→08/15 09/09→08/15 09/09→08/15 09/09→08/15 09/09→08/15 09/09→08/15	➔	7H-6-000001→; +PR 2E3,2E4; → 7H-A-050000		13.0460-2882.2	602882	TRW 23326 17,4 + WK + Zub
			➔	+PR 0WR; → 7H-8-027999		13.0460-7218.2	607218	ATE 24367 19,1 + WK
			➔	+PR 2E3		13.0460-7236.2	607236	ATE 23746 19,7 + WK
			➔	+PR 2E4		13.0460-7286.2	607286	ATE 24623 18,2 + WK
			➔			13.0460-2882.2	602882	TRW 23326 17,4 + WK + Zub
			➔	+PR 2E3		13.0460-7236.2	607236	ATE 23746 19,7 + WK
			➔	+PR 2E4		13.0460-7286.2	607286	ATE 24623 18,2 + WK
			➔			13.0460-2882.2	602882	TRW 23326 17,4 + WK + Zub
2.0 TDI 2.0 TDI 4motion	84 110 150 150	05/11→08/15 07/12→08/15 05/11→08/15 07/11→08/15	➔			13.0460-2882.2	602882	TRW 23326 17,4 + WK + Zub
			➔	+PR 2E3		13.0460-7236.2	607236	ATE 23746 19,7 + WK
			➔	7H-A-200001→; +PR 2E4		13.0460-7286.2	607286	ATE 24623 18,2 + WK
2.0 TDI 2.0 TDI 4motion	100 100	05/10→08/15 05/10→08/15	➔	7H-A-200001→		13.0460-2882.2	602882	TRW 23326 17,4 + WK + Zub
			➔	+PR 2E3		13.0460-7236.2	607236	ATE 23746 19,7 + WK
			➔	7H-A-200001→; +PR 2E4		13.0460-7286.2	607286	ATE 24623 18,2 + WK
3.2 4motion	173	11/03→11/09	➔	7H-A-200001→		13.0460-2882.2	602882	TRW 23326 17,4 + WK + Zub
			➔	07/04→; +PR 2E3		13.0460-7236.2	607236	ATE 23746 19,7 + WK
			➔	07/04→; +PR 2E4; → 7H-A-050000		13.0460-7240.2	607240	ATE 23746 18,1 + WK
			➔	7H-A-200001→; +PR 2E4		13.0460-7286.2	607286	ATE 24623 18,2 + WK
			➔	7H-8-028000→; +PR 0WR; → 7H-8-200000		13.0460-2882.2	602882	TRW 23326 17,4 + WK + Zub
			➔	07/04→; +PR 0WL,0WN / 0WM,0WP,0WQ; → 7H-5-120000		13.0460-2882.2	602882	TRW 23326 17,4 + WK + Zub
			➔	7H-A-200001→		13.0460-2882.2	602882	TRW 23326 17,4 + WK + Zub
			➔	7H-6-000001→; +PR 2E3,2E4; → 7H-A-050000		13.0460-2882.2	602882	TRW 23326 17,4 + WK + Zub
➔	07/04→; +PR 0WR; → 7H-8-027999		13.0460-7218.2	607218	ATE 24367 19,1 + WK			



	kw			 	! #		
<b>VW - TRANSPORTER T5 Kasten (7HA, 7HH, 7EA, 7EH) 04/03→08/15</b>							
<b>Zubehörsatz, Scheibenbremsbelag</b>							
1.9 TDI	62	01/06→11/09	➡	7H-8-028000→; +PR 0WR; → 7H-8-200000		13.0460-0023.2	610023
1.9 TDI	75	06/06→11/09	➡	7H-A-200001→		13.0460-0023.2	610023
			➡	7H-6-000001→; +PR 2E3,2E4; → 7H-A-050000		13.0460-0023.2	610023
1.9 TDI	63	04/03→11/09	➡	7H-8-028000→; +PR 0WR; → 7H-8-200000		13.0460-0023.2	610023
1.9 TDI	77	04/03→11/09					
2.0	85	11/03→08/15	➡	+PR OWL,OWN / OWM,OWP,OWQ; → 7H-5-120000		13.0460-0023.2	610023
2.0 BiFuel	85	05/11→08/15					
2.5 TDI	96	04/03→11/09	➡	7H-6-000001→; +PR 2E3,2E4; → 7H-A-050000		13.0460-0023.2	610023
2.5 TDI	128	04/03→11/09					
2.5 TDI 4motion	96	07/04→11/09	➡	7H-A-200001→		13.0460-0023.2	610023
2.5 TDI 4motion	128	07/04→11/09					
3.2 V6	170	04/03→06/04					
3.2 V6	173	02/04→11/09					
2.0 BiTDI	132	09/09→08/15	➡	7H-A-200001→		13.0460-0023.2	610023
2.0 BiTDI 4motion	132	09/09→08/15					
2.0 TDI	62	09/09→08/15	➡	7H-6-000001→; +PR 2E3,2E4; → 7H-A-050000		13.0460-0023.2	610023
2.0 TDI	75	09/09→08/15					
2.0 TDI	103	09/09→08/15					
2.0 TDI 4motion	103	09/09→08/15					
2.0 TDI	84	05/11→08/15	➡			13.0460-0023.2	610023
2.0 TSI	110	07/12→08/15					
2.0 TSI	150	05/11→08/15					
2.0 TSI 4motion	150	07/11→08/15					
2.0 TDI	100	05/10→08/15	➡	7H-A-200001→		13.0460-0023.2	610023
2.0 TDI 4motion	100	05/10→08/15					
3.2 4motion	173	11/03→11/09	➡	7H-A-200001→		13.0460-0023.2	610023
			➡	7H-8-028000→; +PR 0WR; → 7H-8-200000		13.0460-0023.2	610023
			➡	7H-6-000001→; +PR 2E3,2E4; → 7H-A-050000		13.0460-0023.2	610023
			➡	07/04→; +PR OWL,OWN / OWM,OWP,OWQ; → 7H-5-120000		13.0460-0023.2	610023
<b>Bremsscheibe</b>							
1.9 TDI	62	01/06→11/09	←	+PR 2E3		24.0130-0114.1	430114 Ø 308 29,5 25,5 V
1.9 TDI	75	06/06→11/09	←	→ 7H-A-050000; +PR 2E4		24.0132-0116.1	432116 Ø 333 32,5 28,5 V + S
			←	7H-A-200001→; +PR 2E4		24.0133-0100.1	433100 Ø 340 32,6 29,5 V + S
			➡	7H-A-200001→		24.0122-0211.1	422211 Ø 294 21,9 19,5 V + S
			➡	7H-8-028000→; +PR 0WR; → 7H-8-200000		24.0122-0211.1	422211 Ø 294 21,9 19,5 V + S
			➡	7H-6-000001→; +PR 2E3,2E4; → 7H-A-050000		24.0122-0211.1	422211 Ø 294 21,9 19,5 V + S
			➡	+PR 0WR; → 7H-8-027999		24.0122-0215.1	422215 Ø 314 22 18 V + S
1.9 TDI	63	04/03→11/09	←	+PR 2E3		24.0130-0114.1	430114 Ø 308 29,5 25,5 V
1.9 TDI	77	04/03→11/09					
2.0	85	11/03→08/15	←	→ 7H-A-050000; +PR 2E4		24.0132-0116.1	432116 Ø 333 32,5 28,5 V + S
2.0 BiFuel	85	05/11→08/15	←	7H-A-200001→; +PR 2E4		24.0133-0100.1	433100 Ø 340 32,6 29,5 V + S
2.5 TDI	96	04/03→11/09	➡	7H-8-028000→; +PR 0WR; → 7H-8-200000		24.0122-0211.1	422211 Ø 294 21,9 19,5 V + S
2.5 TDI	128	04/03→11/09					
2.5 TDI 4motion	96	07/04→11/09	➡	7H-A-200001→		24.0122-0211.1	422211 Ø 294 21,9 19,5 V + S
2.5 TDI 4motion	128	07/04→11/09					
3.2 V6	170	04/03→06/04					
3.2 V6	173	02/04→11/09	➡	7H-6-000001→; +PR 2E3,2E4; → 7H-A-050000		24.0122-0211.1	422211 Ø 294 21,9 19,5 V + S
			➡	+PR OWL,OWN / OWM,OWP,OWQ; → 7H-5-120000		24.0122-0211.1	422211 Ø 294 21,9 19,5 V + S
			➡	+PR 0WR; → 7H-8-027999		24.0122-0215.1	422215 Ø 314 22 18 V + S
2.0 BiTDI	132	09/09→08/15	←	+PR 2E3		24.0130-0114.1	430114 Ø 308 29,5 25,5 V
2.0 BiTDI 4motion	132	09/09→08/15					
2.0 TDI	62	09/09→08/15	←	→ 7H-A-050000; +PR 2E4		24.0132-0116.1	432116 Ø 333 32,5 28,5 V + S
2.0 TDI	75	09/09→08/15	←	7H-A-200001→; +PR 2E4		24.0133-0100.1	433100 Ø 340 32,6 29,5 V + S
2.0 TDI	103	09/09→08/15					
2.0 TDI 4motion	103	09/09→08/15	➡	7H-A-200001→		24.0122-0211.1	422211 Ø 294 21,9 19,5 V + S
			➡	7H-6-000001→; +PR 2E3,2E4; → 7H-A-050000		24.0122-0211.1	422211 Ø 294 21,9 19,5 V + S
2.0 TDI	84	05/11→08/15	←	+PR 2E3		24.0130-0114.1	430114 Ø 308 29,5 25,5 V
2.0 TSI	110	07/12→08/15					
2.0 TSI	150	05/11→08/15	←	+PR 2E4		24.0133-0100.1	433100 Ø 340 32,6 29,5 V + S
2.0 TSI 4motion	150	07/11→08/15	➡			24.0122-0211.1	422211 Ø 294 21,9 19,5 V + S
2.0 TDI	100	05/10→08/15	←	+PR 2E3		24.0130-0114.1	430114 Ø 308 29,5 25,5 V
2.0 TDI 4motion	100	05/10→08/15	←	7H-A-200001→; +PR 2E4		24.0133-0100.1	433100 Ø 340 32,6 29,5 V + S
↓							



**VW - TRANSPORTER T5 Kasten (7HA, 7HH, 7EA, 7EH) 04/03→08/15**

**Bremsscheibe**

2.0 TDI	100	05/10→08/15	➔	7H-A-200001→	24.0122-0211.1	422211	Ø 294 21,9 19,5 V + S
2.0 TDI 4motion	100	05/10→08/15					
3.2 4motion	173	11/03→11/09	➔	07/04→; +PR 2E3	24.0130-0114.1	430114	Ø 308 29,5 25,5 V
			➔	07/04→; → 7H-A-050000; +PR 2E4	24.0132-0116.1	432116	Ø 333 32,5 28,5 V + S
			➔	7H-A-200001→; +PR 2E4	24.0133-0100.1	433100	Ø 340 32,6 29,5 V + S
			➔	7H-8-028000→; +PR 0WR; → 7H-8-200000	24.0122-0211.1	422211	Ø 294 21,9 19,5 V + S
			➔	07/04→; +PR 0WL,0WN / 0WM,0WP,0WQ; → 7H-5-120000	24.0122-0211.1	422211	Ø 294 21,9 19,5 V + S
			➔	7H-A-200001→	24.0122-0211.1	422211	Ø 294 21,9 19,5 V + S
			➔	7H-6-000001→; +PR 2E3,2E4; → 7H-A-050000	24.0122-0211.1	422211	Ø 294 21,9 19,5 V + S
			➔	07/04→; +PR 0WR; → 7H-8-027999	24.0122-0215.1	422215	Ø 314 22 18 V + S









**VW - TRANSPORTER T5 Pritsche/Fahrgestell (7JD, 7JE, 7JL, 7JY, 7JZ 04/03→08/15**

**Bremsbelagsatz, Scheibenbremse**













1.9 TDI	62	01/06→11/09	➔	+PR 2E3	13.0460-7236.2	607236	ATE 23746 19,7 + WK
1.9 TDI	63	04/03→11/09	➔	→ 7J-A-010000; +PR 2E4	13.0460-7240.2	607240	ATE 23746 18,1 + WK
1.9 TDI	75	06/06→11/09	➔	7J-A-200001→; +PR 2E4	13.0460-7286.2	607286	ATE 24623 18,2 + WK
1.9 TDI	77	04/03→11/09	➔	7J-A-200001→; +PR 2E4	13.0460-7286.2	607286	ATE 24623 18,2 + WK
2.0	85	11/03→05/13	➔	→ 7J-A-010000; +PR 2E3,2E4	13.0460-2882.2	602882	TRW 23326 17,4 + WK + Zub
2.5 TDI	96	04/03→11/09	➔	7J-8-000789→ 7J-8-030000; +PR 0WR,0E0,0E9	13.0460-2882.2	602882	TRW 23326 17,4 + WK + Zub
2.5 TDI	128	04/03→11/09	➔	7J-8-000789→ 7J-8-030000; +PR 0WR,0E0,0E9	13.0460-2882.2	602882	TRW 23326 17,4 + WK + Zub
2.5 TDI 4motion	96	07/04→11/09	➔	7J-A-200001→	13.0460-2882.2	602882	TRW 23326 17,4 + WK + Zub
3.2 V6	170	02/04→11/09	➔	7J-A-200001→	13.0460-2882.2	602882	TRW 23326 17,4 + WK + Zub
3.2 V6	173	08/03→05/06	➔	→ 7J-8-000788; +PR 0WR,0E0,0E9	13.0460-7218.2	607218	ATE 24367 19,1 + WK
2.0 BiTDI	132	09/09→08/15	➔	+PR 2E3	13.0460-7236.2	607236	ATE 23746 19,7 + WK
2.0 BiTDI 4motion	132	09/09→08/15	➔	→ 7J-A-010000; +PR 2E4	13.0460-7240.2	607240	ATE 23746 18,1 + WK
2.0 TDI	62	09/09→08/15	➔	7J-A-200001→; +PR 2E4	13.0460-7286.2	607286	ATE 24623 18,2 + WK
2.0 TDI	75	09/09→08/15	➔	7J-A-200001→; +PR 2E4	13.0460-7286.2	607286	ATE 24623 18,2 + WK
2.0 TDI	103	09/09→08/15	➔	→ 7J-A-010000; +PR 2E3,2E4	13.0460-2882.2	602882	TRW 23326 17,4 + WK + Zub
2.0 TDI 4motion	103	09/09→08/15	➔	7J-A-200001→	13.0460-2882.2	602882	TRW 23326 17,4 + WK + Zub
2.0 TDI	84	05/11→08/15	➔	+PR 2E3	13.0460-7236.2	607236	ATE 23746 19,7 + WK
2.0 TDI	100	05/10→08/15	➔	+PR 2E4	13.0460-7286.2	607286	ATE 24623 18,2 + WK
2.0 TDI 4motion	100	05/10→08/15	➔		13.0460-2882.2	602882	TRW 23326 17,4 + WK + Zub
2.0 TSI	110	07/12→08/15	➔		13.0460-2882.2	602882	TRW 23326 17,4 + WK + Zub
2.5 TDI 4motion	128	04/04→11/09	➔	07/04→; +PR 2E3	13.0460-7236.2	607236	ATE 23746 19,7 + WK
			➔	07/04→; → 7J-A-010000; +PR 2E4	13.0460-7240.2	607240	ATE 23746 18,1 + WK
			➔	7J-A-200001→; +PR 2E4	13.0460-7286.2	607286	ATE 24623 18,2 + WK
			➔	7J-8-000789→ 7J-8-030000; +PR 0WR,0E0,0E9	13.0460-2882.2	602882	TRW 23326 17,4 + WK + Zub
			➔	07/04→; → 7J-A-010000; +PR 2E3,2E4	13.0460-2882.2	602882	TRW 23326 17,4 + WK + Zub
			➔	7J-A-200001→	13.0460-2882.2	602882	TRW 23326 17,4 + WK + Zub
			➔	07/04→; → 7J-8-000788; +PR 0WR,0E0,0E9	13.0460-7218.2	607218	ATE 24367 19,1 + WK
3.2 4motion	170	11/03→11/09	➔	07/04→; +PR 2E3	13.0460-7236.2	607236	ATE 23746 19,7 + WK
			➔	07/04→; +PR 2E4; → 7H-A-050000	13.0460-7240.2	607240	ATE 23746 18,1 + WK
			➔	7H-A-200001→; +PR 2E4	13.0460-7286.2	607286	ATE 24623 18,2 + WK
			➔	7H-8-028000→; +PR 0WR; → 7H-8-200000	13.0460-2882.2	602882	TRW 23326 17,4 + WK + Zub
			➔	07/04→; +PR 0WL,0WN / 0WM,0WP,0WQ; → 7H-5-120000	13.0460-2882.2	602882	TRW 23326 17,4 + WK + Zub
			➔	7H-A-200001→	13.0460-2882.2	602882	TRW 23326 17,4 + WK + Zub
			➔	7H-6-000001→; +PR 2E3,2E4; → 7H-A-050000	13.0460-2882.2	602882	TRW 23326 17,4 + WK + Zub
			➔	07/04→; +PR 0WR; → 7H-8-027999	13.0460-7218.2	607218	ATE 24367 19,1 + WK













**Zubehörsatz, Scheibenbremsbelag**

1.9 TDI	62	01/06→11/09	➔	7J-8-000789→ 7J-8-030000; +PR 0WR,0E0,0E9	13.0460-0023.2	610023	
1.9 TDI	63	04/03→11/09	➔	→ 7J-A-010000; +PR 2E3,2E4	13.0460-0023.2	610023	
1.9 TDI	75	06/06→11/09	➔	7J-A-200001→	13.0460-0023.2	610023	
1.9 TDI	77	04/03→11/09	➔	7J-A-200001→	13.0460-0023.2	610023	
2.0	85	11/03→05/13	➔	7J-A-200001→	13.0460-0023.2	610023	
2.5 TDI	96	04/03→11/09					
2.5 TDI	128	04/03→11/09					









	kw			 	! #			
<b>VW - TRANSPORTER T5 Pritsche/Fahrgestell (7JD, 7JE, 7JL, 7JY, 7JZ 04/03→08/15)</b>								
<b>Zubehörsatz, Scheibenbremsbelag</b>								
2.5 TDI 4motion 3.2 V6 3.2 V6	96 170 173	07/04→11/09 02/04→11/09 08/03→05/06	➡ ➡ ➡	7J-8-000789→ 7J-8-030000; +PR 0WR,0E0,0E9 → 7J-A-010000; +PR 2E3,2E4 7J-A-200001→		13.0460-0023.2 13.0460-0023.2 13.0460-0023.2	610023 610023 610023	
2.0 BiTDI 2.0 BiTDI 4motion 2.0 TDI 2.0 TDI 2.0 TDI 2.0 TDI 4motion	132 132 62 75 103 103	09/09→08/15 09/09→08/15 09/09→08/15 09/09→08/15 09/09→08/15 09/09→08/15	➡ ➡ ➡ ➡ ➡ ➡	→ 7J-A-010000; +PR 2E3,2E4 7J-A-200001→		13.0460-0023.2 13.0460-0023.2	610023 610023 610023 610023 610023 610023	
2.0 TDI 2.0 TDI 2.0 TDI 4motion 2.0 TSI	84 100 100 110	05/11→08/15 05/10→08/15 05/10→08/15 07/12→08/15	➡ ➡ ➡ ➡			13.0460-0023.2	610023 610023 610023 610023	
2.5 TDI 4motion	128	04/04→11/09	➡ ➡ ➡	07/04→; → 7J-A-010000; +PR 2E3,2E4 7J-8-000789→ 7J-8-030000; +PR 0WR,0E0,0E9 7J-A-200001→		13.0460-0023.2 13.0460-0023.2 13.0460-0023.2	610023 610023 610023	
3.2 4motion	170	11/03→11/09	➡ ➡ ➡ ➡	7H-A-200001→ 7H-8-028000→; +PR 0WR; → 7H-8-200000 7H-6-000001→; +PR 2E3,2E4; → 7H-A-050000 07/04→; +PR 0WL,0WN / 0WM,0WP,0WQ; → 7H-5-120000		13.0460-0023.2 13.0460-0023.2 13.0460-0023.2 13.0460-0023.2	610023 610023 610023 610023	
<b> Bremsscheibe</b>								
1.9 TDI 1.9 TDI 1.9 TDI 1.9 TDI 2.0 2.5 TDI 2.5 TDI 2.5 TDI 4motion 3.2 V6 3.2 V6	62 63 75 77 85 96 128 96 170 173	01/06→11/09 04/03→11/09 06/06→11/09 04/03→11/09 11/03→05/13 04/03→11/09 04/03→11/09 07/04→11/09 02/04→11/09 08/03→05/06	← ← ← ← ➡ ➡ ➡ ➡ ➡ ➡	+PR 2E3 → 7J-A-010000; +PR 2E4 7J-A-200001→; +PR 2E4 → 7J-A-010000; +PR 2E3,2E4 7J-8-000789→ 7J-8-030000; +PR 0WR,0E0,0E9 7J-A-200001→ → 7J-8-000788; +PR 0WR,0E0,0E9		24.0130-0114.1 24.0132-0116.1 24.0133-0100.1 24.0122-0211.1 24.0122-0211.1 24.0122-0211.1 24.0122-0211.1 24.0122-0211.1 24.0122-0211.1 24.0122-0215.1	430114 432116 433100 422211 422211 422211 422211 422211 422211 422215	∅ 308 29,5 25,5 V ∅ 333 32,5 28,5 V + S ∅ 340 32,6 29,5 V + S ∅ 294 21,9 19,5 V + S ∅ 294 21,9 19,5 V + S ∅ 294 21,9 19,5 V + S ∅ 294 21,9 19,5 V + S ∅ 294 21,9 19,5 V + S ∅ 314 22 18 V + S
2.0 BiTDI 2.0 BiTDI 4motion 2.0 TDI 2.0 TDI 2.0 TDI 2.0 TDI 4motion	132 132 62 75 103 103	09/09→08/15 09/09→08/15 09/09→08/15 09/09→08/15 09/09→08/15 09/09→08/15	← ← ← ← ➡ ➡	+PR 2E3 → 7J-A-010000; +PR 2E4 7J-A-200001→; +PR 2E4 → 7J-A-010000; +PR 2E3,2E4 7J-A-200001→		24.0130-0114.1 24.0132-0116.1 24.0133-0100.1 24.0122-0211.1 24.0122-0211.1	430114 432116 433100 422211 422211	∅ 308 29,5 25,5 V ∅ 333 32,5 28,5 V + S ∅ 340 32,6 29,5 V + S ∅ 294 21,9 19,5 V + S ∅ 294 21,9 19,5 V + S
2.0 TDI 2.0 TDI 2.0 TDI 4motion 2.0 TSI	84 100 100 110	05/11→08/15 05/10→08/15 05/10→08/15 07/12→08/15	← ← ➡	+PR 2E3 +PR 2E4		24.0130-0114.1 24.0133-0100.1 24.0122-0211.1	430114 433100 422211	∅ 308 29,5 25,5 V ∅ 340 32,6 29,5 V + S ∅ 294 21,9 19,5 V + S
2.5 TDI 4motion	128	04/04→11/09	← ← ← ➡ ➡ ➡ ➡ ➡ ➡	07/04→; +PR 2E3 07/04→; → 7J-A-010000; +PR 2E4 7J-A-200001→; +PR 2E4 7J-8-000789→ 7J-8-030000; +PR 0WR,0E0,0E9 07/04→; → 7J-A-010000; +PR 2E3,2E4 7J-A-200001→ 07/04→; → 7J-8-000788; +PR 0WR,0E0,0E9		24.0130-0114.1 24.0132-0116.1 24.0133-0100.1 24.0122-0211.1 24.0122-0211.1 24.0122-0211.1 24.0122-0215.1	430114 432116 433100 422211 422211 422211 422215	∅ 308 29,5 25,5 V ∅ 333 32,5 28,5 V + S ∅ 340 32,6 29,5 V + S ∅ 294 21,9 19,5 V + S ∅ 294 21,9 19,5 V + S ∅ 294 21,9 19,5 V + S ∅ 314 22 18 V + S
3.2 4motion	170	11/03→11/09	← ← ← ➡ ➡ ➡ ➡	07/04→; +PR 2E3 07/04→; → 7H-A-050000; +PR 2E4 7H-A-200001→; +PR 2E4 7H-8-028000→; +PR 0WR; → 7H-8-200000 07/04→; +PR 0WL,0WN / 0WM,0WP,0WQ; → 7H-5-120000 7H-A-200001→ 7H-6-000001→; +PR 2E3,2E4; → 7H-A-050000		24.0130-0114.1 24.0132-0116.1 24.0133-0100.1 24.0122-0211.1 24.0122-0211.1 24.0122-0211.1 24.0122-0211.1	430114 432116 433100 422211 422211 422211 422211	∅ 308 29,5 25,5 V ∅ 333 32,5 28,5 V + S ∅ 340 32,6 29,5 V + S ∅ 294 21,9 19,5 V + S ∅ 294 21,9 19,5 V + S ∅ 294 21,9 19,5 V + S ∅ 294 21,9 19,5 V + S











	kw					! #		
<b>VW - TRANSPORTER T5 Pritsche/Fahrgestell (7JD, 7JE, 7JL, 7JY, 7JZ 04/03→08/15</b>								
 <b>Bremsscheibe</b>								
3.2 4motion	170	11/03→11/09	➡	07/04→; +PR 0WR; → 7H-8-027999		24.0122-0215.1	422215	Ø 314 22 18 V + S
<b>VW - TRANSPORTER T6 Bus (SGB, SGG, SGJ) 04/15→</b>								
 <b>Bremsbelagsatz, Scheibenbremse</b>								
2.0 TDI	62	04/15→	←	passend für Felgengröße [Zoll]: 16		13.0460-7236.2	607236	ATE 23746 19,7 + WK
2.0 TDI	75	04/15→	←	passend für Felgengröße [Zoll]: 17		13.0460-7286.2	607286	ATE 24623 18,2 + WK
2.0 TDI	84	05/16→	←					
2.0 TDI	103	04/15→	➡			13.0460-2882.2	602882	TRW 23326 17,4 + WK + Zub
2.0 TDI	110	04/15→						
2.0 TDI	132	04/15→						
2.0 TDI	150	06/15→						
2.0 TDI 4motion	103	06/15→						
2.0 TDI 4motion	110	08/15→						
2.0 TDI 4motion	132	06/15→						
2.0 TDI 4motion	150	06/15→						
2.0 TSI	110	04/15→						
2.0 TSI	150	04/15→						
2.0 TSI 4motion	150	06/15→						
 <b>Bremsscheibe</b>								
2.0 TDI	62	04/15→	←	passend für Felgengröße [Zoll]: 16		24.0130-0114.1	430114	Ø 308 29,5 25,5 V
2.0 TDI	75	04/15→	←	passend für Felgengröße [Zoll]: 17		24.0133-0100.1	433100	Ø 340 32,6 29,5 V + S
2.0 TDI	84	05/16→	←					
2.0 TDI	103	04/15→	➡			24.0122-0211.1	422211	Ø 294 21,9 19,5 V + S
2.0 TDI	110	04/15→						
2.0 TDI	132	04/15→						
2.0 TDI	150	06/15→						
2.0 TDI 4motion	103	06/15→						
2.0 TDI 4motion	110	08/15→						
2.0 TDI 4motion	132	06/15→						
2.0 TDI 4motion	150	06/15→						
2.0 TSI	110	04/15→						
2.0 TSI	150	04/15→						
2.0 TSI 4motion	150	06/15→						
<b>VW - TRANSPORTER T6 Kasten (SGA, SGH) 04/15→</b>								
 <b>Bremsbelagsatz, Scheibenbremse</b>								
2.0 TDI	62	04/15→	←	passend für Felgengröße [Zoll]: 16		13.0460-7236.2	607236	ATE 23746 19,7 + WK
2.0 TDI	75	04/15→	←	passend für Felgengröße [Zoll]: 17		13.0460-7286.2	607286	ATE 24623 18,2 + WK
2.0 TDI	84	05/16→	←					
2.0 TDI	103	04/15→	➡			13.0460-2882.2	602882	TRW 23326 17,4 + WK + Zub
2.0 TDI	110	04/15→						
2.0 TDI	132	04/15→						
2.0 TDI	150	06/15→						
2.0 TDI 4motion	103	06/15→						
2.0 TDI 4motion	110	08/15→						
2.0 TDI 4motion	132	06/15→						
2.0 TDI 4motion	150	06/15→						
2.0 TSI	110	04/15→						
2.0 TSI	150	04/15→						
2.0 TSI 4motion	150	06/15→						
 <b>Bremsscheibe</b>								
2.0 TDI	62	04/15→	←	passend für Felgengröße [Zoll]: 16		24.0130-0114.1	430114	Ø 308 29,5 25,5 V
2.0 TDI	75	04/15→	←	passend für Felgengröße [Zoll]: 17		24.0133-0100.1	433100	Ø 340 32,6 29,5 V + S
2.0 TDI	84	05/16→	←					
2.0 TDI	103	04/15→	➡			24.0122-0211.1	422211	Ø 294 21,9 19,5 V + S
2.0 TDI	110	04/15→						
2.0 TDI	132	04/15→						
2.0 TDI	150	06/15→						
2.0 TDI 4motion	103	06/15→						
2.0 TDI 4motion	110	08/15→						
2.0 TDI 4motion	132	06/15→						
2.0 TDI 4motion	150	06/15→						
2.0 TSI	110	04/15→						
2.0 TSI	150	04/15→						
2.0 TSI 4motion	150	06/15→						
<b>VW - TRANSPORTER T6 Pritsche/Fahrgestell (SFD, SFE, SFL, SFZ) 04/15→</b>								
 <b>Bremsbelagsatz, Scheibenbremse</b>								
2.0 TDI	62	04/15→	←	passend für Felgengröße [Zoll]: 16		13.0460-7236.2	607236	ATE 23746 19,7 + WK
2.0 TDI	75	04/15→	←	passend für Felgengröße [Zoll]: 17		13.0460-7286.2	607286	ATE 24623 18,2 + WK
2.0 TDI	84	05/16→	←					
2.0 TDI	103	04/15→	➡			13.0460-2882.2	602882	TRW 23326 17,4 + WK + Zub
2.0 TDI	110	08/15→						
2.0 TDI	132	04/15→						
2.0 TDI	150	05/16→						
2.0 TDI 4motion	103	06/15→						







	kW					! #		
<b>VW - TRANSPORTER T6 Pritsche/Fahrgestell (SFD, SFE, SFL, SFZ) 04/15→</b>								
 <b>Bremsbelagsatz, Scheibenbremse</b>								
2.0 TDI 4motion	110	05/16→	←	passend für Felgenreöße [Zoll]: 16		13.0460-7236.2	607236	ATE 23746 19,7 + WK
2.0 TDI 4motion	132	06/15→	←	passend für Felgenreöße [Zoll]: 17		13.0460-7286.2	607286	ATE 24623 18,2 + WK
2.0 TDI 4motion	150	05/16→	←					
2.0 TSI	110	04/15→	→			13.0460-2882.2	602882	TRW 23326 17,4 + WK + Zub
 <b>Bremsscheibe</b>								
2.0 TDI	62	04/15→	←	passend für Felgenreöße [Zoll]: 16		24.0130-0114.1	430114	Ø 308 29,5 25,5 V
2.0 TDI	75	04/15→	←	passend für Felgenreöße [Zoll]: 17		24.0133-0100.1	433100	Ø 340 32,6 29,5 V + S
2.0 TDI	84	05/16→	←					
2.0 TDI	103	04/15→	→			24.0122-0211.1	422211	Ø 294 21,9 19,5 V + S
2.0 TDI	110	08/15→						
2.0 TDI	132	04/15→						
2.0 TDI	150	05/16→						
2.0 TDI 4motion	103	06/15→						
2.0 TDI 4motion	110	05/16→						
2.0 TDI 4motion	132	06/15→						
2.0 TDI 4motion	150	05/16→						
2.0 TSI	110	04/15→						
<b>VW - T-ROC (A11) 07/17→</b>								
 <b>Bremsbelagsatz, Scheibenbremse</b>								
1.0 TSI	85	07/17→	←	+PR 1ZB		13.0460-2785.2	602785	TRW 25683 20,4 + WE / + WK
1.5 TSI	110	11/17→	←			13.0470-2785.2	LD2785	TRW 25683 20,4 + WE / + WK Ceramic
1.6 TDI	85	03/18→	←					
2.0 TDI	110	03/18→	←					
2.0 TDI 4motion	110	09/17→	→	+PR 1KE,2EC		13.0460-7293.2	607293	ATE 25008 16,3 - WE / - WK
2.0 TSI 4motion	140	07/17→	→			13.0470-7293.2	LD7293	ATE 25008 16,3 - WE / - WK Ceramic
<b>Warnkontakt, Bremsbelagverschleiß</b>								
1.0 TSI	85	07/17→	←	+PR 1ZB		1	24.8190-0065.2	620065 L= 172
1.5 TSI	110	11/17→	←	+PR 1ZA		1	24.8190-0065.2	620065 L= 172
1.6 TDI	85	03/18→	←					
2.0 TDI	110	03/18→	←					
2.0 TDI 4motion	110	09/17→	←					
2.0 TSI 4motion	140	07/17→	←					
 <b>Bremsscheibe</b>								
1.0 TSI	85	07/17→	←	+PR 1ZA,1ZB		24.0125-0158.1	425158	Ø 312 25 22 V + S
1.5 TSI	110	11/17→	←			24.0325-0158.1	525158	Ø 312 25 22 V + S
1.6 TDI	85	03/18→	←					
2.0 TDI	110	03/18→	→	+PR 1KE,2EC / 0N4		24.0110-0356.1	410356	Ø 272 9,7 8 + S
2.0 TDI 4motion	110	09/17→	→			24.0310-0356.1	510356	Ø 272 9,7 8 + S
2.0 TSI 4motion	140	07/17→	→					
<b>VW - UP (121, 122, BL1, BL2) 08/11→</b>								
 <b>Bremsbelagsatz, Scheibenbremse</b>								
1.0	44	08/11→	←	+PR 1ZE; 05/16→		13.0460-2609.2	602609	TRW 25683 20,4 + WE / - WK
1.0	55	08/11→	←	12/11→; +PR 1LA,1ZQ		13.0460-7111.2	607111	VW 23130 19,6 - WE / - WK
						13.0470-7111.2	LD7111	VW 23130 19,6 - WE / - WK Ceramic
1.0 EcoFuel	50	11/12→	←	+PR 1ZE; 05/16→		13.0460-2609.2	602609	TRW 25683 20,4 + WE / - WK
			←	+PR 1LA,1ZQ		13.0460-7111.2	607111	VW 23130 19,6 - WE / - WK
						13.0470-7111.2	LD7111	VW 23130 19,6 - WE / - WK Ceramic
1.0 GTI	85	11/17→	←	+PR 1ZE		13.0460-2609.2	602609	TRW 25683 20,4 + WE / - WK
1.0 TSI	66	05/16→	←	+PR 1LA,1ZQ		13.0460-7111.2	607111	VW 23130 19,6 - WE / - WK
						13.0470-7111.2	LD7111	VW 23130 19,6 - WE / - WK Ceramic
e-Up	60	07/13→	←	+PR 1ZE; 05/16→		13.0460-2609.2	602609	TRW 25683 20,4 + WE / - WK
			←	09/13→; +PR 1ZQ		13.0460-7111.2	607111	VW 23130 19,6 - WE / - WK
						13.0470-7111.2	LD7111	VW 23130 19,6 - WE / - WK Ceramic
 <b>Bremsscheibe</b>								
1.0	44	08/11→	←	12/11→; +PR 1LA,1ZQ		24.0122-0281.1	422281	Ø 256 22 19 V + S
1.0	55	08/11→	←					
1.0 EcoFuel	50	11/12→	←	+PR 1LA,1ZQ		24.0122-0281.1	422281	Ø 256 22 19 V + S
1.0 GTI	85	11/17→	←					
1.0 TSI	66	05/16→	←					
e-Up	60	07/13→	←	09/13→; +PR 1LA,1ZQ		24.0122-0281.1	422281	Ø 256 22 19 V + S



	kw			 	! #		
<b>VW - VENTO (1H2) 11/91→09/98</b>							
<b> Bremsbelagsatz, Scheibenbremse</b>							
1.4	40	11/91→09/98	←	05/96→ 09/96; + ABS		<b>13.0460-2821.2 602821</b>	TRW 21945 16,0 - WK
1.4	44	11/91→09/98	←	→ 1H-T-015953		<b>13.0460-7032.2 20887</b>	VW 20887 19,7 - WE / - WK + Zub
1.9 D	48	11/91→09/98	←	1H-T-015954→; - ABS		<b>13.0460-7072.2 607072</b>	VW 21866 19,7 - WE / - WK
			←	10/96→; + ABS		<b>13.0460-7101.2 607101</b>	VW 21866 15,3 - WE / - WK
1.6	55	09/92→09/98	←	1H-S-430001→; Vollautomatik		<b>13.0460-2958.2 602958</b>	TRW 20168 19,3 - WK
			←	→ 1H-S-430000; Vollautomatik		<b>13.0460-7032.2 20887</b>	VW 20887 19,7 - WE / - WK + Zub
			←	→ 1H-T-015953; Schaltgetriebe		<b>13.0460-7032.2 20887</b>	VW 20887 19,7 - WE / - WK + Zub
			←	1H-T-015954→; Schaltgetriebe		<b>13.0460-7072.2 607072</b>	VW 21866 19,7 - WE / - WK
1.6	74	10/94→09/98	←			<b>13.0460-2821.2 602821</b>	TRW 21945 16,0 - WK
			←			<b>13.0460-2958.2 602958</b>	TRW 20168 19,3 - WK
			→			<b>13.0460-2937.2 602937</b>	TRW 20961 15,2 - WK + Zub
1.8	55	11/91→09/98	←	01/92→; Vollautomatik		<b>13.0460-2958.2 602958</b>	TRW 20168 19,3 - WK
			←	01/92→; → 1H-T-015953; Schaltgetriebe		<b>13.0460-7032.2 20887</b>	VW 20887 19,7 - WE / - WK + Zub
			←	1H-T-015954→; Schaltgetriebe		<b>13.0460-7072.2 607072</b>	VW 21866 19,7 - WE / - WK
1.8	66	11/91→09/98	←	01/92→		<b>13.0460-2821.2 602821</b>	TRW 21945 16,0 - WK
			←	1H-S-430001→		<b>13.0460-2958.2 602958</b>	TRW 20168 19,3 - WK
			←	01/92→; → 1H-S-430000		<b>13.0460-7032.2 20887</b>	VW 20887 19,7 - WE / - WK + Zub
			→	01/92→		<b>13.0460-2937.2 602937</b>	TRW 20961 15,2 - WK + Zub
1.9 SDI	47	04/97→09/98	←	- ABS		<b>13.0460-7072.2 607072</b>	VW 21866 19,7 - WE / - WK
			←	+ ABS		<b>13.0460-7101.2 607101</b>	VW 21866 15,3 - WE / - WK
1.9 TD	55	11/91→09/98	←	1H-S-430001→		<b>13.0460-2958.2 602958</b>	TRW 20168 19,3 - WK
			←	01/92→; → 1H-S-430000		<b>13.0460-7032.2 20887</b>	VW 20887 19,7 - WE / - WK + Zub
1.9 TDI	66	09/93→09/98	←			<b>13.0460-2821.2 602821</b>	TRW 21945 16,0 - WK
			←	- ABS		<b>13.0460-2958.2 602958</b>	TRW 20168 19,3 - WK
			→			<b>13.0460-2937.2 602937</b>	TRW 20961 15,2 - WK + Zub
1.9 TDI	81	04/96→09/98	←	+ ABS		<b>13.0460-2821.2 602821</b>	TRW 21945 16,0 - WK
			→			<b>13.0460-2984.2 602984</b>	TRW 20961 17,2 - WK + Zub
2.0	85	11/91→09/98	←	→ 1H-S-560000		<b>13.0460-2806.2 602806</b>	TRW 20168 19,3 + WK
			←			<b>13.0460-2821.2 602821</b>	TRW 21945 16,0 - WK
			←	1H-S-560001→; → 04/96		<b>13.0460-2958.2 602958</b>	TRW 20168 19,3 - WK
			←	05/96→		<b>13.0460-7081.2 607081</b> <b>13.0470-7081.2 LD7081</b>	ATE 20676 19,8 - WE / - WK ATE 20676 19,8 - WE / - WK Ceramic
			→			<b>13.0460-2937.2 602937</b>	TRW 20961 15,2 - WK + Zub
			→	→ 1H-P-240000		<b>13.0460-2937.2 602937</b>	TRW 20961 15,2 - WK + Zub
			→	1H-P-240001→		<b>13.0460-2984.2 602984</b>	TRW 20961 17,2 - WK + Zub
2.0 GL	79	05/96→12/97	←	→ 1H-S-560000		<b>13.0460-2806.2 602806</b>	TRW 20168 19,3 + WK
			←			<b>13.0460-2821.2 602821</b> <b>13.0460-7081.2 607081</b> <b>13.0470-7081.2 LD7081</b>	TRW 21945 16,0 - WK ATE 20676 19,8 - WE / - WK ATE 20676 19,8 - WE / - WK Ceramic
			→	→ 1H-P-240000		<b>13.0460-2937.2 602937</b>	TRW 20961 15,2 - WK + Zub
			→			<b>13.0460-2937.2 602937</b>	TRW 20961 15,2 - WK + Zub
			→	1H-P-240001→		<b>13.0460-2984.2 602984</b>	TRW 20961 17,2 - WK + Zub
2.8 VR6	128	01/92→09/98	←	→ 1H-S-560000		<b>13.0460-2806.2 602806</b>	TRW 20168 19,3 + WK
			←	1H-S-560001→		<b>13.0460-7081.2 607081</b> <b>13.0470-7081.2 LD7081</b>	ATE 20676 19,8 - WE / - WK ATE 20676 19,8 - WE / - WK Ceramic
			→	→ 1H-P-240000		<b>13.0460-2937.2 602937</b>	TRW 20961 15,2 - WK + Zub
			→	1H-P-240001→		<b>13.0460-2984.2 602984</b>	TRW 20961 17,2 - WK + Zub

↓

	kw			 	! #		
<b>VW - VENTO (1H2) 11/91→09/98</b>							
<b>Zubehörsatz, Scheibenbremsbelag</b>							
1.6 1.9 TDI	74 66	10/94→09/98 09/93→09/98	➔			13.0460-0419.2 610419	TRW
1.8	66	11/91→09/98	➔	01/92→		13.0460-0419.2 610419	TRW
1.9 TDI	81	04/96→09/98	➔			13.0460-0072.2 610072	TRW
2.0 2.0 GL	85 79	11/91→09/98 05/96→12/97	➔	1H-P-240001→		13.0460-0072.2 610072	TRW
			➔			13.0460-0419.2 610419	TRW
			➔	→ 1H-P-240000		13.0460-0419.2 610419	TRW
2.8 VR6	128	01/92→09/98	➔	1H-P-240001→		13.0460-0072.2 610072	TRW
			➔	→ 1H-P-240000		13.0460-0419.2 610419	TRW
<b> Bremsscheibe</b>							
1.4 1.4 1.9 D	40 44 48	11/91→09/98 11/91→09/98 11/91→09/98	←	- ABS		24.0112-0106.1 412106	Ø 239 12 10 + S
			←			24.0312-0106.1 512106	Ø 239 12 10 + S
			←	10/96→; + ABS		24.0120-0123.1 420123	Ø 239 20 18 V + S
			←			24.0320-0123.1 520123	Ø 239 20 18 V + S
			←	05/96→ 09/96; + ABS		24.0120-0128.1 420128	Ø 256 20 18 V + S
			←			24.0320-0128.1 520128	Ø 256 20 18 V + S
1.6	55	09/92→09/98	←	→ 1H-S-430000; Vollautomatik		24.0112-0106.1 412106	Ø 239 12 10 + S
			←			24.0312-0106.1 512106	Ø 239 12 10 + S
			←	Schaltgetriebe		24.0112-0106.1 412106	Ø 239 12 10 + S
			←			24.0312-0106.1 512106	Ø 239 12 10 + S
			←	1H-S-430001→; Vollautomatik		24.0113-0178.1 413178	Ø 255,6 12,9 11 + S
			←			24.0313-0178.1 513178	Ø 255,6 12,9 11 + S
1.6	74	10/94→09/98	←			24.0113-0178.1 413178	Ø 255,6 12,9 11 + S
			←			24.0120-0128.1 420128	Ø 256 20 18 V + S
			←			24.0313-0178.1 513178	Ø 255,6 12,9 11 + S
			←			24.0320-0128.1 520128	Ø 256 20 18 V + S
			➔	Felge Lochzahl: 4		24.0110-0111.1 410111	Ø 226 10 8 - ABS Ring / - RLG
			➔			24.0110-0275.2 410275	Ø 226 10 8 + ABS Ring / - RLG
1.8	55	11/91→09/98	←	01/92→; Schaltgetriebe		24.0112-0106.1 412106	Ø 239 12 10 + S
			←			24.0312-0106.1 512106	Ø 239 12 10 + S
			←	01/92→; Vollautomatik		24.0113-0178.1 413178	Ø 255,6 12,9 11 + S
			←			24.0313-0178.1 513178	Ø 255,6 12,9 11 + S
1.8	66	11/91→09/98	←	01/92→; → 1H-S-430000		24.0112-0106.1 412106	Ø 239 12 10 + S
			←			24.0312-0106.1 512106	Ø 239 12 10 + S
			←	1H-S-430001→		24.0113-0178.1 413178	Ø 255,6 12,9 11 + S
			←			24.0313-0178.1 513178	Ø 255,6 12,9 11 + S
			←	01/92→		24.0120-0128.1 420128	Ø 256 20 18 V + S
			←			24.0320-0128.1 520128	Ø 256 20 18 V + S
			➔	01/92→; Felge Lochzahl: 4		24.0110-0111.1 410111	Ø 226 10 8 - ABS Ring / - RLG
			➔			24.0110-0275.2 410275	Ø 226 10 8 + ABS Ring / - RLG
1.9 SDI	47	04/97→09/98	←	- ABS		24.0112-0106.1 412106	Ø 239 12 10 + S
			←			24.0312-0106.1 512106	Ø 239 12 10 + S
			←	+ ABS		24.0120-0123.1 420123	Ø 239 20 18 V + S
			←			24.0320-0123.1 520123	Ø 239 20 18 V + S
1.9 TD	55	11/91→09/98	←	→ 1H-S-430000		24.0112-0106.1 412106	Ø 239 12 10 + S
			←			24.0312-0106.1 512106	Ø 239 12 10 + S
			←	1H-S-430001→		24.0113-0178.1 413178	Ø 255,6 12,9 11 + S
			←			24.0313-0178.1 513178	Ø 255,6 12,9 11 + S
1.9 TDI	66	09/93→09/98	←	- ABS		24.0113-0178.1 413178	Ø 255,6 12,9 11 + S
			←			24.0313-0178.1 513178	Ø 255,6 12,9 11 + S
			←	+ ABS		24.0120-0128.1 420128	Ø 256 20 18 V + S
			←			24.0320-0128.1 520128	Ø 256 20 18 V + S
			➔	Felge Lochzahl: 4		24.0110-0111.1 410111	Ø 226 10 8 - ABS Ring / - RLG
			➔			24.0110-0275.2 410275	Ø 226 10 8 + ABS Ring / - RLG
1.9 TDI	81	04/96→09/98	←			24.0120-0128.1 420128	Ø 256 20 18 V + S
			←			24.0320-0128.1 520128	Ø 256 20 18 V + S
			➔	Felge Lochzahl: 4		24.0110-0111.1 410111	Ø 226 10 8 - ABS Ring / - RLG
			➔			24.0110-0275.2 410275	Ø 226 10 8 + ABS Ring / - RLG
↓							

	kW			 	! #		
<b>VW - VENTO (1H2) 11/91→09/98</b>							
<b>Bremsscheibe</b>							
2.0	85	11/91→09/98	←		24.0120-0128.1	420128	Ø 256 20 18 V + S
					24.0320-0128.1	520128	Ø 256 20 18 V + S
			←	→ 04/96	24.0122-0100.1	422100	Ø 280 22 20 V
					24.0322-0100.1	522100	Ø 280 22 20 V
			←	05/96→	24.0125-0108.1	425108	Ø 288 25 23 V
			→	Felge Lochzahl: 4	24.0110-0111.1	410111	Ø 226 10 8 - ABS Ring / - RLG
2.0 GL	79	05/96→12/97	→	Felge Lochzahl: 5	24.0110-0203.1	410203	Ø 226 10 8 - ABS Ring
			→		24.0110-0275.2	410275	Ø 226 10 8 + ABS Ring / - RLG
					24.0110-0276.2	410276	Ø 226 10 8 + ABS Ring
			←		24.0120-0128.1	420128	Ø 256 20 18 V + S
2.8 VR6	128	01/92→09/98	←		24.0122-0100.1	422100	Ø 280 22 20 V
					24.0322-0100.1	522100	Ø 280 22 20 V
			←	→ 1H-S-560000	24.0125-0108.1	425108	Ø 288 25 23 V
			←	1H-S-560001→	24.0125-0108.1	425108	Ø 288 25 23 V
			→	Felge Lochzahl: 4	24.0110-0111.1	410111	Ø 226 10 8 - ABS Ring / - RLG
			→	Felge Lochzahl: 5	24.0110-0203.1	410203	Ø 226 10 8 - ABS Ring
			→		24.0110-0275.2	410275	Ø 226 10 8 + ABS Ring / - RLG
					24.0110-0276.2	410276	Ø 226 10 8 + ABS Ring
			→		24.0120-0128.1	420128	Ø 256 20 18 V + S
					24.0320-0128.1	520128	Ø 256 20 18 V + S





- DE** Abbildungen Scheibenbremsbeläge
- EN** Illustrations disc brake pads
- ES** Ilustraciones de pastillas
- FR** Illustrations Plaquettes de frein à disque
- IT** Illustrazioni Pastiglie Freno

2019



# Abbildungen Scheibenbremsbeläge

Illustrations disc brake pads - Ilustraciones de pastillas - Illustrations Plaquettes de frein à disque - Illustrazioni Pastiglie Freno

13.0460-2600.2 602600

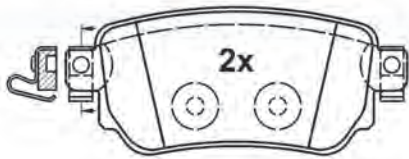

25965 15,0

103,6 x 44,6 x 15,0

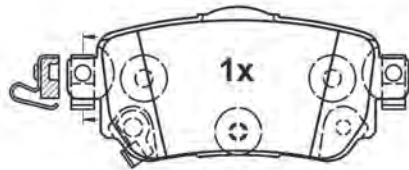

25966 15,0

103,6 x 46,4 x 15,0

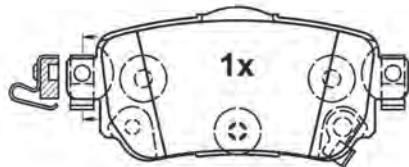

25967 15,0

103,6 x 46,4 x 15,0

13.0460-2601.2 602601

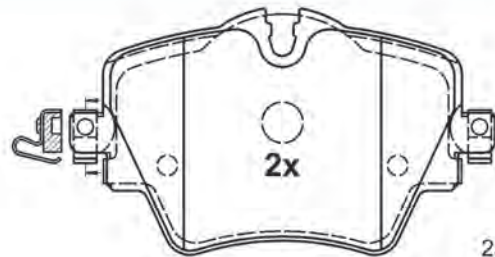

25617 18,5

129,0 x 75,1 x 18,5

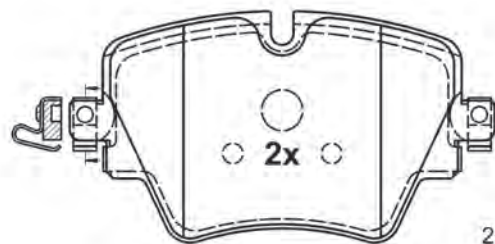

25617 18,5

129,0 x 70,1 x 18,5



13.0460-2602.2 602602

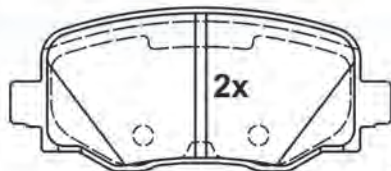

22304 17,3

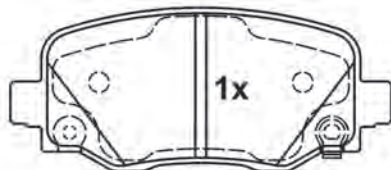

22305 17,3

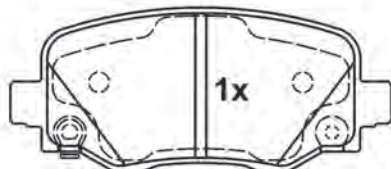

22306 17,3

115,5 x 49,5 x 17,3

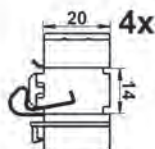
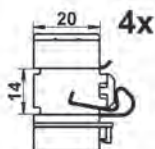

13.0460-2603.2 602603



25220 18,6

129,0 x 53,0 x 18,6



25221 18,6

129,0 x 61,0 x 18,6

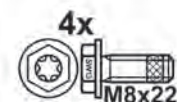

# Abbildungen Scheibenbremsbeläge

Illustrations disc brake pads - Ilustraciones de pastillas - Illustrations Plaquettes de frein à disque - Illustrazioni Pastiglie Freno

13.0460-2604.2 602604

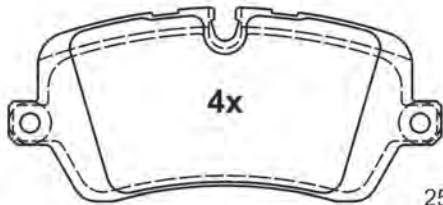

25720 17,7

131,3 x 58,5 x 17,7

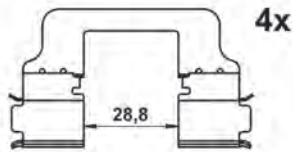

13.0460-2605.2 602605



24283 17,3

125,6 x 51,6 x 17,3

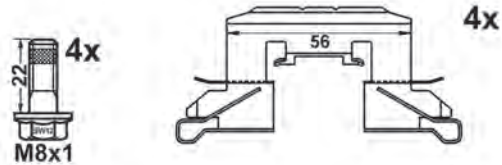

13.0460-2609.2 602609

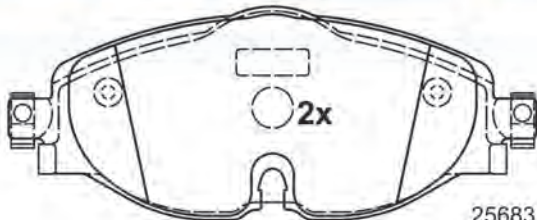

25683 20,4

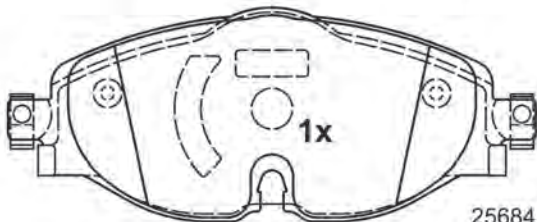

25684 20,4

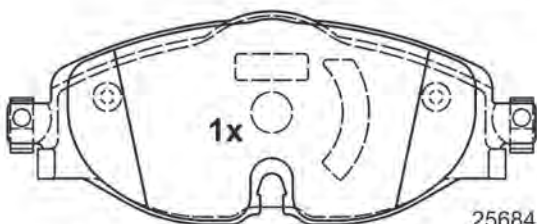

25684 20,4

160,0 x 64,5 x 20,4



13.0460-2610.2 602610

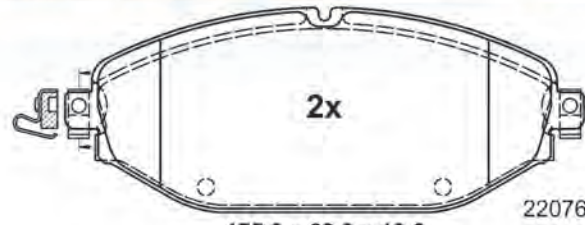

22076 19,6

175,0 x 69,0 x 19,6

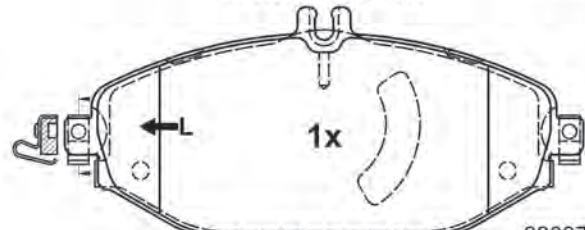

22097 19,6

175,0 x 77,9 x 19,6

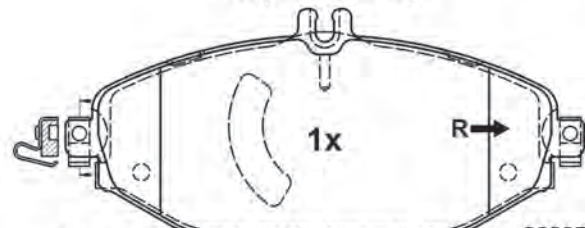

22097 19,6

175,0 x 77,9 x 19,6





# Abbildungen Scheibenbremsbeläge

Illustrations disc brake pads - Ilustraciones de pastillas - Illustrations Plaquettes de frein à disque - Illustrazioni Pastiglie Freno

13.0460-2612.2 602612

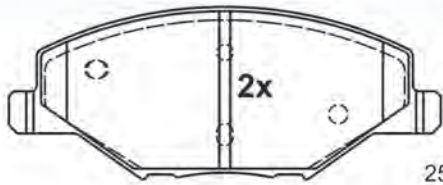

25681 17,7

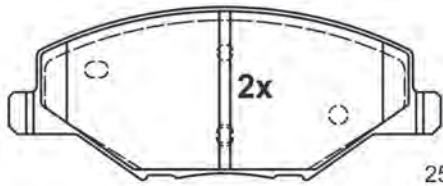

25682 17,7

131,0 x 52,2 x 17,7

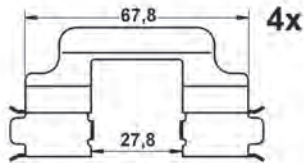

13.0460-2613.2 602613

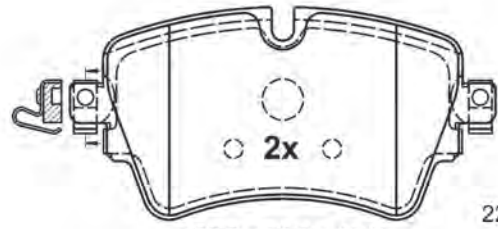

22187 18,6

129,0 x 64,3 x 18,6

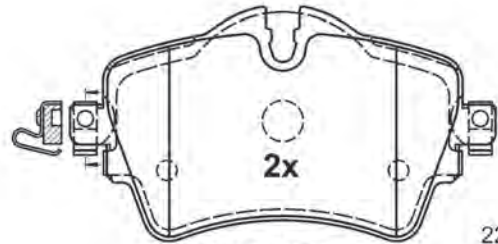

22188 18,6

129,0 x 77,3 x 18,6



13.0460-2615.2 602615

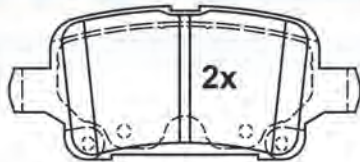

22129 17,4

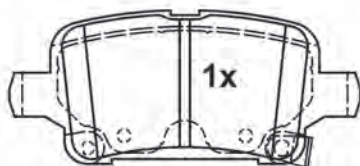

22130 17,4

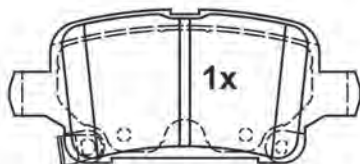

22131 17,4

106,4 x 46,4 x 17,4

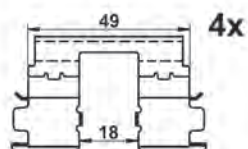

13.0460-2619.2 602619

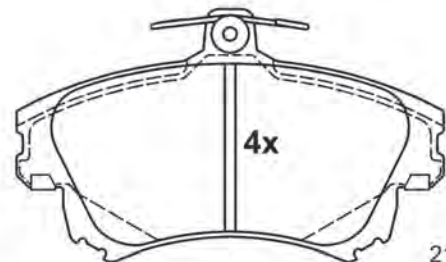

21983 16,3

129,9 x 76,7 x 16,3

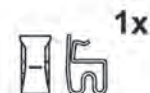

# Abbildungen Scheibenbremsbeläge

Illustrations disc brake pads - Ilustraciones de pastillas - Illustrations Plaquettes de frein à disque - Illustrazioni Pastiglie Freno

13.0460-2621.2 602621

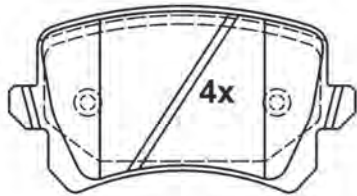

24483 16,9

105,2 x 56,4 x 16,9

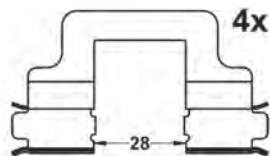

13.0460-2700.2 602700

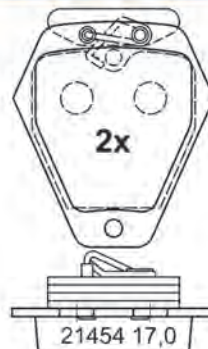

21454 17,0

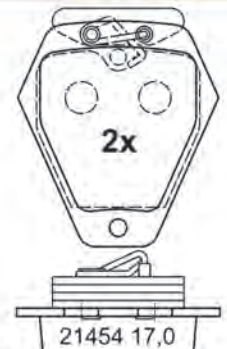

21454 17,0

76,1 x 85,6 x 17,0

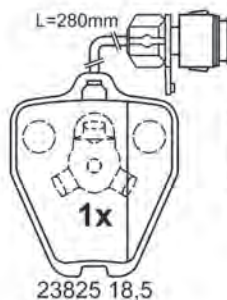

23825 18,5

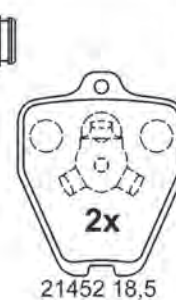

21452 18,5

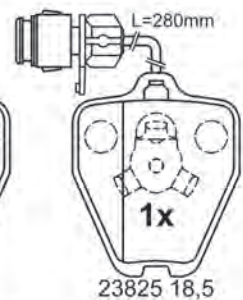

23825 18,5

63,3 x 77,4 x 18,5



13.0460-2701.2 602701

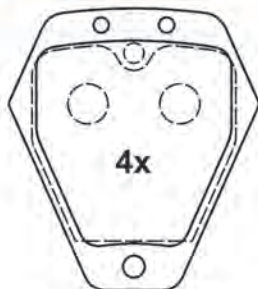

21454 17,0

76,1 x 85,6 x 17,0

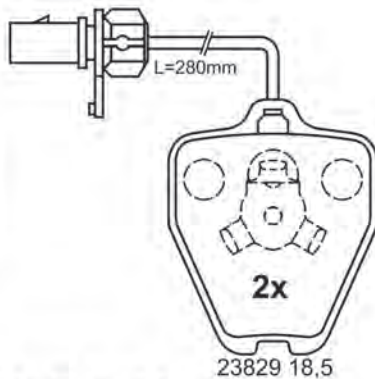

63,3 x 77,4 x 18,5

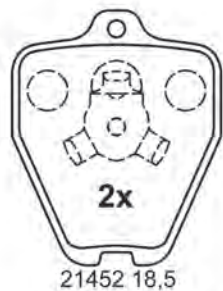

21452 18,5

23829 18,5



13.0460-2704.2 602704

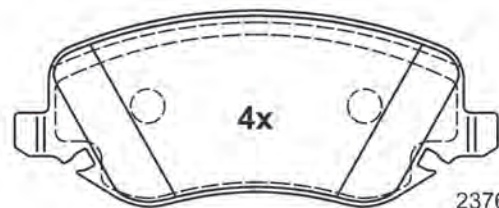

23761 18,8

146,5 x 59,2 x 18,8

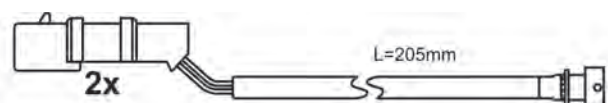

2x





# Abbildungen Scheibenbremsbeläge

Illustrations disc brake pads - Ilustraciones de pastillas - Illustrations Plaquettes de frein à disque - Illustrazioni Pastiglie Freno

13.0460-2705.2 602705

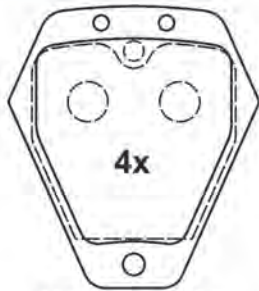

76,1 x 85,6 x 17,0

21454 17,0

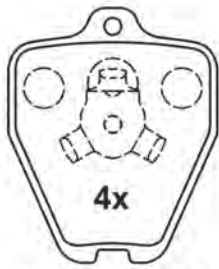

63,3 x 77,4 x 18,5

21452 18,5



13.0460-2706.2 602706

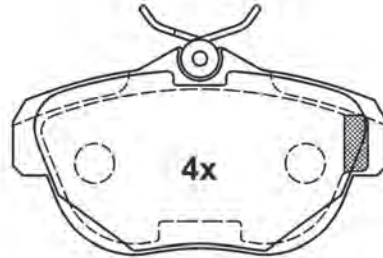

24462 16,7

113,8 x 62,7 x 16,7



13.0460-2707.2 602707

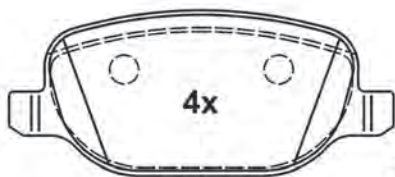

23760 17,7

116,8 x 49,8 x 17,7



13.0460-2708.2 602708

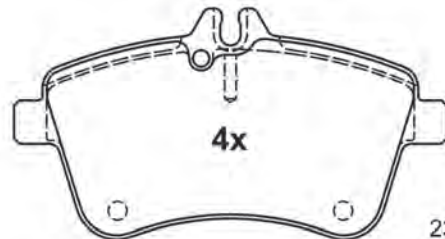

23881 20,0

131,3 x 69,8 x 20,0

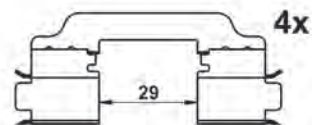

# Abbildungen Scheibenbremsbeläge

Illustrations disc brake pads - Ilustraciones de pastillas - Illustrations Plaquettes de frein à disque - Illustrazioni Pastiglie Freno

13.0460-2709.2 602709

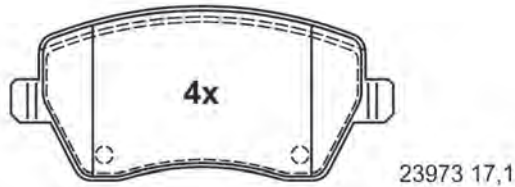

116,3 x 52,4 x 17,1

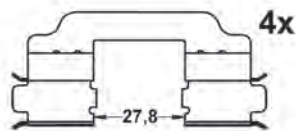

13.0460-2710.2 602710

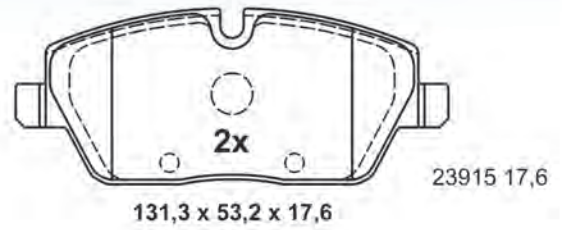

131,3 x 53,2 x 17,6

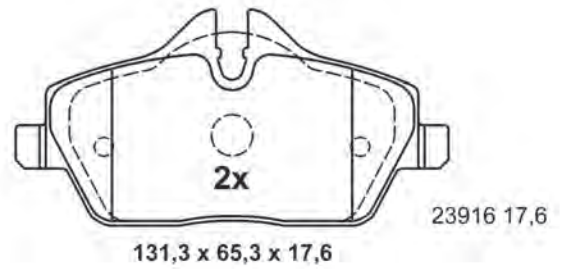

131,3 x 65,3 x 17,6

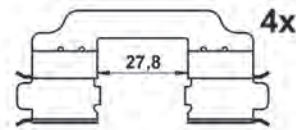

13.0460-2711.2 602711

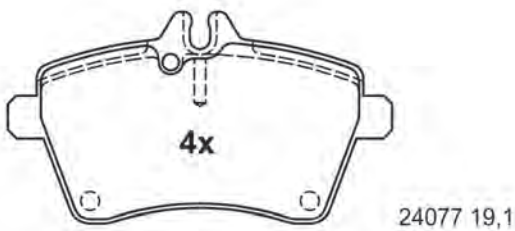

116,4 x 63,8 x 19,1

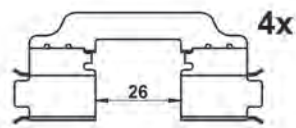

13.0460-2712.2 602712

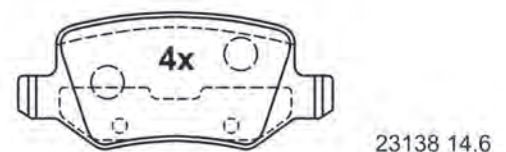

95,7 x 41,3 x 14,6

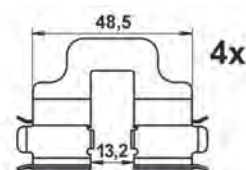

# Abbildungen Scheibenbremsbeläge

Illustrations disc brake pads - Ilustraciones de pastillas - Illustrations Plaquettes de frein à disque - Illustrazioni Pastiglie Freno

13.0460-2713.2 602713

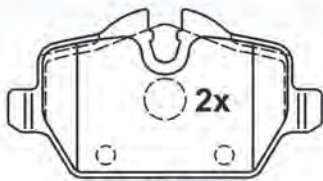

95,2 x 51,0 x 17,4

23623 17,4

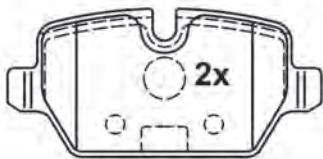

95,2 x 44,6 x 17,4

23624 17,4

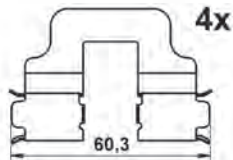

60,3



M8x21

13.0460-2714.2 602714

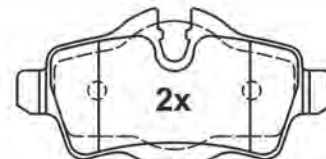

95,3 x 48,3 x 16,9

24289 16,9

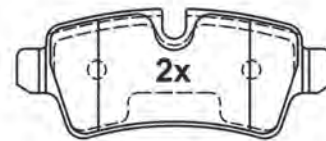

95,3 x 39,0 x 16,9

24290 16,9

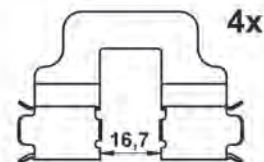

16,7



M8x22

13.0460-2715.2 602715

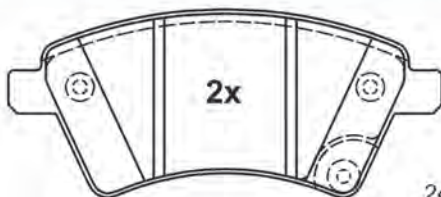

24391 16,6

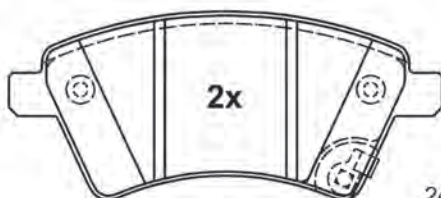

131,3 x 57,0 x 16,6

24392 16,6

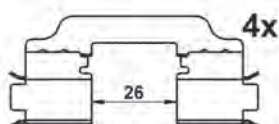

26



M8x21

13.0460-2716.2 602716

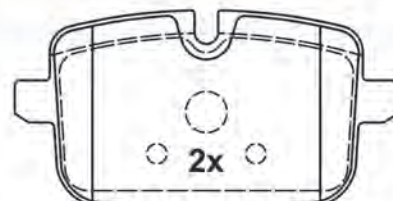

166,0 x 65,5 x 17,8

24703 17,8

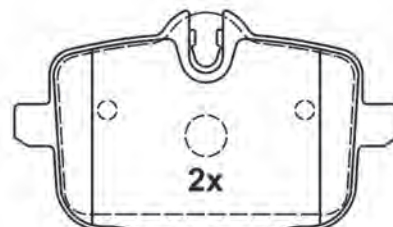

166,0 x 72,4 x 17,8

24704 17,8

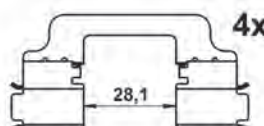

28,1



M8x21



# Abbildungen Scheibenbremsbeläge

Illustrations disc brake pads - Ilustraciones de pastillas - Illustrations Plaquettes de frein à disque - Illustrazioni Pastiglie Freno

13.0460-2717.2 602717

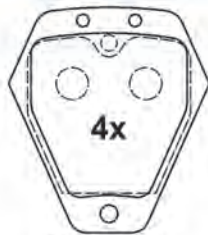

21454 17,0  
76,1 x 85,6 x 17,0

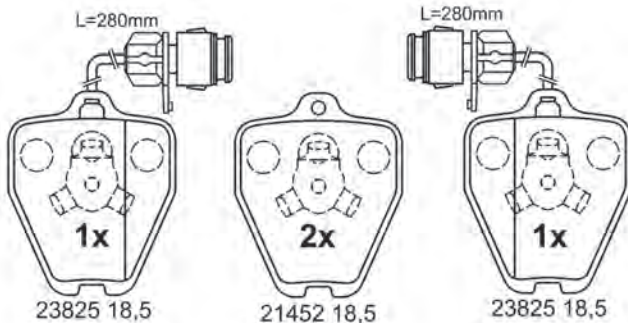

63,3 x 77,4 x 18,5



13.0460-2718.2 602718

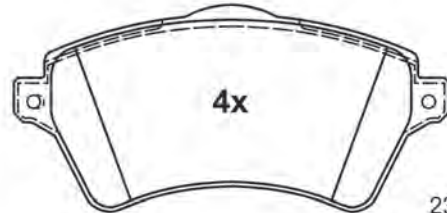

23615 18,3

131,4 x 62,1 x 18,3



13.0460-2719.2 602719

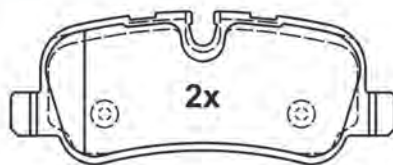

24192 17,4

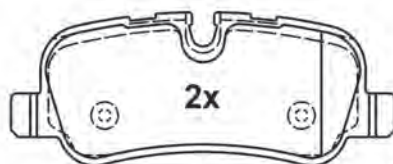

24192 17,4

116,6 x 46,4 x 17,4

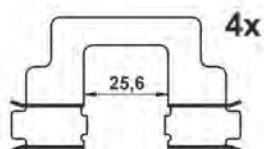

13.0460-2720.2 602720

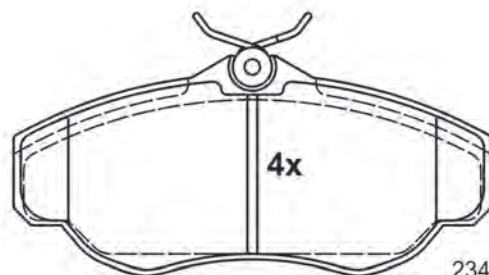

23452 19,0

144,8 x 66,3 x 19,0



# Abbildungen Scheibenbremsbeläge

Illustrations disc brake pads - Ilustraciones de pastillas - Illustrations Plaquettes de frein à disque - Illustrazioni Pastiglie Freno

13.0460-2721.2 602721

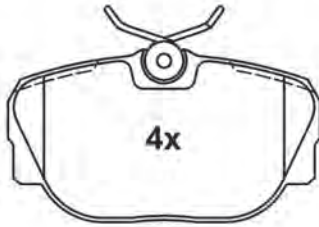

23458 15,6

94,7 x 51,9 x 15,6

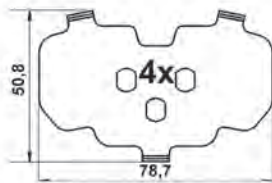

13.0460-2722.2 602722

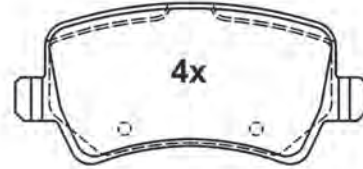

24496 17,3

106,0 x 48,7 x 17,3

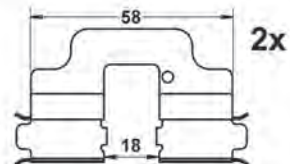
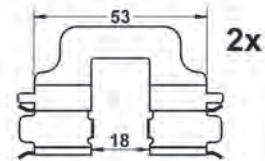

13.0460-2723.2 602723

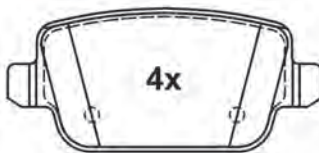

24537 16,1

95,1 x 43,2 x 16,1

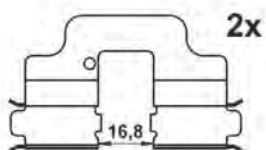
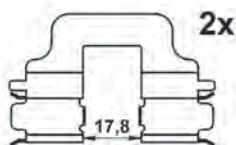

13.0460-2724.2 602724

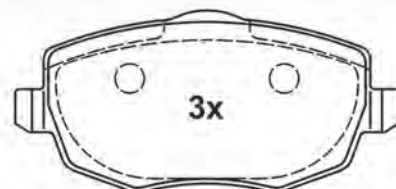

23073 16,7

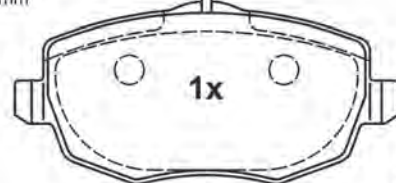

24515 16,7









116,8 x 55,2 x 16,7

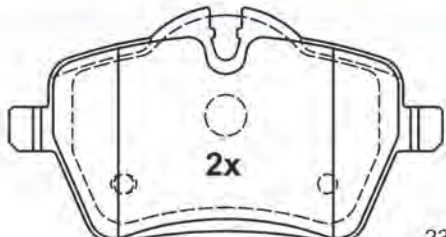
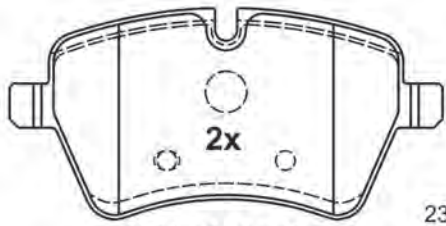
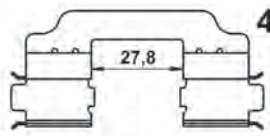

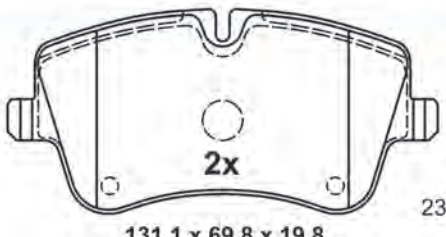
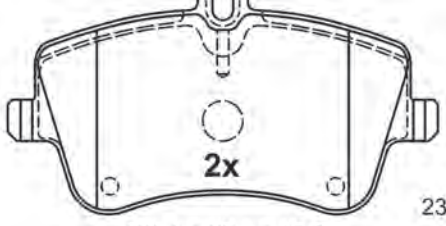
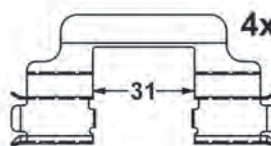
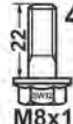
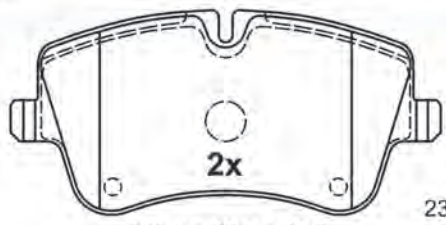

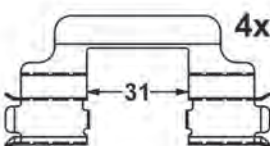
# Abbildungen Scheibenbremsbeläge

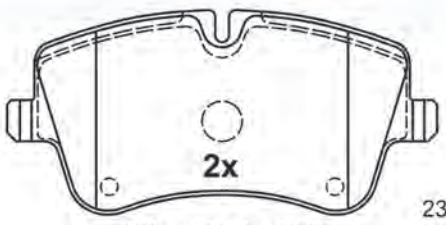
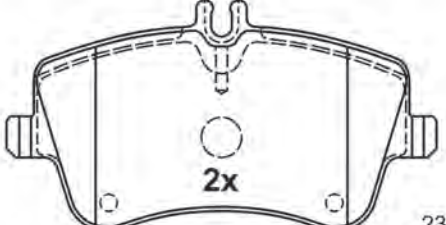
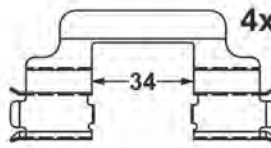
Illustrations disc brake pads - Ilustraciones de pastillas - Illustrations Plaquettes de frein à disque - Illustrazioni Pastiglie Freno

13.0460-2725.2 602725	13.0460-2726.2 602726
 <p>2x 131,6 x 71,3 x 17,8 23984 17,8</p>  <p>2x 131,6 x 63,9 x 17,8 23985 17,8</p>  <p>4x 27,8</p>  <p>2x M8x21</p>	 <p>2x 131,1 x 69,8 x 19,8 23145 19,8</p>  <p>2x 131,1 x 62,1 x 19,8 23144 19,8</p>  <p>4x 31</p>  <p>4x M8x1</p>
13.0460-2726.2 602726	13.0460-2727.2 602727
<p>wahlweise optional</p>  <p>2x 131,1 x 69,8 x 19,8 23145 19,8</p>  <p>2x 131,1 x 62,1 x 19,8 23144 19,8</p>  <p>4x 31</p>  <p>4x M8x1</p>	 <p>2x 131,1 x 69,8 x 19,8 23145 19,8</p>  <p>2x 131,1 x 62,1 x 19,8 23144 19,8</p>  <p>4x 34</p>  <p>4x M8x1</p>

# Abbildungen Scheibenbremsbeläge

Illustrations disc brake pads - Ilustraciones de pastillas - Illustrations Plaquettes de frein à disque - Illustrazioni Pastiglie Freno

13.0460-2728.2 602728

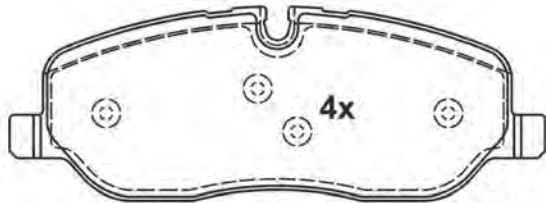

24191 18,1

162,7 x 58,7 x 18,1

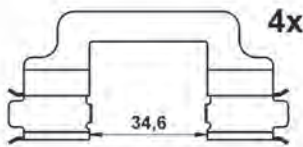

13.0460-2729.2 602729

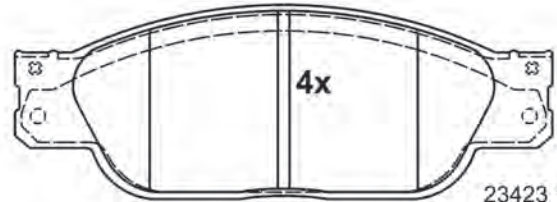

23423 17,8

163,3 x 58,1 x 17,8

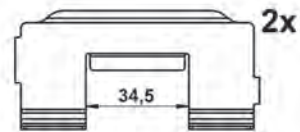
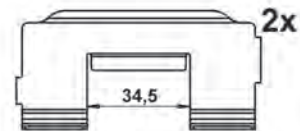

13.0460-2730.2 602730

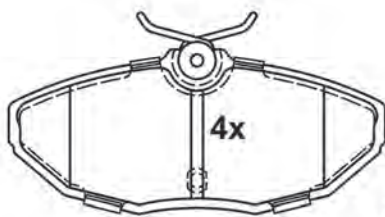

23424 17,6

114,3 x 49,5 x 17,6

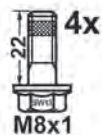

13.0460-2731.2 602731

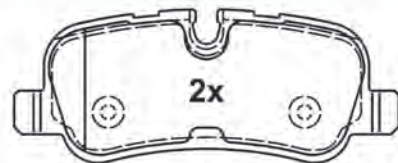

24192 17,1

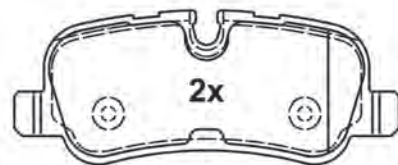

24192 17,1

116,6 x 46,4 x 17,1

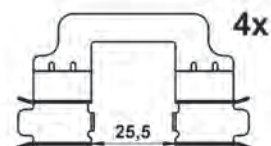

# Abbildungen Scheibenbremsbeläge

Illustrations disc brake pads - Ilustraciones de pastillas - Illustrations Plaquettes de frein à disque - Illustrazioni Pastiglie Freno

13.0460-2732.2 602732

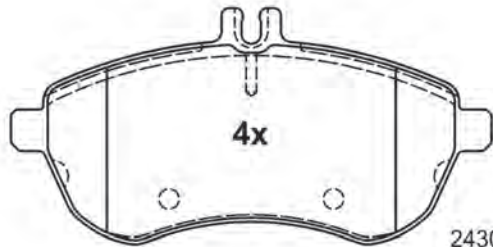

24306 20,3

146,0 x 71,5 x 20,3

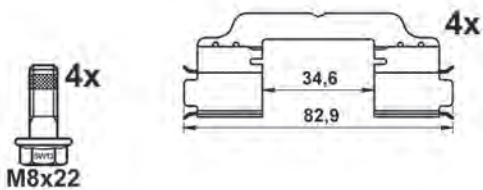

13.0460-2733.2 602733

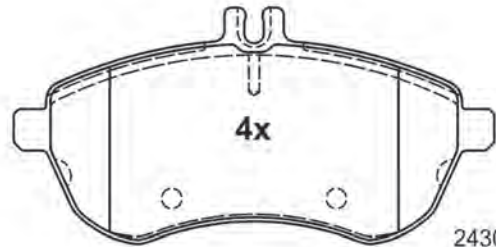

24306 20,3

146,0 x 71,5 x 20,3

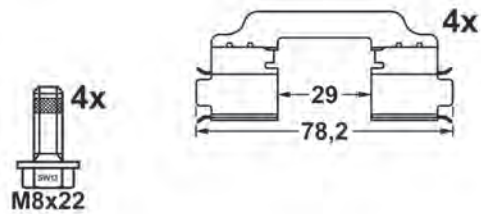

13.0460-2734.2 602734

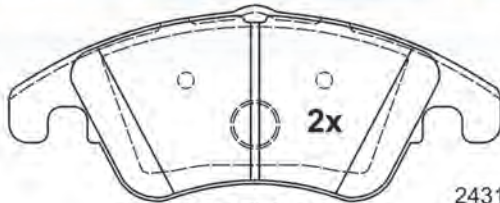

24310 19,0

188,0 x 73,7 x 19,0

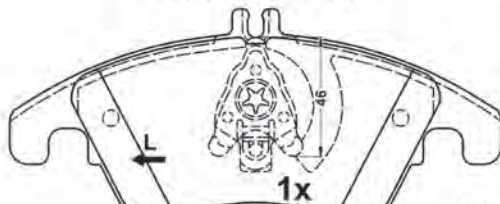

24456 19,0

188,0 x 80,8 x 19,0

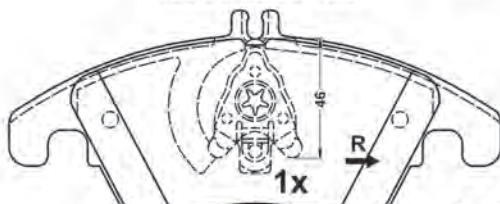

24456 19,0

188,0 x 80,8 x 19,0

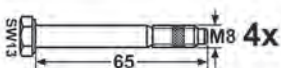

13.0460-2735.2 602735

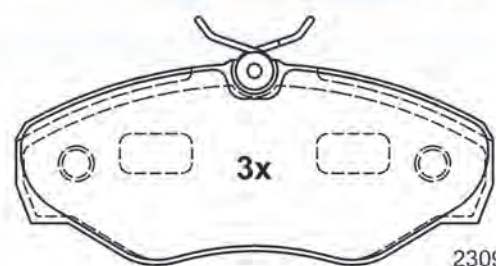

23099 18,4

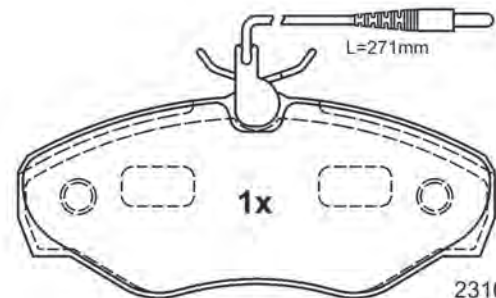

23100 18,4

144,8 x 62,4 x 18,4

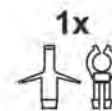



# Abbildungen Scheibenbremsbeläge

Illustrations disc brake pads - Ilustraciones de pastillas - Illustrations Plaquettes de frein à disque - Illustrazioni Pastiglie Freno

13.0460-2736.2 602736

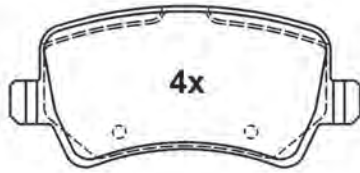

24496 17,3

106,0 x 48,7 x 17,3

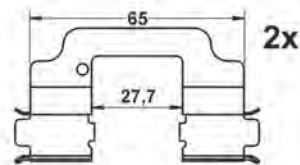
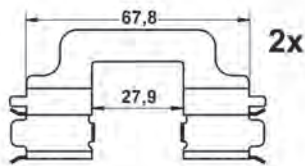

13.0460-2737.2 602737



24537 15,8

95,1 x 43,2 x 15,8

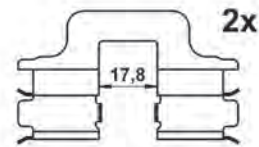
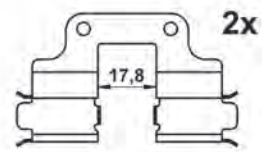

13.0460-2738.2 602738

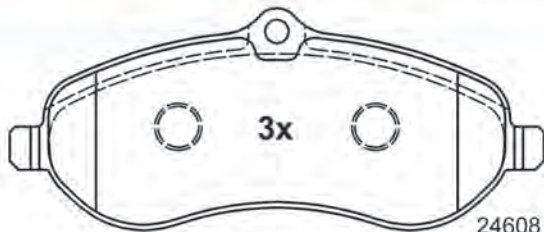

24608 18,5

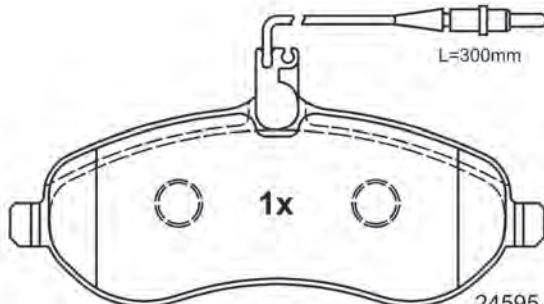

24595 18,5

162,0 x 67,3 x 18,5

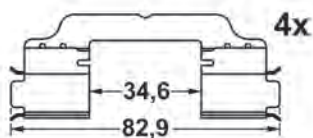

13.0460-2739.2 602739

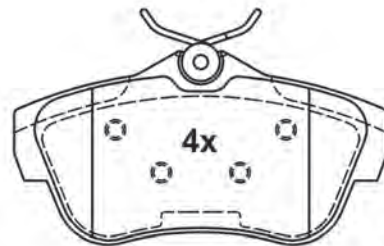

24578 16,5

113,3 x 58,5 x 16,5



# Abbildungen Scheibenbremsbeläge

Illustrations disc brake pads - Ilustraciones de pastillas - Illustrations Plaquettes de frein à disque - Illustrazioni Pastiglie Freno

13.0460-2740.2 602740



23554 17,0

87,6 x 52,9 x 17,0

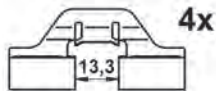

13.0460-2741.2 602741

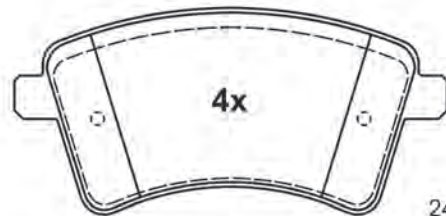

24693 18,5

131,0 x 62,3 x 18,5

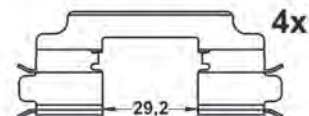

13.0460-2742.2 602742

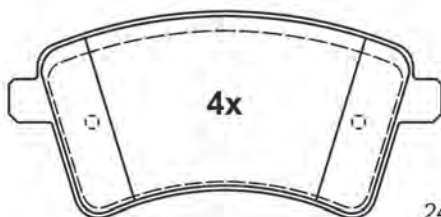

24693 17,5

131,0 x 62,3 x 17,5

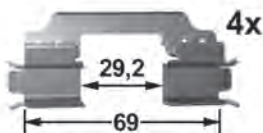

13.0460-2743.2 602743

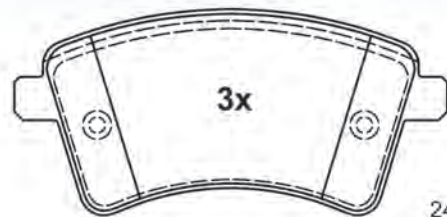

24693 17,5

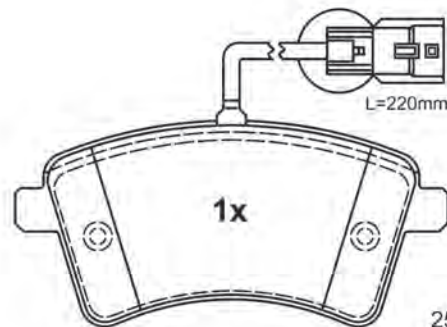

25291 17,5

131,0 x 62,3 x 17,5





# Abbildungen Scheibenbremsbeläge

Illustrations disc brake pads - Ilustraciones de pastillas - Illustrations Plaquettes de frein à disque - Illustrazioni Pastiglie Freno

13.0460-2744.2 602744

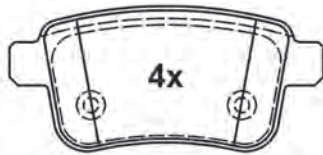

24692 15,9

95,4 x 43,8 x 15,9

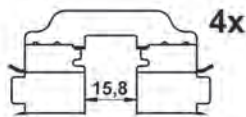

13.0460-2745.2 602745

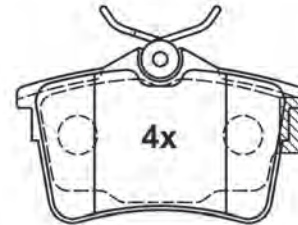

24765 16,5

87,2 x 52,8 x 16,5

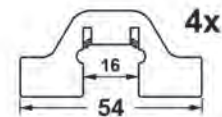

13.0460-2746.2 602746

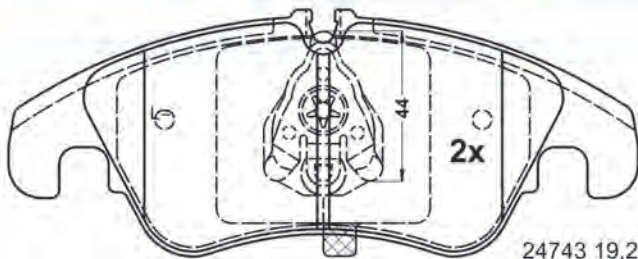

24743 19,2  
(24408)

188,0 x 73,5 x 19,2

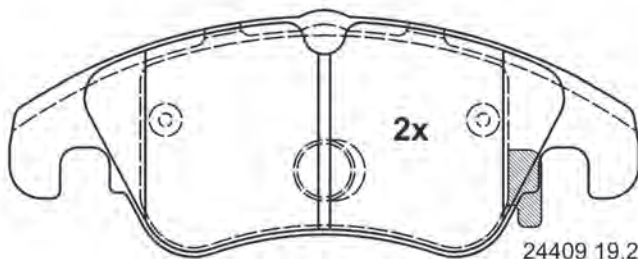

24409 19,2

188,0 x 73,0 x 19,2

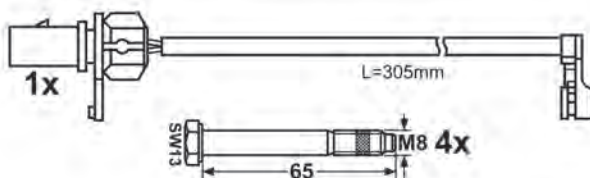

13.0460-2747.2 602747

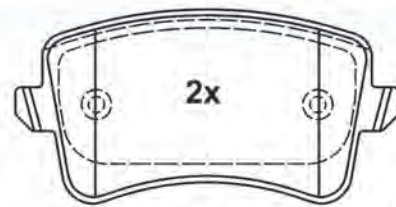

24606 17,4

116,4 x 58,5 x 17,4

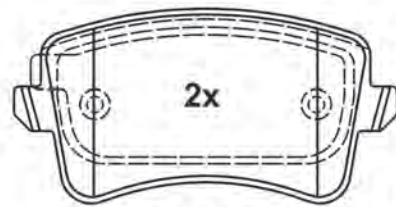

24606 17,7

116,4 x 58,5 x 17,7

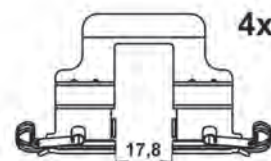

# Abbildungen Scheibenbremsbeläge

Illustrations disc brake pads - Ilustraciones de pastillas - Illustrations Plaquettes de frein à disque - Illustrazioni Pastiglie Freno

13.0460-2748.2 602748

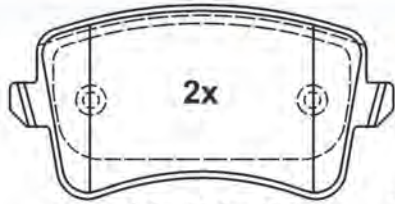

116,4 x 58,5 x 17,4

24606 17,4

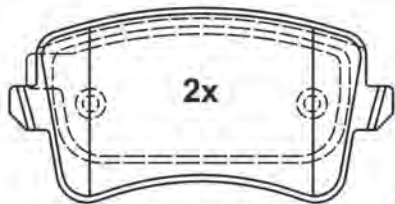

116,4 x 58,5 x 17,7

24606 17,7

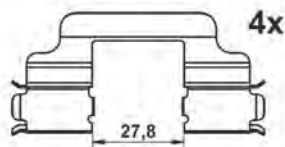

27,8



13.0460-2749.2 602749

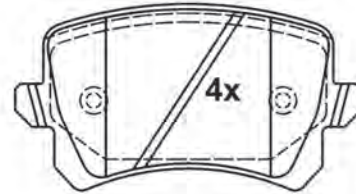

24483 16,9

105,2 x 56,4 x 16,9

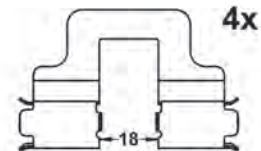

18



13.0460-2750.2 602750

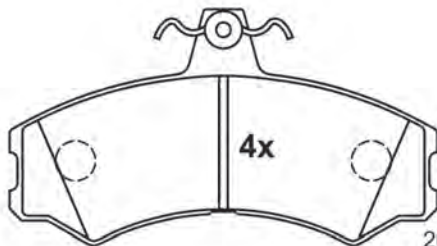

20741 15,0

129,9 x 71,0 x 15,0

13.0460-2751.2 602751

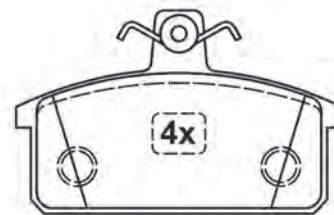

21418 15,5

99,9 x 61,0 x 15,5

# Abbildungen Scheibenbremsbeläge

Illustrations disc brake pads - Ilustraciones de pastillas - Illustrations Plaquettes de frein à disque - Illustrazioni Pastiglie Freno

13.0460-2752.2 602752

B · H · D

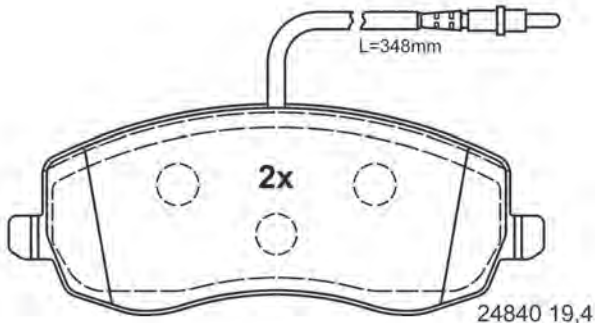
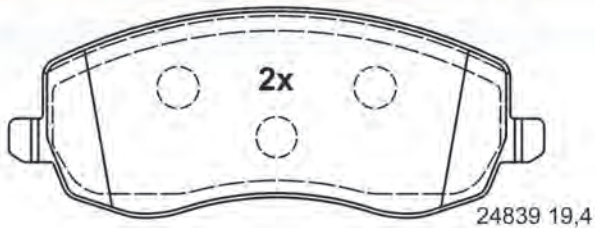

162,5 x 63,8 x 19,4

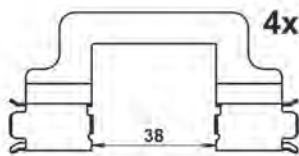

13.0460-2753.2 602753

B · H · D

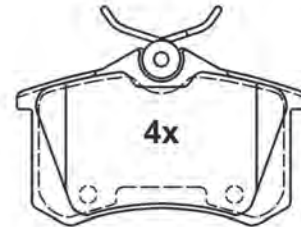

87,6 x 52,9 x 16,0



13.0460-2754.2 602754

B · H · D

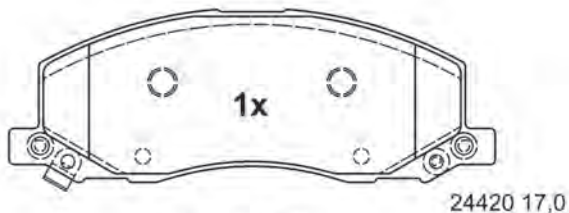
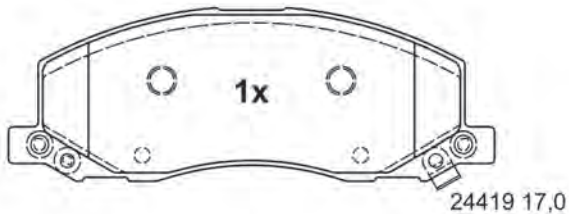
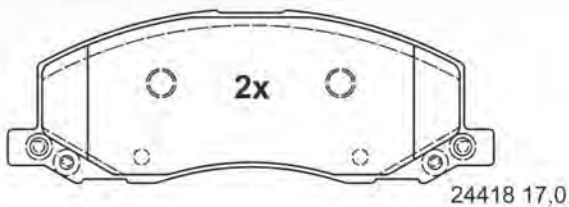

184,5 x 65,4 x 17,0



13.0460-2755.2 602755

B · H · D

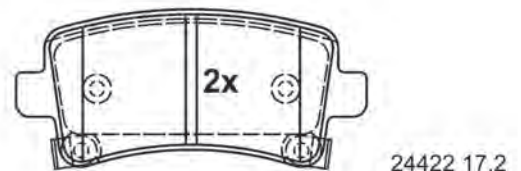
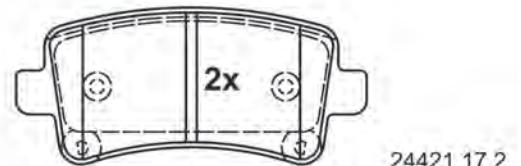

106,3 x 47,1 x 17,2

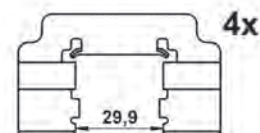



# Abbildungen Scheibenbremsbeläge

Illustrations disc brake pads - Ilustraciones de pastillas - Illustrations Plaquettes de frein à disque - Illustrazioni Pastiglie Freno

13.0460-2756.2 602756

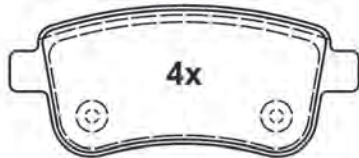

24820 16,1

106,3 x 45,3 x 16,1

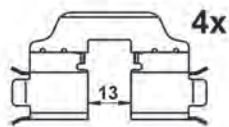

M8x22

13.0460-2757.2 602757

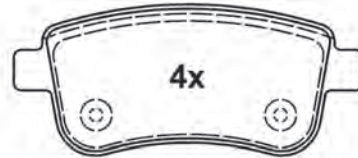

24820 16,1

106,3 x 45,3 x 16,1

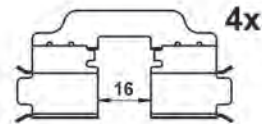

M8x22

13.0460-2758.2 602758

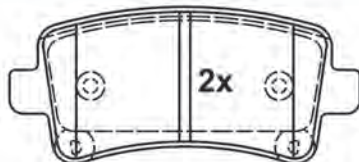

24421 17,2

106,3 x 47,1 x 17,2

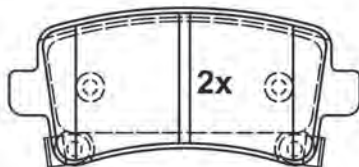

24422 17,2

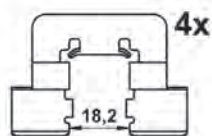

13.0460-2759.2 602759

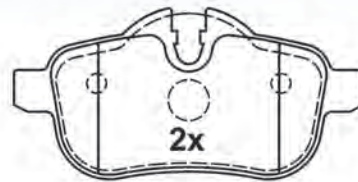

24559 17,8

106,0 x 52,3 x 17,8

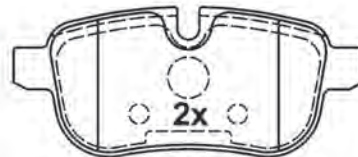

24560 17,8

106,0 x 45,1 x 17,8

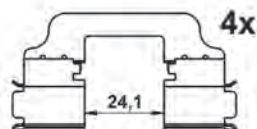

M8x21

# Abbildungen Scheibenbremsbeläge

Illustrations disc brake pads - Ilustraciones de pastillas - Illustrations Plaquettes de frein à disque - Illustrazioni Pastiglie Freno

13.0460-2760.2 602760

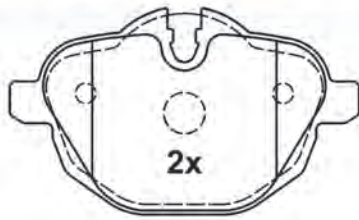

2x

24561 17,7

106,0 x 63,2 x 17,7

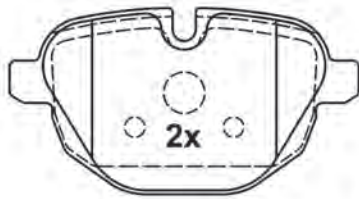

2x

24562 17,7

106,0 x 56,2 x 17,7

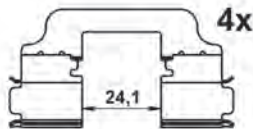

13.0460-2761.2 602761

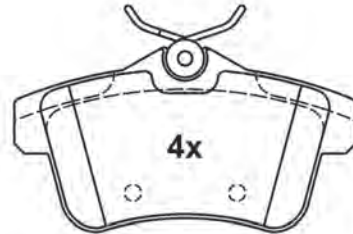

4x

24922 16,5

103,8 x 55,6 x 16,5

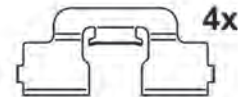

13.0460-2762.2 602762 [1]

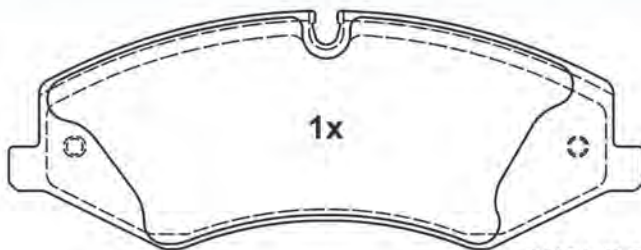

1x

24021 18,5

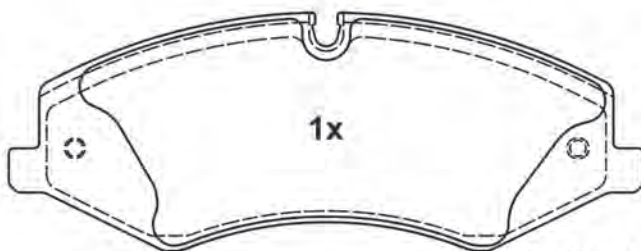

1x

24022 18,5

192,7 x 72,2 x 18,5

13.0460-2762.2 602762 [2]

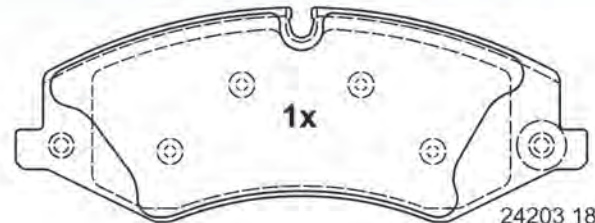

1x

24203 18,5

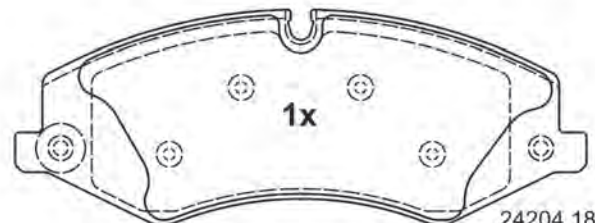

1x

24204 18,5

192,7 x 72,2 x 18,5

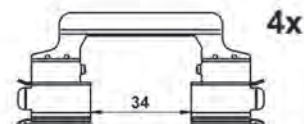



# Abbildungen Scheibenbremsbeläge

Illustrations disc brake pads - Ilustraciones de pastillas - Illustrations Plaquettes de frein à disque - Illustrazioni Pastiglie Freno

13.0460-2763.2 602763



23661 17,2

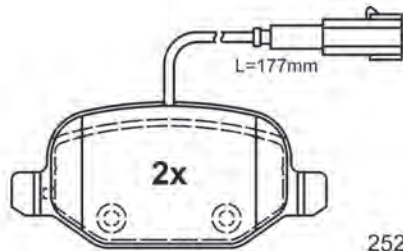

25237 17,2

95,5 x 43,9 x 17,2

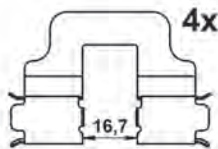

13.0460-2764.2 602764

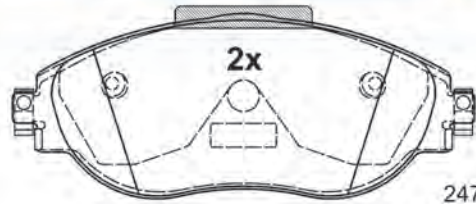

24738 20,0

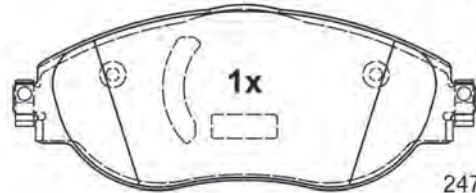

24738 20,0

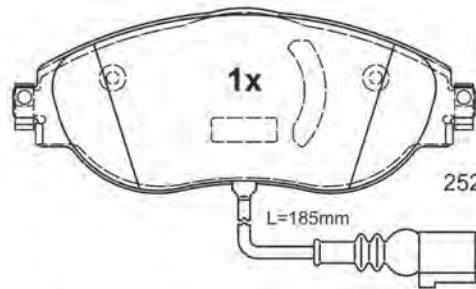

25217 20,0

175,0 x 70,0 x 20,0



13.0460-2765.2 602765

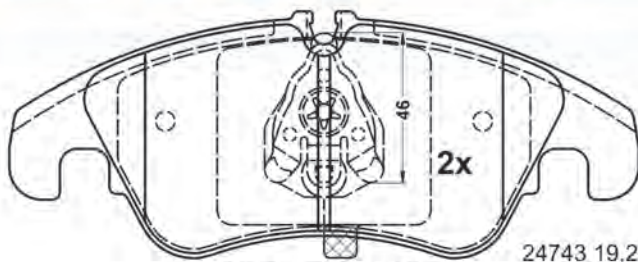

24743 19,2

188,0 x 73,5 x 19,2

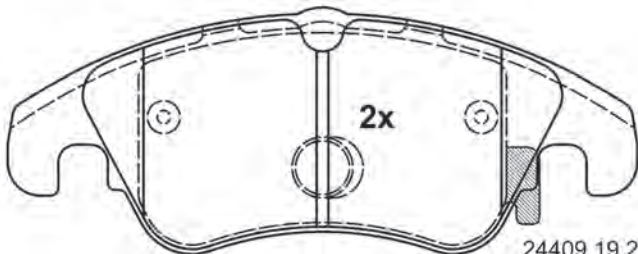

24409 19,2

188,0 x 73,0 x 19,2

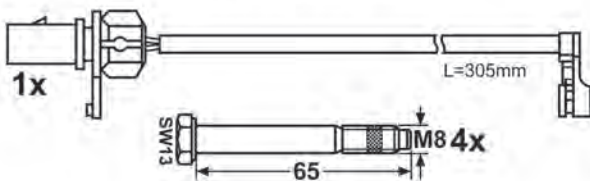

13.0460-2766.2 602766

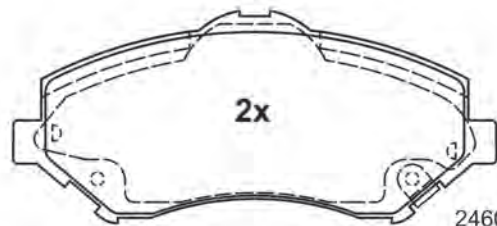

24604 18,7

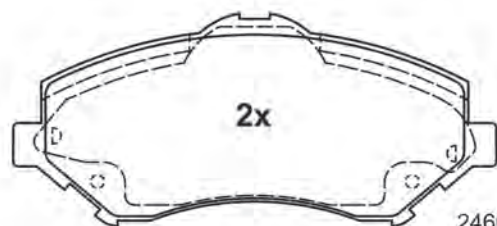

24605 18,7

146,6 x 64,3 x 18,7



# Abbildungen Scheibenbremsbeläge

Illustrations disc brake pads - Ilustraciones de pastillas - Illustrations Plaquettes de frein à disque - Illustrazioni Pastiglie Freno

13.0460-2767.2 602767

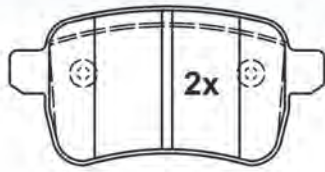

25156 17,4

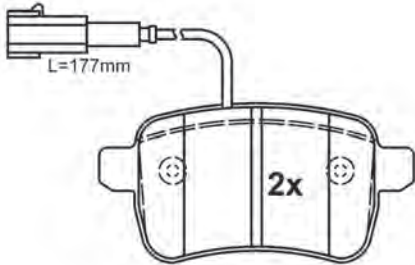

25157 17,4

95,6 x 48,1 x 17,4

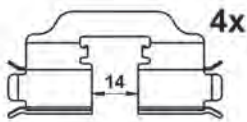

13.0460-2768.2 602768



23811 17,7

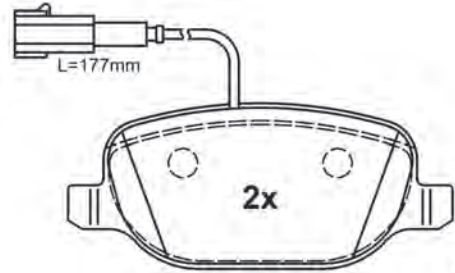

24788 17,7

116,8 x 49,8 x 17,7

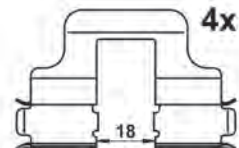

13.0460-2769.2 602769

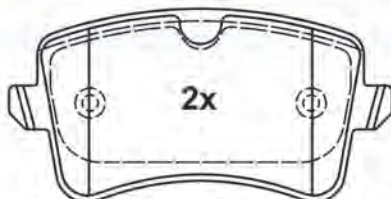

24606 17,4

116,4 x 58,5 x 17,4

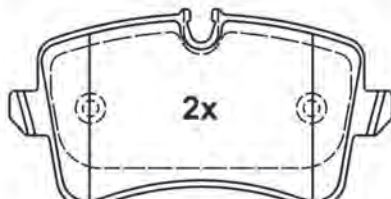

25214 17,4

116,4 x 59,8 x 17,4

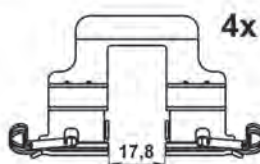

13.0460-2770.2 602770

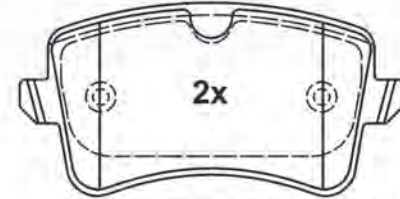

24606 17,4

116,4 x 58,5 x 17,4

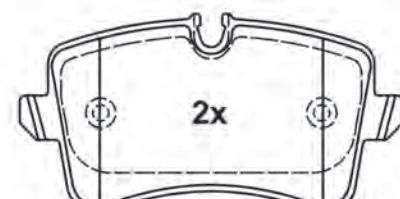

25214 17,4

116,4 x 59,8 x 17,4

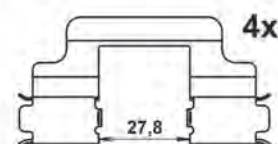
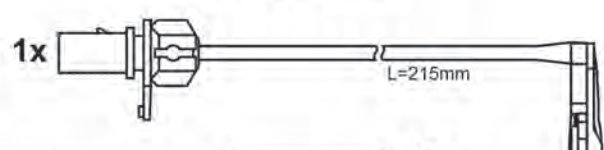



# Abbildungen Scheibenbremsbeläge

Illustrations disc brake pads - Ilustraciones de pastillas - Illustrations Plaquettes de frein à disque - Illustrazioni Pastiglie Freno

13.0460-2771.2 602771

B.H.P.

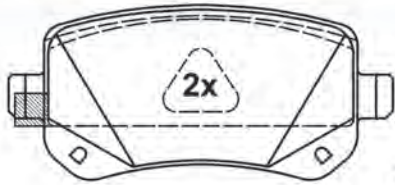

24822 15,7

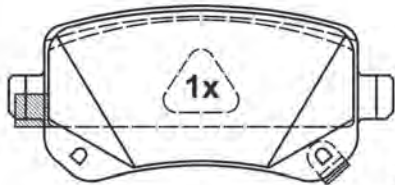

24823 15,7

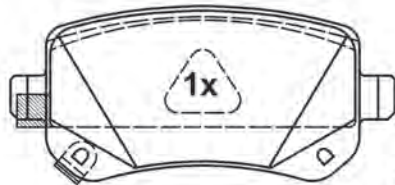

24824 15,7

116,6 x 52,5 x 15,7

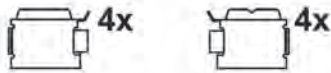

13.0460-2772.2 602772

B.H.P.

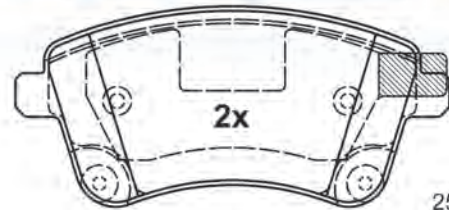

25184 19,4

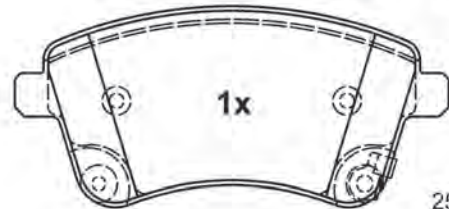

25185 19,4

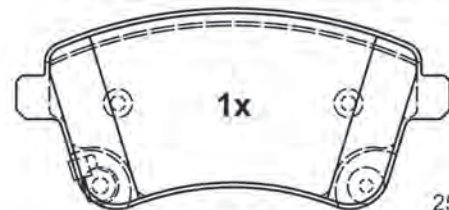

25186 19,4

131,6 x 60,6 x 19,4

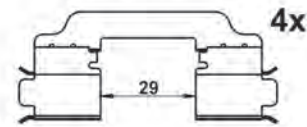

13.0460-2773.2 602773

B.H.P.

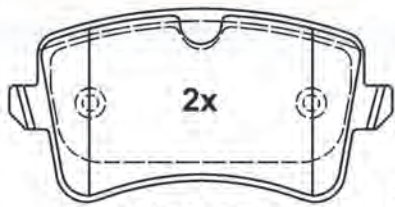

24606 17,4

116,4 x 58,5 x 17,4

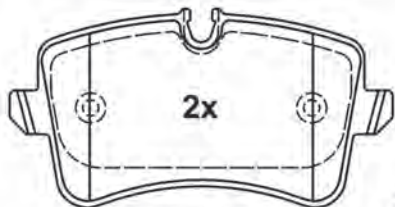

25214 17,4

116,4 x 59,8 x 17,4

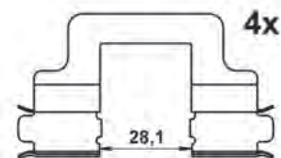
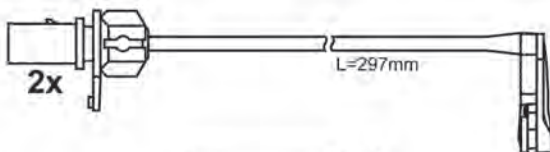

13.0460-2774.2 602774

B.H.P.

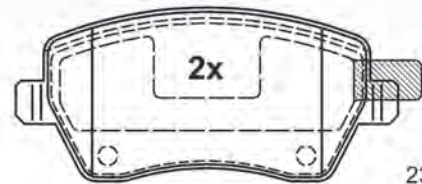

23973 17,4

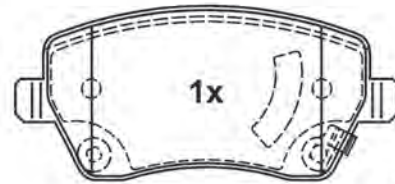

24403 17,4

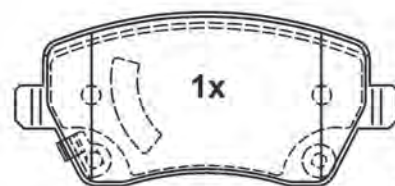

24403 17,4

116,3 x 52,4 x 17,4

# Abbildungen Scheibenbremsbeläge

Illustrations disc brake pads - Ilustraciones de pastillas - Illustrations Plaquettes de frein à disque - Illustrazioni Pastiglie Freno

13.0460-2775.2 602775

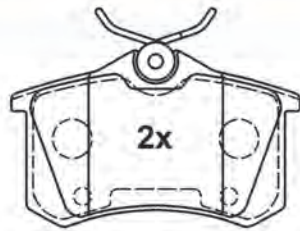

23554 17,0

87,6 x 52,9 x 17,0

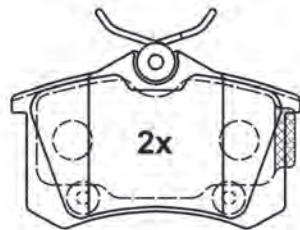

23554 16,4

87,6 x 52,9 x 16,4

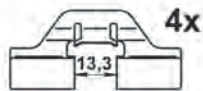

13.0460-2776.2 602776

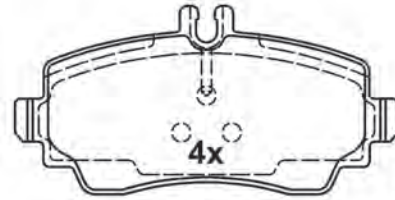

23070 17,0

116,5 x 57,1 x 17,0

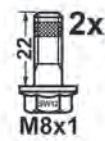
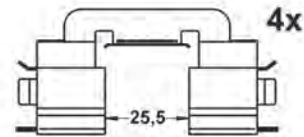

13.0460-2778.2 602778

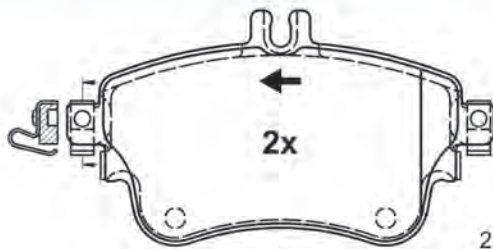

23526 19,3

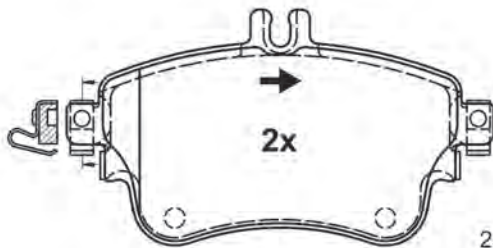

23526 19,3

129,0 x 71,3 x 19,3



13.0460-2779.2 602779

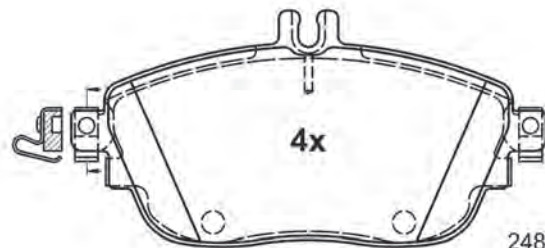

24869 19,3

144,0 x 71,6 x 19,3



# Abbildungen Scheibenbremsbeläge

Illustrations disc brake pads - Ilustraciones de pastillas - Illustrations Plaquettes de frein à disque - Illustrazioni Pastiglie Freno

13.0460-2780.2 602780



25072 18,8

116,2 x 54,7 x 18,8

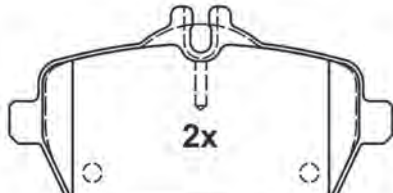

25071 18,8

116,2 x 65,0 x 18,8

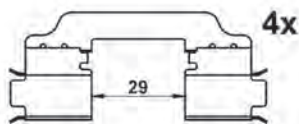

13.0460-2781.2 602781

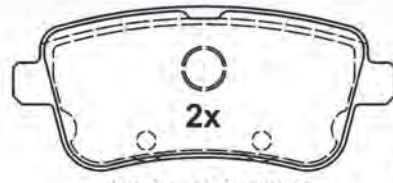

25215 18,6

116,3 x 49,8 x 18,6

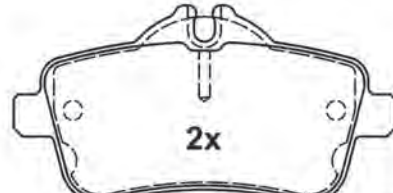

25216 18,6

116,3 x 59,8 x 18,6

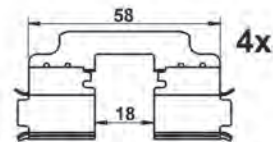

13.0460-2782.2 602782



25215 18,6

116,3 x 49,8 x 18,6

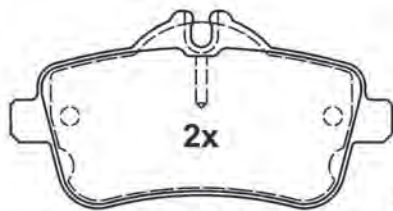

25216 18,6

116,3 x 59,8 x 18,6

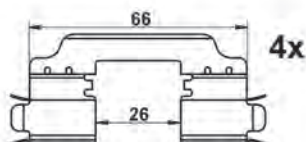

13.0460-2783.2 602783



25410 14,4

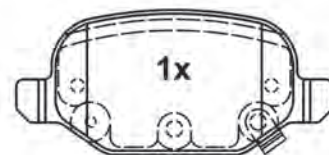

25411 14,4

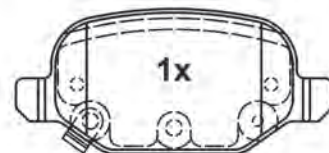

25412 14,4

95,4 x 43,8 x 14,4

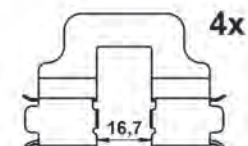



# Abbildungen Scheibenbremsbeläge

Illustrations disc brake pads - Ilustraciones de pastillas - Illustrations Plaquettes de frein à disque - Illustrazioni Pastiglie Freno

13.0460-2784.2 602784

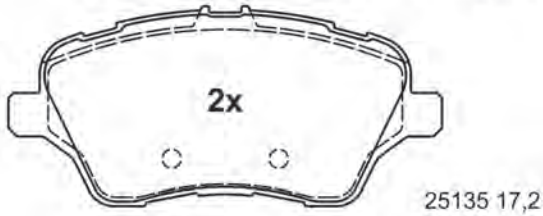
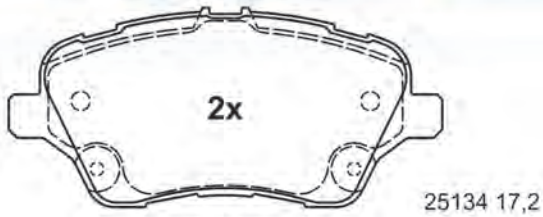

131,5 x 60,0 x 17,2

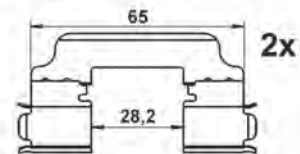
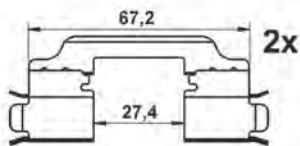

13.0460-2785.2 602785

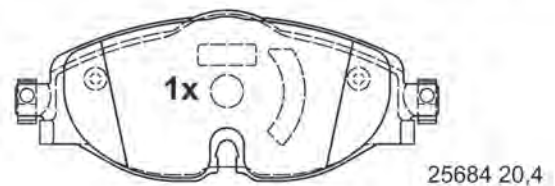
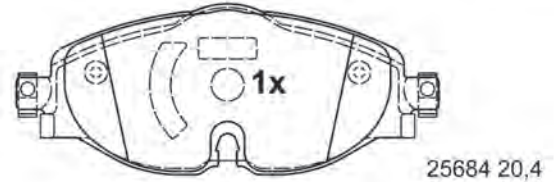
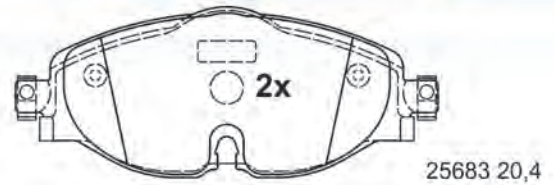

160,0 x 64,5 x 20,4

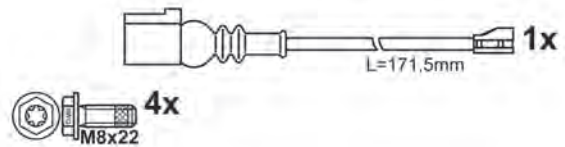

13.0460-2786.2 602786

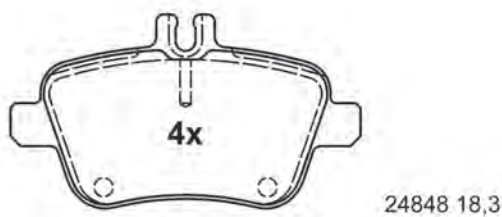

106,4 x 58,9 x 18,3

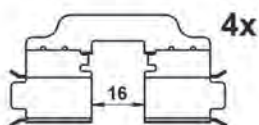

13.0460-2787.2 602787

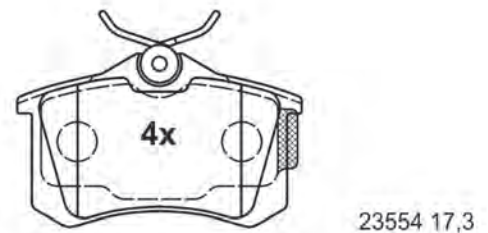

57,5 x 52,9 x 17,3



# Abbildungen Scheibenbremsbeläge

Illustrations disc brake pads - Ilustraciones de pastillas - Illustrations Plaquettes de frein à disque - Illustrazioni Pastiglie Freno

13.0460-2789.2 602789



25652 17,1

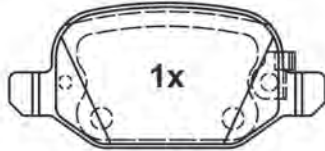

25653 17,1

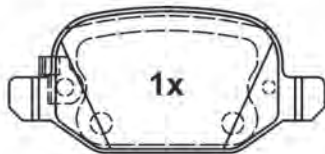

25654 17,1

95,8 x 43,8 x 17,1

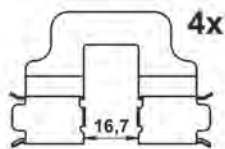

13.0460-2790.2 602790

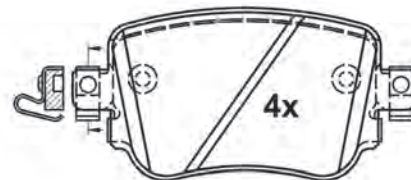

25110 17,5

104,2 x 51,9 x 17,5



13.0460-2792.2 602792

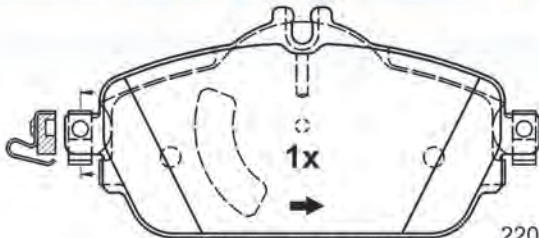

22031 19,6

144,0 x 70,0 x 19,6

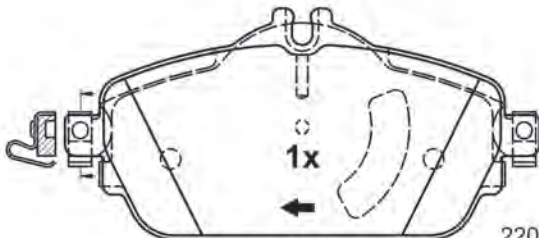

22031 19,6

144,0 x 70,0 x 19,6

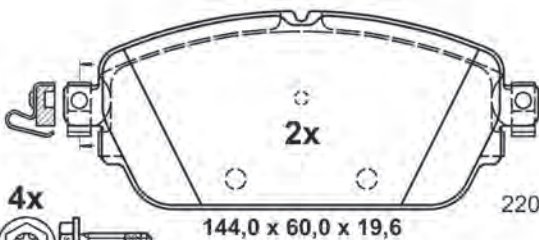

22032 19,6

144,0 x 60,0 x 19,6



13.0460-2793.2 602793

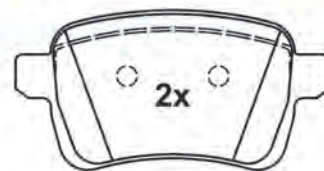

25973 17,2

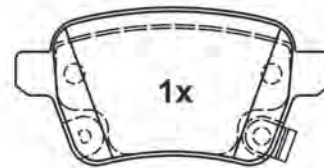

25974 17,2

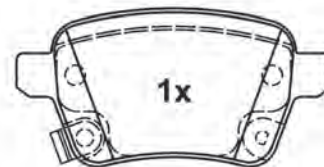

25975 17,2

95,5 x 47,7 x 17,2

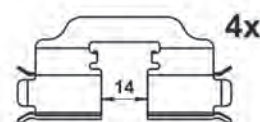

# Abbildungen Scheibenbremsbeläge

Illustrations disc brake pads - Ilustraciones de pastillas - Illustrations Plaquettes de frein à disque - Illustrazioni Pastiglie Freno

13.0460-2794.2 602794

B.H.P.

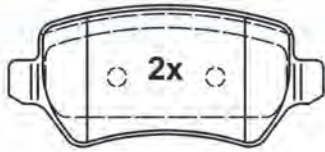

25779 15,0

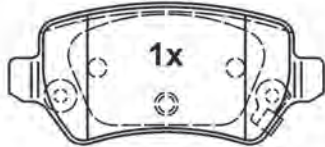

25780 15,0

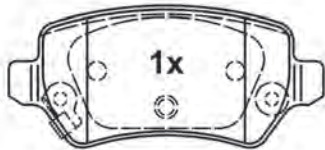

25781 15,0

95,4 x 42,7 x 15,0

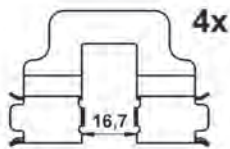

13.0460-2795.2 602795

B.H.P.

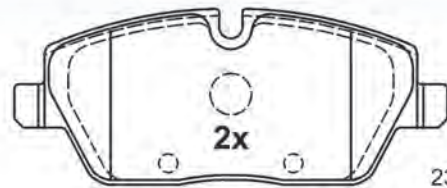

23915 17,6

131,3 x 53,2 x 17,6

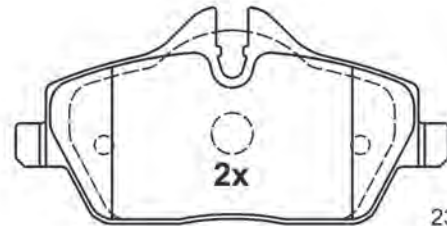

23915 17,6

131,3 x 65,3 x 17,6

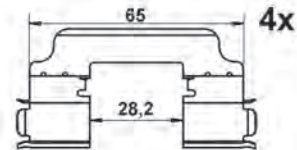

13.0460-2796.2 602796

B.H.P.

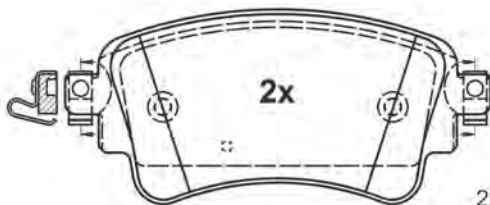

22308 17,7

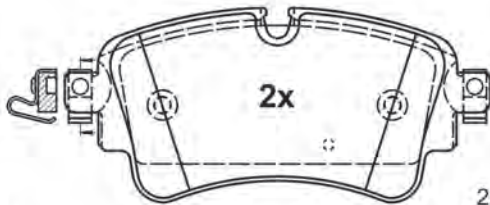

22309 17,7

129,0 x 58,9 x 17,7



13.0460-2797.2 602797

B.H.P.



25980 16,8

99,6 x 44,7 x 16,8



25981 16,8

95,5 x 38,8 x 16,8

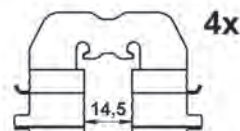
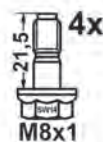



# Abbildungen Scheibenbremsbeläge

Illustrations disc brake pads - Ilustraciones de pastillas - Illustrations Plaquettes de frein à disque - Illustrazioni Pastiglie Freno

13.0460-2799.2 602799 [1]

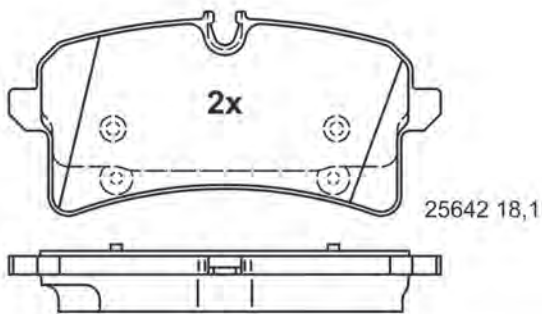
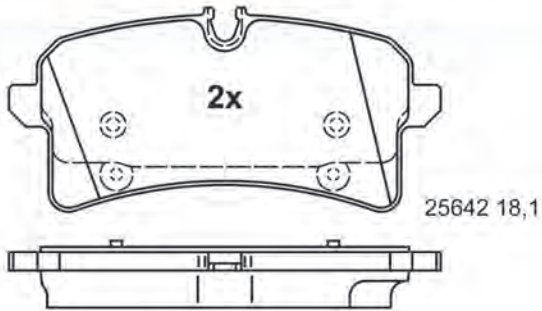

131,0 x 61,9 x 18,1

13.0460-2799.2 602799 [2]

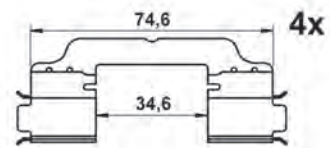
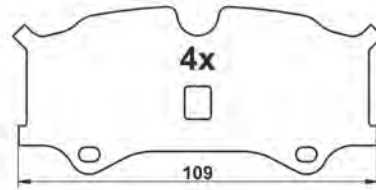

13.0460-2800.2 602800

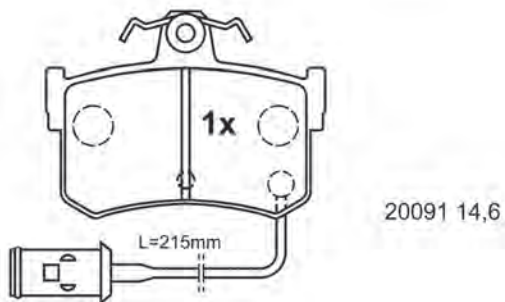
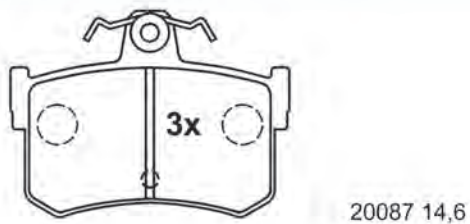

85,1 x 62,2 x 14,6

13.0460-2803.2 602803

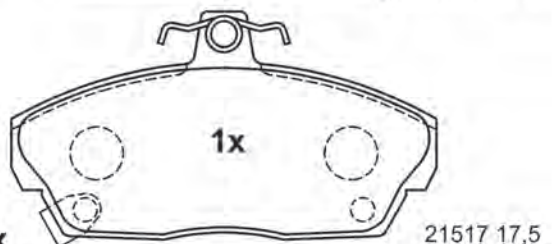
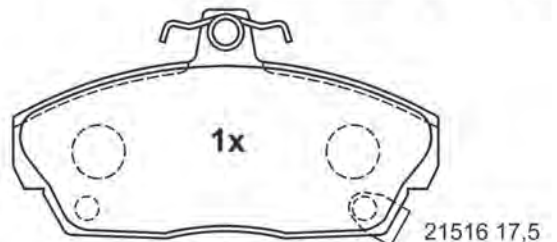
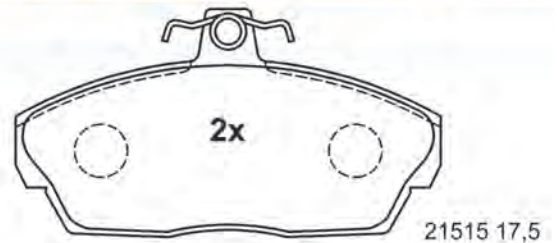

129,1 x 68,8 x 17,5

# Abbildungen Scheibenbremsbeläge

Illustrations disc brake pads - Ilustraciones de pastillas - Illustrations Plaquettes de frein à disque - Illustrazioni Pastiglie Freno

13.0460-2804.2 602804

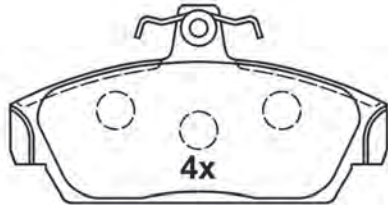

21518 17,0

115,2 x 60,4 x 17,0

13.0460-2805.2 602805

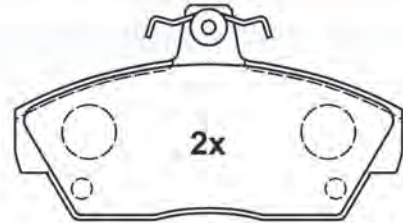

21520 17,5

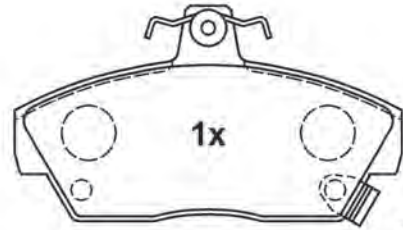

21521 17,5

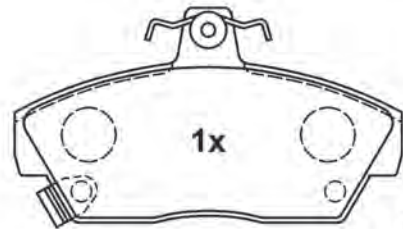

21522 17,5

117,5 x 65,6 x 17,5

13.0460-2806.2 602806

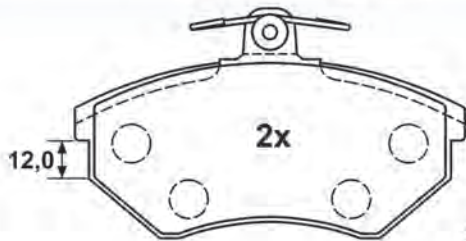

20168 19,3

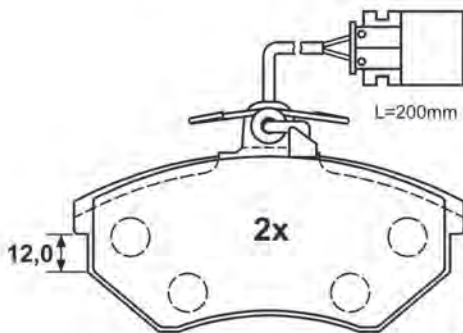

21366 19,3

119,0 x 69,5 x 19,3



13.0460-2810.2 602810

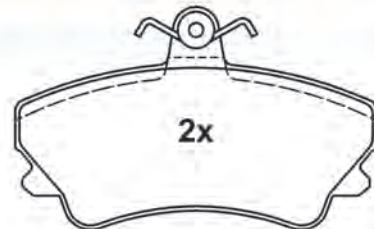

20236 18,0

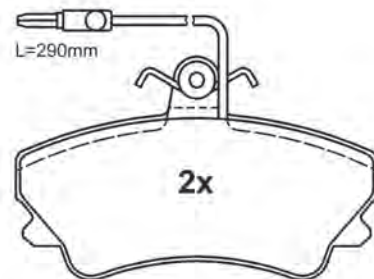

20238 18,0  
(20247)

110,0 x 67,5 x 18,0





# Abbildungen Scheibenbremsbeläge

Illustrations disc brake pads - Ilustraciones de pastillas - Illustrations Plaquettes de frein à disque - Illustrazioni Pastiglie Freno

13.0460-2811.2 602811

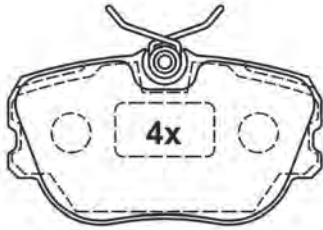

21068 17,0

94,8 x 52,6 x 17,0



13.0460-2812.2 602812

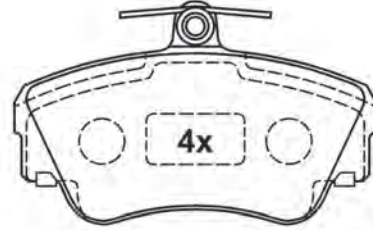

21217 18,0

109,9 x 67,5 x 18,0



13.0460-2815.2 602815

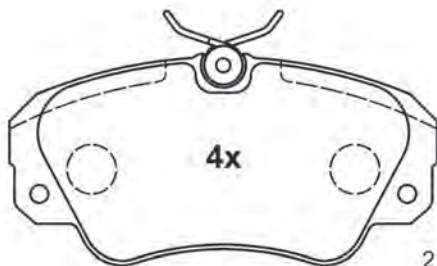

21368 18,3

129,9 x 63,8 x 18,3



13.0460-2816.2 602816

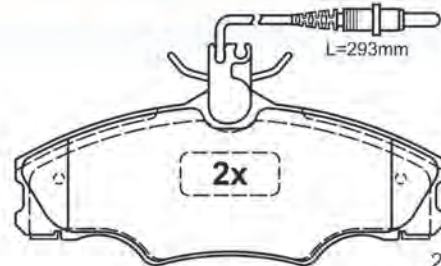

21724 19,3

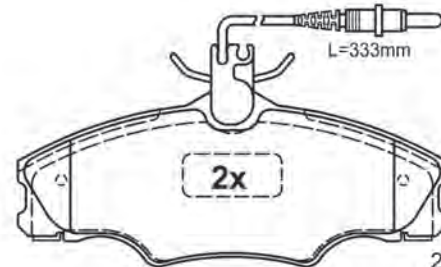

21749 19,3

130,0 x 52,8 x 19,3



# Abbildungen Scheibenbremsbeläge

Illustrations disc brake pads - Ilustraciones de pastillas - Illustrations Plaquettes de frein à disque - Illustrazioni Pastiglie Freno

13.0460-2817.2 602817

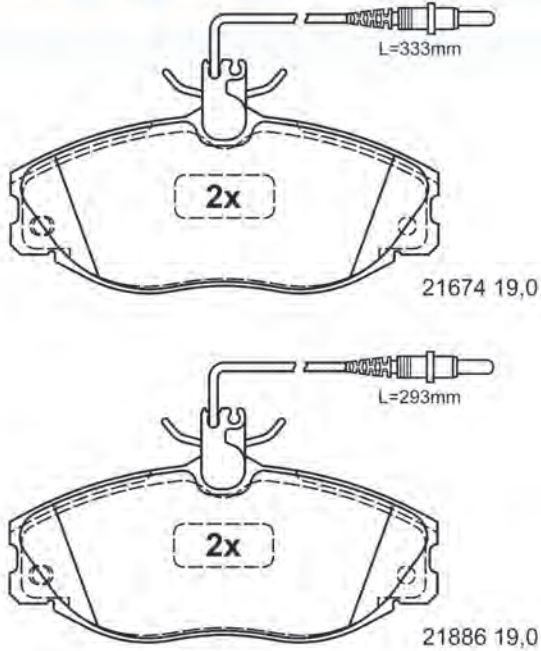

21674 19,0

21886 19,0

129,9 x 56,4 x 19,0



13.0460-2819.2 602819

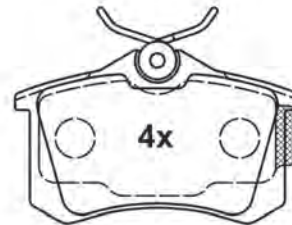

20961 17,2

87,6 x 52,9 x 17,2



13.0460-2820.2 602820

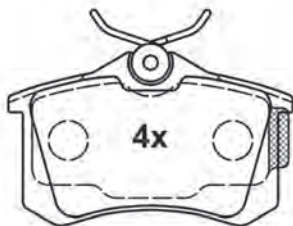

20961 17,2

87,6 x 52,9 x 17,2



13.0460-2821.2 602821

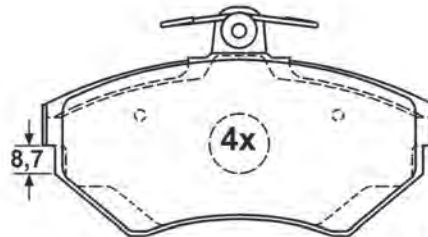

21945 16,0

119,1 x 69,5 x 16,0



# Abbildungen Scheibenbremsbeläge

Illustrations disc brake pads - Ilustraciones de pastillas - Illustrations Plaquettes de frein à disque - Illustrazioni Pastiglie Freno

13.0460-2822.2 602822

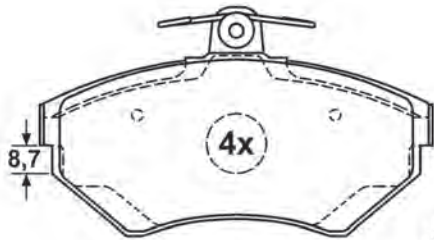

21945 19,6

119,1 x 69,5 x 19,6



13.0460-2824.2 602824

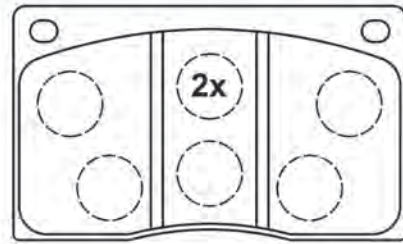

20380 15,6

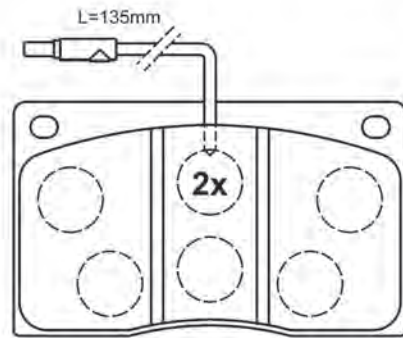

21110 15,6

119,7 x 71,0 x 15,6

13.0460-2825.2 602825

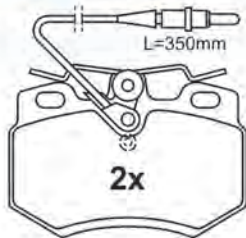

21616 17,7

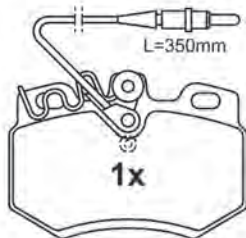

21614 17,7

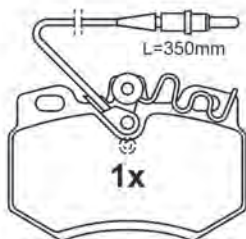

21615 17,7

89,9 x 62,9 x 17,7

13.0460-2826.2 602826

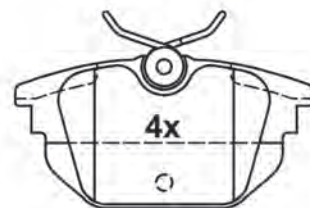

23177 14,2

87,0 x 44,6 x 14,2



# Abbildungen Scheibenbremsbeläge

Illustrations disc brake pads - Ilustraciones de pastillas - Illustrations Plaquettes de frein à disque - Illustrazioni Pastiglie Freno

13.0460-2827.2 602827

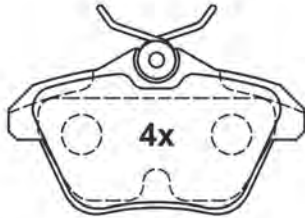

21606 16,7

89,8 x 49,9 x 16,7



13.0460-2828.2 602828

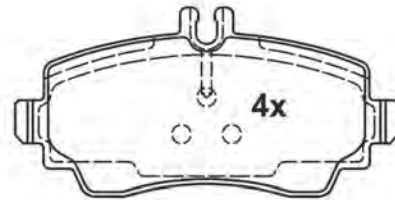

23070 19,5

116,5 x 57,1 x 19,5



13.0460-2829.2 602829

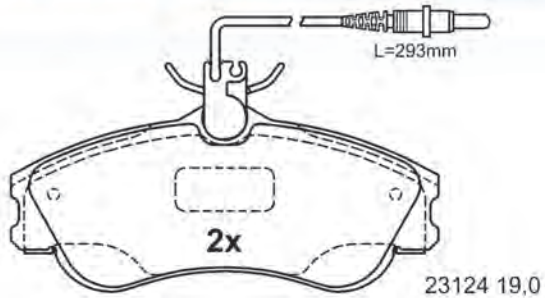

23124 19,0

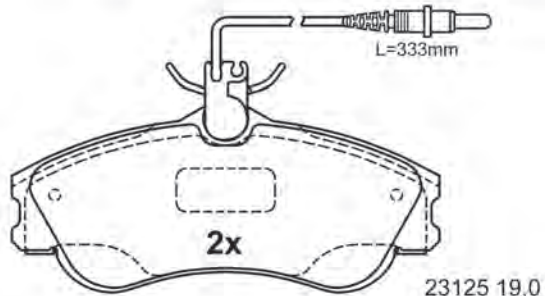

23125 19,0

129,9 x 56,2 x 19,0



13.0460-2830.2 602830

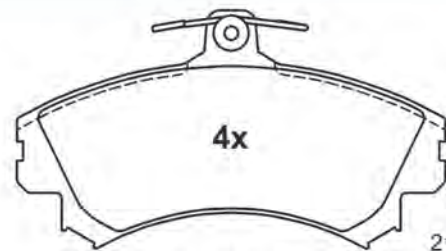

21920 14,6

129,9 x 72,7 x 14,6

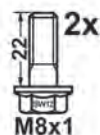
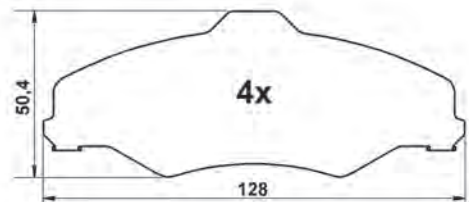



# Abbildungen Scheibenbremsbeläge

Illustrations disc brake pads - Ilustraciones de pastillas - Illustrations Plaquettes de frein à disque - Illustrazioni Pastiglie Freno

13.0460-2831.2 602831

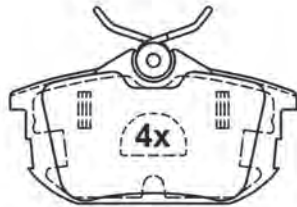

21861 15,2

87,0 x 47,0 x 15,2



13.0460-2832.2 602832

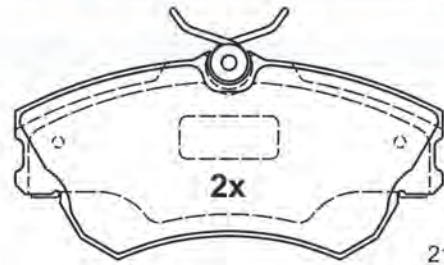

21888 18,1

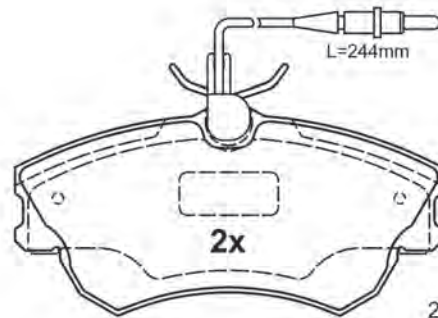

21889 18,1

129,8 x 63,0 x 18,1



13.0460-2833.2 602833

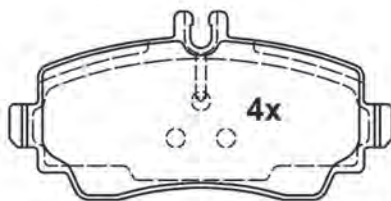

23070 17,0

116,5 x 57,1 x 17,0

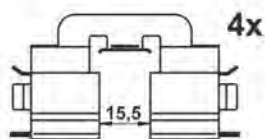
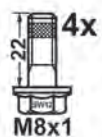

13.0460-2834.2 602834

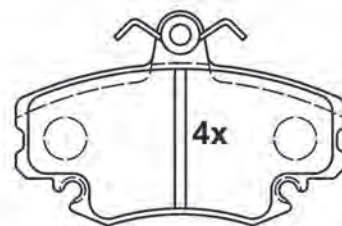

21463 18,0

99,9 x 64,9 x 18,0

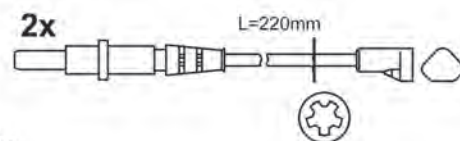



# Abbildungen Scheibenbremsbeläge

Illustrations disc brake pads - Ilustraciones de pastillas - Illustrations Plaquettes de frein à disque - Illustrazioni Pastiglie Freno

13.0460-2835.2 602835

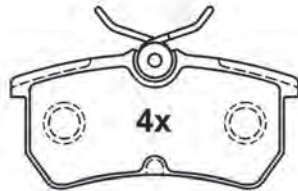

23353 14,8

87,5 x 42,4 x 14,8



13.0460-2836.2 602836

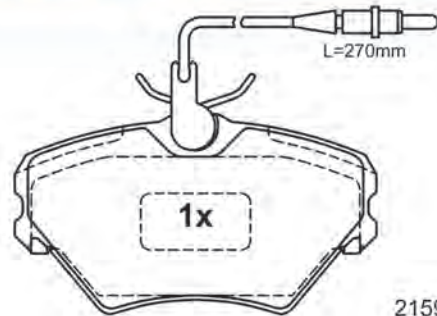

21595 18,3

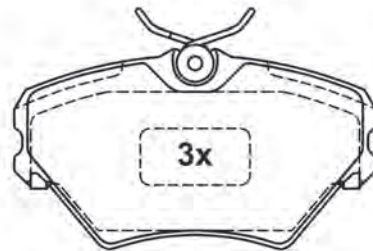

21596 18,3

109,9 x 60,7 x 18,3



13.0460-2837.2 602837

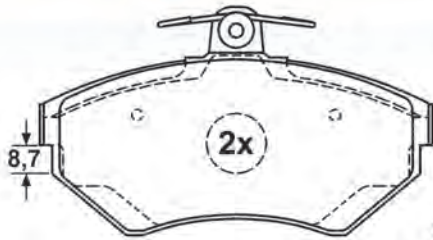

21945 19,6

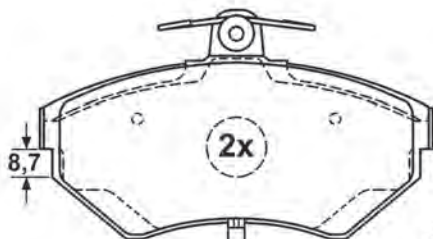

23393 19,6

119,1 x 69,5 x 19,6



13.0460-2838.2 602838

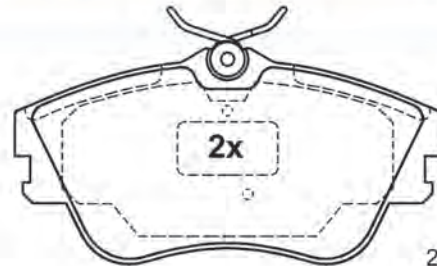

21479 19,2

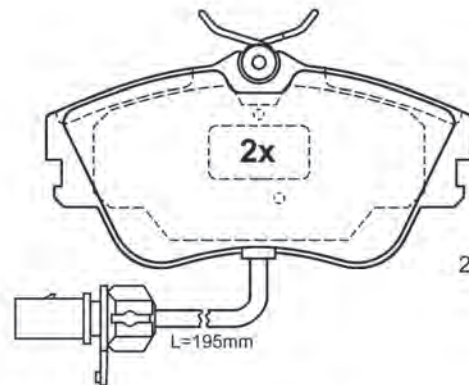

23445 19,2

129,9 x 65,2 x 19,2



# Abbildungen Scheibenbremsbeläge

Illustrations disc brake pads - Ilustraciones de pastillas - Illustrations Plaquettes de frein à disque - Illustrazioni Pastiglie Freno

13.0460-2839.2 602839

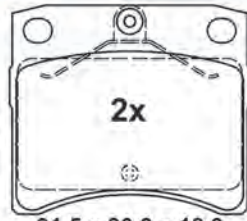

20651 18,3

91,5 x 80,0 x 18,3

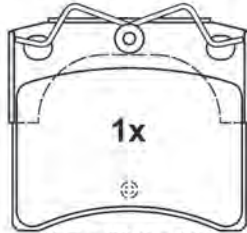

21635 18,7

91,7 x 80,0 x 18,7

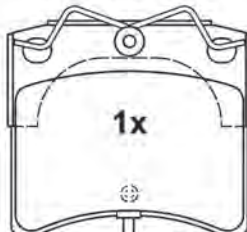

23176 18,7

L=196mm

91,7 x 80,0 x 18,7

13.0460-2840.2 602840

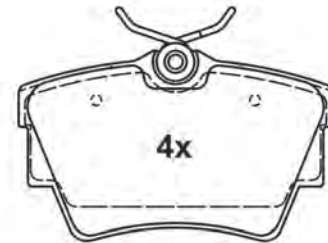

23980 16,5

94,4 x 57,2 x 16,5



13.0460-2842.2 602842



20961 15,2

86,8 x 52,9 x 15,2



13.0460-2844.2 602844

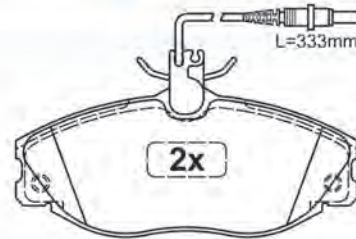

21674 19,4

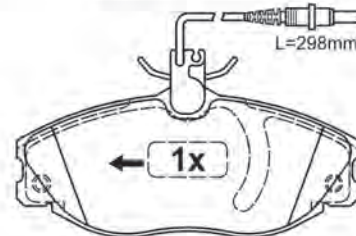

21886 19,4

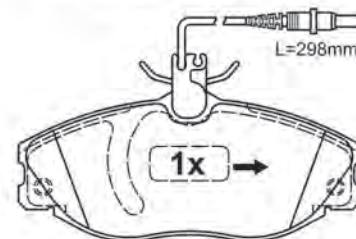

21886 19,4



129,8 x 56,4 x 19,4

# Abbildungen Scheibenbremsbeläge

Illustrations disc brake pads - Ilustraciones de pastillas - Illustrations Plaquettes de frein à disque - Illustrazioni Pastiglie Freno

13.0460-2845.2 602845

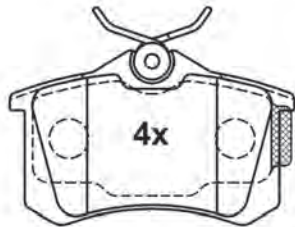

23554 16,4

87,6 x 52,9 x 16,4



13.0460-2846.2 602846

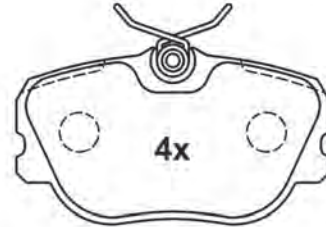

21010 15,8

95,0 x 52,3 x 15,8



13.0460-2850.2 602850

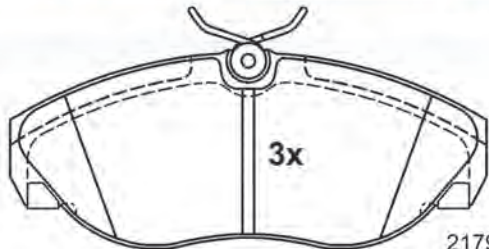

21797 19,7

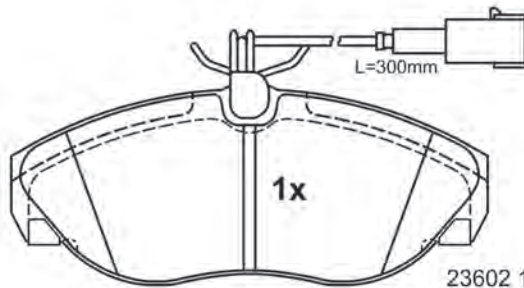

23602 19,7

144,8 x 60,8 x 19,7



13.0460-2852.2 602852

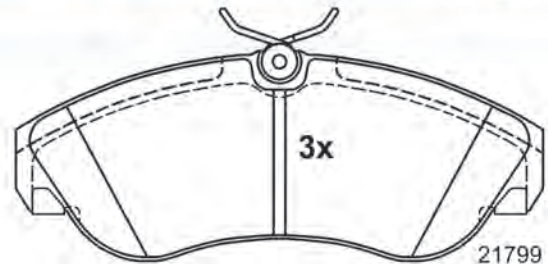

21799 19,7

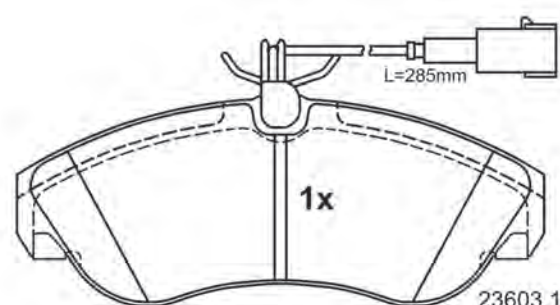

23603 19,7

159,8 x 64,1 x 19,7





# Abbildungen Scheibenbremsbeläge

Illustrations disc brake pads - Ilustraciones de pastillas - Illustrations Plaquettes de frein à disque - Illustrazioni Pastiglie Freno

13.0460-2853.2 602853

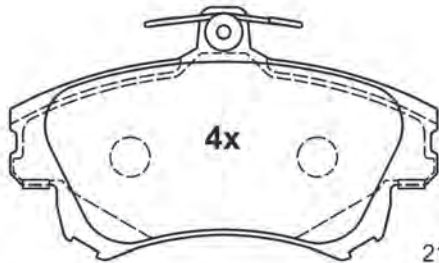

21983 17,2

129,9 x 76,7 x 17,2



13.0460-2855.2 602855

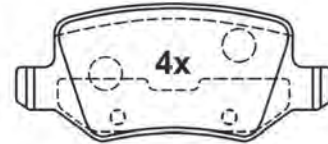

23138 14,6

95,7 x 41,3 x 14,6



13.0460-2857.2 602857

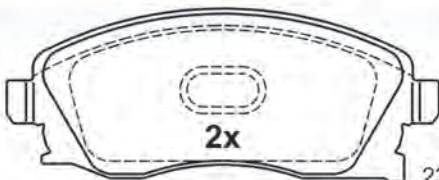

23225 17,0

131,5 x 52,3 x 17,0

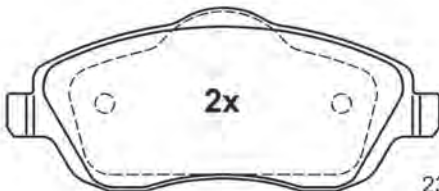

23226 17,0

131,5 x 55,4 x 17,0

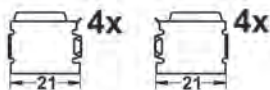
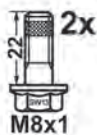

13.0460-2858.2 602858

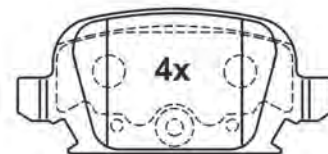

23284 14,0

95,6 x 43,8 x 14,0



# Abbildungen Scheibenbremsbeläge

Illustrations disc brake pads - Ilustraciones de pastillas - Illustrations Plaquettes de frein à disque - Illustrazioni Pastiglie Freno

13.0460-2859.2 602859

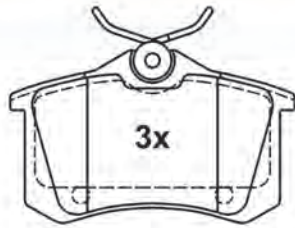

20961 17,0

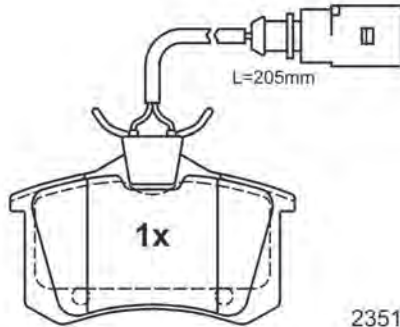

23516 17,0

87,6 x 52,9 x 17,0

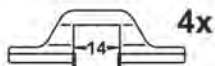

13.0460-2860.2 602860

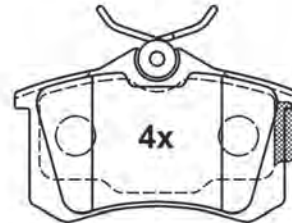

23554 16,4

87,6 x 52,9 x 16,4



13.0460-2862.2 602862

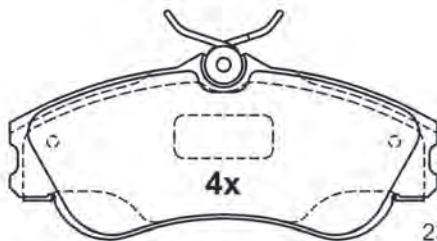

23346 19,0

129,9 x 56,2 x 19,0



13.0460-2863.2 602863

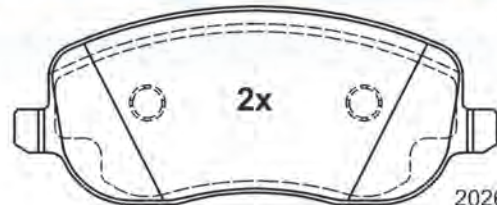

20261 19,0

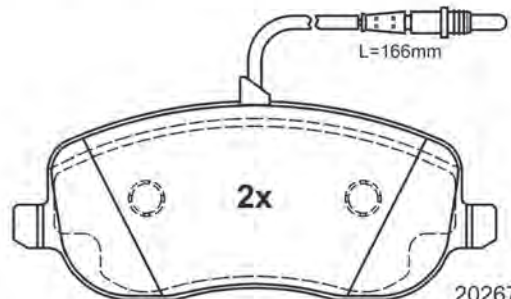

20267 19,0

146,6 x 60,0 19,0

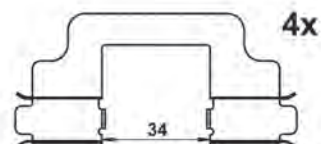
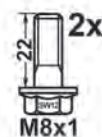



# Abbildungen Scheibenbremsbeläge

Illustrations disc brake pads - Ilustraciones de pastillas - Illustrations Plaquettes de frein à disque - Illustrazioni Pastiglie Freno

13.0460-2864.2 602864  13.0460-2867.2 602867 

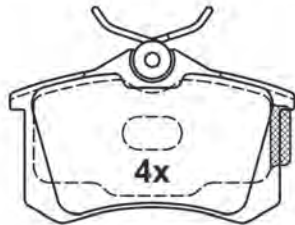

20961 17,2

87,6 x 52,9 x 17,2

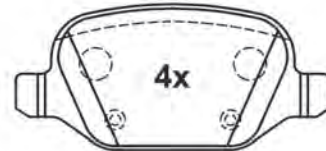

23517 16,6

95,6 x 43,9 x 16,6



13.0460-2868.2 602868  13.0460-2869.2 602869 



23417 15,3

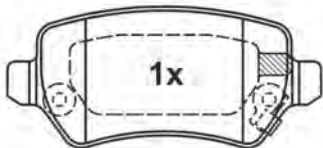

23654 15,3

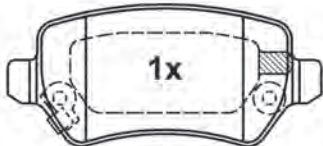

23655 15,3

95,3 x 42,8 x 15,3

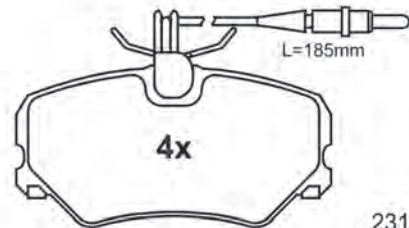

23169 19,4

94,8 x 48,9 x 19,4

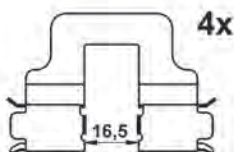

# Abbildungen Scheibenbremsbeläge

Illustrations disc brake pads - Ilustraciones de pastillas - Illustrations Plaquettes de frein à disque - Illustrazioni Pastiglie Freno

13.0460-2870.2 602870

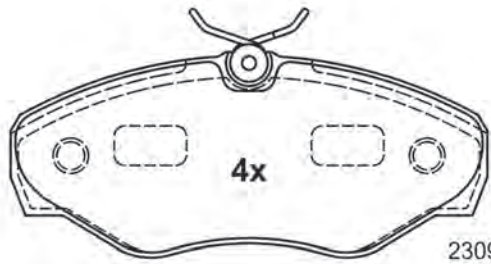

23099 18,4

145,0 x 62,4 x 18,4



13.0460-2871.2 602871

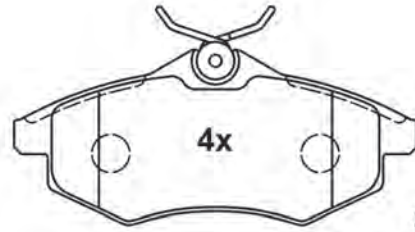

23407 19,0

122,6 x 53,2 x 19,0



13.0460-2872.2 602872

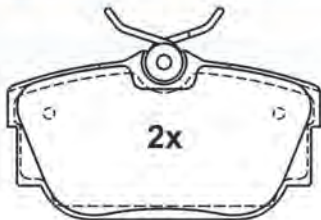

23224 16,5

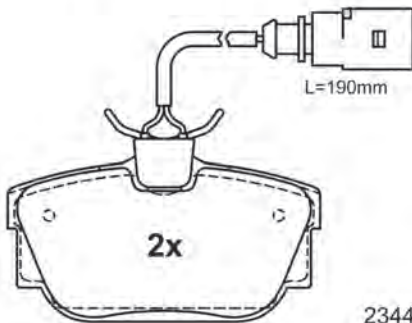

23446 16,5

94,7 x 50,9 x 16,5

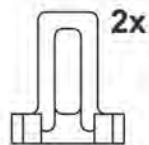
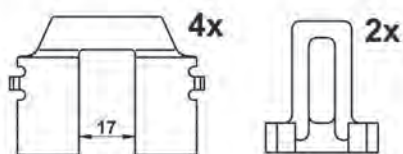

13.0460-2874.2 602874

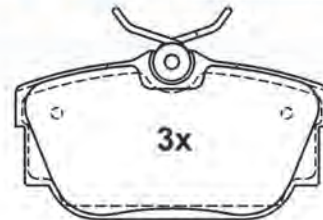

23224 16,5

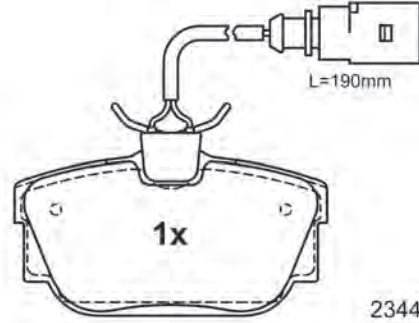

23446 16,5

94,7 x 50,9 x 16,5

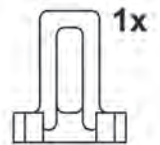
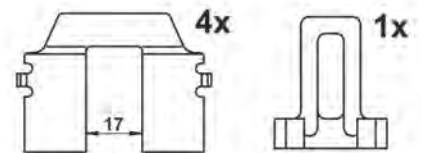

# Abbildungen Scheibenbremsbeläge

Illustrations disc brake pads - Ilustraciones de pastillas - Illustrations Plaquettes de frein à disque - Illustrazioni Pastiglie Freno

13.0460-2875.2 602875



77,1 x 74,7 x 17,5

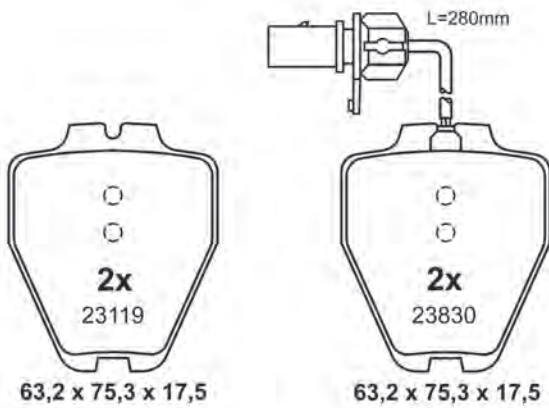

13.0460-2876.2 602876



77,1 x 74,7 x 17,5

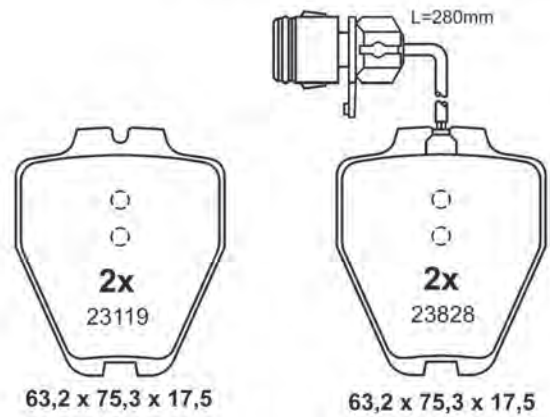

13.0460-2877.2 602877

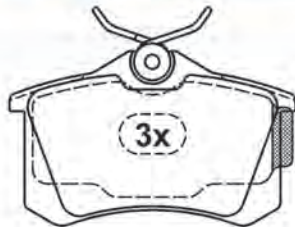

23554 17,2

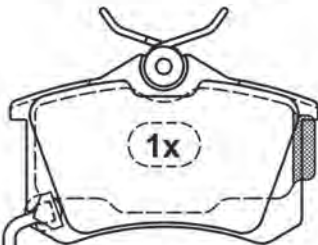

23823 17,2

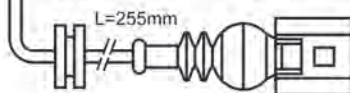

87,6 x 52,9 x 17,2

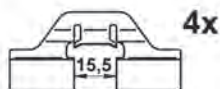

13.0460-2878.2 602878

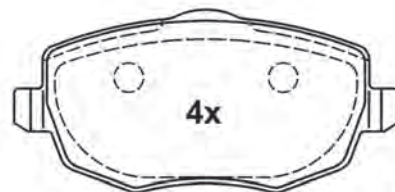

24073 16,7

116,8 x 55,2 x 16,7



# Abbildungen Scheibenbremsbeläge

Illustrations disc brake pads - Ilustraciones de pastillas - Illustrations Plaquettes de frein à disque - Illustrazioni Pastiglie Freno

13.0460-2879.2 602879



23601 13,7

95,6 x 43,9 x 13,7



13.0460-2880.2 602880

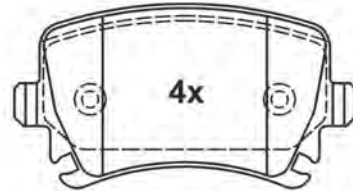

23914 17,1

105,3 x 55,9 x 17,1

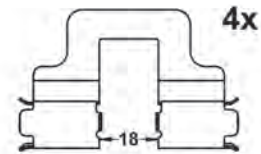

13.0460-2880.2 602880



wahlweise  
optional

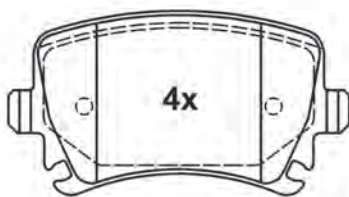

23914 17,1

105,3 x 55,9 x 17,1

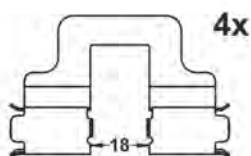

13.0460-2881.2 602881

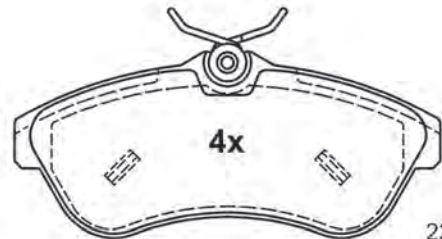

23409 19,3

128,8 x 56,1 x 19,3





# Abbildungen Scheibenbremsbeläge

Illustrations disc brake pads - Ilustraciones de pastillas - Illustrations Plaquettes de frein à disque - Illustrazioni Pastiglie Freno

13.0460-2882.2 602882

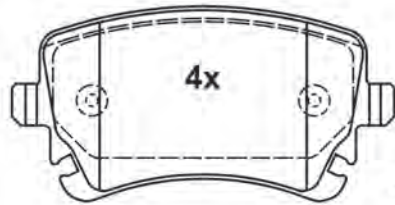

23326 17,4

116,1 x 59,0 x 17,4

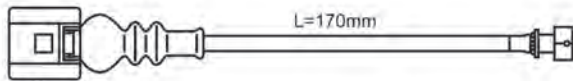

1x

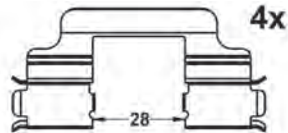

4x



4x

M8x1

13.0460-2882.2 602882



wahlweise  
optional

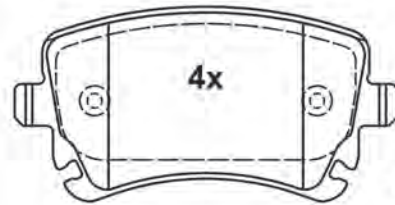

23326 17,4

116,1 x 59,0 x 17,4

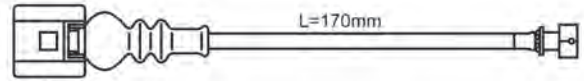

1x

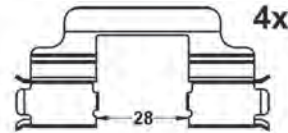

4x



4x

M8x1

13.0460-2883.2 602883

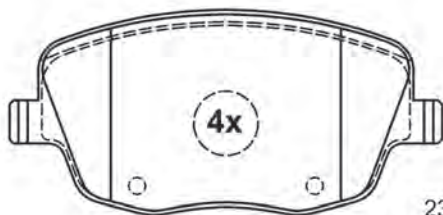

23581 18,8

131,4 x 62,0 x 18,8



4x

M8x22

13.0460-2884.2 602884



23581 18,8

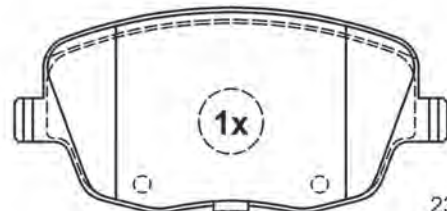

23843 18,8

131,4 x 62,0 x 18,8

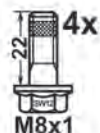

4x

M8x1



# Abbildungen Scheibenbremsbeläge

Illustrations disc brake pads - Ilustraciones de pastillas - Illustrations Plaquettes de frein à disque - Illustrazioni Pastiglie Freno

13.0460-2885.2 602885

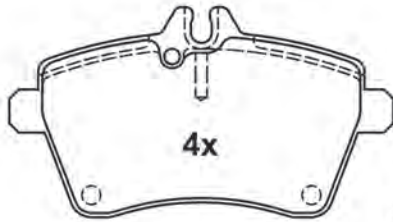

24077 19,1

116,4 x 63,8 x 19,1

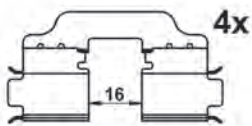

13.0460-2886.2 602886

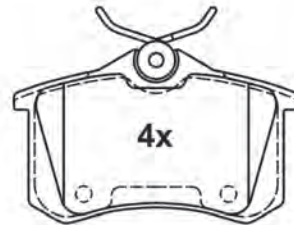

20961 16,0

87,6 x 52,9 x 16,0



13.0460-2887.2 602887

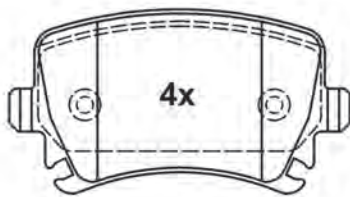

23914 17,1

105,3 x 55,9 x 17,1

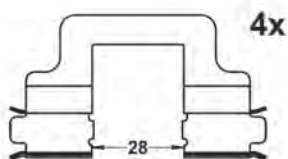

13.0460-2888.2 602888

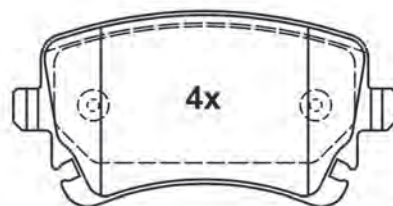

23326 17,4

116,1 x 59,0 x 17,4



# Abbildungen Scheibenbremsbeläge

Illustrations disc brake pads - Ilustraciones de pastillas - Illustrations Plaquettes de frein à disque - Illustrazioni Pastiglie Freno

13.0460-2889.2 602889

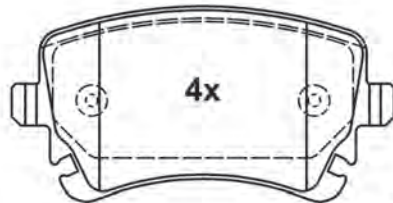

23326 17,4

116,1 x 59,0 x 17,4



13.0460-2890.2 602890

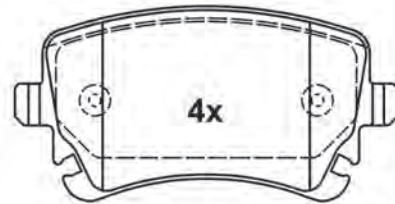

23326 17,4

116,1 x 59,0 x 17,4



13.0460-2891.2 602891

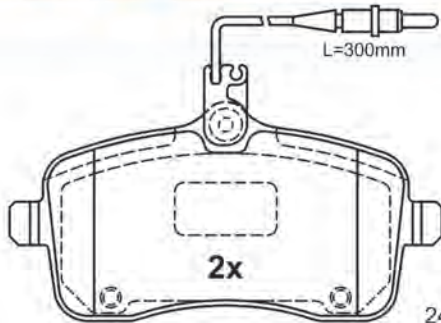

24134 19,6

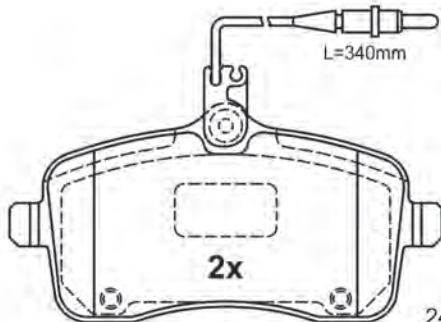

24175 19,6

131,4 x 67,5 x 19,6



13.0460-2892.2 602892

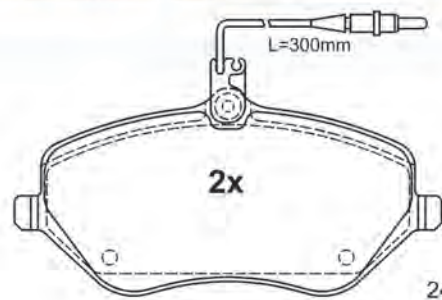

24174 18,6

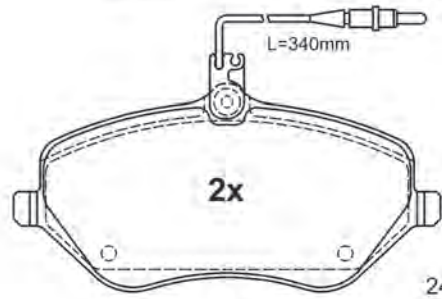

24133 18,6

162,3 x 79,0 x 18,6

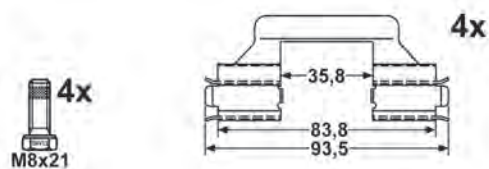

# Abbildungen Scheibenbremsbeläge

Illustrations disc brake pads - Ilustraciones de pastillas - Illustrations Plaquettes de frein à disque - Illustrazioni Pastiglie Freno

13.0460-2893.2 602893



24135 17,7

86,1 x 56,9 x 17,7



M8x22

13.0460-2894.2 602894

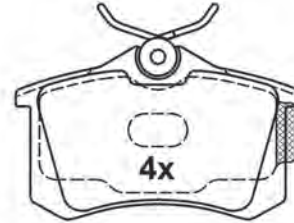

20961 17,2

87,6 x 52,9 x 17,2

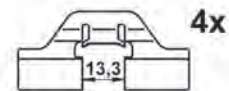

M8x22

13.0460-2895.2 602895

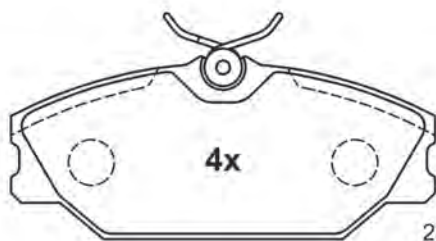

23172 18,0

128,6 x 55,5 x 18,0

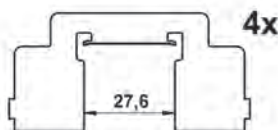

M8x21

13.0460-2896.2 602896

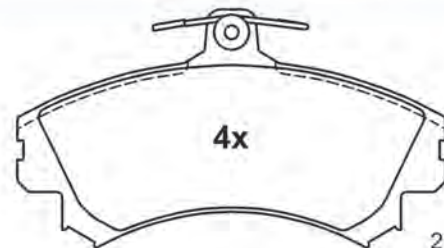

21920 16,6

129,9 x 72,7 x 16,6

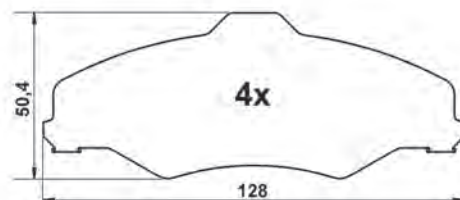

M8x1



1x

# Abbildungen Scheibenbremsbeläge

Illustrations disc brake pads - Ilustraciones de pastillas - Illustrations Plaquettes de frein à disque - Illustrazioni Pastiglie Freno

13.0460-2897.2 602897

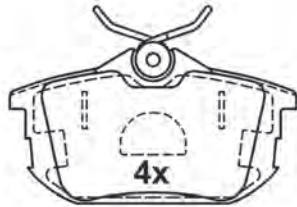

21861 15,2

87,0 x 47,0 x 15,2



13.0460-2898.2 602898

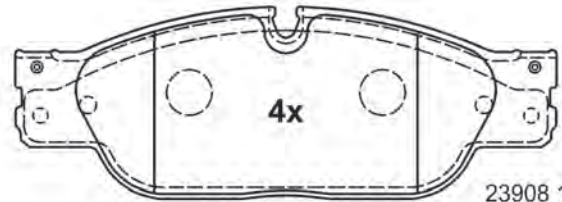

23908 18,0

164,3 x 58,1 x 18,0



13.0460-2899.2 602899

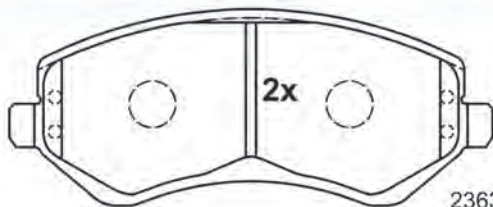

23638 17,5

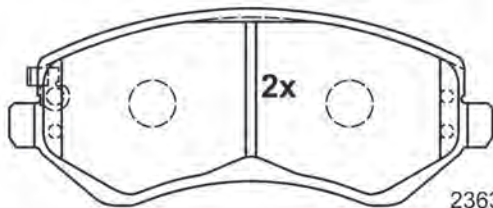

23639 17,5

146,4 x 59,4 x 17,5

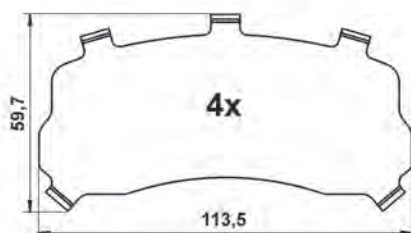

13.0460-2925.2 602925

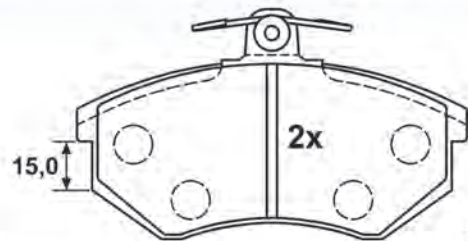

20669 19,0

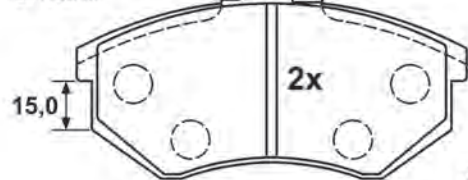
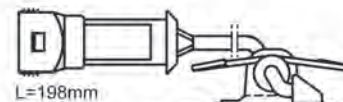

20901 19,0

119,0 x 69,5 x 19,0





# Abbildungen Scheibenbremsbeläge

Illustrations disc brake pads - Ilustraciones de pastillas - Illustrations Plaquettes de frein à disque - Illustrazioni Pastiglie Freno

13.0460-2927.2 602927

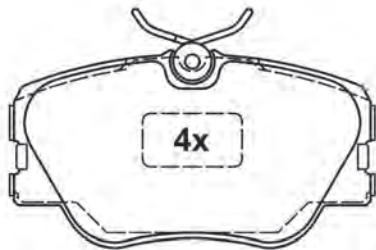

20941 19,3  
(21028)

110,0 x 59,6 x 19,3



13.0460-2928.2 602928

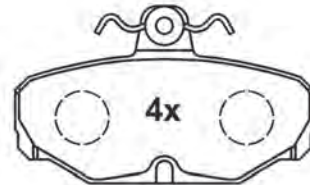

20981 13,8

90,0 x 53,8 x 13,8



13.0460-2934.2 602934

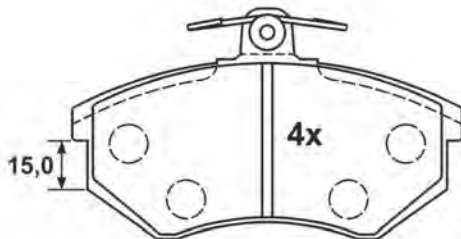

20669 19,0

119,0 x 69,5 x 19,0



13.0460-2935.2 602935

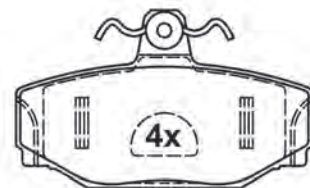

21385 13,8

89,9 x 53,5 x 13,8





# Abbildungen Scheibenbremsbeläge

Illustrations disc brake pads - Ilustraciones de pastillas - Illustrations Plaquettes de frein à disque - Illustrazioni Pastiglie Freno

13.0460-2937.2 602937



20961 15,2

87,6 x 52,9 x 15,2

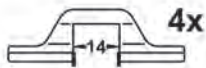

4x



4x

M8x21

13.0460-2941.2 602941

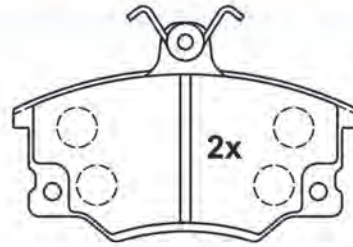

20838 17,0

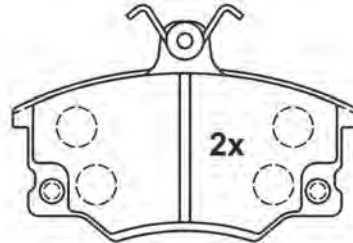

20839 17,0

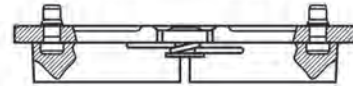

104,6 x 66,6 x 17,0



2x

M8x21

13.0460-2948.2 602948

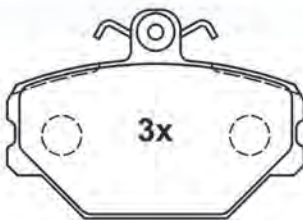

21100 16,7

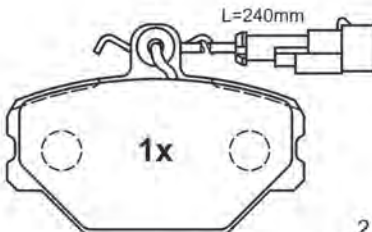

21105 16,7

90,0 x 63,0 x 16,7



2x

M8x21

13.0460-2949.2 602949

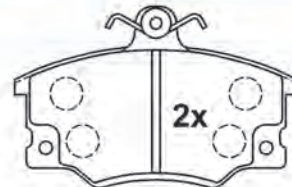

20838 17,0

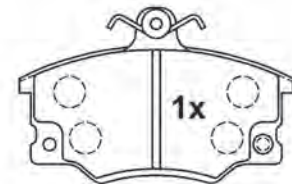

20833 17,0

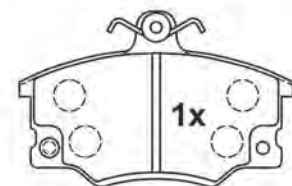

20834 17,0

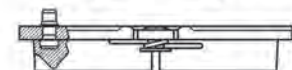

104,0 x 67,0 x 17,0



2x

M8x21

# Abbildungen Scheibenbremsbeläge

Illustrations disc brake pads - Ilustraciones de pastillas - Illustrations Plaquettes de frein à disque - Illustrazioni Pastiglie Freno

13.0460-2951.2 602951

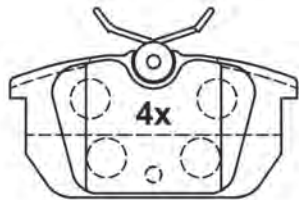

21103 14,2

87,0 x 44,6 x 14,2



13.0460-2952.2 602952

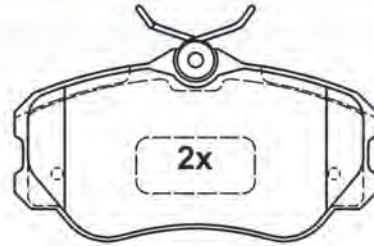

21182 19,4

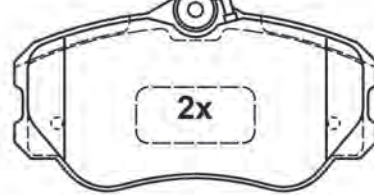
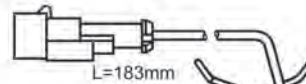

21185 19,4

109,8 x 58,5 x 19,4



13.0460-2955.2 602955

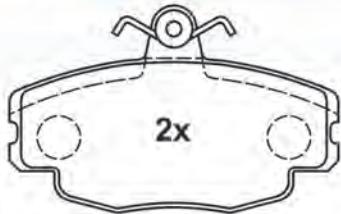

20772 18,0

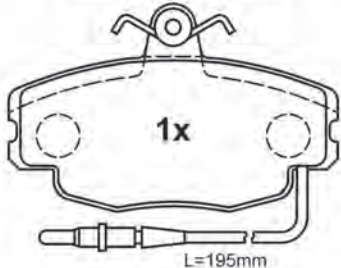

20937 18,0

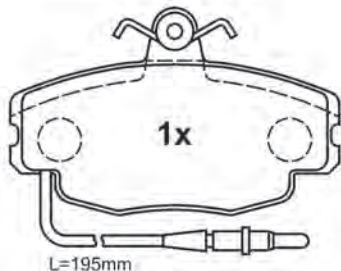

20938 18,0

100,0 x 63,5 x 18,0



13.0460-2956.2 602956

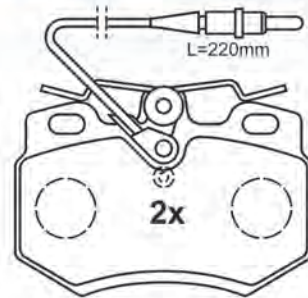

20989 17,7

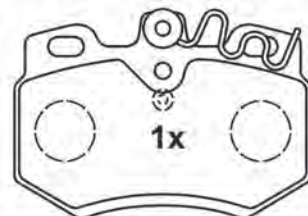

21022 17,7

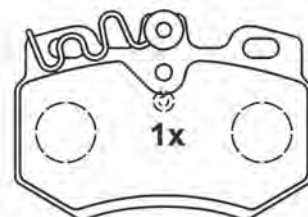

21023 17,7

90,0 x 62,9 x 17,7

# Abbildungen Scheibenbremsbeläge

Illustrations disc brake pads - Ilustraciones de pastillas - Illustrations Plaquettes de frein à disque - Illustrazioni Pastiglie Freno

13.0460-2957.2 602957

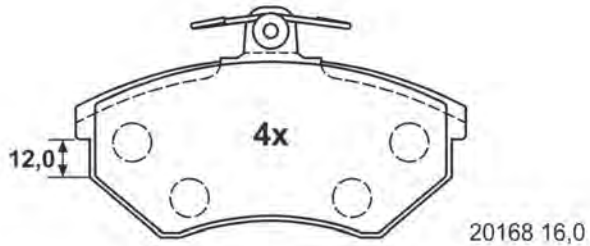

119,0 x 69,5 x 16,0



13.0460-2958.2 602958

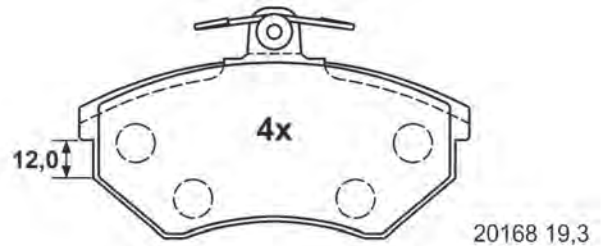

119,0 x 69,5 x 19,3



13.0460-2959.2 602959

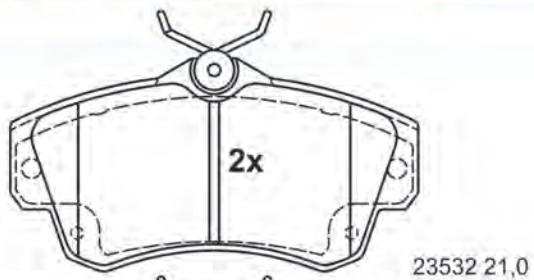

23532 21,0

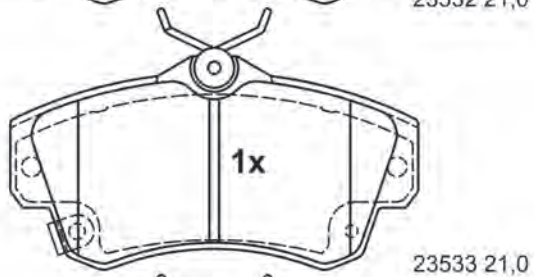

23533 21,0

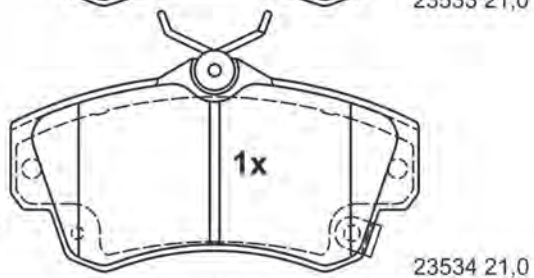

23534 21,0



123,9 x 64,6 x 21,0

13.0460-2963.2 602963

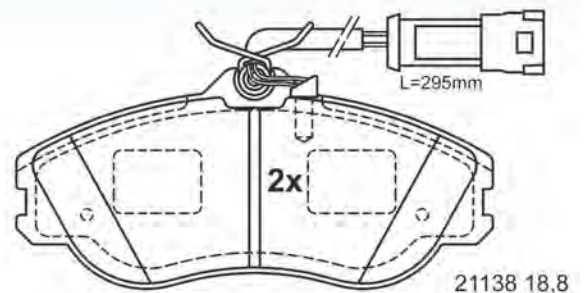

21138 18,8

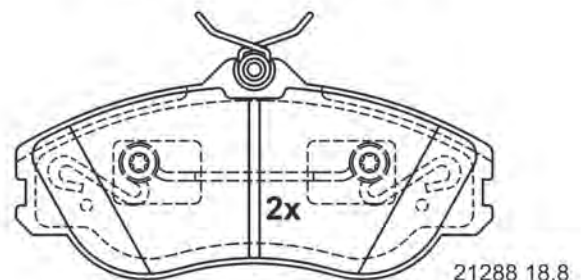

21288 18,8

144,9 x 67,0 x 18,8





# Abbildungen Scheibenbremsbeläge

Illustrations disc brake pads - Ilustraciones de pastillas - Illustrations Plaquettes de frein à disque - Illustrazioni Pastiglie Freno

13.0460-2964.2 602964

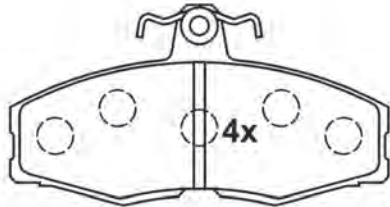

20861 17,5

114,8 x 60,6 x 17,5



13.0460-2965.2 602965

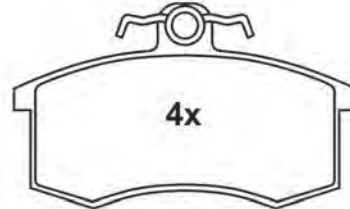

21170 17,3

104,3 x 62,1 x 17,3

13.0460-2966.2 602966



20166 16,0

83,9 x 60,5 x 16,0

13.0460-2971.2 602971

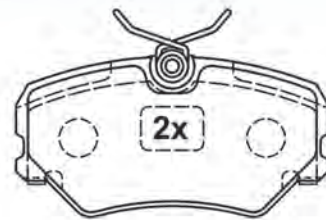

21209 18,5



21210 18,5

94,9 x 48,9 x 18,5



# Abbildungen Scheibenbremsbeläge

Illustrations disc brake pads - Ilustraciones de pastillas - Illustrations Plaquettes de frein à disque - Illustrazioni Pastiglie Freno

13.0460-2972.2 602972

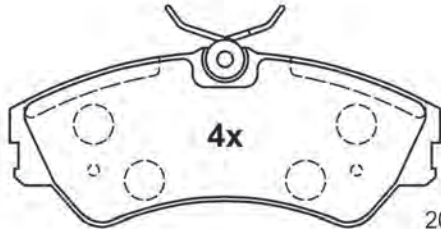

20124 18,9

129,8 x 54,5 x 18,9



13.0460-2973.2 602973

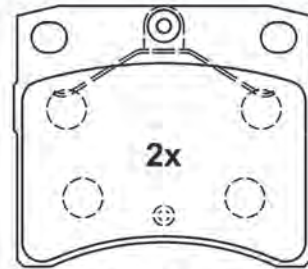

20651 18,0

91,5 x 80,0 x 18,0

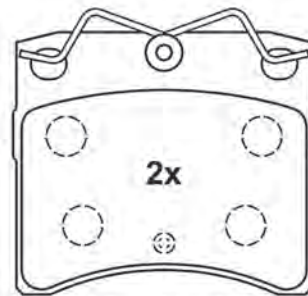

21635 18,0

91,5 x 80,0 x 18,0

13.0460-2975.2 602975

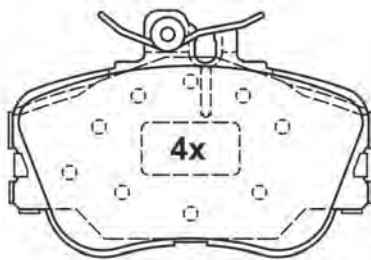

21439 20,3

110,0 x 74,5 x 20,3



13.0460-2976.2 602976

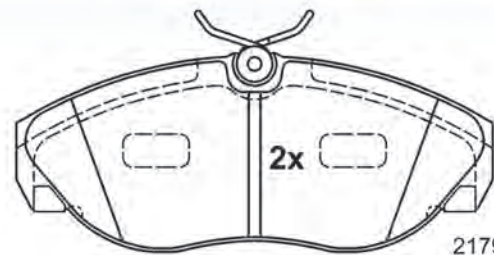

21797 19,7

144,8 x 60,8 x 19,7

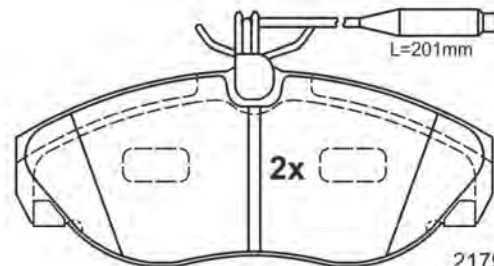

21798 19,7





# Abbildungen Scheibenbremsbeläge

Illustrations disc brake pads - Ilustraciones de pastillas - Illustrations Plaquettes de frein à disque - Illustrazioni Pastiglie Freno

13.0460-2977.2 602977

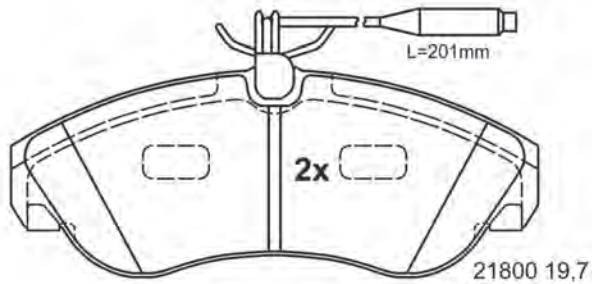
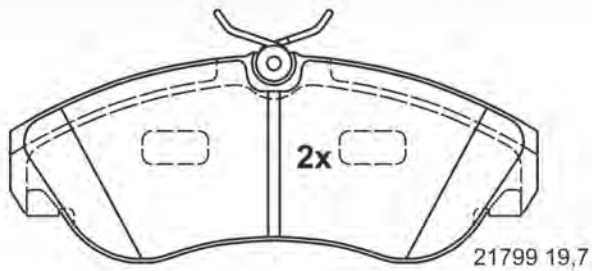

159,8 x 64,1 x 19,7



13.0460-2978.2 602978

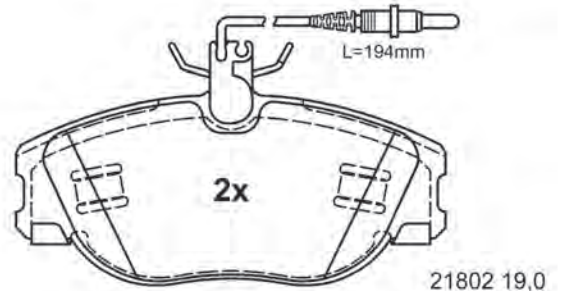
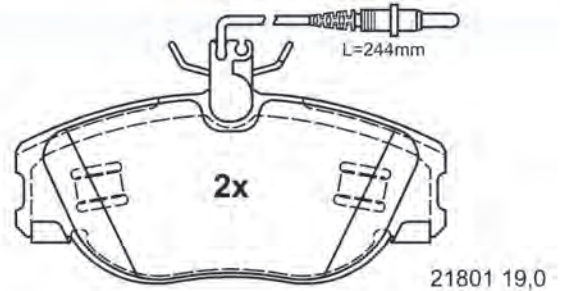

129,8 x 58,7 x 19,0



13.0460-2979.2 602979

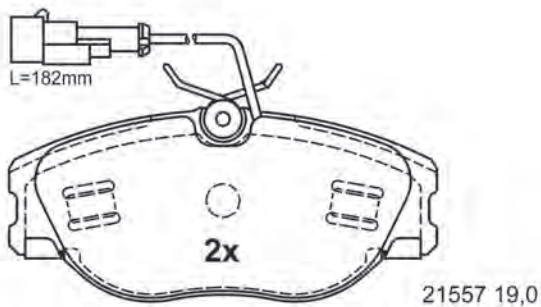
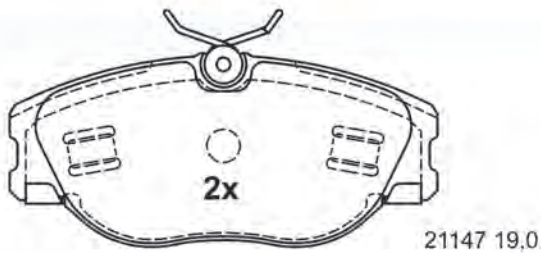

130,0 x 58,7 x 19,0



13.0460-2980.2 602980

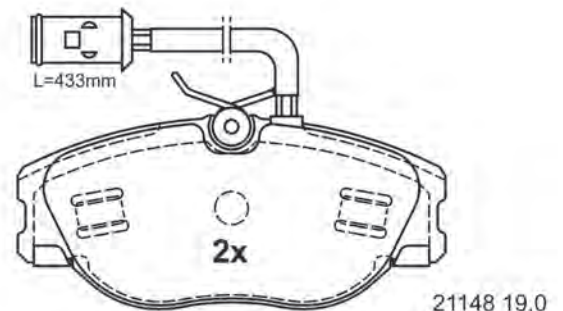
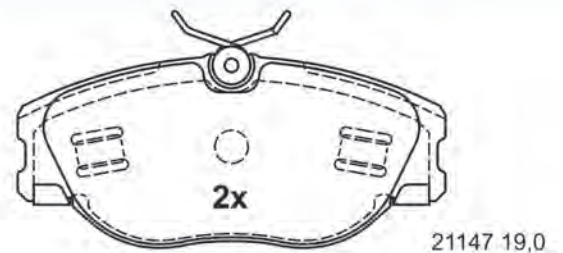

130,0 x 58,7 x 19,0



# Abbildungen Scheibenbremsbeläge

Illustrations disc brake pads - Ilustraciones de pastillas - Illustrations Plaquettes de frein à disque - Illustrazioni Pastiglie Freno

13.0460-2981.2 602981

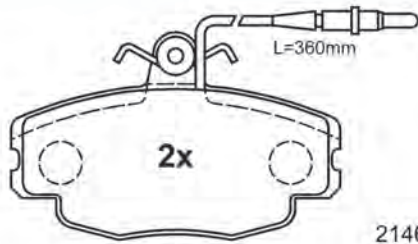

21460 18,0

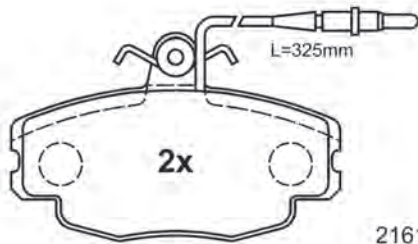

21613 18,0

100,0 x 63,5 x 18,0



13.0460-2982.2 602982

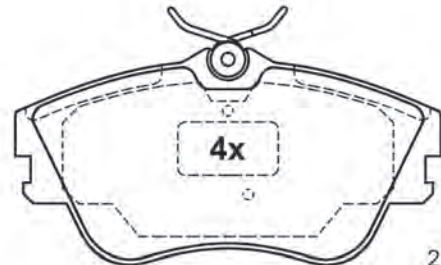

21479 19,2

129,9 x 65,2 x 19,2



13.0460-2983.2 602983

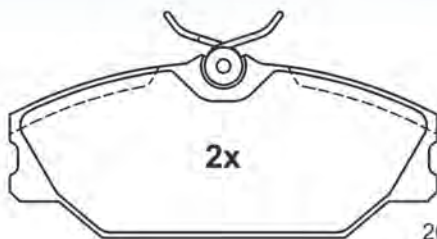

20919 18,0

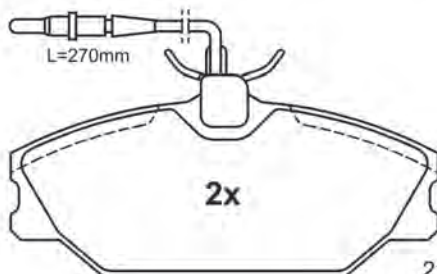

21388 18,0

129,9 x 55,5 x 18,0



13.0460-2984.2 602984

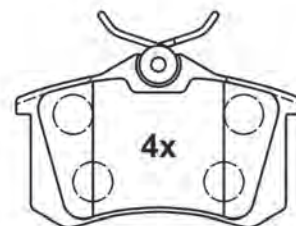

20961 17,2

87,6 x 52,9 x 17,2



# Abbildungen Scheibenbremsbeläge

Illustrations disc brake pads - Ilustraciones de pastillas - Illustrations Plaquettes de frein à disque - Illustrazioni Pastiglie Freno

13.0460-2985.2 602985

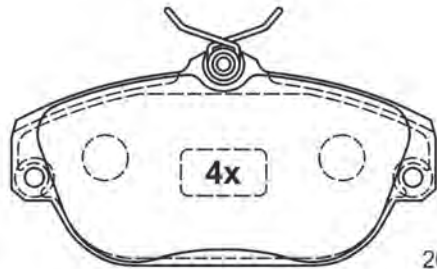

20164 18,2

128,9 x 64,7 x 18,2

13.0460-2987.2 602987

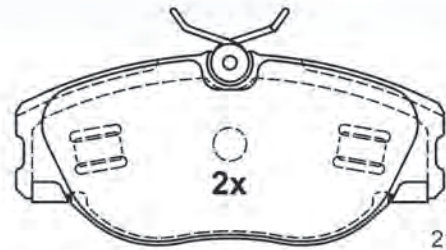

21147 19,0

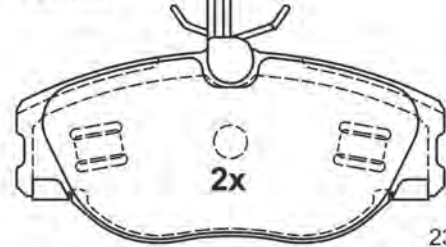
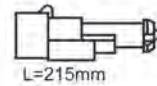

23168 19,0

130,0 x 58,7 x 19,0



13.0460-2997.2 602997

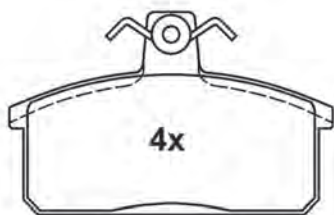

20708 15,8

98,9 x 61,6 x 15,8



13.0460-3306.2 603306



21090 15,0



21089 15,0

125,0 x 37,4 x 15,0



# Abbildungen Scheibenbremsbeläge

Illustrations disc brake pads - Ilustraciones de pastillas - Illustrations Plaquettes de frein à disque - Illustrazioni Pastiglie Freno

13.0460-3401.2 603401



20755 14,4

61,5 x 56,4 x 14,4

13.0460-3403.2 603403

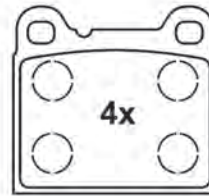

20755 14,4

61,5 x 56,4 x 14,4

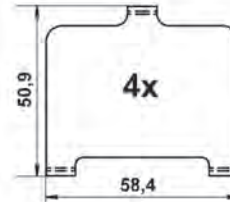

13.0460-3504.2 603504

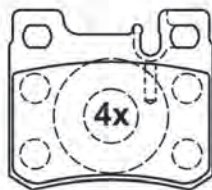

21301 15,5

61,9 x 53,9 x 15,5

13.0460-3602.2 603602

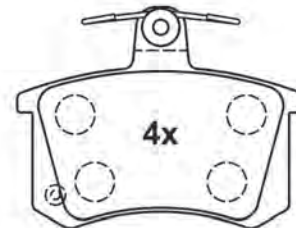

21144 15,8

87,6 x 66,8 x 15,8



# Abbildungen Scheibenbremsbeläge

Illustrations disc brake pads - Ilustraciones de pastillas - Illustrations Plaquettes de frein à disque - Illustrazioni Pastiglie Freno

13.0460-3605.2 603605



20180 17,3

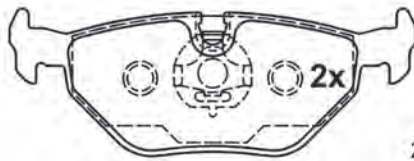

20181 17,3

123,0 x 44,9 x 17,3

13.0460-3800.2 603800



23613 17,7

138,7 x 79,6 x 17,7

13.0460-3803.2 603803

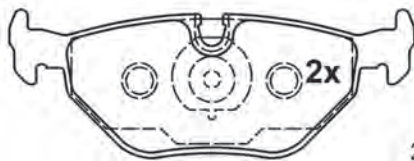

20995 17,3

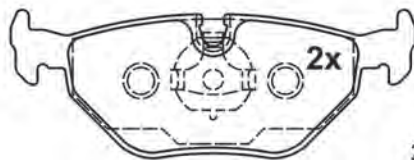

20996 17,3

123,0 x 44,9 x 17,3

13.0460-3805.2 603805

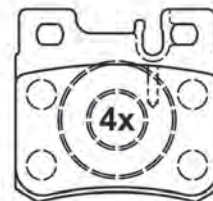

21197 15,0

61,8 x 58,6 x 15,0



# Abbildungen Scheibenbremsbeläge

Illustrations disc brake pads - Ilustraciones de pastillas - Illustrations Plaquettes de frein à disque - Illustrazioni Pastiglie Freno

13.0460-3806.2 603806



23669 16,8

115,9 x 51,4 x 16,8



13.0460-3807.2 603807

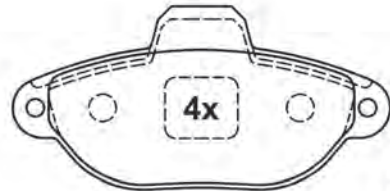

21436 17,0

114,8 x 55,5 x 17,0

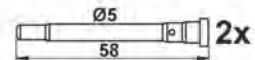

13.0460-3809.2 603809

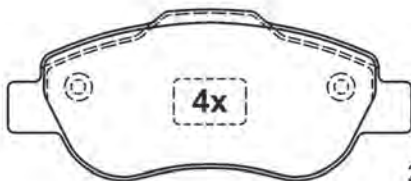

24072 17,9

122,8 x 51,7 x 17,9

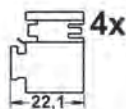
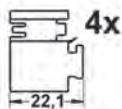
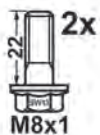

13.0460-3810.2 603810



23705 18,1

122,8 x 53,3 x 18,1

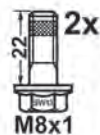

# Abbildungen Scheibenbremsbeläge

Illustrations disc brake pads - Ilustraciones de pastillas - Illustrations Plaquettes de frein à disque - Illustrazioni Pastiglie Freno

13.0460-3811.2 603811



23708 19,2

136,8 x 57,4 x 19,2



13.0460-3813.2 603813

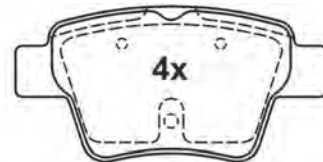

24150 17,6

94,8 x 46,9 x 17,6

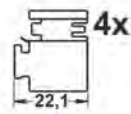
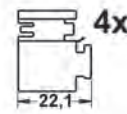

13.0460-3814.2 603814

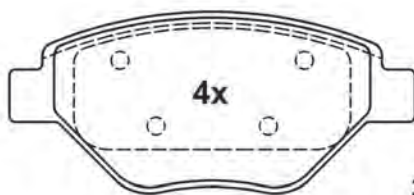

23934 18,2

122,8 x 54,3 x 18,2



13.0460-3815.2 603815

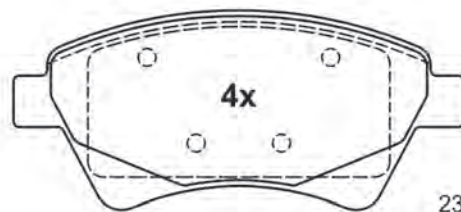

23930 18,2

136,8 x 59,5 x 18,2

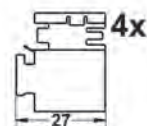
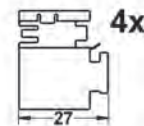

# Abbildungen Scheibenbremsbeläge

Illustrations disc brake pads - Ilustraciones de pastillas - Illustrations Plaquettes de frein à disque - Illustrazioni Pastiglie Freno

13.0460-3818.2 603818

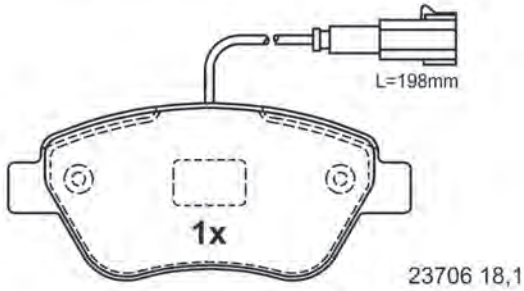
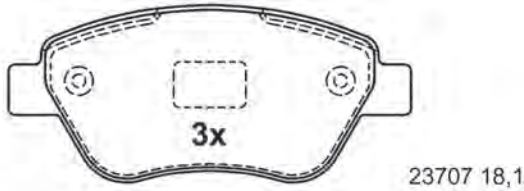

122,8 x 53,3 x 18,1



13.0460-3819.2 603819

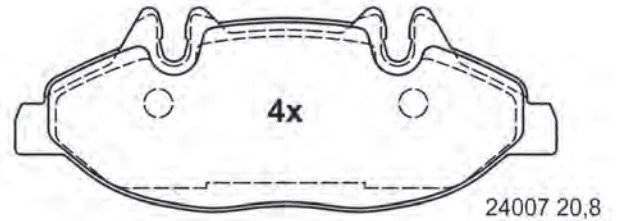

164,8 x 61,8 x 20,8

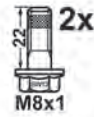
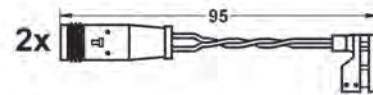

13.0460-3821.2 603821

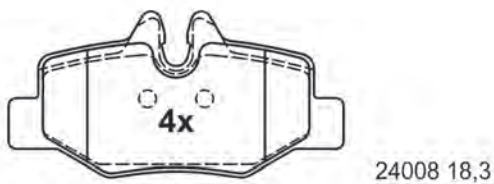

101,8 x 50,2 x 18,3

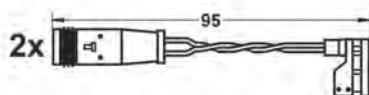

13.0460-3822.2 603822

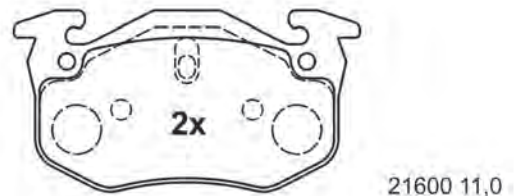
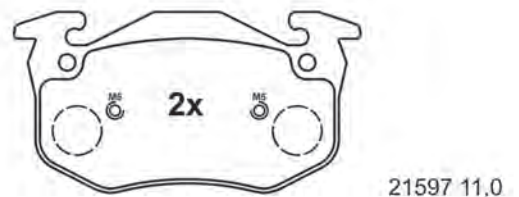

105,0 x 54,9 x 11,0

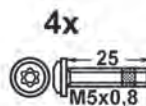

# Abbildungen Scheibenbremsbeläge

Illustrations disc brake pads - Ilustraciones de pastillas - Illustrations Plaquettes de frein à disque - Illustrazioni Pastiglie Freno

13.0460-3823.2 603823

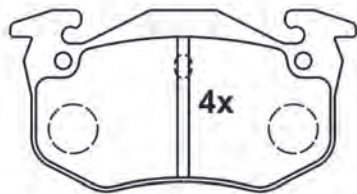

20974 11,0

105,0 x 54,9 x 11,0

13.0460-3824.2 603824

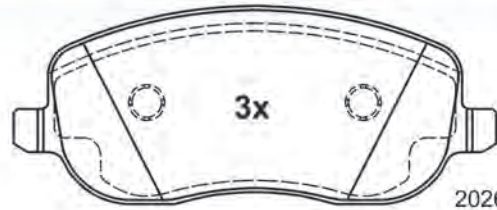

20261 19,0

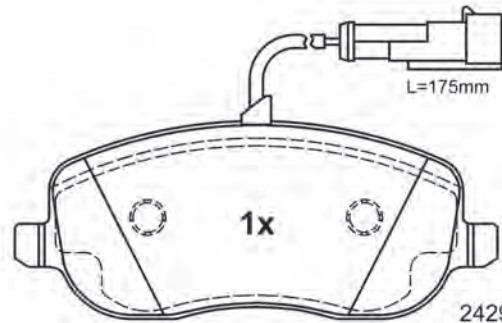

24294 19,0

146,6 x 60,0 x 19,0



13.0460-3825.2 603825



24348 17,1

105,5 x 46,4 x 17,1



13.0460-3826.2 603826

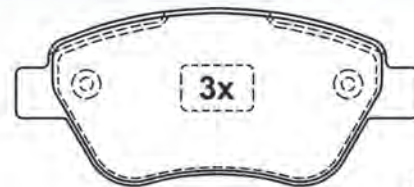

23707 18,0

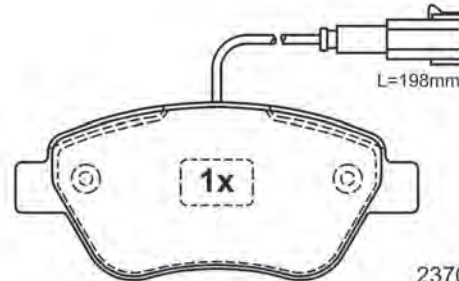

23706 18,0

122,8 x 53,3 x 18,0

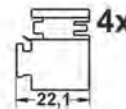
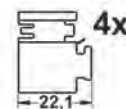



# Abbildungen Scheibenbremsbeläge

Illustrations disc brake pads - Ilustraciones de pastillas - Illustrations Plaquettes de frein à disque - Illustrazioni Pastiglie Freno

13.0460-3827.2 603827

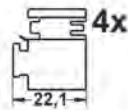
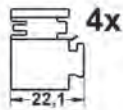
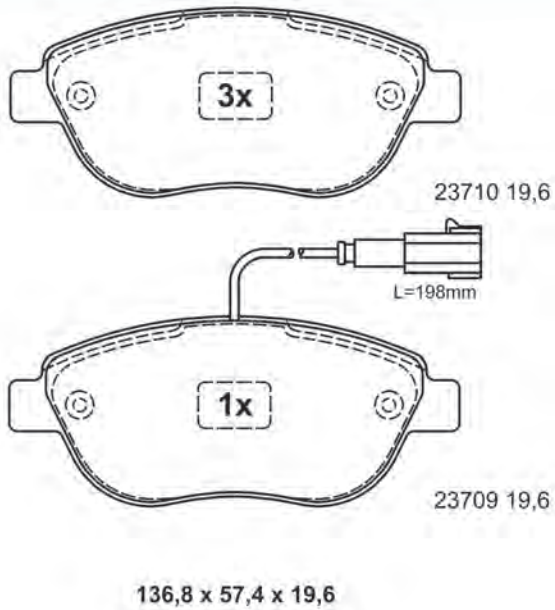

13.0460-3828.2 603828

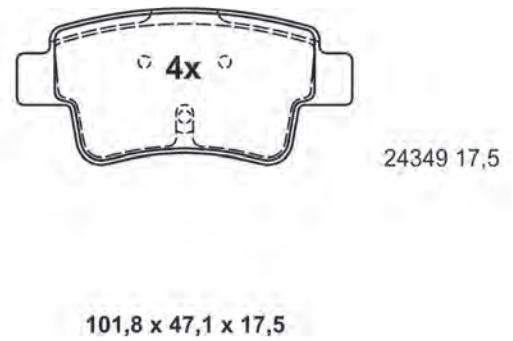

13.0460-3829.2 603829

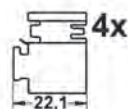
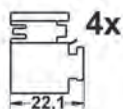
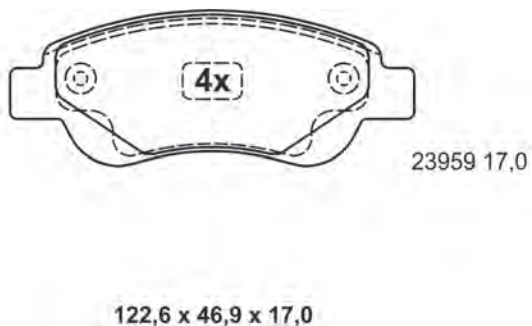

13.0460-3831.2 603831

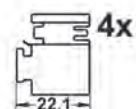
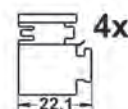
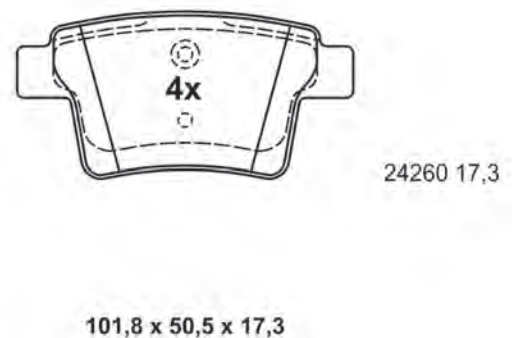



# Abbildungen Scheibenbremsbeläge

Illustrations disc brake pads - Ilustraciones de pastillas - Illustrations Plaquettes de frein à disque - Illustrazioni Pastiglie Freno

13.0460-3832.2 603832

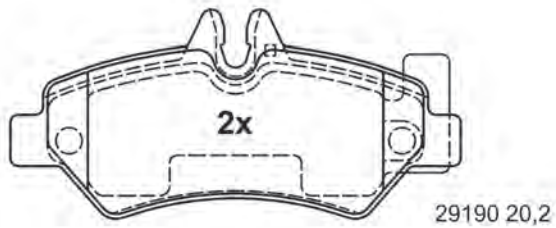
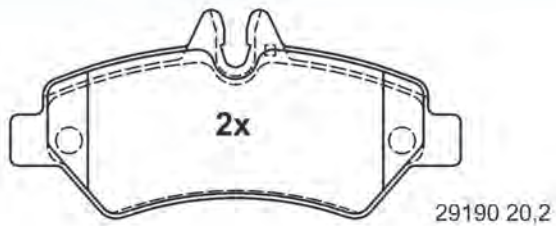

136,8 x 63,0 x 20,2

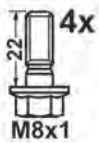

13.0460-3833.2 603833

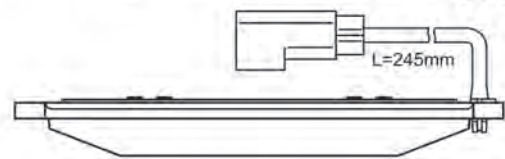
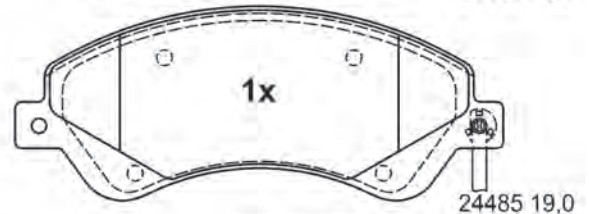
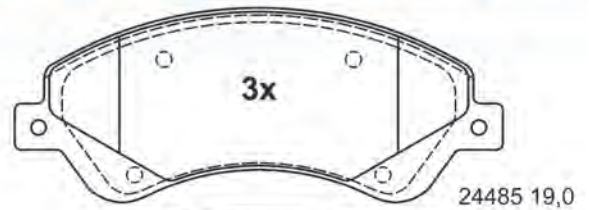

164,8 x 65,5 x 19,0

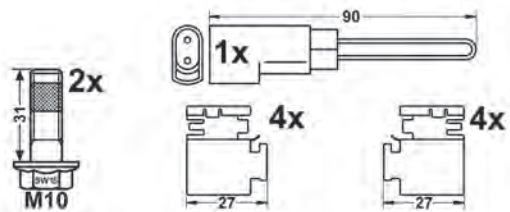

13.0460-3834.2 603834

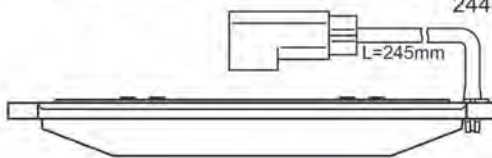
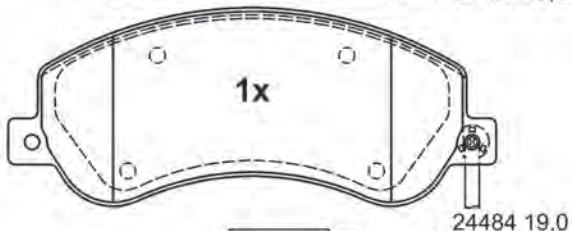
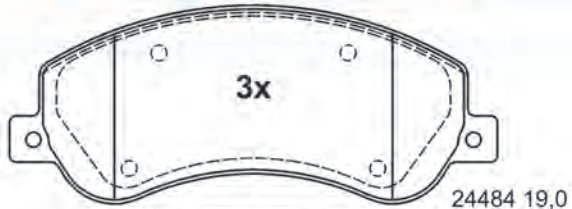

164,8 x 66,8 x 19,0

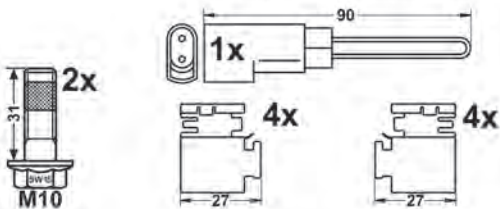

13.0460-3835.2 603835

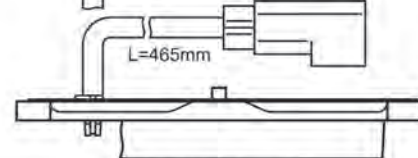
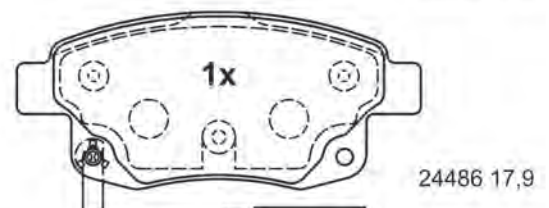
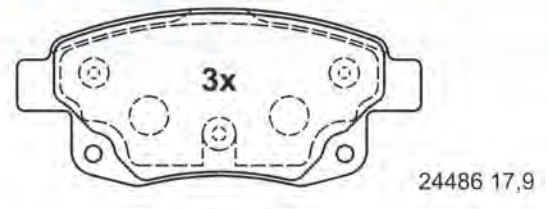

122,8 x 53,6 x 17,9

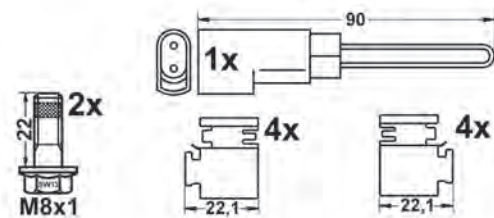

# Abbildungen Scheibenbremsbeläge

Illustrations disc brake pads - Ilustraciones de pastillas - Illustrations Plaquettes de frein à disque - Illustrazioni Pastiglie Freno

13.0460-3836.2 603836

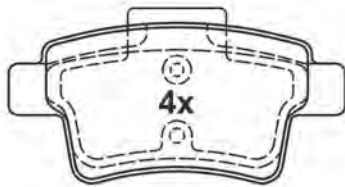

24540 16,3

101,8 x 48,3 x 16,3

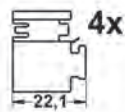
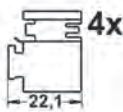
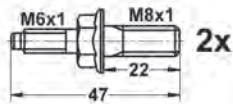

13.0460-3837.2 603837

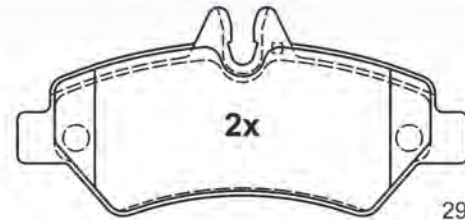

29190 20,2

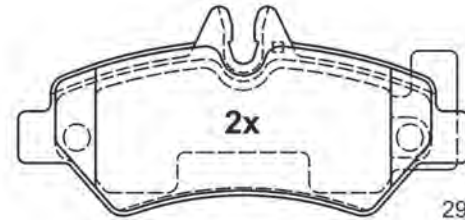

29190 20,2

136,8 x 63,0 x 20,2

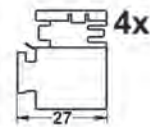
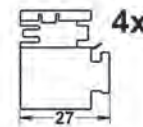
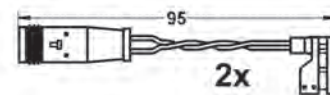

13.0460-3838.2 603838

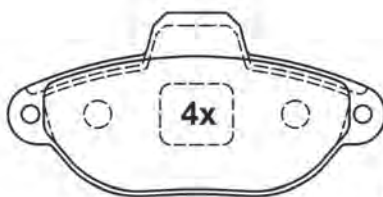

21436 17,0

114,8 x 55,5 x 17,0

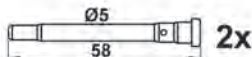
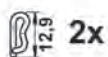

13.0460-3839.2 603839



23982 18,1

122,8 x 53,3 x 18,1

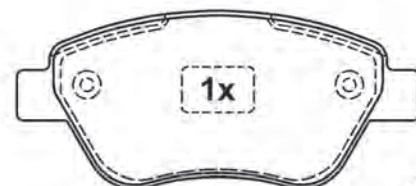

23707 17,9

122,8 x 53,3 x 17,9

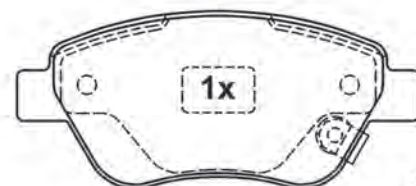

24288 17,9

122,8 x 53,3 x 17,9

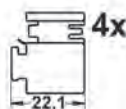
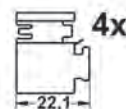



# Abbildungen Scheibenbremsbeläge

Illustrations disc brake pads - Ilustraciones de pastillas - Illustrations Plaquettes de frein à disque - Illustrazioni Pastiglie Freno

13.0460-3840.2 603840



23981 19,6



24549 19,6

136,9 x 57,4 x 19,6

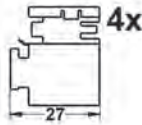
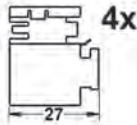

13.0460-3841.2 603841

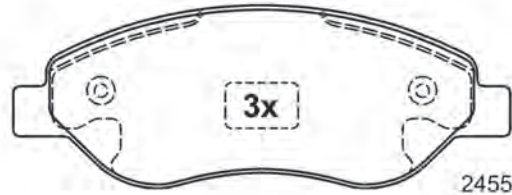

24550 19,5



24551 19,5

150,9 x 54,9 x 19,5

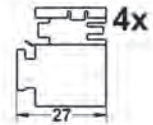
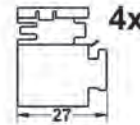
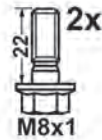

13.0460-3842.2 603842

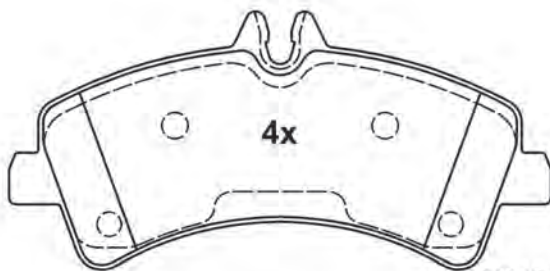

29217 20,5

164,8 x 78,2 x 20,5



13.0460-3846.2 603846

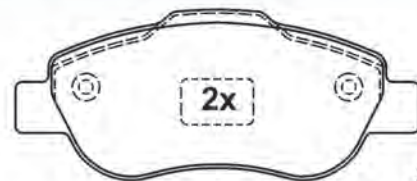

24072 17,9

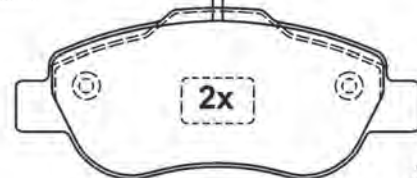

24764 17,9

122,8 x 51,7 x 17,9

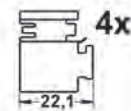
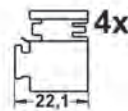
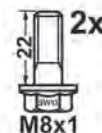

# Abbildungen Scheibenbremsbeläge

Illustrations disc brake pads - Ilustraciones de pastillas - Illustrations Plaquettes de frein à disque - Illustrazioni Pastiglie Freno

13.0460-3847.2 603847

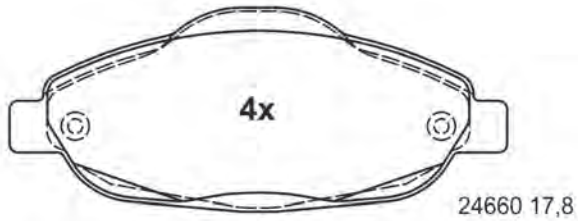

151,0 x 62,0 x 17,8

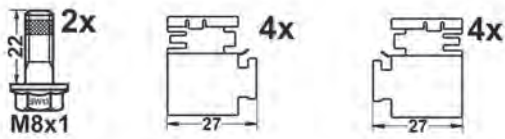

13.0460-3848.2 603848

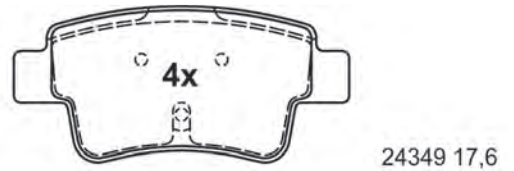

101,8 x 47,1 x 17,6



13.0460-3850.2 603850

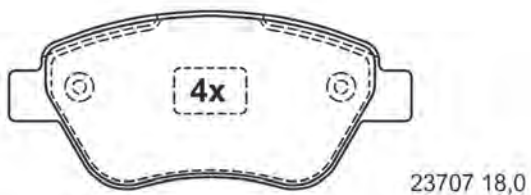

122,9 x 53,3 x 18,0

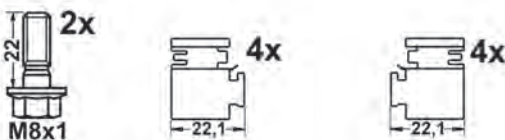

13.0460-3851.2 603851

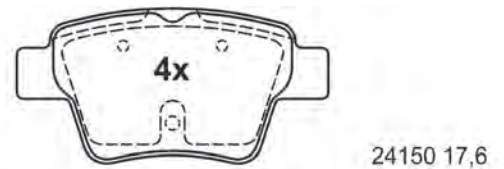

94,8 x 46,9 x 17,6

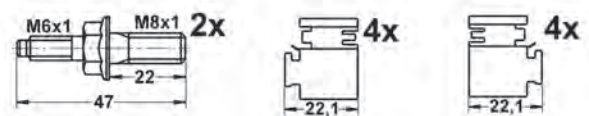

# Abbildungen Scheibenbremsbeläge

Illustrations disc brake pads - Ilustraciones de pastillas - Illustrations Plaquettes de frein à disque - Illustrazioni Pastiglie Freno

13.0460-3852.2 603852

B.H.P.

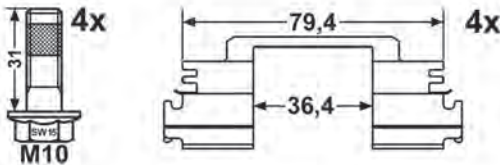
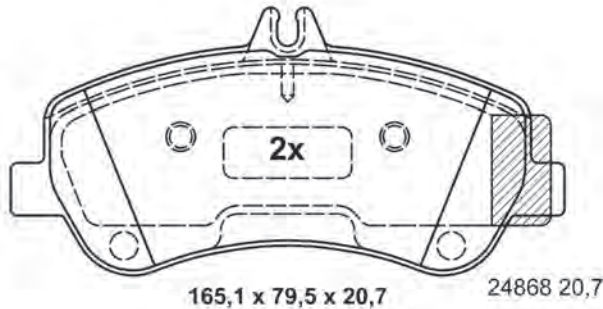
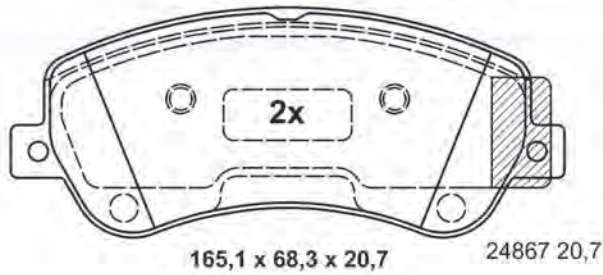

13.0460-3853.2 603853

B.H.P.

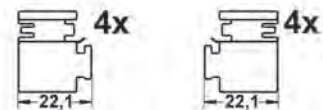
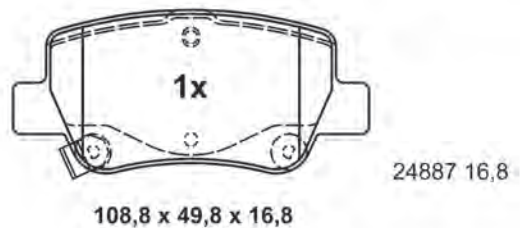
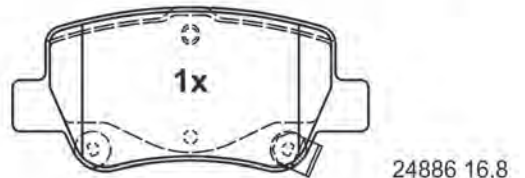

13.0460-3854.2 603854

B.H.P.

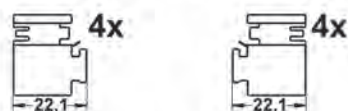
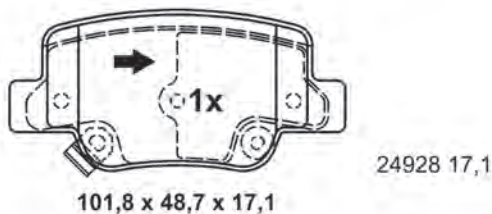
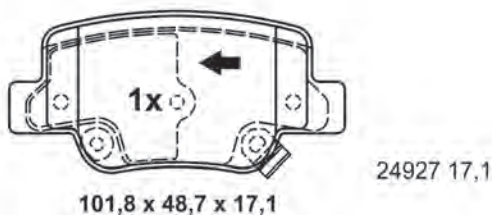
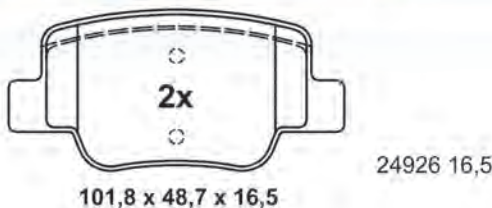

13.0460-3855.2 603855

B.H.P.

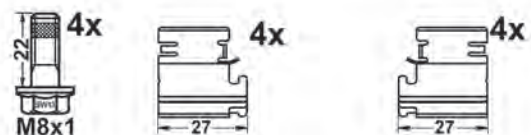
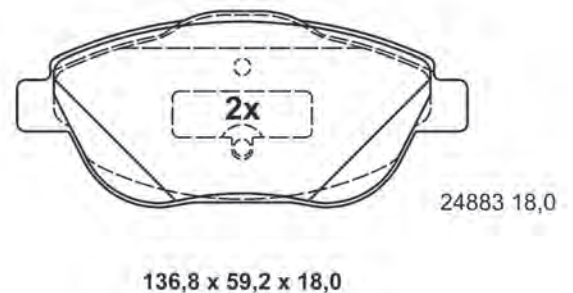
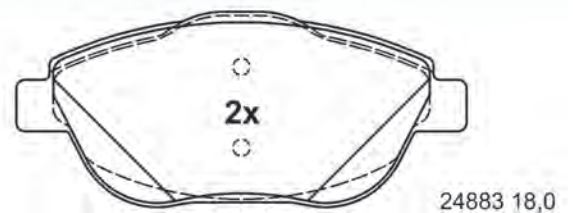



# Abbildungen Scheibenbremsbeläge

Illustrations disc brake pads - Ilustraciones de pastillas - Illustrations Plaquettes de frein à disque - Illustrazioni Pastiglie Freno

13.0460-3856.2 603856 [1]

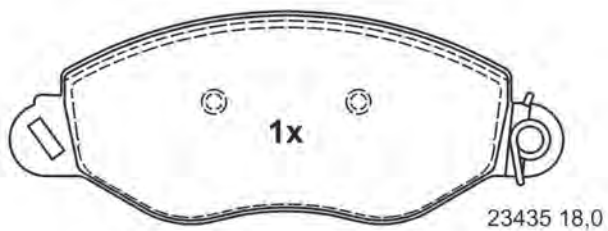
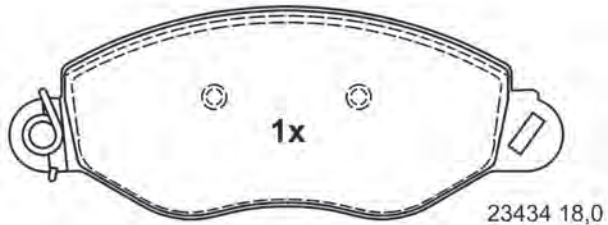

168,3 x 63,9 x 18,0

13.0460-3856.2 603856 [2]

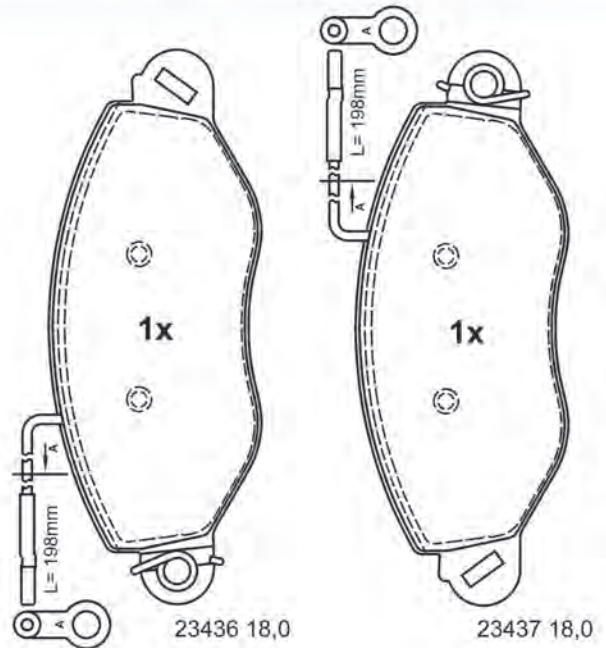

168,3 x 63,9 x 18,0

13.0460-3857.2 603857

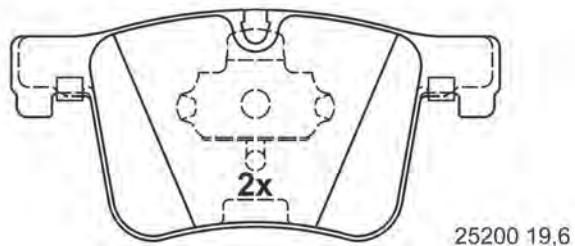
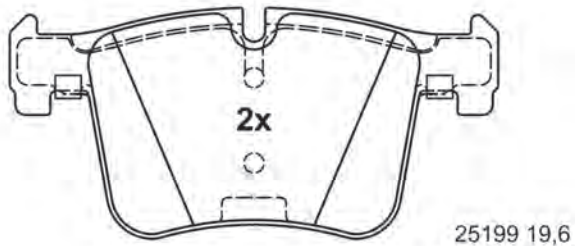

148,2 x 69,8 x 19,6

13.0460-3858.2 603858

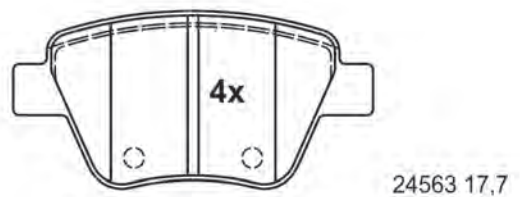

109,3 x 53,4 x 17,7

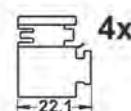
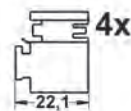

# Abbildungen Scheibenbremsbeläge

Illustrations disc brake pads - Ilustraciones de pastillas - Illustrations Plaquettes de frein à disque - Illustrazioni Pastiglie Freno

13.0460-3859.2 603859

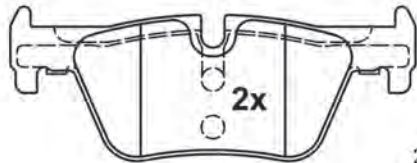

25307 17,5

123,0 x 46,7 x 17,5

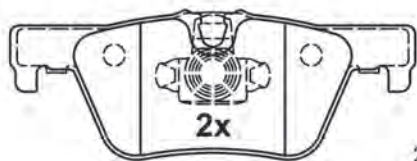

25308 17,5

123,0 x 45,3 x 17,5

13.0460-3860.2 603860

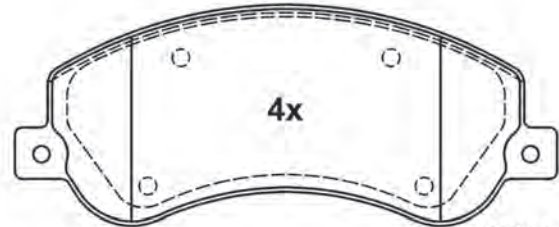

24484 18,8

164,8 x 66,8 x 18,8

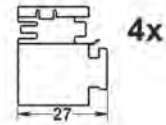
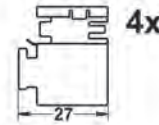
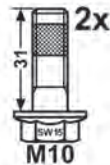

13.0460-3861.2 603861



23714 17,6

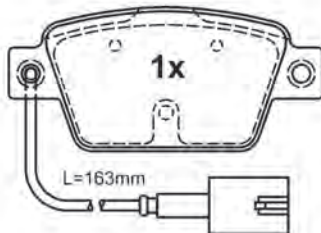

25527 17,6

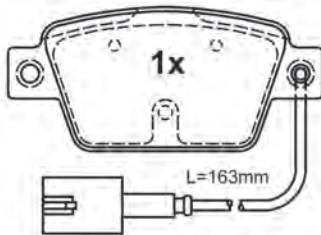

25526 17,6

94,8 x 42,9 x 17,6

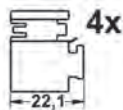
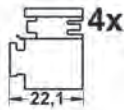

13.0460-3862.2 603862



25451 17,6  
(24349)

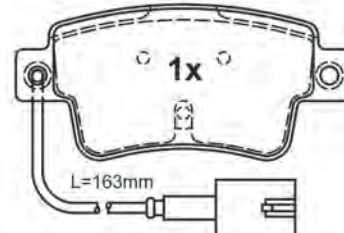

25357 17,6

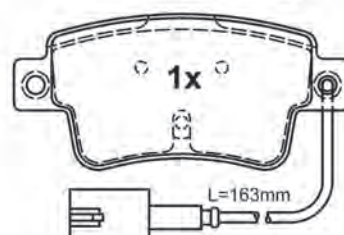

25357 17,6

101,8 x 47,1 x 17,6

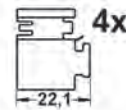
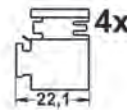

# Abbildungen Scheibenbremsbeläge

Illustrations disc brake pads - Ilustraciones de pastillas - Illustrations Plaquettes de frein à disque - Illustrazioni Pastiglie Freno

13.0460-3863.2 603863

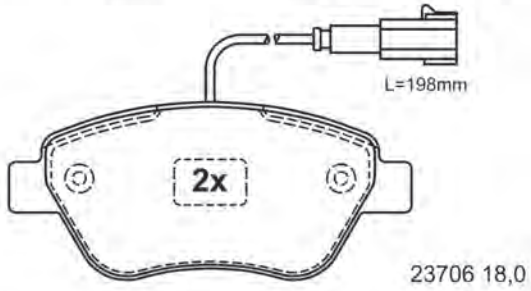
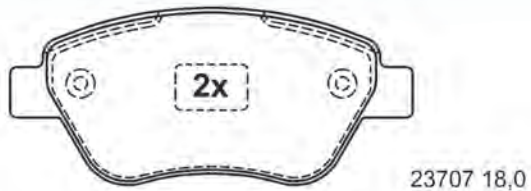

122,8 x 53,3 x 18,0

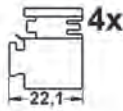
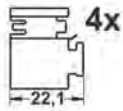
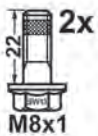

13.0460-3864.2 603864

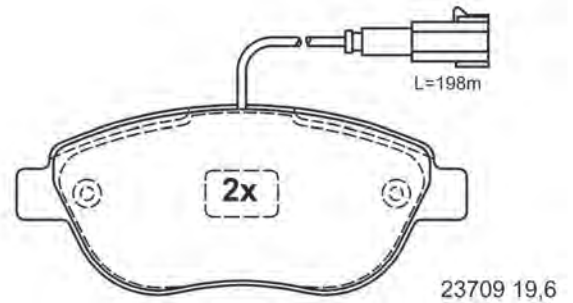
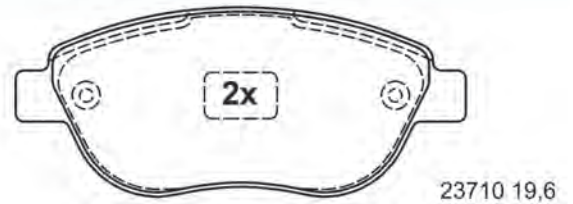

136,8 x 57,4 x 19,6

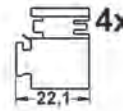
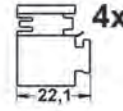

13.0460-3865.2 603865

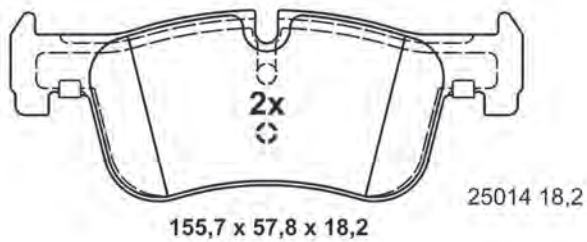

155,7 x 57,8 x 18,2

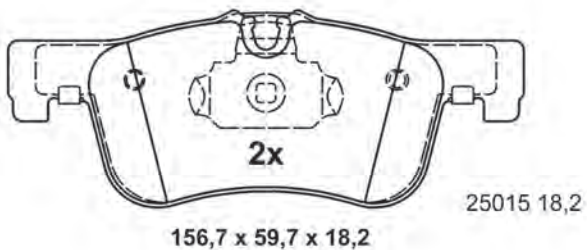

156,7 x 59,7 x 18,2

13.0460-3866.2 603866

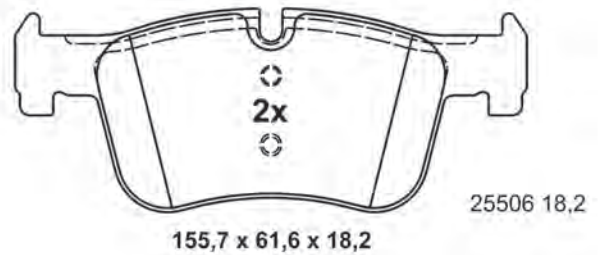

155,7 x 61,6 x 18,2

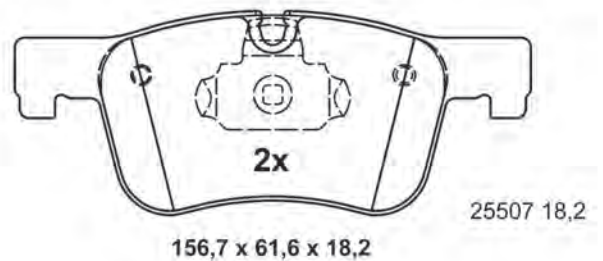

156,7 x 61,6 x 18,2





# Abbildungen Scheibenbremsbeläge

Illustrations disc brake pads - Ilustraciones de pastillas - Illustrations Plaquettes de frein à disque - Illustrazioni Pastiglie Freno

13.0460-3867.2 603867

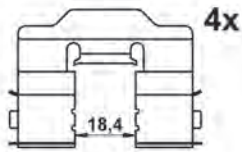
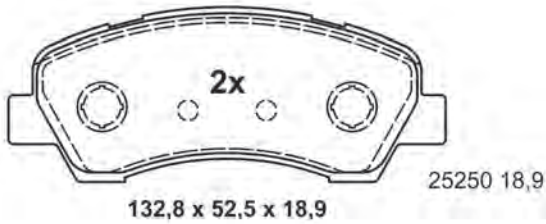
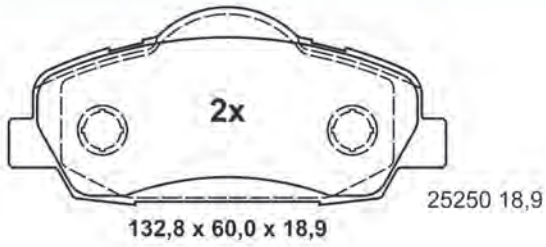

13.0460-3868.2 603868 [1]

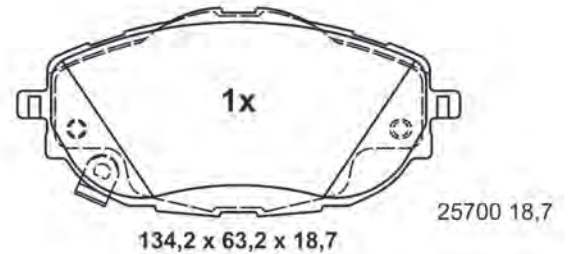
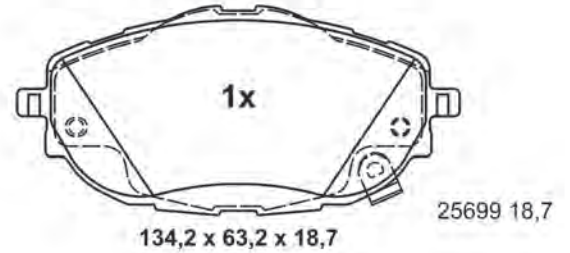
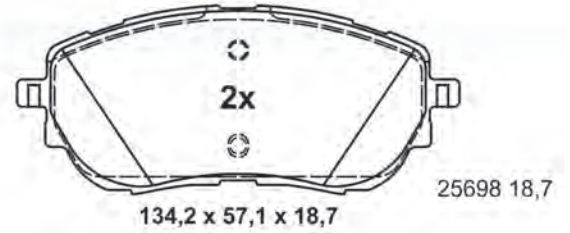

13.0460-3868.2 603868 [2]

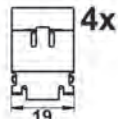
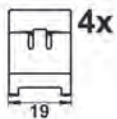
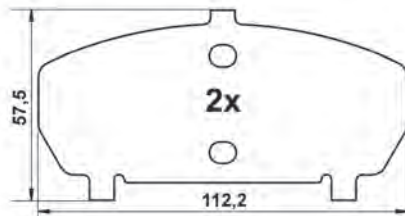
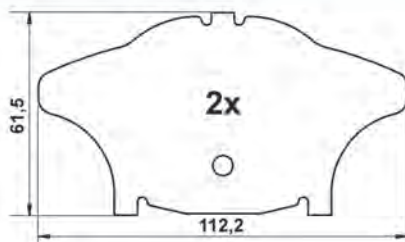

13.0460-3869.2 603869

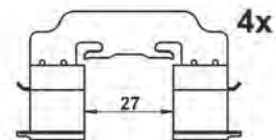
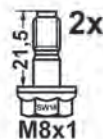
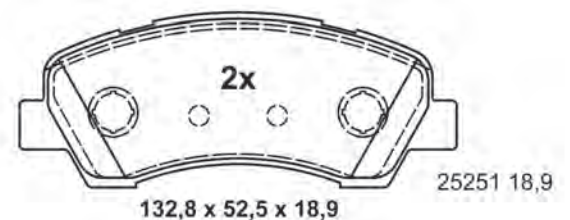
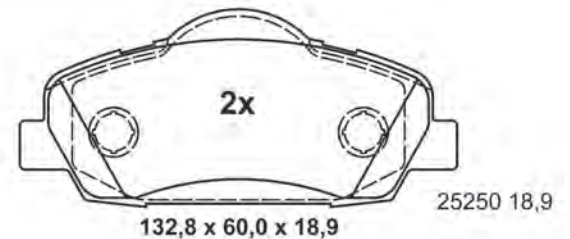

# Abbildungen Scheibenbremsbeläge

Illustrations disc brake pads - Ilustraciones de pastillas - Illustrations Plaquettes de frein à disque - Illustrazioni Pastiglie Freno

13.0460-3870.2 603870

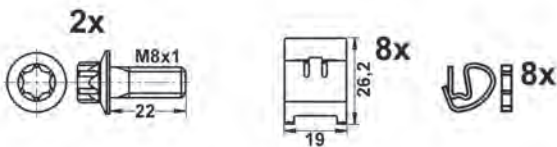
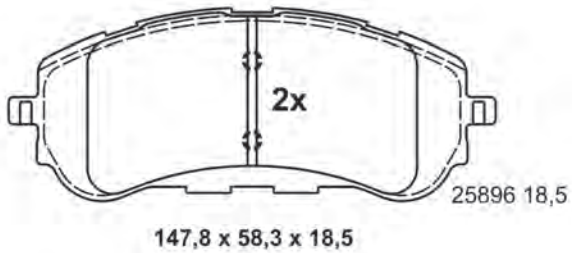
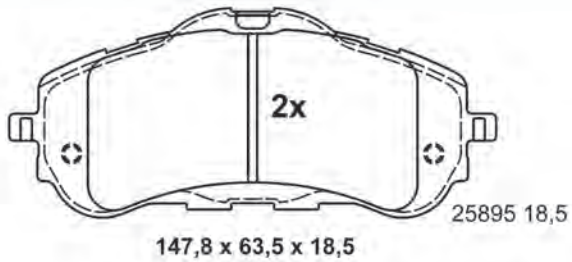

13.0460-3871.2 603871

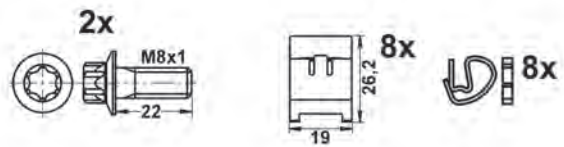
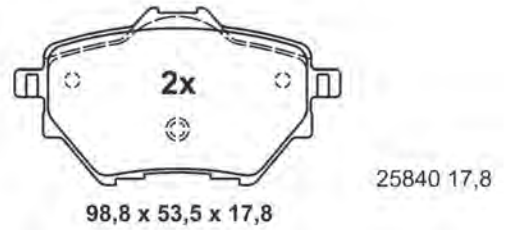

13.0460-3872.2 603872

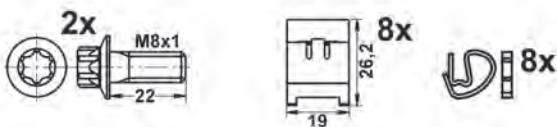
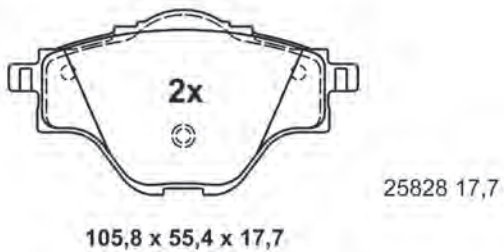
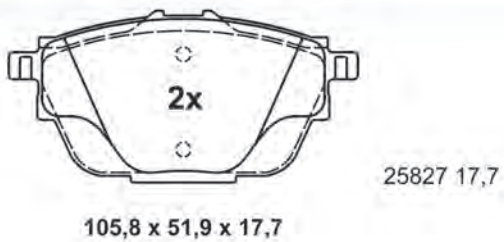

13.0460-3874.2 603874 [1]

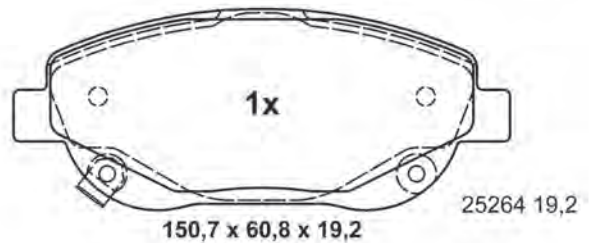
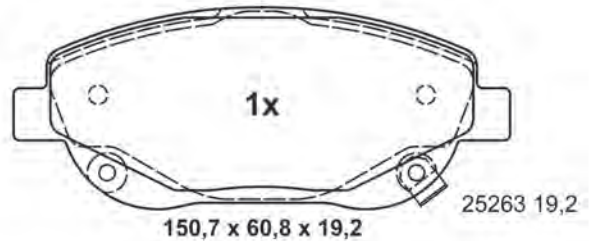
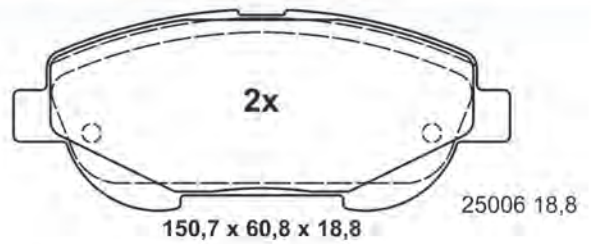



# Abbildungen Scheibenbremsbeläge

Illustrations disc brake pads - Ilustraciones de pastillas - Illustrations Plaquettes de frein à disque - Illustrazioni Pastiglie Freno

13.0460-3874.2 603874 [2]

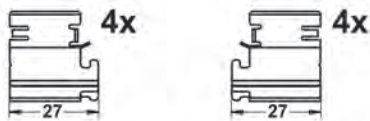
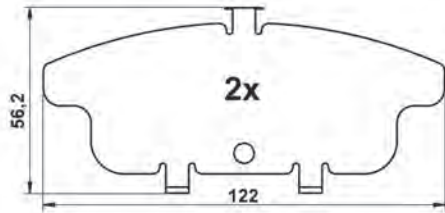

13.0460-3876.2 603876

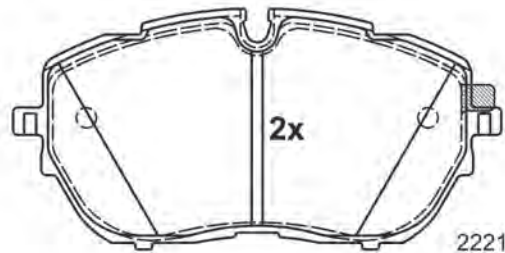
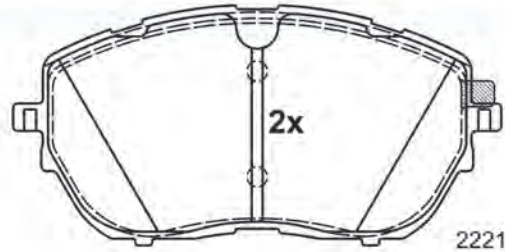

148,3 x 72,6 x 18,3

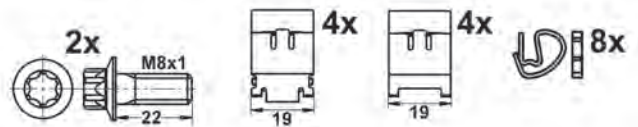

13.0460-3877.2 603877

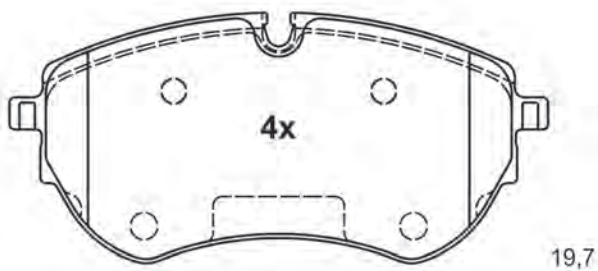

163,5 x 75,8 x 19,7

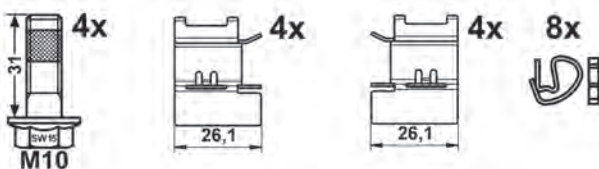

13.0460-3902.2 603902

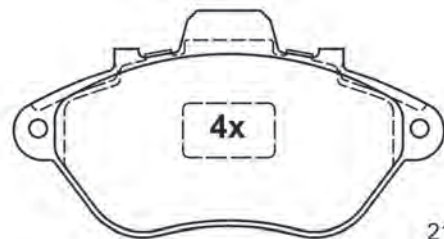

21299 17,0  
(21300)  
(20035)  
(20036)

130,8 x 68,7 x 17,0

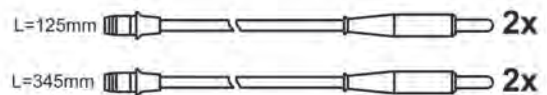

# Abbildungen Scheibenbremsbeläge

Illustrations disc brake pads - Ilustraciones de pastillas - Illustrations Plaquettes de frein à disque - Illustrazioni Pastiglie Freno

13.0460-3904.2 603904

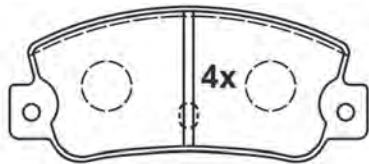

21107 12,0

108,9 x 47,1 x 12,0

13.0460-3911.2 603911

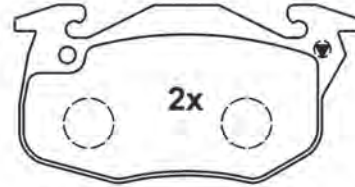

20905 18,0  
(20986)

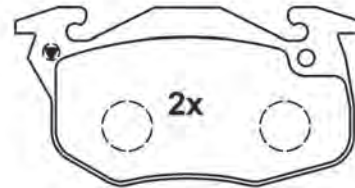

20906 18,0  
(20987)

105,0 x 54,0 x 18,0



13.0460-3914.2 603914

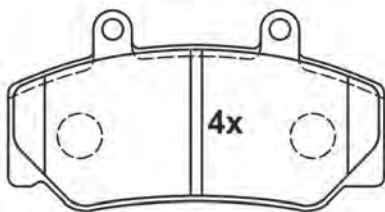

21233 16,7

113,8 x 62,2 x 16,7

13.0460-3926.2 603926

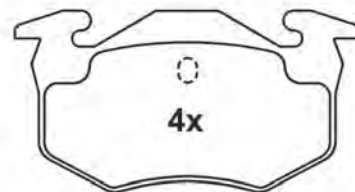

20974 10,8

105,0 x 54,8 x 10,8

# Abbildungen Scheibenbremsbeläge

Illustrations disc brake pads - Ilustraciones de pastillas - Illustrations Plaquettes de frein à disque - Illustrazioni Pastiglie Freno

13.0460-3936.2 603936

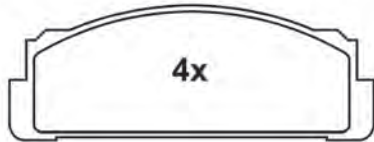

20073 17,3

108,9 x 39,0 x 17,3

13.0460-3939.2 603939

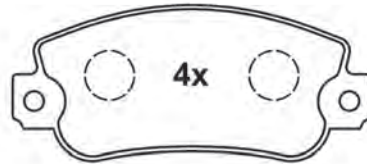

20775 18,0

108,9 x 47,4 x 18,0

13.0460-3940.2 603940



20775 18,0  
(20776)  
(20777)

109,0 x 47,4 x 18,0

13.0460-3942.2 603942

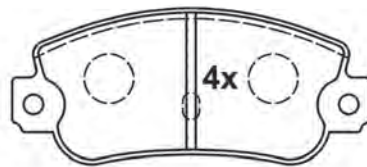

20841 12,0

109,0 x 47,4 x 12,0

# Abbildungen Scheibenbremsbeläge

Illustrations disc brake pads - Ilustraciones de pastillas - Illustrations Plaquettes de frein à disque - Illustrazioni Pastiglie Freno

13.0460-3943.2 603943



20905 18,0

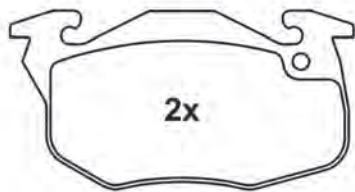

20906 18,0

105,0 x 54,3 x 18,0



13.0460-3945.2 603945

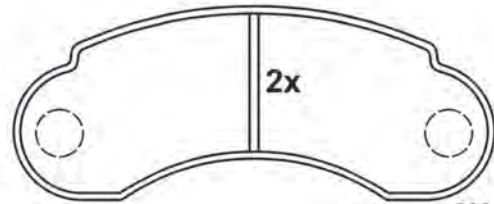

20932 14,0

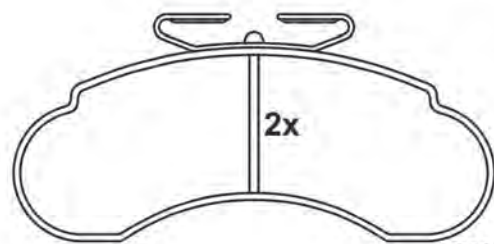

20934 14,0

145,5 x 59,0 x 14,0

13.0460-3946.2 603946



23302 18,0

138,8 x 66,5 x 18,0

13.0460-3947.2 603947

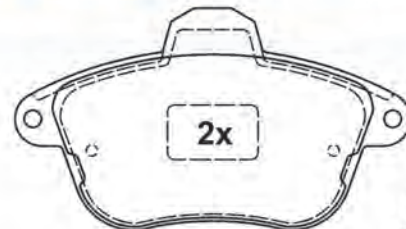

21509 17,0  
(21513)

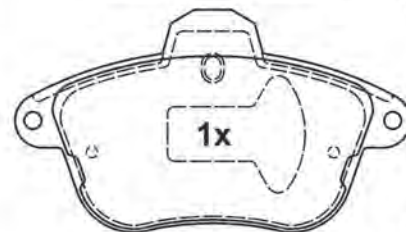

21505 17,0

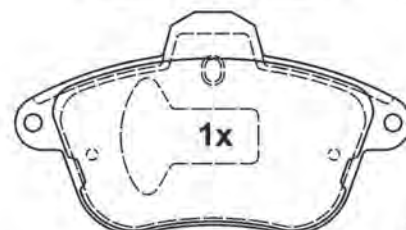

21510 17,0

130,8 x 73,1 x 17,0





# Abbildungen Scheibenbremsbeläge

Illustrations disc brake pads - Ilustraciones de pastillas - Illustrations Plaquettes de frein à disque - Illustrazioni Pastiglie Freno

13.0460-3948.2 603948

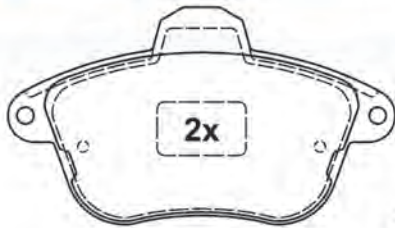

21509 17,0

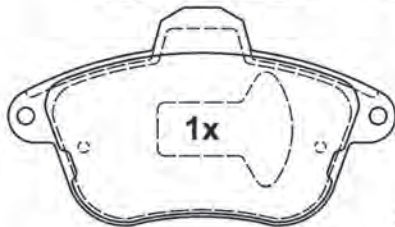

21508 17,0

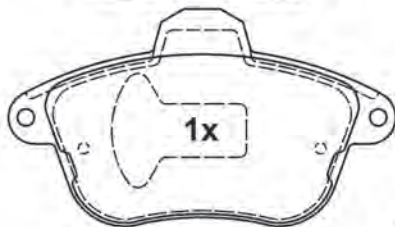

21512 17,0

130,8 x 73,1 x 17,0

L=125mm  **2x**

L=345mm  **2x**

13.0460-3949.2 603949



21365 17,0

114,8 x 54,8 x 17,0

13.0460-3950.2 603950



21436 17,0

115,0 x 55,2 x 17,0

13.0460-3951.2 603951

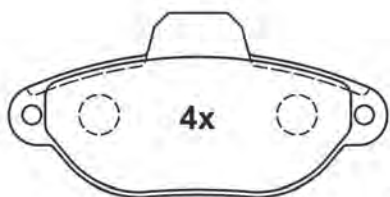

21436 16,2

114,8 x 55,2 x 16,2

L=475mm  **1x**



# Abbildungen Scheibenbremsbeläge

Illustrations disc brake pads - Ilustraciones de pastillas - Illustrations Plaquettes de frein à disque - Illustrazioni Pastiglie Freno

13.0460-3952.2 603952



20905 18,0

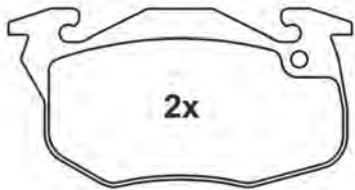

20906 18,0

105,0 x 54,3 x 18,0



13.0460-3953.2 603953

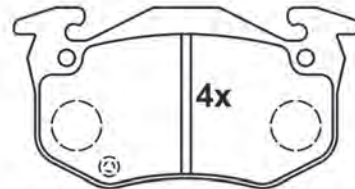

20634 15,0

105,0 x 54,9 x 15,0

13.0460-3954.2 603954

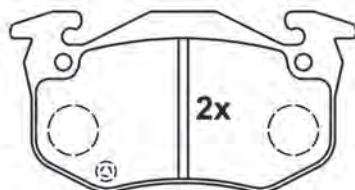

20973 11,0

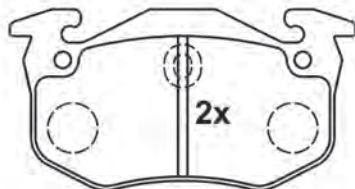

20974 11,0

105,0 x 54,9 x 11,0

13.0460-3955.2 603955

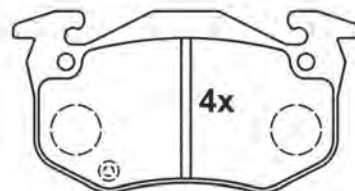

20634 15,0  
(21096)  
(21097)

105,0 x 54,9 x 15,0



# Abbildungen Scheibenbremsbeläge

Illustrations disc brake pads - Ilustraciones de pastillas - Illustrations Plaquettes de frein à disque - Illustrazioni Pastiglie Freno

13.0460-3956.2 603956



21631 17,0

130,8 x 60,0 x 17,0

L=152mm  2x

L=364mm  2x

13.0460-3957.2 603957

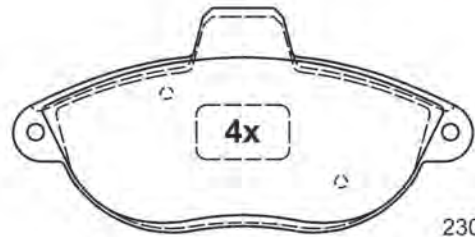

23042 19,0

139,8 x 68,8 x 19,0

L=270mm  2x



2x

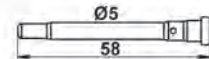

2x



2x

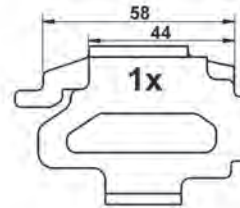

1x

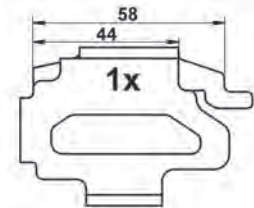

1x

13.0460-3959.2 603959



21469 18,0

138,7 x 72,1 x 18,0

13.0460-3960.2 603960

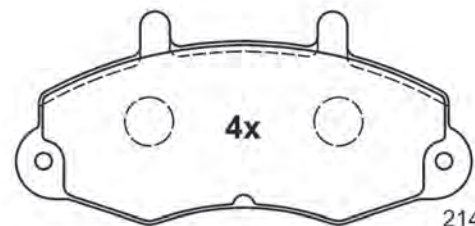

21470 18,0

138,7 x 64,1 x 18,0

# Abbildungen Scheibenbremsbeläge

Illustrations disc brake pads - Ilustraciones de pastillas - Illustrations Plaquettes de frein à disque - Illustrazioni Pastiglie Freno

13.0460-3961.2 603961

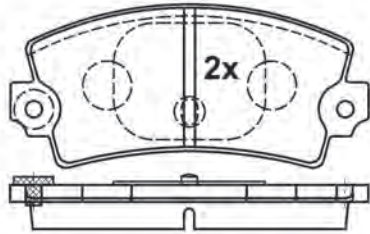

20336 14,0

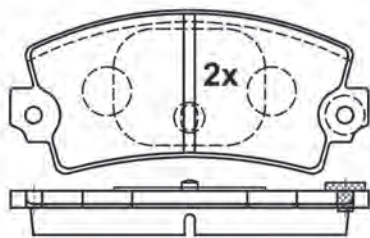

20337 14,0

108,9 x 49,8 x 14,0

2x

13.0460-3962.2 603962

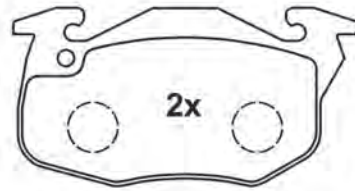

20905 18,0

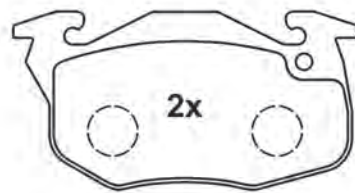

20906 18,0

105,0 x 54,0 x 18,0

13.0460-3963.2 603963



21586 15,0

115,7 x 53,6 x 15,0

13.0460-3964.2 603964



23410 15,0  
(21586)

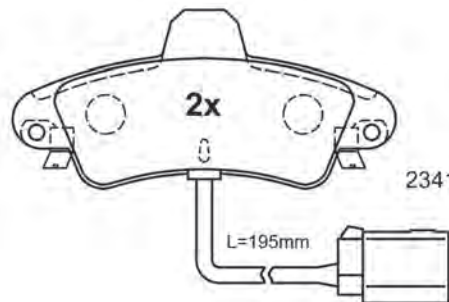

23411 15,0

115,7 x 53,6 x 15,0

# Abbildungen Scheibenbremsbeläge

Illustrations disc brake pads - Ilustraciones de pastillas - Illustrations Plaquettes de frein à disque - Illustrazioni Pastiglie Freno

13.0460-3965.2 603965

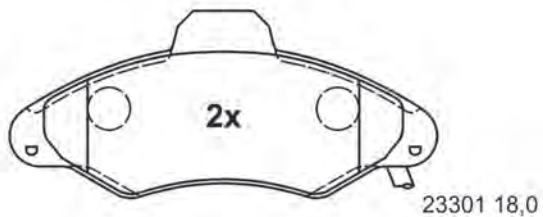
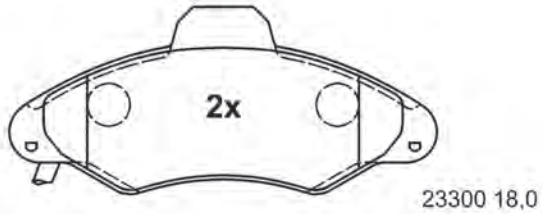

130,8 x 57,3 x 18,0

13.0460-3966.2 603966

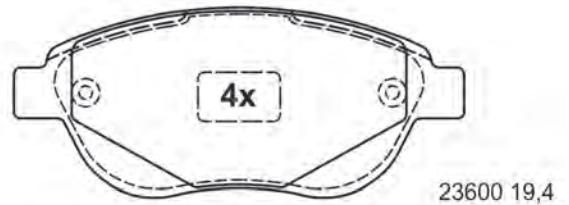

136,8 x 57,5 x 19,4

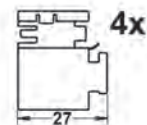
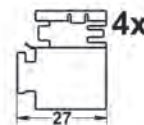

13.0460-3968.2 603968

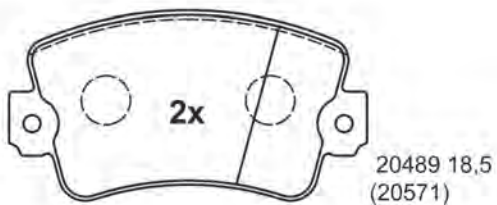
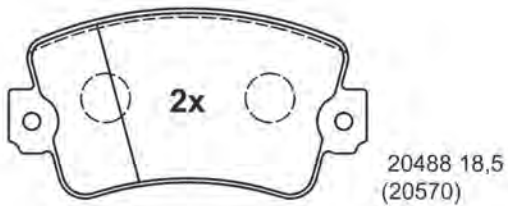

108,9 x 57,5 x 18,5

13.0460-3969.2 603969

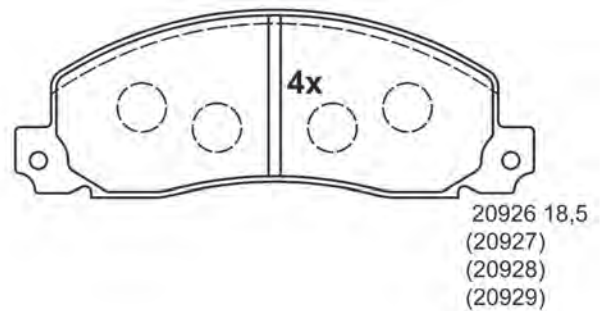

155,8 x 56,6 x 18,5





# Abbildungen Scheibenbremsbeläge

Illustrations disc brake pads - Ilustraciones de pastillas - Illustrations Plaquettes de frein à disque - Illustrazioni Pastiglie Freno

13.0460-3972.2 603972



21632 16,0

130,9 x 69,0 x 16,0

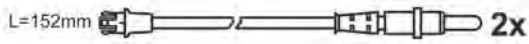

13.0460-3973.2 603973

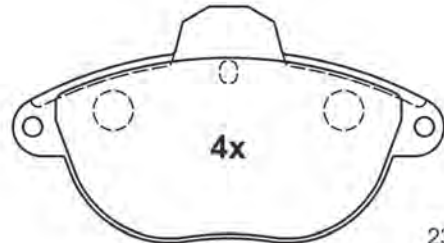

23146 17,0

130,8 x 71,4 x 17,0



13.0460-3975.2 603975

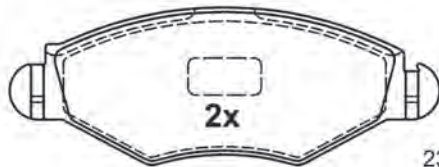

23597 18,0

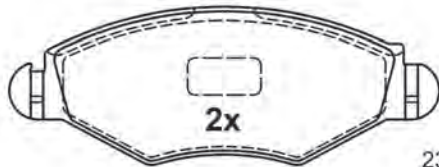

23598 18,0

131,0 x 47,3 x 18,0



13.0460-3976.2 603976

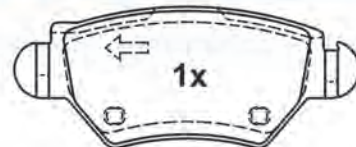

23258 16,5

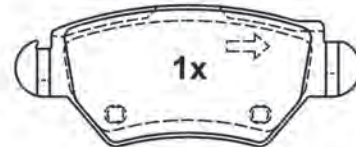

23259 16,5



23262 16,5

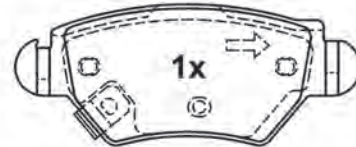

23263 16,5

104,6 x 42,7 x 16,5





# Abbildungen Scheibenbremsbeläge

Illustrations disc brake pads - Ilustraciones de pastillas - Illustrations Plaquettes de frein à disque - Illustrazioni Pastiglie Freno

13.0460-3977.2 603977



21980 18,0

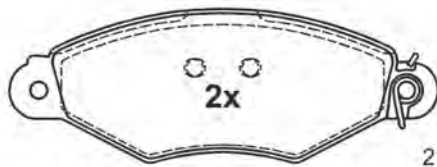

21981 18,0

130,7 x 47,2 x 18,0



13.0460-3978.2 603978

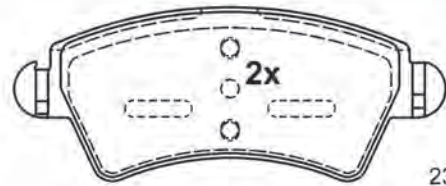

23332 18,0

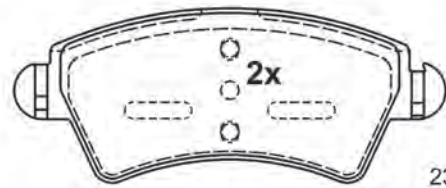

23333 18,0

130,8 x 52,4 x 18,0



13.0460-3979.2 603979

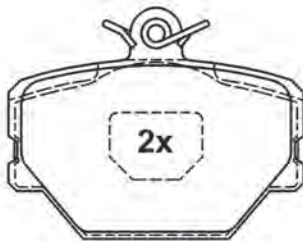

21999 15,8

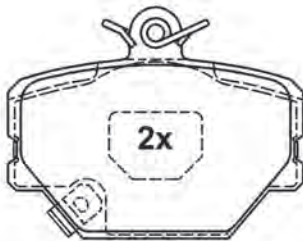

23001 15,8

90,0 x 70,1 x 15,8

13.0460-3980.2 603980

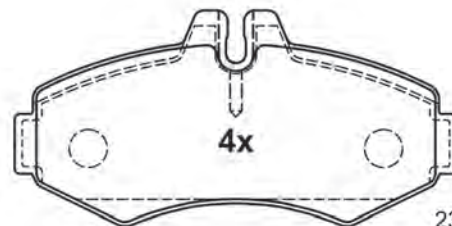

23022 20,9

134,4 x 64,5 x 20,9

# Abbildungen Scheibenbremsbeläge

Illustrations disc brake pads - Ilustraciones de pastillas - Illustrations Plaquettes de frein à disque - Illustrazioni Pastiglie Freno

13.0460-3982.2 603982

B x H x D

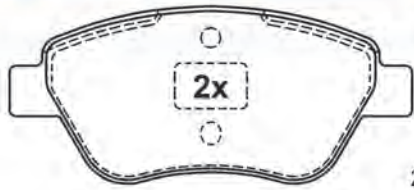

23705 18,1

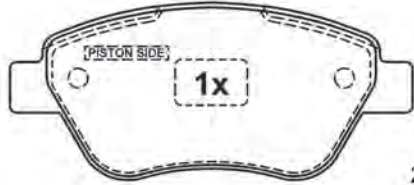

23707 18,1

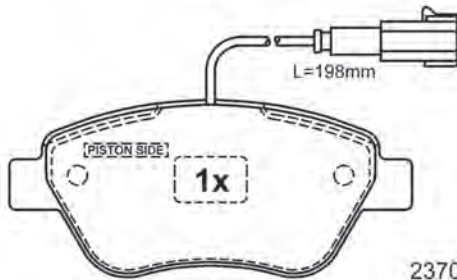

23706 18,1



122,8 x 53,3 x 18,1

13.0460-3983.2 603983

B x H x D

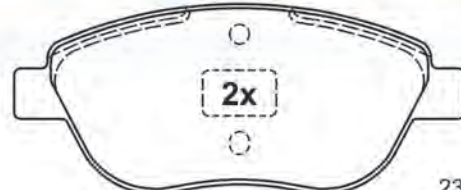

23708 19,4

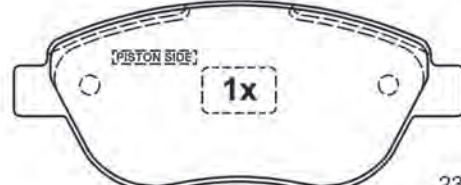

23710 19,4

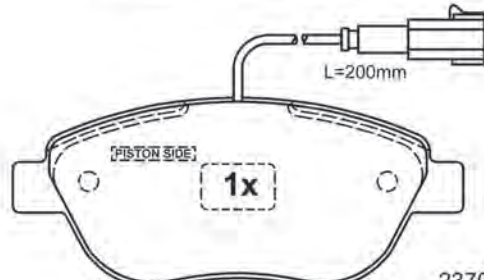

23709 19,4



136,8 x 57,4 x 19,4

13.0460-3984.2 603984

B x H x D

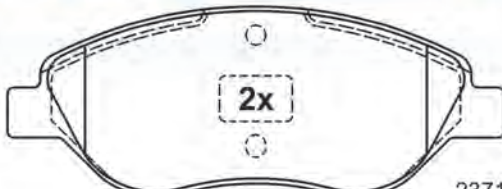

23712 19,4

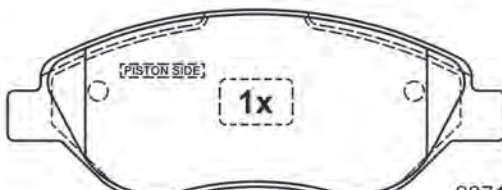

23713 19,4

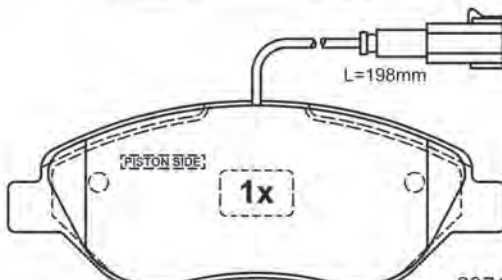

23711 19,4



150,8 x 57,4 x 19,4

13.0460-3985.2 603985

B x H x D

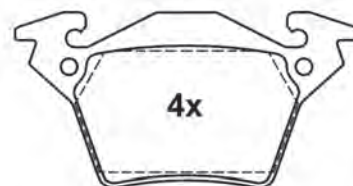

23020 17,9

105,0 x 52,9 x 17,9

# Abbildungen Scheibenbremsbeläge

Illustrations disc brake pads - Ilustraciones de pastillas - Illustrations Plaquettes de frein à disque - Illustrazioni Pastiglie Freno

13.0460-3986.2 603986

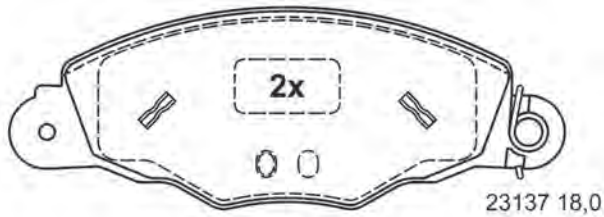
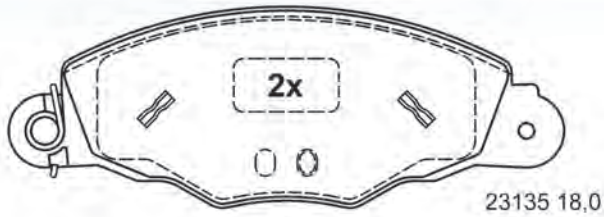

168,9 x 61,1 x 18,0

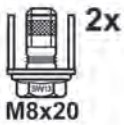

L=410mm 2x

L=180mm 2x

13.0460-3987.2 603987

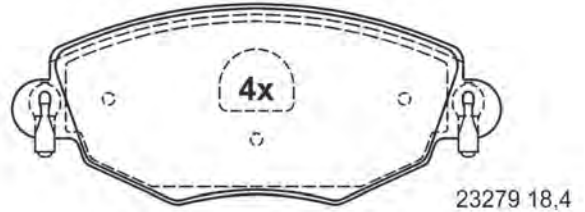

148,8 x 60,5 x 18,4



13.0460-3988.2 603988

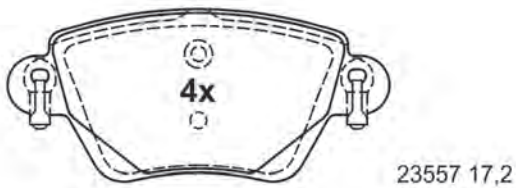

115,7 x 52,0 x 17,2



13.0460-3990.2 603990

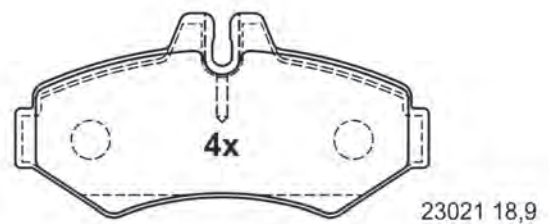

125,8 x 61,9 x 18,9



# Abbildungen Scheibenbremsbeläge

Illustrations disc brake pads - Ilustraciones de pastillas - Illustrations Plaquettes de frein à disque - Illustrazioni Pastiglie Freno

13.0460-3991.2 603991



23714 16,6

94,8 x 42,9 x 16,6



13.0460-3992.2 603992



23434 18,7



23435 18,7



23840 18,7



23841 18,7

168,3 x 63,9 x 18,7

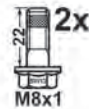

13.0460-3993.2 603993



23577 18,7

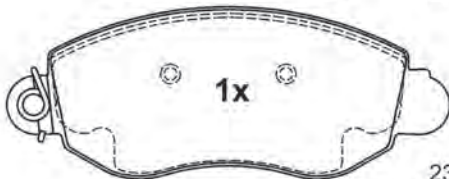

23578 18,7



23579 18,7



23580 18,7

168,5 x 65,1 x 18,7



13.0460-3994.2 603994



23599 19,0

136,8 x 52,0 x 19,0

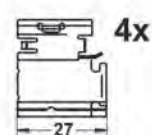
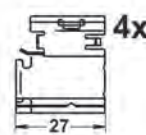

# Abbildungen Scheibenbremsbeläge

Illustrations disc brake pads - Ilustraciones de pastillas - Illustrations Plaquettes de frein à disque - Illustrazioni Pastiglie Freno

13.0460-3994.2 603994

wahlweise  
optional

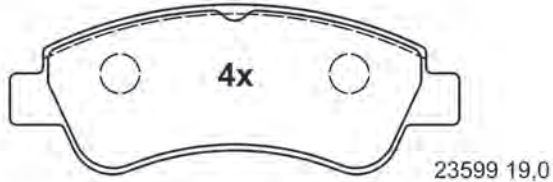

136,8 x 52,0 x 19,0

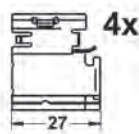
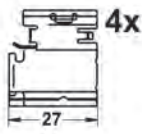
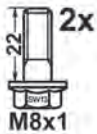
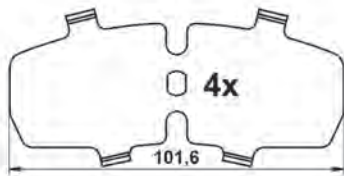

13.0460-3995.2 603995

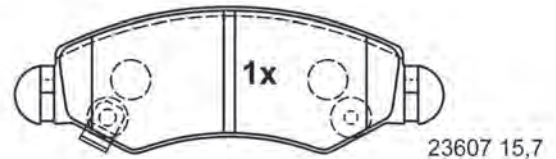
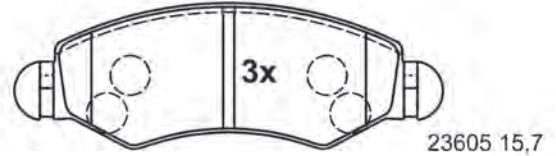

130,7 x 43,9 x 15,7



13.0460-3996.2 603996

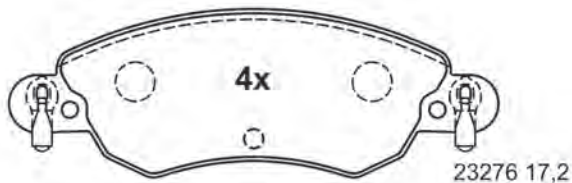

148,8 x 50,9 x 17,2

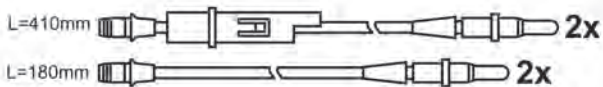

13.0460-3997.2 603997

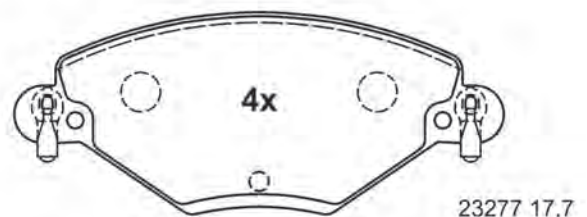

148,7 x 61,2 x 17,7

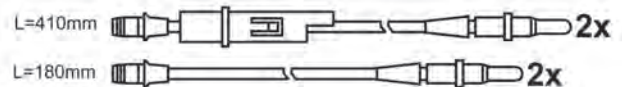



# Abbildungen Scheibenbremsbeläge

Illustrations disc brake pads - Ilustraciones de pastillas - Illustrations Plaquettes de frein à disque - Illustrazioni Pastiglie Freno

13.0460-3998.2 603998

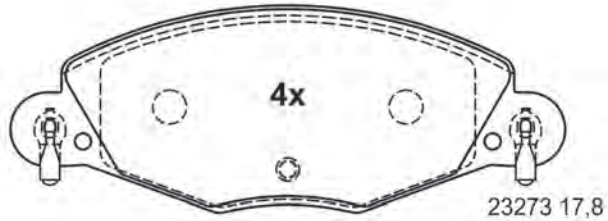

168,7 x 62,8 x 17,8



13.0460-3999.2 603999 [1]

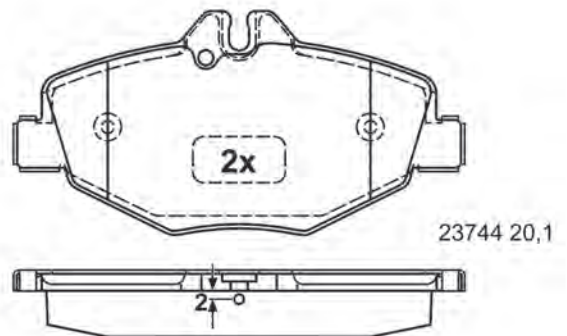
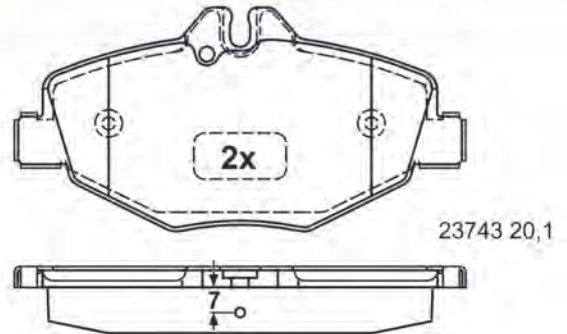

137,0 x 67,8 x 20,1

13.0460-3999.2 603999 [2]

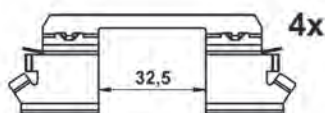
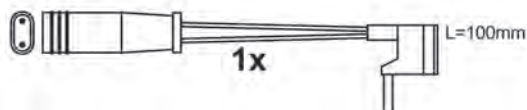
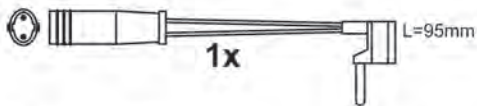
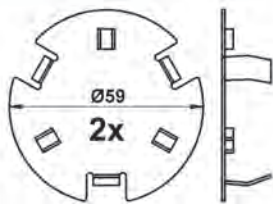

13.0460-4014.2 604014

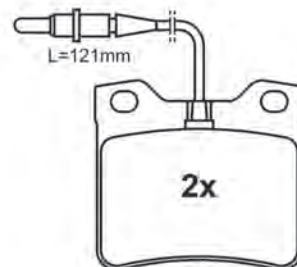
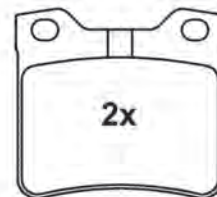

63,7 x 57,8 x 16,4

# Abbildungen Scheibenbremsbeläge

Illustrations disc brake pads - Ilustraciones de pastillas - Illustrations Plaquettes de frein à disque - Illustrazioni Pastiglie Freno

13.0460-4016.2 604016

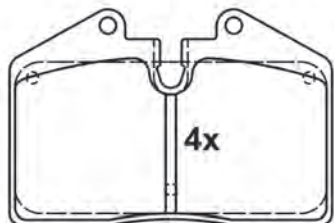

20877 17,5

97,8 x 65,4 x 17,5

13.0460-4034.2 604034



20687 15,5

61,8 x 54,3 x 15,5

13.0460-4040.2 604040

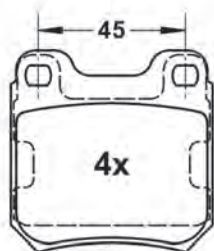

21050 15,8

61,6 x 61,2 x 15,8

13.0460-4041.2 604041

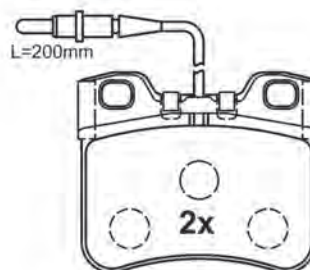

21289 16,8

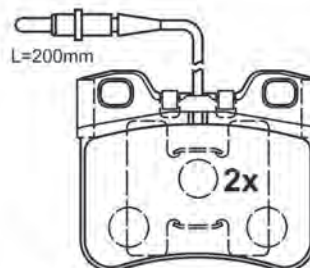

21179 16,8

72,9 x 60,6 x 16,8

# Abbildungen Scheibenbremsbeläge

Illustrations disc brake pads - Ilustraciones de pastillas - Illustrations Plaquettes de frein à disque - Illustrazioni Pastiglie Freno

13.0460-4042.2 604042

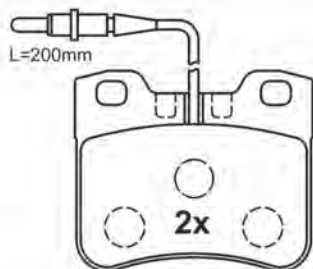

21267 16,8

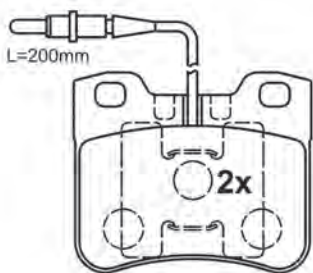

21191 16,8

71,9 x 60,6 x 16,8

13.0460-4043.2 604043



21140 15,0

61,7 x 57,5 x 15,0

13.0460-4044.2 604044



20755 15,1

61,8 x 56,5 x 15,1

13.0460-4047.2 604047

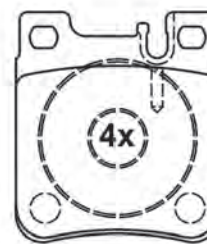

21305 15,7

61,7 x 69,5 x 15,7

# Abbildungen Scheibenbremsbeläge

Illustrations disc brake pads - Ilustraciones de pastillas - Illustrations Plaquettes de frein à disque - Illustrazioni Pastiglie Freno

13.0460-4056.2 604056

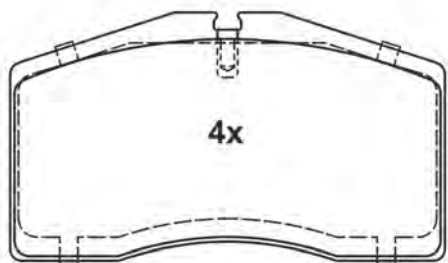

21402 17,5

131,7 x 75,0 x 17,5

13.0460-4059.2 604059

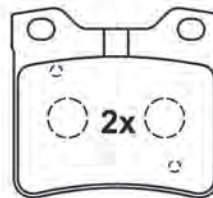

21278 16,4

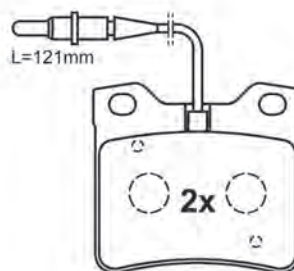

21279 16,4

63,7 x 57,8 x 16,4

13.0460-4060.2 604060



21900 15,0

63,7 x 63,2 x 15,0

13.0460-4064.2 604064

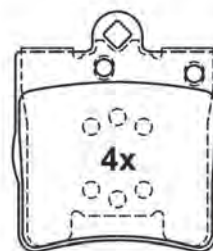

21919 15,3

63,8 x 72,8 x 15,3

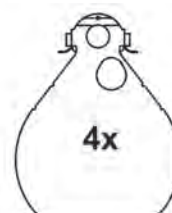

# Abbildungen Scheibenbremsbeläge

Illustrations disc brake pads - Ilustraciones de pastillas - Illustrations Plaquettes de frein à disque - Illustrazioni Pastiglie Freno

13.0460-4065.2 604065

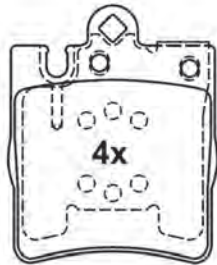

21899 15,3

63,7 x 78,0 x 15,3

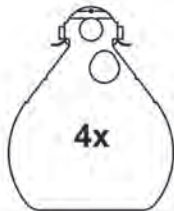

13.0460-4066.2 604066

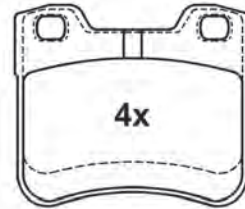

21857 17,7

71,9 x 60,6 x 17,7

13.0460-4069.2 604069

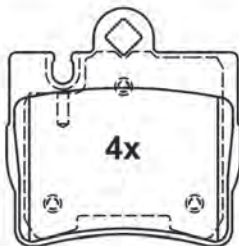

23078 15,9

70,9 x 72,1 x 15,9

13.0460-4201.2 604201

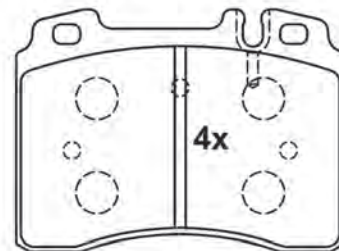

21153 17,5

99,8 x 73,6 x 17,5



# Abbildungen Scheibenbremsbeläge

Illustrations disc brake pads - Ilustraciones de pastillas - Illustrations Plaquettes de frein à disque - Illustrazioni Pastiglie Freno

13.0460-4202.2 604202

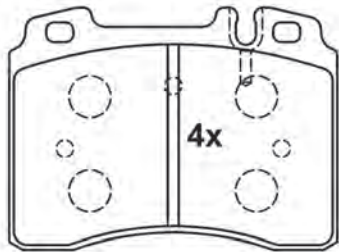

21153 16,0

99,8 x 73,6 x 16,0

13.0460-4401.2 604401

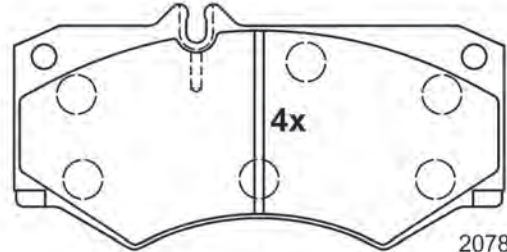

20784 18,0

149,0 x 75,0 x 18,0

13.0460-4800.2 604800

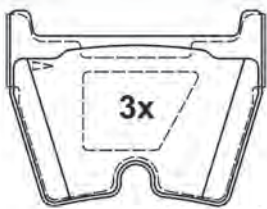

23751 17,0

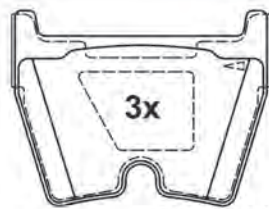

23751 17,0

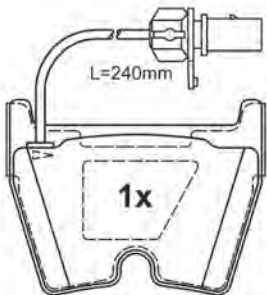

23764 17,0

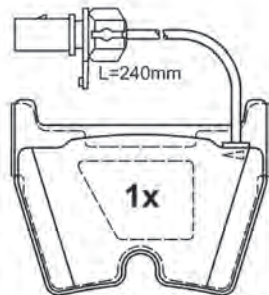

23765 17,0

97,3 x 73,9 x 17,0

13.0460-4801.2 604801

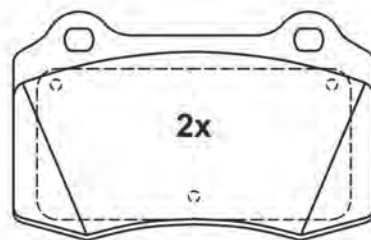

21381 15,0

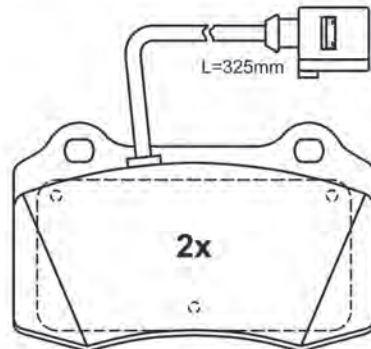

24143 15,0

109,8 x 69,2 x 15,0

# Abbildungen Scheibenbremsbeläge

Illustrations disc brake pads - Ilustraciones de pastillas - Illustrations Plaquettes de frein à disque - Illustrazioni Pastiglie Freno

13.0460-4802.2 604802

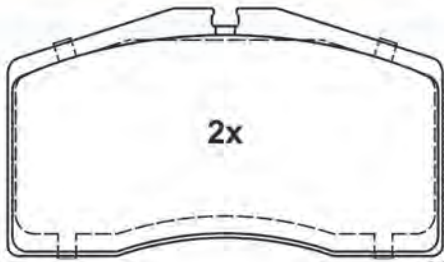

23773 17,5

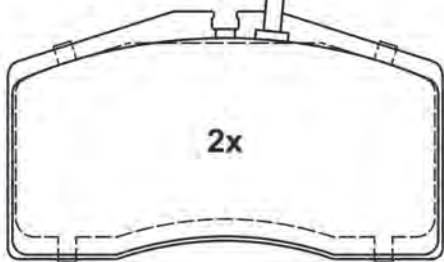
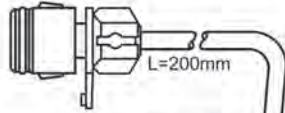

23774 17,5

131,7 x 75,0 x 17,5

13.0460-4803.2 604803 [1]

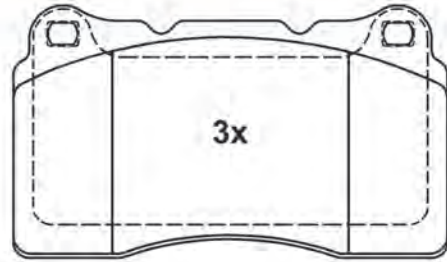

23092 15,6

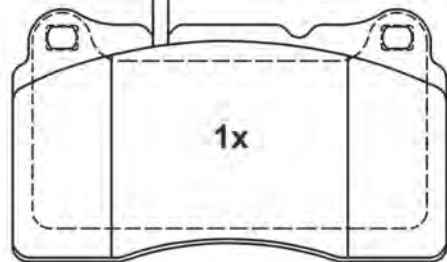

23111 15,6

131,8 x 77,2 x 15,6

13.0460-4803.2 604803 [2]

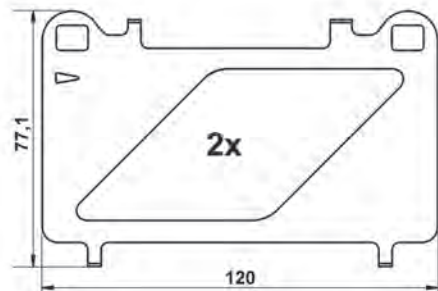
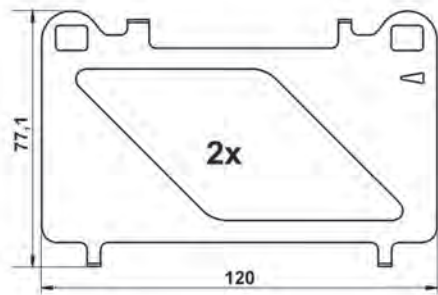

13.0460-4804.2 604804



23092 15,6

131,8 x 77,2 x 15,6



# Abbildungen Scheibenbremsbeläge

Illustrations disc brake pads - Ilustraciones de pastillas - Illustrations Plaquettes de frein à disque - Illustrazioni Pastiglie Freno

13.0460-4805.2 604805



24162 15,2

124,6 x 70,4 x 15,2

13.0460-4806.2 604806

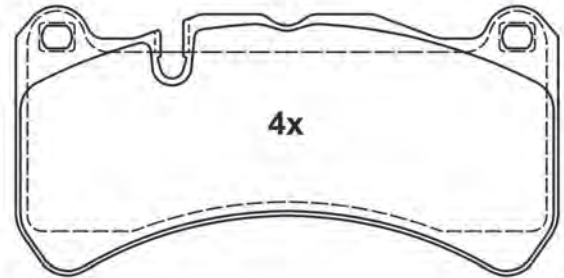

23955 16,2

164,6 x 81,5 x 16,2

13.0460-4807.2 604807

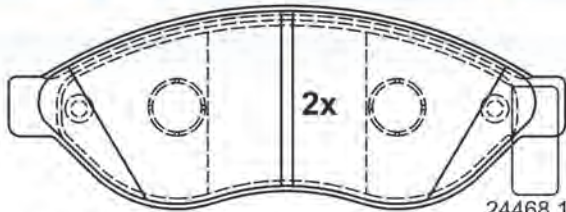

24468 19,1

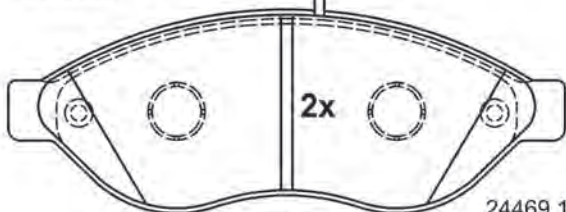

24469 19,1

169,2 x 61,5 x 19,1

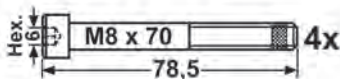
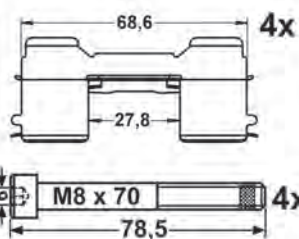

13.0460-4809.2 604809

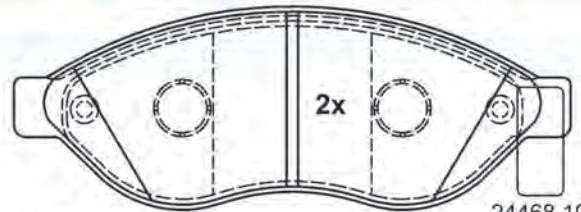

24468 19,1

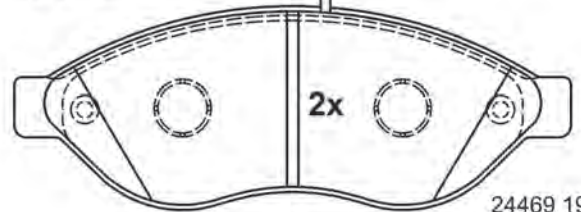

24469 19,1

169,3 x 61,5 x 19,1

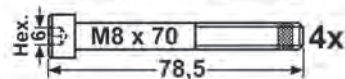
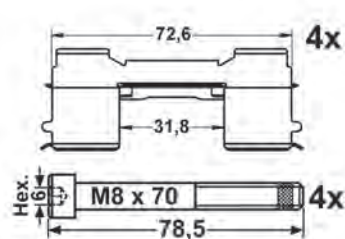



# Abbildungen Scheibenbremsbeläge

Illustrations disc brake pads - Ilustraciones de pastillas - Illustrations Plaquettes de frein à disque - Illustrazioni Pastiglie Freno

13.0460-4810.2 604810

B x H x D

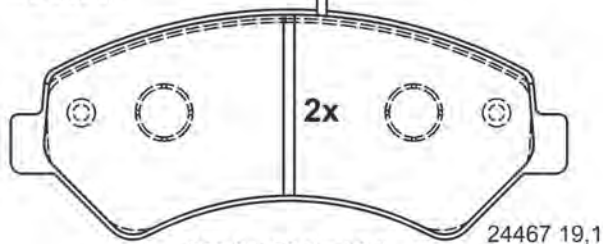
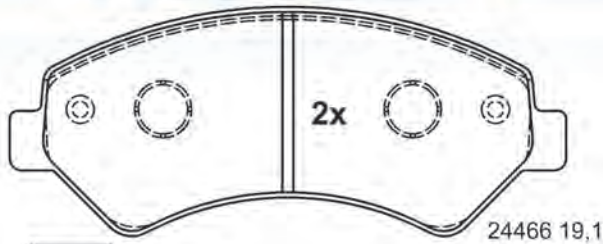

169,3 x 69,1 x 19,1

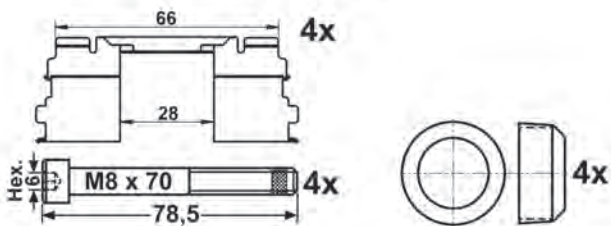

13.0460-4811.2 604811

B x H x D

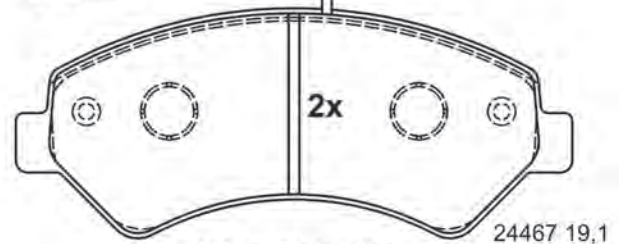
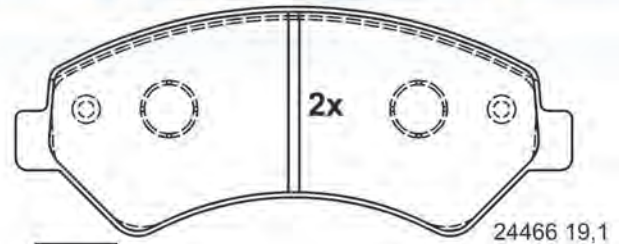

169,3 x 69,1 x 19,1

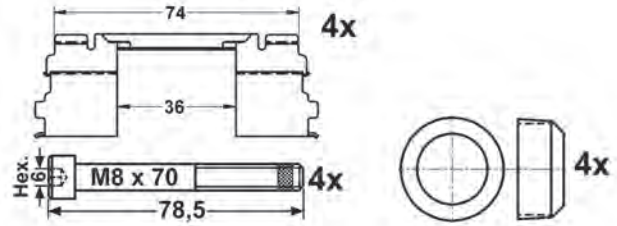

13.0460-4812.2 604812

B x H x D

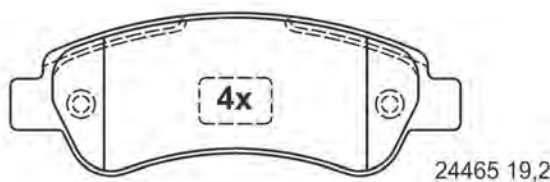

136,8 x 48,9 x 19,2

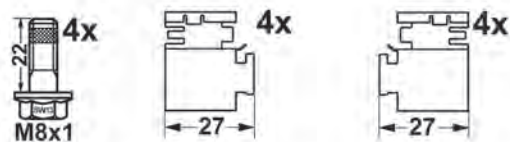

13.0460-4814.2 604814

B x H x D

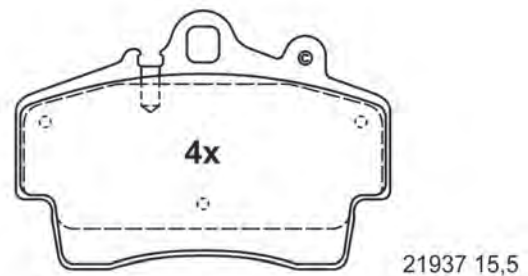

114,0 x 78,0 x 15,5

# Abbildungen Scheibenbremsbeläge

Illustrations disc brake pads - Ilustraciones de pastillas - Illustrations Plaquettes de frein à disque - Illustrazioni Pastiglie Freno

13.0460-4815.2 604815

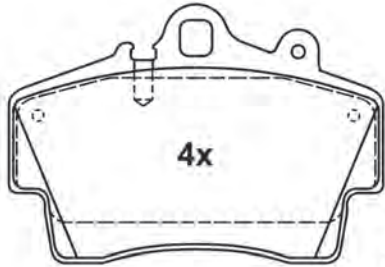

21937 15,5

114,0 x 78,0 x 15,5

13.0460-4816.2 604816

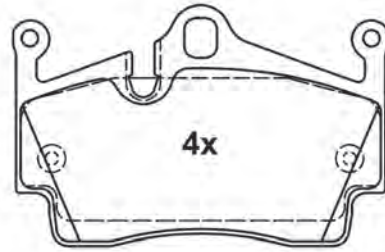

24541 15,5

112,0 x 73,0 x 15,5

13.0460-4817.2 604817

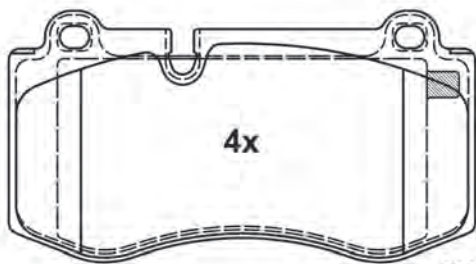

23960 18,3

141,6 x 75,8 x 18,3

13.0460-4818.2 604818

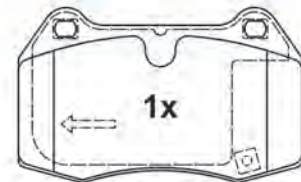

23142 15,1



23142 15,1

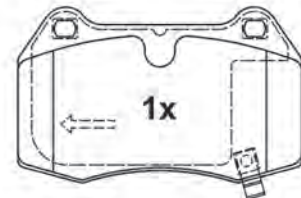

23143 15,1

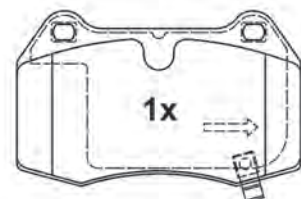

23143 15,1

4x

120,0 x 73,5 x 15,1



# Abbildungen Scheibenbremsbeläge

Illustrations disc brake pads - Ilustraciones de pastillas - Illustrations Plaquettes de frein à disque - Illustrazioni Pastiglie Freno

13.0460-4819.2 604819

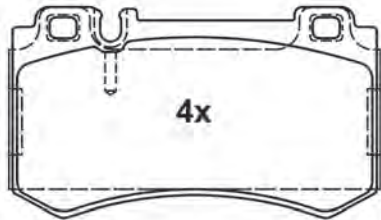

23478 14,6

112,0 x 64,0 x 14,6

13.0460-4823.2 604823

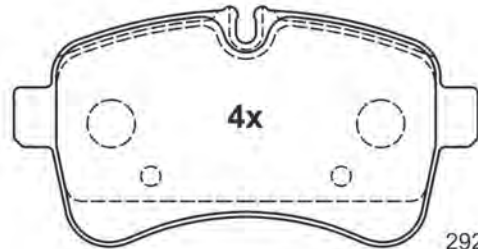

29232 21,0

141,1 x 72,6 x 21,0

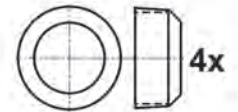
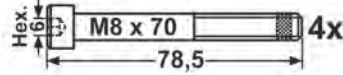
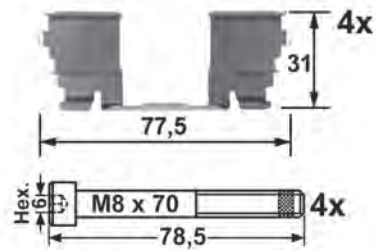

13.0460-4826.2 604826

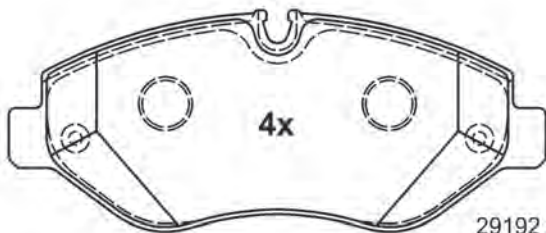

29192 20,7

163,1 x 67,1 x 20,7

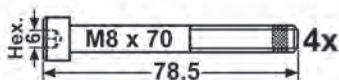
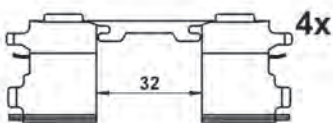

13.0460-4827.2 604827

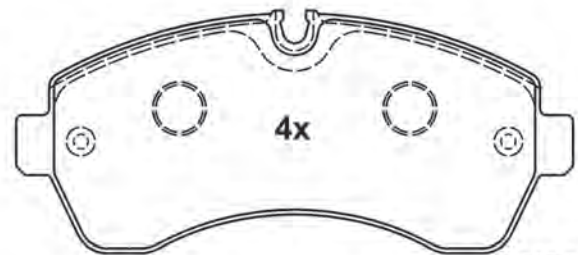

29200 21,0

169,1 x 73,4 x 21,0

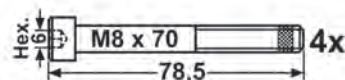

# Abbildungen Scheibenbremsbeläge

Illustrations disc brake pads - Ilustraciones de pastillas - Illustrations Plaquettes de frein à disque - Illustrazioni Pastiglie Freno

13.0460-4828.2 604828

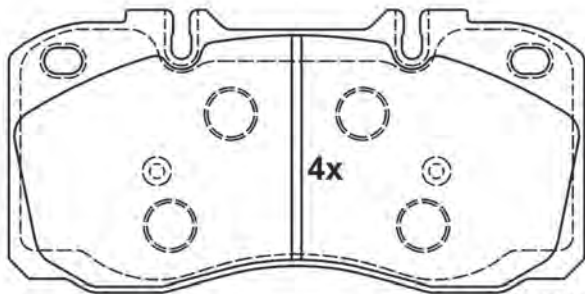

29122 22,1

174,7 x 85,5 x 22,1

13.0460-4829.2 604829

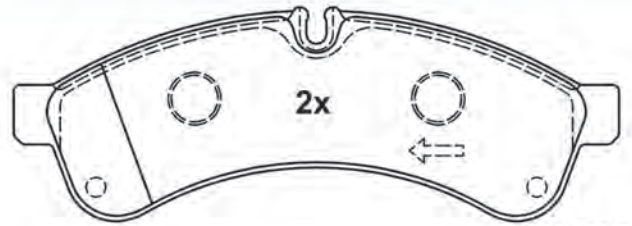

29231 22,7

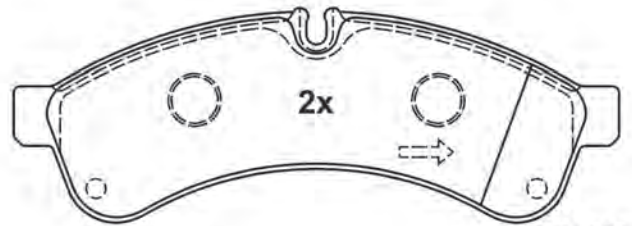

29231 22,7

184,2 x 64,7 x 22,7

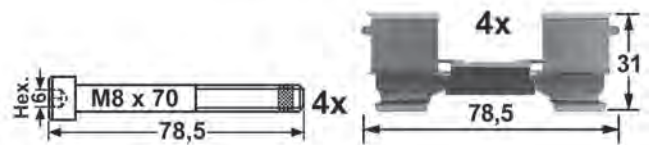

13.0460-4830.2 604830

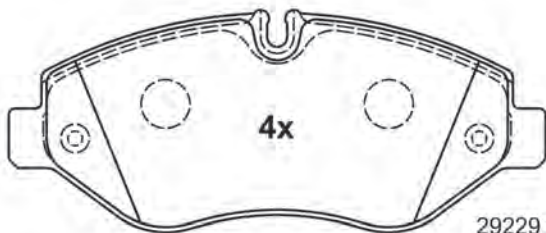

29229 20,7

163,1 x 67,1 x 20,7

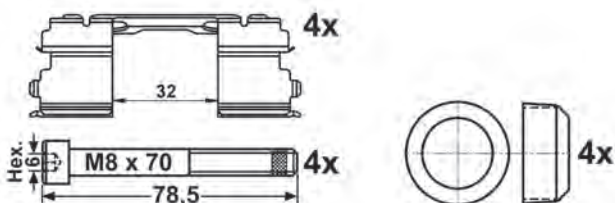

13.0460-4832.2 604832

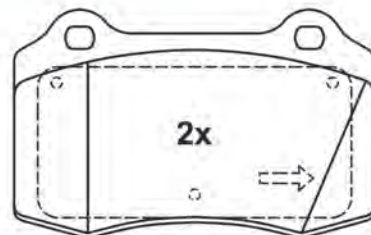

21381 18,0

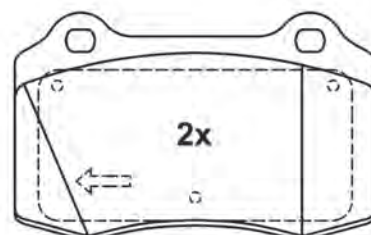

21381 18,0

109,8 x 69,2 x 18,0

# Abbildungen Scheibenbremsbeläge

Illustrations disc brake pads - Ilustraciones de pastillas - Illustrations Plaquettes de frein à disque - Illustrazioni Pastiglie Freno

13.0460-4833.2 604833

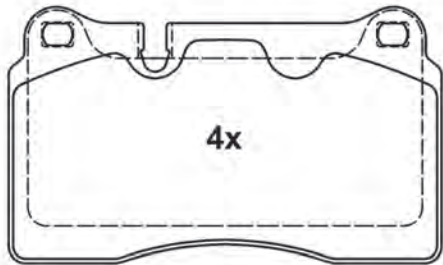

24098 17,1

131,6 x 77,3 x 17,1

13.0460-4834.2 604834

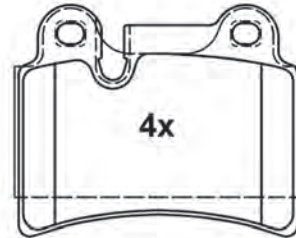

24097 17,1

86,8 x 70,1 x 17,1

13.0460-4837.2 604837

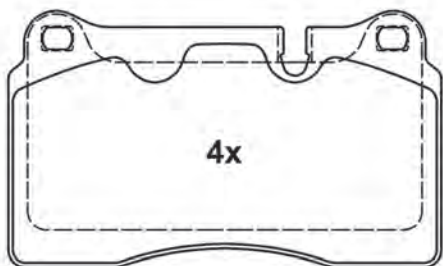

20217 17,1

131,6 x 77,3 x 17,1

13.0460-4839.2 604839

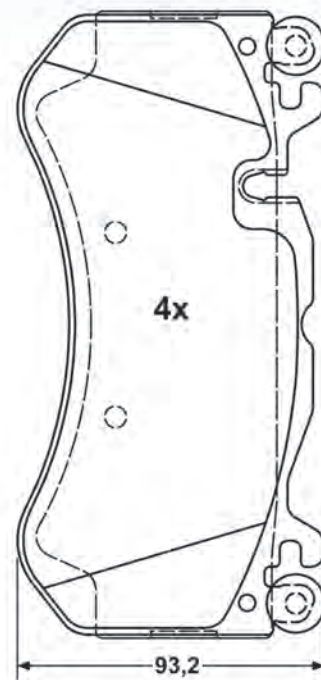

24455 16,8

189,8 x 93,2 x 16,8

# Abbildungen Scheibenbremsbeläge

Illustrations disc brake pads - Ilustraciones de pastillas - Illustrations Plaquettes de frein à disque - Illustrazioni Pastiglie Freno

13.0460-4840.2 604840

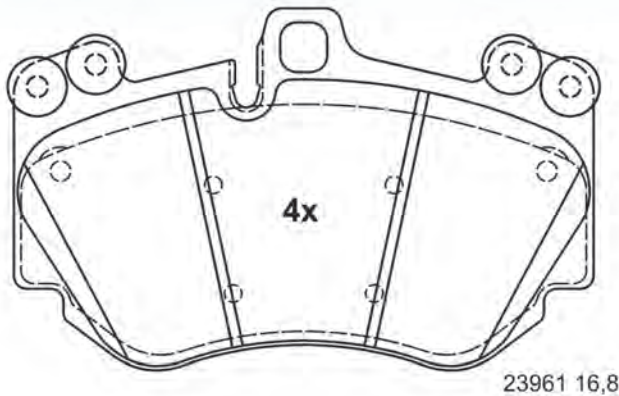

176,0 x 109,6 x 16,8

13.0460-4841.2 604841

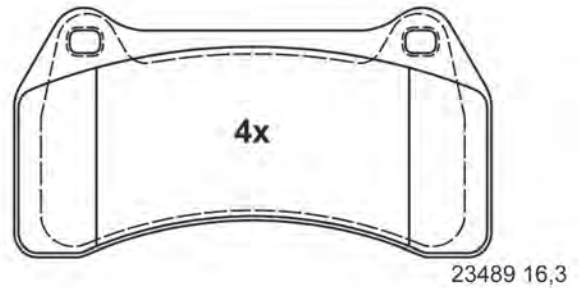

144,7 x 75,3 x 16,3

13.0460-4842.2 604842

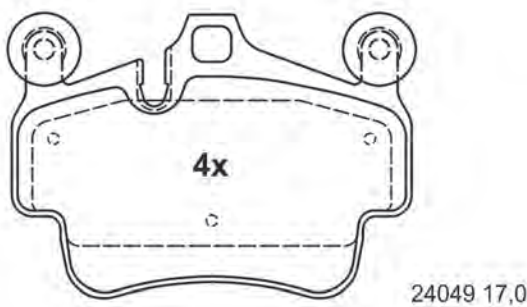

121,0 x 86,0 x 17,0

13.0460-4843.2 604843

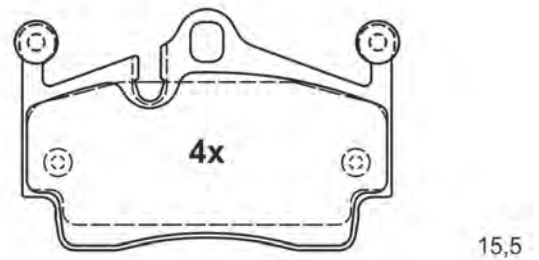

112,0 x 73,0 x 15,5



# Abbildungen Scheibenbremsbeläge

Illustrations disc brake pads - Ilustraciones de pastillas - Illustrations Plaquettes de frein à disque - Illustrazioni Pastiglie Freno

13.0460-4847.2 604847

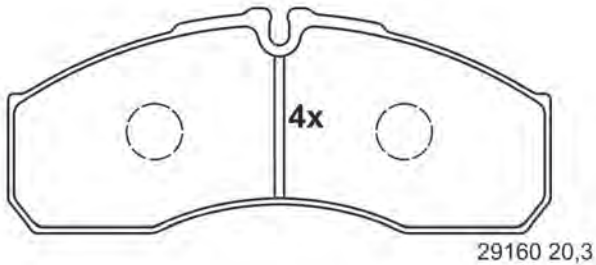

164,6 x 68,0 x 20,3

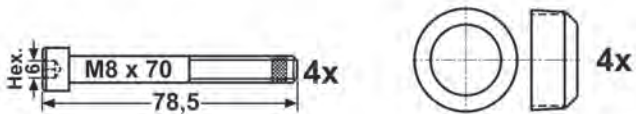

13.0460-4848.2 604848

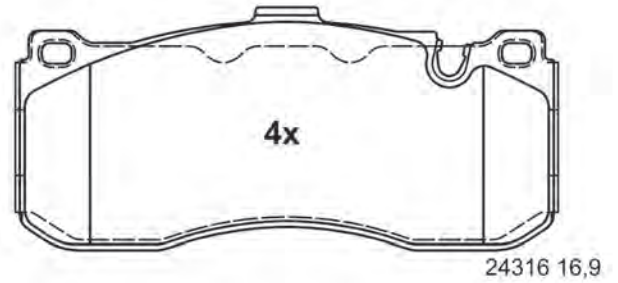

164,7 x 73,5 x 16,9

13.0460-4849.2 604849

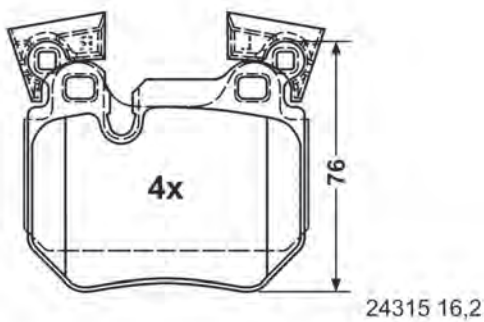

86,7 x 76,0 x 16,2

13.0460-4850.2 604850

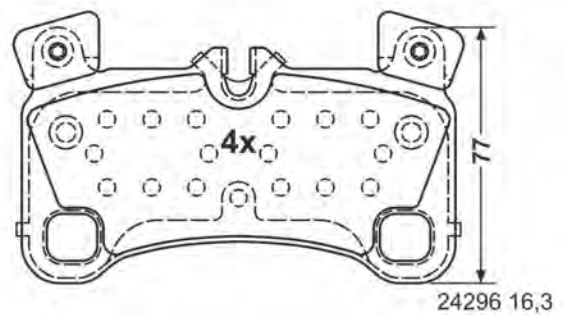

132,1 x 77,0 x 16,3



# Abbildungen Scheibenbremsbeläge

Illustrations disc brake pads - Ilustraciones de pastillas - Illustrations Plaquettes de frein à disque - Illustrazioni Pastiglie Freno

13.0460-4851.2 604851

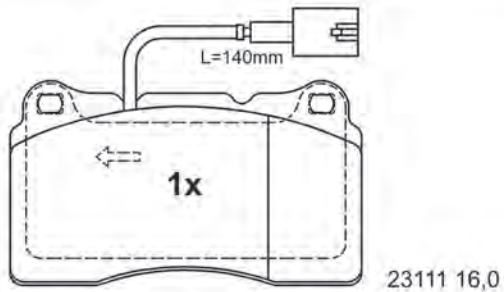
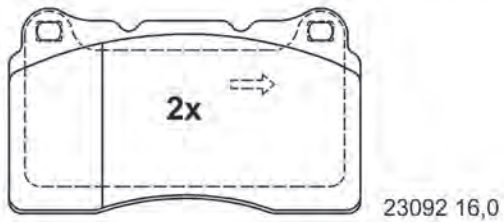
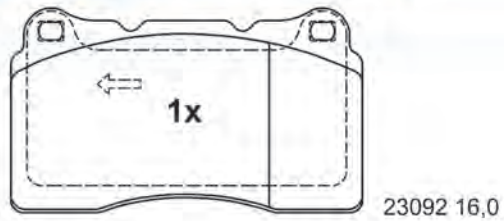

131,8 x 77,2 x 16,0

13.0460-4852.2 604852

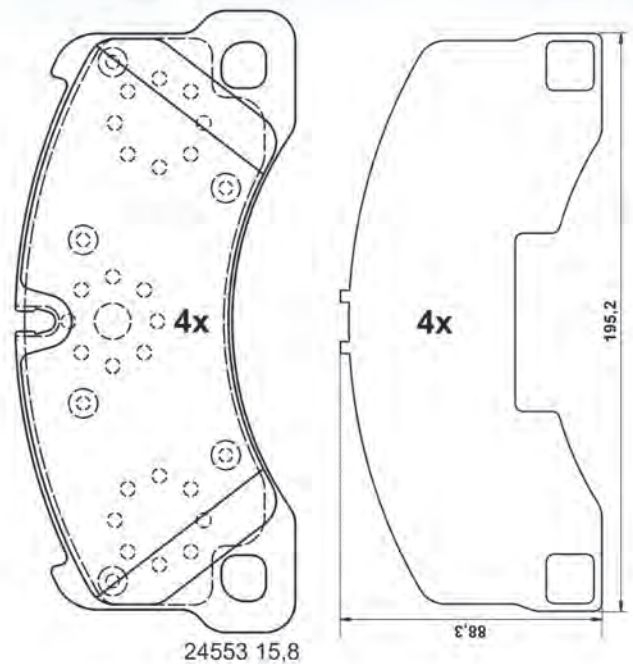

209,5 x 94,2 x 15,8

13.0460-4853.2 604853

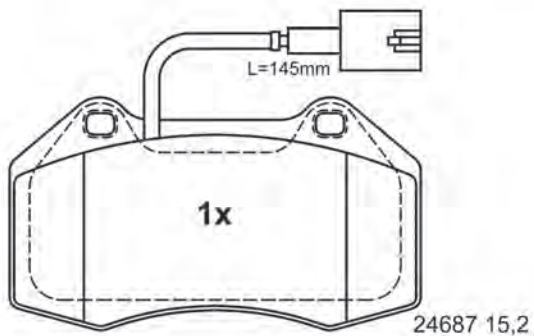
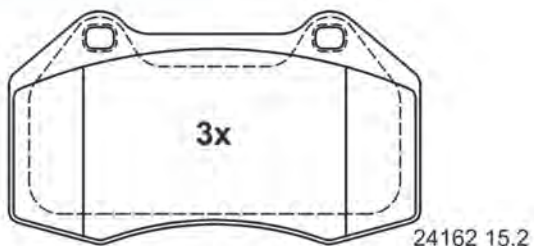

124,6 x 70,4 x 15,2

13.0460-4854.2 604854 [1]

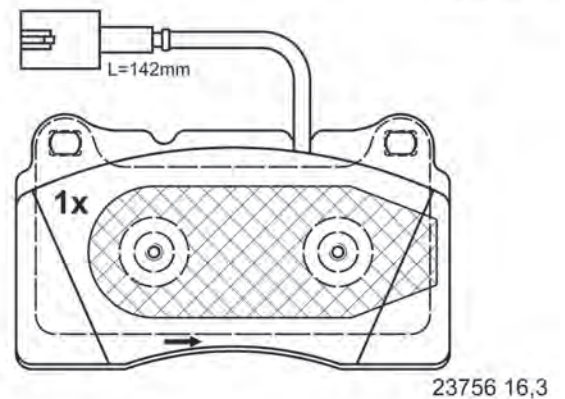
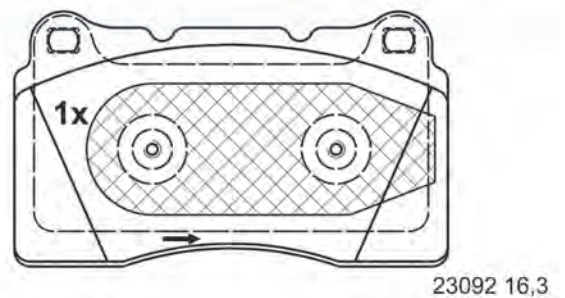

131,8 x 77,2 x 16,3

# Abbildungen Scheibenbremsbeläge

Illustrations disc brake pads - Ilustraciones de pastillas - Illustrations Plaquettes de frein à disque - Illustrazioni Pastiglie Freno

13.0460-4854.2 604854 [2]

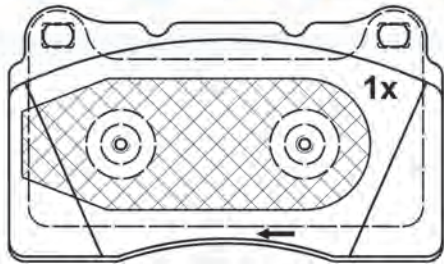

23092 16,3

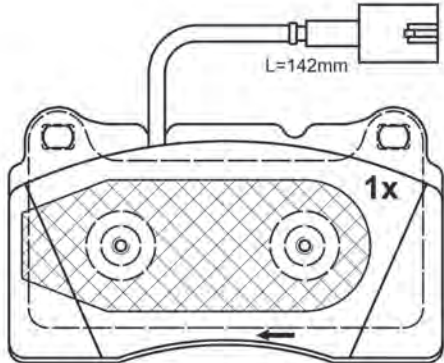

23756 16,3

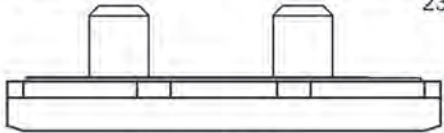

131,8 x 77,2 x 16,3

13.0460-4855.2 604855

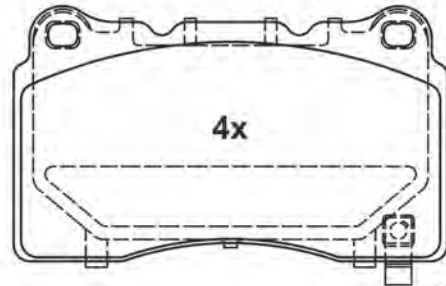

23325 16,4

131,6 x 77,2 x 16,4

13.0460-4856.2 604856

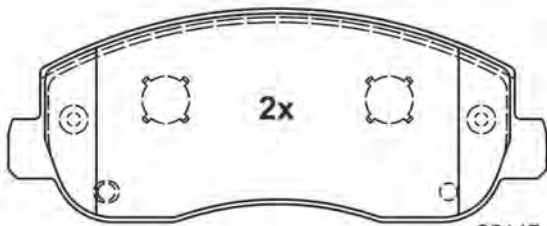

25147 18,4

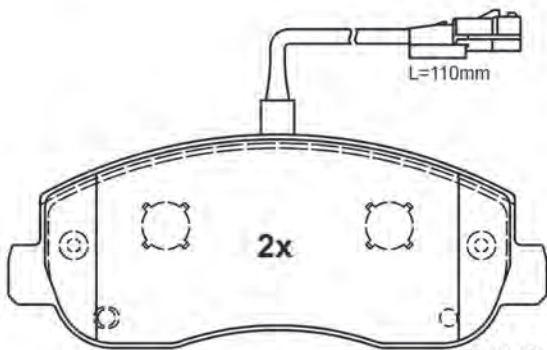

25148 18,4

163,5 x 64,6 x 18,4

13.0460-4857.2 604857

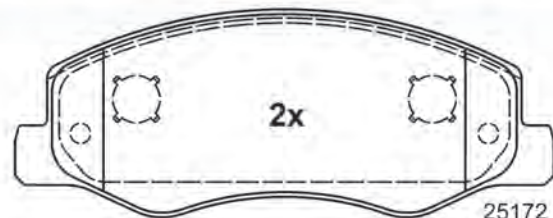

25172 18,4

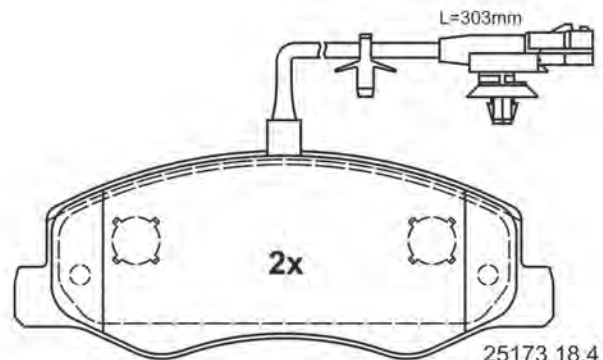

25173 18,4

163,5 x 62,9 x 18,4



# Abbildungen Scheibenbremsbeläge

Illustrations disc brake pads - Ilustraciones de pastillas - Illustrations Plaquettes de frein à disque - Illustrazioni Pastiglie Freno

13.0460-4858.2 604858

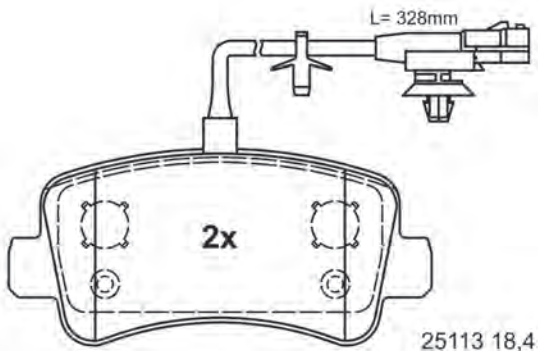
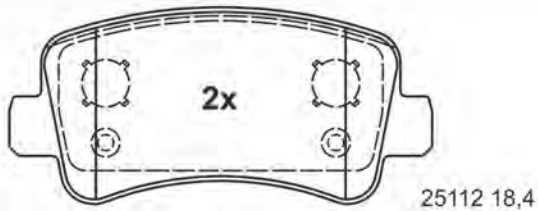

128,5 x 59,5 x 18,4

13.0460-4859.2 604859

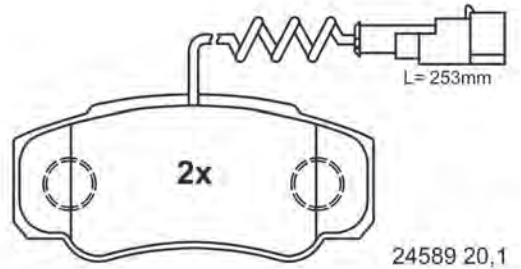
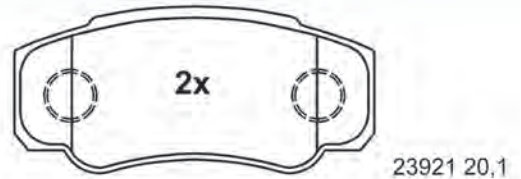

109,6 x 50,0 x 20,1

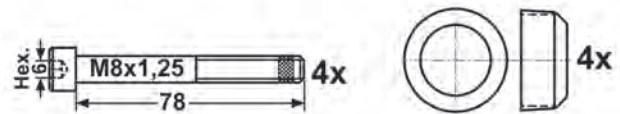

13.0460-4860.2 604860

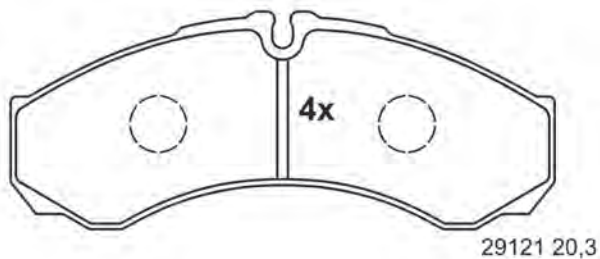

164,6 x 66,5 x 20,3



Alternativer Stecker  
alternative connector

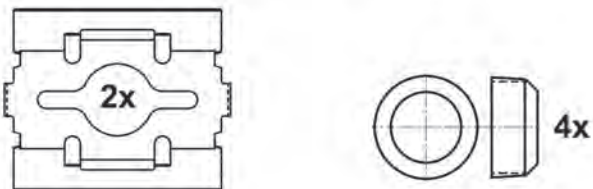

13.0460-4861.2 604861

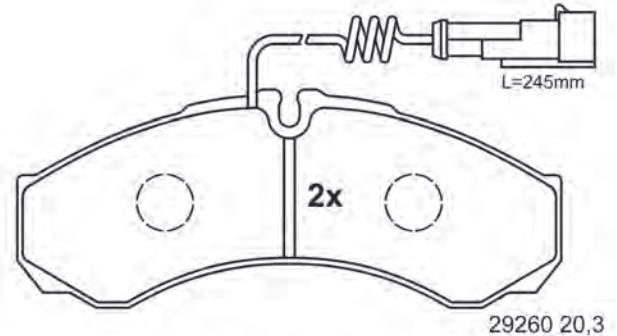
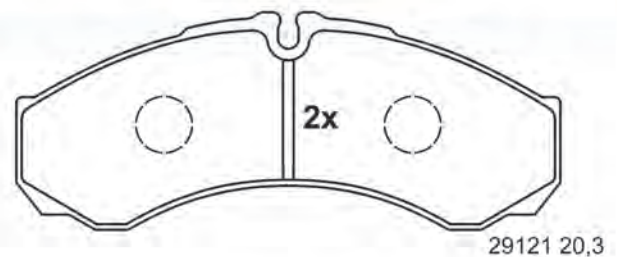

164,6 x 66,5 x 20,3

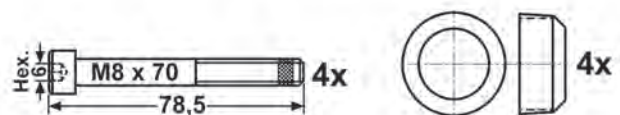

# Abbildungen Scheibenbremsbeläge

Illustrations disc brake pads - Ilustraciones de pastillas - Illustrations Plaquettes de frein à disque - Illustrazioni Pastiglie Freno

13.0460-4862.2 604862

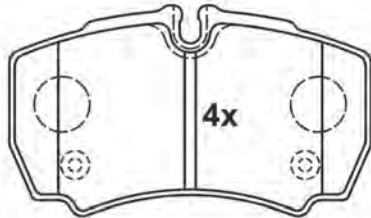

29123 20,3

109,6 x 63,7 x 20,3

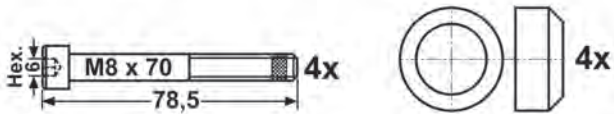
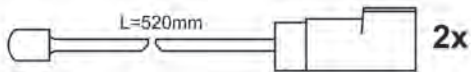

13.0460-4863.2 604863

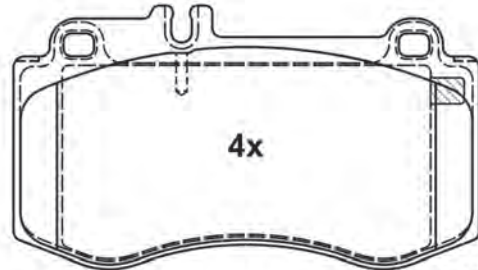

24976 17,5

141,5 x 79,8 x 17,5

13.0460-4864.2 604864

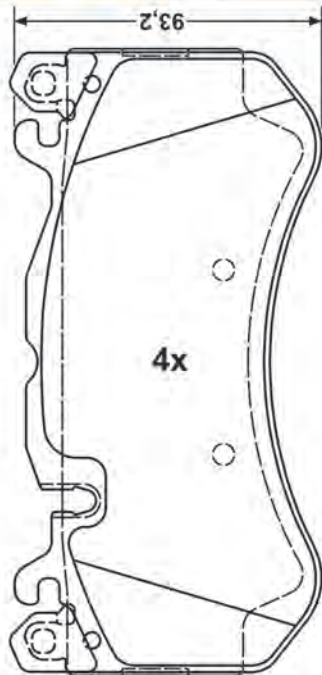

24455 16,8

189,8 x 93,2 x 16,8

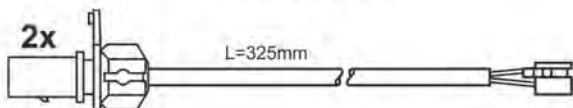

13.0460-4865.2 604865

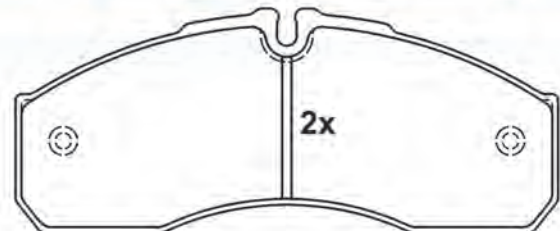

29160 20,3

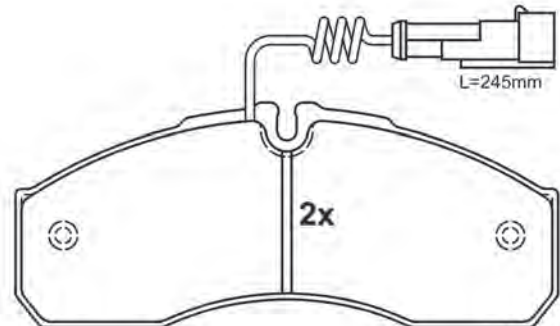

29327 20,3

164,6 x 68,0 x 20,3

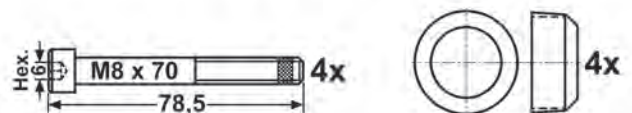

# Abbildungen Scheibenbremsbeläge

Illustrations disc brake pads - Ilustraciones de pastillas - Illustrations Plaquettes de frein à disque - Illustrazioni Pastiglie Freno

13.0460-4866.2 604866

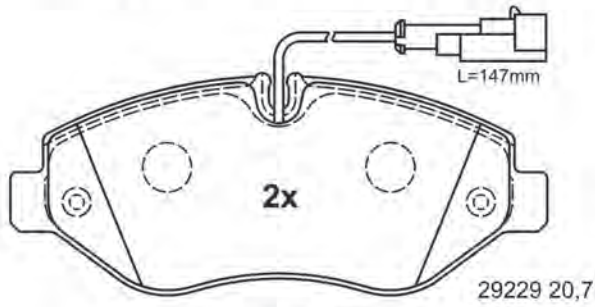
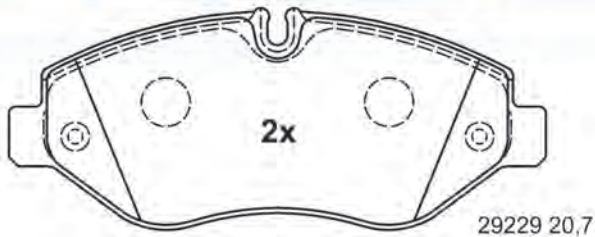

163,1 x 67,1 x 20,7

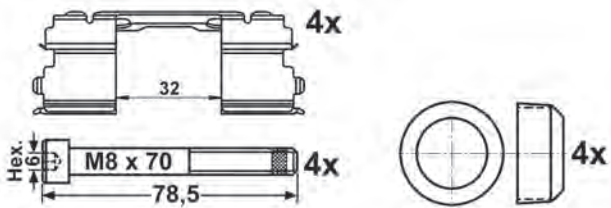

13.0460-4867.2 604867

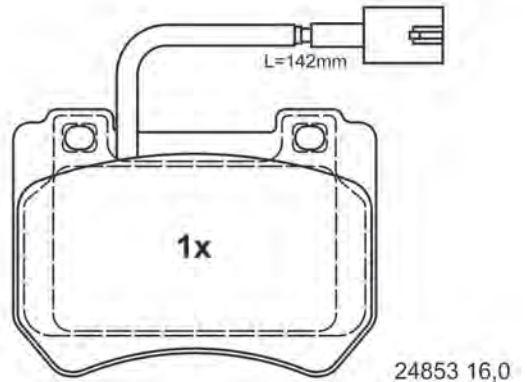
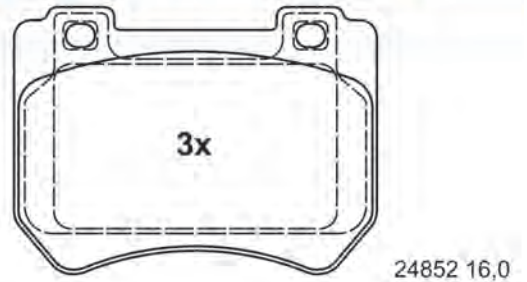

109,8 x 80,8 x 16,0

13.0460-4869.2 604869

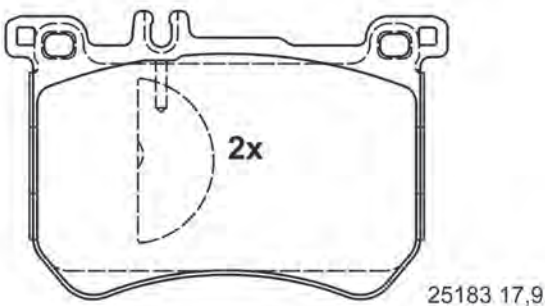
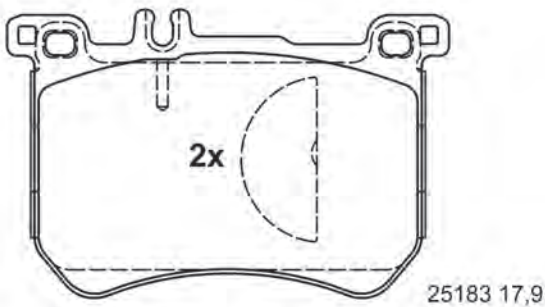

134,4 x 86,0 x 17,9

13.0460-4870.2 604870

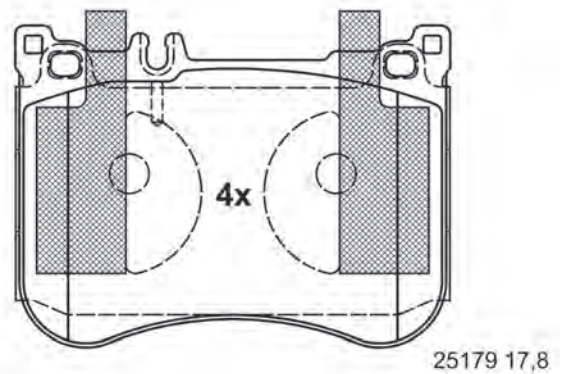

132,0 x 97,5 x 17,8



# Abbildungen Scheibenbremsbeläge

Illustrations disc brake pads - Ilustraciones de pastillas - Illustrations Plaquettes de frein à disque - Illustrazioni Pastiglie Freno

13.0460-4872.2 604872

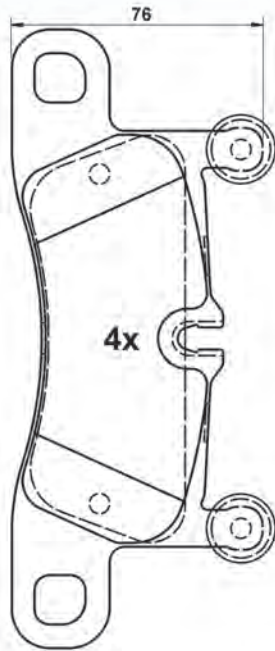

24721 16,9

187,5 x 76,0 x 16,9

13.0460-4873.2 604873

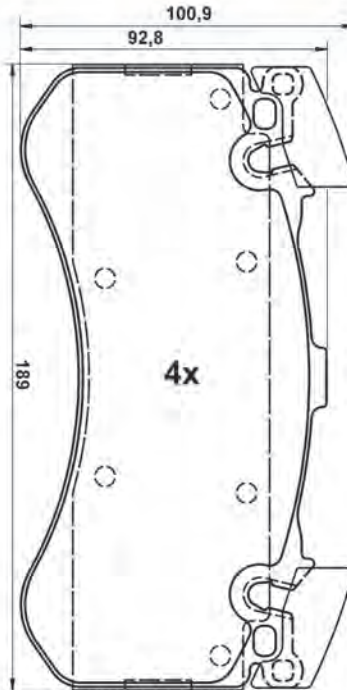

24847 17,0

189,0 x 92,8 x 17,0

13.0460-4874.2 604874

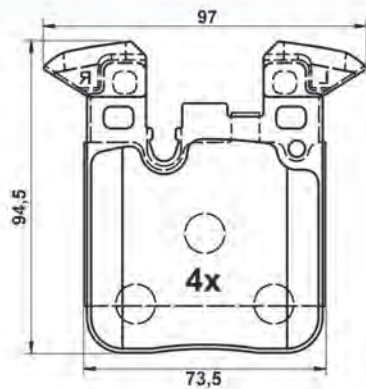

25029 16,7

73,5 x 94,5 x 16,7

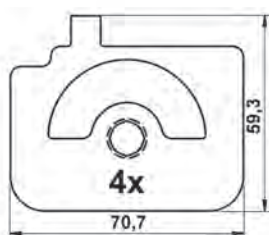

13.0460-4875.2 604875

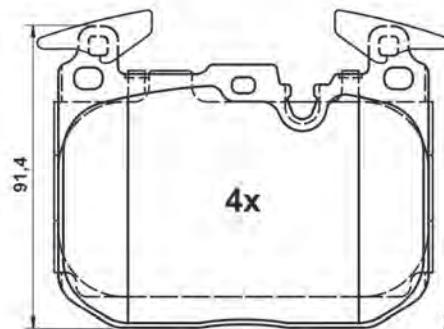

25028 18,0

114,5 x 91,4 x 18,0

# Abbildungen Scheibenbremsbeläge

Illustrations disc brake pads - Ilustraciones de pastillas - Illustrations Plaquettes de frein à disque - Illustrazioni Pastiglie Freno

13.0460-4877.2 604877

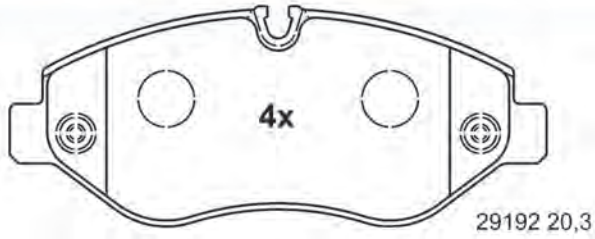

163,2 x 66,8 x 20,3

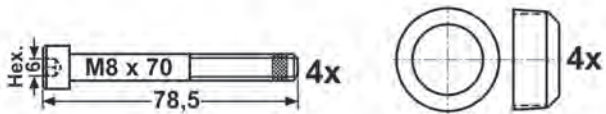
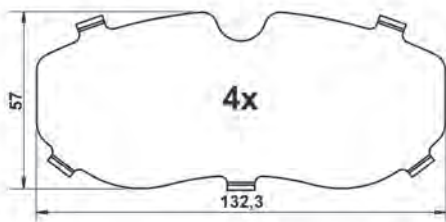

13.0460-4879.2 604879

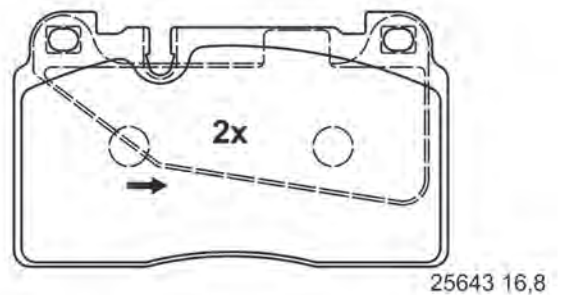
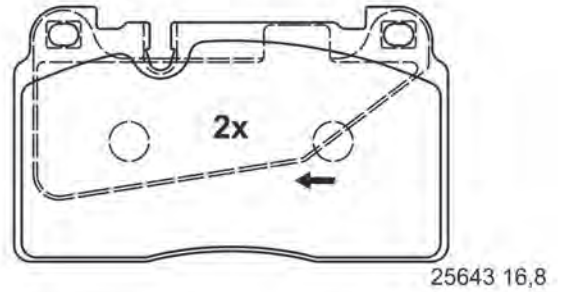

131,8 x 77,2 x 16,8

13.0460-4880.2 604880

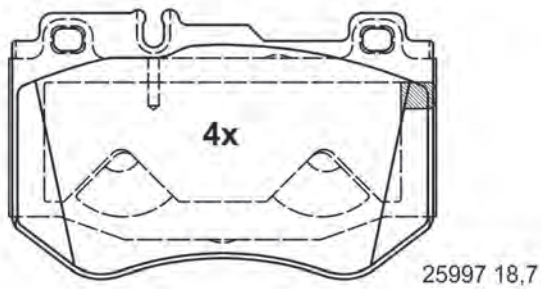

129,3 x 81,6 x 18,7

13.0460-4882.2 604882

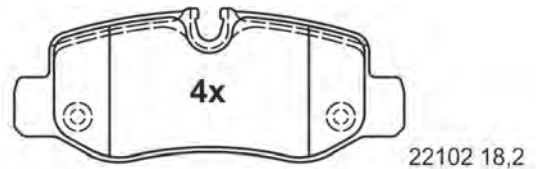

118,5 x 46,4 x 18,2

# Abbildungen Scheibenbremsbeläge

Illustrations disc brake pads - Ilustraciones de pastillas - Illustrations Plaquettes de frein à disque - Illustrazioni Pastiglie Freno

13.0460-4883.2 604883

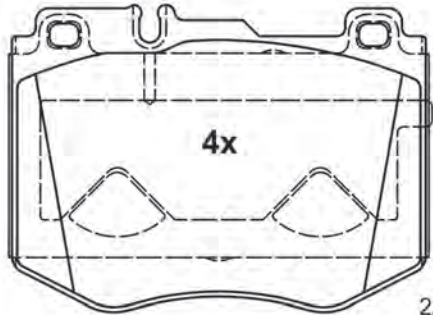

22061 18,7

127,5 x 92,1 x 18,7

13.0460-4884.2 604884

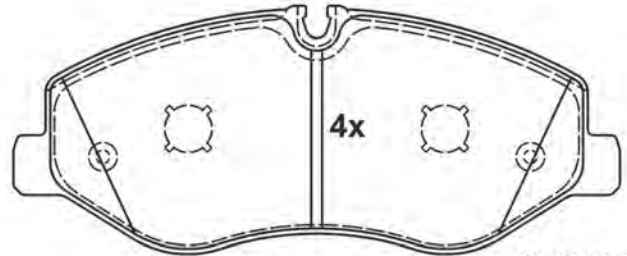

22062 20,7

184,1 x 75,0 x 20,7

13.0460-4887.2 604887

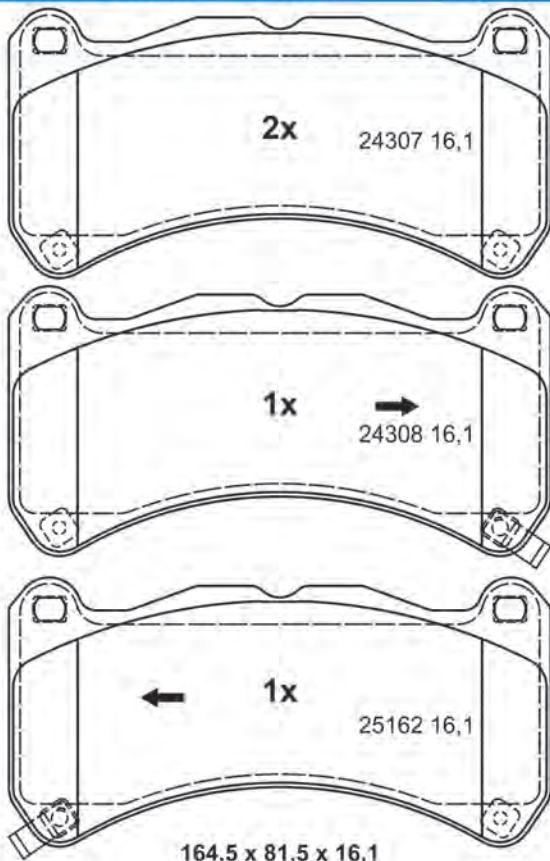

164,5 x 81,5 x 16,1

13.0460-4889.2 604889

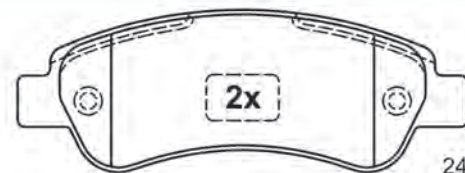

24465 19,2

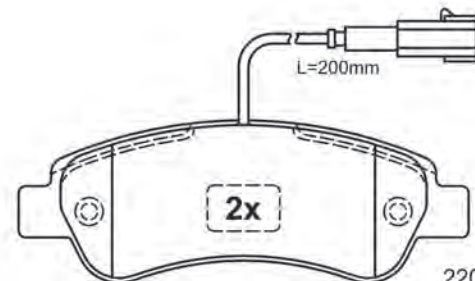

22041 19,2

136,8 x 48,9 x 19,2



4x

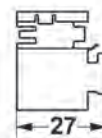

4x



4x





# Abbildungen Scheibenbremsbeläge

Illustrations disc brake pads - Ilustraciones de pastillas - Illustrations Plaquettes de frein à disque - Illustrazioni Pastiglie Freno

13.0460-4890.2 604890

B x H x D

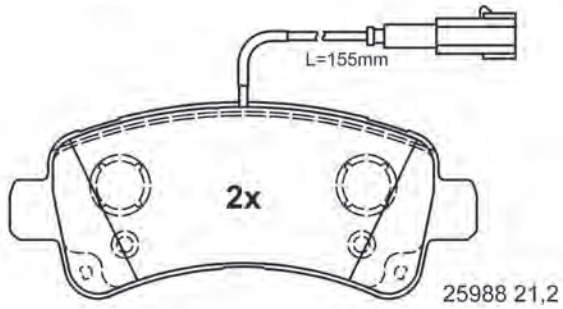
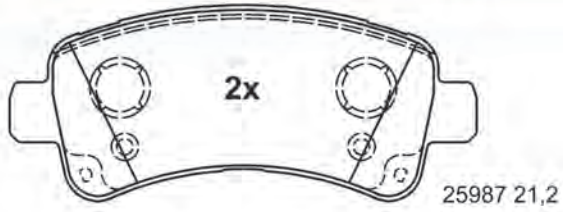

141,7 x 59,3 x 21,2

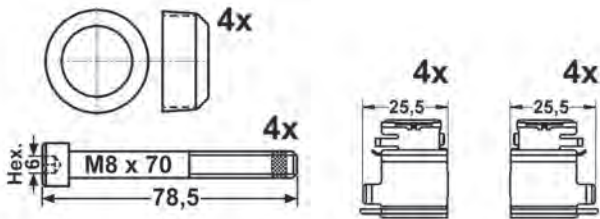

13.0460-4911.2 604911

B x H x D

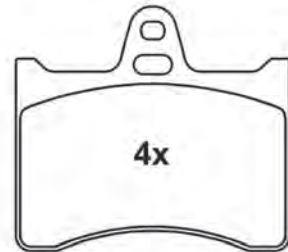

20389 15,4

82,9 x 75,0 x 15,4

13.0460-4918.2 604918

B x H x D

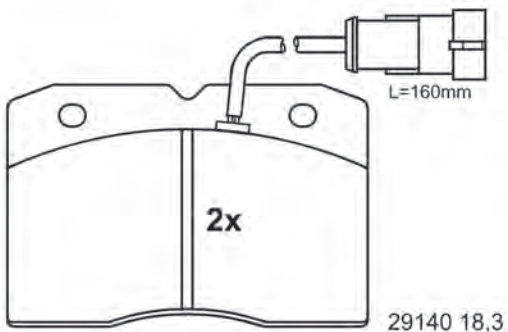
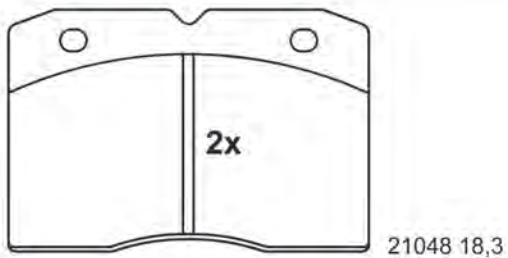

109,5 x 73,0 x 18,3

13.0460-4921.2 604921

B x H x D

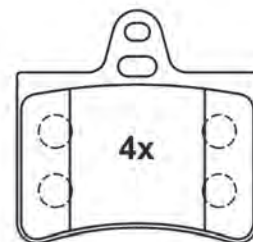

23305 15,2

72,9 x 70,6 x 15,2

# Abbildungen Scheibenbremsbeläge

Illustrations disc brake pads - Ilustraciones de pastillas - Illustrations Plaquettes de frein à disque - Illustrazioni Pastiglie Freno

13.0460-4955.2 604955

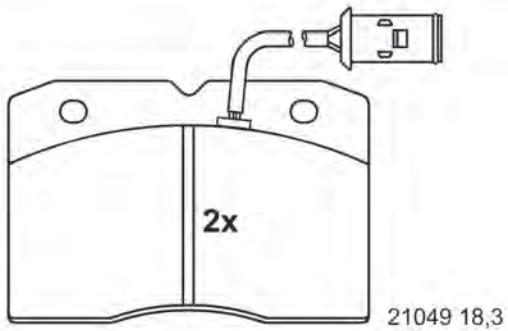
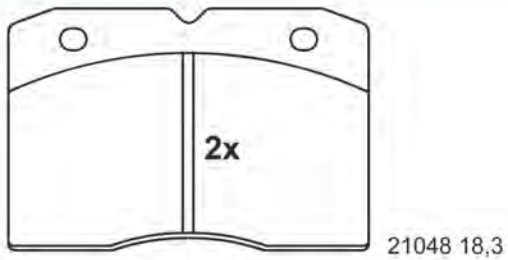

109,5 x 73,0 x 18,3

13.0460-4956.2 604956

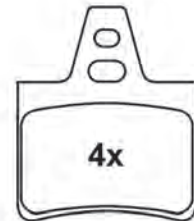

54,0 x 64,7 x 15,4

13.0460-4957.2 604957

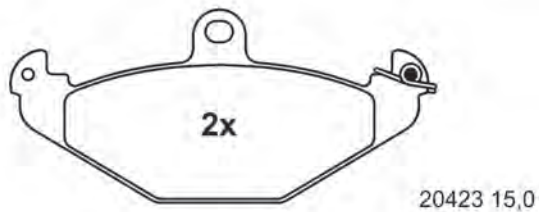
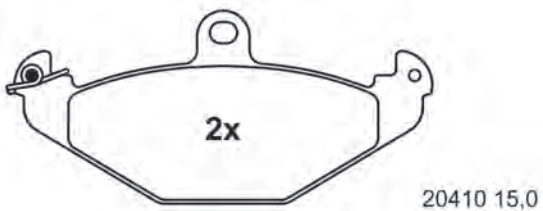

126,0 x 58,0 x 15,0

13.0460-4958.2 604958 [1]

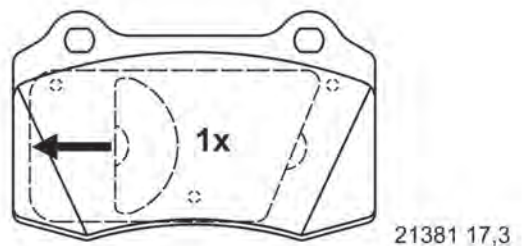
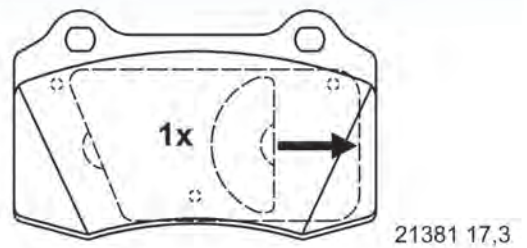

109,8 x 69,2 x 17,3



# Abbildungen Scheibenbremsbeläge

Illustrations disc brake pads - Ilustraciones de pastillas - Illustrations Plaquettes de frein à disque - Illustrazioni Pastiglie Freno

13.0460-4958.2 604958 [2]

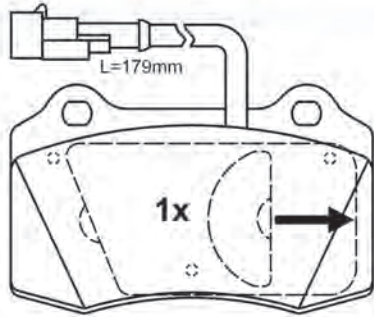

21382 17,3

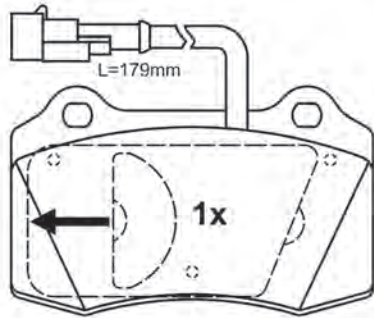

21382 17,3

109,8 x 69,2 x 17,3

13.0460-4964.2 604964

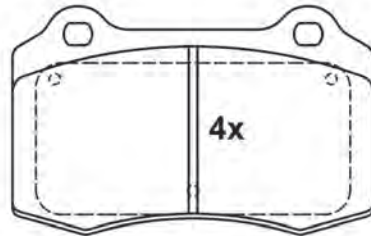

21381 15,0

109,8 x 69,3 x 15,0

13.0460-4965.2 604965

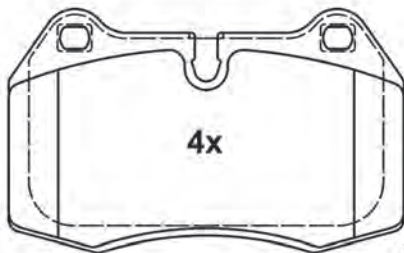

21471 18,0

119,8 x 73,6 x 18,0

13.0460-4966.2 604966

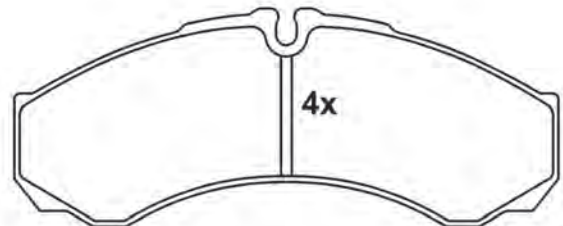

29121 20,3

164,6 x 66,5 x 20,3

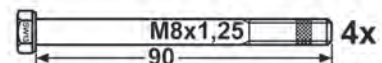

# Abbildungen Scheibenbremsbeläge

Illustrations disc brake pads - Ilustraciones de pastillas - Illustrations Plaquettes de frein à disque - Illustrazioni Pastiglie Freno

13.0460-4968.2 604968

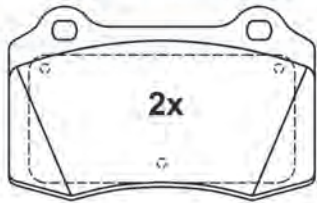

21381 18,0

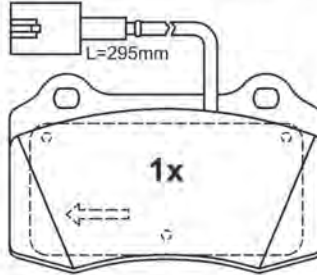

23206 18,0

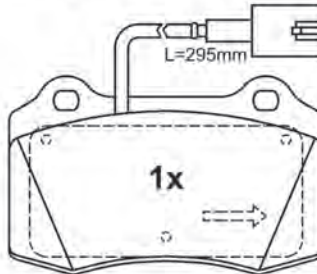

23207 18,0

109,8 x 69,2 x 18,0

13.0460-4969.2 604969

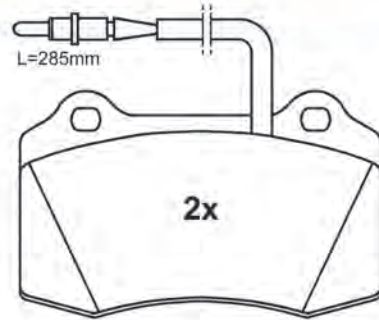

23754 18,0

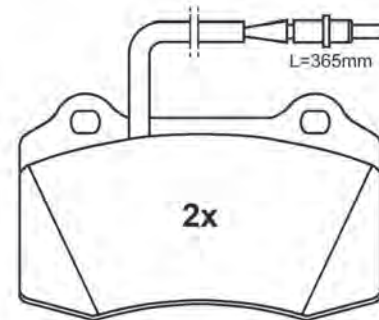

23753 18,0

109,8 x 69,2 x 18,0

13.0460-4969.2 604969 [1]

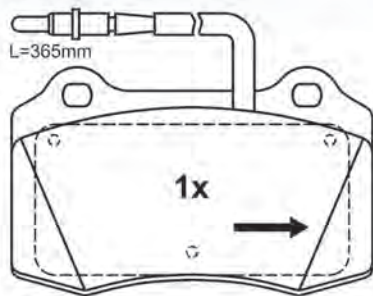

23753 18,0

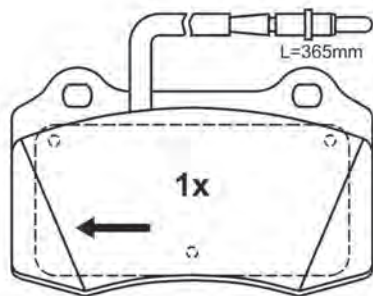

23753 18,0

109,8 x 69,2 x 18,0

13.0460-4969.2 604969 [2]

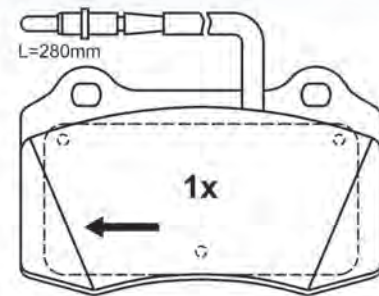

23754 18,0

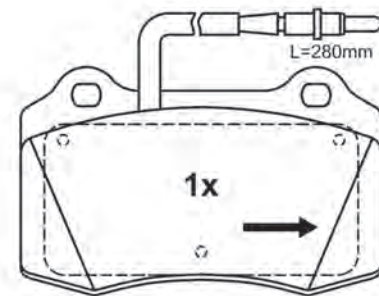

23754 18,0

109,8 x 69,2 x 18,0

# Abbildungen Scheibenbremsbeläge

Illustrations disc brake pads - Ilustraciones de pastillas - Illustrations Plaquettes de frein à disque - Illustrazioni Pastiglie Freno

13.0460-4971.2 604971 [1]

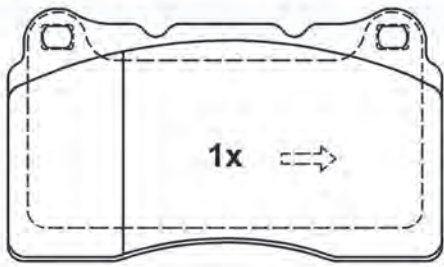

23092 16,0

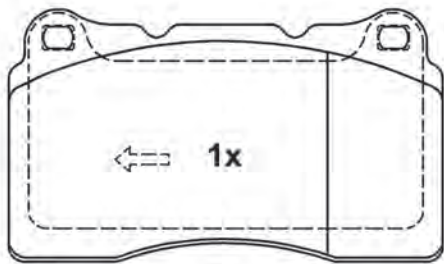

23092 16,0

131,8 x 77,2 x 16,0

13.0460-4971.2 604971 [2]

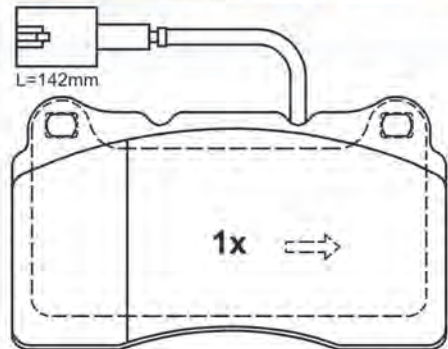

23110 16,0

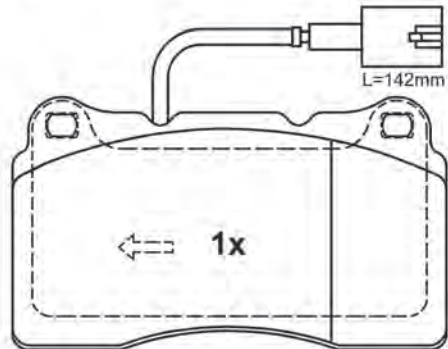

23111 16,0

131,8 x 77,2 x 16,0

13.0460-4972.2 604972

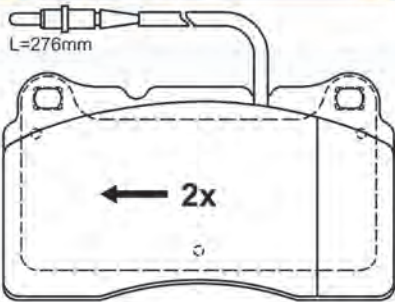

23575 16,0

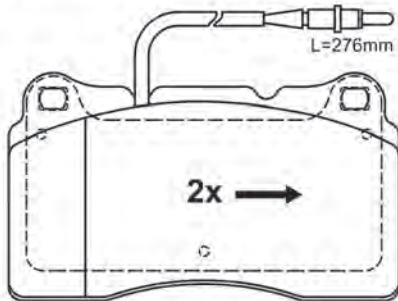

23576 16,0

131,8 x 77,2 x 16,0

13.0460-4973.2 604973 [1]

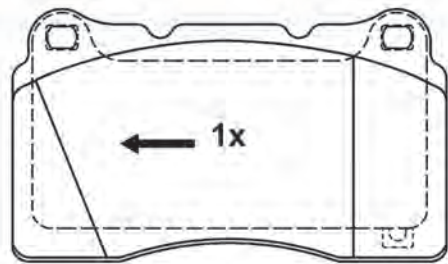

23092 16,0

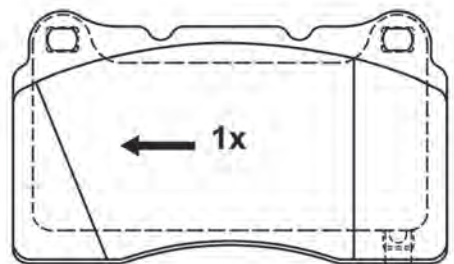

23325 16,0

131,8 x 77,2 x 16,0

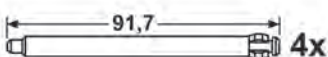

**1x**  
 (UK) Brake pad paste  
 To avoid disk brake squeaking.  
 (D) Bremsklotzpaste  
 Gegen Quietschen von Scheibenbremsen  
 (I) Grasso per freni  
 Contro il fischi in frenatura  
 (F) Pâte pour plaquette de freins  
 Contre le grincement de freins



# Abbildungen Scheibenbremsbeläge

Illustrations disc brake pads - Ilustraciones de pastillas - Illustrations Plaquettes de frein à disque - Illustrazioni Pastiglie Freno

13.0460-4973.2 604973 [2]

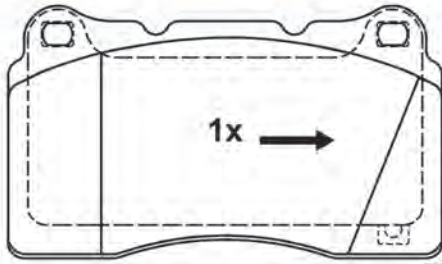

23092 16,0

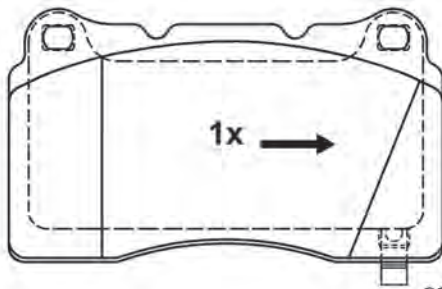

23325 16,0

131,8 x 77,2 x 16,0

13.0460-4974.2 604974

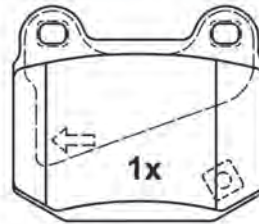

21580 14,6

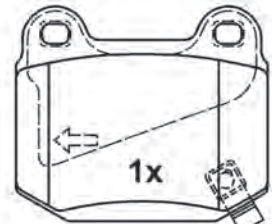

23323 14,6

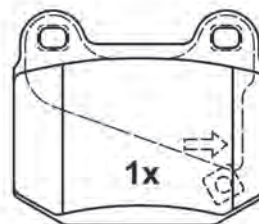

21580 14,6

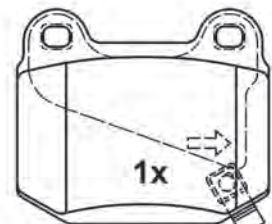

23323 14,6

76,9 x 65,5 x 14,6

13.0460-4975.2 604975

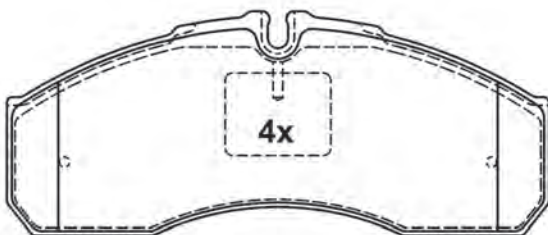

29160 20,8

164,8 x 68,0 x 20,8

13.0460-4976.2 604976

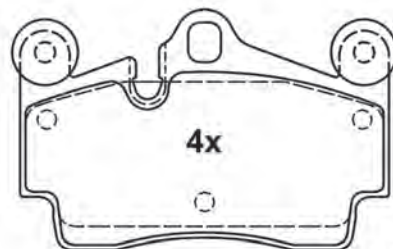

23694 16,7

112,0 x 73,0 x 16,7

# Abbildungen Scheibenbremsbeläge

Illustrations disc brake pads - Ilustraciones de pastillas - Illustrations Plaquettes de frein à disque - Illustrazioni Pastiglie Freno

13.0460-4977.2 604977

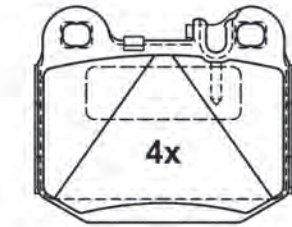

23157 15,8

76,5 x 65,5 x 15,8

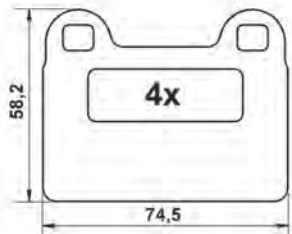

13.0460-4978.2 604978

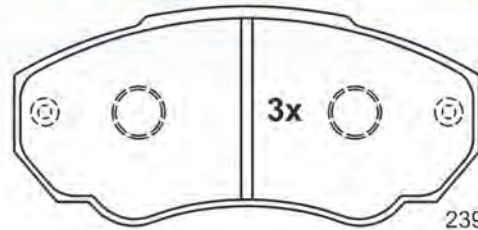

23917 19,3

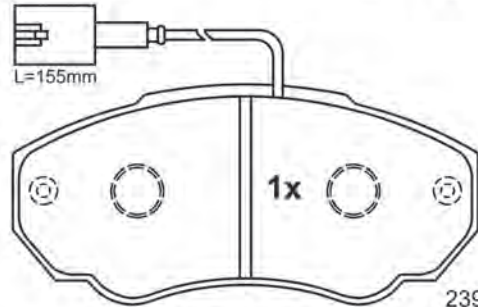

23918 19,3

140,6 x 66,0 x 19,3

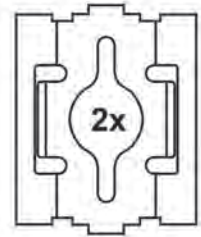
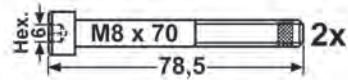
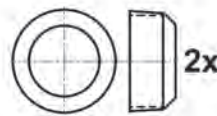

13.0460-4979.2 604979

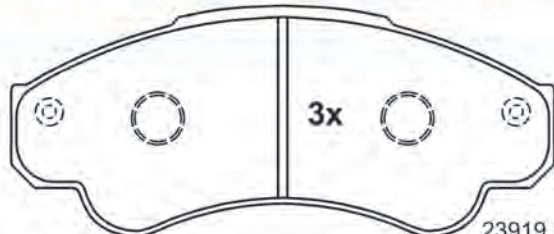

23919 19,3

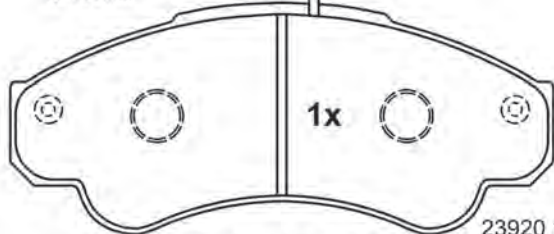
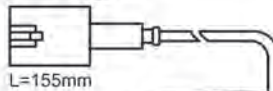

23920 19,3

164,6 x 69,3 x 19,3

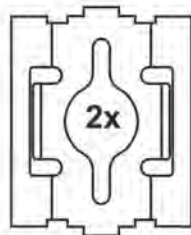
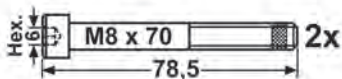

13.0460-4980.2 604980

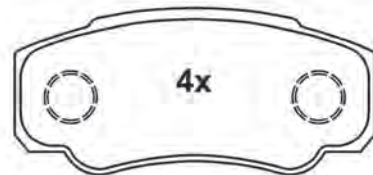

23921 20,3

109,6 x 50,0 x 20,3

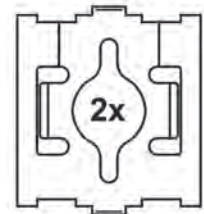
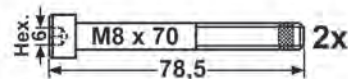
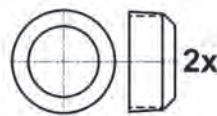



# Abbildungen Scheibenbremsbeläge

Illustrations disc brake pads - Ilustraciones de pastillas - Illustrations Plaquettes de frein à disque - Illustrazioni Pastiglie Freno

13.0460-4984.2 604984

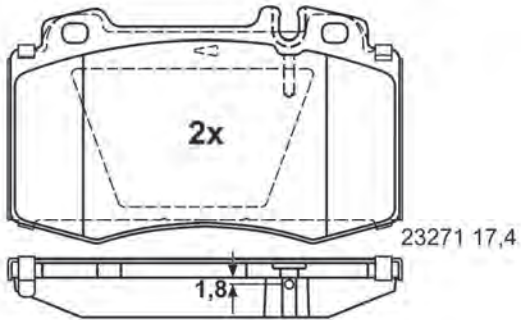
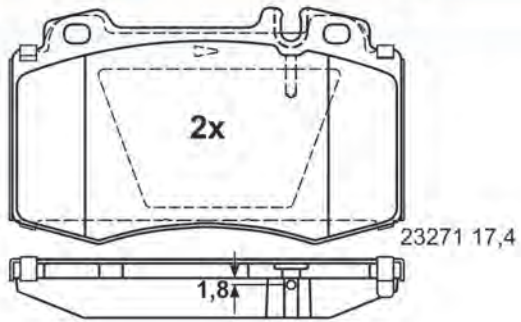

119,5 x 71,7 x 17,4

13.0460-4985.2 604985 [1]

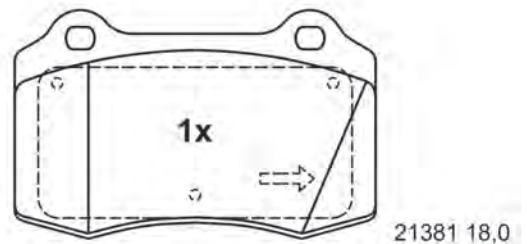
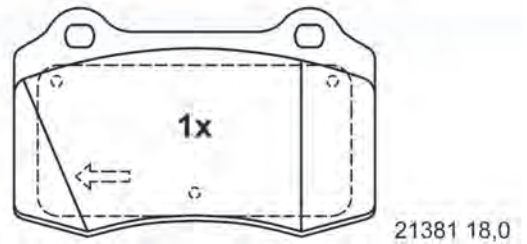

109,8 x 69,2 x 18,0

13.0460-4985.2 604985 [2]

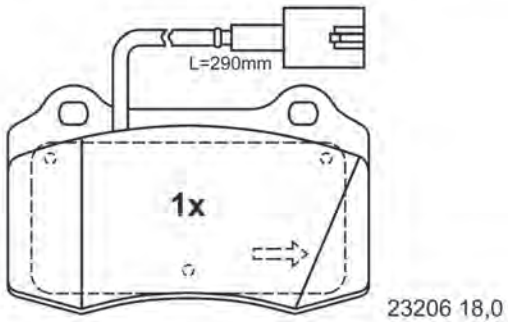
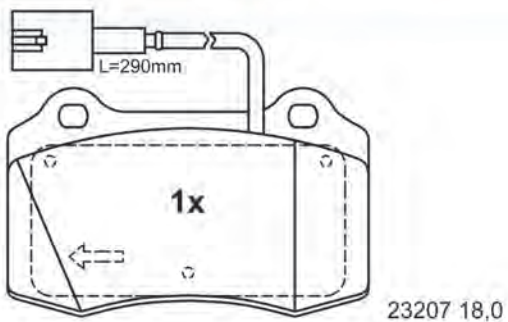

109,8 x 69,2 x 18,0

13.0460-4986.2 604986

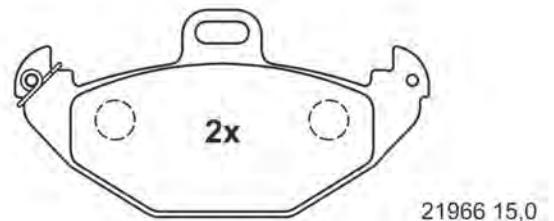
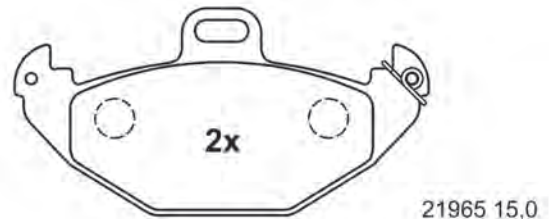

126,1 x 63,0 x 15,0

# Abbildungen Scheibenbremsbeläge

Illustrations disc brake pads - Ilustraciones de pastillas - Illustrations Plaquettes de frein à disque - Illustrazioni Pastiglie Freno

13.0460-4987.2 604987



23329 17,0

121,3 x 90,3 x 17,0

13.0460-4988.2 604988

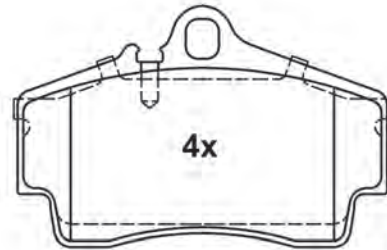

21792 15,2

112,2 x 73,0 x 15,2

13.0460-4989.2 604989

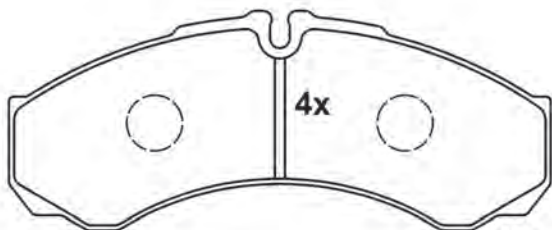

29212 17,3

164,8 x 66,5 x 17,3

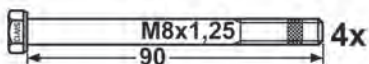

13.0460-4990.2 604990 [1]

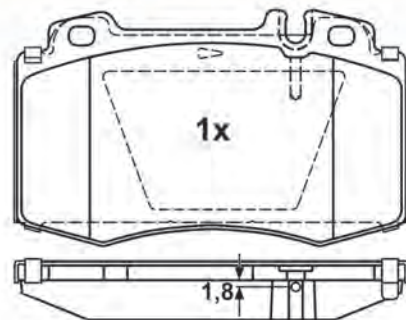

23271 17,4

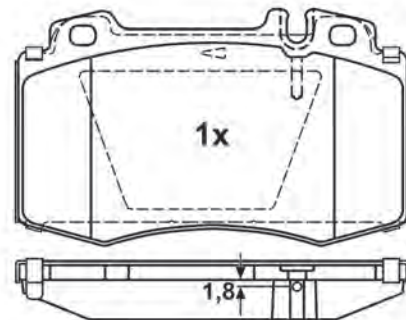

23271 17,4

119,5 x 71,7 x 17,4

# Abbildungen Scheibenbremsbeläge

Illustrations disc brake pads - Ilustraciones de pastillas - Illustrations Plaquettes de frein à disque - Illustrazioni Pastiglie Freno

13.0460-4990.2 604990 [2]

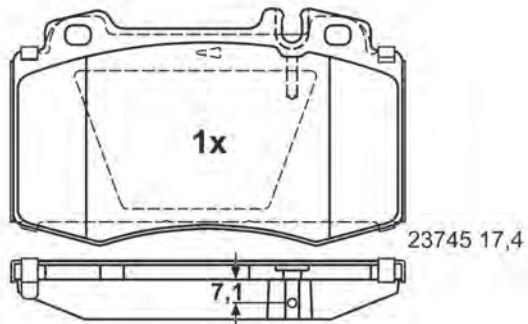
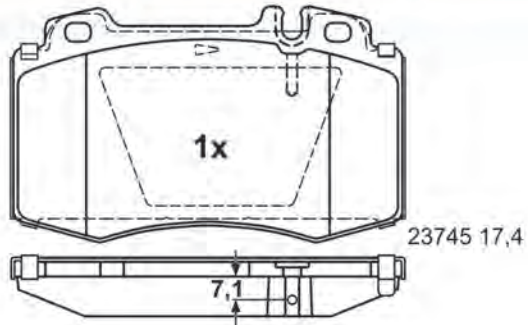

119,5 x 71,7 x 17,4

13.0460-4991.2 604991 [1]

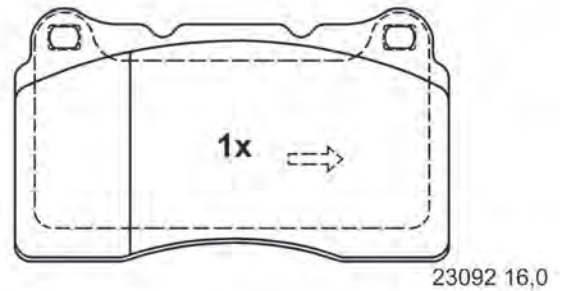
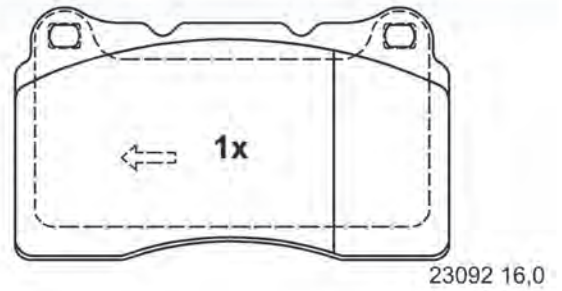

131,8 x 77,2 x 16,0

13.0460-4991.2 604991 [2]

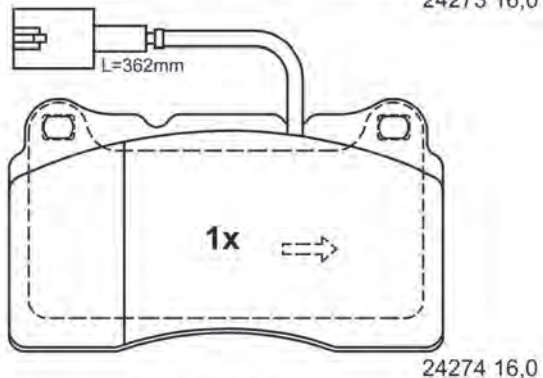
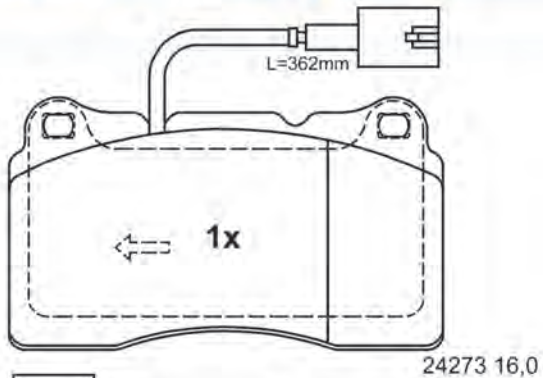

131,8 x 77,2 x 16,0

13.0460-4992.2 604992

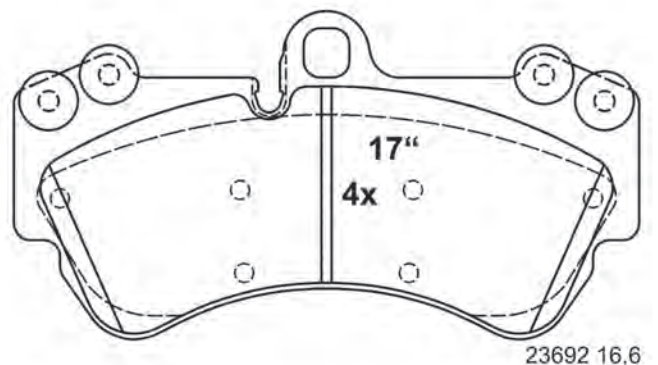

190 x 99,4 x 16,6



# Abbildungen Scheibenbremsbeläge

Illustrations disc brake pads - Ilustraciones de pastillas - Illustrations Plaquettes de frein à disque - Illustrazioni Pastiglie Freno

13.0460-4993.2 604993

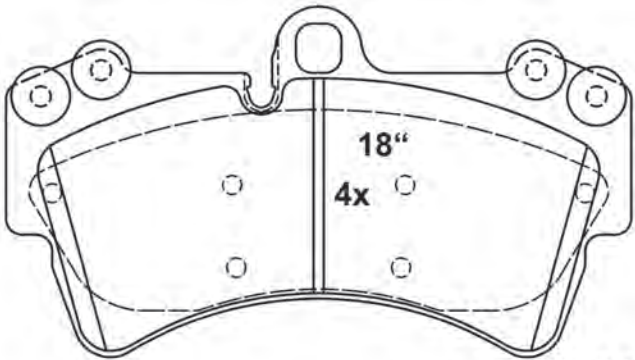

23693 16,6

190,0 x 106,4 x 16,6

13.0460-4994.2 604994

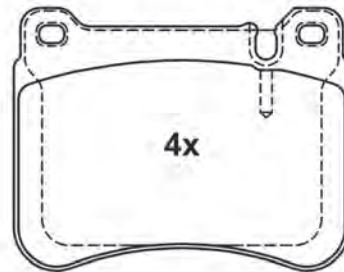

23945 16,5

101,7 x 79,3 x 16,5

13.0460-4995.2 604995 [1]

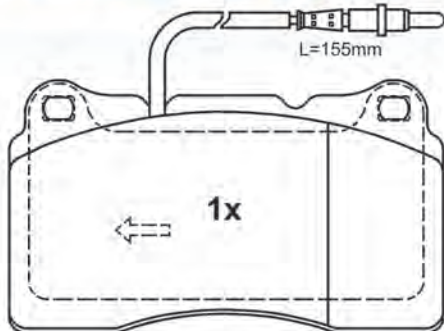

23576 15,6

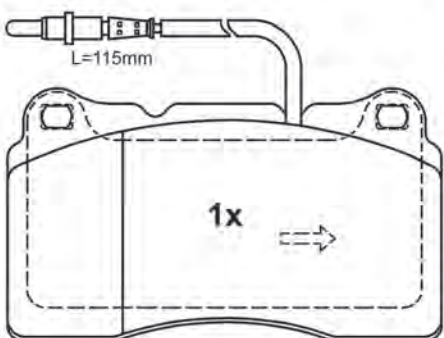

23575 15,6

131,8 x 77,2 x 15,6

13.0460-4995.2 604995 [2]

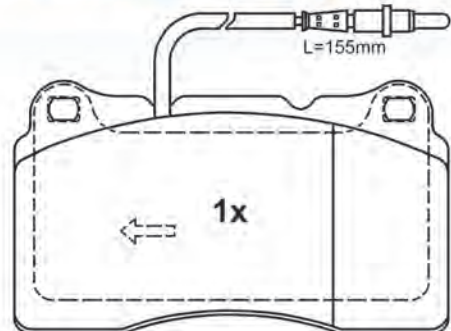

23576 15,6

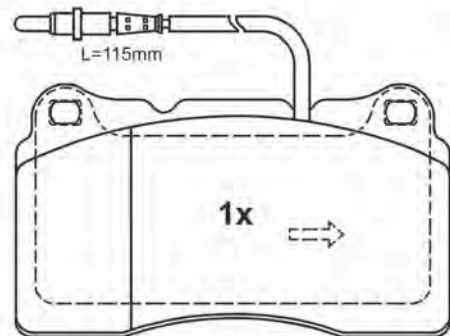

23575 15,6

131,8 x 77,2 x 15,6

# Abbildungen Scheibenbremsbeläge

Illustrations disc brake pads - Ilustraciones de pastillas - Illustrations Plaquettes de frein à disque - Illustrazioni Pastiglie Freno

13.0460-4996.2 604996

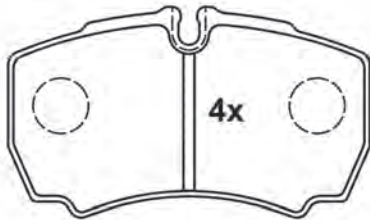

29123 20,3

109,8 x 63,8 x 20,3

13.0460-4997.2 604997

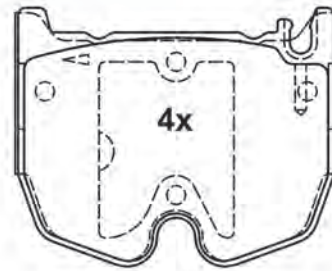

23944 17,5  
(23943)

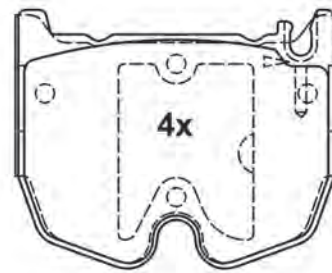

23944 17,5  
(23943)

97,8 x 78,5 x 17,5

13.0460-4998.2 604998

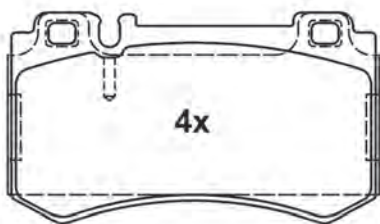

23478 16,5

112,0 x 63,8 x 16,5

13.0460-4999.2 604999

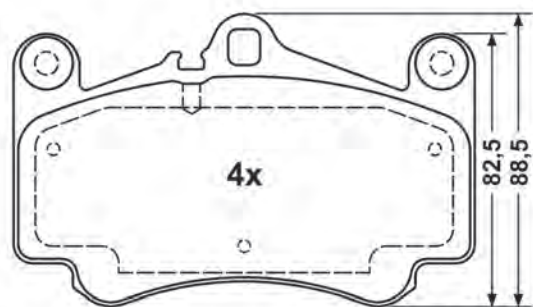

23330 17,0

140,0 x 88,5 x 17,0



# Abbildungen Scheibenbremsbeläge

Illustrations disc brake pads - Ilustraciones de pastillas - Illustrations Plaquettes de frein à disque - Illustrazioni Pastiglie Freno

13.0460-5405.2 605405

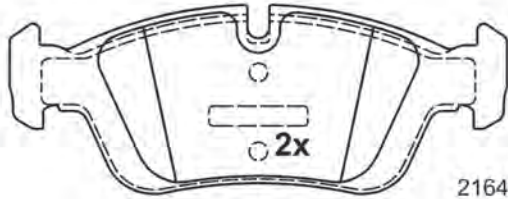

21643 17,8

151,3 x 57,3 x 17,8

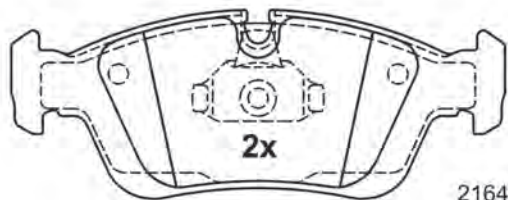

21644 17,8

150,1 x 57,3 x 17,8

13.0460-5409.2 605409



21193 18,0

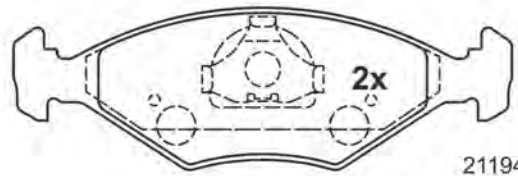

21194 18,0

151,3 x 49,2 x 18,0

13.0460-5410.2 605410

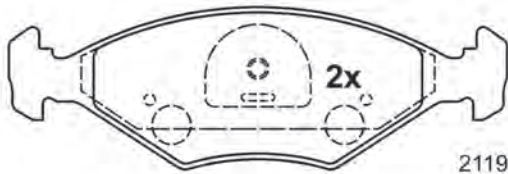

21193 18,0

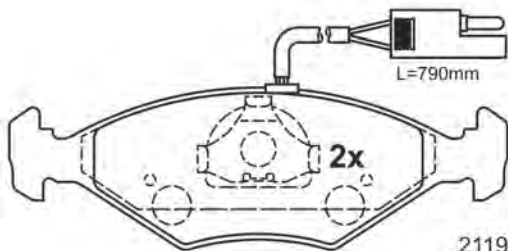

21195 18,0

151,3 x 49,2 x 18,0

13.0460-5600.2 605600

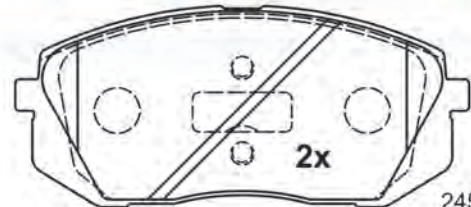

24501 16,7

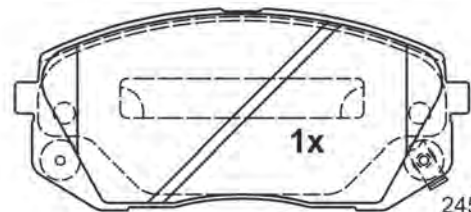

24502 16,7

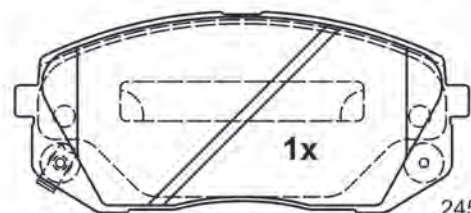

24503 16,7

137,8 x 60,9 x 16,7

# Abbildungen Scheibenbremsbeläge

Illustrations disc brake pads - Ilustraciones de pastillas - Illustrations Plaquettes de frein à disque - Illustrazioni Pastiglie Freno

13.0460-5601.2 605601

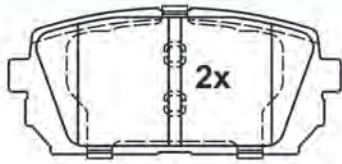

24491 16,0

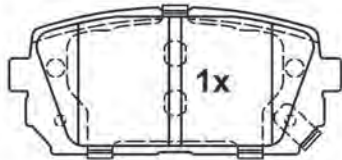

24492 16,0

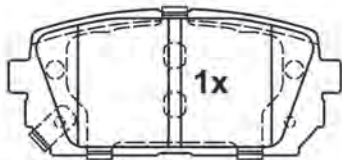

24493 16,0

100,7 x 44,0 x 16,0

13.0460-5602.2 605602

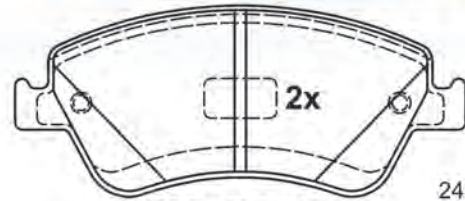

24122 19,0

136,7 x 57,9 x 19,0

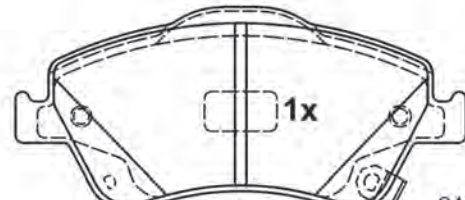

24590 19,0

136,7 x 61,4 x 19,0

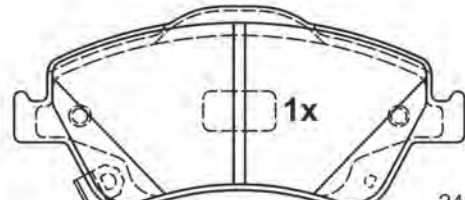

24591 19,0

136,7 x 61,4 x 19,0

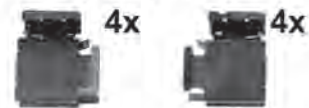

13.0460-5603.2 605603

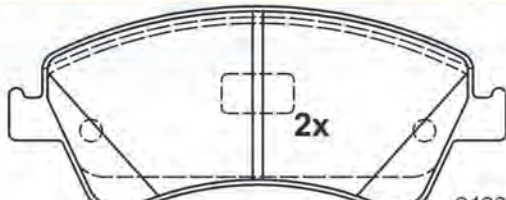

24204 19,2

150,7 x 62,5 x 19,2

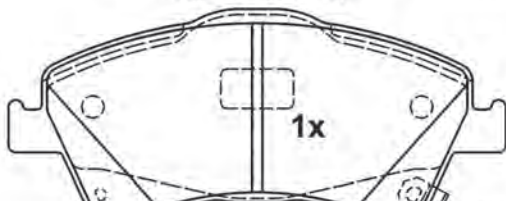

24690 19,2

150,6 x 65,3 x 19,2

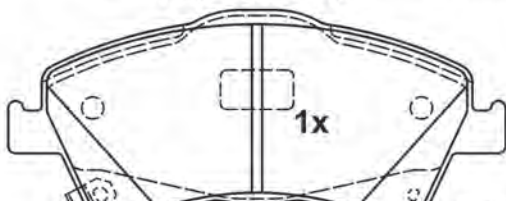

24691 19,2

150,6 x 65,3 x 19,2

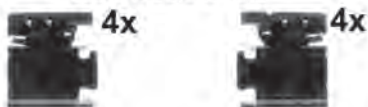

13.0460-5604.2 605604



24664 15,2

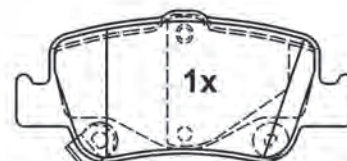

24665 15,2

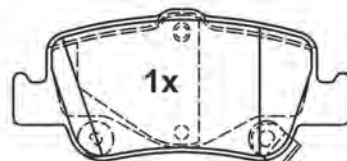

24666 15,2

102,0 x 46,0 x 15,2

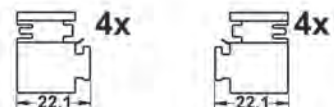

# Abbildungen Scheibenbremsbeläge

Illustrations disc brake pads - Ilustraciones de pastillas - Illustrations Plaquettes de frein à disque - Illustrazioni Pastiglie Freno

13.0460-5605.2 605605

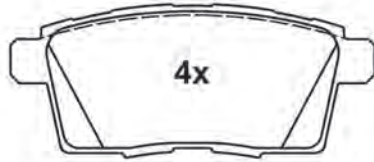

24545 16,9

110,6 x 47,1 x 16,9

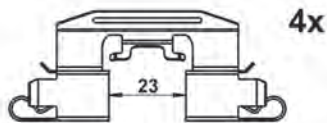
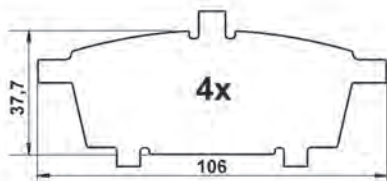

13.0460-5606.2 605606

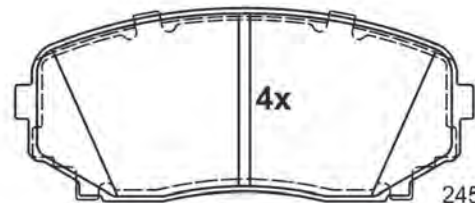

24544 18,1

138,9 x 58,0 x 18,1

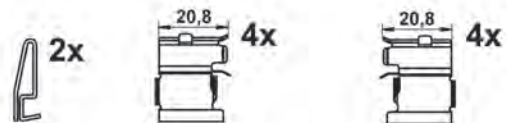

13.0460-5607.2 605607

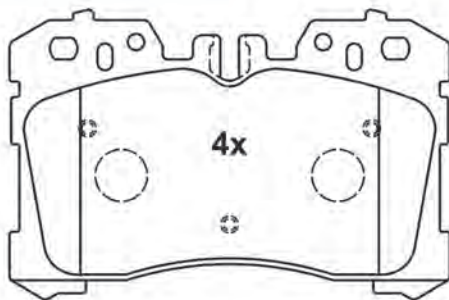

24245 18,5

133,7 x 87,9 x 18,5

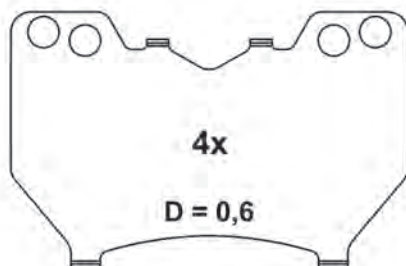

13.0460-5608.2 605608

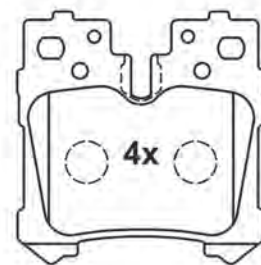

24244 18,5

75,0 x 76,7 x 18,5

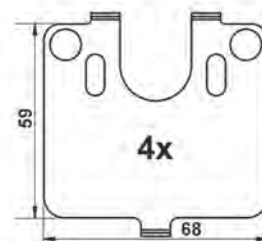



# Abbildungen Scheibenbremsbeläge

Illustrations disc brake pads - Ilustraciones de pastillas - Illustrations Plaquettes de frein à disque - Illustrazioni Pastiglie Freno

13.0460-5609.2 605609

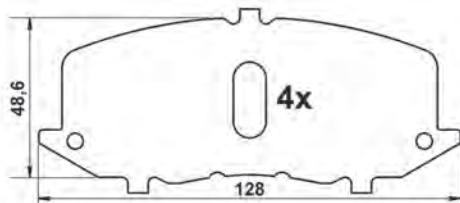
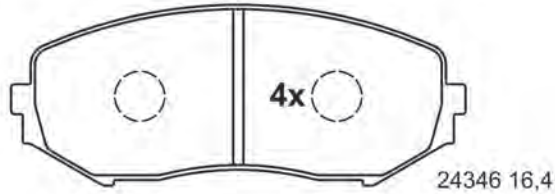

13.0460-5610.2 605610

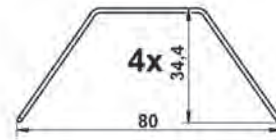
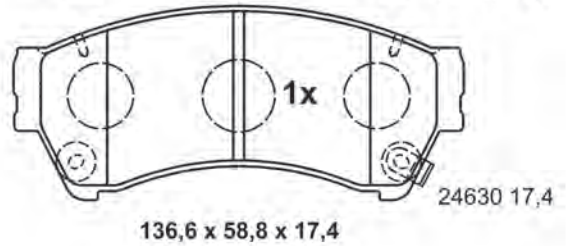
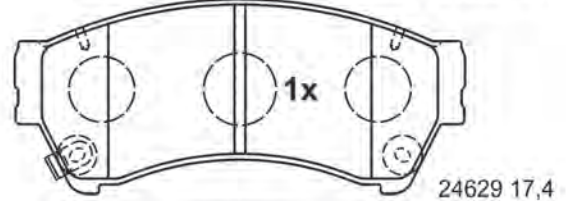
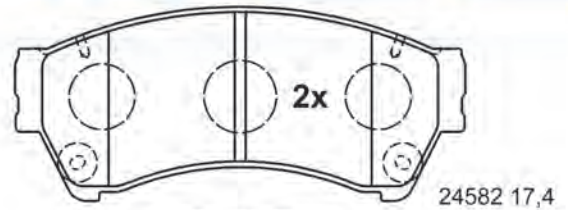

13.0460-5611.2 605611 [1]

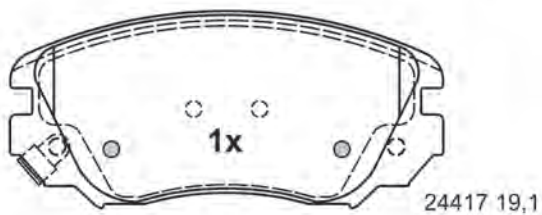
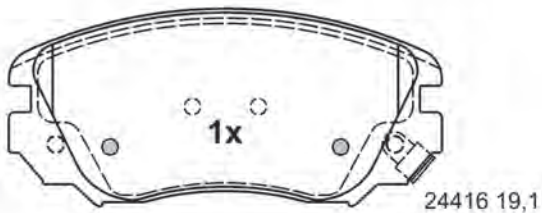
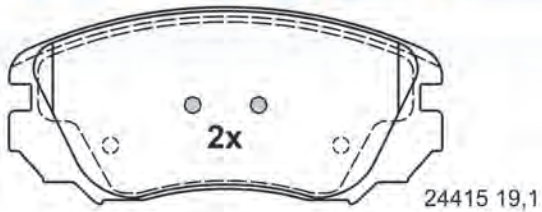

131,4 x 59,7 x 19,1

13.0460-5611.2 605611 [2]

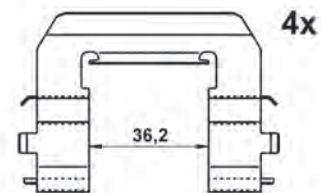
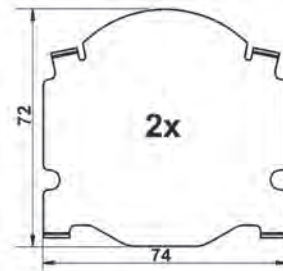

# Abbildungen Scheibenbremsbeläge

Illustrations disc brake pads - Ilustraciones de pastillas - Illustrations Plaquettes de frein à disque - Illustrazioni Pastiglie Freno

13.0460-5612.2 605612 [1]

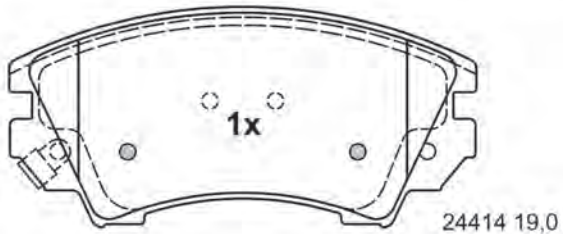
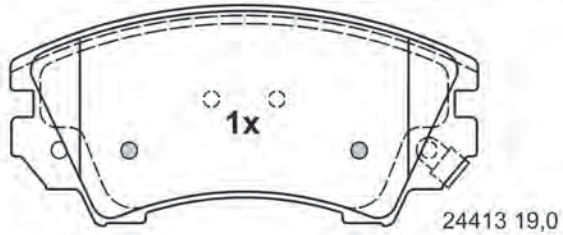
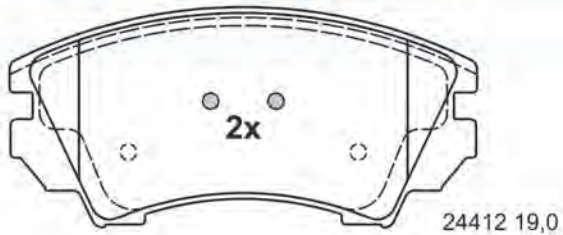

141,9 x 66,7 x 19,0

13.0460-5612.2 605612 [2]

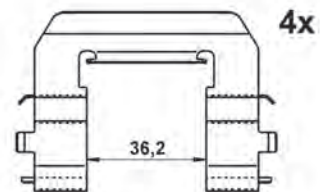
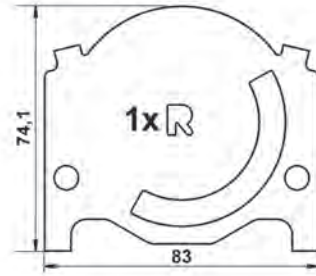
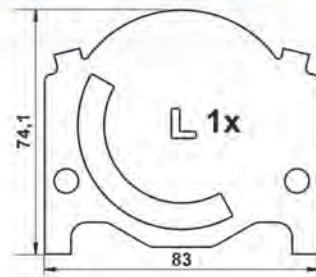

13.0460-5613.2 605613

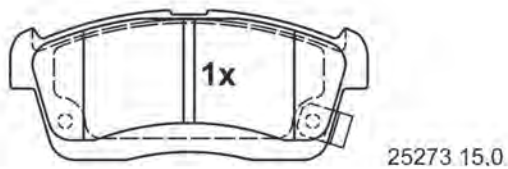
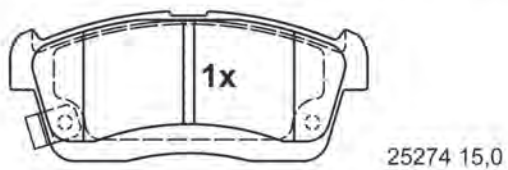

108,4 x 45,6 x 15,0

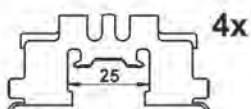

13.0460-5614.2 605614

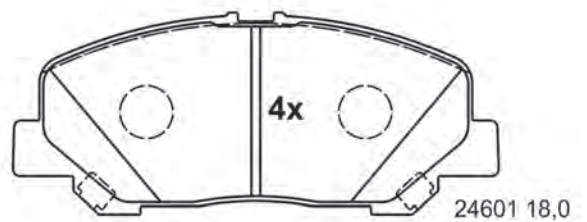

147,6 x 60,8 x 18,0



# Abbildungen Scheibenbremsbeläge

Illustrations disc brake pads - Ilustraciones de pastillas - Illustrations Plaquettes de frein à disque - Illustrazioni Pastiglie Freno

13.0460-5615.2 605615

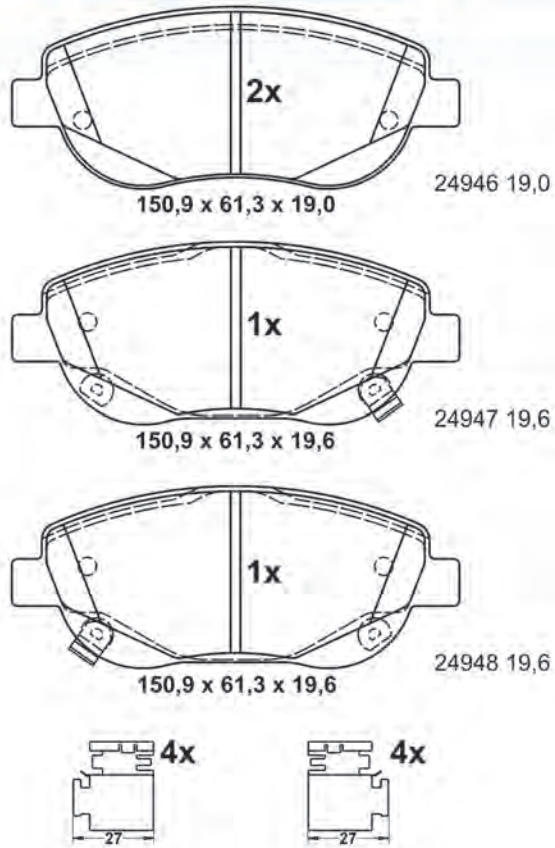

13.0460-5616.2 605616

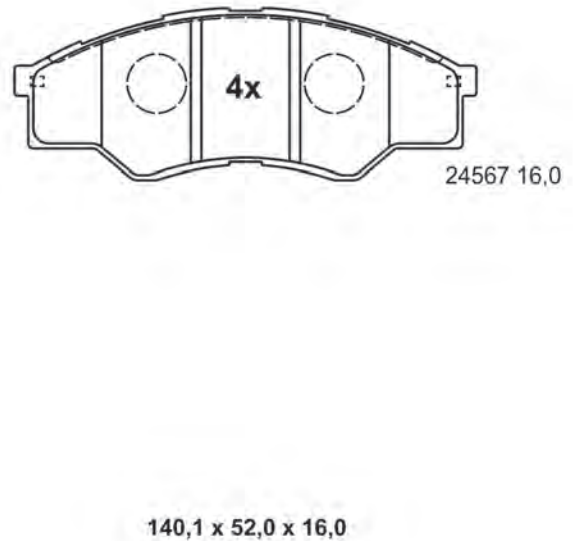

13.0460-5617.2 605617

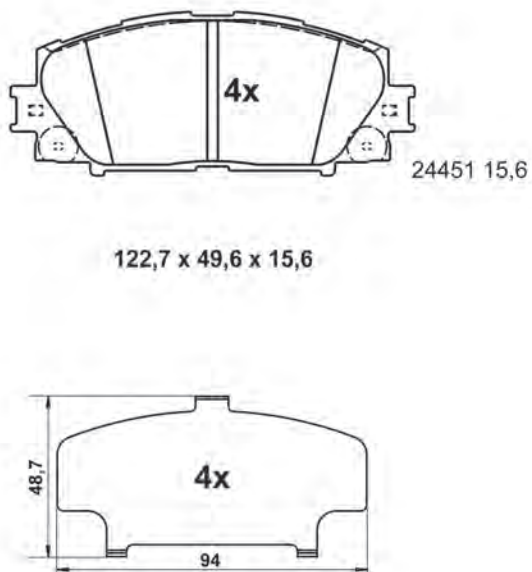

13.0460-5618.2 605618

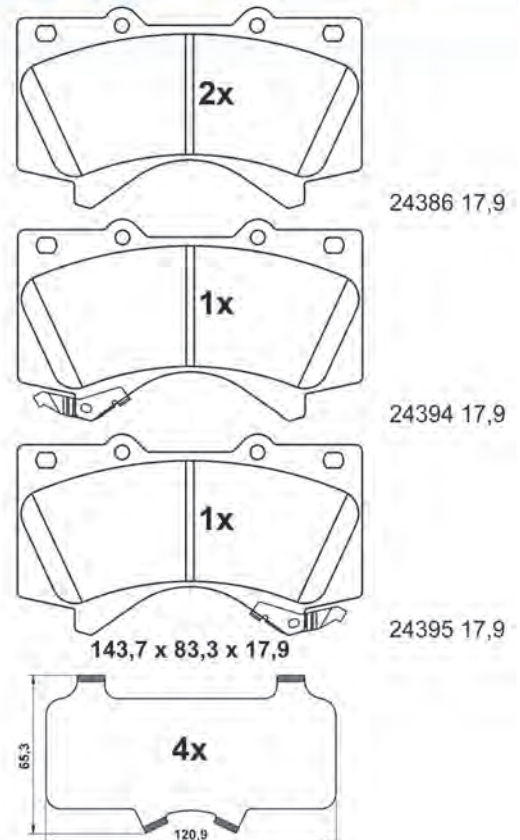

# Abbildungen Scheibenbremsbeläge

Illustrations disc brake pads - Ilustraciones de pastillas - Illustrations Plaquettes de frein à disque - Illustrazioni Pastiglie Freno

13.0460-5619.2 605619

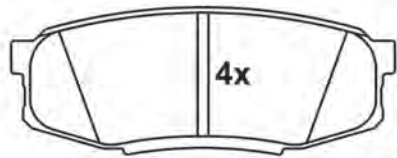

24635 17,3

116,3 x 44,6 x 17,3

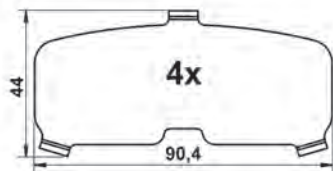

13.0460-5620.2 605620



24979 15,9

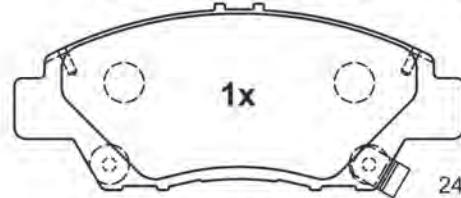

24980 15,9

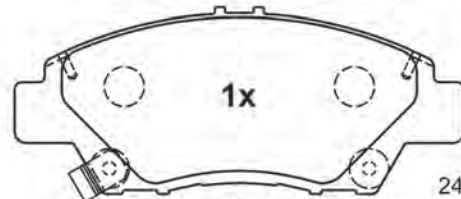

24981 15,9

136,4 x 56,4 x 15,9

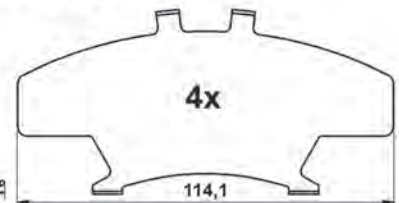
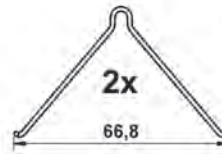

13.0460-5621.2 605621

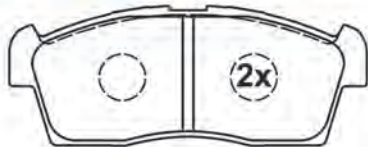

24423 14,6

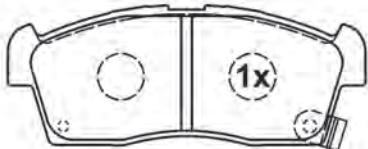

25230 14,6

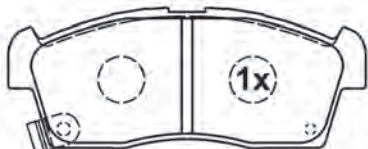

25231 14,6

108,5 x 42,2 x 14,6

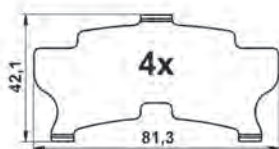

13.0460-5622.2 605622

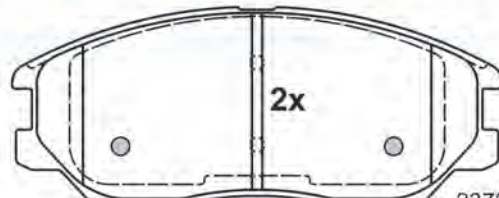

23726 17,2

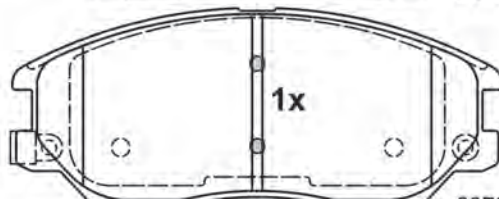

23727 17,2

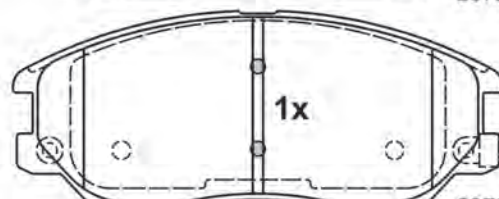

23728 17,2

148,8 x 60,8 x 17,2

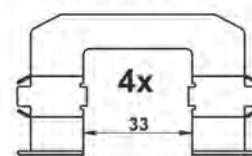

# Abbildungen Scheibenbremsbeläge

Illustrations disc brake pads - Ilustraciones de pastillas - Illustrations Plaquettes de frein à disque - Illustrazioni Pastiglie Freno

13.0460-5623.2 605623

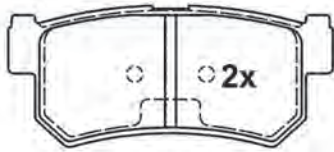

23673 15,9

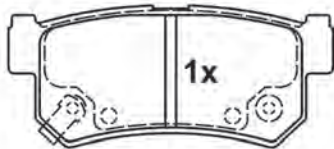

23674 15,9

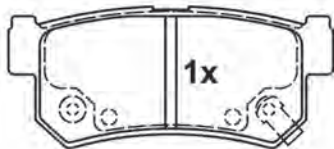

23675 15,9

98,5 x 42,8 x 15,9

13.0460-5625.2 605625

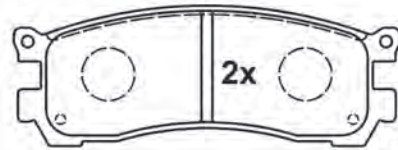

21319 14,9

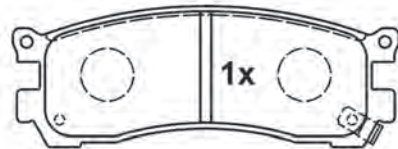

21320 14,9

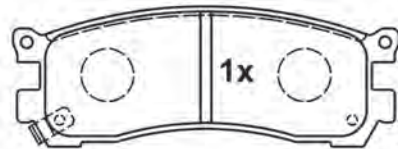

21321 14,9

117,1 x 42,5 x 14,9

13.0460-5626.2 605626

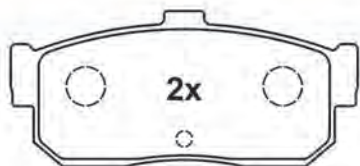

21713 16,0

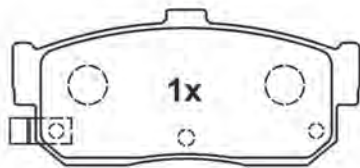

21714 16,0

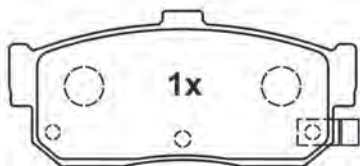

21715 16,0

105,3 x 47,0 x 16,0

13.0460-5627.2 605627

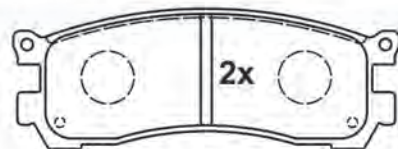

21569 14,9

117,1 x 42,5 x 14,9

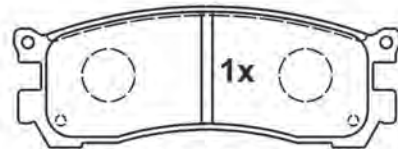

21570 15,9

117,1 x 42,5 x 15,9

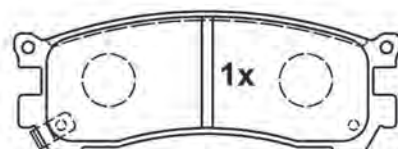

23514 15,9

117,1 x 42,5 x 15,9





# Abbildungen Scheibenbremsbeläge

Illustrations disc brake pads - Ilustraciones de pastillas - Illustrations Plaquettes de frein à disque - Illustrazioni Pastiglie Freno

13.0460-5628.2 605628

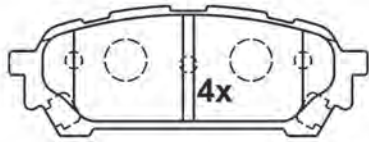

24331 13,8

108,7 x 39,3 x 13,8

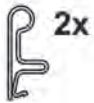

13.0460-5629.2 605629

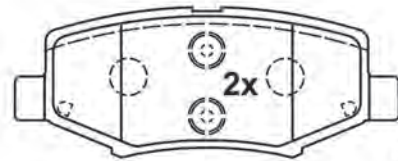

24603 16,0

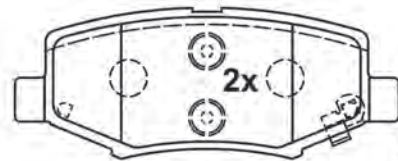

24602 16,0

116,7 x 45,5 x 16,0

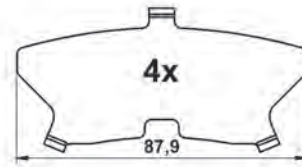

13.0460-5631.2 605631

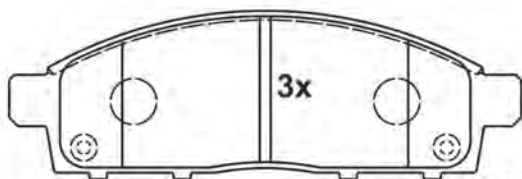

24529 16,0

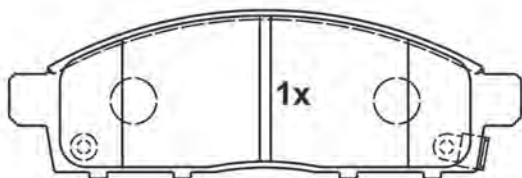

24530 16,0

155,4 x 50,9 x 16,0

13.0460-5632.2 605632

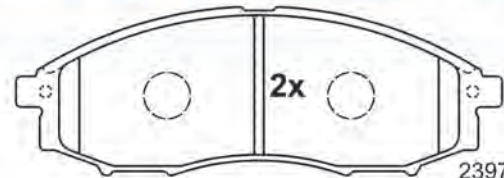

23970 16,8

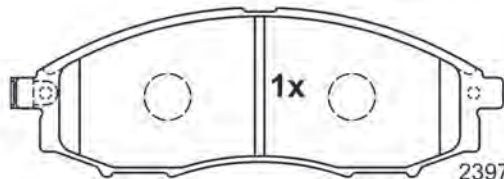

23971 16,8

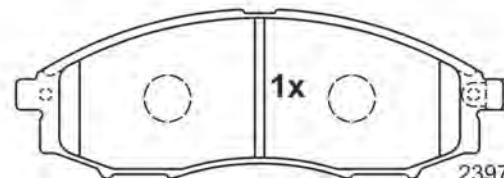

23972 16,8

164,2 x 56,7 x 16,8

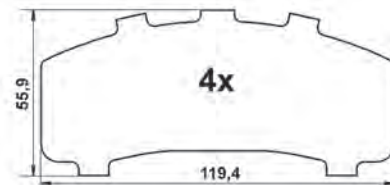

# Abbildungen Scheibenbremsbeläge

Illustrations disc brake pads - Ilustraciones de pastillas - Illustrations Plaquettes de frein à disque - Illustrazioni Pastiglie Freno

13.0460-5633.2 605633

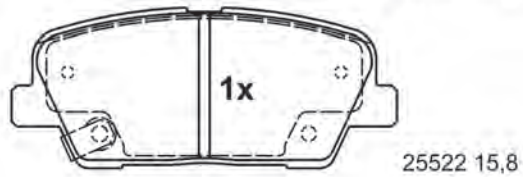
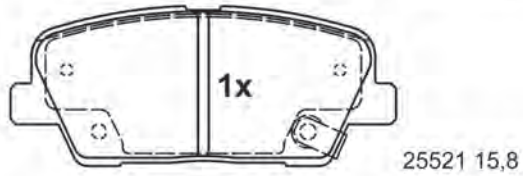
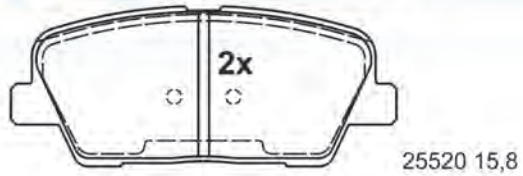

117,0 x 48,4 x 15,8

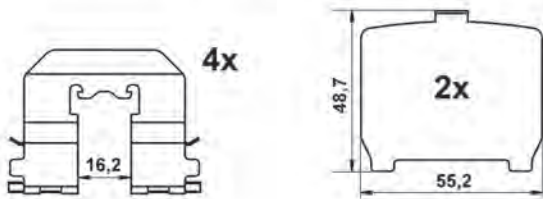

13.0460-5634.2 605634

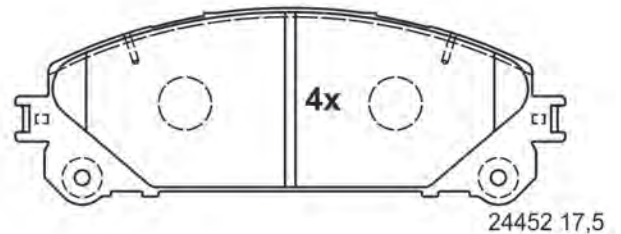

167,0 x 59,4 x 17,5

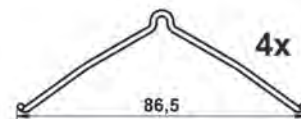

13.0460-5635.2 605635

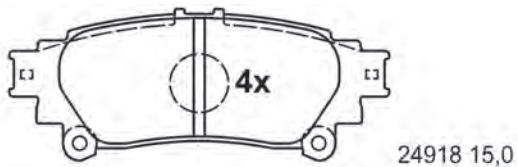

115,2 x 45,7 x 15,0

13.0460-5636.2 605636

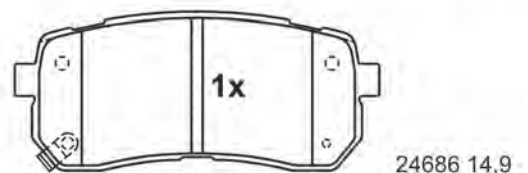
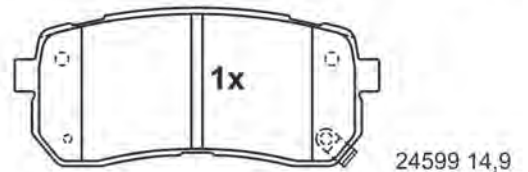

110,6 x 47,7 x 14,9





# Abbildungen Scheibenbremsbeläge

Illustrations disc brake pads - Ilustraciones de pastillas - Illustrations Plaquettes de frein à disque - Illustrazioni Pastiglie Freno

13.0460-5637.2 605637

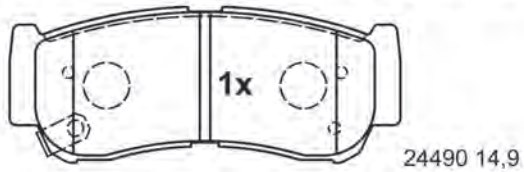
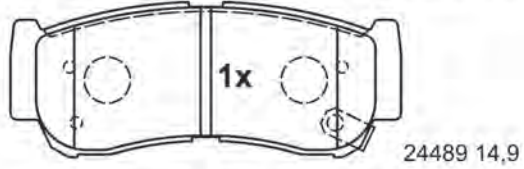
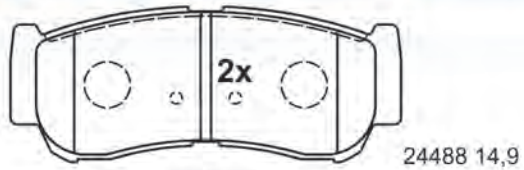

118,6 x 47,0 x 14,9

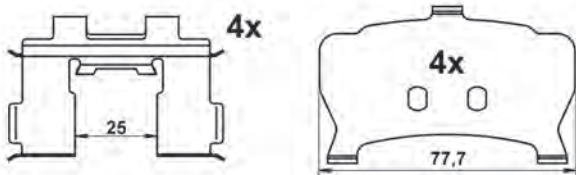

13.0460-5638.2 605638

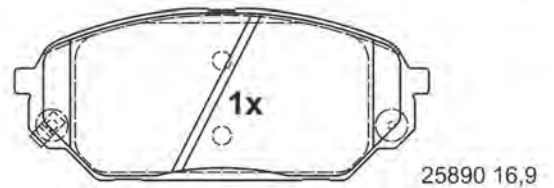
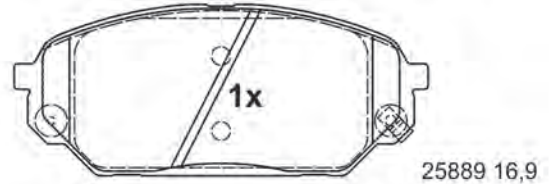
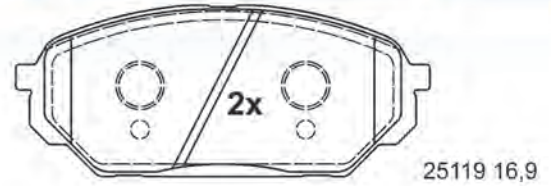

155,0 x 64,5 x 16,9

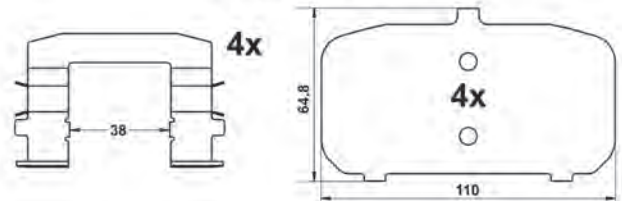

13.0460-5639.2 605639

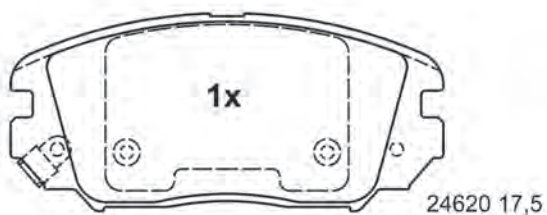
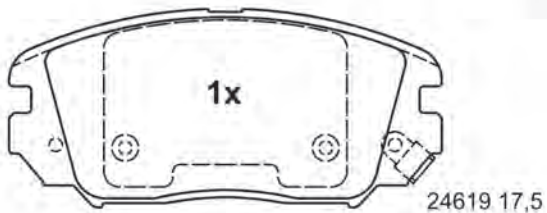

131,3 x 59,9 x 17,5

13.0460-5640.2 605640

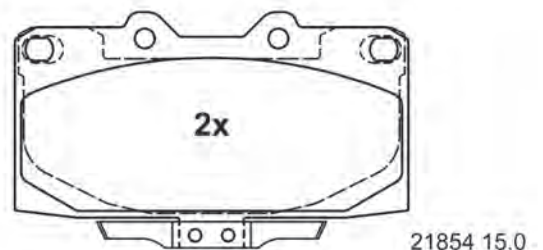
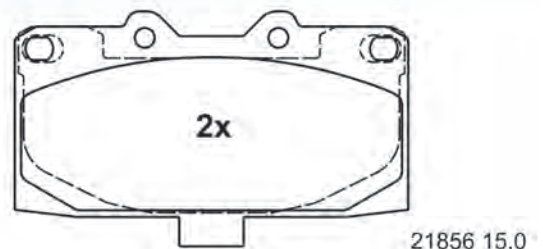

119,3 x 71,2 x 15,0

# Abbildungen Scheibenbremsbeläge

Illustrations disc brake pads - Ilustraciones de pastillas - Illustrations Plaquettes de frein à disque - Illustrazioni Pastiglie Freno

13.0460-5641.2 605641 [1]

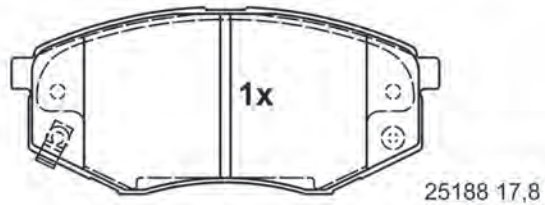
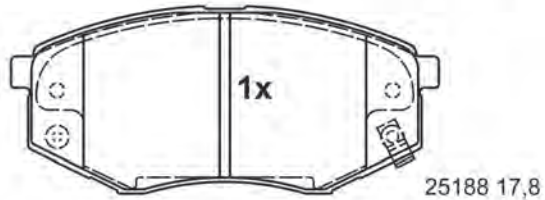
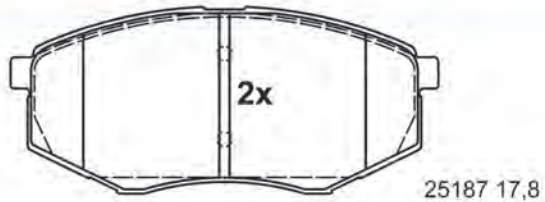

131,3 x 59,9 x 17,8

13.0460-5641.2 605641 [2]

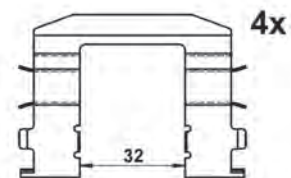
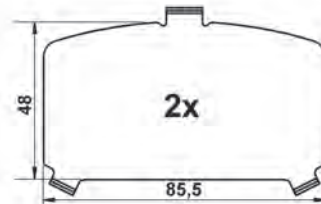

13.0460-5642.2 605642

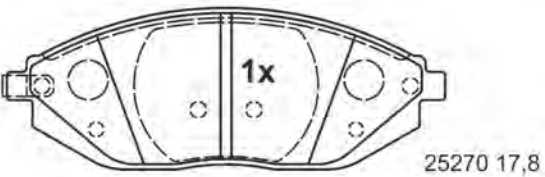
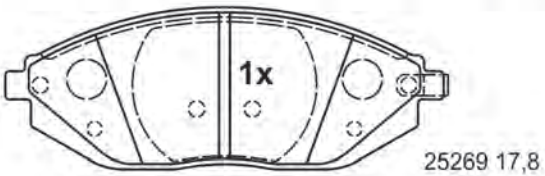
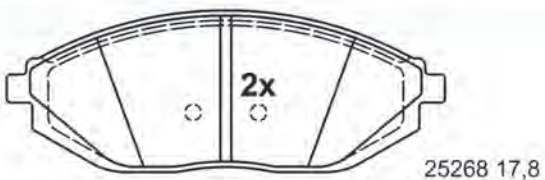

133,2 x 49,0 x 17,8

13.0460-5645.2 605645 [1]

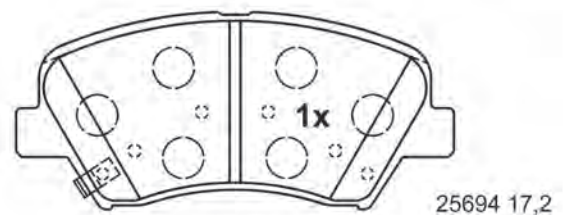
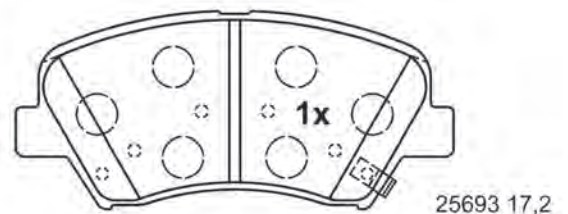
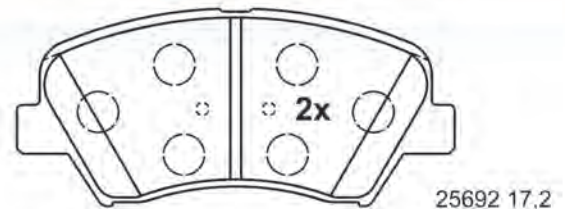

132,9 x 60,0 x 17,2



# Abbildungen Scheibenbremsbeläge

Illustrations disc brake pads - Ilustraciones de pastillas - Illustrations Plaquettes de frein à disque - Illustrazioni Pastiglie Freno

13.0460-5645.2 605645 [2]

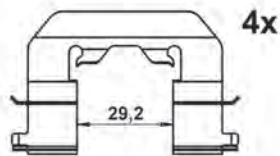
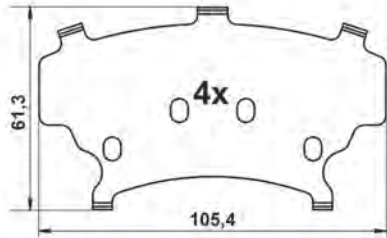

13.0460-5646.2 605646 [1]

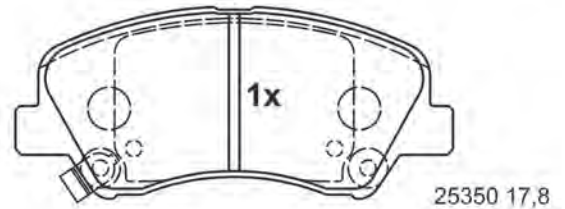
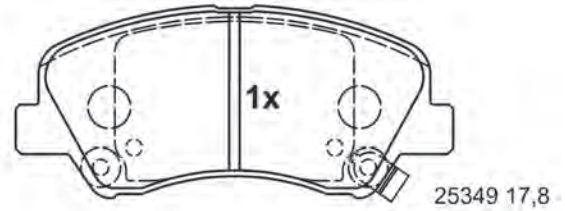
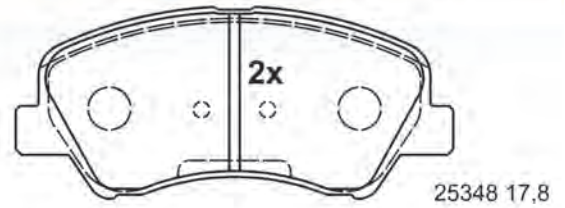

132,7 x 57,9 x 17,8

13.0460-5646.2 605646 [2]

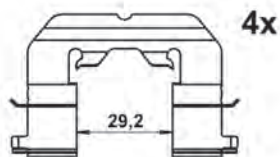
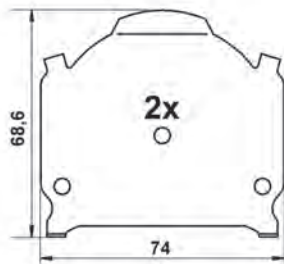

13.0460-5647.2 605647 [1]

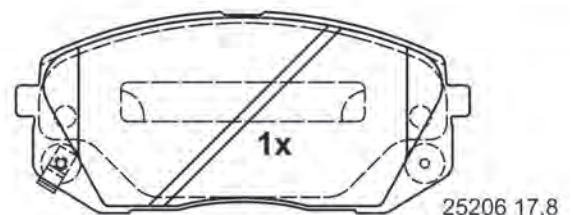
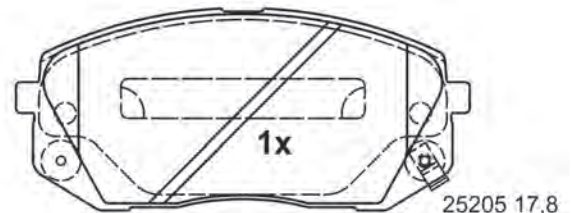
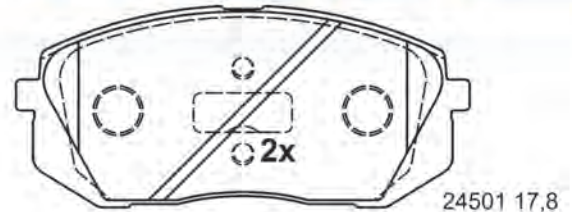

137,8 x 60,9 x 17,8



# Abbildungen Scheibenbremsbeläge

Illustrations disc brake pads - Ilustraciones de pastillas - Illustrations Plaquettes de frein à disque - Illustrazioni Pastiglie Freno

**13.0460-5647.2 605647 [2]** 

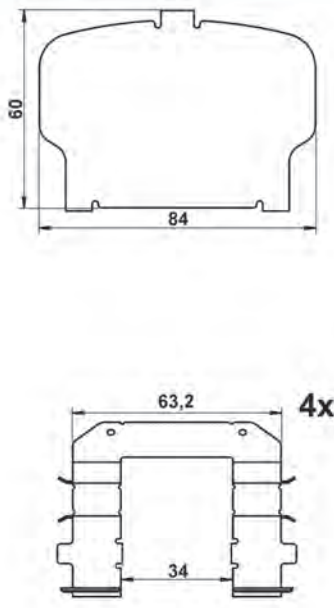

**13.0460-5648.2 605648** 

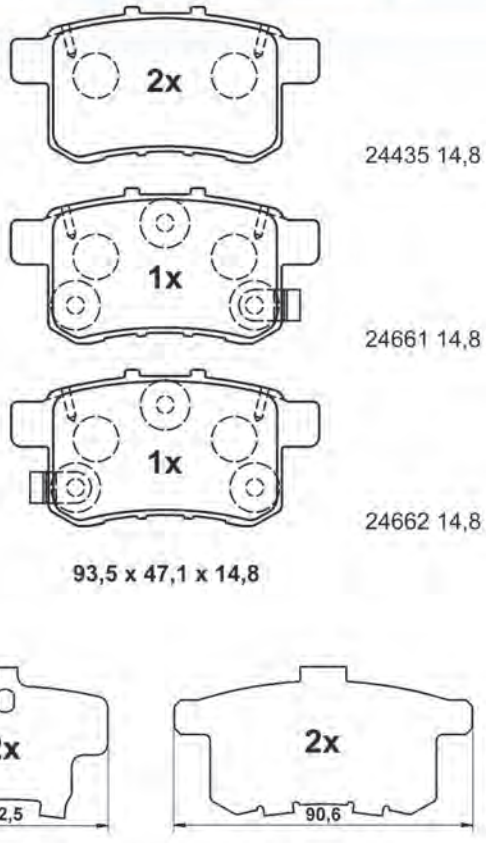

**13.0460-5649.2 605649** 

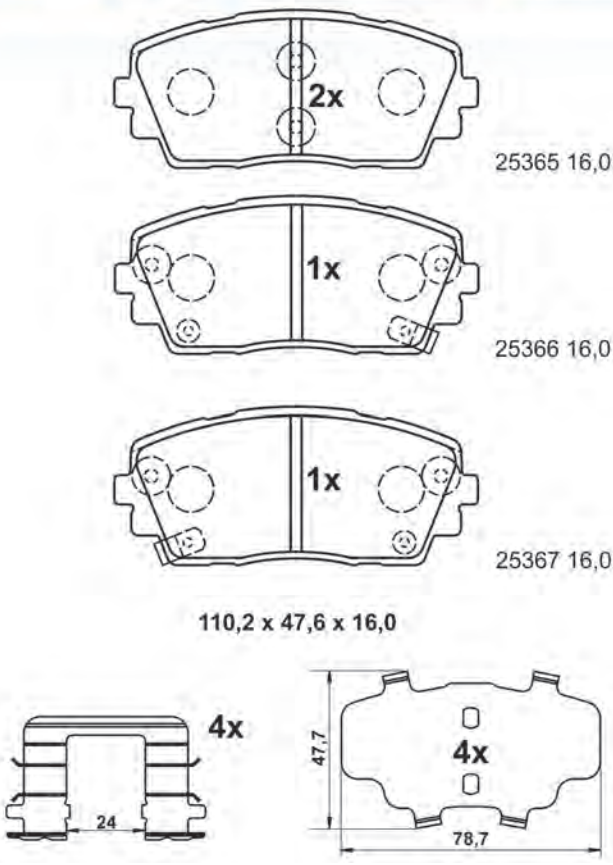

**13.0460-5650.2 605650** 

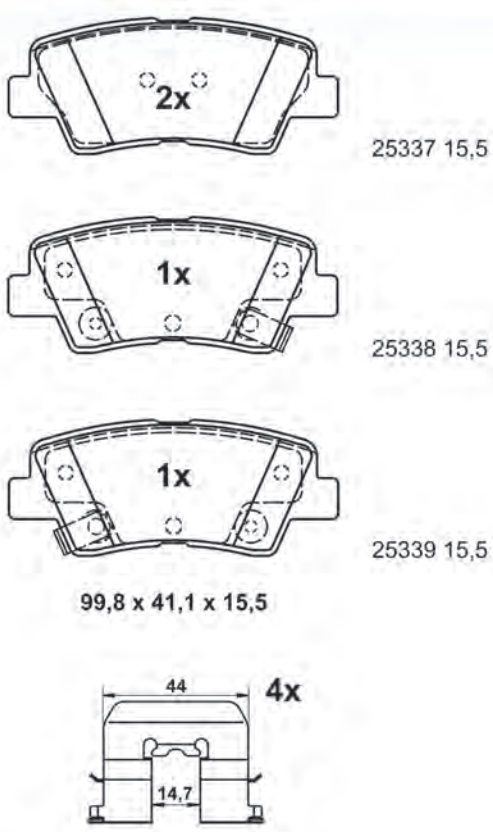



# Abbildungen Scheibenbremsbeläge

Illustrations disc brake pads - Ilustraciones de pastillas - Illustrations Plaquettes de frein à disque - Illustrazioni Pastiglie Freno

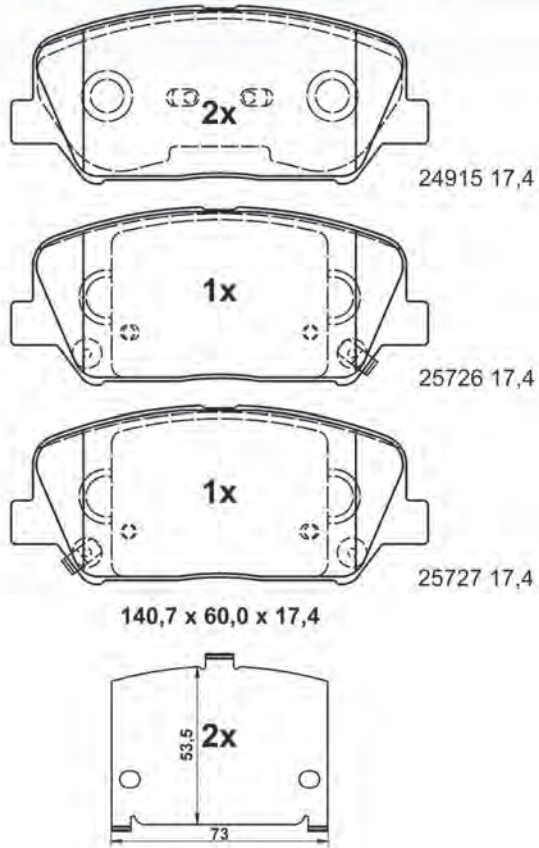
13.0460-5651.2 605651

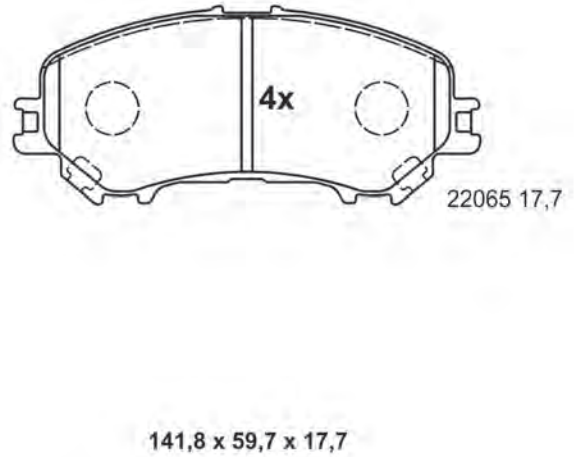

13.0460-5652.2 605652



13.0460-5653.2 605653 [1]

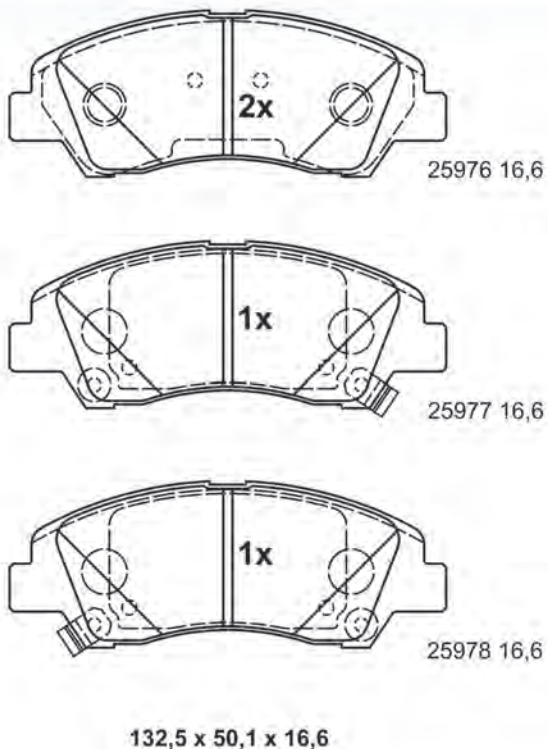

13.0460-5653.2 605653 [2]

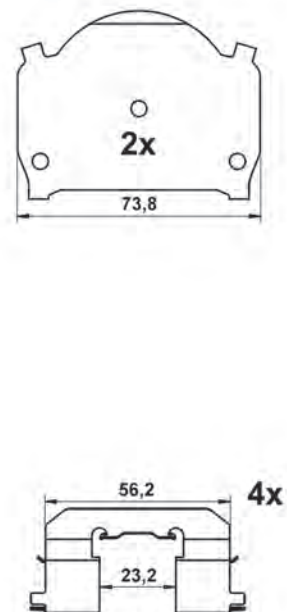



# Abbildungen Scheibenbremsbeläge

Illustrations disc brake pads - Ilustraciones de pastillas - Illustrations Plaquettes de frein à disque - Illustrazioni Pastiglie Freno

13.0460-5654.2 605654

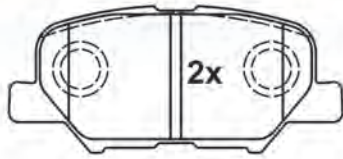

25688 14,4

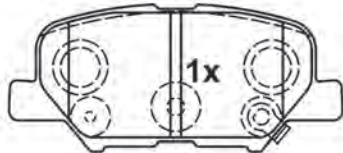

25689 14,4

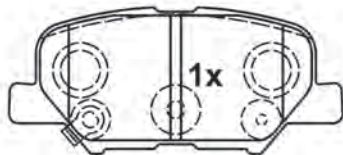

25690 14,4

101,4 x 44,5 x 14,4

13.0460-5655.2 605655

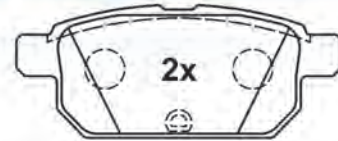

25258 14,4

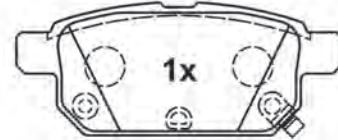

25258 14,4

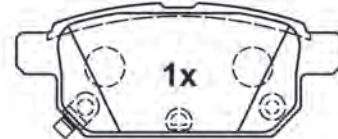

25258 14,4

98,6 x 40,2 x 14,4

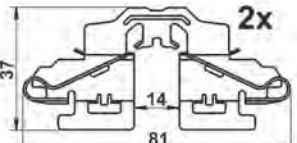
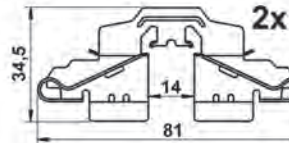
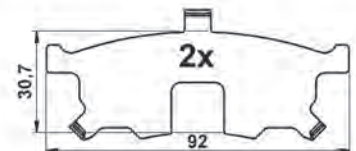
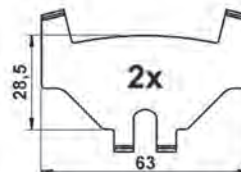

13.0460-5656.2 605656



25979 16,0

142,0 x 55,1 x 16,0

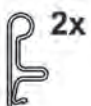
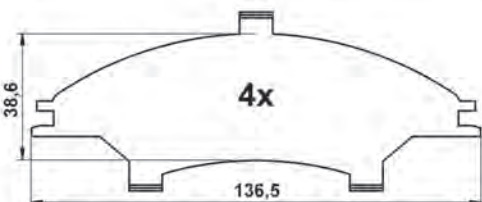
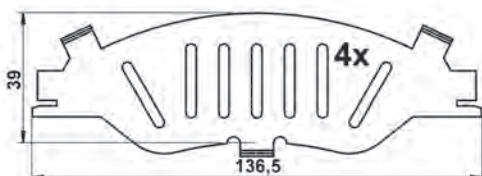

13.0460-5657.2 605657

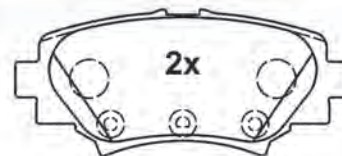

25878 13,8

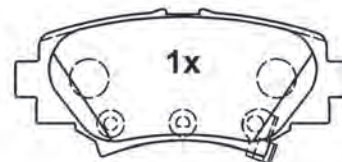

25879 13,8

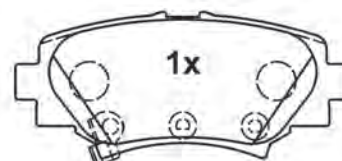

25880 13,8

101,5 x 44,5 x 13,8

# Abbildungen Scheibenbremsbeläge

Illustrations disc brake pads - Ilustraciones de pastillas - Illustrations Plaquettes de frein à disque - Illustrazioni Pastiglie Freno

13.0460-5658.2 605658

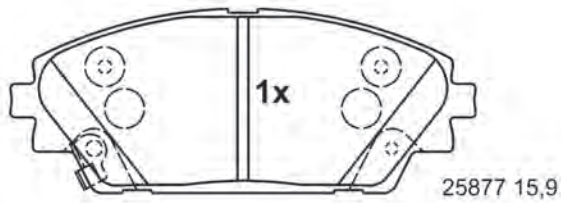
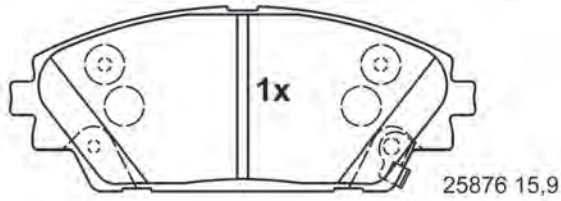
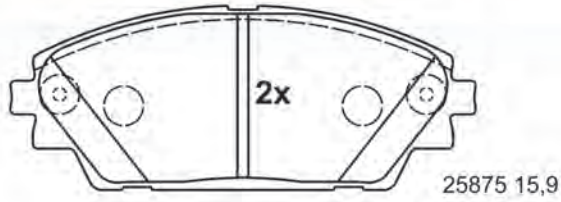

141,0 x 55,8 x 15,9

13.0460-5659.2 605659 [1]

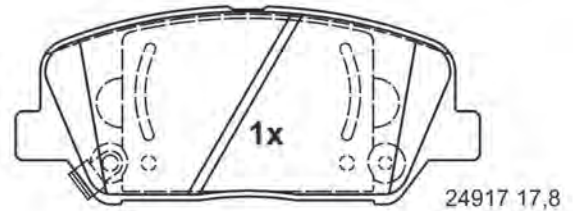
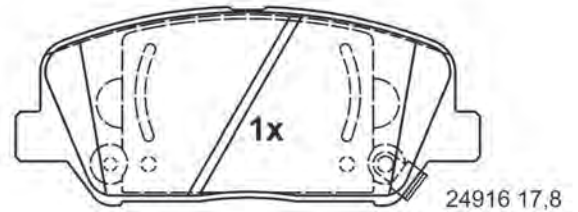
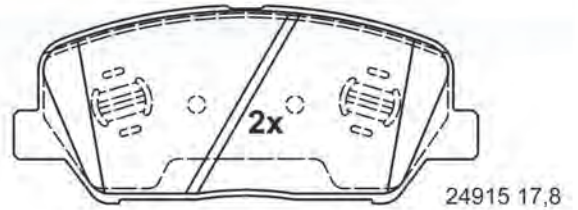

141,0 x 55,9 x 17,8

13.0460-5659.2 605659 [2]

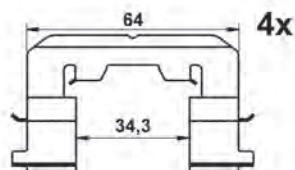
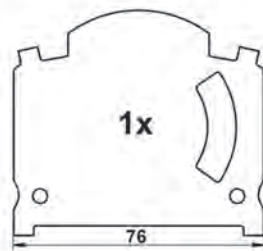
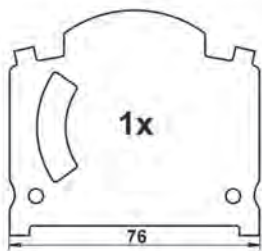

13.0460-5660.2 605660 [1]

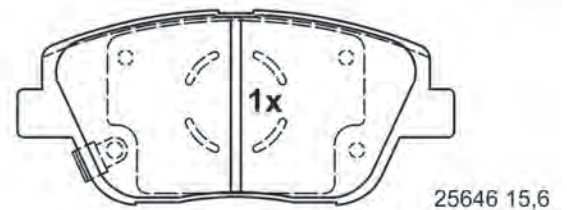
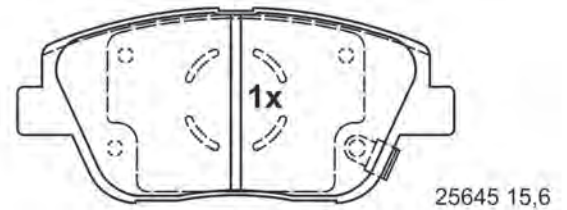
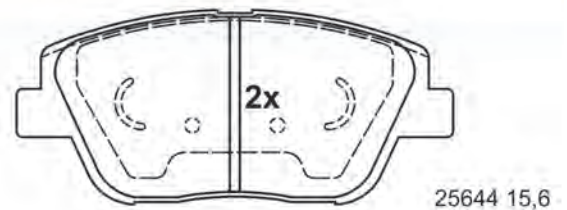

132,8 x 58,9 x 15,6

# Abbildungen Scheibenbremsbeläge

Illustrations disc brake pads - Ilustraciones de pastillas - Illustrations Plaquettes de frein à disque - Illustrazioni Pastiglie Freno

13.0460-5660.2 605660 [2]

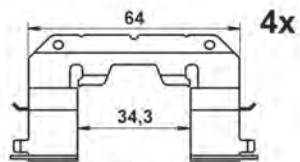
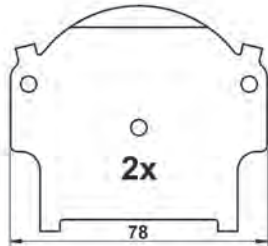

13.0460-5661.2 605661 [1]

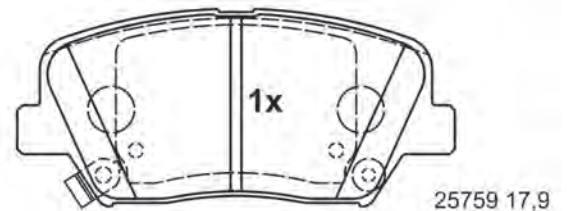
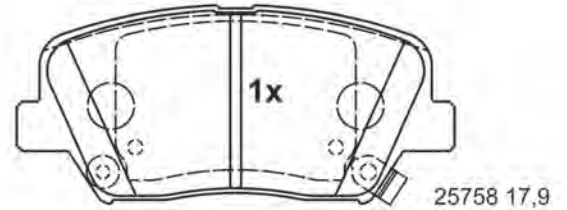
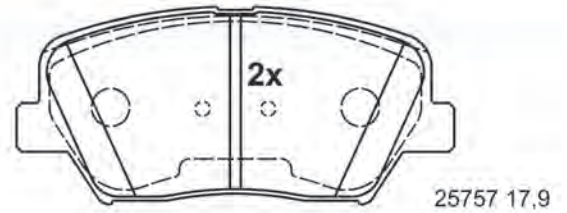

132,8 x 60,0 x 17,9

13.0460-5661.2 605661 [2]

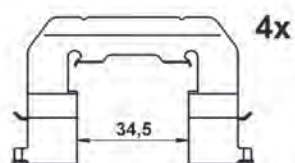
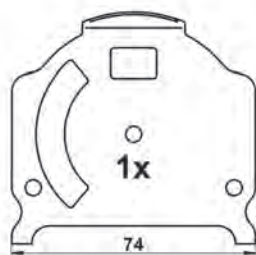
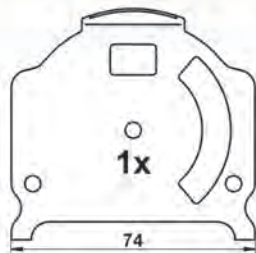

13.0460-5662.2 605662

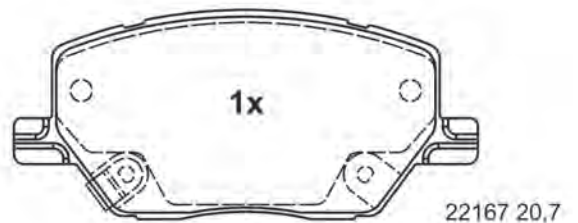
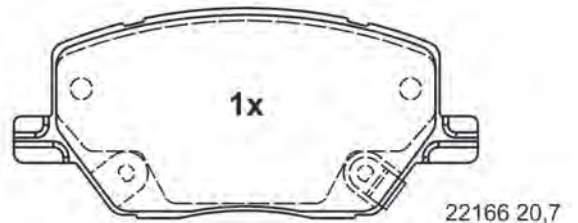
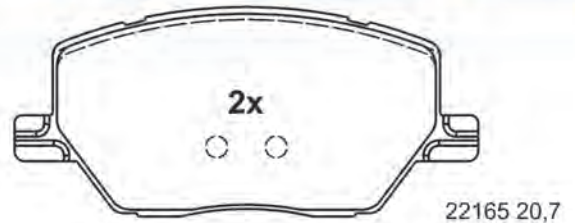

140,8 x 63,3 x 20,7





# Abbildungen Scheibenbremsbeläge

Illustrations disc brake pads - Ilustraciones de pastillas - Illustrations Plaquettes de frein à disque - Illustrazioni Pastiglie Freno

13.0460-5662.2 605662 [1]

wahlweise optional

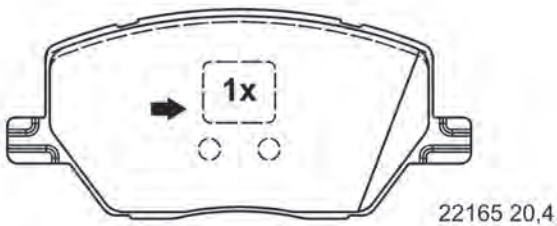
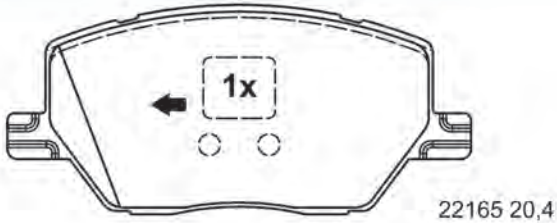

140,8 x 63,3 x 20,4

13.0460-5662.2 605662 [2]

wahlweise optional

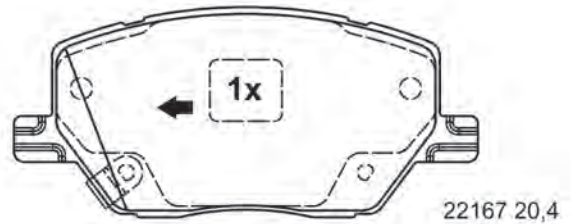
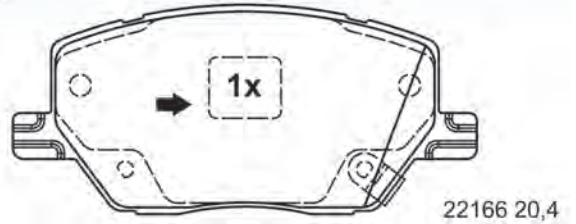

140,8 x 63,3 x 20,4

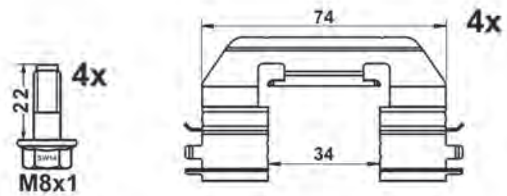

13.0460-5662.2 605662

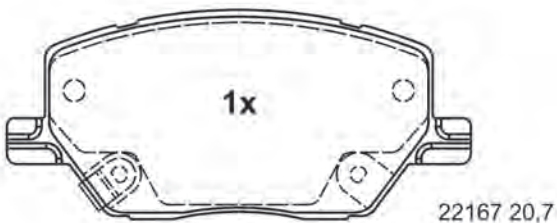
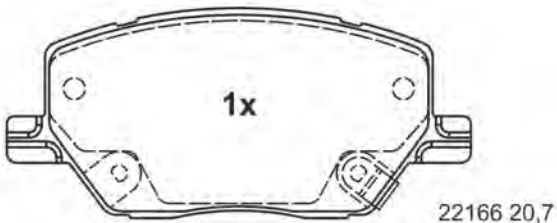
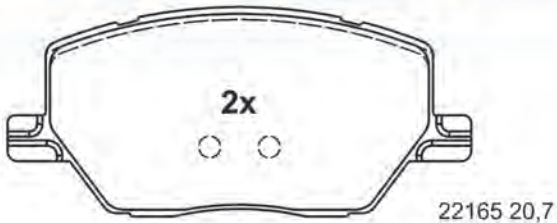

140,8 x 63,3 x 20,7

13.0460-5663.2 605663

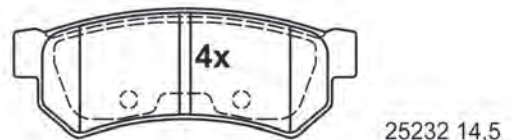

103,8 x 38,9 x 14,5

# Abbildungen Scheibenbremsbeläge

Illustrations disc brake pads - Ilustraciones de pastillas - Illustrations Plaquettes de frein à disque - Illustrazioni Pastiglie Freno

13.0460-5664.2 605664

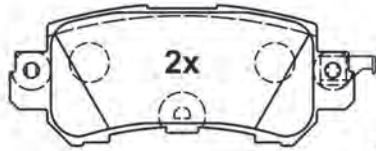

25540 14,5

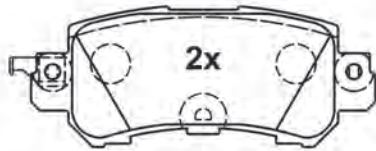

25541 14,5

104,5 x 42,9 x 14,5

13.0460-5673.2 605673

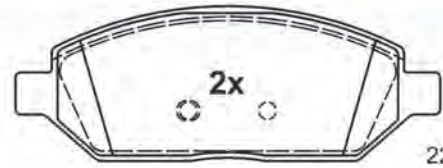

22326 18,0

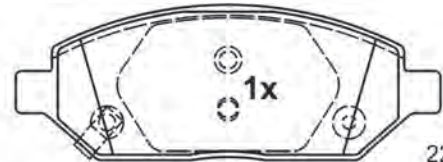

22327 18,0

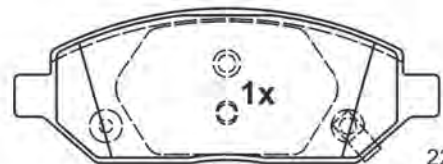

22328 18,0

128,9 x 46,8 x 18,0

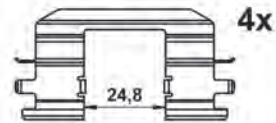

13.0460-5674.2 605674

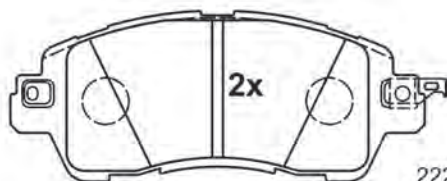

22235 15,3

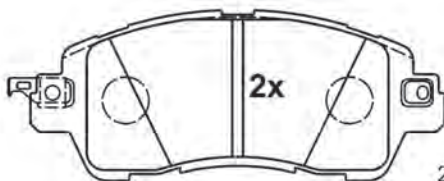

22236 15,3

125,6 x 51,7 x 15,3

13.0460-5679.2 605679



22397 19,6

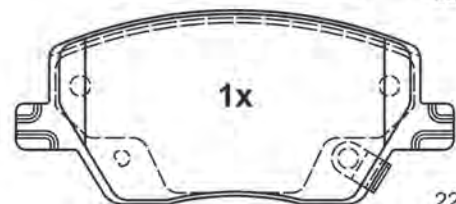

22398 19,6



22399 19,6

99,8 x 42,1 x 19,6

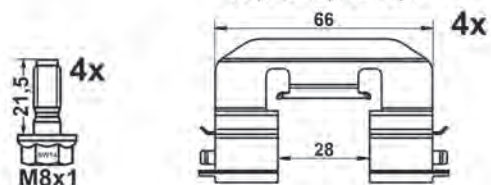



# Abbildungen Scheibenbremsbeläge

Illustrations disc brake pads - Ilustraciones de pastillas - Illustrations Plaquettes de frein à disque - Illustrazioni Pastiglie Freno

13.0460-5683.2 605683

B x H x D



25258 14,4

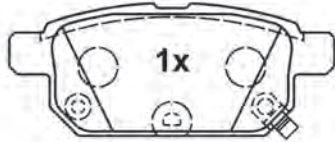

25259 14,4

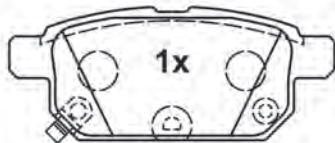

25260 14,4

98,6 x 40,2 x 14,4

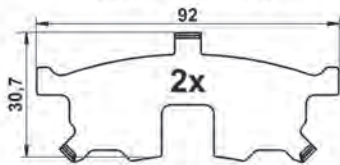

2x

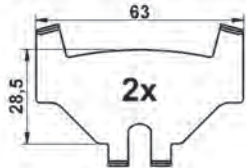

2x

13.0460-5700.2 605700

B x H x D

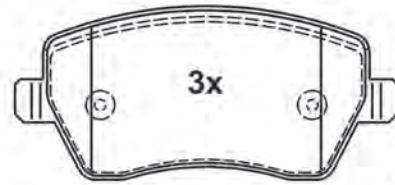

23973 17,0

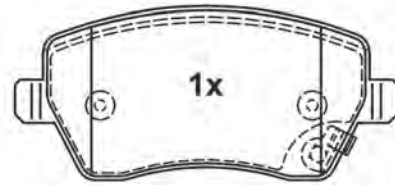

24403 17,0

116,3 x 52,4 x 17,0



4x

M8x21

13.0460-5701.2 605701

B x H x D

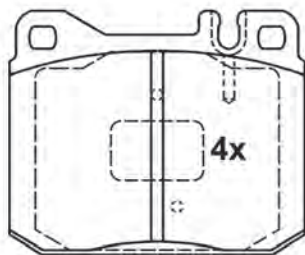

20392 18,5

89,7 x 73,8 x 18,5

13.0460-5703.2 605703

B x H x D

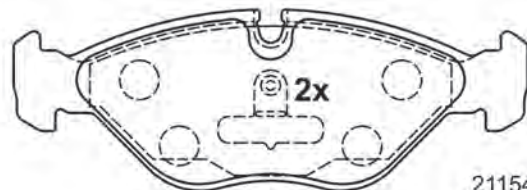

21154 19,5

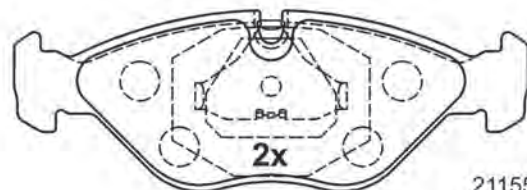

21155 19,5

156,4 x 54,6 x 19,5

# Abbildungen Scheibenbremsbeläge

Illustrations disc brake pads - Ilustraciones de pastillas - Illustrations Plaquettes de frein à disque - Illustrazioni Pastiglie Freno

13.0460-5709.2 605709

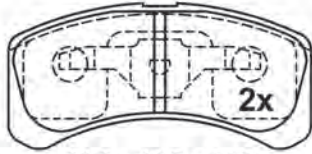

91,9 x 44,3 x 14,8

24229 14,8

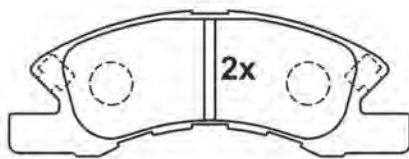

121,9 x 44,3 x 15,3

24230 15,3

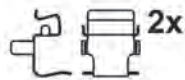
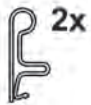

13.0460-5710.2 605710

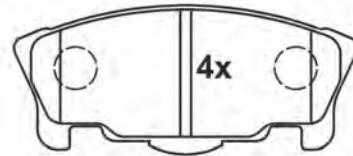

23783 14,0

104,6 x 45,1 x 14,0

13.0460-5711.2 605711

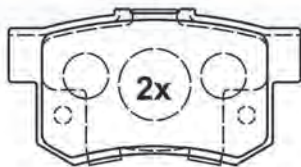

23736 15,7

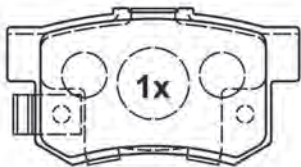

23652 15,7

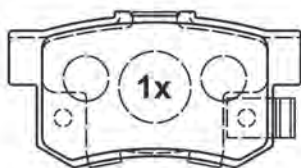

23653 15,7

88,8 x 47,5 x 15,7

13.0460-5712.2 605712

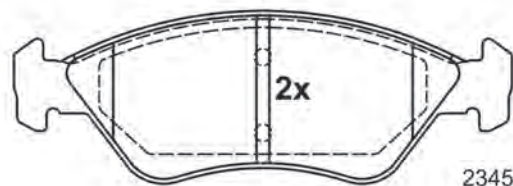

23451 17,5

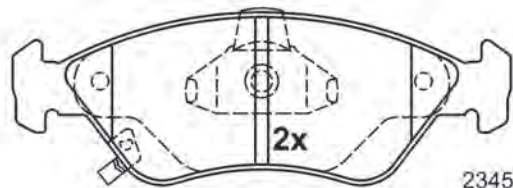

23450 17,5

151,4 x 52,4 x 17,5

# Abbildungen Scheibenbremsbeläge

Illustrations disc brake pads - Ilustraciones de pastillas - Illustrations Plaquettes de frein à disque - Illustrazioni Pastiglie Freno

13.0460-5713.2 605713

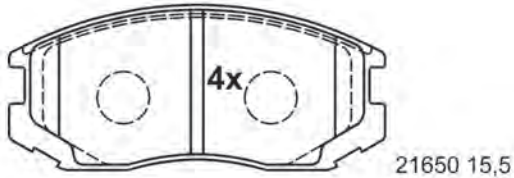

114,1 x 50,0 x 15,5

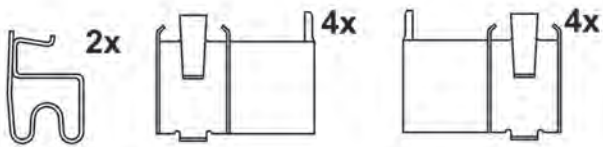

13.0460-5714.2 605714

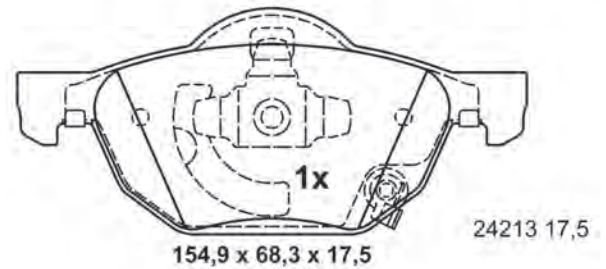
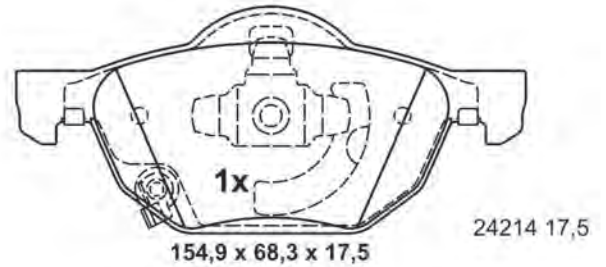
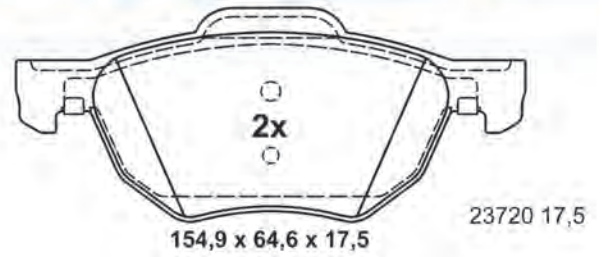

13.0460-5716.2 605716

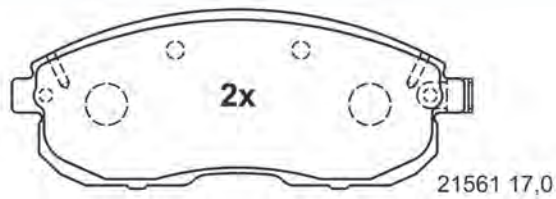

137,3 x 54,4 x 17,0

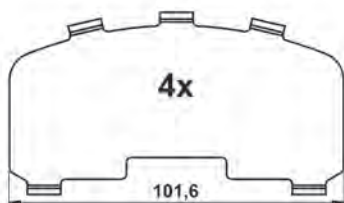

13.0460-5717.2 605717

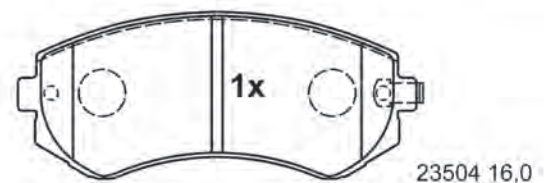
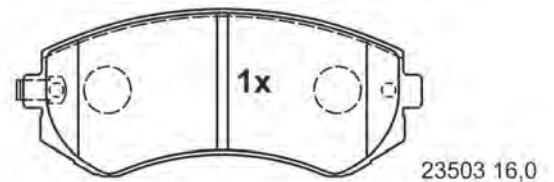
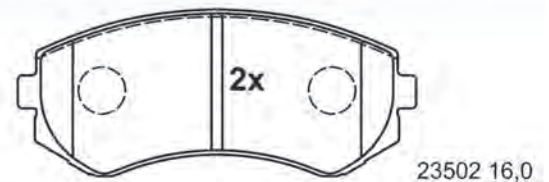

121,0 x 50,5 x 16,0



# Abbildungen Scheibenbremsbeläge

Illustrations disc brake pads - Ilustraciones de pastillas - Illustrations Plaquettes de frein à disque - Illustrazioni Pastiglie Freno

13.0460-5718.2 605718

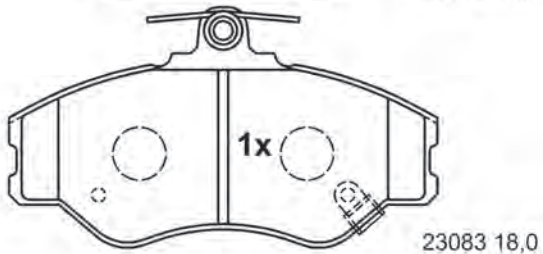
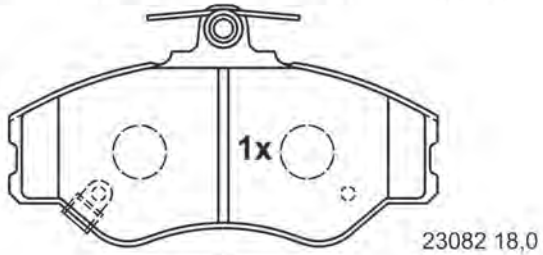
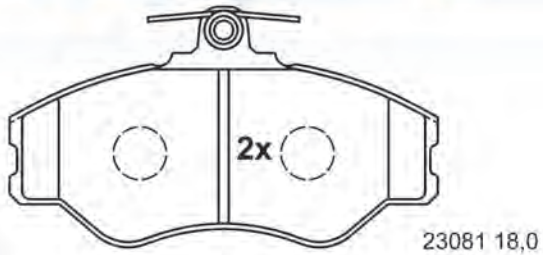

129,9 x 72,8 x 18,0

13.0460-5720.2 605720

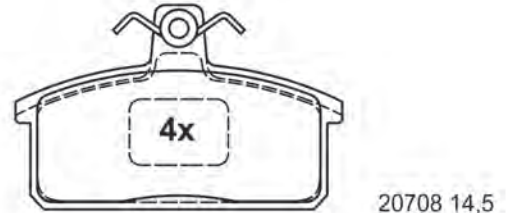

98,9 x 61,5 x 14,5



13.0460-5722.2 605722

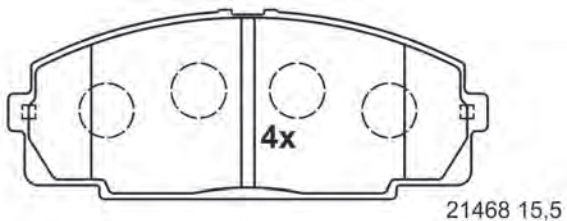

145,4 x 57,0 x 15,5

13.0460-5725.2 605725

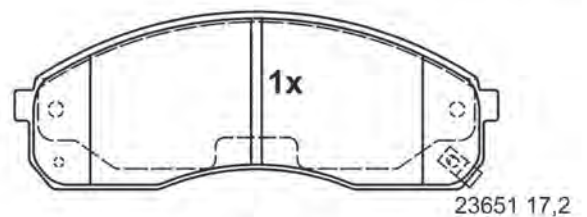
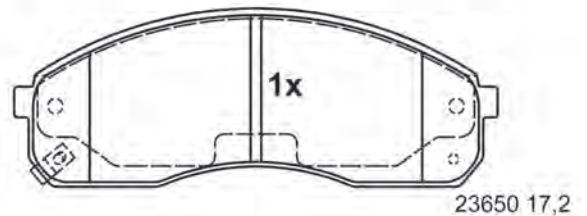
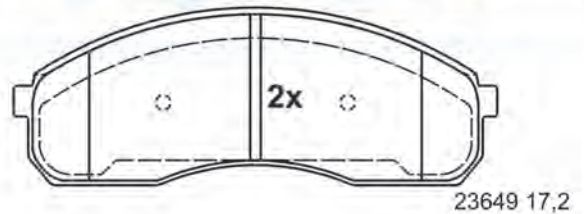

154,1 x 56,5 x 17,2



# Abbildungen Scheibenbremsbeläge

Illustrations disc brake pads - Ilustraciones de pastillas - Illustrations Plaquettes de frein à disque - Illustrazioni Pastiglie Freno

13.0460-5727.2 605727

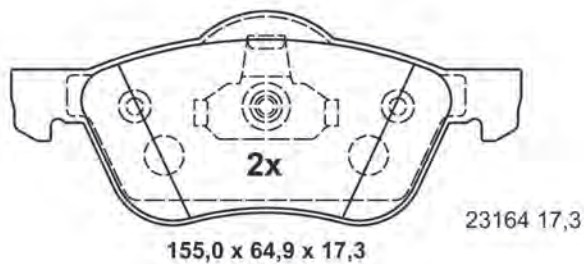
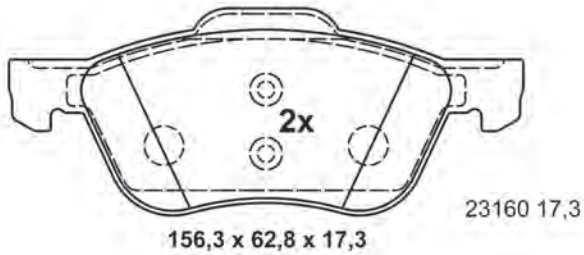

13.0460-5731.2 605731

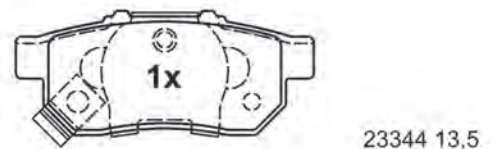
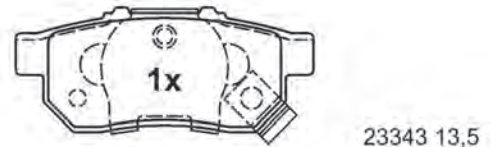
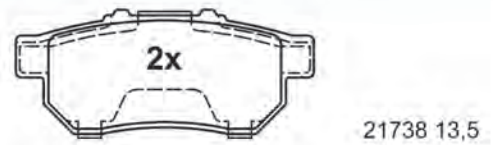

88,8 x 37,6 x 13,5

13.0460-5732.2 605732

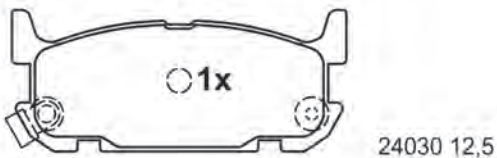
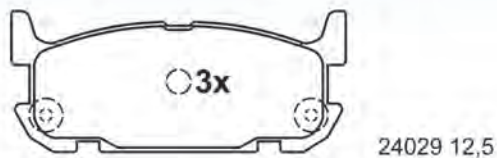

102,1 x 42,7 x 12,5

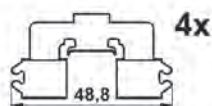
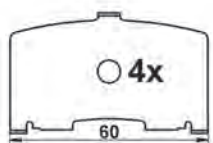

13.0460-5734.2 605734

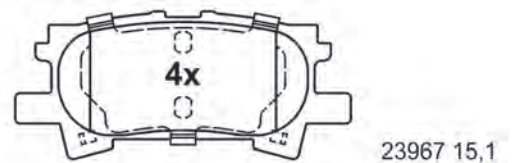

101,8 x 44,0 x 15,1



# Abbildungen Scheibenbremsbeläge

Illustrations disc brake pads - Ilustraciones de pastillas - Illustrations Plaquettes de frein à disque - Illustrazioni Pastiglie Freno

13.0460-5735.2 605735

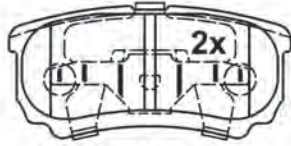

85,5 x 40,1 x 16,0

24014 16,0

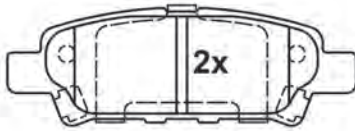

105,9 x 35,7 x 16,0

24015 16,0



13.0460-5736.2 605736

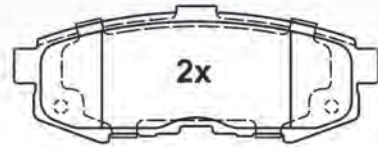

24215 15,7

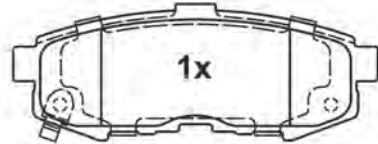

24216 15,7

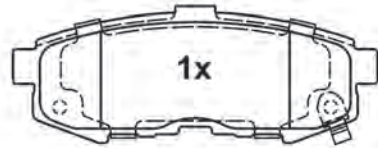

24217 15,7

110,4 x 41,1 x 15,7

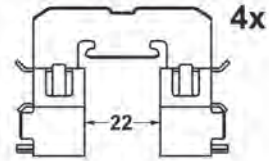

13.0460-5738.2 605738

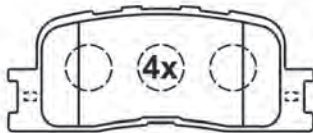

23702 15,1

92,6 x 37,7 x 15,1

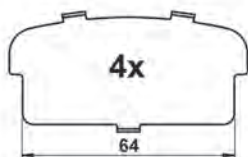

13.0460-5739.2 605739

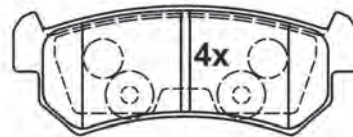

24071 14,9

104,3 x 38,9 x 14,6

# Abbildungen Scheibenbremsbeläge

Illustrations disc brake pads - Ilustraciones de pastillas - Illustrations Plaquettes de frein à disque - Illustrazioni Pastiglie Freno

13.0460-5742.2 605742

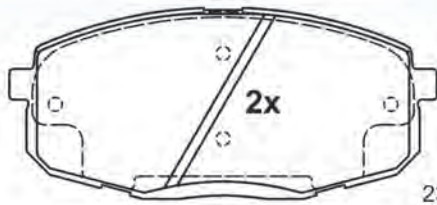

23966 17,7

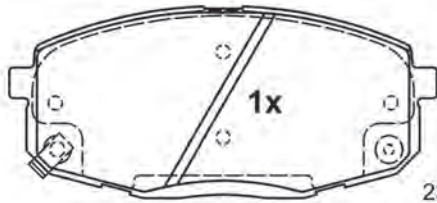

23987 17,7

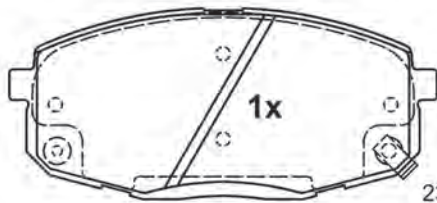

23988 17,7

130,0 x 57,9 x 17,7

13.0460-5743.2 605743

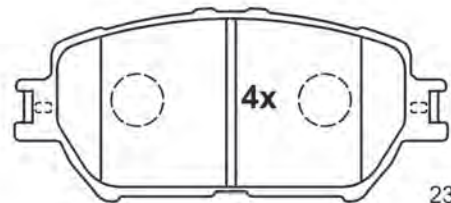

23928 17,3

131,4 x 58,5 x 17,3

13.0460-5744.2 605744

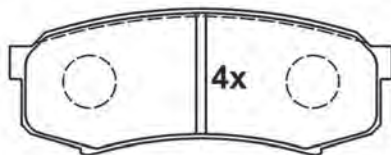

23947 15,4

116,2 x 44,0 x 15,4

13.0460-5745.2 605745

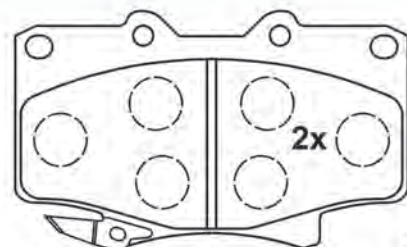

21775 15,0

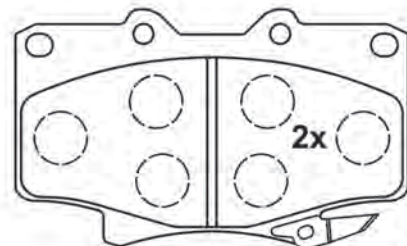

21776 15,0

119,1 x 71,9 x 15,0

# Abbildungen Scheibenbremsbeläge

Illustrations disc brake pads - Ilustraciones de pastillas - Illustrations Plaquettes de frein à disque - Illustrazioni Pastiglie Freno

13.0460-5746.2 605746

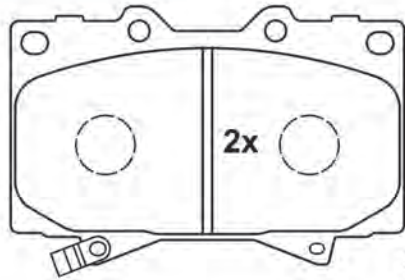

23524 17,4

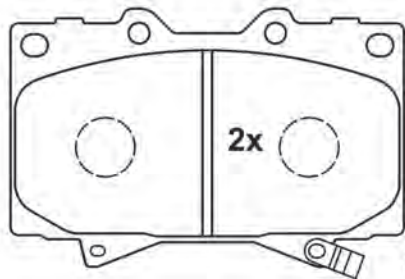

23525 17,4

119,3 x 78,0 x 17,4

13.0460-5747.2 605747

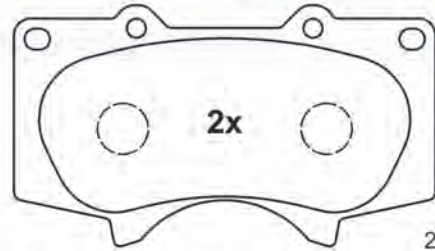

24024 17,0

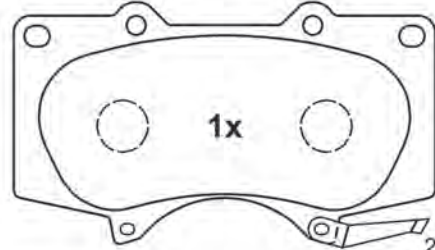

24026 17,0

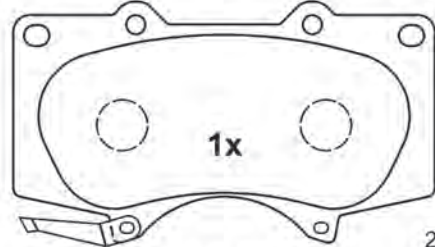

24025 17,0

134,2 x 76,9 x 17,0

13.0460-5748.2 605748

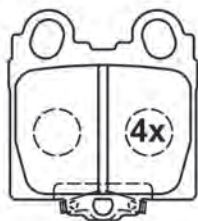

23429 15,5

57,2 x 63,8 x 15,5

13.0460-5749.2 605749

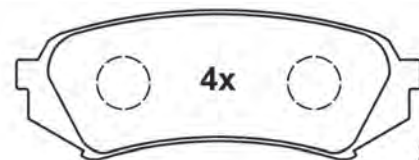

23539 17,3

123,0 x 45,1 x 17,3



# Abbildungen Scheibenbremsbeläge

Illustrations disc brake pads - Ilustraciones de pastillas - Illustrations Plaquettes de frein à disque - Illustrazioni Pastiglie Freno

13.0460-5750.2 605750

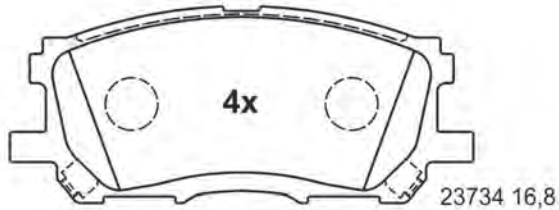

140,8 x 59,5 x 16,8

13.0460-5751.2 605751

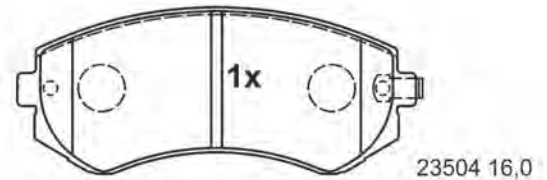
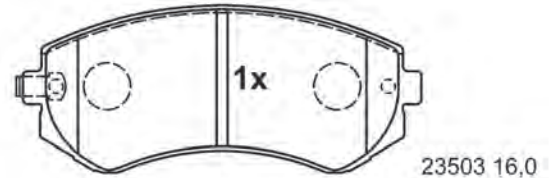
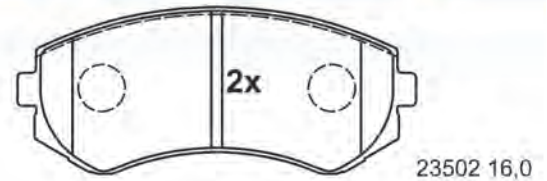

121,0 x 50,5 x 16,0

13.0460-5752.2 605752

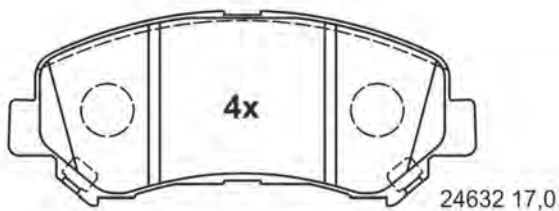

142,0 x 59,0 x 17,0

13.0460-5753.2 605753

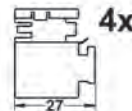
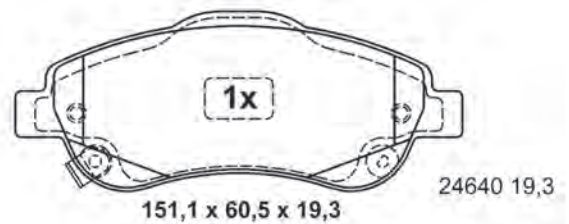
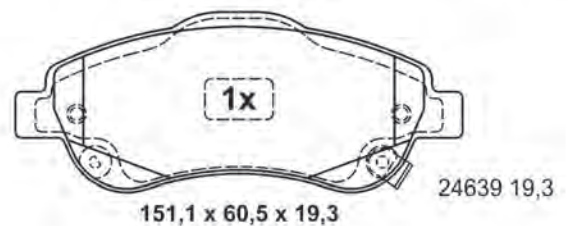
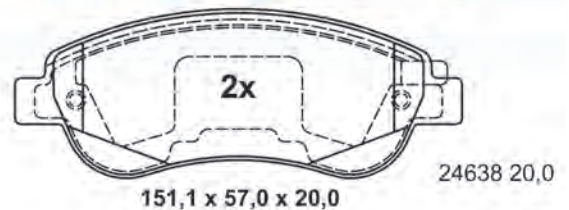

# Abbildungen Scheibenbremsbeläge

Illustrations disc brake pads - Ilustraciones de pastillas - Illustrations Plaquettes de frein à disque - Illustrazioni Pastiglie Freno

13.0460-5754.2 605754

B.H.P.



108,8 x 42,2 x 16,6

24635 16,6

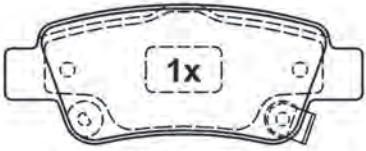

108,8 x 42,2 x 16,9

24636 16,9

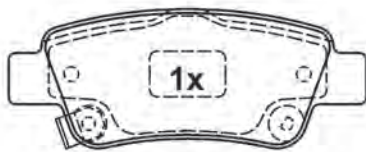

108,8 x 42,2 x 16,9

24637 16,9

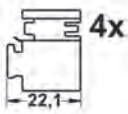
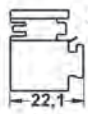
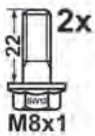

13.0460-5755.2 605755

B.H.P.

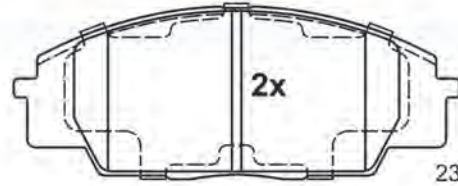

23178 16,6

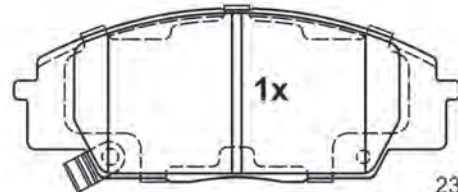

23530 16,6

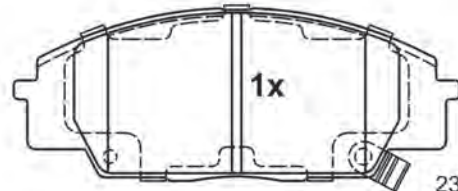

23531 16,6

135,3 x 52,4 x 16,6

13.0460-5756.2 605756

B.H.P.



24087 17,4

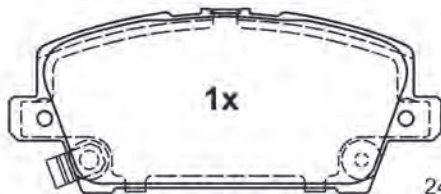

24405 17,4



24405 17,4

131,5 x 55,7 x 17,4

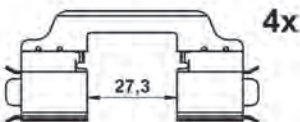

13.0460-5757.2 605757

B.H.P.



24086 15,8

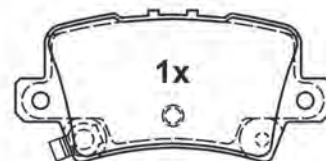

24519 15,8



24518 15,8

95,7 x 46,2 x 15,8





# Abbildungen Scheibenbremsbeläge

Illustrations disc brake pads - Ilustraciones de pastillas - Illustrations Plaquettes de frein à disque - Illustrazioni Pastiglie Freno

13.0460-5760.2 605760

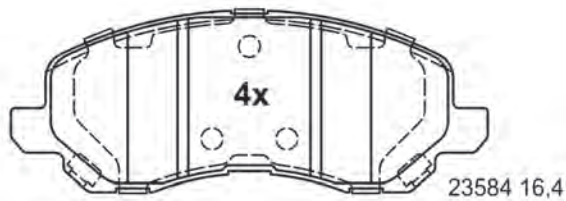

144,8 x 54,9 x 16,4



13.0460-5761.2 605761

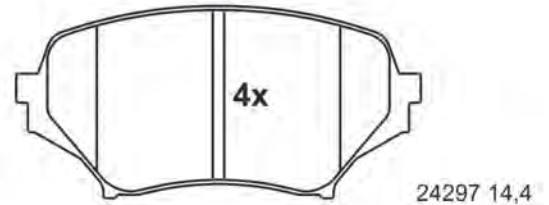

122,9 x 58,3 x 14,4

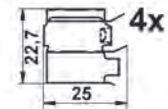
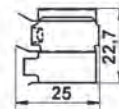
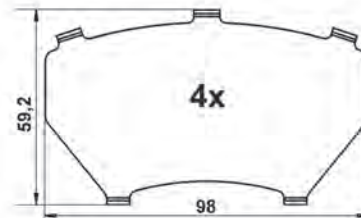

13.0460-5762.2 605762

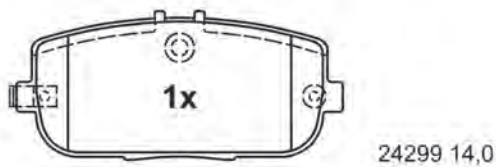
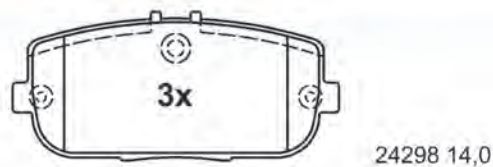

99,2 x 45,0 x 14,0

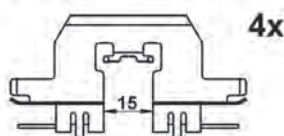
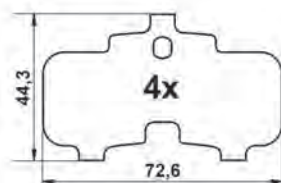

13.0460-5763.2 605763

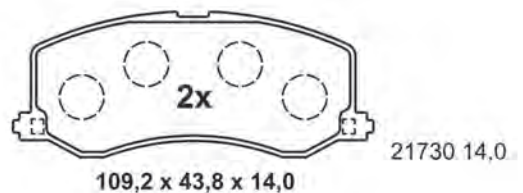

109,2 x 43,8 x 14,0

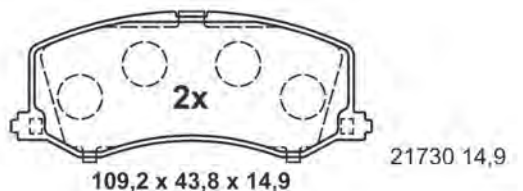

109,2 x 43,8 x 14,9

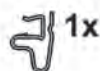

# Abbildungen Scheibenbremsbeläge

Illustrations disc brake pads - Ilustraciones de pastillas - Illustrations Plaquettes de frein à disque - Illustrazioni Pastiglie Freno

13.0460-5764.2 605764

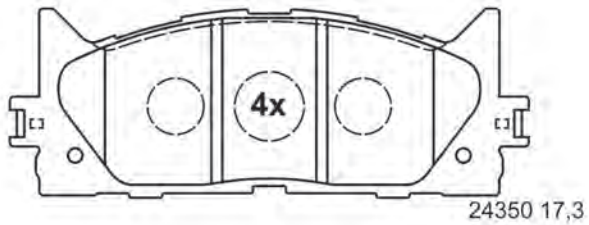

157,6 x 57,0 x 17,3

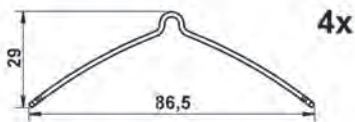

13.0460-5765.2 605765

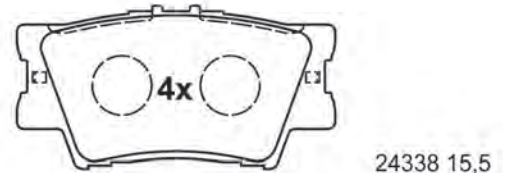

96,6 x 49,2 x 15,5

13.0460-5766.2 605766

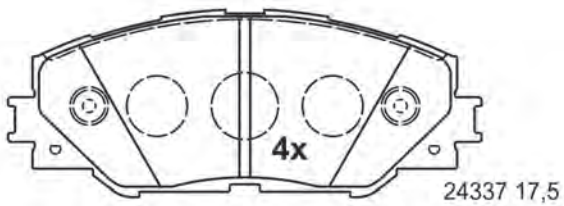

146,4 x 56,8 x 17,5

13.0460-5767.2 605767

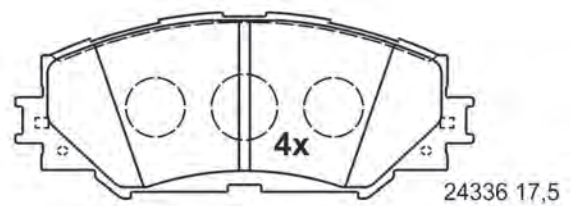

139,0 x 56,1 x 17,5

# Abbildungen Scheibenbremsbeläge

Illustrations disc brake pads - Ilustraciones de pastillas - Illustrations Plaquettes de frein à disque - Illustrazioni Pastiglie Freno

13.0460-5768.2 605768

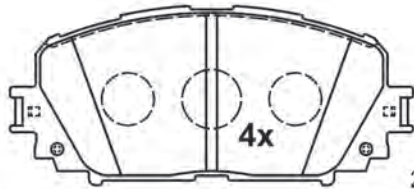

24347 17,5

122,7 x 54,0 x 17,5

13.0460-5769.2 605769

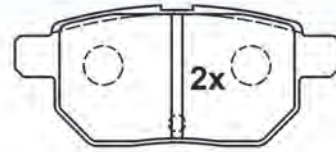

24612 15,0

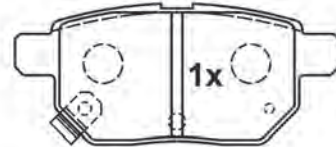

24610 15,0

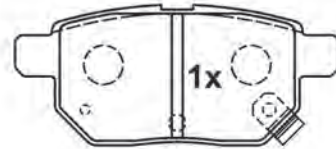

24611 15,0

98,5 x 42,4 x 15,0

13.0460-5770.2 605770

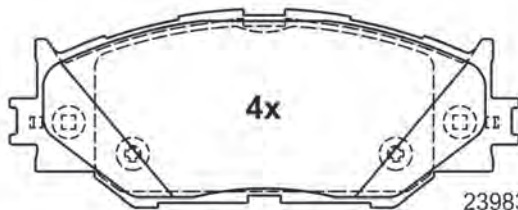

23983 17,0

154,6 x 59,5 x 17,0

13.0460-5771.2 605771

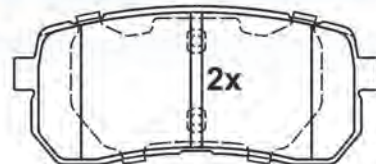

24600 14,9

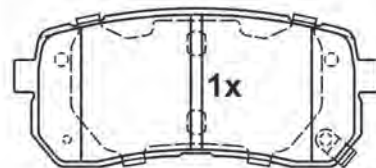

24599 14,9

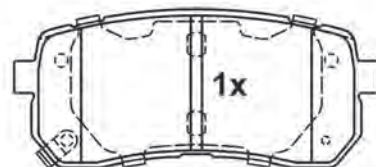

24686 14,9

110,6 x 47,7 x 14,9

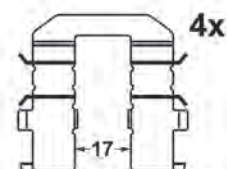



# Abbildungen Scheibenbremsbeläge

Illustrations disc brake pads - Ilustraciones de pastillas - Illustrations Plaquettes de frein à disque - Illustrazioni Pastiglie Freno

13.0460-5772.2 605772

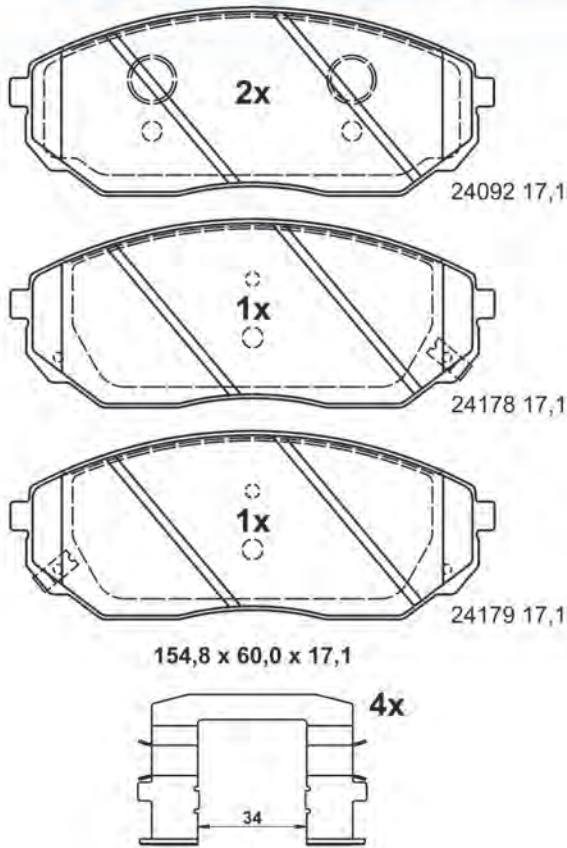

13.0460-5773.2 605773

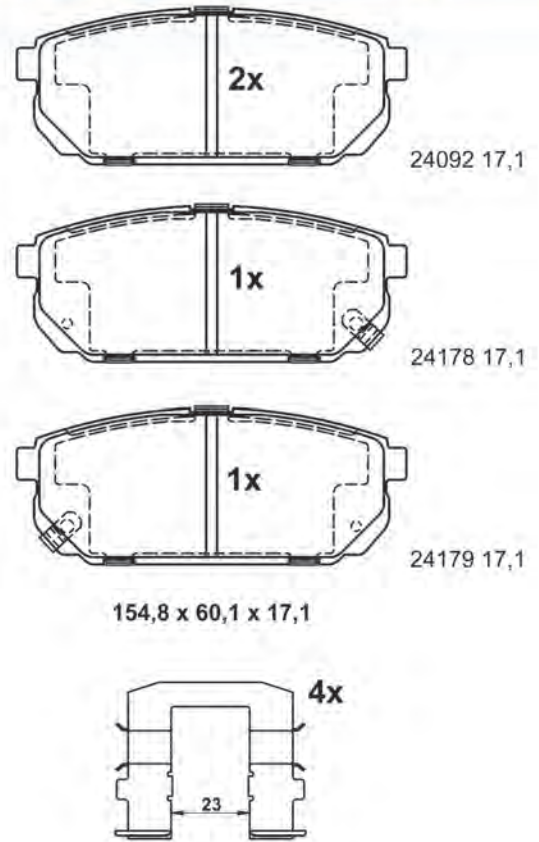

13.0460-5774.2 605774

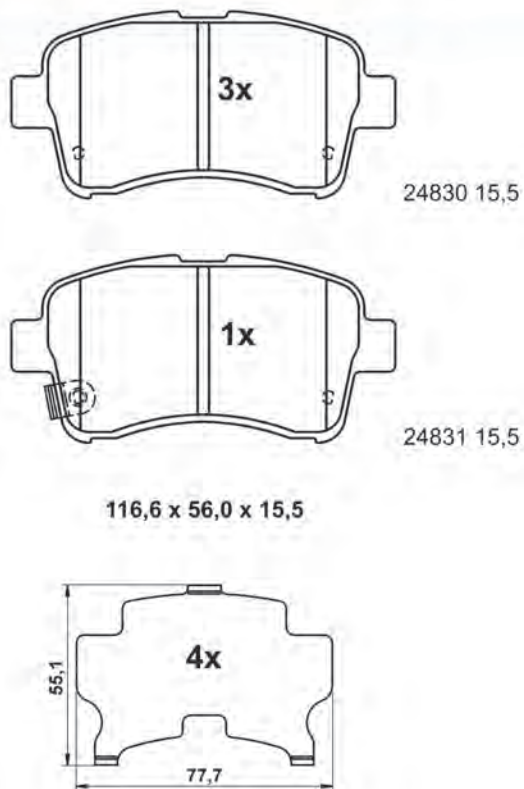

13.0460-5775.2 605775

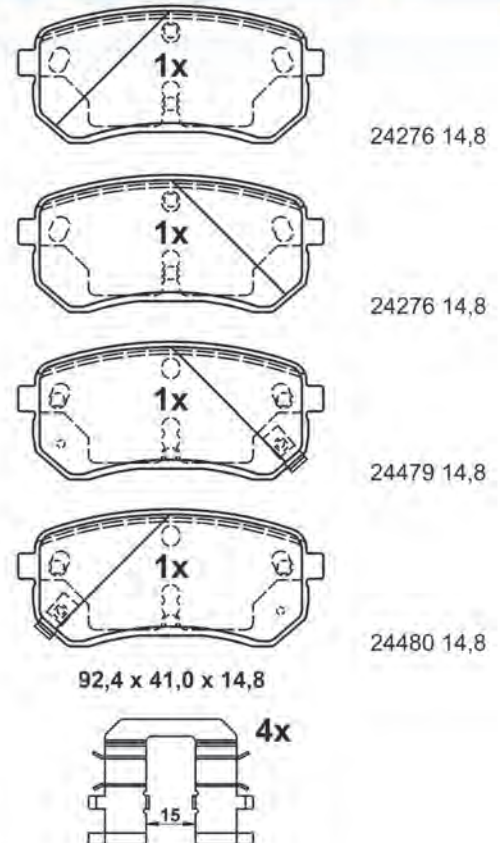

# Abbildungen Scheibenbremsbeläge

Illustrations disc brake pads - Ilustraciones de pastillas - Illustrations Plaquettes de frein à disque - Illustrazioni Pastiglie Freno

13.0460-5776.2 605776

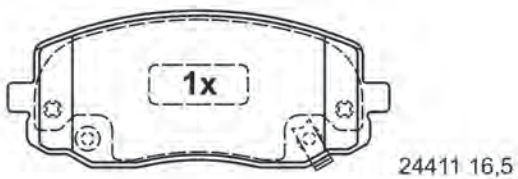
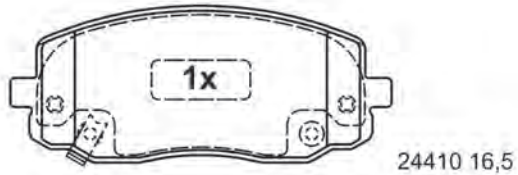
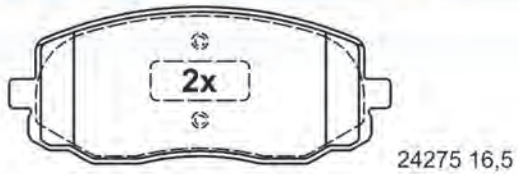

115,9 x 47,3 x 16,5

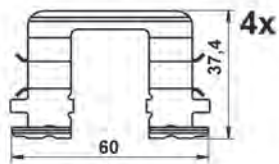

13.0460-5777.2 605777 [1]

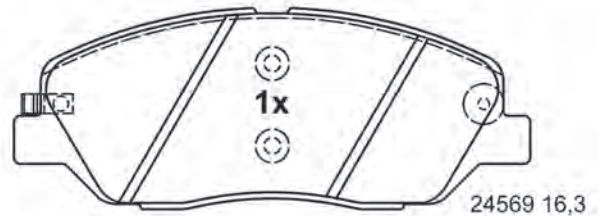
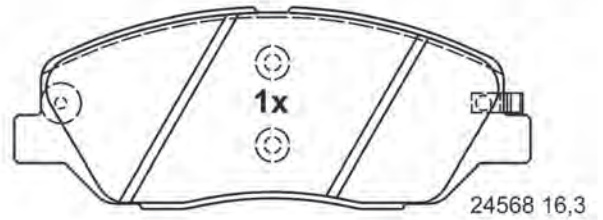
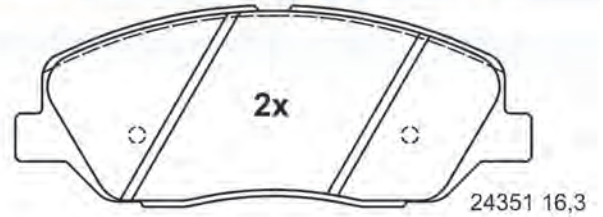

156,7 x 60,9 x 16,3

13.0460-5777.2 605777 [2]

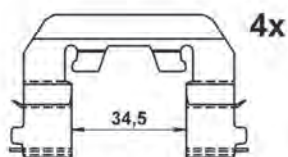
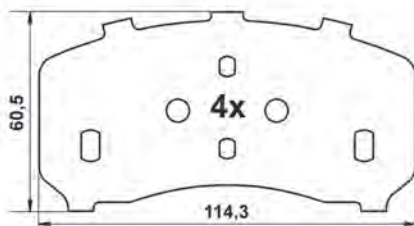

13.0460-5778.2 605778

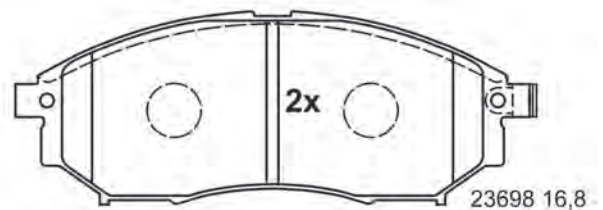
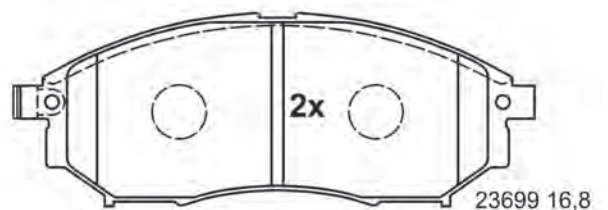

157,0 x 58,5 x 16,8



# Abbildungen Scheibenbremsbeläge

Illustrations disc brake pads - Ilustraciones de pastillas - Illustrations Plaquettes de frein à disque - Illustrazioni Pastiglie Freno

13.0460-5779.2 605779

B.H.P.

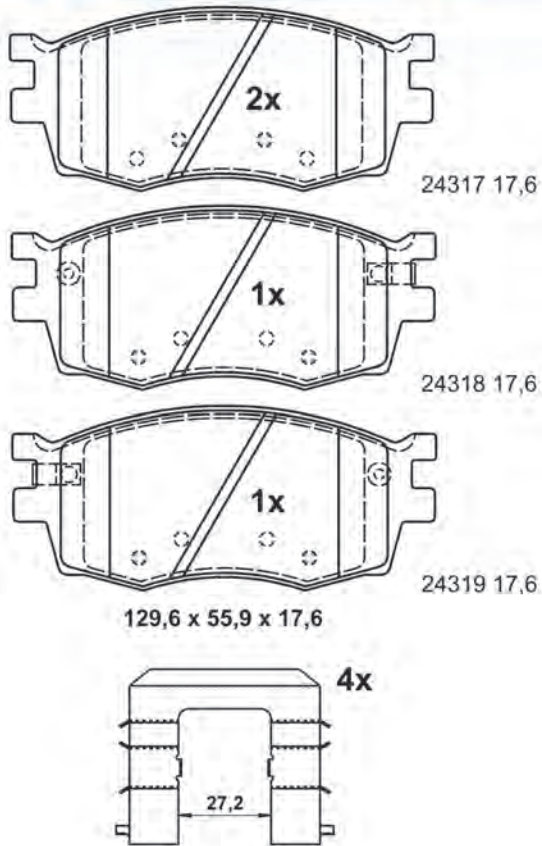

13.0460-5780.2 605780

B.H.P.

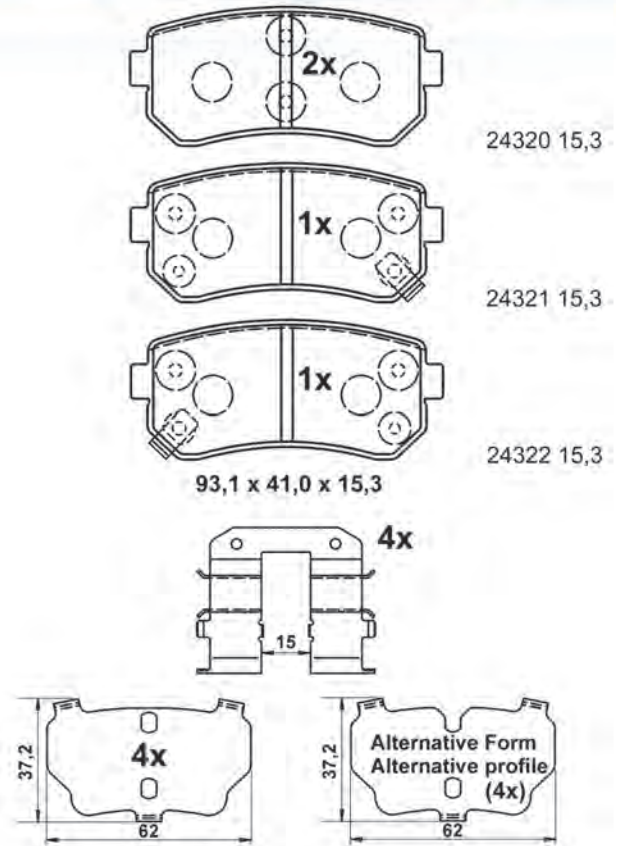

13.0460-5781.2 605781

B.H.P.

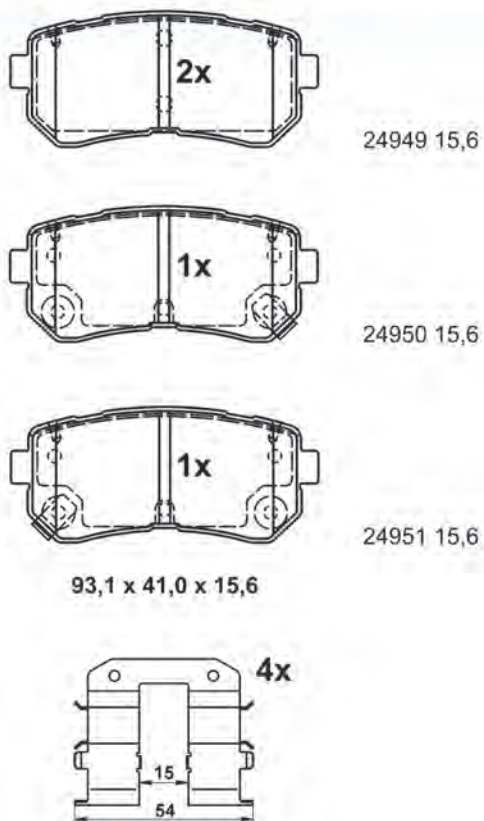

13.0460-5782.2 605782

B.H.P.

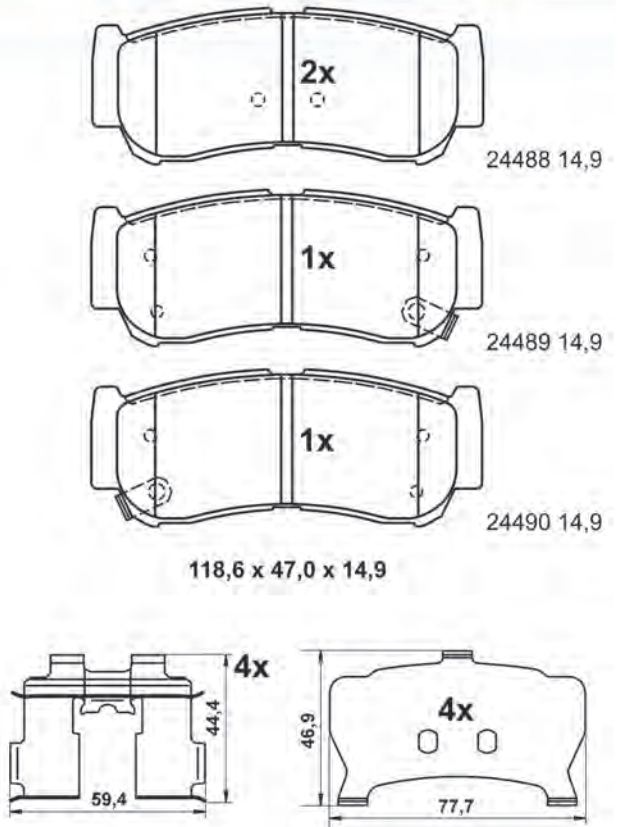

# Abbildungen Scheibenbremsbeläge

Illustrations disc brake pads - Ilustraciones de pastillas - Illustrations Plaquettes de frein à disque - Illustrazioni Pastiglie Freno

13.0460-5783.2 605783

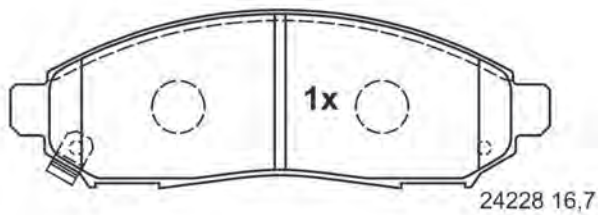
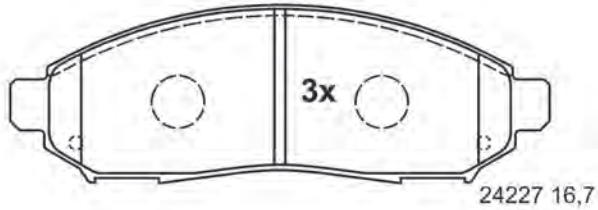

163,7 x 54,2 x 16,7

13.0460-5784.2 605784

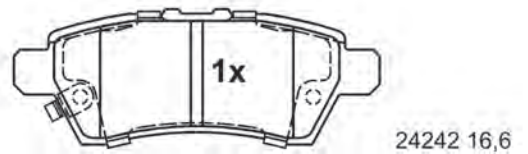
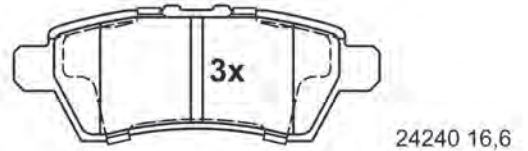

110,6 x 40,8 x 16,6

13.0460-5785.2 605785

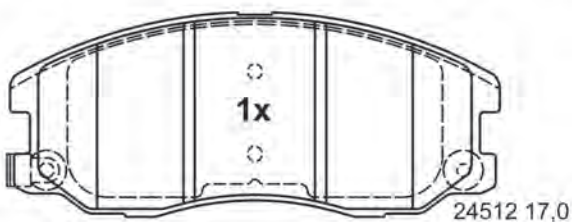
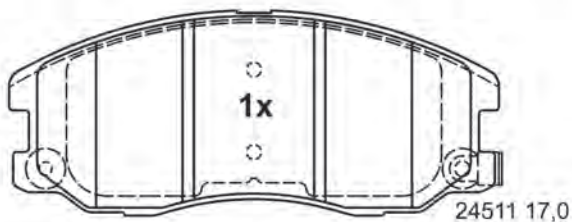
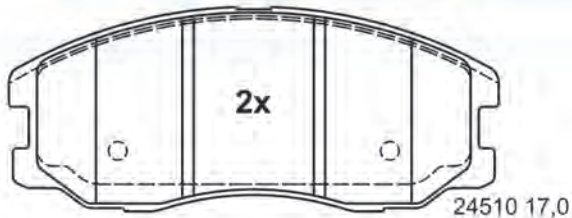

148,9 x 61,9 x 17,0

13.0460-5786.2 605786

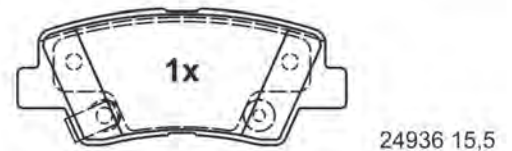
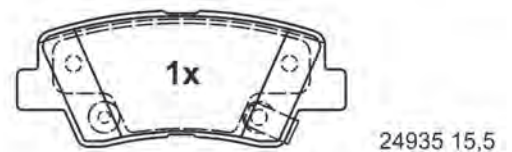

99,8 x 41,1 x 15,5

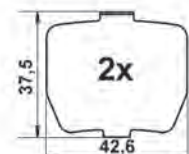
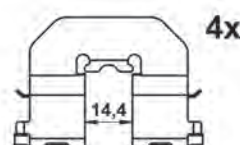



# Abbildungen Scheibenbremsbeläge

Illustrations disc brake pads - Ilustraciones de pastillas - Illustrations Plaquettes de frein à disque - Illustrazioni Pastiglie Freno

13.0460-5787.2 605787

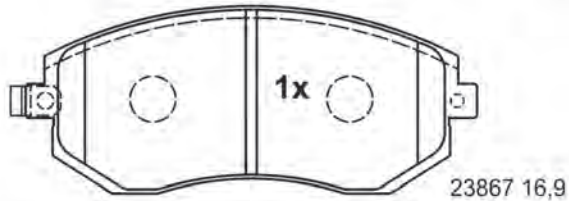
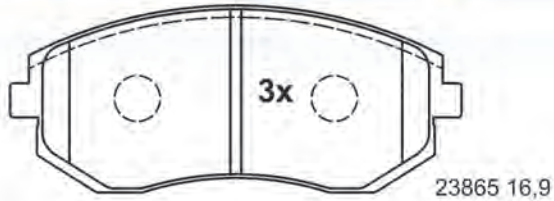

137,0 x 56,8 x 17,6

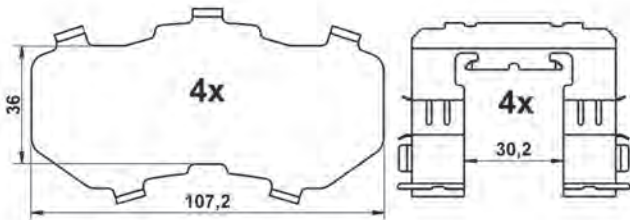

13.0460-5788.2 605788

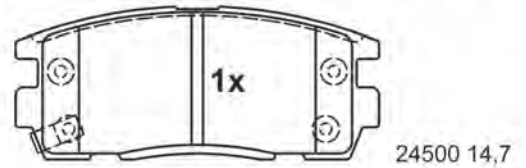
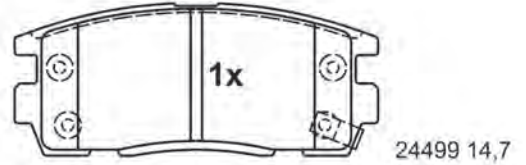
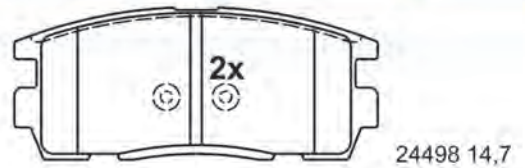

110,4 x 46,0 x 14,7

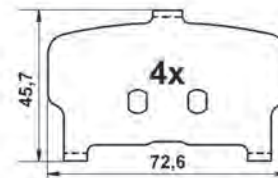

13.0460-5789.2 605789

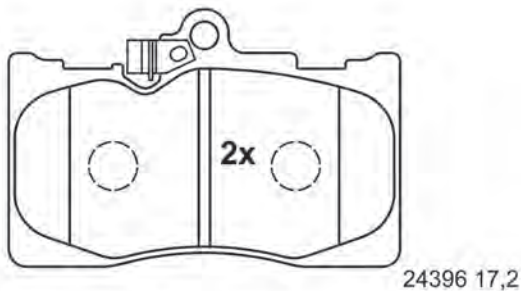
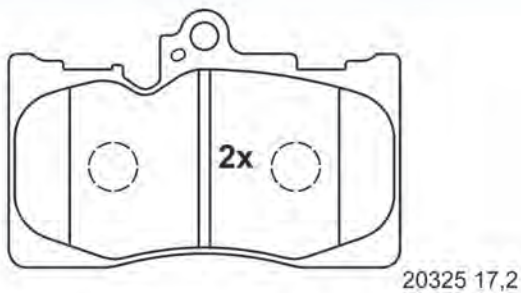

118,5 x 77,7 x 17,2

13.0460-5790.2 605790

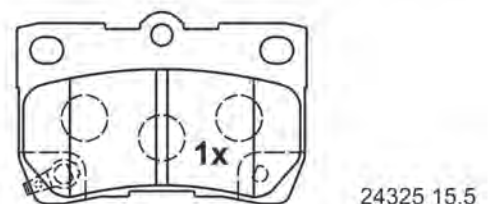
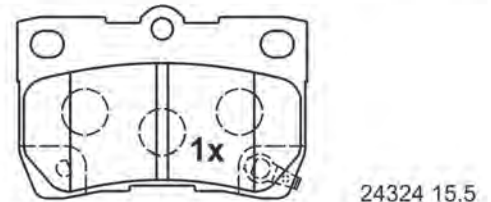
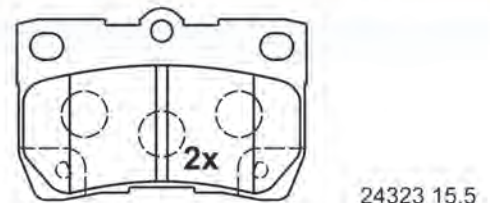

88,0 x 58,2 x 15,5

# Abbildungen Scheibenbremsbeläge

Illustrations disc brake pads - Ilustraciones de pastillas - Illustrations Plaquettes de frein à disque - Illustrazioni Pastiglie Freno

13.0460-5791.2 605791

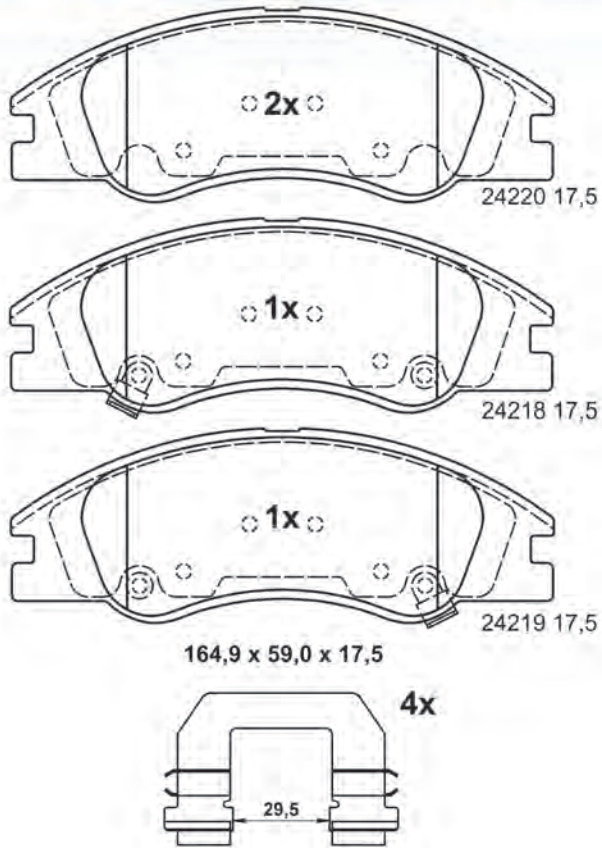

13.0460-5792.2 605792

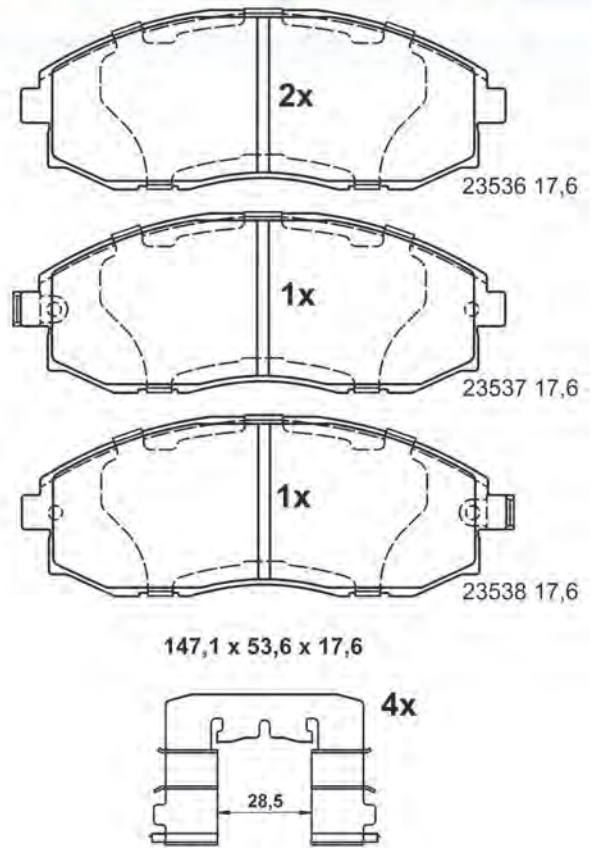

13.0460-5793.2 605793

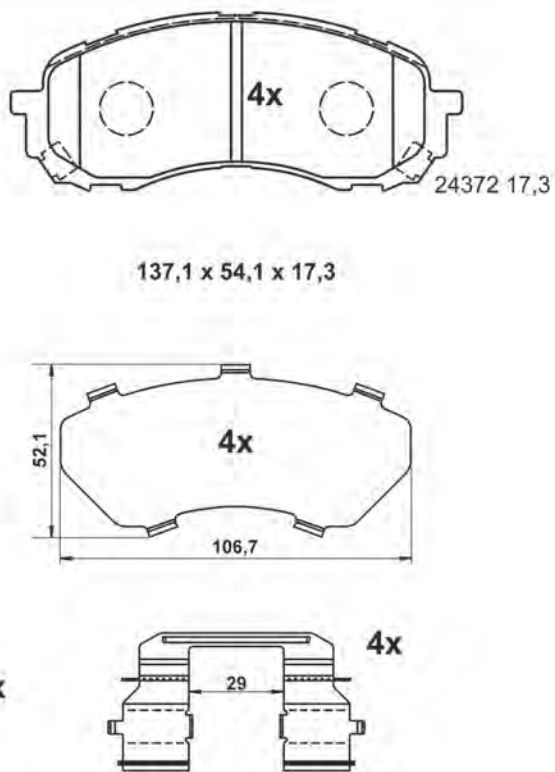

13.0460-5794.2 605794 [1]

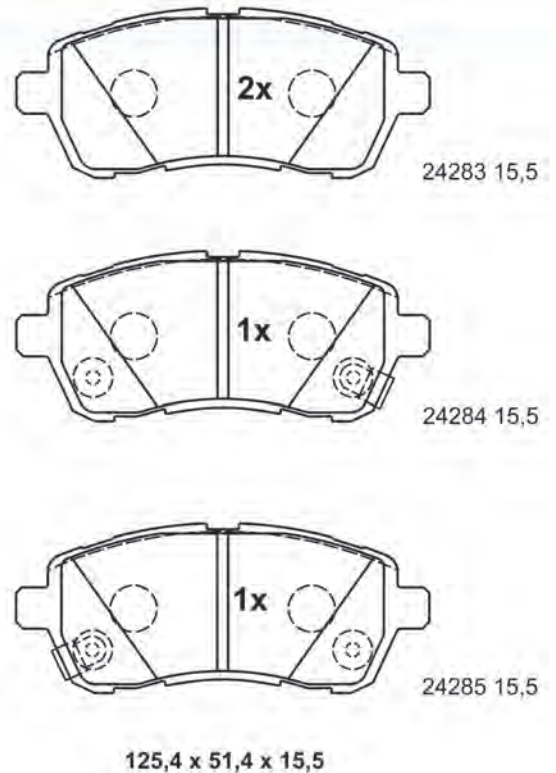

# Abbildungen Scheibenbremsbeläge

Illustrations disc brake pads - Ilustraciones de pastillas - Illustrations Plaquettes de frein à disque - Illustrazioni Pastiglie Freno

13.0460-5794.2 605794 [2]

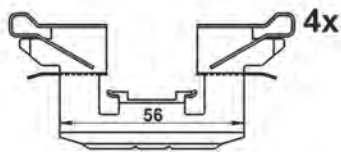
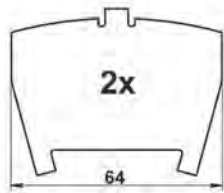
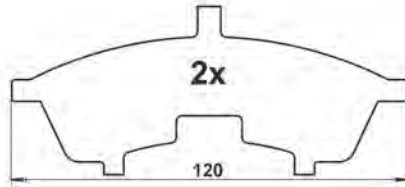

13.0460-5794.2 605794 [1]



wahlweise optional

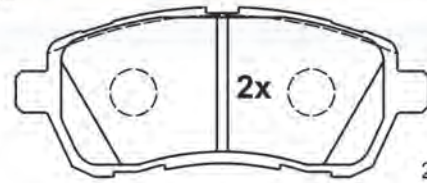

24283 15,5

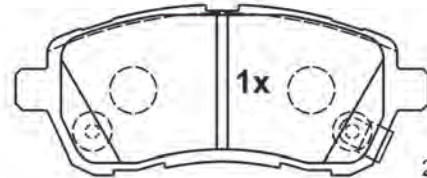

24284 15,5

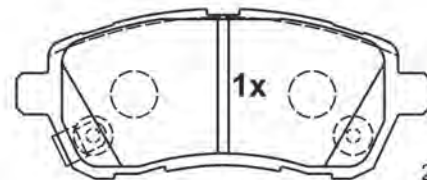

24285 15,5

125,4 x 51,4 x 15,5

13.0460-5794.2 605794 [2]



wahlweise optional

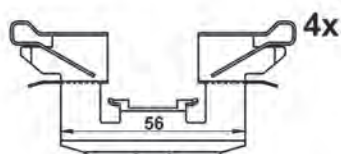
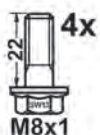
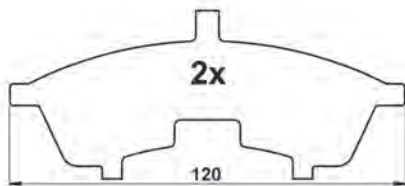

13.0460-5795.2 605795

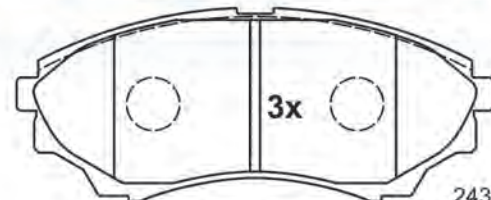

24353 15,4

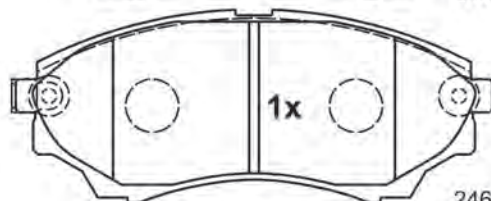

24672 15,4

145,0 x 58,5 x 16,0

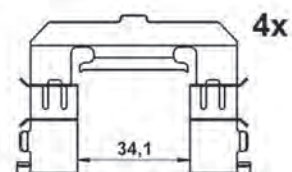
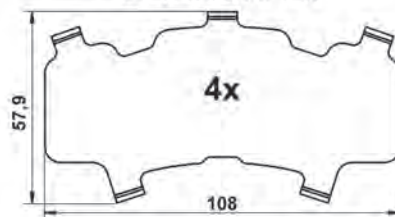



# Abbildungen Scheibenbremsbeläge

Illustrations disc brake pads - Ilustraciones de pastillas - Illustrations Plaquettes de frein à disque - Illustrazioni Pastiglie Freno

13.0460-5797.2 605797 [1]

B.H.P.

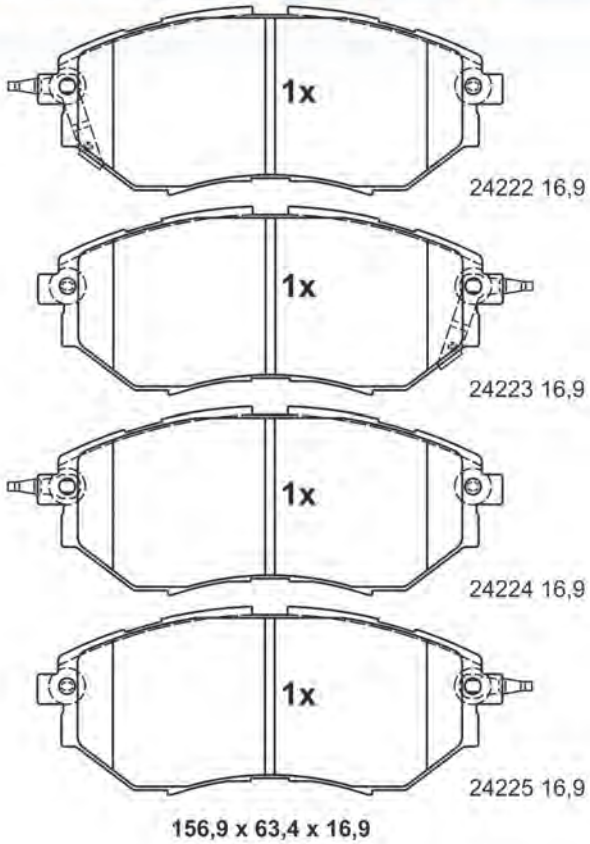

13.0460-5797.2 605797 [2]

B.H.P.

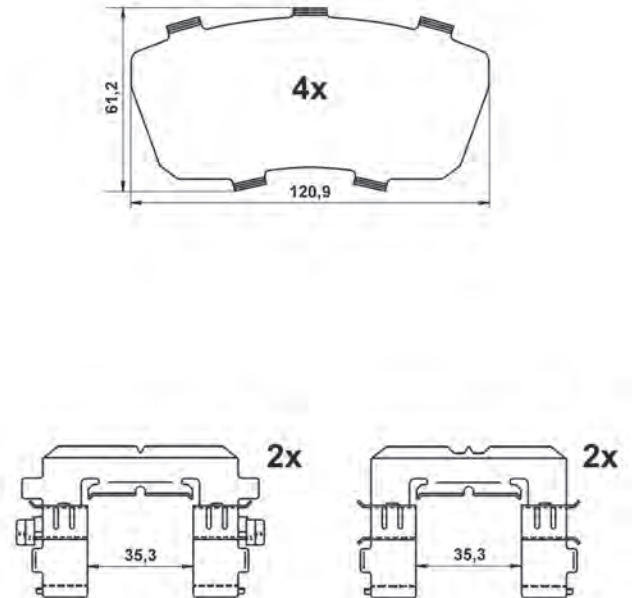

13.0460-5799.2 605799

B.H.P.

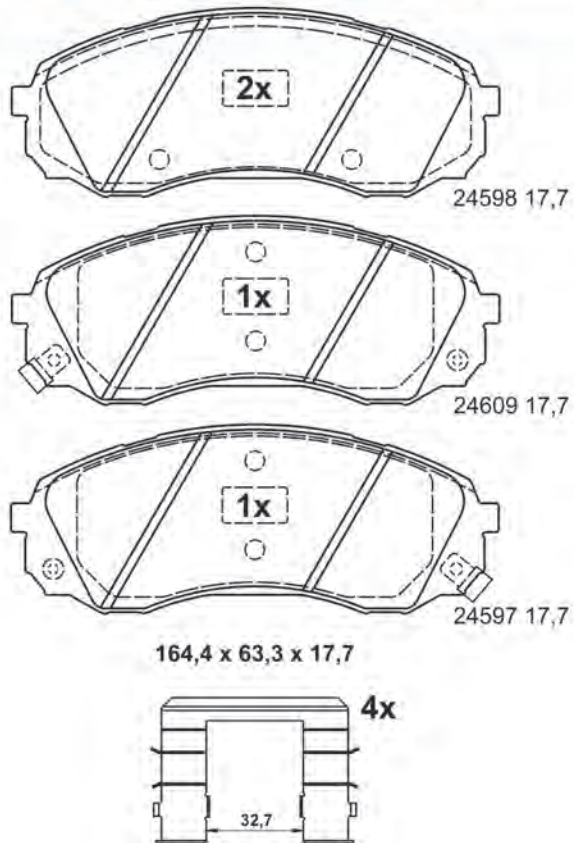

13.0460-5800.2 605800

B.H.P.

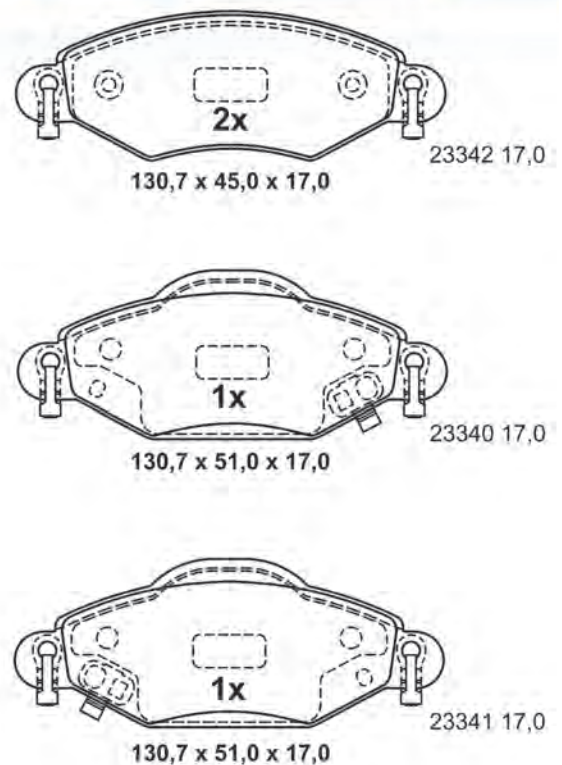

# Abbildungen Scheibenbremsbeläge

Illustrations disc brake pads - Ilustraciones de pastillas - Illustrations Plaquettes de frein à disque - Illustrazioni Pastiglie Freno

13.0460-5801.2 605801

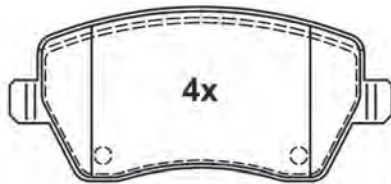

23973 17,1

116,3 x 52,4 x 17,1



13.0460-5802.2 605802

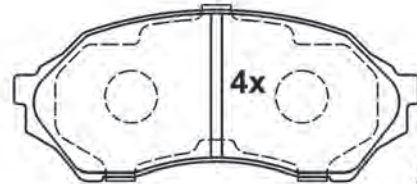

23490 15,4

123,2 x 51,8 x 15,4

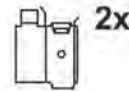
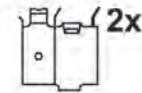

13.0460-5803.2 605803

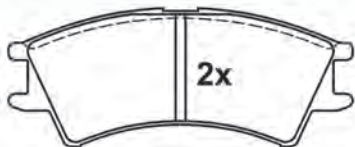

23238 16,0

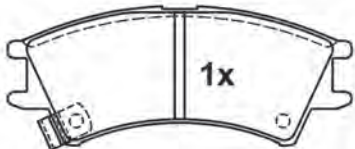

23239 16,0

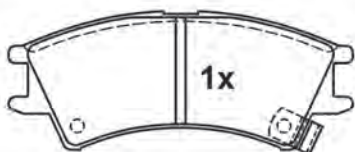

23240 16,0

104,7 x 41,7 x 16,0

13.0460-5804.2 605804

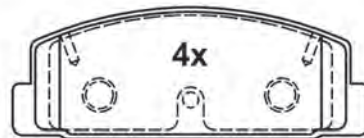

24045 13,7

107,7 x 39,4 x 13,7

# Abbildungen Scheibenbremsbeläge

Illustrations disc brake pads - Ilustraciones de pastillas - Illustrations Plaquettes de frein à disque - Illustrazioni Pastiglie Freno

13.0460-5806.2 605806

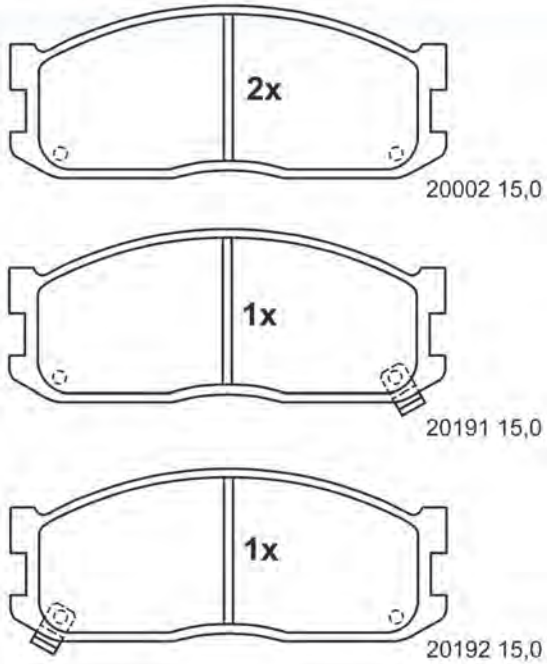

133,1 x 52,1 x 15,0

13.0460-5807.2 605807

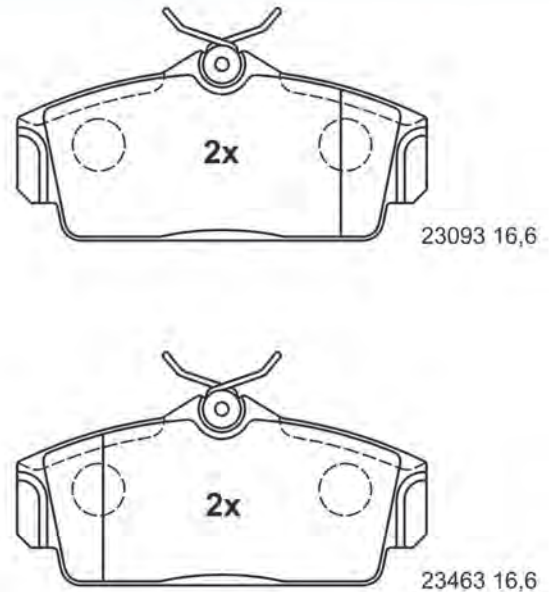

124,0 x 57,2 x 16,6

13.0460-5808.2 605808

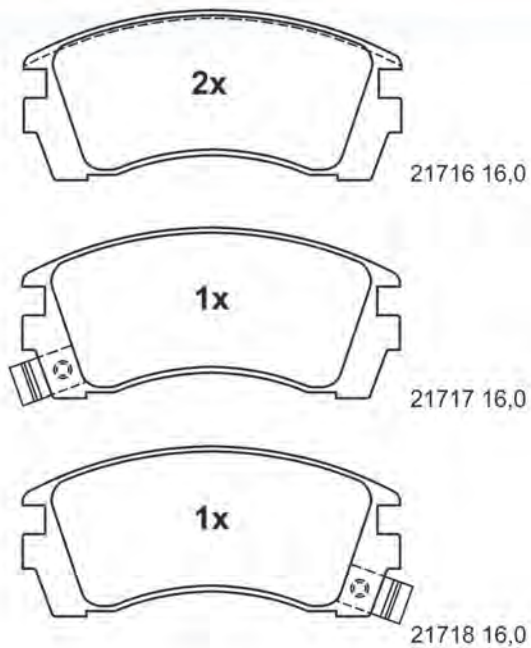

114,9 x 51,5 x 16,0

13.0460-5809.2 605809

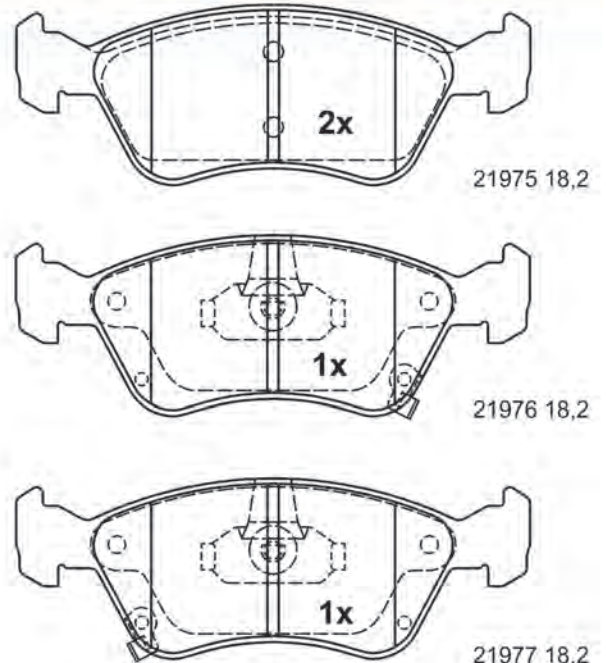

156,3 x 54,8 x 18,2



# Abbildungen Scheibenbremsbeläge

Illustrations disc brake pads - Ilustraciones de pastillas - Illustrations Plaquettes de frein à disque - Illustrazioni Pastiglie Freno

13.0460-5810.2 605810

B.H.P.

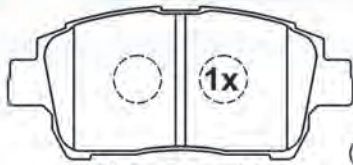

116,3 x 51,6 x 16,5

23904 16,5  
(23510/24778)

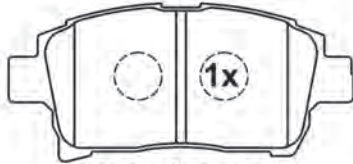

116,5 x 54,5 x 16,5

23905 16,5  
(24779)

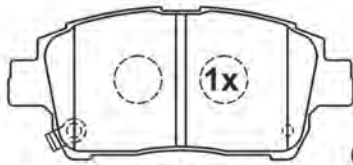

116,3 x 51,6 x 16,5

23906 16,5  
(23511/24780)

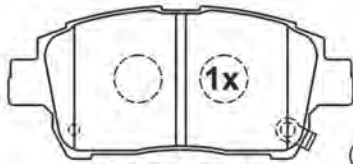

116,3 x 51,6 x 16,5

23907 16,5  
(23512/24781)

13.0460-5811.2 605811

B.H.P.

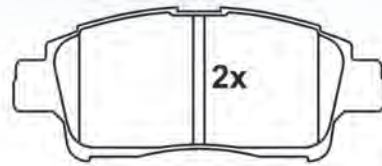

23348 16,5

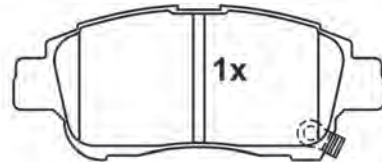

23349 16,5

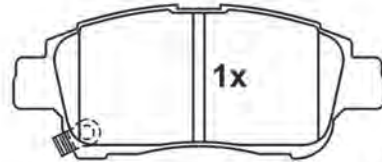

23350 16,5

112,4 x 46,7 x 16,5

13.0460-5812.2 605812

B.H.P.

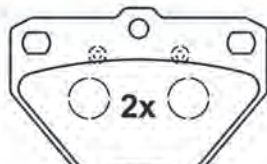

78,5 x 52,0 x 14,0

23521 14,0

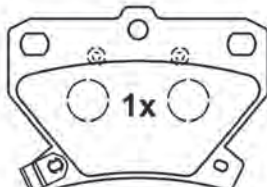

78,5 x 55,6 x 14,0

23522 14,0

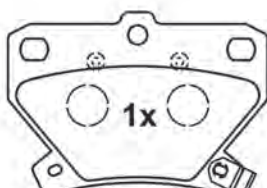

78,5 x 55,6 x 14,0

23523 14,0

13.0460-5813.2 605813

B.H.P.

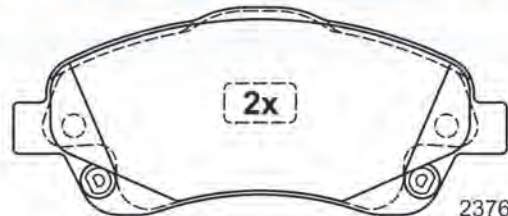

23768 19,3

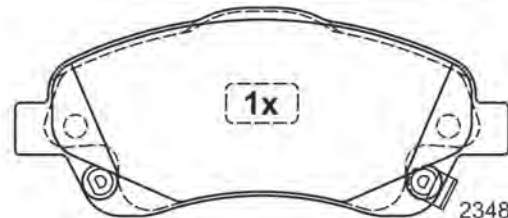

23480 19,3

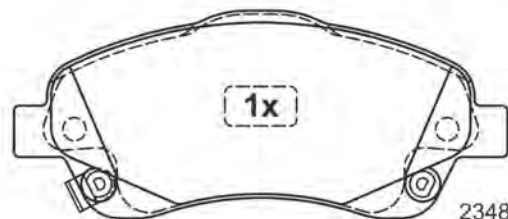

23481 19,3

150,8 x 63,0 x 19,3

# Abbildungen Scheibenbremsbeläge

Illustrations disc brake pads - Ilustraciones de pastillas - Illustrations Plaquettes de frein à disque - Illustrazioni Pastiglie Freno

13.0460-5814.2 605814

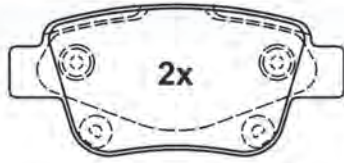

23620 16,4

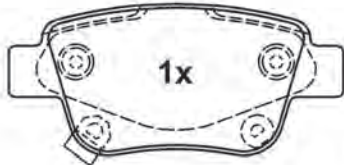

23621 16,4

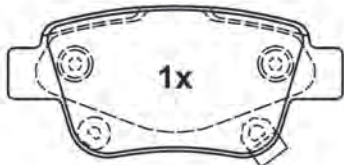

23622 16,4

101,8 x 45,9 x 16,4

13.0460-5815.2 605815

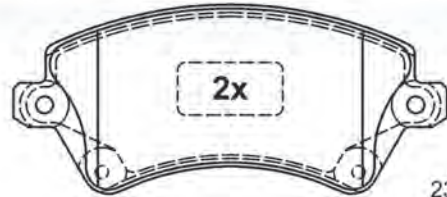

23766 17,8

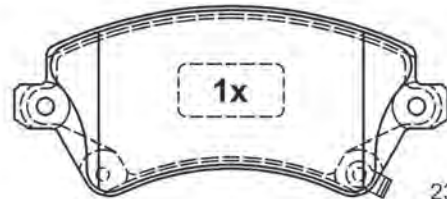

23818 17,8

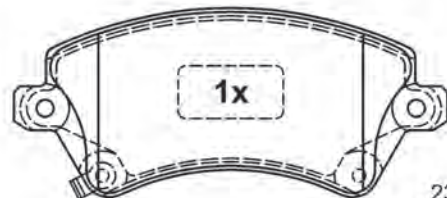

23819 17,8

131,5 x 57,3 x 17,8

13.0460-5816.2 605816

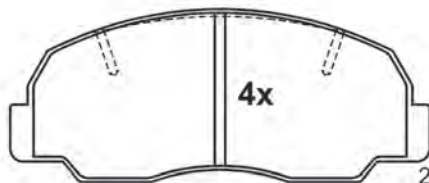

21243 14,0

127,8 x 52,3 x 14,0

13.0460-5817.2 605817

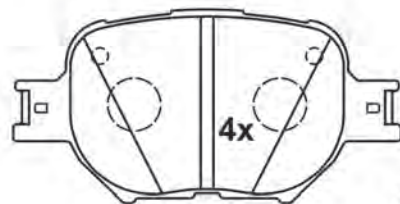

23526 17,5

117,9 x 58,6 x 17,5



# Abbildungen Scheibenbremsbeläge

Illustrations disc brake pads - Ilustraciones de pastillas - Illustrations Plaquettes de frein à disque - Illustrazioni Pastiglie Freno

13.0460-5819.2 605819



23816 16,0

95,6 x 37,9 x 16,0



13.0460-5820.2 605820

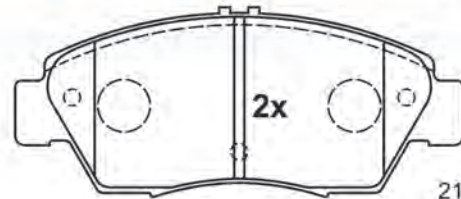

21694 16,3

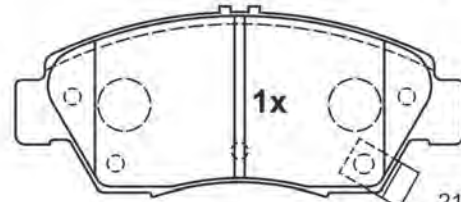

21696 16,3

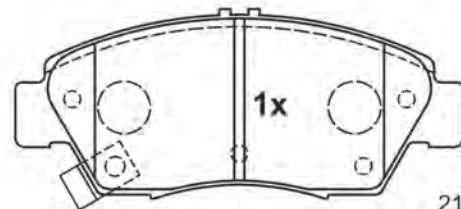

21695 16,3

136,7 x 57,4 x 16,3

13.0460-5821.2 605821

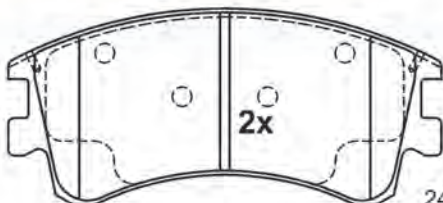

24046 18,6

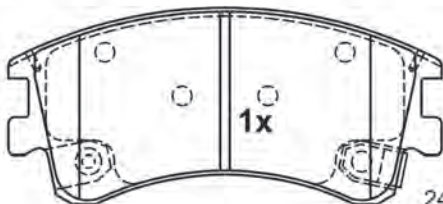

24047 18,6

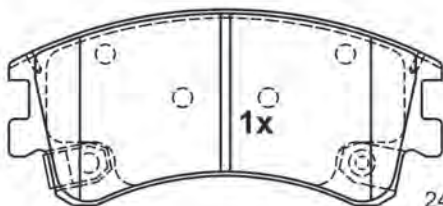

24048 18,6

131,8 x 59,5 x 18,0

13.0460-5822.2 605822

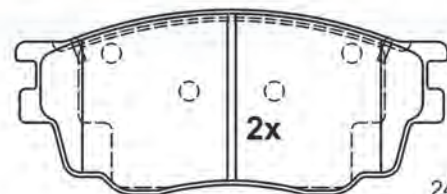

24246 16,8

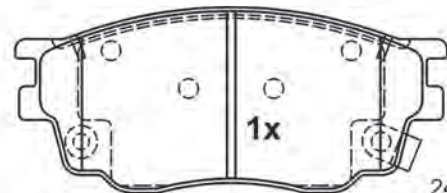

24249 16,8

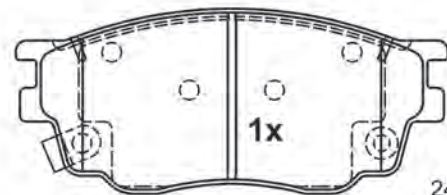

24248 16,8

131,3 x 56,1 x 16,8

# Abbildungen Scheibenbremsbeläge

Illustrations disc brake pads - Ilustraciones de pastillas - Illustrations Plaquettes de frein à disque - Illustrazioni Pastiglie Freno

13.0460-5824.2 605824

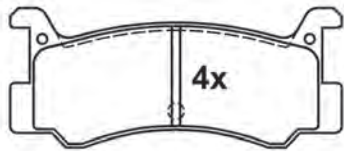

20008 13,0

101,7 x 42,2 x 13,0

13.0460-5825.2 605825 [1]

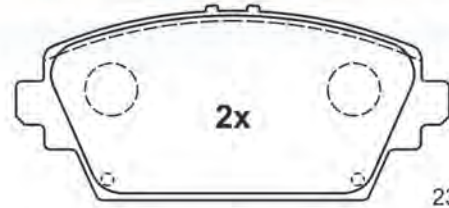

23094 16,5

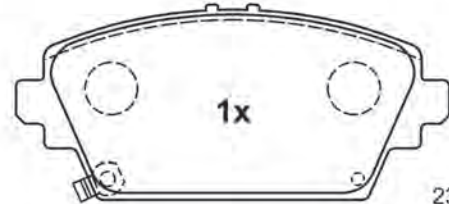

23563 16,5

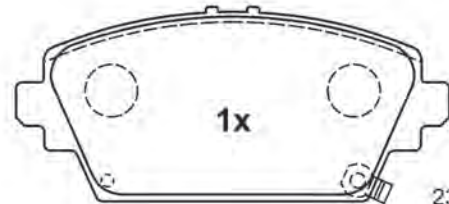

23564 16,5

131,8 x 58,5 x 16,5

13.0460-5825.2 605825 [2]

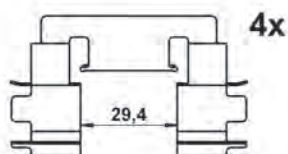
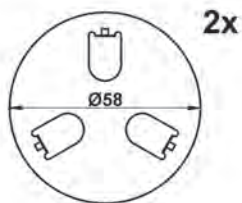

13.0460-5826.2 605826

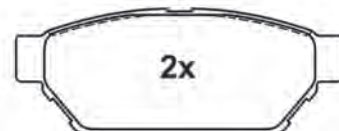

21872 14,5

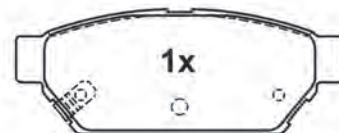

21873 14,5

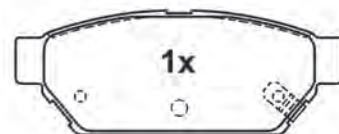

21874 14,5

99,0 x 37,8 x 14,5

# Abbildungen Scheibenbremsbeläge

Illustrations disc brake pads - Ilustraciones de pastillas - Illustrations Plaquettes de frein à disque - Illustrazioni Pastiglie Freno

13.0460-5827.2 605827

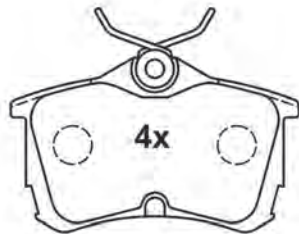

23527 14,5

87,1 x 53,0 x 14,5



13.0460-5829.2 605829

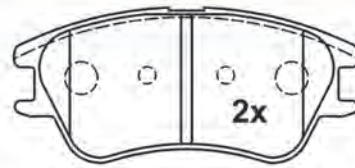

24277 16,0

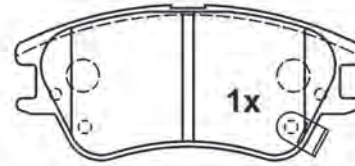

24397 16,0

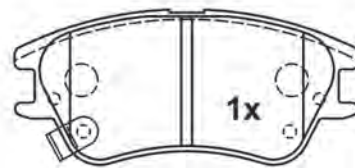

24398 16,0

104,7 x 47,3 x 16,0

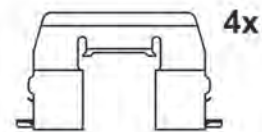

13.0460-5830.2 605830

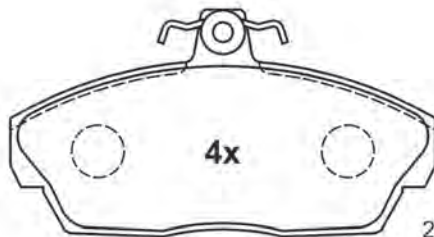

23158 17,5

129,1 x 68,7 x 17,5

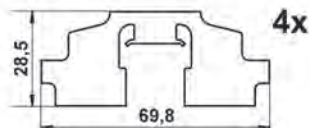
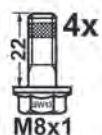

13.0460-5831.2 605831

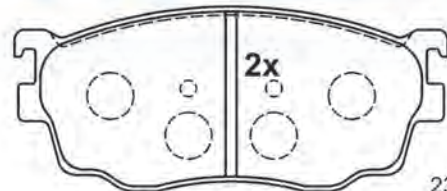

23777 16,0

131,5 x 56,2 x 16,0

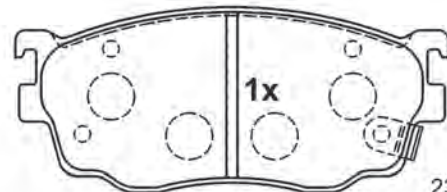

23778 17,0

131,5 x 56,2 x 17,0

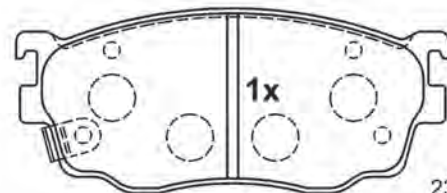

23779 17,0

131,5 x 56,2 x 17,0

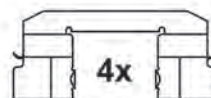



# Abbildungen Scheibenbremsbeläge

Illustrations disc brake pads - Ilustraciones de pastillas - Illustrations Plaquettes de frein à disque - Illustrazioni Pastiglie Freno

13.0460-5832.2 605832

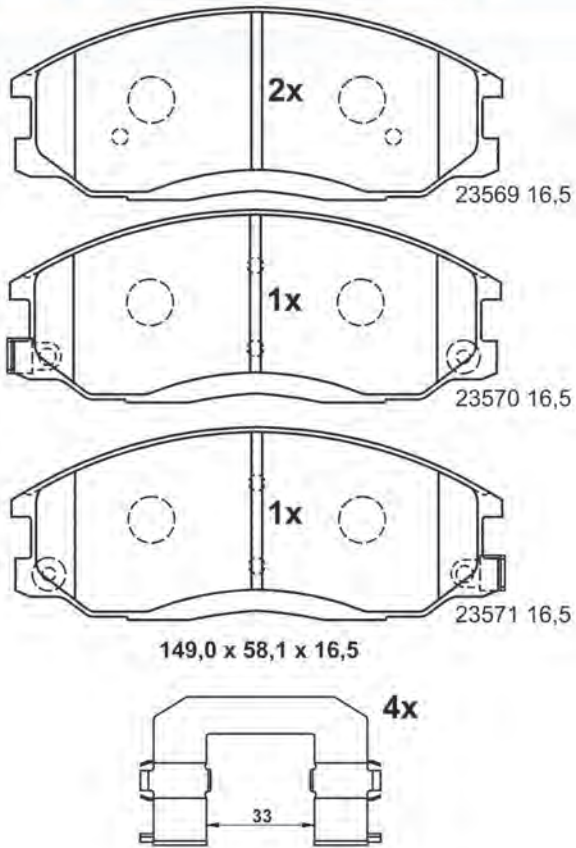

13.0460-5833.2 605833

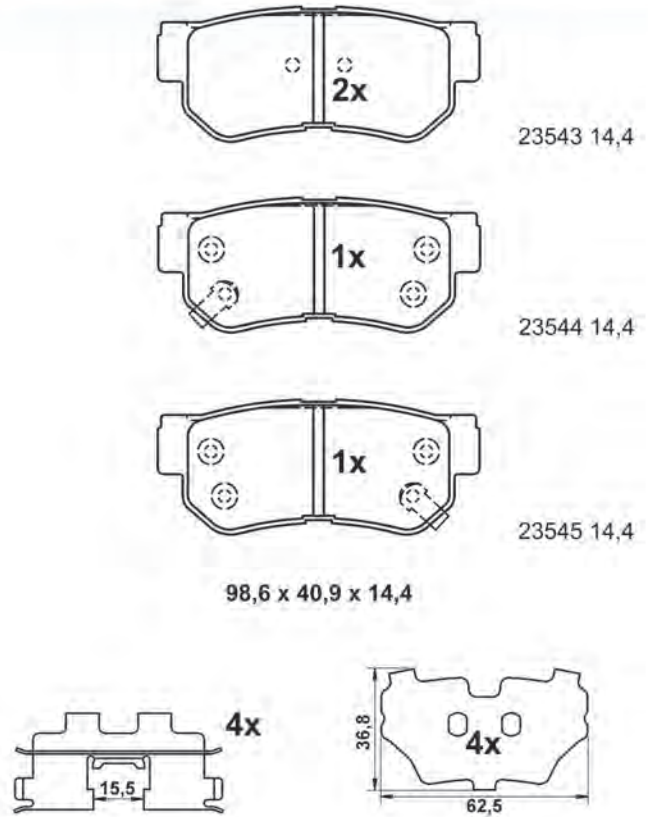

13.0460-5834.2 605834

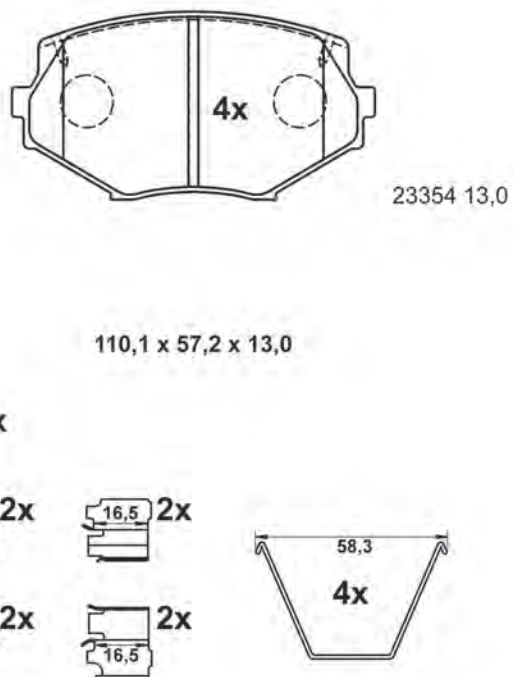

13.0460-5835.2 605835

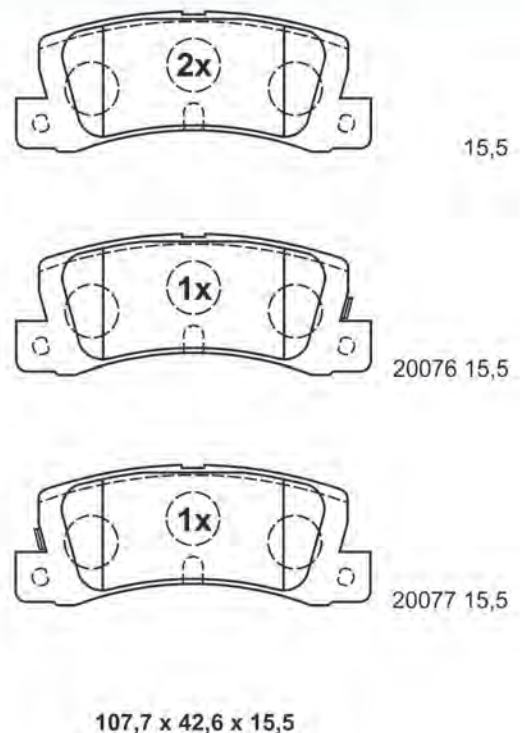

# Abbildungen Scheibenbremsbeläge

Illustrations disc brake pads - Ilustraciones de pastillas - Illustrations Plaquettes de frein à disque - Illustrazioni Pastiglie Freno

13.0460-5836.2 605836

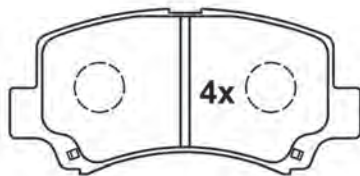

23662 15,0

106,1 x 50,1 x 15,0

2x

13.0460-5837.2 605837

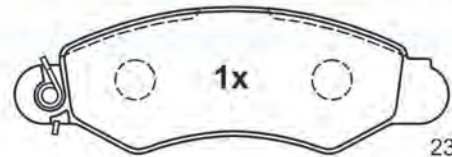

23296 14,5

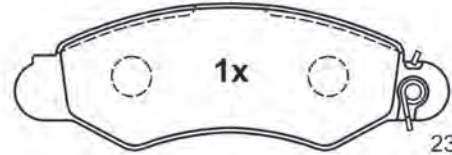

23297 14,5

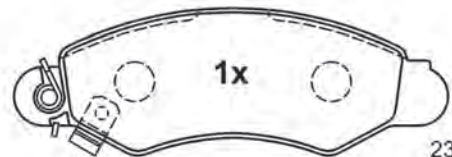

23298 14,5

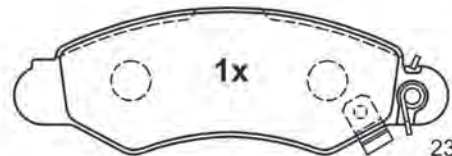

23299 14,5

131,0 x 44,5 x 14,5

13.0460-5838.2 605838

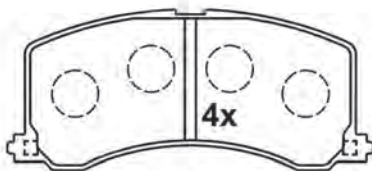

23400 15,5

111,5 x 48,7 x 15,5

4x

13.0460-5839.2 605839

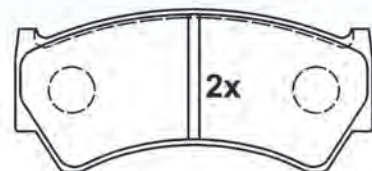

23795 15,0

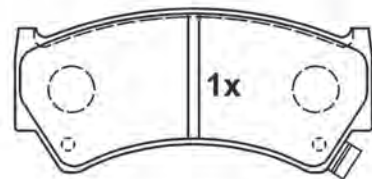

23796 15,0

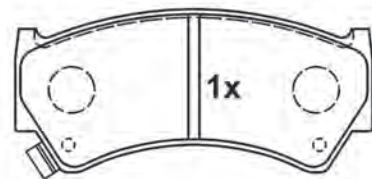

23797 15,0

108,6 x 47,9 x 15,0



# Abbildungen Scheibenbremsbeläge

Illustrations disc brake pads - Ilustraciones de pastillas - Illustrations Plaquettes de frein à disque - Illustrazioni Pastiglie Freno

13.0460-5840.2 605840

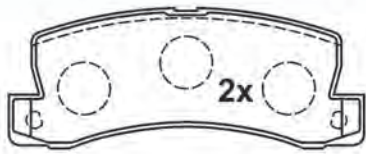

15,0

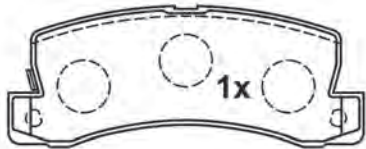

23833 15,0

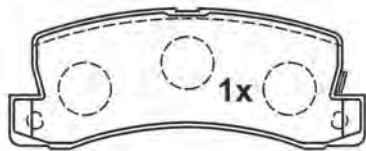

23834 15,0

107,7 x 42,6 x 15,0

13.0460-5841.2 605841

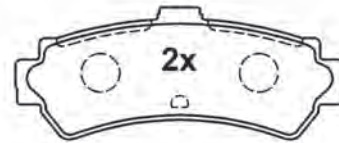

23023 14,8

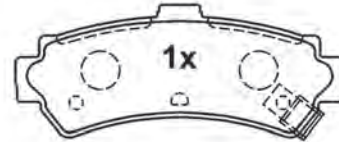

23024 14,8

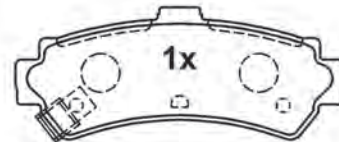

23025 14,8

99,4 x 40,1 x 14,8

13.0460-5842.2 605842

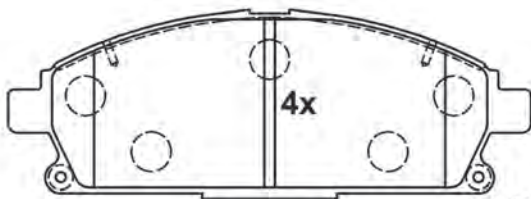

23420 16,5

158,8 x 56,3 x 16,5

13.0460-5843.2 605843

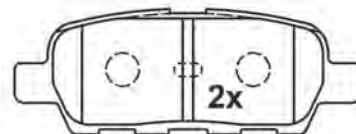

23871 14,3

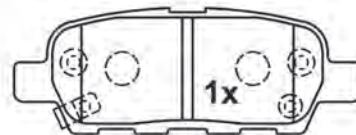

23872 14,3

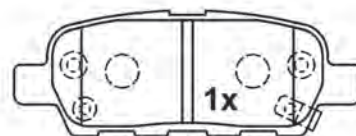

14,3

105,5 x 38,1 x 14,3

# Abbildungen Scheibenbremsbeläge

Illustrations disc brake pads - Ilustraciones de pastillas - Illustrations Plaquettes de frein à disque - Illustrazioni Pastiglie Freno

13.0460-5844.2 605844

B x H x D

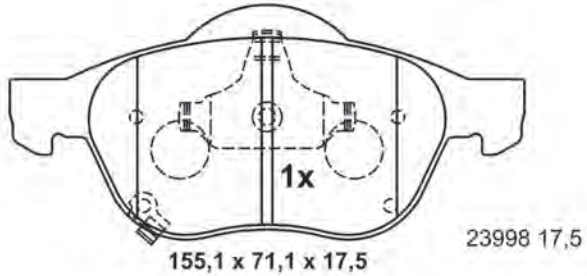
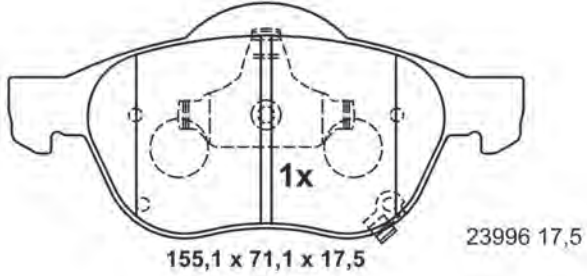
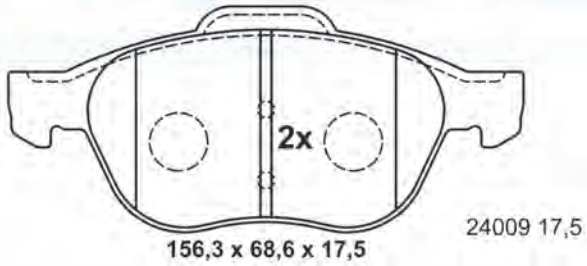

13.0460-5845.2 605845

B x H x D

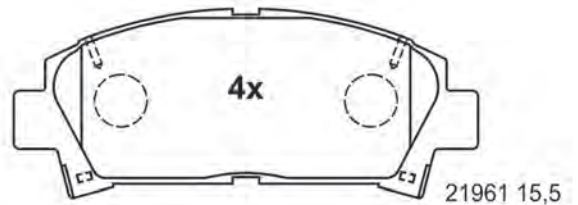

13.0460-5846.2 605846

B x H x D

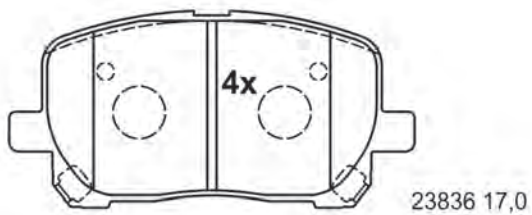

13.0460-5847.2 605847

B x H x D

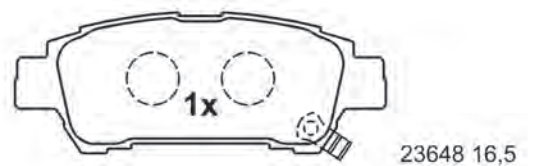
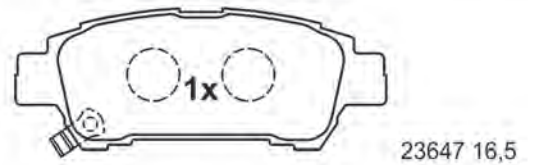
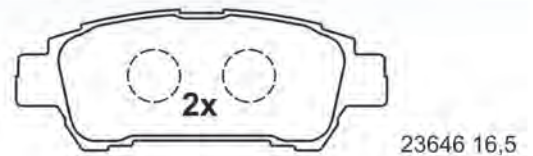

112,8 x 43,0 x 16,5



# Abbildungen Scheibenbremsbeläge

Illustrations disc brake pads - Ilustraciones de pastillas - Illustrations Plaquettes de frein à disque - Illustrazioni Pastiglie Freno

13.0460-5848.2 605848

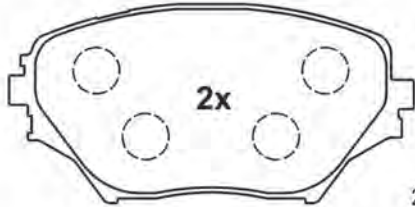

23585 17,4

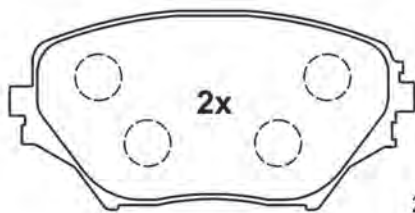

23586 17,4

123,0 x 60,4 x 17,4

13.0460-5849.2 605849

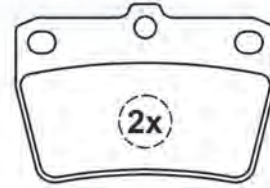

23656 14,0

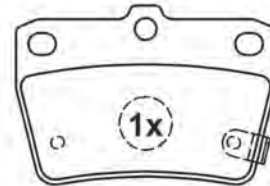

23658 14,0

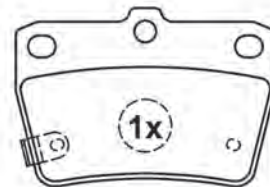

23657 14,0

78,5 x 54,1 x 14,0

13.0460-5850.2 605850

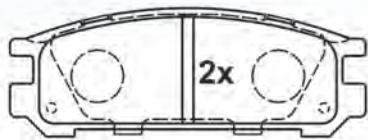

21703 15,0

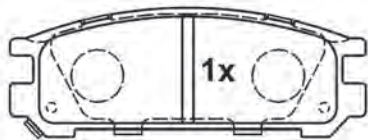

21704 15,0

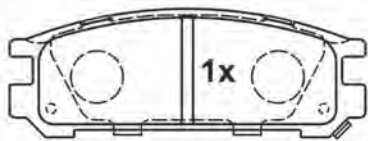

21705 15,0

107,8 x 38,7 x 15,0

13.0460-5851.2 605851

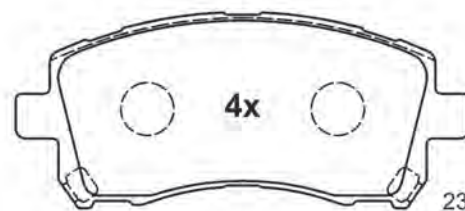

23558 17,2

137,7 x 59,6 x 17,2

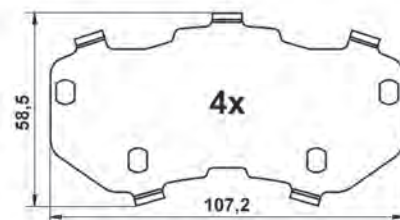



# Abbildungen Scheibenbremsbeläge

Illustrations disc brake pads - Ilustraciones de pastillas - Illustrations Plaquettes de frein à disque - Illustrazioni Pastiglie Freno

13.0460-5852.2 605852

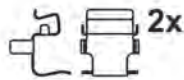
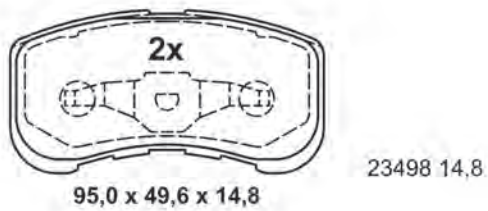
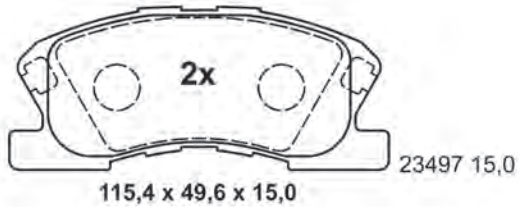

13.0460-5853.2 605853

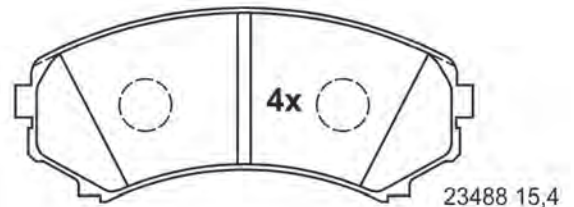

139,0 x 58,6 x 15,4



13.0460-5854.2 605854

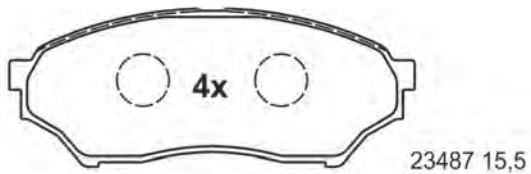

123,0 x 47,9 x 15,5

13.0460-5855.2 605855

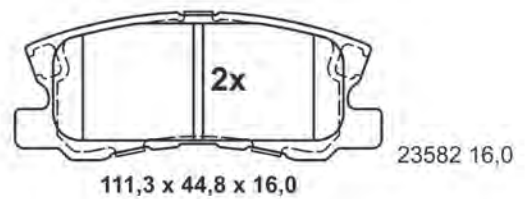

111,3 x 44,8 x 16,0

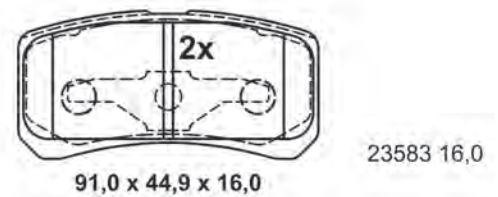

91,0 x 44,9 x 16,0

# Abbildungen Scheibenbremsbeläge

Illustrations disc brake pads - Ilustraciones de pastillas - Illustrations Plaquettes de frein à disque - Illustrazioni Pastiglie Freno

13.0460-5856.2 605856

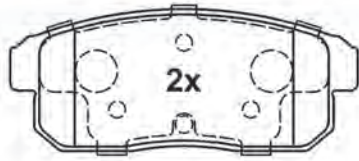

24039 14,4

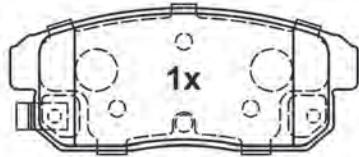

24040 14,4

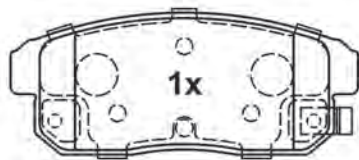

24041 14,4

105,6 x 43,1 x 14,4

13.0460-5857.2 605857

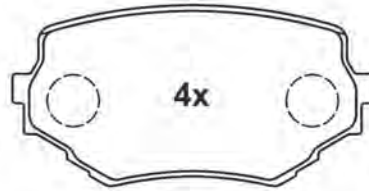

23313 15,0

110,1 x 55,0 x 15,0

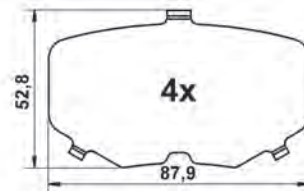

13.0460-5859.2 605859

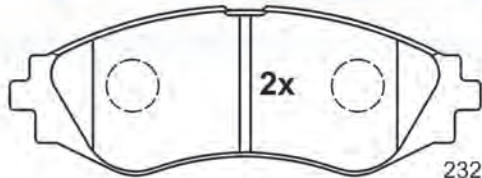

23234 16,9

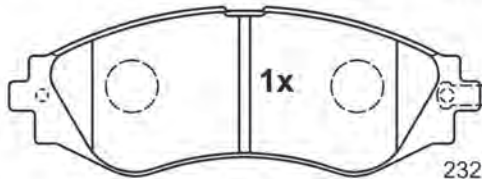

23235 16,9

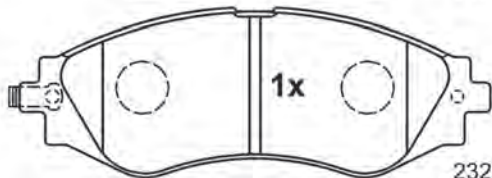

23236 16,9

143,0 x 51,2 x 16,9

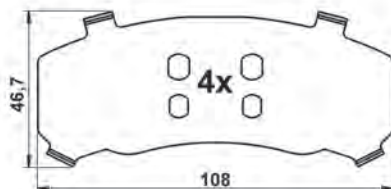

13.0460-5860.2 605860 [1]

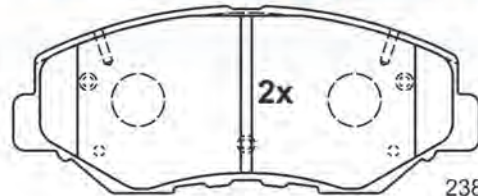

23868 17,1

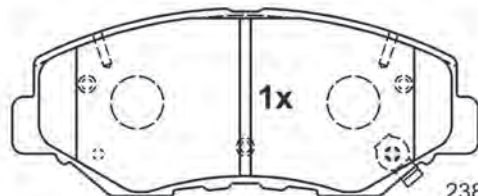

23869 17,1

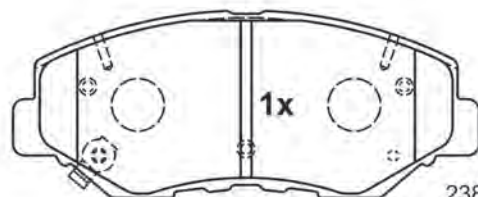

23870 17,1

141,7 x 56,7 x 17,1



# Abbildungen Scheibenbremsbeläge

Illustrations disc brake pads - Ilustraciones de pastillas - Illustrations Plaquettes de frein à disque - Illustrazioni Pastiglie Freno

13.0460-5860.2 605860 [2]

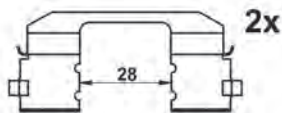
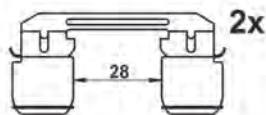
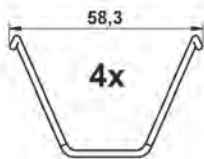
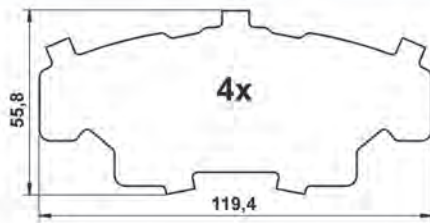

13.0460-5861.2 605861

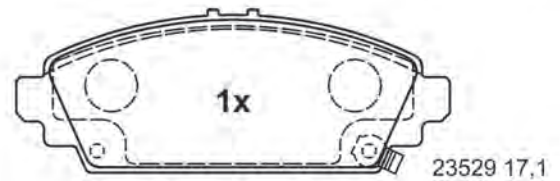
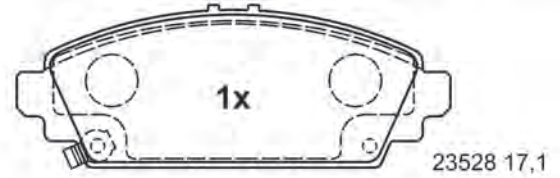
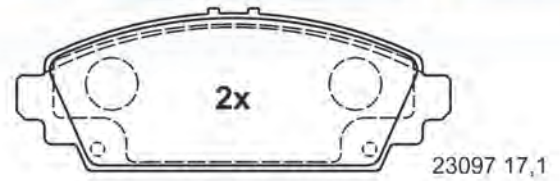

131,7 x 49,2 x 17,1

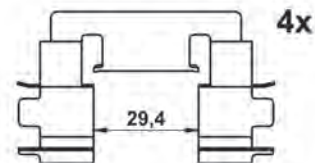

13.0460-5862.2 605862

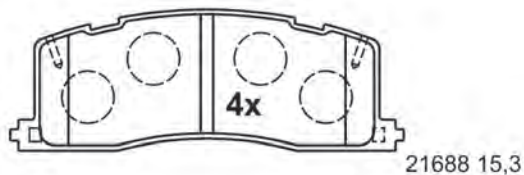

119,7 x 42,8 x 15,3

13.0460-5863.2 605863

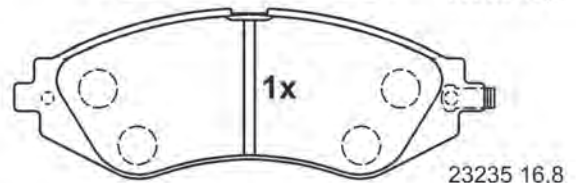
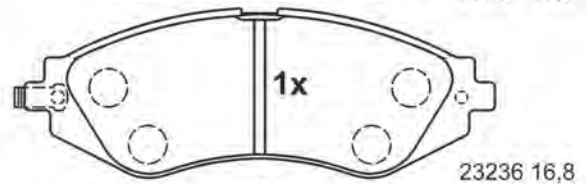
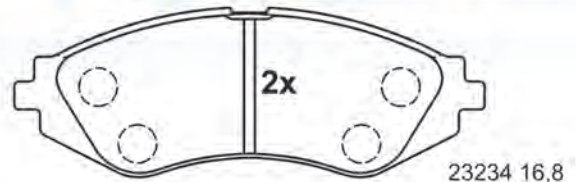

143,0 x 51,4 x 16,8

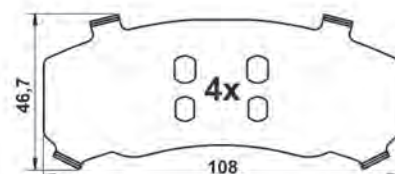

# Abbildungen Scheibenbremsbeläge

Illustrations disc brake pads - Ilustraciones de pastillas - Illustrations Plaquettes de frein à disque - Illustrazioni Pastiglie Freno

13.0460-5864.2 605864



21907 15,5

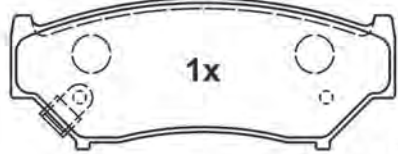

21908 15,5

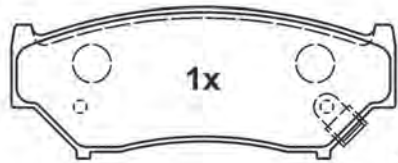

21909 15,5

116,6 x 45,6 x 15,5

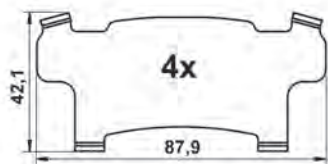

13.0460-5865.2 605865

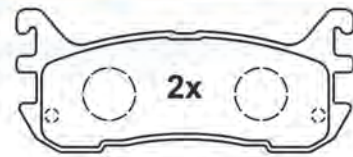

23387 12,6

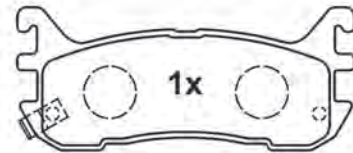

23388 12,6

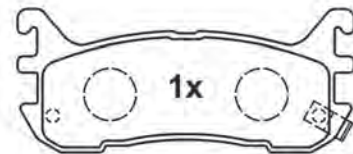

23389 12,6

102,2 x 43,0 x 12,6

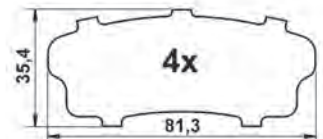
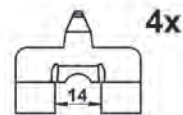

13.0460-5867.2 605867

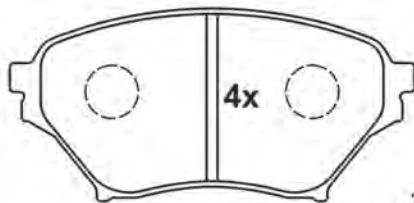

23863 14,3

123,1 x 58,5 x 14,3

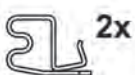
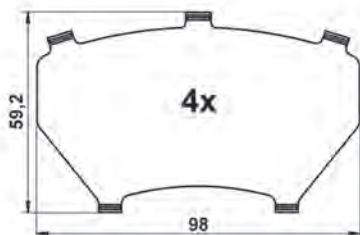

13.0460-5868.2 605868

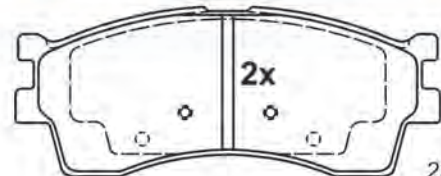

23873 16,5

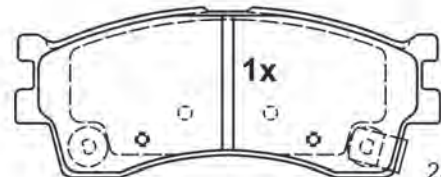

23874 16,5

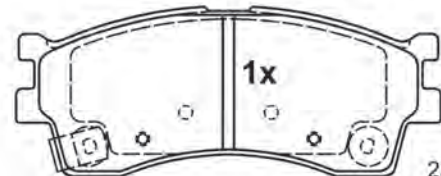

23875 16,5

129,0 x 51,3 x 16,5

# Abbildungen Scheibenbremsbeläge

Illustrations disc brake pads - Ilustraciones de pastillas - Illustrations Plaquettes de frein à disque - Illustrazioni Pastiglie Freno

13.0460-5869.2 605869

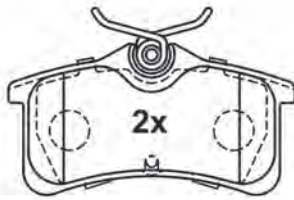

24013 14,9

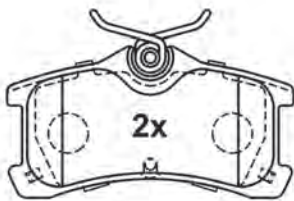

24020 14,9

87,0 x 46,0 x 14,9



13.0460-5871.2 605871

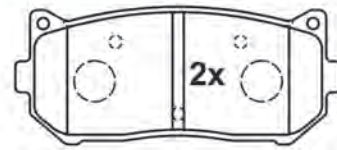

23455 13,7

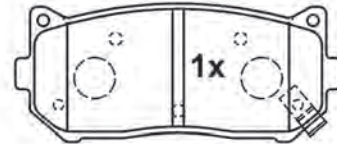

23456 13,7

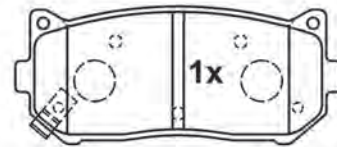

23457 13,7

98,8 x 41,8 x 13,7

13.0460-5872.2 605872

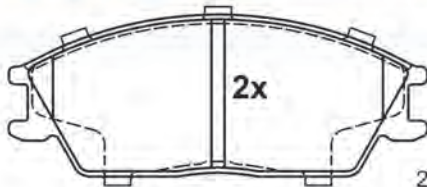

21012 15,0

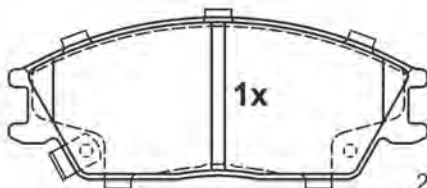

21773 15,0

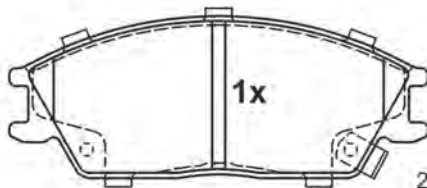

21774 15,0

127,5 x 49,0 x 15,0

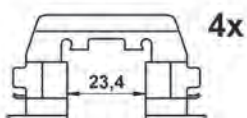

13.0460-5873.2 605873



23891 16,9

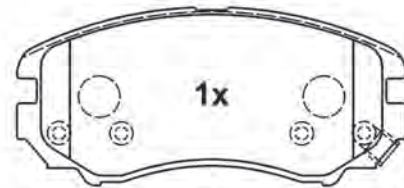

23892 16,9

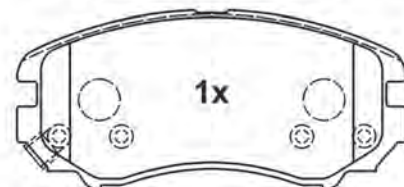

23893 16,9

131,5 x 60,3 x 16,9

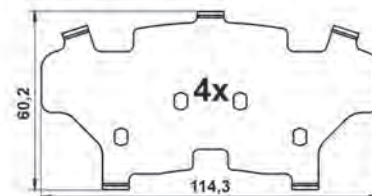



# Abbildungen Scheibenbremsbeläge

Illustrations disc brake pads - Ilustraciones de pastillas - Illustrations Plaquettes de frein à disque - Illustrazioni Pastiglie Freno

13.0460-5874.2 605874



21553 14,0

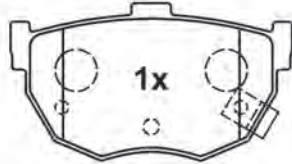

21554 14,0

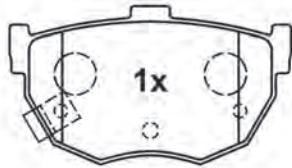

21555 14,0

85,3 x 46,6 x 14,0

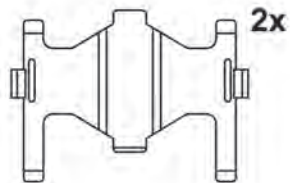
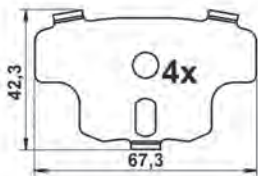

13.0460-5875.2 605875

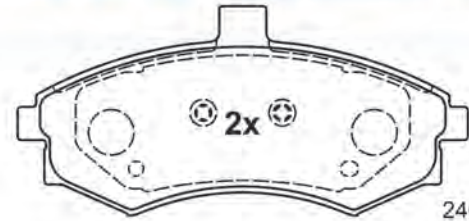

24033 17,7

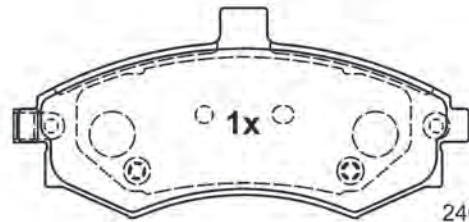

24031 17,7

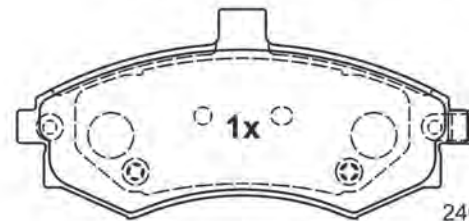

24032 17,7

137,3 x 63,5 x 17,7

13.0460-5876.2 605876

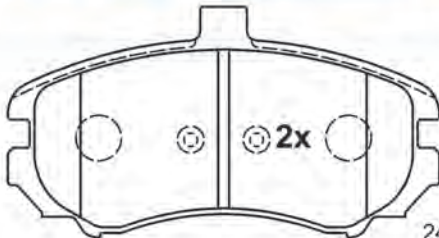

24369 17,2

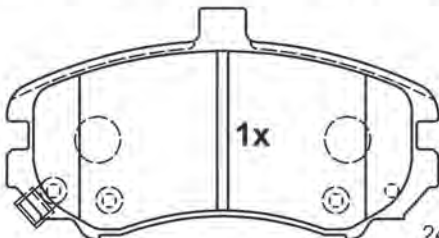

24374 17,2

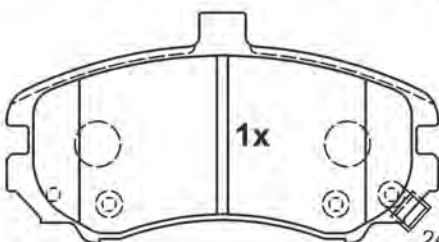

24373 17,2

131,2 x 70,1 x 17,2

13.0460-5877.2 605877

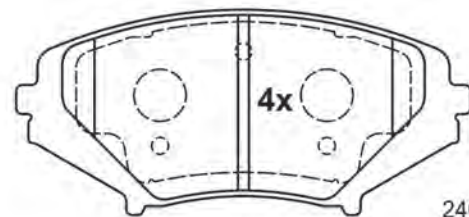

24042 16,3

137,9 x 62,1 x 16,3

# Abbildungen Scheibenbremsbeläge

Illustrations disc brake pads - Ilustraciones de pastillas - Illustrations Plaquettes de frein à disque - Illustrazioni Pastiglie Freno

13.0460-5878.2 605878

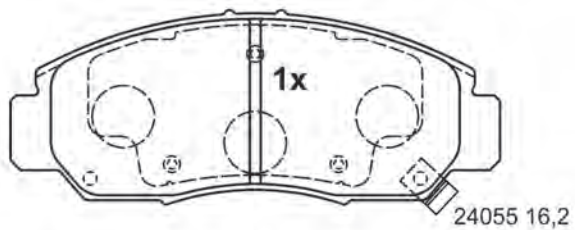
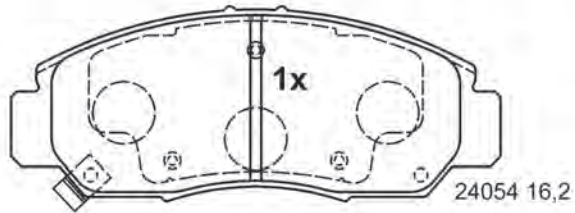
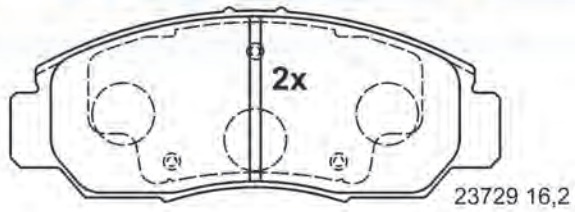

148,7 x 59,0 x 16,2

13.0460-5879.2 605879

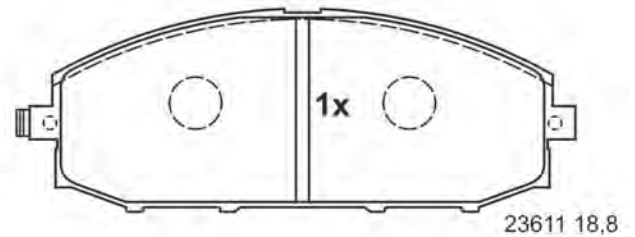
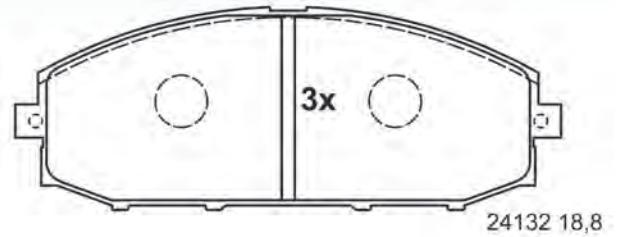

165,8 x 61,4 x 18,8

13.0460-5880.2 605880

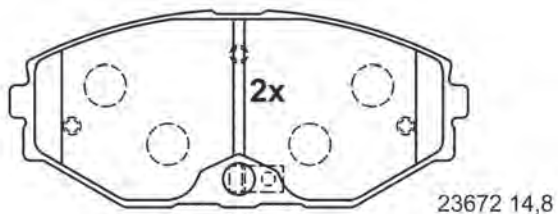
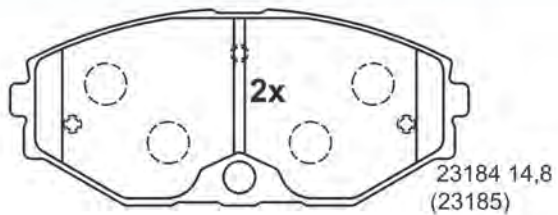

139,1 x 59,5 x 14,8

13.0460-5881.2 605881

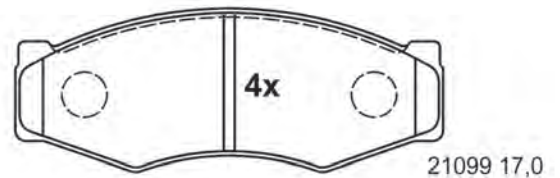

130,0 x 49,5 x 17,0



# Abbildungen Scheibenbremsbeläge

Illustrations disc brake pads - Ilustraciones de pastillas - Illustrations Plaquettes de frein à disque - Illustrazioni Pastiglie Freno

13.0460-5882.2 605882

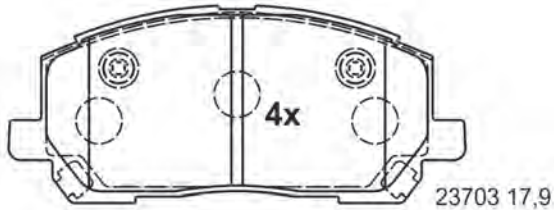

23703 17,9

138,7 x 59,6 x 17,9

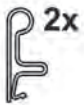

13.0460-5884.2 605884

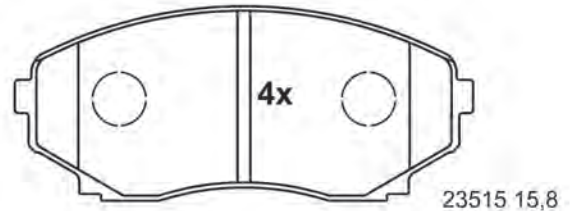

23515 15,8

139,2 x 60,2 x 15,8

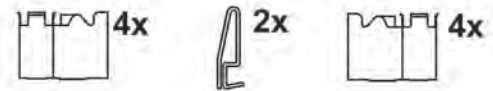
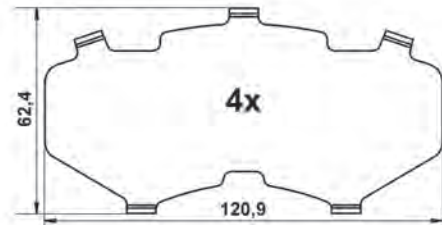

13.0460-5885.2 605885

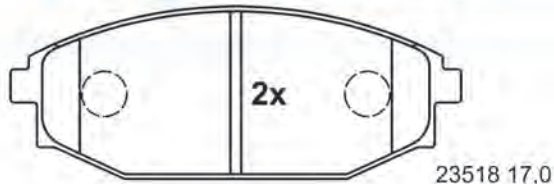

23518 17,0

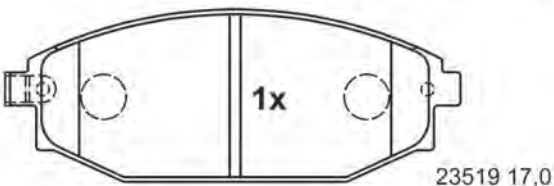

23519 17,0

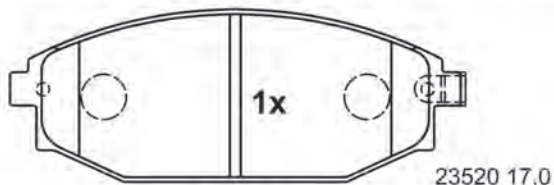

23520 17,0

137,1 x 52,4 x 17,0

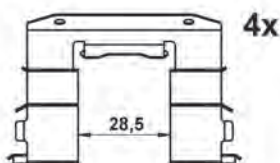

28,5

13.0460-5886.2 605886

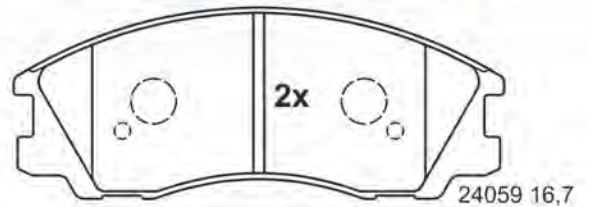

24059 16,7

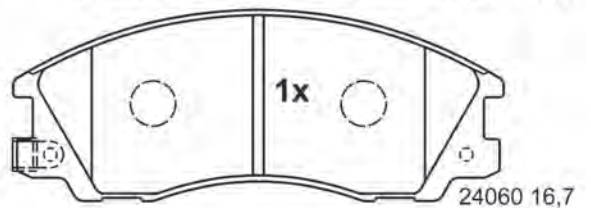

24060 16,7

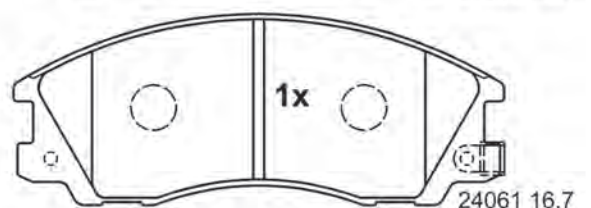

24061 16,7

148,8 x 58,0 x 16,7

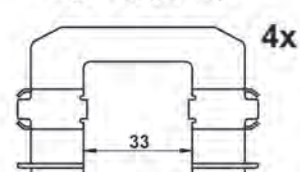

33

# Abbildungen Scheibenbremsbeläge

Illustrations disc brake pads - Ilustraciones de pastillas - Illustrations Plaquettes de frein à disque - Illustrazioni Pastiglie Freno

13.0460-5887.2 605887

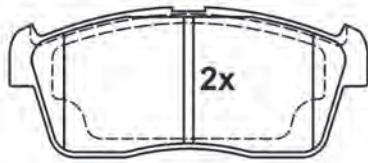

23507 15,2

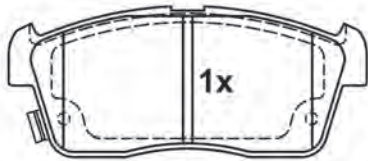

23508 15,2

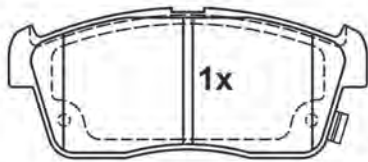

23509 15,2

108,4 x 45,6 x 15,2

13.0460-5888.2 605888

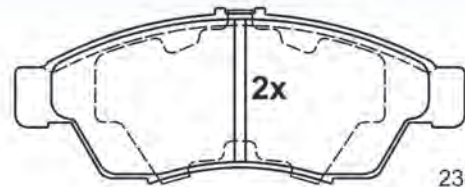

23817 16,6

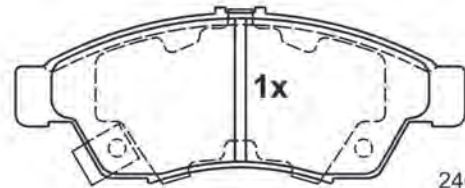

24034 16,6

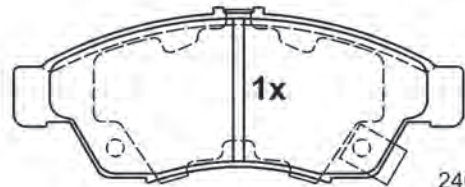

24035 16,6

136,5 x 53,3 x 16,6

13.0460-5889.2 605889

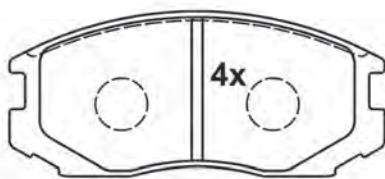

21650 15,0

114,1 x 50,0 x 15,0

13.0460-5890.2 605890

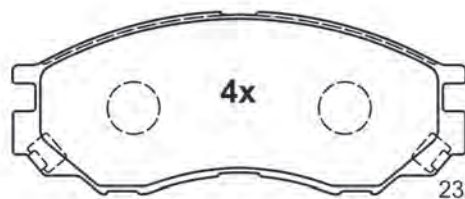

23290 15,5

137,6 x 55,1 x 15,5

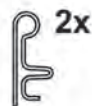

# Abbildungen Scheibenbremsbeläge

Illustrations disc brake pads - Ilustraciones de pastillas - Illustrations Plaquettes de frein à disque - Illustrazioni Pastiglie Freno

13.0460-5891.2 605891

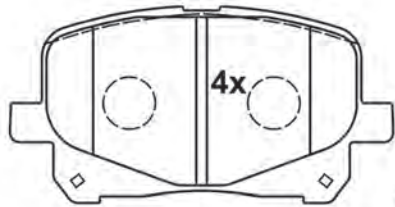

23513 17,0

116,6 x 59,4 x 17,0

13.0460-5892.2 605892

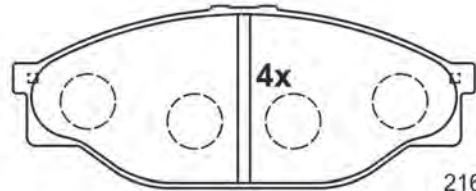

21689 15,5

140,1 x 54,9 x 15,5

13.0460-5894.2 605894

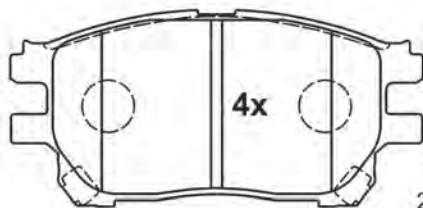

23759 17,0

125,6 x 59,5 x 17,0

13.0460-5895.2 605895

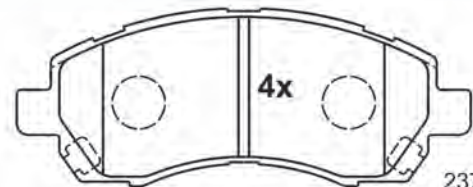

23780 16,7

137,8 x 53,8 x 16,7

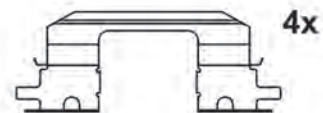
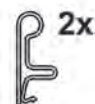
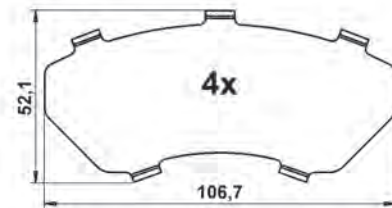



# Abbildungen Scheibenbremsbeläge

Illustrations disc brake pads - Ilustraciones de pastillas - Illustrations Plaquettes de frein à disque - Illustrazioni Pastiglie Freno

13.0460-5896.2 605896

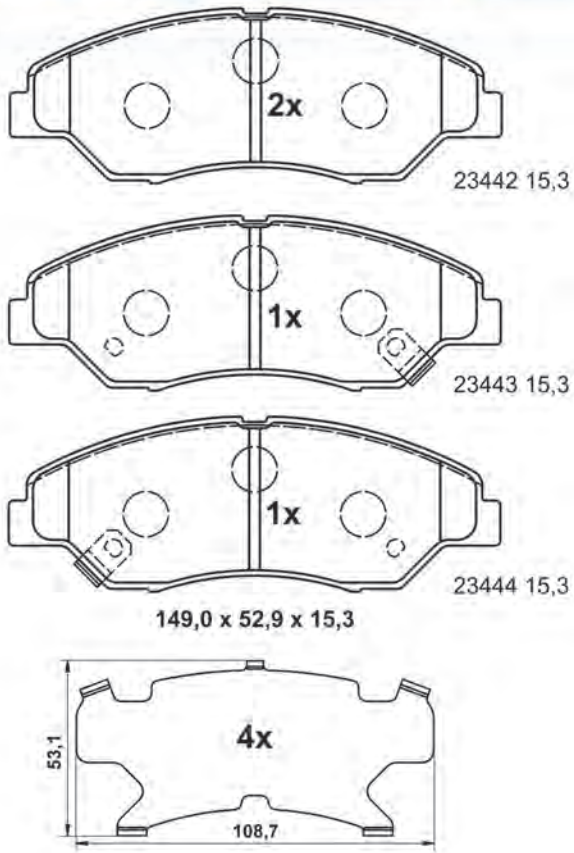

13.0460-5897.2 605897

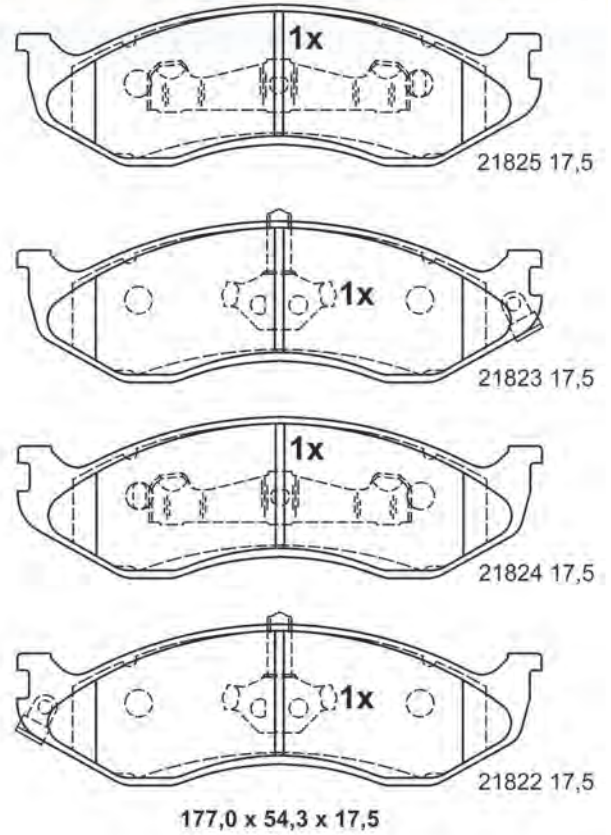

13.0460-5898.2 605898

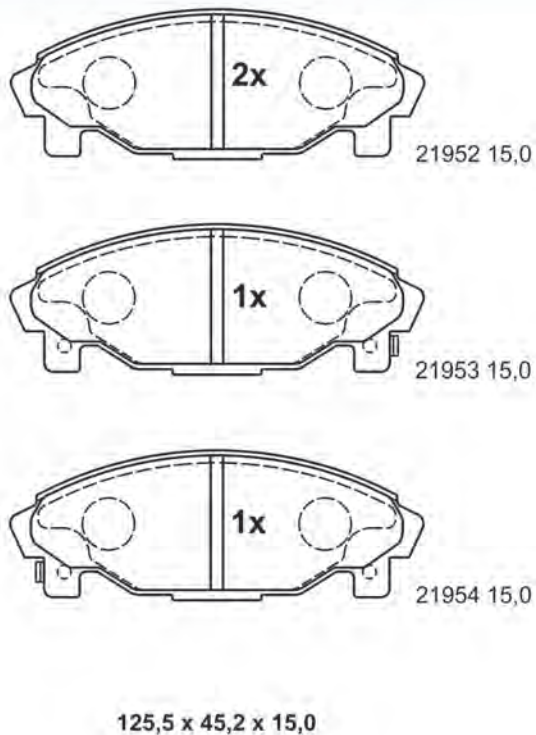

13.0460-5899.2 605899

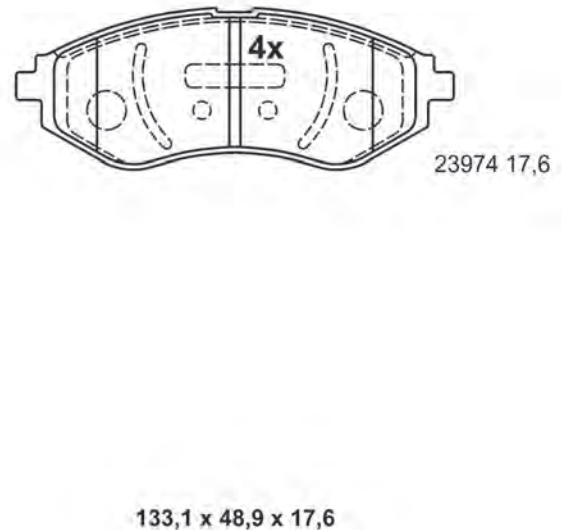

# Abbildungen Scheibenbremsbeläge

Illustrations disc brake pads - Ilustraciones de pastillas - Illustrations Plaquettes de frein à disque - Illustrazioni Pastiglie Freno

13.0460-5916.2 605916

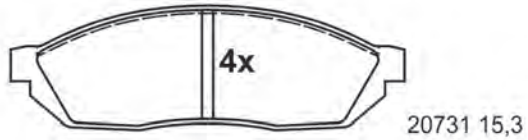

119,4 x 38,2 x 15,3

13.0460-5920.2 605920

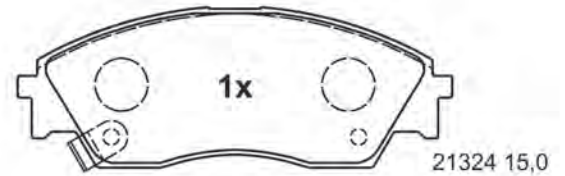
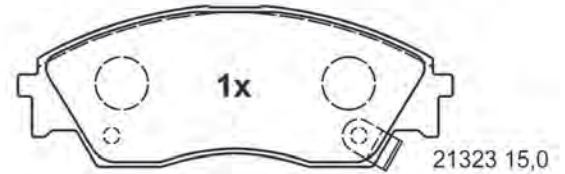
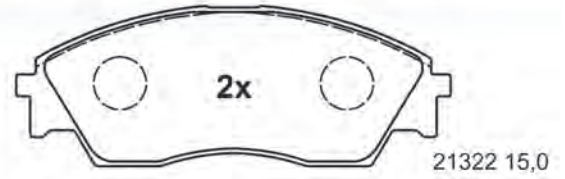

132,2 x 49,2 x 15,0

13.0460-5924.2 605924

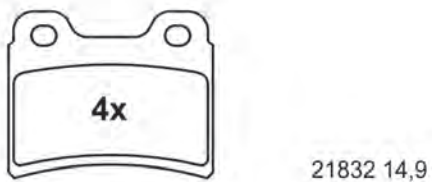

61,7 x 51,1 x 14,9

13.0460-5926.2 605926

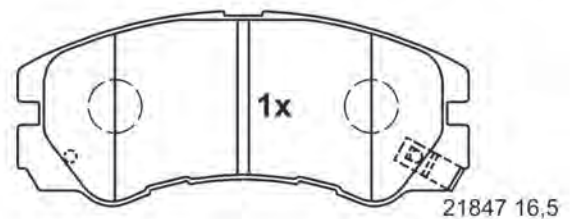
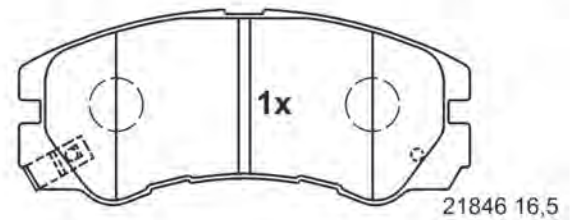
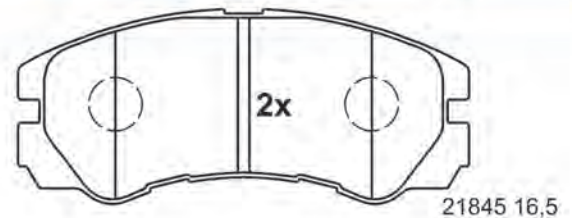

137,7 x 58,6 x 16,5



# Abbildungen Scheibenbremsbeläge

Illustrations disc brake pads - Ilustraciones de pastillas - Illustrations Plaquettes de frein à disque - Illustrazioni Pastiglie Freno

13.0460-5927.2 605927

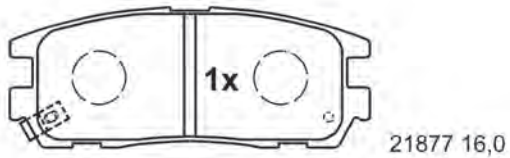
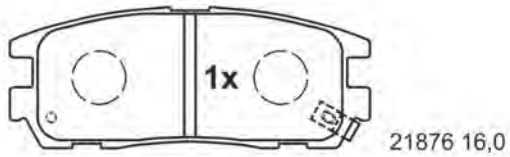
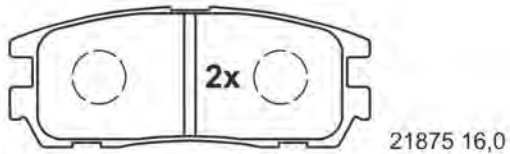

109,6 x 42,8 x 16,0

13.0460-5929.2 605929

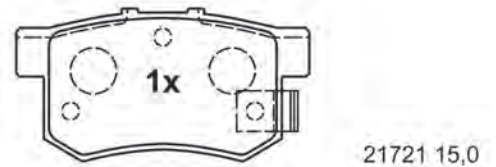
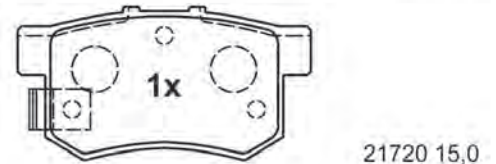
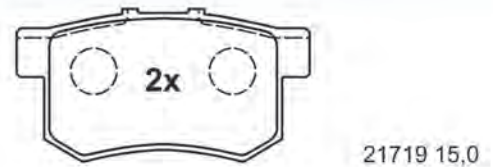

88,9 x 47,1 x 15,0

13.0460-5932.2 605932

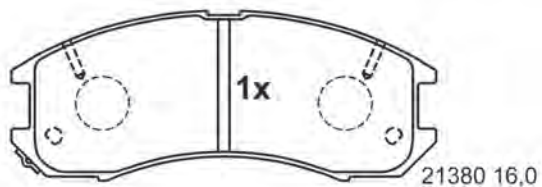
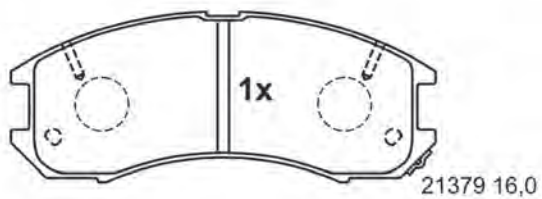
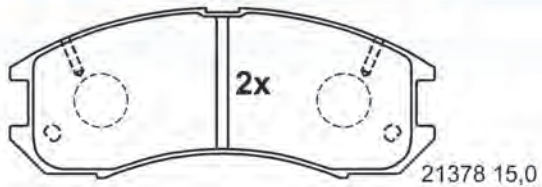

130,0 x 52,5 x 16,0

13.0460-5933.2 605933

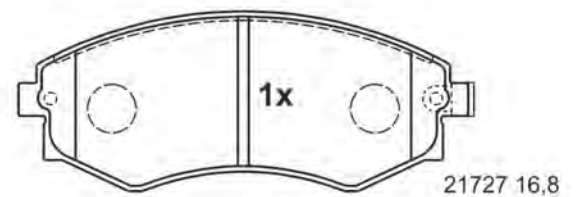
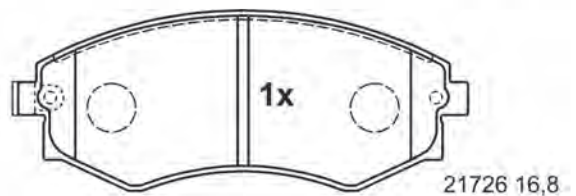
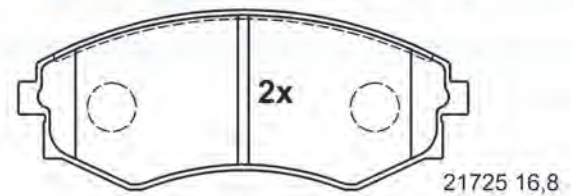

137,0 x 54,5 x 16,8



# Abbildungen Scheibenbremsbeläge

Illustrations disc brake pads - Ilustraciones de pastillas - Illustrations Plaquettes de frein à disque - Illustrazioni Pastiglie Freno

13.0460-5935.2 605935

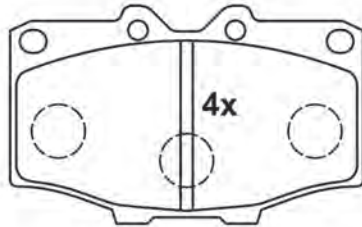

20852 15,5

107,1 x 65,7 x 15,5

13.0460-5936.2 605936

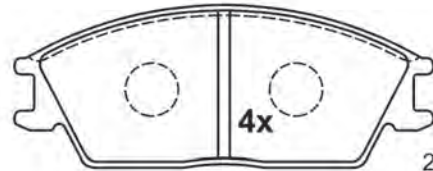

21012 15,0

127,5 x 49,0 x 15,0

13.0460-5937.2 605937

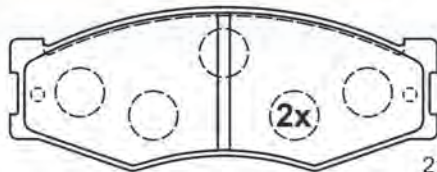

21229 17,0

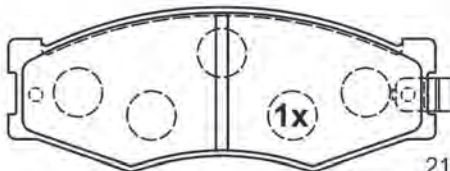

21119 17,0

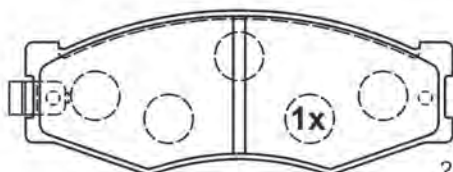

21130 17,0

130,2 x 49,7 x 17,0

13.0460-5938.2 605938

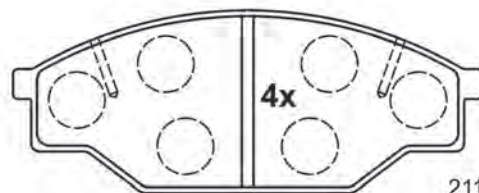

21158 15,5

142,7 x 55,5 x 15,5

# Abbildungen Scheibenbremsbeläge

Illustrations disc brake pads - Ilustraciones de pastillas - Illustrations Plaquettes de frein à disque - Illustrazioni Pastiglie Freno

13.0460-5940.2 605940

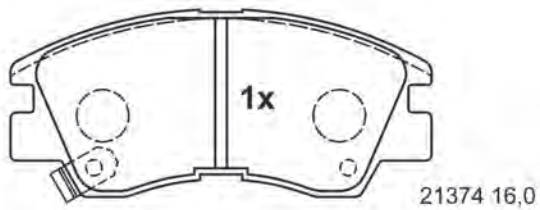
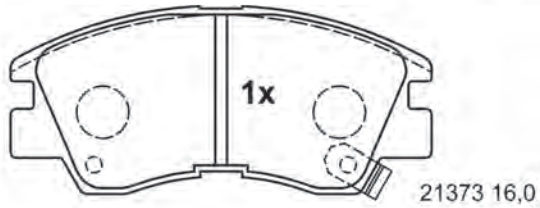
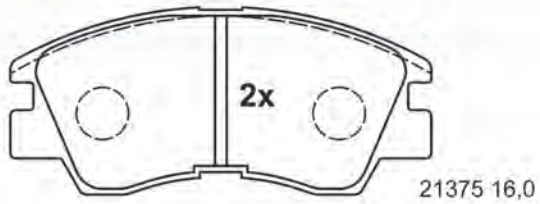

127,9 x 57,1 x 16,0

13.0460-5942.2 605942

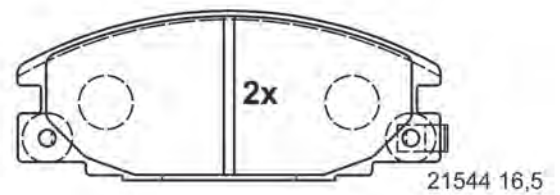
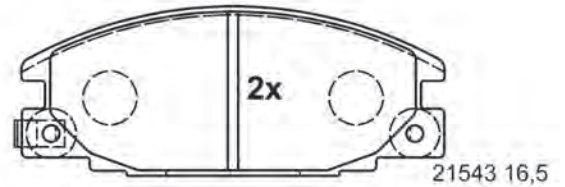

127,1 x 50,9 x 16,5

13.0460-5943.2 605943

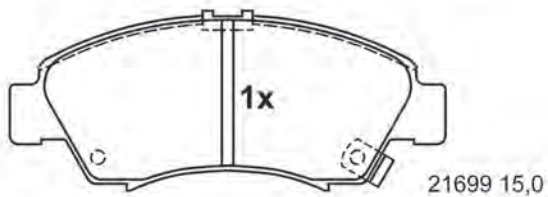
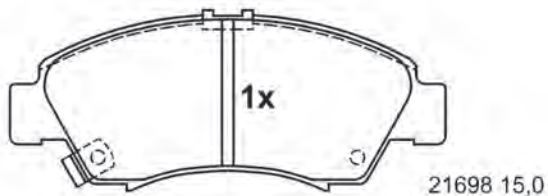
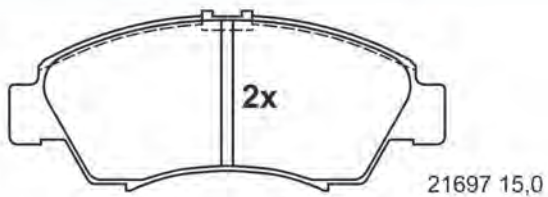

131,3 x 54,6 x 15,0

13.0460-5944.2 605944

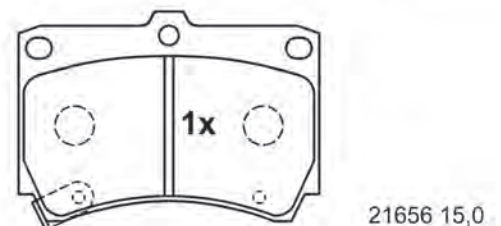
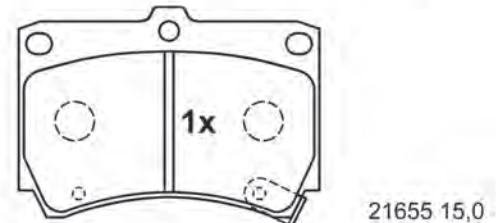
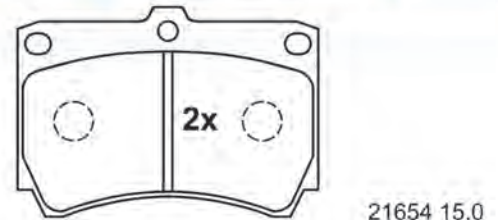

91,6 x 64,2 x 15,0



# Abbildungen Scheibenbremsbeläge

Illustrations disc brake pads - Ilustraciones de pastillas - Illustrations Plaquettes de frein à disque - Illustrazioni Pastiglie Freno

13.0460-5949.2 605949

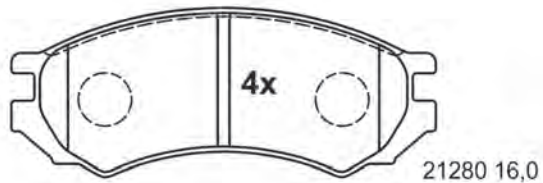

127,6 x 50,4 x 16,0

13.0460-5950.2 605950

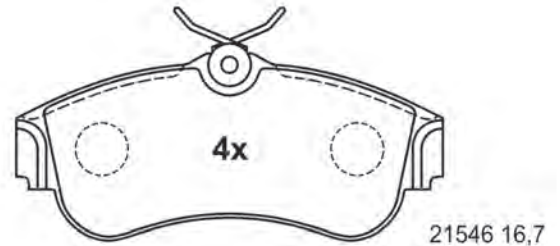

129,2 x 57,4 x 16,7

13.0460-5951.2 605951

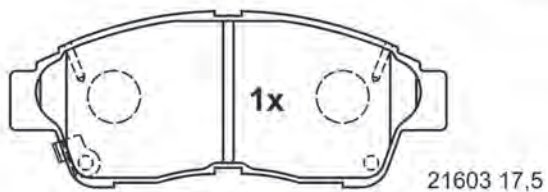
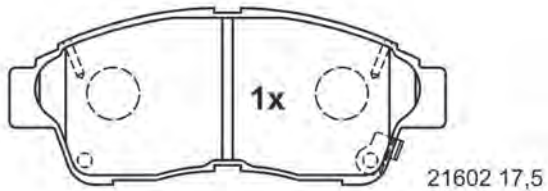
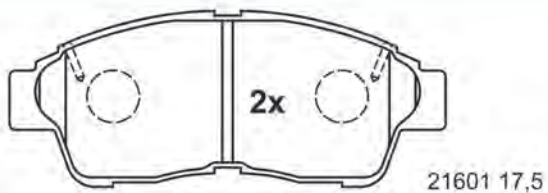

133,0 x 53,0 x 17,5

13.0460-5952.2 605952

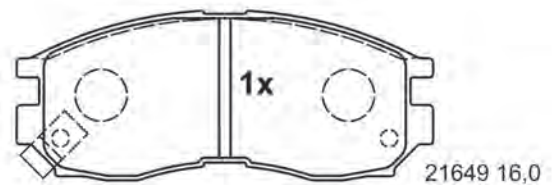
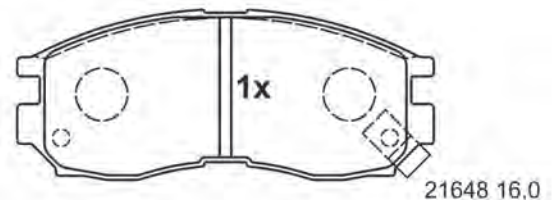
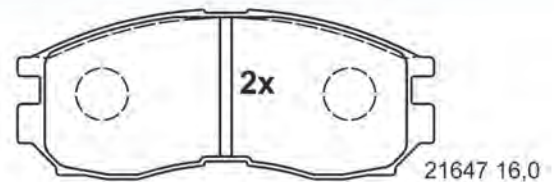

128,0 x 52,1 x 16,0

# Abbildungen Scheibenbremsbeläge

Illustrations disc brake pads - Ilustraciones de pastillas - Illustrations Plaquettes de frein à disque - Illustrazioni Pastiglie Freno

13.0460-5953.2 605953

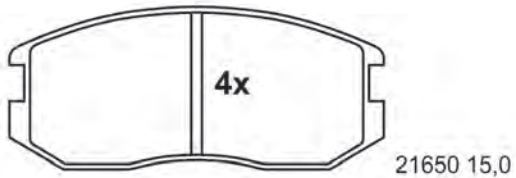

21650 15,0

114,1 x 50,0 x 15,0

13.0460-5954.2 605954

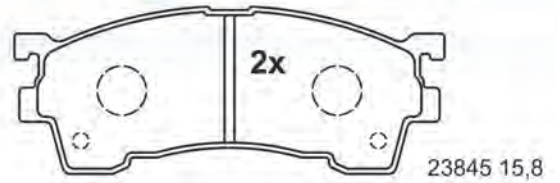

23845 15,8

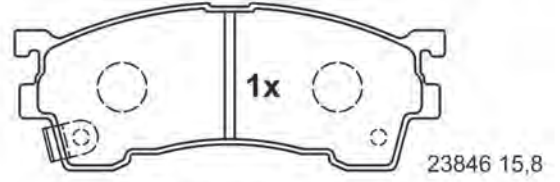

23846 15,8

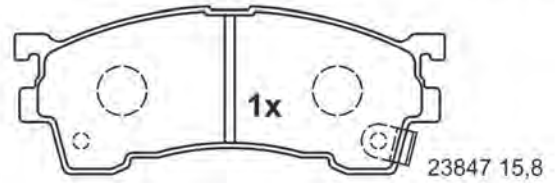

23847 15,8

132,1 x 51,6 x 15,8

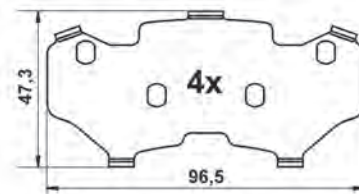

13.0460-5955.2 605955

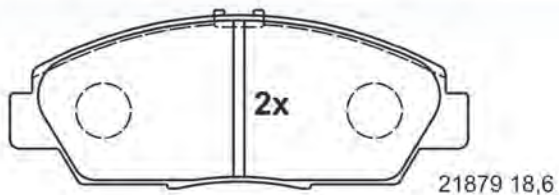

21879 18,6

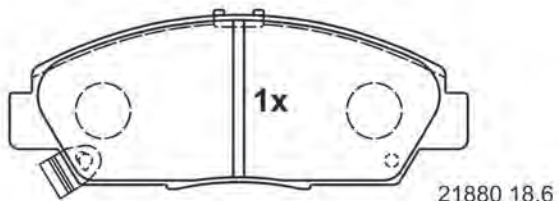

21880 18,6

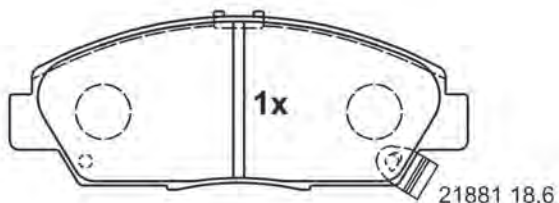

21881 18,6

137,8 x 53,8 x 18,6

13.0460-5956.2 605956

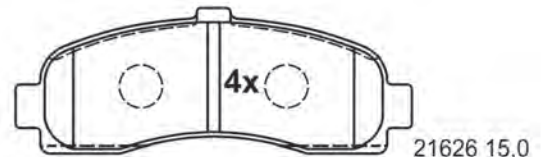

21626 15,0

120,8 x 45,0 x 15,0



# Abbildungen Scheibenbremsbeläge

Illustrations disc brake pads - Ilustraciones de pastillas - Illustrations Plaquettes de frein à disque - Illustrazioni Pastiglie Freno

13.0460-5957.2 605957

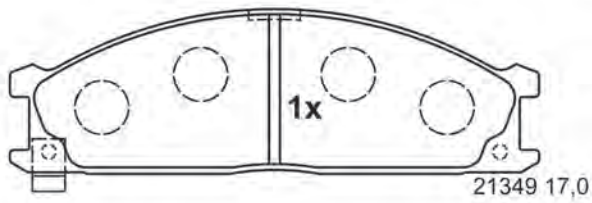
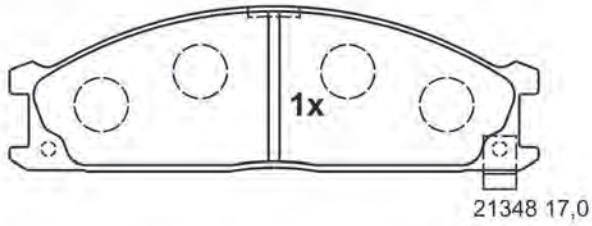
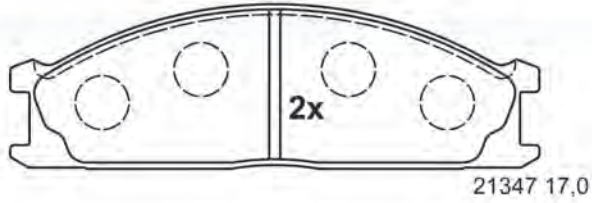

160,6 x 49,3 x 17,0

13.0460-5958.2 605958

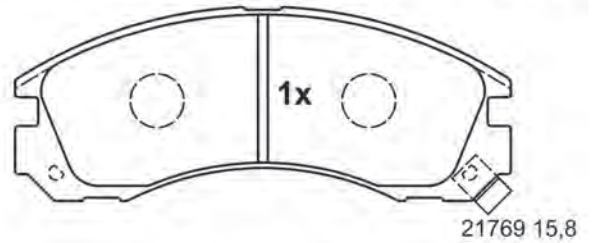
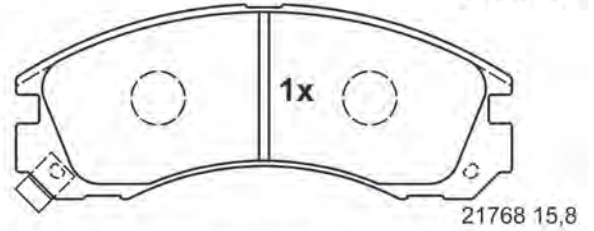
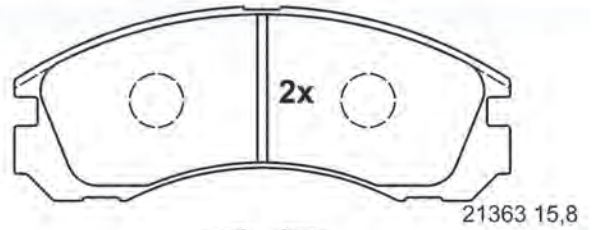

149,9 x 58,8 x 15,8

13.0460-5959.2 605959

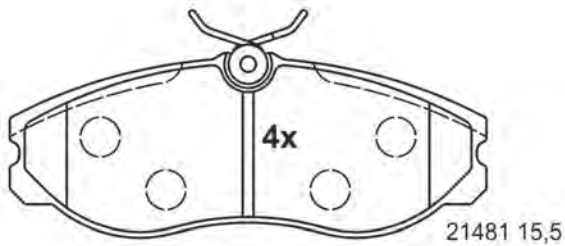

144,9 x 55,6 x 15,5

13.0460-5960.2 605960

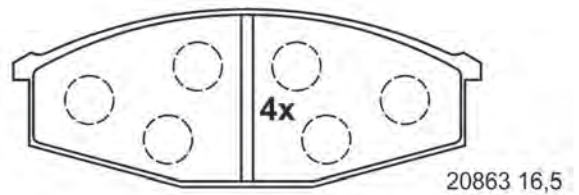

142,1 x 53,5 x 16,5

# Abbildungen Scheibenbremsbeläge

Illustrations disc brake pads - Ilustraciones de pastillas - Illustrations Plaquettes de frein à disque - Illustrazioni Pastiglie Freno

13.0460-5966.2 605966

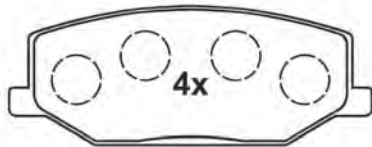

21142 15,0

110,4 x 41,6 x 15,0

13.0460-5967.2 605967

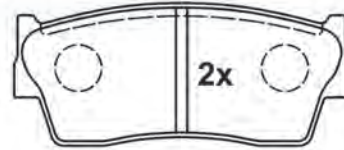

21500 15,0

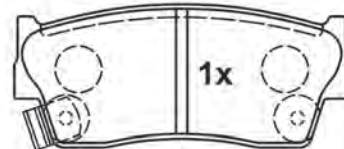

21501 15,0

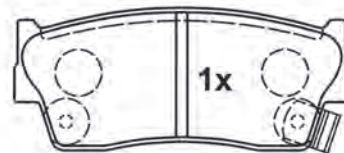

21502 15,0

103,4 x 43,7 x 15,0

13.0460-5968.2 605968

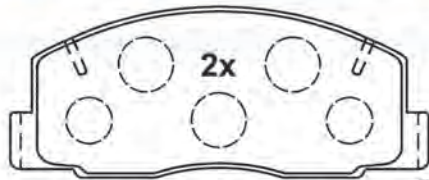

21369 15,5

128,3 x 52,1 x 15,5

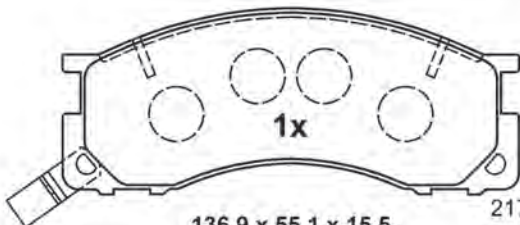

21780 15,5

136,9 x 55,1 x 15,5

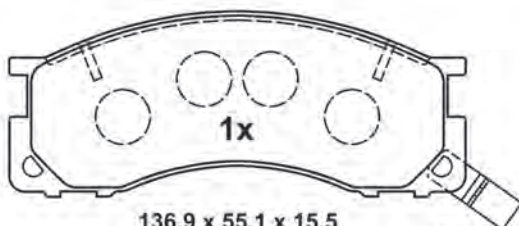

21781 15,5

136,9 x 55,1 x 15,5

13.0460-5969.2 605969



21948 13,5

131,9 x 54,3 x 13,5

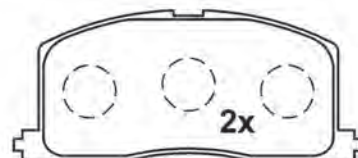

21949 13,5

106,1 x 45,7 x 13,5



# Abbildungen Scheibenbremsbeläge

Illustrations disc brake pads - Ilustraciones de pastillas - Illustrations Plaquettes de frein à disque - Illustrazioni Pastiglie Freno

13.0460-5970.2 605970



21357 13,5



21355 13,5

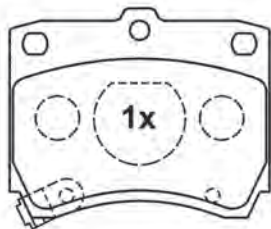

21356 13,5

78,7 x 63,4 x 13,5

13.0460-5972.2 605972

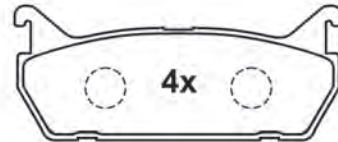

21559 11,5

102,3 x 39,3 x 11,5

13.0460-5973.2 605973

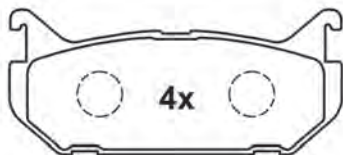

21766 13,5

99,9 x 43,6 x 13,5

13.0460-5974.2 605974

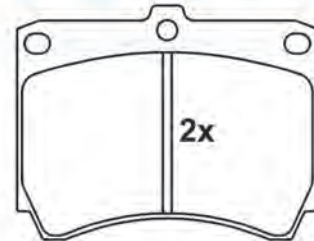

21539 15,0

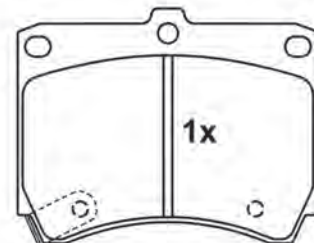

21540 15,0

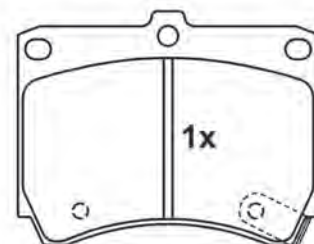

21541 15,0

91,6 x 70,5 x 15,0



# Abbildungen Scheibenbremsbeläge

Illustrations disc brake pads - Ilustraciones de pastillas - Illustrations Plaquettes de frein à disque - Illustrazioni Pastiglie Freno

13.0460-5976.2 605976

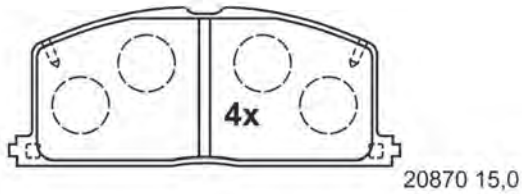

20870 15,0

119,8 x 47,6 x 15,0

13.0460-5978.2 605978

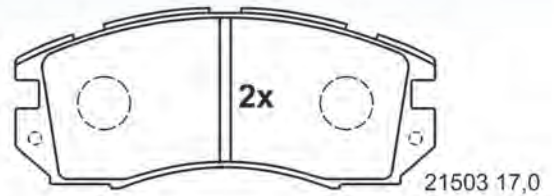

21503 17,0

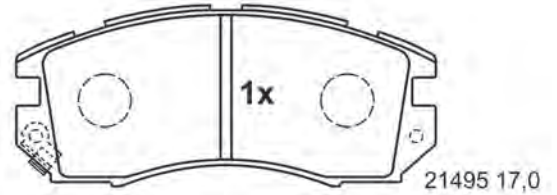

21495 17,0

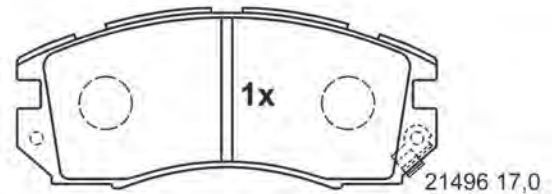

21496 17,0

127,7 x 54,4 x 17,0

13.0460-5980.2 605980

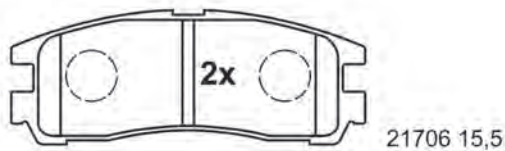

21706 15,5

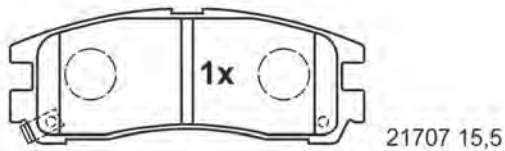

21707 15,5

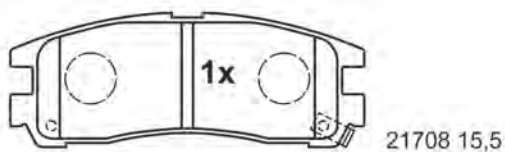

21708 15,5

107,7 x 41,3 x 15,5

13.0460-5981.2 605981

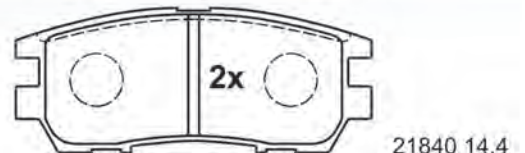

21840 14,4

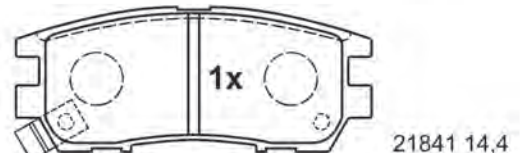

21841 14,4

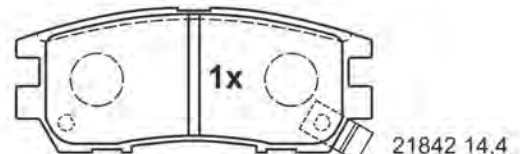

21842 14,4

107,8 x 43,8 x 14,4

# Abbildungen Scheibenbremsbeläge

Illustrations disc brake pads - Ilustraciones de pastillas - Illustrations Plaquettes de frein à disque - Illustrazioni Pastiglie Freno

13.0460-5982.2 605982

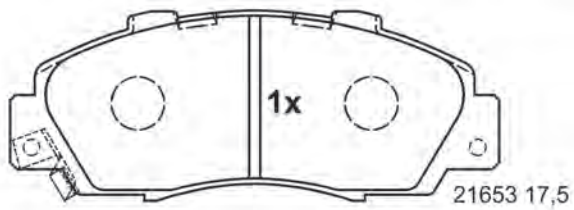
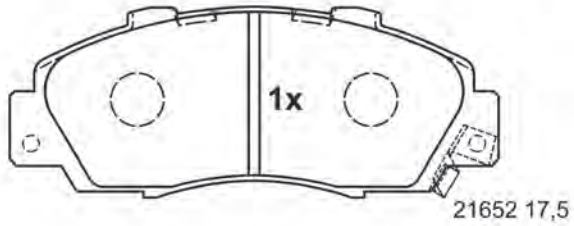
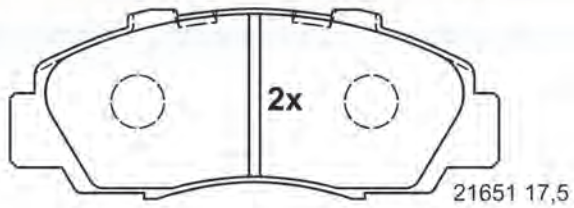

148,7 x 57,8 x 17,5

13.0460-5983.2 605983

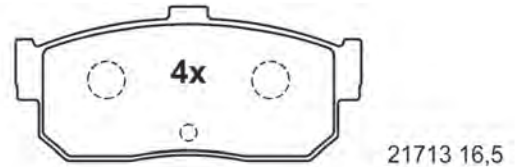

105,3 x 47,0 x 16,5

13.0460-5985.2 605985

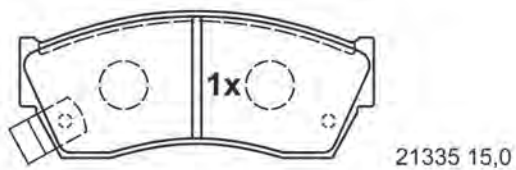
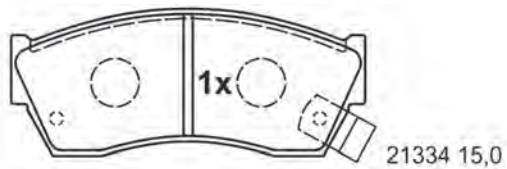
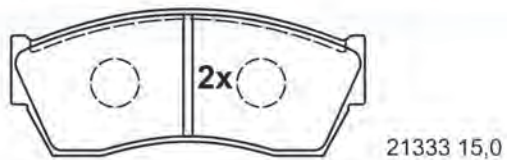

107,5 x 44,6 x 15,0

13.0460-5986.2 605986

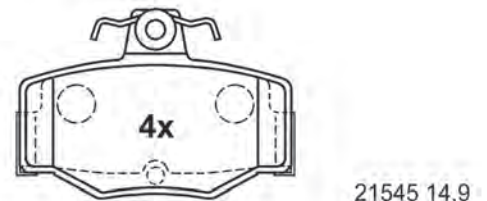

82,2 x 57,0 x 14,9



# Abbildungen Scheibenbremsbeläge

Illustrations disc brake pads - Ilustraciones de pastillas - Illustrations Plaquettes de frein à disque - Illustrazioni Pastiglie Freno

13.0460-5987.2 605987

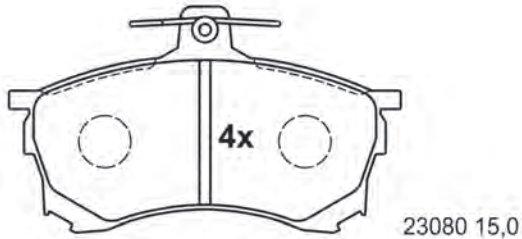

23080 15,0

119,3 x 68,6 x 15,0

13.0460-5988.2 605988

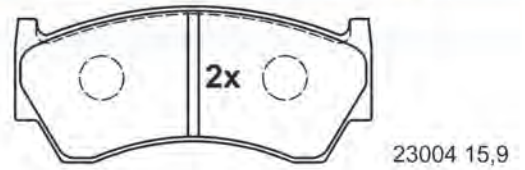

23004 15,9

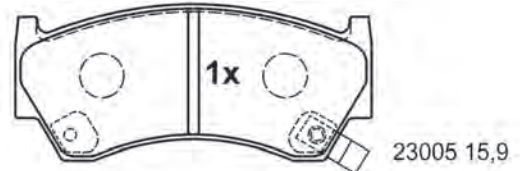

23005 15,9

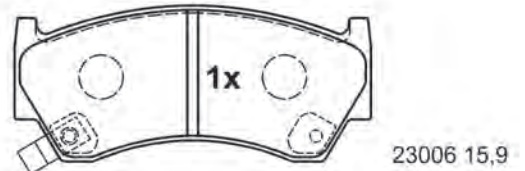

23006 15,9

108,6 x 47,9 x 15,9

13.0460-5989.2 605989



23454 14,9

88,7 x 45,4 x 14,9

13.0460-5992.2 605992

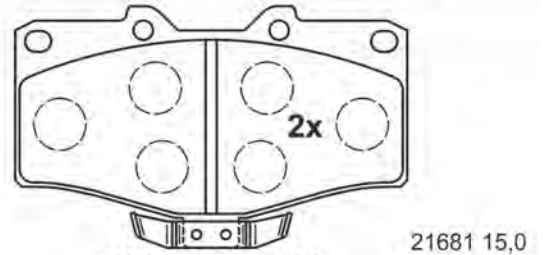

21681 15,0

119,3 x 73,5 x 15,0

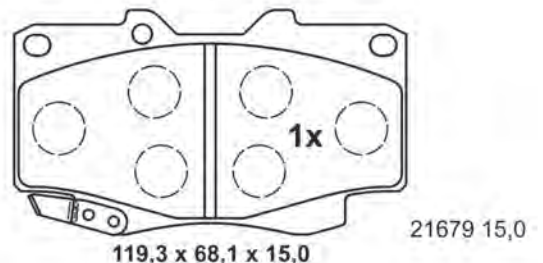

21679 15,0

119,3 x 68,1 x 15,0

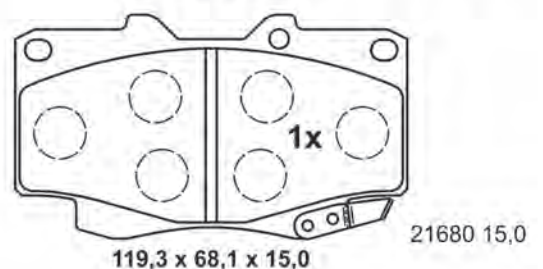

21680 15,0

119,3 x 68,1 x 15,0

# Abbildungen Scheibenbremsbeläge

Illustrations disc brake pads - Ilustraciones de pastillas - Illustrations Plaquettes de frein à disque - Illustrazioni Pastiglie Freno

13.0460-5993.2 605993

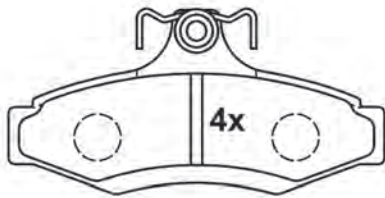

23237 14,5

114,0 x 55,1 x 14,5

13.0460-5994.2 605994

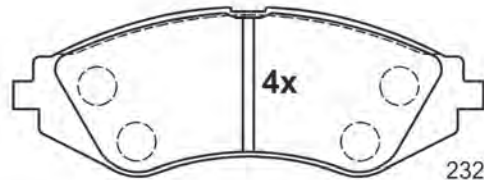

23234 16,8

143,0 x 51,4 x 16,8

13.0460-5995.2 605995

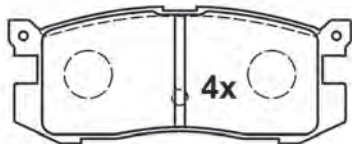

21558 13,0

104,2 x 41,6 x 13,0

13.0460-5996.2 605996

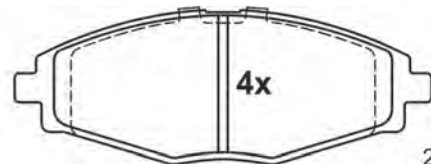

23241 16,1

127,1 x 48,2 x 16,1

# Abbildungen Scheibenbremsbeläge

Illustrations disc brake pads - Ilustraciones de pastillas - Illustrations Plaquettes de frein à disque - Illustrazioni Pastiglie Freno

13.0460-5998.2 605998

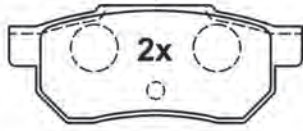

21312 12,8

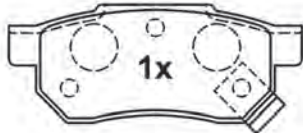

21313 12,8

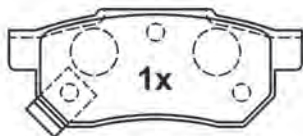

21314 12,8

89,0 x 35,2 x 12,8

13.0460-6015.2 606015

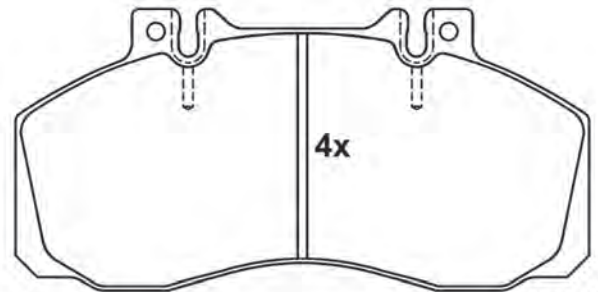

29835 22,0

174,6 x 85,5 x 22,0

13.0460-6033.2 606033

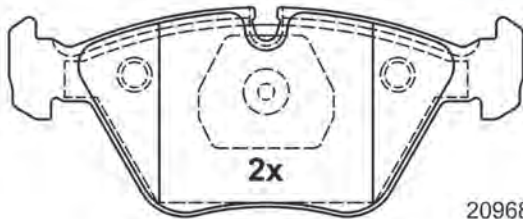

20968 20,3

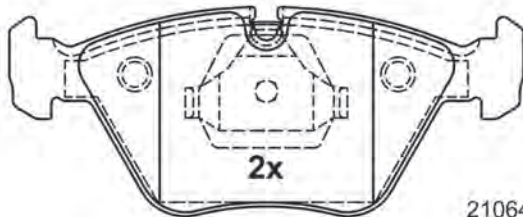

21064 20,3

156,3 x 63,5 x 20,3

13.0460-6036.2 606036

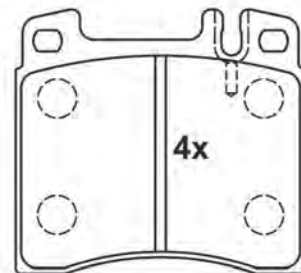

21304 18,5

89,5 x 81,2 x 18,5

# Abbildungen Scheibenbremsbeläge

Illustrations disc brake pads - Ilustraciones de pastillas - Illustrations Plaquettes de frein à disque - Illustrazioni Pastiglie Freno

13.0460-6914.2 606914



20038 14,0

74,2 x 64,1 x 14,0

13.0460-6916.2 606916



21459 18,5

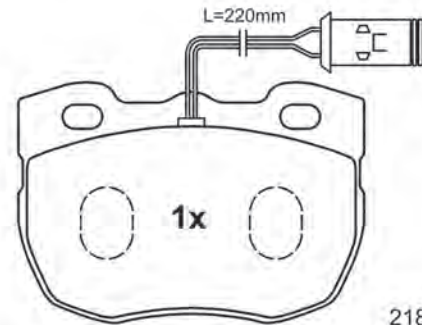

21897 18,5

104,8 x 72,4 x 18,5

13.0460-6917.2 606917

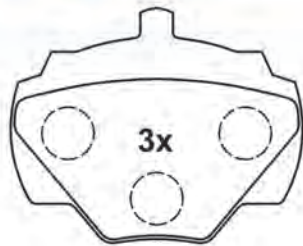

21237 15,5  
(21238)

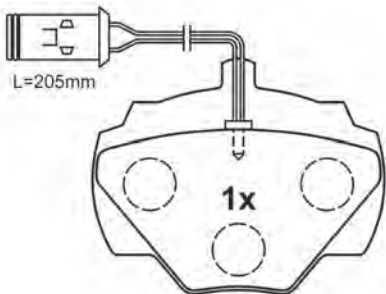

21514 15,5

88,6 x 72,1 x 15,5

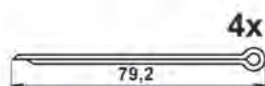
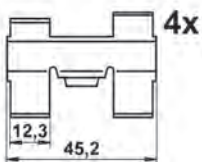

13.0460-6921.2 606921

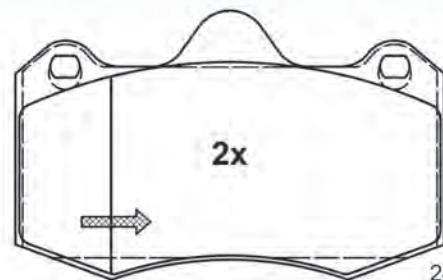

24974 16,8

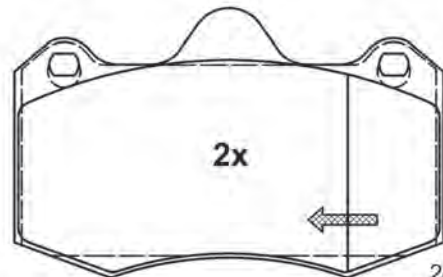

24974 16,8

130,0 x 81,6 x 16,8



# Abbildungen Scheibenbremsbeläge

Illustrations disc brake pads - Ilustraciones de pastillas - Illustrations Plaquettes de frein à disque - Illustrazioni Pastiglie Freno

13.0460-6922.2 606922

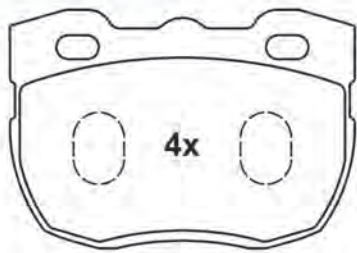

21459 17,5

104,8 x 72,4 x 17,5

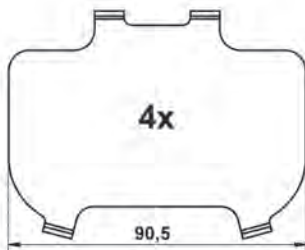

4x

90,5

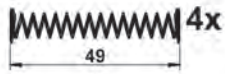
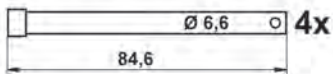
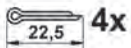

13.0460-6923.2 606923

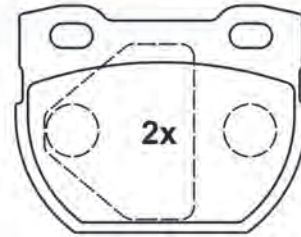

23471 14,5

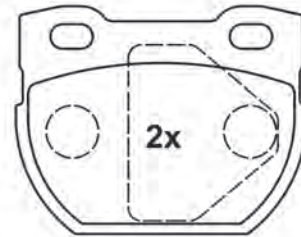

23471 14,5

88,4 x 68,9 x 14,5

13.0460-6924.2 606924

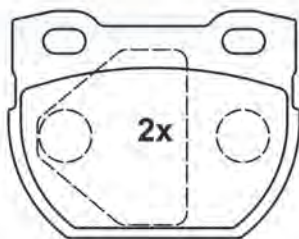

23471 17,5



23471 17,5

88,4 x 68,9 x 17,5

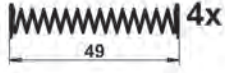
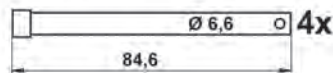
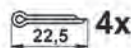

13.0460-6925.2 606925

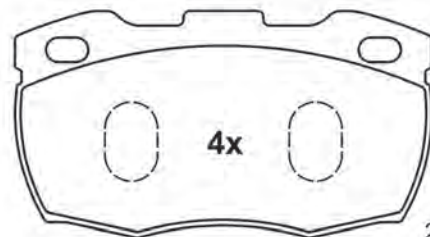

21519 17,8

126,5 x 68,6 x 17,8

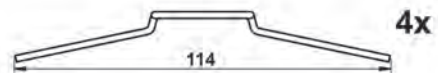



# Abbildungen Scheibenbremsbeläge

Illustrations disc brake pads - Ilustraciones de pastillas - Illustrations Plaquettes de frein à disque - Illustrazioni Pastiglie Freno

13.0460-6926.2 606926



13.0460-7030.2 607030



20359 19,2

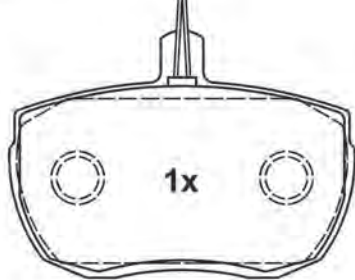
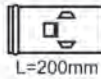

21160 19,2

104,9 x 74,7 x 19,2

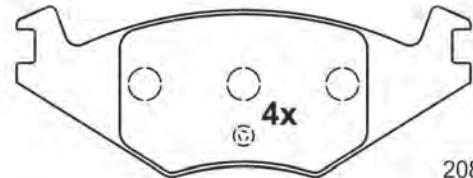
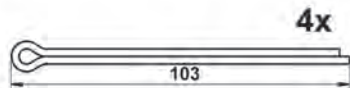
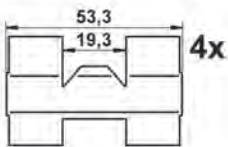

20889 17,3

137,8 x 51,5 x 17,3



13.0460-7032.2 607032



13.0460-7033.2 607033

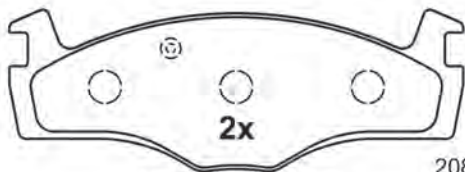

20887 19,7

137,8 x 48,9 x 19,7



20888 19,7

137,8 x 51,5 x 19,7

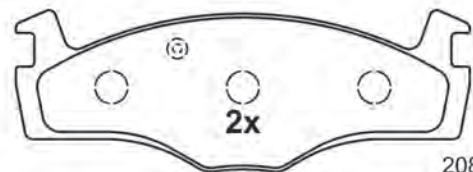
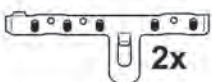

20887 15,3

137,8 x 48,9 x 15,3

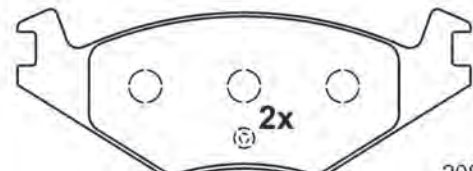

20888 15,3

137,8 x 51,5 x 15,3

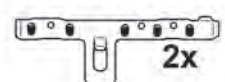

# Abbildungen Scheibenbremsbeläge

Illustrations disc brake pads - Ilustraciones de pastillas - Illustrations Plaquettes de frein à disque - Illustrazioni Pastiglie Freno

13.0460-7040.2 607040



20907 18,0

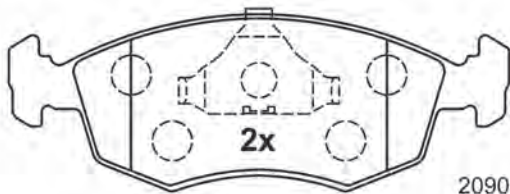

20908 18,0

151,3 x 52,5 x 18,0

13.0460-7050.2 607050

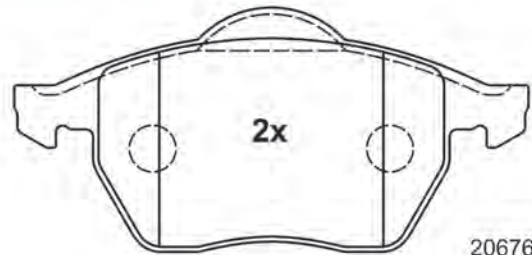

20676 19,5

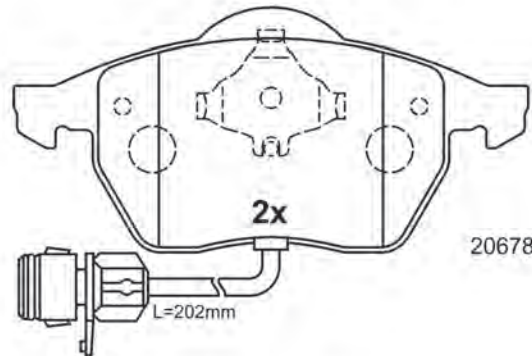

20678 19,5

156,3 x 74,0 x 19,5

13.0460-7051.2 607051

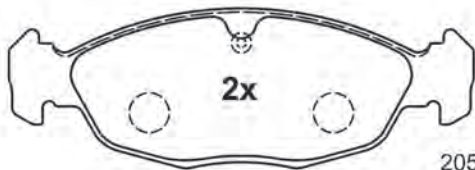

20547 16,5

141,2 x 48,4 x 16,5

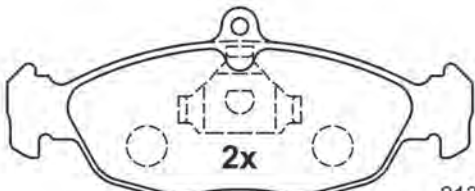

21353 16,5

140,0 x 58,3 x 16,5

13.0460-7052.2 607052

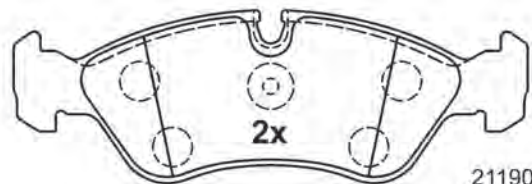

21190 17,5

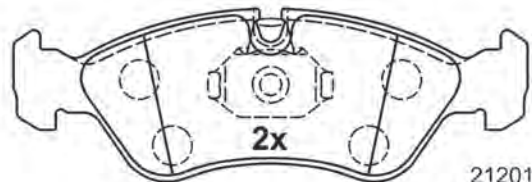

21201 17,5

156,3 x 52,3 x 17,5

# Abbildungen Scheibenbremsbeläge

Illustrations disc brake pads - Ilustraciones de pastillas - Illustrations Plaquettes de frein à disque - Illustrazioni Pastiglie Freno

13.0460-7053.2 607053

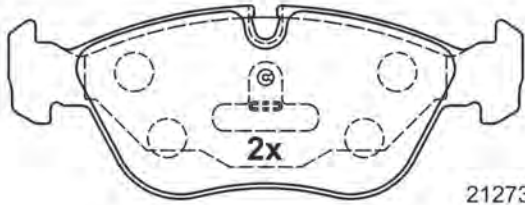

21273 19,5

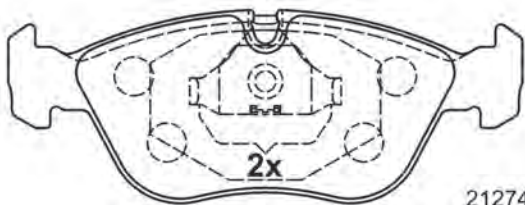

21274 19,5

156,3 x 58,5 x 19,5

13.0460-7056.2 607056

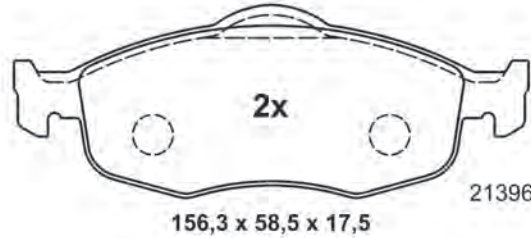

21396 17,5

156,3 x 58,5 x 17,5

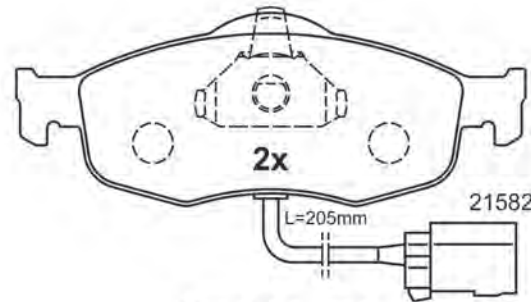

21582 17,5

155,1 x 58,5 x 17,5

13.0460-7057.2 607057

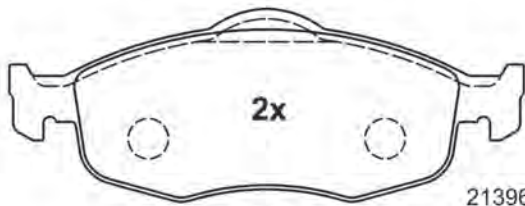

21396 17,5

156,3 x 58,5 x 17,5

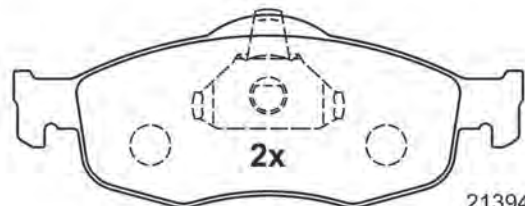

21394 17,5

155,1 x 58,5 x 17,5

13.0460-7058.2 607058

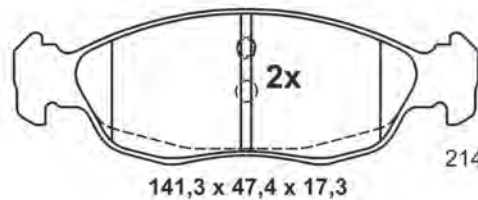

21430 17,3

141,3 x 47,4 x 17,3

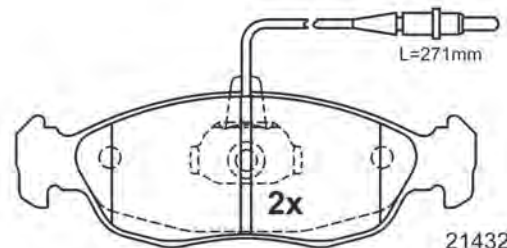

21432 17,3

140,1 x 47,4 x 17,3



# Abbildungen Scheibenbremsbeläge

Illustrations disc brake pads - Ilustraciones de pastillas - Illustrations Plaquettes de frein à disque - Illustrazioni Pastiglie Freno

13.0460-7059.2 607059

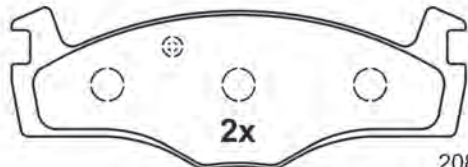

20887 17,3

137,8 x 48,9 x 17,3

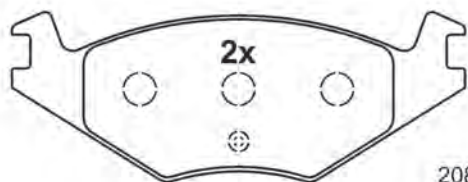

20888 17,3

137,8 x 51,5 x 17,3

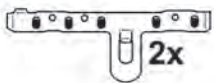

13.0460-7061.2 607061

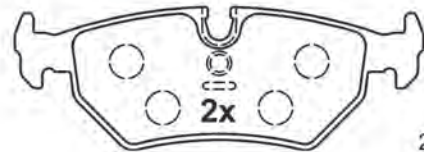

21275 17,0

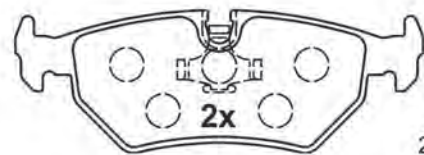

21276 17,0

123,0 x 43,0 x 17,0



13.0460-7063.2 607063



21193 18,0

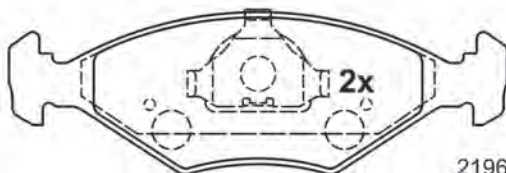

21962 18,0

151,3 x 49,2 x 18,0

13.0460-7064.2 607064

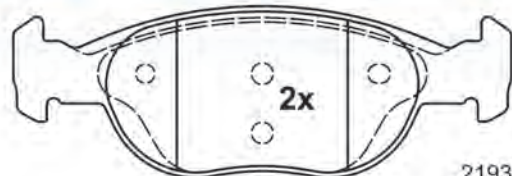

21930 17,9

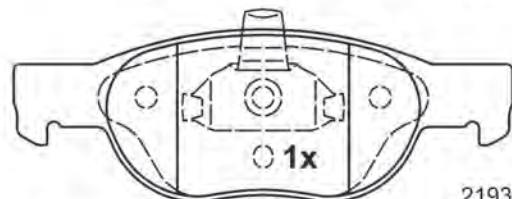

21931 17,9

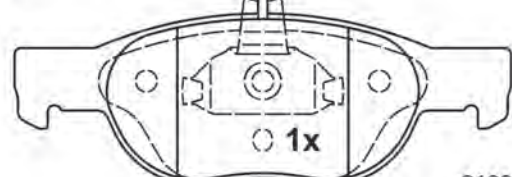

21932 17,9

151,3 x 52,0 x 17,9



# Abbildungen Scheibenbremsbeläge

Illustrations disc brake pads - Ilustraciones de pastillas - Illustrations Plaquettes de frein à disque - Illustrazioni Pastiglie Freno

13.0460-7065.2 607065

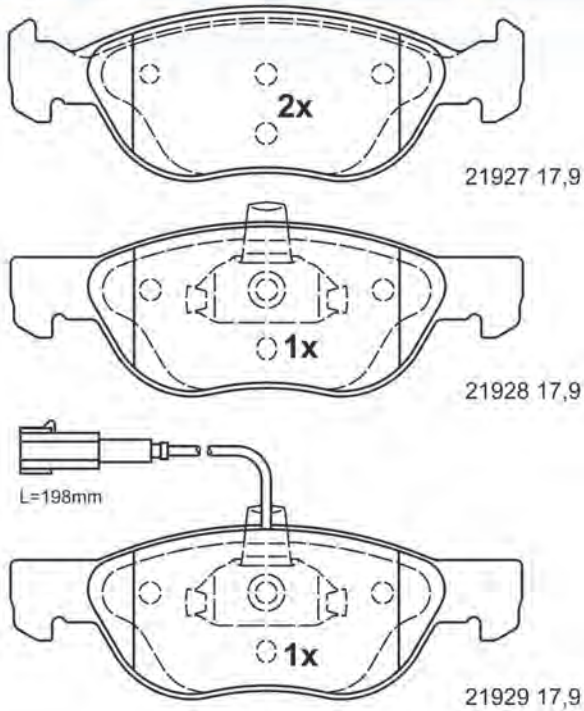

156,3 x 52,7 x 17,9

13.0460-7067.2 607067

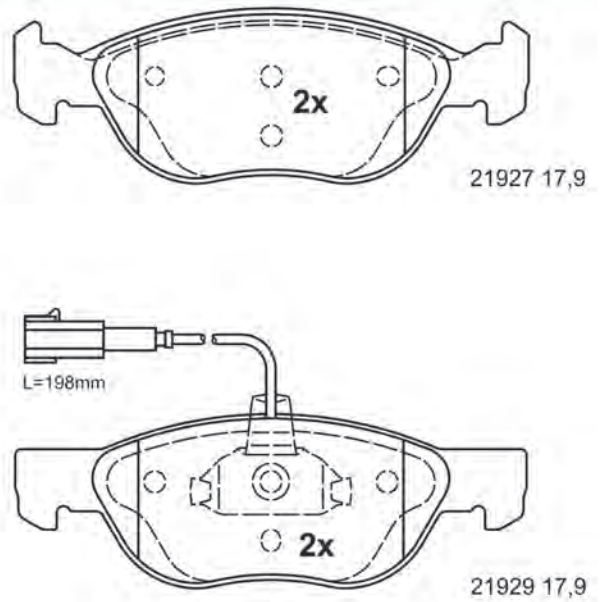

156,3 x 52,7 x 17,9

13.0460-7069.2 607069

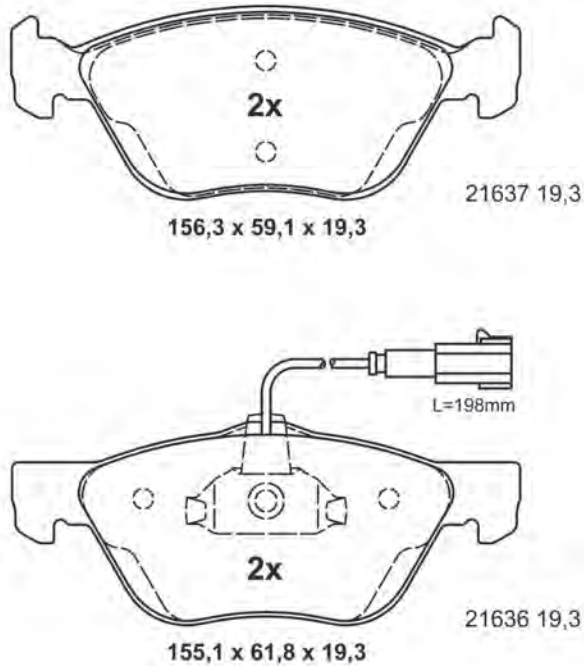

156,3 x 59,1 x 19,3

155,1 x 61,8 x 19,3

13.0460-7071.2 607071

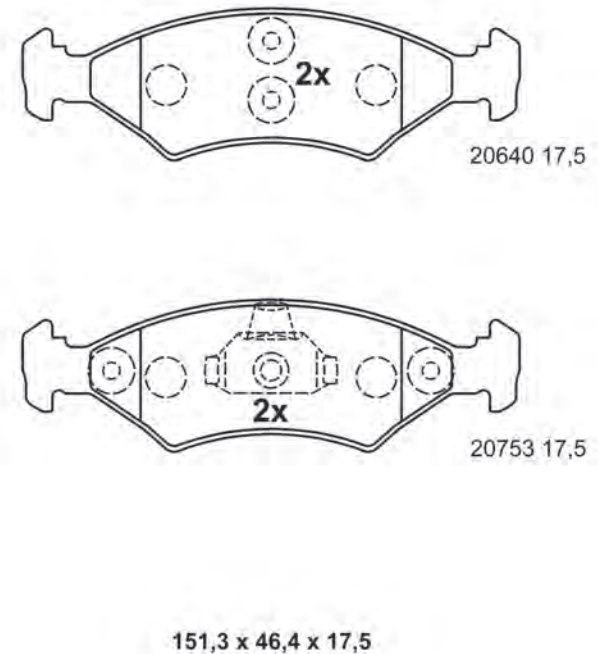

151,3 x 46,4 x 17,5



# Abbildungen Scheibenbremsbeläge

Illustrations disc brake pads - Ilustraciones de pastillas - Illustrations Plaquettes de frein à disque - Illustrazioni Pastiglie Freno

13.0460-7072.2 607072



21866 19,7

141,8 x 51,2 x 19,7

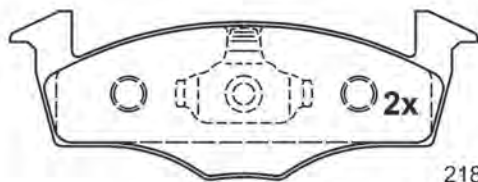

21868 19,7

141,8 x 50,6 x 19,7

13.0460-7073.2 607073

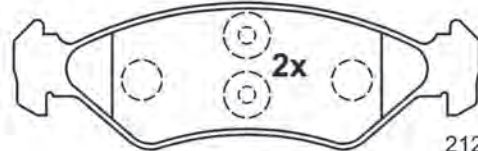

21202 16,9

141,3 x 44,4 x 16,9

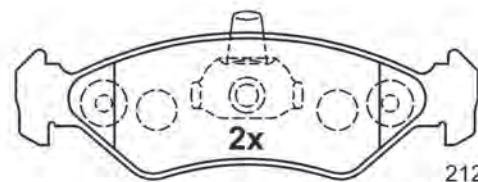

21203 16,9

140,1 x 44,4 x 16,9

13.0460-7076.2 607076

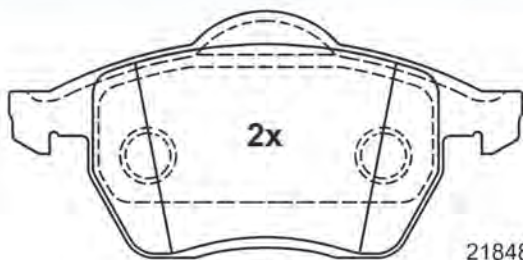

21848 19,8

156,3 x 74,0 x 19,8

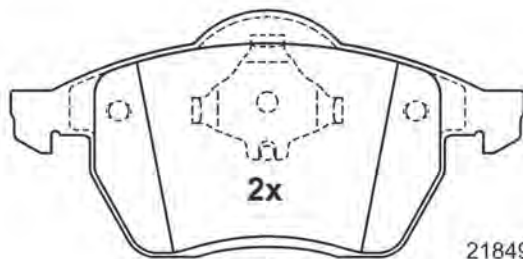

21849 20,3

156,3 x 74,0 x 20,3

13.0460-7077.2 607077

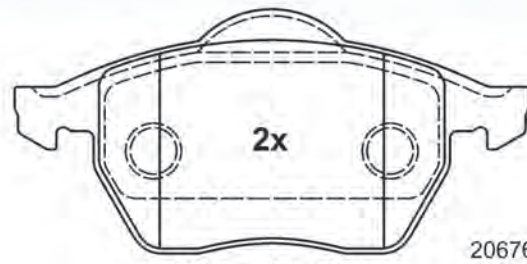

20676 19,8

156,3 x 74,0 x 19,8

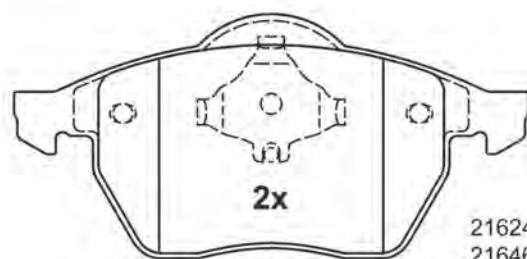

21624 20,3

21646 20,3

156,3 x 74,0 x 20,3

# Abbildungen Scheibenbremsbeläge

Illustrations disc brake pads - Ilustraciones de pastillas - Illustrations Plaquettes de frein à disque - Illustrazioni Pastiglie Freno

13.0460-7078.2 607078

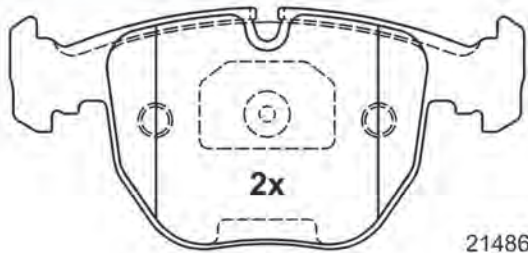

21486 19,5

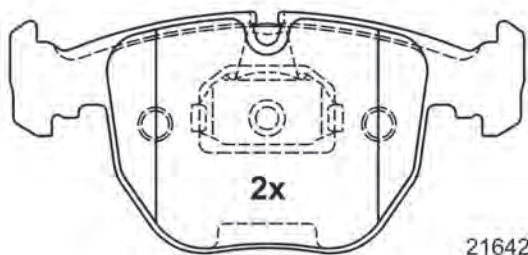

21642 19,5

156,3 x 73,2 x 19,5

13.0460-7079.2 607079

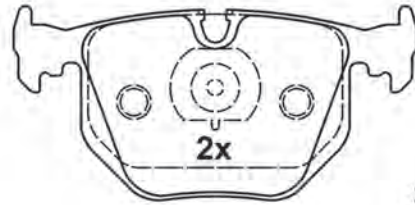

21282 17,3

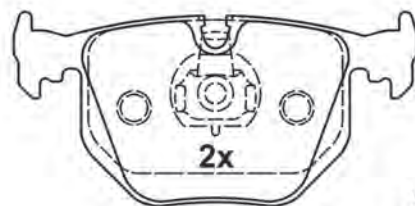

21487 17,3

123,0 x 59,2 x 17,3

13.0460-7080.2 607080

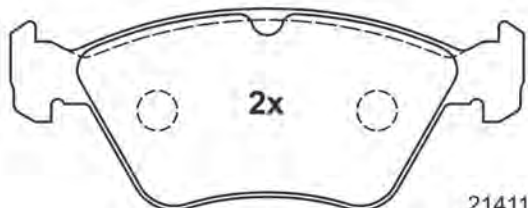

21411 17,5

156,3 x 60,7 x 17,5

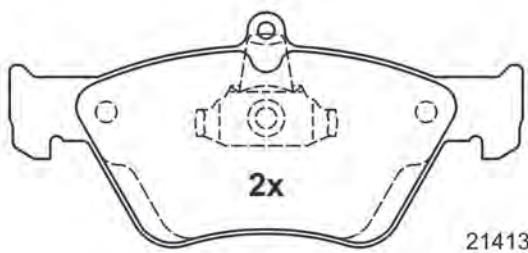

21413 18,3

155,1 x 70,6 x 18,3

13.0460-7081.2 607081

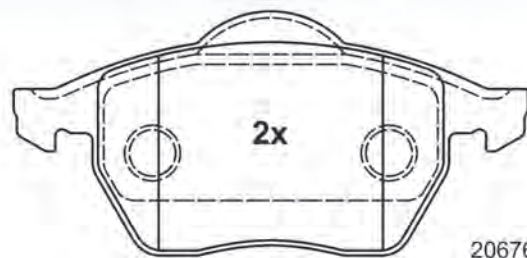

20676 19,8

156,3 x 74,0 x 19,8

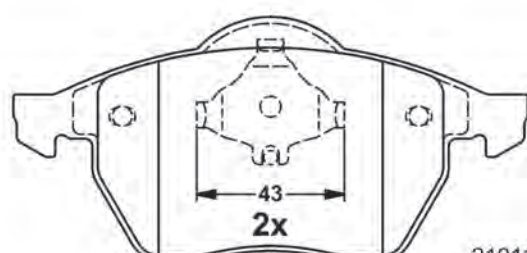

21911 20,3

156,3 x 74,0 x 20,3

# Abbildungen Scheibenbremsbeläge

Illustrations disc brake pads - Ilustraciones de pastillas - Illustrations Plaquettes de frein à disque - Illustrazioni Pastiglie Freno

13.0460-7083.2 607083

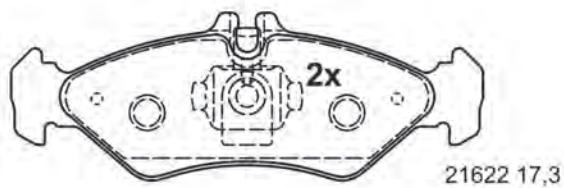
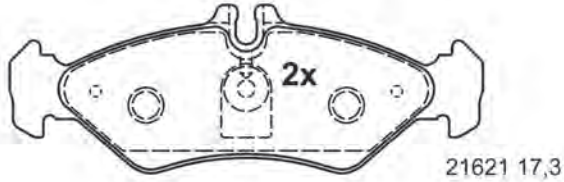

141,3 x 49,9 x 17,3

13.0460-7084.2 607084

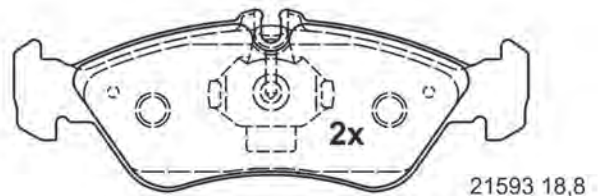
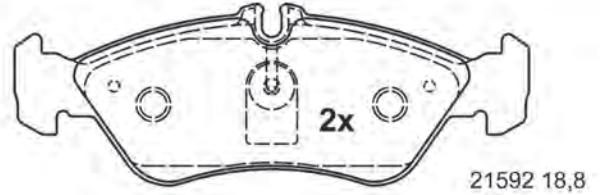

156,3 x 54,8 x 18,8

13.0460-7085.2 607085

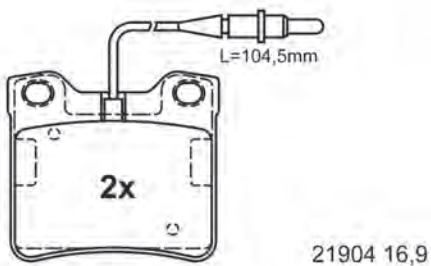
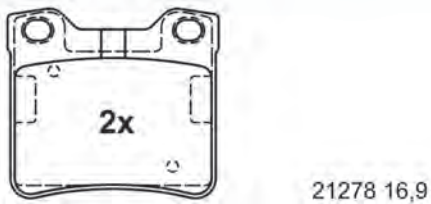

63,7 x 57,4 x 16,9

13.0460-7086.2 607086

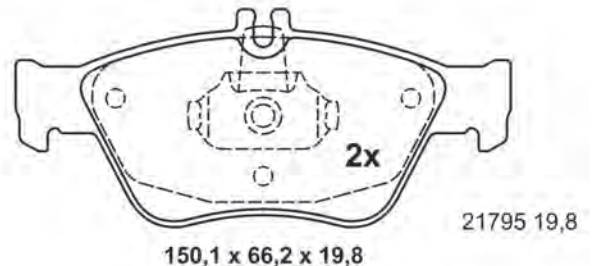
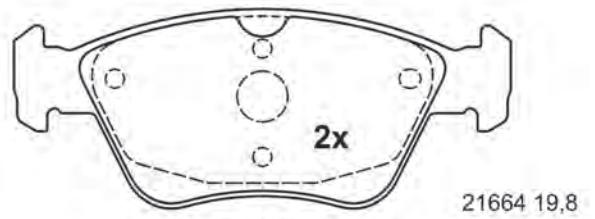

150,1 x 66,2 x 19,8



# Abbildungen Scheibenbremsbeläge

Illustrations disc brake pads - Ilustraciones de pastillas - Illustrations Plaquettes de frein à disque - Illustrazioni Pastiglie Freno

13.0460-7087.2 607087

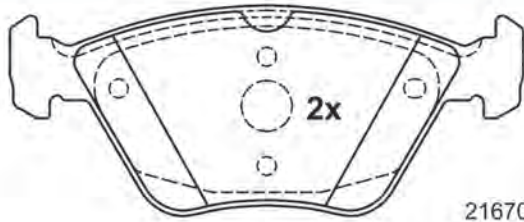

21670 19,3

156,3 x 63,5 x 19,4

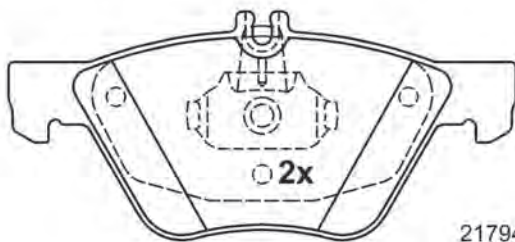

21794 19,3

155,1 x 69,3 x 19,3

13.0460-7088.2 607088

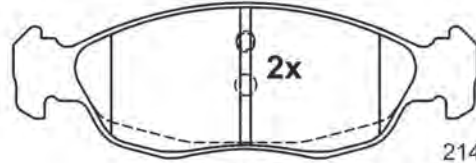

21430 17,3

141,3 x 47,4 x 17,3

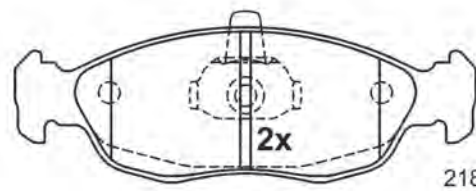

21827 17,3

140,1 x 47,4 x 17,3

13.0460-7089.2 607089

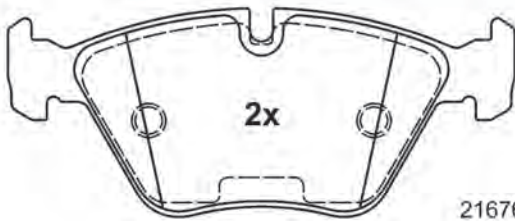

21676 20,3

154,6 x 63,5 x 20,3

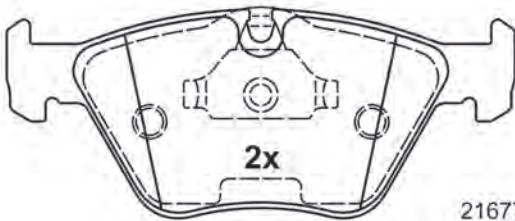

21677 20,3

155,1 x 63,5 x 20,3

13.0460-7090.2 607090

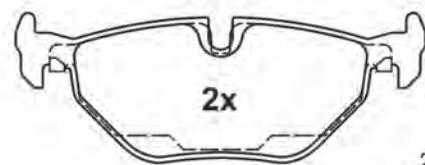

21891 17,3

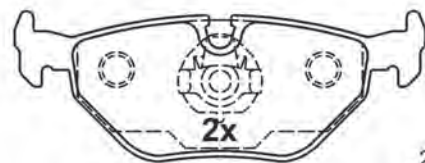

21691 17,3

123,0 x 44,9 x 17,3

# Abbildungen Scheibenbremsbeläge

Illustrations disc brake pads - Ilustraciones de pastillas - Illustrations Plaquettes de frein à disque - Illustrazioni Pastiglie Freno

13.0460-7091.2 607091

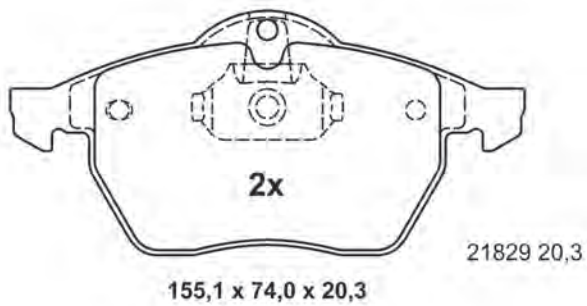
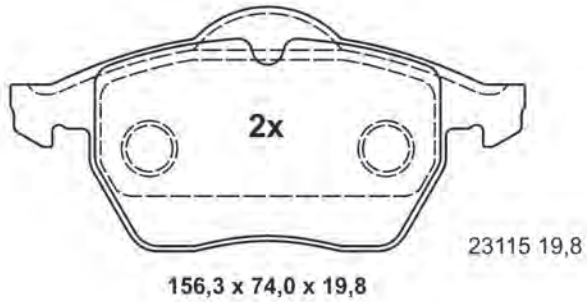

13.0460-7100.2 607100

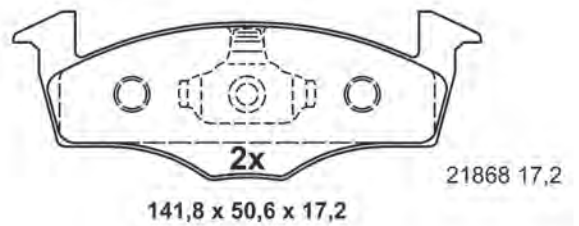
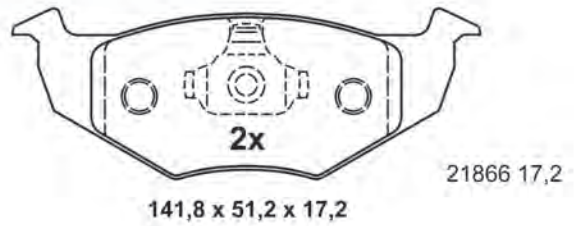

13.0460-7101.2 607101

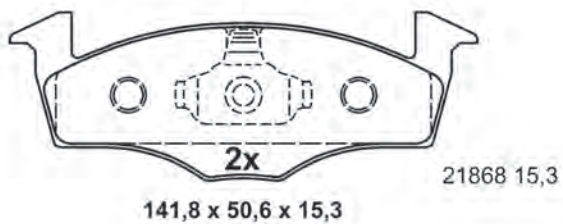
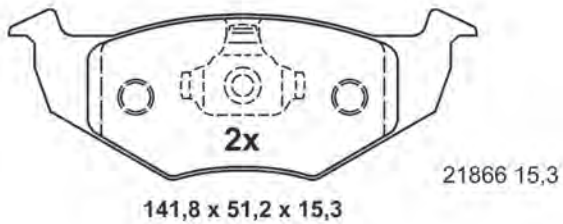

13.0460-7102.2 607102

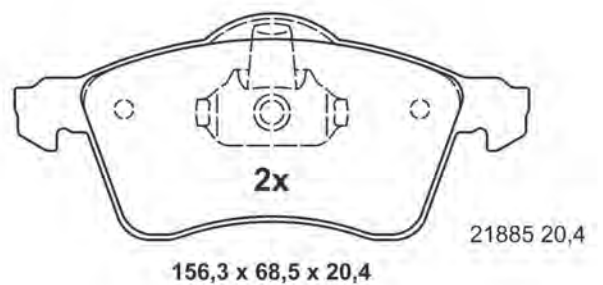
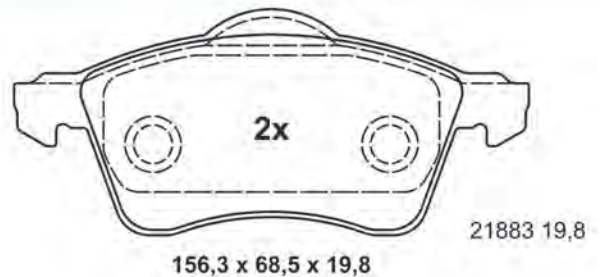



# Abbildungen Scheibenbremsbeläge

Illustrations disc brake pads - Ilustraciones de pastillas - Illustrations Plaquettes de frein à disque - Illustrazioni Pastiglie Freno

13.0460-7105.2 607105

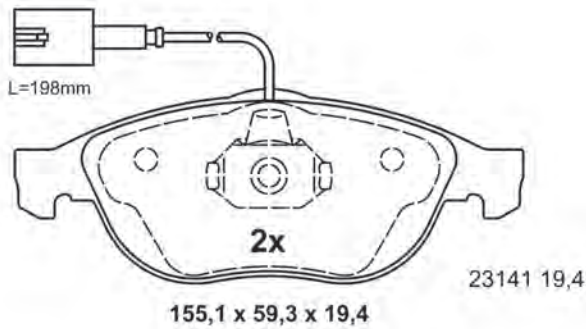
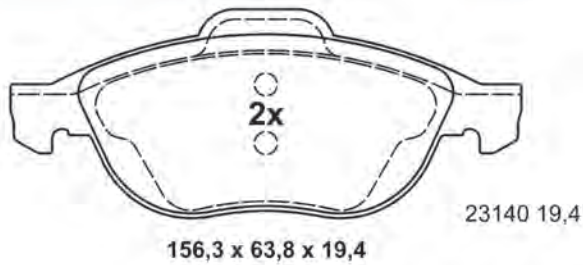

13.0460-7107.2 607107

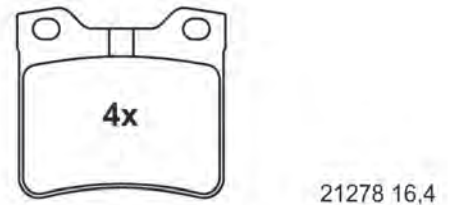

13.0460-7108.2 607108

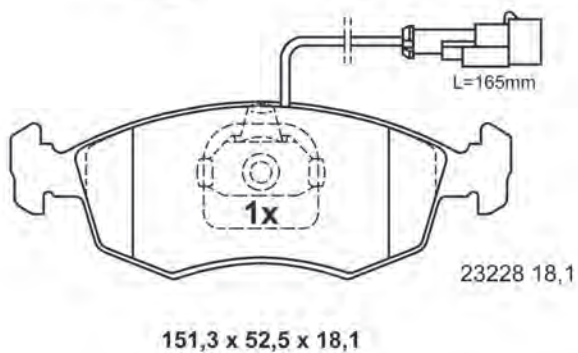
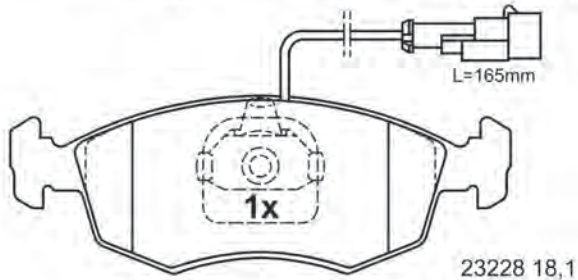
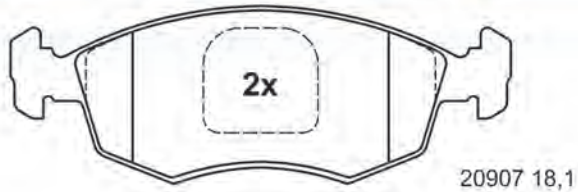

13.0460-7110.2 607110

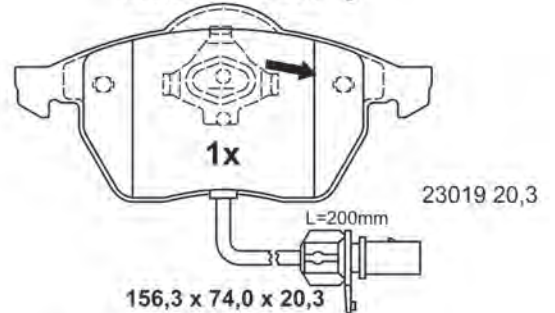
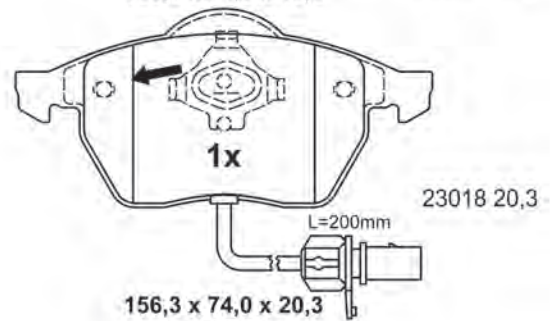
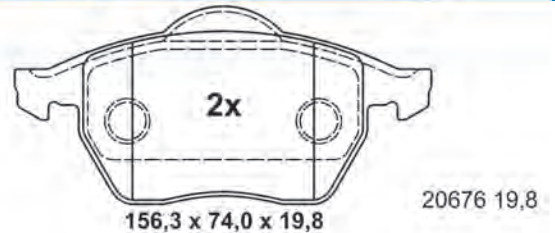

# Abbildungen Scheibenbremsbeläge

Illustrations disc brake pads - Ilustraciones de pastillas - Illustrations Plaquettes de frein à disque - Illustrazioni Pastiglie Freno

13.0460-7111.2 607111

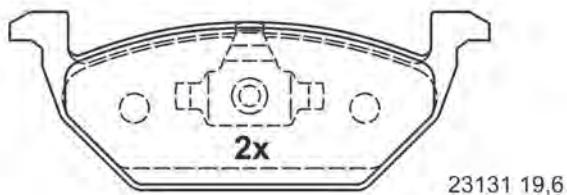
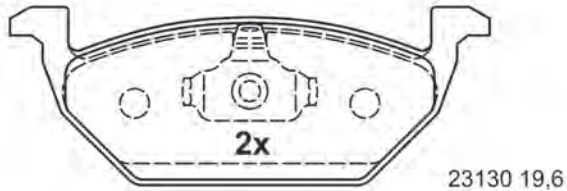

146,0 x 54,7 x 19,6

13.0460-7112.2 607112

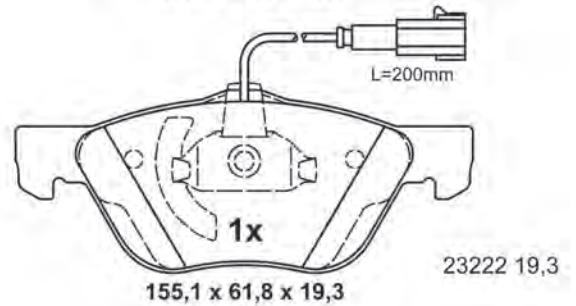
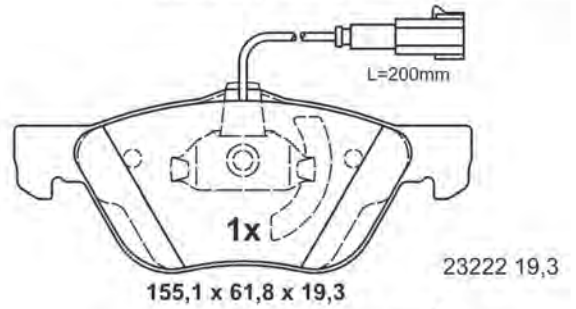
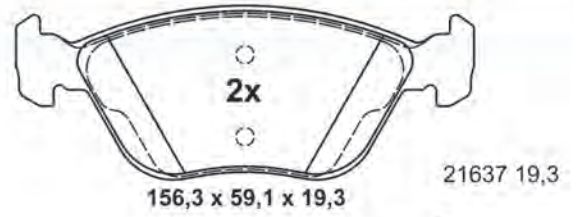

13.0460-7113.2 607113

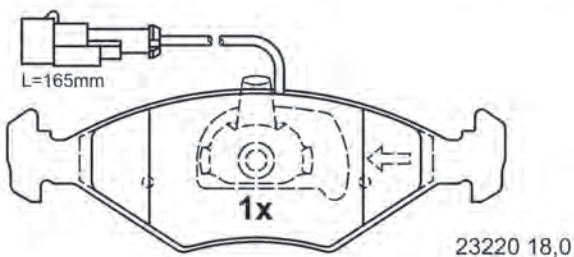
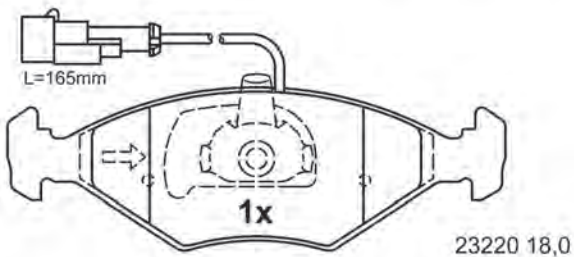
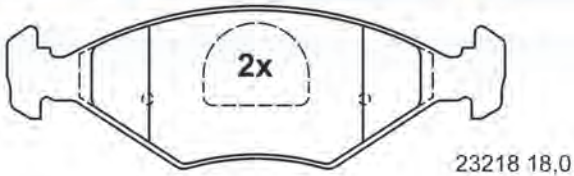

151,3 x 49,2 x 18,0

13.0460-7114.2 607114

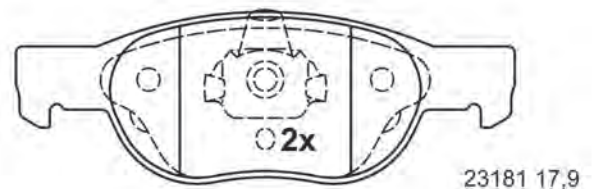
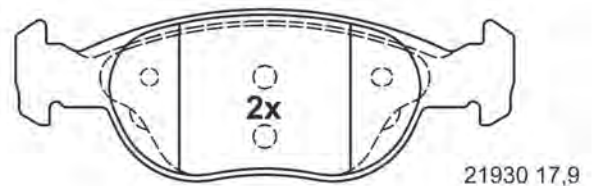

151,3 x 52,0 x 17,9





# Abbildungen Scheibenbremsbeläge

Illustrations disc brake pads - Ilustraciones de pastillas - Illustrations Plaquettes de frein à disque - Illustrazioni Pastiglie Freno

13.0460-7115.2 607115 [1]

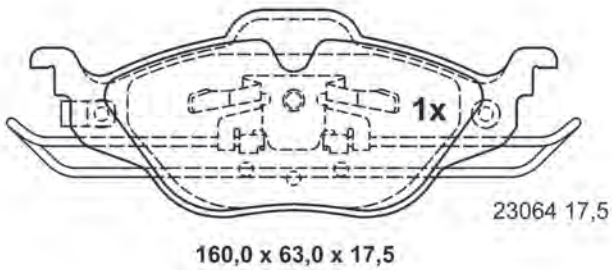
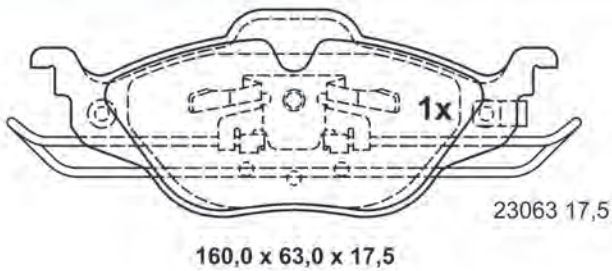

13.0460-7115.2 607115 [2]

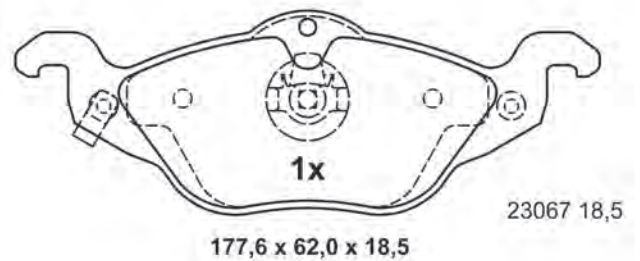
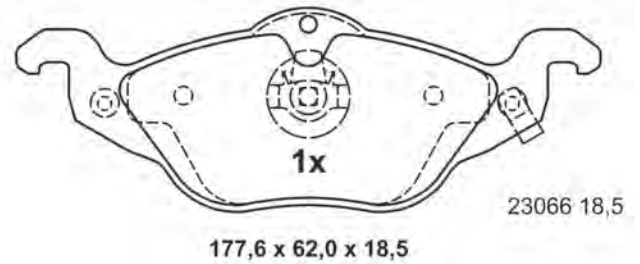

13.0460-7116.2 607116 [1]

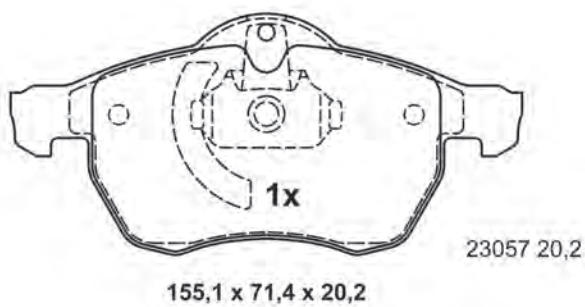
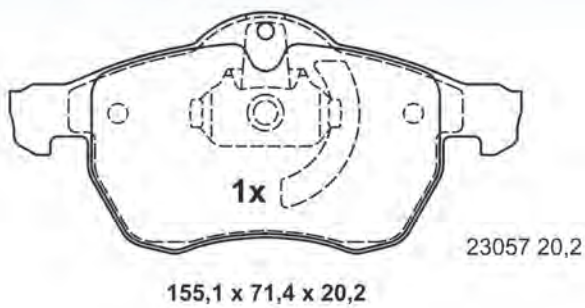

13.0460-7116.2 607116 [2]

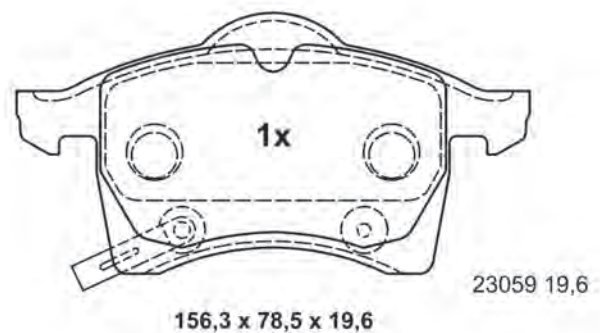
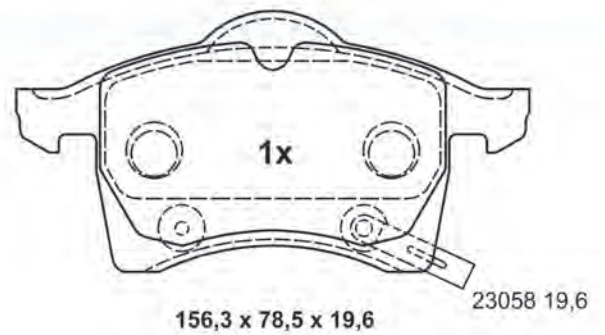

# Abbildungen Scheibenbremsbeläge

Illustrations disc brake pads - Ilustraciones de pastillas - Illustrations Plaquettes de frein à disque - Illustrazioni Pastiglie Freno

13.0460-7117.2 607117

B.H.P.

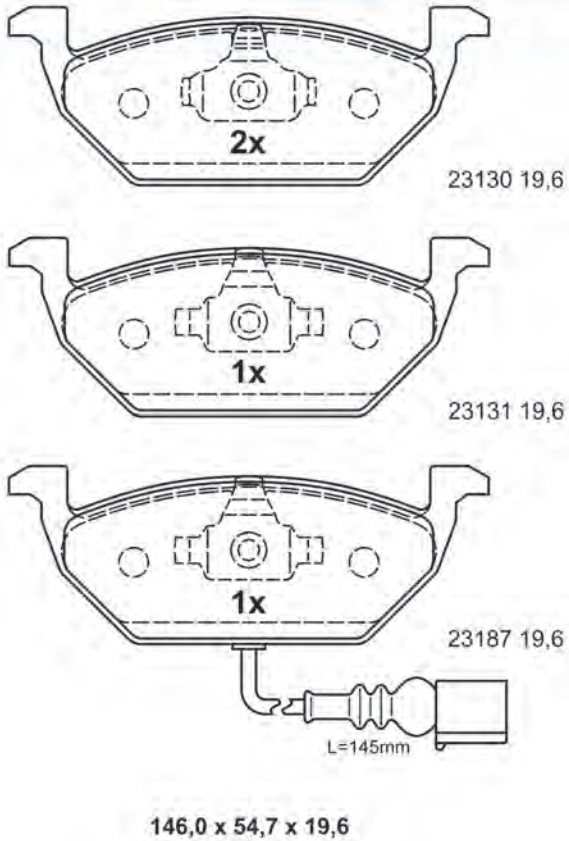

13.0460-7121.2 607121

B.H.P.

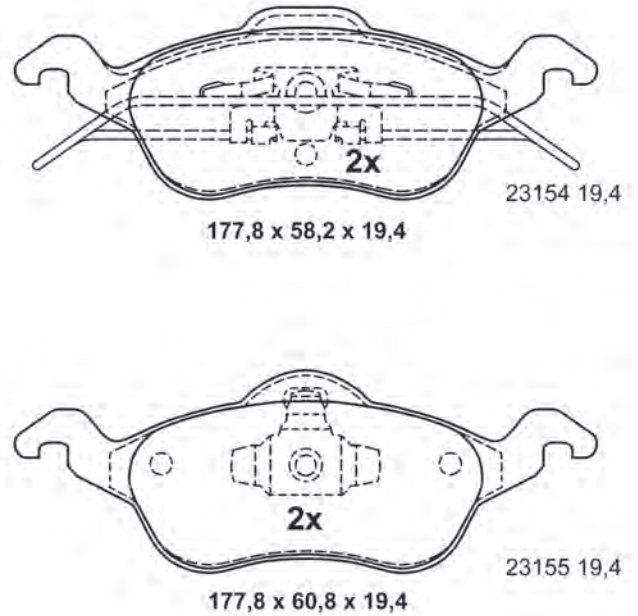

13.0460-7122.2 607122

B.H.P.

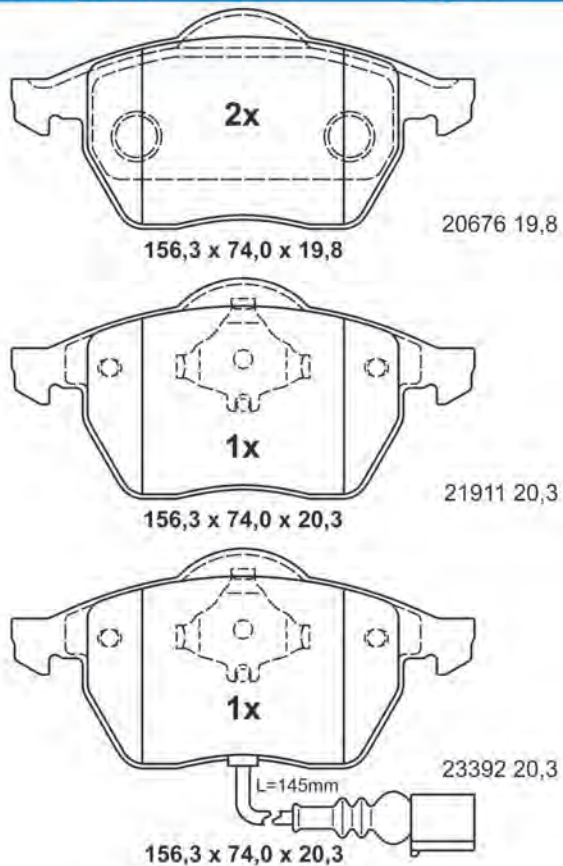

13.0460-7123.2 607123

B.H.P.

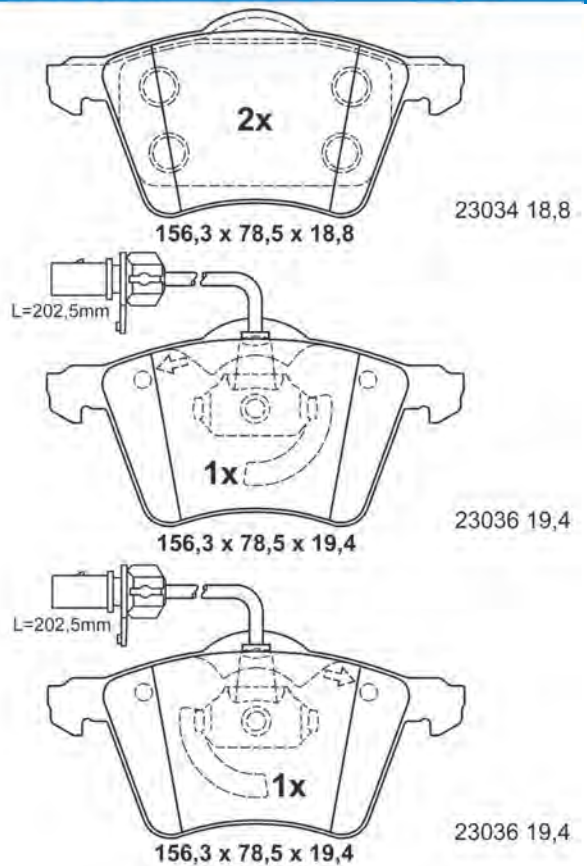



# Abbildungen Scheibenbremsbeläge

Illustrations disc brake pads - Ilustraciones de pastillas - Illustrations Plaquettes de frein à disque - Illustrazioni Pastiglie Freno

13.0460-7124.2 607124

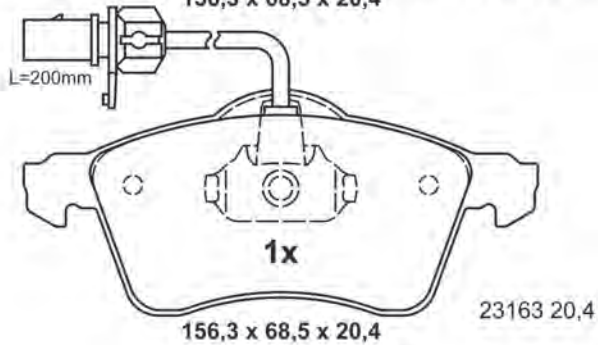
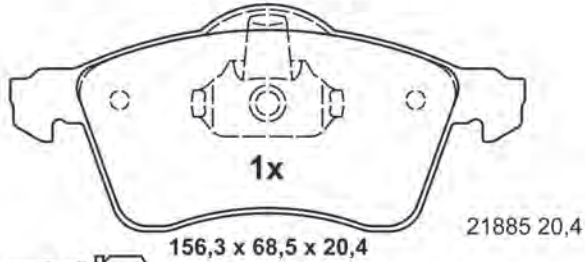
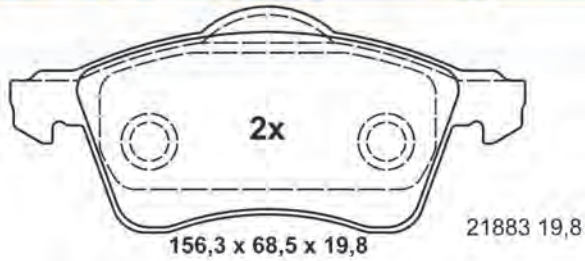

13.0460-7125.2 607125

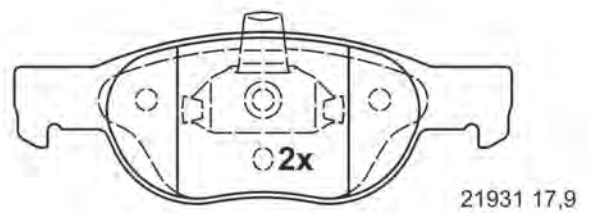
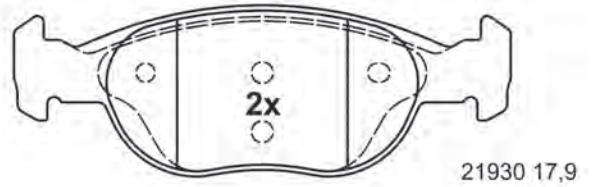

151,3 x 52,0 x 17,9

13.0460-7126.2 607126

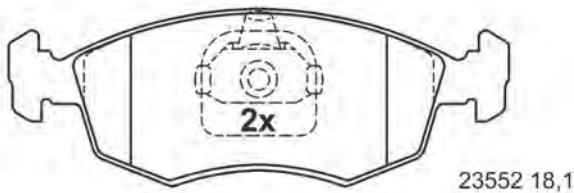
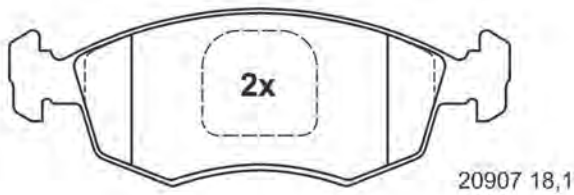

151,3 x 52,5 x 18,1

13.0460-7128.2 607128

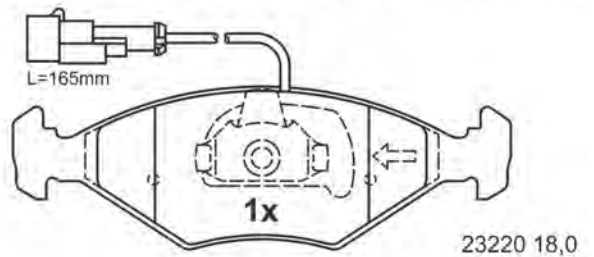
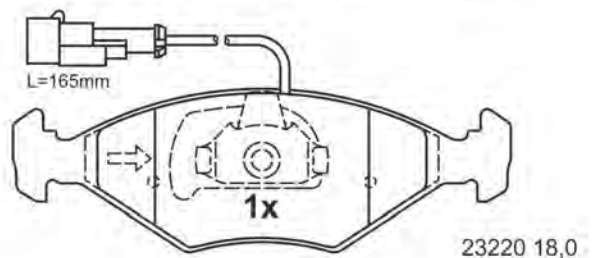
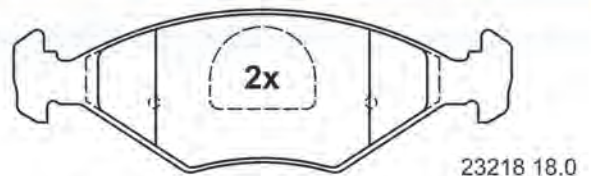

151,3 x 49,2 x 18,0



# Abbildungen Scheibenbremsbeläge

Illustrations disc brake pads - Ilustraciones de pastillas - Illustrations Plaquettes de frein à disque - Illustrazioni Pastiglie Freno

13.0460-7129.2 607129

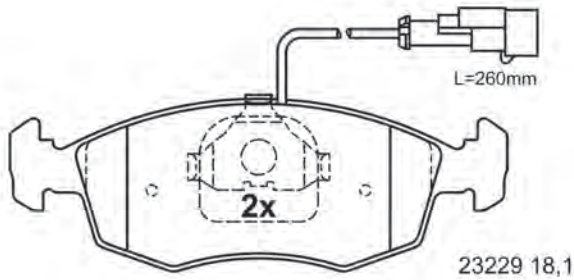
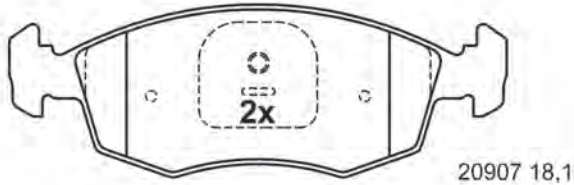

151,3 x 52,5 x 18,1

13.0460-7131.2 607131

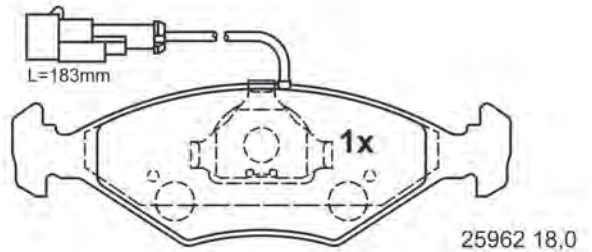
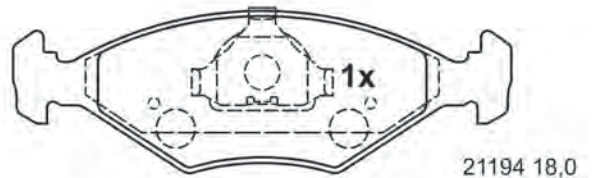
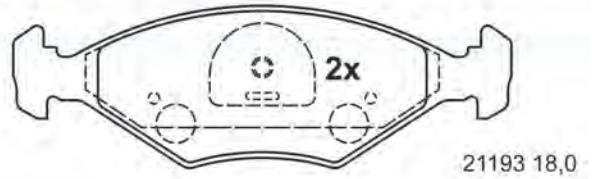

151,3 x 49,2 x 18,0

13.0460-7132.2 607132

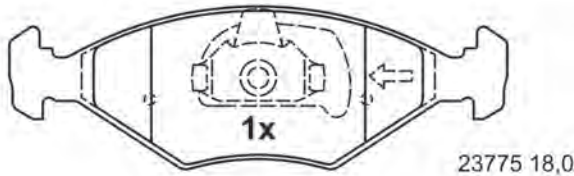
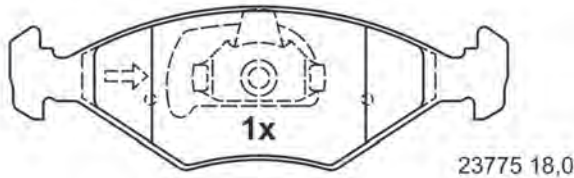
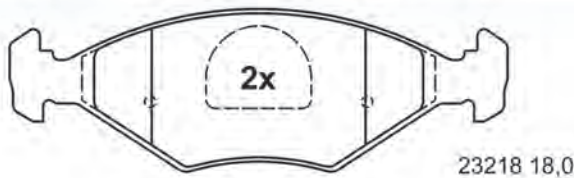

151,3 x 49,2 x 18,0

13.0460-7133.2 607133

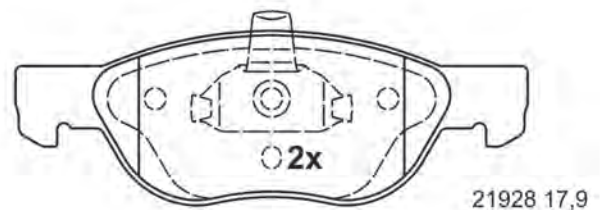
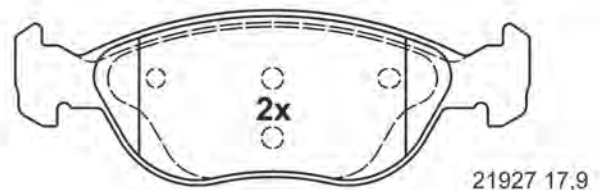

156,3 x 52,7 x 17,9



# Abbildungen Scheibenbremsbeläge

Illustrations disc brake pads - Ilustraciones de pastillas - Illustrations Plaquettes de frein à disque - Illustrazioni Pastiglie Freno

13.0460-7134.2 607134

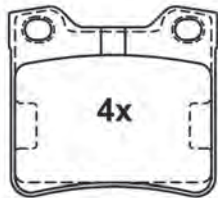

21278 16,4

63,7 x 57,8 x 16,4

13.0460-7135.2 607135

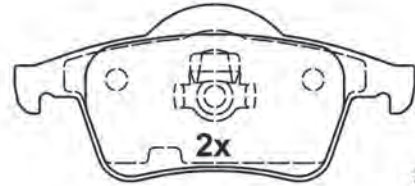

23076 17,5

122,4 x 53,7 x 17,5

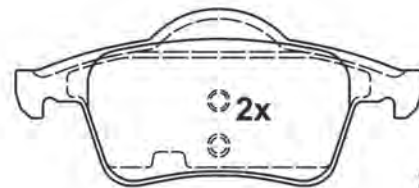

23077 17,5

123,6 x 53,7 x 17,5

13.0460-7137.2 607137



23482 15,8

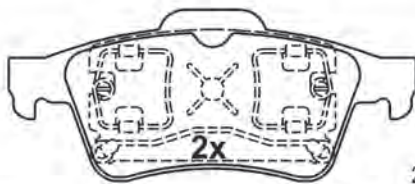

23483 15,8



123,0 x 51,9 x 15,8

13.0460-7138.2 607138

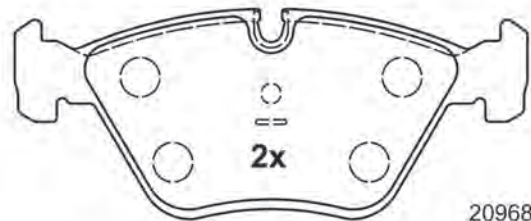

20968 17,5

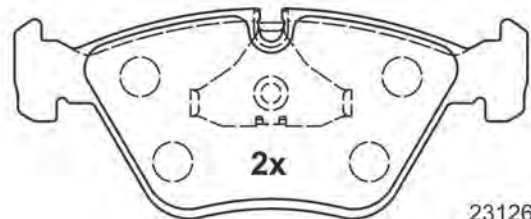

23126 17,5

156,4 x 64,0 x 17,5

# Abbildungen Scheibenbremsbeläge

Illustrations disc brake pads - Ilustraciones de pastillas - Illustrations Plaquettes de frein à disque - Illustrazioni Pastiglie Freno

13.0460-7139.2 607139

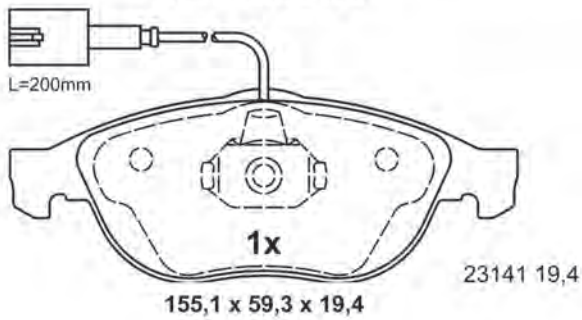
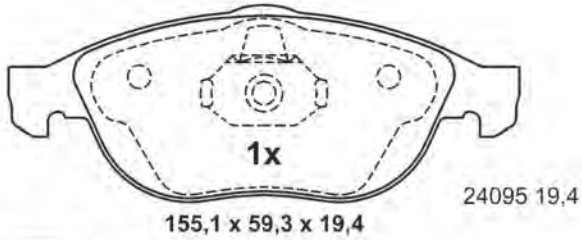
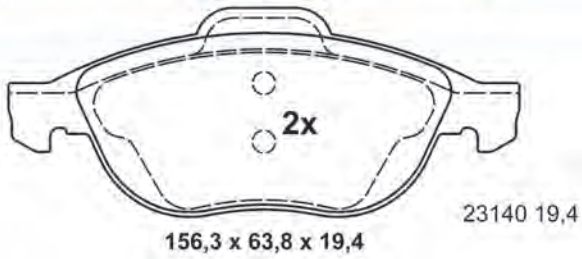

13.0460-7140.2 607140

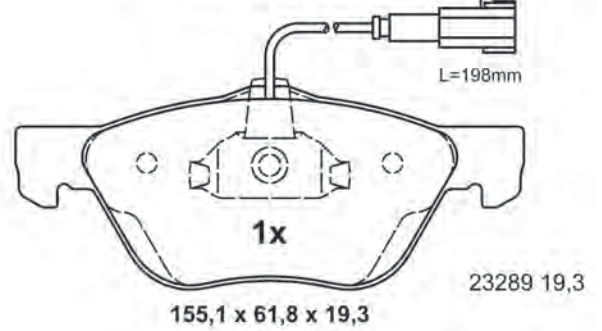
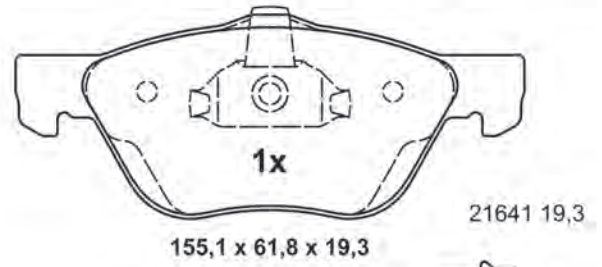
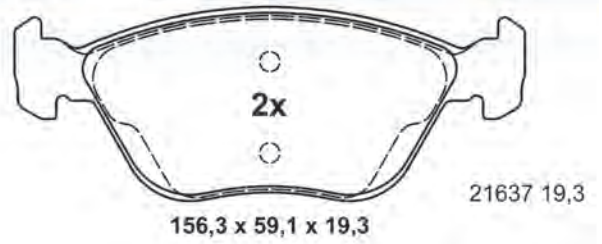

13.0460-7141.2 607141

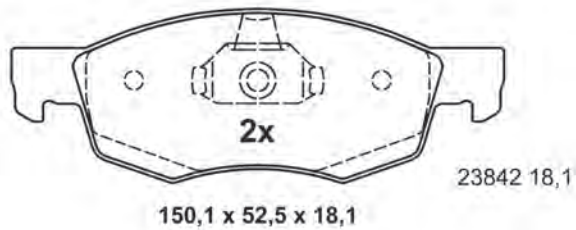
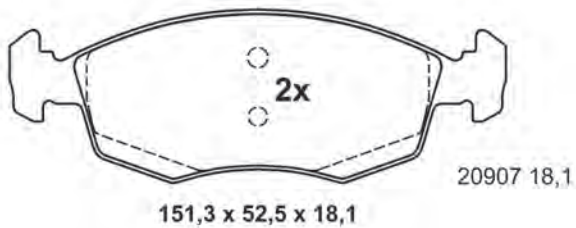

13.0460-7142.2 607142

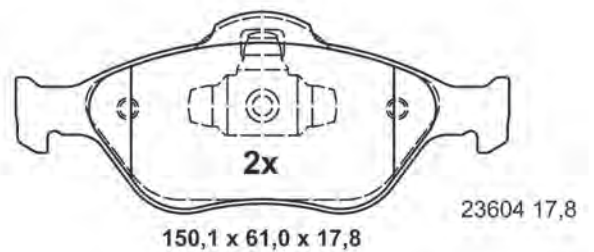
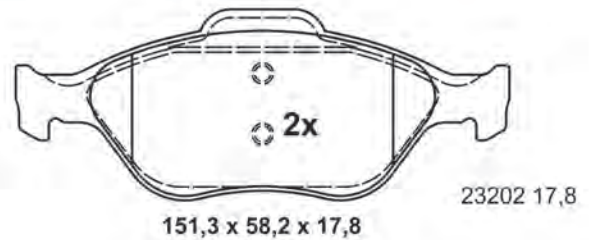



# Abbildungen Scheibenbremsbeläge

Illustrations disc brake pads - Ilustraciones de pastillas - Illustrations Plaquettes de frein à disque - Illustrazioni Pastiglie Freno

13.0460-7143.2 607143

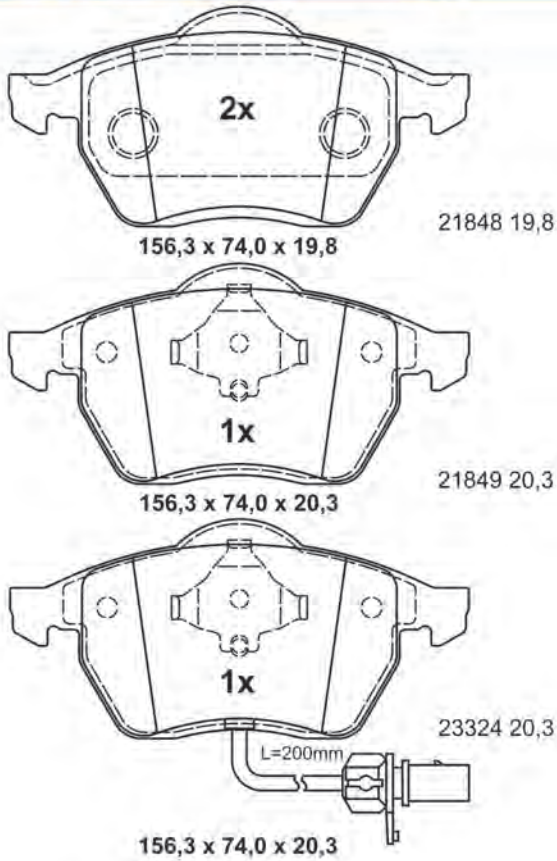

13.0460-7144.2 607144

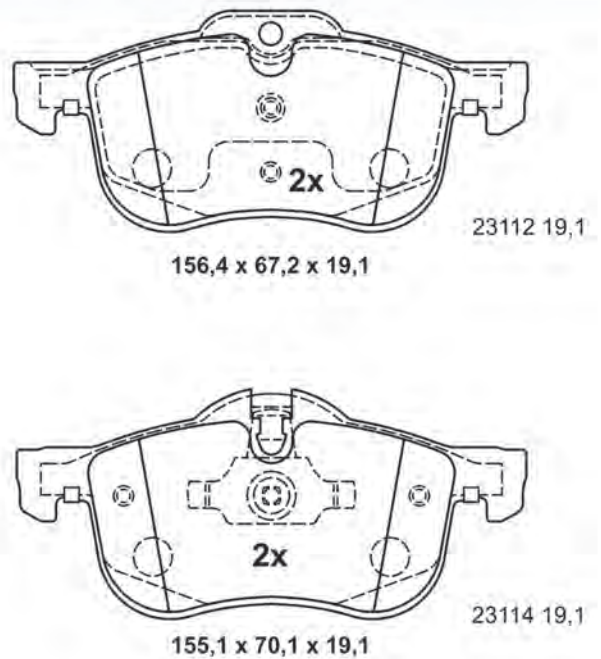

13.0460-7145.2 607145

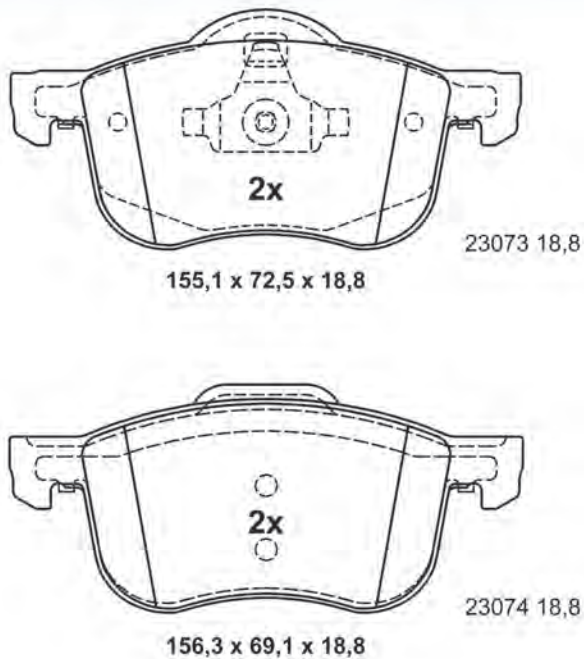

13.0460-7146.2 607146

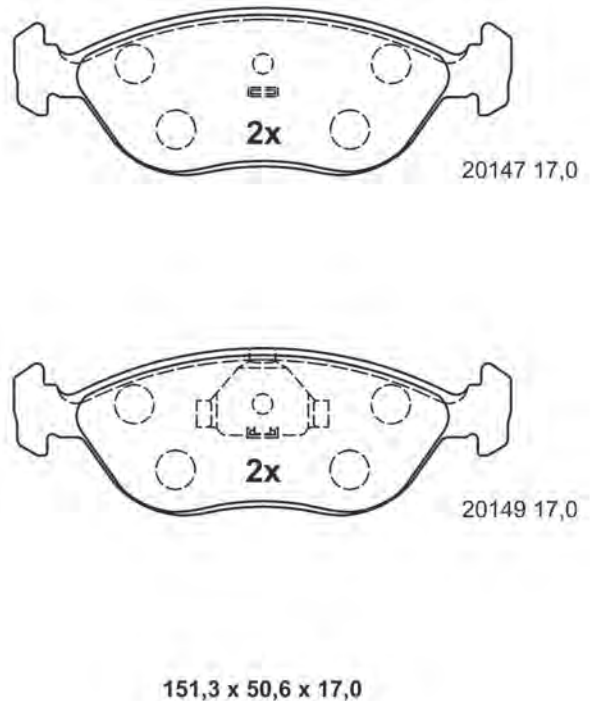

# Abbildungen Scheibenbremsbeläge

Illustrations disc brake pads - Ilustraciones de pastillas - Illustrations Plaquettes de frein à disque - Illustrazioni Pastiglie Freno

13.0460-7147.2 607147

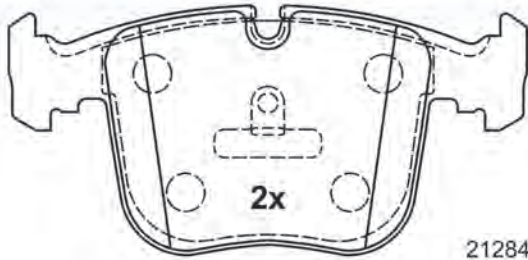

21284 19,1

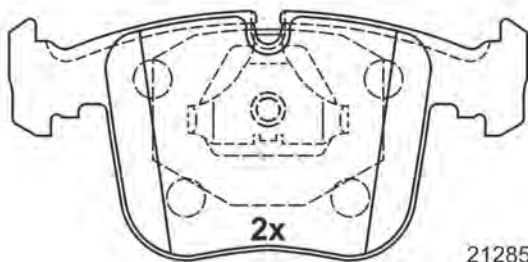

21285 19,1

156,4 x 75,0 x 19,1

13.0460-7148.2 607148

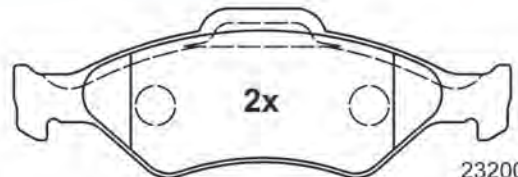

23200 18,0

151,3 x 51,3 x 18,0

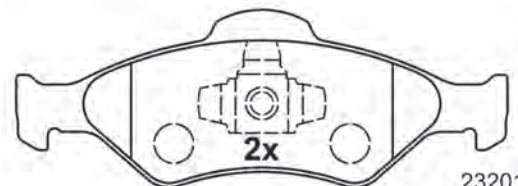

23201 18,0

150,1 x 54,1 x 18,0

13.0460-7153.2 607153



23269 19,8

161,3 x 74,4 x 19,8

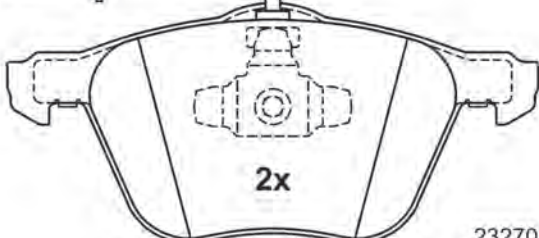
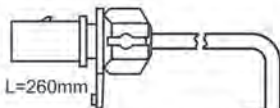

23270 19,8

161,3 x 72,9 x 19,8

13.0460-7154.2 607154

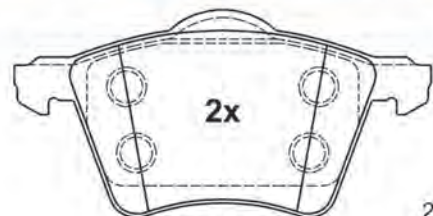

23034 18,8

156,3 x 78,5 x 18,8

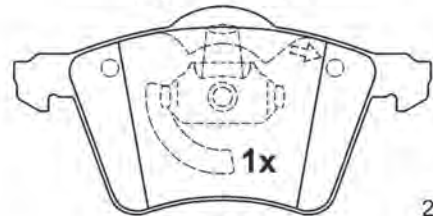

23418 19,4

156,3 x 78,5 x 19,4

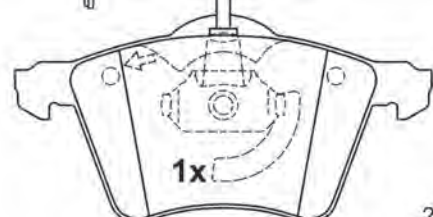
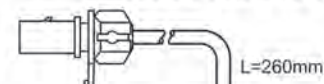

23419 19,4

156,3 x 78,5 x 19,4





# Abbildungen Scheibenbremsbeläge

Illustrations disc brake pads - Ilustraciones de pastillas - Illustrations Plaquettes de frein à disque - Illustrazioni Pastiglie Freno

13.0460-7155.2 607155

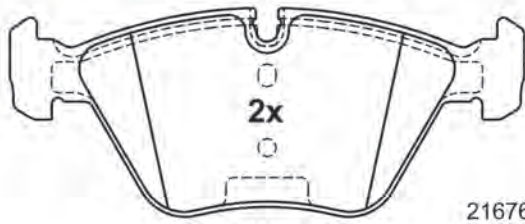

21676 20,3

156,3 x 63,5 x 20,3

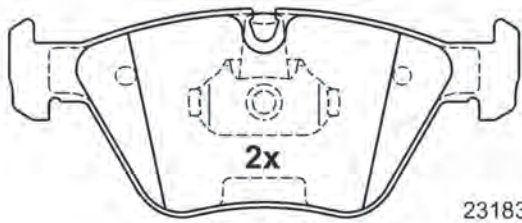

23183 20,3

155,1 x 63,5 x 20,3

13.0460-7156.2 607156

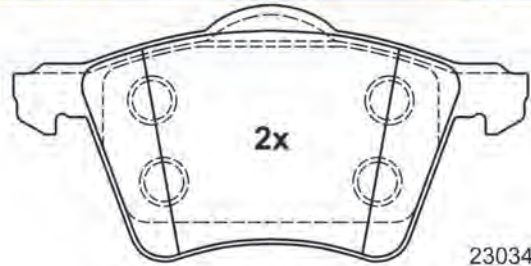

23034 19,4

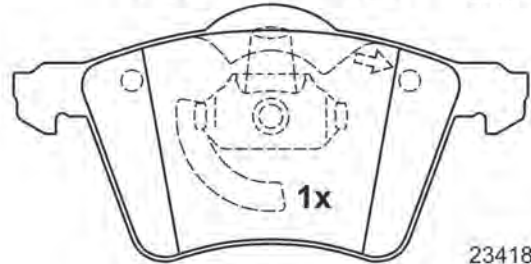

23418 19,4

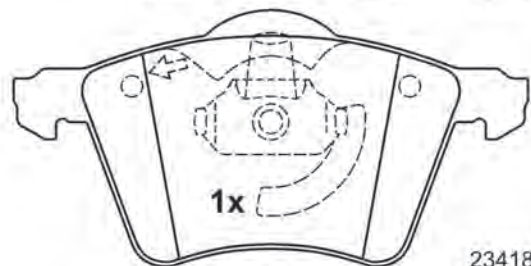

23418 19,4

156,3 x 78,5 x 19,5

13.0460-7157.2 607157

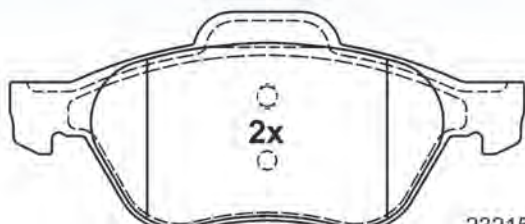

23215 18,3

156,3 x 66,8 x 18,3

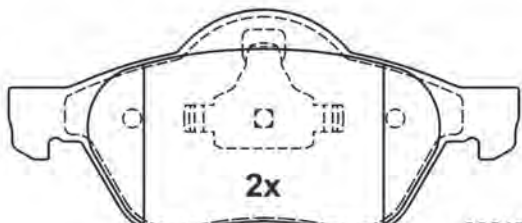

23217 18,3

155,1 x 68,9 x 18,3

13.0460-7158.2 607158

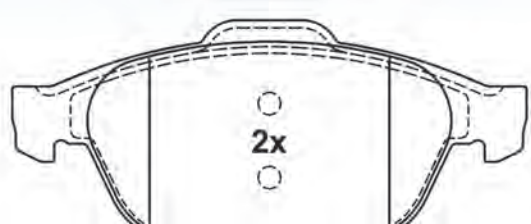

23245 18,3

156,3 x 68,3 x 18,3

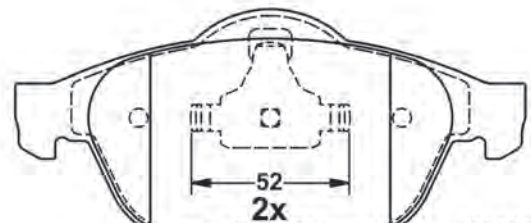

23247 18,3

155,1 x 70,8 x 18,3

# Abbildungen Scheibenbremsbeläge

Illustrations disc brake pads - Ilustraciones de pastillas - Illustrations Plaquettes de frein à disque - Illustrazioni Pastiglie Freno

13.0460-7159.2 607159

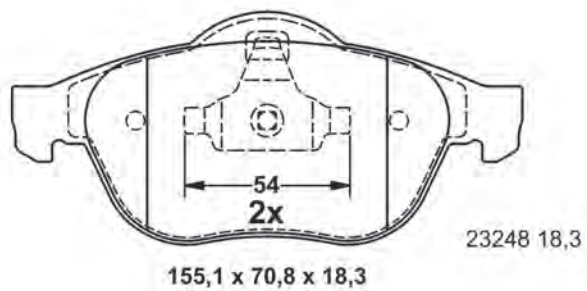
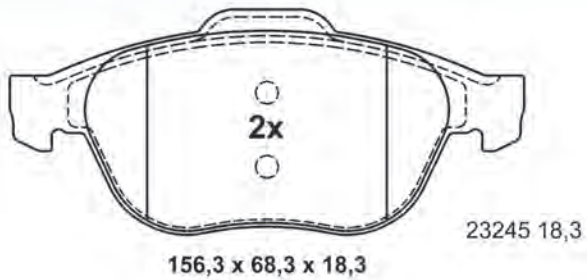

13.0460-7160.2 607160

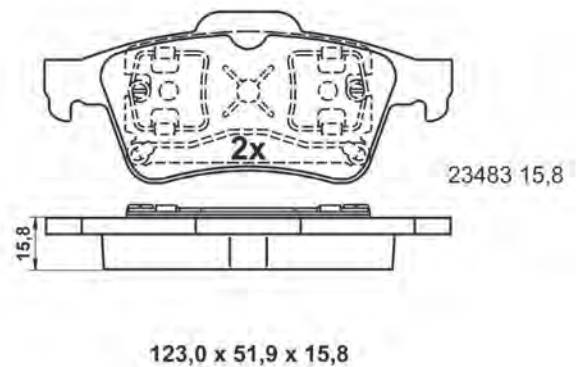
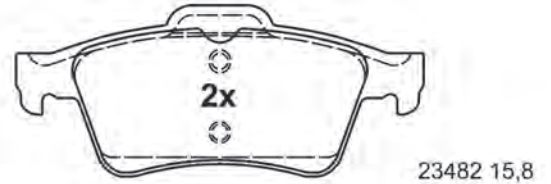

13.0460-7161.2 607161

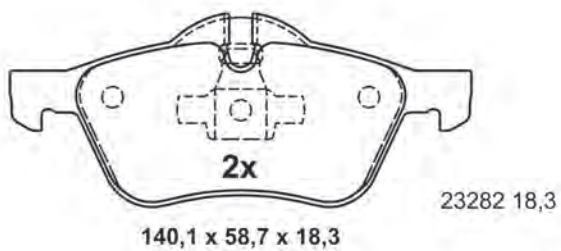

13.0460-7162.2 607162

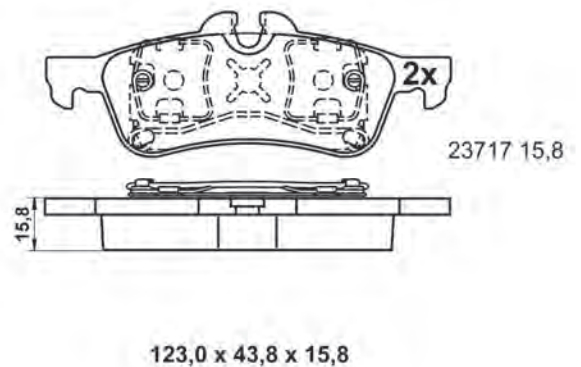
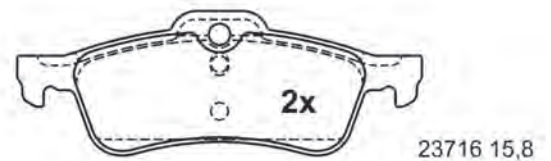

# Abbildungen Scheibenbremsbeläge

Illustrations disc brake pads - Ilustraciones de pastillas - Illustrations Plaquettes de frein à disque - Illustrazioni Pastiglie Freno

13.0460-7163.2 607163

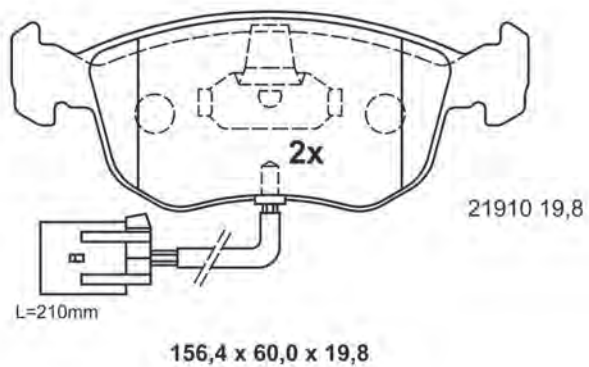
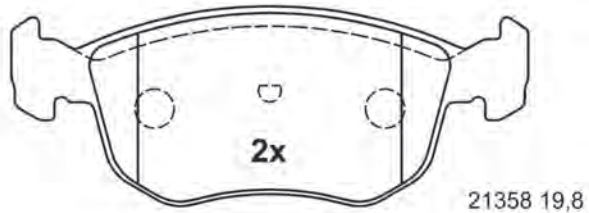

13.0460-7164.2 607164

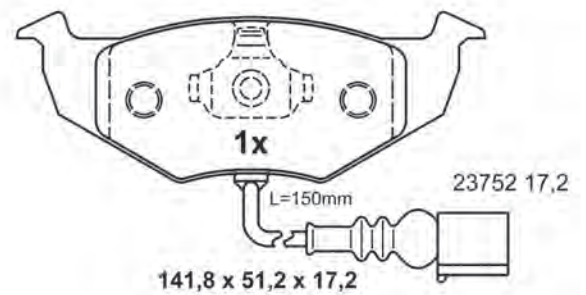
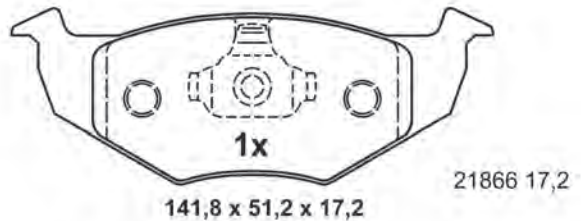
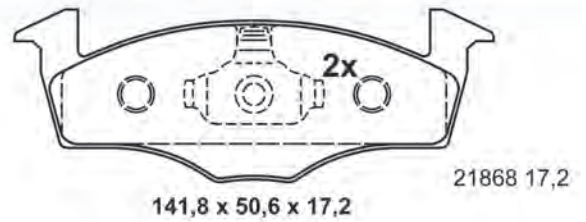

13.0460-7165.2 607165

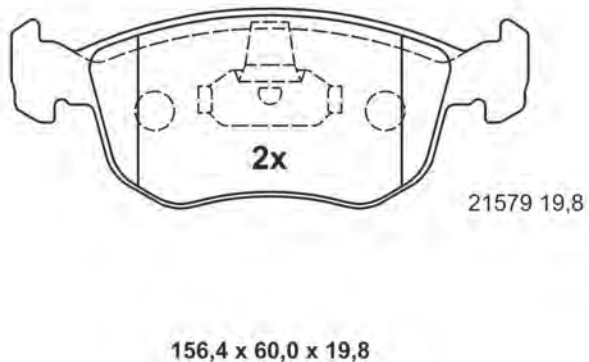
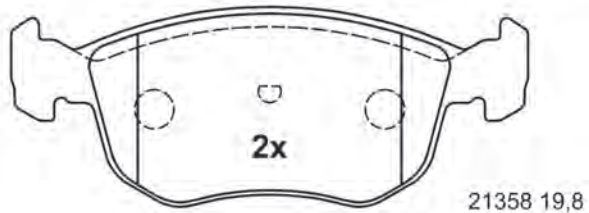

13.0460-7166.2 607166

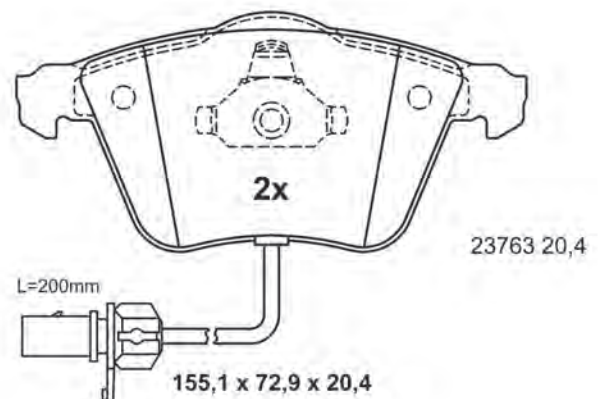
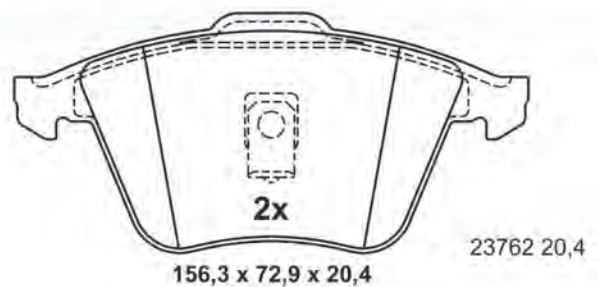



# Abbildungen Scheibenbremsbeläge

Illustrations disc brake pads - Ilustraciones de pastillas - Illustrations Plaquettes de frein à disque - Illustrazioni Pastiglie Freno

13.0460-7167.2 607167

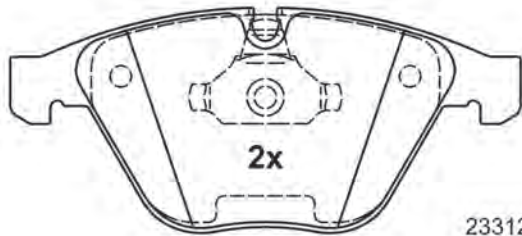

23312 20,3

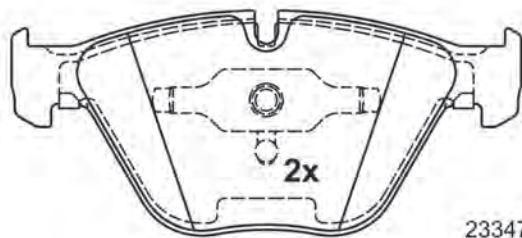

23347 20,3

155,1 x 68,3 x 20,3

13.0460-7168.2 607168

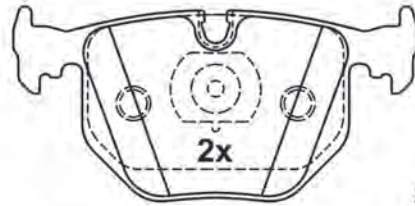

21282 17,3

123,0 x 59,2 x 17,3

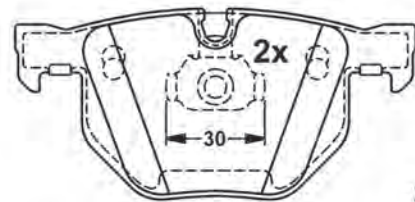

23447 17,3

121,8 x 57,8 x 17,3

13.0460-7169.2 607169

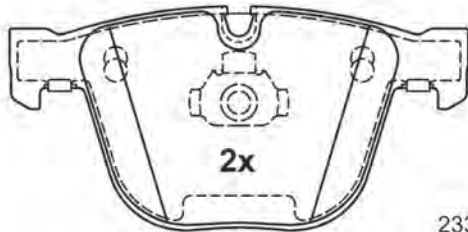

23309 17,3



23310 17,3

139,5 x 67,8 x 17,3

13.0460-7170.2 607170

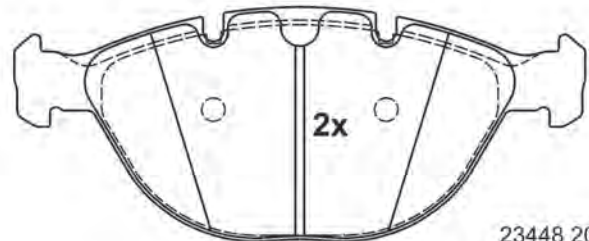

23448 20,8

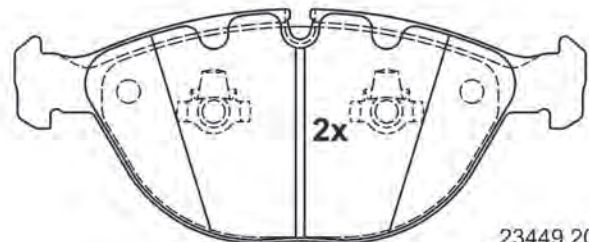

23449 20,8

193,0 x 79,0 x 20,8

# Abbildungen Scheibenbremsbeläge

Illustrations disc brake pads - Ilustraciones de pastillas - Illustrations Plaquettes de frein à disque - Illustrazioni Pastiglie Freno

13.0460-7171.2 607171

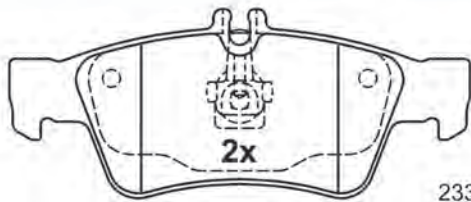

140,1 x 57,5 x 16,7

23334 16,7

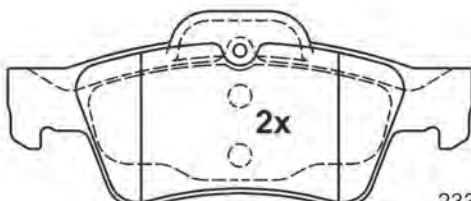

141,3 x 59,4 x 16,7

23335 16,7

13.0460-7172.2 607172

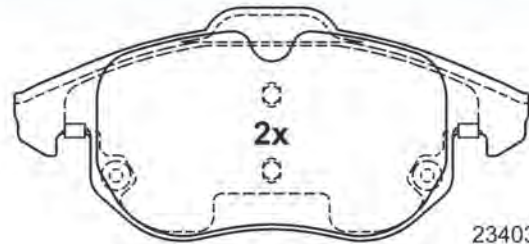

156,3 x 70,7 x 20,1

23403 20,1

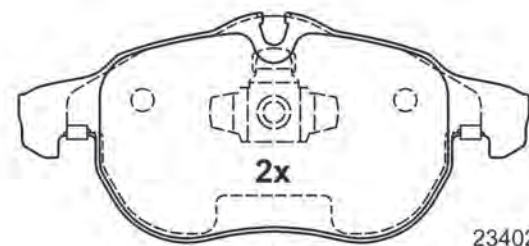

155,1 x 69,6 x 20,1

23402 20,1

13.0460-7173.2 607173

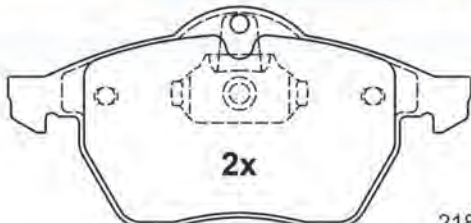

155,1 x 74,0 x 20,3

21829 20,3

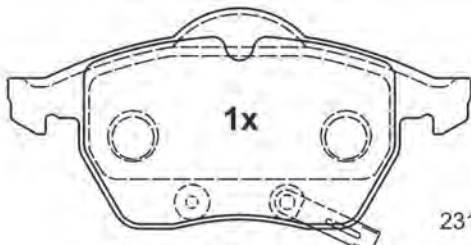

156,3 x 74,0 x 19,6

23116 19,6

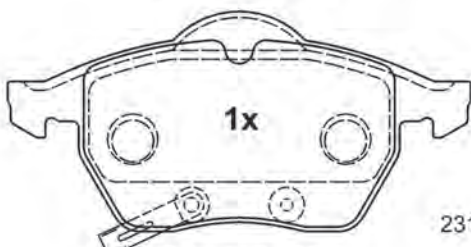

156,3 x 74,0 x 19,6

23117 19,6

13.0460-7174.2 607174

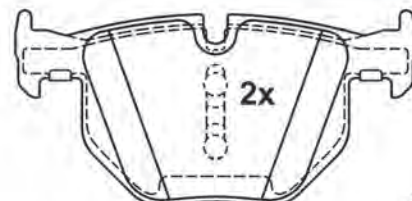

121,8 x 59,2 x 17,3

23732 17,3

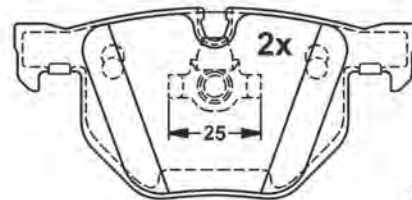

121,8 x 57,8 x 17,3

23737 17,3



# Abbildungen Scheibenbremsbeläge

Illustrations disc brake pads - Ilustraciones de pastillas - Illustrations Plaquettes de frein à disque - Illustrazioni Pastiglie Freno

13.0460-7176.2 607176

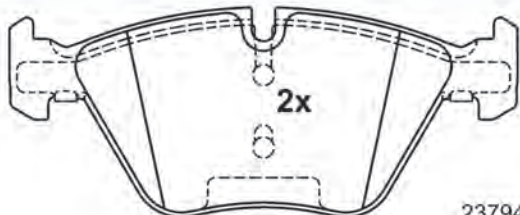

23794 20,3

154,6 x 63,5 x 20,3

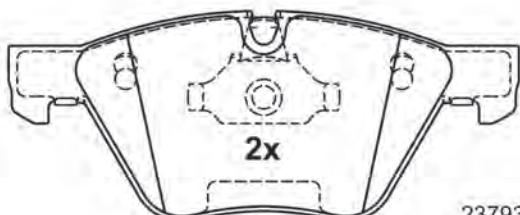

23793 20,3

155,1 x 63,5 x 20,3

13.0460-7177.2 607177

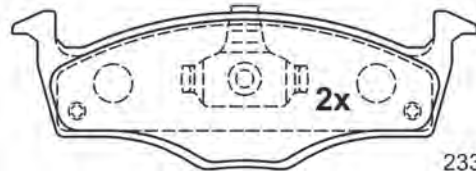

23394 13,7

141,6 x 48,0 x 13,7

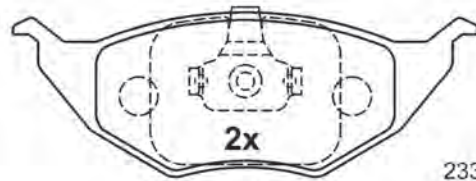

23395 13,7

141,6 x 49,9 x 13,7

13.0460-7178.2 607178

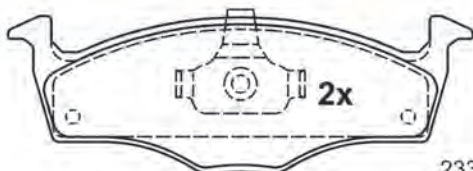

23394 13,7

141,6 x 48,0 x 13,7

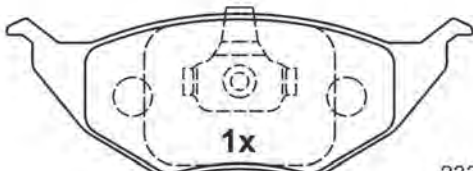

23395 13,7

141,6 x 49,9 x 13,7

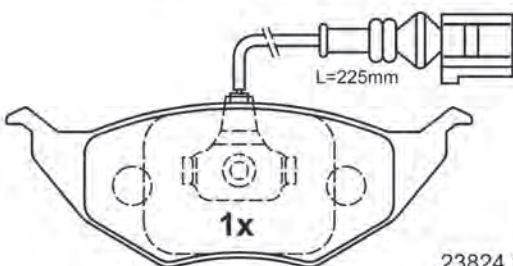

23824 13,7

141,6 x 49,9 x 13,7

13.0460-7179.2 607179 [1]

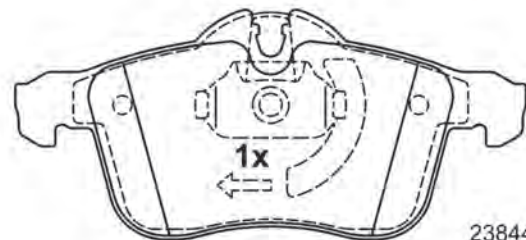

23844 20,5

155,1 x 70,0 x 20,5

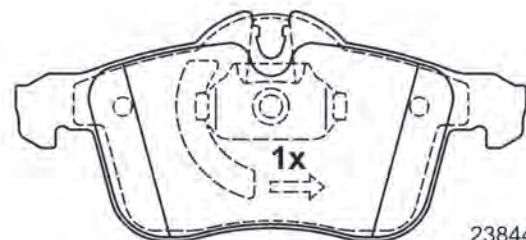

23844 20,5

155,1 x 70,0 x 20,5

# Abbildungen Scheibenbremsbeläge

Illustrations disc brake pads - Ilustraciones de pastillas - Illustrations Plaquettes de frein à disque - Illustrazioni Pastiglie Freno

13.0460-7179.2 607179 [2]

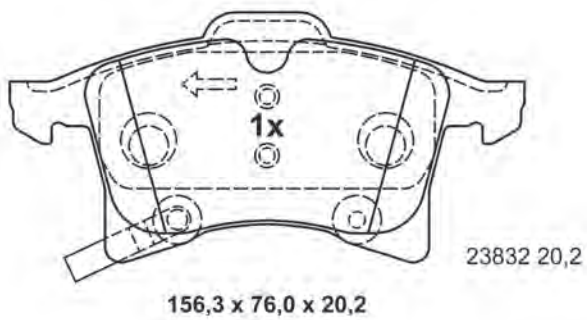
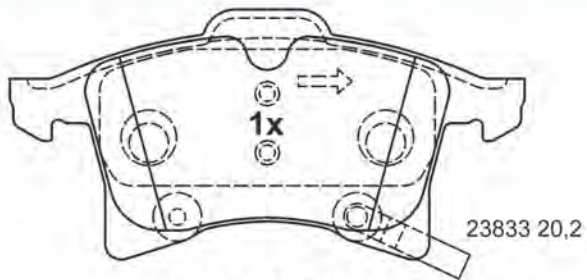

13.0460-7180.2 607180

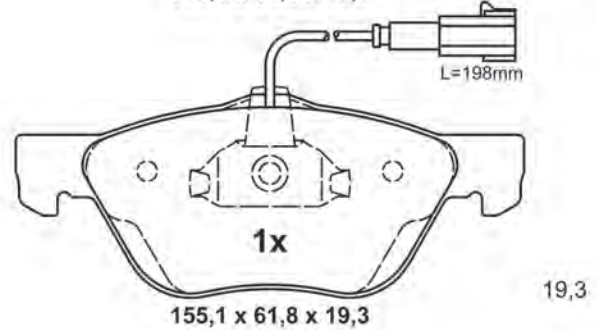
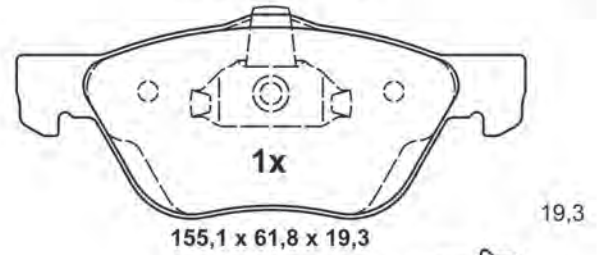
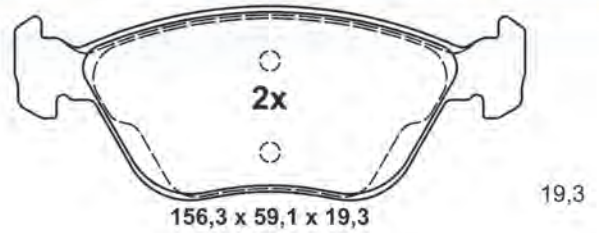
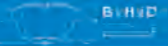

13.0460-7181.2 607181

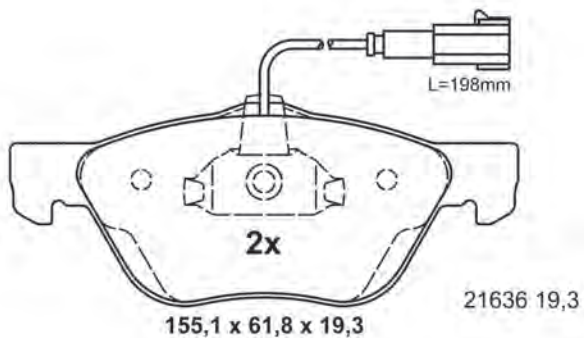
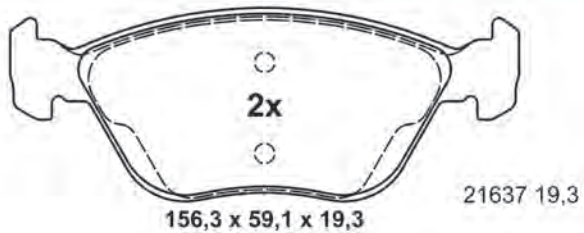

13.0460-7182.2 607182

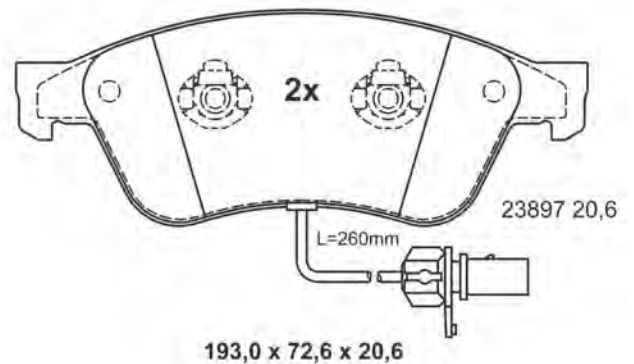
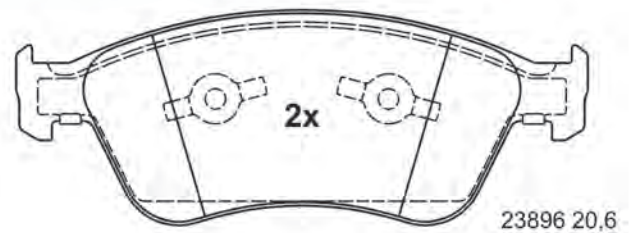
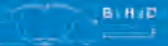



# Abbildungen Scheibenbremsbeläge

Illustrations disc brake pads - Ilustraciones de pastillas - Illustrations Plaquettes de frein à disque - Illustrazioni Pastiglie Freno

13.0460-7183.2 607183

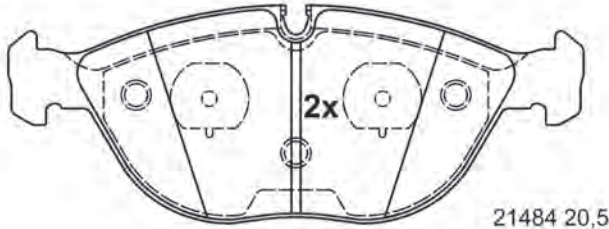

21484 20,5

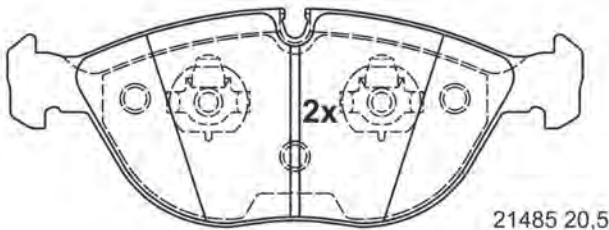

21485 20,5

194,3 x 73,5 x 20,5

13.0460-7184.2 607184

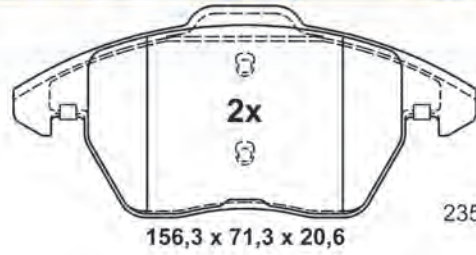

23589 20,6

156,3 x 71,3 x 20,6

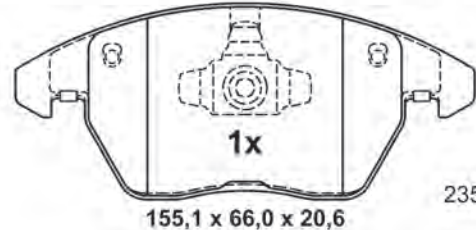

23587 20,6

155,1 x 66,0 x 20,6

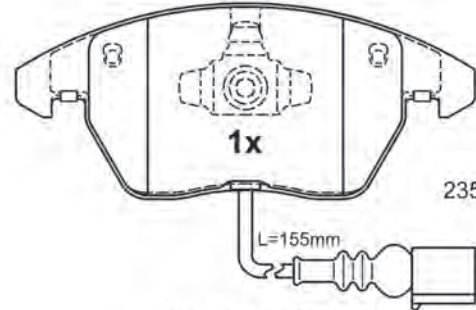

23588 20,6

155,1 x 66,0 x 20,6

13.0460-7185.2 607185

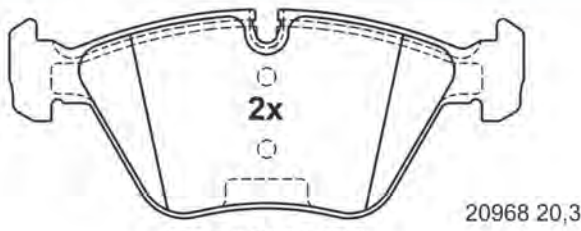

20968 20,3

156,3 x 63,5 x 20,3

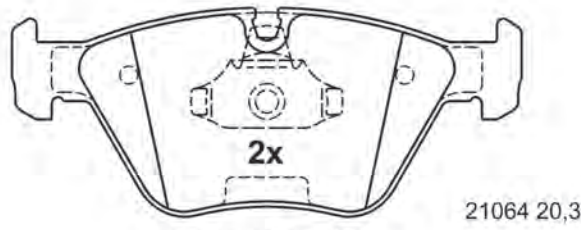

21064 20,3

155,1 x 63,5 x 20,3

13.0460-7186.2 607186

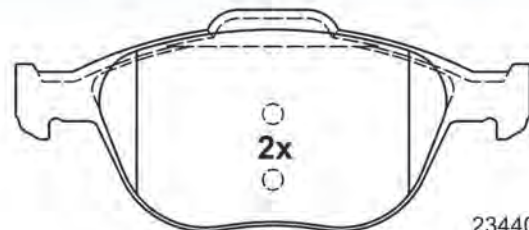

23440 17,6

156,3 x 67,3 x 17,6

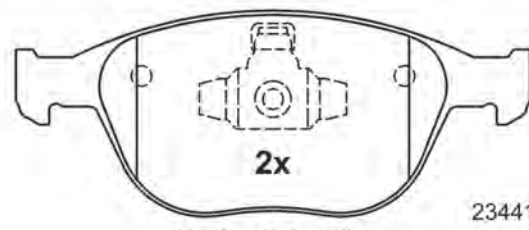

23441 18,1

156,3 x 62,5 x 18,1



# Abbildungen Scheibenbremsbeläge

Illustrations disc brake pads - Ilustraciones de pastillas - Illustrations Plaquettes de frein à disque - Illustrazioni Pastiglie Freno

13.0460-7187.2 607187

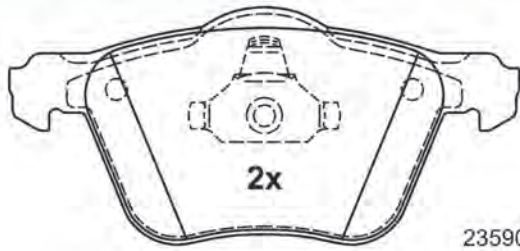

155,1 x 72,0 x 19,5

23590 19,5

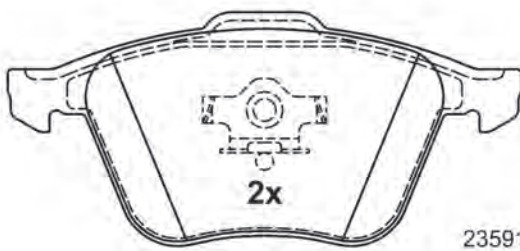

156,3 x 71,0 x 18,0

23591 18,0

13.0460-7188.2 607188

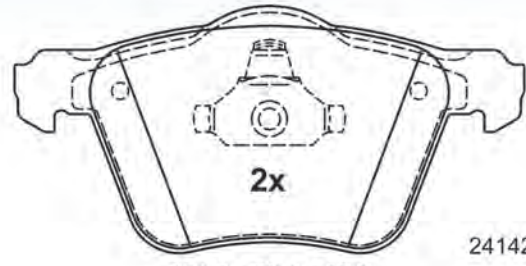

155,1 x 75,1 x 20,6

24142 20,6

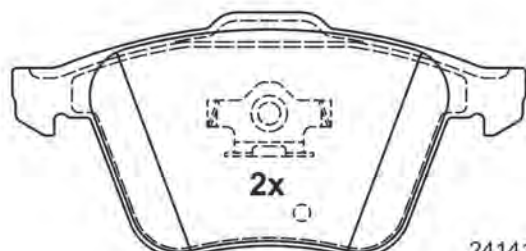

156,3 x 74,1 x 19,1

24141 19,1

13.0460-7189.2 607189



123,0 x 61,7 x 18,7

24011 18,7

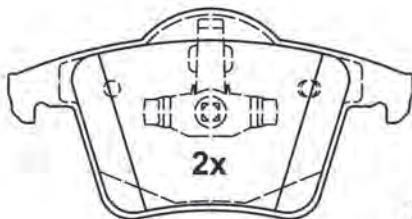

123,0 x 63,7 x 18,7

24012 18,7

13.0460-7190.2 607190



141,3 x 50,9 x 19,1

24367 19,1

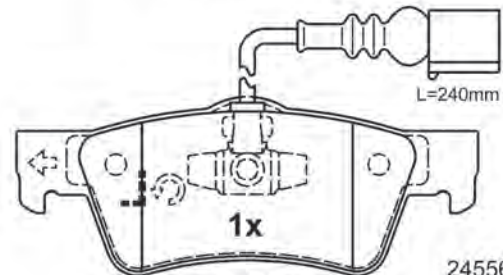

140,7 x 53,9 x 19,1

24556 19,1

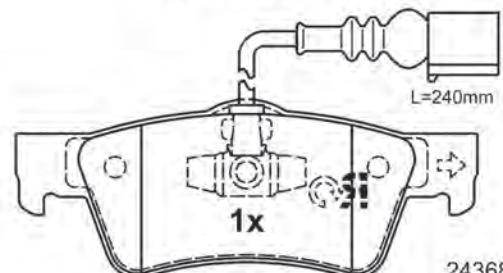

140,7 x 53,9 x 19,1

24368 19,1



# Abbildungen Scheibenbremsbeläge

Illustrations disc brake pads - Ilustraciones de pastillas - Illustrations Plaquettes de frein à disque - Illustrazioni Pastiglie Freno

13.0460-7191.2 607191

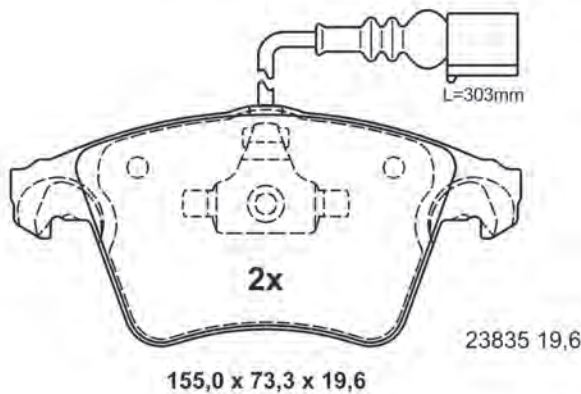
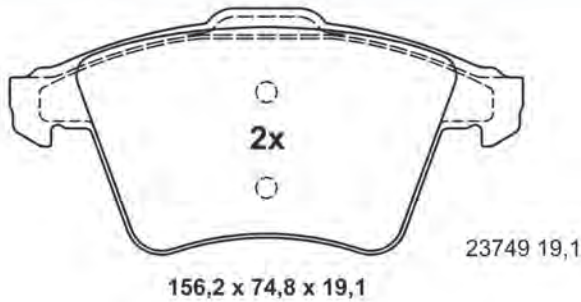

13.0460-7193.2 607193

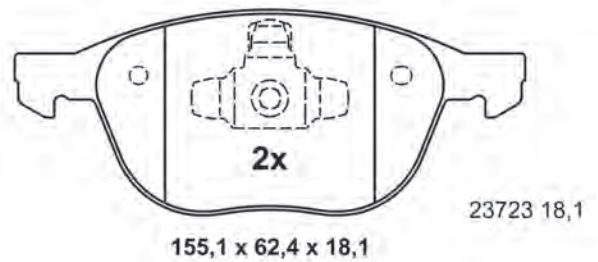
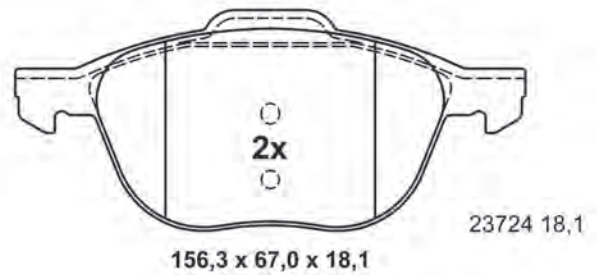

13.0460-7194.2 607194

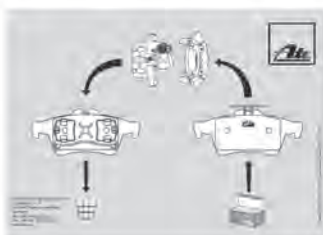
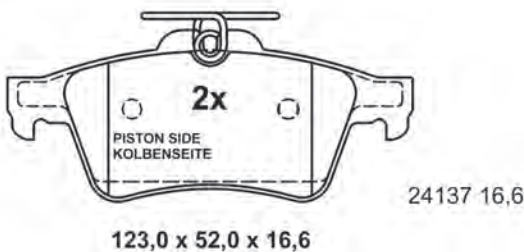

13.0460-7195.2 607195

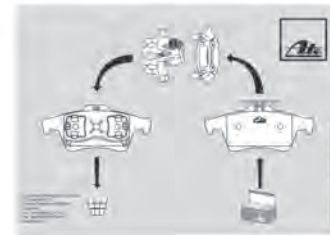
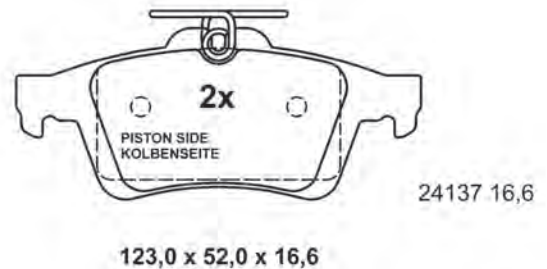
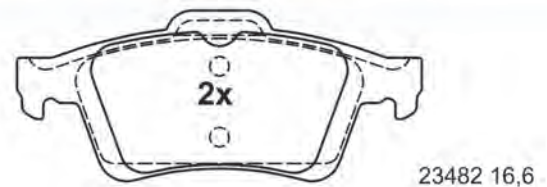



# Abbildungen Scheibenbremsbeläge

Illustrations disc brake pads - Ilustraciones de pastillas - Illustrations Plaquettes de frein à disque - Illustrazioni Pastiglie Freno

13.0460-7196.2 607196

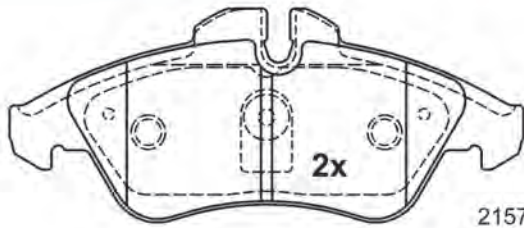

21576 20,7

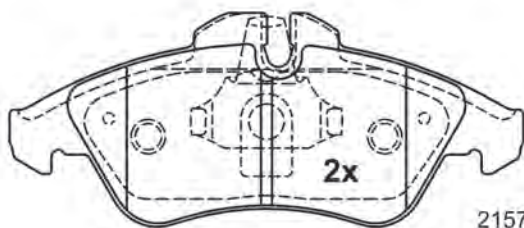

21577 20,7

156,3 x 64,8 x 20,7

13.0460-7199.2 607199

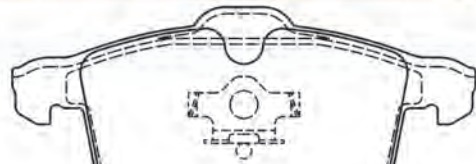

23405 20,1

156,4 x 77,6 x 20,1

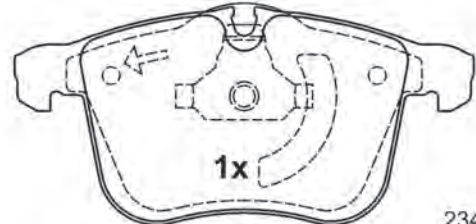

23404 20,6

155,1 x 74,5 x 20,6

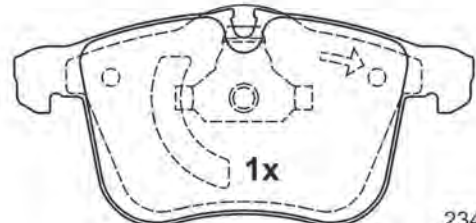

23404 20,6

155,1 x 74,5 x 20,6

13.0460-7200.2 607200

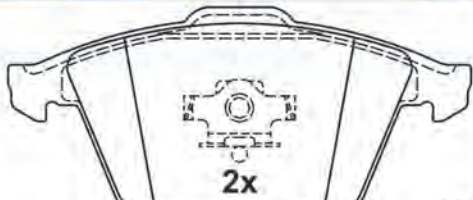

23801 20,3

156,3 x 72,9 x 20,3

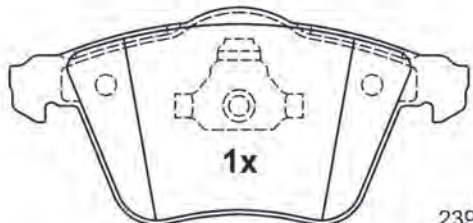

23912 20,3

155,1 x 72,9 x 20,3

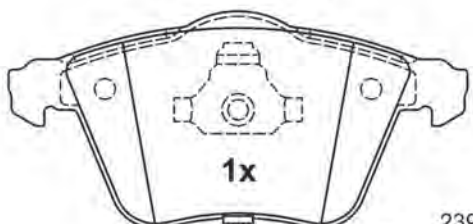

23913 20,3

L=177,5mm

155,1 x 72,9 x 20,3

13.0460-7201.2 607201

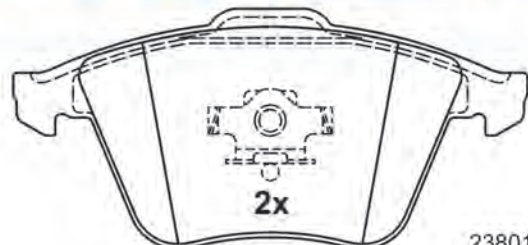

23801 20,3

156,3 x 72,9 x 20,3

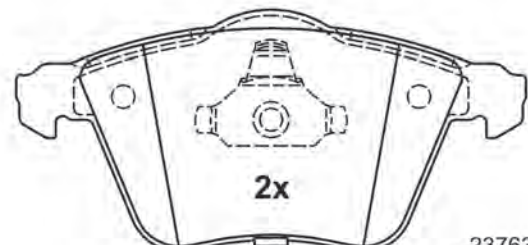

23763 20,3

L=242,5mm

155,1 x 72,9 x 20,3

# Abbildungen Scheibenbremsbeläge

Illustrations disc brake pads - Ilustraciones de pastillas - Illustrations Plaquettes de frein à disque - Illustrazioni Pastiglie Freno

13.0460-7202.2 607202

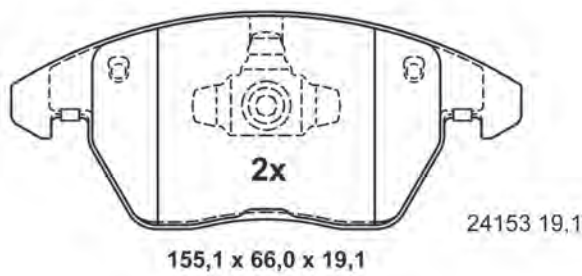
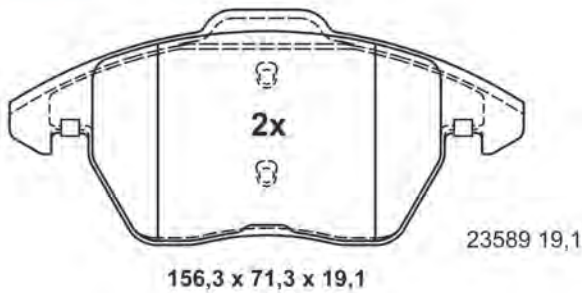

13.0460-7203.2 607203

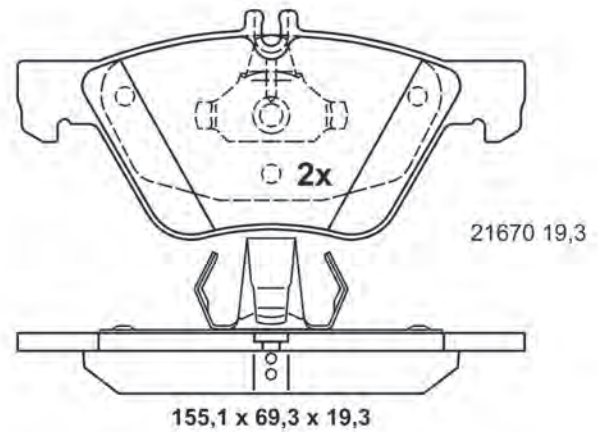
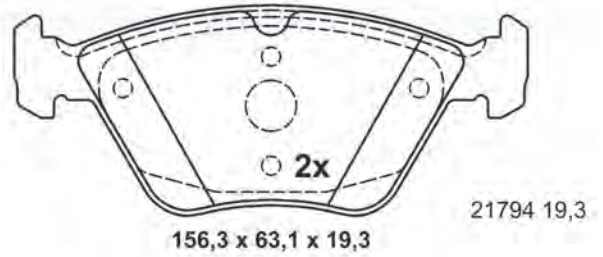

13.0460-7204.2 607204

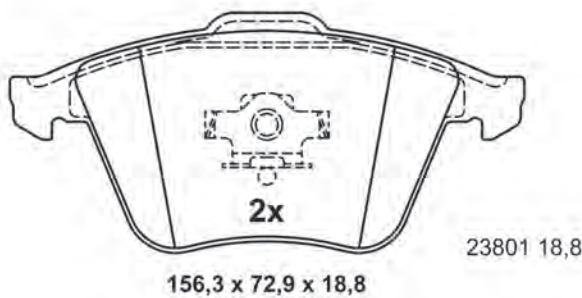
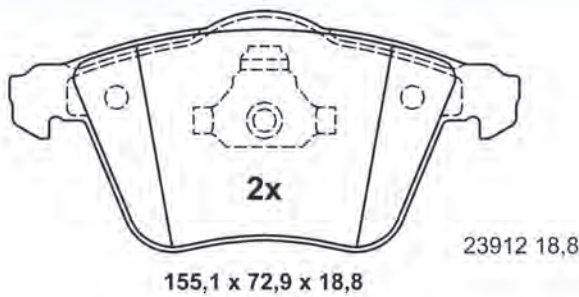

13.0460-7205.2 607205

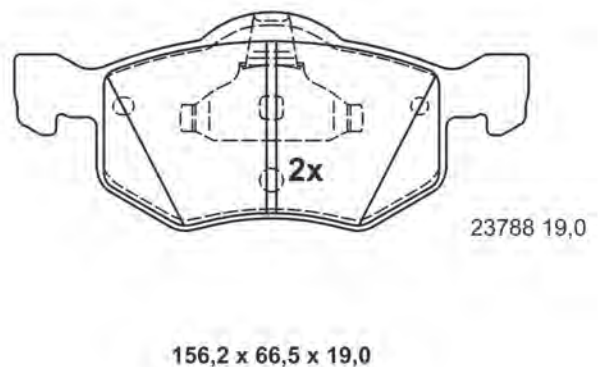
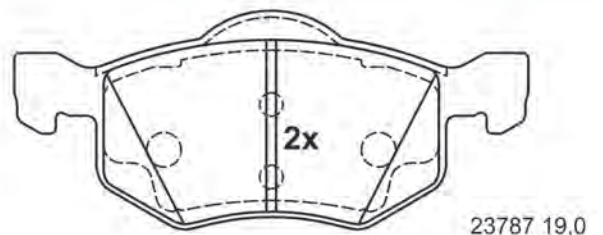



# Abbildungen Scheibenbremsbeläge

Illustrations disc brake pads - Ilustraciones de pastillas - Illustrations Plaquettes de frein à disque - Illustrazioni Pastiglie Freno

13.0460-7206.2 607206

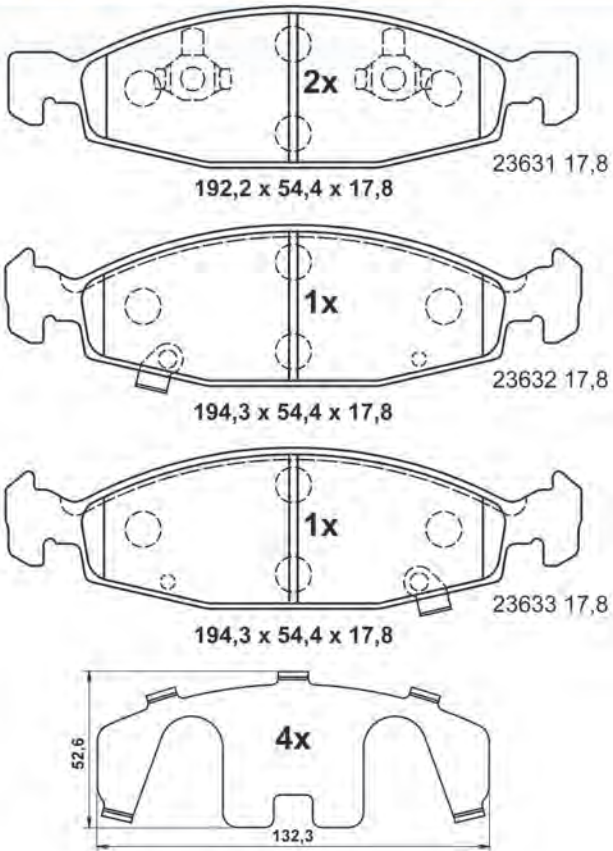

13.0460-7207.2 607207

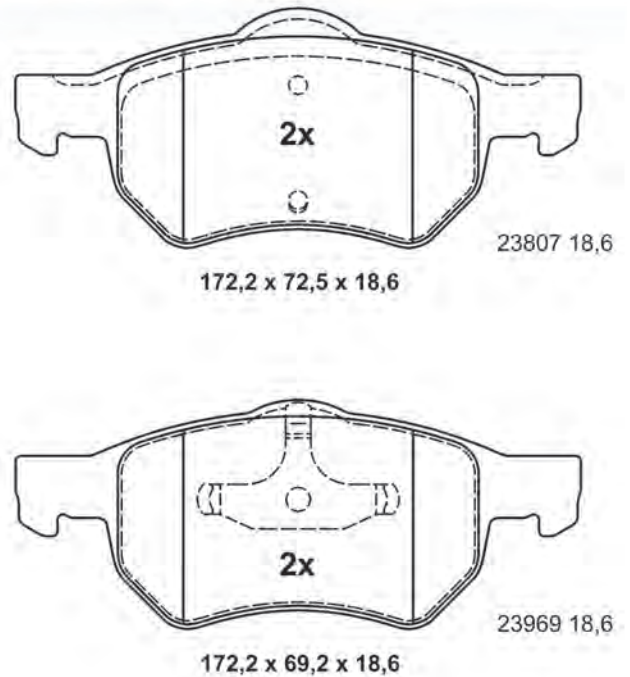

13.0460-7209.2 607209

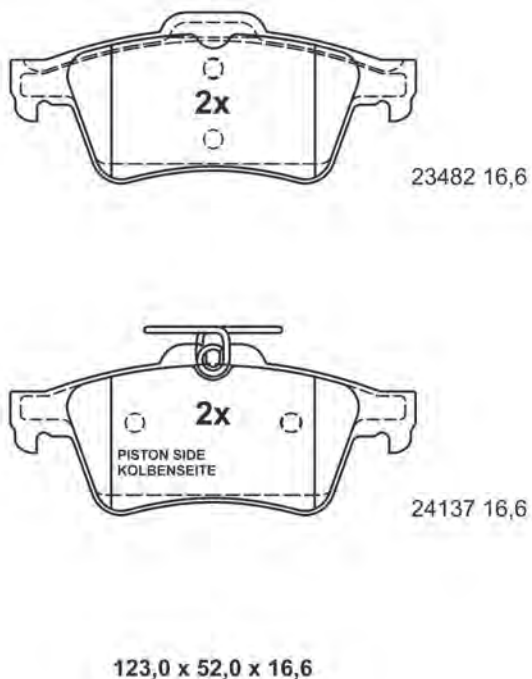

13.0460-7210.2 607210

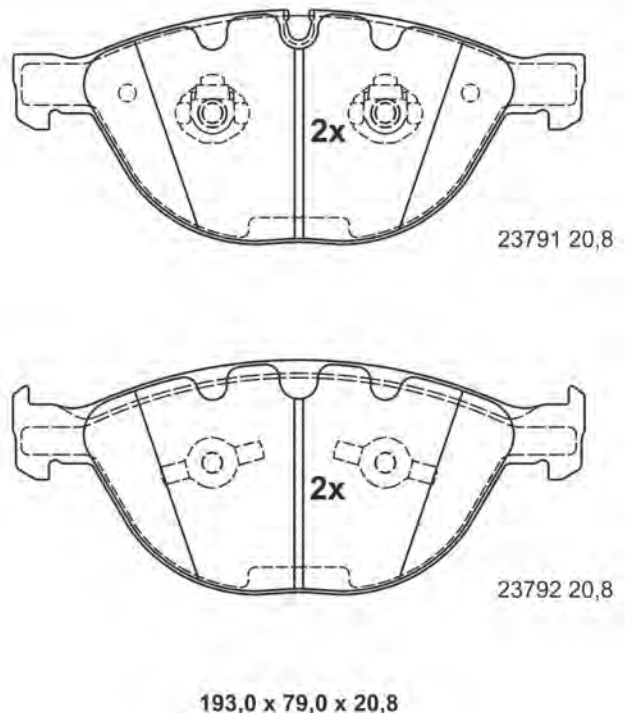

# Abbildungen Scheibenbremsbeläge

Illustrations disc brake pads - Ilustraciones de pastillas - Illustrations Plaquettes de frein à disque - Illustrazioni Pastiglie Freno

13.0460-7211.2 607211

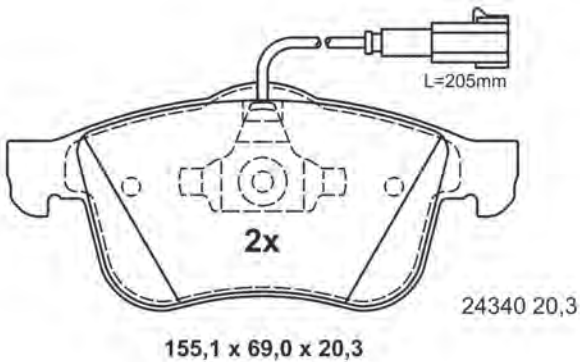
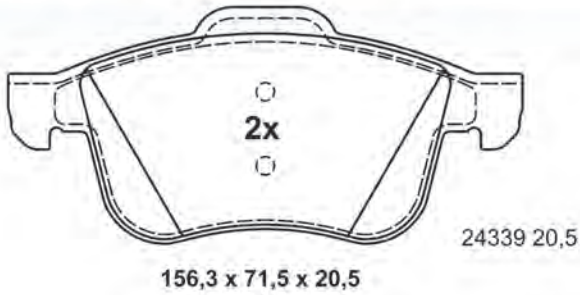

13.0460-7212.2 607212

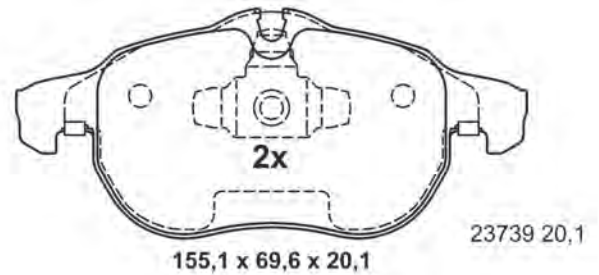
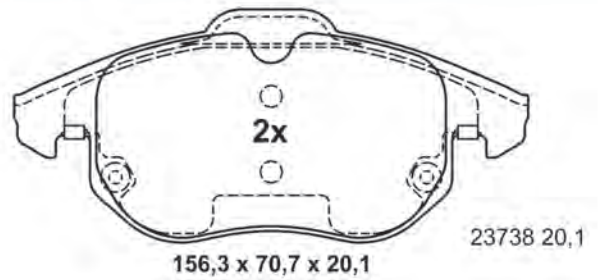

13.0460-7213.2 607213

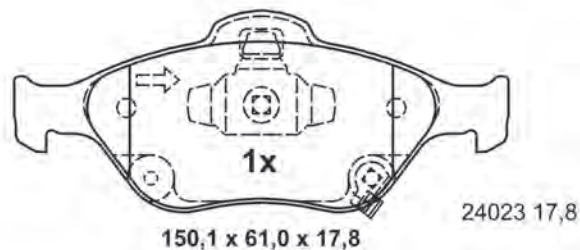
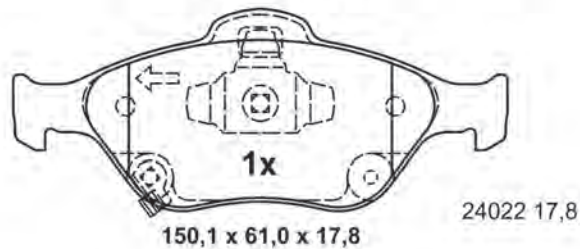
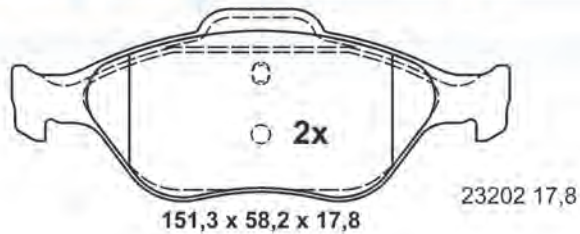

13.0460-7214.2 607214

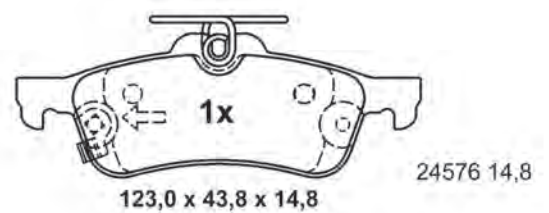
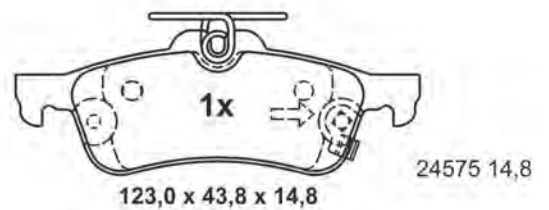



# Abbildungen Scheibenbremsbeläge

Illustrations disc brake pads - Ilustraciones de pastillas - Illustrations Plaquettes de frein à disque - Illustrazioni Pastiglie Freno

13.0460-7215.2 607215

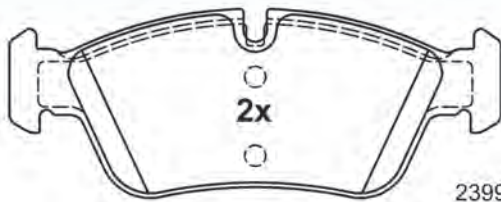

149,3 x 57,3 x 17,8

23999 17,8

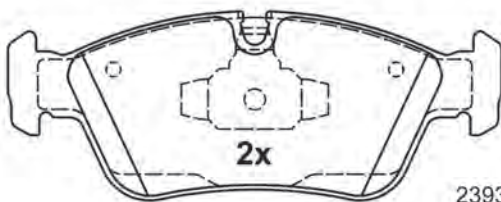

150,1 x 57,3 x 17,8

23935 17,8

13.0460-7216.2 607216

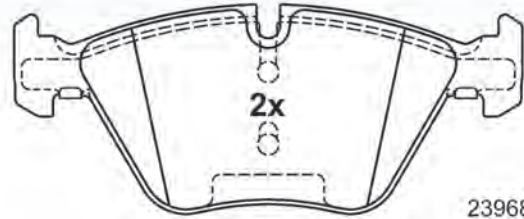

154,6 x 63,5 x 20,3

23968 20,3

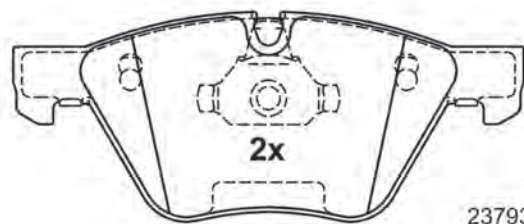

155,1 x 63,5 x 20,3

23793 20,3

13.0460-7217.2 607217

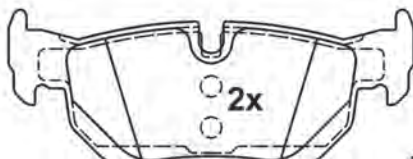

123,0 x 48,1 x 17,3

23927 17,3

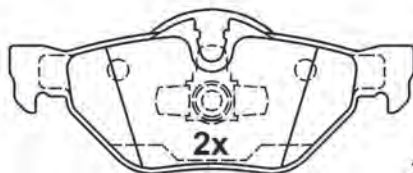

123,0 x 49,7 x 17,3

23926 17,3

13.0460-7218.2 607218

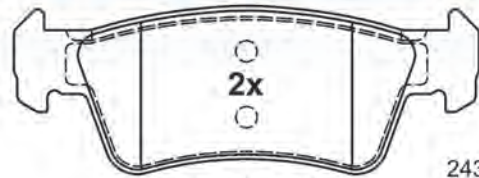

141,3 x 50,9 x 19,1

24367 19,1

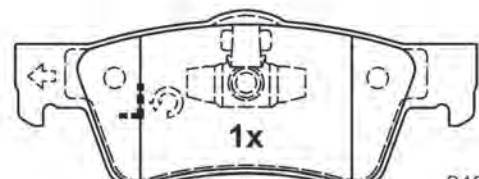

140,7 x 53,9 x 19,1

24645 19,1



140,7 x 53,9 x 19,1

24368 19,1



# Abbildungen Scheibenbremsbeläge

Illustrations disc brake pads - Ilustraciones de pastillas - Illustrations Plaquettes de frein à disque - Illustrazioni Pastiglie Freno

13.0460-7219.2 607219

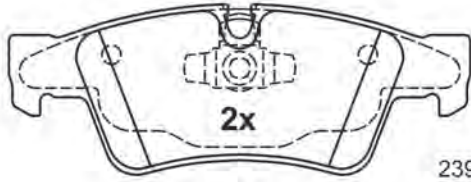

23923 17,6

140,1 x 51,6 x 17,6

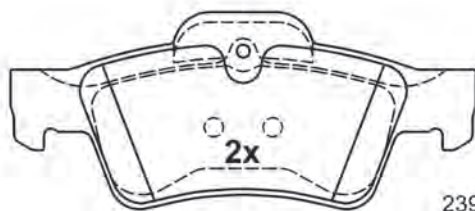

23924 17,6

141,3 x 59,6 x 17,6

13.0460-7220.2 607220

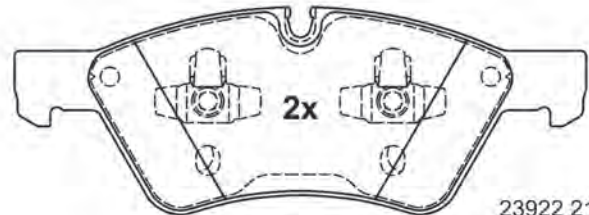

23922 21,0

192,9 x 69,9 x 21,0

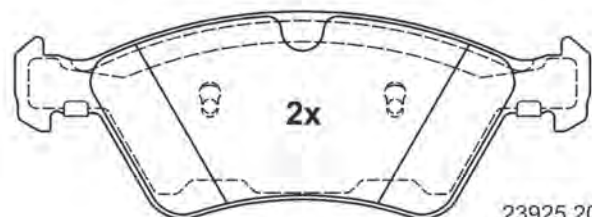

23925 20,5

194,3 x 70,0 x 20,5

13.0460-7221.2 607221

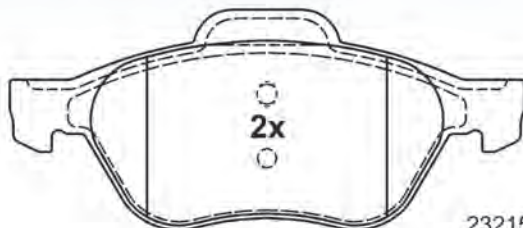

23215 18,3

156,3 x 66,8 x 18,3

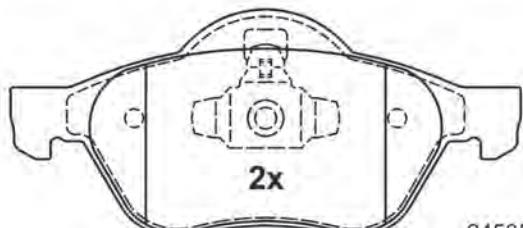

24535 18,3

155,1 x 68,9 x 18,3

13.0460-7222.2 607222

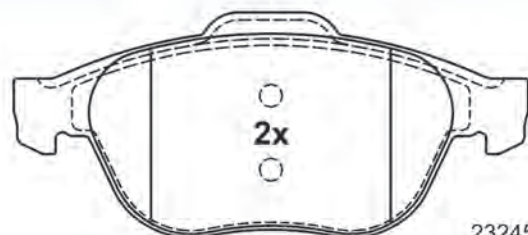

23245 18,3

156,3 x 68,3 x 18,3

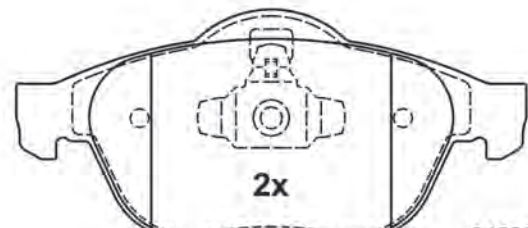

24536 18,3

155,1 x 70,8 x 18,3

# Abbildungen Scheibenbremsbeläge

Illustrations disc brake pads - Ilustraciones de pastillas - Illustrations Plaquettes de frein à disque - Illustrazioni Pastiglie Freno

13.0460-7223.2 607223

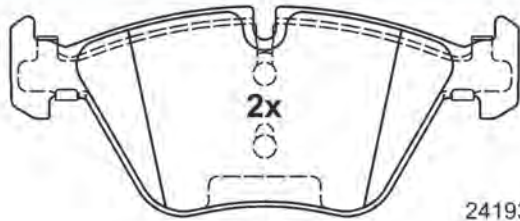

24193 20,3

154,6 x 63,5 x 20,3

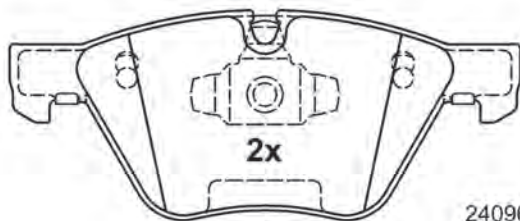

24096 20,3

155,1 x 63,5 x 20,3

13.0460-7224.2 607224

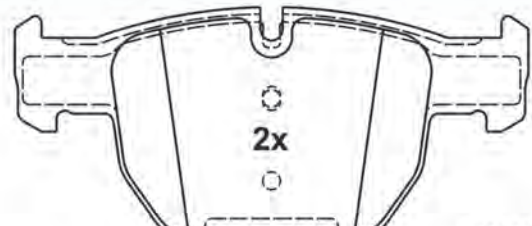

23397 19,4

156,3 x 73,2 x 19,4

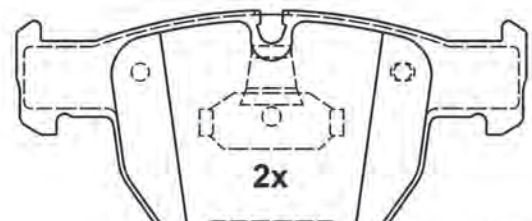

23399 19,4

155,0 x 73,2 x 19,4

13.0460-7225.2 607225

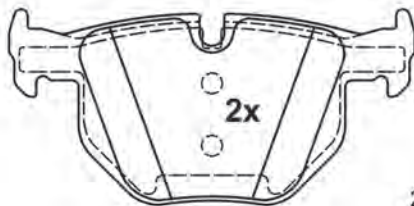

23551 17,3

123,0 x 59,2 x 17,3

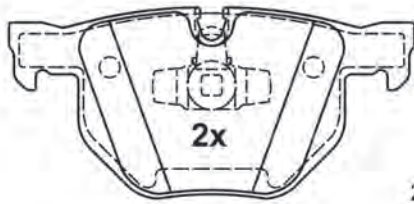

23550 17,3

123,0 x 58,0 x 17,3

13.0460-7226.2 607226

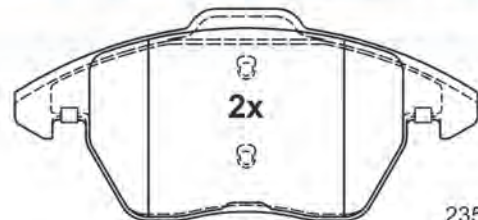

23589 20,4

155,1 x 71,3 x 20,4

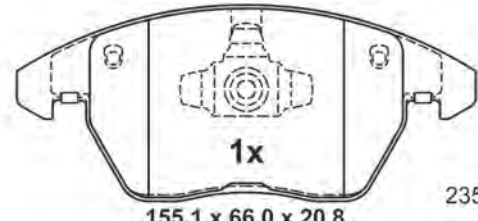

23587 20,8

155,1 x 66,0 x 20,8

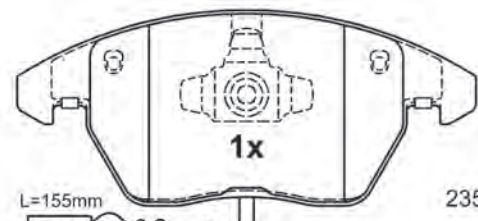

23588 20,8

155,1 x 66,0 x 20,8

L=155mm





# Abbildungen Scheibenbremsbeläge

Illustrations disc brake pads - Ilustraciones de pastillas - Illustrations Plaquettes de frein à disque - Illustrazioni Pastiglie Freno

13.0460-7227.2 607227

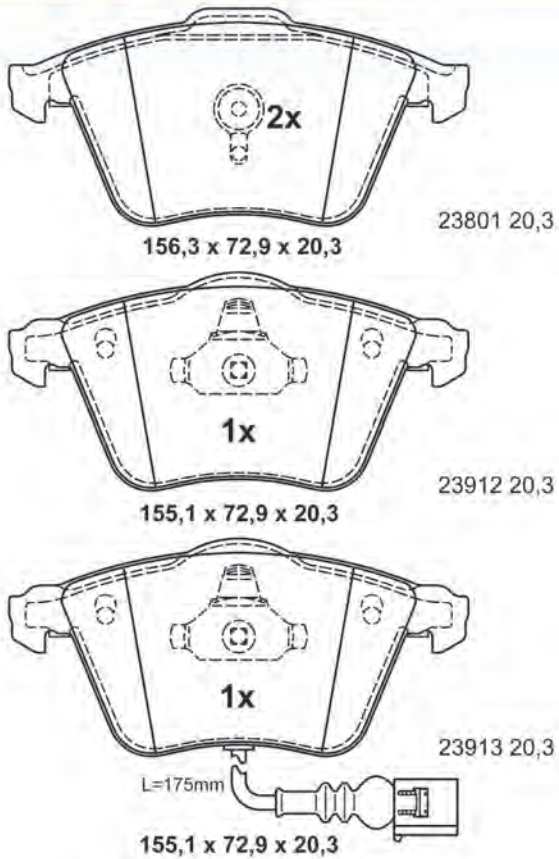

13.0460-7228.2 607228

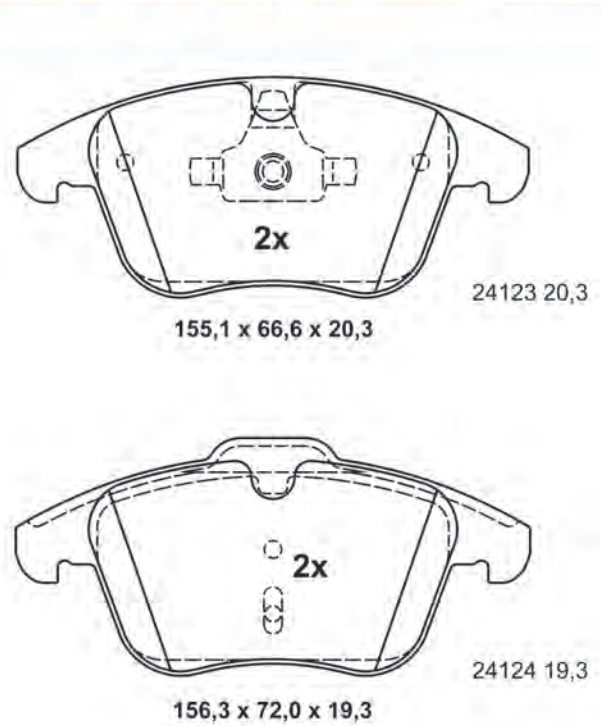

13.0460-7229.2 607229

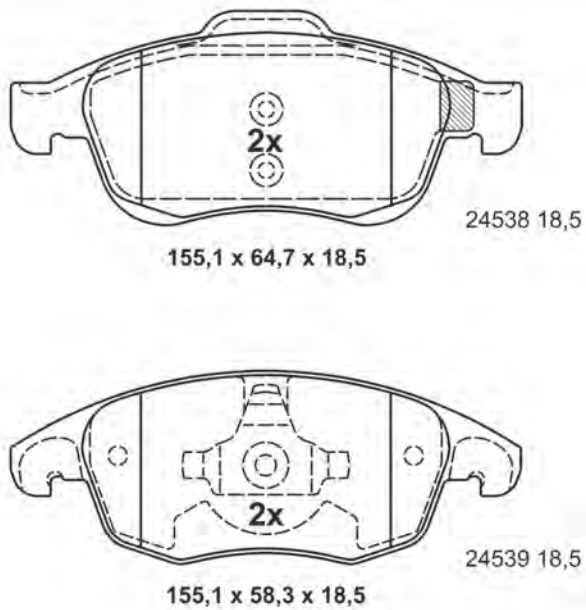

13.0460-7230.2 607230

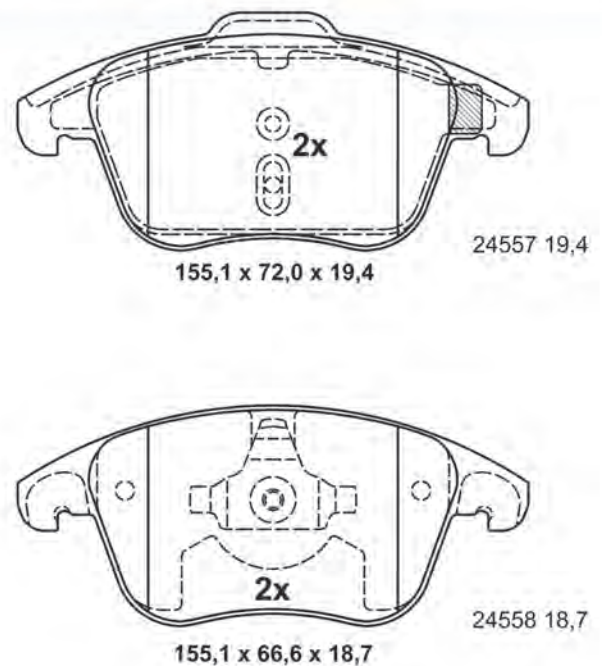

# Abbildungen Scheibenbremsbeläge

Illustrations disc brake pads - Ilustraciones de pastillas - Illustrations Plaquettes de frein à disque - Illustrazioni Pastiglie Freno

13.0460-7231.2 607231

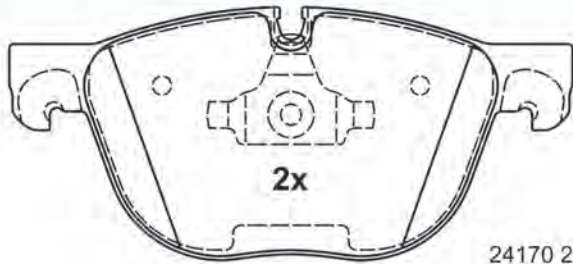

171,1 x 76,8 x 20,2

24170 20,2



170,2 x 76,8 x 20,9

24171 20,9

13.0460-7232.2 607232

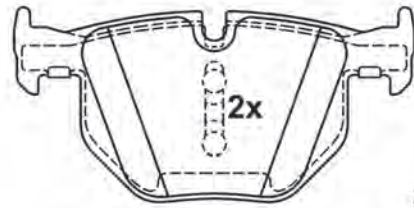

121,8 x 59,2 x 17,3

21282 17,3

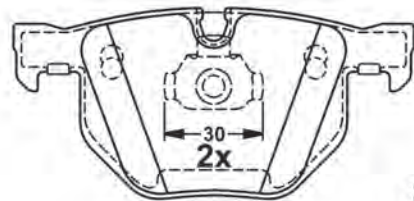

121,8 x 57,8 x 17,3

23447 17,3

13.0460-7234.2 607234

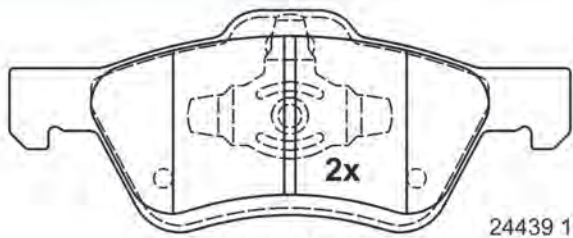

170,4 x 67,3 x 16,1

24439 16,1

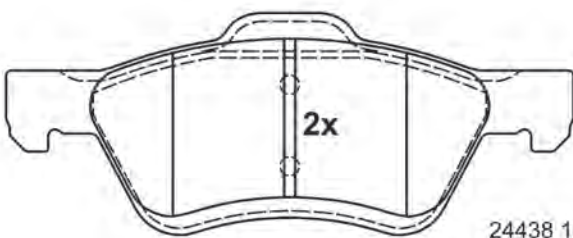

172,4 x 67,3 x 16,1

24438 16,1

13.0460-7235.2 607235

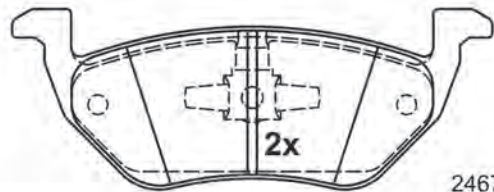

24671 18,0

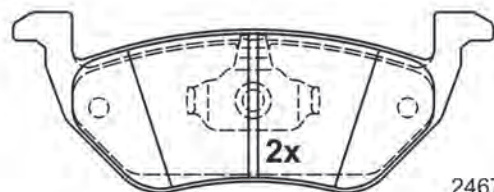

24670 18,0

146,0 x 54,0 x 18,0



# Abbildungen Scheibenbremsbeläge

Illustrations disc brake pads - Ilustraciones de pastillas - Illustrations Plaquettes de frein à disque - Illustrazioni Pastiglie Freno

13.0460-7236.2 607236

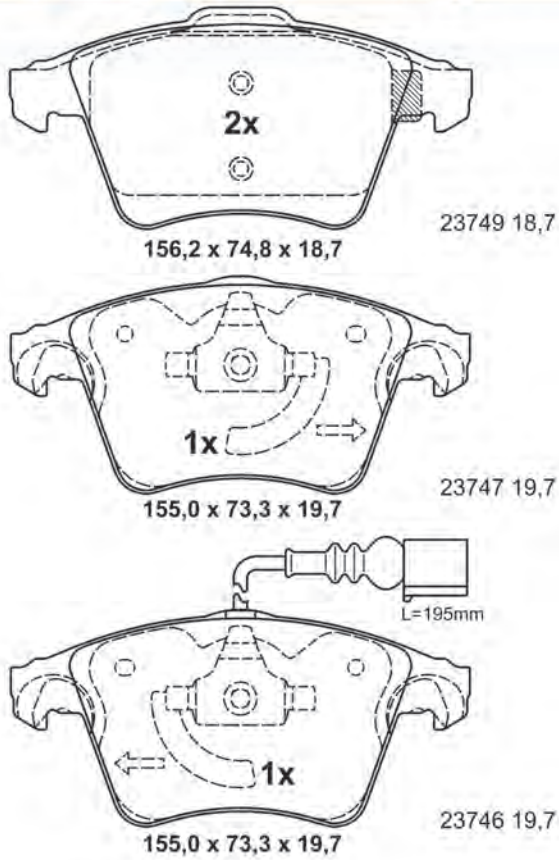

13.0460-7237.2 607237

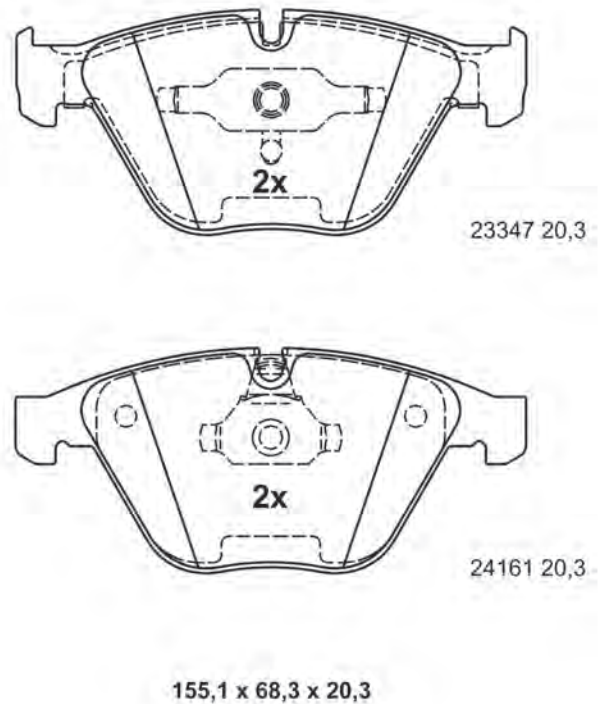

13.0460-7238.2 607238

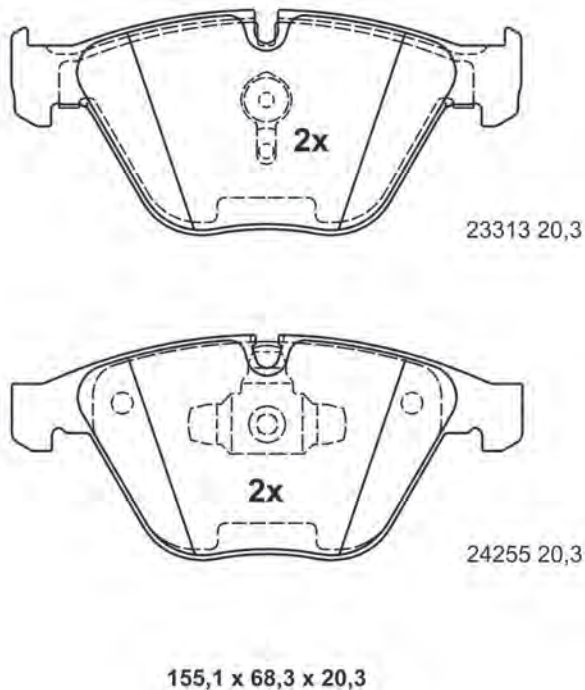

13.0460-7239.2 607239

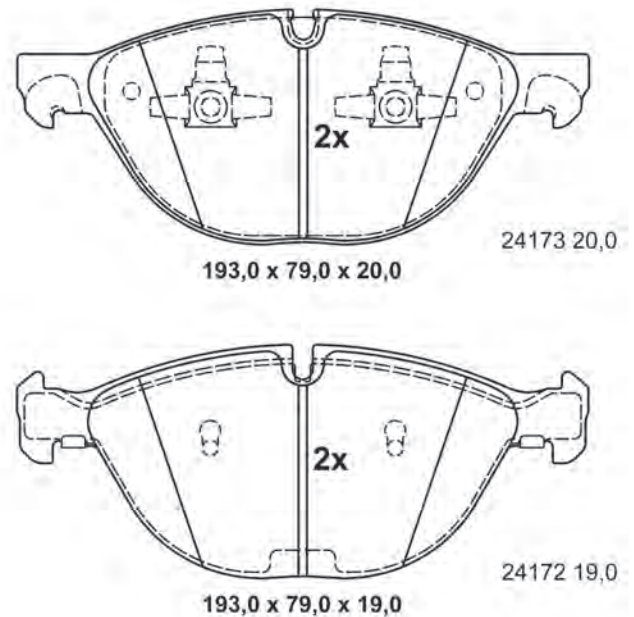



# Abbildungen Scheibenbremsbeläge

Illustrations disc brake pads - Ilustraciones de pastillas - Illustrations Plaquettes de frein à disque - Illustrazioni Pastiglie Freno

13.0460-7240.2 607240

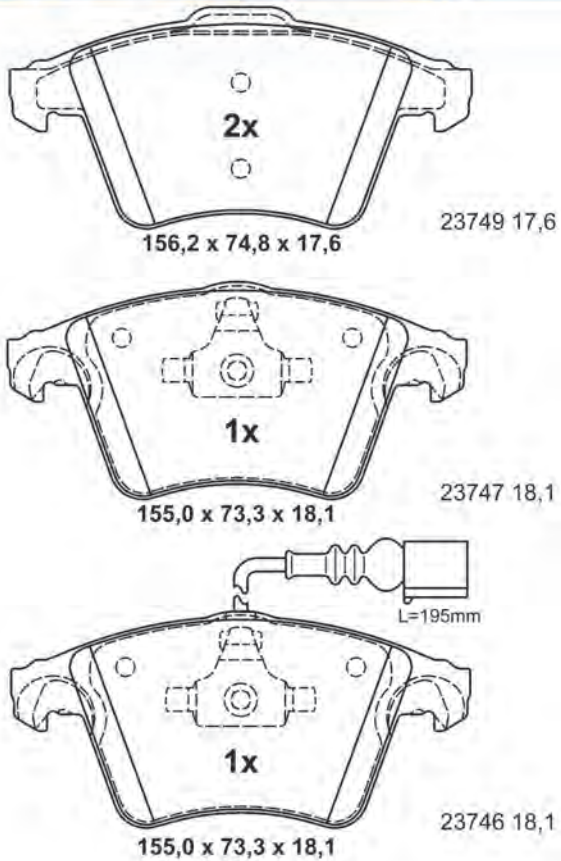

13.0460-7241.2 607241

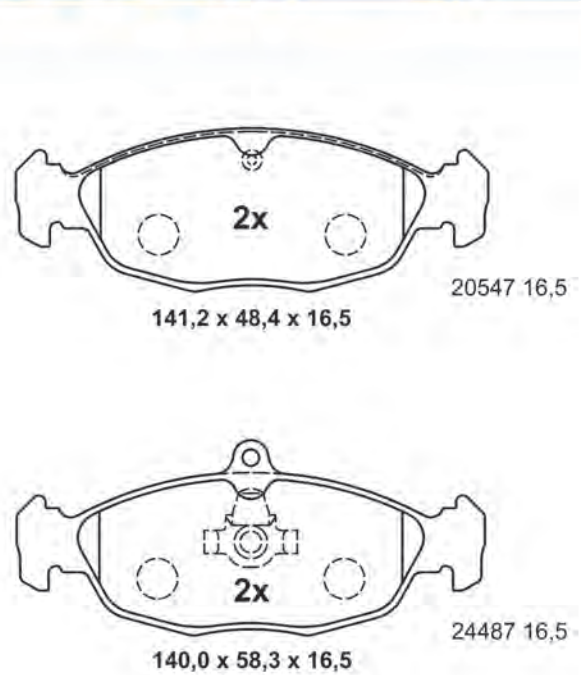

13.0460-7242.2 607242

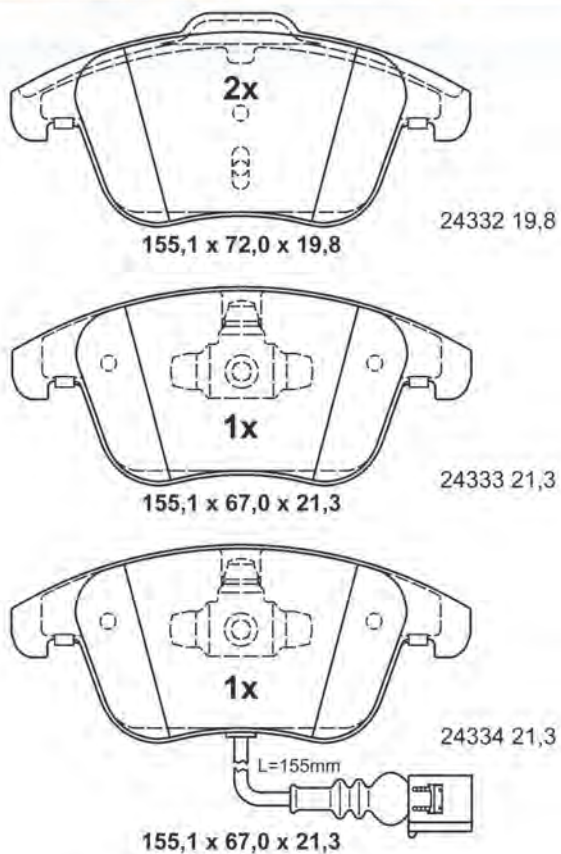

13.0460-7243.2 607243

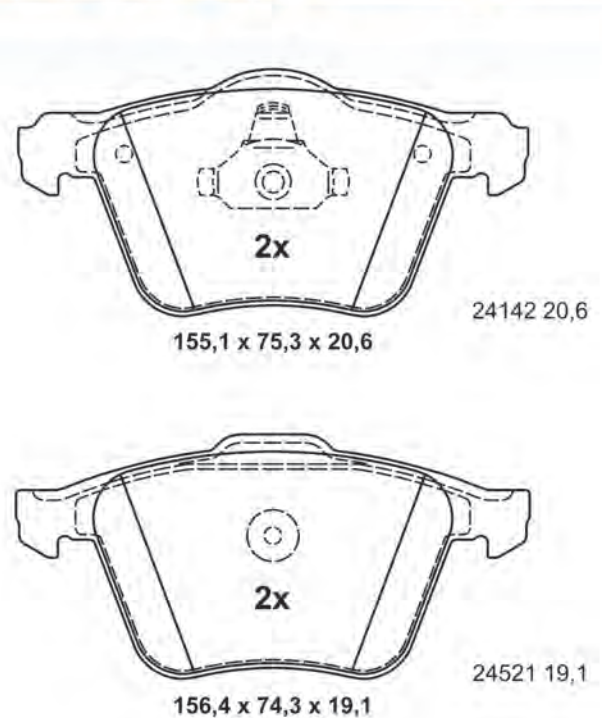

# Abbildungen Scheibenbremsbeläge

Illustrations disc brake pads - Ilustraciones de pastillas - Illustrations Plaquettes de frein à disque - Illustrazioni Pastiglie Freno

13.0460-7244.2 607244

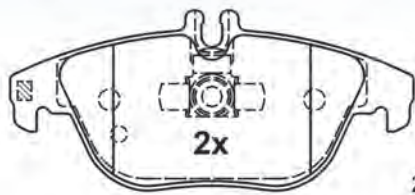

122,5 x 54,4 x 17,8

24253 17,8



122,5 x 52,3 x 18,0

24254 18,0

13.0460-7245.2 607245

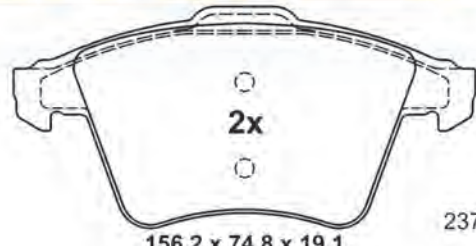

156,2 x 74,8 x 19,1

23759 19,1

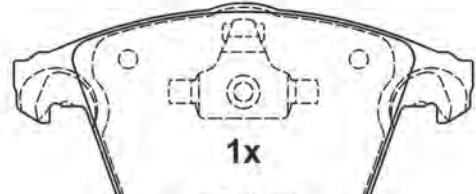

155,0 x 73,3 x 19,6

23747 19,6

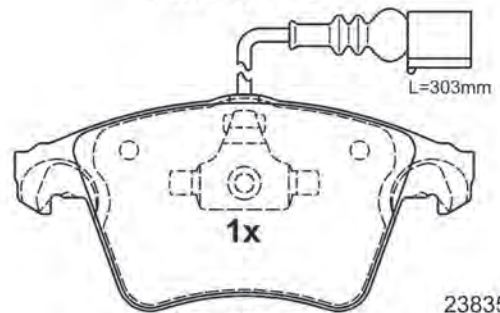

155,0 x 73,3 x 19,6

23835 19,6

13.0460-7246.2 607246

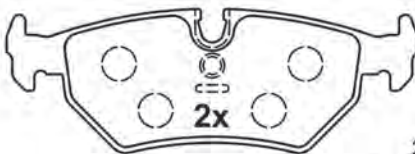

21275 17,0

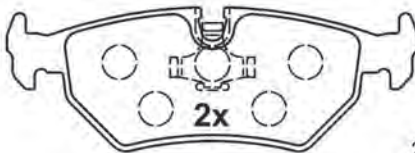

21276 17,0

123,0 x 43,0 x 17,0

13.0460-7248.2 607248

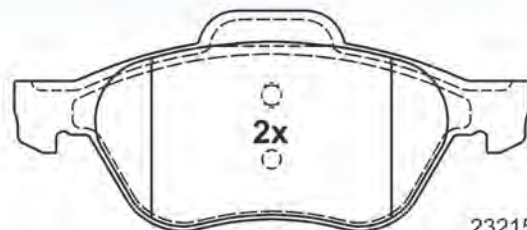

156,3 x 67,0 x 17,5

23215 17,5

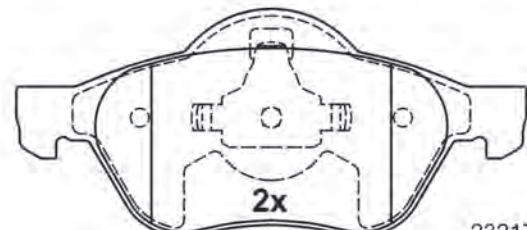

155,2 x 69,0 x 17,5

23217 17,5



# Abbildungen Scheibenbremsbeläge

Illustrations disc brake pads - Ilustraciones de pastillas - Illustrations Plaquettes de frein à disque - Illustrazioni Pastiglie Freno

13.0460-7249.2 607249

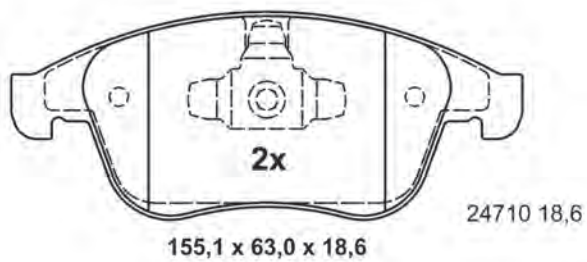
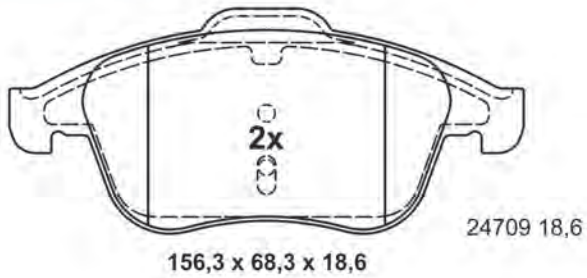

13.0460-7250.2 607250

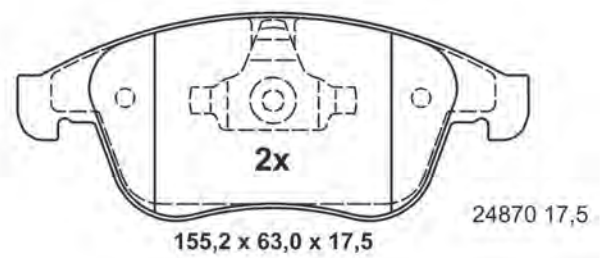

13.0460-7251.2 607251

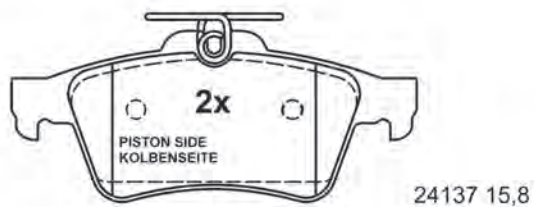

123,0 x 52,0 x 15,8

13.0460-7252.2 607252

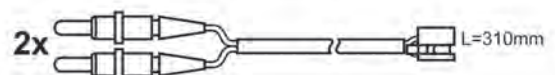
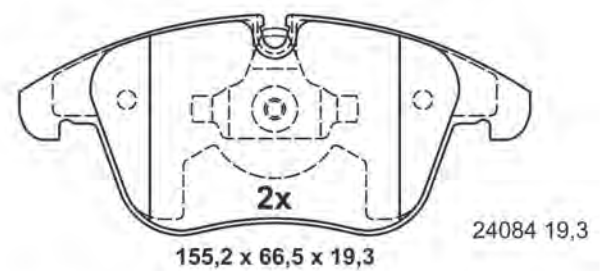

# Abbildungen Scheibenbremsbeläge

Illustrations disc brake pads - Ilustraciones de pastillas - Illustrations Plaquettes de frein à disque - Illustrazioni Pastiglie Freno

13.0460-7253.2 607253

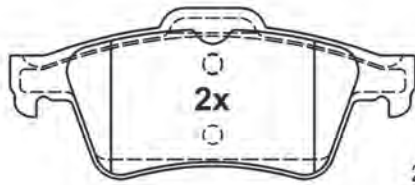

23482 15,8

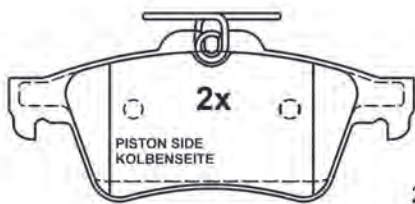

24137 15,8

123,0 x 52,0 x 15,8

13.0460-7255.2 607255

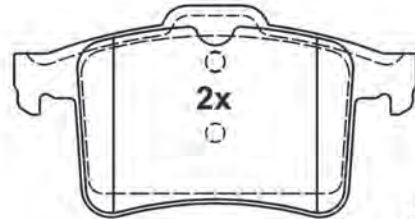

25114 15,8



25115 15,8

122,0 x 64,1 x 15,8

13.0460-7256.2 607256



24705 19,8

155,1 x 72,0 x 19,8

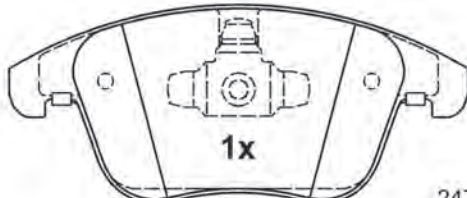

24706 21,3

155,1 x 67,0 x 21,3

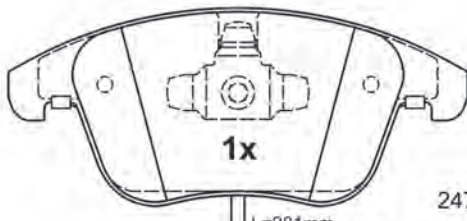

24707 21,3

L=281mm  
155,1 x 67,0 x 21,3

13.0460-7257.2 607257

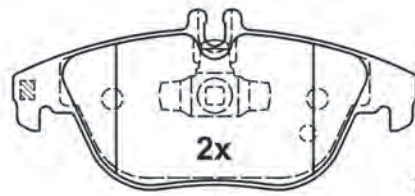

24253 18,0

122,5 x 54,4 x 18,0

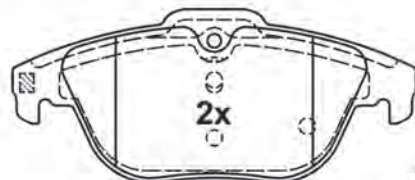

24254 18,0

122,5 x 52,3 x 18,0

# Abbildungen Scheibenbremsbeläge

Illustrations disc brake pads - Ilustraciones de pastillas - Illustrations Plaquettes de frein à disque - Illustrazioni Pastiglie Freno

13.0460-7259.2 607259

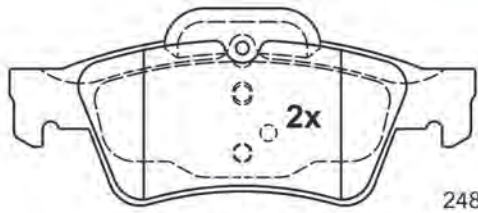

24862 16,7

141,1 x 59,6 x 16,7

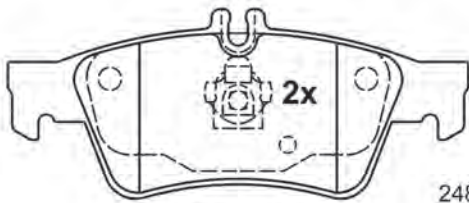

24863 16,7

139,8 x 57,5 x 16,7

13.0460-7260.2 607260

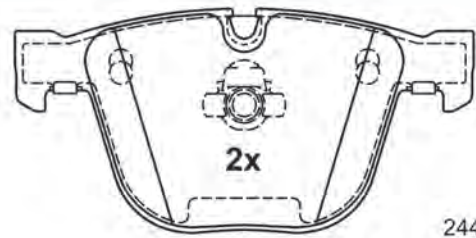

24458 17,3



24495 17,3

139,5 x 67,8 x 17,3

13.0460-7261.2 607261

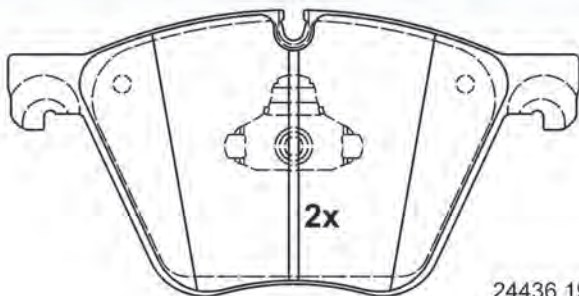

24436 19,7

192,8 x 96,5 x 19,7

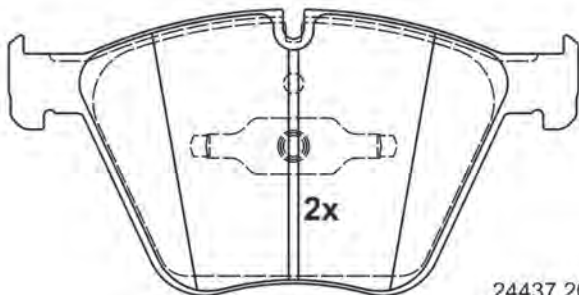

24437 20,2

192,2 x 96,5 x 20,2

13.0460-7262.2 607262

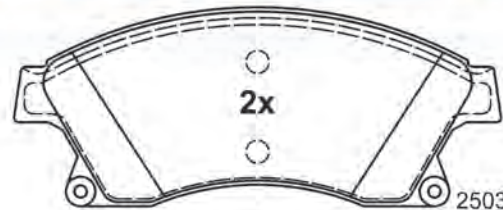

25031 19,1

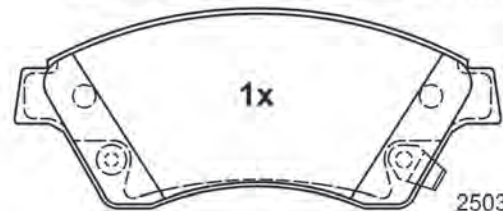

25032 19,1

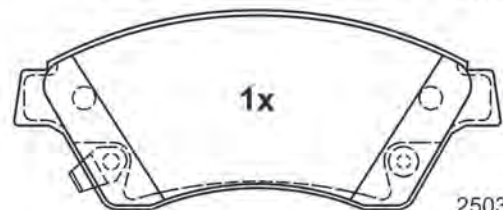

25033 19,1

148,2 x 60,1 x 19,1

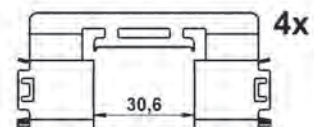

4x

30,6



# Abbildungen Scheibenbremsbeläge

Illustrations disc brake pads - Ilustraciones de pastillas - Illustrations Plaquettes de frein à disque - Illustrazioni Pastiglie Freno

13.0460-7263.2 607263

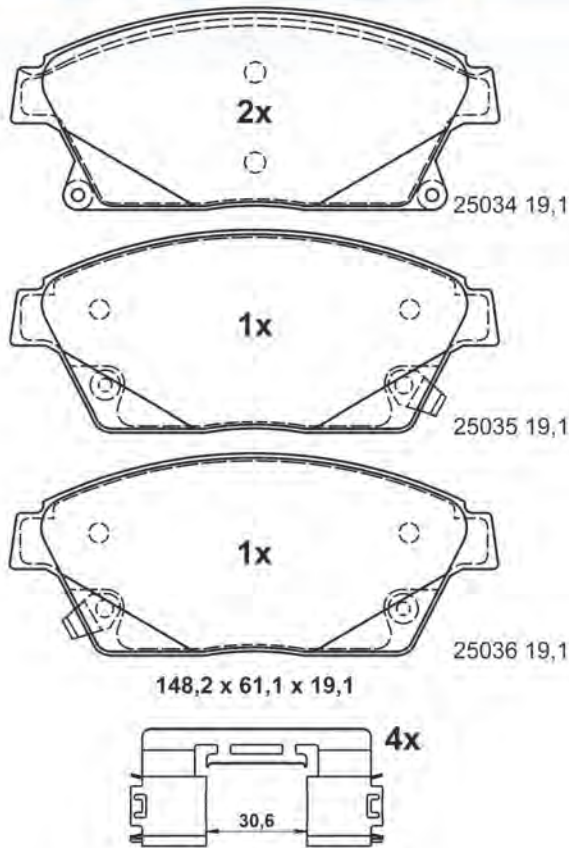

13.0460-7264.2 607264

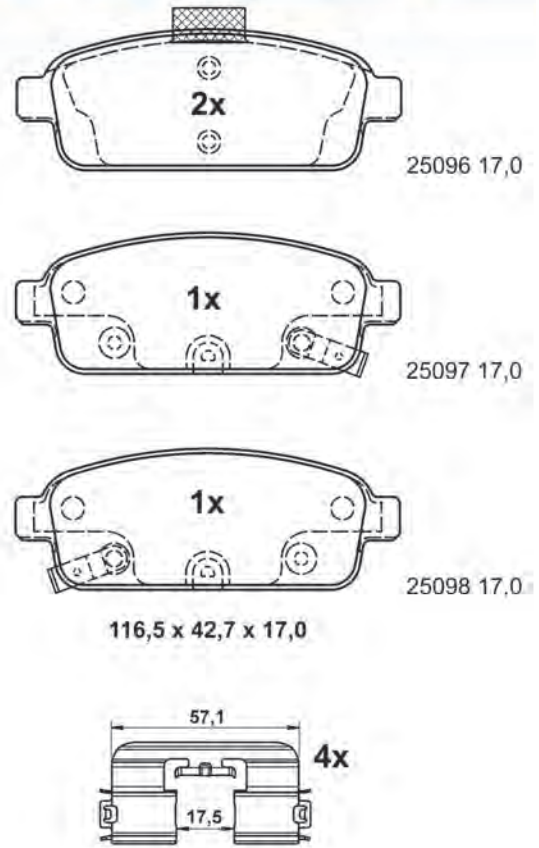

13.0460-7265.2 607265

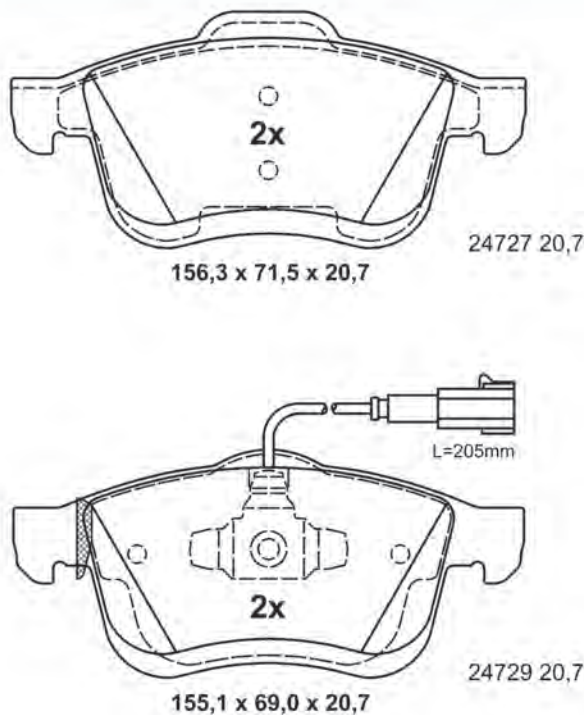

13.0460-7266.2 607266

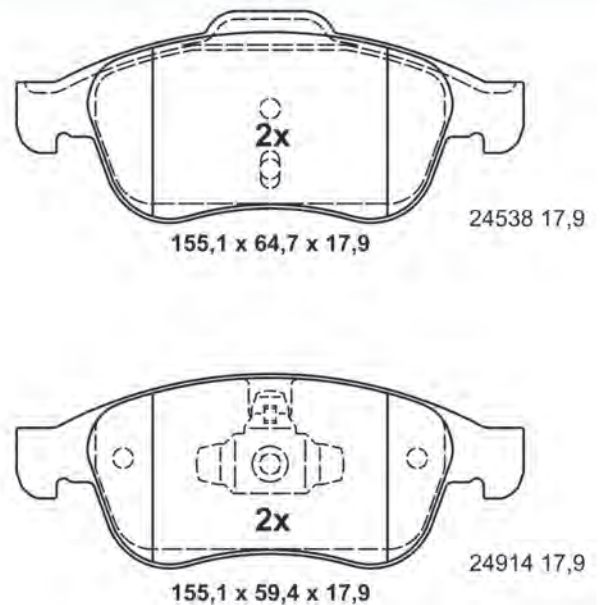

# Abbildungen Scheibenbremsbeläge

Illustrations disc brake pads - Ilustraciones de pastillas - Illustrations Plaquettes de frein à disque - Illustrazioni Pastiglie Freno

13.0460-7267.2 607267

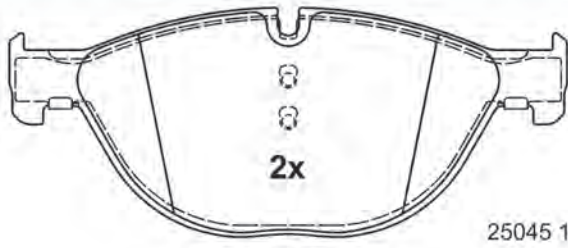

192,2 x 79,2 x 19,5

25045 19,5

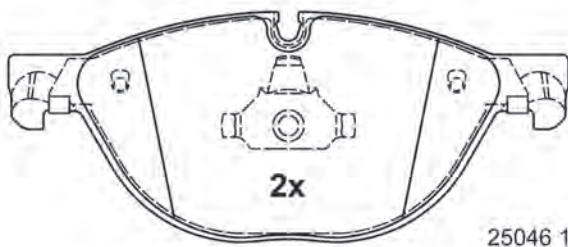

193,0 x 79,2 x 18,5

25046 18,5

13.0460-7268.2 607268

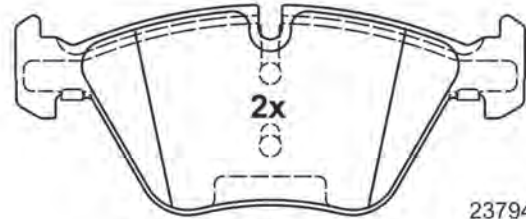

154,6 x 63,5 x 20,3

23794 20,3

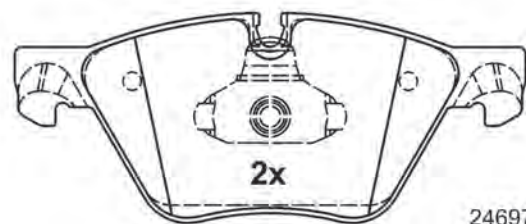

155,1 x 63,5 x 19,3

24697 19,3

13.0460-7269.2 607269

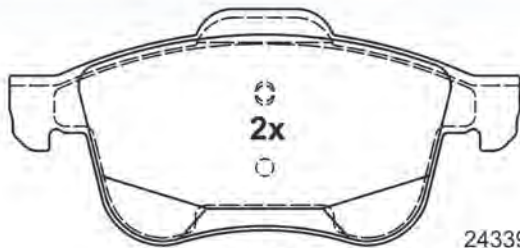

155,1 x 71,5 x 19,5

24339 19,5

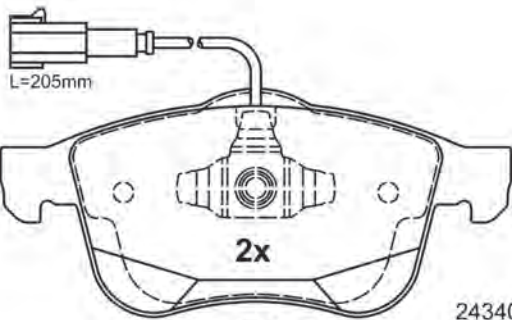

155,1 x 69,0 x 19,5

24340 19,5

13.0460-7270.2 607270



151,3 x 52,5 x 17,5

24673 17,5

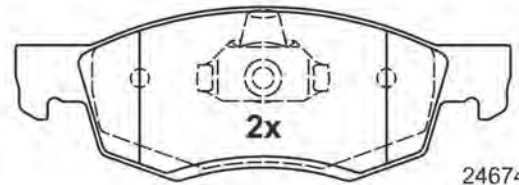

150,1 x 52,5 x 17,5

24674 17,5



# Abbildungen Scheibenbremsbeläge

Illustrations disc brake pads - Ilustraciones de pastillas - Illustrations Plaquettes de frein à disque - Illustrazioni Pastiglie Freno

13.0460-7271.2 607271

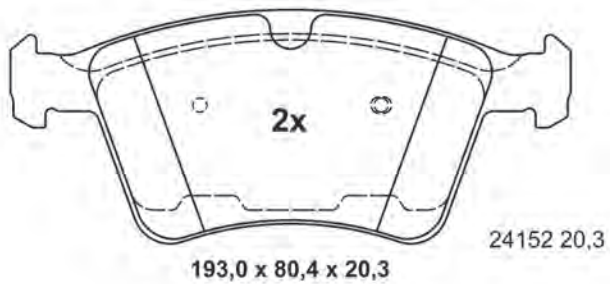
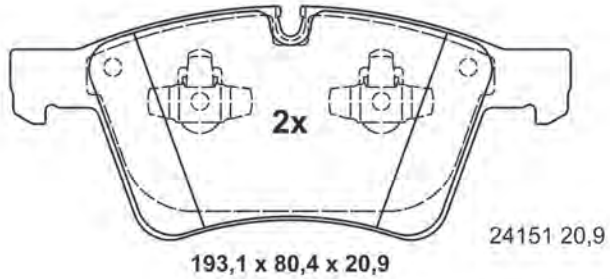

13.0460-7272.2 607272

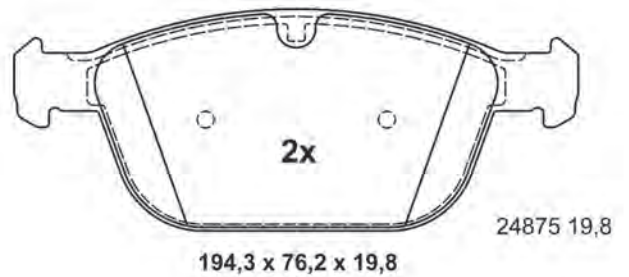
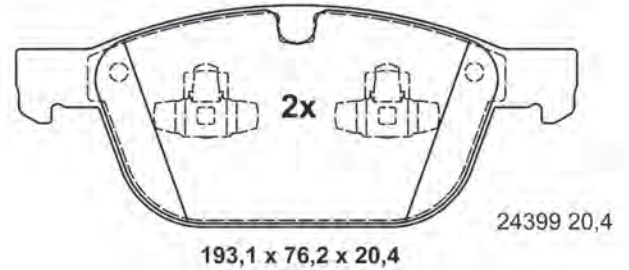

13.0460-7273.2 607273

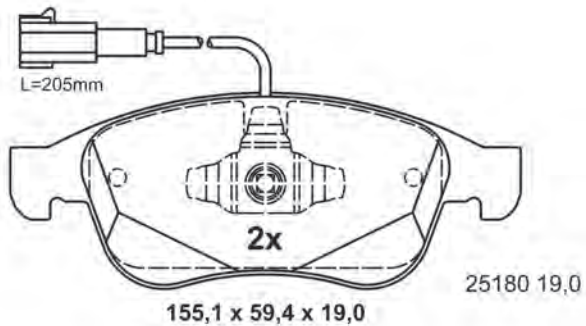
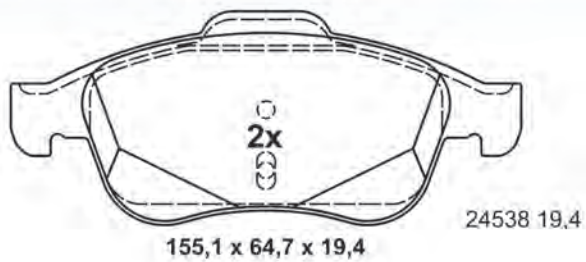

13.0460-7274.2 607274

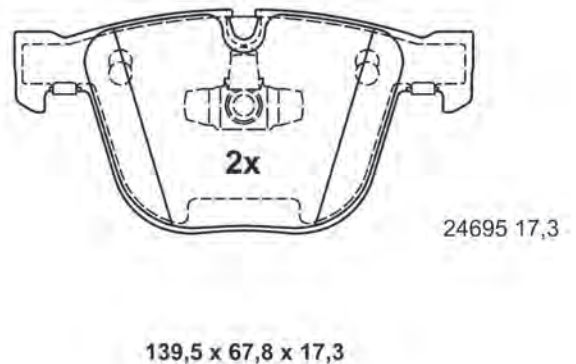
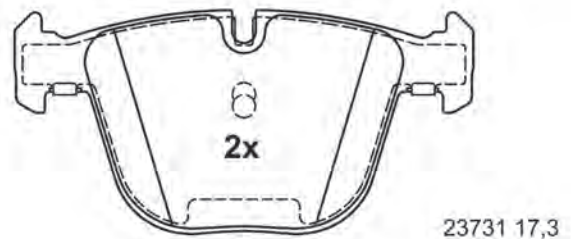

# Abbildungen Scheibenbremsbeläge

Illustrations disc brake pads - Ilustraciones de pastillas - Illustrations Plaquettes de frein à disque - Illustrazioni Pastiglie Freno

13.0460-7275.2 607275

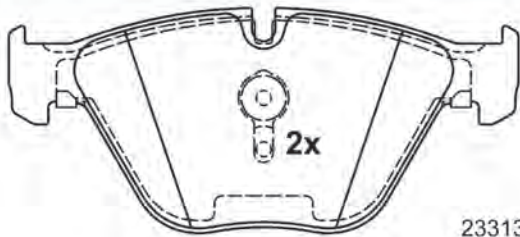

23313 20,2

154,1 x 68,4 x 20,2

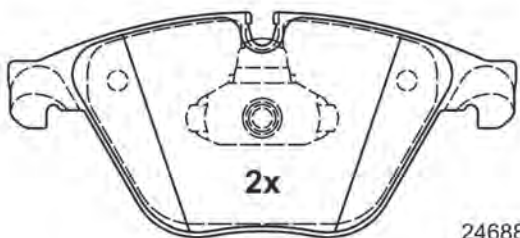

24688 19,2

154,1 x 68,4 x 19,2

13.0460-7276.2 607276

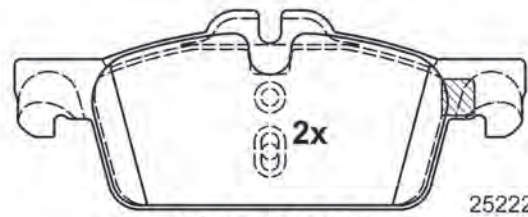

25222 17,3

155,1 x 60,3 x 17,3

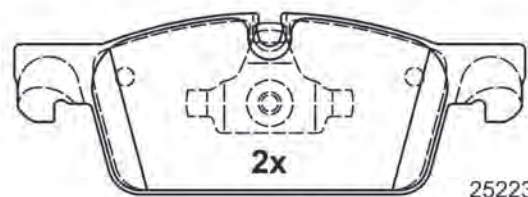

25223 17,3

155,1 x 55,0 x 17,3

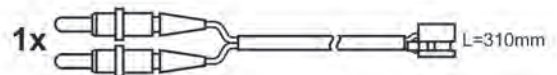

13.0460-7277.2 607277

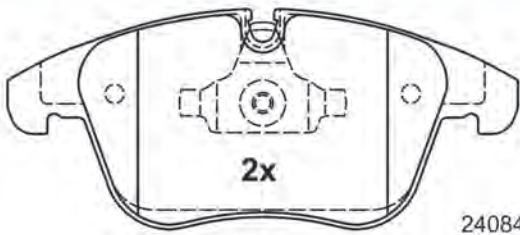

24084 19,3

155,1 x 66,5 x 19,3

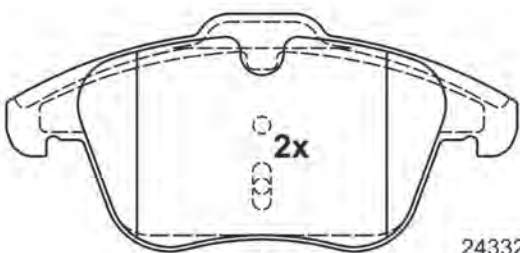

24332 18,3

155,1 x 72,0 x 18,3

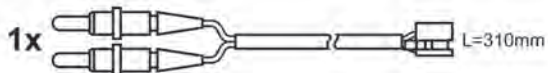

13.0460-7278.2 607278

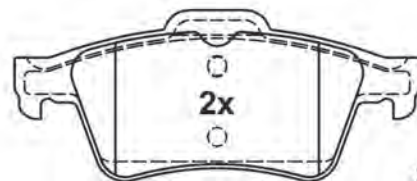

23482 16,6



25218 16,6

123,0 x 52,0 x 16,6



# Abbildungen Scheibenbremsbeläge

Illustrations disc brake pads - Ilustraciones de pastillas - Illustrations Plaquettes de frein à disque - Illustrazioni Pastiglie Freno

13.0460-7279.2 607279

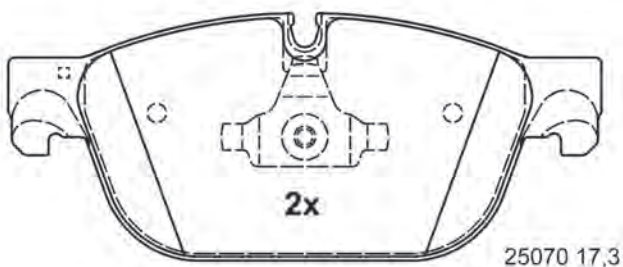

180,1 x 74,9 x 17,3



13.0460-7280.2 607280

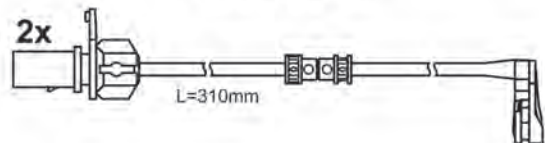
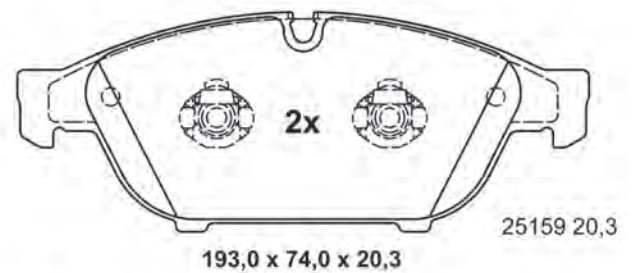
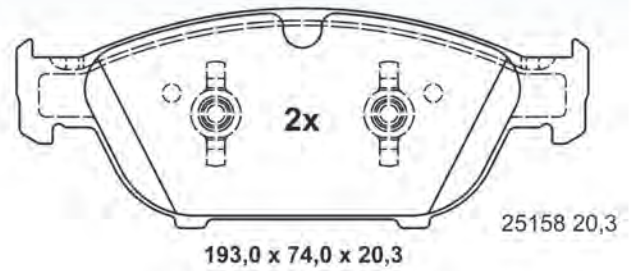

13.0460-7281.2 607281

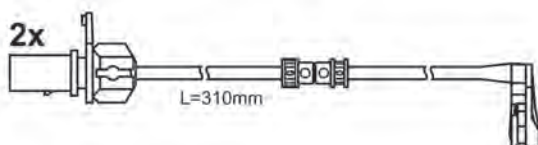
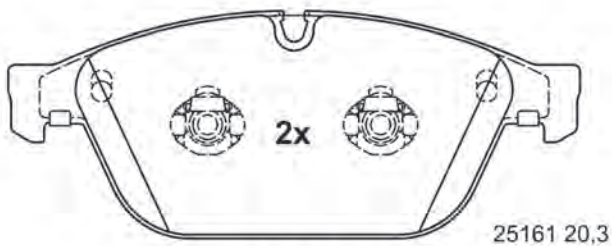
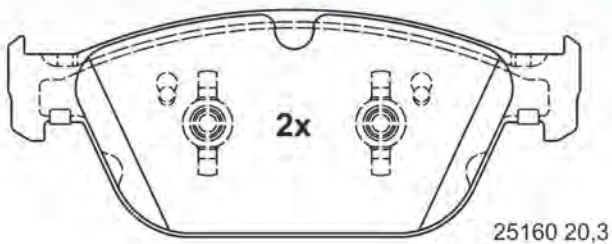

13.0460-7282.2 607282

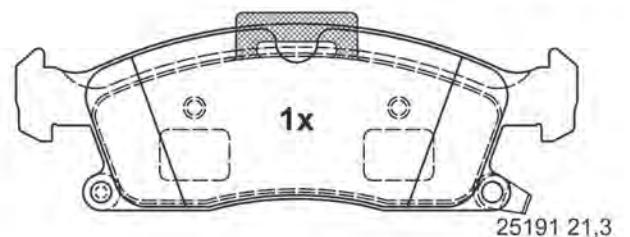
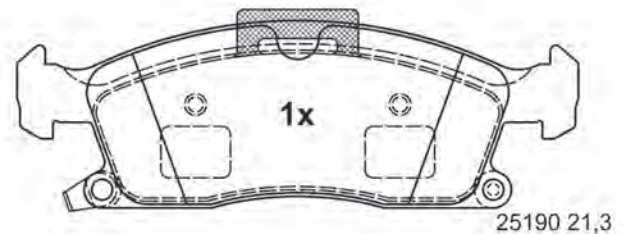
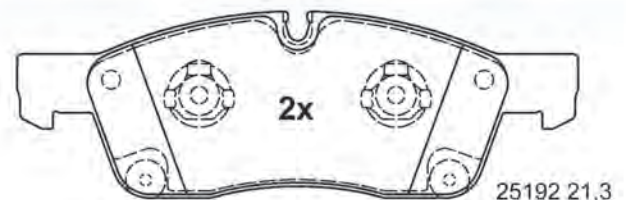



# Abbildungen Scheibenbremsbeläge

Illustrations disc brake pads - Ilustraciones de pastillas - Illustrations Plaquettes de frein à disque - Illustrazioni Pastiglie Freno

13.0460-7283.2 607283

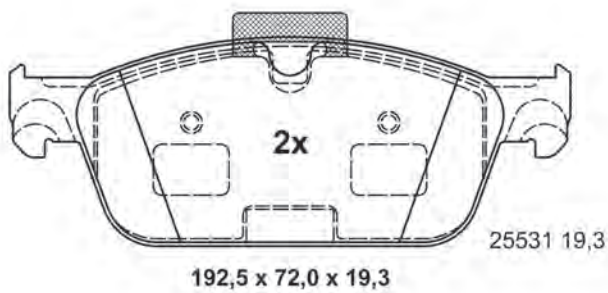
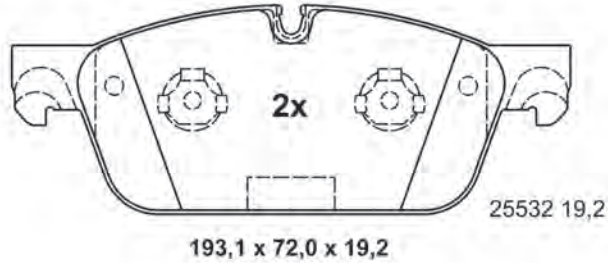

13.0460-7284.2 607284

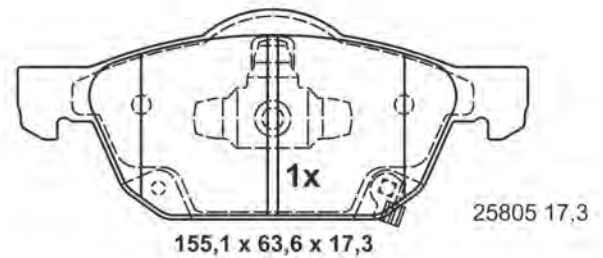
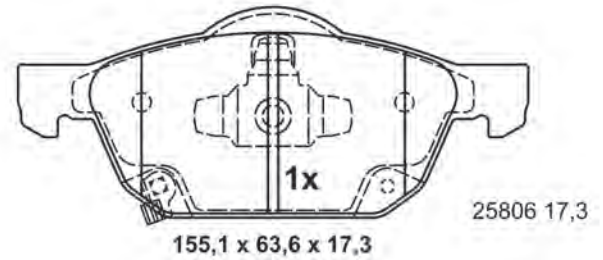
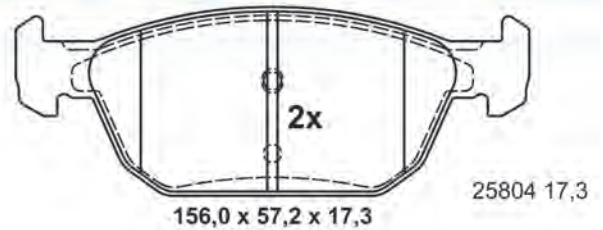

13.0460-7285.2 607285

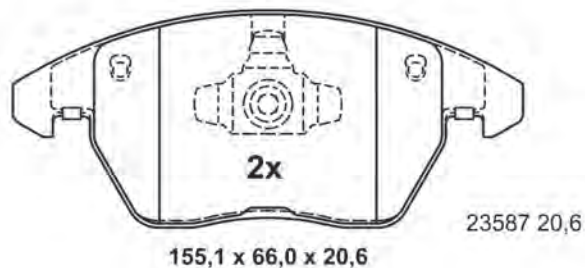
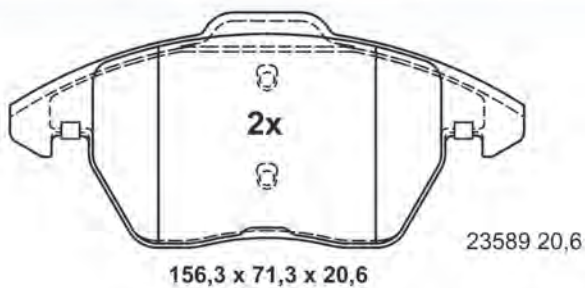

13.0460-7286.2 607286

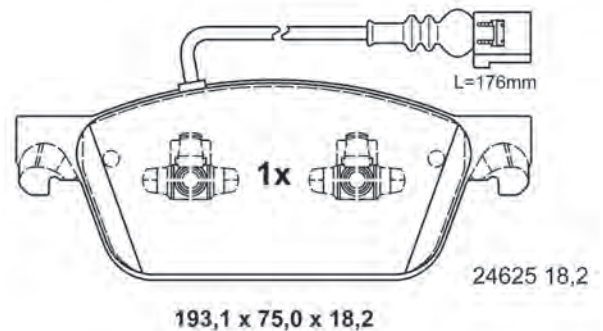
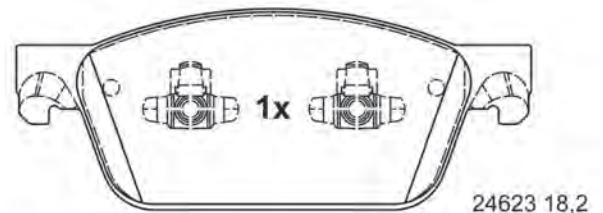
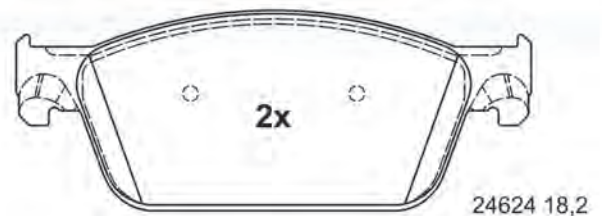

# Abbildungen Scheibenbremsbeläge

Illustrations disc brake pads - Ilustraciones de pastillas - Illustrations Plaquettes de frein à disque - Illustrazioni Pastiglie Freno

13.0460-7287.2 607287



25265 16,6

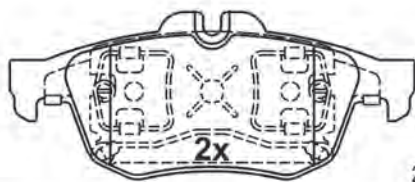

25266 16,6

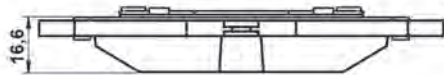

123,0 x 50,5 x 16,6

13.0460-7288.2 607288



25429 17,5

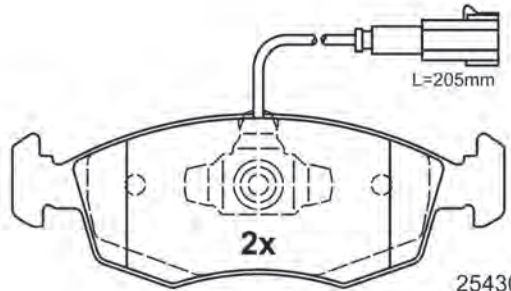

25430 17,5

149,2 x 52,5 x 17,5

13.0460-7289.2 607289

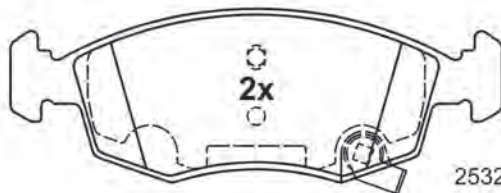

25324 17,3

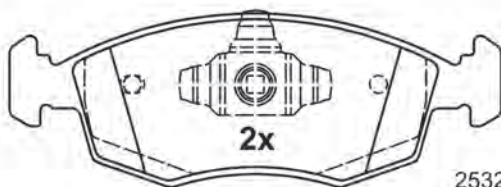

25323 17,3

149,4 x 52,6 x 17,3

13.0460-7289.2 607289

wahlweise optional

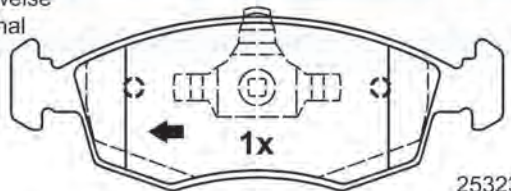

25323 17,3

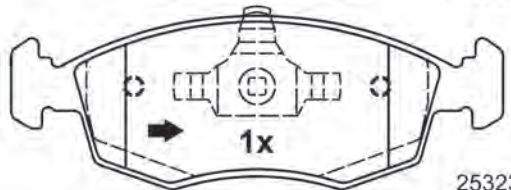

25323 17,3

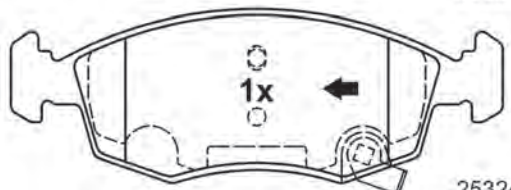

25324 17,3

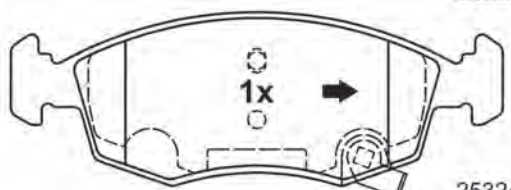

25324 17,3

149,4 x 52,6 x 17,3



# Abbildungen Scheibenbremsbeläge

Illustrations disc brake pads - Ilustraciones de pastillas - Illustrations Plaquettes de frein à disque - Illustrazioni Pastiglie Freno

13.0460-7289.2 607289

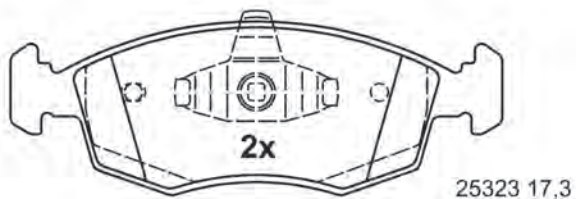
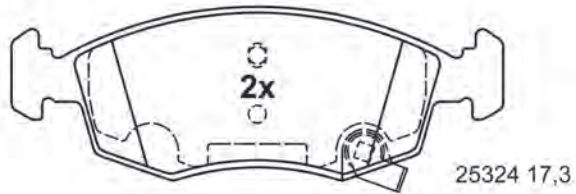

149,4 x 52,6 x 17,3

13.0460-7290.2 607290

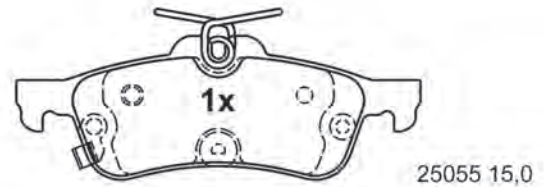
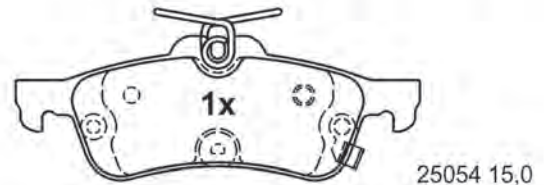

123,1 x 43,8 x 15,0

13.0460-7291.2 607291

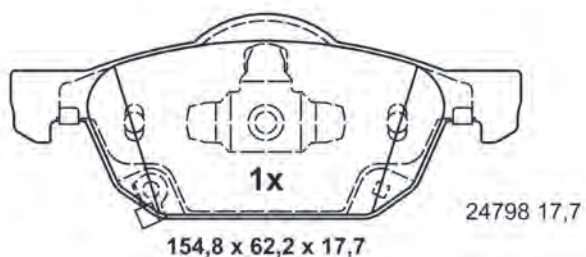
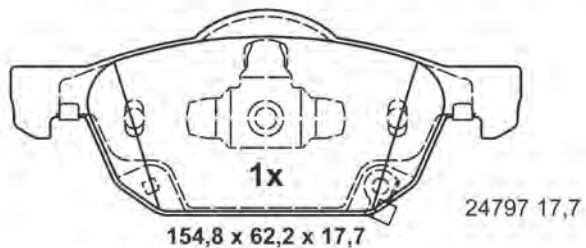
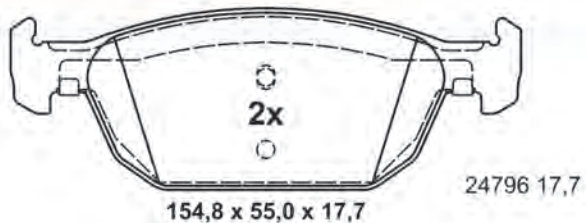

13.0460-7292.2 607292

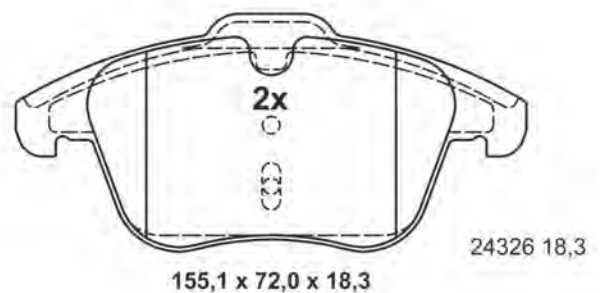
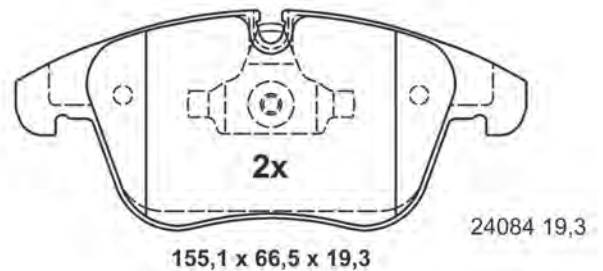

# Abbildungen Scheibenbremsbeläge

Illustrations disc brake pads - Ilustraciones de pastillas - Illustrations Plaquettes de frein à disque - Illustrazioni Pastiglie Freno

13.0460-7293.2 607293

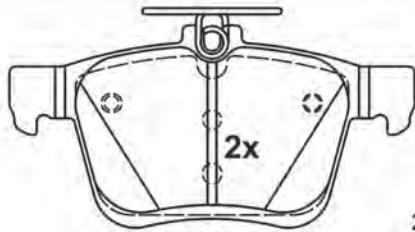

25008 16,3

123,0 x 61,2 x 16,3

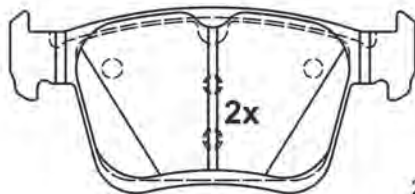

25010 16,3

123,0 x 56,2 x 16,3

13.0460-7294.2 607294

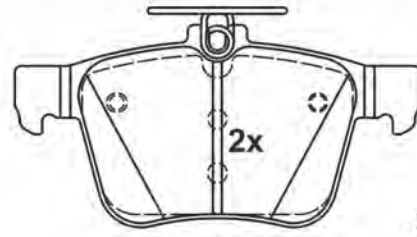

25009 16,4

123,0 x 61,2 x 16,4

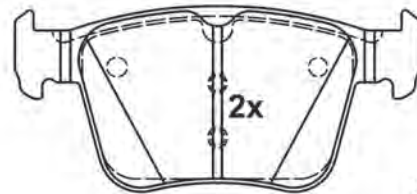

25011 16,4

123,0 x 56,2 x 16,4

13.0460-7295.2 607295



25968 16,1

123,0 x 41,2 x 16,1

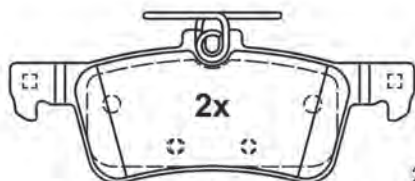

25969 16,1

123,0 x 46,2 x 16,1

13.0460-7296.2 607296

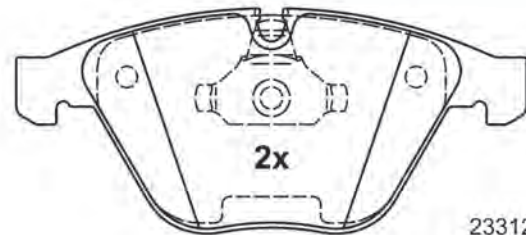

23312 20,3



23313 20,3

155,1 x 68,3 x 20,3





# Abbildungen Scheibenbremsbeläge

Illustrations disc brake pads - Ilustraciones de pastillas - Illustrations Plaquettes de frein à disque - Illustrazioni Pastiglie Freno

13.0460-7298.2 607298

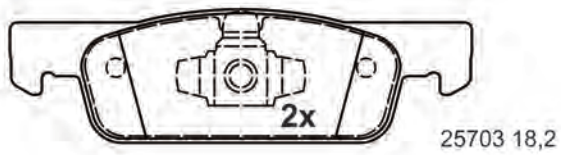
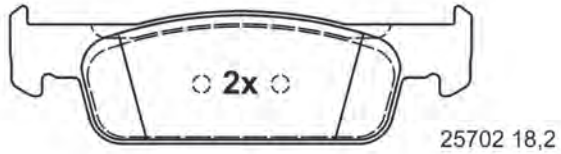

140,1 x 40,0 x 18,2

13.0460-7300.2 607300

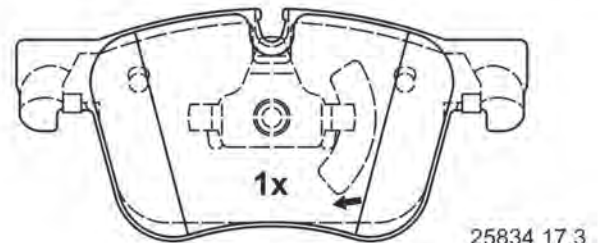
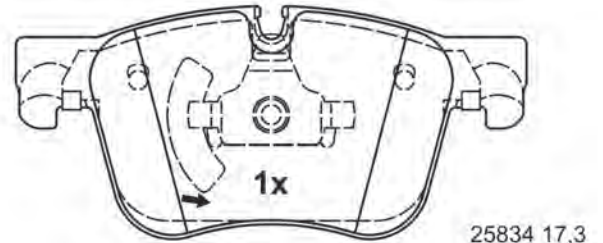
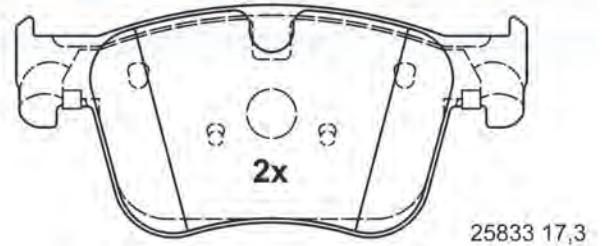

155,1 x 70,5 x 17,3

13.0460-7301.2 607301

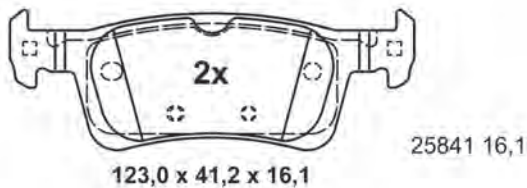

123,0 x 41,2 x 16,1

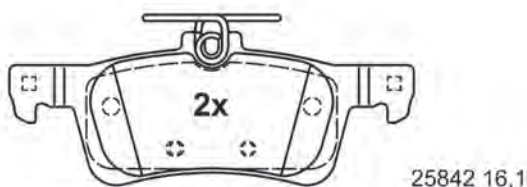

123,0 x 46,2 x 16,1

13.0460-7302.2 607302



156,3 x 71,5 x 20,7

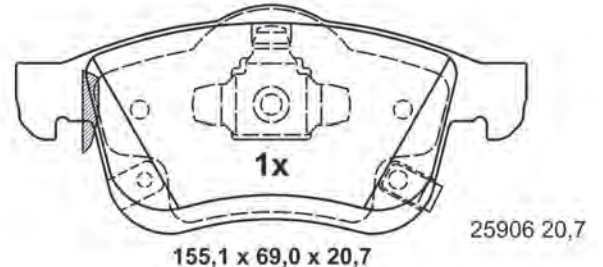

155,1 x 69,0 x 20,7

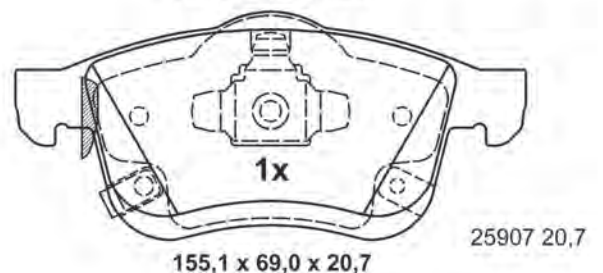

155,1 x 69,0 x 20,7



# Abbildungen Scheibenbremsbeläge

Illustrations disc brake pads - Ilustraciones de pastillas - Illustrations Plaquettes de frein à disque - Illustrazioni Pastiglie Freno

13.0460-7303.2 607303

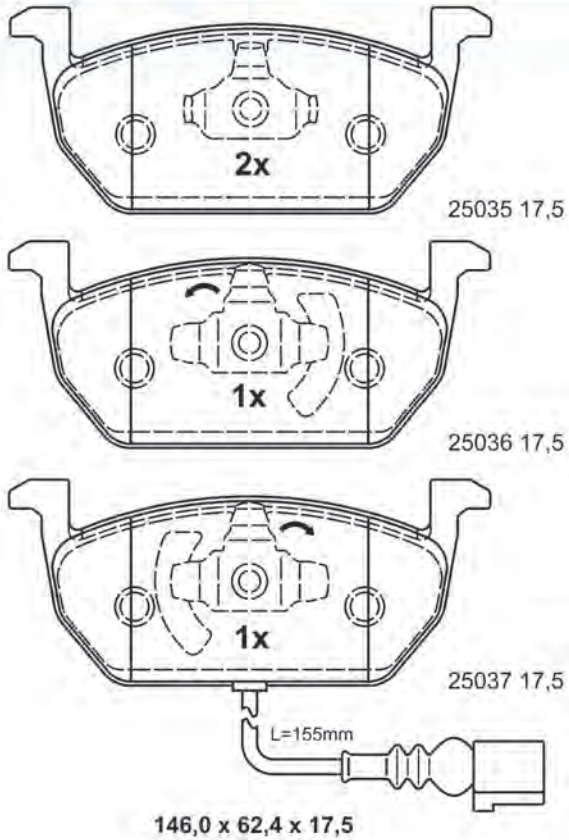

13.0460-7304.2 607304

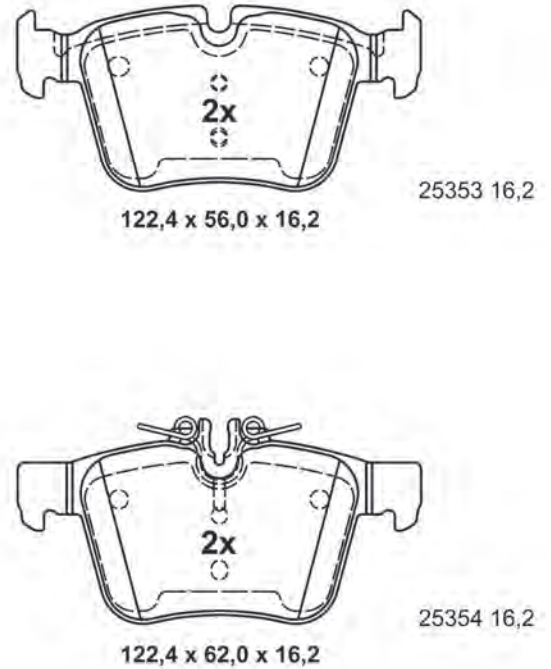

13.0460-7305.2 607305

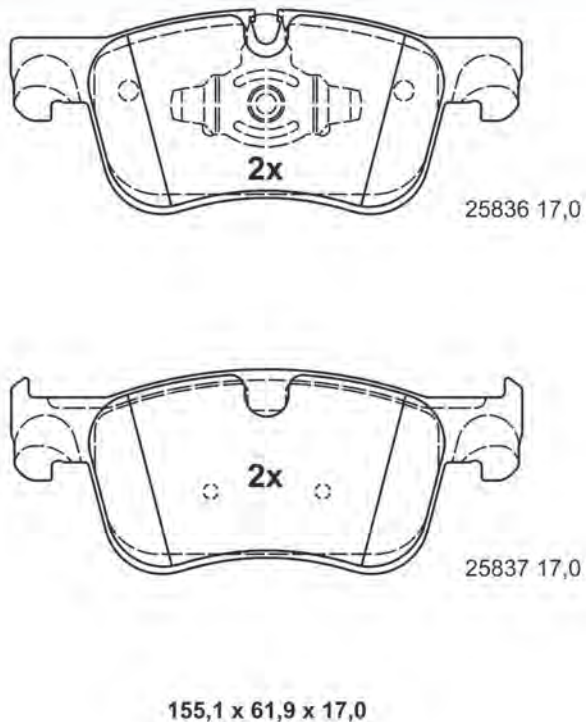

13.0460-7306.2 607306

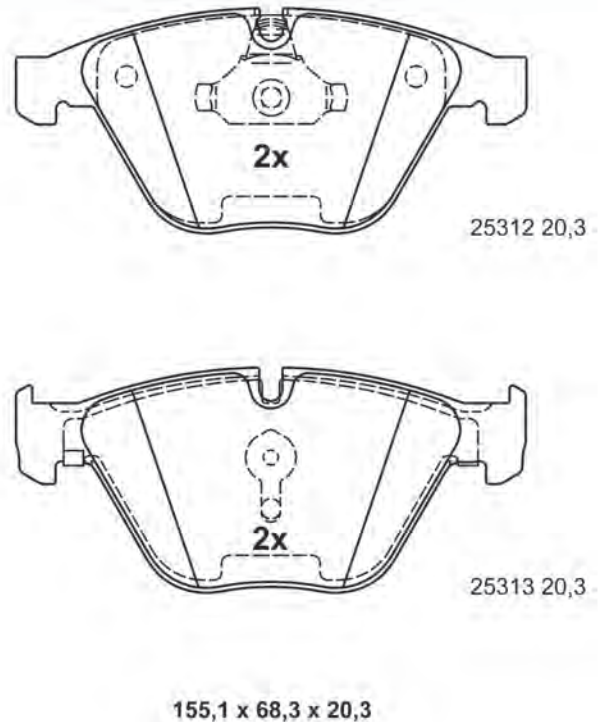

# Abbildungen Scheibenbremsbeläge

Illustrations disc brake pads - Ilustraciones de pastillas - Illustrations Plaquettes de frein à disque - Illustrazioni Pastiglie Freno

13.0460-7307.2 607307

B.H.P

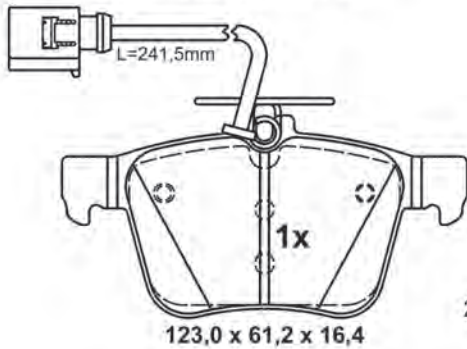
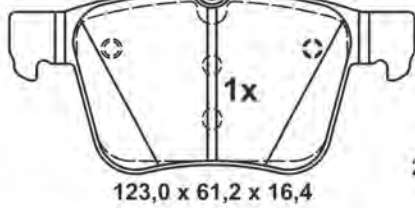
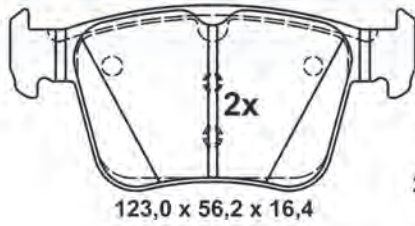

13.0460-7308.2 607308

B.H.P

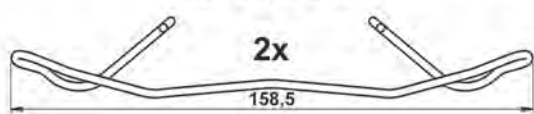
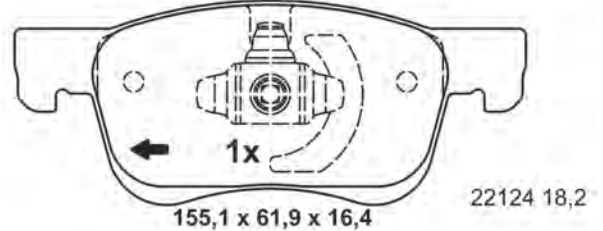
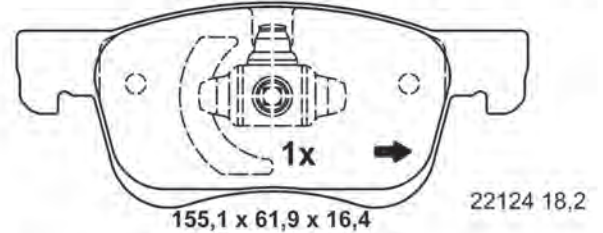
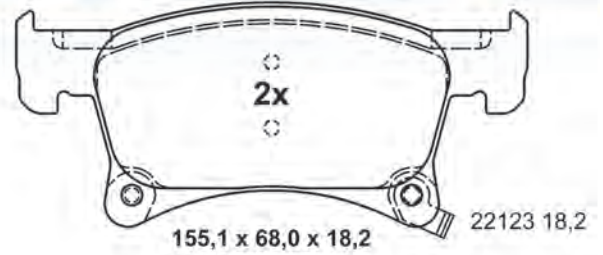

13.0460-7308.2 607308

B.H.P

wahlweise optional

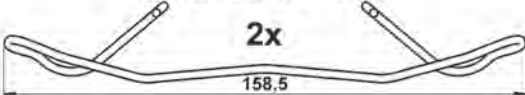
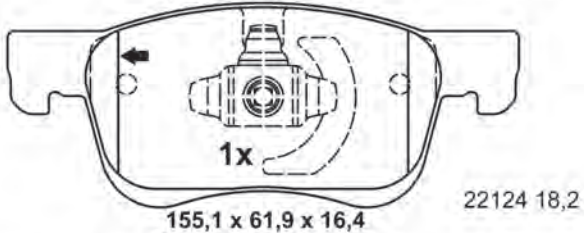
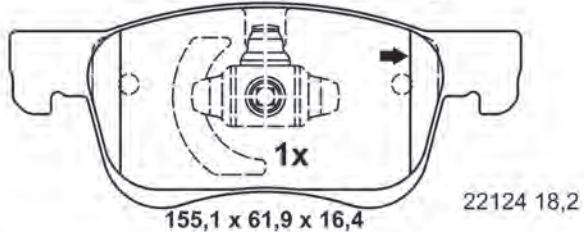
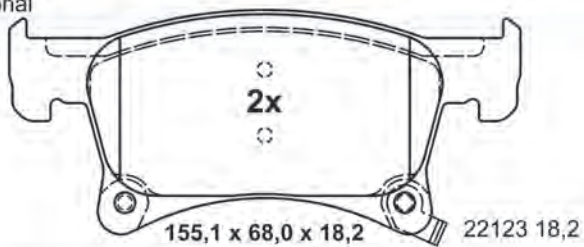

13.0460-7309.2 607309

B.H.P

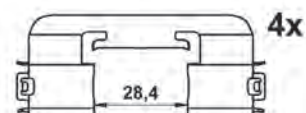
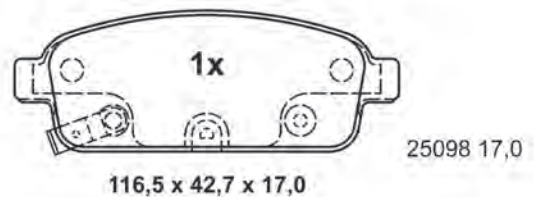
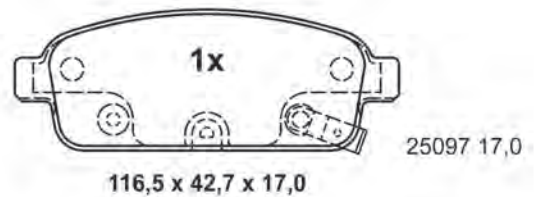
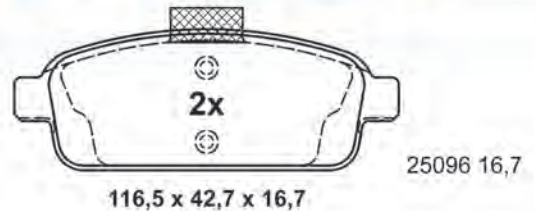



# Abbildungen Scheibenbremsbeläge

Illustrations disc brake pads - Ilustraciones de pastillas - Illustrations Plaquettes de frein à disque - Illustrazioni Pastiglie Freno

13.0460-7310.2 607310

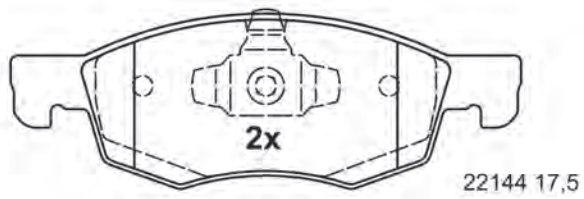
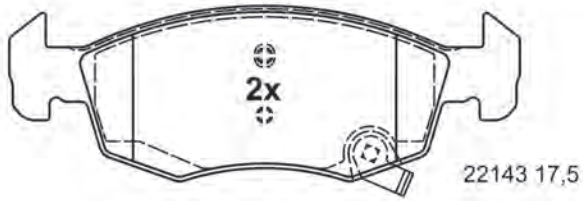

155,1 x 52,5 x 17,5

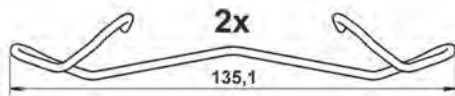

13.0460-7311.2 607311

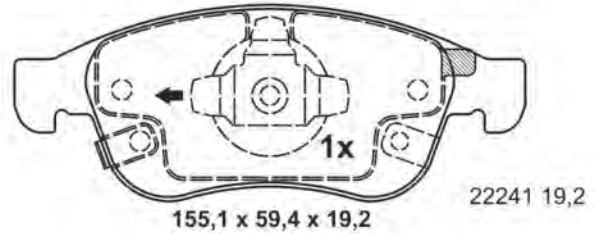
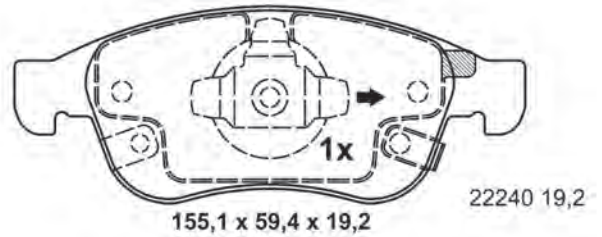
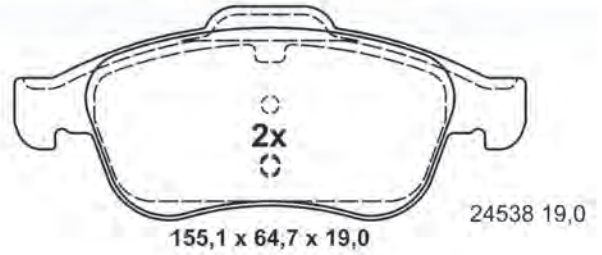

13.0460-7311.2 607311



wahlweise  
optional

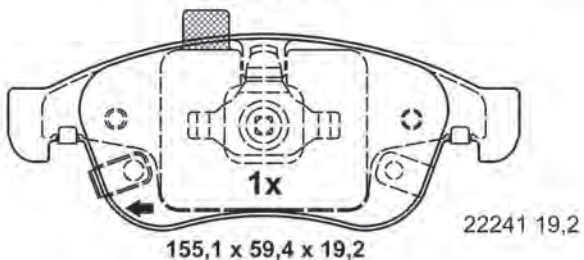
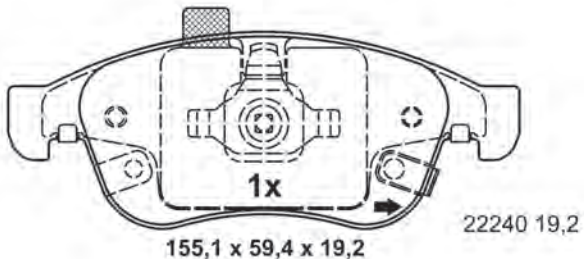
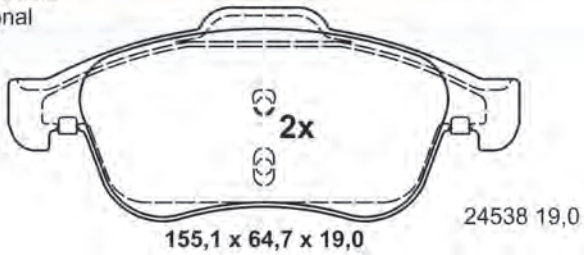

13.0460-7313.2 607313 [1]

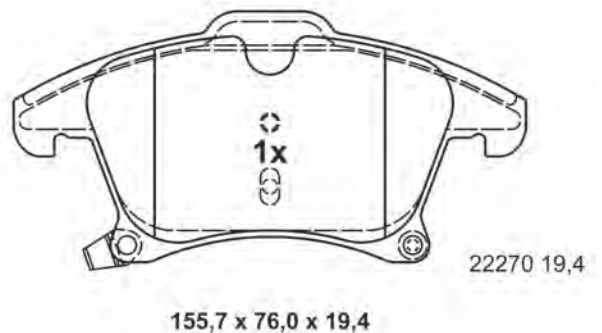
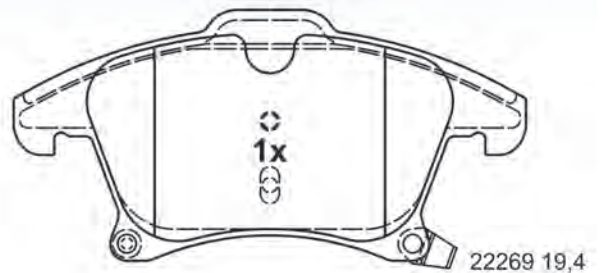

# Abbildungen Scheibenbremsbeläge

Illustrations disc brake pads - Ilustraciones de pastillas - Illustrations Plaquettes de frein à disque - Illustrazioni Pastiglie Freno

13.0460-7313.2 607313 [2]

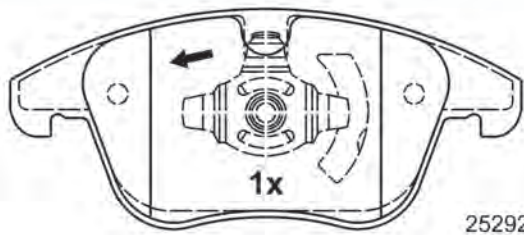

25292 20,3

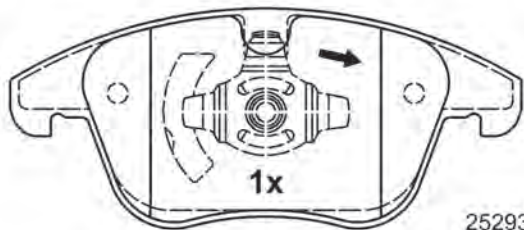

25293 20,3

155,1 x 66,7 x 20,3

13.0460-7314.2 607314

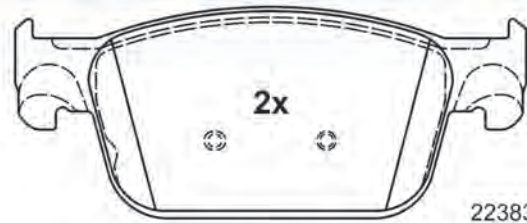

22383 17,3

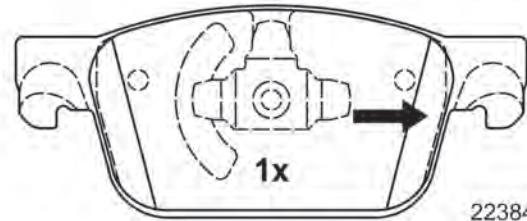

22384 17,3

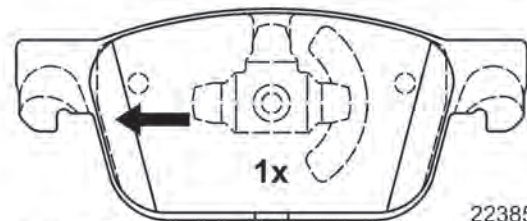

22385 17,3

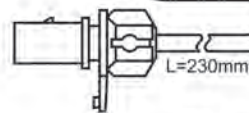

155,1 x 64,0 x 17,3

13.0460-7315.2 607315

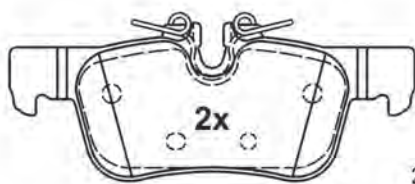

25331 16,2

123,0 x 47,9 x 16,2

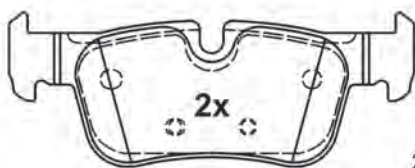

25332 16,2

123,0 x 46,7 x 16,2

13.0460-7316.2 607316 [1]

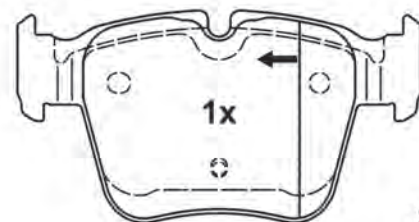

22423 16,4

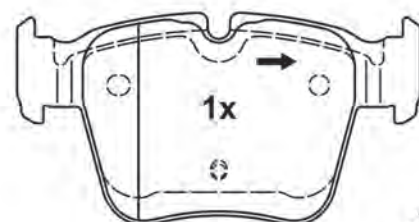

22423 16,4

122,4 x 64,3 x 16,4



# Abbildungen Scheibenbremsbeläge

Illustrations disc brake pads - Ilustraciones de pastillas - Illustrations Plaquettes de frein à disque - Illustrazioni Pastiglie Freno

**13.0460-7316.2 607316 [2]**

22424 16,4

122,4 x 70,1 x 16,4

**13.0460-7320.2 607320**

22231 16,1

123,0 x 48,2 x 16,1

22232 16,1

123,0 x 53,4 x 16,1

22233 16,1

123,0 x 53,4 x 16,1

**13.0460-7324.2 607324 [1]**

22345 19,7

155,1 x 62,4 x 19,7

22345 19,7

**13.0460-7324.2 607324 [2]**

22346 20,1

155,1 x 62,4 x 20,1

22346 20,1





# Abbildungen Scheibenbremsbeläge

Illustrations disc brake pads - Ilustraciones de pastillas - Illustrations Plaquettes de frein à disque - Illustrazioni Pastiglie Freno

13.0460-7325.2 607325

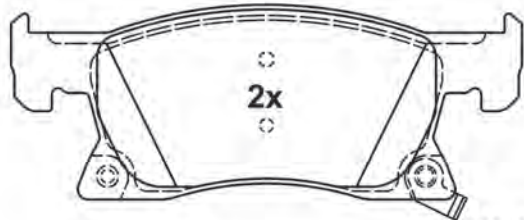

155,1 x 58,9 x 19,8

22342 19,8

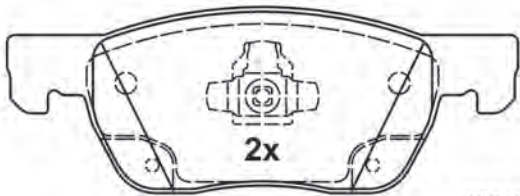

155,1 x 56,3 x 19,8

22343 19,8

13.0460-7326.2 607326

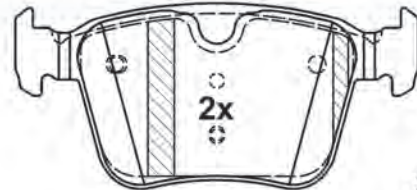

122,4 x 56,2 x 15,5

22141 15,5

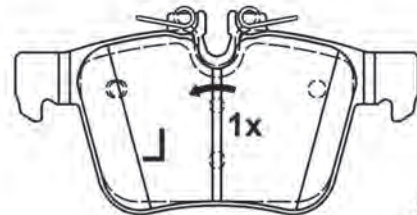

122,4 x 61,2 x 15,5

22142 15,5

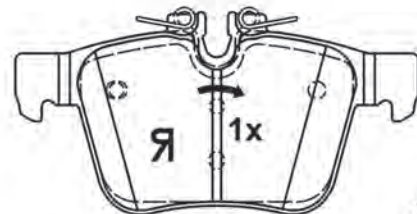

122,4 x 61,2 x 15,5

22142 15,5

13.0460-7327.2 607327

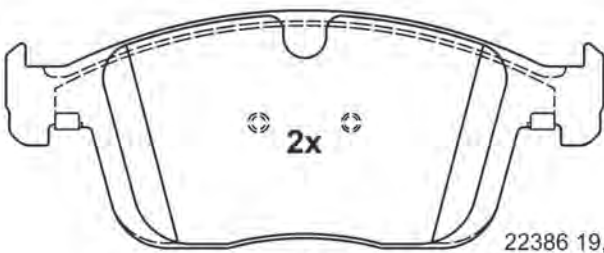

181,3 x 72,0 x 19,0

22386 19,0

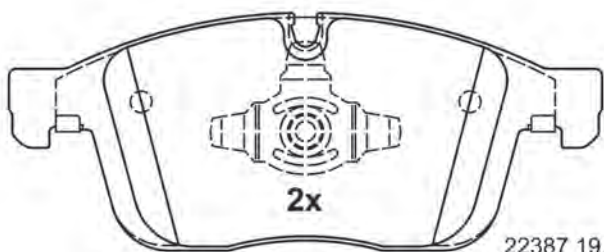

180,1 x 71,9 x 19,5

22387 19,5

13.0460-7328.2 607328

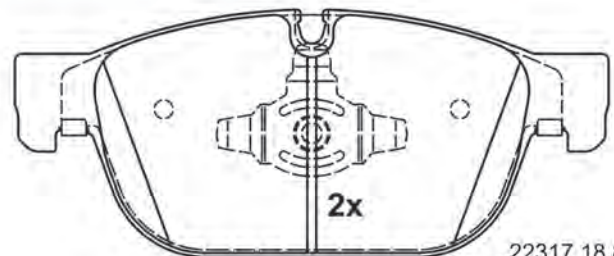

180,3 x 75,0 x 18,8

22317 18,8

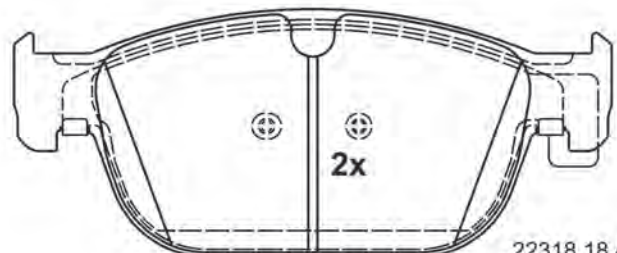

181,4 x 75,0 x 18,4

22318 18,4

# Abbildungen Scheibenbremsbeläge

Illustrations disc brake pads - Ilustraciones de pastillas - Illustrations Plaquettes de frein à disque - Illustrazioni Pastiglie Freno

13.0460-7330.2 607330

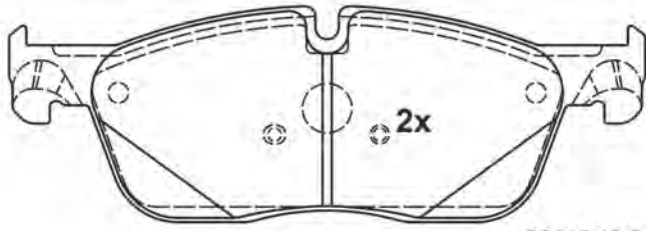

193,1 x 65,4 x 18,6

22145 18,6

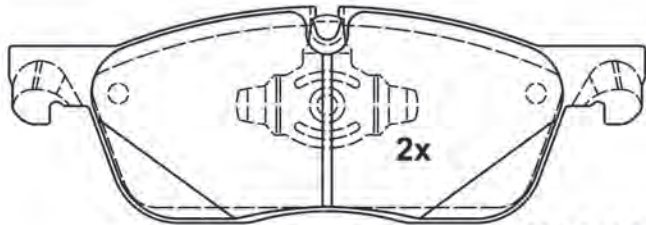

193,1 x 65,4 x 19,6

22146 19,6

13.0460-7331.2 607331

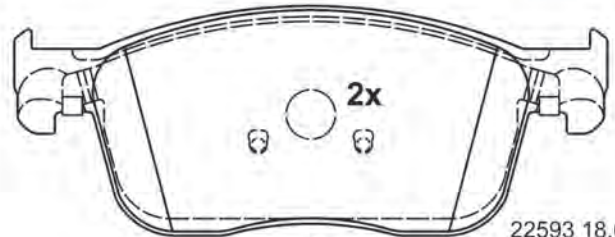

180,1 x 69,5 x 18,0

22593 18,0

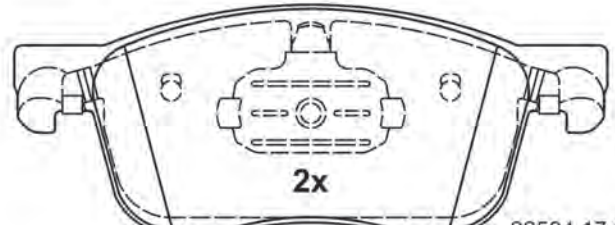

180,1 x 69,5 x 17,6

22594 17,6

13.0460-7903.2 607903

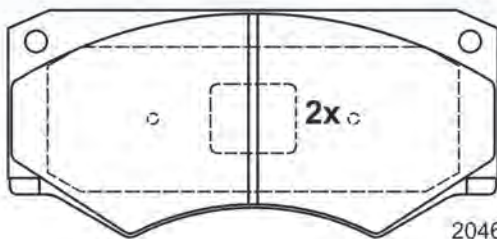

20465 18,0

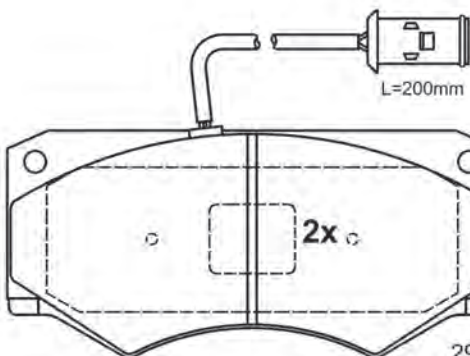

149,0 x 69,0 x 18,0

29012 18,0

13.0460-7906.2 607906

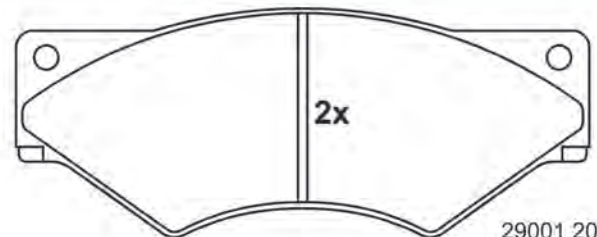

29001 20,0

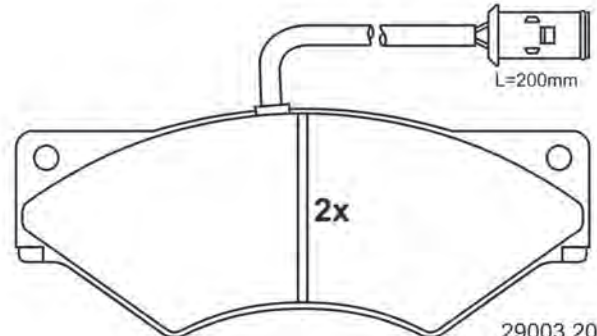

174,5 x 69,2 x 20,0

29003 20,0



# Abbildungen Scheibenbremsbeläge

Illustrations disc brake pads - Ilustraciones de pastillas - Illustrations Plaquettes de frein à disque - Illustrazioni Pastiglie Freno

13.0460-7909.2 607909

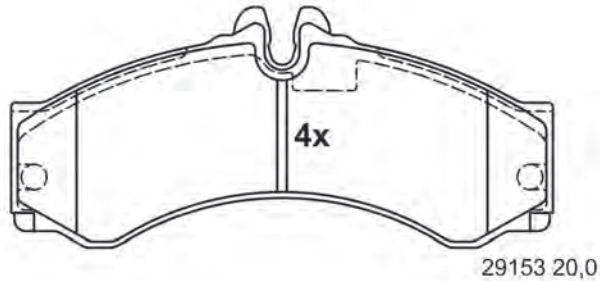

164,6 x 73,0 x 20,0

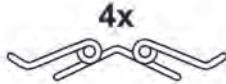

13.0460-8002.2 608002

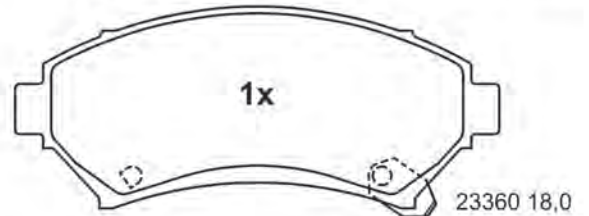
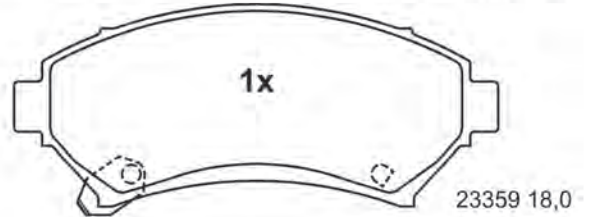
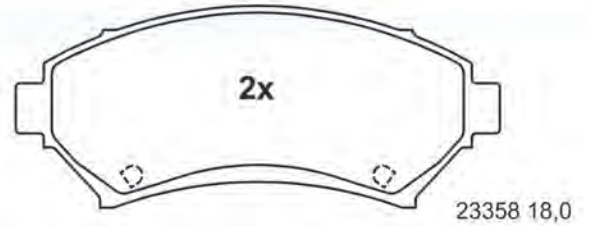

148,0 x 61,2 x 18,0

13.0460-8003.2 608003

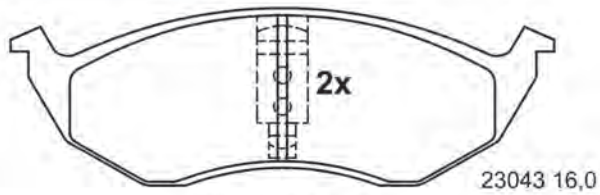

165,4 x 54,4 x 16,0

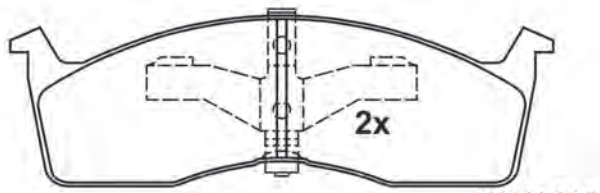

165,4 x 51,3 x 16,0

13.0460-8004.2 608004 [1]

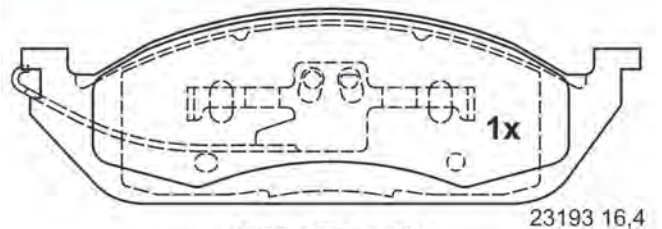

187,9 x 59,1 x 16,4

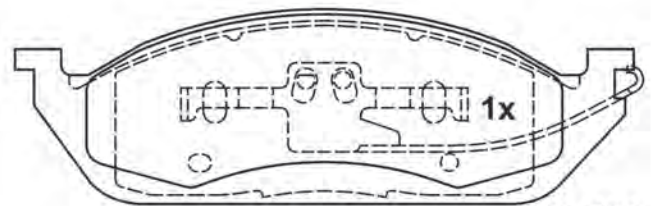

187,9 x 59,1 x 16,4

# Abbildungen Scheibenbremsbeläge

Illustrations disc brake pads - Ilustraciones de pastillas - Illustrations Plaquettes de frein à disque - Illustrazioni Pastiglie Freno

13.0460-8004.2 608004 [2]

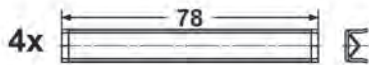
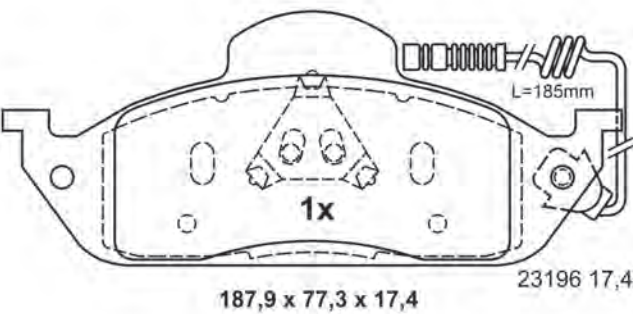
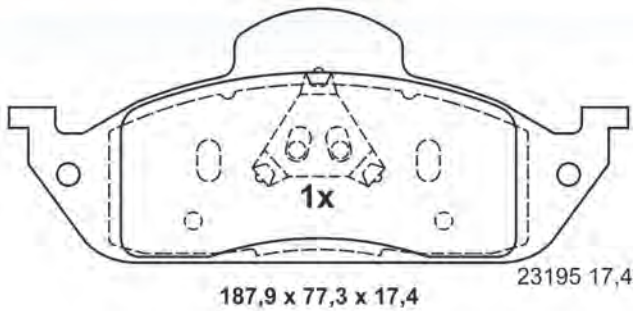

13.0460-8005.2 608005

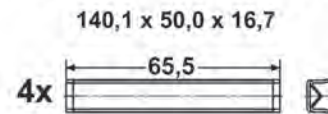
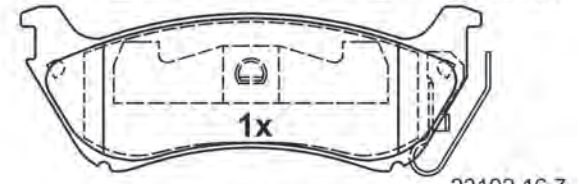
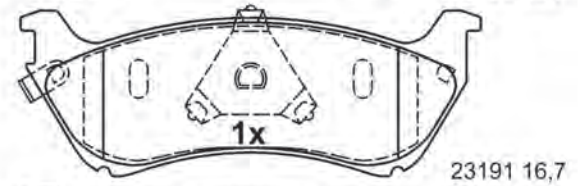
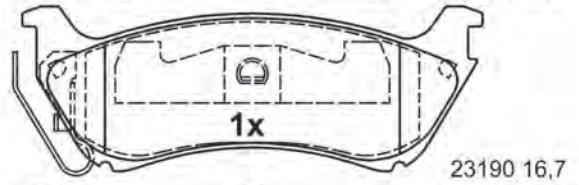
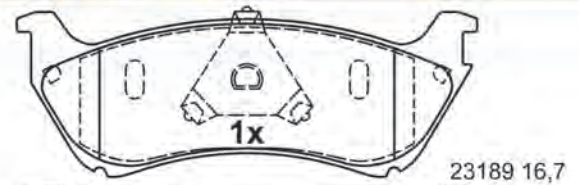

13.0460-8006.2 608006

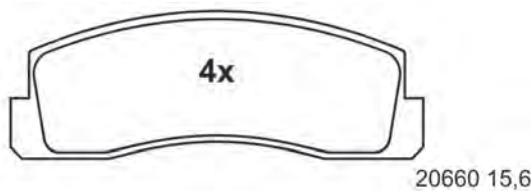

13.0460-8007.2 608007 [1]

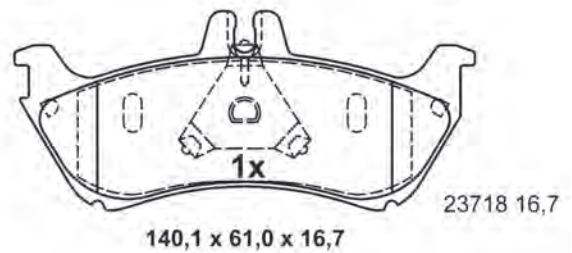
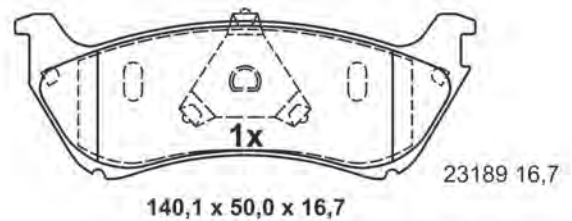



# Abbildungen Scheibenbremsbeläge

Illustrations disc brake pads - Ilustraciones de pastillas - Illustrations Plaquettes de frein à disque - Illustrazioni Pastiglie Freno

13.0460-8007.2 608007 [2]

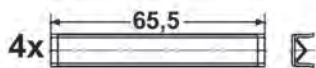
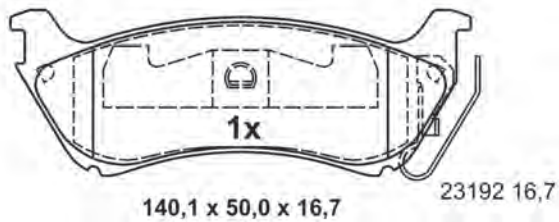
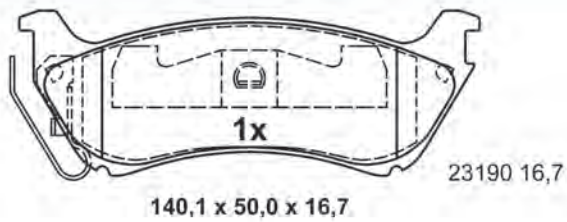

13.0460-8008.2 608008

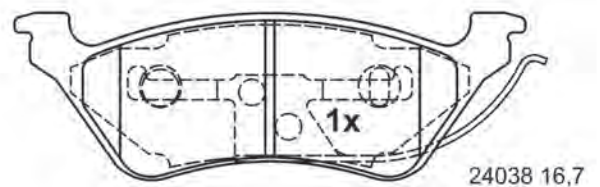
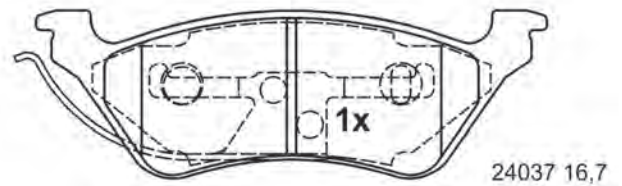
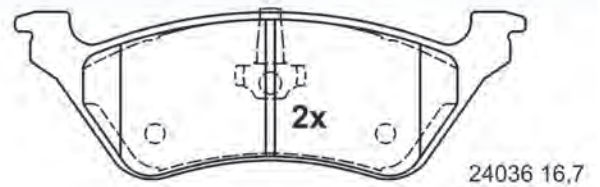

13.0460-8010.2 608010

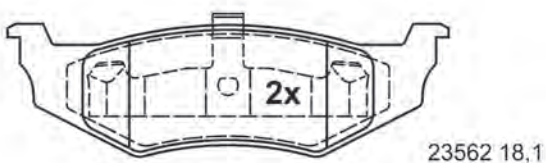

13.0460-8011.2 608011

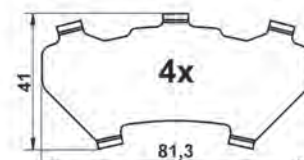
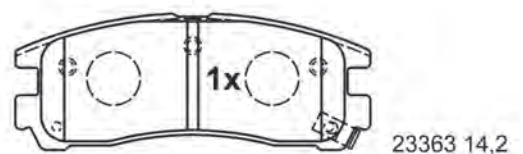
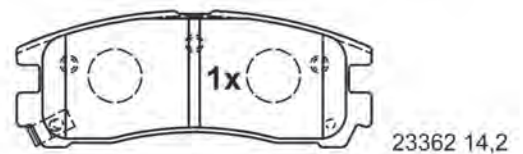
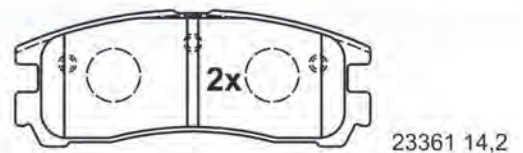



# Abbildungen Scheibenbremsbeläge

Illustrations disc brake pads - Ilustraciones de pastillas - Illustrations Plaquettes de frein à disque - Illustrazioni Pastiglie Freno

13.0460-8013.2 608013

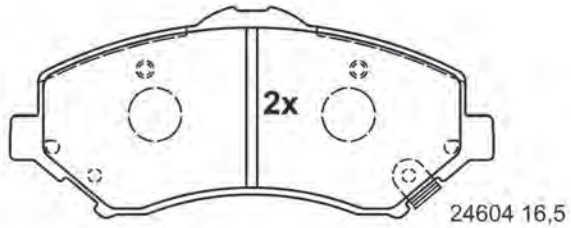
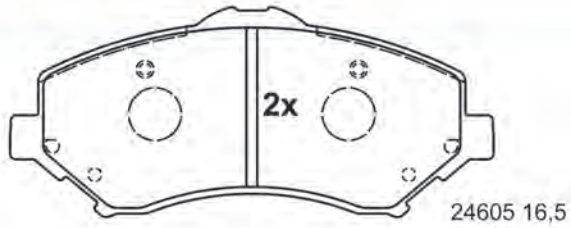

146,7 x 63,8 x 16,5

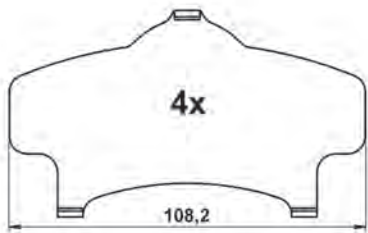

13.0460-8014.2 608014 [1]

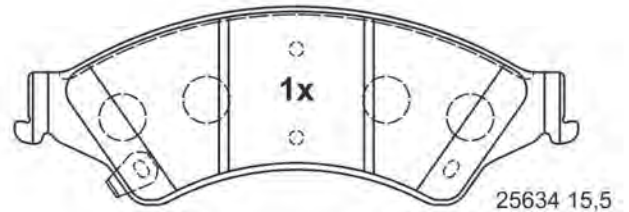
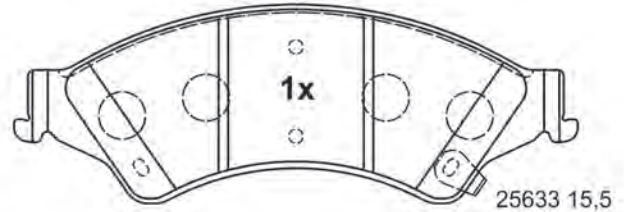
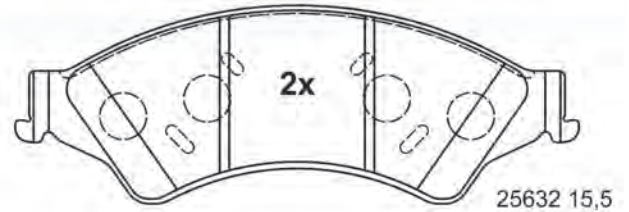

194,0 x 68,1 x 15,5

13.0460-8014.2 608014 [2]

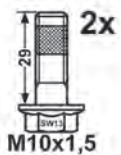
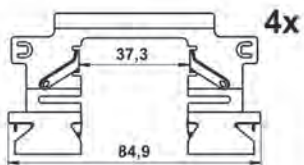

13.0460-9033.2 609033

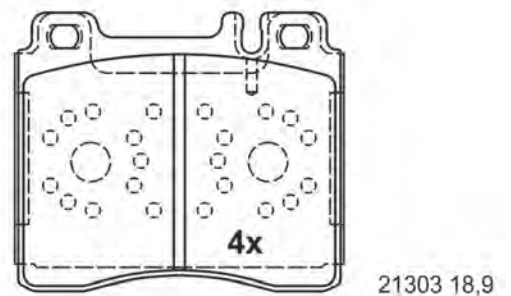

99,6 x 84,5 x 18,9

# Abbildungen Scheibenbremsbeläge

Illustrations disc brake pads - Ilustraciones de pastillas - Illustrations Plaquettes de frein à disque - Illustrazioni Pastiglie Freno

13.0460-9037.2 609037



20309 17,9

99,8 x 83,0 x 17,9

13.0470-2610.2 LD2610

ATE Ceramic



22076 19,6

175,0 x 69,0 x 19,6

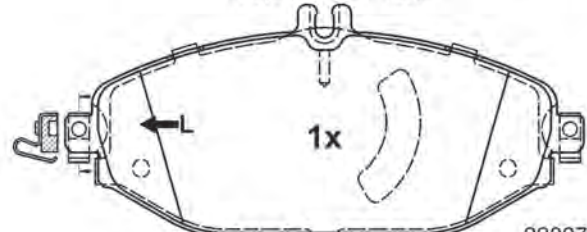

22097 19,6

175,0 x 77,9 x 19,6

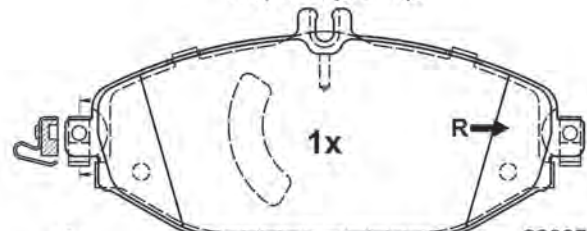

22097 19,6

175,0 x 77,9 x 19,6



13.0470-2613.2 LD2613

ATE Ceramic

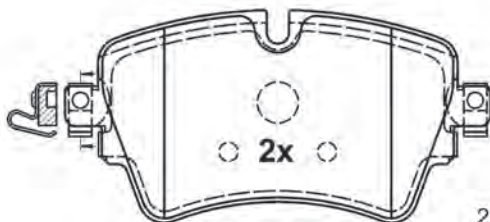

22187 18,6

129,0 x 64,3 x 18,6

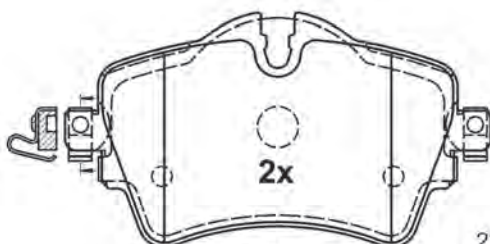

22188 18,6

129,0 x 77,3 x 18,6



13.0470-2615.2 LD2615

ATE Ceramic

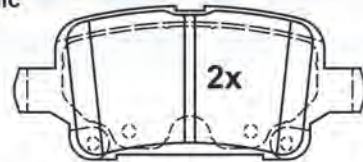

22129 17,4

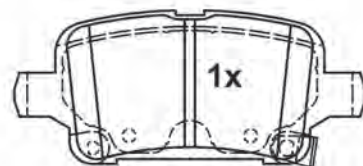

22130 17,4

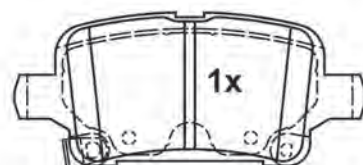

22131 17,4

106,4 x 46,4 x 17,4

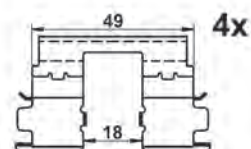

# Abbildungen Scheibenbremsbeläge

Illustrations disc brake pads - Ilustraciones de pastillas - Illustrations Plaquettes de frein à disque - Illustrazioni Pastiglie Freno

13.0470-2621.2 LD2621

ATE Ceramic

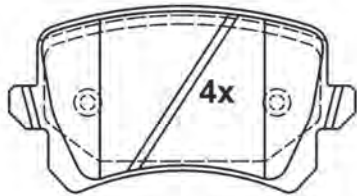

24483 16,9

105,2 x 56,4 x 16,9

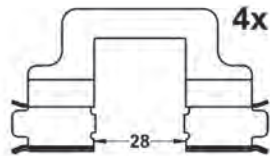

13.0470-2707.2 LD2707

ATE Ceramic

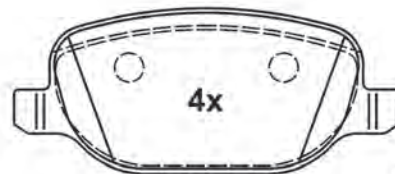

23760 17,7

116,8 x 49,8 x 17,7



13.0470-2708.2 LD2708

ATE Ceramic

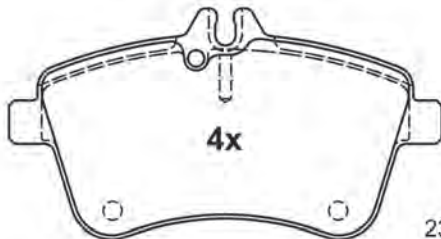

23881 20,0

131,3 x 69,8 x 20,0

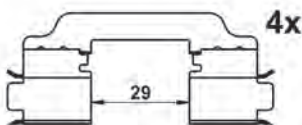

13.0470-2709.2 LD2709

ATE Ceramic



23973 17,1

116,3 x 52,4 x 17,1

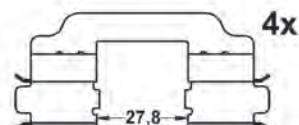



# Abbildungen Scheibenbremsbeläge

Illustrations disc brake pads - Ilustraciones de pastillas - Illustrations Plaquettes de frein à disque - Illustrazioni Pastiglie Freno

13.0470-2710.2 LD2710

ATE Ceramic

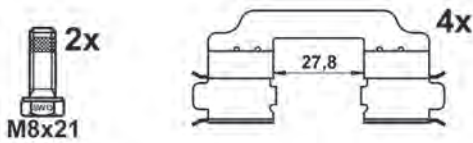
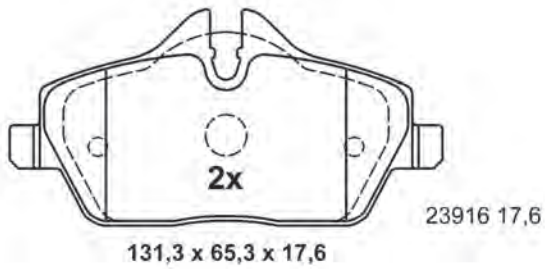
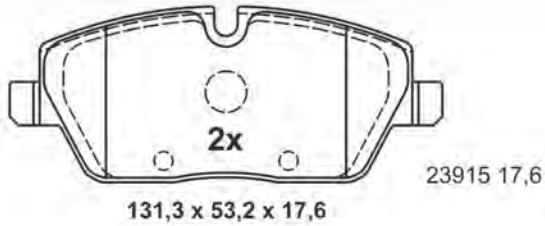

13.0470-2711.2 LD2711

ATE Ceramic

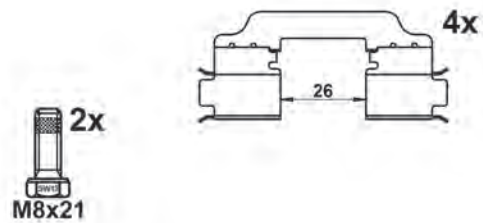
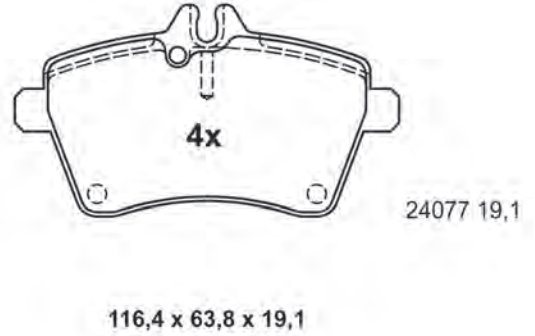

13.0470-2712.2 LD2712

ATE Ceramic

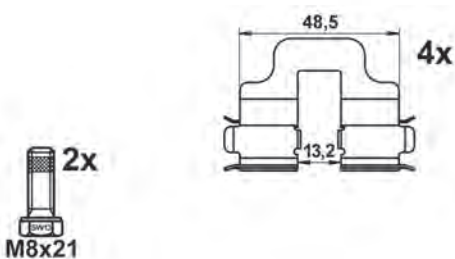
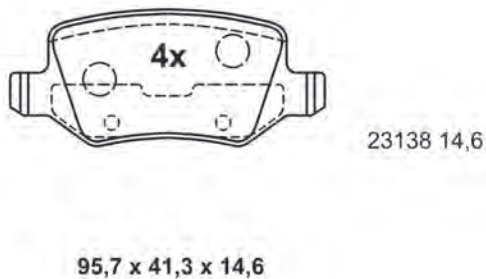

13.0470-2713.2 LD2713

ATE Ceramic

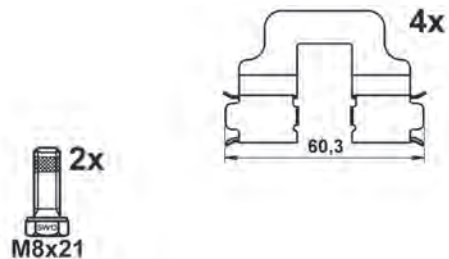
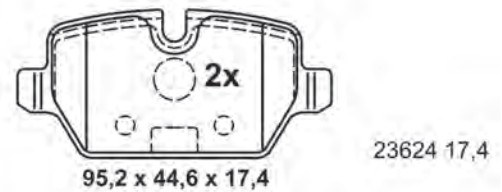
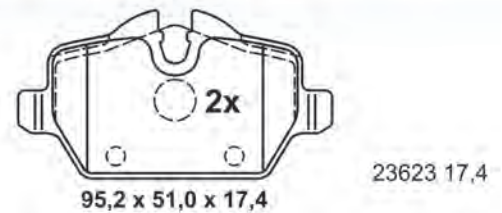

# Abbildungen Scheibenbremsbeläge

Illustrations disc brake pads - Ilustraciones de pastillas - Illustrations Plaquettes de frein à disque - Illustrazioni Pastiglie Freno

13.0470-2714.2 LD2714

ATE Ceramic

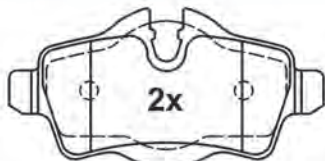

95,3 x 48,3 x 16,9

24289 16,9

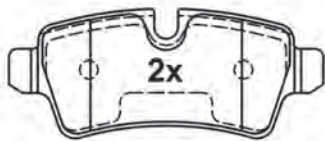

95,3 x 39,0 x 16,9

24290 16,9

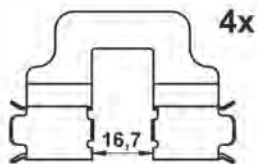

16,7



13.0470-2716.2 LD2716

ATE Ceramic

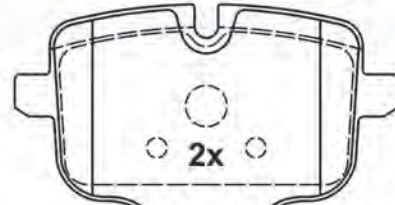

166,0 x 65,5 x 17,8

24703 17,8

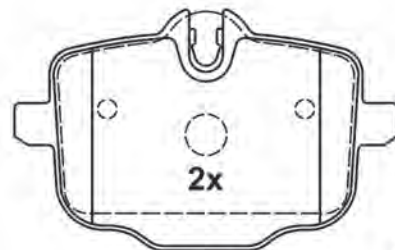

166,0 x 72,4 x 17,8

24704 17,8

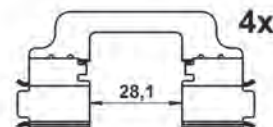

28,1



13.0470-2722.2 LD2722

ATE Ceramic

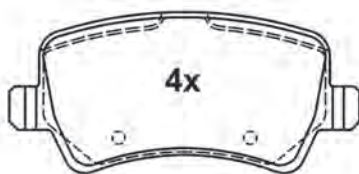

106,0 x 48,7 x 17,3

24496 17,3

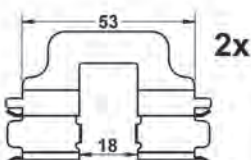

53

18

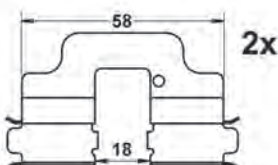

58

18



13.0470-2723.2 LD2723

ATE Ceramic



95,1 x 43,2 x 16,1

24537 16,1

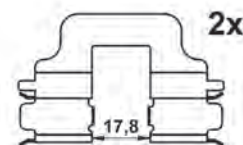

17,8

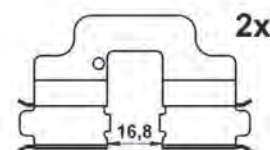

16,8





# Abbildungen Scheibenbremsbeläge

Illustrations disc brake pads - Ilustraciones de pastillas - Illustrations Plaquettes de frein à disque - Illustrazioni Pastiglie Freno

13.0470-2725.2 LD2725

ATE Ceramic

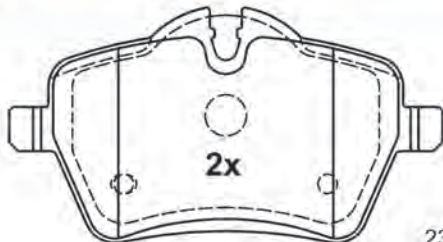

131,6 x 71,3 x 17,8

23984 17,8

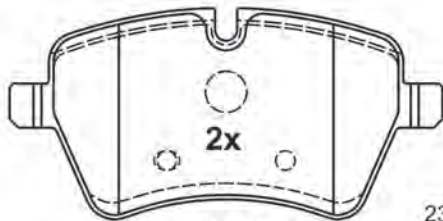

131,6 x 63,9 x 17,8

23985 17,8

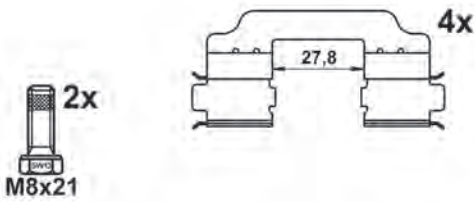

13.0470-2726.2 LD2726

ATE Ceramic

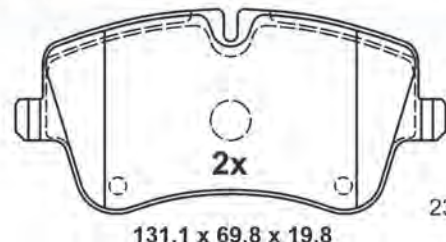

131,1 x 69,8 x 19,8

23145 19,8

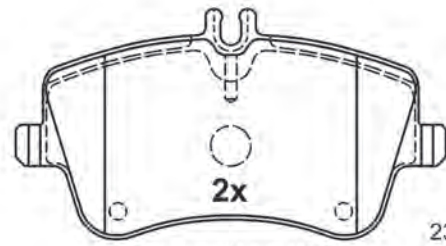

131,1 x 62,1 x 19,8

23144 19,8

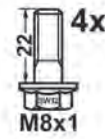
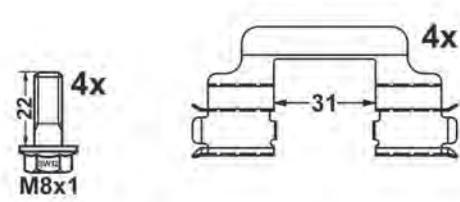

13.0470-2727.2 LD2727

ATE Ceramic

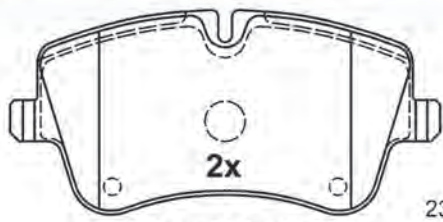

131,1 x 69,8 x 19,8

23145 19,8

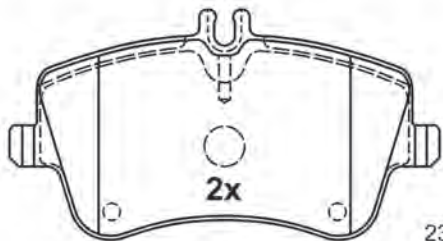

131,1 x 62,1 x 19,8

23144 19,8

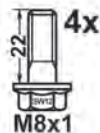
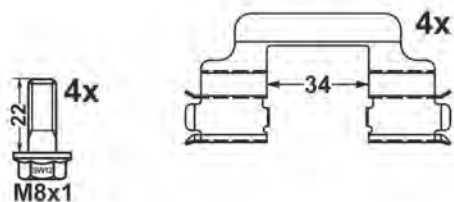

13.0470-2732.2 LD2732

ATE Ceramic

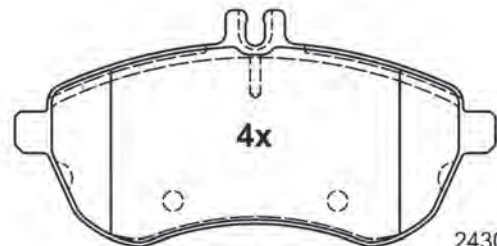

24306 20,3

146,0 x 71,5 x 20,3

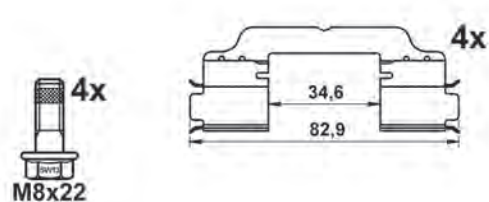

# Abbildungen Scheibenbremsbeläge

Illustrations disc brake pads - Ilustraciones de pastillas - Illustrations Plaquettes de frein à disque - Illustrazioni Pastiglie Freno

13.0470-2733.2 LD2733

ATE Ceramic

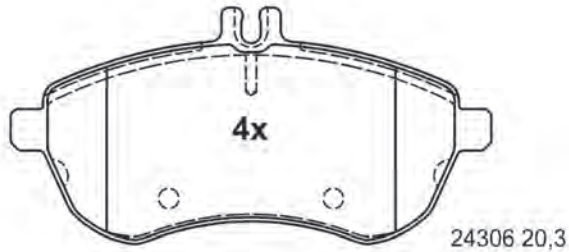

146,0 x 71,5 x 20,3

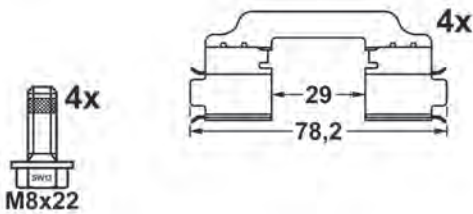

13.0470-2734.2 LD2734

ATE Ceramic

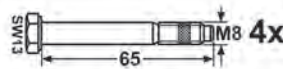
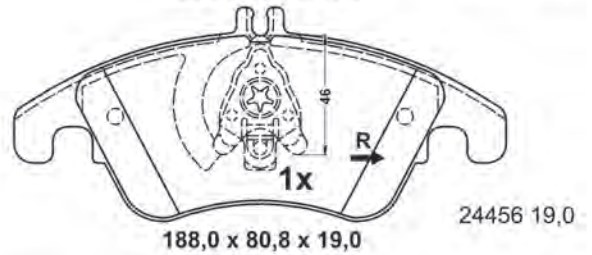
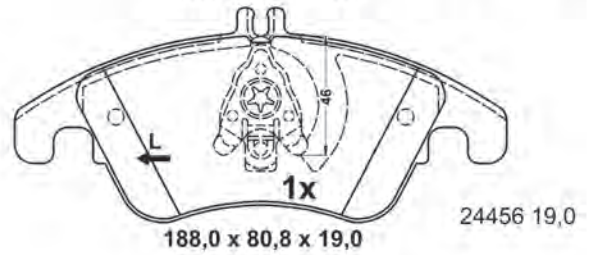
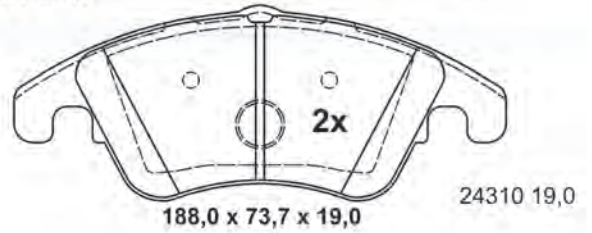

13.0470-2736.2 LD2736

ATE Ceramic



106,0 x 48,7 x 17,3

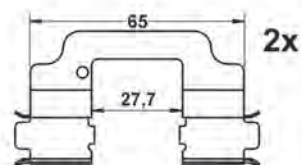
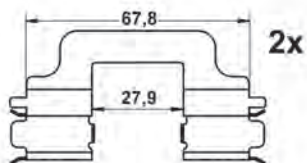

13.0470-2740.2 LD2740

ATE Ceramic

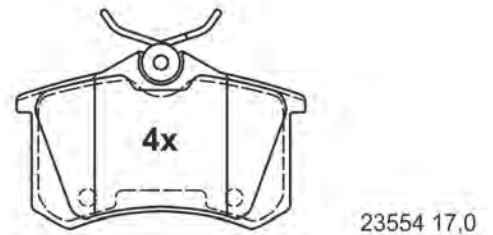

87,6 x 52,9 x 17,0

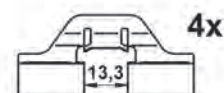



# Abbildungen Scheibenbremsbeläge

Illustrations disc brake pads - Ilustraciones de pastillas - Illustrations Plaquettes de frein à disque - Illustrazioni Pastiglie Freno

13.0470-2746.2 LD2746

B.H.P.

ATE Ceramic

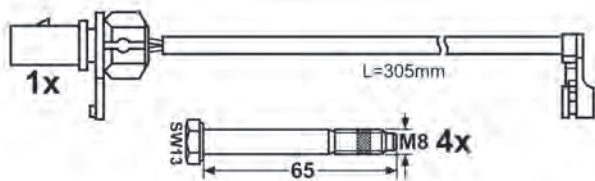
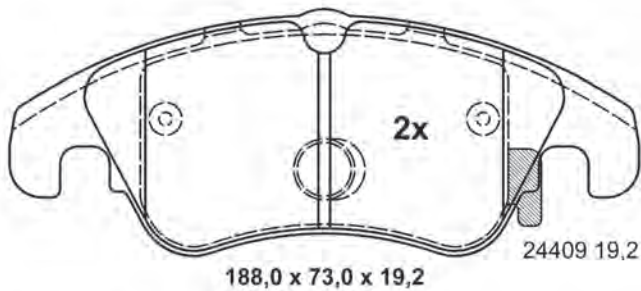
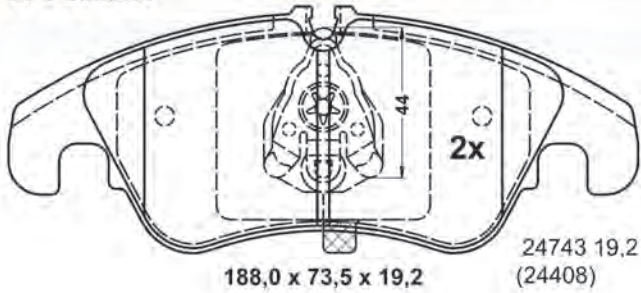

13.0470-2747.2 LD2747

B.H.P.

ATE Ceramic

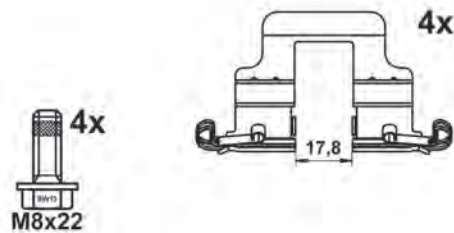
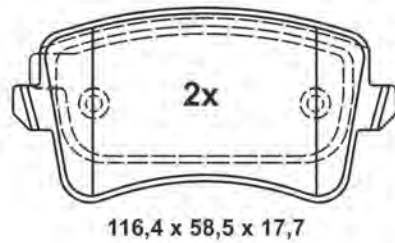
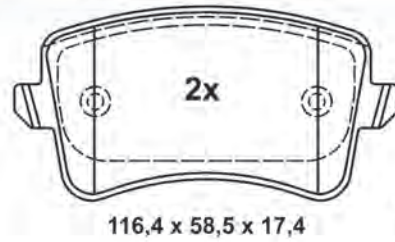

13.0470-2748.2 LD2748

B.H.P.

ATE Ceramic

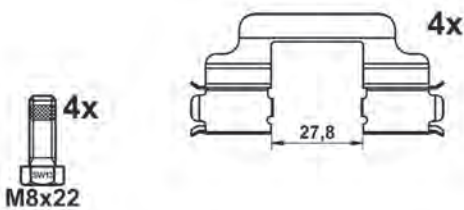
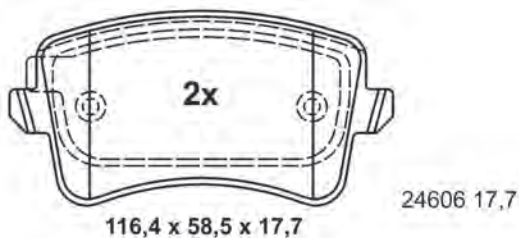
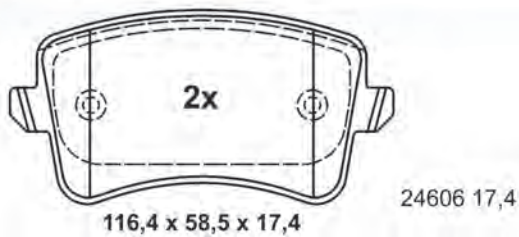

13.0470-2749.2 LD2749

B.H.P.

ATE Ceramic

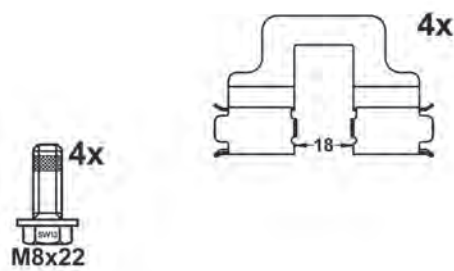

# Abbildungen Scheibenbremsbeläge

Illustrations disc brake pads - Ilustraciones de pastillas - Illustrations Plaquettes de frein à disque - Illustrazioni Pastiglie Freno

13.0470-2755.2 LD2755

ATE Ceramic

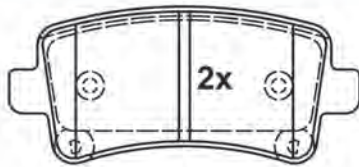

24421 17,2

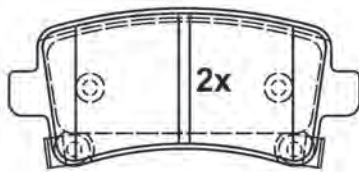

24422 17,2

106,3 x 47,1 x 17,2

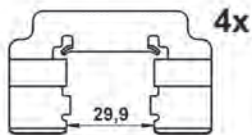

4x

29,9

13.0470-2758.2 LD2758

ATE Ceramic

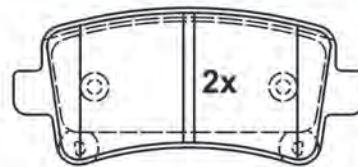

24421 17,2

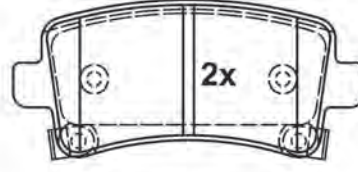

24422 17,2

106,3 x 47,1 x 17,2

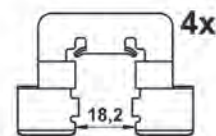

4x

18,2

13.0470-2760.2 LD2760

ATE Ceramic

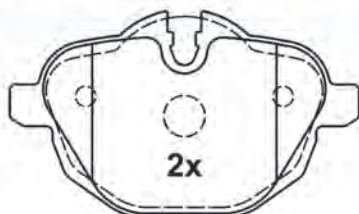

24561 17,7

106,0 x 63,2 x 17,7

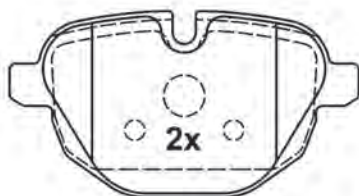

24562 17,7

106,0 x 56,2 x 17,7

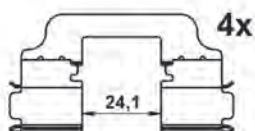

4x

24,1



4x

M8x21

13.0470-2764.2 LD2764

ATE Ceramic

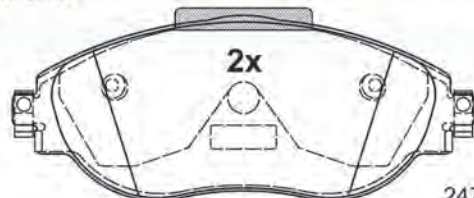

24738 20,0

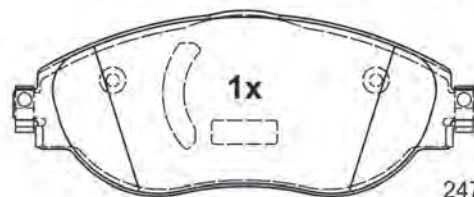

24738 20,0

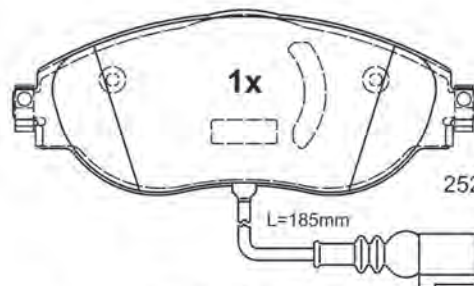

25217 20,0

175,0 x 70,0 x 20,0



4x

M8x22



# Abbildungen Scheibenbremsbeläge

Illustrations disc brake pads - Ilustraciones de pastillas - Illustrations Plaquettes de frein à disque - Illustrazioni Pastiglie Freno

13.0470-2765.2 LD2765

ATE Ceramic

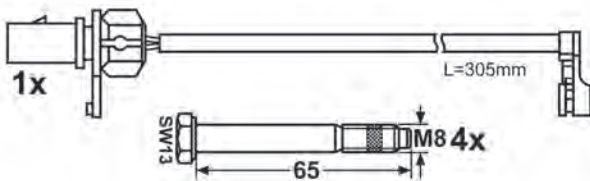
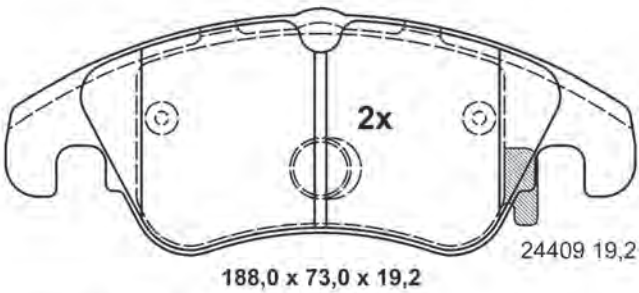
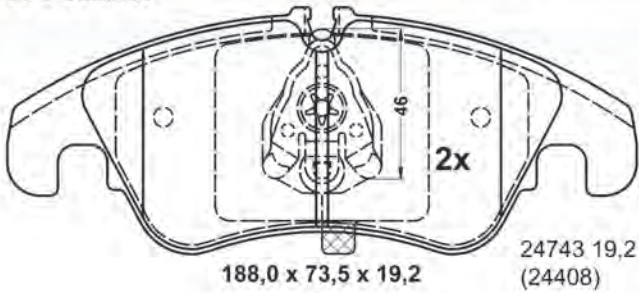

13.0470-2767.2 LD2767

ATE Ceramic

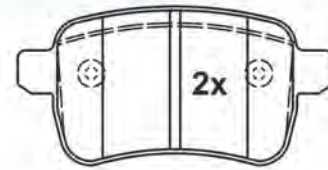

25156 17,4

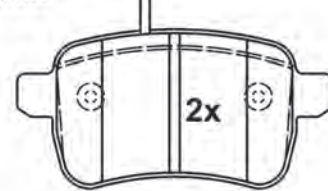
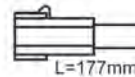

25157 17,4

95,6 x 48,1 x 17,4

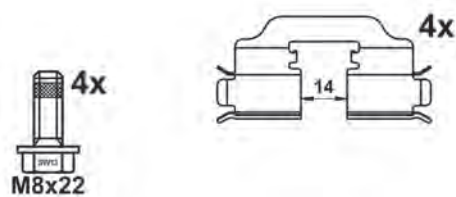

13.0470-2768.2 LD2768

ATE Ceramic



23811 17,7

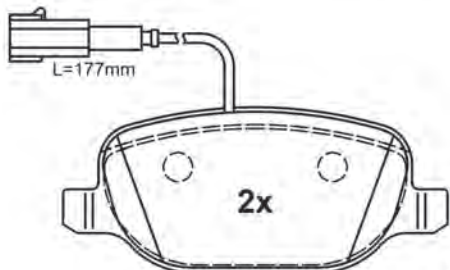

24788 17,7

116,8 x 49,8 x 17,7

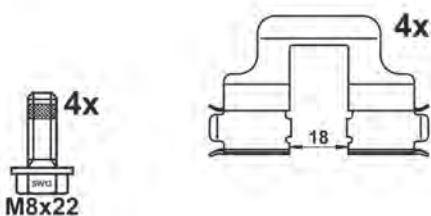

13.0470-2769.2 LD2769

ATE Ceramic

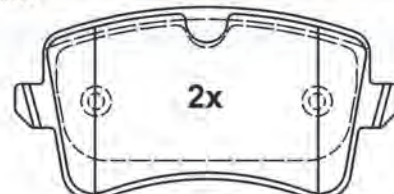

24606 17,4

116,4 x 58,5 x 17,4

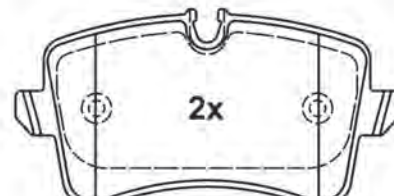

25214 17,4

116,4 x 59,8 x 17,4

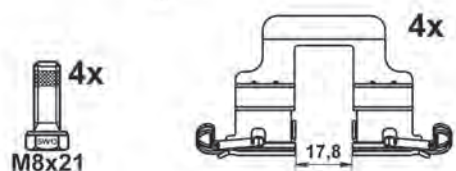
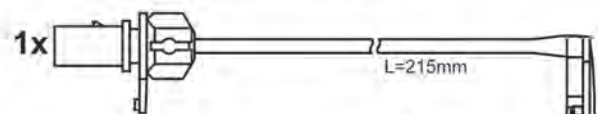



# Abbildungen Scheibenbremsbeläge

Illustrations disc brake pads - Ilustraciones de pastillas - Illustrations Plaquettes de frein à disque - Illustrazioni Pastiglie Freno

13.0470-2770.2 LD2770

ATE Ceramic

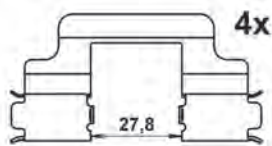
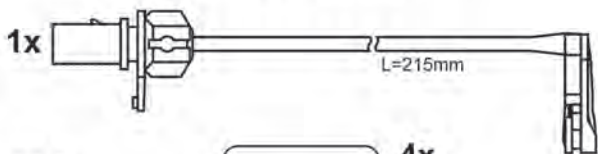
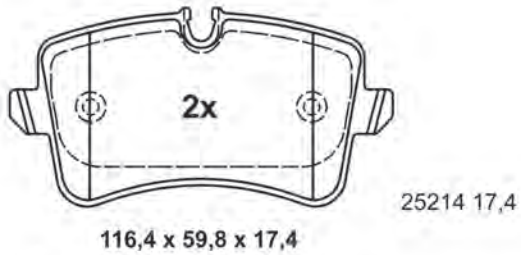
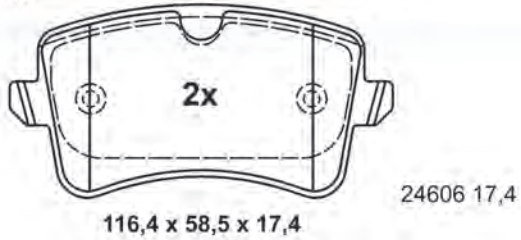

13.0470-2773.2 LD2773

ATE Ceramic

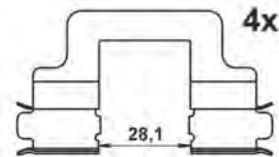
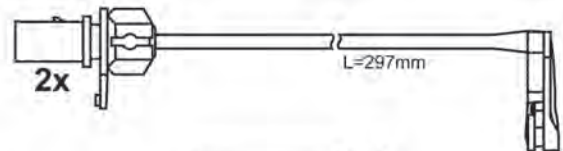
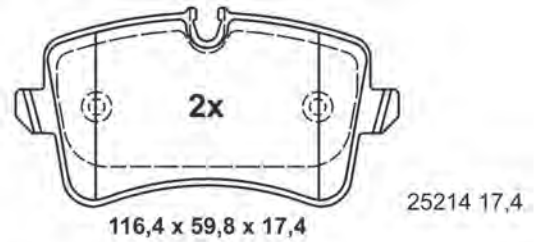
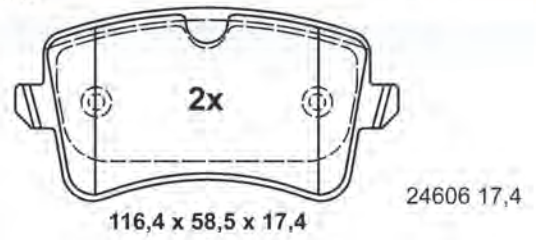

13.0470-2776.2 LD2776

ATE Ceramic

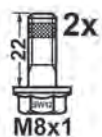
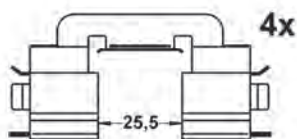
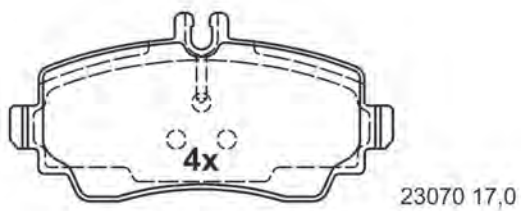

13.0470-2778.2 LD2778

ATE Ceramic

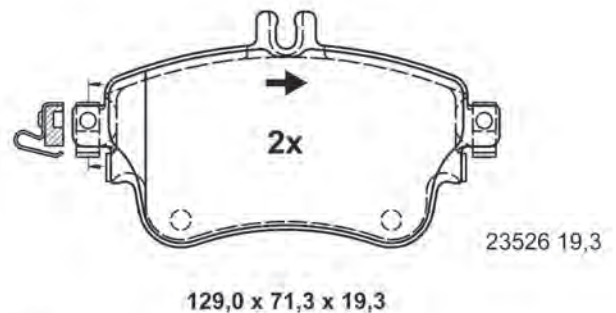
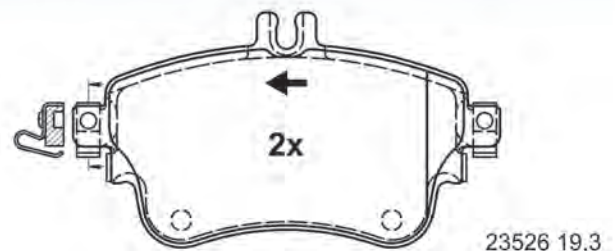

# Abbildungen Scheibenbremsbeläge

Illustrations disc brake pads - Ilustraciones de pastillas - Illustrations Plaquettes de frein à disque - Illustrazioni Pastiglie Freno

13.0470-2779.2 LD2779

ATE Ceramic

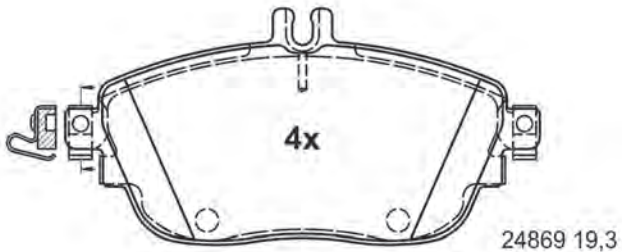

144,0 x 71,6 x 19,3



13.0470-2781.2 LD2781

ATE Ceramic

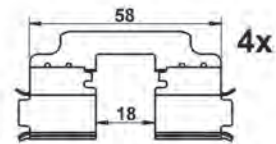
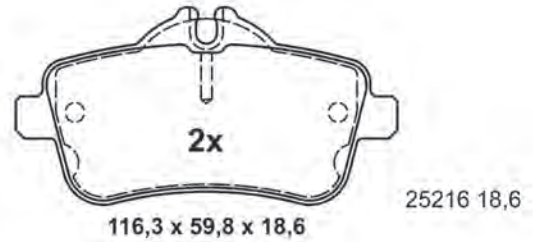
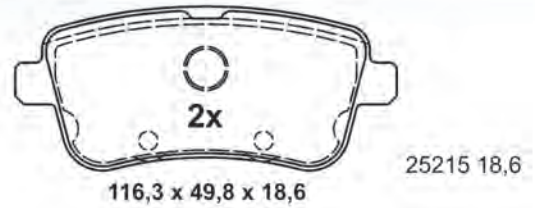

13.0470-2782.2 LD2782

ATE Ceramic

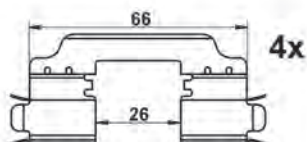
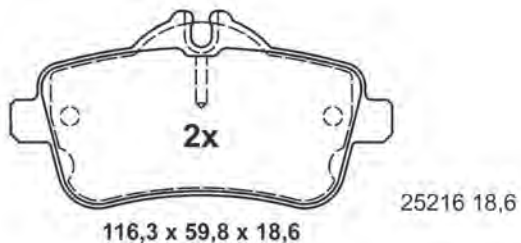
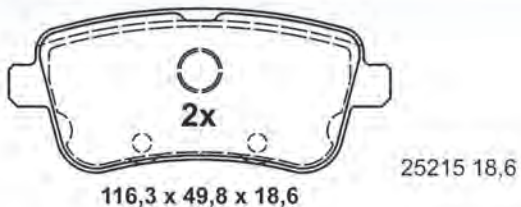

13.0470-2784.2 LD2784

ATE Ceramic

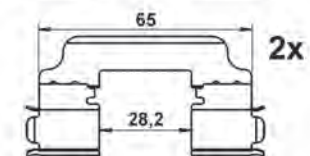
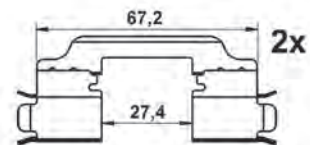
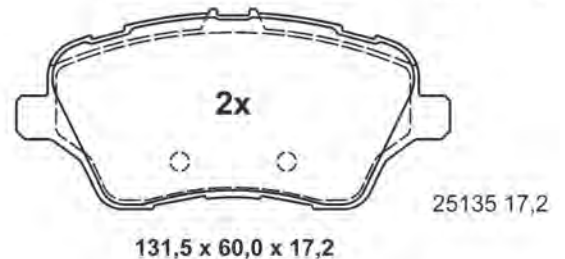
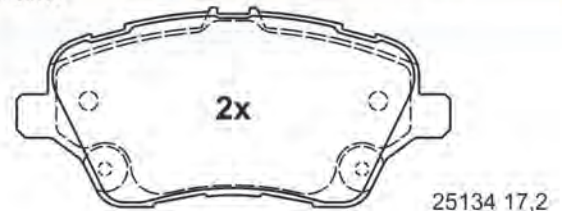

# Abbildungen Scheibenbremsbeläge

Illustrations disc brake pads - Ilustraciones de pastillas - Illustrations Plaquettes de frein à disque - Illustrazioni Pastiglie Freno

13.0470-2785.2 LD2785

ATE Ceramic

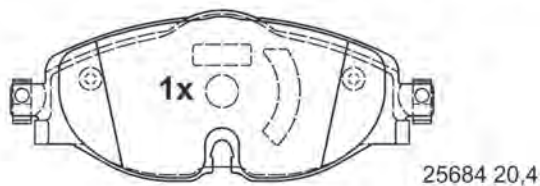
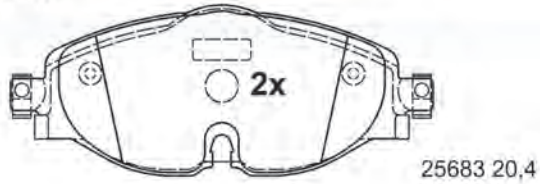

160,0 x 64,5 x 20,4

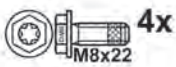
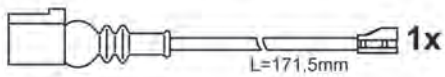

13.0470-2786.2 LD2786

ATE Ceramic

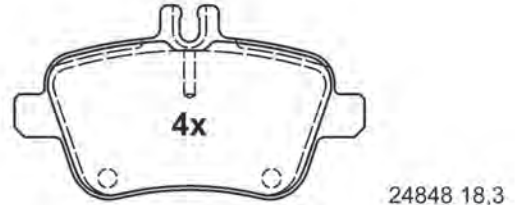

106,4 x 58,9 x 18,3

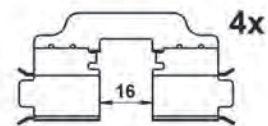

13.0470-2789.2 LD2789

ATE Ceramic

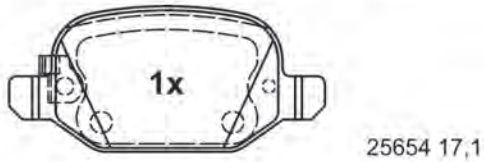
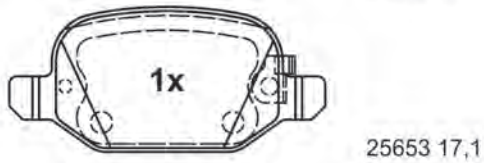
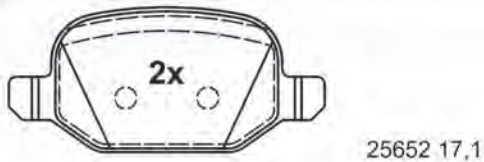

95,8 x 43,8 x 17,1

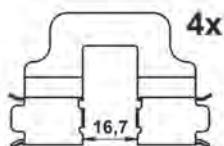

13.0470-2790.2 LD2790

ATE Ceramic

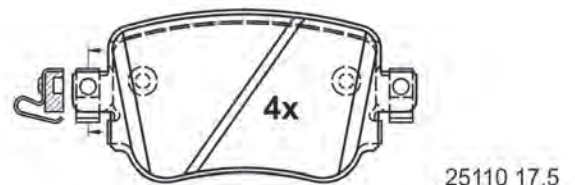

104,2 x 51,9 x 17,5





# Abbildungen Scheibenbremsbeläge

Illustrations disc brake pads - Ilustraciones de pastillas - Illustrations Plaquettes de frein à disque - Illustrazioni Pastiglie Freno

13.0470-2792.2 LD2792

B.H.P.

ATE Ceramic

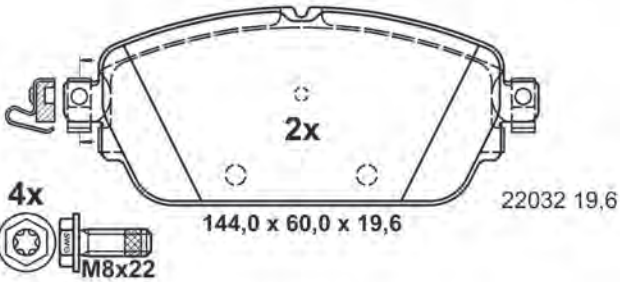
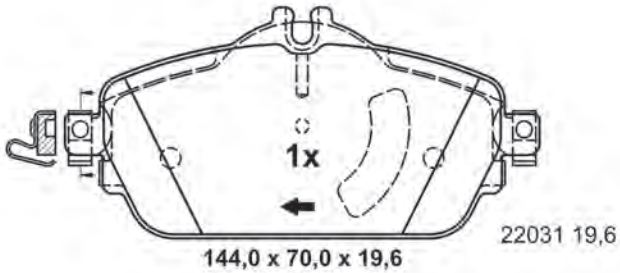
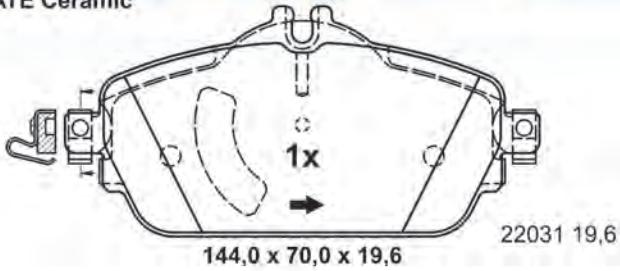

13.0470-2795.2 LD2795

B.H.P.

ATE Ceramic

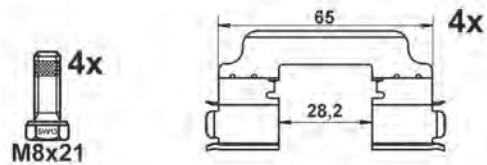
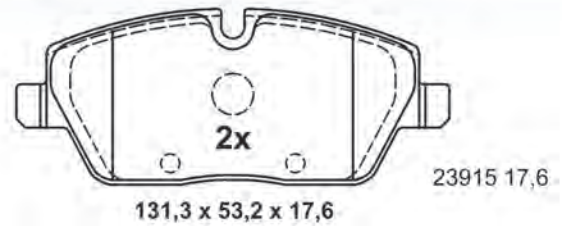

13.0470-2797.2 LD2797

B.H.P.

ATE Ceramic

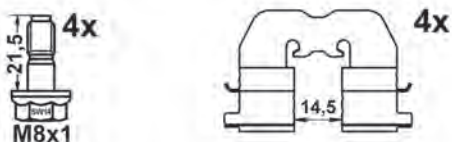
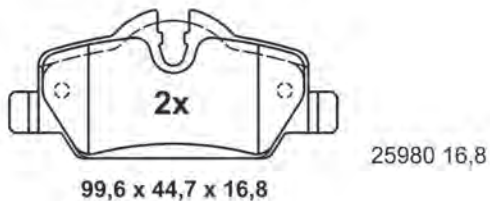

13.0470-2799.2 LD2799 [1]

B.H.P.

ATE Ceramic

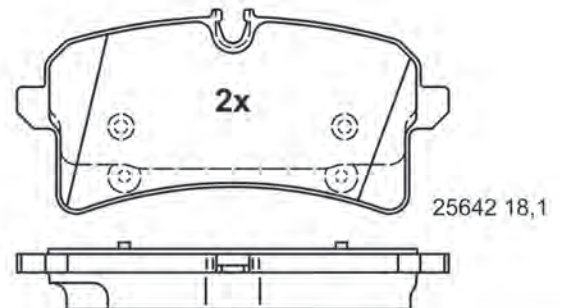
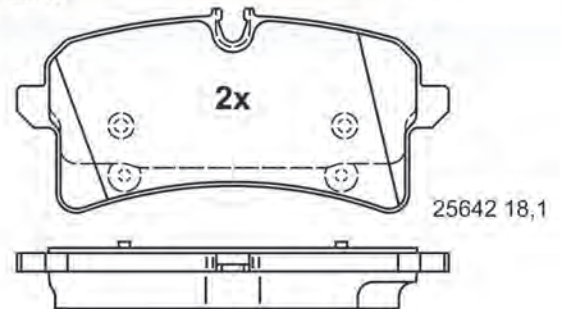

131,0 x 61,9 x 18,1

# Abbildungen Scheibenbremsbeläge

Illustrations disc brake pads - Ilustraciones de pastillas - Illustrations Plaquettes de frein à disque - Illustrazioni Pastiglie Freno

13.0470-2799.2 LD2799 [2]

ATE Ceramic

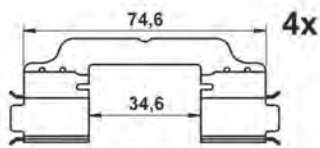
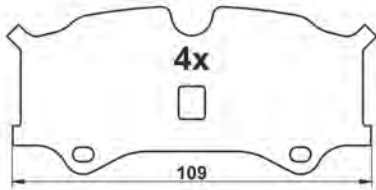

13.0470-2820.2 LD2820

ATE Ceramic

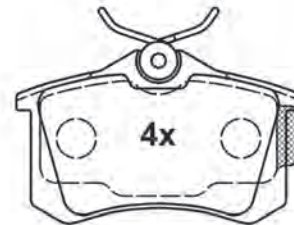

20961 17,2

87,6 x 52,9 x 17,2



13.0470-2833.2 LD2833

ATE Ceramic

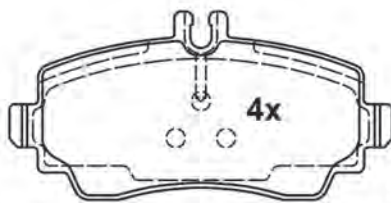

23070 17,0

116,5 x 57,1 x 17,0

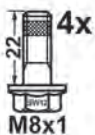
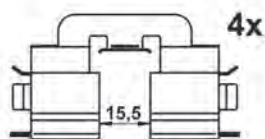

13.0470-2837.2 LD2837

ATE Ceramic

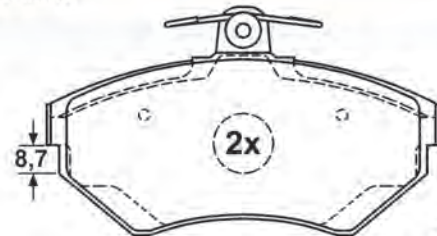

21945 19,6

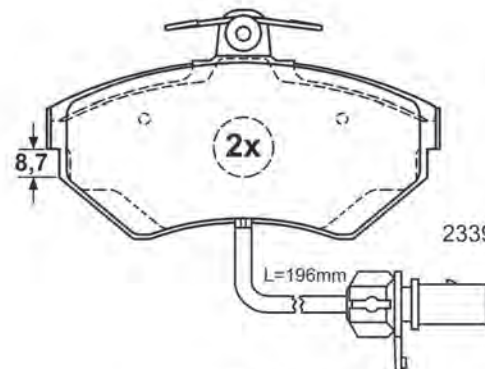

23393 19,6

119,1 x 69,5 x 19,6





# Abbildungen Scheibenbremsbeläge

Illustrations disc brake pads - Ilustraciones de pastillas - Illustrations Plaquettes de frein à disque - Illustrazioni Pastiglie Freno

13.0470-2845.2 LD2845

ATE Ceramic

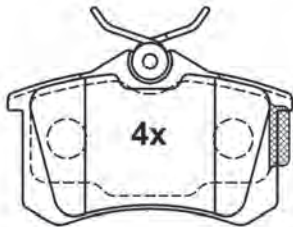

23554 16,4

87,6 x 52,9 x 16,4

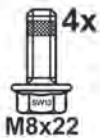

13.0470-2855.2 LD2855

ATE Ceramic

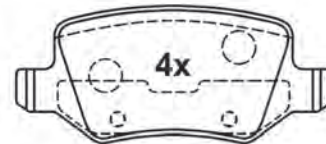

23138 14,6

95,7 x 41,3 x 14,6



13.0470-2857.2 LD2857

ATE Ceramic

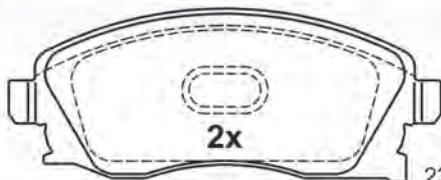

23225 17,0

131,5 x 52,3 x 17,0

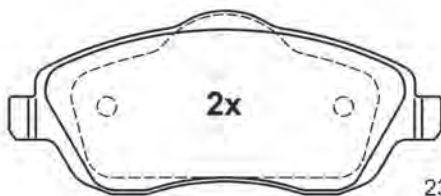

23226 17,0

131,5 x 55,4 x 17,0

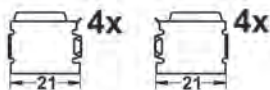
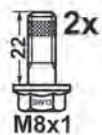

13.0470-2858.2 LD2858

ATE Ceramic

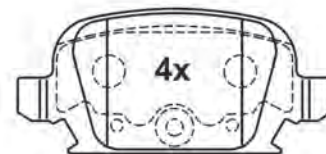











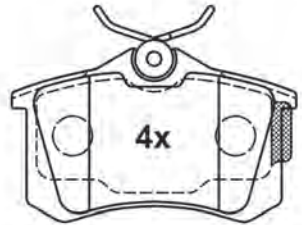

23284 14,0

95,6 x 43,8 x 14,0

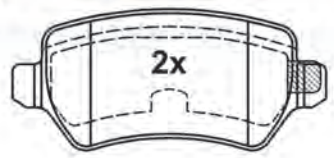
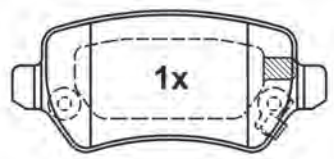
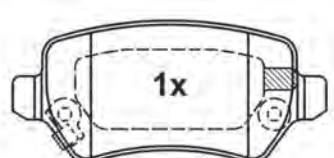

# Abbildungen Scheibenbremsbeläge

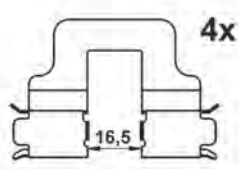
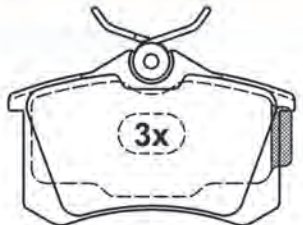
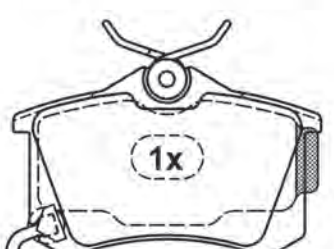
Illustrations disc brake pads - Ilustraciones de pastillas - Illustrations Plaquettes de frein à disque - Illustrazioni Pastiglie Freno

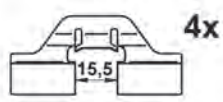
<b>13.0470-2860.2 LD2860</b> 	<b>13.0470-2867.2 LD2867</b> 
<p>ATE Ceramic</p>  <p>4x</p> <p>23554 16,4</p> <p>87,6 x 52,9 x 16,4</p>  <p>4x M8x22</p>	<p>ATE Ceramic</p>  <p>4x</p> <p>23517 16,6</p> <p>95,6 x 43,9 x 16,6</p>  <p>4x M8x22</p>
<b>13.0470-2868.2 LD2868</b> 	<b>13.0470-2877.2 LD2877</b> 
<p>ATE Ceramic</p>  <p>2x</p> <p>23417 15,3</p>  <p>1x</p> <p>23654 15,3</p>  <p>1x</p> <p>23655 15,3</p> <p>95,3 x 42,8 x 15,3</p>  <p>4x M8x22</p>  <p>4x</p> <p>16,5</p>	<p>ATE Ceramic</p>  <p>3x</p> <p>23554 17,2</p>  <p>1x</p> <p>23823 17,2</p> <p>L=255mm</p> <p>87,6 x 52,9 x 17,2</p>  <p>4x M8x22</p>  <p>4x</p> <p>15,5</p>

# Abbildungen Scheibenbremsbeläge

Illustrations disc brake pads - Ilustraciones de pastillas - Illustrations Plaquettes de frein à disque - Illustrazioni Pastiglie Freno

13.0470-2879.2 LD2879

ATE Ceramic



23601 13,7

95,6 x 43,9 x 13,7



13.0470-2880.2 LD2880

ATE Ceramic

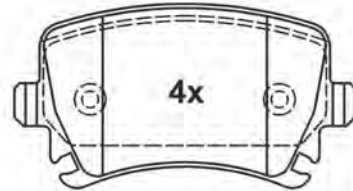

23914 17,1

105,3 x 55,9 x 17,1

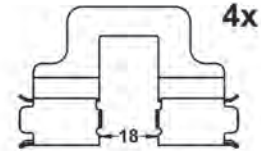

13.0470-2884.2 LD2884

ATE Ceramic



23581 18,8

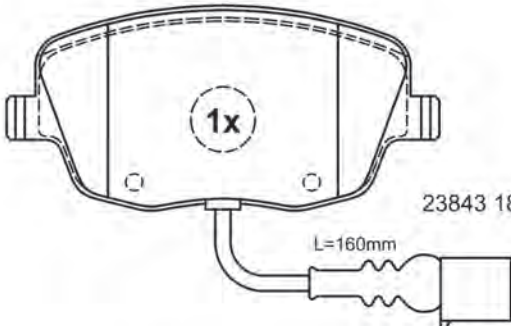

23843 18,8

131,4 x 62,0 x 18,8



13.0470-2885.2 LD2885

ATE Ceramic

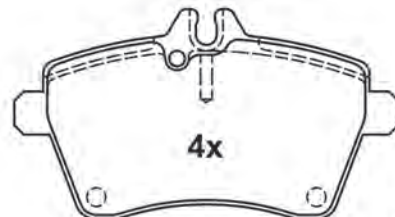

24077 19,1

116,4 x 63,8 x 19,1

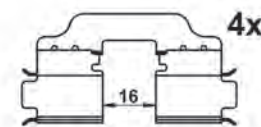

# Abbildungen Scheibenbremsbeläge

Illustrations disc brake pads - Ilustraciones de pastillas - Illustrations Plaquettes de frein à disque - Illustrazioni Pastiglie Freno

13.0470-2886.2 LD2886



ATE Ceramic



20961 16,0

87,6 x 52,9 x 16,0



13.0470-2887.2 LD2887



ATE Ceramic

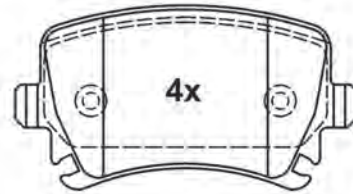

23914 17,1

105,3 x 55,9 x 17,1

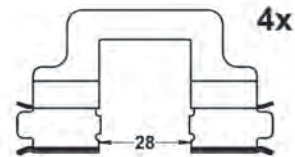

13.0470-2888.2 LD2888



ATE Ceramic

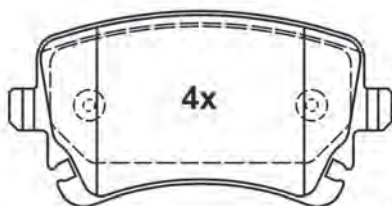

23326 17,4

116,1 x 59,0 x 17,4



13.0470-2891.2 LD2891



ATE Ceramic

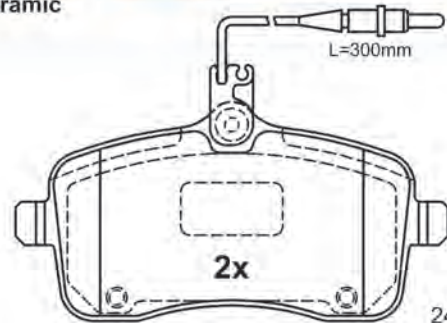

24134 19,6

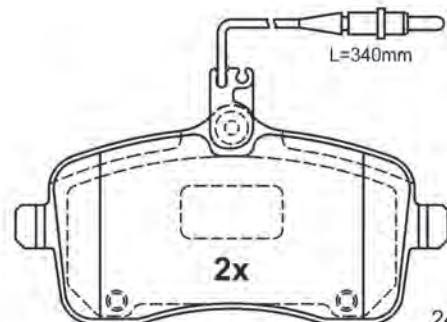

24175 19,6

131,4 x 67,5 x 19,6





# Abbildungen Scheibenbremsbeläge

Illustrations disc brake pads - Ilustraciones de pastillas - Illustrations Plaquettes de frein à disque - Illustrazioni Pastiglie Freno

13.0470-2892.2 LD2892

ATE Ceramic

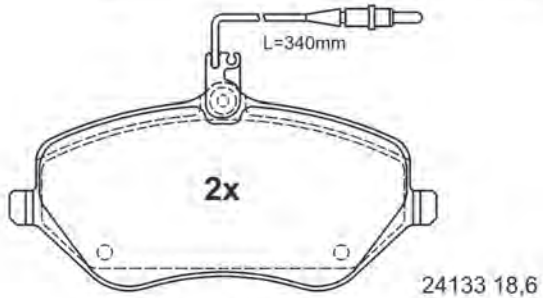
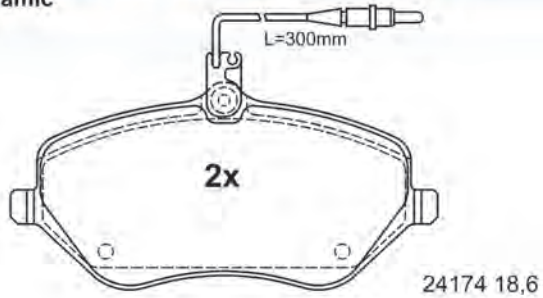

162,3 x 79,0 18,6

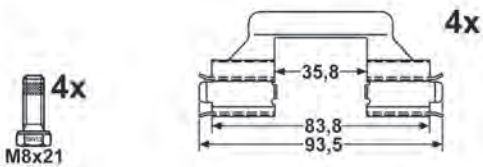

13.0470-2893.2 LD2893

ATE Ceramic

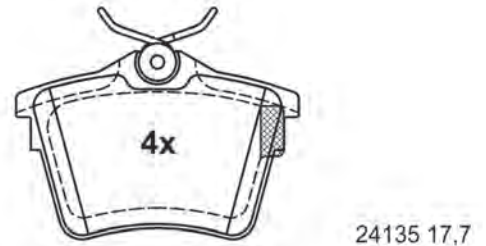

86,1 x 56,9 x 17,7



13.0470-2894.2 LD2894

ATE Ceramic

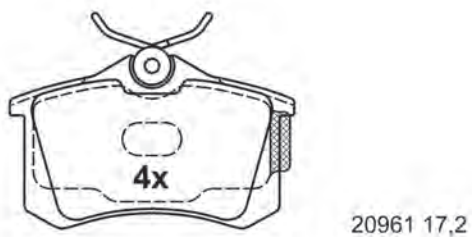

87,6 x 52,9 x 17,2

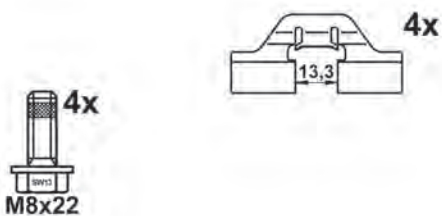

13.0470-2927.2 LD2927

ATE Ceramic

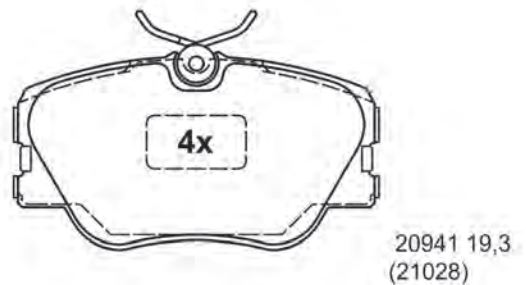

110,0 x 59,6 x 19,3





# Abbildungen Scheibenbremsbeläge

Illustrations disc brake pads - Ilustraciones de pastillas - Illustrations Plaquettes de frein à disque - Illustrazioni Pastiglie Freno

13.0470-2975.2 LD2975



ATE Ceramic

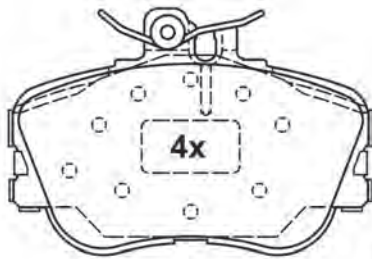

21439 20,3

110,0 x 74,5 x 20,3



13.0470-3605.2 LD3605



ATE Ceramic

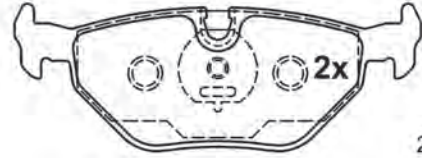

20180 17,3

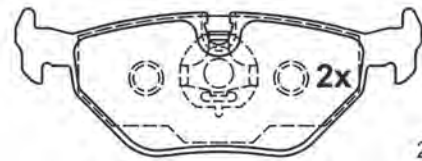

20181 17,3

123,0 x 44,9 x 17,3

13.0470-3805.2 LD3805



ATE Ceramic

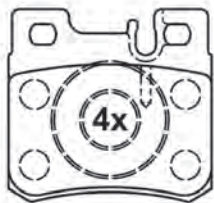

21197 15,0

61,8 x 58,6 x 15,0

13.0470-3813.2 LD3813



ATE Ceramic

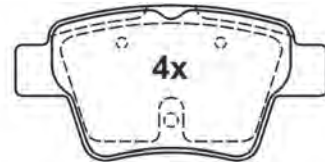

24150 17,6

94,8 x 46,9 x 17,6

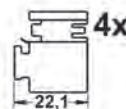
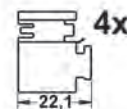
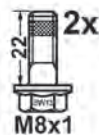

# Abbildungen Scheibenbremsbeläge

Illustrations disc brake pads - Ilustraciones de pastillas - Illustrations Plaquettes de frein à disque - Illustrazioni Pastiglie Freno

13.0470-3814.2 LD3814

ATE Ceramic

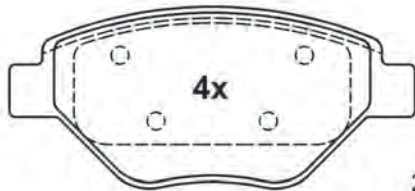

23934 18,2

122,8 x 54,3 x 18,2



13.0470-3815.2 LD3815

ATE Ceramic

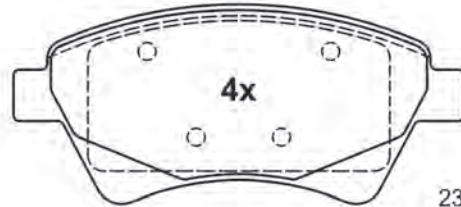

23930 18,2

136,8 x 59,5 x 18,2

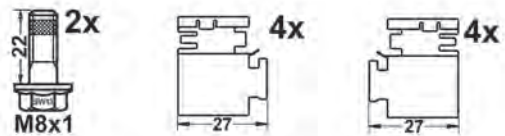

13.0470-3826.2 LD3826

ATE Ceramic

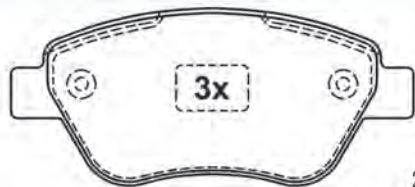

23707 18,0

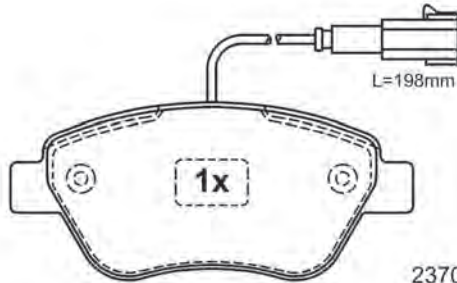

23706 18,0

122,8 x 53,3 x 18,0

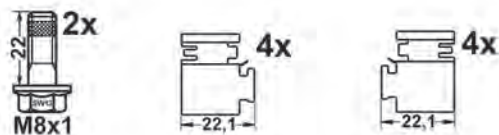

13.0470-3827.2 LD3827

ATE Ceramic

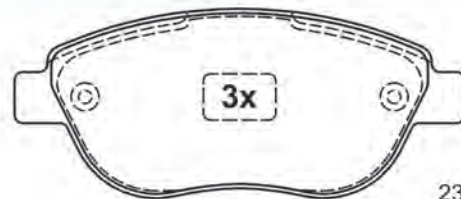

23710 19,6

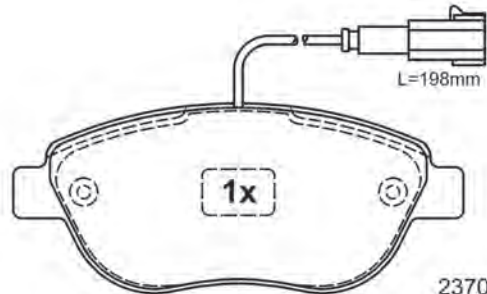

23709 19,6

136,8 x 57,4 x 19,6

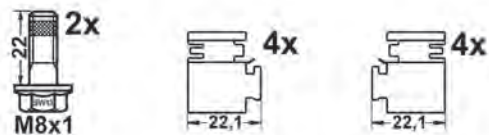

# Abbildungen Scheibenbremsbeläge

Illustrations disc brake pads - Ilustraciones de pastillas - Illustrations Plaquettes de frein à disque - Illustrazioni Pastiglie Freno

13.0470-3828.2 LD3828

ATE Ceramic

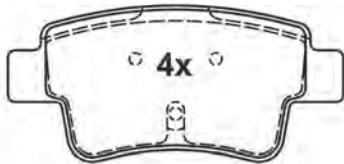

24349 17,5

101,8 x 47,1 x 17,5

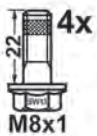

13.0470-3831.2 LD3831

ATE Ceramic



24260 17,3

101,8 x 50,5 x 17,3

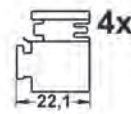
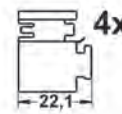

13.0470-3836.2 LD3836

ATE Ceramic

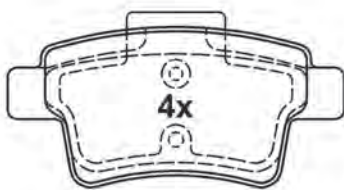

24540 16,3

101,8 x 48,3 x 16,3

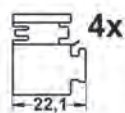
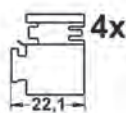
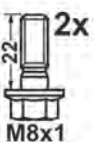
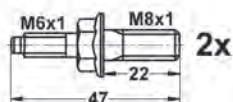

13.0470-3838.2 LD3838

ATE Ceramic

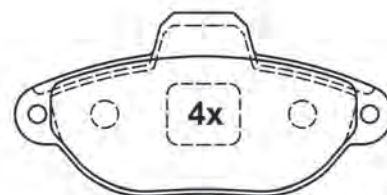

21436 17,0

114,8 x 55,5 x 17,0

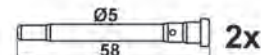
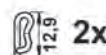



# Abbildungen Scheibenbremsbeläge

Illustrations disc brake pads - Ilustraciones de pastillas - Illustrations Plaquettes de frein à disque - Illustrazioni Pastiglie Freno

13.0470-3839.2 LD3839

ATE Ceramic



122,8 x 53,3 x 18,1

23982 18,1

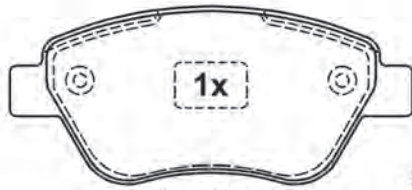

122,8 x 53,3 x 17,9

23707 17,9

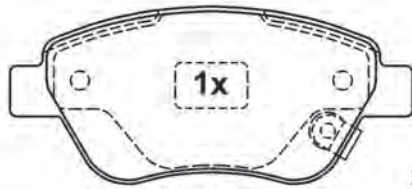

122,8 x 53,3 x 17,9

24288 17,9

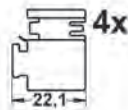
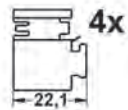

13.0470-3840.2 LD3840

ATE Ceramic



23981 19,6

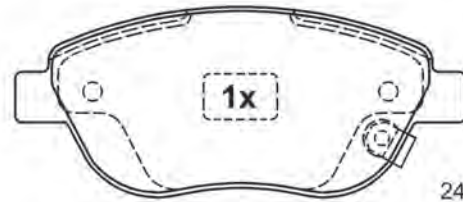

24549 19,6

136,9 x 57,4 x 19,6

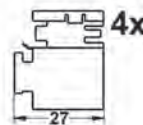
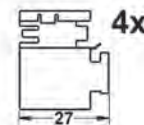

13.0470-3846.2 LD3846

ATE Ceramic

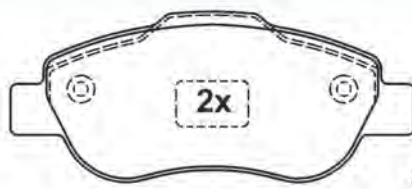

24072 17,9

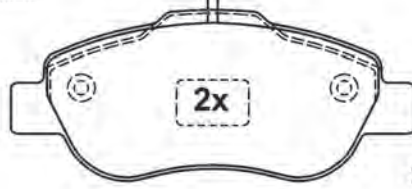
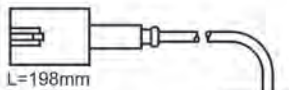

24764 17,9

122,8 x 51,7 x 17,9

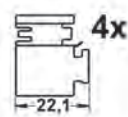
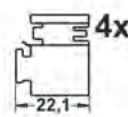

13.0470-3847.2 LD3847

ATE Ceramic

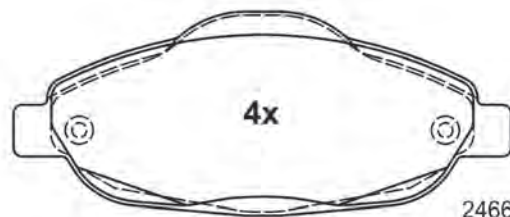

24660 17,8

151,0 x 62,0 x 17,8

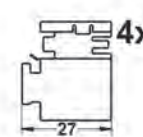
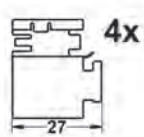
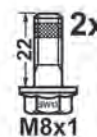

# Abbildungen Scheibenbremsbeläge

Illustrations disc brake pads - Ilustraciones de pastillas - Illustrations Plaquettes de frein à disque - Illustrazioni Pastiglie Freno

13.0470-3852.2 LD3852

ATE Ceramic

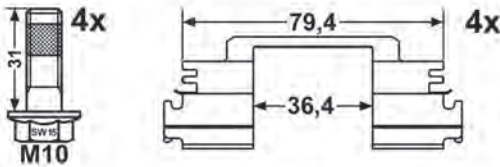
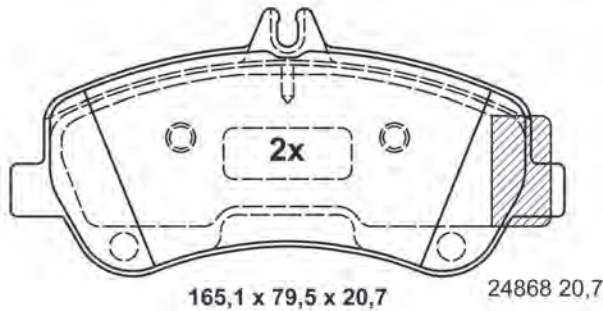
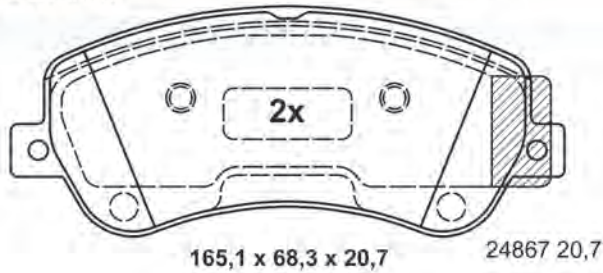

13.0470-3855.2 LD3855

ATE Ceramic

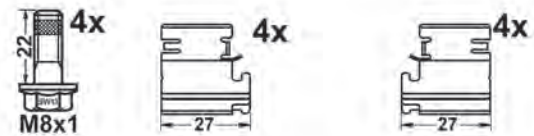
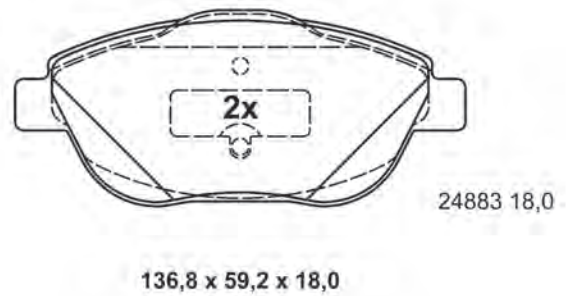
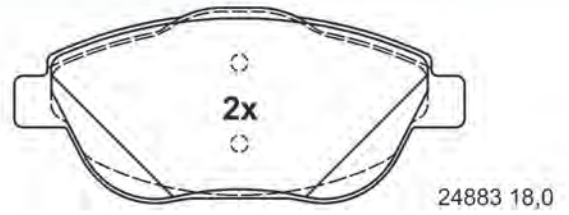

13.0470-3857.2 LD3857

ATE Ceramic

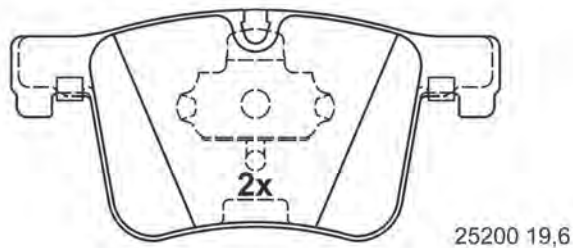
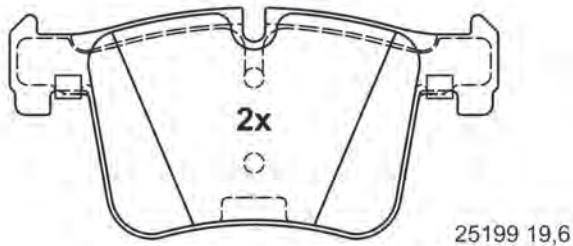

13.0470-3858.2 LD3858

ATE Ceramic

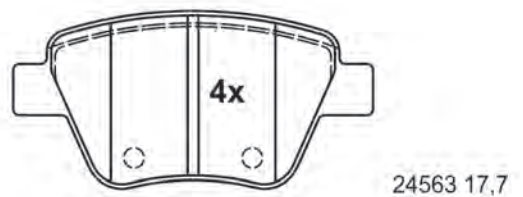

109,3 x 53,4 x 17,7

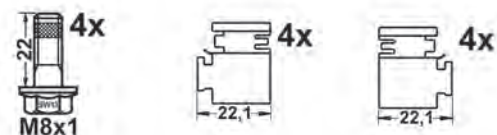



# Abbildungen Scheibenbremsbeläge

Illustrations disc brake pads - Ilustraciones de pastillas - Illustrations Plaquettes de frein à disque - Illustrazioni Pastiglie Freno

13.0470-3859.2 LD3859

ATE Ceramic

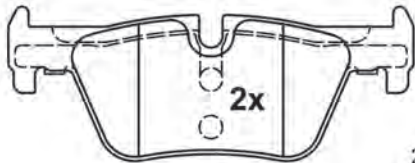

25307 17,5

123,0 x 46,7 x 17,5

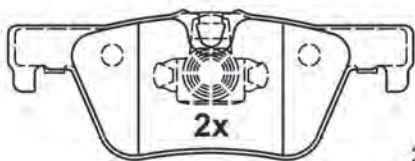

25308 17,5

123,0 x 45,3 x 17,5

13.0470-3860.2 LD3860

ATE Ceramic

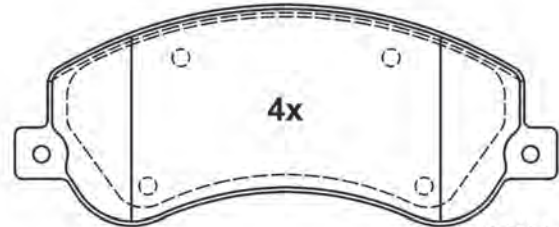

24484 18,8

164,8 x 66,8 x 18,8

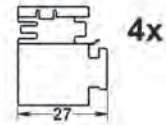
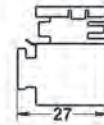
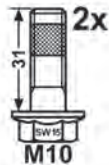

13.0470-3861.2 LD3861

ATE Ceramic



23714 17,6

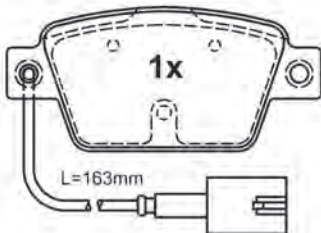

25527 17,6

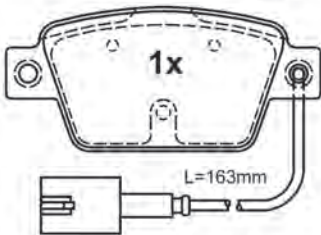

25526 17,6

94,8 x 42,9 x 17,6

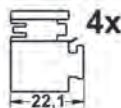
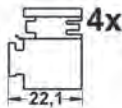

13.0470-3865.2 LD3865

ATE Ceramic

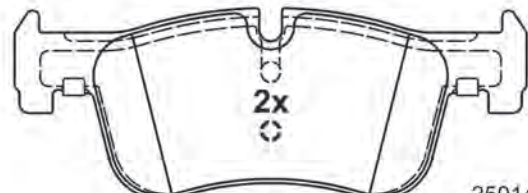

25014 18,2

155,7 x 57,8 x 18,2

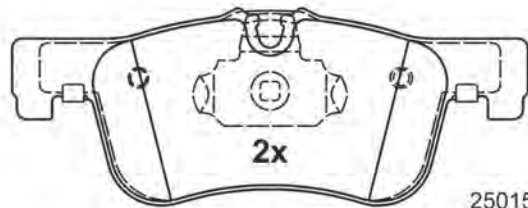

25015 18,2

156,7 x 59,7 x 18,2

# Abbildungen Scheibenbremsbeläge

Illustrations disc brake pads - Ilustraciones de pastillas - Illustrations Plaquettes de frein à disque - Illustrazioni Pastiglie Freno

13.0470-3866.2 LD3866

ATE Ceramic

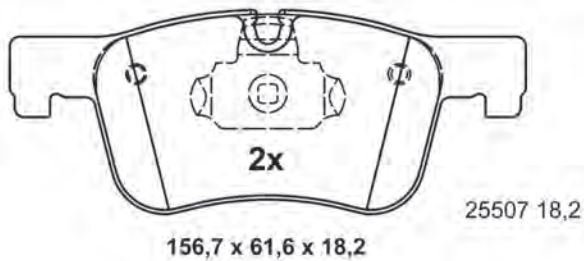
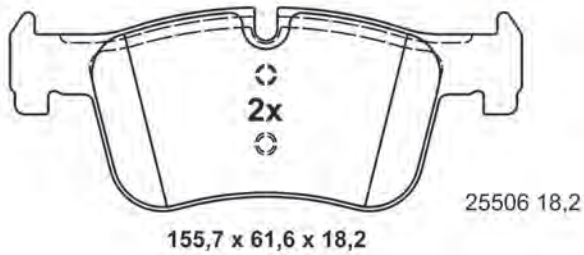

13.0470-3869.2 LD3869

ATE Ceramic

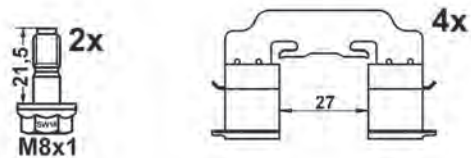
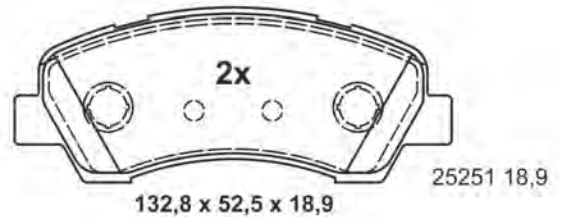
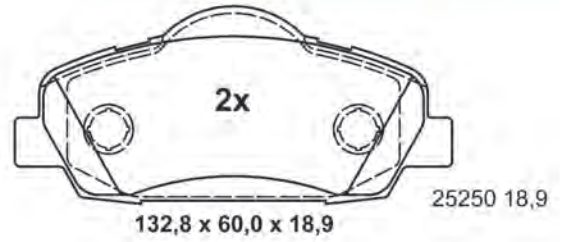

13.0470-3870.2 LD3870

ATE Ceramic

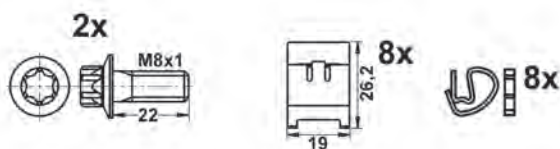
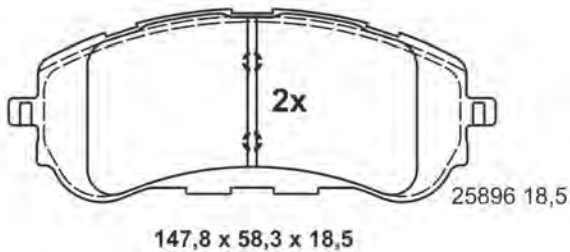
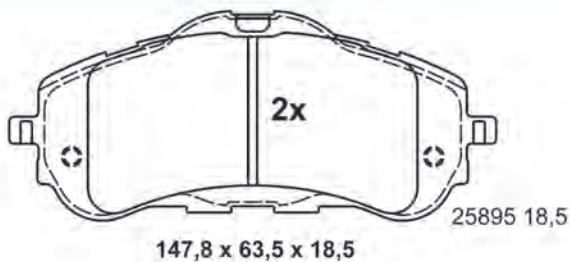

13.0470-3871.2 LD3871

ATE Ceramic

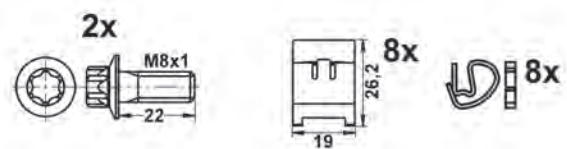
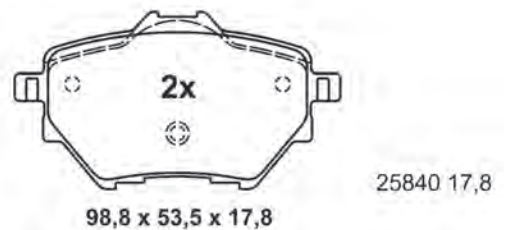

# Abbildungen Scheibenbremsbeläge

Illustrations disc brake pads - Ilustraciones de pastillas - Illustrations Plaquettes de frein à disque - Illustrazioni Pastiglie Freno

13.0470-3872.2 LD3872

ATE Ceramic



25827 17,7

105,8 x 51,9 x 17,7



25828 17,7

105,8 x 55,4 x 17,7

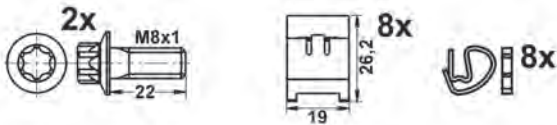

13.0470-3966.2 LD3966

ATE Ceramic

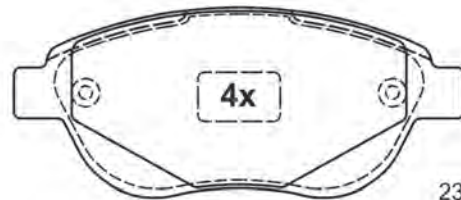

23600 19,4

136,8 x 57,5 x 19,4

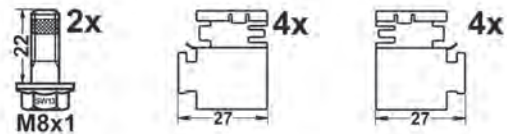

13.0470-3982.2 LD3982

ATE Ceramic

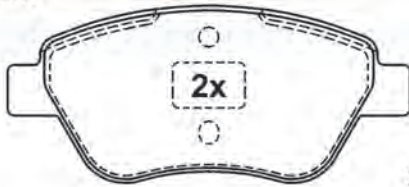

23705 18,1

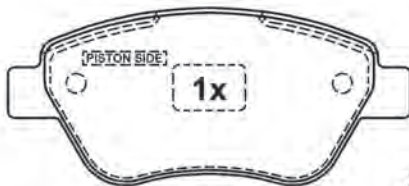

23707 18,1

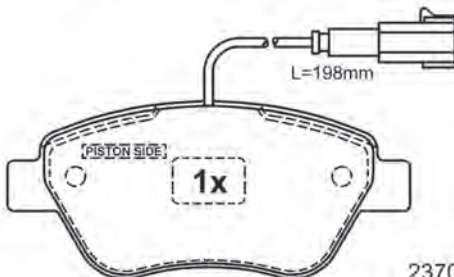

23706 18,1

122,8 x 53,3 x 18,1



13.0470-3983.2 LD3983

ATE Ceramic

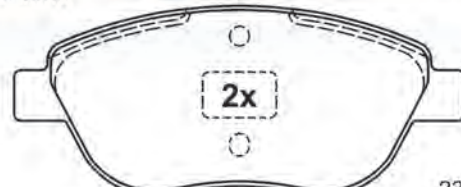

23708 19,4

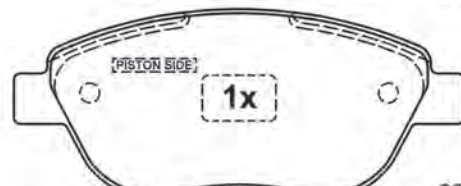

23710 19,4

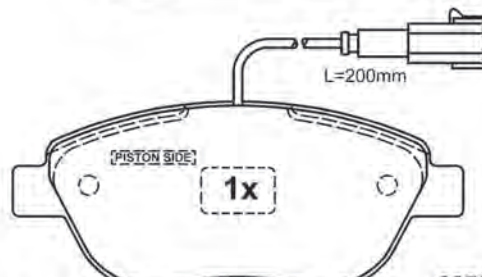

23709 19,4

136,8 x 57,4 x 19,4





# Abbildungen Scheibenbremsbeläge

Illustrations disc brake pads - Ilustraciones de pastillas - Illustrations Plaquettes de frein à disque - Illustrazioni Pastiglie Freno

13.0470-3984.2 LD3984

ATE Ceramic

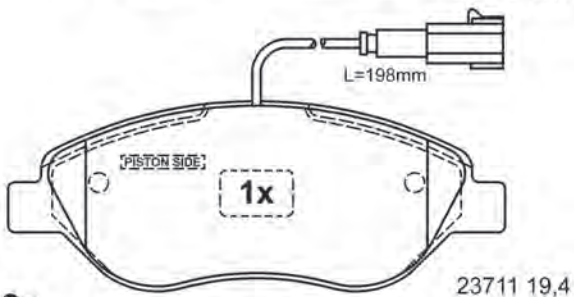
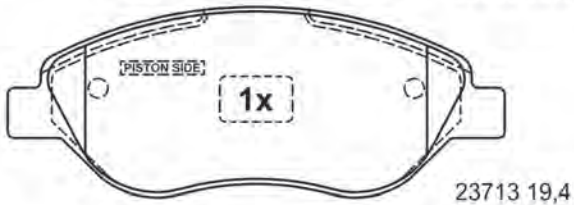
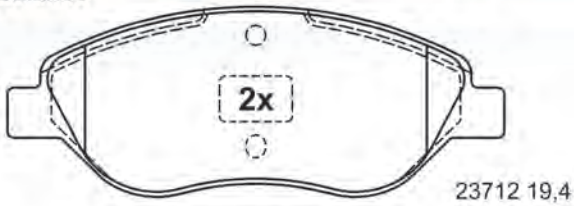

150,8 x 57,4 x 19,4

13.0470-3987.2 LD3987

ATE Ceramic

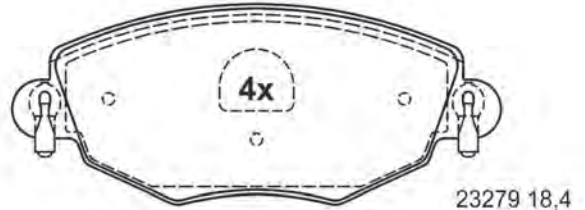

148,8 x 60,5 x 18,4



13.0470-3988.2 LD3988

ATE Ceramic

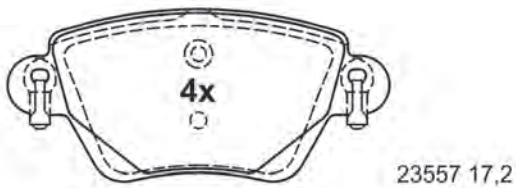

115,7 x 52,0 x 17,2



13.0470-3994.2 LD3994

ATE Ceramic

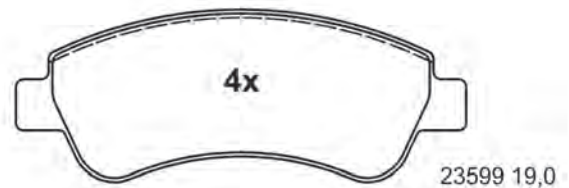

136,8 x 52,0 x 19,0

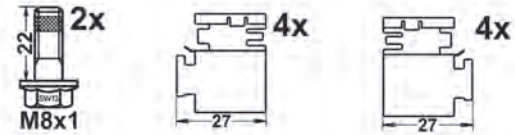

# Abbildungen Scheibenbremsbeläge

Illustrations disc brake pads - Ilustraciones de pastillas - Illustrations Plaquettes de frein à disque - Illustrazioni Pastiglie Freno

13.0470-3999.2 LD3999 [1]

B · H · D

ATE Ceramic

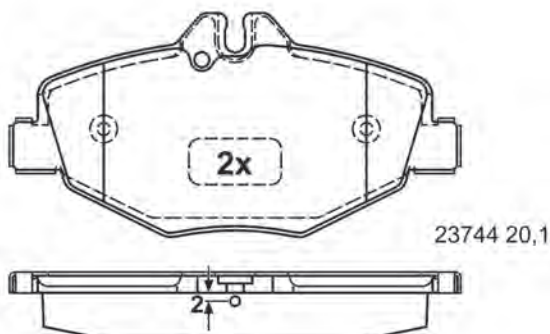
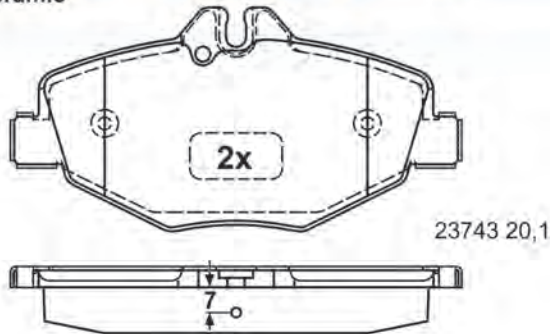

137,0 x 67,8 x 20,1

13.0470-3999.2 LD3999 [2]

B · H · D

ATE Ceramic

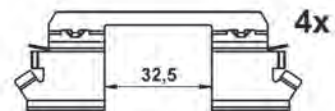
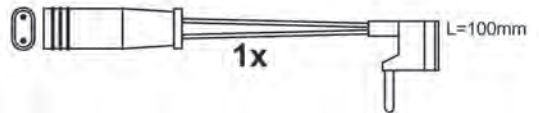
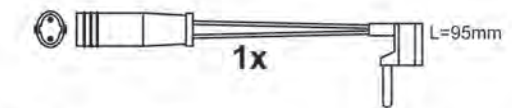
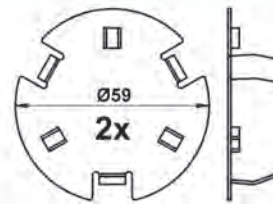

13.0470-4044.2 LD4044

B · H · D

ATE Ceramic

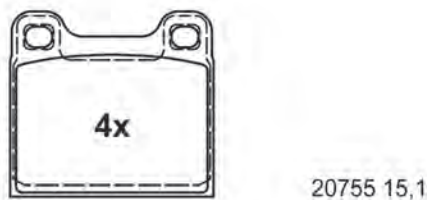

61,8 x 56,5 x 15,1

13.0470-4047.2 LD4047

B · H · D

ATE Ceramic

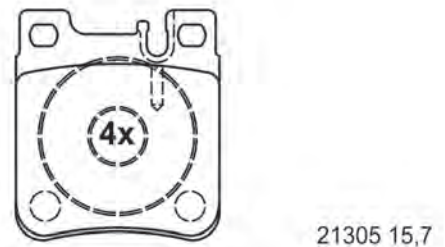

61,7 x 69,5 x 15,7



# Abbildungen Scheibenbremsbeläge

Illustrations disc brake pads - Ilustraciones de pastillas - Illustrations Plaquettes de frein à disque - Illustrazioni Pastiglie Freno

13.0470-4064.2 LD4064



ATE Ceramic

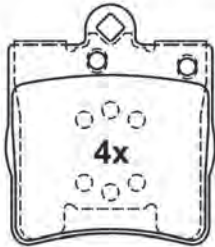

21919 15,3

63,8 x 72,8 x 15,3

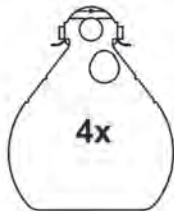

13.0470-4065.2 LD4065



ATE Ceramic

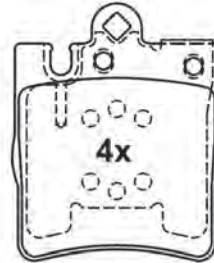

21899 15,3

63,7 x 78,0 x 15,3

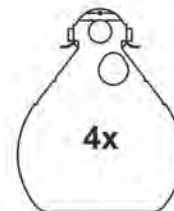

13.0470-4803.2 LD4803 [1]



ATE Ceramic

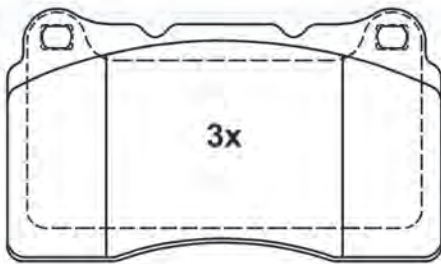

23092 15,6

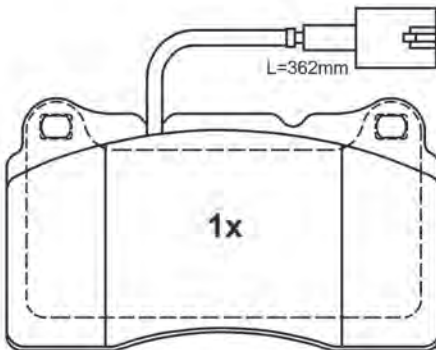

23111 15,6

131,8 x 77,2 x 15,6

13.0470-4803.2 LD4803 [2]



ATE Ceramic

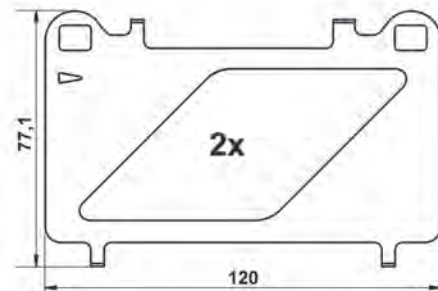
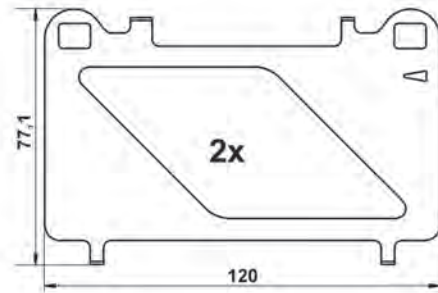

# Abbildungen Scheibenbremsbeläge

Illustrations disc brake pads - Ilustraciones de pastillas - Illustrations Plaquettes de frein à disque - Illustrazioni Pastiglie Freno

13.0470-4814.2 LD4814



ATE Ceramic

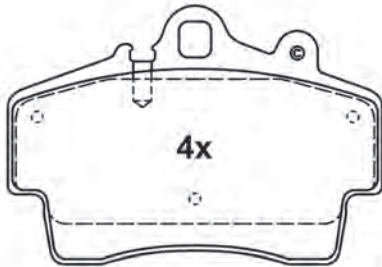

21937 15,5

114,0 x 78,0 x 15,5

13.0470-4833.2 LD4833



ATE Ceramic

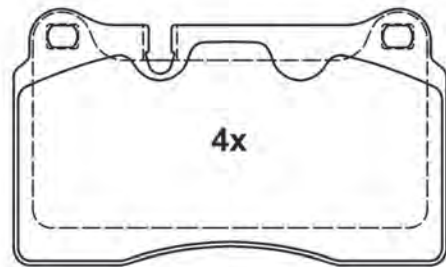

24098 17,1

131,6 x 77,3 x 17,1

13.0470-4834.2 LD4834



ATE Ceramic

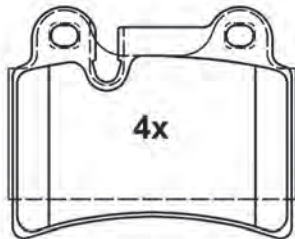

24097 17,1

86,8 x 70,1 x 17,1

13.0470-4850.2 LD4850



ATE Ceramic

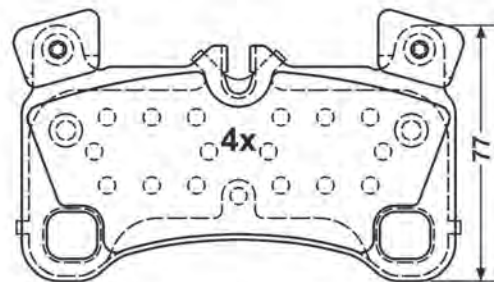

24296 16,3

132,1 x 77,0 x 16,3

# Abbildungen Scheibenbremsbeläge

Illustrations disc brake pads - Ilustraciones de pastillas - Illustrations Plaquettes de frein à disque - Illustrazioni Pastiglie Freno

13.0470-4851.2 LD4851

ATE Ceramic

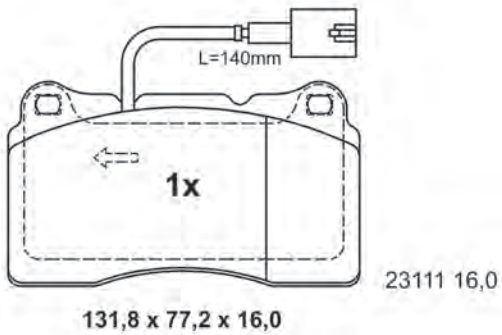
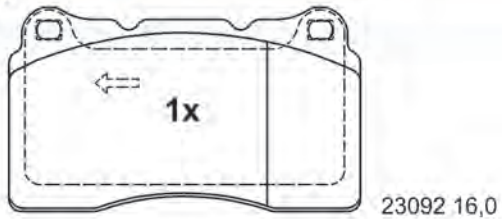

13.0470-4853.2 LD4853

ATE Ceramic

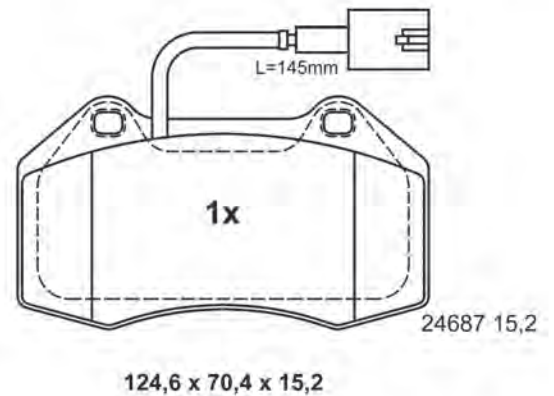
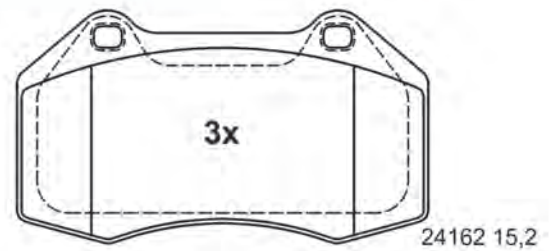

13.0470-4854.2 LD4854 [1]

ATE Ceramic

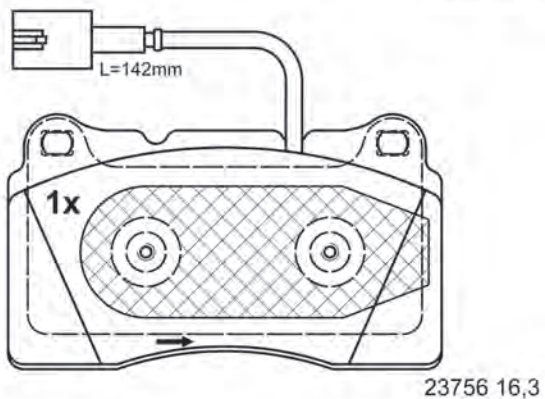
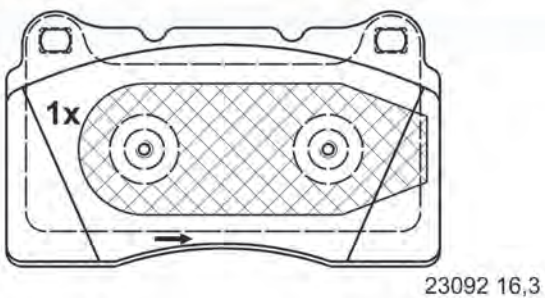

13.0470-4854.2 LD4854 [2]

ATE Ceramic

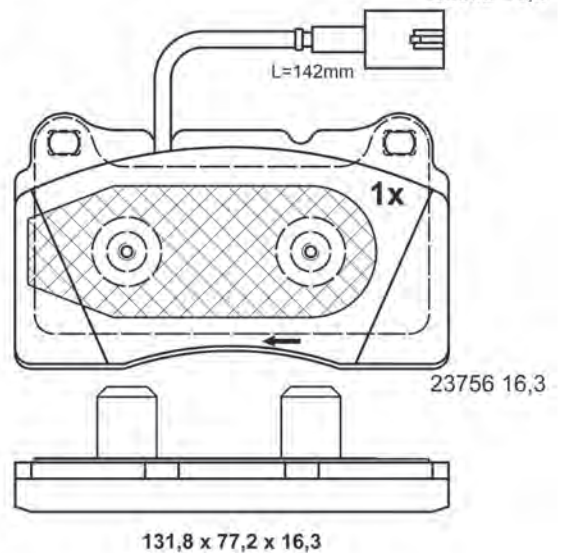
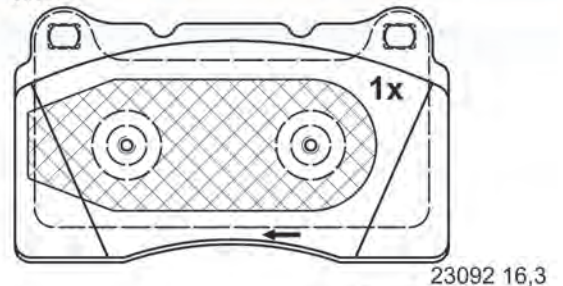



# Abbildungen Scheibenbremsbeläge

Illustrations disc brake pads - Ilustraciones de pastillas - Illustrations Plaquettes de frein à disque - Illustrazioni Pastiglie Freno

13.0470-4867.2 LD4867

ATE Ceramic

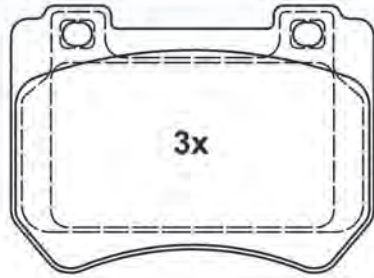

24852 16,0

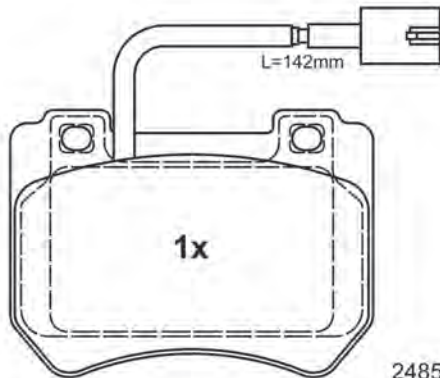

24853 16,0

109,8 x 80,8 x 16,0

13.0470-4872.2 LD4872

ATE Ceramic

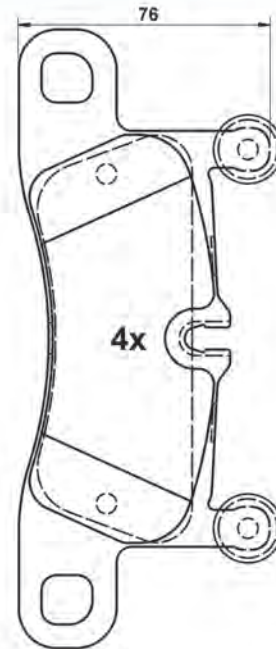

24721 16,9

187,5 x 76,0 x 16,9

13.0470-4875.2 LD4875

ATE Ceramic

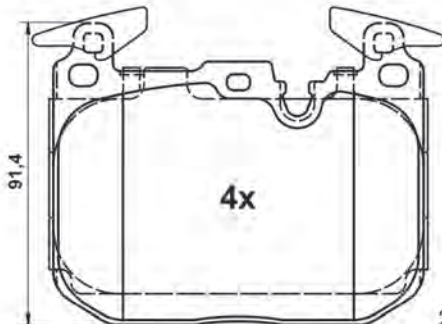

25028 18,0

114,5 x 91,4 x 18,0

13.0470-4879.2 LD4879

ATE Ceramic

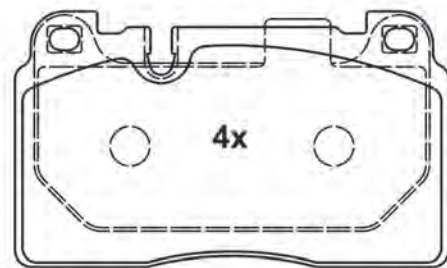

25643 17,0

131,8 x 77,2 x 17,0

# Abbildungen Scheibenbremsbeläge

Illustrations disc brake pads - Ilustraciones de pastillas - Illustrations Plaquettes de frein à disque - Illustrazioni Pastiglie Freno

13.0470-4880.2 LD4880



ATE Ceramic

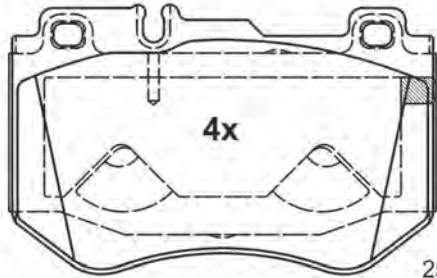

25997 18,7

129,3 x 81,6 x 18,7

13.0470-4882.2 LD4882



ATE Ceramic

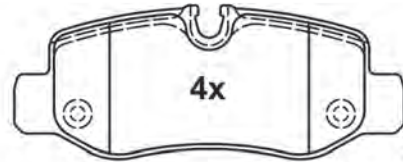

22102 18,2

118,5 x 46,4 x 18,2

13.0470-4883.2 LD4883



ATE Ceramic

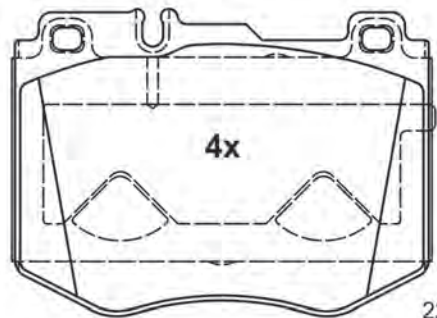

22061 18,7

127,5 x 92,1 x 18,7

13.0470-4884.2 LD4884



ATE Ceramic

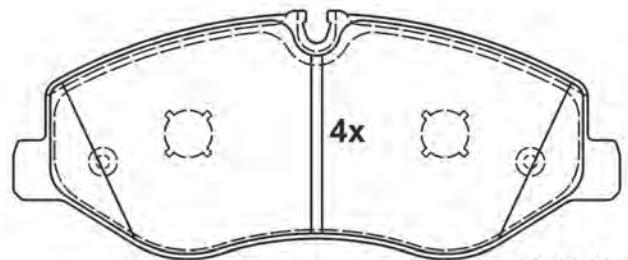

22062 20,7

184,1 x 75,0 x 20,7



# Abbildungen Scheibenbremsbeläge

Illustrations disc brake pads - Ilustraciones de pastillas - Illustrations Plaquettes de frein à disque - Illustrazioni Pastiglie Freno

13.0470-4971.2 LD4971 [1]

ATE Ceramic

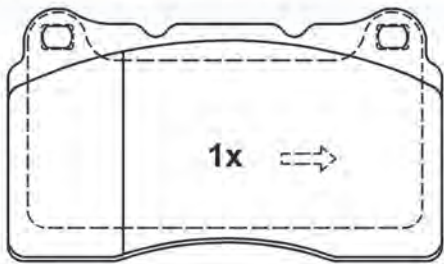

23092 16,0

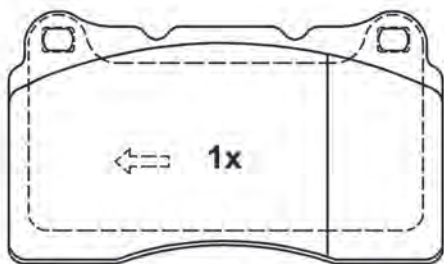

23092 16,0

131,8 x 77,2 x 16,0

13.0470-4971.2 LD4971 [2]

ATE Ceramic

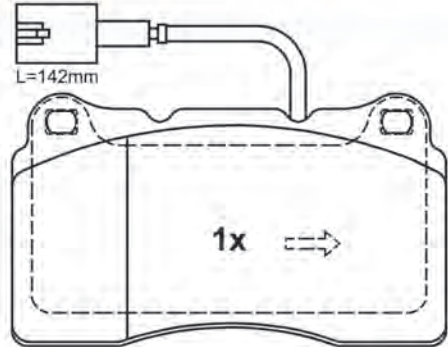

23110 16,0

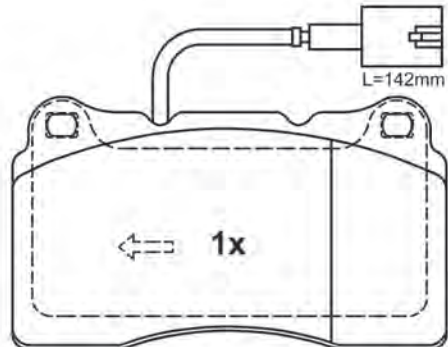

23111 16,0

131,8 x 77,2 x 16,0

13.0470-4976.2 LD4976

ATE Ceramic

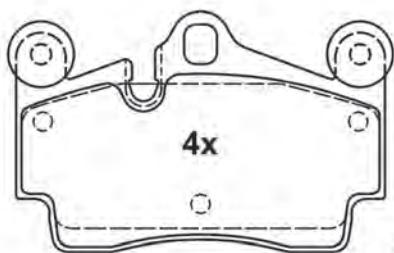

23694 16,4

112,0 x 73,0 x 16,4

13.0470-4977.2 LD4977

ATE Ceramic

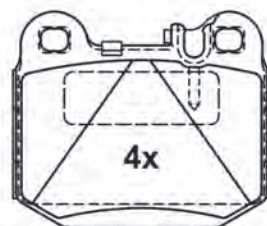

23157 15,8

76,5 x 65,5 x 15,8

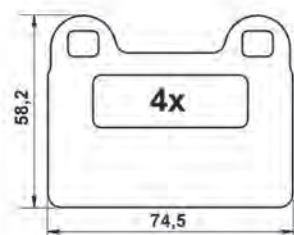

# Abbildungen Scheibenbremsbeläge

Illustrations disc brake pads - Ilustraciones de pastillas - Illustrations Plaquettes de frein à disque - Illustrazioni Pastiglie Freno

13.0470-4984.2 LD4984

ATE Ceramic

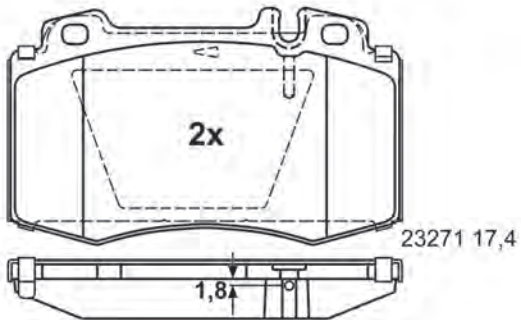
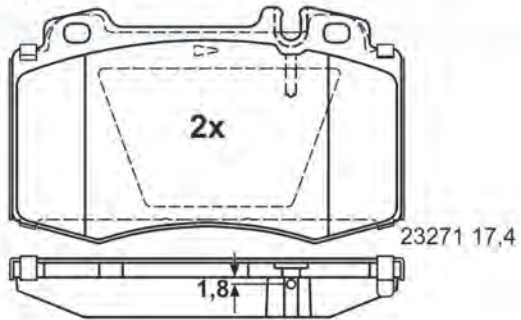

119,5 x 71,7 x 17,4

13.0470-4990.2 LD4990 [1]

ATE Ceramic

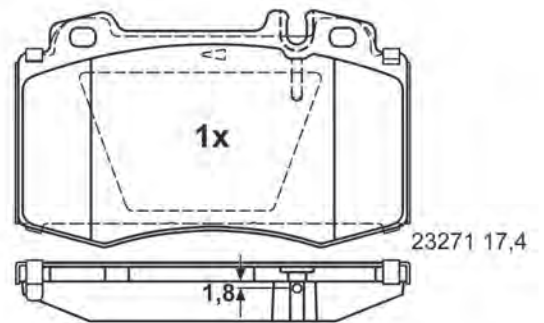
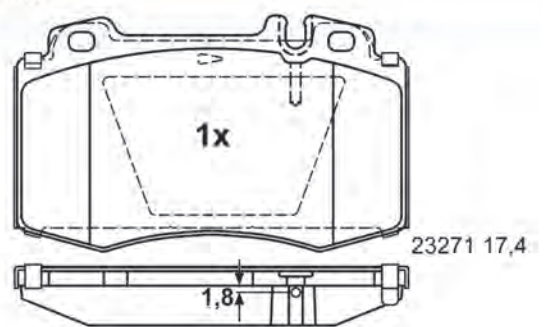

119,5 x 71,7 x 17,4

13.0470-4990.2 LD4990 [2]

ATE Ceramic

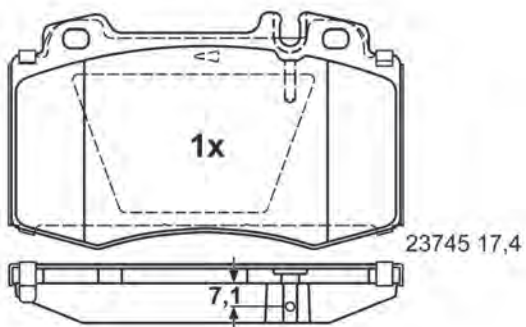
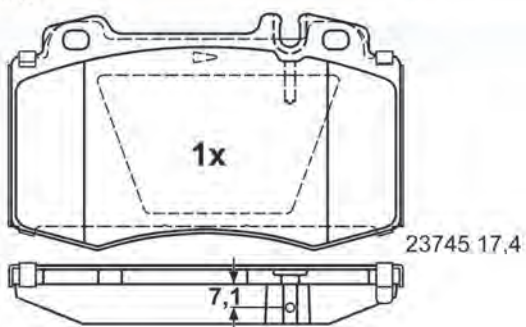

119,5 x 71,7 x 17,4

13.0470-4992.2 LD4992

ATE Ceramic

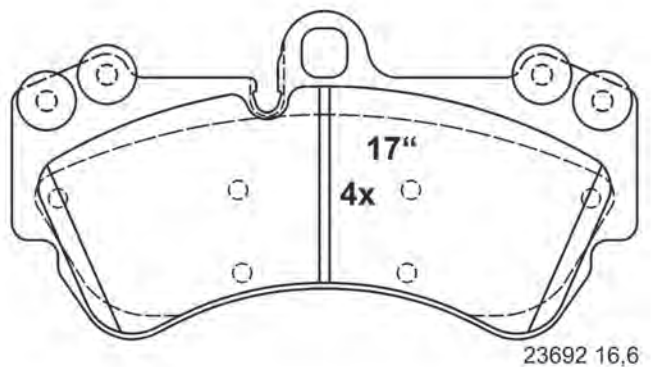

190 x 99,4 x 16,6

# Abbildungen Scheibenbremsbeläge

Illustrations disc brake pads - Ilustraciones de pastillas - Illustrations Plaquettes de frein à disque - Illustrazioni Pastiglie Freno

13.0470-4993.2 LD4993



ATE Ceramic

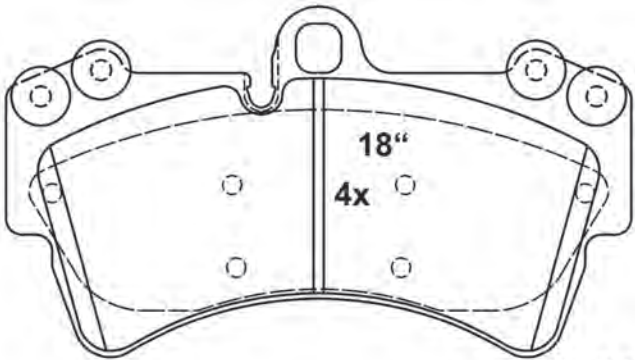

23693 16,6

190,0 x 106,4 x 16,6

13.0470-4994.2 LD4994



ATE Ceramic

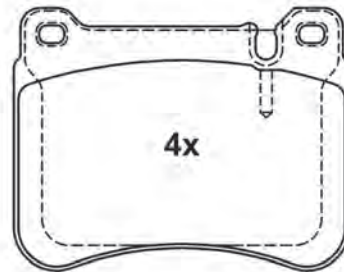

23945 16,5

101,7 x 79,3 x 16,5

13.0470-5405.2 LD5405



ATE Ceramic

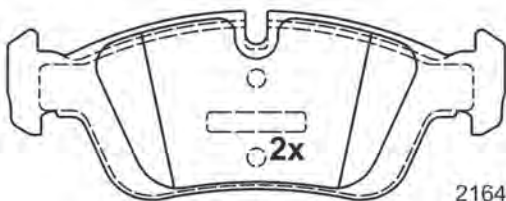

21643 17,8

151,3 x 57,3 x 17,8

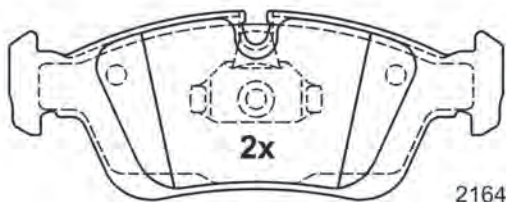

21644 17,8

150,1 x 57,3 x 17,8

13.0470-5611.2 LD5611 [1]



ATE Ceramic

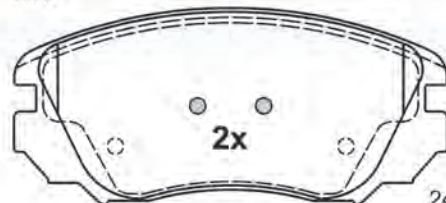

24415 19,1

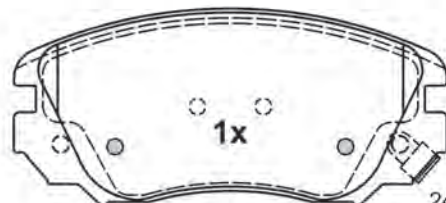

24416 19,1

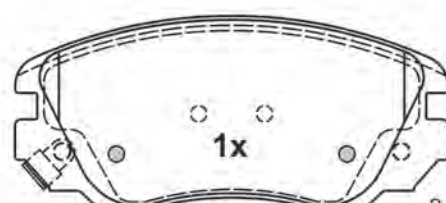

24417 19,1

131,4 x 59,7 x 19,1



# Abbildungen Scheibenbremsbeläge

Illustrations disc brake pads - Ilustraciones de pastillas - Illustrations Plaquettes de frein à disque - Illustrazioni Pastiglie Freno

13.0470-5611.2 LD5611 [2]



ATE Ceramic

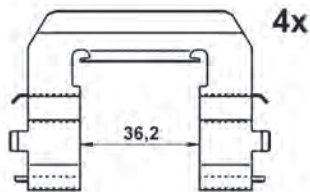
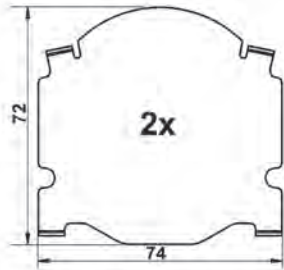

13.0470-5612.2 LD5612 [1]



ATE Ceramic

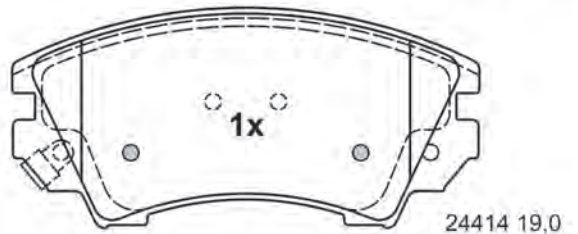
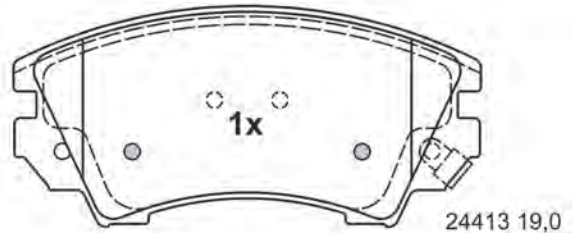
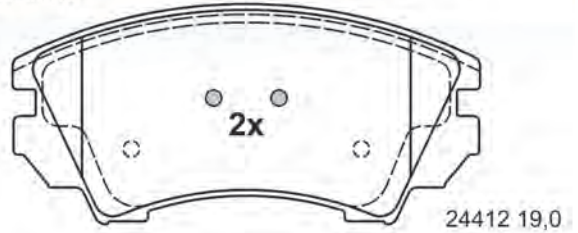

141,9 x 66,7 x 19,0

13.0470-5612.2 LD5612 [2]



ATE Ceramic

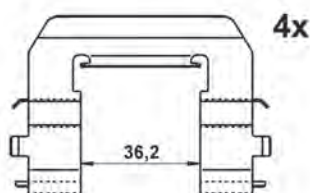
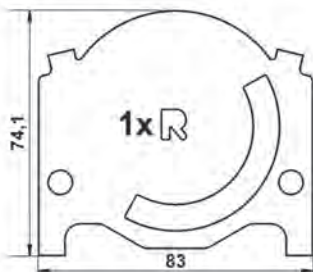
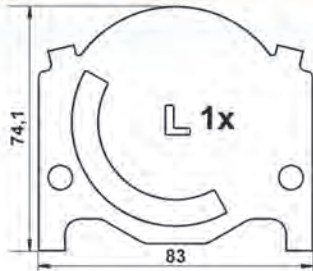

13.0470-5634.2 LD5634



ATE Ceramic

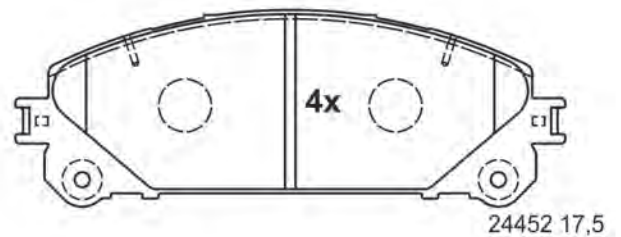

167,0 x 59,4 x 17,5

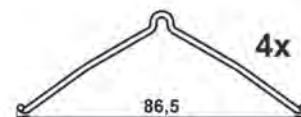

# Abbildungen Scheibenbremsbeläge

Illustrations disc brake pads - Ilustraciones de pastillas - Illustrations Plaquettes de frein à disque - Illustrazioni Pastiglie Freno

13.0470-5635.2 LD5635



ATE Ceramic

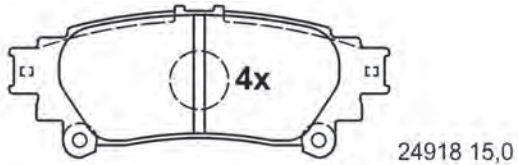

115,2 x 45,7 x 15,0

13.0470-5651.2 LD5651



ATE Ceramic

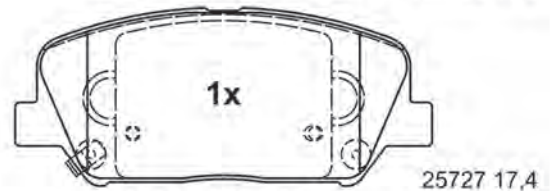
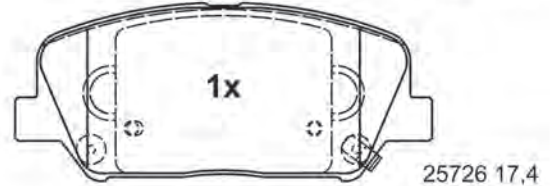
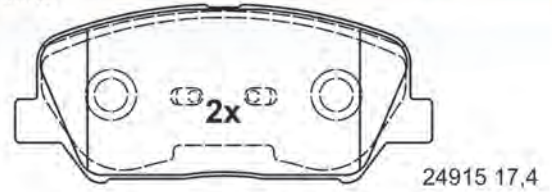

140,7 x 60,0 x 17,4

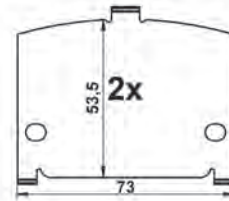

13.0470-5664.2 LD5664



ATE Ceramic

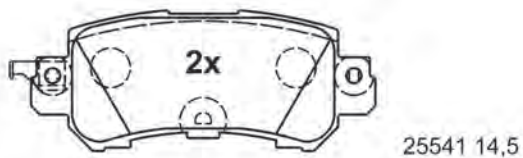
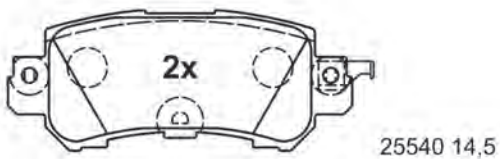

104,5 x 42,9 x 14,5

13.0470-5752.2 LD5752



ATE Ceramic

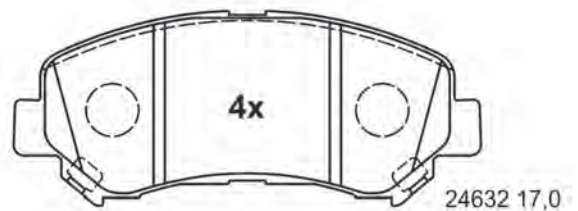

142,0 x 59,0 x 17,0



# Abbildungen Scheibenbremsbeläge

Illustrations disc brake pads - Ilustraciones de pastillas - Illustrations Plaquettes de frein à disque - Illustrazioni Pastiglie Freno

13.0470-5786.2 LD5786



ATE Ceramic



24934 15,5

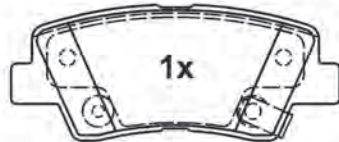

24935 15,5

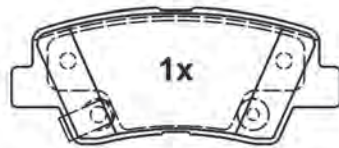

24936 15,5

99,8 x 41,1 x 16,6

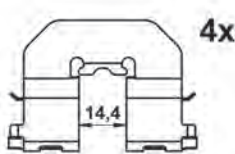

4x

14,4

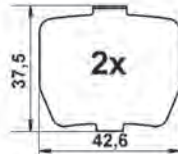

2x

37,5

42,6

13.0470-7053.2 LD7053



ATE Ceramic

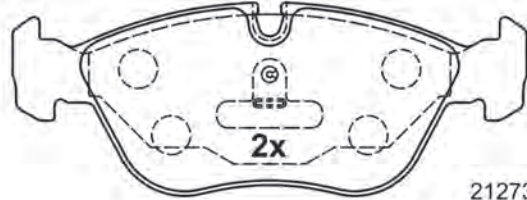

21273 19,5

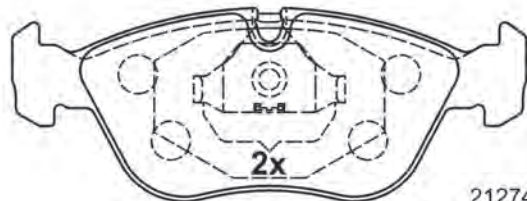

21274 19,5

156,3 x 58,5 x 19,5

13.0470-7078.2 LD7078



ATE Ceramic

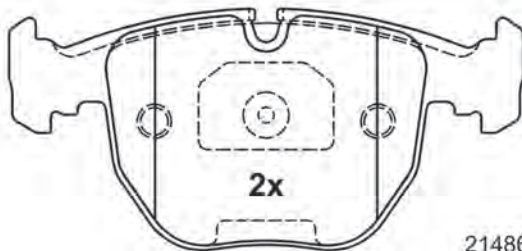

21486 19,5

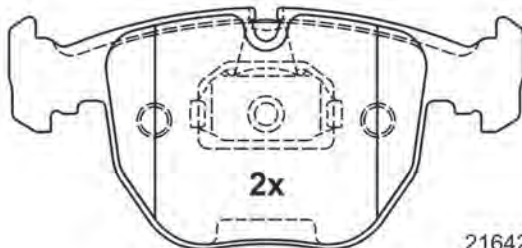

21642 19,5

156,3 x 73,2 x 19,5

13.0470-7079.2 LD7079



ATE Ceramic

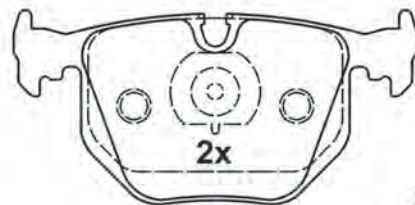

21282 17,3

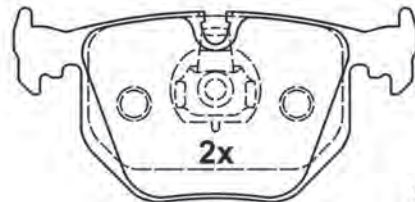

21487 17,3

123,0 x 59,2 x 17,3

# Abbildungen Scheibenbremsbeläge

Illustrations disc brake pads - Ilustraciones de pastillas - Illustrations Plaquettes de frein à disque - Illustrazioni Pastiglie Freno

13.0470-7081.2 LD7081

ATE Ceramic

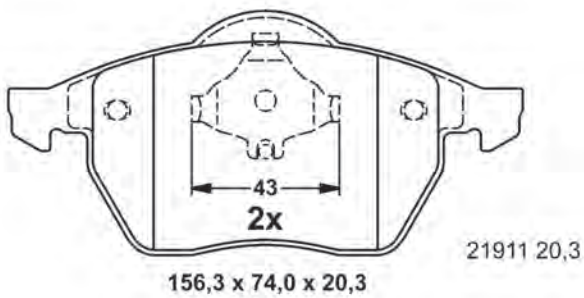
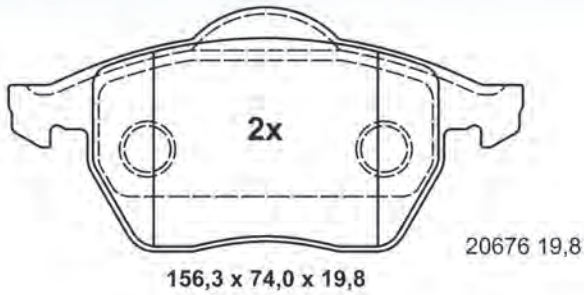

13.0470-7086.2 LD7086

ATE Ceramic

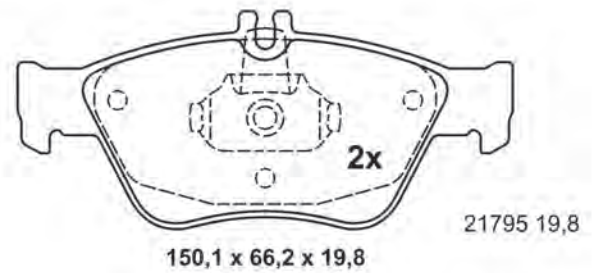
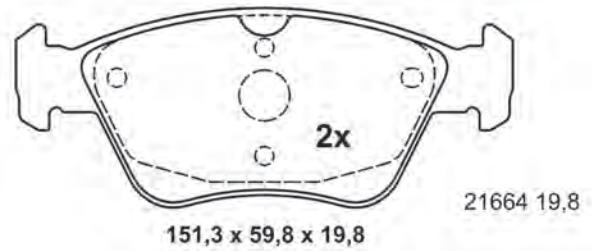

13.0470-7087.2 LD7087

ATE Ceramic

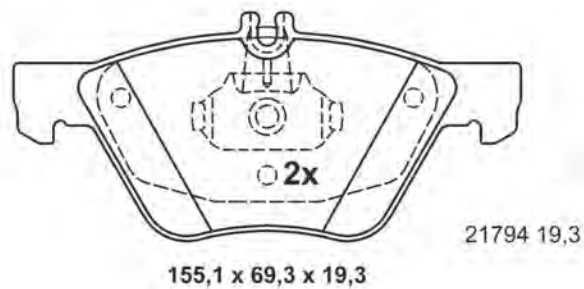
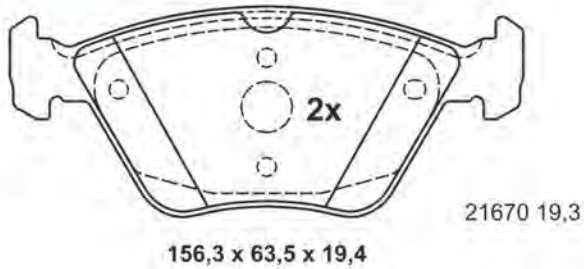

13.0470-7089.2 LD7089

ATE Ceramic

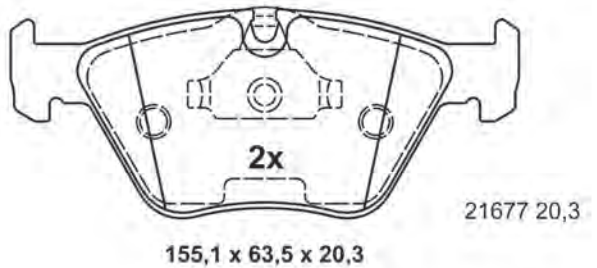
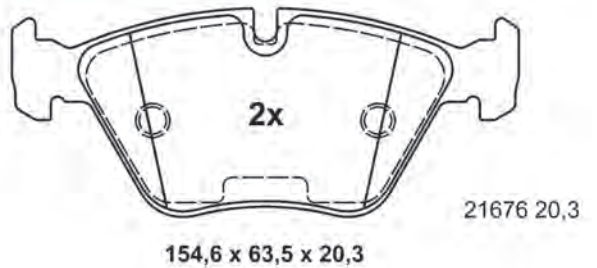

# Abbildungen Scheibenbremsbeläge

Illustrations disc brake pads - Ilustraciones de pastillas - Illustrations Plaquettes de frein à disque - Illustrazioni Pastiglie Freno

13.0470-7090.2 LD7090



ATE Ceramic



21891 17,3



21691 17,3

123,0 x 44,9 x 17,3

13.0470-7100.2 LD7100



ATE Ceramic

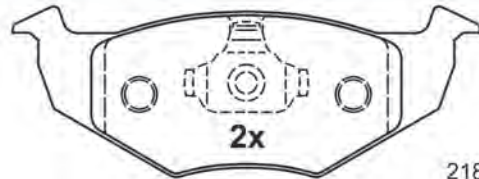

21866 17,2

141,8 x 51,2 x 17,2

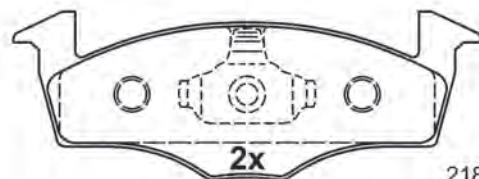

21868 17,2

141,8 x 50,6 x 17,2

13.0470-7110.2 LD7110



ATE Ceramic

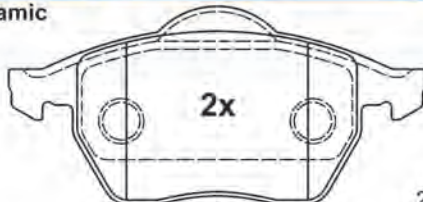

20676 19,8

156,3 x 74,0 x 19,8

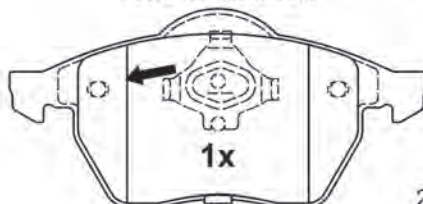

23018 20,3

L=200mm

156,3 x 74,0 x 20,3

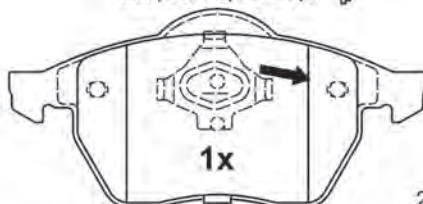

23019 20,3

L=200mm

156,3 x 74,0 x 20,3

13.0470-7111.2 LD7111



ATE Ceramic

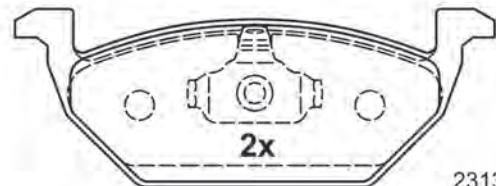

23130 19,6

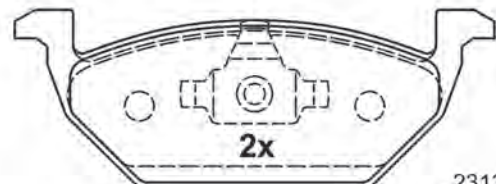

23131 19,6

146,0 x 54,7 x 19,6



# Abbildungen Scheibenbremsbeläge

Illustrations disc brake pads - Ilustraciones de pastillas - Illustrations Plaquettes de frein à disque - Illustrazioni Pastiglie Freno

13.0470-7115.2 LD7115 (1)



ATE Ceramic

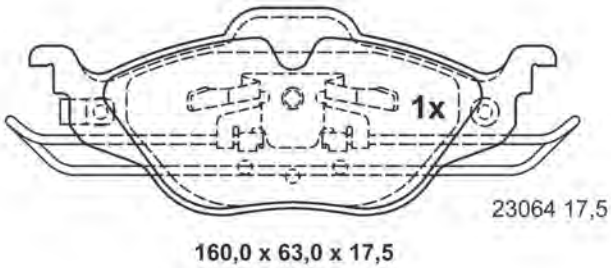
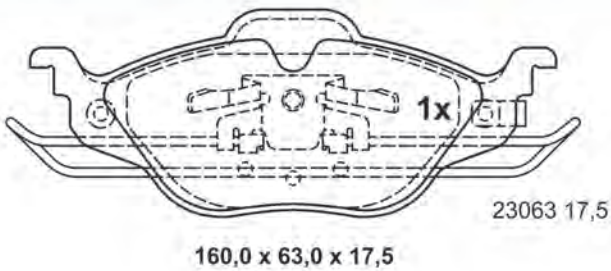

13.0470-7115.2 LD7115 (2)



ATE Ceramic

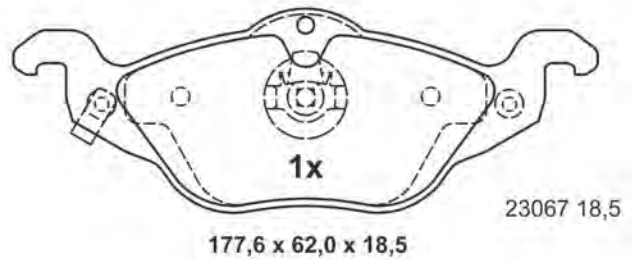
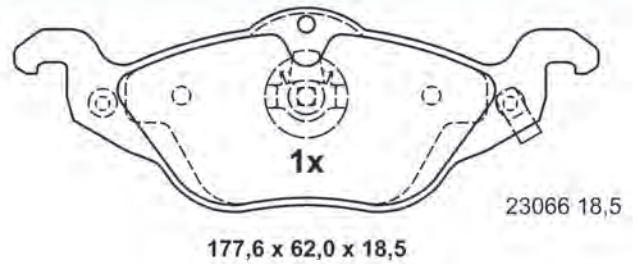

13.0470-7116.2 LD7116 (1)



ATE Ceramic

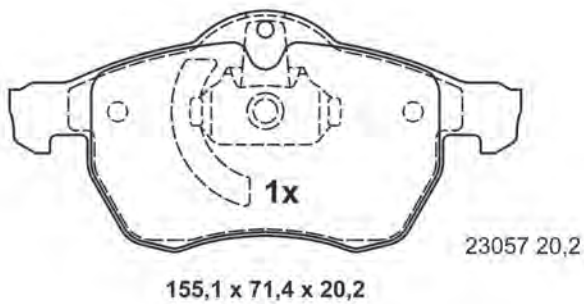
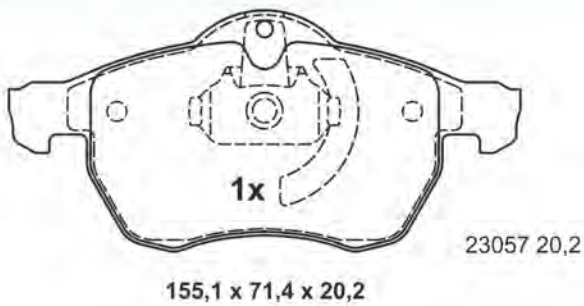

13.0470-7116.2 LD7116 (2)



ATE Ceramic

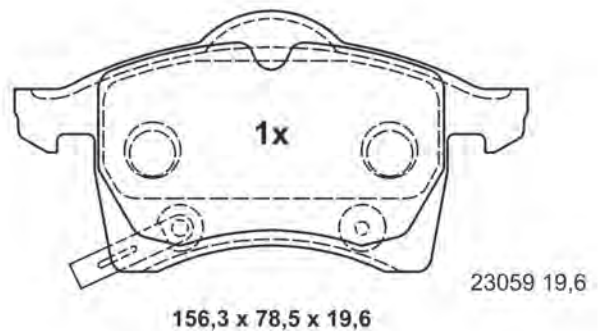
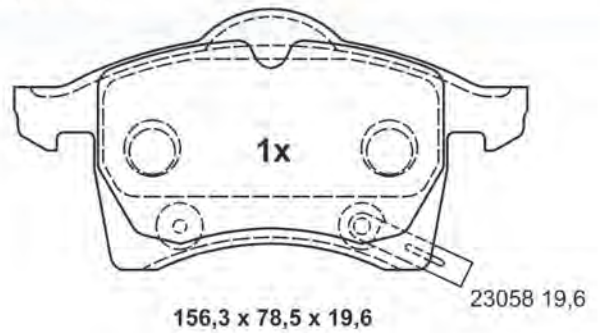

# Abbildungen Scheibenbremsbeläge

Illustrations disc brake pads - Ilustraciones de pastillas - Illustrations Plaquettes de frein à disque - Illustrazioni Pastiglie Freno

13.0470-7117.2 LD7117

B.H.P.

ATE Ceramic

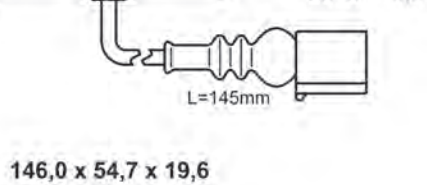
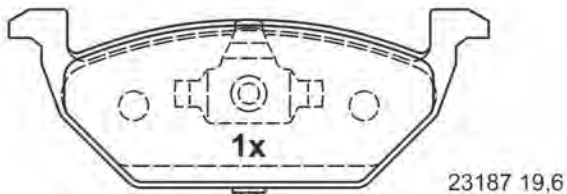
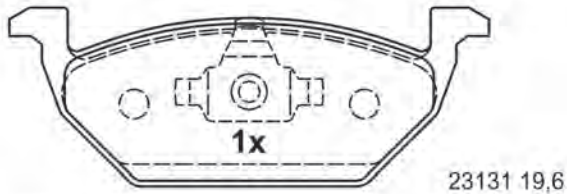
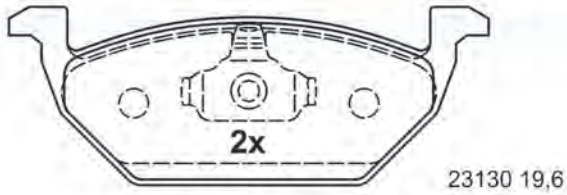

13.0470-7122.2 LD7122

B.H.P.

ATE Ceramic

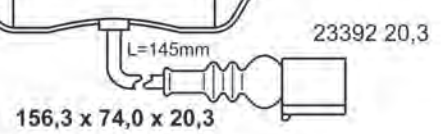
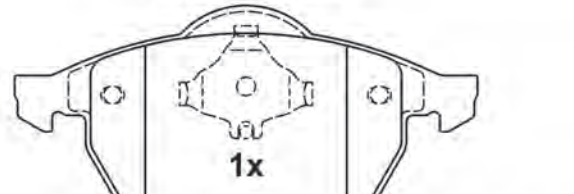
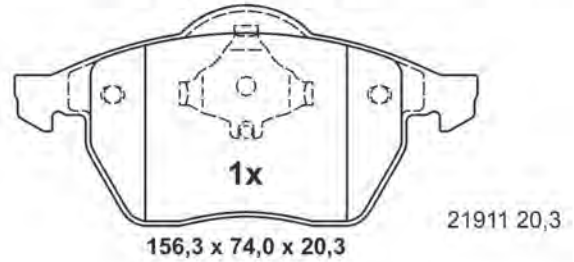
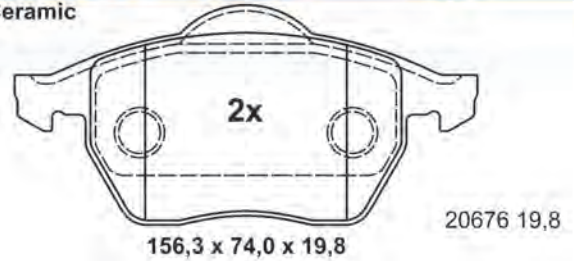

13.0470-7135.2 LD7135

B.H.P.

ATE Ceramic

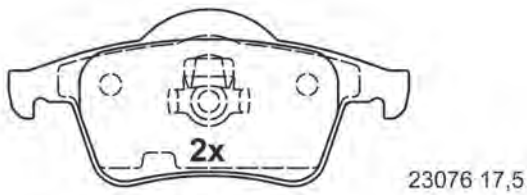

13.0470-7137.2 LD7137

B.H.P.

ATE Ceramic

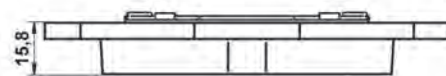
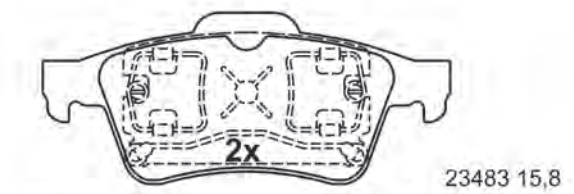

123,0 x 51,9 x 15,8



# Abbildungen Scheibenbremsbeläge

Illustrations disc brake pads - Ilustraciones de pastillas - Illustrations Plaquettes de frein à disque - Illustrazioni Pastiglie Freno

13.0470-7139.2 LD7139

ATE Ceramic

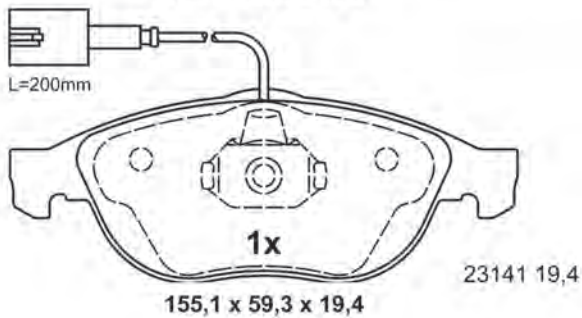
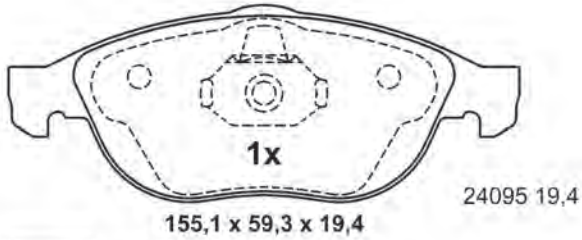
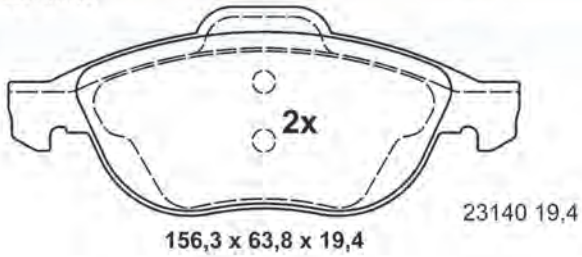

13.0470-7140.2 LD7140

ATE Ceramic

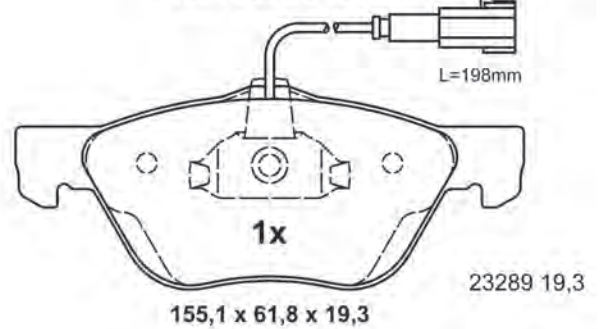
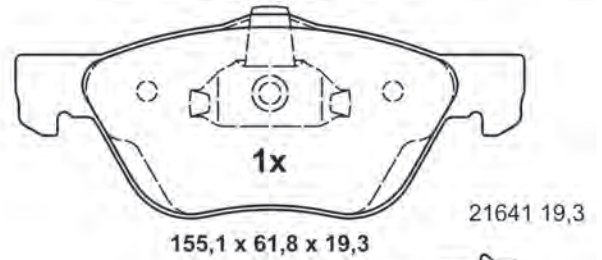
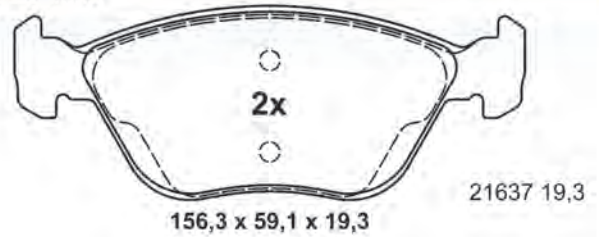

13.0470-7145.2 LD7145

ATE Ceramic

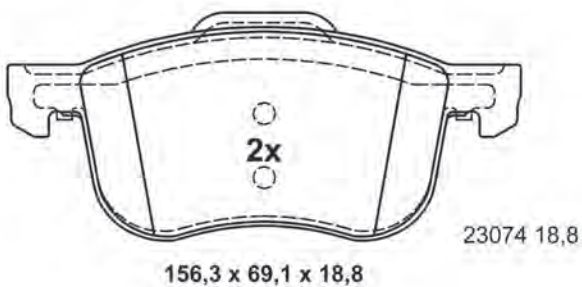
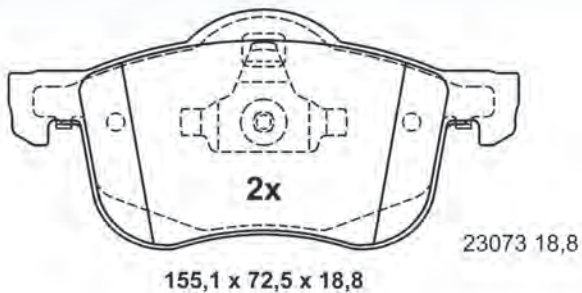

13.0470-7155.2 LD7155

ATE Ceramic

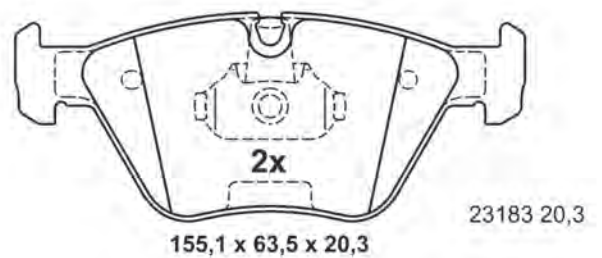
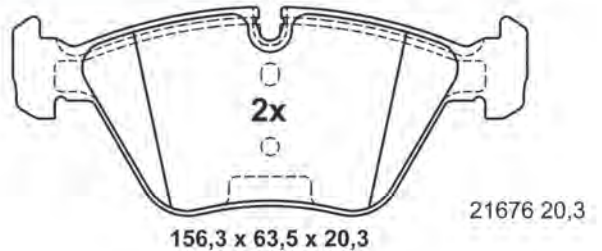

# Abbildungen Scheibenbremsbeläge

Illustrations disc brake pads - Ilustraciones de pastillas - Illustrations Plaquettes de frein à disque - Illustrazioni Pastiglie Freno

13.0470-7157.2 LD7157



ATE Ceramic

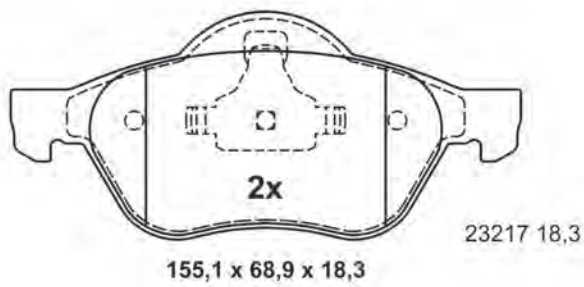
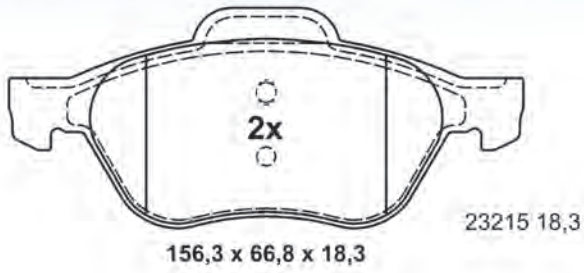

13.0470-7158.2 LD7158



ATE Ceramic

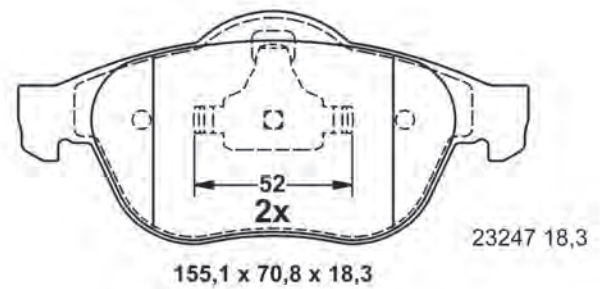
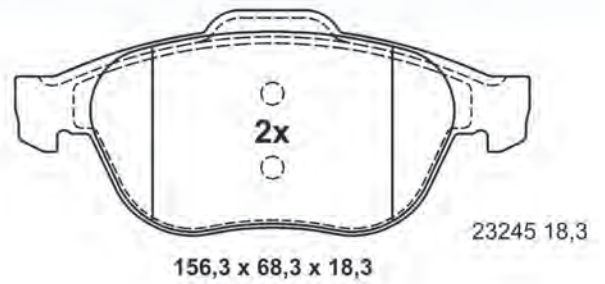

13.0470-7159.2 LD7159



ATE Ceramic

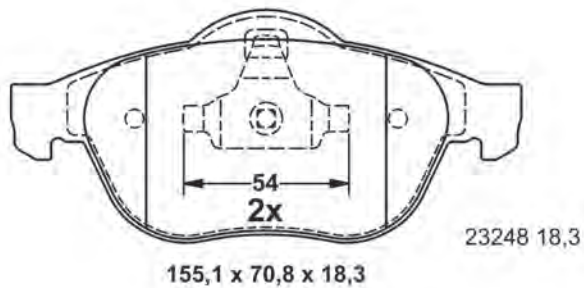
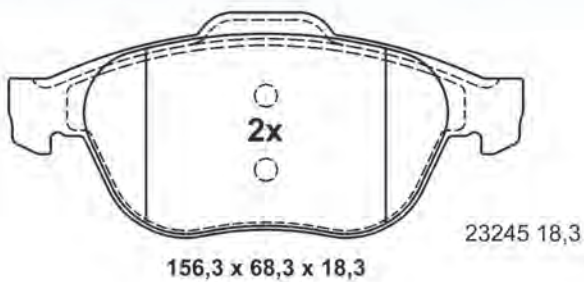

13.0470-7161.2 LD7161



ATE Ceramic

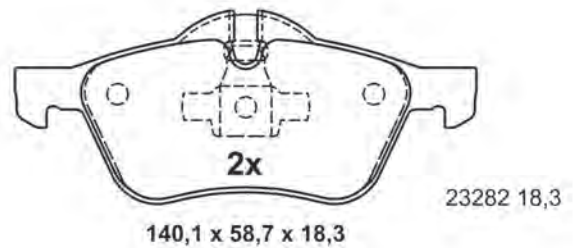
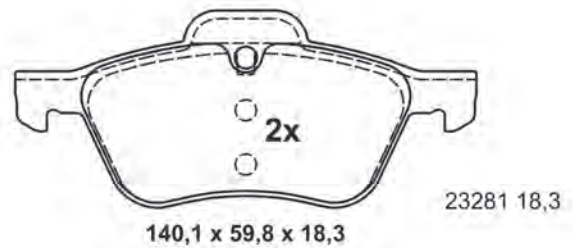



# Abbildungen Scheibenbremsbeläge

Illustrations disc brake pads - Ilustraciones de pastillas - Illustrations Plaquettes de frein à disque - Illustrazioni Pastiglie Freno

13.0470-7162.2 LD7162

ATE Ceramic

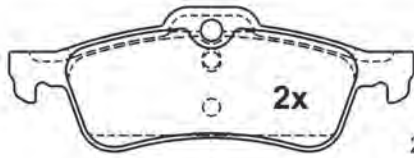

23716 15,8

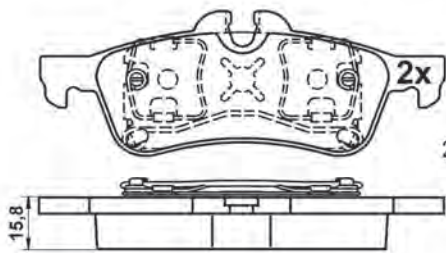

23717 15,8

123,0 x 43,8 x 15,8

13.0470-7166.2 LD7166

ATE Ceramic

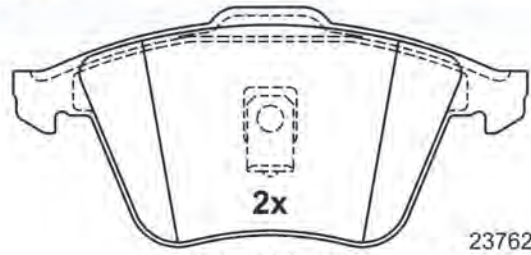

23762 20,4

156,3 x 72,9 x 20,4

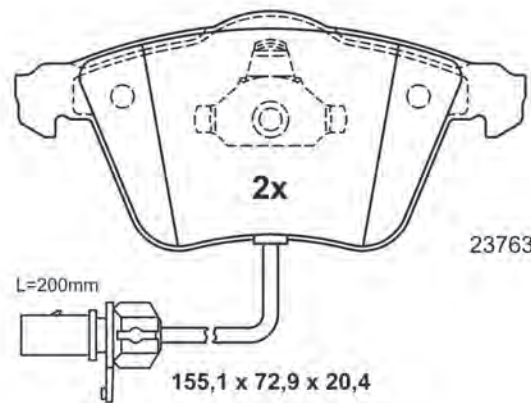

23763 20,4

155,1 x 72,9 x 20,4

13.0470-7167.2 LD7167

ATE Ceramic

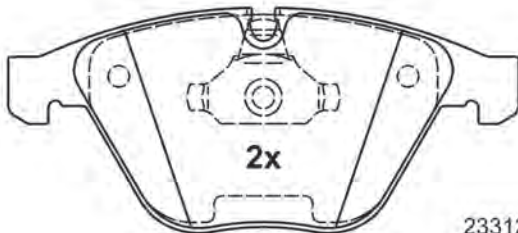

23312 20,3

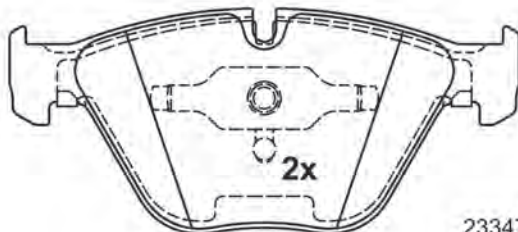

23347 20,3

155,1 x 68,3 x 20,3

13.0470-7168.2 LD7168

ATE Ceramic

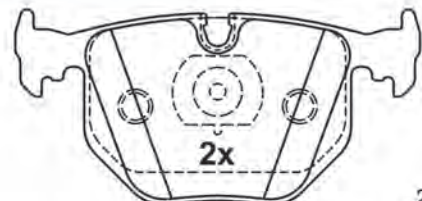

21282 17,3

123,0 x 59,2 x 17,3

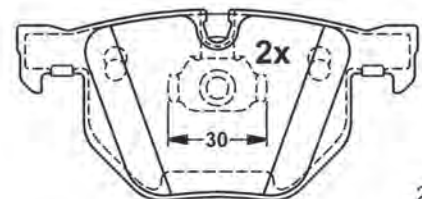

23447 17,3

121,8 x 57,8 x 17,3

# Abbildungen Scheibenbremsbeläge

Illustrations disc brake pads - Ilustraciones de pastillas - Illustrations Plaquettes de frein à disque - Illustrazioni Pastiglie Freno

13.0470-7169.2 LD7169



ATE Ceramic

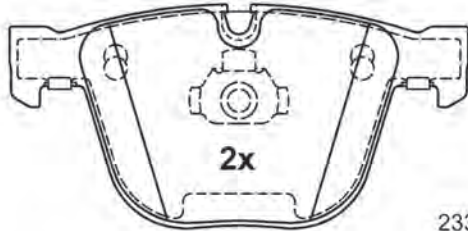

23309 17,3



23310 17,3

139,5 x 67,8 x 17,3

13.0470-7171.2 LD7171



ATE Ceramic

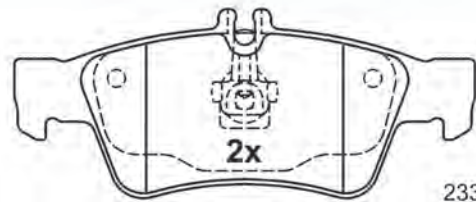

23334 16,7

140,1 x 57,5 x 16,7

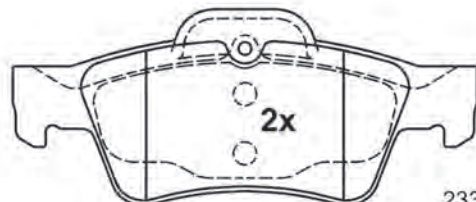

23335 16,7

141,3 x 59,4 x 16,7

13.0470-7172.2 LD7172



ATE Ceramic

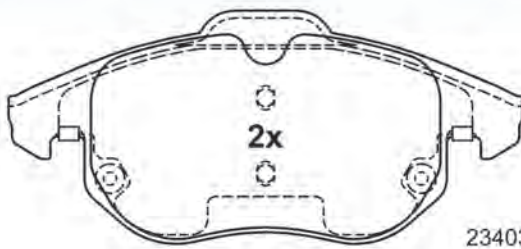

23403 20,1

156,3 x 70,7 x 20,1

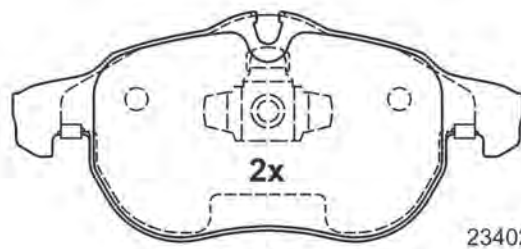

23402 20,1

155,1 x 69,6 x 20,1

13.0470-7174.2 LD7174



ATE Ceramic

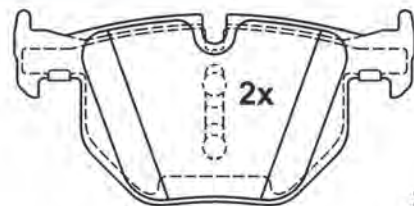

23732 17,3

121,8 x 59,2 x 17,3

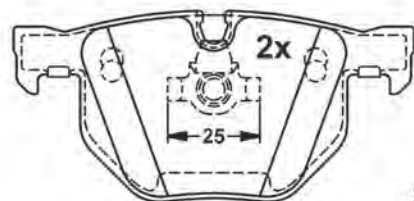

23737 17,3

121,8 x 57,8 x 17,3



# Abbildungen Scheibenbremsbeläge

Illustrations disc brake pads - Ilustraciones de pastillas - Illustrations Plaquettes de frein à disque - Illustrazioni Pastiglie Freno

13.0470-7176.2 LD7176



ATE Ceramic

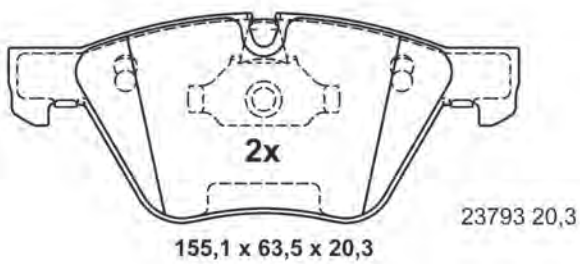
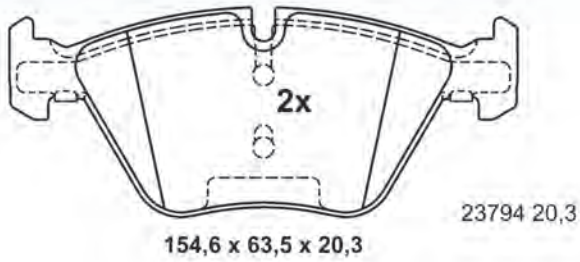

13.0470-7179.2 LD7179 [1]



ATE Ceramic

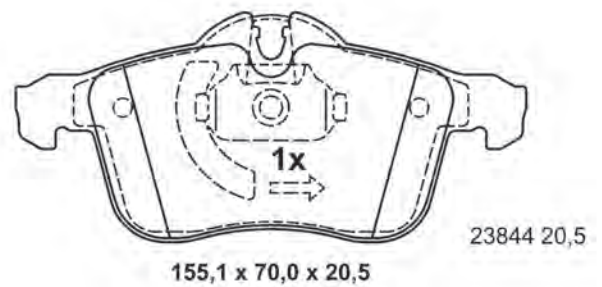
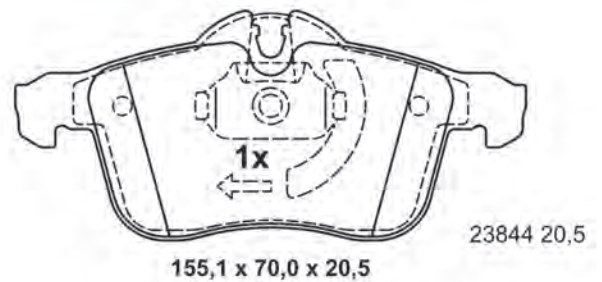

13.0470-7179.2 LD7179 [2]



ATE Ceramic

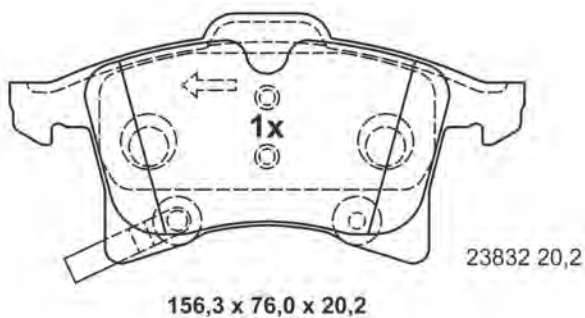
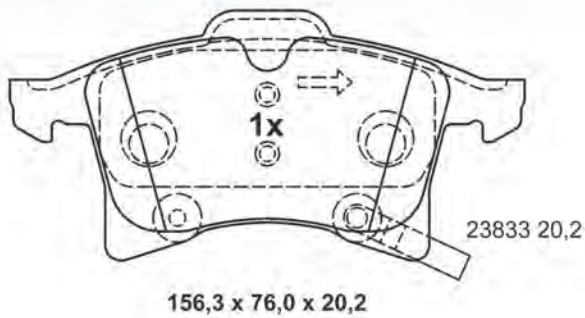

13.0470-7181.2 LD7181



ATE Ceramic

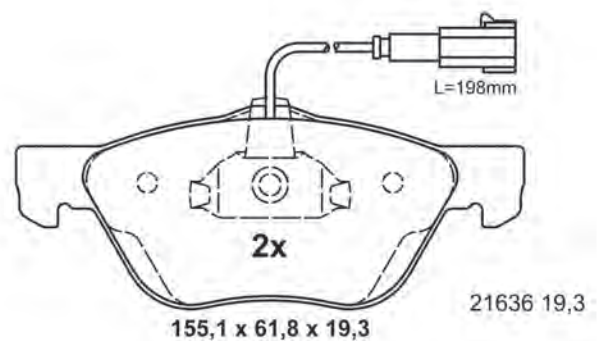
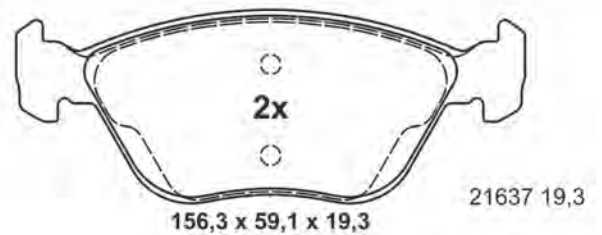



# Abbildungen Scheibenbremsbeläge

Illustrations disc brake pads - Ilustraciones de pastillas - Illustrations Plaquettes de frein à disque - Illustrazioni Pastiglie Freno

13.0470-7187.2 LD7187

ATE Ceramic

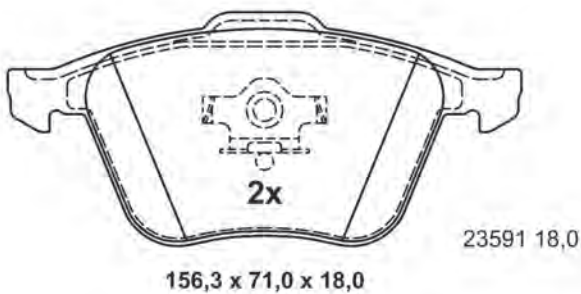
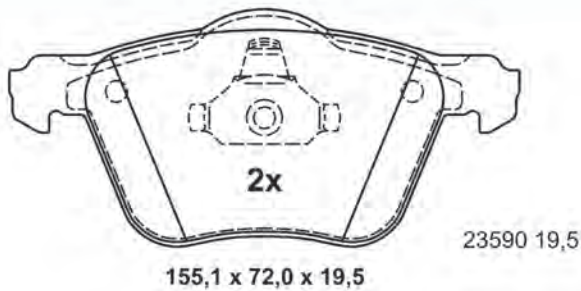

13.0470-7188.2 LD7188

ATE Ceramic

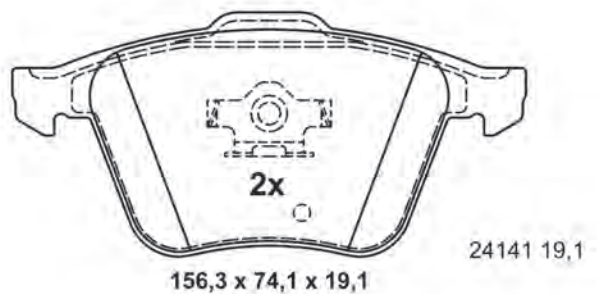
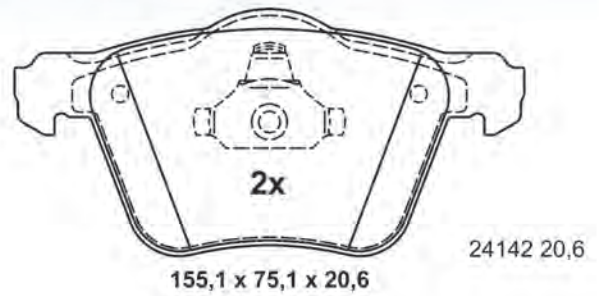

13.0470-7190.2 LD7190

ATE Ceramic

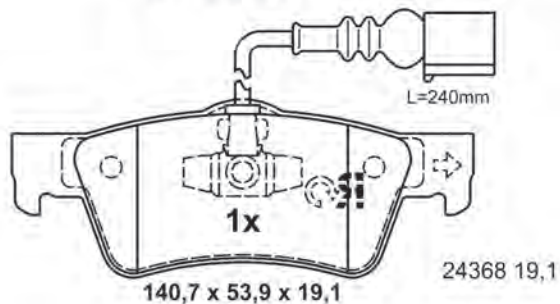
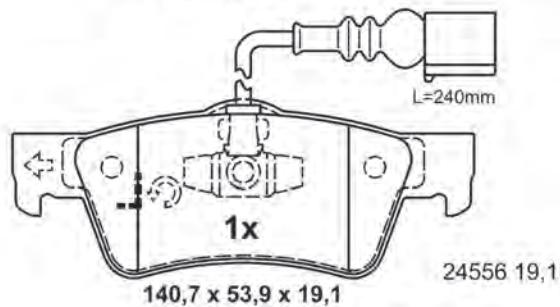
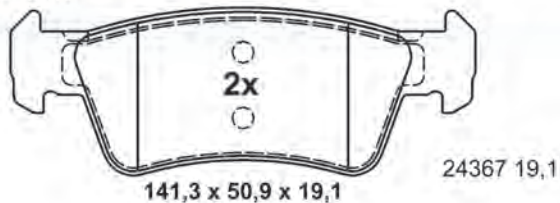

13.0470-7191.2 LD7191

ATE Ceramic

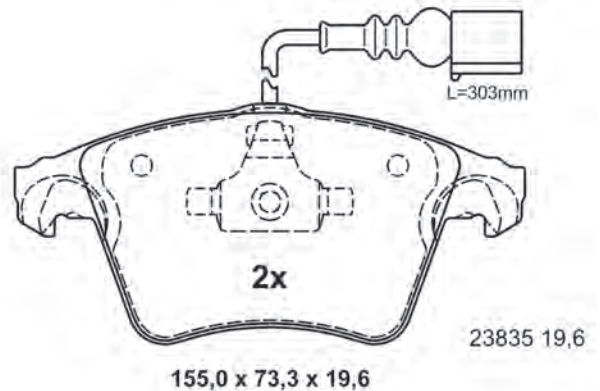
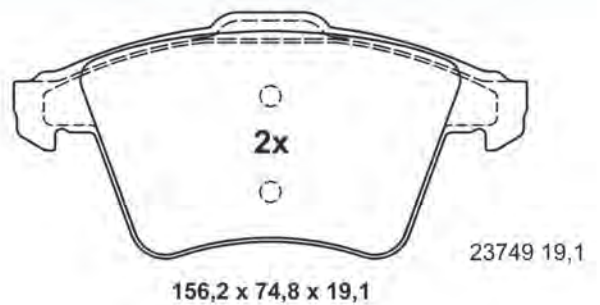

# Abbildungen Scheibenbremsbeläge

Illustrations disc brake pads - Ilustraciones de pastillas - Illustrations Plaquettes de frein à disque - Illustrazioni Pastiglie Freno

13.0470-7193.2 LD7193

ATE Ceramic

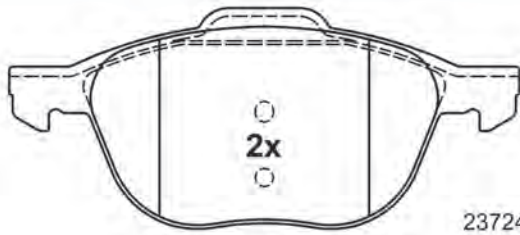

156,3 x 67,0 x 18,1

23724 18,1

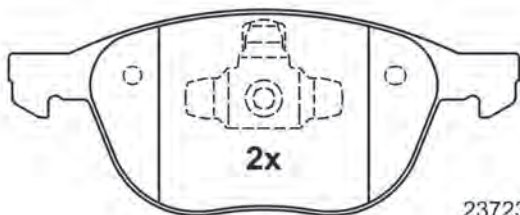

155,1 x 62,4 x 18,1

23723 18,1

13.0470-7194.2 LD7194

ATE Ceramic



23482 16,6

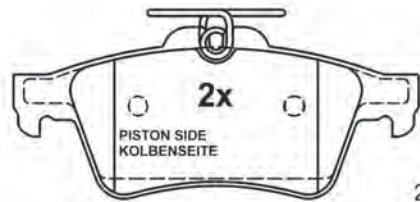

24137 16,6

123,0 x 52,0 x 16,6

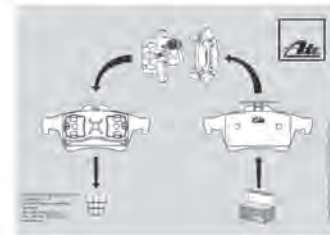

13.0470-7195.2 LD7195

ATE Ceramic

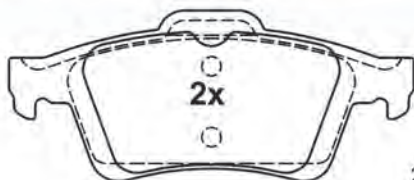

23482 16,6

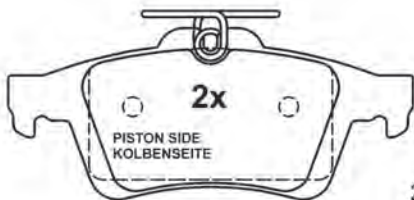

24137 16,6

123,0 x 52,0 x 16,6

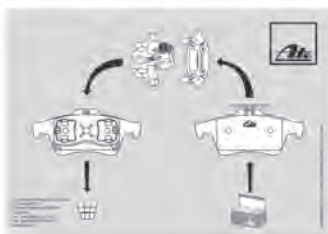

13.0470-7200.2 LD7200

ATE Ceramic

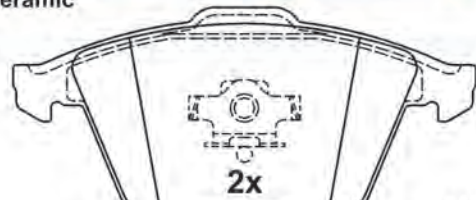

23801 20,3

156,3 x 72,9 x 20,3

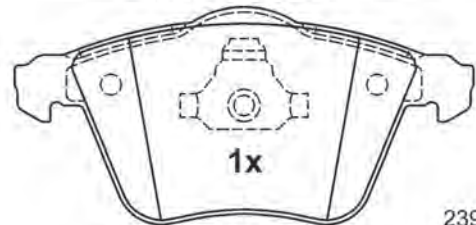

23912 20,3

155,1 x 72,9 x 20,3

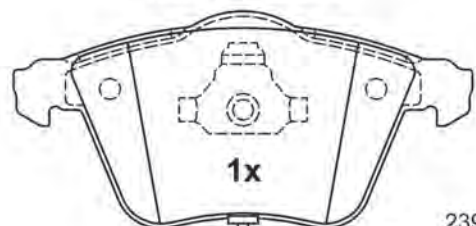

23913 20,3

L=177,5mm

155,1 x 72,9 x 20,3



# Abbildungen Scheibenbremsbeläge

Illustrations disc brake pads - Ilustraciones de pastillas - Illustrations Plaquettes de frein à disque - Illustrazioni Pastiglie Freno

13.0470-7201.2 LD7201

ATE Ceramic

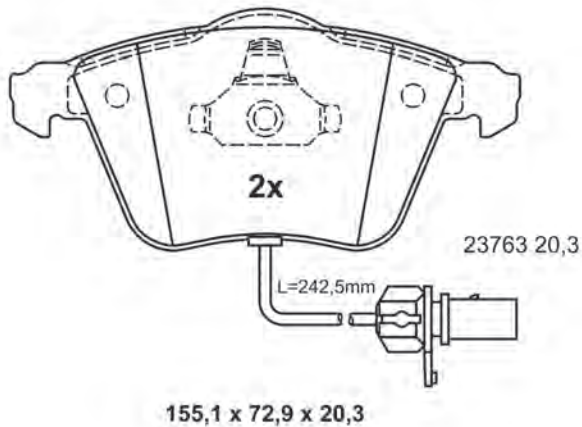
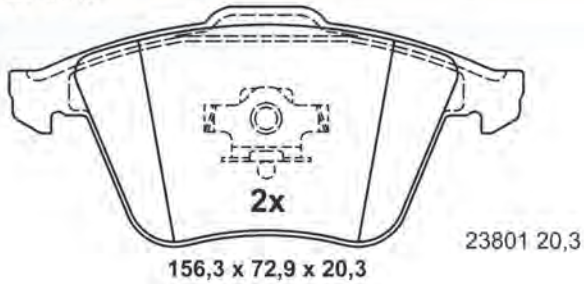

13.0470-7202.2 LD7202

ATE Ceramic

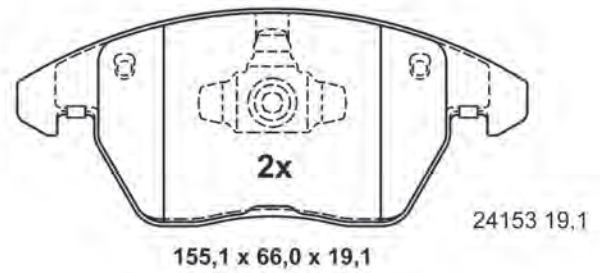
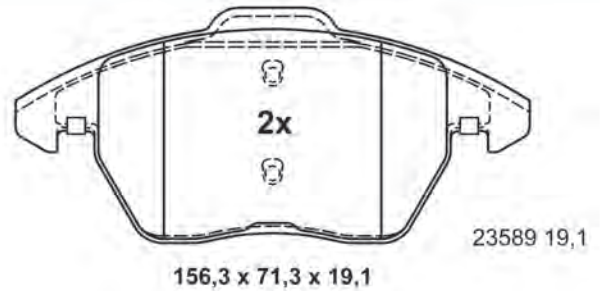

13.0470-7203.2 LD7203

ATE Ceramic

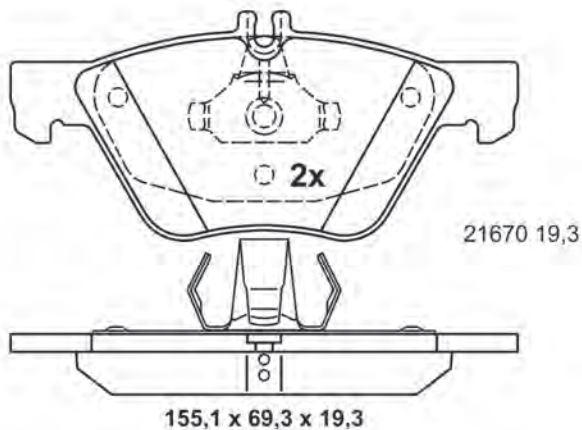
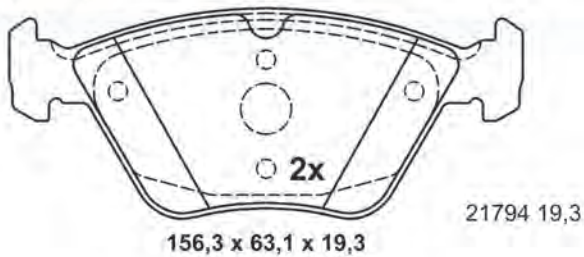

13.0470-7204.2 LD7204

ATE Ceramic

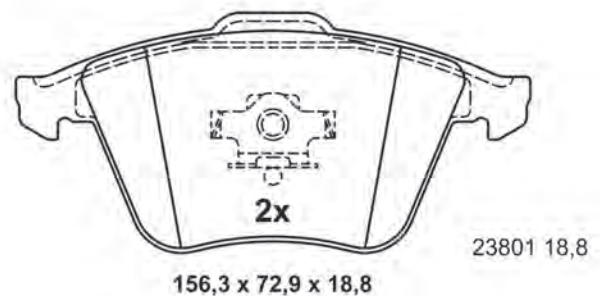
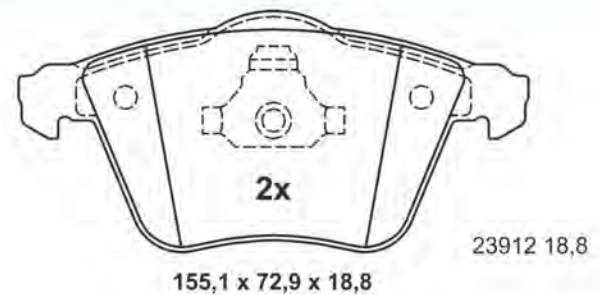

# Abbildungen Scheibenbremsbeläge

Illustrations disc brake pads - Ilustraciones de pastillas - Illustrations Plaquettes de frein à disque - Illustrazioni Pastiglie Freno

13.0470-7210.2 LD7210

ATE Ceramic

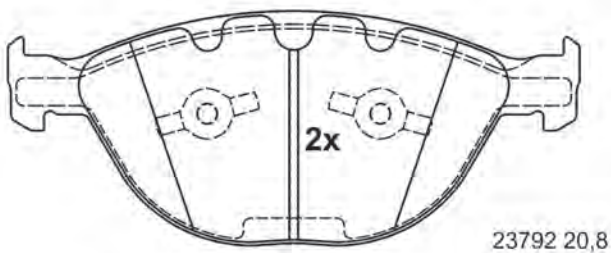
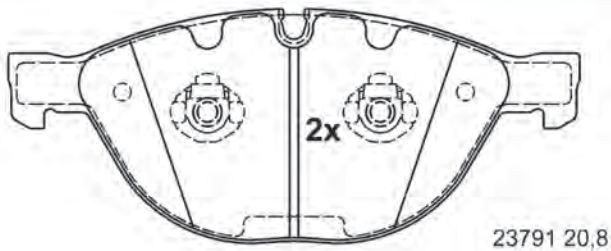

193,0 x 79,0 x 20,8

13.0470-7211.2 LD7211

ATE Ceramic

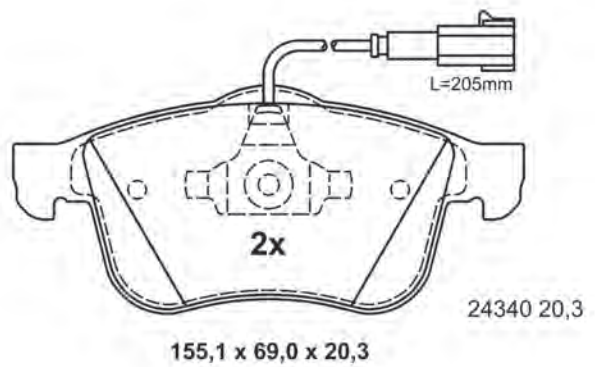
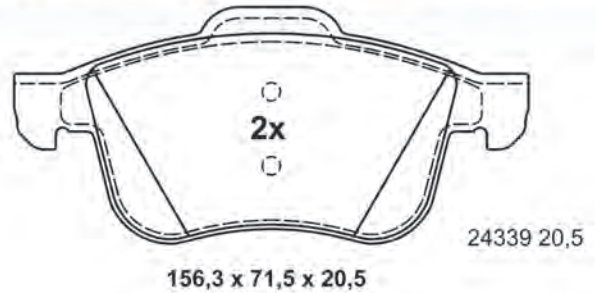

13.0470-7215.2 LD7215

ATE Ceramic

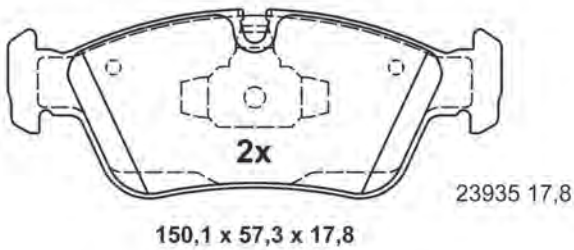
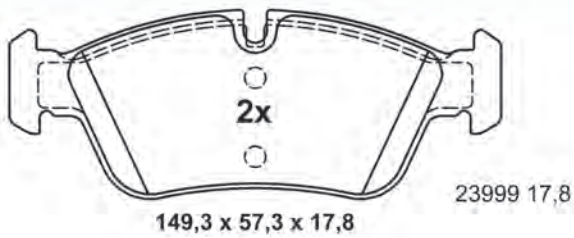

150,1 x 57,3 x 17,8

13.0470-7216.2 LD7216

ATE Ceramic

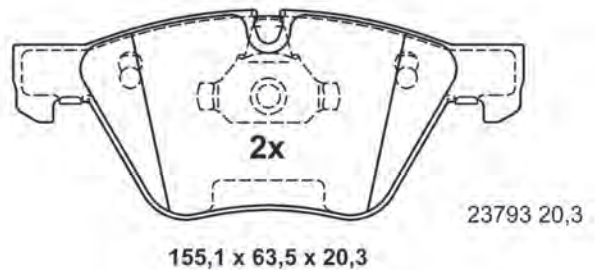
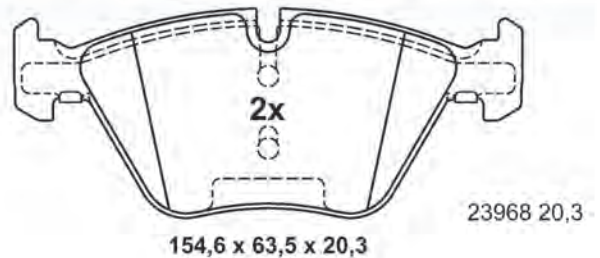

155,1 x 63,5 x 20,3



# Abbildungen Scheibenbremsbeläge

Illustrations disc brake pads - Ilustraciones de pastillas - Illustrations Plaquettes de frein à disque - Illustrazioni Pastiglie Freno

13.0470-7217.2 LD7217

ATE Ceramic

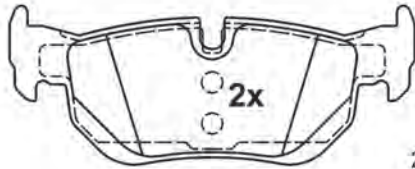

23927 17,3

123,0 x 48,1 x 17,3

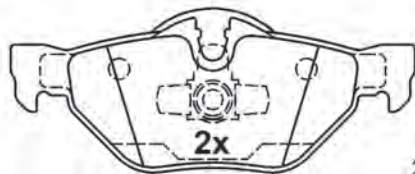

23926 17,3

123,0 x 49,7 x 17,3

13.0470-7219.2 LD7219

ATE Ceramic

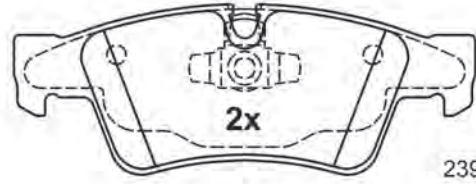

23923 17,6

140,1 x 51,6 x 17,6

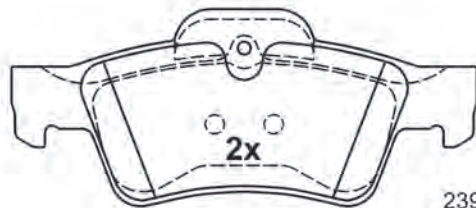

23924 17,6

141,3 x 59,6 x 17,6

13.0470-7220.2 LD7220

ATE Ceramic

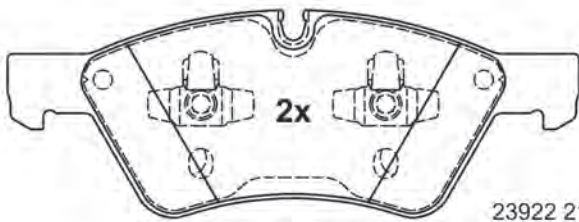

23922 21,0

192,9 x 69,9 x 21,0

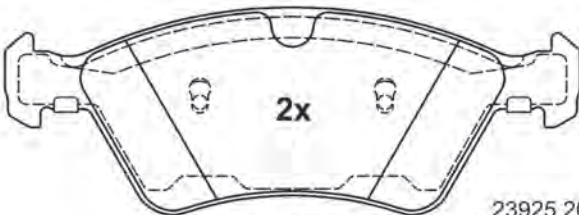

23925 20,5

194,3 x 70,0 x 20,5

13.0470-7221.2 LD7221

ATE Ceramic



23215 18,3

156,3 x 66,8 x 18,3

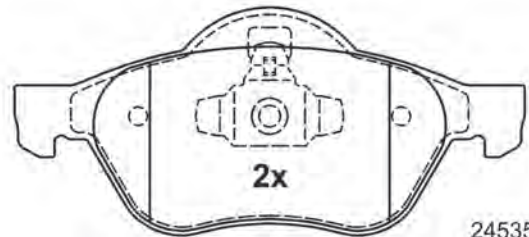

24535 18,3

155,1 x 68,9 x 18,3



# Abbildungen Scheibenbremsbeläge

Illustrations disc brake pads - Ilustraciones de pastillas - Illustrations Plaquettes de frein à disque - Illustrazioni Pastiglie Freno

13.0470-7223.2 LD7223

ATE Ceramic

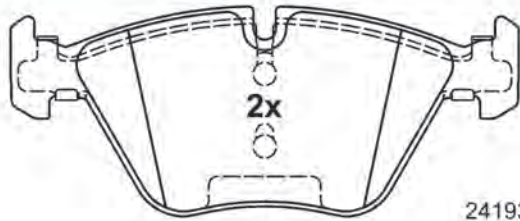

24193 20,3

154,6 x 63,5 x 20,3

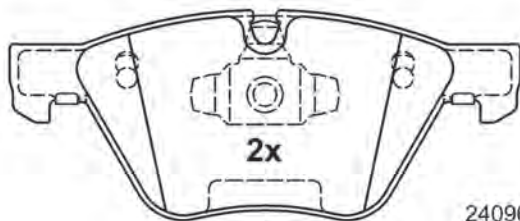

24096 20,3

155,1 x 63,5 x 20,3

13.0470-7225.2 LD7225

ATE Ceramic

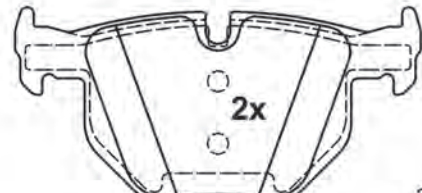

23551 17,3

123,0 x 59,2 x 17,3

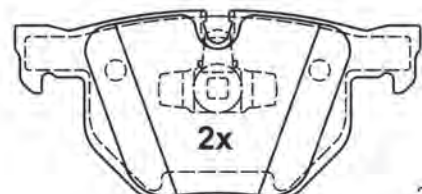

23550 17,3

123,0 x 58,0 x 17,3

13.0470-7226.2 LD7226

ATE Ceramic



23589 20,4

155,1 x 71,3 x 20,4

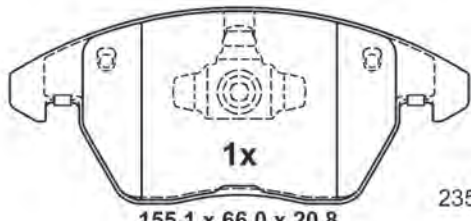

23587 20,8

155,1 x 66,0 x 20,8

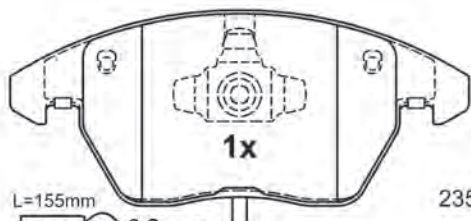

23588 20,8

155,1 x 66,0 x 20,8

L=155mm

13.0470-7227.2 LD7227

ATE Ceramic

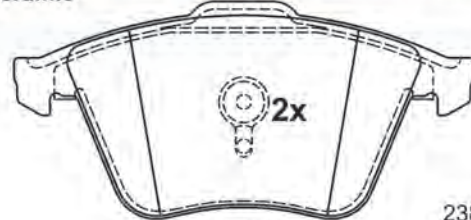

23801 20,3

156,3 x 72,9 x 20,3

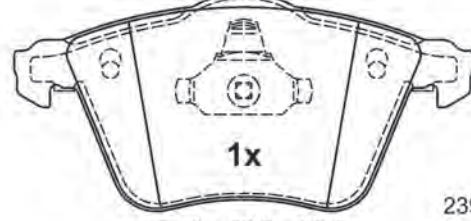

23912 20,3

155,1 x 72,9 x 20,3

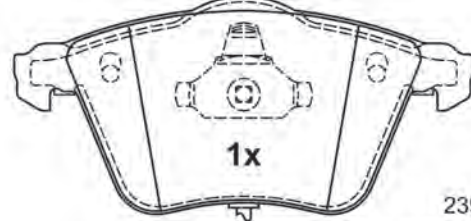

23913 20,3

155,1 x 72,9 x 20,3

L=175mm

# Abbildungen Scheibenbremsbeläge

Illustrations disc brake pads - Ilustraciones de pastillas - Illustrations Plaquettes de frein à disque - Illustrazioni Pastiglie Freno

13.0470-7228.2 LD7228

ATE Ceramic

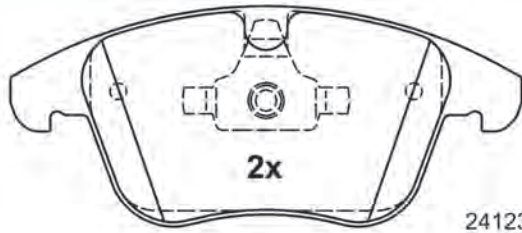

155,1 x 66,6 x 20,3

24123 20,3



156,3 x 72,0 x 19,3

24124 19,3

13.0470-7229.2 LD7229

ATE Ceramic

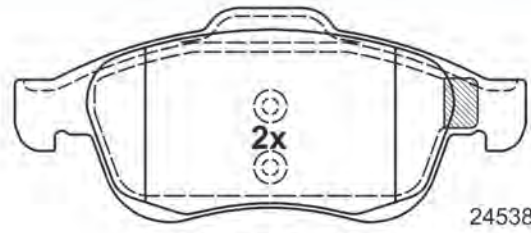

155,1 x 64,7 x 18,5

24538 18,5

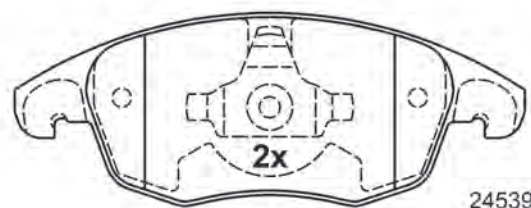

155,1 x 58,3 x 18,5

24539 18,5

13.0470-7230.2 LD7230

ATE Ceramic

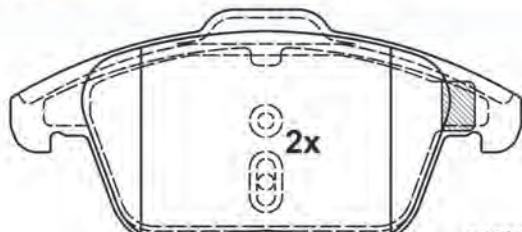

155,1 x 72,0 x 19,4

24557 19,4

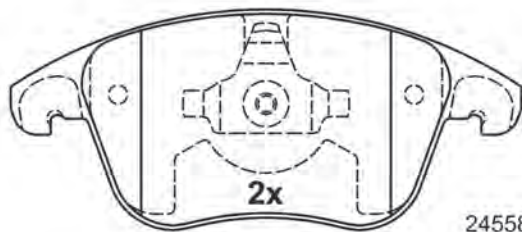

155,1 x 66,6 x 18,7

24558 18,7

13.0470-7231.2 LD7231

ATE Ceramic

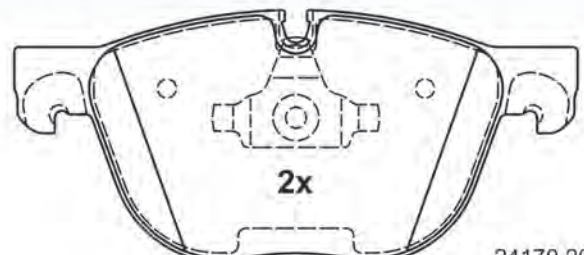

171,1 x 76,8 x 20,2

24170 20,2

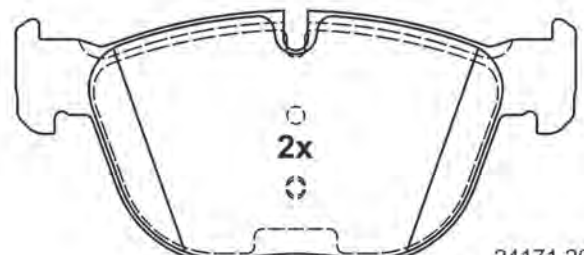

170,2 x 76,8 x 20,9

24171 20,9



# Abbildungen Scheibenbremsbeläge

Illustrations disc brake pads - Ilustraciones de pastillas - Illustrations Plaquettes de frein à disque - Illustrazioni Pastiglie Freno

13.0470-7232.2 LD7232

ATE Ceramic

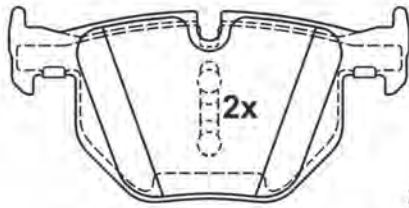

21282 17,3

121,8 x 59,2 x 17,3

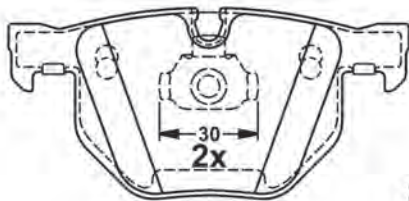

23447 17,3

121,8 x 57,8 x 17,3

13.0470-7237.2 LD7237

ATE Ceramic

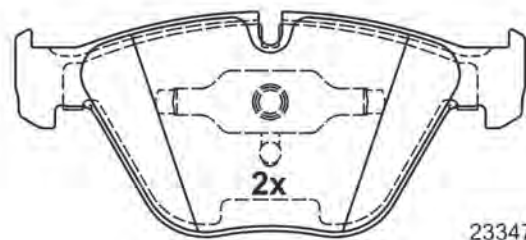

23347 20,3

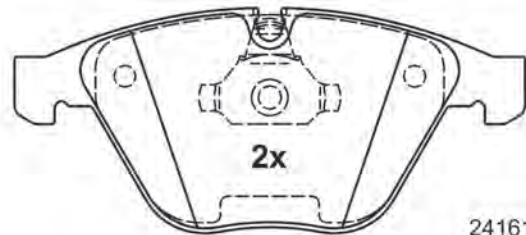

24161 20,3

155,1 x 68,3 x 20,3

13.0470-7238.2 LD7238

ATE Ceramic

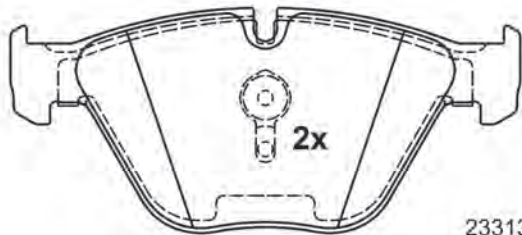

23313 20,3

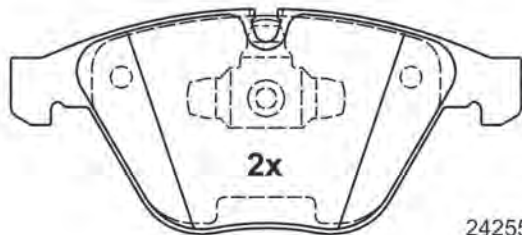

24255 20,3

155,1 x 68,3 x 20,3

13.0470-7239.2 LD7239

ATE Ceramic

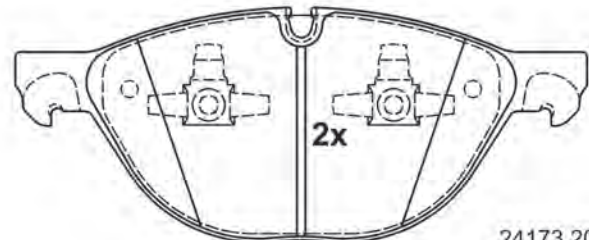

24173 20,0

193,0 x 79,0 x 20,0

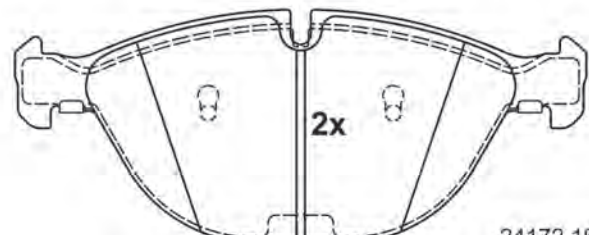

24172 19,0

193,0 x 79,0 x 19,0

# Abbildungen Scheibenbremsbeläge

Illustrations disc brake pads - Ilustraciones de pastillas - Illustrations Plaquettes de frein à disque - Illustrazioni Pastiglie Freno

13.0470-7242.2 LD7242



ATE Ceramic

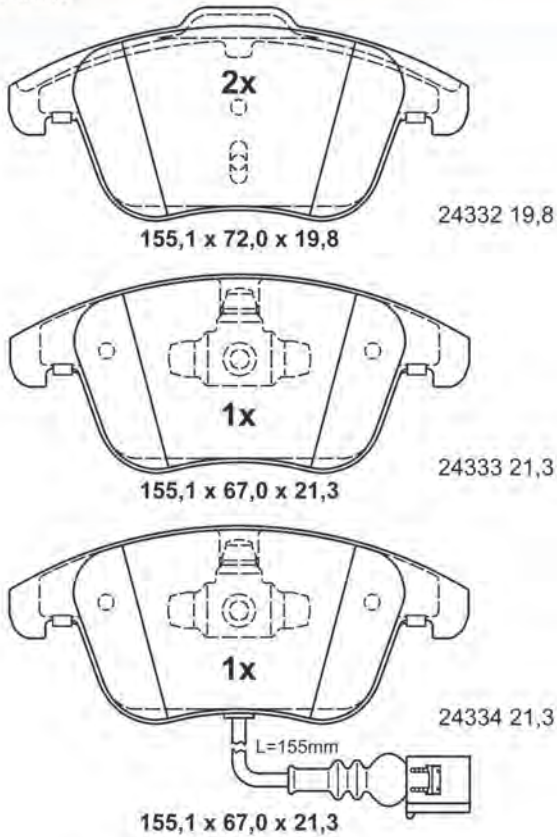

13.0470-7243.2 LD7243



ATE Ceramic

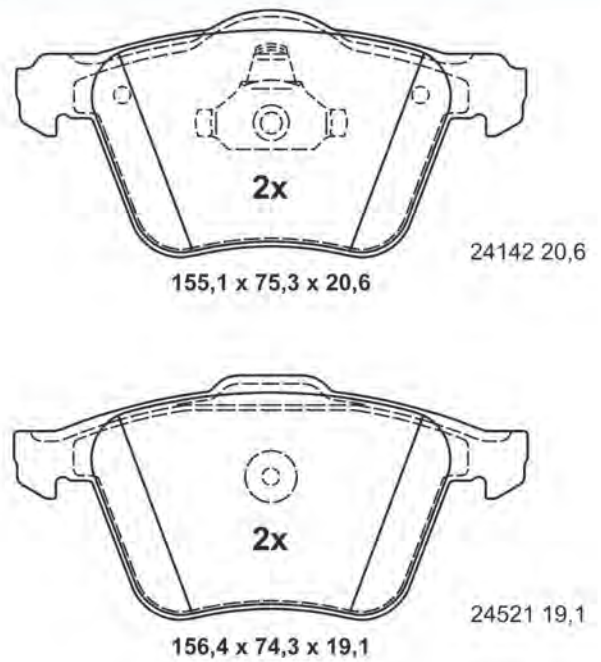

13.0470-7244.2 LD7244



ATE Ceramic

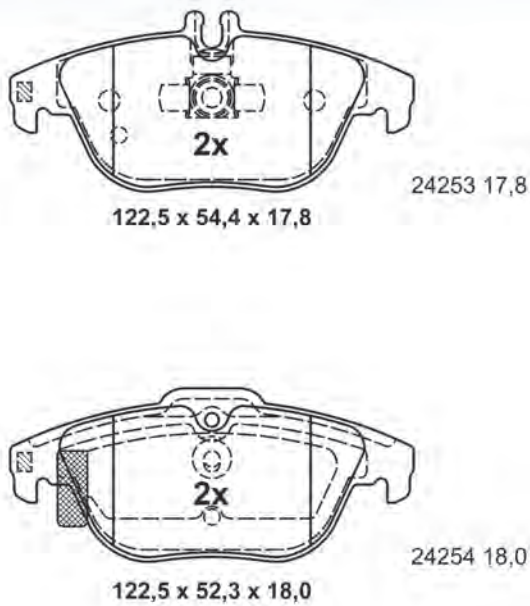

13.0470-7249.2 LD7249



ATE Ceramic

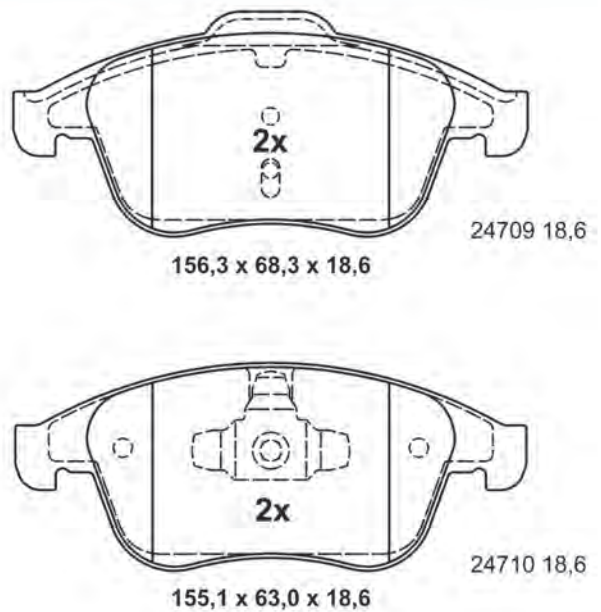



# Abbildungen Scheibenbremsbeläge

Illustrations disc brake pads - Ilustraciones de pastillas - Illustrations Plaquettes de frein à disque - Illustrazioni Pastiglie Freno

13.0470-7251.2 LD7251

ATE Ceramic

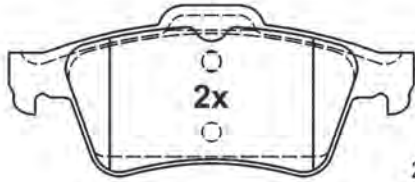

23482 15,8

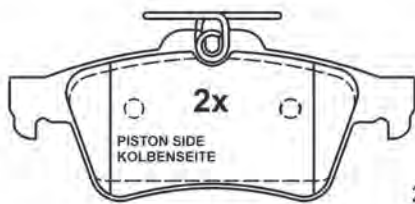

24137 15,8

123,0 x 52,0 x 15,8

13.0470-7252.2 LD7252

ATE Ceramic



24332 18,3

155,1 x 72,0 x 18,3

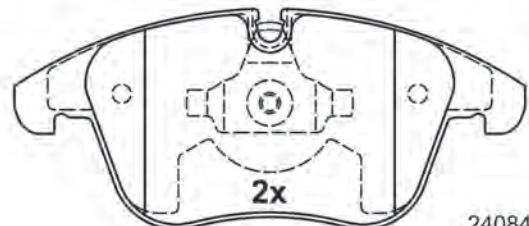

24084 19,3

155,2 x 66,5 x 19,3

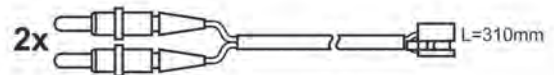

13.0470-7256.2 LD7256

ATE Ceramic



24705 19,8

155,1 x 72,0 x 19,8

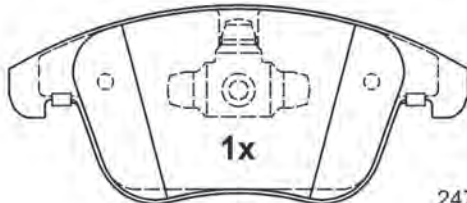

24706 21,3

155,1 x 67,0 x 21,3

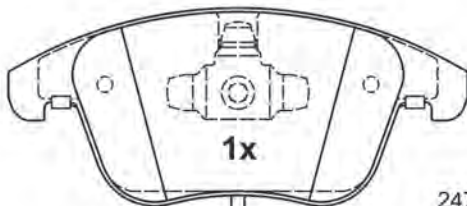

24707 21,3

155,1 x 67,0 x 21,3

L=281mm

13.0470-7257.2 LD7257

ATE Ceramic

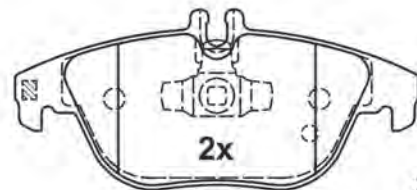

24253 18,0

122,5 x 54,4 x 18,0

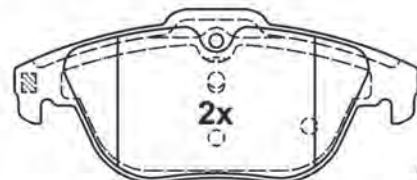

24254 18,0

122,5 x 52,3 x 18,0



# Abbildungen Scheibenbremsbeläge

Illustrations disc brake pads - Ilustraciones de pastillas - Illustrations Plaquettes de frein à disque - Illustrazioni Pastiglie Freno

13.0470-7259.2 LD7259

ATE Ceramic

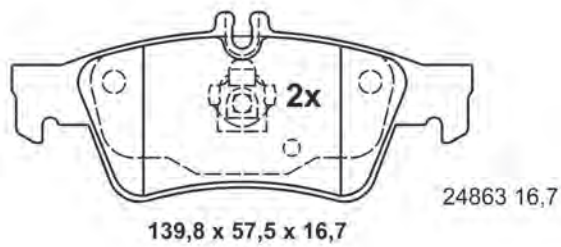
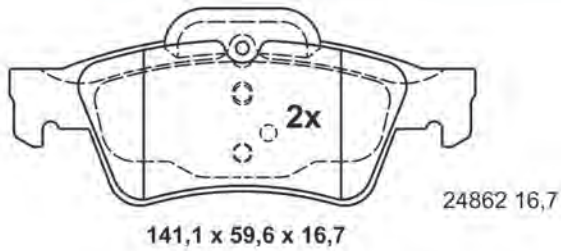

13.0470-7262.2 LD7262

ATE Ceramic

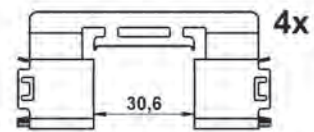
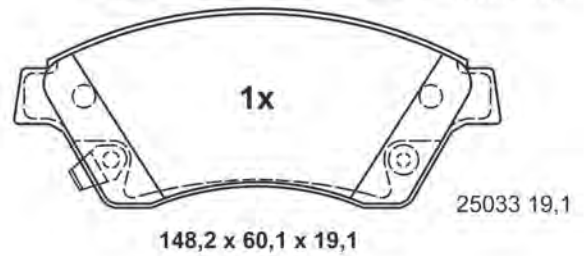
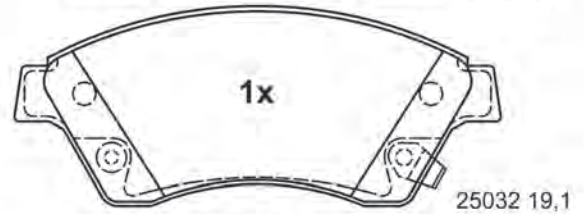
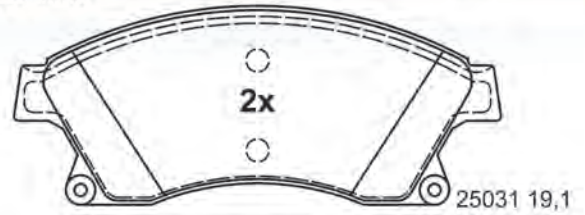

13.0470-7263.2 LD7263

ATE Ceramic

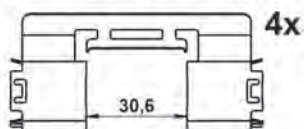
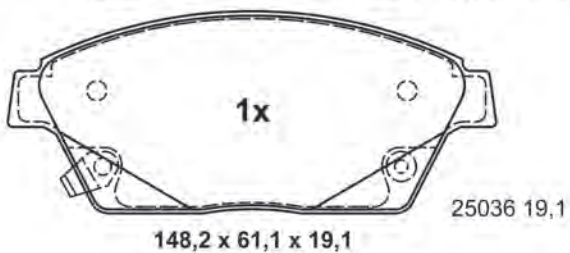
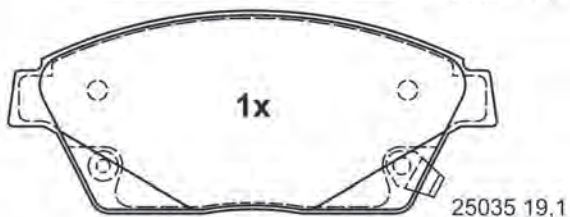
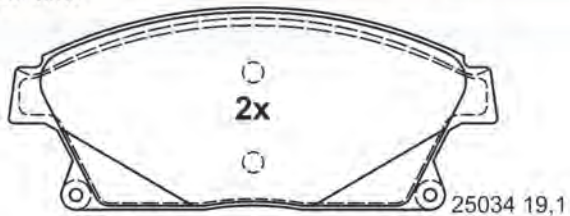

13.0470-7264.2 LD7264

ATE Ceramic

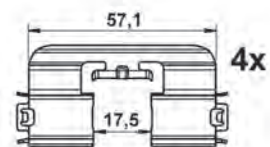
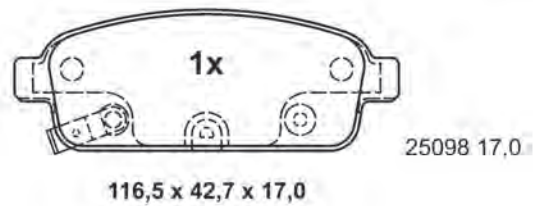
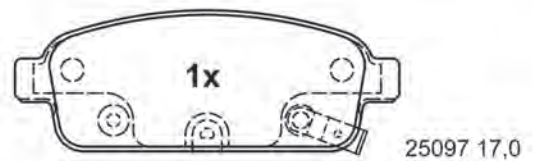
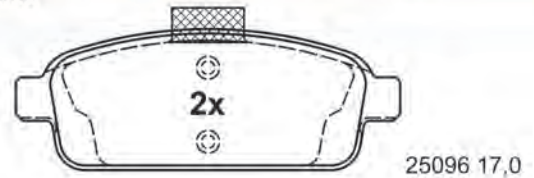

# Abbildungen Scheibenbremsbeläge

Illustrations disc brake pads - Ilustraciones de pastillas - Illustrations Plaquettes de frein à disque - Illustrazioni Pastiglie Freno

13.0470-7266.2 LD7266

ATE Ceramic

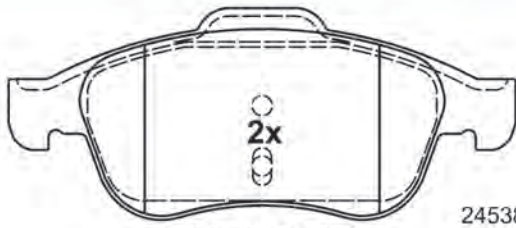

155,1 x 64,7 x 17,9

24538 17,9

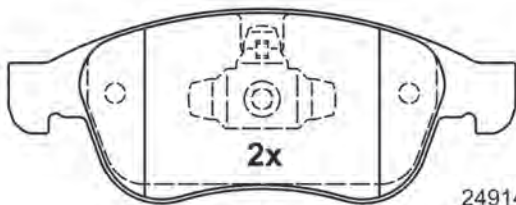

155,1 x 59,4 x 17,9

24914 17,9

13.0470-7267.2 LD7267

ATE Ceramic

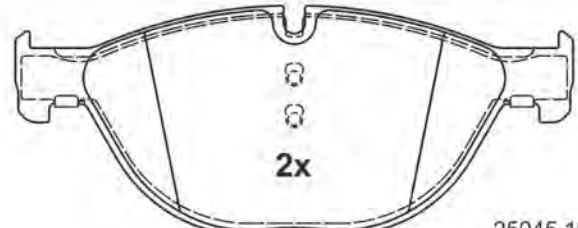

192,2 x 79,2 x 19,5

25045 19,5

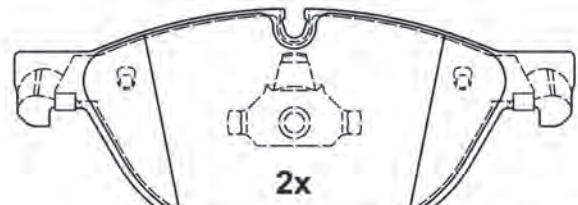

193,0 x 79,2 x 18,5

25046 18,5

13.0470-7268.2 LD7268

ATE Ceramic

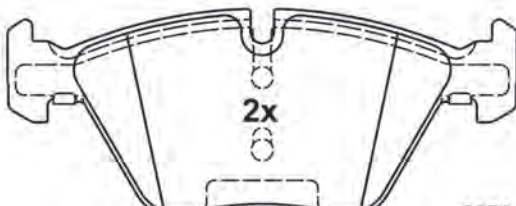

154,6 x 63,5 x 20,3

23794 20,3

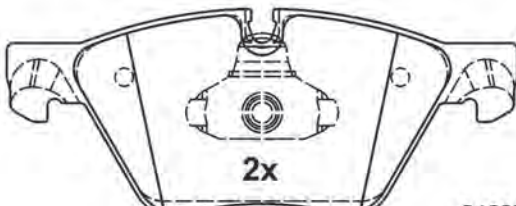

155,1 x 63,5 x 19,3

24697 19,3

13.0470-7269.2 LD7269

ATE Ceramic

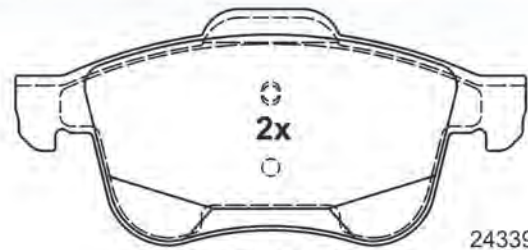

155,1 x 71,5 x 19,5

24339 19,5

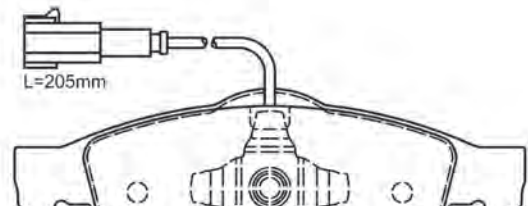

155,1 x 69,0 x 19,5

24340 19,5





# Abbildungen Scheibenbremsbeläge

Illustrations disc brake pads - Ilustraciones de pastillas - Illustrations Plaquettes de frein à disque - Illustrazioni Pastiglie Freno

13.0470-7273.2 LD7273

ATE Ceramic

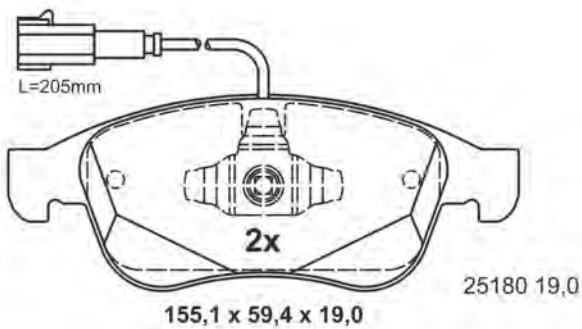
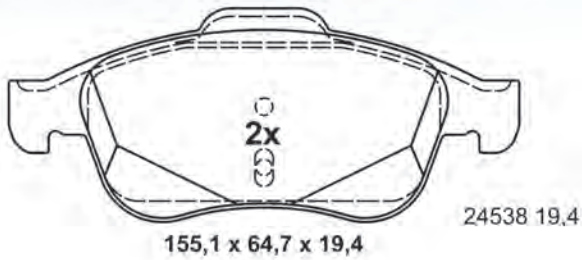

13.0470-7275.2 LD7275

ATE Ceramic

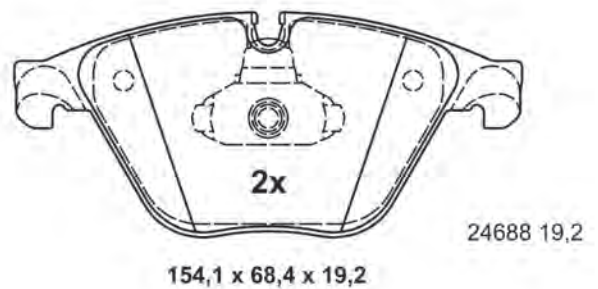
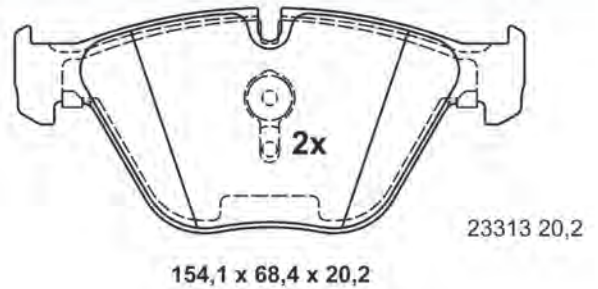

13.0470-7279.2 LD7279

ATE Ceramic

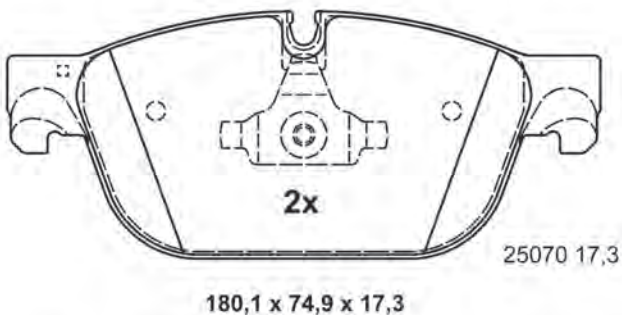
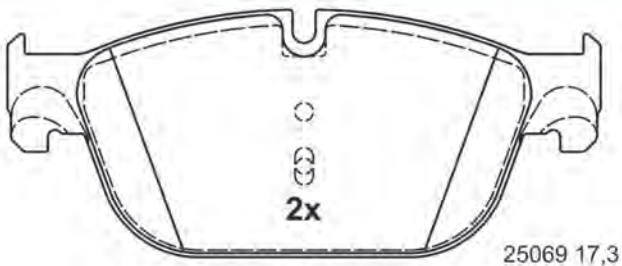

13.0470-7280.2 LD7280

ATE Ceramic

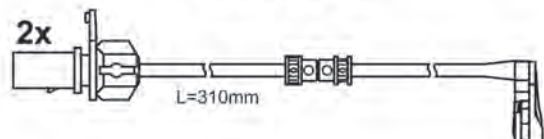
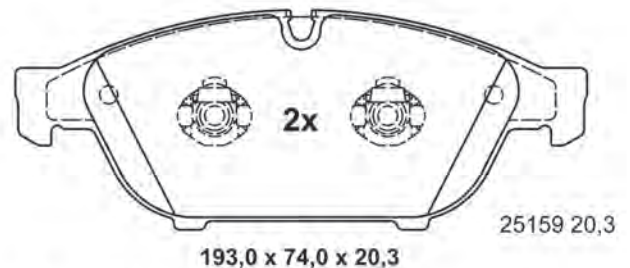
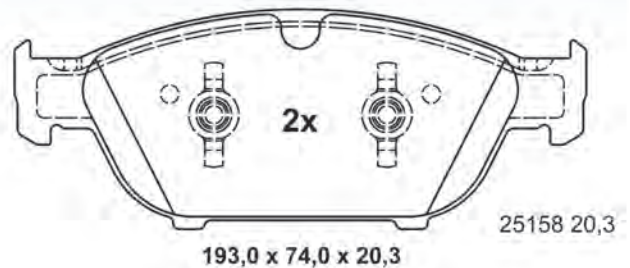

# Abbildungen Scheibenbremsbeläge

Illustrations disc brake pads - Ilustraciones de pastillas - Illustrations Plaquettes de frein à disque - Illustrazioni Pastiglie Freno

13.0470-7281.2 LD7281

ATE Ceramic

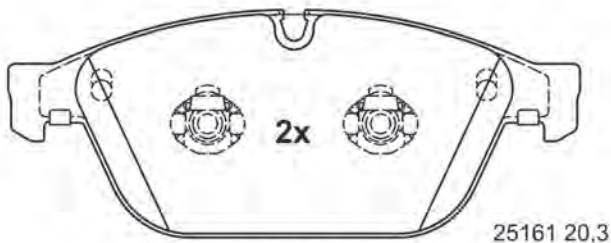
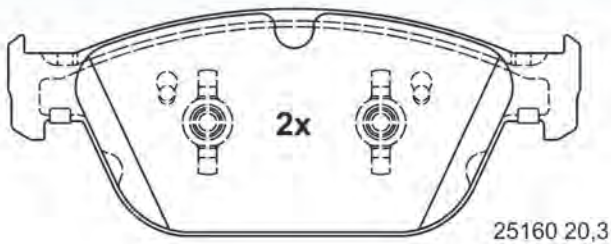

193,0 x 76,5 x 20,3

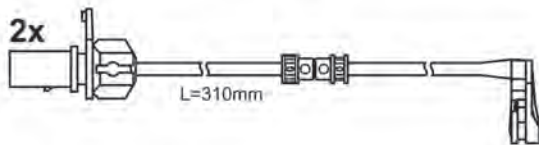

13.0470-7282.2 LD7282

ATE Ceramic

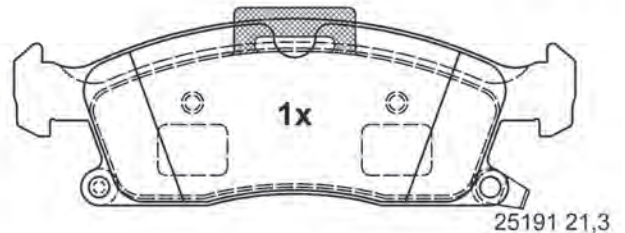
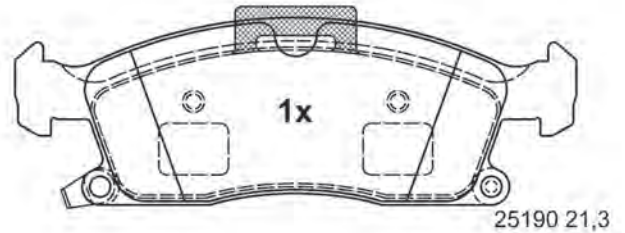
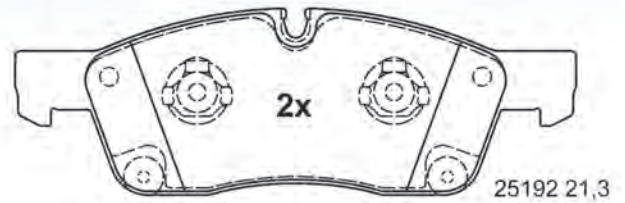

193,1 x 64,1 x 21,3

13.0470-7285.2 LD7285

ATE Ceramic

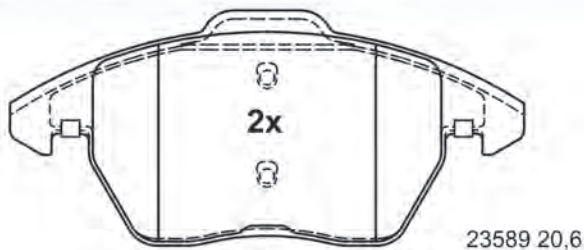

156,3 x 71,3 x 20,6

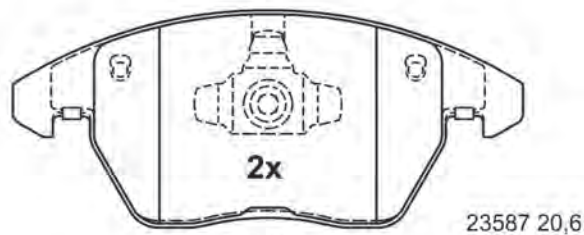

155,1 x 66,0 x 20,6

13.0470-7288.2 LD7288

ATE Ceramic

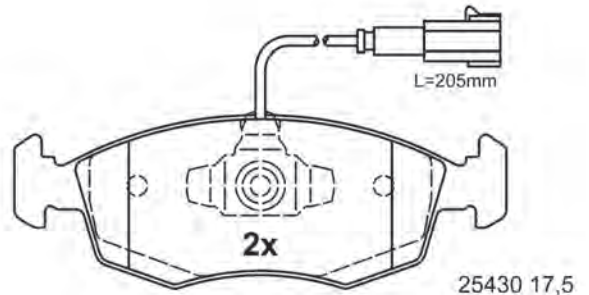
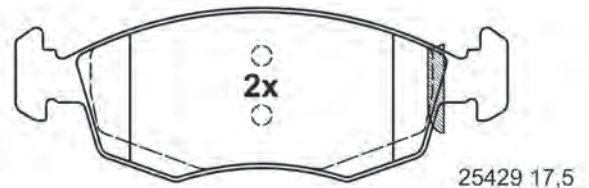

149,2 x 52,5 x 17,5



# Abbildungen Scheibenbremsbeläge

Illustrations disc brake pads - Ilustraciones de pastillas - Illustrations Plaquettes de frein à disque - Illustrazioni Pastiglie Freno

13.0470-7293.2 LD7293

ATE Ceramic

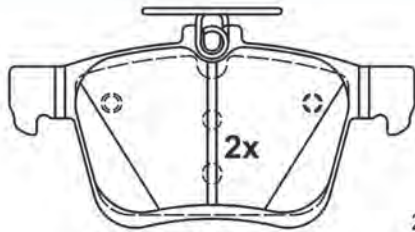

123,0 x 61,2 x 16,3

25008 16,3

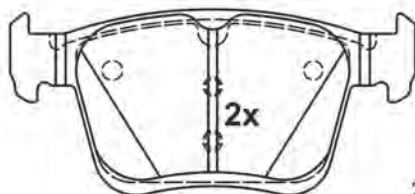

123,0 x 56,2 x 16,3

25010 16,3

13.0470-7294.2 LD7294

ATE Ceramic

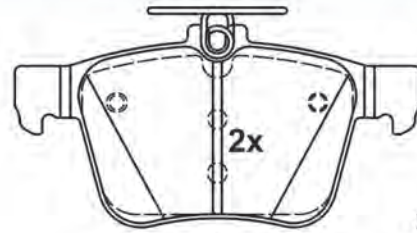

123,0 x 61,2 x 16,4

25009 16,4

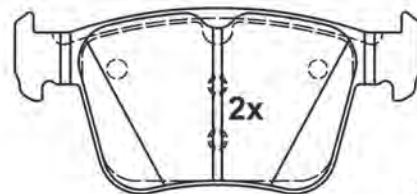

123,0 x 56,2 x 16,4

25011 16,4

13.0470-7295.2 LD7295

ATE Ceramic



123,0 x 41,2 x 16,1

25968 16,1

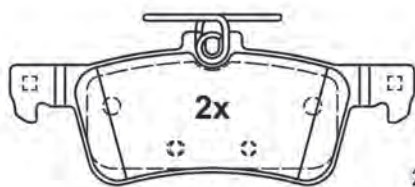

123,0 x 46,2 x 16,1

25969 16,1

13.0470-7296.2 LD7296

ATE Ceramic

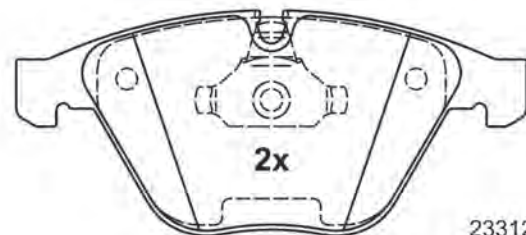

23312 20,3



23313 20,3

155,1 x 68,3 x 20,3



# Abbildungen Scheibenbremsbeläge

Illustrations disc brake pads - Ilustraciones de pastillas - Illustrations Plaquettes de frein à disque - Illustrazioni Pastiglie Freno

13.0470-7298.2 LD7298

ATE Ceramic

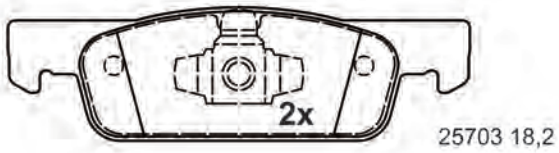
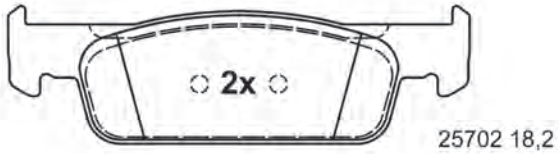

140,1 x 40,0 x 18,2

13.0470-7299.2 LD7299

ATE Ceramic

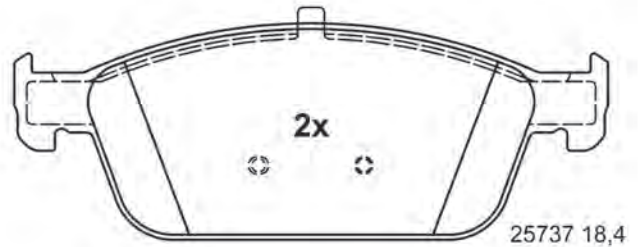
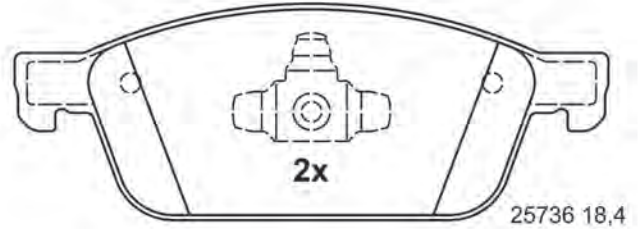

180,1 x 65,5 x 18,4

13.0470-7300.2 LD7300

ATE Ceramic

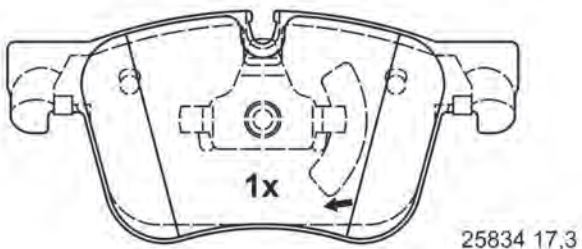
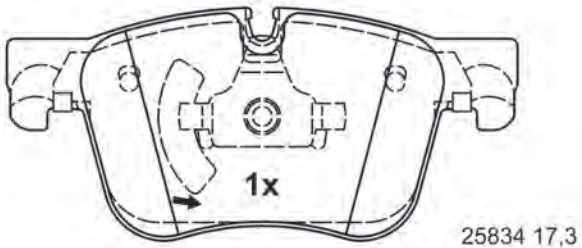
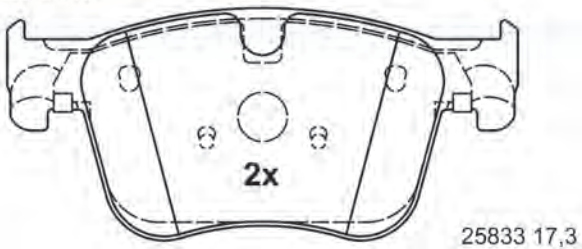

155,1 x 70,5 x 17,3

13.0470-7301.2 LD7301

ATE Ceramic

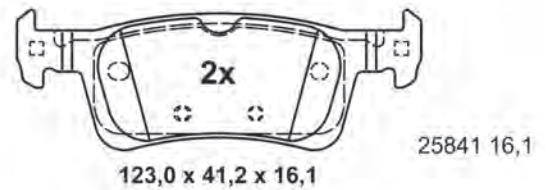

123,0 x 41,2 x 16,1

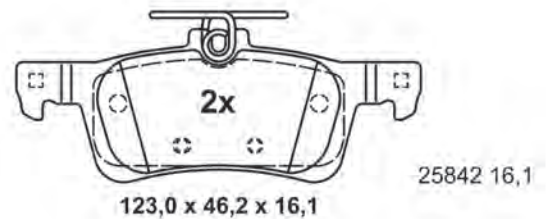

123,0 x 46,2 x 16,1

# Abbildungen Scheibenbremsbeläge

Illustrations disc brake pads - Ilustraciones de pastillas - Illustrations Plaquettes de frein à disque - Illustrazioni Pastiglie Freno

13.0470-7303.2 LD7303

B.H.P.

ATE Ceramic

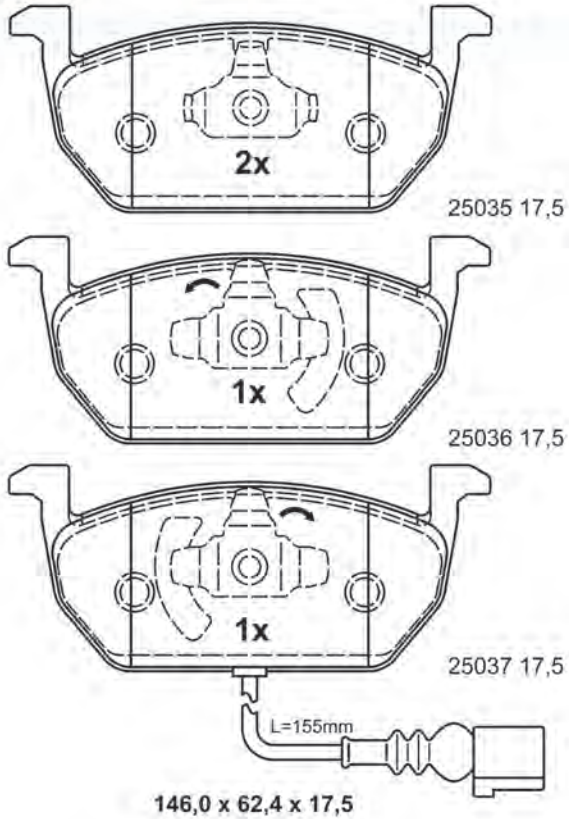

13.0470-7304.2 LD7304

B.H.P.

ATE Ceramic

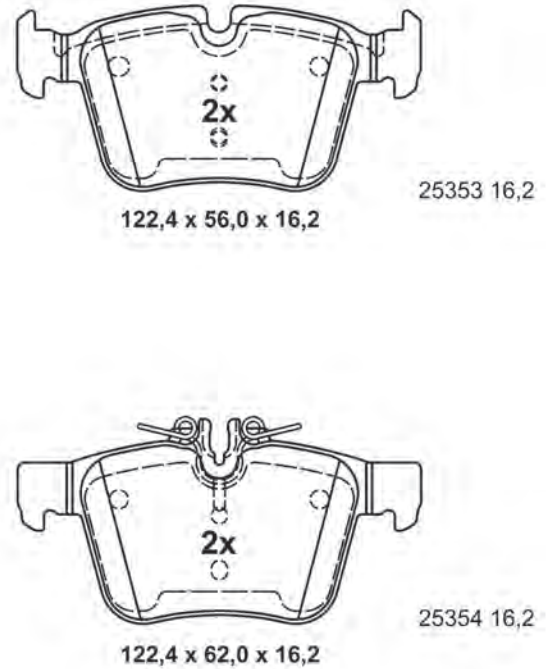

13.0470-7305.2 LD7305

B.H.P.

ATE Ceramic

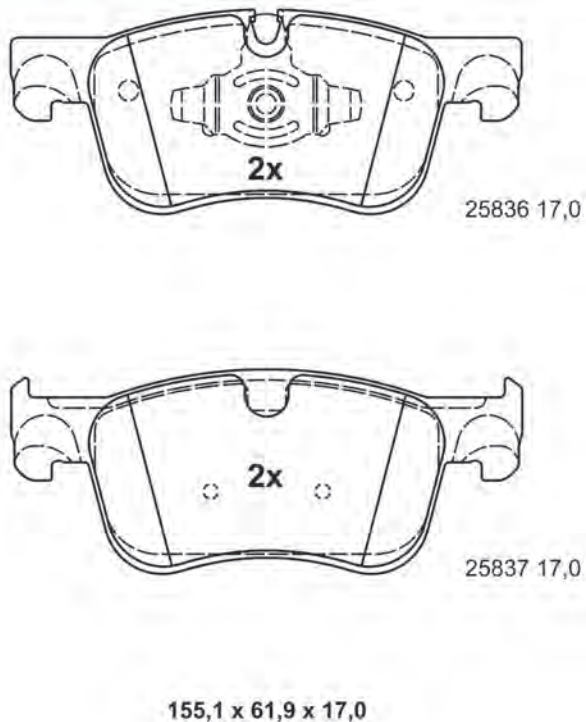

13.0470-7309.2 LD7309

B.H.P.

ATE Ceramic

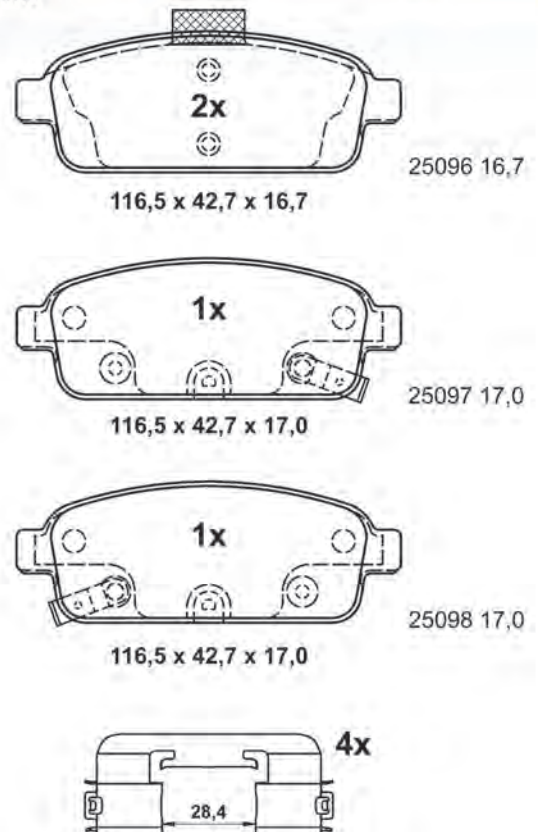



# Abbildungen Scheibenbremsbeläge

Illustrations disc brake pads - Ilustraciones de pastillas - Illustrations Plaquettes de frein à disque - Illustrazioni Pastiglie Freno

13.0470-7314.2 LD7314

ATE Ceramic

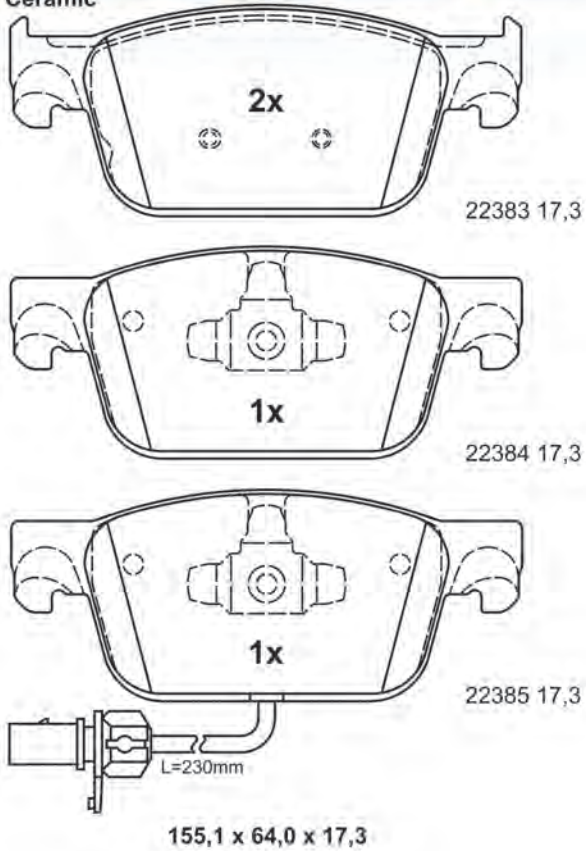

155,1 x 64,0 x 17,3

13.0470-7315.2 LD7315

ATE Ceramic

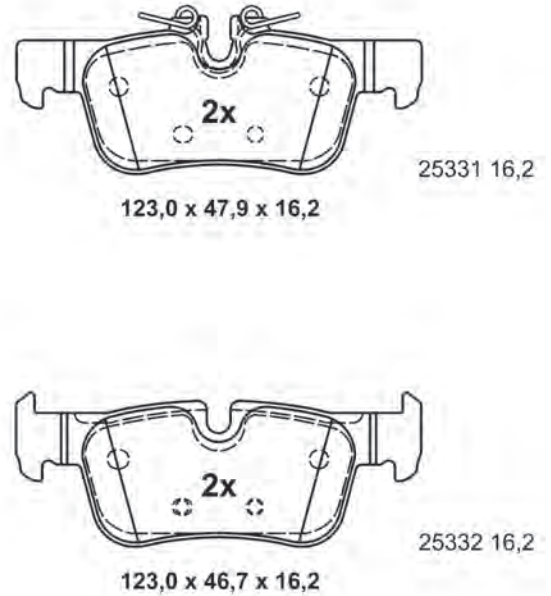

123,0 x 47,9 x 16,2

123,0 x 46,7 x 16,2

13.0470-7316.2 LD7316 [1]

ATE Ceramic

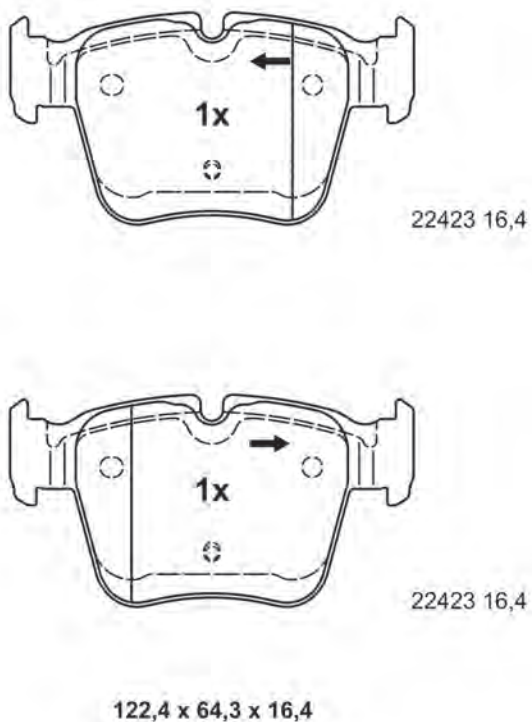

22423 16,4

22423 16,4

122,4 x 64,3 x 16,4

13.0470-7316.2 LD7316 [2]

ATE Ceramic

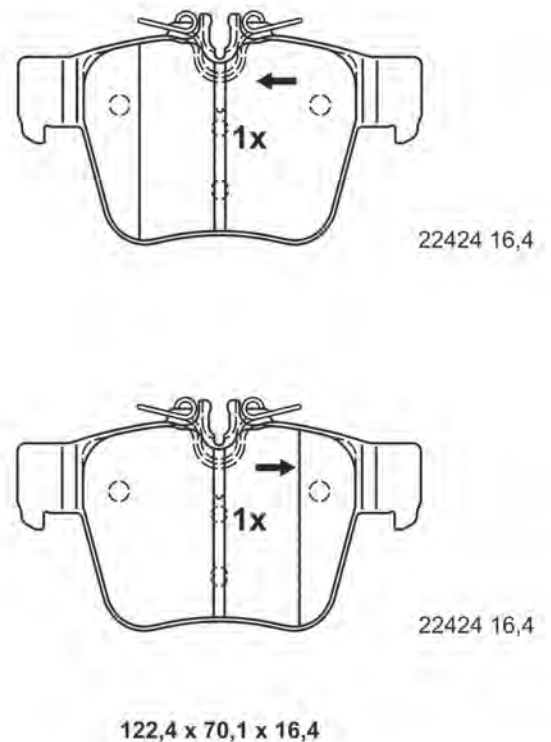

22424 16,4

22424 16,4

122,4 x 70,1 x 16,4

# Abbildungen Scheibenbremsbeläge

Illustrations disc brake pads - Ilustraciones de pastillas - Illustrations Plaquettes de frein à disque - Illustrazioni Pastiglie Freno

13.0470-7320.2 LD7320

ATE Ceramic

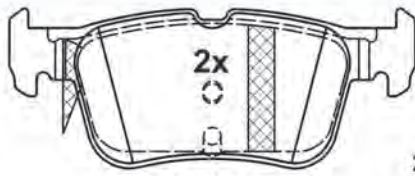

22231 16,1

123,0 x 48,2 x 16,1

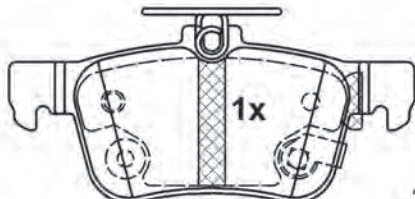

22232 16,1

123,0 x 53,4 x 16,1

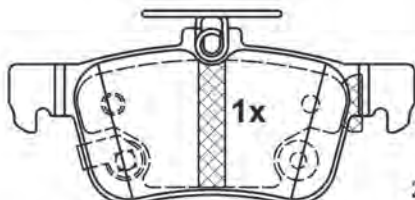

22233 16,1

123,0 x 53,4 x 16,1

13.0470-7324.2 LD7324 [1]

ATE Ceramic

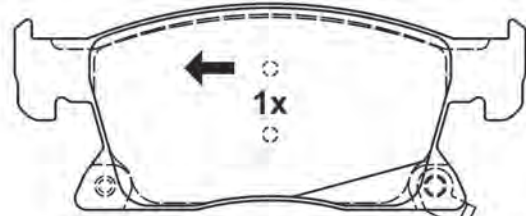

22345 19,7

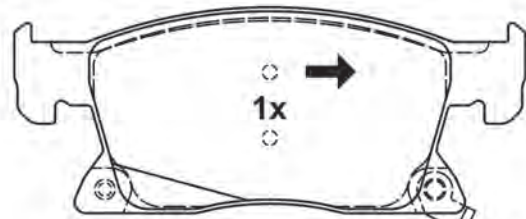

22345 19,7

155,1 x 62,4 x 19,7

13.0470-7324.2 LD7324 [2]

ATE Ceramic

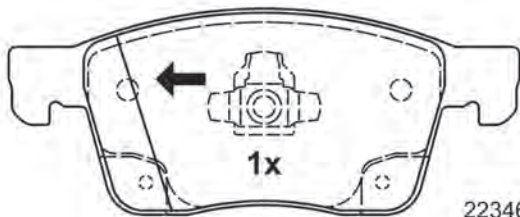

22346 20,1

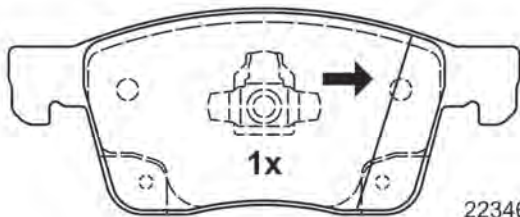

22346 20,1

155,1 x 62,4 x 20,1

13.0470-7325.2 LD7325

ATE Ceramic

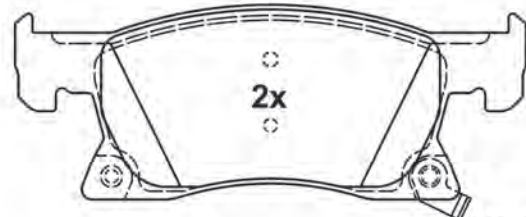

22342 19,8

155,1 x 58,9 x 19,8

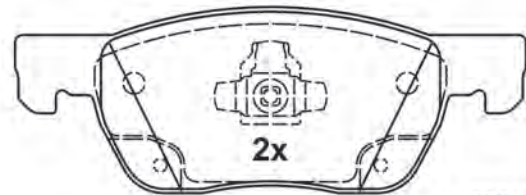

22343 19,8

155,1 x 56,3 x 19,8

# Abbildungen Scheibenbremsbeläge

Illustrations disc brake pads - Ilustraciones de pastillas - Illustrations Plaquettes de frein à disque - Illustrazioni Pastiglie Freno

13.0470-7327.2 LD7327

ATE Ceramic

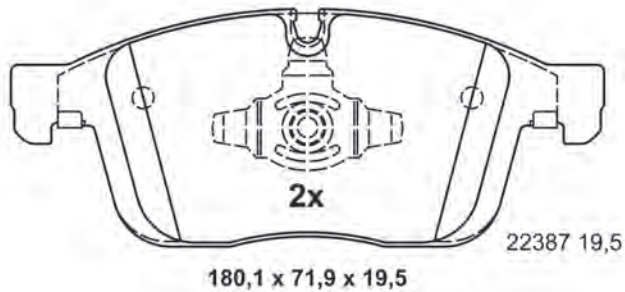
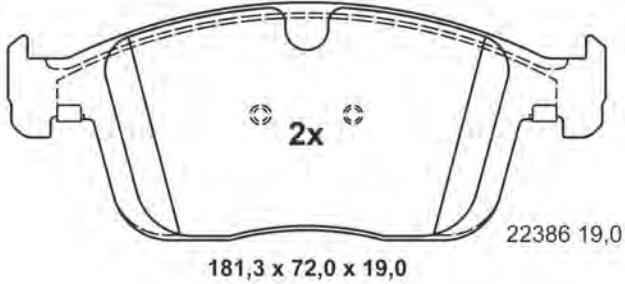

13.0470-7333.2 LD7333

ATE Ceramic

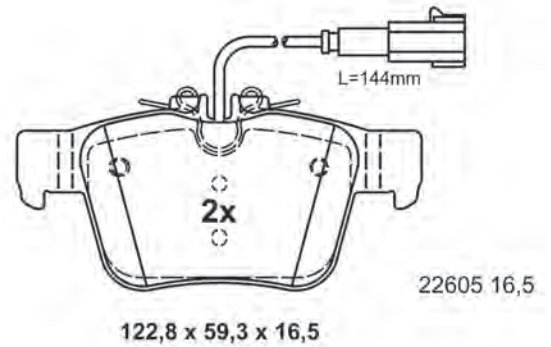
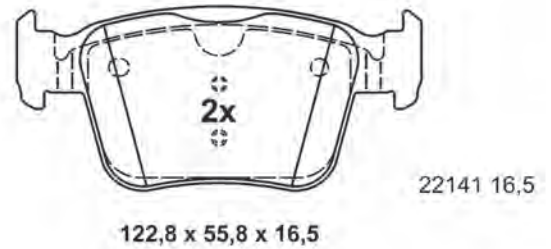

13.0470-9000.2 LD9000

ATE Ceramic

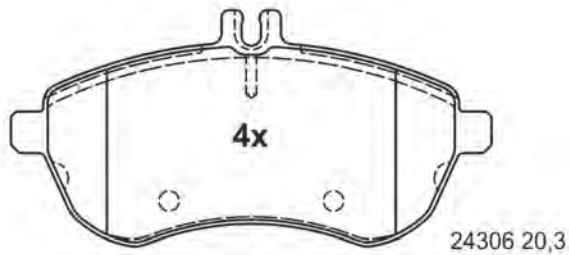

146,0 x 71,5 x 20,3

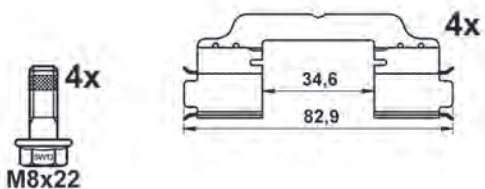
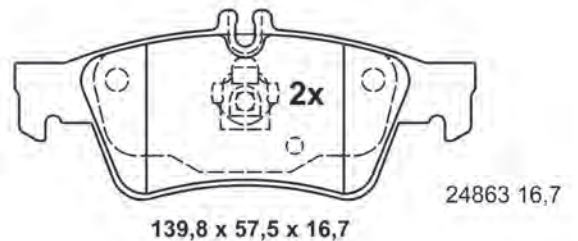







- DE** Abbildungen Bremsbelag-Einbausätze
- EN** Illustrations brake pad installation kits
- ES** Ilustraciones juegos de montaje pastillas
- FR** Illustrations Lots de montage pour plaquettes de frein à disque
- IT** Illustrazioni kit installazione pastiglie freno

2019



# Abbildungen Bremsbelag-Einbausätze

Illustrations brake pad installation kits - Ilustraciones juegos de montaje pastillas - Illustrations Lots de montage pour plaquettes de frein à disque - Illustrazioni kit installazione pastiglie freno

**13.0460-0017.2 610017 13.0460-0023.2 610023 13.0460-0024.2 610024**



**13.0460-0035.2 610035 13.0460-0060.2 610060 13.0460-0072.2 610072**

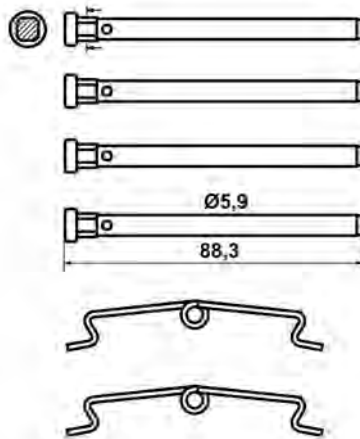

**13.0460-0073.2 610073 13.0460-0074.2 610074 13.0460-0075.2 610075**

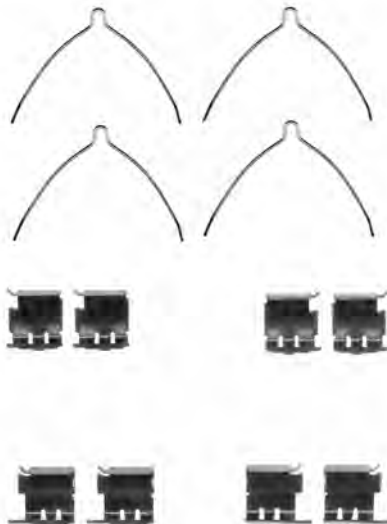

# Abbildungen Bremsbelag-Einbausätze

Illustrations brake pad installation kits - Ilustraciones juegos de montaje pastillas - Illustrations Lots de montage pour plaquettes de frein à disque - Illustrazioni kit installazione pastiglie freno

**13.0460-0077.2 610077 13.0460-0088.2 610088 13.0460-0091.2 610091**

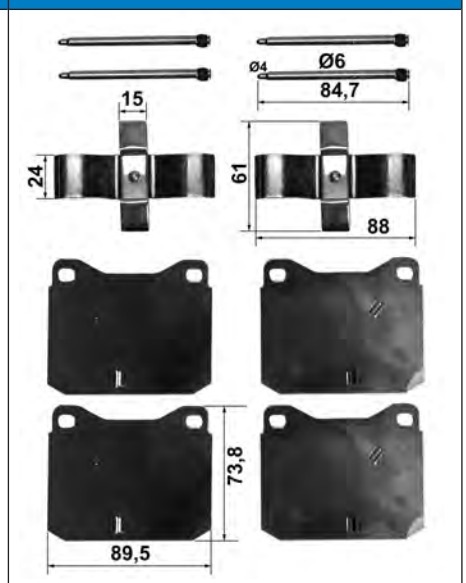
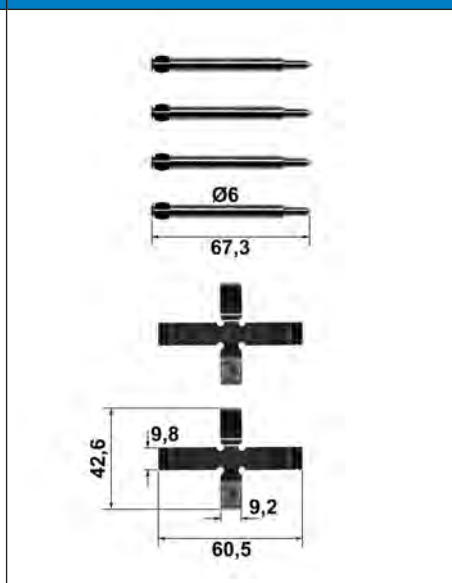
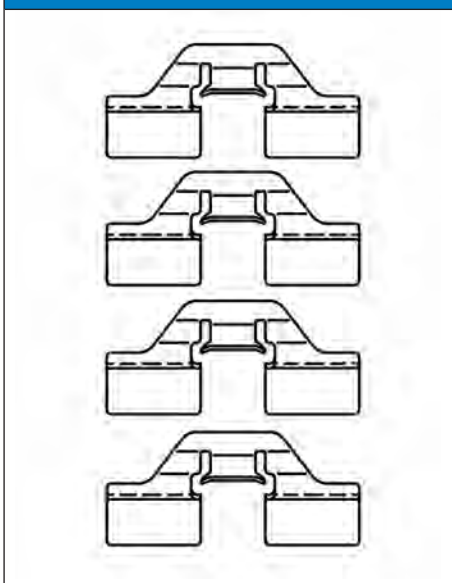

**13.0460-0107.2 610107 13.0460-0112.2 610112 13.0460-0116.2 610116**

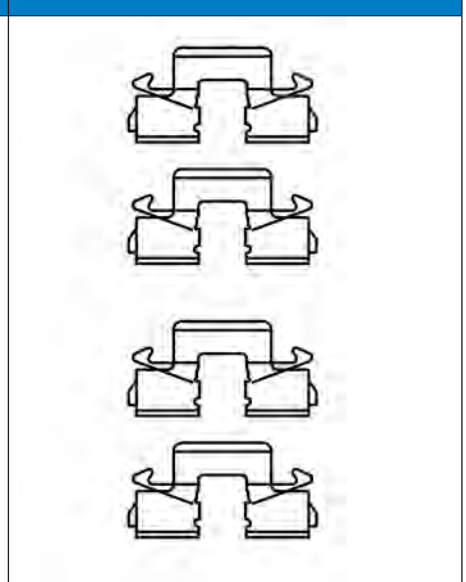
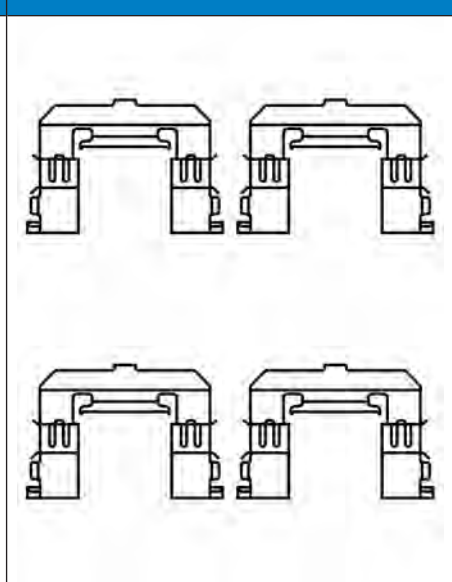

**13.0460-0117.2 610117 13.0460-0134.2 610134 13.0460-0135.2 610135**

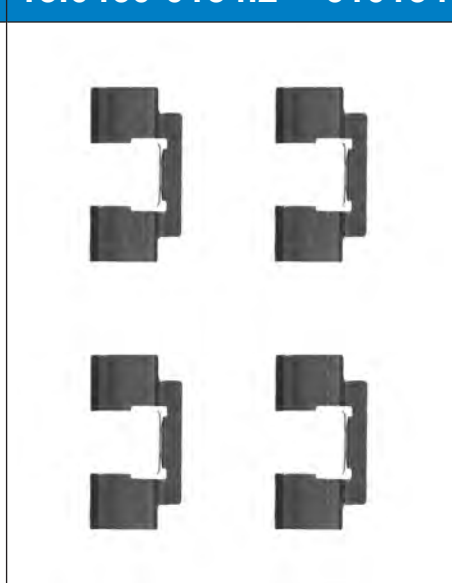
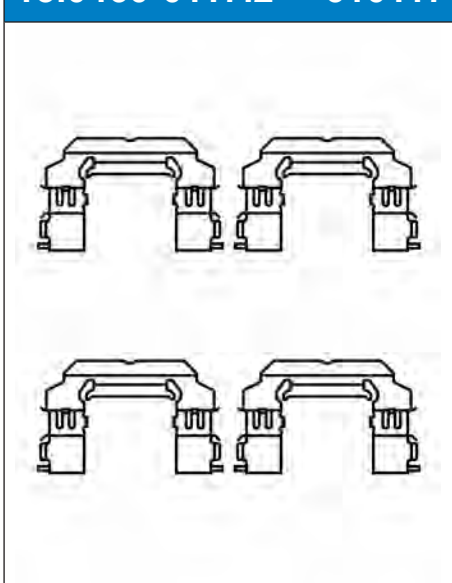

# Abbildungen Bremsbelag-Einbausätze





Illustrations brake pad installation kits - Ilustraciones juegos de montaje pastillas - Illustrations Lots de montage pour plaquettes de frein à disque - Illustrazioni kit installazione pastiglie freno

13.0460-0136.2 610136	13.0460-0137.2 610137	13.0460-0138.2 610138
13.0460-0139.2 610139	13.0460-0140.2 610140	13.0460-0141.2 610141
13.0460-0142.2 610142	13.0460-0143.2 610143	13.0460-0144.2 610144

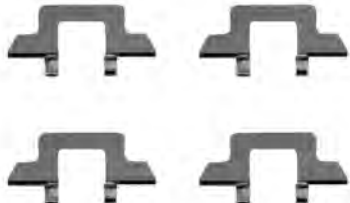

# Abbildungen Bremsbelag-Einbausätze

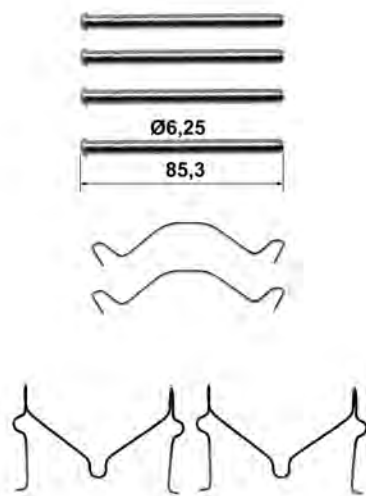
Illustrations brake pad installation kits - Ilustraciones juegos de montaje pastillas - Illustrations Lots de montage pour plaquettes de frein à disque - Illustrazioni kit installazione pastiglie freno

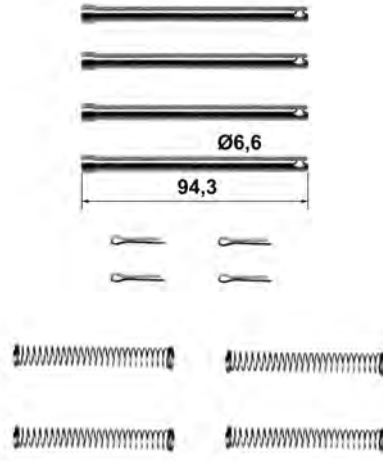
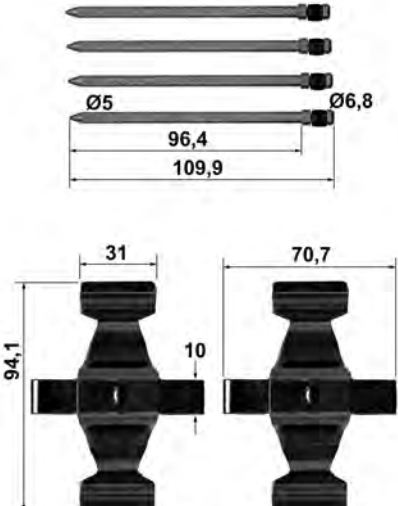
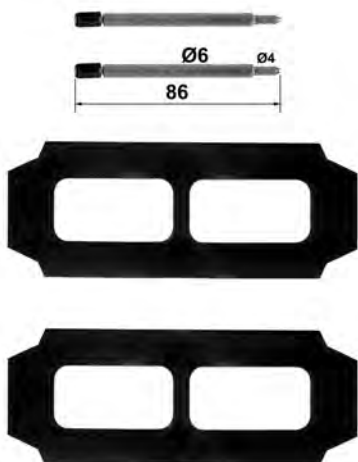
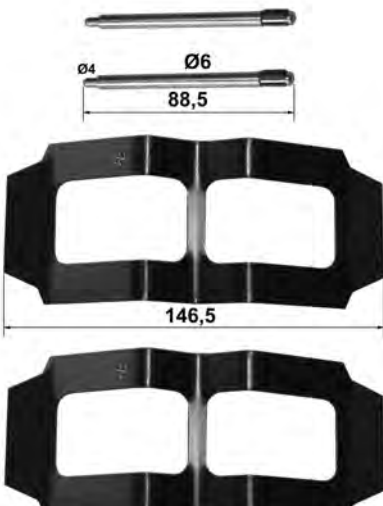
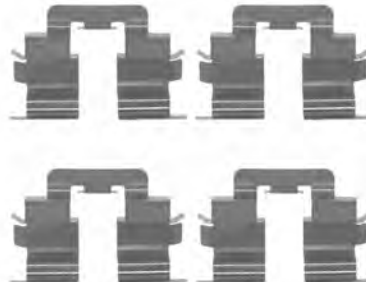
13.0460-0146.2 610146	13.0460-0148.2 610148	13.0460-0149.2 610149
		
13.0460-0150.2 610150	13.0460-0154.2 610154	13.0460-0155.2 610155
		
13.0460-0158.2 610158	13.0460-0160.2 610160	13.0460-0163.2 610163
		

# Abbildungen Bremsbelag-Einbausätze

Illustrations brake pad installation kits - Ilustraciones juegos de montaje pastillas - Illustrations Lots de montage pour plaquettes de frein à disque - Illustrazioni kit installazione pastiglie freno

**13.0460-0170.2 610170 13.0460-0175.2 610175 13.0460-0186.2 610186**

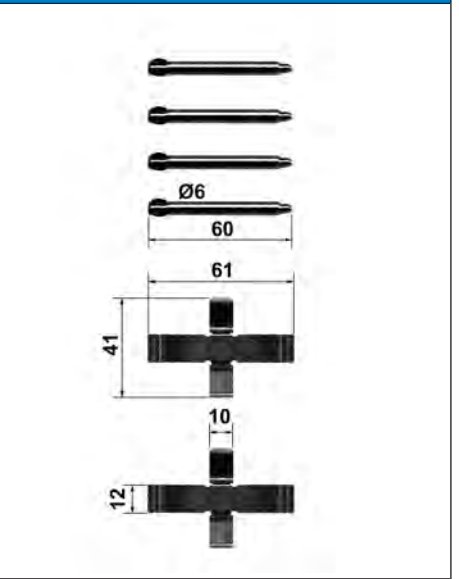
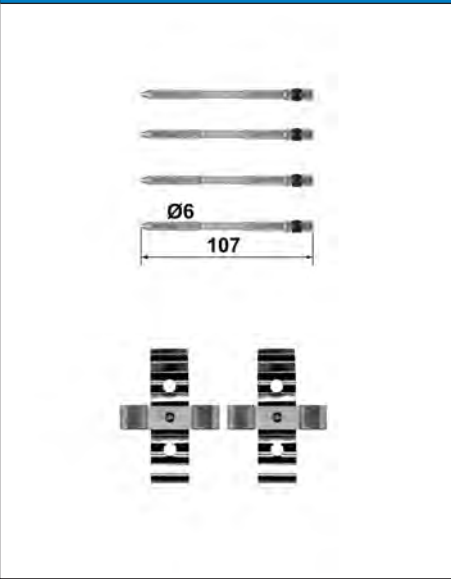
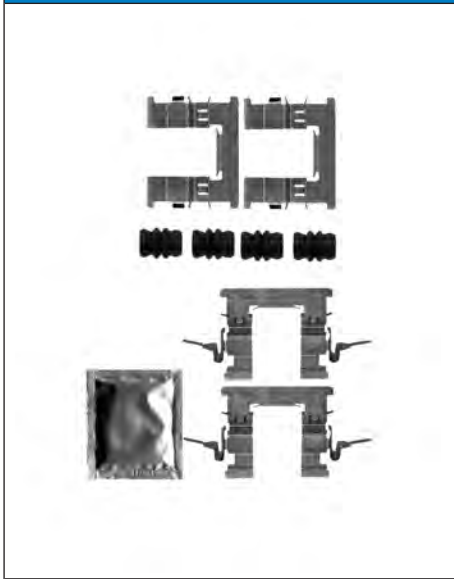

**13.0460-0203.2 610203 13.0460-0206.2 610206 13.0460-0212.2 610212**

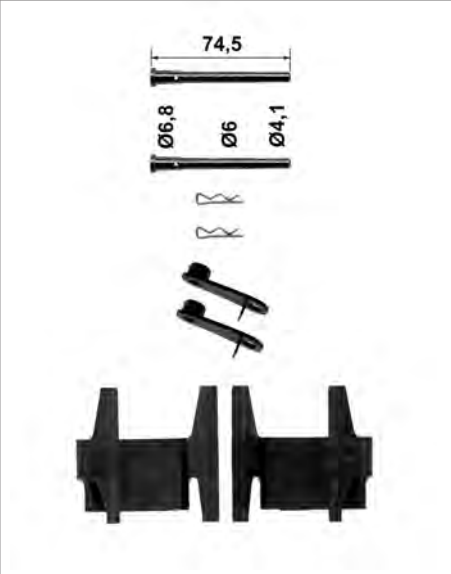
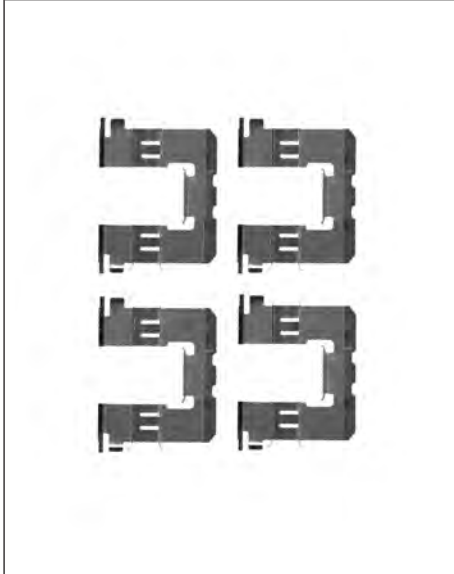

**13.0460-0213.2 610213 13.0460-0215.2 610215 13.0460-0217.2 610217**

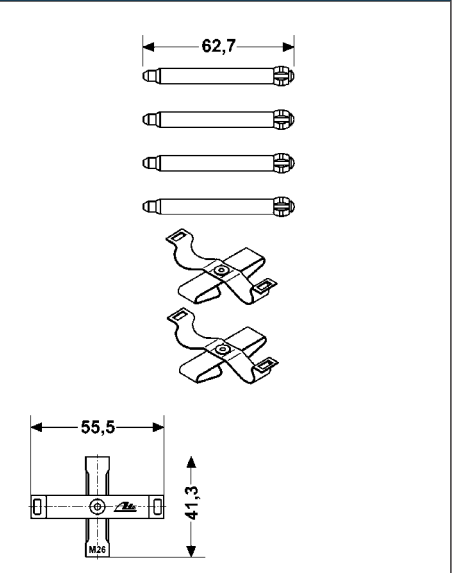
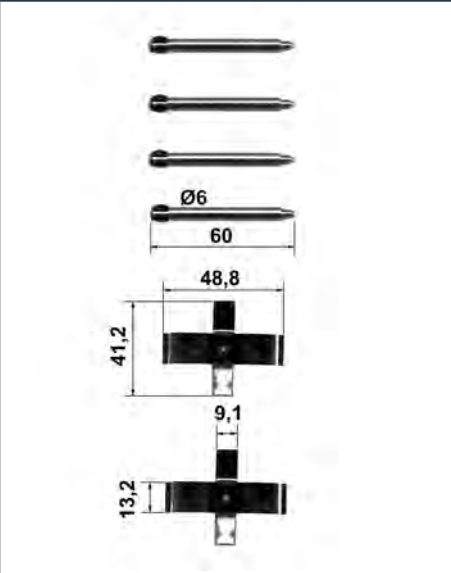
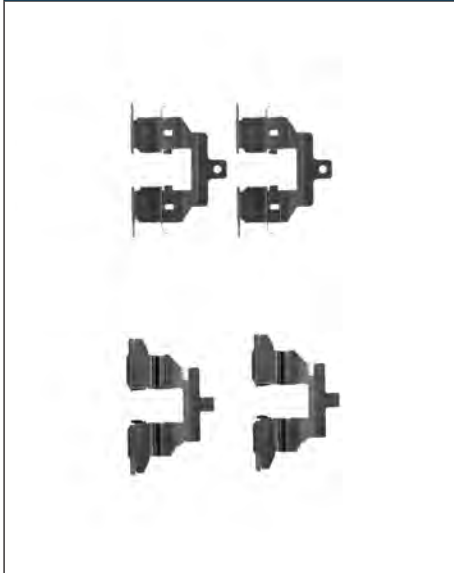

# Abbildungen Bremsbelag-Einbausätze

Illustrations brake pad installation kits - Ilustraciones juegos de montaje pastillas - Illustrations Lots de montage pour plaquettes de frein à disque - Illustrazioni kit installazione pastiglie freno

**13.0460-0219.2 610219 13.0460-0222.2 610222 13.0460-0225.2 610225**

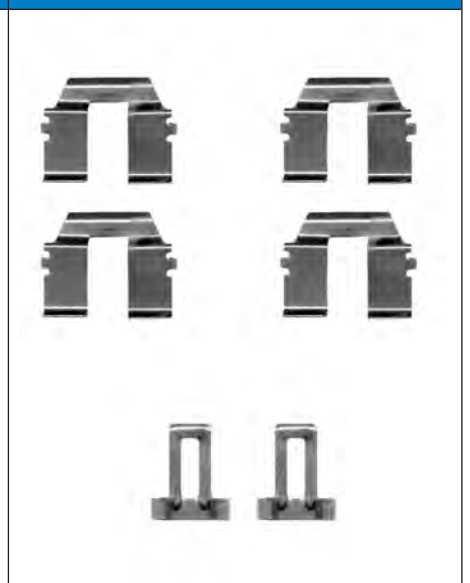
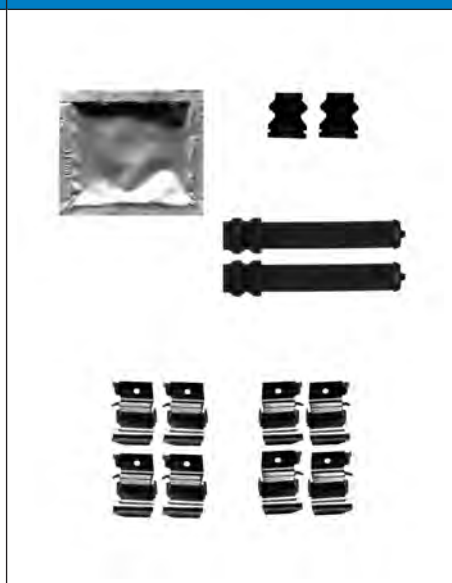
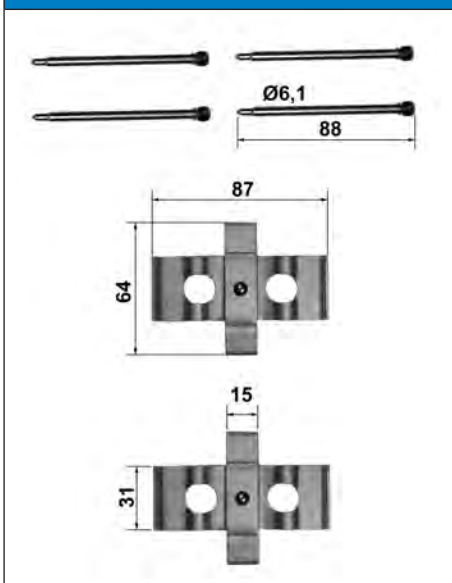

**13.0460-0229.2 610229 13.0460-0231.2 610231 13.0460-0233.2 610233**

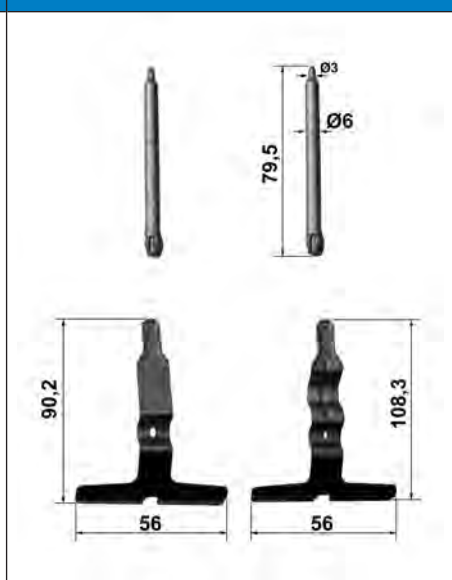
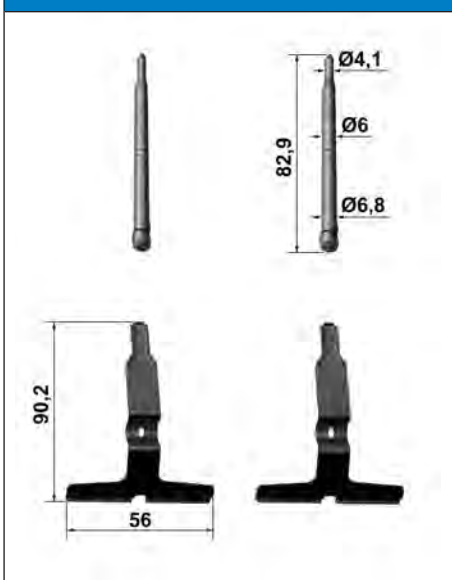

**13.0460-0234.2 610234 13.0460-0235.2 610235 13.0460-0236.2 610236**

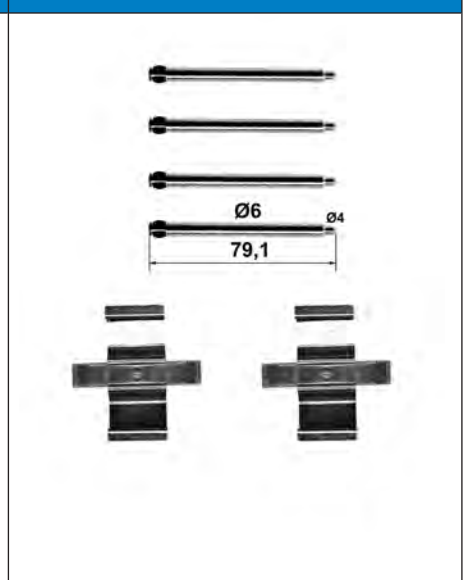
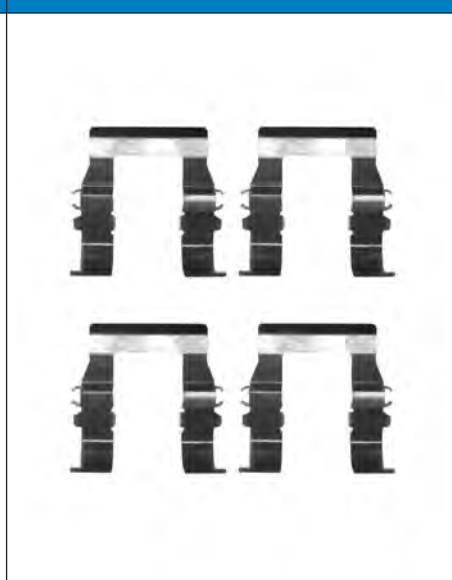
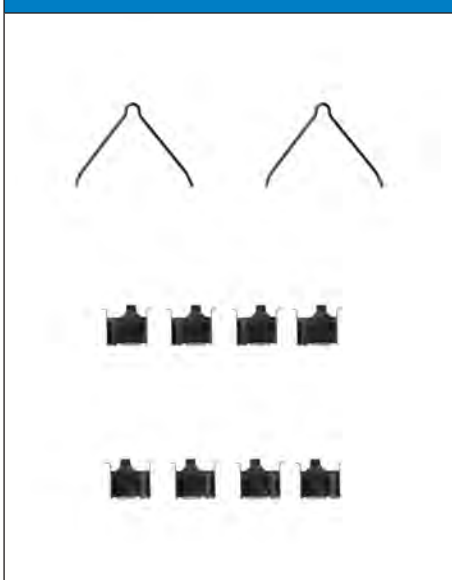







# Abbildungen Bremsbelag-Einbausätze

Illustrations brake pad installation kits - Ilustraciones juegos de montaje pastillas - Illustrations Lots de montage pour plaquettes de frein à disque - Illustrazioni kit installazione pastiglie freno

13.0460-0237.2 610237	13.0460-0238.2 610238	13.0460-0239.2 610239
13.0460-0245.2 610245	13.0460-0246.2 610246	13.0460-0248.2 610248
13.0460-0250.2 610250	13.0460-0252.2 610252	13.0460-0254.2 610254

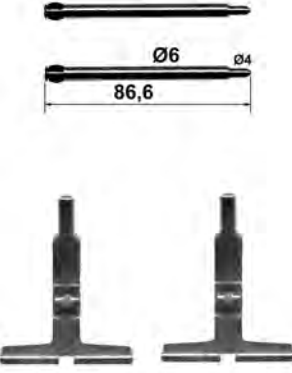
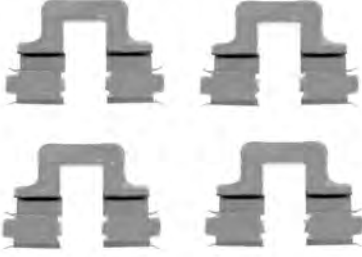
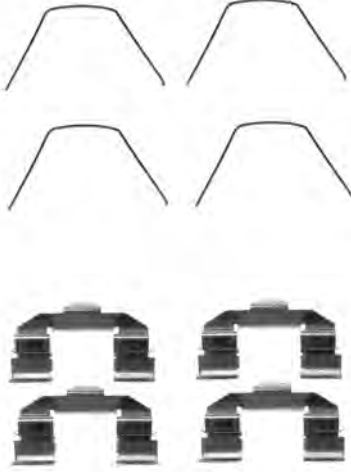
# Abbildungen Bremsbelag-Einbausätze

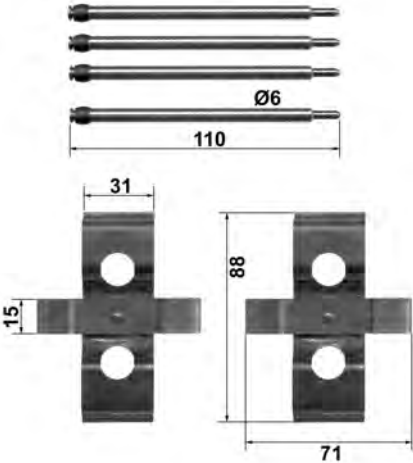
Illustrations brake pad installation kits - Ilustraciones juegos de montaje pastillas - Illustrations Lots de montage pour plaquettes de frein à disque - Illustrazioni kit installazione pastiglie freno

13.0460-0256.2 610256	13.0460-0257.2 610257	13.0460-0258.2 610258
		
13.0460-0259.2 610259	13.0460-0260.2 610260	13.0460-0261.2 610261
		
13.0460-0262.2 610262	13.0460-0263.2 610263	13.0460-0264.2 610264
		



# Abbildungen Bremsbelag-Einbausätze

Illustrations brake pad installation kits - Ilustraciones juegos de montaje pastillas - Illustrations Lots de montage pour plaquettes de frein à disque - Illustrazioni kit installazione pastiglie freno

**13.0460-0265.2 610265 13.0460-0267.2 610267 13.0460-0268.2 610268**

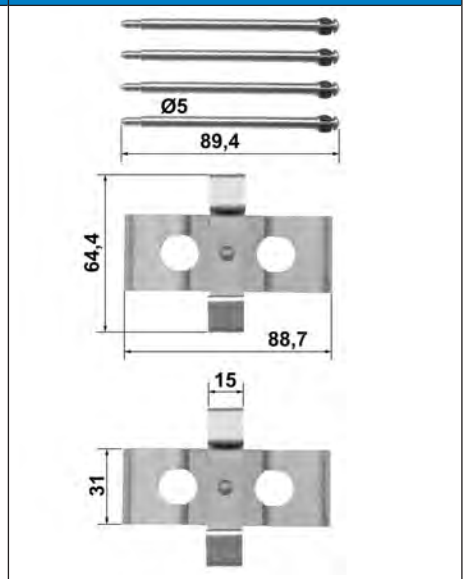
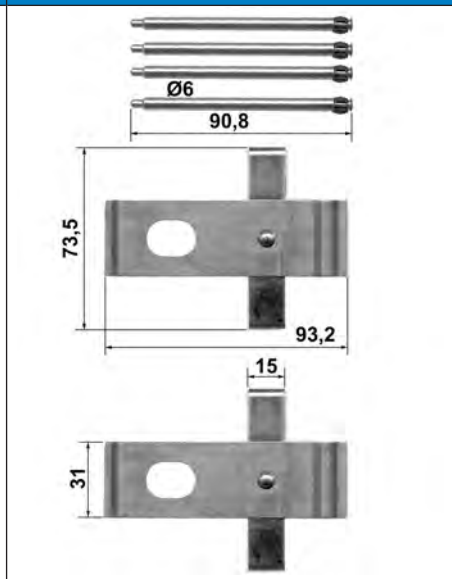
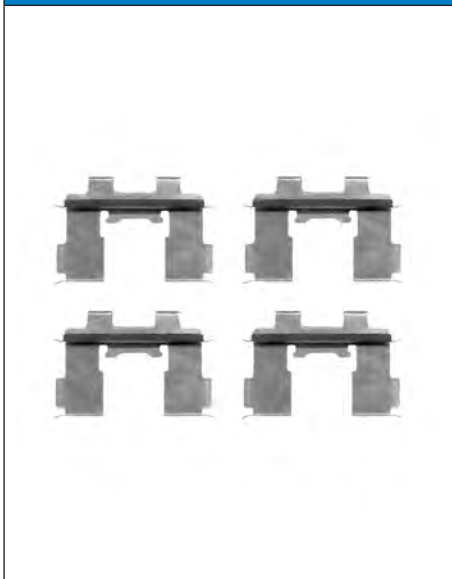

**13.0460-0269.2 610269 13.0460-0275.2 610275 13.0460-0278.2 610278**

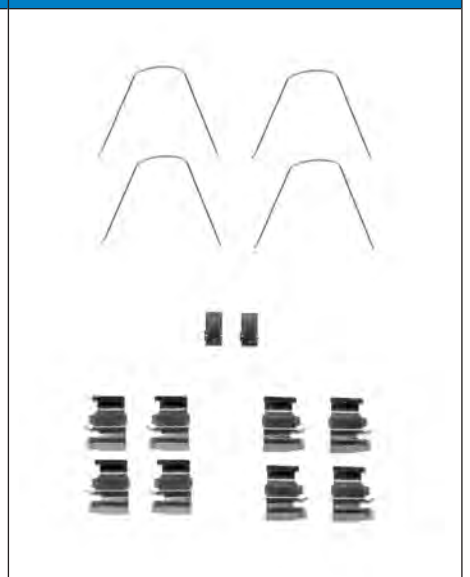
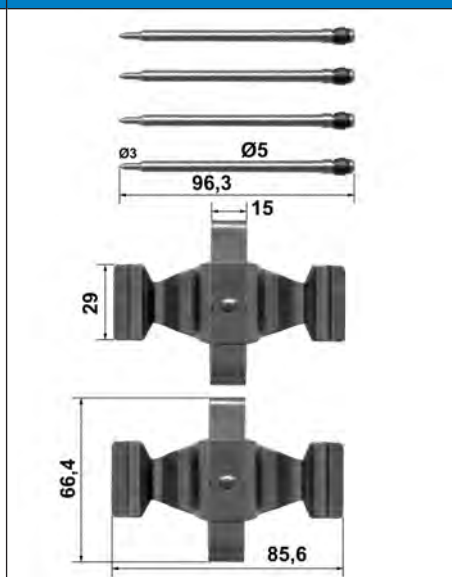
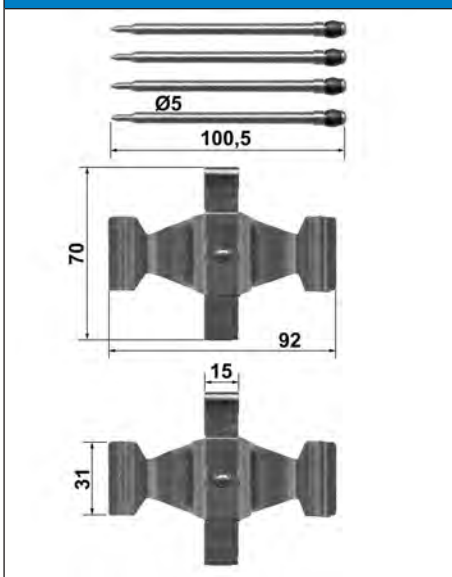

**13.0460-0279.2 610279 13.0460-0280.2 610280 13.0460-0281.2 610281**

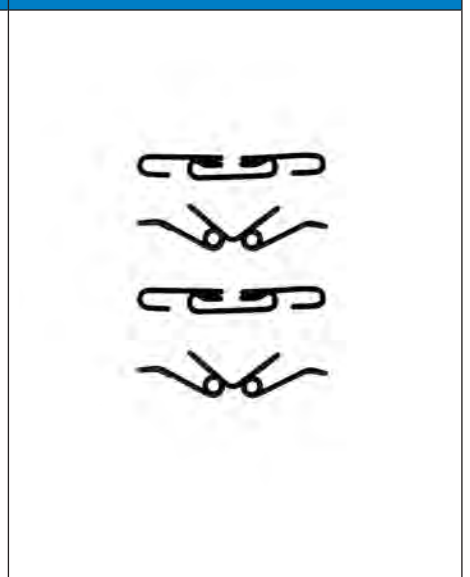
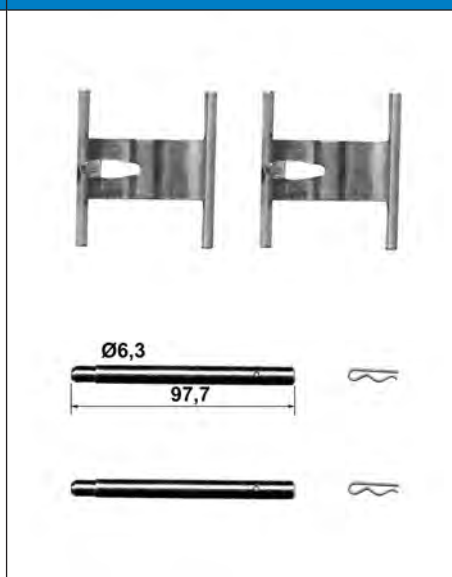
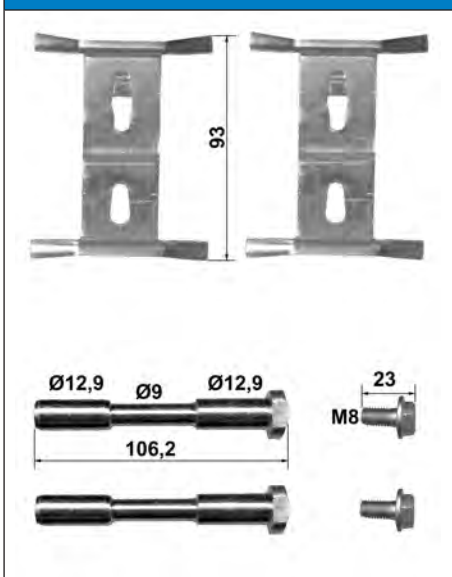

# Abbildungen Bremsbelag-Einbausätze

Illustrations brake pad installation kits - Ilustraciones juegos de montaje pastillas - Illustrations Lots de montage pour plaquettes de frein à disque - Illustrazioni kit installazione pastiglie freno

**13.0460-0282.2 610282 13.0460-0283.2 610283 13.0460-0284.2 610284**

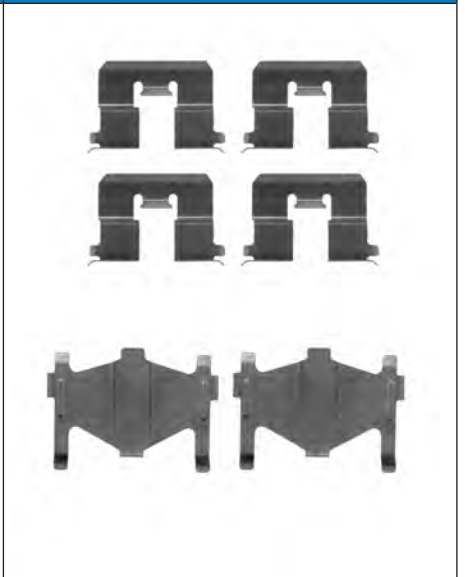
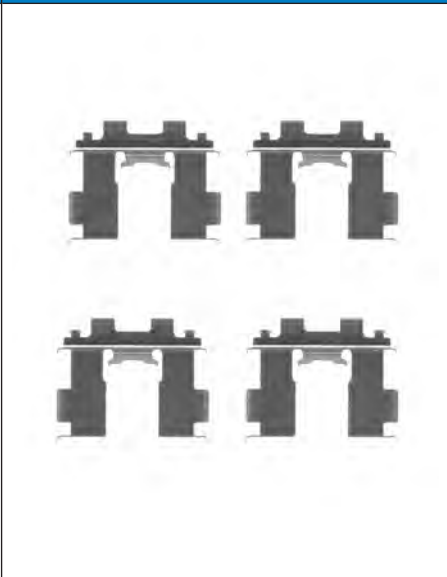
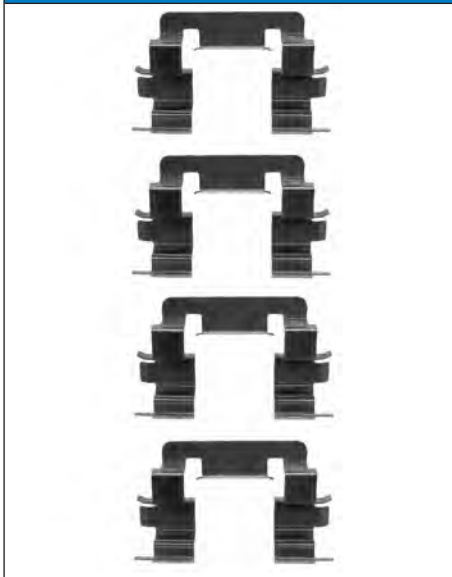

**13.0460-0285.2 610285 13.0460-0286.2 610286 13.0460-0287.2 610287**

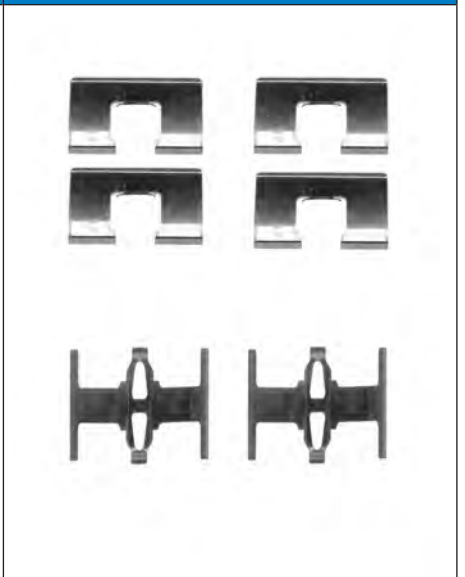
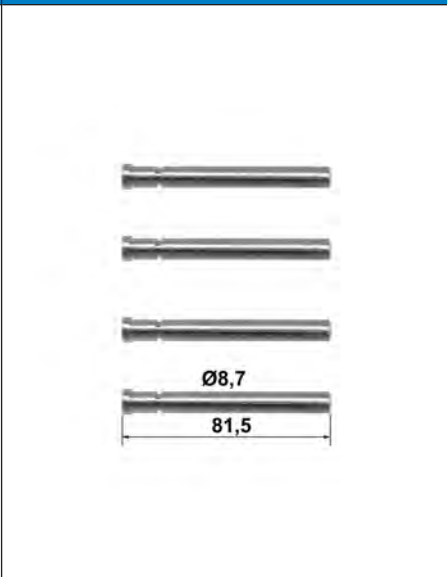

**13.0460-0288.2 610288 13.0460-0289.2 610289 13.0460-0291.2 610291**

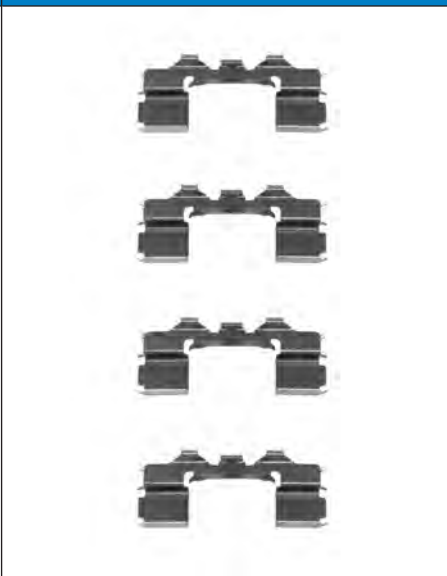
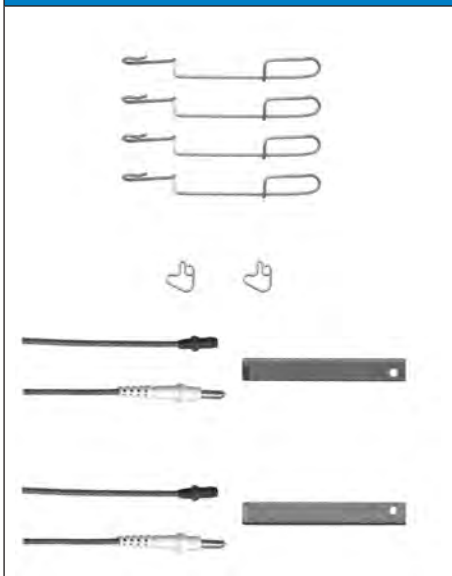

# Abbildungen Bremsbelag-Einbausätze

Illustrations brake pad installation kits - Ilustraciones juegos de montaje pastillas - Illustrations Lots de montage pour plaquettes de frein à disque - Illustrazioni kit installazione pastiglie freno

**13.0460-0295.2 610295**    **13.0460-0296.2 610296**    **13.0460-0308.2 610308**

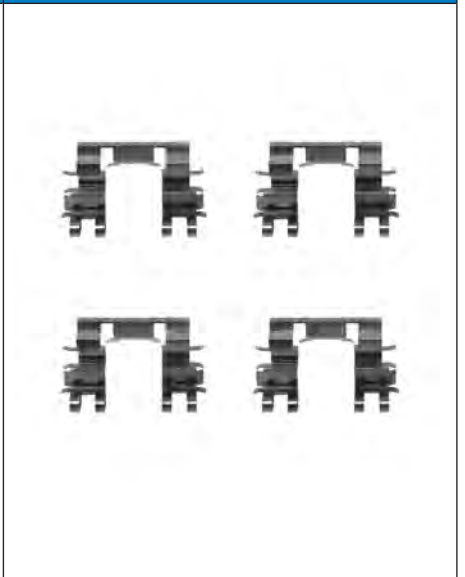
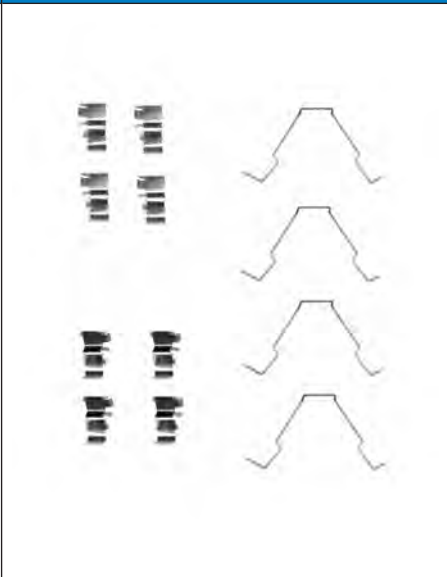
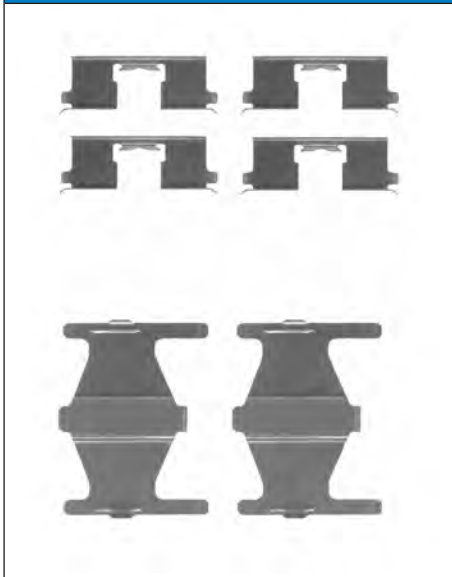

**13.0460-0313.2 610313**    **13.0460-0322.2 610322**    **13.0460-0325.2 610325**

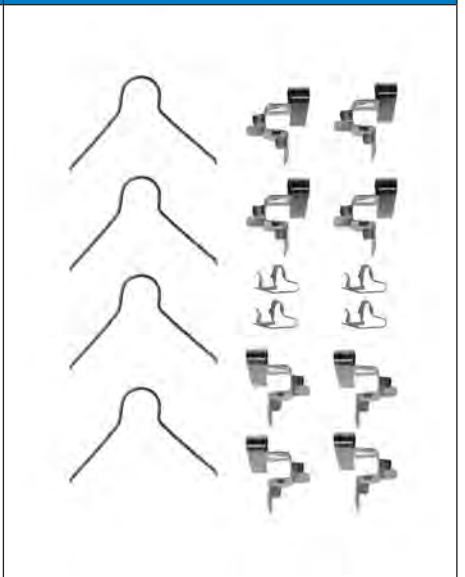
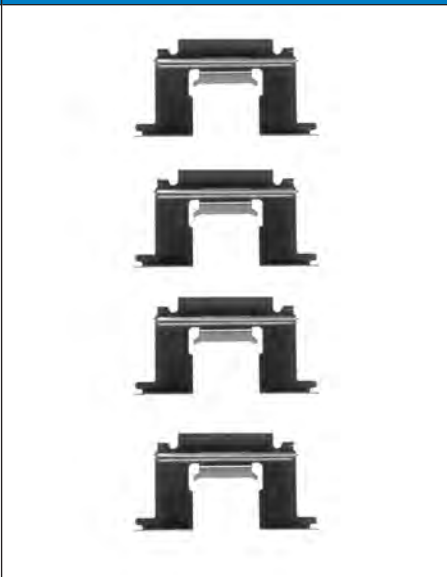
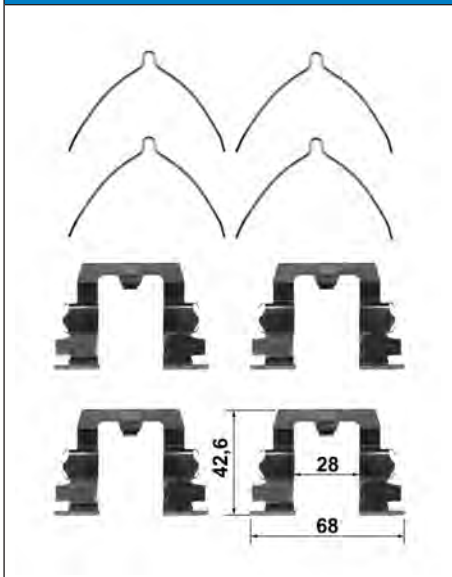



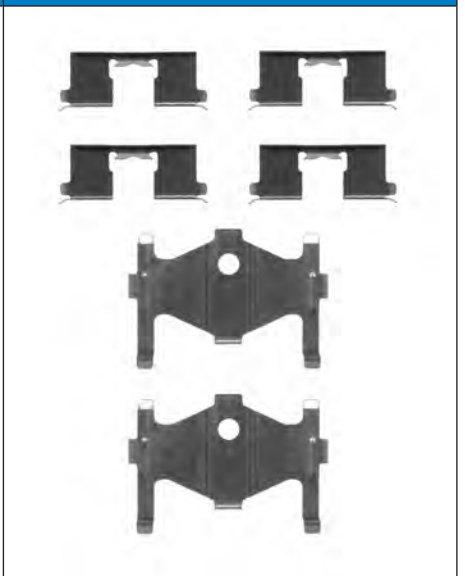
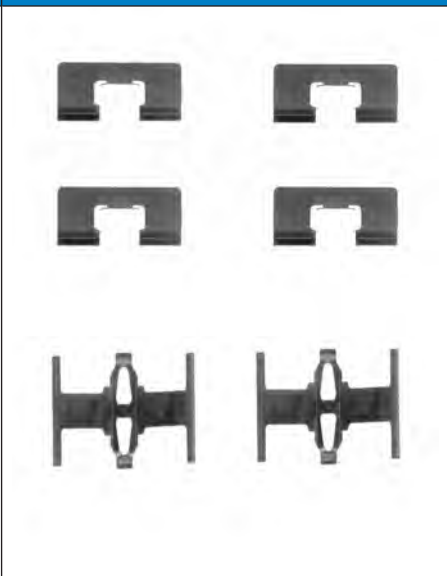
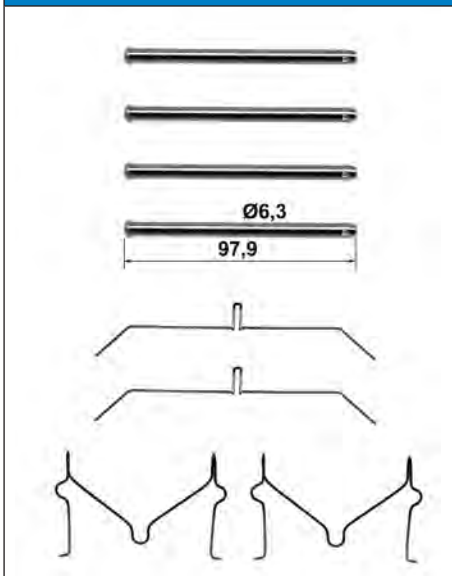





**13.0460-0327.2 610327**    **13.0460-0329.2 610329**    **13.0460-0332.2 610332**

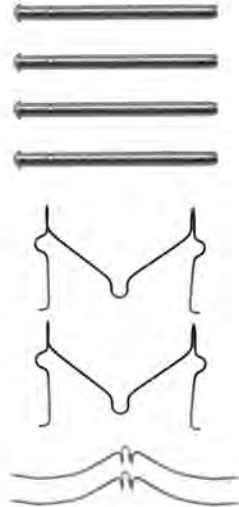

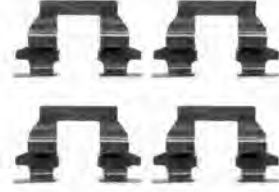
# Abbildungen Bremsbelag-Einbausätze

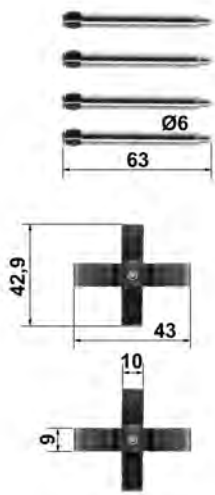
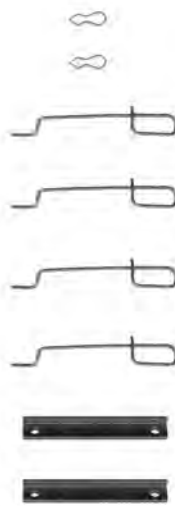
Illustrations brake pad installation kits - Ilustraciones juegos de montaje pastillas - Illustrations Lots de montage pour plaquettes de frein à disque - Illustrazioni kit installazione pastiglie freno

13.0460-0335.2 610335	13.0460-0337.2 610337	13.0460-0339.2 610339
		
13.0460-0340.2 610340	13.0460-0341.2 610341	13.0460-0344.2 610344
		
13.0460-0347.2 610347	13.0460-0402.2 610402	13.0460-0403.2 610403
		

# Abbildungen Bremsbelag-Einbausätze

Illustrations brake pad installation kits - Ilustraciones juegos de montaje pastillas - Illustrations Lots de montage pour plaquettes de frein à disque - Illustrazioni kit installazione pastiglie freno

**13.0460-0404.2 610404 13.0460-0406.2 610406 13.0460-0409.2 610409**

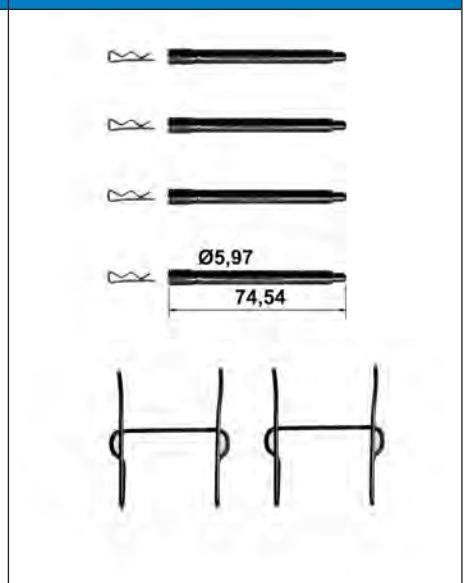
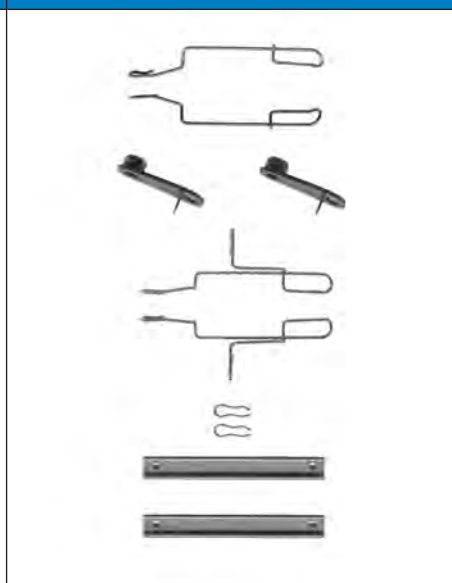
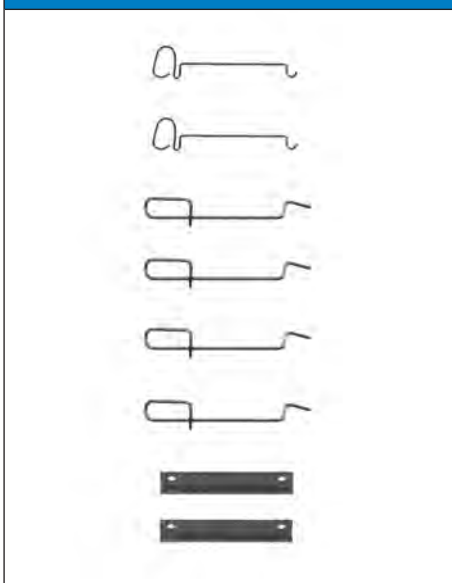

**13.0460-0410.2 610410 13.0460-0411.2 610411 13.0460-0412.2 610412**

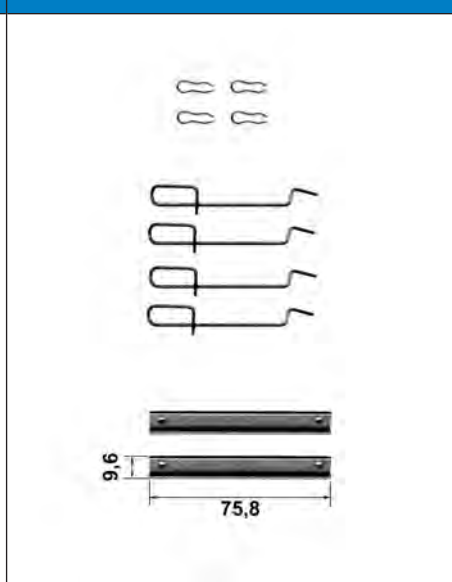
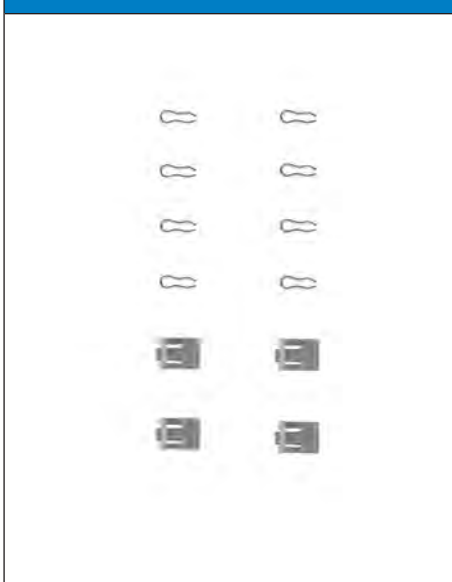

**13.0460-0413.2 610413 13.0460-0414.2 610414 13.0460-0415.2 610415**

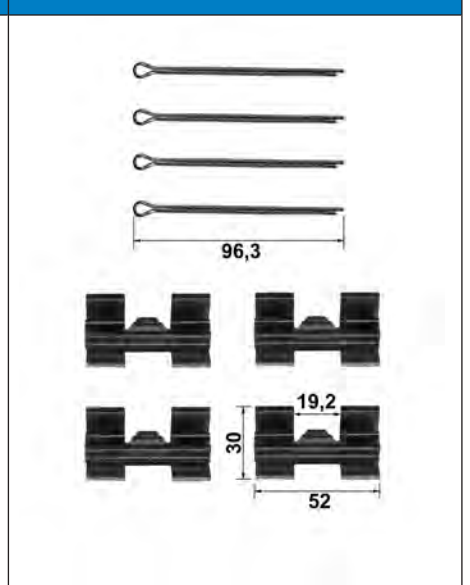
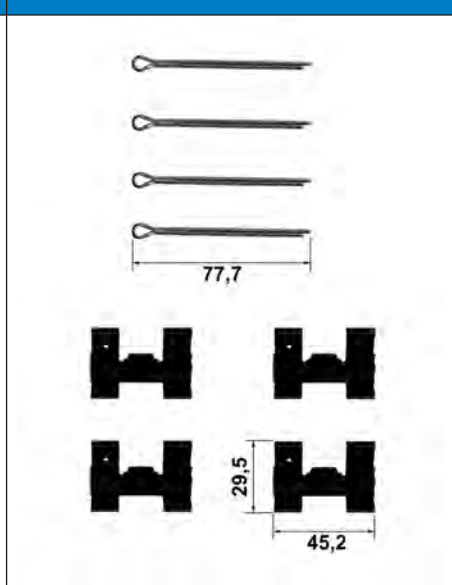
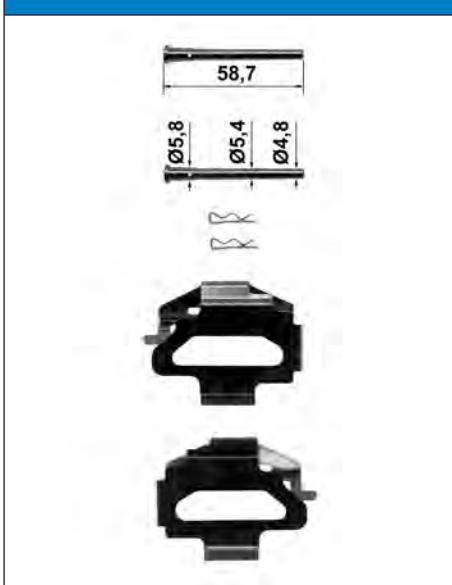



# Abbildungen Bremsbelag-Einbausätze

Illustrations brake pad installation kits - Ilustraciones juegos de montaje pastillas - Illustrations Lots de montage pour plaquettes de frein à disque - Illustrazioni kit installazione pastiglie freno

**13.0460-0419.2 610419 13.0460-0423.2 610423 13.0460-0424.2 610424**

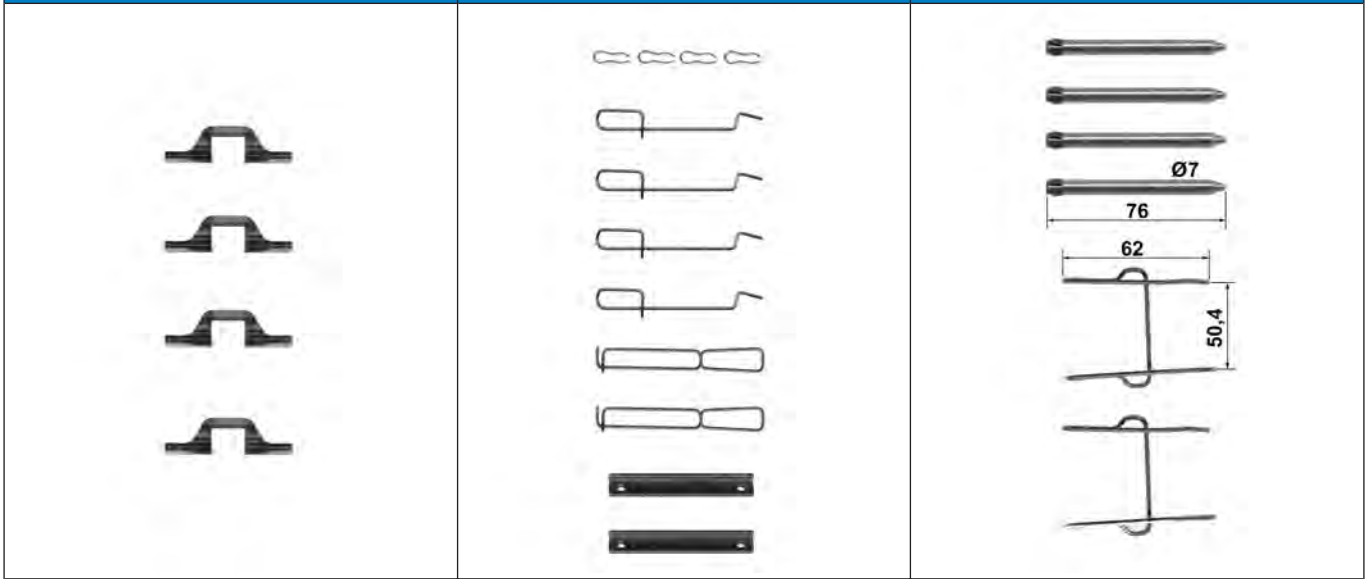

**13.0460-0427.2 610427 13.0460-0428.2 610428 13.0460-0429.2 610429**



**13.0460-0430.2 610430 13.0460-0434.2 610434 13.0460-0435.2 610435**

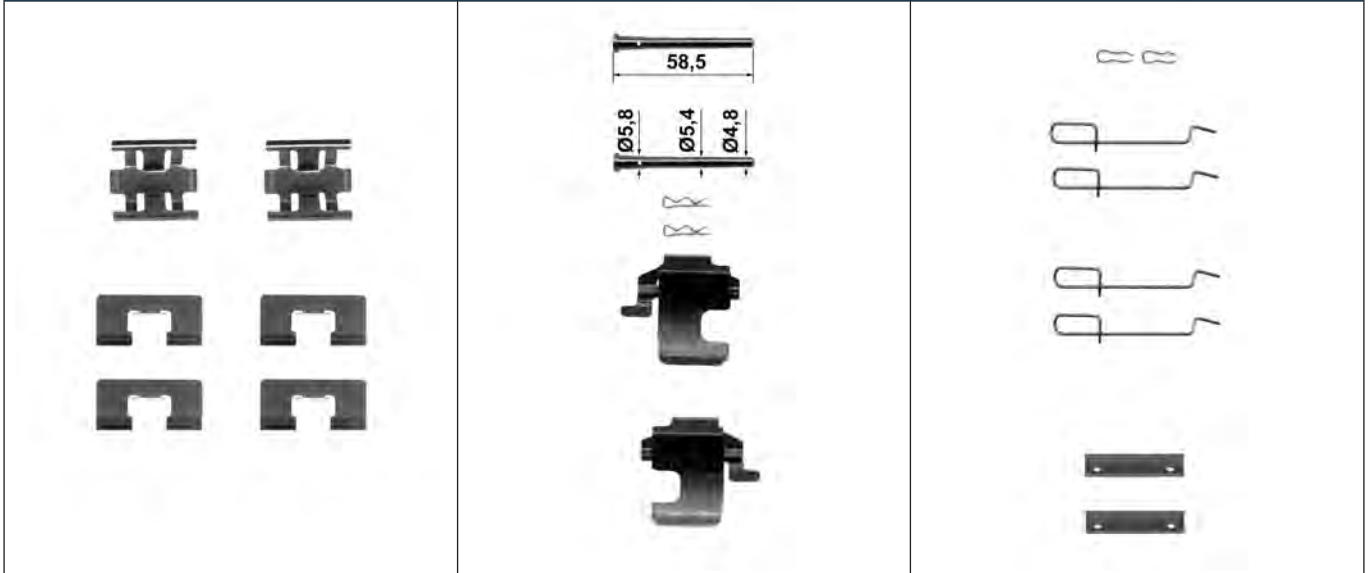

# Abbildungen Bremsbelag-Einbausätze

Illustrations brake pad installation kits - Ilustraciones juegos de montaje pastillas - Illustrations Lots de montage pour plaquettes de frein à disque - Illustrazioni kit installazione pastiglie freno

**13.0460-0436.2 610436 13.0460-0437.2 610437 13.0460-0438.2 610438**

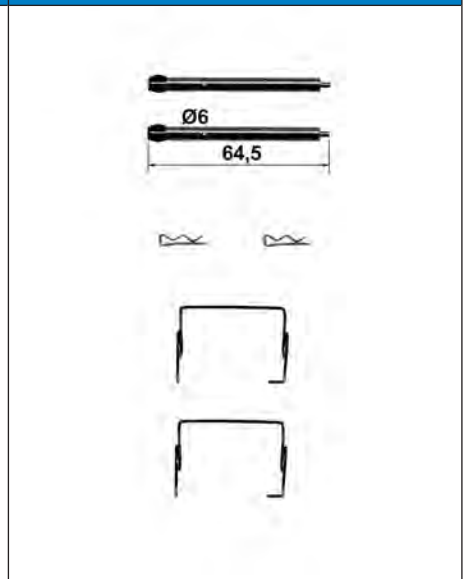
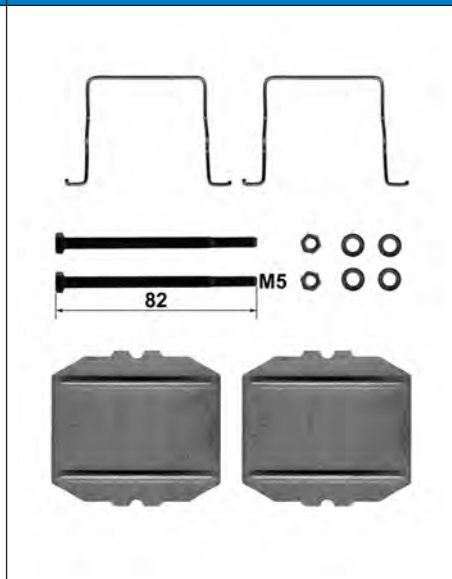
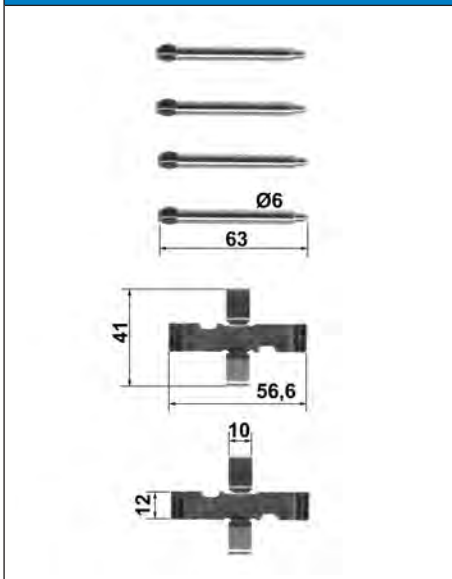

**13.0460-0439.2 610439 13.0460-0440.2 610440 13.0460-0441.2 610441**

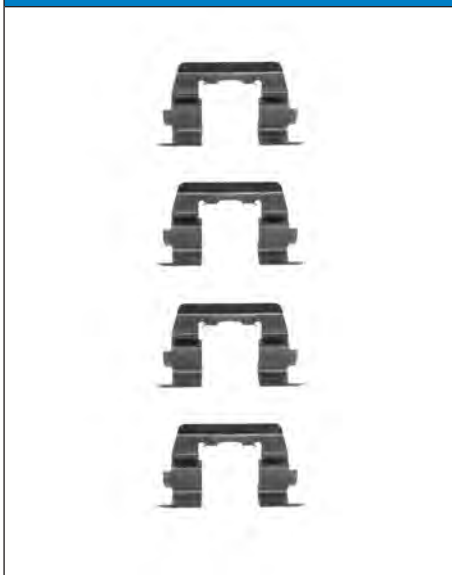



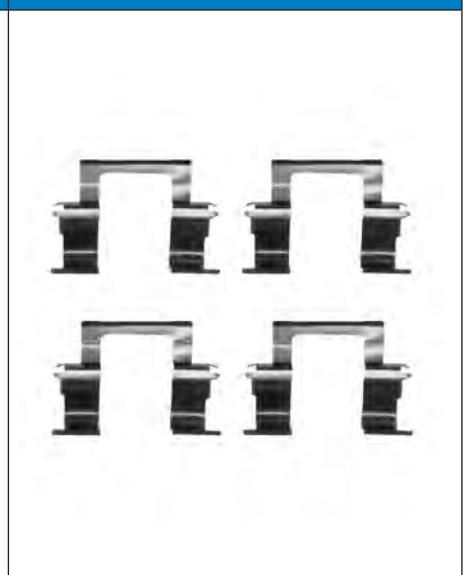
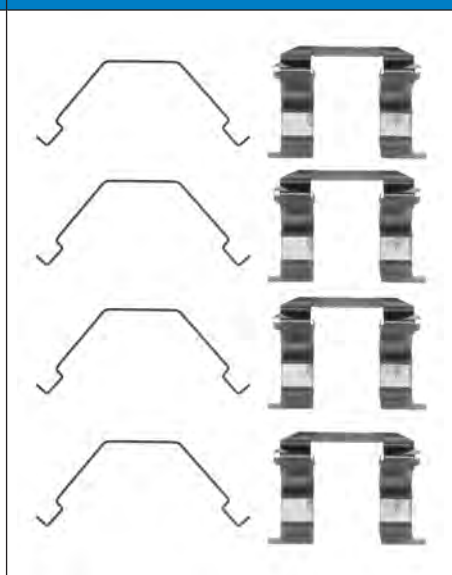
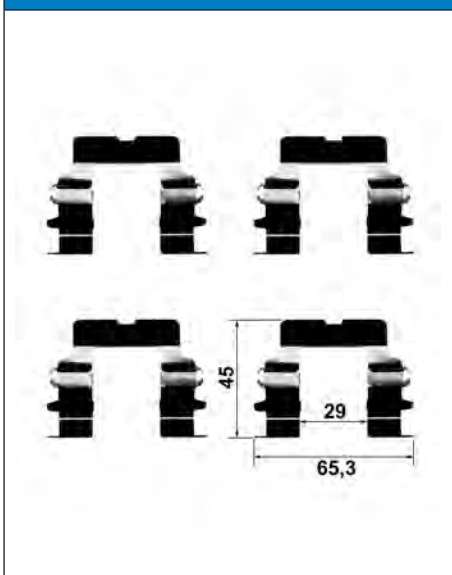





**13.0460-0442.2 610442 13.0460-0443.2 610443 13.0460-0446.2 610446**

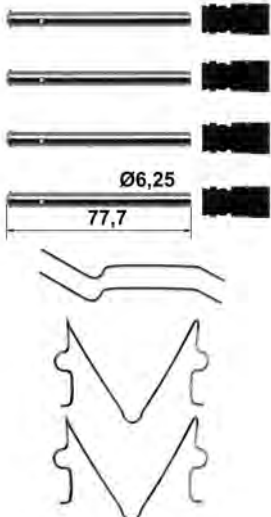

# Abbildungen Bremsbelag-Einbausätze

Illustrations brake pad installation kits - Ilustraciones juegos de montaje pastillas - Illustrations Lots de montage pour plaquettes de frein à disque - Illustrazioni kit installazione pastiglie freno

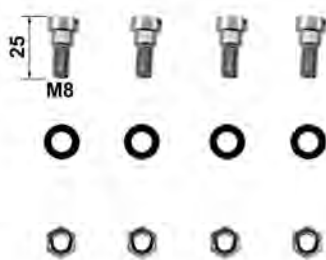
13.0460-0447.2 610447	13.0460-0448.2 610448	13.0460-0449.2 610449
		
13.0460-0450.2 610450	13.0460-0451.2 610451	13.0460-0452.2 610452
		
13.0460-0453.2 610453	13.0460-0454.2 610454	13.0460-0918.2 610918
		





- DE** Abbildungen Warnkontakte
- EN** Illustrations wear indicators
- ES** Ilustraciones contactos de desgaste
- FR** Illustrations témoins d'usure
- IT** Illustrazioni rilevatori usura

2019





# Abbildungen Warnkontakte

Pictures Warning Contacts - Fotos de advertencia Contactos - Photos Avertissement Contacts - Immagini di avvertimento Contatti

**24.8190-0005.2 620005**



## Warnkontakt, Bremsbelagverschleiß

Scheibenbremse

L= 84

### MERCEDES-BENZ

SPRINTER 4,6-t Kasten (906) / SPRINTER 4,6-t Pritsche/Fahrgestell (906) / SPRINTER 5-t Bus / SPRINTER 5-t Kasten (906) / SPRINTER 5-t Pritsche/Fahrgestell (906) / SPRINTER CLASSIC 4,6-t Bus (909)

### VW

CRAFTER 30-35 Bus (2E\_) / CRAFTER 30-50 Kasten (2E\_) / CRAFTER 30-50 Pritsche/Fahrgestell (2F\_)

**24.8190-0006.2 620006**



## Warnkontakt, Bremsbelagverschleiß

Scheibenbremse

L= 675

### BMW

1 (F20) / 1 (F21) / 2 Cabriolet (F23) / 2 Coupe (F22, F87) / 3 (F30, F80) / 3 Gran Turismo (F34) / 3 Touring (F31) / 4 Cabriolet (F33, F83) / 4 Coupe (F32, F82) / 4 Gran Coupe (F36)

**24.8190-0007.2 620007**



## Warnkontakt, Bremsbelagverschleiß

Scheibenbremse

L= 1.045

### BMW

1 (F20) / 1 (F21) / 2 Cabriolet (F23) / 2 Coupe (F22, F87) / 3 (F30, F80) / 3 Gran Turismo (F34) / 3 Touring (F31) / 4 Cabriolet (F33, F83) / 4 Coupe (F32, F82) / 4 Gran Coupe (F36)

**24.8190-0008.2 620008**



## Warnkontakt, Bremsbelagverschleiß

Scheibenbremse

L= 1.000

### BMW

5 (F10) / 6 Cabriolet (F12) / 6 Coupe (F13) / 6 Gran Coupe (F06)

**24.8190-0009.2 620009**



## Warnkontakt, Bremsbelagverschleiß

Scheibenbremse

L= 808

### MINI

MINI CLUBVAN (R55) / MINI Coupe (R58) / MINI Roadster (R59)

# Abbildungen Warnkontakte

Pictures Warning Contacts - Fotos de advertencia Contactos - Photos Avertissement Contacts - Immagini di avvertimento Contatti

## 24.8190-0010.2 620010



### Warnkontakt, Bremsbelagverschleiß

Scheibenbremse

L= 1.141

#### MINI

MINI (R56) / MINI Cabriolet (R57) / MINI CLUBMAN (R55) / MINI CLUBVAN (R55) / MINI Coupe (R58) / MINI Roadster (R59)

## 24.8190-0011.2 620011



### Warnkontakt, Bremsbelagverschleiß

Scheibenbremse

L= 362,5

#### AUDI

Q7 (4LB)

## 24.8190-0012.2 620012



### Warnkontakt, Bremsbelagverschleiß

Scheibenbremse

L= 272,4

#### AUDI

Q7 (4LB)

## 24.8190-0013.2 620013



### Warnkontakt, Bremsbelagverschleiß

Scheibenbremse

L= 323

#### VW

TOUAREG (7P5, 7P6)

## 24.8190-0014.2 620014



### Warnkontakt, Bremsbelagverschleiß

Scheibenbremse

L= 296

#### PORSCHE

CAYENNE (92A) / PANAMERA (970)

#### VW

TOUAREG (7P5, 7P6)

# Abbildungen Warnkontakte

Pictures Warning Contacts - Fotos de advertencia Contactos - Photos Avertissement Contacts - Immagini di avvertimento Contatti

**24.8190-0015.2 620015**



## Warnkontakt, Bremsbelagverschleiß

Scheibenbremse

L= 138

**PORSCHE**  
CAYENNE (92A) / PANAMERA (970)

**VW**  
TOUAREG (7P5, 7P6)

**24.8190-0016.2 620016**



## Warnkontakt, Bremsbelagverschleiß

Scheibenbremse

L= 359,6

**PORSCHE**  
911 (997) / 911 Cabriolet (997)

**24.8190-0017.2 620017**



## Warnkontakt, Bremsbelagverschleiß

Scheibenbremse

L= 388,3

**AUDI**  
A4 Avant (8K5, B8) / A4 Cabriolet (8H7, B6, 8HE, B7) / A5 Cabriolet (8F7) / R8 (422, 423) / R8 Spyder (427, 429)

**24.8190-0018.2 620018**

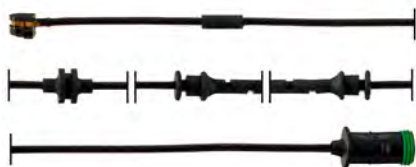

## Warnkontakt, Bremsbelagverschleiß

Scheibenbremse

L= 755

**OPEL**  
ASTRA G Cabriolet (T98) / ASTRA G Caravan (T98) / ASTRA G CC (T98) / ASTRA G Coupe (T98) / ASTRA G Kasten (F70) / ASTRA G Stufenheck (T98) / ZAFIRA A Großraumlimousine (T98)

**VAUXHALL**  
ASTRA Mk IV (G) Cabriolet (T98) / ASTRA Mk IV (G) CC (T98) / ASTRA Mk IV (G) Coupe (T98) / ASTRA Mk IV (G) Kombi (T98) / ASTRA Mk IV (G) Stufenheck (T98) / ASTRAVAN Mk IV (G) (T98) / ZAFIRA Mk I (A) (T98)

# Abbildungen Warnkontakte

Pictures Warning Contacts - Fotos de advertencia Contactos - Photos Avertissement Contacts - Immagini di avvertimento Contatti

**24.8190-0019.2 620019**



## Warnkontakt, Bremsbelagverschleiß

Scheibenbremse

L= 254

### AUDI

A6 (4G2, 4GC, C7) / A6 Avant (4G5, 4GD, C7) / A7 Sportback (4GA, 4GF) / A8 (4H2, 4H8, 4HC, 4HL)

**24.8190-0020.2 620020**



## Warnkontakt, Bremsbelagverschleiß

Scheibenbremse

L= 443,3

### AUDI

A6 (4G2, 4GC, C7) / A6 Avant (4G5, 4GD, C7) / A7 Sportback (4GA, 4GF) / A7 Sportback (4KA) / A8 (4H2, 4H8, 4HC, 4HL)

**24.8190-0021.2 620021**



## Warnkontakt, Bremsbelagverschleiß

Scheibenbremse

L= 478

### FORD

TOURNEO CUSTOM Bus / TRANSIT CUSTOM Bus / TRANSIT CUSTOM Kasten

**24.8190-0023.2 620023**



## Warnkontakt, Bremsbelagverschleiß

Scheibenbremse

L= 484,6

### PORSCHE

911 (997) / 911 Cabriolet (997) / 911 Targa (997)

**24.8190-0024.2 620024**



## Warnkontakt, Bremsbelagverschleiß

Scheibenbremse

L= 369,6

### PORSCHE

911 (997) / BOXSTER (987) / BOXSTER Spyder (987) / CAYMAN (987)

# Abbildungen Warnkontakte

Pictures Warning Contacts - Fotos de advertencia Contactos - Photos Avertissement Contacts - Immagini di avvertimento Contatti

**24.8190-0025.2 620025**



## Warnkontakt, Bremsbelagverschleiß

Scheibenbremse

L= 349,6

### PORSCHE

911 (997) / BOXSTER (987) / BOXSTER Spyder (987) / CAYMAN (987)

**24.8190-0026.2 620026**



## Warnkontakt, Bremsbelagverschleiß

Scheibenbremse

L= 312

### FORD

TOURNEO CUSTOM Bus / TRANSIT Bus / TRANSIT CUSTOM Bus / TRANSIT CUSTOM Kasten / TRANSIT Kasten / TRANSIT Pritsche/Fahrgestell

**24.8190-0027.2 620027**



## Warnkontakt, Bremsbelagverschleiß

Scheibenbremse

L= 514,6

### PORSCHE

911 Targa (997)

**24.8190-0028.2 620028**



## Warnkontakt, Bremsbelagverschleiß

Scheibenbremse

L= 977

### BMW

X5 (E70) / X5 (F15, F85) / X6 (E71, E72) / X6 (F16, F86)



# Abbildungen Warnkontakte

Pictures Warning Contacts - Fotos de advertencia Contactos - Photos Avertissement Contacts - Immagini di avvertimento Contatti

**24.8190-0065.2 620065**



## Warnkontakt, Bremsbelagverschleiß

Scheibenbremse

L= 172

### AUDI

A3 (8V1, 8VK) / A3 Limousine (8VS, 8VM) / A3 Sportback (8VA, 8VF) / Q2 (GAB) / TT (FV3) / TT Roadster (FV9)

### SEAT

ATECA (KH7) / LEON (5F1) / LEON Kasten/Schrägheck (5F1) / LEON SC (5F5) / LEON ST (5F8) / LEON ST Kasten/Kombi (5F8)

### SKODA

KAROQ (NU7) / KODIAQ (NS7) / SUPERB III (3V3) / SUPERB III Kombi (3V5)

### VW

ARTEON (3H7) / GOLF VII (5G1, BQ1, BE1, BE2) / GOLF VII Variant (BA5, BV5) / PASSAT (3G2) / PASSAT ALLTRACK (3G5) / PASSAT Variant (3G5) / TIGUAN (AD1) / TIGUAN ALLSPACE (BW2) / TOURAN (5T1) / T-ROC (A11)

**24.8190-0066.2 620066**



## Warnkontakt, Bremsbelagverschleiß

Scheibenbremse

L= 397,4

### PORSCHE

CAYENNE (9PA)

**24.8190-0067.2 620067**



## Warnkontakt, Bremsbelagverschleiß

Scheibenbremse

L= 92,5

### MERCEDES-BENZ

A-CLASS (W176) / A-CLASS (W177) / B-CLASS (W246, W242) / C-CLASS (W205) / C-CLASS Cabriolet (A205) / C-CLASS Coupe (C205) / C-CLASS T-Model (S205) / CLA Coupe (C117) / CLA Shooting Brake (X117) / CLS (C257) / E-CLASS (W213) / E-CLASS All-Terrain (S213) / E-CLASS Cabriolet (A238) / E-CLASS Coupe (C238) / E-CLASS T-Model (S213) / G-CLASS (W463) / GLA-CLASS (X156) / GLC (X253) / GLC Coupe (C253)

**24.8190-0068.2 620068**



## Warnkontakt, Bremsbelagverschleiß

Scheibenbremse

L= 332

### AUDI

A7 Sportback (4GA, 4GF) / Q5 (8RB)

# Abbildungen Warnkontakte

Pictures Warning Contacts - Fotos de advertencia Contactos - Photos Avertissement Contacts - Immagini di avvertimento Contatti

**24.8190-0069.2 620069**



## Warnkontakt, Bremsbelagverschleiß

Scheibenbremse

L= 248

### PORSCHE

911 (991) / 911 Cabriolet (991) / 911 Targa (991) / BOXSTER (981) / CAYMAN (981)

**24.8190-0070.2 620070**



## Warnkontakt, Bremsbelagverschleiß

Scheibenbremse

L= 268

### PORSCHE

718 BOXSTER (982) / 718 CAYMAN (982) / BOXSTER (981) / CAYMAN (981)

**24.8190-0071.2 620071**



## Warnkontakt, Bremsbelagverschleiß

Scheibenbremse

L= 945

### BMW

X5 (E70) / X5 (F15, F85) / X6 (E71, E72) / X6 (F16, F86)

**24.8190-0106.2 620106**



## Warnkontakt, Bremsbelagverschleiß

Scheibenbremse

L= 270

### AUDI

TT (8N3) / TT Roadster (8N9)

### PORSCHE

911 (991) / 911 Cabriolet (991) / 911 Targa (991)

### VW

GOLF IV (1J1)

**24.8190-0107.2 620107**



## Warnkontakt, Bremsbelagverschleiß

Scheibenbremse

L= 235

### VW

PASSAT (3B3) / PASSAT Variant (3B6)

# Abbildungen Warnkontakte

Pictures Warning Contacts - Fotos de advertencia Contactos - Photos Avertissement Contacts - Immagini di avvertimento Contatti

## 24.8190-0206.2 620206



### Warnkontakt, Bremsbelagverschleiß

Scheibenbremse

L= 790

#### BMW

3 (E36) / 3 Cabriolet (E36) / 3 Coupe (E36) / 3 Touring (E36)

## 24.8190-0207.2 620207



### Warnkontakt, Bremsbelagverschleiß

Scheibenbremse

L= 786

#### BMW

3 (E36) / 3 Cabriolet (E36) / 3 Compact (E36) / 3 Coupe (E36) / 3 Touring (E36) / Z3 Coupe (E36) / Z3 Roadster (E36)

## 24.8190-0208.2 620208



### Warnkontakt, Bremsbelagverschleiß

Scheibenbremse

L= 569

#### BMW

7 (E38)

## 24.8190-0209.2 620209



### Warnkontakt, Bremsbelagverschleiß

Scheibenbremse

L= 620

#### BMW

7 (E38)

## 24.8190-0210.2 620210



### Warnkontakt, Bremsbelagverschleiß

Scheibenbremse

L= 810

#### BMW

3 (E36) / 3 Cabriolet (E36) / 3 Coupe (E36) / Z3 Coupe (E36) / Z3 Roadster (E36)

# Abbildungen Warnkontakte

Pictures Warning Contacts - Fotos de advertencia Contactos - Photos Avertissement Contacts - Immagini di avvertimento Contatti

## 24.8190-0211.2 620211



### Warnkontakt, Bremsbelagverschleiß

Scheibenbremse

L= 840

#### BMW

3 Compact (E36) / Z3 Coupe (E36) / Z3 Roadster (E36)

## 24.8190-0214.2 620214



### Warnkontakt, Bremsbelagverschleiß

Scheibenbremse

L= 235

#### BMW

5 (E28) / 5 (E34) / 5 Touring (E34) / 6 (E24) / 7 (E32) / 8 (E31)

## 24.8190-0218.2 620218



### Warnkontakt, Bremsbelagverschleiß

Scheibenbremse

L= 545

#### BMW

5 (E39) / Z8 Roadster (E52)

## 24.8190-0219.2 620219



### Warnkontakt, Bremsbelagverschleiß

Scheibenbremse

L= 764

#### BMW

5 (E39) / 5 Touring (E39)

## 24.8190-0220.2 620220



### Warnkontakt, Bremsbelagverschleiß

Scheibenbremse

L= 601

#### BMW

3 (E46) / 3 Cabriolet (E46) / 3 Compact (E46) / 3 Coupe (E46) / 3 Touring (E46) / Z4 Roadster (E85)

# Abbildungen Warnkontakte

Pictures Warning Contacts - Fotos de advertencia Contactos - Photos Avertissement Contacts - Immagini di avvertimento Contatti

**24.8190-0221.2 620221**

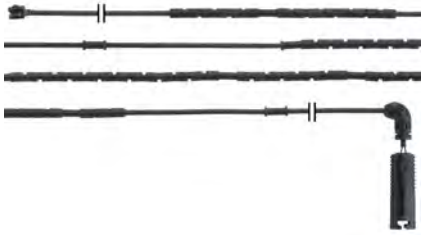

## Warnkontakt, Bremsbelagverschleiß

Scheibenbremse

L= 1.338

### BMW

3 (E46) / 3 Cabriolet (E46) / 3 Compact (E46) / 3 Coupe (E46) / 3 Touring (E46)

**24.8190-0222.2 620222**



## Warnkontakt, Bremsbelagverschleiß

Scheibenbremse

L= 1.090

### BMW

5 Touring (E39)

**24.8190-0223.2 620223**



## Warnkontakt, Bremsbelagverschleiß

Scheibenbremse

L= 261

### BMW

8 (E31)

**24.8190-0224.2 620224**



## Warnkontakt, Bremsbelagverschleiß

Scheibenbremse

L= 311

### BMW

5 (E34) / 5 Touring (E34)

**24.8190-0225.2 620225**



## Warnkontakt, Bremsbelagverschleiß

Scheibenbremse

L= 794

### BMW

X5 (E53)



# Abbildungen Warnkontakte

Pictures Warning Contacts - Fotos de advertencia Contactos - Photos Avertissement Contacts - Immagini di avvertimento Contatti

**24.8190-0226.2 620226**



## Warnkontakt, Bremsbelagverschleiß

Scheibenbremse

L= 712

**BMW**  
X5 (E53)

**24.8190-0227.2 620227**



## Warnkontakt, Bremsbelagverschleiß

Scheibenbremse

L= 651

**BMW**  
3 (E46) / 3 Cabriolet (E46) / 3 Coupe (E46) / 3 Touring (E46)

**24.8190-0228.2 620228**



## Warnkontakt, Bremsbelagverschleiß

Scheibenbremse

L= 1.353

**BMW**  
3 Cabriolet (E46) / 3 Coupe (E46)

**24.8190-0229.2 620229**



## Warnkontakt, Bremsbelagverschleiß

Scheibenbremse

L= 1.143

**BMW**  
Z4 Coupe (E86) / Z4 Roadster (E85)

**24.8190-0230.2 620230**

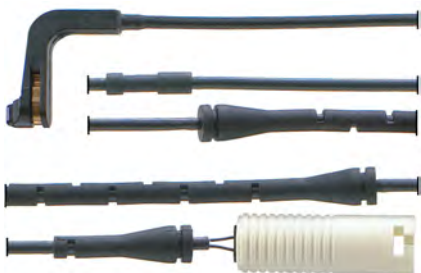

## Warnkontakt, Bremsbelagverschleiß

Scheibenbremse

L= 814

**BMW**  
7 (E65, E66, E67)

# Abbildungen Warnkontakte

Pictures Warning Contacts - Fotos de advertencia Contactos - Photos Avertissement Contacts - Immagini di avvertimento Contatti

24.8190-0231.2 620231

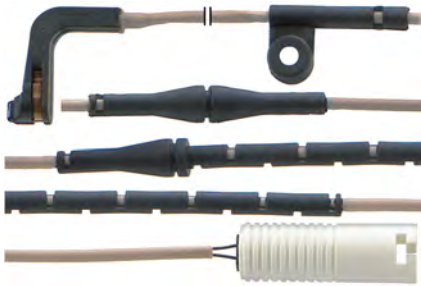

## Warnkontakt, Bremsbelagverschleiß

Scheibenbremse

L= 830

**BMW**  
7 (E65, E66, E67)

24.8190-0232.2 620232



## Warnkontakt, Bremsbelagverschleiß

Scheibenbremse

L= 578

**BMW**  
7 (E38)

24.8190-0233.2 620233



## Warnkontakt, Bremsbelagverschleiß

Scheibenbremse

L= 758

**BMW**  
Z8 Roadster (E52)

24.8190-0234.2 620234



## Warnkontakt, Bremsbelagverschleiß

Scheibenbremse

L= 585

**BMW**  
7 (E38)

24.8190-0235.2 620235



## Warnkontakt, Bremsbelagverschleiß

Scheibenbremse

L= 883

**MINI**  
MINI (R50, R53) / MINI Cabriolet (R52)

# Abbildungen Warnkontakte

Pictures Warning Contacts - Fotos de advertencia Contactos - Photos Avertissement Contacts - Immagini di avvertimento Contatti

**24.8190-0236.2 620236**



## Warnkontakt, Bremsbelagverschleiß

Scheibenbremse

L= 1.130

### MINI

MINI (R50, R53) / MINI Cabriolet (R52)

**24.8190-0240.2 620240**



## Warnkontakt, Bremsbelagverschleiß

Scheibenbremse

L= 735

### BMW

X3 (E83)

**24.8190-0241.2 620241**



## Warnkontakt, Bremsbelagverschleiß

Scheibenbremse

L= 1.055

### BMW

X3 (E83)

**24.8190-0244.2 620244**



## Warnkontakt, Bremsbelagverschleiß

Scheibenbremse

L= 611

### BMW

Z4 Coupe (E86) / Z4 Roadster (E85)

**24.8190-0245.2 620245**



## Warnkontakt, Bremsbelagverschleiß

Scheibenbremse

L= 1.163

### BMW

Z4 Coupe (E86) / Z4 Roadster (E85)

# Abbildungen Warnkontakte

Pictures Warning Contacts - Fotos de advertencia Contactos - Photos Avertissement Contacts - Immagini di avvertimento Contatti

24.8190-0254.2 620254



## Warnkontakt, Bremsbelagverschleiß

Scheibenbremse

L= 745

**BMW**  
X3 (E83)

24.8190-0260.2 620260



## Warnkontakt, Bremsbelagverschleiß

Scheibenbremse

L= 1.060

**BMW**  
5 Gran Turismo (F07) / 7 (F01, F02, F03, F04)

24.8190-0261.2 620261



## Warnkontakt, Bremsbelagverschleiß

Scheibenbremse

L= 1.045

**BMW**  
7 (F01, F02, F03, F04)

24.8190-0262.2 620262



## Warnkontakt, Bremsbelagverschleiß

Scheibenbremse

L= 1.338

**BMW**  
Z4 Roadster (E89)

24.8190-0263.2 620263



## Warnkontakt, Bremsbelagverschleiß

Scheibenbremse

L= 969

**BMW**  
Z4 Roadster (E89)

# Abbildungen Warnkontakte

Pictures Warning Contacts - Fotos de advertencia Contactos - Photos Avertissement Contacts - Immagini di avvertimento Contatti

24.8190-0264.2 620264



## Warnkontakt, Bremsbelagverschleiß

Scheibenbremse

L= 630

### BMW

1 (E81) / 1 (E87) / 1 Cabriolet (E88) / 1 Coupe (E82) / 3 (E90) / 3 Cabriolet (E93) / 3 Coupe (E92) / 3 Touring (E91)

24.8190-0265.2 620265



## Warnkontakt, Bremsbelagverschleiß

Scheibenbremse

L= 1.086

### BMW

1 (E81) / 1 (E87) / 1 Cabriolet (E88) / 1 Coupe (E82) / 3 (E90) / 3 Cabriolet (E93) / 3 Coupe (E92) / 3 Touring (E91)

24.8190-0266.2 620266



## Warnkontakt, Bremsbelagverschleiß

Scheibenbremse

L= 840

### BMW

3 (E90) / 3 Coupe (E92) / 3 Touring (E91) / X1 (E84)

24.8190-0267.2 620267



## Warnkontakt, Bremsbelagverschleiß

Scheibenbremse

L= 679

### BMW

1 (E81) / 1 (E87) / 1 Cabriolet (E88) / 1 Coupe (E82) / 3 (E90) / 3 Cabriolet (E93) / 3 Coupe (E92) / 3 Touring (E91)

24.8190-0268.2 620268



## Warnkontakt, Bremsbelagverschleiß

Scheibenbremse

L= 905

### BMW

X5 (E70) / X6 (E71, E72)



# Abbildungen Warnkontakte

Pictures Warning Contacts - Fotos de advertencia Contactos - Photos Avertissement Contacts - Immagini di avvertimento Contatti

24.8190-0269.2 620269



## Warnkontakt, Bremsbelagverschleiß

Scheibenbremse

L= 965

**BMW**  
X5 (E70) / X6 (E71, E72)

24.8190-0270.2 620270



## Warnkontakt, Bremsbelagverschleiß

Scheibenbremse

L= 898

**BMW**  
X5 (E70) / X6 (E71, E72)

24.8190-0271.2 620271



## Warnkontakt, Bremsbelagverschleiß

Scheibenbremse

L= 659

**BMW**  
1 Coupe (E82) / 3 (E90) / 3 Cabriolet (E93) / 3 Coupe (E92)

24.8190-0272.2 620272



## Warnkontakt, Bremsbelagverschleiß

Scheibenbremse

L= 672

**BMW**  
3 (E90) / 3 Cabriolet (E93) / 3 Coupe (E92)

24.8190-0273.2 620273



## Warnkontakt, Bremsbelagverschleiß

Scheibenbremse

L= 662

**BMW**  
5 (E60) / 5 Touring (E61) / 6 (E63) / 6 Cabriolet (E64)

# Abbildungen Warnkontakte

Pictures Warning Contacts - Fotos de advertencia Contactos - Photos Avertissement Contacts - Immagini di avvertimento Contatti

**24.8190-0274.2 620274**



## Warnkontakt, Bremsbelagverschleiß

Scheibenbremse

L= 664

### BMW

5 (E60) / 6 (E63) / 6 Cabriolet (E64)

**24.8190-0275.2 620275**



## Warnkontakt, Bremsbelagverschleiß

Scheibenbremse

L= 872

### BMW

5 Touring (E61)

**24.8190-0276.2 620276**



## Warnkontakt, Bremsbelagverschleiß

Scheibenbremse

L= 674

### BMW

5 Touring (E61) / 6 (E63) / 6 Cabriolet (E64)

**24.8190-0277.2 620277**



## Warnkontakt, Bremsbelagverschleiß

Scheibenbremse

L= 802

### MINI

MINI (R56) / MINI Cabriolet (R57) / MINI CLUBMAN (R55)

**24.8190-0278.2 620278**



## Warnkontakt, Bremsbelagverschleiß

Scheibenbremse

L= 1.130

### MINI

MINI (R56) / MINI Cabriolet (R57) / MINI CLUBMAN (R55)

# Abbildungen Warnkontakte

Pictures Warning Contacts - Fotos de advertencia Contactos - Photos Avertissement Contacts - Immagini di avvertimento Contatti

24.8190-0279.2 620279



## Warnkontakt, Bremsbelagverschleiß

Scheibenbremse

L= 992

**BMW**  
5 Touring (E61)

24.8190-0280.2 620280



## Warnkontakt, Bremsbelagverschleiß

Scheibenbremse

L= 930

**BMW**  
X6 (E71, E72)

24.8190-0281.2 620281



## Warnkontakt, Bremsbelagverschleiß

Scheibenbremse

L= 962

**BMW**  
X5 (E70) / X6 (E71, E72)

24.8190-0282.2 620282



## Warnkontakt, Bremsbelagverschleiß

Scheibenbremse

L= 1.120

**BMW**  
X1 (E84)

24.8190-0283.2 620283



## Warnkontakt, Bremsbelagverschleiß

Scheibenbremse

L= 632

**BMW**  
X1 (E84)

# Abbildungen Warnkontakte

Pictures Warning Contacts - Fotos de advertencia Contactos - Photos Avertissement Contacts - Immagini di avvertimento Contatti

24.8190-0284.2 620284



## Warnkontakt, Bremsbelagverschleiß

Scheibenbremse

L= 650

### BMW

1 (E81) / 1 (E87) / 1 Cabriolet (E88) / 1 Coupe (E82) / 3 (E90) / 3 Cabriolet (E93) / 3 Coupe (E92) / 3 Touring (E91)

24.8190-0285.2 620285



## Warnkontakt, Bremsbelagverschleiß

Scheibenbremse

L= 1.107

### BMW

1 (E81) / 1 (E87) / 1 Cabriolet (E88) / 1 Coupe (E82) / 3 (E90) / 3 Cabriolet (E93) / 3 Coupe (E92) / 3 Touring (E91)

24.8190-0286.2 620286



## Warnkontakt, Bremsbelagverschleiß

Scheibenbremse

L= 867

### BMW

3 (E90) / 3 Coupe (E92) / 3 Touring (E91) / X1 (E84)

24.8190-0287.2 620287



## Warnkontakt, Bremsbelagverschleiß

Scheibenbremse

L= 723

### BMW

1 (E81) / 1 (E87) / 1 Cabriolet (E88) / 1 Coupe (E82) / 3 (E90) / 3 Cabriolet (E93) / 3 Coupe (E92) / 3 Touring (E91)

24.8190-0288.2 620288



## Warnkontakt, Bremsbelagverschleiß

Scheibenbremse

L= 698

### BMW

1 Cabriolet (E88)

# Abbildungen Warnkontakte

Pictures Warning Contacts - Fotos de advertencia Contactos - Photos Avertissement Contacts - Immagini di avvertimento Contatti

## 24.8190-0289.2 620289



### Warnkontakt, Bremsbelagverschleiß

Scheibenbremse

L= 938

#### BMW

X5 (E70) / X5 (F15, F85) / X6 (E71, E72) / X6 (F16, F86)

## 24.8190-0290.2 620290



### Warnkontakt, Bremsbelagverschleiß

Scheibenbremse

L= 1.002

#### BMW

X5 (E70) / X5 (F15, F85) / X6 (E71, E72) / X6 (F16, F86)

## 24.8190-0291.2 620291



### Warnkontakt, Bremsbelagverschleiß

Scheibenbremse

L= 974

#### BMW

X5 (E70) / X5 (F15, F85) / X6 (E71, E72) / X6 (F16, F86)

## 24.8190-0294.2 620294



### Warnkontakt, Bremsbelagverschleiß

Scheibenbremse

L= 1.361

#### BMW

Z4 Roadster (E89)

## 24.8190-0295.2 620295



### Warnkontakt, Bremsbelagverschleiß

Scheibenbremse

L= 1.013

#### BMW

Z4 Roadster (E89)



# Abbildungen Warnkontakte

Pictures Warning Contacts - Fotos de advertencia Contactos - Photos Avertissement Contacts - Immagini di avvertimento Contatti

**24.8190-0296.2 620296**



## Warnkontakt, Bremsbelagverschleiß

Scheibenbremse

L= 1.141

**BMW**  
X1 (E84)

**24.8190-0297.2 620297**



## Warnkontakt, Bremsbelagverschleiß

Scheibenbremse

L= 676

**BMW**  
X1 (E84)

**24.8190-0298.2 620298**



## Warnkontakt, Bremsbelagverschleiß

Scheibenbremse

L= 1.087

**BMW**  
5 (F10) / 5 Gran Turismo (F07) / 5 Touring (F11) / 6 Cabriolet (F12) / 6 Coupe (F13) / 6 Gran Coupe (F06) / 7 (F01, F02, F03, F04)

**24.8190-0299.2 620299**



## Warnkontakt, Bremsbelagverschleiß

Scheibenbremse

L= 1.065

**BMW**  
7 (F01, F02, F03, F04)

**24.8190-0300.2 620300**



## Warnkontakt, Bremsbelagverschleiß

Scheibenbremse

L= 1.054

**BMW**  
5 Gran Turismo (F07)

# Abbildungen Warnkontakte

Pictures Warning Contacts - Fotos de advertencia Contactos - Photos Avertissement Contacts - Immagini di avvertimento Contatti

24.8190-0301.2 620301



## Warnkontakt, Bremsbelagverschleiß

Scheibenbremse

L= 311,6

### AUDI

A6 (4G2, 4GC, C7) / A6 Allroad (4GH, 4GJ) / A6 Avant (4G5, 4GD, C7) / A7 Sportback (4GA, 4GF) / A8 (4H2, 4H8, 4HC, 4HL) / Q5 (8RB)

24.8190-0302.2 620302



## Warnkontakt, Bremsbelagverschleiß

Scheibenbremse

L= 367,4

### AUDI

A3 Sportback (8PA) / TT (8J3) / TT Roadster (8J9)

### SEAT

LEON (5F1) / LEON Kasten/Schrägheck (5F1) / LEON SC (5F5) / LEON ST (5F8) / LEON ST Kasten/Kombi (5F8)

24.8190-0303.2 620303



## Warnkontakt, Bremsbelagverschleiß

Scheibenbremse

L= 296,6

### AUDI

A8 (4H2, 4H8, 4HC, 4HL)

24.8190-0304.2 620304



## Warnkontakt, Bremsbelagverschleiß

Scheibenbremse

L= 724

### LAND ROVER

RANGE ROVER III (L322)

24.8190-0305.2 620305



## Warnkontakt, Bremsbelagverschleiß

Scheibenbremse

L= 1.158

### LAND ROVER

RANGE ROVER III (L322)

# Abbildungen Warnkontakte

Pictures Warning Contacts - Fotos de advertencia Contactos - Photos Avertissement Contacts - Immagini di avvertimento Contatti

## 24.8190-0306.2 620306



### Warnkontakt, Bremsbelagverschleiß

Scheibenbremse

L= 908

**MINI**  
MINI COUNTRYMAN (R60) / MINI PACEMAN (R61)

## 24.8190-0307.2 620307



### Warnkontakt, Bremsbelagverschleiß

Scheibenbremse

L= 957

**MINI**  
MINI COUNTRYMAN (R60) / MINI PACEMAN (R61)

## 24.8190-0308.2 620308



### Warnkontakt, Bremsbelagverschleiß

Scheibenbremse

L= 1.110

**BMW**  
5 Touring (F11)

## 24.8190-0309.2 620309



### Warnkontakt, Bremsbelagverschleiß

Scheibenbremse

L= 954

**BMW**  
X3 (F25) / X4 (F26)

## 24.8190-0310.2 620310



### Warnkontakt, Bremsbelagverschleiß

Scheibenbremse

L= 1.243

**BMW**  
X3 (F25) / X4 (F26)

# Abbildungen Warnkontakte

Pictures Warning Contacts - Fotos de advertencia Contactos - Photos Avertissement Contacts - Immagini di avvertimento Contatti

**24.8190-0311.2 620311**



## Warnkontakt, Bremsbelagverschleiß

Scheibenbremse

L= 300

### AUDI

A6 Allroad (4GH, 4GJ) / A6 Avant (4G5, 4GD, C7) / A7 Sportback (4GA, 4GF) / A7 Sportback (4KA) / Q5 (8RB)

**24.8190-0312.2 620312**



## Warnkontakt, Bremsbelagverschleiß

Scheibenbremse

L= 915

### BMW

5 (F10) / 6 Cabriolet (F12) / 6 Coupe (F13) / 6 Gran Coupe (F06)

**24.8190-0313.2 620313**



## Warnkontakt, Bremsbelagverschleiß

Scheibenbremse

L= 217

### AUDI

A6 (4G2, 4GC, C7) / A6 Allroad (4GH, 4GJ) / A6 Avant (4G5, 4GD, C7) / A7 Sportback (4GA, 4GF) / A7 Sportback (4KA)

### PORSCHE

MACAN (95B)

**24.8190-0401.2 620401**



## Warnkontakt, Bremsbelagverschleiß

Scheibenbremse

L= 95

### MERCEDES-BENZ

190 (W201) / A-CLASS (W168) / CABRIOLET (A124) / C-CLASS (W202) / C-CLASS T-Model (S202) / CLK (C208) / CLK Cabriolet (A208) / COUPE (C123) / COUPE (C124) / E-CLASS (W124) / E-CLASS (W210) / E-CLASS Cabriolet (A124) / E-CLASS Coupe (C124) / E-CLASS T-Model (S124) / E-CLASS T-Model (S210) / G-CLASS (W460) / KOMBI T-Model (S123) / KOMBI T-Model (S124) / SALOON (W123) / SALOON (W124) / S-CLASS (W116) / S-CLASS (W126) / S-CLASS (W140) / S-CLASS Coupe (C126) / S-CLASS Coupe (C140) / SL (R107) / SL (R129) / SL Coupe (C107) / SLK (R170) / T1/TN Kasten/Kombi / T1/TN Pritsche/Fahrgestell / T1 Bus (601) / T1 Bus (602) / T1 Kasten (601, 611) / T1 Kasten (602) / T1 Pritsche/Fahrgestell (601) / T1 Pritsche/Fahrgestell (602) / T2/LN1 Kasten/Kombi / T2/LN1 Kipper / T2/LN1 Pritsche/Fahrgestell

### PUCH

G-MODELL (W 460)

# Abbildungen Warnkontakte

Pictures Warning Contacts - Fotos de advertencia Contactos - Photos Avertissement Contacts - Immagini di avvertimento Contatti

24.8190-0402.2 620402



## Warnkontakt, Bremsbelagverschleiß

Scheibenbremse

L= 68

L= 150

### MERCEDES-BENZ

190 (W201) / COUPE (C124) / E-CLASS (W124) / E-CLASS Cabriolet (A124) / E-CLASS Coupe (C124) / E-CLASS T-Model (S124) / KOMBI T-Model (S124) / SALOON (W124)

24.8190-0406.2 620406



## Warnkontakt, Bremsbelagverschleiß

Scheibenbremse

L= 261

### MERCEDES-BENZ

G-CLASS (W460) / G-CLASS (W461) / G-CLASS (W463) / G-CLASS Cabrio (W463)

### PUCH

G-MODELL (W 460) / G-MODELL (W 463)

24.8190-0407.2 620407



## Warnkontakt, Bremsbelagverschleiß

Scheibenbremse

L= 115

L= 185

### MERCEDES-BENZ

G-CLASS (W461) / G-CLASS (W463) / G-CLASS Cabrio (W463) / SPRINTER 2-t Bus (901, 902) / SPRINTER 2-t Kasten (901, 902) / SPRINTER 2-t Pritsche/Fahrgestell (901, 902) / SPRINTER 3-t Bus (903) / SPRINTER 3-t Kasten (903) / SPRINTER 3-t Pritsche/Fahrgestell (903) / V-CLASS (638/2) / VITO Bus (638) / VITO Kasten (638)

### VW

LT 28-35 II Bus (2DB, 2DE, 2DK) / LT 28-46 II Kasten (2DA, 2DD, 2DH) / LT 28-46 II Pritsche/Fahrgestell (2DC, 2DF, 2DG, 2DL, 2DM)

24.8190-0410.2 620410



## Warnkontakt, Bremsbelagverschleiß

Scheibenbremse

L= 97,5

### MAYBACH

57 (240\_)

### MERCEDES-BENZ

A-CLASS (W169) / B-CLASS (W245) / C-CLASS (W203) / C-CLASS (W204) / C-CLASS (W205) / C-CLASS Cabriolet (A205) / C-CLASS Coupe (C204) / C-CLASS Coupe (C205) / C-CLASS Coupe (CL203) / C-CLASS T-Model (S203) / C-CLASS T-Model (S204) / CLC-CLASS (CL203) / CLK (C209) / CLK Cabriolet (A209) / CLS (C218) / CLS (C219) / CLS Shooting Brake (X218) / E-CLASS (W211) / E-CLASS (W212) / E-CLASS (W213) / E-CLASS Cabriolet (A207) / E-CLASS Coupe (C207) / E-CLASS T-Model (S211) / E-CLASS T-Model (S212) / E-CLASS T-Model (S213) / GL-CLASS (X166) / GLE (W166) / GLE Coupe (C292) / GLK-CLASS (X204) / GLS (X166) / M-CLASS (W166) / S-CLASS (W220) / S-CLASS (W221) / S-CLASS (W222, V222, X222) / S-CLASS Cabriolet (A217) / S-CLASS Coupe (C215) / S-CLASS Coupe (C216) / S-CLASS Coupe (C217) / SL (R230) / SL (R231) / SLC (R172) / SLK (R171) / SLK (R172) / SLR (R199) / SLR Roadster (R199) / Vaneo (414)



# Abbildungen Warnkontakte

Pictures Warning Contacts - Fotos de advertencia Contactos - Photos Avertissement Contacts - Immagini di avvertimento Contatti

24.8190-0411.2 620411



## Warnkontakt, Bremsbelagverschleiß

Scheibenbremse

L= 72

**MERCEDES-BENZ**  
G-CLASS (W463) / M-CLASS (W163)

**PUCH**  
G-MODELL (W 463)

24.8190-0412.2 620412



## Warnkontakt, Bremsbelagverschleiß

Scheibenbremse

L= 114

**MERCEDES-BENZ**  
M-CLASS (W163)

24.8190-0415.2 620415

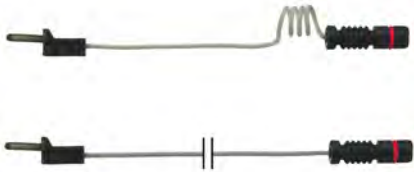

## Warnkontakt, Bremsbelagverschleiß

Scheibenbremse

L= 238

L2= 148

**MERCEDES-BENZ**  
SPRINTER 5-t Pritsche/Fahrgestell (905) / SPRINTER Kipper (905) / T2/LN1 Bus / T2/LN1 Kasten/Kombi / T2/LN1 Kipper / T2/LN1 Pritsche/Fahrgestell / VARIO Bus / VARIO Kasten/Kombi / VARIO Kipper / VARIO Pritsche/Fahrgestell / VARIO Triebkopf

24.8190-0416.2 620416



## Warnkontakt, Bremsbelagverschleiß

Scheibenbremse

L= 100

**MERCEDES-BENZ**  
CLK Cabriolet (A209) / CLS (C219) / E-CLASS (W211) / E-CLASS T-Model (S211) / S-CLASS (W220)

# Abbildungen Warnkontakte

Pictures Warning Contacts - Fotos de advertencia Contactos - Photos Avertissement Contacts - Immagini di avvertimento Contatti

**24.8190-0417.2 620417**



## Warnkontakt, Bremsbelagverschleiß

Scheibenbremse

L= 99

L= 167

### MERCEDES-BENZ

SPRINTER 2-t Bus (901, 902) / SPRINTER 2-t Kasten (901, 902) / SPRINTER 2-t Pritsche/Fahrgestell (901, 902) / SPRINTER 3-t Bus (903) / SPRINTER 3-t Kasten (903) / SPRINTER 3-t Pritsche/Fahrgestell (903) / SPRINTER 4-t Bus (904) / SPRINTER 4-t Kasten (904) / SPRINTER 4-t Pritsche/Fahrgestell (904) / SPRINTER 5-t Pritsche/Fahrgestell (905) / SPRINTER Kipper (905) / V-CLASS (638/2) / VITO Bus (638) / VITO Kasten (638)

### VW

LT 28-35 II Bus (2DB, 2DE, 2DK) / LT 28-46 II Kasten (2DA, 2DD, 2DH) / LT 28-46 II Pritsche/Fahrgestell (2DC, 2DF, 2DG, 2DL, 2DM)

**24.8190-0418.2 620418**



## Warnkontakt, Bremsbelagverschleiß

Scheibenbremse

L= 95

### MERCEDES-BENZ

SPRINTER 3,5-t Bus (906) / SPRINTER 3,5-t Kasten (906) / SPRINTER 3,5-t Pritsche/Fahrgestell (906) / SPRINTER 3-t Bus (906) / SPRINTER 3-t Kasten (906) / SPRINTER 3-t Pritsche/Fahrgestell (906) / SPRINTER CLASSIC 3,5-t Kasten (909) / VIANO (W639) / VITO / MIXTO Kasten (W639) / VITO Bus (W639)

### VW

CRAFTER 30-35 Bus (2E\_) / CRAFTER 30-50 Kasten (2E\_) / CRAFTER 30-50 Pritsche/Fahrgestell (2F\_)

**24.8190-0419.2 620419**



## Warnkontakt, Bremsbelagverschleiß

Scheibenbremse

L= 74

### MERCEDES-BENZ

C-CLASS (W202) / C-CLASS T-Model (S202) / CLK (C208) / CLK Cabriolet (A208) / E-CLASS (W210) / E-CLASS T-Model (S210) / SLK (R170)

**24.8190-0420.2 620420**



## Warnkontakt, Bremsbelagverschleiß

Scheibenbremse

L= 119

### MERCEDES-BENZ

C-CLASS (W204) / C-CLASS Cabriolet (A205) / C-CLASS Coupe (C204) / C-CLASS Coupe (C205) / C-CLASS T-Model (S204) / CLK (C209) / CLK Cabriolet (A209) / CLS (C218) / CLS (C219) / CLS Shooting Brake (X218) / E-CLASS (W211) / E-CLASS (W212) / E-CLASS (W213) / E-CLASS T-Model (S211) / E-CLASS T-Model (S212) / E-CLASS T-Model (S213) / G-CLASS (W463) / GL-CLASS (X166) / GLE (W166) / GLE Coupe (C292) / GLS (X166) / M-CLASS (W166) / S-CLASS (W221) / S-CLASS (W222, V222, X222) / S-CLASS Cabriolet (A217) / S-CLASS Coupe (C216) / S-CLASS Coupe (C217) / SL (R230) / SL (R231) / SLK (R171) / SLS AMG (C197) / SLS AMG Roadster (R197)

# Abbildungen Warnkontakte

Pictures Warning Contacts - Fotos de advertencia Contactos - Photos Avertissement Contacts - Immagini di avvertimento Contatti

**24.8190-0423.2 620423**



## Warnkontakt, Bremsbelagverschleiß

Scheibenbremse

L= 199

L2= 144

### MERCEDES-BENZ

SPRINTER 5-t Pritsche/Fahrgestell (905) / SPRINTER Kipper (905)

**24.8190-0424.2 620424**



## Warnkontakt, Bremsbelagverschleiß

Scheibenbremse

L= 103,2

### MERCEDES-BENZ

SPRINTER 3,5-t Bus (906) / SPRINTER 3,5-t Kasten (906) / SPRINTER 3,5-t Pritsche/Fahrgestell (906) / SPRINTER 3-t Bus (906) / SPRINTER 3-t Kasten (906) / SPRINTER 3-t Pritsche/Fahrgestell (906) / SPRINTER 4,6-t Kasten (906) / SPRINTER 4,6-t Pritsche/Fahrgestell (906) / SPRINTER 5-t Bus / SPRINTER 5-t Kasten (906) / SPRINTER 5-t Pritsche/Fahrgestell (906) / SPRINTER CLASSIC 3,5-t Kasten (909) / SPRINTER CLASSIC 4,6-t Bus (909) / V-CLASS (W447) / VIANO (W639) / VITO / MIXTO Kasten (W639) / VITO Bus (W639) / VITO Kasten (W447) / VITO Mixto (W447) / VITO Tourer (W447)

### VW

CRAFTER 30-35 Bus (2E\_) / CRAFTER 30-50 Kasten (2E\_) / CRAFTER 30-50 Pritsche/Fahrgestell (2F\_)

**24.8190-0425.2 620425**



## Warnkontakt, Bremsbelagverschleiß

Scheibenbremse

L= 98

### MERCEDES-BENZ

E-CLASS (W211) / E-CLASS T-Model (S211) / G-CLASS (W463) / GL-CLASS (X164) / GL-CLASS (X166) / GLE (W166) / GLE Coupe (C292) / GLS (X166) / M-CLASS (W164) / M-CLASS (W166) / R-CLASS (W251, V251) / S-CLASS (W220)

**24.8190-0705.2 620705**



## Warnkontakt, Bremsbelagverschleiß

Scheibenbremse

L= 670

### OPEL

ASTRA F (T92) / ASTRA F Cabriolet (T92) / ASTRA F Caravan (T92) / ASTRA F CC (T92) / ASTRA F Van (T92) / CALIBRA A (C89) / VECTRA A (J89) / VECTRA A CC (J89)

### VAUXHALL

ASTRA Mk III (F) Cabriolet (T92) / ASTRA Mk III (F) CC (T92) / ASTRA Mk III (F) Kombi (T92) / ASTRA Mk III (F) Stufenheck (T92) / ASTRAVAN Mk III (F) (T92) / CALIBRA (C89) / CAVALIER Mk III CC (J89) / CAVALIER Mk III Stufenheck (J89)

# Abbildungen Warnkontakte

Pictures Warning Contacts - Fotos de advertencia Contactos - Photos Avertissement Contacts - Immagini di avvertimento Contatti

**24.8190-0707.2 620707**



## Warnkontakt, Bremsbelagverschleiß

Scheibenbremse

L= 685

### OPEL

ASTRA F (T92) / ASTRA F Cabriolet (T92) / ASTRA F Caravan (T92) / ASTRA F CC (T92) / ASTRA F CLASSIC CC (T92) / ASTRA F CLASSIC Stufenheck (T92) / ASTRA F Van (T92) / CALIBRA A (C89) / VECTRA A (J89) / VECTRA A CC (J89)

### VAUXHALL

ASTRA Mk III (F) Cabriolet (T92) / ASTRA Mk III (F) CC (T92) / ASTRA Mk III (F) Kombi (T92) / ASTRA Mk III (F) Stufenheck (T92) / ASTRAVAN Mk III (F) (T92) / CALIBRA (C89) / CAVALIER Mk III CC (J89) / CAVALIER Mk III Stufenheck (J89)

**24.8190-0710.2 620710**



## Warnkontakt, Bremsbelagverschleiß

Scheibenbremse

L= 730

### OPEL

OMEGA B (V94) / OMEGA B Caravan (V94)

### VAUXHALL

OMEGA (B) Kombi (V94) / OMEGA (B) Stufenheck (V94)

**24.8190-0711.2 620711**



## Warnkontakt, Bremsbelagverschleiß

Scheibenbremse

L= 730

### OPEL

OMEGA B (V94) / OMEGA B Caravan (V94)

### VAUXHALL

OMEGA (B) Kombi (V94) / OMEGA (B) Stufenheck (V94)

**24.8190-0713.2 620713**



## Warnkontakt, Bremsbelagverschleiß

Scheibenbremse

L= 685

### OPEL

CALIBRA A (C89)

### VAUXHALL

CALIBRA (C89)

# Abbildungen Warnkontakte

Pictures Warning Contacts - Fotos de advertencia Contactos - Photos Avertissement Contacts - Immagini di avvertimento Contatti

**24.8190-0714.2 620714**



## Warnkontakt, Bremsbelagverschleiß

Scheibenbremse

L= 660

### OPEL

VECTRA B (J96) / VECTRA B Caravan (J96) / VECTRA B CC (J96)

### VAUXHALL

VECTRA (B) CC (J96) / VECTRA (B) Kombi (J96) / VECTRA (B) Stufenheck (J96)

**24.8190-0715.2 620715**



## Warnkontakt, Bremsbelagverschleiß

Scheibenbremse

L= 660

### OPEL

VECTRA B (J96) / VECTRA B Caravan (J96) / VECTRA B CC (J96)

### VAUXHALL

VECTRA (B) CC (J96) / VECTRA (B) Kombi (J96) / VECTRA (B) Stufenheck (J96)

**24.8190-0718.2 620718**



## Warnkontakt, Bremsbelagverschleiß

Scheibenbremse

L= 720

### OPEL

ASTRA G Cabriolet (T98) / ASTRA G Caravan (T98) / ASTRA G CC (T98) / ASTRA G Coupe (T98) / ASTRA G Kasten (F70) / ASTRA G Stufenheck (T98) / ZAFIRA A Großraumlimousine (T98)

### SAAB

9-3 (YS3D) / 9-3 Cabriolet (YS3D) / 9-5 (YS3E) / 9-5 Kombi (YS3E) / 900 II / 900 II Cabriolet / 900 II Coupe

### VAUXHALL

ASTRA Mk IV (G) Cabriolet (T98) / ASTRA Mk IV (G) CC (T98) / ASTRA Mk IV (G) Coupe (T98) / ASTRA Mk IV (G) Kombi (T98) / ASTRA Mk IV (G) Stufenheck (T98) / ASTRAVAN Mk IV (G) (T98) / ZAFIRA Mk I (A) (T98)

**24.8190-0719.2 620719**



## Warnkontakt, Bremsbelagverschleiß

Scheibenbremse

L= 685,5

### FIAT

CROMA (194\_)

### OPEL

SIGNUM CC (Z03) / VECTRA C (Z02) / VECTRA C Caravan (Z02) / VECTRA C CC (Z02)

### VAUXHALL

SIGNUM (Z03) / VECTRA Mk II (C) (Z02) / VECTRA Mk II (C) CC (Z02) / VECTRA Mk II (C) Kombi (Z02)



# Abbildungen Warnkontakte

Pictures Warning Contacts - Fotos de advertencia Contactos - Photos Avertissement Contacts - Immagini di avvertimento Contatti

24.8190-0720.2 620720



## Warnkontakt, Bremsbelagverschleiß

Scheibenbremse

L= 287

### OPEL

ASTRA CLASSIC Schrägheck (A04) / ASTRA H (A04) / ASTRA H Caravan (A04) / ASTRA H GTC (A04) / ASTRA H Kasten (L70) / ASTRA H Stufenheck (A04) / ASTRA H TwinTop (A04) / SIGNUM CC (Z03) / VECTRA C (Z02) / VECTRA C Caravan (Z02) / VECTRA C CC (Z02) / ZAFIRA B (A05) / ZAFIRA B Van (A05)

### VAUXHALL

ASTRA Mk V (H) CC (A04) / ASTRA Mk V (H) CC (A04) / ASTRA Mk V (H) Convertible (A04) / ASTRA Mk V (H) Kombi (A04) / ASTRAVAN Mk V (H) (A04) / SIGNUM (Z03) / VECTRA Mk II (C) (Z02) / VECTRA Mk II (C) CC (Z02) / VECTRA Mk II (C) Kombi (Z02) / ZAFIRA Mk II (B) (A05)

24.8190-0721.2 620721



## Warnkontakt, Bremsbelagverschleiß

Scheibenbremse

L= 700

### OPEL

SIGNUM CC (Z03) / VECTRA C (Z02) / VECTRA C Caravan (Z02) / VECTRA C CC (Z02)

### VAUXHALL

SIGNUM (Z03) / VECTRA Mk II (C) (Z02) / VECTRA Mk II (C) CC (Z02) / VECTRA Mk II (C) Kombi (Z02)

24.8190-0722.2 620722



## Warnkontakt, Bremsbelagverschleiß

Scheibenbremse

L= 302

### OPEL

SIGNUM CC (Z03) / VECTRA C (Z02) / VECTRA C Caravan (Z02) / VECTRA C CC (Z02)

### VAUXHALL

SIGNUM (Z03) / VECTRA Mk II (C) (Z02) / VECTRA Mk II (C) CC (Z02) / VECTRA Mk II (C) Kombi (Z02)

24.8190-0917.2 620917



## Warnkontakt, Bremsbelagverschleiß

Scheibenbremse

L= 518

### PORSCHE

911 (964) / 911 (993) / 911 Cabriolet (964) / 911 Cabriolet (993) / 911 Speedster (964) / 911 Targa (964) / 911 Targa (993)

# Abbildungen Warnkontakte

Pictures Warning Contacts - Fotos de advertencia Contactos - Photos Avertissement Contacts - Immagini di avvertimento Contatti

**24.8190-0920.2 620920**



## Warnkontakt, Bremsbelagverschleiß

Scheibenbremse

L= 698

### PORSCHE

911 (993) / 911 Cabriolet (993) / 911 Targa (993)

**24.8190-0921.2 620921**



## Warnkontakt, Bremsbelagverschleiß

Scheibenbremse

L= 440

### PORSCHE

911 (996) / 911 (997) / 911 Cabriolet (996) / 911 Cabriolet (997) / 911 Targa (996) / BOXSTER (986)

**24.8190-0922.2 620922**



## Warnkontakt, Bremsbelagverschleiß

Scheibenbremse

L= 440

### PORSCHE

BOXSTER (986) / BOXSTER (987) / BOXSTER Spyder (987) / CAYMAN (987)

**24.8190-0926.2 620926**



## Warnkontakt, Bremsbelagverschleiß

Scheibenbremse

L= 475

### PORSCHE

911 (964) / 911 (993) / 911 Cabriolet (993)

**24.8190-0929.2 620929**



## Warnkontakt, Bremsbelagverschleiß

Scheibenbremse

L= 417,4

### AUDI

Q7 (4LB)

### PORSCHE

CAYENNE (9PA)

### VW

TOUAREG (7LA, 7L6, 7L7)

# Abbildungen Warnkontakte

Pictures Warning Contacts - Fotos de advertencia Contactos - Photos Avertissement Contacts - Immagini di avvertimento Contatti

**24.8190-0930.2 620930**



## Warnkontakt, Bremsbelagverschleiß

Scheibenbremse

L= 252,4

**AUDI**  
Q7 (4LB)

**PORSCHE**  
CAYENNE (9PA)

**VW**  
TOUAREG (7LA, 7L6, 7L7)

**24.8190-0931.2 620931**



## Warnkontakt, Bremsbelagverschleiß

Scheibenbremse

L= 336

**PORSCHE**  
911 (997) / 911 Cabriolet (997)

**24.8190-0932.2 620932**



## Warnkontakt, Bremsbelagverschleiß

Scheibenbremse

L= 461

**PORSCHE**  
BOXSTER (987) / CAYMAN (987)

**24.8190-0933.2 620933**



## Warnkontakt, Bremsbelagverschleiß

Scheibenbremse

L= 305

**PORSCHE**  
911 (997) / 911 Cabriolet (997) / BOXSTER (987) / CAYMAN (987)

**24.8190-0934.2 620934**



## Warnkontakt, Bremsbelagverschleiß

Scheibenbremse

L= 295

**PORSCHE**  
BOXSTER (987) / CAYMAN (987)

# Abbildungen Warnkontakte

Pictures Warning Contacts - Fotos de advertencia Contactos - Photos Avertissement Contacts - Immagini di avvertimento Contatti

24.8190-0935.2 620935



## Warnkontakt, Bremsbelagverschleiß

Scheibenbremse

L= 315

**PORSCHE**  
CAYMAN (987)

24.8190-0936.2 620936



## Warnkontakt, Bremsbelagverschleiß

Scheibenbremse

L= 367,4

**PORSCHE**  
CAYENNE (9PA)

**VW**  
TOUAREG (7LA, 7L6, 7L7)

24.8190-0937.2 620937



## Warnkontakt, Bremsbelagverschleiß

Scheibenbremse

L= 247,4

**AUDI**  
Q7 (4LB)

**PORSCHE**  
CAYENNE (9PA)

24.8190-0938.2 620938



## Warnkontakt, Bremsbelagverschleiß

Scheibenbremse

L= 495

**PORSCHE**  
911 (996) / 911 (997) / 911 Cabriolet (996) / 911 Cabriolet (997) / CARRERA GT (980)

24.8190-0939.2 620939



## Warnkontakt, Bremsbelagverschleiß

Scheibenbremse

L= 372,4

**PORSCHE**  
CAYENNE (92A) / PANAMERA (970)

# Abbildungen Warnkontakte

Pictures Warning Contacts - Fotos de advertencia Contactos - Photos Avertissement Contacts - Immagini di avvertimento Contatti

24.8190-0940.2 620940



## Warnkontakt, Bremsbelagverschleiß

Scheibenbremse

L= 227,4

**PORSCHE**  
CAYENNE (92A) / PANAMERA (970)

24.8190-0941.2 620941



## Warnkontakt, Bremsbelagverschleiß

Scheibenbremse

L= 648

**MINI**  
MINI (F55) / MINI (F56) / MINI Cabriolet (F57) / MINI COUNTRYMAN (F60)

24.8190-0942.2 620942



## Warnkontakt, Bremsbelagverschleiß

Scheibenbremse

L= 641

**BMW**  
2 Active Tourer (F45) / 2 Gran Tourer (F46) / X1 (F48) / X2 (F39)

**MINI**  
MINI (F55) / MINI (F56) / MINI Cabriolet (F57) / MINI CLUBMAN (F54) / MINI COUNTRYMAN (F60)

24.8190-0943.2 620943



## Warnkontakt, Bremsbelagverschleiß

Scheibenbremse

L= 504,6

**PORSCHE**  
911 (996) / 911 (997) / 911 Cabriolet (996) / 911 Cabriolet (997)

24.8190-0944.2 620944



## Warnkontakt, Bremsbelagverschleiß

Scheibenbremse

L= 841,5

**LAND ROVER**  
RANGE ROVER III (L322)



# Abbildungen Warnkontakte

Pictures Warning Contacts - Fotos de advertencia Contactos - Photos Avertissement Contacts - Immagini di avvertimento Contatti

**24.8190-0945.2 620945**



## Warnkontakt, Bremsbelagverschleiß

Scheibenbremse

L= 1.227

**LAND ROVER**  
RANGE ROVER SPORT (L320)

**24.8190-0946.2 620946**

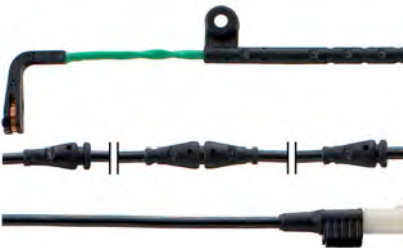

## Warnkontakt, Bremsbelagverschleiß

Scheibenbremse

L= 1.175

**LAND ROVER**  
DISCOVERY III (L319) / DISCOVERY IV (L319)

**24.8190-0948.2 620948**



## Warnkontakt, Bremsbelagverschleiß

Scheibenbremse

L= 1.212

**LAND ROVER**  
RANGE ROVER SPORT (L320)

**24.8190-0949.2 620949**



## Warnkontakt, Bremsbelagverschleiß

Scheibenbremse

L= 1.228

**LAND ROVER**  
RANGE ROVER SPORT (L320)

**24.8190-0950.2 620950**



## Warnkontakt, Bremsbelagverschleiß

Scheibenbremse

L= 525

**PORSCHE**  
911 (997) / 911 Cabriolet (997) / 911 Targa (997)

# Abbildungen Warnkontakte

Pictures Warning Contacts - Fotos de advertencia Contactos - Photos Avertissement Contacts - Immagini di avvertimento Contatti

**24.8190-0951.2 620951**



## Warnkontakt, Bremsbelagverschleiß

Scheibenbremse

L= 500

**PORSCHE**  
911 (997)

**24.8190-0952.2 620952**



## Warnkontakt, Bremsbelagverschleiß

Scheibenbremse

L= 300

**PORSCHE**  
718 BOXSTER (982) / 718 CAYMAN (982) / 911 (991) / 911 Cabriolet (991) / 911 Cabriolet (997) / 911 Targa (991) / BOXSTER (981) / BOXSTER Spyder (981) / CAYMAN (981)

**24.8190-0953.2 620953**



## Warnkontakt, Bremsbelagverschleiß

Scheibenbremse

L= 215

**PORSCHE**  
911 (991) / 911 Cabriolet (991) / 911 Targa (991) / BOXSTER Spyder (981)

**24.8190-0954.2 620954**



## Warnkontakt, Bremsbelagverschleiß

Scheibenbremse

L= 365

**PORSCHE**  
CAYENNE (9PA)

**24.8190-0955.2 620955**



## Warnkontakt, Bremsbelagverschleiß

Scheibenbremse

L= 100

**MERCEDES-BENZ**  
E-CLASS (W211) / E-CLASS T-Model (S211)

# Abbildungen Warnkontakte

Pictures Warning Contacts - Fotos de advertencia Contactos - Photos Avertissement Contacts - Immagini di avvertimento Contatti

24.8190-0956.2 620956



## Warnkontakt, Bremsbelagverschleiß

Scheibenbremse

L= 454,6

**PORSCHE**  
911 (997) / CAYMAN (987)

24.8190-0957.2 620957



## Warnkontakt, Bremsbelagverschleiß

Scheibenbremse

L= 394,6

**PORSCHE**  
911 (997) / CAYMAN (987)

24.8190-0959.2 620959



## Warnkontakt, Bremsbelagverschleiß

Scheibenbremse

L= 102

**MERCEDES-BENZ**  
E-CLASS (W213) / E-CLASS Cabriolet (A238) / E-CLASS Coupe (C238) / E-CLASS T-Model (S213) / S-CLASS (W222, V222, X222) / S-CLASS Cabriolet (A217) / S-CLASS Coupe (C217) / SL (R231)

24.8190-0960.2 620960



## Warnkontakt, Bremsbelagverschleiß

Scheibenbremse

L= 633

**JAGUAR**  
XF (X250) / XF SPORTBRAKE (X250) / XJ (X350) / XJ (X351) / XK Cabriolet (X150) / XK Coupe (X150)

24.8190-0961.2 620961



## Warnkontakt, Bremsbelagverschleiß

Scheibenbremse

L= 100

**MERCEDES-BENZ**  
M-CLASS (W163)

# Abbildungen Warnkontakte

Pictures Warning Contacts - Fotos de advertencia Contactos - Photos Avertissement Contacts - Immagini di avvertimento Contatti

24.8190-0962.2 620962



## Warnkontakt, Bremsbelagverschleiß

Scheibenbremse

L= 353

**PORSCHE**  
MACAN (95B)

24.8190-0963.2 620963



## Warnkontakt, Bremsbelagverschleiß

Scheibenbremse

L= 247

**AUDI**  
A8 (4H2, 4H8, 4HC, 4HL)

24.8190-0964.2 620964



## Warnkontakt, Bremsbelagverschleiß

Scheibenbremse

L= 379

**AUDI**  
A8 (4N2, 4N8) / Q7 (4MB)

**VW**  
TOUAREG (CR7)

24.8190-0965.2 620965



## Warnkontakt, Bremsbelagverschleiß

Scheibenbremse

L= 453

**PORSCHE**  
MACAN (95B)

24.8190-0967.2 620967



## Warnkontakt, Bremsbelagverschleiß

Scheibenbremse

L= 313

**AUDI**  
A7 Sportback (4KA)

**PORSCHE**  
MACAN (95B)

# Abbildungen Warnkontakte

Pictures Warning Contacts - Fotos de advertencia Contactos - Photos Avertissement Contacts - Immagini di avvertimento Contatti

**24.8190-0968.2 620968**



## Warnkontakt, Bremsbelagverschleiß

Scheibenbremse

L= 343

**AUDI**  
A8 (4H2, 4H8, 4HC, 4HL)

**24.8190-0970.2 620970**



## Warnkontakt, Bremsbelagverschleiß

Scheibenbremse

L= 434

**JAGUAR**  
XJ (X300, X330) / XJ (XJ40, XJ81) / XJ Coupe / XJSC Convertible (X27)

**24.8190-0971.2 620971**



## Warnkontakt, Bremsbelagverschleiß

Scheibenbremse

L= 223

**AUDI**  
R8 (4S3) / R8 (422, 423) / R8 Spyder (4S9) / R8 Spyder (427, 429)

**24.8190-0973.2 620973**



## Warnkontakt, Bremsbelagverschleiß

Scheibenbremse

L= 841,5

L1= 617

L2= 224,5

**LAND ROVER**  
RANGE ROVER III (L322)

**24.8190-0977.2 620977**



## Warnkontakt, Bremsbelagverschleiß

Scheibenbremse

L= 431

**AUDI**  
A8 (4N2, 4N8) / Q7 (4MB)



# Abbildungen Warnkontakte

Pictures Warning Contacts - Fotos de advertencia Contactos - Photos Avertissement Contacts - Immagini di avvertimento Contatti

**24.8190-1302.2 621302**



## Warnkontakt, Bremsbelagverschleiß

Scheibenbremse

L= 276

**DAIMLER**  
XJ 40, 81

**JAGUAR**

XJ (X300, X330) / XJ (XJ40, XJ81) / XJ Coupe / XJSC Convertible (X27) / XK 8 Convertible (X100) / XK 8 Coupe (X100)

**24.8190-1304.2 621304**



## Warnkontakt, Bremsbelagverschleiß

Scheibenbremse

L= 289

**IVECO**

DAILY II Kasten/Kombi / DAILY II Kipper / DAILY II Pritsche/Fahrgestell / DAILY III Kasten/Kombi / DAILY III Pritsche/Fahrgestell

**24.8190-1305.2 621305**



## Warnkontakt, Bremsbelagverschleiß

Scheibenbremse

L= 1.147

**LAND ROVER**

DISCOVERY III (L319)

**24.8190-1306.2 621306**



## Warnkontakt, Bremsbelagverschleiß

Scheibenbremse

L= 1.156

**LAND ROVER**

DISCOVERY III (L319) / DISCOVERY IV (L319) / RANGE ROVER SPORT (L320)

**24.8190-1307.2 621307**



## Warnkontakt, Bremsbelagverschleiß

Scheibenbremse

L= 1.185

**LAND ROVER**

RANGE ROVER SPORT (L320)

# Abbildungen Warnkontakte

Pictures Warning Contacts - Fotos de advertencia Contactos - Photos Avertissement Contacts - Immagini di avvertimento Contatti

**24.8190-1308.2 621308**



## Warnkontakt, Bremsbelagverschleiß

Scheibenbremse

L= 1.118

**LAND ROVER**  
RANGE ROVER III (L322)

**24.8190-2801.2 622801**



## Warnkontakt, Bremsbelagverschleiß

Scheibenbremse

L= 1.103

**MG**  
MG ZT / MG ZT- T

**ROVER**  
75 (RJ) / 75 Tourer (RJ)

**24.8190-2802.2 622802**



## Warnkontakt, Bremsbelagverschleiß

Scheibenbremse

L= 846

**MG**  
MG ZT / MG ZT- T

**ROVER**  
75 (RJ) / 75 Tourer (RJ)





**DE** Abmessungen Bremsscheiben

**EN** Dimensions brake discs

**ES** Medidas disco de freno

**FR** Dimensions Disques de frein

**IT** Misure dischi freno

**2019**



# Abmessungen Bremsscheiben

## Dimensions brake discs - Medidas disco de freno - Dimensions Disques de frein - Misure dischi freno

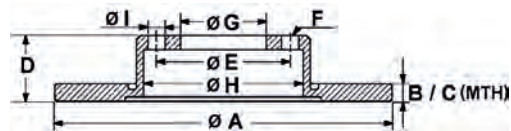

S Fixierschraube - fixing screw - tornillo quefija - vis de fixation - vite di riparazione  
 B beschichtet - coated - recubierto - revêtu - rivestito  
 HC hochgekohlt - high carbon - altamente carbonizado - à haute teneur en carbone - ad alto tenore di carbonio

L legiert - alloyed - aleado - allié - alligato/legato  
 V ventiliert - ventilated - ventilado - ventilé - ventilato  
 \* gelocht - perforated - perforado - poinçonné - perforato

		S	B	HC L	V	A	B	C	D	E	F	G	H	I
24.0107-0108.1	407108					234	7	6	39,5	100	4	68	140	12,8
24.0107-0109.1	407109		B			240	7	6	41	100	4	61	140	12,6
24.0108-0104.1	408104	+ S	B			238	8,2	7	41	100	4	61	129,5	12,4
24.0108-0105.1	408105					247,5	8	6,5	20,3	108	4	71	133	13
24.0108-0106.1	408106	+ S	B			247	8	6	25,3	108	4	71,1	133,5	13
24.0108-0107.1	408107	+ S	B			238	8	6	29	98	3	57	124,5	13
24.0108-0108.1	408108		B			238	8	7	74,6	100	4	52	52,3	M12x1,5
24.0108-0109.1	408109					238	8	7	74,6	100	4	68		M12x1,5
24.0108-0111.1	408111		B			258	8	7	55,3	112	5	67	164	13
24.0108-0113.1	408113	+ S	B			258	8	7	57,3	112	5	67	164	15
24.0108-0114.2	408114		B			240	8	7	80,6	100	4	52,3	55	M12x1,5
24.0108-0116.2	408116		B			260	8	7	86,2	114,3	5	52,3	55	M12x1,5
24.0108-0117.2	408117		B			238	8	7	74,6	100	4	52,3	52	M12x1,5
24.0108-0118.2	408118		B			260	8	7	86,2	114,3	5	52,3	62	M12x1,5
24.0109-0100.2	409100		B			249	9	7	69,2	108	4	56	62	M12x1,25
24.0109-0103.1	409103		B			278	9	7,3	58,5	112	5	67	164	15
24.0109-0108.1	409108					244,5	9	7	43,8	86	3	62	109	10
24.0109-0111.1	409111	+ S	B			239	9	8	47,6	100	4	61	155	13
24.0109-0114.1	409114	+ S	B			278	9	7,3	55,5	112	5	67	164	13,2
24.0109-0120.1	409120	+ S	B			258	9	7,3	55,5	112	5	67	164	12,8
24.0109-0121.2	409121					224	9	8	63,2	108	5	71	135	13
24.0109-0122.1	409122		B			224	9	7	57,5	108	4	71,1	132,7	13
24.0109-0123.1	409123	+ S	B			230	9	7	40,6	100	5	65	125,8	15,6
24.0109-0124.1	409124		B			232	9	7	39,5	100	4	65	125	13,6
24.0109-0125.1	409125					228	9	8	39,5	100	4	60	127	13,5
24.0109-0127.1	409127					231	9	8	34,5	100	4	65	125	13
24.0109-0129.1	409129					258	9	8	44,5	114,3	4	68	154	12,8
24.0109-0130.1	409130					258	9	7,5	43,5	108	4	68	160,7	15,5
24.0109-0131.1	409131		B			251	9	8	34,5	100	4	55	125	13
24.0109-0132.1	409132					282	9	7,5	61	114,3	5	70	170	12,6
24.0109-0133.1	409133	+ S	B			239	8,9	7	33,4	100	5	65	132,5	15,8
24.0109-0137.1	409137	+ S	B			247	9	8	35	108	4	71,1	133	13
24.0109-0138.1	409138		B			258	9	8	55,5	100	4	55	172	14,5
24.0109-0139.1	409139		B			269	9	8	56	100	4	55	173	14,5
24.0109-0140.1	409140		B			279	9	8	55,5	100	4	55	172	14,5
24.0109-0141.1	409141	+ S	B			260	9	8	42,3	114,3	4	64,1	157	12,6
24.0109-0142.1	409142		B			278	9	7	24,7	100	4	55	147	14,3
24.0109-0143.1	409143	+ S	B			260	9	8	48,2	100	4	61	156	13
24.0109-0144.1	409144	+ S	B			282	9	8	58,3	114,3	5	64,1	170	12,5
24.0109-0145.1	409145					260	9	8	48,1	114,3	4	64,1	157	12,6
24.0109-0146.1	409146		B			270	9	7,3	53,3	100	5	57,5	172	14,5
24.0109-0147.1	409147					258	9	8	46,5	114,3	5	68	154	12,5
24.0109-0148.1	409148		B			269	9	8	65	100	5	55	170	14,5
24.0109-0150.2	409150		B			249	9	8	67,1	108	4	55,9	60	M12x1,25
24.0109-0151.1	409151	+ S	B			304,5	9	7,5	61	114,3	5	64,1	200	12,8
24.0109-0152.1	409152		B			303	9	8	62,1	114,3	5	62	190	14,5
24.0109-0154.1	409154	+ S	B			278	9	7,3	57,5	112	5	67	164	15
24.0109-0155.1	409155		B			259	9	7,5	30,5	114,3	5	62	156	14,8
24.0109-0156.1	409156		B			259	9	7,5	30,3	100	4	55	156	14,5
24.0109-0157.1	409157		B			291,5	9	8	62	114,3	5	68	172	12,7
24.0109-0158.1	409158	+ S	B			260	9	8	42,2	114,3	5	64,2	140,5	12,6
24.0109-0159.1	409159		B			266	9	8	36,2	100	4	55	131	14,5
24.0109-0160.1	409160		B			278	9	8	43,1	114,3	5	62	169	12,7
24.0109-0161.1	409161		B			282	9	7,5	61,1	114,3	5	64,2	170	12,6
24.0109-0162.1	409162	+ S	B			260	9	8	31,1	100	4	61	142,4	12,6
24.0109-0163.1	409163		B			259	9	7,5	30,2	100	5	55	156,2	14,5
24.0109-0166.1	409166		B			292	9	8	62	114,3	4	68	172	12,5
24.0109-0167.1	409167		B			278	9	8	43,2	114,3	5	62	169	14
24.0109-0168.1	409168	+ S	B			239	9	8	47,7	100	4	61	151,1	13
24.0109-0169.1	409169	+ S	B			282	9	8	48,7	114,3	5	64,2	157	12,5
24.0109-0170.1	409170		B			259	9	7,5	40,8	100	5	55	156	16,5
24.0109-0171.2	409171		B			249	9	8	73,2	108	4	56	62	M12x1,25
24.0109-0173.1	409173	+ S	B	HC L		276	9	7,3	44	112	5	67	153	15
24.0109-0174.1	409174	+ S	B			232	9	7	39,6	100	5	65	123,8	15,6
24.0109-0175.1	409175		B			259	9	8	43,2	100	4	62	150	14
24.0109-0178.1	409178		B			239	9	8	33,2	100	4	61	148	12,6
24.0109-0181.1	409181		B			265	9	7	39	114,3	5	68	143	13
24.0109-0182.1	409182		B			259,4	9	8	43,2	114,3	5	62	146,6	14
24.0109-0709.1	409709					260	9	8	48,1	114,3	5	64,1	157	12,6





# Abmessungen Bremsscheiben

## Dimensions brake discs - Medidas disco de freno - Dimensions Disques de frein - Misure dischi freno

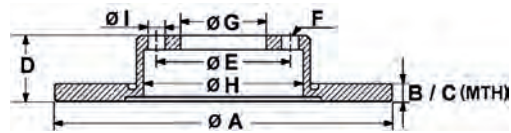

S Fixierschraube - fixing screw - tornillo quefija - vis de fixation - vite di riparazione  
 B beschichtet - coated - recubierto - revêtu - rivestito  
 HC hochgekohlt - high carbon - altamente carbonizado - à haute teneur en carbone - ad alto tenore di carbonio

L legiert - alloyed - aleado - allié - alligato/legato  
 V ventiliert - ventilated - ventilado - ventilé - ventilato  
 \* gelocht - perforated - perforado - poinçonné - perforato

		S	B	HC	L	V	A	B	C	D	E	F	G	H	I
24.0109-0711.1	409711		B				269	9	7,5	56	100	5	55	173	14,5
24.0110-0111.1	410111		B				226	10	8	71,2	100	4	39,8	121,4	M12x1,5
24.0110-0115.1	410115		B				253	10,2	8,9	33	108	4	63,5	155	13,7
24.0110-0116.1	410116		B				245	10	8	46,5	112	5	68	135,5	15,4
24.0110-0117.1	410117	+ S	B	HC			300	10	8,4	61	120	5	75	180	14,5
24.0110-0136.1	410136		B				215	10	8	33	102	4	86	106	M10x1,25
24.0110-0151.1	410151	+ S	B				239	10	8	38,9	100	4	65	124,5	13,6
24.0110-0178.1	410178		B				245	10	8	59,5	108	4	68	135,8	15,4
24.0110-0182.1	410182		B				245	10	8	40,1	108	4	68	135,5	15,4
24.0110-0183.1	410183		B				266	10	8	27	108	4	66	133,2	13
24.0110-0187.1	410187	+ S	B				247	10	9	34,2	108	4	66	133	13
24.0110-0189.1	410189		B				281	9,6	8,4	73,2	108	5	68	160	16,5
24.0110-0190.1	410190		B				251,5	10	9	50,7	98	4	59	127,5	13
24.0110-0192.1	410192		B				289,8	10	9	46	140	5	107	177	13
24.0110-0196.1	410196		B				239,7	10	8	43	108	4	63,6	136	13,8
24.0110-0199.1	410199		B				247	10	8	34,3	108	4	71	133	13
24.0110-0201.1	410201		B				245	10	8	64,2	112	5	68	135,5	15,4
24.0110-0202.1	410202	+ S	B	HC			280	10	8,4	60	120	5	75	160,8	14,5
24.0110-0203.1	410203		B				226	10	8	71,2	100	5			M14x1,5
24.0110-0204.1	410204		B				260	10	8	69,2	100	4	57	160	14
24.0110-0205.1	410205		B				270	9,9	8	77	100	4	57	160	14
24.0110-0206.1	410206		B				265	10	8	53	108	5	68	160	16
24.0110-0209.1	410209		B				251,4	10	9	50,5	98	5	59	127,5	13
24.0110-0210.1	410210		B				245	10	8	83,6	112	5	45,2	135,5	M14x1,5
24.0110-0211.1	410211	+ S	B	HC			272	10	8,4	78	120	5	75	160,8	14,5
24.0110-0212.1	410212	+ S	B				238,5	10	8	48,1	100	4	61	154,5	13
24.0110-0214.1	410214		B				295	9,6	8,4	72	108	5	68	178	14,5
24.0110-0215.1	410215		B				258	10	9	45	114,3	4	68	154	12,6
24.0110-0216.1	410216		B				295	9,6	8,4	72	108	4	68	178	14,5
24.0110-0217.1	410217	+ S	B				290	10	8,3	55,5	112	5	67	164	13,3
24.0110-0218.1	410218		B				295	10	8	56	98	5	59	180	15
24.0110-0219.1	410219		B				265	10,5	9,5	44,3	100	4	66	149,6	13,5
24.0110-0220.1	410220		B				265	10,5	9,5	44,3	108	5	66	149,6	14,5
24.0110-0223.1	410223	+ S	B				268	10	8	45,8	112	5	68,2	154,5	16,8
24.0110-0224.1	410224		B				245	10	8	48	112	5	68	135,5	15,4
24.0110-0225.1	410225	+ S	B				270	10	8	69,3	100	4	57	160	14
24.0110-0226.1	410226	+ S	B				286	10	8	69,3	110	5	65,5	160	14
24.0110-0227.1	410227	+ S	B	HC			298	10	8,4	61	120	5	75	185	14,5
24.0110-0228.1	410228	+ S	B	HC L			280	10	8	65,2	112	5	67	178	15
24.0110-0229.1	410229		B				260	10	8,4	41	114,3	4	90	154	12,6
24.0110-0230.1	410230		B				290,5	10	8	60	108	4	71	185	13
24.0110-0231.1	410231		B				290	10	8	40	108	5	71	185	13
24.0110-0232.1	410232	+ S	B				239	9,9	8	33,6	100	4	65	125	13,8
24.0110-0233.1	410233	+ S	B				260	10	8	48,7	114,3	4	64,1	155	12,8
24.0110-0234.1	410234		B				261	10	8	40	114,3	5	72	142,5	13
24.0110-0235.1	410235		B				211	10	9	35	88	4	70	98	M10x1,25
24.0110-0237.1	410237		B				266	10	8,5	65,8	100	5	58	170	12,8
24.0110-0239.1	410239		B				213,5	9,6	8,6	61,2	73	4	55,6	85	3/8"
24.0110-0240.1	410240		B				262	10	8,4	60,1	114,3	4	90	168	12,6
24.0110-0242.1	410242		B				290	10	8	46,2	139,5	5	107	182,5	13
24.0110-0249.1	410249		B				260	10	8	69,2	110	5	65,5	160	14,3
24.0110-0250.1	410250	+ S	B				264	9,8	8	42	110	5	65,5	145	14
24.0110-0251.1	410251	+ S	B				240	9,8	8	42	100	4	57	140,8	14
24.0110-0253.1	410253		B				270	10	8	77	110	5	65,5	160,1	12,8
24.0110-0255.1	410255		B				260	10	8	43,1	114,3	4	64,1	158,8	12,5
24.0110-0256.1	410256		B				259	10	8	72	114,3	5	47,9	63,9	12,5
24.0110-0258.1	410258		B				245	10	8	54,1	112	5	68	135,5	15,3
24.0110-0259.1	410259		B				255	10	8	54,1	112	5	68	144,5	15,3
24.0110-0260.1	410260		B				255	10	8	48,1	112	5	68	144,5	15,3
24.0110-0261.1	410261	+ S	B				245	10	8	40	112	5/9	68	135,5	15,3
24.0110-0262.1	410262		B				300	10	8,4	95	120	5	75	180	14,5
24.0110-0264.1	410264		B				258	10	8	40,4	114,3	4	76	154	12,6
24.0110-0266.1	410266		B				236	10	8,4	41	100	4	64	144	12,6
24.0110-0267.1	410267		B				260	10	8	43,2	114,3	4	64,1	159	12,6
24.0110-0268.1	410268		B				240	10,2	8,2	40,5	100	4	57	126	14
24.0110-0269.1	410269		B				261	10	8	39,9	100	4	55	124,3	13
24.0110-0270.1	410270		B				280	10	8	61,9	100	5	64	161	15
24.0110-0271.1	410271		B				259	10	8,4	44,1	100	4	64,2	163	16
24.0110-0272.1	410272		B				290	10	8	51	108	5	71	185	13

# Abmessungen Bremsscheiben

## Dimensions brake discs - Medidas disco de freno - Dimensions Disques de frein - Misura dischi freno

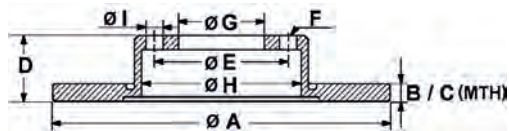

S Fixierschraube - fixing screw - tornillo quefija - vis de fixation - vite di riparazione  
 B beschichtet - coated - recubierto - revêtu - rivestito  
 HC hochgekohlt - high carbon - allamente carbonizado - à haute teneur en carbone - ad alto tenore di carbonio

L legiert - alloyed - aleado - allié - alligato/legato  
 V ventiliert - ventilated - ventilado - ventilé - ventilato  
 \* gelocht - perforated - perforado - poinçonné - perforato

		S	B	HC	L	V	A	B	C	D	E	F	G	H	I
24.0110-0273.1	410273	+ S	B	HC			272	10	8,4	83	120	5	75	161	14,5
24.0110-0274.1	410274	+ S	B				286	10	8	69	110	5	65,5	160	14
24.0110-0275.2	410275		B				226	10	8	71,5	100	4	39,9		M12x1,5
24.0110-0276.2	410276		B				226	10	8	71,5	100	5	39,9		M14x1,5
24.0110-0277.1	410277	+ S	B				253	10	8	51,6	112	5/9	65	140	15,3
24.0110-0278.1	410278	+ S	B				300	10	8,3	68,3	112	5	67	180	15,3
24.0110-0279.1	410279	+ S	B				260	10	8	48,7	114,3	5	64,2	157	12,6
24.0110-0280.1	410280	+ S	B				296	10	8	57,7	112	5	67	186	15
24.0110-0281.1	410281						262	9,5	8,4	60,1	114,3	5	90	168	12,6
24.0110-0282.1	410282						258	10,3	8	64,7	114,3	5	57	168	13
24.0110-0283.1	410283		B				276	10	9	45,7	98	5	59	138	13,2
24.0110-0284.1	410284		B				271	10	9	60,7	100	5	55	151	14,5
24.0110-0285.1	410285		B				278	10	9	45	114,3	5	68	154	12,5
24.0110-0286.1	410286		B				284	10	8,4	61	114,3	5	76	190	12,6
24.0110-0287.1	410287	+ S	B	HC			280	10	8,4	75	120	5	75	160,8	14,7
24.0110-0289.1	410289		B				265	10	8	71	108	5	68	160,1	16
24.0110-0290.1	410290		B				276	10	9	51,5	108	5	59	138	14,7
24.0110-0291.1	410291	+ S	B				264	10	8	42	100	4	57	145	14
24.0110-0292.1	410292						283	10	8	62	108	5	68	190	16
24.0110-0293.1	410293		B	L			290	10	8,3	57	112	5	67	164	13,2
24.0110-0295.1	410295		B				260	10	8	63,7	114,3	4	64,1	155	12,7
24.0110-0298.1	410298						258	10	8	45,3	114,3	5	76	154	12,6
24.0110-0299.1	410299						305	10	8,5	75,2	127	5	72,2	194,5	15,5
24.0110-0300.1	410300						270	10	8	61	100	4	57	180	13
24.0110-0301.1	410301		B				261	10	8	39,9	100	4	57	142,8	13
24.0110-0302.1	410302		B				280	10	8	40,2	114,3	5	72	142	13
24.0110-0304.1	410304		B				250	10	8	38,6	114,3	4	69	147	12,6
24.0110-0305.1	410305		B				288	10	8,5	64,9	100	5	55	170	14,5
24.0110-0307.1	410307		B				276	10	8	34,9	100	4	55	125	13
24.0110-0308.1	410308	+ S	B				261	10	8	40	114,3	4	72	142,5	13
24.0110-0310.1	410310		B				278	10	9	45	114,3	4	68	154	12,6
24.0110-0311.1	410311		B				280	10	9	56	100	5	55	173	14,7
24.0110-0312.1	410312		B				262	10	8,4	64	100	4	62,5	168	12,6
24.0110-0313.1	410313		B				280	10,2	8,9	33	108	4	63,5	155	13,7
24.0110-0314.1	410314	+ S	B	HC			280	10	8,4	65,5	120	5	75	160,8	14,5
24.0110-0315.1	410315	+ S	B	HC			296	10,4	8,9	65,5	120	5	75	160,8	14,5
24.0110-0316.1	410316		B				288	10	8,5	69,8	114,3	5	62	190	14,5
24.0110-0317.1	410317						262	10	8,4	61	114,3	4	76	168	12,8
24.0110-0318.1	410318		B				262	10	8,4	61	114,3	5	76	168	12,6
24.0110-0319.1	410319						295	10	8,8	88	120,7	5	73,8	180	13,4
24.0110-0320.1	410320		B				290	10	8,5	56,8	114,3	5	62	180	14,5
24.0110-0321.1	410321		B				260	10	8	49	114,3	5	64,2	140,4	12,6
24.0110-0323.1	410323		B				264	10	8	40,5	100	4/6	60	136,8	14
24.0110-0324.1	410324		B				234	10	8	37,5	100	4	62,5	142	12,6
24.0110-0325.2	410325		B				270	10	9	80,7	100	4	55	52,3	M12x1,5
24.0110-0326.1	410326						260	10	8	48,5	100	4	61	148,5	12,3
24.0110-0328.1	410328	+ S	B				300	10	8,3	57,5	112	5	67	164	15,3
24.0110-0329.1	410329	+ S	B				302	10	8	61	114,3	5	64,1	200	12,5
24.0110-0330.1	410330		B				302	10	8	58,7	114,3	5	80	190	12,6
24.0110-0331.1	410331	+ S	B	HC			280	9,6	8	38	112	3	58	153,5	12,5
24.0110-0332.1	410332		B				262	10	8	61,1	114,3	5	76	168	12,5
24.0110-0333.1	410333		B				280	10	8,5	59,2	114,3	5	62	173	14,7
24.0110-0334.1	410334		B				258	10	8	41,4	114,3	4	76	154	13
24.0110-0335.1	410335		B				291	10	8,5	61,3	114,3	5	62	190	14,5
24.0110-0336.1	410336		B				284	10	8,4	54,5	114,3	5	76	190	12,6
24.0110-0337.1	410337		B				270	9,9	8	36,8	114,3	5	62	166	14,8
24.0110-0338.1	410338		B				262	10	8,4	61	114,3	5	76	168	12,5
24.0110-0339.1	410339	+ S	B				278	10	8	42	110	5/7	65,5	149	14
24.0110-0340.1	410340	+ S	B				258	10,5	8	57,2	114,3	4	60	168	12,6
24.0110-0341.1	410341		B				275	10	8,4	61	114,3	5	76	168	12,5
24.0110-0344.1	410344		B				302	10	8,4	58,7	114,3	5	69	190	12,5
24.0110-0345.1	410345		B				262	10	8,4	60,1	114,3	5	80	168	12,5
24.0110-0346.1	410346		B				298	10	8,5	64,4	114,3	5	62	190	14,5
24.0110-0347.1	410347		B				264	10	8	40,5	110	5	70	136,8	14
24.0110-0349.1	410349		B				251	10	9	40,5	98	4	59	128	13,2
24.0110-0350.1	410350		B				269	10	9	64,7	100	5	55	170	14,5
24.0110-0351.1	410351	+ S	B	HC L			300	10	8,3	58,3	112	5	67	180	15,3
24.0110-0352.1	410352		B	HC L			299	10,4	8,5	67,6	139,5	6	105,6	190	16
24.0110-0355.1	410355		B				290	10	8	46	139,5	5	108,2	183	12,8



# Abmessungen Bremsscheiben

## Dimensions brake discs - Medidas disco de freno - Dimensions Disques de frein - Misure dischi freno

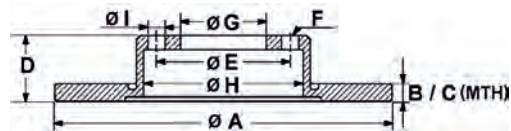

S Fixierschraube - fixing screw - tornillo quefija - vis de fixation - vite di riparazione  
 B beschichtet - coated - recubierto - revêtu - rivestito  
 HC hochgekohlt - high carbon - altamente carbonizado - à haute teneur en carbone - ad alto tenore di carbonio

L legiert - alloyed - aleado - allié - alligato/legato  
 V ventiliert - ventilated - ventilado - ventilé - ventilato  
 \* gelocht - perforated - perforado - poinçonné - perforato

		S	B	HC L	V	A	B	C	D	E	F	G	H	I
24.0110-0356.1	410356	+ S	B			272	9,7	8	48,2	112	9	65	174,5	15,3
24.0110-0357.1	410357		B			258	10	8	40,5	114,3	5	76	154	12,5
24.0110-0358.1	410358	+ S	B			280	10	8,4	50,2	120	5	79	151,8	16,5
24.0110-0359.1	410359	+ S	B			264	10	8	40,5	110	5/5	70	136,8	14/11
24.0110-0360.1	410360		B			302	10	8,4	60,1	114,3	5	80	168	12,6
24.0110-0362.1	410362		B			262	10	8,4	63,8	114,3	5	76	168	12,6
24.0110-0363.1	410363		B			262	10	8,4	60,2	114,3	5	80	168	12,6
24.0110-0364.1	410364		B			279	10	8,5	30,6	100	5	55	155,8	14,5
24.0110-0366.1	410366		B			286	10	8,5	63,5	100	5	58	190	13
24.0110-0367.1	410367		B			284	10	8,4	54,3	114,3	5	76	168	12,5
24.0110-0368.1	410368		B			262	10	8,4	45,9	114,3	5	76	162,3	12,5
24.0110-0369.1	410369		B			300	10	8,4	24,5	114,3	5	76	155	12,5
24.0110-0370.1	410370		B			284	10	8,4	24,7	114,3	5	76	154,5	12,5
24.0110-0372.1	410372		B	HC L		302	10	8,4	60,3	114,3	5	80	168	12,6
24.0110-0374.1	410374		B			281	10	8,5	66,8	114,3	5	62	173	14,5
24.0110-0378.1	410378		B			251	10	9	40,5	98	5	59	128	13,2
24.0110-0379.1	410379		B	HC L		262	10	8,4	45,1	114,3	5	76	162	12,5
24.0110-0380.1	410380		B			276	10	8	31,6	114,3	5	64	143	12,7
24.0110-0381.1	410381		B			303	10	8	39,8	114,3	5	68	143	13
24.0110-0382.1	410382	+ S	B			295	10	8,3	44	112	5	67	161	15,2
24.0110-0383.1	410383		B	HC L		284	10	8,4	25,9	114,3	5	76	155,2	12,5
24.0110-0384.1	410384		B			273,8	10	8,5	63,4	100	5	58	170	13
24.0110-0388.1	410388		B	HC L		284	10	8,4	55,3	114,3	5	76	168	12,5
24.0110-0389.2	410389		B			270	10	9	80,7	108	5	52	55	M12x1,5
24.0110-0391.1	410391	+ S	B	HC L		300	10	8,3	43	112	5	67	161	15,2
24.0110-0392.1	410392		B			284	10	8,4	45	114,3	5	76	184,2	12,5
24.0110-0393.1	410393		B			264	10	8	40,5	98	5	59	137	13
24.0110-0394.1	410394		B			234	10	8,4	44,9	100	4	62,4	142	13
24.0110-0395.1	410395		B			302	10	8,4	36,2	114,3	5	69	144,3	12,6
24.0110-0396.1	410396	+ S	B	HC		259	10	8,4	50,6	112	5	67	155	16,5
24.0110-0398.1	410398		B	HC		262	10	8,4	44	100	4	62,5	162	12,6
24.0110-0400.1	410400		B	HC		284	10	8,4	31,9	144,3	5	76	155	12,5
24.0110-0401.1	410401	+ S	B	HC		280	10	8,4	50,8	112	5	67	155	16,5
24.0110-0404.1	410404	+ S	B			264	10	8	44	105	5	60	147	14
24.0110-0700.1	410700					269	10	9	64,8	114,3	5	62	170	14,5
24.0110-0704.1	410704		B			262	10	8,4	60,1	114,3	5	90	168	12,5
24.0110-0712.1	410712		B			288	10	8,5	60	114,3	5	62	170	14,5
24.0110-0714.1	410714					258	10,3	8	64,7	100	4	57	168	13
24.0110-0728.1	410728		B			273,8	10	8,5	67,5	100	5	58	170	13
24.0111-0100.2	411100		B			300	11	9,5	84,7	108	5	62	52,3	M14x1,5
24.0111-0101.2	411101		B			274	10,9	9,5	82,2	108	5	62	52,3	M12x1,5
24.0111-0115.1	411115		B			252,5	10	9	65	98	4	68	118	13
24.0111-0119.1	411119		B			240,5	11	9,2	40	98	4	59	123	13
24.0111-0125.1	411125		B			230	11	8,4	43,8	114,3	4	67,4	142	12,6
24.0111-0130.1	411130		B			227	10,8	9	45,8	98	4	62	117	13
24.0111-0133.1	411133		B			278	11	9	50,2	117,8	5	70,7	175,3	16,2
24.0111-0139.1	411139					234	11	10	47	100	4	56	128,5	13,4
24.0111-0141.1	411141					256	10,8	8	41,1	100	6	60	123	14,3
24.0111-0142.1	411142		B			240,5	11	9,2	40	98	5	59	123	13,2
24.0111-0144.1	411144		B			265	10,5	9,5	44,3	108	5	61	149,5	15,5
24.0111-0145.1	411145	+ S	B			302	10,9	9	50,8	108	5	63,5	177,6	15,8
24.0111-0146.1	411146		B			302	11	9,4	71,5	114,3	5	69	190	12,5
24.0111-0147.1	411147	+ S	B			302	11	9	40,8	108	5	63,5	177,6	16
24.0111-0148.2	411148		B			274	10,9	9,5	82,2	100	4	62	52,3	M12x1,5
24.0111-0149.1	411149					240,5	11	9,2	40	98	4	59	124,5	13
24.0111-0150.1	411150					257	10,5	9,5	35,3	100	4	61	134	12,6
24.0111-0151.1	411151		B			265	10,5	9,5	54,3	108	5	66	149,6	15,5
24.0111-0152.1	411152		B			240	11	8	41	100	4/6	60	126	14,5
24.0111-0153.1	411153		B			300	11	9,3	58,5	112	5	67	180	15
24.0111-0154.1	411154		B			278	11	9	53,7	108	5	63,5	146	13,7
24.0111-0155.1	411155		B			265	11	9	40,8	108	5	63,5	152	13,7
24.0111-0158.1	411158	+ S	B			280	11	9	41	108	5	63,5	192	13,7
24.0111-0159.1	411159		B			211	11	10	40,9	100	4	55,1	125	13,2
24.0111-0160.1	411160		B			280	11	9	40,8	114,3	5	72	154	14
24.0111-0164.1	411164		B			265	11	9	40,7	114,3	5	72	152	14
24.0111-0165.1	411165		B			302	11	9	40,8	114,3	5	72	153	13,7
24.0111-0166.2	411166		B			274	10,9	9,5	82,2	100	4	62	52,3	M12x1,5
24.0111-0167.2	411167		B			300	11	9,5	84,7	108	5	62	52,3	M12x1,5
24.0111-0168.1	411168		B			297	11	9	58,5	114,3	5	62	180	14,5

# Abmessungen Bremsscheiben

## Dimensions brake discs - Medidas disco de freno - Dimensions Disques de frein - Misure dischi freno

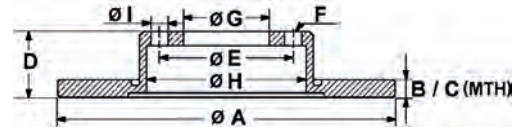

S Fixierschraube - fixing screw - tornillo quefija - vis de fixation - vite di riparazione  
 B beschichtet - coated - recubierto - revêtu - rivestito  
 HC hochgekohlt - high carbon - altamente carbonizado - à haute teneur en carbone - ad alto tenore di carbonio

L legiert - alloyed - aleado - allié - alligato/legato  
 V ventiliert - ventilated - ventilado - ventilé - ventilato  
 \* gelocht - perforated - perforado - poinçonné - perforato

	S	B	HC L	V	A	B	C	D	E	F	G	H	I
24.0111-0169.1	411169		B		290	11	9	33,7	114,3	5	62	155	14,5
24.0111-0170.1	411170		B	HC L	302	11	9,4	71,5	114,3	5	69	190	12,5
24.0111-0171.1	411171		B		271	11	9	40,7	108	5	63,5	152	13,8
24.0111-0172.1	411172		B		280	11	9	50,7	108	5	63,5	153,5	13,7
24.0111-0173.2	411173		B		300	11	9,5	81,7	114,3	5	52	62	M14x1,5
24.0111-0174.2	411174		B		274	11	9,5	88,2	108	5	52	62	M12x1,5
24.0111-0175.1	411175	+ S	B	HC	290	11	9,4	66	120	5	75	160,8	16,5
24.0111-0176.1	411176		B		240,5	11	9,2	40	98	4	59	123	13
24.0111-0180.2	411180		B		274	11	9,5	86,2	114,3	5	52,3	62	M12x1,5
24.0111-0181.2	411181		B		300	11	9,5	101,7	114,3	5	52	62	M14x1,5
24.0111-0182.2	411182		B		274	11	9,5	88,2	108	5	52	62	M12x1,5
24.0111-0183.2	411183		B		300	11	9,5	102,2	108	5	52,3	62	M14x1,5
24.0111-0184.2	411184		B		290	11	9,5	90,2	114,3	5	52,3	62	M12x1,5
24.0111-0185.1	411185		B		302	11	9,5	50,8	108	5	63,5	177,3	13,8
24.0111-0186.2	411186		B		290	11	9,5	104,6	114,3	5	52,3	62	M12x1,5
24.0112-0106.1	412106	+ S	B		239	12	10	35,4	100	4	65	124,5	13,6
24.0112-0112.1	412112		B		257	12	10,8	51,5	98	4	62	135	13
24.0112-0116.1	412116	+ S	B		238	12	10,5	41	100	4	61	129,5	13,5
24.0112-0117.1	412117	+ S	B		284	12	10	46,5	112	5	67	154,3	15
24.0112-0122.1	412122				240	12	10,8	46,5	98	4	59	127,5	13
24.0112-0124.1	412124	+ S	B	HC	302	12	10,4	76	120	5	79	149	14,5
24.0112-0125.1	412125		B		239	12	10,8	42,5	98	4	58,5	127	13,1
24.0112-0126.1	412126	+ S	B		286	12	10,4	51,5	120	5	79	148	14,5
24.0112-0127.1	412127		B		257,5	12	10,2	40,5	98	4	59	123	13
24.0112-0128.1	412128	+ S	B		284	12	10	43,5	112	5	67	154,3	12,8
24.0112-0129.1	412129		B	HC	290	12	9,8	60	112	5	67	164	17
24.0112-0130.1	412130		B		272	11	9,9	50,5	140	5	108	157	14,5
24.0112-0131.1	412131		B		286	12	10	69,5	110	5	65,5	160	14
24.0112-0132.1	412132	+ S	B	HC	324	12	10,4	61	120	5	75	180	14,5
24.0112-0133.1	412133				253,8	12	10,5	54,2	108	5	66	134	14,7
24.0112-0134.1	412134				253,8	12	10,5	54,2	100	4	66	134	12,6
24.0112-0135.1	412135		B		260	12	10,8	40	100	4/6	61	127	13
24.0112-0136.2	412136				251	12	10,8	62,3	108	5	71	134,7	13
24.0112-0137.1	412137		B		234	12	10	45,2	100	4	59	129,5	12,5
24.0112-0138.1	412138	+ S	B		280	12	10	40,4	112	5	68,2	153	16,5
24.0112-0141.1	412141		B		239,5	12	10	42,9	108	4	63,5	136	13,7
24.0112-0142.1	412142	+ S	B	HC L	258	12	10	96,7	130	5	85	160	15
24.0112-0143.1	412143				251	12	10,8	62,4	108	4	71,1	135	13
24.0112-0144.1	412144	+ S	B	HC L	260	12	10	40,4	112	5	67	145	13,3
24.0112-0148.1	412148		B		255	12	10	40	112	5/9	68	144,5	15,3
24.0112-0149.1	412149		B		290	12	10,3	56	112	5	67	164	13
24.0112-0150.1	412150		B		277	11,9	10	71	108	5	68	160	16,5
24.0112-0151.1	412151		B		288	11,9	10	64,8	108	5	68	178	16,5
24.0112-0152.1	412152		B	HC	324	12	10,4	80,2	120	5	75	185	16,8
24.0112-0153.1	412153		B		247	12	10,5	44	100	4	60	125	12,8
24.0112-0154.1	412154		B		280	12	10	34	108	5	63,5	151	13,7
24.0112-0155.1	412155	+ S	B		305	12	10,5	66,8	130	5	90	169,5	15,5
24.0112-0156.1	412156		B		272	12	10	28	98	5	59	134	15
24.0112-0157.1	412157	+ S	B		278	11,9	10	41,4	110	5	65,5	145,2	14
24.0112-0158.1	412158	+ S	B		256	12	10	48,6	112	5/9	65	140	15,3
24.0112-0159.1	412159	+ S	B		302	12	10	49,4	112	5/9	68	177	15,3
24.0112-0160.1	412160		B		280,5	12	11	45,1	100	4	61	149	13,5
24.0112-0162.1	412162	+ S	B		290	12	10	35	108	5	71,1	151,2	13
24.0112-0164.1	412164		B		291	12	10,5	68,4	114,3	5	62	190	14,5
24.0112-0165.1	412165		B		288	12	10	62	108	5	68	178	16
24.0112-0166.1	412166		B		288	12	10	36	112	5	68	162	15,3
24.0112-0167.1	412167	+ S	B	HC L	276	12	10	44,5	112	5	67	145	15,3
24.0112-0168.1	412168		B		354	11,9	10,4	74,9	120	5	79	210	16,6
24.0112-0169.1	412169	+ S	B		282	12	10	48,6	112	5/9	65	159	15,3
24.0112-0170.1	412170	+ S	B		278	12	10	43,2	110	5	70	139	16,6
24.0112-0171.1	412171	+ S	B		259	12	10,6	40,9	100	4	61	130	13,5
24.0112-0172.1	412172	+ S	B		282	12	10	58,5	114,3	5	64,2	170	12,8
24.0112-0173.1	412173		B		232	12	9,5	51	114,3	4	64	137	12,7
24.0112-0174.1	412174		B		290	12	10	50	108	5	71,1	144	13
24.0112-0175.1	412175	+ S	B		286	12	10	58,6	112	5	65	140	15,3
24.0112-0176.1	412176		B	HC L	302	12	10	42,4	112	5/9	68	176,5	15,3
24.0112-0177.2	412177		B		280	12	10	102,2	118	5	68	64,5	M14x1,5
24.0112-0178.1	412178	+ S	B		300	12	10	36,4	112	5	68	169	15,3
24.0112-0180.1	412180	+ S	B		302	12	10	69,2	108	5	63,5	178	15,8





# Abmessungen Bremsscheiben

## Dimensions brake discs - Medidas disco de freno - Dimensions Disques de frein - Misure dischi freno

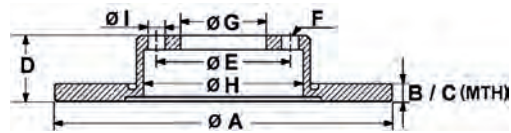

S Fixierschraube - fixing screw - tornillo quefija - vis de fixation - vite di riparazione  
 B beschichtet - coated - recubierto - revêtu - rivestito  
 HC hochgekohlt - high carbon - altamente carbonizado - à haute teneur en carbone - ad alto tenore di carbonio

L legiert - alloyed - aleado - allié - alligato/legato  
 V ventiliert - ventilated - ventilado - ventilé - ventilato  
 \* gelocht - perforated - perforado - poinçonné - perforato

	S	B	HC	L	V	A	B	C	D	E	F	G	H	I
24.0112-0181.1	412181		B			302	12	11	56,1	114,3	5	72	185	14,2
24.0112-0183.1	412183	+ S	B			300	12	10	58,3	112	5	67	180	15,3
24.0112-0184.1	412184	+ S	B			257	12	10	40,5	100	4/6	60	127	14,3
24.0112-0185.1	412185					324	11,9	10,4	69,5	139,6	6	96,3	210	12,5
24.0112-0186.1	412186		B			302	12	10	66	108	5	63,6	185	15,7
24.0112-0187.1	412187	+ S	B			292	12	10,5	48	120	5	67,4	171,5	16,3
24.0112-0188.1	412188	+ S	B			268	12	10	44,9	105	5	60	147	14,2
24.0112-0189.1	412189	+ S	B			292	12	10	45	115	5	70,7	157	14,2
24.0112-0190.1	412190	+ S	B	HC	L	305	12	10	71,5	130	5	91	167,5	17
24.0112-0191.1	412191	+ S	B	HC	L	305	12	10	71,4	130	5	90	167	15,5
24.0112-0193.1	412193		B			316	12	10,4	68,6	127	5	72	206	16,6
24.0112-0194.2	412194		B			268	12	10	73,2	108	4	56	62	M12x1,25
24.0112-0195.1	412195		B			278	12	11	46	114,3	5	62	169,2	12,8
24.0112-0197.1	412197	+ S	B			290	12	10	44	108	5	71,1	136	13
24.0112-0198.1	412198	+ S	B			290	12	10	35	108	4	71,1	151,2	13
24.0112-0199.1	412199		B	HC		305	12	10,4	33	127	5	72,5	167,5	14
24.0112-0202.1	412202		B			292	12	10,5	48	120	5	67,4	171,5	16,3
24.0112-0203.1	412203		B			290	12	10,5	53,2	114,3	5	62	180	14,4
24.0112-0210.1	412210	+ S	B			300	12	10	48,2	112	5/9	65	173	15,3
24.0112-0211.1	412211	+ S	B			268	12	10	35	108	5	71,1	133	13,2
24.0112-0212.1	412212	+ S	B			290	12	10	35	108	5	71,1	133	13,2
24.0112-0213.1	412213	+ S	B	HC	L	300	12	9	57,9	112	5	67	186	15,3
24.0112-0214.1	412214	+ S	B			278	12	10,4	33,2	110	5	70	137	15,7
24.0112-0215.1	412215	+ S	B			320	12	10,4	33,2	110	5/5	70	180,7	15,7/11
24.0112-0216.1	412216	+ S	B			290	12	10	59	108	5	71,1	136	13,2
24.0112-0217.2	412217		B			280	12	10	104,5	108	5	52,3	68	M14x1,5
24.0112-0218.1	412218	+ S	B			300	12	10	36,2	112	5	69	166	15,3
24.0112-0300.1	412300	+ S	B	HC		300	12	10,3	48,7	112	5	69	167	15,4
24.0112-0703.1	412703		B			306,6	12	10,5	63,2	114,3	5	62	190	14,5
24.0112-0707.1	412707		B			282	12	10	39,7	114,3	5	64,2	142	12,6
24.0112-0714.1	412714		B			281	12	10,5	55	114,3	5	62	172	14,5
24.0113-0105.1	413105					302	12,5	11,5	48	139,5	6	100	168,5	15
24.0113-0161.1	413161	+ S	B			236	12,7	9,7	41	100	4/6	60	123	14
24.0113-0166.1	413166		B			256	13	11	56,5	108	4	68	134,5	15,4
24.0113-0178.1	413178	+ S	B			255,6	12,9	11	39,2	100	4	65	135,5	13,6
24.0113-0179.1	413179		B	HC		280	13	11	56,5	108	4	68	159	15,4
24.0113-0181.1	413181		B	HC		280	13	11	46,5	112	5	68	159	15,4
24.0113-0182.1	413182		B			236	12,8	11,4	45,7	100	4	62	125,5	14,8
24.0113-0184.1	413184	+ S	B			266	13	11	27,2	108	4	66	133	13
24.0113-0185.1	413185	+ S	B			247,5	13	11	34,2	108	4	66	133	13
24.0113-0186.1	413186					234	13	11,4	45	100	4	64	126	12,6
24.0113-0189.1	413189		B			290	12,5	11,7	61,5	127	5	101,6	160,5	10
24.0113-0190.1	413190					240	12,8	11,6	43	95,2	4	66	122	13
24.0113-0194.1	413194		B			294	13,5	11,5	41	112	5	68,2	165	16,5
24.0113-0195.1	413195		B			236	12,6	9,7	35,4	102	4	86	107,5	M10x1,25
24.0113-0196.1	413196		B			290	12,5	11,3	56	114,3	5	72	180	14,5
24.0113-0197.1	413197		B			304,5	12,6	11,7	62,8	120	5	70	161,5	14,3
24.0113-0198.1	413198		B			262	13	11	44,5	100	4	64,2	141	13
24.0113-0200.1	413200		B			290	13	11	47	114,3	5	68	158	12,7
24.0114-0108.1	414108		B			298,5	14	13	70	127	5	101,6	160,5	10
24.0114-0110.2	414110	+ S				267	14,2	12,8	111	170	6	58,3	115	M18x1,5
24.0114-0111.1	414111		B			331	13,9	12,3	55,3	112	5	67	184	15,3
24.0114-0112.1	414112	+ S	B			276	14	12	62	108	4	71	136,5	13
24.0114-0113.1	414113		B			262	14	11	51	114,3	5	66,1	140,8	12,6
24.0114-0114.1	414114	+ S	B	HC	L	330	14	11,4	63	112	5	67	210	15,2
24.0114-0115.1	414115					298	14	13	59	127	5	101,6	159,6	10,2
24.0114-0116.1	414116	+ S	B			290	14	12	49	108	5	71	143,7	13,2
24.0114-0118.1	414118		B			320	14	12,5	66,3	127	5	72	205	16,2
24.0114-0119.1	414119	+ S	B	HC	L	325	14	11,4	54	112	5	67	183	15
24.0114-0120.1	414120		B			330	14	12,5	63,4	127	5	72	206,2	17
24.0115-0105.1	415105		B	HC		288	15	13	46,5	112	5	68	135,5	15,4
24.0115-0108.1	415108		B			281	15	13,2	44,7	98	5	59	127	13
24.0115-0109.1	415109		B	HC	V	239	15	13	34,5	100	4/6	65	124,7	13,6
24.0115-0111.1	415111		B			285	15	13	52,5	112	5	67	184	15
24.0115-0112.1	415112					281	15	13,2	44,7	98	4	59	127	13
24.0116-0100.1	416100		B			280	16	13	78,6	112	5	88	133,5	12,5
24.0116-0107.2	416107	+ S	B			238,5	16	14,5	79	140	5	102	138	M14x1,5
24.0116-0108.1	416108		B			260	16	13	64	112	5	68,2	144	16,5
24.0116-0110.1	416110	+ S	B	HC	L	272	16	14	96,7	130	5	85	160	15



# Abmessungen Bremsscheiben

## Dimensions brake discs - Medidas disco de freno - Dimensions Disques de frein - Misure dischi freno

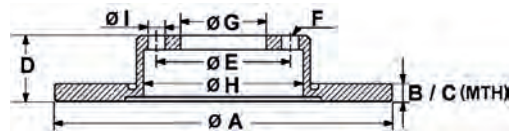

S Fixierschraube - fixing screw - tornillo quefija - vis de fixation - vite di riparazione  
 B beschichtet - coated - recubierto - revêtu - rivestito  
 HC hochgekohlt - high carbon - allamente carbonizado - à haute teneur en carbone - ad alto tenore di carbonio

L legiert - alloyed - aleado - allié - alligato/legato  
 V ventiliert - ventilated - ventilado - ventilé - ventilato  
 \* gelocht - perforated - perforado - poinçonné - perforato

		S	B	HC	L	V	A	B	C	D	E	F	G	H	I
24.0116-0117.1	416117		B				273	16	15	37,5	114,3	5	66,5	162	14
24.0116-0118.1	416118					V	234	16	14	37	88	4	70	111	M10
24.0116-0119.1	416119		B			V	292	16	14	62	114,3	5	68	172	12,7
24.0116-0121.1	416121	+ S	B				298	16	14	71	130	6	85	180	15
24.0116-0122.1	416122		B			V	308	16	14	62	114,3	5	68	190	12,8
24.0116-0123.1	416123		B				300	16	14,2	80	130	5	79	172	17,5
24.0116-0124.1	416124		B				280	16	14,2	82	118	5	72	172	15,6
24.0116-0125.1	416125		B				280	16	14,2	82	130	5	79	172	17,5
24.0116-0126.1	416126		B				280	16	13	16,3	124	5/10	107,5	144,5	10,7
24.0116-0128.1	416128		B				276	16	13	69,5	118	5	73	145	15,5
24.0116-0129.1	416129		B				276	16	13	69,5	118	5	73	145	15,5
24.0116-0130.1	416130		B			V	234	16	15	41	100	4	55	125	14
24.0116-0131.1	416131		B				280	16	13	66,8	127	6	108	164,6	10,8
24.0116-0132.1	416132		B				280	16	13	62,1	127	6	108	164,5	10,8
24.0116-0133.1	416133	+ S	B				303	16	13	83	130	5	85	158,5	15
24.0116-0134.1	416134		B				284	16	13	43,9	124	10	107,1	148	10,7
24.0116-0216.1	416216		B				280	16	13	68,7	160	5	96	120	M10x1,5
24.0117-0101.1	417101		B			V	231	17	15	44	100	4	61	124	12,6
24.0117-0103.1	417103		B			V	231,2	17	15	50	114,3	4	64	137,5	12,8
24.0117-0104.1	417104					V	287	17	15	46,1	140	5	107	183	13
24.0117-0105.1	417105		B			V	231	17	15	49,2	100	4	60	125	12,8
24.0117-0106.1	417106		B			V	253	17	15	49	100	4	60	153	12,5
24.0117-0107.1	417107		B			V	246	17	16	41,9	100	4	55,1	137	13,2
24.0117-0108.1	417108		B			V	257	17	15	49,2	100	4	60	151	12,7
24.0117-0109.1	417109					V	287	17	15	29	140	5	108,2	181,7	13
24.0117-0110.1	417110		B			V	257	17	15	38,3	100	4	64	123,5	12,6
24.0118-0105.1	418105		B				282	18	15	64,5	112	5	68,2	144	16,5
24.0118-0106.1	418106	+ S	B	HC		V	239	18	16	34,5	100	4	65	125	13,6
24.0118-0107.1	418107		B			V	240	18	16	45,2	100	4	61	130	12,6
24.0118-0108.1	418108		B				280	18	15,9	65,5	118	5	73	141,3	15,5
24.0118-0110.1	418110					V	238	18	17	48,2	100	4	54,1	127	14,5
24.0118-0111.1	418111	+ S	B	HC			282	18	15	55	112	5	68,2	144	16,5
24.0118-0113.1	418113		B			V	235	18	16	45	100	4	55	125	13
24.0118-0117.1	418117					V	247	18	16	45,2	100	4	61	130	12,7
24.0118-0118.1	418118					V	232	18	16	45,2	100	4	61	130	12,8
24.0118-0120.1	418120		B			V	236	18	16,4	45	100	4	64	126	12,6
24.0118-0121.1	418121					V	277	18	17	32,5	118	5	96	176	10,6
24.0118-0122.1	418122		B			V	313,5	18	16,6	80,2	139,6	6	101	210	12,6
24.0118-0124.1	418124		B			V	238	18	17	42,8	100	4	55	127	14,6
24.0118-0125.1	418125					V	242	18	16	52,5	100	5	58	128	13
24.0118-0126.1	418126					V	234,5	18	17	47	100	4	56	128,5	13
24.0118-0129.1	418129		B			V	302	18	16	46,2	114,3	5	62	156,7	14,6
24.0118-0131.1	418131		B			V	235	17,9	16	43,2	100	4	55	129,5	14,5
24.0118-0136.1	418136					V	316	18	16	80	139,7	6	111	189	12,8
24.0118-0137.1	418137	+ S	B	HC		V	239	18	16	35	100	5	65	125	15,6
24.0118-0138.1	418138		B			V	234	18	16	50,7	100	4	62,2	126	12,6
24.0118-0139.1	418139		B			V	238	18	16	46,2	100	4	59	130	12,5
24.0118-0140.1	418140		B				315	18	16,4	84,2	139,7	6	108	197	12,5
24.0118-0141.1	418141					V	266	18	16,4	60,2	114,3	4	90	168	12,6
24.0118-0143.1	418143		B			V	329,2	18	16	102,6	150	5	110	230	16,7
24.0118-0144.1	418144		B			V	252	18	16	49	100	4	62,2	126	12,6
24.0118-0145.1	418145		B			V	241	18	16	49	100	4	62,2	126	12,6
24.0118-0146.1	418146		B			V	332	18	16	74,4	139,7	6	94	210	12,8
24.0118-0147.1	418147		B			V	310	18	16,5	67,5	114,3	5	62	190	14,5
24.0118-0148.1	418148		B			V	286	18	16	58,7	114,3	5	72	190	13
24.0118-0149.1	418149		B			V	302	18	16	43,3	114,3	5	72	142,8	13
24.0118-0150.1	418150		B			V	301,6	18	16	56,6	114,3	5	72	190	13
24.0118-0151.1	418151		B			V	256	18	16	46,9	100	4	62,2	126	12,5
24.0118-0153.1	418153		B				302	18	15	51	140	8	120	164	10,9
24.0118-0154.1	418154		B			V	324	18	16	67	114,3	5	69	210	12,5
24.0118-0157.1	418157		B			V	309	18	16,5	69,8	114,3	5	62	210	14,5
24.0118-0158.1	418158		B			V	324	18	16	56,7	114,3	5	72	190	13
24.0118-0160.1	418160		B			V	278	18	16	63,3	100	5	58	170	13
24.0118-0709.1	418709		B			V	312	18	16	68	139,7	6	106	210	14,5
24.0118-0724.1	418724		B			V	308	18	16	62,7	114,3	5	68	190	12,7
24.0118-0725.1	418725		B			V	290	18	16	67,4	100	5	58	170	13
24.0119-0107.1	419107	+ S	B	HC		V	276	19	17,4	60,3	120	5	75	160,8	14,5
24.0119-0108.1	419108	+ S	B	HC		V	294	18,9	17,4	59,7	120	5	75	160,8	14,8
24.0119-0109.1	419109		B			V	242	19,1	17	40,5	104	4	86	143	M10x1,25



# Abmessungen Bremsscheiben

## Dimensions brake discs - Medidas disco de freno - Dimensions Disques de frein - Misure dischi freno

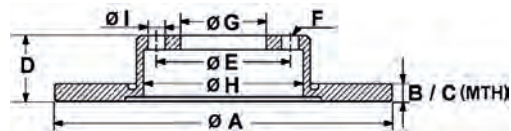

S Fixierschraube - fixing screw - tornillo quefija - vis de fixation - vite di riparazione  
 B beschichtet - coated - recubierto - revêtu - rivestito  
 HC hochgekohlt - high carbon - allamente carbonizado - à haute teneur en carbone - ad alto tenore di carbonio

L legiert - alloyed - aleado - allié - alligato/legato  
 V ventiliert - ventilated - ventilado - ventilé - ventilato  
 \* gelocht - perforated - perforado - poinçonné - perforato

		S	B	HC L	V	A	B	C	D	E	F	G	H	I
24.0119-0111.1	419111		B		V	242	19,2	17	37,2	104	4	86	126	10,4
24.0119-0112.1	419112	+ S	B	HC	V	294	19	17,4	74,7	120	5	75	160,8	14,7
24.0119-0113.1	419113	+ S	B	HC	V	294	19	17,4	60,5	120	5	75	184	14,7
24.0119-0114.1	419114		B		V	241	19	17	52,1	100	4	62,2	126	12,5
24.0119-0115.1	419115		B		V	241	19	17	47,8	100	4	62,2	126	12,5
24.0119-0116.1	419116		B		V	256	19	17	47,9	100	4	62,2	125	12,5
24.0120-0114.2	420114		B			281	19,9	18	80,5	115	5	91	128,5	M14x1,5
24.0120-0115.1	420115	+ S	B	HC L	V	236	20	17	41	100	4/6	60	123	14
24.0120-0119.1	420119		B		V	295	20	18	29	137	6	104	178	M12x1,25
24.0120-0122.1	420122		B		V	308	20	18	64,5	108	5	68	178	16,5
24.0120-0123.1	420123	+ S	B	HC L	V	239	20	18	39	100	4	65	123,8	13,6
24.0120-0125.1	420125	+ S	B		V	238	20,1	17,7	41	100	4	61	128	12,5
24.0120-0126.1	420126		B		V	259	20,2	17,7	46,4	100	4	61	130	12,8
24.0120-0128.1	420128	+ S	B	HC L	V	256	20	18	38,8	100	4	65	131,5	13,8
24.0120-0131.1	420131		B		V	247	20,4	18,5	44,2	108	4	66	133,2	12,8
24.0120-0132.1	420132	+ S	B		V	247	20,4	18,5	34,2	108	4	66	133,2	12,8
24.0120-0133.1	420133	+ S	B		V	266	20,5	18,5	27,6	108	4	66	133	13
24.0120-0137.1	420137		B		V	269	19,9	18	46	112	5	68	156	15,5
24.0120-0140.1	420140	+ S	B	HC L	V	256	20	17	41	100	4/6	60	123	14
24.0120-0142.1	420142		B	HC L	V	257,5	20	18,2	40,5	98	4	59	126,7	13
24.0120-0143.1	420143		B		V	240	20	18,2	46,5	98	4	59	124,5	13
24.0120-0146.1	420146		B		V	253	20	18	43,7	108	4	63,5	153	13,7
24.0120-0147.1	420147		B		V	239,5	20	18	43	108	4	63,5	136	13,7
24.0120-0152.1	420152				V	242	20	18	49,2	114,3	4	68	138	12,5
24.0120-0153.1	420153		B		V	302	20	19	48	139,7	6	100	166,5	15
24.0120-0154.1	420154	+ S	B	HC	V	298	20	18,4	61,3	120	5	75	185	14,5
24.0120-0155.1	420155		B	HC L	V	257,5	20	18,2	40,5	98	5	59	126,7	16,5
24.0120-0159.1	420159				V	257	20	18,2	40,5	98	5	59	126,4	13,2
24.0120-0163.1	420163				V	235	20	18	49,5	100	4	60	125,2	12,7
24.0120-0166.1	420166				V	253	20	18,4	28,6	104	5	84	148	10,6
24.0120-0168.1	420168				V	289	20	18	64,2	127	6	100	156	10,7
24.0120-0169.1	420169		B		V	255	20	18	45	100	4	55	125	13
24.0120-0171.1	420171		B		V	286	20	18	67	110	5	65,5	160	14
24.0120-0172.1	420172		B	HC L	V	269	19,9	18	59,5	112	5/10	68	156	15,3
24.0120-0173.1	420173	+ S	B		V	292	19,9	18	41,4	110	5	65,5	162,5	14
24.0120-0174.1	420174	+ S	B		V	240	20	17	41	100	4/6	60	126	14
24.0120-0175.1	420175		B		V	255	20	18	43,1	100	4	55	129	14,5
24.0120-0176.1	420176		B	HC L	V	292	20	18	67	130	5	98	164	15,4
24.0120-0177.1	420177				V	242	20	18	43,5	100	4	57	136	13
24.0120-0178.1	420178		B	HC	V	324	20	18,4	67	120	5	79	185	16,5
24.0120-0180.1	420180	+ S	B		V	247	20	18	35,3	100	4	55	129	13,2
24.0120-0181.1	420181		B	HC	V	300	20	18,4	61	120	5	75	180	14,5
24.0120-0182.1	420182	+ S	B	HC	V	328	20	18,4	61	120	5	75	180	14,5
24.0120-0183.1	420183	+ S	B	HC	V	320	20	18,4	63,2	120	5	75	185	14,5
24.0120-0184.1	420184		B		V	240,5	20	18,2	40,5	98	4	59	146,5	13
24.0120-0186.1	420186		B		V	239	19,5	18	41,8	98	4	58,5	154	13
24.0120-0187.1	420187				V	260	20	18,5	42	98	4	58,5	174	13
24.0120-0188.1	420188		B		V	305	20	18,5	67,9	120,7	5	73,8	180	13,3
24.0120-0189.1	420189	+ S	B	HC	V	312	20	18,4	61	120	5	75	180	14,5
24.0120-0190.1	420190	+ S	B	HC	V	312	20	18,4	61	120	5	75	180	14,5
24.0120-0191.1	420191		B	HC	V	324	20	18,4	80,3	120	5	75	185	16,6
24.0120-0193.1	420193				V	240	20	18,2	46,5	98	4	59	124,5	13,2
24.0120-0195.1	420195	+ S	B	HC	V	300	20	18,4	66	120	5	75	160,8	14,5
24.0120-0196.1	420196	+ S	B		V	300	20	18	69,1	110	5	65,5	160	14,2
24.0120-0197.1	420197		B		V	246	20	18	50	100	4	60	125	12,8
24.0120-0199.1	420199			HC L	V	278	19,9	17,4	55,2	112	5	67	164	15
24.0120-0200.1	420200		B	HC L	V	354	20	17	74,9	120	5	79	210	16,6
24.0120-0201.1	420201		B		V	350	20	17	59	120	5	79	210	15
24.0120-0202.1	420202				V	315	20	18,4	87,5	139,7	5	96,3	190	12,5
24.0120-0203.1	420203		B		V	252	20	18	45,2	100	4	61	144	12,6
24.0120-0204.1	420204	+ S	B	HC	V	300	20	18,4	66,1	120	5	75	185	14,5
24.0120-0206.1	420206	+ S	B	HC	V	320	19,9	18,4	78,5	120	5	75	185	16,5
24.0120-0207.1	420207		B		V	315	20	18,4	78,5	139,7	5	96,3	190	12,5
24.0120-0208.1	420208	+ S	B	HC L	V	300	22	19,4	57,5	112	5	67	164	15,3
24.0120-0209.1	420209		B	HC L	V	303	20	18,4	71,6	115	5	70,7	190	12,8
24.0120-0210.1	420210		B		V	325	20	17	59	120	5	79	210	15
24.0120-0211.1	420211	+ S	B		V	252	20	18	40	100	4	60	127	12,5
24.0120-0212.1	420212		B	HC L	V*	299	20	18	67	130	5	98	180	15,4
24.0120-0213.1	420213	+ S	B	HC	V	320	20	18,4	86,1	120	5	75	185	14,5

# Abmessungen Bremsscheiben

## Dimensions brake discs - Medidas disco de freno - Dimensions Disques de frein - Misure dischi freno

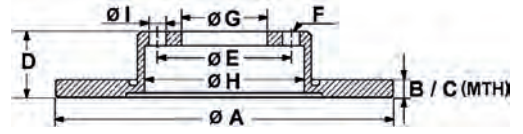

S Fixierschraube - fixing screw - tornillo quefija - vis de fixation - vite di riparazione  
 B beschichtet - coated - recubierto - revêtu - rivestito  
 HC hochgekohlt - high carbon - altamente carbonizado - à haute teneur en carbone - ad alto tenore di carbonio

L legiert - alloyed - aleado - allié - alligato/legato  
 V ventiliert - ventilated - ventilado - ventilé - ventilato  
 \* gelocht - perforated - perforado - poinçonné - perforato

		S	B	HC	L	V	A	B	C	D	E	F	G	H	I
24.0120-0214.1	420214	+ S	B	HC		V	300	20	18,4	76	120	5	75	160,8	14,5
24.0120-0215.1	420215	+ S	B	HC		V	300	20	18,4	76,2	120	5	75	185	14,5
24.0120-0216.1	420216		B			V	276	20	18	40	114,3	5	62	146,5	12,7
24.0120-0217.1	420217		B	HC		V	324	20	18,4	74	120	5	79	185	16,5
24.0120-0218.1	420218		B			V	302	20	18	66	108	5	63,6	185	15,8
24.0120-0219.1	420219		B			V	255	20	18	46,2	100	4	55	131	14,5
24.0120-0221.2	420221	+ S	B	HC		V*	328	20	18,4	61	120	5	75	185	14,5
24.0120-0222.2	420222	+ S	B	HC		V*	328	20	18,4	61	120	5	75	185	14,5
24.0120-0225.1	420225		B			V	231	20	18	51,4	100	4	60	125	12,7
24.0120-0226.1	420226	+ S	B	HC		V	300	20	18,4	54,2	120	5	75	174	14,5
24.0120-0227.1	420227	+ S	B	HC		V	236	20	18	41	100	6	59	123	12,4
24.0120-0228.1	420228	+ S	B	HC		V	324	20	18,4	54,1	120	5	75	174	14,5
24.0120-0229.2	420229	+ S	B	HC		V	330	20	18,4	68,8	120	5	75	185	16,5
24.0120-0232.1	420232		B			V	303	20	18,4	92,5	120	5	75	190	14,5
24.0120-0234.1	420234	+ S	B	HC		V	330	20	18,4	71	120	5	75	154	16,5
24.0120-0235.1	420235		B			V	303	20	18,4	92,5	140	6	75	190	12,3
24.0120-0237.1	420237	+ S	B	HC		V	300	20	18,4	66	120	5	75	160,8	16,5
24.0120-0238.1	420238		B	HC		V	326	20	18	38	108	5	64,5	160,4	14
24.0120-0239.1	420239		B			V	292	20	18	43,7	110	5/7	70	162,2	14
24.0120-0240.1	420240	+ S	B	HC		V	300	20	18,4	66	120	5	75	185	16,5
24.0120-0243.1	420243	+ S	B	HC		V	330	20	18,4	66,2	120	5	75	185	16,5
24.0120-0244.1	420244	+ S	B	HC		V	300	20	18,4	48,8	112	5	67	166	16,5
24.0120-0246.1	420246	+ S	B			V	320	20	17,5	43	108	5	63,5	141	15,8
24.0120-0247.1	420247	+ S	B			V	340	20	17,5	43	108	5	63,5	141	15,8
24.0120-0249.1	420249		B			V	236	20	18	41	100	4	60	125	12,6
24.0120-0708.1	420708		B			V	288	20	18,5	32,5	108	5	64,5	160	14
24.0121-0100.1	421100					V	285	21	19	51,2	114,3	4	64,1	141	12,7
24.0121-0104.1	421104	+ S	B			V	240	21	19	44,8	100	4	61	126	13
24.0121-0105.1	421105	+ S	B			V	262	21	19	44,7	100	4	64,1	141	13
24.0121-0106.1	421106	+ S	B			V	259	20,7	17,7	41	100	4	61	130	12,7
24.0121-0107.1	421107		B			V	262	21	19	47,2	100	4	64,1	141	13
24.0121-0110.1	421110					V	262	21	18	51	114,3	4	64,1	141	12,6
24.0121-0113.1	421113	+ S	B			V	240	21	19	39,2	100	4	61	126,5	13
24.0121-0114.1	421114		B			V	277	21	18	51	114,3	5	66,1	141	12,5
24.0121-0115.1	421115	+ S	B			V	258	21	19	39,2	100	4	64,1	141,3	12,6
24.0121-0702.1	421702	+ S	B			V	262	21	19	47,2	114,3	5	64,2	141	12,6
24.0122-0100.1	422100		B	HC		V	280	22	20	28,5	100	5	65	141	15,6
24.0122-0101.1	422101		B	HC		V	280	22	20	39,5	100	4	65	137	13,6
24.0122-0103.1	422103	+ S	B	HC		V	302	22	20,4	76	120	5	79	149	14,5
24.0122-0107.1	422107		B			V	284	22	20,2	39,4	98	4	59	127	13
24.0122-0108.1	422108		B	HC		V	256	22	20	56,5	108	4	68	132,7	15,4
24.0122-0115.1	422115	+ S	B	HC		V	286	22	20,4	51,5	120	5	79	147,5	14,5
24.0122-0123.1	422123	+ S	B	HC L		V	284	22	19,4	43,5	112	5	67	154,3	15
24.0122-0130.1	422130		B			V	257,2	22	20,2	50,7	98	4	59	127	13,2
24.0122-0132.1	422132	+ S	B	HC L		V	284	22	19,4	43,5	112	5	67	154,3	12,8
24.0122-0133.1	422133			HC		V	300	22	19,4	60	112	5	67	164	17
24.0122-0134.1	422134		B	HC L		V	284	22	19,4	43,5	112	5	67	152	15
24.0122-0136.1	422136		B	HC L		V	295	22	19,4	49,5	112	5	67	154,3	15
24.0122-0139.1	422139		B	HC		V	280	22	20	56,5	108	4	68	146	15,4
24.0122-0140.1	422140			HC		V	280	22	19	78,6	112	5	88	133,5	12,5
24.0122-0141.1	422141		B			V	276	22	20	48	108	5	71	130,5	13
24.0122-0142.1	422142		B	HC L		V	283	22	20	28,2	108	4	66,1	133,5	13
24.0122-0143.1	422143					V	280	22	20	58	108	5	61	131,5	14,7
24.0122-0145.1	422145		B			V	284	22	20,2	43,5	98	5	59	127	13
24.0122-0146.1	422146		B			V	257	22	20	49,2	114,3	4	68	144	12,6
24.0122-0147.1	422147		B			V	284	22	20,2	43,5	98	4	59	127	13
24.0122-0148.1	422148	+ S	B	HC L		V	262	22	19,8	44	100	4	61	132	13,5
24.0122-0149.1	422149		B	HC L		V	262	22	19,8	44	108	5	61	132	15,5
24.0122-0150.1	422150	+ S	B	HC		V	280	22	19	36,7	100	5	65	133,5	15,6
24.0122-0151.1	422151	+ S	B	HC		V	256	22	19	36,7	100	5	65	133,5	15,6
24.0122-0152.1	422152	+ S	B	HC		V	280	22	20	46,3	112	5/9	68	146,5	15,3
24.0122-0156.1	422156		B			V	257	22	20,6	36	109	6	88	152,5	M12x1,25
24.0122-0158.1	422158		B			V	255	22	20	48,1	100	4	55	131,1	14,5
24.0122-0159.1	422159	+ S	B	HC		V	296	22	20,4	76,3	120	5	79	148,8	14,5
24.0122-0160.1	422160	+ S	B	HC		V	300	22	20,4	51,8	120	5	79	164	14,5
24.0122-0161.1	422161	+ S	B	HC L		V	276	22	19	77,2	130	5	85	156,3	15
24.0122-0162.1	422162	+ S	B	HC L		V	276	22	19	60	112	5	67	153	15
24.0122-0163.1	422163		B	HC		V	256	22	20	36,6	100	5	65	135	15,6
24.0122-0165.1	422165		B			V	257	22	20	45	100	4	55	125	13



# Abmessungen Bremsscheiben

## Dimensions brake discs - Medidas disco de freno - Dimensions Disques de frein - Misure dischi freno

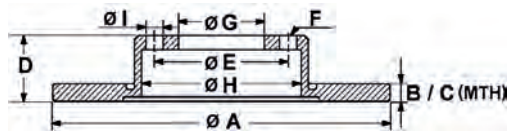

S Fixierschraube - fixing screw - tornillo quefija - vis de fixation - vite di riparazione  
 B beschichtet - coated - recubierto - revêtu - rivestito  
 HC hochgekohlt - high carbon - altamente carbonizado - à haute teneur en carbone - ad alto tenore di carbonio

L legiert - alloyed - aleado - allié - alligato/legato  
 V ventiliert - ventilated - ventilado - ventilé - ventilato  
 \* gelocht - perforated - perforado - poinçonné - perforato

		S	B	HC L	V	A	B	C	D	E	F	G	H	I
24.0122-0166.1	422166		B		V	235	22	20	45	100	4	55	125	13
24.0122-0168.1	422168	+ S	B	HC L	V	260	22	19,4	40,4	112	5	67	145	13,3
24.0122-0170.1	422170		B		V	257	22	20	34	104	4	86	160,5	10,6
24.0122-0172.1	422172		B		V	258	22	20	43,4	108	4	63,5	136	13,7
24.0122-0177.1	422177		B		V	240,5	22	20	43	95,2	4	66	122	13
24.0122-0179.1	422179		B		V	280	22	20	49,2	114,3	4	68	143,5	12,5
24.0122-0180.1	422180				V	267	22	20	39,5	124	6	100	167	M10x1,25
24.0122-0181.1	422181				V	280	22,2	20,7	77	114	5	72	147,5	15,5
24.0122-0183.1	422183		B		V	279	22	20	52,8	114,3	5	62	147	14,6
24.0122-0185.1	422185				V	319	22	20	70,2	139,7	6	108	173	14,6
24.0122-0191.1	422191				V	281	22	20,2	47,5	108	5/10	59	134	14,7
24.0122-0192.1	422192		B	HC L	V	300	22	19,4	58,5	112	5	67	180	15
24.0122-0193.1	422193				V	250	22	20	50,2	114,3	5	68	140	12,7
24.0122-0194.1	422194	+ S	B		V	266	22	20	34,2	108	4	66	133,1	13
24.0122-0196.1	422196		B	HC L	V	285	21,9	19	93	145	6	120	169	15
24.0122-0197.1	422197		B		V	257,5	22	20,2	40,5	98	4	59	127	13
24.0122-0198.1	422198		B	HC	V	269	21,9	20	46,4	112	5	68	135	15,3
24.0122-0199.1	422199		B	HC L	V	270	22	19,4	35,5	112	5	67	145	13,3
24.0122-0200.1	422200				V	310	22	20	29	140	5	108,3	181,2	13
24.0122-0201.1	422201	+ S	B		V	300	22	19,4	68	112	5	67	180	15,3
24.0122-0202.1	422202		B	HC	V	280	22	20	42,4	112	5	68	158,5	15,3
24.0122-0203.1	422203		B	HC	V	269	22	20	47,9	112	5/10	68	135	15,3
24.0122-0204.1	422204		B	HC	V	276	22	20,4	44,2	100	4	64,2	150	14,7
24.0122-0206.1	422206		B		V	284	22	19	38,2	100	5	64,2	142	15,3
24.0122-0207.1	422207		B		V	235	22	20	46	100	4	55	125	13
24.0122-0208.1	422208		B	HC L	V	276	22	19,4	35,5	112	5	67	145	13,3
24.0122-0209.1	422209	+ S	B	HC	V	320	22	20,4	60,5	120	5	75	185	14,5
24.0122-0210.1	422210	+ S	B	HC	V	280	22	19	49,9	112	5/9	65	144	15,3
24.0122-0211.1	422211	+ S	B	HC	V	294	21,9	19,5	44,4	120	5	76	154,6	16,6
24.0122-0212.1	422212		B	HC	V	310	22	20	42,4	112	5	68	178	15,3
24.0122-0213.1	422213		B	HC L	V	315	22	19,4	59,3	112	5	67	180	15
24.0122-0214.1	422214		B	HC	V	335	22	20	42,4	112	5	68	191,5	15,3
24.0122-0215.1	422215	+ S	B		V	314	22	18	75,5	120	5	76	185	16,6
24.0122-0216.1	422216	+ S	B	HC	V	260	22	19,8	44	100	4	61	125	13,6
24.0122-0218.1	422218		B	HC L	V	300	22	19,4	57,5	112	5	67	164	15
24.0122-0219.1	422219		B	HC	V	310	22	20	48,5	112	5/9	65	169	15,3
24.0122-0220.1	422220		B	HC	V	300	22	20	36,2	112	5/9	68	172	15,3
24.0122-0221.1	422221		B	HC	V	256	22	20	48,1	112	5	68	135	15,3
24.0122-0222.1	422222		B	HC	V	269	22	20	54,1	112	5	68	135	15,4
24.0122-0223.1	422223		B	HC	V	330	22	20	49,4	112	5	68	138	15,3
24.0122-0224.1	422224	+ S	B	HC	V	320	22	20,4	79,7	120	5	75	185	16,5
24.0122-0225.1	422225				V	284	22	20,2	39,4	98	5	59	127	13
24.0122-0226.1	422226	+ S	B	HC L	V	330	22	19,4	63	112	5	67	210	15,2
24.0122-0227.1	422227		B		V	235	22	20	45	100	4	55	124,5	13
24.0122-0228.1	422228		B	HC L	V	300	22	19,4	55,3	112	5	67	164	13,2
24.0122-0229.1	422229		B	HC L	V	300	22	19,4	58,3	112	5	67	180	15,2
24.0122-0230.1	422230		B		V	285	22	20,4	38,5	114,3	5	69	145	12,5
24.0122-0231.1	422231	+ S	B		V	257	22	20	40,5	100	4/6	60	126	14,5
24.0122-0232.1	422232	+ S	B	HC L	V	276	22	19,4	44,5	112	5	67	145	15,3
24.0122-0233.1	422233	+ S	B		V	292	22	20	43,2	110	5	70	139	16,6
24.0122-0234.1	422234		B		V	281	22	20,2	47,5	108	5	59	133,8	14,7
24.0122-0235.1	422235		B		V	270	22	20	46	100	4	55	125	13
24.0122-0236.1	422236	+ S	B	HC	V	336	22	20,4	67,3	120	5	75	185	14,5
24.0122-0237.1	422237		B		V	277	22	20,4	45,5	108	6	87	170	10,5
24.0122-0238.1	422238	+ S	B	HC	V	292	22	20,4	73,3	120	5	79	151,5	14,5
24.0122-0239.1	422239	+ S	B	HC	V	284	22	20,4	73,3	120	5	79	151,5	16,6
24.0122-0240.1	422240		B		V	258	22	20	46	100	4	55	131	14,3
24.0122-0241.1	422241	+ S	B		V	284	22	20	43,5	100	4/6	60	127	14,2
24.0122-0242.1	422242	+ S	B	HC	V	310	22	20	58,6	112	5	65	140	15,3
24.0122-0243.1	422243		B	HC	V	330	22	20	42,5	112	5	68	146	15,3
24.0122-0244.1	422244		B	HC	V	294	22	20,4	44,2	100	4	64,2	150	14,7
24.0122-0245.1	422245		B	HC L	V	285	22	19	72	130	5	85	156,3	15
24.0122-0246.1	422246		B		V	255	22	19	46,3	100	4	55	131	14,5
24.0122-0247.1	422247		B	HC	V	294	22	20,4	44,2	100	4	64,2	150	16,2
24.0122-0248.1	422248		B	HC	V	280	22	20,4	44,2	100	4	64,2	150	16,2
24.0122-0249.1	422249		B		V	290	22	20	45	114,3	5	72	142,8	13
24.0122-0252.1	422252		B		V	280	22	20	47	114,3	5	62	146,3	12,7
24.0122-0253.1	422253				V	297	22	20	70,2	139,7	6	108	170	14,5
24.0122-0254.1	422254		B		V	275	22	19	46,5	100	4	55	131	14,5



# Abmessungen Bremsscheiben

## Dimensions brake discs - Medidas disco de freno - Dimensions Disques de frein - Misure dischi freno

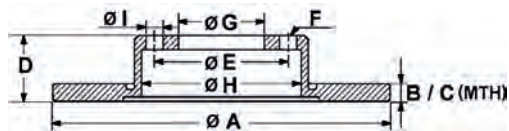

S Fixierschraube - fixing screw - tornillo que fija - vis de fixation - vite di riparazione  
 B beschichtet - coated - recubierto - revêtu - rivestito  
 HC hochgekohlt - high carbon - altamente carbonizado - à haute teneur en carbone - ad alto tenore di carbonio

L legiert - alloyed - aleado - allié - alligato/legato  
 V ventiliert - ventilated - ventilado - ventilé - ventilato  
 \* gelocht - perforated - perforado - poinçonné - perforato

		S	B	HC L	V	A	B	C	D	E	F	G	H	I
24.0122-0255.1	422255		B		V	302	22	20	35	108	5	71,1	132,7	13
24.0122-0256.1	422256		B		V	275	22	19	46,3	114,3	5	62	145	14,8
24.0122-0257.1	422257	+ S	B	HC	V	324	22	20,4	77,3	120	5	75	185	14,5
24.0122-0258.1	422258		B		V	255	22	20	49,3	100	5	55	131	14,5
24.0122-0259.1	422259	+ S	B	HC	V	302	22	20	40,8	108	5	63,5	165	15,8
24.0122-0260.1	422260		B		V	256	22	20	46,6	100	4	62,2	126	12,5
24.0122-0261.1	422261		B	HC	V	302	22	20	50,7	108	5	63,5	165	15,7
24.0122-0262.1	422262					276	22	19	72,5	118	5	73	145	15,5
24.0122-0263.1	422263		B		V	254	22	20	42	100	4	55	137	13
24.0122-0264.1	422264		B		V	290	22	19	78	127	8	110	172	10,7
24.0122-0266.1	422266		B	HC L	V	290	22	19	42,5	120	10	102	144,3	10,5
24.0122-0267.1	422267		B	HC L	V	290	22	19	78	132	8	115	172	10,8
24.0122-0268.1	422268		B		V	322	22	20,2	62	114,3	5	68	172	12,7
24.0122-0270.1	422270	+ S	B	HC	V	258	22	19,8	44	100	4	61	125,3	13,5
24.0122-0271.1	422271	+ S	B	HC	V	294	22	20,4	45,2	120	5	79	152	16,5
24.0122-0272.1	422272	+ S	B	HC	V	330	21,9	20	36	112	5	68	147,7	15,3
24.0122-0273.1	422273	+ S	B	HC	V	356	22	20	36,2	112	5	68	159,8	15,3
24.0122-0276.1	422276		B		V	275	22	19	46,3	100	5	55	131	14,5
24.0122-0277.1	422277		B		V	260	22	20	44	100	4	61	130	12,8
24.0122-0278.1	422278	+ S	B	HC	V	300	22	20,4	73	120	5	79	152	16,5
24.0122-0280.1	422280		B		V	256	22	20	40,2	100	4	60	132,8	12,5
24.0122-0281.1	422281	+ S	B	HC	V	256	22	19	36,7	100	4	65	132	13,8
24.0122-0282.1	422282		B		V	272	22	20	40,2	100	4	60	150	12,5
24.0122-0283.1	422283		B		V*	284	22	20,2	43,5	98	4	59	127	13,2
24.0122-0286.1	422286		B		V	284	22	20	43,5	98	5	59	127	13,5
24.0122-0287.1	422287	+ S	B	HC L	V*	330	22	19,4	54	112	5	67	184	15
24.0122-0288.1	422288	+ S	B	HC L	V	330	22	19,4	54	112	5	67	184	15
24.0122-0289.1	422289	+ S	B	HC L	V	258	22	19,8	43,9	100	4	61	126,5	13,5
24.0122-0290.1	422290		B		V	280	22	20	47	114,3	5	62	146,3	12,7
24.0122-0291.1	422291	+ S	B	HC L	V	266	22	20	48	108	5	71,1	137	13
24.0122-0292.1	422292	+ S	B	HC	V	280	22	20,4	45,1	112	5	67	150,5	16,5
24.0122-0293.1	422293		B	HC	V	256	22	20	43,8	100	4	62,2	126	12,5
24.0122-0294.1	422294		B	HC L	V	280	22	19,4	43,8	100	4	62,2	143,5	12,5
24.0122-0296.1	422296	+ S	B	HC	V	345	22	19,4	54	112	5	67	189	15
24.0122-0724.1	422724		B		V	300	22	20,4	72,3	139,7	6	94	199	12,6
24.0123-0101.1	423101		B		V	280	23,4	21,5	43,5	108	4	68	152,8	15
24.0123-0103.1	423103		B		V	260	23	21	34	114,3	4	92	160	M10x1,25
24.0123-0104.1	423104	+ S	B		V	282	23	21	47,1	114,3	5	70,2	148,5	12,6
24.0123-0105.1	423105				V	260	23	21	47,2	114,3	4	64,1	141	12,8
24.0123-0106.1	423106				V	282	23	21	47,2	114,3	4	64,1	141	13
24.0123-0107.1	423107		B	HC L	V	280	23	21,4	39,2	100	5	61	132	14
24.0123-0108.1	423108		B		V	295	22,5	21	66,5	120,7	5	80	154,3	13,4
24.0123-0109.1	423109	+ S	B		V	282	23	21	47,1	114,3	5	64,1	141	12,5
24.0123-0110.1	423110	+ S	B		V	282	23	21	47,2	114,3	5	64,2	141	12,6
24.0123-0111.1	423111	+ S	B		V	260	23	21	44,5	100	4	64,1	141,5	13
24.0123-0112.1	423112		B	HC	V	258	23	21	43,9	100	4	55	135,8	13
24.0123-0113.1	423113		B	HC	V	258	23	21	43,8	108	4	63,5	136	13
24.0123-0114.1	423114	+ S	B		V	315	22,9	21,5	48	120	5	67,4	172	16,3
24.0123-0116.1	423116	+ S	B		V	315	23	20	45	115	5	70,7	172	14,2
24.0123-0118.1	423118		B	HC L	V	280	23,1	21,4	44,3	114,3	5	69	143,5	12,6
24.0123-0119.1	423119	+ S	B	HC	V	269	22,5	19,8	44,1	114,3	5	68	141	15,7
24.0123-0120.1	423120	+ S	B	HC	V	282,5	23	21,4	32,2	100	5	61	142	14
24.0123-0122.1	423122		B		V	278	23	21	43,9	108	4	63,5	136	13
24.0123-0123.1	423123		B	HC	V	280	23,1	21	44,4	114,3	5	69	143,4	12,7
24.0124-0103.1	424103		B		V	252,5	24	22	53,5	95	6	76	105	M10x1,5
24.0124-0105.1	424105				V	264	24	22	46,5	114,3	5	64	137	12,6
24.0124-0115.1	424115	+ S	B	HC L	V	256	24	21	41	100	4/6	60	123	14
24.0124-0118.1	424118		B	HC L	V	280	24	20	64,5	112	5	68,2	144	16,5
24.0124-0119.1	424119		B	HC L	V	286	24	21	58,4	110	5	70	139	14
24.0124-0120.1	424120		B		V	260	24	22,2	47	108	4	63,5	136	13,6
24.0124-0125.1	424125				V	260	24,2	22,2	44	108	4	63,5	136	13,7
24.0124-0127.1	424127		B		V	280	24	21,9	67,6	118	5	73	142	15,5
24.0124-0128.1	424128	+ S	B	HC	V	280	24	20	55,2	112	5	68,2	144	16,5
24.0124-0129.1	424129		B		V	258	24	22	48,6	114,3	5	72	142,5	13
24.0124-0131.1	424131		B		V	254	24,2	22,2	43	100	5	78,5	104	M10
24.0124-0132.1	424132		B		V	270	24,2	22,2	43	100	5	78,5	104	M10
24.0124-0133.1	424133		B	HC L	V	284	24	21	41	110	5/8	70	145	14
24.0124-0136.1	424136		B		V	256	24	21,5	45,5	114,3	4	69	145	12,6
24.0124-0137.1	424137		B		V	278	24	22	70	120	6	95	136	M12x1





# Abmessungen Bremsscheiben

## Dimensions brake discs - Medidas disco de freno - Dimensions Disques de frein - Misure dischi freno

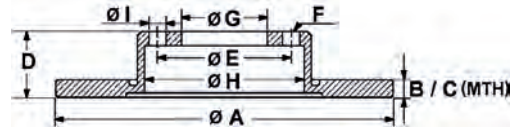

S Fixierschraube - fixing screw - tornillo quefija - vis de fixation - vite di riparazione  
 B beschichtet - coated - recubierto - revêtu - rivestito  
 HC hochgekohlt - high carbon - altamente carbonizado - à haute teneur en carbone - ad alto tenore di carbonio

L legiert - alloyed - aleado - allié - alligato/legato  
 V ventiliert - ventilated - ventilado - ventilé - ventilato  
 \* gelocht - perforated - perforado - poinçonné - perforato

	S	B	HC L	V	A	B	C	D	E	F	G	H	I	
24.0124-0138.1	424138		B		V	300	24	21,9	65,5	130	5	80	161	17,5
24.0124-0139.1	424139	+ S	B		V	260	24	22	28	108	4	66	133,5	13
24.0124-0140.1	424140		B		V	276	24	22,4	45,1	108	6	87	136	10,6
24.0124-0141.1	424141		B		V	260	24	22	56,8	100	5	58	129	12,8
24.0124-0142.1	424142				V	256	24	22,4	45,3	114,3	5	69	145	12,6
24.0124-0143.1	424143		B		V	298,5	24	22	70	127	5	101,6	158	10
24.0124-0145.1	424145		B		V	277	24	22	56,5	100	5	58	129	13
24.0124-0146.1	424146		B		V	256	24	22,4	45,3	114,3	4	69	145	12,6
24.0124-0148.1	424148				V	278	24	22,2	35,5	108	4	63,5	137	13,7
24.0124-0149.1	424149		B		V	278	24,1	22,2	46,9	108	4	63,5	136	13,6
24.0124-0152.1	424152	+ S	B	HC L	V	256	23,8	21	41,1	100	4	60	123	14,3
24.0124-0158.1	424158	+ S	B	HC L	V	280	24	21,8	44	100	4	61	140	13,6
24.0124-0159.1	424159		B		V	281	23,9	21,5	45,7	114,3	4	69	146,5	12,5
24.0124-0161.1	424161		B		V	300	23,9	22	47	108	5	63,5	155	13,7
24.0124-0162.1	424162		B		V	280	24	21	61,5	110	6	79,5	119	M10
24.0124-0163.1	424163	+ S	B		V	256	24	22	47,1	100	4/6	60	134	13,2
24.0124-0164.1	424164		B		V	258	24	22	47	100	4	55	125	13
24.0124-0165.1	424165		B	HC L	V	298	24	22	67	130	5	98	164	15,4
24.0124-0166.1	424166	+ S	B	HC L	V	260	24	21	41	100	4/6	60	126	14,5
24.0124-0167.1	424167		B		V	276	24,5	22,1	43	100	5	82	136	M10
24.0124-0168.1	424168		B		V	294	24,5	22,1	43	100	5	82	136	M10
24.0124-0169.1	424169		B	HC	V	280	24	21,8	46,9	108	5	61	139,8	13,5
24.0124-0170.1	424170		B		V	276	24	22,4	45	114,3	4	69	145	12,5
24.0124-0171.1	424171	+ S	B	HC L	V	280	24	21,8	44	108	5	61	140	15,5
24.0124-0173.1	424173				V	258	24	22	48,6	114,3	4	72	143,7	13
24.0124-0174.1	424174		B		V	284	24,2	22,9	60,5	111,1	5	82,6	138,5	11,5
24.0124-0175.1	424175		B		V	273,5	24	22	47,5	114,3	5	72	143	13
24.0124-0176.1	424176		B	HC L	V*	299	24	22	75	130	5	98	180	15,4
24.0124-0177.1	424177		B	HC	V	345	24	22,4	67	120	5	79	185	16,5
24.0124-0178.1	424178		B		V	282,5	24	22,4	38	114,3	5	73,5	159,8	14
24.0124-0179.1	424179		B		V	278	24	22	44,5	108	5	63,5	136	13,7
24.0124-0181.1	424181	+ S	B	HC	V	310	24	22,4	77	120	5	79	161	14,5
24.0124-0182.1	424182		B		V	276	24	22,4	45	114,3	5	69	145	12,5
24.0124-0183.1	424183		B	HC L	V*	299	24	22	65	130	5	103	180	15,4
24.0124-0184.1	424184		B		V	257	24	22,1	46,7	114,3	4	69	141,5	12,7
24.0124-0185.1	424185		B		V	258	24	22	48,5	100	4	57	143,6	13
24.0124-0186.1	424186		B	HC	V	370	24	22,4	67	120	5	79	185	16,5
24.0124-0187.1	424187		B		V	254	24	22	50,7	100	4	55	141	13
24.0124-0188.1	424188		B	HC L	V	278	24	21,4	55,5	112	5	67	164	15
24.0124-0191.1	424191	+ S	B	HC	V	300	24	21,8	43,9	100	4	61	139,8	13,5
24.0124-0192.1	424192		B		V	256	24	21,5	45,6	114,3	4	69	139	12,7
24.0124-0194.1	424194		B	HC L	V*	299	24	22	67	130	5	98	180	15,4
24.0124-0195.1	424195				V	274	24,1	22	40,5	114,3	5	72	142,5	13
24.0124-0196.1	424196		B		V	293,5	24	22	56,7	100	5	58	129	13
24.0124-0197.1	424197	+ S	B	HC	V	300	24	22,4	73,5	120	5	79	152	14,5
24.0124-0198.1	424198		B		V	300	24	22	44,5	108	4	63,5	156,5	13,7
24.0124-0199.1	424199	+ S	B		V	256	24	21	46,8	114,3	4	60	141	12,6
24.0124-0200.1	424200	+ S	B	HC	V	330	24	22,4	73,3	120	5	79	174	14,5
24.0124-0201.2	424201	+ S	B	HC	V	345	24	22,4	63,2	120	5	75	185	14,5
24.0124-0202.1	424202				V	276	24	22,4	45,2	114,3	6	93	137	10,6
24.0124-0203.1	424203	+ S	B	HC	V	312	23,9	22,4	73,1	120	5	79	152	16,5
24.0124-0207.1	424207				V	254	24	22,4	39	108	6	67	132,6	10,6
24.0124-0210.1	424210		B	HC L	V*	298	24	22	67	130	5	98	164	15,4
24.0124-0211.1	424211		B	HC L	V*	298	24	22	67	130	5	98	164	15,4
24.0124-0212.1	424212	+ S	B	HC L	V	320	24	21,4	58,2	112	5	67	180	15,2
24.0124-0213.1	424213		B	HC	V	345	24	22,4	74	120	5	79	185	16,5
24.0124-0214.1	424214		B	HC	V	370	24	22,4	74	120	5	79	185	16,5
24.0124-0215.1	424215		B		V	294	24	22,4	45,5	114,3	5	69	147,8	12,6
24.0124-0216.1	424216	+ S	B	HC	V	345	24	22,4	78,5	120	5	75	185	16,5
24.0124-0217.1	424217		B		V	302,5	24	22	45	114,3	5	72	144	13
24.0124-0218.1	424218		B		V	322,6	24	22	45	114,3	5	72	144	13
24.0124-0219.2	424219	+ S	B	HC	V	385	24	22,4	78,5	120	5	75	185	16,5
24.0124-0220.1	424220				V	254	24	22,4	40	108	5	87	153,5	10,6
24.0124-0221.1	424221	+ S	B	HC	V	280	24	21,8	44	114,3	5	68	140	15,8
24.0124-0222.1	424222	+ S	B	HC	V	280	24	21,8	44	108	5	61	140	15,8
24.0124-0223.1	424223	+ S	B	HC	V	280	24	21,8	44	108	5	61	140	15,8
24.0124-0224.1	424224	+ S	B	HC	V	300	24	21,8	44	108	5	61	140	15,8
24.0124-0226.1	424226	+ S	B	HC L	V*	320	24	22	58,2	112	5	67	180	15,2
24.0124-0228.1	424228		B		V	294	24	21	87,5	108	8	84	142	10,5

# Abmessungen Bremsscheiben

## Dimensions brake discs - Medidas disco de freno - Dimensions Disques de frein - Misure dischi freno

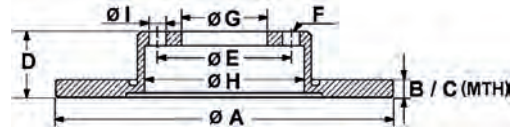

S Fixierschraube - fixing screw - tornillo que fija - vis de fixation - vite di riparazione  
 B beschichtet - coated - recubierto - revêtu - rivestito  
 HC hochgekohlt - high carbon - altamente carbonizado - à haute teneur en carbone - ad alto tenore di carbonio

L legiert - alloyed - aleado - allié - alligato/legato  
 V ventiliert - ventilated - ventilado - ventilé - ventilato  
 \* gelocht - perforated - perforado - poinçonné - perforato

		S	B	HC L	V	A	B	C	D	E	F	G	H	I
24.0124-0229.1	424229		B		V	263	24	22	53	118	6	96	144	M12x1,5
24.0124-0231.2	424231	+ S	B	HC	V*	350	24	22,4	66,5	120	5	75	185	14,5
24.0124-0232.2	424232	+ S	B	HC	V*	350	24	22,4	66,5	120	5	75	185	14,5
24.0124-0233.2	424233	+ S	B	HC	V	345	24	22,4	69	120	5	75	185	16,5
24.0124-0234.2	424234	+ S	B	HC	V*	370	24	22,4	61,6	120	5	75	185	14,5
24.0124-0235.2	424235	+ S	B	HC	V*	370	24	22,4	61,6	120	5	75	185	14,5
24.0124-0236.1	424236	+ S	B	HC L	V	320	24	21,1	68,2	112	5	67	180	15,2
24.0124-0237.1	424237		B		V	278	24	22	47,3	114,3	4	60	141	12,5
24.0124-0238.1	424238		B		V	280	24	22	44	114,3	4	68	143,2	13
24.0124-0239.2	424239	+ S	B	HC	V	330	24	22,4	66	120	5	75	172	16,5
24.0124-0240.1	424240	+ S	B	HC	V	307	24	22,4	45,2	120	5	79	152	16,5
24.0124-0241.1	424241	+ S	B	HC	V	370	23,9	22,4	69	120	5	75	185	16,6
24.0124-0242.2	424242	+ S	B	HC	V	330	24	22,4	73,1	120	5	79	171,8	14,5
24.0124-0243.1	424243		B	HC L	V	254,5	24	22,4	40	108	5	87	152,5	10,6
24.0124-0245.1	424245		B	HC	V	256	24	22	24	108	6	86	155	10,8
24.0124-0247.1	424247		B		V	280	24	22	44	114,3	5	68	144	12,7
24.0124-0248.1	424248	+ S	B	HC	V	330	24	22,4	73	120	5	79	164	16,5
24.0124-0250.2	424250	+ S	B	HC	V	345	24	22,4	66,1	120	5	75	160,8	16,5
24.0124-0251.2	424251	+ S	B	HC	V	345	24	22,4	66,2	120	5	75	185	16,5
24.0124-0252.1	424252		B		V	256	24	21	45,3	100	4	60	124,8	12,6
24.0124-0253.1	424253	+ S	B	HC	V	280	24	21,8	44	100	4	61	140	13,5
24.0124-0258.1	424258	+ S	B	HC	V	276	24	21	49,7	112	9	65	144	15,3
24.0124-0259.1	424259	+ S	B	HC	V	330	24	22,4	45,1	112	5	67	151,4	16,5
24.0124-0260.1	424260	+ S	B	HC	V	307	24	22,4	45,1	112	5	67	151	16,5
24.0124-0262.2	424262	+ S	B	HC	V	345	24	22,4	66,1	112	5	67	171,8	16,5
24.0124-0300.1	424300	+ S	B	HC	V	295	24	21,4	62,8	112	5	69	154,8	15,4
24.0124-0702.1	424702		B		V	280	24	22,7	81,5	114,3	5	72	159	15,5
24.0124-0706.1	424706		B		V	257	24	22,4	45,5	114,3	4	69	141,5	12,5
24.0124-0723.1	424723				V	256	24	21	46,8	114,3	5	60	137	12,6
24.0124-0724.1	424724		B		V	314	24	22,4	45,2	108	6	87	136	10,6
24.0124-0735.1	424735		B		V	278	24	22	47	114,3	5	72	143	14,2
24.0125-0105.1	425105	+ S	B	HC	V	288	25	23	46,5	112	5/9	68	135	15,4
24.0125-0106.1	425106		B	HC	V	276	25	23	56,5	108	4	68	135	15,4
24.0125-0107.1	425107		B	HC L	V	294	25	22,4	49,5	112	5	67	154,3	15
24.0125-0108.1	425108		B	HC	V	288	25	23	28,5	100	5	65	136	15,6
24.0125-0110.1	425110	+ S	B	HC L	V	288	25	22,4	46,5	112	5	67	154,3	13,2
24.0125-0113.1	425113	+ S	B	HC	V	288	25	22	34,5	100	5	65	136	15,6
24.0125-0114.1	425114	+ S	B	HC	V	288	25,1	21	55,4	112	5	68,2	144,2	16,5
24.0125-0115.1	425115		B	HC	V	282,5	25	23	46,5	112	5	68	135	15,3
24.0125-0116.1	425116				V	255	25	23	52,6	114,3	5	62	147	14,4
24.0125-0117.1	425117		B	HC	V	278	25	23	48,5	108	5	63,5	140	13,7
24.0125-0118.1	425118		B		V	257	25	23	46,6	110	5	84	145	M10x1,25
24.0125-0119.1	425119	+ S	B	HC L	V	288	25	22	42	110	5/7	70	139	14
24.0125-0123.1	425123	+ S	B	HC	V	310	25	22	34,5	100	5/9	65	135	15,6
24.0125-0124.1	425124		B		V	255	24,9	24	49,2	100	5	55	156	14,5
24.0125-0125.1	425125		B		V	280	25	23	44	108	4	68	144	15
24.0125-0126.1	425126				V	271	25	23	52,8	114,3	5	62	147	14,6
24.0125-0129.1	425129				V	258	25	24	47	114,3	5	62	145,5	14,5
24.0125-0130.1	425130				V	282	25	23	34,5	114,3	4	92	171	M10x1,25
24.0125-0131.1	425131	+ S	B	HC L	V	280	24,8	22	42	110	5/7	70	139	14
24.0125-0135.1	425135				V	291	25	23	65,8	127	6	100	155	10,7
24.0125-0136.1	425136		B	HC	V	256	25	23	39,5	100	4	65	132,2	13,6
24.0125-0137.1	425137	+ S	B	HC	V	312	25	23	46,5	112	5/9	68	158	15,3
24.0125-0138.1	425138	+ S	B	HC	V	325	24,9	23,4	52,6	120	5	79	174	14,5
24.0125-0139.1	425139		B	HC L	V	276	24,9	23	56,5	112	5	68	135	15,5
24.0125-0140.1	425140		B		V	260	25	23	49,2	100	5	55	131	14,5
24.0125-0141.1	425141	+ S	B	HC	V	285	24,9	22	42,1	110	5/7	70	139	14
24.0125-0142.1	425142	+ S	B	HC L	V	308	25	22	42	110	5/8	70	139	14
24.0125-0143.1	425143		B		V	275	25	23	49,3	114,3	5	62	144	14,5
24.0125-0145.1	425145	+ S	B	HC	V	288	25	22	49,9	112	5/9	65	144	15,3
24.0125-0146.1	425146		B		V	282	25	23	47	114,3	4	64	142,5	13
24.0125-0147.1	425147		B		V	282,5	25	23	48,5	114,3	5	72	142	13
24.0125-0148.1	425148	+ S	B	HC L	V	280	25	22	42	100	4/6	60	139	14,5
24.0125-0149.1	425149		B	HC	V	314	25	23	59,7	112	5	68	144	15,3
24.0125-0155.1	425155		B		V	255	25	23	49,3	100	4	55	131	14,5
24.0125-0156.1	425156		B		V	276	25	23	49,2	100	5	55	131	14,5
24.0125-0157.1	425157		B		V	275	25	23	49,2	100	4	55	129	14,5
24.0125-0158.1	425158	+ S	B	HC	V	312	25	22	49,9	112	5/9	65	146	15,3
24.0125-0160.1	425160	+ S	B	HC	V	325	25	23,4	62,2	120	5	75	174	16,5



# Abmessungen Bremsscheiben

## Dimensions brake discs - Medidas disco de freno - Dimensions Disques de frein - Misura dischi freno

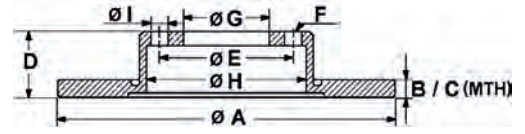

S Fixierschraube - fixing screw - tornillo quefija - vis de fixation - vite di riparazione  
 B beschichtet - coated - recubierto - revêtu - rivestito  
 HC hochgekohlt - high carbon - altamente carbonizado - à haute teneur en carbone - ad alto tenore di carbonio

L legiert - alloyed - aleado - allié - alligato/legato  
 V ventiliert - ventilated - ventilado - ventilé - ventilato  
 \* gelocht - perforated - perforado - poinçonné - perforato

	S	B	HC L	V	A	B	C	D	E	F	G	H	I	
24.0125-0161.1	425161		B		V	282	25	23	44,5	100	4	64,2	143	12,6
24.0125-0162.1	425162		B	HC	V	300	25	23	48,5	108	5	63,5	140	13,7
24.0125-0164.1	425164		B		V	297	25	22	64,7	120	5	70	161,5	14,3
24.0125-0165.1	425165		B	HC	V	278	25	23	48,5	114,3	5	72	140	14
24.0125-0167.1	425167	+ S	B	HC L	V	288	25	22,4	44,5	112	5	67	154,3	15,3
24.0125-0168.1	425168		B		V	275	25	23	49,2	100	4	55	131	14,6
24.0125-0170.1	425170		B	HC	V	300	25	23	48,5	114,3	5	72	140	14
24.0125-0171.1	425171		B	HC	V	288	25	23	46,5	112	5/10	68	137	15,3
24.0125-0172.1	425172		B	HC	V	312	25	23	46,5	112	5/10	68	140	15,3
24.0125-0173.1	425173	+ S	B		V	300	25	23	47,2	114,3	5	64,1	141	12,7
24.0125-0174.1	425174		B		V	300	25	23	47,2	114,3	5	64,2	142	12,6
24.0125-0176.1	425176		B		V	297,5	25	22	91,5	120	5	70,1	161,1	14,3
24.0125-0177.1	425177		B		V	257	24,5	22,4	47,6	114,3	4	69	141,5	12,5
24.0125-0178.1	425178		B		V	275	25	22	46,5	114,3	5	62	145	14,5
24.0125-0179.1	425179	+ S	B	HC L	V	288	25	22	64,5	112	5	67	154,3	15,2
24.0125-0182.1	425182	+ S	B		V	300	25	23	47,1	114,3	5	64,1	141	12,7
24.0125-0183.1	425183				V	282	25	23	47	114,3	5	64,1	142,5	13
24.0125-0184.1	425184	+ S	B	HC	V	314	25	23	52,4	112	5	68	154	15,3
24.0125-0187.1	425187		B		V	280	25	23	47,2	114,3	5	64,1	142,2	13
24.0125-0188.1	425188		B		V	299	25	23	48,4	114,3	5	72	142,8	13
24.0125-0189.1	425189	+ S	B		V	281,5	25	23	47,2	114,3	5	64,1	142,5	12,5
24.0125-0190.1	425190		B		V	294,5	25	23	49	114,3	5	62	154	12,6
24.0125-0192.1	425192		B		V	297	24,9	23,5	67,3	140	6	108	170	14,5
24.0125-0195.1	425195		B	HC	V	320	25	23	48,5	114,3	5	72	148	13,7
24.0125-0196.1	425196		B		V	255	25	22	49,2	100	5	55	136	14,5
24.0125-0197.1	425197		B	HC	V	320	25	23	48,5	108	5	63,5	148	13,7
24.0125-0198.1	425198	+ S	B	HC L	V	280	25	22	43,2	100	4/6	60	139	14,5
24.0125-0199.1	425199		B	HC	V	278	25	23	48,5	108	5	63,5	140	13,7
24.0125-0200.1	425200	+ S	B	HC L	V	280	25	22,4	51	112	5	67	144,5	15
24.0125-0201.1	425201		B		V	280	25	22,4	47,2	114,3	5	64,1	142,2	12,6
24.0125-0202.1	425202		B	HC	V	300	25	23	48,4	108	5	63,5	139,7	13,8
24.0125-0203.1	425203		B	HC	V	278	25	23	48,5	108	5	63,5	140	13,6
24.0125-0208.1	425208		B		V	295	25	23	51,5	114,3	5	68	143	13
24.0125-0209.1	425209		B	HC	V	320	25	23	48,7	108	5	63,5	148	13,7
24.0125-0210.1	425210		B		V	278	25	23	39,8	108	4	63,5	136,2	14
24.0125-0211.1	425211	+ S	B		V	296	25	23	47,2	114,3	5	64,1	142	12,6
24.0125-0213.1	425213		B	HC L	V	305	25	23,4	46,9	114,3	5	69	145	12,5
24.0125-0214.1	425214		B	HC L	V	280	25	23	51,5	114,3	5	68	142,8	13
24.0125-0700.1	425700		B		V	275	25	23	49,2	100	5	55	129	14,5
24.0125-0706.1	425706		B		V	300	25	23	39,7	114,3	5	70,2	142,5	12,6
24.0126-0100.1	426100		B	HC L	V	283	26	24	48	108	5	71	130,5	13
24.0126-0101.1	426101		B		V	280,3	26	23	50,3	108	4	68	139	14,5
24.0126-0102.1	426102		B		V	280,3	26	23	50,3	108	5	68	139	14,5
24.0126-0103.1	426103				V	281	26	24,2	43,7	98	5	59	127	13
24.0126-0104.1	426104		B		V	281	26	24,2	43,7	98	5	59	127	16,5
24.0126-0105.1	426105		B		V	280	26	23	56,3	108	5	68	139	14
24.0126-0106.1	426106	+ S	B		V	283	26	24,2	28,2	108	4	66	133,5	13
24.0126-0107.1	426107		B	HC	V	302	26	23	50	108	5	68	151	14,4
24.0126-0108.1	426108		B		V	257	26	24	52,5	114,3	5	68	139,5	12,8
24.0126-0109.1	426109		B		V	277	26	24	39	124	6	100	164	M10x1,25
24.0126-0111.1	426111		B		V	280	26	24,6	36	109	6	88	175	M12x1,25
24.0126-0112.1	426112				V	257	26	24	45,5	100	4	61	148	12,8
24.0126-0114.1	426114				V	281	26	24,2	54,2	98	5	59	127	13,2
24.0126-0115.1	426115		B	HC	V	300	26	22	56	112	5	68,2	144	16,5
24.0126-0116.1	426116		B	HC	V	303	26	23	51,5	112	5	67	168	15
24.0126-0119.1	426119		B	HC	V	313	25,9	22	56,2	112	5	68,2	148	16,5
24.0126-0120.1	426120	+ S	B		V	283	26	24	34,2	108	4	66	133,5	13
24.0126-0121.1	426121	+ S	B	HC L	V	283	26	24	48,3	108	5	71,1	133	13,2
24.0126-0122.1	426122		B		V	285,5	26	23	50,3	108	5	68	139	16,5
24.0126-0123.1	426123		B	HC	V	300	26	22,8	47	108	5	61	139,6	13,5
24.0126-0125.1	426125		B		V	281	26	24,2	43,5	98	4	59	127	13
24.0126-0126.1	426126		B		V	276	26	24	46,2	114,3	5	69	141,5	12,6
24.0126-0127.1	426127		B		V	294	26	24,4	46,1	114,3	5	69	145	12,6
24.0126-0128.1	426128		B	HC L	V	280	26	24,4	47,4	114,3	5	69	141,5	12,5
24.0126-0129.1	426129		B		V	280	26	24,4	47,3	114,3	4	69	141,4	12,7
24.0126-0130.1	426130		B		V	305	26	24,5	63,5	127	5	72	170	15,5
24.0126-0131.1	426131		B		V	276	26	24,4	45,5	114,3	4	69	145	12,5
24.0126-0133.1	426133		B		V	281	26	24,2	47,2	108	5/10	59	134	14,5
24.0126-0134.1	426134		B		V	276	26	24,4	45,5	114,3	5	69	145	12,5

# Abmessungen Bremsscheiben

## Dimensions brake discs - Medidas disco de freno - Dimensions Disques de frein - Misure dischi freno

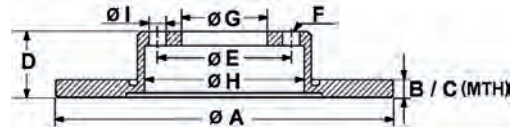

S Fixierschraube - fixing screw - tornillo que fija - vis de fixation - vite di riparazione  
 B beschichtet - coated - recubierto - revêtu - rivestito  
 HC hochgekohlt - high carbon - altamente carbonizado - à haute teneur en carbone - ad alto tenore di carbonio

L legiert - alloyed - aleado - allié - alligato/legato  
 V ventiliert - ventilated - ventilado - ventilé - ventilato  
 \* gelocht - perforated - perforado - poinçonné - perforato

	S	B	HC L	V	A	B	C	D	E	F	G	H	I	
24.0126-0135.1	426135		B		V	274	26,2	24	48,5	114,3	5	72	140,5	13
24.0126-0136.1	426136		B	HC L	V*	330	26	24	68,2	112	5	67	180	15
24.0126-0137.1	426137		B	HC L	V*	330	26	24	60,4	112	5	67	180	17
24.0126-0138.1	426138		B		V	295	26	24	49,2	114,3	5	62	141	14,5
24.0126-0139.1	426139		B		V	277	26	24	49,5	100	5	55	129	14,5
24.0126-0140.1	426140	+ S	B	außenbelüftet	V	302	26	24	34,2	108	4	66	133	13
24.0126-0141.1	426141		B		V	295	26	24	49,5	100	5	55	141	14,5
24.0126-0142.1	426142		B	HC	V	300	26	22,8	44	108	5	61	139,6	15,6
24.0126-0143.1	426143	+ S	B	HC L	V	280	26	24	48,5	114,3	4	72	143,5	13
24.0126-0144.1	426144			HC L	V	290	26	23	70	96	8	70	135	14,5
24.0126-0145.1	426145		B		V	290	26	24,4	46,3	139,7	6	94	171	12,8
24.0126-0146.1	426146		B	HC L	V	278	26	23	43,3	110	5/7	70	136	14
24.0126-0148.1	426148		B		V	273	26	23	49,2	114,3	5	62	142	14,8
24.0126-0149.1	426149	+ S	B	HC L	V	330	26	23,4	58,2	112	5	67	180	15
24.0126-0150.1	426150		B	HC L	V	280	26	24,4	47,2	114,3	5	69	143,5	12,5
24.0126-0151.1	426151		B		V	303	26	24	47	114,3	5	72	159	14
24.0126-0152.2	426152	+ S	B	HC	V	338	25,9	24,4	73	120	5	79	171,5	14,5
24.0126-0154.1	426154		B		V	295,5	26	24	44	114,3	5	68	146,5	12,7
24.0126-0155.1	426155	+ S	B		V	275	26	24	47,3	114,3	4	69	141,6	13
24.0126-0156.1	426156		B		V	295	26	23	49,1	114,3	5	62	143,2	14,8
24.0126-0157.1	426157		B		V	275	26	24	47,4	114,3	5	69	143,3	12,5
24.0126-0158.1	426158	+ S	B	HC L	V	296	26	23,4	44	114,3	5	68	147,7	15,8
24.0126-0159.1	426159	+ S	B		V	302	26	24	34,2	108	4	66	133,2	13
24.0126-0160.1	426160		B		V	320	26	23	49,3	114,3	5	62	143	14,5
24.0126-0161.1	426161		B	HC L	V	290	26	23	42,5	120	10	102	144,5	10,5
24.0126-0162.1	426162		B		V	290	26	24,4	45,8	114,3	5	69	145,5	12,6
24.0126-0163.1	426163		B		V	290	26	23	53	118	6	96	134	M12x1,5
24.0126-0164.1	426164		B		V	276	26	24,4	45,5	114,3	5	69	146	12,5
24.0126-0165.1	426165	+ S	B		V	276	26	23	45,5	105	5	60	139	14,2
24.0126-0166.1	426166	+ S	B	HC	V	300	26	23	45,5	115	5	70,7	149	14,2
24.0126-0168.1	426168	+ S	B		V	281	26,2	24,2	39,8	110	5/5	70	138	16,6
24.0126-0169.1	426169		B		V	274	26	24,4	44,2	108	5	87	132	10,5
24.0126-0170.1	426170		B		V	294	26	24,4	45,8	114,3	5	69	145	13,1
24.0126-0171.1	426171		B	HC L	V	280	26	24	47,3	114,3	5	69	141,5	12,6
24.0126-0172.1	426172		B		V	300	26	24	49,5	114,3	5	62	150	12,8
24.0126-0174.1	426174		B	HC L	V	376	26	24	42	108	5	64,5	167,6	14
24.0126-0175.1	426175		B		V	257	26	24	53,7	114,3	4	68	144	12,8
24.0126-0176.1	426176	+ S	B	HC L	V	302	26	24	34,2	108	5	66	133,5	13,2
24.0126-0177.1	426177		B		V	296	26	24	44	114,3	5	68	146	12,7
24.0126-0179.1	426179		B	HC	V	297	26	24,4	54	114,3	5	73,4	157,5	14
24.0126-0180.1	426180	+ S	B	HC L	V	280	26	23,8	45	108	5	61	139,8	15,8
24.0126-0182.1	426182	+ S	B	HC	V	300	26	23	45,2	105	5	60	149	14,2
24.0126-0183.1	426183	+ S	B	HC L	V	283	26	24	48	108	5	71	134	13,3
24.0126-0184.1	426184		B		V	277	26	23	49,3	114,3	5	62	142	14,6
24.0126-0185.1	426185		B	HC L	V	296	26	24	44	114,3	5	68	148	12,8
24.0126-0186.1	426186	+ S	B	HC	V	280	26	23,8	45	108	5	61	139,7	15,8
24.0126-0187.1	426187	+ S	B		V	276	26	23	45,5	105	5	60	139	14
24.0126-0188.1	426188	+ S	B		V	300	26	23	45,5	105	5	60	149	14
24.0127-0100.1	427100		B		V	281	27	25,4	42,7	108	6	87	136	10,6
24.0128-0100.1	428100	+ S	B	HC L	V*	295	28	26	64,5	112	5	67	154,2	15,2
24.0128-0101.1	428101		B	HC	V	302	28	26,4	75,9	120	5	79	149	14,5
24.0128-0103.1	428103		B	HC L	V	300	28	25,4	45,5	112	5	67	154,3	15
24.0128-0104.1	428104	+ S	B	HC L	V	296	28	25	58,4	110	5	70	139	14
24.0128-0105.1	428105	+ S	B	HC	V	316	28	26,4	77	120	5	79	159	14,5
24.0128-0106.1	428106	+ S	B	HC L	V	300	28	25,4	46,5	112	5	67	154	13,3
24.0128-0113.1	428113				V	255	28	26	49,2	100	5	55	131	14,5
24.0128-0114.1	428114				V	255	28	26	49,1	114,3	5	62	146,5	14,6
24.0128-0115.1	428115		B		V	275	28	26	49,2	114,3	5	62	158,5	14,8
24.0128-0116.1	428116				V	255	28	26	49,3	100	5	55	155,5	14,5
24.0128-0118.1	428118				V	310	28	26	47,3	108	5/10	59	141,5	14,7
24.0128-0119.1	428119				V	305	28	26	44,7	98	5	59	151	13,2
24.0128-0120.1	428120				V	305	28	26	44,7	98	4	59	151	13,2
24.0128-0122.1	428122		B	HC	V	296	28	26,4	55	120	5	79	145,5	14,5
24.0128-0123.1	428123		B		V	305	27,9	25	50,3	108	5	68	139	16,5
24.0128-0125.1	428125		B	HC L	V*	312	28	26	76	112	5	67	154	15
24.0128-0126.1	428126		B	HC L	V	316	28	25,4	46,5	112	5	67	154,3	13
24.0128-0127.1	428127		B	HC L	V	310	28	25,4	82	112	5	67	154	17
24.0128-0128.1	428128	+ S	B		V	288	28	26	34	108	4	66	133	13
24.0128-0129.1	428129	+ S	B		V	305,5	28	25	77,8	130	5	90	157	15,8





# Abmessungen Bremsscheiben

## Dimensions brake discs - Medidas disco de freno - Dimensions Disques de frein - Misure dischi freno

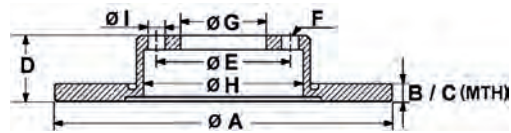

S Fixierschraube - fixing screw - tornillo quefija - vis de fixation - vite di riparazione  
 B beschichtet - coated - recubierto - revêtu - rivestito  
 HC hochgekohlt - high carbon - altamente carbonizado - à haute teneur en carbone - ad alto tenore di carbonio

L legiert - alloyed - aleado - allié - alligato/legato  
 V ventiliert - ventilated - ventilado - ventilé - ventilato  
 \* gelocht - perforated - perforado - poinçonné - perforato

	S	B	HC L	V	A	B	C	D	E	F	G	H	I	
24.0128-0130.1	428130		B	HC L	V•	318	28	26	67	130	5	98	158,8	15,4
24.0128-0131.1	428131		B	HC L	V•	318	28	26	67	130	5	98	158,8	15,4
24.0128-0132.1	428132	+ S	B	HC	V	305	28	24	49,7	118	5	72	154	15,5
24.0128-0133.1	428133		B	HC	V	324	28	25,4	47	108	5	61	150	15,5
24.0128-0134.1	428134		B		V	305	28	26	44	108	5	61	132	15,5
24.0128-0135.1	428135		B	HC	V	308	28	25,8	47	108	5	61	140	15,5
24.0128-0136.1	428136		B		V	285	28	26	43,7	98	5	59	127	16,5
24.0128-0137.1	428137	+ S	B	HC	V	302	28	25	45	110	5/7	70	139	14
24.0128-0138.1	428138		B		V	291	28,1	26	64,8	120,7	5	80	175	13,5
24.0128-0140.1	428140		B		V	280	28	26	49,1	114,3	5	68	144	12,8
24.0128-0142.1	428142		B	HC L	V	312	28	25,4	64,5	112	5	67	154	15,3
24.0128-0143.1	428143				V	305	28	26	28	108	4	66	132,9	13
24.0128-0144.1	428144		B	HC	V	316	28	25	50	108	5	68	144	16,5
24.0128-0145.1	428145	+ S	B	HC L	V	300	28	25	58,5	112	5	67	153	15
24.0128-0147.1	428147		B	HC	V	302	28	26,5	39	114,3	5	73,5	146,3	14
24.0128-0148.1	428148		B		V	281	28	25,3	38	114,3	5	73,5	146	14
24.0128-0149.1	428149	+ S	B	HC	V	330	28	26	73,5	130	5	85	210	15,4
24.0128-0153.1	428153		B	HC	V	320	28	26	49	114,3	5	68	144,5	13
24.0128-0154.1	428154	+ S	B	HC	V	300	28	26	52	108	5	63,5	140	15,8
24.0128-0155.1	428155	+ S	B	HC L	V	295	28	25,4	64,5	112	5	67	154,3	15,2
24.0128-0156.1	428156	+ S	B		V	280	28	25	54,5	111	5	93	136	M10x1,5
24.0128-0157.1	428157	+ S	B		V	300	28	25	54,5	111	5	93	136	M10x1,5
24.0128-0158.1	428158		B		V	321	28	26,4	49,1	114,3	5	69	143	12,5
24.0128-0159.1	428159		B		V	296	28	25	49,2	114,3	5	62	145	14,5
24.0128-0162.1	428162	+ S	B	HC	V	316	28	26	52	108	5	63,5	144	16
24.0128-0163.1	428163		B	HC L	V•	312	28	26	64,5	112	5	67	155,2	15
24.0128-0164.1	428164	+ S	B	HC	V	314	28	25	44,9	110	5/7	70	139	14
24.0128-0166.1	428166		B		V	300	28	26	38	124	6	100	184	M10x1
24.0128-0169.1	428169		B	HC L	V	358	28	26	73,5	130	5	85	210	15,4
24.0128-0175.1	428175				V	273,5	28	26	51	114,3	5	72	142,8	13
24.0128-0176.1	428176	+ S	B	HC L	V	295	28	25,4	54,5	112	5	67	154	15,3
24.0128-0177.1	428177		B	HC L	V•	330	28	26	46,5	112	5	67	154	13
24.0128-0178.1	428178				V	288	28	26	50	108	5	71	130,5	13
24.0128-0179.1	428179		B		V	305,5	28	26	44,8	108	5/10	59	138,9	14,6
24.0128-0180.1	428180				V	296	28	26	51	114,3	5	72	142,8	13
24.0128-0182.1	428182		B	HC	V	308	28	25,4	47	108	5	61	140	13,5
24.0128-0183.1	428183		B		V	275	28	26	49,2	100	5	55	132	14,5
24.0128-0184.1	428184		B	HC	V	320	28	25	50	108	5	68	151	16,5
24.0128-0185.1	428185		B	HC	V	305	28	26	44,7	110	5/7	70	138	14,2
24.0128-0186.1	428186		B		V	296	28	26	49,3	114,3	5	62	141	14,7
24.0128-0188.1	428188	+ S	B	HC L	V	330	28	26	46,5	112	5	67	154	13
24.0128-0189.1	428189		B		V	285	28	26	45,5	127	6	84	149	M10x1,25
24.0128-0190.1	428190		B		V	296	28	26	49,2	114,3	5	62	156	14,7
24.0128-0191.1	428191	+ S	B		V	330	28	26	39,7	110	5	70	151	16,6
24.0128-0192.1	428192	+ S	B		V	305	28	26	39,7	110	5	70	138	16,6
24.0128-0194.1	428194		B		V	338	28	26	67,5	139,7	6	108	172	14,5
24.0128-0195.1	428195				V	295	28	26	50	108	5	71	130,6	13
24.0128-0196.1	428196		B	HC L	V•	330	28	26	75	130	5	98	180	15,4
24.0128-0197.1	428197		B	HC L	V•	330	28	26	75	130	5	98	180	15,4
24.0128-0200.1	428200		B		V	302	28	26	54	139,6	5	96,3	163	12,5
24.0128-0201.1	428201		B	HC L	V	321	28	25	44	110	5/7	70	139	14
24.0128-0202.1	428202		B	HC L	V	303	28	25	93	145	6	120	172	15
24.0128-0203.1	428203	+ S	B	HC L	V	300	28	25	68,5	130	6	85	155	15
24.0128-0204.2	428204	+ S	B	HC	V	315	28	26,4	52,5	120	5	79	155	14,5
24.0128-0205.2	428205	+ S	B	HC	V	315	28	26,4	52,5	120	5	79	155	14,5
24.0128-0206.2	428206	+ S	B	HC	V•	325	28	26,4	52,5	120	5	79	154,8	14,5
24.0128-0207.2	428207	+ S	B	HC	V•	325	28	26,4	52,5	120	5	79	154,8	14,5
24.0128-0208.2	428208	+ S	B	HC	V•	345	28	26,4	52,5	120	5	79		14,5
24.0128-0209.2	428209	+ S	B	HC	V•	345	28	26,4	52,5	120	5	79		14,5
24.0128-0210.1	428210	+ S	B	HC	V	336	28	26	52	108	5	63,5	152	16
24.0128-0211.1	428211		B		V	274	28,3	26	50,6	114,3	5	72	140	13
24.0128-0212.1	428212				V	296	28	26	49,5	114,3	5	62	141,3	14,5
24.0128-0213.1	428213		B		V	280	28	25,9	71,5	118	5	73	142	15,5
24.0128-0214.1	428214	+ S	B		V	280	28	26	48	108	5	71,1	152	13,2
24.0128-0215.1	428215		B		V	332	28	26	56,3	139,7	6	94	171	12,8
24.0128-0216.1	428216	+ S	B		V	304	28	26	48	108	5	71	145,5	13,2
24.0128-0217.1	428217	+ S	B		V	293	28	26	47,1	114,3	5	64,1	155	12,7
24.0128-0219.1	428219		B		V	305	28	26	44,7	100	4	60	139	14,2
24.0128-0220.1	428220		B		V	300	28	26	54	139,6	6	96,3	163	12,5



# Abmessungen Bremsscheiben

## Dimensions brake discs - Medidas disco de freno - Dimensions Disques de frein - Misure dischi freno

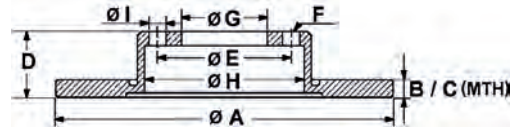

S Fixierschraube - fixing screw - tornillo que fija - vis de fixation - vite di riparazione  
 B beschichtet - coated - recubierto - revêtu - rivestito  
 HC hochgekohlt - high carbon - altamente carbonizado - à haute teneur en carbone - ad alto tenore di carbonio

L legiert - alloyed - aleado - allié - alligato/legato  
 V ventiliert - ventilated - ventilado - ventilé - ventilato  
 \* gelocht - perforated - perforado - poinçonné - perforato

		S	B	HC L	V	A	B	C	D	E	F	G	H	I
24.0128-0223.1	428223	+ S	B	HC	V	312,5	28	26	63	100	5	61	151	15,5
24.0128-0224.1	428224		B		V	303,5	28	26,4	42,7	108	6	87	147	10,6
24.0128-0226.1	428226		B	HC L	V	289	28	26	70,2	140	6	98	164	13
24.0128-0227.1	428227		B		V	302	28	26,4	54	139,6	5	96,3	163	12,5
24.0128-0228.1	428228		B		V	295,6	28	26	48,2	114,3	5	72	142,8	13
24.0128-0229.1	428229		B		V	325	28,3	26	49,5	120,7	5	73,8	155	13,5
24.0128-0231.1	428231		B	HC	V	305	28	26	44,8	98	4	59	139	13,2
24.0128-0232.1	428232		B		V	296	28	25	62	114,3	5	62	154	14,5
24.0128-0233.1	428233		B		V	320	28	26	48,2	114,3	5	72	143	13
24.0128-0234.1	428234		B		V	300	28	26,4	47,3	114,3	5	69	141,5	12,5
24.0128-0238.1	428238		B		V	300	28	25	74,5	125	6	78	156	15,5
24.0128-0239.1	428239		B		V	290	28	25	46	95	9	64	123	12,5
24.0128-0240.1	428240		B	HC L	V	320	28	26	38	114,3	6	68	175	12,8
24.0128-0241.1	428241		B	HC L	V	296	28	26	38	114,3	6	68	161	12,8
24.0128-0242.1	428242		B		V	320	28	26	44	114,3	5	68	146,5	12,7
24.0128-0243.1	428243		B	HC L	V	305	28	26	44,7	98	4	59	191	13
24.0128-0244.1	428244		B	HC L	V	276	28	26	45,2	118	5	94	151,5	M12x1,5
24.0128-0245.1	428245	+ S	B	HC L	V	320	28	25,4	44	114,3	5	68	147,7	15,8
24.0128-0246.1	428246		B	HC L	V*	330	28	26	69	130	5	98	159,7	15,4
24.0128-0247.1	428247		B	HC L	V*	330	28	26	69	130	5	98	159,7	15,4
24.0128-0248.1	428248		B	HC L	V	321	28	26,4	49,1	114,3	5	69	143	12,5
24.0128-0249.1	428249		B		V	258	28	26	62	114,3	5	62	141	14,5
24.0128-0250.1	428250		B	HC	V	300	28	26	52	108	5	63,5	140	13,8
24.0128-0251.1	428251		B	HC	V	303	28	26	56,9	120	5	76	165,2	16,6
24.0128-0252.1	428252	+ S	B		V	302	28	24,5	69,9	130	5	90	160,5	17,4
24.0128-0253.1	428253		B	HC L	V	305	28	26	45,7	98	5	59,2	127	13
24.0128-0254.1	428254	+ S	B	HC	V	328	28	26,4	73,1	120	5	75	153,8	16,5
24.0128-0256.1	428256		B	HC L	V	300	28	26,4	47,3	114,3	5	69	142,5	12,5
24.0128-0258.1	428258		B	HC L	V	320	28,1	26,4	47,3	114,3	5	69	145	12,5
24.0128-0259.1	428259		B		V	332	28	26,4	64	114,3	5	72	165,3	16,6
24.0128-0260.1	428260		B	HC L	V*	315	28	26	69	130	5	98	159	15,4
24.0128-0261.1	428261	+ S	B	HC L	V	340	28	26	63	114,3	5	68	162	13,5
24.0128-0262.1	428262	+ S	B	HC L	V*	295	28	26	51,1	112	5	67	154,6	15
24.0128-0263.1	428263		B	HC	V	302	28	26,4	38,2	127	5	72,5	166	14
24.0128-0264.1	428264		B	HC L	V*	350	28	26	75	130	5	98	180	15,4
24.0128-0265.1	428265		B	HC L	V*	350	28	26	75	130	5	98	180	15,4
24.0128-0266.1	428266		B	HC	V	320	28	26,5	54,5	115	5	72,6	162,8	16,8
24.0128-0268.1	428268		B		V	283	28	26	44	114,3	5	68	154,2	12,8
24.0128-0269.1	428269	+ S	B	HC	V	304	28	26	48	108	5	71	133,2	13,2
24.0128-0270.1	428270		B	HC	V	302	28	26,4	64	114,3	5	72	165	16,6
24.0128-0273.1	428273		B	HC L	V*	315	28	26	69	130	5	98	159	15,4
24.0128-0274.1	428274		B	HC	V	296	28	25	49,4	114,3	5	62	145	14,5
24.0128-0275.1	428275	+ S	B	HC L	V	295	28	25,4	51,1	112	5	67	154,6	15
24.0128-0276.1	428276	+ S	B	HC L	V	295	28	25,4	51	112	5	67	155	15
24.0128-0277.1	428277		B		V	297	28	26	51,5	114,3	5	68	143	13,2
24.0128-0279.1	428279		B		V	297	28	26	51,4	114,3	5	68	143	13,3
24.0128-0280.1	428280		B	HC L	V	300	28	26,4	47,2	114,3	5	69	142,5	12,5
24.0128-0282.1	428282	+ S	B	HC L	V/	330	28	26	75	130	5	98	180	15,4
24.0128-0283.1	428283	+ S	B	HC L	V/	330	28	26	75	130	5	98	180	15,4
24.0128-0286.1	428286		B	HC L	V	300	28	26,5	50,9	108	5	63,5	139,7	13,8
24.0128-0287.1	428287	+ S	B	HC	V	296	28	23,4	44	114,3	5	68	147,7	15,5
24.0128-0288.1	428288	+ S	B	HC L	V/	340	28	26	63	114,3	5	68	162	13,5
24.0128-0289.1	428289	+ S	B	HC L	V	356	28	26	36,1	112	5	68	143,5	15,3
24.0128-0290.1	428290		B	HC	V	302	28	26,4	38,2	127	5	72,5	165,5	14
24.0128-0291.1	428291		B		V	320	28	26	44	114,3	5	68	153,7	12,7
24.0128-0292.1	428292	+ S	B		V	305	28	26	39,7	110	5/5	70	138	16,7/11
24.0128-0293.1	428293		B		V	300	28	24	54,5	113,5	5	93	136	M12x1,5
24.0128-0296.1	428296	+ S	B	HC	V	350	28	26	36,2	112	5	68	150	15,3
24.0128-0330.1	428330	+ S	B	HC L	V	305	28	25,4	62,5	112	5	69	155	15,4
24.0128-0708.1	428708		B	HC	V	288	28	26	64,8	114,3	5	72	158	15,5
24.0128-0722.1	428722				V	282	28	26	47	114,3	5	70,2	148,2	12,6
24.0128-0740.1	428740		B		V	296	28	26	49,2	114,3	5	62	149	14,5
24.0128-0753.1	428753		B		V	319	28	26	49,3	114,3	5	62	178,5	14,7
24.0129-0100.1	429100		B		V	305	28,5	26	49,5	120,7	5	73,8	154,5	13,4
24.0129-0101.1	429101		B	HC L	V	296	29	27,5	51,6	115	5	70,7	154,5	12,8
24.0129-0102.1	429102	+ S	B	HC	V	345	29,5	28	52,1	112	5	68	154	15,3
24.0130-0100.1	430100		B	HC L	V	320	30	27,4	82	112	5	67	154,3	15,2
24.0130-0101.1	430101	+ S	B	HC	V	324	30	28,4	77	120	5	79	149	14,5
24.0130-0103.1	430103			HC L	V	324	30	26	91	140	6	118	122	M12x1,5



# Abmessungen Bremsscheiben

## Dimensions brake discs - Medidas disco de freno - Dimensions Disques de frein - Misure dischi freno

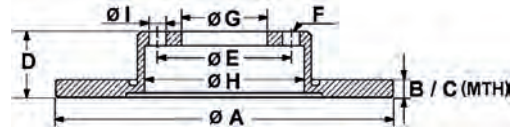

S Fixierschraube - fixing screw - tornillo quefija - vis de fixation - vite di riparazione  
 B beschichtet - coated - recubierto - revêtu - rivestito  
 HC hochgekohlt - high carbon - altamente carbonizado - à haute teneur en carbone - ad alto tenore di carbonio

L legiert - alloyed - aleado - allié - alligato/legato  
 V ventiliert - ventilated - ventilado - ventilé - ventilato  
 \* gelocht - perforated - perforado - poinçonné - perforato

		S	B	HC L	V	A	B	C	D	E	F	G	H	I
24.0130-0104.1	430104		B	HC	V	314	30	28	59,7	112	5/10	68	136	15,3
24.0130-0107.1	430107	+ S	B	HC	V	324	29,9	28,4	73,7	120	5	79	149	14,8
24.0130-0109.1	430109	+ S	B	HC	V	332	29,9	28,4	62,1	120	5	75	158	16,5
24.0130-0113.1	430113	+ S	B	HC	V	320	30	28	46,5	112	5/9	68	137	15,3
24.0130-0114.1	430114		B	HC	V	308	29,5	25,5	55,6	120	5	76	154,6	16,6
24.0130-0115.1	430115		B	HC	V	345	30	27	49,9	112	5/9	65	140	15,3
24.0130-0116.1	430116		B	HC	V	336	30	27	51	108	5	68	150	16,5
24.0130-0117.1	430117		B	HC	V	324	30	28,4	81	120	5	79	169	16,5
24.0130-0118.1	430118		B	HC	V	348	30	28,4	81	120	5	79	164	16,5
24.0130-0119.1	430119		B	HC	V	345	30	28	46,5	112	5/9	68	142	15,3
24.0130-0120.1	430120		B		V	300	30	28	43	108	5	71	143,5	14
24.0130-0121.1	430121		B	HC L	V	320	30	28	50,5	112	5	67	154	13
24.0130-0122.1	430122		B	HC L	V	320	30	28	50,5	112	5	67	154	13
24.0130-0171.1	430171		B	HC L	V	345	30	27,4	46,5	112	5	67	154	13
24.0130-0172.1	430172		B	HC L	V*	304	30	27,4	47,5	112	5	67	154	15
24.0130-0173.1	430173	+ S	B	HC	V	324	30	28,4	77	120	5	79	165	14,5
24.0130-0174.1	430174		B	HC	V	321	30	28	52,5	112	5/10	68	135	15,3
24.0130-0175.1	430175	+ S	B	HC	V	321	30	28	59,7	112	5	68	144,8	15,3
24.0130-0176.1	430176	+ S	B	HC	V	347	30	28	59,7	112	5	68	158	15,3
24.0130-0177.1	430177		B	HC	V	345	30	28	59,7	112	5/10	68	135	15,3
24.0130-0178.1	430178		B		V	317	30	27	62	120	5	79	165	15
24.0130-0179.1	430179		B	HC L	V	304	30	27,4	47,5	112	5	67	154	15
24.0130-0180.1	430180		B	HC L	V*	345	30	28	46,5	112	5	67	154,2	13,1
24.0130-0181.1	430181	+ S	B		V	330	30	28	48	108	5	71,1	171,8	13,2
24.0130-0182.1	430182		B		V	320	30	28,4	43	108	5	71	143,5	14
24.0130-0183.1	430183		B	HC	V	323	30	28	59,7	112	5/9	68	144	15,3
24.0130-0184.1	430184		B	HC	V	344	29,9	28,4	75,9	120	5	79	172,8	16,6
24.0130-0185.1	430185		B	HC	V*	320	30	28	46,5	112	5/9	68	137	15,3
24.0130-0186.2	430186	+ S	B	HC	V	348	30	28,4	77,1	120	5	79	187,3	14,5
24.0130-0188.1	430188		B		V	337,5	30	27	62	120	5	79	166	15
24.0130-0189.1	430189		B	HC	V	345	29,9	27,5	45,3	110	5	70	142	14,2
24.0130-0190.1	430190			HC L	V	304	29,9	26	120,5	192	6	157	134	M12x1,5
24.0130-0191.1	430191			HC L	V	324	29,9	26	120,5	192	6	157	134	M12x1,5
24.0130-0192.1	430192	+ S	B	HC	V	348	30	28,4	73,1	120	5	79	186,8	14,5
24.0130-0193.1	430193	+ S	B	HC	V	320	30	28	52,4	112	5	68	153,4	15,3
24.0130-0195.1	430195		B		V	360	30	27	62	120	5	79	175	15
24.0130-0196.1	430196		B		V	344	30	27	76	120	5	79	172	16,6
24.0130-0197.1	430197		B		V	360	30	27	81	120	5	79	175	16,6
24.0130-0198.1	430198			HC L	V	304	30	26	91	140	6	118	122	M12x1,5
24.0130-0199.1	430199	+ S	B	HC	V	348	29,9	28,4	62,1	120	5	75	154	16,5
24.0130-0200.1	430200	+ S	B	HC	V	332	29,9	28,4	62,1	120	5	75	153	16,5
24.0130-0201.1	430201		B		V	334	30	27	51	114,3	5	62	143,5	14,5
24.0130-0202.1	430202		B		V	334	30	27	51	114,3	5	62	143,5	14,5
24.0130-0203.1	430203		B		V	326	30	28	52,7	114,3	5	58	148	12,8
24.0130-0204.1	430204		B		V	316	30	28	56,8	100	5	58	149	13
24.0130-0206.1	430206	+ S	B	HC L	V	330	30	28	48	108	5	71,1	138	13
24.0130-0207.1	430207	+ S	B	HC L	V	296	30	27	51	120	5	67,4	163,7	16,3
24.0130-0208.1	430208	+ S	B	HC	V	337	30	27	51	120	5	67,4	159,7	16,3
24.0130-0209.1	430209	+ S	B	HC	V	321	30	27	51	120	5	67,4	160	16,3
24.0130-0212.1	430212		B	HC	V	328	30	28	52	108	5	63,5	165,5	15,7
24.0130-0213.2	430213	+ S	B	HC	V*	360	30	28,4	62,3	120	5	79	185	14,5
24.0130-0214.2	430214	+ S	B	HC	V*	360	30	28,4	62,3	120	5	79	185	14,2
24.0130-0215.1	430215		B	HC	V	324	30	28,4	49	114,3	5	68	152	12,7
24.0130-0216.2	430216	+ S	B	HC	V	348	30	28,4	73	120	5	79	186,8	14,5
24.0130-0217.1	430217	+ S	B	HC L	V	315	30	27,4	83	130	5	85	157	15
24.0130-0218.2	430218	+ S	B	HC	V	348	30	28,4	66	120	5	75	186,8	16,5
24.0130-0219.1	430219	+ S	B	HC	V	340	30	28	49,2	112	5	65	139,7	15,3
24.0130-0220.1	430220	+ S	B	HC	V	314	30	27	49,6	112	9	65	145	15,3
24.0130-0221.1	430221	+ S	B	HC	V	320	30	28	52,2	112	5	68	149,3	15,3
24.0130-0222.1	430222	+ S	B	HC	V	345	30	28	52,1	112	5	68	164,6	15,3
24.0130-0223.1	430223		B		V	328	30	28,5	53	127	5	72	177	16,2
24.0130-0224.1	430224	+ S	B	HC	V	321	30	27	45,5	115	5	70,7	160	14,2
24.0130-0225.1	430225	+ S	B	HC	V	340	30	27	49,6	112	5/9	65	145	15,3
24.0130-0226.1	430226		B	HC	V	326	30	28	46,1	108	5	71	161	14
24.0130-0227.1	430227	+ S	B	HC L	V	340	30	28	48	108	5	71,1	136	13,2
24.0130-0229.1	430229	+ S	B	HC L	V	340	30	28	34,2	108	5	71,1	133	13,2
24.0130-0230.1	430230	+ S	B	HC L	V	340	30	28	34,2	108	4	71,1	133	13,2
24.0130-0231.1	430231		B	HC L	V	345	30	28	56,5	114,3	5	69	144	12,5
24.0130-0233.2	430233	+ S	B	HC	V	340	30	28,4	73,2	120	5	79	153,7	16,5

# Abmessungen Bremsscheiben

## Dimensions brake discs - Medidas disco de freno - Dimensions Disques de frein - Misure dischi freno

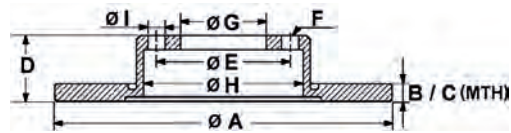

S Fixierschraube - fixing screw - tornillo quefija - vis de fixation - vite di riparazione  
 B beschichtet - coated - recubierto - revêtu - rivestito  
 HC hochgekohlt - high carbon - allamente carbonizado - à haute teneur en carbone - ad alto tenore di carbonio

L legiert - alloyed - aleado - allié - alligato/legato  
 V ventiliert - ventilated - ventilado - ventilé - ventilato  
 \* gelocht - perforated - perforado - poinçonné - perforato

		S	B	HC	L	V	A	B	C	D	E	F	G	H	I
24.0130-0234.2	430234	+ S	B	HC		V	370	30	28,4	73,1	120	5	79	184	16,5
24.0130-0235.1	430235	+ S	B	HC		V	320	30	28	52,4	112	5	68	149,4	15,3
24.0130-0236.1	430236	+ S	B	HC		V	345	30	28	62,1	112	5	68	154	15,3
24.0130-0237.1	430237	+ S	B	HC L		V	320	30	28	51	112	5	67	154	15
24.0130-0238.1	430238	+ S	B	HC L		V*	320	30	28	51	112	5	67	154	15
24.0130-0239.1	430239		B	HC L		V	300	30	28,4	52,4	139,7	6	96,3	163	12,5
24.0130-0240.1	430240		B	HC		V	327,5	30	27	51,3	108	5	68	140	16,5
24.0130-0241.1	430241	+ S	B	HC L		V	330	30	28	48	108	5	71,1	138	13,2
24.0130-0242.1	430242	+ S	B	HC		V	366	30	27,5	48	108	5	63,5	141	15,8
24.0130-0243.1	430243	+ S	B	HC		V	345	30	27,5	41	108	5	63,5	141	15,8
24.0130-0244.1	430244	+ S	B	HC		V	318	30	28	57,2	112	5	68	149,3	15,3
24.0131-0100.1	431100		B			V	308	31	28	61	113,5	5	93,1	135,5	M12x1,5
24.0132-0100.1	432100	+ S	B	HC L		V*	322	32	30	64,5	112	5	67	154,3	15,2
24.0132-0101.1	432101	+ S	B	HC L		V	322	32	29,4	64,5	112	5	67	154,3	15,2
24.0132-0110.1	432110					V	278	32,2	30,7	52	118	5	70,6	150	16,2
24.0132-0111.1	432111					V	311	32	30	58	139,7	6	105	204	M12x1,25
24.0132-0113.1	432113	+ S	B	HC		V	334	31,9	30,4	76,9	120	5	79	159	14,8
24.0132-0114.1	432114		B	HC		V	345	31,9	30	51	112	5	67	156,5	15,3
24.0132-0115.1	432115		B	HC L		V*	330	32	30	76	112	5	67	154	15
24.0132-0116.1	432116	+ S	B	HC		V	333	32,5	28,5	55,6	120	5	76	154,6	16,6
24.0132-0117.1	432117	+ S	B	HC L		V	330	32	30	68,5	130	5	85	174	15,4
24.0132-0118.1	432118	+ S	B	HC L		V	330	32	30	68,5	130	5	85	174	15,4
24.0132-0125.1	432125		B	HC L		V*	345	32	30	76	112	5	67	154	15
24.0132-0126.1	432126		B			V	310	32	30	43,8	98	5	59	138	16,5
24.0132-0129.1	432129		B	HC		V	330	32	30	44,7	98	5	59	149	13
24.0132-0131.1	432131		B			V	300	32	29,9	73,5	130	5	80	161	18
24.0132-0136.1	432136		B	HC L		V*	330	32	30	47,5	112	5	67	154	15
24.0132-0137.1	432137	+ S	B	HC L		V*	335	32	30	64,5	112	5	67	154	15,2
24.0132-0138.1	432138	+ S	B	HC L		V*	350	32	30	64,5	112	5	112	154	15,2
24.0132-0139.1	432139	+ S	B	HC L		V	350	32	29,4	64,5	112	5	67	154	15,2
24.0132-0142.1	432142		B	HC L		V*	304	32	30	72	130	5	103	161	15,4
24.0132-0143.1	432143		B	HC L		V*	304	32	30	72	130	5	103	161	15,4
24.0132-0144.1	432144	+ S	B	HC L		V	330	32	29,4	64,5	112	5	67	154	15
24.0132-0147.1	432147		B	HC L		V*	334	32	30	51,5	112	5	67	154	13
24.0132-0148.1	432148		B			V	313	32	30	70	144	5	115	172,5	12,5
24.0132-0152.1	432152					V	309	32	30	43,1	108	5	71,1	136	13
24.0132-0153.1	432153	+ S	B	HC L		V*	330	32	30	64,5	112	5	67	154	15
24.0132-0154.1	432154		B	HC L		V	330	32	29,4	47,5	112	5	67	154	15
24.0132-0157.1	432157	+ S	B	HC L		V	350	32	29,4	54,5	112	5	67	156,3	15,2
24.0132-0158.1	432158	+ S	B	HC L		V	330	32	29,4	54,5	112	5	67	156,3	15,2
24.0132-0159.1	432159		B	HC L		V	330	32	29,4	46,5	112	5	67	154	13
24.0132-0160.1	432160	+ S	B	HC		V	334	31,9	30,4	62,9	120	5	79	159	14,8
24.0132-0161.2	432161	+ S	B	HC		V	345	32	30,4	77	120	5	79	159,5	14,5
24.0132-0162.2	432162	+ S	B	HC		V	345	32	30,4	77	120	5	79	159,5	14,5
24.0132-0163.2	432163		B	HC L		V*	322	32	30	72	130	5	103	157	15,4
24.0132-0164.2	432164		B	HC L		V*	322	32	30	72	130	5	103	157	15,4
24.0132-0165.2	432165		B	HC		V	334	32	30	35	100	5/9	65	146	15,6
24.0132-0166.2	432166		B	HC		V	334	32	30	35	100	5/9	65	146	15,6
24.0132-0167.1	432167	+ S	B	HC L		V	375	32	29,4	54,5	112	5	67	156,3	15,2
24.0132-0168.1	432168	+ S	B	HC L		V*	344	32	30	64,5	112	5	67	154,3	15
24.0132-0169.1	432169		B	HC		V	321	32	30	51	114,3	5	69	143	12,5
24.0132-0170.1	432170	+ S	B	HC L		V*	322	32	30	51,5	112	5	67	154,2	15,2
24.0132-0172.1	432172	+ S	B	HC		V	320	32	30	47,2	114,3	5	64,2	151	12,6
24.0132-0175.1	432175	+ S	B	HC L		V*	344	32	30	64,5	112	5	67	154,3	15,2
24.0132-0176.1	432176		B			V	302	32	30	61	140	6	98	164	13,2
24.0132-0178.1	432178	+ S	B	HC L		V	330	32	29,4	54,5	112	5	67	158	15
24.0132-0179.1	432179	+ S	B	HC L		V*	350	32	29,4	54	112	5	67	158	15
24.0132-0180.1	432180	+ S	B	HC L		V*	344	32	30	51,5	112	5	67	154	15
24.0132-0181.1	432181		B			V	330	32	30,5	54,5	127	5	72	173	17
24.0132-0184.1	432184	+ S	B	HC L		V	350	32	29,4	54,5	112	5	67	158	15
24.0132-0187.1	432187		B			V	338	32	29	68,3	139,7	6	108	172	14,5
24.0132-0701.1	432701		B			V	296	32	30	50,8	114,3	5	62	143,5	14,5
24.0133-0100.1	433100	+ S	B	HC		V	340	32,6	29,5	55,6	120	5	76	154,8	16,6
24.0133-0101.1	433101	+ S	B	HC L		V	288	33	30	55,3	111	5	93,1	136	M10x1,5
24.0133-0102.1	433102	+ S	B	HC L		V	308	33	30	55,3	111	5	93,1	136	M10x1,5
24.0134-0100.1	434100		B	HC		V	360	34	31	59,7	112	5	68	135	15
24.0134-0101.1	434101		B	HC L		V*	330	34	32	69,5	130	5	98	173,5	15,4
24.0134-0102.1	434102		B	HC L		V*	330	34	32	69,5	130	5	98	173,5	15,4
24.0134-0103.1	434103	+ S	B	HC		V	356	34	31,5	52,4	112	5	68	149	15,3



# Abmessungen Bremsscheiben

## Dimensions brake discs - Medidas disco de freno - Dimensions Disques de frein - Misure dischi freno

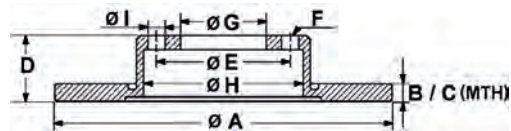

S Fixierschraube - fixing screw - tornillo que fija - vis de fixation - vite di riparazione  
 B beschichtet - coated - recubierto - revêtu - rivestito  
 HC hochgekohlt - high carbon - altamente carbonizado - à haute teneur en carbone - ad alto tenore di carbonio

L legiert - alloyed - aleado - allié - alligato/legato  
 V ventiliert - ventilated - ventilado - ventilé - ventilato  
 \* gelocht - perforated - perforado - poinçonné - perforato

	S	B	HC L	V	A	B	C	D	E	F	G	H	I	
24.0134-0104.1	434104		B		V	328	34	31	49,2	114,3	5	62	142,5	14,5
24.0134-0105.1	434105		B	HC L	V*	350	34	32	67,5	130	5	98	185	15,4
24.0134-0106.1	434106		B	HC L	V*	350	34	32	67,5	130	5	98	185	15,4
24.0134-0107.1	434107	+ S	B	HC	V	356	34	31,5	62,4	112	5	68	149,5	15,3
24.0134-0110.1	434110	+ S	B	HC	V	349	34	32	57,1	112	5	68	151,3	15,3
24.0134-0123.1	434123		B	HC L	V	350	34	32	68,5	130	5	85	185	15,4
24.0134-0124.1	434124		B	HC L	V	350	34	32	68,5	130	5	85	185	15,4
24.0136-0101.1	436101		B	HC	V	374	36	34,4	81	120	5	79	187	16,5
24.0136-0102.1	436102		B	HC L	V*	360	36	34	64,5	112	5	67	154	15,2
24.0136-0103.1	436103		B	HC	V	385	36	33,5	59,7	112	5	68	135	15,3
24.0136-0104.1	436104		B	HC	V	356	36	34,4	61,9	120	5	75	158	16,5
24.0136-0105.1	436105		B	HC L	V*	360	36	34	76	112	5	67	154	15
24.0136-0106.2	436106	+ S	B	HC	V	348	36	34,4	77	120	5	79	154,3	14,5
24.0136-0107.1	436107		B	HC	V	385	36	33,5	61,4	112	5	68	135	15,2
24.0136-0108.1	436108	+ S	B	HC L	V*	360	36	34	64,5	112	5	67	154	15,2
24.0136-0109.1	436109	+ S	B	HC	V	365	36	34,4	62	120	5	75	168	16,5
24.0136-0110.1	436110		B	HC	V	348	35,9	34,4	80,9	120	5	79	154	16,5
24.0136-0111.1	436111		B	HC	V	368	36	34	68,7	130	5	85	157	15,4
24.0136-0112.2	436112	+ S	B	HC	V	385	36	34,4	62	120	5	75	153,7	16,5
24.0136-0113.2	436113	+ S	B	HC	V	385	36	34,4	62	120	5	75	153,7	16,5
24.0136-0114.2	436114	+ S	B	HC	V	348	36	34,4	66	120	5	75	153,7	16,5
24.0136-0115.2	436115	+ S	B	HC	V	348	36	34,4	66	120	5	75	153,7	16,5
24.0136-0116.2	436116	+ S	B	HC	V*	374	36	34,4	77	120	5	79	174	14,5
24.0136-0117.2	436117	+ S	B	HC	V*	374	36	34,4	77	120	5	79	174	14,5
24.0136-0118.2	436118	+ S	B	HC	V	374	36	34,4	66	120	5	75	186,8	16,5
24.0136-0119.2	436119	+ S	B	HC	V	374	36	34,4	66	120	5	75	186,8	16,5
24.0136-0120.2	436120	+ S	B	HC	V	374	36	34,4	66	120	5	75	153,8	16,5
24.0136-0121.2	436121	+ S	B	HC	V	374	36	34,4	66	120	5	75	153,8	16,5
24.0136-0122.1	436122		B	HC	V	380	36	34	48	108	5	71	163	14
24.0136-0123.1	436123	+ S	B	HC	V	360	36	34	68,5	130	5	85	160	15,4
24.0136-0124.1	436124	+ S	B	HC	V	360	36	34	68,5	130	5	85	160	15,4
24.0136-0125.2	436125	+ S	B	HC	V*	400	36	34,4	63,2	120	5	75	198	16,5
24.0136-0126.2	436126	+ S	B	HC	V*	400	36	34,4	63,2	120	5	75	198	16,5
24.0136-0127.1	436127	+ S	B	HC L	V/	360	36	34	68,6	130	5	98	160	15,4
24.0136-0128.1	436128	+ S	B	HC L	V/	360	36	34	68,6	130	5	98	160	15,4
24.0136-0132.2	436132	+ S	B	HC	V	348	36	34,4	66,1	112	5	67	153,7	16,5
24.0136-0133.2	436133	+ S	B	HC	V	348	36	34,4	66,1	112	5	67	153,7	16,5
24.0308-0111.1	508111		B			258	8	7	55,3	112	5	67	164	13
24.0308-0113.1	508113	+ S	B			258	8	7	57,3	112	5	67	164	15
24.0309-0114.1	509114	+ S	B			278	9	7,3	55,5	112	5	67	164	13,2
24.0309-0120.1	509120	+ S	B			258	9	7,3	55,5	112	5	67	164	12,8
24.0309-0123.1	509123	+ S	B			230	9	7	40,6	100	5	65	125,8	15,6
24.0309-0133.1	509133	+ S	B			239	8,9	7	33,4	100	5	65	132,5	15,8
24.0309-0154.1	509154	+ S	B			278	9	7,3	57,5	112	5	67	164	15
24.0310-0115.1	510115		B			253	10,2	8,9	33	108	4	63,5	155	13,7
24.0310-0117.1	510117	+ S	B	HC		300	10	7,6	61	120	5	75	180	14,5
24.0310-0151.1	510151	+ S	B			239	10	8	38,9	100	4	65	124,5	13,6
24.0310-0201.1	510201		B			245	10	8	64,2	112	5	68	135,5	15,4
24.0310-0202.1	510202	+ S	B	HC		280	10	7,6	60	120	5	75	160,8	14,5
24.0310-0217.1	510217	+ S	B			290	10	8,3	55,5	112	5	67	164	13,3
24.0310-0223.1	510223	+ S	B			268	10	8	45,8	112	5	68,2	154,5	16,8
24.0310-0224.1	510224		B			245	10	8	48	112	5	68	135,5	15,4
24.0310-0225.1	510225	+ S	B			270	10	8	69,3	100	4	57	160	14
24.0310-0226.1	510226	+ S	B			286	10	8	69,3	110	5	65,5	160	14
24.0310-0227.1	510227	+ S	B	HC		298	10	7,6	61	120	5	75	185	14,5
24.0310-0250.1	510250	+ S	B			264	9,8	8	42	110	5	65,5	145	14
24.0310-0251.1	510251	+ S	B			240	9,8	8	42	100	4	57	140,8	14
24.0310-0260.1	510260		B			255	10	8	48,1	112	5	68	144,5	15,3
24.0310-0261.1	510261		B			245	10	8	40	112	5/9	68	135,5	15,3
24.0310-0271.1	510271		B			259	10	7,6	44,1	100	4	64,2	163	16
24.0310-0277.1	510277	+ S	B			253	10	8	51,6	112	5/9	65	140	15,3
24.0310-0278.1	510278	+ S	B			300	10	8,3	68,3	112	5	67	180	15,3
24.0310-0291.1	510291	+ S	B			264	10	8	42	100	4	57	145	14
24.0310-0314.1	510314	+ S	B	HC		280	10	7,6	65,5	120	5	75	160,8	14,5
24.0310-0315.1	510315	+ S	B	HC		296	10,4	8,1	65,5	120	5	75	160,8	14,5
24.0310-0328.1	510328	+ S	B			300	10	8,3	57,5	112	5	67	164	15,3
24.0310-0349.1	510349		B			251	10	9	40,5	98	4	59	128	13,2
24.0310-0356.1	510356	+ S	B			272	9,7	8	48,2	112	9	65	174,5	15,3
24.0311-0141.1	511141		B			256	10,8	8	41,1	100	6	60	123	14,3



# Abmessungen Bremsscheiben

## Dimensions brake discs - Medidas disco de freno - Dimensions Disques de frein - Misure dischi freno

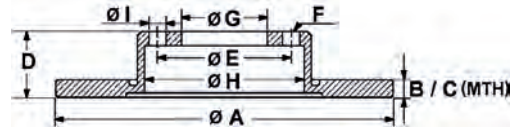

S Fixierschraube - fixing screw - tornillo que fija - vis de fixation - vite di riparazione  
 B beschichtet - coated - recubierto - revêtu - rivestito  
 HC hochgekohlt - high carbon - allamente carbonizado - à haute teneur en carbone - ad alto tenore di carbonio

L legiert - alloyed - aleado - allié - alligato/legato  
 V ventiliert - ventilated - ventilado - ventilé - ventilato  
 \* gelocht - perforated - perforado - poinçonné - perforato

	S	B	HC L	V	A	B	C	D	E	F	G	H	I	
24.0311-0145.1	511145		B		302	10,9	9	50,8	108	5	63,5	177,6	15,8	
24.0311-0155.1	511155		B		265	11	9	40,8	108	5	63,5	152	13,7	
24.0311-0158.1	511158	+ S	B		280	11	9	41	108	5	63,5	192	13,7	
24.0311-0171.1	511171		B		271	11	9	40,7	108	5	63,5	152	13,8	
24.0312-0106.1	512106	+ S	B		239	12	10	35,4	100	4	65	124,5	13,6	
24.0312-0125.1	512125		B		239	12	10,8	42,5	98	4	58,5	127	13,1	
24.0312-0126.1	512126	+ S	B		286	12	9,6	51,5	120	5	79	148	14,5	
24.0312-0141.1	512141		B		239,5	12	10	42,9	108	4	63,5	136	13,7	
24.0312-0144.1	512144	+ S	B	HC L	260	12	10	40,4	112	5	67	145	13,3	
24.0312-0148.1	512148		B		255	12	10	40	112	5/9	68	144,5	15,3	
24.0312-0151.1	512151		B		288	11,9	10	64,8	108	5	68	178	16,5	
24.0312-0152.1	512152		B	HC	324	12	9,6	80,2	120	5	75	185	16,8	
24.0312-0154.1	512154		B		280	12	10	34	108	5	63,5	151	13,7	
24.0312-0157.1	512157	+ S	B		278	11,9	10	41,4	110	5	65,5	145,2	14	
24.0312-0158.1	512158		B		256	12	10	48,6	112	5/9	65	140	15,3	
24.0312-0159.1	512159	+ S	B		302	12	10	49,4	112	5/9	68	177	15,3	
24.0312-0166.1	512166		B		288	12	10	36	112	5	68	162	15,3	
24.0312-0167.1	512167	+ S	B	HC L	276	12	10	44,5	112	5	67	145	15,3	
24.0312-0169.1	512169	+ S	B		282	12	10	48,6	112	5/9	65	159	15,3	
24.0312-0178.1	512178	+ S	B		300	12	10	36,4	112	5	68	169	15,3	
24.0312-0187.1	512187	+ S	B		292	12	10,5	48	120	5	67,4	171,5	16,3	
24.0312-0188.1	512188	+ S	B		268	12	10	44,9	105	5	60	147	14,2	
24.0312-0189.1	512189	+ S	B		292	12	10	45	115	5	70,7	157	14,2	
24.0313-0161.1	513161	+ S	B		236	12,7	9,7	41	100	4	60	123	14	
24.0313-0178.1	513178	+ S	B		255,6	12,9	11	39,2	100	4	65	135,5	13,6	
24.0313-0181.1	513181		B	HC	280	13	11	46,5	112	5	68	159	15,4	
24.0313-0184.1	513184	+ S	B		266	13	11	27,2	108	4	66	133	13	
24.0313-0185.1	513185	+ S	B		247,5	13	11	34,2	108	4	66	133	13	
24.0315-0105.1	515105		B	HC	288	15	13	46,5	112	5	68	135,5	15,4	
24.0318-0106.1	518106	+ S	B	HC	V	239	18	16	34,5	100	4	65	125	13,6
24.0318-0137.1	518137	+ S	B	HC	V	239	18	16	35	100	5	65	125	15,6
24.0319-0107.1	519107	+ S	B	HC	V	276	19	16,6	60,3	120	5	75	160,8	14,5
24.0319-0108.1	519108	+ S	B	HC	V	294	18,9	16,6	59,7	120	5	75	160,8	14,8
24.0320-0115.1	520115	+ S	B	HC L	V	236	20	17	41	100	4	60	123	14
24.0320-0123.1	520123	+ S	B	HC L	V	239	20	18	39	100	4	65	123,8	13,6
24.0320-0128.1	520128	+ S	B	HC L	V	256	20	18	38,8	100	4	65	131,5	13,8
24.0320-0132.1	520132	+ S	B		V	247	20,4	18,5	34,2	108	4	66	133,2	12,8
24.0320-0133.1	520133	+ S	B		V	266	20,5	18,5	27,6	108	4	66	133	13
24.0320-0142.1	520142		B	HC L	V	257,5	20	18,2	40,5	98	4	59	126,7	13
24.0320-0146.1	520146		B		V	253	20	18	43,7	108	4	63,5	153	13,7
24.0320-0147.1	520147		B		V	239,5	20	18	43	108	4	63,5	136	13,7
24.0320-0154.1	520154	+ S	B	HC	V	298	20	17,6	61,3	120	5	75	185	14,5
24.0320-0173.1	520173	+ S	B		V	292	19,9	18	41,4	110	5	65,5	162,5	14
24.0320-0175.1	520175		B		V	255	20	18	43,1	100	4	55	129	14,5
24.0320-0183.1	520183	+ S	B	HC	V	320	20	17,6	63,2	120	5	75	185	14,5
24.0320-0195.1	520195	+ S	B	HC	V	300	20	17,6	66	120	5	75	160,8	14,5
24.0320-0204.1	520204	+ S	B	HC	V	300	20	17,6	66,1	120	5	75	185	14,5
24.0320-0213.1	520213	+ S	B	HC	V	320	20	17,6	86,1	120	5	75	185	14,5
24.0320-0234.1	520234	+ S	B	HC	V	330	20	17,6	71	120	5	75	154	16,5
24.0322-0100.1	522100		B	HC	V	280	22	20	28,5	100	5	65	141	15,6
24.0322-0103.1	522103	+ S	B	HC	V	302	22	19,6	76	120	5	79	149	14,5
24.0322-0115.1	522115	+ S	B	HC	V	286	22	19,6	51,5	120	5	79	147,5	14,5
24.0322-0132.1	522132	+ S	B	HC L	V	284	22	19,4	43,5	112	5	67	154,3	12,8
24.0322-0150.1	522150	+ S	B	HC	V	280	22	19	36,7	100	5	65	133,5	15,6
24.0322-0151.1	522151	+ S	B	HC	V	256	22	19	36,7	100	5	65	133,5	15,6
24.0322-0152.1	522152	+ S	B	HC	V	280	22	20	46,3	112	5/9	68	146,5	15,3
24.0322-0159.1	522159	+ S	B	HC	V	296	22	19,6	76,3	120	5	79	148,8	14,5
24.0322-0160.1	522160	+ S	B	HC	V	300	22	19,6	51,8	120	5	79	164	14,5
24.0322-0161.1	522161	+ S	B	HC L	V	276	22	19	77,2	130	5	85	156,3	15
24.0322-0162.1	522162	+ S	B	HC L	V	276	22	19	60	112	5	67	153	15
24.0322-0163.1	522163		B	HC	V	256	22	20	36,6	100	5	65	135	15,6
24.0322-0168.1	522168	+ S	B	HC L	V	260	22	19,4	40,4	112	5	67	145	13,3
24.0322-0170.1	522170		B		V	257	22	20	34	104	4	86	160,5	10,6
24.0322-0172.1	522172		B		V	258	22	20	43,4	108	4	63,5	136	13,7
24.0322-0197.1	522197		B		V	257,5	22	20,2	40,5	98	4	59	127	13
24.0322-0199.1	522199		B	HC L	V	270	22	19,4	35,5	112	5	67	145	13,3
24.0322-0204.1	522204		B	HC	V	276	22	19,6	44,2	100	4	64,2	150	14,7
24.0322-0209.1	522209	+ S	B	HC	V	320	22	19,6	60,5	120	5	75	185	14,5
24.0322-0210.1	522210	+ S	B	HC	V	280	22	19	49,9	112	5/9	65	144	15,3





# Abmessungen Bremsscheiben

## Dimensions brake discs - Medidas disco de freno - Dimensions Disques de frein - Misure dischi freno

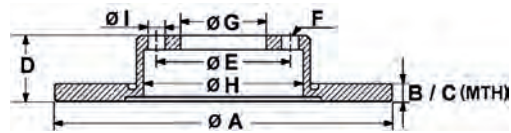

S Fixierschraube - fixing screw - tornillo quefija - vis de fixation - vite di riparazione  
 B beschichtet - coated - recubierto - revêtu - rivestito  
 HC hochgekohlt - high carbon - altamente carbonizado - à haute teneur en carbone - ad alto tenore di carbonio

L legiert - alloyed - aleado - allié - alligato/legato  
 V ventiliert - ventilated - ventilado - ventilé - ventilato  
 \* gelocht - perforated - perforado - poinçonné - perforato

		S	B	HC L	V	A	B	C	D	E	F	G	H	I
24.0322-0223.1	522223		B	HC	V	330	22	20	49,4	112	5	68	138	15,3
24.0322-0224.1	522224	+ S	B	HC	V	320	22	19,6	79,7	120	5	75	185	16,5
24.0322-0231.1	522231	+ S	B		V	257	22	20	40,5	100	4/6	60	126	14,5
24.0322-0232.1	522232	+ S	B	HC L	V	276	22	19,4	44,5	112	5	67	145	15,3
24.0322-0236.1	522236	+ S	B	HC	V	336	22	19,6	67,3	120	5	75	185	14,5
24.0322-0238.1	522238	+ S	B	HC	V	292	22	19,6	73,3	120	5	79	151,5	14,5
24.0322-0239.1	522239	+ S	B	HC	V	284	22	19,6	73,3	120	5	79	151,5	16,6
24.0322-0247.1	522247		B	HC	V	294	22	19,6	44,2	100	4	64,2	150	16,2
24.0322-0248.1	522248		B	HC	V	280	22	19,6	44,2	100	4	64,2	150	16,2
24.0323-0113.1	523113		B	HC	V	258	23	21	43,8	108	4	63,5	136	13
24.0323-0114.1	523114	+ S	B		V	315	22,9	21,5	48	120	5	67,4	172	16,3
24.0324-0115.1	524115	+ S	B	HC L	V	256	24	21	41	100	4	60	123	14
24.0324-0120.1	524120		B		V	260	24	22,2	47	108	4	63,5	136	13,6
24.0324-0152.1	524152	+ S	B	HC L	V	256	23,8	21	41,1	100	4	60	123	14,3
24.0324-0158.1	524158	+ S	B	HC L	V	280	24	21,8	44	100	4	61	140	13,6
24.0324-0159.1	524159		B		V	281	23,9	21,5	45,7	114,3	4	69	146,5	12,5
24.0324-0161.1	524161		B		V	300	23,9	22	47	108	5	63,5	155	13,7
24.0324-0166.1	524166		B	HC L	V	260	24	21	41	100	4/6	60	126	14,5
24.0324-0171.1	524171	+ S	B	HC L	V	280	24	21,8	44	108	5	61	140	15,5
24.0324-0181.1	524181	+ S	B	HC	V	310	24	21,6	77	120	5	79	161	14,5
24.0324-0197.1	524197	+ S	B	HC	V	300	24	21,6	73,3	120	5	79	152	14,5
24.0324-0200.1	524200	+ S	B	HC	V	330	24	21,6	73,3	120	5	79	174	14,5
24.0324-0203.1	524203	+ S	B	HC	V	312	23,9	21,6	73,1	120	5	79	152	16,5
24.0325-0105.1	525105		B	HC	V	288	25	23	46,5	112	5/9	68	135	15,4
24.0325-0110.1	525110	+ S	B	HC L	V	288	25	22,4	46,5	112	5	67	154,3	13,2
24.0325-0113.1	525113	+ S	B	HC	V	288	25	22	34,5	100	5	65	136	15,6
24.0325-0114.1	525114	+ S	B	HC	V	288	25,1	21	55,4	112	5	68,2	144,2	16,5
24.0325-0115.1	525115		B	HC	V	282,5	25	23	46,5	112	5	68	135	15,3
24.0325-0117.1	525117		B	HC	V	278	25	23	48,5	108	5	63,5	140	13,7
24.0325-0119.1	525119	+ S	B	HC L	V	288	25	22	42	110	5/7	70	139	14
24.0325-0123.1	525123	+ S	B	HC	V	310	25	22	34,5	100	5/9	65	135	15,6
24.0325-0131.1	525131	+ S	B	HC L	V	280	24,8	22	42	110	5/7	70	139	14
24.0325-0137.1	525137		B	HC	V	312	25	23	46,5	112	5/9	68	158	15,3
24.0325-0138.1	525138	+ S	B	HC	V	325	24,9	22,6	52,6	120	5	79	174	14,5
24.0325-0141.1	525141	+ S	B	HC	V	285	24,9	22	42,1	110	5	70	139	14
24.0325-0142.1	525142	+ S	B	HC L	V	308	25	23	42	110	5/8	70	139	14
24.0325-0145.1	525145	+ S	B	HC	V	288	25	22	49,9	112	5/9	65	144	15,3
24.0325-0148.1	525148	+ S	B	HC L	V	280	25	22	42	100	4/6	60	139	14,5
24.0325-0149.1	525149		B	HC	V	314	25	23	59,7	112	5	68	144	15,3
24.0325-0158.1	525158	+ S	B	HC	V	312	25	22	49,9	112	5/9	65	146	15,3
24.0325-0160.1	525160	+ S	B	HC	V	325	25	22,6	62,2	120	5	75	174	16,5
24.0325-0162.1	525162		B	HC	V	300	25	23	48,5	108	5	63,5	140	13,7
24.0325-0167.1	525167	+ S	B	HC L	V	288	25	22,4	44,5	112	5	67	154,3	15,3
24.0325-0171.1	525171		B	HC	V	288	25	23	46,5	112	5/10	68	137	15,3
24.0325-0172.1	525172		B	HC	V	312	25	23	46,5	112	5/10	68	140	15,3
24.0325-0179.1	525179	+ S	B	HC L	V	288	25	22	64,5	112	5	67	154,3	15,2
24.0325-0184.1	525184	+ S	B	HC	V	314	25	23	52,4	112	5	68	154	15,3
24.0325-0197.1	525197		B	HC	V	320	25	23	48,5	108	5	63,5	148	13,7
24.0325-0198.1	525198	+ S	B	HC L	V	280	25	22	43,2	100	4/6	60	139	14,5
24.0325-0199.1	525199		B	HC	V	278	25	23	48,5	108	5	63,5	140	13,7
24.0326-0106.1	526106	+ S	B		V	283	26	24,2	28,2	108	4	66	133,5	13
24.0326-0107.1	526107		B	HC	V	302	26	23	50	108	5	68	151	14,4
24.0326-0115.1	526115		B	HC	V	300	26	22	56	112	5	68,2	144	16,5
24.0326-0119.1	526119		B	HC	V	313	25,9	22	56,2	112	5	68,2	148	16,5
24.0326-0120.1	526120	+ S	B		V	283	26	24	34,2	108	4	66	133,5	13
24.0326-0123.1	526123		B	HC	V	300	26	22,8	47	108	5	61	139,6	13,5
24.0326-0165.1	526165	+ S	B		V	276	26	23	45,5	105	5	60	139	14,2
24.0326-0166.1	526166	+ S	B	HC	V	300	26	23	45,5	115	5	70,7	149	14,2
24.0328-0106.1	528106	+ S	B	HC L	V	300	28	25,4	46,5	112	5	67	154	13,3
24.0328-0123.1	528123		B		V	305	27,9	25	50,3	108	5	68	139	16,5
24.0328-0129.1	528129	+ S	B		V	305,5	28	25	77,8	130	5	90	157	15,8
24.0328-0136.1	528136		B		V	285	28	26	43,7	98	5	59	127	16,5
24.0328-0137.1	528137	+ S	B	HC	V	302	28	25	45	110	5	70	139	14
24.0328-0142.1	528142		B	HC L	V	312	28	25,4	64,5	112	5	67	154	15,3
24.0328-0154.1	528154	+ S	B	HC	V	300	28	26	52	108	5	63,5	140	15,8
24.0328-0155.1	528155	+ S	B	HC L	V	295	28	25,4	64,5	112	5	67	154,3	15,2
24.0328-0162.1	528162	+ S	B	HC	V	316	28	26	52	108	5	63,5	144	16
24.0328-0176.1	528176		B	HC L	V	295	28	25,4	54,5	112	5	67	154	15,3
24.0328-0250.1	528250		B	HC	V	300	28	26	52	108	5	63,5	140	13,8

# Abmessungen Bremsscheiben

## Dimensions brake discs - Medidas disco de freno - Dimensions Disques de frein - Misure dischi freno

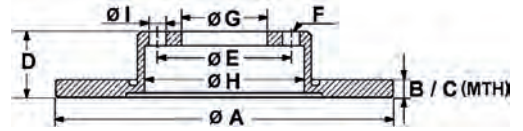

S Fixierschraube - fixing screw - tornillo quefija - vis de fixation - vite di riparazione  
 B beschichtet - coated - recubierto - revêtu - rivestito  
 HC hochgekohlt - high carbon - altamente carbonizado - à haute teneuren carbone - ad alto tenore di carbonio

L legiert - alloyed - aleado - allié - alligato/legato  
 V ventiliert - ventilated - ventilado - ventilé - ventilato  
 \* gelocht - perforated - perforado - poinconné - perforato

		S	B	HC L	V	A	B	C	D	E	F	G	H	I
24.0328-0254.1	528254	+ S	B	HC	V	328	28	25,6	73,1	120	5	75	153,8	16,5
24.0330-0107.1	530107	+ S	B	HC	V	324	29,9	27,6	73,7	120	5	79	149	14,8
24.0330-0109.1	530109	+ S	B	HC	V	332	29,9	27,6	62,1	120	5	75	158	16,5
24.0330-0113.1	530113		B	HC	V	320	30	28	46,5	112	5/9	68	137	15,3
24.0330-0115.1	530115		B	HC	V	345	30	27	49,9	112	5/9	65	140	15,3
24.0330-0173.1	530173	+ S	B	HC	V	324	30	27,6	77	120	5	79	165	14,5
24.0330-0175.1	530175	+ S	B	HC	V	321	30	28	59,7	112	5	68	144,8	15,3
24.0330-0176.1	530176	+ S	B	HC	V	347	30	28	59,7	112	5	68	158	15,3
24.0330-0193.1	530193	+ S	B	HC	V	320	30	28	52,4	112	5	68	153,4	15,3
24.0330-0207.1	530207	+ S	B	HC L	V	296	30	27	51	120	5	67,4	163,7	16,3
24.0330-0209.1	530209	+ S	B	HC	V	321	30	27	51	120	5	67,4	160	16,3
24.0332-0101.1	532101	+ S	B	HC L	V	322	32	29,4	64,5	112	5	67	154,3	15,2
24.0332-0144.1	532144	+ S	B	HC L	V	330	32	29,4	64,5	112	5	67	154	15
24.0332-0158.1	532158	+ S	B	HC L	V	330	32	29,4	54,5	112	5	67	156,3	15,2







- DE** Vergleichsliste WVA → ATE
- EN** Cross reference list WVA → ATE
- ES** Lista referencias WVA → ATE
- FR** Liste des correspondances WVA → ATE
- IT** Tabella di conversione codici WVA → ATE

# 2019

# Vergleichsliste WVA → ATE

Cross reference list WVA → ATE - Lista referencias WVA → ATE - Liste des correspondances WVA → ATE - Tabella di conversione codici WVA → ATE



WVA D 				WVA D 				WVA D 			
20002	15,0	13.0460-5806.2	605806	20863	16,5	13.0460-5960.2	605960	21154	19,5	13.0460-5703.2	605703
20008	13,0	13.0460-5824.2	605824	20870	15,0	13.0460-5976.2	605976	21158	15,5	13.0460-5938.2	605938
20035	17,0	13.0460-3902.2	603902	20877	17,5	13.0460-4016.2	604016	21170	17,3	13.0460-2965.2	602965
20038	14,0	13.0460-6914.2	606914	20887	15,3	13.0460-7033.2	607033	21171	18,0	13.0460-3965.2	603965
20073	17,3	13.0460-3936.2	603936	20887	17,3	13.0460-7059.2	607059	21185	19,4	13.0460-2952.2	602952
20076	15,5	13.0460-5835.2	605835	20887	19,7	13.0460-7032.2	607032	21190	17,5	13.0460-7052.2	607052
20091	14,6	13.0460-2800.2	602800	20889	17,3	13.0460-7030.2	607030	21193	18,0	13.0460-5410.2	605410
20124	18,9	13.0460-2972.2	602972	20905	18,0	13.0460-3911.2	603911	21193	18,0	13.0460-7063.2	607063
20147	17,0	13.0460-7146.2	607146	20905	18,0	13.0460-3943.2	603943	21193	18,0	13.0460-7131.2	607131
20162	15,4	13.0460-4956.2	604956	20905	18,0	13.0460-3952.2	603952	21194	18,0	13.0460-5409.2	605409
20164	18,2	13.0460-2985.2	602985	20905	18,0	13.0460-3962.2	603962	21197	15,0	13.0460-3805.2	603805
20166	16,0	13.0460-2966.2	602966	20907	18,0	13.0460-7040.2	607040	21197	15,0	13.0470-3805.2	LD3805
20168	16,0	13.0460-2957.2	602957	20907	18,1	13.0460-7126.2	607126	21202	16,9	13.0460-7073.2	607073
20168	19,3	13.0460-2958.2	602958	20907	18,1	13.0460-7141.2	607141	21209	18,5	13.0460-2971.2	602971
20180	17,3	13.0470-3605.2	LD3605	20919	18,0	13.0460-2983.2	602983	21217	18,0	13.0460-2812.2	602812
20181	17,3	13.0460-3605.2	603605	20929	18,5	13.0460-3969.2	603969	21233	16,7	13.0460-3914.2	603914
20217	17,1	13.0460-4837.2	604837	20934	14,0	13.0460-3945.2	603945	21238	15,5	13.0460-6917.2	606917
20236	18,0	13.0460-2810.2	602810	20938	18,0	13.0460-2955.2	602955	21243	14,0	13.0460-5816.2	605816
20261	19,0	13.0460-2863.2	602863	20941	19,3	13.0470-2927.2	LD2927	21267	16,8	13.0460-4042.2	604042
20261	19,0	13.0460-3824.2	603824	20961	15,2	13.0460-2842.2	602842	21273	19,5	13.0460-7053.2	607053
20309	17,9	13.0460-9037.2	609037	20961	15,2	13.0460-2937.2	602937	21273	19,5	13.0470-7053.2	LD7053
20325	17,2	13.0460-5789.2	605789	20961	16,0	13.0460-2886.2	602886	21275	17,0	13.0460-7246.2	607246
20336	14,0	13.0460-3961.2	603961	20961	16,0	13.0470-2886.2	LD2886	21276	17,0	13.0460-7061.2	607061
20359	19,2	13.0460-6926.2	606926	20961	17,0	13.0460-2859.2	602859	21278	16,4	13.0460-4014.2	604014
20380	15,6	13.0460-2824.2	602824	20961	17,2	13.0460-2819.2	602819	21278	16,4	13.0460-4059.2	604059
20389	15,4	13.0460-4911.2	604911	20961	17,2	13.0460-2820.2	602820	21278	16,4	13.0460-7107.2	607107
20392	18,5	13.0460-5701.2	605701	20961	17,2	13.0460-2864.2	602864	21278	16,4	13.0460-7134.2	607134
20410	15,0	13.0460-4957.2	604957	20961	17,2	13.0460-2894.2	602894	21278	16,9	13.0460-7085.2	607085
20465	18,0	13.0460-7903.2	607903	20961	17,2	13.0460-2984.2	602984	21280	16,0	13.0460-5949.2	605949
20488	18,5	13.0460-3968.2	603968	20961	17,2	13.0470-2820.2	LD2820	21282	17,3	13.0460-7168.2	607168
20547	16,5	13.0460-7241.2	607241	20961	17,2	13.0470-2894.2	LD2894	21282	17,3	13.0460-7232.2	607232
20634	15,0	13.0460-3953.2	603953	20968	20,3	13.0460-7185.2	607185	21282	17,3	13.0470-7079.2	LD7079
20634	15,0	13.0460-3955.2	603955	20973	11,0	13.0460-3954.2	603954	21282	17,3	13.0470-7168.2	LD7168
20640	17,5	13.0460-7071.2	607071	20974	10,8	13.0460-3926.2	603926	21285	19,1	13.0460-7147.2	607147
20660	15,6	13.0460-8006.2	608006	20974	11,0	13.0460-3823.2	603823	21289	16,8	13.0460-4041.2	604041
20669	19,0	13.0460-2925.2	602925	20974	11,0	13.0460-3823.2	603823	21301	15,5	13.0460-3504.2	603504
20669	19,0	13.0460-2934.2	602934	20981	13,8	13.0460-2928.2	602928	21303	18,9	13.0460-9033.2	609033
20676	19,5	13.0460-7050.2	607050	20989	17,7	13.0460-2956.2	602956	21304	18,5	13.0460-6036.2	606036
20676	19,8	13.0460-7077.2	607077	20996	17,3	13.0460-3803.2	603803	21305	15,7	13.0460-4047.2	604047
20676	19,8	13.0460-7081.2	607081	21010	15,8	13.0460-2846.2	602846	21305	15,7	13.0470-4047.2	LD4047
20676	19,8	13.0460-7110.2	607110	21012	15,0	13.0460-5872.2	605872	21314	12,8	13.0460-5998.2	605998
20676	19,8	13.0470-7081.2	LD7081	21012	15,0	13.0460-5936.2	605936	21319	14,9	13.0460-5625.2	605625
20676	19,8	13.0470-7110.2	LD7110	21028	19,3	13.0460-2927.2	602927	21319	14,9	13.0460-5625.2	605625
20676	19,8	13.0470-7122.2	LD7122	21048	18,3	13.0460-4955.2	604955	21322	15,0	13.0460-5920.2	605920
20687	15,5	13.0460-4034.2	604034	21050	15,8	13.0460-4040.2	604040	21334	15,0	13.0460-5985.2	605985
20708	14,5	13.0460-5720.2	605720	21064	20,3	13.0460-6033.2	606033	21349	17,0	13.0460-5957.2	605957
20708	15,8	13.0460-2997.2	602997	21068	17,0	13.0460-2811.2	602811	21353	16,5	13.0460-7051.2	607051
20731	15,3	13.0460-5916.2	605916	21089	15,0	13.0460-3306.2	603306	21355	13,5	13.0460-5970.2	605970
20741	15,0	13.0460-2750.2	602750	21099	17,0	13.0460-5881.2	605881	21358	19,8	13.0460-7163.2	607163
20755	14,4	13.0460-3401.2	603401	21100	16,7	13.0460-2948.2	602948	21358	19,8	13.0460-7165.2	607165
20755	14,4	13.0460-3403.2	603403	21103	14,2	13.0460-2951.2	602951	21363	15,8	13.0460-5958.2	605958
20755	15,1	13.0460-4044.2	604044	21107	12,0	13.0460-3904.2	603904	21365	17,0	13.0460-3949.2	603949
20755	15,1	13.0470-4044.2	LD4044	21119	17,0	13.0460-5937.2	605937	21366	19,3	13.0460-2806.2	602806
20775	18,0	13.0460-3939.2	603939	21138	18,8	13.0460-2963.2	602963	21368	18,3	13.0460-2815.2	602815
20775	18,0	13.0460-3940.2	603940	21140	15,0	13.0460-4043.2	604043	21375	16,0	13.0460-5940.2	605940
20784	18,0	13.0460-4401.2	604401	21142	15,0	13.0460-5966.2	605966	21378	15,0	13.0460-5932.2	605932
20838	17,0	13.0460-2941.2	602941	21144	15,8	13.0460-3602.2	603602	21381	15,0	13.0460-4801.2	604801
20838	17,0	13.0460-2949.2	602949	21147	19,0	13.0460-2979.2	602979	21381	15,0	13.0460-4964.2	604964
20841	12,0	13.0460-3942.2	603942	21147	19,0	13.0460-2980.2	602980	21381	17,3	13.0460-4958.2	604958
20852	15,5	13.0460-5935.2	605935	21147	19,0	13.0460-2987.2	602987	21381	18,0	13.0460-4832.2	604832
20861	17,5	13.0460-2964.2	602964	21153	16,0	13.0460-4202.2	604202	21381	18,0	13.0460-4968.2	604968
				21153	17,5	13.0460-4201.2	604201	21381	18,0	13.0460-4985.2	604985





# Vergleichsliste WVA → ATE



Cross reference list WVA → ATE - Lista referencias WVA → ATE - Liste des correspondances WVA → ATE - Tabella di conversione codici WVA → ATE

WVA D 				WVA D 				WVA D 			
21385	13,8	13.0460-2935.2	602935	21632	16,0	13.0460-3972.2	603972	21866	17,2	13.0460-7100.2	607100
21394	17,5	13.0460-7057.2	607057	21635	18,0	13.0460-2973.2	602973	21866	17,2	13.0470-7100.2	LD7100
21396	17,5	13.0460-7056.2	607056	21635	18,7	13.0460-2839.2	602839	21868	15,3	13.0460-7101.2	607101
21402	17,5	13.0460-4056.2	604056	21636	19,3	13.0470-7181.2	LD7181	21868	19,7	13.0460-7072.2	607072
21411	17,5	13.0460-7080.2	607080	21637	19,3	13.0460-7069.2	607069	21872	14,5	13.0460-5826.2	605826
21418	15,5	13.0460-2751.2	602751	21637	19,3	13.0460-7112.2	607112	21875	16,0	13.0460-5927.2	605927
21430	17,3	13.0460-7058.2	607058	21637	19,3	13.0460-7181.2	607181	21879	18,6	13.0460-5955.2	605955
21430	17,3	13.0460-7088.2	607088	21637	19,3	13.0470-7140.2	LD7140	21883	19,8	13.0460-7102.2	607102
21436	16,2	13.0460-3951.2	603951	21643	17,8	13.0460-5405.2	605405	21883	19,8	13.0460-7124.2	607124
21436	17,0	13.0460-3807.2	603807	21643	17,8	13.0470-5405.2	LD5405	21886	19,0	13.0460-2817.2	602817
21436	17,0	13.0460-3838.2	603838	21649	16,0	13.0460-5952.2	605952	21889	18,1	13.0460-2832.2	602832
21436	17,0	13.0460-3950.2	603950	21650	15,0	13.0460-5889.2	605889	21891	17,3	13.0460-7090.2	607090
21436	17,0	13.0470-3838.2	LD3838	21650	15,0	13.0460-5953.2	605953	21899	15,3	13.0460-4065.2	604065
21439	20,3	13.0460-2975.2	602975	21650	15,5	13.0460-5713.2	605713	21899	15,3	13.0470-4065.2	LD4065
21439	20,3	13.0470-2975.2	LD2975	21651	17,5	13.0460-5982.2	605982	21900	15,0	13.0460-4060.2	604060
21452	18,5	13.0460-2700.2	602700	21656	15,0	13.0460-5944.2	605944	21907	15,5	13.0460-5864.2	605864
21452	18,5	13.0460-2701.2	602701	21664	19,8	13.0470-7086.2	LD7086	21911	20,3	13.0460-7122.2	607122
21452	18,5	13.0460-2705.2	602705	21670	19,3	13.0460-7087.2	607087	21915	17,2	13.0460-5851.2	605851
21452	18,5	13.0460-2717.2	602717	21670	19,3	13.0460-7203.2	607203	21919	15,3	13.0460-4064.2	604064
21459	17,5	13.0460-6922.2	606922	21670	19,3	13.0470-7087.2	LD7087	21919	15,3	13.0470-4064.2	LD4064
21459	18,5	13.0460-6916.2	606916	21670	19,3	13.0470-7203.2	LD7203	21920	14,6	13.0460-2830.2	602830
21460	18,0	13.0460-2981.2	602981	21674	19,4	13.0460-2844.2	602844	21920	16,6	13.0460-2896.2	602896
21463	18,0	13.0460-2834.2	602834	21676	20,3	13.0460-7155.2	607155	21927	17,9	13.0460-7133.2	607133
21468	15,5	13.0460-5722.2	605722	21676	20,3	13.0470-7089.2	LD7089	21929	17,9	13.0460-7065.2	607065
21469	18,0	13.0460-3959.2	603959	21676	20,3	13.0470-7155.2	LD7155	21929	17,9	13.0460-7067.2	607067
21470	18,0	13.0460-3960.2	603960	21677	20,3	13.0460-7089.2	607089	21930	17,9	13.0460-7114.2	607114
21471	18,0	13.0460-4965.2	604965	21679	15,0	13.0460-5992.2	605992	21930	17,9	13.0460-7125.2	607125
21479	19,2	13.0460-2982.2	602982	21688	15,3	13.0460-5862.2	605862	21932	17,9	13.0460-7064.2	607064
21481	15,5	13.0460-5959.2	605959	21689	15,5	13.0460-5892.2	605892	21937	15,5	13.0460-4814.2	604814
21484	20,5	13.0460-7183.2	607183	21691	17,3	13.0470-7090.2	LD7090	21937	15,5	13.0460-4815.2	604815
21486	19,5	13.0460-7078.2	607078	21696	16,3	13.0460-5820.2	605820	21937	15,5	13.0470-4814.2	LD4814
21486	19,5	13.0470-7078.2	LD7078	21697	15,0	13.0460-5943.2	605943	21945	16,0	13.0460-2821.2	602821
21487	17,3	13.0460-7079.2	607079	21703	15,0	13.0460-5850.2	605850	21945	19,6	13.0460-2822.2	602822
21495	17,0	13.0460-5978.2	605978	21706	15,5	13.0460-5980.2	605980	21945	19,6	13.0470-2837.2	LD2837
21500	15,0	13.0460-5967.2	605967	21713	16,0	13.0460-5626.2	605626	21947	15,4	13.0460-5744.2	605744
21508	17,0	13.0460-3948.2	603948	21713	16,5	13.0460-5983.2	605983	21948	13,5	13.0460-5969.2	605969
21509	17,0	13.0460-3947.2	603947	21716	16,0	13.0460-5808.2	605808	21954	15,0	13.0460-5898.2	605898
21516	17,5	13.0460-2803.2	602803	21719	15,0	13.0460-5929.2	605929	21961	15,5	13.0460-5845.2	605845
21518	17,0	13.0460-2804.2	602804	21724	19,3	13.0460-2816.2	602816	21965	15,0	13.0460-4986.2	604986
21519	17,8	13.0460-6925.2	606925	21725	16,8	13.0460-5933.2	605933	21975	18,2	13.0460-5809.2	605809
21520	17,5	13.0460-2805.2	602805	21730	14,0	13.0460-5763.2	605763	21980	18,0	13.0460-3977.2	603977
21539	15,0	13.0460-5974.2	605974	21766	13,5	13.0460-5973.2	605973	21983	17,2	13.0460-2853.2	602853
21543	16,5	13.0460-5942.2	605942	21775	15,0	13.0460-5745.2	605745	21999	15,8	13.0460-3979.2	603979
21545	14,9	13.0460-5986.2	605986	21781	15,5	13.0460-5968.2	605968	22031	19,6	13.0460-2792.2	602792
21546	16,7	13.0460-5950.2	605950	21792	15,2	13.0460-4988.2	604988	22032	19,6	13.0470-2792.2	LD2792
21553	14,0	13.0460-5874.2	605874	21795	19,8	13.0460-7086.2	607086	22035	17,5	13.0460-7303.2	607303
21558	13,0	13.0460-5995.2	605995	21797	19,7	13.0460-2976.2	602976	22035	17,5	13.0470-7303.2	LD7303
21559	11,5	13.0460-5972.2	605972	21799	19,7	13.0460-2977.2	602977	22041	19,2	13.0460-4889.2	604889
21561	17,0	13.0460-5716.2	605716	21802	19,0	13.0460-2978.2	602978	22061	18,7	13.0460-4883.2	604883
21569	14,9	13.0460-5627.2	605627	21822	17,5	13.0460-5897.2	605897	22061	18,7	13.0470-4883.2	LD4883
21576	20,7	13.0460-7196.2	607196	21829	20,3	13.0460-7173.2	607173	22062	20,7	13.0460-4884.2	604884
21586	15,0	13.0460-3963.2	603963	21832	14,9	13.0460-5924.2	605924	22062	20,7	13.0470-4884.2	LD4884
21593	18,8	13.0460-7084.2	607084	21833	15,0	13.0460-5840.2	605840	22065	17,7	13.0460-5652.2	605652
21595	18,3	13.0460-2836.2	602836	21840	14,4	13.0460-5981.2	605981	22076	19,6	13.0460-2610.2	602610
21597	11,0	13.0460-3822.2	603822	21845	16,5	13.0460-5926.2	605926	22076	19,6	13.0470-2610.2	LD2610
21601	17,5	13.0460-5951.2	605951	21848	19,8	13.0460-7076.2	607076	22102	18,2	13.0460-4882.2	604882
21606	16,7	13.0460-2827.2	602827	21848	19,8	13.0460-7143.2	607143	22102	18,2	13.0470-4882.2	LD4882
21614	17,7	13.0460-2825.2	602825	21854	15,0	13.0460-5640.2	605640	22123	18,2	13.0460-7308.2	607308
21622	17,3	13.0460-7083.2	607083	21857	17,7	13.0460-4066.2	604066	22129	17,4	13.0460-2615.2	602615
21626	15,0	13.0460-5956.2	605956	21861	15,2	13.0460-2831.2	602831	22141	15,5	13.0460-7326.2	607326
21631	17,0	13.0460-3956.2	603956	21861	15,2	13.0460-2897.2	602897	22141	16,5	13.0470-7333.2	LD7333



# Vergleichsliste WVA → ATE



Cross reference list WVA → ATE - Lista referencias WVA → ATE - Liste des correspondances WVA → ATE - Tabella di conversione codici WVA → ATE

WVA D 				WVA D 				WVA D 			
22143	17,5	13.0460-7310.2	607310	23097	17,1	13.0460-5861.2	605861	23245	18,3	13.0460-7158.2	607158
22145	18,6	13.0460-7330.2	607330	23099	18,4	13.0460-2735.2	602735	23245	18,3	13.0460-7159.2	607159
22165	20,7	13.0460-5662.2	605662	23099	18,4	13.0460-2870.2	602870	23245	18,3	13.0460-7222.2	607222
22187	18,6	13.0460-2613.2	602613	23112	19,1	13.0460-7144.2	607144	23245	18,3	13.0470-7158.2	LD7158
22187	18,6	13.0470-2613.2	LD2613	23115	19,8	13.0460-7091.2	607091	23245	18,3	13.0470-7159.2	LD7159
22218	18,3	13.0460-3876.2	603876	23119	17,5	13.0460-2876.2	602876	23258	16,5	13.0460-3976.2	603976
22231	16,1	13.0460-7320.2	607320	23124	19,0	13.0460-2829.2	602829	23269	19,8	13.0460-7153.2	607153
22231	16,1	13.0470-7320.2	LD7320	23126	17,5	13.0460-7138.2	607138	23271	17,4	13.0460-4984.2	604984
22235	15,3	13.0460-5674.2	605674	23130	19,6	13.0460-7117.2	607117	23271	17,4	13.0460-4990.2	604990
22304	17,3	13.0460-2602.2	602602	23130	19,6	13.0470-7111.2	LD7111	23271	17,4	13.0470-4984.2	LD4984
22308	17,7	13.0460-2796.2	602796	23130	19,6	13.0470-7117.2	LD7117	23271	17,4	13.0470-4990.2	LD4990
22317	18,8	13.0460-7328.2	607328	23131	19,6	13.0460-7111.2	607111	23273	17,8	13.0460-3998.2	603998
22326	18,0	13.0460-5673.2	605673	23135	18,0	13.0460-3986.2	603986	23276	17,2	13.0460-3996.2	603996
22342	19,8	13.0460-7325.2	607325	23138	14,6	13.0460-2712.2	602712	23277	17,7	13.0460-3997.2	603997
22342	19,8	13.0470-7325.2	LD7325	23138	14,6	13.0460-2855.2	602855	23279	18,4	13.0460-3987.2	603987
22345	19,7	13.0460-7324.2	607324	23138	14,6	13.0470-2712.2	LD2712	23279	18,4	13.0470-3987.2	LD3987
22345	19,7	13.0470-7324.2	LD7324	23138	14,6	13.0470-2855.2	LD2855	23281	18,3	13.0460-7161.2	607161
22383	17,3	13.0460-7314.2	607314	23140	19,4	13.0460-7105.2	607105	23281	18,3	13.0470-7161.2	LD7161
22383	17,3	13.0470-7314.2	LD7314	23140	19,4	13.0470-7139.2	LD7139	23284	14,0	13.0460-2858.2	602858
22386	19,0	13.0470-7327.2	LD7327	23143	15,1	13.0460-4818.2	604818	23284	14,0	13.0470-2858.2	LD2858
22387	19,5	13.0460-7327.2	607327	23144	19,8	13.0460-2726.2	602726	23289	19,3	13.0460-7140.2	607140
22423	16,4	13.0460-7316.2	607316	23144	19,8	13.0460-2727.2	602727	23290	15,5	13.0460-5890.2	605890
22423	16,4	13.0470-7316.2	LD7316	23144	19,8	13.0470-2726.2	LD2726	23296	14,5	13.0460-5837.2	605837
22593	18,0	13.0460-7331.2	607331	23145	19,8	13.0470-2727.2	LD2727	23302	18,0	13.0460-3946.2	603946
22601	16,4	13.0460-7307.2	607307	23146	17,0	13.0460-3973.2	603973	23305	15,2	13.0460-4921.2	604921
23004	15,9	13.0460-5988.2	605988	23154	19,0	13.0460-7121.2	607121	23309	17,3	13.0460-7169.2	607169
23020	17,9	13.0460-3985.2	603985	23157	15,8	13.0460-4977.2	604977	23309	17,3	13.0470-7169.2	LD7169
23021	18,9	13.0460-3990.2	603990	23157	15,8	13.0470-4977.2	LD4977	23312	20,3	13.0460-7167.2	607167
23022	20,9	13.0460-3980.2	603980	23158	17,5	13.0460-5830.2	605830	23312	20,3	13.0460-7306.2	607306
23023	14,8	13.0460-5841.2	605841	23160	17,3	13.0460-5727.2	605727	23312	20,3	13.0470-7167.2	LD7167
23034	18,8	13.0460-7123.2	607123	23169	19,4	13.0460-2869.2	602869	23313	20,2	13.0460-7275.2	607275
23034	18,8	13.0460-7154.2	607154	23172	18,0	13.0460-2895.2	602895	23313	20,2	13.0470-7275.2	LD7275
23042	19,0	13.0460-3957.2	603957	23177	14,2	13.0460-2826.2	602826	23313	20,3	13.0460-7238.2	607238
23043	16,0	13.0460-8003.2	608003	23178	16,6	13.0460-5755.2	605755	23313	20,3	13.0470-7238.2	LD7238
23057	20,2	13.0460-7116.2	607116	23184	14,8	13.0460-5880.2	605880	23314	15,0	13.0460-5857.2	605857
23058	19,6	13.0470-7116.2	LD7116	23189	16,7	13.0460-8007.2	608007	23323	14,6	13.0460-4974.2	604974
23063	17,5	13.0470-7115.2	LD7115	23190	16,7	13.0460-8005.2	608005	23325	16,4	13.0460-4855.2	604855
23064	17,5	13.0460-7115.2	607115	23193	16,4	13.0460-8004.2	608004	23326	17,4	13.0460-2882.2	602882
23070	17,0	13.0460-2776.2	602776	23200	18,0	13.0460-7148.2	607148	23326	17,4	13.0460-2888.2	602888
23070	17,0	13.0460-2833.2	602833	23202	18,3	13.0460-7142.2	607142	23326	17,4	13.0460-2889.2	602889
23070	17,0	13.0470-2776.2	LD2776	23212	20,3	13.0460-7296.2	607296	23326	17,4	13.0460-2890.2	602890
23070	17,0	13.0470-2833.2	LD2833	23212	20,3	13.0470-7296.2	LD7296	23326	17,4	13.0470-2888.2	LD2888
23070	19,5	13.0460-2828.2	602828	23215	17,5	13.0460-7248.2	607248	23329	17,0	13.0460-4987.2	604987
23073	18,8	13.0460-7145.2	607145	23215	18,3	13.0460-7157.2	607157	23330	17,0	13.0460-4999.2	604999
23073	18,8	13.0470-7145.2	LD7145	23215	18,3	13.0460-7221.2	607221	23332	18,0	13.0460-3978.2	603978
23077	17,5	13.0460-7135.2	607135	23215	18,3	13.0470-7157.2	LD7157	23334	16,7	13.0460-7171.2	607171
23077	17,5	13.0470-7135.2	LD7135	23215	18,3	13.0470-7221.2	LD7221	23334	16,7	13.0470-7171.2	LD7171
23078	15,9	13.0460-4069.2	604069	23218	18,0	13.0460-7113.2	607113	23340	17,0	13.0460-5800.2	605800
23080	15,0	13.0460-5987.2	605987	23218	18,0	13.0460-7128.2	607128	23343	13,5	13.0460-5731.2	605731
23082	18,0	13.0460-5718.2	605718	23218	18,0	13.0460-7132.2	607132	23346	19,0	13.0460-2862.2	602862
23092	15,6	13.0460-4803.2	604803	23224	16,5	13.0460-2874.2	602874	23347	20,3	13.0460-7237.2	607237
23092	15,6	13.0460-4804.2	604804	23225	17,0	13.0460-2857.2	602857	23347	20,3	13.0470-7237.2	LD7237
23092	15,6	13.0470-4803.2	LD4803	23225	17,0	13.0470-2857.2	LD2857	23348	16,5	13.0460-5811.2	605811
23092	16,0	13.0460-4851.2	604851	23228	18,1	13.0460-7108.2	607108	23353	14,8	13.0460-2835.2	602835
23092	16,0	13.0460-4971.2	604971	23229	18,1	13.0460-7129.2	607129	23354	13,0	13.0460-5834.2	605834
23092	16,0	13.0460-4973.2	604973	23234	16,8	13.0460-5994.2	605994	23358	18,0	13.0460-8002.2	608002
23092	16,0	13.0460-4991.2	604991	23234	16,9	13.0460-5859.2	605859	23361	14,2	13.0460-8011.2	608011
23092	16,0	13.0470-4851.2	LD4851	23236	16,8	13.0460-5863.2	605863	23378	20,1	13.0460-7172.2	607172
23092	16,0	13.0470-4971.2	LD4971	23237	14,5	13.0460-5993.2	605993	23378	20,1	13.0470-7172.2	LD7172
23092	16,3	13.0470-4854.2	LD4854	23238	16,0	13.0460-5803.2	605803	23387	12,6	13.0460-5865.2	605865
23094	16,5	13.0460-5825.2	605825	23241	16,1	13.0460-5996.2	605996	23393	19,6	13.0460-2837.2	602837



# Vergleichsliste WVA → ATE



Cross reference list WVA → ATE - Lista referencias WVA → ATE - Liste des correspondances WVA → ATE - Tabella di conversione codici WVA → ATE

WVA D 				WVA D 				WVA D 			
23394	13,7	<b>13.0460-7178.2</b>	607178	23536	17,6	<b>13.0460-5792.2</b>	605792	23669	16,8	<b>13.0460-3806.2</b>	603806
23395	13,7	<b>13.0460-7177.2</b>	607177	23539	17,3	<b>13.0460-5749.2</b>	605749	23673	15,9	<b>13.0460-5623.2</b>	605623
23397	19,4	<b>13.0460-7224.2</b>	607224	23543	14,4	<b>13.0460-5833.2</b>	605833	23692	16,6	<b>13.0460-4992.2</b>	604992
23400	15,5	<b>13.0460-5838.2</b>	605838	23550	17,3	<b>13.0460-7225.2</b>	607225	23692	16,6	<b>13.0470-4992.2</b>	LD4992
23404	20,6	<b>13.0460-7199.2</b>	607199	23550	17,3	<b>13.0470-7225.2</b>	LD7225	23693	16,6	<b>13.0460-4993.2</b>	604993
23407	19,0	<b>13.0460-2871.2</b>	602871	23554	16,0	<b>13.0460-2753.2</b>	602753	23693	16,6	<b>13.0470-4993.2</b>	LD4993
23409	19,3	<b>13.0460-2881.2</b>	602881	23554	16,4	<b>13.0460-2775.2</b>	602775	23694	16,4	<b>13.0470-4976.2</b>	LD4976
23410	15,0	<b>13.0460-3964.2</b>	603964	23554	16,4	<b>13.0460-2845.2</b>	602845	23694	16,7	<b>13.0460-4976.2</b>	604976
23417	15,3	<b>13.0460-2868.2</b>	602868	23554	16,4	<b>13.0460-2860.2</b>	602860	23698	16,8	<b>13.0460-5778.2</b>	605778
23417	15,3	<b>13.0470-2868.2</b>	LD2868	23554	16,4	<b>13.0470-2845.2</b>	LD2845	23702	15,1	<b>13.0460-5738.2</b>	605738
23418	19,4	<b>13.0460-7156.2</b>	607156	23554	16,4	<b>13.0470-2860.2</b>	LD2860	23703	17,9	<b>13.0460-5882.2</b>	605882
23420	16,5	<b>13.0460-5842.2</b>	605842	23554	17,0	<b>13.0460-2740.2</b>	602740	23705	18,1	<b>13.0460-3810.2</b>	603810
23423	17,8	<b>13.0460-2729.2</b>	602729	23554	17,0	<b>13.0470-2740.2</b>	LD2740	23705	18,1	<b>13.0460-3982.2</b>	603982
23424	17,6	<b>13.0460-2730.2</b>	602730	23554	17,2	<b>13.0470-2877.2</b>	LD2877	23705	18,1	<b>13.0470-3982.2</b>	LD3982
23429	15,5	<b>13.0460-5748.2</b>	605748	23554	17,3	<b>13.0460-2787.2</b>	602787	23706	18,0	<b>13.0470-3826.2</b>	LD3826
23434	18,0	<b>13.0460-3856.2</b>	603856	23557	17,2	<b>13.0460-3988.2</b>	603988	23706	18,1	<b>13.0460-3818.2</b>	603818
23440	17,6	<b>13.0460-7186.2</b>	607186	23557	17,2	<b>13.0470-3988.2</b>	LD3988	23707	17,9	<b>13.0460-3839.2</b>	603839
23442	15,3	<b>13.0460-5896.2</b>	605896	23561	18,1	<b>13.0460-8010.2</b>	608010	23707	17,9	<b>13.0470-3839.2</b>	LD3839
23445	19,2	<b>13.0460-2838.2</b>	602838	23570	16,5	<b>13.0460-5832.2</b>	605832	23707	18,0	<b>13.0460-3826.2</b>	603826
23446	16,5	<b>13.0460-2872.2</b>	602872	23575	15,6	<b>13.0460-4995.2</b>	604995	23707	18,0	<b>13.0460-3850.2</b>	603850
23447	17,3	<b>13.0470-7232.2</b>	LD7232	23576	16,0	<b>13.0460-4972.2</b>	604972	23707	18,0	<b>13.0460-3863.2</b>	603863
23448	20,8	<b>13.0460-7170.2</b>	607170	23577	18,7	<b>13.0460-3993.2</b>	603993	23708	19,2	<b>13.0460-3811.2</b>	603811
23450	17,5	<b>13.0460-5712.2</b>	605712	23581	18,8	<b>13.0460-2883.2</b>	602883	23708	19,4	<b>13.0460-3983.2</b>	603983
23452	19,0	<b>13.0460-2720.2</b>	602720	23581	18,8	<b>13.0460-2884.2</b>	602884	23708	19,4	<b>13.0470-3983.2</b>	LD3983
23454	14,9	<b>13.0460-5989.2</b>	605989	23581	18,8	<b>13.0470-2884.2</b>	LD2884	23709	19,6	<b>13.0470-3827.2</b>	LD3827
23455	13,7	<b>13.0460-5871.2</b>	605871	23583	16,0	<b>13.0460-5855.2</b>	605855	23710	19,6	<b>13.0460-3827.2</b>	603827
23458	15,6	<b>13.0460-2721.2</b>	602721	23584	16,4	<b>13.0460-5760.2</b>	605760	23710	19,6	<b>13.0460-3864.2</b>	603864
23463	16,6	<b>13.0460-5807.2</b>	605807	23585	17,4	<b>13.0460-5848.2</b>	605848	23711	19,4	<b>13.0460-3984.2</b>	603984
23471	14,5	<b>13.0460-6923.2</b>	606923	23587	20,6	<b>13.0460-7285.2</b>	607285	23711	19,4	<b>13.0470-3984.2</b>	LD3984
23471	17,5	<b>13.0460-6924.2</b>	606924	23587	20,6	<b>13.0470-7285.2</b>	LD7285	23714	16,6	<b>13.0460-3991.2</b>	603991
23478	14,6	<b>13.0460-4819.2</b>	604819	23587	20,8	<b>13.0460-7226.2</b>	607226	23716	15,8	<b>13.0460-7162.2</b>	607162
23478	16,5	<b>13.0460-4998.2</b>	604998	23587	20,8	<b>13.0470-7226.2</b>	LD7226	23716	15,8	<b>13.0470-7162.2</b>	LD7162
23480	19,3	<b>13.0460-5813.2</b>	605813	23589	19,1	<b>13.0460-7202.2</b>	607202	23720	17,5	<b>13.0460-5714.2</b>	605714
23482	15,8	<b>13.0460-7160.2</b>	607160	23589	19,1	<b>13.0470-7202.2</b>	LD7202	23723	18,1	<b>13.0460-7193.2</b>	607193
23482	15,8	<b>13.0460-7251.2</b>	607251	23589	20,6	<b>13.0460-7184.2</b>	607184	23723	18,1	<b>13.0470-7193.2</b>	LD7193
23482	15,8	<b>13.0470-7137.2</b>	LD7137	23589	20,6	<b>13.0470-7184.2</b>	LD7184	23726	16,5	<b>13.0460-5622.2</b>	605622
23482	15,8	<b>13.0470-7251.2</b>	LD7251	23590	19,5	<b>13.0460-7187.2</b>	607187	23729	16,9	<b>13.0460-5878.2</b>	605878
23482	16,6	<b>13.0460-7194.2</b>	607194	23590	19,5	<b>13.0470-7187.2</b>	LD7187	23731	17,3	<b>13.0460-7274.2</b>	607274
23482	16,6	<b>13.0460-7195.2</b>	607195	23597	18,0	<b>13.0460-3975.2</b>	603975	23732	17,3	<b>13.0460-7174.2</b>	607174
23482	16,6	<b>13.0470-7194.2</b>	LD7194	23599	19,0	<b>13.0460-3994.2</b>	603994	23732	17,3	<b>13.0470-7174.2</b>	LD7174
23482	16,6	<b>13.0470-7195.2</b>	LD7195	23599	19,0	<b>13.0470-3994.2</b>	LD3994	23734	16,8	<b>13.0460-5750.2</b>	605750
23483	15,8	<b>13.0460-7137.2</b>	607137	23600	19,4	<b>13.0460-3966.2</b>	603966	23738	20,1	<b>13.0460-7212.2</b>	607212
23487	15,5	<b>13.0460-5854.2</b>	605854	23600	19,4	<b>13.0470-3966.2</b>	LD3966	23743	20,1	<b>13.0460-3999.2</b>	603999
23488	15,4	<b>13.0460-5853.2</b>	605853	23601	13,7	<b>13.0460-2879.2</b>	602879	23743	20,1	<b>13.0470-3999.2</b>	LD3999
23489	16,3	<b>13.0460-4841.2</b>	604841	23601	13,7	<b>13.0470-2879.2</b>	LD2879	23746	18,1	<b>13.0460-7240.2</b>	607240
23490	15,4	<b>13.0460-5802.2</b>	605802	23602	19,7	<b>13.0460-2850.2</b>	602850	23746	19,7	<b>13.0460-7236.2</b>	607236
23497	15,0	<b>13.0460-5852.2</b>	605852	23603	19,7	<b>13.0460-2852.2</b>	602852	23749	19,1	<b>13.0460-7191.2</b>	607191
23502	16,0	<b>13.0460-5717.2</b>	605717	23605	15,7	<b>13.0460-3995.2</b>	603995	23749	19,1	<b>13.0460-7245.2</b>	607245
23503	16,0	<b>13.0460-5751.2</b>	605751	23611	18,8	<b>13.0460-5879.2</b>	605879	23749	19,1	<b>13.0470-7191.2</b>	LD7191
23507	15,2	<b>13.0460-5887.2</b>	605887	23613	17,7	<b>13.0460-3800.2</b>	603800	23751	17,0	<b>13.0460-4800.2</b>	604800
23513	17,0	<b>13.0460-5891.2</b>	605891	23615	18,3	<b>13.0460-2718.2</b>	602718	23752	17,2	<b>13.0460-7164.2</b>	607164
23515	15,8	<b>13.0460-5884.2</b>	605884	23620	16,4	<b>13.0460-5814.2</b>	605814	23753	18,0	<b>13.0460-4969.2</b>	604969
23517	16,6	<b>13.0460-2867.2</b>	602867	23623	17,4	<b>13.0460-2713.2</b>	602713	23756	16,3	<b>13.0460-4854.2</b>	604854
23517	16,6	<b>13.0470-2867.2</b>	LD2867	23623	17,4	<b>13.0470-2713.2</b>	LD2713	23759	17,0	<b>13.0460-5894.2</b>	605894
23517	17,2	<b>13.0460-2763.2</b>	602763	23631	17,8	<b>13.0460-7206.2</b>	607206	23760	17,7	<b>13.0460-2707.2</b>	602707
23518	17,0	<b>13.0460-5885.2</b>	605885	23638	17,5	<b>13.0460-2899.2</b>	602899	23760	17,7	<b>13.0470-2707.2</b>	LD2707
23521	14,0	<b>13.0460-5812.2</b>	605812	23646	16,5	<b>13.0460-5847.2</b>	605847	23761	18,8	<b>13.0460-2704.2</b>	602704
23524	17,4	<b>13.0460-5746.2</b>	605746	23649	17,2	<b>13.0460-5725.2</b>	605725	23762	20,4	<b>13.0460-7166.2</b>	607166
23526	17,5	<b>13.0460-5817.2</b>	605817	23652	15,7	<b>13.0460-5711.2</b>	605711	23762	20,4	<b>13.0470-7166.2</b>	LD7166
23527	14,5	<b>13.0460-5827.2</b>	605827	23656	14,0	<b>13.0460-5849.2</b>	605849	23766	17,8	<b>13.0460-5815.2</b>	605815
23532	20,1	<b>13.0460-2959.2</b>	602959	23662	15,0	<b>13.0460-5836.2</b>	605836	23773	17,5	<b>13.0460-4802.2</b>	604802



# Vergleichsliste WVA → ATE



Cross reference list WVA → ATE - Lista referencias WVA → ATE - Liste des correspondances WVA → ATE - Tabella di conversione codici WVA → ATE

WVA D			WVA D			WVA D					
23777	16,0	13.0460-5831.2	605831	23930	18,2	13.0460-3815.2	603815	24095	19,4	13.0460-7139.2	607139
23780	16,7	13.0460-5895.2	605895	23930	18,2	13.0470-3815.2	LD3815	24097	17,1	13.0460-4834.2	604834
23783	14,0	13.0460-5710.2	605710	23934	18,2	13.0460-3814.2	603814	24097	17,1	13.0470-4834.2	LD4834
23787	19,0	13.0460-7205.2	607205	23934	18,2	13.0470-3814.2	LD3814	24098	17,1	13.0460-4833.2	604833
23791	20,8	13.0460-7210.2	607210	23935	17,8	13.0460-7215.2	607215	24098	17,1	13.0470-4833.2	LD4833
23791	20,8	13.0470-7210.2	LD7210	23935	17,8	13.0470-7215.2	LD7215	24123	20,3	13.0470-7228.2	LD7228
23793	20,3	13.0460-7176.2	607176	23943	17,5	13.0460-4997.2	604997	24124	19,3	13.0460-7228.2	607228
23793	20,3	13.0470-7176.2	LD7176	23945	16,5	13.0460-4994.2	604994	24133	18,6	13.0470-2892.2	LD2892
23794	20,3	13.0460-7223.2	607223	23945	16,5	13.0470-4994.2	LD4994	24134	19,6	13.0460-2891.2	602891
23794	20,3	13.0460-7268.2	607268	23950	20,3	13.0470-7201.2	LD7201	24134	19,6	13.0470-2891.2	LD2891
23794	20,3	13.0470-7216.2	LD7216	23955	16,2	13.0460-4806.2	604806	24135	17,7	13.0460-2893.2	602893
23794	20,3	13.0470-7223.2	LD7223	23959	17,0	13.0460-3829.2	603829	24135	17,7	13.0470-2893.2	LD2893
23794	20,3	13.0470-7268.2	LD7268	23960	18,3	13.0460-4817.2	604817	24137	15,8	13.0460-7253.2	607253
23795	15,0	13.0460-5839.2	605839	23961	16,8	13.0460-4840.2	604840	24137	16,6	13.0460-7209.2	607209
23801	18,8	13.0460-7204.2	607204	23966	17,7	13.0460-5742.2	605742	24141	19,1	13.0470-7188.2	LD7188
23801	18,8	13.0470-7204.2	LD7204	23967	15,1	13.0460-5734.2	605734	24142	20,6	13.0460-7188.2	607188
23801	20,3	13.0460-7200.2	607200	23968	20,3	13.0460-7216.2	607216	24142	20,6	13.0470-7243.2	LD7243
23801	20,3	13.0460-7201.2	607201	23970	16,8	13.0460-5632.2	605632	24150	17,6	13.0460-3813.2	603813
23801	20,3	13.0460-7227.2	607227	23973	17,1	13.0460-2709.2	602709	24150	17,6	13.0460-3851.2	603851
23801	20,3	13.0470-7200.2	LD7200	23973	17,1	13.0460-5801.2	605801	24150	17,6	13.0470-3813.2	LD3813
23801	20,4	13.0470-7227.2	LD7227	23973	17,1	13.0470-2709.2	LD2709	24151	21,0	13.0460-7271.2	607271
23807	18,6	13.0460-7207.2	607207	23974	17,6	13.0460-5899.2	605899	24162	15,2	13.0460-4805.2	604805
23811	17,7	13.0460-2768.2	602768	23980	16,5	13.0460-2840.2	602840	24162	15,2	13.0460-4853.2	604853
23811	17,7	13.0470-2768.2	LD2768	23981	19,6	13.0470-3840.2	LD3840	24162	15,2	13.0470-4853.2	LD4853
23816	16,0	13.0460-5819.2	605819	23983	17,0	13.0460-5770.2	605770	24170	20,2	13.0460-7231.2	607231
23817	16,6	13.0460-5888.2	605888	23984	17,8	13.0460-2725.2	602725	24170	20,2	13.0470-7231.2	LD7231
23823	17,2	13.0460-2877.2	602877	23984	17,8	13.0470-2725.2	LD2725	24172	19,0	13.0460-7239.2	607239
23830	17,5	13.0460-2875.2	602875	23996	17,5	13.0460-5844.2	605844	24172	19,0	13.0470-7239.2	LD7239
23832	20,2	13.0460-7179.2	607179	24007	20,8	13.0460-3819.2	603819	24174	18,6	13.0460-2892.2	602892
23832	20,2	13.0470-7179.2	LD7179	24008	18,3	13.0460-3821.2	603821	24179	17,1	13.0460-5772.2	605772
23836	17,0	13.0460-5846.2	605846	24011	18,7	13.0460-7189.2	607189	24191	18,1	13.0460-2728.2	602728
23840	18,7	13.0460-3992.2	603992	24013	14,9	13.0460-5869.2	605869	24192	17,1	13.0460-2731.2	602731
23845	15,8	13.0460-5954.2	605954	24014	16,0	13.0460-5735.2	605735	24192	17,4	13.0460-2719.2	602719
23863	14,3	13.0460-5867.2	605867	24022	17,8	13.0460-7213.2	607213	24204	19,2	13.0460-5603.2	605603
23865	16,9	13.0460-5787.2	605787	24024	17,0	13.0460-5747.2	605747	24215	15,7	13.0460-5736.2	605736
23868	17,1	13.0460-5860.2	605860	24029	12,5	13.0460-5732.2	605732	24220	17,5	13.0460-5791.2	605791
23873	15,8	13.0460-5868.2	605868	24031	17,7	13.0460-5875.2	605875	24222	16,9	13.0460-5797.2	605797
23881	20,0	13.0460-2708.2	602708	24034	19,1	13.0460-7263.2	607263	24227	16,7	13.0460-5783.2	605783
23881	20,0	13.0470-2708.2	LD2708	24034	19,1	13.0470-7263.2	LD7263	24230	15,3	13.0460-5709.2	605709
23891	16,9	13.0460-5873.2	605873	24036	16,7	13.0460-8008.2	608008	24240	16,6	13.0460-5784.2	605784
23896	20,6	13.0460-7182.2	607182	24039	14,4	13.0460-5856.2	605856	24244	18,5	13.0460-5608.2	605608
23908	18,0	13.0460-2898.2	602898	24042	16,3	13.0460-5877.2	605877	24245	18,5	13.0460-5607.2	605607
23914	17,1	13.0460-2880.2	602880	24045	13,7	13.0460-5804.2	605804	24246	16,8	13.0460-5822.2	605822
23914	17,1	13.0460-2887.2	602887	24046	18,6	13.0460-5821.2	605821	24253	17,8	13.0460-7244.2	607244
23914	17,1	13.0470-2880.2	LD2880	24049	17,0	13.0460-4842.2	604842	24253	17,8	13.0470-7244.2	LD7244
23914	17,1	13.0470-2887.2	LD2887	24058	15,5	13.0460-5773.2	605773	24253	18,0	13.0460-7257.2	607257
23915	17,6	13.0460-2710.2	602710	24059	16,7	13.0460-5886.2	605886	24253	18,0	13.0470-7257.2	LD7257
23915	17,6	13.0460-2795.2	602795	24067	19,3	13.0460-7180.2	607180	24260	17,3	13.0460-3831.2	603831
23915	17,6	13.0470-2710.2	LD2710	24071	14,6	13.0460-5739.2	605739	24260	17,3	13.0470-3831.2	LD3831
23915	17,6	13.0470-2795.2	LD2795	24072	17,9	13.0460-3809.2	603809	24275	16,5	13.0460-5776.2	605776
23917	19,3	13.0460-4978.2	604978	24072	17,9	13.0470-3846.2	LD3846	24276	14,8	13.0460-5775.2	605775
23919	19,3	13.0460-4979.2	604979	24073	16,7	13.0460-2878.2	602878	24283	15,5	13.0460-5794.2	605794
23921	20,1	13.0460-4859.2	604859	24077	19,1	13.0460-2711.2	602711	24283	17,3	13.0460-2605.2	602605
23921	20,3	13.0460-4980.2	604980	24077	19,1	13.0460-2885.2	602885	24289	16,9	13.0460-2714.2	602714
23922	21,0	13.0460-7220.2	607220	24077	19,1	13.0470-2711.2	LD2711	24289	16,9	13.0470-2714.2	LD2714
23922	21,0	13.0470-7220.2	LD7220	24077	19,1	13.0470-2885.2	LD2885	24296	15,5	13.0460-4850.2	604850
23923	17,6	13.0460-7219.2	607219	24084	19,3	13.0460-7252.2	607252	24296	15,5	13.0470-4850.2	LD4850
23923	17,6	13.0470-7219.2	LD7219	24084	19,3	13.0460-7277.2	607277	24297	14,4	13.0460-5761.2	605761
23926	17,3	13.0460-7217.2	607217	24084	19,3	13.0460-7292.2	607292	24298	14,0	13.0460-5762.2	605762
23926	17,3	13.0470-7217.2	LD7217	24084	19,3	13.0470-7252.2	LD7252	24306	20,3	13.0460-2732.2	602732
23928	17,3	13.0460-5743.2	605743	24087	17,4	13.0460-5756.2	605756	24306	20,3	13.0460-2733.2	602733



# Vergleichsliste WVA → ATE



Cross reference list WVA → ATE - Lista referencias WVA → ATE - Liste des correspondances WVA → ATE - Tabella di conversione codici WVA → ATE

WVA D 				WVA D 				WVA D 			
24306	20,3	13.0470-2732.2	LD2732	24468	19,1	13.0460-4807.2	604807	24599	14,9	13.0460-5636.2	605636
24306	20,3	13.0470-2733.2	LD2733	24469	19,1	13.0460-4809.2	604809	24599	14,9	13.0460-5771.2	605771
24306	20,3	13.0470-9000.2	LD9000	24483	16,9	13.0460-2621.2	602621	24601	18,0	13.0460-5614.2	605614
24310	19,0	13.0470-2734.2	LD2734	24483	16,9	13.0460-2749.2	602749	24602	16,0	13.0460-5629.2	605629
24315	16,2	13.0460-4849.2	604849	24483	16,9	13.0470-2621.2	LD2621	24604	16,5	13.0460-8013.2	608013
24316	16,9	13.0460-4848.2	604848	24483	16,9	13.0470-2749.2	LD2749	24604	18,7	13.0460-2766.2	602766
24317	17,6	13.0460-5779.2	605779	24484	18,8	13.0460-3860.2	603860	24606	17,4	13.0460-2747.2	602747
24320	15,3	13.0460-5780.2	605780	24484	18,8	13.0470-3860.2	LD3860	24606	17,4	13.0460-2748.2	602748
24323	15,5	13.0460-5790.2	605790	24484	19,0	13.0460-3834.2	603834	24606	17,4	13.0460-2769.2	602769
24331	13,8	13.0460-5628.2	605628	24485	19,0	13.0460-3833.2	603833	24606	17,4	13.0460-2770.2	602770
24332	19,8	13.0470-7242.2	LD7242	24486	17,9	13.0460-3835.2	603835	24606	17,4	13.0460-2773.2	602773
24333	21,3	13.0460-7242.2	607242	24488	14,9	13.0460-5637.2	605637	24606	17,4	13.0470-2747.2	LD2747
24336	17,5	13.0460-5767.2	605767	24488	14,9	13.0460-5782.2	605782	24606	17,4	13.0470-2748.2	LD2748
24337	17,5	13.0460-5766.2	605766	24491	16,0	13.0460-5601.2	605601	24606	17,4	13.0470-2769.2	LD2769
24338	15,5	13.0460-5765.2	605765	24496	17,3	13.0460-2722.2	602722	24606	17,4	13.0470-2770.2	LD2770
24339	19,5	13.0460-7269.2	607269	24496	17,3	13.0460-2736.2	602736	24606	17,4	13.0470-2773.2	LD2773
24339	19,5	13.0470-7269.2	LD7269	24496	17,3	13.0470-2722.2	LD2722	24610	15,0	13.0460-5769.2	605769
24339	20,5	13.0460-7211.2	607211	24496	17,3	13.0470-2736.2	LD2736	24618	17,5	13.0460-5639.2	605639
24339	20,5	13.0470-7211.2	LD7211	24498	14,7	13.0460-5788.2	605788	24623	18,2	13.0460-7286.2	607286
24346	16,4	13.0460-5609.2	605609	24501	17,8	13.0460-5647.2	605647	24632	17,0	13.0460-5752.2	605752
24347	17,5	13.0460-5768.2	605768	24502	16,7	13.0460-5600.2	605600	24632	17,0	13.0470-5752.2	LD5752
24348	17,1	13.0460-3825.2	603825	24510	17,0	13.0460-5785.2	605785	24635	16,6	13.0460-5754.2	605754
24349	17,5	13.0460-3828.2	603828	24515	16,7	13.0460-2724.2	602724	24638	20,0	13.0460-5753.2	605753
24349	17,5	13.0470-3828.2	LD3828	24518	15,8	13.0460-5757.2	605757	24645	19,1	13.0460-7218.2	607218
24349	17,6	13.0460-3848.2	603848	24521	19,1	13.0460-7243.2	607243	24653	17,3	13.0460-5619.2	605619
24350	17,3	13.0460-5764.2	605764	24530	16,0	13.0460-5631.2	605631	24660	17,8	13.0460-3847.2	603847
24351	16,3	13.0460-5777.2	605777	24537	15,8	13.0460-2737.2	602737	24660	17,8	13.0470-3847.2	LD3847
24353	15,4	13.0460-5795.2	605795	24537	16,1	13.0460-2723.2	602723	24665	15,2	13.0460-5604.2	605604
24369	17,2	13.0460-5876.2	605876	24537	16,1	13.0470-2723.2	LD2723	24671	18,0	13.0460-7235.2	607235
24372	17,3	13.0460-5793.2	605793	24538	17,9	13.0460-7266.2	607266	24673	18,0	13.0460-7270.2	607270
24386	17,9	13.0460-5618.2	605618	24538	17,9	13.0470-7266.2	LD7266	24692	15,9	13.0460-2744.2	602744
24391	16,6	13.0460-2715.2	602715	24538	18,5	13.0460-7229.2	607229	24693	17,5	13.0460-2742.2	602742
24397	16,0	13.0460-5829.2	605829	24538	18,5	13.0470-7229.2	LD7229	24693	17,5	13.0460-2743.2	602743
24399	20,4	13.0460-7272.2	607272	24538	19,0	13.0460-7311.2	607311	24693	18,5	13.0460-2741.2	602741
24403	17,0	13.0460-5700.2	605700	24538	19,4	13.0460-7273.2	607273	24703	17,8	13.0460-2716.2	602716
24403	17,4	13.0460-2774.2	602774	24538	19,4	13.0470-7273.2	LD7273	24703	17,8	13.0470-2716.2	LD2716
24408	19,2	13.0470-2746.2	LD2746	24540	16,3	13.0460-3836.2	603836	24705	19,8	13.0470-7256.2	LD7256
24412	19,0	13.0460-5612.2	605612	24540	16,3	13.0470-3836.2	LD3836	24706	21,3	13.0460-7256.2	607256
24412	19,0	13.0470-5612.2	LD5612	24541	15,5	13.0460-4816.2	604816	24709	17,5	13.0460-7250.2	607250
24415	19,1	13.0460-5611.2	605611	24544	18,1	13.0460-5606.2	605606	24709	18,6	13.0460-7249.2	607249
24415	19,1	13.0470-5611.2	LD5611	24545	16,9	13.0460-5605.2	605605	24709	18,6	13.0470-7249.2	LD7249
24418	17,0	13.0460-2754.2	602754	24549	19,6	13.0460-3840.2	603840	24727	20,7	13.0460-7265.2	607265
24421	17,2	13.0460-2755.2	602755	24550	19,5	13.0460-3841.2	603841	24727	20,7	13.0460-7302.2	607302
24421	17,2	13.0460-2758.2	602758	24553	15,8	13.0460-4852.2	604852	24738	20,0	13.0460-2764.2	602764
24421	17,2	13.0470-2755.2	LD2755	24556	19,1	13.0460-7190.2	607190	24738	20,0	13.0470-2764.2	LD2764
24421	17,2	13.0470-2758.2	LD2758	24556	19,1	13.0470-7190.2	LD7190	24743	19,2	13.0460-2746.2	602746
24423	14,6	13.0460-5621.2	605621	24557	19,4	13.0460-7230.2	607230	24743	19,2	13.0460-2765.2	602765
24435	14,8	13.0460-5648.2	605648	24557	19,4	13.0470-7230.2	LD7230	24743	19,2	13.0470-2765.2	LD2765
24436	19,7	13.0460-7261.2	607261	24559	17,8	13.0460-2759.2	602759	24764	17,9	13.0460-3846.2	603846
24438	16,1	13.0460-7234.2	607234	24561	17,7	13.0460-2760.2	602760	24765	16,5	13.0460-2745.2	602745
24451	15,6	13.0460-5617.2	605617	24561	17,7	13.0470-2760.2	LD2760	24779	16,5	13.0460-5810.2	605810
24452	17,5	13.0460-5634.2	605634	24563	17,7	13.0460-3858.2	603858	24796	17,7	13.0460-7291.2	607291
24452	17,5	13.0470-5634.2	LD5634	24563	17,7	13.0470-3858.2	LD3858	24820	16,1	13.0460-2756.2	602756
24455	16,8	13.0460-4839.2	604839	24567	16,0	13.0460-5616.2	605616	24820	16,1	13.0460-2757.2	602757
24455	16,8	13.0460-4864.2	604864	24574	15,0	13.0460-7214.2	607214	24822	15,7	13.0460-2771.2	602771
24456	19,0	13.0460-2734.2	602734	24574	15,0	13.0460-7290.2	607290	24830	15,5	13.0460-5774.2	605774
24458	17,3	13.0460-7260.2	607260	24578	16,5	13.0460-2739.2	602739	24839	19,4	13.0460-2752.2	602752
24462	16,7	13.0460-2706.2	602706	24582	17,4	13.0460-5610.2	605610	24847	17,0	13.0460-4873.2	604873
24465	19,2	13.0460-4812.2	604812	24590	19,0	13.0460-5602.2	605602	24848	18,3	13.0460-2786.2	602786
24466	19,1	13.0460-4810.2	604810	24595	18,5	13.0460-2738.2	602738	24848	18,3	13.0470-2786.2	LD2786
24466	19,1	13.0460-4811.2	604811	24597	17,7	13.0460-5799.2	605799	24852	16,0	13.0460-4867.2	604867



# Vergleichsliste WVA → ATE

Cross reference list WVA → ATE - Lista referencias WVA → ATE - Liste des correspondances WVA → ATE - Tabella di conversione codici WVA → ATE

WVA D 				WVA D 				WVA D 			
24852	16,0	13.0470-4867.2	LD4867	25172	18,4	13.0460-4857.2	604857	25692	17,2	13.0460-5645.2	605645
24862	16,7	13.0460-7259.2	607259	25179	17,8	13.0460-4870.2	604870	25700	18,7	13.0460-3868.2	603868
24862	16,7	13.0470-7259.2	LD7259	25183	17,9	13.0460-4869.2	604869	25702	18,2	13.0460-7298.2	607298
24862	16,7	13.0470-9001.2	LD9001	25184	19,5	13.0460-2772.2	602772	25702	18,2	13.0470-7298.2	LD7298
24867	20,7	13.0460-3852.2	603852	25187	17,8	13.0460-5641.2	605641	25720	17,7	13.0460-2604.2	602604
24867	20,7	13.0470-3852.2	LD3852	25190	21,3	13.0470-7282.2	LD7282	25737	18,4	13.0470-7299.2	LD7299
24869	19,3	13.0460-2779.2	602779	25192	21,3	13.0460-7282.2	607282	25759	17,9	13.0460-5661.2	605661
24869	19,3	13.0470-2779.2	LD2779	25199	19,6	13.0470-3857.2	LD3857	25778	14,3	13.0460-5843.2	605843
24883	18,0	13.0460-3855.2	603855	25200	19,6	13.0460-3857.2	603857	25779	15,0	13.0460-2794.2	602794
24883	18,0	13.0470-3855.2	LD3855	25215	18,6	13.0460-2781.2	602781	25804	17,3	13.0460-7284.2	607284
24886	16,8	13.0460-3853.2	603853	25215	18,6	13.0470-2781.2	LD2781	25827	17,7	13.0460-3872.2	603872
24915	17,4	13.0460-5651.2	605651	25218	16,6	13.0460-7278.2	607278	25827	17,7	13.0470-3872.2	LD3872
24915	17,4	13.0470-5651.2	LD5651	25220	18,6	13.0460-2603.2	602603	25833	17,3	13.0460-7300.2	607300
24915	17,8	13.0460-5659.2	605659	25222	17,3	13.0460-7276.2	607276	25833	17,3	13.0470-7300.2	LD7300
24918	15,0	13.0460-5635.2	605635	25232	14,5	13.0460-5663.2	605663	25836	17,0	13.0460-7305.2	607305
24918	15,0	13.0470-5635.2	LD5635	25250	18,9	13.0460-3867.2	603867	25836	17,0	13.0470-7305.2	LD7305
24922	16,5	13.0460-2761.2	602761	25250	18,9	13.0460-3869.2	603869	25839	17,8	13.0470-3871.2	LD3871
24926	16,5	13.0460-3854.2	603854	25250	18,9	13.0470-3869.2	LD3869	25840	17,8	13.0460-3871.2	603871
24934	15,0	13.0460-5786.2	605786	25258	14,4	13.0460-5655.2	605655	25841	16,1	13.0460-7301.2	607301
24934	15,0	13.0470-5786.2	LD5786	25258	14,4	13.0460-5683.2	605683	25841	16,1	13.0470-7301.2	LD7301
24946	19,0	13.0460-5615.2	605615	25262	15,0	13.0460-5613.2	605613	25875	15,9	13.0460-5658.2	605658
24974	16,8	13.0460-6921.2	606921	25265	16,6	13.0460-7287.2	607287	25878	13,8	13.0460-5657.2	605657
24976	17,5	13.0460-4863.2	604863	25268	17,8	13.0460-5642.2	605642	25895	18,5	13.0460-3870.2	603870
24979	15,9	13.0460-5620.2	605620	25307	17,5	13.0460-3859.2	603859	25895	18,5	13.0470-3870.2	LD3870
25006	18,8	13.0460-3874.2	603874	25307	17,5	13.0470-3859.2	LD3859	25965	15,0	13.0460-2600.2	602600
25008	16,3	13.0460-7293.2	607293	25323	17,3	13.0460-7289.2	607289	25968	16,1	13.0460-7295.2	607295
25008	16,3	13.0470-7293.2	LD7293	25326	19,3	13.0460-2778.2	602778	25968	16,1	13.0470-7295.2	LD7295
25009	16,4	13.0460-7294.2	607294	25326	19,3	13.0470-2778.2	LD2778	25973	17,2	13.0460-2793.2	602793
25009	16,4	13.0470-7294.2	LD7294	25331	16,2	13.0460-7315.2	607315	25976	16,6	13.0460-5653.2	605653
25014	18,2	13.0460-3865.2	603865	25331	16,2	13.0470-7315.2	LD7315	25979	16,0	13.0460-5656.2	605656
25014	18,2	13.0470-3865.2	LD3865	25337	15,5	13.0460-5650.2	605650	25980	16,8	13.0460-2797.2	602797
25021	18,5	13.0460-2762.2	602762	25349	17,8	13.0460-5646.2	605646	25980	16,8	13.0470-2797.2	LD2797
25028	18,0	13.0460-4875.2	604875	25353	16,2	13.0460-7304.2	607304	25997	18,7	13.0460-4880.2	604880
25028	18,0	13.0470-4875.2	LD4875	25353	16,2	13.0470-7304.2	LD7304	25997	18,7	13.0470-4880.2	LD4880
25029	16,7	13.0460-4874.2	604874	25367	16,0	13.0460-5649.2	605649	29003	20,0	13.0460-7906.2	607906
25031	19,1	13.0460-7262.2	607262	25410	14,4	13.0460-2783.2	602783	29121	20,3	13.0460-4860.2	604860
25031	19,1	13.0470-7262.2	LD7262	25429	17,5	13.0460-7288.2	607288	29121	20,3	13.0460-4861.2	604861
25045	19,5	13.0470-7267.2	LD7267	25429	17,5	13.0470-7288.2	LD7288	29121	20,3	13.0460-4966.2	604966
25046	18,5	13.0460-7267.2	607267	25451	17,6	13.0460-3862.2	603862	29122	22,1	13.0460-4828.2	604828
25069	17,3	13.0460-7279.2	607279	25506	18,2	13.0460-3866.2	603866	29123	20,3	13.0460-4862.2	604862
25069	17,3	13.0470-7279.2	LD7279	25506	18,2	13.0470-3866.2	LD3866	29123	20,3	13.0460-4996.2	604996
25071	18,8	13.0460-2780.2	602780	25520	15,8	13.0460-5633.2	605633	29140	18,3	13.0460-4918.2	604918
25096	17,0	13.0460-7264.2	607264	25526	17,6	13.0460-3861.2	603861	29153	20,0	13.0460-7909.2	607909
25096	17,0	13.0470-7264.2	LD7264	25531	19,3	13.0460-7283.2	607283	29160	20,3	13.0460-4847.2	604847
25097	17,0	13.0470-7309.2	LD7309	25540	14,5	13.0460-5664.2	605664	29160	20,3	13.0460-4865.2	604865
25098	17,0	13.0460-7309.2	607309	25540	14,5	13.0470-5664.2	LD5664	29160	20,8	13.0460-4975.2	604975
25110	17,5	13.0460-2790.2	602790	25592	20,3	13.0460-7313.2	607313	29190	20,2	13.0460-3832.2	603832
25110	17,5	13.0470-2790.2	LD2790	25617	18,5	13.0460-2601.2	602601	29190	20,2	13.0460-3837.2	603837
25112	18,4	13.0460-4858.2	604858	25632	15,5	13.0460-8014.2	608014	29192	20,3	13.0460-4877.2	604877
25114	15,8	13.0460-7255.2	607255	25642	18,1	13.0460-2799.2	602799	29192	20,7	13.0460-4826.2	604826
25119	16,9	13.0460-5638.2	605638	25643	16,8	13.0460-4879.2	604879	29200	21,0	13.0460-4827.2	604827
25134	17,2	13.0460-2784.2	602784	25643	17,0	13.0470-4879.2	LD4879	29212	17,3	13.0460-4989.2	604989
25134	17,2	13.0470-2784.2	LD2784	25643	18,1	13.0470-2799.2	LD2799	29217	20,5	13.0460-3842.2	603842
25147	18,4	13.0460-4856.2	604856	25644	15,6	13.0460-5660.2	605660	29229	20,7	13.0460-4830.2	604830
25156	17,4	13.0460-2767.2	602767	25652	17,1	13.0460-2789.2	602789	29229	20,7	13.0460-4866.2	604866
25156	17,4	13.0470-2767.2	LD2767	25652	17,1	13.0470-2789.2	LD2789	29231	22,7	13.0460-4829.2	604829
25158	20,3	13.0460-7280.2	607280	25681	17,7	13.0460-2612.2	602612	29232	21,0	13.0460-4823.2	604823
25158	20,3	13.0470-7280.2	LD7280	25683	20,4	13.0460-2609.2	602609	29835	22,0	13.0460-6015.2	606015
25160	20,3	13.0470-7281.2	LD7281	25683	20,4	13.0460-2785.2	602785				
25161	20,3	13.0460-7281.2	607281	25683	20,4	13.0470-2785.2	LD2785				
25162	16,1	13.0460-4887.2	604887	25688	14,4	13.0460-5654.2	605654				









- DE** Vergleichsliste ATE → WVA
- EN** Cross reference list ATE → WVA
- ES** Lista referencias ATE → WVA
- FR** Liste des correspondances ATE → WVA
- IT** Tabella di conversione codici ATE → WVA

2019

# Vergleichsliste ATE → WVA



Cross reference list ATE → WVA - Lista referencias ATE → WVA - Liste des correspondances ATE → WVA - Tabella di conversione codici ATE → WVA

	WVA D					WVA D					WVA D			
13.0460-2600.2	602600	25965	15,0		13.0460-2751.2	602751	21418	15,5		13.0460-2826.2	602826	23177	14,2	
13.0460-2601.2	602601	25617	18,5		13.0460-2752.2	602752	24839	19,4		13.0460-2827.2	602827	21606	16,7	
13.0460-2602.2	602602	22304	17,3		13.0460-2753.2	602753	23554	16,0		13.0460-2828.2	602828	23070	19,5	
13.0460-2603.2	602603	25220	18,6		13.0460-2754.2	602754	24418	17,0		13.0460-2829.2	602829	23124	19,0	
13.0460-2604.2	602604	25720	17,7		13.0460-2755.2	602755	24421	17,2		13.0460-2830.2	602830	21920	14,6	
13.0460-2605.2	602605	24283	17,3		13.0460-2756.2	602756	24820	16,1		13.0460-2831.2	602831	21861	15,2	
13.0460-2609.2	602609	25683	20,4		13.0460-2757.2	602757	24820	16,1		13.0460-2832.2	602832	21889	18,1	
13.0460-2610.2	602610	22076	19,6		13.0460-2758.2	602758	24421	17,2		13.0460-2833.2	602833	23070	17,0	
13.0460-2612.2	602612	25681	17,7		13.0460-2759.2	602759	24559	17,8		13.0460-2834.2	602834	21463	18,0	
13.0460-2613.2	602613	22187	18,6		13.0460-2760.2	602760	24561	17,7		13.0460-2835.2	602835	23353	14,8	
13.0460-2615.2	602615	22129	17,4		13.0460-2761.2	602761	24922	16,5		13.0460-2836.2	602836	21595	18,3	
13.0460-2621.2	602621	24483	16,9		13.0460-2762.2	602762	25021	18,5		13.0460-2837.2	602837	23393	19,6	
13.0460-2700.2	602700	21452	18,5		13.0460-2763.2	602763	23517	17,2		13.0460-2838.2	602838	23445	19,2	
13.0460-2701.2	602701	21452	18,5		13.0460-2764.2	602764	24738	20,0		13.0460-2839.2	602839	21635	18,7	
13.0460-2704.2	602704	23761	18,8		13.0460-2765.2	602765	24743	19,2		13.0460-2840.2	602840	23980	16,5	
13.0460-2705.2	602705	21452	18,5		13.0460-2766.2	602766	24604	18,7		13.0460-2842.2	602842	20961	15,2	
13.0460-2706.2	602706	24462	16,7		13.0460-2767.2	602767	25156	17,4		13.0460-2844.2	602844	21674	19,4	
13.0460-2707.2	602707	23760	17,7		13.0460-2768.2	602768	23811	17,7		13.0460-2845.2	602845	23554	16,4	
13.0460-2708.2	602708	23881	20,0		13.0460-2769.2	602769	24606	17,4		13.0460-2846.2	602846	21010	15,8	
13.0460-2709.2	602709	23973	17,1		13.0460-2770.2	602770	24606	17,4		13.0460-2850.2	602850	23602	19,7	
13.0460-2710.2	602710	23915	17,6		13.0460-2771.2	602771	24822	15,7		13.0460-2852.2	602852	23603	19,7	
13.0460-2711.2	602711	24077	19,1		13.0460-2772.2	602772	25184	19,5		13.0460-2853.2	602853	21983	17,2	
13.0460-2712.2	602712	23138	14,6		13.0460-2773.2	602773	24606	17,4		13.0460-2855.2	602855	23138	14,6	
13.0460-2713.2	602713	23623	17,4		13.0460-2774.2	602774	24403	17,4		13.0460-2857.2	602857	23225	17,0	
13.0460-2714.2	602714	24289	16,9		13.0460-2775.2	602775	23554	16,4		13.0460-2858.2	602858	23284	14,0	
13.0460-2715.2	602715	24391	16,6		13.0460-2776.2	602776	23070	17,0		13.0460-2859.2	602859	20961	17,0	
13.0460-2716.2	602716	24703	17,8		13.0460-2778.2	602778	25326	19,3		13.0460-2860.2	602860	23554	16,4	
13.0460-2717.2	602717	21452	18,5		13.0460-2779.2	602779	24869	19,3		13.0460-2862.2	602862	23346	19,0	
13.0460-2718.2	602718	23615	18,3		13.0460-2780.2	602780	25071	18,8		13.0460-2863.2	602863	20261	19,0	
13.0460-2719.2	602719	24192	17,4		13.0460-2781.2	602781	25215	18,6		13.0460-2864.2	602864	20961	17,2	
13.0460-2720.2	602720	23452	19,0		13.0460-2783.2	602783	25410	14,4		13.0460-2867.2	602867	23517	16,6	
13.0460-2721.2	602721	23458	15,6		13.0460-2784.2	602784	25134	17,2		13.0460-2868.2	602868	23417	15,3	
13.0460-2722.2	602722	24496	17,3		13.0460-2785.2	602785	25683	20,4		13.0460-2869.2	602869	23169	19,4	
13.0460-2723.2	602723	24537	16,1		13.0460-2786.2	602786	24848	18,3		13.0460-2870.2	602870	23099	18,4	
13.0460-2724.2	602724	24515	16,7		13.0460-2787.2	602787	23554	17,3		13.0460-2871.2	602871	23407	19,0	
13.0460-2725.2	602725	23984	17,8		13.0460-2789.2	602789	25652	17,1		13.0460-2872.2	602872	23446	16,5	
13.0460-2726.2	602726	23144	19,8		13.0460-2790.2	602790	25110	17,5		13.0460-2874.2	602874	23224	16,5	
13.0460-2727.2	602727	23144	19,8		13.0460-2792.2	602792	22031	19,6		13.0460-2875.2	602875	23830	17,5	
13.0460-2728.2	602728	24191	18,1		13.0460-2793.2	602793	25973	17,2		13.0460-2876.2	602876	23119	17,5	
13.0460-2729.2	602729	23423	17,8		13.0460-2794.2	602794	25779	15,0		13.0460-2877.2	602877	23823	17,2	
13.0460-2730.2	602730	23424	17,6		13.0460-2795.2	602795	23915	17,6		13.0460-2878.2	602878	24073	16,7	
13.0460-2731.2	602731	24192	17,1		13.0460-2796.2	602796	22308	17,7		13.0460-2879.2	602879	23601	13,7	
13.0460-2732.2	602732	24306	20,3		13.0460-2797.2	602797	25980	16,8		13.0460-2880.2	602880	23914	17,1	
13.0460-2733.2	602733	24306	20,3		13.0460-2799.2	602799	25642	18,1		13.0460-2881.2	602881	23409	19,3	
13.0460-2734.2	602734	24456	19,0		13.0460-2800.2	602800	20091	14,6		13.0460-2882.2	602882	23326	17,4	
13.0460-2735.2	602735	23099	18,4		13.0460-2803.2	602803	21516	17,5		13.0460-2883.2	602883	23581	18,8	
13.0460-2736.2	602736	24496	17,3		13.0460-2804.2	602804	21518	17,0		13.0460-2884.2	602884	23581	18,8	
13.0460-2737.2	602737	24537	15,8		13.0460-2805.2	602805	21520	17,5		13.0460-2885.2	602885	24077	19,1	
13.0460-2738.2	602738	24595	18,5		13.0460-2806.2	602806	21366	19,3		13.0460-2886.2	602886	20961	16,0	
13.0460-2739.2	602739	24578	16,5		13.0460-2810.2	602810	20236	18,0		13.0460-2887.2	602887	23914	17,1	
13.0460-2740.2	602740	23554	17,0		13.0460-2811.2	602811	21068	17,0		13.0460-2888.2	602888	23326	17,4	
13.0460-2741.2	602741	24693	18,5		13.0460-2812.2	602812	21217	18,0		13.0460-2889.2	602889	23326	17,4	
13.0460-2742.2	602742	24693	17,5		13.0460-2815.2	602815	21368	18,3		13.0460-2890.2	602890	23326	17,4	
13.0460-2743.2	602743	24693	17,5		13.0460-2816.2	602816	21724	19,3		13.0460-2891.2	602891	24134	19,6	
13.0460-2744.2	602744	24692	15,9		13.0460-2817.2	602817	21886	19,0		13.0460-2892.2	602892	24174	18,6	
13.0460-2745.2	602745	24765	16,5		13.0460-2819.2	602819	20961	17,2		13.0460-2893.2	602893	24135	17,7	
13.0460-2746.2	602746	24743	19,2		13.0460-2820.2	602820	20961	17,2		13.0460-2894.2	602894	20961	17,2	
13.0460-2747.2	602747	24606	17,4		13.0460-2821.2	602821	21945	16,0		13.0460-2895.2	602895	23172	18,0	
13.0460-2748.2	602748	24606	17,4		13.0460-2822.2	602822	21945	19,6		13.0460-2896.2	602896	21920	16,6	
13.0460-2749.2	602749	24483	16,9		13.0460-2824.2	602824	20380	15,6		13.0460-2897.2	602897	21861	15,2	
13.0460-2750.2	602750	20741	15,0		13.0460-2825.2	602825	21614	17,7		13.0460-2898.2	602898	23908	18,0	



# Vergleichsliste ATE → WVA



Cross reference list ATE → WVA - Lista referencias ATE → WVA - Liste des correspondances ATE → WVA - Tabella di conversione codici ATE → WVA

	WVA D				WVA D				WVA D		
13.0460-2899.2	602899	23638	17,5	13.0460-3826.2	603826	23707	18,0	13.0460-3952.2	603952	20905	18,0
13.0460-2925.2	602925	20669	19,0	13.0460-3827.2	603827	23710	19,6	13.0460-3953.2	603953	20634	15,0
13.0460-2927.2	602927	21028	19,3	13.0460-3828.2	603828	24349	17,5	13.0460-3954.2	603954	20973	11,0
13.0460-2928.2	602928	20981	13,8	13.0460-3829.2	603829	23959	17,0	13.0460-3955.2	603955	20634	15,0
13.0460-2934.2	602934	20669	19,0	13.0460-3831.2	603831	24260	17,3	13.0460-3956.2	603956	21631	17,0
13.0460-2935.2	602935	21385	13,8	13.0460-3832.2	603832	29190	20,2	13.0460-3957.2	603957	23042	19,0
13.0460-2937.2	602937	20961	15,2	13.0460-3833.2	603833	24485	19,0	13.0460-3959.2	603959	21469	18,0
13.0460-2941.2	602941	20838	17,0	13.0460-3834.2	603834	24484	19,0	13.0460-3960.2	603960	21470	18,0
13.0460-2948.2	602948	21100	16,7	13.0460-3835.2	603835	24486	17,9	13.0460-3961.2	603961	20336	14,0
13.0460-2949.2	602949	20838	17,0	13.0460-3836.2	603836	24540	16,3	13.0460-3962.2	603962	20905	18,0
13.0460-2951.2	602951	21103	14,2	13.0460-3837.2	603837	29190	20,2	13.0460-3963.2	603963	21586	15,0
13.0460-2952.2	602952	21185	19,4	13.0460-3838.2	603838	21436	17,0	13.0460-3964.2	603964	23410	15,0
13.0460-2955.2	602955	20938	18,0	13.0460-3839.2	603839	23707	17,9	13.0460-3965.2	603965	21171	18,0
13.0460-2956.2	602956	20989	17,7	13.0460-3840.2	603840	24549	19,6	13.0460-3966.2	603966	23600	19,4
13.0460-2957.2	602957	20168	16,0	13.0460-3841.2	603841	24550	19,5	13.0460-3968.2	603968	20488	18,5
13.0460-2958.2	602958	20168	19,3	13.0460-3842.2	603842	29217	20,5	13.0460-3969.2	603969	20929	18,5
13.0460-2959.2	602959	23532	20,1	13.0460-3846.2	603846	24764	17,9	13.0460-3972.2	603972	21632	16,0
13.0460-2963.2	602963	21138	18,8	13.0460-3847.2	603847	24660	17,8	13.0460-3973.2	603973	23146	17,0
13.0460-2964.2	602964	20861	17,5	13.0460-3848.2	603848	24349	17,6	13.0460-3975.2	603975	23597	18,0
13.0460-2965.2	602965	21170	17,3	13.0460-3850.2	603850	23707	18,0	13.0460-3976.2	603976	23258	16,5
13.0460-2966.2	602966	20166	16,0	13.0460-3851.2	603851	24150	17,6	13.0460-3977.2	603977	21980	18,0
13.0460-2971.2	602971	21209	18,5	13.0460-3852.2	603852	24867	20,7	13.0460-3978.2	603978	23332	18,0
13.0460-2972.2	602972	20124	18,9	13.0460-3853.2	603853	24886	16,8	13.0460-3979.2	603979	21999	15,8
13.0460-2973.2	602973	21635	18,0	13.0460-3854.2	603854	24926	16,5	13.0460-3980.2	603980	23022	20,9
13.0460-2975.2	602975	21439	20,3	13.0460-3855.2	603855	24883	18,0	13.0460-3982.2	603982	23705	18,1
13.0460-2976.2	602976	21797	19,7	13.0460-3856.2	603856	23434	18,0	13.0460-3983.2	603983	23708	19,4
13.0460-2977.2	602977	21799	19,7	13.0460-3857.2	603857	25200	19,6	13.0460-3984.2	603984	23711	19,4
13.0460-2978.2	602978	21802	19,0	13.0460-3858.2	603858	24563	17,7	13.0460-3985.2	603985	23020	17,9
13.0460-2979.2	602979	21147	19,0	13.0460-3859.2	603859	25307	17,5	13.0460-3986.2	603986	23135	18,0
13.0460-2980.2	602980	21147	19,0	13.0460-3860.2	603860	24484	18,8	13.0460-3987.2	603987	23279	18,4
13.0460-2981.2	602981	21460	18,0	13.0460-3861.2	603861	25526	17,6	13.0460-3988.2	603988	23557	17,2
13.0460-2982.2	602982	21479	19,2	13.0460-3862.2	603862	25451	17,6	13.0460-3990.2	603990	23021	18,9
13.0460-2983.2	602983	20919	18,0	13.0460-3863.2	603863	23707	18,0	13.0460-3991.2	603991	23714	16,6
13.0460-2984.2	602984	20961	17,2	13.0460-3864.2	603864	23710	19,6	13.0460-3992.2	603992	23840	18,7
13.0460-2985.2	602985	20164	18,2	13.0460-3865.2	603865	25014	18,2	13.0460-3993.2	603993	23577	18,7
13.0460-2987.2	602987	21147	19,0	13.0460-3866.2	603866	25506	18,2	13.0460-3994.2	603994	23599	19,0
13.0460-2997.2	602997	20708	15,8	13.0460-3867.2	603867	25250	18,9	13.0460-3995.2	603995	23605	15,7
13.0460-3306.2	603306	21089	15,0	13.0460-3868.2	603868	25700	18,7	13.0460-3996.2	603996	23276	17,2
13.0460-3401.2	603401	20755	14,4	13.0460-3869.2	603869	25250	18,9	13.0460-3997.2	603997	23277	17,7
13.0460-3403.2	603403	20755	14,4	13.0460-3870.2	603870	25895	18,5	13.0460-3998.2	603998	23273	17,8
13.0460-3504.2	603504	21301	15,5	13.0460-3871.2	603871	25840	17,8	13.0460-3999.2	603999	23743	20,1
13.0460-3602.2	603602	21144	15,8	13.0460-3872.2	603872	25827	17,7	13.0460-4014.2	604014	21278	16,4
13.0460-3605.2	603605	20181	17,3	13.0460-3874.2	603874	25006	18,8	13.0460-4016.2	604016	20877	17,5
13.0460-3800.2	603800	23613	17,7	13.0460-3876.2	603876	22218	18,3	13.0460-4034.2	604034	20687	15,5
13.0460-3803.2	603803	20996	17,3	13.0460-3902.2	603902	20035	17,0	13.0460-4040.2	604040	21050	15,8
13.0460-3805.2	603805	21197	15,0	13.0460-3904.2	603904	21107	12,0	13.0460-4041.2	604041	21289	16,8
13.0460-3806.2	603806	23669	16,8	13.0460-3911.2	603911	20905	18,0	13.0460-4042.2	604042	21267	16,8
13.0460-3807.2	603807	21436	17,0	13.0460-3914.2	603914	21233	16,7	13.0460-4043.2	604043	21140	15,0
13.0460-3809.2	603809	24072	17,9	13.0460-3926.2	603926	20974	10,8	13.0460-4044.2	604044	20755	15,1
13.0460-3810.2	603810	23705	18,1	13.0460-3936.2	603936	20073	17,3	13.0460-4047.2	604047	21305	15,7
13.0460-3811.2	603811	23708	19,2	13.0460-3939.2	603939	20775	18,0	13.0460-4056.2	604056	21402	17,5
13.0460-3813.2	603813	24150	17,6	13.0460-3940.2	603940	20775	18,0	13.0460-4059.2	604059	21278	16,4
13.0460-3814.2	603814	23934	18,2	13.0460-3942.2	603942	20841	12,0	13.0460-4060.2	604060	21900	15,0
13.0460-3815.2	603815	23930	18,2	13.0460-3943.2	603943	20905	18,0	13.0460-4064.2	604064	21919	15,3
13.0460-3818.2	603818	23706	18,1	13.0460-3945.2	603945	20934	14,0	13.0460-4065.2	604065	21899	15,3
13.0460-3819.2	603819	24007	20,8	13.0460-3946.2	603946	23302	18,0	13.0460-4066.2	604066	21857	17,7
13.0460-3821.2	603821	24008	18,3	13.0460-3947.2	603947	21509	17,0	13.0460-4069.2	604069	23078	15,9
13.0460-3822.2	603822	21597	11,0	13.0460-3948.2	603948	21508	17,0	13.0460-4201.2	604201	21153	17,5
13.0460-3823.2	603823	20974	11,0	13.0460-3949.2	603949	21365	17,0	13.0460-4202.2	604202	21153	16,0
13.0460-3824.2	603824	20261	19,0	13.0460-3950.2	603950	21436	17,0	13.0460-4401.2	604401	20784	18,0
13.0460-3825.2	603825	24348	17,1	13.0460-3951.2	603951	21436	16,2	13.0460-4800.2	604800	23751	17,0



# Vergleichsliste ATE → WVA



Cross reference list ATE → WVA - Lista referencias ATE → WVA - Liste des correspondances ATE → WVA - Tabella di conversione codici ATE → WVA

	WVA D				WVA D				WVA D		
13.0460-4801.2	604801	21381	15,0	13.0460-4883.2	604883	22061	18,7	13.0460-5616.2	605616	24567	16,0
13.0460-4802.2	604802	23773	17,5	13.0460-4884.2	604884	22062	20,7	13.0460-5617.2	605617	24451	15,6
13.0460-4803.2	604803	23092	15,6	13.0460-4887.2	604887	25162	16,1	13.0460-5618.2	605618	24386	17,9
13.0460-4804.2	604804	23092	15,6	13.0460-4889.2	604889	22041	19,2	13.0460-5619.2	605619	24653	17,3
13.0460-4805.2	604805	24162	15,2	13.0460-4911.2	604911	20389	15,4	13.0460-5620.2	605620	24979	15,9
13.0460-4806.2	604806	23955	16,2	13.0460-4918.2	604918	29140	18,3	13.0460-5621.2	605621	24423	14,6
13.0460-4807.2	604807	24468	19,1	13.0460-4921.2	604921	23305	15,2	13.0460-5622.2	605622	23726	16,5
13.0460-4809.2	604809	24469	19,1	13.0460-4955.2	604955	21048	18,3	13.0460-5623.2	605623	23673	15,9
13.0460-4810.2	604810	24466	19,1	13.0460-4956.2	604956	20162	15,4	13.0460-5625.2	605625	21319	14,9
13.0460-4811.2	604811	24466	19,1	13.0460-4957.2	604957	20410	15,0	13.0460-5626.2	605626	21713	16,0
13.0460-4812.2	604812	24465	19,2	13.0460-4958.2	604958	21381	17,3	13.0460-5627.2	605627	21569	14,9
13.0460-4814.2	604814	21937	15,5	13.0460-4964.2	604964	21381	15,0	13.0460-5628.2	605628	24331	13,8
13.0460-4815.2	604815	21937	15,5	13.0460-4965.2	604965	21471	18,0	13.0460-5629.2	605629	24602	16,0
13.0460-4816.2	604816	24541	15,5	13.0460-4966.2	604966	29121	20,3	13.0460-5631.2	605631	24530	16,0
13.0460-4817.2	604817	23960	18,3	13.0460-4968.2	604968	21381	18,0	13.0460-5632.2	605632	23970	16,8
13.0460-4818.2	604818	23143	15,1	13.0460-4969.2	604969	23753	18,0	13.0460-5633.2	605633	25520	15,8
13.0460-4819.2	604819	23478	14,6	13.0460-4971.2	604971	23092	16,0	13.0460-5634.2	605634	24452	17,5
13.0460-4823.2	604823	29232	21,0	13.0460-4972.2	604972	23576	16,0	13.0460-5635.2	605635	24918	15,0
13.0460-4826.2	604826	29192	20,7	13.0460-4973.2	604973	23092	16,0	13.0460-5636.2	605636	24599	14,9
13.0460-4827.2	604827	29200	21,0	13.0460-4974.2	604974	23323	14,6	13.0460-5637.2	605637	24488	14,9
13.0460-4828.2	604828	29122	22,1	13.0460-4975.2	604975	29160	20,8	13.0460-5638.2	605638	25119	16,9
13.0460-4829.2	604829	29231	22,7	13.0460-4976.2	604976	23694	16,7	13.0460-5639.2	605639	24618	17,5
13.0460-4830.2	604830	29229	20,7	13.0460-4977.2	604977	23157	15,8	13.0460-5640.2	605640	21854	15,0
13.0460-4832.2	604832	21381	18,0	13.0460-4978.2	604978	23917	19,3	13.0460-5641.2	605641	25187	17,8
13.0460-4833.2	604833	24098	17,1	13.0460-4979.2	604979	23919	19,3	13.0460-5642.2	605642	25268	17,8
13.0460-4834.2	604834	24097	17,1	13.0460-4980.2	604980	23921	20,3	13.0460-5645.2	605645	25692	17,2
13.0460-4837.2	604837	20217	17,1	13.0460-4984.2	604984	23271	17,4	13.0460-5646.2	605646	25349	17,8
13.0460-4839.2	604839	24455	16,8	13.0460-4985.2	604985	21381	18,0	13.0460-5647.2	605647	24501	17,8
13.0460-4840.2	604840	23961	16,8	13.0460-4986.2	604986	21965	15,0	13.0460-5648.2	605648	24435	14,8
13.0460-4841.2	604841	23489	16,3	13.0460-4987.2	604987	23329	17,0	13.0460-5649.2	605649	25367	16,0
13.0460-4842.2	604842	24049	17,0	13.0460-4988.2	604988	21792	15,2	13.0460-5650.2	605650	25337	15,5
13.0460-4847.2	604847	29160	20,3	13.0460-4989.2	604989	29212	17,3	13.0460-5651.2	605651	24915	17,4
13.0460-4848.2	604848	24316	16,9	13.0460-4990.2	604990	23271	17,4	13.0460-5652.2	605652	22065	17,7
13.0460-4849.2	604849	24315	16,2	13.0460-4991.2	604991	23092	16,0	13.0460-5653.2	605653	25976	16,6
13.0460-4850.2	604850	24296	15,5	13.0460-4992.2	604992	23692	16,6	13.0460-5654.2	605654	25688	14,4
13.0460-4851.2	604851	23092	16,0	13.0460-4993.2	604993	23693	16,6	13.0460-5655.2	605655	25258	14,4
13.0460-4852.2	604852	24553	15,8	13.0460-4994.2	604994	23945	16,5	13.0460-5656.2	605656	25979	16,0
13.0460-4853.2	604853	24162	15,2	13.0460-4995.2	604995	23575	15,6	13.0460-5657.2	605657	25878	13,8
13.0460-4854.2	604854	23756	16,3	13.0460-4996.2	604996	29123	20,3	13.0460-5658.2	605658	25875	15,9
13.0460-4855.2	604855	23325	16,4	13.0460-4997.2	604997	23943	17,5	13.0460-5659.2	605659	24915	17,8
13.0460-4856.2	604856	25147	18,4	13.0460-4998.2	604998	23478	16,5	13.0460-5660.2	605660	25644	15,6
13.0460-4857.2	604857	25172	18,4	13.0460-4999.2	604999	23330	17,0	13.0460-5661.2	605661	25759	17,9
13.0460-4858.2	604858	25112	18,4	13.0460-5405.2	605405	21643	17,8	13.0460-5662.2	605662	22165	20,7
13.0460-4859.2	604859	23921	20,1	13.0460-5409.2	605409	21194	18,0	13.0460-5663.2	605663	25232	14,5
13.0460-4860.2	604860	29121	20,3	13.0460-5410.2	605410	21193	18,0	13.0460-5664.2	605664	25540	14,5
13.0460-4861.2	604861	29121	20,3	13.0460-5600.2	605600	24502	16,7	13.0460-5673.2	605673	22326	18,0
13.0460-4862.2	604862	29123	20,3	13.0460-5601.2	605601	24491	16,0	13.0460-5674.2	605674	22235	15,3
13.0460-4863.2	604863	24976	17,5	13.0460-5602.2	605602	24590	19,0	13.0460-5683.2	605683	25258	14,4
13.0460-4864.2	604864	24455	16,8	13.0460-5603.2	605603	24204	19,2	13.0460-5700.2	605700	24403	17,0
13.0460-4865.2	604865	29160	20,3	13.0460-5604.2	605604	24665	15,2	13.0460-5701.2	605701	20392	18,5
13.0460-4866.2	604866	29229	20,7	13.0460-5605.2	605605	24545	16,9	13.0460-5703.2	605703	21154	19,5
13.0460-4867.2	604867	24852	16,0	13.0460-5606.2	605606	24544	18,1	13.0460-5709.2	605709	24230	15,3
13.0460-4869.2	604869	25183	17,9	13.0460-5607.2	605607	24245	18,5	13.0460-5710.2	605710	23783	14,0
13.0460-4870.2	604870	25179	17,8	13.0460-5608.2	605608	24244	18,5	13.0460-5711.2	605711	23652	15,7
13.0460-4873.2	604873	24847	17,0	13.0460-5609.2	605609	24346	16,4	13.0460-5712.2	605712	23450	17,5
13.0460-4874.2	604874	25029	16,7	13.0460-5610.2	605610	24582	17,4	13.0460-5713.2	605713	21650	15,5
13.0460-4875.2	604875	25028	18,0	13.0460-5611.2	605611	24415	19,1	13.0460-5714.2	605714	23720	17,5
13.0460-4877.2	604877	29192	20,3	13.0460-5612.2	605612	24412	19,0	13.0460-5716.2	605716	21561	17,0
13.0460-4879.2	604879	25643	16,8	13.0460-5613.2	605613	25262	15,0	13.0460-5717.2	605717	23502	16,0
13.0460-4880.2	604880	25997	18,7	13.0460-5614.2	605614	24601	18,0	13.0460-5718.2	605718	23082	18,0
13.0460-4882.2	604882	22102	18,2	13.0460-5615.2	605615	24946	19,0	13.0460-5720.2	605720	20708	14,5



# Vergleichsliste ATE → WVA



Cross reference list ATE → WVA - Lista referencias ATE → WVA - Liste des correspondances ATE → WVA - Tabella di conversione codici ATE → WVA

	WVA D				WVA D				WVA D		
13.0460-5722.2	605722	21468	15,5	13.0460-5797.2	605797	24222	16,9	13.0460-5864.2	605864	21907	15,5
13.0460-5725.2	605725	23649	17,2	13.0460-5799.2	605799	24597	17,7	13.0460-5865.2	605865	23387	12,6
13.0460-5727.2	605727	23160	17,3	13.0460-5800.2	605800	23340	17,0	13.0460-5867.2	605867	23863	14,3
13.0460-5731.2	605731	23343	13,5	13.0460-5801.2	605801	23973	17,1	13.0460-5868.2	605868	23873	15,8
13.0460-5732.2	605732	24029	12,5	13.0460-5802.2	605802	23490	15,4	13.0460-5869.2	605869	24013	14,9
13.0460-5734.2	605734	23967	15,1	13.0460-5803.2	605803	23238	16,0	13.0460-5871.2	605871	23455	13,7
13.0460-5735.2	605735	24014	16,0	13.0460-5804.2	605804	24045	13,7	13.0460-5872.2	605872	21012	15,0
13.0460-5736.2	605736	24215	15,7	13.0460-5806.2	605806	20002	15,0	13.0460-5873.2	605873	23891	16,9
13.0460-5738.2	605738	23702	15,1	13.0460-5807.2	605807	23463	16,6	13.0460-5874.2	605874	21553	14,0
13.0460-5739.2	605739	24071	14,6	13.0460-5808.2	605808	21716	16,0	13.0460-5875.2	605875	24031	17,7
13.0460-5742.2	605742	23966	17,7	13.0460-5809.2	605809	21975	18,2	13.0460-5876.2	605876	24369	17,2
13.0460-5743.2	605743	23928	17,3	13.0460-5810.2	605810	24779	16,5	13.0460-5877.2	605877	24042	16,3
13.0460-5744.2	605744	21947	15,4	13.0460-5811.2	605811	23348	16,5	13.0460-5878.2	605878	23729	16,9
13.0460-5745.2	605745	21775	15,0	13.0460-5812.2	605812	23521	14,0	13.0460-5879.2	605879	23611	18,8
13.0460-5746.2	605746	23524	17,4	13.0460-5813.2	605813	23480	19,3	13.0460-5880.2	605880	23184	14,8
13.0460-5747.2	605747	24024	17,0	13.0460-5814.2	605814	23620	16,4	13.0460-5881.2	605881	21099	17,0
13.0460-5748.2	605748	23429	15,5	13.0460-5815.2	605815	23766	17,8	13.0460-5882.2	605882	23703	17,9
13.0460-5749.2	605749	23539	17,3	13.0460-5816.2	605816	21243	14,0	13.0460-5884.2	605884	23515	15,8
13.0460-5750.2	605750	23734	16,8	13.0460-5817.2	605817	23526	17,5	13.0460-5885.2	605885	23518	17,0
13.0460-5751.2	605751	23503	16,0	13.0460-5819.2	605819	23816	16,0	13.0460-5886.2	605886	24059	16,7
13.0460-5752.2	605752	24632	17,0	13.0460-5820.2	605820	21696	16,3	13.0460-5887.2	605887	23507	15,2
13.0460-5753.2	605753	24638	20,0	13.0460-5821.2	605821	24046	18,6	13.0460-5888.2	605888	23817	16,6
13.0460-5754.2	605754	24635	16,6	13.0460-5822.2	605822	24246	16,8	13.0460-5889.2	605889	21650	15,0
13.0460-5755.2	605755	23178	16,6	13.0460-5824.2	605824	20008	13,0	13.0460-5890.2	605890	23290	15,5
13.0460-5756.2	605756	24087	17,4	13.0460-5825.2	605825	23094	16,5	13.0460-5891.2	605891	23513	17,0
13.0460-5757.2	605757	24518	15,8	13.0460-5826.2	605826	21872	14,5	13.0460-5892.2	605892	21689	15,5
13.0460-5760.2	605760	23584	16,4	13.0460-5827.2	605827	23527	14,5	13.0460-5894.2	605894	23759	17,0
13.0460-5761.2	605761	24297	14,4	13.0460-5829.2	605829	24397	16,0	13.0460-5895.2	605895	23780	16,7
13.0460-5762.2	605762	24298	14,0	13.0460-5830.2	605830	23158	17,5	13.0460-5896.2	605896	23442	15,3
13.0460-5763.2	605763	21730	14,0	13.0460-5831.2	605831	23777	16,0	13.0460-5897.2	605897	21822	17,5
13.0460-5764.2	605764	24350	17,3	13.0460-5832.2	605832	23570	16,5	13.0460-5898.2	605898	21954	15,0
13.0460-5765.2	605765	24338	15,5	13.0460-5833.2	605833	23543	14,4	13.0460-5899.2	605899	23974	17,6
13.0460-5766.2	605766	24337	17,5	13.0460-5834.2	605834	23354	13,0	13.0460-5916.2	605916	20731	15,3
13.0460-5767.2	605767	24336	17,5	13.0460-5835.2	605835	20076	15,5	13.0460-5920.2	605920	21322	15,0
13.0460-5768.2	605768	24347	17,5	13.0460-5836.2	605836	23662	15,0	13.0460-5924.2	605924	21832	14,9
13.0460-5769.2	605769	24610	15,0	13.0460-5837.2	605837	23296	14,5	13.0460-5926.2	605926	21845	16,5
13.0460-5770.2	605770	23983	17,0	13.0460-5838.2	605838	23400	15,5	13.0460-5927.2	605927	21875	16,0
13.0460-5771.2	605771	24599	14,9	13.0460-5839.2	605839	23795	15,0	13.0460-5929.2	605929	21719	15,0
13.0460-5772.2	605772	24179	17,1	13.0460-5840.2	605840	21833	15,0	13.0460-5932.2	605932	21378	15,0
13.0460-5773.2	605773	24058	15,5	13.0460-5841.2	605841	23023	14,8	13.0460-5933.2	605933	21725	16,8
13.0460-5774.2	605774	24830	15,5	13.0460-5842.2	605842	23420	16,5	13.0460-5935.2	605935	20852	15,5
13.0460-5775.2	605775	24276	14,8	13.0460-5843.2	605843	25778	14,3	13.0460-5936.2	605936	21012	15,0
13.0460-5776.2	605776	24275	16,5	13.0460-5844.2	605844	23996	17,5	13.0460-5937.2	605937	21119	17,0
13.0460-5777.2	605777	24351	16,3	13.0460-5845.2	605845	21961	15,5	13.0460-5938.2	605938	21158	15,5
13.0460-5778.2	605778	23698	16,8	13.0460-5846.2	605846	23836	17,0	13.0460-5940.2	605940	21375	16,0
13.0460-5779.2	605779	24317	17,6	13.0460-5847.2	605847	23646	16,5	13.0460-5942.2	605942	21543	16,5
13.0460-5780.2	605780	24320	15,3	13.0460-5848.2	605848	23585	17,4	13.0460-5943.2	605943	21697	15,0
13.0460-5782.2	605782	24488	14,9	13.0460-5849.2	605849	23656	14,0	13.0460-5944.2	605944	21656	15,0
13.0460-5783.2	605783	24227	16,7	13.0460-5850.2	605850	21703	15,0	13.0460-5949.2	605949	21280	16,0
13.0460-5784.2	605784	24240	16,6	13.0460-5851.2	605851	21915	17,2	13.0460-5950.2	605950	21546	16,7
13.0460-5785.2	605785	24510	17,0	13.0460-5852.2	605852	23497	15,0	13.0460-5951.2	605951	21601	17,5
13.0460-5786.2	605786	24934	15,0	13.0460-5853.2	605853	23488	15,4	13.0460-5952.2	605952	21649	16,0
13.0460-5787.2	605787	23865	16,9	13.0460-5854.2	605854	23487	15,5	13.0460-5953.2	605953	21650	15,0
13.0460-5788.2	605788	24498	14,7	13.0460-5855.2	605855	23583	16,0	13.0460-5954.2	605954	23845	15,8
13.0460-5789.2	605789	20325	17,2	13.0460-5856.2	605856	24039	14,4	13.0460-5955.2	605955	21879	18,6
13.0460-5790.2	605790	24323	15,5	13.0460-5857.2	605857	23314	15,0	13.0460-5956.2	605956	21626	15,0
13.0460-5791.2	605791	24220	17,5	13.0460-5859.2	605859	23234	16,9	13.0460-5957.2	605957	21349	17,0
13.0460-5792.2	605792	23536	17,6	13.0460-5860.2	605860	23868	17,1	13.0460-5958.2	605958	21363	15,8
13.0460-5793.2	605793	24372	17,3	13.0460-5861.2	605861	23097	17,1	13.0460-5959.2	605959	21481	15,5
13.0460-5794.2	605794	24283	15,5	13.0460-5862.2	605862	21688	15,3	13.0460-5960.2	605960	20863	16,5
13.0460-5795.2	605795	24353	15,4	13.0460-5863.2	605863	23236	16,8	13.0460-5966.2	605966	21142	15,0



# Vergleichsliste ATE → WVA



Cross reference list ATE → WVA - Lista referencias ATE → WVA - Liste des correspondances ATE → WVA - Tabella di conversione codici ATE → WVA

	WVA D				WVA D				WVA D		
13.0460-5967.2	605967	21500	15,0	13.0460-7080.2	607080	21411	17,5	13.0460-7164.2	607164	23752	17,2
13.0460-5968.2	605968	21781	15,5	13.0460-7081.2	607081	20676	19,8	13.0460-7165.2	607165	21358	19,8
13.0460-5969.2	605969	21948	13,5	13.0460-7083.2	607083	21622	17,3	13.0460-7166.2	607166	23762	20,4
13.0460-5970.2	605970	21355	13,5	13.0460-7084.2	607084	21593	18,8	13.0460-7167.2	607167	23312	20,3
13.0460-5972.2	605972	21559	11,5	13.0460-7085.2	607085	21278	16,9	13.0460-7168.2	607168	21282	17,3
13.0460-5973.2	605973	21766	13,5	13.0460-7086.2	607086	21795	19,8	13.0460-7169.2	607169	23309	17,3
13.0460-5974.2	605974	21539	15,0	13.0460-7087.2	607087	21670	19,3	13.0460-7170.2	607170	23448	20,8
13.0460-5976.2	605976	20870	15,0	13.0460-7088.2	607088	21430	17,3	13.0460-7171.2	607171	23334	16,7
13.0460-5978.2	605978	21495	17,0	13.0460-7089.2	607089	21677	20,3	13.0460-7172.2	607172	23378	20,1
13.0460-5980.2	605980	21706	15,5	13.0460-7090.2	607090	21891	17,3	13.0460-7173.2	607173	21829	20,3
13.0460-5981.2	605981	21840	14,4	13.0460-7091.2	607091	23115	19,8	13.0460-7174.2	607174	23732	17,3
13.0460-5982.2	605982	21651	17,5	13.0460-7100.2	607100	21866	17,2	13.0460-7176.2	607176	23793	20,3
13.0460-5983.2	605983	21713	16,5	13.0460-7101.2	607101	21868	15,3	13.0460-7177.2	607177	23395	13,7
13.0460-5985.2	605985	21334	15,0	13.0460-7102.2	607102	21883	19,8	13.0460-7178.2	607178	23394	13,7
13.0460-5986.2	605986	21545	14,9	13.0460-7105.2	607105	23140	19,4	13.0460-7179.2	607179	23832	20,2
13.0460-5987.2	605987	23080	15,0	13.0460-7107.2	607107	21278	16,4	13.0460-7180.2	607180	24067	19,3
13.0460-5988.2	605988	23004	15,9	13.0460-7108.2	607108	23228	18,1	13.0460-7181.2	607181	21637	19,3
13.0460-5989.2	605989	23454	14,9	13.0460-7110.2	607110	20676	19,8	13.0460-7182.2	607182	23896	20,6
13.0460-5992.2	605992	21679	15,0	13.0460-7111.2	607111	23131	19,6	13.0460-7183.2	607183	21484	20,5
13.0460-5993.2	605993	23237	14,5	13.0460-7112.2	607112	21637	19,3	13.0460-7184.2	607184	23589	20,6
13.0460-5994.2	605994	23234	16,8	13.0460-7113.2	607113	23218	18,0	13.0460-7185.2	607185	20968	20,3
13.0460-5995.2	605995	21558	13,0	13.0460-7114.2	607114	21930	17,9	13.0460-7186.2	607186	23440	17,6
13.0460-5996.2	605996	23241	16,1	13.0460-7115.2	607115	23064	17,5	13.0460-7187.2	607187	23590	19,5
13.0460-5998.2	605998	21314	12,8	13.0460-7116.2	607116	23057	20,2	13.0460-7188.2	607188	24142	20,6
13.0460-6015.2	606015	29835	22,0	13.0460-7117.2	607117	23130	19,6	13.0460-7189.2	607189	24011	18,7
13.0460-6033.2	606033	21064	20,3	13.0460-7121.2	607121	23154	19,0	13.0460-7190.2	607190	24556	19,1
13.0460-6036.2	606036	21304	18,5	13.0460-7122.2	607122	21911	20,3	13.0460-7191.2	607191	23749	19,1
13.0460-6914.2	606914	20038	14,0	13.0460-7123.2	607123	23034	18,8	13.0460-7193.2	607193	23723	18,1
13.0460-6916.2	606916	21459	18,5	13.0460-7124.2	607124	21883	19,8	13.0460-7194.2	607194	23482	16,6
13.0460-6917.2	606917	21238	15,5	13.0460-7125.2	607125	21930	17,9	13.0460-7195.2	607195	23482	16,6
13.0460-6921.2	606921	24974	16,8	13.0460-7126.2	607126	20907	18,1	13.0460-7196.2	607196	21576	20,7
13.0460-6922.2	606922	21459	17,5	13.0460-7128.2	607128	23218	18,0	13.0460-7199.2	607199	23404	20,6
13.0460-6923.2	606923	23471	14,5	13.0460-7129.2	607129	23229	18,1	13.0460-7200.2	607200	23801	20,3
13.0460-6924.2	606924	23471	17,5	13.0460-7131.2	607131	21193	18,0	13.0460-7201.2	607201	23801	20,3
13.0460-6925.2	606925	21519	17,8	13.0460-7132.2	607132	23218	18,0	13.0460-7202.2	607202	23589	19,1
13.0460-6926.2	606926	20359	19,2	13.0460-7133.2	607133	21927	17,9	13.0460-7203.2	607203	21670	19,3
13.0460-7030.2	607030	20889	17,3	13.0460-7134.2	607134	21278	16,4	13.0460-7204.2	607204	23801	18,8
13.0460-7032.2	607032	20887	19,7	13.0460-7135.2	607135	23077	17,5	13.0460-7205.2	607205	23787	19,0
13.0460-7033.2	607033	20887	15,3	13.0460-7137.2	607137	23483	15,8	13.0460-7206.2	607206	23631	17,8
13.0460-7040.2	607040	20907	18,0	13.0460-7138.2	607138	23126	17,5	13.0460-7207.2	607207	23807	18,6
13.0460-7050.2	607050	20676	19,5	13.0460-7139.2	607139	24095	19,4	13.0460-7209.2	607209	24137	16,6
13.0460-7051.2	607051	21353	16,5	13.0460-7140.2	607140	23289	19,3	13.0460-7210.2	607210	23791	20,8
13.0460-7052.2	607052	21190	17,5	13.0460-7141.2	607141	20907	18,1	13.0460-7211.2	607211	24339	20,5
13.0460-7053.2	607053	21273	19,5	13.0460-7142.2	607142	23202	18,3	13.0460-7212.2	607212	23738	20,1
13.0460-7056.2	607056	21396	17,5	13.0460-7143.2	607143	21848	19,8	13.0460-7213.2	607213	24022	17,8
13.0460-7057.2	607057	21394	17,5	13.0460-7144.2	607144	23112	19,1	13.0460-7214.2	607214	24574	15,0
13.0460-7058.2	607058	21430	17,3	13.0460-7145.2	607145	23073	18,8	13.0460-7215.2	607215	23935	17,8
13.0460-7059.2	607059	20887	17,3	13.0460-7146.2	607146	20147	17,0	13.0460-7216.2	607216	23968	20,3
13.0460-7061.2	607061	21276	17,0	13.0460-7147.2	607147	21285	19,1	13.0460-7217.2	607217	23926	17,3
13.0460-7063.2	607063	21193	18,0	13.0460-7148.2	607148	23200	18,0	13.0460-7218.2	607218	24645	19,1
13.0460-7064.2	607064	21932	17,9	13.0460-7153.2	607153	23269	19,8	13.0460-7219.2	607219	23923	17,6
13.0460-7065.2	607065	21929	17,9	13.0460-7154.2	607154	23034	18,8	13.0460-7220.2	607220	23922	21,0
13.0460-7067.2	607067	21929	17,9	13.0460-7155.2	607155	21676	20,3	13.0460-7221.2	607221	23215	18,3
13.0460-7069.2	607069	21637	19,3	13.0460-7156.2	607156	23418	19,4	13.0460-7222.2	607222	23245	18,3
13.0460-7071.2	607071	20640	17,5	13.0460-7157.2	607157	23215	18,3	13.0460-7223.2	607223	23794	20,3
13.0460-7072.2	607072	21868	19,7	13.0460-7158.2	607158	23245	18,3	13.0460-7224.2	607224	23397	19,4
13.0460-7073.2	607073	21202	16,9	13.0460-7159.2	607159	23245	18,3	13.0460-7225.2	607225	23550	17,3
13.0460-7076.2	607076	21848	19,8	13.0460-7160.2	607160	23482	15,8	13.0460-7226.2	607226	23587	20,8
13.0460-7077.2	607077	20676	19,8	13.0460-7161.2	607161	23281	18,3	13.0460-7227.2	607227	23801	20,3
13.0460-7078.2	607078	21486	19,5	13.0460-7162.2	607162	23716	15,8	13.0460-7228.2	607228	24124	19,3
13.0460-7079.2	607079	21487	17,3	13.0460-7163.2	607163	21358	19,8	13.0460-7229.2	607229	24538	18,5



# Vergleichsliste ATE → WVA



Cross reference list ATE → WVA - Lista referencias ATE → WVA - Liste des correspondances ATE → WVA - Tabella di conversione codici ATE → WVA

	WVA D				WVA D				WVA D		
13.0460-7230.2	607230	24557	19,4	13.0460-7295.2	607295	25968	16,1	13.0470-2733.2	LD2733	24306	20,3
13.0460-7231.2	607231	24170	20,2	13.0460-7296.2	607296	23212	20,3	13.0470-2734.2	LD2734	24310	19,0
13.0460-7232.2	607232	21282	17,3	13.0460-7298.2	607298	25702	18,2	13.0470-2736.2	LD2736	24496	17,3
13.0460-7234.2	607234	24438	16,1	13.0460-7300.2	607300	25833	17,3	13.0470-2740.2	LD2740	23554	17,0
13.0460-7235.2	607235	24671	18,0	13.0460-7301.2	607301	25841	16,1	13.0470-2746.2	LD2746	24408	19,2
13.0460-7236.2	607236	23746	19,7	13.0460-7302.2	607302	24727	20,7	13.0470-2747.2	LD2747	24606	17,4
13.0460-7237.2	607237	23347	20,3	13.0460-7303.2	607303	22035	17,5	13.0470-2748.2	LD2748	24606	17,4
13.0460-7238.2	607238	23313	20,3	13.0460-7304.2	607304	25353	16,2	13.0470-2749.2	LD2749	24483	16,9
13.0460-7239.2	607239	24172	19,0	13.0460-7305.2	607305	25836	17,0	13.0470-2755.2	LD2755	24421	17,2
13.0460-7240.2	607240	23746	18,1	13.0460-7306.2	607306	23312	20,3	13.0470-2758.2	LD2758	24421	17,2
13.0460-7241.2	607241	20547	16,5	13.0460-7307.2	607307	22601	16,4	13.0470-2760.2	LD2760	24561	17,7
13.0460-7242.2	607242	24333	21,3	13.0460-7308.2	607308	22123	18,2	13.0470-2764.2	LD2764	24738	20,0
13.0460-7243.2	607243	24521	19,1	13.0460-7309.2	607309	25098	17,0	13.0470-2765.2	LD2765	24743	19,2
13.0460-7244.2	607244	24253	17,8	13.0460-7310.2	607310	22143	17,5	13.0470-2767.2	LD2767	25156	17,4
13.0460-7245.2	607245	23749	19,1	13.0460-7311.2	607311	24538	19,0	13.0470-2768.2	LD2768	23811	17,7
13.0460-7246.2	607246	21275	17,0	13.0460-7313.2	607313	25592	20,3	13.0470-2769.2	LD2769	24606	17,4
13.0460-7248.2	607248	23215	17,5	13.0460-7314.2	607314	22383	17,3	13.0470-2770.2	LD2770	24606	17,4
13.0460-7249.2	607249	24709	18,6	13.0460-7315.2	607315	25331	16,2	13.0470-2773.2	LD2773	24606	17,4
13.0460-7250.2	607250	24709	17,5	13.0460-7316.2	607316	22423	16,4	13.0470-2776.2	LD2776	23070	17,0
13.0460-7251.2	607251	23482	15,8	13.0460-7320.2	607320	22231	16,1	13.0470-2778.2	LD2778	25326	19,3
13.0460-7252.2	607252	24084	19,3	13.0460-7324.2	607324	22345	19,7	13.0470-2779.2	LD2779	24869	19,3
13.0460-7253.2	607253	24137	15,8	13.0460-7325.2	607325	22342	19,8	13.0470-2781.2	LD2781	25215	18,6
13.0460-7255.2	607255	25114	15,8	13.0460-7326.2	607326	22141	15,5	13.0470-2784.2	LD2784	25134	17,2
13.0460-7256.2	607256	24706	21,3	13.0460-7327.2	607327	22387	19,5	13.0470-2785.2	LD2785	25683	20,4
13.0460-7257.2	607257	24253	18,0	13.0460-7328.2	607328	22317	18,8	13.0470-2786.2	LD2786	24848	18,3
13.0460-7259.2	607259	24862	16,7	13.0460-7330.2	607330	22145	18,6	13.0470-2789.2	LD2789	25652	17,1
13.0460-7260.2	607260	24458	17,3	13.0460-7331.2	607331	22593	18,0	13.0470-2790.2	LD2790	25110	17,5
13.0460-7261.2	607261	24436	19,7	13.0460-7903.2	607903	20465	18,0	13.0470-2792.2	LD2792	22032	19,6
13.0460-7262.2	607262	25031	19,1	13.0460-7906.2	607906	29003	20,0	13.0470-2795.2	LD2795	23915	17,6
13.0460-7263.2	607263	24034	19,1	13.0460-7909.2	607909	29153	20,0	13.0470-2797.2	LD2797	25980	16,8
13.0460-7264.2	607264	25096	17,0	13.0460-8002.2	608002	23358	18,0	13.0470-2799.2	LD2799	25643	18,1
13.0460-7265.2	607265	24727	20,7	13.0460-8003.2	608003	23043	16,0	13.0470-2820.2	LD2820	20961	17,2
13.0460-7266.2	607266	24538	17,9	13.0460-8004.2	608004	23193	16,4	13.0470-2833.2	LD2833	23070	17,0
13.0460-7267.2	607267	25046	18,5	13.0460-8005.2	608005	23190	16,7	13.0470-2837.2	LD2837	21945	19,6
13.0460-7268.2	607268	23794	20,3	13.0460-8006.2	608006	20660	15,6	13.0470-2845.2	LD2845	23554	16,4
13.0460-7269.2	607269	24339	19,5	13.0460-8007.2	608007	23189	16,7	13.0470-2855.2	LD2855	23138	14,6
13.0460-7270.2	607270	24673	18,0	13.0460-8008.2	608008	24036	16,7	13.0470-2857.2	LD2857	23225	17,0
13.0460-7271.2	607271	24151	21,0	13.0460-8010.2	608010	23561	18,1	13.0470-2858.2	LD2858	23284	14,0
13.0460-7272.2	607272	24399	20,4	13.0460-8011.2	608011	23361	14,2	13.0470-2860.2	LD2860	23554	16,4
13.0460-7273.2	607273	24538	19,4	13.0460-8013.2	608013	24604	16,5	13.0470-2867.2	LD2867	23517	16,6
13.0460-7274.2	607274	23731	17,3	13.0460-8014.2	608014	25632	15,5	13.0470-2868.2	LD2868	23417	15,3
13.0460-7275.2	607275	23313	20,2	13.0460-9033.2	609033	21303	18,9	13.0470-2877.2	LD2877	23554	17,2
13.0460-7276.2	607276	25222	17,3	13.0460-9037.2	609037	20309	17,9	13.0470-2879.2	LD2879	23601	13,7
13.0460-7277.2	607277	24084	19,3	13.0470-2610.2	LD2610	22076	19,6	13.0470-2880.2	LD2880	23914	17,1
13.0460-7278.2	607278	25218	16,6	13.0470-2613.2	LD2613	22187	18,6	13.0470-2884.2	LD2884	23581	18,8
13.0460-7279.2	607279	25069	17,3	13.0470-2621.2	LD2621	24483	16,9	13.0470-2885.2	LD2885	24077	19,1
13.0460-7280.2	607280	25158	20,3	13.0470-2707.2	LD2707	23760	17,7	13.0470-2886.2	LD2886	20961	16,0
13.0460-7281.2	607281	25161	20,3	13.0470-2708.2	LD2708	23881	20,0	13.0470-2887.2	LD2887	23914	17,1
13.0460-7282.2	607282	25192	21,3	13.0470-2709.2	LD2709	23973	17,1	13.0470-2888.2	LD2888	23326	17,4
13.0460-7283.2	607283	25531	19,3	13.0470-2710.2	LD2710	23915	17,6	13.0470-2891.2	LD2891	24134	19,6
13.0460-7284.2	607284	25804	17,3	13.0470-2711.2	LD2711	24077	19,1	13.0470-2892.2	LD2892	24133	18,6
13.0460-7285.2	607285	23587	20,6	13.0470-2712.2	LD2712	23138	14,6	13.0470-2893.2	LD2893	24135	17,7
13.0460-7286.2	607286	24623	18,2	13.0470-2713.2	LD2713	23623	17,4	13.0470-2894.2	LD2894	20961	17,2
13.0460-7287.2	607287	25265	16,6	13.0470-2714.2	LD2714	24289	16,9	13.0470-2927.2	LD2927	20941	19,3
13.0460-7288.2	607288	25429	17,5	13.0470-2716.2	LD2716	24703	17,8	13.0470-2975.2	LD2975	21439	20,3
13.0460-7289.2	607289	25323	17,3	13.0470-2722.2	LD2722	24496	17,3	13.0470-3605.2	LD3605	20180	17,3
13.0460-7290.2	607290	24574	15,0	13.0470-2723.2	LD2723	24537	16,1	13.0470-3805.2	LD3805	21197	15,0
13.0460-7291.2	607291	24796	17,7	13.0470-2725.2	LD2725	23984	17,8	13.0470-3813.2	LD3813	24150	17,6
13.0460-7292.2	607292	24084	19,3	13.0470-2726.2	LD2726	23144	19,8	13.0470-3814.2	LD3814	23934	18,2
13.0460-7293.2	607293	25008	16,3	13.0470-2727.2	LD2727	23145	19,8	13.0470-3815.2	LD3815	23930	18,2
13.0460-7294.2	607294	25009	16,4	13.0470-2732.2	LD2732	24306	20,3	13.0470-3826.2	LD3826	23706	18,0



# Vergleichsliste ATE → WVA

Cross reference list ATE → WVA - Lista referencias ATE → WVA - Liste des correspondances ATE → WVA - Tabella di conversione codici ATE → WVA

	WVA D				WVA D				WVA D		
13.0470-3827.2	LD3827	23709	19,6	13.0470-5651.2	LD5651	24915	17,4	13.0470-7223.2	LD7223	23794	20,3
13.0470-3828.2	LD3828	24349	17,5	13.0470-5664.2	LD5664	25540	14,5	13.0470-7225.2	LD7225	23550	17,3
13.0470-3831.2	LD3831	24260	17,3	13.0470-5752.2	LD5752	24632	17,0	13.0470-7226.2	LD7226	23587	20,8
13.0470-3836.2	LD3836	24540	16,3	13.0470-5786.2	LD5786	24934	15,0	13.0470-7227.2	LD7227	23801	20,4
13.0470-3838.2	LD3838	21436	17,0	13.0470-7053.2	LD7053	21273	19,5	13.0470-7228.2	LD7228	24123	20,3
13.0470-3839.2	LD3839	23707	17,9	13.0470-7078.2	LD7078	21486	19,5	13.0470-7229.2	LD7229	24538	18,5
13.0470-3840.2	LD3840	23981	19,6	13.0470-7079.2	LD7079	21282	17,3	13.0470-7230.2	LD7230	24557	19,4
13.0470-3846.2	LD3846	24072	17,9	13.0470-7081.2	LD7081	20676	19,8	13.0470-7231.2	LD7231	24170	20,2
13.0470-3847.2	LD3847	24660	17,8	13.0470-7086.2	LD7086	21664	19,8	13.0470-7232.2	LD7232	23447	17,3
13.0470-3852.2	LD3852	24867	20,7	13.0470-7087.2	LD7087	21670	19,3	13.0470-7237.2	LD7237	23347	20,3
13.0470-3855.2	LD3855	24883	18,0	13.0470-7089.2	LD7089	21676	20,3	13.0470-7238.2	LD7238	23313	20,3
13.0470-3857.2	LD3857	25199	19,6	13.0470-7090.2	LD7090	21691	17,3	13.0470-7239.2	LD7239	24172	19,0
13.0470-3858.2	LD3858	24563	17,7	13.0470-7100.2	LD7100	21866	17,2	13.0470-7242.2	LD7242	24332	19,8
13.0470-3859.2	LD3859	25307	17,5	13.0470-7110.2	LD7110	20676	19,8	13.0470-7243.2	LD7243	24142	20,6
13.0470-3860.2	LD3860	24484	18,8	13.0470-7111.2	LD7111	23130	19,6	13.0470-7244.2	LD7244	24253	17,8
13.0470-3865.2	LD3865	25014	18,2	13.0470-7115.2	LD7115	23063	17,5	13.0470-7249.2	LD7249	24709	18,6
13.0470-3866.2	LD3866	25506	18,2	13.0470-7116.2	LD7116	23058	19,6	13.0470-7251.2	LD7251	23482	15,8
13.0470-3869.2	LD3869	25250	18,9	13.0470-7117.2	LD7117	23130	19,6	13.0470-7252.2	LD7252	24084	19,3
13.0470-3870.2	LD3870	25895	18,5	13.0470-7122.2	LD7122	20676	19,8	13.0470-7256.2	LD7256	24705	19,8
13.0470-3871.2	LD3871	25839	17,8	13.0470-7135.2	LD7135	23077	17,5	13.0470-7257.2	LD7257	24253	18,0
13.0470-3872.2	LD3872	25827	17,7	13.0470-7137.2	LD7137	23482	15,8	13.0470-7259.2	LD7259	24862	16,7
13.0470-3966.2	LD3966	23600	19,4	13.0470-7139.2	LD7139	23140	19,4	13.0470-7262.2	LD7262	25031	19,1
13.0470-3982.2	LD3982	23705	18,1	13.0470-7140.2	LD7140	21637	19,3	13.0470-7263.2	LD7263	24034	19,1
13.0470-3983.2	LD3983	23708	19,4	13.0470-7145.2	LD7145	23073	18,8	13.0470-7264.2	LD7264	25096	17,0
13.0470-3984.2	LD3984	23711	19,4	13.0470-7155.2	LD7155	21676	20,3	13.0470-7266.2	LD7266	24538	17,9
13.0470-3987.2	LD3987	23279	18,4	13.0470-7157.2	LD7157	23215	18,3	13.0470-7267.2	LD7267	25045	19,5
13.0470-3988.2	LD3988	23557	17,2	13.0470-7158.2	LD7158	23245	18,3	13.0470-7268.2	LD7268	23794	20,3
13.0470-3994.2	LD3994	23599	19,0	13.0470-7159.2	LD7159	23245	18,3	13.0470-7269.2	LD7269	24339	19,5
13.0470-3999.2	LD3999	23743	20,1	13.0470-7161.2	LD7161	23281	18,3	13.0470-7273.2	LD7273	24538	19,4
13.0470-4044.2	LD4044	20755	15,1	13.0470-7162.2	LD7162	23716	15,8	13.0470-7275.2	LD7275	23313	20,2
13.0470-4047.2	LD4047	21305	15,7	13.0470-7166.2	LD7166	23762	20,4	13.0470-7279.2	LD7279	25069	17,3
13.0470-4064.2	LD4064	21919	15,3	13.0470-7167.2	LD7167	23312	20,3	13.0470-7280.2	LD7280	25158	20,3
13.0470-4065.2	LD4065	21899	15,3	13.0470-7168.2	LD7168	21282	17,3	13.0470-7281.2	LD7281	25160	20,3
13.0470-4803.2	LD4803	23092	15,6	13.0470-7169.2	LD7169	23309	17,3	13.0470-7282.2	LD7282	25190	21,3
13.0470-4814.2	LD4814	21937	15,5	13.0470-7171.2	LD7171	23334	16,7	13.0470-7285.2	LD7285	23587	20,6
13.0470-4833.2	LD4833	24098	17,1	13.0470-7172.2	LD7172	23378	20,1	13.0470-7288.2	LD7288	25429	17,5
13.0470-4834.2	LD4834	24097	17,1	13.0470-7174.2	LD7174	23732	17,3	13.0470-7293.2	LD7293	25008	16,3
13.0470-4850.2	LD4850	24296	15,5	13.0470-7176.2	LD7176	23793	20,3	13.0470-7294.2	LD7294	25009	16,4
13.0470-4851.2	LD4851	23092	16,0	13.0470-7179.2	LD7179	23832	20,2	13.0470-7295.2	LD7295	25968	16,1
13.0470-4853.2	LD4853	24162	15,2	13.0470-7181.2	LD7181	21636	19,3	13.0470-7296.2	LD7296	23212	20,3
13.0470-4854.2	LD4854	23092	16,3	13.0470-7184.2	LD7184	23589	20,6	13.0470-7298.2	LD7298	25702	18,2
13.0470-4867.2	LD4867	24852	16,0	13.0470-7187.2	LD7187	23590	19,5	13.0470-7299.2	LD7299	25737	18,4
13.0470-4875.2	LD4875	25028	18,0	13.0470-7188.2	LD7188	24141	19,1	13.0470-7300.2	LD7300	25833	17,3
13.0470-4879.2	LD4879	25643	17,0	13.0470-7190.2	LD7190	24556	19,1	13.0470-7301.2	LD7301	25841	16,1
13.0470-4880.2	LD4880	25997	18,7	13.0470-7191.2	LD7191	23749	19,1	13.0470-7303.2	LD7303	22035	17,5
13.0470-4882.2	LD4882	22102	18,2	13.0470-7193.2	LD7193	23723	18,1	13.0470-7304.2	LD7304	25353	16,2
13.0470-4883.2	LD4883	22061	18,7	13.0470-7194.2	LD7194	23482	16,6	13.0470-7305.2	LD7305	25836	17,0
13.0470-4884.2	LD4884	22062	20,7	13.0470-7195.2	LD7195	23482	16,6	13.0470-7309.2	LD7309	25097	17,0
13.0470-4971.2	LD4971	23092	16,0	13.0470-7200.2	LD7200	23801	20,3	13.0470-7314.2	LD7314	22383	17,3
13.0470-4976.2	LD4976	23694	16,4	13.0470-7201.2	LD7201	23950	20,3	13.0470-7315.2	LD7315	25331	16,2
13.0470-4977.2	LD4977	23157	15,8	13.0470-7202.2	LD7202	23589	19,1	13.0470-7316.2	LD7316	22423	16,4
13.0470-4984.2	LD4984	23271	17,4	13.0470-7203.2	LD7203	21670	19,3	13.0470-7320.2	LD7320	22231	16,1
13.0470-4990.2	LD4990	23271	17,4	13.0470-7204.2	LD7204	23801	18,8	13.0470-7324.2	LD7324	22345	19,7
13.0470-4992.2	LD4992	23692	16,6	13.0470-7210.2	LD7210	23791	20,8	13.0470-7325.2	LD7325	22342	19,8
13.0470-4993.2	LD4993	23693	16,6	13.0470-7211.2	LD7211	24339	20,5	13.0470-7327.2	LD7327	22386	19,0
13.0470-4994.2	LD4994	23945	16,5	13.0470-7215.2	LD7215	23935	17,8	13.0470-7333.2	LD7333	22141	16,5
13.0470-5405.2	LD5405	21643	17,8	13.0470-7216.2	LD7216	23794	20,3	13.0470-9000.2	LD9000	24306	20,3
13.0470-5611.2	LD5611	24415	19,1	13.0470-7217.2	LD7217	23926	17,3	13.0470-9001.2	LD9001	24862	16,7
13.0470-5612.2	LD5612	24412	19,0	13.0470-7219.2	LD7219	23923	17,6				
13.0470-5634.2	LD5634	24452	17,5	13.0470-7220.2	LD7220	23922	21,0				
13.0470-5635.2	LD5635	24918	15,0	13.0470-7221.2	LD7221	23215	18,3				





**DE** Technische Übersetzungen

**EN** Technical translations

**ES** Traducciones técnicas

**FR** Traductions techniques

**IT** Traduzioni tecniche

**2019**



# Technische Übersetzungen

Technical translations - Traducciones técnicas - Traductions techniques - Traduzioni tecniche

DE		DE	
	Bremsbelagsatz, Scheibenbremse	<b>ABE</b>	mit Allgemeiner Betriebserlaubnis (ABE)
	Bremsscheibe	<b>Abmessungen beachten</b>	Abmessungen beachten
	Hinterachse links	<b>- ABS</b>	für Fahrzeuge ohne ABS nicht für ABS
	Hinterachse rechts	<b>- ABS Ring</b>	ohne ABS-Sensorring
	Vorderachse links	<b>Achsnummer</b>	Achsnummer
	Vorderachse rechts	<b>Achszapfendurchmesser [mm]</b>	Achszapfendurchmesser [mm]
<b>+ ABS</b>	für Fahrzeuge mit ABS für ABS	<b>Adapter, Bremsleitung</b>	Adapter, Bremsleitung
<b>+ ABS Ring</b>	mit ABS-Sensorring	<b>ADV</b>	Bremssystem, Advics
<b>+ ASR</b>	für Fahrzeuge mit ASR	<b>AIS</b>	Bremssystem, Aisin
<b>+ D</b>	Deutschland	<b>AKE</b>	Bremssystem, Akebono
<b>+ eFSB</b>	für Fahrzeuge mit elektronischer Feststellbremse	<b>Allrad</b>	Allrad
<b>+ ESP</b>	für Fahrzeuge mit ESP	<b>ALU</b>	Bremssattel aus Aluminium
<b>+ ETS</b>	für Fahrzeuge mit ETS	<b>Anschlussgewinde</b>	Anschlussgewinde
<b>+ EU</b>	Europa	<b>Anschluss links</b>	Anschluss links
<b>+ J</b>	Japan	<b>Anschluss rechts</b>	Anschluss rechts
<b>+ LG</b>	mit Lager	<b>Anschlussstutzen, Schlauchleitung</b>	Anschlussstutzen, Schlauchleitung
<b>+ Performance Parts</b>	für Fahrzeuge mit Performance Bremse	<b>Anzahl der Bohrungen</b>	Anzahl der Bohrungen
<b>+POC</b>	für POC	<b>Anzahl Sitzplätze</b>	Anzahl Sitzplätze
<b>+PR</b>	für PR-Nummer	<b>AP</b>	Bremssystem, AP Lockheed
<b>+ RO</b>	Rumänien	<b>Artikelnummer des empfohlenen Zubehörs</b>	Artikelnummer des empfohlenen Zubehörs
<b>+ RUS</b>	Russland	<b>- ASR</b>	für Fahrzeuge ohne ASR
<b>+ S</b>	mit Schrauben	<b>ATE Ceramic</b>	Artikelzusatzbezeichnung, ATE Ceramic
<b>+SA</b>	für SA Code	<b>außenbelüftet</b>	außenbelüftet
<b>+ SKA</b>	Skandinavien	<b>Außendurchmesser [mm]</b>	Außendurchmesser [mm]
<b>+ TR</b>	Türkei		
<b>+ USA</b>	USA		
<b>+ WE</b>	für Verschleißwarnanzeiger vorbereitet		
<b>+ WK</b>	inkl. Verschleißwarnkontakt mit integriertem Verschleißwarnkontakt mit akustischer Verschleißwarnung		
<b>+ Zub</b>	mit Zubehör		



# Technische Übersetzungen

Technical translations - Traducciones técnicas - Traductions techniques - Traduzioni tecniche

DE		DE	
<b>Automatikgetriebe</b>	Automatikgetriebe	<b>China</b>	China
<b>B</b>	beschichtet	<b>China-made</b>	China
<b>B1=</b>	Breite 1 [mm]	<b>CIT</b>	Bremssystem, Citroen
<b>B2=</b>	Breite 2 [mm]	<b>CVT-Automatikgetriebe (Stufenlos)</b>	CVT-Automatikgetriebe (Stufenlos)
<b>Baumuster</b>	Baumuster	<b>- D</b>	Deutschland
<b>BDX</b>	Bremssystem, Bendix	<b>Dichtung, Unterdruck-Anschlussstutzen BKV</b>	Dichtung, Unterdruck-Anschlussstutzen BKV
<b>Bearbeitung</b>	Bearbeitung	<b>DIN/ISO</b>	DIN/ISO
<b>Bohrung-Ø 1 [mm]</b>	Bohrung-Ø 1 [mm]	<b>DIN 74235 Form EL</b>	DIN 74235 Form EL
<b>Bohrung-Ø 2 [mm]</b>	Bohrung-Ø 2 [mm]	<b>DIN 74235 Form FL</b>	DIN 74235 Form FL
<b>Bördelform</b>	Bördelform	<b>DOHC</b>	DOHC
<b>BOS</b>	Bremssystem, Bosch	<b>Doppelquerlenkerachse</b>	Doppelquerlenkerachse
<b>BRE</b>	Bremssystem, Brembo	<b>Durchmesser Aufnahme [mm]</b>	Durchmesser Aufnahme [mm]
<b>Brems-/Fahr dyn. Artikelbezug</b>	Brems-/Fahr dyn. Artikelbezug	<b>E</b>	E
<b>Bremsbelagsatz, Scheibenbremse</b>	Bremsbelagsatz, Scheibenbremse	<b>- eFSB</b>	für Fahrzeuge ohne elektronische Feststellbremse
<b>Bremsleitung</b>	Bremsleitung	<b>einteilig</b>	einteilig
<b>Bremsattel(1-Kolben)</b>	Bremsattel(1-Kolben)	<b>Einzelradaufhängung</b>	Einzelradaufhängung
<b>Bremsattel(2-Kolben)</b>	Bremsattel(2-Kolben)	<b>elektrisch-hydraulisch</b>	elektrisch-hydraulisch
<b>Bremsattel(4-Kolben)</b>	Bremsattel(4-Kolben)	<b>Entlüfterschraube/-ventil</b>	Entlüfterschraube/-ventil
<b>Bremssattelfarbe</b>	Bremssattelfarbe	<b>EPDM (Ethylen-Propylen-Dien-Kautschuk)</b>	EPDM (Ethylen-Propylen-Dien-Kautschuk)
<b>Bremssattel mit 1 Haltestift</b>	Bremssattel mit 1 Haltestift	<b>- ESP</b>	für Fahrzeuge ohne ESP
<b>Bremssattel mit 2 Haltestiften</b>	Bremssattel mit 2 Haltestiften	<b>- ETS</b>	für Fahrzeuge ohne ETS
<b>Bremscheibe</b>	Bremscheibe	<b>Europa</b>	Europa
<b>Bremscheibe zweiteilig</b>	Bremscheibe zweiteilig	<b>F</b>	F
<b>- CDN</b>	Kanada	<b>Felge Lochzahl</b>	Felge Lochzahl

# Technische Übersetzungen

Technical translations - Traducciones tecnicas - Traductions techniques - Traduzioni tecniche

DE		DE	
<b>Felgengröße [Zoll]</b>	Felgengröße [Zoll]	<b>für Fahrzeuge mit Active City Stop</b>	für Fahrzeuge mit Active City Stop
<b>Flachstecker</b>	Flachstecker		
<b>Flanschbefestigung</b>	Flanschbefestigung	<b>für Fahrzeuge mit AMG-Sportpaket</b>	für Fahrzeuge mit AMG-Sportpaket
<b>FPM (Fluor-Kautschuk)/ACM (Polyacryl-Kautschuk)</b>	FPM (Fluor-Kautschuk)/ACM (Polyacryl-Kautschuk)	<b>für Fahrzeuge mit Bremsassistent</b>	für Fahrzeuge mit Bremsassistent
<b>Frankreich</b>	Frankreich		
<b>Frontantrieb</b>	Frontantrieb	<b>für Fahrzeuge mit elektr. Dämpferregulierung</b>	für Fahrzeuge mit elektr. Dämpferregulierung
<b>für Automatikgetriebe</b>	für Automatikgetriebe		
<b>für Behördenfahrzeuge</b>	für Behördenfahrzeuge	<b>für Fahrzeuge mit Keramikbremse</b>	für Fahrzeuge mit Keramikbremse
<b>für Bremsattel mit Kunststoffkolben</b>	für Bremsattel mit Kunststoffkolben	<b>für Fahrzeuge mit Klimaanlage</b>	für Fahrzeuge mit Klimaanlage
<b>für Bremsattel mit Stahlkolben</b>	für Bremsattel mit Stahlkolben	<b>für Fahrzeuge mit Niveauregulierung</b>	für Fahrzeuge mit Niveauregulierung
<b>für Bremscheibendicke [mm]</b>	für Bremscheibendicke [mm]	<b>für Fahrzeuge mit Panorama-Sonnendach</b>	für Fahrzeuge mit Panorama-Sonnendach
<b>für Bremscheibendurchmesser [mm]</b>	für Bremscheibendurchmesser [mm]	<b>für Fahrzeuge mit PCS (Pre-Crash Safety System)</b>	für Fahrzeuge mit PCS (Pre-Crash Safety System)
<b>für Bremscheibendurchmesser [Zoll]</b>	für Bremscheibendurchmesser [Zoll]	<b>für Fahrzeuge mit Scheibenbremse an der Hinterachse</b>	für Fahrzeuge mit Scheibenbremse an der Hinterachse
<b>für Doppelbereifung</b>	für Doppelbereifung		
<b>für Einfachbereifung</b>	für Einfachbereifung		
<b>für erhöhte Nutzlast</b>	für erhöhte Nutzlast	<b>für Fahrzeuge mit Schlechtwegeausführung</b>	für Fahrzeuge mit Schlechtwegeausführung
<b>für ESP</b>	für ESP		
<b>für Fahrzeuge mit 3. Sitzreihe</b>	für Fahrzeuge mit 3. Sitzreihe		



# Technische Übersetzungen

Technical translations - Traducciones técnicas - Traductions techniques - Traduzioni tecniche

DE		DE	
für Fahrzeuge mit Servolenkung	für Fahrzeuge mit Servolenkung	für Fahrzeuge ohne Bordcomputer	für Fahrzeuge ohne Bordcomputer
für Fahrzeuge mit Sportfahrwerk	für Fahrzeuge mit Sportfahrwerk	für Fahrzeuge ohne Bremsassistent	für Fahrzeuge ohne Bremsassistent
für Fahrzeuge mit Sportpaket	für Fahrzeuge mit Sportpaket	für Fahrzeuge ohne elektr. Dämpferregulierung	für Fahrzeuge ohne elektr. Dämpferregulierung
für Fahrzeuge mit Start-Stopp-Funktion	für Fahrzeuge mit Start-Stopp-Funktion	für Fahrzeuge ohne Keramikbremse	für Fahrzeuge ohne Keramikbremse
für Fahrzeuge mit Trommelbremse an der Hinterachse	für Fahrzeuge mit Trommelbremse an der Hinterachse	für Fahrzeuge ohne Klimaanlage	für Fahrzeuge ohne Klimaanlage
für Fahrzeuge mit verstärktem Fahrwerk	für Fahrzeuge mit verstärktem Fahrwerk	für Fahrzeuge ohne Motorbremse	für Fahrzeuge ohne Motorbremse
für Fahrzeuge mit verstärkter Bremse	für Fahrzeuge mit verstärkter Bremse	für Fahrzeuge ohne Panorama-Sonnendach	für Fahrzeuge ohne Panorama-Sonnendach
für Fahrzeuge mit Vierradlenkung	für Fahrzeuge mit Vierradlenkung	für Fahrzeuge ohne PCS (Pre-Crash Safety System)	für Fahrzeuge ohne PCS (Pre-Crash Safety System)
für Fahrzeuge ohne 3. Sitzreihe	für Fahrzeuge ohne 3. Sitzreihe	für Fahrzeuge ohne Schlechtwegeausführung	für Fahrzeuge ohne Schlechtwegeausführung
für Fahrzeuge ohne Active City Stop	für Fahrzeuge ohne Active City Stop	für Fahrzeuge ohne Servolenkung	für Fahrzeuge ohne Servolenkung
für Fahrzeuge ohne AMG-Performance Package	für Fahrzeuge ohne AMG-Performance Package	für Fahrzeuge ohne Sportfahrwerk	für Fahrzeuge ohne Sportfahrwerk
für Fahrzeuge ohne AMG-Sportpaket	für Fahrzeuge ohne AMG-Sportpaket	für Fahrzeuge ohne Sportpaket	für Fahrzeuge ohne Sportpaket

# Technische Übersetzungen

Technical translations - Traducciones tecnicas - Traductions techniques - Traduzioni tecniche

DE		DE	
<b>für Fahrzeuge ohne Start-Stopp-Funktion</b>	für Fahrzeuge ohne Start-Stopp-Funktion	<b>Gewindelänge [mm]</b>	Gewindelänge [mm]
<b>für Fahrzeuge ohne verstärktes Fahrwerk</b>	für Fahrzeuge ohne verstärktes Fahrwerk	<b>GG</b>	Bremssattel aus Gusseisen
<b>für Fahrzeuge ohne Vierradlenkung</b>	für Fahrzeuge ohne Vierradlenkung	<b>Groß Britan-nien</b>	Groß Britannien
<b>für gepanzerte Fahrzeuge</b>	für gepanzerte Fahrzeuge	<b>grün</b>	grün
<b>für Geschwindigkeitsregel-anlage</b>	für Geschwindigkeitsregelanlage	<b>Halbauto-matik</b>	Halbautomatik
<b>für Individualausstattungs-ID</b>	für Individualausstattungs-ID	<b>Halter, Bremsleitung</b>	Halter, Bremsleitung
<b>für Leichtmetallfelgen</b>	für Leichtmetallfelgen	<b>Halter, Brems-schlauch</b>	Halter, Bremsschlauch
<b>für Linkslenker</b>	für Linkslenker	<b>HC</b>	hochgekohlt
<b>für OE-Nummer</b>	für OE-Nummer	<b>HC L</b>	legiert/hochgekohlt
<b>für Polizeifahrzeuge</b>	für Polizeifahrzeuge	<b>Herstellerein-schränkung</b>	Herstellereinschränkung
<b>für Rechtslenker</b>	für Rechtslenker	<b>Höhe 1 [mm]</b>	Höhe 1 [mm]
<b>für Schaltgetriebe</b>	für Schaltgetriebe	<b>Höhe 2 [mm]</b>	Höhe 2 [mm]
<b>für Sonderfahrzeuge</b>	für Sonderfahrzeuge	<b>Hohl-schraube</b>	Hohlschraube
<b>für Stahlfelgen</b>	für Stahlfelgen	<b>Informati-onsart</b>	Informationsart
<b>für Taxifahrzeuge</b>	für Taxifahrzeuge	<b>Innendurch-messer [mm]</b>	Innendurchmesser [mm]
<b>gelb</b>	gelb	<b>Innen-Torx</b>	Innen-Torx
<b>Generischer Artikel</b>	Generischer Artikel	<b>- J</b>	Japan
<b>Geschlossen</b>	Geschlossen	<b>Japan</b>	Japan
<b>Gewindeausführung</b>	Gewindeausführung	<b>Kanada</b>	Kanada
		<b>Kasten/Kombi</b>	Kasten/Kombi
		<b>Kombi</b>	Kombi
		<b>Kunststoff</b>	Kunststoff
		<b>kurzer Radstand</b>	kurzer Radstand
		<b>L</b>	legiert
		<b>L=</b>	Länge [mm]
		<b>L=</b>	Länge über Alles [mm] Warnkontaktlänge [mm]
		<b>L1=</b>	Länge 1 [mm]
		<b>L2=</b>	Länge 2 [mm]



# Technische Übersetzungen

Technical translations - Traducciones tecnicas - Traductions techniques - Traduzioni tecniche

DE		DE	
<b>langer Radstand</b>	langer Radstand	<b>nicht für Baumuster</b>	nicht für Baumuster
<b>Leichtmetallfelge</b>	Leichtmetallfelge	<b>nicht für Behördenfahrzeuge</b>	nicht für Behördenfahrzeuge
<b>- LG</b>	ohne Lager	<b>nicht für Bremssattelfarbe</b>	nicht für Bremssattelfarbe
<b>Lochanzahl</b>	Lochanzahl	<b>nicht für erhöhte Nutzlast</b>	nicht für erhöhte Nutzlast
<b>Lochkreis-Ø [mm]</b>	Lochkreis-Ø [mm]	<b>nicht für Fahrzeuge mit verstärkter Bremse</b>	nicht für Fahrzeuge mit verstärkter Bremse
<b>luftgefederte Achse</b>	luftgefederte Achse	<b>nicht für Felgengröße [Zoll]</b>	nicht für Felgengröße [Zoll]
<b>Made in</b>	Fahrzeugproduktionsland	<b>nicht für gepanzerte Fahrzeuge</b>	nicht für gepanzerte Fahrzeuge
<b>MAN</b>	Bremssystem, Mando	<b>nicht für Leichtmetallfelgen</b>	nicht für Leichtmetallfelgen
<b>mit Anti-Quietsch-Blech</b>	mit Anti-Quietsch-Blech	<b>nicht für Motorcode</b>	nicht für Motorcode
<b>mit Bremssattelschrauben</b>	mit Bremssattelschrauben	<b>nicht für Multi-link Achse</b>	nicht für Multi-link Achse
<b>mit Doppelbereifung</b>	mit Doppelbereifung	<b>nicht für Polizeifahrzeuge</b>	nicht für Polizeifahrzeuge
<b>mit Einfachbereifung</b>	mit Einfachbereifung	<b>nicht für Postfahrzeuge</b>	nicht für Postfahrzeuge
<b>mit Entlüfterventil</b>	mit Entlüfterventil	<b>nicht für SA Code</b>	nicht für SA Code
<b>mit Feder</b>	mit Feder	<b>nicht für Sonderfahrzeuge</b>	nicht für Sonderfahrzeuge
<b>mit geregeltem (3-Wege) Katalysator</b>	mit geregeltem (3-Wege) Katalysator	<b>nicht für Taxifahrzeuge</b>	nicht für Taxifahrzeuge
<b>mit Leichtmetallfelge</b>	mit Leichtmetallfelge	<b>NIS</b>	Bremssystem, Nissin
<b>mit Stahlfelge</b>	mit Stahlfelge	<b>nur für Mineralöl</b>	nur für Mineralöl
<b>Motorcode</b>	Motorcode	<b>nur in Verbindung mit</b>	nur in Verbindung mit
<b>Multi-link Achse</b>	Multi-link Achse		
<b>Nabendurchmesser [mm]</b>	Nabendurchmesser [mm]		
<b>nicht für Ausstattungsvariante</b>	nicht für Ausstattungsvariante		
<b>nicht für Automatikgetriebe</b>	nicht für Automatikgetriebe		



# Technische Übersetzungen

Technical translations - Traducciones tecnicas - Traductions techniques - Traduzioni tecniche

DE		DE	
<b>Nutzlast [kg]</b>	Nutzlast [kg]	<b>Schalter, Bremsleuchte</b>	Schalter, Bremsleuchte
<b>Nutzlast ab [kg]</b>	Nutzlast ab [kg]	<b>Schaltgetriebe</b>	Schaltgetriebe
<b>Nutzlast bis [kg]</b>	Nutzlast bis [kg]	<b>Schaltgetriebe, automatisch betätigt</b>	Schaltgetriebe, automatisch betätigt
<b>OE-Hersteller</b>	OE-Hersteller	<b>Schaltgetriebe 5 Gang</b>	Schaltgetriebe 5 Gang
<b>OE-Nummer</b>	OE-Nummer	<b>Scheibenbremse</b>	Scheibenbremse
<b>OE-Referenz</b>	OE-Referenz	<b>Schlauch</b>	Schlauch
<b>ohne integrierten Verschleißsensor</b>	ohne integrierten Verschleißsensor	<b>Schlüsselweite</b>	Schlüsselweite
<b>ohne Katalysator</b>	ohne Katalysator	<b>Schraubanschluss</b>	Schraubanschluss
<b>ohne Leichtmetallfelge</b>	ohne Leichtmetallfelge	<b>Schraubkontakt</b>	Schraubkontakt
<b>Orga →</b>	Organisationsnummer ab	<b>schwarz</b>	schwarz
<b>passend für Felgengröße [Zoll]</b>	passend für Felgengröße [Zoll]	<b>silber</b>	silber
<b>PER</b>	Bremssystem, Perrot	<b>Slowakische Republik</b>	Slowakische Republik
<b>- Performance Parts</b>	für Fahrzeuge ohne Performance Bremse	<b>SOHC/OHC</b>	SOHC/OHC
<b>Pol-Anzahl</b>	Pol-Anzahl	<b>Sortiment, Armaturen</b>	Sortiment, Armaturen
<b>PowerDisc</b>	Artikelzusatzbezeichnung, PowerDisc	<b>Sortiment, Befestigungselemente</b>	Sortiment, Befestigungselemente
<b>Prüfanschluss, Rohrleitungen</b>	Prüfanschluss, Rohrleitungen	<b>Sortiment, Entlüfterschrauben</b>	Sortiment, Entlüfterschrauben
<b>Raddurchmesser [Zoll]</b>	Raddurchmesser [Zoll]	<b>Spezialaufbau</b>	Spezialaufbau
<b>Radstand [mm]</b>	Radstand [mm]	<b>Stahlfelge</b>	Stahlfelge
<b>Republik Korea (Südkorea)</b>	Republik Korea (Südkorea)	<b>Starrachse</b>	Starrachse
<b>Ringstutzen, Rohrleitung</b>	Ringstutzen, Rohrleitung	<b>Steckerausführung</b>	Steckerausführung
<b>- RLG</b>	ohne Radlager	<b>Stopfen, Bremsflüssigkeitsbehälter</b>	Stopfen, Bremsflüssigkeitsbehälter
<b>rot</b>	rot	<b>SUM</b>	Bremssystem, Sumitomo
<b>RPO Nummer</b>	RPO Nummer		
<b>Rückschlagventil</b>	Rückschlagventil		
<b>Russia-made</b>	Russland		









# Technische Übersetzungen

Technical translations - Traducciones tecnicas - Traductions techniques - Traduzioni tecniche

DE		DE	
<b>Textbaustein</b>	Textbaustein	<b>Warnkontakt, Bremsbelagverschleiß</b>	Warnkontakt, Bremsbelagverschleiß
<b>T-Form (T-Stück)</b>	T-Form (T-Stück)	<b>- WE</b>	nicht für Verschleißwarnanzeiger vorbereitet
<b>Thailand</b>	Thailand	<b>- WK</b>	exkl. Verschleißwarnkontakt ohne integrierten Verschleißwarnkontakt
<b>TOK</b>	Bremssystem, Tokico	<b>x</b>	Breite [mm] Höhe [mm]
<b>TRW</b>	Bremssystem, Lucas / TRW	<b>x</b>	Anzahl Verschleißanzeiger [pro Achse] Anschlussanzahl
<b>Tschechische Republik</b>	Tschechische Republik	<b>Zentrierungsdurchmesser [mm]</b>	Zentrierungsdurchmesser [mm]
<b>Türenanzahl</b>	Türenanzahl	<b>- Zub</b>	ohne Zubehör
<b>Überwurfmutter</b>	Überwurfmutter	<b>Zubehörsatz, Scheibenbremsbelag</b>	Zubehörsatz, Scheibenbremsbelag
<b>Überwurfschraube</b>	Überwurfschraube	<b>zul. Gesamtgewicht [kg]</b>	zul. Gesamtgewicht [kg]
<b>Ungarn</b>	Ungarn	<b>Ø</b>	Durchmesser [mm]
<b>USA</b>	USA	<b>Ø1</b>	Durchmesser 1 [mm]
<b>- USA</b>	USA	<b>Ø2</b>	Durchmesser 2 [mm]
<b>V</b>	Innenbelüftet belüftet	<b>•</b>	Gelocht
<b>V/</b>	geschlitzt/innenbelüftet	<b>→</b>	Baujahr ab Fahrgestellnummer ab
<b>Ventil, Unterdruckleitung</b>	Ventil, Unterdruckleitung	<b>→</b>	Baujahr bis Fahrgestellnummer bis
<b>Verbindungs-/ Verteilerstück, Rohrleitungen</b>	Verbindungs-/Verteilerstück, Rohrleitungen	<b>→Orga</b>	Organisationsnummer bis
<b>Verschluss, Bremsflüssigkeitsbehälter</b>	Verschluss, Bremsflüssigkeitsbehälter	<b>→VET</b>	VET-Nummer bis
<b>Verschluss-/ Schutzkappe</b>	Verschluss-/Schutzkappe	<b>→Ø</b>	Durchmesser bis [mm]
<b>Verschluss-schraube</b>	Verschluss-schraube		
<b>Version</b>	Version		
<b>VET →</b>	VET-Nummer ab		
<b>Vollautomatik</b>	Vollautomatik		
<b>VW</b>	Bremssystem, Volkswagen		
<b>V•</b>	Gelocht/innenbel.		
<b>wahlweise</b>	wahlweise		

# Technische Übersetzungen

Technical translations - Traducciones tecnicas - Traductions techniques - Traduzioni tecniche

EN		EN	
	Brake Pad Set, disc brake	<b>Abmessungen beachten</b>	Observe dimensions
	Brake Disc	- <b>ABS</b>	for vehicles without ABS not for ABS
	Rear Axle Left	- <b>ABS Ring</b>	without ABS sensor ring
	Rear Axle Right	<b>Achsnummer</b>	Axle Number
	Front Axle Left	<b>Achszapfendurchmesser [mm]</b>	Axle Stub Diameter [mm]
	Front Axle Right	<b>Adapter, Bremsleitung</b>	Adapter, brake lines
<b>+ ABS</b>	for vehicles with ABS for ABS	<b>ADV</b>	Brake System, Advics
<b>+ ABS Ring</b>	with ABS sensor ring	<b>AIS</b>	Brake System, Aisin
<b>+ ASR</b>	for vehicles with ASR	<b>AKE</b>	Brake System, Akebono
<b>+ D</b>	Germany	<b>Allrad</b>	All-wheel Drive
<b>+ eFSB</b>	for vehicles with electric handbrake	<b>ALU</b>	Aluminium brake caliper
<b>+ ESP</b>	for vehicles with ESP	<b>Anschlussgewinde</b>	Connecting thread
<b>+ ETS</b>	for vehicles with ETS	<b>Anschluss links</b>	Left Connector
<b>+ EU</b>	Europe	<b>Anschluss rechts</b>	Right Connector
<b>+ J</b>	Japan	<b>Anschlussstutzen, Schlauchleitung</b>	Connection Piece, hose line
<b>+ LG</b>	with bearing(s)	<b>Anzahl der Bohrungen</b>	Number of Bores
<b>+ Performance Parts</b>	for vehicles with Performance brakes	<b>Anzahl Sitzplätze</b>	Number of Seats
<b>+POC</b>	for POC	<b>AP</b>	Brake System, AP Lockheed
<b>+PR</b>	for PR number	<b>Artikelnummer des empfohlenen Zubehörs</b>	Part number of recommended accessories
<b>+ RO</b>	Romania	- <b>ASR</b>	for vehicles without ASR
<b>+ RUS</b>	Russia	<b>ATE Ceramic</b>	additional article information, ATE Ceramic
<b>+ S</b>	with screws	<b>außenbelüftet</b>	Externally Vented
<b>+SA</b>	for SA code	<b>Außendurchmesser [mm]</b>	Outer diameter [mm]
<b>+ SKA</b>	Scandinavia	<b>Automatikgetriebe</b>	Automatic Transmission
<b>+ TR</b>	Turkey		
<b>+ USA</b>	USA		
<b>+ WE</b>	prepared for wear indicator		
<b>+ WK</b>	incl. wear warning contact with integrated wear warning contact with acoustic wear warning		
<b>+ Zub</b>	with accessories		
<b>ABE</b>	with General Certification (ABE)		

# Technische Übersetzungen

Technical translations - Traducciones tecnicas - Traductions techniques - Traduzioni tecniche

EN		EN	
<b>B</b>	Coated	<b>China-made</b>	China
<b>B1=</b>	Width 1 [mm]	<b>CIT</b>	Brake System, Citroen
<b>B2=</b>	Width 2 [mm]	<b>CVT-Automatikgetriebe (Stufenlos)</b>	CVT (Stepless)
<b>Baumuster</b>	Type	<b>- D</b>	Germany
<b>BDX</b>	Brake System, Bendix	<b>Dichtung, Unterdruck-Anschlusstutzen BKV</b>	Seal, vacuum hose connector pipe
<b>Bearbeitung</b>	Machining	<b>DIN/ISO</b>	DIN / ISO
<b>Bohrung-Ø 1 [mm]</b>	Bore Ø 1 [mm]	<b>DIN 74235 Form EL</b>	DIN 74235 Form EL
<b>Bohrung-Ø 2 [mm]</b>	Bore Ø 2 [mm]	<b>DIN 74235 Form FL</b>	DIN 74235 Form FL
<b>Bördelform</b>	Flange Shape	<b>DOHC</b>	DOHC
<b>BOS</b>	Brake System, Bosch	<b>Doppelquerlenkerachse</b>	Double Wishbone Axle
<b>BRE</b>	Brake System, Brembo	<b>Durchmesser Aufnahme [mm]</b>	Support plate diameter [mm]
<b>Brems-/Fahrdyn. Artikelbezug</b>	Brakes- / Drive Dynamics Articles	<b>E</b>	E
<b>Bremsbelagsatz, Scheibenbremse</b>	Brake Pad Set, disc brake	<b>- eFSB</b>	for vehicles without electronic handbrake
<b>Bremsleitung</b>	Brake Lines	<b>einteilig</b>	One-piece
<b>Brems-sattel(1-Kolben)</b>	Brake Caliper (1 piston)	<b>Einzelradaufhängung</b>	Independent wheel suspension
<b>Brems-sattel(2-Kolben)</b>	Brake Caliper (2 pistons)	<b>elektrisch-hydraulisch</b>	Electric-hydraulic
<b>Brems-sattel(4-Kolben)</b>	Brake Caliper (4 pistons)	<b>Entlüfterschraube/-ventil</b>	Breather Screw / Valve
<b>Bremssattel-farbe</b>	Brake Caliper Colour	<b>EPDM (Ethylen-Propylen-Dien-Kautschuk)</b>	EPDM (ethylene propylene diene Monomer (M-class) rubber)
<b>Bremssattel mit 1 Haltestift</b>	Brake Caliper with 1 holding pin	<b>- ESP</b>	for vehicles without ESP
<b>Bremssattel mit 2 Haltestiften</b>	Brake Caliper with 2 holding pins	<b>- ETS</b>	for vehicles without ETS
<b>Brems-scheibe</b>	Brake Disc	<b>Europa</b>	Europe
<b>Brems-scheibe zwei-teilig</b>	Two-piece Brake Disc	<b>F</b>	F
<b>- CDN</b>	Canada	<b>Felge Lochzahl</b>	Rim Hole Number
<b>China</b>	China	<b>Felgengröße [Zoll]</b>	Rim Size [in]

# Technische Übersetzungen

Technical translations - Traducciones tecnicas - Traductions techniques - Traduzioni tecniche

EN		EN	
<b>Flachstecker</b>	Blade Terminal	<b>für Fahrzeuge mit AMG-Sportpaket</b>	for vehicles with AMG Sports Package
<b>Flanschbefestigung</b>	Flange mounting	<b>für Fahrzeuge mit Bremsassistent</b>	for vehicles with brake assist
<b>FPM (Fluor-Kautschuk)/ACM (Polyacryl-Kautschuk)</b>	FPM (fluoride rubber)/ACM (polyacrylate rubber)	<b>für Fahrzeuge mit elektr. Dämpferregulierung</b>	for vehicles with electronic suspension control
<b>Frankreich</b>	France	<b>für Fahrzeuge mit Keramikbremse</b>	for vehicles with ceramic brakes
<b>Frontantrieb</b>	Front Wheel Drive	<b>für Fahrzeuge mit Klimaanlage</b>	for vehicles with air conditioning
<b>für Automatikgetriebe</b>	for automatic transmission	<b>für Fahrzeuge mit Niveauregulierung</b>	for vehicles with leveling control
<b>für Behördenfahrzeuge</b>	for government vehicles	<b>für Fahrzeuge mit Panorama-Sonnendach</b>	for vehicles with panorama sunroof
<b>für Bremsattel mit Kunststoffkolben</b>	for brake calipers with plastic pistons	<b>für Fahrzeuge mit PCS (Pre-Crash Safety System)</b>	for vehicles with PCS (Pre-Crash Safety System)
<b>für Bremsattel mit Stahlkolben</b>	for brake calipers with steel pistons	<b>für Fahrzeuge mit Scheibenbremse an der Hinterachse</b>	for vehicles with disc brakes on the rear axle
<b>für Brems Scheibendicke [mm]</b>	for brake disc thickness [mm]	<b>für Fahrzeuge mit Schlechtwegausführung</b>	for vehicles with off-road suspension
<b>für Brems Scheibendurchmesser [mm]</b>	for brake disc diameter [mm]	<b>für Fahrzeuge mit Servolenkung</b>	for vehicles with power steering
<b>für Brems Scheibendurchmesser [Zoll]</b>	for brake disc diameter [inch]		
<b>für Doppelbereifung</b>	for dual tyres		
<b>für Einfachbereifung</b>	for single tyres		
<b>für erhöhte Nutzlast</b>	for increased payload		
<b>für ESP</b>	for ESP		
<b>für Fahrzeuge mit 3. Sitzreihe</b>	for vehicles with 3rd seating row		
<b>für Fahrzeuge mit Active City Stop</b>	for vehicles with Active City Stop		





# Technische Übersetzungen

Technical translations - Traducciones tecnicas - Traductions techniques - Traduzioni tecniche

EN		EN	
<b>für Fahrzeuge mit Sportfahrwerk</b>	for vehicles with sports suspension	<b>für Fahrzeuge ohne Bremsassistent</b>	for vehicles without brake assist
<b>für Fahrzeuge mit Sportpaket</b>	for vehicles with sports package	<b>für Fahrzeuge ohne elektr. Dämpferregulierung</b>	for vehicles without electronic suspension control
<b>für Fahrzeuge mit Start-Stopp-Funktion</b>	for vehicles with start-stop function	<b>für Fahrzeuge ohne Keramikbremse</b>	for vehicles without ceramic brakes
<b>für Fahrzeuge mit Trommelbremse an der Hinterachse</b>	for vehicles with drum brakes on the rear axle	<b>für Fahrzeuge ohne Klimaanlage</b>	for vehicles without air conditioning
<b>für Fahrzeuge mit verstärktem Fahrwerk</b>	for vehicles with heavy duty suspension	<b>für Fahrzeuge ohne Motorbremse</b>	for vehicles without engine brake
<b>für Fahrzeuge mit verstärkter Bremse</b>	for vehicles with reinforced brakes	<b>für Fahrzeuge ohne Panorama-Sonnendach</b>	for vehicles without panorama sunroof
<b>für Fahrzeuge mit Vierradlenkung</b>	for vehicles with four wheel steering	<b>für Fahrzeuge ohne PCS (Pre-Crash Safety System)</b>	for vehicles without PCS (Pre-Crash Safety System)
<b>für Fahrzeuge ohne 3. Sitzreihe</b>	for vehicles without 3rd seating row	<b>für Fahrzeuge ohne Schlechtwegausführung</b>	for vehicles without off-road suspension
<b>für Fahrzeuge ohne Active City Stop</b>	for vehicles without Active City Stop	<b>für Fahrzeuge ohne Servolenkung</b>	for vehicles without power steering
<b>für Fahrzeuge ohne AMG-Performance Package</b>	for vehicles without AMG Performance Package	<b>für Fahrzeuge ohne Sportfahrwerk</b>	for vehicles without sports suspension
<b>für Fahrzeuge ohne AMG-Sportpaket</b>	for vehicles without AMG sports package	<b>für Fahrzeuge ohne Sportpaket</b>	for vehicles without sports package
<b>für Fahrzeuge ohne Bordcomputer</b>	for vehicles without on-board computer	<b>für Fahrzeuge ohne Start-Stopp-Funktion</b>	for vehicles without start-stop function

# Technische Übersetzungen

Technical translations - Traducciones tecnicas - Traductions techniques - Traduzioni tecniche

EN		EN	
<b>für Fahrzeuge ohne verstärktes Fahrwerk</b>	for vehicles without heavy duty suspension	<b>Groß Britan-nien</b>	Great Britain
<b>für Fahrzeuge ohne Vierradlenkung</b>	for vehicles without four wheel steering	<b>grün</b>	Green
<b>für gepanzerte Fahrzeuge</b>	for armoured vehicles	<b>Halbauto-matik</b>	Semi-automatic
<b>für Geschwindigkeitsregel-anlage</b>	for cruise control system	<b>Halter, Bremsleitung</b>	Holder, brake lines
<b>für Individualausstattungs-ID</b>	for individual equipment ID	<b>Halter, Brems-schlauch</b>	Holding Bracket, brake hose
<b>für Leichtmetallfelgen</b>	for light alloy rims	<b>HC</b>	High-carbon
<b>für Linkslenker</b>	for left-hand drive vehicles	<b>HC L</b>	Alloyed / High-carbon
<b>für OE-Nummer</b>	for OE number	<b>Herstellerein-schränkung</b>	Manufacturer Restriction
<b>für Polizeifahrzeuge</b>	for police vehicles	<b>Höhe 1 [mm]</b>	Height 1 [mm]
<b>für Rechtslenker</b>	for right-hand drive vehicles	<b>Höhe 2 [mm]</b>	Height 2 [mm]
<b>für Schaltge-triebe</b>	for manual transmission	<b>Hohl-schraube</b>	Hollow Screw
<b>für Sonder-fahrzeuge</b>	for special-purpose vehicles	<b>Informati-onsart</b>	Information Type
<b>für Stahl-felgen</b>	for steel rims	<b>Innendurch-messer [mm]</b>	Inner diameter [mm]
<b>für Taxifahr-zeuge</b>	for taxis	<b>Innen-Torx</b>	Female Torx
<b>gelb</b>	Yellow	<b>- J</b>	Japan
<b>Generischer Artikel</b>	Generic article	<b>Japan</b>	Japan
<b>Geschlossen</b>	Closed	<b>Kanada</b>	Canada
<b>Gewindeaus-führung</b>	Thread Type	<b>Kasten/Kombi</b>	Box Body / Estate
<b>Gewinde-länge [mm]</b>	Thread Length [mm]	<b>Kombi</b>	Estate
<b>GG</b>	Cast iron brake caliper	<b>Kunststoff</b>	Plastic
		<b>kurzer Radstand</b>	Short Wheelbase
		<b>L</b>	Alloyed
		<b>L=</b>	Length [mm]
		<b>L=</b>	Overall Length [mm] Warning Contact Length [mm]
		<b>L1=</b>	Length 1 [mm]
		<b>L2=</b>	Length 2 [mm]
		<b>langer Radstand</b>	Long Wheelbase
		<b>Leichtmetall-felge</b>	Light Alloy Rim



# Technische Übersetzungen

Technical translations - Traducciones tecnicas - Traductions techniques - Traduzioni tecniche

EN		EN	
- LG	without bearing(s)	nicht für	
Lochanzahl	Number of Holes	Bremssattel-	not for brake caliper colour
Lochkreis-Ø [mm]	Bolt Hole Circle Ø [mm]	farbe	
luftgefederte Achse	Air Suspension Axle	nicht für	
Made in	Vehicle Production Country	erhöhte Nutz-	not for increased payload
MAN	Brake System, Mando	last	
mit Anti-Quietsch-Blech	with anti-squeak plate	nicht für	
mit Brems-sattel-schrauben	with brake caliper screws	Fahrzeuge	
mit Doppel-bereifung	with dual tyres	mit	not for vehicles with reinforced brakes
mit Einfach-bereifung	with single tyres	verstärkter	
mit Entlüfter-ventil	with breather valve	Bremse	
mit Feder	with spring	nicht für	
mit gere-geltem (3-Wege) Kata-lysatoren	with 3 way catalyst	Felgengröße	not for rim size [in]
mit Leichtme-tallfelge	with light alloy rim	[Zoll]	
mit Stahl-felge	with steel rim	nicht für	
Motorcode	Engine Code	gepanzerte	not for armoured vehicles
Multi-link Achse	Multilink Axle	Fahrzeuge	
Nabendurch-messer [mm]	Hub Diameter [mm]	nicht für	
nicht für		Leichtmetall-	not for light alloy rims
Ausstat-tungsvari-ante	not for equipment variant	felgen	
nicht für		nicht für	
Automatikge-triebe	not for automatic transmission	Motorcode	not for engine code
nicht für		nicht für	
Baumuster	not for model	Multi-link	not for multi-link axle
nicht für		Achse	
Behörden-fahrzeuge	not for government vehicles	nicht für	
		Poli-zeifahrzeuge	not for police vehicles
		nicht für	
		Postfahr-zeuge	not for post office vehicles
		nicht für	
		SA	not for SA code
		Code	
		nicht für	
		Sonderfahr-zeuge	not for special-purpose vehicles
		nicht für	
		Taxifahr-zeuge	not for taxis
		NIS	Brake System, Nissin
		nur für Mine-ralöl	Only for mineral oil
		nur in Verbin-dung mit	only in connection with
		Nutzlast [kg]	Payload [kg]
		Nutzlast ab [kg]	Payload from [kg]

# Technische Übersetzungen

Technical translations - Traducciones tecnicas - Traductions techniques - Traduzioni tecniche

EN		EN	
<b>Nutzlast bis [kg]</b>	Payload to [kg]	<b>Schaltgetriebe</b>	Manual Transmission
<b>OE-Hersteller</b>	OE manufacturer	<b>Schaltgetriebe, automatisch betätigt</b>	Automated Manual Transmission
<b>OE-Nummer</b>	OE reference number		
<b>OE-Referenz</b>	OE reference		
<b>ohne integrierten Verschleißsensor</b>	without integrated wear sensor	<b>Schaltgetriebe 5 Gang</b>	Manual Transmission, 5-speed
		<b>Scheibenbremse</b>	Disc Brake
<b>ohne Katalysator</b>	without catalytic convertor	<b>Schlauch</b>	Hose
<b>ohne Leichtmetallfelge</b>	without light alloy rim	<b>Schlüsselweite</b>	Spanner Size
<b>Orga →</b>	RPO number from	<b>Schraubanschluss</b>	Screw Connection
<b>passend für Felgengröße [Zoll]</b>	Fits rim size [inch]	<b>Schraubkontakt</b>	Screw Contact
<b>PER</b>	Brake System, Perrot	<b>schwarz</b>	Black
<b>- Performance Parts</b>	for vehicles without Performance brakes	<b>silber</b>	Silver
<b>Pol-Anzahl</b>	Number of Poles	<b>Slowakische Republik</b>	Slovakia
<b>PowerDisc</b>	additional article information, Power-Disc	<b>SOHC/OHC</b>	SOHC/OHC
<b>Prüfanschluss, Rohrleitungen</b>	Test Connection, piping	<b>Sortiment, Armaturen</b>	Assortment, fittings
		<b>Sortiment, Befestigungselemente</b>	Assortment, fasteners
<b>Raddurchmesser [Zoll]</b>	Wheel Diameter [in]	<b>Sortiment, Entlüfterschrauben</b>	Assortment, breather screws
<b>Radstand [mm]</b>	Wheelbase [mm]	<b>Spezialaufbau</b>	Special Design
<b>Republik Korea (Südkorea)</b>	Republic of Korea (South Korea)	<b>Stahlfelge</b>	Steel Rim
		<b>Starrachse</b>	Rigid Axle
<b>Ringstutzen, Rohrleitung</b>	Connector, metal pipes	<b>Steckerausführung</b>	Plug Type
<b>- RLG</b>	without wheel bearing	<b>Stopfen, Bremsflüssigkeitsbehälter</b>	Plug, brake fluid reservoir
<b>rot</b>	Red		
<b>RPO Nummer</b>	RPO Number	<b>SUM</b>	Brake System, Sumitomo
<b>Rückschlagventil</b>	Non-return Valve	<b>Textbaustein</b>	text module
<b>Russia-made</b>	Russia	<b>T-Form (T-Stück)</b>	T-Piece



# Technische Übersetzungen







Technical translations - Traducciones tecnicas - Traductions techniques - Traduzioni tecniche

EN		EN	
<b>Thailand</b>	Thailand	<b>- WK</b>	excl. wear warning contact without integrated wear warning contact
<b>TOK</b>	Brake System, Tokico		
<b>TRW</b>	Brake System, Lucas / TRW	<b>x</b>	Width [mm] Height [mm]
<b>Tschechische Republik</b>	Czech Republic		Number of wear indicators [per axle] Number of connectors
<b>Türenanzahl</b>	Number of Doors	<b>Zentrierungsdurchmesser [mm]</b>	Centering Diameter [mm]
<b>Überwurfmutter</b>	Union Nut		
<b>Überwurfschraube</b>	Union Bolt	<b>- Zub</b>	without accessories
<b>Ungarn</b>	Hungary	<b>Zubehörsatz, Scheibenbremsbelag</b>	Accessory Kit, disc brake pads
<b>USA</b>	USA		
<b>- USA</b>	USA	<b>zul. Gesamtgewicht [kg]</b>	Gross Vehicle Weight [kg]
<b>V</b>	Internally Vented Vented	<b>Ø</b>	Diameter [mm]
<b>V/</b>	Slotted / Internally Vented	<b>Ø1</b>	Diameter 1 [mm]
<b>Ventil, Unterdruckleitung</b>	Valve, vacuum hose	<b>Ø2</b>	Diameter 2 [mm]
<b>Verbindungs-/ Verteilerstück, Rohrleitungen</b>	Connector, pipes	<b>•</b>	Perforated
		<b>→</b>	Construction year from Chassis number from
		<b>→</b>	Construction year to Chassis number to
		<b>→Orga</b>	RPO number to
<b>Verschluss, Bremsflüssigkeitsbehälter</b>	Sealing Cap, brake fluid reservoir	<b>→VET</b>	VET Number to
<b>Verschluss-/ Schutzkappe</b>	Sealing/Protective Cap	<b>→Ø</b>	Diameter to [mm]
<b>Verschluss-schraube</b>	Screw Plug		
<b>Version</b>	Version		
<b>VET →</b>	VET Number from		
<b>Vollautomatik</b>	Fully Automatic		
<b>VW</b>	Brake System, Volkswagen		
<b>V•</b>	Perforated / Vented		
<b>wahlweise</b>	Alternatively		
<b>Warnkontakt, Bremsbelagverschleiß</b>	Warning Contact, brake pad wear		
<b>- WE</b>	not prepared for wear indicator		



# Technische Übersetzungen

Technical translations - Traducciones técnicas - Traductions techniques - Traduzioni tecniche

ES		ES	
	Juego de pastillas de freno	<b>+ Zub</b>	con accesorios
	Disco de freno	<b>ABE</b>	con Certificado General de Funcionamiento (ABE)
	Eje trasero izquierda	<b>Abmessungen beachten</b>	Observar dimensiones
	Eje trasero, derecha	<b>- ABS</b>	para vehículos sin ABS no para ABS
	Eje delantero, izquierda	<b>- ABS Ring</b>	sin anillo sensor ABS
	Eje delantero, derecha	<b>Achsnummer</b>	Número de eje
<b>+ ABS</b>	para vehículos con ABS para ABS	<b>Achszapfendurchmesser [mm]</b>	Diám. muñón del eje [mm]
<b>+ ABS Ring</b>	con anillo sensor ABS	<b>Adapter, Bremsleitung</b>	Adaptador, tubería de freno
<b>+ ASR</b>	para vehículos con ASR	<b>ADV</b>	Sistema de frenos, Advics
<b>+ D</b>	Alemania	<b>AIS</b>	Sistema de frenos, Aisin
<b>+ eFSB</b>	para vehículos con freno de detención electrónico	<b>AKE</b>	Sistema de frenos, Akebono
<b>+ ESP</b>	para vehículos con ESP	<b>Allrad</b>	A las 4 ruedas
<b>+ ETS</b>	para vehículos sin ETS	<b>ALU</b>	Pinza de frenos de aluminio
<b>+ EU</b>	Europa	<b>Anschlussgewinde</b>	Rosca empalme
<b>+ J</b>	Japón	<b>Anschluss links</b>	Conexión izquierda
<b>+ LG</b>	con apoyo	<b>Anschluss rechts</b>	Conexión derecha
<b>+ Performance Parts</b>	para vehículos con frenos alto rendimiento	<b>Anschlusstutzen, Schlauchleitung</b>	Racores, tubería flexible
<b>+POC</b>	para POC	<b>Anzahl der Bohrungen</b>	Número de taladros
<b>+PR</b>	Número de PR	<b>Anzahl Sitzplätze</b>	Número de asientos
<b>+ RO</b>	Rumania	<b>AP</b>	Sistema de frenos, AP Lockheed
<b>+ RUS</b>	Rusia	<b>Artikelnummer des empfohlenen Zubehörs</b>	Nº art. de accesorio recomendado
<b>+ S</b>	con tornillos	<b>- ASR</b>	para vehículos sin ASR
<b>+SA</b>	para código SA	<b>ATE Ceramic</b>	Denominación adicional del artículo, ATE Ceramic
<b>+ SKA</b>	Escandinavia	<b>außenbelüftet</b>	ventilación externa
<b>+ TR</b>	Turquía		
<b>+ USA</b>	EE UU		
<b>+ WE</b>	preparado para indicador desgaste		
<b>+ WK</b>	con contacto avisador de desgaste con contacto de aviso de desgaste incorporado con avisador acústico de desgaste		



# Technische Übersetzungen

Technical translations - Traducciones técnicas - Traductions techniques - Traduzioni tecniche

ES		ES	
<b>Außendurchmesser [mm]</b>	Diámetro exterior [mm]	<b>Brems-scheibe zwei-teilig</b>	Disco de freno de dos piezas
<b>Automatikgetriebe</b>	Transmisión automática	- CDN	Canadá
<b>B</b>	revestido	<b>China</b>	China
<b>B1=</b>	Ancho 1 [mm]	<b>China-made</b>	China
<b>B2=</b>	Ancho 2 [mm]	<b>CIT</b>	Sistema de frenos, Citroen
<b>Baumuster</b>	Modelo de construcción	<b>CVT-Automatikgetriebe (Stufenlos)</b>	Transmisión automática CVT (continua)
<b>BDX</b>	Sistema de frenos, Bendix	- D	Alemania
<b>Bearbeitung</b>	Procesamiento	<b>Dichtung, Unterdruck-Anschlusstutzen BKV</b>	Junta, racor de conexión de vacío
<b>Bohrung-Ø 1 [mm]</b>	Taladro Ø 1 [mm]	<b>DIN/ISO</b>	DIN / ISO
<b>Bohrung-Ø 2 [mm]</b>	Taladro Ø 2 [mm]	<b>DIN 74235 Form EL</b>	DIN 74235 Forma EL
<b>Bördelform</b>	Tipo rebordeado	<b>DIN 74235 Form FL</b>	DIN 74235 Forma FL
<b>BOS</b>	Sistema de frenos, Bosch	<b>DOHC</b>	DOHC
<b>BRE</b>	Sistema de frenos, Brembo	<b>Doppelquerlenkerachse</b>	Eje con brazo transversal doble
<b>Brems-/ Fahrdyn. Artikelbezug</b>	Ref. artículo dinámica frenado/marcha	<b>Durchmesser Aufnahme [mm]</b>	Diámetro alojamiento [mm]
<b>Bremsbelagsatz, Scheibenbremse</b>	Juego de pastillas de freno	<b>E</b>	E
<b>Bremsleitung</b>	Tubería de frenos	- eFSB	para vehículos sin freno de detención electrónico
<b>Brems-sattel(1-Kolben)</b>	Pinza de freno (1 émbolo)	<b>einteilig</b>	una pieza
<b>Brems-sattel(2-Kolben)</b>	Pinza de freno (2 émbolos)	<b>Einzelradaufhängung</b>	Suspensión independiente
<b>Brems-sattel(4-Kolben)</b>	Pinza de freno (4 émbolos)	<b>elektrisch-hydraulisch</b>	electrohidráulico
<b>Bremssattel-farbe</b>	Color pinza freno	<b>Entlüfterschraube/-ventil</b>	Válvula/tornillo de purga de aire
<b>Bremssattel mit 1 Haltestift</b>	Pinza de freno con 1 pasador de soporte	<b>EPDM (Ethylen-Propylen-Dien-Kautschuk)</b>	EPDM (Ethylen-Propylen-Dien-Caucho)
<b>Bremssattel mit 2 Haltestiften</b>	Pinza de freno con 2 pasadores de soporte	- ESP	para vehículos sin ESP
<b>Brems-scheibe</b>	Disco de freno	- ETS	para vehículos sin ETS
		<b>Europa</b>	Europa

# Technische Übersetzungen

Technical translations - Traducciones técnicas - Traductions techniques - Traduzioni tecniche

ES		ES	
F	F	für Fahr- zeuge mit Active City Stop	para vehículos con Active City Stop
<b>Felge Loch- zahl</b>	Llanta, nº de taladros	für Fahr- zeuge mit AMG-Sport- paket	para vehículos con paquete sport AMG
<b>Felgenreöße [Zoll]</b>	Tamaño de llanta [in]	für Fahr- zeuge mit Bremsassis- tent	para vehículos con asistencia a la frenada
<b>Flachstecker</b>	Conector plano	für Fahr- zeuge mit elektr. Dämp- ferregulie- rung	para vehículos con regulación eléctrica de amortiguación
<b>Flanschbe- festigung</b>	Fijación con brida	für Fahr- zeuge mit Keramik- bremse	para vehículos con freno de cerámica
<b>FPM (Fluor- Kautschuk)/A CM (Poly- acryl-Kaut- schuk)</b>	FPM (caucho fluorado)/ACM (caucho poliacrílico)	für Fahr- zeuge mit Klimaanlage	para vehículos con climatizador
<b>Frankreich</b>	Francia	für Fahr- zeuge mit Niveauregu- lierung	para vehículos con regulación de nivel
<b>Frontantrieb</b>	Tracción delantera	für Fahr- zeuge mit Panorama- Sonnendach	para vehículos con techo solar panorámico
<b>für Automa- tikgetriebe</b>	para transmisión automática	für Fahr- zeuge mit PCS (Pre- Crash Safety System)	para vehículos con PCS (Pre-Crash Safety System)
<b>für Behör- denfahrzeuge</b>	para vehículos admon. pública	für Fahr- zeuge mit Scheiben- bremse an der Hinter- achse	para vehículos con freno de disco en eje trasero
<b>für Brems- sattel mit Kunststoff- kolben</b>	para pinzas de freno con émbolos de plástico	für Fahr- zeuge mit Schlechtwe- geausfüh- rung	para vehículos con dispositivo auxiliar para caminos malos
<b>für Brems- sattel mit Stahlkolben</b>	para pinzas de freno con émbolos de acero		
<b>für Brems- scheiben- dicke [mm]</b>	para espesor de disco [mm]		
<b>für Brems- scheiben- durchmesser [mm]</b>	para diámetro disco de freno [mm]		
<b>für Brems- scheiben- durchmesser [Zoll]</b>	para diám. disco de frenos [inch]		
<b>für Doppelbe- reifung</b>	para neumáticos gemelos		
<b>für Einfach- bereifung</b>	para neumáticos sencillos		
<b>für erhöhte Nutzlast</b>	para carga útil aumentada		
<b>für ESP</b>	para ESP		
<b>für Fahr- zeuge mit 3. Sitzreihe</b>	para vehículos con 3 hileras de asientos		



# Technische Übersetzungen

Technical translations - Traducciones técnicas - Traductions techniques - Traduzioni tecniche

ES		ES	
für Fahrzeuge mit Servolenkung	para vehículos con dirección asistida	für Fahrzeuge ohne Bordcomputer	para vehículos sin ordenador de a bordo
für Fahrzeuge mit Sportfahrwerk	para vehículos con chasis deportivo	für Fahrzeuge ohne Bremsassistent	Para vehículos sin asistencia a la frenada
für Fahrzeuge mit Sportpaket	para vehículos con paquete sport	für Fahrzeuge ohne elektr. Dämpferregulierung	para vehículos sin regulación eléctrica de la amortiguac.
für Fahrzeuge mit Start-Stopp-Funktion	para vehículos con sistema Start&Stop	für Fahrzeuge ohne Keramikbremse	para vehículos sin frenos de cerámica
für Fahrzeuge mit Trommelbremse an der Hinterachse	para vehículos con freno de tambor en eje trasero	für Fahrzeuge ohne Klimaanlage	para vehículos sin aire acondicionado
für Fahrzeuge mit verstärktem Fahrwerk	para vehículos con chasis reforzado	für Fahrzeuge ohne Motorbremse	para vehículos sin freno de motor
für Fahrzeuge mit verstärkter Bremse	para vehículos con freno reforzado	für Fahrzeuge ohne Panorama-Sonnendach	para vehículos sin techo solar panorámico
für Fahrzeuge mit Vierradlenkung	para vehículos con dirección en las 4 ruedas	für Fahrzeuge ohne PCS (Pre-Crash Safety System)	para vehículos sin PCS (Pre-Crash Safety System)
für Fahrzeuge ohne 3. Sitzreihe	para vehículos sin 3 hileras de asientos	für Fahrzeuge ohne Schlechtwegausführung	para vehículos sin dispositivo auxiliar para caminos malos
für Fahrzeuge ohne Active City Stop	para vehículos sin Active City Stop	für Fahrzeuge ohne Servolenkung	para vehículos sin dirección asistida
für Fahrzeuge ohne AMG-Performance Package	para vehículos sin paquete AMG performance	für Fahrzeuge ohne Sportfahrwerk	para vehículos sin chasis deportivo
für Fahrzeuge ohne AMG-Sportpaket	para vehículos sin paquete deportivo AMG	für Fahrzeuge ohne Sportpaket	para vehículos sin paquete sport

# Technische Übersetzungen

Technical translations - Traducciones técnicas - Traduccions techniques - Traduzioni tecniche

ES		ES	
<b>für Fahrzeuge ohne Start-Stopp-Funktion</b>	para vehículos sin sistema Start&Stop	<b>Gewindelänge [mm]</b>	Long. de rosca [mm]
<b>für Fahrzeuge ohne verstärktes Fahrwerk</b>	para vehículos sin chasis reforzado	<b>GG</b>	Pinza de frenos de hierro fundido
<b>für Fahrzeuge ohne Vierradlenkung</b>	para vehículos sin dirección en las 4 ruedas	<b>Groß Britan-nien</b>	Gran Bretaña
<b>für gepanzerte Fahrzeuge</b>	para vehículos blindados	<b>grün</b>	verde
<b>für Geschwindigkeitsregel-anlage</b>	para instalación reguladora de velocidad	<b>Halbauto-matik</b>	semiautomática
<b>für Individualausstattungs-ID</b>	para ID equipamiento individual	<b>Halter, Bremsleitung</b>	Soporte, tubería de freno
<b>für Leichtmetallfelgen</b>	para llantas de metal ligero	<b>Halter, Brems-schlauch</b>	Soporte, tubo flexible de freno
<b>für Linkslenker</b>	para vehic. dirección izquierda	<b>HC</b>	altamente carbonizado
<b>für OE-Nummer</b>	para OE N°	<b>HC L</b>	aleado/alt. carburado
<b>für Polizeifahrzeuge</b>	para vehículo de policía	<b>Herstellerein-schränkung</b>	Restricción de fabricante
<b>für Rechtslenker</b>	para vehíc. dirección a la derecha	<b>Höhe 1 [mm]</b>	Altura 1 [mm]
<b>für Schaltgetriebe</b>	para transmisión manual	<b>Höhe 2 [mm]</b>	Altura 2 [mm]
<b>für Sonderfahrzeuge</b>	para vehículos especiales	<b>Hohl-schraube</b>	Tronillo hueco
<b>für Stahlfelgen</b>	para llantas de acero	<b>Informati-onsart</b>	Tipo información
<b>für Taxifahrzeuge</b>	para taxis	<b>Innendurch-messer [mm]</b>	Diámetro interior [mm]
<b>gelb</b>	amarillo	<b>Innen-Torx</b>	Torx interior
<b>Generischer Artikel</b>	Número de artículo genérico	<b>- J</b>	Japón
<b>Geschlossen</b>	cerrada	<b>Japan</b>	Japón
<b>Gewindeausführung</b>	Tipo de rosca	<b>Kanada</b>	Canadá
		<b>Kasten/Kombi</b>	Furgón/ranchera familiar
		<b>Kombi</b>	Ranchera familiar
		<b>Kunststoff</b>	Plástico
		<b>kurzer Radstand</b>	distancia corta entre ejes
		<b>L</b>	aleado
		<b>L=</b>	Longitud [mm]
		<b>L=</b>	Longitud total [mm] Longitud contacto de aviso
		<b>L1=</b>	Longitud 1 [mm]
		<b>L2=</b>	Longitud 2 [mm]





# Technische Übersetzungen

Technical translations - Traducciones técnicas - Traductions techniques - Traduzioni tecniche

ES		ES	
<b>langer Radstand</b>	Distancia larga entre ejes	<b>nicht für Baumuster</b>	no para tipo de construcción
<b>Leichtmetallfelge</b>	Llantas de aleación ligera	<b>nicht für Behördenfahrzeuge</b>	no para veh. admon. pública
<b>- LG</b>	sin apoyo	<b>nicht für Bremssattel-farbe</b>	no para color pinza freno
<b>Lochanzahl</b>	Número de orificios	<b>nicht für erhöhte Nutzlast</b>	no para carga útil aumentada
<b>Lochkreis-Ø [mm]</b>	corona de agujeros - Ø [mm]	<b>nicht für Fahrzeuge mit verstärkter Bremse</b>	no para vehículos con frenos reforzados
<b>luftgefederte Achse</b>	Eje con suspensión neumática	<b>nicht für Felgengröße [Zoll]</b>	no para dimensión de llantas [Zoll]
<b>Made in</b>	País producción vehículo	<b>nicht für gepanzerte Fahrzeuge</b>	no para vehículos blindados
<b>MAN</b>	Sistema de frenos, Mando	<b>nicht für Leichtmetallfelgen</b>	no para llantas de metal ligero
<b>mit Anti-Quietsch-Blech</b>	Chapa antichirridos	<b>nicht für Motorcode</b>	no para código de motor
<b>mit Brems-sattel-schrauben</b>	con tornillos pinza freno	<b>nicht für Multi-link Achse</b>	no para eje multilink
<b>mit Doppel-bereifung</b>	con neumáticos gemelos	<b>nicht für Polizeifahrzeuge</b>	no para veh. policía
<b>mit Einfach-bereifung</b>	con neumáticos sencillos	<b>nicht für Postfahr-zeuge</b>	no para veh. correos
<b>mit Entlüfter-ventil</b>	con válvula de ventilación	<b>nicht für SA Code</b>	no para código SA
<b>mit Feder</b>	con muelle	<b>nicht für Sonderfahr-zeuge</b>	no para veh. especiales
<b>mit gere-geltem (3-Wege) Kata-lysatör</b>	con catalizador regulado (3 vías)	<b>nicht für Taxifahr-zeuge</b>	no para taxis
<b>mit Leichtme-tallfelge</b>	con llantas de aleación ligera	<b>NIS</b>	Sistema de frenos, Nissin
<b>mit Stahl-felge</b>	con llantas de acero	<b>nur für Mine-ralöl</b>	sólo para aceite mineral
<b>Motorcode</b>	Código de motor	<b>nur in Verbin-dung mit</b>	sólo con
<b>Multi-link Achse</b>	Eje multilink		
<b>Nabendurch-messer [mm]</b>	Diaméto cubo[mm]		
<b>nicht für Ausstat-tungsvari-ante</b>	no para variante de equipamiento		
<b>nicht für Automatikge-triebe</b>	no para transmisión automática		

# Technische Übersetzungen

Technical translations - Traducciones técnicas - Traductions techniques - Traduzioni tecniche

ES		ES	
<b>Nutzlast [kg]</b>	Carga útil [kg]	<b>Russia-made</b>	Rusia
<b>Nutzlast ab [kg]</b>	carga útil desde [kg]	<b>Schalter, Bremsleuchte</b>	Interruptor, luz de freno
<b>Nutzlast bis [kg]</b>	carga útil hasta [kg]	<b>Schaltgetriebe</b>	Caja de cambios manual
<b>OE-Hersteller</b>		<b>Schaltgetriebe, automatisch betätigt</b>	Manual, automatizada
<b>OE-Nummer</b>		<b>Schaltgetriebe 5 Gang</b>	Manual, 5 vel.
<b>OE-Referenz</b>		<b>Scheibenbremse</b>	Discos
<b>ohne integrierten Verschleißsensor</b>	sin sensor de desgaste	<b>Schlauch</b>	Tubo flexible
<b>ohne Katalysator</b>	sin catalizador	<b>Schlüsselweite</b>	Ancho de llave
<b>ohne Leichtmetallfelge</b>	sin llantas de aleación ligera	<b>Schraubanschluss</b>	Conexión roscada
<b>Orga →</b>	nº de organización desde	<b>Schraubkontakt</b>	contacto roscado
<b>passend für Felgengröße [Zoll]</b>	adecuado para tamaño llanta [inch]	<b>schwarz</b>	negro
<b>PER</b>	Sistema de frenos, Perrot	<b>silber</b>	plateado
<b>- Performance Parts</b>	para vehículos sin frenos alto rendimiento	<b>Slowakische Republik</b>	República eslovaca
<b>Pol-Anzahl</b>	Número de polos	<b>SOHC/OHC</b>	SOHC/OHC
<b>PowerDisc</b>	Denominación adicional del artículo, PowerDisc	<b>Sortiment, Armaturen</b>	Surtido de armaduras
<b>Prüfanschluss, Rohrleitungen</b>	Conexión de prueba, tuberías	<b>Sortiment, Befestigungselemente</b>	Surtido, elementos de sujeción
<b>Raddurchmesser [Zoll]</b>	Diámetro de rueda [in]	<b>Sortiment, Entlüfterschrauben</b>	Surtido, tornillos de purga de aire
<b>Radstand [mm]</b>	Distancia entre ejes [mm]	<b>Spezialaufbau</b>	Carrocería especial
<b>Republik Korea (Südkorea)</b>	Rep. Corea (Corea del Sur)	<b>Stahlfelge</b>	Llanta de acero
<b>Ringstutzen, Rohrleitung</b>	Tubuladura anular, tubería	<b>Starrachse</b>	Eje rígido
<b>- RLG</b>	sin cojinete rueda	<b>Steckerausführung</b>	Modelo de conector
<b>rot</b>	rojo	<b>Stopfen, Bremsflüssigkeitsbehälter</b>	Tapón, depósito líquido de frenos
<b>RPO Nummer</b>	Número RPO		
<b>Rückschlagventil</b>	Válvula de retención		





# Technische Übersetzungen

Technical translations - Traducciones técnicas - Traductions techniques - Traduzioni tecniche

ES		ES	
<b>SUM</b>	Sistema de frenos, Sumitomo	<b>Warnkontakt, Bremsbelagverschleiß</b>	Contacto de aviso, desgaste de los frenos
<b>Textbaustein</b>	módulo de texto	<b>- WE</b>	no preparado para indicador de desgaste
<b>T-Form (T-Stück)</b>	en T	<b>- WK</b>	excl. contacto de avisador de desgaste sin contacto de aviso de desgaste
<b>Thailand</b>	Tailandia	<b>x</b>	Ancho [mm] Altura [mm]
<b>TOK</b>	Sistema de frenos, Tokico	<b>x</b>	cantidad indicadores de desgaste [por eje] Número de conexiones
<b>TRW</b>	Sistema de frenos, Lucas / TRW	<b>Zentrierungsdurchmesser [mm]</b>	Diámetro de centrado [mm]
<b>Tschechische Republik</b>	República Checa	<b>- Zub</b>	sin accesorios
<b>Türenanzahl</b>	Número de puertas	<b>Zubehörsatz, Scheibenbremsbelag</b>	Kit de accesorios, pastillas de frenos
<b>Überwurfmutter</b>	Tuerca racor	<b>zul. Gesamtgewicht [kg]</b>	Peso total autorizado [kg]
<b>Überwurfschraube</b>	Tornillo de unión	<b>Ø</b>	Diámetro [mm]
<b>Ungarn</b>	Hungría	<b>Ø1</b>	Diámetro 1 [mm]
<b>USA</b>	EE UU	<b>Ø2</b>	Diámetro 2 [mm]
<b>- USA</b>	EE UU	<b>•</b>	Perforado
<b>V</b>	Ventilación interna ventilado	<b>→</b>	año construcción desde nº de chasis desde
<b>V/</b>	ranurado/vent. interior	<b>→</b>	año construcción hasta nº de chasis hasta
<b>Ventil, Unterdruckleitung</b>	Válvula, tubería de depresión	<b>→Orga</b>	nº de organización hasta
<b>Verbindungs-/Verteilerstück, Rohrleitungen</b>	Piezas distribuidoras/unión, tuberías	<b>→VET</b>	nº VET hasta
<b>Verschluss, Bremsflüssigkeitsbehälter</b>	Tapa, depósito de líquido de frenos	<b>→Ø</b>	Diámetro hasta [mm]
<b>Verschluss-/Schutzkappe</b>	Tapa de cierre/protección		
<b>Verschluss-schraube</b>	Tapón roscado		
<b>Version</b>	Versión		
<b>VET →</b>	nº VET desde		
<b>Vollautomatik</b>	completamente automática		
<b>VW</b>	Sistema de frenos, Volkswagen		
<b>V•</b>	Perforado/ventil. int.		
<b>wahlweise</b>	opcional		

# Technische Übersetzungen

Technical translations - Traducciones técnicas - Traductions techniques - Traduzioni tecniche

FR		FR	
	Kit de plaquettes de frein, frein à disque	<b>+ Zub</b>	avec accessoires
	Disque de frein	<b>ABE</b>	avec autorisation d'exploitation
	Essieu arrière gauche	<b>Abmessungen beachten</b>	Respecter les dimensions
	Essieu arrière droit	<b>- ABS</b>	pour véhicules sans système antiblo-cage pas pour ABS
	Essieu avant gauche	<b>- ABS Ring</b>	sans bague ABS
	Essieu avant droit	<b>Achsnummer</b>	Numéro d'essieu
<b>+ ABS</b>	pour véhicules avec système antiblo-cage pour ABS	<b>Achszapfen-durchmesser [mm]</b>	Diamètre du bout d'essieu [mm]
<b>+ ABS Ring</b>	avec bague ABS	<b>Adapter, Bremsleitung</b>	Adaptateur, conduite de frein
<b>+ ASR</b>	pour véhicules avec ASR	<b>ADV</b>	Système de freinage, Advics
<b>+ D</b>	Allemagne	<b>AIS</b>	Système de freinage, Aisin
<b>+ eFSB</b>	pour véhicules avec frein d'arrêt électro-nique	<b>AKE</b>	Système de freinage, Akebono
<b>+ ESP</b>	pour véhicules avec ESP	<b>Allrad</b>	Traction intégrale
<b>+ ETS</b>	pour véhicules avec ETS	<b>ALU</b>	Étrier de frein en aluminium
<b>+ EU</b>	Europe	<b>Anschluss-gewinde</b>	Filetage de raccordement
<b>+ J</b>	Japon	<b>Anschluss links</b>	Raccord gauche
<b>+ LG</b>	avec bague	<b>Anschluss rechts</b>	Raccord droite
<b>+ Performance Parts</b>	pour véhicule avec frein Performance	<b>Anschluss-tutzen, Schlauchlei-tung</b>	Raccord, tuyau flexible
<b>+POC</b>	pour POC	<b>Anzahl der Bohrungen</b>	Nombre d'alésages
<b>+PR</b>	pour numéro PR	<b>Anzahl Sitz-plätze</b>	Nombre de sièges
<b>+ RO</b>	Roumanie	<b>AP</b>	Système de freinage, AP Lockheed
<b>+ RUS</b>	Russie	<b>Artikel-nummer des empfohlenen Zubehörs</b>	Référence de l'accessoire recommandé
<b>+ S</b>	avec vis/boulons	<b>- ASR</b>	pour véhicules sans ASR
<b>+SA</b>	pour SA code	<b>ATE Ceramic</b>	Designation d'article complémentaire, ATE Ceramic
<b>+ SKA</b>	Scandinavie	<b>außenbe-lüftet</b>	ventilé de l'extérieur
<b>+ TR</b>	Turquie		
<b>+ USA</b>	USA		
<b>+ WE</b>	préparé pour indicateur d'usure		
<b>+ WK</b>	contact de signal d'usure inclu avec contact du palpeur d'usure intégré avec indicateur d'usure		



# Technische Übersetzungen

Technical translations - Traducciones técnicas - Traductions techniques - Traduzioni tecniche

FR		FR	
<b>Außendurchmesser [mm]</b>	Diamètre extérieur [mm]	<b>Brems-scheibe zwei-teilig</b>	Disque de frein en deux pièces
<b>Automatikgetriebe</b>	Boîte automatique	- CDN	Canada
<b>B</b>	revêtu	<b>China</b>	Chine
<b>B1=</b>	Largeur 1 [mm]	<b>China-made</b>	Chine
<b>B2=</b>	Largeur 2 [mm]	<b>CIT</b>	Système de freinage, Citroen
<b>Baumuster</b>	Modèle type	<b>CVT-Automatikgetriebe (Stufenlos)</b>	Boîte de vitesses à variateur classique (CVT, continu)
<b>BDX</b>	Système de freinage, Bendix	- D	Allemagne
<b>Bearbeitung</b>	Traitement	<b>Dichtung, Unterdruck-Anschlusstutzen BKV</b>	Joint, tubulure de prise de dépression
<b>Bohrung-Ø 1 [mm]</b>	Alésage-Ø 1 [mm]	<b>DIN/ISO</b>	DIN/ISO
<b>Bohrung-Ø 2 [mm]</b>	Alésage-Ø 2 [mm]	<b>DIN 74235 Form EL</b>	DIN 74235 forme EL
<b>Bördelform</b>	Forme du bord relevé	<b>DIN 74235 Form FL</b>	DIN 74235 forme FL
<b>BOS</b>	Système de freinage, Bosch	<b>DOHC</b>	DOHC
<b>BRE</b>	Système de freinage, Brembo	<b>Doppelquerlenkerachse</b>	Suspension à bras triangulaires doubles
<b>Brems-/ Fahrdyn. Artikelbezug</b>	Lien d'article avec dynamique de freinage et de mouvement	<b>Durchmesser Aufnahme [mm]</b>	Diamètre réception [mm]
<b>Bremsbelagsatz, Scheibenbremse</b>	Kit de plaquettes de frein, frein à disque	<b>E</b>	E
<b>Bremsleitung</b>	Conduite de frein	- eFSB	pour véhicules sans frein d'arrêt électronique
<b>Brems-sattel(1-Kolben)</b>	Etrier de frein (1 piston)	<b>einteilig</b>	à une seule pièce
<b>Brems-sattel(2-Kolben)</b>	Etrier de frein (2 pistons)	<b>Einzelradaufhängung</b>	Suspension roue indépendante
<b>Brems-sattel(4-Kolben)</b>	Etrier de frein (4 pistons)	<b>elektrisch-hydraulisch</b>	électrique-hydraulique
<b>Bremssattel-farbe</b>	Couleur de l'étrier	<b>Entlüfterschraube/-ventil</b>	Soupape/vis de purge d'air
<b>Bremssattel mit 1 Haltestift</b>	Etrier à une goupille	<b>EPDM (Ethylen-Propylen-Dien-Kautschuk)</b>	EPDM (éthylène-propylène-diène-caoutchouc)
<b>Bremssattel mit 2 Haltestiften</b>	Etrier à deux goupilles	- ESP	pour véhicules sans ESP
<b>Brems-scheibe</b>	Disque de frein	- ETS	pour véhicules sans ETS
		<b>Europa</b>	Europe



# Technische Übersetzungen

Technical translations - Traducciones técnicas - Traductions techniques - Traduzioni tecniche

FR		FR
F	F	
<b>Felge Lochzahl</b>	Jante, nombre de trous	<b>für Fahrzeuge mit Active City Stop</b> pour véhicule avec Active City Stop
<b>Felgenreöße [Zoll]</b>	Dimension de la jante [pouces]	<b>für Fahrzeuge mit AMG-Sportpaket</b> pour véhicules avec équipement-sport AMG
<b>Flachstecker</b>	Fiche plate	
<b>Flanschbefestigung</b>	Fixation par bride	<b>für Fahrzeuge mit Bremsassistent</b> pour véhicules avec assistant au freinage
<b>FPM (Fluor-Kautschuk)/ACM (Polyacryl-Kautschuk)</b>	FPM (caoutchouc fluoré) / ACM (caoutchouc polyacrylique)	<b>für Fahrzeuge mit elektr. Dämpferregulierung</b> pour véhicules avec réglage d'amortisseur électronique
<b>Frankreich</b>	France	
<b>Frontantrieb</b>	Traction avant	
<b>für Automatikgetriebe</b>	pour boîtes de vitesses automatiques	<b>für Fahrzeuge mit Keramikbremse</b> pour véhicules avec frein céramique
<b>für Behördenfahrzeuge</b>	pour véhicules d'administration	<b>für Fahrzeuge mit Klimaanlage</b> pour véhicules avec système de climatisation
<b>für Bremsattel mit Kunststoffkolben</b>	pour étrier de frein avec pistons en plastique	<b>für Fahrzeuge mit Niveauregulierung</b> pour véhicules avec correcteur d'assiette
<b>für Bremsattel mit Stahlkolben</b>	pour étrier de frein avec pistons en acier	<b>für Fahrzeuge mit Panorama-Sonnendach</b> pour véhicules avec toit panoramique
<b>für Bremscheibendicke [mm]</b>	pour épaisseur de disque de frein [mm]	<b>für Fahrzeuge mit PCS (Pre-Crash Safety System)</b> pour véhicules avec PCS (Pre-Crash Safety System)
<b>für Bremscheibendurchmesser [mm]</b>	pour diamètre du disque de frein [mm]	<b>für Fahrzeuge mit Scheibenbremse an der Hinterachse</b> pour véhicules avec frein à disques à l'essieu arrière
<b>für Bremscheibendurchmesser [Zoll]</b>	pour diamètre disque de frein [pouce]	
<b>für Doppelbereifung</b>	pour pneus doubles	
<b>für Einfachbereifung</b>	pour pneus simples	<b>für Fahrzeuge mit Schlechtwegausführung</b> pour véhicules préparés pour routes dégradées
<b>für erhöhte Nutzlast</b>	pour charge utile surélevée	
<b>für ESP</b>	pour ESP	
<b>für Fahrzeuge mit 3. Sitzreihe</b>	pour véhicules avec 3ième rangée de sièges	



# Technische Übersetzungen

Technical translations - Traducciones técnicas - Traductions techniques - Traduzioni tecniche

FR		FR	
für Fahrzeuge mit Servolenkung	pour véhicules avec direction assistée	für Fahrzeuge ohne Bordcomputer	pour véhicules sans ordinateur de bord
für Fahrzeuge mit Sportfahrwerk	pour véhicules avec châssis sportif	für Fahrzeuge ohne Bremsassistent	pour véhicules sans assistant de freinage
für Fahrzeuge mit Sportpaket	pour véhicules avec équipement sport	für Fahrzeuge ohne elektr. Dämpferregulierung	pour véhicules sans réglage d'amortisseur électronique
für Fahrzeuge mit Start-Stopp-Funktion	pour véhicules avec fonction Stop/Start	für Fahrzeuge ohne Keramikbremse	pour véhicules sans frein en céramique
für Fahrzeuge mit Trommelbremse an der Hinterachse	pour véhicules avec frein à tambour à l'essieu arrière	für Fahrzeuge ohne Klimaanlage	pour véhicules sans système de climatisation
für Fahrzeuge mit verstärktem Fahrwerk	pour véhicules avec châssis renforcé	für Fahrzeuge ohne Motorbremse	pour véhicules sans frein-moteur
für Fahrzeuge mit verstärkter Bremse	pour véhicules avec frein assisté	für Fahrzeuge ohne Panorama-Sonnendach	pour véhicules sans toit panoramique
für Fahrzeuge mit Vierradlenkung	pour véhicules avec direction par quatre roues	für Fahrzeuge ohne PCS (Pre-Crash Safety System)	pour véhicules sans PCS (Pre-Crash Safety System)
für Fahrzeuge ohne 3. Sitzreihe	pour véhicules sans 3ième rangée de sièges	für Fahrzeuge ohne Schlechtwegausführung	pour véhicules non-préparés pour routes dégradées
für Fahrzeuge ohne Active City Stop	pour véhicule sans Active City Stop	für Fahrzeuge ohne Servolenkung	pour véhicules sans direction assistée
für Fahrzeuge ohne AMG-Performance Package	pour véhicule sans AMG Performance Package	für Fahrzeuge ohne Sportfahrwerk	pour véhicules sans châssis sportif
für Fahrzeuge ohne AMG-Sportpaket	pour véhicules sans paquet-sport AMG	für Fahrzeuge ohne Sportpaket	pour véhicules sans équipement sport

# Technische Übersetzungen

Technical translations - Traducciones técnicas - Traductions techniques - Traduzioni tecniche

FR	FR
<b>für Fahrzeuge ohne Start-Stopp-Funktion</b> pour véhicules sans fonction Stop/Start	<b>Gewindelänge [mm]</b> Longueur du filetage [mm]
<b>für Fahrzeuge ohne verstärktes Fahrwerk</b> pour véhicules sans châssis renforcé	<b>GG</b> Étrier de frein en fonte
<b>für Fahrzeuge ohne Vierradlenkung</b> pour véhicules sans direction par quatre roues	<b>Groß Britanien</b> Grande-Bretagne
<b>für gepanzerte Fahrzeuge</b> pour véhicules blindés	<b>grün</b> vert
<b>für Geschwindigkeitsregelanlage</b> pour régulateur de vitesse	<b>Halbautomatik</b> semi-automatique
<b>für Individualausstattungs-ID</b> pour ID d'équipement individuel	<b>Halter, Bremsleitung</b> Support, conduite de frein
<b>für Leichtmetallfelgen</b> pour jante en alliage léger	<b>Halter, Bremschlauch</b> Support, flexible de frein
<b>für Linkslenker</b> pour véhicules avec direction à gauche	<b>HC</b> à haute teneur en carbone
<b>für OE-Nummer</b> pour numéro OE	<b>HC L</b> allié/carbonisé
<b>für Polizeifahrzeuge</b> pour voitures de police	<b>Herstellereinschränkung</b> Montage d'origine
<b>für Rechtslenker</b> pour véhicules avec direction à droite	<b>Höhe 1 [mm]</b> Hauteur 1 [mm]
<b>für Schaltgetriebe</b> pour boîte de vitesses manuelle	<b>Höhe 2 [mm]</b> Hauteur 2 [mm]
<b>für Sonderfahrzeuge</b> pour véhicules spéciaux	<b>Hohl-schraube</b> Vis creuse
<b>für Stahlfelgen</b> pour jante en acier	<b>Informati- onsart</b> Genre d'information
<b>für Taxifahrzeuge</b> pour taxis	<b>Innendurch- messer [mm]</b> Diamètre intérieur [mm]
<b>gelb</b> jaune	<b>Innen-Torx</b> Torx intérieur
<b>Generischer Artikel</b> Référence générique de l'article	<b>- J</b> Japon
<b>Geschlossen</b> Carrosserie couverte	<b>Japan</b> Japon
<b>Gewindeausführung</b> Filetage/taraudage	<b>Kanada</b> Canada
	<b>Kasten/ Kombi</b> Camionnette/Break
	<b>Kombi</b> Break
	<b>Kunststoff</b> Matière plastique
	<b>kurzer Radstand</b> Empattement court
	<b>L</b> allié
	<b>L=</b> Longueur [mm]
	<b>L=</b> Longueur globale Longueur de contacts d'avertissement [mm]
	<b>L1=</b> Longueur 1 [mm]
	<b>L2=</b> Longueur 2 [mm]



# Technische Übersetzungen

Technical translations - Traducciones técnicas - Traductions techniques - Traduzioni tecniche

FR		FR	
<b>langer Radstand</b>	Empattement long	<b>nicht für Baumuster</b>	pas pour modèle type
<b>Leichtmetallfelge</b>	Jante en alliage léger	<b>nicht für Behördenfahrzeuge</b>	pas pour véhicules de l'administration
<b>- LG</b>	sans palier	<b>nicht für Bremssattel-farbe</b>	pas pour couleur de l'étrier-frein
<b>Lochanzahl</b>	Nombre de trous	<b>nicht für erhöhte Nutzlast</b>	non pour charge utile surélevée
<b>Lochkreis-Ø [mm]</b>	Cercle de perçage -Ø [mm]	<b>nicht für Fahrzeuge mit verstärkter Bremse</b>	pas pour véhicules avec frein assisté
<b>luftgefederte Achse</b>	Essieu à ressorts pneumatiques	<b>nicht für Felgengröße [Zoll]</b>	pas pour dimension de jante [pouce]
<b>Made in</b>	Pays constructeur du véhicule	<b>nicht für gepanzerte Fahrzeuge</b>	pas pour véhicules blindés
<b>MAN</b>	Système de freinage, Mando	<b>nicht für Leichtmetallfelgen</b>	pas pour jante en alliage léger
<b>mit Anti-Quietsch-Blech</b>	avec tôle anti-bruit	<b>nicht für Motorcode</b>	pas pour code moteur
<b>mit Brems-sattel-schrauben</b>	avec boulon/vis d'étrier de frein	<b>nicht für Multi-link Achse</b>	pas pour essieu multilink
<b>mit Doppel-bereifung</b>	avec pneus doubles	<b>nicht für Polizei-fahrzeuge</b>	pas pour voitures de police
<b>mit Einfach-bereifung</b>	avec pneus simples	<b>nicht für Postfahr-zeuge</b>	pas pour véhicules de la poste
<b>mit Entlüfter-ventil</b>	avec soupape de reniflard	<b>nicht für SA Code</b>	pas pour SA code
<b>mit Feder</b>	avec ressort	<b>nicht für Sonderfahr-zeuge</b>	pas pour véhicules spéciaux
<b>mit gere-geltem (3-Wege) Kata-lysatör</b>	avec catalyseur réglé	<b>nicht für Taxifahr-zeuge</b>	pas pour taxis
<b>mit Leichtme-tallfelge</b>	avec jante en alliage léger	<b>NIS</b>	Système de freinage, Nissin
<b>mit Stahl-felge</b>	avec jante en acier	<b>nur für Mine-ralöl</b>	seulmt. pour huile minérale
<b>Motorcode</b>	Code moteur	<b>nur in Verbin-dung mit</b>	uniquement en connexion avec
<b>Multi-link Achse</b>	Essieu multilink		
<b>Nabendurch-messer [mm]</b>	Diamètre du moyeu [mm]		
<b>nicht für Ausstat-tungsvari-ante</b>	pas pour version d'équipement		
<b>nicht für Automatikge-triebe</b>	pas pour boîte de vitesses automatique		

# Technische Übersetzungen

Technical translations - Traducciones técnicas - Traductions techniques - Traduzioni tecniche

FR		FR	
<b>Nutzlast [kg]</b>	Charge utile [kg]	<b>Russia-made</b>	Russie
<b>Nutzlast ab [kg]</b>	Charge utile à partir de [kg]	<b>Schalter, Bremsleuchte</b>	Contacteur, feu stop
<b>Nutzlast bis [kg]</b>	Charge utile jusqu'à [lb]	<b>Schaltgetriebe</b>	boîte de vitesses manuelle
<b>OE-Hersteller</b>		<b>Schaltgetriebe, automatisch betätigt</b>	Boîte de vitesse commandée automatiquement
<b>OE-Nummer</b>		<b>Schaltgetriebe 5 Gang</b>	Boîte de vitesses manuelle à 5 vitesses
<b>OE-Referenz</b>		<b>Scheibenbremse</b>	Frein à disque
<b>ohne integrierten Verschleißsensor</b>	sans palpeur d'usure intégré	<b>Schlauch</b>	Tuyau
<b>ohne Katalysator</b>	sans catalyseur	<b>Schlüsselweite</b>	Ouverture de la clé
<b>ohne Leichtmetallfelge</b>	sans jante en alliage léger	<b>Schraubanschluss</b>	Raccord fileté
<b>Orga →</b>	N° d'organisation à partir de	<b>Schraubkontakt</b>	Type de vis
<b>passend für Felgengröße [Zoll]</b>	va pour taille de jantes [pouces]	<b>schwarz</b>	noir
<b>PER</b>	Système de freinage, Perrot	<b>silber</b>	argent
<b>- Performance Parts</b>	pour véhicules sans frein Performance	<b>Slowakische Republik</b>	République slovaque
<b>Pol-Anzahl</b>	Nombres de pôles	<b>SOHC/OHC</b>	SOHC/OHC
<b>PowerDisc</b>	Designation d'article complémentaire, PowerDisc	<b>Sortiment, Armaturen</b>	Assortiment, robinetterie et accessoires
<b>Prüfanschluss, Rohrleitungen</b>	Raccord d'essai, tuyaux	<b>Sortiment, Befestigungselemente</b>	Assortiment, éléments de fixation
<b>Raddurchmesser [Zoll]</b>	Diamètre de roue [pouces]	<b>Sortiment, Entlüfterschrauben</b>	Assortiment, vis de purge d'air
<b>Radstand [mm]</b>	Empattement [mm]	<b>Spezialaufbau</b>	Carrosserie spéciale
<b>Republik Korea (Südkorea)</b>	République de Corée (Corée du Sud)	<b>Stahlfelge</b>	Jante en acier
<b>Ringstutzen, Rohrleitung</b>	Raccord annulaire, tuyauterie	<b>Starrachse</b>	Essieu rigide
<b>- RLG</b>	sans roulement de roue	<b>Steckerausführung</b>	Type de fiche
<b>rot</b>	rouge	<b>Stopfen, Bremsflüssigkeitsbehälter</b>	Bouchon, filtre déshydratant du liquide de frein
<b>RPO Nummer</b>	Numéro RPO		
<b>Rückschlagventil</b>	Soupape de retenue		











# Technische Übersetzungen

Technical translations - Traducciones técnicas - Traductions techniques - Traduzioni tecniche

FR		FR	
<b>SUM</b>	Système de freinage, Sumitomo	<b>Warnkontakt, Bremsbelagverschleiß</b>	Contact d'avertissement, usure des plaquettes de frein
<b>Textbaustein</b>	module de texte	<b>- WE</b>	non préparé pour indicateur d'usure
<b>T-Form (T-Stück)</b>	forme de T (pièce T)	<b>- WK</b>	contact de signal d'usure exclu sans contact du palpeur d'usure intégré
<b>Thailand</b>	Thaïlande	<b>x</b>	Largeur [mm] Hauteur [mm]
<b>TOK</b>	Système de freinage, Tokico	<b>x</b>	Nombre d'indicateurs d'usure [par essieu] Nombre de connexions
<b>TRW</b>	Système de freinage, Lucas / TRW	<b>Zentrierungsdurchmesser [mm]</b>	Diamètre du centrage [mm]
<b>Tschechische Republik</b>	République tchèque	<b>- Zub</b>	sans accessoires
<b>Türenanzahl</b>	Nombre de portes	<b>Zubehörsatz, Scheibenbremsbelag</b>	Kit d'accessoires, plaquette de frein à disque
<b>Überwurfmutter</b>	Écrou de raccord	<b>zul. Gesamtgewicht [kg]</b>	Poids total autorisé en charge [kg]
<b>Überwurfschraube</b>	Vis de raccord	<b>Ø</b>	Diamètre [mm]
<b>Ungarn</b>	Hongrie	<b>Ø1</b>	Diamètre 1 [mm]
<b>USA</b>	USA	<b>Ø2</b>	Diamètre 2[mm]
<b>- USA</b>	USA	<b>•</b>	poinçonné
<b>V</b>	ventilé de l'intérieur ventilé	<b>→</b>	Année à partir de N° de châssis à partir de
<b>VI</b>	fendu/ventilé de l'intérieur	<b>→</b>	Année jusqu'à N° de châssis jusqu'à
<b>Ventil, Unterdruckleitung</b>	Soupape, tuyau de dépression	<b>→Orga</b>	N° d'organisation jusqu'à
<b>Verbindungs-/ Verteilerstück, Rohrleitungen</b>	Pièce de raccord / distributeur, tuyaux	<b>→VET</b>	Numéro VET jusqu'à
<b>Verschluss, Bremsflüssigkeitsbehälter</b>	Bouchon, réservoir du liquide	<b>→Ø</b>	Diamètre jusqu'à [mm]
<b>Verschluss-/ Schutzkappe</b>	Capuchon de fermeture/de protection		
<b>Verschluss-schraube</b>	Boulon de fermeture		
<b>Version</b>	Version		
<b>VET →</b>	Numéro VET à partir de		
<b>Vollautomatik</b>	entièrement automatique		
<b>VW</b>	Système de freinage, Volkswagen		
<b>V•</b>	poinçonné/ventilé		
<b>wahlweise</b>	au choix		

# Technische Übersetzungen

Technical translations - Traducciones técnicas - Traductions techniques - Traduzioni tecniche

IT		IT	
	Kit pastiglie freno, Freno a disco	<b>+ Zub</b>	con accessori
	Discofreno	<b>ABE</b>	con autorizzazione generale all'uso (ABE)
	Assale posteriore Sx	<b>Abmessungen beachten</b>	Osservare le misure
	Assale posteriore Dx	<b>- ABS</b>	per veicoli senza ABS Non per ABS
	Assale anteriore Sx	<b>- ABS Ring</b>	senza anello sensore ABS
	Assale anteriore Dx	<b>Achsnummer</b>	N° assale
<b>+ ABS</b>	per veicoli con ABS per ABS	<b>Achszapfendurchmesser [mm]</b>	Diametro fusello [mm]
<b>+ ABS Ring</b>	con anello sensore ABS	<b>Adapter, Bremsleitung</b>	Adattatore, Tubazione freno
<b>+ ASR</b>	per veicoli con ASR	<b>ADV</b>	Sistema frenante, Advics
<b>+ D</b>	Germania	<b>AIS</b>	Sistema frenante, Aisin
<b>+ eFSB</b>	per veicoli con freno stazionamento elettronico	<b>AKE</b>	Sistema frenante, Akebono
<b>+ ESP</b>	per veicoli con ESP	<b>Allrad</b>	Trazione integrale
<b>+ ETS</b>	per veicoli con ETS	<b>ALU</b>	Pinza freno in alluminio
<b>+ EU</b>	Europa	<b>Anschlussgewinde</b>	Filettatura di raccordo
<b>+ J</b>	Giappone	<b>Anschluss links</b>	Attacco/Raccordo Sx
<b>+ LG</b>	con supporto/cuscinetto	<b>Anschluss rechts</b>	Attacco/Raccordo Dx
<b>+ Performance Parts</b>	per veicoli con freno Performance	<b>Anschluss-tutzen, Schlauchleitung</b>	Bocchettone raccordo, tubo flessibile
<b>+POC</b>	per POC	<b>Anzahl der Bohrungen</b>	N° fori
<b>+PR</b>	per N° PR	<b>Anzahl Sitzplätze</b>	N° posti a sedere
<b>+ RO</b>	Romania	<b>AP</b>	Sistema frenante, AP Lockheed
<b>+ RUS</b>	Russia	<b>Artikelnummer des empfohlenen Zubehörs</b>	N° articolo accessorio consigliato
<b>+ S</b>	con bulloni/viti	<b>- ASR</b>	per veicoli senza ASR
<b>+SA</b>	per codice SA	<b>ATE Ceramic</b>	Denominazione aggiuntiva dell'articolo, ATE Ceramic
<b>+ SKA</b>	Scandinavia	<b>außenbelüftet</b>	con ventilazione esterna
<b>+ TR</b>	Turchia		
<b>+ USA</b>	USA		
<b>+ WE</b>	Predisposto per contatto segnalazione usura		
<b>+ WK</b>	Con contatto segnalazione usura con segnalatore usura integrato con segnalazione acustica usura		

# Technische Übersetzungen

Technical translations - Traducciones técnicas - Traductions techniques - Traduzioni tecniche

IT		IT	
<b>Außendurchmesser [mm]</b>	Diametro esterno [mm]	<b>Brems-scheibe zwei-teilig</b>	Disco freno in due parti
<b>Automatikge-triebe</b>	Trasmissione automatica	- CDN	Canada
<b>B</b>	rivestito	<b>China</b>	Cina
<b>B1=</b>	Larghezza 1 [mm]	<b>China-made</b>	Cina
<b>B2=</b>	Larghezza 2 [mm]	<b>CIT</b>	Sistema frenante, Citroen
<b>Baumuster</b>	Modello	<b>CVT-Automa-tikgetriebe (Stufenlos)</b>	CVT-Cambio automatico (a variazione continua)
<b>BDX</b>	Sistema frenante, Bendix	- D	Germania
<b>Bearbeitung</b>	Lavorazione/Trattamento	<b>Dichtung, Unterdruck-Anschlusss-tutzen BKV</b>	Guarnizione, Depressione-manicotto d'attacco servofreno
<b>Bohrung-Ø 1 [mm]</b>	Alesaggio-Ø 1 [mm]	<b>DIN/ISO</b>	DIN/ISO
<b>Bohrung-Ø 2 [mm]</b>	Alesaggio-Ø 2 [mm]	<b>DIN 74235 Form EL</b>	DIN 74235 Form EL
<b>Bördelform</b>	Forma bordatura	<b>DIN 74235 Form FL</b>	DIN 74235 Form FL
<b>BOS</b>	Sistema frenante, Bosch	<b>DOHC</b>	DOHC
<b>BRE</b>	Sistema frenante, Brembo	<b>Doppelquer-lenkerachse</b>	Assale a braccio trasversale doppio
<b>Brems-/ Fahrdyn. Artikelbezug</b>	Dinamica frenata/guida. Riferim. arti-colo	<b>Durchmesser Aufnahme [mm]</b>	Diametro sede [mm]
<b>Bremsbelag-satz, Schei-benbremse</b>	Kit pastiglie freno, Freno a disco	<b>E</b>	E
<b>Bremsleitung</b>	Tubazione freno	- eFSB	per veicoli senza freno stazionamento elettronico
<b>Brems-sattel(1-Kolben)</b>	Pinza freno (1 pistone)	<b>einteilig</b>	monopezzo
<b>Brems-sattel(2-Kolben)</b>	Pinza freno (2 pistoni)	<b>Einzelradauf-hängung</b>	Sospensione a ruote indipendenti
<b>Brems-sattel(4-Kolben)</b>	Pinza freno (4 pistoni)	<b>elektrisch-hydraulisch</b>	elettrico-idraulico
<b>Bremssattel-farbe</b>	Colore pinza freno	<b>Entlüfter-schraube/-ventil</b>	Vite / Valvola di sfiato
<b>Bremssattel mit 1 Halte-stift</b>	Pinza freno con 1 spina di fermo	<b>EPDM (Ethylen-Propylen-Dien-Kaut-schuk)</b>	EPDM (Etilene-Propilene-Diene-Caucciù)
<b>Bremssattel mit 2 Halte-stiften</b>	Pinza freno con 2 spine di fermo	- ESP	per veicoli senza ESP
<b>Brems-scheibe</b>	Discofreno	- ETS	per veicoli senza ETS
		<b>Europa</b>	Europa

# Technische Übersetzungen

Technical translations - Traducciones técnicas - Traductions techniques - Traduzioni tecniche

IT		IT	
F	F	<b>für Fahrzeuge mit Active City Stop</b>	per veicoli con Active City Stop
<b>Felge Lochzahl</b>	Cerchione, N° fori	<b>für Fahrzeuge mit AMG-Sportpaket</b>	per veicoli con pacchetto sportivo AMG
<b>Felgenreöße [Zoll]</b>	Misura cerchione [pollici]	<b>für Fahrzeuge mit Bremsassistent</b>	per veicoli con brake assist
<b>Flachstecker</b>	Spina piatta	<b>für Fahrzeuge mit elektr. Dämpferregulierung</b>	per veicoli con regolazione elettr. ammortizzatori
<b>Flanschbefestigung</b>	Fissaggio a flangia	<b>für Fahrzeuge mit Keramikbremse</b>	per veicoli con freni in ceramica
<b>FPM (Fluor-Kautschuk)/ACM (Polyacryl-Kautschuk)</b>	FPM (Fluoro-Caucciù)/ACM (Poliacrilato-Caucciù)	<b>für Fahrzeuge mit Klimaanlage</b>	per veicoli con aria condizionata
<b>Frankreich</b>	Francia	<b>für Fahrzeuge mit Niveauregulierung</b>	per veicoli con impianto correzione altezza
<b>Frontantrieb</b>	Trazione anteriore	<b>für Fahrzeuge mit Panorama-Sonnendach</b>	per veicoli con tetto vetrato-panoramico
<b>für Automatikgetriebe</b>	per cambio automatico	<b>für Fahrzeuge mit PCS (Pre-Crash Safety System)</b>	per veicoli con PCS (Pre-Crash Safety System)
<b>für Behördenfahrzeuge</b>	per veicoli dell'amministrazione pubblica	<b>für Fahrzeuge mit Scheibenbremse an der Hinterachse</b>	per veicoli con freni a disco ad assale posteriore
<b>für Bremsattel mit Kunststoffkolben</b>	per pinza freno con pistone in plastica	<b>für Fahrzeuge mit Schlechtwegausführung</b>	per veicoli con dotazione per strade dissestate
<b>für Bremsattel mit Stahlkolben</b>	per pinza freno con pistone in acciaio		
<b>für Bremscheibendicke [mm]</b>	per spessore disco freno [mm]		
<b>für Bremscheibendurchmesser [mm]</b>	per diametro disco freno [mm]		
<b>für Bremscheibendurchmesser [Zoll]</b>	per diametro disco freno [pollici]		
<b>für Doppelbereifung</b>	per pneumatici gemellati		
<b>für Einfachbereifung</b>	per pneumatici singoli		
<b>für erhöhte Nutzlast</b>	per elevata portata utile		
<b>für ESP</b>	per ESP		
<b>für Fahrzeuge mit 3. Sitzreihe</b>	per veicoli con 3ª fila sedili		



# Technische Übersetzungen

Technical translations - Traducciones técnicas - Traductions techniques - Traduzioni tecniche

IT		IT	
für Fahrzeuge mit Servolenkung	per veicoli con servosterzo	für Fahrzeuge ohne Bordcomputer	per veicoli senza computer di bordo
für Fahrzeuge mit Sportfahrwerk	per veicoli con autotelaio sportivo	für Fahrzeuge ohne Bremsassistent	per veicoli senza brake assist
für Fahrzeuge mit Sportpaket	per veicoli con pacchetto sportivo	für Fahrzeuge ohne elektr. Dämpferregulierung	per veicoli senza regolazione elettr. ammortizzatori
für Fahrzeuge mit Start-Stopp-Funktion	per veicoli con funzione di start-stop	für Fahrzeuge ohne Keramikbremse	per veicoli senza freni in ceramica
für Fahrzeuge mit Trommelbremse an der Hinterachse	per veicoli con freni a tamburo ad assale posteriore	für Fahrzeuge ohne Klimaanlage	per veicoli senza aria condizionata
für Fahrzeuge mit verstärktem Fahrwerk	per veicoli con autotelaio rinforzato	für Fahrzeuge ohne Motorbremse	per veicoli senza freno motore
für Fahrzeuge mit verstärkter Bremse	per veicoli con freno rinforzato	für Fahrzeuge ohne Panorama-Sonnendach	per veicoli senza tetto vetrato-panoramico
für Fahrzeuge mit Vierradlenkung	per veicoli con quattro ruote sterzanti	für Fahrzeuge ohne PCS (Pre-Crash Safety System)	per veicoli senza PCS (Pre-Crash Safety System)
für Fahrzeuge ohne 3. Sitzreihe	per veicoli senza 3 <sup>a</sup> fila sedili	für Fahrzeuge ohne Schlechtwegeausführung	per veicoli senza dotazione per strade dissestate
für Fahrzeuge ohne Active City Stop	per veicoli senza Active City Stop	für Fahrzeuge ohne Servolenkung	per veicoli senza servosterzo
für Fahrzeuge ohne AMG-Performance Package	per veicoli senza pacchetto Performance AMG	für Fahrzeuge ohne Sportfahrwerk	per veicoli senza autotelaio sportivo
für Fahrzeuge ohne AMG-Sportpaket	per veicoli senza pacchetto sportivo AMG	für Fahrzeuge ohne Sportpaket	per veicoli senza pacchetto sportivo



# Technische Übersetzungen

Technical translations - Traducciones técnicas - Traductions techniques - Traduzioni tecniche

IT		IT	
<b>für Fahrzeuge ohne Start-Stopp-Funktion</b>	per veicoli senza funzione di start-stop	<b>Gewinde-länge [mm]</b>	Lunghezza filettatura [mm]
<b>für Fahrzeuge ohne verstärktes Fahrwerk</b>	per veicoli senza autotelaio rinforzato	<b>GG</b>	Pinza freno in ghisa
<b>für Fahrzeuge ohne Vierradlenkung</b>	per veicoli senza quattro ruote sterzanti	<b>Groß Britan-nien</b>	Gran Bretagna
<b>für gepanzerte Fahrzeuge</b>	per veicoli corazzati	<b>grün</b>	verde
<b>für Geschwindigkeitsregel-anlage</b>	per impianto regolazione velocità	<b>Halbauto-matik</b>	Semiautomatico
<b>für Individualausstattungs-ID</b>	per ID-equipaggiamento individuale	<b>Halter, Bremsleitung</b>	Supporto, Tubazione freno
<b>für Leichtmetallfelgen</b>	per cerchi in lega leggera	<b>Halter, Brems-schlauch</b>	Supporto, Flessibile freno
<b>für Linkslenker</b>	per veicolo con guida a Sx	<b>HC</b>	ad alto tenore di carbonio
<b>für OE-Nummer</b>	per N° OE	<b>HC L</b>	legato /ad alto tenore di carbonio
<b>für Polizeifahrzeuge</b>	per veicoli della polizia	<b>Herstellerein-schränkung</b>	Limitazione costruttore
<b>für Rechtslenker</b>	per veicolo con guida a Dx	<b>Höhe 1 [mm]</b>	Altezza 1 [mm]
<b>für Schaltgetriebe</b>	per cambio manuale	<b>Höhe 2 [mm]</b>	Altezza 2 [mm]
<b>für Sonderfahrzeuge</b>	per veicoli speciali	<b>Hohl-schraube</b>	Vite cava
<b>für Stahlfelgen</b>	per cerchi in acciaio	<b>Informati-onsart</b>	Tipo informazione
<b>für Taxifahrzeuge</b>	per taxi	<b>Innendurch-messer [mm]</b>	Diametro interno [mm]
<b>gelb</b>	giallo	<b>Innen-Torx</b>	Torx interno
<b>Generischer Artikel</b>	Numero generico dell'articolo	<b>- J</b>	Giappone
<b>Geschlossen</b>	Chiuso	<b>Japan</b>	Giappone
<b>Gewindeausführung</b>	Versione filettatura	<b>Kanada</b>	Canadà
		<b>Kasten/Kombi</b>	Cassone / Furgonato / Promiscuo
		<b>Kombi</b>	Station wagon
		<b>Kunststoff</b>	Plastica
		<b>kurzer Radstand</b>	Passo ruote corto
		<b>L</b>	alligato/legato
		<b>L=</b>	Lunghezza [mm]
		<b>L=</b>	Lunghezza totale [mm] Lunghezza contatti di segnalazione [mm]
		<b>L1=</b>	Lunghezza 1 [mm]
		<b>L2=</b>	Lunghezza 2 [mm]



# Technische Übersetzungen

Technical translations - Traducciones técnicas - Traductions techniques - Traduzioni tecniche

IT		IT	
<b>langer Radstand</b>	Passo ruote lungo	<b>nicht für Baumuster</b>	non per modello
<b>Leichtmetallfelge</b>	Cerchione in lega leggera	<b>nicht für Behördenfahrzeuge</b>	Non per veicoli dell'amministrazione pubbl.
<b>- LG</b>	senza supporto	<b>nicht für Bremssattel-farbe</b>	non per colore pinza freno
<b>Lochanzahl</b>	N° fori	<b>nicht für erhöhte Nutzlast</b>	Non per elevata portata utile
<b>Lochkreis-Ø [mm]</b>	Cerchio foro-Ø [mm]	<b>nicht für Fahrzeuge mit verstärkter Bremse</b>	Non per veicoli con freno rinforzato
<b>luftgefederte Achse</b>	Assale a sospensione pneumatica	<b>nicht für Felgenreöße [Zoll]</b>	non per misura cerchione [pollici]
<b>Made in</b>	Paese produzione veicolo	<b>nicht für gepanzerte Fahrzeuge</b>	Non per veicoli corazzati
<b>MAN</b>	Sistema frenante, Mando	<b>nicht für Leichtmetallfelgen</b>	non per cerchioni in lega leggera
<b>mit Anti-Quietsch-Blech</b>	con lamierino anticigolío	<b>nicht für Motorcode</b>	non per codice motore
<b>mit Brems-sattel-schrauben</b>	con bulloni pinza freno	<b>nicht für Multi-link Achse</b>	Non per assale multilink
<b>mit Doppel-bereifung</b>	con pneumatici gemellati	<b>nicht für Polizei-fahrzeuge</b>	Non per mezzi della polizia
<b>mit Einfach-bereifung</b>	con pneumatici singoli	<b>nicht für Postfahr-zeuge</b>	non per veicoli delle poste
<b>mit Entlüfter-ventil</b>	con valvola di sfiato	<b>nicht für SA Code</b>	non per codice SA
<b>mit Feder</b>	con molla	<b>nicht für Sonderfahr-zeuge</b>	Non per veicoli speciali
<b>mit gere-geltem (3-Wege) Kata-lysatör</b>	con catalizzatore a tre vie	<b>nicht für Taxifahr-zeuge</b>	Non per taxi
<b>mit Leichtme-tallfelge</b>	con cerchioni in lega leggera	<b>NIS</b>	Sistema frenante, Nissin
<b>mit Stahl-felge</b>	con cerchione in acciaio	<b>nur für Mine-ralöl</b>	Solo per olio minerale
<b>Motorcode</b>	Codice motore	<b>nur in Verbin-dung mit</b>	solo unitamente a
<b>Multi-link Achse</b>	Assale multilink		
<b>Nabendurch-messer [mm]</b>	Diametro mozzo [mm]		
<b>nicht für Ausstat-tungsvari-ante</b>	non per tipo equipaggiamento		
<b>nicht für Automatikge-triebe</b>	Non per trasmissione automatica		

# Technische Übersetzungen

Technical translations - Traducciones técnicas - Traductions techniques - Traduzioni tecniche

IT		IT	
<b>Nutzlast [kg]</b>	Portatautile [kg]	<b>Russia-made</b>	Russia
<b>Nutzlast ab [kg]</b>	Portata utile da [kg]	<b>Schalter, Bremsleuchte</b>	Interruttore, Luce posteriore di stop
<b>Nutzlast bis [kg]</b>	Portata utile fino a [kg]	<b>Schaltgetriebe</b>	Cambio manuale
<b>OE-Hersteller</b>		<b>Schaltgetriebe, automatisch betätigt</b>	Cambio manuale, azionamento automatico
<b>OE-Nummer</b>		<b>Schaltgetriebe 5 Gang</b>	Cambio manuale a 5 marce
<b>OE-Referenz</b>		<b>Scheibenbremse</b>	Freno a disco
<b>ohne integrierten Verschleißsensor</b>	senza sensore usura integrato	<b>Schlauch</b>	Flessibile
<b>ohne Katalysator</b>	senza catalizzatore	<b>Schlüsselweite</b>	Apertura chiave
<b>ohne Leichtmetallfelge</b>	senza cerchione in lega leggera	<b>Schraubanschluss</b>	Raccordo a vite
<b>Orga →</b>	N° organizzazione da	<b>Schraubkontakt</b>	Contatto a vite
<b>passend für Felgengröße [Zoll]</b>	idoneo per misura cerchione [pollici]	<b>schwarz</b>	nero
<b>PER</b>	Sistema frenante, Perrot	<b>silber</b>	argento
<b>- Performance Parts</b>	per veicoli senza freno Performance	<b>Slowakische Republik</b>	Repubblica slovacca
<b>Pol-Anzahl</b>	N° poli	<b>SOHC/OHC</b>	SOHC/OHC
<b>PowerDisc</b>	Denominazione aggiuntiva dell'articolo, PowerDisc	<b>Sortiment, Armaturen</b>	Assortimento, Strumentazione
<b>Prüfanschluss, Rohrleitungen</b>	Collegamento di controllo, tubazioni	<b>Sortiment, Befestigungselemente</b>	Assortimento, Elementi di fissaggio
<b>Raddurchmesser [Zoll]</b>	Diametro ruota [pollici]	<b>Sortiment, Entlüfterschrauben</b>	Assortimento, Bulloni spurgo aria
<b>Radstand [mm]</b>	Passo ruote [mm]	<b>Spezialaufbau</b>	Carrozzeria speciale
<b>Republik Korea (Südkorea)</b>	Repubblica di Corea(Corea del Sud)	<b>Stahlfelge</b>	Cerchione in acciaio
<b>Ringstutzen, Rohrleitung</b>	Bocchettone anulare, Tubazione	<b>Starrachse</b>	Assale rigido
<b>- RLG</b>	senza cuscinetto ruota	<b>Steckerausführung</b>	Tipo spina
<b>rot</b>	rosso	<b>Stopfen, Bremsflüssigkeitsbehälter</b>	Tappo, Serbatoio liquido freni
<b>RPO Nummer</b>	Numero RPO		
<b>Rückschlagventil</b>	Valvola di non ritorno		



# Technische Übersetzungen

Technical translations - Traducciones técnicas - Traductions techniques - Traduzioni tecniche

IT		IT	
<b>SUM</b>	Sistema frenante, Sumitomo	<b>Warnkontakt, Bremsbelagverschleiß</b>	Contatto segnalazione, Usura past. freno/mat. d'attrito
<b>Textbaustein</b>		<b>- WE</b>	Non predisposto per contatto segnalazione usura
<b>T-Form (T-Stück)</b>	Forma a T ( pezzo T)	<b>- WK</b>	senza contatto segnalazione usura senza segnalatore usura integrato
<b>Thailand</b>	Tailandia	<b>x</b>	Larghezza [mm] Altezza [mm]
<b>TOK</b>	Sistema frenante, Tokico	<b>x</b>	N° indicatori usura [per asse] N° raccordi
<b>TRW</b>	Sistema frenante, Lucas / TRW	<b>Zentrierungsdurchmesser [mm]</b>	Diametro centraggio [mm]
<b>Tschechische Republik</b>	Repubblica ceca	<b>- Zub</b>	senza accessori
<b>Türenanzahl</b>	N° portiere	<b>Zubehörsatz, Scheibenbremsbelag</b>	Kit accessori, Pastiglia freno
<b>Überwurfmutter</b>	Dado a risvolto	<b>zul. Gesamtgewicht [kg]</b>	Peso complessivo omologato [kg]
<b>Überwurfschraube</b>	Vite a cappello	<b>Ø</b>	Diametro [mm]
<b>Ungarn</b>	Ungheria	<b>Ø1</b>	Diametro 1 [mm]
<b>USA</b>	USA	<b>Ø2</b>	Diametro 2 [mm]
<b>- USA</b>	USA	<b>•</b>	perforato
<b>V</b>	Autoventilato ventilato	<b>→</b>	Anno da N° telaio da
<b>V/</b>	intagliato /autoventilato	<b>→</b>	Anno fino a N° telaio fino a
<b>Ventil, Unterdruckleitung</b>	Valvola, Condotto depressione	<b>→Orga</b>	N° organizzazione fino a
<b>Verbindungs-/ Verteilerstück, Rohrleitungen</b>	Pezzo di raccordo / Ripartitore, Tubazioni	<b>→VET</b>	N° VET fino a
<b>Verschluss, Bremsflüssigkeitsbehälter</b>	Chiusura, serbatoio liquido freni	<b>→Ø</b>	Diametro fino a [mm]
<b>Verschluss-/ Schutzkappe</b>	Cappa di chiusura/protezione		
<b>Verschluss-schraube</b>	Vite di chiusura		
<b>Version</b>	Versione		
<b>VET →</b>	N° VET da		
<b>Vollautomatik</b>	Interamente automatizzato		
<b>VW</b>	Sistema frenante, Volkswagen		
<b>V•</b>	perforato / autoventilato		
<b>wahlweise</b>	a scelta		





ATE – A Trademark of the  
Continental Corporation

**Continental Aftermarket GmbH**

Guerickestraße 7  
D-60488 Frankfurt am Main  
Tel. +49 (0) 69 7603-1  
Fax +49 (0) 69 761061

[www.ate.de](http://www.ate.de)

**Continental Automotive Trading  
Italia S.r.l.**

Segmento IAM – ATE  
Via Matteotti, 62  
I-20092 Cinisello Balsamo (MI)  
Tel. +39 02 35680 1  
Fax +39 02 35680 325  
E-Mail: [info.consumatori@continental-corporation.com](mailto:info.consumatori@continental-corporation.com)

[www.ate-freni.it](http://www.ate-freni.it)

**Continental Automotive France SAS**

1 rue de Clairefontaine  
F-78120 Rambouillet  
Tél. +33 (0)1 34 44 10 30  
Fax +33 (0)1 34 57 40 72  
E-Mail: [07GYFMate-technique@continental-corporation.com](mailto:07GYFMate-technique@continental-corporation.com)

[www.ate-freinage.fr](http://www.ate-freinage.fr)

**Continental Automotive Spain, S.A.**

C/ Sepúlveda, 11  
E-28108 Alcobendas (Madrid)  
Phone +34 (0) 657 21 21  
Fax +34 (0)91 657 21 49

[www.frenos-ate.es](http://www.frenos-ate.es)