

2019

Bremshydraulik Hydraulic Components

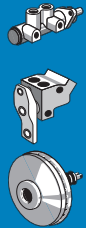

Bremshydraulik Hydraulic Components
Bremsen-Ersatzteilprogramm Brake Parts Program

2019

Bremsen-Ersatzteilprogramm

Brake Parts Program



Brakethrough Technology





Erstklassig First-class

Besser ist besser

Wenn es um Qualität geht, genügt uns ein „sehr gut“ noch lange nicht. Wir erfüllen hohe Ansprüche an das Qualitätsmanagement und die europäische Sicherheitsnorm ECE-R90 wird von ATE sogar übertroffen. Zudem führen wir zahlreiche zusätzliche Tests durch, unter anderem zu Verschleiß und Wärmeleistung.

Auch Nachhaltigkeit ist uns wichtig: Wir stellen die Mischungen für ATE Bremsbeläge auf kupferfreie Materialien um und setzen bei ATE Ceramic auf geringen Abrieb. Nutzen ausschließlich umweltfreundliches Material für die Beschichtung von Bremsscheiben. Und bereiten Produkte wie Bremsattel wieder auf.

Better is better

When it comes to quality, “very good” is simply not good enough for us. We meet high standards of quality management – and ATE even exceeds the European safety standard ECE-R90. We also perform many additional tests, including wear and thermal performance.

Sustainability is also important to us: we convert the compounds for ATE brake pads to copperfree materials and opt for low abrasion with ATE Ceramic. We only use environmentally friendly material for the coating of brake discs – and we remanufacture products like brake callipers.

Original? Mit Sicherheit

Qualität ist für uns nicht nur während der Produktentwicklung und vor der Auslieferung ein Thema. Nach dem Kauf können Sie jederzeit überprüfen, ob Sie ein Original ATE Produkt vor sich haben – über ein zweistufiges Sicherheitsetikett.

Die erste Stufe ist der tesa Priospot®. Hier wurden die Merkmale des tesa Holospot® – der nach wie vor höchste Sicherheit bietet – noch weiter entwickelt. Die fälschungssichere Holografie-Technik mit verschiedenen Prüf- und Sicherheitsmechanismen schützt sogar das Etikett selbst vor Nachahmern.

Die zweite Stufe ist ein DataMatrix-Code, kurz MAPP-Code. Dessen letzte vier Ziffern werden auch im Holospot® bzw. Priospot® dargestellt – für ein Höchstmaß an Sicherheit.

Der Code kann per Scanner oder durch manuelle Eingabe auf der ATE Website überprüft werden und zeigt sofort an, ob es sich bei dem Produkt um ein Originalteil handelt. In Verbindung mit entsprechender Software wie der ATE App ist auch die Abfrage per Smartphone möglich.



Mehrstufiges ATE Sicherheits-etikett mit DataMatrix-Code (Mitte) und Tesa Priospot® (oben rechts).

Multi-stage ATE security label with Data Matrix code (centre) and tesa Priospot® (top right).

Zur Online-Abfrage und zum App-Download:
www.ate.de/original

To online verification and app download:
www.ate-brakes.com/original



Wir engagieren uns bei MAPP –
Manufacturers against Product Piracy.

We are committed to MAPP –
Manufacturers against Product Piracy.

Einfach mehr Tests: ATE Bremsbeläge More tests: ATE brake pads

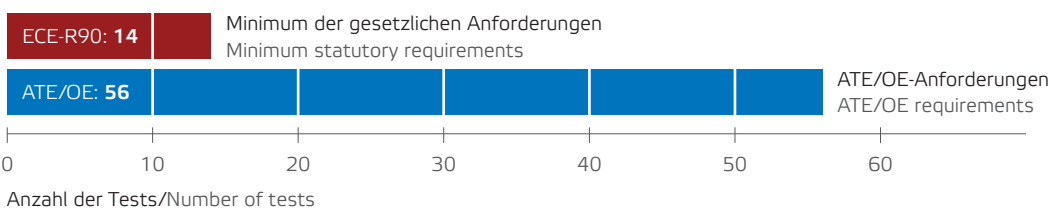

Bremsbeläge

Eine Klasse für sich

Brake pads

A class of their own

ATE Original Bremsbeläge

Andere Hersteller nutzen für Bremsbeläge zehn verschiedene Belagmischungen. Bei uns sind es mehr als 150 und unsere internen Tests sind weit strenger, als es die gesetzlichen Bestimmungen erfordern. So bieten wir für jeden Fahrzeugtyp den optimalen Bremsbelag – mit 98 Prozent Abdeckung in Europa, und das überwiegend mit Original-Erstausrüster-Mischungen. Dabei können sich die Autofahrer auf maximale Sicherheit ebenso verlassen wie auf maximalen Komfort. Es gibt eben nur ein Original.

ATE Original brake pads

Other manufacturers use ten different compounds for their brake pads. We use more than 150 – and our internal tests are far more stringent than required by the regulations. That's why we offer the optimum brake pad for every type of vehicle – with 98 per cent coverage in Europe, mainly with original equipment manufacturer compounds. So motorists can rely on maximum safety and maximum comfort. There is only one original.

ATE Ceramic Bremsbeläge

Wirklich eine saubere Sache. Durch die innovative Belagmischung entsteht bei ATE Ceramic Bremsbelägen nur sehr wenig Abrieb, der zudem kaum haftet. Deshalb setzt sich praktisch kein Bremsstaub ab und schöne Felgen behalten viel länger ihren Glanz. Ceramic Bremsbeläge sind so sicher wie ein konventioneller Belag, besonders langlebig und ideal in Kombination mit den beschichteten ATE Bremsscheiben. Und es gibt noch einen weiteren Vorteil: Sie lassen sich ganz einfach statt der üblichen Bremsbeläge einbauen.

ATE Ceramic brake pads

A clean solution. The innovative ATE Ceramic formula produces very few abraded particles, and they have hardly any adhesive characteristics. This means that hardly any brake dust settles and shiny wheel rims retain their lustre much longer. Ceramic brake pads are as safe as conventional pads, are particularly durable and ideal when used in combination with the coated ATE brake discs. Yet another advantage? They can be easily installed instead of the usual brake pads.

Auf unserer Website www.ate.de/originalbelag können Sie sich näher informieren.

Learn more on our website at www.ate-brakes.com/originalpad

Auf unserer Website www.ate.de/ceramic erfahren Sie mehr.

Learn more on our website at www.ate-brakes.com/ceramic



Bremsverhalten von Original ATE Bremsbelägen

Braking behaviour of ATE Original brake pads

Reibwert beim ersten Einbremsen der Beläge
Coefficient of friction at first application of the pads



Reibwert bei kaltem Bremssystem
Coefficient of friction with cold braking system



Reibwert beim Herunterbremsen aus hohen Geschwindigkeiten
Coefficient of friction when slowing from high speeds



Reibwert, wenn zum ersten Mal im Hochtemperaturbereich gebremst wird
Coefficient of friction when first used at high temperature



■ ATE Original Bremsbeläge / ATE Original brake pads
■ Standardbelag eines Wettbewerbers / Competitor's standard brake pads



Bremsscheiben Für jeden Anspruch die Richtige

Brake discs

The right one for every requirement

Die Details zu ATE Bremsscheiben finden Sie auf unserer Website
www.ate.de/produkte/scheibenbremsen/original-ate-bremsscheiben

You'll find more details about the ATE brake discs on our website at
www.ate-brakes.com/products/disc-brakes/ate-original-brake-pads





Alles für die optimale Bremsleistung

Es gibt so viele unterschiedliche Fahrzeugmodelle und Anforderungen – ATE hat für jeden Bedarf die richtigen Brems Scheiben. Präzise gefertigt aus hervorragenden Erstausrüster-Materialien und in einer Qualität, die die ECE-R90-Norm schon heute im nahezu gesamten Portfolio übertrifft. Besser gehts nicht.

Original ATE Brems Scheiben

In Original ATE Brems Scheiben stecken durchdachte Technologie, hochwertige Materialien und unser ganzes Know-how. Sie entsprechen genau den Brems Scheiben, die vom Hersteller verbaut wurden: Ob glatt, gelocht oder genutet, hochgekohlt, einteilig, gestiftet oder genietet, mit oder ohne Radlager – wir haben immer die passende Lösung für sicheres und komfortables Bremsen. Und auch den passenden Belag dazu. Eine gute Kombination sind zum Beispiel beschichtete Brems Scheiben und die staubarmen ATE Ceramic Bremsbeläge oder natürlich unsere Original Bremsbeläge. Die Original ATE Brems Scheiben sind mit 98 Prozent Abdeckung in Europa verfügbar und auch – wenn der Fahrzeughersteller es vorgibt – mit Befestigungsschrauben erhältlich.

Everything for optimal braking performance

There are so many different vehicle models and requirements – and ATE has the right brake disc for each one. Precisely manufactured from excellent OEM materials, the quality of which already surpasses the ECE-R90 standard throughout most of our portfolio. It just couldn't get any better.

Original ATE brake discs

ATE brake discs are packed full of sophisticated technology, high-quality materials and our entire expertise. They correspond exactly to the brake discs originally installed by the manufacturer. Whether smooth, perforated or grooved, high-carbon, one-piece, pinned or riveted and with or without wheel bearings – we always have the right solution for safe and comfortable braking. With the matching brake pad too. One good combination, for example – our coated brake discs and the low-dust ATE Ceramic brake pads, or our Original brake pads of course. Original ATE brake discs are available in 98 per cent of European countries and are also available with wheel bearings or – if prescribed by the vehicle manufacturer – with fixing screws.



ATE PowerDisc
ATE PowerDisc



Beschichtete Brems Scheibe mit Befestigungsschrauben
Coated brake disc with fixing screws



Beschichtete zweiteilige Brems Scheibe
Coated two-piece brake disc



Brems Scheibe mit Radlager
Brake discs with wheel bearing



Mehr als sicher More than safe

Bremsflüssigkeiten

ATE hat für jedes Fahrzeugmodell und jede Fahrweise die optimale Bremsflüssigkeit. Und alle lassen die gesetzlichen und technischen Standards weit hinter sich. Das Highlight für elektronische Bremssysteme: ATE SL.6. Die dünnflüssige Textur sorgt bei Niedrigtemperaturen für eine schnelle Reaktion von ABS oder ESP® – und so für höchste Sicherheit.

Brake fluids

ATE has the optimal brake fluid for every vehicle model and every driving style – and all our fluids leave the legal and technical standards far behind. Our highlight for electronic braking systems – the ATE SL.6. The low-viscosity texture ensures a quick response from ABS or ESP® at low temperatures, guaranteeing maximum safety.

Die Eigenschaften von ATE Bremsflüssigkeiten

The properties of ATE brake fluids

	Siedepunkt Boiling point	Nass-Siedepunkt Wet boiling point	Viskosität bei -40°C Viscosity at -40°C	Wechselintervall Replacement interval
ATE G DOT 3	min. 245°C	min. 150°C	max. 1.500 mm ² /s max. 1,500 mm ² /s	bis 1 Jahr up to 1 year
ATE SL DOT 4	min. 260°C	min. 165°C	max. 1.400 mm ² /s max. 1,400 mm ² /s	bis 1 Jahr up to 1 year
ATE SL.6 DOT 4 Ideal für/Ideal for ESP®, ABS, ASR	min. 265°C	min. 175°C	max. 700 mm ² /s	bis 2 Jahre up to 2 years
ATE TYP 200 DOT 4 New Racing Quality	min. 280°C	min. 198°C	max. 1.400 mm ² /s max. 1,400 mm ² /s	bis 3 Jahre up to 3 years
ATE SUPER DOT 4	min. 260°C	min. 180°C	max. 1.400 mm ² /s max. 1,400 mm ² /s	bis 2 Jahre up to 2 years

Typ Type	ATE Sachnummer ATE partnumber	EAN-Nr. 4006633 EAN-No. 4006633	Gebinde Container size	Paletteneinheit* Pallet unit*
G SAE Spezifikation J1703 FMVSS §571.116/DOT 3	705302 03.9901-5302.2/02	10199 8	1 l	D
	705303 03.9901-5303.2/02	10201 8	5 l	F
größere Gebinde auf Anfrage – Bigger container sizes on demand				
SL SAE Spezifikation J1704 FMVSS §571.116/DOT 4	705808 03.9901-5808.2/02	49000 9	1/4 l	A
	705801 03.9901-5801.2/02	49001 6	1/2 l	B
	705802 03.9901-5802.2/02	49002 3	1 l	D
	705803 03.9901-5803.2/02	49003 0	5 l	F
	705811 03.9901-5811.2/02	29907 7	20 l	R
	705820 03.9901-5820.2/01	10824 9	30 l	H
	705814 03.9901-5814.2/01	10366 4	50 l	P
	705805 03.9901-5805.2/01	49005 4	200 l	S
SL.6 SAE Spezifikation J1704 FMVSS §571.116/DOT 4 ISO 4925. Klasse 6 – niedrigviskos	706408 03.9901-6408.2/02	22762 9	1/4 l	A
	706402 03.9901-6402.2/02	20746 1	1 l	D
	706403 03.9901-6403.2/02	20748 5	5 l	F
	706411 03.9901-6411.2/02	20750 8	20 l	R
	706420 03.9901-6420.2/02	23120 6	30 l	H
	706414 03.9901-6414.2/02	23005 6	50 l	P
	706405 03.9901-6405.2/02	23121 3	200 l	S
TYP 200 New racing quality SAE Spezifikation J1704 FMVSS §571.116/DOT 4	706202 03.9901-6202.2/02	10825 6	1 l	D
	706203 03.9901-6203.2/02	12166 8	5 l	F
	706220 03.9901-6220.2/01	12780 6	30 l	H
	706214 03.9901-6214.2/01	12779 0	50 l	P
	706205 03.9901-6205.2/01	12778 3	200 l	S
SUPER DOT 4 SAE Spezifikation J1704 FMVSS §571.116/DOT 4	706003 03.9901-6003.2/02	06249 7	5 l	F
	706020 03.9901-6020.2/01	14544 2	30 l	H
	706005 03.9901-6005.2/01	07769 9	200 l	S
ATE Bremszylinder-Paste ATE Brake Cylinder Paste	700009 03.9902-05XX.2/02	13536 8	180 g	L
	700010 03.9902-0503.2/01	13532 0	5 kg	K
	700011 03.9902-0504.2/01	13530 6	40 kg	P
ATE Prüfflüssigkeit ATE Testing Fluid	700002 03.9902-0116.2/02	10374 9	5 l	F
ATE plastilube™	700014 03.9902-1001.2/02	05176 7	35 ml	I
	700015 03.9902-1002.2/02	05184 2	75 ml	J
ATE Leerkanne ATE neutral empty container	740169 03.9302-1474.1/01	07782 8	25 l	S
Ausgiesser für 5-l-Kanne Spout for 5l container	760070 03.9314-5940.3/01	07786 6	1 St.	S
Kannen-Auslass-Hahn für 5-l- und 20-l-Kanne Tap for 5l and 20l tin	760153 03.9314-5960.3/02	30855 7	1 St.	S

***Paletteneinheit:**

A =	1.728 Kannen je Palette	(24 Kannen je Karton)
B =	1.200 Kannen je Palette	(20 Kannen je Karton)
D =	600 Kannen je Palette	(10 Kannen je Karton)
E =	360 Kannen je Palette	(10 Kannen je Karton)
F =	144 Kannen je Palette	(4 Kannen je Karton)
G =	50 Kannen je Palette	
H =	22 Kannen je Palette	
I =	5.040 Tuben je Palette	(24 Tuben je Karton)
J =	1.728 Tuben je Palette	(12 Tuben je Karton)
K =	60 Eimer je Palette	
L =	1.800 Tuben je Palette	(40 Tuben je Karton)
M =	18 Kannen je Palette	
N =	300 Kannen je Palette	(10 Kannen je Karton)
O =	64 Kannen je Palette	(4 Kannen je Karton)
P =	12 Kannen je Palette	
R =	36 Kannen je Palette	
S =	1 Stück	

***Pallet unit:**

A =	1.728 containers per pallet	(24 containers per box)
B =	1.200 containers per pallet	(20 containers per box)
D =	600 containers per pallet	(10 containers per box)
E =	360 containers per pallet	(10 containers per box)
F =	144 containers per pallet	(4 containers per box)
G =	50 containers per pallet	
H =	22 containers per pallet	
I =	5.040 tubes per pallet	(24 tubes per box)
J =	1.728 tubes per pallet	(12 tubes per box)
K =	60 buckets per pallet	
L =	1.800 tubes per pallet	(40 tubes per box)
M =	18 containers per pallet	
N =	300 containers per pallet	(10 tubes per box)
O =	64 containers per pallet	(4 containers per box)
P =	12 containers per pallet	
R =	36 containers per pallet	
S =	1 piece	

Mit sicherer Hand With a steady hand

Einen Überblick über alle Geräte und Werkzeuge bietet Ihnen unser Werkzeugkatalog unter www.ate-info.de

For an overview of all the equipment and tools, see our tool catalogue at www.ate-info.de



Test- und Prüfgeräte

Ob Sie Bremsflüssigkeit, Sensoren oder andere Komponenten testen: ATE Geräte und die passenden Werkzeuge sind exakt und zuverlässig – das macht die Bremsendiagnose einfacher.

Test and inspection equipment

Whether you're testing brake fluid, sensors or other components, ATE devices and their matching tools are accurate and reliable – and that makes brake diagnosis much easier.



Entlüftungsgeräte

Bremsen schnell und effektiv entlüften: Sie haben die Wahl unter verschiedenen Geräten für unterschiedliche Fahrzeugtypen und Bremssysteme – auch mit integrierter Absauganlage.

Brake bleeding units

Bleeding brakes quickly and effectively: choose from different units for different vehicle models and braking systems – integrated exhaust extraction systems are also available.

Professionelle Ausstattung

Werkzeuge und Geräte von ATE sind genau auf unsere Produkte und Services abgestimmt. Das erleichtert Ihnen die Arbeit und gibt Ihnen die Sicherheit, immer einen zuverlässigen Job zu machen. Und wenn es um Fahrzeugelektronik geht, sind VDO Ersatzteile und Services die ideale Ergänzung.

Professional equipment

ATE tools and devices are customised to exactly match our products and services. This makes your work easier and gives you the assurance that you're doing a dependable job. When it comes to vehicle electronics, VDO spare parts and services are also the perfect additions to your equipment.



Entsorgungsgeräte

Um gebrauchte Bremsflüssigkeit umwelt-schonend und kostengünstig zu entsorgen, muss sie zunächst sortenrein gesammelt werden. Kein Problem mit unseren Entsorgungssystemen.

Disposal devices

To dispose of used brake fluid in an environmentally friendly and cost-effective way, it must first be sorted into different types. That's no problem with our disposal systems.



Spezial-Werkzeuge

Bei ATE finden Sie alles, was Sie für den Einbau und die Wartung der verschiedenen Bremsenkomponenten brauchen – in Top-Qualität und genau auf die Anwendung abgestimmt.

Special tools

At ATE, you'll find everything you need for the installation and maintenance of different brake components – all in top quality and exactly tailored to suit their purpose.

Noch besser sein

Be even better

Technische Trainings für ATE

Alles, was Sie zum Thema Bremsen-wartung und -diagnose wissen müssen, anschaulich und praxis-orientiert vermittelt. Zum Beispiel:

- | Diagnose und Instandhaltung moderner Bremsanlagen
- | Direktannahme: So nutzen Sie Potenziale für Ihr Geschäft
- | Fahrerassistenzsysteme

Technische Trainings für VDO

In Fahrzeugen werden immer mehr Elektronik- und Mechatronik-Teile verbaut – bleiben Sie auf dem Laufenden. Einige Themen:

- | Elektrische Grundlagenpraxis am Beispiel ATE/VDO
- | Digitales Serviceheft
- | Diesel: moderne Common-Rail-Einspritzsysteme

Produkt- und Verkaufstrainings

Steigern Sie Ihren Geschäftserfolg durch motivierte Mitarbeiter und neue Angebote für Ihre Kunden. Unter anderem mit diesen Trainings:

- | Qualifizierungen für Hochvolt-Fahrzeuge
- | Sachkundetrainings für Airbag, Klima-anlagen und Abgasuntersuchung
- | Mitarbeiterführung und Entwicklung für Kfz-Betriebe

Die Vorteile für ATE BremsenCenter

Sie nehmen an speziellen Informationsveranstaltungen und Trainings teil, die eigens für ATE BremsenCenter konzipiert wurden. Regelmäßige fach-spezifische Qualifikationen für Sie und Ihre Mitarbeiter sind kostenfrei.

The benefits for ATE BrakeCenters

You take part in special information events and training courses that have been specially designed for ATE BrakeCenters. Regular training for you and your employees is free of charge.

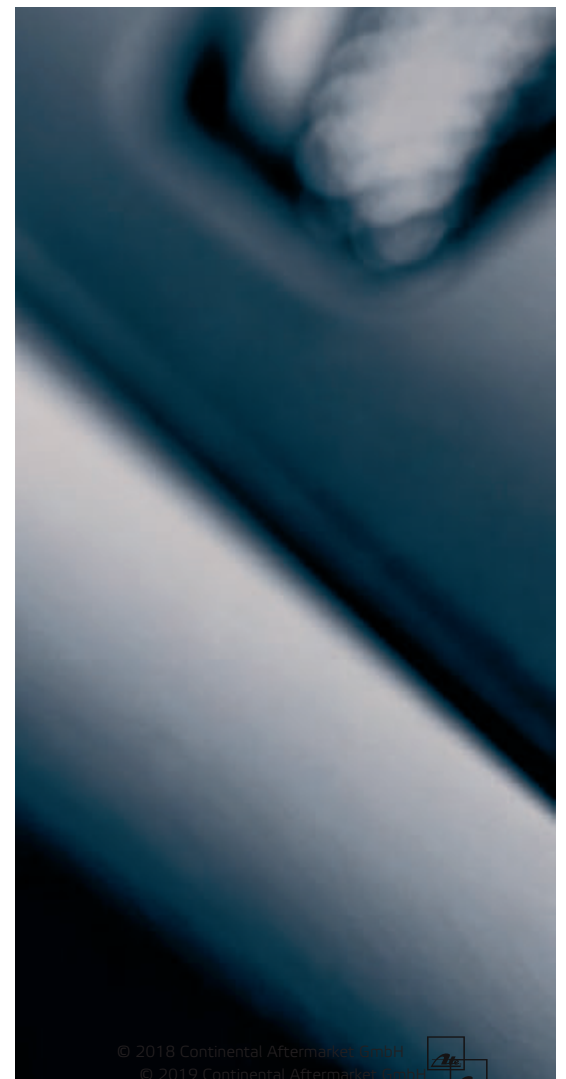

Unter www.morecontinental.com finden Sie eine Auswahl aus dem aktuellen Trainingsprogramm.

A selection from the current training programme is available at www.morecontinental.com



Technical ATE training courses

Everything you need to know about brake maintenance and diagnosis, presented clearly and with a practical emphasis. For example:

- | Diagnosis and maintenance of modern brake systems
- | Service reception bay: helping you to utilise all the potential opportunities for your business
- | Driver assistance systems

Technical VDO training courses

More and more electronic and mecha-
tronic parts are being installed in
today's vehicles – stay up to date!
Some topics:

- | Basic electrical practice using ATE/
VDO as an example
- | Digital service book
- | Diesel: modern common-rail injection
systems

Product and sales training courses

Increase your business success
through motivated employees and
new offers for your customers –
with these training courses (and more):

- | Qualification to work on high-voltage
systems
- | Trainings for airbag, air conditioning
systems and emissions inspection
- | Leadership and development
for vehicle workshops



DE Inhaltsverzeichnis

Neue Artikel	15
Ersetzte Artikel	19
Fahrzeugregister	21
Fahrzeugverwendungen	27
Abbildungen Hauptbremszylinder	421
Universalteile	469
Bremsgeräte komplett	499
Technische Übersetzungen	523

EN Table of contents

New parts	15
Replaced parts	19
Index of vehicles	21
Applications of vehicles	27
Illustrations master cylinder	421
Universalparts	469
Booster units complete	499
Technical translations	523

ES Índice

Nuevas referencias	15
Referencias de sustitución	19
Índice de vehículos	21
Aplicaciones	27
Ilustraciones cilindro freno	421
Piezas universales	469
Servofreno completo	499
Traducciones técnicas	523

FR Table des matières

Nouvelles références	15
Références remplacées	19
Liste des véhicules	21
Applications	27
Illustrations Maître-cylindres	421
Pièces universelles	469
Servo-freins complets	499
Traductions techniques	523

IT Sommario

Codici nuovi	15
Codici sostitutivi	19
Indice autovetture	21
Applicazioni autoveicoli	27
Illustrazioni pompe Freno	421
Parti universali	469
Servofreni completi	499
Traduzioni tecniche	523





DE Neue Artikel

EN New parts

ES Nuevas referencias

FR Nouvelles références



IT Codici nuovi

2019



Neue Artikel

New parts - Nuevas referencias - Nouvelles références - Codici nuovi

			
03.2025-2521.3	010959 MERCEDES-BENZ C-CLASS (W204)	24.4123-1720.3	011022 VAUXHALL CORSA Mk III (D) (S07)
03.2025-2521.3	010959 MERCEDES-BENZ C-CLASS Coupe (C204)	24.4126-1702.3	010875 CITROËN JUMPER Bus
03.2025-2521.3	010959 MERCEDES-BENZ C-CLASS T-Model (S204)	24.4126-1702.3	010875 CITROËN JUMPER Kasten
03.2025-2521.3	010959 MERCEDES-BENZ E-CLASS Cabriolet (A207)	24.4126-1702.3	010875 CITROËN JUMPER Pritsche/Fahrgestell
03.2025-2521.3	010959 MERCEDES-BENZ E-CLASS Coupe (C207)	24.4126-1702.3	010875 FIAT DUCATO Bus (250_, 290_)
03.2025-2521.3	010959 MERCEDES-BENZ GLK-CLASS (X204)	24.4126-1702.3	010875 FIAT DUCATO Kasten (250_, 290_)
03.2123-3624.3	010956 VOLVO C30 (533)	24.4126-1702.3	010875 FIAT DUCATO Pritsche/Fahrgestell (250_, 290_)
03.2123-3624.3	010956 VOLVO C70 II Cabriolet (542)	24.4126-1702.3	010875 PEUGEOT BOXER Bus
03.2123-3624.3	010956 VOLVO S40 II (544)	24.4126-1702.3	010875 PEUGEOT BOXER Kasten
03.2123-3624.3	010956 VOLVO V50 (545)	24.4126-1702.3	010875 PEUGEOT BOXER Pritsche/Fahrgestell
03.2125-5016.3	011010 VOLVO V40 Schrägheck (525, 526)	24.4152-0132.3	011025 SEAT ALTEA (5P1)
03.2126-5132.3	011012 VW AMAROK (2HA, 2HB, S1B, S6B, S7A, S7B)	24.4152-0132.3	011025 SEAT ALTEA XL (5P5, 5P8)
03.2126-5132.3	011012 VW AMAROK Pritsche/Fahrgestell (S1B)	24.4152-0132.3	011025 SEAT LEON (1P1)
03.4152-0153.3	011006 DAIHATSU CHARADE	24.4152-0132.3	011025 SKODA YETI (5L)
03.4152-0153.3	011006 TOYOTA YARIS (_P9_)	24.4152-0132.3	011025 VW BEETLE (5C1, 5C2)
03.7860-4432.4	300313 CITROËN C8 (EA_, EB_)	24.4152-0132.3	011025 VW BEETLE Cabriolet (5C7, 5C8)
03.7860-4432.4	300313 PEUGEOT 807 (E)	24.4152-0132.3	011025 VW CADDY III Kasten (2KA, 2KH, 2CA, 2CH)
03.7868-5902.4	300316 AUDI Q7 (4LB)	24.4152-0132.3	011025 VW CADDY III Kombi (2KB, 2KJ, 2CB, 2CJ)
24.2025-2311.3	011023 MERCEDES-BENZ C-CLASS (W204)	24.4152-0132.3	011025 VW EOS (1F7, 1F8)
24.2025-2311.3	011023 MERCEDES-BENZ C-CLASS Coupe (C204)	24.4152-0132.3	011025 VW GOLF V (1K1)
24.2025-2311.3	011023 MERCEDES-BENZ C-CLASS T-Model (S204)	24.4152-0132.3	011025 VW GOLF V Variant (1K5)
24.2025-2311.3	011023 MERCEDES-BENZ E-CLASS Cabriolet (A207)	24.4152-0132.3	011025 VW GOLF VI (5K1)
24.2025-2311.3	011023 MERCEDES-BENZ E-CLASS Coupe (C207)	24.4152-0132.3	011025 VW GOLF VI Cabriolet (517)
24.2026-1706.3	011040 BMW 5 (F10)	24.4152-0132.3	011025 VW GOLF VI Variant (AJ5)
24.2026-1706.3	011040 BMW 5 Touring (F11)	24.4152-0132.3	011025 VW GOLF PLUS (5M1, 521)
24.2026-1706.3	011040 BMW 6 Cabriolet (F12)	24.4152-0132.3	011025 VW JETTA IV (162, 163)
24.2026-1706.3	011040 BMW 6 Coupe (F13)	24.4152-0132.3	011025 VW SCIROCCO (137, 138)
24.2026-1706.3	011040 BMW 6 Gran Coupe (F06)	24.4152-0132.3	011025 VW TOURAN (1T1, 1T2)
24.2120-1768.3	011041 SKODA FABIA II (542)	24.4152-0132.3	011025 VW TOURAN (1T3)
24.2120-1768.3	011041 SKODA FABIA II Combi (545)	24.4152-0381.3	011032 DACIA DOKKER
24.2120-1768.3	011041 SKODA ROOMSTER (5J)	24.4152-0381.3	011032 DACIA DOKKER Express
24.2120-1768.3	011041 SKODA ROOMSTER Praktik (5J)	24.4152-0381.3	011032 DACIA DUSTER
24.2122-1588.3	011028 FORD FIESTA IV (JA_, JB_)	24.4152-0381.3	011032 DACIA DUSTER Kasten
24.2122-1588.3	011028 FORD FIESTA Kasten (J5_, J3_)	24.4152-0381.3	011032 DACIA LODGY
24.2122-1588.3	011028 FORD FIESTA Kasten (JV_)	24.4152-0391.3	011032 RENAULT DOKKER
24.2123-3396.3	011035 CITROËN JUMPY (VF7)	24.4152-0391.3	011033 DACIA DOKKER Express
24.2123-3396.3	011035 CITROËN JUMPY Kasten	24.4152-0391.3	011033 DACIA DUSTER
24.2123-3396.3	011035 CITROËN JUMPY Pritsche/Fahrgestell	24.4152-0391.3	011033 DACIA DUSTER Kasten
24.2123-3396.3	011035 PEUGEOT EXPERT Kasten (VF3A_, VF3U_, VF3X_)	24.4152-0391.3	011033 DACIA LODGY
24.2123-3396.3	011035 PEUGEOT EXPERT Pritsche/Fahrgestell	24.4153-0192.3	011026 AUDI Q3 (8UB, 8UG)
24.2123-3396.3	011035 PEUGEOT EXPERT Tepee (VF3X_)	24.4153-0192.3	011026 VW CC (358)
24.2125-1747.3	011029 FORD RANGER (ET)	24.4153-0192.3	011026 VW PASSAT (3C2)
24.2125-1747.3	011029 MAZDA BT-50 Pick-up (CD, UN)	24.4153-0192.3	011026 VW PASSAT (362)
24.2125-1747.3	011029 MAZDA BT-50 Pritsche/Fahrgestell (CD, UN)	24.4153-0192.3	011026 VW PASSAT ALLTRACK (365)
24.2125-1748.3	011030 MERCEDES-BENZ CLS (C219)	24.4153-0192.3	011026 VW PASSAT CC (357)
24.2125-1748.3	011030 MERCEDES-BENZ E-CLASS (W211)	24.4153-0192.3	011026 VW PASSAT Variant (3C5)
24.2126-3071.3	011037 AUDI Q7 (4LB)	24.4153-0192.3	011026 VW PASSAT Variant (365)
24.4123-1720.3	011022 ABARTH GRANDE PUNTO (199_)	24.4153-0192.3	011026 VW TIGUAN (5N_)
24.4123-1720.3	011022 ABARTH PUNTO (199_)	24.4153-0202.3	011027 SEAT ALTEA (5P1)
24.4123-1720.3	011022 ABARTH PUNTO EVO (199_)	24.4153-0202.3	011027 SEAT ALTEA XL (5P5, 5P8)
24.4123-1720.3	011022 ALFA ROMEO MITO (955_)	24.4153-0202.3	011027 SEAT LEON (1P1)
24.4123-1720.3	011022 OPEL CORSA D (S07)	24.4153-0202.3	011027 SKODA SUPERB II (3T4)
		24.4153-0202.3	011027 SKODA SUPERB II Kombi (3T5)
		24.4153-0202.3	011027 SKODA YETI (5L)
		24.4153-0202.3	011027 VW BEETLE (5C1, 5C2)
		24.4153-0202.3	011027 VW BEETLE Cabriolet (5C7, 5C8)
		24.4153-0202.3	011027 VW CADDY IV Kasten (SAA, SAH)
		24.4153-0202.3	011027 VW CADDY IV Kombi (SAB, SAJ)

Neue Artikel

New parts - Nuevas referencias - Nouvelles références - Codici nuovi



24.4153-0202.3	011027 VW	CADDY ALLTRACK Kasten (SAA)
24.4153-0202.3	011027 VW	CADDY ALLTRACK Kombi (SAB)
24.4153-0202.3	011027 VW	EOS (1F7, 1F8)
24.4153-0202.3	011027 VW	GOLF V (1K1)
24.4153-0202.3	011027 VW	GOLF V Variant (1K5)
24.4153-0202.3	011027 VW	GOLF VI (5K1)
24.4153-0202.3	011027 VW	GOLF VI Cabriolet (517)
24.4153-0202.3	011027 VW	GOLF VI Variant (AJ5)
24.4153-0202.3	011027 VW	GOLF PLUS (5M1, 521)
24.4153-0202.3	011027 VW	JETTA IV (162, 163)
24.4153-0202.3	011027 VW	SCIROCCO (137, 138)
24.4153-0217.3	011039 AUDI	TT (8J3)
24.4153-0217.3	011039 AUDI	TT Roadster (8J9)
24.9145-0001.2	399005 AUDI	A3 (8P1)
24.9145-0001.2	399005 AUDI	A3 Sportback (8PA)
24.9145-0001.2	399005 SEAT	ALTEA (5P1)
24.9145-0001.2	399005 SEAT	LEON (1P1)
24.9145-0001.2	399005 SEAT	TOLEDO III (5P2)
24.9145-0001.2	399005 SKODA	OCTAVIA II (1Z3)
24.9145-0001.2	399005 SKODA	OCTAVIA II Combi (1Z5)
24.9145-0001.2	399005 VW	CADDY III Kasten (2KA, 2KH, 2CA, 2CH)
24.9145-0001.2	399005 VW	CADDY III Kombi (2KB, 2KJ, 2CB, 2CJ)
24.9145-0001.2	399005 VW	EOS (1F7, 1F8)
24.9145-0001.2	399005 VW	GOLF V (1K1)
24.9145-0001.2	399005 VW	GOLF V Variant (1K5)
24.9145-0001.2	399005 VW	GOLF PLUS (5M1, 521)
24.9145-0001.2	399005 VW	JETTA III (1K2)
24.9145-0001.2	399005 VW	TOURAN (1T1, 1T2)
24.9145-0001.2	399005 VW	TOURAN (1T3)
24.9145-0003.2	399007 BMW	1 (E81)
24.9145-0003.2	399007 BMW	1 (E87)
24.9145-0003.2	399007 BMW	1 Cabriolet (E88)
24.9145-0003.2	399007 BMW	1 Coupe (E82)
24.9145-0003.2	399007 BMW	3 (E90)
24.9145-0003.2	399007 BMW	3 Cabriolet (E93)
24.9145-0003.2	399007 BMW	3 Coupe (E92)
24.9145-0003.2	399007 BMW	3 Touring (E91)
24.9145-0004.2	399008 FORD	C-MAX (DM2)
24.9145-0004.2	399008 FORD	FOCUS II (DA_, HCP, DP)
24.9145-0004.2	399008 FORD	FOCUS II Cabriolet
24.9145-0004.2	399008 FORD	FOCUS II Stufenheck (DB_, FCH, DH)
24.9145-0004.2	399008 FORD	FOCUS II Turnier (DA_, FFS, DS)
24.9145-0004.2	399008 FORD	FOCUS C-MAX
24.9145-0004.2	399008 FORD	KUGA I
24.9145-0005.2	399009 VOLVO	C30 (533)
24.9145-0005.2	399009 VOLVO	C70 II Cabriolet (542)
24.9145-0005.2	399009 VOLVO	S40 II (544)
24.9145-0005.2	399009 VOLVO	V50 (545)







- DE** Ersetzte Artikel
- EN** Replaced parts
- ES** Referencias de sustitución
- FR** Références remplacées
- IT** Codici sostitutivi

2019



Ersetzte Artikel

Replaced parts - Referencias de sustitución - Références remplacées - Codici sostitutivi

 Vorgänger Nr. Replaced No. Codice precedente Ancienne référence Número anterior	 Nachfolge Nr. Replacing No. Codice nuovo Nouvelle référence Número posterior	 Vorgänger Nr. Replaced No. Codice precedente Ancienne référence Número anterior	 Nachfolge Nr. Replacing No. Codice nuovo Nouvelle référence Número posterior
03.2122-1588.3 010733	24.2122-1588.3 011028		
03.4152-0053.3 010884	03.4152-0153.3 011006		
03.7860-4302.4 300231	03.7860-4432.4 300313		
03.7868-4702.4 300253	03.7868-5902.4 300316		





- DE** Fahrzeugregister
- EN** Index of vehicles
- ES** Índice de vehículos
- FR** Liste des véhicules
- IT** Indice autovetture

2019



**ABARTH 28**

500 / 595 / 695 (312_)	28
500C / 595C / 695C (312_)	28
GRANDE PUNTO (199_)	28
PUNTO (199_)	28
PUNTO EVO (199_)	28

ALFA ROMEO 28

145 (930_)	28
146 (930_)	28
155 (167_)	29
156 (932_)	29
156 Sportwagon (932_)	29
159 (939_)	30
159 Sportwagon (939_)	30
166 (936_)	30
BRERA (939_)	30
GIULIETTA (940_)	31
GTV (916_)	31
MITO (955_)	31
SPIDER (916_)	32
SPIDER (939_)	32

AUDI 32

80 Avant (8C5, B4)	32
A1 (8X1, 8XK)	32
A2 (8Z0)	32
A3 (8L1)	33
A3 (8P1)	33
A3 (8V1, 8VK)	36
A3 Cabriolet (8P7)	36
A3 Cabriolet (8V7, 8VE)	36
A3 Limousine (8VS, 8VM)	37
A3 Sportback (8PA)	37
A3 Sportback (8VA, 8VF)	39
A4 (8D2, B5)	40
A4 (8E2, B6)	41
A4 (8EC, B7)	41
A4 (8K2, B8)	42
A4 Allroad (8KH, B8)	42
A4 Avant (8D5, B5)	43
A4 Avant (8E5, B6)	43
A4 Avant (8ED, B7)	44
A4 Avant (8K5, B8)	45
A4 Cabriolet (8H7, B6, 8HE, B7)	45
A5 (8T3)	46
A5 Cabriolet (8F7)	47
A5 Sportback (8TA)	47
A6 (4A2, C4)	48
A6 (4B2, C5)	48
A6 (4F2, C6)	50
A6 Allroad (4FH, C6)	50
A6 Avant (4A5, C4)	50
A6 Avant (4B5, C5)	51
A6 Avant (4F5, C6)	52
A8 (4D2, 4D8)	52
A8 (4H2, 4H8, 4HC, 4HL)	53
ALLROAD (4BH, C5)	53
CABRIOLET (8G7, B4)	53
COUPE (89, 8B)	54
Q2 (GAB)	54
Q3 (8UB, 8UG)	54
Q5 (8RB)	55
Q7 (4LB)	55
TT (8J3)	56
TT (8N3)	56
TT (FV3)	57
TT Roadster (8J9)	57
TT Roadster (8N9)	57
TT Roadster (FV9)	58

AUTOBIANCHI 58

Y10	58
-----	----

BMW 58

1 (E81)	58
---------	----

**BMW 58**

1 (E87)	59
1 Cabriolet (E88)	60
1 Coupe (E82)	61
3 (E36)	61
3 (E46)	62
3 (E90)	63
3 Cabriolet (E36)	64
3 Cabriolet (E46)	65
3 Cabriolet (E93)	65
3 Compact (E36)	66
3 Compact (E46)	67
3 Coupe (E36)	67
3 Coupe (E46)	68
3 Coupe (E92)	69
3 Touring (E36)	70
3 Touring (E46)	71
3 Touring (E91)	71
5 (E34)	73
5 (E39)	73
5 (E60)	73
5 (F10)	74
5 Gran Turismo (F07)	75
5 Touring (E34)	75
5 Touring (E39)	75
5 Touring (E61)	75
5 Touring (F11)	75
6 (E63)	77
6 Cabriolet (E64)	77
6 Cabriolet (F12)	77
6 Coupe (F13)	77
6 Gran Coupe (F06)	77
7 (E38)	78
7 (E65, E66, E67)	78
7 (F01, F02, F03, F04)	78
X1 (E84)	78
X3 (E83)	79
X5 (E53)	79
X5 (E70)	80
X5 (F15, F85)	80
X6 (E71, E72)	80
X6 (F16, F86)	80
Z3 Coupe (E36)	80
Z3 Roadster (E36)	81
Z4 Coupe (E86)	81
Z4 Roadster (E85)	81
Z4 Roadster (E89)	81
Z8 Roadster (E52)	82

CHEVROLET 82

CRUZE (J300)	82
CRUZE Schrägheck (J305)	82
CRUZE Station Wagon (J308)	82
MALIBU (V300)	83
MATIZ (M200, M250)	83
ORLANDO (J309)	83
SPARK	83

CITROËN 83

AX (ZA_)	83
BERLINGO / BERLINGO FIRST Großraumlimousine (MF, GJK, GFK)	84
BERLINGO / BERLINGO FIRST Kasten (M_)	84
BERLINGO (B9)	85
BERLINGO Kasten (B9)	85
BERLINGO Pritsche/Fahrgestell (B9)	85
C1 (PM_, PN_)	86
C15 (VD_)	91
C15 Kombi	91
C2 (JM_)	86
C3 AIRCROSS II	88
C3 I (FC_, FN_)	86
C3 II (SC_)	87
C3 III (SX)	88
C3 Picasso	88
C3 Pluriel (HB_)	88
C4 CACTUS	88
C4 Grand Picasso I (UA_)	88

**CITROËN 83**

C4 Picasso I Großraumlimousine (UD_)	89
C5 III (RD_)	89
C5 III Break (RW_)	90
C6 (TD_)	90
C8 (EA_, EB_)	90
C-ELYSEE	91
DS3	91
DS3 Cabriolet	91
DS5	91
EVASION Großraumlimousine (22, U6)	92
JUMPER Bus	92
JUMPER Bus (230P)	92
JUMPER Bus (244, Z_)	94
JUMPER Kasten	95
JUMPER Kasten (230L)	95
JUMPER Kasten (244)	97
JUMPER Pritsche/Fahrgestell	97
JUMPER Pritsche/Fahrgestell (230)	97
JUMPER Pritsche/Fahrgestell (244)	99
JUMPY (U6U)	99
JUMPY (VF7)	99
JUMPY Kasten	99
JUMPY Kasten (BS_, BT_, BY_, BZ_)	99
JUMPY Pritsche/Fahrgestell (BU_, BV_, BW_, BX_)	99
SAXO (S0, S1)	100
XSARA (N1)	100
XSARA Break (N2)	101
XSARA Coupe (N0)	101
XSARA PICASSO (N68)	102
ZX (N2)	102
ZX Break (N2)	103

DACIA 103

DOKKER	103
DOKKER Express	103
DUSTER	103
DUSTER Kasten	104
LODGY	104
LOGAN (LS_)	104
LOGAN EXPRESS (FS_)	105
LOGAN MCV (KS_)	105
LOGAN Pick-up (US_)	106
SANDERO	106

DAEWOO 106

MATIZ (M100, M150)	106
--------------------	-----

DAIHATSU 106

CHARADE	106
CHARADE IV (G200, G202)	107
CHARADE IV Stufenheck (G203)	107

DS 107

DS 3 Cabriolet	107
DS5	107

FIAT 107

126 (126_)	107
500 (312_)	107
500 C (312_)	107
BARCETTA (183_)	108
BRAVA (182_)	108
BRAVO I (182_)	108
BRAVO II (198_)	108
CINQUECENTO (170_)	108
COUPE (175_)	108
CROMA (194_)	109
DOBLO Cargo (223_)	109
DOBLO Großraumlimousine (119_, 223_)	109
DUCATO Bus (230_)	109
DUCATO Bus (244_)	111
DUCATO Bus (250_, 290_)	111
DUCATO Kasten (230_)	112



**FIAT****107**

DUCATO Kasten (244_)	113
DUCATO Kasten (250_, 290_)	113
DUCATO Pritsche/Fahrgestell (230_)	114
DUCATO Pritsche/Fahrgestell (244_)	115
DUCATO Pritsche/Fahrgestell (250_, 290_)	115
FIORINO Kasten (146_)	116
FIORINO Pick up (146_)	116
GRANDE PUNTO (199_)	116
IDEA (350_)	117
LINEA (323_, 110_)	117
MAREA (185_)	118
MAREA Weekend (185_)	118
PALIO (178_)	118
PALIO Weekend (178_)	118
PANDA (141_)	118
PANDA (169_)	119
PANDA Van (141_)	119
PANDA Van (169_)	119
PUNTO (176_)	119
PUNTO (188_)	120
PUNTO (199_)	121
PUNTO Cabriolet (176_)	121
PUNTO EVO (199_)	121
PUNTO Van (176_)	121
PUNTO Van (188_)	121
SCUDO (270_, 272_)	121
SCUDO Combinato (220_)	122
SCUDO Kasten (220_)	122
SCUDO Kasten (270_, 272_)	122
SCUDO Pritsche/Fahrgestell (220_)	122
SCUDO Pritsche/Fahrgestell (270_, 272_)	122
SEDICI (FY_)	122
SEICENTO / 600 (187_)	122
STILO (192_)	123
STILO Multi Wagon (192_)	123
STRADA Pick-up (178_)	123
TEMPRA (159_)	123
TEMPRA S.W. (159_)	123
TIPO (160_)	123
ULYSSE (179_)	123
ULYSSE (220_)	123
UNO (146_)	124

FORD**124**

C-MAX (DM2)	124
C-MAX II (DXA/CB7, DXA/CEU)	125
COUGAR (EC_)	125
COURIER Kasten (F3L, F5L)	125
COURIER Kasten (J5_, J3_)	125
ESCORT '95 Express (AVL)	125
ESCORT CLASSIC (AAL, ABL)	127
ESCORT CLASSIC Turnier (ANL)	127
ESCORT VI (GAL)	126
ESCORT VI Cabriolet (ALL)	126
ESCORT VII (GAL, AAL, ABL)	126
ESCORT VII Cabriolet (ALL)	126
ESCORT VII Stufenheck (GAL, AFL)	127
ESCORT VII Turnier (GAL, ANL)	127
ESCORT VI Stufenheck (GAL)	126
ESCORT VI Turnier (GAL)	126
FIESTA III (GFJ)	127
FIESTA IV (JA_, JB_)	127
FIESTA Kasten (FVD)	128
FIESTA Kasten (JV_)	129
FIESTA V (JH_, JD_)	128
FIESTA V Van	128
FOCUS (DAW, DBW)	129
FOCUS C-MAX	134
FOCUS II (DA_, HCP, DP)	129
FOCUS II Cabriolet	130
FOCUS III	133
FOCUS III Stufenheck	134
FOCUS III Turnier	134
FOCUS II Stufenheck (DB_, FCH, DH)	131
FOCUS II Turnier (DA_, FFS, DS)	132
FOCUS Stufenheck (DFW)	135
FOCUS Turnier (DNW)	135
FUSION (JU_)	136
GALAXY (WA6)	136

**FORD****124**

GALAXY (WGR)	136
GRAND C-MAX (DXA/CB7, DXA/CEU)	137
KUGA I	137
KUGA II (DM2)	138
MAVERICK (UDS, UNS)	138
MONDEO I (GBP)	138
MONDEO II (BAP)	139
MONDEO II Stufenheck (BFP)	140
MONDEO II Turnier (BNP)	140
MONDEO I Stufenheck (GBP)	138
MONDEO I Turnier (BNP)	139
MONDEO IV (BA7)	140
MONDEO IV Stufenheck (BA7)	141
MONDEO IV Turnier (BA7)	141
PUMA (EC_)	141
RANGER (ET)	141
S-MAX (WA6)	141
TOURNEO CONNECT	142
TOURNEO CONNECT / GRAND	142
TOURNEO CONNECT Kombi	142
TRANSIT Bus (E_)	142
TRANSIT Bus (FD_, FB_, FS_, FZ_, FC_)	142
TRANSIT CONNECT (P65_, P70_, P80_)	143
TRANSIT CONNECT Kasten	143
TRANSIT CONNECT Kombi	143
TRANSIT Kasten (E_)	143
TRANSIT Kasten (FA_)	143
TRANSIT Pritsche/Fahrgestell (E_)	144
TRANSIT Pritsche/Fahrgestell (FM_, FN_)	144
TRANSIT TOURNEO	144

HONDA**145**

ACCORD VII (CL, CN)	145
ACCORD VII Tourer (CM, CN)	145
CIVIC V Coupe (EJ)	145
CIVIC VI Coupe (EJ, EM1)	145
CIVIC VI Hatchback (EJ, EK)	145
CIVIC VIII Hatchback (FN, FK)	145
CIVIC VIII Stufenheck (FD, FA)	145
CIVIC VI Stufenheck (EJ, EK)	145
CR-V I (RD)	145
JAZZ II (GD_, GE3, GE2)	145
JAZZ III (GE_, GG_, GP_)	145

HYUNDAI**145**

ATOS (MX)	146
GETZ (TB)	146
MATRIX (FC)	146

JAGUAR**146**

S-TYPE (X200)	146
XF (X250)	146
XF SPORTBRAKE (X250)	147
XJ (X350)	147
XJ (X351)	147
XK 8 Convertible (X100)	147
XK 8 Coupe (X100)	147
XK Cabriolet (X150)	147
XK Coupe (X150)	148

KIA**148**

SEPHIA (FA)	148
SEPHIA Stufenheck (FA)	148
SORENTO I (JC)	148
VENGA (YN)	148

LADA**148**

110 (2110)	148
111 (2111)	148
112 (2112)	148
1200-1600	148
NIVA Geländewagen geschlossen (2121, 2131)	148

**LADA****148**

NOVA (2105)	149
NOVA Kombi (2104)	149
SAMARA (2108, 2109, 2115, 2113, 2114)	149
SAMARA FORMA Stufenheck (21099, 2115)	149

LANCIA**149**

DEDRA (835_)	149
DELTA II (836_)	149
DELTA III (844_)	149
MUSA (350_)	150
PHEDRA (179_)	150
Y (840_)	150
Y10 (156_)	150
YPSILON (843_)	151
ZETA (22_)	151

LAND ROVER**151**

DISCOVERY IV (L319)	151
FREELANDER (L314)	151
FREELANDER 2 (L359)	151
RANGE ROVER III (L322)	151
RANGE ROVER SPORT (L320)	151
RANGE ROVER SPORT (L494)	152

MAZDA**152**

2 (DY)	152
6 Hatchback (GG)	152
6 Station Wagon (GY)	152
6 Stufenheck (GG)	152
BT-50 Pick-up (CD, UN)	152

MERCEDES-BENZ**152**

100 Bus (631)	152
100 Kasten (631)	152
A-KLASSE (W168)	152
A-KLASSE (W169)	153
A-KLASSE (W176)	153
B-KLASSE (W245)	153
B-KLASSE (W246, W242)	154
C-KLASSE (W202)	154
C-KLASSE (W203)	155
C-KLASSE (W204)	156
C-KLASSE Coupe (C204)	158
C-KLASSE Sportcoupe (CL203)	158
C-KLASSE T-Model (S202)	159
C-KLASSE T-Model (S203)	159
C-KLASSE T-Model (S204)	161
CLA Coupe (C117)	162
CLA Shooting Brake (X117)	162
CLC-KLASSE (CL203)	163
CLK (C208)	163
CLK (C209)	164
CLK Cabriolet (A208)	165
CLK Cabriolet (A209)	165
CLS (C218)	166
CLS (C219)	167
CLS Shooting Brake (X218)	167
E-KLASSE (W124)	167
E-KLASSE (W210)	168
E-KLASSE (W211)	169
E-KLASSE (W212)	169
E-KLASSE Cabriolet (A124)	171
E-KLASSE Cabriolet (A207)	171
E-KLASSE Coupe (C124)	172
E-KLASSE Coupe (C207)	172
E-KLASSE T-Model (S124)	173
E-KLASSE T-Model (S210)	173
E-KLASSE T-Model (S211)	174
E-KLASSE T-Model (S212)	174
G-KLASSE (W461)	176
G-KLASSE (W463)	176
G-KLASSE Cabrio (W463)	178
GLA-KLASSE (X156)	178
GLK-KLASSE (X204)	178
GL-KLASSE (X164)	179

**MERCEDES-BENZ****152**

M-KLASSE (W163)	180
M-KLASSE (W164)	180
R-KLASSE (W251, V251)	181
S-KLASSE (W140)	182
S-KLASSE (W220)	182
S-KLASSE (W221)	183
S-KLASSE Coupe (C140)	185
S-KLASSE Coupe (C215)	185
S-KLASSE Coupe (C216)	185
SL (R129)	186
SL (R230)	186
SL (R231)	186
SLC (R172)	186
SLK (R170)	186
SLK (R171)	187
SLK (R172)	187
SPRINTER 2-t Bus (901, 902)	187
SPRINTER 2-t Kasten (901, 902)	187
SPRINTER 2-t Pritsche/Fahrgestell (901, 902)	187
SPRINTER 3,5-t Bus (906)	188
SPRINTER 3,5-t Kasten (906)	188
SPRINTER 3,5-t Pritsche/Fahrgestell (906)	189
SPRINTER 3-t Bus (903)	190
SPRINTER 3-t Bus (906)	190
SPRINTER 3-t Kasten (903)	190
SPRINTER 3-t Kasten (906)	191
SPRINTER 3-t Pritsche/Fahrgestell (903)	191
SPRINTER 3-t Pritsche/Fahrgestell (906)	191
SPRINTER 4,6-t Kasten (906)	192
SPRINTER 4,6-t Pritsche/Fahrgestell (906)	192
SPRINTER 4-t Bus (904)	192
SPRINTER 4-t Kasten (904)	192
SPRINTER 4-t Pritsche/Fahrgestell (904)	193
SPRINTER 5-t Kasten (906)	193
SPRINTER 5-t Pritsche/Fahrgestell (906)	193
T1/TN Kasten/Kombi	194
T1/TN Pritsche/Fahrgestell	194
T1 Bus (601)	195
T1 Bus (602)	195
T1 Kasten (601, 611)	196
T1 Kasten (602)	196
T1 Pritsche/Fahrgestell (601)	196
T1 Pritsche/Fahrgestell (602)	197
VANEO (414)	197
VARIO Bus	197
VARIO Kasten/Kombi	197
VARIO Kipper	198
VARIO Pritsche/Fahrgestell	198
VARIO Triebkopf	199
VIANO (W639)	199
VITO / MIXTO Kasten (W639)	200
VITO Bus (638)	200
VITO Bus (W639)	200
VITO Kasten (638)	201
V-KLASSE (638/2)	201

MINI**201**

MINI (R50, R53)	201
MINI (R56)	201
MINI Cabriolet (R52)	202
MINI Cabriolet (R57)	202
MINI CLUBMAN (R55)	202
MINI CLUBVAN (R55)	202
MINI COUNTRYMAN (R60)	202
MINI Coupe (R58)	203
MINI PACEMAN (R61)	203
MINI Roadster (R59)	203

MITSUBISHI**203**

CARISMA (DA_)	203
CARISMA Stufenheck (DA_)	203
COLT CZC Cabriolet (RG)	204
COLT VI (Z3_A, Z2_A)	203

NISSAN**204**

ALMERA I (N15)	204
----------------	-----

**NISSAN****204**

ALMERA I Hatchback (N15)	204
ALMERA II (N16)	204
ALMERA II Hatchback (N16)	204
INTERSTAR Bus (X70)	204
INTERSTAR Kasten (X70)	205
INTERSTAR Pritsche/Fahrgestell	205
KUBISTAR Kasten (X76)	205
MICRA C+C III (K12)	205
MICRA III (K12)	205
NOTE (E11, NE11)	205
NP300 NAVARA (D40)	206
NP300 PICKUP (D22)	206
PATHFINDER III (R51)	206
PRIMASTAR Bus (X83)	206
PRIMASTAR Kasten (X83)	206
PRIMERA (P12)	207
PRIMERA Hatchback (P12)	207
PRIMERA Traveller (WP12)	207
TERRANO II (R20)	207
X-TRAIL (T30)	207

OPEL**207**

AGILA (A) (H00)	207
AGILA (B) (H08)	207
ASTRA F (T92)	207
ASTRA F Cabriolet (T92)	208
ASTRA F Caravan (T92)	208
ASTRA F CC (T92)	209
ASTRA F Van (T92)	210
ASTRA G Cabriolet (T98)	210
ASTRA G Caravan (T98)	210
ASTRA G CC (T98)	211
ASTRA G Coupe (T98)	211
ASTRA G Kasten (F70)	212
ASTRA G Stufenheck (T98)	212
ASTRA H (A04)	212
ASTRA H Caravan (A04)	213
ASTRA H GTC (A04)	214
ASTRA H Kasten (L70)	214
ASTRA H Stufenheck (A04)	215
ASTRA H TwinTop (A04)	215
ASTRA J (P10)	216
ASTRA J Caravan (P10)	216
ASTRA J GTC	217
ASTRA J Stufenheck	217
CALIBRA A (C89)	217
CAMPO (TF0, TF1)	218
CASCADA (W13)	218
COMBO (71_)	218
COMBO Kasten/Kombi	218
COMBO Tour	218
CORSA B (S93)	219
CORSA B Caravan (S93)	219
CORSA B Kasten (S93)	219
CORSA C (X01)	220
CORSA C Kasten (X01)	220
CORSA D (S07)	220
CORSA D Van (S07)	221
FRONTERA A (U92)	221
FRONTERA A Sport (U92)	221
INSIGNIA A (G09)	221
INSIGNIA A Country Tourer (G09)	222
INSIGNIA A Stufenheck (G09)	222
INSIGNIA Caravan	223
MERIVA A Großraumlimousine (X03)	224
MERIVA B Großraumlimousine (S10)	224
MOVANO Combi (X70)	224
MOVANO Kasten (X70)	224
MOVANO Kipper (X70)	224
MOVANO Pritsche/Fahrgestell (X70)	225
OMEGA B (V94)	225
OMEGA B Caravan (V94)	225
SIGNUM CC (Z03)	225
TIGRA (S93)	226
TIGRA TwinTop (X04)	226
VECTRA A (J89)	226
VECTRA A CC (J89)	226
VECTRA B (J96)	227
VECTRA B Caravan (J96)	228

**OPEL****207**

VECTRA B CC (J96)	228
VECTRA C (Z02)	229
VECTRA C Caravan (Z02)	229
VECTRA C CC (Z02)	230
VIVARO A Combi (X83)	230
VIVARO A Kasten (X83)	230
VIVARO A Pritsche/Fahrgestell (X83)	230
ZAFIRA A Großraumlimousine (T98)	231
ZAFIRA B (A05)	231
ZAFIRA B Van (A05)	232
ZAFIRA TOURER C (P12)	232

PEUGEOT**232**

1007 (KM_)	251
106 I (1A, 1C)	232
106 II (1)	233
107	233
2008 (CU_)	251
205 II (20A/C)	233
205 Kasten	234
206+ (2L_, 2M_)	238
206 CC (2D)	234
206 Schrägheck (2A/C)	235
206 Stufenheck	236
206 SW (2E/K)	237
207 (WA_, WC_)	238
207 CC (WD_)	239
207 SW (WK_)	239
208 (CA_, CC_)	239
3008 Großraumlimousine (0U_)	251
301	239
306 (7B, N3, N5)	239
306 Break (7E, N3, N5)	242
306 Cabriolet (7D, N3, N5)	242
306 Schrägheck (7A, 7C, N3, N5)	243
405 II (4B)	245
405 II Break (4E)	245
406 (8B)	245
406 Break (8E/F)	246
406 Coupe (8C)	247
407 (6D_)	248
407 Coupe (6C_)	248
407 SW (6E_)	248
5008 (0U_, 0E_)	252
505 (551A)	249
508 I (8D_)	249
508 SW I (8E_)	249
605 (6B)	250
806 (221)	250
807 (E)	250
BOXER Bus	252
BOXER Bus (230P)	252
BOXER Bus (244, Z_)	255
BOXER Kasten	255
BOXER Kasten (230L)	255
BOXER Kasten (244)	257
BOXER Pritsche/Fahrgestell	258
BOXER Pritsche/Fahrgestell (244)	258
BOXER Pritsche/Fahrgestell (ZCT_)	258
EXPERT (224_)	259
EXPERT Kasten (222)	260
EXPERT Kasten (VF3A_, VF3U_, VF3X_)	260
EXPERT Pritsche/Fahrgestell	260
EXPERT Pritsche/Fahrgestell (223)	260
EXPERT Tepee (VF3X_)	261
PARTNER Combispace (5F)	261
PARTNER Kasten	262
PARTNER Kasten (5)	262
PARTNER Tepee	263

PORSCHE**263**

911 (996)	263
911 (997)	263
911 Cabriolet (996)	264
911 Cabriolet (997)	264
911 Targa (996)	264
928	264
968	264



**PORSCHE****263**

968 Cabriolet	264
BOXSTER (986)	264
BOXSTER (987)	264
BOXSTER Spyder (987)	265
CAYENNE (9PA)	265
CAYMAN (987)	265

RENAULT**265**

19 II (B/C53_)	265
19 II Cabriolet (D53_, 853_)	266
19 II Chamade (L53_)	266
19 II Kasten (S53_)	266
21 Kombi (K48_)	267
AVANTIME (DE0_)	267
CLIO Grandtour (KR0/1_)	270
CLIO I (B/C57_, 5/357_)	267
CLIO II (BB_, CB_)	267
CLIO III (BR0/1, CR0/1)	269
CLIO II Kasten (SB0/1/2_)	269
ESPACE II (J/S63_)	270
ESPACE III (JE0_)	271
ESPACE IV (JK0/1_)	271
GRAND SCÉNIC II (JM0/1_)	271
GRAND SCÉNIC III (JZ0/1_)	272
KANGOO (KC0/1_)	272
KANGOO Rapid (FC0/1_)	272
LAGUNA I (B56_, 556_)	272
LAGUNA I Grandtour (K56_)	273
LAGUNA II (BG0/1_)	274
LAGUNA II Grandtour (KG0/1_)	275
LOGAN I (LS_)	277
LOGAN I Kombi (KS_)	277
MASTER I Bus (T_)	277
MASTER II Bus (JD)	278
MASTER III Bus (JV)	278
MASTER III Kasten (FV)	279
MASTER III Pritsche/Fahrgestell (EV, HV, UV)	279
MASTER II Kasten (FD)	278
MASTER II Pritsche/Fahrgestell (ED/HD/UD)	278
MASTER I Kasten (T_)	277
MASTER I Pritsche/Fahrgestell (P_)	277
MEGANE CC (EZ0/1_)	287
MEGANE I (BA0/1_)	280
MEGANE I Cabriolet (EA0/1_)	282
MEGANE I Classic (LA0/1_)	282
MEGANE I Coach (DA0/1_)	284
MEGANE I Grandtour (KA0/1_)	284
MEGANE II (BM0/1_, CM0/1_)	285
MEGANE II Coupé-Cabriolet (EM0/1_)	285
MEGANE II Grandtour (KM0/1_)	286
MEGANE III Coupe (DZ0/1_)	286
MEGANE III Grandtour (KZ0/1)	287
MEGANE III Schrägheck (BZ0/1_)	287
MEGANE II Stufenheck (LM0/1_)	286
MEGANE Scenic (JA0/1_)	287
MODUS / GRAND MODUS (F/JPO_)	288
RAPID Kasten (F40_, G40_)	289
SAFRANE I (B54_)	289
SAFRANE II (B54_)	289
SANDERO/STEPWAY I (BS_)	290
SCÉNIC I Großraumlimousine (JA0/1_, FA0_)	290
SCÉNIC II (JM0/1_)	290
SCÉNIC III (JZ0/1_)	291
SUPER 5 (B/C40_)	291
THALIA I (LB_)	291
THALIA II (LU1/2_)	291
TRAFIC Bus (TXW)	293
TRAFIC II Bus (JL)	292
TRAFIC II Kasten (FL)	292
TRAFIC II Pritsche/Fahrgestell (EL)	292
TRAFIC Kasten (TXX)	293
TRAFIC Pritsche/Fahrgestell (PXX)	293
TWINGO I (C06_)	293
TWINGO II (CN0_)	293
VEL SATIS (BJ0_)	294
WIND (E4M_)	294

**SAAB****294**

9000	298
9000 Schrägheck	298
900 II	297
900 II Cabriolet	298
900 II Coupe	298
9-3 (YS3D)	295
9-3 (YS3F)	295
9-3 Cabriolet (YS3D)	295
9-3 Cabriolet (YS3F)	295
9-3 Kombi (YS3F)	296
9-3X	296
9-5 (YS3E)	296
9-5 (YS3G)	297
9-5 Kombi (YS3E)	297

SEAT**298**

ALHAMBRA (710, 711)	300
ALHAMBRA (7V8, 7V9)	298
ALTEA (5P1)	300
ALTEA XL (5P5, 5P8)	301
ARONA (KJ7)	303
AROSA (6H)	303
ATECA (KH7)	303
CORDOBA (6K1, 6K2)	303
CORDOBA (6L2)	304
CORDOBA Vario (6K5)	305
EXEO (3R2)	305
EXEO ST (3R5)	306
IBIZA II (6K1)	306
IBIZA III (6L1)	308
IBIZA IV (6J5, 6P1)	309
IBIZA IV SPORTCOUPE (6J1, 6P5)	309
IBIZA IV ST (6J8, 6P8)	309
IBIZA V (KJ1)	309
INCA (6K9)	310
LEON (1M1)	310
LEON (1P1)	311
LEON (5F1)	314
LEON SC (5F5)	314
LEON ST (5F8)	315
MARBELLA (28)	315
Mii (KF1)	315
TOLEDO I (1L)	316
TOLEDO II (1M2)	316
TOLEDO III (5P2)	317

SKODA**318**

CITIGO	318
FABIA I (6Y2)	318
FABIA I Combi (6Y5)	319
FABIA II (542)	320
FABIA II Combi (545)	321
FABIA I Praktik (6Y5)	319
FABIA I Stufenheck (6Y3)	319
FELICIA I (6U1)	322
FELICIA II (6U1)	322
FELICIA II Kombi (6U5)	322
FELICIA I Kombi (6U5)	322
FELICIA I Pick-up (6UF, 6U7)	322
KAROQ (NU7)	323
KODIAQ (NS7)	323
OCTAVIA I (1U2)	323
OCTAVIA I Combi (1U5)	324
OCTAVIA II (1Z3)	325
OCTAVIA II Combi (1Z5)	326
OCTAVIA III (5E3, NL3, NR3)	328
OCTAVIA III Combi (5E5)	328
ROOMSTER (5J)	329
ROOMSTER Praktik (5J)	329
SUPERB I (3U4)	329
SUPERB II (3T4)	330
SUPERB III (3V3)	331
SUPERB III Kombi (3V5)	331
SUPERB II Kombi (3T5)	330
YETI (5L)	331

**SMART****331**

CABRIO (450)	331
CITY-COUPE (450)	332
CROSSBLADE (450)	332
FORFOUR (454)	332
FORTWO Cabrio (450)	332
FORTWO Coupe (450)	332

SUBARU**332**

JUSTY III (G3X)	332
-----------------	-----

SUZUKI**332**

IGNIS II (MH)	332
JIMNY Geländewagen geschlossen (SN)	333
SPLASH (EX)	333
SWIFT III (MZ, EZ)	333
SX4 (EY, GY)	333
SX4 Stufenheck (GY)	333
WAGON R+ Schrägheck (MM)	333
WAGON R Schrägheck	333

TOYOTA**333**

AVENSIS (_T22_)	334
AVENSIS (_T25_)	334
AVENSIS Combi (_T25_)	334
AVENSIS Kombi (_T22_)	334
AVENSIS Liftback (_T22_)	334
AVENSIS Stufenheck (_T25_)	335
AYGO (_B1_)	335
COROLLA (_E11_)	335
COROLLA (_E12_)	335
COROLLA Combi (_E12_)	335
COROLLA Compact (_E11_)	335
COROLLA Kombi (_E11_)	336
COROLLA Liftback (_E11_)	336
COROLLA Stufenheck (_E12_)	336
COROLLA Verso (_E12_)	336
COROLLA Verso (ZER_, ZZE12_, R1_)	336
RAV 4 II (_A2_)	336
YARIS (_P1_)	337
YARIS (_P9_)	337

VAUXHALL**337**

ZAFIRA Mk III (P12)	337
---------------------	-----

VOLVO**337**

440 K (445)	337
460 L (464)	338
480 E (482)	338
850 (854)	338
850 Kombi (855)	338
940 II (944)	339
940 II Kombi (945)	339
940 Kombi (945)	339
960 II (964)	339
960 II Kombi (965)	339
C30 (533)	339
C70 I Cabriolet (873)	340
C70 I Coupe (872)	341
C70 II Cabriolet (542)	341
S40 I (644)	342
S40 II (544)	342
S60 I (384)	343
S60 II (134)	346
S70 (874)	346
S80 I (184)	347
S80 II (124)	348
S90 (964)	349
V40 Kombi (645)	349
V40 Schrägheck (525, 526)	349
V50 (545)	349
V60 (155, 157)	350
V70 I (875, 876)	351
V70 II (285)	352
V70 III (135)	354

**VOLVO****337**

V90 Kombi (965)	356
XC60 (156)	356
XC70 CROSS COUNTRY (295)	358
XC70 II (136)	357
XC90 I (275)	358

VW**359**

AMAROK (2HA, 2HB, S1B, S6B, S7A, S7B)	359
ARTEON (3H7)	359
BEETLE (5C1, 5C2)	359
BEETLE Cabriolet (5C7, 5C8)	359
BORA (1J2)	360
BORA Variant (1J6)	361
CADDY ALLTRACK Kasten (SAA)	365
CADDY ALLTRACK Kombi (SAB)	366
CADDY III Kasten (2KA, 2KH, 2CA, 2CH)	363
CADDY III Kombi (2KB, 2KJ, 2CB, 2CJ)	364
CADDY II Kasten (9K9A)	362
CADDY II Kombi (9K9B)	363
CADDY II Pick-up (9U7)	363
CADDY IV Kasten (SAA, SAH)	365
CADDY IV Kombi (SAB, SAJ)	365
CC (358)	366
CORRADO (53I)	366
CRAFTER 30-35 Bus (2E_)	366
CRAFTER 30-50 Kasten (2E_)	367
CRAFTER 30-50 Pritsche/Fahrgestell (2F_)	367
EOS (1F7, 1F8)	367
FOX (5Z1, 5Z3)	368
GOLF ALLTRACK (BA5, BV5)	381
GOLF III (1H1)	368
GOLF III Cabriolet (1E7)	370
GOLF III Variant (1H5)	370
GOLF IV (1J1)	371
GOLF IV Cabriolet (1E7)	373
GOLF IV Variant (1J5)	374
GOLF PLUS (5M1, 521)	381
GOLF SPORTSVAN (AM1)	385
GOLF V (1K1)	375
GOLF VI (5K1)	377
GOLF VI Cabriolet (517)	378
GOLF VII (5G1, BQ1, BE1, BE2)	380
GOLF VII Variant (BA5, BV5)	381
GOLF VI Variant (AJ5)	379
GOLF V Variant (1K5)	376
JETTA III (1K2)	385
JETTA IV (162, 163)	386
LOAD UP (121, 122, BL1, BL2)	386
LT 28-35 I Bus (281-363)	386
LT 28-35 II Bus (2DB, 2DE, 2DK)	387
LT 28-35 I Kasten (281-363)	386
LT 28-35 I Pritsche/Fahrgestell (281-363)	386
LT 28-46 II Kasten (2DA, 2DD, 2DH)	387
LT 28-46 II Pritsche/Fahrgestell (2DC, 2DF, 2DG, 2DL, 2DM)	387
LT 40-55 I Kasten (291-512)	387
LT 40-55 I Pritsche/Fahrgestell (293-909)	387
LUPO (6X1, 6E1)	387
MULTIVAN T5 (7HM, 7HN, 7HF, 7EF, 7EM, 7EN)	388
NEW BEETLE (9C1, 1C1)	389
NEW BEETLE Cabriolet (1Y7)	390
PASSAT (362)	394
PASSAT (3A2, 35I)	391
PASSAT (3B2)	392
PASSAT (3B3)	393
PASSAT (3C2)	393
PASSAT (3G2)	394
PASSAT ALLTRACK (365)	395
PASSAT ALLTRACK (3G5)	395
PASSAT CC (357)	395
PASSAT Variant (365)	399
PASSAT Variant (3A5, 35I)	395
PASSAT Variant (3B5)	397
PASSAT Variant (3B6)	398
PASSAT Variant (3C5)	398
PASSAT Variant (3G5)	399
POLO (6N1)	400
POLO (6N2)	401

**VW****359**

POLO (9N_)	402
POLO CLASSIC (6V2)	403
POLO Stufenheck (9A4, 9A2, 9N2)	404
POLO Van Kasten/Schrägheck (6N1)	404
POLO Variant (6V5)	405
SCIROCCO (137, 138)	405
SHARAN (7M8, 7M9, 7M6)	407
SHARAN (7N1, 7N2)	408
TIGUAN (5N_)	408
TIGUAN (AD1)	409
TOUAREG (7LA, 7L6, 7L7)	409
TOURAN (1T1, 1T2)	410
TOURAN (1T3)	411
TOURAN (5T1)	411
TRANSPORTER T4 Bus (70B, 70C, 7DB, 7DK, 70J, 70K, 7DC, 7DJ)	412
TRANSPORTER T4 Kasten (70A, 70H, 7DA, 7DH)	413
TRANSPORTER T4 Pritsche/Fahrgestell (70E, 70L, 70M, 7DE, 7DL)	415
TRANSPORTER T5 Bus (7HB, 7HJ, 7EB, 7EJ, 7EF, 7EG, 7HF, 7EC)	416
TRANSPORTER T5 Kasten (7HA, 7HH, 7EA, 7EH)	417
TRANSPORTER T5 Pritsche/Fahrgestell (7JD, 7JE, 7JL, 7JY, 7JZ)	418
UP (121, 122, BL1, BL2)	419
VENTO (1H2)	419



DE Fahrzeugverwendungen

EN Applications of vehicles















ES Aplicaciones











FR Applications











IT Applicazioni autoveicoli











2019



























	kw			 	! #		
ABARTH - 500 / 595 / 695 (312_) 01/08→							
 Hauptbremszylinder							
1.4 (312.AXD1A)	99	08/08→				24.4122-1714.3 010914	TRW Ø 22,2 ohne Bremsflüssigkeitsbehälter
1.4 (312.AXF11, 312.AXF1A, 312.AXD1A)	118	08/08→					
1.4 (312.AXF11, 312.AXF1A)	132	08/08→					
1.4 (312.AXF1A, 312.AXD1A)	103	05/10→					
1.4 (312.AXT1A)	139	06/15→					
1.4 (312.AXT1A)	140	08/08→					
1.4 (312.AXY11, 312.AXY1A)	107	05/16→					
1.4 (312.AXZ11)	121	05/16→					
1.4 (312.AYB11, 312.AYB1A)	120	06/16→					
ABARTH - 500C / 595C / 695C (312_) 09/09→							
 Hauptbremszylinder							
1.4 (312.AXD1A)	99	01/11→				24.4122-1714.3 010914	TRW Ø 22,2 ohne Bremsflüssigkeitsbehälter
1.4 (312.AXF11)	132	06/10→					
1.4 (312.AXF1A, 312.AXD1A)	118	05/11→					
1.4 (312.AXF1A, 312.AXF11, 312.AXD1A)	103	09/09→					
1.4 (312.AXY1A)	107	05/16→					
1.4 (312.AXZ1A)	121	05/16→					
ABARTH - GRANDE PUNTO (199_) 12/07→12/12							
 Hauptbremszylinder							
1.4 (199.AXN1B)	114	12/07→06/10				24.4123-1720.3 011022	BOS Ø 23,81 ohne Bremsflüssigkeitsbehälter
1.4 (199.AXX1B)	132	12/07→12/12		→ 01/11		24.4123-1720.3 011022	BOS Ø 23,81 ohne Bremsflüssigkeitsbehälter
ABARTH - PUNTO (199_) 03/12→02/12							
 Hauptbremszylinder							
1.4 (199.AXX1B)	132	03/12→02/12		für Linkslenker		24.4123-1720.3 011022	BOS Ø 23,81 ohne Bremsflüssigkeitsbehälter
ABARTH - PUNTO EVO (199_) 07/08→02/12							
 Hauptbremszylinder							
1.4 (199.AXX1B)	120	10/09→02/12		für Linkslenker		24.4123-1720.3 011022	BOS Ø 23,81 ohne Bremsflüssigkeitsbehälter
1.4 (199.AXX1B)	132	07/08→02/12					
ALFA ROMEO - 145 (930_) 07/94→01/01							
 Hauptbremszylinder							
1.4 i.e. (930.A3)	66	07/94→12/96		GG		24.2122-1716.3 010485	Ø 22,2
1.6 16V T.S. (930.A2C)	82	09/97→12/00					
1.6 i.e. (930.A2)	76	10/94→12/96					
1.7 i.e. 16V (930.A1)	95	10/94→12/96					
1.8 i.e. 16V (930.A1A)	106	03/98→01/01					
1.9 JTD (930.A4B)	77	02/99→01/01					
1.9 TD (930.A4)	66	10/94→02/99					
2.0 16V (930.A5)	114	03/98→01/01					
2.0 16V T.S. (930.A5)	110	10/95→01/01					
1.4 i.e. 16V T.S. (930.A3A)	76	12/96→01/01		01/97→; GG		24.2122-1716.3 010485	Ø 22,2
1.6 i.e. 16V T.S. (930.A2)	88	12/96→01/01					
1.8 i.e. 16V T.S. (930.A1A)	103	12/96→12/98					
ALFA ROMEO - 146 (930_) 12/94→10/01							
 Hauptbremszylinder							
1.4 i.e. (930.B3)	66	12/94→12/96		GG		24.2122-1716.3 010485	Ø 22,2
1.6 16V T.S. (930.B2C)	82	09/97→12/00					
1.6 i.e. (930.B2)	76	12/94→12/96					
1.7 i.e. 16V (930.B1)	95	12/94→12/96					
1.8 i.e. 16V T.S. (930.B1A)	106	03/98→01/01					
1.9 JTD (930.B4B)	77	02/99→01/01					
1.9 TD (930.B4A)	66	12/94→02/99					
2.0 16V (930.B5)	114	03/97→10/01					
2.0 16V T.S. (930.B5)	110	10/95→01/01					
↓							









	kw			 	! #		
ALFA ROMEO - 146 (930_) 12/94→10/01							
 Hauptbremszylinder							
1.4 i.e. 16V T.S. (930.B3A)	76	11/96→01/01		01/97→; GG		24.2122-1716.3 010485	Ø 22,2
1.6 i.e. 16V T.S. (930.B2B, 930.B2C)	88	11/96→10/01					
1.8 i.e. 16V T.S. (930.B1A)	103	11/96→01/01					
ALFA ROMEO - 155 (167_) 01/92→12/97							
 Hauptbremszylinder							
1.6 16V T.S. (167.A6A)	88	05/96→12/97		GG		24.2122-1716.3 010485	Ø 22,2
1.7 T.S. (167.A4D, 167.A4H)	85	04/93→04/96					
1.7 T.S. 16V (167.A4N)	103	05/96→12/97					
1.9 TD (167.A3B, 167.A3)	66	04/93→12/97					
2.0 T.S. 16V (167.A2G)	110	03/95→12/97					
2.5 TD (167.A1A, 167.A1G)	92	04/93→12/97					
2.5 V6 (167.A1C, 167.A1E)	120	09/92→12/97					
1.8 T.S. (167.A4C, 167.A)	77	02/92→12/97		05/92→; GG		24.2122-1716.3 010485	Ø 22,2
1.8 T.S. Sport (167.A4A, 167.A4C, 167.A4E)	93	03/92→12/96					
2.0 T.S. (167.A2A, 167.A2D)	104	02/92→05/95					
2.0 T.S. (167.A2D)	106	02/92→01/95					
2.5 V6 (167.A1C, 167.A1)	121	03/92→05/95					
2.0 16V Turbo Q4 (167.A2B, 167.A2C, 167.A2E)	137	01/92→12/97		11/92→; GG		24.2122-1716.3 010485	Ø 22,2
2.0 16V Turbo Q4 (167.A2B, 167.A2C, 167.A2E)	140	03/92→12/97					
ALFA ROMEO - 156 (932_) 09/97→10/05							
 Hauptbremszylinder							
1.6 16V T.SPARK (932.A4, 932.A4100)	88	09/97→09/05		10/97→ 07/05		24.2120-1735.3 010726	Ø 20,64
1.6 16V T.SPARK (932A4)	82	09/97→09/05					
1.8 16V T.SPARK (932.A3)	106	09/97→10/00		10/97→		24.2120-1735.3 010726	Ø 20,64
1.9 JTD (932B2)	77	09/97→10/00					
1.8 16V T.SPARK (932.A3100)	103	10/00→09/05		→ 07/05		24.2120-1735.3 010726	Ø 20,64
1.9 JTD	93	11/03→09/05					
1.9 JTD (932.A2B00, 932.A2C00)	85	05/01→09/05					
1.9 JTD (932.AXN00, 932.BXE00)	110	07/04→09/05					
1.9 JTD	100	11/02→11/04				24.2120-1735.3 010726	Ø 20,64
1.9 JTD (932.A2B00)	81	10/00→05/01					
ALFA ROMEO - 156 Sportwagon (932_) 02/97→05/06							
 Hauptbremszylinder							
1.6 16V T.SPARK. (932.B4B00)	81	07/00→07/05				24.2120-1735.3 010726	Ø 20,64
1.8 16V T.SPARK (932A3)	106	05/00→10/00					
1.9 JTD	100	11/02→11/04					
1.9 JTD (932.B2B00)	81	10/00→05/01					
1.9 JTD (932B2)	77	05/00→10/00					
1.6 16V T.SPARK. (932A4)	88	05/00→05/06		→ 07/05		24.2120-1735.3 010726	Ø 20,64
1.6 16V T.SPARK (932A4)	82	01/00→09/05					
1.8 16V T.SPARK (932B31__)	103	02/97→05/06					
1.9 JTD	93	11/03→05/06					
1.9 JTD (932B2B, 932B2C)	85	05/01→05/06					







	kw			 	! #		
ALFA ROMEO - 159 (939_) 06/05→12/12							
 Hauptbremszylinder							
1.8 MPI (939AXL1A)	103	06/05→11/11		→ 06/08; für Fahrzeuge mit elektronischer Fahr- dynamikregelung		24.2125-1732.3 010827	TRW Ø 25,4
1.9 JTDM 16V (939AXC1B, 939AXC12)	110	09/05→11/11					
1.9 JTDM 16V (939AXF1B, 939AXC1B)	100	09/05→11/11		→ 06/08; für Fahrzeuge ohne elektronische Fahr- dynamikregelung		24.2125-1733.3 010830	TRW Ø 25,4
1.9 JTDM 8V 1.9 JTDM 8V (939AXE1B)	85 88	09/05→11/11 09/05→11/11		07/08→ 10/11		24.2125-1733.3 010830	TRW Ø 25,4
1.9 JTS (939AXA1B)	118	09/05→11/11					
2.2 JTS (939AXB1B, 939AXB11)	136	09/05→11/11					
2.4 JTDM (939AXD)	154	07/07→11/11					
2.4 JTDM (939AXD12, 939AXD1B)	147	09/05→11/11					
2.4 JTDM Q4 (939AXMB2)	154	05/07→11/11					
3.2 JTS (939AXG2B)	191	01/08→11/11					
3.2 JTS Q4 (939AXH1B, 939AXG22)	191	12/05→11/11					
1.8 TBi (939AXN1B)	147	05/09→12/12		→ 10/11		24.2125-1733.3 010830	TRW Ø 25,4
2.0 JTDM (939AXP1B)	125	05/09→11/11					
2.0 JTDM (939AXQ1B)	120	05/09→11/11					
2.0 JTDM (939AXR1B)	100	06/10→11/11					
ALFA ROMEO - 159 Sportwagon (939_) 06/05→12/12							
 Hauptbremszylinder							
1.8 MPI (939BXL1A)	103	06/05→11/11		→ 06/08; für Fahrzeuge mit elektronischer Fahr- dynamikregelung		24.2125-1732.3 010827	TRW Ø 25,4
1.9 JTDM 16V (939BXC1B, 939BXC12)	110	03/06→11/11					
1.9 JTDM 16V (939BXC1B)	100	03/06→11/11		→ 06/08; für Fahrzeuge ohne elektronische Fahr- dynamikregelung		24.2125-1733.3 010830	TRW Ø 25,4
1.9 JTDM 8V 1.9 JTDM 8V (939BXE1B)	85 88	03/06→11/11 03/06→11/11		07/08→ 10/11		24.2125-1733.3 010830	TRW Ø 25,4
1.9 JTS (939BXA1B)	118	03/06→11/11					
2.2 JTS (939BXB1B, 939BXB11)	136	03/06→11/11					
2.4 JTDM (939BXM1B)	154	05/07→12/12					
2.4 JTDM (939BXD1B, 939BXD12)	147	03/06→11/11					
2.4 JTDM Q4 (939BXM2B)	154	05/07→11/11					
3.2 JTS (939BXH1B)	191	02/08→11/11					
3.2 JTS Q4 (939BXG2B, 939BXG22)	191	03/06→11/11					
1.8 TBi (939BXN1B)	147	07/09→11/11		→ 10/11		24.2125-1733.3 010830	TRW Ø 25,4
2.0 JTDM (939BXP1B)	125	07/09→11/11					
2.0 JTDM (939BXQ1B)	120	05/09→11/11					
2.0 JTDM (939BXR1B)	100	06/10→11/11					
ALFA ROMEO - 166 (936_) 09/98→06/07							
 Hauptbremszylinder							
2.0 T.Spark (936A3A_))	114	09/98→10/00		10/98→; + ABS		24.2125-1723.3 010689	Ø 25,4
2.0 V6 (936A3_))	151	09/98→10/00				24.2125-1729.3 010752	Ø 25,4
2.4 JTD (936A2A_))	100	09/98→10/00					
2.5 V6 24V (936A2_))	140	09/98→12/06		10/98→; für Fahrzeuge mit elektronischer Fahr- dynamikregelung			
3.0 V6 24V (936A1000, 936A1001)	166	09/98→06/07					
2.0 T.Spark (936A3B00)	110	10/00→06/07		→ 10/00; + ABS		24.2125-1723.3 010689	Ø 25,4
				→ 10/00; für Fahrzeuge mit elektronischer Fahr- dynamikregelung		24.2125-1729.3 010752	Ø 25,4
2.4 JTD	110	04/02→06/07		+ ABS		24.2125-1723.3 010689	Ø 25,4
2.4 JTD	120	10/03→06/07					
2.4 JTD	129	10/03→06/07				24.2125-1729.3 010752	Ø 25,4
2.4 JTD	132	07/06→06/07					
2.4 JTD	136	07/05→06/07					
2.4 JTD (936A2B_))	103	10/00→06/07					
2.5 V6 24V (936A21_))	138	10/00→06/07					
3.0 V6 24V (936A11_))	162	10/00→06/07					
3.2 V6 24V	176	10/03→06/07					
ALFA ROMEO - BRERA (939_) 01/06→05/11							
 Hauptbremszylinder							
1.8 TBi	147	05/09→06/10				24.2125-1732.3 010827	TRW Ø 25,4
2.0 JTDM	125	05/09→06/10					
2.2 JTS (939.DXB11)	136	01/06→05/11					
2.4 JTDM 20V	147	01/06→06/10					
2.4 JTDM 20V	154	05/07→06/10					
↓							







	kw			 	! #		
ALFA ROMEO - BRERA (939_) 01/06→05/11							
 Hauptbremszylinder							
3.2 JTS	191	03/08→06/10				24.2125-1732.3 010827	TRW Ø 25,4
3.2 JTS Q4 (939.DXG22)	191	01/06→05/11					
2.0 JTDM	120	03/08→06/10		05/09→		24.2125-1732.3 010827	TRW Ø 25,4
ALFA ROMEO - GIULIETTA (940_) 04/10→							
 Hauptbremszylinder							
1.4 BiFuel	88	12/11→				03.2123-3571.3 010962	ATE Ø 23,81
1.4 TB	77	04/11→					
1.4 TB	85	04/10→					
1.4 TB	110	09/14→					
1.4 TB	120	04/10→					
1.4 TB (940FXA1A)	88	04/10→					
1.4 TB (940FXB1A)	125	04/10→					
1.6 JTDM (940.FYB1_)	88	02/15→					
1.6 JTDM (940.FYE1_)	85	09/15→					
1.6 JTDM (940FXD1A)	77	04/10→					
1.8 TBi	169	04/10→09/13					
1.8 TBi (940FXC1A)	173	04/10→					
1.8 TBi (940FXR11)	177	09/13→					
2.0 JTDM	100	04/10→					
2.0 JTDM	120	04/10→					
2.0 JTDM	125	04/10→					
2.0 JTDM	129	11/13→					
2.0 JTDM (940.FXL1A)	103	04/10→					
2.0 JTDM (940.FYC1A, 940.FXQ1A)	110	08/13→					
ALFA ROMEO - GTV (916_) 09/94→10/05							
 Hauptbremszylinder							
1.8 16V (916C3)	106	05/98→10/05		GG		24.2122-1716.3 010485	Ø 22,2
2.0 JTS	121	04/03→10/05					
2.0 T.SPARK 16V (916.C2_, 916C2C00)	110	06/95→10/05					
2.0 T.SPARK 16V (916C2C)	114	09/97→03/03					
2.0 V6 Turbo (916.C2A)	148	06/95→09/98					
3.0 V6 24V (916.C1)	162	10/96→10/00					
3.0 V6 24V (916.C1B_)	160	10/00→10/05					
3.2 V6 24V	176	04/03→10/05					
ALFA ROMEO - MITO (955_) 08/08→							
 Hauptbremszylinder							
0.9	74	12/13→				24.4122-1709.3 010871	BOS Ø 22,2 ohne Bremsflüssigkeitsbehälter
0.9 TwinAir	63	07/11→					
0.9 TwinAir (955AXY1B)	77	04/13→					
1.4	70	09/08→					
1.4 (955AXB1B)	57	03/11→					
1.4 (955AXB1B)	58	08/08→					
1.4 MultiAir (955AXL1B)	77	09/09→					
1.3 MultiJet	59	12/13→				24.4123-1720.3 011022	BOS Ø 23,81 ohne Bremsflüssigkeitsbehälter
1.3 MultiJet	62	01/11→					
1.3 MultiJet	66	09/08→					
1.3 MultiJet	70	10/09→					
1.4 Bifuel	88	07/11→					
1.4 Bifuel (955.AXG1A)	88	04/16→					
1.4 MultiAir (955AXN1B)	125	09/09→					
1.4 TB	103	12/13→					
1.4 TJet	110	09/08→					
1.4 TJet (955AXA1B)	114	08/08→					
1.4 TJet (955AXG1A)	88	08/08→					
1.4 Turbo MultiAir	120	10/09→					
1.4 Turbo MultiAir (955AXM1A, 955AXR11)	99	10/09→					
1.6 JTDM	85	09/08→					
1.6 JTDM (955AXC1B)	88	08/08→					
1.4	51	05/11→				24.4122-1709.3 010871	BOS Ø 22,2 ohne Bremsflüssigkeitsbehälter
						24.4123-1720.3 011022	BOS Ø 23,81 ohne Bremsflüssigkeitsbehälter
1.4 (955.AXB1B, 955.AXU1A)	57	03/11→		05/11→		24.4122-1709.3 010871	BOS Ø 22,2 ohne Bremsflüssigkeitsbehälter
						24.4123-1720.3 011022	BOS Ø 23,81 ohne Bremsflüssigkeitsbehälter











	kw			 	! #		
ALFA ROMEO - SPIDER (916_) 09/94→04/05							
 Hauptbremszylinder							
1.8 16V (916S3)	106	05/98→04/05		GG		24.2122-1716.3 010485	Ø 22,2
2.0 JTS	121	04/03→04/05					
2.0 T.SPARK 16V (916S2B)	114	05/98→08/00					
2.0 T.SPARK 16V (916S2C00)	110	06/95→04/05					
2.0 V6 Turbo (916S2A)	148	05/98→04/05					
3.0 V6 (916S1)	141	06/95→04/05					
3.0 V6 24V (916S1)	162	01/99→10/03					
3.2 V6 24V	176	04/03→04/05					
3.0 V6 (916S1B00)	160	09/94→04/05		10/00→; GG		24.2122-1716.3 010485	Ø 22,2
ALFA ROMEO - SPIDER (939_) 03/06→03/11							
 Hauptbremszylinder							
1.8 TBi (939DXN1B)	147	05/09→03/11				24.2125-1733.3 010830	TRW Ø 25,4
2.0 JTDM	120	04/09→06/10					
2.0 JTDM	125	05/09→06/10					
2.4 JTDM	147	04/07→06/10					
2.4 JTDM	154	03/08→06/10					
3.2 JTS (939EXG2B)	191	03/08→03/11					
2.2 JTS	136	03/06→03/11		04/06→ 09/06		24.2125-1732.3 010827	TRW Ø 25,4
3.2 JTS Q4	191	03/06→03/11		10/06→		24.2125-1733.3 010830	TRW Ø 25,4
AUDI - 80 Avant (8C5, B4) 09/91→01/96							
 Bremskraftverstärker							
1.6 E	74	06/93→01/96		→ 8C-N-300000; für Linkslenker		03.7750-0302.4 300071	ATE Ø 9" pneumatisch
1.9 TDI	66	07/92→01/96					
2.0	66	07/92→01/96					
2.0 E	85	07/92→01/96					
2.0 E 16V	103	02/93→01/96					
2.3 E	98	07/92→01/96					
2.0 E 16V quattro	103	12/92→07/95		für Linkslenker		03.7750-0302.4 300071	ATE Ø 9" pneumatisch
RS2 quattro	232	03/94→05/95		→ 8C-S-000368; für Linkslenker		10.0124-3202.3 340011	ATE hydraulisch
S2 quattro	169	02/93→07/95		für Linkslenker		10.0124-3202.3 340011	ATE hydraulisch
 Hauptbremszylinder							
1.6 E	74	06/93→01/96		8C-P-000001→; → 12/95; für Linkslenker; - ABS		03.2123-0491.3 010167	Ø 23,81
1.9 TDI	66	07/92→01/96					
2.0	66	07/92→01/96					
2.0 E	85	07/92→01/96		→ 12/95; + ABS		24.2123-1602.3 010384	TRW Ø 23,81
2.0 E 16V	103	02/93→01/96					
2.3 E	98	07/92→01/96					
2.0 E 16V quattro	103	12/92→07/95		8C-P-000001→; für Linkslenker		03.2123-0491.3 010167	Ø 23,81
2.6	110	07/92→01/96		08/92→ 12/95; + ABS		24.2123-1602.3 010384	TRW Ø 23,81
2.8	128	09/91→01/96		→ 12/95; + ABS		24.2123-1602.3 010384	TRW Ø 23,81
RS2 quattro	232	03/94→05/95		→ 8C-S-000368; für Linkslenker		03.2125-3610.3 010214	Ø 25,4
				für Rechtslenker		03.2125-3610.3 010214	Ø 25,4
S2 quattro	169	02/93→07/95				03.2125-3610.3 010214	Ø 25,4
 Bremskraftregler							
1.6 E	74	06/93→01/96		→ 12/95		03.6584-0107.3 320110	ATE lastabhängig 8/4 4x
1.9 TDI	66	07/92→01/96					
2.0	66	07/92→01/96					
2.0 E	85	07/92→01/96					
2.0 E 16V	103	02/93→01/96					
2.3 E	98	07/92→01/96					
2.6	110	07/92→01/96					
2.8	128	09/91→01/96					
AUDI - A1 (8X1, 8XK) 05/10→10/18							
 Hauptbremszylinder							
2.0 TFSI quattro	188	03/12→11/12		10/12→; für Linkslenker		03.2125-5112.3 010966	ATE Ø 25,4
AUDI - A2 (8Z0) 02/00→08/05							
 Bremskraftverstärker							
1.2 TDI	45	03/01→08/05		8Z-2-013001→; für Linkslenker; → 07/05		03.7850-0102.4 300180	ATE Ø 9" pneumatisch
				→ 8Z-2-013000; für Linkslenker		03.7853-0202.4 300181	ATE Ø 9" pneumatisch
1.4	55	02/00→08/05		8Z-2-013001→; für Linkslenker; → 07/05		03.7850-0102.4 300180	ATE Ø 9" pneumatisch
1.4 TDI	55	02/00→08/05		06/00→; → 8Z-2-013000; für Linkslenker		03.7853-0202.4 300181	ATE Ø 9" pneumatisch
1.4 TDI	66	11/03→08/05		für Linkslenker; → 07/05		03.7850-0102.4 300180	ATE Ø 9" pneumatisch
1.6 FSI	81	05/02→08/05					







	kw			 	! #		
AUDI - A2 (8Z0) 02/00→08/05							
 Hauptbremszylinder							
1.2 TDI	45	03/01→08/05		→ 8Z-2-013000; für Linkslenker		03.2122-1663.3 010734	ATE Ø 22,2
				→ 8Z-3-019000; für Rechtslenker		03.2122-1663.3 010734	ATE Ø 22,2
				8Z-3-019001→; → 07/05		03.2122-1888.3 010736	ATE Ø 22,2
1.4 1.4 TDI	55 55	02/00→08/05 02/00→08/05		06/00→; → 8Z-2-013000; für Linkslenker		03.2122-1663.3 010734	ATE Ø 22,2
				06/00→; → 8Z-3-019000; für Rechtslenker		03.2122-1663.3 010734	ATE Ø 22,2
				8Z-3-019001→; → 07/05		03.2122-1888.3 010736	ATE Ø 22,2
1.4 TDI	66	11/03→08/05		→ 07/05		03.2122-1888.3 010736	ATE Ø 22,2
1.6 FSI	81	05/02→08/05		→ 8Z-3-019000; für Rechtslenker		03.2122-1663.3 010734	ATE Ø 22,2
				8Z-3-019001→; → 07/05		03.2122-1888.3 010736	ATE Ø 22,2
AUDI - A3 (8L1) 09/96→09/06							
 Bremskraftverstärker							
1.6	74	09/96→05/03		09/00→; → 8L-2-037877; für Linkslenker; + ESP		03.7860-0602.4 300141	ATE Ø 10" pneumatisch
1.6	75	08/00→05/03					
1.8	92	09/96→05/03		→ 08/00; + ESP; für Linkslenker		03.7863-0402.4 300124	ATE Ø 10" pneumatisch
1.8 T	110	12/96→05/03					
1.8 T	132	12/98→05/03		8L-2-037878→; für Linkslenker; + ESP		03.7863-3502.4 300128	ATE Ø 10" pneumatisch
1.8 T quattro	132	10/98→05/03					
S3 quattro	154	03/99→04/02					
1.8 T quattro	110	12/96→05/03		09/00→; → 8L-2-037877; für Linkslenker; + ESP		03.7860-0602.4 300141	ATE Ø 10" pneumatisch
				08/98→ 08/00; für Linkslenker; + ESP		03.7863-0402.4 300124	ATE Ø 10" pneumatisch
				8L-2-037878→; für Linkslenker; + ESP		03.7863-3502.4 300128	ATE Ø 10" pneumatisch
1.9 TDI	66	09/96→07/01		09/00→ 06/01; für Linkslenker; + ESP		03.7860-0602.4 300141	ATE Ø 10" pneumatisch
1.9 TDI	81	08/97→07/01		→ 08/00; + ESP; für Linkslenker		03.7863-0402.4 300124	ATE Ø 10" pneumatisch
1.9 TDI	74	10/00→05/03		→ 8L-2-037877; für Linkslenker; + ESP		03.7860-0602.4 300141	ATE Ø 10" pneumatisch
S3 quattro	165	10/01→05/03		8L-2-037878→; für Linkslenker; + ESP		03.7863-3502.4 300128	ATE Ø 10" pneumatisch
1.9 TDI	96	08/00→05/03		09/00→; → 8L-2-037877; für Linkslenker; + ESP		03.7860-0602.4 300141	ATE Ø 10" pneumatisch
1.9 TDI quattro	96	08/00→05/03					
				8L-2-037878→; für Linkslenker; + ESP		03.7863-3502.4 300128	ATE Ø 10" pneumatisch
 Hauptbremszylinder							
1.6	74	09/96→05/03		→ 08/00; für Linkslenker; + ESP		03.2123-2024.3 010597	ATE Ø 23,81
1.6	75	08/00→05/03		→ 08/00; für Rechtslenker; + ESP		03.2123-2064.3 010598	ATE Ø 23,81
1.8	92	09/96→05/03		09/00→; für Linkslenker; + ESP		03.2123-2715.3 010802	ATE Ø 23,81
1.8 T	110	12/96→05/03		09/00→; für Rechtslenker; + ESP		03.2123-2774.3 010803	ATE Ø 23,81
1.8 T	132	12/98→05/03					
S3 quattro	154	03/99→04/02		für Linkslenker; - ESP		24.2123-1709.3 010503	Ø 23,81
1.8 T quattro	110	12/96→05/03		08/98→ 08/00; für Rechtslenker; + ESP		03.2123-2064.3 010598	ATE Ø 23,81
				09/00→; für Linkslenker; + ESP		03.2123-2715.3 010802	ATE Ø 23,81
				09/00→; für Rechtslenker; + ESP		03.2123-2774.3 010803	ATE Ø 23,81
				08/98→; - ESP; für Linkslenker		24.2123-1709.3 010503	Ø 23,81
1.8 T quattro	132	10/98→05/03		→ 08/00; für Rechtslenker; + ESP		03.2123-2064.3 010598	ATE Ø 23,81
				09/00→; für Linkslenker; + ESP		03.2123-2715.3 010802	ATE Ø 23,81
				09/00→; für Rechtslenker; + ESP		03.2123-2774.3 010803	ATE Ø 23,81
				für Linkslenker; - ESP		24.2123-1709.3 010503	Ø 23,81
1.9 TDI	66	09/96→07/01		→ 08/00; für Linkslenker; + ESP		03.2123-2024.3 010597	ATE Ø 23,81
1.9 TDI	81	08/97→07/01		→ 08/00; für Rechtslenker; + ESP		03.2123-2064.3 010598	ATE Ø 23,81
				09/00→ 06/01; für Linkslenker; + ESP		03.2123-2715.3 010802	ATE Ø 23,81
				09/00→ 06/01; für Rechtslenker; + ESP		03.2123-2774.3 010803	ATE Ø 23,81
				→ 06/01; für Linkslenker; - ESP		24.2123-1709.3 010503	Ø 23,81
1.9 TDI	74	10/00→05/03		für Linkslenker; + ESP		03.2123-2715.3 010802	ATE Ø 23,81
S3 quattro	165	10/01→05/03		für Rechtslenker; + ESP		03.2123-2774.3 010803	ATE Ø 23,81
				für Linkslenker; - ESP		24.2123-1709.3 010503	Ø 23,81
1.9 TDI	96	08/00→05/03		09/00→; für Linkslenker; + ESP		03.2123-2715.3 010802	ATE Ø 23,81
1.9 TDI quattro	96	08/00→05/03		09/00→; für Rechtslenker; + ESP		03.2123-2774.3 010803	ATE Ø 23,81
				09/00→; für Linkslenker; - ESP		24.2123-1709.3 010503	Ø 23,81
AUDI - A3 (8P1) 05/03→12/13							
 Bremskraftverstärker							
1.2 TSI	77	04/10→08/12		für Linkslenker; +PR 1AC,1AT		03.7863-3232.4 300307	ATE Ø 10" pneumatisch
1.4 TFSI	92	09/07→08/12		für Linkslenker; +PR 1AS		03.7863-9602.4 300206	ATE Ø 10" pneumatisch
1.6	75	05/03→08/12					
1.6 E-Power	75	01/11→08/12					
1.6 FSI	85	08/03→09/07					
↓							







	kw			 	! #		
AUDI - A3 (8P1) 05/03→12/13							
 Bremskraftverstärker							
1.6 TDI	66	05/09→08/12		für Linkslenker; +PR 1AC,1AT		03.7863-3232.4 300307	ATE Ø 10" pneumatisch
1.6 TDI	77	05/09→08/12					
1.8 TFSI quattro	118	07/08→08/12		für Linkslenker; +PR 1AS		03.7863-9602.4 300206	ATE Ø 10" pneumatisch
2.0 FSI	110	05/03→06/08					
2.0 TDI	100	05/03→08/12					
2.0 TDI	103	06/05→06/08					
2.0 TDI	120	06/06→06/08					
2.0 TDI	125	03/06→08/12					
2.0 TDI 16V	103	05/03→08/12					
2.0 TDI 16V quattro	103	08/04→08/12					
2.0 TDI quattro	100	05/03→06/08					
2.0 TDI quattro	103	01/06→06/08					
2.0 TDI quattro	125	03/06→08/12					
2.0 TFSI	147	09/04→08/12					
2.0 TFSI quattro	147	09/04→08/12					
1.8 TFSI	118	11/06→08/12		01/07→; +PR 1AC,1AT; für Linkslenker		03.7863-3232.4 300307	ATE Ø 10" pneumatisch
				01/07→; +PR 1AS; für Linkslenker		03.7863-9602.4 300206	ATE Ø 10" pneumatisch
1.9 TDI	77	05/03→05/10		06/03→; für Linkslenker; +PR 1AC,1AT		03.7863-3232.4 300307	ATE Ø 10" pneumatisch
				06/03→; für Linkslenker; +PR 1AS		03.7863-9602.4 300206	ATE Ø 10" pneumatisch
3.2 V6 quattro	184	07/03→05/09		für Linkslenker		03.7863-3332.4 300308	ATE Ø 10" pneumatisch
S3 quattro	195	11/06→08/12					
S3 quattro	188	02/07→08/12		07/08→; für Linkslenker		03.7863-3332.4 300308	ATE Ø 10" pneumatisch
 Hauptbremszylinder							
1.2 TSI	77	04/10→08/12		für Linkslenker; → 8P-6A094000; +PR 1ZE;1ZF;1ZP;1ZD / 1LJ;1ZM		03.2122-2129.3 010799	ATE Ø 22,2
				für Linkslenker; → 8P-6B009600; +PR 1ZE;1ZF;1ZP;1ZD / 1LJ;1ZM		03.2122-2129.3 010799	ATE Ø 22,2
				für Linkslenker; +PR 1ZE;1ZF;1ZP;1ZD / 1LJ;1ZM		03.2122-2129.3 010799	ATE Ø 22,2
				8P-6A094001→; für Linkslenker; +PR 1ZE;1ZF;1ZP;1ZD / 1LJ;1ZM		03.2122-2129.3 010799	ATE Ø 22,2
				8P-6A094001→; für Linkslenker; +PR 1LK;1ZK		03.2123-3449.3 010808	ATE Ø 23,81
				für Linkslenker; → 8P-6B009600; +PR 1LK		03.2123-3449.3 010808	ATE Ø 23,81
				für Linkslenker; +PR 1LK;1ZK		03.2123-3449.3 010808	ATE Ø 23,81
				für Linkslenker; → 8P-6A094000; +PR 1LK		03.2123-3449.3 010808	ATE Ø 23,81
1.4 TFSI	92	09/07→08/12		für Linkslenker; +PR 1ZE;1ZF;1ZP;1ZD / 1LJ;1ZM		03.2122-2129.3 010799	ATE Ø 22,2
1.8 TFSI quattro	118	07/08→08/12		für Linkslenker; +PR 1LK;1ZK		03.2123-3449.3 010808	ATE Ø 23,81
1.6	75	05/03→08/12		8P-6A094001→; für Linkslenker; +PR 1ZE;1ZF;1ZP;1ZD / 1LJ;1ZM		03.2122-2129.3 010799	ATE Ø 22,2
1.6 E-Power	75	01/11→08/12					
1.6 FSI	85	08/03→09/07		8P-6B009601→; für Linkslenker; +PR 1ZE;1ZF;1ZP;1ZD / 1LJ;1ZM		03.2122-2129.3 010799	ATE Ø 22,2
1.6 TDI	66	05/09→08/12					
1.6 TDI	77	05/09→08/12		für Linkslenker; → 8P-6B009600; +PR 1ZE;1ZF;1ZP;1ZD / 1LJ;1ZM		03.2122-2129.3 010799	ATE Ø 22,2
2.0 FSI	110	05/03→06/08					
2.0 TDI	100	05/03→08/12		für Linkslenker; → 8P-6A094000; +PR 1ZE;1ZF;1ZP;1ZD / 1LJ;1ZM		03.2122-2129.3 010799	ATE Ø 22,2
2.0 TDI	103	06/05→06/08					
2.0 TDI 16V	103	05/03→08/12		für Linkslenker; → 8P-6B009600; +PR 1LK		03.2123-3449.3 010808	ATE Ø 23,81
2.0 TDI 16V quattro	103	08/04→08/12					
2.0 TDI quattro	100	05/03→06/08		8P-6A094001→; für Linkslenker; +PR 1LK;1ZK		03.2123-3449.3 010808	ATE Ø 23,81
2.0 TDI quattro	103	01/06→06/08		8P-6B009601→; für Linkslenker; +PR 1LK;1ZK		03.2123-3449.3 010808	ATE Ø 23,81
				für Linkslenker; → 8P-6A094000; +PR 1LK		03.2123-3449.3 010808	ATE Ø 23,81
1.8 TFSI	118	11/06→08/12		01/07→; für Linkslenker; +PR 1ZE;1ZF;1ZP;1ZD / 1LJ;1ZM		03.2122-2129.3 010799	ATE Ø 22,2
				01/07→; für Linkslenker; +PR 1LK;1ZK		03.2123-3449.3 010808	ATE Ø 23,81
1.9 TDI	77	05/03→05/10		8P-6A094001→; für Linkslenker; +PR 1ZE;1ZF;1ZP;1ZD / 1LJ;1ZM		03.2122-2129.3 010799	ATE Ø 22,2
				8P-6B009601→; für Linkslenker; +PR 1ZE;1ZF;1ZP;1ZD / 1LJ;1ZM		03.2122-2129.3 010799	ATE Ø 22,2
				06/03→; für Linkslenker; → 8P-6A094000; +PR 1ZE;1ZF;1ZP;1ZD / 1LJ;1ZM		03.2122-2129.3 010799	ATE Ø 22,2
				06/03→; für Linkslenker; → 8P-6B009600; +PR 1ZE;1ZF;1ZP;1ZD / 1LJ;1ZM		03.2122-2129.3 010799	ATE Ø 22,2
				8P-6A094001→; für Linkslenker; +PR 1LK;1ZK		03.2123-3449.3 010808	ATE Ø 23,81
				8P-6B009601→; für Linkslenker; +PR 1LK;1ZK		03.2123-3449.3 010808	ATE Ø 23,81









	kw			 	! #		
AUDI - A3 (8P1) 05/03→12/13							
Hauptbremszylinder							
1.9 TDI	77	05/03→05/10		06/03→; für Linkslenker; → 8P-6B009600; +PR 1LK		03.2123-3449.3 010808	ATE Ø 23,81
				06/03→; für Linkslenker; → 8P-6A094000; +PR 1LK		03.2123-3449.3 010808	ATE Ø 23,81
2.0 TDI	120	06/06→06/08		8P-6A094001→; für Linkslenker; +PR 1ZE;1ZF;1ZP;1ZD / 1LJ;1ZM		03.2122-2129.3 010799	ATE Ø 22,2
				8P-6B009601→; für Linkslenker; +PR 1ZE;1ZF;1ZP;1ZD / 1LJ;1ZM		03.2122-2129.3 010799	ATE Ø 22,2
				für Linkslenker; → 8P-6B009600; +PR 1ZE;1ZF;1ZP;1ZD / 1LJ;1ZM		03.2122-2129.3 010799	ATE Ø 22,2
				für Linkslenker; → 8P-6A094000; +PR 1ZE;1ZF;1ZP;1ZD / 1LJ;1ZM		03.2122-2129.3 010799	ATE Ø 22,2
				8P-6A094001→; für Linkslenker; +PR 1LK;1ZK		03.2123-3449.3 010808	ATE Ø 23,81
				für Linkslenker; → 8P-6B009600; +PR 1LK		03.2123-3449.3 010808	ATE Ø 23,81
				für Linkslenker; → 8P-6A094000; +PR 1LK		03.2123-3449.3 010808	ATE Ø 23,81
2.0 TDI	125	03/06→08/12		+PR 1ZE;1ZF;1ZP;1ZD / 1LJ;1ZM		03.2123-3449.3 010808	ATE Ø 23,81
2.0 TDI quattro	125	03/06→08/12		für Linkslenker; +PR 1LK;1ZK		03.2123-3449.3 010808	ATE Ø 23,81
2.0 TFSI	147	09/04→08/12		8P-6B009601→; für Linkslenker; → 8P-7-103000; +PR 1ZE;1ZF;1ZP;1ZD / 1LJ;1ZM		03.2122-2129.3 010799	ATE Ø 22,2
2.0 TFSI quattro	147	09/04→08/12		für Linkslenker; → 8P-6A094000; +PR 1ZE;1ZF;1ZP;1ZD / 1LJ;1ZM		03.2122-2129.3 010799	ATE Ø 22,2
				8P-6A094001→; für Linkslenker; → 8P-7-103000; +PR 1ZE;1ZF;1ZP;1ZD / 1LJ;1ZM		03.2122-2129.3 010799	ATE Ø 22,2
				für Linkslenker; → 8P-6B009600; +PR 1ZE;1ZF;1ZP;1ZD / 1LJ;1ZM		03.2122-2129.3 010799	ATE Ø 22,2
				8P-6B009601→; für Linkslenker; → 8P-7-103000; +PR 1LK;1ZK		03.2123-3449.3 010808	ATE Ø 23,81
				8P-6A094001→; für Linkslenker; → 8P-7-103000; +PR 1LK;1ZK		03.2123-3449.3 010808	ATE Ø 23,81
				für Linkslenker; → 8P-6B009600; +PR 1LK		03.2123-3449.3 010808	ATE Ø 23,81
				für Linkslenker; → 8P-6A094000; +PR 1LK		03.2123-3449.3 010808	ATE Ø 23,81
				8P-7-103001→; +PR 1ZE;1ZF;1ZP;1ZD / 1LJ;1ZM		03.2123-3449.3 010808	ATE Ø 23,81
3.2 V6 quattro	184	07/03→05/09		für Linkslenker; - ESP		03.2122-2129.3 010799	ATE Ø 22,2
S3 quattro	195	11/06→08/12		für Linkslenker; + ESP		03.2123-3449.3 010808	ATE Ø 23,81
S3 quattro	188	02/07→08/12		07/08→; für Linkslenker; - ESP		03.2122-2129.3 010799	ATE Ø 22,2
				07/08→; für Linkslenker; + ESP		03.2123-3449.3 010808	ATE Ø 23,81
Hydraulikaggregat, Bremsanlage							
1.4 TFSI	92	09/07→08/12		→ 12/08; +PR 1AT,1AS		24.9145-0001.2 399005	
1.6	75	05/03→08/12					
1.8 TFSI quattro	118	07/08→08/12					
2.0 TDI	100	05/03→08/12					
2.0 TDI	125	03/06→08/12					
2.0 TDI 16V	103	05/03→08/12					
2.0 TDI 16V quattro	103	08/04→08/12					
2.0 TDI quattro	125	03/06→08/12					
2.0 TFSI	147	09/04→08/12					
2.0 TFSI quattro	147	09/04→08/12					
3.2 V6 quattro	184	07/03→05/09					
S3 quattro	195	11/06→08/12					
1.6 FSI	85	08/03→09/07		+PR 1AT,1AS		24.9145-0001.2 399005	
2.0 FSI	110	05/03→06/08					
2.0 TDI	103	06/05→06/08					
2.0 TDI	120	06/06→06/08					
2.0 TDI quattro	100	05/03→06/08					
2.0 TDI quattro	103	01/06→06/08					
1.8 TFSI	118	11/06→08/12		01/07→ 12/08; +PR 1AT,1AS		24.9145-0001.2 399005	
1.9 TDI	77	05/03→05/10		06/03→ 12/08; +PR 1AT,1AS		24.9145-0001.2 399005	
S3 quattro	188	02/07→08/12		07/08→ 12/08; +PR 1AT,1AS		24.9145-0001.2 399005	
Drucksensor, Bremskraftverstärker							
1.2 TSI	77	04/10→08/12		für Linkslenker; +PR 1AS		03.0655-0101.2 370008	ATE
1.4 TFSI	92	09/07→08/12					
1.6	75	05/03→08/12					
1.6 E-Power	75	01/11→08/12					
1.6 FSI	85	08/03→09/07					
1.6 TDI	66	05/09→08/12					
↓							











	kw			 	! #		
AUDI - A3 (8P1) 05/03→12/13							
Drucksensor, Bremskraftverstärker							
1.6 TDI	77	05/09→08/12		für Linkslenker; +PR 1AS		03.0655-0101.2	370008 ATE
1.8 TFSI quattro	118	07/08→08/12					
2.0 FSI	110	05/03→06/08					
2.0 TDI	100	05/03→08/12					
2.0 TDI	103	06/05→06/08					
2.0 TDI	120	06/06→06/08					
2.0 TDI	125	03/06→08/12					
2.0 TDI 16V	103	05/03→08/12					
2.0 TDI 16V quattro	103	08/04→08/12					
2.0 TDI quattro	100	05/03→06/08					
2.0 TDI quattro	103	01/06→06/08					
2.0 TDI quattro	125	03/06→08/12					
2.0 TFSI	147	09/04→08/12					
2.0 TFSI quattro	147	09/04→08/12					
1.8 TFSI	118	11/06→08/12		01/07→; +PR 1AS; für Linkslenker		03.0655-0101.2	370008 ATE
1.9 TDI	77	05/03→05/10		06/03→; für Linkslenker; +PR 1AS		03.0655-0101.2	370008 ATE
AUDI - A3 (8V1, 8VK) 04/12→							
Hauptbremszylinder							
1.0 TFSI	85	07/16→		für Linkslenker		03.4153-5403.3	010994 ATE Ø 23,81
1.2 TFSI	77	02/13→				24.4123-1719.3	011017 TRW Ø 23,81 ohne Bremsflüssigkeitsbehälter
1.2 TFSI	81	05/14→					
1.4 TFSI	92	05/14→					
1.4 TFSI	103	03/13→					
1.4 TSI	110	05/14→					
1.5 TFSI	110	05/17→					
1.6 TDI	77	10/12→					
1.6 TDI	81	09/13→					
1.6 TDI	85	02/17→					
1.8 TFSI quattro	132	08/12→					
2.0 TDI	81	01/13→					
2.0 TDI	100	05/13→					
2.0 TDI	105	09/12→					
2.0 TDI	135	05/13→					
2.0 TDI quattro	110	10/12→					
2.0 TDI quattro	135	12/12→					
2.0 TFSI	140	05/16→					
2.0 TFSI quattro	140	05/16→					
1.4 TFSI	90	04/12→		08/12→; für Linkslenker		03.4153-5403.3	010994 ATE Ø 23,81
1.8 TFSI	132	04/12→				24.4123-1719.3	011017 TRW Ø 23,81 ohne Bremsflüssigkeitsbehälter
2.0 TDI	110	04/12→					
AUDI - A3 Cabriolet (8P7) 04/08→05/13							
Bremskraftverstärker							
1.2 TFSI	77	03/10→05/13		für Linkslenker; +PR 1ZE,1ZF,1LJ,1ZA		03.7863-3232.4	300307 ATE Ø 10" pneumatisch
1.4 TFSI	92	02/11→05/13					
1.6	75	09/08→05/10					
1.6 TDI	77	05/09→05/13					
1.8 TFSI	118	04/08→05/13					
1.9 TDI	77	04/08→10/09					
2.0 TDI	100	04/08→05/13					
2.0 TDI	103	04/08→05/13					
2.0 TFSI	147	04/08→05/13		für Linkslenker; +PR 1ZE;1ZF;1LJ		03.7863-3332.4	300308 ATE Ø 10" pneumatisch
Hauptbremszylinder							
1.2 TFSI	77	03/10→05/13		für Linkslenker; +PR 1ZE,1ZF,1LJ,1ZA		03.2122-2129.3	010799 ATE Ø 22,2
1.4 TFSI	92	02/11→05/13					
1.6	75	09/08→05/10					
1.6 TDI	77	05/09→05/13					
1.8 TFSI	118	04/08→05/13					
1.9 TDI	77	04/08→10/09					
2.0 TDI	100	04/08→05/13					
2.0 TDI	103	04/08→05/13					
2.0 TFSI	147	04/08→05/13		für Linkslenker; +PR 1ZE,1ZF,1LJ,1ZA		03.2123-3449.3	010808 ATE Ø 23,81
AUDI - A3 Cabriolet (8V7, 8VE) 10/13→							
Hauptbremszylinder							
1.4 TFSI	85	02/16→		für Linkslenker		03.4153-5403.3	010994 ATE Ø 23,81
1.4 TFSI	92	02/14→				24.4123-1719.3	011017 TRW Ø 23,81 ohne Bremsflüssigkeitsbehälter
1.4 TFSI	103	10/13→					
1.4 TSI	110	05/14→					
1.5 TFSI	110	05/17→					
1.6 TDI	81	02/14→					
1.8 TFSI	125	05/14→					
1.8 TFSI	132	10/13→					
1.8 TFSI quattro	132	03/14→					
2.0 TDI	100	10/13→					
↓							













	kw			 	! #						
AUDI - A3 Cabriolet (8V7, 8VE) 10/13→											
 Hauptbremszylinder											
2.0 TDI	110	10/13→		für Linkslenker		03.4153-5403.3 010994	ATE Ø 23,81				
2.0 TDI	135	05/14→		für Linkslenker; +PR 1ZA,1ZD,1ZE,1ZF / 1ZP		24.4123-1719.3 011017	TRW Ø 23,81 ohne Bremsflüssigkeitsbehälter				
2.0 TDI quattro	110	03/14→									
2.0 TDI quattro	135	05/14→									
2.0 TFSI	140	05/16→									
2.0 TFSI quattro	140	05/16→									
2.0 TFSI quattro	162	05/14→									
S3 quattro	210	03/14→		04/14→; für Linkslenker		03.4153-5403.3 010994	ATE Ø 23,81				
S3 quattro	221	04/14→		für Linkslenker		03.4153-5403.3 010994	ATE Ø 23,81				
S3 quattro	228	07/16→									
AUDI - A3 Limousine (8VS, 8VM) 05/13→											
 Hauptbremszylinder											
1.0 TFSI	85	07/16→		für Linkslenker		03.4153-5403.3 010994	ATE Ø 23,81				
1.2 TFSI	77	10/13→				24.4123-1719.3 011017	TRW Ø 23,81 ohne Bremsflüssigkeitsbehälter				
1.2 TFSI	81	05/14→									
1.4 TFSI	90	09/13→									
1.4 TFSI	92	09/13→									
1.4 TFSI	103	05/13→									
1.4 TFSI	110	05/14→									
1.5 TFSI	110	05/17→									
1.6 TDI	77	09/13→									
1.6 TDI	81	05/14→									
1.6 TDI	85	03/17→									
1.6 TDI quattro	81	05/15→									
1.8 TFSI	125	11/13→									
1.8 TFSI	132	05/13→									
1.8 TFSI quattro	132	11/13→									
2.0 TDI	81	05/13→									
2.0 TDI	100	09/13→									
2.0 TDI	105	10/13→									
2.0 TDI	110	05/13→									
2.0 TDI	135	05/14→									
2.0 TDI quattro	110	10/13→									
2.0 TDI quattro	135	05/14→									
2.0 TFSI	140	05/16→									
2.0 TFSI quattro	140	05/16→									
AUDI - A3 Sportback (8PA) 09/04→12/15											
 Bremskraftverstärker											
1.2 TSI	77	04/10→03/13						für Linkslenker; +PR 1AC,1AT		03.7863-3232.4 300307	ATE Ø 10" pneumatisch
1.4 TFSI	92	09/07→03/13						für Linkslenker; +PR 1AS		03.7863-9602.4 300206	ATE Ø 10" pneumatisch
1.6	75	09/04→03/13									
1.6 E-Power	75	01/11→03/13									
1.6 FSI	85	09/04→09/07									
1.6 TDI	66	05/09→03/13									
1.6 TDI	77	05/09→03/13									
1.8 TFSI quattro	118	07/08→03/13									
1.9 TDI	77	09/04→05/10									
2.0 FSI	110	09/04→06/08									
2.0 TDI	103	06/05→06/08									
2.0 TDI	120	06/06→06/08									
2.0 TDI	125	03/06→03/13									
2.0 TDI 16V	103	09/04→03/13									
2.0 TDI 16V quattro	103	11/05→03/13									
2.0 TDI quattro	103	01/06→06/08									
2.0 TDI quattro	125	03/06→03/13									
2.0 TFSI	147	09/04→03/13									
2.0 TFSI quattro	147	09/04→03/13									
1.8 TFSI	118	11/06→03/13		01/07→; +PR 1AC,1AT; für Linkslenker		03.7863-3232.4 300307	ATE Ø 10" pneumatisch				
				01/07→; +PR 1AS; für Linkslenker		03.7863-9602.4 300206	ATE Ø 10" pneumatisch				
3.2 V6 quattro	184	09/04→05/09		für Linkslenker		03.7863-3332.4 300308	ATE Ø 10" pneumatisch				
S3 quattro	188	07/08→03/13									
S3 quattro	195	06/08→03/13									
 Hauptbremszylinder											
1.2 TSI	77	04/10→03/13		für Linkslenker; → 8P-6A094000; +PR 1ZE;1ZF;1ZP;1ZD / 1LJ;1ZM		03.2122-2129.3 010799	ATE Ø 22,2				
				für Linkslenker; → 8P-6B009600; +PR 1ZE;1ZF;1ZP;1ZD / 1LJ;1ZM		03.2122-2129.3 010799	ATE Ø 22,2				
				für Linkslenker; +PR 1ZE;1ZF;1ZP;1ZD / 1LJ;1ZM		03.2122-2129.3 010799	ATE Ø 22,2				
				8P-6A094001→; für Linkslenker; +PR 1ZE;1ZF;1ZP;1ZD / 1LJ;1ZM		03.2122-2129.3 010799	ATE Ø 22,2				
				8P-6A094001→; für Linkslenker; +PR 1LK;1ZK		03.2123-3449.3 010808	ATE Ø 23,81				
				für Linkslenker; → 8P-6B009600; +PR 1LK		03.2123-3449.3 010808	ATE Ø 23,81				
↓											











	kw			 	! #		
AUDI - A3 Sportback (8PA) 09/04→12/15							
Hauptbremszylinder							
1.2 TSI	77	04/10→03/13		für Linkslenker; +PR 1LK;1ZK		03.2123-3449.3 010808	ATE Ø 23,81
				für Linkslenker; → 8P-6A094000; +PR 1LK		03.2123-3449.3 010808	ATE Ø 23,81
1.4 TFSI	92	09/07→03/13		für Linkslenker; +PR 1ZE;1ZF;1ZP;1ZD / 1LJ;1ZM		03.2122-2129.3 010799	ATE Ø 22,2
1.8 TFSI quattro	118	07/08→03/13		für Linkslenker; +PR 1LK;1ZK		03.2123-3449.3 010808	ATE Ø 23,81
1.6	75	09/04→03/13		8P-6A094001→; für Linkslenker; +PR 1ZE;1ZF;1ZP;1ZD / 1LJ;1ZM		03.2122-2129.3 010799	ATE Ø 22,2
1.6 E-Power	75	01/11→03/13					
1.6 FSI	85	09/04→09/07		8P-6B009601→; für Linkslenker; +PR 1ZE;1ZF;1ZP;1ZD / 1LJ;1ZM		03.2122-2129.3 010799	ATE Ø 22,2
1.6 TDI	66	05/09→03/13					
1.6 TDI	77	05/09→03/13		für Linkslenker; → 8P-6B009600; +PR 1ZE;1ZF;1ZP;1ZD / 1LJ;1ZM		03.2122-2129.3 010799	ATE Ø 22,2
1.9 TDI	77	09/04→05/10					
2.0 FSI	110	09/04→06/08		für Linkslenker; → 8P-6A094000; +PR 1ZE;1ZF;1ZP;1ZD / 1LJ;1ZM		03.2122-2129.3 010799	ATE Ø 22,2
2.0 TDI	103	06/05→06/08					
2.0 TDI 16V	103	09/04→03/13		für Linkslenker; → 8P-6B009600; +PR 1LK		03.2123-3449.3 010808	ATE Ø 23,81
2.0 TDI 16V quattro	103	11/05→03/13					
2.0 TDI quattro	103	01/06→06/08		8P-6A094001→; für Linkslenker; +PR 1LK;1ZK		03.2123-3449.3 010808	ATE Ø 23,81
				8P-6B009601→; für Linkslenker; +PR 1LK;1ZK		03.2123-3449.3 010808	ATE Ø 23,81
				für Linkslenker; → 8P-6A094000; +PR 1LK		03.2123-3449.3 010808	ATE Ø 23,81
1.8 TFSI	118	11/06→03/13		01/07→; für Linkslenker; +PR 1ZE;1ZF;1ZP;1ZD / 1LJ;1ZM		03.2122-2129.3 010799	ATE Ø 22,2
				01/07→; für Linkslenker; +PR 1LK;1ZK		03.2123-3449.3 010808	ATE Ø 23,81
2.0 TDI	120	06/06→06/08		8P-6A094001→; für Linkslenker; +PR 1ZE;1ZF;1ZP;1ZD / 1LJ;1ZM		03.2122-2129.3 010799	ATE Ø 22,2
				8P-6B009601→; für Linkslenker; +PR 1ZE;1ZF;1ZP;1ZD / 1LJ;1ZM		03.2122-2129.3 010799	ATE Ø 22,2
				für Linkslenker; → 8P-6B009600; +PR 1ZE;1ZF;1ZP;1ZD / 1LJ;1ZM		03.2122-2129.3 010799	ATE Ø 22,2
				für Linkslenker; → 8P-6A094000; +PR 1ZE;1ZF;1ZP;1ZD / 1LJ;1ZM		03.2122-2129.3 010799	ATE Ø 22,2
				8P-6A094001→; für Linkslenker; +PR 1LK;1ZK		03.2123-3449.3 010808	ATE Ø 23,81
				für Linkslenker; → 8P-6B009600; +PR 1LK		03.2123-3449.3 010808	ATE Ø 23,81
				für Linkslenker; → 8P-6A094000; +PR 1LK		03.2123-3449.3 010808	ATE Ø 23,81
2.0 TDI	125	03/06→03/13		+PR 1ZE;1ZF;1ZP;1ZD / 1LJ;1ZM		03.2123-3449.3 010808	ATE Ø 23,81
2.0 TDI quattro	125	03/06→03/13		für Linkslenker; +PR 1LK;1ZK		03.2123-3449.3 010808	ATE Ø 23,81
2.0 TFSI	147	09/04→03/13		8P-6B009601→; für Linkslenker; → 8P-7-103000; +PR 1ZE;1ZF;1ZP;1ZD / 1LJ;1ZM		03.2122-2129.3 010799	ATE Ø 22,2
2.0 TFSI quattro	147	09/04→03/13		für Linkslenker; → 8P-6A094000; +PR 1ZE;1ZF;1ZP;1ZD / 1LJ;1ZM		03.2122-2129.3 010799	ATE Ø 22,2
				8P-6A094001→; für Linkslenker; → 8P-7-103000; +PR 1ZE;1ZF;1ZP;1ZD / 1LJ;1ZM		03.2122-2129.3 010799	ATE Ø 22,2
				für Linkslenker; → 8P-6B009600; +PR 1ZE;1ZF;1ZP;1ZD / 1LJ;1ZM		03.2122-2129.3 010799	ATE Ø 22,2
				8P-6B009601→; für Linkslenker; → 8P-7-103000; +PR 1LK;1ZK		03.2123-3449.3 010808	ATE Ø 23,81
				8P-6A094001→; für Linkslenker; → 8P-7-103000; +PR 1LK;1ZK		03.2123-3449.3 010808	ATE Ø 23,81
				für Linkslenker; → 8P-6B009600; +PR 1LK		03.2123-3449.3 010808	ATE Ø 23,81
				für Linkslenker; → 8P-6A094000; +PR 1LK		03.2123-3449.3 010808	ATE Ø 23,81
				8P-7-103001→; +PR 1ZE;1ZF;1ZP;1ZD / 1LJ;1ZM		03.2123-3449.3 010808	ATE Ø 23,81
3.2 V6 quattro	184	09/04→05/09		für Linkslenker; - ESP		03.2122-2129.3 010799	ATE Ø 22,2
S3 quattro	188	07/08→03/13					
S3 quattro	195	06/08→03/13		für Linkslenker; + ESP		03.2123-3449.3 010808	ATE Ø 23,81
RS3 quattro	250	01/11→12/12		04/11→; für Linkslenker		03.2125-5112.3 010966	ATE Ø 25,4
Hydraulikaggregat, Bremsanlage							
1.4 TFSI	92	09/07→03/13		→ 12/08; +PR 1AT,1AS		24.9145-0001.2 399005	
1.6	75	09/04→03/13					
1.8 TFSI quattro	118	07/08→03/13					
1.9 TDI	77	09/04→05/10					
2.0 TDI	125	03/06→03/13					
2.0 TDI 16V	103	09/04→03/13					
2.0 TDI 16V quattro	103	11/05→03/13					
2.0 TDI quattro	125	03/06→03/13					
↓							











	kW			 	! #		
AUDI - A3 Sportback (8PA) 09/04→12/15							
Hydraulikaggregat, Bremsanlage							
2.0 TFSI	147	09/04→03/13		→ 12/08; +PR 1AT,1AS		24.9145-0001.2	399005
2.0 TFSI quattro	147	09/04→03/13					
3.2 V6 quattro	184	09/04→05/09					
S3 quattro	188	07/08→03/13					
S3 quattro	195	06/08→03/13					
1.6 FSI	85	09/04→09/07		+PR 1AT,1AS		24.9145-0001.2	399005
2.0 FSI	110	09/04→06/08					
2.0 TDI	103	06/05→06/08					
2.0 TDI	120	06/06→06/08					
2.0 TDI quattro	103	01/06→06/08					
1.8 TFSI	118	11/06→03/13		01/07→ 12/08; +PR 1AT,1AS		24.9145-0001.2	399005
Drucksensor, Bremskraftverstärker							
1.2 TSI	77	04/10→03/13		für Linkslenker; +PR 1AS		03.0655-0101.2	370008 ATE
1.4 TFSI	92	09/07→03/13					
1.6	75	09/04→03/13					
1.6 E-Power	75	01/11→03/13					
1.6 FSI	85	09/04→09/07					
1.6 TDI	66	05/09→03/13					
1.6 TDI	77	05/09→03/13					
1.8 TFSI quattro	118	07/08→03/13					
1.9 TDI	77	09/04→05/10					
2.0 FSI	110	09/04→06/08					
2.0 TDI	103	06/05→06/08					
2.0 TDI	120	06/06→06/08					
2.0 TDI	125	03/06→03/13					
2.0 TDI 16V	103	09/04→03/13					
2.0 TDI 16V quattro	103	11/05→03/13					
2.0 TDI quattro	103	01/06→06/08					
2.0 TDI quattro	125	03/06→03/13					
2.0 TFSI	147	09/04→03/13					
2.0 TFSI quattro	147	09/04→03/13					
1.8 TFSI	118	11/06→03/13		01/07→; +PR 1AS; für Linkslenker		03.0655-0101.2	370008 ATE
AUDI - A3 Sportback (8VA, 8VF) 09/12→							
Hauptbremszylinder							
1.0 TFSI	85	07/16→		für Linkslenker		03.4153-5403.3	010994 ATE Ø 23,81
1.2 TFSI	77	05/13→				24.4123-1719.3	011017 TRW Ø 23,81 ohne Bremsflüssigkeitsbehälter
1.2 TFSI	81	05/14→					
1.4 TFSI	90	09/12→					
1.4 TFSI	92	05/14→					
1.4 TFSI	103	03/13→					
1.4 TFSI e-tron	110	05/14→					
1.4 TSI	110	05/14→					
1.5 TFSI	110	05/17→					
1.6 TDI	77	10/12→					
1.6 TDI	81	09/13→					
1.6 TDI	85	02/17→					
1.6 TDI quattro	81	05/15→					
1.8 TFSI	132	09/12→					
1.8 TFSI quattro	132	05/13→					
2.0 TDI	81	05/13→					
2.0 TDI	100	05/13→					
2.0 TDI	105	03/13→					
2.0 TDI	110	09/12→					
2.0 TDI	135	05/13→					
2.0 TDI quattro	110	02/13→					
2.0 TDI quattro	135	05/13→					
2.0 TFSI	140	05/16→					
2.0 TFSI quattro	140	05/16→					
1.4 TFSI g-tron	81	11/13→		02/14→; für Linkslenker		03.4153-5403.3	010994 ATE Ø 23,81 TRW Ø 23,81 ohne Bremsflüssigkeitsbehälter
						24.4123-1719.3	011017
AUDI - A4 (8D2, B5) 11/94→12/01							
Hauptbremszylinder							
1.6	74	11/94→10/00		→ 01/99		24.2123-1717.3	010521 Ø 23,81
1.8	92	11/94→11/00					
1.8 T	132	12/97→11/00		02/99→; - ESP; für Linkslenker		24.2125-1712.3	010622 Ø 25,4
1.9 TDI	66	01/95→11/00		02/99→; + ESP; für Linkslenker		24.2125-1713.3	010623 Ø 25,4
2.4	120	08/97→11/00					
2.5 TDI	110	09/97→11/00					
2.6	110	01/95→11/00					
2.8	142	10/96→11/00					
1.6	75	07/00→11/00		- ESP; für Linkslenker		24.2125-1712.3	010622 Ø 25,4
1.9 TDI	85	03/00→11/00					
1.9 TDI quattro	85	03/00→11/00		+ ESP; für Linkslenker		24.2125-1713.3	010623 Ø 25,4
1.8 quattro	92	01/95→11/00		→ 01/99; - ESP		24.2123-1717.3	010521 Ø 23,81
1.8 T quattro	132	12/97→11/00		→ 01/99; + ESP		24.2123-1730.3	010620 Ø 23,81











	kw				! #		
AUDI - A4 (8D2, B5) 11/94→12/01							
 Hauptbremszylinder							
1.9 TDI quattro	81	09/96→11/00		02/99→; - ESP; für Linkslenker		24.2125-1712.3 010622	Ø 25,4
2.4 quattro	120	08/97→11/00		02/99→; + ESP; für Linkslenker		24.2125-1713.3 010623	Ø 25,4
2.6 quattro	110	01/95→11/00					
1.8 T	110	01/95→11/00		05/95→ 01/99		24.2123-1717.3 010521	Ø 23,81
				02/99→; - ESP; für Linkslenker		24.2125-1712.3 010622	Ø 25,4
				02/99→; + ESP; für Linkslenker		24.2125-1713.3 010623	Ø 25,4
1.8 T quattro	110	01/95→11/00		02/95→ 01/99; - ESP		24.2123-1717.3 010521	Ø 23,81
				02/95→ 01/99; + ESP		24.2123-1730.3 010620	Ø 23,81
				02/99→; - ESP; für Linkslenker		24.2125-1712.3 010622	Ø 25,4
				02/99→; + ESP; für Linkslenker		24.2125-1713.3 010623	Ø 25,4
1.9 TDI	55	12/95→11/00		03/96→ 01/99		24.2123-1717.3 010521	Ø 23,81
				02/99→; - ESP; für Linkslenker		24.2125-1712.3 010622	Ø 25,4
				02/99→; + ESP; für Linkslenker		24.2125-1713.3 010623	Ø 25,4
1.9 TDI	81	10/95→11/00		02/96→ 01/99		24.2123-1717.3 010521	Ø 23,81
				02/99→; - ESP; für Linkslenker		24.2125-1712.3 010622	Ø 25,4
				02/99→; + ESP; für Linkslenker		24.2125-1713.3 010623	Ø 25,4
2.4	121	03/97→11/00		→ 07/97		24.2123-1717.3 010521	Ø 23,81
				08/97→ 01/99		24.2123-1717.3 010521	Ø 23,81
				02/99→; - ESP; für Linkslenker		24.2125-1712.3 010622	Ø 25,4
				02/99→; + ESP; für Linkslenker		24.2125-1713.3 010623	Ø 25,4
2.4 quattro	121	03/97→11/00		08/97→ 01/99; - ESP		24.2123-1717.3 010521	Ø 23,81
				08/97→ 01/99; + ESP		24.2123-1730.3 010620	Ø 23,81
				02/99→; - ESP; für Linkslenker		24.2125-1712.3 010622	Ø 25,4
				02/99→; + ESP; für Linkslenker		24.2125-1713.3 010623	Ø 25,4
2.5 TDI quattro	110	09/97→11/00		11/97→ 01/99		24.2123-1717.3 010521	Ø 23,81
				11/97→ 01/99; + ESP		24.2123-1730.3 010620	Ø 23,81
				02/99→; - ESP; für Linkslenker		24.2125-1712.3 010622	Ø 25,4
				02/99→; + ESP; für Linkslenker		24.2125-1713.3 010623	Ø 25,4
2.8	128	09/95→07/97				24.2123-1717.3 010521	Ø 23,81
2.8 quattro	128	01/95→07/97		→ 07/96; - ESP		24.2123-1717.3 010521	Ø 23,81
				→ 07/96; + ESP		24.2123-1730.3 010620	Ø 23,81
2.8 quattro	142	10/96→08/01		→ 01/99; - ESP		24.2123-1717.3 010521	Ø 23,81
				→ 01/99; + ESP		24.2123-1730.3 010620	Ø 23,81
				02/99→ 04/01; - ESP; für Linkslenker		24.2125-1712.3 010622	Ø 25,4
				02/99→ 04/01; + ESP; für Linkslenker		24.2125-1713.3 010623	Ø 25,4
S4 quattro	195	09/97→09/01		10/97→ 01/99; - ESP		24.2123-1717.3 010521	Ø 23,81
				10/97→ 01/99; + ESP		24.2123-1730.3 010620	Ø 23,81
				02/99→ 04/01; - ESP; für Linkslenker		24.2125-1712.3 010622	Ø 25,4
				02/99→ 04/01; + ESP; für Linkslenker		24.2125-1713.3 010623	Ø 25,4
AUDI - A4 (8E2, B6) 11/00→12/05							
 Bremskraftverstärker							
1.6	75	11/00→12/04		8E-3-235001→		03.7858-4502.4 300202	ATE Ø 9 / 8" pneumatisch
1.8 T	110	11/00→07/02					
1.8 T	120	07/02→12/04					
1.8 T	140	11/02→12/04					
1.8 T quattro	110	11/00→07/02					
1.8 T quattro	120	07/02→12/04					
1.8 T quattro	140	11/02→12/04					
1.9 TDI	74	05/01→12/04					
1.9 TDI	96	11/00→12/04					
1.9 TDI quattro	96	11/01→12/04					
2.0	96	11/00→12/04					
2.0 FSI	110	07/02→12/04					
2.4	120	09/01→12/04					
2.4	125	09/01→12/04					
2.5 TDI	114	08/01→07/02					
2.5 TDI	120	07/02→12/04					
2.5 TDI quattro	132	11/00→12/04					
3.0	160	04/01→12/04					
3.0	162	11/00→12/04					
3.0 quattro	160	04/01→12/04					
3.0 quattro	162	11/00→12/04					
1.9 TDI	85	06/04→12/04				03.7858-4502.4 300202	ATE Ø 9 / 8" pneumatisch
 Hauptbremszylinder							
1.6	75	11/00→12/04		12/00→		03.2125-0373.3 010810	ATE Ø 25,4











	kw			 	! #		
AUDI - A4 (8E2, B6) 11/00→12/05							
 Hauptbremszylinder							
1.8 T	110	11/00→07/02		12/00→		24.2125-1720.3 010688	TRW Ø 25,4
1.8 T quattro	110	11/00→07/02					
1.9 TDI	96	11/00→12/04					
2.0	96	11/00→12/04					
2.5 TDI quattro	132	11/00→12/04					
3.0	162	11/00→12/04					
3.0 quattro	162	11/00→12/04					
1.8 T	120	07/02→12/04				03.2125-0373.3 010810	ATE Ø 25,4
1.8 T	140	11/02→12/04				24.2125-1720.3 010688	TRW Ø 25,4
1.8 T quattro	120	07/02→12/04					
1.8 T quattro	140	11/02→12/04					
1.9 TDI	74	05/01→12/04					
1.9 TDI	85	06/04→12/04					
1.9 TDI quattro	96	11/01→12/04					
2.0 FSI	110	07/02→12/04					
2.4	120	09/01→12/04					
2.4	125	09/01→12/04					
2.5 TDI	114	08/01→07/02					
2.5 TDI	120	07/02→12/04					
3.0	160	04/01→12/04					
3.0 quattro	160	04/01→12/04					
S4 quattro	253	03/03→12/04				24.2126-1705.3 010999	TRW Ø 26,99
AUDI - A4 (8EC, B7) 11/04→06/08							
 Bremskraftverstärker							
1.6	75	11/04→06/08		8E-3-235001→		03.7858-4502.4 300202	ATE Ø 9 / 8" pneumatisch
1.8 T	120	11/04→06/08					
1.8 T quattro	120	11/04→06/08					
2.0	96	11/04→06/08					
2.5 TDI	120	11/04→05/06					
3.0 quattro	160	11/04→07/06					
1.9 TDI	85	11/04→06/08				03.7858-4502.4 300202	ATE Ø 9 / 8" pneumatisch
2.0 TDI	120	06/06→06/08					
2.0 TDI	125	06/06→06/08					
2.0 TDI quattro	103	01/06→06/08					
2.0 TDI quattro	120	06/06→06/08					
2.0 TDI quattro	125	06/06→06/08					
2.0 TFSI	125	10/06→06/08					
2.0 TFSI	147	11/04→06/08					
2.0 TFSI	162	06/05→06/08					
2.7 TDI	120	11/05→06/08					
2.7 TDI	132	01/06→06/08					
3.0 TDI quattro	171	01/06→06/08					
3.2 FSI	188	01/05→06/08					
2.0 TDI	89	09/05→09/06		8E-5-400001→		03.7858-4502.4 300202	ATE Ø 9 / 8" pneumatisch
2.0 TDI	100	11/04→06/08					
2.0 TDI	103	11/04→06/08					
2.0 TDI 16V	103	11/04→06/08					
2.0 TFSI quattro	147	11/04→06/08					
2.0 TFSI quattro	162	06/05→06/08					
3.0 TDI quattro	150	11/04→06/08					
3.2 FSI quattro	188	01/05→06/08					
2.0 TDI	93	11/05→11/06		06/06→		03.7858-4502.4 300202	ATE Ø 9 / 8" pneumatisch
 Hauptbremszylinder							
1.6	75	11/04→06/08				03.2125-0373.3 010810	ATE Ø 25,4
1.8 T	120	11/04→06/08				24.2125-1720.3 010688	TRW Ø 25,4
1.8 T quattro	120	11/04→06/08					
1.9 TDI	85	11/04→06/08					
2.0	96	11/04→06/08					
2.0 TDI	89	09/05→09/06					
2.0 TDI	100	11/04→06/08					
2.0 TDI	103	11/04→06/08					
2.0 TDI	120	06/06→06/08					
2.0 TDI	125	06/06→06/08					
2.0 TDI 16V	103	11/04→06/08					
2.0 TDI quattro	103	01/06→06/08					
2.0 TDI quattro	120	06/06→06/08					
2.0 TDI quattro	125	06/06→06/08					
2.0 TFSI	125	10/06→06/08					
2.0 TFSI	162	06/05→06/08					
2.0 TFSI quattro	147	11/04→06/08					
2.0 TFSI quattro	162	06/05→06/08					
2.5 TDI	120	11/04→05/06					
2.7 TDI	120	11/05→06/08					
2.7 TDI	132	01/06→06/08					
3.0 quattro	160	11/04→07/06					
3.0 TDI quattro	150	11/04→06/08					
3.0 TDI quattro	171	01/06→06/08					
3.2 FSI	188	01/05→06/08					
3.2 FSI quattro	188	01/05→06/08					
↓							













	kW			 	! #		
AUDI - A4 (8EC, B7) 11/04→06/08							
 Hauptbremszylinder							
2.0 TDI	93	11/05→11/06		06/06→		03.2125-0373.3 010810 24.2125-1720.3 010688	ATE Ø 25,4 TRW Ø 25,4
2.0 TFSI	147	11/04→06/08		12/04→		03.2125-0373.3 010810 24.2125-1720.3 010688	ATE Ø 25,4 TRW Ø 25,4
RS4 quattro	309	09/05→06/08		11/05→		24.2126-1705.3 010999	TRW Ø 26,99
S4 quattro	253	11/04→06/08				24.2126-1705.3 010999	TRW Ø 26,99
AUDI - A4 (8K2, B8) 08/07→12/15							
 Bremskraftverstärker							
1.8 TFSI	88	01/08→12/15				03.7858-4632.4 300273	ATE Ø 9 / 8" pneumatisch
1.8 TFSI	118	11/07→03/12					
1.8 TFSI quattro	118	09/08→03/12					
2.0 TDI	88	06/08→12/15					
2.0 TDI	100	11/07→12/15					
2.0 TDI	105	11/07→12/15					
2.0 TDI	120	08/08→12/15					
2.0 TDI	125	01/08→03/12					
2.0 TDI quattro	105	11/08→12/15					
2.0 TDI quattro	125	01/08→03/12					
2.0 TFSI	132	06/08→12/15					
2.0 TFSI	155	06/08→05/13					
2.0 TFSI flexible fuel	132	11/09→12/15					
2.0 TFSI flexible fuel	132	11/09→12/15					
quattro							
2.0 TFSI quattro	155	06/08→12/15					
2.7 TDI	120	11/07→03/12					
2.7 TDI	140	11/07→03/12					
3.0 TDI quattro	155	06/08→05/10					
3.0 TDI quattro	176	11/07→03/12					
3.2 FSI	195	09/08→03/12					
3.2 FSI quattro	195	11/07→03/12					
S4 quattro	245	11/08→12/15					
 Hauptbremszylinder							
1.8 TFSI	88	01/08→12/15				03.2125-0493.3 010940	ATE Ø 25,4
1.8 TFSI	118	11/07→03/12				24.2125-1739.3 010948	TRW Ø 25,4
1.8 TFSI quattro	118	09/08→03/12					
2.0 TDI	88	06/08→12/15					
2.0 TDI	100	11/07→12/15					
2.0 TDI	105	11/07→12/15					
2.0 TDI	120	08/08→12/15					
2.0 TDI	125	01/08→03/12					
2.0 TDI quattro	105	11/08→12/15					
2.0 TDI quattro	125	01/08→03/12					
2.0 TFSI	132	06/08→12/15					
2.0 TFSI	155	06/08→05/13					
2.0 TFSI flexible fuel	132	11/09→12/15					
2.0 TFSI flexible fuel	132	11/09→12/15					
quattro							
2.0 TFSI quattro	155	06/08→12/15					
2.7 TDI	120	11/07→03/12					
2.7 TDI	140	11/07→03/12					
3.0 TDI quattro	155	06/08→05/10					
3.0 TDI quattro	176	11/07→03/12					
3.2 FSI	195	09/08→03/12					
3.2 FSI quattro	195	11/07→03/12					
S4 quattro	245	11/08→12/15					
AUDI - A4 Allroad (8KH, B8) 04/09→05/16							
 Bremskraftverstärker							
2.0 TDI quattro	100	09/09→05/16				03.7858-4632.4 300273	ATE Ø 9 / 8" pneumatisch
2.0 TDI quattro	105	09/09→05/16					
2.0 TDI quattro	120	04/09→05/16					
2.0 TDI quattro	125	04/09→05/16					
2.0 TFSI quattro	155	04/09→05/16					
3.0 TDI quattro	176	04/09→01/12					
2.0 TDI quattro	110	05/13→05/16		+PR GP0,GP1		03.7858-4632.4 300273	ATE Ø 9 / 8" pneumatisch
2.0 TDI quattro	140	09/13→05/16					
2.0 TFSI quattro	162	05/13→05/16					
2.0 TFSI quattro	165	05/13→05/16					
3.0 TDI quattro	180	01/12→05/16					
2.0 TDI quattro	130	11/11→05/16		01/12→; +PR GP0,GP1		03.7858-4632.4 300273	ATE Ø 9 / 8" pneumatisch
 Hauptbremszylinder							
2.0 TDI quattro	100	09/09→05/16				03.2125-0493.3 010940	ATE Ø 25,4
2.0 TDI quattro	105	09/09→05/16				24.2125-1739.3 010948	TRW Ø 25,4
2.0 TDI quattro	120	04/09→05/16					
↓							













	kw			 	! #		
AUDI - A4 Allroad (8KH, B8) 04/09→05/16							
 Hauptbremszylinder							
2.0 TDI quattro	125	04/09→05/16				03.2125-0493.3 010940	ATE Ø 25,4
2.0 TFSI quattro	155	04/09→05/16				24.2125-1739.3 010948	TRW Ø 25,4
3.0 TDI quattro	176	04/09→01/12					
2.0 TDI quattro	110	05/13→05/16		+PR GP0,GP1		03.2125-0493.3 010940	ATE Ø 25,4
2.0 TDI quattro	140	09/13→05/16				24.2125-1739.3 010948	TRW Ø 25,4
2.0 TFSI quattro	162	05/13→05/16					
2.0 TFSI quattro	165	05/13→05/16					
3.0 TDI quattro	180	01/12→05/16					
2.0 TDI quattro	130	11/11→05/16		01/12→; +PR GP0,GP1		03.2125-0493.3 010940	ATE Ø 25,4
						24.2125-1739.3 010948	TRW Ø 25,4
AUDI - A4 Avant (8D5, B5) 11/94→09/01							
 Hauptbremszylinder							
1.6	74	11/94→09/01		→ 01/99		24.2123-1717.3 010521	Ø 23,81
1.8	92	02/96→09/01		02/99→ 04/01; - ESP; für Linkslenker		24.2125-1712.3 010622	Ø 25,4
1.8 T	110	03/96→09/01		02/99→ 04/01; + ESP; für Linkslenker		24.2125-1713.3 010623	Ø 25,4
1.8 T	132	12/97→09/01					
1.9 DUO	66	03/98→09/01					
1.9 TDI	55	03/96→09/01					
1.9 TDI	66	02/96→09/01					
1.9 TDI	81	02/96→09/01					
2.4	120	08/97→09/01					
2.5 TDI	110	09/97→09/01					
2.6	110	02/96→09/01					
2.8	142	10/96→09/01					
1.6	75	07/00→09/01		→ 04/01; - ESP; für Linkslenker		24.2125-1712.3 010622	Ø 25,4
1.9 TDI	85	03/00→09/01		→ 04/01; + ESP; für Linkslenker		24.2125-1713.3 010623	Ø 25,4
1.9 TDI quattro	85	03/00→09/01					
1.8 quattro	92	01/96→09/01		→ 01/99; - ESP		24.2123-1717.3 010521	Ø 23,81
1.8 T quattro	110	01/96→09/01		→ 01/99; + ESP		24.2123-1730.3 010620	Ø 23,81
1.8 T quattro	132	12/97→09/01					
1.9 TDI quattro	81	09/96→09/01		02/99→ 04/01; - ESP; für Linkslenker		24.2125-1712.3 010622	Ø 25,4
2.4 quattro	120	08/97→09/01		02/99→ 04/01; + ESP; für Linkslenker		24.2125-1713.3 010623	Ø 25,4
2.6 quattro	110	01/96→09/01					
2.8 quattro	142	10/96→09/01					
2.4	121	03/97→09/01		08/97→ 01/99		24.2123-1717.3 010521	Ø 23,81
				02/99→ 04/01; - ESP; für Linkslenker		24.2125-1712.3 010622	Ø 25,4
				02/99→ 04/01; + ESP; für Linkslenker		24.2125-1713.3 010623	Ø 25,4
2.4 quattro	121	03/97→09/01		08/97→ 01/99; - ESP		24.2123-1717.3 010521	Ø 23,81
				08/97→ 01/99; + ESP		24.2123-1730.3 010620	Ø 23,81
				02/99→ 04/01; - ESP; für Linkslenker		24.2125-1712.3 010622	Ø 25,4
				02/99→ 04/01; + ESP; für Linkslenker		24.2125-1713.3 010623	Ø 25,4
2.5 TDI quattro	110	09/97→09/01		11/97→ 01/99		24.2123-1717.3 010521	Ø 23,81
				11/97→ 01/99; + ESP		24.2123-1730.3 010620	Ø 23,81
				02/99→ 04/01; - ESP; für Linkslenker		24.2125-1712.3 010622	Ø 25,4
				02/99→ 04/01; + ESP; für Linkslenker		24.2125-1713.3 010623	Ø 25,4
2.8	128	03/96→09/96				24.2123-1717.3 010521	Ø 23,81
2.8 quattro	128	01/96→09/96		→ 07/96; - ESP		24.2123-1717.3 010521	Ø 23,81
				→ 07/96; + ESP		24.2123-1730.3 010620	Ø 23,81
RS4 quattro	280	05/00→09/01		06/00→ 04/01; für Linkslenker		24.2125-1713.3 010623	Ø 25,4
S4 quattro	195	09/97→09/01		10/97→ 01/99; - ESP		24.2123-1717.3 010521	Ø 23,81
				10/97→ 01/99; + ESP		24.2123-1730.3 010620	Ø 23,81
				02/99→ 04/01; - ESP; für Linkslenker		24.2125-1712.3 010622	Ø 25,4
				02/99→ 04/01; + ESP; für Linkslenker		24.2125-1713.3 010623	Ø 25,4
AUDI - A4 Avant (8E5, B6) 02/00→12/05							
 Bremskraftverstärker							
1.6	75	09/01→12/04		8E-3-235001→		03.7858-4502.4 300202	ATE Ø 9 / 8" pneumatisch
1.8 T	110	09/01→07/02					
1.8 T	120	07/02→12/04					
1.8 T	140	11/02→12/04					
1.8 T quattro	110	09/01→07/02					
1.8 T quattro	120	07/02→12/04					
1.8 T quattro	140	11/02→12/04					
1.9 TDI	74	11/01→12/04					
1.9 TDI	96	09/01→12/04					
1.9 TDI quattro	96	11/01→12/04					
2.0	96	09/01→12/04					
2.0 FSI	110	07/02→12/04					
2.4	120	09/01→12/04					
2.4	125	09/01→12/04					
2.5 TDI	114	09/01→07/02					
2.5 TDI	120	07/02→12/04					
↓							







	kw			 	! #		
AUDI - A4 Avant (8E5, B6) 02/00→12/05							
 Bremskraftverstärker							
2.5 TDI quattro	132	09/01→12/04		8E-3-235001→		03.7858-4502.4 300202	ATE Ø 9 / 8" pneumatisch
3.0	160	04/01→12/04					
3.0	162	09/01→12/04					
3.0 quattro	160	04/01→12/04					
3.0 quattro	162	09/01→12/04					
1.9 TDI	85	06/04→12/04				03.7858-4502.4 300202	ATE Ø 9 / 8" pneumatisch
 Hauptbremszylinder							
1.6	75	09/01→12/04				03.2125-0373.3 010810	ATE Ø 25,4
1.8 T	110	09/01→07/02				24.2125-1720.3 010688	TRW Ø 25,4
1.8 T	120	07/02→12/04					
1.8 T	140	11/02→12/04					
1.8 T quattro	110	09/01→07/02					
1.8 T quattro	120	07/02→12/04					
1.8 T quattro	140	11/02→12/04					
1.9 TDI	74	11/01→12/04					
1.9 TDI	85	06/04→12/04					
1.9 TDI	96	09/01→12/04					
1.9 TDI quattro	96	11/01→12/04					
2.0	96	09/01→12/04					
2.0 FSI	110	07/02→12/04					
2.4	120	09/01→12/04					
2.4	125	09/01→12/04					
2.5 TDI	114	09/01→07/02					
2.5 TDI	120	07/02→12/04					
2.5 TDI quattro	132	09/01→12/04					
3.0	160	04/01→12/04					
3.0	162	09/01→12/04					
3.0 quattro	160	04/01→12/04					
3.0 quattro	162	09/01→12/04					
S4 quattro	253	03/03→12/04				24.2126-1705.3 010999	TRW Ø 26,99
AUDI - A4 Avant (8ED, B7) 11/04→06/08							
 Bremskraftverstärker							
1.6	75	11/04→06/08		8E-3-235001→		03.7858-4502.4 300202	ATE Ø 9 / 8" pneumatisch
1.8 T	120	11/04→06/08					
1.8 T quattro	120	11/04→06/08					
2.0	96	11/04→06/08					
2.5 TDI	120	11/04→05/06					
3.0	160	11/04→05/06					
3.0 quattro	160	11/04→07/06					
1.9 TDI	85	11/04→06/08				03.7858-4502.4 300202	ATE Ø 9 / 8" pneumatisch
2.0 TDI	120	06/06→06/08					
2.0 TDI	125	06/06→06/08					
2.0 TDI quattro	103	01/06→06/08					
2.0 TDI quattro	120	06/06→06/08					
2.0 TDI quattro	125	06/06→06/08					
2.0 TFSI	125	10/06→06/08					
2.0 TFSI	147	11/04→06/08					
2.0 TFSI	162	06/05→06/08					
2.7 TDi	120	11/05→03/08					
2.7 TDI	132	01/06→06/08					
3.0 TDI quattro	171	01/06→06/08					
3.2 FSI	188	01/05→06/08					
2.0 TDI	89	09/05→09/06		8E-5-400001→		03.7858-4502.4 300202	ATE Ø 9 / 8" pneumatisch
2.0 TDI	100	11/04→06/08					
2.0 TDI	103	11/04→06/08					
2.0 TDI 16V	103	11/04→06/08					
2.0 TFSI quattro	147	11/04→06/08					
2.0 TFSI quattro	162	06/05→06/08					
3.0 TDI quattro	150	11/04→06/08					
3.2 FSI quattro	188	01/05→06/08					
2.0 TDI	93	11/05→11/06		06/06→		03.7858-4502.4 300202	ATE Ø 9 / 8" pneumatisch
 Hauptbremszylinder							
1.6	75	11/04→06/08				03.2125-0373.3 010810	ATE Ø 25,4
1.8 T	120	11/04→06/08				24.2125-1720.3 010688	TRW Ø 25,4
1.8 T quattro	120	11/04→06/08					
1.9 TDI	85	11/04→06/08					
2.0	96	11/04→06/08					
2.0 TDI	89	09/05→09/06					
2.0 TDI	100	11/04→06/08					
2.0 TDI	103	11/04→06/08					
2.0 TDI	120	06/06→06/08					
2.0 TDI	125	06/06→06/08					
2.0 TDI 16V	103	11/04→06/08					
2.0 TDI quattro	103	01/06→06/08					
2.0 TDI quattro	120	06/06→06/08					
2.0 TDI quattro	125	06/06→06/08					
2.0 TFSI	125	10/06→06/08					













	kW			 	! #		
AUDI - A4 Avant (8ED, B7) 11/04→06/08							
 Hauptbremszylinder							
2.0 TFSI	162	06/05→06/08				03.2125-0373.3 010810	ATE Ø 25,4
2.0 TFSI quattro	147	11/04→06/08				24.2125-1720.3 010688	TRW Ø 25,4
2.0 TFSI quattro	162	06/05→06/08					
2.5 TDI	120	11/04→05/06					
2.7 TDi	120	11/05→03/08					
2.7 TDI	132	01/06→06/08					
3.0	160	11/04→05/06					
3.0 quattro	160	11/04→07/06					
3.0 TDI quattro	150	11/04→06/08					
3.0 TDI quattro	171	01/06→06/08					
3.2 FSI	188	01/05→06/08					
3.2 FSI quattro	188	01/05→06/08					
2.0 TDI	93	11/05→11/06		06/06→		03.2125-0373.3 010810	ATE Ø 25,4
						24.2125-1720.3 010688	TRW Ø 25,4
2.0 TFSI	147	11/04→06/08		12/04→		03.2125-0373.3 010810	ATE Ø 25,4
						24.2125-1720.3 010688	TRW Ø 25,4
RS4 quattro	309	09/05→06/08		11/05→		24.2126-1705.3 010999	TRW Ø 26,99
S4 quattro	253	11/04→06/08				24.2126-1705.3 010999	TRW Ø 26,99
AUDI - A4 Avant (8K5, B8) 11/07→12/15							
 Bremskraftverstärker							
1.8 TFSI	88	04/08→12/15				03.7858-4632.4 300273	ATE Ø 9 / 8" pneumatisch
1.8 TFSI quattro	118	09/08→03/12					
2.0 TDI	88	06/08→12/15					
2.0 TDI	100	04/08→12/15					
2.0 TDI	105	04/08→12/15					
2.0 TDI	120	08/08→12/15					
2.0 TDI	125	04/08→03/12					
2.0 TDI quattro	105	04/08→12/15					
2.0 TDI quattro	125	08/08→03/12					
2.0 TFSI	132	06/08→12/15					
2.0 TFSI	155	06/08→05/13					
2.0 TFSI flexible fuel	132	11/09→12/15					
2.0 TFSI flexible fuel quattro	132	11/09→12/15					
2.0 TFSI quattro	155	06/08→12/15					
2.7 TDI	120	06/08→03/12					
3.0 TDI quattro	155	06/08→05/10					
3.0 TDI quattro	176	04/08→03/12					
3.2 FSI	195	09/08→03/12					
3.2 FSI quattro	195	04/08→03/12					
S4 quattro	245	11/08→12/15					
1.8 TFSI	118	11/07→03/12		04/08→		03.7858-4632.4 300273	ATE Ø 9 / 8" pneumatisch
2.7 TDI	140	04/08→03/12		06/08→		03.7858-4632.4 300273	ATE Ø 9 / 8" pneumatisch
 Hauptbremszylinder							
1.8 TFSI	88	04/08→12/15				03.2125-0493.3 010940	ATE Ø 25,4
1.8 TFSI quattro	118	09/08→03/12				24.2125-1739.3 010948	TRW Ø 25,4
2.0 TDI	88	06/08→12/15					
2.0 TDI	100	04/08→12/15					
2.0 TDI	105	04/08→12/15					
2.0 TDI	120	08/08→12/15					
2.0 TDI	125	04/08→03/12					
2.0 TDI quattro	105	04/08→12/15					
2.0 TDI quattro	125	08/08→03/12					
2.0 TFSI	132	06/08→12/15					
2.0 TFSI	155	06/08→05/13					
2.0 TFSI flexible fuel	132	11/09→12/15					
2.0 TFSI flexible fuel quattro	132	11/09→12/15					
2.0 TFSI quattro	155	06/08→12/15					
2.7 TDI	120	06/08→03/12					
3.0 TDI quattro	155	06/08→05/10					
3.0 TDI quattro	176	04/08→03/12					
3.2 FSI	195	09/08→03/12					
3.2 FSI quattro	195	04/08→03/12					
S4 quattro	245	11/08→12/15					
1.8 TFSI	118	11/07→03/12		04/08→		03.2125-0493.3 010940	ATE Ø 25,4
						24.2125-1739.3 010948	TRW Ø 25,4
2.7 TDI	140	04/08→03/12		06/08→		03.2125-0493.3 010940	ATE Ø 25,4
						24.2125-1739.3 010948	TRW Ø 25,4
AUDI - A4 Cabriolet (8H7, B6, 8HE, B7) 01/02→12/09							
 Bremskraftverstärker							
1.8 T	120	07/02→03/09		8H-3-017415→; → 11/08		03.7858-4502.4 300202	ATE Ø 9 / 8" pneumatisch
↓							

	kw					! #		
AUDI - A4 Cabriolet (8H7, B6, 8HE, B7) 01/02→12/09								
 Bremskraftverstärker								
1.8 T quattro	120	05/03→03/09			→ 11/08		03.7858-4502.4 300202	ATE Ø 9 / 8" pneumatisch
2.0 TDI	100	01/06→03/09						
2.0 TDI	103	01/06→03/09						
2.0 TFSI 16V	147	01/06→03/09						
2.7 TDI	132	06/06→03/09						
3.0 TDI quattro	150	01/06→03/09						
3.0 TDI quattro	171	01/06→03/09						
3.2 FSI	188	01/06→03/09						
3.2 FSI quattro	188	01/06→03/09						
2.0	96	09/04→12/05					03.7858-4502.4 300202	ATE Ø 9 / 8" pneumatisch
3.0 quattro	162	05/03→12/05						
2.4	120	04/02→12/05			8H-3-017415→		03.7858-4502.4 300202	ATE Ø 9 / 8" pneumatisch
2.4	125	04/02→12/05						
2.5 TDI	120	08/02→12/05						
3.0	162	04/02→12/05						
3.0	160	04/02→12/05			8E-3-235001→		03.7858-4502.4 300202	ATE Ø 9 / 8" pneumatisch
 Hauptbremszylinder								
1.8 T	120	07/02→03/09			8H-7-022001→; → 11/08		03.2125-0373.3 010810	ATE Ø 25,4
					8H-3-017415→ 8H-7-022000		03.2125-0373.3 010810	ATE Ø 25,4
					→ 11/08		24.2125-1720.3 010688	TRW Ø 25,4
1.8 T quattro	120	05/03→03/09			→ 8H-7-022000		03.2125-0373.3 010810	ATE Ø 25,4
2.0 TDI	100	01/06→03/09			8H-7-022001→; → 11/08		03.2125-0373.3 010810	ATE Ø 25,4
2.0 TDI	103	01/06→03/09						
2.0 TFSI 16V	147	01/06→03/09			→ 11/08		24.2125-1720.3 010688	TRW Ø 25,4
2.7 TDI	132	06/06→03/09						
3.0 TDI quattro	150	01/06→03/09						
3.0 TDI quattro	171	01/06→03/09						
3.2 FSI	188	01/06→03/09						
3.2 FSI quattro	188	01/06→03/09						
2.0	96	09/04→12/05			8H-7-022001→		03.2125-0373.3 010810	ATE Ø 25,4
3.0 quattro	162	05/03→12/05			→ 8H-7-022000		03.2125-0373.3 010810	ATE Ø 25,4
							24.2125-1720.3 010688	TRW Ø 25,4
2.4	120	04/02→12/05			8H-7-022001→		03.2125-0373.3 010810	ATE Ø 25,4
2.4	125	04/02→12/05						
2.5 TDI	120	08/02→12/05			8H-3-017415→ 8H-7-022000		03.2125-0373.3 010810	ATE Ø 25,4
3.0	162	04/02→12/05					24.2125-1720.3 010688	TRW Ø 25,4
3.0	160	04/02→12/05					03.2125-0373.3 010810	ATE Ø 25,4
							24.2125-1720.3 010688	TRW Ø 25,4
RS4 quattro	309	06/06→03/09			→ 11/08		24.2126-1705.3 010999	TRW Ø 26,99
S4 quattro	253	03/04→03/09						
AUDI - A5 (8T3) 06/07→01/17								
 Bremskraftverstärker								
1.8 TFSI	118	05/09→09/11					03.7858-4632.4 300273	ATE Ø 9 / 8" pneumatisch
1.8 TFSI	125	10/07→01/17						
2.0 TDI	125	08/08→03/12						
2.0 TDI	130	10/11→01/17						
2.0 TDI quattro	125	08/08→03/12						
2.0 TFSI	132	11/08→03/12						
2.0 TFSI	155	06/08→11/13						
2.0 TFSI quattro	155	06/08→01/17						
2.7 TDI	120	09/07→03/12						
2.7 TDI	140	06/07→03/12						
3.0 TDI	150	10/11→01/17						
3.0 TDI quattro	155	03/08→05/10						
3.0 TDI quattro	176	06/07→03/12						
3.0 TDI quattro	180	10/11→01/17						
3.2 FSI	195	06/07→03/12						
3.2 FSI quattro	195	06/07→03/12						
S5 quattro	245	10/11→01/17						
S5 quattro	260	06/07→03/12						
2.0 TDI	120	08/08→01/17			10/08→		03.7858-4632.4 300273	ATE Ø 9 / 8" pneumatisch
 Hauptbremszylinder								
1.8 TFSI	118	05/09→09/11					03.2125-0493.3 010940	ATE Ø 25,4
1.8 TFSI	125	10/07→01/17					24.2125-1739.3 010948	TRW Ø 25,4
2.0 TDI	125	08/08→03/12						
2.0 TDI	130	10/11→01/17						
2.0 TDI quattro	125	08/08→03/12						
2.0 TFSI	132	11/08→03/12						
2.0 TFSI	155	06/08→11/13						
2.0 TFSI quattro	155	06/08→01/17						
2.7 TDI	120	09/07→03/12						
2.7 TDI	140	06/07→03/12						
3.0 TDI	150	10/11→01/17						
3.0 TDI quattro	155	03/08→05/10						

	kw			 	! #		
AUDI - A5 (8T3) 06/07→01/17							
 Hauptbremszylinder							
3.0 TDI quattro	176	06/07→03/12				03.2125-0493.3 010940	ATE Ø 25,4
3.0 TDI quattro	180	10/11→01/17				24.2125-1739.3 010948	TRW Ø 25,4
3.2 FSI	195	06/07→03/12					
3.2 FSI quattro	195	06/07→03/12					
S5 quattro	245	10/11→01/17					
S5 quattro	260	06/07→03/12					
2.0 TDI	120	08/08→01/17		10/08→		03.2125-0493.3 010940	ATE Ø 25,4
						24.2125-1739.3 010948	TRW Ø 25,4
AUDI - A5 Cabriolet (8F7) 02/09→01/17							
 Bremskraftverstärker							
1.8 TFSI	118	09/09→03/12				03.7858-4632.4 300273	ATE Ø 9 / 8" pneumatisch
1.8 TFSI	125	10/11→03/16					
2.0 TDI	120	05/09→06/14					
2.0 TDI	125	05/09→03/12					
2.0 TDI	130	10/11→01/17					
2.0 TFSI	132	03/09→03/12					
2.0 TFSI quattro	155	03/09→01/17					
2.7 TDI	120	05/09→03/12					
2.7 TDI	140	03/09→03/12					
3.0 TDI	150	10/11→01/17					
3.0 TDI quattro	176	03/09→03/12					
3.0 TDI quattro	180	10/11→01/17					
3.2 FSI	195	03/09→03/12					
3.2 FSI quattro	195	03/09→03/12					
S5 quattro	245	06/09→01/17					
2.0 TFSI	155	03/09→06/14		+PR 1LT		03.7858-4632.4 300273	ATE Ø 9 / 8" pneumatisch
 Hauptbremszylinder							
1.8 TFSI	118	09/09→03/12				03.2125-0493.3 010940	ATE Ø 25,4
1.8 TFSI	125	10/11→03/16				24.2125-1739.3 010948	TRW Ø 25,4
2.0 TDI	120	05/09→06/14					
2.0 TDI	125	05/09→03/12					
2.0 TDI	130	10/11→01/17					
2.0 TFSI	132	03/09→03/12					
2.0 TFSI quattro	155	03/09→01/17					
2.7 TDI	120	05/09→03/12					
2.7 TDI	140	03/09→03/12					
3.0 TDI	150	10/11→01/17					
3.0 TDI quattro	176	03/09→03/12					
3.0 TDI quattro	180	10/11→01/17					
3.2 FSI	195	03/09→03/12					
3.2 FSI quattro	195	03/09→03/12					
S5 quattro	245	06/09→01/17					
2.0 TFSI	155	03/09→06/14		+PR 1LT		03.2125-0493.3 010940	ATE Ø 25,4
						24.2125-1739.3 010948	TRW Ø 25,4
AUDI - A5 Sportback (8TA) 09/09→01/17							
 Bremskraftverstärker							
1.8 TFSI	118	11/09→09/11				03.7858-4632.4 300273	ATE Ø 9 / 8" pneumatisch
1.8 TFSI	125	08/11→01/17					
2.0 TDI	100	09/09→01/17					
2.0 TDI	105	09/09→01/17					
2.0 TDI	120	09/09→01/17					
2.0 TDI	125	09/09→03/12					
2.0 TDI	130	10/11→01/17					
2.0 TDI quattro	125	09/09→03/12					
2.0 TFSI	132	09/09→06/14					
2.0 TFSI	155	09/09→11/13					
2.0 TFSI quattro	155	09/09→01/17					
2.7 TDI	120	09/09→01/17					
2.7 TDI	140	09/09→03/12					
3.0 TDI	150	10/11→01/17					
3.0 TDI quattro	176	09/09→03/12					
3.0 TDI quattro	180	10/11→01/17					
3.2 FSI quattro	195	09/09→03/12					
S5 quattro	245	01/10→01/17					
 Hauptbremszylinder							
1.8 TFSI	118	11/09→09/11				03.2125-0493.3 010940	ATE Ø 25,4
1.8 TFSI	125	08/11→01/17				24.2125-1739.3 010948	TRW Ø 25,4
2.0 TDI	100	09/09→01/17					
2.0 TDI	105	09/09→01/17					
2.0 TDI	120	09/09→01/17					
2.0 TDI	125	09/09→03/12					
2.0 TDI	130	10/11→01/17					
2.0 TDI quattro	125	09/09→03/12					
2.0 TFSI	132	09/09→06/14					
↓							

	kw			 	! #		
AUDI - A5 Sportback (8TA) 09/09→01/17							
 Hauptbremszylinder							
2.0 TFSI	155	09/09→11/13				03.2125-0493.3 010940	ATE Ø 25,4
2.0 TFSI quattro	155	09/09→01/17				24.2125-1739.3 010948	TRW Ø 25,4
2.7 TDI	120	09/09→01/17					
2.7 TDI	140	09/09→03/12					
3.0 TDI	150	10/11→01/17					
3.0 TDI quattro	176	09/09→03/12					
3.0 TDI quattro	180	10/11→01/17					
3.2 FSI quattro	195	09/09→03/12					
S5 quattro	245	01/10→01/17					
AUDI - A6 (4A2, C4) 06/94→10/97							
 Bremskraftverstärker							
S6 4.2 quattro	213	06/94→10/97		09/94→		10.0124-3202.3 340011	ATE hydraulisch
S6 Plus quattro	240	04/96→10/97		06/96→		10.0124-3202.3 340011	ATE hydraulisch
S6 Turbo quattro	169	06/94→10/97				10.0124-3202.3 340011	ATE hydraulisch
 Hauptbremszylinder							
1.8	92	12/95→10/97		+ ABS		24.2123-1731.3 010621	Ø 23,81
2.8	142	12/95→10/97					
1.8 quattro	92	12/95→10/97				24.2123-1731.3 010621	Ø 23,81
2.0 16V quattro	103	06/94→10/97					
2.5 TDI quattro	103	10/95→10/97					
2.6 quattro	110	06/94→10/97					
2.8 quattro	128	06/94→10/97					
2.8 quattro	142	12/95→10/97					
1.9 TDI	66	06/94→10/97		→ 06/95; - ABS		03.2123-0491.3 010167	Ø 23,81
2.0	74	06/94→10/97		→ 06/95; - EDS / + ABS		24.2123-1602.3 010384	TRW Ø 23,81
2.0	79	06/94→07/95					
2.0	85	06/94→10/97		→ 06/95; + EDS / + ABS		24.2123-1731.3 010621	Ø 23,81
2.0 16V	103	06/94→10/97					
2.3	98	06/94→12/95		07/95→; + ABS		24.2123-1731.3 010621	Ø 23,81
2.5 TDI	84	01/95→10/97					
2.5 TDI	85	06/94→10/97					
2.5 TDI	103	08/94→10/97					
2.6	110	06/94→10/97					
2.8	128	06/94→10/97					
2.3 quattro	98	06/94→12/95		08/94→		24.2123-1731.3 010621	Ø 23,81
 Bremskraftregler							
1.8	92	12/95→10/97		für Fahrzeuge ohne Niveauregulierung		03.6585-0108.3 320115	ATE lastabhängig 8/5 4x
1.9 TDI	66	06/94→10/97					
2.0	74	06/94→10/97					
2.0	79	06/94→07/95					
2.0	85	06/94→10/97					
2.0 16V	103	06/94→10/97					
2.3	98	06/94→12/95					
2.5 TDI	84	01/95→10/97					
2.5 TDI	85	06/94→10/97					
2.5 TDI	103	08/94→10/97					
2.6	110	06/94→10/97					
2.8	128	06/94→10/97					
2.8	142	12/95→10/97					
AUDI - A6 (4B2, C5) 01/97→08/05							
 Bremskraftverstärker							
1.8	92	07/97→01/05		4B-2-130001→		03.7858-4502.4 300202	ATE Ø 9 / 8" pneumatisch
1.8 T	110	01/97→01/05					
1.8 T	132	12/97→01/05					
1.8 T quattro	110	02/97→01/05					
1.8 T quattro	132	12/97→01/05					
1.9 TDI	81	04/97→10/00					
1.9 TDI	85	07/00→01/05					
1.9 TDI	96	08/01→01/05					
2.0	96	08/01→01/05					
2.4	100	07/98→01/05					
2.4	115	02/97→01/05					
2.4	120	02/97→01/05					
2.4	121	02/97→01/05					
2.4	125	08/01→01/05					
2.4 quattro	115	08/98→07/99					
2.4 quattro	120	02/97→01/05					
2.4 quattro	121	02/97→01/05					
2.4 quattro	125	08/01→01/05					
2.5 TDI	110	07/97→01/05					
2.5 TDI	114	08/01→01/05					
2.5 TDI	120	07/02→01/05					
2.5 TDI	132	02/00→01/05					
2.5 TDI quattro	110	07/97→01/05					
↓							

	kw			 	! #		
AUDI - A6 (4B2, C5) 01/97→08/05							
Bremskraftverstärker							
2.5 TDI quattro	132	02/00→01/05		4B-2-130001→		03.7858-4502.4 300202	ATE Ø 9 / 8" pneumatisch
2.7 T	169	02/99→01/05					
2.7 T quattro	169	12/97→01/05					
2.7 T quattro	184	08/01→01/05					
2.8	132	10/97→05/00					
2.8	140	07/99→01/05					
2.8	142	02/97→01/05					
2.8 quattro	140	07/99→05/01					
2.8 quattro	142	02/97→01/05					
3.0	162	08/01→01/05					
3.0 quattro	162	08/01→01/05					
3.7	191	03/99→01/05					
3.7 quattro	191	03/99→01/05					
4.2 quattro	220	11/98→01/05					
S6 quattro	250	09/99→01/05					
Hauptbremszylinder							
1.8	92	07/97→01/05		4B-2-130136→		03.2125-0373.3 010810	ATE Ø 25,4
1.8 T	132	12/97→01/05		→ 4B-X-130000; + EDS		24.2123-1717.3 010521	Ø 23,81
1.8 T quattro	132	12/97→01/05					
1.9 TDI	85	07/00→01/05		→ 4B-X-130000; + ESP		24.2123-1730.3 010620	Ø 23,81
2.4	100	07/98→01/05					
2.5 TDI	110	07/97→01/05		4B-X-130001→; → 05/01; für Linkslenker; + EDS		24.2125-1712.3 010622	Ø 25,4
2.5 TDI quattro	110	07/97→01/05					
2.5 TDI quattro	132	02/00→01/05		4B-X-130001→; → 05/01; für Linkslenker; + ESP		24.2125-1713.3 010623	Ø 25,4
2.8	140	07/99→01/05					
				06/01→		24.2125-1720.3 010688	TRW Ø 25,4
1.8 T	110	01/97→01/05		4B-2-130136→		03.2125-0373.3 010810	ATE Ø 25,4
1.8 T quattro	110	02/97→01/05					
2.4	115	02/97→01/05		04/97→; → 4B-X-130000; + EDS		24.2123-1717.3 010521	Ø 23,81
2.4	120	02/97→01/05		04/97→; → 4B-X-130000; + ESP		24.2123-1730.3 010620	Ø 23,81
2.4	121	02/97→01/05					
2.4 quattro	120	02/97→01/05		4B-X-130001→; → 05/01; für Linkslenker; + EDS		24.2125-1712.3 010622	Ø 25,4
2.4 quattro	121	02/97→01/05					
2.8	142	02/97→01/05		4B-X-130001→; → 05/01; für Linkslenker; + ESP		24.2125-1713.3 010623	Ø 25,4
2.8 quattro	142	02/97→01/05					
				06/01→		24.2125-1720.3 010688	TRW Ø 25,4
1.9 TDI	81	04/97→10/00		4B-2-130136→		03.2125-0373.3 010810	ATE Ø 25,4
2.4 quattro	115	08/98→07/99		→ 4B-X-130000; + EDS		24.2123-1717.3 010521	Ø 23,81
2.8	132	10/97→05/00					
2.8 quattro	140	07/99→05/01		→ 4B-X-130000; + ESP		24.2123-1730.3 010620	Ø 23,81
				4B-X-130001→; für Linkslenker; + EDS		24.2125-1712.3 010622	Ø 25,4
				4B-X-130001→; für Linkslenker; + ESP		24.2125-1713.3 010623	Ø 25,4
1.9 TDI	96	08/01→01/05		4B-2-130136→		03.2125-0373.3 010810	ATE Ø 25,4
2.4	125	08/01→01/05		→ 4B-X-130000; + EDS		24.2123-1717.3 010521	Ø 23,81
2.4 quattro	125	08/01→01/05					
2.5 TDI	114	08/01→01/05		→ 4B-X-130000; + ESP		24.2123-1730.3 010620	Ø 23,81
2.7 T quattro	184	08/01→01/05				24.2125-1720.3 010688	TRW Ø 25,4
2.0	96	08/01→01/05		4B-2-130136→		03.2125-0373.3 010810	ATE Ø 25,4
2.5 TDI	120	07/02→01/05				24.2125-1720.3 010688	TRW Ø 25,4
3.0	162	08/01→01/05					
3.0 quattro	162	08/01→01/05					
3.7	191	03/99→01/05					
3.7 quattro	191	03/99→01/05					
2.5 TDI	132	02/00→01/05		4B-2-130136→		03.2125-0373.3 010810	ATE Ø 25,4
2.7 T	169	02/99→01/05		→ 05/01; für Linkslenker; + EDS		24.2125-1712.3 010622	Ø 25,4
				→ 05/01; für Linkslenker; + ESP		24.2125-1713.3 010623	Ø 25,4
				06/01→		24.2125-1720.3 010688	TRW Ø 25,4
2.7 T quattro	169	12/97→01/05		4B-2-130136→		03.2125-0373.3 010810	ATE Ø 25,4
				→ 4B-X-130000; + EDS		24.2123-1717.3 010521	Ø 23,81
				→ 4B-X-130000; + ESP		24.2123-1730.3 010620	Ø 23,81
				→ 05/01; für Linkslenker; + EDS		24.2125-1712.3 010622	Ø 25,4
				4B-X-130001→; → 05/01; für Linkslenker; + ESP		24.2125-1713.3 010623	Ø 25,4
				06/01→		24.2125-1720.3 010688	TRW Ø 25,4
4.2 quattro	220	11/98→01/05		4B-2-130136→		03.2125-0373.3 010810	ATE Ø 25,4
				→ 05/01; + EDS		24.2125-1712.3 010622	Ø 25,4
				→ 05/01; + ESP		24.2125-1713.3 010623	Ø 25,4
				06/01→		24.2125-1720.3 010688	TRW Ø 25,4
RS6 quattro	331	07/02→01/05				24.2126-1705.3 010999	TRW Ø 26,99
S6 quattro	250	09/99→01/05		4B-2-130136→		03.2125-0373.3 010810	ATE Ø 25,4
				→ 05/01		24.2125-1712.3 010622	Ø 25,4
						24.2125-1713.3 010623	Ø 25,4
				06/01→		24.2125-1720.3 010688	TRW Ø 25,4

	kW			 	! #		
AUDI - A6 (4F2, C6) 04/04→06/11							
 Hauptbremszylinder							
2.0 TDI	89	09/05→06/06				24.2126-1705.3 010999	TRW Ø 26,99
2.0 TDI	103	07/04→10/08					
2.0 TDI	120	04/09→03/11					
2.0 TDI	125	11/08→03/11					
2.0 TFSI	125	06/05→03/11					
2.4	130	05/04→10/08					
2.4 quattro	130	01/05→10/08					
2.7 TDI	120	11/04→03/11					
2.7 TDI	132	11/04→10/08					
2.7 TDI	140	10/08→03/11					
2.7 TDI quattro	120	06/05→03/11					
2.7 TDI quattro	132	11/04→10/08					
2.7 TDI quattro	140	10/08→03/11					
2.8 FSI	140	10/08→03/11					
2.8 FSI	154	11/06→10/08					
2.8 FSI	162	10/08→03/11					
2.8 FSI quattro	140	10/08→03/11					
2.8 FSI quattro	154	06/07→10/08					
2.8 FSI quattro	162	10/08→03/11					
3.0	160	08/04→05/06					
3.0 quattro	160	05/04→05/06					
3.0 TDI quattro	155	05/04→03/11					
3.0 TDI quattro	165	05/04→05/06					
3.0 TDI quattro	171	06/06→10/08					
3.0 TDI quattro	176	10/08→03/11					
3.0 TFSI quattro	213	10/08→03/11					
3.0 TFSI quattro	220	10/08→03/11					
3.2 FSI	188	05/04→05/09					
3.2 FSI	195	05/09→03/11					
3.2 FSI quattro	188	05/04→10/08					
4.2 FSI quattro	257	06/06→03/11					
4.2 quattro	246	05/04→05/06					
RS6 quattro	426	09/08→08/10					
S6 quattro	320	03/06→03/11					
2.0 TDI	100	07/04→03/11		06/05→		24.2126-1705.3 010999	TRW Ø 26,99
AUDI - A6 Allroad (4FH, C6) 05/06→08/11							
 Hauptbremszylinder							
2.7 TDI quattro	120	05/06→08/11		→ 05/11		24.2126-1705.3 010999	TRW Ø 26,99
2.7 TDI quattro	140	10/08→08/11					
3.0 TDI quattro	155	05/06→08/11					
3.0 TDI quattro	176	10/08→08/11					
3.0 TFSI quattro	213	10/08→08/11					
2.7 TDI quattro	132	05/06→10/08				24.2126-1705.3 010999	TRW Ø 26,99
3.0 TDI quattro	171	05/06→10/08					
3.2 FSI quattro	188	05/06→10/08					
4.2 FSI quattro	257	05/06→12/10					
AUDI - A6 Avant (4A5, C4) 06/94→12/97							
 Bremskraftverstärker							
S6 4.2 quattro	213	06/94→12/97		09/94→		10.0124-3202.3 340011	ATE hydraulisch
S6 Plus quattro	240	04/96→12/97		06/96→		10.0124-3202.3 340011	ATE hydraulisch
S6 Turbo quattro	169	06/94→12/97				10.0124-3202.3 340011	ATE hydraulisch
 Hauptbremszylinder							
1.8	92	12/95→12/97		+ ABS		24.2123-1731.3 010621	Ø 23,81
2.8	142	12/95→12/97					
1.8 quattro	92	12/95→12/97				24.2123-1731.3 010621	Ø 23,81
2.0 16V quattro	103	06/94→12/97					
2.5 TDI quattro	103	07/95→12/97					
2.6 quattro	110	06/94→12/97					
2.8 quattro	128	06/94→12/97					
2.8 quattro	142	12/95→12/97					
1.9 TDI	66	06/94→12/97		→ 06/95; - ABS		03.2123-0491.3 010167	Ø 23,81
2.0	74	06/94→12/97		→ 06/95; - EDS / + ABS		24.2123-1602.3 010384	TRW Ø 23,81
2.0	85	06/94→12/97					
2.0 16V	103	06/94→12/97		→ 06/95; + EDS / + ABS		24.2123-1731.3 010621	Ø 23,81
2.3	98	06/94→12/95					
2.5 TDI	84	01/95→12/97		07/95→; + ABS		24.2123-1731.3 010621	Ø 23,81
2.5 TDI	85	06/94→12/97					
2.5 TDI	103	08/94→12/97					
2.6	110	06/94→12/97					
2.8	128	06/94→12/97					
2.3 quattro	98	06/94→12/95		08/94→		24.2123-1731.3 010621	Ø 23,81
 Bremskraftregler							
1.8	92	12/95→12/97		für Fahrzeuge ohne Niveauregulierung		03.6585-0108.3 320115	ATE lastabhängig 8/5 4x
1.9 TDI	66	06/94→12/97					
↓							

AUDI - A6 Avant (4A5, C4) 06/94→12/97

Bremskraftregler

2.0	74	06/94→12/97		für Fahrzeuge ohne Niveauregulierung	03.6585-0108.3	320115	ATE lastabhängig 8/5 4x
2.0	85	06/94→12/97					
2.0 16V	103	06/94→12/97					
2.3	98	06/94→12/95					
2.5 TDI	84	01/95→12/97					
2.5 TDI	85	06/94→12/97					
2.5 TDI	103	08/94→12/97					
2.6	110	06/94→12/97					
2.8	128	06/94→12/97					
2.8	142	12/95→12/97					











AUDI - A6 Avant (4B5, C5) 11/97→01/05













Bremskraftverstärker













1.8	92	12/97→01/05		4B-2-130001→	03.7858-4502.4	300202	ATE Ø 9 / 8" pneumatisch
1.8 T	110	12/97→01/05					
1.8 T	132	04/99→01/05					
1.8 T quattro	110	12/97→01/05					
1.8 T quattro	132	12/97→01/05					
1.9 TDI	81	02/98→04/01					
1.9 TDI	85	07/00→01/05					
1.9 TDI	96	08/01→01/05					
2.0	96	08/01→01/05					
2.4	100	07/98→01/05					
2.4	115	12/97→01/05					
2.4	120	12/97→01/05					
2.4	121	12/97→01/05					
2.4	125	08/01→01/05					
2.4 quattro	115	08/98→05/01					
2.4 quattro	120	12/97→01/05					
2.4 quattro	121	12/97→01/05					
2.4 quattro	125	08/01→01/05					
2.5 TDI	110	12/97→01/05					
2.5 TDI	114	08/01→01/05					
2.5 TDI	120	07/02→01/05					
2.5 TDI	132	02/00→01/05					
2.5 TDI quattro	110	12/97→01/05					
2.5 TDI quattro	132	02/00→01/05					
2.7 T	169	02/99→01/05					
2.7 T quattro	169	12/97→01/05					
2.7 T quattro	184	08/01→01/05					
2.8	132	12/97→05/00					
2.8	140	07/99→01/05					
2.8	142	12/97→01/05					
2.8 quattro	142	12/97→01/05					
3.0	162	08/01→01/05					
3.0 quattro	162	08/01→01/05					
3.7 quattro	191	03/99→01/05					
4.2 quattro	220	11/98→01/05					
S6 quattro	250	09/99→01/05					











Hauptbremszylinder













1.8	92	12/97→01/05		4B-2-130136→	03.2125-0373.3	010810	ATE Ø 25,4
1.8 T	110	12/97→01/05		→ 4B-X-130000; + EDS	24.2123-1717.3	010521	Ø 23,81
1.8 T	132	04/99→01/05		→ 4B-X-130000; + ESP	24.2123-1730.3	010620	Ø 23,81
1.8 T quattro	110	12/97→01/05		→ 4B-X-130000; + ESP	24.2123-1730.3	010620	Ø 23,81
1.8 T quattro	132	12/97→01/05		4B-X-130001→; → 05/01; für Linkslenker; + EDS	24.2125-1712.3	010622	Ø 25,4
1.9 TDI	85	07/00→01/05		4B-X-130001→; → 05/01; für Linkslenker; + ESP	24.2125-1713.3	010623	Ø 25,4
2.4	100	07/98→01/05		06/01→	24.2125-1720.3	010688	TRW Ø 25,4
2.4	115	12/97→01/05					
2.4	120	12/97→01/05					
2.4	121	12/97→01/05					
2.4 quattro	120	12/97→01/05					
2.4 quattro	121	12/97→01/05					
2.5 TDI	110	12/97→01/05					
2.5 TDI quattro	110	12/97→01/05					
2.5 TDI quattro	132	02/00→01/05					
2.8	140	07/99→01/05					
2.8	142	12/97→01/05					
2.8 quattro	142	12/97→01/05					
1.9 TDI	81	02/98→04/01		4B-2-130136→	03.2125-0373.3	010810	ATE Ø 25,4
2.4 quattro	115	08/98→05/01		→ 4B-X-130000; + EDS	24.2123-1717.3	010521	Ø 23,81
2.8	132	12/97→05/00		→ 4B-X-130000; + ESP	24.2123-1730.3	010620	Ø 23,81
				4B-X-130001→; für Linkslenker; + EDS	24.2125-1712.3	010622	Ø 25,4
				4B-X-130001→; für Linkslenker; + ESP	24.2125-1713.3	010623	Ø 25,4
1.9 TDI	96	08/01→01/05		4B-2-130136→	03.2125-0373.3	010810	ATE Ø 25,4
2.4	125	08/01→01/05		→ 4B-X-130000; + EDS	24.2123-1717.3	010521	Ø 23,81
2.4 quattro	125	08/01→01/05		→ 4B-X-130000; + ESP	24.2123-1730.3	010620	Ø 23,81
2.5 TDI	114	08/01→01/05		→ 4B-X-130000; + ESP	24.2123-1730.3	010620	Ø 23,81
2.7 T quattro	184	08/01→01/05			24.2125-1720.3	010688	TRW Ø 25,4
↓							













	kW			 	! #		
AUDI - A6 Avant (4B5, C5) 11/97→01/05							
 Hauptbremszylinder							
2.0	96	08/01→01/05		4B-2-130136→		03.2125-0373.3 010810	ATE Ø 25,4
2.5 TDI	120	07/02→01/05				24.2125-1720.3 010688	TRW Ø 25,4
3.0	162	08/01→01/05					
3.0 quattro	162	08/01→01/05					
3.7 quattro	191	03/99→01/05					
2.5 TDI	132	02/00→01/05		4B-2-130136→		03.2125-0373.3 010810	ATE Ø 25,4
2.7 T	169	02/99→01/05		→ 05/01; für Linkslenker; + EDS		24.2125-1712.3 010622	Ø 25,4
				→ 05/01; für Linkslenker; + ESP		24.2125-1713.3 010623	Ø 25,4
				06/01→		24.2125-1720.3 010688	TRW Ø 25,4
2.7 T quattro	169	12/97→01/05		4B-2-130136→		03.2125-0373.3 010810	ATE Ø 25,4
				→ 4B-X-130000; + EDS		24.2123-1717.3 010521	Ø 23,81
				→ 4B-X-130000; + ESP		24.2123-1730.3 010620	Ø 23,81
				→ 05/01; für Linkslenker; + EDS		24.2125-1712.3 010622	Ø 25,4
				4B-X-130001→; → 05/01; für Linkslenker; + ESP		24.2125-1713.3 010623	Ø 25,4
				06/01→		24.2125-1720.3 010688	TRW Ø 25,4
4.2 quattro	220	11/98→01/05		4B-2-130136→		03.2125-0373.3 010810	ATE Ø 25,4
				→ 05/01; + EDS		24.2125-1712.3 010622	Ø 25,4
				→ 05/01; + ESP		24.2125-1713.3 010623	Ø 25,4
				06/01→		24.2125-1720.3 010688	TRW Ø 25,4
RS6 plus quattro	353	04/04→01/05				24.2126-1705.3 010999	TRW Ø 26,99
RS6 quattro	331	07/02→01/05					
S6 quattro	250	09/99→01/05		4B-2-130136→		03.2125-0373.3 010810	ATE Ø 25,4
				→ 05/01		24.2125-1712.3 010622	Ø 25,4
						24.2125-1713.3 010623	Ø 25,4
				06/01→		24.2125-1720.3 010688	TRW Ø 25,4
AUDI - A6 Avant (4F5, C6) 03/05→08/11							
 Hauptbremszylinder							
2.0 TDI	89	09/05→06/06				24.2126-1705.3 010999	TRW Ø 26,99
2.0 TDI	100	06/05→08/11					
2.0 TDI	103	06/05→10/08					
2.0 TDI	120	04/09→08/11					
2.0 TDI	125	10/08→08/11					
2.0 TFSI	125	06/05→08/11					
2.4	130	03/05→10/08					
2.4 quattro	130	03/05→10/08					
2.7 TDI	120	03/05→08/11					
2.7 TDI	132	03/05→10/08					
2.7 TDI	140	10/08→08/11					
2.7 TDI quattro	120	06/05→08/11					
2.7 TDI quattro	132	03/05→10/08					
2.7 TDI quattro	140	10/08→08/11					
2.8 FSI	140	10/08→08/11					
2.8 FSI	154	11/06→10/08					
2.8 FSI	162	10/08→08/11					
2.8 FSI quattro	140	10/08→08/11					
2.8 FSI quattro	154	06/07→10/08					
2.8 FSI quattro	162	10/08→08/11					
3.0	160	03/05→05/06					
3.0 quattro	160	03/05→05/06					
3.0 TDI quattro	155	03/05→08/11					
3.0 TDI quattro	165	03/05→05/06					
3.0 TDI quattro	171	06/06→10/08					
3.0 TDI quattro	176	10/08→08/11					
3.0 TFSI quattro	213	10/08→08/11					
3.0 TFSI quattro	220	10/08→08/11					
3.2 FSI	188	03/05→10/08					
3.2 FSI quattro	188	03/05→10/08					
4.2 FSI quattro	257	06/06→08/11					
4.2 quattro	246	03/05→05/06					
RS6 quattro	426	04/08→08/10					
S6 quattro	320	03/06→08/11					
AUDI - A8 (4D2, 4D8) 03/94→12/05							
 Hauptbremszylinder							
2.5 TDI	110	01/97→04/00		06/97→; - ESP		24.2125-1712.3 010622	Ø 25,4
				06/97→; + ESP		24.2125-1713.3 010623	Ø 25,4
2.5 TDI	132	09/00→09/02		- ESP		24.2125-1712.3 010622	Ø 25,4
2.5 TDI quattro	110	07/97→04/00					
2.5 TDI quattro	132	09/00→09/02		+ ESP		24.2125-1713.3 010623	Ø 25,4
2.8	120	07/95→03/96					
2.8	142	04/96→09/02					
↓							













	kw					! #		
AUDI - A8 (4D2, 4D8) 03/94→12/05								
 Hauptbremszylinder								
2.8 quattro	120	07/95→03/96		- ESP			24.2125-1712.3 010622	Ø 25,4
2.8 quattro	142	04/96→09/02		+ ESP			24.2125-1713.3 010623	Ø 25,4
3.3 TDI quattro	165	06/00→09/02						
3.7	169	07/95→12/98						
3.7	191	11/98→09/02						
3.7 quattro	191	11/98→09/02						
4.2 quattro	175	02/99→04/00						
4.2 quattro	228	11/98→09/02						
6.0 W12 quattro	309	01/01→09/02						
S8 quattro	250	07/96→06/99						
S 8 quattro	265	06/99→09/02						
2.8	128	03/94→03/96		06/94→; - ESP			24.2125-1712.3 010622	Ø 25,4
2.8 quattro	128	03/94→03/96		06/94→; + ESP			24.2125-1713.3 010623	Ø 25,4
4.2 quattro	180	03/94→07/96						
4.2 quattro	220	03/94→11/98						
3.7 quattro	169	07/95→11/98		10/95→; - ESP			24.2125-1712.3 010622	Ø 25,4
				10/95→; + ESP			24.2125-1713.3 010623	Ø 25,4
AUDI - A8 (4H2, 4H8, 4HC, 4HL) 11/09→								
 Hauptbremszylinder								
2.0 TFSI hybrid	155	02/12→		05/12→; nicht für gepanzerte Fahrzeuge			24.2125-1739.3 010948	TRW Ø 25,4
2.0 TFSI quattro	185	09/16→		nicht für gepanzerte Fahrzeuge			24.2125-1739.3 010948	TRW Ø 25,4
2.5 TFSI	150	07/12→						
3.0 TDI	150	09/11→						
3.0 TDI quattro	155	08/10→						
3.0 TDI quattro	176	11/12→						
3.0 TDI quattro	184	07/10→						
3.0 TDI quattro	190	10/13→						
3.0 TDI quattro	193	05/15→						
3.0 TFSI quattro	213	07/10→						
3.0 TFSI quattro	228	11/11→						
4.0 TFSI quattro	309	03/12→						
4.0 TFSI quattro	320	10/13→						
4.2 FSI quattro	273	11/09→						
4.2 TDI quattro	258	11/09→						
4.2 TDI quattro	283	10/13→						
6.3 W12 quattro	368	01/11→						
S8 plus quattro	445	11/15→						
S8 quattro	382	04/12→						
3.0 TFSI quattro	245	06/10→		07/10→; nicht für gepanzerte Fahrzeuge			24.2125-1739.3 010948	TRW Ø 25,4
AUDI - ALLROAD (4BH, C5) 05/00→08/05								
 Hauptbremszylinder								
2.5 TDI quattro	120	05/03→08/05		für Linkslenker; → 07/05			24.2125-1713.3 010623	Ø 25,4
2.5 TDI quattro	132	05/00→08/05						
2.7 T quattro	184	05/00→08/05						
4.2 V8 quattro	220	07/02→08/05						
AUDI - CABRIOLET (8G7, B4) 05/91→08/00								
 Hauptbremszylinder								
1.9 TDI	66	06/95→08/00		07/95→; → 8G-V-010000; für Rechtslenker; - ABS			03.2122-9612.3 010159	Ø 22,2
				8G-P-000001→ 8G-V-010000; für Linkslenker; - ABS			03.2123-0491.3 010167	Ø 23,81
				07/95→; für Linkslenker; + ABS			24.2123-1602.3 010384	TRW Ø 23,81
2.0 16V	103	06/95→07/96		8G-P-000001→ 8G-V-010000; für Linkslenker; - ABS			03.2123-0491.3 010167	Ø 23,81
				für Linkslenker; + ABS			24.2123-1602.3 010384	TRW Ø 23,81
2.0 E	85	01/93→07/98		→ 8G-V-010000; für Rechtslenker; - ABS			03.2122-9612.3 010159	Ø 22,2
				8G-P-000001→ 8G-V-010000; für Linkslenker; - ABS			03.2123-0491.3 010167	Ø 23,81
2.6	110	06/93→08/00		01/94→; für Linkslenker			24.2123-1602.3 010384	TRW Ø 23,81
2.8	128	11/92→08/00		für Linkslenker			24.2123-1602.3 010384	TRW Ø 23,81
Verschlusschraube, Hauptbremszylinder								
1.9 TDI	66	06/95→08/00		8G-P-000001→ 8G-V-010000; für Linkslenker; - ABS			03.3517-0101.2 390322	
2.0 16V	103	06/95→07/96						
2.0 E	85	01/93→07/98						
 Bremskraftregler								
1.8	92	01/97→08/00		04/97→			03.6585-0108.3 320115	ATE lastabhängig 8/5 4x
1.9 TDI	66	06/95→08/00		07/95→			03.6585-0108.3 320115	ATE lastabhängig 8/5 4x
2.0 16V	103	06/95→07/96					03.6585-0108.3 320115	ATE lastabhängig 8/5 4x
2.0 E	85	01/93→07/98						
↓								











	kW					! #		
AUDI - CABRIOLET (8G7, B4) 05/91→08/00								
 Bremskraftregler								
2.6	110	06/93→08/00		01/94→			03.6585-0108.3 320115	ATE lastabhängig 8/5 4x
AUDI - COUPE (89, 8B) 10/88→12/96								
 Bremskraftverstärker								
2.0	85	05/89→12/96		→ 8B-N-500000; für Linkslenker			03.7750-0302.4 300071	ATE Ø 9" pneumatisch
2.0 16 V	103	08/92→12/96						
2.3	98	03/90→12/96						
2.3 20V quattro	123	05/90→12/96		für Linkslenker			10.0124-3202.3 340011	ATE hydraulisch
S2 quattro	169	10/92→12/96						
2.3 quattro	98	05/90→12/96		für Linkslenker			03.7750-0302.4 300071	ATE Ø 9" pneumatisch
 Hauptbremszylinder								
2.0	85	05/89→12/96		→ 07/92; für Linkslenker; - ABS			03.2122-9612.3 010159	Ø 22,2
				für Rechtslenker; - ABS			03.2122-9612.3 010159	Ø 22,2
				08/92→; für Linkslenker; - ABS			03.2123-0491.3 010167	Ø 23,81
				08/92→; für Linkslenker; + ABS			24.2123-1602.3 010384	TRW Ø 23,81
2.0 16 V	103	08/92→12/96		für Linkslenker; - ABS			03.2123-0491.3 010167	Ø 23,81
				für Linkslenker; + ABS			24.2123-1602.3 010384	TRW Ø 23,81
2.3	98	03/90→12/96		→ 07/92; für Linkslenker; - ABS			03.2122-9612.3 010159	Ø 22,2
				→ 07/94; für Rechtslenker; - ABS			03.2122-9612.3 010159	Ø 22,2
				08/92→; für Linkslenker; - ABS			03.2123-0491.3 010167	Ø 23,81
				08/92→; für Linkslenker; + ABS			24.2123-1602.3 010384	TRW Ø 23,81
2.3 20V quattro	123	05/90→12/96				03.2125-3210.3 010212	Ø 25,4	
2.3 quattro	98	05/90→12/96		- ABS		03.2122-9612.3 010159	Ø 22,2	
2.6	110	08/92→12/96		→ 06/94; für Linkslenker			24.2123-1602.3 010384	TRW Ø 23,81
2.8	128	09/91→12/96		für Linkslenker; - ABS			03.2123-0491.3 010167	Ø 23,81
				→ 06/94; für Linkslenker; + ABS			24.2123-1602.3 010384	TRW Ø 23,81
S2 quattro	169	10/92→12/96					03.2125-3610.3 010214	Ø 25,4
Verschlusschraube, Hauptbremszylinder								
2.0	85	05/89→12/96		07/94→; für Rechtslenker			03.3517-0101.2 390322	
2.0 16 V	103	08/92→12/96						
2.6	110	08/92→12/96		für Rechtslenker			03.3517-0101.2 390322	
2.6 quattro	110	08/92→12/96						
2.8	128	09/91→12/96						
2.8 quattro	128	08/91→12/96						
 Bremskraftregler								
2.0	85	05/89→12/96					03.6585-0108.3 320115	ATE lastabhängig 8/5 4x
2.3	98	03/90→12/96						
2.6	110	08/92→12/96						
2.0 16 V	103	08/92→12/96		→ 07/94			03.6585-0108.3 320115	ATE lastabhängig 8/5 4x
AUDI - Q2 (GAB) 06/16→								
 Hauptbremszylinder								
1.0 TFSI	85	10/16→		für Linkslenker			24.4123-1719.3 011017	TRW Ø 23,81
2.0 TDI	110	09/16→						ohne Bremsflüssigkeitsbehälter
2.0 TDI quattro	110	09/16→						
2.0 TFSI quattro	140	05/17→						
1.4 TSI	110	06/16→		09/16→; für Linkslenker			24.4123-1719.3 011017	TRW Ø 23,81
1.6 TDI	85	06/16→						ohne Bremsflüssigkeitsbehälter
2.0 TDI quattro	140	07/16→						
AUDI - Q3 (8UB, 8UG) 06/11→								
 Hauptbremszylinder								
1.4 TFSI	92	07/16→		für Linkslenker			03.2123-3549.3 010809	ATE Ø 23,81
1.4 TSI	110	10/13→						
2.0 TDI	88	03/15→		für Rechtslenker			24.4153-0192.3 011026	ATE Ø 23,81
2.0 TDI	100	09/11→						ohne Bremsflüssigkeitsbehälter
2.0 TDI	103	09/11→						
2.0 TDI	110	11/14→						
2.0 TDI	130	05/13→						
2.0 TDI	135	05/15→						
2.0 TDI quattro	103	01/12→						
2.0 TDI quattro	110	11/14→						
2.0 TDI quattro	120	06/11→						
2.0 TDI quattro	130	06/11→						
2.0 TDI quattro	135	11/14→						
2.0 TFSI	132	05/15→		für Linkslenker			03.4153-0186.3 010816	ATE Ø 23,81
2.0 TFSI quattro	125	06/11→						
2.0 TFSI quattro	132	11/14→						











	kw					! #		
AUDI - Q3 (8UB, 8UG) 06/11→								
 Hauptbremszylinder								
2.0 TFSI quattro	155	06/11→			für Rechtslenker		24.4153-0192.3 011026	ATE Ø 23,81 ohne Bremsflüssigkeitsbehälter
2.0 TFSI quattro	162	11/14→						
RS 2.5 quattro	228	10/13→			für Linkslenker		03.2125-5112.3 010966	ATE Ø 25,4
RS performance 2.5 quattro	270	01/15→						
RS 2.5 quattro	250	05/13→			03/15→; für Linkslenker		03.2125-5112.3 010966	ATE Ø 25,4
AUDI - Q5 (8RB) 11/08→								
 Bremskraftverstärker								
2.0 TDI	100	11/10→					03.7858-4432.4 300304	ATE Ø 9 / 8" pneumatisch
2.0 TDI	105	11/10→						
2.0 TDI	110	05/13→						
2.0 TDI	140	09/15→						
2.0 TDI quattro	100	08/09→						
2.0 TDI quattro	105	08/09→						
2.0 TDI quattro	110	05/13→						
2.0 TDI quattro	140	11/13→						
2.0 TFSI quattro	132	08/09→						
2.0 TFSI quattro	162	05/13→						
2.0 TFSI quattro	169	08/15→						
3.0 TDI quattro	190	11/13→						
SQ5 TDI quattro	230	12/12→						
SQ5 TDI quattro	240	04/15→						
SQ5 TDI quattro	250	11/15→						
SQ5 TFSI quattro	260	05/13→						
2.0 TDI quattro	120	11/08→			03/09→		03.7858-4432.4 300304	ATE Ø 9 / 8" pneumatisch
2.0 TDI quattro	125	11/08→						
2.0 TFSI quattro	155	11/08→			→ 02/09		03.7858-4432.4 300304	ATE Ø 9 / 8" pneumatisch
3.0 TDI quattro	155	11/08→						
3.0 TDI quattro	176	11/08→						
3.2 FSI quattro	199	11/08→						
2.0 TDI quattro	130	06/12→			09/12→		03.7858-4432.4 300304	ATE Ø 9 / 8" pneumatisch
2.0 TFSI quattro	165	06/12→						
3.0 TDI quattro	180	06/12→						
3.0 TDI quattro	184	06/12→						
3.0 TFSI quattro	200	06/12→						
2.0 TFSI hybrid quattro	155	06/11→					03.7858-4632.4 300273	ATE Ø 9 / 8" pneumatisch
 Hauptbremszylinder								
2.0 TDI	100	11/10→					03.2125-0493.3 010940	ATE Ø 25,4
2.0 TDI	105	11/10→						
2.0 TDI	110	05/13→						
2.0 TDI	140	09/15→						
2.0 TDI quattro	100	08/09→						
2.0 TDI quattro	105	08/09→						
2.0 TDI quattro	110	05/13→						
2.0 TDI quattro	140	11/13→						
2.0 TFSI quattro	132	08/09→						
2.0 TFSI quattro	162	05/13→						
3.0 TDI quattro	190	11/13→						
SQ5 TDI quattro	230	12/12→						
SQ5 TDI quattro	240	04/15→						
SQ5 TDI quattro	250	11/15→						
SQ5 TFSI quattro	260	05/13→						
2.0 TDI quattro	120	11/08→			03/09→		03.2125-0493.3 010940	ATE Ø 25,4
2.0 TDI quattro	125	11/08→						
2.0 TFSI quattro	155	11/08→						
3.0 TDI quattro	155	11/08→						
3.0 TDI quattro	176	11/08→						
3.2 FSI quattro	199	11/08→						
2.0 TDI quattro	130	06/12→			09/12→		03.2125-0493.3 010940	ATE Ø 25,4
2.0 TFSI quattro	165	06/12→						
3.0 TDI quattro	180	06/12→						
3.0 TDI quattro	184	06/12→						
3.0 TFSI quattro	200	06/12→						
AUDI - Q7 (4LB) 03/06→01/16								
 Bremskraftverstärker								
3.0 TDI quattro	150	05/10→08/15			für Fahrzeuge ohne autom. Distanzregelung; für Linkslenker		03.7868-4503.4 300245	ATE Ø 10 / 8" pneumatisch
3.0 TDI quattro	155	03/06→05/10						
3.0 TDI quattro	165	06/09→05/12						
3.0 TDI quattro	171	03/06→05/08			für Linkslenker;		03.7868-5902.4 300316	ATE Ø 10 / 8" pneumatisch
3.0 TDI quattro	176	11/07→08/15			für Fahrzeuge mit autom. Distanzregelung			
3.0 TDI quattro	180	05/11→08/15						
3.0 TFSI quattro	200	05/10→08/15						
3.0 TFSI quattro	206	05/11→08/15						
3.0 TFSI quattro	245	05/10→08/15						
3.6 FSI quattro	206	08/06→05/10						
4.2 FSI quattro	257	03/06→05/10						











	kw			 	! #		
AUDI - Q7 (4LB) 03/06→01/16							
 Bremskraftverstärker							
4.2 TDI quattro	240	03/07→06/09		für Fahrzeuge ohne autom. Distanzregelung; für Linkslenker		03.7868-4503.4 300245	ATE Ø 10 / 8" pneumatisch
4.2 TDI quattro	250	05/09→08/15					
6.0 TDI quattro	368	09/08→05/14		für Linkslenker; für Fahrzeuge mit autom. Distanzregelung		03.7868-5902.4 300316	ATE Ø 10 / 8" pneumatisch
Pedalwegsensor, Bremspedal							
3.0 TDI quattro	150	05/10→08/15		für Fahrzeuge mit autom. Distanzregelung		03.0655-0006.2 370006	ATE
3.0 TDI quattro	155	03/06→05/10					
3.0 TDI quattro	165	06/09→05/12					
3.0 TDI quattro	171	03/06→05/08					
3.0 TDI quattro	176	11/07→08/15					
3.0 TDI quattro	180	05/11→08/15					
3.0 TFSI quattro	200	05/10→08/15					
3.0 TFSI quattro	206	05/11→08/15					
3.0 TFSI quattro	245	05/10→08/15					
3.6 FSI quattro	206	08/06→05/10					
4.2 FSI quattro	257	03/06→05/10					
4.2 TDI quattro	240	03/07→06/09					
4.2 TDI quattro	250	05/09→08/15					
6.0 TDI quattro	368	09/08→05/14					
 Hauptbremszylinder							
3.0 TDI quattro	150	05/10→08/15		für Linkslenker		03.2126-3063.3 010812	ATE Ø 26,99
3.0 TDI quattro	155	03/06→05/10					
3.0 TDI quattro	171	03/06→05/08		für Rechtslenker		24.2126-3071.3 011037	ATE Ø 26,99 ohne Bremsflüssigkeitsbehälter
3.0 TDI quattro	176	11/07→08/15					
3.0 TDI quattro	180	05/11→08/15					
3.0 TFSI quattro	200	05/10→08/15					
3.0 TFSI quattro	206	05/11→08/15					
3.0 TFSI quattro	245	05/10→08/15					
3.6 FSI quattro	206	08/06→05/10					
4.2 FSI quattro	257	03/06→05/10					
4.2 TDI quattro	240	03/07→06/09					
4.2 TDI quattro	250	05/09→08/15					
6.0 TDI quattro	368	09/08→05/14					
3.0 TDI quattro	165	06/09→05/12		für Linkslenker		03.2126-3063.3 010812	ATE Ø 26,99
				→ 05/10; für Rechtslenker		24.2126-3071.3 011037	ATE Ø 26,99 ohne Bremsflüssigkeitsbehälter
AUDI - TT (8J3) 07/06→06/14							
 Bremskraftverstärker							
1.8 TFSI	118	06/08→06/14		für Linkslenker		03.7860-4203.4 300243	ATE Ø 10" pneumatisch
2.0 TDI quattro	125	06/08→06/14					
2.0 TFSI	147	08/06→06/10					
2.0 TFSI	155	05/10→06/14					
2.0 TFSI quattro	147	06/08→06/10					
2.0 TFSI quattro	155	05/10→06/14					
2.0 TTS quattro	195	05/08→06/14					
2.0 TTS quattro	200	05/08→06/14		für Linkslenker		03.7870-0602.4 300310	ATE Ø 11" pneumatisch
2.5 RS quattro	250	07/09→06/14					
2.5 RS quattro	265	05/11→06/14		02/12→; für Linkslenker		03.7870-0602.4 300310	ATE Ø 11" pneumatisch
3.2 V6 quattro	184	08/06→06/10		für Linkslenker; +PR 1AT		03.7870-0602.4 300310	ATE Ø 11" pneumatisch
 Hauptbremszylinder							
1.8 TFSI	118	06/08→06/14		für Linkslenker		03.2123-3549.3 010809	ATE Ø 23,81
2.0 TDI quattro	125	06/08→06/14					
2.0 TFSI	147	08/06→06/10		für Rechtslenker		24.4153-0217.3 011039	ATE Ø 23,81 ohne Bremsflüssigkeitsbehälter
2.0 TFSI	155	05/10→06/14					
2.0 TFSI quattro	147	06/08→06/10					
2.0 TFSI quattro	155	05/10→06/14					
2.0 TTS quattro	195	05/08→06/14					
2.0 TTS quattro	200	05/08→06/14		für Linkslenker		03.2125-5112.3 010966	ATE Ø 25,4
2.5 RS quattro	250	07/09→06/14					
2.5 RS quattro	265	05/11→06/14					
3.2 V6 quattro	184	08/06→06/10					
Drucksensor, Bremskraftverstärker							
2.0 TTS quattro	200	05/08→06/14		für Rechtslenker; +PR 1AS		03.0655-0101.2 370008	ATE
2.5 RS quattro	250	07/09→06/14					
2.5 RS quattro	265	05/11→06/14					
3.2 V6 quattro	184	08/06→06/10		für Linkslenker; +PR 1AS		03.0655-0101.2 370008	ATE
AUDI - TT (8N3) 10/98→06/06							
 Bremskraftverstärker							
1.8 T	110	09/02→06/06		für Linkslenker		03.7860-0602.4 300141	ATE Ø 10" pneumatisch
1.8 T	120	09/05→06/06					
↓							











	kw					! #		
AUDI - TT (8N3) 10/98→06/06								
 Bremskraftverstärker								
1.8 T	140	09/05→06/06		für Linkslenker		03.7860-0602.4	300141	ATE Ø 10" pneumatisch
1.8 T quattro	140	09/05→06/06						
1.8 T quattro	176	03/05→06/06						
3.2 VR6 quattro	184	07/03→06/06						
1.8 T	132	10/98→06/06		8N-2-014301→; für Linkslenker		03.7860-0602.4	300141	ATE Ø 10" pneumatisch
1.8 T quattro	132	10/98→06/06		→ 8N-2-014300; für Linkslenker; + ESP		03.7863-0402.4	300124	ATE Ø 10" pneumatisch
1.8 T quattro	165	10/98→06/06						
 Hauptbremszylinder								
1.8 T	110	09/02→06/06		für Linkslenker		03.2123-2654.3	010801	ATE Ø 23,81
1.8 T	120	09/05→06/06						
1.8 T	140	09/05→06/06						
1.8 T quattro	140	09/05→06/06						
1.8 T quattro	176	03/05→06/06						
3.2 VR6 quattro	184	07/03→06/06						
1.8 T	132	10/98→06/06		→ 8N-2-014300; für Linkslenker; + ESP		03.2123-2024.3	010597	ATE Ø 23,81
1.8 T quattro	132	10/98→06/06		→ 8N-2-014300; für Rechtslenker; + ESP		03.2123-2064.3	010598	ATE Ø 23,81
1.8 T quattro	165	10/98→06/06						
				09/02→; für Linkslenker		03.2123-2654.3	010801	ATE Ø 23,81
				8N-2-014301→; → 08/02; für Linkslenker		03.2123-2715.3	010802	ATE Ø 23,81
				8N-2-014301→; → 08/02; für Rechtslenker		03.2123-2774.3	010803	ATE Ø 23,81
				→ 8N-2-014300; für Linkslenker; - ESP		24.2123-1709.3	010503	Ø 23,81
AUDI - TT (FV3) 07/14→								
 Hauptbremszylinder								
1.8 TFSI	132	08/15→		für Linkslenker		24.4123-1719.3	011017	TRW Ø 23,81 ohne Bremsflüssigkeitsbehälter
2.0 TDI	135	07/14→						
2.0 TDI quattro	135	01/17→						
2.0 TFSI	169	07/14→						
2.0 TFSI quattro	169	07/14→						
AUDI - TT Roadster (8J9) 03/07→06/14								
 Bremskraftverstärker								
1.8 TFSI	118	06/08→06/14		für Linkslenker		03.7860-4203.4	300243	ATE Ø 10" pneumatisch
2.0 TDI quattro	125	06/08→06/14						
2.0 TFSI	147	03/07→06/10						
2.0 TFSI	155	05/10→06/14						
2.0 TFSI quattro	147	06/08→06/10						
2.0 TFSI quattro	155	05/10→06/14						
2.0 TTS quattro	195	05/08→06/14						
2.0 TTS quattro	200	05/08→06/14		für Linkslenker		03.7870-0602.4	300310	ATE Ø 11" pneumatisch
2.5 RS quattro	250	07/09→06/14						
2.5 RS quattro	265	03/12→06/14						
3.2 V6 quattro	184	03/07→06/10		für Linkslenker; +PR 1AT		03.7870-0602.4	300310	ATE Ø 11" pneumatisch
 Hauptbremszylinder								
1.8 TFSI	118	06/08→06/14		für Linkslenker		03.2123-3549.3	010809	ATE Ø 23,81
2.0 TDI quattro	125	06/08→06/14		für Rechtslenker		24.4153-0217.3	011039	ATE Ø 23,81 ohne Bremsflüssigkeitsbehälter
2.0 TFSI	147	03/07→06/10						
2.0 TFSI quattro	147	06/08→06/10						
2.0 TTS quattro	195	05/08→06/14						
2.0 TTS quattro	200	05/08→06/14		für Linkslenker		03.2125-5112.3	010966	ATE Ø 25,4
2.5 RS quattro	250	07/09→06/14						
2.5 RS quattro	265	03/12→06/14						
3.2 V6 quattro	184	03/07→06/10						
Drucksensor, Bremskraftverstärker								
2.0 TTS quattro	200	05/08→06/14		für Rechtslenker; +PR 1AS		03.0655-0101.2	370008	ATE
2.5 RS quattro	250	07/09→06/14						
2.5 RS quattro	265	03/12→06/14						
3.2 V6 quattro	184	03/07→06/10		für Linkslenker; +PR 1AS		03.0655-0101.2	370008	ATE
AUDI - TT Roadster (8N9) 10/99→06/06								
 Bremskraftverstärker								
1.8 T	110	01/01→06/06		8N-2-014301→; für Linkslenker		03.7860-0602.4	300141	ATE Ø 10" pneumatisch
1.8 T	132	10/99→06/06						
1.8 T quattro	132	02/00→06/06		→ 8N-2-014300; für Linkslenker; + ESP		03.7863-0402.4	300124	ATE Ø 10" pneumatisch
1.8 T quattro	165	10/99→06/06						
1.8 T	120	09/05→06/06		für Linkslenker		03.7860-0602.4	300141	ATE Ø 10" pneumatisch
1.8 T	140	09/05→06/06						
1.8 T quattro	140	09/05→06/06						
3.2 VR6 quattro	184	07/03→06/06						
↓								

	kw			 	! #		
AUDI - TT Roadster (8N9) 10/99→06/06							
 Hauptbremszylinder							
1.8 T	110	01/01→06/06		→ 8N-2-014300; für Linkslenker; + ESP		03.2123-2024.3 010597	ATE Ø 23,81
1.8 T	132	10/99→06/06		→ 8N-2-014300; für Rechtslenker; + ESP		03.2123-2064.3 010598	ATE Ø 23,81
1.8 T quattro	132	02/00→06/06					
1.8 T quattro	165	10/99→06/06		09/02→; für Linkslenker		03.2123-2654.3 010801	ATE Ø 23,81
				8N-2-014301→; → 08/02; für Linkslenker		03.2123-2715.3 010802	ATE Ø 23,81
				8N-2-014301→; → 08/02; für Rechtslenker		03.2123-2774.3 010803	ATE Ø 23,81
				→ 8N-2-014300; für Linkslenker; - ESP		24.2123-1709.3 010503	Ø 23,81
1.8 T	120	09/05→06/06		für Linkslenker		03.2123-2654.3 010801	ATE Ø 23,81
1.8 T	140	09/05→06/06					
1.8 T quattro	140	09/05→06/06					
3.2 VR6 quattro	184	07/03→06/06					
AUDI - TT Roadster (FV9) 11/14→							
 Hauptbremszylinder							
1.8 TFSI	132	08/15→		für Linkslenker		24.4123-1719.3 011017	TRW Ø 23,81
2.0 TDI	135	11/14→					ohne Bremsflüssigkeitsbehälter
2.0 TDI quattro	135	01/17→					
2.0 TFSI	169	11/14→					
2.0 TFSI quattro	169	11/14→					
AUTOBIANCHI - Y10 03/85→10/95							
 Hauptbremszylinder							
1.0	33	03/85→10/95		06/85→ 12/89		24.2120-0801.3 010362	Ø 20,64
1.0	41	03/85→10/95		12/87→ 12/89		24.2120-0801.3 010362	Ø 20,64
1.0 4WD	37	12/86→10/95		→ 12/89		24.2120-0801.3 010362	Ø 20,64
1.0 Cat	33	10/87→10/95		12/87→ 12/89		24.2120-0801.3 010362	Ø 20,64
1.0 Turbo	63	03/85→10/95		06/85→ 12/89		24.2120-0801.3 010362	Ø 20,64
1.1	42	06/89→10/95		01/90→ 12/92		24.2120-0801.3 010362	Ø 20,64
				01/93→		24.2120-1733.3 010686	Ø 20,64
1.1 i.e. Cat	42	09/90→10/95		→ 12/92		24.2120-0801.3 010362	Ø 20,64
1.3 i.e. GT	54	06/89→10/95		01/93→		24.2120-1733.3 010686	Ø 20,64
1.3 i.e. GT	57	06/89→10/95					
 Bremskraftregler							
1.0	33	03/85→10/95		06/85→ 12/89		24.6513-0801.3 320117	lastabhängig 1/3 2x
1.0	41	03/85→10/95		12/87→ 12/89		24.6513-0801.3 320117	lastabhängig 1/3 2x
1.0 4WD	37	12/86→10/95		→ 12/89		24.6513-0801.3 320117	lastabhängig 1/3 2x
1.0 Cat	33	10/87→10/95		12/87→ 12/89		24.6513-0801.3 320117	lastabhängig 1/3 2x
1.0 Turbo	63	03/85→10/95		06/85→ 12/89		24.6513-0801.3 320117	lastabhängig 1/3 2x
1.1	42	06/89→10/95		01/90→		24.6513-0801.3 320117	lastabhängig 1/3 2x
1.1 i.e. Cat	42	09/90→10/95				24.6513-0801.3 320117	lastabhängig 1/3 2x
1.3 i.e. GT	54	06/89→10/95					
1.3 i.e. GT	57	06/89→10/95					
BMW - 1 (E81) 09/06→09/12							
 Bremskraftverstärker							
116 d	66	01/11→12/11		für Fahrzeuge ohne Start-Stopp-Funktion		03.7848-4003.4 300235	ATE Ø 8" pneumatisch
116 d	85	11/08→12/11		03/09→ 08/09		03.7848-4003.4 300235	ATE Ø 8" pneumatisch
				09/09→ 05/11; für Fahrzeuge ohne Start-Stopp-Funktion		03.7848-4003.4 300235	ATE Ø 8" pneumatisch
116 i	85	04/07→12/11		→ 08/07		03.7848-4003.4 300235	ATE Ø 8" pneumatisch
116 i	89	08/07→11/11		09/07→ 12/08		03.7848-4003.4 300235	ATE Ø 8" pneumatisch
116 i	90	03/07→11/11					
116 i	90	11/08→12/11		09/09→ 05/11; für Fahrzeuge ohne Start-Stopp-Funktion		03.7848-4003.4 300235	ATE Ø 8" pneumatisch
				01/09→ 08/09		03.7848-4003.4 300235	ATE Ø 8" pneumatisch
118 d	100	09/06→12/11		04/07→ 08/09		03.7848-4003.4 300235	ATE Ø 8" pneumatisch
118 d	105	09/06→12/11					
118 i	100	09/06→12/11		09/09→ 05/11; für Fahrzeuge ohne Start-Stopp-Funktion		03.7848-4003.4 300235	ATE Ø 8" pneumatisch
118 i	105	09/06→12/11					
120 i	120	09/06→12/11					
120 i	125	01/07→09/12					
120 d	120	03/07→12/11				03.7848-4003.4 300235	ATE Ø 8" pneumatisch
120 d	130	03/07→12/11		→ 08/09		03.7848-4003.4 300235	ATE Ø 8" pneumatisch
120 d	145	03/07→12/11		09/09→ 05/11; für Fahrzeuge ohne Start-Stopp-Funktion		03.7848-4003.4 300235	ATE Ø 8" pneumatisch
120 i	115	09/06→10/11		→ 03/07		03.7848-4003.4 300235	ATE Ø 8" pneumatisch
↓							









	kw			 	! #		
BMW - 1 (E81) 09/06→09/12							
 Bremskraftverstärker							
123 d	150	03/07→12/11		10/07→ 08/09		03.7848-5003.4 300236	ATE Ø 8" pneumatisch
				09/09→ 05/11; für Fahrzeuge ohne Start-Stopp-Funktion		03.7848-5003.4 300236	ATE Ø 8" pneumatisch
130 i	190	09/06→12/11		→ 05/11		03.7848-5003.4 300236	ATE Ø 8" pneumatisch
130 i	195	09/06→12/11					
 Hauptbremszylinder							
116 d	66	01/11→12/11		für Linkslenker		03.2023-2407.3 010796	ATE Ø1 23,81 Ø2 22,2
120 d	120	03/07→12/11					
116 d	85	11/08→12/11		03/09→ 05/11; für Linkslenker		03.2023-2407.3 010796	ATE Ø1 23,81 Ø2 22,2
116 i	85	04/07→12/11		→ 08/07; für Linkslenker		03.2023-2407.3 010796	ATE Ø1 23,81 Ø2 22,2
116 i	89	08/07→11/11		09/07→ 12/08; für Linkslenker		03.2023-2407.3 010796	ATE Ø1 23,81 Ø2 22,2
116 i	90	03/07→11/11					
116 i	90	11/08→12/11		01/09→ 05/11; für Linkslenker		03.2023-2407.3 010796	ATE Ø1 23,81 Ø2 22,2
118 d	100	09/06→12/11		04/07→ 05/11; für Linkslenker		03.2023-2407.3 010796	ATE Ø1 23,81 Ø2 22,2
118 d	105	09/06→12/11					
118 i	100	09/06→12/11					
118 i	105	09/06→12/11					
120 i	120	09/06→12/11					
120 i	125	01/07→09/12					
120 d	130	03/07→12/11		→ 05/11; für Linkslenker		03.2023-2407.3 010796	ATE Ø1 23,81 Ø2 22,2
120 d	145	03/07→12/11					
120 i	115	09/06→10/11		→ 03/07; für Linkslenker		03.2023-2407.3 010796	ATE Ø1 23,81 Ø2 22,2
123 d	150	03/07→12/11		10/07→ 05/11; für Linkslenker		03.2025-1904.3 010797	ATE Ø1 25,4 Ø2 22,2
130 i	190	09/06→12/11		→ 05/11; für Linkslenker		03.2025-1904.3 010797	ATE Ø1 25,4 Ø2 22,2
130 i	195	09/06→12/11					
Hydraulikaggregat, Bremsanlage							
116 d	66	01/11→12/11				24.9145-0003.2 399007	
116 d	85	11/08→12/11		03/09→ 05/11		24.9145-0003.2 399007	
116 i	89	08/07→11/11		09/08→ 12/08		24.9145-0003.2 399007	
116 i	90	03/07→11/11					
116 i	90	11/08→12/11		01/09→ 05/11		24.9145-0003.2 399007	
118 d	100	09/06→12/11		09/08→ 05/11		24.9145-0003.2 399007	
118 d	105	09/06→12/11					
118 i	100	09/06→12/11					
118 i	105	09/06→12/11					
120 d	130	03/07→12/11					
120 d	145	03/07→12/11					
120 i	120	09/06→12/11					
120 i	125	01/07→09/12					
123 d	150	03/07→12/11		09/08→ 05/11; für Fahrzeuge ohne Aktivlenkung		24.9145-0003.2 399007	
BMW - 1 (E87) 02/03→01/13							
 Bremskraftverstärker							
116 d	85	12/08→09/12		03/09→ 08/09		03.7848-4003.4 300235	ATE Ø 8" pneumatisch
				09/09→ 05/11; für Fahrzeuge ohne Start-Stopp-Funktion		03.7848-4003.4 300235	ATE Ø 8" pneumatisch
116 i	85	11/03→06/11		09/04→ 08/07		03.7848-4003.4 300235	ATE Ø 8" pneumatisch
116 i	89	03/07→06/11		09/07→ 12/08		03.7848-4003.4 300235	ATE Ø 8" pneumatisch
116 i	90	03/07→06/11					
116 i	90	01/09→06/11		→ 08/09		03.7848-4003.4 300235	ATE Ø 8" pneumatisch
				09/09→ 05/11; für Fahrzeuge ohne Start-Stopp-Funktion		03.7848-4003.4 300235	ATE Ø 8" pneumatisch
118 d	90	11/03→02/07		09/04→		03.7848-4003.4 300235	ATE Ø 8" pneumatisch
118 i	95	07/04→02/07					
120 d	110	03/03→02/07					
118 d	100	09/06→06/11		04/07→ 08/09		03.7848-4003.4 300235	ATE Ø 8" pneumatisch
118 d	105	09/06→06/11					
118 i	105	09/06→06/11		09/09→ 05/11; für Fahrzeuge ohne Start-Stopp-Funktion		03.7848-4003.4 300235	ATE Ø 8" pneumatisch
120 i	120	09/06→06/11					
120 i	125	09/06→06/11					
118 i	100	10/06→06/11		→ 03/07		03.7848-4003.4 300235	ATE Ø 8" pneumatisch
120 d	120	03/03→06/11		09/04→ 02/07		03.7848-4003.4 300235	ATE Ø 8" pneumatisch
120 d	130	09/06→06/11		03/07→ 08/09		03.7848-4003.4 300235	ATE Ø 8" pneumatisch
				09/09→ 05/11; für Fahrzeuge ohne Start-Stopp-Funktion		03.7848-4003.4 300235	ATE Ø 8" pneumatisch
120 i	110	11/03→06/11		09/04→ 03/07		03.7848-4003.4 300235	ATE Ø 8" pneumatisch
120 i	115	11/03→06/11					
123 d	150	03/07→09/12		10/07→ 08/09		03.7848-5003.4 300236	ATE Ø 8" pneumatisch
				09/09→ 05/11; für Fahrzeuge ohne Start-Stopp-Funktion		03.7848-5003.4 300236	ATE Ø 8" pneumatisch
↓							











	kw			 	! #		
BMW - 1 (E87) 02/03→01/13							
 Bremskraftverstärker							
130 i	190	03/05→09/12		→ 05/11		03.7848-5003.4 300236	ATE Ø 8" pneumatisch
130 i	195	03/05→09/12		09/05→ 05/11		03.7848-5003.4 300236	ATE Ø 8" pneumatisch
 Hauptbremszylinder							
116 d	85	12/08→09/12		03/09→ 05/11; für Linkslenker		03.2023-2407.3 010796	ATE Ø1 23,81 Ø2 22,2
116 i	85	11/03→06/11		09/04→ 08/07; für Linkslenker		03.2023-2407.3 010796	ATE Ø1 23,81 Ø2 22,2
116 i	89	03/07→06/11		09/07→ 12/08; für Linkslenker		03.2023-2407.3 010796	ATE Ø1 23,81 Ø2 22,2
116 i	90	03/07→06/11					
116 i	90	01/09→06/11		→ 05/11; für Linkslenker		03.2023-2407.3 010796	ATE Ø1 23,81 Ø2 22,2
118 d	90	11/03→02/07		09/04→; für Linkslenker		03.2023-2407.3 010796	ATE Ø1 23,81 Ø2 22,2
118 i	95	07/04→02/07					
120 d	110	03/03→02/07					
118 d	100	09/06→06/11		04/07→ 05/11; für Linkslenker		03.2023-2407.3 010796	ATE Ø1 23,81 Ø2 22,2
118 d	105	09/06→06/11					
118 i	105	09/06→06/11					
120 i	120	09/06→06/11					
120 i	125	09/06→06/11					
118 i	100	10/06→06/11		→ 03/07; für Linkslenker		03.2023-2407.3 010796	ATE Ø1 23,81 Ø2 22,2
120 d	120	03/03→06/11		09/04→ 02/07; für Linkslenker		03.2023-2407.3 010796	ATE Ø1 23,81 Ø2 22,2
120 d	130	09/06→06/11		03/07→ 05/11; für Linkslenker		03.2023-2407.3 010796	ATE Ø1 23,81 Ø2 22,2
120 i	110	11/03→06/11		09/04→ 03/07; für Linkslenker		03.2023-2407.3 010796	ATE Ø1 23,81 Ø2 22,2
120 i	115	11/03→06/11					
123 d	150	03/07→09/12		10/07→ 05/11; für Linkslenker		03.2025-1904.3 010797	ATE Ø1 25,4 Ø2 22,2
130 i	190	03/05→09/12		→ 05/11; für Linkslenker		03.2025-1904.3 010797	ATE Ø1 25,4 Ø2 22,2
130 i	195	03/05→09/12		09/05→ 05/11; für Linkslenker		03.2025-1904.3 010797	ATE Ø1 25,4 Ø2 22,2
Hydraulikaggregat, Bremsanlage							
116 d	85	12/08→09/12		03/09→ 05/11		24.9145-0003.2 399007	
116 i	89	03/07→06/11		09/08→ 12/08		24.9145-0003.2 399007	
116 i	90	03/07→06/11					
116 i	90	01/09→06/11		→ 05/11		24.9145-0003.2 399007	
118 d	100	09/06→06/11		09/08→ 05/11		24.9145-0003.2 399007	
118 d	105	09/06→06/11					
118 i	100	10/06→06/11					
118 i	105	09/06→06/11					
120 d	130	09/06→06/11					
120 i	120	09/06→06/11					
120 i	125	09/06→06/11					
123 d	150	03/07→09/12		09/08→ 05/11; für Fahrzeuge ohne Aktivlenkung		24.9145-0003.2 399007	
BMW - 1 Cabriolet (E88) 03/08→12/13							
 Bremskraftverstärker							
118 d	100	09/08→12/13		→ 10/13; für Fahrzeuge ohne Start-Stopp-Funktion		03.7848-4003.4 300235	ATE Ø 8" pneumatisch
118 d	105	09/08→12/13					
118 i	100	09/08→12/13					
118 i	105	03/08→12/13					
120 d	120	03/08→12/13					
120 d	130	03/08→12/13					
120 d	145	03/08→12/13					
120 i	115	03/08→12/13					
120 i	120	03/08→12/13					
120 i	125	03/08→12/13					
128 i	171	03/08→12/13					
123 d	150	09/08→12/13		→ 10/13; für Fahrzeuge ohne Start-Stopp-Funktion		03.7848-5003.4 300236	ATE Ø 8" pneumatisch
125 i	160	03/08→12/13		→ 10/13		03.7848-4003.4 300235	ATE Ø 8" pneumatisch
135 i	225	03/08→12/13		→ 10/13		03.7845-0103.4 300268	ATE Ø 8" pneumatisch
135 i	240	03/08→12/13					
 Hauptbremszylinder							
118 d	100	09/08→12/13		→ 10/13; für Linkslenker		03.2023-2407.3 010796	ATE Ø1 23,81 Ø2 22,2
118 d	105	09/08→12/13					
118 i	100	09/08→12/13					
118 i	105	03/08→12/13					
120 d	120	03/08→12/13					
120 d	130	03/08→12/13					
120 d	145	03/08→12/13					
120 i	115	03/08→12/13					
120 i	120	03/08→12/13					
120 i	125	03/08→12/13					
125 i	160	03/08→12/13					
128 i	171	03/08→12/13					
123 d	150	09/08→12/13		→ 10/13; für Linkslenker		03.2025-1904.3 010797	ATE Ø1 25,4 Ø2 22,2













	kw			 	! #		
BMW - 1 Cabriolet (E88) 03/08→12/13							
 Hauptbremszylinder							
135 i	225	03/08→12/13		→ 10/13; für Linkslenker		03.2025-1904.3 010797	ATE Ø1 25,4 Ø2 22,2
135 i	240	03/08→12/13					
Hydraulikaggregat, Bremsanlage							
118 d	100	09/08→12/13		→ 10/13		24.9145-0003.2 399007	
118 d	105	09/08→12/13					
118 i	100	09/08→12/13					
118 i	105	03/08→12/13		09/08→ 10/13		24.9145-0003.2 399007	
120 d	120	03/08→12/13		09/08→ 10/13;		24.9145-0003.2 399007	
120 d	130	03/08→12/13		für Fahrzeuge ohne Aktivlenkung			
120 d	145	03/08→12/13					
120 i	115	03/08→12/13					
120 i	120	03/08→12/13					
120 i	125	03/08→12/13					
123 d	150	09/08→12/13		→ 10/13;		24.9145-0003.2 399007	
				für Fahrzeuge ohne Aktivlenkung			
BMW - 1 Coupe (E82) 10/06→10/13							
 Bremskraftverstärker							
118 d	100	09/09→10/13		für Fahrzeuge ohne Start-Stopp-Funktion		03.7848-4003.4 300235	ATE Ø 8" pneumatisch
118 d	105	09/09→10/13					
120 d	120	09/07→10/13					
120 d	130	09/07→10/13					
120 i	115	09/09→10/13					
120 d	145	09/07→10/13		10/07→;		03.7848-4003.4 300235	ATE Ø 8" pneumatisch
				für Fahrzeuge ohne Start-Stopp-Funktion			
120 i	125	10/07→10/13		09/09→;		03.7848-4003.4 300235	ATE Ø 8" pneumatisch
				für Fahrzeuge ohne Start-Stopp-Funktion			
123 d	150	10/07→10/13		→ 08/09		03.7848-4003.4 300235	ATE Ø 8" pneumatisch
				09/09→;		03.7848-5003.4 300236	ATE Ø 8" pneumatisch
				für Fahrzeuge ohne Start-Stopp-Funktion			
125 i	160	10/07→10/13		03/08→		03.7848-4003.4 300235	ATE Ø 8" pneumatisch
135 i	225	10/07→10/13				03.7845-0103.4 300268	ATE Ø 8" pneumatisch
135 i	240	10/07→10/13					
 Hauptbremszylinder							
118 d	100	09/09→10/13		für Linkslenker		03.2023-2407.3 010796	ATE Ø1 23,81 Ø2 22,2
118 d	105	09/09→10/13					
120 d	120	09/07→10/13					
120 d	130	09/07→10/13					
120 i	115	09/09→10/13					
120 d	145	09/07→10/13		10/07→; für Linkslenker		03.2023-2407.3 010796	ATE Ø1 23,81 Ø2 22,2
120 i	125	10/07→10/13		09/09→; für Linkslenker		03.2023-2407.3 010796	ATE Ø1 23,81 Ø2 22,2
123 d	150	10/07→10/13		für Linkslenker		03.2025-1904.3 010797	ATE Ø1 25,4 Ø2 22,2
135 i	225	10/07→10/13					
135 i	240	10/07→10/13					
125 i	160	10/07→10/13		03/08→; für Linkslenker		03.2023-2407.3 010796	ATE Ø1 23,81 Ø2 22,2
Hydraulikaggregat, Bremsanlage							
118 d	100	09/09→10/13				24.9145-0003.2 399007	
118 d	105	09/09→10/13					
120 d	120	09/07→10/13		09/08→;		24.9145-0003.2 399007	
120 d	130	09/07→10/13		für Fahrzeuge ohne Aktivlenkung			
120 d	145	09/07→10/13					
123 d	150	10/07→10/13					
120 i	115	09/09→10/13		für Fahrzeuge ohne Aktivlenkung		24.9145-0003.2 399007	
120 i	125	10/07→10/13		09/09→;		24.9145-0003.2 399007	
				für Fahrzeuge ohne Aktivlenkung			
BMW - 3 (E36) 09/90→12/98							
 Bremskraftverstärker							
316 i	75	07/93→02/98		09/94→; + ABS		03.7760-3102.4 300139	ATE Ø 10" pneumatisch
318 i	85	10/93→02/98		→ 08/94; + ABS		10.6360-1903.4 300093	ATE Ø 10" pneumatisch
318 is	103	03/93→02/98					
318 is	103	09/95→02/98		+ ABS		03.7760-3102.4 300139	ATE Ø 10" pneumatisch
318 tds	66	01/95→02/98					
320 i	110	09/90→02/98		09/94→; - ASC		03.7760-3102.4 300139	ATE Ø 10" pneumatisch
325 td	85	09/91→02/98		09/96→; + ASC		03.7760-3102.4 300139	ATE Ø 10" pneumatisch
325 tds	105	05/93→02/98		→ 08/96; + ASC		10.6360-1903.4 300093	ATE Ø 10" pneumatisch
				→ 08/94; - ASC		10.6360-1903.4 300093	ATE Ø 10" pneumatisch
323 i 2.5	125	03/95→02/98		- ASC		03.7760-3102.4 300139	ATE Ø 10" pneumatisch
328 i	142	08/94→12/98		09/96→; + ASC		03.7760-3102.4 300139	ATE Ø 10" pneumatisch
↓							











	kw			 	! #		
BMW - 3 (E36) 09/90→12/98							
 Bremskraftverstärker							
323 i 2.5 328 i	125 142	03/95→02/98 08/94→12/98		→ 08/96; + ASC		10.6360-1903.4 300093	ATE Ø 10" pneumatisch
325 i	141	09/90→09/95		09/94→; - ASC		03.7760-3102.4 300139	ATE Ø 10" pneumatisch
				→ 08/94; - ASC		10.6360-1903.4 300093	ATE Ø 10" pneumatisch
				+ ASC		10.6360-1903.4 300093	ATE Ø 10" pneumatisch
Pedalwegsensord, Bremspedal							
316 i 318 i 318 is	75 85 103	07/93→02/98 10/93→02/98 03/93→02/98		→ 08/94; + ABS		03.0655-0002.2 370002	ATE
320 i 325 td 325 tds	110 85 105	09/90→02/98 09/91→02/98 05/93→02/98		→ 08/94; - ASC → 08/96; + ASC		03.0655-0002.2 370002	ATE
323 i 2.5 328 i	125 142	03/95→02/98 08/94→12/98		→ 08/96; + ASC		03.0655-0002.2 370002	ATE
325 i	141	09/90→09/95		→ 08/94; - ASC		03.0655-0002.2 370002	ATE
				+ ASC		03.0655-0002.2 370002	ATE
 Hauptbremszylinder							
316 i 318 i 318 is	75 85 103	07/93→02/98 10/93→02/98 03/93→02/98		09/94→; + ABS → 08/94; + ABS		03.2023-0987.3 010473 10.6123-0239.3 010335	Ø1 23,81 Ø2 20,64 ATE Ø 23,81
318 is 318 tds	103 66	09/95→02/98 01/95→02/98		+ ABS		03.2023-0987.3 010473	Ø1 23,81 Ø2 20,64
320 i 325 td	110 85	09/90→02/98 09/91→02/98		09/96→; + ASC		03.2023-0987.3 010473	Ø1 23,81 Ø2 20,64
				09/94→; - ASC		03.2023-0987.3 010473	Ø1 23,81 Ø2 20,64
				→ 08/94; - ASC		10.6123-0239.3 010335	ATE Ø 23,81
				→ 08/96; + ASC		10.6123-0239.3 010335	ATE Ø 23,81
323 i 2.5 328 i	125 142	03/95→02/98 08/94→12/98		- ABS		24.2023-1601.3 010341	TRW Ø 23,81
				- ASC		03.2023-0987.3 010473	Ø1 23,81 Ø2 20,64
				09/96→; + ASC		03.2023-0987.3 010473	Ø1 23,81 Ø2 20,64
				→ 08/96; + ASC		10.6123-0239.3 010335	ATE Ø 23,81
325 i	141	09/90→09/95		09/94→; - ASC		03.2023-0987.3 010473	Ø1 23,81 Ø2 20,64
				→ 08/94; - ASC		10.6123-0239.3 010335	ATE Ø 23,81
				+ ASC		10.6123-0239.3 010335	ATE Ø 23,81
325 tds	105	05/93→02/98		09/94→; - ASC		03.2023-0987.3 010473	Ø1 23,81 Ø2 20,64
				09/96→; + ASC		03.2023-0987.3 010473	Ø1 23,81 Ø2 20,64
				→ 08/96; + ASC		10.6123-0239.3 010335	ATE Ø 23,81
				→ 08/94; - ASC		10.6123-0239.3 010335	ATE Ø 23,81
BMW - 3 (E46) 02/98→04/05							
 Bremskraftverstärker							
316 i 316 i 316 i 316 i 318 d 318 d 318 i 318 i 318 i 320 d 320 d 320 d 320 i 320 i 320 i 323 i 323 i 325 i 325 xi 328 i 330 d 330 d 330 i 330 xi	77 85 85 77 85 85 87 100 105 95 100 110 110 120 125 120 125 141 141 142 135 150 170 170	04/00→02/05 06/02→02/05 02/02→02/05 09/98→02/05 09/01→03/03 03/03→02/05 02/98→09/01 09/01→02/05 09/01→02/05 02/98→08/01 04/98→09/01 09/01→02/05 03/98→09/00 09/00→02/05 09/00→02/05 03/98→09/00 03/98→09/00 09/00→02/05 09/00→02/05 02/98→06/00 10/99→02/05 03/03→02/05 06/00→02/05 06/00→02/05				03.7860-0702.4 300123	ATE Ø 10" pneumatisch
330 xd 330 xd	135 150	01/00→02/03 09/02→12/04		06/00→ 03/03→		03.7860-0702.4 300123	ATE Ø 10" pneumatisch ATE Ø 10" pneumatisch
 Hauptbremszylinder							
316 i 316 i ↓	77 77	04/00→02/05 09/98→02/05		→ 08/01; - DSC		03.2022-2624.3 010588	Ø1 22,2 Ø2 20,64

























	kw			 	! #		
BMW - 3 (E46) 02/98→04/05							
 Hauptbremszylinder							
316 i	77	04/00→02/05		→ 08/00; + DSC		03.2022-2829.3 010589	ATE Ø1 22,2 Ø2 20,64
316 i	77	09/98→02/05		02/01→; + DSC		03.2023-2256.3 010870	ATE Ø1 23,81 Ø2 22,2
				09/01→; - DSC		03.2023-2344.3 010647	ATE Ø1 23,81 Ø2 22,2
316 i	85	06/02→02/05		+ DSC		03.2023-2256.3 010870	ATE Ø1 23,81 Ø2 22,2
316 i	85	02/02→02/05		- DSC		03.2023-2344.3 010647	ATE Ø1 23,81 Ø2 22,2
318 d	85	09/01→03/03					
318 d	85	03/03→02/05					
318 i	100	09/01→02/05					
318 i	105	09/01→02/05					
320 d	110	09/01→02/05					
318 i	87	02/98→09/01		- DSC		03.2022-2624.3 010588	Ø1 22,2 Ø2 20,64
320 i	110	03/98→09/00		→ 08/00; + DSC		03.2022-2829.3 010589	ATE Ø1 22,2 Ø2 20,64
320 d	95	02/98→08/01		- DSC		03.2022-2624.3 010588	Ø1 22,2 Ø2 20,64
320 d	100	04/98→09/01		→ 08/00; + DSC		03.2022-2829.3 010589	ATE Ø1 22,2 Ø2 20,64
				02/01→; + DSC		03.2023-2256.3 010870	ATE Ø1 23,81 Ø2 22,2
320 i	120	09/00→02/05		→ 08/01; - DSC		03.2022-2624.3 010588	Ø1 22,2 Ø2 20,64
320 i	125	09/00→02/05		02/01→; + DSC		03.2023-2256.3 010870	ATE Ø1 23,81 Ø2 22,2
325 i	141	09/00→02/05		09/01→; - DSC		03.2023-2344.3 010647	ATE Ø1 23,81 Ø2 22,2
323 i	120	03/98→09/00		- DSC		03.2022-2624.3 010588	Ø1 22,2 Ø2 20,64
323 i	125	03/98→09/00		+ DSC		03.2022-2829.3 010589	ATE Ø1 22,2 Ø2 20,64
328 i	142	02/98→06/00					
330 d	135	10/99→02/05		→ 08/00; + DSC		03.2023-2204.3 010644	ATE Ø1 23,81 Ø2 22,2
330 i	170	06/00→02/05		02/01→; + DSC		03.2023-2256.3 010870	ATE Ø1 23,81 Ø2 22,2
				→ 08/01; - DSC		03.2023-2304.3 010646	ATE Ø1 23,81 Ø2 22,2
				09/01→; - DSC		03.2023-2344.3 010647	ATE Ø1 23,81 Ø2 22,2
330 d	150	03/03→02/05		+ DSC		03.2023-2256.3 010870	ATE Ø1 23,81 Ø2 22,2
BMW - 3 (E90) 02/04→12/11							
 Bremskraftverstärker							
316 d	85	07/09→12/11		für Fahrzeuge ohne Start-Stopp-Funktion		03.7848-4003.4 300235	ATE Ø 8" pneumatisch
316 i	90	09/07→10/11					
316 i	85	09/05→10/11		→ 08/07;		03.7848-4003.4 300235	ATE Ø 8" pneumatisch
320 i	115	02/07→12/11		für Fahrzeuge ohne Start-Stopp-Funktion			
318 d	90	03/05→08/07		09/05→;		03.7848-4003.4 300235	ATE Ø 8" pneumatisch
318 i	95	03/05→08/07		für Fahrzeuge ohne Start-Stopp-Funktion			
318 d	100	02/07→03/10		09/07→;		03.7848-4003.4 300235	ATE Ø 8" pneumatisch
318 d	105	02/07→10/11		für Fahrzeuge ohne Start-Stopp-Funktion			
318 i	100	03/07→10/11					
318 i	105	02/07→10/11					
320 i	120	03/07→12/11					
320 i	125	03/07→12/11					
320 d	110	12/04→09/07		09/05→;		03.7845-0103.4 300268	ATE Ø 8" pneumatisch
				für Fahrzeuge ohne Start-Stopp-Funktion			
320 d	120	12/04→12/11				03.7848-5003.4 300236	ATE Ø 8" pneumatisch
320 si	127	09/05→08/06					
323 i	140	03/07→12/11					
325 d	145	09/06→02/10					
325 d	150	03/10→10/11					
325 i	155	01/06→12/11					
325 i	160	01/05→10/11					
325 i	160	03/07→12/11					
330 d	155	09/05→12/11					
330 d	170	09/05→09/08					
330 i	190	12/04→08/07					
330 i xDrive	200	09/08→10/11					
330 xd	170	09/05→08/08					
330 xi	190	09/05→08/07					
330 xi	200	09/07→08/08					
320 d	130	09/07→03/10		für Fahrzeuge ohne Start-Stopp-Funktion		03.7845-0103.4 300268	ATE Ø 8" pneumatisch
320 d	135	03/10→12/11					
320 d xDrive	120	09/08→10/11					
320 d xDrive	130	09/08→02/10					
320 d xDrive	135	03/10→10/11					
335 d	210	09/06→12/11					
335 i xDrive	225	05/08→10/11					
335 i xDrive	240	05/08→10/11					
335 xi	225	09/06→06/08					
335 xi	240	09/06→06/08					
320 i	110	06/04→09/07		12/04→ 08/07;		03.7848-4003.4 300235	ATE Ø 8" pneumatisch
				für Fahrzeuge ohne Start-Stopp-Funktion			
325 i xDrive	160	06/08→10/11		Motorcode: N53		03.7848-5003.4 300236	ATE Ø 8" pneumatisch
325 xi	160	03/05→10/11		→ 08/07; Motorcode: N52N;		03.7845-0103.4 300268	ATE Ø 8" pneumatisch
325 xi	160	03/07→06/08		für Fahrzeuge ohne Start-Stopp-Funktion			
				→ 08/07; Motorcode: N52		03.7848-5003.4 300236	ATE Ø 8" pneumatisch

	kw			 	! #		
BMW - 3 (E90) 02/04→12/11							
 Bremskraftverstärker							
325 xi	160	03/05→10/11		09/07→; Motorcode: N53		03.7848-5003.4 300236	ATE Ø 8" pneumatisch
325 xi	160	03/07→06/08					
330 d	180	09/08→12/11		→ 08/09;		03.7845-0103.4 300268	ATE Ø 8" pneumatisch
330 d xDrive	180	09/08→10/11		für Fahrzeuge ohne Start-Stopp-Funktion			
330 i	200	09/07→10/11		09/09→		03.7848-5003.4 300236	ATE Ø 8" pneumatisch
330 i	200	09/07→12/11					
335 i	225	03/06→12/11		09/06→;		03.7845-0103.4 300268	ATE Ø 8" pneumatisch
335 i	240	03/06→12/11		für Fahrzeuge ohne Start-Stopp-Funktion			
 Hauptbremszylinder							
316 d	85	07/09→12/11		für Linkslenker		03.2023-2407.3 010796	ATE Ø1 23,81 Ø2 22,2
316 i	90	09/07→10/11					
318 i	100	03/07→10/11					
320 i	120	03/07→12/11					
320 i	125	03/07→12/11					
316 i	85	09/05→10/11		→ 08/07; für Linkslenker		03.2023-2407.3 010796	ATE Ø1 23,81 Ø2 22,2
320 i	115	02/07→12/11					
318 d	90	03/05→08/07		09/05→; für Linkslenker		03.2023-2407.3 010796	ATE Ø1 23,81 Ø2 22,2
318 i	95	03/05→08/07					
318 d	100	02/07→03/10		09/07→; für Linkslenker		03.2023-2407.3 010796	ATE Ø1 23,81 Ø2 22,2
318 d	105	02/07→10/11					
318 i	105	02/07→10/11					
320 d	110	12/04→09/07		09/05→; für Linkslenker		03.2025-1904.3 010797	ATE Ø1 25,4 Ø2 22,2
320 d	120	12/04→12/11		für Linkslenker		03.2025-1904.3 010797	ATE Ø1 25,4 Ø2 22,2
320 d	130	09/07→03/10					
320 d	135	03/10→12/11					
320 si	127	09/05→08/06					
323 i	140	03/07→12/11					
325 i	155	01/06→12/11					
325 i	160	01/05→10/11					
325 i	160	03/07→12/11					
330 d	180	09/08→12/11					
330 i	190	12/04→08/07					
330 i	200	09/07→10/11					
330 i	200	09/07→12/11					
320 d xDrive	120	09/08→10/11				03.2025-1904.3 010797	ATE Ø1 25,4 Ø2 22,2
320 d xDrive	130	09/08→02/10					
320 d xDrive	135	03/10→10/11					
325 d	145	09/06→02/10					
325 d	150	03/10→10/11					
325 i xDrive	160	06/08→10/11					
325 xi	160	03/05→10/11					
325 xi	160	03/07→06/08					
330 d	155	09/05→12/11					
330 d	170	09/05→09/08					
330 d xDrive	180	09/08→10/11					
330 i xDrive	200	09/08→10/11					
330 xd	170	09/05→08/08					
330 xi	190	09/05→08/07					
330 xi	200	09/07→08/08					
335 d	210	09/06→12/11					
335 i xDrive	225	05/08→10/11					
335 i xDrive	240	05/08→10/11					
335 xi	225	09/06→06/08					
320 i	110	06/04→09/07		12/04→; für Linkslenker; → 08/07		03.2023-2407.3 010796	ATE Ø1 23,81 Ø2 22,2
335 i	225	03/06→12/11		09/06→; für Linkslenker		03.2025-1904.3 010797	ATE Ø1 25,4 Ø2 22,2
335 i	240	03/06→12/11					
335 xi	240	09/06→06/08		03/07→		03.2025-1904.3 010797	ATE Ø1 25,4 Ø2 22,2
Hydraulikaggregat, Bremsanlage							
316 d	85	07/09→12/11				24.9145-0003.2 399007	
316 i	90	09/07→10/11		09/08→		24.9145-0003.2 399007	
318 d	100	02/07→03/10					
318 d	105	02/07→10/11					
318 i	100	03/07→10/11					
318 i	105	02/07→10/11					
320 d	120	12/04→12/11		09/08→;		24.9145-0003.2 399007	
320 d	130	09/07→03/10		für Fahrzeuge ohne Aktivlenkung			
320 i	120	03/07→12/11					
320 i	125	03/07→12/11					
320 d	135	03/10→12/11		für Fahrzeuge ohne Aktivlenkung		24.9145-0003.2 399007	
BMW - 3 Cabriolet (E36) 03/93→04/99							
 Bremskraftverstärker							
318 i	85	01/94→04/99		09/94→; - ASC		03.7760-3102.4 300139	ATE Ø 10" pneumatisch
320 i	110	12/93→04/99		09/96→; + ASC		03.7760-3102.4 300139	ATE Ø 10" pneumatisch
				→ 08/96; + ASC		10.6360-1903.4 300093	ATE Ø 10" pneumatisch
↓							











	kw			 	! #		
BMW - 3 Cabriolet (E36) 03/93→04/99							
 Bremskraftverstärker							
318 i 320 i	85 110	01/94→04/99 12/93→04/99		→ 08/94; - ASC		10.6360-1903.4 300093	ATE Ø 10" pneumatisch
323 i 328 i	125 142	06/95→04/99 03/95→04/99		- ASC		03.7760-3102.4 300139	ATE Ø 10" pneumatisch
				09/96→; + ASC		03.7760-3102.4 300139	ATE Ø 10" pneumatisch
				→ 08/96; + ASC		10.6360-1903.4 300093	ATE Ø 10" pneumatisch
325 i	141	03/93→12/95		09/94→; - ASC		03.7760-3102.4 300139	ATE Ø 10" pneumatisch
				→ 08/94; - ASC		10.6360-1903.4 300093	ATE Ø 10" pneumatisch
				+ ASC		10.6360-1903.4 300093	ATE Ø 10" pneumatisch
M3 3.0	210	01/94→10/95				10.6360-1903.4 300093	ATE Ø 10" pneumatisch
Pedalwegsensor, Bremspedal							
318 i 320 i	85 110	01/94→04/99 12/93→04/99		→ 08/94; - ASC		03.0655-0002.2 370002	ATE
				→ 08/96; + ASC		03.0655-0002.2 370002	ATE
323 i 328 i	125 142	06/95→04/99 03/95→04/99		→ 08/96; + ASC		03.0655-0002.2 370002	ATE
325 i	141	03/93→12/95		→ 08/94; - ASC		03.0655-0002.2 370002	ATE
				+ ASC		03.0655-0002.2 370002	ATE
M3 3.0	210	01/94→10/95				03.0655-0002.2 370002	ATE
 Hauptbremszylinder							
318 i 320 i 325 i	85 110 141	01/94→04/99 12/93→04/99 03/93→12/95		09/94→; + ASC		03.2023-0987.3 010473	Ø1 23,81 Ø2 20,64
				- ASC		03.2023-0987.3 010473	Ø1 23,81 Ø2 20,64
				→ 08/94; + ASC		10.6123-0239.3 010335	ATE Ø 23,81
323 i 328 i	125 142	06/95→04/99 03/95→04/99		- ASC		03.2023-0987.3 010473	Ø1 23,81 Ø2 20,64
				09/96→; + ASC		03.2023-0987.3 010473	Ø1 23,81 Ø2 20,64
				→ 08/96; + ASC		10.6123-0239.3 010335	ATE Ø 23,81
BMW - 3 Cabriolet (E46) 04/00→12/07							
 Bremskraftverstärker							
318 Ci	100	12/00→08/06		09/01→		03.7860-0702.4 300123	ATE Ø 10" pneumatisch
318 Ci 318 Ci 320 Cd 320 Ci 320 Ci 325 Ci 330 Cd 330 Ci	105 110 110 120 125 141 150 170	09/01→12/07 02/05→12/07 02/05→12/07 01/06→12/07 09/00→12/07 09/00→12/07 08/05→12/07 06/00→12/07		→ 09/06		03.7860-0702.4 300123	ATE Ø 10" pneumatisch
323 Ci 323 Ci	120 125	04/00→09/00 04/00→09/00				03.7860-0702.4 300123	ATE Ø 10" pneumatisch
 Hauptbremszylinder							
318 Ci	100	12/00→08/06		09/01→; + DSC		03.2023-2256.3 010870	ATE Ø1 23,81 Ø2 22,2
				09/01→; - DSC		03.2023-2344.3 010647	ATE Ø1 23,81 Ø2 22,2
318 Ci 320 Ci	105 120	09/01→12/07 01/06→12/07		→ 09/06; + DSC		03.2023-2256.3 010870	ATE Ø1 23,81 Ø2 22,2
				→ 09/06; - DSC		03.2023-2344.3 010647	ATE Ø1 23,81 Ø2 22,2
318 Ci 320 Cd 330 Cd	110 110 150	02/05→12/07 02/05→12/07 08/05→12/07		→ 09/06		03.2023-2256.3 010870	ATE Ø1 23,81 Ø2 22,2
320 Ci 325 Ci	125 141	09/00→12/07 09/00→12/07		→ 08/01; - DSC		03.2022-2624.3 010588	Ø1 22,2 Ø2 20,64
				→ 09/06; + DSC		03.2023-2256.3 010870	ATE Ø1 23,81 Ø2 22,2
				09/01→ 09/06; - DSC		03.2023-2344.3 010647	ATE Ø1 23,81 Ø2 22,2
323 Ci 323 Ci	120 125	04/00→09/00 04/00→09/00		- DSC		03.2022-2624.3 010588	Ø1 22,2 Ø2 20,64
				+ DSC		03.2022-2829.3 010589	ATE Ø1 22,2 Ø2 20,64
330 Ci	170	06/00→12/07		→ 08/00; + DSC		03.2023-2204.3 010644	ATE Ø1 23,81 Ø2 22,2
				09/00→ 09/06; + DSC		03.2023-2256.3 010870	ATE Ø1 23,81 Ø2 22,2
				→ 08/01; - DSC		03.2023-2304.3 010646	ATE Ø1 23,81 Ø2 22,2
				09/01→ 09/06; - DSC		03.2023-2344.3 010647	ATE Ø1 23,81 Ø2 22,2
BMW - 3 Cabriolet (E93) 05/06→12/13							
 Bremskraftverstärker							
318 i	105	03/10→12/13		→ 11/13; für Fahrzeuge ohne Start-Stopp-Funktion		03.7848-4003.4 300235	ATE Ø 8" pneumatisch
320 d	120	01/08→12/13		→ 11/13; für Fahrzeuge ohne Start-Stopp-Funktion		03.7845-0103.4 300268	ATE Ø 8" pneumatisch
↓							











	kw			 	! #		
BMW - 3 Cabriolet (E93) 05/06→12/13							
 Bremskraftverstärker							
320 d	130	09/07→02/10		03/08→;		03.7845-0103.4 300268	ATE Ø 8" pneumatisch
320 d	145	09/07→02/10		für Fahrzeuge ohne Start-Stopp-Funktion			
320 d	135	03/10→10/13		für Fahrzeuge ohne Start-Stopp-Funktion		03.7845-0103.4 300268	ATE Ø 8" pneumatisch
320 d	147	03/10→10/13					
320 i	115	01/07→08/13		03/07→ 03/08; Motorcode: N43		03.7845-0103.4 300268	ATE Ø 8" pneumatisch
320 i	120	09/06→10/13		04/08→;		03.7848-4003.4 300235	ATE Ø 8" pneumatisch
320 i	125	09/06→10/13		für Fahrzeuge ohne Start-Stopp-Funktion			
				03/07→ 03/08; Motorcode: N46N		03.7848-5003.4 300236	ATE Ø 8" pneumatisch
323 i	140	03/07→09/11				03.7845-0103.4 300268	ATE Ø 8" pneumatisch
325 d	145	03/07→12/10		09/07→		03.7848-5003.4 300236	ATE Ø 8" pneumatisch
325 d	155	03/07→12/10					
325 d	150	09/09→09/13		03/10→		03.7848-5003.4 300236	ATE Ø 8" pneumatisch
325 i	150	03/10→09/13		Motorcode: N52N		03.7845-0103.4 300268	ATE Ø 8" pneumatisch
				Motorcode: N53		03.7848-5003.4 300236	ATE Ø 8" pneumatisch
325 i	160	03/07→12/13		Motorcode: N52N; → 11/13		03.7845-0103.4 300268	ATE Ø 8" pneumatisch
				Motorcode: N53; → 11/13		03.7848-5003.4 300236	ATE Ø 8" pneumatisch
				Motorcode: N53		03.7848-5003.4 300236	ATE Ø 8" pneumatisch
325 i	155	10/06→12/13		03/07→; Motorcode: N52N; → 11/13		03.7845-0103.4 300268	ATE Ø 8" pneumatisch
				03/07→; Motorcode: N53; → 11/13		03.7848-5003.4 300236	ATE Ø 8" pneumatisch
330 d	170	03/07→12/13		→ 08/09		03.7845-0103.4 300268	ATE Ø 8" pneumatisch
330 d	180	01/09→12/13		09/09→ 11/13		03.7848-5003.4 300236	ATE Ø 8" pneumatisch
330 i	190	03/07→12/13		→ 08/09; Motorcode: N53		03.7845-0103.4 300268	ATE Ø 8" pneumatisch
330 i	200	03/07→12/13		Motorcode: N52N; → 11/13		03.7848-5003.4 300236	ATE Ø 8" pneumatisch
				09/09→; Motorcode: N53; → 11/13		03.7848-5003.4 300236	ATE Ø 8" pneumatisch
335 i	225	05/06→10/13		03/07→		03.7845-0103.4 300268	ATE Ø 8" pneumatisch
335 i	240	05/06→10/13					
 Hauptbremszylinder							
318 i	105	03/10→12/13		→ 11/13		03.2023-2407.3 010796	ATE Ø1 23,81 Ø2 22,2
320 d	120	01/08→12/13		für Linkslenker; → 11/13		03.2025-1904.3 010797	ATE Ø1 25,4 Ø2 22,2
330 d	170	03/07→12/13					
330 d	180	01/09→12/13					
330 i	190	03/07→12/13					
330 i	200	03/07→12/13					
320 d	130	09/07→02/10		03/08→; für Linkslenker		03.2025-1904.3 010797	ATE Ø1 25,4 Ø2 22,2
320 d	135	03/10→10/13		für Linkslenker		03.2025-1904.3 010797	ATE Ø1 25,4 Ø2 22,2
320 d	145	09/07→02/10					
320 d	147	03/10→10/13					
325 i	150	03/10→09/13					
320 i	115	01/07→08/13		06/08→; für Linkslenker		03.2023-2407.3 010796	ATE Ø1 23,81 Ø2 22,2
320 i	120	09/06→10/13		03/07→; für Linkslenker; → 05/08		03.2025-1904.3 010797	ATE Ø1 25,4 Ø2 22,2
320 i	125	09/06→10/13					
325 d	145	03/07→12/10		09/07→; für Linkslenker		03.2025-1904.3 010797	ATE Ø1 25,4 Ø2 22,2
325 d	155	03/07→12/10					
325 d	150	09/09→09/13		03/10→; für Linkslenker		03.2025-1904.3 010797	ATE Ø1 25,4 Ø2 22,2
325 i	160	03/07→12/13		für Linkslenker		03.2025-1904.3 010797	ATE Ø1 25,4 Ø2 22,2
				für Linkslenker; → 11/13		03.2025-1904.3 010797	ATE Ø1 25,4 Ø2 22,2
325 i	155	10/06→12/13		03/07→; für Linkslenker; → 11/13		03.2025-1904.3 010797	ATE Ø1 25,4 Ø2 22,2
335 i	225	05/06→10/13		03/07→; für Linkslenker		03.2025-1904.3 010797	ATE Ø1 25,4 Ø2 22,2
335 i	240	05/06→10/13					
Hydraulikaggregat, Bremsanlage							
318 i	105	03/10→12/13		→ 11/13		24.9145-0003.2 399007	
320 d	120	01/08→12/13		09/08→ 11/13; für Fahrzeuge ohne Aktivlenkung		24.9145-0003.2 399007	
320 d	130	09/07→02/10		09/08→;		24.9145-0003.2 399007	
320 d	145	09/07→02/10		für Fahrzeuge ohne Aktivlenkung			
320 i	115	01/07→08/13					
320 i	120	09/06→10/13					
320 i	125	09/06→10/13					
320 d	135	03/10→10/13		für Fahrzeuge ohne Aktivlenkung		24.9145-0003.2 399007	
320 d	147	03/10→10/13					
BMW - 3 Compact (E36) 03/94→05/01							
 Bremskraftverstärker							
316 g	75	03/94→08/00				03.7760-3102.4 300139	ATE Ø 10" pneumatisch
316 i	77	12/98→08/00					
318 tds	66	03/94→05/01					
323 ti	120	01/99→08/00					
323 ti	125	08/97→08/00					
↓							











	kw					! #		
BMW - 3 Compact (E36) 03/94→05/01								
 Bremskraftverstärker								
316 i	75	03/94→08/00		09/96→; + ABS		03.7760-3102.4	300139	ATE Ø 10" pneumatisch
				→ 08/96; + ABS		10.6360-1903.4	300093	ATE Ø 10" pneumatisch
318 ti	103	11/94→08/95		- ASC		03.7760-3102.4	300139	ATE Ø 10" pneumatisch
				+ ASC		10.6360-1903.4	300093	ATE Ø 10" pneumatisch
318 ti	103	07/95→08/00		- ASC		03.7760-3102.4	300139	ATE Ø 10" pneumatisch
				09/96→; + ASC		03.7760-3102.4	300139	ATE Ø 10" pneumatisch
				→ 08/96; + ASC		10.6360-1903.4	300093	ATE Ø 10" pneumatisch
Pedalwegsensoren, Bremspedal								
316 i	75	03/94→08/00		→ 08/96; + ABS		03.0655-0002.2	370002	ATE
318 ti	103	11/94→08/95		+ ASC		03.0655-0002.2	370002	ATE
318 ti	103	07/95→08/00		→ 08/96; + ASC		03.0655-0002.2	370002	ATE
 Hauptbremszylinder								
316 g	75	03/94→08/00				03.2023-0987.3	010473	Ø1 23,81 Ø2 20,64
316 i	77	12/98→08/00						
318 tds	66	03/94→05/01						
318 ti	103	11/94→08/95						
318 ti	103	07/95→08/00						
323 ti	120	01/99→08/00						
323 ti	125	08/97→08/00						
316 i	75	03/94→08/00		09/94→; + ABS		03.2023-0987.3	010473	Ø1 23,81 Ø2 20,64
				→ 08/94; + ABS		10.6123-0239.3	010335	ATE Ø 23,81
				- ABS		24.2023-1601.3	010341	TRW Ø 23,81
BMW - 3 Compact (E46) 03/01→02/05								
 Bremskraftverstärker								
316 ti	85	06/02→02/05				03.7860-0702.4	300123	ATE Ø 10" pneumatisch
316 ti	85	06/01→02/05						
318 td	85	03/03→02/05						
320 td	110	09/01→02/05						
325 ti	141	06/01→02/05						
318 ti	100	03/01→12/04		09/01→		03.7860-0702.4	300123	ATE Ø 10" pneumatisch
318 ti	105	03/01→12/04						
 Hauptbremszylinder								
316 ti	85	06/02→02/05		+ DSC		03.2023-2256.3	010870	ATE Ø1 23,81 Ø2 22,2
320 td	110	09/01→02/05		- DSC		03.2023-2344.3	010647	ATE Ø1 23,81 Ø2 22,2
316 ti	85	06/01→02/05		→ 08/01; - DSC		03.2022-2624.3	010588	Ø1 22,2 Ø2 20,64
325 ti	141	06/01→02/05		09/01→; + DSC		03.2023-2256.3	010870	ATE Ø1 23,81 Ø2 22,2
				09/01→; - DSC		03.2023-2344.3	010647	ATE Ø1 23,81 Ø2 22,2
318 td	85	03/03→02/05		+ DSC		03.2023-2256.3	010870	ATE Ø1 23,81 Ø2 22,2
318 ti	100	03/01→12/04		09/01→; + DSC		03.2023-2256.3	010870	ATE Ø1 23,81 Ø2 22,2
318 ti	105	03/01→12/04		09/01→; - DSC		03.2023-2344.3	010647	ATE Ø1 23,81 Ø2 22,2
BMW - 3 Coupe (E36) 09/91→04/99								
 Bremskraftverstärker								
316 i	75	09/93→04/99		09/94→; - ASC		03.7760-3102.4	300139	ATE Ø 10" pneumatisch
320 i	110	03/92→04/99		09/96→; + ASC		03.7760-3102.4	300139	ATE Ø 10" pneumatisch
				→ 08/96; + ASC		10.6360-1903.4	300093	ATE Ø 10" pneumatisch
				→ 08/94; - ASC		10.6360-1903.4	300093	ATE Ø 10" pneumatisch
318 is	103	03/92→10/95		09/94→; - ASC		03.7760-3102.4	300139	ATE Ø 10" pneumatisch
				→ 08/94; - ASC		10.6360-1903.4	300093	ATE Ø 10" pneumatisch
				+ ASC		10.6360-1903.4	300093	ATE Ø 10" pneumatisch
318 is	103	09/95→04/99		09/96→; + ASC		03.7760-3102.4	300139	ATE Ø 10" pneumatisch
				→ 08/96; + ASC		10.6360-1903.4	300093	ATE Ø 10" pneumatisch
323 i	125	03/95→04/99		- ASC		03.7760-3102.4	300139	ATE Ø 10" pneumatisch
328 i	142	01/95→04/99		09/96→; + ASC		03.7760-3102.4	300139	ATE Ø 10" pneumatisch
				→ 08/96; + ASC		10.6360-1903.4	300093	ATE Ø 10" pneumatisch
325 i	141	09/91→04/99		09/94→; - ASC		03.7760-3102.4	300139	ATE Ø 10" pneumatisch
				06/96→; + ASC		03.7760-3102.4	300139	ATE Ø 10" pneumatisch
				→ 08/94; - ASC		10.6360-1903.4	300093	ATE Ø 10" pneumatisch
				→ 08/96; + ASC		10.6360-1903.4	300093	ATE Ø 10" pneumatisch
M3 3.0	210	10/92→01/95				10.6360-1903.4	300093	ATE Ø 10" pneumatisch
M3 3.0	217	01/95→10/95						
↓								









	kw			 	! #		
BMW - 3 Coupe (E36) 09/91→04/99							
 Hauptbremszylinder							
316 i	75	09/93→04/99		09/94→; - ASC		03.2023-0987.3 010473	Ø1 23,81 Ø2 20,64
320 i	110	03/92→04/99		09/96→; + ASC		03.2023-0987.3 010473	Ø1 23,81 Ø2 20,64
				→ 08/96; + ASC		10.6123-0239.3 010335	ATE Ø 23,81
				→ 08/94; - ASC		10.6123-0239.3 010335	ATE Ø 23,81
318 is	103	03/92→10/95		09/94→; - ASC		03.2023-0987.3 010473	Ø1 23,81 Ø2 20,64
				→ 08/94; - ASC		10.6123-0239.3 010335	ATE Ø 23,81
				+ ASC		10.6123-0239.3 010335	ATE Ø 23,81
318 is	103	09/95→04/99		09/96→; + ASC		03.2023-0987.3 010473	Ø1 23,81 Ø2 20,64
				→ 08/96; + ASC		10.6123-0239.3 010335	ATE Ø 23,81
323 i	125	03/95→04/99		- ASC		03.2023-0987.3 010473	Ø1 23,81 Ø2 20,64
328 i	142	01/95→04/99		09/96→; + ASC		03.2023-0987.3 010473	Ø1 23,81 Ø2 20,64
				→ 08/96; + ASC		10.6123-0239.3 010335	ATE Ø 23,81
325 i	141	09/91→04/99		09/94→; - ASC		03.2023-0987.3 010473	Ø1 23,81 Ø2 20,64
				06/96→; + ASC		03.2023-0987.3 010473	Ø1 23,81 Ø2 20,64
				→ 08/94; - ASC		10.6123-0239.3 010335	ATE Ø 23,81
				→ 08/96; + ASC		10.6123-0239.3 010335	ATE Ø 23,81
BMW - 3 Coupe (E46) 02/99→12/06							
 Bremskraftverstärker							
316 Ci	77	04/00→07/06				03.7860-0702.4 300123	ATE Ø 10" pneumatisch
316 Ci	85	06/02→07/06					
318 Ci	85	11/99→09/01					
318 Ci	87	11/99→09/01					
318 Ci	110	03/05→07/06					
320 Cd	110	11/03→07/06					
323 Ci	120	04/99→09/00					
323 Ci	125	04/99→09/00					
325 Ci	141	09/00→07/06					
328 Ci	142	04/99→06/00					
330 Cd	150	03/03→07/06					
330 Ci	170	06/00→07/06					
330 xi	170	06/00→07/06					
318 Ci	100	12/00→05/06		09/01→		03.7860-0702.4 300123	ATE Ø 10" pneumatisch
318 Ci	105	12/00→05/06					
320 Ci	110	02/99→08/01		08/99→ 09/00		03.7860-0702.4 300123	ATE Ø 10" pneumatisch
320 Ci	120	01/00→05/06		09/00→		03.7860-0702.4 300123	ATE Ø 10" pneumatisch
320 Ci	125	01/00→05/06					
 Hauptbremszylinder							
316 Ci	77	04/00→07/06		→ 08/01; - DSC		03.2022-2624.3 010588	Ø1 22,2 Ø2 20,64
				→ 08/00; + DSC		03.2022-2829.3 010589	ATE Ø1 22,2 Ø2 20,64
				02/01→; + DSC		03.2023-2256.3 010870	ATE Ø1 23,81 Ø2 22,2
				09/01→; - DSC		03.2023-2344.3 010647	ATE Ø1 23,81 Ø2 22,2
316 Ci	85	06/02→07/06		+ DSC		03.2023-2256.3 010870	ATE Ø1 23,81 Ø2 22,2
				- DSC		03.2023-2344.3 010647	ATE Ø1 23,81 Ø2 22,2
318 Ci	85	11/99→09/01		- DSC		03.2022-2624.3 010588	Ø1 22,2 Ø2 20,64
318 Ci	87	11/99→09/01		→ 08/00; + DSC		03.2022-2829.3 010589	ATE Ø1 22,2 Ø2 20,64
				02/01→; + DSC		03.2023-2256.3 010870	ATE Ø1 23,81 Ø2 22,2
318 Ci	100	12/00→05/06		09/01→; + DSC		03.2023-2256.3 010870	ATE Ø1 23,81 Ø2 22,2
318 Ci	105	12/00→05/06		09/01→; - DSC		03.2023-2344.3 010647	ATE Ø1 23,81 Ø2 22,2
318 Ci	110	03/05→07/06				03.2023-2256.3 010870	ATE Ø1 23,81 Ø2 22,2
320 Cd	110	11/03→07/06					
330 Cd	150	03/03→07/06					
320 Ci	110	02/99→08/01		08/99→ 09/00; - DSC		03.2022-2624.3 010588	Ø1 22,2 Ø2 20,64
				08/99→ 09/00; + DSC		03.2022-2829.3 010589	ATE Ø1 22,2 Ø2 20,64
320 Ci	120	01/00→05/06		09/00→ 08/01; - DSC		03.2022-2624.3 010588	Ø1 22,2 Ø2 20,64
320 Ci	125	01/00→05/06		09/00→; + DSC		03.2023-2256.3 010870	ATE Ø1 23,81 Ø2 22,2
				09/01→; - DSC		03.2023-2344.3 010647	ATE Ø1 23,81 Ø2 22,2
323 Ci	120	04/99→09/00		- DSC		03.2022-2624.3 010588	Ø1 22,2 Ø2 20,64
323 Ci	125	04/99→09/00		+ DSC		03.2022-2829.3 010589	ATE Ø1 22,2 Ø2 20,64
328 Ci	142	04/99→06/00					
325 Ci	141	09/00→07/06		→ 08/01; - DSC		03.2022-2624.3 010588	Ø1 22,2 Ø2 20,64
				+ DSC		03.2023-2256.3 010870	ATE Ø1 23,81 Ø2 22,2
				09/01→; - DSC		03.2023-2344.3 010647	ATE Ø1 23,81 Ø2 22,2
330 Ci	170	06/00→07/06		→ 08/00; + DSC		03.2023-2204.3 010644	ATE Ø1 23,81 Ø2 22,2
330 xi	170	06/00→07/06		09/00→; + DSC		03.2023-2256.3 010870	ATE Ø1 23,81 Ø2 22,2
↓							





	kw			 	! #		
BMW - 3 Coupe (E46) 02/99→12/06							
 Hauptbremszylinder							
330 Ci	170	06/00→07/06		→ 08/01; - DSC		03.2023-2304.3 010646	ATE Ø1 23,81 Ø2 22,2
330 xi	170	06/00→07/06		09/01→; - DSC		03.2023-2344.3 010647	ATE Ø1 23,81 Ø2 22,2
BMW - 3 Coupe (E92) 01/05→12/13							
 Bremskraftverstärker							
316 i	90	09/07→12/13		09/09→ 06/13; für Fahrzeuge ohne Start-Stopp-Funktion		03.7848-4003.4 300235	ATE Ø 8" pneumatisch
320 i	115	06/07→12/13		→ 08/09		03.7848-4003.4 300235	ATE Ø 8" pneumatisch
320 i	125	03/07→12/13					
318 i	105	03/10→12/13		→ 06/13; für Fahrzeuge ohne Start-Stopp-Funktion		03.7848-4003.4 300235	ATE Ø 8" pneumatisch
320 d	120	03/07→06/13		09/09→; für Fahrzeuge ohne Start-Stopp-Funktion		03.7845-0103.4 300268	ATE Ø 8" pneumatisch
				→ 08/09		03.7848-5003.4 300236	ATE Ø 8" pneumatisch
320 d	130	09/06→02/10		09/09→; für Fahrzeuge ohne Start-Stopp-Funktion		03.7845-0103.4 300268	ATE Ø 8" pneumatisch
320 d	145	09/06→02/10					
				03/07→ 08/09		03.7848-5003.4 300236	ATE Ø 8" pneumatisch
320 d	135	03/10→06/13		für Fahrzeuge ohne Start-Stopp-Funktion		03.7845-0103.4 300268	ATE Ø 8" pneumatisch
320 d	147	03/10→06/13					
320 d xDrive	120	03/10→06/13					
320 d xDrive	130	09/09→02/10					
320 d xDrive	135	03/10→06/13					
320 d xDrive	145	09/09→02/10					
320 d xDrive	147	03/10→06/13					
320 i	120	01/07→12/13		03/07→ 08/09		03.7848-4003.4 300235	ATE Ø 8" pneumatisch
				09/09→ 06/13; für Fahrzeuge ohne Start-Stopp-Funktion		03.7848-4003.4 300235	ATE Ø 8" pneumatisch
320 xd	120	03/08→02/10		09/09→; für Fahrzeuge ohne Start-Stopp-Funktion		03.7845-0103.4 300268	ATE Ø 8" pneumatisch
320 xd	130	03/08→02/10					
320 xd	145	03/08→02/10		→ 08/09		03.7845-0103.4 300268	ATE Ø 8" pneumatisch
323 i	140	04/06→02/12		09/07→		03.7845-0103.4 300268	ATE Ø 8" pneumatisch
				09/06→ 08/07		03.7848-5003.4 300236	ATE Ø 8" pneumatisch
325 d	145	02/07→02/10		03/07→		03.7848-5003.4 300236	ATE Ø 8" pneumatisch
325 d	155	02/07→02/10					
325 d	150	09/09→12/13		→ 06/13		03.7848-5003.4 300236	ATE Ø 8" pneumatisch
325 i xDrive	160	09/08→12/13					
325 i	155	03/10→06/13				03.7848-5003.4 300236	ATE Ø 8" pneumatisch
325 i	160	03/07→06/13					
325 i xDrive	155	03/10→04/13					
325 xi	160	09/06→02/10					
325 xi	160	09/07→02/10					
330 d xDrive	180	02/10→06/13					
330 i xDrive	200	03/10→06/13					
325 i	160	11/05→02/10		09/06→		03.7848-5003.4 300236	ATE Ø 8" pneumatisch
330 d	170	03/06→08/08		09/06→		03.7845-0103.4 300268	ATE Ø 8" pneumatisch
330 xd	170	03/06→08/08					
335 d	210	03/06→03/13					
335 i	225	11/05→06/13					
335 i	240	11/05→06/13					
330 d	180	01/09→12/13		→ 08/09		03.7845-0103.4 300268	ATE Ø 8" pneumatisch
				09/09→ 06/13		03.7848-5003.4 300236	ATE Ø 8" pneumatisch
330 i	190	09/06→02/10		→ 08/09		03.7845-0103.4 300268	ATE Ø 8" pneumatisch
330 i	200	09/06→08/12					
330 i	200	03/07→06/13		09/09→		03.7848-5003.4 300236	ATE Ø 8" pneumatisch
330 xd	180	03/08→02/10					
330 xi	200	09/06→08/07				03.7845-0103.4 300268	ATE Ø 8" pneumatisch
335 i xDrive	225	11/08→12/13					
335 i xDrive	240	11/08→06/13					
330 xi	200	03/07→02/10		→ 08/09		03.7845-0103.4 300268	ATE Ø 8" pneumatisch
						03.7848-5003.4 300236	ATE Ø 8" pneumatisch
335 xi	225	03/07→02/10		09/07→		03.7845-0103.4 300268	ATE Ø 8" pneumatisch
335 xi	240	03/07→02/10					
 Hauptbremszylinder							
316 i	90	09/07→12/13		für Linkslenker; → 06/13		03.2023-2407.3 010796	ATE Ø1 23,81 Ø2 22,2
318 i	105	03/10→12/13					
320 d	120	03/07→06/13		für Linkslenker		03.2025-1904.3 010797	ATE Ø1 25,4 Ø2 22,2
320 d	135	03/10→06/13					
320 d	147	03/10→06/13					
325 i	155	03/10→06/13					
325 i	160	03/07→06/13					
330 i	190	09/06→02/10					
330 i	200	09/06→08/12					
330 i	200	03/07→06/13					
↓							









	kw			 	! #		
BMW - 3 Coupe (E92) 01/05→12/13							
 Hauptbremszylinder							
320 d	130	09/06→02/10		03/07→; für Linkslenker		03.2025-1904.3 010797	ATE Ø1 25,4 Ø2 22,2
320 d	145	09/06→02/10					
325 d	145	02/07→02/10					
325 d	155	02/07→02/10					
320 d xDrive	120	03/10→06/13				03.2025-1904.3 010797	ATE Ø1 25,4 Ø2 22,2
320 d xDrive	130	09/09→02/10					
320 d xDrive	135	03/10→06/13					
320 d xDrive	145	09/09→02/10					
320 d xDrive	147	03/10→06/13					
320 xd	120	03/08→02/10					
320 xd	130	03/08→02/10					
320 xd	145	03/08→02/10					
325 i xDrive	155	03/10→04/13					
325 xi	160	09/06→02/10					
325 xi	160	09/07→02/10					
330 d xDrive	180	02/10→06/13					
330 i xDrive	200	03/10→06/13					
330 xd	180	03/08→02/10					
330 xi	200	09/06→08/07					
330 xi	200	03/07→02/10					
335 i xDrive	225	11/08→12/13					
335 i xDrive	240	11/08→06/13					
320 i	115	06/07→12/13		09/07→ 06/13; für Linkslenker		03.2023-2407.3 010796	ATE Ø1 23,81 Ø2 22,2
320 i	125	03/07→12/13		→ 08/07; für Linkslenker		03.2025-1904.3 010797	ATE Ø1 25,4 Ø2 22,2
320 i	120	01/07→12/13		09/07→ 06/13; für Linkslenker		03.2023-2407.3 010796	ATE Ø1 23,81 Ø2 22,2
				03/07→ 08/07; für Linkslenker		03.2025-1904.3 010797	ATE Ø1 25,4 Ø2 22,2
325 d	150	09/09→12/13		→ 06/13; für Linkslenker		03.2025-1904.3 010797	ATE Ø1 25,4 Ø2 22,2
330 d	180	01/09→12/13					
325 i	160	11/05→02/10		09/06→; für Linkslenker		03.2025-1904.3 010797	ATE Ø1 25,4 Ø2 22,2
330 d	170	03/06→08/08					
335 d	210	03/06→03/13					
335 i	225	11/05→06/13					
335 i	240	11/05→06/13					
325 i xDrive	160	09/08→12/13		→ 06/13		03.2025-1904.3 010797	ATE Ø1 25,4 Ø2 22,2
330 xd	170	03/06→08/08		09/06→		03.2025-1904.3 010797	ATE Ø1 25,4 Ø2 22,2
335 xi	225	03/07→02/10		09/07→		03.2025-1904.3 010797	ATE Ø1 25,4 Ø2 22,2
335 xi	240	03/07→02/10					
Hydraulikaggregat, Bremsanlage							
316 i	90	09/07→12/13		09/08→ 06/13		24.9145-0003.2 399007	
318 i	105	03/10→12/13		→ 06/13		24.9145-0003.2 399007	
320 d	120	03/07→06/13		09/08→;		24.9145-0003.2 399007	
320 d	130	09/06→02/10		für Fahrzeuge ohne Aktivlenkung			
320 d	145	09/06→02/10					
320 d	135	03/10→06/13		für Fahrzeuge ohne Aktivlenkung		24.9145-0003.2 399007	
320 d	147	03/10→06/13					
320 i	115	06/07→12/13		09/08→ 06/13;		24.9145-0003.2 399007	
320 i	120	01/07→12/13		für Fahrzeuge ohne Aktivlenkung			
320 i	125	03/07→12/13					
BMW - 3 Touring (E36) 08/94→12/99							
 Bremskraftverstärker							
316 i	75	01/96→10/99				03.7760-3102.4 300139	ATE Ø 10" pneumatisch
318 i	85	07/95→10/99					
318 tds	66	01/95→10/99					
325 tds	105	01/95→10/99					
320 i	110	01/95→10/99		- ASC		03.7760-3102.4 300139	ATE Ø 10" pneumatisch
323 i	125	09/95→10/99		09/96→; + ASC		03.7760-3102.4 300139	ATE Ø 10" pneumatisch
328 i	142	08/94→12/99		→ 08/96; + ASC		10.6360-1903.4 300093	ATE Ø 10" pneumatisch
Pedalwegsensoren, Bremspedal							
320 i	110	01/95→10/99		→ 08/96		03.0655-0002.2 370002	ATE
323 i	125	09/95→10/99					
328 i	142	08/94→12/99					
 Hauptbremszylinder							
316 i	75	01/96→10/99				03.2023-0987.3 010473	Ø1 23,81 Ø2 20,64
318 i	85	07/95→10/99					
318 tds	66	01/95→10/99					
325 tds	105	01/95→10/99					
320 i	110	01/95→10/99		10/96→; - ASC		03.2023-0987.3 010473	Ø1 23,81 Ø2 20,64
323 i	125	09/95→10/99		09/96→; + ASC		03.2023-0987.3 010473	Ø1 23,81 Ø2 20,64
328 i	142	08/94→12/99		→ 08/96; + ASC		10.6123-0239.3 010335	ATE Ø 23,81













	kw			 	! #		
BMW - 3 Touring (E46) 10/99→05/05							
 Bremskraftverstärker							
316 i	85	06/02→02/05				03.7860-0702.4 300123	ATE Ø 10" pneumatisch
316 i	85	03/02→02/05					
318 d	85	10/02→03/03					
318 d	85	03/03→02/05					
318 i	85	10/99→09/01					
318 i	87	10/99→09/01					
318 i	105	09/01→02/05					
320 d	100	03/00→09/01					
320 d	110	09/01→02/05					
320 i	110	10/99→09/00					
320 i	120	09/00→02/05					
320 i	125	09/00→02/05					
325 i	141	09/00→02/05					
325 xi	141	09/00→02/05					
328 i	142	10/99→06/00					
330 d	135	10/99→02/05					
330 d	150	03/03→02/05					
330 i	170	06/00→02/05					
330 xi	170	06/00→02/05					
330 xd	135	01/00→03/03	06/00→			03.7860-0702.4 300123	ATE Ø 10" pneumatisch
330 xd	150	08/02→05/05	03/03→ 02/05			03.7860-0702.4 300123	ATE Ø 10" pneumatisch
 Hauptbremszylinder							
316 i	85	06/02→02/05		+ DSC		03.2023-2256.3 010870	ATE Ø1 23,81 Ø2 22,2
316 i	85	03/02→02/05		- DSC		03.2023-2344.3 010647	ATE Ø1 23,81 Ø2 22,2
318 d	85	10/02→03/03					
318 d	85	03/03→02/05					
318 i	105	09/01→02/05					
320 d	110	09/01→02/05					
318 i	85	10/99→09/01		- DSC		03.2022-2624.3 010588	Ø1 22,2 Ø2 20,64
318 i	87	10/99→09/01					
320 d	100	03/00→09/01		→ 08/00; + DSC		03.2022-2829.3 010589	ATE Ø1 22,2 Ø2 20,64
320 i	110	10/99→09/00					
320 i	120	09/00→02/05		→ 08/01; - DSC		03.2022-2624.3 010588	Ø1 22,2 Ø2 20,64
320 i	125	09/00→02/05		+ DSC		03.2023-2256.3 010870	ATE Ø1 23,81 Ø2 22,2
				09/01→; - DSC		03.2023-2344.3 010647	ATE Ø1 23,81 Ø2 22,2
325 i	141	09/00→02/05		→ 08/01; - DSC		03.2022-2624.3 010588	Ø1 22,2 Ø2 20,64
				02/01→; + DSC		03.2023-2256.3 010870	ATE Ø1 23,81 Ø2 22,2
				09/01→; - DSC		03.2023-2344.3 010647	ATE Ø1 23,81 Ø2 22,2
328 i	142	10/99→06/00		- DSC		03.2022-2624.3 010588	Ø1 22,2 Ø2 20,64
				+ DSC		03.2022-2829.3 010589	ATE Ø1 22,2 Ø2 20,64
330 d	135	10/99→02/05		→ 08/00; + DSC		03.2023-2204.3 010644	ATE Ø1 23,81 Ø2 22,2
				09/00→; + DSC		03.2023-2256.3 010870	ATE Ø1 23,81 Ø2 22,2
				→ 08/01; - DSC		03.2023-2304.3 010646	ATE Ø1 23,81 Ø2 22,2
				09/01→; - DSC		03.2023-2344.3 010647	ATE Ø1 23,81 Ø2 22,2
330 d	150	03/03→02/05		+ DSC		03.2023-2256.3 010870	ATE Ø1 23,81 Ø2 22,2
330 i	170	06/00→02/05		→ 08/01; + DSC		03.2023-2204.3 010644	ATE Ø1 23,81 Ø2 22,2
				09/01→; + DSC		03.2023-2256.3 010870	ATE Ø1 23,81 Ø2 22,2
				→ 08/01; - DSC		03.2023-2304.3 010646	ATE Ø1 23,81 Ø2 22,2
				09/01→; - DSC		03.2023-2344.3 010647	ATE Ø1 23,81 Ø2 22,2
BMW - 3 Touring (E91) 12/04→12/12							
 Bremskraftverstärker							
316 d	85	09/09→06/12		→ 05/12; für Fahrzeuge ohne Start-Stopp-Funktion		03.7848-4003.4 300235	ATE Ø 8" pneumatisch
316 i	90	05/08→05/12		für Fahrzeuge ohne Start-Stopp-Funktion		03.7848-4003.4 300235	ATE Ø 8" pneumatisch
318 d	90	09/05→08/07				03.7848-5003.4 300236	ATE Ø 8" pneumatisch
325 xi	160	08/05→08/11					
325 xi	160	09/07→06/12					
330 i	190	08/05→08/07					
330 xi	190	09/05→08/07					
318 d	100	07/07→06/12	09/07→ 05/12			03.7845-0103.4 300268	ATE Ø 8" pneumatisch
318 d	105	09/07→06/12	→ 05/12			03.7845-0103.4 300268	ATE Ø 8" pneumatisch
320 d xDrive	120	07/09→06/12					
330 i	200	09/07→06/12					
335 d	210	09/06→06/12					
318 i	95	01/06→08/07		03/07→; Motorcode: N46N		03.7845-0103.4 300268	ATE Ø 8" pneumatisch
				Motorcode: N46		03.7848-5003.4 300236	ATE Ø 8" pneumatisch
318 i	100	09/07→03/12				03.7845-0103.4 300268	ATE Ø 8" pneumatisch
320 d	135	03/10→05/12					
320 d	147	03/10→05/12					
320 d xDrive	130	02/08→02/10					
↓							









	kw			 	! #		
BMW - 3 Touring (E91) 12/04→12/12							
 Bremskraftverstärker							
320 d xDrive	135	03/10→05/12				03.7845-0103.4 300268	ATE Ø 8" pneumatisch
320 d xDrive	145	02/08→02/10					
320 d xDrive	147	03/10→05/12					
323 i	140	09/06→07/08					
330 d xDrive	180	01/09→06/12					
335 i	225	09/06→06/12					
335 i	240	09/06→06/12					
335 i xDrive	225	09/08→06/12					
335 i xDrive	240	09/08→06/12					
335 xi	225	03/07→08/08					
335 xi	240	03/07→08/08					
318 i	105	05/07→05/12		09/07→		03.7845-0103.4 300268	ATE Ø 8" pneumatisch
320 d	130	02/07→12/10					
320 d	145	02/07→02/10					
320 i	120	02/07→05/12					
320 i	125	02/07→12/12					
320 d	110	12/04→08/07		06/05→		03.7848-5003.4 300236	ATE Ø 8" pneumatisch
320 d	120	12/04→06/12					
325 i	155	12/04→12/10					
325 i	160	12/04→12/12					
330 d	155	12/04→05/12					
330 d	170	12/04→08/08					
320 i	110	09/05→06/12		→ 08/07; Motorcode: N46N		03.7845-0103.4 300268	ATE Ø 8" pneumatisch
				→ 08/07; Motorcode: N46		03.7848-5003.4 300236	ATE Ø 8" pneumatisch
325 d	145	09/06→06/12		→ 05/12		03.7848-5003.4 300236	ATE Ø 8" pneumatisch
325 d	150	02/10→06/12					
325 i	160	09/07→06/12					
325 i xDrive	160	09/07→06/12					
330 i xDrive	200	09/07→06/12					
330 xd	170	09/05→06/12					
330 xi	200	09/07→06/12					
325 i	155	09/07→06/12		01/12→ 05/12		03.7848-5003.4 300236	ATE Ø 8" pneumatisch
330 d	180	02/08→05/12		09/08→		03.7845-0103.4 300268	ATE Ø 8" pneumatisch
 Hauptbremszylinder							
316 d	85	09/09→06/12		für Linkslenker; → 05/12		03.2023-2407.3 010796	ATE Ø1 23,81 Ø2 22,2
316 i	90	05/08→05/12				03.2023-2407.3 010796	ATE Ø1 23,81 Ø2 22,2
318 d	90	09/05→08/07		für Linkslenker		03.2025-1904.3 010797	ATE Ø1 25,4 Ø2 22,2
318 i	95	01/06→08/07					
320 d	135	03/10→05/12					
320 d	147	03/10→05/12					
330 d xDrive	180	01/09→06/12					
330 i	190	08/05→08/07					
335 i	225	09/06→06/12					
335 i	240	09/06→06/12					
318 d	100	07/07→06/12		09/07→ 05/12		03.2025-1904.3 010797	ATE Ø1 25,4 Ø2 22,2
318 d	105	09/07→06/12		→ 05/12		03.2025-1904.3 010797	ATE Ø1 25,4 Ø2 22,2
320 d xDrive	120	07/09→06/12					
325 d	145	09/06→06/12					
325 d	150	02/10→06/12					
325 i xDrive	160	09/07→06/12					
330 i xDrive	200	09/07→06/12					
330 xd	170	09/05→06/12					
330 xi	200	09/07→06/12					
318 i	100	09/07→03/12				03.2025-1904.3 010797	ATE Ø1 25,4 Ø2 22,2
320 d xDrive	130	02/08→02/10					
320 d xDrive	135	03/10→05/12					
320 d xDrive	145	02/08→02/10					
320 d xDrive	147	03/10→05/12					
325 xi	160	08/05→08/11					
325 xi	160	09/07→06/12					
330 xi	190	09/05→08/07					
335 i xDrive	225	09/08→06/12					
335 i xDrive	240	09/08→06/12					
335 xi	225	03/07→08/08					
335 xi	240	03/07→08/08					
318 i	105	05/07→05/12		09/07→		03.2025-1904.3 010797	ATE Ø1 25,4 Ø2 22,2
320 d	110	12/04→08/07		06/05→; für Linkslenker		03.2025-1904.3 010797	ATE Ø1 25,4 Ø2 22,2
320 d	120	12/04→06/12					
325 i	155	12/04→12/10					
325 i	160	12/04→12/12					
320 d	130	02/07→12/10		09/07→; für Linkslenker		03.2025-1904.3 010797	ATE Ø1 25,4 Ø2 22,2
320 d	145	02/07→02/10					
320 i	120	02/07→05/12					
320 i	125	02/07→12/12					
320 i	110	09/05→06/12		→ 08/07; für Linkslenker		03.2025-1904.3 010797	ATE Ø1 25,4 Ø2 22,2
325 i	155	09/07→06/12		01/12→; für Linkslenker; → 05/12		03.2025-1904.3 010797	ATE Ø1 25,4 Ø2 22,2
325 i	160	09/07→06/12		→ 05/12; für Linkslenker		03.2025-1904.3 010797	ATE Ø1 25,4 Ø2 22,2
↓							



























	kW			 	! #		
BMW - 3 Touring (E91) 12/04→12/12							
 Hauptbremszylinder							
330 i	200	09/07→06/12		→ 05/12; für Linkslenker		03.2025-1904.3 010797	ATE Ø1 25,4 Ø2 22,2
335 d	210	09/06→06/12					
330 d	155	12/04→05/12		06/05→		03.2025-1904.3 010797	ATE Ø1 25,4 Ø2 22,2
330 d	170	12/04→08/08					
330 d	180	02/08→05/12		09/08→; für Linkslenker		03.2025-1904.3 010797	ATE Ø1 25,4 Ø2 22,2
Hydraulikaggregat, Bremsanlage							
316 d	85	09/09→06/12		→ 05/12		24.9145-0003.2 399007	
316 i	90	05/08→05/12		09/08→		24.9145-0003.2 399007	
318 i	100	09/07→03/12					
318 i	105	05/07→05/12					
318 d	100	07/07→06/12		09/08→ 05/12		24.9145-0003.2 399007	
318 d	105	09/07→06/12					
320 d	130	02/07→12/10		09/08→;		24.9145-0003.2 399007	
320 d	145	02/07→02/10		für Fahrzeuge ohne Aktivlenkung			
320 i	120	02/07→05/12					
320 i	125	02/07→12/12					
320 d	135	03/10→05/12		für Fahrzeuge ohne Aktivlenkung		24.9145-0003.2 399007	
320 d	147	03/10→05/12					
BMW - 5 (E34) 12/87→12/95							
 Hauptbremszylinder							
518 i	83	08/89→09/95		09/91→		03.2025-1211.3 010475	ATE Ø1 25,4 Ø2 20,64
518 i	85	08/89→09/95					
520 i 24V	110	09/89→09/95		→ 08/91		03.2125-3011.3 010211	Ø 25,4
525 i 24V	141	09/89→12/95					
524 td	85	03/88→09/95		→ 08/91		03.2125-3011.3 010211	Ø 25,4
525 tds	105	09/91→09/95				03.2025-1211.3 010475	ATE Ø1 25,4 Ø2 20,64
530 i V8	160	09/92→09/95		→ 08/93; für Linkslenker		24.2125-1716.3 010663	Ø 25,4
540 i V8	210	09/92→09/95					
535 i	155	01/88→09/95				03.2125-3011.3 010211	Ø 25,4
M5	250	03/92→09/95					
BMW - 5 (E39) 09/95→07/03							
 Hauptbremszylinder							
520 d	100	02/00→06/03		04/00→		24.2025-1705.3 010624	TRW Ø1 25,4 Ø2 20,64
520 i	100	04/99→06/03		+ DSC		24.2025-1704.3 010619	Ø 25,4
520 i	120	09/00→06/03		- DSC		24.2025-1705.3 010624	TRW Ø1 25,4 Ø2 20,64
520 i	125	09/00→06/03					
530 d	142	09/98→06/03					
520 i	110	01/96→06/03		03/96→; + DSC		24.2025-1704.3 010619	Ø 25,4
				09/97→; - DSC		24.2025-1705.3 010624	TRW Ø1 25,4 Ø2 20,64
				03/96→ 08/97; - DSC		24.2120-1721.3 010553	Ø 20,64
523 i	125	11/95→09/00		12/95→; + DSC		24.2025-1704.3 010619	Ø 25,4
528 i	142	11/95→09/00		09/97→; - DSC		24.2025-1705.3 010624	TRW Ø1 25,4 Ø2 20,64
				12/95→ 08/97; - DSC		24.2120-1721.3 010553	Ø 20,64
525 d	120	02/00→06/03		04/00→; + DSC		24.2025-1704.3 010619	Ø 25,4
				04/00→; - DSC		24.2025-1705.3 010624	TRW Ø1 25,4 Ø2 20,64
525 i	141	09/00→06/03		10/00→; + DSC		24.2025-1704.3 010619	Ø 25,4
530 i	170	09/00→06/03		10/00→; - DSC		24.2025-1705.3 010624	TRW Ø1 25,4 Ø2 20,64
525 td	85	01/97→06/03		09/97→ 09/00		24.2025-1705.3 010624	TRW Ø1 25,4 Ø2 20,64
				→ 08/97		24.2120-1721.3 010553	Ø 20,64
525 tds	105	01/96→06/03		09/97→ 09/00		24.2025-1705.3 010624	TRW Ø1 25,4 Ø2 20,64
				02/96→ 08/97		24.2120-1721.3 010553	Ø 20,64
530 d	135	08/98→09/00		09/98→; + DSC		24.2025-1704.3 010619	Ø 25,4
				09/98→; - DSC		24.2025-1705.3 010624	TRW Ø1 25,4 Ø2 20,64
535 i	173	04/96→03/99		09/97→		24.2025-1704.3 010619	Ø 25,4
540 i	210	04/96→06/03		05/96→ 08/97		24.2120-1721.3 010553	Ø 20,64
535 i	180	04/99→06/03				24.2025-1704.3 010619	Ø 25,4
M5	294	10/98→06/03					
BMW - 5 (E60) 12/01→03/10							
 Hauptbremszylinder							
520 d	110	02/05→02/08		07/05→		24.2026-1702.3 010850	TRW Ø 26,99 Ø2 22,2
520 d	120	02/05→02/08					
523 i	130	10/04→02/07					
525 i	160	10/04→12/09					
530 i	190	09/04→02/07					
530 xd	170	02/05→02/07					
↓							











	kW			 	! #		
BMW - 5 (E60) 12/01→03/10							
 Hauptbremszylinder							
530 xi	190	09/04→02/07		07/05→		24.2026-1702.3 010850	TRW Ø 26,99 Ø2 22,2
520 d	130	04/06→12/09		09/07→		24.2026-1702.3 010850	TRW Ø 26,99 Ø2 22,2
520 i	125	07/03→03/10		→ 03/05		24.2025-1710.3 010833	TRW Ø 25,4
523 i	140	01/07→03/10		03/07→ 02/10		24.2026-1702.3 010850	TRW Ø 26,99 Ø2 22,2
525 d	145	01/07→03/10					
535 d	210	01/07→03/10					
525 d	120	12/04→03/10		→ 03/07		24.2026-1702.3 010850	TRW Ø 26,99 Ø2 22,2
525 d	130	06/04→03/10					
535 d	200	09/04→03/10					
525 d xDrive	145	09/07→12/09				24.2026-1702.3 010850	TRW Ø 26,99 Ø2 22,2
530 d	170	04/05→02/07					
530 d xDrive	173	09/07→12/09					
530 i xDrive	200	09/08→12/09					
530 xd	173	03/07→08/07					
530 xi	200	03/07→10/09					
525 i	141	09/03→03/10		→ 06/05		24.2025-1710.3 010833	TRW Ø 25,4
525 i	155	07/05→03/10		→ 02/10		24.2026-1702.3 010850	TRW Ø 26,99 Ø2 22,2
525 i	155	01/07→03/10					
525 i	160	01/07→03/10					
525 i xDrive	160	09/08→03/10					
525 xi	160	07/05→03/10					
525 xi	160	01/07→03/10					
540 i	225	07/05→03/10					
550 i	270	07/05→03/10					
M5	373	09/04→03/10					
525 xd	145	11/06→08/07		03/07→		24.2026-1702.3 010850	TRW Ø 26,99 Ø2 22,2
530 d	173	02/07→12/09					
530 xi	200	02/07→08/08					
530 d	155	09/02→12/09		07/03→ 08/05		24.2026-1702.3 010850	TRW Ø 26,99 Ø2 22,2
530 d	160	09/02→09/05					
530 i	170	12/01→02/05		07/03→		24.2025-1710.3 010833	TRW Ø 25,4
530 i	200	09/06→12/09		01/07→		24.2026-1702.3 010850	TRW Ø 26,99 Ø2 22,2
545 i	245	09/03→03/10		→ 08/05		24.2026-1702.3 010850	TRW Ø 26,99 Ø2 22,2
BMW - 5 (F10) 01/09→10/16							
 Hauptbremszylinder							
518 d	100	02/13→06/14				24.2026-1706.3 011040	TRW Ø 26,99 Ø2 22,2
518 d	105	02/13→06/14					
520 d	100	01/13→06/14					
520 d	135	03/10→06/14					
520 d	147	01/13→06/14					
520 d	151	07/14→10/16					
520 d xDrive	100	01/13→06/14					
520 d xDrive	120	10/13→10/16					
520 d xDrive	151	07/14→10/16					
520 i	125	07/13→10/16					
525 d	150	03/10→08/11					
530 d xDrive	190	03/11→10/16					
535 d	220	03/10→08/11					
535 d	230	01/11→10/16					
535 d xDrive	230	02/11→10/16					
535 i	240	07/13→10/16					
535 i xDrive	240	07/13→10/16					
518 d	110	10/13→10/16		07/14→		24.2026-1706.3 011040	TRW Ø 26,99 Ø2 22,2
518 d	120	10/13→10/16					
520 d	140	10/13→10/16					
520 d	155	10/13→10/16					
520 d xDrive	140	10/13→10/16					
520 d xDrive	155	10/13→10/16					
520 d	120	01/09→10/16		03/10→		24.2026-1706.3 011040	TRW Ø 26,99 Ø2 22,2
523 i	150	01/09→08/11					
523 i	150	06/09→08/11					
523 i	155	06/09→08/11					
523 i	160	06/09→08/11					
528 i	190	01/09→08/11					
530 d	180	01/09→08/11					
535 i	225	01/09→10/16					
550 i	300	01/09→06/13					
520 d xDrive	135	01/13→06/14		02/13→		24.2026-1706.3 011040	TRW Ø 26,99 Ø2 22,2
520 d xDrive	147	01/13→06/14					
520 i	120	10/10→10/16		09/11→		24.2026-1706.3 011040	TRW Ø 26,99 Ø2 22,2
520 i	135	10/10→10/16					
525 d	155	01/11→10/16					
525 d	160	01/11→10/16					
525 d xDrive	155	01/11→10/16					
525 d xDrive	160	01/11→10/16					
528 i	180	10/10→10/16					
528 i xDrive	180	10/10→10/16					
↓							













	kW			 	! #		
BMW - 5 (F10) 01/09→10/16							
 Hauptbremszylinder							
530 d	190	01/11→10/16		09/11→		24.2026-1706.3 011040	TRW Ø 26,99 Ø2 22,2
530 i	190	06/09→06/13					
530 i	200	05/11→06/13					
530 d	210	09/10→10/16		10/15→		24.2026-1706.3 011040	TRW Ø 26,99 Ø2 22,2
530 d xDrive	210	09/10→10/16					
535 i xDrive	225	03/10→10/16		03/11→		24.2026-1706.3 011040	TRW Ø 26,99 Ø2 22,2
550 i	330	08/12→10/16		05/13→		24.2026-1706.3 011040	TRW Ø 26,99 Ø2 22,2
550 i xDrive	330	01/13→10/16					
550 i xDrive	300	08/10→06/13		09/10→		24.2026-1706.3 011040	TRW Ø 26,99 Ø2 22,2
M5	412	10/10→10/16		09/11→		24.4126-1703.3 010991	TRW Ø 26,99
M 550 d xDrive	280	07/11→10/16		03/12→		24.2026-1706.3 011040	TRW Ø 26,99 Ø2 22,2
M5 Competition	423	02/13→10/16		01/14→		24.4126-1703.3 010991	TRW Ø 26,99
M5 Edition 30	441	07/14→10/16				24.4126-1703.3 010991	TRW Ø 26,99
BMW - 5 Gran Turismo (F07) 01/09→02/17							
 Hauptbremszylinder							
520 d	100	10/12→02/17				24.2026-1702.3 010850	TRW Ø 26,99 Ø2 22,2
520 d	120	04/11→02/17					
530 d	155	09/10→06/12					
530 d	190	07/12→02/17					
530 d xDrive	190	07/12→02/17					
535 d	220	03/10→06/12					
535 d	230	07/12→02/17					
535 d xDrive	230	07/12→02/17					
550 i	330	07/12→02/17					
550 i xDrive	330	07/12→06/13					
520 d	135	04/11→02/17		10/11→		24.2026-1702.3 010850	TRW Ø 26,99 Ø2 22,2
528 i	180	07/13→02/17		08/13→		24.2026-1702.3 010850	TRW Ø 26,99 Ø2 22,2
530 d	180	08/09→06/12		10/09→		24.2026-1702.3 010850	TRW Ø 26,99 Ø2 22,2
535 i	225	01/09→02/17					
550 i	300	08/09→06/12					
530 d xDrive	180	06/10→06/12		09/10→		24.2026-1702.3 010850	TRW Ø 26,99 Ø2 22,2
535 d xDrive	220	03/10→06/12					
535 i xDrive	225	01/10→02/17					
550 i xDrive	300	06/10→06/12					
BMW - 5 Touring (E34) 11/91→01/97							
 Hauptbremszylinder							
530 i V8	160	09/92→01/97		→ 08/93; für Linkslenker		24.2125-1716.3 010663	Ø 25,4
M5	250	09/94→01/97		→ 11/96		03.2125-3011.3 010211	Ø 25,4
BMW - 5 Touring (E39) 09/96→05/04							
 Hauptbremszylinder							
520 d	100	02/00→09/03		04/00→ 07/03		24.2025-1705.3 010624	TRW Ø1 25,4 Ø2 20,64
520 i	100	04/99→05/04		→ 07/03; + DSC		24.2025-1704.3 010619	Ø 25,4
520 i	120	09/00→05/04					
520 i	125	09/00→05/04		→ 07/03; - DSC		24.2025-1705.3 010624	TRW Ø1 25,4 Ø2 20,64
530 d	142	09/00→05/04					
520 i	110	01/97→09/00		05/97→; + DSC		24.2025-1704.3 010619	Ø 25,4
523 i	125	09/96→08/00		09/97→; - DSC		24.2025-1705.3 010624	TRW Ø1 25,4 Ø2 20,64
528 i	142	01/97→09/00		05/97→ 08/97; - DSC		24.2120-1721.3 010553	Ø 20,64
523 i	120	09/98→08/00		+ DSC		24.2025-1704.3 010619	Ø 25,4
				- DSC		24.2025-1705.3 010624	TRW Ø1 25,4 Ø2 20,64
525 d	120	02/00→05/04		04/00→ 07/03; + DSC		24.2025-1704.3 010619	Ø 25,4
				04/00→ 07/03; - DSC		24.2025-1705.3 010624	TRW Ø1 25,4 Ø2 20,64
525 i	141	09/00→05/04		10/00→ 07/03; + DSC		24.2025-1704.3 010619	Ø 25,4
530 i	170	09/00→05/04		10/00→ 07/03; - DSC		24.2025-1705.3 010624	TRW Ø1 25,4 Ø2 20,64
525 tds	105	03/97→05/04		06/98→ 09/00		24.2025-1705.3 010624	TRW Ø1 25,4 Ø2 20,64
530 d	135	08/98→09/00		09/98→; + DSC		24.2025-1704.3 010619	Ø 25,4
				09/98→; - DSC		24.2025-1705.3 010624	TRW Ø1 25,4 Ø2 20,64
540 i	210	01/97→05/04		09/97→ 07/03		24.2025-1704.3 010619	Ø 25,4
				05/97→ 08/97		24.2120-1721.3 010553	Ø 20,64
BMW - 5 Touring (E61) 03/04→12/10							
 Hauptbremszylinder							
520 d	110	04/05→02/08		09/05→		24.2026-1702.3 010850	TRW Ø 26,99 Ø2 22,2
520 d	120	04/05→02/08		07/05→		24.2026-1702.3 010850	TRW Ø 26,99 Ø2 22,2
530 d	170	02/05→02/07					
↓							















	kw			 	! #		
BMW - 5 Touring (E61) 03/04→12/10							
 Hauptbremszylinder							
530 xd	170	02/05→02/07		07/05→		24.2026-1702.3 010850	TRW Ø 26,99 Ø2 22,2
530 xi	190	04/05→02/07					
520 d	130	03/07→05/10		09/07→		24.2026-1702.3 010850	TRW Ø 26,99 Ø2 22,2
520 i	120	07/07→08/10		→ 05/10		24.2026-1702.3 010850	TRW Ø 26,99 Ø2 22,2
520 i	125	09/07→12/10					
525 i xDrive	160	09/08→12/10					
525 xi	160	07/05→12/10					
525 xi	160	01/07→12/10					
550 i	270	07/05→12/10					
M5	373	02/07→12/10					
523 i	130	10/04→02/07		07/05→		24.2025-1710.3 010833	TRW Ø 25,4
530 i	190	09/04→02/07					
523 i	140	01/07→12/10		03/07→ 05/10		24.2026-1702.3 010850	TRW Ø 26,99 Ø2 22,2
530 i	200	01/07→12/10					
535 d	210	01/07→12/10					
523 i	140	03/07→01/10				24.2026-1702.3 010850	TRW Ø 26,99 Ø2 22,2
525 d	145	03/07→05/10					
525 d xDrive	145	09/08→05/10					
525 xd	145	09/07→09/08					
530 d xDrive	173	09/07→05/10					
530 i xDrive	200	09/08→05/10					
530 xi	200	09/06→09/08					
530 xi	200	03/07→05/10					
525 d	120	03/04→03/07		12/04→		24.2026-1702.3 010850	TRW Ø 26,99 Ø2 22,2
525 d	130	03/04→03/07		05/04→		24.2026-1702.3 010850	TRW Ø 26,99 Ø2 22,2
530 d	155	03/04→05/10					
530 d	160	03/04→09/05					
525 i	141	06/04→12/10		→ 03/05		24.2025-1710.3 010833	TRW Ø 25,4
525 i	155	07/05→12/10		→ 03/07		24.2025-1710.3 010833	TRW Ø 25,4
				03/07→		24.2026-1702.3 010850	TRW Ø 26,99 Ø2 22,2
525 i	160	10/04→03/10		07/05→ 03/07		24.2025-1710.3 010833	TRW Ø 25,4
				03/07→		24.2026-1702.3 010850	TRW Ø 26,99 Ø2 22,2
525 i	155	01/07→12/10		→ 03/07		24.2025-1710.3 010833	TRW Ø 25,4
525 i	160	01/07→12/10		03/07→ 05/10		24.2026-1702.3 010850	TRW Ø 26,99 Ø2 22,2
530 d	173	02/07→05/10		03/07→		24.2026-1702.3 010850	TRW Ø 26,99 Ø2 22,2
530 i	200	09/06→03/10					
530 xd	173	01/07→08/07					
535 d	200	09/04→12/10		→ 03/07		24.2026-1702.3 010850	TRW Ø 26,99 Ø2 22,2
545 i	245	06/04→12/10		→ 08/05		24.2026-1702.3 010850	TRW Ø 26,99 Ø2 22,2
BMW - 5 Touring (F11) 11/09→							
 Hauptbremszylinder							
518 d	100	10/12→		01/13→		24.2026-1706.3 011040	TRW Ø 26,99 Ø2 22,2
518 d	105	10/12→07/14					
518 d	110	01/14→		05/14→		24.2026-1706.3 011040	TRW Ø 26,99 Ø2 22,2
520 d	140	10/13→					
520 d	155	10/13→					
520 d xDrive	140	10/13→					
520 d xDrive	155	10/13→					
518 d	120	05/14→				24.2026-1706.3 011040	TRW Ø 26,99 Ø2 22,2
520 d	151	07/14→10/16					
520 d xDrive	100	07/13→07/14					
520 d xDrive	120	10/13→06/13					
520 d xDrive	135	02/13→07/14					
520 d xDrive	147	02/13→07/14					
520 d xDrive	151	07/14→10/16					
520 i	120	09/11→02/17					
520 d	100	11/09→10/16		09/10→		24.2026-1706.3 011040	TRW Ø 26,99 Ø2 22,2
520 d	120	11/09→06/13					
520 d	135	11/09→10/16					
520 d	147	11/09→10/16					
523 i	150	11/09→08/11					
525 d	150	11/09→08/11					
528 i	190	11/09→08/11					
530 d	180	11/09→08/11					
535 d	220	03/10→08/11					
535 i	225	11/09→					
520 i	135	10/10→		09/11→		24.2026-1706.3 011040	TRW Ø 26,99 Ø2 22,2
525 d	155	03/11→					
525 d	160	03/11→					
525 d xDrive	155	02/11→					
525 d xDrive	160	02/11→					
528 i	180	10/10→					
528 i xDrive	180	03/11→					
530 d	190	02/11→					
530 i	190	03/10→05/13					
530 i	200	07/11→06/13					
↓							















	kW			 	! #		
BMW - 5 Touring (F11) 11/09→							
 Hauptbremszylinder							
535 d	230	03/11→		09/11→		24.2026-1706.3 011040	TRW Ø 26,99 Ø2 22,2
535 d xDrive	230	01/11→					
535 i xDrive	225	07/10→					
550 i	300	09/10→06/13					
530 d	210	09/11→		10/15→		24.2026-1706.3 011040	TRW Ø 26,99 Ø2 22,2
530 d xDrive	210	09/11→					
535 i	240	01/13→					
535 i xDrive	240	07/13→					
530 d xDrive	190	07/10→		03/11→		24.2026-1706.3 011040	TRW Ø 26,99 Ø2 22,2
550 i	330	08/12→		05/13→		24.2026-1706.3 011040	TRW Ø 26,99 Ø2 22,2
M 550 d xDrive	280	10/10→		03/12→		24.2026-1706.3 011040	TRW Ø 26,99 Ø2 22,2
BMW - 6 (E63) 01/04→12/10							
 Hauptbremszylinder							
630 i	190	02/04→07/07		07/04→		24.2026-1702.3 010850	TRW Ø 26,99 Ø2 22,2
630 i	200	07/07→07/10		09/07→		24.2026-1702.3 010850	TRW Ø 26,99 Ø2 22,2
635 d	210	07/07→07/10					
645 Ci	245	01/04→08/05				24.2026-1702.3 010850	TRW Ø 26,99 Ø2 22,2
650 i	270	07/05→07/10					
M	373	09/05→07/10					
BMW - 6 Cabriolet (E64) 03/04→12/10							
 Hauptbremszylinder							
630 i	190	03/04→07/07		07/04→		24.2026-1702.3 010850	TRW Ø 26,99 Ø2 22,2
630 i	200	07/07→07/10		09/07→		24.2026-1702.3 010850	TRW Ø 26,99 Ø2 22,2
635 d	210	07/07→07/10					
645 Ci	245	04/04→08/05				24.2026-1702.3 010850	TRW Ø 26,99 Ø2 22,2
650 i	270	07/05→07/10					
M	373	07/06→07/10					
BMW - 6 Cabriolet (F12) 03/11→							
 Hauptbremszylinder							
640 d	230	09/11→				24.2026-1706.3 011040	TRW Ø 26,99 Ø2 22,2
640 i	235	03/11→					
640 i xDrive	235	01/13→					
650 i	300	03/11→					
650 i	330	10/11→					
650 i xDrive	300	06/11→					
640 d xDrive	230	09/11→		03/12→		24.2026-1706.3 011040	TRW Ø 26,99 Ø2 22,2
650 i xDrive	330	11/11→		09/12→		24.2026-1706.3 011040	TRW Ø 26,99 Ø2 22,2
M6	412	01/12→		06/12→		24.4126-1703.3 010991	TRW Ø 26,99
M6	423	02/14→				24.4126-1703.3 010991	TRW Ø 26,99
M6	441	07/15→					
BMW - 6 Coupe (F13) 11/10→							
 Hauptbremszylinder							
640 d	230	11/10→		06/11→		24.2026-1706.3 011040	TRW Ø 26,99 Ø2 22,2
640 i	235	11/10→					
650 i	300	11/10→					
640 d xDrive	230	09/11→		03/12→		24.2026-1706.3 011040	TRW Ø 26,99 Ø2 22,2
640 i xDrive	235	01/13→					
650 i xDrive	300	06/11→				24.2026-1706.3 011040	TRW Ø 26,99 Ø2 22,2
650 i	330	10/11→		09/12→		24.2026-1706.3 011040	TRW Ø 26,99 Ø2 22,2
650 i xDrive	330	11/11→					
M6	412	01/12→		06/12→		24.4126-1703.3 010991	TRW Ø 26,99
M6	423	02/14→				24.4126-1703.3 010991	TRW Ø 26,99
M6	441	07/15→					
BMW - 6 Gran Coupe (F06) 09/11→							
 Hauptbremszylinder							
640 d	230	09/11→				24.2026-1706.3 011040	TRW Ø 26,99 Ø2 22,2
640 d xDrive	230	01/13→					
640 i xDrive	235	01/13→					
650 i	330	11/11→					
650 i xDrive	330	11/11→					
640 i	235	09/11→		03/12→		24.2026-1706.3 011040	TRW Ø 26,99 Ø2 22,2
M6	412	12/12→				24.4126-1703.3 010991	TRW Ø 26,99
M6	423	02/14→					
M6	441	07/15→					















	kw			 	! #		
BMW - 7 (E38) 09/94→11/01							
 Hauptbremszylinder							
725 tds	105	04/96→11/01		09/98→		24.2025-1704.3 010619	Ø 25,4
				09/97→ 08/98		24.2025-1705.3 010624	TRW Ø1 25,4 Ø2 20,64
				05/96→ 08/97		24.2120-1721.3 010553	Ø 20,64
728 i, iL	142	08/95→11/01		09/98→		24.2025-1704.3 010619	Ø 25,4
				09/97→ 08/98		24.2025-1705.3 010624	TRW Ø1 25,4 Ø2 20,64
				01/96→ 08/97		24.2120-1721.3 010553	Ø 20,64
				→ 08/97		24.2120-1721.3 010553	Ø 20,64
730 d	135	08/98→04/00		09/98→; + DSC		24.2025-1704.3 010619	Ø 25,4
				09/98→; - DSC		24.2025-1705.3 010624	TRW Ø1 25,4 Ø2 20,64
730 d	142	04/00→11/01		+ DSC		24.2025-1704.3 010619	Ø 25,4
740 d	180	05/99→11/01		- DSC		24.2025-1705.3 010624	TRW Ø1 25,4 Ø2 20,64
730 i, iL	155	10/94→11/01		09/98→		24.2025-1704.3 010619	Ø 25,4
730 i, iL	160	10/94→11/01		09/97→ 08/98		24.2025-1705.3 010624	TRW Ø1 25,4 Ø2 20,64
735 i, iL	173	01/96→12/98					
740 i, iL	210	10/94→11/01		→ 08/97		24.2120-1721.3 010553	Ø 20,64
740 i, iL	210	01/96→11/01					
750 i, iL	240	09/94→11/01					
735 i, iL	175	09/98→07/01				24.2025-1704.3 010619	Ø 25,4
BMW - 7 (E65, E66, E67) 11/01→12/09							
 Hauptbremszylinder							
730 d	150	10/02→07/08				24.2026-1701.3 010746	Ø 26,99 Ø2 20,64
730 d	155	10/02→07/08					
730 Ld	170	07/05→08/08					
735 i, Li	200	11/01→02/05					
740 d	190	10/02→02/05					
740 i, Li	225	07/05→07/08					
745 d	220	03/05→08/05					
745 d	242	07/05→07/08					
745 i, Li	245	11/01→07/08					
750 i, Li	270	07/05→07/08					
730 d	160	06/02→02/05		09/02→		24.2026-1701.3 010746	Ø 26,99 Ø2 20,64
730 i, Li	170	03/03→07/08				24.2026-1701.3 010746	Ø 26,99 Ø2 20,64
						24.2026-1705.3 010992	TRW Ø 26,99 Ø2 20,64
730 i, Li	190	03/05→07/08		07/05→		24.2026-1701.3 010746	Ø 26,99 Ø2 20,64
760 i, Li	327	01/03→07/08		03/03→		24.2026-1701.3 010746	Ø 26,99 Ø2 20,64
BMW - 7 (F01, F02, F03, F04) 02/08→12/15							
 Hauptbremszylinder							
730 d	155	02/08→05/15		09/08→		24.2026-1702.3 010850	TRW Ø 26,99 Ø2 22,2
730 d	180	02/08→07/12					
730 i, Li	190	06/08→12/15					
730 d	190	07/12→05/15				24.2026-1702.3 010850	TRW Ø 26,99 Ø2 22,2
740 d	225	09/09→12/15					
740 d	230	07/12→12/15					
740 d xDrive	230	07/12→12/15					
740 i	240	10/08→12/15					
740 i, Li	235	07/12→12/15					
740 i, Li xDrive	235	07/12→12/15					
750 d xDrive	280	07/12→12/15					
750 i	300	10/08→12/15					
750 i	330	10/12→12/15					
750 i xDrive	300	09/09→12/15					
750 i xDrive	330	10/12→12/15					
760 i	400	09/09→12/15					
730 d xDrive	155	11/11→05/15		06/12→		24.2026-1702.3 010850	TRW Ø 26,99 Ø2 22,2
730 d xDrive	190	11/11→05/15					
740 d xDrive	225	09/09→12/15		09/10→		24.2026-1702.3 010850	TRW Ø 26,99 Ø2 22,2
BMW - X1 (E84) 03/09→06/15							
 Bremskraftverstärker							
sDrive 16 d	85	04/12→06/15		07/12→; für Fahrzeuge ohne Start-Stopp-Funktion		03.7845-0103.4 300268	ATE Ø 8" pneumatisch
sDrive 16 i	105	03/13→06/15		Automatikgetriebe		03.7845-0103.4 300268	ATE Ø 8" pneumatisch
sDrive 18 d	100	03/09→06/15		10/09→;		03.7845-0103.4 300268	ATE Ø 8" pneumatisch
xDrive 18 d	100	03/09→06/15		für Fahrzeuge ohne Start-Stopp-Funktion			
sDrive 18 d	105	10/09→06/15		für Fahrzeuge ohne Start-Stopp-Funktion		03.7845-0103.4 300268	ATE Ø 8" pneumatisch
sDrive 20 d	120	03/10→06/15					
sDrive 20 d	130	10/09→06/15					
sDrive 20 d	135	07/12→06/15					
sDrive 20 i	135	09/11→06/15					
xDrive 18 d	105	10/09→06/15					
↓							









	kW			 	! #		
BMW - X1 (E84) 03/09→06/15							
 Bremskraftverstärker							
xDrive 20 d	120	03/10→06/15		für Fahrzeuge ohne Start-Stopp-Funktion		03.7845-0103.4 300268	ATE Ø 8" pneumatisch
xDrive 20 d	130	10/09→06/15					
xDrive 20 d	135	07/12→06/15					
xDrive 20 i	135	09/11→06/15					
xDrive 28 i	180	04/11→06/15					
xDrive 28 i	190	10/09→06/15					
sDrive 18 i	100	03/09→06/15		03/10→;		03.7845-0103.4 300268	ATE Ø 8" pneumatisch
sDrive 18 i	110	01/10→06/15		für Fahrzeuge ohne Start-Stopp-Funktion			
xDrive 25 i	160	01/10→06/15					
xDrive 23 d	150	10/09→06/15		für Fahrzeuge ohne Start-Stopp-Funktion		03.7848-5003.4 300236	ATE Ø 8" pneumatisch
xDrive 25 d	160	10/09→06/15		07/12→; Automatikgetriebe		03.7845-0103.4 300268	ATE Ø 8" pneumatisch
 Hauptbremszylinder							
sDrive 16 d	85	04/12→06/15		07/12→; für Linkslenker		03.2025-1904.3 010797	ATE Ø1 25,4 Ø2 22,2
xDrive 25 d	160	10/09→06/15					
sDrive 16 i	105	03/13→06/15				03.2025-1904.3 010797	ATE Ø1 25,4 Ø2 22,2
sDrive 18 d	100	03/09→06/15		10/09→; für Linkslenker		03.2025-1904.3 010797	ATE Ø1 25,4 Ø2 22,2
xDrive 18 d	100	03/09→06/15					
sDrive 18 d	105	10/09→06/15		für Linkslenker		03.2025-1904.3 010797	ATE Ø1 25,4 Ø2 22,2
sDrive 20 d	120	03/10→06/15					
sDrive 20 d	130	10/09→06/15					
sDrive 20 d	135	07/12→06/15					
sDrive 20 i	135	09/11→06/15					
xDrive 18 d	105	10/09→06/15					
xDrive 20 d	120	03/10→06/15					
xDrive 20 d	130	10/09→06/15					
xDrive 20 d	135	07/12→06/15					
xDrive 20 i	135	09/11→06/15					
xDrive 23 d	150	10/09→06/15					
xDrive 28 i	180	04/11→06/15					
xDrive 28 i	190	10/09→06/15					
sDrive 18 i	100	03/09→06/15		03/10→; für Linkslenker		03.2025-1904.3 010797	ATE Ø1 25,4 Ø2 22,2
sDrive 18 i	110	01/10→06/15					
xDrive 25 i	160	01/10→06/15					
BMW - X3 (E83) 01/03→12/11							
 Hauptbremszylinder							
2.0 d	110	11/03→08/07		08/04→		24.2025-1710.3 010833	TRW Ø 25,4
2.0 d	130	03/07→03/09				24.2025-1710.3 010833	TRW Ø 25,4
2.0 i	110	07/05→08/08					
2.5 si	160	09/06→08/08					
2.5 si xDrive	155	07/06→12/08					
3.0 d	150	01/04→08/05					
3.0 d	155	09/05→08/08					
3.0 d	160	09/05→08/08					
3.0 i xDrive	170	01/04→08/06					
3.0 sd	210	09/06→08/08					
3.0 si	200	09/06→08/08					
xDrive 25 i	160	09/08→12/11					
xDrive 30 d	155	09/08→08/10					
xDrive 30 d	160	09/08→08/10					
2.5 i	141	01/04→08/06		03/04→		24.2025-1710.3 010833	TRW Ø 25,4
xDrive 18 d	100	04/09→12/11		→ 08/10		24.2025-1710.3 010833	TRW Ø 25,4
xDrive 18 d	105	09/08→12/11					
xDrive 20 i	110	09/08→08/11					
xDrive 30 i	200	09/08→12/11					
xDrive 35 d	210	09/08→08/11					
xDrive 20 d	120	09/07→08/10		09/08→		24.2025-1710.3 010833	TRW Ø 25,4
xDrive 20 d	130	09/07→08/10					
BMW - X5 (E53) 05/00→02/07							
 Hauptbremszylinder							
3.0 d	135	05/01→12/03		→ 08/01		24.2025-1704.3 010619	Ø 25,4
				09/01→ 09/03		24.2025-1707.3 010691	Ø 25,4
3.0 d	155	09/03→12/06		10/03→		24.2025-1707.3 010691	Ø 25,4
3.0 d	160	12/03→12/06				24.2025-1707.3 010691	Ø 25,4
4.4 i	235	12/03→09/06					
4.8 is	265	04/04→09/06					
3.0 i	170	05/00→12/06		→ 08/01		24.2025-1704.3 010619	Ø 25,4
4.4 i	210	05/00→12/03		09/01→		24.2025-1707.3 010691	Ø 25,4
4.6 is	255	02/02→12/03		→ 09/03		24.2025-1707.3 010691	Ø 25,4













	kW			 	! #				
BMW - X5 (E70) 02/06→07/13									
 Hauptbremszylinder									
3.0 d	155	02/07→09/08				24.2026-1703.3 010910	TRW Ø 26,99 Ø2 22,2		
3.0 d	173	02/07→09/08							
4.8 i xDrive	261	02/07→09/08							
M	408	09/09→06/13							
xDrive 30 d	155	10/08→07/13							
xDrive 30 d	173	10/08→03/10							
xDrive 30 i	200	09/08→03/10							
xDrive 35 d	210	09/08→06/13							
xDrive 35 i	225	09/10→06/13							
xDrive 35 i	235	02/12→06/13							
xDrive 40 d	225	09/10→06/13							
xDrive 48 i	261	09/08→06/13							
3.0 sd	210	10/07→03/10		→ 09/08					
3.0 si	200	02/06→09/08		01/07→					
M 50 d	280	08/11→06/13		06/12→					
xDrive 30 d	180	04/10→07/13		09/10→					
xDrive 50 i	300	07/09→06/13		03/10→					
BMW - X5 (F15, F85) 06/12→10/18									
 Hauptbremszylinder									
M	423	12/14→				24.2026-1703.3 010910	TRW Ø 26,99 Ø2 22,2		
sDrive 25 d	155	11/13→							
sDrive 25 d	160	11/13→							
sDrive 25 d	170	07/15→							
xDrive 25 d	155	11/13→							
xDrive 25 d	160	11/13→							
xDrive 25 d	170	07/15→							
xDrive 30 d	183	04/15→							
xDrive 30 d	204	11/13→							
xDrive 35 i	225	11/13→							
xDrive 35 i	240	11/13→							
xDrive 40 d	230	12/13→							
M 50 d	280	07/13→		08/13→					
xDrive 30 d	190	07/13→							
xDrive 30 d	210	07/13→							
xDrive 50 i	330	07/13→							
BMW - X6 (E71, E72) 06/07→06/14									
 Hauptbremszylinder									
M	408	07/08→06/14		09/09→		24.2026-1703.3 010910	TRW Ø 26,99 Ø2 22,2		
M 50 d	280	08/11→06/14		06/12→					
xDrive 30 d	155	07/09→06/14							
xDrive 35 i	235	07/09→06/14							
xDrive 30 d	173	09/07→06/14		09/08→					
xDrive 35 d	210	06/07→03/10							
xDrive 35 i	225	06/07→06/14							
xDrive 35 i	240	06/07→03/10							
xDrive 50 i	300	10/07→06/14							
xDrive 50 i	330	10/07→06/14							
xDrive 30 d	180	04/09→06/14		09/10→					
xDrive 40 d	225	07/09→06/14		10/10→					
BMW - X6 (F16, F86) 08/14→									
 Hauptbremszylinder									
M	423	12/14→				24.2026-1703.3 010910	TRW Ø 26,99 Ø2 22,2		
M 50 d	280	08/14→							
xDrive 30 d	155	08/14→							
xDrive 30 d	183	12/15→							
xDrive 30 d	190	08/14→							
xDrive 30 d	204	02/15→							
xDrive 35 i	225	12/14→							
xDrive 35 i	240	02/15→							
xDrive 40 d	230	12/14→							
xDrive 50 i	330	08/14→							
BMW - Z3 Coupe (E36) 04/97→06/03									
 Bremskraftverstärker									
2.8 i	142	07/97→06/00				03.7760-3102.4 300139	ATE Ø 10" pneumatisch		
3.0 i	170	06/00→06/03		→ 12/02					
 Hauptbremszylinder									
2.8 i	142	07/97→06/00		- DSC		03.2023-0987.3 010473	Ø1 23,81 Ø2 20,64		
				+ DSC					
						03.2023-1904.3 010724	ATE Ø1 23,81 Ø2 20,64		
↓									











	kw					! #		
BMW - Z3 Coupe (E36) 04/97→06/03								
 Hauptbremszylinder								
3.0 i	170	06/00→06/03		→ 12/02; - DSC		03.2023-0987.3	010473	Ø1 23,81 Ø2 20,64
				→ 08/00; + DSC		03.2023-1904.3	010724	ATE Ø1 23,81 Ø2 20,64
				09/00→ 12/02; + DSC		03.2023-1949.3	010725	ATE Ø1 23,81 Ø2 20,64
BMW - Z3 Roadster (E36) 10/95→01/03								
 Bremskraftverstärker								
1.8 i	85	10/95→10/98				03.7760-3102.4	300139	ATE Ø 10" pneumatisch
1.9 i	103	10/95→03/99						
1.9 i	85	01/99→01/03		→ 12/02		03.7760-3102.4	300139	ATE Ø 10" pneumatisch
1.9 i	87	07/98→01/03						
3.0 i	170	06/00→01/03						
2.0 i	110	04/99→01/03		→ 08/00		03.7760-3102.4	300139	ATE Ø 10" pneumatisch
2.2 i	120	08/00→01/03		10/00→ 12/02		03.7760-3102.4	300139	ATE Ø 10" pneumatisch
2.2 i	125	08/00→01/03						
2.8 i	142	04/97→06/00		05/97→		03.7760-3102.4	300139	ATE Ø 10" pneumatisch
 Hauptbremszylinder								
1.8 i	85	10/95→10/98				03.2023-0987.3	010473	Ø1 23,81 Ø2 20,64
1.9 i	103	10/95→03/99						
1.9 i	85	01/99→01/03		→ 12/02		03.2023-0987.3	010473	Ø1 23,81 Ø2 20,64
1.9 i	87	07/98→01/03		09/00→ 12/02; + DSC		03.2023-1949.3	010725	ATE Ø1 23,81 Ø2 20,64
2.0 i	110	04/99→01/03		→ 08/00; - DSC		03.2023-0987.3	010473	Ø1 23,81 Ø2 20,64
				→ 08/00; + DSC		03.2023-1904.3	010724	ATE Ø1 23,81 Ø2 20,64
2.2 i	120	08/00→01/03		10/00→ 12/02; - DSC		03.2023-0987.3	010473	Ø1 23,81 Ø2 20,64
2.2 i	125	08/00→01/03		10/00→ 12/02; + DSC		03.2023-1949.3	010725	ATE Ø1 23,81 Ø2 20,64
2.8 i	142	04/97→06/00		05/97→; - DSC		03.2023-0987.3	010473	Ø1 23,81 Ø2 20,64
				05/97→; + DSC		03.2023-1904.3	010724	ATE Ø1 23,81 Ø2 20,64
3.0 i	170	06/00→01/03		→ 12/02; - DSC		03.2023-0987.3	010473	Ø1 23,81 Ø2 20,64
				→ 08/00; + DSC		03.2023-1904.3	010724	ATE Ø1 23,81 Ø2 20,64
				09/00→ 12/02; + DSC		03.2023-1949.3	010725	ATE Ø1 23,81 Ø2 20,64
BMW - Z4 Coupe (E86) 03/06→01/09								
 Bremskraftverstärker								
3.0 si	195	03/06→01/09		→ 09/08; für Rechtslenker		03.7860-0702.4	300123	ATE Ø 10" pneumatisch
				→ 09/08; für Linkslenker		03.7860-1302.4	300222	ATE Ø 10" pneumatisch
 Hauptbremszylinder								
3.0 si	195	03/06→01/09		→ 09/08		03.2023-2256.3	010870	ATE Ø1 23,81 Ø2 22,2
BMW - Z4 Roadster (E85) 02/03→12/09								
 Bremskraftverstärker								
2.0 i	110	03/05→02/09		04/05→ 12/08; für Rechtslenker		03.7860-0702.4	300123	ATE Ø 10" pneumatisch
				04/05→ 12/08; für Linkslenker		03.7860-1302.4	300222	ATE Ø 10" pneumatisch
2.2 i	125	10/03→10/05		für Rechtslenker		03.7860-0702.4	300123	ATE Ø 10" pneumatisch
2.5 i	141	02/03→12/05		für Linkslenker		03.7860-1302.4	300222	ATE Ø 10" pneumatisch
3.0 i	170	02/03→10/05						
3.0 si	195	01/06→12/08						
2.5 i	130	09/05→02/09		01/06→ 12/08; für Rechtslenker		03.7860-0702.4	300123	ATE Ø 10" pneumatisch
2.5 si	155	09/05→02/09		01/06→ 12/08; für Linkslenker		03.7860-1302.4	300222	ATE Ø 10" pneumatisch
2.5 si	160	09/05→02/09						
 Hauptbremszylinder								
2.0 i	110	03/05→02/09		04/05→ 12/08		03.2023-2249.3	010869	ATE Ø1 23,81 Ø2 22,2
2.2 i	125	10/03→10/05				03.2023-2249.3	010869	ATE Ø1 23,81 Ø2 22,2
2.5 i	141	02/03→12/05						
3.0 i	170	02/03→10/05						
2.5 i	130	09/05→02/09		01/06→ 12/08		03.2023-2256.3	010870	ATE Ø1 23,81 Ø2 22,2
2.5 si	155	09/05→02/09						
2.5 si	160	09/05→02/09						
3.0 si	195	01/06→12/08				03.2023-2256.3	010870	ATE Ø1 23,81 Ø2 22,2
BMW - Z4 Roadster (E89) 05/09→								
 Hauptbremszylinder								
sDrive 18 i	115	04/13→				03.2025-5826.3	010960	ATE Ø1 25,4 Ø2 22,2
sDrive 20 i	120	09/11→						
sDrive 20 i	135	09/11→						
sDrive 23 i	150	05/09→						
sDrive 28 i	180	09/11→						
↓								









	kw			 	! #		
BMW - Z4 Roadster (E89) 05/09→							
 Hauptbremszylinder							
sDrive 30 i	190	05/09→				03.2025-5826.3 010960	ATE Ø1 25,4 Ø2 22,2
sDrive 35 i	225	05/09→					
sDrive 35 is	250	09/10→					
BMW - Z8 Roadster (E52) 06/00→06/03							
 Hauptbremszylinder							
4.9	294	06/00→06/03				24.2026-1705.3 010992	TRW Ø 26,99 Ø2 20,64
CHEVROLET - CRUZE (J300) 05/09→							
 Bremskraftverstärker							
1.4	74	07/13→		für Linkslenker		03.7858-0732.4 300272	ATE Ø 9 / 8" pneumatisch
1.4	103	09/10→					
1.6	80	05/09→					
1.6	83	05/09→					
1.6	86	12/12→					
1.6	91	05/09→					
1.7 D	96	01/12→					
1.7 TD	81	11/13→					
1.8	104	05/09→					
1.8 LPG	104	06/11→					
2.0 CDI	92	05/09→05/11					
2.0 CDI	110	05/09→					
2.0 CDI	120	08/10→					
 Hauptbremszylinder							
1.4	74	07/13→		für Linkslenker; + ESP		03.2125-0421.3 010934	ATE Ø 25,4
1.4	103	09/10→					
1.6	80	05/09→					
1.6	83	05/09→					
1.6	86	12/12→					
1.6	91	05/09→					
1.7 D	96	01/12→					
1.7 TD	81	11/13→					
1.8	104	05/09→					
1.8 LPG	104	06/11→					
2.0 CDI	92	05/09→05/11					
2.0 CDI	110	05/09→					
2.0 CDI	120	08/10→					
CHEVROLET - CRUZE Schrägheck (J305) 12/10→							
 Bremskraftverstärker							
1.4	74	07/13→		für Linkslenker		03.7858-0732.4 300272	ATE Ø 9 / 8" pneumatisch
1.6	86	12/12→					
1.6	91	06/11→					
1.7 D	96	01/12→					
1.7 TD	81	08/13→					
1.8	104	06/11→					
1.8 LPG	104	06/11→					
2.0 CDI	120	06/11→					
1.4	103	06/12→		08/12→; für Linkslenker		03.7858-0732.4 300272	ATE Ø 9 / 8" pneumatisch
 Hauptbremszylinder							
1.4	74	07/13→		für Linkslenker; + ESP		03.2125-0421.3 010934	ATE Ø 25,4
1.6	86	12/12→					
1.6	91	06/11→					
1.7 D	96	01/12→					
1.7 TD	81	08/13→					
1.8	104	06/11→					
1.8 LPG	104	06/11→					
2.0 CDI	120	06/11→					
1.4	103	06/12→		08/12→; für Linkslenker; + ESP		03.2125-0421.3 010934	ATE Ø 25,4
CHEVROLET - CRUZE Station Wagon (J308) 08/12→							
 Bremskraftverstärker							
1.4	74	07/13→		für Linkslenker		03.7858-0732.4 300272	ATE Ø 9 / 8" pneumatisch
1.4	103	08/12→					
1.6	86	12/12→					
1.6	91	08/12→					
1.7 TD	81	11/13→					
1.7 TD	96	08/12→					
1.8	104	08/12→					
2.0 TD	120	08/12→					
 Hauptbremszylinder							
1.4	74	07/13→		für Linkslenker; + ESP		03.2125-0421.3 010934	ATE Ø 25,4
1.4	103	08/12→					
↓							















	kw					! #		
CHEVROLET - CRUZE Station Wagon (J308) 08/12→								
 Hauptbremszylinder								
1.6	86	12/12→			für Linkslenker; + ESP		03.2125-0421.3 010934	ATE Ø 25,4
1.6	91	08/12→						
1.7 TD	81	11/13→						
1.7 TD	96	08/12→						
1.8	104	08/12→						
2.0 TD	120	08/12→						
CHEVROLET - MALIBU (V300) 01/12→								
 Bremskraftverstärker								
2.0 D	118	04/12→					03.7858-0732.4 300272	ATE Ø 9 / 8" pneumatisch
2.4	123	01/12→						
 Hauptbremszylinder								
2.0 D	118	04/12→					03.2125-0421.3 010934	ATE Ø 25,4
2.4	123	01/12→						
CHEVROLET - MATIZ (M200, M250) 03/05→								
 Hauptbremszylinder								
0.8	38	03/05→			645872→; → 12/10; + ABS		24.2120-1755.3 010974	Ø 20,64 ohne Bremsflüssigkeitsbehälter
0.8 LPG	38	03/05→						
1.0	47	03/05→			→ 645871; + ABS		24.2120-1755.3 010974	Ø 20,64 ohne Bremsflüssigkeitsbehälter
1.0	49	03/05→						
1.0 LPG	49	03/05→			→ 645871; - ABS		24.2120-1765.3 011003	Ø 20,64 ohne Bremsflüssigkeitsbehälter
					645872→; → 12/10; - ABS		24.2120-1765.3 011003	Ø 20,64 ohne Bremsflüssigkeitsbehälter
CHEVROLET - ORLANDO (J309) 12/10→								
 Bremskraftverstärker								
1.8	104	02/11→					03.7858-0732.4 300272	ATE Ø 9 / 8" pneumatisch
1.8 LPG	104	06/11→						
2.0 D	96	02/11→						
2.0 D	120	02/11→						
 Hauptbremszylinder								
1.8	104	02/11→			+ ESP		03.2125-0421.3 010934	ATE Ø 25,4
1.8 LPG	104	06/11→						
2.0 D	96	02/11→						
2.0 D	120	02/11→						
CHEVROLET - SPARK 05/05→								
 Hauptbremszylinder								
0.8	37	05/05→			→ 645871; für Linkslenker; Schaltgetriebe; + ABS		24.2120-1755.3 010974	Ø 20,64 ohne Bremsflüssigkeitsbehälter
					645872→; → 02/10; für Linkslenker; Schaltgetriebe; + ABS		24.2120-1755.3 010974	Ø 20,64 ohne Bremsflüssigkeitsbehälter
					→ 645871; für Linkslenker; Schaltgetriebe; - ABS		24.2120-1765.3 011003	Ø 20,64 ohne Bremsflüssigkeitsbehälter
					645872→; → 02/10; für Linkslenker; Schaltgetriebe; - ABS		24.2120-1765.3 011003	Ø 20,64 ohne Bremsflüssigkeitsbehälter
1.0 SX	46	05/05→			→ 645871; für Linkslenker; + ABS		24.2120-1755.3 010974	Ø 20,64 ohne Bremsflüssigkeitsbehälter
					645872→; → 02/10; für Linkslenker; + ABS		24.2120-1755.3 010974	Ø 20,64 ohne Bremsflüssigkeitsbehälter
					645872→; → 02/10; für Linkslenker; - ABS		24.2120-1765.3 011003	Ø 20,64 ohne Bremsflüssigkeitsbehälter
					→ 645871; für Linkslenker; - ABS		24.2120-1765.3 011003	Ø 20,64 ohne Bremsflüssigkeitsbehälter
CITROËN - AX (ZA-) 07/86→12/98								
 Hauptbremszylinder								
1.4 GTi	66	08/91→12/96			- ABS		03.2120-2031.3 010106	ATE Ø 20,64
1.4 GTi	69	06/91→12/96						
10	33	07/86→12/98			Orga 03826→		03.2120-2031.3 010106	ATE Ø 20,64
10	37	02/87→12/98			07/92→		03.2120-2031.3 010106	ATE Ø 20,64
11	44	09/86→12/97			10/89→		03.2120-2031.3 010106	ATE Ø 20,64
14 (ZA)	55	04/87→04/97			03/89→ 12/96		03.2120-2031.3 010106	ATE Ø 20,64
14 D	37	08/91→12/97					03.2119-3389.3 010057	ATE Ø 19,05
15 D	40	08/94→12/97						













	kw				! #		
CITROËN - BERLINGO / BERLINGO FIRST Großraumlimousine (MF, GJK, GFK) 07/96→12/11							
 Hauptbremszylinder							
1.1 i (MFHDZ, MFHFX) 1.4 i (MFKFX, MFKFW, GJKFWB, GJKFWC, GFKFWC)	44 55	07/96→05/08 07/96→12/11		Orga 08610→; → 03/08; - ABS		03.2123-2781.3 010631 24.2123-1714.3 010587	ATE Ø 23,81 BDX Ø 23,81
				→Orga 08609; - ABS		24.2123-1710.3 010504	Ø 23,81
				→Orga 08609; für Linkslenker; + ABS		24.2123-1713.3 010505	Ø 23,81
				Orga 08610→; → 03/08; - ESP		24.2123-1715.3 010520	BDX Ø 23,81
1.4 bivalent 1.4 i bivalent (MFKFW) 1.6 16V (MFNFU) 1.6 HDI 75 (MF9HW, GJ9HWC, GF9HWC, GN9HWC) 1.6 HDI 90 (MF9HX)	48 55 80 55 66	11/02→12/11 04/03→10/08 10/00→12/11 07/05→12/11 07/05→05/08		→ 03/08; - ABS		03.2123-2781.3 010631 24.2123-1714.3 010587	ATE Ø 23,81 BDX Ø 23,81
				→ 03/08; - ESP		24.2123-1715.3 010520	BDX Ø 23,81
1.8 D (MFA9A) 1.8 i (MFLFX) 1.9 D (MFDJY) 1.9 D (MFWJZ) 1.9 D 4WD (MFWJZ)	43 66 50 51 51	07/98→10/02 05/97→10/02 07/96→12/03 07/98→10/05 07/98→10/05		Orga 08610→; - ABS		03.2123-2781.3 010631 24.2123-1714.3 010587	ATE Ø 23,81 BDX Ø 23,81
				→Orga 08609; - ABS		24.2123-1710.3 010504	Ø 23,81
				→Orga 08609; für Linkslenker; + ABS		24.2123-1713.3 010505	Ø 23,81
				Orga 08610→; - ESP		24.2123-1715.3 010520	BDX Ø 23,81
1.8 i 4WD (MFLFX)	66	04/97→10/01		Orga 08610→; - ABS		03.2123-2781.3 010631 24.2123-1714.3 010587	ATE Ø 23,81 BDX Ø 23,81
				05/97→; →Orga 08609; - ABS		24.2123-1710.3 010504	Ø 23,81
				05/97→; →Orga 08609; für Linkslenker; + ABS		24.2123-1713.3 010505	Ø 23,81
				Orga 08610→; - ESP		24.2123-1715.3 010520	BDX Ø 23,81
2.0 HDI 90 (MFRHY)	66	12/99→10/05		- ABS		03.2123-2781.3 010631 24.2123-1714.3 010587	ATE Ø 23,81 BDX Ø 23,81
				- ESP		24.2123-1715.3 010520	BDX Ø 23,81
 Bremskraftregler							
1.1 i (MFHDZ, MFHFX) 1.4 bivalent 1.4 i (MFKFX, MFKFW, GJKFWB, GJKFWC, GFKFWC) 1.4 i bivalent (MFKFW) 1.6 16V (MFNFU) 1.6 HDI 75 (MF9HW, GJ9HWC, GF9HWC, GN9HWC) 1.6 HDI 90 (MF9HX)	44 48 55 55 80 55 66	07/96→05/08 11/02→12/11 07/96→12/11 04/03→10/08 10/00→12/11 07/05→12/11 07/05→05/08		→ 03/08; - Mehrfunktionsdach; für Fahrzeuge ohne verstärktes Fahrwerk		03.6582-0010.3 320145 03.6582-0011.3 320232	ATE lastabhängig 8/1,5 4x ATE lastabhängig 8/1,5 4x
				→ 03/08; - ABS; für Fahrzeuge mit verstärktem Fahrwerk		03.6582-0012.3 320233	ATE lastabhängig 8/1,5 4x
				→ 03/08; + ABS; für Fahrzeuge mit verstärktem Fahrwerk		03.6582-0015.3 320227	ATE lastabhängig 8/1,5 4x
1.8 D (MFA9A) 1.8 i (MFLFX) 1.9 D (MFDJY) 1.9 D (MFWJZ) 1.9 D 4WD (MFWJZ) 2.0 HDI 90 (MFRHY)	43 66 50 51 51 66	07/98→10/02 05/97→10/02 07/96→12/03 07/98→10/05 07/98→10/05 12/99→10/05		- Mehrfunktionsdach; für Fahrzeuge ohne verstärktes Fahrwerk		03.6582-0010.3 320145 03.6582-0011.3 320232	ATE lastabhängig 8/1,5 4x ATE lastabhängig 8/1,5 4x
				- ABS; für Fahrzeuge mit verstärktem Fahrwerk		03.6582-0012.3 320233	ATE lastabhängig 8/1,5 4x
				+ ABS; für Fahrzeuge mit verstärktem Fahrwerk		03.6582-0015.3 320227	ATE lastabhängig 8/1,5 4x
				+ Mehrfunktionsdach; für Fahrzeuge ohne verstärktes Fahrwerk		03.6582-0010.3 320145 03.6582-0011.3 320232	ATE lastabhängig 8/1,5 4x ATE lastabhängig 8/1,5 4x
				05/97→; - Mehrfunktionsdach; für Fahrzeuge ohne verstärktes Fahrwerk		03.6582-0012.3 320233	ATE lastabhängig 8/1,5 4x
				05/97→; - ABS; für Fahrzeuge mit verstärktem Fahrwerk		03.6582-0015.3 320227	ATE lastabhängig 8/1,5 4x
				05/97→; + ABS; für Fahrzeuge mit verstärktem Fahrwerk		03.6582-0010.3 320145 03.6582-0011.3 320232	ATE lastabhängig 8/1,5 4x ATE lastabhängig 8/1,5 4x
				05/97→; + Mehrfunktionsdach; für Fahrzeuge ohne verstärktes Fahrwerk		03.6582-0012.3 320233 03.6582-0015.3 320227	ATE lastabhängig 8/1,5 4x ATE lastabhängig 8/1,5 4x
CITROËN - BERLINGO / BERLINGO FIRST Kasten (M_) 07/96→12/11							
 Hauptbremszylinder							
1.1 i (MAHDZ, MBHDZ, MBHFX) 1.8 D (MBA9A, MCA9A) 1.9 D (MBDJY) 1.9 D 70 4WD (MBWJZ, MCWJZ) 2.0 HDI 90 4WD (MBRHY, MCRHY)	44 43 51 51 66	07/96→03/08 07/96→10/02 07/96→12/03 07/98→03/06 11/00→10/05		Orga 08610→; - ABS		03.2123-2781.3 010631 24.2123-1714.3 010587	ATE Ø 23,81 BDX Ø 23,81
				→Orga 08609; - ABS		24.2123-1710.3 010504	Ø 23,81
				→Orga 08609; + ABS; für Linkslenker		24.2123-1713.3 010505	Ø 23,81
				Orga 08610→; + ABS		24.2123-1715.3 010520	BDX Ø 23,81
1.4 bivalent 1.6 HDI 75 (MB9HW)	48 55	11/02→12/11 07/05→12/11		→ 03/08; - ABS		03.2123-2781.3 010631 24.2123-1714.3 010587	ATE Ø 23,81 BDX Ø 23,81
				→ 03/08; + ABS		24.2123-1715.3 010520	BDX Ø 23,81
1.4 i (MBKFX, MBKFW) 1.9 D 70 (MBWJZ, MCWJZ)	55 51	07/96→12/11 04/99→12/11		Orga 08610→; → 03/08; - ABS		03.2123-2781.3 010631 24.2123-1714.3 010587	ATE Ø 23,81 BDX Ø 23,81













	kw					! #		
CITROËN - BERLINGO / BERLINGO FIRST Kasten (M_) 07/96→12/11								
 Hauptbremszylinder								
2.0 HDI 90 (MBRHY, MCRHY)	66	12/99→12/11		→Orga 08609; - ABS	24.2123-1710.3	010504	Ø 23,81	
				→Orga 08609; + ABS; für Linkslenker	24.2123-1713.3	010505	Ø 23,81	
				Orga 08610→; → 03/08; + ABS	24.2123-1715.3	010520	BDX Ø 23,81	
1.4 i bivalent (MBKFW) 1.6 16V (MBNFU)	55	04/03→10/05		- ABS	03.2123-2781.3	010631	ATE Ø 23,81	
	80	10/00→03/08		+ ABS	24.2123-1714.3	010587	BDX Ø 23,81	
					24.2123-1715.3	010520	BDX Ø 23,81	
 Bremskraftregler								
1.1 i (MAHDZ, MBHDZ, MBHFX)	44	07/96→03/08		Nutzlast [kg]: 500 / 600; für Fahrzeuge ohne verstärktes Fahrwerk	03.6582-0009.3	320143	ATE lastabhängig 8/1,5 4x	
1.4 i bivalent (MBKFW)	55	04/03→10/05		Nutzlast [kg]: 500 / 600; für Fahrzeuge mit verstärktem Fahrwerk	03.6582-0012.3	320233	ATE lastabhängig 8/1,5 4x	
1.4 bivalent 1.4 i (MBKFX, MBKFW)	48	11/02→12/11		→ 03/08; Nutzlast [kg]: 500 / 600; für Fahrzeuge ohne verstärktes Fahrwerk	03.6582-0009.3	320143	ATE lastabhängig 8/1,5 4x	
	55	07/96→12/11		→ 03/08; Nutzlast [kg]: 500 / 600; für Fahrzeuge mit verstärktem Fahrwerk	03.6582-0012.3	320233	ATE lastabhängig 8/1,5 4x	
1.6 16V (MBNFU)	80	10/00→03/08		Nutzlast [kg]: 600; für Fahrzeuge ohne verstärktes Fahrwerk	03.6582-0009.3	320143	ATE lastabhängig 8/1,5 4x	
1.8 D (MBA9A, MCA9A)	43	07/96→10/02		Nutzlast [kg]: 600; für Fahrzeuge mit verstärktem Fahrwerk	03.6582-0012.3	320233	ATE lastabhängig 8/1,5 4x	
1.9 D (MBDJY)	51	07/96→12/03		Nutzlast [kg]: 800	03.6582-0015.3	320227	ATE lastabhängig 8/1,5 4x	
1.9 D 70 4WD (MBWJZ, MCWJZ)	51	07/98→03/06						
2.0 HDI 90 4WD (MBRHY, MCRHY)	66	11/00→10/05						
1.6 HDI 75 (MB9HW)	55	07/05→12/11		→ 03/08; Nutzlast [kg]: 600; für Fahrzeuge ohne verstärktes Fahrwerk	03.6582-0009.3	320143	ATE lastabhängig 8/1,5 4x	
1.9 D 70 (MBWJZ, MCWJZ)	51	04/99→12/11		→ 03/08; Nutzlast [kg]: 600; für Fahrzeuge mit verstärktem Fahrwerk	03.6582-0012.3	320233	ATE lastabhängig 8/1,5 4x	
2.0 HDI 90 (MBRHY, MCRHY)	66	12/99→12/11		→ 03/08; Nutzlast [kg]: 800	03.6582-0015.3	320227	ATE lastabhängig 8/1,5 4x	
CITROËN - BERLINGO (B9) 04/08→								
 Hauptbremszylinder								
1.2 PureTech 110	81	02/16→		+ ESP	24.4123-1714.3	010979	TRW Ø 23,81	
1.6	66	04/08→						
1.6	80	04/08→						
1.6 BlueHdi 100	73	12/14→						
1.6 BlueHdi 120	88	12/14→						
1.6 HDi 110	80	04/08→						
1.6 HDi 110	82	07/10→						
1.6 HDi 115	84	07/10→						
1.6 HDi 115 4x4	84	02/12→						
1.6 HDi 75 16V	55	04/08→						
1.6 HDi 90	66	04/08→						
1.6 HDi 90	68	07/10→						
1.6 HDi 90 4x4	66	02/12→12/14						
1.6 VTi 120	88	11/09→						
1.6 VTi 95	72	07/10→						
1.6 HDi 75 / BlueHdi 75	55	04/08→		04/15→; + ESP	24.4123-1714.3	010979	TRW Ø 23,81	
CITROËN - BERLINGO Kasten (B9) 04/08→								
 Hauptbremszylinder								
1.6	66	04/08→		+ ESP	24.4123-1714.3	010979	TRW Ø 23,81	
1.6	80	04/08→						
1.6 BlueHdi 100	73	12/14→						
1.6 BlueHdi 100 4x4	73	12/14→						
1.6 BlueHdi 120	88	12/14→						
1.6 HDi 110	80	04/08→						
1.6 HDi 110	82	07/10→						
1.6 HDi 115	84	07/10→						
1.6 HDi 75	55	04/08→						
1.6 HDi 75 4x4	55	02/12→						
1.6 HDi 90	66	07/10→						
1.6 HDi 90	68	07/10→						
1.6 HDi 90 16V	66	04/08→						
1.6 HDi 90 4x4	66	02/12→						
1.6 VTi 120	88	11/09→						
1.6 VTi 95	72	07/10→						
Electric	49	03/14→						
1.6 HDi / BlueHdi 75	55	07/10→		04/15→; + ESP	24.4123-1714.3	010979	TRW Ø 23,81	
Electric	35	01/13→		02/13→; + ESP	24.4123-1714.3	010979	TRW Ø 23,81	
CITROËN - BERLINGO Pritsche/Fahrgestell (B9) 04/08→								
 Hauptbremszylinder								
1.6 HDi 90 16V	66	04/08→		+ ESP	24.4123-1714.3	010979	TRW Ø 23,81	















	kw			 	! #		
CITROËN - C1 (PM_, PN_) 06/05→09/14							
 Hauptbremszylinder							
1.0	50	06/05→09/14		für Linkslenker; → 04/14; - ESP	24.4120-1701.3	010846	BOS Ø 20,64
1.4 HDi	40	06/05→09/14		→ 12/08; für Linkslenker; - ESP	24.4120-1701.3	010846	BOS Ø 20,64
CITROËN - C2 (JM_) 09/03→							
 Hauptbremszylinder							
1.1	44	09/03→		→ 12/09; - ABS	24.2120-1741.3	010775	Ø 20,64
				Orga 10815→ Orga 11192; für Linkslenker; - ESP	24.2122-1764.3	010851	BOS Ø 22,2
				→Orga 10800; - ESP	24.2122-1766.3	010840	TRW Ø 22,2
				→Orga 10800; + ESP	24.2122-1767.3	010841	TRW Ø 22,2 ohne Drucksensor
				→ 12/09; Orga 10801→; + ESP	24.4122-1703.3	010843	TRW Ø 22,2
				Orga 10801→ Orga 11192; für Rechtslenker; - ESP	24.4122-1704.3	010847	TRW Ø 22,2
				Orga 10808→ Orga 10810; für Linkslenker; - ESP	24.4122-1704.3	010847	TRW Ø 22,2
				Orga 10801→ Orga 10807; für Linkslenker; - ESP	24.4122-1708.3	010865	BOS Ø 22,2 ohne Bremsflüssigkeitsbehälter
				Orga 11193→; → 12/09; für Linkslenker; - ESP	24.4122-1708.3	010865	BOS Ø 22,2 ohne Bremsflüssigkeitsbehälter
				Orga 10811→ Orga 10814; für Linkslenker; - ESP	24.4122-1708.3	010865	BOS Ø 22,2 ohne Bremsflüssigkeitsbehälter
1.4 1.4 HDi	54 50	09/03→ 09/03→		→ 12/09; - ABS	24.2120-1741.3	010775	Ø 20,64
				Orga 10815→ Orga 11192; für Linkslenker; - ESP	24.2122-1764.3	010851	BOS Ø 22,2
				→Orga 10800; - ESP	24.2122-1766.3	010840	TRW Ø 22,2
				→Orga 10800; + ESP	24.2122-1767.3	010841	TRW Ø 22,2 ohne Drucksensor
				→ 12/09; Orga 10801→; + ESP	24.4122-1703.3	010843	TRW Ø 22,2
				Orga 10808→ Orga 10810; für Linkslenker; - ESP	24.4122-1704.3	010847	TRW Ø 22,2
				Orga 10801→; → 12/09; für Rechtslenker; - ESP	24.4122-1704.3	010847	TRW Ø 22,2
				Orga 10801→ Orga 10807; für Linkslenker; - ESP	24.4122-1708.3	010865	BOS Ø 22,2 ohne Bremsflüssigkeitsbehälter
				Orga 10811→ Orga 10814; für Linkslenker; - ESP	24.4122-1708.3	010865	BOS Ø 22,2 ohne Bremsflüssigkeitsbehälter
				Orga 11193→; → 12/09; für Linkslenker; - ESP	24.4122-1708.3	010865	BOS Ø 22,2 ohne Bremsflüssigkeitsbehälter
1.4 16V	65	06/06→		→ 12/09; - ABS	24.2120-1741.3	010775	Ø 20,64
				Orga 10815→ Orga 11192; für Linkslenker; - ESP	24.2122-1764.3	010851	BOS Ø 22,2
				→ 12/09; Orga 10801→; + ESP	24.4122-1703.3	010843	TRW Ø 22,2
				Orga 10808→ Orga 10810; für Linkslenker; - ESP	24.4122-1704.3	010847	TRW Ø 22,2
				Orga 10801→; → 12/09; für Rechtslenker; - ESP	24.4122-1704.3	010847	TRW Ø 22,2
				Orga 10801→ Orga 10807; für Linkslenker; - ESP	24.4122-1708.3	010865	BOS Ø 22,2 ohne Bremsflüssigkeitsbehälter
				Orga 11193→; → 12/09; für Linkslenker; - ESP	24.4122-1708.3	010865	BOS Ø 22,2 ohne Bremsflüssigkeitsbehälter
				Orga 10811→ Orga 10814; für Linkslenker; - ESP	24.4122-1708.3	010865	BOS Ø 22,2 ohne Bremsflüssigkeitsbehälter
1.6	80	09/03→		→ 12/09; - ABS	24.2120-1741.3	010775	Ø 20,64
				→Orga 10800; - ESP	24.2122-1766.3	010840	TRW Ø 22,2
				→Orga 10800; + ESP	24.2122-1767.3	010841	TRW Ø 22,2 ohne Drucksensor
				→ 12/09; Orga 10801→; + ESP	24.4122-1703.3	010843	TRW Ø 22,2
				Orga 10801→; → 12/09; für Linkslenker; - ESP	24.4122-1704.3	010847	TRW Ø 22,2
1.6 HDi	80	09/05→		→ 12/09; Orga 10801→; + ESP	24.4122-1703.3	010843	TRW Ø 22,2
1.6 VTS	90	01/05→		→Orga 10800; - ESP	24.2122-1766.3	010840	TRW Ø 22,2
				→Orga 10800; + ESP	24.2122-1767.3	010841	TRW Ø 22,2 ohne Drucksensor
				→ 12/09; Orga 10801→; + ESP	24.4122-1703.3	010843	TRW Ø 22,2
CITROËN - C3 I (FC_, FN_) 02/02→							
 Hauptbremszylinder							
1.1 i 1.4 HDi 1.4 i	44 50 54	02/02→ 02/02→ 02/02→		→ 08/09; - ABS	24.2120-1741.3	010775	Ø 20,64
				Orga 10815→; → 08/09; für Linkslenker; - ESP	24.2122-1764.3	010851	BOS Ø 22,2
↓							













	kw			 	! #		
CITROËN - C3 I (FC_, FN_) 02/02→							
 Hauptbremszylinder							
1.1 i	44	02/02→		→Orga 10800; für Linkslenker; - ESP	24.2122-1764.3	010851	BOS Ø 22,2
1.4 HDi	50	02/02→		→Orga 10800; - ESP	24.2122-1766.3	010840	TRW Ø 22,2
1.4 i	54	02/02→		→Orga 10800; + ESP	24.2122-1767.3	010841	TRW Ø 22,2 ohne Drucksensor
				Orga 10801→; → 08/09; + ESP	24.4122-1703.3	010843	TRW Ø 22,2
				→ 08/09; für Rechtslenker; - ESP	24.4122-1704.3	010847	TRW Ø 22,2
				Orga 10808→ Orga 10814; für Linkslenker; - ESP	24.4122-1704.3	010847	TRW Ø 22,2
				Orga 10801→ Orga 10807; für Linkslenker; - ESP	24.4122-1708.3	010865	BOS Ø 22,2 ohne Bremsflüssigkeitsbehälter
1.4 16V	65	12/03→		→ 08/09; - ABS	24.2120-1741.3	010775	Ø 20,64
1.6 16V	80	02/02→		→Orga 10800; für Linkslenker; - ESP	24.2122-1764.3	010851	BOS Ø 22,2
				→Orga 10800; - ESP	24.2122-1766.3	010840	TRW Ø 22,2
				→Orga 10800; + ESP	24.2122-1767.3	010841	TRW Ø 22,2 ohne Drucksensor
				Orga 10801→; → 08/09; + ESP	24.4122-1703.3	010843	TRW Ø 22,2
				→ 08/09; - ESP	24.4122-1704.3	010847	TRW Ø 22,2
1.4 16V HDi	66	02/02→		→ 08/09; - ABS	24.2120-1741.3	010775	Ø 20,64
				→Orga 10800; für Linkslenker; - ESP	24.2122-1764.3	010851	BOS Ø 22,2
				Orga 10815→; → 08/09; für Linkslenker; - ESP	24.2122-1764.3	010851	BOS Ø 22,2
				→Orga 10800; - ESP	24.2122-1766.3	010840	TRW Ø 22,2
				→Orga 10800; + ESP	24.2122-1767.3	010841	TRW Ø 22,2 ohne Drucksensor
				Orga 10801→; → 08/09; + ESP	24.4122-1703.3	010843	TRW Ø 22,2
				→ 08/09; - ESP	24.4122-1704.3	010847	TRW Ø 22,2
				Orga 10801→ Orga 10807; für Linkslenker; - ESP	24.4122-1708.3	010865	BOS Ø 22,2 ohne Bremsflüssigkeitsbehälter
1.4 i Bivalent	54	02/02→		09/05→ 08/09; - ABS	24.2120-1741.3	010775	Ø 20,64
				09/05→; →Orga 10800; für Linkslenker; - ESP	24.2122-1764.3	010851	BOS Ø 22,2
				09/05→; →Orga 10800; - ESP	24.2122-1766.3	010840	TRW Ø 22,2
				09/05→; →Orga 10800; + ESP	24.2122-1767.3	010841	TRW Ø 22,2 ohne Drucksensor
				Orga 10801→; → 08/09; + ESP	24.4122-1703.3	010843	TRW Ø 22,2
				09/05→ 08/09; für Linkslenker; - ESP	24.4122-1704.3	010847	TRW Ø 22,2
				Orga 10801→ Orga 10807; für Linkslenker; - ESP	24.4122-1708.3	010865	BOS Ø 22,2 ohne Bremsflüssigkeitsbehälter
1.6 16V HDi	66	10/05→		→Orga 10800; für Linkslenker; - ESP	24.2122-1764.3	010851	BOS Ø 22,2
				→Orga 10800; - ESP	24.2122-1766.3	010840	TRW Ø 22,2
				→Orga 10800; + ESP	24.2122-1767.3	010841	TRW Ø 22,2 ohne Drucksensor
				Orga 10801→; → 08/09; + ESP	24.4122-1703.3	010843	TRW Ø 22,2
				→ 08/09; - ESP	24.4122-1704.3	010847	TRW Ø 22,2
1.6 16V HDi	80	09/05→		→Orga 10800; für Linkslenker; - ESP	24.2122-1764.3	010851	BOS Ø 22,2
				→Orga 10800; - ESP	24.2122-1766.3	010840	TRW Ø 22,2
				→Orga 10800; + ESP	24.2122-1767.3	010841	TRW Ø 22,2 ohne Drucksensor
				Orga 10801→; → 08/09; + ESP	24.4122-1703.3	010843	TRW Ø 22,2
				→ 08/09; - ESP	24.4122-1704.3	010847	TRW Ø 22,2
				Orga 10801→ Orga 10807; für Linkslenker; - ESP	24.4122-1708.3	010865	BOS Ø 22,2 ohne Bremsflüssigkeitsbehälter
CITROËN - C3 II (SC_) 11/09→							
 Hauptbremszylinder							
1.1	44	11/09→		Orga 13153→; + DSC	24.4122-1703.3	010843	TRW Ø 22,2
1.4	54	11/09→		Orga 13153→; - DSC	24.4122-1704.3	010847	TRW Ø 22,2
1.4 HDi 70	50	11/09→					
1.6 HDi 90	66	11/09→					
1.4 VTi	72	11/09→		Orga 13153→; + DSC	24.4123-1704.3	010828	TRW Ø 23,81
1.4 VTi 95	70	11/09→		Orga 13153→; - DSC	24.4123-1705.3	010832	TRW Ø 23,81
1.6 HDi 110	82	11/09→					
1.6 HDi 115	84	09/12→					
1.6 VTi 120	88	11/09→					
1.6 BlueHDi 100	73	07/14→		+ DSC	24.4122-1703.3	010843	TRW Ø 22,2
1.6 BlueHDi 75	55	04/15→		- DSC	24.4122-1704.3	010847	TRW Ø 22,2
1.6 HDi	68	11/09→		Orga 13153→; Trommelbremse; + DSC	24.4122-1703.3	010843	TRW Ø 22,2
				Orga 13153→; Trommelbremse; - DSC	24.4122-1704.3	010847	TRW Ø 22,2
				Orga 13153→; Scheibenbremse; + DSC	24.4123-1704.3	010828	TRW Ø 23,81
				Orga 13153→; Scheibenbremse; - DSC	24.4123-1705.3	010832	TRW Ø 23,81









	kw			 	! #		
CITROËN - C3 III (SX) 07/16→							
 Hauptbremszylinder							
1.2 THP 110	81	07/16→		Trommelbremse		24.4122-1703.3 010843	TRW Ø 22,2
1.2 VTi 68	50	07/16→		Scheibenbremse		24.4123-1704.3 010828	TRW Ø 23,81
1.2 VTi 82	60	07/16→					
1.6 BlueHDi 100	73	07/16→					
1.6 BlueHDi 75	55	07/16→					
CITROËN - C3 AIRCROSS II 06/17→							
 Hauptbremszylinder							
1.2 Puretech 110	81	06/17→				24.4123-1704.3 010828	TRW Ø 23,81
1.2 Puretech 130	96	07/17→					
1.2 Puretech 82	60	06/17→					
1.6 BlueHDi 100	73	07/17→					
1.6 BlueHDi 115	85	06/17→					
1.6 BlueHDi 120	88	07/17→					
CITROËN - C3 Picasso 02/09→							
 Hauptbremszylinder							
1.2 THP 110	81	01/15→		+ ESP		24.4123-1704.3 010828	TRW Ø 23,81
1.4 VTi 95	70	02/09→		- ESP		24.4123-1705.3 010832	TRW Ø 23,81
1.4 VTi 95 LPG	70	01/12→					
1.6 BlueHDi 100	73	01/15→					
1.6 HDi	66	02/09→					
1.6 HDi	80	02/09→					
1.6 HDi 110	82	05/10→					
1.6 HDi 115	84	01/13→					
1.6 HDi 90	68	07/10→					
1.6 VTi 120	88	02/09→					
1.6 VTi	84	07/09→		10/16→; + ESP		24.4123-1704.3 010828	TRW Ø 23,81
				10/16→; - ESP		24.4123-1705.3 010832	TRW Ø 23,81
CITROËN - C3 Pluriel (HB_) 05/03→							
 Hauptbremszylinder							
1.4	54	05/03→		→ 07/10; - ABS		24.2120-1741.3 010775	Ø 20,64
1.4 HDi	50	04/04→		→Orga 10800; - ESP		24.2122-1764.3 010851	BOS Ø 22,2
				→Orga 10800; + ESP		24.2122-1766.3 010840	TRW Ø 22,2
				→Orga 10800; + ESP		24.2122-1767.3 010841	TRW Ø 22,2 ohne Drucksensor
				Orga 10801→; → 07/10; + ESP		24.4122-1703.3 010843	TRW Ø 22,2
				Orga 10801→; → 07/10; - ESP		24.4122-1704.3 010847	TRW Ø 22,2
1.6	80	05/03→		→ 07/10; - ABS		24.2120-1741.3 010775	Ø 20,64
				→Orga 10800; - ESP		24.2122-1764.3 010851	BOS Ø 22,2
				→Orga 10800; - ESP		24.2122-1766.3 010840	TRW Ø 22,2
				→Orga 10800; - ESP		24.2122-1767.3 010841	TRW Ø 22,2 ohne Drucksensor
				Orga 10801→; → 07/10; + ESP		24.4122-1703.3 010843	TRW Ø 22,2
				Orga 10801→; → 07/10; - ESP		24.4122-1704.3 010847	TRW Ø 22,2
CITROËN - C4 CACTUS 09/14→							
 Hauptbremszylinder							
1.2 THP 110	81	09/14→		für Fahrzeuge mit Trommelbremse an der Hinterachse		24.4122-1703.3 010843	TRW Ø 22,2
1.2 VTi 75	55	09/14→					
1.2 VTi 82	60	09/14→		für Fahrzeuge mit Scheibenbremse an der Hinterachse		24.4123-1704.3 010828	TRW Ø 23,81
1.6 BlueHDi 100	73	09/14→					
1.6 HDi 90	68	09/14→					
CITROËN - C4 Grand Picasso I (UA_) 10/06→							
 Bremskraftverstärker							
1.6 16V	103	07/08→		→ 07/13		03.7860-5702.4 300279	ATE Ø 10" pneumatisch
1.6 16V	110	10/08→					
1.6 HDi 110	82	09/10→					
1.6 VTi 120	88	07/08→					
2.0 HDi 150	110	07/09→					
1.6 HDi	80	10/06→		→Orga 11437		03.7860-4103.4 300242	ATE Ø 10" pneumatisch
2.0 HDi 138	100	10/06→		Orga 11438→; → 07/13		03.7860-5702.4 300279	ATE Ø 10" pneumatisch
1.6 THP 155	115	09/10→		11/10→ 07/13		03.7860-5702.4 300279	ATE Ø 10" pneumatisch
2.0 HDi 165	120	09/10→					
1.8 i 16V	92	10/06→		→ 07/13		03.7870-1002.4 300282	ATE Ø 11" pneumatisch
2.0 i 16V	103	10/06→					
 Hauptbremszylinder							
1.6 16V	103	07/08→		→ 07/13		03.4153-0173.3 010815	ATE Ø 23,81
1.6 16V	110	10/08→					
1.6 HDi	80	10/06→					

	kw			 	! #		
CITROËN - C4 Grand Picasso I (UA_) 10/06→							
 Hauptbremszylinder							
1.6 HDi 110	82	09/10→		→ 07/13		03.4153-0173.3 010815	ATE Ø 23,81
1.6 VTi 120	88	07/08→					
1.8 i 16V	92	10/06→					
2.0 HDi 138	100	10/06→					
2.0 HDi 150	110	07/09→					
2.0 i 16V	103	10/06→					
1.6 THP 155	115	09/10→		11/10→ 07/13		03.4153-0173.3 010815	ATE Ø 23,81
2.0 HDi 165	120	09/10→					
CITROËN - C4 Picasso I Großraumlimousine (UD_) 10/06→10/13							
 Bremskraftverstärker							
1.6 16V	110	07/08→08/13		→ 07/13		03.7860-5702.4 300279	ATE Ø 10" pneumatisch
1.6 THP 140	103	07/08→08/13					
1.6 VTi 120	88	07/08→08/13					
2.0 HDi 150	110	07/09→08/13					
1.6 HDi	80	02/07→08/13		→Orga 11437		03.7860-4103.4 300242	ATE Ø 10" pneumatisch
				Orga 11438→; → 07/13		03.7860-5702.4 300279	ATE Ø 10" pneumatisch
1.6 HDi 110	82	09/10→08/13		11/10→ 07/13		03.7860-5702.4 300279	ATE Ø 10" pneumatisch
1.6 THP 155	115	09/10→08/13					
2.0 HDi 165	120	09/10→08/13					
1.8 i 16V	92	02/07→12/11				03.7870-1002.4 300282	ATE Ø 11" pneumatisch
2.0 HDi 138	100	10/06→08/13		02/07→; →Orga 11437		03.7860-4103.4 300242	ATE Ø 10" pneumatisch
				Orga 11438→; → 07/13		03.7860-5702.4 300279	ATE Ø 10" pneumatisch
2.0 i 16V	103	02/07→08/13		→ 07/13		03.7870-1002.4 300282	ATE Ø 11" pneumatisch
 Hauptbremszylinder							
1.6 16V	110	07/08→08/13		→ 07/13		03.4153-0173.3 010815	ATE Ø 23,81
1.6 HDi	80	02/07→08/13					
1.6 THP 140	103	07/08→08/13					
1.6 VTi 120	88	07/08→08/13					
2.0 HDi 150	110	07/09→08/13					
2.0 i 16V	103	02/07→08/13					
1.6 HDi 110	82	09/10→08/13		11/10→ 07/13		03.4153-0173.3 010815	ATE Ø 23,81
1.6 THP 155	115	09/10→08/13					
2.0 HDi 165	120	09/10→08/13					
1.8 i 16V	92	02/07→12/11				03.4153-0173.3 010815	ATE Ø 23,81
2.0 HDi 138	100	10/06→08/13		02/07→ 07/13		03.4153-0173.3 010815	ATE Ø 23,81
CITROËN - C5 III (RD_) 02/08→							
 Bremskraftverstärker							
1.6 HDi 110	80	02/08→		für Linkslenker		03.7860-7802.4 300280	ATE Ø 10" pneumatisch
1.6 THP 150	110	07/10→					
1.6 THP 155	115	04/09→					
1.6 VTi 120	88	07/10→					
1.8 16V	92	02/08→					
2.0 16V	103	02/08→					
2.0 HDi	100	02/08→					
2.0 HDi 140	103	04/09→					
2.0 HDi 165	120	04/09→					
2.2 HDi	125	02/08→					
2.2 HDi 200	150	07/10→					
2.7 HDi	150	02/08→					
3.0 HDi 240	177	04/09→					
3.0 V6	155	02/08→					
1.6 HDi 110	82	07/10→		für Linkslenker;		03.7860-7802.4 300280	ATE Ø 10" pneumatisch
1.6 HDi 115	84	01/12→		für Fahrzeuge ohne Start-Stopp-Funktion			
2.0 HDi 180	133	03/15→					
 Hauptbremszylinder							
1.6 HDi 110	80	02/08→		Orga 12348→		03.2123-3131.3 010977	ATE Ø 23,81
1.6 HDi 110	82	07/10→					
1.6 THP 150	110	07/10→					
1.6 THP 155	115	04/09→					
1.6 VTi 120	88	07/10→					
1.8 16V	92	02/08→					
2.0 16V	103	02/08→					
2.0 HDi	100	02/08→					
2.0 HDi 140	103	04/09→					
2.0 HDi 165	120	04/09→					
2.2 HDi	125	02/08→					
2.2 HDi 200	150	07/10→					
2.7 HDi	150	02/08→					
3.0 HDi 240	177	04/09→					
3.0 V6	155	02/08→					
1.6 HDi 115	84	01/12→				03.2123-3131.3 010977	ATE Ø 23,81
2.0 HDi 180	133	03/15→					
↓							











	kW			 	! #		
CITROËN - C5 III (RD_) 02/08→							
 Hauptbremszylinder							
2.0 HDi 150 / BlueHDi 150	110	04/09→		05/15→		03.2123-3131.3 010977	ATE Ø 23,81
CITROËN - C5 III Break (RW_) 02/08→							
 Bremskraftverstärker							
1.6 HDi 110	80	02/08→		für Linkslenker		03.7860-7802.4 300280	ATE Ø 10" pneumatisch
1.6 THP 150	110	04/09→					
1.6 THP 155	115	04/09→					
1.6 VTI 120	88	07/10→					
1.8 16V	92	02/08→					
2.0 16V	103	02/08→					
2.0 HDi	100	02/08→					
2.0 HDi 140	103	04/09→					
2.0 HDi 150 / BlueHDi 150	110	04/09→					
2.0 HDi 165	120	04/09→					
2.2 HDi	125	02/08→					
2.2 HDi 165	120	02/08→					
2.2 HDi 200	150	07/10→					
2.7 HDi	150	02/08→					
3.0 HDi 240	177	04/09→					
3.0 V6	155	02/08→					
1.6 HDi 110	82	07/10→		für Linkslenker;		03.7860-7802.4 300280	ATE Ø 10" pneumatisch
1.6 HDi 115	84	01/12→		für Fahrzeuge ohne Start-Stopp-Funktion			
2.0 HDi 180	133	03/15→					
 Hauptbremszylinder							
1.6 HDi 110	80	02/08→		01/12→		03.2123-3131.3 010977	ATE Ø 23,81
1.6 HDi 110	82	07/10→		Orga 12348→		03.2123-3131.3 010977	ATE Ø 23,81
1.6 HDi 115	84	01/12→					
1.6 THP 150	110	04/09→					
1.6 THP 155	115	04/09→					
1.6 VTI 120	88	07/10→					
1.8 16V	92	02/08→					
2.0 16V	103	02/08→					
2.0 HDi	100	02/08→					
2.0 HDi 140	103	04/09→					
2.0 HDi 150 / BlueHDi 150	110	04/09→					
2.0 HDi 165	120	04/09→					
2.2 HDi	125	02/08→					
2.2 HDi 165	120	02/08→					
2.2 HDi 200	150	07/10→					
2.7 HDi	150	02/08→					
3.0 HDi 240	177	04/09→					
3.0 V6	155	02/08→					
2.0 HDi 180	133	03/15→				03.2123-3131.3 010977	ATE Ø 23,81
CITROËN - C6 (TD_) 09/05→							
 Bremskraftverstärker							
2.2 HDi	120	06/06→		für Linkslenker; →Orga 11192		03.7860-3402.4 300217	ATE Ø 10" pneumatisch
2.2 HDi	125	06/06→		Orga 12047→; für Linkslenker; → 12/12		03.7860-8002.4 300258	ATE Ø 10" pneumatisch
2.7 HDi	150	09/05→		→Orga 11073; für Linkslenker		03.7860-3402.4 300217	ATE Ø 10" pneumatisch
3.0 HDi	177	04/09→		07/09→; für Linkslenker; → 12/12		03.7860-8002.4 300258	ATE Ø 10" pneumatisch
3.0 V6	155	09/05→		für Linkslenker; →Orga 11192		03.7860-3402.4 300217	ATE Ø 10" pneumatisch
 Hauptbremszylinder							
2.2 HDi	120	06/06→		Orga 12348→; → 12/12		03.2123-3131.3 010977	ATE Ø 23,81
2.2 HDi	125	06/06→					
2.7 HDi	150	09/05→					
3.0 HDi	177	04/09→					
3.0 V6	155	09/05→					
CITROËN - C8 (EA_, EB_) 07/02→							
 Bremskraftverstärker							
2.0 16V	103	09/05→		→Orga 10919; für Linkslenker		03.7860-2002.4 300216	ATE Ø 10" pneumatisch
2.0 HDi 135	100	03/06→		Orga 10920→; für Linkslenker; → 07/14		03.7860-4432.4 300313	ATE Ø 10" pneumatisch
2.0 HDi	79	07/02→		Orga 10528→; für Linkslenker; → 07/14		03.7860-2002.4 300216	ATE Ø 10" pneumatisch
2.0 HDi	80	07/02→					
2.2 HDi	94	07/02→					
2.0 HDi	88	07/06→		02/07→; für Linkslenker; → 07/14		03.7860-4432.4 300313	ATE Ø 10" pneumatisch
2.0 HDi 165	120	03/06→		für Linkslenker; → 07/14		03.7870-1602.4 300311	ATE Ø 11" pneumatisch
↓							

	kw			 	! #		
CITROËN - C8 (EA_, EB_) 07/02→							
 Hauptbremszylinder							
2.0 16V 2.0 HDi 135	103 100	09/05→ 03/06→		→ 07/14		03.2122-2163.3 010800	ATE Ø 22,2
2.0 HDi 2.0 HDi 2.2 HDi	79 80 94	07/02→ 07/02→ 07/02→		Orga 10528→; → 07/14		03.2122-2163.3 010800	ATE Ø 22,2
2.0 HDi	88	07/06→		02/07→ 07/14		03.2122-2163.3 010800	ATE Ø 22,2
2.0 HDi 165 2.2 HDi 2.2 HDi	120 120 125	03/06→ 06/07→ 06/06→		→ 07/14		03.2123-3421.3 010933	ATE Ø 23,81
CITROËN - C15 (VD_) 10/84→10/06							
 Hauptbremszylinder							
1.4 1.4 E 1.4 i	49 44 55	07/87→12/96 05/87→12/96 05/91→12/96		→Orga 04195; für Rechtslenker		24.2119-1705.3 010460	Ø 19,05
 Bremskraftregler							
1.1 1.1 i 1.4 1.4 E 1.4 i 1.8 D	35 44 49 44 55 44	10/84→12/96 07/88→12/96 07/87→12/96 05/87→12/96 05/91→12/96 07/86→12/00				24.6512-1507.3 320023	lastabhängig 3x
CITROËN - C15 Kombi 04/87→08/00							
 Hauptbremszylinder							
1.4	55	05/91→07/96		→Orga 04195; für Rechtslenker		24.2119-1705.3 010460	Ø 19,05
 Bremskraftregler							
1.1 1.4 1.8 D	44 55 44	08/88→07/96 05/91→07/96 04/87→08/00				24.6512-1507.3 320023	lastabhängig 3x
CITROËN - C-ELYSEE 11/12→							
 Hauptbremszylinder							
1.6 HDi 92	68	11/12→		+ ESP		24.4122-1703.3 010843	TRW Ø 22,2
CITROËN - DS3 11/09→07/15							
 Hauptbremszylinder							
1.4 HDi 70 1.6 HDi 110 1.6 HDi 90 1.6 Racing 1.6 Racing 1.6 THP 150 1.6 THP 155 1.6 VTi 120	50 82 68 149 152 110 115 88	04/10→07/15 11/09→07/15 11/09→07/15 02/11→07/15 02/11→07/15 01/10→07/15 04/10→07/15 04/10→07/15		Orga 12999→ Orga 13341		24.4123-1704.3 010828	TRW Ø 23,81
1.4 VTi 95 1.4 VTi 95 LPG 1.4 VTi 98 1.6 HDi 115	70 70 72 84	04/10→07/15 08/12→07/15 11/09→07/15 08/12→07/15		Orga 12999→ Orga 13341		24.4122-1703.3 010843	TRW Ø 22,2
				→Orga 13341		24.4123-1704.3 010828	TRW Ø 23,81
CITROËN - DS3 Cabriolet 01/13→07/15							
 Hauptbremszylinder							
1.2 THP 110 1.6 BlueHDi 100 1.6 BlueHDi 115 1.6 BlueHDi 120 1.6 Racing 1.6 THP 165	81 73 85 88 152 121	10/14→07/15 07/14→07/15 10/13→07/15 07/14→07/15 03/14→07/15 10/14→07/15				24.4123-1704.3 010828	TRW Ø 23,81
1.6 HDi 90 1.6 THP 150 1.6 THP 155 1.6 VTi 120	69 110 115 88	01/13→07/15 01/13→07/15 01/13→07/15 01/13→07/15		03/13→		24.4123-1704.3 010828	TRW Ø 23,81
CITROËN - DS5 11/11→07/15							
 Bremskraftverstärker							
1.6 BlueHDi 120 1.6 HDi 1.6 HDi 110 1.6 THP 155 1.6 THP 165 1.6 THP 200 ↓	88 85 82 115 121 147	07/14→07/15 11/13→07/15 11/11→07/15 11/11→07/15 01/12→07/15 11/11→07/15		für Fahrzeuge ohne Start-Stopp-Funktion		03.7860-3732.4 300306	ATE Ø 10" pneumatisch

	kw					! #		
CITROËN - DS5 11/11→07/15								
 Bremskraftverstärker								
2.0 BlueHDi 150	110	07/14→07/15		für Fahrzeuge ohne Start-Stopp-Funktion			03.7860-3732.4 300306	ATE Ø 10" pneumatisch
2.0 BlueHDi 180	133	08/13→07/15						
2.0 HDi 135	100	11/11→07/15						
2.0 HDi 150 Hybrid	110	11/11→07/15						
2.0 HDi 165	120	11/11→07/15						
1.6 HDi 115	84	06/12→07/15		08/12→; für Fahrzeuge ohne Start-Stopp-Funktion			03.7860-3732.4 300306	ATE Ø 10" pneumatisch
 Hauptbremszylinder								
1.6 BlueHDi 120	88	07/14→07/15		Nabendurchmesser [mm]: 82			03.4153-0173.3 010815	ATE Ø 23,81
1.6 HDi	85	11/13→07/15						
1.6 HDi 110	82	11/11→07/15						
1.6 THP 155	115	11/11→07/15						
1.6 THP 165	121	01/12→07/15						
1.6 THP 200	147	11/11→07/15						
2.0 BlueHDi 150	110	07/14→07/15						
2.0 BlueHDi 180	133	08/13→07/15						
2.0 HDi 135	100	11/11→07/15						
2.0 HDi 150 Hybrid	110	11/11→07/15						
2.0 HDi 165	120	11/11→07/15						
2.0 HDi 165 Hybrid4 4x4	120	12/11→07/15						
1.6 HDi 115	84	06/12→07/15		08/12→; Nabendurchmesser [mm]: 82			03.4153-0173.3 010815	ATE Ø 23,81
CITROËN - EVASION Großraumlimousine (22, U6) 03/94→07/02								
 Hauptbremszylinder								
1.8	73	05/97→07/02		→Orga 08206; - ABS			24.2122-1703.3 010422	Ø 22,2
				→Orga 08206; + ABS			24.2122-1708.3 010437	Ø 22,2
				Orga 08207→; - ABS			24.2122-1741.3 010695	Ø 22,2
				Orga 08207→; + ABS			24.2122-1742.3 010696	Ø 22,2
1.9 TD	66	11/94→07/02		02/95→; →Orga 08206; - ABS			24.2123-1707.3 010492	Ø 23,81
				Orga 08207→; + ABS			24.2123-1733.3 010657	BOS Ø 23,81
				Orga 08207→; - ABS			24.2123-1738.3 010658	Ø 23,81
1.9 TD	68	10/95→12/98		- ABS			24.2123-1707.3 010492	Ø 23,81
2.0	89	06/94→07/02		→Orga 08206; - ABS			24.2123-1707.3 010492	Ø 23,81
2.0 16V	100	05/00→07/02		Orga 08207→; + ABS			24.2123-1733.3 010657	BOS Ø 23,81
2.0 Turbo C.T.	108	06/94→07/02		Orga 08207→; - ABS			24.2123-1738.3 010658	Ø 23,81
2.1 TD	80	05/96→07/02		Orga 08207→; - ABS			24.2123-1738.3 010658	Ø 23,81
2.0 16V	97	05/98→04/00		12/98→; →Orga 08206; - ABS			24.2123-1707.3 010492	Ø 23,81
				Orga 08207→; + ABS			24.2123-1733.3 010657	BOS Ø 23,81
				Orga 08207→; - ABS			24.2123-1738.3 010658	Ø 23,81
2.0 HDi	80	08/99→07/02		+ ABS			24.2123-1733.3 010657	BOS Ø 23,81
2.0 HDi 16V	80	09/99→07/02		- ABS			24.2123-1738.3 010658	Ø 23,81
CITROËN - JUMPER Bus 04/06→								
 Hauptbremszylinder								
2.2 HDi 100	74	04/06→		Nutzlast ab [kg] 1.600 Nutzlast bis [kg] 2.000; Nutzlast 16Q/20Q; + ESP			24.4125-1701.3 010867	BOS Ø 25,4 ohne Bremsflüssigkeitsbehälter
2.2 HDi 110	81	07/11→						
2.2 HDi 120	88	04/06→		Nutzlast ab [kg] 1.200 Nutzlast bis [kg] 1.400; Nutzlast 12Q/14Q; - ESP			24.4125-1702.3 010872	BOS Ø 25,4 ohne Bremsflüssigkeitsbehälter
2.2 HDi 130	96	07/11→						
2.2 HDi 150	110	07/11→						
3.0 HDi 155	115	07/10→		Nutzlast ab [kg] 1.200 Nutzlast bis [kg] 1.400; Nutzlast 12Q/14Q; + ESP			24.4126-1701.3 010868	BOS Ø 26,99 ohne Bremsflüssigkeitsbehälter
3.0 HDi 160	116	09/06→						
3.0 HDi 180	130	07/11→		Nutzlast ab [kg] 1.600 Nutzlast bis [kg] 2.000; Nutzlast 16Q/20Q; - ESP			24.4126-1702.3 010875	BOS Ø 26,99 ohne Bremsflüssigkeitsbehälter
CITROËN - JUMPER Bus (230P) 02/94→04/02								
 Hauptbremszylinder								
1.9 D	51	01/99→04/02		→ S 15064995; Nutzlast [kg]: 1.000; + ABS			24.2122-1714.3 010480	Ø 22,2
				→ S 15064995; Nutzlast [kg]: 1.000; für Linkslenker; - ABS			24.2122-1715.3 010481	Ø 22,2
				S 15064996→ S 16206233; Nutzlast [kg]: 1.000; + ABS			24.2125-1702.3 010482	Ø 25,4
				S 15064996→ S 16205754; Nutzlast [kg]: 1.000; für Linkslenker; - ABS			24.2125-1703.3 010483	Ø 25,4
				S 16205755→; → 03/02; Nutzlast [kg]: 1.000; - ABS			24.2125-1725.3 010717	Ø 25,4
				S 16206234→; → 03/02; Nutzlast [kg]: 1.000; + ABS			24.2125-1726.3 010718	Ø 25,4
1.9 TD	66	08/94→04/02		→ S 15064995; Nutzlast ab [kg] 1.000			24.2122-1714.3 010480	Ø 22,2
1.9 TD	68	02/94→04/02		Nutzlast bis [kg] 1.400; + ABS				

	kw			 	! #		
CITROËN - JUMPER Bus (230P) 02/94→04/02							
 Hauptbremszylinder							
1.9 TD 4x4	68	08/96→04/02	→ S 15064995; Nutzlast ab [kg] 1.000 Nutzlast bis [kg] 1.400; für Linkslenker; - ABS	24.2122-1715.3	010481	Ø 22,2	
			S 15064996→ S 16206233; Nutzlast ab [kg] 1.000 Nutzlast bis [kg] 1.400; + ABS	24.2125-1702.3	010482	Ø 25,4	
			S 15064996→ S 16205754; Nutzlast ab [kg] 1.000 Nutzlast bis [kg] 1.400; für Linkslenker; - ABS	24.2125-1703.3	010483	Ø 25,4	
			S 16205755→; → 03/02; Nutzlast ab [kg] 1.000 Nutzlast bis [kg] 1.400; - ABS	24.2125-1725.3	010717	Ø 25,4	
			S 16206234→; → 03/02; Nutzlast ab [kg] 1.000 Nutzlast bis [kg] 1.400; + ABS	24.2125-1726.3	010718	Ø 25,4	
2.0	80	02/94→04/02	→ S 15064995; Nutzlast ab [kg] 1.000 Nutzlast bis [kg] 1.400; + ABS	24.2122-1714.3	010480	Ø 22,2	
			→ S 15064995; Nutzlast [kg]: 1.000; für Linkslenker; - ABS	24.2122-1715.3	010481	Ø 22,2	
			→ S 16194399; Nutzlast [kg]: 1.800; + ABS	24.2125-1702.3	010482	Ø 25,4	
			S 15064996→ S 16206233; Nutzlast ab [kg] 1.000 Nutzlast bis [kg] 1.400; + ABS	24.2125-1702.3	010482	Ø 25,4	
			→ S 16205754; Nutzlast [kg]: 1.800; für Linkslenker; - ABS	24.2125-1703.3	010483	Ø 25,4	
			S 15064996→ S 16205754; Nutzlast ab [kg] 1.000 Nutzlast bis [kg] 1.400; für Linkslenker; - ABS	24.2125-1703.3	010483	Ø 25,4	
			S 16205755→; → 03/02; Nutzlast ab [kg] 1.000 Nutzlast bis [kg] 1.400; - ABS	24.2125-1725.3	010717	Ø 25,4	
			S 16205353→; → 03/02; Nutzlast [kg]: 1.800; - ABS	24.2125-1725.3	010717	Ø 25,4	
			S 16206234→; → 03/02; Nutzlast ab [kg] 1.000 Nutzlast bis [kg] 1.400; + ABS	24.2125-1726.3	010718	Ø 25,4	
			S 16194400→; → 03/02; Nutzlast [kg]: 1.800; + ABS	24.2125-1726.3	010718	Ø 25,4	
2.0 4x4	80	08/96→04/02	→ S 15064995; Nutzlast ab [kg] 1.000 Nutzlast bis [kg] 1.400; + ABS	24.2122-1714.3	010480	Ø 22,2	
			S 15064996→ S 16206233; Nutzlast ab [kg] 1.000 Nutzlast bis [kg] 1.400; + ABS	24.2125-1702.3	010482	Ø 25,4	
			S 15064996→ S 16205754; Nutzlast ab [kg] 1.000 Nutzlast bis [kg] 1.400; für Linkslenker; - ABS	24.2125-1703.3	010483	Ø 25,4	
			S 16205755→; → 03/02; Nutzlast ab [kg] 1.000 Nutzlast bis [kg] 1.400; - ABS	24.2125-1725.3	010717	Ø 25,4	
			S 16206234→; → 03/02; Nutzlast ab [kg] 1.000 Nutzlast bis [kg] 1.400; + ABS	24.2125-1726.3	010718	Ø 25,4	
			S 16194400→; → 03/02; Nutzlast [kg]: 1.800; + ABS	24.2125-1726.3	010718	Ø 25,4	
2.5 D 2.5 TD	63 76	08/94→04/02 08/94→04/02	→ S 15064995; Nutzlast [kg]: 1.400; + ABS	24.2122-1714.3	010480	Ø 22,2	
			→ S 15064995; Nutzlast [kg]: 1.400; für Linkslenker; - ABS	24.2122-1715.3	010481	Ø 22,2	
			S 15064996→ S 16206233; Nutzlast [kg]: 1.400; + ABS	24.2125-1702.3	010482	Ø 25,4	
			→ S 16194399; Nutzlast [kg]: 1.800; + ABS	24.2125-1702.3	010482	Ø 25,4	
			→ S 16205754; Nutzlast [kg]: 1.800; für Linkslenker; - ABS	24.2125-1703.3	010483	Ø 25,4	
			S 15064996→ S 16205754; Nutzlast [kg]: 1.400; für Linkslenker; - ABS	24.2125-1703.3	010483	Ø 25,4	
			S 16205353→; → 03/02; Nutzlast [kg]: 1.800; - ABS	24.2125-1725.3	010717	Ø 25,4	
			S 16205755→; → 03/02; Nutzlast [kg]: 1.400; - ABS	24.2125-1725.3	010717	Ø 25,4	
			S 16194400→; → 03/02; Nutzlast [kg]: 1.800; + ABS	24.2125-1726.3	010718	Ø 25,4	
			S 16206234→; → 03/02; Nutzlast [kg]: 1.400; + ABS	24.2125-1726.3	010718	Ø 25,4	
			→ S 16194399; Nutzlast [kg]: 1.800; + ABS	24.2125-1702.3	010482	Ø 25,4	
2.5 TDi	79	12/96→11/00	S 15064996→ S 16206233; Nutzlast [kg]: 1.400; + ABS	24.2125-1702.3	010482	Ø 25,4	
			→ S 16205754; Nutzlast ab [kg] 1.400 Nutzlast bis [kg] 1.800; für Linkslenker; - ABS	24.2125-1703.3	010483	Ø 25,4	
			S 16205353→; Nutzlast [kg]: 1.800; - ABS	24.2125-1725.3	010717	Ø 25,4	
			S 16205755→; Nutzlast [kg]: 1.400; - ABS	24.2125-1725.3	010717	Ø 25,4	



	kw			 	! #		
CITROËN - JUMPER Bus (230P) 02/94→04/02							
 Hauptbremszylinder							
2.5 TDi	79	12/96→11/00		S 16194400→; Nutzlast [kg]: 1.800; + ABS	24.2125-1726.3	010718	Ø 25,4
				S 16206234→; Nutzlast [kg]: 1.400; + ABS	24.2125-1726.3	010718	Ø 25,4
2.5 TDi 4x4 2.8 HDi 4x4	79 94	12/96→11/00 09/00→04/02		→ S 16205754; Nutzlast ab [kg] 1.400 Nutzlast bis [kg] 1.800; für Linkslenker; - ABS	24.2125-1703.3	010483	Ø 25,4
2.8 D	64	01/99→02/02		→ S 15064995; Nutzlast [kg]: 1.400; + ABS	24.2122-1714.3	010480	Ø 22,2
				→ S 15064995; Nutzlast [kg]: 1.400; für Linkslenker; - ABS	24.2122-1715.3	010481	Ø 22,2
				S 15064996→ S 16206253; Nutzlast [kg]: 1.400; + ABS	24.2125-1702.3	010482	Ø 25,4
				→ S 16194399; Nutzlast [kg]: 1.800	24.2125-1702.3	010482	Ø 25,4
				→ S 16205352; Nutzlast [kg]: 1.800; für Linkslenker; - ABS	24.2125-1703.3	010483	Ø 25,4
				S 15064996→ S 16205754; Nutzlast [kg]: 1.400; für Linkslenker; - ABS	24.2125-1703.3	010483	Ø 25,4
				S 16205755→; Nutzlast [kg]: 1.400; - ABS	24.2125-1725.3	010717	Ø 25,4
				S 16205353→; Nutzlast [kg]: 1.800; - ABS	24.2125-1725.3	010717	Ø 25,4
				S 16206254→; Nutzlast [kg]: 1.400; + ABS	24.2125-1726.3	010718	Ø 25,4
2.8 HDi	94	09/00→04/02		→ S 16206233; Nutzlast [kg]: 1.400; + ABS	24.2125-1702.3	010482	Ø 25,4
				→ S 16194399; Nutzlast [kg]: 1.800; + ABS	24.2125-1702.3	010482	Ø 25,4
				→ S 16205754; Nutzlast ab [kg] 1.400 Nutzlast bis [kg] 1.800; für Linkslenker; - ABS	24.2125-1703.3	010483	Ø 25,4
				S 16205755→; → 03/02; Nutzlast [kg]: 1.400; - ABS	24.2125-1725.3	010717	Ø 25,4
				S 16205353→; → 03/02; Nutzlast [kg]: 1.800; - ABS	24.2125-1725.3	010717	Ø 25,4
				S 16194400→; → 03/02; Nutzlast [kg]: 1.800; + ABS	24.2125-1726.3	010718	Ø 25,4
				S 16206234→; → 03/02; Nutzlast [kg]: 1.400; + ABS	24.2125-1726.3	010718	Ø 25,4
 Bremskraftregler							
1.9 D	51	01/99→04/02		→ S 16206244; Nutzlast [kg]: 1.000; - ABS	24.6512-1701.3	320153	lastabhängig 2x
1.9 TD	66	08/94→04/02		→ S 16206244; Nutzlast ab [kg] 1.000	24.6512-1701.3	320153	lastabhängig 2x
1.9 TD	68	02/94→04/02		Nutzlast bis [kg] 1.400; - ABS			
1.9 TD 4x4	68	08/96→04/02					
2.0	80	02/94→04/02		→ S 16206244; Nutzlast ab [kg] 1.000	24.6512-1701.3	320153	lastabhängig 2x
2.0 4x4	80	08/96→04/02		Nutzlast bis [kg] 1.800; - ABS			
2.5 D	63	08/94→04/02		→ S 16206244; Nutzlast ab [kg] 1.400	24.6512-1701.3	320153	lastabhängig 2x
2.5 D 4x4	63	08/96→04/02		Nutzlast bis [kg] 1.800; - ABS			
2.5 TD	76	08/94→04/02					
2.5 TD 4x4	76	08/96→04/02					
2.8 D	64	01/99→02/02					
2.8 HDi	94	09/00→04/02					
2.8 HDi 4x4	94	09/00→04/02					
2.5 TDi	79	12/96→11/00		Nutzlast ab [kg] 1.400 Nutzlast bis [kg]	24.6512-1701.3	320153	lastabhängig 2x
2.5 TDi 4x4	79	12/96→11/00		1.800; - ABS			
CITROËN - JUMPER Bus (244, Z_) 04/02→							
 Hauptbremszylinder							
2.0	81	04/02→		→ 03/06; Nutzlast ab [kg] 1.000 Nutzlast	24.2125-1725.3	010717	Ø 25,4
2.0 HDi	62	04/02→		bis [kg] 1.800; - ABS			
2.2 HDi	74	04/02→		→ 03/06; Nutzlast ab [kg] 1.000 Nutzlast	24.2125-1726.3	010718	Ø 25,4
2.8 HDi	94	04/02→		bis [kg] 1.800; + ABS			
2.0 bivalent	81	02/03→		→ S 15064995; Nutzlast [kg]: 1.000; für Linkslenker; - ABS	24.2122-1715.3	010481	Ø 22,2
2.8 HDi Allrad	94	04/02→		→ 03/06; - ABS	24.2125-1725.3	010717	Ø 25,4
				→ 03/06; + ABS	24.2125-1726.3	010718	Ø 25,4
 Bremskraftregler							
2.8 HDi Allrad	94	04/02→		→ 03/06; Nutzlast ab [kg] 1.000 Nutzlast	24.6512-1701.3	320153	lastabhängig 2x
				bis [kg] 1.800; - ABS			

CITROËN - JUMPER Kasten 04/06→









Hauptbremszylinder













2.2 HDi 100	74	04/06→		Nutzlast ab [kg] 1.600 Nutzlast bis [kg] 2.000; Nutzlast 16Q/20Q; + ESP	24.4125-1701.3	010867	BOS Ø 25,4 ohne Bremsflüssigkeitsbehälter
2.2 HDi 110	81	07/11→					
2.2 HDi 120	88	04/06→		Nutzlast ab [kg] 1.200 Nutzlast bis [kg] 1.400; Nutzlast 12Q/14Q; - ESP	24.4125-1702.3	010872	BOS Ø 25,4 ohne Bremsflüssigkeitsbehälter
2.2 HDi 130	96	07/11→					
2.2 HDi 150	110	07/11→					
3.0 HDi 145	107	07/10→		Nutzlast ab [kg] 1.200 Nutzlast bis [kg] 1.400; Nutzlast 12Q/14Q; + ESP	24.4126-1701.3	010868	BOS Ø 26,99 ohne Bremsflüssigkeitsbehälter
3.0 HDi 155	115	07/10→					
3.0 HDi 160	116	09/06→					
3.0 HDi 180	130	07/11→		Nutzlast ab [kg] 1.600 Nutzlast bis [kg] 2.000; Nutzlast 16Q/20Q; - ESP	24.4126-1702.3	010875	BOS Ø 26,99 ohne Bremsflüssigkeitsbehälter









CITROËN - JUMPER Kasten (230L) 02/94→04/02

Hauptbremszylinder















1.9 D	50 51	07/99→04/02 02/94→04/02		→ S 15064995; Nutzlast [kg]: 1.000; + ABS	24.2122-1714.3	010480	Ø 22,2
				→ S 15064995; Nutzlast [kg]: 1.000; für Linkslenker; - ABS	24.2122-1715.3	010481	Ø 22,2
				S 15064996→ S 16206233; Nutzlast [kg]: 1.000; + ABS	24.2125-1702.3	010482	Ø 25,4
				S 15064996→ S 16205754; Nutzlast [kg]: 1.000; für Linkslenker; - ABS	24.2125-1703.3	010483	Ø 25,4
				S 16205755→; → 03/02; Nutzlast [kg]: 1.000; - ABS	24.2125-1725.3	010717	Ø 25,4
				S 16206234→; → 03/02; Nutzlast [kg]: 1.000; + ABS	24.2125-1726.3	010718	Ø 25,4
1.9 TD	66 68	03/94→04/02 03/94→04/02		→ S 15064995; Nutzlast ab [kg] 1.000 Nutzlast bis [kg] 1.400; + ABS	24.2122-1714.3	010480	Ø 22,2
				→ S 15064995; Nutzlast ab [kg] 1.000 Nutzlast bis [kg] 1.400; für Linkslenker; - ABS	24.2122-1715.3	010481	Ø 22,2
				S 15064996→ S 16206233; Nutzlast ab [kg] 1.000 Nutzlast bis [kg] 1.400; + ABS	24.2125-1702.3	010482	Ø 25,4
				S 15064996→ S 16205754; Nutzlast ab [kg] 1.000 Nutzlast bis [kg] 1.400; für Linkslenker; - ABS	24.2125-1703.3	010483	Ø 25,4
				S 16205755→; → 03/02; Nutzlast ab [kg] 1.000 Nutzlast bis [kg] 1.400; - ABS	24.2125-1725.3	010717	Ø 25,4
				S 16206234→; → 03/02; Nutzlast ab [kg] 1.000 Nutzlast bis [kg] 1.400; + ABS	24.2125-1726.3	010718	Ø 25,4
2.0	80	03/94→04/02		→ S 15064995; Nutzlast ab [kg] 1.000 Nutzlast bis [kg] 1.400; + ABS	24.2122-1714.3	010480	Ø 22,2
				→ S 15064995; Nutzlast ab [kg] 1.000 Nutzlast bis [kg] 1.400; für Linkslenker; - ABS	24.2122-1715.3	010481	Ø 22,2
				S 15064996→ S 16206233; Nutzlast ab [kg] 1.000 Nutzlast bis [kg] 1.400; + ABS	24.2125-1702.3	010482	Ø 25,4
				→ S 16194399; Nutzlast [kg]: 1.800; + ABS	24.2125-1702.3	010482	Ø 25,4
				S 15064996→ S 16205754; Nutzlast ab [kg] 1.000 Nutzlast bis [kg] 1.400; für Linkslenker; - ABS	24.2125-1703.3	010483	Ø 25,4
				→ S 16205754; Nutzlast [kg]: 1.800; für Linkslenker; - ABS	24.2125-1703.3	010483	Ø 25,4
				S 16205353→; → 03/02; Nutzlast [kg]: 1.800; - ABS	24.2125-1725.3	010717	Ø 25,4
				S 16205755→; → 03/02; Nutzlast ab [kg] 1.000 Nutzlast bis [kg] 1.400; - ABS	24.2125-1725.3	010717	Ø 25,4
				S 16194400→; → 03/02; Nutzlast [kg]: 1.800; + ABS	24.2125-1726.3	010718	Ø 25,4
				S 16206234→; → 03/02; Nutzlast ab [kg] 1.000 Nutzlast bis [kg] 1.400; + ABS	24.2125-1726.3	010718	Ø 25,4
2.0 4x4	80	10/96→01/02		→ S 15064995; Nutzlast ab [kg] 1.000 Nutzlast bis [kg] 1.400; + ABS	24.2122-1714.3	010480	Ø 22,2
				→ S 15064995; Nutzlast ab [kg] 1.000 Nutzlast bis [kg] 1.400; für Linkslenker; - ABS	24.2122-1715.3	010481	Ø 22,2
				→ S 16194399; Nutzlast [kg]: 1.800; + ABS	24.2125-1702.3	010482	Ø 25,4
				S 15064996→ S 16206233; Nutzlast ab [kg] 1.000 Nutzlast bis [kg] 1.400; + ABS	24.2125-1702.3	010482	Ø 25,4
				→ S 16205754; Nutzlast [kg]: 1.800; für Linkslenker; - ABS	24.2125-1703.3	010483	Ø 25,4
				S 15064996→ S 16205754; Nutzlast ab [kg] 1.000 Nutzlast bis [kg] 1.400; für Linkslenker; - ABS	24.2125-1703.3	010483	Ø 25,4

























	kw			 	! #		
CITROËN - JUMPER Kasten (230L) 02/94→04/02							
 Hauptbremszylinder							
2.0 4x4	80	10/96→01/02		S 16205755→; Nutzlast ab [kg] 1.000 Nutzlast bis [kg] 1.400; - ABS	24.2125-1725.3	010717	Ø 25,4
				S 16205353→; Nutzlast [kg]: 1.800; - ABS	24.2125-1725.3	010717	Ø 25,4
				S 16194400→; Nutzlast [kg]: 1.800; + ABS	24.2125-1726.3	010718	Ø 25,4
2.0 HDI	62	11/01→04/02		S 16206234→; Nutzlast ab [kg] 1.000 Nutzlast bis [kg] 1.400; + ABS	24.2125-1726.3	010718	Ø 25,4
				→ 03/02; Nutzlast ab [kg] 1.000 Nutzlast bis [kg] 1.800; - ABS	24.2125-1725.3	010717	Ø 25,4
				→ 03/02; Nutzlast ab [kg] 1.000 Nutzlast bis [kg] 1.800; + ABS	24.2125-1726.3	010718	Ø 25,4
2.5 D 2.5 D 4x4 2.5 TD	63	03/94→04/02		→ S 15064995; Nutzlast [kg]: 1.400; + ABS	24.2122-1714.3	010480	Ø 22,2
	63	03/00→04/02		→ S 15064995; Nutzlast [kg]: 1.400; für Linkslenker; - ABS	24.2122-1715.3	010481	Ø 22,2
	76	03/94→04/02		S 15064996→ S 16206233; Nutzlast [kg]: 1.400; + ABS	24.2125-1702.3	010482	Ø 25,4
				→ S 16194399; Nutzlast [kg]: 1.800; + ABS	24.2125-1702.3	010482	Ø 25,4
				→ S 16205754; Nutzlast [kg]: 1.800; für Linkslenker; - ABS	24.2125-1703.3	010483	Ø 25,4
				S 15064996→ S 16205754; Nutzlast [kg]: 1.400; für Linkslenker; - ABS	24.2125-1703.3	010483	Ø 25,4
				S 16205353→; → 03/02; Nutzlast [kg]: 1.800; - ABS	24.2125-1725.3	010717	Ø 25,4
				S 16205755→; → 03/02; Nutzlast [kg]: 1.400; - ABS	24.2125-1725.3	010717	Ø 25,4
				S 16194400→; → 03/02; Nutzlast [kg]: 1.800; + ABS	24.2125-1726.3	010718	Ø 25,4
				S 16206234→; → 03/02; Nutzlast [kg]: 1.400; + ABS	24.2125-1726.3	010718	Ø 25,4
2.5 DT 4x4	76	10/96→08/97		→ S 15064995; Nutzlast [kg]: 1.400; + ABS	24.2122-1714.3	010480	Ø 22,2
				→ S 15064995; Nutzlast [kg]: 1.400; für Linkslenker; - ABS	24.2122-1715.3	010481	Ø 22,2
				S 15064996→ S 16206233; Nutzlast [kg]: 1.400; + ABS	24.2125-1702.3	010482	Ø 25,4
				S 15064996→ S 16205754; Nutzlast [kg]: 1.400; für Linkslenker; - ABS	24.2125-1703.3	010483	Ø 25,4
				S 16205755→; Nutzlast [kg]: 1.400; - ABS	24.2125-1725.3	010717	Ø 25,4
				S 16206234→; Nutzlast [kg]: 1.400; + ABS	24.2125-1726.3	010718	Ø 25,4
2.5 TDi 2.5 TDi 4x4	79	12/96→11/00		→ S 16194399; Nutzlast [kg]: 1.800; + ABS	24.2125-1702.3	010482	Ø 25,4
	79	03/00→11/00		S 15064996→ S 16206233; Nutzlast [kg]: 1.400; + ABS	24.2125-1702.3	010482	Ø 25,4
				→ S 16205754; Nutzlast ab [kg] 1.400 Nutzlast bis [kg] 1.800; für Linkslenker; - ABS	24.2125-1703.3	010483	Ø 25,4
				S 16205353→; Nutzlast [kg]: 1.800; - ABS	24.2125-1725.3	010717	Ø 25,4
				S 16205755→; Nutzlast [kg]: 1.400; - ABS	24.2125-1725.3	010717	Ø 25,4
				S 16194400→; Nutzlast [kg]: 1.800; + ABS	24.2125-1726.3	010718	Ø 25,4
				S 16206234→; Nutzlast [kg]: 1.400; + ABS	24.2125-1726.3	010718	Ø 25,4
2.8 HDi 2.8 HDi 4x4	94	09/00→04/02		S 15064996→ S 16206233; Nutzlast [kg]: 1.400; + ABS	24.2125-1702.3	010482	Ø 25,4
	94	09/00→04/02		→ S 16194399; Nutzlast [kg]: 1.800; + ABS	24.2125-1702.3	010482	Ø 25,4
				→ S 16205754; Nutzlast ab [kg] 1.400 Nutzlast bis [kg] 1.800; für Linkslenker; - ABS	24.2125-1703.3	010483	Ø 25,4
				S 16205755→; → 03/02; Nutzlast [kg]: 1.400; - ABS	24.2125-1725.3	010717	Ø 25,4
				S 16205353→; → 03/02; Nutzlast [kg]: 1.800; - ABS	24.2125-1725.3	010717	Ø 25,4
				S 16194400→; → 03/02; Nutzlast [kg]: 1.800; + ABS	24.2125-1726.3	010718	Ø 25,4
				S 16206234→; → 03/02; Nutzlast [kg]: 1.400; + ABS	24.2125-1726.3	010718	Ø 25,4













	kw					! #		
CITROËN - JUMPER Kasten (230L) 02/94→04/02								
 Bremskraftregler								
1.9 D	50	07/99→04/02		→ S 16206244; Nutzlast [kg]: 1.000;		24.6512-1701.3	320153	lastabhängig 2x
1.9 D	51	02/94→04/02		- ABS				
1.9 TD	66	03/94→04/02		→ S 16206244; Nutzlast ab [kg] 1.000		24.6512-1701.3	320153	lastabhängig 2x
1.9 TD	68	03/94→04/02		Nutzlast bis [kg] 1.400; - ABS				
2.0	80	03/94→04/02		→ S 16206244; Nutzlast ab [kg] 1.000		24.6512-1701.3	320153	lastabhängig 2x
2.0 4x4	80	10/96→01/02		Nutzlast bis [kg] 1.800; - ABS				
2.5 D	63	03/94→04/02		→ S 16206244; Nutzlast ab [kg] 1.400		24.6512-1701.3	320153	lastabhängig 2x
2.5 D 4x4	63	03/00→04/02		Nutzlast bis [kg] 1.800; - ABS				
2.5 TD	76	03/94→04/02						
2.5 TDi	79	12/96→11/00						
2.5 TDi 4x4	79	03/00→11/00						
2.8 HDi	94	09/00→04/02						
2.8 HDi 4x4	94	09/00→04/02						
CITROËN - JUMPER Kasten (244) 04/02→								
 Hauptbremszylinder								
2.0	81	04/02→		→ 03/06; Nutzlast ab [kg] 1.000 Nutzlast		24.2125-1725.3	010717	Ø 25,4
2.0 bivalent	81	02/03→		bis [kg] 1.800; - ABS				
2.0 HDi	62	04/02→		→ 03/06; Nutzlast ab [kg] 1.000 Nutzlast		24.2125-1726.3	010718	Ø 25,4
2.2 HDi	74	04/02→		bis [kg] 1.800; + ABS				
2.8 HDi	94	04/02→						
2.8 HDi	107	05/04→						
2.8 HDi 4x4	94	04/02→		→ 03/06; - ABS		24.2125-1725.3	010717	Ø 25,4
				→ 03/06; + ABS		24.2125-1726.3	010718	Ø 25,4
 Bremskraftregler								
2.8 HDi 4x4	94	04/02→		→ 03/06; Nutzlast ab [kg] 1.000 Nutzlast		24.6512-1701.3	320153	lastabhängig 2x
				bis [kg] 1.800; - ABS				
CITROËN - JUMPER Pritsche/Fahrgestell 04/06→								
 Hauptbremszylinder								
2.2 HDi 100	74	04/06→		Nutzlast ab [kg] 1.600 Nutzlast bis [kg]		24.4125-1701.3	010867	BOS Ø 25,4
2.2 HDi 110	81	07/11→		2.000; Nutzlast 16Q/20Q; + ESP				ohne Bremsflüssigkeitsbehälter
2.2 HDi 120	88	04/06→						
2.2 HDi 130	96	07/11→		Nutzlast ab [kg] 1.200 Nutzlast bis [kg]		24.4125-1702.3	010872	BOS Ø 25,4
2.2 HDi 150	110	07/11→		1.400; Nutzlast 12Q/14Q; - ESP				ohne Bremsflüssigkeitsbehälter
3.0 HDi 145	107	07/10→		Nutzlast ab [kg] 1.200 Nutzlast bis [kg]		24.4126-1701.3	010868	BOS Ø 26,99
3.0 HDi 160	116	09/06→		1.400; Nutzlast 12Q/14Q; + ESP				ohne Bremsflüssigkeitsbehälter
3.0 HDi 180	130	07/11→		Nutzlast ab [kg] 1.600 Nutzlast bis [kg]		24.4126-1702.3	010875	BOS Ø 26,99
				2.000; Nutzlast 16Q/20Q; - ESP				ohne Bremsflüssigkeitsbehälter
CITROËN - JUMPER Pritsche/Fahrgestell (230) 03/94→04/02								
 Hauptbremszylinder								
1.9 TD	66	03/94→04/02		→ S 15064995; Nutzlast ab [kg] 1.000		24.2122-1714.3	010480	Ø 22,2
1.9 TD	68	03/94→04/02		Nutzlast bis [kg] 1.400; + ABS				
				→ S 15064995; Nutzlast ab [kg] 1.000		24.2122-1715.3	010481	Ø 22,2
				Nutzlast bis [kg] 1.400; - ABS;				
				für Linkslenker				
				S 15064996→ S 16206233; Nutzlast ab		24.2125-1702.3	010482	Ø 25,4
				[kg] 1.000 Nutzlast bis [kg] 1.400; + ABS				
				S 15064996→ S 16205754; Nutzlast ab		24.2125-1703.3	010483	Ø 25,4
				[kg] 1.000 Nutzlast bis [kg] 1.400; - ABS;				
				für Linkslenker				
				S 16205755→; → 03/02; Nutzlast ab [kg]		24.2125-1725.3	010717	Ø 25,4
				1.000 Nutzlast bis [kg] 1.400; - ABS				
				S 16206234→; → 03/02; Nutzlast ab [kg]		24.2125-1726.3	010718	Ø 25,4
				1.000 Nutzlast bis [kg] 1.400; + ABS				
2.0	80	03/94→04/02		→ S 15064995; Nutzlast ab [kg] 1.000		24.2122-1714.3	010480	Ø 22,2
				Nutzlast bis [kg] 1.400; + ABS				
				→ S 15064995; Nutzlast ab [kg] 1.000		24.2122-1715.3	010481	Ø 22,2
				Nutzlast bis [kg] 1.400; - ABS;				
				für Linkslenker				
				S 15064996→ S 16206233; Nutzlast ab		24.2125-1702.3	010482	Ø 25,4
				[kg] 1.000 Nutzlast bis [kg] 1.400; + ABS				
				→ S 16194399; Nutzlast [kg]: 1.800;		24.2125-1702.3	010482	Ø 25,4
				+ ABS				
				S 15064996→ S 16205754; Nutzlast ab		24.2125-1703.3	010483	Ø 25,4
				[kg] 1.000 Nutzlast bis [kg] 1.400; - ABS;				
				für Linkslenker				
				→ S 16205754; Nutzlast [kg]: 1.800;		24.2125-1703.3	010483	Ø 25,4
				- ABS; für Linkslenker				
				S 16205353→; → 03/02;		24.2125-1725.3	010717	Ø 25,4
				Nutzlast [kg]: 1.800; - ABS				









	kw			 	! #		
CITROËN - JUMPER Pritsche/Fahrgestell (230) 03/94 → 04/02							
 Hauptbremszylinder							
2.0	80	03/94 → 04/02		S 16205755 →; → 03/02; Nutzlast ab [kg] 1.000 Nutzlast bis [kg] 1.400; - ABS		24.2125-1725.3 010717	Ø 25,4
				S 16194400 →; → 03/02; Nutzlast [kg]: 1.800; + ABS		24.2125-1726.3 010718	Ø 25,4
				S 16206234 →; → 03/02; Nutzlast ab [kg] 1.000 Nutzlast bis [kg] 1.400; + ABS		24.2125-1726.3 010718	Ø 25,4
2.5 D 2.5 D 4x4 2.5 TD	63 63 76	03/94 → 04/02 03/00 → 04/02 03/94 → 04/02		→ S 15064995; Nutzlast [kg]: 1.400; + ABS		24.2122-1714.3 010480	Ø 22,2
				→ S 15064995; Nutzlast [kg]: 1.400; - ABS; für Linkslenker		24.2122-1715.3 010481	Ø 22,2
				S 15064996 → S 16206233; Nutzlast [kg]: 1.400; + ABS		24.2125-1702.3 010482	Ø 25,4
				→ S 16194399; Nutzlast [kg]: 1.800; + ABS		24.2125-1702.3 010482	Ø 25,4
				→ S 16205754; Nutzlast [kg]: 1.800; - ABS; für Linkslenker		24.2125-1703.3 010483	Ø 25,4
				S 15064996 → S 16205754; Nutzlast [kg]: 1.400; - ABS; für Linkslenker		24.2125-1703.3 010483	Ø 25,4
				S 16205353 →; → 03/02; Nutzlast [kg]: 1.800; - ABS		24.2125-1725.3 010717	Ø 25,4
				S 16205755 →; → 03/02; Nutzlast [kg]: 1.400; - ABS		24.2125-1725.3 010717	Ø 25,4
				S 16194400 →; → 03/02; Nutzlast [kg]: 1.800; + ABS		24.2125-1726.3 010718	Ø 25,4
				S 16206234 →; → 03/02; Nutzlast [kg]: 1.400; + ABS		24.2125-1726.3 010718	Ø 25,4
2.5 TDi 2.5 TDi 4x4 2.8 HDi	79 79 94	12/96 → 04/02 03/00 → 04/02 09/00 → 04/02		→ S 16206233; Nutzlast [kg]: 1.400; + ABS		24.2125-1702.3 010482	Ø 25,4
				→ S 16194399; Nutzlast [kg]: 1.800; + ABS		24.2125-1702.3 010482	Ø 25,4
				→ S 16205754; Nutzlast ab [kg] 1.400 Nutzlast bis [kg] 1.800; - ABS; für Linkslenker		24.2125-1703.3 010483	Ø 25,4
				S 16205755 →; → 03/02; Nutzlast [kg]: 1.400; - ABS		24.2125-1725.3 010717	Ø 25,4
				S 16205353 →; → 03/02; Nutzlast [kg]: 1.800; - ABS		24.2125-1725.3 010717	Ø 25,4
				S 16194400 →; → 03/02; Nutzlast [kg]: 1.800; + ABS		24.2125-1726.3 010718	Ø 25,4
				S 16206234 →; → 03/02; Nutzlast [kg]: 1.400; + ABS		24.2125-1726.3 010718	Ø 25,4
2.8 D	64	01/99 → 02/02		→ S 15064995; Nutzlast [kg]: 1.400; + ABS		24.2122-1714.3 010480	Ø 22,2
				→ S 15064995; Nutzlast [kg]: 1.400; - ABS; für Linkslenker		24.2122-1715.3 010481	Ø 22,2
				→ S 16194399; Nutzlast [kg]: 1.800; + ABS		24.2125-1702.3 010482	Ø 25,4
				S 15064996 → S 16206253; Nutzlast [kg]: 1.400; + ABS		24.2125-1702.3 010482	Ø 25,4
				→ S 16205352; Nutzlast [kg]: 1.800; für Linkslenker; - ABS		24.2125-1703.3 010483	Ø 25,4
				S 15064996 → S 16205754; Nutzlast [kg]: 1.400; - ABS; für Linkslenker		24.2125-1703.3 010483	Ø 25,4
				S 16205755 →; Nutzlast [kg]: 1.400; - ABS		24.2125-1725.3 010717	Ø 25,4
				S 16205353 →; Nutzlast [kg]: 1.800; - ABS		24.2125-1725.3 010717	Ø 25,4
				S 16206254 →; Nutzlast [kg]: 1.400; + ABS		24.2125-1726.3 010718	Ø 25,4
				S 16194400 →; Nutzlast [kg]: 1.800; + ABS		24.2125-1726.3 010718	Ø 25,4
 Bremskraftregler							
1.9 TD 1.9 TD	66 68	03/94 → 04/02 03/94 → 04/02		→ S 16206244; Nutzlast ab [kg] 1.000 Nutzlast bis [kg] 1.400; - ABS		24.6512-1701.3 320153	lastabhängig 2x
2.0	80	03/94 → 04/02		→ S 16206244; Nutzlast ab [kg] 1.000 Nutzlast bis [kg] 1.800; - ABS		24.6512-1701.3 320153	lastabhängig 2x
2.5 D 2.5 D 4x4 2.5 TD 2.5 TDi 2.5 TDi 4x4 2.8 D 2.8 HDi	63 63 76 79 79 64 94	03/94 → 04/02 03/00 → 04/02 03/94 → 04/02 12/96 → 04/02 03/00 → 04/02 01/99 → 02/02 09/00 → 04/02		→ S 16206244; Nutzlast ab [kg] 1.400 Nutzlast bis [kg] 1.800; - ABS		24.6512-1701.3 320153	lastabhängig 2x













	kw					! #			
CITROËN - JUMPER Pritsche/Fahrgestell (244) 02/02→									
 Hauptbremszylinder									
2.0 HDi 2.2 HDi 2.8 HDi 2.8 HDi	62 74 94 107	04/02→ 04/02→ 04/02→ 05/04→			→ 03/06; Nutzlast ab [kg] 1.000 Nutzlast bis [kg] 1.800; - ABS → 03/06; Nutzlast ab [kg] 1.000 Nutzlast bis [kg] 1.800; + ABS		24.2125-1725.3 24.2125-1726.3	010717 010718	Ø 25,4 Ø 25,4
2.2 HDi	74	02/02→06/06			04/02→ 03/06; Nutzlast ab [kg] 1.000 Nutzlast bis [kg] 1.800; - ABS 04/02→ 03/06; Nutzlast ab [kg] 1.000 Nutzlast bis [kg] 1.800; + ABS		24.2125-1725.3 24.2125-1726.3	010717 010718	Ø 25,4 Ø 25,4
2.8 HDi 4x4	94	02/02→06/06			04/02→ 03/06; - ABS 04/02→ 03/06; + ABS		24.2125-1725.3 24.2125-1726.3	010717 010718	Ø 25,4 Ø 25,4
 Bremskraftregler									
2.8 HDi 4x4	94	02/02→06/06			04/02→ 03/06; Nutzlast ab [kg] 1.000 Nutzlast bis [kg] 1.800; - ABS		24.6512-1701.3	320153	lastabhängig 2x
CITROËN - JUMPY (U6U) 06/94→12/06									
 Hauptbremszylinder									
1.6 1.9 D 1.9 D 70 1.9 TD 1.9 TD	58 51 51 66 68	10/95→08/00 10/95→08/98 04/98→11/03 10/95→08/00 04/96→11/03			→Orga 08206; - ABS; Nutzlast [kg]: 800 →Orga 08206; + ABS; Nutzlast [kg]: 800 Orga 08207→; - ABS; Nutzlast [kg]: 800 Orga 08207→; + ABS; Nutzlast [kg]: 800		24.2122-1703.3 24.2122-1708.3 24.2122-1741.3 24.2122-1742.3	010422 010437 010695 010696	Ø 22,2 Ø 22,2 Ø 22,2 Ø 22,2
					→Orga 08206; - ABS; Nutzlast [kg]: 900 Orga 08207→; + ABS; Nutzlast [kg]: 900 Orga 08207→; - ABS; Nutzlast [kg]: 900		24.2123-1707.3 24.2123-1733.3 24.2123-1738.3	010492 010657 010658	Ø 23,81 BOS Ø 23,81 Ø 23,81
2.0 2.0 HDi 110 2.0 HDi 95 2.0 i 16V	100 80 69 102	04/00→12/06 03/00→10/06 10/99→10/06 03/00→10/06			+ ABS - ABS		24.2123-1733.3 24.2123-1738.3	010657 010658	BOS Ø 23,81 Ø 23,81
CITROËN - JUMPY (VF7) 01/07→									
 Hauptbremszylinder									
1.6 HDi 90 16V 2.0 HDi 120 2.0 HDi 125 2.0 HDi 140 2.0 HDi 165 2.0 HDi 95 2.0 i	66 88 94 100 120 72 103	01/07→ 01/07→ 07/11→ 01/07→ 07/10→ 07/11→ 01/07→			für Linkslenker; - ESP für Linkslenker; + ESP für Rechtslenker; - ESP		03.2125-0298.3 03.2125-0671.3 24.2123-3396.3	010818 010965 011035	ATE Ø 25,4 ATE Ø 25,4 ATE Ø 23,81 ohne Bremsflüssigkeitsbehälter
CITROËN - JUMPY Kasten 01/07→									
 Hauptbremszylinder									
1.6 HDi 90 16V 1.6 HDi 90 8V 2.0 HDi 120 2.0 HDi 125 2.0 HDi 140 2.0 HDi 165 2.0 HDi 95 2.0 i	66 66 88 94 100 120 72 103	01/07→ 01/07→ 01/07→ 07/11→ 01/07→ 07/10→ 07/11→ 01/07→			für Linkslenker; - ESP für Linkslenker; + ESP für Rechtslenker; - ESP		03.2125-0298.3 03.2125-0671.3 24.2123-3396.3	010818 010965 011035	ATE Ø 25,4 ATE Ø 25,4 ATE Ø 23,81 ohne Bremsflüssigkeitsbehälter
CITROËN - JUMPY Kasten (BS_, BT_, BY_, BZ_) 06/94→10/06									
 Hauptbremszylinder									
1.6 i 1.9 D 70 1.9 TD	58 51 66	10/95→08/00 04/98→10/06 10/95→08/00			→Orga 08206; - ABS; Nutzlast [kg]: 800 →Orga 08206; + ABS; Nutzlast [kg]: 800 Orga 08207→; - ABS; Nutzlast [kg]: 800 Orga 08207→; + ABS; Nutzlast [kg]: 800 →Orga 08206; - ABS; Nutzlast [kg]: 900 Orga 08207→; + ABS; Nutzlast [kg]: 900 Orga 08207→; - ABS; Nutzlast [kg]: 900		24.2122-1703.3 24.2122-1708.3 24.2122-1741.3 24.2122-1742.3 24.2123-1707.3 24.2123-1733.3 24.2123-1738.3	010422 010437 010695 010696 010492 010657 010658	Ø 22,2 Ø 22,2 Ø 22,2 Ø 22,2 Ø 23,81 BOS Ø 23,81 Ø 23,81
2.0 2.0 HDi 110 2.0 HDi 95 2.0 i 16V 2.0 HDi 110	100 80 69 102 80	04/00→10/06 01/02→10/06 10/99→10/06 03/00→10/06 10/01→10/06			+ ABS - ABS 01/02→; + ABS 01/02→; - ABS		24.2123-1733.3 24.2123-1738.3 24.2123-1733.3 24.2123-1738.3	010657 010658 010657 010658	BOS Ø 23,81 Ø 23,81 BOS Ø 23,81 Ø 23,81
CITROËN - JUMPY Pritsche/Fahrgestell (BU_, BV_, BW_, BX_) 10/99→10/06									
 Hauptbremszylinder									
1.9 TD ↓	68	10/99→10/06			- ABS; Nutzlast [kg]: 800		24.2122-1741.3	010695	Ø 22,2













	kw					! #		
CITROËN - JUMPY Pritsche/Fahrgestell (BU_, BV_, BW_, BX_) 10/99→10/06								
 Hauptbremszylinder								
1.9 TD	68	10/99→10/06		+ ABS; Nutzlast [kg]: 800		24.2122-1742.3	010696	Ø 22,2
				+ ABS; Nutzlast [kg]: 900		24.2123-1733.3	010657	BOS Ø 23,81
				- ABS; Nutzlast [kg]: 900		24.2123-1738.3	010658	Ø 23,81
2.0 HDi 110 16V	80	12/03→10/06		+ ABS		24.2123-1733.3	010657	BOS Ø 23,81
2.0 HDi 95	69	10/99→10/06		- ABS		24.2123-1738.3	010658	Ø 23,81
CITROËN - SAXO (S0, S1) 02/96→04/04								
 Bremskraftverstärker								
1.0 X	33	05/96→11/98		für Linkslenker; - ABS		03.7740-3302.4	300107	ATE Ø 8" pneumatisch
1.0 X	37	05/98→06/03						
1.1 X,SX	40	05/96→09/03						
1.1 X,SX	44	05/96→09/03						
1.5 D	43	07/01→04/04						
1.6	66	02/96→06/03						
1.6	74	02/01→04/04						
1.6	88	02/96→04/04						
1.6 VTL,VTR	65	05/96→06/03						
1.6 VTS	72	09/00→09/03						
1.6 VTS	87	06/96→09/03		07/96→; für Linkslenker; - ABS		03.7740-3302.4	300107	ATE Ø 8" pneumatisch
 Hauptbremszylinder								
1.0 X	33	05/96→11/98		- ABS; Felge Lochzahl: 3		03.2120-4166.3	010452	ATE Ø 20,64
1.0 X	37	05/98→06/03				24.2120-1722.3	010544	Ø 20,64
1.1 X,SX	40	05/96→09/03						
1.1 X,SX	44	05/96→09/03		- ABS; Felge Lochzahl: 4		24.2119-1708.3	010543	BDX Ø 19,05
				+ ABS		24.2120-1728.3	010626	Ø 20,64
1.4 VTS	55	05/96→06/03		- ABS		03.2120-4166.3	010452	ATE Ø 20,64
1.5 D	40	09/96→09/03				24.2120-1722.3	010544	Ø 20,64
1.5 D	42	09/96→06/01						
1.5 D	43	07/01→04/04				24.2119-1708.3	010543	BDX Ø 19,05
1.6	66	02/96→06/03						
1.6 VTL,VTR	65	05/96→06/03		+ ABS		24.2120-1728.3	010626	Ø 20,64
1.6	74	02/01→04/04		- ABS		03.2120-4166.3	010452	ATE Ø 20,64
1.6	88	02/96→04/04				24.2120-1722.3	010544	Ø 20,64
1.6 VTS	72	09/00→09/03				24.2119-1708.3	010543	BDX Ø 19,05
1.6 VTS	87	06/96→09/03		07/96→; - ABS		03.2120-4166.3	010452	ATE Ø 20,64
						24.2120-1722.3	010544	Ø 20,64
				07/96→		24.2119-1708.3	010543	BDX Ø 19,05
CITROËN - XSARA (N1) 04/97→12/05								
 Bremskraftverstärker								
1.4 HDi	50	01/03→03/05		für Linkslenker; + ABS		03.7853-0902.4	300150	ATE Ø 9" pneumatisch
1.4 i	55	04/97→03/05		→ 08/00		03.7750-9302.4	300116	ATE Ø 9" pneumatisch
1.9 D	51	07/98→03/05						
2.0 HDi 90	66	02/99→03/05		Orga 09002→; für Linkslenker; + ABS		03.7853-0902.4	300150	ATE Ø 9" pneumatisch
1.5 D	42	04/97→09/00		→ 08/00		03.7750-9302.4	300116	ATE Ø 9" pneumatisch
1.6 i	65	04/97→09/00						
1.8 D	43	04/97→09/00						
1.8 i	66	04/97→09/00						
1.8 i Aut.	74	04/97→09/00						
1.9 D	50	04/97→09/00						
1.9 SD	55	01/98→09/00						
1.9 TD	66	04/97→09/00						
1.6 16V	80	09/00→03/05		Orga 09002→; für Linkslenker; + ABS		03.7853-0902.4	300150	ATE Ø 9" pneumatisch
2.0 16V	100	09/00→03/05						
2.0 HDi 109	80	05/01→03/05						
 Hauptbremszylinder								
1.4 HDi	50	01/03→03/05		+ ESP		03.2123-2761.3	010886	ATE Ø 23,81
				- ABS		03.2123-2781.3	010631	ATE Ø 23,81
1.4 i	55	04/97→03/05		→ 08/00; + ABS		03.2122-1351.3	010528	Ø 22,2
1.9 D	51	07/98→03/05				24.2122-1733.3	010668	Ø 22,2
2.0 HDi 90	66	02/99→03/05		→ 08/00; - ABS		03.2122-1356.3	010529	Ø 22,2
						24.2122-1743.3	010712	Ø 22,2
				Orga 09065→; + ESP		03.2123-2761.3	010886	ATE Ø 23,81
				Orga 09002→; - ABS		03.2123-2781.3	010631	ATE Ø 23,81
				09/00→; →Orga 09001; - ABS		24.2123-1714.3	010587	BDX Ø 23,81
				09/00→; →Orga 09001; + ABS		24.2123-1715.3	010520	BDX Ø 23,81
1.5 D	42	04/97→09/00		→ 08/00; + ABS		03.2122-1351.3	010528	Ø 22,2
1.6 i	65	04/97→09/00				24.2122-1733.3	010668	Ø 22,2
↓								















	kw			 	! #		
CITROËN - XSARA (N1) 04/97→12/05							
 Hauptbremszylinder							
1.8 D	43	04/97→09/00		→ 08/00; - ABS		03.2122-1356.3 010529	Ø 22,2
1.8 i	66	04/97→09/00				24.2122-1743.3 010712	Ø 22,2
1.8 i Aut.	74	04/97→09/00					
1.9 D	50	04/97→09/00					
1.9 SD	55	01/98→09/00					
1.9 TD	66	04/97→09/00					
1.6 16V	80	09/00→03/05		Orga 09065→; + ESP		03.2123-2761.3 010886	ATE Ø 23,81
2.0 HDi 109	80	05/01→03/05		Orga 09002→; - ABS		03.2123-2781.3 010631	ATE Ø 23,81
				→Orga 09001; - ABS		24.2123-1714.3 010587	BDX Ø 23,81
				→Orga 09001; + ABS		24.2123-1715.3 010520	BDX Ø 23,81
1.8 i 16V	81	04/97→09/00		→ 08/00; - ABS		24.2123-1714.3 010587	BDX Ø 23,81
2.0 16V	97	07/98→09/00		→ 08/00; + ABS		24.2123-1715.3 010520	BDX Ø 23,81
2.0 16V	120	04/97→09/00					
2.0 16V	100	09/00→03/05		Orga 09065→; + ESP		03.2123-2761.3 010886	ATE Ø 23,81
				Orga 09002→; - ABS		03.2123-2781.3 010631	ATE Ø 23,81
CITROËN - XSARA Break (N2) 10/97→03/10							
 Bremskraftverstärker							
1.4 HDi	50	01/03→08/05		für Linkslenker; + ABS		03.7853-0902.4 300150	ATE Ø 9" pneumatisch
1.4 i	55	10/97→08/05		→ 08/00; - ABS		03.7750-9302.4 300116	ATE Ø 9" pneumatisch
1.9 D	51	07/98→08/05					
2.0 HDi 90	66	02/99→08/05		Orga 09002→; für Linkslenker; + ABS		03.7853-0902.4 300150	ATE Ø 9" pneumatisch
1.5 D	42	10/97→09/00		→ 08/00; - ABS		03.7750-9302.4 300116	ATE Ø 9" pneumatisch
1.6 i	65	10/97→09/00					
1.8 D	43	10/97→09/00					
1.9 D	50	10/97→09/00					
1.9 D	55	01/98→09/00					
1.9 TD	66	10/97→09/00					
1.6 16V	80	09/00→08/05		Orga 09002→; für Linkslenker; + ABS		03.7853-0902.4 300150	ATE Ø 9" pneumatisch
2.0 16V	100	09/00→08/05					
2.0 HDi 109	80	05/01→08/05					
 Hauptbremszylinder							
1.4 HDi	50	01/03→08/05		+ ESP		03.2123-2761.3 010886	ATE Ø 23,81
				- ABS		03.2123-2781.3 010631	ATE Ø 23,81
1.4 i	55	10/97→08/05		→ 08/00; - ABS		03.2122-1356.3 010529	Ø 22,2
				Orga 09065→; + ESP		03.2123-2761.3 010886	ATE Ø 23,81
				Orga 09002→; - ABS		03.2123-2781.3 010631	ATE Ø 23,81
				→Orga 09001; - ABS		24.2123-1714.3 010587	BDX Ø 23,81
				→Orga 09001; + ABS		24.2123-1715.3 010520	BDX Ø 23,81
1.5 D	42	10/97→09/00		→ 08/00; - ABS		03.2122-1356.3 010529	Ø 22,2
1.6 i	65	10/97→09/00				24.2123-1714.3 010587	BDX Ø 23,81
1.8 D	43	10/97→09/00					
1.9 D	50	10/97→09/00		→ 08/00; + ABS		24.2123-1715.3 010520	BDX Ø 23,81
1.6 16V	80	09/00→08/05		Orga 09065→; + ESP		03.2123-2761.3 010886	ATE Ø 23,81
2.0 16V	100	09/00→08/05		Orga 09002→; - ABS		03.2123-2781.3 010631	ATE Ø 23,81
2.0 HDi 109	80	05/01→08/05					
2.0 HDi 90	66	02/99→08/05		→Orga 09001; - ABS		24.2123-1714.3 010587	BDX Ø 23,81
				→Orga 09001; + ABS		24.2123-1715.3 010520	BDX Ø 23,81
1.8 i	66	10/97→09/00		→ 08/00; - ABS		24.2123-1714.3 010587	BDX Ø 23,81
1.8 i 16V	81	10/97→09/00		→ 08/00; + ABS		24.2123-1715.3 010520	BDX Ø 23,81
1.8 i Aut.	74	10/97→09/00					
1.9 D	55	01/98→09/00					
1.9 TD	66	10/97→09/00					
2.0 16V	97	07/98→09/00					
1.9 D	51	07/98→08/05		Orga 09065→; + ESP		03.2123-2761.3 010886	ATE Ø 23,81
				Orga 09002→; - ABS		03.2123-2781.3 010631	ATE Ø 23,81
CITROËN - XSARA Coupe (N0) 01/98→04/05							
 Bremskraftverstärker							
1.4 HDi	50	01/03→03/05		für Linkslenker; + ABS		03.7853-0902.4 300150	ATE Ø 9" pneumatisch
1.4 i	55	03/98→03/05		→ 08/00		03.7750-9302.4 300116	ATE Ø 9" pneumatisch
1.9 D	51	02/99→03/05					
2.0 HDi 90	66	02/99→03/05		Orga 09002→; für Linkslenker; + ABS		03.7853-0902.4 300150	ATE Ø 9" pneumatisch
1.6 16V	80	09/00→03/05		Orga 09002→; für Linkslenker; + ABS		03.7853-0902.4 300150	ATE Ø 9" pneumatisch
2.0 16V	100	09/00→03/05					
2.0 HDi 109	80	05/01→03/05					
2.0 i 16V	120	02/98→03/05					
1.8 i	66	02/98→09/00		→ 08/00		03.7750-9302.4 300116	ATE Ø 9" pneumatisch
1.8 i 16V	81	02/98→09/00					
1.9 D	50	02/98→09/00					
1.9 TD	66	02/98→09/00					
↓							















	kw					! #		
CITROËN - XSARA Coupe (N0) 01/98→04/05								
 Hauptbremszylinder								
1.4 HDi	50	01/03→03/05		+ ESP			03.2123-2761.3 010886	ATE Ø 23,81
				- ABS			03.2123-2781.3 010631	ATE Ø 23,81
1.4 i	55	03/98→03/05		→ 08/00; + ABS			03.2122-1351.3 010528	Ø 22,2
1.9 D	51	02/99→03/05					24.2122-1733.3 010668	Ø 22,2
2.0 HDi 90	66	02/99→03/05		→ 08/00; - ABS			03.2122-1356.3 010529	Ø 22,2
							24.2122-1743.3 010712	Ø 22,2
				Orga 09065→; + ESP			03.2123-2761.3 010886	ATE Ø 23,81
				Orga 09002→; - ABS			03.2123-2781.3 010631	ATE Ø 23,81
				09/00→; →Orga 09001; - ABS			24.2123-1714.3 010587	BDX Ø 23,81
				09/00→; →Orga 09001; + ABS			24.2123-1715.3 010520	BDX Ø 23,81
1.6 16V	80	09/00→03/05		Orga 09065→; + ESP			03.2123-2761.3 010886	ATE Ø 23,81
2.0 16V	100	09/00→03/05		Orga 09002→; - ABS			03.2123-2781.3 010631	ATE Ø 23,81
2.0 HDi 109	80	05/01→03/05		→Orga 09001; - ABS			24.2123-1714.3 010587	BDX Ø 23,81
2.0 i 16V	120	02/98→03/05		→Orga 09001; + ABS			24.2123-1715.3 010520	BDX Ø 23,81
1.8 i	66	02/98→09/00		→ 08/00; + ABS			03.2122-1351.3 010528	Ø 22,2
1.9 D	50	02/98→09/00					24.2122-1733.3 010668	Ø 22,2
1.9 TD	66	02/98→09/00		→ 08/00; - ABS			03.2122-1356.3 010529	Ø 22,2
							24.2122-1743.3 010712	Ø 22,2
1.8 i 16V	81	02/98→09/00		→ 08/00; - ABS			24.2123-1714.3 010587	BDX Ø 23,81
				→ 08/00; + ABS			24.2123-1715.3 010520	BDX Ø 23,81
CITROËN - XSARA PICASSO (N68) 12/99→								
 Hauptbremszylinder								
1.6	65	12/99→		Orga 0882078→; → 03/10;			03.2123-2781.3 010631	ATE Ø 23,81
2.0 HDi	66	12/99→		für Linkslenker; - ABS				
				06/00→ 03/10; - ABS			24.2123-1714.3 010587	BDX Ø 23,81
1.6	70	12/99→		Orga 0882078→; → 03/10;			03.2123-2781.3 010631	ATE Ø 23,81
				für Linkslenker; - ABS				
				09/00→ 03/10; - ABS			24.2123-1714.3 010587	BDX Ø 23,81
1.6 16V	80	09/05→		→ 03/10; für Linkslenker; - ABS			03.2123-2781.3 010631	ATE Ø 23,81
1.6 HDi	66	09/05→					24.2123-1714.3 010587	BDX Ø 23,81
1.6 HDi	80	05/04→		→ 03/10; - ABS				
2.0 16V	100	01/03→						
1.8 16V	85	02/00→		Orga 0882078→; → 03/10;			03.2123-2781.3 010631	ATE Ø 23,81
				für Linkslenker; - ABS				
				→ 03/10; - ABS			24.2123-1714.3 010587	BDX Ø 23,81
 Bremskraftregler								
1.6	65	12/99→		06/00→ 03/10; - ABS			03.6582-0015.3 320227	ATE lastabhängig 8/1,5 4x
2.0 HDi	66	12/99→						
1.6	70	12/99→		09/00→ 03/10; - ABS			03.6582-0015.3 320227	ATE lastabhängig 8/1,5 4x
1.6 16V	80	09/05→		→ 03/10; - ABS			03.6582-0015.3 320227	ATE lastabhängig 8/1,5 4x
1.6 HDi	66	09/05→						
1.6 HDi	80	05/04→						
1.8 16V	85	02/00→						
2.0 16V	100	01/03→						
CITROËN - ZX (N2) 03/91→07/99								
 Bremskraftverstärker								
1.1	44	03/91→06/97		- ABS			03.7740-4002.4 300108	ATE Ø 8" pneumatisch
1.4	55	03/91→06/97						
1.4 i	55	03/91→06/97						
1.6 i	65	03/91→06/97						
1.8 D	44	06/93→06/97						
1.8 i	74	07/92→06/97						
1.9	93	03/91→06/97						
1.9 D	47	03/91→06/97						
1.9 i	88	03/91→06/97						
1.9 TD	66	07/92→06/97						
2.0 i	89	07/92→06/97						
1.6	66	07/94→10/97		→ 06/97; - ABS			03.7740-4002.4 300108	ATE Ø 8" pneumatisch
1.8	76	07/94→10/97						
1.9 DT	65	07/94→10/97						
2.0	90	07/94→10/97						
1.9 D	50	07/93→06/97		06/94→; - ABS			03.7740-4002.4 300108	ATE Ø 8" pneumatisch
 Hauptbremszylinder								
1.1	44	03/91→06/97		→Orga 07125; - ABS			03.2120-2031.3 010106	ATE Ø 20,64
1.4	55	03/91→06/97					24.2120-1722.3 010544	Ø 20,64
↓								















	kw			 	! #		
CITROËN - ZX (N2) 03/91→07/99							
 Hauptbremszylinder							
1.4 i	55	03/91→06/97		Orga 07126→; - ABS		03.2120-4221.3 010605	ATE Ø 20,64
1.6 i	65	03/91→06/97		Orga 07070→; + ABS; für Linkslenker		03.2122-1331.3 010607	ATE Ø 22,2
1.8 D	44	06/93→06/97					
1.8 i	74	07/92→06/97		→Orga 07069; + ABS		24.2122-1704.3 010423	Ø 22,2
1.8 i 16V	81	01/96→06/97					
1.9	93	03/91→06/97					
1.9 D	47	03/91→06/97					
1.9 i	88	03/91→06/97					
1.9 TD	66	07/92→06/97					
2.0 i	89	07/92→06/97					
1.6	66	07/94→10/97		→Orga 07125; - ABS		03.2120-2031.3 010106	ATE Ø 20,64
1.8	76	07/94→10/97		Orga 07126→; → 06/97; - ABS		24.2120-1722.3 010544	Ø 20,64
1.9 DT	65	07/94→10/97					
2.0	90	07/94→10/97					
				Orga 07070→; → 06/97; + ABS; für Linkslenker		03.2122-1331.3 010607	ATE Ø 22,2
				→Orga 07069; + ABS		24.2122-1704.3 010423	Ø 22,2
1.9 D	50	07/93→06/97		06/94→; →Orga 07125; - ABS		03.2120-2031.3 010106	ATE Ø 20,64
				Orga 07126→; - ABS		24.2120-1722.3 010544	Ø 20,64
				Orga 07070→; + ABS; für Linkslenker		03.2122-1331.3 010607	ATE Ø 22,2
				06/94→; →Orga 07069; + ABS		24.2122-1704.3 010423	Ø 22,2
CITROËN - ZX Break (N2) 10/93→07/99							
 Hauptbremszylinder							
1.4 i	55	10/93→10/97		Orga 07070→; für Linkslenker		03.2122-1331.3 010607	ATE Ø 22,2
1.6 i	65	10/93→10/97		→Orga 07069; + ABS		24.2122-1704.3 010423	Ø 22,2
1.8 D	44	10/93→10/97					
1.8 i	74	10/93→10/97					
1.9 D	47	10/93→10/97					
1.9 D	50	06/94→10/97					
1.9 TD	66	10/93→10/97					
1.8 i 16V	81	01/96→02/98		Orga 07070→; + ABS; für Linkslenker		03.2122-1331.3 010607	ATE Ø 22,2
				- ABS; für Linkslenker		03.2122-1331.3 010607	ATE Ø 22,2
				→Orga 07069; + ABS		24.2122-1704.3 010423	Ø 22,2
DACIA - DOKKER 11/12→							
 Hauptbremszylinder							
1.2 TCe	85	11/12→		- ESP		24.4152-0381.3 011032	ATE Ø 22,2 ohne Bremsflüssigkeitsbehälter
1.5 dCi	55	11/12→					
1.5 dCi	66	11/12→		+ ESP		24.4152-0391.3 011033	ATE Ø 22,2 ohne Bremsflüssigkeitsbehälter
1.6	61	11/12→					
1.6	75	04/15→					
1.6 LPG	61	11/13→					
1.6 LPG	75	04/15→					
DACIA - DOKKER Express 12/12→							
 Hauptbremszylinder							
1.2 TCe 115	84	12/12→		- ESP		24.4152-0381.3 011032	ATE Ø 22,2 ohne Bremsflüssigkeitsbehälter
1.2 TCe 115	85	07/15→					
1.5 dCi	55	12/12→		+ ESP		24.4152-0391.3 011033	ATE Ø 22,2 ohne Bremsflüssigkeitsbehälter
1.5 dCi	66	12/12→					
1.6	61	12/12→					
1.6	75	04/15→					
1.6 LPG	61	11/13→					
1.6 LPG	75	04/15→					
DACIA - DUSTER 04/10→							
 Bremskraftverstärker							
1.5 dCi	63	04/10→		→ 10/13; + ABS		03.7853-4602.4 300302	ATE Ø 9" pneumatisch
1.5 dCi	66	10/10→					
1.5 dCi	79	06/10→					
1.5 dCi 4x4	66	10/10→					
1.5 dCi 4x4	79	06/10→					
1.5 dCi 4x4	81	10/10→					
1.6 16V	77	04/10→					
1.6 16V 4x4	77	06/10→					
1.6 16V LPG	77	04/11→					
1.5 dCi 4x4	80	08/13→			+ ABS		
1.6 16V Hi-Flex	77	08/10→		04/11→ 10/13; + ABS		03.7853-4602.4 300302	ATE Ø 9" pneumatisch













	kw			 	! #		
DACIA - DUSTER 04/10→							
 Hauptbremszylinder							
1.2 TCe 125	92	10/13→		+ ABS / - ESP		24.4152-0381.3 011032	ATE Ø 22,2 ohne Bremsflüssigkeitsbehälter
1.2 TCe 125 4x4	92	06/15→					
1.6 SCe 115	84	06/15→		+ ABS / + ESP		24.4152-0391.3 011033	ATE Ø 22,2 ohne Bremsflüssigkeitsbehälter
1.6 SCe 115 4x4	84	06/15→					
1.6 SCe 115 LPG	84	06/15→					
1.5 dCi	63	04/10→		+ ABS / - ESP; → 10/13		03.2122-2031.3 010938	ATE Ø 22,2
1.5 dCi	66	10/10→					
1.5 dCi	79	06/10→		+ ABS / + ESP; → 10/13		03.2122-2261.3 010964	ATE Ø 22,2
1.5 dCi 4x4	66	10/10→					
1.5 dCi 4x4	79	06/10→		11/13→; + ABS / - ESP		24.4152-0381.3 011032	ATE Ø 22,2 ohne Bremsflüssigkeitsbehälter
1.5 dCi 4x4	81	10/10→					
1.6 16V	77	04/10→		11/13→; + ABS / + ESP		24.4152-0391.3 011033	ATE Ø 22,2 ohne Bremsflüssigkeitsbehälter
1.6 16V 4x4	77	06/10→					
1.6 16V LPG	77	04/11→					
1.5 dCi 4x4	80	08/13→		+ ABS / - ESP		03.2122-2031.3 010938	ATE Ø 22,2
				+ ABS / + ESP		03.2122-2261.3 010964	ATE Ø 22,2
1.6 16V Hi-Flex	77	08/10→		04/11→; + ABS / - ESP; → 10/13		03.2122-2031.3 010938	ATE Ø 22,2
				11/13→; + ABS / - ESP		24.4152-0381.3 011032	ATE Ø 22,2 ohne Bremsflüssigkeitsbehälter
DACIA - DUSTER Kasten 04/11→							
 Bremskraftverstärker							
1.5 dCi	66	04/11→		→ 10/13; + ABS		03.7853-4602.4 300302	ATE Ø 9" pneumatisch
1.5 dCi 4x4	66	04/11→					
1.6 16V 4x4	77	04/11→					
1.6 16V Hi-Flex	77	04/11→					
1.5 dCi 4x4	80	04/13→		08/13→; + ABS		03.7853-4602.4 300302	ATE Ø 9" pneumatisch
 Hauptbremszylinder							
1.2 TCe 125 4x4	92	10/13→		06/15→; + ABS / - ESP		24.4152-0381.3 011032	ATE Ø 22,2 ohne Bremsflüssigkeitsbehälter
				06/15→; + ABS / + ESP		24.4152-0391.3 011033	ATE Ø 22,2 ohne Bremsflüssigkeitsbehälter
1.5 dCi	66	04/11→		+ ABS / - ESP; → 10/13		03.2122-2031.3 010938	ATE Ø 22,2
1.5 dCi 4x4	66	04/11→					
1.6 16V 4x4	77	04/11→		+ ABS / + ESP; → 10/13		03.2122-2261.3 010964	ATE Ø 22,2
				11/13→; + ABS / - ESP		24.4152-0381.3 011032	ATE Ø 22,2 ohne Bremsflüssigkeitsbehälter
				11/13→; + ABS / + ESP		24.4152-0391.3 011033	ATE Ø 22,2 ohne Bremsflüssigkeitsbehälter
1.5 dCi 4x4	80	04/13→		08/13→; + ABS / - ESP		03.2122-2031.3 010938	ATE Ø 22,2
				08/13→; + ABS / + ESP		03.2122-2261.3 010964	ATE Ø 22,2
1.6 16V Hi-Flex	77	04/11→		+ ABS / - ESP; → 10/13		03.2122-2031.3 010938	ATE Ø 22,2
				11/13→; + ABS / - ESP		24.4152-0381.3 011032	ATE Ø 22,2 ohne Bremsflüssigkeitsbehälter
1.6 SCe 115	84	06/15→		+ ABS / - ESP		24.4152-0381.3 011032	ATE Ø 22,2 ohne Bremsflüssigkeitsbehälter
1.6 SCe 115 4x4	84	06/15→					
				+ ABS / + ESP		24.4152-0391.3 011033	ATE Ø 22,2 ohne Bremsflüssigkeitsbehälter
DACIA - LODGY 03/12→							
 Hauptbremszylinder							
1.2 TCe	85	03/12→		- ESP		24.4152-0381.3 011032	ATE Ø 22,2 ohne Bremsflüssigkeitsbehälter
1.5 dCi	66	03/12→					
1.5 dCi	79	01/13→		+ ESP		24.4152-0391.3 011033	ATE Ø 22,2 ohne Bremsflüssigkeitsbehälter
1.5 dCi	80	06/15→					
1.6	61	03/12→					
1.6 LPG	61	11/13→					
1.6 LPG	75	04/15→					
1.6 SCe 115	75	06/15→		für Linkslenker; - ESP		24.4152-0381.3 011032	ATE Ø 22,2 ohne Bremsflüssigkeitsbehälter
				für Linkslenker; + ESP		24.4152-0391.3 011033	ATE Ø 22,2 ohne Bremsflüssigkeitsbehälter
DACIA - LOGAN (LS_) 09/04→							
 Bremskraftverstärker							
1.2 16V	55	02/06→		→ 04/13; + ABS		03.7853-4102.4 300271	ATE Ø 9" pneumatisch
1.2 16V LPG	55	02/06→					
1.5 dCi (LS04)	55	05/10→		→ 04/13		03.7853-4602.4 300302	ATE Ø 9" pneumatisch
1.5 dCi (LS04)	65	05/10→					
1.6 Bifuel	62	05/10→					
1.6 MPI 85	62	05/10→					
↓							







	kw			 	! #		
DACIA - LOGAN (LS_) 09/04→							
 Bremskraftverstärker							
1.5 dCi (LS0W)	63	09/07→		→ 04/13; + ABS		03.7750-8532.4 300264	ATE Ø 9" pneumatisch
1.6 (LS0B, LS0D, LS0F, LS0H)	64	09/04→					
1.6 16V Flexifuel	77	07/10→		01/11→ 04/13; + ABS		03.7853-4102.4 300271	ATE Ø 9" pneumatisch
				01/11→ 04/13		03.7853-4602.4 300302	ATE Ø 9" pneumatisch
 Hauptbremszylinder							
1.2 16V	55	02/06→		+ ABS; → 04/13		03.2120-4611.3 010937	ATE Ø 20,64
1.2 16V LPG	55	02/06→		- ABS; → 04/13		24.2120-1762.3 011002	Ø 20,64 ohne Bremsflüssigkeitsbehälter
1.5 dCi (LS04)	55	05/10→					
1.5 dCi (LS04)	65	05/10→					
1.5 dCi (LS0W)	63	09/07→					
1.6 Bifuel	62	05/10→					
1.6 MPI 85	62	05/10→					
1.4 (LS0A, LS0C, LS0E, LS0G)	55	09/04→		→ 04/13; + ABS		24.2120-1754.3 010949	Ø 20,64
1.4 MPI LPG (LS0C)	55	02/06→		- ABS; → 04/13		24.2120-1762.3 011002	Ø 20,64 ohne Bremsflüssigkeitsbehälter
1.5 dCi (LS0J, LS0Y)	48	09/05→					
1.5 dCi (LS0K)	50	01/06→					
1.6 (LS0B, LS0D, LS0F, LS0H)	64	09/04→					
1.6 16V (LS09, LS0L, LS0M, LS0P, LS0V, LS18, LS1S, LS1V,...)	77	02/06→					
1.6 16V Flexifuel	77	07/10→		01/11→; + ABS; → 04/13		03.2120-4611.3 010937	ATE Ø 20,64
				01/11→; - ABS; → 04/13		24.2120-1762.3 011002	Ø 20,64 ohne Bremsflüssigkeitsbehälter
DACIA - LOGAN EXPRESS (FS_) 03/09→							
 Bremskraftverstärker							
1.4	55	03/09→		→ 06/13		03.7750-8532.4 300264	ATE Ø 9" pneumatisch
1.5 dCi	55	05/10→		+ ABS; → 06/13		03.7750-8532.4 300264	ATE Ø 9" pneumatisch
1.5 dCi	65	05/10→					
1.5 dCi (FS0K)	50	03/09→					
1.5 dCi (FS0W)	63	03/09→					
1.6 MPI 85	62	05/10→					
 Hauptbremszylinder							
1.4	55	03/09→		+ ABS; → 06/13		03.2122-2031.3 010938	ATE Ø 22,2
				- ABS; → 06/13		24.2120-1762.3 011002	Ø 20,64 ohne Bremsflüssigkeitsbehälter
1.5 dCi	55	05/10→		+ ABS; → 06/13		03.2122-2031.3 010938	ATE Ø 22,2
1.5 dCi	65	05/10→					
1.5 dCi (FS0K)	50	03/09→					
1.5 dCi (FS0W)	63	03/09→					
1.6 MPI 85	62	05/10→					
DACIA - LOGAN MCV (KS_) 02/07→							
 Bremskraftverstärker							
1.4	55	02/07→		→ 04/13; + ABS		03.7750-8532.4 300264	ATE Ø 9" pneumatisch
1.5 dCi (KS04)	55	05/10→					
1.5 dCi (KS04)	65	05/10→					
1.5 dCi (KS0K)	50	02/07→					
1.5 dCi (KS0W)	63	09/07→					
1.6	64	02/07→					
1.6 16V (KS0L, KS0M, KS0P, KS1S)	77	02/07→					
1.6 16V Hi-Flex	77	11/09→					
1.6 Bifuel	62	05/10→					
1.6 Bifuel	64	11/08→					
1.6 MPI 85	62	05/10→					
 Hauptbremszylinder							
1.4	55	02/07→		- ABS; → 04/13		24.2120-1762.3 011002	Ø 20,64 ohne Bremsflüssigkeitsbehälter
1.5 dCi (KS0K)	50	02/07→					
1.6	64	02/07→					
1.6 16V (KS0L, KS0M, KS0P, KS1S)	77	02/07→					
1.5 dCi (KS04)	55	05/10→		+ ABS; → 04/13		03.2122-2031.3 010938	ATE Ø 22,2
1.5 dCi (KS04)	65	05/10→		- ABS; → 04/13		24.2120-1762.3 011002	Ø 20,64 ohne Bremsflüssigkeitsbehälter
1.5 dCi (KS0W)	63	09/07→					
1.6 16V Hi-Flex	77	11/09→					
1.6 Bifuel	62	05/10→		+ ABS; → 04/13		24.2120-1754.3 010949	Ø 20,64
1.6 Bifuel	64	11/08→		- ABS; → 04/13		24.2120-1762.3 011002	Ø 20,64 ohne Bremsflüssigkeitsbehälter
1.6 MPI 85	62	05/10→					











	kw			 	! #		
DACIA - LOGAN Pick-up (US_) 03/08→							
 Bremskraftverstärker							
1.4	55	01/09→		→ 06/13		03.7750-8532.4 300264	ATE Ø 9" pneumatisch
1.5 dCi	55	05/10→					
1.5 dCi	65	05/10→					
1.5 dCi (US0W)	63	03/08→					
1.6	64	03/08→					
1.6 Bifuel	62	05/10→					
1.6 MPI 85	62	05/10→					
1.5 dCi (US0K)	50	03/08→		→ 06/13; + ABS		03.7750-8532.4 300264	ATE Ø 9" pneumatisch
 Hauptbremszylinder							
1.4	55	01/09→		+ ABS; → 06/13		03.2122-2031.3 010938	ATE Ø 22,2
				- ABS; → 06/13		24.2120-1762.3 011002	Ø 20,64 ohne Bremsflüssigkeitsbehälter
1.5 dCi	55	05/10→		+ ABS; → 06/13		03.2122-2031.3 010938	ATE Ø 22,2
1.5 dCi	65	05/10→					
1.5 dCi (US0K)	50	03/08→					
1.5 dCi (US0W)	63	03/08→					
1.6	64	03/08→					
1.6 Bifuel	62	05/10→					
1.6 MPI 85	62	05/10→					
DACIA - SANDERO 06/08→							
 Bremskraftverstärker							
1.2 16V	55	11/08→		→ 02/13; + ABS		03.7853-4102.4 300271	ATE Ø 9" pneumatisch
1.2 16V LPG	55	11/08→				03.7853-4602.4 300302	ATE Ø 9" pneumatisch
1.4	55	06/08→					
1.4 MPI LPG	53	01/09→					
1.5 dCi	50	11/08→					
1.5 dCi	55	05/10→					
1.5 dCi	65	05/10→					
1.6	64	06/08→					
1.6 16V	77	07/11→					
1.6 16V Bifuel	77	01/11→					
1.6 MPI 85	62	05/10→					
1.5 dCi	63	11/08→		→ 02/13		03.7750-8532.4 300264	ATE Ø 9" pneumatisch
1.6 LPG	62	05/10→10/12		+ ABS		03.7853-4102.4 300271	ATE Ø 9" pneumatisch
						03.7853-4602.4 300302	ATE Ø 9" pneumatisch
 Hauptbremszylinder							
1.2 16V	55	11/08→		→ 02/13; + ABS		03.2120-4611.3 010937	ATE Ø 20,64
1.2 16V LPG	55	11/08→					
1.4	55	06/08→		→ 02/13; - ABS		24.2120-1762.3 011002	Ø 20,64 ohne Bremsflüssigkeitsbehälter
1.4 MPI LPG	53	01/09→					
1.5 dCi	50	11/08→					
1.5 dCi	55	05/10→					
1.5 dCi	65	05/10→					
1.6	64	06/08→					
1.6 16V	77	07/11→					
1.6 16V Bifuel	77	01/11→					
1.6 MPI 85	62	05/10→					
1.5 dCi	63	11/08→		→ 02/13; + ABS		03.2122-2031.3 010938	ATE Ø 22,2
1.6 LPG	62	05/10→10/12		+ ABS		03.2120-4611.3 010937	ATE Ø 20,64
				- ABS		24.2120-1762.3 011002	Ø 20,64 ohne Bremsflüssigkeitsbehälter
DAEWOO - MATIZ (M100, M150) 09/98→							
 Hauptbremszylinder							
0.8	38	09/98→		→ 02/05; für Linkslenker; + ABS		24.2120-1755.3 010974	Ø 20,64 ohne Bremsflüssigkeitsbehälter
1.0	47	01/03→					
				→ 02/05; für Linkslenker; - ABS		24.2120-1765.3 011003	Ø 20,64 ohne Bremsflüssigkeitsbehälter
DAIHATSU - CHARADE 05/11→							
 Bremskraftverstärker							
1.33 16V	73	05/11→		→ 01/13; für Linkslenker; + ESP		03.7750-7132.4 300255	ATE Ø 9" pneumatisch
				→ 01/13; für Linkslenker; - ESP		03.7853-3203.4 300241	ATE Ø 9" pneumatisch
 Hauptbremszylinder							
1.33 16V	73	05/11→		→ 01/13; für Linkslenker; - ESP		03.4152-0153.3 011006	ATE Ø 22,2 ohne Bremsflüssigkeitsbehälter
				→ 01/13; für Linkslenker; + ESP		03.4152-0158.3 011007	ATE Ø 22,2 ohne Bremsflüssigkeitsbehälter









	kW					! #		
DAIHATSU - CHARADE IV (G200, G202) 01/93→09/00								
 Hauptbremszylinder								
1.3	44	09/96→11/99			- ABS		24.2119-1710.3 010880	TRW Ø 19,05 mit Bremsflüssigkeitsbehälter
1.3 16V	55	05/96→11/99						
1.3 i 16V	62	01/93→09/00						
1.5 i 16V	66	01/97→11/99						
1.6 GTi	77	03/93→11/99			→ 03/96; - ABS		24.2119-1710.3 010880	TRW Ø 19,05 mit Bremsflüssigkeitsbehälter
DAIHATSU - CHARADE IV Stufenheck (G203) 03/93→01/01								
 Hauptbremszylinder								
1.5 16V	55	10/94→01/01			→ 11/99; - ABS		24.2119-1710.3 010880	TRW Ø 19,05 mit Bremsflüssigkeitsbehälter
1.5 i 16V	66	06/94→11/99			08/94→; - ABS		24.2119-1710.3 010880	TRW Ø 19,05 mit Bremsflüssigkeitsbehälter
DS - DS5 04/15→								
 Bremskraftverstärker								
1.6 BlueHDi 120	88	06/15→			für Fahrzeuge ohne Start-Stopp-Funktion		03.7860-3732.4 300306	ATE Ø 10" pneumatisch
1.6 THP 165	121	07/15→						
1.6 THP 210	155	04/15→						
2.0 BlueHDi 150	110	04/15→						
2.0 BlueHDi 180	133	04/15→						
 Hauptbremszylinder								
1.6 BlueHDi 120	88	06/15→			Nabendurchmesser [mm]: 82		03.4153-0173.3 010815	ATE Ø 23,81
1.6 THP 165	121	07/15→						
1.6 THP 210	155	04/15→						
2.0 BlueHDi 150	110	04/15→						
2.0 BlueHDi 180	133	04/15→						
2.0 HDi 165 Hybrid4 4x4	120	04/15→						
DS - DS 3 Cabriolet 07/15→								
 Hauptbremszylinder								
1.2 THP 110	81	07/15→					24.4123-1704.3 010828	TRW Ø 23,81
1.2 THP 130	96	09/15→						
1.6 BlueHDi 100	73	07/15→						
1.6 BlueHDi 120	88	07/15→						
1.6 THP 165	121	07/15→						
1.6 THP 208	153	09/15→						
FIAT - 126 (126_) 09/72→09/00								
 Hauptbremszylinder								
650	18	07/81→09/00			→ 08/87		24.2119-0815.3 010347	Ø 19,05
700	19	09/87→06/96			→ 07/90		24.2119-0815.3 010347	Ø 19,05
FIAT - 500 (312_) 07/07→								
 Hauptbremszylinder								
0.9	44	12/13→					24.4122-1714.3 010914	TRW Ø 22,2 ohne Bremsflüssigkeitsbehälter
0.9	48	09/12→						
0.9	59	12/13→						
0.9	63	07/10→						
1.3 D Multijet	57	06/16→						
1.4	74	10/07→						
0.9	77	10/13→			12/13→		24.4122-1714.3 010914	TRW Ø 22,2 ohne Bremsflüssigkeitsbehälter
1.2	51	10/07→					24.4120-1702.3 010913	TRW Ø 20,64 ohne Bremsflüssigkeitsbehälter
1.2 LPG	51	12/10→						
1.3 D Multijet	55	10/07→						
1.3 D Multijet	70	12/09→						
FIAT - 500 C (312_) 09/09→								
 Hauptbremszylinder								
0.9	44	12/13→					24.4122-1714.3 010914	TRW Ø 22,2 ohne Bremsflüssigkeitsbehälter
0.9	48	09/12→						
0.9	59	12/13→						
0.9	63	09/09→						
0.9	77	12/13→						
1.3 D Multijet	55	09/09→						
1.3 D Multijet	70	09/09→						
1.4	74	09/09→						
1.2	51	09/09→					24.4120-1702.3 010913	TRW Ø 20,64 ohne Bremsflüssigkeitsbehälter

	kw			 	! #		
FIAT - BARCHETTA (183_) 03/95→05/05							
 Hauptbremszylinder							
1.8 16V	96	04/95→05/05		→ 10/04; GG		24.2122-1716.3 010485	Ø 22,2
 Bremskraftregler							
1.8 16V	96	04/95→05/05		 + ABS; → 10/04		24.6513-1705.3 320237	lastabhängig 2x
FIAT - BRAVA (182_) 10/95→06/03							
 Hauptbremszylinder							
1.2 16V 80	59	10/00→10/01		für Linkslenker; GG		24.2122-1716.3 010485	Ø 22,2
1.4 (182.BG)	55	10/95→10/01					
1.4 12 V (182.BA)	59	10/95→08/98					
1.6 16V (182.BB)	76	02/96→10/01					
1.6 16V (182.BH)	66	10/95→10/01					
1.8 GT 16V (182.BC)	83	10/95→08/01					
1.9 JTD	74	09/00→10/01					
1.9 JTD 105	77	12/98→10/01					
2.0	113	09/98→08/00					
1.2 16V 80	60	12/98→12/02		→ 10/01; für Linkslenker; GG		24.2122-1716.3 010485	Ø 22,2
1.9 TD 100 S (182.BF)	74	03/96→10/01		06/96→; für Linkslenker; GG		24.2122-1716.3 010485	Ø 22,2
1.9 TD 75 S (182.BF)	55	03/96→10/01					
FIAT - BRAVO I (182_) 10/95→10/01							
 Hauptbremszylinder							
1.2 16V 80	59	10/00→10/01		für Linkslenker; GG		24.2122-1716.3 010485	Ø 22,2
1.2 16V 80	60	12/98→10/00					
1.4 (182.AA)	59	10/95→10/01					
1.4 (182.AG)	55	10/95→10/01					
1.6	76	09/00→10/01					
1.6 16V (182.AB)	76	03/96→10/01					
1.6 16V (182.AH)	66	10/95→10/01					
1.8 GT (182.AC)	83	10/95→10/01					
1.9 JTD	74	09/00→10/01					
1.9 JTD 105	77	12/98→10/01					
2.0 HGT 20V (182.AD)	108	10/95→07/98					
2.0 HGT 20V (182.AQ)	113	07/98→10/01					
1.9 TD 100 S (182.AF)	74	03/96→10/01		06/96→; für Linkslenker; GG		24.2122-1716.3 010485	Ø 22,2
1.9 TD 75 S (182.AF)	55	03/96→10/01					
FIAT - BRAVO II (198_) 11/06→							
 Hauptbremszylinder							
1.4 (198AXA1B)	66	04/07→12/14		01/08→		24.4123-1710.3 010866	BOS Ø 23,81 ohne Bremsflüssigkeitsbehälter
1.4 T-Jet	88	09/07→					
1.4 T-Jet (198AXF1B)	110	09/07→12/14					
1.9 D Multijet	66	04/07→12/08					
1.9 D Multijet	85	11/06→					
1.9 D Multijet	88	04/07→					
1.9 D Multijet	110	04/07→					
1.4 16V	103	03/08→		04/08→		24.4123-1710.3 010866	BOS Ø 23,81 ohne Bremsflüssigkeitsbehälter
1.4 LPG	66	12/08→12/14		11/09→		24.4123-1710.3 010866	BOS Ø 23,81 ohne Bremsflüssigkeitsbehälter
1.6 D Multijet	66	03/08→				24.4123-1710.3 010866	BOS Ø 23,81 ohne Bremsflüssigkeitsbehälter
1.6 D Multijet	85	11/08→					
1.6 D Multijet	88	03/08→					
2.0 D Multijet	120	09/08→					
2.0 D Multijet	121	09/08→					
1.6 D Multijet	77	09/07→		03/08→		24.4123-1710.3 010866	BOS Ø 23,81 ohne Bremsflüssigkeitsbehälter
FIAT - CINQUECENTO (170_) 07/91→07/99							
 Hauptbremszylinder							
0.7 (170AA)	23	12/91→01/96		02/92→		24.2119-0833.3 010418	Ø 19,05
0.7 i (170AD)	22	07/94→01/98				24.2119-0833.3 010418	Ø 19,05
0.9 i.e. S (170AF, 170CF)	29	07/91→07/99		02/92→ 05/98		24.2119-0833.3 010418	Ø 19,05
1.1 Sporting (170AH)	40	10/94→01/98		11/94→		24.2119-0833.3 010418	Ø 19,05
FIAT - COUPE (175_) 11/93→08/00							
 Hauptbremszylinder							
1.8 16V	96	03/96→08/00		07/96→; GG		24.2122-1716.3 010485	Ø 22,2
2.0 16V	102	11/93→08/96		12/93→ 06/96; GG		24.2122-1716.3 010485	Ø 22,2
2.0 16V Turbo	140	11/93→08/96					

	kw					! #		
FIAT - CROMA (194_) 06/05→								
 Hauptbremszylinder								
1.8 16V	103	12/05→		01/06→; für Linkslenker; → 11/10; für Fahrzeuge mit elektronischer Fahrdynamikregelung			24.2125-1732.3 010827	TRW Ø 25,4
				01/06→; für Linkslenker; → 11/10; für Fahrzeuge ohne elektronische Fahrdynamikregelung			24.2125-1733.3 010830	TRW Ø 25,4
1.9 D Multijet	85	06/05→		für Linkslenker; → 11/10;			24.2125-1732.3 010827	TRW Ø 25,4
1.9 D Multijet	100	12/05→		für Fahrzeuge mit elektronischer Fahrdynamikregelung				
1.9 D Multijet (194AXB1B)	88	06/05→12/11		für Linkslenker; → 11/10; für Fahrzeuge ohne elektronische Fahrdynamikregelung			24.2125-1733.3 010830	TRW Ø 25,4
1.9 D Multijet (194AXC1B, 194AXC12)	110	06/05→12/11		für Linkslenker; → 11/10; für Fahrzeuge ohne elektronische Fahrdynamikregelung				
2.2 16V	108	06/05→						
2.4 D Multijet	147	06/05→						
FIAT - DOBLO Cargo (223_) 11/00→								
 Hauptbremszylinder								
1.2 (223ZX1A)	48	03/01→		→ 09/05; + ABS			20.5522-1128.3 010747	ATE Ø 22,2
1.3 JTD 16V	51	05/04→12/06		→ 09/05; - ABS			24.2122-1750.3 010740	Ø 22,2
1.6 16V (223ZXD1A)	76	10/01→						
1.6 Natural Power	76	09/02→						
1.9 D (223ZXB1A)	46	03/01→						
1.3 D Multijet	55	10/05→01/10		+ ABS			24.4123-1710.3 010866	BOS Ø 23,81 ohne Bremsflüssigkeitsbehälter
1.3 JTD 16V Multijet	62	08/06→		→ 01/10; + ABS			24.4123-1710.3 010866	BOS Ø 23,81 ohne Bremsflüssigkeitsbehälter
1.9 JTD Multijet	88	12/06→						
1.9 JTD	77	07/03→		→ 09/05; + ABS			20.5522-1128.3 010747	ATE Ø 22,2
1.9 JTD (223ZXE1A)	74	10/01→		→ 09/05; - ABS			24.2122-1750.3 010740	Ø 22,2
				10/05→ 01/10; + ABS			24.4123-1710.3 010866	BOS Ø 23,81 ohne Bremsflüssigkeitsbehälter
 Bremskraftregler								
1.2 (223ZX1A)	48	03/01→		→ 01/10; nicht für gepanzerte Fahrzeuge			03.6582-0014.3 320198	ATE lastabhängig 8/1,5 4x
1.6 16V (223ZXD1A)	76	10/01→						
1.6 Natural Power	76	09/02→						
1.9 D (223ZXB1A)	46	03/01→						
1.9 JTD	77	07/03→						
1.9 JTD (223ZXE1A)	74	10/01→						
1.3 JTD 16V	51	05/04→12/06		nicht für gepanzerte Fahrzeuge			03.6582-0014.3 320198	ATE lastabhängig 8/1,5 4x
FIAT - DOBLO Großraumlimousine (119_, 223_) 03/01→								
 Hauptbremszylinder								
1.2 (223AX1A)	48	03/01→		→ 09/05; + ABS			20.5522-1128.3 010747	ATE Ø 22,2
1.6 16V (223AXD1A)	76	10/01→		→ 09/05; - ABS			24.2122-1750.3 010740	Ø 22,2
1.9 D (223AXB1A)	46	03/01→						
1.3 D Multijet	62	10/05→		→ 01/10; + ABS			24.4123-1710.3 010866	BOS Ø 23,81 ohne Bremsflüssigkeitsbehälter
1.9 D Multijet	88	10/05→						
1.3 JTD 16V	51	12/04→05/05		+ ABS			20.5522-1128.3 010747	ATE Ø 22,2
				- ABS			24.2122-1750.3 010740	Ø 22,2
1.6 Natural Power	76	09/02→		→ 09/05; + ABS			20.5522-1128.3 010747	ATE Ø 22,2
				→ 09/05; - ABS			24.2122-1750.3 010740	Ø 22,2
				→ 01/10; + ABS			24.4123-1710.3 010866	BOS Ø 23,81 ohne Bremsflüssigkeitsbehälter
1.9 JTD	77	07/03→		→ 09/05; + ABS			20.5522-1128.3 010747	ATE Ø 22,2
1.9 JTD (223AXE1A)	74	10/01→		→ 09/05; - ABS			24.2122-1750.3 010740	Ø 22,2
				10/05→ 01/10; + ABS			24.4123-1710.3 010866	BOS Ø 23,81 ohne Bremsflüssigkeitsbehälter
 Bremskraftregler								
1.3 JTD 16V	51	12/04→05/05		nicht für gepanzerte Fahrzeuge			03.6582-0014.3 320198	ATE lastabhängig 8/1,5 4x
FIAT - DUCATO Bus (230_) 03/94→04/02								
 Hauptbremszylinder								
1.9 D	50	04/98→04/02		→ 10/01; Nutzlast [kg]: 1.000; + ABS			24.2125-1702.3 010482	Ø 25,4
1.9 D Combinato	51	06/95→04/02		→ 10/01; Nutzlast [kg]: 1.000; - ABS			24.2125-1703.3 010483	Ø 25,4
1.9 TD	66	04/98→04/02		11/01→ 03/02; Nutzlast [kg]: 1.000; - ABS			24.2125-1725.3 010717	Ø 25,4
				11/01→ 03/02; Nutzlast [kg]: 1.000; + ABS			24.2125-1726.3 010718	Ø 25,4
1.9 TD Combinato	59	08/94→04/02		→ 10/94; Nutzlast [kg]: 1.000; + ABS			24.2122-1714.3 010480	Ø 22,2
↓								

	kw			 	! #		
FIAT - DUCATO Bus (230_) 03/94→04/02							
Hauptbremszylinder							
1.9 TD Panorama/ Combinato	60	03/94→04/02		→ 10/94; Nutzlast [kg]: 1.000; - ABS	24.2122-1715.3	010481	Ø 22,2
				11/94→ 10/01; Nutzlast [kg]: 1.000; + ABS	24.2125-1702.3	010482	Ø 25,4
				11/94→ 10/01; Nutzlast [kg]: 1.000; - ABS	24.2125-1703.3	010483	Ø 25,4
				11/01→ 03/02; Nutzlast [kg]: 1.000; - ABS	24.2125-1725.3	010717	Ø 25,4
				11/01→ 03/02; Nutzlast [kg]: 1.000; + ABS	24.2125-1726.3	010718	Ø 25,4
2.0 4x4	80	11/94→11/01		→ 10/01; Nutzlast ab [kg] 1.000 Nutzlast bis [kg] 1.400; + ABS	24.2125-1702.3	010482	Ø 25,4
				→ 10/01; Nutzlast [kg]: 1.800; + ABS	24.2125-1702.3	010482	Ø 25,4
				→ 10/01; Nutzlast ab [kg] 1.000 Nutzlast bis [kg] 1.400; - ABS	24.2125-1703.3	010483	Ø 25,4
				→ 10/01; Nutzlast [kg]: 1.800; - ABS	24.2125-1703.3	010483	Ø 25,4
				11/01→; Nutzlast [kg]: 1.800; - ABS	24.2125-1725.3	010717	Ø 25,4
				11/01→; Nutzlast ab [kg] 1.000 Nutzlast bis [kg] 1.400; - ABS	24.2125-1725.3	010717	Ø 25,4
				11/01→; Nutzlast ab [kg] 1.000 Nutzlast bis [kg] 1.400; + ABS	24.2125-1726.3	010718	Ø 25,4
2.0 JTD	62	10/01→04/02		→ 03/02; Nutzlast [kg]: 1.800; - ABS	24.2125-1725.3	010717	Ø 25,4
				→ 03/02; Nutzlast [kg]: 1.400; - ABS	24.2125-1725.3	010717	Ø 25,4
				→ 03/02; Nutzlast [kg]: 1.800; + ABS	24.2125-1726.3	010718	Ø 25,4
				→ 03/02; Nutzlast [kg]: 1.400; + ABS	24.2125-1726.3	010718	Ø 25,4
2.0 Panorama/Combi- nato	80	03/94→04/02		→ 10/94; Nutzlast ab [kg] 1.000 Nutzlast bis [kg] 1.400; + ABS	24.2122-1714.3	010480	Ø 22,2
				→ 10/94; Nutzlast ab [kg] 1.000 Nutzlast bis [kg] 1.400; - ABS	24.2122-1715.3	010481	Ø 22,2
				11/94→ 10/01; Nutzlast ab [kg] 1.000 Nutzlast bis [kg] 1.400; + ABS	24.2125-1702.3	010482	Ø 25,4
				→ 10/01; Nutzlast [kg]: 1.800; + ABS	24.2125-1702.3	010482	Ø 25,4
				→ 10/01; Nutzlast [kg]: 1.800; - ABS	24.2125-1703.3	010483	Ø 25,4
				11/94→ 10/01; Nutzlast ab [kg] 1.000 Nutzlast bis [kg] 1.400; - ABS	24.2125-1703.3	010483	Ø 25,4
				11/01→ 03/02; Nutzlast ab [kg] 1.000 Nutzlast bis [kg] 1.400; - ABS	24.2125-1725.3	010717	Ø 25,4
				11/01→ 03/02; Nutzlast [kg]: 1.800; - ABS	24.2125-1725.3	010717	Ø 25,4
				11/01→ 03/02; Nutzlast [kg]: 1.800; + ABS	24.2125-1726.3	010718	Ø 25,4
				11/01→ 03/02; Nutzlast ab [kg] 1.000 Nutzlast bis [kg] 1.400; + ABS	24.2125-1726.3	010718	Ø 25,4
2.5 D Combinato	62	08/94→04/02		→ 10/94; Nutzlast [kg]: 1.400; + ABS	24.2122-1714.3	010480	Ø 22,2
				→ 10/94; Nutzlast [kg]: 1.400; - ABS	24.2122-1715.3	010481	Ø 22,2
2.5 TDI Panorama/ Combinato	80	07/94→04/02		→ 10/94; Nutzlast [kg]: 1.400; - ABS	24.2122-1715.3	010481	Ø 22,2
				→ 10/94; Nutzlast [kg]: 1.400; + ABS	24.2122-1714.3	010480	Ø 22,2
2.5 TDI Panorama/ Combinato	85	03/94→04/02		11/94→ 10/01; Nutzlast [kg]: 1.400; + ABS	24.2125-1702.3	010482	Ø 25,4
				→ 10/01; Nutzlast [kg]: 1.800; + ABS	24.2125-1702.3	010482	Ø 25,4
				11/94→ 10/01; Nutzlast [kg]: 1.400; - ABS	24.2125-1703.3	010483	Ø 25,4
				→ 10/01; Nutzlast [kg]: 1.800; - ABS	24.2125-1703.3	010483	Ø 25,4
				11/01→ 03/02; Nutzlast [kg]: 1.400; - ABS	24.2125-1725.3	010717	Ø 25,4
				11/01→ 03/02; Nutzlast [kg]: 1.800; - ABS	24.2125-1725.3	010717	Ø 25,4
				11/01→ 03/02; Nutzlast [kg]: 1.800; + ABS	24.2125-1726.3	010718	Ø 25,4
				11/01→ 03/02; Nutzlast [kg]: 1.400; + ABS	24.2125-1726.3	010718	Ø 25,4
2.5 TDI 4x4	85	04/97→04/02		→ 10/01; Nutzlast [kg]: 1.400; + ABS	24.2125-1702.3	010482	Ø 25,4
				→ 10/01; Nutzlast [kg]: 1.400; - ABS	24.2125-1703.3	010483	Ø 25,4
				11/01→ 03/02; Nutzlast [kg]: 1.400; - ABS	24.2125-1725.3	010717	Ø 25,4
				11/01→ 03/02; Nutzlast [kg]: 1.400; + ABS	24.2125-1726.3	010718	Ø 25,4
2.8 D 2.8 JTD 2.8 JTD 4x4 2.8 TDI 2.8 TDI 4x4	64 94 94 90 90	02/98→04/02 11/00→04/02 11/00→04/02 10/97→04/02 07/99→04/02		→ 10/01; Nutzlast [kg]: 1.400; + ABS	24.2125-1702.3	010482	Ø 25,4
				→ 10/01; Nutzlast [kg]: 1.800; + ABS	24.2125-1702.3	010482	Ø 25,4
				→ 10/01; Nutzlast [kg]: 1.400; - ABS	24.2125-1703.3	010483	Ø 25,4
				→ 10/01; Nutzlast [kg]: 1.800; - ABS	24.2125-1703.3	010483	Ø 25,4
				→ 10/01; Nutzlast [kg]: 1.800; - ABS	24.2125-1703.3	010483	Ø 25,4
↓							

	kw			 	! #		
FIAT - DUCATO Bus (230_) 03/94→04/02							
 Hauptbremszylinder							
2.8 D	64	02/98→04/02		11/01→ 03/02; Nutzlast [kg]: 1.800; - ABS		24.2125-1725.3 010717	Ø 25,4
2.8 JTD	94	11/00→04/02					
2.8 JTD 4x4	94	11/00→04/02		11/01→ 03/02; Nutzlast [kg]: 1.400; - ABS		24.2125-1725.3 010717	Ø 25,4
2.8 TDI	90	10/97→04/02					
2.8 TDI 4x4	90	07/99→04/02		11/01→ 03/02; Nutzlast [kg]: 1.400; + ABS		24.2125-1726.3 010718	Ø 25,4
				11/01→ 03/02; Nutzlast [kg]: 1.800; + ABS		24.2125-1726.3 010718	Ø 25,4
 Bremskraftregler							
1.9 D	50	04/98→04/02		→ 10/01; Nutzlast [kg]: 1.000; - ABS		24.6512-1701.3 320153	lastabhängig 2x
1.9 D Combinato	51	06/95→04/02					
1.9 TD	66	04/98→04/02					
1.9 TD Combinato	59	08/94→04/02					
1.9 TD Panorama/Combinato	60	03/94→04/02					
2.0 4x4	80	11/94→11/01		→ 10/01; Nutzlast ab [kg] 1.000 Nutzlast bis [kg] 1.800; - ABS		24.6512-1701.3 320153	lastabhängig 2x
2.0 Panorama/Combinato	80	03/94→04/02					
2.5 D Combinato	62	08/94→04/02		→ 10/01; Nutzlast ab [kg] 1.400 Nutzlast bis [kg] 1.800; - ABS		24.6512-1701.3 320153	lastabhängig 2x
2.5 TDI 4x4	85	04/97→04/02					
2.5 TDI Panorama/Combinato	80	07/94→04/02					
2.5 TDI Panorama/Combinato	85	03/94→04/02					
2.8 D	64	02/98→04/02					
2.8 JTD	94	11/00→04/02					
2.8 JTD 4x4	94	11/00→04/02					
2.8 TDI	90	10/97→04/02					
2.8 TDI 4x4	90	07/99→04/02					
FIAT - DUCATO Bus (244_) 04/02→							
 Hauptbremszylinder							
2.0	81	04/02→		→ 07/06; Nutzlast ab [kg] 1.100 Nutzlast bis [kg] 1.800; - ABS		24.2125-1725.3 010717	Ø 25,4
2.0 Bipower	81	11/02→					
2.0 JTD	62	04/02→		→ 07/06; Nutzlast ab [kg] 1.100 Nutzlast bis [kg] 1.800; + ABS		24.2125-1726.3 010718	Ø 25,4
2.3 JTD	81	04/02→					
2.8 JTD	94	04/02→					
2.8 JTD 4x4	94	07/02→					
2.0 4x4	81	05/02→07/06		Nutzlast ab [kg] 1.100 Nutzlast bis [kg] 1.800; - ABS		24.2125-1725.3 010717	Ø 25,4
2.8 JTD	107	04/04→07/06		Nutzlast ab [kg] 1.100 Nutzlast bis [kg] 1.800; + ABS		24.2125-1726.3 010718	Ø 25,4
FIAT - DUCATO Bus (250_, 290_) 07/06→							
 Hauptbremszylinder							
100 Multijet 2,2 D	74	07/06→05/11		Nutzlast ab [kg] 1.100 Nutzlast bis [kg] 1.500; für Fahrzeuge mit elektronischer Fahr-dynamikregelung		24.4125-1701.3 010867	BOS Ø 25,4 ohne Bremsflüssigkeitsbehälter
110 Multijet 2,3 D	83	10/11→					
115 Multijet 2,0 D	85	06/11→					
120 Multijet 2,2 D	88	07/06→07/14					
120 Multijet 2,3 D	88	07/06→		Nutzlast ab [kg] 1.100 Nutzlast bis [kg] 1.500; für Fahrzeuge ohne elektronische Fahr-dynamikregelung		24.4125-1702.3 010872	BOS Ø 25,4 ohne Bremsflüssigkeitsbehälter
130 Multijet 2,3 D	96	06/11→					
140 Multijet 3,0 D	103	07/06→07/14					
140 Natural Power	100	04/09→					
160 Multijet 3,0 D	115	10/06→					
160 Multijet 3,0 D	116	07/06→		Nutzlast ab [kg] 1.700 Nutzlast bis [kg] 2.000; light/heavy; für Fahrzeuge mit elektronischer Fahr-dynamikregelung		24.4126-1701.3 010868	BOS Ø 26,99 ohne Bremsflüssigkeitsbehälter
180 Multijet 3,0 D	130	06/11→		Nutzlast ab [kg] 1.700 Nutzlast bis [kg] 2.000; light/heavy; für Fahrzeuge ohne elektronische Fahr-dynamikregelung		24.4126-1702.3 010875	BOS Ø 26,99 ohne Bremsflüssigkeitsbehälter
150 Multijet 2,3 D	109	06/11→		Nutzlast ab [kg] 1.700 Nutzlast bis [kg] 2.000; light/heavy; für Fahrzeuge mit elektronischer Fahr-dynamikregelung		24.4126-1701.3 010868	BOS Ø 26,99 ohne Bremsflüssigkeitsbehälter
				Nutzlast ab [kg] 1.700 Nutzlast bis [kg] 2.000; light/heavy; für Fahrzeuge ohne elektronische Fahr-dynamikregelung		24.4126-1702.3 010875	BOS Ø 26,99 ohne Bremsflüssigkeitsbehälter
150 Multijet 3,0 D	107	04/10→		06/11→; Nutzlast ab [kg] 1.100 Nutzlast bis [kg] 1.500; für Fahrzeuge mit elektronischer Fahr-dynamikregelung		24.4125-1701.3 010867	BOS Ø 25,4 ohne Bremsflüssigkeitsbehälter
				Nutzlast ab [kg] 1.100 Nutzlast bis [kg] 1.500;		24.4125-1701.3 010867	BOS Ø 25,4 ohne Bremsflüssigkeitsbehälter

	kw			 	! #		
FIAT - DUCATO Bus (250_, 290_) 07/06→							
 Hauptbremszylinder							
150 Multijet 3,0 D	107	04/10→		für Fahrzeuge mit elektronischer Fahr- dynamikregelung			
				Nutzlast ab [kg] 1.100 Nutzlast bis [kg] 1.500; für Fahrzeuge ohne elektronische Fahr- dynamikregelung	24.4125-1702.3	010872	BOS Ø 25,4 ohne Bremsflüssigkeitsbehälter
				06/11→; Nutzlast ab [kg] 1.100 Nutzlast bis [kg] 1.500; für Fahrzeuge ohne elektronische Fahr- dynamikregelung	24.4125-1702.3	010872	BOS Ø 25,4 ohne Bremsflüssigkeitsbehälter
				Nutzlast ab [kg] 1.700 Nutzlast bis [kg] 2.000; light/heavy; für Fahrzeuge mit elektronischer Fahr- dynamikregelung	24.4126-1701.3	010868	BOS Ø 26,99 ohne Bremsflüssigkeitsbehälter
				Nutzlast ab [kg] 1.700 Nutzlast bis [kg] 2.000; light/heavy; für Fahrzeuge ohne elektronische Fahr- dynamikregelung	24.4126-1702.3	010875	BOS Ø 26,99 ohne Bremsflüssigkeitsbehälter
FIAT - DUCATO Kasten (230_) 03/94→05/05							
 Hauptbremszylinder							
1.9 D 1.9 TD	50 66	04/98→04/02 04/98→04/02		→ 10/01; Nutzlast [kg]: 1.000; + ABS	24.2125-1702.3	010482	Ø 25,4
				→ 10/01; Nutzlast [kg]: 1.000; - ABS	24.2125-1703.3	010483	Ø 25,4
				11/01→ 03/02; Nutzlast [kg]: 1.000; - ABS	24.2125-1725.3	010717	Ø 25,4
				11/01→ 03/02; Nutzlast [kg]: 1.000; + ABS	24.2125-1726.3	010718	Ø 25,4
1.9 D 1.9 TD 1.9 TD CAT	51 60 59	03/94→04/02 03/94→04/02 08/94→04/02		→ 10/94; Nutzlast [kg]: 1.000; + ABS	24.2122-1714.3	010480	Ø 22,2
				→ 10/94; Nutzlast [kg]: 1.000; - ABS	24.2122-1715.3	010481	Ø 22,2
				11/94→ 10/01; Nutzlast [kg]: 1.000; + ABS	24.2125-1702.3	010482	Ø 25,4
				11/94→ 10/01; Nutzlast [kg]: 1.000; - ABS	24.2125-1703.3	010483	Ø 25,4
				11/01→ 03/02; Nutzlast [kg]: 1.000; - ABS	24.2125-1725.3	010717	Ø 25,4
2.0	80	03/94→04/02		→ 10/94; Nutzlast ab [kg] 1.000 Nutzlast bis [kg] 1.400; + ABS	24.2122-1714.3	010480	Ø 22,2
				→ 10/94; Nutzlast ab [kg] 1.000 Nutzlast bis [kg] 1.400; - ABS	24.2122-1715.3	010481	Ø 22,2
				11/94→ 10/01; Nutzlast ab [kg] 1.000 Nutzlast bis [kg] 1.400; + ABS	24.2125-1702.3	010482	Ø 25,4
				→ 10/01; Nutzlast [kg]: 1.800; + ABS	24.2125-1702.3	010482	Ø 25,4
				→ 10/01; Nutzlast [kg]: 1.800; - ABS	24.2125-1703.3	010483	Ø 25,4
				11/94→ 10/01; Nutzlast ab [kg] 1.000 Nutzlast bis [kg] 1.400; - ABS	24.2125-1703.3	010483	Ø 25,4
				11/01→ 03/02; Nutzlast ab [kg] 1.000 Nutzlast bis [kg] 1.400; - ABS	24.2125-1725.3	010717	Ø 25,4
				11/01→ 03/02; Nutzlast [kg]: 1.800; - ABS	24.2125-1725.3	010717	Ø 25,4
				11/01→ 03/02; Nutzlast [kg]: 1.800; + ABS	24.2125-1726.3	010718	Ø 25,4
				11/01→ 03/02; Nutzlast ab [kg] 1.000 Nutzlast bis [kg] 1.400; + ABS	24.2125-1726.3	010718	Ø 25,4
2.0 4x4	80	11/94→04/02		→ 10/01; Nutzlast ab [kg] 1.000 Nutzlast bis [kg] 1.400; + ABS	24.2125-1702.3	010482	Ø 25,4
				→ 10/01; Nutzlast [kg]: 1.800; + ABS	24.2125-1702.3	010482	Ø 25,4
				→ 10/01; Nutzlast ab [kg] 1.000 Nutzlast bis [kg] 1.400; - ABS	24.2125-1703.3	010483	Ø 25,4
				→ 10/01; Nutzlast [kg]: 1.800; - ABS	24.2125-1703.3	010483	Ø 25,4
				11/01→ 03/02; Nutzlast ab [kg] 1.000 Nutzlast bis [kg] 1.400; - ABS	24.2125-1725.3	010717	Ø 25,4
				11/01→ 03/02; Nutzlast [kg]: 1.800; - ABS	24.2125-1725.3	010717	Ø 25,4
				11/01→ 03/02; Nutzlast [kg]: 1.800; + ABS	24.2125-1726.3	010718	Ø 25,4
				11/01→ 03/02; Nutzlast ab [kg] 1.000 Nutzlast bis [kg] 1.400; + ABS	24.2125-1726.3	010718	Ø 25,4
2.5 D 2.5 D 4x4 2.5 TDI 2.5 TDI	62 62 80 85	03/94→04/02 03/94→04/02 03/94→04/02 03/94→04/02		→ 10/94; Nutzlast [kg]: 1.400; + ABS	24.2122-1714.3	010480	Ø 22,2
				→ 10/94; Nutzlast [kg]: 1.400; - ABS	24.2122-1715.3	010481	Ø 22,2
				11/94→ 10/01; Nutzlast [kg]: 1.400; + ABS	24.2125-1702.3	010482	Ø 25,4

FIAT - DUCATO Kasten (230_) 03/94→05/05

Hauptbremszylinder

2.5 D	62	03/94→04/02		→ 10/01; Nutzlast [kg]: 1.800; + ABS	24.2125-1702.3	010482	Ø 25,4
2.5 D 4x4	62	03/94→04/02		11/94→ 10/01; Nutzlast [kg]: 1.400;	24.2125-1703.3	010483	Ø 25,4
2.5 TDI	80	03/94→04/02		- ABS			
2.5 TDI	85	03/94→04/02		→ 10/01; Nutzlast [kg]: 1.800; - ABS	24.2125-1703.3	010483	Ø 25,4
				11/01→ 03/02; Nutzlast [kg]: 1.400;	24.2125-1725.3	010717	Ø 25,4
				- ABS			
				11/01→ 03/02; Nutzlast [kg]: 1.800;	24.2125-1725.3	010717	Ø 25,4
				- ABS			
				11/01→ 03/02; Nutzlast [kg]: 1.800;	24.2125-1726.3	010718	Ø 25,4
				+ ABS			
				11/01→ 03/02; Nutzlast [kg]: 1.400;	24.2125-1726.3	010718	Ø 25,4
				+ ABS			
2.5 TDI 4x4	85	05/98→04/02		→ 10/01; Nutzlast [kg]: 1.400; + ABS	24.2125-1702.3	010482	Ø 25,4
2.8 D	64	05/98→04/02		→ 10/01; Nutzlast [kg]: 1.800; + ABS	24.2125-1702.3	010482	Ø 25,4
2.8 D 4x4	64	08/98→04/02					
2.8 JTD	94	11/00→04/02		→ 10/01; Nutzlast [kg]: 1.400; - ABS	24.2125-1703.3	010483	Ø 25,4
2.8 JTD 4x4	94	11/00→04/02		→ 10/01; Nutzlast [kg]: 1.800; - ABS	24.2125-1703.3	010483	Ø 25,4
2.8 TDI	90	10/97→04/02					
2.8 TDI 4x4	90	06/99→04/02		11/01→ 03/02; Nutzlast [kg]: 1.800;	24.2125-1725.3	010717	Ø 25,4
				- ABS			
				11/01→ 03/02; Nutzlast [kg]: 1.400;	24.2125-1725.3	010717	Ø 25,4
				- ABS			
				11/01→ 03/02; Nutzlast [kg]: 1.400;	24.2125-1726.3	010718	Ø 25,4
				+ ABS			
				11/01→ 03/02; Nutzlast [kg]: 1.800;	24.2125-1726.3	010718	Ø 25,4
				+ ABS			

Bremskraftregler

1.9 D	50	04/98→04/02		→ 10/01; Nutzlast [kg]: 1.000; - ABS	24.6512-1701.3	320153	lastabhängig 2x
1.9 D	51	03/94→04/02					
1.9 TD	60	03/94→04/02					
1.9 TD	66	04/98→04/02					
1.9 TD CAT	59	08/94→04/02					
2.0	80	03/94→04/02		→ 10/01; Nutzlast ab [kg] 1.000 Nutzlast	24.6512-1701.3	320153	lastabhängig 2x
2.0 4x4	80	11/94→04/02		bis [kg] 1.800; - ABS			
2.5 D	62	03/94→04/02		→ 10/01; Nutzlast ab [kg] 1.400 Nutzlast	24.6512-1701.3	320153	lastabhängig 2x
2.5 D 4x4	62	03/94→04/02		bis [kg] 1.800; - ABS			
2.5 TDI	80	03/94→04/02					
2.5 TDI	85	03/94→04/02					
2.5 TDI 4x4	85	05/98→04/02					
2.8 D	64	05/98→04/02					
2.8 D 4x4	64	08/98→04/02					
2.8 JTD	94	11/00→04/02					
2.8 JTD 4x4	94	11/00→04/02					
2.8 TDI	90	10/97→04/02					
2.8 TDI 4x4	90	06/99→04/02					

FIAT - DUCATO Kasten (244_) 04/02→

Hauptbremszylinder

2.0	81	04/02→		→ 07/06; Nutzlast ab [kg] 1.100 Nutzlast	24.2125-1725.3	010717	Ø 25,4
2.0 Bipower	81	11/02→		bis [kg] 1.800; - ABS			
2.0 JTD	62	04/02→					
2.3 JTD	81	04/02→		→ 07/06; Nutzlast ab [kg] 1.100 Nutzlast	24.2125-1726.3	010718	Ø 25,4
2.8 JTD	94	04/02→		bis [kg] 1.800; + ABS			
2.8 JTD 4x4	94	07/02→					
2.8 JTD Power	107	05/04→					

FIAT - DUCATO Kasten (250_, 290_) 07/06→

Hauptbremszylinder

100 Multijet 2,2 D	74	07/06→		Nutzlast ab [kg] 1.100 Nutzlast bis [kg]	24.4125-1701.3	010867	BOS Ø 25,4
110 Multijet 2,3 D	83	10/11→		1.500;			ohne Bremsflüssigkeitsbehälter
115 Multijet 2,0 D	85	06/11→		für Fahrzeuge mit elektronischer Fahr-			
120 Multijet 2,3 D	88	07/06→		dynamikregelung			
120 Multijet 2,3 D 4x4	88	03/10→		Nutzlast ab [kg] 1.100 Nutzlast bis [kg]	24.4125-1702.3	010872	BOS Ø 25,4
130 Multijet 2,3 D	96	06/11→		1.500;			ohne Bremsflüssigkeitsbehälter
140 Natural Power	100	04/09→		für Fahrzeuge ohne elektronische Fahr-			
160 Multijet 3,0 D	115	07/06→12/11		dynamikregelung			
160 Multijet 3,0 D	116	07/06→		Nutzlast ab [kg] 1.700 Nutzlast bis [kg]	24.4126-1701.3	010868	BOS Ø 26,99
180 Multijet 3,0 D	130	06/11→		2.000; light/heavy;			ohne Bremsflüssigkeitsbehälter
				für Fahrzeuge mit elektronischer Fahr-			
				dynamikregelung			
				Nutzlast ab [kg] 1.700 Nutzlast bis [kg]	24.4126-1702.3	010875	BOS Ø 26,99
				2.000; light/heavy;			ohne Bremsflüssigkeitsbehälter
				für Fahrzeuge ohne elektronische Fahr-			
				dynamikregelung			
150 Multijet 2,3 D	109	06/11→		Nutzlast ab [kg] 1.700 Nutzlast bis [kg]	24.4126-1701.3	010868	BOS Ø 26,99
				2.000; light/heavy;			ohne Bremsflüssigkeitsbehälter



FIAT - DUCATO Kasten (250_, 290_) 07/06→

Hauptbremszylinder

150 Multijet 2,3 D	109	06/11→		für Fahrzeuge mit elektronischer Fahr- dynamikregelung			
				Nutzlast ab [kg] 1.700 Nutzlast bis [kg] 2.000; light/heavy; für Fahrzeuge ohne elektronische Fahr- dynamikregelung	24.4126-1702.3	010875	BOS Ø 26,99 ohne Bremsflüssigkeitsbehälter
150 Multijet 3,0 D	107	04/10→		06/11→; Nutzlast ab [kg] 1.100 Nutzlast bis [kg] 1.500; für Fahrzeuge mit elektronischer Fahr- dynamikregelung	24.4125-1701.3	010867	BOS Ø 25,4 ohne Bremsflüssigkeitsbehälter
				Nutzlast ab [kg] 1.100 Nutzlast bis [kg] 1.500; für Fahrzeuge mit elektronischer Fahr- dynamikregelung	24.4125-1701.3	010867	BOS Ø 25,4 ohne Bremsflüssigkeitsbehälter
				Nutzlast ab [kg] 1.100 Nutzlast bis [kg] 1.500; für Fahrzeuge ohne elektronische Fahr- dynamikregelung	24.4125-1702.3	010872	BOS Ø 25,4 ohne Bremsflüssigkeitsbehälter
				06/11→; Nutzlast ab [kg] 1.100 Nutzlast bis [kg] 1.500; für Fahrzeuge ohne elektronische Fahr- dynamikregelung	24.4125-1702.3	010872	BOS Ø 25,4 ohne Bremsflüssigkeitsbehälter
				Nutzlast ab [kg] 1.700 Nutzlast bis [kg] 2.000; light/heavy; für Fahrzeuge mit elektronischer Fahr- dynamikregelung	24.4126-1701.3	010868	BOS Ø 26,99 ohne Bremsflüssigkeitsbehälter
				Nutzlast ab [kg] 1.700 Nutzlast bis [kg] 2.000; light/heavy; für Fahrzeuge ohne elektronische Fahr- dynamikregelung	24.4126-1702.3	010875	BOS Ø 26,99 ohne Bremsflüssigkeitsbehälter

FIAT - DUCATO Pritsche/Fahrgestell (230_) 03/94→04/02

Hauptbremszylinder

1.9 D 1.9 TD	50 66	04/98→04/02 04/98→04/02		→ 10/01; Nutzlast [kg]: 1.000; + ABS	24.2125-1702.3	010482	Ø 25,4
				→ 10/01; Nutzlast [kg]: 1.000; - ABS	24.2125-1703.3	010483	Ø 25,4
				11/01→ 03/02; Nutzlast [kg]: 1.000; - ABS	24.2125-1725.3	010717	Ø 25,4
				11/01→ 03/02; Nutzlast [kg]: 1.000; + ABS	24.2125-1726.3	010718	Ø 25,4
1.9 D 1.9 TD 1.9 TD CAT	51 60 59	03/94→04/02 03/94→04/02 08/94→04/02		→ 10/94; Nutzlast [kg]: 1.000; + ABS	24.2122-1714.3	010480	Ø 22,2
				→ 10/94; Nutzlast [kg]: 1.000; - ABS	24.2122-1715.3	010481	Ø 22,2
				11/94→ 10/01; Nutzlast [kg]: 1.000; + ABS	24.2125-1702.3	010482	Ø 25,4
				11/94→ 10/01; Nutzlast [kg]: 1.000; - ABS	24.2125-1703.3	010483	Ø 25,4
				11/01→ 03/02; Nutzlast [kg]: 1.000; - ABS	24.2125-1725.3	010717	Ø 25,4
2.0	80	03/94→04/02		→ 10/94; Nutzlast ab [kg] 1.000 Nutzlast bis [kg] 1.400; + ABS	24.2122-1714.3	010480	Ø 22,2
				→ 10/94; Nutzlast ab [kg] 1.000 Nutzlast bis [kg] 1.400; - ABS	24.2122-1715.3	010481	Ø 22,2
				11/94→ 10/01; Nutzlast ab [kg] 1.000 Nutzlast bis [kg] 1.400; + ABS	24.2125-1702.3	010482	Ø 25,4
				→ 10/01; Nutzlast [kg]: 1.800; + ABS	24.2125-1702.3	010482	Ø 25,4
				→ 10/01; Nutzlast [kg]: 1.800; - ABS	24.2125-1703.3	010483	Ø 25,4
				11/94→ 10/01; Nutzlast ab [kg] 1.000 Nutzlast bis [kg] 1.400; - ABS	24.2125-1703.3	010483	Ø 25,4
				11/01→ 03/02; Nutzlast ab [kg] 1.000 Nutzlast bis [kg] 1.400; - ABS	24.2125-1725.3	010717	Ø 25,4
				11/01→ 03/02; Nutzlast [kg]: 1.800; - ABS	24.2125-1725.3	010717	Ø 25,4
				11/01→ 03/02; Nutzlast [kg]: 1.800; + ABS	24.2125-1726.3	010718	Ø 25,4
2.5 D 2.5 D 4x4 2.5 TDI 2.5 TDI	62 62 80 85	03/94→04/02 03/94→04/02 03/94→04/02 03/94→04/02		→ 10/94; Nutzlast [kg]: 1.400; + ABS	24.2122-1714.3	010480	Ø 22,2
				→ 10/94; Nutzlast [kg]: 1.400; - ABS	24.2122-1715.3	010481	Ø 22,2
				11/94→ 10/01; Nutzlast [kg]: 1.400; + ABS	24.2125-1702.3	010482	Ø 25,4
				→ 10/01; Nutzlast [kg]: 1.800; + ABS	24.2125-1702.3	010482	Ø 25,4
			11/94→ 10/01; Nutzlast [kg]: 1.400; - ABS	24.2125-1703.3	010483	Ø 25,4	



FIAT - DUCATO Pritsche/Fahrgestell (230_) 03/94→04/02

Hauptbremszylinder

2.5 D	62	03/94→04/02		→ 10/01; Nutzlast [kg]: 1.800; - ABS	24.2125-1703.3 010483	Ø 25,4
2.5 D 4x4	62	03/94→04/02		11/01→ 03/02; Nutzlast [kg]: 1.400;	24.2125-1725.3 010717	Ø 25,4
2.5 TDI	80	03/94→04/02		- ABS		
2.5 TDI	85	03/94→04/02		11/01→ 03/02; Nutzlast [kg]: 1.800;	24.2125-1725.3 010717	Ø 25,4
				- ABS		
				11/01→ 03/02; Nutzlast [kg]: 1.800;	24.2125-1726.3 010718	Ø 25,4
				+ ABS		
				11/01→ 03/02; Nutzlast [kg]: 1.400;	24.2125-1726.3 010718	Ø 25,4
				+ ABS		
2.5 TDI 4x4	85	06/98→04/02		→ 10/01; Nutzlast [kg]: 1.400; + ABS	24.2125-1702.3 010482	Ø 25,4
2.8 D	64	02/98→04/02		→ 10/01; Nutzlast [kg]: 1.800; + ABS	24.2125-1702.3 010482	Ø 25,4
2.8 JTD	94	11/00→04/02				
2.8 JTD	94	03/01→04/02		→ 10/01; Nutzlast [kg]: 1.400; - ABS	24.2125-1703.3 010483	Ø 25,4
2.8 JTD 4x4	94	10/01→04/02		→ 10/01; Nutzlast [kg]: 1.800; - ABS	24.2125-1703.3 010483	Ø 25,4
2.8 TDI	90	12/98→04/02		11/01→ 03/02; Nutzlast [kg]: 1.800;	24.2125-1725.3 010717	Ø 25,4
				- ABS		
				11/01→ 03/02; Nutzlast [kg]: 1.400;	24.2125-1725.3 010717	Ø 25,4
				- ABS		
				11/01→ 03/02; Nutzlast [kg]: 1.400;	24.2125-1726.3 010718	Ø 25,4
				+ ABS		
				11/01→ 03/02; Nutzlast [kg]: 1.800;	24.2125-1726.3 010718	Ø 25,4
				+ ABS		
2.8 iDTD 4x4	90	05/98→09/01		Nutzlast ab [kg] 1.400 Nutzlast bis [kg]	24.2125-1702.3 010482	Ø 25,4
				1.800; + ABS		
				Nutzlast ab [kg] 1.400 Nutzlast bis [kg]	24.2125-1703.3 010483	Ø 25,4
				1.800; - ABS		

Bremskraftregler

1.9 D	50	04/98→04/02		→ 10/01; Nutzlast [kg]: 1.000; - ABS	24.6512-1701.3 320153	lastabhängig 2x
1.9 D	51	03/94→04/02				
1.9 TD	60	03/94→04/02				
1.9 TD	66	04/98→04/02				
1.9 TD CAT	59	08/94→04/02				
2.0	80	03/94→04/02		→ 10/01; Nutzlast ab [kg] 1.000 Nutzlast	24.6512-1701.3 320153	lastabhängig 2x
				bis [kg] 1.800; - ABS		
2.5 D	62	03/94→04/02		→ 10/01; Nutzlast ab [kg] 1.400 Nutzlast	24.6512-1701.3 320153	lastabhängig 2x
2.5 D 4x4	62	03/94→04/02		bis [kg] 1.800; - ABS		
2.5 TDI	80	03/94→04/02				
2.5 TDI	85	03/94→04/02				
2.5 TDI 4x4	85	06/98→04/02				
2.8 D	64	02/98→04/02				
2.8 JTD	94	11/00→04/02				
2.8 JTD	94	03/01→04/02				
2.8 JTD 4x4	94	10/01→04/02				
2.8 TDI	90	12/98→04/02				
2.8 iDTD 4x4	90	05/98→09/01		Nutzlast ab [kg] 1.400 Nutzlast bis [kg]	24.6512-1701.3 320153	lastabhängig 2x
				1.800; - ABS		

FIAT - DUCATO Pritsche/Fahrgestell (244_) 04/02→

Hauptbremszylinder













2.0	81	04/02→07/06		Nutzlast ab [kg] 1.100 Nutzlast bis [kg]	24.2125-1725.3 010717	Ø 25,4
2.0 JTD	62	04/02→07/06		1.800; - ABS		
2.3 JTD	81	04/02→07/06		Nutzlast ab [kg] 1.100 Nutzlast bis [kg]	24.2125-1726.3 010718	Ø 25,4
2.8 JTD	94	04/02→07/06		1.800; + ABS		
2.8 JTD 4x4	94	10/02→07/06				
2.8 JTD Power	107	05/04→07/06				











FIAT - DUCATO Pritsche/Fahrgestell (250_, 290_) 07/06→















Hauptbremszylinder











100 Multijet 2,2 D	74	07/06→		Nutzlast ab [kg] 1.100 Nutzlast bis [kg]	24.4125-1701.3 010867	BOS Ø 25,4
110 Multijet 2,3 D	83	10/11→		1.500;		ohne Bremsflüssigkeitsbehälter
115 Multijet 2,0 D	85	06/11→		für Fahrzeuge mit elektronischer Fahr-		
120 Multijet 2,3 D	88	07/06→		dynamikregelung		
120 Multijet 2,3 D 4x4	88	03/10→		Nutzlast ab [kg] 1.100 Nutzlast bis [kg]	24.4125-1702.3 010872	BOS Ø 25,4
140 Multijet 3,0 D	103	07/06→07/14		1.500;		ohne Bremsflüssigkeitsbehälter
160 Multijet 3,0 D	115	07/06→12/11		für Fahrzeuge ohne elektronische Fahr-		
160 Multijet 3,0 D	116	07/06→		dynamikregelung		
180 Multijet 3,0 D	130	06/11→		Nutzlast ab [kg] 1.700 Nutzlast bis [kg]	24.4126-1701.3 010868	BOS Ø 26,99
				2.000; light/heavy;		ohne Bremsflüssigkeitsbehälter
				für Fahrzeuge mit elektronischer Fahr-		
				dynamikregelung		
				Nutzlast ab [kg] 1.700 Nutzlast bis [kg]	24.4126-1702.3 010875	BOS Ø 26,99
				2.000; light/heavy;		ohne Bremsflüssigkeitsbehälter
				für Fahrzeuge ohne elektronische Fahr-		
				dynamikregelung		

















↓



















	kw					! #		
FIAT - DUCATO Pritsche/Fahrgestell (250_, 290_) 07/06→								
 Hauptbremszylinder								
130 Multijet 2,3 D	96	07/06→		01/07→; Nutzlast ab [kg] 1.100 Nutzlast bis [kg] 1.500; für Fahrzeuge mit elektronischer Fahrdynamikregelung		24.4125-1701.3	010867	BOS Ø 25,4 ohne Bremsflüssigkeitsbehälter
				01/07→; Nutzlast ab [kg] 1.100 Nutzlast bis [kg] 1.500; für Fahrzeuge ohne elektronische Fahrdynamikregelung		24.4125-1702.3	010872	BOS Ø 25,4 ohne Bremsflüssigkeitsbehälter
				01/07→; Nutzlast ab [kg] 1.700 Nutzlast bis [kg] 2.000; light/heavy; für Fahrzeuge mit elektronischer Fahrdynamikregelung		24.4126-1701.3	010868	BOS Ø 26,99 ohne Bremsflüssigkeitsbehälter
				01/07→; Nutzlast ab [kg] 1.700 Nutzlast bis [kg] 2.000; light/heavy; für Fahrzeuge ohne elektronische Fahrdynamikregelung		24.4126-1702.3	010875	BOS Ø 26,99 ohne Bremsflüssigkeitsbehälter
150 Multijet 2,3 D	109	06/11→		Nutzlast ab [kg] 1.700 Nutzlast bis [kg] 2.000; light/heavy; für Fahrzeuge mit elektronischer Fahrdynamikregelung		24.4126-1701.3	010868	BOS Ø 26,99 ohne Bremsflüssigkeitsbehälter
				Nutzlast ab [kg] 1.700 Nutzlast bis [kg] 2.000; light/heavy; für Fahrzeuge ohne elektronische Fahrdynamikregelung		24.4126-1702.3	010875	BOS Ø 26,99 ohne Bremsflüssigkeitsbehälter
150 Multijet 3,0 D	107	04/10→		06/11→; Nutzlast ab [kg] 1.100 Nutzlast bis [kg] 1.500; für Fahrzeuge mit elektronischer Fahrdynamikregelung		24.4125-1701.3	010867	BOS Ø 25,4 ohne Bremsflüssigkeitsbehälter
				Nutzlast ab [kg] 1.100 Nutzlast bis [kg] 1.500; für Fahrzeuge mit elektronischer Fahrdynamikregelung		24.4125-1701.3	010867	BOS Ø 25,4 ohne Bremsflüssigkeitsbehälter
				Nutzlast ab [kg] 1.100 Nutzlast bis [kg] 1.500; für Fahrzeuge ohne elektronische Fahrdynamikregelung		24.4125-1702.3	010872	BOS Ø 25,4 ohne Bremsflüssigkeitsbehälter
				06/11→; Nutzlast ab [kg] 1.100 Nutzlast bis [kg] 1.500; für Fahrzeuge ohne elektronische Fahrdynamikregelung		24.4125-1702.3	010872	BOS Ø 25,4 ohne Bremsflüssigkeitsbehälter
				Nutzlast ab [kg] 1.700 Nutzlast bis [kg] 2.000; light/heavy; für Fahrzeuge mit elektronischer Fahrdynamikregelung		24.4126-1701.3	010868	BOS Ø 26,99 ohne Bremsflüssigkeitsbehälter
				Nutzlast ab [kg] 1.700 Nutzlast bis [kg] 2.000; light/heavy; für Fahrzeuge ohne elektronische Fahrdynamikregelung		24.4126-1702.3	010875	BOS Ø 26,99 ohne Bremsflüssigkeitsbehälter
FIAT - FIORINO Kasten (146_) 01/88→								
 Hauptbremszylinder								
60 1.7 D	42	05/88→10/96		09/93→; + ABS		20.5522-1093.3	010731	ATE Ø 22,2
60 1.7 D	44	05/88→05/00		09/88→ 08/93		24.2120-0802.3	010363	ATE Ø 20,64
65 1.7 TD	46	01/97→05/01		→ 03/01; + ABS		20.5522-1093.3	010731	ATE Ø 22,2
70 i.e. 1.4	49	05/94→05/01						
75 i.e. 1.6	55	10/93→05/01						
 Bremskraftregler								
60 1.7 D	42	05/88→10/96		09/88→; → 8220596		24.6513-0801.3	320117	lastabhängig 1/3 2x
60 1.7 D	44	05/88→05/00						
65 1.7 TD	46	01/97→05/01		→ 8220596		24.6513-0801.3	320117	lastabhängig 1/3 2x
FIAT - FIORINO Pick up (146_) 01/88→05/01								
 Hauptbremszylinder								
1.4	49	05/94→05/01		→ 03/01; + ABS		20.5522-1093.3	010731	ATE Ø 22,2
1.6	55	01/94→05/01						
1.7 TD	46	01/97→05/01						
1.7 D	42	10/93→10/99		+ ABS		20.5522-1093.3	010731	ATE Ø 22,2
1.7 D	44	05/88→10/99		09/93→; + ABS		20.5522-1093.3	010731	ATE Ø 22,2
FIAT - GRANDE PUNTO (199_) 06/05→								
 Hauptbremszylinder								
1.2	48	10/05→		09/10→ 01/11		24.4122-1709.3	010871	BOS Ø 22,2 ohne Bremsflüssigkeitsbehälter
1.3 D Multijet	51	07/08→						
1.3 D Multijet	62	04/10→						















	kw			 	! #		
FIAT - GRANDE PUNTO (199_) 06/05→							
 Hauptbremszylinder							
1.3 D Multijet 1.4 16V 1.4 LPG 1.4 Natural Power 1.4 T-Jet 1.6 D Multijet 1.9 D Multijet	66 70 57 57 88 88 88	10/05→ 10/05→ 12/08→ 07/08→ 09/07→ 07/08→ 10/05→		→ 08/10; für Fahrzeuge mit elektronischer Fahr- dynamikregelung		24.4122-1709.3 010871	BOS Ø 22,2 ohne Bremsflüssigkeitsbehälter
1.2	51	09/10→		→ 01/11		24.4122-1709.3 010871	BOS Ø 22,2 ohne Bremsflüssigkeitsbehälter
1.3 D Multijet	55	10/05→		04/08→ 08/10; für Fahrzeuge mit elektronischer Fahr- dynamikregelung		24.4122-1709.3 010871	BOS Ø 22,2 ohne Bremsflüssigkeitsbehälter
				09/10→ 01/11		24.4122-1709.3 010871	BOS Ø 22,2 ohne Bremsflüssigkeitsbehälter
1.4 (199.AXB11, 199.AXB1A)	57	06/05→12/15		→ 08/10; für Fahrzeuge mit elektronischer Fahr- dynamikregelung		24.4122-1709.3 010871	BOS Ø 22,2 ohne Bremsflüssigkeitsbehälter
1.4 (199.AXB1A) 1.9 D Multijet	55 85	10/05→07/07 06/06→12/09		für Fahrzeuge mit elektronischer Fahr- dynamikregelung		24.4122-1709.3 010871	BOS Ø 22,2 ohne Bremsflüssigkeitsbehälter
1.9 D Multijet	96	10/05→		09/10→ 01/11		24.4122-1709.3 010871	BOS Ø 22,2 ohne Bremsflüssigkeitsbehälter
				02/06→ 08/10; für Fahrzeuge mit elektronischer Fahr- dynamikregelung		24.4122-1709.3 010871	BOS Ø 22,2 ohne Bremsflüssigkeitsbehälter
FIAT - IDEA (350_) 12/03→							
 Hauptbremszylinder							
1.2 16V 1.9 JTD	59 74	01/04→ 01/04→		→ 11/06; für Fahrzeuge ohne elektronische Fahr- dynamikregelung		24.2123-1763.3 010842	Ø 23,81
				→ 11/06; für Fahrzeuge mit elektronischer Fahr- dynamikregelung		24.2123-1769.3 010863	BOS Ø 23,81
				→ 02/08		24.4123-1708.3 010859	BOS Ø 23,81
1.3 D Multijet 1.4 16V	51 70	01/04→ 01/04→		→ 11/06; für Fahrzeuge ohne elektronische Fahr- dynamikregelung		24.2123-1763.3 010842	Ø 23,81
				→ 11/06; für Fahrzeuge mit elektronischer Fahr- dynamikregelung		24.2123-1769.3 010863	BOS Ø 23,81
				12/06→ 02/08		24.4123-1708.3 010859	BOS Ø 23,81
1.3 D Multijet	66	10/05→		11/05→ 11/06; für Fahrzeuge ohne elektronische Fahr- dynamikregelung		24.2123-1763.3 010842	Ø 23,81
				11/05→ 11/06; für Fahrzeuge mit elektronischer Fahr- dynamikregelung		24.2123-1769.3 010863	BOS Ø 23,81
				12/06→ 02/08		24.4123-1708.3 010859	BOS Ø 23,81
1.3 D Multijet 1.4 LPG 1.6 D Multijet	70 57 88	05/08→12/12 03/09→ 05/08→		→ 09/10		24.4123-1708.3 010859	BOS Ø 23,81
				10/10→ 07/12		24.4123-1708.3 010859	BOS Ø 23,81
1.4	57	10/05→		11/05→ 11/06; für Fahrzeuge ohne elektronische Fahr- dynamikregelung		24.2123-1763.3 010842	Ø 23,81
				11/05→ 11/06; für Fahrzeuge mit elektronischer Fahr- dynamikregelung		24.2123-1769.3 010863	BOS Ø 23,81
				11/05→ 02/08		24.4123-1708.3 010859	BOS Ø 23,81
1.4	66	12/03→		01/04→ 11/06; für Fahrzeuge ohne elektronische Fahr- dynamikregelung		24.2123-1763.3 010842	Ø 23,81
				01/04→ 11/06; für Fahrzeuge mit elektronischer Fahr- dynamikregelung		24.2123-1769.3 010863	BOS Ø 23,81
				12/06→ 02/08		24.4123-1708.3 010859	BOS Ø 23,81
1.6 D Multijet	85	11/08→12/10		10/10→		24.4123-1708.3 010859	BOS Ø 23,81
				→ 09/10		24.4123-1708.3 010859	BOS Ø 23,81
FIAT - LINEA (323_, 110_) 06/07→							
 Hauptbremszylinder							
1.3 D Multijet 1.4	66 57	06/07→ 06/07→		07/07→ 05/11; für Fahrzeuge mit elektronischer Fahr- dynamikregelung		24.4122-1709.3 010871	BOS Ø 22,2 ohne Bremsflüssigkeitsbehälter
↓							















	kw			 	! #					
FIAT - LINEA (323_, 110_) 06/07→										
 Hauptbremszylinder										
1.4 T-Jet	88	09/07→		→ 05/11;	24.4122-1709.3	010871	BOS Ø 22,2 ohne Bremsflüssigkeitsbehälter			
1.6 (323.AXD1A)	80	07/08→		für Fahrzeuge mit elektronischer Fahrdr-						
1.6 D Multijet	77	06/09→		namikregelung						
1.9 16V	94	07/08→								
FIAT - MAREA (185_) 05/96→12/07										
 Hauptbremszylinder										
1.2 16V	60	10/98→05/02		04/99→; für Linkslenker; GG	24.2122-1716.3	010485	Ø 22,2			
1.4 80 12V	59	09/96→05/02		für Linkslenker; GG						
1.6 100 16V	76	09/96→05/02								
1.6 100 16V Bipower	76	04/99→05/02								
1.8 115 16V	83	09/96→05/02								
1.9 JTD 105 (185AXN1A)	77	12/98→12/02								
1.9 JTD 110 (185AXT1A)	81	09/00→08/02								
1.9 TD 100 (185AX_)	74	05/96→12/02								
1.9 TD 75	55	09/96→05/02								
2.0 150 20V	108	09/96→04/99								
2.0 150 20V	110	01/01→05/02								
2.0 155 20V	113	04/99→01/01								
2.4 JTD 130	96	04/99→05/02								
2.4 TD 125	91	09/96→04/99								
FIAT - MAREA Weekend (185_) 09/96→12/07										
 Hauptbremszylinder										
1.2 16V	60	10/98→05/02		04/99→; für Linkslenker; GG				24.2122-1716.3	010485	Ø 22,2
1.4 80 12V	59	09/96→05/02		für Linkslenker; GG						
1.6 100 16V	76	09/96→05/02								
1.8 115 16V	83	09/96→05/02								
1.9 JTD 105 (185BXN1A)	77	12/98→12/02								
1.9 JTD 110 (185BXT1A)	81	09/00→08/02								
1.9 TD 100 (185BX_)	74	09/96→06/03								
1.9 TD 75	55	09/96→05/02								
2.0 150 20V	108	09/96→04/99								
2.0 150 20V	110	01/01→05/02								
2.4 JTD 130	96	04/99→05/02								
2.4 TD 125	91	09/96→04/99								
2.0 155 20V	113	04/99→02/03		→ 12/02; für Linkslenker; GG						
FIAT - PALIO (178_) 04/96→										
 Hauptbremszylinder										
1.2	44	07/97→08/02		10/97→; + ABS	20.5522-1093.3	010731	ATE Ø 22,2			
1.2	50	06/99→10/00		+ ABS						
FIAT - PALIO Weekend (178_) 04/96→										
 Hauptbremszylinder										
1.2	44	07/97→10/04		10/97→; + ABS	20.5522-1093.3	010731	ATE Ø 22,2			
1.2	54	04/96→02/01								
1.6 16V	74	04/96→02/01								
1.7 TD	51	04/96→03/01								
1.2	59	09/01→		→ 12/06; + ABS	20.5522-1093.3	010731	ATE Ø 22,2			
1.6 16V	76	02/01→								
1.9 D	46	03/01→								
1.9 JTD	59	09/01→								
FIAT - PANDA (141_) 03/80→07/04										
 Hauptbremszylinder										
1000 i.e. Cat	33	10/87→08/98		für Linkslenker	24.2119-0826.3	010349	Ø 19,05			
				→ 12/92; für Linkslenker						
1100 900	37 29	05/91→12/99 04/92→12/96		für Linkslenker	24.2119-0826.3	010349	Ø 19,05			
1100	40	02/95→09/03		→ 12/02; für Linkslenker						
1100 4x4 1100 Trekking 4x4	40 37	02/95→07/04 10/91→07/04		→ 12/02; für Linkslenker	24.2120-0801.3	010362	Ø 20,64			
750	25	01/86→10/03		→ 12/97; für Linkslenker						
 Bremskraftregler										
1100 4x4 1100 Trekking 4x4	40 37	02/95→07/04 10/91→07/04		→ 12/02	24.6046-0801.3	320116	4/6 2x			













	kw			 	! #		
FIAT - PANDA (169_) 09/03→							
 Hauptbremszylinder							
1.1	40	09/03→		→ 06/13; - ABS		24.2120-1744.3 010820	Ø 20,64
1.2	44	09/03→		→ 06/13;		24.2120-1746.3 010835	BOS Ø 20,64
1.2 LPG	51	03/10→		für Fahrzeuge mit elektronischer Fahr- dynamikregelung			
1.2 LPG	44	04/09→					
1.2 LPG	51	11/10→					
1.3 D Multijet	51	09/03→		→ 06/13; + ABS		24.2120-1747.3 010836	BOS Ø 20,64
1.3 D Multijet	55	06/06→					
1.4 Natural Power	57	09/10→					
1.2 4x4	44	10/04→		→ 06/13; + Diff		24.2120-1745.3 010834	Ø 20,64
				→ 06/13; - Diff		24.4120-1702.3 010913	TRW Ø 20,64 ohne Bremsflüssigkeitsbehälter
1.2 4x4	51	11/09→		10/10→ 06/13; + Diff		24.2120-1745.3 010834	Ø 20,64
				10/10→ 06/13; - Diff		24.4120-1702.3 010913	TRW Ø 20,64 ohne Bremsflüssigkeitsbehälter
1.2 Natural Power	44	01/07→12/11		- ABS		24.2120-1744.3 010820	Ø 20,64
1.4 Natural Power	51	01/10→		für Fahrzeuge mit elektronischer Fahr- dynamikregelung		24.2120-1746.3 010835	BOS Ø 20,64
				+ ABS		24.2120-1747.3 010836	BOS Ø 20,64
1.3 D Multijet 4x4	51	10/04→		04/06→ 08/11; - ABS		24.2120-1744.3 010820	Ø 20,64
				04/06→ 08/11; für Fahrzeuge mit elektronischer Fahr- dynamikregelung		24.2120-1746.3 010835	BOS Ø 20,64
				04/06→ 08/11; + ABS		24.2120-1747.3 010836	BOS Ø 20,64
				→ 06/13		24.4122-1714.3 010914	TRW Ø 22,2 ohne Bremsflüssigkeitsbehälter
				04/06→ 08/11		24.4122-1714.3 010914	TRW Ø 22,2 ohne Bremsflüssigkeitsbehälter
1.3 D Multijet 4x4	55	09/10→		→ 06/13		24.4122-1714.3 010914	TRW Ø 22,2 ohne Bremsflüssigkeitsbehälter
1.4 (169AXE1B)	74	10/06→		11/06→ 06/13; für Fahrzeuge ohne elektronische Fahr- dynamikregelung		24.2122-1762.3 010837	Ø 22,2
				11/06→ 06/13; für Fahrzeuge mit elektronischer Fahr- dynamikregelung		24.2122-1768.3 010853	Ø 22,2
FIAT - PANDA Van (141_) 01/86→02/04							
 Hauptbremszylinder							
1.1	40	09/00→02/04		→ 12/02; für Linkslenker		24.2119-0826.3 010349	Ø 19,05
1000 i.e	33	08/92→02/04					
FIAT - PANDA Van (169_) 03/04→							
 Hauptbremszylinder							
1.2 LPG	44	04/09→		→ 06/13; - ABS		24.2120-1744.3 010820	Ø 20,64
1.4 Natural Power	57	10/09→		→ 06/13;		24.2120-1746.3 010835	BOS Ø 20,64
				für Fahrzeuge mit elektronischer Fahr- dynamikregelung			
				→ 06/13; + ABS		24.2120-1747.3 010836	BOS Ø 20,64
1.2 Natural Power	44	01/07→11/09		- ABS		24.2120-1744.3 010820	Ø 20,64
				für Fahrzeuge mit elektronischer Fahr- dynamikregelung		24.2120-1746.3 010835	BOS Ø 20,64
				+ ABS		24.2120-1747.3 010836	BOS Ø 20,64
1.3 D Multijet 4x4	51	10/04→12/06				24.4122-1714.3 010914	TRW Ø 22,2 ohne Bremsflüssigkeitsbehälter
FIAT - PUNTO (176_) 09/93→09/99							
 Hauptbremszylinder							
1.2 16V	63	04/97→09/99		06/97→		24.2120-1710.3 010468	Ø 20,64
1.4 GT Turbo (176AD_)	98	10/93→03/97		GG		24.2122-1716.3 010485	Ø 22,2
1.4 GT Turbo (176AS_)	96	09/96→07/99		06/97→		24.2120-1710.3 010468	Ø 20,64
				→ 05/97; GG		24.2122-1716.3 010485	Ø 22,2
1.6	65	01/94→04/97		03/94→		24.2120-1710.3 010468	Ø 20,64
1.7 D	42	04/94→09/97		01/95→ 05/97		24.2120-1710.3 010468	Ø 20,64
1.7 TD	51	01/94→09/99				24.2120-1710.3 010468	Ø 20,64
1.7 TD	52	01/94→09/99					
1.7 TD (176AT)	46	09/96→09/99					
60 1.2	43	01/94→09/99					
55 1.1	40	09/93→09/99		11/93→		24.2120-1710.3 010468	Ø 20,64
60 1.2 (176AP, 176AR, 176AQ, 176BB)	44	09/93→09/99					













	kw			 	! #		
FIAT - PUNTO (176_) 09/93→09/99							
 Hauptbremszylinder							
75 1.2	54	10/93→09/99		11/93→		24.2120-1710.3 010468	Ø 20,64
 Bremskraftregler							
1.2 16V	63	04/97→09/99		 ; 06/97→; - ABS		24.6513-1705.3 320237	lastabhängig 2x
1.4 GT Turbo (176AS_)	96	09/96→07/99					
55 1.1	40	09/93→09/99		 ; 06/97→		24.6513-1705.3 320237	lastabhängig 2x
60 1.2 (176AP, 176AR, 176AQ, 176BB)	44	09/93→09/99		 ; 11/93→ 05/97; - ABS		24.6513-1705.3 320237	lastabhängig 2x
60 1.2	43	01/94→09/99		 ; 06/97→		24.6513-1705.3 320237	lastabhängig 2x
				 ; → 05/97; - ABS		24.6513-1705.3 320237	lastabhängig 2x
75 1.2	54	10/93→09/99		 ; 11/93→ 05/97; - ABS		24.6513-1705.3 320237	lastabhängig 2x
FIAT - PUNTO (188_) 09/99→07/12							
 Hauptbremszylinder							
1.2 16V 80 (188.233, .235, .253, .255, .333, .353, .639,...)	59	09/99→12/06		07/03→ 11/05; - ABS		24.2120-1742.3 010776	Ø 20,64
				10/99→ 06/03		24.2120-1742.3 010776	Ø 20,64
1.2 60 (188.030, .050, .130, .150, .230, .250)	44	09/99→12/10		07/03→ 11/05; + ABS		24.2120-1743.3 010777	Ø 20,64
1.2 Natural Power	44	09/03→03/12		→ 11/05; - ABS		24.2120-1742.3 010776	Ø 20,64
				→ 11/05; + ABS		24.2120-1743.3 010777	Ø 20,64
1.3 JTD 16V	51	06/03→03/12		07/03→ 11/05; - ABS		24.2122-1760.3 010821	Ø 22,2
				07/03→ 11/05; + ABS		24.2122-1763.3 010838	Ø 22,2
				07/03→ 11/05; für Fahrzeuge mit elektronischer Fahrtdynamikregelung		24.2122-1768.3 010853	Ø 22,2
1.4	70	09/03→03/12		→ 11/05; - ABS		24.2122-1760.3 010821	Ø 22,2
				→ 11/05; + ABS		24.2122-1763.3 010838	Ø 22,2
				→ 11/05; für Fahrzeuge mit elektronischer Fahrtdynamikregelung		24.2122-1768.3 010853	Ø 22,2
1.8 130 HGT (188.738, .718)	96	09/99→03/12		10/99→ 06/03		24.2120-1742.3 010776	Ø 20,64
				07/03→ 11/05; für Fahrzeuge mit elektronischer Fahrtdynamikregelung		24.2122-1768.3 010853	Ø 22,2
1.9 DS 60 (188.031, .051, .231, .251)	44	09/99→03/12		10/99→ 06/03		24.2120-1742.3 010776	Ø 20,64
1.9 JTD 80 (188.237, .257, .337, .357)	59	09/99→03/12					
1.9 JTD	63	10/01→03/12		→ 06/03		24.2120-1742.3 010776	Ø 20,64
				07/03→ 11/05; - ABS		24.2122-1760.3 010821	Ø 22,2
				07/03→ 11/05; + ABS		24.2122-1763.3 010838	Ø 22,2
				07/03→ 11/05; für Fahrzeuge mit elektronischer Fahrtdynamikregelung		24.2122-1768.3 010853	Ø 22,2
1.9 JTD	74	06/03→03/12		07/03→ 11/05; für Fahrzeuge mit elektronischer Fahrtdynamikregelung		24.2122-1768.3 010853	Ø 22,2
 Bremskraftregler							
1.2 16V 80 (188.233, .235, .253, .255, .333, .353, .639,...)	59	09/99→12/06		10/99→ 06/03; - ABS		03.0101-0032.2 320231	ATE Satz 3/25 2x
1.2 60 (188.030, .050, .130, .150, .230, .250)	44	09/99→12/10					
1.8 130 HGT (188.738, .718)	96	09/99→03/12					
1.9 DS 60 (188.031, .051, .231, .251)	44	09/99→03/12					
1.9 JTD 80 (188.237, .257, .337, .357)	59	09/99→03/12					
1.9 JTD	63	10/01→03/12		→ 06/03; - ABS		03.0101-0032.2 320231	ATE Satz 3/25 2x













	kW			 	! #		
FIAT - PUNTO (199_) 03/12→							
 Hauptbremszylinder							
0.9	74	12/13→		für Linkslenker		24.4122-1709.3 010871	BOS Ø 22,2 ohne Bremsflüssigkeitsbehälter
0.9	77	07/13→					
0.9 Bifuel	63	03/12→					
0.9 Twinair Turbo	63	03/12→					
1.2	49	02/14→					
1.2	51	03/12→					
1.3 D Multijet	55	03/12→					
1.3 D Multijet	59	12/13→					
1.3 D Multijet	62	03/12→					
1.3 D Multijet	70	03/12→					
1.3 JTD Multijet (199.AYR1A, 199.BYR1A)	66	05/18→					
1.4	55	03/12→					
1.4	57	03/12→					
1.4 Bifuel	57	03/12→					
1.4 Multi Air	77	03/12→					
1.4 Natural Power	57	03/12→					
1.4 Turbo Multi Air	99	03/12→					
FIAT - PUNTO Cabriolet (176_) 04/94→06/00							
 Hauptbremszylinder							
60 1.2	43	04/94→06/00				24.2120-1710.3 010468	Ø 20,64
60 1.2 (176AR_, 176BR_)	44	05/95→06/00					
90 1.6	65	04/94→04/97					
85 16V 1.2	63	04/97→06/00		06/97→		24.2120-1710.3 010468	Ø 20,64
 Bremskraftregler							
60 1.2	43	04/94→06/00		 ; → 05/95; - ABS		24.6513-1705.3 320237	lastabhängig 2x
60 1.2 (176AR_, 176BR_)	44	05/95→06/00					
FIAT - PUNTO EVO (199_) 07/08→							
 Hauptbremszylinder							
1.2	48	10/09→02/12		für Linkslenker		24.4122-1709.3 010871	BOS Ø 22,2 ohne Bremsflüssigkeitsbehälter
1.2	51	10/09→02/12					
1.3 D Multijet	51	07/08→02/12					
1.3 D Multijet	55	10/09→02/12					
1.3 D Multijet	62	10/09→02/12					
1.3 D Multijet	66	10/09→02/12					
1.3 D Multijet	70	10/09→02/12					
1.4	57	10/09→02/12					
1.4 16V	77	10/09→02/12					
1.4 16V (199AXW1A)	99	10/09→02/12					
1.4 LPG	57	06/09→02/12					
1.4 Natural Power	57	10/09→02/12					
1.6 D Multijet	88	10/09→02/12					
1.4	55	07/09→02/12		10/09→; für Linkslenker		24.4122-1709.3 010871	BOS Ø 22,2 ohne Bremsflüssigkeitsbehälter
FIAT - PUNTO Van (176_) 04/96→02/00							
 Hauptbremszylinder							
1.1	40	04/96→02/00		→ 09/99		24.2120-1710.3 010468	Ø 20,64
1.7 TD	52	04/96→02/00					
1.7 D	42	04/96→02/00		→ 05/97		24.2120-1710.3 010468	Ø 20,64
 Bremskraftregler							
1.1	40	04/96→02/00		 ; → 05/97; - ABS		24.6513-1705.3 320237	lastabhängig 2x
				 ; 06/97→ 09/99		24.6513-1705.3 320237	lastabhängig 2x
FIAT - PUNTO Van (188_) 02/00→10/09							
 Hauptbremszylinder							
1.2 60	44	02/00→10/09		→ 06/03		24.2120-1742.3 010776	Ø 20,64
1.9 D 60	44	02/00→10/09					
 Bremskraftregler							
1.2 60	44	02/00→10/09		→ 06/03; - ABS		03.0101-0032.2 320231	ATE Satz 3/25 2x
1.9 D 60	44	02/00→10/09					
FIAT - SCUDO (270_, 272_) 01/07→							
 Hauptbremszylinder							
1.6 D Multijet	66	01/07→		für Linkslenker; - ESP		03.2125-0298.3 010818	ATE Ø 25,4
1.6 D Multijet	66	02/11→					













	kw					! #		
FIAT - SCUDO (270_, 272_) 01/07→								
 Hauptbremszylinder								
2.0 D Multijet	88	01/07→			für Linkslenker; + ESP		03.2125-0671.3 010965	ATE Ø 25,4
2.0 D Multijet	94	04/11→						
2.0 D Multijet	100	01/07→						
2.0 D Multijet	120	07/10→						
FIAT - SCUDO Combinato (220_) 02/96→12/06								
 Hauptbremszylinder								
1.6	58	02/96→12/06			- ABS		24.2122-1703.3 010422	Ø 22,2
1.9 D	51	02/96→04/98						
1.9 D	51	04/98→12/06			+ ABS		24.2122-1708.3 010437	Ø 22,2
1.9 TD	68	02/96→12/06						
1.9 TD Eco	66	02/96→12/06						
2.0 16V	100	06/00→12/06						
2.0 JTD	69	01/04→12/06						
2.0 JTD	80	12/99→12/06						
2.0 JTD 16V	80	05/99→12/06			12/99→; - ABS		24.2122-1703.3 010422	Ø 22,2
					12/99→; + ABS		24.2122-1708.3 010437	Ø 22,2
FIAT - SCUDO Kasten (220_) 02/96→12/06								
 Hauptbremszylinder								
1.6	58	02/96→12/06			- ABS		24.2122-1703.3 010422	Ø 22,2
1.9 D	51	02/96→12/06						
1.9 D	51	04/98→12/06			+ ABS		24.2122-1708.3 010437	Ø 22,2
1.9 TD	66	02/96→12/06						
1.9 TD	68	02/98→12/06						
2.0 JTD	80	12/02→12/06						
2.0	100	05/00→12/06			06/00→; - ABS		24.2122-1703.3 010422	Ø 22,2
					06/00→; + ABS		24.2122-1708.3 010437	Ø 22,2
2.0 JTD	69	10/99→12/06			12/99→; - ABS		24.2122-1703.3 010422	Ø 22,2
2.0 JTD 16V	80	05/99→12/06			12/99→; + ABS		24.2122-1708.3 010437	Ø 22,2
FIAT - SCUDO Kasten (270_, 272_) 01/07→								
 Hauptbremszylinder								
1.6 D Multijet	66	01/07→			für Linkslenker; - ESP		03.2125-0298.3 010818	ATE Ø 25,4
1.6 D Multijet	66	02/11→						
2.0 D Multijet	88	01/07→			für Linkslenker; + ESP		03.2125-0671.3 010965	ATE Ø 25,4
2.0 D Multijet	94	05/11→						
2.0 D Multijet	100	01/07→						
2.0 D Multijet	120	07/10→						
FIAT - SCUDO Pritsche/Fahrgestell (220_) 09/96→12/06								
 Hauptbremszylinder								
1.9 D	51	04/98→12/06			- ABS		24.2122-1703.3 010422	Ø 22,2
					+ ABS		24.2122-1708.3 010437	Ø 22,2
2.0 JTD	69	10/99→12/06			12/99→; - ABS		24.2122-1703.3 010422	Ø 22,2
2.0 JTD 16V	80	05/99→12/06			12/99→; + ABS		24.2122-1708.3 010437	Ø 22,2
FIAT - SCUDO Pritsche/Fahrgestell (270_, 272_) 01/07→								
 Hauptbremszylinder								
1.6 D Multijet	66	01/07→			für Linkslenker; - ESP		03.2125-0298.3 010818	ATE Ø 25,4
2.0 D Multijet	100	01/07→			für Linkslenker; + ESP		03.2125-0671.3 010965	ATE Ø 25,4
FIAT - SEDICI (FY_) 06/06→10/14								
 Hauptbremszylinder								
1.6 16V	79	06/06→10/14			für Fahrzeuge ohne elektronische Fahr- dynamikregelung		24.4122-1712.3 010899	BOS Ø 22,2 ohne Bremsflüssigkeitsbehälter
1.6 16V	88	06/06→10/14						
1.6 16V 4x4	79	06/06→10/14						
1.6 16V 4x4	88	06/06→10/14			für Fahrzeuge mit elektronischer Fahr- dynamikregelung		24.4122-1713.3 010900	BOS Ø 22,2 ohne Bremsflüssigkeitsbehälter
1.9 D Multijet	88	06/06→10/11						
1.9 D Multijet 4x4	88	06/06→10/11						
2.0 D Multijet	99	06/06→10/14						
2.0 D Multijet 4x4	99	06/06→10/14						
FIAT - SEICENTO / 600 (187_) 11/97→01/10								
 Hauptbremszylinder								
0.9 (187AXA, 187AXA1A)	29	11/97→12/08			04/98→ 03/08		24.2119-0833.3 010418	Ø 19,05
1.1 (187AXB, 187AXB1A, 187AXC1A02)	40	01/98→01/10						















	kw			 	! #		
FIAT - STILO (192_) 10/01→11/10							
 Hauptbremszylinder							
1.9 D Multijet	110	09/05→11/06				24.2123-1769.3 010863	BOS Ø 23,81
1.9 JTD	103	01/04→11/06					
2.4 20V (192_XD1A, 192AXD12)	125	10/01→04/07					
FIAT - STILO Multi Wagon (192_) 01/03→08/08							
 Hauptbremszylinder							
1.9 D Multijet (192DXT1B)	110	09/05→08/08		→ 03/08		24.2123-1769.3 010863	BOS Ø 23,81
1.9 JTD	103	01/04→08/08					
FIAT - STRADA Pick-up (178_) 02/98→							
 Hauptbremszylinder							
1.2	44	04/03→		→ 12/11; + ABS		20.5522-1093.3 010731	ATE Ø 22,2
1.3 D Multijet	62	05/06→					
1.9 D	46	12/00→					
1.9 JTD	59	04/03→					
1.2	54	06/99→12/06		+ ABS		20.5522-1093.3 010731	ATE Ø 22,2
1.7 TD	51	06/99→12/06					
FIAT - TEMPRA (159_) 03/90→12/98							
 Hauptbremszylinder							
1.4 i.e. (159.AC, 159.AX)	51	04/90→08/96		→ 04/93; für Linkslenker; - ABS		24.2120-1710.3 010468	Ø 20,64
1.6 i.e. (159.AS, 159.AT)	55	06/92→08/96					
1.8 i.e. (159.AN)	77	03/92→08/96					
1.9 TD (159.AQ)	59	07/92→08/96					
1.9 TD (159.CU, 159.AU, 159.AI, 159.BI)	66	05/90→08/96					
2.0 i.e. (159.AP)	83	10/90→08/96					
FIAT - TEMPRA S.W. (159_) 03/90→10/97							
 Hauptbremszylinder							
1.4 i.e. (159.AC, 159.AX)	51	10/92→08/96		→ 04/93; für Linkslenker; - ABS		24.2120-1710.3 010468	Ø 20,64
1.6 i.e. (159.AE)	57	10/90→08/96					
1.6 i.e. (159.AS, 159.AT)	55	10/92→08/96					
1.9 TD (159.AI, 159.BI, 159.CU, 159.AU)	66	07/91→02/95					
2.0 i.e. (159.AP)	83	01/91→03/95					
FIAT - TIPO (160_) 07/87→10/97							
 Hauptbremszylinder							
1.4 i.e.	57	05/89→04/95		→ 04/93; für Linkslenker; - ABS		24.2120-1710.3 010468	Ø 20,64
1.4 i.e. (160.AP, 160.AD, 160.EA)	51	05/89→04/95					
1.6 i.e. (160.A1, 160.EC, 160.EB)	55	10/92→04/95					
1.9 TD (160.EL, 160.GL, 160.AQ, 160.EI, 160.AR)	66	09/90→04/95					
2.0 16V (160.AV)	107	07/91→04/95					
2.0 i.e. 16V Sport (160.EF)	102	03/93→04/95					
2.0 i.e. (160.AT, 160.AJ)	83	03/90→04/95		09/90→ 04/93; für Linkslenker; - ABS		24.2120-1710.3 010468	Ø 20,64
FIAT - ULYSSE (179_) 08/02→06/11							
 Hauptbremszylinder							
2.0	100	08/02→06/11		→ 01/11		03.2122-2163.3 010800	ATE Ø 22,2
2.0 D Multijet	88	05/06→06/11					
2.0 D Multijet	100	05/06→06/11					
2.2 D Multijet	125	03/08→06/11					
2.2 JTD	120	03/08→06/11					
2.0 JTD	79	05/03→08/06				03.2122-2163.3 010800	ATE Ø 22,2
2.0 JTD	80	08/02→08/06					
2.2 JTD	94	08/02→08/06					
FIAT - ULYSSE (220_) 06/94→08/02							
 Hauptbremszylinder							
1.8 (220.BB5)	73	05/97→08/02		→ 04/99; - ABS		24.2123-1707.3 010492	Ø 23,81
1.9 TD (220AH5)	66	02/95→08/02				24.2123-1733.3 010657	BOS Ø 23,81
2.0 (220.AC5)	89	06/94→08/02		05/99→ 07/02; + ABS			
				05/99→ 07/02; - ABS		24.2123-1738.3 010658	Ø 23,81
1.9 TD	68	05/97→12/99		→ 04/99; - ABS		24.2123-1707.3 010492	Ø 23,81
				05/99→; + ABS		24.2123-1733.3 010657	BOS Ø 23,81
				05/99→; - ABS		24.2123-1738.3 010658	Ø 23,81
↓							











	kw			 	! #		
FIAT - ULYSSE (220_) 06/94→08/02							
 Hauptbremszylinder							
2.0 16V 2.1 TD	97 80	05/98→09/00 03/96→10/99		05/99→		24.2123-1733.3 010657	BOS Ø 23,81
2.0 16V 2.0 JTD 2.0 JTD 16V	100 80 80	09/00→08/02 10/99→08/02 05/99→08/02		→ 07/02		24.2123-1733.3 010657	BOS Ø 23,81
2.0 Turbo (220.AD5)	108	06/94→08/02		05/99→ 07/02		24.2123-1733.3 010657	BOS Ø 23,81
FIAT - UNO (146_) 01/83→06/06							
 Hauptbremszylinder							
1.1 70 i.e. 1.4 70 S 1.4	41 51 52	04/86→06/06 09/89→07/96 10/88→06/06		10/89→ 06/95		24.2120-0801.3 010362	Ø 20,64
45 i.e. 1.0	33	04/84→10/95		→ 12/85		24.2119-0826.3 010349	Ø 19,05
				10/89→ 06/95		24.2120-0801.3 010362	Ø 20,64
				01/86→ 09/89		24.2120-0801.3 010362	Ø 20,64
 Bremskraftregler							
1.1 70 i.e. 1.4 70 S 1.4	41 51 52	04/86→06/06 09/89→07/96 10/88→06/06		10/89→ 06/95		24.6513-0801.3 320117	lastabhängig 1/3 2x
45 i.e. 1.0	33	04/84→10/95		10/89→ 06/95		24.6513-0801.3 320117	lastabhängig 1/3 2x
				→ 09/89		24.6513-0801.3 320117	lastabhängig 1/3 2x
FORD - C-MAX (DM2) 02/07→09/10							
 Bremskraftverstärker							
1.6 1.6 TDCi 1.6 TDCi 1.6 TDCi 1.8 1.8 1.8 Flexifuel 1.8 TDCi 2.0 2.0 TDCi 2.0 TDCi	74 66 74 80 90 92 92 85 107 98 100	02/07→09/10 02/07→09/10 02/07→09/10 02/07→09/10 02/07→09/10 02/07→09/10 02/07→09/10 02/07→09/10 02/07→09/10 02/07→09/10 02/07→09/10		03/07→ 04/07		03.7863-0332.4 300203	ATE Ø 10" pneumatisch
				05/07→; für Fahrzeuge mit Bremsassistent		03.7863-3932.4 300288	ATE Ø 10" pneumatisch
1.6	85	04/07→09/10		→ 04/07		03.7863-0332.4 300203	ATE Ø 10" pneumatisch
				05/07→; für Fahrzeuge mit Bremsassistent		03.7863-3932.4 300288	ATE Ø 10" pneumatisch
2.0 CNG 2.0 LPG 2.0 TDCi	107 107 81	04/09→09/10 06/08→09/10 02/08→09/10		für Fahrzeuge mit Bremsassistent		03.7863-3932.4 300288	ATE Ø 10" pneumatisch
 Hauptbremszylinder							
1.6 1.6 TDCi 1.6 TDCi 1.6 TDCi 1.8 1.8 1.8 Flexifuel 1.8 TDCi 2.0 2.0 TDCi 2.0 TDCi	74 66 74 80 90 92 92 85 107 98 100	02/07→09/10 02/07→09/10 02/07→09/10 02/07→09/10 02/07→09/10 02/07→09/10 02/07→09/10 02/07→09/10 02/07→09/10 02/07→09/10 02/07→09/10		03/07→ 05/07		03.2123-3103.3 010781	ATE Ø 23,81
				06/07→ 10/08		03.2125-0483.3 010783	ATE Ø 25,4 ohne Bremsflüssigkeitsbehälter
				11/08→		03.2125-0661.3 010917	ATE Ø 25,4
1.6	85	04/07→09/10		→ 05/07		03.2123-3103.3 010781	ATE Ø 23,81
				06/07→ 10/08		03.2125-0483.3 010783	ATE Ø 25,4 ohne Bremsflüssigkeitsbehälter
				11/08→		03.2125-0661.3 010917	ATE Ø 25,4
2.0 CNG 2.0 LPG 2.0 TDCi	107 107 81	04/09→09/10 06/08→09/10 02/08→09/10		→ 10/08		03.2125-0483.3 010783	ATE Ø 25,4 ohne Bremsflüssigkeitsbehälter
				11/08→		03.2125-0661.3 010917	ATE Ø 25,4
Hydraulikaggregat, Bremsanlage							
1.6 1.6 TDCi 1.6 TDCi 1.6 TDCi 1.8 1.8 1.8 Flexifuel 1.8 TDCi 2.0 ↓	74 66 74 80 90 92 92 85 107	02/07→09/10 02/07→09/10 02/07→09/10 02/07→09/10 02/07→09/10 02/07→09/10 02/07→09/10 02/07→09/10 02/07→09/10		03/07→		24.9145-0004.2 399008	











	kw			 	! #		
FORD - C-MAX (DM2) 02/07→09/10							
Hydraulikaggregat, Bremsanlage							
2.0 TDCi	98	02/07→09/10		03/07→		24.9145-0004.2	399008
2.0 TDCi	100	02/07→09/10					
1.6	85	04/07→09/10				24.9145-0004.2	399008
2.0 CNG	107	04/09→09/10					
2.0 LPG	107	06/08→09/10					
2.0 TDCi	81	02/08→09/10					
FORD - C-MAX II (DXA/CB7, DXA/CEU) 04/10→							
 Hauptbremszylinder							
1.0 EcoBoost	74	10/12→				03.4155-5451.3	010995 ATE Ø 25,4
1.0 EcoBoost	92	10/12→					
1.5 EcoBoost	110	03/15→					
1.5 EcoBoost	134	03/15→					
1.6 EcoBoost	110	12/10→					
1.6 EcoBoost	134	12/10→					
1.6 Flexifuel	88	02/11→					
1.6 LPG	86	02/12→					
1.6 LPG	88	02/12→					
1.6 TDCi	70	12/10→					
1.6 TDCi	85	12/10→					
1.6 Ti	63	12/10→					
1.6 Ti	77	12/10→					
1.6 Ti	88	02/12→					
1.6 Ti	92	12/10→					
2.0 TDCi	85	02/11→					
2.0 TDCi	100	02/11→					
2.0 TDCi	103	04/10→					
2.0 TDCi	110	03/15→					
2.0 TDCi	120	12/10→					
2.0 TDCi	125	03/15→					
FORD - COUGAR (EC_) 08/98→12/01							
 Hauptbremszylinder							
2.0 16V	96	08/98→12/01		09/98→		24.2125-1709.3	010499 Ø 25,4
2.5 V6 24V	125	08/98→12/01					
2.5 ST 200	151	01/00→12/01				24.2125-1709.3	010499 Ø 25,4
2.5 V6 24V	125	06/00→12/01					
FORD - COURIER Kasten (F3L, F5L) 04/89→02/96							
 Hauptbremszylinder							
1.3	44	09/91→02/96		→ 01/94; - SCS		24.2120-1604.3	010370 Ø 20,64
1.8 D	44	09/91→02/96		02/94→; - SCS		24.2120-1758.3	011008 TRW Ø 20,64 ohne Bremsflüssigkeitsbehälter
				+ SCS		24.2122-1603.3	010381 Ø 22,2
FORD - COURIER Kasten (J5_, J3_) 02/96→							
 Bremskraftverstärker							
1.3	44	02/96→08/03		02/00→ 03/02; für Linkslenker; - ABS		03.7750-2332.4	300113 ATE Ø 9" pneumatisch
1.8 D	44	02/96→04/02					
1.8 DI	55	09/00→08/03		→ 03/02; für Linkslenker; - ABS		03.7750-2332.4	300113 ATE Ø 9" pneumatisch
 Hauptbremszylinder							
1.3	44	02/96→08/03		02/00→ 03/02; + ABS		03.2122-1564.3	010594 ATE Ø 22,2
1.8 D	44	02/96→04/02		02/00→ 03/02; - ABS		24.2122-1588.3	011028 ATE Ø 22,2 ohne Druckregler
				→ 01/00; - ABS		24.2123-1737.3	010654 Ø 23,81
1.4 i	66	04/96→10/99		- ABS		24.2123-1735.3	010652 Ø 23,81
1.8 DI	55	09/00→08/03		→ 03/02; + ABS		03.2123-2243.3	010748 ATE Ø 23,81
				→ 03/02; - ABS		24.2122-1775.3	010981 Ø 22,2 ohne Bremsflüssigkeitsbehälter
FORD - ESCORT '95 Express (AVL) 01/95→06/01							
 Hauptbremszylinder							
1.4	54	01/95→08/00		08/95→ 02/99; + ABS		03.2123-1581.3	010487 Ø 23,81
1.8 D	44	01/95→08/00		02/95→ 02/99; - ABS		24.2123-1732.3	010625 Ø 23,81 ohne Bremsflüssigkeitsbehälter
1.8 Turbo D	51	12/95→06/01		→ 07/00; + ABS		03.2123-1581.3	010487 Ø 23,81
				→ 02/99; + ABS		03.2123-1581.3	010487 Ø 23,81
				→ 02/99; - ABS		24.2123-1732.3	010625 Ø 23,81 ohne Bremsflüssigkeitsbehälter











	kw			 	! #		
FORD - ESCORT VI (GAL) 01/92→09/96							
 Hauptbremszylinder							
1.3	44	09/92→01/95		- ABS		24.2123-1606.3 010386	Ø 23,81
1.4	52	09/92→01/95					
1.4	55	01/94→01/95					
1.6 i 16V	65	01/94→01/95					
1.6 i 16V	66	09/92→01/95					
1.8 D	44	09/92→01/95					
1.8 TD	66	02/93→01/95					
RS 2000	110	09/92→01/95					
RS 2000 4x4	110	08/93→01/95					
RS Cosworth 4x4	162	09/92→01/95					
FORD - ESCORT VI Cabriolet (ALL) 01/92→01/95							
 Hauptbremszylinder							
1.4 i	55	07/93→01/95		- ABS		24.2123-1606.3 010386	Ø 23,81
1.6 16V XR3i	66	12/92→01/95					
1.6 i 16V	65	02/94→01/95					
FORD - ESCORT VI Stufenheck (GAL) 08/93→01/95							
 Hauptbremszylinder							
1.3	44	08/93→01/95		- ABS		24.2123-1606.3 010386	Ø 23,81
1.4	55	08/93→01/95					
1.6 i 16V	65	01/94→01/95					
1.6 i 16V	66	08/93→01/95					
1.8 D	44	08/93→01/95					
1.8 TD	66	08/93→01/95					
FORD - ESCORT VI Turnier (GAL) 09/92→01/95							
 Hauptbremszylinder							
1.3	44	09/92→01/95		- ABS		24.2123-1606.3 010386	Ø 23,81
1.4	52	09/92→01/95					
1.4	55	01/94→01/95					
1.6 i 16V	65	01/94→01/95					
1.6 i 16V	66	09/92→01/95					
1.8 D	44	09/92→01/95					
1.8 TD	66	02/93→01/95					
FORD - ESCORT VII (GAL, AAL, ABL) 01/95→10/02							
 Hauptbremszylinder							
1.3	44	01/95→10/98		08/95→; + ABS		03.2123-1581.3 010487	Ø 23,81
1.4	55	01/95→10/98					
1.6 16V	66	01/95→10/98		02/95→; - ABS		24.2123-1732.3 010625	Ø 23,81 ohne Bremsflüssigkeitsbehälter
1.6 16V 4x4	66	01/95→10/98					
1.6 i 16V	65	01/95→08/95					
1.8 16V	77	01/95→08/95					
1.8 16V	85	01/95→10/98					
1.8 TD	66	01/95→10/98					
1.8 D	44	01/95→12/96		08/95→; + ABS		03.2123-1581.3 010487	Ø 23,81
				→ 01/95; - ABS		24.2123-1606.3 010386	Ø 23,81
				02/95→; - ABS		24.2123-1732.3 010625	Ø 23,81 ohne Bremsflüssigkeitsbehälter
1.8 Turbo D	51	12/95→10/98		+ ABS		03.2123-1581.3 010487	Ø 23,81
				- ABS		24.2123-1732.3 010625	Ø 23,81 ohne Bremsflüssigkeitsbehälter
FORD - ESCORT VII Cabriolet (ALL) 02/95→08/00							
 Hauptbremszylinder							
1.4	55	02/95→08/98		08/95→; + ABS		03.2123-1581.3 010487	Ø 23,81
1.6 16V XR3i	65	02/95→12/96		- ABS		24.2123-1732.3 010625	Ø 23,81 ohne Bremsflüssigkeitsbehälter
1.6 16V XR3i	66	02/95→09/99		08/95→; + ABS		03.2123-1581.3 010487	Ø 23,81
				→ 02/99; - ABS		24.2123-1732.3 010625	Ø 23,81 ohne Bremsflüssigkeitsbehälter
1.8 16V XR3i	77	02/95→08/98		- ABS		24.2123-1732.3 010625	Ø 23,81 ohne Bremsflüssigkeitsbehälter
1.8 16V XR3i	85	10/95→08/98		+ ABS		03.2123-1581.3 010487	Ø 23,81
			1.8 TD	66	09/95→08/98		- ABS
1.8 Turbo D	51	10/96→08/99					+ ABS
				→ 02/99; - ABS		24.2123-1732.3 010625	Ø 23,81 ohne Bremsflüssigkeitsbehälter







	kw					! #		
FORD - ESCORT VII Stufenheck (GAL, AFL) 01/95→08/02								
 Hauptbremszylinder								
1.3	44	01/95→02/99		08/95→; + ABS			03.2123-1581.3 010487	Ø 23,81
1.4	55	01/95→02/99		02/95→; - ABS			24.2123-1732.3 010625	Ø 23,81 ohne Bremsflüssigkeitsbehälter
1.6 i 16V	65	01/95→08/95						
1.6 i 16V	66	01/95→02/99						
1.8 16V	77	01/95→08/95						
1.8 16V	85	01/95→02/99						
1.8 TD	66	01/95→02/99						
1.8 D	44	01/95→12/96		08/95→; + ABS			03.2123-1581.3 010487	Ø 23,81
				→ 01/95; - ABS			24.2123-1606.3 010386	Ø 23,81
				02/95→; - ABS			24.2123-1732.3 010625	Ø 23,81 ohne Bremsflüssigkeitsbehälter
1.8 Turbo D	51	12/95→02/99		+ ABS			03.2123-1581.3 010487	Ø 23,81
				- ABS			24.2123-1732.3 010625	Ø 23,81 ohne Bremsflüssigkeitsbehälter
FORD - ESCORT VII Turnier (GAL, ANL) 01/95→10/02								
 Hauptbremszylinder								
1.3	44	01/95→01/99		08/95→; + ABS			03.2123-1581.3 010487	Ø 23,81
1.4	55	01/95→02/99		02/95→; - ABS			24.2123-1732.3 010625	Ø 23,81 ohne Bremsflüssigkeitsbehälter
1.6 16V	66	01/95→02/99						
1.6 i 16V	65	01/95→08/95						
1.8 16V	77	01/95→08/95						
1.8 16V	85	01/95→02/99						
1.8 D	44	01/95→02/99						
1.8 TD	66	01/95→02/99						
1.8 Turbo D	51	12/95→02/99		+ ABS			03.2123-1581.3 010487	Ø 23,81
				- ABS			24.2123-1732.3 010625	Ø 23,81 ohne Bremsflüssigkeitsbehälter
FORD - ESCORT CLASSIC (AAL, ABL) 10/98→07/00								
 Hauptbremszylinder								
1.6 16V	66	10/98→07/00		+ ABS			03.2123-1581.3 010487	Ø 23,81
1.8 TD	66	10/98→07/00		→ 02/99; - ABS			24.2123-1732.3 010625	Ø 23,81 ohne Bremsflüssigkeitsbehälter
FORD - ESCORT CLASSIC Turnier (ANL) 02/99→07/00								
 Hauptbremszylinder								
1.6 16V	66	02/99→07/00		+ ABS			03.2123-1581.3 010487	Ø 23,81
1.8 TD	66	02/99→07/00		→ 02/99; - ABS			24.2123-1732.3 010625	Ø 23,81 ohne Bremsflüssigkeitsbehälter
FORD - FIESTA III (GFJ) 01/89→01/97								
 Hauptbremszylinder								
1.1	37	03/89→12/95		05/91→ 01/94; - SCS			24.2120-1604.3 010370	Ø 20,64
1.1	40	03/89→12/95		05/89→ 04/91; - SCS			24.2120-1739.3 010762	TRW Ø 20,64 ohne Bremsflüssigkeitsbehälter
1.8 D	44	03/89→12/95						
					02/94→; - SCS			
				05/89→; + SCS			24.2122-1603.3 010381	Ø 22,2
1.3	44	03/89→12/95		05/91→ 01/94; - SCS			24.2120-1604.3 010370	Ø 20,64
1.4	52	03/89→12/95		→ 04/91; - SCS			24.2120-1739.3 010762	TRW Ø 20,64 ohne Bremsflüssigkeitsbehälter
1.4	54	03/89→12/95						
1.4 Cat	54	03/89→12/95		02/94→; - SCS			24.2120-1758.3 011008	TRW Ø 20,64 ohne Bremsflüssigkeitsbehälter
				+ SCS			24.2122-1603.3 010381	Ø 22,2
1.3 Cat	44	05/91→01/97		→ 01/94; - SCS			24.2120-1604.3 010370	Ø 20,64
				02/94→ 11/96; - SCS			24.2120-1758.3 011008	TRW Ø 20,64 ohne Bremsflüssigkeitsbehälter
				→ 11/96; + SCS			24.2122-1603.3 010381	Ø 22,2
1.6 i 16V	65	01/94→12/95		+ SCS			24.2122-1603.3 010381	Ø 22,2
1.8 16V	77	02/92→12/95						
1.8 XR2i 16V	96	02/92→12/95						
FORD - FIESTA IV (JA_, JB_) 08/95→09/02								
 Bremskraftverstärker								
1.25 i 16V	55	08/95→01/02		02/00→; für Linkslenker; - ABS			03.7750-2332.4 300113	ATE Ø 9" pneumatisch
1.3 i	37	08/95→01/02						
1.3 i	44	08/95→01/02						
1.4 i 16V	66	04/96→01/02						
↓								

	kw					! #			
FORD - FIESTA IV (JA_, JB_) 08/95→09/02									
 Bremskraftverstärker									
1.8 D	44	08/95→04/00		02/00→;	für Linkslenker; - ABS		03.7750-2332.4 300113	ATE Ø 9" pneumatisch	
1.6 16V Sport	76	02/00→01/02			für Linkslenker; - ABS		03.7750-2332.4 300113	ATE Ø 9" pneumatisch	
1.8 DI	55	04/00→01/02							
 Hauptbremszylinder									
1.25 i 16V	55	08/95→01/02		02/00→;	+ ABS		03.2123-2243.3 010748	ATE Ø 23,81	
				02/00→;	- ABS		24.2122-1588.3 011028	ATE Ø 22,2 ohne Druckregler	
				01/96→	01/00;	Schaltgetriebe; - ABS		24.2122-1775.3 010981	Ø 22,2 ohne Bremsflüssigkeitsbehälter
				01/96→	01/00;	Vollautomatik; - ABS		24.2123-1735.3 010652	Ø 23,81
1.3 i	37	08/95→01/02		02/00→;	+ ABS		03.2123-2243.3 010748	ATE Ø 23,81	
1.3 i	44	08/95→01/02		01/96→;	- ABS		24.2122-1775.3 010981	Ø 22,2 ohne Bremsflüssigkeitsbehälter	
1.8 D	44	08/95→04/00							
1.4 i 16V	66	04/96→01/02		02/00→;	+ ABS		03.2123-2243.3 010748	ATE Ø 23,81	
					- ABS		24.2123-1735.3 010652	Ø 23,81	
1.6 16V Sport	76	02/00→01/02			+ ABS		03.2123-2243.3 010748	ATE Ø 23,81	
					- ABS		24.2123-1735.3 010652	Ø 23,81	
1.8 DI	55	04/00→01/02			+ ABS		03.2123-2243.3 010748	ATE Ø 23,81	
					- ABS		24.2122-1775.3 010981	Ø 22,2 ohne Bremsflüssigkeitsbehälter	
FORD - FIESTA V (JH_, JD_) 11/01→03/10									
 Bremskraftverstärker									
1.25 16V	51	03/03→06/08			für Fahrzeuge ohne Bremsassistent		03.7750-8732.4 300199	ATE Ø 9" pneumatisch	
1.25 16V	55	05/02→06/08			für Fahrzeuge mit Bremsassistent		03.7853-2102.4 300201	ATE Ø 9" pneumatisch	
1.6 TDCi	66	11/04→06/08							
1.3	44	11/01→06/08		04/02→;			03.7750-8732.4 300199	ATE Ø 9" pneumatisch	
					für Fahrzeuge ohne Bremsassistent				
1.4 16V	59	11/01→06/08		04/02→;			03.7853-2102.4 300201	ATE Ø 9" pneumatisch	
					für Fahrzeuge mit Bremsassistent				
1.4 TDCi	50	11/01→06/08							
1.6 16V	74	11/01→06/08							
 Hauptbremszylinder									
1.25 16V	51	03/03→06/08			für Linkslenker; - ABS		03.4153-0015.3 011005	ATE Ø 23,81 ohne Bremsflüssigkeitsbehälter	
1.25 16V	55	05/02→06/08							
1.6 TDCi	66	11/04→06/08			für Linkslenker; + ABS		03.4153-5287.4 010953	ATE Ø 23,81 mit Bremsflüssigkeitsbehälter	
1.3	44	11/01→06/08		04/02→;	für Linkslenker; - ABS		03.4153-0015.3 011005	ATE Ø 23,81 ohne Bremsflüssigkeitsbehälter	
1.3	51	11/01→06/08							
1.4 16V	59	11/01→06/08		04/02→;	für Linkslenker; + ABS		03.4153-5287.4 010953	ATE Ø 23,81 mit Bremsflüssigkeitsbehälter	
1.4 TDCi	50	11/01→06/08							
1.6 16V	74	11/01→06/08							
FORD - FIESTA V Van 10/03→12/10									
 Bremskraftverstärker									
1.3	51	10/03→07/05			für Fahrzeuge ohne Bremsassistent		03.7750-8732.4 300199	ATE Ø 9" pneumatisch	
					für Fahrzeuge mit Bremsassistent		03.7853-2102.4 300201	ATE Ø 9" pneumatisch	
1.4 TDCi	50	10/03→12/10		→ 08/08;			03.7750-8732.4 300199	ATE Ø 9" pneumatisch	
1.6 TDCi	66	04/07→09/09		→ 08/08;	für Fahrzeuge ohne Bremsassistent		03.7853-2102.4 300201	ATE Ø 9" pneumatisch	
				→ 08/08;	für Fahrzeuge mit Bremsassistent				
 Hauptbremszylinder									
1.3	51	10/03→07/05			für Linkslenker; - ABS		03.4153-0015.3 011005	ATE Ø 23,81 ohne Bremsflüssigkeitsbehälter	
					für Linkslenker; + ABS		03.4153-5287.4 010953	ATE Ø 23,81 mit Bremsflüssigkeitsbehälter	
1.4 TDCi	50	10/03→12/10		→ 08/08;	für Linkslenker; - ABS		03.4153-0015.3 011005	ATE Ø 23,81 ohne Bremsflüssigkeitsbehälter	
1.6 TDCi	66	04/07→09/09		→ 08/08;	für Linkslenker; + ABS		03.4153-5287.4 010953	ATE Ø 23,81 mit Bremsflüssigkeitsbehälter	
FORD - FIESTA Kasten (FVD) 03/83→12/95									
 Hauptbremszylinder									
1.8 D (FVJ)	43	03/89→12/95		09/91→	01/94; - SCS		24.2120-1604.3 010370	Ø 20,64	
				02/94→;	- SCS		24.2120-1758.3 011008	TRW Ø 20,64 ohne Bremsflüssigkeitsbehälter	
				09/91→;	+ SCS		24.2122-1603.3 010381	Ø 22,2	

	kw			 	! #						
FORD - FIESTA Kasten (JV_) 05/98→08/03											
 Bremskraftverstärker											
D 1.8	44	05/98→04/02		02/00→ 03/02; für Linkslenker; - ABS	03.7750-2332.4	300113	ATE Ø 9" pneumatisch				
 Hauptbremszylinder											
D 1.8	44	05/98→04/02		02/00→ 03/02; + ABS	03.2122-1564.3	010594	ATE Ø 22,2				
				02/00→ 03/02; - ABS	24.2122-1588.3	011028	ATE Ø 22,2 ohne Druckregler				
				→ 01/00; - ABS	24.2123-1737.3	010654	Ø 23,81				
TD 1.8	55	03/00→08/03		→ 03/02; + ABS	03.2122-1564.3	010594	ATE Ø 22,2				
				→ 03/02; - ABS	24.2122-1588.3	011028	ATE Ø 22,2 ohne Druckregler				
FORD - FOCUS (DAW, DBW) 09/98→12/07											
 Hauptbremszylinder											
1.4 16V	55	10/98→09/99		+ ABS	24.4123-1713.3	010905	BOS Ø 23,81 ohne Bremsflüssigkeitsbehälter				
1.4 16V	55	10/98→11/04		11/01→ 09/04; + ESP	03.4123-0153.3	010659	ATE Ø 23,81				
1.6 16V	74	10/98→11/04		→ 09/04; + ABS	24.4123-1713.3	010905	BOS Ø 23,81 ohne Bremsflüssigkeitsbehälter				
1.8 16V	85	10/98→11/04									
1.8 DI / TDDi	55	08/99→11/04									
1.8 TDCi	85	03/01→11/04									
1.8 Turbo DI / TDDi	66	10/98→11/04									
2.0 16V	96	10/98→11/04									
1.8 TDCi	74	08/02→11/04		→ 09/04; + ESP	03.4123-0153.3	010659	ATE Ø 23,81				
				→ 09/04; + ABS	24.4123-1713.3	010905	BOS Ø 23,81 ohne Bremsflüssigkeitsbehälter				
FORD - FOCUS II (DA_, HCP, DP) 07/04→09/13											
 Bremskraftverstärker											
1.4	59	07/04→09/12		05/07→ 02/11;	03.7760-2232.4	300266	ATE Ø 10" pneumatisch				
1.6	74	07/04→09/12		+ ABS / für Fahrzeuge ohne Bremsassistent							
1.6 TDCi	74	07/04→09/12		10/04→ 02/11;	03.7760-2332.4	300267	ATE Ø 10" pneumatisch				
1.6 TDCi	80	07/04→09/12									
1.6 Ti	85	07/04→09/12									
2.0	107	07/04→09/12									
2.0 TDCi	100	07/04→09/12									
								10/04→ 04/07;	03.7760-8103.4	300240	ATE Ø 10" pneumatisch
								+ ABS / für Fahrzeuge ohne Bremsassistent			
				10/04→ 04/07;	03.7863-0332.4	300203	ATE Ø 10" pneumatisch				
				+ ABS / für Fahrzeuge mit Bremsassistent							
				05/07→ 02/11;	03.7863-3932.4	300288	ATE Ø 10" pneumatisch				
				+ ABS / für Fahrzeuge mit Bremsassistent							
1.6 LPG	85	10/09→07/11		→ 02/11;	03.7760-2232.4	300266	ATE Ø 10" pneumatisch				
2.0 CNG	107	04/09→07/11		+ ABS / für Fahrzeuge ohne Bremsassistent							
2.0 LPG	107	06/08→07/11		→ 02/11;	03.7760-2332.4	300267	ATE Ø 10" pneumatisch				
2.0 TDCi	81	02/08→07/11									
				→ 02/11;	03.7863-3932.4	300288	ATE Ø 10" pneumatisch				
				+ ABS / für Fahrzeuge mit Bremsassistent							
1.6 TDCi	66	01/05→09/12		05/07→ 02/11;	03.7760-2232.4	300266	ATE Ø 10" pneumatisch				
1.8	92	03/06→09/12		+ ABS / für Fahrzeuge ohne Bremsassistent							
1.8 Flexifuel	92	01/06→09/12		→ 02/11;	03.7760-2332.4	300267	ATE Ø 10" pneumatisch				
1.8 TDCi	85	01/05→09/12									
								→ 04/07;	03.7760-8103.4	300240	ATE Ø 10" pneumatisch
								+ ABS / für Fahrzeuge ohne Bremsassistent			
								→ 04/07;	03.7863-0332.4	300203	ATE Ø 10" pneumatisch
				+ ABS / für Fahrzeuge mit Bremsassistent							
				05/07→ 02/11;	03.7863-3932.4	300288	ATE Ø 10" pneumatisch				
				+ ABS / für Fahrzeuge mit Bremsassistent							
2.0 TDCi	98	07/04→01/08		05/07→;	03.7760-2232.4	300266	ATE Ø 10" pneumatisch				
				+ ABS / für Fahrzeuge ohne Bremsassistent							
				10/04→;	03.7760-2332.4	300267	ATE Ø 10" pneumatisch				
				- ABS / für Fahrzeuge ohne Bremsassistent							
				10/04→ 04/07;	03.7760-8103.4	300240	ATE Ø 10" pneumatisch				
				+ ABS / für Fahrzeuge ohne Bremsassistent							

	kw			 	! #		
FORD - FOCUS II (DA_, HCP, DP) 07/04→09/13							
 Bremskraftverstärker							
2.0 TDCi	98	07/04→01/08		10/04→ 04/07; + ABS / für Fahrzeuge mit Bremsassistent		03.7863-0332.4 300203	ATE Ø 10" pneumatisch
				05/07→; + ABS / für Fahrzeuge mit Bremsassistent		03.7863-3932.4 300288	ATE Ø 10" pneumatisch
2.5 RS 2.5 RS 500	224 257	01/09→07/11 05/10→07/11		für Linkslenker; → 02/11		03.7755-3532.4 300290	ATE Ø 9 / 8" pneumatisch
 Hauptbremszylinder							
1.4 1.6 1.6 TDCi	59 74 74	07/04→09/12 07/04→09/12 07/04→09/12		10/04→ 02/11; - ABS		03.2123-3041.3 010887	ATE Ø 23,81 ohne Bremsflüssigkeitsbehälter / mit Druckregler
1.6 TDCi 1.6 Ti	80 85	07/04→09/12 07/04→09/12		10/04→ 04/07; + ABS		03.2123-3103.3 010781	ATE Ø 23,81
2.0 2.0 TDCi	107 100	07/04→09/12 07/04→09/12		05/07→ 10/08; + ABS		03.2125-0483.3 010783	ATE Ø 25,4 ohne Bremsflüssigkeitsbehälter
				11/08→ 02/11; + ABS		03.2125-0661.3 010917	ATE Ø 25,4
1.6 LPG 2.0 CNG	85 107	10/09→07/11 04/09→07/11		→ 02/11; - ABS		03.2123-3041.3 010887	ATE Ø 23,81 ohne Bremsflüssigkeitsbehälter / mit Druckregler
				→ 02/11; + ABS		03.2125-0661.3 010917	ATE Ø 25,4
1.6 TDCi 1.8 1.8 Flexifuel 1.8 TDCi 2.5 ST	66 92 92 85 166	01/05→09/12 03/06→09/12 01/06→09/12 01/05→09/12 10/05→09/12		→ 02/11; - ABS		03.2123-3041.3 010887	ATE Ø 23,81 ohne Bremsflüssigkeitsbehälter / mit Druckregler
				→ 04/07; + ABS		03.2123-3103.3 010781	ATE Ø 23,81
				05/07→ 10/08; + ABS		03.2125-0483.3 010783	ATE Ø 25,4 ohne Bremsflüssigkeitsbehälter
				11/08→ 02/11; + ABS		03.2125-0661.3 010917	ATE Ø 25,4
2.0 LPG 2.0 TDCi	107 81	06/08→07/11 02/08→07/11		→ 02/11; - ABS		03.2123-3041.3 010887	ATE Ø 23,81 ohne Bremsflüssigkeitsbehälter / mit Druckregler
				→ 10/08; + ABS		03.2125-0483.3 010783	ATE Ø 25,4 ohne Bremsflüssigkeitsbehälter
				11/08→ 02/11; + ABS		03.2125-0661.3 010917	ATE Ø 25,4
2.0 TDCi	98	07/04→01/08		10/04→; - ABS		03.2123-3041.3 010887	ATE Ø 23,81 ohne Bremsflüssigkeitsbehälter / mit Druckregler
				10/04→ 04/07; + ABS		03.2123-3103.3 010781	ATE Ø 23,81
				05/07→; + ABS		03.2125-0483.3 010783	ATE Ø 25,4 ohne Bremsflüssigkeitsbehälter
2.5 RS 2.5 RS 500	224 257	01/09→07/11 05/10→07/11		für Linkslenker; → 02/11		03.2125-0651.3 010935	ATE Ø 25,4
Hydraulikaggregat, Bremsanlage							
1.4 1.6 1.6 TDCi 1.6 TDCi 1.6 Ti 2.0 2.0 TDCi	59 74 74 80 85 107 100	07/04→09/12 07/04→09/12 07/04→09/12 07/04→09/12 07/04→09/12 07/04→09/12 07/04→09/12		10/04→ 02/11		24.9145-0004.2 399008	
1.6 LPG 1.6 TDCi 1.8 1.8 Flexifuel 1.8 TDCi 2.0 CNG 2.0 LPG 2.0 TDCi 2.5 ST	85 66 92 92 85 107 107 81 166	10/09→07/11 01/05→09/12 03/06→09/12 01/06→09/12 01/05→09/12 04/09→07/11 06/08→07/11 02/08→07/11 10/05→09/12		→ 02/11		24.9145-0004.2 399008	
2.0 TDCi	98	07/04→01/08		10/04→		24.9145-0004.2 399008	
FORD - FOCUS II Cabriolet 10/06→09/10							
 Bremskraftverstärker							
1.6 2.0 2.0 TDCi	74 107 100	10/06→09/10 10/06→09/10 10/06→09/10		05/07→; + ABS / für Fahrzeuge ohne Bremsassistent		03.7760-2232.4 300266	ATE Ø 10" pneumatisch
				- ABS / für Fahrzeuge ohne Bremsassistent		03.7760-2332.4 300267	ATE Ø 10" pneumatisch
				→ 04/07; + ABS / für Fahrzeuge ohne Bremsassistent		03.7760-8103.4 300240	ATE Ø 10" pneumatisch
↓							

	kw			 	! #		
FORD - FOCUS II Cabriolet 10/06→09/10							
 Bremskraftverstärker							
1.6 2.0 2.0 TDCi	74 107 100	10/06→09/10 10/06→09/10 10/06→09/10		→ 04/07; + ABS / für Fahrzeuge mit Bremsassistent		03.7863-0332.4 300203	ATE Ø 10" pneumatisch
				05/07→; + ABS / für Fahrzeuge mit Bremsassistent		03.7863-3932.4 300288	ATE Ø 10" pneumatisch
 Hauptbremszylinder							
1.6 2.0 2.0 TDCi	74 107 100	10/06→09/10 10/06→09/10 10/06→09/10		- ABS		03.2123-3041.3 010887	ATE Ø 23,81 ohne Bremsflüssigkeitsbehälter / mit Druckregler
				→ 04/07; + ABS		03.2123-3103.3 010781	ATE Ø 23,81
				05/07→ 10/08; + ABS		03.2125-0483.3 010783	ATE Ø 25,4 ohne Bremsflüssigkeitsbehälter
				11/08→; + ABS		03.2125-0661.3 010917	ATE Ø 25,4
Hydraulikaggregat, Bremsanlage							
1.6 2.0 2.0 TDCi	74 107 100	10/06→09/10 10/06→09/10 10/06→09/10				24.9145-0004.2 399008	
FORD - FOCUS II Stufenheck (DB_, FCH, DH) 04/05→							
 Bremskraftverstärker							
1.4 1.6 1.6 TDCi 1.6 TDCi 1.6 TDCi 1.6 Ti 1.8 1.8 Flexifuel 1.8 TDCi 2.0 2.0 TDCi	59 74 66 74 80 85 92 92 85 107 100	04/05→09/12 04/05→09/12 04/05→09/12 04/05→09/12 04/05→09/12 04/05→09/12 03/06→09/12 06/06→07/11 04/05→09/12 04/05→07/11 04/05→09/12		05/07→ 02/11; + ABS / für Fahrzeuge ohne Bremsassistent		03.7760-2232.4 300266	ATE Ø 10" pneumatisch
				→ 02/11; - ABS / für Fahrzeuge ohne Bremsassistent		03.7760-2332.4 300267	ATE Ø 10" pneumatisch
				→ 04/07; + ABS / für Fahrzeuge ohne Bremsassistent		03.7760-8103.4 300240	ATE Ø 10" pneumatisch
				→ 04/07; + ABS / für Fahrzeuge mit Bremsassistent		03.7863-0332.4 300203	ATE Ø 10" pneumatisch
				05/07→ 02/11; + ABS / für Fahrzeuge mit Bremsassistent		03.7863-3932.4 300288	ATE Ø 10" pneumatisch
2.0 TDCi	81	02/08→07/11		→ 02/11; + ABS / für Fahrzeuge ohne Bremsassistent		03.7760-2232.4 300266	ATE Ø 10" pneumatisch
				→ 02/11; - ABS / für Fahrzeuge ohne Bremsassistent		03.7760-2332.4 300267	ATE Ø 10" pneumatisch
				→ 02/11; + ABS / für Fahrzeuge mit Bremsassistent		03.7863-3932.4 300288	ATE Ø 10" pneumatisch
 Hauptbremszylinder							
1.4 1.6 1.6 TDCi 1.6 TDCi 1.6 TDCi 1.6 Ti 1.8 1.8 Flexifuel 1.8 TDCi 2.0 2.0 TDCi	59 74 66 74 80 85 92 92 85 107 100	04/05→09/12 04/05→09/12 04/05→09/12 04/05→09/12 04/05→09/12 04/05→09/12 03/06→09/12 06/06→07/11 04/05→09/12 04/05→07/11 04/05→09/12		→ 02/11; - ABS		03.2123-3041.3 010887	ATE Ø 23,81 ohne Bremsflüssigkeitsbehälter / mit Druckregler
				→ 04/07; + ABS		03.2123-3103.3 010781	ATE Ø 23,81
				05/07→ 10/08; + ABS		03.2125-0483.3 010783	ATE Ø 25,4 ohne Bremsflüssigkeitsbehälter
				11/08→ 02/11; + ABS		03.2125-0661.3 010917	ATE Ø 25,4
2.0 TDCi	81	02/08→07/11		→ 02/11; - ABS		03.2123-3041.3 010887	ATE Ø 23,81 ohne Bremsflüssigkeitsbehälter / mit Druckregler
				→ 10/08; + ABS		03.2125-0483.3 010783	ATE Ø 25,4 ohne Bremsflüssigkeitsbehälter
				11/08→ 02/11; + ABS		03.2125-0661.3 010917	ATE Ø 25,4
Hydraulikaggregat, Bremsanlage							
1.4 1.6 1.6 TDCi 1.6 TDCi 1.6 TDCi 1.6 Ti 1.8 1.8 Flexifuel ↓	59 74 66 74 80 85 92 92	04/05→09/12 04/05→09/12 04/05→09/12 04/05→09/12 04/05→09/12 04/05→09/12 03/06→09/12 06/06→07/11		→ 02/11		24.9145-0004.2 399008	

	kw					! #		
FORD - FOCUS II Stufenheck (DB_, FCH, DH) 04/05→								
Hydraulikaggregat, Bremsanlage								
1.8 TDCi	85	04/05→09/12		→ 02/11			24.9145-0004.2	399008
2.0	107	04/05→07/11						
2.0 TDCi	81	02/08→07/11						
2.0 TDCi	100	04/05→09/12						
FORD - FOCUS II Turnier (DA_, FFS, DS) 07/04→09/12								
Bremskraftverstärker								
1.4	59	07/04→09/12		05/07→ 02/11;			03.7760-2232.4	300266
1.6	74	07/04→07/11		+ ABS / für Fahrzeuge ohne Bremsassistent				ATE Ø 10" pneumatisch
1.6 TDCi	74	07/04→09/12						
1.6 TDCi	80	07/04→09/12		10/04→ 02/11;			03.7760-2332.4	300267
1.6 Ti	85	07/04→09/12		- ABS / für Fahrzeuge ohne Bremsassistent				ATE Ø 10" pneumatisch
2.0	107	07/04→09/12						
2.0 TDCi	100	07/04→09/12		10/04→ 04/07;			03.7760-8103.4	300240
				+ ABS / für Fahrzeuge ohne Bremsassistent				ATE Ø 10" pneumatisch
				10/04→ 04/07;			03.7863-0332.4	300203
				+ ABS / für Fahrzeuge mit Bremsassistent				ATE Ø 10" pneumatisch
				05/07→ 02/11;			03.7863-3932.4	300288
				+ ABS / für Fahrzeuge mit Bremsassistent				ATE Ø 10" pneumatisch
1.6 LPG	85	10/09→09/12		→ 02/11;			03.7760-2232.4	300266
2.0 LPG	107	06/08→07/11		+ ABS / für Fahrzeuge ohne Bremsassistent				ATE Ø 10" pneumatisch
2.0 TDCi	81	02/08→07/11						
				→ 02/11;			03.7760-2332.4	300267
				- ABS / für Fahrzeuge ohne Bremsassistent				ATE Ø 10" pneumatisch
				→ 02/11;			03.7863-3932.4	300288
				+ ABS / für Fahrzeuge mit Bremsassistent				ATE Ø 10" pneumatisch
1.6 TDCi	66	07/04→09/12		05/07→ 02/11;			03.7760-2232.4	300266
1.8 TDCi	85	07/04→09/12		+ ABS / für Fahrzeuge ohne Bremsassistent				ATE Ø 10" pneumatisch
				01/05→ 02/11;			03.7760-2332.4	300267
				- ABS / für Fahrzeuge ohne Bremsassistent				ATE Ø 10" pneumatisch
				01/05→ 04/07;			03.7760-8103.4	300240
				+ ABS / für Fahrzeuge ohne Bremsassistent				ATE Ø 10" pneumatisch
				01/05→ 04/07;			03.7863-0332.4	300203
				+ ABS / für Fahrzeuge mit Bremsassistent				ATE Ø 10" pneumatisch
				05/07→ 02/11;			03.7863-3932.4	300288
				+ ABS / für Fahrzeuge mit Bremsassistent				ATE Ø 10" pneumatisch
1.8	92	03/06→09/12		05/07→ 02/11;			03.7760-2232.4	300266
1.8 Flexifuel	92	01/06→09/12		+ ABS / für Fahrzeuge ohne Bremsassistent				ATE Ø 10" pneumatisch
				→ 02/11;			03.7760-2332.4	300267
				- ABS / für Fahrzeuge ohne Bremsassistent				ATE Ø 10" pneumatisch
				→ 04/07;			03.7760-8103.4	300240
				+ ABS / für Fahrzeuge ohne Bremsassistent				ATE Ø 10" pneumatisch
				→ 04/07;			03.7863-0332.4	300203
				+ ABS / für Fahrzeuge mit Bremsassistent				ATE Ø 10" pneumatisch
				05/07→ 02/11;			03.7863-3932.4	300288
				+ ABS / für Fahrzeuge mit Bremsassistent				ATE Ø 10" pneumatisch
2.0 TDCi	98	07/04→01/08		05/07→;			03.7760-2232.4	300266
				+ ABS / für Fahrzeuge ohne Bremsassistent				ATE Ø 10" pneumatisch
				10/04→;			03.7760-2332.4	300267
				- ABS / für Fahrzeuge ohne Bremsassistent				ATE Ø 10" pneumatisch
				10/04→ 04/07;			03.7760-8103.4	300240
				+ ABS / für Fahrzeuge ohne Bremsassistent				ATE Ø 10" pneumatisch
				10/04→ 04/07;			03.7863-0332.4	300203
				+ ABS / für Fahrzeuge mit Bremsassistent				ATE Ø 10" pneumatisch
				05/07→;			03.7863-3932.4	300288
				+ ABS / für Fahrzeuge mit Bremsassistent				ATE Ø 10" pneumatisch

FORD - FOCUS II Turnier (DA_, FFS, DS) 07/04→09/12

Hauptbremszylinder

1.4 1.6 1.6 TDCi 1.6 TDCi 1.6 Ti 2.0 2.0 TDCi	59 74 74 80 85 107 100	07/04→09/12 07/04→07/11 07/04→09/12 07/04→09/12 07/04→09/12 07/04→09/12 07/04→09/12		10/04→ 02/11; - ABS		03.2123-3041.3	010887	ATE Ø 23,81 ohne Bremsflüssigkeitsbehälter / mit Druckregler
				10/04→ 04/07; + ABS		03.2123-3103.3	010781	ATE Ø 23,81
				05/07→ 10/08; + ABS		03.2125-0483.3	010783	ATE Ø 25,4 ohne Bremsflüssigkeitsbehälter
				11/08→ 02/11; + ABS		03.2125-0661.3	010917	ATE Ø 25,4
1.6 LPG	85	10/09→09/12		→ 02/11; - ABS		03.2123-3041.3	010887	ATE Ø 23,81 ohne Bremsflüssigkeitsbehälter / mit Druckregler
				→ 02/11; + ABS		03.2125-0661.3	010917	ATE Ø 25,4
1.6 TDCi 1.8 TDCi	66 85	07/04→09/12 07/04→09/12		01/05→ 02/11; - ABS		03.2123-3041.3	010887	ATE Ø 23,81 ohne Bremsflüssigkeitsbehälter / mit Druckregler
				01/05→ 04/07; + ABS		03.2123-3103.3	010781	ATE Ø 23,81
				05/07→ 10/08; + ABS		03.2125-0483.3	010783	ATE Ø 25,4 ohne Bremsflüssigkeitsbehälter
				11/08→ 02/11; + ABS		03.2125-0661.3	010917	ATE Ø 25,4
1.8 1.8 Flexifuel	92 92	03/06→09/12 01/06→09/12		→ 02/11; - ABS		03.2123-3041.3	010887	ATE Ø 23,81 ohne Bremsflüssigkeitsbehälter / mit Druckregler
				→ 04/07; + ABS		03.2123-3103.3	010781	ATE Ø 23,81
				05/07→ 10/08; + ABS		03.2125-0483.3	010783	ATE Ø 25,4 ohne Bremsflüssigkeitsbehälter
				11/08→ 02/11; + ABS		03.2125-0661.3	010917	ATE Ø 25,4
2.0 LPG 2.0 TDCi	107 81	06/08→07/11 02/08→07/11		→ 02/11; - ABS		03.2123-3041.3	010887	ATE Ø 23,81 ohne Bremsflüssigkeitsbehälter / mit Druckregler
				→ 10/08; + ABS		03.2125-0483.3	010783	ATE Ø 25,4 ohne Bremsflüssigkeitsbehälter
				11/08→ 02/11; + ABS		03.2125-0661.3	010917	ATE Ø 25,4
2.0 TDCi	98	07/04→01/08		10/04→; - ABS		03.2123-3041.3	010887	ATE Ø 23,81 ohne Bremsflüssigkeitsbehälter / mit Druckregler
				10/04→ 04/07; + ABS		03.2123-3103.3	010781	ATE Ø 23,81
				05/07→; + ABS		03.2125-0483.3	010783	ATE Ø 25,4 ohne Bremsflüssigkeitsbehälter











Hydraulikaggregat, Bremsanlage











1.4 1.6 1.6 TDCi 1.6 TDCi 1.6 Ti 2.0 2.0 TDCi	59 74 74 80 85 107 100	07/04→09/12 07/04→07/11 07/04→09/12 07/04→09/12 07/04→09/12 07/04→09/12 07/04→09/12		10/04→ 02/11		24.9145-0004.2	399008	
1.6 LPG 1.8 1.8 Flexifuel 2.0 LPG 2.0 TDCi	85 92 92 107 81	10/09→09/12 03/06→09/12 01/06→09/12 06/08→07/11 02/08→07/11		→ 02/11		24.9145-0004.2	399008	
1.6 TDCi 1.8 TDCi 2.0 TDCi	66 85 98	07/04→09/12 07/04→09/12 07/04→01/08		01/05→ 02/11 10/04→		24.9145-0004.2	399008	













FORD - FOCUS III 07/10→











Hauptbremszylinder













1.0 EcoBoost 1.0 EcoBoost 1.0 EcoBoost 1.5 EcoBoost 1.5 EcoBoost 1.5 TDCi 1.5 TDCi 1.5 TDCi ECONetic 1.6 Flexifuel 1.6 LPG 1.6 LPG 1.6 TDCi ECONetic 1.6 Ti 1.6 Ti 2.0 ST 2.0 TDCi 2.0 TDCi ST	74 92 103 110 134 70 88 77 110 86 88 77 63 88 184 110 136	02/12→ 02/12→ 10/17→ 09/14→ 09/14→ 09/14→ 09/14→ 09/14→ 07/13→ 02/12→ 02/12→ 05/12→ 08/11→ 02/12→ 07/12→ 11/14→ 11/14→				03.4155-5451.3	010995	ATE Ø 25,4
------------------------------------------------------------------------------------------------------------------------------------------------------------------------------------------------------------------------------------------------	-----------------------------------------------------------------------------------------------------------	------------------------------------------------------------------------------------------------------------------------------------------------------------------------	--	--	--	-----------------------	---------------	------------













	kW			 	! #		
FORD - FOCUS III 07/10→							
 Hauptbremszylinder							
1.6 EcoBoost	110	07/10→		03/11→		03.4155-5451.3 010995	ATE Ø 25,4
1.6 EcoBoost	134	07/10→					
1.6 Flexifuel	88	07/10→					
1.6 TDCi	70	07/10→					
1.6 TDCi	85	07/10→					
1.6 Ti	77	07/10→					
1.6 Ti	92	07/10→					
2.0 TDCi	85	07/10→					
2.0 TDCi	100	07/10→					
2.0 TDCi	103	07/10→					
2.0 TDCi	120	07/10→					
2.0 Ti-GDi	125	08/11→				03.4155-5456.3 010996	ATE Ø 25,4
2.3 RS AWD	257	07/15→					
FORD - FOCUS III Stufenheck 07/10→							
 Hauptbremszylinder							
1.0 EcoBoost	74	02/12→				03.4155-5451.3 010995	ATE Ø 25,4
1.0 EcoBoost	92	02/12→					
1.0 EcoBoost	103	10/17→					
1.5 EcoBoost	110	11/14→					
1.5 EcoBoost	134	11/14→					
1.5 TDCi	70	11/14→					
1.5 TDCi	88	11/14→					
1.5 TDCi ECONetic	77	11/14→					
1.6 Flexifuel	110	07/13→					
1.6 TDCi	77	05/12→					
1.6 Ti	63	08/11→					
2.0 TDCi	110	11/14→					
1.6 EcoBoost	110	07/10→		03/11→		03.4155-5451.3 010995	ATE Ø 25,4
1.6 EcoBoost	134	07/10→					
1.6 Flexifuel	88	07/10→					
1.6 TDCi	70	07/10→					
1.6 TDCi	85	07/10→					
1.6 Ti	77	07/10→					
1.6 Ti	92	07/10→					
2.0 TDCi	85	07/10→					
2.0 TDCi	100	07/10→					
2.0 TDCi	103	07/10→					
2.0 TDCi	120	07/10→					
2.0 GDi	125	08/11→				03.4155-5456.3 010996	ATE Ø 25,4
FORD - FOCUS III Turnier 07/10→							
 Hauptbremszylinder							
1.0 EcoBoost	74	02/12→				03.4155-5451.3 010995	ATE Ø 25,4
1.0 EcoBoost	92	02/12→					
1.0 EcoBoost	103	10/17→					
1.5 EcoBoost	110	09/14→					
1.5 EcoBoost	134	09/14→					
1.5 TDCi	70	09/14→					
1.5 TDCi	88	09/14→					
1.5 TDCi ECONetic	77	09/14→					
1.6 Flexifuel	110	07/13→					
1.6 LPG	86	02/12→					
1.6 LPG	88	02/12→					
1.6 TDCi ECONetic	77	05/12→					
1.6 Ti	63	08/11→					
1.6 Ti	88	02/12→					
2.0 ST	184	07/12→					
2.0 TDCi	110	11/14→					
2.0 TDCi ST	136	11/14→					
1.6 EcoBoost	110	07/10→		03/11→		03.4155-5451.3 010995	ATE Ø 25,4
1.6 EcoBoost	134	07/10→					
1.6 Flexifuel	88	07/10→					
1.6 TDCi	70	07/10→					
1.6 TDCi	85	07/10→					
1.6 Ti	77	07/10→					
1.6 Ti	92	07/10→					
2.0 TDCi	85	07/10→					
2.0 TDCi	100	07/10→					
2.0 TDCi	103	07/10→					
2.0 TDCi	120	07/10→					
2.0 Ti-GDi	125	07/10→		08/11→		03.4155-5456.3 010996	ATE Ø 25,4
FORD - FOCUS C-MAX 10/03→03/07							
 Bremskraftverstärker							
1.6	74	10/03→03/07		09/06→;		03.7760-2232.4 300266	ATE Ø 10" pneumatisch
1.6 TDCi	66	02/05→03/07		für Fahrzeuge ohne Bremsassistent			
1.6 TDCi	80	10/03→03/07					
1.6 Ti	85	08/04→03/07					
↓							













	kw			 	! #		
FORD - FOCUS C-MAX 10/03→03/07							
 Bremskraftverstärker							
1.8	88	10/03→03/07		→ 08/06;		03.7760-8103.4	300240 ATE Ø 10" pneumatisch
1.8	90	09/05→03/07		für Fahrzeuge ohne Bremsassistent			
1.8	92	04/04→03/07		→ 08/06;		03.7863-0332.4	300203 ATE Ø 10" pneumatisch
1.8 Flexifuel	92	01/06→03/07		für Fahrzeuge mit Bremsassistent			
1.8 TDCi	85	01/05→03/07					
2.0 TDCi	98	10/03→03/07		09/06→;		03.7863-3932.4	300288 ATE Ø 10" pneumatisch
2.0 TDCi	100	10/03→03/07		für Fahrzeuge mit Bremsassistent			
2.0	107	03/04→03/07		09/06→;		03.7760-2232.4	300266 ATE Ø 10" pneumatisch
				für Fahrzeuge ohne Bremsassistent			
				04/04→ 08/06;		03.7760-8103.4	300240 ATE Ø 10" pneumatisch
				für Fahrzeuge ohne Bremsassistent			
				04/04→ 08/06;		03.7863-0332.4	300203 ATE Ø 10" pneumatisch
				für Fahrzeuge mit Bremsassistent			
				09/06→;		03.7863-3932.4	300288 ATE Ø 10" pneumatisch
				für Fahrzeuge mit Bremsassistent			
 Hauptbremszylinder							
1.6	74	10/03→03/07				03.2123-3103.3	010781 ATE Ø 23,81
1.6 TDCi	66	02/05→03/07				03.2125-0483.3	010783 ATE Ø 25,4
1.6 TDCi	80	10/03→03/07					ohne Bremsflüssigkeitsbehälter
1.6 Ti	85	08/04→03/07					
1.8	88	10/03→03/07					
1.8	90	09/05→03/07					
1.8	92	04/04→03/07					
1.8 Flexifuel	92	01/06→03/07					
1.8 TDCi	85	01/05→03/07					
2.0 TDCi	98	10/03→03/07					
2.0 TDCi	100	10/03→03/07					
2.0	107	03/04→03/07		04/04→		03.2123-3103.3	010781 ATE Ø 23,81
						03.2125-0483.3	010783 ATE Ø 25,4
							ohne Bremsflüssigkeitsbehälter
Hydraulikaggregat, Bremsanlage							
1.6	74	10/03→03/07				24.9145-0004.2	399008
1.6 TDCi	66	02/05→03/07					
1.6 TDCi	80	10/03→03/07					
1.6 Ti	85	08/04→03/07					
1.8	88	10/03→03/07					
1.8	90	09/05→03/07					
1.8	92	04/04→03/07					
1.8 Flexifuel	92	01/06→03/07					
1.8 TDCi	85	01/05→03/07					
2.0 TDCi	98	10/03→03/07					
2.0 TDCi	100	10/03→03/07					
2.0	107	03/04→03/07		04/04→		24.9145-0004.2	399008
FORD - FOCUS Stufenheck (DFW) 02/99→12/07							
 Hauptbremszylinder							
1.4 16V	55	02/99→11/04		11/01→ 09/04; + ESP		03.4123-0153.3	010659 ATE Ø 23,81
1.6 16V	74	02/99→11/04					
1.8 16V	85	02/99→11/04		→ 09/04; + ABS		24.4123-1713.3	010905 BOS Ø 23,81
1.8 TDCi	85	03/01→11/04					ohne Bremsflüssigkeitsbehälter
1.8 Turbo DI / TDDi	55	08/01→03/05					
1.8 Turbo DI / TDDi	66	02/99→11/04					
2.0 16V	96	02/99→11/04					
1.8 TDCi	74	08/02→11/04		→ 09/04; + ESP		03.4123-0153.3	010659 ATE Ø 23,81
				→ 09/04; + ABS		24.4123-1713.3	010905 BOS Ø 23,81
							ohne Bremsflüssigkeitsbehälter
FORD - FOCUS Turnier (DNW) 02/99→12/07							
 Hauptbremszylinder							
1.4 16V	55	02/99→11/04		11/01→ 09/04; + ESP		03.4123-0153.3	010659 ATE Ø 23,81
1.6 16V	74	02/99→11/04					
1.8 16V	85	02/99→11/04		→ 09/04; + ABS		24.4123-1713.3	010905 BOS Ø 23,81
1.8 DI / TDDi	55	08/99→11/04					ohne Bremsflüssigkeitsbehälter
1.8 TDCi	85	03/01→11/04					
1.8 Turbo DI / TDDi	66	02/99→11/04					
2.0 16V	96	02/99→11/04					
1.8 TDCi	74	08/02→11/04		→ 09/04; + ESP		03.4123-0153.3	010659 ATE Ø 23,81
				→ 09/04; + ABS		24.4123-1713.3	010905 BOS Ø 23,81
							ohne Bremsflüssigkeitsbehälter

	kw			 	! #		
FORD - FUSION (JU_) 08/02→12/12							
 Bremskraftverstärker							
1.25	55	08/04→12/12		→ 09/12; für Fahrzeuge ohne Bremsassistent		03.7750-8732.4 300199	ATE Ø 9" pneumatisch
1.4	59	08/02→12/12					
1.4 LPG	59	01/10→12/12					
1.4 TDCi	50	08/02→12/12		→ 09/12; für Fahrzeuge mit Bremsassistent		03.7853-2102.4 300201	ATE Ø 9" pneumatisch
1.6 TDCi	66	11/04→12/12					
1.6	74	08/02→11/08		für Fahrzeuge ohne Bremsassistent		03.7750-8732.4 300199	ATE Ø 9" pneumatisch
				für Fahrzeuge mit Bremsassistent		03.7853-2102.4 300201	ATE Ø 9" pneumatisch
 Hauptbremszylinder							
1.25	55	08/04→12/12		→ 09/12; für Linkslenker; - ABS		03.4153-0015.3 011005	ATE Ø 23,81 ohne Bremsflüssigkeitsbehälter
1.4	59	08/02→12/12					
1.4 LPG	59	01/10→12/12					
1.4 TDCi	50	08/02→12/12		→ 09/12; für Linkslenker		03.4153-5287.4 010953	ATE Ø 23,81 mit Bremsflüssigkeitsbehälter
1.6 TDCi	66	11/04→12/12					
1.6	74	08/02→11/08		für Linkslenker; - ABS		03.4153-0015.3 011005	ATE Ø 23,81 ohne Bremsflüssigkeitsbehälter
				für Linkslenker		03.4153-5287.4 010953	ATE Ø 23,81 mit Bremsflüssigkeitsbehälter
FORD - GALAXY (WA6) 05/06→06/15							
 Bremskraftverstärker							
1.6 EcoBoost	118	11/10→06/15		02/11→		03.7755-1432.4 300300	ATE Ø 9 / 8" pneumatisch
1.6 TDCi	85	02/11→06/15				03.7755-1432.4 300300	ATE Ø 9 / 8" pneumatisch
1.8 TDCi	74	05/06→06/15					
1.8 TDCi	92	05/06→06/15					
2.0	107	05/06→06/15					
2.0 EcoBoost	146	07/10→06/15					
2.0 EcoBoost	149	03/10→06/15					
2.0 Flexifuel	107	05/06→06/15					
2.0 TDCi	85	11/07→06/15					
2.0 TDCi	96	05/06→06/15					
2.0 TDCi	100	05/06→06/15					
2.0 TDCi	103	05/06→06/15					
2.0 TDCi	120	03/10→06/15					
2.2 TDCi	147	11/10→06/15					
2.3	118	09/07→06/15					
2.2 TDCi	129	03/08→12/12		04/08→		03.7755-1432.4 300300	ATE Ø 9 / 8" pneumatisch
FORD - GALAXY (WGR) 03/95→05/06							
 Bremskraftverstärker							
1.9 TDI	66	03/95→05/06		09/97→ 03/00; für Linkslenker; + ABS		03.7755-1902.4 300138	ATE Ø 9 / 8" pneumatisch
				04/00→ 04/06; für Rechtslenker; - ESP		03.7755-6302.4 300221	ATE Ø 9 / 8" pneumatisch
				04/00→ 10/02; für Linkslenker; - ESP		03.7755-6302.4 300221	ATE Ø 9 / 8" pneumatisch
				01/96→ 08/97; für Linkslenker		03.7760-3002.4 300120	ATE Ø 10" pneumatisch
				04/00→ 10/02; für Linkslenker; + ESP		03.7858-3302.4 300122	ATE Ø 9 / 8" pneumatisch
1.9 TDI	81	08/97→04/00		10/97→ 03/00; für Linkslenker; + ABS		03.7755-1902.4 300138	ATE Ø 9 / 8" pneumatisch
1.9 TDI	85	04/00→05/06		→ 04/06; für Rechtslenker; - ESP		03.7755-6302.4 300221	ATE Ø 9 / 8" pneumatisch
2.3 16V	103	09/01→05/06		→ 10/02; für Linkslenker; - ESP		03.7755-6302.4 300221	ATE Ø 9 / 8" pneumatisch
2.8 V6	150	04/00→05/06		→ 10/02; für Linkslenker; + ESP		03.7858-3302.4 300122	ATE Ø 9 / 8" pneumatisch
1.9 TDI	96	02/03→05/06		→ 04/06; für Rechtslenker; - ESP		03.7755-6302.4 300221	ATE Ø 9 / 8" pneumatisch
2.0 i	85	11/95→05/06		09/97→ 03/00; für Linkslenker; + ABS		03.7755-1902.4 300138	ATE Ø 9 / 8" pneumatisch
2.3 16V	107	01/97→05/06		04/00→ 04/06; für Rechtslenker; - ESP		03.7755-6302.4 300221	ATE Ø 9 / 8" pneumatisch
				04/00→ 10/02; für Linkslenker; - ESP		03.7755-6302.4 300221	ATE Ø 9 / 8" pneumatisch
				→ 08/97; für Linkslenker		03.7760-3002.4 300120	ATE Ø 10" pneumatisch
				04/00→ 10/02; für Linkslenker; + ESP		03.7858-3302.4 300122	ATE Ø 9 / 8" pneumatisch
2.8 i V6	128	11/95→04/00		09/97→ 03/00; für Linkslenker; + ABS		03.7755-1902.4 300138	ATE Ø 9 / 8" pneumatisch
2.8 i V6 4x4	128	04/96→04/00		→ 08/97; für Linkslenker		03.7760-3002.4 300120	ATE Ø 10" pneumatisch
 Hauptbremszylinder							
1.9 TDI	66	03/95→05/06		01/96→ 08/97; + ABS		03.2123-1526.3 010477	Ø 23,81
				01/96→ 08/97; - ABS		03.2123-1548.3 010478	Ø 23,81
				04/00→ 10/02; - ESP		03.2125-0332.3 010952	Ø 25,4
				09/97→ 03/00; + ABS		03.2125-0332.3 010952	Ø 25,4
				11/02→ 04/06; - ESP		03.2125-0332.3 010952	Ø 25,4
				09/97→ 03/00; - ABS		03.2125-8404.3 010583	ATE Ø 25,4
				04/00→ 10/02; + ESP		03.2125-9604.3 010581	Ø 25,4
1.9 TDI	81	08/97→04/00		10/97→ 03/00; + ABS		03.2125-0332.3 010952	Ø 25,4
↓							













	kw					! #		
FORD - GALAXY (WGR) 03/95→05/06								
 Hauptbremszylinder								
1.9 TDI	81	08/97→04/00		10/97→ 03/00; - ABS			03.2125-8404.3 010583	ATE Ø 25,4
1.9 TDI	85	04/00→05/06		→ 10/02; - ESP			03.2125-0332.3 010952	Ø 25,4
2.3 16V	103	09/01→05/06		11/02→ 04/06; - ESP			03.2125-0332.3 010952	Ø 25,4
2.8 V6	150	04/00→05/06		→ 10/02; + ESP			03.2125-9604.3 010581	Ø 25,4
1.9 TDI	96	02/03→05/06		→ 04/06; - ESP			03.2125-0332.3 010952	Ø 25,4
1.9 TDI	110	05/05→05/06						
2.0 i	85	11/95→05/06		→ 08/97; + ABS			03.2123-1526.3 010477	Ø 23,81
2.3 16V	107	01/97→05/06		→ 08/97; - ABS			03.2123-1548.3 010478	Ø 23,81
				04/00→ 10/02; - ESP			03.2125-0332.3 010952	Ø 25,4
				09/97→ 03/00; + ABS			03.2125-0332.3 010952	Ø 25,4
				11/02→ 04/06; - ESP			03.2125-0332.3 010952	Ø 25,4
				09/97→ 03/00; - ABS			03.2125-8404.3 010583	ATE Ø 25,4
				04/00→ 10/02; + ESP			03.2125-9604.3 010581	Ø 25,4
2.8 i V6	128	11/95→04/00		→ 08/97; + ABS			03.2123-1526.3 010477	Ø 23,81
2.8 i V6 4x4	128	04/96→04/00		→ 08/97; - ABS			03.2123-1548.3 010478	Ø 23,81
				09/97→ 03/00; + ABS			03.2125-0332.3 010952	Ø 25,4
				09/97→ 03/00; - ABS			03.2125-8404.3 010583	ATE Ø 25,4
Verschlusschraube, Hauptbremszylinder								
1.9 TDI	66	03/95→05/06		01/96→ 08/97; - ABS			03.3517-5100.1 390326	
2.0 i	85	11/95→05/06		→ 08/97; - ABS			03.3517-5100.1 390326	
2.3 16V	107	01/97→05/06						
2.8 i V6	128	11/95→04/00						
2.8 i V6 4x4	128	04/96→04/00						
FORD - GRAND C-MAX (DXA/CB7, DXA/CEU) 12/10→								
 Hauptbremszylinder								
1.0 EcoBoost	74	10/12→		für Linkslenker			03.4155-5456.3 010996	ATE Ø 25,4
1.0 EcoBoost	92	10/12→						
1.5 EcoBoost	110	03/15→						
1.5 EcoBoost	134	03/15→						
1.5 TDCi	70	03/15→						
1.5 TDCi	88	03/15→						
1.6 EcoBoost	110	12/10→						
1.6 EcoBoost	134	12/10→						
1.6 TDCi	70	12/10→						
1.6 TDCi	85	12/10→						
1.6 Ti	77	12/10→						
1.6 Ti	92	12/10→						
2.0 TDCi	85	02/11→		für Linkslenker			03.4155-5451.3 010995	ATE Ø 25,4
2.0 TDCi	103	02/11→					03.4155-5456.3 010996	ATE Ø 25,4
2.0 TDCi	120	12/10→						
2.0 TDCi	100	02/11→		für Linkslenker			03.4155-5451.3 010995	ATE Ø 25,4
2.0 TDCi	110	03/15→						
2.0 TDCi	125	03/15→						
FORD - KUGA I 03/08→								
 Bremskraftverstärker								
2.0 TDCi	100	03/08→11/12		04/08→; für Linkslenker			03.7755-3532.4 300290	ATE Ø 9 / 8" pneumatisch
2.0 TDCi 4x4	100	03/08→11/12		04/08→; für Rechtslenker			03.7760-2232.4 300266	ATE Ø 10" pneumatisch
2.0 TDCi	103	03/10→11/12		für Linkslenker			03.7755-3532.4 300290	ATE Ø 9 / 8" pneumatisch
2.0 TDCi 4x4	103	03/10→11/12		für Rechtslenker			03.7760-2232.4 300266	ATE Ø 10" pneumatisch
2.0 TDCi 4x4	120	03/10→11/12						
2.5	147	03/09→11/12		für Linkslenker			03.7755-3532.4 300290	ATE Ø 9 / 8" pneumatisch
2.5 4x4	147	03/09→		→ 12/12; für Linkslenker			03.7755-3532.4 300290	ATE Ø 9 / 8" pneumatisch
 Hauptbremszylinder								
2.0 TDCi	100	03/08→11/12		04/08→; für Rechtslenker; → 10/08			03.2125-0483.3 010783	ATE Ø 25,4 ohne Bremsflüssigkeitsbehälter
2.0 TDCi 4x4	100	03/08→11/12		11/08→; für Linkslenker			03.2125-0651.3 010935	ATE Ø 25,4
				11/08→; für Rechtslenker			03.2125-0661.3 010917	ATE Ø 25,4
2.0 TDCi	103	03/10→11/12		für Linkslenker			03.2125-0651.3 010935	ATE Ø 25,4
2.0 TDCi 4x4	103	03/10→11/12						
2.0 TDCi 4x4	120	03/10→11/12						
2.5	147	03/09→11/12						
2.5 4x4	147	03/09→		→ 12/12; für Linkslenker			03.2125-0651.3 010935	ATE Ø 25,4
Hydraulikaggregat, Bremsanlage								
2.0 TDCi	100	03/08→11/12		04/08→			24.9145-0004.2 399008	
2.0 TDCi 4x4	100	03/08→11/12						
↓								













	kw					! #		
FORD - KUGA I 03/08→								
Hydraulikaggregat, Bremsanlage								
2.0 TDCi	103	03/10→11/12					24.9145-0004.2	399008
2.0 TDCi 4x4	103	03/10→11/12						
2.0 TDCi 4x4	120	03/10→11/12						
2.5	147	03/09→11/12						
2.5 4x4	147	03/09→		→ 12/12			24.9145-0004.2	399008
FORD - KUGA II (DM2) 05/12→								
 Hauptbremszylinder								
1.5 EcoBoost	88	01/16→					03.4155-5456.3	010996 ATE Ø 25,4
1.5 EcoBoost	110	09/14→						
1.5 EcoBoost 4x4	134	09/14→						
1.6 EcoBoost	110	03/13→						
1.6 EcoBoost 4x4	110	03/13→						
1.6 EcoBoost 4x4	134	03/13→						
2.0 TDCi	85	03/13→						
2.0 TDCi	88	09/14→						
2.0 TDCi	100	03/13→						
2.0 TDCi	103	03/13→						
2.0 TDCi	110	09/14→						
2.0 TDCi 4x4	100	03/13→						
2.0 TDCi 4x4	103	03/13→						
2.0 TDCi 4x4	110	09/14→						
2.0 TDCi 4x4	120	03/13→						
2.0 TDCi 4x4	132	09/14→						
FORD - MAVERICK (UDS, UNS) 02/93→04/98								
 Hauptbremszylinder								
2.4 i	91	02/93→08/96					24.2123-1726.3	010557 Ø 23,81
2.7 TD	74	02/93→08/96						ohne Bremsflüssigkeitsbehälter
FORD - MONDEO I (GBP) 02/93→08/96								
 Hauptbremszylinder								
1.6 i 16V	65	07/94→08/96		01/96→; - ABS			24.2125-1706.3	010496 Ø 25,4
1.6 i 16V	66	02/93→08/96		→ 12/95; + ABS			24.2125-1707.3	010497 Ø 25,4
1.8 i 16V	82	07/94→08/96						
1.8 i 16V	85	02/93→08/96		01/96→; + ABS			24.2125-1708.3	010498 Ø 25,4
1.8 i 16V 4x4	85	02/93→08/96						
1.8 TD	65	06/93→08/96						
1.8 TD	66	10/95→08/96						
2.0 i 16V	100	02/93→08/96						
2.0 i 16V 4x4	97	12/94→08/96						
2.0 i 16V 4x4	100	04/93→08/96						
2.5 i 24V	125	07/94→08/96		08/94→ 12/95			24.2125-1707.3	010497 Ø 25,4
				01/96→			24.2125-1708.3	010498 Ø 25,4
 Bremskraftregler								
1.6 i 16V	65	07/94→08/96		→ 12/95; - ABS			03.6043-1774.3	320031 ATE 3/30 2x
1.6 i 16V	66	02/93→08/96		→ 12/95; + ABS			03.6043-1776.3	320032 ATE 3/40 2x
1.8 i 16V	82	07/94→08/96						
1.8 i 16V	85	02/93→08/96		→ 12/95; - ABS			03.6043-1784.3	320034 ATE 3/30 2x
1.8 i 16V 4x4	85	02/93→08/96		→ 12/95; + ABS			03.6043-1786.3	320035 ATE 3/40 2x
2.0 i 16V	100	02/93→08/96						
				01/96→; - ABS	2		03.6043-1954.3	320226 ATE 3/30 2x
				01/96→; + ABS	2		03.6043-1956.3	320202 ATE 3/40 2x
1.8 TD	65	06/93→08/96		→ 12/95; - ABS			03.6043-1773.3	320030 ATE 3/25 2x
1.8 TD	66	10/95→08/96		→ 12/95; + ABS			03.6043-1776.3	320032 ATE 3/40 2x
				→ 12/95; - ABS			03.6043-1783.3	320033 ATE 3/25 2x
				→ 12/95; + ABS			03.6043-1786.3	320035 ATE 3/40 2x
				01/96→; + ABS	2		03.6043-1956.3	320202 ATE 3/40 2x
2.5 i 24V	125	07/94→08/96		08/94→ 12/95			03.6043-1776.3	320032 ATE 3/40 2x
				08/94→ 12/95			03.6043-1786.3	320035 ATE 3/40 2x
				01/96→	2		03.6043-1956.3	320202 ATE 3/40 2x
FORD - MONDEO I Stufenheck (GBP) 02/93→08/96								
 Hauptbremszylinder								
1.6 i 16V	65	07/94→08/96		01/96→; - ABS			24.2125-1706.3	010496 Ø 25,4
1.6 i 16V	66	02/93→08/96		→ 12/95; + ABS			24.2125-1707.3	010497 Ø 25,4
1.8 i 16V	82	01/94→08/96						
1.8 i 16V	85	02/93→08/96		01/96→; + ABS			24.2125-1708.3	010498 Ø 25,4
1.8 TD	65	06/93→08/96						
1.8 TD	66	10/95→08/96						
2.0 i 16V	100	02/93→08/96						
2.0 i 16V 4x4	97	12/94→08/96						
↓								

	kw					! #		
FORD - MONDEO I Stufenheck (GBP) 02/93→08/96								
 Hauptbremszylinder								
2.5 i 24V	125	07/94→08/96		08/94→12/95			24.2125-1707.3 010497	Ø 25,4
				01/96→			24.2125-1708.3 010498	Ø 25,4
 Bremskraftregler								
1.6 i 16V	65	07/94→08/96		→ 12/95; - ABS			03.6043-1774.3 320031	ATE 3/30 2x
1.6 i 16V	66	02/93→08/96		→ 12/95; + ABS			03.6043-1776.3 320032	ATE 3/40 2x
1.8 i 16V	82	01/94→08/96		→ 12/95; - ABS			03.6043-1784.3 320034	ATE 3/30 2x
1.8 i 16V	85	02/93→08/96		→ 12/95; + ABS			03.6043-1786.3 320035	ATE 3/40 2x
				01/96→; - ABS	2		03.6043-1954.3 320226	ATE 3/30 2x
				01/96→; + ABS	2		03.6043-1956.3 320202	ATE 3/40 2x
1.8 TD	65	06/93→08/96		→ 12/95; - ABS			03.6043-1773.3 320030	ATE 3/25 2x
1.8 TD	66	10/95→08/96		→ 12/95; + ABS			03.6043-1776.3 320032	ATE 3/40 2x
				→ 12/95; - ABS			03.6043-1783.3 320033	ATE 3/25 2x
				→ 12/95; + ABS			03.6043-1786.3 320035	ATE 3/40 2x
				01/96→; + ABS	2		03.6043-1956.3 320202	ATE 3/40 2x
2.0 i 16V	100	02/93→08/96		→ 12/95; + ABS			03.6043-1776.3 320032	ATE 3/40 2x
				→ 12/95; + ABS			03.6043-1786.3 320035	ATE 3/40 2x
				01/96→; + ABS	2		03.6043-1956.3 320202	ATE 3/40 2x
2.5 i 24V	125	07/94→08/96		08/94→12/95			03.6043-1776.3 320032	ATE 3/40 2x
				08/94→12/95			03.6043-1786.3 320035	ATE 3/40 2x
				01/96→	2		03.6043-1956.3 320202	ATE 3/40 2x
FORD - MONDEO I Turnier (BNP) 01/93→08/96								
 Hauptbremszylinder								
1.6 i 16V	65	07/94→08/96		01/96→; - ABS			24.2125-1706.3 010496	Ø 25,4
1.6 i 16V	66	04/93→08/96		→ 12/95; + ABS			24.2125-1707.3 010497	Ø 25,4
1.8 i 16V	82	07/94→08/96		01/96→; + ABS			24.2125-1708.3 010498	Ø 25,4
1.8 i 16V	85	04/93→08/96						
1.8 i 16V 4x4	85	04/93→08/96						
1.8 TD	65	06/93→08/96						
1.8 TD	66	11/95→08/96						
2.0 i 16V	100	04/93→08/96						
2.0 i 16V 4x4	97	12/94→08/96						
2.0 i 16V 4x4	100	04/93→08/96						
2.5 i 24V	125	07/94→08/96		08/94→12/95			24.2125-1707.3 010497	Ø 25,4
				01/96→			24.2125-1708.3 010498	Ø 25,4
 Bremskraftregler								
1.6 i 16V	65	07/94→08/96		→ 12/95; - ABS			03.6043-1773.3 320030	ATE 3/25 2x
1.6 i 16V	66	04/93→08/96		→ 12/95; + ABS			03.6043-1776.3 320032	ATE 3/40 2x
1.8 i 16V	82	07/94→08/96		→ 12/95; - ABS			03.6043-1783.3 320033	ATE 3/25 2x
1.8 i 16V	85	04/93→08/96		→ 12/95; + ABS			03.6043-1786.3 320035	ATE 3/40 2x
1.8 i 16V 4x4	85	04/93→08/96		→ 12/95; + ABS			03.6043-1786.3 320035	ATE 3/40 2x
1.8 TD	65	06/93→08/96		01/96→; - ABS	2		03.6043-1953.3 320201	ATE 3/45 2x
1.8 TD	66	11/95→08/96		01/96→; + ABS	2		03.6043-1956.3 320202	ATE 3/40 2x
2.0 i 16V	100	04/93→08/96		01/96→; + ABS	2		03.6043-1956.3 320202	ATE 3/40 2x
2.5 i 24V	125	07/94→08/96		08/94→12/95			03.6043-1776.3 320032	ATE 3/40 2x
				08/94→12/95			03.6043-1786.3 320035	ATE 3/40 2x
				01/96→	2		03.6043-1956.3 320202	ATE 3/40 2x
FORD - MONDEO II (BAP) 08/96→09/00								
 Hauptbremszylinder								
1.6 i	66	08/96→09/00		10/96→; - ABS			24.2125-1706.3 010496	Ø 25,4
1.8 i	85	08/96→09/00		10/96→; + ABS			24.2125-1709.3 010499	Ø 25,4
1.8 TD	66	08/96→09/00						
2.0 i	96	08/96→09/00						
2.5 24V	125	08/96→09/00						
1.6 i 16V	70	05/98→09/00		- ABS			24.2125-1706.3 010496	Ø 25,4
2.5 24V	125	06/00→09/00		+ ABS			24.2125-1709.3 010499	Ø 25,4
2.5 ST 200	151	05/99→09/00						
 Bremskraftregler								
1.6 i	66	08/96→09/00		10/96→; - ABS; Scheibenbremse			03.6043-1954.3 320226	ATE 3/30 2x
1.6 i 16V	70	05/98→09/00		- ABS; Scheibenbremse			03.6043-1954.3 320226	ATE 3/30 2x
1.8 i	85	08/96→09/00		10/96→; - ABS; Scheibenbremse			03.6043-1954.3 320226	ATE 3/30 2x
2.0 i	96	08/96→09/00		10/96→; + ABS / + ASR	2		03.6043-1956.3 320202	ATE 3/40 2x
1.8 TD	66	08/96→09/00		10/96→; - ABS; Scheibenbremse			03.6043-1954.3 320226	ATE 3/30 2x
↓								















	kw					! #		
FORD - MONDEO II (BAP) 08/96→09/00								
 Bremskraftregler								
1.8 TD	66	08/96→09/00		10/96→; + ABS		2	03.6043-1956.3 320202	ATE 3/40 2x
2.5 24V	125	08/96→09/00		10/96→		2	03.6043-1956.3 320202	ATE 3/40 2x
2.5 24V	125	06/00→09/00				2	03.6043-1956.3 320202	ATE 3/40 2x
2.5 ST 200	151	05/99→09/00						
FORD - MONDEO II Stufenheck (BFP) 08/96→09/00								
 Hauptbremszylinder								
1.6 i	66	08/96→09/00		10/96→; - ABS			24.2125-1706.3 010496	Ø 25,4
1.8 i	85	08/96→09/00		10/96→; + ABS			24.2125-1709.3 010499	Ø 25,4
1.8 TD	66	08/96→09/00						
2.0 i	96	08/96→09/00						
2.5 24V	125	08/96→09/00						
1.6 i 16V	70	05/98→09/00		- ABS			24.2125-1706.3 010496	Ø 25,4
2.5 24V	125	06/00→09/00		+ ABS			24.2125-1709.3 010499	Ø 25,4
2.5 ST 200	151	05/99→09/00						
 Bremskraftregler								
1.6 i	66	08/96→09/00		10/96→; - ABS; Scheibenbremse			03.6043-1954.3 320226	ATE 3/30 2x
1.6 i 16V	70	05/98→09/00		- ABS; Scheibenbremse			03.6043-1954.3 320226	ATE 3/30 2x
1.8 i	85	08/96→09/00		10/96→; - ABS; Scheibenbremse			03.6043-1954.3 320226	ATE 3/30 2x
2.0 i	96	08/96→09/00		10/96→; + ABS / + ASR	2		03.6043-1956.3 320202	ATE 3/40 2x
1.8 TD	66	08/96→09/00		10/96→; - ABS; Scheibenbremse			03.6043-1954.3 320226	ATE 3/30 2x
				10/96→; + ABS	2		03.6043-1956.3 320202	ATE 3/40 2x
2.5 24V	125	08/96→09/00		10/96→	2		03.6043-1956.3 320202	ATE 3/40 2x
2.5 24V	125	06/00→09/00			2		03.6043-1956.3 320202	ATE 3/40 2x
2.5 ST 200	151	05/99→09/00						
FORD - MONDEO II Turnier (BNP) 08/96→09/00								
 Hauptbremszylinder								
1.6 i	66	08/96→09/00		10/96→; - ABS			24.2125-1706.3 010496	Ø 25,4
1.8 i	85	08/96→09/00		10/96→; + ABS			24.2125-1709.3 010499	Ø 25,4
1.8 TD	66	08/96→09/00						
2.0 i	96	08/96→09/00						
2.5 24V	125	08/96→09/00						
1.6 i 16V	70	05/98→09/00		- ABS			24.2125-1706.3 010496	Ø 25,4
2.5 24V	125	10/99→09/00		+ ABS			24.2125-1709.3 010499	Ø 25,4
2.5 ST 200	151	05/99→09/00						
 Bremskraftregler								
1.6 i	66	08/96→09/00		10/96→; - ABS	2		03.6043-1953.3 320201	ATE 3/45 2x
1.6 i 16V	70	05/98→09/00		- ABS	2		03.6043-1953.3 320201	ATE 3/45 2x
1.8 i	85	08/96→09/00		10/96→; - ABS	2		03.6043-1953.3 320201	ATE 3/45 2x
2.0 i	96	08/96→09/00		10/96→; + ABS / + ASR	2		03.6043-1956.3 320202	ATE 3/40 2x
1.8 TD	66	08/96→09/00		10/96→; - ABS	2		03.6043-1953.3 320201	ATE 3/45 2x
				10/96→; + ABS	2		03.6043-1956.3 320202	ATE 3/40 2x
2.5 24V	125	08/96→09/00		10/96→	2		03.6043-1956.3 320202	ATE 3/40 2x
2.5 24V	125	10/99→09/00			2		03.6043-1956.3 320202	ATE 3/40 2x
2.5 ST 200	151	05/99→09/00						
FORD - MONDEO IV (BA7) 03/07→01/15								
 Bremskraftverstärker								
1.6 EcoBoost	118	02/11→01/15		→ 09/14			03.7755-1432.4 300300	ATE Ø 9 / 8" pneumatisch
1.6 TDCi	85	02/11→01/15						
1.6 Ti	88	07/10→01/15						
1.8 TDCi	92	06/07→01/15						
2.0 EcoBoost	176	07/10→01/15						
2.0 Flexifuel	107	03/09→01/15						
2.0 LPG	107	07/09→01/15						
2.0 SCTi	149	03/10→01/15						
2.0 TDCi	85	11/07→01/15						
2.0 TDCi	100	03/07→01/15						
2.0 TDCi	120	03/10→01/15						
2.3	118	07/07→01/15						
1.6 Ti	81	03/07→01/15		04/07→ 09/14			03.7755-1432.4 300300	ATE Ø 9 / 8" pneumatisch
1.6 Ti	92	03/07→01/15						
1.8 TDCi	74	03/07→01/15						
2.0	107	03/07→01/15						
2.0 TDCi	96	03/07→01/15						
2.0 TDCi	103	03/07→01/15						
2.5	162	03/07→01/15						
2.2 TDCi	129	03/08→10/10		04/08→			03.7755-1432.4 300300	ATE Ø 9 / 8" pneumatisch
2.2 TDCi	147	07/10→01/15		11/10→ 09/14			03.7755-1432.4 300300	ATE Ø 9 / 8" pneumatisch



































	kw			 	! #		
FORD - MONDEO IV Stufenheck (BA7) 03/07→01/15							
 Bremskraftverstärker							
1.6 EcoBoost	118	11/10→01/15		02/11→ 09/14		03.7755-1432.4 300300	ATE Ø 9 / 8" pneumatisch
1.6 TDCi	85	12/10→01/15					
1.6 Ti	81	03/07→01/15		04/07→ 09/14		03.7755-1432.4 300300	ATE Ø 9 / 8" pneumatisch
1.6 Ti	92	03/07→01/15					
1.8 TDCi	74	03/07→01/15					
2.0	107	03/07→01/15					
2.0 TDCi	96	03/07→01/15					
2.0 TDCi	103	03/07→01/15					
2.5	162	03/07→01/15					
1.6 Ti	88	03/10→01/15		→ 09/14		03.7755-1432.4 300300	ATE Ø 9 / 8" pneumatisch
1.8 TDCi	92	06/07→01/15					
2.0 Flexifuel	107	03/09→01/15					
2.0 LPG	107	07/09→01/15					
2.0 SCTi	149	03/10→01/15					
2.0 TDCi	85	11/07→01/15					
2.0 TDCi	120	03/10→01/15					
2.3	118	07/07→01/15					
2.0 TDCi	100	08/08→01/15				03.7755-1432.4 300300	ATE Ø 9 / 8" pneumatisch
2.2 TDCi	129	03/08→10/10		04/08→		03.7755-1432.4 300300	ATE Ø 9 / 8" pneumatisch
2.2 TDCi	147	10/10→01/15		11/10→ 09/14		03.7755-1432.4 300300	ATE Ø 9 / 8" pneumatisch
FORD - MONDEO IV Turnier (BA7) 03/07→01/15							
 Bremskraftverstärker							
1.6 EcoBoost	118	02/11→01/15		→ 09/14		03.7755-1432.4 300300	ATE Ø 9 / 8" pneumatisch
1.6 TDCi	85	02/11→01/15					
1.6 Ti	88	07/10→01/15					
2.0 EcoBoost	176	07/10→01/15					
2.0 Flexifuel	107	03/09→01/15					
2.0 LPG	107	07/09→01/15					
2.0 SCTi	149	03/10→01/15					
2.0 TDCi	85	11/07→01/15					
2.0 TDCi	100	03/07→01/15					
2.0 TDCi	120	03/10→01/15					
2.3	118	07/07→01/15					
1.6 Ti	81	03/07→12/12		04/07→		03.7755-1432.4 300300	ATE Ø 9 / 8" pneumatisch
1.6 Ti	92	03/07→12/10					
1.8 TDCi	74	03/07→12/12					
2.0 TDCi	96	03/07→12/12					
2.5	162	03/07→12/12					
1.8 TDCi	92	06/07→12/12				03.7755-1432.4 300300	ATE Ø 9 / 8" pneumatisch
2.0	107	03/07→01/15		04/07→ 09/14		03.7755-1432.4 300300	ATE Ø 9 / 8" pneumatisch
2.0 TDCi	103	03/07→01/15					
2.2 TDCi	129	03/08→10/10		04/08→		03.7755-1432.4 300300	ATE Ø 9 / 8" pneumatisch
2.2 TDCi	147	07/10→01/15		11/10→ 09/14		03.7755-1432.4 300300	ATE Ø 9 / 8" pneumatisch
FORD - PUMA (EC_) 03/97→06/02							
 Hauptbremszylinder							
1.4 16V	66	11/97→10/00		02/00→; + ABS		03.2123-2243.3 010748	ATE Ø 23,81
				02/98→ 01/00; - ABS		24.2123-1735.3 010652	Ø 23,81
1.6 16V	76	08/00→06/02		→ 12/01; + ABS		03.2123-2243.3 010748	ATE Ø 23,81
1.7 16V	92	03/97→06/02		02/00→ 12/01; + ABS		03.2123-2243.3 010748	ATE Ø 23,81
				01/98→ 01/00; - ABS		24.2123-1735.3 010652	Ø 23,81
FORD - RANGER (ET) 01/05→07/12							
 Hauptbremszylinder							
2.5 TDCi 4x4	105	05/06→07/12		04/10→ 10/11		24.2125-1747.3 011029	Ø 25,4
2.5 TDi	105	05/06→07/12					
3.0 TDCi	115	05/06→07/12					
3.0 TDCi 4x4	115	05/06→07/12					
FORD - S-MAX (WA6) 05/06→12/14							
 Bremskraftverstärker							
1.6 EcoBoost	118	02/11→12/14				03.7755-1432.4 300300	ATE Ø 9 / 8" pneumatisch
1.6 TDCi	85	02/11→12/14					
1.8 TDCi	74	01/07→12/10					
1.8 TDCi	92	05/06→12/14					
2.0	107	05/06→12/14					
2.0 EcoBoost	146	07/10→12/14					
2.0 EcoBoost	149	03/10→12/14					
2.0 EcoBoost	176	07/10→12/14					
2.0 Flexifuel	107	05/06→12/14					
2.0 TDCi	85	11/07→12/14					
2.0 TDCi	96	05/06→12/14					
2.0 TDCi	100	05/06→12/14					
↓							













	kw					! #		
FORD - S-MAX (WA6) 05/06→12/14								
 Bremskraftverstärker								
2.0 TDCi	103	05/06→12/14					03.7755-1432.4 300300	ATE Ø 9 / 8" pneumatisch
2.0 TDCi	120	03/10→12/14						
2.2 TDCi	147	07/10→12/14						
2.3	118	07/07→12/14						
2.5 ST	162	05/06→12/14						
2.2 TDCi	129	03/08→12/12		04/08→			03.7755-1432.4 300300	ATE Ø 9 / 8" pneumatisch
FORD - TOURNEO CONNECT 06/02→12/13								
 Bremskraftregler								
1.8 16V	85	06/02→12/13		→ 08/13			03.6582-0118.3 320281	ATE lastabhängig 8/1,5 4x
1.8 TDCi	66	06/02→12/13						
1.8 TDCi	81	08/06→12/13						
1.8 TDCi /TDDi /DI	55	06/02→12/13						
FORD - TOURNEO CONNECT / GRAND TOURNEO CONNECT Kombi 09/13→								
 Hauptbremszylinder								
1.0 EcoBoost	74	11/13→		kurzer Radstand			03.4155-5451.3 010995	ATE Ø 25,4
1.6 EcoBoost	110	11/13→		langer Radstand			03.4155-5456.3 010996	ATE Ø 25,4
1.6 TDCi	55	09/13→						
1.6 TDCi	70	09/13→						
1.6 TDCi	85	09/13→						
FORD - TRANSIT Bus (E_) 06/94→07/00								
 Bremskraftverstärker								
2.0 (EBL, EBS, ECL, EDS, EDL, EGL, ESS, ESL, EUS)	84	09/95→03/00		→ 03/97; + ABS			10.6360-1302.4 300286	ATE Ø 10" pneumatisch
2.0 CNG	84	06/94→03/00						
2.5 DI (EBL, ECL, EDS, EDL)	56	07/94→03/00						
2.5 DI (EBL, EDS, ESL, ESS, EUS)	51	08/94→03/00						
2.5 TD (EB_, ED_, ES_)	55	08/94→06/00						
2.5 TD (EBL, EDL, EDS, EGL, ESL, ESS, EUS)	63	01/95→03/00						
2.5 TD (ECL, EDL, EDS, ESL, ESS, EUS)	74	07/94→03/00						
 Hauptbremszylinder								
2.0 (EBL, EBS, ECL, EDS, EDL, EGL, ESS, ESL, EUS)	84	09/95→03/00		→ 03/97; + ABS			10.6123-0154.3 010578	ATE Ø 23,81
				→ 03/97; - ABS			24.2123-1724.3 010566	BDX Ø 23,81
2.5 DI (EBL, ECL, EDS, EDL)	56	07/94→03/00		04/97→; + ABS			24.2123-1742.3 010671	Ø 23,81
2.5 DI (EBL, EDS, ESL, ESS, EUS)	51	08/94→03/00		04/97→; - ABS			24.2123-1749.3 010713	Ø 23,81
2.5 TD (EBL, EDL, EDS, EGL, ESL, ESS, EUS)	63	01/95→03/00						
2.5 TD (ECL, EDL, EDS, ESL, ESS, EUS)	74	07/94→03/00						
2.0 CNG	84	06/94→03/00		→ 03/97; + ABS			10.6123-0154.3 010578	ATE Ø 23,81
				07/94→ 03/97; + ABS			10.6123-0154.3 010578	ATE Ø 23,81
				→ 03/97; - ABS			24.2123-1724.3 010566	BDX Ø 23,81
				07/94→ 03/97; - ABS			24.2123-1724.3 010566	BDX Ø 23,81
				04/97→; + ABS			24.2123-1742.3 010671	Ø 23,81
				04/97→; - ABS			24.2123-1749.3 010713	Ø 23,81
2.5 DI (EBL, EDL, EDS, ESL, ESS)	85	08/97→03/00		+ ABS			24.2123-1742.3 010671	Ø 23,81
				- ABS			24.2123-1749.3 010713	Ø 23,81
2.5 TD (EB_, ED_, ES_)	55	08/94→06/00		→ 03/97; + ABS			10.6123-0154.3 010578	ATE Ø 23,81
				→ 03/97; - ABS			24.2123-1724.3 010566	BDX Ø 23,81
				04/97→ 03/00; + ABS			24.2123-1742.3 010671	Ø 23,81
				04/97→ 03/00; - ABS			24.2123-1749.3 010713	Ø 23,81
FORD - TRANSIT Bus (FD_, FB_, FS_, FZ_, FC_) 01/00→05/06								
 Hauptbremszylinder								
2.0 DI (F_E_, F_F_, F_G_)	55	08/00→05/06		→ 04/06; - ABS			24.2125-1721.3 010673	Ø 25,4 ohne Bremsflüssigkeitsbehälter
2.0 DI (F_E_, F_F_, F_G_)	63	08/00→05/06		→ 04/06; + ABS			24.2125-1722.3 010674	Ø 25,4 ohne Bremsflüssigkeitsbehälter
2.0 DI (F_E_, F_F_, F_G_)	74	08/00→05/06						
2.0 TDCi (F_F_, F_E_, F_G_)	92	08/02→05/06						
↓								

































	kW					! #		
FORD - TRANSIT Bus (FD_, FB_, FS_, FZ_, FC_) 01/00→05/06								
 Hauptbremszylinder								
2.3 16V RWD (F_B_, F_C_, F_A_) 2.4 DI (F_B_, F_C_, F_A_) 2.4 DI RWD (F_B_, F_C_, F_A_) 2.4 DI RWD (F_B_, F_C_) 2.4 TDCi 2.4 TDE	107 66 88 55 101 85	08/00→05/06 01/00→05/06 01/00→05/06 01/00→05/06 03/04→05/06 03/04→05/06		→ 04/06; - ABS → 04/06; + ABS			24.2125-1721.3 010673 24.2125-1722.3 010674	Ø 25,4 ohne Bremsflüssigkeitsbehälter Ø 25,4 ohne Bremsflüssigkeitsbehälter
2.4 TDE (F_C_, F_B_, F_A_)	92	07/01→05/06		11/01→ 04/06; - ABS 11/01→ 04/06; + ABS			24.2125-1721.3 010673 24.2125-1722.3 010674	Ø 25,4 ohne Bremsflüssigkeitsbehälter Ø 25,4 ohne Bremsflüssigkeitsbehälter
FORD - TRANSIT CONNECT (P65_, P70_, P80_) 06/02→								
 Bremskraftregler								
1.8 16V 1.8 Di 1.8 TDCi 1.8 TDCi	85 55 66 81	06/02→12/13 06/02→12/13 06/02→12/13 08/06→12/13		→ 08/13			03.6582-0118.3 320281	ATE lastabhängig 8/1,5 4x
FORD - TRANSIT CONNECT Kasten 02/13→								
 Hauptbremszylinder								
1.0 EcoBoost 1.6 TDCi 1.6 TDCi 1.6 TDCi	74 55 70 85	02/13→ 02/13→ 02/13→ 02/13→		09/13→; kurzer Radstand 09/13→; langer Radstand			03.4155-5451.3 010995 03.4155-5456.3 010996	ATE Ø 25,4 ATE Ø 25,4
1.6 EcoBoost	110	11/13→		kurzer Radstand langer Radstand			03.4155-5451.3 010995 03.4155-5456.3 010996	ATE Ø 25,4 ATE Ø 25,4
FORD - TRANSIT CONNECT Kombi 02/13→								
 Hauptbremszylinder								
1.6 TDCi 1.6 TDCi 1.6 TDCi	55 70 85	02/13→ 02/13→ 02/13→		09/13→; kurzer Radstand 09/13→; langer Radstand			03.4155-5451.3 010995 03.4155-5456.3 010996	ATE Ø 25,4 ATE Ø 25,4
FORD - TRANSIT Kasten (E_) 06/94→07/00								
 Bremskraftverstärker								
2.0 (EAL, EAS) 2.5 DI (EAL, EAS) 2.5 DI (EAL, EAS) 2.5 TD (EAL, EAS) 2.5 TDI (EAL, EAS)	84 51 56 63 74	06/94→03/00 06/94→03/00 06/94→03/00 06/94→03/00 06/94→03/00		→ 03/97; + ABS			10.6360-1302.4 300286	ATE Ø 10" pneumatisch
 Hauptbremszylinder								
2.0 (EAL, EAS) 2.5 DI (EAL, EAS) 2.5 DI (EAL, EAS) 2.5 TD (EAL, EAS) 2.5 TDI (EAL, EAS)	84 51 56 63 74	06/94→03/00 06/94→03/00 06/94→03/00 06/94→03/00 06/94→03/00		→ 03/97; + ABS → 03/97; - ABS 04/97→; + ABS 04/97→; - ABS			10.6123-0154.3 010578 24.2123-1724.3 010566 24.2123-1742.3 010671 24.2123-1749.3 010713	ATE Ø 23,81 BDX Ø 23,81 Ø 23,81 Ø 23,81
2.5 DI (EAL, EAS) 2.5 TD (EAS)	85 56	05/99→03/00 10/98→03/00		+ ABS - ABS			24.2123-1742.3 010671 24.2123-1749.3 010713	Ø 23,81 Ø 23,81
FORD - TRANSIT Kasten (FA_) 01/00→05/06								
 Hauptbremszylinder								
2.0 DI (FAE_, FAF_, FAG_) 2.0 DI (FAE_, FAF_, FAG_) 2.0 DI (FAE_, FAF_, FAG_) 2.0 TDCi 2.3 16V RWD (FAA_, FAB_, FAC_) 2.4 DI (FAA_, FAB_, FAC_, FAD_) 2.4 DI RWD (FAA_, FAB_, FAC_, FAD_) 2.4 DI RWD (FAA_, FAB_, FAC_, FAD_) 2.4 TDCi 2.4 TDE	55 63 74 92 107 66 55 88 101 85	08/00→05/06 08/00→05/06 08/00→05/06 08/02→05/06 04/01→05/06 01/00→05/06 01/00→05/06 01/00→05/06 03/04→05/06 03/04→05/06		→ 04/06; - ABS → 04/06; + ABS			24.2125-1721.3 010673 24.2125-1722.3 010674	Ø 25,4 ohne Bremsflüssigkeitsbehälter Ø 25,4 ohne Bremsflüssigkeitsbehälter
↓								















	kw			 	! #		
FORD - TRANSIT Kasten (FA_) 01/00→05/06							
 Hauptbremszylinder							
2.4 TDE	92	07/01→05/06		11/01→ 04/06; - ABS		24.2125-1721.3 010673	Ø 25,4 ohne Bremsflüssigkeitsbehälter
				11/01→ 04/06; + ABS		24.2125-1722.3 010674	Ø 25,4 ohne Bremsflüssigkeitsbehälter
FORD - TRANSIT Pritsche/Fahrgestell (E_) 08/94→07/00							
 Bremskraftverstärker							
2.0 (EME/L/S, ENE/L/S)	84	08/94→03/00		→ 03/97; + ABS		10.6360-1302.4 300286	ATE Ø 10" pneumatisch
2.5 DI (EME/L/S, ENE/L/S)	56	08/94→03/00					
2.5 DI (EML/S, ENL/S)	51	08/94→03/00					
2.5 TD (EME/L/S, ENE/L/S)	63	08/94→03/00					
2.5 TD (EME/L/S, ENE/L/S)	74	08/94→03/00					
 Hauptbremszylinder							
2.0 (EME/L/S, ENE/L/S)	84	08/94→03/00		→ 03/97; + ABS		10.6123-0154.3 010578	ATE Ø 23,81
2.5 DI (EME/L/S, ENE/L/S)	56	08/94→03/00		→ 03/97; - ABS		24.2123-1724.3 010566	BDX Ø 23,81
2.5 DI (EML/S, ENL/S)	51	08/94→03/00		04/97→; + ABS		24.2123-1742.3 010671	Ø 23,81
2.5 TD (EME/L/S, ENE/L/S)	63	08/94→03/00		04/97→; - ABS		24.2123-1749.3 010713	Ø 23,81
2.5 TD (EME/L/S, ENE/L/S)	74	08/94→03/00					
2.5 DI (EML, ENE/L)	85	05/99→03/00		+ ABS		24.2123-1742.3 010671	Ø 23,81
				- ABS		24.2123-1749.3 010713	Ø 23,81
2.5 TD (EME/L/S, ENE/L/S)	55	10/98→07/00		→ 03/00; + ABS		24.2123-1742.3 010671	Ø 23,81
				→ 03/00; - ABS		24.2123-1749.3 010713	Ø 23,81
FORD - TRANSIT Pritsche/Fahrgestell (FM_ , FN_) 01/00→05/06							
 Hauptbremszylinder							
2.0 DI (F_E_ , F_F_)	55	08/00→05/06		→ 04/06; - ABS		24.2125-1721.3 010673	Ø 25,4 ohne Bremsflüssigkeitsbehälter
2.0 DI (F_E_ , F_F_)	63	08/00→05/06					
2.0 DI (F_E_ , F_F_)	74	08/00→05/06					
2.0 TDCi (F_E_ , F_F_)	92	08/02→05/06		→ 04/06; + ABS		24.2125-1722.3 010674	Ø 25,4 ohne Bremsflüssigkeitsbehälter
2.3 16V (F_A_ , F_B_ , F_C_ , F_D_)	107	04/01→05/06					
2.4 DI (F_A_ , F_B_ , F_C_ , F_D_)	55	01/00→05/06					
2.4 DI (F_A_ , F_B_ , F_C_ , F_D_)	66	01/00→05/06					
2.4 DI (F_A_ , F_B_ , F_C_ , F_D_)	88	01/00→05/06					
2.4 TDCi	101	03/04→05/06					
2.4 TDE	85	03/04→05/06					
2.4 TDE	92	07/01→05/06		11/01→ 04/06; - ABS		24.2125-1721.3 010673	Ø 25,4 ohne Bremsflüssigkeitsbehälter
				11/01→ 04/06; + ABS		24.2125-1722.3 010674	Ø 25,4 ohne Bremsflüssigkeitsbehälter
FORD - TRANSIT TOURNEO 08/94→12/00							
 Bremskraftverstärker							
2.0	84	11/94→12/00		09/95→ 03/97; + ABS		10.6360-1302.4 300286	ATE Ø 10" pneumatisch
2.5 DI	51	11/94→12/00		→ 03/97; + ABS		10.6360-1302.4 300286	ATE Ø 10" pneumatisch
2.5 DI	56	11/94→12/00					
2.5 TD	63	11/94→12/00		01/95→ 03/97; + ABS		10.6360-1302.4 300286	ATE Ø 10" pneumatisch
 Hauptbremszylinder							
2.0	84	11/94→12/00		09/95→ 03/97; + ABS		10.6123-0154.3 010578	ATE Ø 23,81
				09/95→ 03/97; - ABS		24.2123-1724.3 010566	BDX Ø 23,81
				04/97→ 03/00; + ABS		24.2123-1742.3 010671	Ø 23,81
				04/97→ 03/00; - ABS		24.2123-1749.3 010713	Ø 23,81
2.5 DI	51	11/94→12/00		→ 03/97; + ABS		10.6123-0154.3 010578	ATE Ø 23,81
2.5 DI	56	11/94→12/00		→ 03/97; - ABS		24.2123-1724.3 010566	BDX Ø 23,81
				04/97→ 03/00; + ABS		24.2123-1742.3 010671	Ø 23,81
				04/97→ 03/00; - ABS		24.2123-1749.3 010713	Ø 23,81
2.5 TD	63	11/94→12/00		01/95→ 03/97; + ABS		10.6123-0154.3 010578	ATE Ø 23,81
				01/95→ 03/97; - ABS		24.2123-1724.3 010566	BDX Ø 23,81
				04/97→ 03/00; + ABS		24.2123-1742.3 010671	Ø 23,81
↓							



















	kw			 	! #		
FORD - TRANSIT TOURNEO 08/94 → 12/00							
 Hauptbremszylinder							
2.5 TD	63	11/94 → 12/00		04/97 → 03/00; - ABS		24.2123-1749.3 010713	Ø 23,81
2.5 TD	74	04/98 → 12/00		→ 03/00; + ABS		24.2123-1742.3 010671	Ø 23,81
				→ 03/00; - ABS		24.2123-1749.3 010713	Ø 23,81
HONDA - ACCORD VII (CL, CN) 01/03 → 09/12							
 Hauptbremszylinder							
2.0 (CL7)	114	02/03 → 05/08		01/06 →; für Linkslenker		24.2120-1752.3 010928	ATE Ø 20,64 mit Bremsflüssigkeitsbehälter
2.4 (CL9)	140	02/03 → 05/08					
2.0 Allrad (CL8)	114	02/03 → 05/08		01/06 →		24.2120-1752.3 010928	ATE Ø 20,64 mit Bremsflüssigkeitsbehälter
2.2 i-CTDi (CN1)	103	01/04 → 05/08					
HONDA - ACCORD VII Tourer (CM, CN) 04/03 → 05/08							
 Hauptbremszylinder							
2.0 (CM1)	114	04/03 → 05/08		01/06 →		24.2120-1752.3 010928	ATE Ø 20,64 mit Bremsflüssigkeitsbehälter
2.2 i-CTDi (CN2)	103	01/04 → 05/08					
2.4 (CM2)	140	04/03 → 05/08					
HONDA - CIVIC V Coupe (EJ) 08/93 → 03/96							
 Hauptbremszylinder							
1.6 i (EJ6)	77	01/94 → 11/95		- ABS		24.2120-1751.3 010909	Ø 20,64
HONDA - CIVIC VI Coupe (EJ, EM1) 03/96 → 12/00							
 Hauptbremszylinder							
1.6 i	77	03/96 → 03/00		→ 12/98; - ABS		24.2120-1751.3 010909	Ø 20,64
HONDA - CIVIC VI Hatchback (EJ, EK) 10/95 → 02/01							
 Hauptbremszylinder							
1.4 i (EJ9)	55	11/95 → 02/01		→ 01/01; - ABS; für Linkslenker		24.2120-1751.3 010909	Ø 20,64
1.4 i S (EJ9)	66	11/95 → 02/01					
HONDA - CIVIC VI Stufenheck (EJ, EK) 06/95 → 03/01							
 Hauptbremszylinder							
1.4 i (EJ9)	66	11/95 → 02/01		→ 01/01; - ABS; für Linkslenker		24.2120-1751.3 010909	Ø 20,64
HONDA - CIVIC VIII Hatchback (FN, FK) 09/05 →							
 Hauptbremszylinder							
1.4 (FK1, FN4)	73	10/08 →		→ 12/12		24.2119-1709.3 010876	TRW Ø 19,05 mit Bremsflüssigkeitsbehälter
HONDA - CIVIC VIII Stufenheck (FD, FA) 09/05 →							
 Hauptbremszylinder							
1.8 (FD1, FD7)	103	09/05 → 02/12		für Linkslenker		24.2119-1709.3 010876	TRW Ø 19,05 mit Bremsflüssigkeitsbehälter
HONDA - CR-V I (RD) 10/95 → 02/02							
 Hauptbremszylinder							
2.0 16V 4WD (RD1, RD3)	94	10/95 → 12/01		01/98 → 04/99; - ABS		24.2123-1774.3 010877	TRW Ø 23,81 mit Bremsflüssigkeitsbehälter
2.0 16V 4WD (RD1, RD3)	108	01/99 → 02/02		04/99 → 12/01; - ABS		24.2123-1774.3 010877	TRW Ø 23,81 mit Bremsflüssigkeitsbehälter
HONDA - JAZZ II (GD_, GE3, GE2) 06/01 → 12/08							
 Hauptbremszylinder							
1.2 i-DSI (GD5, GE2)	57	03/02 → 07/08		01/04 →; - ESP		24.2122-1771.3 010901	TRW Ø 22,2 mit Bremsflüssigkeitsbehälter
1.3 (GD1)	61	03/02 → 07/08					
HONDA - JAZZ III (GE_, GG_, GP_) 10/07 →							
 Hauptbremszylinder							
1.2	66	07/08 →		→ 12/08; für Linkslenker; - ESP		24.2122-1771.3 010901	TRW Ø 22,2 mit Bremsflüssigkeitsbehälter
1.3 i	73	07/08 →					















	kw			 	! #		
HYUNDAI - ATOS (MX) 01/97→							
 Hauptbremszylinder							
1.1	43	08/03→12/08		→ 08/08; + ABS		24.2120-1767.3 011004	Ø 20,64 ohne Bremsflüssigkeitsbehälter
1.1	46	08/03→12/08		03/04→ 02/08; + ABS		24.2120-1767.3 011004	Ø 20,64 ohne Bremsflüssigkeitsbehälter
HYUNDAI - GETZ (TB) 08/02→12/10							
 Hauptbremszylinder							
1.1	46	09/02→09/05		→ 07/05; - ABS		24.2122-1761.3 010822	Ø 22,2
1.6	77	09/02→09/05		→ 07/05; + ABS		24.2122-1765.3 010839	Ø 22,2
1.1	49	09/05→06/09		→ 02/09; - ESP		24.2122-1765.3 010839	Ø 22,2
1.4 i	71	08/05→12/10					
1.5 CRDi	65	08/05→06/09					
1.5 CRDi GLS	81	08/05→06/09					
1.3	63	09/03→09/05		→ 04/05; - ABS		24.2122-1761.3 010822	Ø 22,2
				→ 04/05; + ABS		24.2122-1765.3 010839	Ø 22,2
1.3 i	60	09/02→03/04		- ABS		24.2122-1761.3 010822	Ø 22,2
				+ ABS		24.2122-1765.3 010839	Ø 22,2
1.5 CRDi	60	03/03→09/05		→ 04/05; - ESP		24.2122-1765.3 010839	Ø 22,2
1.6	78	06/05→12/06		08/05→; - ESP		24.2122-1765.3 010839	Ø 22,2
HYUNDAI - MATRIX (FC) 06/01→08/10							
 Hauptbremszylinder							
1.5	75	06/01→08/10		→ 07/03; - ABS		24.2123-1762.3 010823	Ø 23,81
1.5 CRDi	60	10/01→08/10					
1.6	66	01/02→12/05					
1.6	76	06/01→08/10					
1.8	90	06/01→08/10		→ 07/03		24.2123-1762.3 010823	Ø 23,81
JAGUAR - S-TYPE (X200) 10/98→12/08							
Pedalwegsensor, Bremspedal							
2.5 V6	147	04/02→10/07		02/03→		03.0655-0007.2 370007	ATE
4.2 V8	219	04/02→10/07					
2.7 D	152	06/04→10/07				03.0655-0007.2 370007	ATE
3.0 V6	175	01/99→10/07		05/03→		03.0655-0007.2 370007	ATE
R 4,2 V8	291	04/02→10/07		08/03→		03.0655-0007.2 370007	ATE
 Hauptbremszylinder							
2.5 V6	147	04/02→10/07		M45255→ N52047; für Linkslenker; + ESP		03.4125-0032.3 010955	ATE Ø 25,4
2.7 D	152	06/04→10/07					
3.0 V6	175	01/99→10/07		N52048→; für Linkslenker; + ESP		03.4156-0051.3 011011	ATE Ø 26,99 ohne Bremsflüssigkeitsbehälter
4.0 V8	203	01/99→04/02					
4.2 V8	219	04/02→10/07					
R 4,2 V8	291	04/02→10/07					
JAGUAR - XF (X250) 03/08→04/15							
 Bremskraftverstärker							
2.0	177	06/12→04/15				03.7745-6502.4 300296	ATE Ø 8" pneumatisch
2.2 D	120	04/11→04/15					
2.2 D	140	05/11→04/15					
2.2 D	147	03/12→04/15					
2.7 D	152	03/08→04/15					
3.0	250	03/12→04/15					
3.0 AWD	250	10/12→04/15					
3.0 D	155	03/09→04/15					
3.0 D	177	03/09→04/15					
3.0 D	202	03/09→04/15					
4.2	219	03/08→04/15					
4.2 Kompressor	306	03/08→04/15					
5.0	283	03/09→04/15					
 Hauptbremszylinder							
2.0	177	06/12→04/15		für Linkslenker		03.4156-0016.3 010970	ATE Ø 26,99
2.2 D	120	04/11→04/15					
2.2 D	140	05/11→04/15					
2.2 D	147	03/12→04/15					
2.7 D	152	03/08→04/15					
3.0	175	03/08→04/15					
3.0	250	03/12→04/15					
3.0 AWD	250	10/12→04/15					
3.0 D	155	03/09→04/15					
3.0 D	177	03/09→04/15					
3.0 D	202	03/09→04/15					
↓							

















	kw			 	! #		
JAGUAR - XF (X250) 03/08→04/15							
 Hauptbremszylinder							
4.2	219	03/08→04/15		für Linkslenker		03.4156-0016.3 010970	ATE Ø 26,99
4.2 Kompressor	306	03/08→04/15					
5.0	283	03/09→04/15					
5.0 Kompressor	346	01/09→04/15					
5.0 Kompressor	375	03/09→04/15					
5.0 XFR-S	405	10/12→04/15					
JAGUAR - XF SPORTBRAKE (X250) 09/12→12/15							
 Bremskraftverstärker							
2.2 D	120	09/12→04/14				03.7745-6502.4 300296	ATE Ø 8" pneumatisch
2.2 D	147	09/12→04/14					
 Hauptbremszylinder							
2.2 D	120	09/12→04/14		für Linkslenker		03.4156-0016.3 010970	ATE Ø 26,99
2.2 D	147	09/12→04/14					
3.0 D	177	09/12→04/14					
3.0 D	202	09/12→04/14					
5.0 XFR-S	405	02/13→04/14		02/14→; für Linkslenker		03.4156-0016.3 010970	ATE Ø 26,99
JAGUAR - XJ (X350) 03/03→03/09							
Pedalwegsensoren, Bremspedal							
3.0	175	05/03→03/09		für Rechtslenker		03.0655-0007.2 370007	ATE
3.6	190	05/03→03/09				03.0655-0007.2 370007	ATE
4.2	219	05/03→03/09					
R 4.2	291	03/03→03/09		05/03→		03.0655-0007.2 370007	ATE
 Hauptbremszylinder							
3.0	175	05/03→03/09		für Linkslenker		03.4125-0032.3 010955	ATE Ø 25,4
3.6	190	05/03→03/09					
4.2	219	05/03→03/09					
D 2.7	152	10/05→03/09		→ G49700; für Linkslenker		03.4125-0032.3 010955	ATE Ø 25,4
				H17287→; für Linkslenker		03.4156-0051.3 011011	ATE Ø 26,99 ohne Bremsflüssigkeitsbehälter
				G49701→ H17286; für Linkslenker		03.4156-0051.3 011011	ATE Ø 26,99 ohne Bremsflüssigkeitsbehälter
R 4.2	291	03/03→03/09		05/03→; für Linkslenker		03.4125-0032.3 010955	ATE Ø 25,4
JAGUAR - XJ (X351) 10/09→							
 Hauptbremszylinder							
2.0	177	05/12→		für Linkslenker		03.4156-0076.3 011013	ATE Ø 26,99
3.0	250	03/12→					
3.0 AWD	250	10/12→					
3.0 D	202	10/09→12/15					
3.0 D	221	04/15→					
5.0 V8	346	10/09→					
5.0 V8	375	10/09→					
5.0 V8	405	06/13→					
5.0 V 8	283	10/09→					
JAGUAR - XK 8 Convertible (X100) 03/96→12/06							
Pedalwegsensoren, Bremspedal							
4.2	219	08/02→12/06		→ 07/05		03.0655-0007.2 370007	ATE
R 4.2	291	08/02→12/06					
JAGUAR - XK 8 Coupe (X100) 03/96→12/06							
Pedalwegsensoren, Bremspedal							
4.2	219	08/02→07/05				03.0655-0007.2 370007	ATE
R 4.2	291	08/02→07/05					
JAGUAR - XK Cabriolet (X150) 03/06→07/14							
 Hauptbremszylinder							
3.6	190	10/07→07/14		B13391→; für Linkslenker		03.4156-0051.3 011011	ATE Ø 26,99 ohne Bremsflüssigkeitsbehälter
4.2 XK8	219	03/06→07/14					
4.2 XKR	306	03/06→07/14		→ B13390; für Linkslenker		03.4156-0051.3 011011	ATE Ø 26,99 ohne Bremsflüssigkeitsbehälter
5.0 V8	283	01/09→07/14					
5.0 XKR	375	01/09→07/14					
5.0 XKR-S	405	01/11→07/14		B13391→; für Linkslenker		03.4156-0051.3 011011	ATE Ø 26,99 ohne Bremsflüssigkeitsbehälter











	kw			 	! #		
JAGUAR - XK Coupe (X150) 03/06→07/14							
 Hauptbremszylinder							
3.6	190	07/07→07/14		→ B13390; für Linkslenker		03.4156-0051.3 011011	ATE Ø 26,99 ohne Bremsflüssigkeitsbehälter
4.2 XK8	219	03/06→07/14					
4.2 XKR	291	03/06→07/14		B13391→; für Linkslenker		03.4156-0051.3 011011	ATE Ø 26,99 ohne Bremsflüssigkeitsbehälter
4.2 XKR	306	03/06→07/14					
5.0 V8	283	01/09→07/14					
5.0 XKR	375	01/09→07/14					
5.0 XKR	390	09/10→07/14					
5.0 XKR-S	405	01/11→07/14		B13391→; für Linkslenker		03.4156-0051.3 011011	ATE Ø 26,99 ohne Bremsflüssigkeitsbehälter
KIA - SEPHIA (FA) 01/95→10/97							
 Bremskraftregler							
1.6 i	59	01/95→10/97		→ 03/95		03.0101-0014.2 320004	ATE Satz 3/25 2x
KIA - SEPHIA Stufenheck (FA) 01/92→09/01							
 Bremskraftregler							
1.6 i	59	09/93→10/97		10/93→ 03/95		03.0101-0014.2 320004	ATE Satz 3/25 2x
KIA - SORENTO I (JC) 08/02→							
 Hauptbremszylinder							
2.5 CRDi	103	08/02→		→ 11/06; + ABS		24.2126-1702.3 010950	Ø 26,99
3.5 V6 4WD	143	08/02→		→ 11/06; + ABS; Vollautomatik		24.2126-1702.3 010950	Ø 26,99
KIA - VENGA (YN) 02/10→							
 Hauptbremszylinder							
1.4 CRDi 75	55	02/10→		für Linkslenker; + ESP		24.4122-1715.3 010982	TRW Ø 22,2 ohne Bremsflüssigkeitsbehälter
1.4 CRDi 75	57	02/10→					
1.4 CRDi 90	66	02/10→		für Linkslenker; - ESP		24.4122-1716.3 010983	TRW Ø 22,2 ohne Bremsflüssigkeitsbehälter
1.4 CVVT	66	02/10→					
1.6 CRDi 115	85	02/10→					
1.6 CRDi 128	94	02/10→					
1.6 CVVT	92	02/10→					
LADA - 110 (2110) 01/95→12/12							
 Hauptbremszylinder							
1.5	54	01/95→12/05				24.2120-0803.3 010415	Ø 20,64
1.5	57	01/95→12/05					
1.5 16V	70	01/95→12/05					
1.6	66	01/00→04/07					
2.0 i	110	08/96→07/00					
Wankel	88	06/97→09/04					
1.6	60	01/00→12/12		→ 08/07		24.2120-0803.3 010415	Ø 20,64
LADA - 111 (2111) 01/95→							
 Hauptbremszylinder							
1.5	57	01/96→12/05				24.2120-0803.3 010415	Ø 20,64
1.5 16V	70	01/95→08/02					
1.6	60	09/04→12/13		01/05→ 12/08		24.2120-0803.3 010415	Ø 20,64
1.6	66	09/04→		03/06→ 12/08		24.2120-0803.3 010415	Ø 20,64
LADA - 112 (2112) 01/95→12/11							
 Hauptbremszylinder							
1.5	54	01/95→10/00				24.2120-0803.3 010415	Ø 20,64
1.5	57	01/95→09/04					
1.5 16V	70	01/95→09/00					
1.6	66	03/06→12/08					
1.6	60	01/05→12/11		→ 12/08		24.2120-0803.3 010415	Ø 20,64
LADA - 1200-1600 01/70→12/05							
 Hauptbremszylinder							
1600 N/L (VAZ2106, VAZ2103)	57	03/79→12/05		→ 06/85		24.2119-0831.3 010416	Ø 19,05
LADA - NIVA Geländewagen geschlossen (2121, 2131) 12/76→							
 Hauptbremszylinder							
1600 4x4	54	01/87→03/95				24.2119-0832.3 010417	Ø 19,05
1700 i	59	06/96→12/06					
1700 i 4x4	60	10/00→12/10					
1900 Diesel	55	01/99→12/06					
↓							

	kw					! #		
LADA - NIVA Geländewagen geschlossen (2121, 2131) 12/76→								
 Hauptbremszylinder								
1700 i 4x4	61	09/10→					24.2120-0803.3 010415	Ø 20,64
1900 Diesel	48	01/93→08/99		03/93→			24.2119-0832.3 010417	Ø 19,05
LADA - NOVA (2105) 05/81→04/12								
 Hauptbremszylinder								
1200 Junior/L (VAZ, WAS2105)	44	09/81→04/12		→ 12/96			24.2119-0832.3 010417	Ø 19,05
1300 Spezial/L (VAZ, WAS2105)	48	05/81→04/12						
1500 S (WAS21093)	52	06/89→04/12						
1500 Special (VAZ2105, WAS21053)	55	03/85→04/12						
1600 (WAS21074)	56	01/88→10/01						
1700 i Classic (VAZ2107)	62	06/96→04/12						
LADA - NOVA Kombi (2104) 09/84→04/12								
 Hauptbremszylinder								
1500	49	08/94→04/12		→ 12/96			24.2119-0832.3 010417	Ø 19,05
1700	62	08/94→04/12						
LADA - SAMARA (2108, 2109, 2115, 2113, 2114) 01/86→12/13								
 Hauptbremszylinder								
1.5	56	04/96→12/13		→ 12/99			24.2120-0803.3 010415	Ø 20,64
1500	52	02/95→12/06						
1100	43	02/96→08/99					24.2120-0803.3 010415	Ø 20,64
1300	45	09/91→08/99						
1300	46	06/87→12/96						
1300	50	02/96→12/96						
1500	50	09/91→12/96						
1500	53	09/87→12/96						
LADA - SAMARA FORMA Stufenheck (21099, 2115) 09/87→12/12								
 Hauptbremszylinder								
1100	39	07/91→08/99		→ 12/95			24.2120-0803.3 010415	Ø 20,64
1300	45	07/91→08/99						
1300	46	05/90→08/99						
1300	48	05/89→07/97						
1500	50	07/91→12/96						
1500	52	11/94→12/06						
1500	53	09/91→12/96						
LANCIA - DEDRA (835_) 01/89→07/99								
 Hauptbremszylinder								
1.6 i.e. (835AN)	55	04/93→07/99		→ 10/93; für Linkslenker; - ABS			24.2120-1710.3 010468	Ø 20,64
1.8 i.e. (835AT)	66	08/93→07/99						
1.8 i.e. (835BD, 835AD)	77	09/89→07/99		01/90→ 10/93; für Linkslenker; - ABS			24.2120-1710.3 010468	Ø 20,64
2.0 i.e. (835AL)	83	09/89→07/99						
1.9 TDS (835EE, 835EF)	66	04/89→07/99		01/90→ 10/93; für Linkslenker; - ABS			24.2120-1710.3 010468	Ø 20,64
				01/90→ 10/93; - ABS			24.2120-1710.3 010468	Ø 20,64
2.0 i.e. Turbo (835AR)	119	04/91→07/99		05/91→ 10/93; GG			24.2122-1716.3 010485	Ø 22,2
LANCIA - DELTA II (836_) 06/93→09/99								
 Hauptbremszylinder								
1.4 i.e. (836AF, 836AH)	51	10/94→08/99		GG			24.2122-1716.3 010485	Ø 22,2
1.6 i.e. (836AP)	66	03/96→08/99						
1.6 i.e. 16V (836AO)	76	01/96→08/99						
1.8 i.e. (836AG, 836AL)	66	07/94→08/99						
1.8 i.e. 16V (836AQ)	83	03/96→08/99						
1.8 i.e. 16V GT (836AR)	96	03/96→08/99						
2.0 16V Turbo (836AS)	142	07/96→08/99						
1.6 i.e. (836AD)	55	06/93→08/99		→ 10/93			24.2119-0829.3 010351	Ø 19,05
				11/93→; GG			24.2122-1716.3 010485	Ø 22,2
1.8 i.e. (836AE)	76	06/93→08/99		11/93→; GG			24.2122-1716.3 010485	Ø 22,2
2.0 16V (836AA, 836CA)	102	06/93→08/99						
2.0 16V Turbo (836AB)	137	06/93→08/99						
LANCIA - DELTA III (844_) 08/08→08/14								
 Hauptbremszylinder								
1.4	88	09/08→08/14					24.4123-1710.3 010866	BOS Ø 23,81
1.4	110	09/08→08/14						ohne Bremsflüssigkeitsbehälter
1.4 16V	103	07/10→08/14						
↓								

	kw					! #		
LANCIA - DELTA III (844_) 08/08→08/14								
 Hauptbremszylinder								
1.4 Bifuel	88	07/11→08/14					24.4123-1710.3 010866	BOS Ø 23,81 ohne Bremsflüssigkeitsbehälter
1.6 D Multijet	77	04/11→08/14						
1.6 D Multijet	85	08/08→08/14						
1.6 D Multijet	88	09/08→08/14						
1.8	147	01/09→08/14						
1.9 D Multijet	140	01/09→08/14						
2.0 D Multijet	120	09/08→08/14						
2.0 D Multijet	121	09/08→08/14						
LANCIA - MUSA (350_) 10/04→09/12								
 Hauptbremszylinder								
1.3 D Multijet	51	10/04→09/12		→ 11/06; für Fahrzeuge ohne elektronische Fahr- dynamikregelung			24.2123-1763.3 010842	Ø 23,81
1.3 D Multijet	66	09/06→09/12						
1.4	57	09/05→09/12						
1.4	70	10/04→09/12		→ 11/06; für Fahrzeuge mit elektronischer Fahr- dynamikregelung			24.2123-1769.3 010863	BOS Ø 23,81
1.9 D Multijet	74	10/04→09/12						
				12/06→			24.4123-1708.3 010859	BOS Ø 23,81
1.3 D Multijet	70	03/09→09/12		08/09→			24.4123-1708.3 010859	BOS Ø 23,81
1.4	66	10/07→09/12					24.4123-1708.3 010859	BOS Ø 23,81
1.4 LPG	57	11/10→09/12						
1.6 D Multijet	85	07/08→09/12						
1.6 D Multijet	88	07/08→09/12						
LANCIA - PHEDRA (179_) 09/02→11/10								
 Hauptbremszylinder								
2.0 (179AXA11)	100	09/02→11/10		→ 09/10			03.2122-2163.3 010800	ATE Ø 22,2
2.0 D Multijet	100	07/06→11/10						
2.0 JTD	79	07/03→11/10						
2.0 JTD	88	06/06→11/10						
2.0 JTD (179AXB1A)	80	09/02→11/10						
2.2 D Multijet	125	03/08→11/10						
2.2 JTD	120	04/06→11/10						
2.2 JTD (179AXC1A)	94	09/02→11/10						
LANCIA - Y (840_) 11/95→09/03								
 Hauptbremszylinder								
1.1 (840AE)	40	11/95→09/03		05/97→ 12/98			24.2120-1710.3 010468	Ø 20,64
1.2 (840AA, 840AF1A)	44	03/96→09/03		→ 07/03			24.2120-1710.3 010468	Ø 20,64
1.2 16V (840AG1A)	59	10/00→09/03						
1.2 16V (840AD)	63	04/97→09/03		05/97→ 09/00			24.2120-1710.3 010468	Ø 20,64
1.4 12V (840AB)	59	10/96→09/03		→ 12/98			24.2120-1710.3 010468	Ø 20,64
1.4 12V (840AC)	55	03/96→09/03						
 Bremskraftregler								
1.1 (840AE)	40	11/95→09/03		 05/97→ 12/98; - ABS			24.6513-1705.3 320237	lastabhängig 2x
1.2 (840AA, 840AF1A)	44	03/96→09/03		 → 07/03; - ABS			24.6513-1705.3 320237	lastabhängig 2x
1.2 16V (840AG1A)	59	10/00→09/03						
1.2 16V (840AD)	63	04/97→09/03		 05/97→ 09/00; - ABS			24.6513-1705.3 320237	lastabhängig 2x
1.4 12V (840AB)	59	10/96→09/03		 → 12/98; - ABS			24.6513-1705.3 320237	lastabhängig 2x
1.4 12V (840AC)	55	03/96→09/03						
LANCIA - Y10 (156_) 03/85→12/95								
 Hauptbremszylinder								
1.1 Fire (156AG)	40	01/95→12/95					24.2120-1733.3 010686	Ø 20,64
1.1 Fire Allrad (156AG)	40	01/95→12/95						
1.1 i.e. Fire (156AG)	37	07/89→09/95		01/90→ 12/92			24.2120-0801.3 010362	Ø 20,64
				01/93→			24.2120-1733.3 010686	Ø 20,64
1.1 i.e. Fire Allrad (156AG)	37	09/92→12/95		→ 12/92			24.2120-0801.3 010362	Ø 20,64
1.3 i.e. (156AF)	53	02/89→12/95		01/93→			24.2120-1733.3 010686	Ø 20,64
 Bremskraftregler								
1.1 Fire (156AG)	40	01/95→12/95					24.6513-0801.3 320117	lastabhängig 1/3 2x
1.1 Fire Allrad (156AG)	40	01/95→12/95						
1.1 i.e. Fire Allrad (156AG)	37	09/92→12/95						
1.3 i.e. (156AF)	53	02/89→12/95						
1.1 i.e. Fire (156AG)	37	07/89→09/95		01/90→			24.6513-0801.3 320117	lastabhängig 1/3 2x

	kw					! #		
LANCIA - YPSILON (843_) 10/03→12/11								
 Hauptbremszylinder								
1.2	44	10/03→12/11		→ 06/11			24.2120-1745.3 010834	Ø 20,64
1.2	51	08/10→12/11		→ 06/11;			24.2122-1762.3 010837	Ø 22,2
1.2	59	10/03→12/11		für Fahrzeuge ohne elektronische Fahr-				
1.3 JTD	51	10/03→12/11		dynamikregelung				
1.4	57	02/06→12/11		→ 06/11;			24.2122-1768.3 010853	Ø 22,2
1.4 16V	70	10/03→12/11		für Fahrzeuge mit elektronischer Fahr-				
1.4 LPG	57	11/10→12/11		dynamikregelung				
1.3 D Multijet	55	09/06→12/11		10/06→ 06/11;			24.2122-1762.3 010837	Ø 22,2
1.3 D Multijet	66	09/06→12/11		für Fahrzeuge ohne elektronische Fahr-				
				dynamikregelung				
				10/06→ 06/11;			24.2122-1768.3 010853	Ø 22,2
				für Fahrzeuge mit elektronischer Fahr-				
				dynamikregelung				
1.3 D Multijet	77	05/07→12/11		07/07→ 06/11;			24.2122-1762.3 010837	Ø 22,2
				für Fahrzeuge ohne elektronische Fahr-				
				dynamikregelung				
				07/07→ 06/11;			24.2122-1768.3 010853	Ø 22,2
				für Fahrzeuge mit elektronischer Fahr-				
				dynamikregelung				
LANCIA - ZETA (22_) 05/95→09/02								
 Hauptbremszylinder								
2.0 16V (220AL5)	97	05/98→07/00		05/99→			24.2123-1733.3 010657	BOS Ø 23,81
2.0 Turbo (220AD5, 220CD5)	108	05/95→09/02						
2.1 TD (220AJ5)	80	05/96→09/99						
2.0 16V (220AQ5)	100	07/00→09/02					24.2123-1733.3 010657	BOS Ø 23,81
2.0 JTD	80	04/00→09/02						
2.0 JTD 16V (220AN5)	80	09/99→09/02						
LAND ROVER - DISCOVERY IV (L319) 09/09→								
 Hauptbremszylinder								
2.7 TD 4x4	140	09/09→					24.2026-1704.3 010989	TRW Ø 26,99 Ø2 20,64
3.0 4x4	250	08/13→						
3.0 SDV6 4x4	188	11/09→						
3.0 TD 4x4	155	05/10→						
3.0 TD 4x4	180	09/09→						
3.0 TD 4x4	183	07/12→						
5.0 V8 4x4	276	09/09→						
LAND ROVER - FREELANDER (L314) 02/98→10/06								
 Hauptbremszylinder								
1.8 16V 4x4	86	11/00→10/06		02/01→			24.4125-1707.3 010986	TRW Ø 25,4
2.0 Td4 4x4	82	11/00→10/06						
2.5 V6 4x4	130	11/00→10/06						
2.0 Td4 4x4	80	03/01→10/06		11/01→			24.4125-1707.3 010986	TRW Ø 25,4
LAND ROVER - FREELANDER 2 (L359) 10/06→10/14								
 Bremskraftverstärker								
2.0 Si4 4x4	177	10/11→10/14					03.7755-1232.4 300260	ATE Ø 9 / 8" pneumatisch
2.2 eD4	110	08/10→10/14						
2.2 SD4 4x4	140	08/10→10/14						
2.2 TD4 4x4	110	10/06→10/14						
2.2 TD4 4x4	112	01/07→10/14						
2.2 TD4 4x4	118	10/06→10/14						
3.2 4x4	171	10/06→10/14						
LAND ROVER - RANGE ROVER III (L322) 03/02→12/12								
 Hauptbremszylinder								
3.0 D 4x4	130	03/02→08/12		→ 5A999999			24.2026-1705.3 010992	TRW Ø 26,99 Ø2 20,64
3.6 D 4x4	200	04/06→08/12						
4.2 4x4	291	05/05→08/12						
4.4 4x4	210	03/02→08/05						
4.4 4x4	225	05/05→08/12						
LAND ROVER - RANGE ROVER SPORT (L320) 02/05→03/13								
 Hauptbremszylinder								
3.0 D 4x4	155	05/10→03/13		für Linkslenker			24.2026-1704.3 010989	TRW Ø 26,99 Ø2 20,64
3.0 D 4x4	180	09/09→03/13						
3.0 D 4x4	183	08/12→03/13						
3.0 D 4x4	188	06/11→03/13						
5.0 4x4	276	07/09→03/13						
5.0 4x4	372	04/09→03/13						
5.0 4x4	375	09/09→03/13						
3.6 D 4x4	200	04/06→03/13		AA000001→; für Linkslenker			24.2026-1704.3 010989	TRW Ø 26,99 Ø2 20,64

	kW					! #		
LAND ROVER - RANGE ROVER SPORT (L494) 04/13→								
 Hauptbremszylinder								
3.0 D 4x4	155	04/13→			→ 06/13; für Linkslenker		24.2026-1704.3 010989	TRW Ø 26,99 Ø2 20,64
3.0 D 4x4	183	04/13→						
3.0 D 4x4	190	04/13→						
3.0 D 4x4	215	04/13→						
5.0 4x4	375	04/13→						
MAZDA - 2 (DY) 02/03→06/07								
 Hauptbremszylinder								
1.25	55	04/03→06/07			- ABS		03.4153-0015.3 011005	ATE Ø 23,81 ohne Bremsflüssigkeitsbehälter
1.4	59	04/03→06/07						
1.4 CD	50	04/03→06/07			+ ABS		03.4153-5287.4 010953	ATE Ø 23,81 mit Bremsflüssigkeitsbehälter
1.6	74	04/03→06/07						
MAZDA - 6 Hatchback (GG) 08/02→12/08								
 Hauptbremszylinder								
1.8	88	08/02→08/07			→ 07/07; + ESP; Schaltgetriebe		24.2120-1756.3 010975	Ø 20,64 ohne Bremsflüssigkeitsbehälter
2.0	104	08/02→08/07						
2.0	108	03/05→08/07						
2.0 DI	89	08/02→08/07						
2.0 DI	100	08/02→08/07						
2.0 DI	105	06/05→08/07						
2.3	122	08/02→08/07						
MAZDA - 6 Station Wagon (GY) 01/02→02/08								
 Hauptbremszylinder								
1.8	88	08/02→08/07			→ 07/07; + ESP; Schaltgetriebe		24.2120-1756.3 010975	Ø 20,64 ohne Bremsflüssigkeitsbehälter
2.0	104	08/02→08/07						
2.0	108	03/05→08/07						
2.0 DI	89	08/02→08/07						
2.0 DI	105	06/05→08/07						
2.3	122	01/02→02/08						
2.3 AWD	119	11/02→08/07						
2.0 DI	100	08/02→02/05			+ ESP; Schaltgetriebe		24.2120-1756.3 010975	Ø 20,64 ohne Bremsflüssigkeitsbehälter
MAZDA - 6 Stufenheck (GG) 06/02→12/08								
 Hauptbremszylinder								
1.8	88	08/02→08/07			→ 07/07; + ESP; Schaltgetriebe		24.2120-1756.3 010975	Ø 20,64 ohne Bremsflüssigkeitsbehälter
2.0	104	06/02→08/07						
2.0	108	03/05→08/07						
2.0 DI	89	08/02→08/07						
2.0 DI	100	06/02→08/07						
2.0 DI	105	06/05→08/07						
2.3	122	06/02→08/07						
2.3 MPS Turbo	191	12/05→08/07						
MAZDA - BT-50 Pick-up (CD, UN) 08/06→12/15								
 Hauptbremszylinder								
2.5 MRZ-CD	105	08/06→06/13			für Linkslenker; Brems-/Fahrdyn. Artikelbezug: + ABS		24.2125-1747.3 011029	Ø 25,4
2.5 MRZ-CD 4x4	105	12/06→12/15			+ ABS; Vollautomatik; → 07/12		24.2125-1747.3 011029	Ø 25,4
					+ ABS; Schaltgetriebe; → 07/12		24.2125-1747.3 011029	Ø 25,4
MERCEDES-BENZ - 100 Bus (631) 02/88→04/96								
 Hauptbremszylinder								
D (631.333, 631.343, 631.334, 631.344)	55	12/90→02/96			021972→		24.2125-1719.3 010666	Ø 25,4
MERCEDES-BENZ - 100 Kasten (631) 02/88→04/96								
 Hauptbremszylinder								
D (631.332, 631.342)	55	12/90→02/96			021972→		24.2125-1719.3 010666	Ø 25,4
MERCEDES-BENZ - A-KLASSE (W168) 07/97→08/05								
 Hauptbremszylinder								
A 140 (168.031, 168.131)	60	07/97→08/04			09/97→		24.4122-1701.3 010533	TRW Ø 22,2
A 160 (168.033, 168.133)	75	07/97→08/04						
A 140 (168.031, 168.131)	60	01/01→08/04					24.4122-1701.3 010533	TRW Ø 22,2
A 160 CDI (168.006)	55	02/01→08/04						
↓								

	kW					! #		
MERCEDES-BENZ - A-KLASSE (W168) 07/97→08/05								
 Hauptbremszylinder								
A 170 CDI (168.009, 168.109)	70	02/01→08/04					24.4122-1701.3 010533	TRW Ø 22,2
A 210 (168.035, 168.135)	103	12/01→08/04						
A 160 CDI (168.007)	44	07/98→02/01		08/98→ 01/01			24.4122-1701.3 010533	TRW Ø 22,2
A 170 CDI (168.008)	66	07/98→02/01		→ 01/01			24.4122-1701.3 010533	TRW Ø 22,2
A 190 (168.032, 168.132)	92	03/99→08/04		05/99→			24.4122-1701.3 010533	TRW Ø 22,2
MERCEDES-BENZ - A-KLASSE (W169) 09/04→06/12								
 Hauptbremszylinder								
A 150 (169.031, 169.331)	70	09/04→06/12		→ 05/12			24.2123-1776.3 010926	TRW Ø 23,81
A 160 (169.031, 169.331)	70	04/09→06/12						
A 160 CDI (169.006, 169.306)	60	09/04→06/12						
A 170 (169.032, 169.332)	85	09/04→06/12						
A 180 (169.032, 169.332)	85	04/09→06/12						
A 180 CDI (169.007, 169.307)	80	09/04→06/12						
A 200 (169.033, 169.333)	100	09/04→06/12						
A 200 CDI (169.008, 169.308)	103	09/04→06/12						
A 200 CDI (169.308, 169.008)	100	09/04→06/12						
A 200 TURBO (169.034, 169.334)	142	09/05→06/12						
E-CELL (169.090)	50	12/10→06/12						
MERCEDES-BENZ - A-KLASSE (W176) 06/12→								
 Hauptbremszylinder								
A 160 (176.041)	75	07/15→		für Linkslenker			24.4123-1718.3 011016	TRW Ø 23,81
A 160 CDI / d (176.011)	66	06/13→						ohne Bremsflüssigkeitsbehälter
A 180 (176.042)	90	06/12→						
A 180 CDI / d (176.012)	80	06/12→						
A 180 CDI (176.000)	80	06/12→						
A 200 (176.043)	115	06/12→						
A 200 CDI / d (176.008)	100	02/14→						
A 200 CDI / d 4-matic (176.002)	100	02/14→						
A 220 4-matic (176.047)	135	05/14→						
A 220 CDI (176.003)	120	01/14→						
A 220 CDI (176.003)	125	09/12→						
A 220 CDI 4-matic (176.005)	125	09/12→						
A 220 d (176.003)	130	07/15→						
A 220 d 4-matic (176.005)	130	07/15→						
A 250 (176.044)	155	06/12→06/15						
A 250 (176.050)	160	07/15→						
A 250 4-matic (176.051)	160	07/15→						
A 45 AMG 4-matic (176.052)	265	06/13→06/15						
AMG A 45 4-matic (176.052)	280	07/15→						
A 200 CDI (176.001)	100	06/12→		für Linkslenker; → 02/14			24.4123-1718.3 011016	TRW Ø 23,81 ohne Bremsflüssigkeitsbehälter
A 250 4-matic (176.046)	155	06/12→06/15		06/13→; für Linkslenker			24.4123-1718.3 011016	TRW Ø 23,81 ohne Bremsflüssigkeitsbehälter
MERCEDES-BENZ - B-KLASSE (W245) 03/05→11/11								
 Hauptbremszylinder								
B 150 (245.231)	70	03/05→11/11		→ 04/11			24.2123-1776.3 010926	TRW Ø 23,81
B 160 (245.231)	70	04/09→11/11						
B 170 (245.232)	85	03/05→11/11						
B 180 (245.232)	85	04/09→11/11						
B 180 CDI (245.207)	80	03/05→11/11						
B 200 (245.233)	100	03/05→11/11						
B 200 CDI (245.208)	100	03/05→11/11						
B 200 CDI (245.208)	103	03/05→11/11						
B 200 TURBO (245.234)	142	03/05→11/11						
B 170 NGT (245.233)	85	04/08→11/11		→ 04/09			24.2123-1776.3 010926	TRW Ø 23,81
B 180 NGT (245.233)	85	04/08→11/11		04/09→ 04/11			24.2123-1776.3 010926	TRW Ø 23,81

MERCEDES-BENZ - B-KLASSE (W246, W242) 10/11→

Hauptbremszylinder

B 160 (246.241)	75	07/15→		für Linkslenker		24.4123-1718.3	011016	TRW Ø 23,81 ohne Bremsflüssigkeitsbehälter
B 160 CDI / d (246.211)	66	05/13→						
B 180 (246.242)	90	11/11→						
B 180 CDI / d (246.212)	80	02/13→						
B 180 CDI (246.200)	80	11/11→						
B 200 (246.243)	115	11/11→						
B 200 CDI / d (246.208)	100	08/14→						
B 200 CDI / d 4-matic (246.202)	100	08/14→						
B 200 CDI (246.201)	100	11/11→						
B 200 Natural Gas Drive / B 200 c (242.848)	115	11/12→						
B 220 4-matic (246.247)	135	05/13→						
B 220 CDI / d (246.203)	120	06/13→						
B 220 CDI / d (246.203)	130	09/14→						
B 220 CDI / d 4-matic (246.205)	130	09/14→						
B 250 4-matic (246.246)	155	08/14→						
B 220 CDI / d (246.203)	125	11/11→		12/12→; für Linkslenker		24.4123-1718.3	011016	TRW Ø 23,81 ohne Bremsflüssigkeitsbehälter
B 250 (246.244)	155	05/12→		09/12→; für Linkslenker		24.4123-1718.3	011016	TRW Ø 23,81 ohne Bremsflüssigkeitsbehälter

MERCEDES-BENZ - C-KLASSE (W202) 03/93→05/00









Bremskraftverstärker









C 180 (202.018)	89	11/94→05/00		A021677 / F011180→ A519673 / F619720		03.7760-2702.4	300090	ATE Ø 10" pneumatisch
C 180 (202.018)	90	03/93→05/00						
C 200 (202.020)	100	01/94→05/00		→ A519673 / F619720		03.7760-2702.4	300090	ATE Ø 10" pneumatisch
C 200 Kompressor (202.025)	132	10/95→05/00						
C 200 Kompressor (202.025)	141	11/96→05/00						
C 230 Kompressor (202.024)	142	10/95→05/00						
C 250 Turbo-D (202.128)	110	10/95→05/00						
C 200 D (202.120)	55	03/93→05/00		A072908 / F060570→ A519673 / F619720		03.7760-2702.4	300090	ATE Ø 10" pneumatisch
C 200 D (202.122)	65	10/96→05/00						
C 220 D (202.021)	55	07/96→05/00						
C 220 D (202.121)	70	08/93→05/00						
C 220 (202.022)	110	03/93→05/00		→ 08/96		03.7760-2702.4	300090	ATE Ø 10" pneumatisch
C 230 (202.023)	110	06/96→06/97		07/96→		03.7760-2702.4	300090	ATE Ø 10" pneumatisch
C 250 D (202.125)	83	05/93→05/00		→ 08/95; A072908 / F060570→		03.7760-2702.4	300090	ATE Ø 10" pneumatisch
C 280 (202.028)	142	05/93→05/00		06/93→ 05/97		03.7760-2702.4	300090	ATE Ø 10" pneumatisch
C 36 AMG (202.028)	206	05/94→05/00		→ 08/97		03.7760-2702.4	300090	ATE Ø 10" pneumatisch









Hauptbremszylinder







C 180 (202.018)	89	11/94→05/00		A021677→ A136773		03.2023-0825.3	010028	Ø1 23,81 Ø2 19,05
C 180 (202.018)	90	03/93→05/00		F011180→		03.2023-0825.3	010028	Ø1 23,81 Ø2 19,05
				→ A021676 / F011179		24.2022-1601.3	010340	Ø1 22,2 Ø2 17,46
				A136774→		24.2023-1701.3	010514	TRW Ø1 23,81 Ø2 19,05
C 200 (202.020)	100	01/94→05/00		→ A136773 / F110261		03.2023-0825.3	010028	Ø1 23,81 Ø2 19,05
				A136774 / F110262→		24.2023-1701.3	010514	TRW Ø1 23,81 Ø2 19,05
C 200 CDI (202.134)	75	03/98→05/00				24.2023-1702.3	010534	TRW Ø1 23,81 Ø2 19,05
C 220 CDI (202.133)	92	09/97→05/00						
C 200 D (202.120)	55	03/93→05/00		A072908 / F060570→		03.2023-0825.3	010028	Ø1 23,81 Ø2 19,05
C 200 D (202.122)	65	10/96→05/00		→ A072907 / F060569		24.2022-1601.3	010340	Ø1 22,2 Ø2 17,46
C 200 Kompressor (202.025)	132	10/95→05/00		→ A519673 / F619720		24.2023-1701.3	010514	TRW Ø1 23,81 Ø2 19,05
C 200 Kompressor (202.025)	141	11/96→05/00		A519674 / F619721→		24.2023-1702.3	010534	TRW Ø1 23,81 Ø2 19,05
C 230 Kompressor (202.024)	142	10/95→05/00						
C 250 Turbo-D (202.128)	110	10/95→05/00						
C 220 (202.022)	110	03/93→05/00		06/93→; → A136773 / F110261		03.2023-0825.3	010028	Ø1 23,81 Ø2 19,05
				→ 08/96; A136774 / F110262→		24.2023-1701.3	010514	TRW Ø1 23,81 Ø2 19,05
C 220 D (202.021)	55	07/96→05/00		A072908 / F060570→ A136773 / F110261		03.2023-0825.3	010028	Ø1 23,81 Ø2 19,05
C 220 D (202.121)	70	08/93→05/00		→ A072907 / F060569		24.2022-1601.3	010340	Ø1 22,2 Ø2 17,46
				A136774 / F110262→ A519673 / F619720		24.2023-1701.3	010514	TRW Ø1 23,81 Ø2 19,05
				A519674 / F619721→		24.2023-1702.3	010534	TRW Ø1 23,81 Ø2 19,05
C 230 (202.023)	110	06/96→06/97		07/96→		24.2023-1701.3	010514	TRW Ø1 23,81 Ø2 19,05























	kw					! #		
MERCEDES-BENZ - C-KLASSE (W202) 03/93→05/00								
 Hauptbremszylinder								
C 240 (202.026)	125	06/97→05/00		- ESP		24.2023-1702.3	010534	TRW Ø1 23,81 Ø2 19,05
				+ ESP		24.2023-1704.3	010635	TRW Ø 23,81
C 250 D (202.125)	83	05/93→05/00		A072908 / F060570→; → 08/95		03.2023-0825.3	010028	Ø1 23,81 Ø2 19,05
				06/93→; → A072907 / F060569		24.2022-1601.3	010340	Ø1 22,2 Ø2 17,46
C 280 (202.028)	142	05/93→05/00		06/93→; → A136773 / F110261		03.2023-0825.3	010028	Ø1 23,81 Ø2 19,05
				→ 05/97; A136774 / F110262→		24.2023-1701.3	010514	TRW Ø1 23,81 Ø2 19,05
				06/97→; - ESP		24.2023-1702.3	010534	TRW Ø1 23,81 Ø2 19,05
				06/97→; + ESP		24.2023-1704.3	010635	TRW Ø 23,81
C 280 (202.029)	145	06/97→05/00		→ A136773 / F110261		03.2023-0825.3	010028	Ø1 23,81 Ø2 19,05
				- ESP		24.2023-1702.3	010534	TRW Ø1 23,81 Ø2 19,05
				+ ESP		24.2023-1704.3	010635	TRW Ø 23,81
C 36 AMG (202.028)	206	05/94→05/00		→ A136773 / F110261		03.2023-0825.3	010028	Ø1 23,81 Ø2 19,05
				→ 08/97; A136774 / F110262→		24.2023-1701.3	010514	TRW Ø1 23,81 Ø2 19,05
C 43 AMG (202.033)	225	08/97→05/00		09/97→		24.2023-1704.3	010635	TRW Ø 23,81
MERCEDES-BENZ - C-KLASSE (W203) 05/00→12/07								
 Bremskraftverstärker								
C 180 (203.035)	95	10/00→05/02		für Linkslenker		03.7848-2002.4	300166	ATE Ø 7 / 8" pneumatisch
C 180 Kompressor (203.046)	105	05/02→02/07						
C 200 CDI (203.004)	75	02/01→02/07						
C 200 CDI (203.004)	85	09/00→02/07						
C 200 CDI (203.007)	90	04/03→02/07						
C 200 CGI Kompressor (203.043)	125	07/03→02/07						
C 200 Kompressor (203.042)	120	05/02→02/07						
C 220 CDI (203.006)	100	05/00→02/07						
C 220 CDI (203.006)	105	05/00→02/07						
C 230 Kompressor (203.040)	141	02/04→02/07						
C 240 (203.061)	125	05/00→02/07						
C 240 4-matic (203.081)	125	07/02→02/07						
C 270 CDI (203.016)	120	12/00→02/07						
C 270 CDI (203.016)	125	12/00→02/07						
C 30 CDI AMG (203.018)	170	01/03→02/07						
C 320 (203.064)	160	05/00→02/07						
C 320 4-matic (203.084)	160	07/02→02/07						
C 55 AMG (203.076)	270	02/04→02/07						
C 200 Kompressor (203.045)	120	05/00→06/02		→ 05/02; für Linkslenker		03.7848-2002.4	300166	ATE Ø 7 / 8" pneumatisch
C 220 CDI (203.008)	110	02/03→02/07		02/04→; für Linkslenker		03.7848-2002.4	300166	ATE Ø 7 / 8" pneumatisch
C 230 (203.052)	150	01/05→02/07		06/05→; für Linkslenker		03.7848-2002.4	300166	ATE Ø 7 / 8" pneumatisch
C 280 (203.054)	170	01/05→02/07						
C 280 4-matic (203.092)	170	01/05→02/07						
C 350 (203.056)	200	01/05→02/07						
C 350 4-matic (203.087)	200	01/05→02/07						
C 320 CDI (203.020)	165	01/05→02/07		02/05→; für Linkslenker		03.7848-2002.4	300166	ATE Ø 7 / 8" pneumatisch
C 32 AMG Kompressor (203.065)	260	02/01→02/07		03/01→; für Linkslenker		03.7848-2002.4	300166	ATE Ø 7 / 8" pneumatisch
Pedalwegsensor, Bremspedal								
C 180 (203.035)	95	10/00→05/02				03.0655-0007.2	370007	ATE
C 180 Kompressor (203.046)	105	05/02→02/07						
C 200 CDI (203.004)	75	02/01→02/07						
C 200 CDI (203.004)	85	09/00→02/07						
C 200 CDI (203.007)	90	04/03→02/07						
C 200 CGI Kompressor (203.043)	125	07/03→02/07						
C 200 Kompressor (203.042)	120	05/02→02/07						
C 220 CDI (203.006)	100	05/00→02/07						
C 220 CDI (203.006)	105	05/00→02/07						
C 230 Kompressor (203.040)	141	02/04→02/07						
C 240 (203.061)	125	05/00→02/07						
C 240 4-matic (203.081)	125	07/02→02/07						
C 270 CDI (203.016)	120	12/00→02/07						
C 270 CDI (203.016)	125	12/00→02/07						
C 30 CDI AMG (203.018)	170	01/03→02/07						
C 320 (203.064)	160	05/00→02/07						
C 320 4-matic (203.084)	160	07/02→02/07						
↓								

	kW					! #		
MERCEDES-BENZ - C-KLASSE (W203) 05/00→12/07								
Pedalwegsensor, Bremspedal								
C 55 AMG (203.076)	270	02/04→02/07					03.0655-0007.2 370007	ATE
C 200 Kompressor (203.045)	120	05/00→06/02		→ 05/02			03.0655-0007.2 370007	ATE
C 220 CDI (203.008)	110	02/03→02/07		02/04→			03.0655-0007.2 370007	ATE
C 230 (203.052)	150	01/05→02/07		06/05→			03.0655-0007.2 370007	ATE
C 280 (203.054)	170	01/05→02/07						
C 350 (203.056)	200	01/05→02/07						
C 350 4-matic (203.087)	200	01/05→02/07						
C 280 4-matic (203.092)	170	01/05→02/07		06/05→; für Linkslenker			03.0655-0007.2 370007	ATE
C 320 CDI (203.020)	165	01/05→02/07		02/05→			03.0655-0007.2 370007	ATE
C 32 AMG Kompressor (203.065)	260	02/01→02/07		03/01→			03.0655-0007.2 370007	ATE
 Hauptbremszylinder								
C 180 (203.035)	95	10/00→05/02		für Linkslenker			03.2023-1741.3 010703	ATE Ø1 23,81 Ø2 20,64
C 180 Kompressor (203.046)	105	05/02→02/07						
C 200 CDI (203.004)	75	02/01→02/07						
C 200 CDI (203.004)	85	09/00→02/07						
C 200 CDI (203.007)	90	04/03→02/07						
C 200 CGI Kompressor (203.043)	125	07/03→02/07						
C 200 Kompressor (203.042)	120	05/02→02/07						
C 220 CDI (203.006)	100	05/00→02/07						
C 220 CDI (203.006)	105	05/00→02/07						
C 230 Kompressor (203.040)	141	02/04→02/07						
C 240 (203.061)	125	05/00→02/07						
C 200 Kompressor (203.045)	120	05/00→06/02		→ 05/02; für Linkslenker			03.2023-1741.3 010703	ATE Ø1 23,81 Ø2 20,64
C 220 CDI (203.008)	110	02/03→02/07		02/04→; für Linkslenker			03.2023-1741.3 010703	ATE Ø1 23,81 Ø2 20,64
C 230 (203.052)	150	01/05→02/07		06/05→; für Linkslenker			03.2025-1741.3 010705	ATE Ø1 25,4 Ø2 20,64
C 280 (203.054)	170	01/05→02/07						
C 280 4-matic (203.092)	170	01/05→02/07						
C 350 (203.056)	200	01/05→02/07						
C 350 4-matic (203.087)	200	01/05→02/07						
C 240 4-matic (203.081)	125	07/02→02/07		für Linkslenker			03.2025-1741.3 010705	ATE Ø1 25,4 Ø2 20,64
C 270 CDI (203.016)	120	12/00→02/07						
C 270 CDI (203.016)	125	12/00→02/07						
C 30 CDI AMG (203.018)	170	01/03→02/07						
C 320 (203.064)	160	05/00→02/07						
C 320 4-matic (203.084)	160	07/02→02/07						
C 55 AMG (203.076)	270	02/04→02/07						
C 320 CDI (203.020)	165	01/05→02/07		02/05→; für Linkslenker			03.2025-1741.3 010705	ATE Ø1 25,4 Ø2 20,64
C 32 AMG Kompressor (203.065)	260	02/01→02/07		03/01→; für Linkslenker			03.2025-1741.3 010705	ATE Ø1 25,4 Ø2 20,64
MERCEDES-BENZ - C-KLASSE (W204) 01/07→01/14								
 Bremskraftverstärker								
C 180 CDI (204.000)	88	01/11→01/14		für Linkslenker;			03.7745-6302.4 300261	ATE Ø 8" pneumatisch
C 180 Kompressor (204.044, 204.045)	115	01/08→01/14		für Fahrzeuge ohne Start-Stopp-Funktion				
C 200 CDI (204.001)	100	01/11→01/14		für Linkslenker;			03.7745-8902.4 300297	ATE Ø 8" pneumatisch
C 220 CDI (204.002)	120	10/08→01/14		für Fahrzeuge mit Start-Stopp-Funktion				
C 220 CDI (204.002)	125	12/08→01/14						
C 220 CDI 4-matic (204.084)	125	02/13→01/14						
C 230 4-matic (204.085)	150	07/07→01/14						
C 250 CDI (204.003)	150	08/08→01/14						
C 250 CDI 4-matic (204.082)	150	01/11→01/14						
C 250 CGI (204.047)	150	07/09→01/14						
C 280 4-matic (204.081)	170	07/07→01/14						
C 300 (204.055)	185	02/11→01/14						
C 300 4-matic (204.080)	185	02/11→01/14						
C 300 CDI 4-matic (204.092)	170	01/11→01/14						
C 320 CDI 4-matic (204.089)	165	07/07→01/14						
C 350 (204.057)	225	01/11→01/14						
C 350 4-matic (204.087)	200	07/07→01/14						
C 350 4-matic (204.088)	225	01/11→01/14						
C 350 CDI (204.023)	195	06/11→01/14						
C 350 CDI (204.025)	170	10/09→01/14						
C 350 CDI 4-matic (204.089)	165	07/09→01/14						
↓								











	kw			 	! #		
MERCEDES-BENZ - C-KLASSE (W204) 01/07→01/14							
 Bremskraftverstärker							
C 350 CDI 4-matic (204.092)	170	10/09→01/14		für Linkslenker; für Fahrzeuge ohne Start-Stopp-Funktion		03.7745-6302.4 300261	ATE Ø 8" pneumatisch
C 350 CGI (204.065)	215	09/08→01/14		für Linkslenker; für Fahrzeuge mit Start-Stopp-Funktion		03.7745-8902.4 300297	ATE Ø 8" pneumatisch
C 180 CGI (204.031)	115	01/08→01/14		04/09→; für Linkslenker; für Fahrzeuge ohne Start-Stopp-Funktion		03.7745-6302.4 300261	ATE Ø 8" pneumatisch
C 180 CGI (204.049)	115	01/07→01/14					
C 200 CGI (204.048)	135	01/07→01/14		04/09→; für Linkslenker; für Fahrzeuge mit Start-Stopp-Funktion		03.7745-8902.4 300297	ATE Ø 8" pneumatisch
C 300 4-matic (204.081)	170	07/07→01/14					
C 180 Kompressor (204.046)	115	01/07→01/14		03/07→; für Linkslenker; für Fahrzeuge ohne Start-Stopp-Funktion		03.7745-6302.4 300261	ATE Ø 8" pneumatisch
C 200 CDI (204.007, 204.006)	100	01/07→12/10		03/07→; für Linkslenker; für Fahrzeuge mit Start-Stopp-Funktion		03.7745-8902.4 300297	ATE Ø 8" pneumatisch
C 220 CDI (204.008)	120	01/07→11/08					
C 230 (204.052)	150	01/07→01/14					
C 200 Kompressor (204.041)	135	01/07→01/14		A 017628 / F 015295→; für Linkslenker; für Fahrzeuge ohne Start-Stopp-Funktion		03.7745-6302.4 300261	ATE Ø 8" pneumatisch
C 220 CDI (204.008)	125	01/07→11/08		A 017628 / F 015295→; für Linkslenker; für Fahrzeuge mit Start-Stopp-Funktion		03.7745-8902.4 300297	ATE Ø 8" pneumatisch
C 280 (204.054)	170	01/07→01/14					
C 300 (204.054)	170	07/09→01/14					
C 320 CDI (204.022)	165	01/07→01/14					
C 350 (204.056)	200	01/07→01/14					
C 350 CDI (204.022)	165	07/09→01/14					
C 63 AMG (204.077)	336	02/08→01/14					
C 63 AMG (204.077)	358	02/08→01/14					
C 63 AMG (204.077)	373	02/08→01/14					
 Hauptbremszylinder							
C 180 CDI (204.000)	88	01/11→01/14		für Linkslenker		03.2025-2521.3 010959	ATE Ø1 25,4 Ø2 22,2
C 180 Kompressor (204.044, 204.045)	115	01/08→01/14		für Rechtslenker		24.2025-2311.3 011023	ATE Ø1 25,4 Ø2 20,64
C 200 CDI (204.001)	100	01/11→01/14					
C 220 CDI (204.002)	120	10/08→01/14					
C 220 CDI (204.002)	125	12/08→01/14					
C 220 CDI 4-matic (204.084)	125	02/13→01/14					
C 230 4-matic (204.085)	150	07/07→01/14					
C 250 CDI 4-matic (204.082)	150	01/11→01/14					
C 250 CGI (204.047)	150	07/09→01/14					
C 280 4-matic (204.081)	170	07/07→01/14					
C 300 (204.054)	170	07/09→01/14					
C 300 (204.055)	185	02/11→01/14					
C 300 4-matic (204.080)	185	02/11→01/14					
C 300 CDI 4-matic (204.092)	170	01/11→01/14					
C 320 CDI 4-matic (204.089)	165	07/07→01/14					
C 350 (204.057)	225	01/11→01/14					
C 350 4-matic (204.087)	200	07/07→01/14					
C 350 4-matic (204.088)	225	01/11→01/14					
C 350 CDI (204.022)	165	07/09→01/14					
C 350 CDI (204.023)	195	06/11→01/14					
C 350 CDI (204.025)	170	10/09→01/14					
C 350 CDI 4-matic (204.089)	165	07/09→01/14					
C 350 CDI 4-matic (204.092)	170	10/09→01/14					
C 350 CGI (204.065)	215	09/08→01/14					
C 63 AMG (204.077)	336	02/08→01/14					
C 63 AMG (204.077)	358	02/08→01/14					
C 63 AMG (204.077)	373	02/08→01/14					
C 180 CGI (204.031)	115	01/08→01/14		04/09→; für Linkslenker		03.2025-2521.3 010959	ATE Ø1 25,4 Ø2 22,2
C 180 CGI (204.049)	115	01/07→01/14		04/09→; für Rechtslenker		24.2025-2311.3 011023	ATE Ø1 25,4 Ø2 20,64
C 200 CGI (204.048)	135	01/07→01/14					
C 300 4-matic (204.081)	170	07/07→01/14					
C 180 Kompressor (204.046)	115	01/07→01/14		03/07→; für Linkslenker		03.2025-2521.3 010959	ATE Ø1 25,4 Ø2 22,2
C 200 CDI (204.007, 204.006)	100	01/07→12/10		03/07→; für Rechtslenker		24.2025-2311.3 011023	ATE Ø1 25,4 Ø2 20,64
C 200 Kompressor (204.041)	135	01/07→01/14					
C 220 CDI (204.008)	120	01/07→11/08					
C 220 CDI (204.008)	125	01/07→11/08					
C 230 (204.052)	150	01/07→01/14					
C 280 (204.054)	170	01/07→01/14					
C 320 CDI (204.022)	165	01/07→01/14					
C 350 (204.056)	200	01/07→01/14					
C 250 CDI (204.003)	150	08/08→01/14		10/08→; für Linkslenker		03.2025-2521.3 010959	ATE Ø1 25,4 Ø2 22,2
				10/08→; für Rechtslenker		24.2025-2311.3 011023	ATE Ø1 25,4 Ø2 20,64











	kw					! #			
MERCEDES-BENZ - C-KLASSE Coupe (C204) 01/11→									
Bremskraftverstärker									
C 180 (204.331)	115	01/13→		für Linkslenker;			03.7745-6302.4	300261	ATE Ø 8" pneumatisch
C 180 (204.349)	115	06/11→		für Fahrzeuge ohne Start-Stopp-Funktion					
C 200 CGI (204.348)	135	06/11→		für Linkslenker;			03.7745-8902.4	300297	ATE Ø 8" pneumatisch
C 220 CDI (204.302)	120	06/11→		für Fahrzeuge mit Start-Stopp-Funktion					
C 220 CDI (204.302)	125	06/11→							
C 250 (204.347)	150	06/11→							
C 250 CDI (204.303)	150	06/11→							
C 350 (204.357)	225	06/11→							
C 63 AMG (204.377)	336	06/11→							
C 63 AMG (204.377)	358	01/12→							
C 63 AMG (204.377)	373	11/12→							
C 63 AMG (204.377)	380	01/12→							
Hauptbremszylinder									
C 180 (204.331)	115	01/13→		für Linkslenker			03.2025-2521.3	010959	ATE Ø1 25,4 Ø2 22,2
C 180 (204.349)	115	06/11→		für Rechtslenker			24.2025-2311.3	011023	ATE Ø1 25,4 Ø2 20,64
C 200 CGI (204.348)	135	06/11→							
C 220 CDI (204.302)	120	06/11→							
C 220 CDI (204.302)	125	06/11→							
C 250 (204.347)	150	06/11→							
C 250 CDI (204.303)	150	06/11→							
C 350 (204.357)	225	06/11→							
C 63 AMG (204.377)	336	06/11→							
C 63 AMG (204.377)	358	01/12→							
C 63 AMG (204.377)	373	11/12→							
C 63 AMG (204.377)	380	01/12→							
MERCEDES-BENZ - C-KLASSE Sportcoupe (CL203) 03/01→06/11									
Bremskraftverstärker									
C 160 Kompressor (203.730)	90	05/02→05/08		04/05→; für Linkslenker			03.7848-2002.4	300166	ATE Ø 7 / 8" pneumatisch
C 180 (203.735)	95	03/01→05/02		für Linkslenker			03.7848-2002.4	300166	ATE Ø 7 / 8" pneumatisch
C 180 Kompressor (203.746)	105	05/02→05/08							
C 200 Kompressor (203.742)	120	05/02→05/08							
C 200 Kompressor (203.745)	120	03/01→05/02							
C 220 CDI	100	03/01→01/04							
C 220 CDI (203.706)	105	03/01→01/04							
C 220 CDI (203.708)	110	02/04→05/08							
C 230 Kompressor (203.740)	141	05/02→05/08							
C 230 Kompressor (203.747)	145	03/01→05/02							
C 30 CDI AMG (203.718)	170	09/02→05/08							
C 320 (203.764)	160	09/02→05/08							
C 200 CDI (203.707)	90	03/03→05/08		07/03→; für Linkslenker			03.7848-2002.4	300166	ATE Ø 7 / 8" pneumatisch
C 200 CGI Kompressor (203.743)	125	03/03→05/08							
C 230 (203.752)	150	01/05→05/08		06/05→; für Linkslenker			03.7848-2002.4	300166	ATE Ø 7 / 8" pneumatisch
C 350 (203.756)	200	01/05→05/08							
Pedalwegsensor, Bremspedal									
C 160 Kompressor (203.730)	90	05/02→05/08		04/05→			03.0655-0007.2	370007	ATE
C 180 (203.735)	95	03/01→05/02					03.0655-0007.2	370007	ATE
C 180 Kompressor (203.746)	105	05/02→05/08							
C 200 Kompressor (203.742)	120	05/02→05/08							
C 200 Kompressor (203.745)	120	03/01→05/02							
C 220 CDI	100	03/01→01/04							
C 220 CDI (203.706)	105	03/01→01/04							
C 220 CDI (203.708)	110	02/04→05/08							
C 230 Kompressor (203.740)	141	05/02→05/08							
C 230 Kompressor (203.747)	145	03/01→05/02							
C 30 CDI AMG (203.718)	170	09/02→05/08							
C 320 (203.764)	160	09/02→05/08							
C 200 CDI (203.707)	90	03/03→05/08		07/03→			03.0655-0007.2	370007	ATE
C 200 CGI Kompressor (203.743)	125	03/03→05/08							
C 230 (203.752)	150	01/05→05/08		06/05→			03.0655-0007.2	370007	ATE
C 350 (203.756)	200	01/05→05/08							
↓									













	kw					! #		
MERCEDES-BENZ - C-KLASSE Sportcoupe (CL203) 03/01→06/11								
 Hauptbremszylinder								
C 160 Kompressor (203.730)	90	05/02→05/08		04/05→; für Linkslenker			03.2023-1741.3 010703	ATE Ø1 23,81 Ø2 20,64
C 180 (203.735) C 180 Kompressor (203.746) C 200 Kompressor (203.742) C 200 Kompressor (203.745) C 220 CDI C 220 CDI (203.706) C 220 CDI (203.708) C 230 Kompressor (203.740) C 230 Kompressor (203.747)	95 105 120 120 100 105 110 141 145	03/01→05/02 05/02→05/08 05/02→05/08 03/01→05/02 03/01→01/04 03/01→01/04 02/04→05/08 05/02→05/08 03/01→05/02		für Linkslenker			03.2023-1741.3 010703	ATE Ø1 23,81 Ø2 20,64
C 200 CDI (203.707) C 200 CGI Kompressor (203.743)	90 125	03/03→05/08 03/03→05/08		07/03→; für Linkslenker			03.2023-1741.3 010703	ATE Ø1 23,81 Ø2 20,64
C 230 (203.752) C 350 (203.756)	150 200	01/05→05/08 01/05→05/08		06/05→; für Linkslenker			03.2025-1741.3 010705	ATE Ø1 25,4 Ø2 20,64
C 30 CDI AMG (203.718) C 320 (203.764)	170 160	09/02→05/08 09/02→05/08		für Linkslenker			03.2025-1741.3 010705	ATE Ø1 25,4 Ø2 20,64
MERCEDES-BENZ - C-KLASSE T-Model (S202) 06/96→03/01								
 Bremskraftverstärker								
C 180 T (202.078) C 180 T (202.081) C 200 T (202.080) C 200 T D (202.180) C 200 T Kompressor (202.082) C 200 T Kompressor (202.087) C 220 T D (202.182) C 220 T D (202.182) C 230 T (202.083) C 250 T Turbo-D (202.188)	90 95 100 65 141 120 55 70 110 110	06/96→09/00 09/00→03/01 06/96→03/01 10/96→03/01 11/96→03/01 09/00→03/01 06/96→03/01 06/96→09/98 06/96→06/98 06/96→03/01		→ F619720			03.7760-2702.4 300090	ATE Ø 10" pneumatisch
 Hauptbremszylinder								
C 180 T (202.078) C 180 T (202.081) C 200 T (202.080) C 200 T D (202.180) C 200 T Kompressor (202.082) C 220 T D (202.182) C 220 T D (202.182) C 250 T Turbo-D (202.188)	90 95 100 65 141 55 70 110	06/96→09/00 09/00→03/01 06/96→03/01 10/96→03/01 11/96→03/01 06/96→03/01 06/96→09/98 06/96→03/01		→ F619720 F619721→			24.2023-1701.3 010514 24.2023-1702.3 010534	TRW Ø1 23,81 Ø2 19,05 TRW Ø1 23,81 Ø2 19,05
C 200 T CDI (202.194) C 220 T CDI (202.193) C 230 T Kompressor (202.085)	75 92 142	03/98→03/01 09/97→03/01 06/97→09/00					24.2023-1702.3 010534	TRW Ø1 23,81 Ø2 19,05
C 200 T Kompressor (202.087)	120	09/00→03/01		→ F619720 F619621→			24.2023-1701.3 010514 24.2023-1702.3 010534	TRW Ø1 23,81 Ø2 19,05 TRW Ø1 23,81 Ø2 19,05
C 230 T (202.083)	110	06/96→06/98		→ F619720 → 06/97; F619721→			24.2023-1701.3 010514 24.2023-1702.3 010534	TRW Ø1 23,81 Ø2 19,05 TRW Ø1 23,81 Ø2 19,05
C 240 T (202.086) C 240 T (202.088) C 280 T (202.089)	125 125 145	06/97→09/00 09/00→03/01 06/97→03/01		- ESP + ESP			24.2023-1702.3 010534 24.2023-1704.3 010635	TRW Ø1 23,81 Ø2 19,05 TRW Ø 23,81
C 43 AMG (202.093)	225	08/97→03/01		09/97→			24.2023-1704.3 010635	TRW Ø 23,81
MERCEDES-BENZ - C-KLASSE T-Model (S203) 03/01→08/07								
 Bremskraftverstärker								
C 180 (203.235) C 180 Kompressor (203.246) C 200 CDI (203.204, 203.207) C 200 CDI (203.204) C 200 CDI (203.207) C 200 CGI Kompressor (203.243) C 200 Kompressor (203.242) ↓	95 105 75 85 90 125 120	03/01→05/02 05/02→08/07 03/01→08/07 03/01→08/07 04/03→08/07 07/03→08/07 05/02→08/07		für Linkslenker			03.7848-2002.4 300166	ATE Ø 7 / 8" pneumatisch











	kW			 	! #		
MERCEDES-BENZ - C-KLASSE T-Model (S203) 03/01→08/07							
 Bremskraftverstärker							
C 220 CDI (203.206)	105	03/01→08/07		für Linkslenker		03.7848-2002.4 300166	ATE Ø 7 / 8" pneumatisch
C 220 CDI (203.208)	100	08/06→08/07					
C 220 CDI (203.208)	110	02/04→08/07					
C 230 Kompressor (203.240)	141	02/04→08/07					
C 240 (203.261)	125	03/01→08/07					
C 240 4-matic (203.281)	125	07/02→08/07					
C 270 CDI (203.216)	120	03/01→08/07					
C 270 CDI (203.216)	125	03/01→08/07					
C 30 CDI AMG (203.218)	170	01/03→08/07					
C 320 (203.264)	160	03/01→08/07					
C 320 4-matic (203.284)	160	07/02→08/07					
C 320 CDI (203.220)	165	06/05→08/07					
C 32 AMG Kompressor (203.265)	260	03/01→08/07					
C 55 AMG (203.276)	270	02/04→08/07					
C 200 Kompressor (203.245)	120	03/01→05/02		→ 04/02; für Linkslenker		03.7848-2002.4 300166	ATE Ø 7 / 8" pneumatisch
C 230 (203.252)	150	01/05→08/07		06/05→; für Linkslenker		03.7848-2002.4 300166	ATE Ø 7 / 8" pneumatisch
C 280 (203.254)	170	01/05→08/07					
C 280 4-matic (203.292)	170	01/05→08/07					
C 350 (203.256)	200	01/05→08/07					
C 350 4-matic (203.287)	200	01/05→08/07					
Pedalwegsensoren, Bremspedal							
C 180 (203.235)	95	03/01→05/02				03.0655-0007.2 370007	ATE
C 180 Kompressor (203.246)	105	05/02→08/07					
C 200 CDI (203.204, 203.207)	75	03/01→08/07					
C 200 CDI (203.204)	85	03/01→08/07					
C 200 CDI (203.207)	90	04/03→08/07					
C 200 CGI Kompressor (203.243)	125	07/03→08/07					
C 200 Kompressor (203.242)	120	05/02→08/07					
C 220 CDI (203.206)	105	03/01→08/07					
C 220 CDI (203.208)	100	08/06→08/07					
C 220 CDI (203.208)	110	02/04→08/07					
C 230 Kompressor (203.240)	141	02/04→08/07					
C 240 (203.261)	125	03/01→08/07					
C 240 4-matic (203.281)	125	07/02→08/07					
C 270 CDI (203.216)	120	03/01→08/07					
C 270 CDI (203.216)	125	03/01→08/07					
C 30 CDI AMG (203.218)	170	01/03→08/07					
C 320 (203.264)	160	03/01→08/07					
C 320 4-matic (203.284)	160	07/02→08/07					
C 320 CDI (203.220)	165	06/05→08/07					
C 32 AMG Kompressor (203.265)	260	03/01→08/07					
C 55 AMG (203.276)	270	02/04→08/07					
C 200 Kompressor (203.245)	120	03/01→05/02		→ 04/02		03.0655-0007.2 370007	ATE
C 230 (203.252)	150	01/05→08/07		06/05→		03.0655-0007.2 370007	ATE
C 280 (203.254)	170	01/05→08/07					
C 350 (203.256)	200	01/05→08/07					
C 350 4-matic (203.287)	200	01/05→08/07					
C 280 4-matic (203.292)	170	01/05→08/07		06/05→; für Linkslenker		03.0655-0007.2 370007	ATE
 Hauptbremszylinder							
C 180 (203.235)	95	03/01→05/02		für Linkslenker		03.2023-1741.3 010703	ATE Ø1 23,81 Ø2 20,64
C 180 Kompressor (203.246)	105	05/02→08/07					
C 200 CDI (203.204, 203.207)	75	03/01→08/07					
C 200 CDI (203.204)	85	03/01→08/07					
C 200 CDI (203.207)	90	04/03→08/07					
C 200 CGI Kompressor (203.243)	125	07/03→08/07					
C 200 Kompressor (203.242)	120	05/02→08/07					
C 220 CDI (203.206)	105	03/01→08/07					
C 220 CDI (203.208)	100	08/06→08/07					
C 220 CDI (203.208)	110	02/04→08/07					
C 230 Kompressor (203.240)	141	02/04→08/07					
C 240 (203.261)	125	03/01→08/07					
C 200 Kompressor (203.245)	120	03/01→05/02		→ 04/02; für Linkslenker		03.2023-1741.3 010703	ATE Ø1 23,81 Ø2 20,64
↓							























	kw					! #		
MERCEDES-BENZ - C-KLASSE T-Model (S203) 03/01→08/07								
 Hauptbremszylinder								
C 230 (203.252)	150	01/05→08/07		06/05→; für Linkslenker			03.2025-1741.3 010705	ATE Ø1 25,4 Ø2 20,64
C 280 (203.254)	170	01/05→08/07						
C 280 4-matic (203.292)	170	01/05→08/07						
C 350 (203.256)	200	01/05→08/07						
C 350 4-matic (203.287)	200	01/05→08/07						
C 240 4-matic (203.281)	125	07/02→08/07		für Linkslenker			03.2025-1741.3 010705	ATE Ø1 25,4 Ø2 20,64
C 270 CDI (203.216)	120	03/01→08/07						
C 270 CDI (203.216)	125	03/01→08/07						
C 30 CDI AMG (203.218)	170	01/03→08/07						
C 320 (203.264)	160	03/01→08/07						
C 320 4-matic (203.284)	160	07/02→08/07						
C 320 CDI (203.220)	165	06/05→08/07						
C 32 AMG Kompressor (203.265)	260	03/01→08/07						
C 55 AMG (203.276)	270	02/04→08/07						
MERCEDES-BENZ - C-KLASSE T-Model (S204) 08/07→08/14								
 Bremskraftverstärker								
C 180 (204.231)	115	02/12→08/14		für Linkslenker;			03.7745-6302.4 300261	ATE Ø 8" pneumatisch
C 180 CDI (204.200)	88	01/11→08/14		für Fahrzeuge ohne Start-Stopp-Funktion				
C 180 CGI (204.249)	115	11/09→08/14						
C 180 Kompressor (204.245)	115	01/08→08/14		für Linkslenker;			03.7745-8902.4 300297	ATE Ø 8" pneumatisch
C 200 CDI (204.201)	100	08/10→08/14						
C 220 CDI (204.202)	120	12/08→08/14						
C 220 CDI (204.202)	125	12/08→08/14						
C 220 CDI 4-matic (204.284)	125	02/13→08/14						
C 250 CDI 4-matic (204.282)	150	04/10→08/14						
C 250 CGI (204.247)	150	07/09→08/14						
C 350 CDI (204.223)	195	06/11→08/14						
C 350 CDI (204.225)	170	10/09→08/14						
C 350 CDI 4-matic (204.292)	170	10/09→08/14						
C 350 CGI (204.257)	225	06/11→08/14						
C 63 AMG	373	06/13→08/14						
C 63 AMG (204.277)	336	02/08→08/14						
C 63 AMG (204.277)	358	01/12→08/14						
C 180 Kompressor (204.246)	115	08/07→08/14		09/07→; für Linkslenker;			03.7745-6302.4 300261	ATE Ø 8" pneumatisch
C 200 CDI (204.207)	100	08/07→12/11		für Fahrzeuge ohne Start-Stopp-Funktion				
C 200 Kompressor (204.241)	135	08/07→08/14		09/07→; für Linkslenker;			03.7745-8902.4 300297	ATE Ø 8" pneumatisch
C 220 CDI (204.208)	125	08/07→11/08						
C 230 (204.252)	150	08/07→08/14						
C 280 (204.254)	170	08/07→08/14						
C 320 CDI (204.222)	165	08/07→08/14						
C 320 CDI 4-matic (204.289)	165	08/07→08/14						
C 350 (204.256)	200	08/07→08/14						
C 200 CGI (204.248)	135	08/07→08/14		04/09→; für Linkslenker;			03.7745-6302.4 300261	ATE Ø 8" pneumatisch
C 250 CDI (204.203)	150	01/09→08/14		für Fahrzeuge ohne Start-Stopp-Funktion				
				04/09→; für Linkslenker;			03.7745-8902.4 300297	ATE Ø 8" pneumatisch
				für Fahrzeuge mit Start-Stopp-Funktion				
C 220 CDI (204.208)	120	08/07→11/08		09/07→; für Linkslenker;			03.7745-6302.4 300261	ATE Ø 8" pneumatisch
				für Fahrzeuge ohne Start-Stopp-Funktion				
				für Linkslenker;			03.7745-6302.4 300261	ATE Ø 8" pneumatisch
				für Fahrzeuge ohne Start-Stopp-Funktion				
				für Linkslenker;			03.7745-8902.4 300297	ATE Ø 8" pneumatisch
				für Fahrzeuge mit Start-Stopp-Funktion				
				09/07→; für Linkslenker;			03.7745-8902.4 300297	ATE Ø 8" pneumatisch
				für Fahrzeuge mit Start-Stopp-Funktion				
 Hauptbremszylinder								
C 180 (204.231)	115	02/12→08/14		für Linkslenker			03.2025-2521.3 010959	ATE Ø1 25,4 Ø2 22,2
C 180 CDI (204.200)	88	01/11→08/14						
C 180 CGI (204.249)	115	11/09→08/14		für Rechtslenker			24.2025-2311.3 011023	ATE Ø1 25,4 Ø2 20,64
C 180 Kompressor (204.245)	115	01/08→08/14						
C 200 CDI (204.201)	100	08/10→08/14						
C 220 CDI (204.202)	120	12/08→08/14						
C 220 CDI (204.202)	125	12/08→08/14						
C 220 CDI 4-matic (204.284)	125	02/13→08/14						
C 250 CDI 4-matic (204.282)	150	04/10→08/14						
C 250 CGI (204.247)	150	07/09→08/14						
C 350 CDI (204.223)	195	06/11→08/14						
↓								











	kW			 	! #		
MERCEDES-BENZ - C-KLASSE T-Model (S204) 08/07→08/14							
 Hauptbremszylinder							
C 350 CDI (204.225)	170	10/09→08/14		für Linkslenker		03.2025-2521.3 010959	ATE Ø1 25,4 Ø2 22,2
C 350 CDI 4-matic (204.292)	170	10/09→08/14		für Rechtslenker		24.2025-2311.3 011023	ATE Ø1 25,4 Ø2 20,64
C 350 CGI (204.257)	225	06/11→08/14					
C 63 AMG	373	06/13→08/14					
C 63 AMG (204.277)	336	02/08→08/14					
C 63 AMG (204.277)	358	01/12→08/14					
C 180 Kompressor (204.246)	115	08/07→08/14		09/07→; für Linkslenker		03.2025-2521.3 010959	ATE Ø1 25,4 Ø2 22,2
C 200 CDI (204.207)	100	08/07→12/11		09/07→; für Rechtslenker		24.2025-2311.3 011023	ATE Ø1 25,4 Ø2 20,64
C 200 Kompressor (204.241)	135	08/07→08/14					
C 220 CDI (204.208)	125	08/07→11/08					
C 230 (204.252)	150	08/07→08/14					
C 280 (204.254)	170	08/07→08/14					
C 320 CDI (204.222)	165	08/07→08/14					
C 320 CDI 4-matic (204.289)	165	08/07→08/14					
C 350 (204.256)	200	08/07→08/14					
C 200 CGI (204.248)	135	08/07→08/14		04/09→; für Linkslenker		03.2025-2521.3 010959	ATE Ø1 25,4 Ø2 22,2
C 250 CDI (204.203)	150	01/09→08/14		04/09→; für Rechtslenker		24.2025-2311.3 011023	ATE Ø1 25,4 Ø2 20,64
C 220 CDI (204.208)	120	08/07→11/08		für Linkslenker		03.2025-2521.3 010959	ATE Ø1 25,4 Ø2 22,2
				09/07→; für Linkslenker		03.2025-2521.3 010959	ATE Ø1 25,4 Ø2 22,2
				09/07→; für Rechtslenker		24.2025-2311.3 011023	ATE Ø1 25,4 Ø2 20,64
				für Rechtslenker		24.2025-2311.3 011023	ATE Ø1 25,4 Ø2 20,64
MERCEDES-BENZ - CLA Coupe (C117) 01/13→							
 Hauptbremszylinder							
AMG CLA 45 4-matic (117.352)	280	07/15→		für Linkslenker		24.4123-1718.3 011016	TRW Ø 23,81 ohne Bremsflüssigkeitsbehälter
CLA 180 (117.342)	90	01/13→					
CLA 180 CDI / d (117.312)	80	10/13→					
CLA 200 (117.343)	115	01/13→					
CLA 200 CDI / d (117.308)	100	07/14→					
CLA 200 CDI / d 4-matic (117.302)	100	07/14→					
CLA 200 CDI (117.301)	100	06/13→					
CLA 220 4-matic (117.347)	135	04/16→					
CLA 220 CDI / d (117.303)	120	01/13→					
CLA 220 CDI / d (117.303)	125	01/13→					
CLA 220 CDI / d (117.303)	130	09/14→					
CLA 220 CDI / d 4-matic (117.305)	120	08/14→					
CLA 220 CDI / d 4-matic (117.305)	130	09/14→					
CLA 220 CDI 4-matic (117.305)	125	07/14→					
CLA 250 (117.344)	155	01/13→					
CLA 250 (117.350)	160	07/15→					
CLA 250 4-matic (117.346)	155	07/13→					
CLA 250 4-matic (117.351)	160	07/15→					
CLA 45 AMG 4-matic (117.352)	265	07/13→06/15					
MERCEDES-BENZ - CLA Shooting Brake (X117) 01/15→							
 Hauptbremszylinder							
AMG CLA 45 4-matic (117.952)	280	07/15→		für Linkslenker		24.4123-1718.3 011016	TRW Ø 23,81 ohne Bremsflüssigkeitsbehälter
CLA 180 (117.942)	90	01/15→					
CLA 180 d (117.912)	80	07/15→					
CLA 200 (117.943)	115	01/15→					
CLA 200 CDI / d (117.908)	100	01/15→					
CLA 200 CDI / d 4-matic (117.902)	100	01/15→					
CLA 220 4-matic (117.947)	135	04/16→					
CLA 220 CDI / d (117.903)	120	01/15→					
CLA 220 CDI / d (117.903)	130	01/15→					
↓							











	kW			 	! #		
MERCEDES-BENZ - CLA Shooting Brake (X117) 01/15→							
 Hauptbremszylinder							
CLA 220 CDI / d 4-matic (117.905)	120	09/15→		für Linkslenker		24.4123-1718.3 011016	TRW Ø 23,81 ohne Bremsflüssigkeitsbehälter
CLA 220 CDI / d 4-matic (117.905)	130	01/15→					
CLA 220 d (117.903)	125	07/18→					
CLA 220 d 4-matic (117.905)	125	07/18→					
CLA 250 (117.944)	155	01/15→					
CLA 250 4-matic (117.946)	155	01/15→					
CLA 250 4-matic (117.951)	160	07/15→					
CLA 45 AMG 4-matic (117.952)	265	01/15→06/15					
MERCEDES-BENZ - CLC-KLASSE (CL203) 05/08→06/11							
 Bremskraftverstärker							
CLC 160 (203.731)	95	02/09→06/11		→ 10/10; für Linkslenker		03.7848-2002.4 300166	ATE Ø 7 / 8" pneumatisch
CLC 180 Kompressor (203.746)	105	05/08→06/11					
CLC 200 CDI (203.707)	90	05/08→06/11					
CLC 200 Kompressor (203.741)	135	05/08→06/11					
CLC 220 CDI (203.708)	110	05/08→06/11					
CLC 230 (203.752)	150	05/08→06/11					
CLC 350 (203.756)	200	05/08→06/11					
Pedalwegsensoren, Bremspedal							
CLC 160 (203.731)	95	02/09→06/11		→ 10/10		03.0655-0007.2 370007	ATE
CLC 180 Kompressor (203.746)	105	05/08→06/11					
CLC 200 CDI (203.707)	90	05/08→06/11					
CLC 200 Kompressor (203.741)	135	05/08→06/11					
CLC 220 CDI (203.708)	110	05/08→06/11					
CLC 230 (203.752)	150	05/08→06/11					
CLC 350 (203.756)	200	05/08→06/11					
 Hauptbremszylinder							
CLC 160 (203.731)	95	02/09→06/11		→ 10/10; für Linkslenker		03.2023-1741.3 010703	ATE Ø1 23,81 Ø2 20,64
CLC 180 Kompressor (203.746)	105	05/08→06/11					
CLC 200 CDI (203.707)	90	05/08→06/11					
CLC 200 Kompressor (203.741)	135	05/08→06/11					
CLC 220 CDI (203.708)	110	05/08→06/11					
CLC 230 (203.752)	150	05/08→06/11		→ 10/10; für Linkslenker		03.2025-1741.3 010705	ATE Ø1 25,4 Ø2 20,64
CLC 350 (203.756)	200	05/08→06/11					
MERCEDES-BENZ - CLK (C208) 06/97→12/03							
 Bremskraftverstärker							
200 (208.335)	100	06/97→06/02		F 129679→		03.7863-0903.4 300244	ATE Ø 10" pneumatisch
200 Kompressor (208.345)	141	06/97→06/00					
230 Kompressor (208.347)	142	06/97→06/00					
200 Kompressor (208.344)	120	06/00→06/02				03.7863-0903.4 300244	ATE Ø 10" pneumatisch
230 Kompressor (208.348)	145	06/00→06/02					
Pedalwegsensoren, Bremspedal							
200 (208.335)	100	06/97→06/02		F 129679→		03.0655-0007.2 370007	ATE
200 Kompressor (208.345)	141	06/97→06/00					
230 Kompressor (208.347)	142	06/97→06/00					
200 Kompressor (208.344)	120	06/00→06/02				03.0655-0007.2 370007	ATE
230 Kompressor (208.348)	145	06/00→06/02					
 Hauptbremszylinder							
200 (208.335)	100	06/97→06/02		F 129679→; für Linkslenker		03.2023-2004.3 010788	ATE Ø1 23,81 Ø2 19,05
200 Kompressor (208.345)	141	06/97→06/00		→ F 129678; - ESP		24.2023-1702.3 010534	TRW Ø1 23,81 Ø2 19,05
230 Kompressor (208.347)	142	06/97→06/00					
↓							

	kW			 	! #		
MERCEDES-BENZ - CLK (C208) 06/97→12/03							
 Hauptbremszylinder							
200 Kompressor (208.344)	120	06/00→06/02		für Linkslenker		03.2023-2004.3 010788	ATE Ø1 23,81 Ø2 19,05
230 Kompressor (208.348)	145	06/00→06/02					
320 (208.365)	160	06/97→06/02		→ F 129678; - ESP		24.2023-1702.3 010534	TRW Ø1 23,81 Ø2 19,05
				F 129679→		24.2023-1704.3 010635	TRW Ø 23,81
				→ F 129678; + ESP		24.2023-1704.3 010635	TRW Ø 23,81
430 (208.370)	205	07/98→06/02				24.2025-1709.3 010693	Ø 25,4
55 AMG (208.374)	255	08/99→06/02					
MERCEDES-BENZ - CLK (C209) 06/02→05/09							
 Bremskraftverstärker							
200 CGI (209.343)	125	07/03→05/09		→ 04/09; für Linkslenker		03.7848-2002.4 300166	ATE Ø 7 / 8" pneumatisch
200 Kompressor (209.341)	135	10/06→05/09					
200 Kompressor (209.342)	120	09/02→05/09					
240 (209.361)	120	06/02→05/09					
240 (209.361)	125	06/02→05/09					
270 CDI (209.316)	125	10/02→05/09					
320 (209.365)	160	06/02→05/09					
500 (209.372)	285	06/06→05/09					
500 (209.375)	225	06/02→05/09					
55 AMG (209.376)	270	09/02→05/09					
63 AMG (209.377)	354	04/06→05/09					
63 AMG (209.377)	373	05/07→05/09					
220 CDI (209.308)	100	01/05→05/09		05/05→ 04/09; für Linkslenker		03.7848-2002.4 300166	ATE Ø 7 / 8" pneumatisch
220 CDI (209.308)	110	01/05→05/09					
280 (209.354)	170	01/05→05/09					
320 CDI (209.320)	165	01/05→05/09					
350 (209.356)	200	01/05→05/09					
270 CDI (209.316)	120	02/03→06/05		für Linkslenker		03.7848-2002.4 300166	ATE Ø 7 / 8" pneumatisch
Pedalwegsensor, Bremspedal							
200 CGI (209.343)	125	07/03→05/09		→ 04/09		03.0655-0007.2 370007	ATE
200 Kompressor (209.341)	135	10/06→05/09					
200 Kompressor (209.342)	120	09/02→05/09					
240 (209.361)	120	06/02→05/09					
240 (209.361)	125	06/02→05/09					
270 CDI (209.316)	125	10/02→05/09					
320 (209.365)	160	06/02→05/09					
500 (209.372)	285	06/06→05/09					
500 (209.375)	225	06/02→05/09					
55 AMG (209.376)	270	09/02→05/09					
63 AMG (209.377)	354	04/06→05/09					
63 AMG (209.377)	373	05/07→05/09					
220 CDI (209.308)	100	01/05→05/09		05/05→ 04/09		03.0655-0007.2 370007	ATE
220 CDI (209.308)	110	01/05→05/09					
280 (209.354)	170	01/05→05/09					
320 CDI (209.320)	165	01/05→05/09					
350 (209.356)	200	01/05→05/09					
270 CDI (209.316)	120	02/03→06/05				03.0655-0007.2 370007	ATE
 Hauptbremszylinder							
200 CGI (209.343)	125	07/03→05/09		→ 04/09; für Linkslenker;		03.2023-1741.3 010703	ATE Ø1 23,81 Ø2 20,64
200 Kompressor (209.342)	120	09/02→05/09		für Fahrzeuge ohne Sportpaket / für Fahrzeuge ohne AMG-Sportpaket			
270 CDI (209.316)	125	10/02→05/09		→ 04/09; für Linkslenker;		03.2025-1741.3 010705	ATE Ø1 25,4 Ø2 20,64
				für Fahrzeuge mit Sportpaket / für Fahrzeuge mit AMG-Sportpaket			
200 Kompressor (209.341)	135	10/06→05/09		→ 04/09; für Linkslenker;		03.2023-1741.3 010703	ATE Ø1 23,81 Ø2 20,64
				für Fahrzeuge ohne AMG-Sportpaket / für Fahrzeuge ohne Sportpaket			
				→ 04/09; für Linkslenker;		03.2025-1741.3 010705	ATE Ø1 25,4 Ø2 20,64
				für Fahrzeuge mit Sportpaket / für Fahrzeuge mit AMG-Sportpaket			
220 CDI (209.308)	100	01/05→05/09		05/05→ 04/09; für Linkslenker		03.2025-1741.3 010705	ATE Ø1 25,4 Ø2 20,64
220 CDI (209.308)	110	01/05→05/09					
280 (209.354)	170	01/05→05/09					
320 CDI (209.320)	165	01/05→05/09					
350 (209.356)	200	01/05→05/09					
240 (209.361)	120	06/02→05/09		→ 04/09; für Linkslenker		03.2025-1741.3 010705	ATE Ø1 25,4 Ø2 20,64
240 (209.361)	125	06/02→05/09					
320 (209.365)	160	06/02→05/09					
500 (209.372)	285	06/06→05/09					
500 (209.375)	225	06/02→05/09					
↓							











	kw			 	! #		
MERCEDES-BENZ - CLK (C209) 06/02→05/09							
 Hauptbremszylinder							
55 AMG (209.376)	270	09/02→05/09		→ 04/09; für Linkslenker		03.2025-1741.3 010705	ATE Ø1 25,4 Ø2 20,64
63 AMG (209.377)	354	04/06→05/09					
63 AMG (209.377)	373	05/07→05/09					
270 CDI (209.316)	120	02/03→06/05		für Linkslenker; für Fahrzeuge ohne Sportpaket / für Fahrzeuge ohne AMG-Sportpaket		03.2023-1741.3 010703	ATE Ø1 23,81 Ø2 20,64
				für Linkslenker; für Fahrzeuge mit Sportpaket / für Fahr- zeuge mit AMG-Sportpaket		03.2025-1741.3 010705	ATE Ø1 25,4 Ø2 20,64
MERCEDES-BENZ - CLK Cabriolet (A208) 03/98→03/02							
 Bremskraftverstärker							
200 (208.435)	100	03/98→03/02		T 028296→		03.7863-0903.4 300244	ATE Ø 10" pneumatisch
200 Kompressor (208.445)	141	03/98→06/00					
230 Kompressor (208.447)	142	03/98→06/00					
200 Kompressor (208.444)	120	06/00→03/02		T 028296→		03.7863-0903.4 300244	ATE Ø 10" pneumatisch
230 Kompressor (208.448)	145	06/00→03/02				03.7863-0903.4 300244	ATE Ø 10" pneumatisch
Pedalwegsensor, Bremspedal							
200 (208.435)	100	03/98→03/02		T 028296→		03.0655-0007.2 370007	ATE
200 Kompressor (208.445)	141	03/98→06/00					
230 Kompressor (208.447)	142	03/98→06/00					
200 Kompressor (208.444)	120	06/00→03/02		T 028296→		03.0655-0007.2 370007	ATE
230 Kompressor (208.448)	145	06/00→03/02				03.0655-0007.2 370007	ATE
 Hauptbremszylinder							
200 (208.435)	100	03/98→03/02		T 028296→; für Linkslenker		03.2023-2004.3 010788	ATE Ø1 23,81 Ø2 19,05
200 Kompressor (208.445)	141	03/98→06/00		06/98→; → T 028295; - ESP		24.2023-1702.3 010534	TRW Ø1 23,81 Ø2 19,05
230 Kompressor (208.447)	142	03/98→06/00					
200 Kompressor (208.444)	120	06/00→03/02		T 028296→; für Linkslenker		03.2023-2004.3 010788	ATE Ø1 23,81 Ø2 19,05
230 Kompressor (208.448)	145	06/00→03/02		für Linkslenker		03.2023-2004.3 010788	ATE Ø1 23,81 Ø2 19,05
				→ T 028295; - ESP		24.2023-1702.3 010534	TRW Ø1 23,81 Ø2 19,05
320 (208.465)	160	03/98→03/02		06/98→; → T 028295; - ESP		24.2023-1702.3 010534	TRW Ø1 23,81 Ø2 19,05
				06/98→; → T 028295; + ESP		24.2023-1704.3 010635	TRW Ø 23,81
				T 028296→		24.2023-1704.3 010635	TRW Ø 23,81
430 (208.470)	205	09/98→03/02		06/99→		24.2025-1709.3 010693	Ø 25,4
55 AMG (208.474)	255	01/00→03/02				24.2025-1709.3 010693	Ø 25,4
MERCEDES-BENZ - CLK Cabriolet (A209) 02/03→03/10							
 Bremskraftverstärker							
CLK 200 CGI (209.343)	125	07/03→03/10		→ 12/09; für Linkslenker		03.7848-2002.4 300166	ATE Ø 7 / 8" pneumatisch
CLK 200 Kompressor (209.441)	135	10/06→03/10					
CLK 500 (209.472)	285	06/06→03/10					
CLK 63 AMG (209.477)	354	04/06→03/10					
CLK 200 Kompressor (209.442)	120	02/03→03/10		05/03→ 12/09; für Linkslenker		03.7848-2002.4 300166	ATE Ø 7 / 8" pneumatisch
CLK 240 (209.461)	125	02/03→03/10					
CLK 320 (209.465)	160	02/03→03/10					
CLK 500 (209.475)	225	02/03→03/10					
CLK 55 AMG (209.476)	270	02/03→03/10					
CLK 280 (209.454)	170	01/05→03/10		05/05→ 12/09; für Linkslenker		03.7848-2002.4 300166	ATE Ø 7 / 8" pneumatisch
CLK 320 CDI (209.420)	165	03/05→03/10					
CLK 350 (209.456)	200	01/05→03/10					
Pedalwegsensor, Bremspedal							
CLK 200 CGI (209.343)	125	07/03→03/10		→ 12/09		03.0655-0007.2 370007	ATE
CLK 200 Kompressor (209.441)	135	10/06→03/10					
CLK 500 (209.472)	285	06/06→03/10					
CLK 63 AMG (209.477)	354	04/06→03/10					
CLK 200 Kompressor (209.442)	120	02/03→03/10		05/03→ 12/09		03.0655-0007.2 370007	ATE
CLK 240 (209.461)	125	02/03→03/10					
CLK 320 (209.465)	160	02/03→03/10					
CLK 500 (209.475)	225	02/03→03/10					









	kW					! #		
MERCEDES-BENZ - CLK Cabriolet (A209) 02/03→03/10								
Pedalwegsensor, Bremspedal								
CLK 55 AMG (209.476)	270	02/03→03/10		05/03→ 12/09			03.0655-0007.2 370007	ATE
CLK 280 (209.454)	170	01/05→03/10		05/05→ 12/09			03.0655-0007.2 370007	ATE
CLK 320 CDI (209.420)	165	03/05→03/10						
CLK 350 (209.456)	200	01/05→03/10						
 Hauptbremszylinder								
CLK 200 CGI (209.343)	125	07/03→03/10		→ 12/09; für Linkslenker			03.2023-1741.3 010703	ATE Ø1 23,81 Ø2 20,64
CLK 200 Kompressor (209.441)	135	10/06→03/10		→ 12/09; für Linkslenker			03.2025-1741.3 010705	ATE Ø1 25,4 Ø2 20,64
CLK 500 (209.472)	285	06/06→03/10						
CLK 63 AMG (209.477)	354	04/06→03/10						
CLK 200 Kompressor (209.442)	120	02/03→03/10		05/03→ 12/09; für Linkslenker			03.2025-1741.3 010705	ATE Ø1 25,4 Ø2 20,64
CLK 240 (209.461)	125	02/03→03/10						
CLK 320 (209.465)	160	02/03→03/10						
CLK 500 (209.475)	225	02/03→03/10						
CLK 55 AMG (209.476)	270	02/03→03/10						
CLK 280 (209.454)	170	01/05→03/10		05/05→ 12/09; für Linkslenker			03.2025-1741.3 010705	ATE Ø1 25,4 Ø2 20,64
CLK 320 CDI (209.420)	165	03/05→03/10						
CLK 350 (209.456)	200	01/05→03/10						
MERCEDES-BENZ - CLS (C218) 10/10→								
 Bremskraftverstärker								
CLS 250 CDI / BlueTEC / d (218.303, 218.304)	150	04/11→		für Linkslenker			03.7755-8202.4 300301	ATE Ø 9 / 8" pneumatisch
CLS 350 (218.359)	225	01/11→						
CLS 350 CDI / d (218.323)	195	01/11→						
CLS 350 CDI / d 4-matic (218.393)	195	09/11→						
CLS 350 d 4-matic (218.394)	190	04/15→						
CLS 500 (218.373)	300	02/11→						
CLS 500 4-matic (218.391)	300	09/11→						
CLS 63 AMG (218.374)	410	01/11→						
CLS 63 AMG (218.374)	386	02/11→		03/11→; für Linkslenker			03.7755-8202.4 300301	ATE Ø 9 / 8" pneumatisch
 Hauptbremszylinder								
CLS 220 BlueTEC / d (218.301)	120	05/14→		für Linkslenker			03.2126-3196.3 010968	ATE Ø 26,99
CLS 220 BlueTEC / d (218.301)	125	05/14→						
CLS 220 BlueTEC / d (218.301)	130	05/14→						
CLS 250 BlueTEC / d 4-matic (218.397)	150	05/14→						
CLS 250 CDI / BlueTEC / d (218.303, 218.304)	150	04/11→						
CLS 350 (218.359)	225	01/11→						
CLS 350 BlueTEC / d (218.326)	190	06/14→						
CLS 350 CDI / d (218.323)	195	01/11→						
CLS 350 CDI / d 4-matic (218.393)	195	09/11→						
CLS 350 d 4-matic (218.394)	190	04/15→						
CLS 400 (218.361)	245	07/14→						
CLS 400 (218.365)	245	05/14→						
CLS 400 4-matic (218.367)	245	05/14→						
CLS 400 4-matic (218.368)	245	07/14→						
CLS 500 (218.373)	300	02/11→						
CLS 500 4-matic (218.391)	300	09/11→						
CLS 63 AMG (218.374)	410	01/11→						
CLS 63 AMG (218.375)	430	02/13→						
CLS 63 AMG 4-matic (218.376)	430	02/13→						
CLS 63 AMG 4-matic (218.392)	410	05/13→						
CLS 350 BlueTEC / d (218.326)	185	11/12→		01/13→; für Linkslenker			03.2126-3196.3 010968	ATE Ø 26,99
CLS 350 BlueTEC / d 4-matic (218.394)	185	11/12→						
CLS 63 AMG (218.374)	386	02/11→		03/11→; für Linkslenker			03.2126-3196.3 010968	ATE Ø 26,99













	kW			 	! #						
MERCEDES-BENZ - CLS (C219) 10/04→02/11											
 Hauptbremszylinder											
CLS 280 (219.354)	170	07/08→12/10		→ 10/10; für Linkslenker		24.2125-1745.3 010998	TRW Ø 25,4				
CLS 300 (219.354)	170	04/09→12/10		→ 10/10; für Rechtslenker		24.2125-1748.3 011030	TRW Ø 25,4				
CLS 350 (219.356)	200	10/04→12/10									
CLS 350 (219.357)	215	04/06→12/10									
CLS 350 CDI (219.322)	165	04/09→12/10									
CLS 500 (219.372)	285	04/06→12/10									
CLS 500 (219.375)	225	10/04→12/10									
CLS 55 AMG (219.376)	350	01/05→12/10									
CLS 63 AMG (219.377)	378	04/06→12/10									
CLS 320 CDI	155	01/05→12/10		05/05→ 10/10; für Linkslenker		24.2125-1745.3 010998	TRW Ø 25,4				
CLS 320 CDI (219.322)	165	01/05→12/10		05/05→ 10/10; für Rechtslenker		24.2125-1748.3 011030	TRW Ø 25,4				
MERCEDES-BENZ - CLS Shooting Brake (X218) 10/12→											
 Bremskraftverstärker											
CLS 250 CDI / BlueTEC / d (218.903, 218.904)	150	10/12→		→ A 26541; für Linkslenker		03.7858-1932.4 300263	ATE Ø 9 / 8" pneumatisch				
CLS 350 (218.959)	225	10/12→									
CLS 350 CDI / d (218.923)	195	10/12→									
CLS 350 CDI / d 4-matic (218.993)	195	10/12→									
 Hauptbremszylinder											
CLS 220 BlueTEC / d (218.901)	120	05/14→		für Linkslenker		03.2126-3196.3 010968	ATE Ø 26,99				
CLS 220 BlueTEC / d (218.901)	125	05/14→									
CLS 220 BlueTEC / d (218.901)	130	05/14→									
CLS 250 BlueTEC / d 4-matic (218.997)	150	05/14→									
CLS 250 CDI / BlueTEC / d (218.903, 218.904)	150	10/12→									
CLS 350 (218.959)	225	10/12→									
CLS 350 BlueTEC / d (218.926)	190	05/14→									
CLS 350 BlueTEC / d 4-matic (218.994)	185	05/14→									
CLS 350 CDI / d (218.923)	195	10/12→									
CLS 350 CDI / d 4-matic (218.993)	195	10/12→									
CLS 350 d 4-matic (218.994)	190	04/15→									
CLS 400 (218.961)	245	07/14→									
CLS 400 (218.965)	245	05/14→									
CLS 400 4-matic (218.967)	245	05/14→									
CLS 400 4-matic (218.968)	245	07/14→									
CLS 500 (218.973)	300	10/12→									
CLS 500 4-matic (218.991)	300	10/12→									
CLS 63 AMG (218.974)	386	10/12→									
CLS 63 AMG (218.974)	410	05/13→									
CLS 63 AMG (218.975)	430	02/13→									
CLS 63 AMG 4-matic (218.976)	430	02/13→									
CLS 63 AMG 4-matic (218.992)	410	05/13→									
MERCEDES-BENZ - E-KLASSE (W124) 02/93→06/96											
 Bremskraftverstärker											
E 200 (124.019)	100	06/93→06/95								03.7760-2702.4 300090	ATE Ø 10" pneumatisch
E 200 D (124.120)	55	06/93→06/95									
E 220 (124.022)	110	06/93→06/95									
E 250 D (124.126, 124.129)	83	07/93→06/95									
E 250 Turbo-D (124.128)	93	06/93→06/95									
E 280 (124.028)	145	06/93→06/95									
E 300 4-matic (124.230)	132	06/93→06/95									
E 300 D (124.131)	100	07/93→06/95									
E 300 Turbo-D (124.133)	108	06/93→06/95									
E 300 Turbo-D 4-matic (124.333)	108	06/93→06/95									
E 320 (124.032)	162	06/93→06/95									
↓											













	kw			 	! #		
MERCEDES-BENZ - E-KLASSE (W124) 02/93→06/96							
 Hauptbremszylinder							
E 200 (124.019)	100	06/93→06/95		→ C 164263		03.2023-0825.3 010028	Ø1 23,81 Ø2 19,05
E 200 D (124.120)	55	06/93→06/95					
E 220 (124.022)	110	06/93→06/95					
E 250 D (124.126, 124.129)	83	07/93→06/95					
E 250 Turbo-D (124.128)	93	06/93→06/95					
E 280 (124.028)	145	06/93→06/95					
E 280 (124.029)	142	06/93→06/95					
E 300 4-matic (124.230)	132	06/93→06/95					
E 300 D (124.131)	100	07/93→06/95					
E 300 Turbo-D (124.133)	108	06/93→06/95					
E 300 Turbo-D 4-matic (124.333)	108	06/93→06/95					
E 320 (124.032)	162	06/93→06/95		→ C 164263		03.2023-0825.3 010028 03.2025-0211.3 010034	Ø1 23,81 Ø2 19,05 Ø1 25,4 Ø2 19,05
E 420 (124.034)	205	06/93→06/95		→ C 164263		03.2025-0211.3 010034	Ø1 25,4 Ø2 19,05
E 500 (124.036)	235	06/93→06/95		→ B 927760		03.2025-0211.3 010034	Ø1 25,4 Ø2 19,05
E 60 AMG (124.036)	280	05/94→06/95					
MERCEDES-BENZ - E-KLASSE (W210) 06/95→08/03							
 Bremskraftverstärker							
E 200 (210.035)	100	06/95→08/00		→ A394035		03.7760-4102.4 300091	ATE Ø 10" pneumatisch
E 220 D	55	05/96→03/02					
E 220 D (210.004)	70	06/95→07/99					
E 230 (210.037)	110	06/95→06/97					
E 290 Turbo-D (210.017)	95	03/96→07/99					
E 300 D (210.020)	100	06/95→06/97					
E 200 D (210.003)	65	01/96→03/02		10/96→; → A394035		03.7760-4102.4 300091	ATE Ø 10" pneumatisch
E 250 D (210.010)	83	06/95→07/99		→ A394035; für Rechtslenker		03.7760-4102.4 300091	ATE Ø 10" pneumatisch
				→ A394035		03.7760-4102.4 300091	ATE Ø 10" pneumatisch
 Hauptbremszylinder							
E 200 (210.035)	100	06/95→08/00		→ A394035		03.2023-1066.3 010032	Ø1 23,81 Ø2 19,05
E 290 Turbo-D (210.017)	95	03/96→07/99		A394036→		03.2023-1812.3 010570	Ø1 23,81 Ø2 19,05
E 300 D (210.020)	100	06/95→06/97					
E 200 CDI (210.007)	75	06/98→03/02		07/98→		03.2023-1812.3 010570	Ø1 23,81 Ø2 19,05
E 220 CDI (210.006)	92	06/98→07/99					
E 200 CDI (210.007)	85	07/99→03/02				03.2023-1812.3 010570	Ø1 23,81 Ø2 19,05
E 220 CDI (210.006)	100	07/99→03/02					
E 220 CDI (210.006)	105	07/99→03/02					
E 200 D (210.003)	65	01/96→03/02		10/96→; → A394035		03.2023-1066.3 010032	Ø1 23,81 Ø2 19,05
				A394036→		03.2023-1812.3 010570	Ø1 23,81 Ø2 19,05
E 200 Kompressor (210.045)	137	06/97→03/02		09/97→		24.2025-1703.3 010516	Ø1 25,4 Ø2 19,05
E 430 (210.070)	205	06/97→03/02					
E 55 AMG (210.074)	260	08/97→03/02					
E 200 Kompressor (210.048)	120	08/00→03/02				24.2025-1703.3 010516	Ø1 25,4 Ø2 19,05
E 270 CDI (210.016)	120	07/99→03/02					
E 270 CDI (210.016)	125	07/99→03/02					
E 280 (210.063)	150	12/96→03/02					
E 280 4-matic (210.081)	150	12/96→03/02					
E 300 Turbo-D (210.025)	130	12/96→07/99					
E 320 (210.065)	165	06/97→03/02					
E 320 4-matic (210.082)	165	06/97→03/02					
E 320 CDI (210.026)	145	07/99→03/02					
E 430 4-matic (210.083)	205	05/99→03/02					
E 55 AMG 4-matic (210.074)	260	03/01→03/02					
E 220 D	55	05/96→03/02		→ A394035		03.2023-1066.3 010032	Ø1 23,81 Ø2 19,05
E 220 D (210.004)	70	06/95→07/99		→ 06/98; A394036→		03.2023-1812.3 010570	Ø1 23,81 Ø2 19,05
E 230 (210.037)	110	06/95→06/97		→ A394035		03.2023-1066.3 010032	Ø1 23,81 Ø2 19,05
E 240 (210.061)	125	06/97→08/00		09/97→; - ESP		03.2023-1812.3 010570	Ø1 23,81 Ø2 19,05
				09/97→; + ESP		24.2025-1703.3 010516	Ø1 25,4 Ø2 19,05
E 240 (210.062)	125	08/00→03/02		- ESP		03.2023-1812.3 010570	Ø1 23,81 Ø2 19,05
				+ ESP		24.2025-1703.3 010516	Ø1 25,4 Ø2 19,05
E 250 D (210.010)	83	06/95→07/99		→ A394035; für Rechtslenker		03.2023-1066.3 010032	Ø1 23,81 Ø2 19,05
				→ A394035		03.2023-1066.3 010032	Ø1 23,81 Ø2 19,05
				A394036→		03.2023-1812.3 010570	Ø1 23,81 Ø2 19,05
				A394036→; für Rechtslenker		03.2023-1812.3 010570	Ø1 23,81 Ø2 19,05
E 250 Turbo-D (210.015)	110	06/97→07/99		09/97→		03.2023-1812.3 010570	Ø1 23,81 Ø2 19,05
E 280 (210.053)	142	01/96→06/97		→ 09/96		24.2025-1702.3 010515	Ø1 25,4 Ø2 19,05
↓							

























	kw					! #		
MERCEDES-BENZ - E-KLASSE (W210) 06/95→08/03								
 Hauptbremszylinder								
E 320 (210.055)	162	06/95→06/97		10/96→			24.2025-1703.3 010516	Ø1 25,4 Ø2 19,05
E 420 (210.072)	205	01/96→06/97					24.2025-1702.3 010515	Ø1 25,4 Ø2 19,05
E 50 AMG (210.072)	255	02/96→08/97						
MERCEDES-BENZ - E-KLASSE (W211) 03/02→03/09								
 Hauptbremszylinder								
E 200 CDI (211.004)	75	07/02→12/08		für Linkslenker			24.2125-1745.3 010998	TRW Ø 25,4
E 200 CDI (211.004)	90	07/02→12/08		für Rechtslenker			24.2125-1748.3 011030	TRW Ø 25,4
E 200 CDI (211.007)	100	04/06→12/08						
E 200 Kompressor (211.041)	135	04/06→12/08						
E 200 Kompressor (211.042)	120	11/02→12/08						
E 200 NGT (211.042)	120	03/04→12/08						
E 220 CDI	120	03/03→12/08						
E 220 CDI (211.006)	100	03/02→12/08						
E 220 CDI (211.006)	110	03/02→12/08						
E 220 CDI (211.008)	125	04/06→12/08						
E 230 (211.052)	150	09/07→12/08						
E 240 (211.061)	130	03/02→12/08						
E 240 4-matic (211.080)	130	03/03→12/08						
E 270 CDI (211.016)	120	03/02→12/08						
E 270 CDI (211.016)	130	03/02→12/08						
E 280 4-matic (211.092)	170	01/06→12/08						
E 280 CDI (211.020)	140	03/05→12/08						
E 280 CDI (211.023)	130	05/04→12/08						
E 280 CDI 4-matic (211.084)	140	03/05→12/08						
E 300 BlueTEC (211.024)	155	09/07→12/08						
E 320 (211.065)	165	03/02→12/08						
E 320 4-matic (211.082)	165	03/03→12/08						
E 320 CDI (211.022)	165	03/05→12/08						
E 320 CDI (211.026)	150	11/02→12/08						
E 320 CDI 4-matic (211.089)	165	03/05→12/08						
E 350 (211.056)	200	03/05→12/08						
E 350 4-matic (211.087)	200	03/05→12/08						
E 350 CGI (211.057)	215	09/07→12/08						
E 420 CDI (211.029)	231	01/06→12/08						
E 500 (211.070)	225	03/02→12/08						
E 500 (211.072)	285	04/06→12/08						
E 500 4-matic (211.083)	225	10/03→12/08						
E 500 4-matic (211.090)	285	04/06→12/08						
E 55 AMG Kompressor (211.076)	350	10/02→12/08						
E 63 AMG (211.077)	378	03/06→12/08						
E 280 (211.054)	170	03/05→12/08		05/05→; für Linkslenker			24.2125-1745.3 010998	TRW Ø 25,4
				05/05→; für Rechtslenker			24.2125-1748.3 011030	TRW Ø 25,4
E 400 CDI (211.028)	191	02/03→12/08		03/03→; für Linkslenker			24.2125-1745.3 010998	TRW Ø 25,4
				03/03→; für Rechtslenker			24.2125-1748.3 011030	TRW Ø 25,4
MERCEDES-BENZ - E-KLASSE (W212) 01/09→								
 Bremskraftverstärker								
E 200 (212.034)	135	01/13→		für Linkslenker			03.7755-8202.4 300301	ATE Ø 9 / 8" pneumatisch
E 200 CGI (212.048, 212.148)	135	08/09→						
E 200 NGT (212.035)	115	07/13→						
E 200 NGT (212.041)	120	03/11→						
E 220 BlueTEC (212.001)	130	05/14→						
E 220 BlueTEC 4-matic (212.011)	125	01/15→						
E 250 (212.036)	155	01/13→						
E 300 (212.055)	185	07/11→						
E 300 4-matic (212.080)	185	07/11→						
E 350 (212.059)	225	09/11→						
E 350 4-matic (212.088)	225	09/11→						
E 350 BlueTEC (212.026)	190	05/14→						
E 350 BlueTEC 4-matic (212.094)	190	05/14→						
E 350 CDI (212.023)	195	03/11→						
E 350 CDI 4-matic (212.089)	170	09/09→						
E 350 CDI 4-matic (212.093)	195	03/11→						
E 400 (212.061)	245	07/14→						
E 400 (212.065)	245	01/13→						
↓								

	kw			 	! #		
MERCEDES-BENZ - E-KLASSE (W212) 01/09→							
 Bremskraftverstärker							
E 400 4-matic (212.067)	245	01/13→		für Linkslenker		03.7755-8202.4 300301	ATE Ø 9 / 8" pneumatisch
E 400 4-matic (212.099)	245	07/14→					
E 500 (212.073)	300	09/11→					
E 500 4-matic (212.091)	300	09/11→					
E 63 AMG (212.074)	386	02/11→					
E 63 AMG (212.074)	410	02/11→					
E 63 AMG (212.077)	386	12/09→					
E 63 AMG 4-matic (212.092)	410	02/11→					
E 200 CDI / BlueTEC (212.005, 212.006)	100	01/09→		03/09→; für Linkslenker		03.7755-8202.4 300301	ATE Ø 9 / 8" pneumatisch
E 220 CDI	120	01/09→					
E 220 CDI / BlueTEC (212.001, 212.002)	125	01/09→					
E 250 CDI / BlueTEC (212.003, 212.004)	150	01/09→					
E 250 CDI / BlueTEC 4-matic (212.082, 212.097)	150	01/09→					
E 250 CGI (212.047, 212.147)	150	01/09→					
E 300 (212.054)	170	01/09→					
E 350 (212.056)	200	01/09→					
E 350 4-matic (212.087)	200	01/09→08/11					
E 350 BlueTEC (212.024)	155	01/09→					
E 350 CDI (212.025)	170	01/09→					
E 350 CGI (212.057)	215	01/09→08/11					
E 500 (212.072)	285	01/09→					
E 500 4-matic (212.090)	285	01/09→					
E 300 CDI / BlueTEC (212.020, 212.021, 212.027)	170	03/11→		04/11→; für Linkslenker		03.7755-8202.4 300301	ATE Ø 9 / 8" pneumatisch
E 350 BlueTEC	185	11/12→		01/13→; für Linkslenker		03.7755-8202.4 300301	ATE Ø 9 / 8" pneumatisch
E 350 BlueTEC 4-matic (212.094)	185	11/12→					
E 63 AMG (212.075)	430	02/13→		04/13→; für Linkslenker		03.7755-8202.4 300301	ATE Ø 9 / 8" pneumatisch
E 63 AMG 4-matic (212.076)	430	02/13→					
 Hauptbremszylinder							
E 200 (212.034)	135	01/13→		für Linkslenker		03.2126-3196.3 010968	ATE Ø 26,99
E 200 CGI (212.048, 212.148)	135	08/09→				03.4156-5106.3 010997	ATE Ø 26,99
E 200 NGT (212.035)	115	07/13→					
E 200 NGT (212.041)	120	03/11→					
E 220 BlueTEC (212.001)	130	05/14→					
E 220 BlueTEC 4-matic (212.011)	125	01/15→					
E 250 (212.036)	155	01/13→					
E 250 CGI (212.047, 212.147)	150	01/09→					
E 300 (212.055)	185	07/11→					
E 300 4-matic (212.080)	185	07/11→					
E 350 (212.059)	225	09/11→					
E 350 4-matic (212.088)	225	09/11→					
E 350 BlueTEC (212.026)	190	05/14→					
E 350 BlueTEC 4-matic (212.094)	190	05/14→					
E 350 CDI (212.023)	195	03/11→					
E 350 CDI 4-matic (212.089)	170	09/09→					
E 350 CDI 4-matic (212.093)	195	03/11→					
E 400 (212.061)	245	07/14→					
E 400 (212.065)	245	01/13→					
E 400 4-matic (212.067)	245	01/13→					
E 400 4-matic (212.099)	245	07/14→					
E 500 (212.073)	300	09/11→					
E 500 4-matic (212.091)	300	09/11→					
E 63 AMG (212.074)	386	02/11→					
E 63 AMG (212.074)	410	02/11→					
E 63 AMG (212.077)	386	12/09→					
E 63 AMG 4-matic (212.092)	410	02/11→					
E 200 CDI / BlueTEC (212.005, 212.006)	100	01/09→		03/09→; für Linkslenker		03.2126-3196.3 010968	ATE Ø 26,99
E 220 CDI	120	01/09→				03.4156-5106.3 010997	ATE Ø 26,99
E 220 CDI / BlueTEC (212.001, 212.002)	125	01/09→					
↓							

	kw					! #		
MERCEDES-BENZ - E-KLASSE (W212) 01/09→								
 Hauptbremszylinder								
E 250 CDI / BlueTEC (212.003, 212.004)	150	01/09→		03/09→; für Linkslenker		03.2126-3196.3	010968	ATE Ø 26,99
E 250 CDI / BlueTEC 4-matic (212.082, 212.097)	150	01/09→				03.4156-5106.3	010997	ATE Ø 26,99
E 300 (212.054)	170	01/09→						
E 350 (212.056)	200	01/09→						
E 350 4-matic (212.087)	200	01/09→08/11						
E 350 BlueTEC (212.024)	155	01/09→						
E 350 CDI (212.025)	170	01/09→						
E 350 CGI (212.057)	215	01/09→08/11						
E 500 (212.072)	285	01/09→						
E 500 4-matic (212.090)	285	01/09→						
E 300 CDI / BlueTEC (212.020, 212.021, 212.027)	170	03/11→		04/11→; für Linkslenker		03.2126-3196.3	010968	ATE Ø 26,99
						03.4156-5106.3	010997	ATE Ø 26,99
E 350 BlueTEC	185	11/12→		01/13→; für Linkslenker		03.2126-3196.3	010968	ATE Ø 26,99
E 350 BlueTEC 4-matic (212.094)	185	11/12→				03.4156-5106.3	010997	ATE Ø 26,99
E 63 AMG (212.075)	430	02/13→		04/13→; für Linkslenker		03.2126-3196.3	010968	ATE Ø 26,99
E 63 AMG 4-matic (212.076)	430	02/13→				03.4156-5106.3	010997	ATE Ø 26,99
MERCEDES-BENZ - E-KLASSE Cabriolet (A124) 05/93→03/98								
 Bremskraftverstärker								
E 200 (124.060)	100	06/93→03/98				03.7760-2702.4	300090	ATE Ø 10" pneumatisch
E 220 (124.062)	110	06/93→03/98						
E 320 (124.066)	162	06/93→03/98						
E 36 AMG (124.066)	200	05/94→03/98						
 Hauptbremszylinder								
E 200 (124.060)	100	06/93→03/98		→ C 164263		03.2023-0825.3	010028	Ø1 23,81 Ø2 19,05
E 220 (124.062)	110	06/93→03/98						
E 320 (124.066)	162	06/93→03/98						
E 36 AMG (124.066)	200	05/94→03/98						
MERCEDES-BENZ - E-KLASSE Cabriolet (A207) 01/10→								
 Bremskraftverstärker								
E 200 (207.434)	135	03/13→		für Linkslenker;		03.7745-6302.4	300261	ATE Ø 8" pneumatisch
E 220 BlueTEC (207.401)	130	05/14→		für Fahrzeuge ohne Start-Stopp-Funktion				
E 250 (207.436)	155	06/13→		für Linkslenker;		03.7745-8902.4	300297	ATE Ø 8" pneumatisch
E 300 (207.455)	185	04/11→		für Fahrzeuge mit Start-Stopp-Funktion				
E 320 (207.462)	200	07/14→						
E 350 (207.459)	225	04/11→						
E 350 BlueTEC/ d (207.426)	190	05/14→						
E 350 BlueTEC (207.426)	185	06/13→						
E 350 CDI	195	04/11→						
E 400 (207.461)	245	07/14→						
E 400 (207.465)	245	06/13→						
E 500 (207.473)	300	09/11→						
E 200 CGI (207.448)	135	01/10→		03/10→; für Linkslenker;		03.7745-6302.4	300261	ATE Ø 8" pneumatisch
E 220 CDI / BlueTEC / d (207.402, 207.401)	125	01/10→		für Fahrzeuge ohne Start-Stopp-Funktion				
E 220 CDI (207.402)	120	02/10→		03/10→; für Linkslenker;		03.7745-8902.4	300297	ATE Ø 8" pneumatisch
E 250 CDI / BlueTEC / d (207.403, 207.404)	150	01/10→		für Fahrzeuge mit Start-Stopp-Funktion				
E 250 CGI (207.447)	150	01/10→						
E 350 CDI (207.422)	170	01/10→						
E 350 CGI (207.457)	215	01/10→						
E 500 (207.472)	285	01/10→						
 Hauptbremszylinder								
E 200 (207.434)	135	03/13→		für Linkslenker		03.2025-2521.3	010959	ATE Ø1 25,4 Ø2 22,2
E 220 BlueTEC (207.401)	130	05/14→		für Rechtslenker		24.2025-2311.3	011023	ATE Ø1 25,4 Ø2 20,64
E 250 (207.436)	155	06/13→						
E 300 (207.455)	185	04/11→						
E 320 (207.462)	200	07/14→						
E 350 (207.459)	225	04/11→						
E 350 BlueTEC/ d (207.426)	190	05/14→						
E 350 BlueTEC (207.426)	185	06/13→						
E 350 CDI	195	04/11→						
E 400 (207.461)	245	07/14→						
E 400 (207.465)	245	06/13→						

	kw					! #		
MERCEDES-BENZ - E-KLASSE Cabriolet (A207) 01/10→								
 Hauptbremszylinder								
E 500 (207.473)	300	09/11→		für Linkslenker		03.2025-2521.3	010959	ATE Ø1 25,4 Ø2 22,2
				für Rechtslenker		24.2025-2311.3	011023	ATE Ø1 25,4 Ø2 20,64
E 200 CGI (207.448)	135	01/10→		03/10→; für Linkslenker		03.2025-2521.3	010959	ATE Ø1 25,4 Ø2 22,2
E 220 CDI / BlueTEC / d (207.402, 207.401)	125	01/10→		03/10→; für Rechtslenker		24.2025-2311.3	011023	ATE Ø1 25,4 Ø2 20,64
E 220 CDI (207.402)	120	02/10→						
E 250 CDI / BlueTEC / d (207.403, 207.404)	150	01/10→						
E 250 CGI (207.447)	150	01/10→						
E 350 CDI (207.422)	170	01/10→						
E 350 CGI (207.457)	215	01/10→						
E 500 (207.472)	285	01/10→						
MERCEDES-BENZ - E-KLASSE Coupe (C124) 06/93→06/97								
 Bremskraftverstärker								
E 200 (124.040)	100	06/93→06/97				03.7760-2702.4	300090	ATE Ø 10" pneumatisch
E 220 (124.042)	110	06/93→06/97						
E 320 (124.052)	162	06/93→06/97						
E 36 AMG (124.052)	195	06/93→04/95						
E 36 AMG (124.052)	200	05/94→06/97						
 Hauptbremszylinder								
E 200 (124.040)	100	06/93→06/97		→ C 164263		03.2023-0825.3	010028	Ø1 23,81 Ø2 19,05
E 220 (124.042)	110	06/93→06/97						
E 320 (124.052)	162	06/93→06/97						
E 36 AMG (124.052)	195	06/93→04/95						
E 36 AMG (124.052)	200	05/94→06/97						
MERCEDES-BENZ - E-KLASSE Coupe (C207) 01/09→								
 Bremskraftverstärker								
E 200 (207.334)	135	06/13→		für Linkslenker;		03.7745-6302.4	300261	ATE Ø 8" pneumatisch
E 200 CGI (207.348)	135	01/10→		für Fahrzeuge ohne Start-Stopp-Funktion				
E 220 BlueTEC (207.301)	130	05/14→		für Linkslenker;		03.7745-8902.4	300297	ATE Ø 8" pneumatisch
E 220 CDI	120	07/14→		für Fahrzeuge mit Start-Stopp-Funktion				
E 220 CDI / d (207.302, 207.301)	125	01/10→						
E 250 (207.336)	155	06/13→						
E 300 (207.355)	185	04/11→						
E 320 (207.362)	200	07/14→						
E 350 (207.359)	225	04/11→						
E 350 4-matic (207.388)	225	02/13→						
E 350 BlueTEC	185	03/13→						
E 350 BlueTEC / d (207.326)	190	05/14→						
E 350 CDI	195	04/11→						
E 400	245	06/13→						
E 400 (207.361)	245	07/14→						
E 500 (207.373)	300	09/11→						
E 250 CDI / BlueTEC / d (207.303, 207.304)	150	01/09→		05/09→; für Linkslenker;		03.7745-6302.4	300261	ATE Ø 8" pneumatisch
E 250 CGI (207.347)	150	01/09→		für Fahrzeuge ohne Start-Stopp-Funktion				
E 350 CDI (207.322)	170	01/09→		05/09→; für Linkslenker;		03.7745-8902.4	300297	ATE Ø 8" pneumatisch
E 350 CGI (207.357)	215	01/09→		für Fahrzeuge mit Start-Stopp-Funktion				
E 500 (207.372)	285	01/09→						
 Hauptbremszylinder								
E 200 (207.334)	135	06/13→		für Linkslenker		03.2025-2521.3	010959	ATE Ø1 25,4 Ø2 22,2
E 200 CGI (207.348)	135	01/10→		für Rechtslenker		24.2025-2311.3	011023	ATE Ø1 25,4 Ø2 20,64
E 220 BlueTEC (207.301)	130	05/14→						
E 220 CDI	120	07/14→						
E 220 CDI / d (207.302, 207.301)	125	01/10→						
E 250 (207.336)	155	06/13→						
E 300 (207.355)	185	04/11→						
E 320 (207.362)	200	07/14→						
E 350 (207.359)	225	04/11→						
E 350 4-matic (207.388)	225	02/13→						
E 350 BlueTEC	185	03/13→						
E 350 BlueTEC / d (207.326)	190	05/14→						
E 350 CDI	195	04/11→						
E 400	245	06/13→						
E 400 (207.361)	245	07/14→						
E 500 (207.373)	300	09/11→						
E 250 CDI / BlueTEC / d (207.303, 207.304)	150	01/09→		05/09→; für Linkslenker		03.2025-2521.3	010959	ATE Ø1 25,4 Ø2 22,2
E 250 CGI (207.347)	150	01/09→		05/09→; für Rechtslenker		24.2025-2311.3	011023	ATE Ø1 25,4 Ø2 20,64

	kw					! #		
MERCEDES-BENZ - E-KLASSE Coupe (C207) 01/09→								
 Hauptbremszylinder								
E 350 CDI (207.322)	170	01/09→		05/09→; für Linkslenker		03.2025-2521.3	010959	ATE Ø1 25,4 Ø2 22,2
E 350 CGI (207.357)	215	01/09→		05/09→; für Rechtslenker		24.2025-2311.3	011023	ATE Ø1 25,4 Ø2 20,64
E 500 (207.372)	285	01/09→						
MERCEDES-BENZ - E-KLASSE T-Model (S124) 06/93→06/96								
 Bremskraftverstärker								
E 200 T (124.079)	100	06/93→06/96				03.7760-2702.4	300090	ATE Ø 10" pneumatisch
E 220 T (124.082)	110	06/93→06/96						
E 250 TD (124.186)	83	06/93→06/96						
E 250 Turbo D	93	06/93→06/96						
E 280 T (124.088)	142	06/93→06/96						
E 280 T (124.088)	145	06/93→06/96						
E 300 T 4-matic (124.290)	132	06/93→06/96						
E 300 TD (124.191)	100	06/93→06/96						
E 300 T Turbo-D (124.193)	108	06/93→06/96						
E 300 T Turbo-D 4-matic (124.393)	108	06/93→06/96						
E 320 T (124.092)	162	06/93→06/96						
E 36 T AMG (124.092)	200	05/94→06/96						
 Hauptbremszylinder								
E 200 T (124.079)	100	06/93→06/96		→ F 298225		03.2023-0825.3	010028	Ø1 23,81 Ø2 19,05
E 220 T (124.082)	110	06/93→06/96						
E 250 TD (124.186)	83	06/93→06/96						
E 250 Turbo D	93	06/93→06/96						
E 280 T (124.088)	142	06/93→06/96						
E 280 T (124.088)	145	06/93→06/96						
E 300 T 4-matic (124.290)	132	06/93→06/96						
E 300 T Turbo-D 4-matic (124.393)	108	06/93→06/96						
E 320 T (124.092)	162	06/93→06/96						
E 36 T AMG (124.092)	200	05/94→06/96						
E 300 TD (124.191)	100	06/93→06/96		→ C 164263		03.2023-0825.3	010028	Ø1 23,81 Ø2 19,05
E 300 T Turbo-D (124.193)	108	06/93→06/96						
MERCEDES-BENZ - E-KLASSE T-Model (S210) 06/96→03/03								
 Bremskraftverstärker								
E 200 T (210.235)	100	06/96→08/00		→ A394035		03.7760-4102.4	300091	ATE Ø 10" pneumatisch
E 230 T (210.237)	110	06/96→06/97						
E 250 T D (210.210)	83	06/96→07/99		→ A394035; Radstand [mm]: 2.833		03.7760-4102.4	300091	ATE Ø 10" pneumatisch
				→ A394035; für Rechtslenker; Radstand [mm]: 2.833		03.7760-4102.4	300091	ATE Ø 10" pneumatisch
E 290 T Turbo-D (210.217)	95	06/96→07/99		→ A394035; Radstand [mm]: 2.833		03.7760-4102.4	300091	ATE Ø 10" pneumatisch
 Hauptbremszylinder								
E 200 T (210.235)	100	06/96→08/00		→ A394035		03.2023-1066.3	010032	Ø1 23,81 Ø2 19,05
E 230 T (210.237)	110	06/96→06/97		A394036→		03.2023-1812.3	010570	Ø1 23,81 Ø2 19,05
E 200 T Kompressor (210.245)	137	06/97→03/03		09/97→		24.2025-1703.3	010516	Ø1 25,4 Ø2 19,05
E 250 T Turbo-D (210.215)	110	06/97→07/99						
E 430 T (210.270)	205	06/97→03/03						
E 55 T AMG (210.274)	260	08/97→03/03						
E 200 T Kompressor (210.248)	120	08/00→03/03				24.2025-1703.3	010516	Ø1 25,4 Ø2 19,05
E 270 T CDI	120	02/00→03/03						
E 270 T CDI (210.216)	125	07/99→03/03						
E 280 T 4-matic (210.281)	150	12/96→03/03						
E 300 T Turbo-D (210.225)	130	12/96→07/99						
E 320 T (210.265)	165	12/96→03/03						
E 320 T CDI (210.226)	145	07/99→03/03						
E 430 T 4-matic (210.283)	205	05/99→03/03						
E 55 T AMG 4-matic (210.274)	260	03/01→03/03						
E 220 T CDI (210.206)	100	05/99→03/03		für Linkslenker; Radstand [mm]: 2.833		03.2023-1812.3	010570	Ø1 23,81 Ø2 19,05
E 220 T CDI (210.206)	105	07/99→03/03		für Linkslenker; Radstand [mm]: 3.570		24.2025-1703.3	010516	Ø1 25,4 Ø2 19,05
E 220 T CDI (210.206)	92	06/98→07/99		07/98→; für Linkslenker; Radstand [mm]: 2.833		03.2023-1812.3	010570	Ø1 23,81 Ø2 19,05
↓								

	kw					! #		
MERCEDES-BENZ - E-KLASSE T-Model (S210) 06/96→03/03								
 Hauptbremszylinder								
E 220 T CDI (210.206)	92	06/98→07/99		07/98→; für Linkslenker; Radstand [mm]: 3.570			24.2025-1703.3 010516	Ø1 25,4 Ø2 19,05
E 240 T (210.261)	125	06/97→03/03		09/97→; - ESP		03.2023-1812.3 010570	Ø1 23,81 Ø2 19,05	
				09/97→; + ESP		24.2025-1703.3 010516	Ø1 25,4 Ø2 19,05	
E 240 T (210.262)	125	08/00→03/03		- ESP		03.2023-1812.3 010570	Ø1 23,81 Ø2 19,05	
				+ ESP		24.2025-1703.3 010516	Ø1 25,4 Ø2 19,05	
E 250 T D (210.210)	83	06/96→07/99		→ A394035; Radstand [mm]: 2.833		03.2023-1066.3 010032	Ø1 23,81 Ø2 19,05	
				→ A394035; für Rechtslenker; Radstand [mm]: 2.833		03.2023-1066.3 010032	Ø1 23,81 Ø2 19,05	
				→ A394035; Radstand [mm]: 3.570		24.2025-1702.3 010515	Ø1 25,4 Ø2 19,05	
				A394036→; Radstand [mm]: 3.570		24.2025-1703.3 010516	Ø1 25,4 Ø2 19,05	
				A394036→; für Rechtslenker; Radstand [mm]: 2.833		24.2025-1703.3 010516	Ø1 25,4 Ø2 19,05	
				A394036→; Radstand [mm]: 2.833		24.2025-1703.3 010516	Ø1 25,4 Ø2 19,05	
E 280 T (210.263)	150	12/96→03/03		Radstand [mm]: 3.570		24.2025-1703.3 010516	Ø1 25,4 Ø2 19,05	
E 290 T Turbo-D (210.217)	95	06/96→07/99		→ A394035; Radstand [mm]: 2.833		03.2023-1066.3 010032	Ø1 23,81 Ø2 19,05	
				→ A394035; Radstand [mm]: 3.570		24.2025-1702.3 010515	Ø1 25,4 Ø2 19,05	
				A394036→		24.2025-1703.3 010516	Ø1 25,4 Ø2 19,05	
E 320 T 4-matic (210.282)	165	12/96→03/03		06/97→		24.2025-1703.3 010516	Ø1 25,4 Ø2 19,05	
E 420 T (210.272)	205	06/96→06/97				24.2025-1702.3 010515	Ø1 25,4 Ø2 19,05	
MERCEDES-BENZ - E-KLASSE T-Model (S211) 02/03→07/09								
 Hauptbremszylinder								
350 CGI (211.257)	215	05/06→07/09		für Linkslenker		24.2125-1745.3 010998	TRW Ø 25,4	
E 200 CDI (211.207)	100	04/06→07/09						
E 200 Kompressor (211.241)	135	04/06→07/09						
E 200 T Kompressor (211.242)	120	03/03→07/09						
E 220 CDI (211.206)	100	03/03→07/09						
E 220 T CDI	120	03/03→07/09						
E 220 T CDI (211.206)	110	03/03→07/09						
E 220 T CDI (211.208)	125	04/06→07/09						
E 230 T (211.252)	150	05/07→07/09						
E 240 T (211.261)	130	03/03→07/09						
E 240 T 4-matic (211.280)	130	07/03→07/09						
E 270 T CDI (211.216)	120	03/03→07/09						
E 270 T CDI (211.216)	130	03/03→07/09						
E 280 T CDI (211.220)	140	03/05→07/09						
E 280 T CDI (211.223)	130	05/04→07/09						
E 320 T (211.265)	165	03/03→07/09						
E 320 T 4-matic (211.282)	165	07/03→07/09						
E 320 T CDI (211.222)	155	11/07→07/09						
E 320 T CDI (211.222)	165	03/05→07/09						
E 320 T CDI (211.226)	150	03/03→07/09						
E 350 T (211.256)	200	03/05→07/09						
E 350 T 4-matic (211.287)	200	03/05→07/09						
E 500 T (211.270)	225	10/03→07/09						
E 500 T (211.272)	285	04/06→07/09						
E 500 T 4-matic (211.283)	225	10/03→07/09						
E 500 T 4-matic (211.290)	285	04/06→07/09						
E 55 T AMG Kompressor (211.276)	350	07/03→07/09						
E 63 AMG (211.277)	378	03/06→07/09						
E 280 T (211.254)	170	03/05→07/09		05/05→; für Linkslenker		24.2125-1745.3 010998	TRW Ø 25,4	
E 280 T 4-matic (211.292)	170	03/05→07/09						
E 280 T CDI 4-matic (211.284)	140	03/05→07/09						
E 320 T CDI 4-matic (211.289)	165	03/05→07/09						
MERCEDES-BENZ - E-KLASSE T-Model (S212) 08/09→								
 Bremskraftverstärker								
E 200 (212.234)	135	11/12→		03/13→; für Linkslenker		03.7755-8202.4 300301	ATE Ø 9 / 8" pneumatisch	
E 250 (212.236)	155	11/12→						
E 200 CDI / BlueTEC (212.205, 212.206)	100	11/09→		für Linkslenker		03.7755-8202.4 300301	ATE Ø 9 / 8" pneumatisch	
E 200 CGI (212.248)	135	11/09→						
↓								













MERCEDES-BENZ - E-KLASSE T-Model (S212) 08/09 →











 **Bremskraftverstärker**













E 220 BlueTEC	130	05/15 →		für Linkslenker		03.7755-8202.4	300301	ATE Ø 9 / 8" pneumatisch
E 220 BlueTEC 4-matic (212.211)	125	12/14 →						
E 220 CDI / BlueTEC (212.202, 212.201)	125	11/09 →						
E 250 CDI / BlueTEC (212.203, 212.204)	150	11/09 →						
E 250 CDI / BlueTEC 4-matic (212.282, 212.297)	150	07/10 →						
E 250 CGI (212.247)	150	11/09 →						
E 300 (212.254)	170	11/09 →						
E 300 (212.255)	185	07/11 →						
E 300 4-matic (212.280)	185	07/11 →						
E 300 CDI / BlueTEC (212.227, 212.221)	170	11/09 →						
E 350 (212.259)	225	09/11 →						
E 350 4-matic (212.287)	200	11/09 →						
E 350 4-matic (212.288, 212.287)	225	09/11 →						
E 350 BlueTEC (212.224)	155	11/09 →						
E 350 BlueTEC (212.226)	190	07/14 →						
E 350 BlueTEC 4-matic (212.294)	190	07/14 →						
E 350 CDI (212.223)	195	07/11 →						
E 350 CDI (212.225)	170	11/09 →						
E 350 CDI 4-matic (212.289)	170	11/09 →						
E 350 CDI 4-matic (212.293)	195	07/11 →						
E 350 CGI (212.257)	215	11/09 →						
E 400	245	01/13 →						
E 400 (212.261)	245	07/14 →						
E 400 4-matic	245	01/13 →						
E 400 4-matic (212.299)	245	07/14 →						
E 500 (212.272)	285	11/09 →						
E 500 (212.273)	300	09/11 →						
E 500 4-matic (212.291)	300	09/11 →						
E 63 AMG (212.274)	386	02/11 →						
E 63 AMG (212.274)	410	02/11 →						
E 63 AMG 4-matic (212.292)	410	02/11 →						
E 220 CDI (212.202)	120	08/09 →		11/09 →; für Linkslenker		03.7755-8202.4	300301	ATE Ø 9 / 8" pneumatisch
E 350 (212.256)	200	08/09 →						
E 63 AMG (212.277)	386	08/09 →						
E 350 BlueTEC	185	11/12 →		01/13 →; für Linkslenker		03.7755-8202.4	300301	ATE Ø 9 / 8" pneumatisch
E 350 BlueTEC 4-matic	185	11/12 →						
E 63 AMG (212.275)	430	02/13 →		04/13 →; für Linkslenker		03.7755-8202.4	300301	ATE Ø 9 / 8" pneumatisch
E 63 AMG 4-matic (212.276)	430	02/13 →						

 **Hauptbremszylinder**

E 200 (212.234)	135	11/12 →		03/13 →; für Linkslenker		03.2126-3196.3	010968	ATE Ø 26,99
E 250 (212.236)	155	11/12 →				03.4156-5106.3	010997	ATE Ø 26,99
E 200 CDI / BlueTEC (212.205, 212.206)	100	11/09 →		für Linkslenker		03.2126-3196.3	010968	ATE Ø 26,99
E 200 CGI (212.248)	135	11/09 →				03.4156-5106.3	010997	ATE Ø 26,99
E 220 BlueTEC	130	05/15 →						
E 220 BlueTEC 4-matic (212.211)	125	12/14 →						
E 220 CDI / BlueTEC (212.202, 212.201)	125	11/09 →						
E 250 CDI / BlueTEC (212.203, 212.204)	150	11/09 →						
E 250 CDI / BlueTEC 4-matic (212.282, 212.297)	150	07/10 →						
E 250 CGI (212.247)	150	11/09 →						
E 300 (212.254)	170	11/09 →						
E 300 (212.255)	185	07/11 →						
E 300 4-matic (212.280)	185	07/11 →						
E 300 CDI / BlueTEC (212.227, 212.221)	170	11/09 →						
E 350 (212.259)	225	09/11 →						
E 350 4-matic (212.287)	200	11/09 →						
E 350 4-matic (212.288, 212.287)	225	09/11 →						
E 350 BlueTEC (212.224)	155	11/09 →						
E 350 BlueTEC (212.226)	190	07/14 →						
↓								

	kW					! #		
MERCEDES-BENZ - E-KLASSE T-Model (S212) 08/09 →								
 Hauptbremszylinder								
E 350 BlueTEC 4-matic (212.294)	190	07/14 →			für Linkslenker		03.2126-3196.3 010968	ATE Ø 26,99
E 350 CDI (212.223)	195	07/11 →					03.4156-5106.3 010997	ATE Ø 26,99
E 350 CDI (212.225)	170	11/09 →						
E 350 CDI 4-matic (212.289)	170	11/09 →						
E 350 CDI 4-matic (212.293)	195	07/11 →						
E 350 CGI (212.257)	215	11/09 →						
E 400	245	01/13 →						
E 400 (212.261)	245	07/14 →						
E 400 4-matic	245	01/13 →						
E 400 4-matic (212.299)	245	07/14 →						
E 500 (212.272)	285	11/09 →						
E 500 (212.273)	300	09/11 →						
E 500 4-matic (212.291)	300	09/11 →						
E 63 AMG (212.274)	386	02/11 →						
E 63 AMG (212.274)	410	02/11 →						
E 63 AMG 4-matic (212.292)	410	02/11 →						
E 220 CDI (212.202)	120	08/09 →			11/09 →; für Linkslenker		03.2126-3196.3 010968	ATE Ø 26,99
E 350 (212.256)	200	08/09 →					03.4156-5106.3 010997	ATE Ø 26,99
E 63 AMG (212.277)	386	08/09 →						
E 350 BlueTEC	185	11/12 →			01/13 →; für Linkslenker		03.2126-3196.3 010968	ATE Ø 26,99
E 350 BlueTEC 4-matic	185	11/12 →					03.4156-5106.3 010997	ATE Ø 26,99
E 63 AMG (212.275)	430	02/13 →			04/13 →; für Linkslenker		03.2126-3196.3 010968	ATE Ø 26,99
E 63 AMG 4-matic (212.276)	430	02/13 →					03.4156-5106.3 010997	ATE Ø 26,99
MERCEDES-BENZ - G-KLASSE (W461) 09/89 →								
 Bremskraftverstärker								
230 GE (461.238, 461.239)	90	09/89 → 07/96			02/93 →; für Linkslenker		03.6855-1402.4 300057	ATE Ø 9" pneumatisch
					02/93 →; für Rechtslenker		03.6855-1902.4 300059	ATE Ø 9" pneumatisch
230 GE (461)	92	06/93 → 07/00			für Linkslenker		03.6855-1402.4 300057	ATE Ø 9" pneumatisch
290 GD/G 290 D (461.337, 461.338)	70	06/93 → 07/00			für Rechtslenker		03.6855-1902.4 300059	ATE Ø 9" pneumatisch
G 270 CDI	115	01/03 →						
G 290 TD (461.335, 461.336)	88	07/97 →						
G 280 CDI (461.304, 461.346, 461.370, 461.334, 461.339, ...)	135	04/09 →			für Linkslenker		03.6855-1402.4 300057	ATE Ø 9" pneumatisch
G 300 CDI	135	04/10 →						
 Hauptbremszylinder								
230 GE (461.238, 461.239)	90	09/89 → 07/96			02/93 →		03.2125-2102.3 010207	Ø 25,4
230 GE (461)	92	06/93 → 07/00					03.2125-2102.3 010207	Ø 25,4
290 GD/G 290 D (461.337, 461.338)	70	06/93 → 07/00						
G 290 TD (461.335, 461.336)	88	07/97 →						
G 270 CDI	115	01/03 →			für Rechtslenker		03.2125-2102.3 010207	Ø 25,4
 Bremskraftregler								
230 GE (461.238, 461.239)	90	09/89 → 07/96			02/93 →		03.6513-0340.3 320084	ATE lastabhängig 1/3 2x
230 GE (461)	92	06/93 → 07/00					03.6513-0340.3 320084	ATE lastabhängig 1/3 2x
290 GD/G 290 D (461.337, 461.338)	70	06/93 → 07/00						
G 290 TD (461.335, 461.336)	88	07/97 →						
G 270 CDI	115	01/03 →					03.6515-0305.3 320087	ATE lastabhängig 1/5 2x
G 280 CDI (461.304, 461.346, 461.370, 461.334, 461.339, ...)	135	04/09 →						
MERCEDES-BENZ - G-KLASSE (W463) 09/89 →								
 Bremskraftverstärker								
300 GE (463.227, 463.228)	128	06/90 → 08/97			für Linkslenker		03.6855-1402.4 300057	ATE Ø 9" pneumatisch
350 Turbo GD (463.320, 463.321)	100	09/91 → 08/96			für Rechtslenker		03.6855-1902.4 300059	ATE Ø 9" pneumatisch
G 270 CDI (463.322, 463.323)	115	10/01 →						
G 300 TD (463.330, 463.331)	130	08/96 → 07/00						
↓								

	kw			 	! #		
MERCEDES-BENZ - G-KLASSE (W463) 09/89→							
 Bremskraftverstärker							
G 320 (463.230, 463.231)	155	09/94→12/97		für Linkslenker		03.6855-1402.4 300057	ATE Ø 9" pneumatisch
G 320 (463.232, 463.233, 463.244, 463.245)	158	07/97→		für Rechtslenker		03.6855-1902.4 300059	ATE Ø 9" pneumatisch
G 36 AMG (463.230)	200	01/95→07/98					
G 400 CDI (463.332, 463.333)	184	12/00→					
G 500 (463.247, 463.248, 463.249, 463.240, 463.241)	218	04/98→					
G 55 AMG (463.243, 463.246)	260	04/99→					
G 55 AMG (463.270, 463.271)	350	06/04→					
G 55 AMG (463.270, 463.271)	368	08/06→					
G 55 AMG (463.270, 463.271)	373	08/08→					
 Hauptbremszylinder							
300 GE (463.227, 463.228)	128	06/90→08/97		für Linkslenker; - ABS		03.2125-2102.3 010207	Ø 25,4
350 Turbo GD (463.320, 463.321)	100	09/91→08/96					
G 270 CDI (463.322, 463.323)	115	10/01→					
G 300 TD (463.330, 463.331)	130	08/96→07/00					
G 320 (463.230, 463.231)	155	09/94→12/97					
G 320 (463.232, 463.233, 463.244, 463.245)	158	07/97→					
G 36 AMG (463.230)	200	01/95→07/98					
G 400 CDI (463.332, 463.333)	184	12/00→					
G 500 (463.247, 463.248, 463.249, 463.240, 463.241)	218	04/98→					
G 55 AMG (463.243, 463.246)	260	04/99→					
G 55 AMG (463.270, 463.271)	350	06/04→					
G 55 AMG (463.270, 463.271)	368	08/06→					
G 55 AMG (463.270, 463.271)	373	08/08→					
G 320 CDI (463.340, 463.341, 463.343)	165	09/06→				24.2125-1745.3 010998	TRW Ø 25,4
G 350 CDI	155	07/11→					
G 500 (463.222, 463.236, 463.237, 463.342)	285	05/08→		→ 12/11		24.2125-1745.3 010998	TRW Ø 25,4
 Bremskraftregler							
300 GE (463.227, 463.228)	128	06/90→08/97				03.6513-0340.3 320084	ATE lastabhängig 1/3 2x
350 Turbo GD (463.320, 463.321)	100	09/91→08/96					
G 270 CDI (463.322, 463.323)	115	10/01→					
G 300 TD (463.330, 463.331)	130	08/96→07/00					
G 320 (463.230, 463.231)	155	09/94→12/97					
G 320 (463.232, 463.233, 463.244, 463.245)	158	07/97→					
G 36 AMG (463.230)	200	01/95→07/98					
G 400 CDI (463.332, 463.333)	184	12/00→					
G 500 (463.247, 463.248, 463.249, 463.240, 463.241)	218	04/98→					
G 55 AMG (463.243, 463.246)	260	04/99→					
G 55 AMG (463.270, 463.271)	350	06/04→					
G 55 AMG (463.270, 463.271)	368	08/06→					
↓							

	kw					! #		
MERCEDES-BENZ - G-KLASSE (W463) 09/89→								
 Bremskraftregler								
G 55 AMG (463.270, 463.271)	373	08/08→					03.6513-0340.3 320084	ATE lastabhängig 1/3 2x
MERCEDES-BENZ - G-KLASSE Cabrio (W463) 09/89→								
 Bremskraftverstärker								
300 GD (463.307)	83	12/90→09/97		für Linkslenker			03.6855-1402.4 300057	ATE Ø 9" pneumatisch
300 GE (463.207)	125	09/89→09/97						
320 GE (463.208)	155	09/94→11/97		für Rechtslenker			03.6855-1902.4 300059	ATE Ø 9" pneumatisch
350 G Turbo-D (463.300)	100	09/91→09/97						
G 300 TD (463.308)	130	09/96→07/00						
G 320 (463.209)	158	11/97→						
G 400 CDI (463.309)	184	12/00→						
G 500 (463.202)	285	12/09→						
G 500 (463)	218	04/98→						
 Hauptbremszylinder								
300 GD (463.307)	83	12/90→09/97		für Linkslenker; - ABS			03.2125-2102.3 010207	Ø 25,4
300 GE (463.207)	125	09/89→09/97						
320 GE (463.208)	155	09/94→11/97						
350 G Turbo-D (463.300)	100	09/91→09/97						
G 300 TD (463.308)	130	09/96→07/00						
G 320 (463.209)	158	11/97→						
G 400 CDI (463.309)	184	12/00→						
G 500 (463.202)	285	12/09→						
G 500 (463)	218	04/98→						
G 320 CDI (463.303)	165	09/06→					24.2125-1745.3 010998	TRW Ø 25,4
G 350 CDI	155	07/11→						
 Bremskraftregler								
300 GD (463.307)	83	12/90→09/97					03.6513-0340.3 320084	ATE lastabhängig 1/3 2x
300 GE (463.207)	125	09/89→09/97						
320 GE (463.208)	155	09/94→11/97						
350 G Turbo-D (463.300)	100	09/91→09/97						
G 300 TD (463.308)	130	09/96→07/00						
G 320 (463.209)	158	11/97→						
G 400 CDI (463.309)	184	12/00→						
G 500 (463.202)	285	12/09→						
G 500 (463)	218	04/98→						
MERCEDES-BENZ - GLA-KLASSE (X156) 12/13→								
 Hauptbremszylinder								
AMG GLA 45 4-matic (156.952)	280	07/15→		für Linkslenker			24.4123-1718.3 011016	TRW Ø 23,81 ohne Bremsflüssigkeitsbehälter
GLA 180 (156.942)	90	02/15→						
GLA 180 CDI / d (156.912)	80	07/14→						
GLA 200 (156.943)	115	12/13→						
GLA 200 CDI / d (156.908)	100	12/13→						
GLA 200 CDI 4-matic (156.902)	100	12/13→						
GLA 220 4-matic (156.947)	135	01/17→						
GLA 220 CDI / d (156.903)	120	12/13→						
GLA 220 CDI / d 4-matic (156.905)	120	12/13→						
GLA 220 CDI (156.903)	125	12/13→						
GLA 220 CDI 4-matic (156.905)	125	12/13→						
GLA 220 d (156.903)	130	07/15→						
GLA 220 d 4-matic (156.905)	130	07/15→						
GLA 250 (156.944)	155	12/13→						
GLA 250 4-matic (156.946)	155	12/13→						
GLA 45 AMG 4-matic (156.952)	265	05/14→06/15						
MERCEDES-BENZ - GLK-KLASSE (X204) 06/08→								
 Bremskraftverstärker								
200 (204.934)	135	08/13→06/15		für Linkslenker;			03.7745-6302.4 300261	ATE Ø 8" pneumatisch
200 CDI (204.901)	100	12/13→06/15		für Fahrzeuge ohne Start-Stopp-Funktion				
200 CDI (204.901)	105	07/10→06/15						
250 (204.936)	155	08/13→06/15		für Linkslenker;			03.7745-8902.4 300297	ATE Ø 8" pneumatisch
250 4-matic (204.937)	155	08/13→06/15		für Fahrzeuge mit Start-Stopp-Funktion				
↓								

MERCEDES-BENZ - GLK-KLASSE (X204) 06/08 →

Bremskraftverstärker

250 CDI 4-matic (204.982, 204.904)	150	09/09 → 06/15		für Linkslenker; für Fahrzeuge ohne Start-Stopp-Funktion	03.7745-6302.4	300261	ATE Ø 8" pneumatisch
300 4-matic	185	09/09 → 06/15		für Linkslenker; für Fahrzeuge mit Start-Stopp-Funktion	03.7745-8902.4	300297	ATE Ø 8" pneumatisch
300 4-matic (204.981)	170	07/09 → 04/11					
350 (204.956)	200	04/09 → 06/15					
350 CDI 4-matic (204.992)	165	07/09 → 01/10					
350 CDI 4-matic (204.992)	170	02/10 → 05/10					
350 CDI 4-matic (204.993)	195	07/12 → 06/15					
220 CDI (204.902)	120	12/08 → 06/15		04/09 →; für Linkslenker; für Fahrzeuge ohne Start-Stopp-Funktion	03.7745-6302.4	300261	ATE Ø 8" pneumatisch
220 CDI (204.902)	125	12/08 → 06/15		04/09 →; für Linkslenker; für Fahrzeuge mit Start-Stopp-Funktion	03.7745-8902.4	300297	ATE Ø 8" pneumatisch
220 CDI 4-matic (204.984, 204.997)	125	12/08 → 06/15					
220 CDI 4-matic (204.984)	120	12/08 → 06/15					
280 4-matic (204.981)	170	06/08 → 06/09		09/08 →; für Linkslenker; für Fahrzeuge ohne Start-Stopp-Funktion	03.7745-6302.4	300261	ATE Ø 8" pneumatisch
320 CDI 4-matic (204.983)	165	06/08 → 06/15		09/08 →; für Linkslenker; für Fahrzeuge mit Start-Stopp-Funktion	03.7745-8902.4	300297	ATE Ø 8" pneumatisch
350 4-matic (204.987)	200	06/08 → 04/11					
350 4-matic (204.988)	225	06/08 → 06/15					

Hauptbremszylinder

200 (204.934)	135	08/13 → 06/15		für Linkslenker	03.2025-2521.3	010959	ATE Ø1 25,4 Ø2 22,2				
200 CDI (204.901)	100	12/13 → 06/15		für Linkslenker	03.2025-2521.3	010959	ATE Ø1 25,4 Ø2 22,2				
200 CDI (204.901)	105	07/10 → 06/15									
250 (204.936)	155	08/13 → 06/15									
250 4-matic (204.937)	155	08/13 → 06/15									
250 CDI 4-matic (204.982, 204.904)	150	09/09 → 06/15									
300 4-matic	185	09/09 → 06/15									
300 4-matic (204.981)	170	07/09 → 04/11									
350 (204.956)	200	04/09 → 06/15									
350 CDI 4-matic (204.992)	165	07/09 → 01/10									
350 CDI 4-matic (204.992)	170	02/10 → 05/10									
350 CDI 4-matic (204.993)	195	07/12 → 06/15									
220 CDI (204.902)	120	12/08 → 06/15						04/09 →; für Linkslenker	03.2025-2521.3	010959	ATE Ø1 25,4 Ø2 22,2
220 CDI (204.902)	125	12/08 → 06/15						für Linkslenker	03.2025-2521.3	010959	ATE Ø1 25,4 Ø2 22,2
220 CDI 4-matic (204.984, 204.997)	125	12/08 → 06/15									
220 CDI 4-matic (204.984)	120	12/08 → 06/15									
280 4-matic (204.981)	170	06/08 → 06/09						09/08 →; für Linkslenker	03.2025-2521.3	010959	ATE Ø1 25,4 Ø2 22,2
320 CDI 4-matic (204.983)	165	06/08 → 06/15						für Linkslenker	03.2025-2521.3	010959	ATE Ø1 25,4 Ø2 22,2
350 4-matic (204.987)	200	06/08 → 04/11									
350 4-matic (204.988)	225	06/08 → 06/15									











MERCEDES-BENZ - GL-KLASSE (X164) 09/06 →









Pedalwegsensoren, Bremspedal











GL 320 CDI / 350 BlueTEC 4-matic (164.824, 164.825)	155	12/09 →		→ 06/12	03.0655-0007.2	370007	ATE
GL 350 CDI 4-matic (164.822)	165	05/09 →		→ 06/12	03.0655-0007.2	370007	ATE
GL 350 CDI 4-matic (164.823)	195	10/10 →					
GL 450 4-matic (164.871)	250	09/06 →					
GL 450 CDI 4-matic (164.828)	225	05/09 →					
GL 500 4-matic (164.886)	285	09/06 →					
GL 320 CDI 4-matic (164.822)	165	09/06 → 05/09					
GL 420 CDI 4-matic (164.828)	225	09/06 → 05/09					









Hauptbremszylinder









GL 320 CDI / 350 BlueTEC 4-matic (164.824, 164.825)	155	12/09 →		→ 06/12	03.4156-0014.3	010930	ATE Ø 26,99 ohne Bremsflüssigkeitsbehälter
GL 350 CDI 4-matic (164.822)	165	05/09 →		→ 06/12	03.4156-0014.3	010930	ATE Ø 26,99 ohne Bremsflüssigkeitsbehälter
GL 350 CDI 4-matic (164.823)	195	10/10 →					
↓							

	kW					! #		
MERCEDES-BENZ - GL-KLASSE (X164) 09/06→								
 Hauptbremszylinder								
GL 450 4-matic (164.871)	250	09/06→			→ 06/12		03.4156-0014.3 010930	ATE Ø 26,99 ohne Bremsflüssigkeitsbehälter
GL 450 CDI 4-matic (164.828)	225	05/09→						
GL 500 4-matic (164.886)	285	09/06→						
GL 320 CDI 4-matic (164.822)	165	09/06→05/09					03.4156-0014.3 010930	ATE Ø 26,99 ohne Bremsflüssigkeitsbehälter
GL 420 CDI 4-matic (164.828)	225	09/06→05/09						
MERCEDES-BENZ - M-KLASSE (W163) 02/98→06/05								
Pedalwegsensor, Bremspedal								
ML 270 CDI (163.113)	120	12/99→06/05					03.0655-0007.2 370007	ATE
ML 350	173	02/03→06/05						
ML 400 CDI (163.128)	184	09/01→06/05						
ML 500 (163.175)	215	09/01→06/05						
ML 55 AMG (163.174)	255	02/00→06/05						
ML 320 (163.154)	160	02/98→08/02			03/98→; + ESP		03.0655-0007.2 370007	ATE
ML 430 (163.172)	200	02/98→06/05			09/98→		03.0655-0007.2 370007	ATE
 Hauptbremszylinder								
ML 230 (163.136)	110	02/98→06/05			03/98→		03.2125-7310.3 010743	ATE Ø 25,4
ML 320 (163.154)	160	02/98→08/02						
ML 270 CDI (163.113)	120	12/99→06/05					03.2125-7310.3 010743	ATE Ø 25,4
ML 350	173	02/03→06/05						
ML 400 CDI (163.128)	184	09/01→06/05						
ML 500 (163.175)	215	09/01→06/05						
ML 55 AMG (163.174)	255	02/00→06/05						
ML 430 (163.172)	200	02/98→06/05			09/98→		03.2125-7310.3 010743	ATE Ø 25,4
MERCEDES-BENZ - M-KLASSE (W164) 02/05→12/12								
Pedalwegsensor, Bremspedal								
ML 280 CDI 4-matic (164.120)	140	07/05→07/09					03.0655-0007.2 370007	ATE
ML 320 CDI 4-matic (164.122)	155	07/05→07/11						
ML 320 CDI 4-matic (164.122)	165	07/05→07/09						
ML 300 CDI 4-matic (164.120)	140	07/09→12/11			→ 05/11		03.0655-0007.2 370007	ATE
ML 300 CDI 4-matic (164.121)	150	02/10→12/11						
ML 350 4-matic (164.186)	200	02/05→12/11						
ML 350 CDI 4-matic (164.122)	165	07/09→12/11						
ML 350 CDI 4-matic (164.125)	155	09/09→12/11						
ML 350 CDI 4-matic (164.125)	170	02/10→12/11						
ML 450 CDI 4-matic (164.128)	225	09/09→12/11						
ML 500 4-matic (164.172)	285	12/07→12/11						
ML 500 4-matic (164.175)	225	07/05→12/11						
ML 63 AMG 4-matic (164.177)	375	01/06→12/11						
ML 420 CDI 4-matic (164.128)	225	02/06→09/09			04/06→		03.0655-0007.2 370007	ATE
 Hauptbremszylinder								
ML 280 CDI 4-matic (164.120)	140	07/05→07/09					03.4156-0014.3 010930	ATE Ø 26,99 ohne Bremsflüssigkeitsbehälter
ML 320 CDI 4-matic (164.122)	155	07/05→07/11						
ML 320 CDI 4-matic (164.122)	165	07/05→07/09						
ML 300 CDI 4-matic (164.120)	140	07/09→12/11			→ 05/11		03.4156-0014.3 010930	ATE Ø 26,99 ohne Bremsflüssigkeitsbehälter
ML 300 CDI 4-matic (164.121)	150	02/10→12/11						
ML 350 4-matic (164.186)	200	02/05→12/11						
ML 350 CDI 4-matic (164.122)	165	07/09→12/11						
ML 350 CDI 4-matic (164.125)	155	09/09→12/11						













	kw			 	! #		
MERCEDES-BENZ - M-KLASSE (W164) 02/05→12/12							
 Hauptbremszylinder							
ML 350 CDI 4-matic (164.125)	170	02/10→12/11		→ 05/11		03.4156-0014.3 010930	ATE Ø 26,99 ohne Bremsflüssigkeitsbehälter
ML 450 CDI 4-matic (164.128)	225	09/09→12/11					
ML 500 4-matic (164.172)	285	12/07→12/11					
ML 500 4-matic (164.175)	225	07/05→12/11					
ML 63 AMG 4-matic (164.177)	375	01/06→12/11					
ML 420 CDI 4-matic (164.128)	225	02/06→09/09		04/06→		03.4156-0014.3 010930	ATE Ø 26,99 ohne Bremsflüssigkeitsbehälter
MERCEDES-BENZ - R-KLASSE (W251, V251) 01/05→							
Pedalwegsensor, Bremspedal							
R 280 (251.054, 251.154)	170	01/07→				03.0655-0007.2 370007	ATE
R 280 CDI (251.121, 251.026, 251.126)	140	05/06→					
R 280 CDI 4-matic (251.020)	140	05/06→					
R 300 (251.054, 251.154)	170	07/09→					
R 300 CDI (251.021, 251.121, 251.026, 251.126)	140	07/09→					
R 300 CDI 4-matic (251.020)	140	07/09→					
R 320 CDI 4-matic (251.022, 251.122)	165	01/06→					
R 320 CDI 4-matic (251.125)	155	01/06→					
R 350 (251.056, 251.156)	200	01/07→					
R 350 4-matic (251.065, 251.165)	200	01/06→					
R 350 CDI 4-matic (251.022, 251.122)	165	07/09→					
R 350 CDI 4-matic (251.023, 251.123)	195	08/10→					
R 350 CGI 4-matic (251.057, 251.157)	225	01/06→					
R 500 4-matic (251.072, 251.172)	285	01/07→					
R 500 4-matic (251.075, 251.175)	225	01/06→					
R 63 AMG 4-matic (251.077, 251.177)	375	02/06→					
R 350 CDI 4-matic (251.124, 251.125)	155	01/06→		05/09→		03.0655-0007.2 370007	ATE
 Hauptbremszylinder							
R 280 (251.054, 251.154)	170	01/07→				03.4156-0014.3 010930	ATE Ø 26,99 ohne Bremsflüssigkeitsbehälter
R 280 CDI (251.121, 251.026, 251.126)	140	05/06→					
R 280 CDI 4-matic (251.020)	140	05/06→					
R 300 (251.054, 251.154)	170	07/09→					
R 300 CDI (251.021, 251.121, 251.026, 251.126)	140	07/09→					
R 300 CDI 4-matic (251.020)	140	07/09→					
R 320 CDI 4-matic (251.022, 251.122)	165	01/06→					
R 320 CDI 4-matic (251.125)	155	01/06→					
R 350 (251.056, 251.156)	200	01/07→					
R 350 4-matic (251.065, 251.165)	200	01/06→					
R 350 CDI 4-matic (251.022, 251.122)	165	07/09→					
R 350 CDI 4-matic (251.023, 251.123)	195	08/10→					
R 350 CGI 4-matic (251.057, 251.157)	225	01/06→					
R 500 4-matic (251.072, 251.172)	285	01/07→					
↓							













	kW					! #								
MERCEDES-BENZ - R-KLASSE (W251, V251) 01/05→														
 Hauptbremszylinder														
R 500 4-matic (251.075, 251.175)	225	01/06→					03.4156-0014.3 010930	ATE Ø 26,99 ohne Bremsflüssigkeitsbehälter						
R 63 AMG 4-matic (251.077, 251.177)	375	02/06→												
R 350 CDI 4-matic (251.124, 251.125)	155	01/06→		05/09→			03.4156-0014.3 010930	ATE Ø 26,99 ohne Bremsflüssigkeitsbehälter						
MERCEDES-BENZ - S-KLASSE (W140) 02/91→10/98														
 Bremskraftverstärker														
300 SE, SEL/S320 (140.032, 140.033)	170	03/91→10/98		A 358833→; für Linkslenker			03.7858-0102.4 300262	ATE Ø 9 / 8" pneumatisch						
300 SE 2.8 (140.028)	145	01/93→10/98												
S 280 (140.028)	142	02/93→10/98												
S 300 Turbo-D (140.135)	130	05/96→10/98												
S 350 Turbo-D (140.134)	110	01/93→10/98		A 358833→; → 06/96; für Linkslenker			03.7858-0102.4 300262	ATE Ø 9 / 8" pneumatisch						
 Hauptbremszylinder														
300 SE, SEL/S320 (140.032, 140.033)	170	03/91→10/98		07/93→; → A212244			03.2025-0211.3 010034	Ø1 25,4 Ø2 19,05						
				04/91→ 06/93			03.2025-0211.3 010034	Ø1 25,4 Ø2 19,05						
				A212245→			24.2025-1702.3 010515	Ø1 25,4 Ø2 19,05						
300 SE 2.8 (140.028)	145	01/93→10/98		07/93→; → A212244			03.2025-0211.3 010034	Ø1 25,4 Ø2 19,05						
			142	02/93→10/98		→ 06/93			03.2025-0211.3 010034	Ø1 25,4 Ø2 19,05				
						A212245→			24.2025-1702.3 010515	Ø1 25,4 Ø2 19,05				
400 SE, SEL/S420 (140.042, 140.043)	210	02/91→10/98		→ 06/93; A110607→; für Linkslenker			03.2026-0462.3 010728	Ø1 26,99 Ø2 25,4						
			240	02/91→10/98		07/93→; → A358832; für Linkslenker			03.2026-0462.3 010728	Ø1 26,99 Ø2 25,4				
						07/93→; → A212244; für Rechtslenker			03.2026-0512.3 010038	Ø1 26,99 Ø2 25,4				
	→ 06/93; A110607→; für Rechtslenker					03.2026-0512.3 010038	Ø1 26,99 Ø2 25,4							
500 SE, SEL (140.050, 140.051)	240	02/91→10/98		A212245→ A358832; für Rechtslenker			03.2026-0562.3 010729	Ø1 26,99 Ø2 25,4						
				A358833→; für Linkslenker			03.2026-0712.3 010730	Ø1 26,99 Ø2 25,4						
							24.2025-1702.3 010515	Ø1 25,4 Ø2 19,05						
S 300 Turbo-D (140.135)	130	05/96→10/98					24.2025-1702.3 010515	Ø1 25,4 Ø2 19,05						
S 350 Turbo-D (140.134)	110	01/93→10/98		03/93→ 06/93			03.2025-0211.3 010034	Ø1 25,4 Ø2 19,05						
				07/93→; → A212244			03.2025-0211.3 010034	Ø1 25,4 Ø2 19,05						
				→ 06/96; A212245→			24.2025-1702.3 010515	Ø1 25,4 Ø2 19,05						
S 420 (140.042)	205	01/93→10/98		07/93→; → A358832; für Linkslenker			03.2026-0462.3 010728	Ø1 26,99 Ø2 25,4						
S 500 (140.050, 140.051)	235	01/93→10/98		07/93→; → A212244; für Rechtslenker			03.2026-0512.3 010038	Ø1 26,99 Ø2 25,4						
S 600 (140.056, 140.057)	290	01/93→10/98		A212245→ A358832; für Rechtslenker			03.2026-0562.3 010729	Ø1 26,99 Ø2 25,4						
				A358833→; für Linkslenker			03.2026-0712.3 010730	Ø1 26,99 Ø2 25,4						
MERCEDES-BENZ - S-KLASSE (W220) 10/98→08/05														
 Hauptbremszylinder														
S 280 (220.063, 220.163)	150	10/98→08/05		11/98→			24.4025-1701.3 010719	Ø 25,4						
			S 320 (220.065, 220.165)	165	10/98→08/05									
						S 430 (220.070, 220.170)	205	10/98→08/05						
									S 500 (220.075, 220.175, 220.875)	220	10/98→12/03			
												S 500 (220.075, 220.175, 220.875)	225	10/98→08/05
S 320 CDI (220.025, 220.125)	150	09/02→08/05					24.4025-1701.3 010719	Ø 25,4						
			S 320 CDI (220.026, 220.126)	145	08/99→09/02									
			S 350 (220.067, 220.167)	180	09/02→08/05									
			S 350 4-matic (220.087, 220.187)	180	06/03→08/05									
			S 400 CDI (220.028, 220.128)	191	06/03→08/05									
			S 430 4-matic (220.083, 220.183)	205	09/02→08/05									
			S 500 4-matic (220.084, 220.184)	225	09/02→08/05									
			S 55 AMG (220.073, 220.173)	265	04/99→08/05									
			S 55 AMG Kompressor (220.074, 220.174)	368	06/02→08/05									
			S 600 (220.176)	368	09/02→08/05									
			S 600 (220.878, 220.178)	270	01/00→08/05									
			S 63 AMG	326	09/01→08/05									
			↓											













	kw			 	! #		
MERCEDES-BENZ - S-KLASSE (W220) 10/98→08/05							
 Hauptbremszylinder							
S 65 AMG (220.179)	450	03/04→08/05				24.4025-1701.3 010719	Ø 25,4
S 400 CDI (220.028, 220.128)	184	06/00→08/05		08/00→		24.4025-1701.3 010719	Ø 25,4
MERCEDES-BENZ - S-KLASSE (W221) 09/05→12/13							
 Bremskraftverstärker							
S 280 (221.054)	170	08/06→12/13		→ A 265574		03.7858-1932.4 300263	ATE Ø 9 / 8" pneumatisch
S 300 (221.054, 221.154)	170	08/06→12/13					
S 320 CDI (221.022, 221.122)	173	12/05→06/09					
S 320 CDI 4-matic (221.080, 221.180)	155	10/05→12/13					
S 320 CDI 4-matic (221.080, 221.180)	173	10/06→12/13					
S 350 4-matic (221.087, 221.187)	200	02/08→12/13					
S 350 CDI	173	06/09→12/13					
S 350 CDI 4-matic (221.080, 221.081)	155	01/09→12/10					
S 420 CDI (221.028, 221.128)	235	10/06→12/09					
S 450 CDI (221.028, 221.128)	235	01/09→12/13					
S 63 AMG (221.074, 221.174)	400	03/11→12/13					
S 63 AMG (221.074, 221.174)	420	02/12→12/13					
S 320 CDI	155	10/05→12/13		12/05→; → A 265574		03.7858-1932.4 300263	ATE Ø 9 / 8" pneumatisch
S 350 (221.056, 221.156)	200	10/05→12/13					
S 500 (221.071, 221.171)	285	10/05→12/13					
S 450 (221.070, 221.170)	250	12/05→12/13		04/06→; → A 265574		03.7858-1932.4 300263	ATE Ø 9 / 8" pneumatisch
S 450 4-matic (221.084, 221.184)	250	12/05→12/13					
S 500 4-matic (221.086, 221.186)	285	10/05→12/13					
S 63 AMG (221.077, 221.177)	386	10/06→12/13		01/07→; → A 265574		03.7858-1932.4 300263	ATE Ø 9 / 8" pneumatisch
Pedalwegsensoren, Bremspedal							
S 250 CDI (221.003, 221.103)	150	01/11→12/13		→ 05/13; + DISTRONIC Plus		03.0655-0007.2 370007	ATE
S 350 BlueTec (221.026, 221.126)	190	04/11→12/13					
S 350 BlueTEC 4-matic (221.083, 221.183)	190	04/11→12/13					
S 350 CGI (221.057, 221.157)	225	04/11→12/13					
S 350 CGI 4-matic (221.082, 221.182)	225	04/11→12/13					
S 500 CGI (221.073, 221.173)	320	04/11→12/13					
S 500 CGI 4-matic (221.094, 221.194)	320	03/11→12/13					
S 280 (221.054)	170	08/06→12/13		A 265575→; → 05/13; + DISTRONIC Plus		03.0655-0007.2 370007	ATE
S 300 (221.054, 221.154)	170	08/06→12/13		→ A 265574		03.0655-0007.2 370007	ATE
S 320 CDI 4-matic (221.080, 221.180)	173	10/06→12/13					
S 350 4-matic (221.087, 221.187)	200	02/08→12/13					
S 350 CDI	173	06/09→12/13					
S 320 CDI	155	10/05→12/13		A 265575→; → 05/13; + DISTRONIC Plus		03.0655-0007.2 370007	ATE
S 350 (221.056, 221.156)	200	10/05→12/13		12/05→; → A 265574		03.0655-0007.2 370007	ATE
S 500 (221.071, 221.171)	285	10/05→12/13					
S 320 CDI (221.022, 221.122)	173	12/05→06/09		A 265575→; + DISTRONIC Plus		03.0655-0007.2 370007	ATE
S 320 CDI 4-matic (221.080, 221.180)	155	10/05→12/13		→ A 265574		03.0655-0007.2 370007	ATE
S 350 CDI 4-matic (221.080, 221.081)	155	01/09→12/10					
S 420 CDI (221.028, 221.128)	235	10/06→12/09					
S 450 CDI (221.028, 221.128)	235	01/09→12/13					
↓							











	kw			 	! #		
MERCEDES-BENZ - S-KLASSE (W221) 09/05→12/13							
Pedalwegsensor, Bremspedal							
S 400 Hybrid (221.095, 221.195)	205	01/09→12/13		06/09→ 05/13		03.0655-0007.2 370007	ATE
S 450 (221.070, 221.170)	250	12/05→12/13		A 265575→; → 05/13; + DISTRONIC Plus		03.0655-0007.2 370007	ATE
S 450 4-matic (221.084, 221.184)	250	12/05→12/13		04/06→; → A 265574		03.0655-0007.2 370007	ATE
S 500 4-matic (221.086, 221.186)	285	10/05→12/13					
S 600 (221.176)	380	12/05→12/13		A 060621→; für Fahrzeuge ohne Start-Stopp-Funktion; → 05/13		03.0655-0007.2 370007	ATE
				→ A 060620; für Fahrzeuge ohne Start-Stopp-Funktion		03.0655-0007.2 370007	ATE
				für Fahrzeuge ohne Start-Stopp-Funktion; → 05/13		03.0655-0007.2 370007	ATE
S 63 AMG (221.074, 221.174)	400	03/11→12/13		A 265575→; → 05/13; + DISTRONIC Plus		03.0655-0007.2 370007	ATE
S 63 AMG (221.074, 221.174)	420	02/12→12/13		→ A 265574		03.0655-0007.2 370007	ATE
				→ 05/13		03.0655-0007.2 370007	ATE
S 63 AMG (221.077, 221.177)	386	10/06→12/13		A 265575→; → 05/13; + DISTRONIC Plus		03.0655-0007.2 370007	ATE
				01/07→; → A 265574		03.0655-0007.2 370007	ATE
				01/07→ 05/13		03.0655-0007.2 370007	ATE
S 65 AMG (221.179)	450	12/05→12/13		04/06→; → A 060620		03.0655-0007.2 370007	ATE
				A 060621→; → 05/13		03.0655-0007.2 370007	ATE
				04/06→ 05/13		03.0655-0007.2 370007	ATE
S 65 AMG (221.179)	463	04/11→12/13		A 060621→; → 05/13		03.0655-0007.2 370007	ATE
				→ A 060620		03.0655-0007.2 370007	ATE
				→ 05/13		03.0655-0007.2 370007	ATE
 Hauptbremszylinder							
S 250 CDI (221.003, 221.103)	150	01/11→12/13		→ 05/13		03.4156-0073.3 010942	ATE Ø 26,99
S 350 BlueTec (221.026, 221.126)	190	04/11→12/13					
S 350 BlueTEC 4-matic (221.083, 221.183)	190	04/11→12/13					
S 350 CGI (221.057, 221.157)	225	04/11→12/13					
S 350 CGI 4-matic (221.082, 221.182)	225	04/11→12/13					
S 500 CGI (221.073, 221.173)	320	04/11→12/13					
S 500 CGI 4-matic (221.094, 221.194)	320	03/11→12/13					
S 280 (221.054)	170	08/06→12/13		→ A 293047; nicht für gepanzerte Fahrzeuge		03.4055-0013.3 010793	ATE Ø 25,4
S 300 (221.054, 221.154)	170	08/06→12/13					
S 320 CDI 4-matic (221.080, 221.180)	173	10/06→12/13		A 293048→; → 05/13; nicht für gepanzerte Fahrzeuge		03.4156-0073.3 010942	ATE Ø 26,99
S 350 4-matic (221.087, 221.187)	200	02/08→12/13					
S 350 CDI	173	06/09→12/13					
S 600 (221.176)	380	12/05→12/13					
S 63 AMG (221.074, 221.174)	400	03/11→12/13					
S 63 AMG (221.074, 221.174)	420	02/12→12/13					
S 65 AMG (221.179)	463	04/11→12/13					
S 320 CDI	155	10/05→12/13		12/05→; → A 293047; nicht für gepanzerte Fahrzeuge		03.4055-0013.3 010793	ATE Ø 25,4
S 350 (221.056, 221.156)	200	10/05→12/13					
S 500 (221.071, 221.171)	285	10/05→12/13		A 293048→; → 05/13; nicht für gepanzerte Fahrzeuge		03.4156-0073.3 010942	ATE Ø 26,99
S 320 CDI (221.022, 221.122)	173	12/05→06/09		→ A 293047; nicht für gepanzerte Fahrzeuge		03.4055-0013.3 010793	ATE Ø 25,4
S 320 CDI 4-matic (221.080, 221.180)	155	10/05→12/13		A 293048→; nicht für gepanzerte Fahrzeuge		03.4156-0073.3 010942	ATE Ø 26,99
S 350 CDI 4-matic (221.080, 221.081)	155	01/09→12/10					
S 420 CDI (221.028, 221.128)	235	10/06→12/09					
S 450 CDI (221.028, 221.128)	235	01/09→12/13					
S 400 Hybrid (221.095, 221.195)	205	01/09→12/13		06/09→ 05/13		03.4155-5141.3 010969	ATE Ø 25,4
S 450 (221.070, 221.170)	250	12/05→12/13		04/06→; → A 293047; nicht für gepanzerte Fahrzeuge		03.4055-0013.3 010793	ATE Ø 25,4
↓							



	kW					! #		
MERCEDES-BENZ - S-KLASSE (W221) 09/05→12/13								
 Hauptbremszylinder								
S 450 4-matic (221.084, 221.184)	250	12/05→12/13		A 293048→; → 05/13; nicht für gepanzerte Fahrzeuge			03.4156-0073.3 010942	ATE Ø 26,99
S 500 4-matic (221.086, 221.186)	285	10/05→12/13						
S 65 AMG (221.179)	450	12/05→12/13						
S 63 AMG (221.077, 221.177)	386	10/06→12/13		01/07→; → A 293047; nicht für gepanzerte Fahrzeuge			03.4055-0013.3 010793	ATE Ø 25,4
				A 293048→; → 05/13; nicht für gepanzerte Fahrzeuge			03.4156-0073.3 010942	ATE Ø 26,99
MERCEDES-BENZ - S-KLASSE Coupe (C140) 07/92→02/99								
 Hauptbremszylinder								
SEC/CL 420 (140.063)	205	10/94→02/99		06/96→; für Linkslenker			03.2026-0462.3 010728	Ø1 26,99 Ø2 25,4
				→ 05/96; für Linkslenker			03.2026-0462.3 010728	Ø1 26,99 Ø2 25,4
				→ 05/96; für Rechtslenker			03.2026-0562.3 010729	Ø1 26,99 Ø2 25,4
				06/96→; für Rechtslenker			03.2026-0562.3 010729	Ø1 26,99 Ø2 25,4
SEC/CL 500 (140.070)	235	10/92→02/99		06/96→; für Linkslenker			03.2026-0462.3 010728	Ø1 26,99 Ø2 25,4
SEC/CL 600 (140.076)	290	09/92→02/99		→ 06/93; A110607→; für Linkslenker			03.2026-0462.3 010728	Ø1 26,99 Ø2 25,4
				07/93→; → A358832; für Linkslenker			03.2026-0462.3 010728	Ø1 26,99 Ø2 25,4
				→ 06/93; A110607→; für Rechtslenker			03.2026-0512.3 010038	Ø1 26,99 Ø2 25,4
				07/93→; → A212244; für Rechtslenker			03.2026-0512.3 010038	Ø1 26,99 Ø2 25,4
				06/96→; für Rechtslenker			03.2026-0562.3 010729	Ø1 26,99 Ø2 25,4
				A212245→ A358832; für Rechtslenker			03.2026-0562.3 010729	Ø1 26,99 Ø2 25,4
				A358833→; → 05/96; für Linkslenker			03.2026-0712.3 010730	Ø1 26,99 Ø2 25,4
MERCEDES-BENZ - S-KLASSE Coupe (C215) 03/99→12/06								
 Hauptbremszylinder								
CL 500 (215.375)	225	03/99→03/06					24.4025-1701.3 010719	Ø 25,4
CL 55 AMG (215.373)	265	10/99→03/06						
CL 55 AMG Kompressor (215.374)	368	06/02→03/06						
CL 600 (215.376)	368	09/02→03/06						
CL 600 (215.378)	270	03/99→03/06						
CL 65 AMG (215.379)	450	09/03→03/06						
MERCEDES-BENZ - S-KLASSE Coupe (C216) 05/06→12/13								
 Bremskraftverstärker								
CL 500 (216.371)	285	06/06→12/13		07/06→; → A 024306			03.7858-1932.4 300263	ATE Ø 9 / 8" pneumatisch
CL 600 (216.376)	380	05/06→12/13						
CL 500 (216.373)	320	02/11→12/13		→ A 024306			03.7858-1932.4 300263	ATE Ø 9 / 8" pneumatisch
CL 500 4-matic (216.394)	320	02/11→12/13						
CL 63 AMG (216.374)	400	02/11→12/13						
CL 63 AMG (216.374)	420	01/10→12/13						
CL 65 AMG (216.379)	463	02/11→12/13						
CL 500 4-matic (216.386)	285	02/08→12/13		03/08→; → A 024306			03.7858-1932.4 300263	ATE Ø 9 / 8" pneumatisch
CL 63 AMG (216.377)	386	10/06→12/13		01/07→; → A 024306			03.7858-1932.4 300263	ATE Ø 9 / 8" pneumatisch
CL 65 AMG (216.379)	450	10/06→12/10						
Pedalwegsensor, Bremspedal								
CL 500 (216.371)	285	06/06→12/13		07/06→; → A 024306			03.0655-0007.2 370007	ATE
CL 600 (216.376)	380	05/06→12/13		A 024307→			03.0655-0007.2 370007	ATE
CL 500 (216.373)	320	02/11→12/13		A 024307→			03.0655-0007.2 370007	ATE
CL 500 4-matic (216.394)	320	02/11→12/13		→ A 024306			03.0655-0007.2 370007	ATE
CL 63 AMG (216.374)	400	02/11→12/13						
CL 63 AMG (216.374)	420	01/10→12/13						
CL 65 AMG (216.379)	463	02/11→12/13						
CL 500 4-matic (216.386)	285	02/08→12/13		A 024307→			03.0655-0007.2 370007	ATE
				03/08→; → A 024306			03.0655-0007.2 370007	ATE
CL 63 AMG (216.377)	386	10/06→12/13		01/07→; → A 024306			03.0655-0007.2 370007	ATE
CL 65 AMG (216.379)	450	10/06→12/10		A 024307→			03.0655-0007.2 370007	ATE
 Hauptbremszylinder								
CL 500 (216.371)	285	06/06→12/13		07/06→; → A 024016			03.4055-0013.3 010793	ATE Ø 25,4
CL 600 (216.376)	380	05/06→12/13		A 024017→			03.4156-0073.3 010942	ATE Ø 26,99
CL 500 (216.373)	320	02/11→12/13					03.4156-0073.3 010942	ATE Ø 26,99
CL 500 4-matic (216.394)	320	02/11→12/13						
↓								

	kw					! #		
MERCEDES-BENZ - S-KLASSE Coupe (C216) 05/06→12/13								
 Hauptbremszylinder								
CL 63 AMG (216.374)	400	02/11→12/13					03.4156-0073.3 010942	ATE Ø 26,99
CL 63 AMG (216.374)	420	01/10→12/13						
CL 500 4-matic (216.386)	285	02/08→12/13		03/08→; → A 024016			03.4055-0013.3 010793	ATE Ø 25,4
				A 024017→			03.4156-0073.3 010942	ATE Ø 26,99
CL 63 AMG (216.377)	386	10/06→12/13		01/07→; → A 024016			03.4055-0013.3 010793	ATE Ø 25,4
CL 65 AMG (216.379)	450	10/06→12/10		A 024017→			03.4156-0073.3 010942	ATE Ø 26,99
CL 65 AMG (216.379)	463	02/11→12/13		→ A 024016			03.4055-0013.3 010793	ATE Ø 25,4
				A 024017→			03.4156-0073.3 010942	ATE Ø 26,99
MERCEDES-BENZ - SL (R129) 03/89→12/01								
 Hauptbremszylinder								
280 (129.058)	142	08/93→10/01		→ F102744; für Linkslenker			03.2025-0211.3 010034	Ø1 25,4 Ø2 19,05
320 (129.063)	170	09/93→10/01		F102745→ F148143; für Linkslenker			24.2025-1702.3 010515	Ø1 25,4 Ø2 19,05
500 (129.067)	235	09/92→10/01		08/93→; → F102744; - ESP; für Linkslenker			03.2025-0211.3 010034	Ø1 25,4 Ø2 19,05
				F102745→ F148143; - ESP; für Linkslenker			24.2025-1702.3 010515	Ø1 25,4 Ø2 19,05
60 AMG (129.067)	280	05/97→10/01		→ F102744; - ESP; für Linkslenker			03.2025-0211.3 010034	Ø1 25,4 Ø2 19,05
				F102745→ F148143; - ESP; für Linkslenker			24.2025-1702.3 010515	Ø1 25,4 Ø2 19,05
MERCEDES-BENZ - SL (R230) 10/01→01/12								
 Bremskraftverstärker								
65 AMG Black Series (230.479)	493	07/08→01/12		→ 11/11; für Linkslenker			03.7848-2002.4 300166	ATE Ø 7 / 8" pneumatisch
Pedalwegsensoren, Bremspedal								
65 AMG Black Series (230.479)	493	07/08→01/12		→ 11/11; für Linkslenker			03.0655-0007.2 370007	ATE
MERCEDES-BENZ - SL (R231) 01/12→								
 Hauptbremszylinder								
350 (231.457)	225	02/12→		03/12→			03.2126-3196.3 010968	ATE Ø 26,99
500 (231.473)	320	01/12→						
63 AMG (231.474)	395	01/12→						
63 AMG (231.474)	415	01/12→						
400 (231.465)	245	04/14→					03.2126-3196.3 010968	ATE Ø 26,99
400 (231.466)	270	01/16→						
500 (231.473)	335	04/15→						
63 AMG (231.474)	430	04/14→						
65 AMG (231.479)	463	05/12→						
MERCEDES-BENZ - SLC (R172) 01/16→								
 Bremskraftverstärker								
180 (172.431)	115	01/16→		für Linkslenker;			03.7745-1632.4 300293	ATE Ø 8 / 7" pneumatisch
200 (172.434)	135	01/16→		für Fahrzeuge ohne Start-Stopp-Funktion				
250 d (172.404)	150	01/16→10/17		für Linkslenker;			03.7745-1832.4 300294	ATE Ø 8 / 7" pneumatisch
300 (172.438)	180	01/16→		für Fahrzeuge mit Start-Stopp-Funktion				
AMG SLC 43 (172.466)	270	01/16→						
MERCEDES-BENZ - SLK (R170) 04/96→04/04								
Pedalwegsensoren, Bremspedal								
200 Kompressor (170.444)	120	03/00→04/04		→ 03/04			03.0655-0007.2 370007	ATE
230 Kompressor (170.449)	145	03/00→04/04						
32 AMG Kompressor (170.466)	260	03/01→04/04						
320 (170.465)	160	03/00→04/04		04/00→ 03/04			03.0655-0007.2 370007	ATE
 Hauptbremszylinder								
200 (170.435)	100	09/96→03/00		→ F025730			24.2023-1701.3 010514	TRW Ø1 23,81 Ø2 19,05
200 Kompressor (170.445)	141	10/96→03/00		F025731→			24.2023-1702.3 010534	TRW Ø1 23,81 Ø2 19,05
230 Kompressor (170.447)	142	09/96→03/00						
200 Kompressor (170.444)	120	03/00→04/04		→ 03/04; für Rechtslenker			03.2025-1741.3 010705	ATE Ø1 25,4 Ø2 20,64
230 Kompressor (170.449)	145	03/00→04/04						
32 AMG Kompressor (170.466)	260	03/01→04/04						
320 (170.465)	160	03/00→04/04		04/00→ 03/04; für Rechtslenker			03.2025-1741.3 010705	ATE Ø1 25,4 Ø2 20,64

	kW					! #		
MERCEDES-BENZ - SLK (R171) 03/04→12/11								
 Bremskraftverstärker								
200 Kompressor (171.442)	120	03/04→02/11		→ F 196638; für Linkslenker			03.7848-9402.4 300227	ATE Ø 7 / 8" pneumatisch
200 Kompressor (171.445)	135	01/08→02/11						
300 (171.454)	170	04/09→02/11						
350 (171.456)	200	06/04→02/11						
350 (171.458)	224	01/08→02/11						
55 AMG (171.473)	265	06/04→02/11						
55 AMG (171.473)	294	06/06→02/11						
280 (171.454)	170	01/05→02/11		04/05→; → F 196638; für Linkslenker			03.7848-9402.4 300227	ATE Ø 7 / 8" pneumatisch
Pedalwegsensor, Bremspedal								
200 Kompressor (171.442)	120	03/04→02/11		→ F 196638			03.0655-0007.2 370007	ATE
200 Kompressor (171.445)	135	01/08→02/11		F 196639→; → 01/11			03.0655-0007.2 370007	ATE
300 (171.454)	170	04/09→02/11						
350 (171.456)	200	06/04→02/11						
350 (171.458)	224	01/08→02/11						
55 AMG (171.473)	265	06/04→02/11						
55 AMG (171.473)	294	06/06→02/11						
280 (171.454)	170	01/05→02/11		04/05→; → F 196638			03.0655-0007.2 370007	ATE
				F 196639→; → 01/11			03.0655-0007.2 370007	ATE
 Hauptbremszylinder								
200 Kompressor (171.442)	120	03/04→02/11		→ 01/11; für Linkslenker			03.2025-1741.3 010705	ATE Ø1 25,4 Ø2 20,64
200 Kompressor (171.445)	135	01/08→02/11						
300 (171.454)	170	04/09→02/11						
350 (171.456)	200	06/04→02/11						
350 (171.458)	224	01/08→02/11						
55 AMG (171.473)	265	06/04→02/11						
55 AMG (171.473)	294	06/06→02/11						
280 (171.454)	170	01/05→02/11		04/05→ 01/11; für Linkslenker			03.2025-1741.3 010705	ATE Ø1 25,4 Ø2 20,64
MERCEDES-BENZ - SLK (R172) 01/11→								
 Bremskraftverstärker								
200 (172.434)	135	04/15→		für Linkslenker;			03.7745-1632.4 300293	ATE Ø 8 / 7" pneumatisch
200 (172.448)	135	02/11→		für Fahrzeuge ohne Start-Stopp-Funktion				
250 (172.447)	150	02/11→						
250 CDI / d (172.403)	150	01/12→		für Linkslenker;			03.7745-1832.4 300294	ATE Ø 8 / 7" pneumatisch
300 (172.438)	180	07/15→		für Fahrzeuge mit Start-Stopp-Funktion				
350 (172.457)	225	02/11→						
55 AMG (172.475)	310	01/12→						
MERCEDES-BENZ - SPRINTER 2-t Bus (901, 902) 01/95→05/06								
 Hauptbremszylinder								
208 CDI	60	04/00→05/06		→ A906425			24.2123-1711.3 010518	Ø 23,81
208 D	58	02/95→04/00						
210 D	75	03/97→04/00		A906426→			24.2123-1754.3 010741	Ø 23,81
211 CDI	80	04/00→05/06						
212 D	90	02/95→04/00						
213 CDI	95	04/00→05/06						
214 (902.071, 902.072, 902.671, 902.672)	105	02/95→05/06						
214 NGT	95	02/95→05/06						
216 CDI	115	04/00→05/06						
MERCEDES-BENZ - SPRINTER 2-t Kasten (901, 902) 01/95→05/06								
 Hauptbremszylinder								
208 CDI	60	04/00→05/06		→ A906425			24.2123-1711.3 010518	Ø 23,81
208 D	58	02/95→04/00						
208 D	60	10/96→04/00		A906426→			24.2123-1754.3 010741	Ø 23,81
210 D	75	01/97→04/00						
211 CDI	80	04/00→05/06						
212 D	90	02/95→04/00						
213 CDI	95	04/00→05/06						
214	105	02/95→05/06						
214 NGT	95	02/95→05/06						
216 CDI	115	04/00→05/06						
MERCEDES-BENZ - SPRINTER 2-t Pritsche/Fahrgestell (901, 902) 01/95→05/06								
 Hauptbremszylinder								
208 CDI	60	04/00→05/06		→ A906425			24.2123-1711.3 010518	Ø 23,81
208 D	60	09/96→04/00						
↓								

	kW					! #		
MERCEDES-BENZ - SPRINTER 2-t Pritsche/Fahrgestell (901, 902) 01/95—05/06								
 Hauptbremszylinder								
210 D	75	01/97→04/00		A906426→			24.2123-1754.3 010741	Ø 23,81
211 CDI	80	04/00→05/06						
212 D	90	02/95→04/00						
213 CDI	95	04/00→05/06						
214 (902.011, 902.012, 902.611, 902.612)	105	02/95→05/06						
214 NGT	95	02/95→05/06						
216 CDI	115	04/00→05/06						
208 D	58	01/95→04/00		02/95→; → A906425			24.2123-1711.3 010518	Ø 23,81
				A906426→			24.2123-1754.3 010741	Ø 23,81
MERCEDES-BENZ - SPRINTER 3,5-t Bus (906) 06/06→								
 Hauptbremszylinder								
310 CDI (906.731, 906.733, 906.735)	70	03/09→12/13		10/09→			24.2126-1704.3 010990	TRW Ø 26,99
311 CDI (906.731, 906.733, 906.735)	80	06/06→12/09						
311 CDI 4x4 (906.731, 906.733, 906.735)	80	02/08→12/09						
315 CDI (906.731, 906.733, 906.735)	110	06/06→12/09						
315 CDI 4x4 (906.731, 906.733, 906.735)	110	02/08→12/09						
316 (906.733, 906.735)	115	09/08→						
316 LGT	115	09/08→						
316 NGT (906.733, 906.735)	115	09/08→						
318 CDI (906.731, 906.733, 906.735)	135	02/08→12/09						
318 CDI 4x4 (906.731, 906.733, 906.735)	135	02/08→12/09						
319 CDI / BlueTEC (906.731, 906.733, 906.735)	140	03/09→						
319 CDI / BlueTEC 4x4 (906.731, 906.733, 906.735)	140	03/09→						
324 (906.733, 906.735)	190	06/06→12/13						
311 CDI (906.731, 906.733, 906.735)	84	05/16→					24.2126-1704.3 010990	TRW Ø 26,99
313 CDI (906.731, 906.733, 906.735)	95	08/11→05/16						
313 CDI 4x4 (906.731, 906.733, 906.735)	95	08/11→05/16						
314 CDI (906.731, 906.733, 906.735)	105	05/16→						
314 CDI 4x4 (906.731, 906.733, 906.735)	105	05/16→						
316 CDI (906.731, 906.733, 906.735)	120	08/11→						
316 CDI 4x4 (906.731, 906.733, 906.735)	120	08/11→						
MERCEDES-BENZ - SPRINTER 3,5-t Kasten (906) 06/06→								
 Hauptbremszylinder								
309 CDI (906.631, 906.633, 906.635, 906.637)	65	06/06→12/09		10/09→			24.2126-1704.3 010990	TRW Ø 26,99
310 CDI (906.631, 906.633, 906.635, 906.637)	70	03/09→						
311 CDI (906.631, 906.633, 906.635, 906.637)	80	06/06→12/09						
311 CDI 4x4 (906.631, 906.633, 906.635, 906.637)	80	02/08→12/09						
313 CDI (906.631, 906.633, 906.635, 906.637)	95	06/06→						
313 CDI (906.631, 906.633, 906.635, 906.637)	95	05/09→						
313 CDI 4x4 (906.631, 906.633, 906.635, 906.637)	95	05/09→						
315 CDI (906.631, 906.633, 906.635, 906.637)	110	06/06→12/09						
↓								

MERCEDES-BENZ - SPRINTER 3,5-t Kasten (906) 06/06→











Hauptbremszylinder

315 CDI 4x4 (906.631, 906.633, 906.635, 906.637)	110	02/08→12/09		10/09→	24.2126-1704.3	010990	TRW Ø 26,99
316 (906.635, 906.633)	115	09/08→					
316 CDI (906.631, 906.633, 906.635, 906.637)	120	03/09→					
316 CDI 4x4 (906.631, 906.633, 906.635, 906.637)	120	03/09→					
316 LGT (906.633, 906.635)	115	09/08→					
316 NGT (906.633, 906.635)	115	09/08→					
318 CDI (906.631, 906.633, 906.635, 906.637)	135	06/06→12/09					
318 CDI 4x4 (906.631, 906.633, 906.635, 906.637)	135	02/08→12/09					
319 CDI / BlueTEC (906.631, 906.633, 906.635, 906.637)	140	03/09→					
319 CDI / BlueTEC 4x4 (906.631, 906.633, 906.635, ...)	140	03/09→					
324 (906.633, 906.635, 906.637)	190	06/06→12/13					
311 CDI (906.631, 906.633, 906.635, 906.637)	84	05/16→					
314 CDI (906.631, 906.633, 906.635, 906.637)	105	05/16→					
314 CDI 4x4 (906.631, 906.633, 906.635, 906.637)	105	05/16→					

MERCEDES-BENZ - SPRINTER 3,5-t Pritsche/Fahrgestell (906) 06/06→

Hauptbremszylinder

309 CDI (906.131, 906.133, 906.135, 906.231, 906.233, ...)	65	06/06→12/09		10/09→	24.2126-1704.3	010990	TRW Ø 26,99
310 CDI (906.131, 906.133, 906.135, 906.231, 906.233, ...)	70	03/09→05/16					
311 CDI (906.131, 906.133, 906.135, 906.231, 906.233, ...)	80	06/06→12/09					
311 CDI 4x4 (906.131, 906.133, 906.135, 906.231, 906.233, ...)	80	02/08→12/09					
313 CDI (906.131, 906.133, 906.135, 906.231, 906.233, ...)	95	06/06→05/16					
313 CDI 4x4 (906.131, 906.133, 906.135, 906.231, 906.233, ...)	95	06/06→05/16					
315 CDI (906.131, 906.133, 906.135, 906.231, 906.233, ...)	110	06/06→12/09					
315 CDI 4x4 (906.131, 906.133, 906.135, 906.231, 906.233, ...)	110	02/08→12/09					
316 (906.133, 906.135, 906.233, 906.235)	115	09/08→					
316 CDI (906.131, 906.133, 906.135, 906.231, 906.233, ...)	120	03/09→					
316 CDI 4x4 (906.131, 906.133, 906.135, 906.231, 906.233, ...)	120	03/09→					
316 LGT (906.133, 906.135, 906.233, 906.235)	115	09/08→					
316 NGT (906.133, 906.135, 906.233, 906.235)	115	09/08→					
318 CDI (906.131, 906.133, 906.135, 906.231, 906.233, ...)	135	06/06→12/09					
↓							

	kW					! #		
MERCEDES-BENZ - SPRINTER 3,5-t Pritsche/Fahrgestell (906) 06/06→								
 Hauptbremszylinder								
318 CDI 4x4 (906.131, 906.133, 906.135, 906.231, 906.233...)	135	02/08→12/09		10/09→			24.2126-1704.3 010990	TRW Ø 26,99
319 CDI / BlueTEC (906.131, 906.133, 906.135, 906.231,...)	140	03/09→						
324 (906.133, 906.135, 906.233, 906.235)	190	06/06→12/13						
311 CDI (906.131, 906.133, 906.135, 906.231, 906.233,...)	84	05/16→					24.2126-1704.3 010990	TRW Ø 26,99
314 CDI (906.131, 906.133, 906.135, 906.231, 906.233,...)	105	05/16→						
314 CDI 4x4 (906.131, 906.133, 906.135, 906.231, 906.233...)	105	05/16→						
319 CDI / BlueTEC 4x4 (906.131, 906.133, 906.135....)	140	05/11→						
MERCEDES-BENZ - SPRINTER 3-t Bus (903) 01/95→05/06								
 Hauptbremszylinder								
308 CDI	60	04/00→05/06		→ A905511 / R400726			24.2123-1711.3 010518	Ø 23,81
308 D	58	02/95→04/00		A905512 / R400727→			24.2123-1754.3 010741	Ø 23,81
308 D (903.371, 903.372, 903.373)	60	03/97→04/00						
310 D 4x4	75	05/97→08/02						
311 CDI	80	04/00→05/06						
311 CDI 4x4	80	08/02→05/06						
312 D 2.9	90	02/95→04/00						
312 D 2.9 4x4	90	05/97→08/02						
313 CDI	95	04/00→05/06						
313 CDI 4x4	95	08/02→05/06						
314 (903.071, 903.072, 903.073, 903.671, 903.672,...)	105	02/95→05/06						
314 4x4	105	08/02→05/06						
316 CDI	115	04/00→05/06						
316 CDI 4x4	115	08/02→05/06						
MERCEDES-BENZ - SPRINTER 3-t Bus (906) 06/06→								
 Hauptbremszylinder								
210 CDI (906.711, 906.713)	70	03/09→12/13		10/09→			24.2126-1704.3 010990	TRW Ø 26,99
211 CDI (906.711, 906.713)	80	06/06→12/09						
213 CDI (906.711, 906.713)	95	06/06→05/16						
215 CDI (906.711, 906.713)	110	06/06→12/09						
216 (906.713)	115	09/08→						
216 CDI (906.711, 906.713)	120	06/06→						
224 (906.713)	190	06/06→12/13						
211 CDI (906.711, 906.713)	84	04/16→					24.2126-1704.3 010990	TRW Ø 26,99
214 CDI (906.711, 906.713)	105	04/16→						
MERCEDES-BENZ - SPRINTER 3-t Kasten (903) 01/95→05/06								
 Hauptbremszylinder								
308 CDI	60	04/00→05/06		→ A905511 / R400726			24.2123-1711.3 010518	Ø 23,81
308 D 2.3	58	02/95→04/00		A905512 / R400727→			24.2123-1754.3 010741	Ø 23,81
308 D 2.3	60	02/95→04/00						
310 D 2.9	75	02/95→04/00						
311 CDI	80	04/00→05/06						
311 CDI 4x4	80	08/02→05/06						
312 D 2.9	90	02/95→04/00						
312 D 2.9 4x4	90	05/97→08/02						
313 CDI	95	04/00→05/06						
313 CDI 4x4	95	08/02→05/06						
314	105	02/95→05/06						
314 4x4	105	08/02→05/06						
316 CDI	115	04/00→05/06						
316 CDI 4x4	115	08/02→05/06						

MERCEDES-BENZ - SPRINTER 3-t Kasten (906) 06/06→

 **Hauptbremszylinder**

209 CDI (906.611, 906.613)	65	06/06→12/09		10/09→		24.2126-1704.3 010990	TRW Ø 26,99
210 CDI (906.611, 906.613)	70	03/09→					
211 CDI (906.611, 906.613)	80	06/06→12/09					
213 CDI (906.611, 906.613)	95	06/06→					
213 CDI (906.611, 906.613)	95	06/06→12/09					
215 CDI (906.611, 906.613)	110	06/06→12/09					
216 (906.613)	115	09/08→					
216 CDI (906.611, 906.613)	120	03/09→					
218 CDI (906.611, 906.613)	135	06/06→12/09					
219 CDI / BlueTEC (906.611, 906.613)	140	03/09→					
224 (906.613)	190	06/06→					
211 CDI (906.611, 906.613)	84	04/16→				24.2126-1704.3 010990	TRW Ø 26,99
214 CDI (906.611, 906.613)	105	04/16→					

MERCEDES-BENZ - SPRINTER 3-t Pritsche/Fahrgestell (903) 01/95→05/06













 **Hauptbremszylinder**

308 CDI	60	04/00→05/06		→ A905511 / R400726		24.2123-1711.3 010518	Ø 23,81
308 D 2.3	58	02/95→04/00					
308 D 2.3	60	11/96→04/00		A905512 / R400727→		24.2123-1754.3 010741	Ø 23,81
310 D 2.9	75	01/97→04/00					
311 CDI	80	04/00→05/06					
312 D 2.9	90	02/95→04/00					
312 D 2.9 (903.411, 903.412, 903.413, 903.421, 903.422,...)	85	12/98→09/01					
313 CDI	95	04/00→05/06					
313 CDI 4x4	95	08/02→05/06					
314 (903.011, 903.012, 903.013, 903.022, 903.611,...)	105	02/95→05/06					
314 NGT (903.611, 903.612)	95	02/95→05/06					
316 CDI	115	04/00→05/06					
316 CDI 4x4	115	08/02→05/06					











MERCEDES-BENZ - SPRINTER 3-t Pritsche/Fahrgestell (906) 06/06→













 **Hauptbremszylinder**















209 CDI (906.111, 906.113, 906.211, 906.213)	65	06/06→12/09		10/09→		24.2126-1704.3 010990	TRW Ø 26,99
210 CDI (906.111, 906.113, 906.211, 906.213)	70	03/09→05/16					
211 CDI (906.111, 906.113, 906.211, 906.213)	80	06/06→12/09					
213 CDI (906.111, 906.113, 906.211, 906.213)	95	06/06→12/09					
213 CDI (906.111, 906.113, 906.211, 906.213)	95	03/09→05/16					
215 CDI (906.111, 906.113, 906.211, 906.213)	110	06/06→12/09					
216 (906.113, 906.213)	115	09/08→05/16					
216 CDI (906.111, 906.113, 906.211, 906.213)	120	03/09→					
218 CDI (906.111, 906.113, 906.211, 906.213)	135	06/06→12/09					
219 CDI / BlueTEC (906.111, 906.113, 906.211, 906.213)	140	03/09→05/16					
224 (906.113, 906.213)	190	06/06→12/13					
211 CDI (906.111, 906.113, 906.211, 906.213) ↓	84	04/16→				24.2126-1704.3 010990	TRW Ø 26,99

















	kW					! #		
MERCEDES-BENZ - SPRINTER 3-t Pritsche/Fahrgestell (906) 06/06 →								
 Hauptbremszylinder								
214 CDI (906.111, 906.113, 906.211, 906.213)	105	04/16 →					24.2126-1704.3 010990	TRW Ø 26,99
MERCEDES-BENZ - SPRINTER 4,6-t Kasten (906) 06/06 →								
 Hauptbremszylinder								
411 CDI (906.653, 906.655, 906.657)	80	06/09 → 12/09		10/09 →			24.2126-1704.3 010990	TRW Ø 26,99
413 CDI (906.653, 906.655, 906.657)	95	06/06 → 05/16						
415 CDI (906.653, 906.655, 906.657)	110	06/09 → 12/09						
416 CDI (906.653, 906.655, 906.657)	120	03/09 →						
418 CDI (906.653, 906.655, 906.657)	135	06/09 → 05/16						
419 CDI (906.653, 906.655, 906.657)	140	03/09 →						
424 (906.655, 906.657, 906.653)	190	06/06 → 12/13						
414 CDI	105	05/16 →					24.2126-1704.3 010990	TRW Ø 26,99
MERCEDES-BENZ - SPRINTER 4,6-t Pritsche/Fahrgestell (906) 06/06 →								
 Hauptbremszylinder								
411 CDI (906.153, 906.155, 906.253, 906.255)	80	06/09 → 12/09		10/09 →			24.2126-1704.3 010990	TRW Ø 26,99
413 CDI	95	03/09 →						
415 CDI (906.153, 906.155, 906.253, 906.255)	110	06/06 → 12/09						
416 CDI (906.153, 906.155, 906.253, 906.255)	120	03/09 →						
418 CDI (906.153, 906.155, 906.253, 906.255)	135	06/06 → 12/09						
419 CDI (906.153, 906.155, 906.253, 906.255)	140	03/09 →						
424 (906.153, 906.155, 906.253, 906.255)	190	06/06 → 12/13						
414 CDI	105	05/16 →					24.2126-1704.3 010990	TRW Ø 26,99
MERCEDES-BENZ - SPRINTER 4-t Bus (904) 02/96 → 05/06								
 Hauptbremszylinder								
408 CDI	60	04/00 → 05/06		→ A906425 / R400726			24.2125-1727.3 010723	Ø 25,4
411 CDI	80	04/00 → 05/06						
413 CDI	95	04/00 → 05/06		A906426 / R400727 →			24.2125-1728.3 010751	Ø 25,4
414	105	02/96 → 05/06						
416 CDI	115	04/00 → 05/06						
MERCEDES-BENZ - SPRINTER 4-t Kasten (904) 02/96 → 05/06								
 Hauptbremszylinder								
408 CDI	60	04/00 → 05/06		→ A906425 / R400726			24.2125-1727.3 010723	Ø 25,4
408 D	58	02/96 → 05/06						
410 D 4x4	75	05/97 → 05/06		A906426 / R400727 →			24.2125-1728.3 010751	Ø 25,4
411 CDI	80	04/00 → 05/06						
411 CDI 4x4	80	04/00 → 05/06						
412 D	85	02/96 → 05/06						
412 D	90	02/96 → 05/06						
412 D 4x4	85	05/97 → 05/06						
412 D 4x4	90	05/97 → 05/06						
413 CDI	95	04/00 → 05/06						
413 CDI 4x4	95	04/00 → 05/06						
414 (904.062, 904.063, 904.662, 904.663)	105	02/96 → 05/06						
414 4x4 (904.062, 904.063, 904.662, 904.663)	105	05/97 → 05/06						
416 CDI	115	04/00 → 05/06						
416 CDI 4x4	115	04/00 → 05/06						
410 D	75	02/96 → 05/06		09/96 →; → A906425 / R400726			24.2125-1727.3 010723	Ø 25,4
				A906426 / R400727 →			24.2125-1728.3 010751	Ø 25,4













	kW			 	! #		
MERCEDES-BENZ - SPRINTER 4-t Pritsche/Fahrgestell (904) 02/96→05/06							
 Hauptbremszylinder							
408 CDI	60	04/00→05/06		→ A906425 / R400726		24.2125-1727.3 010723	Ø 25,4
408 D	58	02/96→05/06					
410 D 4x4	75	05/97→05/06		A906426 / R400727→		24.2125-1728.3 010751	Ø 25,4
411 CDI	80	04/00→05/06					
411 CDI 4x4	80	04/00→05/06					
412 D	85	02/96→05/06					
412 D	90	02/96→05/06					
412 D 4x4	85	05/97→05/06					
412 D 4x4	90	05/97→05/06					
413 CDI	95	04/00→05/06					
413 CDI 4x4	95	04/00→05/06					
414 (904.012, 904.013, 904.612, 904.613)	105	02/95→05/06					
414 4x4 (904.012, 904.013, 904.612, 904.613)	105	05/97→05/06					
416 CDI	115	04/00→05/06					
416 CDI 4x4	115	04/00→05/06					
410 D	75	02/96→05/06		09/96→; → A906425 / R400726		24.2125-1727.3 010723	Ø 25,4
				A906426 / R400727→		24.2125-1728.3 010751	Ø 25,4
MERCEDES-BENZ - SPRINTER 5-t Kasten (906) 06/06→							
 Hauptbremszylinder							
509 CDI (906.653, 906.655, 906.657)	65	06/06→12/09		10/09→		24.2126-1704.3 010990	TRW Ø 26,99
510 CDI (906.653, 906.655, 906.657)	70	03/09→05/16					
511 CDI (906.653, 906.655, 906.657)	80	06/06→12/09					
511 CDI 4x4 (906.653, 906.655, 906.657)	80	06/06→12/09					
513 CDI (906.653, 906.655, 906.657)	95	06/06→					
513 CDI 4x4 (906.653, 906.655, 906.657)	95	06/06→					
515 CDI (906.653, 906.655, 906.657)	110	06/06→12/09					
515 CDI 4x4 (906.653, 906.655, 906.657)	110	06/06→12/09					
516 CDI (906.653, 906.655, 906.657)	120	03/09→					
516 CDI 4x4 (906.653, 906.655, 906.657)	120	06/06→					
518 CDI (906.653, 906.655, 906.657)	135	06/06→12/09					
518 CDI 4x4 (906.653, 906.655, 906.657)	135	06/06→12/09					
519 CDI / BlueTEC (906.653, 906.655, 906.657)	140	03/09→					
519 CDI / BlueTEC 4x4 (906.653, 906.655, 906.657)	140	03/09→					
524 (906.653, 906.655, 906.657)	190	06/06→12/13					
511 CDI (906.653, 906.655, 906.657)	84	05/16→				24.2126-1704.3 010990	TRW Ø 26,99
514 CDI (906.653, 906.655, 906.657)	105	05/16→					
514 CDI 4x4 (906.653, 906.655, 906.657)	105	05/16→					
MERCEDES-BENZ - SPRINTER 5-t Pritsche/Fahrgestell (906) 06/06→							
 Hauptbremszylinder							
509 CDI (906.153, 906.155, 906.253, 906.255)	65	06/06→12/09		10/09→		24.2126-1704.3 010990	TRW Ø 26,99
510 CDI (906.153, 906.155, 906.253, 906.255)	70	03/09→					
511 CDI (906.153, 906.155, 906.253, 906.255)	80	06/06→12/09					
511 CDI 4x4 (906.153, 906.155, 906.253, 906.255)	80	06/06→12/09					
513 CDI (906.153, 906.155, 906.253, 906.255)	95	06/06→05/16					
515 CDI (906.153, 906.155, 906.253, 906.255)	110	06/06→12/09					
↓							











	kW			 	! #		
MERCEDES-BENZ - SPRINTER 5-t Pritsche/Fahrgestell (906) 06/06 →							
 Hauptbremszylinder							
515 CDI 4x4 (906.153, 906.155, 906.253, 906.255)	110	06/06 → 12/09		10/09 →		24.2126-1704.3 010990	TRW Ø 26,99
516 (906.153, 906.155, 906.253, 906.255)	115	09/08 →					
516 CDI (906.153, 906.155, 906.253, 906.255)	120	03/09 →					
516 NGT (906.153, 906.155, 906.253, 906.255)	115	09/08 →					
518 CDI (906.153, 906.155, 906.253, 906.255)	135	06/06 → 12/09					
518 CDI 4x4 (906.153, 906.155, 906.253, 906.255)	135	06/06 → 12/09					
519 CDI / BlueTEC (906.153, 906.155, 906.253, 906.255)	140	03/09 →					
519 CDI / BlueTEC 4x4 (906.153, 906.155, 906.253, ...)	140	03/09 →					
524 (906.153, 906.155, 906.253, 906.255)	190	06/06 → 12/13					
511 CDI (906.153, 906.155, 906.253, 906.255)	84	05/16 →				24.2126-1704.3 010990	TRW Ø 26,99
513 CDI 4x4 (906.155, 906.253, 906.255)	95	05/11 → 05/16					
514 CDI (906.153, 906.155, 906.253, 906.255)	105	05/16 →					
514 CDI 4x4 (906.153, 906.155, 906.253, 906.255)	105	05/16 →					
516 CDI 4x4 (906.153, 906.155, 906.255)	120	05/11 →					
MERCEDES-BENZ - T1/TN Kasten/Kombi 07/81 → 06/95							
 Bremskraftverstärker							
408 D (611.367, 611.368)	58	11/88 → 06/95		598435 →		03.6855-1402.4 300057	ATE Ø 9" pneumatisch
408 D (611.367, 611.368)	60	11/88 → 06/95					
410 (611.067, 611.068)	70	08/82 → 06/95					
410 (611.067, 611.068)	77	08/82 → 06/95					
410 D (611.467, 611.468)	70	11/88 → 06/95					
410 D (611.467, 611.468)	72	11/88 → 06/95					
 Hauptbremszylinder							
408 D (611.367, 611.368)	58	11/88 → 06/95		598435 →; - ABS		03.2126-0512.3 010217	Ø 26,99
408 D (611.367, 611.368)	60	11/88 → 06/95					
410 (611.067, 611.068)	70	08/82 → 06/95					
410 (611.067, 611.068)	77	08/82 → 06/95					
410 D (611.467, 611.468)	70	11/88 → 06/95					
410 D (611.467, 611.468)	72	11/88 → 06/95					
 Bremskraftregler							
408 D (611.367, 611.368)	58	11/88 → 06/95				03.6513-0340.3 320084	ATE lastabhängig 1/3 2x
408 D (611.367, 611.368)	60	11/88 → 06/95					
410 (611.067, 611.068)	70	08/82 → 06/95					
410 (611.067, 611.068)	77	08/82 → 06/95					
410 D (611.467, 611.468)	70	11/88 → 06/95					
410 D (611.467, 611.468)	72	11/88 → 06/95					
MERCEDES-BENZ - T1/TN Pritsche/Fahrgestell 07/81 → 06/95							
 Bremskraftverstärker							
408 D (611.317, 611.318)	58	11/88 → 06/95		598435 →		03.6855-1402.4 300057	ATE Ø 9" pneumatisch
↓							











	kw					! #		
MERCEDES-BENZ - T1/TN Pritsche/Fahrgestell 07/81→06/95								
 Bremskraftverstärker								
408 D (611.317, 611.318)	60	11/88→06/95		598435→			03.6855-1402.4 300057	ATE Ø 9" pneumatisch
410 (611.017, 611.018)	70	08/82→06/95						
410 (611.017, 611.018)	77	08/82→06/95						
410 D (611.417, 611.418)	70	11/88→06/95						
410 D (611.417, 611.418)	72	11/88→06/95						
 Hauptbremszylinder								
408 D (611.317, 611.318)	58	11/88→06/95		598435→; - ABS			03.2126-0512.3 010217	Ø 26,99
408 D (611.317, 611.318)	60	11/88→06/95						
410 (611.017, 611.018)	70	08/82→06/95						
410 (611.017, 611.018)	77	08/82→06/95						
410 D (611.417, 611.418)	70	11/88→06/95						
410 D (611.417, 611.418)	72	11/88→06/95						
 Bremskraftregler								
408 D (611.317, 611.318)	58	11/88→06/95					03.6513-0340.3 320084	ATE lastabhängig 1/3 2x
408 D (611.317, 611.318)	60	11/88→06/95						
410 (611.017, 611.018)	70	08/82→06/95						
410 (611.017, 611.018)	77	08/82→06/95						
410 D (611.417, 611.418)	70	11/88→06/95						
410 D (611.417, 611.418)	72	11/88→06/95						
MERCEDES-BENZ - T1 Bus (601) 05/77→02/96								
 Bremskraftverstärker								
208 D 2.3	60	10/88→02/96		→ 649390			03.6850-2602.4 300049	ATE Ø 9" pneumatisch
208 D 2.3 (601.371, 601.372, 601.376, 601.377)	58	10/88→02/96		→ 614796			03.6850-2602.4 300049	ATE Ø 9" pneumatisch
				614797→			03.6855-1402.4 300057	ATE Ø 9" pneumatisch
210 2.3	77	05/89→02/96		649391→			03.6855-1402.4 300057	ATE Ø 9" pneumatisch
210 D 2.8	70	11/88→02/96						
210 D 2.8	72	11/88→02/96						
 Hauptbremszylinder								
208 D 2.3	60	10/88→02/96		→ 649390 / P000000			03.2123-6002.3 010184	Ø 23,81
208 D 2.3 (601.371, 601.372, 601.376, 601.377)	58	10/88→02/96		→ 614796 / P000000			03.2123-6002.3 010184	Ø 23,81
				649391 / P000001→; - ABS			03.2125-1902.3 010206	Ø 25,4
210 2.3	77	05/89→02/96		614797 / P000001→; - ABS			03.2125-1902.3 010206	Ø 25,4
210 D 2.8	70	11/88→02/96						
210 D 2.8	72	11/88→02/96						
 Bremskraftregler								
208 D 2.3	60	10/88→02/96		649391→			03.6515-0305.3 320087	ATE lastabhängig 1/5 2x
208 D 2.3 (601.371, 601.372, 601.376, 601.377)	58	10/88→02/96						
210 2.3	77	05/89→02/96						
210 D 2.8	70	11/88→02/96		649391→			03.6515-0305.3 320087	ATE lastabhängig 1/5 2x
210 D 2.8	72	11/88→02/96		614797→			03.6515-0305.3 320087	ATE lastabhängig 1/5 2x
MERCEDES-BENZ - T1 Bus (602) 04/77→02/96								
 Bremskraftverstärker								
308 D 2.3	58	05/90→02/96		→ 649390			03.6850-2602.4 300049	ATE Ø 9" pneumatisch
308 D 2.3	60	06/89→02/96		→ 625656			03.6850-2602.4 300049	ATE Ø 9" pneumatisch
				625657→			03.6855-1402.4 300057	ATE Ø 9" pneumatisch
				649391→			03.6855-1402.4 300057	ATE Ø 9" pneumatisch
310 D 2.9	70	06/89→02/96		→ 649390			03.6850-2602.4 300049	ATE Ø 9" pneumatisch
310 D 2.9	72	06/90→02/96		649391→			03.6855-1402.4 300057	ATE Ø 9" pneumatisch
 Hauptbremszylinder								
308 D 2.3	58	05/90→02/96		→ 649390			03.2123-6002.3 010184	Ø 23,81
308 D 2.3	60	06/89→02/96		→ 625656			03.2123-6002.3 010184	Ø 23,81
				649391→; - ABS			03.2125-1902.3 010206	Ø 25,4
↓								













	kw					! #		
MERCEDES-BENZ - T1 Bus (602) 04/77→02/96								
 Hauptbremszylinder								
308 D 2.3	58	05/90→02/96		625657→; - ABS			03.2125-1902.3 010206	Ø 25,4
308 D 2.3	60	06/89→02/96						
310 D 2.9	70	06/89→02/96		→ 649390			03.2123-6002.3 010184	Ø 23,81
310 D 2.9	72	06/90→02/96		649391→; - ABS			03.2125-1902.3 010206	Ø 25,4
 Bremskraftregler								
308 D 2.3	58	05/90→02/96		649391→			03.6513-0340.3 320084	ATE lastabhängig 1/3 2x
308 D 2.3	60	06/89→02/96						
310 D 2.9	70	06/89→02/96						
310 D 2.9	72	06/90→02/96						
MERCEDES-BENZ - T1 Kasten (601, 611) 05/77→02/96								
 Bremskraftverstärker								
208 D 2.3	58	11/88→02/96		→ 649390			03.6850-2602.4 300049	ATE Ø 9" pneumatisch
208 D 2.3	60	10/88→02/96		→ 614796			03.6850-2602.4 300049	ATE Ø 9" pneumatisch
210 2.3	70	07/82→02/96						
210 2.3	77	05/89→02/96		614797→			03.6855-1402.4 300057	ATE Ø 9" pneumatisch
210 D 2.8	70	10/88→02/96		649391→			03.6855-1402.4 300057	ATE Ø 9" pneumatisch
210 D 2.8	72	10/88→02/96						
 Hauptbremszylinder								
208 D 2.3	58	11/88→02/96		→ 649390 / P000000			03.2123-6002.3 010184	Ø 23,81
208 D 2.3	60	10/88→02/96		→ 614796 / P000000			03.2123-6002.3 010184	Ø 23,81
210 2.3	70	07/82→02/96						
210 2.3	77	05/89→02/96		649391 / P000001→; - ABS			03.2125-1902.3 010206	Ø 25,4
210 D 2.8	70	10/88→02/96		614797 / P000001→; - ABS			03.2125-1902.3 010206	Ø 25,4
210 D 2.8	72	10/88→02/96						
 Bremskraftregler								
208 D 2.3	58	11/88→02/96		649391→			03.6515-0305.3 320087	ATE lastabhängig 1/5 2x
208 D 2.3	60	10/88→02/96						
210 2.3	70	07/82→02/96						
210 2.3	77	05/89→02/96						
210 D 2.8	70	10/88→02/96		649391→			03.6515-0305.3 320087	ATE lastabhängig 1/5 2x
210 D 2.8	72	10/88→02/96		614797→			03.6515-0305.3 320087	ATE lastabhängig 1/5 2x
MERCEDES-BENZ - T1 Kasten (602) 10/82→02/96								
 Bremskraftverstärker								
308 D 2.3	58	11/88→02/96		→ 649390			03.6850-2602.4 300049	ATE Ø 9" pneumatisch
308 D 2.3	60	06/89→02/96		→ 625656			03.6850-2602.4 300049	ATE Ø 9" pneumatisch
310 2.3	70	06/89→02/96						
				625657→			03.6855-1402.4 300057	ATE Ø 9" pneumatisch
				649391→			03.6855-1402.4 300057	ATE Ø 9" pneumatisch
310 D 2.9	70	06/89→02/96		→ 649390			03.6850-2602.4 300049	ATE Ø 9" pneumatisch
310 D 2.9	72	06/89→02/96		649391→			03.6855-1402.4 300057	ATE Ø 9" pneumatisch
 Hauptbremszylinder								
308 D 2.3	58	11/88→02/96		→ 649390			03.2123-6002.3 010184	Ø 23,81
308 D 2.3	60	06/89→02/96		→ 625656			03.2123-6002.3 010184	Ø 23,81
310 2.3	70	06/89→02/96						
				649391→; - ABS			03.2125-1902.3 010206	Ø 25,4
				625657→; - ABS			03.2125-1902.3 010206	Ø 25,4
310 D 2.9	70	06/89→02/96		→ 649390			03.2123-6002.3 010184	Ø 23,81
310 D 2.9	72	06/89→02/96		649391→; - ABS			03.2125-1902.3 010206	Ø 25,4
 Bremskraftregler								
308 D 2.3	58	11/88→02/96		649391→			03.6513-0340.3 320084	ATE lastabhängig 1/3 2x
308 D 2.3	60	06/89→02/96						
310 2.3	70	06/89→02/96						
310 D 2.9	70	06/89→02/96						
310 D 2.9	72	06/89→02/96						
MERCEDES-BENZ - T1 Pritsche/Fahrgestell (601) 01/77→02/96								
 Bremskraftverstärker								
208 D 2.3	58	11/88→02/96		→ 649390			03.6850-2602.4 300049	ATE Ø 9" pneumatisch
208 D 2.3	60	06/89→02/96		→ 614796			03.6850-2602.4 300049	ATE Ø 9" pneumatisch
210 D 2.8	72	11/88→02/96						
210 D 2.9	70	11/88→02/96		614797→			03.6855-1402.4 300057	ATE Ø 9" pneumatisch
				649391→			03.6855-1402.4 300057	ATE Ø 9" pneumatisch
↓								















	kw					! #		
MERCEDES-BENZ - T1 Pritsche/Fahrgestell (601) 01/77→02/96								
 Hauptbremszylinder								
208 D 2.3	58	11/88→02/96		→ 649390 / P000000			03.2123-6002.3 010184	Ø 23,81
208 D 2.3	60	06/89→02/96		→ 614796 / P000000			03.2123-6002.3 010184	Ø 23,81
210 D 2.8	72	11/88→02/96						
210 D 2.9	70	11/88→02/96		649391 / P000001→; - ABS			03.2125-1902.3 010206	Ø 25,4
				614797 / P000001→; - ABS			03.2125-1902.3 010206	Ø 25,4
 Bremskraftregler								
208 D 2.3	58	11/88→02/96		649391→			03.6515-0305.3 320087	ATE lastabhängig 1/5 2x
208 D 2.3	60	06/89→02/96						
210 D 2.8	72	11/88→02/96		649391→			03.6515-0305.3 320087	ATE lastabhängig 1/5 2x
210 D 2.9	70	11/88→02/96		614797→			03.6515-0305.3 320087	ATE lastabhängig 1/5 2x
MERCEDES-BENZ - T1 Pritsche/Fahrgestell (602) 01/77→02/96								
 Bremskraftverstärker								
308 D 2.3	58	06/89→02/96		→ 649390			03.6850-2602.4 300049	ATE Ø 9" pneumatisch
308 D 2.3	60	06/89→02/96		→ 625656			03.6850-2602.4 300049	ATE Ø 9" pneumatisch
				625657→			03.6855-1402.4 300057	ATE Ø 9" pneumatisch
				649391→			03.6855-1402.4 300057	ATE Ø 9" pneumatisch
310 D 2.9	70	06/89→02/96		→ 649390			03.6850-2602.4 300049	ATE Ø 9" pneumatisch
310 D 2.9	72	06/89→02/96		649391→			03.6855-1402.4 300057	ATE Ø 9" pneumatisch
 Hauptbremszylinder								
308 D 2.3	58	06/89→02/96		→ 649390			03.2123-6002.3 010184	Ø 23,81
308 D 2.3	60	06/89→02/96		→ 625656			03.2123-6002.3 010184	Ø 23,81
				649391→; - ABS			03.2125-1902.3 010206	Ø 25,4
				625657→; - ABS			03.2125-1902.3 010206	Ø 25,4
310 D 2.9	70	06/89→02/96		→ 649390			03.2123-6002.3 010184	Ø 23,81
310 D 2.9	72	06/89→02/96		649391→; - ABS			03.2125-1902.3 010206	Ø 25,4
 Bremskraftregler								
308 D 2.3	58	06/89→02/96		649391→			03.6513-0340.3 320084	ATE lastabhängig 1/3 2x
308 D 2.3	60	06/89→02/96						
310 D 2.9	70	06/89→02/96						
310 D 2.9	72	06/89→02/96						
MERCEDES-BENZ - Vaneo (414) 02/02→07/05								
 Hauptbremszylinder								
1.6 (414.700)	60	02/02→07/05					24.4123-1703.3 010831	TRW Ø 23,81
1.6 (414.700)	75	02/02→07/05						
1.7 CDI (414.700)	55	02/02→07/05						
1.7 CDI (414.700)	67	02/02→07/05						
1.9 (414.700)	92	02/02→07/05						
MERCEDES-BENZ - Vario Bus 09/96→								
 Hauptbremszylinder								
O 810 (670.373, 670.374)	75	09/96→12/10					03.2128-1203.3 010922	ATE Ø 28,57
O 812 (670.373, 670.674)	90	09/96→12/10						
O 814 (670.373, 670.374)	100	09/96→12/10						
O 815 (670.373, 670.374)	112	09/96→12/10						
O 813 (670.373, 670.374)	95	01/06→		→ 12/13			03.2128-1203.3 010922	ATE Ø 28,57
O 816 D (670.373, 670.374)	115	01/06→						
O 818 D (670.373, 670.374)	130	09/06→						
MERCEDES-BENZ - Vario Kasten/Kombi 09/96→								
 Hauptbremszylinder								
512 D (667.351, 667.352, 667.353)	90	09/96→12/10					03.2128-1203.3 010922	ATE Ø 28,57
612 D (668.351, 668.352, 668.353)	90	09/96→12/10						
613 D, 614 D (668.351, 668.352, 668.353)	95	09/96→12/13						
613 D, 614 D (668.351, 668.352, 668.353)	100	09/96→12/11						
↓								















	kW			 	! #		
MERCEDES-BENZ - VARIO Kasten/Kombi 09/96→							
 Hauptbremszylinder							
812 D (670.351, 670.352, 670.353)	90	09/96→12/10				03.2128-1203.3 010922	ATE Ø 28,57
813 D, 814 D (670.351, 670.352, 670.353)	95	09/96→12/13					
813 D, 814 D (670.351, 670.352, 670.353)	100	09/96→12/13					
813 DA, 814 DA 4x4 (669.599, 670.451, 670.452, 670.453)	95	09/96→12/13					
815 D, 816 D (670.351, 670.352, 670.353)	112	09/96→12/10					
815 D, 816 D (670.351, 670.352, 670.353)	115	09/96→12/13					
815 DA, 816 DA 4x4 (669.599, 670.451, 670.452, 670.453)	112	09/96→12/10					
815 DA, 816 DA 4x4 (669.599, 670.451, 670.452, 670.453)	115	09/96→12/13					
615 D, 616 D (668.351, 668.352, 668.353)	112	09/98→		→ 12/13		03.2128-1203.3 010922	ATE Ø 28,57
615 D, 616 D (668.351, 668.352, 668.353)	115	09/98→					
618 D	130	09/06→					
813 DA, 814 DA 4x4 (669.599, 670.451, 670.452, 670.453)	100	09/96→					
818 D (670.351, 670.352, 670.353)	130	09/06→					
MERCEDES-BENZ - VARIO Kipper 09/96→							
 Hauptbremszylinder							
612 D (668.331, 668.332)	90	09/96→12/10				03.2128-1203.3 010922	ATE Ø 28,57
613 D, 614 D (668.331, 668.332)	95	09/96→12/13					
613 D, 614 D (668.331, 668.332)	100	09/96→11/12					
812 D (670.331, 670.332)	90	09/96→12/10					
813 D, 814 D (670.331, 670.332)	95	09/96→12/13					
813 D, 814 D (670.331, 670.332)	100	09/96→12/13					
813 DA, 814 DA 4x4 (670.431, 670.432)	95	09/96→12/13					
813 DA, 814 DA 4x4 (670.431, 670.432)	100	09/96→12/13					
815 D, 816 D (670.331, 670.332)	115	09/96→12/13					
815 DA, 816 DA 4x4 (670.431, 670.432)	112	09/96→12/10					
815 DA, 816 DA 4x4 (670.431, 670.432)	115	09/96→12/13					
615 D, 616 D (668.331, 668.332)	112	09/98→		→ 12/13		03.2128-1203.3 010922	ATE Ø 28,57
615 D, 616 D (668.331, 668.332)	115	09/98→					
618 D	130	09/06→					
815 D, 816 D (670.331, 670.332)	112	09/96→					
818 D (670.321, 670.322)	130	09/06→					
818 DA 4x4	130	09/06→					
MERCEDES-BENZ - VARIO Pritsche/Fahrgestell 09/96→							
 Hauptbremszylinder							
512 D (667.321, 667.322, 667.323)	90	09/96→12/10				03.2128-1203.3 010922	ATE Ø 28,57
612 D (668.321, 668.322, 668.323)	90	09/96→12/10					
613 D, 614 D (668.321, 668.322, 668.323)	100	09/96→12/11					
812 D (670.321, 670.322, 670.323, 670.324)	90	09/96→12/10					
813 D, 814 D (670.321, 670.322, 670.323, 670.324)	95	09/96→12/13					
↓							















	kW					! #		
MERCEDES-BENZ - VARIO Pritsche/Fahrgestell 09/96 →								
 Hauptbremszylinder								
813 D, 814 D (670.321, 670.322, 670.323, 670.324)	100	09/96 → 12/13					03.2128-1203.3 010922	ATE Ø 28,57
813 DA, 814 DA 4x4 (670.421, 670.422, 670.423)	95	09/96 → 12/13						
813 DA, 814 DA 4x4 (670.421, 670.422, 670.423)	100	09/96 → 12/13						
815 D, 816 D (670.321, 670.322, 670.323, 670.324)	112	09/96 → 12/10						
815 D, 816 D (670.321, 670.322, 670.323, 670.324)	115	09/96 → 12/13						
815 DA, 816 DA 4x4 (670.421, 670.422, 670.423)	112	09/96 → 12/10						
815 DA, 816 DA 4x4 (670.421, 670.422, 670.423)	115	09/96 → 12/13						
613 D, 614 D (668.321, 668.322, 668.323)	95	09/96 →		→ 12/13			03.2128-1203.3 010922	ATE Ø 28,57
615 D, 616 D (668.321, 668.322, 668.323)	112	09/98 →						
615 D, 616 D (668.321, 668.322, 668.323)	115	09/98 →						
618 D (668.321, 668.322, 668.323)	130	09/06 →						
818 D (670.321, 670.322, 670.323, 670.324)	130	09/06 →						
818 DA 4x4	130	09/06 →						
MERCEDES-BENZ - VARIO Triebkopf 09/96 →								
 Hauptbremszylinder								
613 D, 614 D (669.599, 669.899)	95	01/06 →		→ 12/13			03.2128-1203.3 010922	ATE Ø 28,57
615 D, 616 D (669.599, 669.899)	115	01/06 →						
618 D (669.599, 669.899)	130	09/06 →						
814 DT (670.398)	100	09/96 →						
816 DT (670.398)	112	09/96 →						
810 DT (670.398)	75	09/96 → 12/10					03.2128-1203.3 010922	ATE Ø 28,57
812 DT	90	09/96 → 12/10						
MERCEDES-BENZ - VIANO (W639) 09/03 →								
 Hauptbremszylinder								
3,0 (639.711, 639.811)	140	09/03 →		→ 02/14			24.2123-1772.3 010858	BOS Ø 23,81
3.2 (639.713, 639.813, 639.815)	160	09/03 →						
3.5 (639.811, 639.813, 639.815)	190	09/07 →						
3.7 (639.815)	170	06/04 →						
CDI 2.0 (639.711, 639.713, 639.811, 639.813, 639.815)	80	09/03 →						
CDI 2.0 (639.711, 639.713, 639.811, 639.813, 639.815)	85	08/05 →						
CDI 2.0 (639.811, 639.813, 639.815)	100	07/10 →						
CDI 2.0 4-matic (639.811, 639.813, 639.815)	100	07/10 →						
CDI 2.2 (639.711, 639.713, 639.811, 639.813, 639.815)	110	09/03 →						
CDI 2.2 (639.811, 639.813, 639.815)	120	07/10 →						
CDI 2.2 4-matic (639.811, 639.813, 639.815)	120	07/10 →						
CDI 3.0 (639.811, 639.813, 639.815)	150	03/06 →						
CDI 3.0 (639.811, 639.813, 639.815)	165	07/10 →						
CDI 2.0 4-matic (639.713) ↓	80	07/05 →		07/10 → 02/14			24.2123-1772.3 010858	BOS Ø 23,81















	kW			 	! #		
MERCEDES-BENZ - VIANO (W639) 09/03→							
 Hauptbremszylinder							
CDI 2.2 4-matic (639.711, 639.713, 639.811, 639.813,...	110	07/05→		07/10→ 02/14		24.2123-1772.3 010858	BOS Ø 23,81
MERCEDES-BENZ - VITO / MIXTO Kasten (W639) 09/03→							
 Hauptbremszylinder							
109 CDI (639.601, 639.603, 639.605)	65	09/03→		→ 3558104		24.2123-1772.3 010858	BOS Ø 23,81
109 CDI (639.601, 639.603, 639.605)	70	08/06→		3558105→; → 02/14		24.2123-1778.3 010947	TRW Ø 23,81
110 CDI (639.601, 639.603, 639.605)	70	09/10→					
111 CDI (639.601, 639.603, 639.605)	80	09/03→					
111 CDI (639.601, 639.603)	85	09/07→					
111 CDI 4x4 (639.601, 639.603, 639.605)	80	09/07→					
113 CDI (639.601, 639.603, 639.605)	100	09/10→					
113 CDI 4x4 (639.601, 639.603, 639.605)	100	09/10→					
115 CDI (639.601, 639.603, 639.605)	110	09/03→					
116 CDI (639.601, 639.603, 639.605)	120	09/10→					
116 CDI 4x4 (639.601, 639.603, 639.605)	120	09/10→					
119 (639.601, 639.603, 639.605)	140	09/03→					
122 (639.601, 639.603, 639.605)	160	09/03→					
122 CDI (639.601, 639.603, 639.605)	165	09/10→					
126 (639.601, 639.603, 639.605)	190	09/07→					
115 CDI 4x4 (639.601, 639.603, 639.605)	110	07/06→		09/07→; → 3558104		24.2123-1772.3 010858	BOS Ø 23,81
120 CDI (639.601, 639.603, 639.605)	150	07/06→		3558105→; → 02/14		24.2123-1778.3 010947	TRW Ø 23,81
123 (639.601)	170	06/04→07/08		→ 3558104		24.2123-1772.3 010858	BOS Ø 23,81
				3558105→		24.2123-1778.3 010947	TRW Ø 23,81
MERCEDES-BENZ - VITO Bus (638) 02/96→07/03							
 Hauptbremszylinder							
108 CDI 2.2 (638.194)	60	03/99→07/03		- ABS		24.2123-1712.3 010519	Ø 23,81
110 CDI 2.2 (638.194)	75	03/99→07/03		+ ABS		24.2123-1729.3 010567	Ø 23,81
112 CDI 2.2 (638.194)	90	03/99→07/03					
114 2.3 (638.134, 638.194)	105	12/96→07/03					
108 D 2.3 (638.164)	58	02/96→07/03		03/96→; - ABS		24.2123-1712.3 010519	Ø 23,81
110 TD 2.3 (638.174)	72	02/96→07/03		03/96→; + ABS		24.2123-1729.3 010567	Ø 23,81
113 2.0 (638.114, 638.194)	95	02/96→07/03					
MERCEDES-BENZ - VITO Bus (W639) 09/03→							
 Hauptbremszylinder							
109 CDI (639.701, 639.703)	70	09/06→		→ 3558104		24.2123-1772.3 010858	BOS Ø 23,81
109 CDI (639.701)	65	09/03→		3558105→; → 02/14		24.2123-1778.3 010947	TRW Ø 23,81
109 CDI 4x4 (639.701)	70	09/07→					
110 CDI (639.701, 639.703, 639.705)	70	09/10→					
111 CDI (639.701, 639.703, 639.705)	80	09/03→					
111 CDI (639.701, 639.703, 639.705)	85	09/07→					
111 CDI 4x4 (639.701, 639.703, 639.705)	80	09/07→					
113 CDI (639.701, 639.703, 639.705)	100	09/10→					
113 CDI 4x4 (639.701, 639.703, 639.705)	100	09/10→					
115 CDI (639.701, 639.703, 639.705)	110	09/03→					
115 CDI 4x4 (639.701, 639.705)	110	09/07→					
116 CDI (639.701, 639.703, 639.705)	120	09/10→					
↓							















	kw					! #		
MERCEDES-BENZ - VITO Bus (W639) 09/03→								
 Hauptbremszylinder								
116 CDI 4x4 (639.701, 639.703, 639.705)	120	09/10→			→ 3558104		24.2123-1772.3 010858	BOS Ø 23,81
119 (639.701, 639.703, 639.705)	140	09/03→			3558105→; → 02/14		24.2123-1778.3 010947	TRW Ø 23,81
122 (639.701, 639.703, 639.705)	160	09/03→						
122 CDI (639.701, 639.703, 639.705)	165	09/10→						
123 (639.701)	170	06/04→						
126 (639.701, 639.703, 639.705)	190	09/07→						
120 CDI (639.701, 639.703, 639.705)	150	07/06→			09/07→; → 3558104		24.2123-1772.3 010858	BOS Ø 23,81
					3558105→; → 02/14		24.2123-1778.3 010947	TRW Ø 23,81
MERCEDES-BENZ - VITO Kasten (638) 03/97→07/03								
 Hauptbremszylinder								
108 CDI 2.2 (638.094)	60	03/99→07/03			- ABS		24.2123-1712.3 010519	Ø 23,81
108 D 2.3 (638.064, 638.068)	58	03/97→07/03			+ ABS		24.2123-1729.3 010567	Ø 23,81
110 CDI 2.2 (638.094)	75	03/99→07/03						
110 D 2.3 (638.074, 638.078)	72	03/97→07/03						
112 CDI 2.2 (638.094)	90	03/99→07/03						
113 2.0 (638.014, 638.094)	95	03/97→07/03						
114 2.3 (638.034, 638.094)	105	03/97→07/03						
MERCEDES-BENZ - V-KLASSE (638/2) 02/96→07/03								
 Hauptbremszylinder								
V 200 (638.214, 638.294)	95	02/97→07/03			- ABS		24.2123-1712.3 010519	Ø 23,81
V 200 CDI (638.294)	75	03/99→07/03			+ ABS		24.2123-1729.3 010567	Ø 23,81
V 220 CDI (638.294)	90	03/99→07/03						
V 230 (638.234, 638.294)	105	10/96→07/03						
V 230 TD (638.274)	72	09/96→07/03						
V 280 (638.244, 638.294)	128	08/97→07/03			09/97→; - ABS		24.2123-1712.3 010519	Ø 23,81
					09/97→; + ABS		24.2123-1729.3 010567	Ø 23,81
MINI - MINI (R50, R53) 06/01→09/06								
 Bremskraftverstärker								
Cooper	85	06/01→09/06					03.7860-1402.4 300228	ATE Ø 10" pneumatisch
Cooper S	125	07/04→09/06						
One	66	06/01→09/06						
One D	55	06/03→09/06						
One D	65	06/03→09/06						
S Works	149	11/03→06/05						
Works	155	11/03→09/06						
Cooper S	120	03/02→09/06			07/02→		03.7860-1402.4 300228	ATE Ø 10" pneumatisch
 Hauptbremszylinder								
Cooper	85	06/01→09/06			+ DSC		03.2122-1824.3 010892	ATE Ø 22,2
Cooper S	125	07/04→09/06						
One	66	06/01→09/06			- DSC		03.2122-1853.3 010893	ATE Ø 22,2
One D	55	06/03→09/06						
One D	65	06/03→09/06						
S Works	149	11/03→06/05						
Works	155	11/03→09/06						
Cooper S	120	03/02→09/06			07/02→; + DSC		03.2122-1824.3 010892	ATE Ø 22,2
					07/02→; - DSC		03.2122-1853.3 010893	ATE Ø 22,2
MINI - MINI (R56) 11/05→01/14								
 Hauptbremszylinder								
Cooper	85	09/06→11/13			03/10→		24.4123-1712.3 010897	TRW Ø 23,81
Cooper	90	09/09→11/13						
One D	66	06/09→07/10						
Cooper	88	10/06→02/12			11/06→		24.4123-1712.3 010897	TRW Ø 23,81
Cooper S	128	10/06→02/10						
Cooper D	80	11/06→09/10			04/07→		24.4123-1712.3 010897	TRW Ø 23,81
One	70	11/06→03/10						
Cooper D	82	06/10→11/13					24.4123-1712.3 010897	TRW Ø 23,81
Cooper D	82	02/11→11/13						
Cooper S	120	03/10→11/13						
Cooper S	135	03/10→11/13						
↓								















	kw			 	! #		
MINI - MINI (R56) 11/05→01/14							
 Hauptbremszylinder							
Cooper S	147	01/12→11/13				24.4123-1712.3 010897	TRW Ø 23,81
Cooper SD	100	02/11→11/13					
Cooper SD	105	02/11→11/13					
One	55	03/09→03/10					
One	55	03/10→11/13					
One	72	03/10→11/13					
One D	66	07/10→11/13					
Cooper S John Cooper Works	141	11/06→02/10		03/08→		24.4123-1712.3 010897	TRW Ø 23,81
John Cooper Works	155	11/07→11/13					
MINI - MINI Cabriolet (R52) 07/04→01/08							
 Bremskraftverstärker							
Cooper	85	07/04→11/07				03.7860-1402.4 300228	ATE Ø 10" pneumatisch
Cooper S	120	07/04→11/07					
Cooper S	125	07/04→11/07					
John Cooper Works	155	07/04→11/07					
One	66	07/04→11/07					
 Hauptbremszylinder							
Cooper	85	07/04→11/07		+ DSC		03.2122-1824.3 010892	ATE Ø 22,2
Cooper S	120	07/04→11/07		- DSC		03.2122-1853.3 010893	ATE Ø 22,2
Cooper S	125	07/04→11/07					
John Cooper Works	155	07/04→11/07					
One	66	07/04→11/07					
MINI - MINI Cabriolet (R57) 10/07→06/15							
 Hauptbremszylinder							
Cooper	85	10/07→06/10		01/09→		24.4123-1712.3 010897	TRW Ø 23,81
Cooper S	128	04/08→07/10					
Cooper S	141	04/08→07/10					
Cooper S	88	10/07→06/15		01/09→ 06/14		24.4123-1712.3 010897	TRW Ø 23,81
Cooper S	120	10/07→06/15					
Cooper	90	09/09→06/15		03/10→ 06/14		24.4123-1712.3 010897	TRW Ø 23,81
Cooper S	135	02/10→06/15					
Cooper S	147	02/10→06/15					
One	72	09/09→06/15					
Cooper D	82	05/09→11/13		06/10→		24.4123-1712.3 010897	TRW Ø 23,81
Cooper D	82	02/11→05/15		→ 06/14		24.4123-1712.3 010897	TRW Ø 23,81
Cooper SD	100	01/11→05/15		02/11→ 06/14		24.4123-1712.3 010897	TRW Ø 23,81
Cooper SD	105	06/09→05/15					
John Cooper Works	155	08/08→05/15		03/09→ 06/14		24.4123-1712.3 010897	TRW Ø 23,81
MINI - MINI CLUBMAN (R55) 10/06→12/15							
 Hauptbremszylinder							
Cooper	85	03/10→06/14				24.4123-1712.3 010897	TRW Ø 23,81
Cooper	88	10/07→12/13					
Cooper	90	03/10→06/14					
Cooper D	80	10/07→02/10					
Cooper D	82	03/10→06/14					
Cooper D	82	02/11→06/14					
Cooper S	120	10/07→02/10					
Cooper S	128	10/07→02/10					
Cooper S	135	03/10→06/14					
Cooper S	147	03/10→06/14					
Cooper SD	100	02/11→06/14					
Cooper SD	105	02/11→06/14					
Cooper S John Cooper Works	141	10/08→02/10					
One	72	03/10→06/14					
One D	66	03/10→06/14					
John Cooper Works	155	11/07→06/14		03/08→		24.4123-1712.3 010897	TRW Ø 23,81
MINI - MINI CLUBVAN (R55) 12/12→06/14							
 Hauptbremszylinder							
Cooper	90	12/12→06/14				24.4123-1712.3 010897	TRW Ø 23,81
Cooper D	82	12/12→06/14					
One	72	12/12→06/14					
MINI - MINI COUNTRYMAN (R60) 01/10→10/16							
 Hauptbremszylinder							
Cooper	85	01/10→10/16		09/10→		24.4123-1712.3 010897	TRW Ø 23,81
Cooper	88	01/10→10/16					
Cooper	90	01/10→10/16					
Cooper D	82	01/10→10/16					
↓							













	kw			 	! #		
MINI - MINI COUNTRYMAN (R60) 01/10→10/16							
 Hauptbremszylinder							
Cooper D ALL4	82	01/10→09/16		09/10→		24.4123-1712.3 010897	TRW Ø 23,81
Cooper D ALL4	82	07/10→09/16					
Cooper S	135	01/10→10/16					
Cooper S ALL4	120	01/10→10/16					
Cooper S ALL4	135	01/10→10/16					
One	72	01/10→09/16					
One D	66	01/10→10/16					
Cooper ALL4	90	11/12→09/16		11/14→		24.4123-1712.3 010897	TRW Ø 23,81
Cooper ALL4	90	11/12→10/16					
Cooper S	140	01/10→10/16				24.4123-1712.3 010897	TRW Ø 23,81
Cooper S ALL4	140	01/10→10/16					
Cooper S	147	01/10→10/16		02/12→		24.4123-1712.3 010897	TRW Ø 23,81
Cooper SD	100	01/10→10/16		02/11→		24.4123-1712.3 010897	TRW Ø 23,81
Cooper SD	105	01/10→10/16					
Cooper SD ALL4	100	01/10→09/16					
Cooper SD ALL4	105	01/10→09/16					
John Cooper Works ALL4	160	04/11→10/16		09/12→		24.4123-1712.3 010897	TRW Ø 23,81
MINI - MINI Coupe (R58) 12/10→05/15							
 Hauptbremszylinder							
Cooper	85	12/10→04/15		10/11→		24.4123-1712.3 010897	TRW Ø 23,81
Cooper	90	12/10→04/15					
Cooper S	120	12/10→04/15					
Cooper S	135	12/10→04/15					
Cooper SD	100	12/10→05/15					
Cooper SD	105	12/10→05/15					
Cooper S JCW	147	12/10→04/15					
John Cooper Works	155	12/10→05/15					
MINI - MINI PACEMAN (R61) 03/12→09/16							
 Hauptbremszylinder							
Cooper	88	04/12→09/16		11/12→		24.4123-1712.3 010897	TRW Ø 23,81
Cooper	90	04/12→09/16					
Cooper D	82	04/12→09/16					
Cooper D	82	07/12→09/16					
Cooper D ALL4	82	04/12→09/16					
Cooper D ALL4	82	03/12→09/16					
Cooper S	135	04/12→09/16					
Cooper S	140	04/12→09/16					
Cooper S ALL4	120	03/12→09/16					
Cooper S ALL4	135	03/12→09/16					
Cooper S ALL4	140	03/12→09/16					
Cooper SD	105	03/12→09/16					
Cooper SD ALL4	100	04/12→09/16					
Cooper SD ALL4	105	04/12→09/16					
John Cooper Works	160	09/12→09/16					
Cooper ALL4	90	11/12→09/16		07/14→		24.4123-1712.3 010897	TRW Ø 23,81
Cooper ALL4	90	02/13→09/16					
MINI - MINI Roadster (R59) 01/11→04/15							
 Hauptbremszylinder							
Cooper	85	11/11→04/15		02/12→		24.4123-1712.3 010897	TRW Ø 23,81
Cooper	90	11/11→04/15					
Cooper S	120	11/11→04/15					
Cooper S	135	11/11→04/15					
Cooper SD	100	11/11→04/15					
Cooper SD	105	11/11→04/15					
Cooper S JCW	147	11/11→04/15					
John Cooper Works	155	11/11→04/15					
MITSUBISHI - CARISMA (DA_) 07/95→06/06							
 Hauptbremszylinder							
1.6 (DA1A)	66	07/95→06/06		- ABS		24.2122-1718.3 010517	Ø 22,2
1.8 (DA2A)	85	07/95→07/97					
1.8 MSX - 16V (DA2A)	103	07/95→07/97					
MITSUBISHI - CARISMA Stufenheck (DA_) 09/96→06/06							
 Hauptbremszylinder							
1.6 (DA1A)	66	09/96→06/06		- ABS		24.2122-1718.3 010517	Ø 22,2
1.8 (DA2A)	85	09/96→09/97					
MITSUBISHI - COLT VI (Z3_A, Z2_A) 10/02→12/12							
 Hauptbremszylinder							
1.1	55	10/04→06/12		→ 09/08		24.2122-1770.3 010898	TRW Ø 22,2
↓							











	kw					! #		
MITSUBISHI - COLT VI (Z3_A, Z2_A) 10/02→12/12								
 Hauptbremszylinder								
1.3	70	06/04→06/12		10/08→		24.4122-1717.3	010993	TRW Ø 22,2 ohne Bremsflüssigkeitsbehälter
1.5	80	06/04→06/12						
1.5 CZT	110	03/05→06/12						
1.5 DI-D	50	08/04→06/12				24.2122-1770.3	010898	TRW Ø 22,2
1.5 DI-D	70	08/04→06/12						
MITSUBISHI - COLT CZC Cabriolet (RG) 05/06→07/09								
 Hauptbremszylinder								
1.5 (Z23)	80	05/06→07/09				24.2122-1770.3	010898	TRW Ø 22,2
1.5 Turbo (Z23)	110	05/06→07/09						
NISSAN - ALMERA I (N15) 07/95→07/00								
 Hauptbremszylinder								
1.4	64	09/95→07/00		02/98→ 04/00; + ABS		24.2123-1761.3	010780	TRW Ø 23,81 mit Bremsflüssigkeitsbehälter
1.4 GX,LX	55	09/95→07/00						
1.6	73	09/95→07/00		01/98→ 04/00; + ABS		24.2123-1761.3	010780	TRW Ø 23,81 mit Bremsflüssigkeitsbehälter
1.6 SLX	66	09/95→07/00						
2.0 D	55	11/95→07/00						
NISSAN - ALMERA I Hatchback (N15) 07/95→01/01								
 Hauptbremszylinder								
1.4	64	09/95→03/00		02/98→; + ABS		24.2123-1761.3	010780	TRW Ø 23,81 mit Bremsflüssigkeitsbehälter
1.4 S,GX,LX	55	09/95→03/00						
1.6	73	09/95→03/00		01/98→; + ABS		24.2123-1761.3	010780	TRW Ø 23,81 mit Bremsflüssigkeitsbehälter
1.6 SR,SLX	66	09/95→03/00						
2.0 D	55	11/95→03/00						
2.0 GTi	105	07/96→03/00		01/98→		24.2123-1761.3	010780	TRW Ø 23,81 mit Bremsflüssigkeitsbehälter
NISSAN - ALMERA II (N16) 04/00→								
 Hauptbremszylinder								
1.5	66	07/00→11/06		→ 03/01; + ASR / + ETS; für Linkslenker		24.2123-1761.3	010780	TRW Ø 23,81 mit Bremsflüssigkeitsbehälter
1.8	84	07/00→11/02		→ 03/01; + ABS; für Linkslenker		24.2123-1761.3	010780	TRW Ø 23,81 mit Bremsflüssigkeitsbehälter
2.2 Di	81	07/00→04/03		→ 03/01		24.2123-1761.3	010780	TRW Ø 23,81 mit Bremsflüssigkeitsbehälter
NISSAN - ALMERA II Hatchback (N16) 01/00→								
 Hauptbremszylinder								
1.5	66	03/00→11/06		→ 03/01; + ASR / + ETS; für Linkslenker		24.2123-1761.3	010780	TRW Ø 23,81 mit Bremsflüssigkeitsbehälter
1.8	84	01/00→11/02		03/00→ 03/01; + ABS; für Linkslenker		24.2123-1761.3	010780	TRW Ø 23,81 mit Bremsflüssigkeitsbehälter
2.2 Di	81	03/00→04/03		→ 03/01		24.2123-1761.3	010780	TRW Ø 23,81 mit Bremsflüssigkeitsbehälter
NISSAN - INTERSTAR Bus (X70) 04/02→								
 Hauptbremszylinder								
dCi 100	73	11/03→		→ 06/10; - ABS		24.2025-1708.3	010692	Ø 25,4
dCi 100	74	04/06→		→ 06/10; + ABS		24.2123-1759.3	010768	BOS Ø 23,81
dCi 120	88	09/06→						
dCi 150	107	09/06→						
dCi 120	84	07/02→08/06		→ 12/02; + ABS		24.2025-1706.3	010676	Ø 25,4
				- ABS		24.2025-1708.3	010692	Ø 25,4
				01/03→; + ABS		24.2123-1759.3	010768	BOS Ø 23,81
dCi 140	100	11/03→		→ 08/06; - ABS		24.2025-1708.3	010692	Ø 25,4
				→ 08/06; + ABS		24.2123-1759.3	010768	BOS Ø 23,81
dCi 80	60	04/02→08/06		07/02→ 12/02; + ABS		24.2025-1706.3	010676	Ø 25,4
				07/02→; - ABS		24.2025-1708.3	010692	Ø 25,4
				01/03→; + ABS		24.2123-1759.3	010768	BOS Ø 23,81
dCi 90	66	07/02→		→ 12/02; + ABS		24.2025-1706.3	010676	Ø 25,4
				→ 08/06; - ABS		24.2025-1708.3	010692	Ø 25,4
				01/03→ 08/06; + ABS		24.2123-1759.3	010768	BOS Ø 23,81











	kw			 	! #		
NISSAN - INTERSTAR Kasten (X70) 04/02→							
 Hauptbremszylinder							
dCi 100	73	11/03→		→ 06/10; - ABS		24.2025-1708.3 010692	Ø 25,4
dCi 100	74	04/06→		→ 06/10; + ABS		24.2123-1759.3 010768	BOS Ø 23,81
dCi 120	88	09/06→					
dCi 150	107	09/06→					
dCi 120	84	04/02→		→ 12/02; + ABS		24.2025-1706.3 010676	Ø 25,4
dCi 90	66	07/02→		→ 08/06; - ABS		24.2025-1708.3 010692	Ø 25,4
				01/03→ 08/06; + ABS		24.2123-1759.3 010768	BOS Ø 23,81
dCi 140	100	11/03→		→ 08/06; - ABS		24.2025-1708.3 010692	Ø 25,4
				→ 08/06; + ABS		24.2123-1759.3 010768	BOS Ø 23,81
dCi 80	60	04/02→08/06		07/02→ 12/02; + ABS		24.2025-1706.3 010676	Ø 25,4
				07/02→; - ABS		24.2025-1708.3 010692	Ø 25,4
				01/03→; + ABS		24.2123-1759.3 010768	BOS Ø 23,81
NISSAN - INTERSTAR Pritsche/Fahrgestell 08/03→							
 Hauptbremszylinder							
dCi 100	73	02/04→		→ 06/10; - ABS		24.2025-1708.3 010692	Ø 25,4
				→ 06/10; + ABS		24.2123-1759.3 010768	BOS Ø 23,81
dCi 120	84	08/03→		→ 08/06; - ABS		24.2025-1708.3 010692	Ø 25,4
dCi 140	100	11/03→		→ 08/06; + ABS		24.2123-1759.3 010768	BOS Ø 23,81
dCi 120	88	08/06→		09/06→ 06/10; - ABS		24.2025-1708.3 010692	Ø 25,4
dCi 150	107	08/06→		09/06→ 06/10; + ABS		24.2123-1759.3 010768	BOS Ø 23,81
NISSAN - KUBISTAR Kasten (X76) 08/03→							
 Hauptbremszylinder							
1.2	44	08/03→		→ 08/05; - ABS		24.2122-1727.3 010586	BDX Ø 22,2
1.5 dCi	42	08/03→10/09					
1.5 dCi	48	08/03→					
1.5 dCi	60	08/03→					
1.2 16V	55	04/06→		→ 10/09; - ABS		24.2122-1727.3 010586	BDX Ø 22,2
1.6 16V	70	08/03→					
1.5 dCi	45	08/05→		09/05→ 10/09; - ABS		24.2122-1727.3 010586	BDX Ø 22,2
1.5 dCi 70	51	09/05→10/09		- ABS		24.2122-1727.3 010586	BDX Ø 22,2
dCi 85	62	04/06→10/09					
NISSAN - MICRA III (K12) 03/02→06/10							
 Bremskraftverstärker							
1.0 16V	48	01/03→06/10		für Linkslenker		03.7863-3002.4 300223	ATE Ø 10" pneumatisch
1.2 16V	48	01/03→06/10					
1.2 16V	59	01/03→06/10					
1.4 16V	65	01/03→06/10					
1.5 dCi	48	01/03→06/10					
1.5 dCi	50	06/05→06/10					
1.5 dCi	60	09/03→06/10					
1.5 dCi	63	06/05→06/10					
160 SR	81	05/05→06/10					
 Hauptbremszylinder							
1.0 16V	48	01/03→06/10		für Linkslenker; - ESP		03.2123-2863.3 010790	ATE Ø 23,81
1.2 16V	48	01/03→06/10		für Linkslenker; + ESP		03.2123-2923.3 010791	ATE Ø 23,81
1.2 16V	59	01/03→06/10					
1.4 16V	65	01/03→06/10					
1.5 dCi	48	01/03→06/10					
1.5 dCi	50	06/05→06/10					
1.5 dCi	60	09/03→06/10					
1.5 dCi	63	06/05→06/10					
160 SR	81	05/05→06/10					
NISSAN - MICRA C+C III (K12) 08/05→							
 Bremskraftverstärker							
1.4 16V	65	08/05→		→ 12/10; für Linkslenker		03.7863-3002.4 300223	ATE Ø 10" pneumatisch
1.6 160 SR	81	08/05→					
 Hauptbremszylinder							
1.4 16V	65	08/05→		→ 12/10; - ESP		03.2123-2863.3 010790	ATE Ø 23,81
1.6 160 SR	81	08/05→		→ 12/10; + ESP		03.2123-2923.3 010791	ATE Ø 23,81
NISSAN - NOTE (E11, NE11) 01/05→06/12							
 Bremskraftverstärker							
1.4	65	03/06→06/12		für Linkslenker		03.7863-3002.4 300223	ATE Ø 10" pneumatisch
↓							

	kw					! #		
NISSAN - NOTE (E11, NE11) 01/05→06/12								
 Bremskraftverstärker								
1.5 dCi	50	03/06→06/12			für Linkslenker		03.7863-3002.4 300223	ATE Ø 10" pneumatisch
1.5 dCi	63	03/06→06/12						
1.5 dCi	66	09/10→06/12						
1.5 dCi	76	07/08→06/12						
1.6	81	03/06→06/12						
 Hauptbremszylinder								
1.4	65	03/06→06/12			- ESP		03.2123-2863.3 010790	ATE Ø 23,81
1.5 dCi	50	03/06→06/12			+ ESP		03.2123-2923.3 010791	ATE Ø 23,81
1.5 dCi	63	03/06→06/12						
1.5 dCi	66	09/10→06/12						
1.5 dCi	76	07/08→06/12						
1.6	81	03/06→06/12						
NISSAN - NP300 NAVARA (D40) 10/04→								
 Hauptbremszylinder								
2.5 dCi	106	07/05→			→ 09/06		03.2125-0161.3 010920	ATE Ø 25,4
2.5 dCi 4WD	128	07/05→						
NISSAN - NP300 PICKUP (D22) 04/08→								
 Hauptbremszylinder								
2.5 dCi	98	04/08→					03.2125-0161.3 010920	ATE Ø 25,4
2.5 dCi 4x4	98	04/08→						
NISSAN - PATHFINDER III (R51) 01/05→								
 Hauptbremszylinder								
2.5 dCi 4WD	120	01/05→					03.2125-0531.3 010945	ATE Ø 25,4
4.0 4WD	198	09/05→						
2.5 dCi 4WD	126	10/06→			ohne Spezialausrüst.		03.2125-0161.3 010920	ATE Ø 25,4
2.5 dCi 4WD	128	03/05→			mit Spezialausrüst.		03.2125-0531.3 010945	ATE Ø 25,4
2.5 dCi 4WD	140	08/10→					03.2125-0161.3 010920	ATE Ø 25,4
NISSAN - PRIMASTAR Bus (X83) 03/01→								
 Hauptbremszylinder								
2.0	88	03/01→			→ 01/03; - ABS		24.2120-1738.3 010759	TRW Ø 20,64
					02/03→; - ABS		24.2120-1740.3 010764	TRW Ø 20,64
					02/03→; + ABS		24.2125-1731.3 010826	TRW Ø 25,4
					02/03→; + ESP		24.2125-1734.3 010878	TRW Ø 25,4
dCi 100	74	03/01→			→ 01/03; - ABS		24.2120-1738.3 010759	TRW Ø 20,64
dCi 80	60	03/01→			02/03→ 08/06; - ABS		24.2120-1740.3 010764	TRW Ø 20,64
					02/03→ 08/06; + ABS		24.2125-1731.3 010826	TRW Ø 25,4
					04/06→; + ESP		24.2125-1734.3 010878	TRW Ø 25,4
dCi 115	84	09/08→			- ABS		24.2120-1740.3 010764	TRW Ø 20,64
dCi 120	84	09/06→			+ ABS		24.2125-1731.3 010826	TRW Ø 25,4
dCi 150	107	09/06→			+ ESP		24.2125-1734.3 010878	TRW Ø 25,4
dCi 90	66	09/06→						
dCi 140	99	07/03→			→ 08/06; - ABS		24.2120-1740.3 010764	TRW Ø 20,64
					→ 08/06; + ABS		24.2125-1731.3 010826	TRW Ø 25,4
					+ ESP		24.2125-1734.3 010878	TRW Ø 25,4
NISSAN - PRIMASTAR Kasten (X83) 09/02→								
 Hauptbremszylinder								
1.9 dCi 100	74	09/02→			→ 01/03; - ABS		24.2120-1738.3 010759	TRW Ø 20,64
1.9 dCi 80	60	09/02→			02/03→ 08/06; - ABS		24.2120-1740.3 010764	TRW Ø 20,64
					02/03→ 08/06; + ABS		24.2125-1731.3 010826	TRW Ø 25,4
					04/06→; + ESP		24.2125-1734.3 010878	TRW Ø 25,4
2.0	88	02/03→			- ABS		24.2120-1740.3 010764	TRW Ø 20,64
2.0 dCi 115	84	09/06→			+ ABS		24.2125-1731.3 010826	TRW Ø 25,4
2.0 dCi 90	66	09/06→			+ ESP		24.2125-1734.3 010878	TRW Ø 25,4
2.5 dCi 150	107	09/06→						
2.5 dCi 115	84	09/08→			- ABS		24.2120-1740.3 010764	TRW Ø 20,64
					+ ABS		24.2125-1731.3 010826	TRW Ø 25,4
2.5 dCi 140	99	07/03→			→ 08/06; - ABS		24.2120-1740.3 010764	TRW Ø 20,64
					→ 08/06; + ABS		24.2125-1731.3 010826	TRW Ø 25,4
					+ ESP		24.2125-1734.3 010878	TRW Ø 25,4











	kw			 	! #		
NISSAN - PRIMERA (P12) 01/02 →							
 Hauptbremszylinder							
1.6	80	01/02 → 04/06		06/04 →		24.2122-1774.3 010987	Ø 22,2 ohne Bremsflüssigkeitsbehälter
1.8	85	03/02 → 10/08					
1.9 dCi	85	08/02 → 10/07					
1.9 dCi	88	04/03 → 10/07					
2.0	103	03/02 → 10/08					
2.2 dCi	102	04/03 →		06/04 → 10/07		24.2122-1774.3 010987	Ø 22,2 ohne Bremsflüssigkeitsbehälter
NISSAN - PRIMERA Hatchback (P12) 01/02 →							
 Hauptbremszylinder							
1.6	80	07/02 → 04/06		06/04 →		24.2122-1774.3 010987	Ø 22,2 ohne Bremsflüssigkeitsbehälter
1.8	85	07/02 → 10/08					
1.9 dCi	85	08/02 → 10/07					
1.9 dCi	88	04/03 → 10/07					
2.0	103	07/02 → 10/08					
2.2 dCi	102	04/03 →		06/04 → 10/07		24.2122-1774.3 010987	Ø 22,2 ohne Bremsflüssigkeitsbehälter
NISSAN - PRIMERA Traveller (WP12) 01/02 →							
 Hauptbremszylinder							
1.6 Visia	80	01/02 → 04/06		06/04 →		24.2122-1774.3 010987	Ø 22,2 ohne Bremsflüssigkeitsbehälter
1.8	85	03/02 → 05/07					
1.9 dCi	85	08/02 → 10/07					
1.9 dCi	88	04/03 →		06/04 → 10/07		24.2122-1774.3 010987	Ø 22,2 ohne Bremsflüssigkeitsbehälter
2.2 dCi	102	04/03 →					
2.0	103	03/02 →		06/04 → 10/08		24.2122-1774.3 010987	Ø 22,2 ohne Bremsflüssigkeitsbehälter
NISSAN - TERRANO II (R20) 10/92 → 09/07							
 Hauptbremszylinder							
2.4 i 12V 4WD	91	02/93 → 12/97		→ 04/96; - ABS		24.2123-1726.3 010557	Ø 23,81 ohne Bremsflüssigkeitsbehälter
2.7 TD 4WD	74	02/93 → 01/02					
NISSAN - X-TRAIL (T30) 01/01 → 12/13							
 Hauptbremszylinder							
2.0	103	07/01 → 01/13		→ 08/03; Schaltgetriebe; - ESP		24.2125-1741.3 010988	Ø 25,4 ohne Bremsflüssigkeitsbehälter
2.0 4x4	103	07/01 → 01/13					
2.2 Di 4x4	84	07/01 → 10/05		→ 09/03; Schaltgetriebe; - ESP		24.2125-1741.3 010988	Ø 25,4 ohne Bremsflüssigkeitsbehälter
2.5 4x4	121	09/02 → 01/13		01/03 → 08/03; Schaltgetriebe; - ESP		24.2125-1741.3 010988	Ø 25,4 ohne Bremsflüssigkeitsbehälter
OPEL - AGILA (A) (H00) 09/00 → 12/07							
 Hauptbremszylinder							
1.0 (F68)	44	08/03 → 12/07		+ ABS; → 07/07		24.2120-1730.3 010678	Ø 20,64
1.0 12V (F68)	43	09/00 → 12/07					
1.2 16V (F68)	55	09/00 → 12/07					
1.3 CDTI (F68)	51	08/03 → 12/07					
OPEL - AGILA (B) (H08) 04/08 → 10/14							
 Hauptbremszylinder							
1.0 (F68)	48	04/08 → 06/11		für Linkslenker; - ESP		24.4122-1718.3 011019	BOS Ø 22,2 ohne Bremsflüssigkeitsbehälter
1.0 (F68)	50	07/11 → 07/14					
1.0 LPG (F68)	48	01/10 → 06/11		für Linkslenker; + ESP		24.4122-1719.3 011020	Ø 22,2 ohne Bremsflüssigkeitsbehälter
1.2 (F68)	63	04/08 → 10/12					
1.2 (F68)	69	04/10 → 10/14					
1.2 LPG (F68)	63	04/08 → 10/10					
1.3 CDTI (F68)	55	04/08 → 04/10					
OPEL - ASTRA F (T92) 09/91 → 09/98							
 Hauptbremszylinder							
1.4 i (F19, M19)	44	09/91 → 09/98		10/91 →; + ABS		03.2122-0282.3 010130	ATE Ø 22,2
				10/91 →; - ABS		24.2120-0702.3 010361	Ø 20,64
1.4 i 16V (F19, M19)	66	02/96 → 09/98		- ABS; für Fahrzeuge mit verstärkter Bremse		03.2122-0264.3 010129	ATE Ø 22,2
1.7 D (F19, M19)	44	07/92 → 09/98		+ ABS		03.2122-0282.3 010130	ATE Ø 22,2
				- ABS; nicht für Fahrzeuge mit verstärkter Bremse		24.2120-0702.3 010361	Ø 20,64
↓							













	kw					! #		
OPEL - ASTRA F (T92) 09/91→09/98								
 Hauptbremszylinder								
1.4 Si (F19, M19)	60	03/92→09/98		- ABS; für Fahrzeuge mit verstärkter Bremse		03.2122-0264.3	010129	ATE Ø 22,2
				- ABS; nicht für Fahrzeuge mit verstärkter Bremse		24.2120-0702.3	010361	Ø 20,64
1.6 i (F19, M19)	52	05/93→07/96		+ ABS		03.2122-0282.3	010130	ATE Ø 22,2
1.7 TD (F19, M19)	50	11/94→09/98		- ABS		24.2120-0702.3	010361	Ø 20,64
1.7 TDS (F19, M19)	60	03/92→09/98						
1.8 i (F19, M19)	66	03/92→09/98						
1.6 i (F19, M19)	55	03/92→09/98		+ ABS		03.2122-0282.3	010130	ATE Ø 22,2
2.0 i 16V (F19, M19)	100	02/95→09/98						
1.6 i 16V (F19, M19)	74	08/94→09/98		- ABS		03.2122-0264.3	010129	ATE Ø 22,2
1.8 i 16V (F19, M19)	82	09/95→09/96		+ ABS		03.2122-0282.3	010130	ATE Ø 22,2
1.8 i 16V (F19, M19)	85	11/94→09/98						
1.8 i 16V (F19, M19)	85	09/95→08/97						
2.0 i (F19, M19)	85	03/92→09/98						
 Bremskraftregler								
1.4 i (F19, M19)	44	09/91→09/98		10/91→		03.0101-0027.2	320022	ATE Satz 3/45 2x
1.4 i 16V (F19, M19)	66	02/96→09/98		Schaltgetriebe		03.0101-0027.2	320022	ATE Satz 3/45 2x
1.4 Si (F19, M19)	60	03/92→09/98						
1.6 i (F19, M19)	52	05/93→07/96		R2500001→ T2526383		03.0101-0025.2	320014	ATE Satz 3/35 2x
1.6 i (F19, M19)	55	03/92→09/98		→ R2500000		03.0101-0027.2	320022	ATE Satz 3/45 2x
				T2526384→		03.0101-0031.2	320211	ATE Satz 3/30 2x
1.6 i 16V (F19, M19)	74	08/94→09/98				03.6583-0054.3	320146	ATE lastabhängig 8/3 4x
						03.6585-0018.3	320114	ATE lastabhängig 8/5 4x
1.7 D (F19, M19)	44	07/92→09/98		→ 07/93		03.0101-0026.2	320230	ATE Satz 3/40 2x
				08/93→		03.0101-0031.2	320211	ATE Satz 3/30 2x
1.7 TD (F19, M19)	50	11/94→09/98		für Fahrzeuge mit verstärkter Bremse		03.0101-0025.2	320014	ATE Satz 3/35 2x
				nicht für Fahrzeuge mit verstärkter Bremse		03.0101-0032.2	320231	ATE Satz 3/25 2x
1.7 TDS (F19, M19)	60	03/92→09/98		08/93→; für Fahrzeuge mit verstärkter Bremse		03.0101-0025.2	320014	ATE Satz 3/35 2x
				→ 07/93		03.0101-0025.2	320014	ATE Satz 3/35 2x
				08/93→; nicht für Fahrzeuge mit verstärkter Bremse		03.0101-0032.2	320231	ATE Satz 3/25 2x
1.8 i (F19, M19)	66	03/92→09/98		→ 07/93		03.0101-0027.2	320022	ATE Satz 3/45 2x
2.0 i (F19, M19)	85	03/92→09/98		08/93→		03.6583-0054.3	320146	ATE lastabhängig 8/3 4x
2.0 i 16V (F19, M19)	100	02/95→09/98				03.6583-0054.3	320146	ATE lastabhängig 8/3 4x
OPEL - ASTRA F Cabriolet (T92) 03/93→03/01								
 Hauptbremszylinder								
1.4 i 16V	66	01/96→03/01		→ 09/98; - ABS; für Fahrzeuge mit verstärkter Bremse		03.2122-0264.3	010129	ATE Ø 22,2
1.4 Si	60	05/93→03/01		→ 09/98; + ABS		03.2122-0282.3	010130	ATE Ø 22,2
				→ 09/98; - ABS; nicht für Fahrzeuge mit verstärkter Bremse		24.2120-0702.3	010361	Ø 20,64
1.6 i	52	03/93→08/96		- ABS		24.2120-0702.3	010361	Ø 20,64
1.6 i	55	01/96→03/01		→ 09/98; + ABS		03.2122-0282.3	010130	ATE Ø 22,2
1.8 i 16V	85	11/94→03/01		→ 09/98; - ABS		03.2122-0264.3	010129	ATE Ø 22,2
				→ 09/98; + ABS		03.2122-0282.3	010130	ATE Ø 22,2
 Bremskraftregler								
1.6 i	52	03/93→08/96		R2500001→ T2526383		03.0101-0025.2	320014	ATE Satz 3/35 2x
1.6 i	55	01/96→03/01		→ R2500000		03.0101-0027.2	320022	ATE Satz 3/45 2x
				T2526384→		03.0101-0031.2	320211	ATE Satz 3/30 2x
OPEL - ASTRA F Caravan (T92) 09/91→01/98								
 Hauptbremszylinder								
1.4 i (F08, C05)	44	09/91→01/98		10/91→; + ABS		03.2122-0282.3	010130	ATE Ø 22,2
1.8 i (F08, C05)	66	09/91→01/98		10/91→; - ABS		24.2120-0702.3	010361	Ø 20,64
1.4 i 16V (F08, C05)	66	02/96→01/98		- ABS;		03.2122-0264.3	010129	ATE Ø 22,2
1.4 Si (F08, C05)	60	03/92→01/98		für Fahrzeuge mit verstärkter Bremse				
1.7 D (F08, C05)	44	07/92→01/98		+ ABS		03.2122-0282.3	010130	ATE Ø 22,2
				- ABS; nicht für Fahrzeuge mit verstärkter Bremse		24.2120-0702.3	010361	Ø 20,64
↓								

	kw					! #		
OPEL - ASTRA F Caravan (T92) 09/91→01/98								
 Hauptbremszylinder								
1.6 i (F08, C05)	52	05/93→07/96		+ ABS			03.2122-0282.3 010130	ATE Ø 22,2
1.7 TD (F08, C05)	50	11/94→01/98		- ABS			24.2120-0702.3 010361	Ø 20,64
1.7 TDS (F08, C05)	60	12/91→01/98						
1.6 i (F08, C05)	55	09/91→01/98		10/91→; + ABS			03.2122-0282.3 010130	ATE Ø 22,2
1.6 i 16V (F08, C05)	74	08/94→01/98		- ABS			03.2122-0264.3 010129	ATE Ø 22,2
1.8 i 16V (F08, C05)	85	07/94→01/98		+ ABS			03.2122-0282.3 010130	ATE Ø 22,2
1.8 i 16V (F08, C05)	92	06/93→01/98						
OPEL - ASTRA F CC (T92) 09/91→02/98								
 Hauptbremszylinder								
1.4 i (F08, M08, F68, M68)	44	09/91→01/98		+ ABS			03.2122-0282.3 010130	ATE Ø 22,2
1.6 i (F08, M08, F68, M68)	52	05/93→07/96		- ABS			24.2120-0702.3 010361	Ø 20,64
1.7 TD (F08, M08, F68, M68)	50	11/94→01/98						
1.7 TDS (F08, M08, F68, M68)	60	12/91→01/98						
1.4 i 16V (F08, M08, F68, M68)	66	09/96→02/98		- ABS; für Fahrzeuge mit verstärkter Bremse			03.2122-0264.3 010129	ATE Ø 22,2
1.4 Si (F08, M08, F68, M68)	60	03/92→01/98		+ ABS			03.2122-0282.3 010130	ATE Ø 22,2
1.7 D (F08, M08, F68, M68)	44	07/92→01/98		- ABS; nicht für Fahrzeuge mit verstärkter Bremse			24.2120-0702.3 010361	Ø 20,64
1.6 i (F08, M08, F68, M68)	55	09/91→01/98		10/91→; + ABS			03.2122-0282.3 010130	ATE Ø 22,2
2.0 GSI 16V (F08, M08, F68, M68)	110	09/91→01/98						
1.6 i 16V (F08, M08, F68, M68)	74	08/94→01/98		- ABS			03.2122-0264.3 010129	ATE Ø 22,2
1.8 i 16V (F08, M08, F68, M68)	85	09/94→01/98		+ ABS			03.2122-0282.3 010130	ATE Ø 22,2
1.8 i (F08, M08, F68, M68)	66	09/91→01/98		10/91→; + ABS			03.2122-0282.3 010130	ATE Ø 22,2
				10/91→; - ABS			24.2120-0702.3 010361	Ø 20,64
2.0 i (F08, M08, F68, M68)	85	09/91→01/98		10/91→; - ABS			03.2122-0264.3 010129	ATE Ø 22,2
				10/91→; + ABS			03.2122-0282.3 010130	ATE Ø 22,2
2.0 i 16V (F08, M08, F68, M68)	100	02/95→01/98		+ ABS			03.2122-0282.3 010130	ATE Ø 22,2
 Bremskraftregler								
1.4 i (F08, M08, F68, M68)	44	09/91→01/98					03.0101-0027.2 320022	ATE Satz 3/45 2x
1.4 i 16V (F08, M08, F68, M68)	66	09/96→02/98		Schaltgetriebe			03.0101-0027.2 320022	ATE Satz 3/45 2x
1.4 Si (F08, M08, F68, M68)	60	03/92→01/98						
1.6 i (F08, M08, F68, M68)	52	05/93→07/96		R2500001→ T2526383			03.0101-0025.2 320014	ATE Satz 3/35 2x
				→ R2500000			03.0101-0027.2 320022	ATE Satz 3/45 2x
				T2526384→			03.0101-0031.2 320211	ATE Satz 3/30 2x
1.6 i (F08, M08, F68, M68)	55	09/91→01/98		R2500001→ T2526383			03.0101-0025.2 320014	ATE Satz 3/35 2x
				10/91→; → R2500000			03.0101-0027.2 320022	ATE Satz 3/45 2x
				T2526384→			03.0101-0031.2 320211	ATE Satz 3/30 2x
1.6 i 16V (F08, M08, F68, M68)	74	08/94→01/98					03.6583-0054.3 320146	ATE lastabhängig 8/3 4x
							03.6585-0018.3 320114	ATE lastabhängig 8/5 4x
1.7 D (F08, M08, F68, M68)	44	07/92→01/98		→ 07/93			03.0101-0026.2 320230	ATE Satz 3/40 2x
				08/93→			03.0101-0031.2 320211	ATE Satz 3/30 2x
1.7 TD (F08, M08, F68, M68)	50	11/94→01/98		für Fahrzeuge mit verstärkter Bremse			03.0101-0025.2 320014	ATE Satz 3/35 2x
				nicht für Fahrzeuge mit verstärkter Bremse			03.0101-0032.2 320231	ATE Satz 3/25 2x
1.7 TDS (F08, M08, F68, M68)	60	12/91→01/98		08/93→; für Fahrzeuge mit verstärkter Bremse			03.0101-0025.2 320014	ATE Satz 3/35 2x
				→ 07/93			03.0101-0025.2 320014	ATE Satz 3/35 2x
				08/93→; nicht für Fahrzeuge mit verstärkter Bremse			03.0101-0032.2 320231	ATE Satz 3/25 2x
1.8 i (F08, M08, F68, M68)	66	09/91→01/98		10/91→ 07/93			03.0101-0027.2 320022	ATE Satz 3/45 2x
2.0 i (F08, M08, F68, M68)	85	09/91→01/98		08/93→			03.6583-0054.3 320146	ATE lastabhängig 8/3 4x
2.0 GSI 16V (F08, M08, F68, M68)	110	09/91→01/98		08/92→			03.6583-0054.3 320146	ATE lastabhängig 8/3 4x
2.0 i 16V (F08, M08, F68, M68)	100	02/95→01/98					03.6583-0054.3 320146	ATE lastabhängig 8/3 4x

	kw				! #		
OPEL - ASTRA F Van (T92) 10/91→01/99							
 Hauptbremszylinder							
1.4 i (F70)	44	10/91→01/99		→ 09/98; + ABS		03.2122-0282.3 010130	ATE Ø 22,2
1.6 i (F70)	52	02/93→07/96		+ ABS		03.2122-0282.3 010130	ATE Ø 22,2
				- ABS		24.2120-0702.3 010361	Ø 20,64
1.6 i 16V (F70)	74	08/94→03/98		- ABS		03.2122-0264.3 010129	ATE Ø 22,2
				+ ABS		03.2122-0282.3 010130	ATE Ø 22,2
1.7 D (F70)	44	07/92→01/99		→ 09/98; - ABS; für Fahrzeuge mit verstärkter Bremse		03.2122-0264.3 010129	ATE Ø 22,2
				→ 09/98; + ABS		03.2122-0282.3 010130	ATE Ø 22,2
				→ 09/98; - ABS; nicht für Fahrzeuge mit verstärkter Bremse		24.2120-0702.3 010361	Ø 20,64
1.7 TD (F70)	50	08/94→01/99		→ 09/98; + ABS		03.2122-0282.3 010130	ATE Ø 22,2
				→ 09/98; - ABS		24.2120-0702.3 010361	Ø 20,64
OPEL - ASTRA G Cabriolet (T98) 03/01→10/05							
 Hauptbremszylinder							
1.6 (F67)	76	01/03→10/05		- ESP		24.2123-1734.3 010640	TRW Ø 23,81
1.6 16V (F67)	74	03/01→10/05		+ ESP		24.2123-1739.3 010661	Ø 23,81
1.8 16V (F67)	92	03/01→10/05					
2.0 16V Turbo (F67)	147	11/02→10/05					
2.0 OPC (F67)	141	03/02→10/05					
2.2 16V (F67)	108	03/01→10/05					
2.2 DTI (F67)	92	09/02→10/05		- ESP		24.2123-1734.3 010640	TRW Ø 23,81
OPEL - ASTRA G Caravan (T98) 02/98→12/09							
 Hauptbremszylinder							
1.2 16V (F35)	48	02/98→09/00		04/98→; - ESP; für Fahrzeuge mit Scheibenbremse an der Hinterachse		24.2123-1734.3 010640	TRW Ø 23,81
1.6 (F35)	55	02/98→09/00					
1.6 16V (F35)	74	02/98→07/04					
				22000001→; - ESP; für Fahrzeuge mit Trommelbremse an der Hinterachse		24.2123-1734.3 010640	TRW Ø 23,81
				04/98→; + ESP		24.2123-1739.3 010661	Ø 23,81
1.2 16V (F35)	55	09/00→07/04		- ESP; für Fahrzeuge mit Scheibenbremse an der Hinterachse		24.2123-1734.3 010640	TRW Ø 23,81
1.4 16V (F35)	66	06/98→07/04					
1.6 (F35)	62	09/00→07/04					
1.6 (F35)	76	12/02→07/09					
1.7 DTI 16V (F35)	55	02/00→07/04		22000001→; - ESP; für Fahrzeuge mit Trommelbremse an der Hinterachse		24.2123-1734.3 010640	TRW Ø 23,81
				+ ESP		24.2123-1739.3 010661	Ø 23,81
1.4 (F35)	66	10/04→12/09		09/07→; - ESP		24.2123-1734.3 010640	TRW Ø 23,81
				09/07→; + ESP		24.2123-1739.3 010661	Ø 23,81
1.6 CNG (F35)	71	03/03→07/04		- ESP		24.2123-1734.3 010640	TRW Ø 23,81
1.8 16V (F35)	92	09/00→07/04					
2.0 DTI 16V (F35)	74	08/99→07/04					
2.0 OPC (F35)	141	09/02→07/04					
2.0 OPC (F35)	147	11/02→07/04					
2.2 16V (F35)	108	03/01→07/04					
2.2 DTI (F35)	86	09/02→07/04					
2.2 DTI (F35)	92	09/02→07/04					
1.7 CDTI (F35)	59	04/03→07/09			- ESP		
1.7 TD (F35)	50	02/98→08/00		04/98→; - ESP; für Fahrzeuge mit Scheibenbremse an der Hinterachse		24.2123-1734.3 010640	TRW Ø 23,81
				04/98→; + ESP		24.2123-1739.3 010661	Ø 23,81
1.8 16V (F35)	85	02/98→09/00		04/98→; - ESP		24.2123-1734.3 010640	TRW Ø 23,81
2.0 16V (F35)	100	02/98→07/04		04/98→; + ESP		24.2123-1739.3 010661	Ø 23,81
2.0 DI (F35)	60	02/98→07/04					
 Bremskraftregler							
1.2 16V (F35)	48	02/98→09/00		04/98→; - ABS		03.6583-0073.3 320234	ATE lastabhängig 8/3 4x
1.6 (F35)	55	02/98→09/00					
1.6 16V (F35)	74	02/98→07/04					
1.7 TD (F35)	50	02/98→08/00					
1.8 16V (F35)	85	02/98→09/00					
2.0 16V (F35)	100	02/98→07/04					
1.2 16V (F35)	55	09/00→07/04		- ABS		03.6583-0073.3 320234	ATE lastabhängig 8/3 4x
1.4 16V (F35)	66	06/98→07/04					
1.6 (F35)	62	09/00→07/04					
1.6 (F35)	76	12/02→07/09					
1.6 CNG (F35)	71	03/03→07/04					
1.7 CDTI (F35)	59	04/03→07/09					
1.7 DTI 16V (F35)	55	02/00→07/04					
↓							



	kw				! #		
OPEL - ASTRA G Caravan (T98) 02/98→12/09							
 Bremskraftregler							
1.8 16V (F35)	92	09/00→07/04		- ABS		03.6583-0073.3 320234	ATE lastabhängig 8/3 4x
1.4 (F35)	66	10/04→12/09		09/07→; - ABS		03.6583-0073.3 320234	ATE lastabhängig 8/3 4x
2.0 DI (F35)	60	02/98→07/04		04/98→; - ABS		03.6583-0074.3 320235	ATE lastabhängig 8/3 4x
2.0 DTI 16V (F35)	74	08/99→07/04		- ABS		03.6583-0074.3 320235	ATE lastabhängig 8/3 4x
OPEL - ASTRA G CC (T98) 02/98→12/09							
 Hauptbremszylinder							
1.2 16V (F08, F48)	48	02/98→09/00		04/98→; - ESP; für Fahrzeuge mit Scheibenbremse an der Hinterachse		24.2123-1734.3 010640	TRW Ø 23,81
1.4 16V (F08, F48)	66	02/98→01/05					
1.6 (F08, F48)	55	02/98→09/00					
1.6 16V (F08, F48)	74	02/98→01/05		22000001→; - ESP; für Fahrzeuge mit Trommelbremse an der Hinterachse		24.2123-1734.3 010640	TRW Ø 23,81
				04/98→; + ESP		24.2123-1739.3 010661	Ø 23,81
1.2 16V (F08, F48)	55	09/00→01/05		- ESP; für Fahrzeuge mit Scheibenbremse an der Hinterachse		24.2123-1734.3 010640	TRW Ø 23,81
1.4 (F08, F48)	66	09/07→12/09					
1.6 (F08, F48)	62	09/00→01/05					
1.6 (F08, F48)	76	12/02→12/09					
1.7 DTI 16V (F08, F48)	55	02/00→01/05		22000001→; - ESP; für Fahrzeuge mit Trommelbremse an der Hinterachse		24.2123-1734.3 010640	TRW Ø 23,81
				+ ESP		24.2123-1739.3 010661	Ø 23,81
1.7 CDTI (F08, F48)	59	04/03→12/09		- ESP		24.2123-1734.3 010640	TRW Ø 23,81
1.7 TD (F08, F48)	50	02/98→08/00		04/98→; - ESP; für Fahrzeuge mit Scheibenbremse an der Hinterachse		24.2123-1734.3 010640	TRW Ø 23,81
				04/98→; + ESP		24.2123-1739.3 010661	Ø 23,81
1.8 16V (F08, F48)	85	02/98→09/00		04/98→; - ESP		24.2123-1734.3 010640	TRW Ø 23,81
2.0 16V (F08, F48)	100	02/98→01/05					
2.0 DI (F08, F48)	60	02/98→01/05		04/98→; + ESP		24.2123-1739.3 010661	Ø 23,81
1.8 16V (F08, F48)	92	09/00→01/05		- ESP		24.2123-1734.3 010640	TRW Ø 23,81
2.0 16V OPC (F08, F48)	118	11/99→09/02					
2.0 DTI 16V (F08, F48)	74	08/99→01/05		+ ESP		24.2123-1739.3 010661	Ø 23,81
2.0 OPC (F08, F48)	141	09/02→01/05					
2.0 OPC (F08, F48)	147	11/02→01/05					
2.2 DTI (F08, F48)	86	09/02→01/05					
2.2 DTI (F08, F48)	92	09/02→01/05					
2.2 16V (F08, F48)	108	06/00→01/05		09/00→; - ESP		24.2123-1734.3 010640	TRW Ø 23,81
				09/00→; + ESP		24.2123-1739.3 010661	Ø 23,81
 Bremskraftregler							
1.2 16V (F08, F48)	48	02/98→09/00		04/98→; - ABS		03.6583-0073.3 320234	ATE lastabhängig 8/3 4x
1.2 16V (F08, F48)	55	09/00→01/05		- ABS		03.6583-0073.3 320234	ATE lastabhängig 8/3 4x
1.4 16V (F08, F48)	66	02/98→01/05		04/98→; - ABS		03.6583-0074.3 320235	ATE lastabhängig 8/3 4x
1.6 (F08, F48)	55	02/98→09/00					
1.6 16V (F08, F48)	74	02/98→01/05					
1.7 TD (F08, F48)	50	02/98→08/00					
1.8 16V (F08, F48)	85	02/98→09/00					
2.0 16V (F08, F48)	100	02/98→01/05					
2.0 DI (F08, F48)	60	02/98→01/05					
1.6 (F08, F48)	62	09/00→01/05		- ABS		03.6583-0074.3 320235	ATE lastabhängig 8/3 4x
1.6 (F08, F48)	76	12/02→12/09					
1.7 CDTI (F08, F48)	59	04/03→12/09					
1.7 DTI 16V (F08, F48)	55	02/00→01/05					
1.8 16V (F08, F48)	92	09/00→01/05					
2.0 DTI 16V (F08, F48)	74	08/99→01/05					
OPEL - ASTRA G Coupe (T98) 03/00→05/05							
 Hauptbremszylinder							
1.6 16V (F07)	74	03/00→05/05		- ESP; für Fahrzeuge mit Scheibenbremse an der Hinterachse		24.2123-1734.3 010640	TRW Ø 23,81
1.6 16V (F07)	76	03/00→05/05					
				22000001→; - ESP; für Fahrzeuge mit Trommelbremse an der Hinterachse		24.2123-1734.3 010640	TRW Ø 23,81
				+ ESP		24.2123-1739.3 010661	Ø 23,81
1.8 16V (F07)	85	03/00→10/00		- ESP		24.2123-1734.3 010640	TRW Ø 23,81
1.8 16V (F07)	92	09/00→05/05					
2.0 16V Turbo (F07)	140	09/00→08/01		+ ESP		24.2123-1739.3 010661	Ø 23,81
2.0 16V Turbo (F07)	141	08/01→05/05					
2.0 16V Turbo (F07)	147	11/02→05/05					
2.2 16V (F07)	108	09/00→05/05					
2.2 DTI (F07)	92	09/02→05/05					

	kw			 	! #		
OPEL - ASTRA G Kasten (F70) 01/99→04/05							
 Hauptbremszylinder							
1.6 (F70)	55	01/99→09/00		- ESP;		24.2123-1734.3 010640	TRW Ø 23,81
1.6 (F70)	62	09/00→04/05		für Fahrzeuge mit Scheibenbremse an der Hinterachse			
1.7 DTI 16V (F70)	55	02/00→04/05		22000001→; - ESP;		24.2123-1734.3 010640	TRW Ø 23,81
				für Fahrzeuge mit Trommelbremse an der Hinterachse			
				+ ESP		24.2123-1739.3 010661	Ø 23,81
1.7 TD (F70)	50	01/99→04/05		- ESP;		24.2123-1734.3 010640	TRW Ø 23,81
				für Fahrzeuge mit Scheibenbremse an der Hinterachse			
				+ ESP		24.2123-1739.3 010661	Ø 23,81
2.0 DI (F70)	60	01/99→04/05		- ESP		24.2123-1734.3 010640	TRW Ø 23,81
				+ ESP		24.2123-1739.3 010661	Ø 23,81
 Bremskraftregler							
1.6 (F70)	55	01/99→09/00		- ABS		03.6583-0073.3 320234	ATE lastabhängig 8/3 4x
1.6 (F70)	62	09/00→04/05					
1.7 TD (F70)	50	01/99→04/05					
2.0 DI (F70)	60	01/99→04/05		- ABS		03.6583-0074.3 320235	ATE lastabhängig 8/3 4x
OPEL - ASTRA G Stufenheck (T98) 09/98→12/09							
 Hauptbremszylinder							
1.2 16V (F69)	48	09/98→09/00		- ESP;		24.2123-1734.3 010640	TRW Ø 23,81
1.2 16V (F69)	55	09/00→01/05		für Fahrzeuge mit Scheibenbremse an der Hinterachse			
1.4 16V (F69)	66	09/98→01/05					
1.6 (F69)	55	09/98→09/00		22000001→; - ESP;		24.2123-1734.3 010640	TRW Ø 23,81
1.6 (F69)	62	09/00→01/05		für Fahrzeuge mit Trommelbremse an der Hinterachse			
1.6 (F69)	76	12/02→12/09					
1.6 16V (F69)	74	09/98→01/05		+ ESP		24.2123-1739.3 010661	Ø 23,81
1.7 DTI 16V (F69)	55	02/00→01/05					
1.4 (F69)	66	09/07→12/09		- ESP		24.2123-1734.3 010640	TRW Ø 23,81
1.8 16V (F69)	85	09/98→09/00		+ ESP		24.2123-1739.3 010661	Ø 23,81
1.8 16V (F69)	92	06/00→01/05					
2.0 16V (F69)	100	09/98→01/05					
2.0 DI (F69)	60	09/98→01/05					
2.0 DTI 16V (F69)	74	08/99→01/05					
2.2 16V (F69)	108	03/01→01/05					
2.2 DTI (F69)	86	09/02→01/05					
2.2 DTI (F69)	92	09/02→01/05					
1.7 CDTI (F69)	59	04/03→12/09		- ESP		24.2123-1734.3 010640	TRW Ø 23,81
1.7 TD (F69)	50	09/98→08/00		- ESP;		24.2123-1734.3 010640	TRW Ø 23,81
				für Fahrzeuge mit Scheibenbremse an der Hinterachse			
				+ ESP		24.2123-1739.3 010661	Ø 23,81
 Bremskraftregler							
1.2 16V (F69)	48	09/98→09/00		- ABS		03.6583-0073.3 320234	ATE lastabhängig 8/3 4x
1.2 16V (F69)	55	09/00→01/05					
1.4 (F69)	66	09/07→12/09		- ABS		03.6583-0074.3 320235	ATE lastabhängig 8/3 4x
1.4 16V (F69)	66	09/98→01/05					
1.6 (F69)	55	09/98→09/00					
1.6 (F69)	62	09/00→01/05					
1.6 (F69)	76	12/02→12/09					
1.6 16V (F69)	74	09/98→01/05					
1.7 CDTI (F69)	59	04/03→12/09					
1.7 DTI 16V (F69)	55	02/00→01/05					
1.7 TD (F69)	50	09/98→08/00					
1.8 16V (F69)	85	09/98→09/00					
1.8 16V (F69)	92	06/00→01/05					
2.0 16V (F69)	100	09/98→01/05					
2.0 DI (F69)	60	09/98→01/05					
2.0 DTI 16V (F69)	74	08/99→01/05					
OPEL - ASTRA H (A04) 01/04→05/14							
 Bremskraftverstärker							
1.9 CDTI (L48)	74	09/05→10/10		für Linkslenker		03.7863-7803.4 300237	ATE Ø 10" pneumatisch
1.9 CDTI (L48)	110	09/04→10/10					
1.9 CDTI (L48)	88	06/04→10/10		09/04→; für Linkslenker		03.7863-7803.4 300237	ATE Ø 10" pneumatisch
1.9 CDTI 16V (L48)	88	04/04→10/10					
 Hauptbremszylinder							
1.2 (L48)	59	08/05→10/10		für Rechtslenker; → 68999999		24.2125-1736.3 010904	TRW Ø 25,4
1.3 CDTI (L48)	66	08/05→10/10					
1.4 (L48)	55	04/04→10/04		für Linkslenker; → 68999999; + ESP		24.2125-1736.3 010904	TRW Ø 25,4
1.4 (L48)	66	03/04→10/10		für Linkslenker; → 68999999; - ESP		24.2125-1737.3 010906	TRW Ø 25,4
↓							

OPEL - ASTRA H (A04) 01/04→05/14

 **Hauptbremszylinder**

1.4 LPG (L48)	66	08/09→10/10		72000001→; für Linkslenker; + ESP	24.4125-1703.3	010907	TRW Ø 25,4
1.6 (L48)	77	03/04→10/10					
1.6 Turbo (L48)	132	02/07→10/10		72000001→; für Rechtslenker	24.4125-1703.3	010907	TRW Ø 25,4
1.7 CDTI (L48)	59	03/04→10/10		72000001→; für Linkslenker; - ESP	24.4125-1704.3	010908	TRW Ø 25,4
1.7 CDTI (L48)	74	03/04→10/10					
1.8 (L48)	92	01/04→10/10					
1.8 (L48)	103	01/06→10/10					
2.0 Turbo (L48)	125	03/04→10/10					
2.0 Turbo (L48)	147	09/04→10/10					
2.0 Turbo (L48)	177	03/05→10/10					
1.6 (L48)	85	12/06→05/14		01/07→; → 68999999; für Rechtslenker	24.2125-1736.3	010904	TRW Ø 25,4
				01/07→; → 68999999; für Linkslenker; + ESP	24.2125-1736.3	010904	TRW Ø 25,4
				01/07→; → 68999999; für Linkslenker; - ESP	24.2125-1737.3	010906	TRW Ø 25,4
				72000001→; → 11/10; für Linkslenker; + ESP	24.4125-1703.3	010907	TRW Ø 25,4
				72000001→; → 11/10; für Rechtslenker	24.4125-1703.3	010907	TRW Ø 25,4
				72000001→; → 11/10; für Linkslenker; - ESP	24.4125-1704.3	010908	TRW Ø 25,4
1.7 CDTI (L48)	81	02/07→05/14		04/07→; → 68999999; für Rechtslenker	24.2125-1736.3	010904	TRW Ø 25,4
1.7 CDTI (L48)	92	02/07→05/14		04/07→; → 68999999; für Linkslenker; + ESP	24.2125-1736.3	010904	TRW Ø 25,4
				04/07→; → 68999999; für Linkslenker; - ESP	24.2125-1737.3	010906	TRW Ø 25,4
				72000001→; → 11/10; für Rechtslenker	24.4125-1703.3	010907	TRW Ø 25,4
				72000001→; → 11/10; für Linkslenker; + ESP	24.4125-1703.3	010907	TRW Ø 25,4
				72000001→; → 11/10; für Linkslenker; - ESP	24.4125-1704.3	010908	TRW Ø 25,4
1.9 CDTI (L48)	74	09/05→10/10			03.4155-0156.3	010862	ATE Ø 25,4
1.9 CDTI (L48)	110	09/04→10/10					
1.9 CDTI (L48)	88	06/04→10/10		09/04→	03.4155-0156.3	010862	ATE Ø 25,4
1.9 CDTI 16V (L48)	88	04/04→10/10					

OPEL - ASTRA H Caravan (A04) 08/04→05/14













 **Bremskraftverstärker**

1.9 CDTI (L35)	74	09/05→10/10		für Linkslenker	03.7863-7803.4	300237	ATE Ø 10" pneumatisch
1.9 CDTI (L35)	88	09/05→10/10					
1.9 CDTI (L35)	110	09/04→10/10					
1.9 CDTI 16V (L35)	88	08/04→10/10					

 **Hauptbremszylinder**

1.3 CDTI (L35)	66	08/05→10/10		72000001→; für Linkslenker; + ESP	24.2125-1703.3	010483	Ø 25,4
1.4 (L35)	55	08/04→10/10		72000001→; für Linkslenker; - ESP	24.2125-1704.3	010446	TRW Ø 25,4
1.4 (L35)	66	08/04→10/10					
1.4 LPG (L35)	66	08/09→10/10		→ 62999999; für Rechtslenker	24.2125-1736.3	010904	TRW Ø 25,4
1.6 (L35)	77	08/04→10/10		→ 68999999; für Linkslenker; + ESP	24.2125-1736.3	010904	TRW Ø 25,4
1.6 LPG (L35)	85	08/09→10/10		→ 68999999; für Linkslenker; - ESP	24.2125-1737.3	010906	TRW Ø 25,4
1.6 Turbo (L35)	132	02/07→10/10					
1.7 CDTI (L35)	59	08/04→10/10		72000001→; für Rechtslenker	24.4125-1703.3	010907	TRW Ø 25,4
1.7 CDTI (L35)	74	08/04→10/10					
1.8 (L35)	92	08/04→10/10					
1.8 (L35)	103	08/05→10/10					
2.0 Turbo (L35)	125	08/04→10/10					
2.0 Turbo (L35)	147	09/04→10/10					
1.6 (L35)	85	12/06→05/14		72000001→; → 11/10; für Linkslenker; + ESP	24.2125-1703.3	010483	Ø 25,4
				72000001→; → 11/10; für Linkslenker; - ESP	24.2125-1704.3	010446	TRW Ø 25,4
				01/07→; → 68999999; für Linkslenker; + ESP	24.2125-1736.3	010904	TRW Ø 25,4
				01/07→; → 62999999; für Rechtslenker	24.2125-1736.3	010904	TRW Ø 25,4
				01/07→; → 68999999; für Linkslenker; - ESP	24.2125-1737.3	010906	TRW Ø 25,4
				72000001→; → 11/10; für Rechtslenker	24.4125-1703.3	010907	TRW Ø 25,4
1.7 CDTI (L35)	81	02/07→05/14		72000001→; → 11/10; für Linkslenker; + ESP	24.2125-1703.3	010483	Ø 25,4
1.7 CDTI (L35)	92	02/07→05/14		72000001→; → 11/10; für Linkslenker; - ESP	24.2125-1704.3	010446	TRW Ø 25,4
				04/07→; → 68999999; für Linkslenker; + ESP	24.2125-1736.3	010904	TRW Ø 25,4
				04/07→; → 62999999; für Rechtslenker	24.2125-1736.3	010904	TRW Ø 25,4
				04/07→; → 68999999; für Linkslenker; - ESP	24.2125-1737.3	010906	TRW Ø 25,4



	kw			 	! #		
OPEL - ASTRA H Caravan (A04) 08/04→05/14							
 Hauptbremszylinder							
1.7 CDTi (L35)	81	02/07→05/14		72000001→; → 11/10; für Rechtslenker		24.4125-1703.3 010907	TRW Ø 25,4
1.7 CDTi (L35)	92	02/07→05/14					
1.9 CDTi (L35)	74	09/05→10/10				03.4155-0156.3 010862	ATE Ø 25,4
1.9 CDTi (L35)	88	09/05→10/10					
1.9 CDTi (L35)	110	09/04→10/10					
1.9 CDTi 16V (L35)	88	08/04→10/10					
OPEL - ASTRA H GTC (A04) 03/05→10/10							
 Bremskraftverstärker							
1.9 CDTi (L08)	110	03/05→10/10		für Linkslenker		03.7863-7803.4 300237	ATE Ø 10" pneumatisch
1.9 CDTi (L08)	74	01/06→10/10					
1.9 CDTi (L08)	88	09/05→10/10					
1.9 CDTi 16V (L08)	88	03/05→10/10					
 Hauptbremszylinder							
1.2 (L08)	59	08/05→10/10		für Rechtslenker; → 68999999		24.2125-1736.3 010904	TRW Ø 25,4
1.4 (L08)	55	03/05→10/10		für Linkslenker; → 68999999; + ESP		24.2125-1736.3 010904	TRW Ø 25,4
1.4 (L08)	66	03/05→10/10					
1.6 (L08)	77	03/05→10/10		für Linkslenker; → 68999999; - ESP		24.2125-1737.3 010906	TRW Ø 25,4
1.6 Turbo (L08)	132	02/07→10/10		72000001→; für Linkslenker; + ESP		24.4125-1703.3 010907	TRW Ø 25,4
1.7 CDTi (L08)	74	03/05→10/10					
1.7 CDTi (L08)	59	03/05→10/10		72000001→; für Rechtslenker		24.4125-1703.3 010907	TRW Ø 25,4
1.8 (L08)	92	03/05→10/10		72000001→; für Linkslenker; - ESP		24.4125-1704.3 010908	TRW Ø 25,4
1.8 (L08)	103	01/06→10/10					
2.0 Turbo (L08)	125	03/05→10/10					
2.0 Turbo (L08)	147	03/05→10/10					
2.0 Turbo (L08)	177	08/05→10/10					
1.3 CDTi (L08)	66	04/05→10/10		08/05→; → 68999999; für Linkslenker; + ESP		24.2125-1736.3 010904	TRW Ø 25,4
				08/05→; → 68999999; für Rechtslenker		24.2125-1736.3 010904	TRW Ø 25,4
				08/05→; → 68999999; für Linkslenker; - ESP		24.2125-1737.3 010906	TRW Ø 25,4
				72000001→; für Linkslenker; + ESP		24.4125-1703.3 010907	TRW Ø 25,4
				72000001→; für Rechtslenker		24.4125-1703.3 010907	TRW Ø 25,4
				72000001→; für Linkslenker; - ESP		24.4125-1704.3 010908	TRW Ø 25,4
1.6 (L08)	85	12/06→10/10		01/07→; → 68999999; für Rechtslenker		24.2125-1736.3 010904	TRW Ø 25,4
				01/07→; → 68999999; für Linkslenker; + ESP		24.2125-1736.3 010904	TRW Ø 25,4
				01/07→; → 68999999; für Linkslenker; - ESP		24.2125-1737.3 010906	TRW Ø 25,4
				72000001→; für Linkslenker; + ESP		24.4125-1703.3 010907	TRW Ø 25,4
				72000001→; für Rechtslenker		24.4125-1703.3 010907	TRW Ø 25,4
				72000001→; für Linkslenker; - ESP		24.4125-1704.3 010908	TRW Ø 25,4
1.7 CDTi (L08)	81	02/07→10/10		04/07→; → 68999999; für Rechtslenker		24.2125-1736.3 010904	TRW Ø 25,4
1.7 CDTi (L08)	92	02/07→10/10		04/07→; → 68999999; für Linkslenker; + ESP		24.2125-1736.3 010904	TRW Ø 25,4
				04/07→; → 68999999; für Linkslenker; - ESP		24.2125-1737.3 010906	TRW Ø 25,4
				72000001→; für Rechtslenker		24.4125-1703.3 010907	TRW Ø 25,4
				72000001→; für Linkslenker; + ESP		24.4125-1703.3 010907	TRW Ø 25,4
				72000001→; für Linkslenker; - ESP		24.4125-1704.3 010908	TRW Ø 25,4
1.9 CDTi (L08)	110	03/05→10/10				03.4155-0156.3 010862	ATE Ø 25,4
1.9 CDTi (L08)	74	01/06→10/10					
1.9 CDTi (L08)	88	09/05→10/10					
1.9 CDTi 16V (L08)	88	03/05→10/10					
OPEL - ASTRA H Kasten (L70) 02/04→12/13							
 Bremskraftverstärker							
1.9 CDTi (L70)	88	09/05→10/10		für Linkslenker		03.7863-7803.4 300237	ATE Ø 10" pneumatisch
1.9 CDTi (L70)	110	09/04→10/10					
1.9 CDTi 16V (L70)	88	08/04→10/10					
 Hauptbremszylinder							
1.3 CDTi (L70)	66	08/05→10/10		72000001→; für Linkslenker; + ESP		24.2125-1703.3 010483	Ø 25,4
				72000001→; für Linkslenker; - ESP		24.2125-1704.3 010446	TRW Ø 25,4
				→ 62999999; für Rechtslenker		24.2125-1736.3 010904	TRW Ø 25,4
				→ 68999999; für Linkslenker; + ESP		24.2125-1736.3 010904	TRW Ø 25,4
				→ 68999999; für Linkslenker; - ESP		24.2125-1737.3 010906	TRW Ø 25,4
				72000001→; für Rechtslenker		24.4125-1703.3 010907	TRW Ø 25,4
1.7 CDTi (L70)	74	03/04→10/10		72000001→; für Linkslenker; + ESP		24.2125-1703.3 010483	Ø 25,4
↓							



OPEL - ASTRA H Kasten (L70) 02/04→12/13

 **Hauptbremszylinder**

1.7 CDTi (L70)	74	03/04→10/10		72000001→; für Linkslenker; - ESP	24.2125-1704.3 010446	TRW Ø 25,4
				08/04→; → 68999999; für Linkslenker; + ESP	24.2125-1736.3 010904	TRW Ø 25,4
				08/04→; → 62999999; für Rechtslenker	24.2125-1736.3 010904	TRW Ø 25,4
				08/04→; → 68999999; für Linkslenker; - ESP	24.2125-1737.3 010906	TRW Ø 25,4
				72000001→; für Rechtslenker	24.4125-1703.3 010907	TRW Ø 25,4
1.7 CDTi (L70) 1.7 CDTi (L70)	81 92	02/07→10/10 02/07→10/10		72000001→; für Linkslenker; + ESP	24.2125-1703.3 010483	Ø 25,4
				72000001→; für Linkslenker; - ESP	24.2125-1704.3 010446	TRW Ø 25,4
				04/07→; → 68999999; für Linkslenker; + ESP	24.2125-1736.3 010904	TRW Ø 25,4
				04/07→; → 62999999; für Rechtslenker	24.2125-1736.3 010904	TRW Ø 25,4
				04/07→; → 68999999; für Linkslenker; - ESP	24.2125-1737.3 010906	TRW Ø 25,4
	72000001→; für Rechtslenker	24.4125-1703.3 010907	TRW Ø 25,4			
1.9 CDTi (L70)	88	09/05→10/10			03.4155-0156.3 010862	ATE Ø 25,4
1.9 CDTi (L70)	110	09/04→10/10				
1.9 CDTi 16V (L70)	88	08/04→10/10				

OPEL - ASTRA H Stufenheck (A04) 02/07→05/14

 **Hauptbremszylinder**

1.3 CDTi (L69) 1.7 CDTi (L69) 1.8 (L69)	66 74 103	02/07→10/10 02/07→10/10 02/07→10/10		→ 68999999; für Rechtslenker	24.2125-1736.3 010904	TRW Ø 25,4
				→ 68999999; für Linkslenker; + ESP	24.2125-1736.3 010904	TRW Ø 25,4
				→ 68999999; für Linkslenker; - ESP	24.2125-1737.3 010906	TRW Ø 25,4
				72000001→; für Linkslenker; + ESP	24.4125-1703.3 010907	TRW Ø 25,4
				72000001→; für Rechtslenker	24.4125-1703.3 010907	TRW Ø 25,4
				72000001→; für Linkslenker; - ESP	24.4125-1704.3 010908	TRW Ø 25,4
1.6 (L69)	85	02/07→05/14		→ 68999999; für Rechtslenker	24.2125-1736.3 010904	TRW Ø 25,4
				→ 68999999; für Linkslenker; + ESP	24.2125-1736.3 010904	TRW Ø 25,4
				→ 68999999; für Linkslenker; - ESP	24.2125-1737.3 010906	TRW Ø 25,4
				72000001→; → 11/10; für Rechtslenker	24.4125-1703.3 010907	TRW Ø 25,4
				72000001→; → 11/10; für Linkslenker; + ESP	24.4125-1703.3 010907	TRW Ø 25,4
				72000001→; → 11/10; für Linkslenker; - ESP	24.4125-1704.3 010908	TRW Ø 25,4
1.7 CDTi (L69)	81	02/07→05/14		04/07→; → 68999999; für Rechtslenker	24.2125-1736.3 010904	TRW Ø 25,4
				04/07→; → 68999999; für Linkslenker; + ESP	24.2125-1736.3 010904	TRW Ø 25,4
				04/07→; → 68999999; für Linkslenker; - ESP	24.2125-1737.3 010906	TRW Ø 25,4
				72000001→; → 11/10; für Rechtslenker	24.4125-1703.3 010907	TRW Ø 25,4
				72000001→; → 11/10; für Linkslenker; + ESP	24.4125-1703.3 010907	TRW Ø 25,4
				72000001→; → 11/10; für Linkslenker; - ESP	24.4125-1704.3 010908	TRW Ø 25,4











OPEL - ASTRA H TwinTop (A04) 09/05→10/10













 **Bremskraftverstärker**















1.9 CDTi (L67)	110	09/05→10/10	03/06→; für Linkslenker	03.7863-7803.4 300237	ATE Ø 10" pneumatisch
----------------	-----	-------------	-------------------------	-----------------------	-----------------------















 **Hauptbremszylinder**













1.6 (L67) 1.8 (L67) 1.8 (L67) 2.0 Turbo (L67) 2.0 Turbo (L67)	77 92 103 125 147	09/05→10/10 09/05→10/10 09/05→10/10 09/05→10/10 09/05→10/10		03/06→; → 68999999; für Rechtslenker	24.2125-1736.3 010904	TRW Ø 25,4
				03/06→; → 68999999; für Linkslenker; + ESP	24.2125-1736.3 010904	TRW Ø 25,4
				03/06→; → 68999999; für Linkslenker; - ESP	24.2125-1737.3 010906	TRW Ø 25,4
				03/06→; für Rechtslenker	24.4125-1703.3 010907	TRW Ø 25,4
				72000001→; für Linkslenker; + ESP	24.4125-1703.3 010907	TRW Ø 25,4
	72000001→; für Linkslenker; - ESP	24.4125-1704.3 010908	TRW Ø 25,4			
1.6 (L67) 1.6 Turbo (L67)	85 132	12/06→10/10 02/07→10/10		→ 68999999; für Rechtslenker	24.2125-1736.3 010904	TRW Ø 25,4
				→ 68999999; für Linkslenker; + ESP	24.2125-1736.3 010904	TRW Ø 25,4
				→ 68999999; für Linkslenker; - ESP	24.2125-1737.3 010906	TRW Ø 25,4
				für Rechtslenker	24.4125-1703.3 010907	TRW Ø 25,4
				72000001→; für Linkslenker; + ESP	24.4125-1703.3 010907	TRW Ø 25,4
	72000001→; für Linkslenker; - ESP	24.4125-1704.3 010908	TRW Ø 25,4			
1.9 CDTi (L67)	110	09/05→10/10		03/06→; für Rechtslenker	03.4155-0156.3 010862	ATE Ø 25,4
				03/06→; für Linkslenker; + ESP	03.4155-0156.3 010862	ATE Ø 25,4













	kW			 	! #				
OPEL - ASTRA J (P10) 09/09→10/15									
 Bremskraftverstärker									
1.3 CDTI (68)	70	12/09→10/15		für Linkslenker		03.7858-0732.4 300272	ATE Ø 9 / 8" pneumatisch		
1.4 (68)	64	12/09→10/15							
1.4 (68)	74	12/09→10/15							
1.4 LPG (68)	103	01/12→10/15							
1.4 Turbo (68)	103	12/09→10/15							
1.6 (68)	85	12/09→10/15							
1.6 CDTi (68)	81	02/14→10/15							
1.6 CDTi (68)	100	11/13→10/15							
1.6 SIDI (68)	125	12/12→10/15							
1.6 Turbo (68)	132	12/09→10/15							
1.7 CDTI (68)	74	10/10→10/15							
1.7 CDTI (68)	81	09/09→10/15							
1.7 CDTI (68)	92	12/09→10/15							
1.7 CDTI (68)	96	07/11→10/15							
2.0 BiTurbo CDTI (68)	143	09/12→10/15							
2.0 CDTI (68)	118	09/09→10/15							
2.0 CDTI (68)	121	06/11→10/15							
1.4 Turbo (68)	88	10/10→10/15		11/10→; für Linkslenker		03.7858-0732.4 300272	ATE Ø 9 / 8" pneumatisch		
 Hauptbremszylinder									
1.3 CDTI (68)	70	12/09→10/15		für Linkslenker		03.2125-0421.3 010934	ATE Ø 25,4		
1.4 (68)	64	12/09→10/15							
1.4 (68)	74	12/09→10/15							
1.4 LPG (68)	103	01/12→10/15							
1.4 Turbo (68)	103	12/09→10/15							
1.6 (68)	85	12/09→10/15							
1.6 CDTi (68)	81	02/14→10/15							
1.6 CDTi (68)	100	11/13→10/15							
1.6 SIDI (68)	125	12/12→10/15							
1.6 Turbo (68)	132	12/09→10/15							
1.7 CDTI (68)	74	10/10→10/15							
1.7 CDTI (68)	81	09/09→10/15							
1.7 CDTI (68)	92	12/09→10/15							
1.7 CDTI (68)	96	07/11→10/15							
2.0 BiTurbo CDTI (68)	143	09/12→10/15							
2.0 CDTI (68)	118	09/09→10/15							
2.0 CDTI (68)	121	06/11→10/15							
1.4 Turbo (68)	88	10/10→10/15		11/10→; für Linkslenker		03.2125-0421.3 010934	ATE Ø 25,4		
OPEL - ASTRA J Caravan (P10) 10/10→10/15									
 Bremskraftverstärker									
1.3 CDTI (35)	70	10/10→10/14		11/10→; für Linkslenker		03.7858-0732.4 300272	ATE Ø 9 / 8" pneumatisch		
1.4 (35)	64	10/10→10/15							
1.4 (35)	74	10/10→10/15							
1.4 Turbo (35)	88	10/10→10/15							
1.4 Turbo (35)	103	10/10→10/15							
1.6 (35)	85	10/10→10/15							
1.6 Turbo (35)	132	10/10→10/15							
1.7 CDTI (35)	74	10/10→10/15							
1.7 CDTI (35)	81	10/10→10/15							
1.7 CDTI (35)	92	10/10→10/15							
1.7 CDTI (35)	96	10/10→10/15							
2.0 CDTI (35)	118	10/10→10/15							
1.4 LPG (35)	103	12/11→10/15		für Linkslenker				03.7858-0732.4 300272	ATE Ø 9 / 8" pneumatisch
1.6 CDTi (35)	81	02/14→10/15							
1.6 CDTi (35)	100	11/13→10/15							
1.6 LPG (35)	84	10/12→10/15							
1.6 SIDI (35)	125	12/12→10/15							
2.0 BiTurbo CDTI (35)	143	09/12→10/15							
2.0 CDTI (35)	121	08/11→10/15							
 Hauptbremszylinder									
1.3 CDTI (35)	70	10/10→10/14		11/10→; für Linkslenker		03.2125-0421.3 010934	ATE Ø 25,4		
1.4 (35)	64	10/10→10/15							
1.4 (35)	74	10/10→10/15							
1.4 Turbo (35)	88	10/10→10/15							
1.4 Turbo (35)	103	10/10→10/15							
1.6 (35)	85	10/10→10/15							
1.6 Turbo (35)	132	10/10→10/15							
1.7 CDTI (35)	74	10/10→10/15							
1.7 CDTI (35)	81	10/10→10/15							
1.7 CDTI (35)	92	10/10→10/15							
1.7 CDTI (35)	96	10/10→10/15							
2.0 CDTI (35)	118	10/10→10/15							
1.4 LPG (35)	103	12/11→10/15		für Linkslenker				03.2125-0421.3 010934	ATE Ø 25,4
1.6 CDTi (35)	81	02/14→10/15							
1.6 CDTi (35)	100	11/13→10/15							
1.6 LPG (35)	84	10/12→10/15							
1.6 SIDI (35)	125	12/12→10/15							
2.0 BiTurbo CDTI (35)	143	09/12→10/15							
2.0 CDTI (35)	121	08/11→10/15							













	kW			 	! #		
OPEL - ASTRA J GTC 10/11→							
 Bremskraftverstärker							
1.4 (08)	74	10/11→10/15		für Linkslenker		03.7858-0732.4 300272	ATE Ø 9 / 8" pneumatisch
1.4 (08)	88	10/11→					
1.4 (08)	103	10/11→					
1.6 (08)	132	10/11→					
1.6 CDTi (08)	81	07/14→					
1.6 CDTi (08)	100	07/14→					
1.6 SIDI (08)	125	12/12→					
1.6 SIDI (08)	147	07/13→					
1.7 CDTi (08)	81	10/11→10/15					
1.7 CDTi (08)	96	10/11→10/15					
1.8 (08)	103	10/11→10/15					
2.0 CDTi (08)	121	10/11→10/15					
2.0 BiTurbo CDTi (08)	143	10/12→10/15		12/12→; für Linkslenker		03.7858-0732.4 300272	ATE Ø 9 / 8" pneumatisch
 Hauptbremszylinder							
1.4 (08)	74	10/11→10/15		für Linkslenker		03.2125-0421.3 010934	ATE Ø 25,4
1.4 (08)	88	10/11→					
1.4 (08)	103	10/11→					
1.6 (08)	132	10/11→					
1.6 CDTi (08)	81	07/14→					
1.6 CDTi (08)	100	07/14→					
1.6 SIDI (08)	125	12/12→					
1.6 SIDI (08)	147	07/13→					
1.7 CDTi (08)	81	10/11→10/15					
1.7 CDTi (08)	96	10/11→10/15					
1.8 (08)	103	10/11→10/15					
2.0 CDTi (08)	121	10/11→10/15					
2.0 BiTurbo CDTi (08)	143	10/12→10/15		12/12→; für Linkslenker		03.2125-0421.3 010934	ATE Ø 25,4
OPEL - ASTRA J Stufenheck 06/12→							
 Bremskraftverstärker							
1.3 CDTi (69)	70	06/12→10/15		für Linkslenker		03.7858-0732.4 300272	ATE Ø 9 / 8" pneumatisch
1.4 (69)	74	06/12→10/15					
1.4 LPG (69)	103	07/14→					
1.4 Turbo (69)	88	06/12→10/15					
1.4 Turbo (69)	103	06/12→					
1.6 (69)	85	06/12→					
1.6 CDTi (69)	81	04/14→					
1.6 CDTi (69)	100	01/14→					
1.6 SIDI (69)	125	12/12→10/16					
1.6 Turbo (69)	132	06/12→10/13					
1.7 CDTi (69)	81	06/12→10/15					
1.7 CDTi (69)	96	06/12→10/15					
 Hauptbremszylinder							
1.3 CDTi (69)	70	06/12→10/15		für Linkslenker		03.2125-0421.3 010934	ATE Ø 25,4
1.4 (69)	74	06/12→10/15					
1.4 LPG (69)	103	07/14→					
1.4 Turbo (69)	88	06/12→10/15					
1.4 Turbo (69)	103	06/12→					
1.6 (69)	85	06/12→					
1.6 CDTi (69)	81	04/14→					
1.6 CDTi (69)	100	01/14→					
1.6 SIDI (69)	125	12/12→10/16					
1.6 Turbo (69)	132	06/12→10/13					
1.7 CDTi (69)	81	06/12→10/15					
1.7 CDTi (69)	96	06/12→10/15					
OPEL - CALIBRA A (C89) 08/89→07/97							
 Hauptbremszylinder							
2.0 i (M07)	85	08/89→12/96				03.2122-0282.3 010130	ATE Ø 22,2
2.0 i 16V (M07)	100	02/94→07/97					
2.0 i 16V 4x4 (M07)	100	02/94→07/97					
2.0 i 4x4 (M07)	85	06/90→07/97					
2.0 i Turbo 4x4 (M07)	150	08/91→07/97				03.2123-1121.3 010176	Ø 23,81
2.5 i V6 (M07)	125	04/93→07/97		für Linkslenker		03.2123-1121.3 010176	Ø 23,81
 Bremskraftregler							
2.0 i (M07)	85	08/89→12/96		P1000001→		03.0101-0038.2 320245	Satz 2x
2.0 i 16V (M07)	100	02/94→07/97					
2.0 i 16V 4x4 (M07)	100	02/94→07/97					
2.0 i 4x4 (M07)	85	06/90→07/97					
2.5 i V6 (M07)	125	04/93→07/97		T1000001→		03.0101-0038.2 320245	Satz 2x

	kw					! #		
OPEL - CAMPO (TF0, TF1) 08/87→06/02								
 Hauptbremszylinder								
2.2 D (TFR52)	39	08/91→09/96		01/92→09/92			03.2120-1981.3 010105	DEL Ø 20,64
2.2 D 4x4 (TFS52)	39	08/91→09/96		→09/92			03.2120-1981.3 010105	DEL Ø 20,64
2.5 TD (TFR54)	56	07/94→06/01		→08/96			03.2120-1981.3 010105	DEL Ø 20,64
2.5 TD 4x4 (TFS54)	56	07/94→06/01						
OPEL - CASCADA (W13) 03/13→								
 Bremskraftverstärker								
1.4	88	03/13→		für Linkslenker			03.7858-0732.4 300272	ATE Ø 9 / 8" pneumatisch
1.4 Turbo	103	03/13→						
1.6	147	11/13→						
1.6 SIDI	125	03/13→						
2.0 CDTI	121	03/13→						
2.0 CDTI	125	07/15→						
2.0 CDTI	143	03/13→						
 Hauptbremszylinder								
1.4	88	03/13→		für Linkslenker			03.2125-0421.3 010934	ATE Ø 25,4
1.4 Turbo	103	03/13→						
1.6	147	11/13→						
1.6 SIDI	125	03/13→						
2.0 CDTI	121	03/13→						
2.0 CDTI	125	07/15→						
2.0 CDTI	143	03/13→						
OPEL - COMBO (71_) 07/94→10/01								
 Hauptbremszylinder								
1.2	33	07/94→10/01		→09/00; für Linkslenker; - ABS			24.2120-0702.3 010361	Ø 20,64
1.4	44	07/94→10/01		→09/00; für Linkslenker; + ABS			24.2120-1714.3 010455	Ø 20,64
1.4	60	07/94→10/01						
1.7 D	44	07/94→10/01						
 Bremskraftregler								
1.2	33	07/94→10/01					03.6585-0019.3 320239	ATE lastabhängig 8/5 4x
1.4	44	07/94→10/01						
1.4	60	07/94→10/01						
1.7 D	44	07/94→10/01						
OPEL - COMBO Kasten/Kombi 10/01→								
 Hauptbremszylinder								
1.3 CDTI 16V	51	08/05→		→ 33999999			24.2122-1740.3 010711	DEL Ø 22,2
1.3 CDTI 16V	55	10/05→12/12		43000001→; → 10/11; + ESP; Trommelbremse			24.2122-1757.3 010769	BOS Ø 22,2
1.4 16V	66	08/05→						
1.6	64	10/01→		43000001→; → 10/11; - ESP; Scheibenbremse			24.2123-1767.3 010844	BOS Ø 23,81
1.7 DI 16V	48	10/01→		43000001→; → 10/11; + ESP; Scheibenbremse			24.2123-1768.3 010845	BOS Ø 23,81
1.7 DTI 16V	55	10/01→						
1.6 CNG 16V	69	06/06→		→ 10/11; + ESP; Trommelbremse			24.2122-1757.3 010769	BOS Ø 22,2
1.6 CNG 16V	71	04/05→		→ 10/11; - ESP; Scheibenbremse			24.2123-1767.3 010844	BOS Ø 23,81
1.7 CDTI 16V	74	12/04→		→ 10/11; + ESP; Scheibenbremse			24.2123-1768.3 010845	BOS Ø 23,81
 Bremskraftregler								
1.3 CDTI 16V	51	08/05→		→ 10/11; - ABS			03.6583-0196.3 320246	ATE lastabhängig 8/3 4x
1.3 CDTI 16V	55	10/05→12/12						
1.4 16V	66	08/05→						
1.6	64	10/01→						
1.6 CNG 16V	69	06/06→						
1.6 CNG 16V	71	04/05→						
1.7 CDTI 16V	74	12/04→						
1.7 DI 16V	48	10/01→						
1.7 DTI 16V	55	10/01→						
OPEL - COMBO Tour 10/01→12/11								
 Hauptbremszylinder								
1.3 CDTI 16V	51	06/04→01/11		→ 33999999			24.2122-1740.3 010711	DEL Ø 22,2
1.6	64	10/01→09/06		43000001→; + ESP; Trommelbremse			24.2122-1757.3 010769	BOS Ø 22,2
1.7 DI 16V	48	10/01→06/04		43000001→; - ESP; Scheibenbremse			24.2123-1767.3 010844	BOS Ø 23,81
1.7 DTI 16V	55	10/01→06/04		43000001→; + ESP; Scheibenbremse			24.2123-1768.3 010845	BOS Ø 23,81
1.3 CDTI 16V	55	10/05→12/11		→ 33999999			24.2122-1740.3 010711	DEL Ø 22,2
1.4	66	10/04→12/11		43000001→; → 10/11; + ESP; Trommelbremse			24.2122-1757.3 010769	BOS Ø 22,2
				43000001→; → 10/11; - ESP; Scheibenbremse			24.2123-1767.3 010844	BOS Ø 23,81

	kw			 	! #		
OPEL - COMBO Tour 10/01→12/11							
 Hauptbremszylinder							
1.3 CDTI 16V 1.4	55 66	10/05→12/11 10/04→12/11		43000001→; → 10/11; + ESP; Scheibenbremse		24.2123-1768.3 010845	BOS Ø 23,81
1.6 CNG 1.7 CDTI 16V	69 74	06/06→12/11 07/04→12/11		→ 10/11; + ESP; Trommelbremse		24.2122-1757.3 010769	BOS Ø 22,2
				→ 10/11; - ESP; Scheibenbremse		24.2123-1767.3 010844	BOS Ø 23,81
				→ 10/11; + ESP; Scheibenbremse		24.2123-1768.3 010845	BOS Ø 23,81
1.6 CNG	71	04/05→01/11		+ ESP; Trommelbremse		24.2122-1757.3 010769	BOS Ø 22,2
				- ESP; Scheibenbremse		24.2123-1767.3 010844	BOS Ø 23,81
				+ ESP; Scheibenbremse		24.2123-1768.3 010845	BOS Ø 23,81
 Bremskraftregler							
1.3 CDTI 16V 1.6 1.6 CNG 1.7 DI 16V 1.7 DTI 16V	51 64 71 48 55	06/04→01/11 10/01→09/06 04/05→01/11 10/01→06/04 10/01→06/04		- ABS		03.6583-0196.3 320246	ATE lastabhängig 8/3 4x
1.3 CDTI 16V 1.4 1.6 CNG 1.7 CDTI 16V	55 66 69 74	10/05→12/11 10/04→12/11 06/06→12/11 07/04→12/11		→ 10/11; - ABS		03.6583-0196.3 320246	ATE lastabhängig 8/3 4x
OPEL - CORSA B (S93) 03/93→12/02							
 Hauptbremszylinder							
1.0 i 12V (F08, F68, M68)	40	11/96→09/00		für Linkslenker; - ABS		24.2120-0702.3 010361	Ø 20,64
1.2 i (F08, F68, M68)	33	03/93→09/00		für Linkslenker; + ABS		24.2120-1714.3 010455	Ø 20,64
1.4 i (F08, F68, M68)	40	03/93→09/00					
1.4 i (F08, F68, M68)	44	03/93→09/00					
1.4 i 16V (F08, F68, M68)	66	09/94→09/00					
1.4 Si (F08, F68, M68)	60	03/93→09/00					
1.5 D (F08, F68, M68)	37	03/93→09/00					
1.5 TD (F08, F68, M68)	49	03/93→09/00					
1.6 i 16V (F08, F68, M68)	78	09/94→09/00					
1.7 D (F08, F68, M68)	44	02/96→09/00					
1.2 i 16V (F08, F68, M68)	48	03/98→09/00		04/98→; für Linkslenker; - ABS		24.2120-0702.3 010361	Ø 20,64
				04/98→; für Linkslenker; + ABS		24.2120-1714.3 010455	Ø 20,64
1.6 GSI 16V (F08, F68, M68)	80	03/93→09/00		09/93→; für Linkslenker; - ABS		24.2120-0702.3 010361	Ø 20,64
				09/93→; für Linkslenker; + ABS		24.2120-1714.3 010455	Ø 20,64
 Bremskraftregler							
1.0 i 12V (F08, F68, M68)	40	11/96→09/00				03.0101-0031.2 320211	ATE Satz 3/30 2x
1.2 i (F08, F68, M68)	33	03/93→09/00					
1.2 i 16V (F08, F68, M68)	48	03/98→09/00		04/98→		03.6585-0018.3 320114	ATE lastabhängig 8/5 4x
1.4 i (F08, F68, M68)	40	03/93→09/00				03.6585-0018.3 320114	ATE lastabhängig 8/5 4x
1.4 i (F08, F68, M68)	44	03/93→09/00					
1.4 i 16V (F08, F68, M68)	66	09/94→09/00					
1.4 Si (F08, F68, M68)	60	03/93→09/00					
1.5 D (F08, F68, M68)	37	03/93→09/00					
1.5 TD (F08, F68, M68)	49	03/93→09/00					
1.6 i 16V (F08, F68, M68)	78	09/94→09/00					
1.7 D (F08, F68, M68)	44	02/96→09/00					
1.6 GSI 16V (F08, F68, M68)	80	03/93→09/00		09/93→		03.6585-0018.3 320114	ATE lastabhängig 8/5 4x
OPEL - CORSA B Caravan (S93) 01/99→12/02							
 Hauptbremszylinder							
1.4 i 16V (F35)	66	01/99→12/02		→ 09/00; für Linkslenker; - ABS		24.2120-0702.3 010361	Ø 20,64
1.7 D (F35)	44	01/99→12/02		→ 09/00; für Linkslenker; + ABS		24.2120-1714.3 010455	Ø 20,64
 Bremskraftregler							
1.4 i 16V (F35)	66	01/99→12/02		→ 09/00		03.6585-0018.3 320114	ATE lastabhängig 8/5 4x
1.7 D (F35)	44	01/99→12/02					
OPEL - CORSA B Kasten (S93) 08/99→09/00							
 Hauptbremszylinder							
1.4 i (F08, W5L)	44	08/99→09/00		für Linkslenker; - ABS		24.2120-0702.3 010361	Ø 20,64
1.7 D (F08, W5L)	44	08/99→09/00		für Linkslenker; + ABS		24.2120-1714.3 010455	Ø 20,64
↓							

	kw			 	! #		
OPEL - CORSA B Kasten (S93) 08/99→09/00							
 Bremskraftregler							
1.4 i (F08, W5L)	44	08/99→09/00				03.6585-0018.3 320114	ATE lastabhängig 8/5 4x
1.7 D (F08, W5L)	44	08/99→09/00					
OPEL - CORSA C (X01) 09/00→12/09							
 Hauptbremszylinder							
1.0 (F08, F68)	43	09/00→06/03		→ 36999999		24.2122-1740.3 010711	DEL Ø 22,2
				43000001→; + ESP		24.2122-1757.3 010769	BOS Ø 22,2
1.0 (F08, F68)	44	06/03→12/09		→ 36999999		24.2122-1740.3 010711	DEL Ø 22,2
1.2 (F08, F68)	55	09/00→12/09					
1.2 Twinport (F08, F68)	59	07/04→12/09		43000001→; + ESP; → 09/06		24.2122-1757.3 010769	BOS Ø 22,2
1.3 CDTi (F08, F68)	51	06/03→12/09					
1.7 CDTi (F08, F68)	74	06/03→12/09					
1.7 DI (F08, F68)	48	09/00→12/09					
1.7 DTi (F08, F68)	55	09/00→12/09					
1.4 (F08, F68)	66	09/00→12/09		43000001→; → 09/06; - ESP		24.2123-1767.3 010844	BOS Ø 23,81
1.4 Twinport (F08, F68)	66	06/03→12/09		43000001→; → 09/06; + ESP		24.2123-1768.3 010845	BOS Ø 23,81
1.8 (F08, F68)	92	09/00→12/09					
 Bremskraftregler							
1.0 (F08, F68)	43	09/00→06/03		- ABS; M10		03.6043-0964.3 320268	ATE 3/30 2x
				- ABS; M12		03.6043-0974.3 320244	ATE 3/30 2x
1.0 (F08, F68)	44	06/03→12/09		- ABS; → 09/06; M10		03.6043-0964.3 320268	ATE 3/30 2x
1.2 (F08, F68)	55	09/00→12/09					
1.2 Twinport (F08, F68)	59	07/04→12/09		- ABS; → 09/06; M12		03.6043-0974.3 320244	ATE 3/30 2x
OPEL - CORSA C Kasten (X01) 09/00→							
 Hauptbremszylinder							
1.2 (F08, W5L)	59	07/05→		→ 36999999		24.2122-1740.3 010711	DEL Ø 22,2
1.2 16V (F08, W5L)	55	09/00→					
1.3 CDTi 16V (F08, W5L)	51	08/05→		43000001→; + ESP		24.2122-1757.3 010769	BOS Ø 22,2
1.7 DI 16V (F08, W5L)	48	09/00→					
1.7 DTi 16V (F08, W5L)	55	09/00→					
1.4 (W5L, F08)	66	08/03→		43000001→; → 09/06; - ESP		24.2123-1767.3 010844	BOS Ø 23,81
				43000001→; → 09/06; + ESP		24.2123-1768.3 010845	BOS Ø 23,81
1.7 CDTi (F08, W5L)	74	08/03→		→ 36999999		24.2122-1740.3 010711	DEL Ø 22,2
				43000001→; + ESP; → 09/06		24.2122-1757.3 010769	BOS Ø 22,2
 Bremskraftregler							
1.2 (F08, W5L)	59	07/05→		- ABS; M10		03.6043-0964.3 320268	ATE 3/30 2x
1.2 16V (F08, W5L)	55	09/00→		- ABS; M12		03.6043-0974.3 320244	ATE 3/30 2x
OPEL - CORSA D (S07) 07/06→08/14							
 Hauptbremszylinder							
1.0 (L08, L68)	44	07/06→12/10		10/06→; für Linkslenker; + ESP		24.4122-1705.3 010852	BOS Ø 22,2 ohne Bremsflüssigkeitsbehälter
1.2 (L08, L68)	59	07/06→08/14					
1.3 CDTi (L08, L68)	55	07/06→08/14					
1.3 CDTi (L08, L68)	66	07/06→06/11		10/06→; für Linkslenker; - ESP		24.4122-1709.3 010871	BOS Ø 22,2 ohne Bremsflüssigkeitsbehälter
1.4 (L08, L68)	66	07/06→08/14					
1.4 LPG (L08, L68)	66	08/06→12/11					
1.0 (L08, L68)	48	12/09→08/14		für Linkslenker; + ESP		24.4122-1705.3 010852	BOS Ø 22,2 ohne Bremsflüssigkeitsbehälter
1.2 (L08, L68)	51	12/09→08/14					
1.2 (L08, L68)	63	12/09→08/14					
1.2 LPG (L08, L68)	59	08/06→08/14		für Linkslenker; - ESP		24.4122-1709.3 010871	BOS Ø 22,2 ohne Bremsflüssigkeitsbehälter
1.2 LPG (L08, L68)	61	06/11→08/14					
1.2 LPG (L08, L68)	63	06/11→08/14					
1.3 CDTi (L08, L68)	70	06/09→08/14					
1.4 (L08, L68)	64	09/09→08/14					
1.4 (L08, L68)	74	12/09→08/14					
1.4 LPG (L08, L68)	64	09/09→08/14					
1.4 (L08, L68)	88	07/12→08/14		für Linkslenker; - ESP		24.4123-1720.3 011022	BOS Ø 23,81 ohne Bremsflüssigkeitsbehälter
1.6 Turbo (L08, L68)	155	06/11→08/14					
1.7 CDTi (L08, L68)	96	12/09→08/14					
1.6 Turbo (L08, L68)	110	05/07→08/14		06/07→; für Linkslenker; - ESP		24.4123-1720.3 011022	BOS Ø 23,81 ohne Bremsflüssigkeitsbehälter
1.6 Turbo (L08, L68)	141	11/06→08/14		03/07→; für Linkslenker; - ESP		24.4123-1720.3 011022	BOS Ø 23,81 ohne Bremsflüssigkeitsbehälter
1.7 CDTi (L08, L68)	92	08/06→12/11		10/06→; für Linkslenker; - ESP		24.4123-1720.3 011022	BOS Ø 23,81 ohne Bremsflüssigkeitsbehälter

	kw					! #		
OPEL - CORSA D Van (S07) 07/06→								
 Hauptbremszylinder								
1.0 (L08)	44	07/06→		10/06→; für Linkslenker; + ESP			24.4122-1705.3 010852	BOS Ø 22,2 ohne Bremsflüssigkeitsbehälter
1.3 CDTi (L08)	55	07/06→						
1.3 CDTi (L08)	66	07/06→		10/06→; für Linkslenker; - ESP			24.4122-1709.3 010871	BOS Ø 22,2 ohne Bremsflüssigkeitsbehälter
1.0 (L08)	48	01/10→		für Linkslenker; + ESP			24.4122-1705.3 010852	BOS Ø 22,2 ohne Bremsflüssigkeitsbehälter
1.2 (L08)	51	06/10→						
1.2 (L08)	59	07/09→						
1.2 (L08)	63	06/10→		für Linkslenker; - ESP			24.4122-1709.3 010871	BOS Ø 22,2 ohne Bremsflüssigkeitsbehälter
1.3 CDTi (L08)	70	06/10→						
OPEL - FRONTERA A (U92) 03/92→10/98								
 Hauptbremszylinder								
2.2 i (54MWL4)	100	03/95→10/98		→ PV561117; für Rechtslenker			03.2120-1981.3 010105	DEL Ø 20,64
				→ PV561270; für Linkslenker			03.2120-1981.3 010105	DEL Ø 20,64
2.3 TD (5JMWL4)	74	03/92→10/98		→ PV561398; für Linkslenker			03.2120-1981.3 010105	DEL Ø 20,64
				→ PV563935; für Rechtslenker			03.2120-1981.3 010105	DEL Ø 20,64
2.4 i (53MWL4)	92	03/92→10/98		→ PV567152; für Rechtslenker			03.2120-1981.3 010105	DEL Ø 20,64
2.5 TDS	85	09/96→10/98						
2.8 TD (5BMWL4)	83	03/95→10/98		→ PV560157; für Linkslenker			03.2120-1981.3 010105	DEL Ø 20,64
OPEL - FRONTERA A Sport (U92) 03/92→10/98								
 Hauptbremszylinder								
2.0 i (52SUD2, 55SUD2)	85	03/92→10/98		→ PV561117; für Rechtslenker			03.2120-1981.3 010105	DEL Ø 20,64
				→ PV561270; für Linkslenker			03.2120-1981.3 010105	DEL Ø 20,64
2.5 TDS	85	09/96→10/98		→ PV567152; für Rechtslenker			03.2120-1981.3 010105	DEL Ø 20,64
2.8 TD (5BSUD2)	83	03/95→08/96		→ PV560157; für Linkslenker			03.2120-1981.3 010105	DEL Ø 20,64
OPEL - INSIGNIA A (G09) 07/08→03/17								
 Bremskraftverstärker								
1.4 (68)	103	04/11→03/17		06/11→; für Linkslenker			03.7858-0732.4 300272	ATE Ø 9 / 8" pneumatisch
1.4 LPG (68)	103	07/12→03/17		für Linkslenker			03.7858-0732.4 300272	ATE Ø 9 / 8" pneumatisch
1.6 (68)	85	07/08→03/17						
1.6 CDTi (68)	88	07/15→03/17						
1.6 CDTi (68)	100	07/15→03/17						
1.6 SIDI (68)	125	03/13→03/17						
1.8 (68)	103	07/08→03/17						
2.0 Biturbo CDTi (68)	140	07/08→12/11						
2.0 Biturbo CDTi (68)	143	01/12→03/17						
2.0 Biturbo CDTi 4x4 (68)	140	05/09→12/11						
2.0 Biturbo CDTi 4x4 (68)	143	01/12→03/17						
2.0 CDTi (68)	81	07/08→03/17						
2.0 CDTi (68)	96	07/08→03/17						
2.0 CDTi (68)	103	06/13→03/17						
2.0 CDTi (68)	118	07/08→03/17						
2.0 CDTi (68)	120	07/13→03/17						
2.0 CDTi (68)	125	11/14→03/17						
2.0 CDTi 4x4 (68)	118	06/10→03/17						
2.0 CDTi 4x4 (68)	120	07/13→03/17						
2.0 CDTi 4x4 (68)	125	11/14→03/17						
2.0 E85 Turbo (68)	162	10/10→03/17						
2.0 Turbo (68)	162	07/08→03/17						
2.0 Turbo (68)	184	04/14→03/17						
2.0 Turbo 4x4 (68)	162	07/08→03/17						
2.0 Turbo 4x4 (68)	184	07/11→03/17						
1.6 Turbo (68)	132	07/08→03/17		10/08→; für Linkslenker			03.7858-0732.4 300272	ATE Ø 9 / 8" pneumatisch
2.0 CDTi (68)	88	03/12→03/17		03/13→; für Linkslenker			03.7858-0732.4 300272	ATE Ø 9 / 8" pneumatisch
 Hauptbremszylinder								
1.4 (68)	103	04/11→03/17		06/11→; für Linkslenker			03.2125-0421.3 010934	ATE Ø 25,4
1.4 LPG (68)	103	07/12→03/17		für Linkslenker			03.2125-0421.3 010934	ATE Ø 25,4
1.6 (68)	85	07/08→03/17						
1.6 CDTi (68)	88	07/15→03/17						
1.6 CDTi (68)	100	07/15→03/17						
1.6 SIDI (68)	125	03/13→03/17						
1.8 (68)	103	07/08→03/17						
2.0 Biturbo CDTi (68)	140	07/08→12/11						
2.0 Biturbo CDTi (68)	143	01/12→03/17						
2.0 Biturbo CDTi 4x4 (68)	140	05/09→12/11						
2.0 Biturbo CDTi 4x4 (68)	143	01/12→03/17						
2.0 CDTi (68)	81	07/08→03/17						
↓								

	kw			 	! #		
OPEL - INSIGNIA A (G09) 07/08→03/17							
 Hauptbremszylinder							
2.0 CDTi (68)	96	07/08→03/17		für Linkslenker		03.2125-0421.3 010934	ATE Ø 25,4
2.0 CDTi (68)	103	06/13→03/17					
2.0 CDTi (68)	118	07/08→03/17					
2.0 CDTi (68)	120	07/13→03/17					
2.0 CDTi (68)	125	11/14→03/17					
2.0 CDTi 4x4 (68)	118	06/10→03/17					
2.0 CDTi 4x4 (68)	120	07/13→03/17					
2.0 CDTi 4x4 (68)	125	11/14→03/17					
2.0 E85 Turbo (68)	162	10/10→03/17					
2.0 Turbo (68)	162	07/08→03/17					
2.0 Turbo (68)	184	04/14→03/17					
2.0 Turbo 4x4 (68)	162	07/08→03/17					
2.0 Turbo 4x4 (68)	184	07/11→03/17					
2.8 V6 Turbo 4x4 (68)	191	07/08→03/17					
2.8 V6 Turbo OPC 4x4 (68)	239	07/09→03/17					
1.6 Turbo (68)	132	07/08→03/17		10/08→; für Linkslenker		03.2125-0421.3 010934	ATE Ø 25,4
2.0 CDTi (68)	88	03/12→03/17		03/13→; für Linkslenker		03.2125-0421.3 010934	ATE Ø 25,4
OPEL - INSIGNIA A Country Tourer (G09) 07/08→03/17							
 Bremskraftverstärker							
2.0 CDTi 4x4 (47)	120	09/13→03/17		für Linkslenker		03.7858-0732.4 300272	ATE Ø 9 / 8" pneumatisch
2.0 Turbo 4x4 (47)	184	09/13→03/17					
 Hauptbremszylinder							
2.0 CDTi 4x4 (47)	120	09/13→03/17		für Linkslenker		03.2125-0421.3 010934	ATE Ø 25,4
2.0 Turbo 4x4 (47)	184	09/13→03/17					
OPEL - INSIGNIA A Stufenheck (G09) 07/08→03/17							
 Bremskraftverstärker							
1.4 (69)	103	04/11→03/17		06/11→; für Linkslenker		03.7858-0732.4 300272	ATE Ø 9 / 8" pneumatisch
1.4 LPG (69)	103	07/12→03/17		für Linkslenker		03.7858-0732.4 300272	ATE Ø 9 / 8" pneumatisch
1.6 (69)	85	07/08→03/17					
1.6 CDTi (69)	88	07/15→03/17					
1.6 CDTi (69)	100	07/15→03/17					
1.6 SIDI (69)	125	03/13→03/17					
1.6 Turbo (69)	132	07/08→03/17					
1.8 (69)	103	07/08→03/17					
2.0 Biturbo CDTi (69)	143	01/12→03/17					
2.0 Biturbo CDTi 4x4 (69)	140	07/08→12/11					
2.0 Biturbo CDTi 4x4 (69)	143	01/12→03/17					
2.0 CDTi (69)	81	07/08→03/17					
2.0 CDTi (69)	96	07/08→03/17					
2.0 CDTi (69)	103	06/13→03/17					
2.0 CDTi (69)	118	07/08→03/17					
2.0 CDTi (69)	120	07/13→03/17					
2.0 CDTi (69)	125	11/14→03/17					
2.0 CDTi 4x4 (69)	118	06/10→03/17					
2.0 CDTi 4x4 (69)	120	07/13→03/17					
2.0 CDTi 4x4 (69)	125	11/14→03/17					
2.0 Turbo (69)	162	07/08→03/17					
2.0 Turbo (69)	184	04/14→03/17					
2.0 Turbo 4x4 (69)	162	07/08→03/17					
2.0 Turbo 4x4 (69)	184	07/11→03/17					
2.0 Turbo E85 (69)	162	07/08→03/17					
2.0 CDTi (69)	88	03/12→03/17		03/13→; für Linkslenker		03.7858-0732.4 300272	ATE Ø 9 / 8" pneumatisch
 Hauptbremszylinder							
1.4 (69)	103	04/11→03/17		06/11→; für Linkslenker		03.2125-0421.3 010934	ATE Ø 25,4
1.4 LPG (69)	103	07/12→03/17		für Linkslenker		03.2125-0421.3 010934	ATE Ø 25,4
1.6 (69)	85	07/08→03/17					
1.6 CDTi (69)	88	07/15→03/17					
1.6 CDTi (69)	100	07/15→03/17					
1.6 SIDI (69)	125	03/13→03/17					
1.6 Turbo (69)	132	07/08→03/17					
1.8 (69)	103	07/08→03/17					
2.0 Biturbo CDTi (69)	143	01/12→03/17					
2.0 Biturbo CDTi 4x4 (69)	140	07/08→12/11					
2.0 Biturbo CDTi 4x4 (69)	143	01/12→03/17					
2.0 CDTi (69)	81	07/08→03/17					
2.0 CDTi (69)	96	07/08→03/17					
2.0 CDTi (69)	103	06/13→03/17					
2.0 CDTi (69)	118	07/08→03/17					
2.0 CDTi (69)	120	07/13→03/17					
↓							

OPEL - INSIGNIA A Stufenheck (G09) 07/08→03/17

 **Hauptbremszylinder**

2.0 CDTI (69)	125	11/14→03/17	für Linkslenker		03.2125-0421.3	010934	ATE Ø 25,4
2.0 CDTI 4x4 (69)	118	06/10→03/17					
2.0 CDTI 4x4 (69)	120	07/13→03/17					
2.0 CDTI 4x4 (69)	125	11/14→03/17					
2.0 Turbo (69)	162	07/08→03/17					
2.0 Turbo (69)	184	04/14→03/17					
2.0 Turbo 4x4 (69)	162	07/08→03/17					
2.0 Turbo 4x4 (69)	184	07/11→03/17					
2.0 Turbo E85 (69)	162	07/08→03/17					
2.8 V6 Turbo 4x4 (69)	191	07/08→03/17					
2.8 V6 Turbo OPC 4x4 (69)	239	07/09→03/17					
2.0 CDTI (69)	88	03/12→03/17	03/13→; für Linkslenker		03.2125-0421.3	010934	ATE Ø 25,4













OPEL - INSIGNIA Caravan 07/08→03/17













 **Bremskraftverstärker**















1.4 (35)	103	09/11→06/13	für Linkslenker		03.7858-0732.4	300272	ATE Ø 9 / 8" pneumatisch
1.4 LPG (35)	103	07/12→06/13					
1.6 (35)	85	07/08→06/12					
1.6 CDTi (35)	88	07/15→01/17					
1.6 CDTi (35)	100	07/15→12/16					
1.6 SIDI (35)	125	03/13→11/14					
1.6 Turbo (35)	132	01/09→06/13					
1.8 (35)	103	07/08→06/13					
2.0 Biturbo CDTI (35)	140	07/08→03/17					
2.0 Biturbo CDTI (35)	143	01/12→06/15					
2.0 Biturbo CDTI 4x4 (35)	140	07/08→03/17					
2.0 Biturbo CDTI 4x4 (35)	143	01/12→06/15					
2.0 CDTI (35)	81	07/08→06/13					
2.0 CDTI (35)	96	07/08→06/15					
2.0 CDTI (35)	103	07/13→06/15					
2.0 CDTI (35)	118	07/08→06/15					
2.0 CDTI (35)	120	07/13→06/15					
2.0 CDTI (35)	125	11/14→12/16					
2.0 CDTI 4x4 (35)	118	06/10→06/15					
2.0 CDTI 4x4 (35)	120	07/13→06/15					
2.0 CDTI 4x4 (35)	125	11/14→12/16					
2.0 E85 Turbo (35)	162	09/10→11/11					
2.0 Turbo (35)	162	07/08→06/13					
2.0 Turbo (35)	184	04/14→11/14					
2.0 Turbo 4x4 (35)	162	07/08→06/11					
2.0 Turbo 4x4 (35)	184	09/11→06/13					
2.0 CDTI (35)	88	03/12→06/15	03/13→; für Linkslenker		03.7858-0732.4	300272	ATE Ø 9 / 8" pneumatisch











 **Hauptbremszylinder**











1.4 (35)	103	09/11→06/13	für Linkslenker		03.2125-0421.3	010934	ATE Ø 25,4
1.4 LPG (35)	103	07/12→06/13					
1.6 (35)	85	07/08→06/12					
1.6 CDTi (35)	88	07/15→01/17					
1.6 CDTi (35)	100	07/15→12/16					
1.6 SIDI (35)	125	03/13→11/14					
1.6 Turbo (35)	132	01/09→06/13					
1.8 (35)	103	07/08→06/13					
2.0 Biturbo CDTI (35)	140	07/08→03/17					
2.0 Biturbo CDTI (35)	143	01/12→06/15					
2.0 Biturbo CDTI 4x4 (35)	140	07/08→03/17					
2.0 Biturbo CDTI 4x4 (35)	143	01/12→06/15					
2.0 CDTI (35)	81	07/08→06/13					
2.0 CDTI (35)	96	07/08→06/15					
2.0 CDTI (35)	103	07/13→06/15					
2.0 CDTI (35)	118	07/08→06/15					
2.0 CDTI (35)	120	07/13→06/15					
2.0 CDTI (35)	125	11/14→12/16					
2.0 CDTI 4x4 (35)	118	06/10→06/15					
2.0 CDTI 4x4 (35)	120	07/13→06/15					
2.0 CDTI 4x4 (35)	125	11/14→12/16					
2.0 E85 Turbo (35)	162	09/10→11/11					
2.0 Turbo (35)	162	07/08→06/13					
2.0 Turbo (35)	184	04/14→11/14					
2.0 Turbo 4x4 (35)	162	07/08→06/11					
2.0 Turbo 4x4 (35)	184	09/11→06/13					
2.8 V6 Turbo 4x4 (35)	191	10/08→06/13					
2.8 V6 Turbo OPC 4x4 (35)	239	07/09→06/15					
2.0 CDTI (35)	88	03/12→06/15	03/13→; für Linkslenker		03.2125-0421.3	010934	ATE Ø 25,4











	kw					! #		
OPEL - MERIVA A Großraumlimousine (X03) 05/03→05/10								
 Hauptbremszylinder								
1.3 CDTi (E75)	51	04/05→05/10		→ 449999999; - ESP			24.2123-1764.3 010824	TRW Ø 23,81
1.3 CDTi (E75)	55	09/03→05/10		74237192→; - ESP			24.4123-1716.3 010984	TRW Ø 23,81
1.4 16V Twinport (E75)	66	07/04→05/10						ohne Bremsflüssigkeitsbehälter
1.4 16V Twinport LPG (E75)	66	07/04→05/10		74237192→; + ESP			24.4123-1717.3 010985	TRW Ø 23,81
1.6 (E75)	64	05/03→05/10						ohne Bremsflüssigkeitsbehälter
1.6 (E75)	77	01/06→05/10						
1.6 16V (E75)	74	05/03→01/06						
1.6 Turbo (E75)	132	09/05→05/10						
1.7 CDTi (E75)	74	09/03→05/10						
1.7 CDTi (E75)	92	09/06→05/10						
1.7 DTi (E75)	55	09/03→05/10						
1.8 (E75)	92	05/03→05/10						
 Bremskraftregler								
1.3 CDTi (E75)	51	04/05→05/10		- ABS			03.6583-0102.3 320280	ATE lastabhängig 8/3 4x
1.3 CDTi (E75)	55	09/03→05/10						
1.4 16V Twinport (E75)	66	07/04→05/10						
1.4 16V Twinport LPG (E75)	66	07/04→05/10						
1.6 (E75)	64	05/03→05/10						
1.6 (E75)	77	01/06→05/10						
1.6 16V (E75)	74	05/03→01/06						
1.7 CDTi (E75)	74	09/03→05/10						
1.7 CDTi (E75)	92	09/06→05/10						
1.7 DTi (E75)	55	09/03→05/10						
1.8 (E75)	92	05/03→05/10						
OPEL - MERIVA B Großraumlimousine (S10) 06/10→03/17								
 Hauptbremszylinder								
1.3 CDTi (75)	55	06/10→10/13		für Linkslenker; - ESP			24.4125-1705.3 010972	TRW Ø 25,4
1.3 CDTi (75)	70	06/10→11/14						
1.4 (75)	74	06/10→03/17		für Linkslenker; + ESP			24.4125-1706.3 010973	TRW Ø 25,4
1.4 (75)	88	06/10→03/17						
1.4 (75)	103	06/10→03/17						
1.4 LPG (75)	88	06/11→03/17						
1.7 CDTi (75)	74	06/10→01/17						
1.7 CDTi (75)	81	06/10→06/15						
1.7 CDTi (75)	96	06/10→10/13						
1.6 CDTi (75)	100	08/13→01/17		für Linkslenker; - ESP			24.4125-1705.3 010972	TRW Ø 25,4
1.6 CDTi (75)	81	03/14→03/17						
1.6 CDTi (75)	70	01/14→01/17		03/14→; für Linkslenker; - ESP			24.4125-1705.3 010972	TRW Ø 25,4
OPEL - MOVANO Combi (X70) 07/98→								
 Hauptbremszylinder								
1.9 DTi (JD)	59	09/00→10/01		+ ABS			24.2025-1706.3 010676	Ø 25,4
2.5 D (JD)	59	07/98→09/00						
2.8 DTi (JD)	84	07/98→10/01		- ABS			24.2025-1708.3 010692	Ø 25,4
1.9 DTi (JD)	60	10/01→		→ 08/03; + ABS			24.2025-1706.3 010676	Ø 25,4
2.2 DTi (JD)	66	09/00→		→ 01/10; - ABS			24.2025-1708.3 010692	Ø 25,4
2.5 DTi (JD)	84	10/01→		09/03→; + ABS; → 08/06			24.2123-1759.3 010768	BOS Ø 23,81
3.0 DTi (JD)	100	10/03→		→ 01/10; - ABS			24.2025-1708.3 010692	Ø 25,4
				→ 08/06; + ABS			24.2123-1759.3 010768	BOS Ø 23,81
OPEL - MOVANO Kasten (X70) 01/99→								
 Hauptbremszylinder								
1.9 DTi (FD)	59	09/00→10/01		+ ABS			24.2025-1706.3 010676	Ø 25,4
2.5 D (FD)	59	01/99→09/00						
2.8 DTi (FD)	84	01/99→10/01		- ABS			24.2025-1708.3 010692	Ø 25,4
1.9 DTi (FD)	60	10/01→		→ 08/03; + ABS			24.2025-1706.3 010676	Ø 25,4
2.2 DTi (FD)	66	09/00→		→ 01/10; - ABS			24.2025-1708.3 010692	Ø 25,4
2.5 DTi (FD)	84	10/01→		09/03→; + ABS; → 08/06			24.2123-1759.3 010768	BOS Ø 23,81
2.5 DTi (FD)	73	10/03→		→ 01/10; - ABS			24.2025-1708.3 010692	Ø 25,4
3.0 DTi (FD)	100	10/03→		→ 08/06; + ABS			24.2123-1759.3 010768	BOS Ø 23,81
OPEL - MOVANO Kipper (X70) 01/99→								
 Hauptbremszylinder								
2.2 DTi (ED, HD, UDO, UD4)	66	09/00→		→ 08/03; + ABS			24.2025-1706.3 010676	Ø 25,4
2.5 DTi (ED, HD, UDO, UD4)	84	10/01→		→ 01/10; - ABS			24.2025-1708.3 010692	Ø 25,4
				09/03→; + ABS; → 08/06			24.2123-1759.3 010768	BOS Ø 23,81
2.5 D (ED, HD, UDO, UD4)	59	01/99→09/00		+ ABS			24.2025-1706.3 010676	Ø 25,4
				- ABS			24.2025-1708.3 010692	Ø 25,4













	kw			 	! #		
OPEL - MOVANO Kipper (X70) 01/99→							
 Hauptbremszylinder							
2.8 DTI (ED, HD, UD0, UD4)	84	01/99→10/01		+ ABS		24.2025-1706.3 010676	Ø 25,4
				- ABS		24.2025-1708.3 010692	Ø 25,4
2.5 DTI (ED, HD, UD0, UD4)	73	10/03→		→ 01/10; - ABS		24.2025-1708.3 010692	Ø 25,4
3.0 DTI (ED, HD, UD0, UD4)	100	10/03→		→ 08/06; + ABS		24.2123-1759.3 010768	BOS Ø 23,81
OPEL - MOVANO Pritsche/Fahrgestell (X70) 07/98→							
 Hauptbremszylinder							
2.2 DTI (ED, HD, UD0, UD4)	66	09/00→		→ 08/03; + ABS		24.2025-1706.3 010676	Ø 25,4
2.5 DTI (ED, HD, UD0, UD4)	84	10/01→		→ 01/10; - ABS		24.2025-1708.3 010692	Ø 25,4
				09/03→; + ABS; → 08/06		24.2123-1759.3 010768	BOS Ø 23,81
2.5 D (ED, HD, UD0, UD4)	59	07/98→09/00		+ ABS		24.2025-1706.3 010676	Ø 25,4
2.8 DTI (ED, HD, UD0, UD4)	84	07/98→10/01		- ABS		24.2025-1708.3 010692	Ø 25,4
2.5 DTi (ED, HD, UD0, UD4)	73	10/03→		→ 01/10; - ABS		24.2025-1708.3 010692	Ø 25,4
3.0 DTI (ED, HD, UD0, UD4)	100	10/03→		+ ABS; → 08/06		24.2123-1759.3 010768	BOS Ø 23,81
OPEL - OMEGA B (V94) 03/94→07/03							
 Hauptbremszylinder							
2.0 (F69, M69, P69)	85	03/94→09/99		→ V1999999; für Linkslenker; nicht für Polizeifahrzeuge		24.2123-1740.3 010662	Ø 23,81
2.0 16V (F69, M69, P69)	100	03/94→09/99		W1000001→; für Linkslenker; + ESP		24.2125-1740.3 010971	TRW Ø 25,4
2.0 DTI 16V (F69, M69, P69)	74	09/97→09/00		→ 08/00; für Linkslenker; + ESP		24.2125-1740.3 010971	TRW Ø 25,4
2.2 16V (F69, M69, P69)	106	09/99→07/03		10/99→; für Linkslenker; + ESP		24.2125-1740.3 010971	TRW Ø 25,4
2.2 DTI 16V (F69, M69, P69)	81	09/00→07/03		für Linkslenker; + ESP		24.2125-1740.3 010971	TRW Ø 25,4
2.2 DTI 16V (F69, M69, P69)	88	09/00→07/03					
2.5 DTI (F69, M69, P69)	110	09/01→07/03					
2.5 TD (F69, M69, P69)	96	04/94→07/03		W1000001→; für Linkslenker; + ESP		24.2125-1740.3 010971	TRW Ø 25,4
2.5 V6 (F69, M69, P69)	125	03/94→09/00		W1000001→; für Linkslenker; nicht für Sonderfahrzeuge; + ESP		24.2125-1740.3 010971	TRW Ø 25,4
2.6 V6 (F69, M69, P69)	132	09/00→07/03		für Linkslenker; nicht für Sonderfahrzeuge; + ESP		24.2125-1740.3 010971	TRW Ø 25,4
3.2 V6 (F69, M69, P69)	160	02/01→07/03					
3.0 V6 (F69, M69, P69)	155	04/94→02/01		W1000001→; → 01/01; für Linkslenker; nicht für Sonderfahrzeuge; + ESP		24.2125-1740.3 010971	TRW Ø 25,4
OPEL - OMEGA B Caravan (V94) 03/94→07/03							
 Hauptbremszylinder							
2.0 (F35, M35, P35)	85	03/94→09/99		→ V1999999; für Linkslenker; nicht für Polizeifahrzeuge		24.2123-1740.3 010662	Ø 23,81
2.0 16V (F35, M35, P35)	100	03/94→09/99		W1000001→; für Linkslenker; + ESP		24.2125-1740.3 010971	TRW Ø 25,4
2.0 DTI 16V (F35, M35, P35)	74	09/97→09/00		→ 08/00; für Linkslenker; + ESP		24.2125-1740.3 010971	TRW Ø 25,4
2.2 16V (F35, M35, P35)	106	09/99→07/03		10/99→; für Linkslenker; + ESP		24.2125-1740.3 010971	TRW Ø 25,4
2.2 DTI 16V (F35, M35, P35)	81	09/00→07/03		für Linkslenker; + ESP		24.2125-1740.3 010971	TRW Ø 25,4
2.2 DTI 16V (F35, M35, P35)	88	09/00→07/03					
2.5 DTI (F35, M35, P35)	110	09/01→07/03					
2.5 TD (F35, M35, P35)	96	04/94→07/01		W1000001→; für Linkslenker; + ESP		24.2125-1740.3 010971	TRW Ø 25,4
2.5 V6 (F35, M35, P35)	125	03/94→09/00		W1000001→; für Linkslenker; nicht für Sonderfahrzeuge; + ESP		24.2125-1740.3 010971	TRW Ø 25,4
2.6 V6 (F35, M35, P35)	132	09/00→07/03		für Linkslenker; nicht für Sonderfahrzeuge; + ESP		24.2125-1740.3 010971	TRW Ø 25,4
3.2 V6 (F35, M35, P35)	160	02/01→07/03					
3.0 V6 (F35, M35, P35)	155	04/94→02/01		W1000001→; → 01/01; für Linkslenker; nicht für Sonderfahrzeuge; + ESP		24.2125-1740.3 010971	TRW Ø 25,4
OPEL - SIGNUM CC (Z03) 05/03→12/08							
 Hauptbremszylinder							
1.8 (F48)	90	05/03→07/05		für Linkslenker; + ESP		24.2125-1732.3 010827	TRW Ø 25,4
1.9 CDTI (F48)	74	08/05→02/08					
1.9 CDTI (F48)	88	04/04→02/08					
1.9 CDTI (F48)	110	04/04→02/08					
2.0 DTI (F48)	74	05/03→04/04					
2.2 DTI (F48)	92	05/03→04/04					
3.0 V6 CDTI (F48)	130	05/03→07/05					
↓							













	kW					! #		
OPEL - SIGNUM CC (Z03) 05/03→12/08								
 Hauptbremszylinder								
3.2 V6 (F48)	155	05/03→07/05			für Linkslenker; + ESP		24.2125-1732.3 010827	TRW Ø 25,4
1.8 (F48)	103	09/05→12/08			für Linkslenker; → 05/08; + ESP		24.2125-1732.3 010827	TRW Ø 25,4
2.0 Turbo (F48)	129	05/03→12/08						
2.2 direct (F48)	114	05/03→09/08						
3.0 V6 CDTi (F48)	135	09/05→12/08						
OPEL - TIGRA (S93) 07/94→12/00								
 Hauptbremszylinder								
1.4 16V (F07)	66	07/94→12/00			für Linkslenker; - ABS		24.2120-0702.3 010361	Ø 20,64
1.6 16V (F07)	78	07/94→08/98			für Linkslenker; + ABS		24.2120-1714.3 010455	Ø 20,64
 Bremskraftregler								
1.4 16V (F07)	66	07/94→12/00					03.6585-0018.3 320114	ATE lastabhängig 8/5 4x
1.6 16V (F07)	78	07/94→08/98						
OPEL - TIGRA TwinTop (X04) 06/04→12/10								
 Hauptbremszylinder								
1.3 CDTi (R97)	51	06/04→12/10			- ESP; → 08/09		24.2123-1767.3 010844	BOS Ø 23,81
1.4 (R97)	66	06/04→12/10			+ ESP; → 08/09		24.2123-1768.3 010845	BOS Ø 23,81
1.8 (R97)	92	06/04→12/10						
OPEL - VECTRA A (J89) 08/88→12/95								
 Hauptbremszylinder								
1.6 i (F19, M19)	52	09/93→11/95			→ 08/95; + ABS		03.2122-0282.3 010130	ATE Ø 22,2
1.6 i (F19, M19)	55	09/88→11/95			P1000001→; → 08/95; - ABS		24.2120-0702.3 010361	Ø 20,64
1.7 D (F19, M19)	44	07/92→11/95						
1.7 TD (F19, M19)	60	03/90→11/95			→ N5299999; - ABS		24.2120-0913.3 010392	DEL Ø 20,64
1.8 i Cat (F19, M19)	66	03/90→11/95						
2.0 i 16V (F19, M19)	100	08/92→08/95			→ N5299999; - ABS		03.2122-0264.3 010129	ATE Ø 22,2
					P1000001→; - ABS		03.2122-0264.3 010129	ATE Ø 22,2
					→ NV129999; - ABS		03.2122-0264.3 010129	ATE Ø 22,2
					P5000001→; - ABS		03.2122-0264.3 010129	ATE Ø 22,2
					→ N1299999; - ABS		03.2122-0264.3 010129	ATE Ø 22,2
					P7000001→; - ABS		03.2122-0264.3 010129	ATE Ø 22,2
					+ ABS		03.2122-0282.3 010130	ATE Ø 22,2
2.0 i 16V 4x4 (F19, M19)	100	06/94→11/95			→ N5299999; - ABS		03.2122-0264.3 010129	ATE Ø 22,2
2000/GT 16V Cat (F19, M19)	110	02/90→11/95			P1000001→; → 08/95; - ABS		03.2122-0264.3 010129	ATE Ø 22,2
					→ NV129999; - ABS		03.2122-0264.3 010129	ATE Ø 22,2
					P5000001→; → 08/95; - ABS		03.2122-0264.3 010129	ATE Ø 22,2
					→ N1299999; - ABS		03.2122-0264.3 010129	ATE Ø 22,2
					P7000001→; → 08/95; - ABS		03.2122-0264.3 010129	ATE Ø 22,2
					→ 08/95; + ABS		03.2122-0282.3 010130	ATE Ø 22,2
2.0 i Cat (F19, M19)	85	09/88→11/95			P1000001→; → 08/95; - ABS		03.2122-0264.3 010129	ATE Ø 22,2
					→ NV129999; - ABS		03.2122-0264.3 010129	ATE Ø 22,2
					P7000001→; → 08/95; + TCS		03.2122-0264.3 010129	ATE Ø 22,2
					→ N5299999; - ABS		03.2122-0264.3 010129	ATE Ø 22,2
					→ N1299999; - ABS		03.2122-0264.3 010129	ATE Ø 22,2
					P5000001→; → 08/95; - ABS		03.2122-0264.3 010129	ATE Ø 22,2
					→ 08/95; + ABS		03.2122-0282.3 010130	ATE Ø 22,2
2.0 i Turbo 4x4 (F19, M19)	150	06/94→11/95			→ 08/95		03.2123-1121.3 010176	Ø 23,81
2.5 V6 (F19, M19)	125	02/93→11/95			→ 08/95; für Linkslenker		03.2123-1121.3 010176	Ø 23,81
 Bremskraftregler								
1.6 i (F19, M19)	52	09/93→11/95			P1000001→; → 08/95		03.0101-0027.2 320022	ATE Satz 3/45 2x
1.6 i (F19, M19)	55	09/88→11/95						
1.7 D (F19, M19)	44	07/92→11/95						
1.7 TD (F19, M19)	60	03/90→11/95						
1.8 i Cat (F19, M19)	66	03/90→11/95						
2.5 V6 (F19, M19)	125	02/93→11/95			→ 08/95		03.0101-0025.2 320014	ATE Satz 3/35 2x
OPEL - VECTRA A CC (J89) 04/88→12/95								
 Hauptbremszylinder								
1.6 i (F68, M68)	52	09/93→11/95			→ 08/95; + ABS		03.2122-0282.3 010130	ATE Ø 22,2
1.6 i Cat (F68, M68)	55	09/88→11/95			P1000001→; → 08/95; - ABS		24.2120-0702.3 010361	Ø 20,64
1.7 D (F68, M68)	44	07/92→11/95						
1.7 TD (F68, M68)	60	03/90→11/95			→ N5299999; - ABS		24.2120-0913.3 010392	DEL Ø 20,64
↓								













	kw					! #					
OPEL - VECTRA A CC (J89) 04/88→12/95											
 Hauptbremszylinder											
1.8 i Cat (F68, M68)	66	03/90→11/95	→ 08/95; + ABS			03.2122-0282.3	010130	ATE Ø 22,2			
			P1000001→; → 08/95; - ABS			24.2120-0702.3	010361	Ø 20,64			
			→ N5299999; - ABS			24.2120-0913.3	010392	DEL Ø 20,64			
2.0 i 16V (F68, M68)	100	08/92→08/95	→ N5299999; - ABS			03.2122-0264.3	010129	ATE Ø 22,2			
			P1000001→; - ABS			03.2122-0264.3	010129	ATE Ø 22,2			
			→ NV129999; - ABS			03.2122-0264.3	010129	ATE Ø 22,2			
			P5000001→; - ABS			03.2122-0264.3	010129	ATE Ø 22,2			
			→ N1299999; - ABS			03.2122-0264.3	010129	ATE Ø 22,2			
			P7000001→; - ABS			03.2122-0264.3	010129	ATE Ø 22,2			
			+ ABS			03.2122-0282.3	010130	ATE Ø 22,2			
2.0 i 16V Cat (F68, M68)	110	02/90→11/95	→ N5299999; - ABS			03.2122-0264.3	010129	ATE Ø 22,2			
			P1000001→; → 08/95; - ABS			03.2122-0264.3	010129	ATE Ø 22,2			
			→ NV129999; - ABS			03.2122-0264.3	010129	ATE Ø 22,2			
			P5000001→; → 08/95; - ABS			03.2122-0264.3	010129	ATE Ø 22,2			
			→ N1299999; - ABS			03.2122-0264.3	010129	ATE Ø 22,2			
			P7000001→; → 08/95; - ABS			03.2122-0264.3	010129	ATE Ø 22,2			
2.0 i Cat (F68, M68) 2.0 i GT (F68, M68)	85	09/88→11/95	→ N5299999; - ABS			03.2122-0264.3	010129	ATE Ø 22,2			
	95	09/88→11/95	P1000001→; → 08/95; - ABS			03.2122-0264.3	010129	ATE Ø 22,2			
			→ NV129999; - ABS			03.2122-0264.3	010129	ATE Ø 22,2			
			P7000001→; → 08/95; + TCS			03.2122-0264.3	010129	ATE Ø 22,2			
			→ N5299999; - ABS			03.2122-0264.3	010129	ATE Ø 22,2			
			→ N1299999; - ABS			03.2122-0264.3	010129	ATE Ø 22,2			
			P5000001→; → 08/95; - ABS			03.2122-0264.3	010129	ATE Ø 22,2			
2.5 V6 (F68, M68)	125	02/93→11/95	→ 08/95; + ABS			03.2122-0282.3	010130	ATE Ø 22,2			
			→ 08/95; für Linkslenker			03.2123-1121.3	010176	Ø 23,81			
 Bremskraftregler											
1.6 i (F68, M68)	52	09/93→11/95	P1000001→; → 08/95			03.0101-0027.2	320022	ATE Satz 3/45 2x			
1.6 i Cat (F68, M68)	55	09/88→11/95									
1.7 D (F68, M68)	44	07/92→11/95									
1.7 TD (F68, M68)	60	03/90→11/95									
1.8 i Cat (F68, M68)	66	03/90→11/95									
2.5 V6 (F68, M68)	125	02/93→11/95							→ 08/95		
OPEL - VECTRA B (J96) 09/95→04/02											
 Bremskraftverstärker											
2.0 i 16V (F19)	100	10/95→06/00	für Linkslenker; → W1285446			03.7745-3003.4	300157	ATE Ø 8 / 7" pneumatisch			
2.5 i V6 (F19)	125	10/95→09/00	für Linkslenker			03.7745-3003.4	300157	ATE Ø 8 / 7" pneumatisch			
2.6 i V6 (F19)	125	09/00→04/02									
 Hauptbremszylinder											
1.6 i (F19)	55	10/95→04/02	→ W5999999; für Rechtslenker			24.2122-1724.3	010561	Ø 22,2			
1.6 i 16V (F19)	74	10/95→04/02	→ V5999999; für Linkslenker			24.2122-1724.3	010561	Ø 22,2			
1.8 i 16V (F19)	85	10/95→09/00	→ V7999999; für Linkslenker			24.2122-1724.3	010561	Ø 22,2			
1.8 i 16V (F19)	92	09/00→04/02	→ V7999999; für Linkslenker			24.2122-1724.3	010561	Ø 22,2			
2.0 DI 16V (F19)	60	11/96→04/02	→ W7999999; für Rechtslenker			24.2122-1724.3	010561	Ø 22,2			
2.0 DTI 16V (F19)	74	06/97→04/02	→ V1999999; für Linkslenker			24.2122-1724.3	010561	Ø 22,2			
			→ W1999999; für Rechtslenker			24.2122-1724.3	010561	Ø 22,2			
			W1000001→ W1999999; für Linkslenker			24.2123-1777.3	010943	Ø 23,81			
			W5000001→ W5999999; für Linkslenker			24.2123-1777.3	010943	Ø 23,81			
			W7000001→ W7999999; für Linkslenker			24.2123-1777.3	010943	Ø 23,81			
			1.7 TD (F19)	60	10/95→12/98	→ 11/96			24.2122-1724.3	010561	Ø 22,2
			2.0 i 16V (F19)	100	10/95→06/00	→ W1285446; für Linkslenker			03.2123-1622.3	010470	Ø 23,81
→ W7154258; für Linkslenker						03.2123-1622.3	010470	Ø 23,81			
→ W5276825; für Linkslenker						03.2123-1622.3	010470	Ø 23,81			
→ W7154258; für Rechtslenker						03.2123-1722.3	010471	Ø 23,81			
→ W1285446; für Rechtslenker						03.2123-1722.3	010471	Ø 23,81			
→ W5276825; für Rechtslenker						03.2123-1722.3	010471	Ø 23,81			
W5276826→; für Rechtslenker						03.2125-7502.3	010616	ATE Ø 25,4			
W7154259→; für Rechtslenker						03.2125-7502.3	010616	ATE Ø 25,4			
W1285447→; für Rechtslenker						03.2125-7502.3	010616	ATE Ø 25,4			
2.2 i 16V (F19)	108	09/00→04/02				für Rechtslenker			03.2125-7502.3	010616	ATE Ø 25,4
2.5 i V6 (F19)	125	10/95→09/00	→ W1285446; für Linkslenker			03.2123-1622.3	010470	Ø 23,81			
↓											













	kw			 	! #		
OPEL - VECTRA B (J96) 09/95→04/02							
 Hauptbremszylinder							
2.5 i V6 (F19)	125	10/95→09/00		→ W7154258; für Linkslenker	03.2123-1622.3	010470	Ø 23,81
				→ W5276825; für Linkslenker	03.2123-1622.3	010470	Ø 23,81
				→ W1285446; für Rechtslenker	03.2123-1722.3	010471	Ø 23,81
				→ W7154258; für Rechtslenker	03.2123-1722.3	010471	Ø 23,81
				→ W5276825; für Rechtslenker	03.2123-1722.3	010471	Ø 23,81
				W1285447→; für Linkslenker	03.2125-7402.3	010541	ATE Ø 25,4
				W5276826→; für Linkslenker	03.2125-7402.3	010541	ATE Ø 25,4
				W7154259→; für Linkslenker	03.2125-7402.3	010541	ATE Ø 25,4
				W1285447→; für Rechtslenker	03.2125-7502.3	010616	ATE Ø 25,4
				W7154259→; für Rechtslenker	03.2125-7502.3	010616	ATE Ø 25,4
				W5276826→; für Rechtslenker	03.2125-7502.3	010616	ATE Ø 25,4
2.6 i V6 (F19)	125	09/00→04/02		für Linkslenker	03.2125-7402.3	010541	ATE Ø 25,4
				für Rechtslenker	03.2125-7502.3	010616	ATE Ø 25,4
OPEL - VECTRA B Caravan (J96) 11/96→07/03							
 Bremskraftverstärker							
2.0 i 16V (F35)	100	11/96→09/00		für Linkslenker; → W1285446	03.7745-3003.4	300157	ATE Ø 8 / 7" pneumatisch
2.5 i V6 (F35)	125	11/96→09/00		für Linkslenker	03.7745-3003.4	300157	ATE Ø 8 / 7" pneumatisch
2.6 i V6 (F35)	125	09/00→07/03		→ 04/02; für Linkslenker	03.7745-3003.4	300157	ATE Ø 8 / 7" pneumatisch
 Hauptbremszylinder							
1.6 i (F35)	55	11/96→06/00		→ W5999999; für Rechtslenker	24.2122-1724.3	010561	Ø 22,2
1.6 i 16V (F35)	74	11/96→07/02		→ V5999999; für Linkslenker	24.2122-1724.3	010561	Ø 22,2
1.8 i 16V (F35)	85	11/96→09/00					
1.8 i 16V (F35)	92	09/00→07/03		→ V7999999; für Linkslenker	24.2122-1724.3	010561	Ø 22,2
2.0 DI 16V (F35)	60	11/96→06/00		→ W7999999; für Rechtslenker	24.2122-1724.3	010561	Ø 22,2
2.0 DTI 16V (F35)	74	06/97→07/03		→ V1999999; für Linkslenker	24.2122-1724.3	010561	Ø 22,2
				→ W1999999; für Rechtslenker	24.2122-1724.3	010561	Ø 22,2
				W1000001→ W1999999; für Linkslenker	24.2123-1777.3	010943	Ø 23,81
				W5000001→ W5999999; für Linkslenker	24.2123-1777.3	010943	Ø 23,81
				W7000001→ W7999999; für Linkslenker	24.2123-1777.3	010943	Ø 23,81
1.7 TD (F35)	60	11/96→12/97		→ 11/96	24.2122-1724.3	010561	Ø 22,2
2.0 i 16V (F35)	100	11/96→09/00		→ W1285446; für Linkslenker	03.2123-1622.3	010470	Ø 23,81
				→ W7154258; für Linkslenker	03.2123-1622.3	010470	Ø 23,81
				→ W5276825; für Linkslenker	03.2123-1622.3	010470	Ø 23,81
				→ W7154258; für Rechtslenker	03.2123-1722.3	010471	Ø 23,81
				→ W1285446; für Rechtslenker	03.2123-1722.3	010471	Ø 23,81
				→ W5276825; für Rechtslenker	03.2123-1722.3	010471	Ø 23,81
				W5276826→; für Rechtslenker	03.2125-7502.3	010616	ATE Ø 25,4
				W7154259→; für Rechtslenker	03.2125-7502.3	010616	ATE Ø 25,4
				W1285447→; für Rechtslenker	03.2125-7502.3	010616	ATE Ø 25,4
2.2 i 16V (F35)	108	09/00→07/03		→ 04/02; für Rechtslenker	03.2125-7502.3	010616	ATE Ø 25,4
2.5 i V6 (F35)	125	11/96→09/00		→ W1285446; für Linkslenker	03.2123-1622.3	010470	Ø 23,81
				→ W7154258; für Linkslenker	03.2123-1622.3	010470	Ø 23,81
				→ W5276825; für Linkslenker	03.2123-1622.3	010470	Ø 23,81
				→ W1285446; für Rechtslenker	03.2123-1722.3	010471	Ø 23,81
				→ W7154258; für Rechtslenker	03.2123-1722.3	010471	Ø 23,81
				→ W5276825; für Rechtslenker	03.2123-1722.3	010471	Ø 23,81
				W1285447→; für Linkslenker	03.2125-7402.3	010541	ATE Ø 25,4
				W5276826→; für Linkslenker	03.2125-7402.3	010541	ATE Ø 25,4
				W7154259→; für Linkslenker	03.2125-7402.3	010541	ATE Ø 25,4
				W1285447→; für Rechtslenker	03.2125-7502.3	010616	ATE Ø 25,4
				W7154259→; für Rechtslenker	03.2125-7502.3	010616	ATE Ø 25,4
				W5276826→; für Rechtslenker	03.2125-7502.3	010616	ATE Ø 25,4
			2.6 i V6 (F35)	125	09/00→07/03		→ 04/02; für Linkslenker
				→ 04/02; für Rechtslenker	03.2125-7502.3	010616	ATE Ø 25,4
OPEL - VECTRA B CC (J96) 10/95→07/03							
 Bremskraftverstärker							
2.0 i 16V (F68)	100	10/95→06/00		für Linkslenker; → W1285446	03.7745-3003.4	300157	ATE Ø 8 / 7" pneumatisch
2.5 (F68)	144	10/99→06/00		für Linkslenker	03.7745-3003.4	300157	ATE Ø 8 / 7" pneumatisch
2.5 i V6 (F68)	125	10/95→09/00					
↓							













	kw					! #		
OPEL - VECTRA B CC (J96) 10/95→07/03								
 Bremskraftverstärker								
2.6 i V6 (F68)	125	09/00→07/03		→ 04/02; für Linkslenker		03.7745-3003.4	300157	ATE Ø 8 / 7" pneumatisch
 Hauptbremszylinder								
1.6 i (F68)	55	10/95→07/03		→ W5999999; für Rechtslenker		24.2122-1724.3	010561	Ø 22,2
1.6 i 16V (F68)	74	10/95→07/02		→ V5999999; für Linkslenker		24.2122-1724.3	010561	Ø 22,2
1.8 i 16V (F68)	85	10/95→09/00						
1.8 i 16V (F68)	92	09/00→07/03		→ V7999999; für Linkslenker		24.2122-1724.3	010561	Ø 22,2
2.0 DI 16V (F68)	60	11/96→06/00		→ W7999999; für Rechtslenker		24.2122-1724.3	010561	Ø 22,2
2.0 DTI 16V (F68)	74	06/97→07/03		→ V1999999; für Linkslenker		24.2122-1724.3	010561	Ø 22,2
				→ W1999999; für Rechtslenker		24.2122-1724.3	010561	Ø 22,2
				W1000001→ W1999999; für Linkslenker		24.2123-1777.3	010943	Ø 23,81
				W5000001→ W5999999; für Linkslenker		24.2123-1777.3	010943	Ø 23,81
				W7000001→ W7999999; für Linkslenker		24.2123-1777.3	010943	Ø 23,81
1.7 TD (F68)	60	10/95→12/98		→ 11/96		24.2122-1724.3	010561	Ø 22,2
2.0 i 16V (F68)	100	10/95→06/00		→ W1285446; für Linkslenker		03.2123-1622.3	010470	Ø 23,81
				→ W7154258; für Linkslenker		03.2123-1622.3	010470	Ø 23,81
				→ W5276825; für Linkslenker		03.2123-1622.3	010470	Ø 23,81
				→ W7154258; für Rechtslenker		03.2123-1722.3	010471	Ø 23,81
				→ W1285446; für Rechtslenker		03.2123-1722.3	010471	Ø 23,81
				→ W5276825; für Rechtslenker		03.2123-1722.3	010471	Ø 23,81
				W5276826→; für Rechtslenker		03.2125-7502.3	010616	ATE Ø 25,4
				W7154259→; für Rechtslenker		03.2125-7502.3	010616	ATE Ø 25,4
				W1285447→; für Rechtslenker		03.2125-7502.3	010616	ATE Ø 25,4
2.2 i 16V (F68)	108	09/00→07/03		→ 04/02; für Rechtslenker		03.2125-7502.3	010616	ATE Ø 25,4
2.5 (F68)	144	10/99→06/00		→ W1285446; für Linkslenker		03.2123-1622.3	010470	Ø 23,81
2.5 i V6 (F68)	125	10/95→09/00		→ W7154258; für Linkslenker		03.2123-1622.3	010470	Ø 23,81
				→ W5276825; für Linkslenker		03.2123-1622.3	010470	Ø 23,81
				→ W1285446; für Rechtslenker		03.2123-1722.3	010471	Ø 23,81
				→ W7154258; für Rechtslenker		03.2123-1722.3	010471	Ø 23,81
				→ W5276825; für Rechtslenker		03.2123-1722.3	010471	Ø 23,81
				W1285447→; für Linkslenker		03.2125-7402.3	010541	ATE Ø 25,4
				W5276826→; für Linkslenker		03.2125-7402.3	010541	ATE Ø 25,4
				W7154259→; für Linkslenker		03.2125-7402.3	010541	ATE Ø 25,4
				W1285447→; für Rechtslenker		03.2125-7502.3	010616	ATE Ø 25,4
				W7154259→; für Rechtslenker		03.2125-7502.3	010616	ATE Ø 25,4
				W5276826→; für Rechtslenker		03.2125-7502.3	010616	ATE Ø 25,4
2.6 i V6 (F68)	125	09/00→07/03		→ 04/02; für Linkslenker		03.2125-7402.3	010541	ATE Ø 25,4
				→ 04/02; für Rechtslenker		03.2125-7502.3	010616	ATE Ø 25,4
OPEL - VECTRA C (Z02) 04/02→01/09								
 Hauptbremszylinder								
1.6 (F69)	77	08/05→08/08		für Linkslenker; + ESP		24.2125-1732.3	010827	TRW Ø 25,4
1.6 16V (F69)	74	06/04→09/08						
1.8 (F69)	81	04/02→07/08						
1.8 (F69)	103	08/05→08/08						
1.8 16V	90	04/02→09/08						
1.9 CDTI (F69)	74	10/05→08/08						
1.9 CDTI (F69)	110	04/04→08/08						
2.0 16V Turbo (F69)	129	03/03→08/08						
2.0 DTI 16V (F69)	74	04/02→08/06						
2.2 DGi (F69)	114	10/03→08/08						
2.2 DTI 16V (F69)	86	04/02→12/04						
2.2 DTI 16V (F69)	92	04/02→07/04						
3.0 CDTi (F69)	135	08/05→08/08						
3.0 CDTi (F69)	130	02/03→07/05						
3.2 V6 (F69)	155	08/02→07/06						
1.9 CDTI (F69)	88	04/04→01/09		für Linkslenker; + ESP; → 10/08		24.2125-1732.3	010827	TRW Ø 25,4
2.2 16V (F69)	108	04/02→12/08						
OPEL - VECTRA C Caravan (Z02) 10/03→01/09								
 Hauptbremszylinder								
1.6 (F35)	77	12/05→08/08		06/06→; für Linkslenker; + ESP		24.2125-1732.3	010827	TRW Ø 25,4
1.6 16V (F35)	74	06/04→09/05						
1.8 (F35)	90	10/03→09/06		für Linkslenker; + ESP		24.2125-1732.3	010827	TRW Ø 25,4
1.8 (F35)	103	08/05→08/08						
1.9 CDTI (F35)	74	06/05→08/08						
1.9 CDTI (F35)	110	04/04→08/08						
↓								

	kw					! #		
OPEL - VECTRA C Caravan (Z02) 10/03→01/09								
 Hauptbremszylinder								
2.0 DTI (F35)	74	10/03→08/05		für Linkslenker; + ESP			24.2125-1732.3 010827	TRW Ø 25,4
2.0 Turbo (F35)	129	10/03→08/08						
2.2 direct (F35)	114	10/03→08/08						
2.2 DTI (F35)	92	10/03→12/05						
3.0 V6 CDTI (F35)	130	10/03→07/05						
3.0 V6 CDTI (F35)	135	08/05→08/08						
3.2 V6 (F35)	155	10/03→07/05						
1.9 CDTI (F35)	88	04/04→01/09		für Linkslenker; + ESP; → 10/08			24.2125-1732.3 010827	TRW Ø 25,4
OPEL - VECTRA C CC (Z02) 08/02→01/09								
 Hauptbremszylinder								
1.6 (F68)	74	08/05→08/08		für Linkslenker; + ESP			24.2125-1732.3 010827	TRW Ø 25,4
1.6 (F68)	77	01/06→08/08						
1.8 (F68)	103	08/05→08/08						
1.8 16V (F68)	81	08/02→12/06						
1.8 16V (F68)	90	08/02→09/08						
1.9 CDTI (F68)	74	06/05→08/08						
1.9 CDTI (F68)	110	04/04→08/08						
2.0 16V Turbo (F68)	129	03/03→08/08						
2.0 DTI 16V (F68)	74	08/02→08/05						
2.2 16V (F68)	108	08/02→08/08						
2.2 DGi (F68)	114	10/03→08/08						
2.2 DTI 16V (F68)	86	08/02→06/08						
2.2 DTI 16V (F68)	92	08/02→07/06						
3.0 CDTI (F68)	135	08/05→08/08						
3.0 CDTI (F68)	130	06/03→07/05						
3.2 V6 (F68)	155	08/02→07/06						
1.9 CDTI (F68)	88	04/04→01/09		für Linkslenker; + ESP; → 10/08			24.2125-1732.3 010827	TRW Ø 25,4
OPEL - VIVARO A Combi (X83) 08/01→								
 Hauptbremszylinder								
1.9 DI (F7, J7, A07)	60	08/01→		7V600001 / 7Y000001→; → 06/14; + ABS			24.2120-1748.3 010894	TRW Ø 20,64
1.9 DTI (F7, J7, A07)	74	08/01→		7V600001 / 7Y000001→; → 06/14; + ASR			24.2120-1753.3 010946	TRW Ø 20,64
				4V602168→ 6V699999; für Rechtslenker; - ASR			24.2125-1731.3 010826	TRW Ø 25,4
				für Linkslenker; → 6V699999; + ASR			24.2125-1734.3 010878	TRW Ø 25,4
2.0 16V (F7, J7, A07)	88	08/01→		7V600001 / 7Y000001→; → 06/14; + ABS			24.2120-1748.3 010894	TRW Ø 20,64
2.0 CDTI (F7, J7, A07)	66	08/06→						
2.0 CDTI (F7, J7, A07)	84	08/06→		7V600001 / 7Y000001→; → 06/14; + ASR			24.2120-1753.3 010946	TRW Ø 20,64
2.0 ECOTEC (F7, A07, J7)	86	08/06→						
2.5 CDTI (F7, J7, A07)	84	08/06→		4V602168→ 6V699999; - ASR			24.2125-1731.3 010826	TRW Ø 25,4
2.5 CDTI (F7, J7, A07)	107	08/06→		→ 6V699999; + ASR			24.2125-1734.3 010878	TRW Ø 25,4
2.5 DTI (F7, J7, A07)	99	05/03→						
OPEL - VIVARO A Kasten (X83) 08/01→								
 Hauptbremszylinder								
1.9 DI (F7)	60	08/01→		7V600001 / 7Y000001→; → 06/14; + ABS			24.2120-1748.3 010894	TRW Ø 20,64
1.9 DTI (F7)	74	08/01→		7V600001 / 7Y000001→; → 06/14; + ASR			24.2120-1753.3 010946	TRW Ø 20,64
				4V602168→ 6V699999; für Rechtslenker; - ASR			24.2125-1731.3 010826	TRW Ø 25,4
				für Linkslenker; → 6V699999; + ASR			24.2125-1734.3 010878	TRW Ø 25,4
2.0 16V (F7)	88	08/01→		7V600001 / 7Y000001→; → 06/14; + ABS			24.2120-1748.3 010894	TRW Ø 20,64
2.0 CDTI (F7)	66	08/06→						
2.0 CDTI (F7)	84	08/06→		7V600001 / 7Y000001→; → 06/14; + ASR			24.2120-1753.3 010946	TRW Ø 20,64
2.0 ECOTEC (F7)	86	08/06→						
2.5 CDTI (F7)	84	08/06→		4V602168→ 6V699999; - ASR			24.2125-1731.3 010826	TRW Ø 25,4
2.5 CDTI (F7)	107	08/06→		→ 6V699999; + ASR			24.2125-1734.3 010878	TRW Ø 25,4
2.5 DTI (F7)	99	05/03→						
OPEL - VIVARO A Pritsche/Fahrgestell (X83) 08/01→								
 Hauptbremszylinder								
1.9 Di	60	08/01→		7V600001 / 7Y000001→; → 06/14; + ABS			24.2120-1748.3 010894	TRW Ø 20,64
				7V600001 / 7Y000001→; → 06/14; + ASR			24.2120-1753.3 010946	TRW Ø 20,64
				4V602168→ 6V699999; für Rechtslenker; - ASR			24.2125-1731.3 010826	TRW Ø 25,4
				08/06→; → 6V699999; für Linkslenker; + ASR			24.2125-1734.3 010878	TRW Ø 25,4
↓								







	kw					! #		
OPEL - VIVARO A Pritsche/Fahrgestell (X83) 08/01→								
 Hauptbremszylinder								
1.9 DTI	74	08/06→		7V600001 / 7Y000001→; → 06/14; + ABS		24.2120-1748.3	010894	TRW Ø 20,64
				7V600001 / 7Y000001→; → 06/14; + ASR		24.2120-1753.3	010946	TRW Ø 20,64
				4V602168→ 6V699999; für Rechtslenker; - ASR		24.2125-1731.3	010826	TRW Ø 25,4
				für Linkslenker; → 6V699999; + ASR		24.2125-1734.3	010878	TRW Ø 25,4
2.0 16V	88	08/03→		7V600001 / 7Y000001→; → 06/14; + ABS		24.2120-1748.3	010894	TRW Ø 20,64
2.0 CDTI	84	08/06→						
2.0 ECOTEC	86	08/06→		7V600001 / 7Y000001→; → 06/14; + ASR		24.2120-1753.3	010946	TRW Ø 20,64
2.5 CDTI	84	08/06→						
2.5 CDTI	107	08/06→		4V602168→ 6V699999; - ASR		24.2125-1731.3	010826	TRW Ø 25,4
				→ 6V699999; + ASR		24.2125-1734.3	010878	TRW Ø 25,4
2.0 CDTI	66	01/06→		7V600001 / 7Y000001→; → 06/14; + ABS		24.2120-1748.3	010894	TRW Ø 20,64
2.5 DTi	99	08/03→						
				7V600001 / 7Y000001→; → 06/14; + ASR		24.2120-1753.3	010946	TRW Ø 20,64
				4V602168→ 6V699999; - ASR		24.2125-1731.3	010826	TRW Ø 25,4
				08/06→; → 6V699999; + ASR		24.2125-1734.3	010878	TRW Ø 25,4
OPEL - ZAFIRA A Großraumlimousine (T98) 04/99→06/05								
 Hauptbremszylinder								
1.6 16V (F75)	74	04/99→06/05		- ESP		24.2123-1734.3	010640	TRW Ø 23,81
1.6 CNG (F75)	71	09/01→06/05						
1.8 16V (F75)	85	04/99→09/00		+ ESP		24.2123-1739.3	010661	Ø 23,81
1.8 16V (F75)	92	09/00→06/05						
2.0 DTI 16V (F75)	74	09/00→06/05						
2.0 OPC (F75)	141	09/01→06/05						
2.0 OPC (F75)	147	11/02→06/05						
2.2 16V (F75)	108	09/00→06/05						
2.2 DTI 16V (F75)	86	01/02→06/05						
2.2 DTI 16V (F75)	92	01/02→06/05						
2.0 DI (F75)	63	07/99→06/00		06/00→; - ESP		24.2123-1734.3	010640	TRW Ø 23,81
				06/00→; + ESP		24.2123-1739.3	010661	Ø 23,81
2.0 DI 16V (F75)	60	07/99→06/05		10/99→; - ESP		24.2123-1734.3	010640	TRW Ø 23,81
				10/99→; + ESP		24.2123-1739.3	010661	Ø 23,81
 Bremskraftregler								
1.6 16V (F75)	74	04/99→06/05		- ABS		03.6583-0085.3	320238	ATE lastabhängig 8/3 4x
1.6 CNG (F75)	71	09/01→06/05						
1.8 16V (F75)	85	04/99→09/00						
1.8 16V (F75)	92	09/00→06/05						
2.0 DTI 16V (F75)	74	09/00→06/05						
2.0 OPC (F75)	141	09/01→06/05						
2.0 OPC (F75)	147	11/02→06/05						
2.2 16V (F75)	108	09/00→06/05						
2.2 DTI 16V (F75)	86	01/02→06/05						
2.2 DTI 16V (F75)	92	01/02→06/05						
2.0 DI (F75)	63	07/99→06/00		06/00→; - ABS		03.6583-0085.3	320238	ATE lastabhängig 8/3 4x
2.0 DI 16V (F75)	60	07/99→06/05		10/99→; - ABS		03.6583-0085.3	320238	ATE lastabhängig 8/3 4x
OPEL - ZAFIRA B (A05) 07/05→04/15								
 Bremskraftverstärker								
1.6 (M75)	77	07/05→09/12		für Linkslenker; + ESP		03.7863-7803.4	300237	ATE Ø 10" pneumatisch
1.6 (M75)	85	01/08→04/15						
1.6 CNG (M75)	69	07/05→04/15						
1.6 CNG Turbo (M75)	110	02/09→04/15						
1.7 CDTI (M75)	81	01/08→04/15						
1.7 CDTI (M75)	92	01/08→04/15						
1.8 (M75)	88	06/13→04/15						
1.8 (M75)	103	07/05→04/15						
1.9 CDTI (M75)	74	07/05→12/10						
1.9 CDTI (M75)	88	07/05→04/15						
1.9 CDTI (M75)	110	07/05→04/15						
2.0 (M75)	147	07/05→12/10						
2.0 (M75)	177	01/06→12/10						
2.2 (M75)	110	07/05→12/12						
 Hauptbremszylinder								
1.6 (M75)	77	07/05→09/12		für Linkslenker; - ESP		03.4155-0153.3	010927	ATE Ø 25,4
1.6 CNG Turbo (M75)	110	02/09→04/15						
1.8 (M75)	103	07/05→04/15		für Linkslenker; + ESP		03.4155-0156.3	010862	ATE Ø 25,4
2.0 (M75)	147	07/05→12/10		→ 6G999999; für Rechtslenker		24.2125-1736.3	010904	TRW Ø 25,4
2.0 (M75)	177	01/06→12/10		72000001→; für Rechtslenker		24.4125-1703.3	010907	TRW Ø 25,4
↓								









	kw			 	! #		
OPEL - ZAFIRA B (A05) 07/05→04/15							
 Hauptbremszylinder							
1.6 (M75)	85	01/08→04/15		für Linkslenker; - ESP		03.4155-0153.3 010927	ATE Ø 25,4
1.6 CNG (M75)	69	07/05→04/15		für Linkslenker; + ESP		03.4155-0156.3 010862	ATE Ø 25,4
1.7 CDTi (M75)	81	01/08→04/15		für Linkslenker; - ESP		03.4155-0153.3 010927	ATE Ø 25,4
1.7 CDTi (M75)	92	01/08→04/15		für Linkslenker; + ESP		03.4155-0156.3 010862	ATE Ø 25,4
1.9 CDTi (M75)	74	07/05→12/10					
1.9 CDTi (M75)	88	07/05→04/15		für Rechtslenker		03.4155-0156.3 010862	ATE Ø 25,4
1.9 CDTi (M75)	110	07/05→04/15					
2.2 (M75)	110	07/05→12/12					
1.8 (M75)	88	06/13→04/15		für Linkslenker; - ESP		03.4155-0153.3 010927	ATE Ø 25,4
				für Linkslenker; + ESP		03.4155-0156.3 010862	ATE Ø 25,4
				für Rechtslenker		24.4125-1703.3 010907	TRW Ø 25,4
OPEL - ZAFIRA B Van (A05) 07/05→04/15							
 Bremskraftverstärker							
1.6 CNG Turbo (M75)	110	02/09→04/15		für Linkslenker; + ESP		03.7863-7803.4 300237	ATE Ø 10" pneumatisch
1.7 CDTi (M75)	81	01/08→04/15					
1.7 CDTi (M75)	92	01/08→04/15					
1.8 (M75)	103	07/05→04/15					
 Hauptbremszylinder							
1.6 CNG Turbo (M75)	110	02/09→04/15		für Linkslenker; - ESP		03.4155-0153.3 010927	ATE Ø 25,4
1.8 (M75)	103	07/05→04/15		für Linkslenker; + ESP		03.4155-0156.3 010862	ATE Ø 25,4
				→ 6G999999; für Rechtslenker		24.2125-1736.3 010904	TRW Ø 25,4
				72000001→; für Rechtslenker		24.4125-1703.3 010907	TRW Ø 25,4
1.7 CDTi (M75)	81	01/08→04/15		für Linkslenker; - ESP		03.4155-0153.3 010927	ATE Ø 25,4
1.7 CDTi (M75)	92	01/08→04/15		für Linkslenker; + ESP		03.4155-0156.3 010862	ATE Ø 25,4
				für Rechtslenker		03.4155-0156.3 010862	ATE Ø 25,4
OPEL - ZAFIRA TOURER C (P12) 10/11→							
 Bremskraftverstärker							
1.4 (75)	88	10/11→		11/11→; für Linkslenker		03.7858-0732.4 300272	ATE Ø 9 / 8" pneumatisch
1.4 (75)	103	10/11→					
1.4 LPG (75)	103	10/11→					
1.6 CNG (75)	110	10/11→					
1.8 (75)	85	10/11→					
1.8 (75)	103	10/11→					
2.0 CDTi (75)	81	10/11→					
2.0 CDTi (75)	96	10/11→					
2.0 CDTi (75)	118	10/11→					
2.0 CDTi (75)	121	10/11→					
1.6 CDTi (75)	88	07/14→		für Linkslenker		03.7858-0732.4 300272	ATE Ø 9 / 8" pneumatisch
1.6 CDTi (75)	99	11/16→					
1.6 SIDI (75)	125	12/12→					
1.6 SIDI (75)	147	07/13→					
2.0 BiTurbo CDTi (75)	143	01/13→					
2.0 CDTi (75)	125	01/15→					
1.6 CDTi (75)	100	02/13→		03/13→; für Linkslenker		03.7858-0732.4 300272	ATE Ø 9 / 8" pneumatisch
 Hauptbremszylinder							
1.4 (75)	88	10/11→		11/11→; für Linkslenker		03.2125-0421.3 010934	ATE Ø 25,4
1.4 (75)	103	10/11→					
1.4 LPG (75)	103	10/11→					
1.6 CNG (75)	110	10/11→					
1.8 (75)	85	10/11→					
1.8 (75)	103	10/11→					
2.0 CDTi (75)	81	10/11→					
2.0 CDTi (75)	96	10/11→					
2.0 CDTi (75)	118	10/11→					
2.0 CDTi (75)	121	10/11→					
1.6 CDTi (75)	88	07/14→		für Linkslenker		03.2125-0421.3 010934	ATE Ø 25,4
1.6 CDTi (75)	99	11/16→					
1.6 SIDI (75)	125	12/12→					
1.6 SIDI (75)	147	07/13→					
2.0 BiTurbo CDTi (75)	143	01/13→					
2.0 CDTi (75)	125	01/15→					
1.6 CDTi (75)	100	02/13→		03/13→; für Linkslenker		03.2125-0421.3 010934	ATE Ø 25,4
PEUGEOT - 106 I (1A, 1C) 08/91→04/96							
 Hauptbremszylinder							
1.0	33	09/91→04/96		- ABS; Türenanzahl: 3		03.2119-3389.3 010057	ATE Ø 19,05
1.1	44	09/91→04/96		- ABS; Türenanzahl: 5		03.2120-2031.3 010106	ATE Ø 20,64
1.3	72	10/93→04/96		- ABS		03.2120-2031.3 010106	ATE Ø 20,64
↓							







	kw			 	! #		
PEUGEOT - 106 I (1A, 1C) 08/91→04/96							
 Hauptbremszylinder							
1.4	69	09/91→04/96		- ABS		03.2120-2031.3 010106	ATE Ø 20,64
1.6	76	01/94→04/96					
1.4	51	08/91→03/96		- ABS		03.2119-3389.3 010057	ATE Ø 19,05
1.4	55	09/91→04/96					
1.4 D	37	09/92→04/96					
1.5 D	40	06/94→04/96					
1.5 D	43	06/94→04/96					
1.6	65	06/93→04/96					
PEUGEOT - 106 II (1) 04/96→05/05							
 Bremskraftverstärker							
1.0 i	33	05/96→10/99		→Orga 08787; für Linkslenker; - ABS		03.7740-3302.4 300107	ATE Ø 8" pneumatisch
1.0 i	37	01/97→03/01					
1.1 i	40	01/97→03/01					
1.1 i	44	05/96→07/04					
1.6 i	65	05/96→10/99		für Linkslenker; - ABS		03.7740-3302.4 300107	ATE Ø 8" pneumatisch
1.6 i	74	05/96→01/01					
1.6 S16	87	05/96→07/04		→ 03/04; für Linkslenker; - ABS		03.7740-3302.4 300107	ATE Ø 8" pneumatisch
 Hauptbremszylinder							
1.0 i	33	05/96→10/99		→Orga 08787; - ABS		03.2120-4166.3 010452	ATE Ø 20,64
1.0 i	37	01/97→03/01				24.2120-1722.3 010544	Ø 20,64
1.1 i	40	01/97→03/01		Orga 08788→; - ABS		24.2119-1708.3 010543	BDX Ø 19,05
				+ ABS		24.2120-1728.3 010626	Ø 20,64
1.1 i	44	05/96→07/04		→Orga 08787; - ABS		03.2120-4166.3 010452	ATE Ø 20,64
				Orga 08788→; → 03/04; - ABS		24.2119-1708.3 010543	BDX Ø 19,05
				→ 03/04; + ABS		24.2120-1728.3 010626	Ø 20,64
1.4 i	55	05/96→07/04		→ 03/04; - ABS		24.2119-1708.3 010543	BDX Ø 19,05
				→ 03/04; + ABS		24.2120-1728.3 010626	Ø 20,64
1.5 D	40	05/96→03/01		- ABS		24.2119-1708.3 010543	BDX Ø 19,05
				+ ABS		24.2120-1728.3 010626	Ø 20,64
1.5 D	42	04/98→07/04		10/00→ 03/04; - ABS		24.2119-1708.3 010543	BDX Ø 19,05
				10/00→ 03/04; + ABS		24.2120-1728.3 010626	Ø 20,64
1.6 i	65	05/96→10/99		- ABS		03.2120-4166.3 010452	ATE Ø 20,64
1.6 i	74	05/96→01/01				24.2120-1722.3 010544	Ø 20,64
				+ ABS		24.2120-1728.3 010626	Ø 20,64
1.6 S16	87	05/96→07/04		→ 03/04; - ABS		03.2120-4166.3 010452	ATE Ø 20,64
						24.2120-1722.3 010544	Ø 20,64
PEUGEOT - 107 06/05→							
 Hauptbremszylinder							
1.0	50	06/05→		für Linkslenker; → 05/14; - DSC		24.4120-1701.3 010846	BOS Ø 20,64
1.4 HDi	40	06/05→05/14		für Linkslenker; - DSC		24.4120-1701.3 010846	BOS Ø 20,64
PEUGEOT - 205 II (20A/C) 01/87→12/00							
 Hauptbremszylinder							
1.0	33	10/87→09/98		09/90→		03.2119-3389.3 010057	ATE Ø 19,05
						03.2120-2031.3 010106	ATE Ø 20,64
1.1	44	07/89→09/98		09/90→		03.2119-3389.3 010057	ATE Ø 19,05
1.4	55	07/88→09/98				03.2120-2031.3 010106	ATE Ø 20,64
1.6	53	10/87→09/98					
1.6	55	10/87→09/98		→ 08/90		03.2119-3389.3 010057	ATE Ø 19,05
						03.2120-2031.3 010106	ATE Ø 20,64
1.6 Aut.	65	05/90→09/98		→ 08/90; Automatikgetriebe		03.2119-3389.3 010057	ATE Ø 19,05
						03.2120-2031.3 010106	ATE Ø 20,64
				09/90→; - ABS		03.2119-3389.3 010057	ATE Ø 19,05
						03.2120-2031.3 010106	ATE Ø 20,64
1.7 Diesel	44	07/87→09/98		03/94→		03.2119-3389.3 010057	ATE Ø 19,05
						03.2120-2031.3 010106	ATE Ø 20,64
				→ 08/90		03.2119-3389.3 010057	ATE Ø 19,05
1.8 XDT	58	08/90→05/97				03.2119-3389.3 010057	ATE Ø 19,05
						03.2120-2031.3 010106	ATE Ø 20,64
1.9 Diesel	47	10/87→09/98		09/90→		03.2119-3389.3 010057	ATE Ø 19,05
						03.2120-2031.3 010106	ATE Ø 20,64
↓							













	kw			 	! #		
PEUGEOT - 205 II (20A/C) 01/87→12/00							
 Hauptbremszylinder							
1.9 Diesel	47	10/87→09/98		09/88→ 08/90		03.2119-3389.3 010057	ATE Ø 19,05
1.9 GTI	94	10/87→09/98		→ 08/88; - ABS		03.2119-3389.3 010057	ATE Ø 19,05
						03.2120-2031.3 010106	ATE Ø 20,64
						03.2119-3389.3 010057	ATE Ø 19,05
						03.2120-2031.3 010106	ATE Ø 20,64
Verschlusschraube, Hauptbremszylinder							
1.0	33	10/87→09/98		09/90→		03.3517-5100.1 390326	
1.9 Diesel	47	10/87→09/98					
1.1	44	07/89→09/98		→ 08/90		03.3517-5100.1 390326	
1.4	55	07/88→09/98					
1.6	53	10/87→09/98		09/90→		03.3517-5100.1 390326	
1.6	55	10/87→09/98					
1.6 Aut.	65	05/90→09/98		→ 08/90; Automatikgetriebe		03.3517-5100.1 390326	
				09/90→; - ABS		03.3517-5100.1 390326	
1.7 Diesel	44	07/87→09/98		03/94→		03.3517-5100.1 390326	
1.8 XDT	58	08/90→05/97				03.3517-5100.1 390326	
1.9 GTI	94	10/87→09/98		→ 08/88; - ABS		03.3517-5100.1 390326	
				09/90→; - ABS		03.3517-5100.1 390326	
 Bremskraftregler							
1.9 GTI	94	10/87→09/98		09/90→; - ABS		24.6042-1701.3 320149	2/20 2x
				→ S 1831920; - ABS		24.6043-1701.3 320150	3/15 2x
				→ S 1811241; - ABS		24.6043-1701.3 320150	3/15 2x
PEUGEOT - 205 Kasten 03/94→05/97							
 Hauptbremszylinder							
1.7 Diesel	44	03/94→05/97				03.2119-3389.3 010057	ATE Ø 19,05
						03.2120-2031.3 010106	ATE Ø 20,64
Verschlusschraube, Hauptbremszylinder							
1.7 Diesel	44	03/94→05/97				03.3517-5100.1 390326	
PEUGEOT - 206 CC (2D) 09/00→							
 Bremskraftverstärker							
1.6 16V	80	09/00→		→Orga 09456; + ABS; Schaltgetriebe		03.7750-1832.4 300111	ATE Ø 9" pneumatisch
				→Orga 09820; - ABS; Schaltgetriebe		03.7750-1832.4 300111	ATE Ø 9" pneumatisch
				→Orga 09820; - ABS; Automatikgetriebe		03.7750-2232.4 300112	ATE Ø 9" pneumatisch
				→Orga 09456; + ABS; Automatikgetriebe		03.7750-2232.4 300112	ATE Ø 9" pneumatisch
				Orga 09821→; → 01/07; - ABS; Schaltgetriebe		03.7750-6232.4 300215	ATE Ø 9" pneumatisch
				Orga 09821→; → 01/07; - ABS; Vollautomatik		03.7750-6332.4 300226	ATE Ø 9" pneumatisch
				Orga 09457→ Orga 09740; + ABS; Schaltgetriebe		03.7853-1602.4 300167	ATE Ø 9" pneumatisch
				Orga 09741→; → 01/07; + ABS; Schaltgetriebe		03.7853-2602.4 300196	ATE Ø 9" pneumatisch
1.6 HDi 110	80	04/05→		→ 01/07		03.7853-2602.4 300196	ATE Ø 9" pneumatisch
						03.7853-2702.4 300269	ATE Ø 9" pneumatisch
 Hauptbremszylinder							
1.6 16V	80	09/00→		→ 01/07; Schaltgetriebe; - ESP		03.2122-1351.3 010528	Ø 22,2
				→ 01/07; Schaltgetriebe; - ABS		03.2122-1356.3 010529	Ø 22,2
				→ 01/07; Schaltgetriebe; + ESP		03.2122-1942.3 010700	ATE Ø 22,2
				→ 01/07; Vollautomatik; - ABS		03.4122-0031.3 010611	ATE Ø 22,2
				→ 01/07; Vollautomatik; - ESP		03.4122-0041.3 010612	ATE Ø 22,2
				→ 01/07; Vollautomatik; + ESP		03.4122-0054.3 010813	ATE Ø 22,2
1.6 HDi 110	80	04/05→		→ 01/07; - ESP		03.2122-1351.3 010528	Ø 22,2
						03.4122-0041.3 010612	ATE Ø 22,2
				→ 01/07; + ESP		03.2122-1942.3 010700	ATE Ø 22,2
2.0 S16	100	09/00→		→ 01/07; - ESP		03.2122-1351.3 010528	Ø 22,2
				→ 01/07; + ESP		03.2122-1942.3 010700	ATE Ø 22,2























	kw			 	! #		
PEUGEOT - 206 Schrägheck (2A/C) 08/98→							
Bremskraftverstärker							
1.1	40	08/98→07/00		09/98→; →Orga 09456; + ABS	03.7750-1832.4	300111	ATE Ø 9" pneumatisch
				Orga 09457→ Orga 09740; + ABS	03.7853-1602.4	300167	ATE Ø 9" pneumatisch
				Orga 09741→; + ABS	03.7853-2602.4	300196	ATE Ø 9" pneumatisch
1.1 i	44	09/98→		→Orga 09456; + ABS	03.7750-1832.4	300111	ATE Ø 9" pneumatisch
				Orga 09457→ Orga 09740; + ABS	03.7853-1602.4	300167	ATE Ø 9" pneumatisch
				Orga 09741→; → 02/09; + ABS	03.7853-2602.4	300196	ATE Ø 9" pneumatisch
1.4 16V	65	10/03→		→ 02/09; - ABS	03.7750-6232.4	300215	ATE Ø 9" pneumatisch
				→ 02/09	03.7853-2602.4	300196	ATE Ø 9" pneumatisch
1.4 HDi eco 70	50	09/01→		→Orga 09820; - ABS	03.7750-0532.4	300110	ATE Ø 9" pneumatisch
				→Orga 09456; + ABS	03.7750-1832.4	300111	ATE Ø 9" pneumatisch
				Orga 09457→ Orga 09740; + ABS	03.7853-1602.4	300167	ATE Ø 9" pneumatisch
				Orga 09821→; → 02/09	03.7853-2602.4	300196	ATE Ø 9" pneumatisch
1.4 i	55	09/98→		→Orga 09820; Schaltgetriebe; - ABS	03.7750-0532.4	300110	ATE Ø 9" pneumatisch
				→Orga 09456; Schaltgetriebe; + ABS	03.7750-1832.4	300111	ATE Ø 9" pneumatisch
				→Orga 09820; Vollautomatik; - ABS	03.7750-2232.4	300112	ATE Ø 9" pneumatisch
				→Orga 09456; Vollautomatik; + ABS	03.7750-2232.4	300112	ATE Ø 9" pneumatisch
				Orga 09821→; → 02/09; Vollautomatik; - ABS	03.7750-6332.4	300226	ATE Ø 9" pneumatisch
				Orga 09457→ Orga 09740; Schaltgetriebe; + ABS	03.7853-1602.4	300167	ATE Ø 9" pneumatisch
				Orga 09741→; → 02/09; Schaltgetriebe	03.7853-2602.4	300196	ATE Ø 9" pneumatisch
				Orga 09741→; → 02/09; Vollautomatik	03.7853-2702.4	300269	ATE Ø 9" pneumatisch
1.6 16V	80	12/00→		→Orga 09820; - ABS / + ABS; Schaltgetriebe	03.7750-1832.4	300111	ATE Ø 9" pneumatisch
				→Orga 09456; Schaltgetriebe; + ABS	03.7750-1832.4	300111	ATE Ø 9" pneumatisch
				→Orga 09820; Vollautomatik; - ABS	03.7750-2232.4	300112	ATE Ø 9" pneumatisch
				→Orga 09456; Vollautomatik; + ABS	03.7750-2232.4	300112	ATE Ø 9" pneumatisch
				Orga 09821→ Orga 10996; - ABS; Schaltgetriebe	03.7750-6232.4	300215	ATE Ø 9" pneumatisch
				Orga 09821→ Orga 10996; Vollautomatik; - ABS	03.7750-6332.4	300226	ATE Ø 9" pneumatisch
				Orga 09457→ Orga 09740; Schaltgetriebe; + ABS	03.7853-1602.4	300167	ATE Ø 9" pneumatisch
				Orga 09741→ Orga 10996; Schaltgetriebe	03.7853-2602.4	300196	ATE Ø 9" pneumatisch
1.6 HDi 110	80	05/04→		→ 02/09	03.7853-2602.4	300196	ATE Ø 9" pneumatisch
				→ 02/09; + ABS	03.7853-2702.4	300269	ATE Ø 9" pneumatisch
1.6 i	65	09/98→12/00		Schaltgetriebe; - ABS	03.7750-0532.4	300110	ATE Ø 9" pneumatisch
				Schaltgetriebe; + ABS	03.7750-1832.4	300111	ATE Ø 9" pneumatisch
				Vollautomatik	03.7750-2232.4	300112	ATE Ø 9" pneumatisch
1.9 D	51	09/98→11/01			03.7750-0532.4	300110	ATE Ø 9" pneumatisch
					03.7750-2232.4	300112	ATE Ø 9" pneumatisch
				→Orga 09456; + ABS	03.7750-1832.4	300111	ATE Ø 9" pneumatisch
				Orga 09457→; + ABS	03.7750-2232.4	300112	ATE Ø 9" pneumatisch
2.0 HDi 90	66	12/99→		→Orga 09456	03.7750-1832.4	300111	ATE Ø 9" pneumatisch
					03.7750-2232.4	300112	ATE Ø 9" pneumatisch
				→Orga 09820	03.7750-1832.4	300111	ATE Ø 9" pneumatisch
					03.7750-2232.4	300112	ATE Ø 9" pneumatisch
				Orga 09821→; → 02/09	03.7750-6232.4	300215	ATE Ø 9" pneumatisch
					03.7750-6332.4	300226	ATE Ø 9" pneumatisch
	Orga 09457→ Orga 09820; + ABS	03.7853-1602.4	300167	ATE Ø 9" pneumatisch			
	Orga 09821→; → 02/09; + ABS	03.7853-2602.4	300196	ATE Ø 9" pneumatisch			
			03.7853-2702.4	300269	ATE Ø 9" pneumatisch		
Hauptbremszylinder							
1.1	40	08/98→07/00		09/98→; - ABS	03.2120-4321.3	010525	ATE Ø 20,64
				09/98→; + ABS	03.2122-1351.3	010528	Ø 22,2
				09/98→	24.2120-1737.3	010757	Ø 20,64
1.1 i	44	09/98→		→ 02/09; - ABS	03.2120-4321.3	010525	ATE Ø 20,64
				→ 02/09; + ABS	03.2122-1351.3	010528	Ø 22,2
				→ 02/09	24.2120-1737.3	010757	Ø 20,64
↓							







	kw			 	! #		
PEUGEOT - 206 Schrägheck (2A/C) 08/98→							
 Hauptbremszylinder							
1.4 16V	65	10/03→		→ 02/09; - ESP	03.2122-1351.3	010528	Ø 22,2
				→ 02/09; - ABS	03.2122-1356.3	010529	Ø 22,2
				→ 02/09; + ESP	03.2122-1942.3	010700	ATE Ø 22,2
1.4 HDi eco 70	50	09/01→		→ 02/09; - ABS	03.2120-4321.3	010525	ATE Ø 20,64
				→ 02/09; - ESP	03.2122-1351.3	010528	Ø 22,2
				→ 02/09; + ESP	03.2122-1942.3	010700	ATE Ø 22,2
1.4 i	55	09/98→		→ 02/09; Schaltgetriebe; - ABS	03.2120-4321.3	010525	ATE Ø 20,64
				→ 02/09; Schaltgetriebe; + ABS	03.2122-1351.3	010528	Ø 22,2
				→ 02/09; Vollautomatik; - ABS	03.4122-0031.3	010611	ATE Ø 22,2
				→ 02/09; Vollautomatik; + ABS	03.4122-0041.3	010612	ATE Ø 22,2
				→ 02/09; Schaltgetriebe	24.2120-1737.3	010757	Ø 20,64
1.6 16V	80	12/00→		→ 02/09; Schaltgetriebe; - ESP	03.2122-1351.3	010528	Ø 22,2
				→ 02/09; Schaltgetriebe; + ABS	03.2122-1351.3	010528	Ø 22,2
				→ 02/09; Schaltgetriebe; - ABS	03.2122-1356.3	010529	Ø 22,2
				→ 02/09; Schaltgetriebe; + ESP	03.2122-1942.3	010700	ATE Ø 22,2
				→ 02/09; Vollautomatik; - ABS	03.4122-0031.3	010611	ATE Ø 22,2
				→ 02/09; Vollautomatik; - ESP	03.4122-0041.3	010612	ATE Ø 22,2
1.6 HDi 110	80	05/04→		→ 02/09; - ESP	03.2122-1351.3	010528	Ø 22,2
				→ 02/09; + ESP	03.2122-1942.3	010700	ATE Ø 22,2
					03.4122-0054.3	010813	ATE Ø 22,2
1.6 i	65	09/98→12/00		Schaltgetriebe; - ABS	03.2120-4321.3	010525	ATE Ø 20,64
				Schaltgetriebe; + ABS	03.2122-1351.3	010528	Ø 22,2
				Vollautomatik; - ABS	03.4122-0031.3	010611	ATE Ø 22,2
				Vollautomatik; + ABS	03.4122-0041.3	010612	ATE Ø 22,2
				Schaltgetriebe	24.2120-1737.3	010757	Ø 20,64
1.9 D	51	09/98→11/01		- ABS	03.2120-4321.3	010525	ATE Ø 20,64
				+ ABS	03.2122-1351.3	010528	Ø 22,2
					03.4122-0041.3	010612	ATE Ø 22,2
				24.2120-1737.3	010757	Ø 20,64	
2.0 HDi 90	66	12/99→		→ 02/09; - ESP	03.2122-1351.3	010528	Ø 22,2
				→ 02/09; - ABS	03.4122-0041.3	010612	ATE Ø 22,2
				→ 02/09; + ESP	03.2122-1356.3	010529	Ø 22,2
				→ 02/09; + ABS	03.2122-1942.3	010700	ATE Ø 22,2
				03.4122-0054.3	010813	ATE Ø 22,2	
				03.4122-0041.3	010612	ATE Ø 22,2	
2.0 RC	130	07/03→		→ 02/09	03.2122-1942.3	010700	ATE Ø 22,2
2.0 S16	99	04/99→10/00		- ESP	03.2122-1351.3	010528	Ø 22,2
				+ ESP	03.2122-1942.3	010700	ATE Ø 22,2
2.0 S16	100	06/99→		10/00→ 02/07; - ESP	03.2122-1351.3	010528	Ø 22,2
				10/00→ 02/07; + ESP	03.2122-1942.3	010700	ATE Ø 22,2
PEUGEOT - 206 Stufenheck 03/07→							
 Bremskraftverstärker							
1.4	55	03/07→		→ 02/09; - ABS; Vollautomatik	03.7750-6332.4	300226	ATE Ø 9" pneumatisch
				→ 02/09; + ABS; Schaltgetriebe	03.7853-2602.4	300196	ATE Ø 9" pneumatisch
				→ 02/09; + ABS; Vollautomatik	03.7853-2702.4	300269	ATE Ø 9" pneumatisch
1.4 HDi eco 70	50	09/08→		→ 02/09	03.7853-2602.4	300196	ATE Ø 9" pneumatisch
1.6 16V	80	03/07→		→Orga 09820; - ABS / + ABS; Schaltgetriebe	03.7750-1832.4	300111	ATE Ø 9" pneumatisch
				→Orga 09456; Schaltgetriebe; + ABS	03.7750-1832.4	300111	ATE Ø 9" pneumatisch
				→Orga 09820; Vollautomatik; - ABS	03.7750-2232.4	300112	ATE Ø 9" pneumatisch
				→Orga 09456; Vollautomatik; + ABS	03.7750-2232.4	300112	ATE Ø 9" pneumatisch
				Orga 09821→ Orga 10996; - ABS; Schaltgetriebe	03.7750-6232.4	300215	ATE Ø 9" pneumatisch
				Orga 09821→ Orga 10996; Vollautomatik; - ABS	03.7750-6332.4	300226	ATE Ø 9" pneumatisch
↓							













	kw			 	! #		
PEUGEOT - 206 Stufenheck 03/07→							
 Bremskraftverstärker							
1.6 16V	80	03/07→		Orga 09457→ Orga 09740; Schaltgetriebe; + ABS	03.7853-1602.4	300167	ATE Ø 9" pneumatisch
				Orga 09741→ Orga 10996; Schaltgetriebe	03.7853-2602.4	300196	ATE Ø 9" pneumatisch
				Orga 09741→ Orga 10996; Vollautomatik; + ABS	03.7853-2702.4	300269	ATE Ø 9" pneumatisch
 Hauptbremszylinder							
1.4	55	03/07→		→ 02/09; Schaltgetriebe; - ABS	03.2120-4321.3	010525	ATE Ø 20,64
				→ 02/09; Schaltgetriebe; + ABS	03.2122-1351.3	010528	Ø 22,2
				→ 02/09; Vollautomatik; - ABS	03.4122-0031.3	010611	ATE Ø 22,2
				→ 02/09; Vollautomatik; + ABS	03.4122-0041.3	010612	ATE Ø 22,2
				→ 02/09; Schaltgetriebe	24.2120-1737.3	010757	Ø 20,64
1.4 HDi eco 70	50	09/08→		→ 02/09; - ABS	03.2120-4321.3	010525	ATE Ø 20,64
				→ 02/09; + ABS	03.2122-1351.3	010528	Ø 22,2
				→ 02/09; - ESP	03.2122-1351.3	010528	Ø 22,2
				→ 02/09; + ESP	03.2122-1942.3	010700	ATE Ø 22,2
				→ 02/09	24.2120-1737.3	010757	Ø 20,64
1.6 16V	80	03/07→		→ 02/09; Schaltgetriebe; - ESP	03.2122-1351.3	010528	Ø 22,2
				→ 02/09; Schaltgetriebe; + ABS	03.2122-1351.3	010528	Ø 22,2
				→ 02/09; Schaltgetriebe; - ABS	03.2122-1356.3	010529	Ø 22,2
				→ 02/09; Schaltgetriebe; + ESP	03.2122-1942.3	010700	ATE Ø 22,2
				→ 02/09; Vollautomatik; - ABS	03.4122-0031.3	010611	ATE Ø 22,2
				→ 02/09; Vollautomatik; - ESP	03.4122-0041.3	010612	ATE Ø 22,2
				→ 02/09; Vollautomatik; + ESP	03.4122-0054.3	010813	ATE Ø 22,2
PEUGEOT - 206 SW (2E/K) 07/02→							
 Bremskraftverstärker							
1.1	44	07/02→		→Orga 09456; + ABS	03.7750-1832.4	300111	ATE Ø 9" pneumatisch
				Orga 09457→ Orga 09740; + ABS	03.7853-1602.4	300167	ATE Ø 9" pneumatisch
				Orga 09741→; → 05/07; + ABS	03.7853-2602.4	300196	ATE Ø 9" pneumatisch
1.4	55	07/02→		→Orga 09820; Schaltgetriebe; - ABS	03.7750-0532.4	300110	ATE Ø 9" pneumatisch
				→Orga 09456; Schaltgetriebe; + ABS	03.7750-1832.4	300111	ATE Ø 9" pneumatisch
				→Orga 09820; - ABS; Vollautomatik	03.7750-2232.4	300112	ATE Ø 9" pneumatisch
				→Orga 09456; + ABS; Vollautomatik	03.7750-2232.4	300112	ATE Ø 9" pneumatisch
				Orga 09821→; → 05/07; - ABS; Automatikgetriebe	03.7750-6332.4	300226	ATE Ø 9" pneumatisch
				Orga 09457→ Orga 09740; Schaltgetriebe; + ABS	03.7853-1602.4	300167	ATE Ø 9" pneumatisch
				Orga 09741→; → 05/07; + ABS; Schaltgetriebe	03.7853-2602.4	300196	ATE Ø 9" pneumatisch
				Orga 09741→; → 05/07; + ABS; Automatikgetriebe	03.7853-2702.4	300269	ATE Ø 9" pneumatisch
1.4 16V	65	10/03→		→ 05/07; + ABS	03.7853-2602.4	300196	ATE Ø 9" pneumatisch
1.4 HDi	50	07/02→		→Orga 09820; - ABS	03.7750-0532.4	300110	ATE Ø 9" pneumatisch
				→Orga 09456; + ABS	03.7750-1832.4	300111	ATE Ø 9" pneumatisch
				Orga 09457→ Orga 09820; + ABS	03.7853-1602.4	300167	ATE Ø 9" pneumatisch
				Orga 09821→; → 05/07; + ABS	03.7853-2602.4	300196	ATE Ø 9" pneumatisch
1.6 16V	80	07/02→		→Orga 09820; Schaltgetriebe; + ABS	03.7750-1832.4	300111	ATE Ø 9" pneumatisch
				→Orga 09456; Schaltgetriebe; + ABS	03.7750-1832.4	300111	ATE Ø 9" pneumatisch
				→Orga 09820; - ABS; Automatikgetriebe	03.7750-2232.4	300112	ATE Ø 9" pneumatisch
				→Orga 09456; + ABS; Vollautomatik	03.7750-2232.4	300112	ATE Ø 9" pneumatisch
				Orga 09821→; → 05/07; Schaltgetriebe; - ABS	03.7750-6232.4	300215	ATE Ø 9" pneumatisch
				Orga 09821→; → 05/07; - ABS; Automatikgetriebe	03.7750-6332.4	300226	ATE Ø 9" pneumatisch
				Orga 09457→ Orga 09740; Schaltgetriebe; + ABS	03.7853-1602.4	300167	ATE Ø 9" pneumatisch
				Orga 09741→; → 05/07; + ABS; Schaltgetriebe	03.7853-2602.4	300196	ATE Ø 9" pneumatisch
				Orga 09741→; → 05/07; + ABS; Automatikgetriebe	03.7853-2702.4	300269	ATE Ø 9" pneumatisch
1.6 HDi 110	80	05/04→		→ 05/07; + ABS	03.7853-2602.4	300196	ATE Ø 9" pneumatisch
					03.7853-2702.4	300269	ATE Ø 9" pneumatisch
2.0 HDi ↓	66	07/02→		→Orga 09820; - ABS	03.7750-1832.4	300111	ATE Ø 9" pneumatisch











	kw			 	! #		
PEUGEOT - 206 SW (2E/K) 07/02→							
 Bremskraftverstärker							
2.0 HDi	66	07/02→		→Orga 09820; - ABS	03.7750-2232.4	300112	ATE Ø 9" pneumatisch
				→Orga 09456; + ABS	03.7750-1832.4	300111	ATE Ø 9" pneumatisch
					03.7750-2232.4	300112	ATE Ø 9" pneumatisch
				Orga 09821→; → 05/07; - ABS	03.7750-6232.4	300215	ATE Ø 9" pneumatisch
					03.7750-6332.4	300226	ATE Ø 9" pneumatisch
				Orga 09457→ Orga 09820; + ABS	03.7853-1602.4	300167	ATE Ø 9" pneumatisch
	Orga 09821→; → 05/07; + ABS	03.7853-2602.4	300196	ATE Ø 9" pneumatisch			
				03.7853-2702.4	300269	ATE Ø 9" pneumatisch	
 Hauptbremszylinder							
1.1	44	07/02→		→ 05/07; - ABS	03.2120-4321.3	010525	ATE Ø 20,64
				→ 05/07; + ABS	24.2120-1737.3	010757	Ø 20,64
1.4	55	07/02→		→ 05/07; Schaltgetriebe; - ABS	03.2120-4321.3	010525	ATE Ø 20,64
					24.2120-1737.3	010757	Ø 20,64
				→ 05/07; Schaltgetriebe; + ABS	03.2122-1351.3	010528	Ø 22,2
				→ 05/07; Vollautomatik; - ABS	03.4122-0031.3	010611	ATE Ø 22,2
				→ 05/07; Vollautomatik; - ESP	03.4122-0041.3	010612	ATE Ø 22,2
				→ 05/07; Vollautomatik; + ESP	03.4122-0054.3	010813	ATE Ø 22,2
1.4 16V	65	10/03→		→ 05/07; - ESP	03.2122-1351.3	010528	Ø 22,2
				→ 05/07; - ABS	03.2122-1356.3	010529	Ø 22,2
				→ 05/07; + ESP	03.2122-1942.3	010700	ATE Ø 22,2
1.4 HDi	50	07/02→		→ 05/07; - ABS	03.2120-4321.3	010525	ATE Ø 20,64
					24.2120-1737.3	010757	Ø 20,64
				→ 05/07; - ESP	03.2122-1351.3	010528	Ø 22,2
		→ 05/07; + ESP	03.2122-1942.3	010700	ATE Ø 22,2		
1.6 16V	80	07/02→		→ 05/07; Schaltgetriebe; - ESP	03.2122-1351.3	010528	Ø 22,2
				→ 05/07; Schaltgetriebe; - ABS	03.2122-1356.3	010529	Ø 22,2
				→ 05/07; Schaltgetriebe; + ESP	03.2122-1942.3	010700	ATE Ø 22,2
				→ 05/07; Vollautomatik; - ABS	03.4122-0031.3	010611	ATE Ø 22,2
				→ 05/07; Vollautomatik; - ESP	03.4122-0041.3	010612	ATE Ø 22,2
				→ 05/07; Vollautomatik; + ESP	03.4122-0054.3	010813	ATE Ø 22,2
1.6 HDi 110	80	05/04→		→ 05/07; - ESP	03.2122-1351.3	010528	Ø 22,2
				→ 05/07; + ESP	03.2122-1942.3	010700	ATE Ø 22,2
					03.4122-0054.3	010813	ATE Ø 22,2
2.0 16V	100	07/02→02/07		- ESP	03.2122-1351.3	010528	Ø 22,2
				+ ESP	03.2122-1942.3	010700	ATE Ø 22,2
2.0 HDi	66	07/02→		→ 05/07; - ESP	03.2122-1351.3	010528	Ø 22,2
					03.4122-0041.3	010612	ATE Ø 22,2
				→ 05/07; - ABS	03.2122-1356.3	010529	Ø 22,2
					03.4122-0031.3	010611	ATE Ø 22,2
		→ 05/07; + ESP	03.2122-1942.3	010700	ATE Ø 22,2		
				03.4122-0054.3	010813	ATE Ø 22,2	
PEUGEOT - 206+ (2L_, 2M_) 01/09→							
 Bremskraftverstärker							
1.1	44	01/09→		→ 05/13; + ABS	03.7853-2602.4	300196	ATE Ø 9" pneumatisch
1.4 HDi eco 70	50	01/09→					
1.4 i	54	09/10→					
1.4 i	55	01/09→					
 Hauptbremszylinder							
1.1	44	01/09→		→ 05/13; - ABS	03.2120-4321.3	010525	ATE Ø 20,64
1.4 HDi eco 70	50	01/09→			24.2120-1737.3	010757	Ø 20,64
1.4 i	54	09/10→		→ 05/13; + ABS	03.2122-1351.3	010528	Ø 22,2
1.4 i	55	01/09→		→ 05/13; + ESP	03.2122-1942.3	010700	ATE Ø 22,2
PEUGEOT - 207 (WA_, WC_) 02/06→							
 Hauptbremszylinder							
1.4	54	12/07→		→ 06/12; + ESP	24.4122-1703.3	010843	TRW Ø 22,2
1.4 16V	65	02/06→					
1.4 16V	72	10/09→		→ 06/12; - ESP	24.4122-1704.3	010847	TRW Ø 22,2
↓							







	kw			 	! #		
PEUGEOT - 207 (WA_, WC_) 02/06→							
 Hauptbremszylinder							
1.4 HDi	50	02/06→		→ 06/12; + ESP		24.4122-1703.3 010843	TRW Ø 22,2
1.6 16V	80	02/06→		→ 06/12; - ESP		24.4122-1704.3 010847	TRW Ø 22,2
1.6 HDi	66	02/06→10/13					
1.4 16V	70	06/07→		08/07→ 06/12; + ESP		24.4122-1703.3 010843	TRW Ø 22,2
				08/07→ 06/12; - ESP		24.4122-1704.3 010847	TRW Ø 22,2
1.6 16V RC	128	02/07→		→ 06/12; + ESP		24.4123-1704.3 010828	TRW Ø 23,81
1.6 16V Turbo	110	02/06→		→ 06/12; - ESP		24.4123-1705.3 010832	TRW Ø 23,81
1.6 16V VTi	88	02/07→					
1.6 HDi	68	11/09→					
1.6 HDi	80	02/06→					
1.6 HDi 110	82	08/09→					
1.6 16V Turbo	115	10/09→		01/10→ 06/12; + ESP		24.4123-1704.3 010828	TRW Ø 23,81
				01/10→ 06/12; - ESP		24.4123-1705.3 010832	TRW Ø 23,81
PEUGEOT - 207 CC (WD_) 02/07→							
 Hauptbremszylinder							
1.6 16V	88	02/07→		+ ESP		24.4123-1704.3 010828	TRW Ø 23,81
1.6 16V Turbo	110	02/07→		- ESP		24.4123-1705.3 010832	TRW Ø 23,81
1.6 16V Turbo	115	10/09→					
1.6 HDi	80	02/07→					
1.6 HDi	82	08/09→					
PEUGEOT - 207 SW (WK_) 02/07→							
 Hauptbremszylinder							
1.4	54	06/07→		→ 07/13; + ESP		24.4122-1703.3 010843	TRW Ø 22,2
1.4 16V	70	06/07→		→ 07/13; - ESP		24.4122-1704.3 010847	TRW Ø 22,2
1.4 16V	72	11/09→					
1.6 16V	88	06/07→		→ 07/13; + ESP		24.4123-1704.3 010828	TRW Ø 23,81
1.6 HDi	68	11/09→		→ 07/13; - ESP		24.4123-1705.3 010832	TRW Ø 23,81
1.6 HDi	82	08/09→					
1.6 16V RC	128	02/07→		11/07→ 07/13; + ESP		24.4123-1704.3 010828	TRW Ø 23,81
				11/07→ 07/13; - ESP		24.4123-1705.3 010832	TRW Ø 23,81
1.6 HDi	66	06/07→12/12		+ ESP		24.4122-1703.3 010843	TRW Ø 22,2
				- ESP		24.4122-1704.3 010847	TRW Ø 22,2
1.6 HDi	80	06/07→12/12		+ ESP		24.4123-1704.3 010828	TRW Ø 23,81
				- ESP		24.4123-1705.3 010832	TRW Ø 23,81
PEUGEOT - 208 (CA_, CC_) 03/12→							
 Hauptbremszylinder							
1.0	50	03/12→		Orga 13342→; Trommelbremse; + DSC		24.4122-1703.3 010843	TRW Ø 22,2
1.2	60	03/12→		Orga 13342→; Trommelbremse; - DSC		24.4122-1704.3 010847	TRW Ø 22,2
1.2 GPL	60	06/15→					
1.2 THP	81	01/13→		Scheibenbremse; + DSC		24.4123-1704.3 010828	TRW Ø 23,81
				Scheibenbremse; - DSC		24.4123-1705.3 010832	TRW Ø 23,81
1.2	50	08/16→		Scheibenbremse; + DSC		24.4123-1704.3 010828	TRW Ø 23,81
1.5 BlueHDi 100	75	05/18→		Scheibenbremse; - DSC		24.4123-1705.3 010832	TRW Ø 23,81
1.6 BlueHDi 100	73	01/15→					
1.6 THP 165	121	03/15→					
1.4 HDi	50	03/12→		Trommelbremse; + DSC		24.4122-1703.3 010843	TRW Ø 22,2
1.4 VTi	70	03/12→		Trommelbremse; - DSC		24.4122-1704.3 010847	TRW Ø 22,2
1.6	88	03/12→					
1.6	115	03/12→		Scheibenbremse; + DSC		24.4123-1704.3 010828	TRW Ø 23,81
1.6 BlueHDi 120	88	11/13→		Scheibenbremse; - DSC		24.4123-1705.3 010832	TRW Ø 23,81
1.6 HDi	68	03/12→					
1.6 HDi	84	03/12→					
1.6 HDi	85	04/14→					
1.6 HDi / BlueHDi 75	55	01/13→					
1.6 GTi	147	08/12→		03/13→; + DSC		24.4123-1704.3 010828	TRW Ø 23,81
				03/13→; - DSC		24.4123-1705.3 010832	TRW Ø 23,81
1.6 GTi	153	10/14→		+ DSC		24.4123-1704.3 010828	TRW Ø 23,81
				- DSC		24.4123-1705.3 010832	TRW Ø 23,81
PEUGEOT - 301 11/12→							
 Hauptbremszylinder							
1.6 BlueHDi 100	73	04/14→		+ ESP		24.4122-1703.3 010843	TRW Ø 22,2
1.6 HDi 90	68	11/12→					
PEUGEOT - 306 (7B, N3, N5) 04/93→10/03							
 Bremskraftverstärker							
1.1	44	06/94→05/01		→ 04/97; + ABS; für Linkslenker		03.7750-9402.4 300117	ATE Ø 9" pneumatisch
↓							















	kw			 	! #		
PEUGEOT - 306 (7B, N3, N5) 04/93→10/03							
Bremskraftverstärker							
1.4 SL	55	06/94→05/01		05/97→; - ABS		03.7750-9302.4 300116	ATE Ø 9" pneumatisch
				10/94→; →Orga 08575; + ABS; für Linkslenker		03.7750-9402.4 300117	ATE Ø 9" pneumatisch
1.6	72	10/00→05/01		- ABS		03.7750-9302.4 300116	ATE Ø 9" pneumatisch
1.6 SR	65	06/94→10/00		10/94→ 04/97; für Rechtslenker; + ABS		03.7750-2232.4 300112	ATE Ø 9" pneumatisch
				05/97→; - ABS; Türenanzahl: 4		03.7750-9302.4 300116	ATE Ø 9" pneumatisch
				10/94→; →Orga 08575; + ABS; für Linkslenker		03.7750-9402.4 300117	ATE Ø 9" pneumatisch
1.8 16V	81	03/97→05/01		05/97→; - ABS; für Linkslenker; Türenanzahl: 4		03.7750-9302.4 300116	ATE Ø 9" pneumatisch
1.8 ST	74	06/94→05/01					
2.0 ST	89	07/94→05/01		→Orga 08575; + ABS; für Linkslenker		03.7750-9402.4 300117	ATE Ø 9" pneumatisch
1.9 D	51	09/98→05/01		- ABS; für Linkslenker		03.7750-9302.4 300116	ATE Ø 9" pneumatisch
2.0 HDI 90	66	06/99→12/01		→Orga 08575; + ABS; für Linkslenker		03.7750-9402.4 300117	ATE Ø 9" pneumatisch
1.9 D	55	03/98→05/01		- ABS; für Linkslenker		03.7750-9302.4 300116	ATE Ø 9" pneumatisch
				+ ABS; für Linkslenker		03.7750-9402.4 300117	ATE Ø 9" pneumatisch
1.9 SLD	47	06/94→05/01		05/97→; - ABS; für Linkslenker		03.7750-9302.4 300116	ATE Ø 9" pneumatisch
1.9 SLD	50	06/94→05/01					
1.9 SRDT	66	06/94→05/01		10/94→; + ABS; für Linkslenker		03.7750-9402.4 300117	ATE Ø 9" pneumatisch
2.0	97	03/97→05/01		05/97→; - ABS; für Linkslenker		03.7750-9302.4 300116	ATE Ø 9" pneumatisch
				05/97→; - ABS; für Linkslenker; Türenanzahl: 4		03.7750-9302.4 300116	ATE Ø 9" pneumatisch
				→Orga 08575; + ABS; für Linkslenker		03.7750-9402.4 300117	ATE Ø 9" pneumatisch
2.0 S16	110	06/94→05/01		05/97→; - ABS; für Linkslenker		03.7750-9302.4 300116	ATE Ø 9" pneumatisch
				→Orga 08575; + ABS; für Linkslenker		03.7750-9402.4 300117	ATE Ø 9" pneumatisch
2.0 S16	112	06/94→05/01		05/97→; - ABS; für Linkslenker		03.7750-9302.4 300116	ATE Ø 9" pneumatisch
				07/94→; →Orga 08575; + ABS; für Linkslenker		03.7750-9402.4 300117	ATE Ø 9" pneumatisch
Hauptbremszylinder							
1.1	44	06/94→05/01		→ 04/97; - ABS; Türenanzahl: 5		03.2119-3391.3 010058	ATE Ø 19,05
				→ 04/97; - ABS; Türenanzahl: 3		24.2119-1702.3 010435	BDX Ø 19,05
				→ 04/97; S 30209025→; + ABS		24.2122-1705.3 010434	Ø 22,2
1.4 SL	55	06/94→05/01		10/94→ 04/97; - ABS; nicht für Fahrschulwagen		03.2119-3391.3 010058	ATE Ø 19,05
				05/97→; - ABS		03.2120-4321.3 010525	ATE Ø 20,64
						24.2120-1726.3 010564	BDX Ø 20,64
				05/97→; →Orga 08575; + ABS; für Linkslenker		03.2122-1351.3 010528	Ø 22,2
				10/94→ 04/97; - ABS; für Fahrschulwagen		24.2120-1704.3 010429	BDX Ø 20,64
				→ 04/97; S 30209025→; + ABS		24.2122-1705.3 010434	Ø 22,2
				Orga 08576→; + ABS; für Linkslenker		24.2123-1715.3 010520	BDX Ø 23,81
1.6	72	10/00→05/01		- ABS		03.2120-4321.3 010525	ATE Ø 20,64
						24.2120-1726.3 010564	BDX Ø 20,64
				+ ABS; für Linkslenker		24.2123-1715.3 010520	BDX Ø 23,81
1.6 SR	65	06/94→10/00		10/94→ 04/97; - ABS; für Linkslenker		03.2120-1897.3 010103	ATE Ø 20,64
						24.2120-1704.3 010429	BDX Ø 20,64
				05/97→; - ABS; Türenanzahl: 4		03.2120-4321.3 010525	ATE Ø 20,64
						24.2120-1726.3 010564	BDX Ø 20,64
				05/97→; →Orga 08575; + ABS; für Linkslenker		03.2122-1351.3 010528	Ø 22,2
				→ 04/97; S 30209025→; + ABS		24.2122-1705.3 010434	Ø 22,2
				Orga 08576→; + ABS; für Linkslenker		24.2123-1715.3 010520	BDX Ø 23,81
1.8 16V	81	03/97→05/01		→ 04/97; - ABS; für Linkslenker; Türenanzahl: 4		03.2120-1897.3 010103	ATE Ø 20,64
						24.2120-1704.3 010429	BDX Ø 20,64
				05/97→; →Orga 08575; + ABS; für Linkslenker		03.2122-1351.3 010528	Ø 22,2
				05/97→; - ABS; für Linkslenker; Türenanzahl: 4		03.2122-1356.3 010529	Ø 22,2
				→ 04/97; + ABS		24.2122-1705.3 010434	Ø 22,2
				Orga 08576→; + ABS; für Linkslenker		24.2123-1715.3 010520	BDX Ø 23,81
1.8 ST	74	06/94→05/01		10/94→ 04/97; - ABS; für Linkslenker		03.2120-1897.3 010103	ATE Ø 20,64
						24.2120-1704.3 010429	BDX Ø 20,64
				10/94→; - ABS; für Rechtslenker; Türenanzahl: 4		03.2120-4246.3 010614	ATE Ø 20,64











	kw			 	! #		
PEUGEOT - 306 (7B, N3, N5) 04/93→10/03							
Hauptbremszylinder							
1.8 ST	74	06/94→05/01		10/94→; - ABS; für Rechtslenker; Türenanzahl: 4		24.2120-1722.3 010544	Ø 20,64
				05/97→; - ABS; für Linkslenker; Türenanzahl: 4		03.2120-4321.3 010525 24.2120-1726.3 010564	ATE Ø 20,64 BDX Ø 20,64
				05/97→; →Orga 08575; + ABS; für Linkslenker		03.2122-1351.3 010528	Ø 22,2
				→ 04/97; S 30209025→; + ABS		24.2122-1705.3 010434	Ø 22,2
				Orga 08576→; + ABS; für Linkslenker		24.2123-1715.3 010520	BDX Ø 23,81
1.9 D	51	09/98→05/01		- ABS; für Linkslenker		03.2120-4321.3 010525 24.2120-1726.3 010564	ATE Ø 20,64 BDX Ø 20,64
				→Orga 08575; + ABS; für Linkslenker		03.2122-1351.3 010528	Ø 22,2
				→Orga 08575; + ABS; für Rechtslenker		03.2122-1461.3 010610	ATE Ø 22,2
				- ABS; für Rechtslenker		03.2122-1461.3 010610	ATE Ø 22,2
				Orga 08576→; + ABS; für Linkslenker		24.2123-1715.3 010520	BDX Ø 23,81
1.9 D	55	03/98→05/01		- ABS; für Rechtslenker		03.2120-4246.3 010614 24.2120-1722.3 010544	ATE Ø 20,64 Ø 20,64
				- ABS; für Linkslenker		03.2120-4321.3 010525 24.2120-1726.3 010564	ATE Ø 20,64 BDX Ø 20,64
				→Orga 08575; + ABS; für Linkslenker		03.2122-1351.3 010528	Ø 22,2
				Orga 08576→; + ABS; für Linkslenker		24.2123-1715.3 010520	BDX Ø 23,81
1.9 SLD 1.9 SLD	47 50	06/94→05/01 06/94→05/01		10/94→ 04/97; - ABS; für Linkslenker		03.2120-1897.3 010103 24.2120-1704.3 010429	ATE Ø 20,64 BDX Ø 20,64
				10/94→; - ABS; für Rechtslenker		03.2120-4246.3 010614 24.2120-1722.3 010544	ATE Ø 20,64 Ø 20,64
				05/97→; - ABS; für Linkslenker		03.2120-4321.3 010525 24.2120-1726.3 010564	ATE Ø 20,64 BDX Ø 20,64
				05/97→; →Orga 08575; + ABS; für Linkslenker		03.2122-1351.3 010528	Ø 22,2
				→ 04/97; S 30209025→; + ABS		24.2122-1705.3 010434	Ø 22,2
				Orga 08576→; + ABS; für Linkslenker		24.2123-1715.3 010520	BDX Ø 23,81
1.9 SRDT	66	06/94→05/01		10/94→ 04/97; - ABS; für Linkslenker		03.2120-1897.3 010103 24.2120-1704.3 010429	ATE Ø 20,64 BDX Ø 20,64
				05/97→; →Orga 08575; + ABS; für Linkslenker		03.2122-1351.3 010528	Ø 22,2
				05/97→; - ABS; für Linkslenker		03.2122-1356.3 010529	Ø 22,2
				10/94→ 04/97; + ABS		24.2122-1705.3 010434	Ø 22,2
				Orga 08576→; + ABS; für Linkslenker		24.2123-1715.3 010520	BDX Ø 23,81
2.0	97	03/97→05/01		→ 04/97; - ABS; für Linkslenker; Türenanzahl: 4		03.2120-1897.3 010103 24.2120-1704.3 010429	ATE Ø 20,64 BDX Ø 20,64
				→ 04/97; - ABS; für Linkslenker		03.2120-1897.3 010103 24.2120-1704.3 010429	ATE Ø 20,64 BDX Ø 20,64
				05/97→; →Orga 08575; + ABS; für Linkslenker		03.2122-1351.3 010528 24.2122-1733.3 010668	Ø 22,2 Ø 22,2
				05/97→; - ABS; für Linkslenker		03.2122-1356.3 010529	Ø 22,2
				05/97→; - ABS; für Linkslenker; Türenanzahl: 4		03.2122-1356.3 010529	Ø 22,2
				→ 04/97		24.2122-1705.3 010434	Ø 22,2
				→ 04/97; + ABS		24.2122-1705.3 010434	Ø 22,2
				Orga 08576→; + ABS; für Linkslenker		24.2123-1715.3 010520	BDX Ø 23,81
2.0 HDI 90	66	06/99→12/01		- ABS; für Linkslenker		03.2122-1356.3 010529	Ø 22,2
				+ ABS; für Linkslenker		24.2123-1715.3 010520	BDX Ø 23,81
2.0 S16	110	06/94→05/01		→ 04/97; - ABS; für Linkslenker		03.2120-1897.3 010103 24.2120-1704.3 010429	ATE Ø 20,64 BDX Ø 20,64
				05/97→; →Orga 08575; + ABS; für Linkslenker		03.2122-1351.3 010528	Ø 22,2
				05/97→; - ABS; für Linkslenker		03.2122-1356.3 010529	Ø 22,2
				→ 04/97; + ABS		24.2122-1705.3 010434	Ø 22,2
				Orga 08576→; + ABS; für Linkslenker		24.2123-1715.3 010520	BDX Ø 23,81
2.0 S16	112	06/94→05/01		07/94→ 04/97; - ABS; für Linkslenker		03.2120-1897.3 010103 24.2120-1704.3 010429	ATE Ø 20,64 BDX Ø 20,64
				05/97→; →Orga 08575; + ABS; für Linkslenker		03.2122-1351.3 010528	Ø 22,2
				05/97→; - ABS; für Linkslenker		03.2122-1356.3 010529	Ø 22,2
↓							











	kw					! #		
PEUGEOT - 306 (7B, N3, N5) 04/93→10/03								
 Hauptbremszylinder								
2.0 S16	112	06/94→05/01		07/94→04/97; + ABS		24.2122-1705.3	010434	Ø 22,2
				Orga 08576→; + ABS; für Linkslenker		24.2123-1715.3	010520	BDX Ø 23,81
2.0 ST	89	07/94→05/01		10/94→04/97; - ABS; für Linkslenker; Türenanzahl: 4		03.2120-1897.3	010103	ATE Ø 20,64
				05/97→; →Orga 08575; + ABS; für Linkslenker		24.2120-1704.3	010429	BDX Ø 20,64
				05/97→; - ABS; für Linkslenker; Türenanzahl: 4		03.2122-1351.3	010528	Ø 22,2
				→ 04/97; + ABS		03.2122-1356.3	010529	Ø 22,2
				→ 04/97; + ABS		24.2122-1705.3	010434	Ø 22,2
				Orga 08576→; + ABS; für Linkslenker		24.2123-1715.3	010520	BDX Ø 23,81
 Bremskraftregler								
1.1	44	06/94→05/01		→ 04/97; + ABS		24.6042-1701.3	320149	2/20 2x
1.4 SL	55	06/94→05/01		10/94→04/97; + ABS;		24.6042-1701.3	320149	2/20 2x
1.9 SLD	47	06/94→05/01		für Fahrzeuge ohne verstärktes Fahrwerk				
1.9 SLD	50	06/94→05/01						
1.6 SR	65	06/94→10/00		10/94→04/97; + ABS;		24.6042-1701.3	320149	2/20 2x
1.8 ST	74	06/94→05/01		für Fahrzeuge ohne verstärktes Fahrwerk; Türenanzahl: 4				
1.8 16V	81	03/97→05/01		→ 04/97; für Fahrzeuge ohne verstärktes Fahrwerk; Türenanzahl: 4		24.6042-1701.3	320149	2/20 2x
2.0	97	03/97→05/01		→ 04/97; Türenanzahl: 4		24.6042-1701.3	320149	2/20 2x
2.0 ST	89	07/94→05/01		10/94→04/97; für Fahrzeuge ohne verstärktes Fahrwerk; Türenanzahl: 4		24.6042-1701.3	320149	2/20 2x
PEUGEOT - 306 Break (7E, N3, N5) 06/94→04/02								
 Bremskraftverstärker								
1.4	55	03/97→04/02		→ 03/02; - ABS		03.7750-9302.4	300116	ATE Ø 9" pneumatisch
1.6	72	10/00→04/02						
1.6	65	03/97→10/00		- ABS		03.7750-9302.4	300116	ATE Ø 9" pneumatisch
1.9 D	50	03/97→04/02		→ 03/02; - ABS; für Linkslenker		03.7750-9302.4	300116	ATE Ø 9" pneumatisch
1.9 D	51	09/98→04/02						
1.9 D	55	03/98→04/02						
 Hauptbremszylinder								
1.4	55	03/97→04/02		→ 03/02; - ABS		03.2122-1356.3	010529	Ø 22,2
1.6	72	10/00→04/02		→ 03/02; + ABS; für Linkslenker		24.2123-1715.3	010520	BDX Ø 23,81
1.6	65	03/97→10/00		- ABS		03.2122-1356.3	010529	Ø 22,2
				+ ABS; für Linkslenker		24.2123-1715.3	010520	BDX Ø 23,81
1.8	74	03/97→04/02		→ 03/02; - ABS; für Linkslenker		24.2123-1714.3	010587	BDX Ø 23,81
1.8 16V	81	03/97→04/02						
2.0	97	03/97→04/02		→ 03/02; + ABS; für Linkslenker		24.2123-1715.3	010520	BDX Ø 23,81
2.0 HDI 90	66	06/99→04/02						
1.9 D	50	03/97→04/02		→ 03/02; - ABS; für Linkslenker		03.2122-1356.3	010529	Ø 22,2
1.9 D	51	09/98→04/02						
1.9 D	55	03/98→04/02		→ 03/02; + ABS; für Linkslenker		24.2123-1715.3	010520	BDX Ø 23,81
1.9 TD	66	02/97→04/02		03/97→03/02; - ABS; für Linkslenker		03.2122-1356.3	010529	Ø 22,2
						24.2123-1714.3	010587	BDX Ø 23,81
				03/97→03/02; + ABS; für Linkslenker		24.2123-1715.3	010520	BDX Ø 23,81
PEUGEOT - 306 Cabriolet (7D, N3, N5) 01/94→04/02								
 Bremskraftverstärker								
1.6	65	04/96→10/00		für Rechtslenker		03.7750-2232.4	300112	ATE Ø 9" pneumatisch
				→Orga 08575; für Linkslenker		03.7750-9402.4	300117	ATE Ø 9" pneumatisch
1.8	74	03/94→04/02		→Orga 08575; für Linkslenker		03.7750-9402.4	300117	ATE Ø 9" pneumatisch
2.0	89	03/94→04/02						
2.0 16V	97	03/97→04/02						
 Hauptbremszylinder								
1.6	65	04/96→10/00		→Orga 07737; - ABS		03.2120-4241.3	010524	ATE Ø 20,64
						24.2120-1722.3	010544	Ø 20,64
				→Orga 08575; + ABS; für Linkslenker		03.2122-1351.3	010528	Ø 22,2
				Orga 08576→; + ABS; für Linkslenker		24.2123-1715.3	010520	BDX Ø 23,81
1.6	72	10/00→04/02		+ ABS; für Linkslenker		24.2123-1715.3	010520	BDX Ø 23,81
1.8 16V	81	05/97→04/02						
1.8	74	03/94→04/02		→Orga 08575; + ABS; für Linkslenker		03.2122-1351.3	010528	Ø 22,2
				→ 10/00; - ABS		24.2120-1722.3	010544	Ø 20,64













	kw			 	! #		
PEUGEOT - 306 Cabriolet (7D, N3, N5) 01/94→04/02							
 Hauptbremszylinder							
1.8	74	03/94→04/02		Orga 08576→; → 10/00; + ABS; für Linkslenker		24.2123-1715.3 010520	BDX Ø 23,81
2.0	89	03/94→04/02		→ 04/97; + ABS; für Linkslenker		03.2122-1351.3 010528	Ø 22,2
				→Orga 07744; - ABS		24.2122-1705.3 010434	Ø 22,2
2.0 16V	97	03/97→04/02		→Orga 08575; + ABS; für Linkslenker		03.2122-1351.3 010528	Ø 22,2
				→Orga 07744; - ABS		24.2122-1705.3 010434	Ø 22,2
				Orga 08576→; → 10/00; + ABS; für Linkslenker		24.2123-1715.3 010520	BDX Ø 23,81
PEUGEOT - 306 Schrägheck (7A, 7C, N3, N5) 01/93→10/03							
 Bremskraftverstärker							
1.1	44	05/93→05/01		03/94→ 04/97; + ABS; für Linkslenker		03.7750-9402.4 300117	ATE Ø 9" pneumatisch
1.4	55	04/93→07/01		05/97→; - ABS		03.7750-9302.4 300116	ATE Ø 9" pneumatisch
				→Orga 08575; + ABS; für Linkslenker		03.7750-9402.4 300117	ATE Ø 9" pneumatisch
1.6	65	05/93→10/00		→ 04/97; + ABS; für Rechtslenker		03.7750-2232.4 300112	ATE Ø 9" pneumatisch
				05/97→; - ABS		03.7750-9302.4 300116	ATE Ø 9" pneumatisch
				→Orga 08575; + ABS; für Linkslenker		03.7750-9402.4 300117	ATE Ø 9" pneumatisch
1.6	72	10/00→05/01		- ABS		03.7750-9302.4 300116	ATE Ø 9" pneumatisch
1.8	74	05/93→05/01		05/97→; - ABS; für Linkslenker		03.7750-9302.4 300116	ATE Ø 9" pneumatisch
1.8 16V	81	03/97→05/01		→Orga 08575; + ABS; für Linkslenker		03.7750-9402.4 300117	ATE Ø 9" pneumatisch
2.0 S16	110	06/94→05/01					
1.8 D	43	05/93→05/01		05/97→; - ABS; für Linkslenker		03.7750-9302.4 300116	ATE Ø 9" pneumatisch
1.9 D	47	05/93→05/01		+ ABS; für Linkslenker		03.7750-9402.4 300117	ATE Ø 9" pneumatisch
1.9 D	50	06/94→05/01					
1.9 D	51	09/98→05/01		- ABS; für Linkslenker		03.7750-9302.4 300116	ATE Ø 9" pneumatisch
2.0 HDI 90	66	06/99→12/02		→Orga 08575; + ABS; für Linkslenker		03.7750-9402.4 300117	ATE Ø 9" pneumatisch
1.9 D	55	03/98→05/01		- ABS; für Linkslenker		03.7750-9302.4 300116	ATE Ø 9" pneumatisch
				+ ABS; für Linkslenker		03.7750-9402.4 300117	ATE Ø 9" pneumatisch
1.9 DT	66	05/93→05/01		05/97→; - ABS; für Linkslenker		03.7750-9302.4 300116	ATE Ø 9" pneumatisch
				10/93→; →Orga 08575; + ABS; für Linkslenker		03.7750-9402.4 300117	ATE Ø 9" pneumatisch
2.0 16V	97	03/97→05/01		05/97→; - ABS; für Linkslenker; Türenanzahl: 4		03.7750-9302.4 300116	ATE Ø 9" pneumatisch
				→Orga 08575; + ABS; für Linkslenker		03.7750-9402.4 300117	ATE Ø 9" pneumatisch
2.0 S16	112	05/93→05/01		05/97→; - ABS; für Linkslenker		03.7750-9302.4 300116	ATE Ø 9" pneumatisch
				07/94→; →Orga 08575; + ABS; für Linkslenker		03.7750-9402.4 300117	ATE Ø 9" pneumatisch
2.0 XSi	89	05/93→05/01		05/97→; - ABS; für Linkslenker		03.7750-9302.4 300116	ATE Ø 9" pneumatisch
				03/94→; →Orga 08575; + ABS; für Linkslenker		03.7750-9402.4 300117	ATE Ø 9" pneumatisch
 Hauptbremszylinder							
1.1	44	05/93→05/01		03/94→ 04/97; - ABS; Türenanzahl: 5		03.2119-3391.3 010058	ATE Ø 19,05
						24.2119-1702.3 010435	BDX Ø 19,05
				03/94→ 04/97; - ABS; Türenanzahl: 3		24.2120-1704.3 010429	BDX Ø 20,64
				→ 04/97; S 30209025→; + ABS		24.2122-1705.3 010434	Ø 22,2
1.4	55	04/93→07/01		→ 04/97; - ABS; nicht für Fahrschulwagen; Türenanzahl: 5		03.2119-3391.3 010058	ATE Ø 19,05
						24.2119-1702.3 010435	BDX Ø 19,05
				05/97→; - ABS		03.2120-4321.3 010525	ATE Ø 20,64
						24.2120-1726.3 010564	BDX Ø 20,64
				05/97→; →Orga 08575; + ABS; für Linkslenker		03.2122-1351.3 010528	Ø 22,2
						24.2122-1733.3 010668	Ø 22,2
				→ 04/97; - ABS; für Fahrschulwagen; Türenanzahl: 3		24.2120-1704.3 010429	BDX Ø 20,64
				→ 04/97; S 30209025→; + ABS		24.2122-1705.3 010434	Ø 22,2
				Orga 08576→; + ABS; für Linkslenker		24.2123-1715.3 010520	BDX Ø 23,81
1.6	65	05/93→10/00		→ 04/97; - ABS		03.2120-1897.3 010103	ATE Ø 20,64
						24.2120-1704.3 010429	BDX Ø 20,64
				05/97→; - ABS		03.2120-4321.3 010525	ATE Ø 20,64
						24.2120-1726.3 010564	BDX Ø 20,64
				05/97→; →Orga 08575; + ABS; für Linkslenker		03.2122-1351.3 010528	Ø 22,2
						24.2122-1733.3 010668	Ø 22,2
				→ 04/97; S 30209025→; + ABS		24.2122-1705.3 010434	Ø 22,2
				Orga 08576→; + ABS; für Linkslenker		24.2123-1715.3 010520	BDX Ø 23,81
↓							













	kw			 	! #		
PEUGEOT - 306 Schrägheck (7A, 7C, N3, N5) 01/93→10/03							
Hauptbremszylinder							
1.6	72	10/00→05/01		- ABS		03.2120-4321.3 010525 24.2120-1726.3 010564	ATE Ø 20,64 BDX Ø 20,64
				+ ABS; für Linkslenker		24.2123-1715.3 010520	BDX Ø 23,81
1.8	74	05/93→05/01		→ 04/97; - ABS; für Linkslenker		03.2120-1897.3 010103	ATE Ø 20,64
1.8 D	43	05/93→05/01				24.2120-1704.3 010429	BDX Ø 20,64
1.9 D	47	05/93→05/01					
1.9 D	50	06/94→05/01		- ABS; für Rechtslenker		03.2120-4246.3 010614 24.2120-1722.3 010544	ATE Ø 20,64 Ø 20,64
				05/97→; - ABS; für Linkslenker		03.2120-4321.3 010525 24.2120-1726.3 010564	ATE Ø 20,64 BDX Ø 20,64
				05/97→; →Orga 08575; + ABS; für Linkslenker		03.2122-1351.3 010528 24.2122-1733.3 010668	Ø 22,2 Ø 22,2
				→ 04/97; S 30209025→; + ABS		24.2122-1705.3 010434	Ø 22,2
				Orga 08576→; + ABS; für Linkslenker		24.2123-1715.3 010520	BDX Ø 23,81
1.8 16V	81	03/97→05/01		→ 04/97; - ABS; für Linkslenker		03.2120-1897.3 010103 24.2120-1704.3 010429	ATE Ø 20,64 BDX Ø 20,64
2.0 S16	110	06/94→05/01					
				05/97→; →Orga 08575; + ABS; für Linkslenker		03.2122-1351.3 010528 24.2122-1733.3 010668	Ø 22,2 Ø 22,2
				05/97→; - ABS; für Linkslenker		03.2122-1356.3 010529	Ø 22,2
				→ 04/97; + ABS		24.2122-1705.3 010434	Ø 22,2
				Orga 08576→; + ABS; für Linkslenker		24.2123-1715.3 010520	BDX Ø 23,81
1.9 D	51	09/98→05/01		- ABS; für Linkslenker		03.2120-4321.3 010525 24.2120-1726.3 010564	ATE Ø 20,64 BDX Ø 20,64
				→Orga 08575; + ABS; für Linkslenker		03.2122-1351.3 010528 24.2122-1733.3 010668	Ø 22,2 Ø 22,2
				→Orga 08575; + ABS; für Rechtslenker		03.2122-1461.3 010610	ATE Ø 22,2
				- ABS; für Rechtslenker		03.2122-1461.3 010610	ATE Ø 22,2
				Orga 08576→; + ABS; für Linkslenker		24.2123-1715.3 010520	BDX Ø 23,81
1.9 D	55	03/98→05/01		- ABS; für Linkslenker		03.2120-4321.3 010525 24.2120-1726.3 010564	ATE Ø 20,64 BDX Ø 20,64
				→Orga 08575; + ABS; für Linkslenker		03.2122-1351.3 010528 24.2122-1733.3 010668	Ø 22,2 Ø 22,2
				Orga 08576→; + ABS; für Linkslenker		24.2123-1715.3 010520	BDX Ø 23,81
1.9 DT	66	05/93→05/01		10/93→ 04/97; - ABS; für Linkslenker		03.2120-1897.3 010103 24.2120-1704.3 010429	ATE Ø 20,64 BDX Ø 20,64
				05/97→; →Orga 08575; + ABS; für Linkslenker		03.2122-1351.3 010528 24.2122-1733.3 010668	Ø 22,2 Ø 22,2
				05/97→; - ABS; für Linkslenker		03.2122-1356.3 010529	Ø 22,2
				10/93→ 04/97; + ABS		24.2122-1705.3 010434	Ø 22,2
				Orga 08576→; + ABS; für Linkslenker		24.2123-1715.3 010520	BDX Ø 23,81
2.0 16V	97	03/97→05/01		→ 04/97; - ABS; für Linkslenker; Türenanzahl: 4		03.2120-1897.3 010103 24.2120-1704.3 010429	ATE Ø 20,64 BDX Ø 20,64
				05/97→; →Orga 08575; + ABS; für Linkslenker		03.2122-1351.3 010528	Ø 22,2
				05/97→; - ABS; für Linkslenker; Türenanzahl: 4		03.2122-1356.3 010529	Ø 22,2
				→ 04/97		24.2122-1705.3 010434	Ø 22,2
				Orga 08576→; + ABS; für Linkslenker		24.2123-1715.3 010520	BDX Ø 23,81
2.0 HDI 90	66	06/99→12/02		→Orga 08575; + ABS; für Linkslenker		03.2122-1351.3 010528 24.2122-1733.3 010668	Ø 22,2 Ø 22,2
				- ABS; für Linkslenker		03.2122-1356.3 010529	Ø 22,2
				Orga 08576→; + ABS; für Linkslenker		24.2123-1715.3 010520	BDX Ø 23,81
2.0 S16	112	05/93→05/01		07/94→ 04/97; - ABS; für Linkslenker		03.2120-1897.3 010103 24.2120-1704.3 010429	ATE Ø 20,64 BDX Ø 20,64
				05/97→; →Orga 08575; + ABS; für Linkslenker		03.2122-1351.3 010528 24.2122-1733.3 010668	Ø 22,2 Ø 22,2
				05/97→; - ABS; für Linkslenker		03.2122-1356.3 010529	Ø 22,2
				07/94→ 04/97; + ABS		24.2122-1705.3 010434	Ø 22,2
				Orga 08576→; + ABS; für Linkslenker		24.2123-1715.3 010520	BDX Ø 23,81
2.0 S16	120	07/96→05/01		- ABS		24.2123-1714.3 010587	BDX Ø 23,81
				+ ABS; für Linkslenker		24.2123-1715.3 010520	BDX Ø 23,81
2.0 XSi	89	05/93→05/01		03/94→ 04/97; - ABS; für Linkslenker		03.2120-1897.3 010103	ATE Ø 20,64













	kw					! #		
PEUGEOT - 306 Schrägheck (7A, 7C, N3, N5) 01/93→10/03								
 Hauptbremszylinder								
2.0 XSi	89	05/93→05/01		03/94→ 04/97; - ABS; für Linkslenker		24.2120-1704.3	010429	BDX Ø 20,64
				05/97→; →Orga 08575; + ABS; für Linkslenker		03.2122-1351.3	010528	Ø 22,2
						24.2122-1733.3	010668	Ø 22,2
				05/97→; - ABS; für Linkslenker		03.2122-1356.3	010529	Ø 22,2
				03/94→ 04/97; + ABS		24.2122-1705.3	010434	Ø 22,2
				Orga 08576→; + ABS; für Linkslenker		24.2123-1715.3	010520	BDX Ø 23,81
 Bremskraftregler								
1.1	44	05/93→05/01		03/94→ 04/97; + ABS		24.6042-1701.3	320149	2/20 2x
1.4	55	04/93→07/01		→ 04/97; + ABS		24.6042-1701.3	320149	2/20 2x
1.6	65	05/93→10/00						
1.8 D	43	05/93→05/01						
1.9 D	47	05/93→05/01						
1.9 D	50	06/94→05/01						
2.0 16V	97	03/97→05/01		→ 04/97; TÜrenanzahl: 4		24.6042-1701.3	320149	2/20 2x
PEUGEOT - 405 II (4B) 01/92→11/99								
 Hauptbremszylinder								
1.4	55	08/92→10/95		09/92→; - ABS		24.2120-1701.3	010427	Ø 20,64
1.6	65	08/92→10/95						
1.8	74	08/92→10/95		09/92→; + ABS		24.2122-1704.3	010423	Ø 22,2
1.9 D	47	08/92→10/95		09/92→; + ABS		24.2122-1704.3	010423	Ø 22,2
1.9 TD	66	08/92→10/95						
2.0	89	08/92→10/95						
2.0 MI-16	112	08/92→10/95						
2.0 X4	89	08/92→10/95						
1.9 D	50	06/94→10/95		+ ABS		24.2122-1704.3	010423	Ø 22,2
2.0 16V	110	06/94→10/95						
 Bremskraftregler								
1.4	55	08/92→10/95		09/92→		03.6583-0037.3	320107	ATE lastabhängig 8/3 4x
1.6	65	08/92→10/95						
1.8	74	08/92→10/95						
1.9 D	47	08/92→10/95						
1.9 TD	66	08/92→10/95						
2.0	89	08/92→10/95						
2.0 MI-16	112	08/92→10/95						
1.9 D	50	06/94→10/95				03.6583-0037.3	320107	ATE lastabhängig 8/3 4x
2.0 16V	110	06/94→10/95						
PEUGEOT - 405 II Break (4E) 08/92→10/98								
 Hauptbremszylinder								
1.4	55	08/92→10/96		09/92→ 10/95; - ABS		24.2120-1701.3	010427	Ø 20,64
1.6	65	08/92→10/96						
1.8	74	08/92→10/96		09/92→ 10/95; + ABS		24.2122-1704.3	010423	Ø 22,2
1.9 D	47	08/92→10/96		09/92→ 10/95; + ABS		24.2122-1704.3	010423	Ø 22,2
1.9 TD	66	08/92→10/96						
2.0	89	08/92→10/96						
2.0 4x4	89	08/92→10/96						
2.0 4x4	144	08/92→12/95						
1.9 D	50	06/94→10/96		→ 10/95; + ABS		24.2122-1704.3	010423	Ø 22,2
 Bremskraftregler								
1.4	55	08/92→10/96		09/92→ 10/95		03.6583-0037.3	320107	ATE lastabhängig 8/3 4x
1.6	65	08/92→10/96						
1.8	74	08/92→10/96						
1.9 D	47	08/92→10/96						
1.9 TD	66	08/92→10/96						
2.0	89	08/92→10/96						
2.0 4x4	144	08/92→12/95						
1.9 D	50	06/94→10/96		→ 10/95		03.6583-0037.3	320107	ATE lastabhängig 8/3 4x
PEUGEOT - 406 (8B) 10/95→01/05								
 Bremskraftverstärker								
1.6	65	11/95→05/04		Orga 08701→; → 04/04; für Linkslenker		03.7863-2202.4	300127	ATE Ø 10" pneumatisch
1.8 16V	81	11/95→10/00		Orga 08701→; für Linkslenker		03.7863-2202.4	300127	ATE Ø 10" pneumatisch
1.8 16V	85	10/00→05/04		→ 04/04; für Linkslenker		03.7863-2202.4	300127	ATE Ø 10" pneumatisch
2.0 16V	97	11/95→05/04		Orga 08701→; → 04/04; - ESP; für Linkslenker		03.7863-2202.4	300127	ATE Ø 10" pneumatisch
2.0 16V	100	08/00→06/04						
2.0 HDI 90	66	02/99→05/04		Orga 08701→; → 04/04; + ESP; für Linkslenker		03.7863-2802.4	300188	ATE Ø 10" pneumatisch
2.0 Turbo	108	04/96→05/04						
2.2	116	07/00→05/04						
2.2 HDi	98	03/00→05/04						













	kw					! #		
PEUGEOT - 406 (8B) 10/95→01/05								
 Bremskraftverstärker								
2.0 16V HPi 2.0 HDi 110	103 79	05/01→05/04 08/01→05/04		→ 04/04; - ESP; für Linkslenker		03.7863-2202.4	300127	ATE Ø 10" pneumatisch
				→ 04/04; für Linkslenker; + ESP		03.7863-2802.4	300188	ATE Ø 10" pneumatisch
2.0 HDi 110	80	06/98→08/01		Orga 08701→; - ESP; für Linkslenker		03.7863-2202.4	300127	ATE Ø 10" pneumatisch
				Orga 08701→; + ESP; für Linkslenker		03.7863-2802.4	300188	ATE Ø 10" pneumatisch
 Hauptbremszylinder								
1.6 1.8 1.9 TD 1.9 TD 3.0 24V	65 66 66 68 140	11/95→05/04 05/97→05/04 01/96→05/04 01/96→05/04 10/96→05/04		Orga 08701→; → 04/04		03.2123-2581.3	010613	ATE Ø 23,81
				→ 01/99; - ABS		24.2123-1710.3	010504	Ø 23,81
				→ 01/99; + ABS		24.2123-1713.3	010505	Ø 23,81
				02/99→; →Orga 08700; + ABS		24.2123-1741.3	010681	Ø 23,81
				02/99→; →Orga 08700; - ABS		24.2123-1751.3	010698	Ø 23,81
1.8 16V	81	11/95→10/00		Orga 08701→		03.2123-2581.3	010613	ATE Ø 23,81
				→ 01/99; - ABS		24.2123-1710.3	010504	Ø 23,81
				→ 01/99; + ABS		24.2123-1713.3	010505	Ø 23,81
				02/99→; →Orga 08700; + ABS		24.2123-1741.3	010681	Ø 23,81
				02/99→; →Orga 08700; - ABS		24.2123-1751.3	010698	Ø 23,81
1.8 16V	85	10/00→05/04		→ 04/04		03.2123-2561.3	010629	ATE Ø 23,81
				→ 04/04; - ESP		03.2123-2581.3	010613	ATE Ø 23,81
2.0 16V	97	11/95→05/04		Orga 08701→; → 04/04; + ESP		03.2123-2561.3	010629	ATE Ø 23,81
				Orga 08701→; → 04/04; - ESP		03.2123-2581.3	010613	ATE Ø 23,81
				→ 01/99; - ABS		24.2123-1710.3	010504	Ø 23,81
				→ 01/99; + ABS		24.2123-1713.3	010505	Ø 23,81
				02/99→; →Orga 08700; + ABS		24.2123-1741.3	010681	Ø 23,81
				02/99→; →Orga 08700; - ABS		24.2123-1751.3	010698	Ø 23,81
2.0 16V	99	01/99→08/00		02/99→; + ABS		24.2123-1741.3	010681	Ø 23,81
				02/99→; - ABS		24.2123-1751.3	010698	Ø 23,81
2.0 16V 2.0 HDi 90 2.2 2.2 HDi	100 66 116 98	08/00→06/04 02/99→05/04 07/00→05/04 03/00→05/04		Orga 08701→; → 04/04; + ESP		03.2123-2561.3	010629	ATE Ø 23,81
				Orga 08701→; → 04/04; - ESP		03.2123-2581.3	010613	ATE Ø 23,81
				→Orga 08700; + ABS		24.2123-1741.3	010681	Ø 23,81
				→Orga 08700; - ABS		24.2123-1751.3	010698	Ø 23,81
2.0 16V HPi 2.0 HDi 110	103 79	05/01→05/04 08/01→05/04		→ 04/04; + ESP		03.2123-2561.3	010629	ATE Ø 23,81
				→ 04/04; - ESP		03.2123-2581.3	010613	ATE Ø 23,81
2.0 HDi 110	80	06/98→08/01		Orga 08701→; + ESP		03.2123-2561.3	010629	ATE Ø 23,81
				Orga 08701→; - ESP		03.2123-2581.3	010613	ATE Ø 23,81
				02/99→; →Orga 08700; + ABS		24.2123-1741.3	010681	Ø 23,81
				02/99→; →Orga 08700; - ABS		24.2123-1751.3	010698	Ø 23,81
2.0 Turbo 2.1 TD 12V	108 80	04/96→05/04 01/96→05/04		→ 01/99; - ABS		24.2123-1710.3	010504	Ø 23,81
				→ 01/99; + ABS		24.2123-1713.3	010505	Ø 23,81
				02/99→; →Orga 08700; + ABS		24.2123-1741.3	010681	Ø 23,81
				02/99→; →Orga 08700; - ABS		24.2123-1751.3	010698	Ø 23,81
3.0 V6	152	03/00→05/04		Orga 08701→; → 04/04		03.2123-2581.3	010613	ATE Ø 23,81
				→Orga 08700; + ABS		24.2123-1741.3	010681	Ø 23,81
				→Orga 08700; - ABS		24.2123-1751.3	010698	Ø 23,81
PEUGEOT - 406 Break (8E/F) 10/96→10/04								
 Bremskraftverstärker								
1.8 1.9 D 1.9 TD	66 55 66	05/97→10/04 10/96→10/04 10/96→10/04		Orga 08701→; → 04/04; für Linkslenker		03.7863-2202.4	300127	ATE Ø 10" pneumatisch
1.8 16V	81	10/96→10/00		Orga 08701→; für Linkslenker		03.7863-2202.4	300127	ATE Ø 10" pneumatisch
1.8 16V	85	10/00→10/04		→ 04/04; für Linkslenker		03.7863-2202.4	300127	ATE Ø 10" pneumatisch
2.0 16V 2.0 HDi 90	97 66	10/96→10/04 02/99→10/04		Orga 08701→; → 04/04; - ESP; für Linkslenker		03.7863-2202.4	300127	ATE Ø 10" pneumatisch
2.0 Turbo 2.2 2.2 HDi	108 116 98	10/96→10/04 07/00→10/04 03/00→10/04		Orga 08701→; → 04/04; + ESP; für Linkslenker		03.7863-2802.4	300188	ATE Ø 10" pneumatisch
2.0 16V	99	01/99→10/00		Orga 08701→; - ESP; für Linkslenker		03.7863-2202.4	300127	ATE Ø 10" pneumatisch
				Orga 08701→; + ESP; für Linkslenker		03.7863-2802.4	300188	ATE Ø 10" pneumatisch
2.0 16V 2.0 HDi 110	100 79	10/00→10/04 08/01→10/04		→ 04/04; - ESP; für Linkslenker		03.7863-2202.4	300127	ATE Ø 10" pneumatisch
				→ 04/04; + ESP; für Linkslenker		03.7863-2802.4	300188	ATE Ø 10" pneumatisch
2.0 16V HPi	103	05/01→10/04		→ 04/04; + ESP; für Linkslenker		03.7863-2802.4	300188	ATE Ø 10" pneumatisch
2.0 HDi 110	80	02/99→04/04		Orga 08701→; → 08/01; - ESP; für Linkslenker		03.7863-2202.4	300127	ATE Ø 10" pneumatisch
↓								













	kW			 	! #		
PEUGEOT - 406 Break (8E/F) 10/96→10/04							
 Bremskraftverstärker							
2.0 HDI 110	80	02/99→04/04		Orga 08701→; → 08/01; + ESP; für Linkslenker		03.7863-2802.4 300188	ATE Ø 10" pneumatisch
 Hauptbremszylinder							
1.8	66	05/97→10/04		Orga 08701→; → 04/04		03.2123-2581.3 010613	ATE Ø 23,81
1.9 D	55	10/96→10/04		→ 01/99; - ABS		24.2123-1710.3 010504	Ø 23,81
1.9 TD	66	10/96→10/04		→ 01/99; + ABS		24.2123-1713.3 010505	Ø 23,81
3.0 24V	140	10/96→10/04		02/99→; →Orga 08700; + ABS		24.2123-1741.3 010681	Ø 23,81
				02/99→; →Orga 08700; - ABS		24.2123-1751.3 010698	Ø 23,81
1.8 16V	81	10/96→10/00		Orga 08701→		03.2123-2581.3 010613	ATE Ø 23,81
				→ 01/99; - ABS		24.2123-1710.3 010504	Ø 23,81
				→ 01/99; + ABS		24.2123-1713.3 010505	Ø 23,81
				02/99→; →Orga 08700; + ABS		24.2123-1741.3 010681	Ø 23,81
				02/99→; →Orga 08700; - ABS		24.2123-1751.3 010698	Ø 23,81
1.8 16V	85	10/00→10/04		→ 04/04; + ESP		03.2123-2561.3 010629	ATE Ø 23,81
2.0 16V	100	10/00→10/04		→ 04/04; - ESP		03.2123-2581.3 010613	ATE Ø 23,81
2.0 16V HPi	103	05/01→10/04					
2.0 HDi 110	79	08/01→10/04					
2.0 16V	97	10/96→10/04		Orga 08701→; → 04/04; + ESP		03.2123-2561.3 010629	ATE Ø 23,81
2.0 Turbo	108	10/96→10/04		Orga 08701→; → 04/04; - ESP		03.2123-2581.3 010613	ATE Ø 23,81
2.1 TD 12V	80	10/96→10/04		→ 01/99; - ABS		24.2123-1710.3 010504	Ø 23,81
				→ 01/99; + ABS		24.2123-1713.3 010505	Ø 23,81
				02/99→; →Orga 08700; + ABS		24.2123-1741.3 010681	Ø 23,81
				02/99→; →Orga 08700; - ABS		24.2123-1751.3 010698	Ø 23,81
2.0 16V	99	01/99→10/00		Orga 08701→; + ESP		03.2123-2561.3 010629	ATE Ø 23,81
				Orga 08701→; - ESP		03.2123-2581.3 010613	ATE Ø 23,81
				→Orga 08700; + ABS		24.2123-1741.3 010681	Ø 23,81
				→Orga 08700; - ABS		24.2123-1751.3 010698	Ø 23,81
2.0 HDI 110	80	02/99→04/04		Orga 08701→; → 08/01; + ESP		03.2123-2561.3 010629	ATE Ø 23,81
				Orga 08701→; → 08/01; - ESP		03.2123-2581.3 010613	ATE Ø 23,81
				→Orga 08700; + ABS		24.2123-1741.3 010681	Ø 23,81
				→Orga 08700; - ABS		24.2123-1751.3 010698	Ø 23,81
2.0 HDI 90	66	02/99→10/04		Orga 08701→; → 04/04; + ESP		03.2123-2561.3 010629	ATE Ø 23,81
2.2	116	07/00→10/04		Orga 08701→; → 04/04; - ESP		03.2123-2581.3 010613	ATE Ø 23,81
2.2 HDi	98	03/00→10/04		→Orga 08700; + ABS		24.2123-1741.3 010681	Ø 23,81
				→Orga 08700; - ABS		24.2123-1751.3 010698	Ø 23,81
3.0 V6	152	03/00→10/04		Orga 08701→; → 04/04		03.2123-2581.3 010613	ATE Ø 23,81
				→Orga 08700; + ABS		24.2123-1741.3 010681	Ø 23,81
				→Orga 08700; - ABS		24.2123-1751.3 010698	Ø 23,81
PEUGEOT - 406 Coupe (8C) 03/97→02/05							
 Bremskraftverstärker							
2.0 16V	97	03/97→12/04		Orga 08701→; - ESP; für Linkslenker		03.7863-2202.4 300127	ATE Ø 10" pneumatisch
2.0 16V	99	01/99→10/00		Orga 08701→; + ESP; für Linkslenker		03.7863-2802.4 300188	ATE Ø 10" pneumatisch
2.2 HDI	98	03/00→12/04					
2.0 16V	100	10/00→12/04		- ESP; für Linkslenker		03.7863-2202.4 300127	ATE Ø 10" pneumatisch
2.2	116	03/02→12/04		+ ESP; für Linkslenker		03.7863-2802.4 300188	ATE Ø 10" pneumatisch
 Hauptbremszylinder							
2.0 16V	97	03/97→12/04		Orga 08701→; + ESP		03.2123-2561.3 010629	ATE Ø 23,81
				Orga 08701→; - ESP		03.2123-2581.3 010613	ATE Ø 23,81
				→ 01/99; - ABS		24.2123-1710.3 010504	Ø 23,81
				→ 01/99; + ABS		24.2123-1713.3 010505	Ø 23,81
				02/99→; →Orga 08700; + ABS		24.2123-1741.3 010681	Ø 23,81
				02/99→; →Orga 08700; - ABS		24.2123-1751.3 010698	Ø 23,81
2.0 16V	99	01/99→10/00		Orga 08701→; + ESP		03.2123-2561.3 010629	ATE Ø 23,81
2.2 HDI	98	03/00→12/04		Orga 08701→; - ESP		03.2123-2581.3 010613	ATE Ø 23,81
				→Orga 08700; + ABS		24.2123-1741.3 010681	Ø 23,81
				→Orga 08700; - ABS		24.2123-1751.3 010698	Ø 23,81
2.0 16V	100	10/00→12/04		+ ESP		03.2123-2561.3 010629	ATE Ø 23,81
2.2	116	03/02→12/04		- ESP		03.2123-2581.3 010613	ATE Ø 23,81
3.0 V6	152	03/00→12/04		Orga 08701→		03.2123-2581.3 010613	ATE Ø 23,81
				→Orga 08700; + ABS		24.2123-1741.3 010681	Ø 23,81









	kw			 	! #		
PEUGEOT - 406 Coupe (8C) 03/97→02/05							
 Hauptbremszylinder							
3.0 V6	152	03/00→12/04		→Orga 08700; - ABS		24.2123-1751.3 010698	Ø 23,81
3.0 V6 24V	140	03/97→12/04		Orga 08701→		03.2123-2581.3 010613	ATE Ø 23,81
				→ 01/99; - ABS		24.2123-1710.3 010504	Ø 23,81
				→ 01/99; + ABS		24.2123-1713.3 010505	Ø 23,81
				02/99→; →Orga 08700; + ABS		24.2123-1741.3 010681	Ø 23,81
				02/99→; →Orga 08700; - ABS		24.2123-1751.3 010698	Ø 23,81
PEUGEOT - 407 (6D_) 05/04→							
 Bremskraftverstärker							
1.6 HDi 110	80	05/04→		für Linkslenker; →Orga 11192		03.7860-3402.4 300217	ATE Ø 10" pneumatisch
1.8 16V	92	09/05→		Orga 12047→; → 02/11; für Linkslenker		03.7860-8002.4 300258	ATE Ø 10" pneumatisch
2.0 16V	103	09/05→					
2.0 Bioflex	103	09/07→					
2.0 HDi 135	100	05/04→					
2.2 HDi 170	125	05/06→					
3.0	155	05/04→					
1.8	85	05/04→		für Linkslenker; → 02/11		03.7860-3402.4 300217	ATE Ø 10" pneumatisch
2.0	100	05/04→					
2.0 HDi	103	06/09→12/10		Orga 12047→; für Linkslenker		03.7860-8002.4 300258	ATE Ø 10" pneumatisch
2.2 HDi	120	06/08→					
2.0 HDi	110	02/10→		→ 02/11; für Linkslenker		03.7860-8002.4 300258	ATE Ø 10" pneumatisch
2.0 HDi	120	07/09→					
2.2	116	05/04→		für Linkslenker; →Orga 11283		03.7860-3402.4 300217	ATE Ø 10" pneumatisch
2.2 16V	120	09/05→					
2.7 HDi	150	10/05→		→Orga 11073; für Linkslenker		03.7860-3402.4 300217	ATE Ø 10" pneumatisch
 Hauptbremszylinder							
1.6 HDi 110	80	05/04→		→ 02/11		03.2122-2171.3 010961	ATE Ø 22,2
1.8	85	05/04→					
1.8 16V	92	09/05→					
2.0	100	05/04→					
2.0 16V	103	09/05→					
2.0 Bioflex	103	09/07→					
2.0 HDi	103	06/09→12/10		Orga 12348→		03.2123-3131.3 010977	ATE Ø 23,81
2.2 HDi	120	06/08→					
2.0 HDi	110	02/10→		Orga 12348→; → 02/11		03.2123-3131.3 010977	ATE Ø 23,81
2.0 HDi	120	07/09→					
2.2 HDi 170	125	05/06→					
3.0	155	05/04→					
2.0 HDi 135	100	05/04→		→Orga 11682		03.2122-2171.3 010961	ATE Ø 22,2
				Orga 12348→; → 02/11		03.2123-3131.3 010977	ATE Ø 23,81
PEUGEOT - 407 Coupe (6C_) 10/05→							
 Bremskraftverstärker							
2.0 HDi	100	10/05→		07/07→; →Orga 11192; für Linkslenker		03.7860-3402.4 300217	ATE Ø 10" pneumatisch
				Orga 12047→; → 12/11; für Linkslenker		03.7860-8002.4 300258	ATE Ø 10" pneumatisch
2.0 HDi	110	02/10→		→ 12/11; für Linkslenker		03.7860-8002.4 300258	ATE Ø 10" pneumatisch
2.0 HDi	120	06/09→					
3.0 HDi	177	06/09→					
2.2 16V	120	10/05→		→Orga 11283; für Linkslenker		03.7860-3402.4 300217	ATE Ø 10" pneumatisch
2.7 HDi	150	10/05→		→Orga 11073; für Linkslenker		03.7860-3402.4 300217	ATE Ø 10" pneumatisch
3.0 V6	155	10/05→		→Orga 11192; für Linkslenker		03.7860-3402.4 300217	ATE Ø 10" pneumatisch
				Orga 12047→; → 12/11; für Linkslenker		03.7860-8002.4 300258	ATE Ø 10" pneumatisch
 Hauptbremszylinder							
2.0 HDi	100	10/05→		Orga 12348→; → 12/11		03.2123-3131.3 010977	ATE Ø 23,81
2.0 HDi	120	06/09→					
2.2 16V	120	10/05→					
3.0 HDi	177	06/09→					
3.0 V6	155	10/05→					
2.0 HDi	110	02/10→		→ 12/11		03.2123-3131.3 010977	ATE Ø 23,81
PEUGEOT - 407 SW (6E_) 05/04→							
 Bremskraftverstärker							
1.6 HDi 110	80	05/04→		für Linkslenker; →Orga 11192		03.7860-3402.4 300217	ATE Ø 10" pneumatisch
1.8 16V	92	09/05→		Orga 12047→; → 02/11; für Linkslenker		03.7860-8002.4 300258	ATE Ø 10" pneumatisch
2.0 16V	103	09/05→					
2.2 HDi 170	125	05/06→					
3.0	155	05/04→					
1.8	85	05/04→		für Linkslenker; → 02/11		03.7860-3402.4 300217	ATE Ø 10" pneumatisch
2.0	100	05/04→					
↓							









	kw			 	! #		
PEUGEOT - 407 SW (6E_) 05/04→							
 Bremskraftverstärker							
2.0 HDi	103	08/08→		Orga 12047→; → 02/11; für Linkslenker		03.7860-8002.4 300258	ATE Ø 10" pneumatisch
2.2 HDi	120	06/08→					
2.0 HDi	110	02/10→		→ 02/11; für Linkslenker		03.7860-8002.4 300258	ATE Ø 10" pneumatisch
2.0 HDi	120	07/09→					
2.0 HDi 135	100	07/04→12/10		für Linkslenker; →Orga 11192		03.7860-3402.4 300217	ATE Ø 10" pneumatisch
				Orga 12047→; für Linkslenker		03.7860-8002.4 300258	ATE Ø 10" pneumatisch
2.2	116	05/04→		für Linkslenker; →Orga 11283		03.7860-3402.4 300217	ATE Ø 10" pneumatisch
2.2 16V	120	09/05→					
2.7 HDi	150	10/05→		→Orga 11073; für Linkslenker		03.7860-3402.4 300217	ATE Ø 10" pneumatisch
 Hauptbremszylinder							
1.6 HDi 110	80	05/04→		→ 02/11		03.2122-2171.3 010961	ATE Ø 22,2
1.8	85	05/04→					
1.8 16V	92	09/05→					
2.0	100	05/04→					
2.0 16V	103	09/05→					
2.0 HDi	103	08/08→		Orga 12348→; → 02/11		03.2123-3131.3 010977	ATE Ø 23,81
2.0 HDi	110	02/10→					
2.0 HDi	120	07/09→					
2.2 HDi	120	06/08→					
2.2 HDi 170	125	05/06→					
3.0	155	05/04→					
2.0 HDi 135	100	07/04→12/10		→Orga 11682		03.2122-2171.3 010961	ATE Ø 22,2
				Orga 12348→		03.2123-3131.3 010977	ATE Ø 23,81
PEUGEOT - 505 (551A) 05/79→10/96							
 Hauptbremszylinder							
2.0	72	09/85→09/95		→ 10/86		03.2120-1122.3 010084	Ø 20,64
PEUGEOT - 508 I (8D_) 11/10→							
 Bremskraftverstärker							
1.6 HDi	82	11/10→		für Linkslenker;		03.7860-7802.4 300280	ATE Ø 10" pneumatisch
1.6 HDi	84	02/12→		für Fahrzeuge ohne Start-Stopp-Funktion; + DSC			
1.6 HDi	85	09/14→					
1.6 THP	115	11/10→		für Linkslenker; + DSC		03.7860-7802.4 300280	ATE Ø 10" pneumatisch
1.6 VTi	85	11/10→					
1.6 VTi	88	11/10→					
2.0 HDi	100	11/10→					
2.0 HDi	103	11/10→					
2.0 HDi	120	11/10→					
2.0 HDi Hybrid4 AWC	120	11/10→					
2.2 HDi	150	11/10→					
 Hauptbremszylinder							
1.6	120	01/12→		+ DSC		03.2123-3131.3 010977	ATE Ø 23,81
1.6	121	09/11→		- DSC		03.2123-3641.3 010963	ATE Ø 23,81
1.6 BlueHDi 120	88	03/14→					
1.6 HDi	82	11/10→					
1.6 HDi	84	02/12→					
1.6 HDi	85	09/14→					
1.6 THP	110	11/10→					
1.6 THP	115	11/10→					
1.6 VTi	85	11/10→					
1.6 VTi	88	11/10→					
2.0 BlueHDi 150	110	04/14→					
2.0 BlueHDi 180	133	04/14→					
2.0 HDi	100	11/10→					
2.0 HDi	103	11/10→					
2.0 HDi	120	11/10→					
2.0 HDi Hybrid4 AWC	120	11/10→					
2.2 HDi	150	11/10→					
2.0 HDi Hybrid4 AWC	147	11/10→		06/12→; + DSC		03.2123-3131.3 010977	ATE Ø 23,81
				06/12→; - DSC		03.2123-3641.3 010963	ATE Ø 23,81
PEUGEOT - 508 SW I (8E_) 11/10→							
 Bremskraftverstärker							
1.6 HDi	82	11/10→		für Linkslenker;		03.7860-7802.4 300280	ATE Ø 10" pneumatisch
1.6 HDi	84	02/12→		für Fahrzeuge ohne Start-Stopp-Funktion; + DSC			
1.6 HDi	85	09/14→					
1.6 THP	115	11/10→		für Linkslenker; + DSC		03.7860-7802.4 300280	ATE Ø 10" pneumatisch
1.6 VTi	85	11/10→					
1.6 VTi	88	11/10→					
2.0 HDi	100	11/10→					
2.0 HDi	103	11/10→					
2.0 HDi	120	11/10→					

	kw			 	! #		
PEUGEOT - 508 SW I (8E_) 11/10→							
 Bremskraftverstärker							
2.0 HDi RXH Hybrid4	120	11/10→		für Linkslenker; + DSC	03.7860-7802.4	300280	ATE Ø 10" pneumatisch
2.2 HDi	150	11/10→					
 Hauptbremszylinder							
1.6	121	02/12→		+ DSC	03.2123-3131.3	010977	ATE Ø 23,81
1.6 BlueHDi 120	88	03/14→		- DSC	03.2123-3641.3	010963	ATE Ø 23,81
1.6 HDi	82	11/10→					
1.6 HDi	84	02/12→					
1.6 HDi	85	09/14→					
1.6 THP	110	11/10→					
1.6 THP	115	11/10→					
1.6 VTi	85	11/10→					
1.6 VTi	88	11/10→					
2.0 BlueHDi 150	110	04/14→					
2.0 BlueHDi 180	133	04/14→					
2.0 HDi	100	11/10→					
2.0 HDi	103	11/10→					
2.0 HDi	120	11/10→					
2.0 HDi 180 RXH	133	10/14→					
2.0 HDi RXH Hybrid4	120	11/10→					
2.2 HDi	150	11/10→					
PEUGEOT - 605 (6B) 06/89→09/99							
 Hauptbremszylinder							
2.0	79	02/90→09/99		04/90→; - ABS	24.2122-1703.3	010422	Ø 22,2
2.0	89	06/89→09/99		04/90→; + ABS	24.2122-1708.3	010437	Ø 22,2
2.0 16V	97	07/94→09/99		09/94→; →Orga 07692; - ABS	24.2122-1703.3	010422	Ø 22,2
				09/94→; →Orga 07692; + ABS	24.2122-1708.3	010437	Ø 22,2
				Orga 07693→	24.2122-1708.3	010437	Ø 22,2
2.1 D	60	06/89→07/95		04/90→ 08/94; - ABS	24.2122-1703.3	010422	Ø 22,2
				04/90→ 08/94; + ABS	24.2122-1708.3	010437	Ø 22,2
2.1 TD 12V	80	08/94→09/99		- ABS	24.2122-1703.3	010422	Ø 22,2
				+ ABS	24.2122-1708.3	010437	Ø 22,2
2.1 Turbo Diesel	80	06/89→09/99		10/90→; - ABS	24.2122-1703.3	010422	Ø 22,2
				10/90→; + ABS	24.2122-1708.3	010437	Ø 22,2
3.0	123	10/89→09/99		04/90→ 08/94; - ABS	24.2122-1703.3	010422	Ø 22,2
PEUGEOT - 806 (221) 06/94→08/02							
 Hauptbremszylinder							
1.8	73	07/95→08/02		10/96→; →Orga 08206; - ABS	24.2122-1703.3	010422	Ø 22,2
				10/96→; →Orga 08206; + ABS	24.2122-1708.3	010437	Ø 22,2
				Orga 08207→; → 06/02; - ABS	24.2122-1741.3	010695	Ø 22,2
				Orga 08207→; → 06/02; + ABS	24.2122-1742.3	010696	Ø 22,2
1.9 TD	66	07/95→08/02		→Orga 08206; - ABS	24.2123-1707.3	010492	Ø 23,81
1.9 TD	68	05/97→08/02		Orga 08207→; → 06/02; + ABS	24.2123-1733.3	010657	BOS Ø 23,81
2.0 16V	100	09/00→08/02		Orga 08207→; → 06/02; - ABS	24.2123-1738.3	010658	Ø 23,81
2.0	89	06/94→08/02		08/94→; →Orga 08206; - ABS	24.2123-1707.3	010492	Ø 23,81
2.0 Turbo	108	06/94→08/02		Orga 08207→; → 06/02; + ABS	24.2123-1733.3	010657	BOS Ø 23,81
				Orga 08207→; → 06/02; - ABS	24.2123-1738.3	010658	Ø 23,81
2.0 16V	97	05/98→09/00		10/98→; →Orga 08206; - ABS	24.2123-1707.3	010492	Ø 23,81
				Orga 08207→; + ABS	24.2123-1733.3	010657	BOS Ø 23,81
				Orga 08207→; - ABS	24.2123-1738.3	010658	Ø 23,81
2.0 HDI	80	08/99→08/02		→ 06/02; + ABS	24.2123-1733.3	010657	BOS Ø 23,81
2.0 HDI 16V	80	08/99→08/02		→ 06/02; - ABS	24.2123-1738.3	010658	Ø 23,81
2.1 td 12V	80	06/96→08/99		→Orga 08206; - ABS	24.2123-1707.3	010492	Ø 23,81
				Orga 08207→; + ABS	24.2123-1733.3	010657	BOS Ø 23,81
				Orga 08207→; - ABS	24.2123-1738.3	010658	Ø 23,81
PEUGEOT - 807 (E) 06/02→							
 Bremskraftverstärker							
2.0	100	06/02→		Orga 10528→; für Linkslenker; → 06/14	03.7860-2002.4	300216	ATE Ø 10" pneumatisch
2.0 HDI	100	06/06→					
2.2	116	06/02→					
2.0 16V	103	09/05→		Orga 10528→; für Linkslenker;	03.7860-2002.4	300216	ATE Ø 10" pneumatisch
2.0 HDi	79	06/02→		→Orga 10919			
2.0 HDi	88	02/06→		Orga 10920→; für Linkslenker; → 06/14	03.7860-4432.4	300313	ATE Ø 10" pneumatisch
2.2 HDi	94	06/02→					
2.2 HDi	100	04/04→					

	kW					! #		
PEUGEOT - 807 (E) 06/02→								
 Bremskraftverstärker								
2.0 HDi	80	04/04→05/06		Orga 10528→; für Linkslenker; →Orga 10919		03.7860-2002.4	300216	ATE Ø 10" pneumatisch
				Orga 10920→; → 05/06; für Linkslenker		03.7860-4432.4	300313	ATE Ø 10" pneumatisch
2.0 HDi	120	06/09→		für Linkslenker; → 06/14		03.7870-1602.4	300311	ATE Ø 11" pneumatisch
 Hauptbremszylinder								
2.0	100	06/02→		Orga 10528→; → 06/14		03.2122-2163.3	010800	ATE Ø 22,2
2.0 HDi	79	06/02→						
2.0 HDi	88	02/06→						
2.2	116	06/02→						
2.2 HDi	94	06/02→						
2.2 HDi	100	04/04→						
2.0 16V	103	09/05→		→ 06/14		03.2122-2163.3	010800	ATE Ø 22,2
2.0 HDi	100	06/06→						
2.0 HDi	80	04/04→05/06		Orga 10528→; → 05/06		03.2122-2163.3	010800	ATE Ø 22,2
2.0 HDi	120	06/09→		→ 06/14		03.2123-3421.3	010933	ATE Ø 23,81
2.2 HDi	120	06/06→		10/07→ 06/14		03.2123-3421.3	010933	ATE Ø 23,81
2.2 HDi	125	06/06→						
PEUGEOT - 1007 (KM_) 04/05→								
 Hauptbremszylinder								
1.4	54	04/05→		→Orga 11009; - DSC		24.2122-1764.3	010851	BOS Ø 22,2
1.4 16V	65	10/05→				24.2122-1766.3	010840	TRW Ø 22,2
1.4 HDi	50	04/05→						
1.6 16V	80	04/05→		→Orga 11009; + DSC		24.2122-1767.3	010841	TRW Ø 22,2 ohne Drucksensor
				Orga 11010→; → 02/11; + DSC		24.4122-1703.3	010843	TRW Ø 22,2
				Orga 11010→; → 02/11; - DSC		24.4122-1704.3	010847	TRW Ø 22,2
1.6 HDi	80	06/07→		→ 02/11; + DSC		24.4122-1703.3	010843	TRW Ø 22,2
				→ 02/11; - DSC		24.4122-1704.3	010847	TRW Ø 22,2
PEUGEOT - 2008 (CU_) 03/13→								
 Hauptbremszylinder								
1.2 PureTech 82	61	03/18→		Orga 13384→		24.4123-1704.3	010828	TRW Ø 23,81
1.2 VTi	60	03/13→						
1.2 THP 110	81	01/15→				24.4123-1704.3	010828	TRW Ø 23,81
1.2 THP 130	96	01/15→						
1.4 HDi	50	06/13→						
1.5 BlueHDi 100	75	05/18→						
1.5 BlueHDi 120	88	05/18→						
1.6 BlueHDi 100	73	01/15→						
1.6 BlueHDi 120	88	07/14→						
1.6 BlueHDi 75	55	01/15→						
1.6 HDi	68	03/13→						
1.6 HDi	84	03/13→						
1.6 HDi	85	07/14→						
1.6 VTi	88	03/13→						
PEUGEOT - 3008 Großraumlimousine (0U_) 06/09→12/16								
 Bremskraftverstärker								
1.2	96	01/15→				03.7860-3732.4	300306	ATE Ø 10" pneumatisch
1.6 BlueHDi 120	88	05/14→						
1.6 HDi	80	06/09→						
1.6 HDi 115 / BlueHDi 115	85	02/13→						
1.6 THP	110	06/09→						
1.6 THP	115	06/09→						
1.6 VTi	88	06/09→						
2.0 HDi	100	09/11→						
2.0 HDi	120	06/09→						
2.0 HDi 150 / BlueHDi 150	110	06/09→						
1.6 HDi	82	12/09→08/16		Orga 12621→; für Fahrzeuge ohne Start-Stopp-Funktion		03.7860-3732.4	300306	ATE Ø 10" pneumatisch
				→Orga 12620		03.7860-3732.4	300306	ATE Ø 10" pneumatisch
1.6 HDi	84	03/13→		für Fahrzeuge ohne Start-Stopp-Funktion		03.7860-3732.4	300306	ATE Ø 10" pneumatisch
 Hauptbremszylinder								
1.2	96	01/15→				03.4153-0173.3	010815	ATE Ø 23,81
1.6 BlueHDi 120	88	05/14→						
1.6 HDi	80	06/09→						
1.6 HDi	82	12/09→08/16						
1.6 HDi	84	03/13→						
1.6 HDi 115 / BlueHDi 115	85	02/13→						
↓								

	kw					! #		
PEUGEOT - 3008 Großraumlimousine (0U_) 06/09→12/16								
 Hauptbremszylinder								
1.6 THP	110	06/09→					03.4153-0173.3 010815	ATE Ø 23,81
1.6 THP	115	06/09→						
1.6 Turbo	121	05/14→						
1.6 VTi	88	06/09→						
2.0 HDi	100	09/11→						
2.0 HDi	120	06/09→						
2.0 HDi 150 / BlueHDi 150	110	06/09→						
2.0 HDi Hybrid4	120	02/11→						
PEUGEOT - 5008 (0U_, 0E_) 06/09→								
 Bremskraftverstärker								
1.2	96	01/15→					03.7860-3732.4 300306	ATE Ø 10" pneumatisch
1.6 16V	88	09/09→						
1.6 16V	115	09/09→						
1.6 HDi	80	09/09→						
1.6 THP 150	110	02/12→						
1.6 THP 163	120	02/12→						
1.6 THP 165	121	02/12→						
2.0 HDi	120	09/09→						
2.0 HDi 136 / BlueHDi 136	100	02/12→						
1.6 BlueHDi 120	88	05/14→03/17			für Fahrzeuge ohne Start-Stopp-Funktion		03.7860-3732.4 300306	ATE Ø 10" pneumatisch
1.6 HDi	84	03/13→						
1.6 HDi	82	08/10→			Orga 12656→; für Fahrzeuge ohne Start-Stopp-Funktion		03.7860-3732.4 300306	ATE Ø 10" pneumatisch
					→Orga 12655		03.7860-3732.4 300306	ATE Ø 10" pneumatisch
2.0 HDi 150 / BlueHDi 150	110	06/09→			09/09→		03.7860-3732.4 300306	ATE Ø 10" pneumatisch
 Hauptbremszylinder								
1.2	96	01/15→					03.4153-0173.3 010815	ATE Ø 23,81
1.6 16V	88	09/09→						
1.6 16V	115	09/09→						
1.6 HDi	80	09/09→						
1.6 HDi	82	08/10→						
1.6 HDi	84	03/13→						
2.0 HDi	120	09/09→						
2.0 HDi 136 / BlueHDi 136	100	02/12→						
2.0 HDi 150 / BlueHDi 150	110	06/09→			09/09→		03.4153-0173.3 010815	ATE Ø 23,81
PEUGEOT - BOXER Bus 09/05→								
 Hauptbremszylinder								
2.2 HDi 100	74	04/06→			Nutzlast ab [kg] 1.600 Nutzlast bis [kg] 2.000; Nutzlast 16Q/20Q; + DSC		24.4125-1701.3 010867	BOS Ø 25,4 ohne Bremsflüssigkeitsbehälter
2.2 HDi 110	81	03/11→						
2.2 HDi 120	88	04/06→						
2.2 HDi 130	96	03/11→			Nutzlast ab [kg] 1.200 Nutzlast bis [kg] 1.400; Nutzlast 12Q/14Q; - DSC		24.4125-1702.3 010872	BOS Ø 25,4 ohne Bremsflüssigkeitsbehälter
2.2 HDi 150	110	03/11→						
3.0 HDi 145	107	04/10→						
3.0 HDi 160	116	04/06→			Nutzlast ab [kg] 1.200 Nutzlast bis [kg] 1.400; Nutzlast 12Q/14Q; + DSC		24.4126-1701.3 010868	BOS Ø 26,99 ohne Bremsflüssigkeitsbehälter
3.0 HDi 175	130	03/11→			Nutzlast ab [kg] 1.600 Nutzlast bis [kg] 2.000; Nutzlast 16Q/20Q; - DSC		24.4126-1702.3 010875	BOS Ø 26,99 ohne Bremsflüssigkeitsbehälter
PEUGEOT - BOXER Bus (230P) 03/94→04/02								
 Hauptbremszylinder								
1.9 D	51	03/94→04/02			→ S 15064995; Nutzlast [kg]: 1.000; + ABS		24.2122-1714.3 010480	Ø 22,2
					→ S 15064995; Nutzlast [kg]: 1.000; für Linkslenker; - ABS		24.2122-1715.3 010481	Ø 22,2
					S 15064996→ S 16206253; Nutzlast [kg]: 1.000; + ABS		24.2125-1702.3 010482	Ø 25,4
					S 15064996→ S 16205754; Nutzlast [kg]: 1.000; für Linkslenker; - ABS		24.2125-1703.3 010483	Ø 25,4
					S 16205755→; → 03/02; Nutzlast [kg]: 1.000; - ABS		24.2125-1725.3 010717	Ø 25,4
					S 16206254→; → 03/02; Nutzlast [kg]: 1.000; + ABS		24.2125-1726.3 010718	Ø 25,4
1.9 TD	66	08/94→04/02			→ S 15064995; Nutzlast ab [kg] 1.000		24.2122-1714.3 010480	Ø 22,2
1.9 TD	68	03/94→04/02			Nutzlast bis [kg] 1.400; + ABS			
1.9 TD 4x4	68	07/96→04/02			→ S 15064995; Nutzlast ab [kg] 1.000 Nutzlast bis [kg] 1.400; - ABS; für Linkslenker		24.2122-1715.3 010481	Ø 22,2
↓								

	kw			 	! #		
PEUGEOT - BOXER Bus (230P) 03/94→04/02							
 Hauptbremszylinder							
1.9 TD	66	08/94→04/02		S 15064996→ S 16206253; Nutzlast ab [kg] 1.000 Nutzlast bis [kg] 1.400; + ABS		24.2125-1702.3 010482	Ø 25,4
1.9 TD	68	03/94→04/02					
1.9 TD 4x4	68	07/96→04/02		S 15064996→ S 16205754; Nutzlast ab [kg] 1.000 Nutzlast bis [kg] 1.400; für Linkslenker; - ABS		24.2125-1703.3 010483	Ø 25,4
				S 16205755→; → 03/02; Nutzlast ab [kg] 1.000 Nutzlast bis [kg] 1.400; - ABS		24.2125-1725.3 010717	Ø 25,4
				S 16206254→; → 03/02; Nutzlast ab [kg] 1.000 Nutzlast bis [kg] 1.400; + ABS		24.2125-1726.3 010718	Ø 25,4
2.0 i	80	03/94→04/02		→ S 15064995; Nutzlast ab [kg] 1.000 Nutzlast bis [kg] 1.400; + ABS		24.2122-1714.3 010480	Ø 22,2
2.0 i 4x4	80	08/96→04/02					
				→ S 15064995; Nutzlast ab [kg] 1.000 Nutzlast bis [kg] 1.400; - ABS; für Linkslenker		24.2122-1715.3 010481	Ø 22,2
				S 15064996→ S 16206253; Nutzlast ab [kg] 1.000 Nutzlast bis [kg] 1.400; + ABS		24.2125-1702.3 010482	Ø 25,4
				→ S 16194399; Nutzlast [kg]: 1.800; + ABS		24.2125-1702.3 010482	Ø 25,4
				→ S 16205352; Nutzlast [kg]: 1.800; für Linkslenker; - ABS		24.2125-1703.3 010483	Ø 25,4
				S 15064996→ S 16205754; Nutzlast ab [kg] 1.000 Nutzlast bis [kg] 1.400; für Linkslenker; - ABS		24.2125-1703.3 010483	Ø 25,4
				S 16205755→; → 03/02; Nutzlast ab [kg] 1.000 Nutzlast bis [kg] 1.400; - ABS		24.2125-1725.3 010717	Ø 25,4
				S 16205353→; → 03/02; Nutzlast [kg]: 1.800; - ABS		24.2125-1725.3 010717	Ø 25,4
				S 16206254→; → 03/02; Nutzlast ab [kg] 1.000 Nutzlast bis [kg] 1.400; + ABS		24.2125-1726.3 010718	Ø 25,4
				S 16194400→; → 03/02; Nutzlast [kg]: 1.800; + ABS		24.2125-1726.3 010718	Ø 25,4
2.5 D	63	08/94→04/02		→ S 15064995; Nutzlast [kg]: 1.400; + ABS		24.2122-1714.3 010480	Ø 22,2
2.5 D 4x4	63	07/96→04/02					
				→ S 15064995; Nutzlast [kg]: 1.400; für Linkslenker; - ABS		24.2122-1715.3 010481	Ø 22,2
				S 15064996→ S 16206253; Nutzlast [kg]: 1.400; + ABS		24.2125-1702.3 010482	Ø 25,4
				→ S 16194399; Nutzlast [kg]: 1.800; + ABS		24.2125-1702.3 010482	Ø 25,4
				S 15064996→ S 16205754; Nutzlast [kg]: 1.400; für Linkslenker; + ABS		24.2125-1703.3 010483	Ø 25,4
				→ S 16205352; Nutzlast [kg]: 1.800; für Linkslenker; - ABS		24.2125-1703.3 010483	Ø 25,4
				S 16205755→; → 03/02; Nutzlast [kg]: 1.400; + ABS		24.2125-1725.3 010717	Ø 25,4
				S 16205353→; → 03/02; Nutzlast [kg]: 1.800; - ABS		24.2125-1725.3 010717	Ø 25,4
				S 16194400→; → 03/02; Nutzlast [kg]: 1.800; + ABS		24.2125-1726.3 010718	Ø 25,4
				S 16206254→; → 03/02; Nutzlast [kg]: 1.400; + ABS		24.2125-1726.3 010718	Ø 25,4
2.5 TD	76	07/94→04/02		08/94→; → S 15064995; Nutzlast [kg]: 1.400; + ABS		24.2122-1714.3 010480	Ø 22,2
				08/94→; → S 15064995; Nutzlast [kg]: 1.400; für Linkslenker; - ABS		24.2122-1715.3 010481	Ø 22,2
				S 15064996→ S 16206253; Nutzlast [kg]: 1.400; + ABS		24.2125-1702.3 010482	Ø 25,4
				08/94→; → S 16194399; Nutzlast [kg]: 1.800; + ABS		24.2125-1702.3 010482	Ø 25,4
				S 15064996→ S 16205754; Nutzlast [kg]: 1.400; für Linkslenker; - ABS		24.2125-1703.3 010483	Ø 25,4
				08/94→; → S 16205352; Nutzlast [kg]: 1.800; für Linkslenker; - ABS		24.2125-1703.3 010483	Ø 25,4
				S 16205353→; → 03/02; Nutzlast [kg]: 1.800; - ABS		24.2125-1725.3 010717	Ø 25,4
				S 16205755→; → 03/02; Nutzlast [kg]: 1.400; - ABS		24.2125-1725.3 010717	Ø 25,4
				S 16206254→; → 03/02; Nutzlast [kg]: 1.400; + ABS		24.2125-1726.3 010718	Ø 25,4
				S 16194400→; → 03/02; Nutzlast [kg]: 1.800; + ABS		24.2125-1726.3 010718	Ø 25,4
↓							

	kw			 	! #		
PEUGEOT - BOXER Bus (230P) 03/94→04/02							
 Hauptbremszylinder							
2.5 TD 4x4	76	07/96→04/02		→ S 15064995; Nutzlast [kg]: 1.400; + ABS	24.2122-1714.3	010480	Ø 22,2
				→ S 15064995; Nutzlast [kg]: 1.400; für Linkslenker; - ABS	24.2122-1715.3	010481	Ø 22,2
				→ S 16194399; Nutzlast [kg]: 1.800; + ABS	24.2125-1702.3	010482	Ø 25,4
				S 15064996→ S 16206253; Nutzlast [kg]: 1.400; + ABS	24.2125-1702.3	010482	Ø 25,4
				S 15064996→ S 16205754; Nutzlast [kg]: 1.400; für Linkslenker; - ABS	24.2125-1703.3	010483	Ø 25,4
				→ S 16205352; Nutzlast [kg]: 1.800; für Linkslenker; - ABS	24.2125-1703.3	010483	Ø 25,4
				S 16205353→; → 03/02; Nutzlast [kg]: 1.800; - ABS	24.2125-1725.3	010717	Ø 25,4
				S 16205755→; → 03/02; Nutzlast [kg]: 1.400; - ABS	24.2125-1725.3	010717	Ø 25,4
				S 16206254→; → 03/02; Nutzlast [kg]: 1.400; + ABS	24.2125-1726.3	010718	Ø 25,4
				S 16194400→; → 03/02; Nutzlast [kg]: 1.800; + ABS	24.2125-1726.3	010718	Ø 25,4
2.5 TDI 2.5 TDI 4x4	79 79	01/97→04/02 01/97→04/02		→ S 16206253; Nutzlast [kg]: 1.400; + ABS	24.2125-1702.3	010482	Ø 25,4
				→ S 16194399; Nutzlast [kg]: 1.800; + ABS	24.2125-1702.3	010482	Ø 25,4
				S 15064996→ S 16205754; Nutzlast [kg]: 1.400; für Linkslenker; - ABS	24.2125-1703.3	010483	Ø 25,4
				→ S 16205352; Nutzlast [kg]: 1.800; für Linkslenker; - ABS	24.2125-1703.3	010483	Ø 25,4
				S 16205755→; → 03/02; Nutzlast [kg]: 1.400; - ABS	24.2125-1725.3	010717	Ø 25,4
				S 16205353→; → 03/02; Nutzlast [kg]: 1.800; - ABS	24.2125-1725.3	010717	Ø 25,4
				S 16206254→; → 03/02; Nutzlast [kg]: 1.400; + ABS	24.2125-1726.3	010718	Ø 25,4
				S 16194400→; → 03/02; Nutzlast [kg]: 1.800; + ABS	24.2125-1726.3	010718	Ø 25,4
2.8 D	64	01/99→02/02		→ S 15064995; Nutzlast [kg]: 1.400; + ABS	24.2122-1714.3	010480	Ø 22,2
				→ S 15064995; Nutzlast [kg]: 1.400; für Linkslenker; - ABS	24.2122-1715.3	010481	Ø 22,2
				S 15064995→ S 16206253; Nutzlast [kg]: 1.400; + ABS	24.2125-1702.3	010482	Ø 25,4
				→ S 16194399; Nutzlast [kg]: 1.800; + ABS	24.2125-1702.3	010482	Ø 25,4
				→ S 16205352; Nutzlast [kg]: 1.800; für Linkslenker; - ABS	24.2125-1703.3	010483	Ø 25,4
				S 15064996→ S 16205754; Nutzlast [kg]: 1.400; für Linkslenker; - ABS	24.2125-1703.3	010483	Ø 25,4
				S 16205755→; Nutzlast [kg]: 1.400; - ABS	24.2125-1725.3	010717	Ø 25,4
				S 16205353→; Nutzlast [kg]: 1.800; - ABS	24.2125-1725.3	010717	Ø 25,4
				S 16206254→; Nutzlast [kg]: 1.400; + ABS	24.2125-1726.3	010718	Ø 25,4
				S 16194400→; Nutzlast [kg]: 1.800; + ABS	24.2125-1726.3	010718	Ø 25,4
2.8 HDI	94	11/00→04/02		→ S 16194399; Nutzlast [kg]: 1.800; + ABS	24.2125-1702.3	010482	Ø 25,4
				→ S 16206253; Nutzlast [kg]: 1.400; + ABS	24.2125-1702.3	010482	Ø 25,4
				→ S 16205754; Nutzlast [kg]: 1.400; für Linkslenker; - ABS	24.2125-1703.3	010483	Ø 25,4
				→ S 16205352; Nutzlast [kg]: 1.800; für Linkslenker; - ABS	24.2125-1703.3	010483	Ø 25,4
				S 16205755→; → 03/02; Nutzlast [kg]: 1.400; - ABS	24.2125-1725.3	010717	Ø 25,4
				S 16205353→; → 03/02; Nutzlast [kg]: 1.800; - ABS	24.2125-1725.3	010717	Ø 25,4
				S 16206254→; → 03/02; Nutzlast [kg]: 1.400; + ABS	24.2125-1726.3	010718	Ø 25,4
				S 16194400→; → 03/02; Nutzlast [kg]: 1.800; + ABS	24.2125-1726.3	010718	Ø 25,4
↓							

PEUGEOT - BOXER Bus (230P) 03/94→04/02

Hauptbremszylinder

2.8 HDi 4x4	94	10/00→04/02		→ S 15064995; Nutzlast ab [kg] 1.000 Nutzlast bis [kg] 1.400; + ABS	24.2122-1714.3	010480	Ø 22,2
				→ S 15064995; Nutzlast ab [kg] 1.000 Nutzlast bis [kg] 1.400; - ABS; für Linkslenker	24.2122-1715.3	010481	Ø 22,2
				→ S 16194399; Nutzlast [kg]: 1.800; + ABS	24.2125-1702.3	010482	Ø 25,4
				S 15064995→ S 16206253; Nutzlast ab [kg] 1.000 Nutzlast bis [kg] 1.400; + ABS	24.2125-1702.3	010482	Ø 25,4
				→ S 16205352; Nutzlast [kg]: 1.800; für Linkslenker; - ABS	24.2125-1703.3	010483	Ø 25,4
				S 15064996→ S 16205754; Nutzlast ab [kg] 1.000 Nutzlast bis [kg] 1.400; für Linkslenker; - ABS	24.2125-1703.3	010483	Ø 25,4
				S 16205755→; → 03/02; Nutzlast ab [kg] 1.000 Nutzlast bis [kg] 1.400; - ABS	24.2125-1725.3	010717	Ø 25,4
				S 16205353→; → 03/02; Nutzlast [kg]: 1.800; - ABS	24.2125-1725.3	010717	Ø 25,4
				S 16206254→; → 03/02; Nutzlast ab [kg] 1.000 Nutzlast bis [kg] 1.400; + ABS	24.2125-1726.3	010718	Ø 25,4
				S 16194400→; → 03/02; Nutzlast [kg]: 1.800; + ABS	24.2125-1726.3	010718	Ø 25,4

Bremskraftregler

1.9 D	51	03/94→04/02		→ S 16206244; Nutzlast [kg]: 1.000; - ABS	24.6512-1701.3	320153	lastabhängig 2x
1.9 TD	66	08/94→04/02		→ S 16206244; Nutzlast ab [kg] 1.000 Nutzlast bis [kg] 1.400; - ABS	24.6512-1701.3	320153	lastabhängig 2x
1.9 TD	68	03/94→04/02					
1.9 TD 4x4	68	07/96→04/02					
2.0 i	80	03/94→04/02		→ S 16206244; Nutzlast ab [kg] 1.000 Nutzlast bis [kg] 1.800; - ABS	24.6512-1701.3	320153	lastabhängig 2x
2.0 i 4x4	80	08/96→04/02					
2.5 TD	76	07/94→04/02		08/94→; → S 16206244; Nutzlast ab [kg] 1.400 Nutzlast bis [kg] 1.800; - ABS	24.6512-1701.3	320153	lastabhängig 2x
2.5 TD 4x4	76	07/96→04/02		→ S 16206244; Nutzlast ab [kg] 1.400 Nutzlast bis [kg] 1.800; - ABS	24.6512-1701.3	320153	lastabhängig 2x
2.5 TDI	79	01/97→04/02					
2.5 TDI 4x4	79	01/97→04/02					
2.8 D	64	01/99→02/02					
2.8 HDI	94	11/00→04/02					
2.8 HDi	93	10/00→11/01		11/00→; → S 16206244; Nutzlast ab [kg] 1.400 Nutzlast bis [kg] 1.800; - ABS	24.6512-1701.3	320153	lastabhängig 2x

PEUGEOT - BOXER Bus (244, Z_) 12/01→

Hauptbremszylinder

2.0	81	04/02→		→ 03/06; Nutzlast ab [kg] 1.000 Nutzlast bis [kg] 1.800; - ABS	24.2125-1725.3	010717	Ø 25,4
2.0 HDi	62	04/02→					
2.2 HDi	74	04/02→		→ 03/06; Nutzlast ab [kg] 1.000 Nutzlast bis [kg] 1.800; + ABS	24.2125-1726.3	010718	Ø 25,4
2.8 HDi	94	04/02→					
2.8 HDi	107	04/04→					
2.8 HDi 4x4	94	04/02→					

Bremskraftregler

2.8 HDi 4x4	94	04/02→		→ 03/06; Nutzlast ab [kg] 1.000 Nutzlast bis [kg] 1.800; - ABS	24.6512-1701.3	320153	lastabhängig 2x
-------------	----	--------	--	-------------------------------------------------------------------	----------------	--------	-----------------

PEUGEOT - BOXER Kasten 04/06→

Hauptbremszylinder









2.2 HDi 100	74	04/06→		Nutzlast ab [kg] 1.600 Nutzlast bis [kg] 2.000; Nutzlast 16Q/20Q; + DSC	24.4125-1701.3	010867	BOS Ø 25,4 ohne Bremsflüssigkeitsbehälter
2.2 HDi 110	81	03/11→					
2.2 HDi 120	88	04/06→					
2.2 HDi 130	96	03/11→		Nutzlast ab [kg] 1.200 Nutzlast bis [kg] 1.400; Nutzlast 12Q/14Q; - DSC	24.4125-1702.3	010872	BOS Ø 25,4 ohne Bremsflüssigkeitsbehälter
2.2 HDi 150	110	03/11→					
3.0 HDi	115	07/06→		Nutzlast ab [kg] 1.200 Nutzlast bis [kg] 1.400; Nutzlast 12Q/14Q; + DSC	24.4126-1701.3	010868	BOS Ø 26,99 ohne Bremsflüssigkeitsbehälter
3.0 HDi 145	107	04/10→					
3.0 HDi 160	116	04/06→					
3.0 HDi 175	130	03/11→		Nutzlast ab [kg] 1.600 Nutzlast bis [kg] 2.000; Nutzlast 16Q/20Q; - DSC	24.4126-1702.3	010875	BOS Ø 26,99 ohne Bremsflüssigkeitsbehälter

PEUGEOT - BOXER Kasten (230L) 03/94→06/03

Hauptbremszylinder

1.9 D	50	07/99→04/02		→ S 16206253; Nutzlast [kg]: 1.000; + ABS	24.2125-1702.3	010482	Ø 25,4
				→ S 16205754; Nutzlast [kg]: 1.000; - ABS; für Linkslenker	24.2125-1703.3	010483	Ø 25,4
				S 16205755→; → 03/02; Nutzlast [kg]: 1.000; - ABS	24.2125-1725.3	010717	Ø 25,4



	kw			 	! #		
PEUGEOT - BOXER Kasten (230L) 03/94→06/03							
 Hauptbremszylinder							
1.9 D	50	07/99→04/02		S 16206254→; → 03/02; Nutzlast [kg]: 1.000; + ABS		24.2125-1726.3 010718	Ø 25,4
1.9 D	51	03/94→04/02		→ S 15064995; Nutzlast [kg]: 1.000; + ABS		24.2122-1714.3 010480	Ø 22,2
				→ S 15064995; Nutzlast [kg]: 1.000; - ABS; für Linkslenker		24.2122-1715.3 010481	Ø 22,2
				S 15064996→ S 16206253; Nutzlast [kg]: 1.000; + ABS		24.2125-1702.3 010482	Ø 25,4
				S 15064996→ S 16205754; Nutzlast [kg]: 1.000; - ABS; für Linkslenker		24.2125-1703.3 010483	Ø 25,4
				S 16205755→; → 03/02; Nutzlast [kg]: 1.000; - ABS		24.2125-1725.3 010717	Ø 25,4
				S 16206254→; → 03/02; Nutzlast [kg]: 1.000; + ABS		24.2125-1726.3 010718	Ø 25,4
1.9 TD	66	07/99→04/02		→ S 16206253; Nutzlast ab [kg] 1.000 Nutzlast bis [kg] 1.400; + ABS		24.2125-1702.3 010482	Ø 25,4
				→ S 16205754; Nutzlast ab [kg] 1.000 Nutzlast bis [kg] 1.400; - ABS; für Linkslenker		24.2125-1703.3 010483	Ø 25,4
				S 16205755→; → 03/02; Nutzlast ab [kg] 1.000 Nutzlast bis [kg] 1.400; - ABS		24.2125-1725.3 010717	Ø 25,4
				S 16206254→; → 03/02; Nutzlast ab [kg] 1.000 Nutzlast bis [kg] 1.400; + ABS		24.2125-1726.3 010718	Ø 25,4
1.9 TD	68	03/94→04/02		→ S 15064995; Nutzlast ab [kg] 1.000 Nutzlast bis [kg] 1.400; + ABS		24.2122-1714.3 010480	Ø 22,2
				→ S 15064995; Nutzlast ab [kg] 1.000 Nutzlast bis [kg] 1.400; - ABS; für Linkslenker		24.2122-1715.3 010481	Ø 22,2
				S 15064996→ S 16206253; Nutzlast ab [kg] 1.000 Nutzlast bis [kg] 1.400; + ABS		24.2125-1702.3 010482	Ø 25,4
				S 15064996→ S 16205754; Nutzlast ab [kg] 1.000 Nutzlast bis [kg] 1.400; - ABS; für Linkslenker		24.2125-1703.3 010483	Ø 25,4
				S 16205755→; → 03/02; Nutzlast ab [kg] 1.000 Nutzlast bis [kg] 1.400; - ABS		24.2125-1725.3 010717	Ø 25,4
				S 16206254→; → 03/02; Nutzlast ab [kg] 1.000 Nutzlast bis [kg] 1.400; + ABS		24.2125-1726.3 010718	Ø 25,4
2.0 HDI	62	08/01→04/02		→ 03/02; Nutzlast ab [kg] 1.000 Nutzlast bis [kg] 1.800; - ABS		24.2125-1725.3 010717	Ø 25,4
				→ 03/02; Nutzlast ab [kg] 1.000 Nutzlast bis [kg] 1.800; + ABS		24.2125-1726.3 010718	Ø 25,4
2.0 i	80	06/94→04/02		→ S 15064995; Nutzlast ab [kg] 1.000 Nutzlast bis [kg] 1.400; + ABS		24.2122-1714.3 010480	Ø 22,2
				→ S 15064995; Nutzlast ab [kg] 1.000 Nutzlast bis [kg] 1.400; - ABS; für Linkslenker		24.2122-1715.3 010481	Ø 22,2
				S 15064996→ S 16206253; Nutzlast ab [kg] 1.000 Nutzlast bis [kg] 1.400; + ABS		24.2125-1702.3 010482	Ø 25,4
				→ S 16194399; Nutzlast [kg]: 1.800; + ABS		24.2125-1702.3 010482	Ø 25,4
				→ S 16205352; Nutzlast [kg]: 1.800; - ABS; für Linkslenker		24.2125-1703.3 010483	Ø 25,4
				S 15064996→ S 16205754; Nutzlast ab [kg] 1.000 Nutzlast bis [kg] 1.400; - ABS; für Linkslenker		24.2125-1703.3 010483	Ø 25,4
				S 16205755→; → 03/02; Nutzlast ab [kg] 1.000 Nutzlast bis [kg] 1.400; - ABS		24.2125-1725.3 010717	Ø 25,4
				S 16205353→; → 03/02; Nutzlast [kg]: 1.800; - ABS		24.2125-1725.3 010717	Ø 25,4
				S 16206254→; → 03/02; Nutzlast ab [kg] 1.000 Nutzlast bis [kg] 1.400; + ABS		24.2125-1726.3 010718	Ø 25,4
				S 16194400→; → 03/02; Nutzlast [kg]: 1.800; + ABS		24.2125-1726.3 010718	Ø 25,4
2.5 D 2.5 D 4x4 2.5 TD	63	03/94→04/02		→ S 15064995; Nutzlast [kg]: 1.400; + ABS		24.2122-1714.3 010480	Ø 22,2
	63	07/99→04/02		→ S 15064995; Nutzlast [kg]: 1.400; - ABS; für Linkslenker		24.2122-1715.3 010481	Ø 22,2
	76	03/94→04/02		→ S 16194399; Nutzlast [kg]: 1.800; + ABS		24.2125-1702.3 010482	Ø 25,4
			S 15064996→ S 16206253; Nutzlast [kg]: 1.400; + ABS		24.2125-1702.3 010482	Ø 25,4	
			S 15064996→ S 16205754; Nutzlast [kg]: 1.400; - ABS; für Linkslenker		24.2125-1703.3 010483	Ø 25,4	
↓							

PEUGEOT - BOXER Kasten (230L) 03/94→06/03

Hauptbremszylinder

2.5 D 2.5 D 4x4 2.5 TD	63	03/94→04/02	→ S 16205352; Nutzlast [kg]: 1.800; - ABS; für Linkslenker	24.2125-1703.3	010483	Ø 25,4
	63	07/99→04/02				
	76	03/94→04/02	S 16205353→; → 03/02; Nutzlast [kg]: 1.800; - ABS	24.2125-1725.3	010717	Ø 25,4
			S 16205755→; → 03/02; Nutzlast [kg]: 1.400; - ABS	24.2125-1725.3	010717	Ø 25,4
			S 16206254→; → 03/02; Nutzlast [kg]: 1.400; + ABS	24.2125-1726.3	010718	Ø 25,4
		S 16194400→; → 03/02; Nutzlast [kg]: 1.800; + ABS	24.2125-1726.3	010718	Ø 25,4	
2.5 TDI 2.5 TDI 4x4 2.8 HDI	79	01/97→04/02	→ S 16194399; Nutzlast [kg]: 1.800; + ABS	24.2125-1702.3	010482	Ø 25,4
	79	07/99→04/02				
	94	11/00→04/02	→ S 16206253; Nutzlast [kg]: 1.400; + ABS	24.2125-1702.3	010482	Ø 25,4
			→ S 16205754; Nutzlast [kg]: 1.400; - ABS; für Linkslenker	24.2125-1703.3	010483	Ø 25,4
			→ S 16205352; Nutzlast [kg]: 1.800; - ABS; für Linkslenker	24.2125-1703.3	010483	Ø 25,4
			S 16205755→; → 03/02; Nutzlast [kg]: 1.400; - ABS	24.2125-1725.3	010717	Ø 25,4
			S 16205353→; → 03/02; Nutzlast [kg]: 1.800; - ABS	24.2125-1725.3	010717	Ø 25,4
		S 16206254→; → 03/02; Nutzlast [kg]: 1.400; + ABS	24.2125-1726.3	010718	Ø 25,4	
		S 16194400→; → 03/02; Nutzlast [kg]: 1.800; + ABS	24.2125-1726.3	010718	Ø 25,4	
2.8 D	64	01/99→02/02	→ S 15064995; Nutzlast [kg]: 1.400; + ABS	24.2122-1714.3	010480	Ø 22,2
			→ S 15064995; Nutzlast [kg]: 1.400; - ABS; für Linkslenker	24.2122-1715.3	010481	Ø 22,2
			→ S 16194399; Nutzlast [kg]: 1.800; + ABS	24.2125-1702.3	010482	Ø 25,4
			S 15064996→ S 16206253; Nutzlast [kg]: 1.400; + ABS	24.2125-1702.3	010482	Ø 25,4
			→ S 16205352; Nutzlast [kg]: 1.800; - ABS; für Linkslenker	24.2125-1703.3	010483	Ø 25,4
			S 15064996→ S 16205754; Nutzlast [kg]: 1.400; - ABS; für Linkslenker	24.2125-1703.3	010483	Ø 25,4
			S 16205755→; Nutzlast [kg]: 1.400; - ABS	24.2125-1725.3	010717	Ø 25,4
			S 16205353→; Nutzlast [kg]: 1.800; - ABS	24.2125-1725.3	010717	Ø 25,4
			S 16206254→; Nutzlast [kg]: 1.400; + ABS	24.2125-1726.3	010718	Ø 25,4
S 16194400→; Nutzlast [kg]: 1.800; + ABS	24.2125-1726.3	010718	Ø 25,4			













Bremskraftregler

1.9 D	50	07/99→04/02	→ S 16206244; Nutzlast [kg]: 1.000; - ABS	24.6512-1701.3	320153	lastabhängig 2x
	51	03/94→04/02				
1.9 TD	66	07/99→04/02	→ S 16206244; Nutzlast ab [kg] 1.000 Nutzlast bis [kg] 1.400; - ABS	24.6512-1701.3	320153	lastabhängig 2x
	68	03/94→04/02				
2.0 HDI	62	08/01→04/02	→ S 16206244; Nutzlast ab [kg] 1.000 Nutzlast bis [kg] 1.800; - ABS	24.6512-1701.3	320153	lastabhängig 2x
	80	06/94→04/02				
2.5 D 2.5 D 4x4 2.5 TD 2.5 TDI 2.5 TDI 4x4 2.8 D 2.8 HDI	63	03/94→04/02	→ S 16206244; Nutzlast ab [kg] 1.400 Nutzlast bis [kg] 1.800; - ABS	24.6512-1701.3	320153	lastabhängig 2x
	63	07/99→04/02				
	76	03/94→04/02				
	79	01/97→04/02				
	79	07/99→04/02				
	64	01/99→02/02				
	94	11/00→04/02				
	93	10/00→11/01	11/00→; → S 16206244; Nutzlast ab [kg] 1.400 Nutzlast bis [kg] 1.800; - ABS	24.6512-1701.3	320153	lastabhängig 2x

PEUGEOT - BOXER Kasten (244) 12/01→

Hauptbremszylinder

2.0 2.0 HDi	81	04/02→	→ 03/06; Nutzlast ab [kg] 1.000 Nutzlast bis [kg] 1.800; - ABS	24.2125-1725.3	010717	Ø 25,4
	62	04/02→				
2.2 HDi 2.8 HDi 2.8 HDi 2.8 HDi 4x4 ↓	74	04/02→	→ 03/06; Nutzlast ab [kg] 1.000 Nutzlast bis [kg] 1.800; + ABS	24.2125-1726.3	010718	Ø 25,4
	94	04/02→				
	107	04/04→				
	94	04/02→				

	kw					! #		
PEUGEOT - BOXER Kasten (244) 12/01→								
 Bremskraftregler								
2.8 HDi 4x4	94	04/02→			→ 03/06; Nutzlast ab [kg] 1.000 Nutzlast bis [kg] 1.800; - ABS		24.6512-1701.3 320153	lastabhängig 2x
PEUGEOT - BOXER Pritsche/Fahrgestell 04/06→								
 Hauptbremszylinder								
2.2 HDi 100	74	04/06→			Nutzlast ab [kg] 1.600 Nutzlast bis [kg] 2.000; Nutzlast 16Q/20Q; + DSC		24.4125-1701.3 010867	BOS Ø 25,4 ohne Bremsflüssigkeitsbehälter
2.2 HDi 110	81	03/11→						
2.2 HDi 120	88	04/06→			Nutzlast ab [kg] 1.200 Nutzlast bis [kg] 1.400; Nutzlast 12Q/14Q; - DSC		24.4125-1702.3 010872	BOS Ø 25,4 ohne Bremsflüssigkeitsbehälter
2.2 HDi 130	96	03/11→						
2.2 HDi 150	110	03/11→						
3.0 HDi 145	107	04/10→			Nutzlast ab [kg] 1.200 Nutzlast bis [kg] 1.400; Nutzlast 12Q/14Q; + DSC		24.4126-1701.3 010868	BOS Ø 26,99 ohne Bremsflüssigkeitsbehälter
3.0 HDi 160	116	04/06→						
3.0 HDi 175	130	03/11→			Nutzlast ab [kg] 1.600 Nutzlast bis [kg] 2.000; Nutzlast 16Q/20Q; - DSC		24.4126-1702.3 010875	BOS Ø 26,99 ohne Bremsflüssigkeitsbehälter
PEUGEOT - BOXER Pritsche/Fahrgestell (244) 12/01→								
 Hauptbremszylinder								
2.0 HDi	62	04/02→			→ 03/06; Nutzlast ab [kg] 1.000 Nutzlast bis [kg] 1.800; - ABS		24.2125-1725.3 010717	Ø 25,4
2.2 HDi	74	04/02→						
2.8 HDi	94	04/02→						
2.8 HDi	107	04/04→			→ 03/06; Nutzlast ab [kg] 1.000 Nutzlast bis [kg] 1.800; + ABS		24.2125-1726.3 010718	Ø 25,4
2.8 HDi 4x4	94	04/02→						
 Bremskraftregler								
2.8 HDi 4x4	94	04/02→			→ 03/06; Nutzlast ab [kg] 1.000 Nutzlast bis [kg] 1.800; - ABS		24.6512-1701.3 320153	lastabhängig 2x
PEUGEOT - BOXER Pritsche/Fahrgestell (ZCT_) 03/94→04/02								
 Hauptbremszylinder								
1.9 TD	66	06/94→04/02			12/98→; → S 16206253; Nutzlast ab [kg] 1.000 Nutzlast bis [kg] 1.400; + ABS		24.2125-1702.3 010482	Ø 25,4
					12/98→; → S 16205754; Nutzlast ab [kg] 1.000 Nutzlast bis [kg] 1.400; - ABS; für Linkslenker		24.2125-1703.3 010483	Ø 25,4
					S 16205755→; → 03/02; Nutzlast ab [kg] 1.000 Nutzlast bis [kg] 1.400; - ABS		24.2125-1725.3 010717	Ø 25,4
					S 16206254→; → 03/02; Nutzlast ab [kg] 1.000 Nutzlast bis [kg] 1.400; + ABS		24.2125-1726.3 010718	Ø 25,4
1.9 TD	68	07/94→04/02			07/96→; → S 16206253; Nutzlast ab [kg] 1.000 Nutzlast bis [kg] 1.400; + ABS		24.2125-1702.3 010482	Ø 25,4
					07/96→; → S 16205754; Nutzlast ab [kg] 1.000 Nutzlast bis [kg] 1.400; - ABS; für Linkslenker		24.2125-1703.3 010483	Ø 25,4
					S 16205755→; → 03/02; Nutzlast ab [kg] 1.000 Nutzlast bis [kg] 1.400; - ABS		24.2125-1725.3 010717	Ø 25,4
					S 16206254→; → 03/02; Nutzlast ab [kg] 1.000 Nutzlast bis [kg] 1.400; + ABS		24.2125-1726.3 010718	Ø 25,4
2.0 i	80	06/94→04/02			→ S 15064995; Nutzlast ab [kg] 1.000 Nutzlast bis [kg] 1.400; + ABS		24.2122-1714.3 010480	Ø 22,2
					→ S 15064995; Nutzlast ab [kg] 1.000 Nutzlast bis [kg] 1.400; - ABS; für Linkslenker		24.2122-1715.3 010481	Ø 22,2
					S 15064996→ S 16206253; Nutzlast ab [kg] 1.000 Nutzlast bis [kg] 1.400; + ABS		24.2125-1702.3 010482	Ø 25,4
					→ S 16194399; Nutzlast [kg]: 1.800; + ABS		24.2125-1702.3 010482	Ø 25,4
					→ S 16205352; Nutzlast [kg]: 1.800; - ABS; für Linkslenker		24.2125-1703.3 010483	Ø 25,4
					S 15064996→ S 16205754; Nutzlast ab [kg] 1.000 Nutzlast bis [kg] 1.400; - ABS; für Linkslenker		24.2125-1703.3 010483	Ø 25,4
					S 16205755→; → 03/02; Nutzlast ab [kg] 1.000 Nutzlast bis [kg] 1.400; - ABS		24.2125-1725.3 010717	Ø 25,4
					S 16205353→; → 03/02; Nutzlast [kg]: 1.800; - ABS		24.2125-1725.3 010717	Ø 25,4
					S 16206254→; → 03/02; Nutzlast ab [kg] 1.000 Nutzlast bis [kg] 1.400; + ABS		24.2125-1726.3 010718	Ø 25,4
2.5 D 2.5 D 4x4 2.5 TD	63	03/94→04/02			→ S 15064995; Nutzlast [kg]: 1.400; + ABS		24.2122-1714.3 010480	Ø 22,2
	63	07/99→04/02						
	76	03/94→04/02			→ S 15064995; Nutzlast [kg]: 1.400; - ABS; für Linkslenker		24.2122-1715.3 010481	Ø 22,2

PEUGEOT - BOXER Pritsche/Fahrgestell (ZCT_) 03/94 → 04/02

 **Hauptbremszylinder**

2.5 D 2.5 D 4x4 2.5 TD	63	03/94 → 04/02	→ S 16194399; Nutzlast [kg]: 1.800; + ABS	24.2125-1702.3	010482	Ø 25,4
	63	07/99 → 04/02				
	76	03/94 → 04/02	S 15064996 → S 16206253; Nutzlast [kg]: 1.400; + ABS	24.2125-1702.3	010482	Ø 25,4
			S 15064996 → S 16205754; Nutzlast [kg]: 1.400; - ABS; für Linkslenker	24.2125-1703.3	010483	Ø 25,4
			→ S 16205352; Nutzlast [kg]: 1.800; - ABS; für Linkslenker	24.2125-1703.3	010483	Ø 25,4
			S 16205353 →; → 03/02; Nutzlast [kg]: 1.800; - ABS	24.2125-1725.3	010717	Ø 25,4
			S 16205755 →; → 03/02; Nutzlast [kg]: 1.400; - ABS	24.2125-1725.3	010717	Ø 25,4
			S 16206254 →; → 03/02; Nutzlast [kg]: 1.400; + ABS	24.2125-1726.3	010718	Ø 25,4
		S 16194400 →; → 03/02; Nutzlast [kg]: 1.800; + ABS	24.2125-1726.3	010718	Ø 25,4	
2.5 TDI 2.5 TDI 4x4 2.8 HDI	79	01/97 → 04/02	→ S 16194399; Nutzlast [kg]: 1.800; + ABS	24.2125-1702.3	010482	Ø 25,4
	79	07/99 → 04/02				
	94	11/00 → 04/02	→ S 16206253; Nutzlast [kg]: 1.400; + ABS	24.2125-1702.3	010482	Ø 25,4
			→ S 16205754; Nutzlast [kg]: 1.400; - ABS; für Linkslenker	24.2125-1703.3	010483	Ø 25,4
			→ S 16205352; Nutzlast [kg]: 1.800; - ABS; für Linkslenker	24.2125-1703.3	010483	Ø 25,4
			S 16205755 →; → 03/02; Nutzlast [kg]: 1.400; - ABS	24.2125-1725.3	010717	Ø 25,4
			S 16205353 →; → 03/02; Nutzlast [kg]: 1.800; - ABS	24.2125-1725.3	010717	Ø 25,4
			S 16206254 →; → 03/02; Nutzlast [kg]: 1.400; + ABS	24.2125-1726.3	010718	Ø 25,4
		S 16194400 →; → 03/02; Nutzlast [kg]: 1.800; + ABS	24.2125-1726.3	010718	Ø 25,4	
2.8 D	64	01/99 → 02/02	→ S 15064995; Nutzlast [kg]: 1.400; + ABS	24.2122-1714.3	010480	Ø 22,2
			→ S 15064995; Nutzlast [kg]: 1.400; - ABS; für Linkslenker	24.2122-1715.3	010481	Ø 22,2
			S 15064995 → S 16206253; Nutzlast [kg]: 1.400; + ABS	24.2125-1702.3	010482	Ø 25,4
			→ S 16194399; Nutzlast [kg]: 1.800; + ABS	24.2125-1702.3	010482	Ø 25,4
			→ S 16205352; Nutzlast [kg]: 1.800; - ABS; für Linkslenker	24.2125-1703.3	010483	Ø 25,4
			S 15064996 → S 16205754; Nutzlast [kg]: 1.400; - ABS; für Linkslenker	24.2125-1703.3	010483	Ø 25,4
			S 16205755 →; Nutzlast [kg]: 1.400; - ABS	24.2125-1725.3	010717	Ø 25,4
			S 16205353 →; Nutzlast [kg]: 1.800; - ABS	24.2125-1725.3	010717	Ø 25,4
			S 16206254 →; Nutzlast [kg]: 1.400; + ABS	24.2125-1726.3	010718	Ø 25,4
			S 16194400 →; Nutzlast [kg]: 1.800; + ABS	24.2125-1726.3	010718	Ø 25,4













 **Bremskraftregler**

1.9 TD	66	06/94 → 04/02	12/98 →; → S 16206244; Nutzlast ab [kg] 1.000 Nutzlast bis [kg] 1.400; - ABS	24.6512-1701.3	320153	lastabhängig 2x
1.9 TD	68	07/94 → 04/02	07/96 →; → S 16206244; Nutzlast ab [kg] 1.000 Nutzlast bis [kg] 1.400; - ABS	24.6512-1701.3	320153	lastabhängig 2x
2.0 i	80	06/94 → 04/02	→ S 16206244; Nutzlast ab [kg] 1.000 Nutzlast bis [kg] 1.800; - ABS	24.6512-1701.3	320153	lastabhängig 2x
2.5 D 2.5 D 4x4 2.5 TD 2.5 TDI 2.5 TDI 4x4 2.8 D 2.8 HDI 2.8 HDi	63 63 76 79 79 64 94 93	03/94 → 04/02 07/99 → 04/02 03/94 → 04/02 01/97 → 04/02 07/99 → 04/02 01/99 → 02/02 11/00 → 04/02 10/00 → 11/01	→ S 16206244; Nutzlast ab [kg] 1.400 Nutzlast bis [kg] 1.800; - ABS	24.6512-1701.3	320153	lastabhängig 2x
			11/00 →; → S 16206244; Nutzlast ab [kg] 1.400 Nutzlast bis [kg] 1.800; - ABS	24.6512-1701.3	320153	lastabhängig 2x

PEUGEOT - EXPERT (224_) 10/95 → 12/06

 **Hauptbremszylinder**

1.6 ↓	58	02/96 → 09/00	→ Orga 08206; - ABS; Nutzlast [kg]: 800	24.2122-1703.3	010422	Ø 22,2
----------	----	---------------	-----------------------------------------	----------------	--------	--------

	kw			 	! #		
PEUGEOT - EXPERT (224_) 10/95→12/06							
 Hauptbremszylinder							
1.8	74	10/96→09/00		→Orga 08206; + ABS; Nutzlast [kg]: 800	24.2122-1708.3	010437	Ø 22,2
1.9 D	51	02/96→12/98		Orga 08207→; - ABS; Nutzlast [kg]: 800	24.2122-1741.3	010695	Ø 22,2
1.9 D	51	12/03→12/06					
1.9 TD	66	02/96→09/00		Orga 08207→; + ABS; Nutzlast [kg]: 800	24.2122-1742.3	010696	Ø 22,2
				→Orga 08206; - ABS; Nutzlast [kg]: 900	24.2123-1707.3	010492	Ø 23,81
				Orga 08207→; + ABS; Nutzlast [kg]: 900	24.2123-1733.3	010657	BOS Ø 23,81
				Orga 08207→; - ABS; Nutzlast [kg]: 900	24.2123-1738.3	010658	Ø 23,81
1.9 TD	68	02/96→05/98		04/96→; →Orga 08206; - ABS; Nutzlast [kg]: 800	24.2122-1703.3	010422	Ø 22,2
				04/96→; →Orga 08206; + ABS; Nutzlast [kg]: 800	24.2122-1708.3	010437	Ø 22,2
				Orga 08207→; - ABS; Nutzlast [kg]: 800	24.2122-1741.3	010695	Ø 22,2
				Orga 08207→; + ABS; Nutzlast [kg]: 800	24.2122-1742.3	010696	Ø 22,2
				04/96→; →Orga 08206; - ABS; Nutzlast [kg]: 900	24.2123-1707.3	010492	Ø 23,81
				Orga 08207→; + ABS; Nutzlast [kg]: 900	24.2123-1733.3	010657	BOS Ø 23,81
				Orga 08207→; - ABS; Nutzlast [kg]: 900	24.2123-1738.3	010658	Ø 23,81
2.0	100	07/00→12/06		+ ABS	24.2123-1733.3	010657	BOS Ø 23,81
2.0 HDi	69	10/00→10/06					
2.0 HDi	80	07/00→12/06		- ABS	24.2123-1738.3	010658	Ø 23,81
2.0 HDi 16V	80	07/00→12/06					
PEUGEOT - EXPERT Kasten (222) 07/95→12/06							
 Hauptbremszylinder							
1.6	58	02/96→09/00		→Orga 08206; - ABS; Nutzlast [kg]: 800	24.2122-1703.3	010422	Ø 22,2
1.8	74	10/96→09/00		→Orga 08206; + ABS; Nutzlast [kg]: 800	24.2122-1708.3	010437	Ø 22,2
1.9 D	51	02/96→12/98		Orga 08207→; - ABS; Nutzlast [kg]: 800	24.2122-1741.3	010695	Ø 22,2
1.9 D 70	51	12/98→12/06					
1.9 TD	66	02/96→09/00		Orga 08207→; + ABS; Nutzlast [kg]: 800	24.2122-1742.3	010696	Ø 22,2
				→Orga 08206; - ABS; Nutzlast [kg]: 900	24.2123-1707.3	010492	Ø 23,81
				Orga 08207→; + ABS; Nutzlast [kg]: 900	24.2123-1733.3	010657	BOS Ø 23,81
				Orga 08207→; - ABS; Nutzlast [kg]: 900	24.2123-1738.3	010658	Ø 23,81
1.9 TD	68	02/96→05/98		04/96→; →Orga 08206; - ABS; Nutzlast [kg]: 800	24.2122-1703.3	010422	Ø 22,2
				04/96→; →Orga 08206; + ABS; Nutzlast [kg]: 800	24.2122-1708.3	010437	Ø 22,2
				Orga 08207→; - ABS; Nutzlast [kg]: 800	24.2122-1741.3	010695	Ø 22,2
				Orga 08207→; + ABS; Nutzlast [kg]: 800	24.2122-1742.3	010696	Ø 22,2
				04/96→; →Orga 08206; - ABS; Nutzlast [kg]: 900	24.2123-1707.3	010492	Ø 23,81
				Orga 08207→; + ABS; Nutzlast [kg]: 900	24.2123-1733.3	010657	BOS Ø 23,81
				Orga 08207→; - ABS; Nutzlast [kg]: 900	24.2123-1738.3	010658	Ø 23,81
2.0	100	09/02→12/06		+ ABS	24.2123-1733.3	010657	BOS Ø 23,81
2.0 HDi	69	07/00→12/06					
2.0 HDi	80	07/00→12/06		- ABS	24.2123-1738.3	010658	Ø 23,81
PEUGEOT - EXPERT Kasten (VF3A_, VF3U_, VF3X_) 01/07→							
 Hauptbremszylinder							
1.6 HDi 90 16V	66	01/07→		für Linkslenker; - ESP	03.2125-0298.3	010818	ATE Ø 25,4
1.6 HDi 90 8V	66	01/07→		für Linkslenker; + ESP	03.2125-0671.3	010965	ATE Ø 25,4
2.0 16V	103	01/07→					
2.0 HDi 100	72	03/11→		für Rechtslenker; - ESP	24.2123-3396.3	011035	ATE Ø 23,81 ohne Bremsflüssigkeitsbehälter
2.0 HDi 120	88	01/07→					
2.0 HDi 130	94	03/11→					
2.0 HDi 140	100	01/07→					
2.0 HDi 165	120	09/09→					
PEUGEOT - EXPERT Pritsche/Fahrgestell 01/07→							
 Hauptbremszylinder							
1.6 HDi 90 16V	66	01/07→		für Linkslenker; - ESP	03.2125-0298.3	010818	ATE Ø 25,4
1.6 HDi 90 8V	66	01/07→		für Linkslenker; + ESP	03.2125-0671.3	010965	ATE Ø 25,4
2.0 HDi 120	88	01/07→					
2.0 HDi 130	94	03/11→		für Rechtslenker; - ESP	24.2123-3396.3	011035	ATE Ø 23,81 ohne Bremsflüssigkeitsbehälter
2.0 HDi 140	100	01/07→					
2.0 HDi 165	120	09/09→					
PEUGEOT - EXPERT Pritsche/Fahrgestell (223) 12/95→12/06							
 Hauptbremszylinder							
1.6	58	02/96→09/00		→Orga 08206; - ABS; Nutzlast [kg]: 800	24.2122-1703.3	010422	Ø 22,2
1.9 D	51	02/96→12/98		→Orga 08206; + ABS; Nutzlast [kg]: 800	24.2122-1708.3	010437	Ø 22,2
1.9 TD	66	02/96→09/00					
↓							

PEUGEOT - EXPERT Pritsche/Fahrgestell (223) 12/95→12/06

Hauptbremszylinder

1.6 1.9 D 1.9 TD	58	02/96→09/00		Orga 08207→; - ABS; Nutzlast [kg]: 800	24.2122-1741.3	010695	Ø 22,2
	51	02/96→12/98		Orga 08207→; + ABS; Nutzlast [kg]: 800	24.2122-1742.3	010696	Ø 22,2
	66	02/96→09/00		→Orga 08206; - ABS; Nutzlast [kg]: 900	24.2123-1707.3	010492	Ø 23,81
				Orga 08207→; + ABS; Nutzlast [kg]: 900	24.2123-1733.3	010657	BOS Ø 23,81
				Orga 08207→; - ABS; Nutzlast [kg]: 900	24.2123-1738.3	010658	Ø 23,81
1.9 TD	68	02/96→05/98		04/96→; →Orga 08206; - ABS; Nutzlast [kg]: 800	24.2122-1703.3	010422	Ø 22,2
				04/96→; →Orga 08206; + ABS; Nutzlast [kg]: 800	24.2122-1708.3	010437	Ø 22,2
				Orga 08207→; - ABS; Nutzlast [kg]: 800	24.2122-1741.3	010695	Ø 22,2
				Orga 08207→; + ABS; Nutzlast [kg]: 800	24.2122-1742.3	010696	Ø 22,2
				04/96→; →Orga 08206; - ABS; Nutzlast [kg]: 900	24.2123-1707.3	010492	Ø 23,81
				Orga 08207→; + ABS; Nutzlast [kg]: 900	24.2123-1733.3	010657	BOS Ø 23,81
				Orga 08207→; - ABS; Nutzlast [kg]: 900	24.2123-1738.3	010658	Ø 23,81

PEUGEOT - EXPERT Tepee (VF3X_) 01/07→

Hauptbremszylinder











1.6 HDi 90 16V 1.6 HDi 90 8V	66	01/07→		für Linkslenker; - ESP	03.2125-0298.3	010818	ATE Ø 25,4
	66	01/07→		für Linkslenker; + ESP	03.2125-0671.3	010965	ATE Ø 25,4
2.0 16V	103	01/07→					
2.0 HDi 100	72	03/11→		für Rechtslenker; - ESP	24.2123-3396.3	011035	ATE Ø 23,81
2.0 HDi 120	88	01/07→					ohne Bremsflüssigkeitsbehälter
2.0 HDi 120 4x4	88	01/07→					
2.0 HDi 130	94	03/11→					
2.0 HDi 140	100	01/07→					
2.0 HDi 165	120	09/09→					











PEUGEOT - PARTNER Combispace (5F) 05/96→12/15



















Hauptbremszylinder

1.1 1.9 D	44	06/96→10/02		Orga 08610→; - ABS	03.2123-2781.3	010631	ATE Ø 23,81
	50	06/96→12/02			24.2123-1714.3	010587	BDX Ø 23,81
				07/96→; →Orga 08609; - ABS	24.2123-1710.3	010504	Ø 23,81
				07/96→; →Orga 08609; + ABS; für Linkslenker	24.2123-1713.3	010505	Ø 23,81
1.4	55	06/96→12/15		Orga 08610→; → 03/08; - ABS	03.2123-2781.3	010631	ATE Ø 23,81
					24.2123-1714.3	010587	BDX Ø 23,81
				07/96→; →Orga 08609; - ABS	24.2123-1710.3	010504	Ø 23,81
				07/96→; →Orga 08609; + ABS; für Linkslenker	24.2123-1713.3	010505	Ø 23,81
1.6 16V 2.0 HDi 4x4	80	07/01→03/08		- ESP / - ABS	03.2123-2781.3	010631	ATE Ø 23,81
	66	04/04→08/05			24.2123-1714.3	010587	BDX Ø 23,81
				- ESP / + ABS	24.2123-1715.3	010520	BDX Ø 23,81
1.6 HDi 75	55	02/06→12/13		→ 03/08; - ABS	03.2123-2781.3	010631	ATE Ø 23,81
					24.2123-1714.3	010587	BDX Ø 23,81
				→ 03/08; + ABS	24.2123-1715.3	010520	BDX Ø 23,81
1.6 HDi 90	66	10/05→12/15		02/06→ 03/08; - ABS	03.2123-2781.3	010631	ATE Ø 23,81
					24.2123-1714.3	010587	BDX Ø 23,81
				02/06→ 03/08; + ABS	24.2123-1715.3	010520	BDX Ø 23,81
1.8	66	05/97→12/03		Orga 08610→; - ABS	03.2123-2781.3	010631	ATE Ø 23,81
					24.2123-1714.3	010587	BDX Ø 23,81
				→Orga 08609; - ABS	24.2123-1710.3	010504	Ø 23,81
				→Orga 08609; + ABS; für Linkslenker	24.2123-1713.3	010505	Ø 23,81
1.9 D	51	05/96→12/98		Orga 08610→; + ABS	24.2123-1715.3	010520	BDX Ø 23,81
				Orga 08610→; - ABS	03.2123-2781.3	010631	ATE Ø 23,81
					24.2123-1714.3	010587	BDX Ø 23,81
				12/98→; →Orga 08609; - ABS	24.2123-1710.3	010504	Ø 23,81
1.9 D	51	12/98→07/08		12/98→; →Orga 08609; + ABS; für Linkslenker	24.2123-1713.3	010505	Ø 23,81
				Orga 08610→; + ABS	24.2123-1715.3	010520	BDX Ø 23,81
				Orga 08610→; → 03/08; - ABS	03.2123-2781.3	010631	ATE Ø 23,81
					24.2123-1714.3	010587	BDX Ø 23,81
				→Orga 08609; - ABS	24.2123-1710.3	010504	Ø 23,81



























	kw					! #		
PEUGEOT - PARTNER Combispace (5F) 05/96→12/15								
 Hauptbremszylinder								
1.9 D	51	12/98→07/08		→Orga 08609; + ABS; für Linkslenker		24.2123-1713.3 010505	Ø 23,81	
				Orga 08610→; → 03/08; + ABS		24.2123-1715.3 010520	BDX Ø 23,81	
2.0 HDI	66	02/00→07/08		→ 03/08; - ESP / - ABS		03.2123-2781.3 010631	ATE Ø 23,81	
				→ 03/08; - ESP / + ABS		24.2123-1714.3 010587	BDX Ø 23,81	
				→ 03/08; - ESP / + ABS		24.2123-1715.3 010520	BDX Ø 23,81	
 Bremskraftregler								
1.1	44	06/96→10/02		07/96→;		03.6582-0010.3 320145	ATE lastabhängig 8/1,5 4x	
1.9 D	50	06/96→12/02		für Fahrzeuge ohne verstärktes Fahrwerk				
				07/96→;		03.6582-0011.3 320232	ATE lastabhängig 8/1,5 4x	
				für Fahrzeuge mit verstärktem Fahrwerk				
1.4	55	06/96→12/15		07/96→ 03/08;		03.6582-0010.3 320145	ATE lastabhängig 8/1,5 4x	
				für Fahrzeuge ohne verstärktes Fahrwerk				
				07/96→ 03/08;		03.6582-0011.3 320232	ATE lastabhängig 8/1,5 4x	
				für Fahrzeuge mit verstärktem Fahrwerk				
1.6 16V	80	07/01→03/08		für Fahrzeuge ohne verstärktes Fahrwerk		03.6582-0010.3 320145	ATE lastabhängig 8/1,5 4x	
1.8	66	05/97→12/03		für Fahrzeuge mit verstärktem Fahrwerk		03.6582-0011.3 320232	ATE lastabhängig 8/1,5 4x	
2.0 HDi 4x4	66	04/04→08/05		für Fahrzeuge mit verstärktem Fahrwerk		03.6582-0011.3 320232	ATE lastabhängig 8/1,5 4x	
1.6 HDi 75	55	02/06→12/13		→ 03/08;		03.6582-0010.3 320145	ATE lastabhängig 8/1,5 4x	
1.9 D	51	12/98→07/08		für Fahrzeuge ohne verstärktes Fahrwerk				
2.0 HDI	66	02/00→07/08		→ 03/08;		03.6582-0011.3 320232	ATE lastabhängig 8/1,5 4x	
				für Fahrzeuge mit verstärktem Fahrwerk				
1.6 HDi 90	66	10/05→12/15		02/06→ 03/08;		03.6582-0010.3 320145	ATE lastabhängig 8/1,5 4x	
				für Fahrzeuge ohne verstärktes Fahrwerk				
				02/06→ 03/08;		03.6582-0011.3 320232	ATE lastabhängig 8/1,5 4x	
				für Fahrzeuge mit verstärktem Fahrwerk				
1.9 D	51	05/96→12/98		12/98→;		03.6582-0010.3 320145	ATE lastabhängig 8/1,5 4x	
				für Fahrzeuge ohne verstärktes Fahrwerk				
				12/98→;		03.6582-0011.3 320232	ATE lastabhängig 8/1,5 4x	
				für Fahrzeuge mit verstärktem Fahrwerk				
PEUGEOT - PARTNER Kasten 04/08→								
 Hauptbremszylinder								
1.6	66	04/08→		+ ESP		24.4123-1714.3 010979	TRW Ø 23,81	
1.6	72	11/10→						
1.6	80	04/08→						
1.6	88	04/10→						
1.6 BlueHDi 100	73	04/15→						
1.6 BlueHDi 120	88	04/15→						
1.6 HDi	55	04/08→						
1.6 HDi	66	12/11→						
1.6 HDi	80	04/08→						
1.6 HDi	84	03/13→						
1.6 HDi 16V	66	04/08→						
1.6 HDi 90	68	04/10→						
Électrique	49	06/13→						
1.6 HDi / BlueHDi 75	55	07/11→		01/15→; + ESP		24.4123-1714.3 010979	TRW Ø 23,81	
PEUGEOT - PARTNER Kasten (5) 04/96→12/15								
 Hauptbremszylinder								
1.1	44	06/96→09/05		Orga 08610→; - ABS		03.2123-2781.3 010631	ATE Ø 23,81	
1.8 D	43	06/96→12/02				24.2123-1714.3 010587	BDX Ø 23,81	
1.9 D	51	06/96→12/02		07/96→; →Orga 08609; - ABS		24.2123-1710.3 010504	Ø 23,81	
				07/96→; →Orga 08609; + ABS;		24.2123-1713.3 010505	Ø 23,81	
				für Linkslenker				
				Orga 08610→; + ABS		24.2123-1715.3 010520	BDX Ø 23,81	
1.4	55	06/96→12/15		Orga 08610→; → 03/08; - ABS		03.2123-2781.3 010631	ATE Ø 23,81	
1.9 D	51	06/96→12/15				24.2123-1714.3 010587	BDX Ø 23,81	
				07/96→; →Orga 08609; - ABS		24.2123-1710.3 010504	Ø 23,81	
				07/96→; →Orga 08609; + ABS;		24.2123-1713.3 010505	Ø 23,81	
				für Linkslenker				
				Orga 08610→; → 03/08; + ABS		24.2123-1715.3 010520	BDX Ø 23,81	
1.4 BiFuel	55	04/03→10/06		Orga 08610→; - ABS		03.2123-2781.3 010631	ATE Ø 23,81	
1.9 D 4x4	51	04/04→11/07				24.2123-1714.3 010587	BDX Ø 23,81	
				→Orga 08609; - ABS		24.2123-1710.3 010504	Ø 23,81	
				→Orga 08609; + ABS; für Linkslenker		24.2123-1713.3 010505	Ø 23,81	
				Orga 08610→; + ABS		24.2123-1715.3 010520	BDX Ø 23,81	
1.6 HDi 75	55	02/06→07/08		→ 03/08; - ABS		03.2123-2781.3 010631	ATE Ø 23,81	
1.6 HDi 90	66	02/06→12/15				24.2123-1714.3 010587	BDX Ø 23,81	
2.0 HDi	66	04/00→07/08				24.2123-1715.3 010520	BDX Ø 23,81	
				→ 03/08; + ABS				













	kw			 	! #		
PEUGEOT - PARTNER Kasten (5) 04/96→12/15							
 Bremskraftregler							
1.1	44	06/96→09/05		07/96→; Nutzlast ab [kg] 500 Nutzlast bis [kg] 600; für Fahrzeuge ohne verstärktes Fahrwerk		03.6582-0009.3 320143	ATE lastabhängig 8/1,5 4x
				07/96→; Nutzlast ab [kg] 500 Nutzlast bis [kg] 600; für Fahrzeuge mit verstärktem Fahrwerk		03.6582-0012.3 320233	ATE lastabhängig 8/1,5 4x
1.4	55	06/96→12/15		07/96→ 03/08; Nutzlast ab [kg] 500 Nutzlast bis [kg] 600; für Fahrzeuge ohne verstärktes Fahrwerk		03.6582-0009.3 320143	ATE lastabhängig 8/1,5 4x
				07/96→ 03/08; Nutzlast ab [kg] 500 Nutzlast bis [kg] 600; für Fahrzeuge mit verstärktem Fahrwerk		03.6582-0012.3 320233	ATE lastabhängig 8/1,5 4x
1.4 BiFuel	55	04/03→10/06		Nutzlast ab [kg] 500 Nutzlast bis [kg] 600; für Fahrzeuge ohne verstärktes Fahrwerk		03.6582-0009.3 320143	ATE lastabhängig 8/1,5 4x
				Nutzlast ab [kg] 500 Nutzlast bis [kg] 600; für Fahrzeuge mit verstärktem Fahrwerk		03.6582-0012.3 320233	ATE lastabhängig 8/1,5 4x
1.6 HDi 75	55	02/06→07/08		→ 03/08; Nutzlast [kg]: 600; für Fahrzeuge ohne verstärktes Fahrwerk		03.6582-0009.3 320143	ATE lastabhängig 8/1,5 4x
1.6 HDi 90	66	02/06→12/15					
2.0 HDi	66	04/00→07/08		→ 03/08; Nutzlast [kg]: 600; für Fahrzeuge mit verstärktem Fahrwerk		03.6582-0012.3 320233	ATE lastabhängig 8/1,5 4x
				→ 03/08; Nutzlast [kg]: 800; für Fahrzeuge ohne verstärktes Fahrwerk		03.6582-0015.3 320227	ATE lastabhängig 8/1,5 4x
1.8 D	43	06/96→12/02		07/96→; Nutzlast [kg]: 600; für Fahrzeuge ohne verstärktes Fahrwerk		03.6582-0009.3 320143	ATE lastabhängig 8/1,5 4x
1.9 D	51	06/96→12/02		07/96→; Nutzlast [kg]: 600; für Fahrzeuge mit verstärktem Fahrwerk		03.6582-0012.3 320233	ATE lastabhängig 8/1,5 4x
				07/96→; Nutzlast [kg]: 800; für Fahrzeuge ohne verstärktes Fahrwerk		03.6582-0015.3 320227	ATE lastabhängig 8/1,5 4x
1.9 D	51	06/96→12/15		07/96→ 03/08; Nutzlast [kg]: 600; für Fahrzeuge ohne verstärktes Fahrwerk		03.6582-0009.3 320143	ATE lastabhängig 8/1,5 4x
				07/96→ 03/08; Nutzlast [kg]: 600; für Fahrzeuge mit verstärktem Fahrwerk		03.6582-0012.3 320233	ATE lastabhängig 8/1,5 4x
				07/96→ 03/08; Nutzlast [kg]: 800; für Fahrzeuge ohne verstärktes Fahrwerk		03.6582-0015.3 320227	ATE lastabhängig 8/1,5 4x
1.9 D 4x4	51	04/04→11/07		Nutzlast [kg]: 600; für Fahrzeuge ohne verstärktes Fahrwerk		03.6582-0009.3 320143	ATE lastabhängig 8/1,5 4x
				Nutzlast [kg]: 600; für Fahrzeuge mit verstärktem Fahrwerk		03.6582-0012.3 320233	ATE lastabhängig 8/1,5 4x
				Nutzlast [kg]: 800; für Fahrzeuge ohne verstärktes Fahrwerk		03.6582-0015.3 320227	ATE lastabhängig 8/1,5 4x
PEUGEOT - PARTNER Tepee 04/08→							
 Hauptbremszylinder							
1.2 THP	81	02/16→		+ ESP		24.4123-1714.3 010979	TRW Ø 23,81
1.6	66	04/08→					
1.6	72	08/10→					
1.6	80	04/08→					
1.6	88	04/10→					
1.6 BlueHDi 100	73	12/14→					
1.6 BlueHDi 120	88	12/14→					
1.6 HDi	55	04/08→					
1.6 HDi	80	04/08→					
1.6 HDi	82	08/10→					
1.6 HDi	84	03/13→					
1.6 HDi / BlueHDi 75	55	01/15→					
1.6 HDi 16V	66	04/08→					
1.6 HDi 90	68	04/10→					
PORSCHE - 911 (996) 09/97→09/05							
 Hauptbremszylinder							
3.4 Carrera	221	09/97→09/01				24.2123-1717.3 010521	Ø 23,81
3.6 Carrera	235	10/01→08/05					
3.6 Carrera S	254	02/03→08/05					
3.4 Carrera	235	05/01→08/05		→ 09/01		24.2123-1717.3 010521	Ø 23,81
3.4 Carrera 4	221	09/97→09/01				24.2123-1730.3 010620	Ø 23,81
3.6 Carrera 4	235	10/01→08/05					
3.6 Carrera 4S	254	02/03→08/05					
3.4 Carrera 4	235	05/01→08/05		→ 09/01		24.2123-1730.3 010620	Ø 23,81
PORSCHE - 911 (997) 07/04→12/12							
 Hauptbremszylinder							
3.6 Carrera	239	07/04→12/08				24.2123-1766.3 010825	TRW Ø 23,81











	kw					! #		
PORSCHE - 911 Cabriolet (996) 02/98→08/05								
 Hauptbremszylinder								
3.4 Carrera	221	02/98→09/01					24.2123-1717.3 010521	Ø 23,81
3.6 Carrera	235	10/01→08/05						
3.6 Carrera S	254	06/02→08/05						
3.4 Carrera	235	05/01→08/05		→ 09/01			24.2123-1717.3 010521	Ø 23,81
3.4 Carrera 4	221	02/98→09/01					24.2123-1730.3 010620	Ø 23,81
3.6 Carrera 4	235	10/01→08/05						
3.6 Carrera 4S	254	06/02→08/05						
3.4 Carrera 4	235	05/01→08/05		→ 09/01			24.2123-1730.3 010620	Ø 23,81
PORSCHE - 911 Cabriolet (997) 04/05→12/12								
 Hauptbremszylinder								
3.6 Carrera	239	04/05→12/08					24.2123-1766.3 010825	TRW Ø 23,81
3.6 Carrera	254	06/08→12/11						
3.6 Carrera 4	239	04/05→12/08						
3.6 Carrera 4	254	06/08→12/12						
PORSCHE - 911 Targa (996) 12/01→08/05								
 Hauptbremszylinder								
3.6	235	12/01→08/05					24.2123-1717.3 010521	Ø 23,81
PORSCHE - 928 09/77→11/95								
 Bremskraftverstärker								
5.4 GTS	257	08/91→11/95					03.7760-0402.4 300087	ATE Ø 10" pneumatisch
 Hauptbremszylinder								
5.4 GTS	257	08/91→11/95		für Linkslenker			03.2023-0262.3 010020	Ø1 23,81 Ø2 20,64
PORSCHE - 968 06/91→11/95								
 Bremskraftverstärker								
3.0	176	06/91→11/95					03.7750-5702.4 300083	ATE Ø 9" pneumatisch
3.0 Turbo S	224	03/93→11/95						
 Hauptbremszylinder								
3.0	176	06/91→11/95					03.2023-0542.3 010024	Ø1 23,81 Ø2 20,64
3.0 Turbo S	224	03/93→11/95						
Verschlusschraube, Hauptbremszylinder								
3.0	176	06/91→11/95					03.3517-0101.2 390322	
3.0 Turbo S	224	03/93→11/95						
PORSCHE - 968 Cabriolet 06/91→11/95								
 Bremskraftverstärker								
3.0	176	06/91→11/95					03.7750-5702.4 300083	ATE Ø 9" pneumatisch
 Hauptbremszylinder								
3.0	176	06/91→11/95					03.2023-0542.3 010024	Ø1 23,81 Ø2 20,64
Verschlusschraube, Hauptbremszylinder								
3.0	176	06/91→11/95					03.3517-0101.2 390322	
PORSCHE - BOXSTER (986) 09/96→12/04								
 Hauptbremszylinder								
2.5	150	09/96→08/99		→ 07/99			24.2123-1717.3 010521	Ø 23,81
2.7	155	06/99→12/02		08/99→ 12/00			24.2123-1717.3 010521	Ø 23,81
				12/01→ 06/02			24.2123-1730.3 010620	Ø 23,81
2.7	162	08/99→07/02		→ 12/00			24.2123-1717.3 010521	Ø 23,81
S 3.2	185	08/99→07/02		12/01→ 06/02			24.2123-1730.3 010620	Ø 23,81
2.7	168	07/02→12/04					24.2123-1730.3 010620	Ø 23,81
S 3.2	191	07/02→12/04						
S 3.2	196	01/04→12/04						
PORSCHE - BOXSTER (987) 11/04→12/11								
 Hauptbremszylinder								
2.7	176	11/04→12/06		→ 07/06;			24.2123-1766.3 010825	TRW Ø 23,81
S 3.2	206	11/04→12/06		für Fahrzeuge ohne Keramikbremse				
2.7	180	07/06→12/09		für Fahrzeuge ohne Keramikbremse			24.2123-1766.3 010825	TRW Ø 23,81
S 3.4	217	07/06→12/09						
↓								















	kW			 	! #		
PORSCHE - BOXSTER (987) 11/04→12/11							
 Hauptbremszylinder							
2.9 S 3.4	188 228	06/09→12/11 06/09→12/11		→ 09/11; für Fahrzeuge ohne Keramikbremse		24.2123-1766.3 010825	TRW Ø 23,81
S 3.4	223	08/08→12/09		06/09→; für Fahrzeuge ohne Keramikbremse		24.2123-1766.3 010825	TRW Ø 23,81
PORSCHE - BOXSTER Spyder (987) 09/07→12/11							
 Hauptbremszylinder							
3.4 RS 60	223	09/07→12/08		08/08→; für Fahrzeuge ohne Keramikbremse		24.2123-1766.3 010825	TRW Ø 23,81
PORSCHE - CAYENNE (9PA) 09/02→12/10							
 Bremskraftverstärker							
3.0 TDI 3.6 S 4.8	176 213 283	02/09→09/10 02/07→09/10 02/07→09/10		→ 04/10; für Linkslenker		03.7868-4102.4 300250	ATE Ø 10 / 8" pneumatisch
Turbo S 4.8	368	02/07→09/10		→ 04/10; für Linkslenker		03.7868-5302.4 300251	ATE Ø 10 / 8" pneumatisch
Pedalwegsensor, Bremspedal							
3.2 S 4.5 Turbo 4.5	184 250 331	10/03→09/07 09/02→09/07 09/02→09/07		→ 12/06		03.0655-0006.2 370006	ATE
 Hauptbremszylinder							
3.0 TDI 3.6 GTS 4.8 S 4.8 Turbo S 4.8 Turbo S 4.8 Turbo S 4.8	176 213 298 283 368 397 404	02/09→09/10 02/07→09/10 10/07→09/10 02/07→09/10 02/07→09/10 02/07→09/10 08/08→09/10		für Linkslenker; → 04/10		03.2126-3014.3 010811	ATE Ø 26,99
3.2 S 4.5 Turbo 4.5	184 250 331	10/03→09/07 09/02→09/07 09/02→09/07		→ 12/06; für Linkslenker		03.2126-3014.3 010811	ATE Ø 26,99
Turbo S 4.5 Turbo S 4.5	368 383	01/04→09/07 03/06→09/07		für Linkslenker		03.2126-3014.3 010811	ATE Ø 26,99
PORSCHE - CAYMAN (987) 11/05→12/13							
 Hauptbremszylinder							
2.7 S 3.4	180 217	07/06→12/09 11/05→12/09		für Fahrzeuge ohne Keramikbremse		24.2123-1766.3 010825	TRW Ø 23,81
2.9 R 3.4 S 3,4 Sport S 3.4	195 243 223 235	02/09→12/12 11/10→12/12 08/08→12/12 02/09→06/13		→ 05/12; für Fahrzeuge ohne Keramikbremse		24.2123-1766.3 010825	TRW Ø 23,81
RENAULT - 19 II (B/C53_) 01/91→06/01							
 Hauptbremszylinder							
1.4 (B/C532)	43	04/92→12/95				03.2120-2031.3 010106	ATE Ø 20,64
1.4 (B/C535)	55	01/92→12/95		09/94→; - ABS		03.2120-2031.3 010106	ATE Ø 20,64
				09/94→; Schaltgetriebe; + ABS		24.2120-1725.3 010579	BDX Ø 20,64
1.7 (B/C53B)	54	04/92→12/95		- ABS		03.2119-3389.3 010057	ATE Ø 19,05
				für Fahrschulwagen; - ABS		03.2120-2031.3 010106	ATE Ø 20,64
						03.2119-3389.3 010057	ATE Ø 19,05
				- ABS; nicht für Fahrschulwagen Schaltgetriebe; + ABS		03.2120-2031.3 010106	ATE Ø 20,64
1.7 (B/C53C)	66	04/92→12/95		für Fahrschulwagen; - ABS		03.2119-3389.3 010057	ATE Ø 19,05
				Schaltgetriebe; + ABS		24.2120-1725.3 010579	BDX Ø 20,64
1.8 (5/353A)	66	04/92→12/95		09/94→		03.2120-2031.3 010106	ATE Ø 20,64
				09/94→; - ABS		03.2120-2031.3 010106	ATE Ø 20,64
				09/94→; Schaltgetriebe; + ABS		24.2120-1725.3 010579	BDX Ø 20,64
1.8 (B/C53Y)	65	04/92→12/95		05/92→; - ABS		03.2120-2031.3 010106	ATE Ø 20,64
				05/92→; Schaltgetriebe; + ABS		24.2120-1725.3 010579	BDX Ø 20,64
1.8 16V (B/C53D)	99	04/92→12/95		- ABS		03.2120-2031.3 010106	ATE Ø 20,64
				+ ABS		24.2120-1725.3 010579	BDX Ø 20,64
				Schaltgetriebe; + ABS		24.2120-1725.3 010579	BDX Ø 20,64
1.9 D (B/C53J)	47	04/92→12/95		- ABS		03.2120-2031.3 010106	ATE Ø 20,64
				- ABS; nicht für Fahrschulwagen		03.2120-2031.3 010106	ATE Ø 20,64
↓							













	kw					! #		
RENAULT - 19 II (B/C53_) 01/91→06/01								
 Hauptbremszylinder								
1.9 D (B/C53J)	47	04/92→12/95		05/92→; - ABS		03.2120-2031.3 010106	ATE Ø 20,64	
					03.2120-2031.3 010106	ATE Ø 20,64		
				05/92→	03.2120-2031.3 010106	ATE Ø 20,64		
				Schaltgetriebe; + ABS	24.2120-1725.3 010579	BDX Ø 20,64		
1.9 dT (B/C53T)	66	04/92→12/95		- ABS		03.2120-2031.3 010106	ATE Ø 20,64	
				05/92→	03.2120-2031.3 010106	ATE Ø 20,64		
					03.2120-2031.3 010106	ATE Ø 20,64		
				10/95→; Schaltgetriebe; + ABS	24.2120-1725.3 010579	BDX Ø 20,64		
RENAULT - 19 II Cabriolet (D53_, 853_) 04/92→06/01								
 Hauptbremszylinder								
1.8 (853A)	66	09/93→06/96		→ 12/94		03.2120-2031.3 010106	ATE Ø 20,64	
				Schaltgetriebe; + ABS	24.2120-1725.3 010579	BDX Ø 20,64		
1.8 (D53V, 853F, D53C)	79	07/94→06/96		- ABS		03.2120-2031.3 010106	ATE Ø 20,64	
1.8 (D53Y)	65	04/92→06/96		→ 12/94		03.2120-2031.3 010106	ATE Ø 20,64	
1.8 16V (D53D)	99	04/92→06/96		→ 03/95; - ABS		03.2120-2031.3 010106	ATE Ø 20,64	
				→ 03/95; + ABS	24.2120-1725.3 010579	BDX Ø 20,64		
RENAULT - 19 II Chamade (L53_) 04/92→08/03								
 Hauptbremszylinder								
1.4 (532)	43	04/92→12/95		für Fahrschulwagen; - ABS		03.2119-3389.3 010057	ATE Ø 19,05	
				für Linkslenker	03.2120-2031.3 010106	ATE Ø 20,64		
				- ABS; nicht für Fahrschulwagen	03.2120-2031.3 010106	ATE Ø 20,64		
				05/92→	03.2120-2031.3 010106	ATE Ø 20,64		
1.4 (L535)	55	11/93→12/95		für Fahrschulwagen; - ABS		03.2119-3389.3 010057	ATE Ø 19,05	
				- ABS; nicht für Fahrschulwagen	03.2120-2031.3 010106	ATE Ø 20,64		
				nicht für Fahrschulwagen	03.2120-2031.3 010106	ATE Ø 20,64		
					03.2120-2031.3 010106	ATE Ø 20,64		
			09/94→; - ABS	03.2120-2031.3 010106	ATE Ø 20,64			
			09/94→; Schaltgetriebe; + ABS	24.2120-1725.3 010579	BDX Ø 20,64			
1.7	55	05/92→11/95		Schaltgetriebe; + ABS		24.2120-1725.3 010579	BDX Ø 20,64	
1.7 (L533)	68	01/93→08/95		für Fahrschulwagen; - ABS		03.2119-3389.3 010057	ATE Ø 19,05	
				Schaltgetriebe; + ABS	24.2120-1725.3 010579	BDX Ø 20,64		
1.7 (L53B)	54	04/92→12/95		für Fahrschulwagen; - ABS		03.2119-3389.3 010057	ATE Ø 19,05	
					03.2119-3389.3 010057	ATE Ø 19,05		
				- ABS; nicht für Fahrschulwagen	03.2120-2031.3 010106	ATE Ø 20,64		
			Schaltgetriebe; + ABS	24.2120-1725.3 010579	BDX Ø 20,64			
1.7 (L53C)	66	04/92→12/95		für Fahrschulwagen; - ABS		03.2119-3389.3 010057	ATE Ø 19,05	
				- ABS; nicht für Fahrschulwagen	03.2120-2031.3 010106	ATE Ø 20,64		
				Schaltgetriebe; + ABS	24.2120-1725.3 010579	BDX Ø 20,64		
1.8 (L53V, L538)	79	05/92→11/95		- ABS		03.2120-2031.3 010106	ATE Ø 20,64	
				Schaltgetriebe; + ABS	24.2120-1725.3 010579	BDX Ø 20,64		
1.8 16V (L53D)	99	04/92→12/95				24.2120-1725.3 010579	BDX Ø 20,64	
				09/94→	03.2120-2031.3 010106	ATE Ø 20,64		
				09/94→; - ABS	03.2120-2031.3 010106	ATE Ø 20,64		
			09/94→; Schaltgetriebe; + ABS	24.2120-1725.3 010579	BDX Ø 20,64			
1.8 (L53Y)	65	04/92→12/95		05/92→; - ABS		03.2120-2031.3 010106	ATE Ø 20,64	
				05/92→; Schaltgetriebe; + ABS	24.2120-1725.3 010579	BDX Ø 20,64		
1.9 D (L53J)	47	04/92→12/95		für Fahrschulwagen; - ABS		03.2119-3389.3 010057	ATE Ø 19,05	
				05/92→; - ABS	03.2120-2031.3 010106	ATE Ø 20,64		
				- ABS; nicht für Fahrschulwagen	03.2120-2031.3 010106	ATE Ø 20,64		
				Schaltgetriebe; + ABS	24.2120-1725.3 010579	BDX Ø 20,64		
1.9 dT (L53T)	66	04/92→12/95		für Fahrschulwagen; - ABS		03.2119-3389.3 010057	ATE Ø 19,05	
				- ABS; nicht für Fahrschulwagen	03.2120-2031.3 010106	ATE Ø 20,64		
				10/95→; Schaltgetriebe; + ABS	24.2120-1725.3 010579	BDX Ø 20,64		
RENAULT - 19 II Kasten (S53_) 03/92→12/95								
 Hauptbremszylinder								
1.9 dT	68	03/92→12/95		- ABS; für Fahrschulwagen		03.2119-3389.3 010057	ATE Ø 19,05	
				- ABS; nicht für Fahrschulwagen	03.2120-2031.3 010106	ATE Ø 20,64		
↓								

	kw					! #		
RENAULT - 19 II Kasten (S53_) 03/92→12/95								
 Hauptbremszylinder								
1.9 dT	68	03/92→12/95				03.2120-2031.3	010106	ATE Ø 20,64
				10/95→; Schaltgetriebe; + ABS		24.2120-1725.3	010579	BDX Ø 20,64
RENAULT - 21 Kombi (K48_) 03/86→07/97								
 Hauptbremszylinder								
2.1 D (K480)	51	02/92→09/95		04/92→; - ABS		03.2122-9631.3	010160	ATE Ø 22,2
RENAULT - AVANTIME (DE0_) 09/01→05/03								
 Hauptbremszylinder								
2.0 16V Turbo (DE0U, DE0V)	120	11/01→05/03				03.2123-1486.3	010488	Ø 23,81
2.2 dCi (DE01)	110	05/02→05/03		- ASR		03.2123-1486.3	010488	Ø 23,81
3.0 V6 (DE04, DE0T)	152	09/01→05/03		+ ASR		03.2123-2621.3	010701	ATE Ø 23,81
RENAULT - CLIO I (B/C57_, 5/357_) 05/90→09/98								
 Hauptbremszylinder								
1.2 (5/357Y, 5/357K)	40	01/96→09/98		- ABS; für Fahrschulwagen		03.2119-3389.3	010057	ATE Ø 19,05
1.2 (5/357Y, 5/357K)	43	01/96→09/98		- ABS; nicht für Fahrschulwagen		03.2120-2031.3	010106	ATE Ø 20,64
1.2 (B/C/S572)	44	05/90→03/96						
1.9 D	40	01/97→09/98		+ ABS; für Linkslenker		24.2120-1725.3	010579	BDX Ø 20,64
1.2 (B/C/S577)	40	01/96→12/96		- ABS; für Fahrschulwagen		03.2119-3389.3	010057	ATE Ø 19,05
				- ABS; nicht für Fahrschulwagen		03.2120-2031.3	010106	ATE Ø 20,64
				+ ASC; für Linkslenker		24.2120-1725.3	010579	BDX Ø 20,64
1.2 (B/C/S57A, B/C57S, 5/357F, 5/357J, 5/357L, 5/357R)	43	05/90→09/98		- ABS; für Fahrschulwagen		03.2119-3389.3	010057	ATE Ø 19,05
				10/94→; - ABS; für Fahrschulwagen		03.2119-3389.3	010057	ATE Ø 19,05
				- ABS; nicht für Fahrschulwagen		03.2120-2031.3	010106	ATE Ø 20,64
				10/94→; - ABS; nicht für Fahrschulwagen		03.2120-2031.3	010106	ATE Ø 20,64
				10/94→; + ABS; für Linkslenker		24.2120-1725.3	010579	BDX Ø 20,64
				+ ABS; für Linkslenker		24.2120-1725.3	010579	BDX Ø 20,64
1.2 (B/C57R)	40	01/91→06/96		→ 01/96; - ABS; für Fahrschulwagen		03.2119-3389.3	010057	ATE Ø 19,05
				→ 01/96; - ABS; nicht für Fahrschulwagen		03.2120-2031.3	010106	ATE Ø 20,64
				→ 01/96; + ABS; für Linkslenker		24.2120-1725.3	010579	BDX Ø 20,64
1.4 (B/C57T, B/C57Y)	58	01/91→09/98		- ABS; für Rechtslenker		03.2119-3389.3	010057	ATE Ø 19,05
1.4 (B57J, C57J)	55	01/91→09/98		- ABS; nicht für Fahrschulwagen; für Linkslenker		03.2120-2031.3	010106	ATE Ø 20,64
				für Rechtslenker		03.2120-2031.3	010106	ATE Ø 20,64
				+ ABS; für Linkslenker		24.2120-1725.3	010579	BDX Ø 20,64
1.8	66	08/90→04/96		08/94→; - ABS; für Rechtslenker		03.2119-3389.3	010057	ATE Ø 19,05
				08/94→; - ABS; für Linkslenker		03.2120-2031.3	010106	ATE Ø 20,64
				08/94→; + ABS; für Linkslenker		24.2120-1725.3	010579	BDX Ø 20,64
1.8 (B/C578)	66	08/94→09/98		- ABS; für Rechtslenker		03.2119-3389.3	010057	ATE Ø 19,05
1.8 (B/C57C, B/C57U)	65	01/91→09/98		- ABS; für Linkslenker		03.2120-2031.3	010106	ATE Ø 20,64
1.8 Rsi (B/C579)	80	01/93→08/95						
1.8 Rsi (B/C57H)	79	08/95→09/98		+ ABS; für Linkslenker		24.2120-1725.3	010579	BDX Ø 20,64
1.8 16V (C57D)	99	01/91→03/96		08/91→ 06/94; - ABS; für Rechtslenker		03.2119-3389.3	010057	ATE Ø 19,05
				08/91→ 06/94; - ABS; für Linkslenker		03.2120-2031.3	010106	ATE Ø 20,64
				08/91→ 06/94; + ABS; für Linkslenker		24.2120-1725.3	010579	BDX Ø 20,64
1.9 D (B/C/S576, B/C/S57L)	47	01/91→09/98		- ABS; nicht für Fahrschulwagen		03.2119-3389.3	010057	ATE Ø 19,05
						03.2120-2031.3	010106	ATE Ø 20,64
				+ ABS; für Linkslenker		24.2120-1725.3	010579	BDX Ø 20,64
Electric Williams (B/C57M)	21	05/96→02/98				03.2120-2031.3	010106	ATE Ø 20,64
	108	01/94→09/98						
RENAULT - CLIO II (BB_, CB_) 09/98→								
 Bremskraftverstärker								
1.2 (BB0A, BB0F, BB10, BB1K, BB28, BB2D, BB2H, CB0A,...)	43	09/98→		für Linkslenker; → 12/12; - ABS		03.7750-1332.4	300155	ATE Ø 9" pneumatisch
1.5 dCi (B/CB3M)	47	06/05→						
1.6 16V (BB01, BB0H, BB0T, BB14, BB1D, BB1R, BB2KL, BB3G...)	79	09/98→						
1.2 16V (BB05, BB0W, BB11, BB27, BB2T, BB2U, BB2V, CB05,...)	55	06/01→		→ 10/03; für Linkslenker; - ABS		03.7750-1332.4	300155	ATE Ø 9" pneumatisch
				→ 10/03; + ESP		03.7853-0702.4	300195	ATE Ø 9" pneumatisch













	kw			 	! #		
RENAULT - CLIO II (BB_, CB_) 09/98→							
 Bremskraftverstärker							
1.2 16V (BB05, BB0W, BB11, BB27, BB2T, BB2U, BB2V, CB05,...	55	06/01→		→ 10/03; - ESP		03.7853-1502.4 300200	ATE Ø 9" pneumatisch
1.2 LPG	43	09/98→06/09		für Linkslenker; - ABS		03.7750-1332.4 300155	ATE Ø 9" pneumatisch
1.2 LPG (BB0A, CB0A)	44	03/99→05/01					
1.4 (B/CB0C)	55	09/98→05/05					
1.6 (B/CB0D)	66	09/98→05/05					
1.9 D (B/CB0E)	47	09/98→05/05					
1.9 D (B/CB0J)	48	02/00→05/01					
1.4 16V (B/CB0L)	70	10/99→09/04		→ 07/00; für Linkslenker; - ABS		03.7750-1332.4 300155	ATE Ø 9" pneumatisch
				→ 07/00; + ESP		03.7853-0702.4 300195	ATE Ø 9" pneumatisch
				→ 07/00; - ESP		03.7853-1502.4 300200	ATE Ø 9" pneumatisch
1.4 16V (B/CB0P)	72	08/00→		für Linkslenker; → 12/12; - ABS		03.7750-1332.4 300155	ATE Ø 9" pneumatisch
1.5 dCi	74	01/04→					
1.5 dCi (B/C2J)	50	08/04→		→ 12/12; + ESP		03.7853-0702.4 300195	ATE Ø 9" pneumatisch
1.5 dCi (B/CB07)	48	06/01→		→ 12/12; - ESP		03.7853-1502.4 300200	ATE Ø 9" pneumatisch
1.5 dCi (B/CB08)	60	06/01→					
1.5 dCi	42	06/01→12/06		für Linkslenker; - ABS		03.7750-1332.4 300155	ATE Ø 9" pneumatisch
1.5 dCi (B/CB03)	59	06/01→10/03		+ ESP		03.7853-0702.4 300195	ATE Ø 9" pneumatisch
1.5 dCi (BB3N, CB3N)	62	02/07→06/09		- ESP		03.7853-1502.4 300200	ATE Ø 9" pneumatisch
1.9 dTi (B/CB0U)	59	12/99→05/05		02/00→; für Linkslenker; - ABS		03.7750-1332.4 300155	ATE Ø 9" pneumatisch
 Hauptbremszylinder							
1.2 (BB0A, BB0F, BB10, BB1K, BB28, BB2D, BB2H, CB0A,...	43	09/98→		für Linkslenker; → 12/12; - ABS		03.2120-4381.3 010526	ATE Ø 20,64
				für Linkslenker; → 12/12; + ABS		03.2120-4461.3 010571	ATE Ø 20,64
1.4 16V (B/CB0P)	72	08/00→		für Linkslenker; → 12/12; + ESP		03.2120-4468.3 010789	ATE Ø 20,64
1.5 dCi	74	01/04→					
1.5 dCi (B/C2J)	50	08/04→					
1.5 dCi (B/CB07)	48	06/01→					
1.5 dCi (B/CB08)	60	06/01→					
1.5 dCi (B/CB3M)	47	06/05→					
1.6 16V (BB01, BB0H, BB0T, BB14, BB1D, BB1R, BB2KL, BB3G...	79	09/98→					
1.2 16V (BB05, BB0W, BB11, BB27, BB2T, BB2U, BB2V, CB05,...	55	06/01→		→ 10/03; für Linkslenker; - ABS		03.2120-4381.3 010526	ATE Ø 20,64
				→ 10/03; für Linkslenker; + ABS		03.2120-4461.3 010571	ATE Ø 20,64
				→ 10/03; für Linkslenker; + ESP		03.2120-4468.3 010789	ATE Ø 20,64
1.2 LPG	43	09/98→06/09		für Linkslenker; - ABS		03.2120-4381.3 010526	ATE Ø 20,64
1.2 LPG (BB0A, CB0A)	44	03/99→05/01		für Linkslenker; + ABS		03.2120-4461.3 010571	ATE Ø 20,64
1.4 (B/CB0C)	55	09/98→05/05					
1.5 dCi	42	06/01→12/06		für Linkslenker; + ESP		03.2120-4468.3 010789	ATE Ø 20,64
1.5 dCi (B/CB03)	59	06/01→10/03					
1.5 dCi (BB3N, CB3N)	62	02/07→06/09					
1.6 (B/CB0D)	66	09/98→05/05					
1.9 D (B/CB0E)	47	09/98→05/05					
1.9 D (B/CB0J)	48	02/00→05/01					
1.4 16V (B/CB0L)	70	10/99→09/04		→ 07/00; für Linkslenker; - ABS		03.2120-4381.3 010526	ATE Ø 20,64
				→ 07/00; für Linkslenker; + ABS		03.2120-4461.3 010571	ATE Ø 20,64
				→ 07/00; für Linkslenker; + ESP		03.2120-4468.3 010789	ATE Ø 20,64
1.9 dTi (B/CB0U)	59	12/99→05/05		02/00→; für Linkslenker; - ABS		03.2120-4381.3 010526	ATE Ø 20,64
				02/00→; für Linkslenker; + ABS		03.2120-4461.3 010571	ATE Ø 20,64
				02/00→; für Linkslenker; + ESP		03.2120-4468.3 010789	ATE Ø 20,64
2.0 16V Sport	132	01/04→					
2.0 16V Sport (CB0M)	124	02/00→		→ 12/12; für Linkslenker		03.2122-1926.3 010916	ATE Ø 22,2
 Bremskraftregler							
1.2 (BB0A, BB0F, BB10, BB1K, BB28, BB2D, BB2H, CB0A,...	43	09/98→		→ 12/12; - ABS		24.6582-1721.3 320212	lastabhängig 4x
1.2 16V (BB05, BB0W, BB11, BB27, BB2T, BB2U, BB2V, CB05,...	55	06/01→					
1.4 16V (B/CB0P)	72	08/00→					
1.5 dCi	74	01/04→					
1.5 dCi (B/C2J)	50	08/04→					
1.5 dCi (B/CB07)	48	06/01→					
1.5 dCi (B/CB08)	60	06/01→					
1.5 dCi (B/CB3M)	47	06/05→					
1.6 16V (BB01, BB0H, BB0T, BB14, BB1D, BB1R, BB2KL, BB3G...	79	09/98→					
1.2 LPG	43	09/98→06/09		- ABS		24.6582-1721.3 320212	lastabhängig 4x
1.2 LPG (BB0A, CB0A)	44	03/99→05/01					
1.4 (B/CB0C)	55	09/98→05/05					













	kw					! #		
RENAULT - CLIO II (BB_, CB_) 09/98→								
 Bremskraftregler								
1.5 dCi	42	06/01→12/06			- ABS		24.6582-1721.3 320212	lastabhängig 4x
1.5 dCi (B/CB03)	59	06/01→10/03						
1.5 dCi (BB3N, CB3N)	62	02/07→06/09						
1.6 (B/CB0D)	66	09/98→05/05						
1.9 D (B/CB0E)	47	09/98→05/05						
1.9 D (B/CB0J)	48	02/00→05/01						
1.4 16V (B/CB0L)	70	10/99→09/04			→ 07/00; - ABS		24.6582-1721.3 320212	lastabhängig 4x
1.9 dTi (B/CB0U)	59	12/99→05/05			02/00→; - ABS		24.6582-1721.3 320212	lastabhängig 4x
RENAULT - CLIO II Kasten (SB0/1/2_) 09/98→								
 Bremskraftverstärker								
1.5 dCi (SB07)	48	06/01→			für Linkslenker; → 12/12; - ABS		03.7750-1332.4 300155	ATE Ø 9" pneumatisch
					→ 12/12; + ESP		03.7853-0702.4 300195	ATE Ø 9" pneumatisch
					→ 12/12; - ESP		03.7853-1502.4 300200	ATE Ø 9" pneumatisch
 Hauptbremszylinder								
1.5 dCi (SB07)	48	06/01→			für Linkslenker; → 12/12; - ABS		03.2120-4381.3 010526	ATE Ø 20,64
					für Linkslenker; → 12/12; - ESP		03.2120-4461.3 010571	ATE Ø 20,64
					für Linkslenker; → 12/12; + ESP		03.2120-4468.3 010789	ATE Ø 20,64
 Bremskraftregler								
1.5 dCi (SB07)	48	06/01→			→ 12/12; - ABS		24.6582-1721.3 320212	lastabhängig 4x
RENAULT - CLIO III (BR0/1, CR0/1) 01/05→								
 Bremskraftverstärker								
1.2 16V	58	06/05→			→ 11/07; für Linkslenker; + ABS		03.7863-4502.4 300230	ATE Ø 10" pneumatisch
1.2 16V (BR02, BR0J, BR11, CR02, CR0J, CR11)	55	06/05→						
1.2 16V (BR0P, CR0P)	74	05/07→						
1.2 16V (BR0R, BR1D, BR1L, CR0R)	48	06/05→						
1.4 16V	72	06/05→						
1.5 dCi (BR0H, CR0H, CR1S, BR1S)	78	06/05→						
1.5 dCi (BR17, CR17)	63	06/05→						
1.5 dCi (BR1C, CR1C)	76	06/05→						
1.5 dCi (C/BR0G, C/BR1G)	50	06/05→						
1.6 16V (BR05, BR0B, BR0Y, BR15, BR1J, BR1M, BR1Y, CR0B,...)	82	06/05→						
1.6 16V (BR09, BR0T, CR09, CR0T)	65	06/05→						
2.0 16V (BR0C, BR0K, CR0C, CR0K)	102	09/06→						
1.5 dCi	48	05/05→			→ 10/06; für Linkslenker; + ABS		03.7863-4502.4 300230	ATE Ø 10" pneumatisch
2.0 16V Sport	148	09/08→			für Linkslenker; → 12/12		03.7860-3702.4 300305	ATE Ø 9" pneumatisch
2.0 16V Sport (CR0N, CR1P)	145	02/06→						
 Hauptbremszylinder								
1.2 16V	58	06/05→			→ 12/12; - ABS		03.2123-2821.3 010944	ATE Ø 23,81
1.2 16V (BR02, BR0J, BR11, CR02, CR0J, CR11)	55	06/05→			12/07→; für Linkslenker; → 12/12; - ESP		03.2123-2863.3 010790	ATE Ø 23,81
					12/07→; für Linkslenker; → 12/12; + ESP		03.2123-2923.3 010791	ATE Ø 23,81
1.2 16V (BR0P, CR0P)	74	05/07→			→ 11/07; für Linkslenker; - ESP		03.2123-3241.3 010882	ATE Ø 23,81
1.2 16V (BR0R, BR1D, BR1L, CR0R)	48	06/05→			→ 11/07; für Linkslenker; + ESP		03.2123-3493.3 010792	ATE Ø 23,81
1.4 16V	72	06/05→						
1.5 dCi (BR0H, CR0H, CR1S, BR1S)	78	06/05→						
1.5 dCi (BR17, CR17)	63	06/05→						
1.5 dCi (BR1C, CR1C)	76	06/05→						
1.5 dCi (C/BR0G, C/BR1G)	50	06/05→						
1.6 16V (BR05, BR0B, BR0Y, BR15, BR1J, BR1M, BR1Y, CR0B,...)	82	06/05→						
1.6 16V (BR09, BR0T, CR09, CR0T)	65	06/05→						
2.0 16V (BR0C, BR0K, CR0C, CR0K)	102	09/06→						
1.2 16V	76	09/10→			→ 12/12; - ABS		03.2123-2821.3 010944	ATE Ø 23,81
1.2 16V Hi-Flex (BR1U, CR1U)	55	07/08→			für Linkslenker; → 12/12; - ESP		03.2123-2863.3 010790	ATE Ø 23,81

	kw			 	! #		
RENAULT - CLIO III (BR0/1, CR0/1) 01/05→							
 Hauptbremszylinder							
1.2 Ethanol (CR1U, BR1U)	55	07/08→		für Linkslenker; → 12/12; + ESP		03.2123-2923.3 010791	ATE Ø 23,81
1.5 dCi	55	08/10→					
1.5 dCi	65	08/10→					
1.6 16V GT (BR10, CR10)	94	06/09→					
1.5 dCi	48	05/05→		→ 10/06; - ABS		03.2123-2821.3 010944	ATE Ø 23,81
				→ 10/06; für Linkslenker; - ESP		03.2123-3241.3 010882	ATE Ø 23,81
				→ 10/06; für Linkslenker; + ESP		03.2123-3493.3 010792	ATE Ø 23,81
2.0 16V Sport	148	09/08→		→ 12/12; - ABS		03.2123-2821.3 010944	ATE Ø 23,81
2.0 16V Sport (CR0N, CR1P)	145	02/06→		für Linkslenker; → 12/12		03.2123-3493.3 010792	ATE Ø 23,81
RENAULT - CLIO Grandtour (KR0/1_) 02/08→							
 Bremskraftverstärker							
1.2 16V	76	03/10→		für Linkslenker; → 12/12		03.7863-4502.4 300230	ATE Ø 10" pneumatisch
1.2 16V (KR02, KR0J)	55	02/08→					
1.2 16V (KR0E)	58	02/08→					
1.2 16V (KR0P)	74	02/08→					
1.2 16V Hi-Flex (KR0S)	55	07/08→					
1.4 16V	72	02/10→					
1.5 dCi	48	02/10→					
1.5 dCi	55	08/10→					
1.5 dCi	65	08/10→					
1.5 dCi (KR0F)	63	02/08→					
1.5 dCi (KR0G)	50	02/08→					
1.5 dCi (KR1C, KR1N)	76	02/08→					
1.6 16V (KR0B)	82	02/08→					
1.6 16V (KR10)	94	11/08→					
1.5 dCi (KR0H, KR1S)	78	02/08→12/12		für Linkslenker		03.7863-4502.4 300230	ATE Ø 10" pneumatisch
 Hauptbremszylinder							
1.2 16V	76	03/10→		→ 12/12; - ABS		03.2123-2821.3 010944	ATE Ø 23,81
1.2 16V (KR02, KR0J)	55	02/08→		→ 12/12; - ESP		03.2123-3241.3 010882	ATE Ø 23,81
1.2 16V (KR0E)	58	02/08→					
1.2 16V (KR0P)	74	02/08→		→ 12/12; + ESP		03.2123-3493.3 010792	ATE Ø 23,81
1.2 16V Hi-Flex (KR0S)	55	07/08→					
1.5 dCi	48	02/10→					
1.5 dCi	55	08/10→					
1.5 dCi	65	08/10→					
1.5 dCi (KR0F)	63	02/08→					
1.5 dCi (KR0G)	50	02/08→					
1.5 dCi (KR1C, KR1N)	76	02/08→					
1.6 16V (KR0B)	82	02/08→					
1.4 16V	72	02/10→		→ 12/12; - ESP		03.2123-3241.3 010882	ATE Ø 23,81
				→ 12/12; + ESP		03.2123-3493.3 010792	ATE Ø 23,81
1.5 dCi (KR0H, KR1S)	78	02/08→12/12		- ABS		03.2123-2821.3 010944	ATE Ø 23,81
				- ESP		03.2123-3241.3 010882	ATE Ø 23,81
				+ ESP		03.2123-3493.3 010792	ATE Ø 23,81
1.6 16V (KR10)	94	11/08→		→ 12/12; - ESP		03.2123-2863.3 010790	ATE Ø 23,81
				→ 12/12; + ESP		03.2123-2923.3 010791	ATE Ø 23,81
RENAULT - ESPACE II (J/S63_) 01/91→10/97							
 Bremskraftverstärker							
2.0 (J636)	76	01/91→10/96		für Linkslenker		03.6750-2902.4 300037	ATE Ø 9" pneumatisch
2.1 TD (J633, J634, J/S635, J/S63D)	65	01/91→10/96					
2.1 TD (J63E)	66	11/94→10/96					
2.2 (J/S637, J63G)	79	01/91→10/96				03.6750-2902.4 300037	ATE Ø 9" pneumatisch
2.2 4x4 (J/S637, J63G)	79	03/91→12/96					
 Hauptbremszylinder							
2.0 (J636)	76	01/91→10/96		- ABS; für Fahrzeuge ohne Niveauregulierung		03.2120-2682.3 010118	ATE Ø 20,64
				07/93→; + ABS; für Linkslenker		03.2122-0626.3 010539	ATE Ø 22,2
				- ABS		03.2122-9631.3 010160	ATE Ø 22,2
2.1 TD (J633, J634, J/S635, J/S63D)	65	01/91→10/96		für Fahrzeuge ohne Niveauregulierung		03.2120-2682.3 010118	ATE Ø 20,64
				07/93→; + ABS; für Linkslenker		03.2122-0626.3 010539	ATE Ø 22,2
				- ABS		03.2122-9631.3 010160	ATE Ø 22,2
2.1 TD (J63E)	66	11/94→10/96		+ ABS; für Linkslenker		03.2122-0626.3 010539	ATE Ø 22,2
				- ABS		03.2122-9631.3 010160	ATE Ø 22,2
↓							



	kw			 	! #			
RENAULT - ESPACE II (J/S63_) 01/91→10/97								
 Hauptbremszylinder								
2.2 (J/S637, J63G)	79	01/91→10/96		- ABS;		03.2120-2682.3	010118	ATE Ø 20,64
2.2 4x4 (J/S637, J63G)	79	03/91→12/96		für Fahrzeuge ohne Niveauregulierung				
				07/93→; + ABS		03.2122-0626.3	010539	ATE Ø 22,2
				- ABS		03.2122-9631.3	010160	ATE Ø 22,2
2.8 V6 (J638, J63J)	110	01/91→10/96				24.2123-1701.3	010424	Ø 23,81
RENAULT - ESPACE III (JE0_) 11/96→10/02								
 Hauptbremszylinder								
1.9 dTi (JE0M)	72	02/99→10/02		+ ABS		03.2123-1486.3	010488	Ø 23,81
2.0	102	09/01→10/02		- ABS				
2.0 (JE0A)	84	11/96→10/00				03.2123-1546.3	010536	ATE Ø 23,81
2.0 16V (JE0N, JE0L, JE02)	103	10/98→10/02						
2.2 12V TD (JE0E, JE0H, JE0P)	83	11/96→10/00		+ ABS		03.2123-1486.3	010488	Ø 23,81
2.2 D	84	11/97→01/00		- ABS		03.2123-1741.3	010537	ATE Ø 23,81
3.0 (JE0D)	123	11/96→10/98						
3.0 V6 24V (JE0G, JE0R)	140	10/98→10/02						
2.2 dCi (JE0K)	95	10/00→10/02				03.2123-1486.3	010488	Ø 23,81
2.2 dCi (JE0S)	85	07/00→10/02				03.2123-1741.3	010537	ATE Ø 23,81
RENAULT - ESPACE IV (JK0/1_) 11/02→								
 Bremskraftverstärker								
1.9 dCi (JK0U, JK0G)	88	11/02→		für Linkslenker		03.7868-1602.4	300220	ATE Ø 10 / 8" pneumatisch
1.9 dCi (JK0U)	85	04/03→02/05						
2.0 (JK09)	100	11/02→						
2.0 (JK0A, JK1D, JK0N)	125	04/05→						
2.0 dCi (JK01, JK02, JK1J, JK1K)	110	01/06→						
2.0 dCi (JK02, JK03)	96	01/06→						
2.0 dCi (JK03, JK04)	127	01/06→						
2.0 Turbo (JK0A, JK0B, JK0N)	120	11/02→						
2.2 dCi (JK07)	102	02/06→						
2.2 dCi (JK0H)	110	11/02→						
3.0 dCi	120	09/05→						
3.0 dCi (JK0E, JK0Y)	133	01/06→						
3.0 dCi (JK0J, JK0V)	130	11/02→						
3.5 V6 (JK00, JK0F, JK0P, JK0S, JK0W)	177	11/02→						
 Hauptbremszylinder								
1.9 dCi (JK0U, JK0G)	88	11/02→		→ 12/04; + ESP		03.4125-0014.3	010794	ATE Ø 25,4
1.9 dCi (JK0U)	85	04/03→02/05		- ESP		03.4125-0021.3	010888	ATE Ø 25,4
2.0 (JK09)	100	11/02→						
2.0 Turbo (JK0A, JK0B, JK0N)	120	11/02→		01/05→; + ESP		03.4155-0043.3	010795	ATE Ø 25,4
2.2 dCi (JK0H)	110	11/02→						
3.0 dCi (JK0J, JK0V)	130	11/02→						
3.5 V6 (JK00, JK0F, JK0P, JK0S, JK0W)	177	11/02→						
2.0 (JK0A, JK1D, JK0N)	125	04/05→		- ESP		03.4125-0021.3	010888	ATE Ø 25,4
2.0 dCi (JK01, JK02, JK1J, JK1K)	110	01/06→		+ ESP		03.4155-0043.3	010795	ATE Ø 25,4
2.0 dCi (JK02, JK03)	96	01/06→						
2.0 dCi (JK03, JK04)	127	01/06→						
2.2 dCi (JK07)	102	02/06→						
3.0 dCi	120	09/05→						
3.0 dCi (JK0E, JK0Y)	133	01/06→						
RENAULT - GRAND SCÉNIC II (JM0/1_) 04/04→								
 Hauptbremszylinder								
1.5 dCi	76	06/06→11/08				24.2123-1760.3	010779	TRW Ø 23,81
1.9 dCi	85	05/05→01/09						
1.5 dCi (JM02, JM13)	74	04/04→		→ 03/09		24.2123-1760.3	010779	TRW Ø 23,81
1.6	83	04/04→						
1.9 dCi (JM0G, JM12, JM1G, JM2C)	88	04/04→						
1.9 dCi (JM14)	96	05/05→						
1.9 dCi (JM15)	81	05/05→						
2.0	99	04/04→						
2.0	120	04/04→						
2.0 dCi (JM1K)	110	09/05→						
1.5 dCi (JM1E)	78	05/05→		06/06→ 03/09		24.2123-1760.3	010779	TRW Ø 23,81

	kW					! #		
RENAULT - GRAND SCÉNIC III (JZ0/1_) 02/09→								
 Hauptbremszylinder								
1.2 TCe	85	04/12→					24.4123-1715.3 010980	TRW Ø 23,81
1.4 16V (JZ0F)	96	02/09→						
1.5 dCi	63	04/09→						
1.5 dCi	70	11/10→						
1.5 dCi	78	02/09→						
1.5 dCi	81	04/09→						
1.6 16V (JZ0U)	81	02/09→						
1.6 16V Bifuel	79	04/12→						
1.6 16V Bifuel	81	02/09→						
1.6 dCi (JZ00, JZ12)	96	04/11→						
1.6 E85	81	02/09→						
1.9 dCi	96	02/09→						
2.0 16V (JZ0G)	103	02/09→						
2.0 dCi (JZ0L)	118	04/09→						
2.0 dCi (JZ0Y)	110	02/09→						
1.2 TCe (JZ16)	97	01/13→		03/13→			24.4123-1715.3 010980	TRW Ø 23,81
RENAULT - KANGOO (KC0/1_) 08/97→								
 Hauptbremszylinder								
1.2 (KC0A, KC0K, KC0F, KC01)	43	08/97→		03/98→ 12/07; - ABS			24.2122-1727.3 010586	BDX Ø 22,2
1.4 (KC0C, KC0H, KC0B, KC0M)	55	08/97→						
D 55 1.9 (KC0D)	40	08/97→						
D 65 1.9 (KC0E, KC02, KC0J, KC0N)	47	08/97→						
1.2 16V (KC05, KC06, KC03, KC0T, KC0W, KC1D)	55	06/01→		→ 12/07; - ABS			24.2122-1727.3 010586	BDX Ø 22,2
1.5 dCi	45	04/05→06/10						
1.5 dCi	50	06/05→						
1.5 dCi (KC07)	48	12/01→						
1.5 dCi (KC08, KC09)	60	07/02→						
1.6 16V	70	06/01→						
1.6 16V 4x4 (KC0P, KC0S, KC0L)	70	10/01→						
1.9 dCi 4x4	62	10/03→						
1.9 dCi 4x4 (KC0V)	59	10/01→						
1.9 dTi (KC0U)	59	02/00→						
RENAULT - KANGOO Rapid (FC0/1_) 08/97→								
 Hauptbremszylinder								
1.2 (FC01, FC0A, FC0F)	43	08/97→		03/98→ 12/07; - ABS			24.2122-1727.3 010586	BDX Ø 22,2
1.4 (FC0C, FC0B, FC0H, FC0M)	55	08/97→06/08						
D 55 1.9 (FC0D)	40	08/97→						
D 65 1.9 (FC0E, FC02, FC0J, FC0N)	47	08/97→						
1.2 (FC1A)	44	07/98→07/01		- ABS			24.2122-1727.3 010586	BDX Ø 22,2
1.9 D (FC0J)	48	09/99→06/03						
1.2 16V (FC05, FC0W, FC1D, FC1P, FC1K, FC0T)	55	10/01→		→ 12/07; - ABS			24.2122-1727.3 010586	BDX Ø 22,2
1.5 dCi	45	10/05→						
1.5 dCi (FC07, FC1R)	48	12/01→						
1.5 dCi (FC08, FC09)	60	04/03→						
1.5 dCi (FC1E)	50	06/05→						
1.5 dCi (FC1G)	62	06/05→						
1.5 dCi (FC1R)	42	12/02→						
1.6 16V	70	10/01→						
1.6 16V 4x4 (FC0L, FC0P, FC0S)	70	10/01→						
1.6 16V bivalent	60	06/05→						
1.9 dCi 4x4 (FC0V)	59	10/01→						
1.9 dCi 4x4 (FC0V)	62	07/03→						
1.9 dTi (FC0U)	59	02/00→						
RENAULT - LAGUNA I (B56_, 556_) 11/93→08/02								
 Hauptbremszylinder								
1.6 16V (B568, B561)	79	11/97→03/01		02/99→ 02/01			24.2123-1701.3 010424	Ø 23,81
1.8 16V (B563, B564)	88	04/98→03/01						
1.9 dTi (B56J)	72	10/97→03/01		→ 01/99			24.2123-1725.3 010549	Ø 23,81
3.0 24V (B56V)	140	03/97→03/01						
1.8	69	06/95→02/01		- ABS			03.2122-1001.3 010562	Ø 22,2
1.8	70	06/95→06/98		→ 01/97; + ABS			10.6123-0312.3 010457	ATE Ø 23,81
				02/97→; + ABS			24.2123-1725.3 010549	Ø 23,81
1.8 (B56A/B)	66	11/93→03/01		→ 02/01; - ABS			03.2122-1001.3 010562	Ø 22,2
1.8 (B56Z)	69	08/95→03/01						

RENAULT - LAGUNA I (B56_, 556_) 11/93→08/02







Hauptbremszylinder









2.2 D (B56F/2)	61	11/93→03/01	→ 01/97; + ABS	10.6123-0312.3 010457	ATE Ø 23,81
			02/97→ 02/01; + ABS	24.2123-1725.3 010549	Ø 23,81
1.8 (B56S/T/0)	66	08/95→03/01	02/99→ 02/01; + ABS	24.2123-1701.3 010424	Ø 23,81
			02/97→ 02/01; + ABS	24.2123-1725.3 010549	Ø 23,81
1.9 dCi (B56W)	79	09/99→03/01	→ 02/01	24.2123-1701.3 010424	Ø 23,81
2.0	80	03/99→03/01			
2.0	84	06/95→02/01	→ 01/97; + ABS	10.6123-0312.3 010457	ATE Ø 23,81
2.0 (B56C/H/N)	83	11/93→03/01	→ 02/01; - ABS	24.2123-1725.3 010549	Ø 23,81
			02/97→ 02/01; + ABS	24.2123-1725.3 010549	Ø 23,81
2.0 16V (B56D/M)	102	06/95→03/01	→ 02/01; + ABS	10.6123-0312.3 010457	ATE Ø 23,81
			02/99→ 02/01; + ABS	24.2123-1701.3 010424	Ø 23,81
			→ 02/01; - ABS	24.2123-1725.3 010549	Ø 23,81
			02/97→ 01/99; + ABS	24.2123-1725.3 010549	Ø 23,81
2.2 dT (B569)	83	03/96→03/01	→ 01/97; + ABS	10.6123-0312.3 010457	ATE Ø 23,81
			02/99→ 02/01; + ABS	24.2123-1701.3 010424	Ø 23,81
			→ 02/01; - ABS	24.2123-1725.3 010549	Ø 23,81
			02/97→ 01/99; + ABS	24.2123-1725.3 010549	Ø 23,81
3.0 (B56E/R, B565)	123	11/93→03/01	→ 01/97; + ABS	10.6123-0312.3 010457	ATE Ø 23,81
			02/97→ 02/01	24.2123-1725.3 010549	Ø 23,81







RENAULT - LAGUNA I Grandtour (K56_) 09/95→08/02















Hauptbremszylinder













1.6 16V (K568)	79	11/97→03/01	02/99→ 02/01	24.2123-1701.3 010424	Ø 23,81
1.8 16V (K563, K564)	88	04/98→03/01	→ 01/99	24.2123-1725.3 010549	Ø 23,81
1.9 dTi (K56J)	72	10/97→03/01			
3.0 24V (K56V)	140	03/97→03/01			
1.8 (K56S/T/0)	66	09/95→03/01	→ 01/97; + ABS	10.6123-0312.3 010457	ATE Ø 23,81
			02/99→ 02/01; + ABS	24.2123-1701.3 010424	Ø 23,81
			→ 02/01; - ABS	24.2123-1725.3 010549	Ø 23,81
			02/97→ 01/99; + ABS	24.2123-1725.3 010549	Ø 23,81
			02/97→ 02/01; + ABS	24.2123-1725.3 010549	Ø 23,81
1.8 (K56Z)	69	09/95→03/01	→ 01/97; + ABS	10.6123-0312.3 010457	ATE Ø 23,81
2.2 D (K56F/2, S56F)	61	09/95→03/01	→ 02/01; - ABS	24.2123-1725.3 010549	Ø 23,81
			02/97→ 02/01; + ABS	24.2123-1725.3 010549	Ø 23,81
1.9 dCi (K56W)	79	09/99→03/01	→ 02/01	24.2123-1701.3 010424	Ø 23,81
2.0	84	10/98→01/01	+ ABS	10.6123-0312.3 010457	ATE Ø 23,81
			- ABS	24.2123-1725.3 010549	Ø 23,81
2.0 (K56C/H)	83	09/95→03/01	→ 01/97; + ABS	10.6123-0312.3 010457	ATE Ø 23,81
			11/95→ 01/97; + ABS	10.6123-0312.3 010457	ATE Ø 23,81
			→ 02/01; + ABS	10.6123-0312.3 010457	ATE Ø 23,81
			02/99→ 02/01; + ABS	24.2123-1701.3 010424	Ø 23,81
			02/97→ 01/99; + ABS	24.2123-1725.3 010549	Ø 23,81
			→ 02/01; - ABS	24.2123-1725.3 010549	Ø 23,81
			11/95→ 02/01; - ABS	24.2123-1725.3 010549	Ø 23,81
			→ 02/01	24.2123-1725.3 010549	Ø 23,81
			02/97→ 02/01; + ABS	24.2123-1725.3 010549	Ø 23,81
2.0 16V (K56D/M)	102	09/95→03/01	→ 02/01; + ABS	10.6123-0312.3 010457	ATE Ø 23,81
			→ 01/97; + ABS	10.6123-0312.3 010457	ATE Ø 23,81
			02/99→ 02/01; + ABS	24.2123-1701.3 010424	Ø 23,81
			09/99→ 02/01	24.2123-1701.3 010424	Ø 23,81
			→ 02/01; - ABS	24.2123-1725.3 010549	Ø 23,81
			02/97→ 01/99	24.2123-1725.3 010549	Ø 23,81
2.2 dT (K569)	83	03/96→03/01	→ 01/97; + ABS	10.6123-0312.3 010457	ATE Ø 23,81
			02/99→ 02/01; + ABS	24.2123-1701.3 010424	Ø 23,81
			→ 02/01; - ABS	24.2123-1725.3 010549	Ø 23,81
			02/97→ 01/99; + ABS	24.2123-1725.3 010549	Ø 23,81
3.0 (K56R, K565)	123	02/96→03/01	→ 02/01; + ABS	10.6123-0312.3 010457	ATE Ø 23,81
			03/96→ 01/97; + ABS	10.6123-0312.3 010457	ATE Ø 23,81
			02/97→ 02/01	24.2123-1725.3 010549	Ø 23,81











	kw			 	! #		
RENAULT - LAGUNA II (BG0/1_) 03/01→12/07							
Bremskraftverstärker							
1.6 16V (BG0A, BG0L)	79	03/01→05/05		06/01→; für Linkslenker		03.7873-1202.4 300197	ATE Ø 11" pneumatisch
1.8 16V (BG04, BG0B, BG0C, BG0V)	86	03/01→05/05					
1.8 16V (BG0B, BG0C, BG0J, BG0M, BG0V)	89	03/01→05/05					
1.6 16V (BG1G, BG1H)	82	02/05→08/07		→ 06/07; für Linkslenker		03.7873-1202.4 300197	ATE Ø 11" pneumatisch
1.9 dCi	79	03/01→09/07					
1.9 dCi	92	09/05→12/07					
1.9 dCi (BG12)	85	09/05→12/07					
1.9 dCi (BG1A, BG1V)	96	05/05→08/07					
1.9 dCi (BG1A, BG1W)	81	01/05→08/07					
2.0 16V (BG00, BG0K, BG0P, BG0W)	99	08/02→12/07					
2.0 16V (BG03, BG0Z, BG0T, BG1Y)	125	01/05→09/07					
2.0 16V (BG1Y)	150	01/05→09/07					
2.0 dCi (BG14, BG1S)	127	01/06→08/07					
2.2 dCi	102	05/05→08/07					
1.8 16V (BG06, BG0J, BG0M)	85	03/01→12/07		06/01→ 06/07; für Linkslenker		03.7873-1202.4 300197	ATE Ø 11" pneumatisch
1.8 16V (BG0B, BG0M)	88	03/01→09/07					
1.9 dCi (BG08, BG0G)	88	03/01→09/07					
2.0 16V IDE (BG0N)	103	04/01→09/07					
3.0 V6 24V (BG01, BG02, BG0D, BG0Y)	152	03/01→08/07					
1.9 dCi (BG05)	68	03/04→05/05		für Linkslenker		03.7873-1202.4 300197	ATE Ø 11" pneumatisch
1.9 dCi (BG0E)	77	06/01→05/05					
1.9 dCi (BG0R)	74	10/01→05/05					
2.0 16V (BG00, BG0W, BG0K, BG0P)	98	08/02→12/06					
2.0 16V Turbo (BG0S, BG1L, BG1M)	120	01/03→03/05					
2.0 dCi (BG1T)	110	08/05→08/06					
2.2 dCi (BG0F)	110	10/01→08/06					
Pedalwegsensor, Bremspedal							
1.6 16V (BG0A, BG0L)	79	03/01→05/05		für Rechtslenker		03.0655-0007.2 370007	ATE
1.8 16V (BG04, BG0B, BG0C, BG0V)	86	03/01→05/05		→ 05/01; für Linkslenker		03.0655-0007.2 370007	ATE
1.8 16V (BG0B, BG0C, BG0J, BG0M, BG0V)	89	03/01→05/05					
1.6 16V (BG1G, BG1H)	82	02/05→08/07		→ 06/07; für Rechtslenker		03.0655-0007.2 370007	ATE
1.9 dCi	79	03/01→09/07					
1.9 dCi	92	09/05→12/07					
1.9 dCi (BG12)	85	09/05→12/07					
1.9 dCi (BG1A, BG1V)	96	05/05→08/07					
1.9 dCi (BG1A, BG1W)	81	01/05→08/07					
2.0 16V (BG00, BG0K, BG0P, BG0W)	99	08/02→12/07					
2.0 16V (BG03, BG0Z, BG0T, BG1Y)	125	01/05→09/07					
2.0 16V (BG1Y)	150	01/05→09/07					
2.0 dCi (BG14, BG1S)	127	01/06→08/07					
2.2 dCi	102	05/05→08/07					
1.8 16V (BG06, BG0J, BG0M)	85	03/01→12/07		→ 05/01; für Linkslenker		03.0655-0007.2 370007	ATE
1.8 16V (BG0B, BG0M)	88	03/01→09/07		→ 06/07; für Rechtslenker		03.0655-0007.2 370007	ATE
1.9 dCi (BG08, BG0G)	88	03/01→09/07					
2.0 16V IDE (BG0N)	103	04/01→09/07					
3.0 V6 24V (BG01, BG02, BG0D, BG0Y)	152	03/01→08/07					
1.9 dCi (BG05)	68	03/04→05/05		für Rechtslenker		03.0655-0007.2 370007	ATE
1.9 dCi (BG0E)	77	06/01→05/05					
1.9 dCi (BG0R)	74	10/01→05/05					
2.0 16V (BG00, BG0W, BG0K, BG0P)	98	08/02→12/06					
2.0 16V Turbo (BG0S, BG1L, BG1M)	120	01/03→03/05					
2.0 dCi (BG1T)	110	08/05→08/06					
2.2 dCi (BG0F)	110	10/01→08/06					
Hauptbremszylinder							
1.6 16V (BG0A, BG0L)	79	03/01→05/05		→ 03/05		03.4123-0081.3 010585	ATE Ø 23,81
1.8 16V (BG04, BG0B, BG0C, BG0V)	86	03/01→05/05		04/05→		03.4153-0063.3 010773	ATE Ø 23,81
1.8 16V (BG0B, BG0C, BG0J, BG0M, BG0V)	89	03/01→05/05					
1.9 dCi (BG05)	68	03/04→05/05					
1.9 dCi (BG0E)	77	06/01→05/05					
1.9 dCi (BG0R)	74	10/01→05/05					
2.0 16V (BG00, BG0W, BG0K, BG0P)	98	08/02→12/06					
↓							











	kw			 	! #		
RENAULT - LAGUNA II (BG0/1_) 03/01→12/07							
 Hauptbremszylinder							
2.2 dCi (BG0F)	110	10/01→08/06		→ 03/05		03.4123-0081.3 010585	ATE Ø 23,81
				04/05→		03.4153-0063.3 010773	ATE Ø 23,81
1.6 16V (BG1G, BG1H)	82	02/05→08/07		→ 06/07		03.4153-0063.3 010773	ATE Ø 23,81
1.9 dCi	92	09/05→12/07					
1.9 dCi (BG12)	85	09/05→12/07					
1.9 dCi (BG1A, BG1V)	96	05/05→08/07					
2.0 dCi (BG14, BG1S)	127	01/06→08/07					
2.2 dCi	102	05/05→08/07					
1.8 16V (BG06, BG0J, BG0M)	85	03/01→12/07		→ 03/05		03.4123-0081.3 010585	ATE Ø 23,81
1.8 16V (BG0B, BG0M)	88	03/01→09/07		04/05→ 06/07		03.4153-0063.3 010773	ATE Ø 23,81
1.9 dCi	79	03/01→09/07					
1.9 dCi (BG08, BG0G)	88	03/01→09/07					
1.9 dCi (BG1A, BG1W)	81	01/05→08/07					
2.0 16V (BG00, BG0K, BG0P, BG0W)	99	08/02→12/07					
2.0 16V (BG03, BG0Z, BG0T, BG1Y)	125	01/05→09/07					
2.0 16V (BG1Y)	150	01/05→09/07					
2.0 16V IDE (BG0N)	103	04/01→09/07					
3.0 V6 24V (BG01, BG02, BG0D, BG0Y)	152	03/01→08/07					
2.0 16V Turbo (BG0S, BG1L, BG1M)	120	01/03→03/05				03.4153-0063.3 010773	ATE Ø 23,81
2.0 dCi (BG1T)	110	08/05→08/06					
Verschlusschraube, Hauptbremszylinder							
1.6 16V (BG0A, BG0L)	79	03/01→05/05		→ 03/05; - ESP		03.3517-0300.1 390323	
1.8 16V (BG04, BG0B, BG0C, BG0V)	86	03/01→05/05					
1.8 16V (BG06, BG0J, BG0M)	85	03/01→12/07					
1.8 16V (BG0B, BG0C, BG0J, BG0M, BG0V)	89	03/01→05/05					
1.8 16V (BG0B, BG0M)	88	03/01→09/07					
1.9 dCi	79	03/01→09/07					
1.9 dCi (BG05)	68	03/04→05/05					
1.9 dCi (BG08, BG0G)	88	03/01→09/07					
1.9 dCi (BG0E)	77	06/01→05/05					
1.9 dCi (BG0R)	74	10/01→05/05					
1.9 dCi (BG1A, BG1W)	81	01/05→08/07					
2.0 16V (BG00, BG0K, BG0P, BG0W)	99	08/02→12/07					
2.0 16V (BG00, BG0W, BG0K, BG0P)	98	08/02→12/06					
2.0 16V (BG03, BG0Z, BG0T, BG1Y)	125	01/05→09/07					
2.0 16V (BG1Y)	150	01/05→09/07					
2.0 16V IDE (BG0N)	103	04/01→09/07					
2.2 dCi (BG0F)	110	10/01→08/06					
3.0 V6 24V (BG01, BG02, BG0D, BG0Y)	152	03/01→08/07					
RENAULT - LAGUNA II Grandtour (KG0/1_) 03/01→12/07							
 Bremskraftverstärker							
1.6 16V	82	02/05→08/07		→ 06/07; für Linkslenker		03.7873-1202.4 300197	ATE Ø 11" pneumatisch
1.9 dCi	79	03/01→12/07					
1.9 dCi	92	09/05→12/07					
1.9 dCi (KG12)	85	08/05→09/07					
1.9 dCi (KG1A, KG1W)	81	01/05→12/07					
1.9 dCi (KG1V)	96	05/05→12/07					
2.0 16V (KG00, KG0K, KG0W, KG0P)	98	10/04→09/07					
2.0 16V (KG00, KG0K, KG0W, KG0P)	99	08/02→12/07					
2.0 16V (KG03, KG0Z, KG0T, KG1Y)	125	01/05→09/07					
2.0 16V (KG1Y)	150	01/05→09/07					
2.0 dCi (KG1S)	127	01/06→12/07					
2.2 dCi	102	05/05→12/07					
1.6 16V (KG0A, KG0L)	79	03/01→12/07		06/01→ 06/07; für Linkslenker		03.7873-1202.4 300197	ATE Ø 11" pneumatisch
1.9 dCi (KG0G)	88	03/01→09/07					
2.0 16V IDE (KG0N)	103	04/01→09/07					
3.0 V6 24V (KG0D)	152	03/01→12/07					
1.8 16V	86	03/01→05/05		06/01→; für Linkslenker		03.7873-1202.4 300197	ATE Ø 11" pneumatisch
1.8 16V	89	03/01→05/05					
1.8 16V (KG0B, KG0M)	88	03/01→05/05					
1.8 16V (KG0J)	85	03/01→05/05					
1.9 dCi	66	08/03→09/07		03/04→ 06/07; für Linkslenker		03.7873-1202.4 300197	ATE Ø 11" pneumatisch
1.9 dCi (KG05)	68	03/04→05/05		für Linkslenker		03.7873-1202.4 300197	ATE Ø 11" pneumatisch
↓							

	kw					! #		
RENAULT - LAGUNA II Grandtour (KG0/1_) 03/01→12/07								
Bremskraftverstärker								
1.9 dCi (KG0E, KG0R)	74	10/01→05/05		für Linkslenker			03.7873-1202.4 300197	ATE Ø 11" pneumatisch
1.9 dCi (KG0E)	77	06/01→05/05						
2.0 16V Turbo (KG0S, KG1L, KG03)	120	01/03→08/05						
2.0 dCi (KG1T)	110	08/05→08/06						
2.2 dCi (KG0F)	110	10/01→08/06						
Pedalwegsensord, Bremspedal								
1.6 16V	82	02/05→08/07		→ 06/07; für Rechtslenker			03.0655-0007.2 370007	ATE
1.9 dCi	79	03/01→12/07						
1.9 dCi	92	09/05→12/07						
1.9 dCi (KG12)	85	08/05→09/07						
1.9 dCi (KG1A, KG1W)	81	01/05→12/07						
1.9 dCi (KG1V)	96	05/05→12/07						
2.0 16V (KG00, KG0K, KG0W, KG0P)	98	10/04→09/07						
2.0 16V (KG00, KG0K, KG0W, KG0P)	99	08/02→12/07						
2.0 16V (KG03, KG0Z, KG0T, KG1Y)	125	01/05→09/07						
2.0 16V (KG1Y)	150	01/05→09/07						
2.0 dCi (KG1S)	127	01/06→12/07						
2.2 dCi	102	05/05→12/07						
1.6 16V (KG0A, KG0L)	79	03/01→12/07		→ 05/01; für Linkslenker			03.0655-0007.2 370007	ATE
2.0 16V IDE (KG0N)	103	04/01→09/07		→ 06/07; für Rechtslenker			03.0655-0007.2 370007	ATE
3.0 V6 24V (KG0D)	152	03/01→12/07						
1.8 16V	86	03/01→05/05		für Rechtslenker			03.0655-0007.2 370007	ATE
1.8 16V	89	03/01→05/05						
1.8 16V (KG0B, KG0M)	88	03/01→05/05		→ 05/01; für Linkslenker			03.0655-0007.2 370007	ATE
1.8 16V (KG0J)	85	03/01→05/05						
1.9 dCi	66	08/03→09/07		03/04→ 06/07; für Rechtslenker			03.0655-0007.2 370007	ATE
1.9 dCi (KG05)	68	03/04→05/05		für Rechtslenker			03.0655-0007.2 370007	ATE
1.9 dCi (KG0E, KG0R)	74	10/01→05/05						
1.9 dCi (KG0E)	77	06/01→05/05						
2.0 16V Turbo (KG0S, KG1L, KG03)	120	01/03→08/05						
2.0 dCi (KG1T)	110	08/05→08/06						
2.2 dCi (KG0F)	110	10/01→08/06						
1.9 dCi (KG0G)	88	03/01→09/07		06/01→ 06/07; für Rechtslenker			03.0655-0007.2 370007	ATE
				→ 05/01; für Linkslenker			03.0655-0007.2 370007	ATE
Hauptbremszylinder								
1.6 16V	82	02/05→08/07		→ 03/05			03.4123-0081.3 010585	ATE Ø 23,81
1.6 16V (KG0A, KG0L)	79	03/01→12/07		04/05→ 06/07			03.4153-0063.3 010773	ATE Ø 23,81
1.9 dCi	79	03/01→12/07						
1.9 dCi (KG0G)	88	03/01→09/07						
2.0 16V (KG00, KG0K, KG0W, KG0P)	98	10/04→09/07						
2.0 16V (KG00, KG0K, KG0W, KG0P)	99	08/02→12/07						
2.0 16V IDE (KG0N)	103	04/01→09/07						
3.0 V6 24V (KG0D)	152	03/01→12/07						
1.8 16V	86	03/01→05/05		→ 03/05			03.4123-0081.3 010585	ATE Ø 23,81
1.8 16V	89	03/01→05/05		04/05→			03.4153-0063.3 010773	ATE Ø 23,81
1.8 16V (KG0B, KG0M)	88	03/01→05/05						
1.8 16V (KG0J)	85	03/01→05/05						
1.9 dCi (KG05)	68	03/04→05/05						
1.9 dCi (KG0E, KG0R)	74	10/01→05/05						
1.9 dCi (KG0E)	77	06/01→05/05						
2.2 dCi (KG0F)	110	10/01→08/06						
1.9 dCi	66	08/03→09/07		03/04→ 03/05			03.4123-0081.3 010585	ATE Ø 23,81
				04/05→ 06/07			03.4153-0063.3 010773	ATE Ø 23,81
1.9 dCi	92	09/05→12/07		→ 06/07			03.4153-0063.3 010773	ATE Ø 23,81
1.9 dCi (KG12)	85	08/05→09/07						
1.9 dCi (KG1V)	96	05/05→12/07						
2.0 16V (KG03, KG0Z, KG0T, KG1Y)	125	01/05→09/07						
2.0 16V (KG1Y)	150	01/05→09/07						
2.0 dCi (KG1S)	127	01/06→12/07						
2.2 dCi	102	05/05→12/07						
1.9 dCi (KG1A, KG1W)	81	01/05→12/07		→ 03/05			03.4123-0081.3 010585	ATE Ø 23,81
				→ 06/07			03.4153-0063.3 010773	ATE Ø 23,81
2.0 16V Turbo (KG0S, KG1L, KG03)	120	01/03→08/05					03.4153-0063.3 010773	ATE Ø 23,81
2.0 dCi (KG1T)	110	08/05→08/06						
Verschlusschraube, Hauptbremszylinder								
1.6 16V	82	02/05→08/07		→ 03/05; - ESP			03.3517-0300.1 390323	
1.6 16V (KG0A, KG0L)	79	03/01→12/07						
↓								







	kw					! #		
RENAULT - LAGUNA II Grandtour (KG0/1_) 03/01→12/07								
Verschlusschraube, Hauptbremszylinder								
1.8 16V	86	03/01→05/05		→ 03/05; - ESP			03.3517-0300.1	390323
1.8 16V	89	03/01→05/05						
1.8 16V (KG0B, KG0M)	88	03/01→05/05						
1.8 16V (KG0J)	85	03/01→05/05						
1.9 dCi	79	03/01→12/07						
1.9 dCi (KG05)	68	03/04→05/05						
1.9 dCi (KG0E, KG0R)	74	10/01→05/05						
1.9 dCi (KG0E)	77	06/01→05/05						
1.9 dCi (KG0G)	88	03/01→09/07						
1.9 dCi (KG1A, KG1W)	81	01/05→12/07						
2.0 16V (KG00, KG0K, KG0W, KG0P)	98	10/04→09/07						
2.0 16V (KG00, KG0K, KG0W, KG0P)	99	08/02→12/07						
2.0 16V IDE (KG0N)	103	04/01→09/07						
2.2 dCi (KG0F)	110	10/01→08/06						
3.0 V6 24V (KG0D)	152	03/01→12/07						
1.9 dCi	66	08/03→09/07		03/04→ 03/05; - ESP			03.3517-0300.1	390323
RENAULT - LOGAN I (LS_) 09/04→								
 Bremskraftverstärker								
1.4	55	09/04→		→ 10/09; + ABS			03.7750-8532.4	300264 ATE Ø 9" pneumatisch
1.5 dCi	50	04/07→						
1.5 dCi	63	02/08→06/15		11/09→ 04/13; + ABS			03.7853-4102.4	300271 ATE Ø 9" pneumatisch
1.6	64	09/04→					03.7853-4602.4	300302 ATE Ø 9" pneumatisch
1.6 (LS0L, LS09, LS0V, LS0P, LS18, LS1S, LS1V, LS1Y,...)	77	04/07→						
 Hauptbremszylinder								
1.4	55	09/04→		+ ABS; → 04/13			24.2120-1754.3	010949 Ø 20,64
1.5 dCi	50	04/07→						
1.5 dCi	63	02/08→06/15		- ABS; → 04/13			24.2120-1762.3	011002 Ø 20,64 ohne Bremsflüssigkeitsbehälter
1.6	64	09/04→						
1.6 (LS0L, LS09, LS0V, LS0P, LS18, LS1S, LS1V, LS1Y,...)	77	04/07→						
RENAULT - LOGAN I Kombi (KS_) 04/07→								
 Bremskraftverstärker								
1.4	55	10/07→		→ 10/09; + ABS			03.7750-8532.4	300264 ATE Ø 9" pneumatisch
1.5 dCi	50	04/07→						
1.5 dCi	63	02/08→06/15		11/09→ 04/13; + ABS			03.7853-4102.4	300271 ATE Ø 9" pneumatisch
1.6	64	04/07→					03.7853-4602.4	300302 ATE Ø 9" pneumatisch
1.6 (KS0L, KS0M, KS0P, KS1S)	77	04/07→						
 Hauptbremszylinder								
1.4	55	10/07→		+ ABS; → 04/13			24.2120-1754.3	010949 Ø 20,64
1.5 dCi	50	04/07→						
1.5 dCi	63	02/08→06/15		- ABS; → 04/13			24.2120-1762.3	011002 Ø 20,64 ohne Bremsflüssigkeitsbehälter
1.6	64	04/07→						
1.6 (KS0L, KS0M, KS0P, KS1S)	77	04/07→						
RENAULT - MASTER I Bus (T_) 08/80→07/98								
 Hauptbremszylinder								
28-35 2,5 TD	72	08/89→07/98		→ 08/94			24.2125-1704.3	010446 TRW Ø 25,4
28-35 2.0	58	10/86→07/98					24.2125-1704.3	010446 TRW Ø 25,4
28-35 2.1 D	44	08/80→07/98						
28-35 2.5 D	55	08/89→07/98						
35 2,5 TD	69	08/89→07/98						
RENAULT - MASTER I Kasten (T_) 07/80→07/98								
 Hauptbremszylinder								
28-35 2,5 D	55	08/89→07/98					24.2125-1704.3	010446 TRW Ø 25,4
28-35 2,5 TD	72	08/89→07/98						
28-35 2.0	58	10/86→07/98						
RENAULT - MASTER I Pritsche/Fahrgestell (P_) 07/80→07/98								
 Hauptbremszylinder								
28-35 2.0	58	10/86→07/98					24.2125-1704.3	010446 TRW Ø 25,4
28-35 2.5 D	52	09/80→07/98		08/89→			24.2125-1704.3	010446 TRW Ø 25,4











	kw					! #		
RENAULT - MASTER II Bus (JD) 03/98→								
 Hauptbremszylinder								
1.9 dCi 80	60	11/01→			→ 10/03; + ABS		24.2025-1706.3 010676	Ø 25,4
1.9 dTi	59	09/00→			11/03→ 08/06; - ABS		24.2025-1708.3 010692	Ø 25,4
2.2 dCi 90	66	09/00→			→ 10/03; - ABS		24.2025-1708.3 010692	Ø 25,4
2.5 dCi 120	84	10/01→			11/03→ 08/06; + ABS		24.2123-1759.3 010768	BOS Ø 23,81
2.5 D	59	07/98→01/01			+ ABS		24.2025-1706.3 010676	Ø 25,4
2.8 dTi	84	07/98→10/01			- ABS		24.2025-1708.3 010692	Ø 25,4
2.5 dCi	74	08/06→			- ABS; → 12/10		24.2025-1708.3 010692	Ø 25,4
2.5 dCi	88	08/06→						
2.5 dCi	107	08/06→						
2.5 dCi 100 (JDCV)	73	10/03→			→ 08/06; - ABS		24.2025-1708.3 010692	Ø 25,4
3.0 dCi 140 (JD0T)	100	10/03→			→ 08/06; + ABS		24.2123-1759.3 010768	BOS Ø 23,81
RENAULT - MASTER II Kasten (FD) 07/98→								
 Hauptbremszylinder								
1.9 dCi 80	60	11/01→			→ 10/03; + ABS		24.2025-1706.3 010676	Ø 25,4
1.9 dTi	59	09/00→			11/03→ 08/06; - ABS		24.2025-1708.3 010692	Ø 25,4
2.2 dCi 90	66	09/00→			→ 10/03; - ABS		24.2025-1708.3 010692	Ø 25,4
2.5 dCi 120	84	10/01→			11/03→ 08/06; + ABS		24.2123-1759.3 010768	BOS Ø 23,81
2.5 D	59	07/98→01/01			+ ABS		24.2025-1706.3 010676	Ø 25,4
2.8 dTi	84	07/98→10/01			- ABS		24.2025-1708.3 010692	Ø 25,4
2.5 dCi	74	08/06→			- ABS; → 12/10		24.2025-1708.3 010692	Ø 25,4
2.5 dCi	88	08/06→						
2.5 dCi	107	08/06→						
2.5 dCi 100 (FD0U, FD0V)	73	10/03→			→ 08/06; - ABS		24.2025-1708.3 010692	Ø 25,4
3.0 dCi 120	85	06/05→			→ 08/06; + ABS		24.2123-1759.3 010768	BOS Ø 23,81
3.0 dCi 140 (HD0S, FD0S, HD1S)	100	10/03→						
3.0 dCi 160	115	06/05→						
RENAULT - MASTER II Pritsche/Fahrgestell (ED/HD/UD) 07/98→								
 Hauptbremszylinder								
2.2 dCi 90	66	09/00→			→ 10/03; + ABS		24.2025-1706.3 010676	Ø 25,4
2.5 dCi 120	84	10/01→			11/03→ 08/06; - ABS		24.2025-1708.3 010692	Ø 25,4
					→ 10/03; - ABS		24.2025-1708.3 010692	Ø 25,4
					11/03→ 08/06; + ABS		24.2123-1759.3 010768	BOS Ø 23,81
2.5 D	59	07/98→01/01			+ ABS		24.2025-1706.3 010676	Ø 25,4
2.8 dTi	84	07/98→10/01			- ABS		24.2025-1708.3 010692	Ø 25,4
2.5 dCi	74	08/06→			- ABS; → 12/10		24.2025-1708.3 010692	Ø 25,4
2.5 dCi	88	08/06→						
2.5 dCi	107	08/06→						
2.5 dCi 100 (ED4V, ED8V)	73	10/03→			→ 08/06; - ABS		24.2025-1708.3 010692	Ø 25,4
3.0 dCi 120	85	06/05→			→ 08/06; + ABS		24.2123-1759.3 010768	BOS Ø 23,81
3.0 dCi 140 (ED0S, UD0S)	100	10/03→						
3.0 dCi 160	115	06/05→						
RENAULT - MASTER III Bus (JV) 02/11→								
 Bremskraftverstärker								
2.3 dCi 100 FWD (JV0A, JV0B)	74	02/11→					03.7868-5202.4 300309	ATE Ø 10 / 8" pneumatisch
2.3 dCi 110 FWD	81	09/14→						
2.3 dCi 125 FWD (JV0C, JV0D, JV0H)	92	02/11→						
2.3 dCi 135 FWD	100	07/14→						
2.3 dCi 145 FWD (JV0F, JV0H)	107	02/11→						
2.3 dCi 165 FWD	120	07/14→						
2.3 dCi 170 FWD	125	07/15→						
2.3 dCi 150 FWD	110	10/12→			01/13→		03.7868-5202.4 300309	ATE Ø 10 / 8" pneumatisch
 Hauptbremszylinder								
2.3 dCi 100 FWD (JV0A, JV0B)	74	02/11→					03.2126-3121.3 010967	ATE Ø 26,99
2.3 dCi 110 FWD	81	09/14→						
2.3 dCi 125 FWD (JV0C, JV0D, JV0H)	92	02/11→						
2.3 dCi 135 FWD	100	07/14→						
2.3 dCi 145 FWD (JV0F, JV0H)	107	02/11→						







	kw			 	! #		
RENAULT - MASTER III Bus (JV) 02/11→							
 Hauptbremszylinder							
2.3 dCi 165 FWD	120	07/14→				03.2126-3121.3 010967	ATE Ø 26,99
2.3 dCi 170 FWD	125	07/15→					
2.3 dCi 150 FWD	110	10/12→		01/13→		03.2126-3121.3 010967	ATE Ø 26,99
RENAULT - MASTER III Kasten (FV) 02/10→							
 Bremskraftverstärker							
2.3 dCi 100 FWD (FV0A, FV0B, FV0G, FV0K)	74	02/10→				03.7868-5202.4 300309	ATE Ø 10 / 8" pneumatisch
2.3 dCi 100 RWD (FV0B, FV0C, FV0D)	74	02/10→					
2.3 dCi 110 FWD	81	09/14→					
2.3 dCi 125 FWD (FV0C, FV0D)	92	02/10→					
2.3 dCi 125 RWD (FV0C, FV0D, FV0H, FV0J)	92	02/10→					
2.3 dCi 130 FWD	96	06/16→					
2.3 dCi 130 RWD	96	03/12→					
2.3 dCi 135 FWD	100	07/14→					
2.3 dCi 135 RWD	100	07/14→					
2.3 dCi 145 FWD (FV0E, FV0F, FV0H, FV0J)	107	02/10→					
2.3 dCi 145 RWD (FV0E, FV0F, FV0J)	107	02/10→					
2.3 dCi 150 FWD	110	03/13→					
2.3 dCi 150 RWD	110	03/13→					
2.3 dCi 165 FWD	120	07/14→					
2.3 dCi 165 RWD	120	07/14→					
2.3 dCi 170 FWD	125	07/15→					
 Hauptbremszylinder							
2.3 dCi 100 FWD (FV0A, FV0B, FV0G, FV0K)	74	02/10→				03.2126-3121.3 010967	ATE Ø 26,99
2.3 dCi 100 RWD (FV0B, FV0C, FV0D)	74	02/10→					
2.3 dCi 110 FWD	81	09/14→					
2.3 dCi 125 FWD (FV0C, FV0D)	92	02/10→					
2.3 dCi 125 RWD (FV0C, FV0D, FV0H, FV0J)	92	02/10→					
2.3 dCi 130 FWD	96	06/16→					
2.3 dCi 130 RWD	96	03/12→					
2.3 dCi 135 FWD	100	07/14→					
2.3 dCi 135 RWD	100	07/14→					
2.3 dCi 145 FWD (FV0E, FV0F, FV0H, FV0J)	107	02/10→					
2.3 dCi 145 RWD (FV0E, FV0F, FV0J)	107	02/10→					
2.3 dCi 150 FWD	110	03/13→					
2.3 dCi 150 RWD	110	03/13→					
2.3 dCi 165 FWD	120	07/14→					
2.3 dCi 165 RWD	120	07/14→					
2.3 dCi 170 FWD	125	07/15→					
RENAULT - MASTER III Pritsche/Fahrgestell (EV, HV, UV) 02/10→							
 Bremskraftverstärker							
2.3 dCi 100 FWD (EV0A, EV0B, HV0A, HV0B, HV0G, UV0A,...)	74	02/10→				03.7868-5202.4 300309	ATE Ø 10 / 8" pneumatisch
2.3 dCi 100 RWD (UV0C, UV0D, HV0C, HV0D)	74	02/10→					
2.3 dCi 110 FWD	81	09/14→					
2.3 dCi 125 FWD (EV0C, EV0D, EV0J, HV0C, HV0D, HV0H,...)	92	02/10→					
2.3 dCi 125 RWD (HV0C, HV0D, UV0C, UV0D, UV0H, UV0J)	92	02/10→					
2.3 dCi 130 FWD	96	03/12→					
2.3 dCi 130 RWD	96	07/16→					
2.3 dCi 135 FWD	100	07/14→					
2.3 dCi 135 RWD	100	07/14→					
2.3 dCi 145 FWD (EV0E, EV0F, HV0E, HV0F, UV0E, UV0F)	107	02/10→					
2.3 dCi 145 RWD (UV0F, UV0E)	107	02/10→					
2.3 dCi 150 FWD	110	03/13→					
↓							











	kw					! #		
RENAULT - MASTER III Pritsche/Fahrgestell (EV, HV, UV) 02/10→								
 Bremskraftverstärker								
2.3 dCi 150 RWD	110	03/13→					03.7868-5202.4 300309	ATE Ø 10 / 8" pneumatisch
2.3 dCi 165 FWD	120	07/14→						
2.3 dCi 165 RWD	120	07/14→						
2.3 dCi 170 FWD	125	06/16→						
 Hauptbremszylinder								
2.3 dCi 100 FWD (EV0A, EV0B, HV0A, HV0B, HV0G, UV0A,...)	74	02/10→					03.2126-3121.3 010967	ATE Ø 26,99
2.3 dCi 100 RWD (UV0C, UV0D, HV0C, HV0D)	74	02/10→						
2.3 dCi 110 FWD	81	09/14→						
2.3 dCi 125 FWD (EV0C, EV0D, EV0J, HV0C, HV0D, HV0H,...)	92	02/10→						
2.3 dCi 125 RWD (HV0C, HV0D, UV0C, UV0D, UV0H, UV0J)	92	02/10→						
2.3 dCi 130 FWD	96	03/12→						
2.3 dCi 130 RWD	96	07/16→						
2.3 dCi 135 FWD	100	07/14→						
2.3 dCi 135 RWD	100	07/14→						
2.3 dCi 145 FWD (EV0E, EV0F, HV0E, HV0F, UV0E, UV0F)	107	02/10→						
2.3 dCi 145 RWD (UV0F, UV0E)	107	02/10→						
2.3 dCi 150 FWD	110	03/13→						
2.3 dCi 150 RWD	110	03/13→						
2.3 dCi 165 FWD	120	07/14→						
2.3 dCi 165 RWD	120	07/14→						
2.3 dCi 170 FWD	125	06/16→						
RENAULT - MEGANE I (BA0/1_) 08/95→12/04								
 Bremskraftverstärker								
1.4 16V (BA0D, BA1H, BA0W, BA10)	70	03/99→08/03		→ 12/02; + ABS; für Linkslenker			03.7760-5502.4 300151	ATE Ø 10" pneumatisch
				→ 12/02; - ABS			03.7863-2002.4 300126	ATE Ø 10" pneumatisch
1.4 e (BA0E, BA0V)	55	01/96→08/03		03/99→ 12/02; + ABS; für Linkslenker			03.7760-5502.4 300151	ATE Ø 10" pneumatisch
				03/99→ 12/02; - ABS			03.7760-5602.4 300121	ATE Ø 10" pneumatisch
1.6 16V (BA04, BA0B, BA11, BA1J, BA16, BA19, BA1K, BA1V,...)	79	03/99→08/02		+ ABS; für Linkslenker; für Fahrzeuge ohne verstärktes Fahrwerk			03.7760-5102.4 300140	ATE Ø 10" pneumatisch
				+ ABS; für Linkslenker			03.7760-5502.4 300151	ATE Ø 10" pneumatisch
				+ ABS; für Linkslenker; für Fahrzeuge mit verstärktem Fahrwerk			03.7863-2002.4 300126	ATE Ø 10" pneumatisch
				- ABS			03.7760-5502.4 300151	ATE Ø 10" pneumatisch
				- ABS; für Fahrzeuge mit verstärktem Fahrwerk			03.7760-5602.4 300121	ATE Ø 10" pneumatisch
1.8 16V (BA06, BA12, BA1A, BA1M, BA1R)	85	01/01→08/03		→ 12/02; für Linkslenker			03.7863-2002.4 300126	ATE Ø 10" pneumatisch
1.9 dCi (BA05, BA1F)	75	02/01→08/03		→ 12/02; + ABS; für Linkslenker			03.7760-5102.4 300140	ATE Ø 10" pneumatisch
				→ 12/02; - ABS			03.7863-2002.4 300126	ATE Ø 10" pneumatisch
							03.7760-5602.4 300121	ATE Ø 10" pneumatisch
1.9 D Eco (BA0A, BA0U, BA0R)	47	01/96→08/03		06/98→ 12/02; + ABS; für Linkslenker			03.7760-5502.4 300151	ATE Ø 10" pneumatisch
				06/98→ 12/02; - ABS			03.7760-5602.4 300121	ATE Ø 10" pneumatisch
1.9 dTi (BA08, BA0N)	72	03/97→02/01		03/99→; für Linkslenker			03.7760-5102.4 300140	ATE Ø 10" pneumatisch
1.9 dTi (BA1U)	59	02/01→08/03		→ 12/02; + ABS; für Linkslenker			03.7863-2002.4 300126	ATE Ø 10" pneumatisch
 Hauptbremszylinder								
1.4 16V (BA0D, BA1H, BA0W, BA10)	70	03/99→08/03		→ 12/02; für Rechtslenker			03.2120-4441.3 010510	ATE Ø 20,64
				→ 12/02; + ABS; für Linkslenker			03.2122-1521.3 010494	Ø 22,2
				→ 12/02; - ABS			03.2122-1541.3 010511	Ø 22,2
1.4 e (BA0E, BA0V)	55	01/96→08/03		06/98→ 02/99; - ABS			03.2120-2031.3 010106	ATE Ø 20,64
				→ 12/02; - ABS			03.2120-2031.3 010106	ATE Ø 20,64
				06/98→ 02/99; + ABS			03.2120-4441.3 010510	ATE Ø 20,64
				03/99→ 12/02; + ABS			03.2122-1521.3 010494	Ø 22,2
				03/99→ 12/02; - ABS			03.2122-1541.3 010511	Ø 22,2
				→ 12/02; + ABS; für Linkslenker			24.2120-1723.3 010545	BDX Ø 20,64
				→ 12/02; + ABS; für Rechtslenker			24.2120-1725.3 010579	BDX Ø 20,64
↓								













	kw			 	! #		
RENAULT - MEGANE I (BA0/1_) 08/95→12/04							
Hauptbremszylinder							
1.4 Eco (BA0T)	52	01/96→03/99		- ABS		03.2120-2031.3 010106	ATE Ø 20,64
1.6 i (BA0L)	55	01/96→03/99		+ ABS		24.2120-1723.3 010545	BDX Ø 20,64
1.6 16V (BA04, BA0B, BA11, BA1J, BA16, BA19, BA1K, BA1V,...)	79	03/99→08/02		+ ABS		03.2122-1521.3 010494	Ø 22,2
				+ ABS; für Linkslenker; für Fahrzeuge mit verstärktem Fahrwerk		03.2122-1521.3 010494	Ø 22,2
				- ABS; für Fahrzeuge mit verstärktem Fahrwerk		03.2122-1541.3 010511	Ø 22,2
				- ABS		03.2122-1541.3 010511	Ø 22,2
				+ ABS; für Linkslenker		03.2123-2146.3 010572	Ø 23,81
1.6 e (BA0F, BA0S)	66	01/96→03/99		- ABS		03.2120-2031.3 010106	ATE Ø 20,64
				+ ABS; für Linkslenker		24.2120-1723.3 010545	BDX Ø 20,64
				+ ABS		24.2120-1723.3 010545	BDX Ø 20,64
				+ ABS; für Rechtslenker		24.2120-1725.3 010579	BDX Ø 20,64
1.8 16V (BA06, BA12, BA1A, BA1M, BA1R)	85	01/01→08/03		→ 12/02; für Linkslenker		03.2123-2146.3 010572	Ø 23,81
1.9 dCi (BA05, BA1F)	75	02/01→08/03		→ 12/02; - ABS		03.2122-1541.3 010511	Ø 22,2
				→ 12/02; + ABS; für Linkslenker		03.2123-2146.3 010572	Ø 23,81
1.9 D Eco (BA0A, BA0U, BA0R)	47	01/96→08/03		→ 12/02; - ABS; für Fahrschulwagen		03.2119-3389.3 010057	ATE Ø 19,05
				→ 12/02; - ABS; für Linkslenker; nicht für Fahrschulwagen		03.2120-2031.3 010106	ATE Ø 20,64
				→ 12/02; - ABS; für Rechtslenker		03.2120-2031.3 010106	ATE Ø 20,64
				→ 12/02; - ABS		03.2120-2031.3 010106	ATE Ø 20,64
				06/98→ 12/02; für Rechtslenker		03.2120-4441.3 010510	ATE Ø 20,64
				→ 12/02; + ABS; für Linkslenker; nicht für Fahrschulwagen		03.2120-4441.3 010510	ATE Ø 20,64
						24.2120-1723.3 010545	BDX Ø 20,64
				→ 12/02; + ABS; für Linkslenker		03.2120-4441.3 010510	ATE Ø 20,64
						24.2120-1723.3 010545	BDX Ø 20,64
				06/98→ 12/02; für Linkslenker; + ABS		03.2122-1521.3 010494	Ø 22,2
	06/98→ 12/02; - ABS		03.2122-1541.3 010511	Ø 22,2			
	→ 03/99; + ABS; für Rechtslenker		24.2120-1725.3 010579	BDX Ø 20,64			
	→ 12/02; + ABS; für Rechtslenker		24.2120-1725.3 010579	BDX Ø 20,64			
1.9 dT (B/SA0K, B/SA0Y)	66	01/96→08/03		→ 12/02; - ABS		03.2120-2031.3 010106	ATE Ø 20,64
						03.2122-1541.3 010511	Ø 22,2
				03/96→ 12/02; - ABS		03.2120-2031.3 010106	ATE Ø 20,64
				→ 12/02; + ABS		03.2120-4441.3 010510	ATE Ø 20,64
						24.2120-1723.3 010545	BDX Ø 20,64
				→ 12/02; + ABS; für Linkslenker		03.2120-4441.3 010510	ATE Ø 20,64
			24.2120-1723.3 010545	BDX Ø 20,64			
	03/99→ 12/02; + ABS		03.2122-1521.3 010494	Ø 22,2			
	→ 12/02; + ABS; für Rechtslenker		24.2120-1725.3 010579	BDX Ø 20,64			
1.9 dTi (BA08, BA0N)	72	03/97→02/01		- ABS		03.2120-2031.3 010106	ATE Ø 20,64
						03.2122-1541.3 010511	Ø 22,2
				→ 02/99; + ABS		03.2120-4441.3 010510	ATE Ø 20,64
						24.2120-1723.3 010545	BDX Ø 20,64
				+ ABS; für Linkslenker		03.2120-4441.3 010510	ATE Ø 20,64
						24.2120-1723.3 010545	BDX Ø 20,64
				→ 02/99; + ABS; für Linkslenker		03.2120-4441.3 010510	ATE Ø 20,64
						24.2120-1723.3 010545	BDX Ø 20,64
				+ ABS		03.2122-1521.3 010494	Ø 22,2
				03/99→; + ABS; für Linkslenker		03.2123-2146.3 010572	Ø 23,81
	03/99→; + ABS		03.2123-2146.3 010572	Ø 23,81			
	→ 02/99; + ABS; für Rechtslenker		24.2120-1725.3 010579	BDX Ø 20,64			
	+ ABS; für Rechtslenker		24.2120-1725.3 010579	BDX Ø 20,64			
1.9 dTi (BA1U)	59	02/01→08/03		→ 12/02; + ABS; für Linkslenker		03.2123-2146.3 010572	Ø 23,81
1.9 TDI	69	09/96→08/03		→ 12/02; - ABS		03.2120-2031.3 010106	ATE Ø 20,64
				→ 12/02; + ABS		24.2120-1723.3 010545	BDX Ø 20,64
2.0 16V (BA0H)	108	07/96→08/03		→ 12/02		24.2123-1701.3 010424	Ø 23,81
2.0 i	80	03/99→08/03		→ 12/02		03.2120-2031.3 010106	ATE Ø 20,64
2.0 i (BA0G)	84	01/96→08/03		→ 12/02; - ABS		03.2120-2031.3 010106	ATE Ø 20,64
						03.2122-1541.3 010511	Ø 22,2
↓							











	kw			 	! #		
RENAULT - MEGANE I (BA0/1_) 08/95→12/04							
 Hauptbremszylinder							
2.0 i (BA0G)	84	01/96→08/03		→ 12/02; + ABS; für Linkslenker	03.2120-4441.3	010510	ATE Ø 20,64
				→ 12/02; + ABS	24.2120-1723.3	010545	BDX Ø 20,64
				→ 12/02; + ABS; für Rechtslenker	03.2122-1521.3	010494	Ø 22,2
				→ 12/02; + ABS; für Rechtslenker	24.2120-1725.3	010579	BDX Ø 20,64
RENAULT - MEGANE I Cabriolet (EA0/1_) 10/96→08/03							
 Bremskraftverstärker							
1.4 16V (EA0D, EA1H, EA0W, EA10)	70	03/99→08/03		+ ABS; für Linkslenker	03.7760-5502.4	300151	ATE Ø 10" pneumatisch
				- ABS	03.7760-5602.4	300121	ATE Ø 10" pneumatisch
				10/00→; + ABS; für Linkslenker	03.7863-2002.4	300126	ATE Ø 10" pneumatisch
1.6 16V (EA04, EA0B, EA11, EA1J)	79	03/99→07/03		+ ABS; für Linkslenker	03.7760-5102.4	300140	ATE Ø 10" pneumatisch
				10/00→; - ABS	03.7760-5602.4	300121	ATE Ø 10" pneumatisch
				10/00→; + ABS; für Linkslenker	03.7863-2002.4	300126	ATE Ø 10" pneumatisch
2.0 16V	102	01/02→08/03		für Linkslenker	03.7760-5102.4	300140	ATE Ø 10" pneumatisch
2.0 16V IDE (EA03, EA0P, EA14)	103	11/99→08/03		für Linkslenker	03.7760-5102.4	300140	ATE Ø 10" pneumatisch
				10/00→; - ABS	03.7760-5602.4	300121	ATE Ø 10" pneumatisch
				10/00→; + ABS; für Linkslenker	03.7863-2002.4	300126	ATE Ø 10" pneumatisch
 Hauptbremszylinder							
1.4 16V (EA0D, EA1H, EA0W, EA10)	70	03/99→08/03		+ ABS; für Linkslenker	03.2122-1521.3	010494	Ø 22,2
				- ABS	03.2122-1541.3	010511	Ø 22,2
				10/00→; + ABS; für Linkslenker	03.2123-2146.3	010572	Ø 23,81
1.6 16V (EA04, EA0B, EA11, EA1J)	79	03/99→07/03		10/00→; - ABS	03.2122-1541.3	010511	Ø 22,2
				+ ABS; für Linkslenker	03.2123-2146.3	010572	Ø 23,81
				10/00→; + ABS; für Linkslenker	03.2123-2146.3	010572	Ø 23,81
1.6 e (EA0F) 2.0 (EA0G) 2.0 i (EA0G)	66	10/96→03/99		- ABS; für Linkslenker	03.2120-2031.3	010106	ATE Ø 20,64
	84	04/97→08/03		+ ABS; für Linkslenker	03.2120-4441.3	010510	ATE Ø 20,64
	80	03/99→08/03		+ ABS; für Linkslenker	24.2120-1723.3	010545	BDX Ø 20,64
				+ ABS; für Rechtslenker	24.2120-1725.3	010579	BDX Ø 20,64
2.0 16V	102	01/02→08/03		für Linkslenker	03.2123-2146.3	010572	Ø 23,81
2.0 16V (EA0H)	108	10/96→11/99			24.2123-1701.3	010424	Ø 23,81
2.0 16V IDE (EA03, EA0P, EA14)	103	11/99→08/03		10/00→; - ABS	03.2122-1541.3	010511	Ø 22,2
				für Linkslenker	03.2123-2146.3	010572	Ø 23,81
				10/00→; + ABS; für Linkslenker	03.2123-2146.3	010572	Ø 23,81
RENAULT - MEGANE I Classic (LA0/1_) 09/96→08/08							
 Bremskraftverstärker							
1.4 (LA0E, LA0V)	55	09/96→08/03		09/98→ 12/02; + ABS	03.7760-5502.4	300151	ATE Ø 10" pneumatisch
				04/98→ 12/02; + ABS	03.7760-5602.4	300121	ATE Ø 10" pneumatisch
1.4 16V (LA0D, LA1H, IA0W, LA10)	70	03/99→08/03		→ 12/02; + ABS; für Linkslenker	03.7760-5502.4	300151	ATE Ø 10" pneumatisch
				→ 12/02; - ABS	03.7863-2002.4	300126	ATE Ø 10" pneumatisch
				→ 12/02; - ABS	03.7760-5602.4	300121	ATE Ø 10" pneumatisch
1.6 16V (LA00, LA04, LA0B, LA11, LA16, LA19, LA1J, LA1K,...)	79	03/99→07/03		→ 12/02; + ABS; für Linkslenker; für Fahrzeuge ohne verstärktes Fahrwerk	03.7760-5102.4	300140	ATE Ø 10" pneumatisch
				→ 12/02; + ABS; für Linkslenker; für Fahrzeuge mit verstärktem Fahrwerk	03.7760-5502.4	300151	ATE Ø 10" pneumatisch
				09/99→ 12/02; + ABS	03.7760-5502.4	300151	ATE Ø 10" pneumatisch
				09/99→ 12/02; - ABS	03.7760-5602.4	300121	ATE Ø 10" pneumatisch
				→ 12/02; - ABS; für Fahrzeuge mit verstärktem Fahrwerk	03.7760-5602.4	300121	ATE Ø 10" pneumatisch
1.6 e (LA0F, LA0S)	66	09/96→03/99		+ ABS; für Linkslenker	03.7760-5502.4	300151	ATE Ø 10" pneumatisch
				- ABS; für Linkslenker; für Fahrzeuge mit verstärktem Fahrwerk	03.7760-5602.4	300121	ATE Ø 10" pneumatisch
1.8 16V (LA06, LA12, LA1A, LA1M, LA1R)	85	01/01→08/03		→ 12/02; + ABS; für Linkslenker	03.7863-2002.4	300126	ATE Ø 10" pneumatisch
1.9 D (LA0A, LA0U, LA0R)	47	09/96→08/03		09/98→ 12/02; + ABS; für Linkslenker	03.7760-5502.4	300151	ATE Ø 10" pneumatisch
				09/98→ 12/02; - ABS	03.7760-5602.4	300121	ATE Ø 10" pneumatisch
1.9 dCi (LA05, LA1F)	75	02/01→08/03		→ 12/02; + ABS; für Linkslenker	03.7760-5102.4	300140	ATE Ø 10" pneumatisch
					03.7863-2002.4	300126	ATE Ø 10" pneumatisch
1.9 dTi (LA08, LA0N)	72	03/97→02/01		03/99→; für Linkslenker	03.7760-5102.4	300140	ATE Ø 10" pneumatisch
				03/99→; + ABS; für Linkslenker	03.7760-5502.4	300151	ATE Ø 10" pneumatisch
				- ABS	03.7760-5602.4	300121	ATE Ø 10" pneumatisch
↓							

	kw			 	! #		
RENAULT - MEGANE I Classic (LA0/1) 09/96→08/08							
Bremskraftverstärker							
1.9 dTi (LA08, LA0N)	72	03/97→02/01		+ ABS; für Linkslenker		03.7863-2002.4 300126	ATE Ø 10" pneumatisch
1.9 TDI	69	09/96→08/03		→ 12/02; + ABS		03.7760-5502.4 300151	ATE Ø 10" pneumatisch
				→ 12/02; - ABS		03.7760-5602.4 300121	ATE Ø 10" pneumatisch
2.0 i (LA07, LA0G)	84	09/96→08/03		09/98→ 12/02; + ABS; für Linkslenker		03.7760-5502.4 300151	ATE Ø 10" pneumatisch
				→ 12/02; - ABS; für Linkslenker		03.7760-5602.4 300121	ATE Ø 10" pneumatisch
Hauptbremszylinder							
1.4 (LA0E, LA0V)	55	09/96→08/03		→ 12/02; - ABS		03.2120-2031.3 010106	ATE Ø 20,64
				→ 03/99; + ABS		03.2120-4441.3 010510	ATE Ø 20,64
				03/99→ 12/02; + ABS		03.2122-1521.3 010494	Ø 22,2
				04/98→ 12/02; - ABS		03.2122-1541.3 010511	Ø 22,2
				→ 12/02; + ABS		24.2120-1723.3 010545	BDX Ø 20,64
1.4 16V (LA0D, LA1H, IA0W, LA10)	70	03/99→08/03		→ 12/02; + ABS; für Rechtslenker		03.2120-4441.3 010510	ATE Ø 20,64
				→ 12/02; + ABS; für Linkslenker		03.2122-1521.3 010494	Ø 22,2
1.6 16V (LA00, LA04, LA0B, LA11, LA16, LA19, LA1J, LA1K,....)	79	03/99→07/03		→ 12/02; - ABS		03.2122-1541.3 010511	Ø 22,2
				09/99→ 12/02		03.2122-1521.3 010494	Ø 22,2
				→ 12/02; + ABS; für Linkslenker; für Fahrzeuge mit verstärktem Fahrwerk		03.2122-1521.3 010494	Ø 22,2
				09/99→ 12/02; - ABS		03.2122-1541.3 010511	Ø 22,2
1.6 e (LA0F, LA0S)	66	09/96→03/99		→ 12/02; - ABS; für Fahrzeuge mit verstärktem Fahrwerk		03.2122-1541.3 010511	Ø 22,2
				→ 12/02; + ABS; für Linkslenker; für Fahrzeuge ohne verstärktes Fahrwerk		03.2123-2146.3 010572	Ø 23,81
				- ABS		03.2120-2031.3 010106	ATE Ø 20,64
1.6 i (LA0L)	55	09/96→03/99		+ ABS; für Linkslenker		03.2120-4441.3 010510	ATE Ø 20,64
				+ ABS; für Rechtslenker		24.2120-1723.3 010545	BDX Ø 20,64
				- ABS		24.2120-1725.3 010579	BDX Ø 20,64
1.8 16V (LA06, LA12, LA1A, LA1M, LA1R)	85	01/01→08/03		- ABS		03.2120-2031.3 010106	ATE Ø 20,64
				+ ABS		03.2120-4441.3 010510	ATE Ø 20,64
1.9 D (LA0A, LA0U, LA0R)	47	09/96→08/03		→ 12/02; - ABS		24.2120-1723.3 010545	BDX Ø 20,64
				→ 12/02; + ABS		03.2120-2031.3 010106	ATE Ø 20,64
				→ 12/02; + ABS; für Linkslenker		03.2120-4441.3 010510	ATE Ø 20,64
				→ 12/02; + ABS; für Linkslenker		24.2120-1723.3 010545	BDX Ø 20,64
				09/98→ 12/02; + ABS; für Linkslenker		03.2122-1521.3 010494	Ø 22,2
				09/98→ 12/02; - ABS		03.2122-1541.3 010511	Ø 22,2
1.9 dCi (LA05, LA1F)	75	02/01→08/03		→ 12/02; + ABS; für Rechtslenker		24.2120-1725.3 010579	BDX Ø 20,64
				→ 12/02; - ABS		03.2122-1541.3 010511	Ø 22,2
1.9 dT (LA0K, LA0Y)	66	09/96→08/03		→ 12/02; + ABS; für Linkslenker		03.2123-2146.3 010572	Ø 23,81
				→ 12/02; - ABS		03.2120-2031.3 010106	ATE Ø 20,64
				→ 12/02; + ABS		03.2120-4441.3 010510	ATE Ø 20,64
				→ 12/02; + ABS; für Linkslenker		24.2120-1723.3 010545	BDX Ø 20,64
				→ 12/02; + ABS; für Rechtslenker		24.2120-1725.3 010579	BDX Ø 20,64
1.9 dTi (LA08, LA0N)	72	03/97→02/01		- ABS		03.2120-2031.3 010106	ATE Ø 20,64
				+ ABS; für Linkslenker		03.2120-4441.3 010510	ATE Ø 20,64
				+ ABS; für Linkslenker; für Fahrzeuge mit verstärktem Fahrwerk		03.2123-2146.3 010572	Ø 23,81
				08/99→; + ABS; für Linkslenker; für Fahrzeuge mit verstärktem Fahrwerk		03.2122-1521.3 010494	Ø 22,2
				03/99→; - ABS; für Linkslenker		03.2122-1541.3 010511	Ø 22,2
				+ ABS; für Linkslenker; für Fahrzeuge ohne verstärktes Fahrwerk		03.2123-2146.3 010572	Ø 23,81
				→ 02/99; + ABS; für Rechtslenker		24.2120-1725.3 010579	BDX Ø 20,64
1.9 TDI	69	09/96→08/03		+ ABS; für Rechtslenker		24.2120-1725.3 010579	BDX Ø 20,64
				→ 12/02; + ABS		03.2122-1521.3 010494	Ø 22,2
				→ 12/02; - ABS		03.2122-1541.3 010511	Ø 22,2
2.0 i (LA07, LA0G)	84	09/96→08/03		→ 12/02; - ABS		03.2120-2031.3 010106	ATE Ø 20,64













	kw					! #		
RENAULT - MEGANE I Classic (LA0/1_) 09/96→08/08								
 Hauptbremszylinder								
2.0 i (LA07, LA0G)	84	09/96→08/03		→ 12/02		03.2120-2031.3	010106	ATE Ø 20,64
				→ 12/02; + ABS; für Linkslenker		03.2120-4441.3	010510	ATE Ø 20,64
				→ 12/02; + ABS; für Linkslenker		24.2120-1723.3	010545	BDX Ø 20,64
				08/99→ 12/02; + ABS; für Linkslenker		03.2122-1521.3	010494	Ø 22,2
				03/99→ 12/02; - ABS; für Linkslenker		03.2122-1541.3	010511	Ø 22,2
			→ 12/02; + ABS; für Rechtslenker		24.2120-1725.3	010579	BDX Ø 20,64	
RENAULT - MEGANE I Coach (DA0/1_) 03/96→08/03								
 Bremskraftverstärker								
1.4 16V (DA0D, DA1H, DA0W, DA10)	70	03/99→07/03		→ 02/03; + ABS; für Linkslenker		03.7760-5502.4	300151	ATE Ø 10" pneumatisch
				→ 02/03; - ABS		03.7760-5602.4	300121	ATE Ø 10" pneumatisch
				10/00→ 02/03; + ABS; für Linkslenker		03.7863-2002.4	300126	ATE Ø 10" pneumatisch
1.6 16V (DA0B, DA04, DA11)	79	03/99→07/03		→ 02/03; + ABS; für Linkslenker		03.7760-5102.4	300140	ATE Ø 10" pneumatisch
				10/00→ 02/03; - ABS		03.7760-5602.4	300121	ATE Ø 10" pneumatisch
				10/00→ 02/03; + ABS; für Linkslenker		03.7863-2002.4	300126	ATE Ø 10" pneumatisch
1.9 dCi (DA05, DA1F)	75	02/01→08/03		→ 02/03; + ABS; für Linkslenker		03.7760-5102.4	300140	ATE Ø 10" pneumatisch
						03.7863-2002.4	300126	ATE Ø 10" pneumatisch
1.9 dTi (DA0N) 2.0 16V (DA0H)	72 108	03/97→02/01 03/96→11/99		03/99→; für Linkslenker		03.7760-5102.4	300140	ATE Ø 10" pneumatisch
2.0 16V	102	01/02→08/03		→ 02/03; für Linkslenker		03.7760-5102.4	300140	ATE Ø 10" pneumatisch
				→ 02/03; - ABS		03.7760-5602.4	300121	ATE Ø 10" pneumatisch
				→ 02/03; + ABS; für Linkslenker		03.7863-2002.4	300126	ATE Ø 10" pneumatisch
2.0 16V IDE (DA03, DA0P, DA14)	103	11/99→08/03		→ 02/03; für Linkslenker		03.7760-5102.4	300140	ATE Ø 10" pneumatisch
				10/00→ 02/03; - ABS		03.7760-5602.4	300121	ATE Ø 10" pneumatisch
				10/00→ 02/03; + ABS; für Linkslenker		03.7863-2002.4	300126	ATE Ø 10" pneumatisch
 Hauptbremszylinder								
1.4 16V (DA0D, DA1H, DA0W, DA10)	70	03/99→07/03		→ 02/03; für Rechtslenker		03.2120-4441.3	010510	ATE Ø 20,64
				→ 02/03; + ABS; für Linkslenker		03.2122-1521.3	010494	Ø 22,2
				→ 02/03; - ABS		03.2122-1541.3	010511	Ø 22,2
				10/00→ 02/03; + ABS; für Linkslenker		03.2123-2146.3	010572	Ø 23,81
1.6 16V (DA0B, DA04, DA11)	79	03/99→07/03		10/00→ 02/03; - ABS		03.2122-1541.3	010511	Ø 22,2
				10/00→ 02/03; + ABS; für Linkslenker		03.2123-2146.3	010572	Ø 23,81
				→ 02/03; + ABS; für Linkslenker		03.2123-2146.3	010572	Ø 23,81
1.6 e (DA0F)	66	03/96→03/99		- ABS; für Linkslenker		03.2120-2031.3	010106	ATE Ø 20,64
				+ ABS		03.2120-4441.3	010510	ATE Ø 20,64
				+ ABS; für Linkslenker		24.2120-1723.3	010545	BDX Ø 20,64
				+ ABS; für Rechtslenker		24.2120-1725.3	010579	BDX Ø 20,64
1.9 dCi (DA05, DA1F) 2.0 16V	75 102	02/01→08/03 01/02→08/03		→ 02/03; - ABS		03.2122-1541.3	010511	Ø 22,2
				→ 02/03; + ABS; für Linkslenker		03.2123-2146.3	010572	Ø 23,81
1.9 dTi (DA0N)	72	03/97→02/01		05/97→; - ABS		03.2120-2031.3	010106	ATE Ø 20,64
				05/97→ 02/99; + ABS		03.2120-4441.3	010510	ATE Ø 20,64
						24.2120-1723.3	010545	BDX Ø 20,64
2.0 16V (DA0H)	108	03/96→11/99		03/99→; für Linkslenker		03.2123-2146.3	010572	Ø 23,81
				→ 02/99		24.2123-1701.3	010424	Ø 23,81
2.0 16V IDE (DA03, DA0P, DA14)	103	11/99→08/03		10/00→ 02/03; - ABS		03.2122-1541.3	010511	Ø 22,2
				10/00→ 02/03; + ABS; für Linkslenker		03.2123-2146.3	010572	Ø 23,81
				→ 02/03; für Linkslenker		03.2123-2146.3	010572	Ø 23,81
2.0 i 2.0 i (DA0G)	80 84	03/99→08/03 03/96→08/03		→ 02/03; - ABS; für Linkslenker		03.2120-2031.3	010106	ATE Ø 20,64
				→ 02/03; + ABS		03.2120-4441.3	010510	ATE Ø 20,64
				→ 02/03; + ABS; für Linkslenker		24.2120-1723.3	010545	BDX Ø 20,64
				→ 02/03; + ABS; für Rechtslenker		24.2120-1725.3	010579	BDX Ø 20,64
RENAULT - MEGANE I Grandtour (KA0/1_) 03/99→08/03								
 Bremskraftverstärker								
1.4 16V (KA0D, KA1H, KA0W, KA10)	70	03/99→08/03		+ ABS; Motorcode: KA0W; für Fahrzeuge mit verstärktem Fahrwerk		03.7760-5502.4	300151	ATE Ø 10" pneumatisch
				- ABS		03.7760-5602.4	300121	ATE Ø 10" pneumatisch
				+ ABS; für Linkslenker; Motorcode: KA0D		03.7863-2002.4	300126	ATE Ø 10" pneumatisch
↓								



	kw					! #		
RENAULT - MEGANE I Grandtour (KA0/1_) 03/99→08/03								
 Bremskraftverstärker								
1.4 e (KA0V)	55	03/99→08/03		+ ABS;			03.7760-5502.4 300151	ATE Ø 10" pneumatisch
1.6 e (KA0F)	66	03/99→08/03		für Fahrzeuge mit verstärktem Fahrwerk				
1.9 D (KA0J, KA0R)	47	04/99→08/03		- ABS			03.7760-5602.4 300121	ATE Ø 10" pneumatisch
1.6 16V (KA0B, KA04, KA11)	79	03/99→08/03		+ ABS; für Linkslenker; Motorcode: KA04; für Fahrzeuge ohne verstärktes Fahrwerk			03.7760-5102.4 300140	ATE Ø 10" pneumatisch
				- ABS			03.7760-5602.4 300121	ATE Ø 10" pneumatisch
				+ ABS; für Linkslenker; Motorcode: KA0B			03.7863-2002.4 300126	ATE Ø 10" pneumatisch
1.8 16V (KA0S, KA12, KA1A, KA1M, KA1R)	85	01/01→08/03		+ ABS; für Linkslenker			03.7863-2002.4 300126	ATE Ø 10" pneumatisch
1.9 dCi (KA05, KA1F)	75	02/01→08/03		+ ABS; für Linkslenker; Motorcode: KA05; für Fahrzeuge ohne verstärktes Fahrwerk			03.7760-5102.4 300140	ATE Ø 10" pneumatisch
				+ ABS; für Linkslenker; Motorcode: KA1F			03.7863-2002.4 300126	ATE Ø 10" pneumatisch
1.9 dTi (KA0N)	72	03/99→02/01		+ ABS; für Linkslenker; Motorcode: KA0N; für Fahrzeuge ohne verstärktes Fahrwerk			03.7760-5102.4 300140	ATE Ø 10" pneumatisch
				- ABS; Motorcode: KA0N			03.7760-5602.4 300121	ATE Ø 10" pneumatisch
1.9 dTi (KA1U)	59	02/01→08/03		- ABS; Motorcode: KA1U			03.7760-5602.4 300121	ATE Ø 10" pneumatisch
				+ ABS; für Linkslenker; Motorcode: KA1U			03.7863-2002.4 300126	ATE Ø 10" pneumatisch
 Hauptbremszylinder								
1.4 16V (KA0D, KA1H, KA0W, KA10)	70	03/99→08/03		+ ABS			03.2122-1521.3 010494	Ø 22,2
	55	03/99→08/03		- ABS			03.2122-1541.3 010511	Ø 22,2
	66	03/99→08/03						
	47	04/99→08/03						
1.6 16V (KA0B, KA04, KA11)	79	03/99→08/03		- ABS			03.2123-1551.3 010512	Ø 23,81
1.9 dCi (KA05, KA1F)	75	02/01→08/03		+ ABS			03.2123-2146.3 010572	Ø 23,81
1.9 dTi (KA0N)	72	03/99→02/01						
1.8 16V (KA0S, KA12, KA1A, KA1M, KA1R)	85	01/01→08/03		+ ABS			03.2123-2146.3 010572	Ø 23,81
							03.2123-2621.3 010701	ATE Ø 23,81
1.9 dTi (KA1U)	59	02/01→08/03		- ABS			03.2123-2146.3 010572	Ø 23,81
				+ ABS			03.2123-2621.3 010701	ATE Ø 23,81
RENAULT - MEGANE II (BM0/1_, CM0/1_) 07/01→10/12								
 Hauptbremszylinder								
1.4 16V	60	10/03→02/08					24.2123-1760.3 010779	TRW Ø 23,81
1.4 16V (BM0B, CM0B)	72	11/02→02/08						
1.5 dCi (BM02, BM13, BM2A, CM02, CM13)	74	10/03→02/08						
1.5 dCi (BM1E, CM1E)	78	05/05→06/08						
1.5 dCi (BM1F, CM1F)	63	05/05→02/08						
1.6	77	06/05→02/08						
1.6 16V	82	01/06→06/08						
1.6 16V (BM0C, CM0C)	83	11/02→02/08						
1.6 Flex-Fuel	77	01/07→02/08						
1.9 dCi (BM0G, CM0G)	88	11/02→02/08						
2.0	169	08/06→02/08						
2.0 16V (BM0U, CM0U)	99	11/02→02/08						
2.0 16V Turbo	120	05/04→02/08						
2.0 dCi	127	01/07→02/08						
2.0 dCi (BM1K, CM1K)	110	09/05→02/08						
1.5 dCi (BM0F, BM0T, BM2B, CM0F, CM0T)	60	09/02→02/08		11/02→			24.2123-1760.3 010779	TRW Ø 23,81
1.5 dCi (BM16, CM16)	76	01/07→03/09		→ 11/08			24.2123-1760.3 010779	TRW Ø 23,81
1.9 dCi	96	05/05→12/09						
2.0 Renault Sport	165	05/04→10/09						
1.9 dCi	68	03/04→08/06		01/06→			24.2123-1760.3 010779	TRW Ø 23,81
1.9 dCi	81	05/05→02/08						
1.9 dCi	85	11/02→02/08						
RENAULT - MEGANE II Coupé-Cabriolet (EM0/1_) 09/03→03/10								
 Hauptbremszylinder								
1.5 dCi (EM16)	76	01/07→06/09					24.2123-1760.3 010779	TRW Ø 23,81
1.6	83	09/03→03/09						
1.9 dCi	81	05/05→03/09						
1.9 dCi	88	09/03→03/09						
1.9 dCi	96	05/05→02/07						
2.0 16V Turbo	120	05/04→03/09						
2.0 dCi	110	09/05→03/09						
1.5 dCi (EM1E)	78	03/06→01/09		→ 06/08			24.2123-1760.3 010779	TRW Ø 23,81
↓								

	kw					! #		
RENAULT - MEGANE II Coupé-Cabriolet (EM0/1_) 09/03→03/10								
 Hauptbremszylinder								
1.6 16V	82	01/06→06/08		01/07→			24.2123-1760.3 010779	TRW Ø 23,81
1.9 dCi	85	09/03→03/09		01/06→			24.2123-1760.3 010779	TRW Ø 23,81
2.0	99	09/03→12/09		→ 03/07			24.2123-1760.3 010779	TRW Ø 23,81
RENAULT - MEGANE II Grandtour (KM0/1_) 08/03→08/12								
 Hauptbremszylinder								
1.4	72	08/03→07/09		09/03→ 12/08			24.2123-1760.3 010779	TRW Ø 23,81
1.6	83	08/03→07/09						
1.9 dCi	88	08/03→07/09						
2.0	99	08/03→07/09						
1.5 dCi (KM02, KM13)	74	02/04→03/06					24.2123-1760.3 010779	TRW Ø 23,81
1.5 dCi (KM16, KM1E)	78	05/05→06/08						
1.6 16V	77	05/05→07/09						
1.9 dCi	66	04/04→12/05						
1.9 dCi	68	03/04→02/07						
1.5 dCi (KM0F, KM0T, KM2B)	60	08/03→05/06		09/03→			24.2123-1760.3 010779	TRW Ø 23,81
1.5 dCi (KM16)	76	01/07→07/09		→ 12/08			24.2123-1760.3 010779	TRW Ø 23,81
1.5 dCi (KM1F)	63	05/05→07/09						
1.6 16V Hi-Flex	77	02/08→07/09						
1.9 dCi	81	05/05→07/09						
1.9 dCi	85	05/05→07/09						
2.0 dCi	110	09/05→07/09						
1.6 16V	82	01/06→08/09		01/07→ 12/08			24.2123-1760.3 010779	TRW Ø 23,81
1.9 dCi	96	05/05→07/09		→ 02/07			24.2123-1760.3 010779	TRW Ø 23,81
RENAULT - MEGANE II Stufenheck (LM0/1_) 08/03→								
 Hauptbremszylinder								
1.4	60	09/03→		→ 08/06			24.2123-1760.3 010779	TRW Ø 23,81
1.4	72	09/03→		→ 12/08			24.2123-1760.3 010779	TRW Ø 23,81
1.5 dCi (LM1E)	78	05/05→12/10						
1.6	77	05/05→						
1.6	83	09/03→						
1.9 dCi	96	05/05→						
1.9 dCi (LM0G, LM1G, LM2C)	88	09/03→						
1.9 dCi (LM14, LM1D)	81	05/05→						
2.0 dCi	110	09/05→						
1.5 dCi (LM02, LM13, LM2A)	74	02/04→12/10		→ 03/06; für Fahrzeuge ohne Sportfahrwerk			24.2123-1760.3 010779	TRW Ø 23,81
				→ 03/06; für Fahrzeuge mit Sportfahrwerk			24.2125-1742.3 010978	TRW Ø 25,4
1.5 dCi (LM0F, LM0T, LM2B)	60	08/03→12/10		09/03→ 12/08			24.2123-1760.3 010779	TRW Ø 23,81
1.5 dCi (LM16)	76	10/03→12/10		01/07→; für Fahrzeuge ohne Sportfahrwerk; → 12/08			24.2123-1760.3 010779	TRW Ø 23,81
				01/07→; für Fahrzeuge mit Sportfahrwerk; → 12/08			24.2125-1742.3 010978	TRW Ø 25,4
1.5 dCi (LM1F)	63	05/05→12/10		für Fahrzeuge ohne Sportfahrwerk; → 12/08			24.2123-1760.3 010779	TRW Ø 23,81
1.9 dCi	68	03/04→						
2.0	99	09/03→		für Fahrzeuge mit Sportfahrwerk; → 12/08			24.2125-1742.3 010978	TRW Ø 25,4
1.6 16V (LM1R, LM0C)	82	01/06→		01/07→ 12/08			24.2123-1760.3 010779	TRW Ø 23,81
1.9 dCi	66	09/03→12/05		für Fahrzeuge ohne Sportfahrwerk			24.2123-1760.3 010779	TRW Ø 23,81
				für Fahrzeuge mit Sportfahrwerk			24.2125-1742.3 010978	TRW Ø 25,4
RENAULT - MEGANE III Coupe (DZ0/1_) 11/08→								
 Hauptbremszylinder								
1.2 TCe	85	03/12→					24.4123-1715.3 010980	TRW Ø 23,81
1.2 TCe (DZ16)	97	01/13→						
1.4 TCe (DZ0F, DZ1V)	96	04/09→						
1.5 dCi	70	07/14→						
1.5 dCi (DZ09, DZ0D, DZ1F, DZ1G)	81	02/09→						
1.5 dCi (DZ0A)	63	11/08→						
1.5 dCi (DZ0B)	78	02/09→						
1.5 dCi (DZ0C, DZ1A)	66	11/08→						
1.6 16V (DZ0H)	74	11/08→						
1.6 16V (DZ0U, DZ1B, DZ1H)	81	11/08→						
1.6 16V Bifuel (DZ03, DZ1Y)	81	11/08→						
1.6 dCi (DZ00)	96	04/11→						



	kw					! #		
RENAULT - MEGANE III Coupe (DZ0/1_) 11/08→								
 Hauptbremszylinder								
1.9 dCi (DZ0N, DZ0J, DZ1J, DZ1K)	96	11/08→					24.4123-1715.3 010980	TRW Ø 23,81
2.0 CVT (DZ0G, DZ1E)	103	05/09→						
2.0 dCi	120	07/12→						
2.0 dCi (DZ0L)	118	04/09→						
2.0 dCi (DZ0Y)	110	04/09→						
2.0 TCe (DZ0K)	132	11/08→						
2.0 TCe (DZ1N)	184	05/09→						
RENAULT - MEGANE III Grandtour (KZ0/1) 11/08→								
 Hauptbremszylinder								
1.2 TCe	85	03/12→					24.4123-1715.3 010980	TRW Ø 23,81
1.2 TCe (KZ16)	97	01/13→						
1.4 TCe (KZ0F, KZ1V)	96	05/09→						
1.5 dCi	70	11/13→						
1.5 dCi (KZ09, KZ0D, KZ1G)	81	02/09→						
1.5 dCi (KZ0C, KZ1A)	66	05/09→						
1.6 16V (KZ0H)	74	05/09→						
1.6 16V (KZ0U, KZ1B, KZ1U)	81	05/09→						
1.6 16V Bifuel (KZ03)	81	11/08→						
1.6 dCi (KZ00, KZ12)	96	04/11→						
1.9 dCi (KZ0J, KZ0N, KZ1S)	96	05/09→						
2.0 CVT (KZ0G, KZ1P)	103	05/09→						
2.0 dCi	120	07/12→						
2.0 dCi (KZ0L)	118	04/09→						
2.0 dCi (KZ0Y)	110	10/10→						
2.0 TCe	140	09/12→						
2.0 TCe	162	09/12→						
1.5 dCi	63	03/09→		08/09→			24.4123-1715.3 010980	TRW Ø 23,81
1.5 dCi (KZ1M, KZ1W)	78	02/09→		05/09→			24.4123-1715.3 010980	TRW Ø 23,81
2.0 TCe (KZ0K, KZ1T)	132	11/08→						
RENAULT - MEGANE III Schrägheck (BZ0/1_) 11/08→								
 Hauptbremszylinder								
1.2 TCe	85	03/12→					24.4123-1715.3 010980	TRW Ø 23,81
1.2 TCe (BZ16)	97	01/13→						
1.4 TCe (BZ0F, BZ1V)	96	04/09→						
1.5 dCi	63	12/09→						
1.5 dCi	78	02/09→						
1.5 dCi (BZ09, BZ0D)	81	02/09→						
1.5 dCi (BZ0C)	66	11/08→						
1.5 dCi (BZ1G, BZ1W, BZ0R)	70	11/13→						
1.6 16V	82	11/08→						
1.6 16V (BZ0H)	74	11/08→						
1.6 16V (BZ1B, BZ1H)	81	11/08→						
1.6 16V Bifuel (BZ03)	81	11/08→						
1.6 dCi (BZ00, BZ12)	96	04/11→						
1.9 dCi (BZ0N, BZ0J)	96	11/08→						
2.0 CVT (BZ0G, BZ1P)	103	02/09→						
2.0 dCi	120	07/12→						
2.0 dCi (BZ0L)	118	04/09→						
2.0 dCi (BZ0Y)	110	10/10→						
2.0 TCe (BZ0K)	132	11/08→						
RENAULT - MEGANE CC (EZ0/1_) 06/10→								
 Hauptbremszylinder								
1.2 TCe (EZ16)	97	01/13→		04/13→			24.4123-1715.3 010980	TRW Ø 23,81
1.4 TCe (EZ0F, EZ1V)	96	06/10→					24.4123-1715.3 010980	TRW Ø 23,81
1.5 dCi (EZ09, EZ1G, EZ0D)	81	06/10→						
1.6 16V (EZ0U, EZ1U)	81	06/10→						
1.6 dCi (EZ00)	96	04/11→						
1.9 dCi (EZ0J, EZ1S)	96	06/10→						
2.0 CVT (EZ0G, EZ1E, EZ1P)	103	06/10→						
2.0 dCi (EZ0L)	118	06/10→						
2.0 TCe (EZ1T)	132	06/10→						
RENAULT - MEGANE Scenic (JA0/1_) 10/96→12/01								
 Bremskraftverstärker								
1.4 i (JA0E)	55	01/97→09/99		10/98→			03.7760-5102.4 300140	ATE Ø 10" pneumatisch
1.6 i (JA0L)	55	01/97→09/99						
1.6 16V (JA0B, JA04, JA11)	79	04/98→10/99		10/98→ 09/99; für Linkslenker			03.7760-5102.4 300140	ATE Ø 10" pneumatisch

RENAULT - MEGANE Scenic (JA0/1_) 10/96→12/01

Bremskraftverstärker

1.6 e (JA0F)	66	10/96→10/99		10/98→ 09/99; für Linkslenker	03.7760-5102.4	300140	ATE Ø 10" pneumatisch
1.9 D (JA0J)	47	03/97→09/99		10/98→; für Linkslenker	03.7760-5102.4	300140	ATE Ø 10" pneumatisch
1.9 dTi (JA0N)	72	04/97→09/99		10/98→	03.7760-5102.4	300140	ATE Ø 10" pneumatisch
2.0 i (JA02, JA0G)	80	01/99→09/99		für Linkslenker	03.7760-5102.4	300140	ATE Ø 10" pneumatisch
2.0 i (JA0G)	84	01/97→09/99		10/98→; für Linkslenker	03.7760-5102.4	300140	ATE Ø 10" pneumatisch

Hauptbremszylinder

1.4 i (JA0E)	55	01/97→09/99		→ 09/98; - ABS	03.2120-2031.3	010106	ATE Ø 20,64
1.6 i (JA0L)	55	01/97→09/99		10/98→; - ABS	03.2123-1551.3	010512	Ø 23,81
				10/98→; + ABS	03.2123-2146.3	010572	Ø 23,81
				→ 09/98; + ABS	24.2120-1723.3	010545	BDX Ø 20,64
1.6 16V (JA0B, JA04, JA11)	79	04/98→10/99		10/98→ 09/99; für Linkslenker; - ABS	03.2123-1551.3	010512	Ø 23,81
				10/98→ 09/99; für Linkslenker; + ABS	03.2123-2146.3	010572	Ø 23,81
1.6 e (JA0F)	66	10/96→10/99		11/96→ 09/98; - ABS; Schaltgetriebe	03.2120-2031.3	010106	ATE Ø 20,64
				10/98→ 09/99; für Linkslenker; - ABS	03.2123-1551.3	010512	Ø 23,81
				10/98→ 09/99; für Linkslenker; + ABS	03.2123-2146.3	010572	Ø 23,81
				11/96→ 09/98; + ABS; für Linkslenker; Schaltgetriebe	24.2120-1723.3	010545	BDX Ø 20,64
				11/96→ 09/98; + ABS; für Rechtslenker; Schaltgetriebe	24.2120-1725.3	010579	BDX Ø 20,64
1.9 D (JA0J)	47	03/97→09/99		10/98→; - ABS	03.2123-1551.3	010512	Ø 23,81
1.9 dTi (JA0N)	72	04/97→09/99		10/98→; - ABS; für Linkslenker	03.2123-1551.3	010512	Ø 23,81
				10/98→; + ABS	03.2123-2146.3	010572	Ø 23,81
				10/98→; + ABS; für Linkslenker	03.2123-2146.3	010572	Ø 23,81
2.0 i (JA02, JA0G)	80	01/99→09/99		- ABS; für Linkslenker	03.2123-1551.3	010512	Ø 23,81
				+ ABS; für Linkslenker	03.2123-2146.3	010572	Ø 23,81
2.0 i (JA0G)	84	01/97→09/99		10/98→; - ABS; für Linkslenker	03.2123-1551.3	010512	Ø 23,81
				10/98→; + ABS; für Linkslenker	03.2123-2146.3	010572	Ø 23,81













RENAULT - MODUS / GRAND MODUS (F/JP0_) 09/04→













Bremskraftverstärker















1.2 (FP0C, FP0K, FP0P)	48	05/05→		für Linkslenker; → 06/13; + ABS	03.7863-4502.4	300230	ATE Ø 10" pneumatisch
1.2 (JP0S)	58	12/04→					
1.2 16V (JP0W)	74	05/07→					
1.2 (JP0C, JP0K, FP0C, FP0K, FP0P, JP0P, JP0T)	55	12/04→		für Linkslenker; → 06/13; + ABS	03.7863-4502.4	300230	ATE Ø 10" pneumatisch
				→ 01/05; für Linkslenker	03.7863-6002.4	300249	ATE Ø 10" pneumatisch
1.4 (JP01, JP0J)	72	12/04→		02/05→; für Linkslenker; → 10/07; + ABS	03.7863-4502.4	300230	ATE Ø 10" pneumatisch
				→ 01/05; für Linkslenker	03.7863-6002.4	300249	ATE Ø 10" pneumatisch
1.5 dCi (FP0D, JP0D)	60	09/04→		02/05→; für Linkslenker; → 06/13; + ABS	03.7863-4502.4	300230	ATE Ø 10" pneumatisch
1.5 dCi (FP0F, JP0F)	63	12/04→					
1.5 dCi (FP0G, JP0G)	50	12/04→		→ 01/05; für Linkslenker	03.7863-6002.4	300249	ATE Ø 10" pneumatisch
1.6 (JP03, JP0B, JP0U, JP0Y, JP1G)	82	12/04→					
1.6 (JP0L, JP0V)	65	12/04→					
1.5 dCi (FP0E, JP0E)	48	12/04→		02/05→; für Linkslenker; → 06/13; + ABS	03.7863-4502.4	300230	ATE Ø 10" pneumatisch
1.5 dCi (JP02)	76	05/07→		→ 10/07; für Linkslenker; + ABS	03.7863-4502.4	300230	ATE Ø 10" pneumatisch











Hauptbremszylinder

















1.2	76	04/11→		für Linkslenker; → 06/13; - ESP	03.2123-3241.3	010882	ATE Ø 23,81
1.2 (FP0C, FP0K, FP0P)	48	05/05→					
1.2 (JP0S)	58	12/04→		für Linkslenker; → 06/13; + ESP	03.2123-3493.3	010792	ATE Ø 23,81
1.5 dCi 75	55	10/10→					
1.5 dCi 90	65	10/10→					
1.2 (JP0C, JP0K, FP0C, FP0K, FP0P, JP0P, JP0T)	55	12/04→		für Linkslenker; → 06/13; - ABS	03.2123-2821.3	010944	ATE Ø 23,81
				für Linkslenker; → 01/05; + ABS / - ESP	03.2123-2863.3	010790	ATE Ø 23,81
1.4 (JP01, JP0J)	72	12/04→		für Linkslenker; → 01/05; + ESP	03.2123-2923.3	010791	ATE Ø 23,81
1.5 dCi (FP0F, JP0F)	63	12/04→		02/05→; für Linkslenker; → 06/13; - ESP	03.2123-3241.3	010882	ATE Ø 23,81
1.5 dCi (FP0G, JP0G)	50	12/04→		02/05→; für Linkslenker; → 06/13; + ESP	03.2123-3493.3	010792	ATE Ø 23,81
1.2 16V (JP0W)	74	05/07→		für Linkslenker; → 06/13; - ABS	03.2123-2821.3	010944	ATE Ø 23,81
1.5 dCi (JP02)	76	05/07→		für Linkslenker; → 06/13; - ESP	03.2123-3241.3	010882	ATE Ø 23,81
				für Linkslenker; → 06/13; + ESP	03.2123-3493.3	010792	ATE Ø 23,81
1.2 16V Hi-Flex	55	10/08→		für Linkslenker; → 06/13; - ABS	03.2123-2821.3	010944	ATE Ø 23,81
1.5 dCi (FP0D, JP0D)	60	09/04→		09/05→; für Linkslenker; → 06/13; - ABS	03.2123-2821.3	010944	ATE Ø 23,81
				für Linkslenker; → 01/05; + ABS / - ESP	03.2123-2863.3	010790	ATE Ø 23,81
				für Linkslenker; → 01/05; + ESP	03.2123-2923.3	010791	ATE Ø 23,81













	kw					! #		
RENAULT - MODUS / GRAND MODUS (F/JP0_) 09/04 →								
 Hauptbremszylinder								
1.5 dCi (FP0D, JP0D)	60	09/04 →		02/05 →; für Linkslenker; → 06/13; - ESP		03.2123-3241.3	010882	ATE Ø 23,81
				02/05 →; für Linkslenker; → 06/13; + ESP		03.2123-3493.3	010792	ATE Ø 23,81
1.5 dCi (FP0E, JP0E)	48	12/04 →		02/05 →; für Linkslenker; → 06/13; - ESP		03.2123-3241.3	010882	ATE Ø 23,81
				02/05 →; für Linkslenker; → 06/13; + ESP		03.2123-3493.3	010792	ATE Ø 23,81
1.5 dCi (JP0G, JP0H)	78	05/05 →		05/07 →; für Linkslenker; → 06/13; - ESP		03.2123-3241.3	010882	ATE Ø 23,81
				05/07 →; für Linkslenker; → 06/13; + ESP		03.2123-3493.3	010792	ATE Ø 23,81
1.6 (JP03, JP0B, JP0U, JP0Y, JP1G)	82	12/04 →		für Linkslenker; → 06/13; - ABS		03.2123-2821.3	010944	ATE Ø 23,81
1.6 (JP0L, JP0V)	65	12/04 →		für Linkslenker; → 01/05; + ABS / - ESP		03.2123-2863.3	010790	ATE Ø 23,81
				für Linkslenker; → 01/05; + ESP		03.2123-2923.3	010791	ATE Ø 23,81
				für Linkslenker; → 06/13; - ESP		03.2123-3241.3	010882	ATE Ø 23,81
				für Linkslenker; → 06/13; + ESP		03.2123-3493.3	010792	ATE Ø 23,81
RENAULT - RAPID Kasten (F40_, G40_) 07/85 → 11/01								
 Hauptbremszylinder								
1.1 (F401)	33	07/85 → 04/95		09/91 →		03.2119-3389.3	010057	ATE Ø 19,05
						03.2119-3389.3	010057	ATE Ø 19,05
1.2 (F406, G40A)	40	09/91 → 03/98		10/92 →; für Linkslenker		03.2120-2031.3	010106	ATE Ø 20,64
						03.2120-2031.3	010106	ATE Ø 20,64
1.4	59	05/95 → 08/97		für Linkslenker		03.2120-2031.3	010106	ATE Ø 20,64
1.9 D (F40R)	40	09/94 → 03/98				03.2120-2031.3	010106	ATE Ø 20,64
1.4 (F40D)	58	01/94 → 03/98		für Linkslenker		03.2120-2031.3	010106	ATE Ø 20,64
				09/94 →		03.2120-2031.3	010106	ATE Ø 20,64
						03.2120-2031.3	010106	ATE Ø 20,64
1.4 (F40U, F40V)	55	09/91 → 03/98		für Linkslenker		03.2120-2031.3	010106	ATE Ø 20,64
						03.2120-2031.3	010106	ATE Ø 20,64
1.4 Cat (F407)	43	08/88 → 03/98		→ 08/91		03.2119-3389.3	010057	ATE Ø 19,05
1.6 D (F404)	40	03/86 → 08/98		09/91 →		03.2120-2031.3	010106	ATE Ø 20,64
1.9 D (F40P, F40N, F40E)	47	09/91 → 03/98		09/92 →		03.2119-3389.3	010057	ATE Ø 19,05
				09/95 →		03.2120-2031.3	010106	ATE Ø 20,64
						03.2120-2031.3	010106	ATE Ø 20,64
 Bremskraftregler								
1.1 (F401)	33	07/85 → 04/95		→ 08/91		03.6583-0006.3	320100	ATE lastabhängig 8/3 4x
1.4 Cat (F407)	43	08/88 → 03/98						
1.6 D (F404)	40	03/86 → 08/98						
RENAULT - SAFRANE I (B54_) 04/92 → 10/97								
 Hauptbremszylinder								
2.0 12V (B542, B54E)	97	04/92 → 07/96				24.2122-1707.3	010438	Ø 22,2
2.2 (B543)	101	04/92 → 07/96						
2.1 dT (B546)	65	11/93 → 07/96		→ 01/95; - ABS		03.2122-0621.3	010131	ATE Ø 22,2
				→ 01/95; + ABS		24.2122-1707.3	010438	Ø 22,2
				02/95 →		24.2122-1707.3	010438	Ø 22,2
2.2 (B541)	79	04/92 → 07/96		→ 01/95; - ABS		03.2122-0621.3	010131	ATE Ø 22,2
				→ 01/95; + ABS		24.2122-1707.3	010438	Ø 22,2
2.5 dT (B548)	83	12/92 → 07/96		07/93 → 05/94; Schaltgetriebe		24.2122-1707.3	010438	Ø 22,2
				→ 06/93		24.2122-1707.3	010438	Ø 22,2
				06/94 →		24.2123-1701.3	010424	Ø 23,81
				07/93 → 05/94; Automatikgetriebe		24.2123-1701.3	010424	Ø 23,81
3.0 Biturbo 4x4 (B545)	193	02/93 → 07/96				24.2123-1701.3	010424	Ø 23,81
3.0 V6 (B54B, B544)	123	12/92 → 07/96						
3.0 V6 4x4 (B54B, B544)	123	12/92 → 07/96						
RENAULT - SAFRANE II (B54_) 07/96 → 12/00								
 Hauptbremszylinder								
2.0 16V (B54L)	100	07/96 → 12/00		08/96 →; für Rechtslenker		24.2122-1707.3	010438	Ø 22,2
				08/96 →; für Linkslenker		24.2123-1701.3	010424	Ø 23,81
2.2 dT (B54G)	83	07/96 → 12/00		08/96 →		24.2123-1701.3	010424	Ø 23,81
2.5 20V (B54F)	121	07/96 → 12/00						
2.9 24V (B54N)	140	03/99 → 12/00				24.2123-1701.3	010424	Ø 23,81
3.0 V6 (B54M)	123	07/96 → 12/00		→ 07/96		24.2123-1701.3	010424	Ø 23,81
				10/96 →		24.2123-1701.3	010424	Ø 23,81

	kw					! #		
RENAULT - SANDERO/STEPWAY I (BS_) 11/07→								
 Bremskraftverstärker								
1.4	55	02/09→			+ ABS		03.7853-4102.4 300271	ATE Ø 9" pneumatisch
1.6	64	02/09→					03.7853-4602.4 300302	ATE Ø 9" pneumatisch
 Hauptbremszylinder								
1.4	55	02/09→			+ ABS		03.2120-4611.3 010937	ATE Ø 20,64
1.6	64	02/09→			- ABS		24.2120-1762.3 011002	Ø 20,64 ohne Bremsflüssigkeitsbehälter
RENAULT - SCÉNIC I Großraumlimousine (JA0/1_, FA0_) 08/99→10/03								
 Bremskraftverstärker								
1.4 16V (JA0D, JA1H, Ja0W, JA10)	70	09/99→08/03			- ABS; → 06/03; für Linkslenker		03.7760-5102.4 300140	ATE Ø 10" pneumatisch
1.6 (JA00, JA16, JA15, JA19, JA1V, JA2B, JA2C, JA0B)	79	09/99→09/03			→ 06/03; + ABS; für Linkslenker		03.7863-2002.4 300126	ATE Ø 10" pneumatisch
1.8 16V (JA12, JA1R, JA1M, JA1A)	85	01/01→08/03						
1.9 dCi (JA05, JA1F)	75	09/99→08/03						
1.9 dCi RX4	74	12/02→08/03						
1.9 dCi RX4	75	11/00→08/03						
2.0 16V	103	09/99→08/03						
2.0 16V RX4	102	06/00→08/03						
1.6 BiFuel (JA04)	79	09/99→04/01			- ABS; für Linkslenker		03.7760-5102.4 300140	ATE Ø 10" pneumatisch
1.8 4x4	85	07/00→04/01			+ ABS; für Linkslenker		03.7863-2002.4 300126	ATE Ø 10" pneumatisch
1.9 D (JA0J, FA0J)	47	09/99→03/01			+ ABS; für Linkslenker		03.7863-2002.4 300126	ATE Ø 10" pneumatisch
1.9 dTi (JA0N)	72	09/99→08/03			- ABS; → 06/03; für Linkslenker		03.7760-5102.4 300140	ATE Ø 10" pneumatisch
2.0 16V (JA1B, JA1D)	102	07/00→08/03						
1.9 dTi (JA1U)	59	02/01→08/03			→ 06/03; + ABS; für Linkslenker		03.7863-2002.4 300126	ATE Ø 10" pneumatisch
 Hauptbremszylinder								
1.4 16V (JA0D, JA1H, Ja0W, JA10)	70	09/99→08/03			→ 06/03; - ABS; für Linkslenker		03.2123-1551.3 010512	Ø 23,81
1.6 (JA00, JA16, JA15, JA19, JA1V, JA2B, JA2C, JA0B)	79	09/99→09/03			→ 06/03; + ABS / - ESP; für Linkslenker		03.2123-2146.3 010572	Ø 23,81
1.8 16V (JA12, JA1R, JA1M, JA1A)	85	01/01→08/03			→ 06/03; + ABS / + ESP; für Linkslenker		03.2123-2621.3 010701	ATE Ø 23,81
1.9 dCi (JA05, JA1F)	75	09/99→08/03						
1.9 dCi RX4	74	12/02→08/03						
1.9 dCi RX4	75	11/00→08/03						
2.0 16V	103	09/99→08/03						
2.0 16V (JA1B, JA1D)	102	07/00→08/03						
2.0 16V RX4	102	06/00→08/03						
1.6 BiFuel (JA04)	79	09/99→04/01			für Linkslenker; - ABS		03.2123-1551.3 010512	Ø 23,81
1.8 4x4	85	07/00→04/01			+ ABS / - ESP; für Linkslenker		03.2123-2146.3 010572	Ø 23,81
					+ ABS / + ESP; für Linkslenker		03.2123-2621.3 010701	ATE Ø 23,81
1.9 D (JA0J, FA0J)	47	09/99→03/01			+ ABS / - ESP; für Linkslenker		03.2123-2146.3 010572	Ø 23,81
					+ ABS / + ESP; für Linkslenker		03.2123-2621.3 010701	ATE Ø 23,81
1.9 dTi (JA0N)	72	09/99→08/03			→ 06/03; - ABS; für Linkslenker		03.2123-1551.3 010512	Ø 23,81
					→ 06/03; + ABS; für Linkslenker		03.2123-2146.3 010572	Ø 23,81
1.9 dTi (JA1U)	59	02/01→08/03			→ 06/03; + ABS / - ESP; für Linkslenker		03.2123-2146.3 010572	Ø 23,81
					→ 06/03; + ABS / + ESP; für Linkslenker		03.2123-2621.3 010701	ATE Ø 23,81
RENAULT - SCÉNIC II (JM0/1_) 06/03→								
 Hauptbremszylinder								
1.4 (JM0B, JM0H, JM1A)	72	06/03→			→ 03/09		24.2123-1760.3 010779	TRW Ø 23,81
1.5 dCi (JM02, JM13)	74	11/03→						
1.5 dCi (JM0F)	60	06/03→						
1.5 dCi (JM16)	76	01/07→						
1.5 dCi (JM1E)	78	05/05→						
1.5 dCi (JM1F)	63	05/05→						
1.6 (JM0C, JM0J, JM1B)	83	06/03→						
1.9 D	85	06/06→						
1.9 dCi	92	06/03→						
1.9 dCi (JM0G, JM12, JM1G, JM2C)	88	06/03→						
1.9 dCi (JM14)	96	05/05→						
1.9 dCi (JM15)	81	05/05→						
2.0 (JM05, JM0U, JM1N, JM1U, JM2V)	99	06/03→						
2.0 16V Turbo (JM0W)	120	05/04→						
2.0 dCi (JM1K)	110	09/05→						
1.6 16V (JM1R)	82	10/05→			01/07→ 03/09		24.2123-1760.3 010779	TRW Ø 23,81













	kw			 	! #		
RENAULT - SCÉNIC III (JZ0/1_) 02/09→							
 Hauptbremszylinder							
1.2 TCe	85	04/12→				24.4123-1715.3 010980	TRW Ø 23,81
1.5 dCi	63	04/09→					
1.5 dCi	81	04/09→					
1.5 dCi (JZ02, JZ0R)	70	11/10→					
1.6 16V Bifuel	79	04/12→					
1.6 dCi (JZ00, JZ12)	96	04/11→					
2.0 dCi (JZ0L)	118	04/09→					
1.2 TCe (JZ16)	97	01/13→		03/13→		24.4123-1715.3 010980	TRW Ø 23,81
1.4 16V (JZ0F, JZ1V)	96	02/09→		04/09→		24.4123-1715.3 010980	TRW Ø 23,81
1.5 dCi	78	02/09→					
1.6 16V (JZ0U, JZ1B)	81	02/09→					
1.9 dCi (JZ0J, JZ1J, JZ1K, JZ1S)	96	02/09→					
2.0 16V (JZ0G, JZ0P, JZ1E, JZ1P)	103	02/09→					
2.0 dCi (JZ0Y, JZ26)	110	02/09→					
1.6 16V Bifuel	81	02/09→		06/09→		24.4123-1715.3 010980	TRW Ø 23,81
1.6 E85 (JZ03, JZ1Y)	81	02/09→					
RENAULT - SUPER 5 (B/C40_) 10/84→12/96							
 Hauptbremszylinder							
1.1 (B/C/401, B/C40H)	33	01/86→03/95		06/87→ 08/90		03.2119-3389.3 010057	ATE Ø 19,05
						03.2119-3389.3 010057	ATE Ø 19,05
1.4 Cat (B/C/407)	43	10/85→12/96				03.2119-3389.3 010057	ATE Ø 19,05
1.6 D (B/C/404)	40	08/85→12/96					
1.7 (B/C40K, B/C40G)	64	06/87→03/95					
1.7 (B/C408)	54	10/86→03/95		01/87→		03.2119-3389.3 010057	ATE Ø 19,05
 Bremskraftregler							
1.1 (B/C/401, B/C40H)	33	01/86→03/95				03.6583-0007.3 320101	ATE lastabhängig 8/3 4x
1.6 D (B/C/404)	40	08/85→12/96		01/86→ 05/87		03.6583-0007.3 320101	ATE lastabhängig 8/3 4x
				→ 05/87		03.6583-0007.3 320101	ATE lastabhängig 8/3 4x
				06/87→		03.6583-0007.3 320101	ATE lastabhängig 8/3 4x
1.7 (B/C408)	54	10/86→03/95		01/87→ 05/87		03.6583-0007.3 320101	ATE lastabhängig 8/3 4x
1.7 (B/C40K, B/C40G)	64	06/87→03/95		→ 08/90		03.6583-0007.3 320101	ATE lastabhängig 8/3 4x
RENAULT - THALIA I (LB_) 02/98→							
 Bremskraftverstärker							
1.2 16V	55	04/02→				03.7750-1332.4 300155	ATE Ø 9" pneumatisch
1.4	55	08/00→					
1.4 16V	72	08/00→					
1.5 dCi	47	06/05→					
1.5 dCi	48	04/02→					
1.5 dCi	50	02/03→					
1.5 dCi	60	06/01→					
 Hauptbremszylinder							
1.2 16V	55	04/02→		- ABS		03.2120-2031.3 010106	ATE Ø 20,64
1.4	55	08/00→		+ ABS		03.2120-4461.3 010571	ATE Ø 20,64
1.4 16V	72	08/00→					
1.5 dCi	47	06/05→					
1.5 dCi	48	04/02→					
1.5 dCi	50	02/03→					
1.5 dCi	60	06/01→					
 Bremskraftregler							
1.2 16V	55	04/02→				24.6582-1721.3 320212	lastabhängig 4x
1.4	55	08/00→					
1.4 16V	72	08/00→					
1.5 dCi	47	06/05→					
1.5 dCi	48	04/02→					
1.5 dCi	50	02/03→					
1.5 dCi	60	06/01→					
RENAULT - THALIA II (LU1/2_) 09/08→							
 Bremskraftverstärker							
1.5 dCi	62	09/08→		12/10→		03.7853-1502.4 300200	ATE Ø 9" pneumatisch
1.6 16V	77	09/08→					
 Hauptbremszylinder							
1.5 dCi	62	09/08→		- ABS		03.2120-2031.3 010106	ATE Ø 20,64
1.6 16V	77	09/08→		+ ABS		03.2120-4461.3 010571	ATE Ø 20,64
↓							













	kW					! #		
RENAULT - THALIA II (LU1/2_) 09/08→								
 Bremskraftregler								
1.6 16V	77	09/08→					24.6582-1721.3 320212	lastabhängig 4x
RENAULT - TRAFIC II Bus (JL) 03/01→								
 Hauptbremszylinder								
1.9 dCi 100 (JLOC)	74	03/01→		→ 09/03; für Linkslenker; - ESP	24.2120-1738.3	010759	TRW Ø 20,64	
				10/03→; für Linkslenker; → 08/14; - ESP	24.2120-1740.3	010764	TRW Ø 20,64	
				10/03→; für Rechtslenker; → 08/14; - ESP	24.2125-1731.3	010826	TRW Ø 25,4	
				10/03→; für Linkslenker; → 08/14	24.2125-1734.3	010878	TRW Ø 25,4	
				→ 09/03; für Linkslenker; + ESP	24.2125-1734.3	010878	TRW Ø 25,4	
1.9 dCi 80 (JLOB)	60	03/01→		→ 09/03; für Linkslenker; - ESP	24.2120-1738.3	010759	TRW Ø 20,64	
				10/03→; für Linkslenker; → 08/14; - ESP	24.2120-1740.3	010764	TRW Ø 20,64	
				für Rechtslenker; → 08/14; - ESP	24.2125-1731.3	010826	TRW Ø 25,4	
				10/03→; für Linkslenker; → 08/14	24.2125-1734.3	010878	TRW Ø 25,4	
				→ 09/03; für Linkslenker; + ESP	24.2125-1734.3	010878	TRW Ø 25,4	
2.0 (JLOA)	88	03/01→		→ 08/14; - ESP	24.2125-1731.3	010826	TRW Ø 25,4	
2.5 dCi 135 (JLOD)	99	05/03→						
2.0 16V	86	08/06→		für Linkslenker; → 08/14; - ESP	24.2120-1740.3	010764	TRW Ø 20,64	
				für Rechtslenker; → 08/14; - ESP	24.2125-1731.3	010826	TRW Ø 25,4	
				für Linkslenker; → 08/14	24.2125-1734.3	010878	TRW Ø 25,4	
2.0 dCi 115 (JLOH)	84	08/06→		10/06→ 08/14; + ABS / - ESP	24.2120-1748.3	010894	TRW Ø 20,64	
			107	08/06→		10/06→ 08/14; + ABS / + ESP	24.2120-1753.3	010946
2.0 dCi 90 (JLOH)	66	08/06→		10/06→ 08/14; - ESP	24.2125-1731.3	010826	TRW Ø 25,4	
2.5 dCi 115	84	02/08→		→ 08/14; + ABS / - ESP	24.2120-1748.3	010894	TRW Ø 20,64	
				→ 08/14; + ABS / + ESP	24.2120-1753.3	010946	TRW Ø 20,64	
RENAULT - TRAFIC II Kasten (FL) 03/01→								
 Hauptbremszylinder								
1.9 dCi 100 (FLOC)	74	03/01→		→ 09/03; für Linkslenker; - ESP	24.2120-1738.3	010759	TRW Ø 20,64	
				10/03→; für Linkslenker; → 08/14; - ESP	24.2120-1740.3	010764	TRW Ø 20,64	
				10/03→; für Rechtslenker; → 08/14; - ESP	24.2125-1731.3	010826	TRW Ø 25,4	
				10/03→; für Linkslenker; → 08/14	24.2125-1734.3	010878	TRW Ø 25,4	
				→ 09/03; für Linkslenker; + ESP	24.2125-1734.3	010878	TRW Ø 25,4	
1.9 dCi 80 (FLOB)	60	03/01→		→ 09/03; für Linkslenker; - ESP	24.2120-1738.3	010759	TRW Ø 20,64	
				10/03→; für Linkslenker; → 08/14; - ESP	24.2120-1740.3	010764	TRW Ø 20,64	
				für Rechtslenker; → 08/14; - ESP	24.2125-1731.3	010826	TRW Ø 25,4	
				10/03→; für Linkslenker; → 08/14	24.2125-1734.3	010878	TRW Ø 25,4	
				→ 09/03; für Linkslenker; + ESP	24.2125-1734.3	010878	TRW Ø 25,4	
2.0 (FLOA)	88	03/01→		→ 08/14; - ESP	24.2125-1731.3	010826	TRW Ø 25,4	
2.5 dCi 135 (FLOD)	99	05/03→						
2.0 16V	86	08/06→		für Linkslenker; → 08/14; - ESP	24.2120-1740.3	010764	TRW Ø 20,64	
				für Rechtslenker; → 08/14; - ESP	24.2125-1731.3	010826	TRW Ø 25,4	
				für Linkslenker; → 08/14	24.2125-1734.3	010878	TRW Ø 25,4	
2.0 dCi 115 (FLO1, FLOU)	84	08/06→		10/06→ 08/14; + ABS / - ESP	24.2120-1748.3	010894	TRW Ø 20,64	
			107	08/06→		10/06→ 08/14; + ABS / + ESP	24.2120-1753.3	010946
2.0 dCi 90 (FLOH)	66	08/06→		10/06→ 08/14; - ESP	24.2125-1731.3	010826	TRW Ø 25,4	
RENAULT - TRAFIC II Pritsche/Fahrgestell (EL) 03/01→								
 Hauptbremszylinder								
1.9 dCi 100 (ELOC)	74	03/01→		→ 09/03; für Linkslenker; - ESP	24.2120-1738.3	010759	TRW Ø 20,64	
				10/03→; für Linkslenker; → 08/14; - ESP	24.2120-1740.3	010764	TRW Ø 20,64	
				10/03→; für Rechtslenker; → 08/14; - ESP	24.2125-1731.3	010826	TRW Ø 25,4	
				10/03→; für Linkslenker; → 08/14	24.2125-1734.3	010878	TRW Ø 25,4	
				→ 09/03; für Linkslenker; + ESP	24.2125-1734.3	010878	TRW Ø 25,4	
1.9 dCi 80 (ELOB)	60	03/01→		→ 09/03; für Linkslenker; - ESP	24.2120-1738.3	010759	TRW Ø 20,64	
				10/03→; für Linkslenker; → 08/14; - ESP	24.2120-1740.3	010764	TRW Ø 20,64	
				für Rechtslenker; → 08/14; - ESP	24.2125-1731.3	010826	TRW Ø 25,4	
				10/03→; für Linkslenker; → 08/14	24.2125-1734.3	010878	TRW Ø 25,4	
				→ 09/03; für Linkslenker; + ESP	24.2125-1734.3	010878	TRW Ø 25,4	
2.0 (ELOA)	88	03/01→		→ 08/14; - ESP	24.2125-1731.3	010826	TRW Ø 25,4	
↓								

	kw					! #		
RENAULT - TRAFIC II Pritsche/Fahrgestell (EL) 03/01→								
 Hauptbremszylinder								
2.0 dCi 115 (ELOH)	84	08/06→			10/06→ 08/14; + ABS / - ESP		24.2120-1748.3 010894	TRW Ø 20,64
2.5 dCi 145 (ELOJ)	107	08/06→			10/06→ 08/14; + ABS / + ESP		24.2120-1753.3 010946	TRW Ø 20,64
2.0 dCi 90 (ELOH)	66	08/06→			10/06→ 08/14; - ESP		24.2125-1731.3 010826	TRW Ø 25,4
2.5 dCi 135 (ELOD)	99	03/01→			05/03→ 08/14; - ESP		24.2125-1731.3 010826	TRW Ø 25,4
RENAULT - TRAFIC Bus (TXW) 03/89→03/01								
 Hauptbremszylinder								
2.1 D	47	06/94→10/97					03.2125-3801.3 010215	Ø 25,4
					+ ABS		03.2125-7002.3 010628	ATE Ø 25,4
2.2	74	06/94→10/97			- ABS; für Rechtslenker		03.2125-3801.3 010215	Ø 25,4
2.5 D	55	05/89→03/01					03.2125-3801.3 010215	Ø 25,4
					→ 10/97; + ABS		03.2125-7002.3 010628	ATE Ø 25,4
					11/97→; + ABS		24.2025-1706.3 010676	Ø 25,4
					11/97→; - ABS		24.2025-1708.3 010692	Ø 25,4
2.5 D 4x4	55	08/89→03/01					03.2125-3801.3 010215	Ø 25,4
					11/97→; + ABS		24.2025-1706.3 010676	Ø 25,4
					11/97→; - ABS		24.2025-1708.3 010692	Ø 25,4
 Bremskraftregler								
1.9 D	44	06/97→03/01					03.6512-0100.3 320077	ATE lastabhängig 1/2 2x
2.1 D	47	06/94→10/97						
2.2	74	06/94→10/97						
2.5 D	55	05/89→03/01						
2.5 D 4x4	55	08/89→03/01						
RENAULT - TRAFIC Kasten (TXX) 03/89→12/01								
 Hauptbremszylinder								
2.1 D	47	06/94→10/97					03.2125-3801.3 010215	Ø 25,4
2.2	74	06/94→10/97			- ABS; für Rechtslenker		03.2125-3801.3 010215	Ø 25,4
2.5 D	55	05/89→03/01			→ 10/97		03.2125-3801.3 010215	Ø 25,4
					11/97→; + ABS		24.2025-1706.3 010676	Ø 25,4
					11/97→; - ABS		24.2025-1708.3 010692	Ø 25,4
 Bremskraftregler								
1.9 D	44	06/97→03/01			→ 10/97		03.6512-0100.3 320077	ATE lastabhängig 1/2 2x
2.1 D	47	06/94→10/97					03.6512-0100.3 320077	ATE lastabhängig 1/2 2x
2.2	74	06/94→10/97						
2.5 D	55	05/89→03/01						
RENAULT - TRAFIC Pritsche/Fahrgestell (PXX) 03/89→03/01								
 Hauptbremszylinder								
2.0 RWD	59	05/89→10/97					03.2125-3801.3 010215	Ø 25,4
2.1 D RWD	47	06/94→10/97			→ 0005150		03.2120-1142.3 010085	Ø 20,64
							03.2125-3801.3 010215	Ø 25,4
 Bremskraftregler								
2.0 RWD	59	05/89→10/97					03.6512-0100.3 320077	ATE lastabhängig 1/2 2x
2.1 D RWD	47	06/94→10/97						
RENAULT - TWINGO I (C06_) 03/93→10/12								
 Hauptbremszylinder								
1.2 (C063, C064)	40	03/93→10/96			- ABS		24.2120-1706.3 010262	Ø 20,64
1.2 (C066, C068)	43	05/96→06/07					24.2120-1723.3 010545	BDX Ø 20,64
1.2 (C067)	40	05/96→03/07			+ ABS			
1.2 16V (C060)	44	08/04→06/07						
1.2 16V (C06C, C06D, C06K)	55	01/01→06/07						
1.2 LPG	44	10/03→06/07			08/04→; - ABS		24.2120-1706.3 010262	Ø 20,64
					08/04→; + ABS		24.2120-1723.3 010545	BDX Ø 20,64
RENAULT - TWINGO II (CN0_) 03/07→								
 Bremskraftverstärker								
1.2 (CN0D)	43	03/07→			→ 07/14; für Linkslenker; + ESP		03.7750-7332.4 300298	ATE Ø 9" pneumatisch
1.2 16V	55	03/08→						
1.2 16V (CN04, CN0A, CN0B)	55	03/07→			→ 07/14; für Linkslenker; - ESP		03.7853-3902.4 300270	ATE Ø 9" pneumatisch
↓								













	kw			 	! #					
RENAULT - TWINGO II (CN0_) 03/07→										
 Bremskraftverstärker										
1.2 16V (CN0K, CN0V)	56	03/07→		→ 07/14; für Linkslenker; + ESP		03.7750-7332.4 300298	ATE Ø 9" pneumatisch			
1.2 TCe 100 (CN0P)	75	02/11→		→ 07/14; für Linkslenker; - ESP		03.7853-3902.4 300270	ATE Ø 9" pneumatisch			
1.2 Turbo (CN0C, CN0F)	74	03/07→								
1.5 dCi (CN0E)	47	03/07→								
1.5 dCi (CN0U)	62	04/08→								
1.5 dCi 75	55	10/10→								
1.5 dCi 90	63	10/10→								
1.6 RS (CN0N, CN0R, CN0S)	98	05/08→		für Linkslenker; → 07/14		03.7750-8832.4 300299	ATE Ø 9" pneumatisch			
 Hauptbremszylinder										
1.2 (CN0D)	43	03/07→		→ 07/14; für Linkslenker; - ESP		03.2120-4581.3 010915	ATE Ø 20,64			
1.2 16V	55	03/08→		→ 07/14; für Linkslenker; + ESP		03.2120-4641.3 010932	ATE Ø 20,64			
1.2 16V (CN04, CN0A, CN0B)	55	03/07→								
1.2 16V (CN0K, CN0V)	56	03/07→								
1.2 TCe 100 (CN0P)	75	02/11→								
1.2 Turbo (CN0C, CN0F)	74	03/07→								
1.5 dCi (CN0E)	47	03/07→								
1.5 dCi (CN0U)	62	04/08→								
1.5 dCi 75	55	10/10→								
1.5 dCi 90	63	10/10→								
1.6 RS (CN0N, CN0R, CN0S)	98	05/08→		für Linkslenker; → 07/14		03.2123-2751.3 011014	ATE Ø 23,81			
RENAULT - VEL SATIS (BJ0_) 06/02→										
 Bremskraftverstärker										
2.0 16 V Turbo	125	04/04→		→ 10/05; für Linkslenker; für Fahrzeuge ohne autom. Distanzregelung		03.7858-2802.4 300303	ATE Ø 9 / 8" pneumatisch			
2.0 16V Turbo (BJ0K)	120	06/02→								
2.2 dCi (BJ0E, BJ0F, BJ0G, BJ0H)	102	09/04→								
2.2 dCi (BJ0E, BJ0F)	110	06/02→								
2.2 dCi (BJ0H)	85	04/04→								
2.2 dCi (BJ0M)	83	12/04→								
3.0 dCi (BJ0J, BJ0N)	130	06/02→								
3.5 V6 (BJ0R, BJ0V, BJ0U)	177	06/02→								
Pedalwegsensord, Bremspedal										
2.0 16 V Turbo	125	04/04→			→ 10/05; für Fahrzeuge mit autom. Distanzregelung				03.0655-0005.2 370005	ATE
2.0 16V Turbo (BJ0K)	120	06/02→								
2.2 dCi (BJ0E, BJ0F, BJ0G, BJ0H)	102	09/04→								
2.2 dCi (BJ0E, BJ0F)	110	06/02→								
2.2 dCi (BJ0H)	85	04/04→								
2.2 dCi (BJ0M)	83	12/04→								
3.0 dCi (BJ0J, BJ0N)	130	06/02→								
3.5 V6 (BJ0R, BJ0V, BJ0U)	177	06/02→								
 Hauptbremszylinder										
2.0 16 V Turbo	125	04/04→		→ 03/05		03.4125-0014.3 010794	ATE Ø 25,4			
2.0 16V Turbo (BJ0K)	120	06/02→		04/05→ 12/09		03.4155-0043.3 010795	ATE Ø 25,4			
2.2 dCi (BJ0E, BJ0F, BJ0G, BJ0H)	102	09/04→								
2.2 dCi (BJ0E, BJ0F)	110	06/02→								
2.2 dCi (BJ0H)	85	04/04→								
2.2 dCi (BJ0M)	83	12/04→								
3.0 dCi (BJ0J, BJ0N)	130	06/02→								
3.5 V6 (BJ0R, BJ0V, BJ0U)	177	06/02→								
2.0 dCi (BJ03, BJ0B)	127	01/06→		→ 12/09		03.4155-0043.3 010795	ATE Ø 25,4			
2.0 dCi (BJ03)	110	08/05→								
3.0 dCi (BJ0S)	133	06/06→								
RENAULT - WIND (E4M_) 07/10→										
 Bremskraftverstärker										
1.2 (E4MF)	74	07/10→		für Linkslenker; → 09/13		03.7750-8832.4 300299	ATE Ø 9" pneumatisch			
1.2 TCe 100 (E4MA)	75	02/11→								
1.6 (E4MB, E4MC)	98	07/10→								
 Hauptbremszylinder										
1.2 (E4MF)	74	07/10→		für Linkslenker; → 09/13		03.2123-2751.3 011014	ATE Ø 23,81			
1.2 TCe 100 (E4MA)	75	02/11→								
1.6 (E4MB, E4MC)	98	07/10→								





















	kw			 	! #		
SAAB - 9-3 (YS3D) 02/98→08/03							
 Bremskraftverstärker							
2.0 i	96	02/98→09/02		01/01→; für Linkslenker		03.7750-2932.4 300175	ATE Ø 9" pneumatisch
2.0 SE Turbo	147	02/98→09/02					
2.0 Turbo	113	10/98→09/02					
2.0 Turbo	136	02/98→09/02					
2.0 Turbo	151	10/99→09/02					
2.2 TiD	92	11/00→09/02					
2.3 i	110	02/98→09/02					
2.0 Turbo	110	03/99→09/02		für Linkslenker		03.7750-2932.4 300175	ATE Ø 9" pneumatisch
 Hauptbremszylinder							
2.0 i	96	02/98→09/02		→ 12/00; für Linkslenker		03.2123-1121.3 010176	Ø 23,81
2.0 SE Turbo	147	02/98→09/02					
2.0 Turbo	113	10/98→09/02		01/01→		03.2123-1626.3 010727	ATE Ø 23,81
2.0 Turbo	136	02/98→09/02					
2.0 Turbo	151	10/99→09/02					
2.2 TiD	92	11/00→09/02					
2.3 i	110	02/98→09/02					
2.0 Turbo	110	03/99→09/02				03.2123-1626.3 010727	ATE Ø 23,81
2.2 TiD	85	02/98→11/00		für Linkslenker		03.2123-1121.3 010176	Ø 23,81
2.3 Turbo	165	10/98→09/02				03.2125-7502.3 010616	ATE Ø 25,4
SAAB - 9-3 (YS3F) 09/02→02/15							
 Hauptbremszylinder							
1,8t	110	09/02→02/15		für Linkslenker; → 06/12		24.2125-1732.3 010827	TRW Ø 25,4
1.9 TiD	88	09/04→02/15					
1.9 TiD	110	09/04→02/15					
1.9 TTiD	96	12/07→02/15					
1.9 TTiD	118	12/07→02/15					
1.9 TTiD	132	12/07→02/15					
2.0 t	120	01/07→02/15					
2.0 t	129	09/02→02/15					
2.0 t	154	09/02→02/15					
2.0 t	162	01/11→02/15					
2.0 t	177	05/09→02/15					
2.0 t BioPower	129	01/07→02/15					
2.0 t Bio Power	120	01/07→02/15					
2.0 t BioPower XWD	120	01/08→02/15					
2.0 t BioPower XWD	154	01/08→02/15					
2.0 t BioPower XWD	162	01/08→02/15					
2.0 Turbo XWD	154	01/08→02/15					
2.0 t XWD	120	01/07→02/15					
2.0 t XWD	162	01/08→02/15					
2.0 t XWD	177	05/09→02/15					
2.2 TiD	92	09/02→02/15					
1.8 i	90	01/04→02/15		03/04→; für Linkslenker; → 06/12		24.2125-1732.3 010827	TRW Ø 25,4
2.8 Turbo V6	184	03/05→02/15		→ 12/05; für Linkslenker		24.2125-1732.3 010827	TRW Ø 25,4
SAAB - 9-3 Cabriolet (YS3D) 02/98→08/03							
 Bremskraftverstärker							
2.0 i	96	02/98→08/03		09/00→ 07/03; für Linkslenker		03.7750-2932.4 300175	ATE Ø 9" pneumatisch
2.0 Turbo	113	10/98→08/03					
2.0 Turbo	136	02/98→08/03					
2.0 Turbo	151	10/99→08/03					
2.3 i	110	02/98→08/03					
2.3 Turbo	165	10/99→08/03					
2.0 SE Turbo	147	02/98→08/03		01/01→ 07/03; für Linkslenker		03.7750-2932.4 300175	ATE Ø 9" pneumatisch
2.0 Turbo	110	01/01→08/03		→ 07/03; für Linkslenker		03.7750-2932.4 300175	ATE Ø 9" pneumatisch
 Hauptbremszylinder							
2.0 i	96	02/98→08/03		→ 08/00; für Linkslenker		03.2123-1121.3 010176	Ø 23,81
2.0 Turbo	113	10/98→08/03					
2.0 Turbo	136	02/98→08/03		09/00→ 07/03		03.2123-1626.3 010727	ATE Ø 23,81
2.0 Turbo	151	10/99→08/03					
2.3 i	110	02/98→08/03					
2.3 Turbo	165	10/99→08/03					
2.0 SE Turbo	147	02/98→08/03		→ 08/00; für Linkslenker		03.2123-1121.3 010176	Ø 23,81
				01/01→ 07/03		03.2123-1626.3 010727	ATE Ø 23,81
2.0 Turbo	110	01/01→08/03		→ 07/03		03.2123-1626.3 010727	ATE Ø 23,81
SAAB - 9-3 Cabriolet (YS3F) 08/03→02/15							
 Hauptbremszylinder							
1,8t	110	08/03→02/15		→ 06/12; für Linkslenker		24.2125-1732.3 010827	TRW Ø 25,4
1.8 i	90	01/04→02/15					
1.9 TiD	88	09/04→02/15					
↓							











	kw			 	! #		
SAAB - 9-3 Cabriolet (YS3F) 08/03→02/15							
 Hauptbremszylinder							
1.9 TiD	110	01/06→02/15		→ 06/12; für Linkslenker		24.2125-1732.3 010827	TRW Ø 25,4
1.9 TTiD	96	12/07→02/15					
1.9 TTiD	118	12/07→02/15					
1.9 TTiD	132	12/07→02/15					
2.0 t	120	01/11→02/15					
2.0 t	129	08/03→02/15					
2.0 t	154	08/03→02/15					
2.0 t	162	01/11→02/15					
2.0 t BioPower	120	01/11→02/15					
2.0 t BioPower	129	01/07→02/15					
2.0 t BioPower	162	01/11→02/15					
1.8t BioPower	129	01/07→02/15		07/07→ 06/12; für Linkslenker		24.2125-1732.3 010827	TRW Ø 25,4
2.0 t BioPower	147	06/07→02/15					
SAAB - 9-3 Kombi (YS3F) 03/05→02/15							
 Hauptbremszylinder							
1.8 i	90	03/05→02/15		→ 06/12; für Linkslenker		24.2125-1732.3 010827	TRW Ø 25,4
1.8t 2.0	110	03/05→02/15					
1.9 TiD	88	03/05→02/15					
1.9 TiD	110	03/05→02/15					
1.9 TTiD	96	12/07→02/15					
1.9 TTiD	118	12/07→02/15					
1.9 TTiD	132	12/07→02/15					
2.0 t	110	03/05→02/15					
2.0 t	120	01/07→02/15					
2.0 t	129	03/05→02/15					
2.0 t	147	02/09→02/15					
2.0 t	154	03/05→02/15					
2.0 t	162	01/11→02/15					
2.0 t	177	05/09→02/15					
2.0 t BioPower	120	01/11→02/15					
2.0 t BioPower	129	01/07→02/15					
2.0 t BioPower	162	01/11→02/15					
2.0 t Bio Power	147	02/09→02/15					
2.0 t BioPower XWD	120	01/11→02/15					
2.0 t BioPower XWD	162	01/11→02/15					
2.0 t Bio Power XWD	154	06/08→02/15					
2.0 t XWD	120	01/07→02/15					
2.0 t XWD	162	01/11→02/15					
2.0 t XWD	177	05/09→02/15					
2.0 t XWD	154	06/08→02/15		07/08→ 06/12; für Linkslenker		24.2125-1732.3 010827	TRW Ø 25,4
SAAB - 9-3X 02/09→12/12							
 Hauptbremszylinder							
1.9 TTiD AWD	132	02/09→12/12		03/09→ 06/12; für Linkslenker		24.2125-1732.3 010827	TRW Ø 25,4
2.0 t BioPower XWD	154	02/09→12/12					
2.0 t XWD	154	02/09→12/12					
2.0 t BioPower XWD	162	01/11→12/12		→ 06/12; für Linkslenker		24.2125-1732.3 010827	TRW Ø 25,4
SAAB - 9-5 (YS3E) 09/97→12/09							
 Bremskraftverstärker							
1.9 TiD	110	01/06→12/09		für Linkslenker		03.7745-3902.4 300129	ATE Ø 8 / 7" pneumatisch
2.2 TiD	88	03/02→12/09					
2.3 Turbo	162	07/03→12/09					
2.3 Turbo	191	11/05→12/09					
2.0 t	110	09/97→12/09		→ 12/01; für Linkslenker		03.7745-3003.4 300157	ATE Ø 8 / 7" pneumatisch
2.0 t	136	07/00→12/09					
2.3 t	125	09/97→12/09		01/02→; für Linkslenker		03.7745-3902.4 300129	ATE Ø 8 / 7" pneumatisch
2.3 t	136	01/01→12/09					
2.3 Turbo	184	09/01→12/09					
3.0 TiD	130	07/01→12/09					
3.0 V6t	147	01/98→12/09					
2.0 Turbo SE	141	10/98→07/00		für Linkslenker		03.7745-3003.4 300157	ATE Ø 8 / 7" pneumatisch
2.3 Turbo	169	10/99→09/01					
2.3 Turbo	224	06/03→08/05		→ 03/04; für Linkslenker		03.7745-3902.4 300129	ATE Ø 8 / 7" pneumatisch
 Hauptbremszylinder							
1.9 TiD	110	01/06→12/09		für Linkslenker		03.2125-9911.3 010883	ATE Ø 25,4
2.0 t	110	09/97→12/09		→ 12/01; für Linkslenker		03.2125-7402.3 010541	ATE Ø 25,4
2.0 t	136	07/00→12/09					
2.3 t	125	09/97→12/09		→ 12/01; für Rechtslenker		03.2125-7502.3 010616	ATE Ø 25,4
2.3 t	136	01/01→12/09		01/02→ 12/05; für Linkslenker		03.2125-9901.3 010634	ATE Ø 25,4
2.3 Turbo	184	09/01→12/09					
3.0 TiD	130	07/01→12/09		01/06→; für Linkslenker		03.2125-9911.3 010883	ATE Ø 25,4
3.0 V6t	147	01/98→12/09					
2.0 Turbo SE	141	10/98→07/00		für Linkslenker		03.2125-7402.3 010541	ATE Ø 25,4
2.3 Turbo	169	10/99→09/01		für Rechtslenker		03.2125-7502.3 010616	ATE Ø 25,4
↓							



















	kw			 	! #					
SAAB - 9-5 (YS3E) 09/97→12/09										
 Hauptbremszylinder										
2.2 TiD	88	03/02→12/09		→ 12/05; für Linkslenker		03.2125-9901.3 010634	ATE Ø 25,4			
2.3 Turbo	162	07/03→12/09		01/06→; für Linkslenker		03.2125-9911.3 010883	ATE Ø 25,4			
2.3 Turbo	191	11/05→12/09								
2.3 Turbo	224	06/03→08/05		→ 03/04; für Linkslenker		03.2125-9901.3 010634	ATE Ø 25,4			
SAAB - 9-5 (YS3G) 01/10→01/12										
 Bremskraftverstärker										
1.6 Turbo	132	05/10→01/12		für Linkslenker		03.7858-0732.4 300272	ATE Ø 9 / 8" pneumatisch			
2.0 t BioPower	162	05/10→01/12								
2.0 t BioPower XWD	162	05/10→01/12								
2.0 TiD	118	05/10→01/12								
2.0 TTiD	140	05/10→01/12								
2.0 TTiD XWD	140	05/10→01/12								
2.0 Turbo	162	05/10→01/12								
2.0 Turbo XWD	162	05/10→01/12								
2.8 Turbo V6 XWD	221	05/10→01/12								
 Hauptbremszylinder										
1.6 Turbo	132	05/10→01/12			für Linkslenker				03.2125-0421.3 010934	ATE Ø 25,4
2.0 t BioPower	162	05/10→01/12								
2.0 t BioPower XWD	162	05/10→01/12								
2.0 TiD	118	05/10→01/12								
2.0 TTiD	140	05/10→01/12								
2.0 TTiD XWD	140	05/10→01/12								
2.0 Turbo	162	05/10→01/12								
2.0 Turbo XWD	162	05/10→01/12								
2.8 Turbo V6 XWD	221	05/10→01/12								
SAAB - 9-5 Kombi (YS3E) 10/98→12/09										
 Bremskraftverstärker										
1.9 TiD	110	01/06→12/09		für Linkslenker		03.7745-3902.4 300129	ATE Ø 8 / 7" pneumatisch			
2.2 TiD	88	03/02→12/09								
2.3 Turbo	162	07/03→12/09								
2.3 Turbo	191	01/06→12/09								
2.0 t	110	10/98→12/09			→ 12/01; für Linkslenker				03.7745-3003.4 300157	ATE Ø 8 / 7" pneumatisch
2.3 t	125	10/98→12/09		01/02→; für Linkslenker		03.7745-3902.4 300129	ATE Ø 8 / 7" pneumatisch			
2.3 t	136	01/01→12/09								
3.0 TiD	130	07/01→12/09								
3.0 V6t	147	10/98→12/09								
2.0 t	136	07/00→07/01			für Linkslenker				03.7745-3003.4 300157	ATE Ø 8 / 7" pneumatisch
2.0 t	141	10/98→07/00								
2.3 Turbo	169	10/99→09/01								
2.3 t BioPower	154	11/06→12/09		01/07→; für Linkslenker		03.7745-3902.4 300129	ATE Ø 8 / 7" pneumatisch			
2.3 Turbo	184	09/01→12/09		01/02→; für Linkslenker		03.7745-3902.4 300129	ATE Ø 8 / 7" pneumatisch			
 Hauptbremszylinder										
1.9 TiD	110	01/06→12/09		für Linkslenker		03.2125-9911.3 010883	ATE Ø 25,4			
2.3 Turbo	191	01/06→12/09								
2.0 t	110	10/98→12/09			→ 12/01; für Linkslenker				03.2125-7402.3 010541	ATE Ø 25,4
2.3 t	125	10/98→12/09			→ 12/01; für Rechtslenker				03.2125-7502.3 010616	ATE Ø 25,4
2.3 t	136	01/01→12/09			01/02→ 12/05; für Linkslenker				03.2125-9901.3 010634	ATE Ø 25,4
3.0 TiD	130	07/01→12/09								
3.0 V6t	147	10/98→12/09			01/06→; für Linkslenker				03.2125-9911.3 010883	ATE Ø 25,4
2.0 t	136	07/00→07/01			für Linkslenker				03.2125-7402.3 010541	ATE Ø 25,4
2.0 t	141	10/98→07/00			für Rechtslenker				03.2125-7502.3 010616	ATE Ø 25,4
2.3 Turbo	169	10/99→09/01								
2.2 TiD	88	03/02→12/09			→ 12/05; für Linkslenker				03.2125-9901.3 010634	ATE Ø 25,4
2.3 Turbo	162	07/03→12/09		01/06→; für Linkslenker		03.2125-9911.3 010883	ATE Ø 25,4			
2.3 t BioPower	154	11/06→12/09		01/07→; für Linkslenker		03.2125-9911.3 010883	ATE Ø 25,4			
2.3 Turbo	184	09/01→12/09		01/02→ 12/05; für Linkslenker		03.2125-9901.3 010634	ATE Ø 25,4			
				01/06→; für Linkslenker		03.2125-9911.3 010883	ATE Ø 25,4			
SAAB - 900 II 07/93→04/99										
 Hauptbremszylinder										
2.0 -16 Turbo	136	07/93→02/98		09/93→; → T2024503; für Rechtslenker		03.2123-1121.3 010176	Ø 23,81			
2.3 -16	110	07/93→02/98		09/93→; → T7003723; für Rechtslenker		03.2123-1121.3 010176	Ø 23,81			
				09/93→; für Linkslenker		03.2123-1121.3 010176	Ø 23,81			
2.0 i	96	08/94→02/98		für Linkslenker		03.2123-1121.3 010176	Ø 23,81			
				→ T7003723; für Rechtslenker		03.2123-1121.3 010176	Ø 23,81			
				→ T2024503; für Rechtslenker		03.2123-1121.3 010176	Ø 23,81			
2.5 -24 V6	125	07/93→02/98		09/93→; für Linkslenker		03.2123-1121.3 010176	Ø 23,81			













	kw			 	! #		
SAAB - 900 II Cabriolet 09/93→04/99							
 Hauptbremszylinder							
2.0 -16 Turbo	136	12/93→02/98		für Linkslenker		03.2123-1121.3 010176	Ø 23,81
2.0 i	96	12/93→02/98		→ T7003723; für Rechtslenker		03.2123-1121.3 010176	Ø 23,81
2.3 -16	110	12/93→02/98		→ T2024503; für Rechtslenker		03.2123-1121.3 010176	Ø 23,81
2.5 -24 V6	125	12/93→02/98		für Linkslenker		03.2123-1121.3 010176	Ø 23,81
SAAB - 900 II Coupe 12/93→04/99							
 Hauptbremszylinder							
2.0 -16 Turbo	136	12/93→02/98		für Linkslenker		03.2123-1121.3 010176	Ø 23,81
2.0 i	96	08/94→02/98		→ T7003723; für Rechtslenker		03.2123-1121.3 010176	Ø 23,81
2.3 -16	110	12/93→02/98		→ T2024503; für Rechtslenker		03.2123-1121.3 010176	Ø 23,81
2.5 -24 V6	125	12/93→02/98		für Linkslenker		03.2123-1121.3 010176	Ø 23,81
SAAB - 9000 04/85→12/98							
 Hauptbremszylinder							
2.0 -16 CD	96	09/93→12/98		→ 05/98; - ASR		10.6123-0522.3 010633	ATE Ø 23,81
2.0 -16 CD	110	09/93→12/98					
2.3 -16 CDE	108	09/93→12/98					
2.3 -16 CDE Eco-Power	125	09/93→12/98					
2.0 -16 Turbo CD	108	09/92→12/98		09/93→ 05/98; - ASR		10.6123-0522.3 010633	ATE Ø 23,81
				→ 08/93; + ABS / - ASR		10.6123-0522.3 010633	ATE Ø 23,81
2.0 -16 Turbo CD	136	09/89→12/98		08/92→ 08/93; + ABS / - ASR		10.6123-0522.3 010633	ATE Ø 23,81
				09/93→ 05/98; - ASR		10.6123-0522.3 010633	ATE Ø 23,81
2.3 -16 CD	107	08/89→12/98		08/92→ 08/93; + ABS / - ASR		10.6123-0522.3 010633	ATE Ø 23,81
2.3 -16 CD Turbo	147	07/90→12/98		09/93→ 05/98; - ASR		10.6123-0522.3 010633	ATE Ø 23,81
2.3 -16 Turbo	143	09/90→12/98		08/92→; + ABS / - ASR		10.6123-0522.3 010633	ATE Ø 23,81
3.0 -24 V6 CD/CDE	155	07/94→12/98		09/94→ 05/98; - ASR		10.6123-0522.3 010633	ATE Ø 23,81
SAAB - 9000 Schrägheck 09/84→12/98							
 Hauptbremszylinder							
2.0 -16 CS	94	01/89→12/98		08/92→ 08/93; + ABS / - ASR		10.6123-0522.3 010633	ATE Ø 23,81
2.3 -16 CS	107	09/89→12/98					
2.0 -16 CS	96	09/93→12/98		→ 05/98; - ASR		10.6123-0522.3 010633	ATE Ø 23,81
2.0 -16 ND Turbo	110	09/93→12/98					
2.3 -16 CSE	108	09/93→12/98					
2.3 -16 CSE Eco Power	125	09/93→12/98					
2.3 -16 Turbo CSE	147	09/93→12/98					
2.0 -16 Turbo CS	136	09/88→12/98		08/92→ 08/93; + ABS / - ASR		10.6123-0522.3 010633	ATE Ø 23,81
				09/93→ 05/98; - ASR		10.6123-0522.3 010633	ATE Ø 23,81
2.3 -16 Aero CS	162	02/93→12/98		09/93→ 05/98; - ASR		10.6123-0522.3 010633	ATE Ø 23,81
2.3 -16 Aero CS	165	02/93→12/98					
2.3 -16 Turbo	143	09/90→12/98					
3.0 -24 V6 CS/CSE	155	07/94→12/98		09/94→ 05/98; - ASR		10.6123-0522.3 010633	ATE Ø 23,81
SEAT - ALHAMBRA (7V8, 7V9) 04/96→03/10							
 Bremskraftverstärker							
1.8 T 20V	110	10/97→03/10		7M-W-507042→; → 05/00; für Linkslenker; + ABS		03.7755-1902.4 300138	ATE Ø 9 / 8" pneumatisch
				7M-3-515800→; für Linkslenker; - ESP		03.7755-6302.4 300221	ATE Ø 9 / 8" pneumatisch
				06/00→; für Rechtslenker; - ESP		03.7755-6302.4 300221	ATE Ø 9 / 8" pneumatisch
				06/00→; → 7M-3-515799; für Linkslenker; - ESP		03.7755-6302.4 300221	ATE Ø 9 / 8" pneumatisch
				05/98→; → 7M-W-507041; für Linkslenker; + ABS		03.7760-3002.4 300120	ATE Ø 10" pneumatisch
				05/98→ 05/00; für Rechtslenker; + ABS		03.7760-3002.4 300120	ATE Ø 10" pneumatisch
				06/00→; → 7M-3-515799; für Linkslenker; + ESP		03.7858-3302.4 300122	ATE Ø 9 / 8" pneumatisch
				7M-3-515800→; für Linkslenker; + ESP		03.7858-9502.4 300205	ATE Ø 9 / 8" pneumatisch
1.9 TDI 2.0 i	66 85	04/96→03/10 04/96→03/10		7M-W-507042→; → 05/00; für Linkslenker; + ABS		03.7755-1902.4 300138	ATE Ø 9 / 8" pneumatisch
				7M-3-515800→; für Linkslenker; - ESP		03.7755-6302.4 300221	ATE Ø 9 / 8" pneumatisch
				06/00→; → 7M-3-515799; für Linkslenker; - ESP		03.7755-6302.4 300221	ATE Ø 9 / 8" pneumatisch
				06/00→; für Rechtslenker; - ESP		03.7755-6302.4 300221	ATE Ø 9 / 8" pneumatisch
				→ 7M-W-507041; für Linkslenker; + ABS		03.7760-3002.4 300120	ATE Ø 10" pneumatisch
				→ 05/00; für Rechtslenker; + ABS		03.7760-3002.4 300120	ATE Ø 10" pneumatisch











	kw			 	! #		
SEAT - ALHAMBRA (7V8, 7V9) 04/96→03/10							
Bremskraftverstärker							
1.9 TDI 2.0 i	66 85	04/96→03/10 04/96→03/10		06/00→; → 7M-3-515799; für Linkslenker; + ESP		03.7858-3302.4 300122	ATE Ø 9 / 8" pneumatisch
				7M-3-515800→; für Linkslenker; + ESP		03.7858-9502.4 300205	ATE Ø 9 / 8" pneumatisch
1.9 TDI	81	08/96→06/00		7M-W-507042→; → 05/00; für Linkslenker; + ABS		03.7755-1902.4 300138	ATE Ø 9 / 8" pneumatisch
				10/97→ 05/00; für Rechtslenker; + ABS		03.7760-3002.4 300120	ATE Ø 10" pneumatisch
				10/97→; → 7M-W-507041; für Linkslenker; + ABS		03.7760-3002.4 300120	ATE Ø 10" pneumatisch
1.9 TDI 1.9 TDI 2.8 V6	85 96 150	06/00→03/10 11/02→11/08 06/00→03/10		für Rechtslenker; - ESP		03.7755-6302.4 300221	ATE Ø 9 / 8" pneumatisch
				→ 7M-3-515799; für Linkslenker; - ESP		03.7755-6302.4 300221	ATE Ø 9 / 8" pneumatisch
				7M-3-515800→; für Linkslenker; - ESP		03.7755-6302.4 300221	ATE Ø 9 / 8" pneumatisch
				→ 7M-3-515799; für Linkslenker; + ESP		03.7858-3302.4 300122	ATE Ø 9 / 8" pneumatisch
				7M-3-515800→; für Linkslenker; + ESP		03.7858-9502.4 300205	ATE Ø 9 / 8" pneumatisch
1.9 TDI 2.0 TDI	110 103	05/05→05/07 11/05→03/10		- ESP		03.7755-6302.4 300221	ATE Ø 9 / 8" pneumatisch
				für Linkslenker; + ESP		03.7858-9502.4 300205	ATE Ø 9 / 8" pneumatisch
1.9 TDI 4motion 2.8 V6 4motion	85 150	06/00→03/10 06/00→03/10		7M-3-515800→; für Linkslenker; - ESP		03.7755-6302.4 300221	ATE Ø 9 / 8" pneumatisch
				02/01→; für Rechtslenker; - ESP		03.7755-6302.4 300221	ATE Ø 9 / 8" pneumatisch
				02/01→; → 7M-3-515799; für Linkslenker; - ESP		03.7755-6302.4 300221	ATE Ø 9 / 8" pneumatisch
				02/01→; → 7M-3-515799; für Linkslenker; + ESP		03.7858-3302.4 300122	ATE Ø 9 / 8" pneumatisch
				7M-3-515800→; für Linkslenker; + ESP		03.7858-9502.4 300205	ATE Ø 9 / 8" pneumatisch
Pedalwegsensor, Bremspedal							
1.8 T 20V 1.9 TDI 1.9 TDI 1.9 TDI 1.9 TDI 4motion 2.0 i 2.8 V6 2.8 V6 4motion	110 66 85 96 85 85 150 150	10/97→03/10 04/96→03/10 06/00→03/10 11/02→11/08 06/00→03/10 04/96→03/10 06/00→03/10 06/00→03/10		7M-3-515800→; für Linkslenker; + ESP		03.0655-0006.2 370006	ATE
1.9 TDI 2.0 TDI	110 103	05/05→05/07 11/05→03/10		für Linkslenker; + ESP		03.0655-0006.2 370006	ATE
Hauptbremszylinder							
1.8 T 20V	110	10/97→03/10		05/98→; → 7M-W-507041; + ABS		03.2123-1526.3 010477	Ø 23,81
				05/98→; → 7M-W-507041; - ABS		03.2123-1548.3 010478	Ø 23,81
				06/00→; → 7M-3-515799; - ESP		03.2125-0332.3 010952	Ø 25,4
				7M-W-507042→; → 05/00; + ABS		03.2125-0332.3 010952	Ø 25,4
				7M-3-515800→; - ESP		03.2125-0332.3 010952	Ø 25,4
				7M-W-507042→; → 05/00; - ABS		03.2125-8404.3 010583	ATE Ø 25,4
				06/00→; → 7M-3-515799; + ESP		03.2125-9604.3 010581	Ø 25,4
1.9 TDI 2.0 i	66 85	04/96→03/10 04/96→03/10		→ 7M-W-507041; + ABS		03.2123-1526.3 010477	Ø 23,81
				→ 7M-W-507041; - ABS		03.2123-1548.3 010478	Ø 23,81
				06/00→; → 7M-3-515799; - ESP		03.2125-0332.3 010952	Ø 25,4
				7M-W-507042→; → 05/00; + ABS		03.2125-0332.3 010952	Ø 25,4
				7M-3-515800→; - ESP		03.2125-0332.3 010952	Ø 25,4
				7M-W-507042→; → 05/00; - ABS		03.2125-8404.3 010583	ATE Ø 25,4
				06/00→; → 7M-3-515799; + ESP		03.2125-9604.3 010581	Ø 25,4
1.9 TDI	81	08/96→06/00		10/97→; → 7M-W-507041; + ABS		03.2123-1526.3 010477	Ø 23,81
				10/97→; → 7M-W-507041; - ABS		03.2123-1548.3 010478	Ø 23,81
				7M-W-507042→; → 05/00; + ABS		03.2125-0332.3 010952	Ø 25,4
				7M-W-507042→; → 05/00; - ABS		03.2125-8404.3 010583	ATE Ø 25,4
1.9 TDI 1.9 TDI 2.8 V6	85 96 150	06/00→03/10 11/02→11/08 06/00→03/10		→ 7M-3-515799; - ESP		03.2125-0332.3 010952	Ø 25,4
				7M-3-515800→; - ESP		03.2125-0332.3 010952	Ø 25,4
				→ 7M-3-515799; + ESP		03.2125-9604.3 010581	Ø 25,4
1.9 TDI 2.0 TDI	110 103	05/05→05/07 11/05→03/10		- ESP		03.2125-0332.3 010952	Ø 25,4
1.9 TDI 4motion 2.8 V6 4motion	85 150	06/00→03/10 06/00→03/10		02/01→; → 7M-3-515799; - ESP		03.2125-0332.3 010952	Ø 25,4
				7M-3-515800→; - ESP		03.2125-0332.3 010952	Ø 25,4
				02/01→; → 7M-3-515799; + ESP		03.2125-9604.3 010581	Ø 25,4
Verschlusschraube, Hauptbremszylinder							
1.8 T 20V	110	10/97→03/10		05/98→; → 7M-W-507041; - ABS		03.3517-5100.1 390326	
1.9 TDI	66	04/96→03/10		→ 7M-W-507041; - ABS		03.3517-5100.1 390326	
↓							













	kw			 	! #		
SEAT - ALHAMBRA (7V8, 7V9) 04/96→03/10							
Verschlusschraube, Hauptbremszylinder							
2.0 i	85	04/96→03/10		→ 7M-W-507041; - ABS		03.3517-5100.1	390326
1.9 TDI	81	08/96→06/00		10/97→; → 7M-W-507041; - ABS		03.3517-5100.1	390326
SEAT - ALHAMBRA (710, 711) 06/10→							
 Bremskraftverstärker							
1.4 TSI	110	06/10→		09/10→; für Linkslenker		03.7873-4502.4	300284
2.0 TDI	100	06/10→05/11					ATE Ø 11" pneumatisch
2.0 TDI	125	06/10→					
1.4 TSI	110	05/15→		für Linkslenker		03.7873-4502.4	300284
1.8 TSI	118	11/12→					ATE Ø 11" pneumatisch
2.0 TDI	85	05/11→					
2.0 TDI	103	06/10→					
2.0 TDI	130	11/12→					
2.0 TDI 4Drive	103	05/11→					
2.0 TSI	147	11/10→					
 Hauptbremszylinder							
1.4 TSI	110	06/10→		09/10→; für Linkslenker		03.4153-0186.3	010816
2.0 TDI	100	06/10→05/11					ATE Ø 23,81
2.0 TDI	125	06/10→					
1.4 TSI	110	05/15→		für Linkslenker		03.4153-0186.3	010816
1.8 TSI	118	11/12→					ATE Ø 23,81
2.0 TDI	85	05/11→					
2.0 TDI	103	06/10→					
2.0 TDI	110	05/15→					
2.0 TDI	130	11/12→					
2.0 TDI	135	05/15→					
2.0 TDI 4Drive	103	05/11→					
2.0 TDI 4Drive	110	05/15→					
2.0 TDI 4Drive	135	05/16→					
2.0 TSI	147	11/10→					
2.0 TSI	162	05/15→					
SEAT - ALTEA (5P1) 03/04→							
 Bremskraftverstärker							
1.2 TSI	77	04/10→		05/10→; für Linkslenker		03.7863-3232.4	300307
1.4 16V	63	05/06→				03.7863-3332.4	300308
1.4 TSI	92	11/07→					ATE Ø 10" pneumatisch
1.6	75	03/04→		→ 04/10; +PR 1AC,1AT; für Linkslenker		03.7863-3232.4	300307
1.6 LPG	75	09/09→					ATE Ø 10" pneumatisch
1.6 TDI	77	10/09→		→ 04/10; +PR 1AS; für Linkslenker		03.7863-9602.4	300206
1.8 TFSI	118	01/07→					ATE Ø 10" pneumatisch
1.9 TDI	66	08/09→					
1.9 TDI	77	04/04→					
2.0 TDI	103	11/05→					
2.0 TDI	125	03/06→					
2.0 TDI 16V	103	03/04→					
1.6 TDI	66	11/10→		für Linkslenker		03.7863-3232.4	300307
						03.7863-3332.4	300308
2.0 FSI	110	05/04→03/09		+PR 1AC,1AT; für Linkslenker		03.7863-3232.4	300307
2.0 TDI	100	03/04→05/09					ATE Ø 10" pneumatisch
2.0 TFSI	147	04/06→05/09		+PR 1AS; für Linkslenker		03.7863-9602.4	300206
							ATE Ø 10" pneumatisch
 Hauptbremszylinder							
1.2 TSI	77	04/10→		05/10→; +PR 1AC,1AT,1AS; für Linkslenker		03.2122-2129.3	010799
1.4 TSI	92	11/07→					ATE Ø 22,2
1.6	75	03/04→		→ 04/10; für Linkslenker		03.2122-2129.3	010799
1.6 LPG	75	09/09→					ATE Ø 22,2
1.6 TDI	77	10/09→		05/10→; +PR 1AC,1AT,1LJ; für Linkslenker		03.2123-3449.3	010808
1.8 TFSI	118	01/07→					ATE Ø 23,81
1.9 TDI	66	08/09→		05/10→; +PR 1AC,1AT,1AS,1ZD / 1LJ,1LV; für Rechtslenker		24.4152-0132.3	011025
1.9 TDI	77	04/04→					ATE Ø 22,2 ohne Bremsflüssigkeitsbehälter
2.0 TDI	103	11/05→					
2.0 TDI	125	03/06→		→ 04/10; für Rechtslenker		24.4152-0132.3	011025
2.0 TDI 16V	103	03/04→					ATE Ø 22,2 ohne Bremsflüssigkeitsbehälter
				05/10→; für Rechtslenker		24.4153-0202.3	011027
							ATE Ø 23,81 ohne Bremsflüssigkeitsbehälter
1.4 16V	63	05/06→		05/10→; +PR 1AC,1AT,1AS; für Linkslenker		03.2122-2129.3	010799
				→ 04/10; für Linkslenker		03.2122-2129.3	010799
				05/10→; +PR 1AC,1AT,1LJ; für Linkslenker		03.2123-3449.3	010808
							ATE Ø 23,81
				05/10→; +PR 1LJ,1LV / 1AC,1AT,1AS,1ZD; für Rechtslenker		24.4152-0132.3	011025
							ATE Ø 22,2 ohne Bremsflüssigkeitsbehälter
↓							













	kw			 	! #		
SEAT - ALTEA (5P1) 03/04→							
 Hauptbremszylinder							
1.4 16V	63	05/06→		→ 04/10; für Rechtslenker	24.4152-0132.3	011025	ATE Ø 22,2 ohne Bremsflüssigkeitsbehälter
				05/10→; für Rechtslenker	24.4153-0202.3	011027	ATE Ø 23,81 ohne Bremsflüssigkeitsbehälter
1.6 TDI	66	11/10→		für Linkslenker; +PR 1AC,1AT,1AS	03.2122-2129.3	010799	ATE Ø 22,2
				für Linkslenker; +PR 1AC,1AT,1LJ	03.2123-3449.3	010808	ATE Ø 23,81
				+PR 1AC,1AT,1AS,1ZD / 1LJ,1LV; für Rechtslenker	24.4152-0132.3	011025	ATE Ø 22,2 ohne Bremsflüssigkeitsbehälter
				für Rechtslenker	24.4153-0202.3	011027	ATE Ø 23,81 ohne Bremsflüssigkeitsbehälter
2.0 FSI	110	05/04→03/09		für Linkslenker	03.2122-2129.3	010799	ATE Ø 22,2
				für Rechtslenker	24.4152-0132.3	011025	ATE Ø 22,2 ohne Bremsflüssigkeitsbehälter
2.0 TDI 2.0 TFSI	100 147	03/04→05/09 04/06→05/09		für Linkslenker	03.2122-2129.3	010799	ATE Ø 22,2
				+PR 1AC,1AT,1AS,1ZD / 1LJ,1LV; für Rechtslenker	24.4152-0132.3	011025	ATE Ø 22,2 ohne Bremsflüssigkeitsbehälter
				für Rechtslenker	24.4153-0202.3	011027	ATE Ø 23,81 ohne Bremsflüssigkeitsbehälter
Hydraulikaggregat, Bremsanlage							
1.2 TSI 1.4 16V 1.4 TSI 1.6 1.6 LPG 1.6 TDI 1.6 TDI 1.8 TFSI 1.9 TDI 1.9 TDI 2.0 FSI 2.0 TDI 2.0 TDI 2.0 TDI 2.0 TDI 16V 2.0 TFSI	77 63 92 75 75 66 77 118 66 77 110 100 103 125 103 147	04/10→ 05/06→ 11/07→ 03/04→ 09/09→ 11/10→ 10/09→ 01/07→ 08/09→ 04/04→ 05/04→03/09 03/04→05/09 11/05→ 03/06→ 03/04→ 04/06→05/09		+PR 1AT,1AS	24.9145-0001.2	399005	
Drucksensor, Bremskraftverstärker							
1.2 TSI 1.4 16V 1.4 TSI 1.6 1.6 LPG 1.6 TDI 1.6 TDI 1.8 TFSI 1.9 TDI 1.9 TDI 2.0 TDI 2.0 TDI 2.0 TDI 16V	77 63 92 75 75 77 118 66 77 103 125 103	04/10→ 05/06→ 11/07→ 03/04→ 09/09→ 10/09→ 01/07→ 08/09→ 04/04→ 11/05→ 03/06→ 03/04→		→ 04/10; +PR 1AS; für Linkslenker	03.0655-0101.2	370008	ATE
2.0 FSI 2.0 TDI 2.0 TFSI	110 100 147	05/04→03/09 03/04→05/09 04/06→05/09		+PR 1AS; für Linkslenker	03.0655-0101.2	370008	ATE
SEAT - ALTEA XL (5P5, 5P8) 10/06→							
 Bremskraftverstärker							
1.2 TSI 1.4 TSI 1.6 1.6 LPG 1.6 Multifuel 1.6 TDI 1.8 TFSI 1.9 TDI 1.9 TDI 2.0 TDI 2.0 TDI 2.0 TDI 16V 2.0 TDI 4x4 2.0 TDI 4x4 2.0 TFSI 4x4	77 92 75 75 75 77 118 66 77 103 125 103 125 155	04/10→ 11/07→ 10/06→ 09/09→ 10/06→ 10/09→ 01/07→ 08/09→ 10/06→ 10/06→ 06/07→ 10/06→ 06/07→ 06/07→ 05/09→		05/10→; für Linkslenker	03.7863-3232.4	300307	ATE Ø 10" pneumatisch
				+PR 1AC,1AT; → 04/10; für Linkslenker	03.7863-3332.4	300308	ATE Ø 10" pneumatisch
				+PR 1AS; → 04/10; für Linkslenker	03.7863-3232.4	300307	ATE Ø 10" pneumatisch
				+PR 1AS; → 04/10; für Linkslenker	03.7863-9602.4	300206	ATE Ø 10" pneumatisch
1.4 16V	63	10/06→		05/08→; +PR 1AC,1AT; → 04/10; für Linkslenker	03.7863-3232.4	300307	ATE Ø 10" pneumatisch
				05/10→; für Linkslenker	03.7863-3232.4	300307	ATE Ø 10" pneumatisch
					03.7863-3332.4	300308	ATE Ø 10" pneumatisch
↓							







	kw			 	! #		
SEAT - ALTEA XL (5P5, 5P8) 10/06→							
Bremskraftverstärker							
1.4 16V	63	10/06→		05/08→; +PR 1AS; → 04/10; für Linkslenker		03.7863-9602.4 300206	ATE Ø 10" pneumatisch
1.6 TDI	66	11/10→		für Linkslenker		03.7863-3232.4 300307	ATE Ø 10" pneumatisch
2.0 TDI 16V 4x4	103	10/10→				03.7863-3332.4 300308	ATE Ø 10" pneumatisch
2.0 FSI	110	10/06→03/09		+PR 1AC,1AT; für Linkslenker		03.7863-3232.4 300307	ATE Ø 10" pneumatisch
2.0 TDI	100	11/06→03/09					
2.0 TFSI	147	10/06→05/09		+PR 1AS; für Linkslenker		03.7863-9602.4 300206	ATE Ø 10" pneumatisch
2.0 TFSI 4x4	147	06/07→05/09					
Hauptbremszylinder							
1.2 TSI	77	04/10→		05/10→; +PR 1AC,1AT,1AS; für Linkslenker		03.2122-2129.3 010799	ATE Ø 22,2
1.4 TSI	92	11/07→					
1.6	75	10/06→		→ 04/10; für Linkslenker		03.2122-2129.3 010799	ATE Ø 22,2
1.6 LPG	75	09/09→					
1.6 Multifuel	75	10/06→		05/10→; +PR 1AC,1AT,1LJ; für Linkslenker		03.2123-3449.3 010808	ATE Ø 23,81
1.6 TDI	77	10/09→					
1.8 TFSI	118	01/07→		→ 04/10; für Rechtslenker		24.4152-0132.3 011025	ATE Ø 22,2 ohne Bremsflüssigkeitsbehälter
1.9 TDI	66	08/09→					
1.9 TDI	77	10/06→		05/10→;		24.4152-0132.3 011025	ATE Ø 22,2 ohne Bremsflüssigkeitsbehälter
2.0 TDI	103	10/06→		+PR 1AC,1AT,1AS,1ZD / 1LJ,1LV; für Rechtslenker			
2.0 TDI	125	06/07→					
2.0 TDI 16V	103	10/06→		05/10→; für Rechtslenker		24.4153-0202.3 011027	ATE Ø 23,81 ohne Bremsflüssigkeitsbehälter
2.0 TDI 4x4	103	06/07→					
2.0 TDI 4x4	125	06/07→					
2.0 TFSI 4x4	155	05/09→					
1.4 16V	63	10/06→		05/08→ 04/10; für Linkslenker		03.2122-2129.3 010799	ATE Ø 22,2
				05/10→; +PR 1AC,1AT,1AS; für Linkslenker		03.2122-2129.3 010799	ATE Ø 22,2
				05/10→; +PR 1AC,1AT,1LJ; für Linkslenker		03.2123-3449.3 010808	ATE Ø 23,81
				05/10→; +PR 1AC,1AT,1AS,1ZD / 1LJ,1LV; für Rechtslenker		24.4152-0132.3 011025	ATE Ø 22,2 ohne Bremsflüssigkeitsbehälter
				05/08→ 04/10; für Rechtslenker		24.4152-0132.3 011025	ATE Ø 22,2 ohne Bremsflüssigkeitsbehälter
				05/10→; für Rechtslenker		24.4153-0202.3 011027	ATE Ø 23,81 ohne Bremsflüssigkeitsbehälter
1.6 TDI	66	11/10→		für Linkslenker; +PR 1AC,1AT,1AS		03.2122-2129.3 010799	ATE Ø 22,2
2.0 TDI 16V 4x4	103	10/10→		für Linkslenker; +PR 1AC,1AT,1LJ		03.2123-3449.3 010808	ATE Ø 23,81
				+PR 1AC,1AT,1AS,1ZD / 1LJ,1LV; für Rechtslenker		24.4152-0132.3 011025	ATE Ø 22,2 ohne Bremsflüssigkeitsbehälter
				für Rechtslenker		24.4153-0202.3 011027	ATE Ø 23,81 ohne Bremsflüssigkeitsbehälter
2.0 FSI	110	10/06→03/09		für Linkslenker		03.2122-2129.3 010799	ATE Ø 22,2
2.0 TDI	100	11/06→03/09					
2.0 TFSI 4x4	147	06/07→05/09		+PR 1AC,1AT,1AS,1ZD / 1LJ,1LV; für Rechtslenker		24.4152-0132.3 011025	ATE Ø 22,2 ohne Bremsflüssigkeitsbehälter
				für Rechtslenker		24.4153-0202.3 011027	ATE Ø 23,81 ohne Bremsflüssigkeitsbehälter
2.0 TFSI	147	10/06→05/09		für Linkslenker		03.2122-2129.3 010799	ATE Ø 22,2
				+PR 1AC,1AT,1AS,1ZD / 1LJ,1LV; für Rechtslenker		24.4152-0132.3 011025	ATE Ø 22,2 ohne Bremsflüssigkeitsbehälter
Drucksensor, Bremskraftverstärker							
1.2 TSI	77	04/10→		+PR 1AS; → 04/10; für Linkslenker		03.0655-0101.2 370008	ATE
1.4 TSI	92	11/07→					
1.6	75	10/06→					
1.6 LPG	75	09/09→					
1.6 Multifuel	75	10/06→					
1.6 TDI	77	10/09→					
1.8 TFSI	118	01/07→					
1.9 TDI	66	08/09→					
1.9 TDI	77	10/06→					
2.0 TDI	103	10/06→					
2.0 TDI	125	06/07→					
2.0 TDI 16V	103	10/06→					
2.0 TDI 4x4	103	06/07→					
2.0 TDI 4x4	125	06/07→					
2.0 TFSI 4x4	155	05/09→					
1.4 16V	63	10/06→		05/08→; +PR 1AS; → 04/10; für Linkslenker		03.0655-0101.2 370008	ATE
2.0 FSI	110	10/06→03/09		+PR 1AS; für Linkslenker		03.0655-0101.2 370008	ATE
2.0 TDI	100	11/06→03/09					
2.0 TFSI	147	10/06→05/09					
2.0 TFSI 4x4	147	06/07→05/09					











	kw					! #		
SEAT - ARONA (KJ7) 07/17→								
 Hauptbremszylinder								
1.0 TSI	70	07/17→			für Linkslenker; +PR 1ZE,1ZQ,1ZR,1ZS		24.4123-1719.3 011017	TRW Ø 23,81 ohne Bremsflüssigkeitsbehälter
1.0 TSI	85	07/17→						
1.5 TSI	110	07/17→						
1.6 TDI	70	11/17→						
1.6 TDI	85	07/17→						
SEAT - AROSA (6H) 05/97→06/04								
 Hauptbremszylinder								
1.0	37	05/97→06/04			für Linkslenker; - ABS		03.2120-3943.3 010532	ATE Ø 20,64
1.0	37	10/98→01/01						
1.4	44	05/97→06/04			für Rechtslenker; + ABS		03.2122-1184.3 010592	ATE Ø 22,2
1.4 16V	74	01/00→06/04			für Linkslenker; + ABS		03.2122-1344.3 010593	ATE Ø 22,2
1.4 TDI	55	01/00→06/04						
1.7 SDI	44	08/97→06/04			11/97→; für Linkslenker; - ABS		03.2120-3943.3 010532	ATE Ø 20,64
					11/97→; für Rechtslenker; + ABS		03.2122-1184.3 010592	ATE Ø 22,2
					11/97→; für Linkslenker; + ABS		03.2122-1344.3 010593	ATE Ø 22,2
 Bremskraftregler								
1.0	37	05/97→06/04					03.6583-0184.3 320229	ATE lastabhängig 8/3 4x
1.0	37	10/98→01/01						
1.4	44	05/97→06/04						
1.4 16V	74	01/00→06/04						
1.4 TDI	55	01/00→06/04						
1.7 SDI	44	08/97→06/04			11/97→		03.6583-0184.3 320229	ATE lastabhängig 8/3 4x
SEAT - ATECA (KH7) 04/16→								
 Hauptbremszylinder								
1.0 TSI	85	05/16→			06/16→; für Linkslenker		24.4123-1719.3 011017	TRW Ø 23,81 ohne Bremsflüssigkeitsbehälter
1.6 TDI	85	04/16→						
2.0 TDI	110	04/16→						
2.0 TDI 4Drive	110	04/16→						
1.4 TSI	110	06/16→			für Linkslenker		24.4123-1719.3 011017	TRW Ø 23,81 ohne Bremsflüssigkeitsbehälter
1.4 TSI 4Drive	110	06/16→						
2.0 TDI	81	10/16→						
2.0 TDI	105	10/16→						
2.0 TDI 4Drive	140	06/16→						
2.0 TSI 4Drive	140	05/17→						
SEAT - CORDOBA (6K1, 6K2) 02/93→12/02								
 Bremskraftverstärker								
1.0 i	37	09/96→10/02			06/99→ 09/02; für Linkslenker; - ABS		03.7750-6302.4 300161	ATE Ø 9" pneumatisch
1.4 i	44	06/94→10/02						
1.4 i 16V	74	09/96→10/02			06/99→ 09/02; für Linkslenker; + ABS; +PR 1KB		10.6350-3902.4 300213	ATE Ø 9" pneumatisch
1.6 i	55	02/93→10/02						
1.6 i	74	07/96→10/02			06/99→ 09/02; für Linkslenker; + ABS; +PR 1KK,1KM,1KQ		10.6350-4002.4 300285	ATE Ø 9" pneumatisch
1.9 TDI	66	08/96→10/02						
1.9 TDI	81	03/97→10/02						
1.4 16V	55	05/00→10/02			→ 09/02; für Linkslenker; - ABS		03.7750-6302.4 300161	ATE Ø 9" pneumatisch
1.8 T 20V Cupra	115	07/00→10/02						
1.9 SDI	50	06/99→10/02			→ 09/02; für Linkslenker; + ABS; +PR 1KB		10.6350-3902.4 300213	ATE Ø 9" pneumatisch
					→ 09/02; für Linkslenker; + ABS; +PR 1KK,1KM,1KQ		10.6350-4002.4 300285	ATE Ø 9" pneumatisch
1.8 i 16V	95	10/93→08/96			02/94→; für Linkslenker; - ABS		03.7740-1402.4 300133	ATE Ø 8" pneumatisch
2.0 i	85	02/93→06/99			11/93→ 05/99; für Linkslenker; - ABS		03.7740-1402.4 300133	ATE Ø 8" pneumatisch
 Hauptbremszylinder								
1.0 i	37	09/96→10/02			06/99→ 09/02; für Linkslenker; - ABS		03.2122-1042.3 010137	Ø 22,2
					06/99→ 09/02; für Linkslenker; + ABS		03.2123-1424.3 010637	ATE Ø 23,81
1.4 16V	55	05/00→10/02			→ 09/02; für Linkslenker; - ABS		03.2122-1042.3 010137	Ø 22,2
1.8 T 20V Cupra	115	07/00→10/02						
1.9 SDI	50	06/99→10/02			→ 09/02; für Linkslenker; + ABS		03.2123-1424.3 010637	ATE Ø 23,81
1.4 i	44	06/94→10/02			→ 05/99; - ABS		03.2120-3943.3 010532	ATE Ø 20,64
1.4 i 16V	74	09/96→10/02			06/99→ 09/02; für Linkslenker; - ABS		03.2122-1042.3 010137	Ø 22,2
1.6 i	74	07/96→10/02						
					06/99→ 09/02; für Linkslenker; + ABS		03.2123-1424.3 010637	ATE Ø 23,81
1.6 i	55	02/93→10/02			11/93→ 05/99; - ABS		03.2120-3943.3 010532	ATE Ø 20,64
					06/99→ 09/02; für Linkslenker; - ABS		03.2122-1042.3 010137	Ø 22,2
					06/99→ 09/02; für Linkslenker; + ABS		03.2123-1424.3 010637	ATE Ø 23,81
1.6 i	55	05/94→06/99			→ 05/99; - ABS		03.2120-3943.3 010532	ATE Ø 20,64
1.9 SDI	47	08/96→06/99						
1.8 i	66	02/93→09/02			11/93→ 05/99; - ABS		03.2120-3943.3 010532	ATE Ø 20,64
1.8 i 16V	95	10/93→08/96			02/94→; - ABS		03.2122-1042.3 010137	Ø 22,2
↓								

	kw			 	! #		
SEAT - CORDOBA (6K1, 6K2) 02/93→12/02							
 Hauptbremszylinder							
1.8 i 16V	95	10/93→08/96		02/94→; für Linkslenker; + ABS		10.6123-0674.3 010639	ATE Ø 23,81
1.9 D	47	01/96→08/96		- ABS		03.2120-3943.3 010532	ATE Ø 20,64
1.9 D	50	02/93→08/96		11/93→; - ABS		03.2120-3943.3 010532	ATE Ø 20,64
1.9 TD	55	02/93→08/96					
1.9 TDI	66	08/96→10/02		06/99→ 09/02; für Linkslenker; - ABS		03.2122-1042.3 010137	Ø 22,2
1.9 TDI	81	03/97→10/02		→ 05/99; - ABS		03.2122-1042.3 010137	Ø 22,2
				06/99→ 09/02; für Linkslenker; + ABS		03.2123-1424.3 010637	ATE Ø 23,81
2.0 i	85	02/93→06/99		11/93→ 05/99; - ABS		03.2122-1042.3 010137	Ø 22,2
				11/93→ 05/99; für Linkslenker; + ABS		10.6123-0674.3 010639	ATE Ø 23,81
Verschlusschraube, Hauptbremszylinder							
1.4 i	44	06/94→10/02		→ 05/99; - ABS		03.3517-0101.2 390322	
1.4 i 16V	74	09/96→10/02					
1.6 i	55	05/94→06/99					
1.6 i	74	07/96→10/02					
1.9 SDI	47	08/96→06/99					
1.9 TDI	66	08/96→10/02					
1.9 TDI	81	03/97→10/02					
1.6 i	55	02/93→10/02		11/93→ 05/99; - ABS		03.3517-0101.2 390322	
1.8 i	66	02/93→09/02					
2.0 i	85	02/93→06/99					
1.8 i 16V	95	10/93→08/96		02/94→; - ABS		03.3517-0101.2 390322	
1.9 D	47	01/96→08/96		- ABS		03.3517-0101.2 390322	
1.9 D	50	02/93→08/96		11/93→; - ABS		03.3517-0101.2 390322	
1.9 TD	55	02/93→08/96					
 Bremskraftregler							
1.4 i	44	06/94→10/02		→ 05/99		03.0101-0025.2 320014	ATE Satz 3/35 2x
1.4 i 16V	74	09/96→10/02				03.6584-0113.3 320111	ATE lastabhängig 8/4 4x
1.6 i	55	05/94→06/99					
1.6 i	74	07/96→10/02					
1.9 SDI	47	08/96→06/99					
1.9 TDI	66	08/96→10/02					
1.9 TDI	81	03/97→10/02					
1.6 i	55	02/93→10/02		11/93→ 05/99		03.0101-0025.2 320014	ATE Satz 3/35 2x
1.8 i	66	02/93→09/02				03.6584-0113.3 320111	ATE lastabhängig 8/4 4x
2.0 i	85	02/93→06/99					
1.8 i 16V	95	10/93→08/96				03.0101-0025.2 320014	ATE Satz 3/35 2x
1.9 D	47	01/96→08/96				03.6584-0113.3 320111	ATE lastabhängig 8/4 4x
1.9 D	50	02/93→08/96		11/93→		03.0101-0025.2 320014	ATE Satz 3/35 2x
1.9 TD	55	02/93→08/96				03.6584-0113.3 320111	ATE lastabhängig 8/4 4x
SEAT - CORDOBA (6L2) 09/02→11/09							
 Bremskraftverstärker							
1.2	47	10/02→06/06		für Linkslenker		03.7750-6302.4 300161	ATE Ø 9" pneumatisch
1.4 TDI	55	10/02→12/05					
1.2 12V	51	05/06→11/09		→ 06/09; für Linkslenker		03.7750-6302.4 300161	ATE Ø 9" pneumatisch
1.4 16V	63	05/06→11/09					
1.4 16V	74	10/02→11/09					
1.4 TDI	51	05/05→11/09					
1.4 TDI	59	06/05→11/09					
1.6	74	04/03→11/09					
1.6 16V	77	11/06→11/09					
1.9 TDI	96	10/02→11/09					
1.4 16V	55	09/02→12/07		10/02→; für Linkslenker		03.7750-6302.4 300161	ATE Ø 9" pneumatisch
1.9 SDI	47	09/02→11/09		10/02→ 06/09; für Linkslenker		03.7750-6302.4 300161	ATE Ø 9" pneumatisch
1.9 TDI	74	09/02→11/09					
2.0	85	09/02→11/09					
 Hauptbremszylinder							
1.2	47	10/02→06/06		+ ABS		24.2120-1734.3 010702	Ø 20,64
1.4 TDI	55	10/02→12/05		- ABS		24.2120-1736.3 010732	Ø 20,64
1.2 12V	51	05/06→11/09		→ 06/09; + ABS		24.2120-1734.3 010702	Ø 20,64
1.4 16V	63	05/06→11/09		→ 06/09; - ABS		24.2120-1736.3 010732	Ø 20,64
1.4 16V	74	10/02→11/09					
1.4 TDI	51	05/05→11/09					
1.4 TDI	59	06/05→11/09					
1.6	74	04/03→11/09					
1.6 16V	77	11/06→11/09					
1.9 TDI	96	10/02→11/09					
1.4 16V	55	09/02→12/07		10/02→; + ABS		24.2120-1734.3 010702	Ø 20,64
				10/02→; - ABS		24.2120-1736.3 010732	Ø 20,64
1.9 SDI	47	09/02→11/09		10/02→ 06/09; + ABS		24.2120-1734.3 010702	Ø 20,64
↓							













	kw					! #		
SEAT - CORDOBA (6L2) 09/02→11/09								
 Hauptbremszylinder								
1.9 TDI 2.0	74 85	09/02→11/09 09/02→11/09		10/02→06/09; - ABS			24.2120-1736.3 010732	Ø 20,64
 Bremskraftregler								
1.2 1.4 TDI	47 55	10/02→06/06 10/02→12/05		- ABS			03.6583-0216.3 320247 03.6584-0120.3 320279	ATE lastabhängig 8/3 4x ATE lastabhängig 8/4 4x
1.2 12V 1.4 16V 1.4 16V 1.4 TDI 1.4 TDI 1.6 1.6 16V 1.9 TDI	51 63 74 51 59 74 77 96	05/06→11/09 05/06→11/09 10/02→11/09 05/05→11/09 06/05→11/09 04/03→11/09 11/06→11/09 10/02→11/09		→ 06/09; - ABS			03.6583-0216.3 320247 03.6584-0120.3 320279	ATE lastabhängig 8/3 4x ATE lastabhängig 8/4 4x
1.4 16V	55	09/02→12/07		10/02→; - ABS			03.6583-0216.3 320247 03.6584-0120.3 320279	ATE lastabhängig 8/3 4x ATE lastabhängig 8/4 4x
1.9 SDI 1.9 TDI 2.0	47 74 85	09/02→11/09 09/02→11/09 09/02→11/09		10/02→06/09; - ABS			03.6583-0216.3 320247 03.6584-0120.3 320279	ATE lastabhängig 8/3 4x ATE lastabhängig 8/4 4x
SEAT - CORDOBA Vario (6K5) 07/96→12/02								
 Bremskraftverstärker								
1.4 16V 1.9 SDI	55 50	06/99→12/02 06/99→12/02		→ 09/02; für Linkslenker; - ABS			03.7750-6302.4 300161	ATE Ø 9" pneumatisch
				→ 09/02; für Linkslenker; + ABS; +PR 1KB			10.6350-3902.4 300213	ATE Ø 9" pneumatisch
				→ 09/02; für Linkslenker; + ABS; +PR 1KK,1KM,1KQ			10.6350-4002.4 300285	ATE Ø 9" pneumatisch
1.4 i 1.6 i 1.6 i 1.9 TDI 1.9 TDI	44 55 74 66 81	09/96→12/02 09/96→12/02 09/96→12/02 08/96→12/02 07/97→12/02		06/99→09/02; für Linkslenker; - ABS			03.7750-6302.4 300161 10.6350-3902.4 300213	ATE Ø 9" pneumatisch ATE Ø 9" pneumatisch
				06/99→09/02; für Linkslenker; + ABS; +PR 1KB			10.6350-3902.4 300213	ATE Ø 9" pneumatisch
				06/99→09/02; für Linkslenker; + ABS; +PR 1KK,1KM,1KQ			10.6350-4002.4 300285	ATE Ø 9" pneumatisch
 Hauptbremszylinder								
1.4 16V 1.9 SDI	55 50	06/99→12/02 06/99→12/02		→ 09/02; für Linkslenker; - ABS			03.2122-1042.3 010137	Ø 22,2
				→ 09/02; für Linkslenker; + ABS			03.2123-1424.3 010637	ATE Ø 23,81
1.4 i 1.6 i 1.6 i	44 55 74	09/96→12/02 09/96→12/02 09/96→12/02		→ 05/99; - ABS			03.2120-3943.3 010532	ATE Ø 20,64
				06/99→09/02; für Linkslenker; - ABS			03.2122-1042.3 010137	Ø 22,2
				06/99→09/02; für Linkslenker; + ABS			03.2123-1424.3 010637	ATE Ø 23,81
1.6 i 1.9 SDI	55 47	05/97→06/99 09/96→06/99		→ 05/99; - ABS			03.2120-3943.3 010532	ATE Ø 20,64
1.9 TDI 1.9 TDI	66 81	08/96→12/02 07/97→12/02		06/99→09/02; für Linkslenker; - ABS			03.2122-1042.3 010137	Ø 22,2
				→ 05/99; - ABS			03.2122-1042.3 010137	Ø 22,2
				06/99→09/02; für Linkslenker; + ABS			03.2123-1424.3 010637	ATE Ø 23,81
Verschlusschraube, Hauptbremszylinder								
1.4 i 1.6 i 1.6 i 1.6 i 1.9 SDI 1.9 TDI 1.9 TDI	44 55 55 74 47 66 81	09/96→12/02 09/96→12/02 05/97→06/99 09/96→12/02 09/96→06/99 08/96→12/02 07/97→12/02		→ 05/99; - ABS			03.3517-0101.2 390322	
 Bremskraftregler								
1.4 i 1.6 i 1.6 i 1.6 i 1.9 SDI 1.9 TDI 1.9 TDI	44 55 55 74 47 66 81	09/96→12/02 09/96→12/02 05/97→06/99 09/96→12/02 09/96→06/99 08/96→12/02 07/97→12/02		→ 05/99			03.0101-0025.2 320014 03.6584-0113.3 320111	ATE Satz 3/35 2x ATE lastabhängig 8/4 4x
SEAT - EXEO (3R2) 12/08→								
 Bremskraftverstärker								
1.6 1.8 T	75 110	03/09→09/10 12/08→05/10		04/09→			03.7858-4502.4 300202	ATE Ø 9 / 8" pneumatisch
1.8 TSI 1.8 TSI 2.0 TFSI	88 118 155	09/10→ 05/10→ 05/10→		→ 06/13			03.7858-4502.4 300202	ATE Ø 9 / 8" pneumatisch
2.0 TDI 2.0 TDI ↓	88 105	12/08→ 12/08→		04/09→06/13			03.7858-4502.4 300202	ATE Ø 9 / 8" pneumatisch











	kw					! #		
SEAT - EXEO (3R2) 12/08→								
 Bremskraftverstärker								
2.0 TDI	125	02/09→		04/09→ 06/13			03.7858-4502.4 300202	ATE Ø 9 / 8" pneumatisch
2.0 TFSI	147	03/09→						
 Hauptbremszylinder								
1.6	75	03/09→09/10		04/09→			03.2125-0373.3 010810	ATE Ø 25,4
1.8 T	110	12/08→05/10					24.2125-1720.3 010688	TRW Ø 25,4
1.8 TSI	88	09/10→		→ 06/13			03.2125-0373.3 010810	ATE Ø 25,4
1.8 TSI	118	05/10→					24.2125-1720.3 010688	TRW Ø 25,4
2.0 TFSI	155	05/10→						
2.0 TDI	88	12/08→		04/09→ 06/13			03.2125-0373.3 010810	ATE Ø 25,4
2.0 TDI	105	12/08→					24.2125-1720.3 010688	TRW Ø 25,4
2.0 TDI	125	02/09→						
2.0 TFSI	147	03/09→						
SEAT - EXEO ST (3R5) 05/09→								
 Bremskraftverstärker								
1.6	75	06/09→09/10					03.7858-4502.4 300202	ATE Ø 9 / 8" pneumatisch
1.8 T	110	06/09→05/10						
1.8 TSI	88	09/10→		→ 06/13			03.7858-4502.4 300202	ATE Ø 9 / 8" pneumatisch
1.8 TSI	118	05/10→						
2.0 TDI	88	07/09→						
2.0 TDI	105	05/09→						
2.0 TDI	125	05/09→						
2.0 TFSI	147	06/09→						
2.0 TFSI	155	05/10→						
 Hauptbremszylinder								
1.6	75	06/09→09/10					03.2125-0373.3 010810	ATE Ø 25,4
1.8 T	110	06/09→05/10					24.2125-1720.3 010688	TRW Ø 25,4
1.8 TSI	88	09/10→		→ 06/13			03.2125-0373.3 010810	ATE Ø 25,4
1.8 TSI	118	05/10→					24.2125-1720.3 010688	TRW Ø 25,4
2.0 TDI	88	07/09→						
2.0 TDI	105	05/09→						
2.0 TDI	125	05/09→						
2.0 TFSI	147	06/09→						
2.0 TFSI	155	05/10→						
SEAT - IBIZA II (6K1) 03/93→02/02								
 Bremskraftverstärker								
1.0	33	03/93→09/96		für Linkslenker; - ABS			03.7740-1402.4 300133	ATE Ø 8" pneumatisch
1.4	40	12/97→04/99		6K-TR069487→; für Linkslenker			10.6350-3902.4 300213	ATE Ø 9" pneumatisch
				6K-TR069487→; für Linkslenker; + ABS			10.6350-4002.4 300285	ATE Ø 9" pneumatisch
1.0 i	37	09/96→02/02		→ 07/99; für Linkslenker; - ABS			03.7740-1402.4 300133	ATE Ø 8" pneumatisch
1.4 i	44	09/93→02/02		08/99→ 01/02; für Linkslenker; - ABS			03.7750-6302.4 300161	ATE Ø 9" pneumatisch
				08/99→ 01/02; für Linkslenker; +PR 0G1, 0G3, 1KB; Schaltgetriebe			10.6350-3902.4 300213	ATE Ø 9" pneumatisch
				6K-TR069487→; → 07/99; für Linkslenker			10.6350-3902.4 300213	ATE Ø 9" pneumatisch
				08/99→ 01/02; für Linkslenker; +PR 1KM,1KK,1KQ,1ZK / 1KB; Automatikgetriebe			10.6350-4002.4 300285	ATE Ø 9" pneumatisch
				6K-TR069487→; → 07/99; für Linkslenker; + ABS			10.6350-4002.4 300285	ATE Ø 9" pneumatisch
				08/99→ 01/02; für Linkslenker; +PR 0G4; Schaltgetriebe			10.6350-4002.4 300285	ATE Ø 9" pneumatisch
1.3 i	40	03/93→08/99		→ 07/99; für Linkslenker; - ABS			03.7740-1402.4 300133	ATE Ø 8" pneumatisch
				6K-TR069487→; → 07/99; für Linkslenker			10.6350-3902.4 300213	ATE Ø 9" pneumatisch
				6K-TR069487→; → 07/99; für Linkslenker; + ABS			10.6350-4002.4 300285	ATE Ø 9" pneumatisch
1.4 16V	55	05/00→02/02		→ 01/02; für Linkslenker; - ABS			03.7750-6302.4 300161	ATE Ø 9" pneumatisch
1.8 T 20V Cupra	115	07/00→02/02		→ 01/02; für Linkslenker; +PR 0G1, 0G3, 1KB; Schaltgetriebe			10.6350-3902.4 300213	ATE Ø 9" pneumatisch
1.9 SDI	50	08/99→02/02		→ 01/02; für Linkslenker; +PR 0G4; Schaltgetriebe			10.6350-4002.4 300285	ATE Ø 9" pneumatisch
				→ 01/02; für Linkslenker; +PR 1KM,1KK,1KQ,1ZK / 1KB; Automatikgetriebe			10.6350-4002.4 300285	ATE Ø 9" pneumatisch
1.4 i 16V	74	06/97→02/02		08/99→ 01/02; für Linkslenker; - ABS			03.7750-6302.4 300161	ATE Ø 9" pneumatisch
1.9 TDI	66	08/96→02/02		08/99→ 01/02; für Linkslenker; +PR 0G1, 0G3, 1KB; Schaltgetriebe			10.6350-3902.4 300213	ATE Ø 9" pneumatisch
1.9 TDI	81	02/97→02/02						
↓								

	kw			 	! #		
SEAT - IBIZA II (6K1) 03/93→02/02							
Bremskraftverstärker							
1.4 i 16V 1.9 TDI 1.9 TDI	74 66 81	06/97→02/02 08/96→02/02 02/97→02/02		6K-TR069487→; → 07/99; für Linkslenker		10.6350-3902.4 300213	ATE Ø 9" pneumatisch
				08/99→ 01/02; für Linkslenker; +PR 0G4; Schaltgetriebe		10.6350-4002.4 300285	ATE Ø 9" pneumatisch
				08/99→ 01/02; für Linkslenker; +PR 1KM,1KK,1KQ,1ZK / 1KB; Automatikgetriebe		10.6350-4002.4 300285	ATE Ø 9" pneumatisch
				6K-TR069487→; → 07/99; für Linkslenker; + ABS		10.6350-4002.4 300285	ATE Ø 9" pneumatisch
1.6 i 1.6 i	55 74	03/93→02/02 04/96→02/02		→ 07/99; für Linkslenker; - ABS		03.7740-1402.4 300133	ATE Ø 8" pneumatisch
				08/99→ 01/02; für Linkslenker; - ABS		03.7750-6302.4 300161	ATE Ø 9" pneumatisch
				08/99→ 01/02; für Linkslenker; +PR 0G1, 0G3, 1KB; Schaltgetriebe		10.6350-3902.4 300213	ATE Ø 9" pneumatisch
				6K-TR069487→; → 07/99; für Linkslenker		10.6350-3902.4 300213	ATE Ø 9" pneumatisch
				08/99→ 01/02; für Linkslenker; +PR 1KM,1KK,1KQ,1ZK / 1KB; Automatikgetriebe		10.6350-4002.4 300285	ATE Ø 9" pneumatisch
				6K-TR069487→; → 07/99; für Linkslenker; + ABS		10.6350-4002.4 300285	ATE Ø 9" pneumatisch
				08/99→ 01/02; für Linkslenker; +PR 0G4; Schaltgetriebe		10.6350-4002.4 300285	ATE Ø 9" pneumatisch
1.6 i	55	09/94→06/99		für Linkslenker; - ABS		03.7740-1402.4 300133	ATE Ø 8" pneumatisch
				6K-TR069487→; für Linkslenker		03.7750-6302.4 300161	ATE Ø 9" pneumatisch
				6K-TR069487→; für Linkslenker; + ABS		10.6350-3902.4 300213	ATE Ø 9" pneumatisch
1.8 i 1.9 SDI 2.0 i	66 47 85	03/93→08/99 08/96→08/99 03/93→08/99		→ 07/99; für Linkslenker; - ABS		03.7750-6302.4 300161	ATE Ø 9" pneumatisch
				6K-TR069487→; → 07/99; für Linkslenker		10.6350-3902.4 300213	ATE Ø 9" pneumatisch
				6K-TR069487→; → 07/99; für Linkslenker; + ABS		10.6350-4002.4 300285	ATE Ø 9" pneumatisch
1.8 i 16V	95	11/93→08/96		02/94→; für Linkslenker; - ABS		03.7750-6302.4 300161	ATE Ø 9" pneumatisch
				6K-TR069487→; für Linkslenker		10.6350-3902.4 300213	ATE Ø 9" pneumatisch
				6K-TR069487→; für Linkslenker; + ABS		10.6350-4002.4 300285	ATE Ø 9" pneumatisch
1.9 D 1.9 D 1.9 TD	47 50 55	04/93→08/96 10/94→08/96 03/93→08/96		für Linkslenker; - ABS		03.7750-6302.4 300161	ATE Ø 9" pneumatisch
				6K-TR069487→; für Linkslenker		10.6350-3902.4 300213	ATE Ø 9" pneumatisch
				6K-TR069487→; für Linkslenker; + ABS		10.6350-4002.4 300285	ATE Ø 9" pneumatisch
2.0 i 16V	110	08/96→08/99		6K-TR069487→; → 07/99; für Linkslenker		10.6350-3902.4 300213	ATE Ø 9" pneumatisch
				6K-TR069487→; → 07/99; für Linkslenker; + ABS		10.6350-4002.4 300285	ATE Ø 9" pneumatisch
Hauptbremszylinder							
1.0 1.4 1.6 i 1.9 D 1.9 D 1.9 TD	33 40 55 47 50 55	03/93→09/96 12/97→04/99 09/94→06/99 04/93→08/96 10/94→08/96 03/93→08/96		- ABS		03.2120-3943.3 010532	ATE Ø 20,64
1.0 i 1.4 i 1.6 i 1.6 i	37 44 55 74	09/96→02/02 09/93→02/02 03/93→02/02 04/96→02/02		→ 07/99; - ABS		03.2120-3943.3 010532	ATE Ø 20,64
				08/99→ 01/02; für Linkslenker; - ABS		03.2122-1042.3 010137	Ø 22,2
				08/99→ 01/02; für Linkslenker; + ABS		03.2123-1424.3 010637	ATE Ø 23,81
1.3 i 1.8 i 1.9 SDI	40 66 47	03/93→08/99 03/93→08/99 08/96→08/99		→ 07/99; - ABS		03.2120-3943.3 010532	ATE Ø 20,64
1.4 16V 1.8 T 20V Cupra 1.9 SDI	55 115 50	05/00→02/02 07/00→02/02 08/99→02/02		→ 01/02; für Linkslenker; - ABS		03.2122-1042.3 010137	Ø 22,2
				→ 01/02; für Linkslenker; + ABS		03.2123-1424.3 010637	ATE Ø 23,81
1.4 i 16V	74	06/97→02/02		08/99→ 01/02; für Linkslenker; - ABS		03.2122-1042.3 010137	Ø 22,2
				08/99→ 01/02; für Linkslenker; + ABS		03.2123-1424.3 010637	ATE Ø 23,81
1.8 i 16V	95	11/93→08/96		02/94→; - ABS		03.2122-1042.3 010137	Ø 22,2
				02/94→; für Linkslenker; + ABS		10.6123-0674.3 010639	ATE Ø 23,81
1.9 TDI	66	08/96→02/02		08/99→ 01/02; für Linkslenker; - ABS		03.2122-1042.3 010137	Ø 22,2
				→ 07/99; - ABS		03.2122-1042.3 010137	Ø 22,2
				08/99→ 01/02; für Linkslenker; + ABS		03.2123-1424.3 010637	ATE Ø 23,81
1.9 TDI	81	02/97→02/02		03/97→ 07/99; - ABS		03.2122-1042.3 010137	Ø 22,2
				08/99→ 01/02; für Linkslenker; - ABS		03.2122-1042.3 010137	Ø 22,2
				08/99→ 01/02; für Linkslenker; + ABS		03.2123-1424.3 010637	ATE Ø 23,81
↓							











	kW			 	! #		
SEAT - IBIZA II (6K1) 03/93→02/02							
 Hauptbremszylinder							
2.0 i	85	03/93→08/99		→ 07/99; - ABS		03.2122-1042.3 010137	Ø 22,2
				→ 07/99; für Linklenker; + ABS		10.6123-0674.3 010639	ATE Ø 23,81
Verschlusschraube, Hauptbremszylinder							
1.0	33	03/93→09/96		- ABS		03.3517-0101.2 390322	
1.4	40	12/97→04/99					
1.6 i	55	09/94→06/99					
1.9 D	47	04/93→08/96					
1.9 D	50	10/94→08/96					
1.9 TD	55	03/93→08/96					
1.0 i	37	09/96→02/02		→ 07/99; - ABS		03.3517-0101.2 390322	
1.3 i	40	03/93→08/99					
1.4 i	44	09/93→02/02					
1.6 i	55	03/93→02/02					
1.6 i	74	04/96→02/02					
1.8 i	66	03/93→08/99					
1.9 SDI	47	08/96→08/99					
1.9 TDI	66	08/96→02/02					
2.0 i	85	03/93→08/99					
1.8 i 16V	95	11/93→08/96		02/94→; - ABS		03.3517-0101.2 390322	
1.9 TDI	81	02/97→02/02		03/97→ 07/99; - ABS		03.3517-0101.2 390322	
 Bremskraftregler							
1.0	33	03/93→09/96				03.0101-0025.2 320014	ATE Satz 3/35 2x
1.4	40	12/97→04/99				03.6584-0113.3 320111	ATE lastabhängig 8/4 4x
1.6 i	55	09/94→06/99					
1.9 D	47	04/93→08/96					
1.9 D	50	10/94→08/96					
1.9 TD	55	03/93→08/96					
1.0 i	37	09/96→02/02		→ 07/99		03.0101-0025.2 320014	ATE Satz 3/35 2x
1.3 i	40	03/93→08/99				03.6584-0113.3 320111	ATE lastabhängig 8/4 4x
1.4 i	44	09/93→02/02					
1.6 i	55	03/93→02/02					
1.6 i	74	04/96→02/02					
1.8 i	66	03/93→08/99					
1.9 SDI	47	08/96→08/99					
1.9 TDI	66	08/96→02/02					
2.0 i	85	03/93→08/99					
1.8 i 16V	95	11/93→08/96		02/94→		03.0101-0025.2 320014	ATE Satz 3/35 2x
						03.6584-0113.3 320111	ATE lastabhängig 8/4 4x
1.9 TDI	81	02/97→02/02		03/97→ 07/99		03.0101-0025.2 320014	ATE Satz 3/35 2x
						03.6584-0113.3 320111	ATE lastabhängig 8/4 4x
SEAT - IBIZA III (6L1) 02/02→11/09							
 Hauptbremszylinder							
1.2	44	06/07→05/08		+ ABS		24.2120-1734.3 010702	Ø 20,64
1.2	47	02/02→06/06		- ABS		24.2120-1736.3 010732	Ø 20,64
1.2 12V	51	05/06→11/09					
1.4 16V	55	02/02→12/07					
1.4 16V	63	05/06→11/09					
1.4 16V	74	02/02→11/09					
1.4 TDI	51	05/05→11/09					
1.4 TDI	55	05/02→12/05					
1.4 TDI	59	06/05→11/09					
1.6	74	02/03→11/09					
1.6 16V	77	11/06→11/09					
1.8 T Cupra R	132	01/04→02/08					
1.8 T FR	110	12/03→05/08					
1.9 SDI	47	02/02→12/05					
1.9 TDI	74	02/02→11/09					
1.9 TDI	96	02/02→11/09					
1.9 TDI Cupra R	118	03/04→02/08					
2.0	85	04/02→11/09					
 Bremskraftregler							
1.2	44	06/07→05/08		- ABS		03.6583-0216.3 320247	ATE lastabhängig 8/3 4x
1.2	47	02/02→06/06				03.6584-0120.3 320279	ATE lastabhängig 8/4 4x
1.2 12V	51	05/06→11/09					
1.4 16V	55	02/02→12/07					
1.4 16V	63	05/06→11/09					
1.4 16V	74	02/02→11/09					
1.4 TDI	51	05/05→11/09					
1.4 TDI	55	05/02→12/05					
1.4 TDI	59	06/05→11/09					
1.6	74	02/03→11/09					
1.6 16V	77	11/06→11/09					
1.8 T Cupra R	132	01/04→02/08					
1.8 T FR	110	12/03→05/08					









	kW			 	! #		
SEAT - IBIZA III (6L1) 02/02→11/09							
 Bremskraftregler							
1.9 SDI	47	02/02→12/05		- ABS		03.6583-0216.3 320247	ATE lastabhängig 8/3 4x
1.9 TDI	74	02/02→11/09				03.6584-0120.3 320279	ATE lastabhängig 8/4 4x
1.9 TDI	96	02/02→11/09					
1.9 TDI Cupra R	118	03/04→02/08					
2.0	85	04/02→11/09					
SEAT - IBIZA IV (6J5, 6P1) 03/08→							
 Bremskraftregler							
1.0	55	05/15→		- ABS		03.6583-0216.3 320247	ATE lastabhängig 8/3 4x
1.0 TSI	70	05/15→				03.6584-0120.3 320279	ATE lastabhängig 8/4 4x
1.0 TSI	81	05/15→					
1.2	44	07/09→					
1.2 TDI	55	05/10→					
1.2 TSI	63	08/12→					
1.2 TSI	66	05/15→					
1.2 TSI	77	09/10→					
1.2 TSI	81	09/15→					
1.4 TDI	55	05/15→					
1.4 TDI	59	07/08→06/10					
1.4 TDI	66	05/15→					
1.4 TDI	77	05/15→					
1.6 LPG	60	05/11→					
1.9 TDI	66	07/08→06/10					
1.2	51	03/08→		07/08→; - ABS		03.6583-0216.3 320247	ATE lastabhängig 8/3 4x
1.4	63	03/08→				03.6584-0120.3 320279	ATE lastabhängig 8/4 4x
1.6	77	05/08→					
1.9 TDI	77	03/08→06/10					
SEAT - IBIZA IV SPORTCOUPE (6J1, 6P5) 07/08→							
 Bremskraftregler							
1.0	55	05/15→		- ABS		03.6583-0216.3 320247	ATE lastabhängig 8/3 4x
1.0 TSI	70	05/15→				03.6584-0120.3 320279	ATE lastabhängig 8/4 4x
1.0 TSI	81	05/15→					
1.2	44	07/09→					
1.2	51	07/08→					
1.2 TDI	55	05/10→					
1.2 TSI	63	08/12→					
1.2 TSI	66	05/15→					
1.2 TSI	77	09/10→					
1.2 TSI	81	09/15→					
1.4	63	07/08→					
1.4 TDI	55	05/15→					
1.4 TDI	59	07/08→06/10					
1.4 TDI	66	05/15→					
1.4 TDI	77	05/15→					
1.6	77	07/08→					
1.6 LPG	60	05/11→					
1.9 TDI	66	07/08→06/10					
1.9 TDI	77	07/08→06/10					
SEAT - IBIZA IV ST (6J8, 6P8) 03/10→							
 Bremskraftregler							
1.0	55	05/15→		- ABS		03.6583-0216.3 320247	ATE lastabhängig 8/3 4x
1.0 TSI	70	05/15→				03.6584-0120.3 320279	ATE lastabhängig 8/4 4x
1.0 TSI	81	05/15→					
1.2	44	05/10→					
1.2	51	05/10→					
1.2 TDI	55	04/10→					
1.2 TSI	63	09/12→					
1.2 TSI	66	05/15→					
1.2 TSI	77	09/10→					
1.2 TSI	81	09/15→					
1.4	63	03/10→					
1.4 TDI	55	05/15→					
1.4 TDI	66	05/15→					
1.4 TDI	77	05/15→					
SEAT - IBIZA V (KJ1) 01/17→							
 Hauptbremszylinder							
1.0	48	07/17→		für Linklenker; +PR 1ZE,1ZQ		24.4123-1719.3 011017	TRW Ø 23,81 ohne Bremsflüssigkeitsbehälter
1.0	55	01/17→					
1.0 TGI	66	11/17→					
1.0 TSI	70	01/17→					
1.0 TSI	85	01/17→					
1.5 TSI	110	07/17→					
1.6 TDI	59	11/17→					
1.6 TDI	70	09/17→					
1.6 TDI	85	12/17→					









	kw			 	! #		
SEAT - INCA (6K9) 11/95→11/03							
 Bremskraftverstärker							
1.4 16V	55	04/00→06/03		für Linkslenker; - ABS		03.7750-6302.4 300161	ATE Ø 9" pneumatisch
1.4 i	44	11/95→06/03		für Linkslenker; + ABS		10.6350-4002.4 300285	ATE Ø 9" pneumatisch
1.6 i	55	11/95→05/98					
1.6 i	55	06/97→09/00					
1.7 D	42	09/96→06/03					
1.9 D	47	11/95→06/03					
1.9 SDI	47	11/95→06/03					
1.9 TDI	66	09/96→06/03					
 Hauptbremszylinder							
1.4 16V	55	04/00→06/03		- ABS		03.2122-1042.3 010137	Ø 22,2
				+ ABS		03.2123-1424.3 010637	ATE Ø 23,81
						03.2123-1484.3 010595	ATE Ø 23,81
1.4 i	44	11/95→06/03		→ 9K-X-006000; für Rechtslenker; - ABS		03.2122-1042.3 010137	Ø 22,2
1.6 i	55	11/95→05/98		für Linkslenker; - ABS		03.2122-1042.3 010137	Ø 22,2
1.6 i	55	06/97→09/00					
1.7 D	42	09/96→06/03		für Linkslenker; + ABS		03.2123-1424.3 010637	ATE Ø 23,81
1.9 D	47	11/95→06/03		für Rechtslenker; + ABS		03.2123-1484.3 010595	ATE Ø 23,81
1.9 SDI	47	11/95→06/03					
1.9 TDI	66	09/96→06/03					
Verschlusschraube, Hauptbremszylinder							
1.4 16V	55	04/00→06/03		- ABS		03.3517-0101.2 390322	
1.4 i	44	11/95→06/03		→ 9K-X-006000; für Rechtslenker; - ABS		03.3517-0101.2 390322	
1.6 i	55	11/95→05/98		für Linkslenker; - ABS		03.3517-0101.2 390322	
1.6 i	55	06/97→09/00					
1.7 D	42	09/96→06/03					
1.9 D	47	11/95→06/03					
1.9 SDI	47	11/95→06/03					
1.9 TDI	66	09/96→06/03					
SEAT - LEON (1M1) 11/99→06/06							
 Bremskraftverstärker							
1.4 16V	55	11/99→06/06		1M-1B018342→; → 07/05; für Linkslenker; + ESP		03.7860-0602.4 300141	ATE Ø 10" pneumatisch
1.6	74	11/99→06/06					
1.6 16 V	77	09/00→06/06		1M-1R023639→; → 07/05; für Linkslenker; + ESP		03.7860-0602.4 300141	ATE Ø 10" pneumatisch
1.8 20V	92	11/99→06/06					
1.8 20V T	132	11/99→06/06		→ 1M-1B018341; für Linkslenker; + ESP		03.7863-0402.4 300124	ATE Ø 10" pneumatisch
1.8 20V T 4	132	11/99→06/06					
1.8 T Cupra R	165	07/03→06/06		→ 1M-1R023638; für Linkslenker; + ESP		03.7863-0402.4 300124	ATE Ø 10" pneumatisch
1.9 SDI	50	11/99→06/06					
1.9 TDI	66	11/99→06/06					
1.9 TDI	81	11/99→06/06					
1.9 TDI	96	05/03→06/06					
1.9 TDI Syncro	110	05/02→06/06					
2.8 Cupra 4	150	02/01→06/06					
1.6	75	10/05→06/06		→ 1M-1R023638; für Linkslenker; + ESP		03.7863-0402.4 300124	ATE Ø 10" pneumatisch
1.9 TDI	74	10/05→06/06		→ 1M-1B018341; für Linkslenker; + ESP		03.7863-0402.4 300124	ATE Ø 10" pneumatisch
1.8 T Cupra R	154	02/02→06/06		1M-1R023639→; → 07/05; für Linkslenker; + ESP		03.7860-0602.4 300141	ATE Ø 10" pneumatisch
				1M-1B018342→; → 07/05; für Linkslenker; + ESP		03.7860-0602.4 300141	ATE Ø 10" pneumatisch
				05/02→; → 1M-1B018341; + ESP; für Linkslenker		03.7863-0402.4 300124	ATE Ø 10" pneumatisch
				05/02→; → 1M-1R023638; + ESP; für Linkslenker		03.7863-0402.4 300124	ATE Ø 10" pneumatisch
1.9 TDI	110	09/00→06/06		1M-1B018342→; → 07/05; für Linkslenker; + ESP		03.7860-0602.4 300141	ATE Ø 10" pneumatisch
				1M-1R023639→; → 07/05; für Linkslenker; + ESP		03.7860-0602.4 300141	ATE Ø 10" pneumatisch
				02/01→; → 1M-1R023638; für Linkslenker; + ESP		03.7863-0402.4 300124	ATE Ø 10" pneumatisch
				02/01→; → 1M-1B018341; für Linkslenker; + ESP		03.7863-0402.4 300124	ATE Ø 10" pneumatisch
 Hauptbremszylinder							
1.4 16V	55	11/99→06/06		→ 08/00; für Linkslenker; + ESP		03.2123-2024.3 010597	ATE Ø 23,81
1.6	74	11/99→06/06		→ 08/00; für Rechtslenker; + ESP		03.2123-2064.3 010598	ATE Ø 23,81
1.8 20V	92	11/99→06/06					
1.8 20V T	132	11/99→06/06		09/00→ 07/05; für Linkslenker; + ESP		03.2123-2715.3 010802	ATE Ø 23,81
1.9 SDI	50	11/99→06/06		09/00→ 07/05; für Rechtslenker; + ESP		03.2123-2774.3 010803	ATE Ø 23,81
1.9 TDI	66	11/99→06/06		→ 07/05; für Linkslenker; - ESP		24.2123-1709.3 010503	Ø 23,81
1.6 16 V	77	09/00→06/06		→ 07/05; für Linkslenker; + ESP		03.2123-2715.3 010802	ATE Ø 23,81
1.8 T Cupra R	165	07/03→06/06		→ 07/05; + ESP; für Rechtslenker		03.2123-2774.3 010803	ATE Ø 23,81
1.9 TDI	96	05/03→06/06					
1.9 TDI Syncro	110	05/02→06/06		→ 07/05; für Linkslenker; - ESP		24.2123-1709.3 010503	Ø 23,81























	kw			 	! #		
SEAT - LEON (1M1) 11/99→06/06							
 Hauptbremszylinder							
2.8 Cupra 4	150	02/01→06/06		→ 07/05; für Linkslenker; + ESP	03.2123-2715.3	010802	ATE Ø 23,81
				→ 07/05; + ESP; für Rechtslenker	03.2123-2774.3	010803	ATE Ø 23,81
				→ 07/05; für Linkslenker; - ESP	24.2123-1709.3	010503	Ø 23,81
1.8 20V T 4	132	11/99→06/06		→ 08/00; für Linkslenker; + ESP	03.2123-2024.3	010597	ATE Ø 23,81
				→ 08/00; für Rechtslenker; + ESP	03.2123-2064.3	010598	ATE Ø 23,81
				→ 07/05; für Linkslenker; + ESP	03.2123-2715.3	010802	ATE Ø 23,81
				→ 07/05; + ESP; für Rechtslenker	03.2123-2774.3	010803	ATE Ø 23,81
				→ 07/05; für Linkslenker; - ESP	24.2123-1709.3	010503	Ø 23,81
1.8 T Cupra R	154	02/02→06/06		05/02→ 07/05; für Linkslenker; + ESP	03.2123-2715.3	010802	ATE Ø 23,81
				05/02→ 07/05; + ESP; für Rechtslenker	03.2123-2774.3	010803	ATE Ø 23,81
				05/02→ 07/05; für Linkslenker; - ESP	24.2123-1709.3	010503	Ø 23,81
1.9 TDI	81	11/99→06/06		→ 08/00; für Linkslenker; + ESP	03.2123-2024.3	010597	ATE Ø 23,81
				→ 08/00; für Rechtslenker; + ESP	03.2123-2064.3	010598	ATE Ø 23,81
				→ 07/05; für Linkslenker; + ESP	03.2123-2715.3	010802	ATE Ø 23,81
				09/00→ 07/05; für Rechtslenker; + ESP	03.2123-2774.3	010803	ATE Ø 23,81
				→ 07/05; für Linkslenker; - ESP	24.2123-1709.3	010503	Ø 23,81
1.9 TDI	110	09/00→06/06		02/01→ 07/05; + ESP; für Linkslenker	03.2123-2715.3	010802	ATE Ø 23,81
				02/01→ 07/05; für Rechtslenker; + ESP	03.2123-2774.3	010803	ATE Ø 23,81
				02/01→ 07/05; für Linkslenker; - ESP	24.2123-1709.3	010503	Ø 23,81
 Bremskraftregler							
1.4 16V	55	11/99→06/06		→ 07/05	03.6583-0179.3	320228	ATE lastabhängig 8/3 4x
1.6	74	11/99→06/06					
1.6 16 V	77	09/00→06/06					
1.8 20V	92	11/99→06/06					
1.8 20V T	132	11/99→06/06					
1.8 20V T 4	132	11/99→06/06					
1.8 T Cupra R	165	07/03→06/06					
1.9 SDI	50	11/99→06/06					
1.9 TDI	66	11/99→06/06					
1.9 TDI	81	11/99→06/06					
1.9 TDI	96	05/03→06/06					
1.9 TDI Syncro	110	05/02→06/06					
2.8 Cupra 4	150	02/01→06/06					
1.8 T Cupra R	154	02/02→06/06		05/02→ 07/05	03.6583-0179.3	320228	ATE lastabhängig 8/3 4x
1.9 TDI	110	09/00→06/06		02/01→ 07/05	03.6583-0179.3	320228	ATE lastabhängig 8/3 4x
SEAT - LEON (1P1) 05/05→12/13							
 Bremskraftverstärker							
1.2 TSI	77	02/10→12/12		06/10→; +PR 1AC,1AT; → 10/12; für Linkslenker; für Kolben-Ø [mm]: 22,2	03.7863-3232.4	300307	ATE Ø 10" pneumatisch
1.4 16V	63	06/06→12/12					
1.4 TSI	92	11/07→12/12		→ 05/10; +PR 1AC,1AT; für Linkslenker; für Kolben-Ø [mm]: 22,2	03.7863-3232.4	300307	ATE Ø 10" pneumatisch
1.6 LPG	75	12/09→12/12					
1.6 TDI	77	02/10→12/12		→ 05/10; +PR 1AC,1AT; für Linkslenker; für Kolben-Ø [mm]: 23,81	03.7863-3332.4	300308	ATE Ø 10" pneumatisch
1.8 TSI	118	06/07→12/12					
2.0 Cupra R	195	09/09→12/12		06/10→; +PR 1AC,1AT; → 10/12; für Linkslenker; für Kolben-Ø [mm]: 23,81	03.7863-3332.4	300308	ATE Ø 10" pneumatisch
2.0 TDI	125	05/06→12/12					
2.0 TFSI	155	06/09→12/12		+PR 1AS; → 10/12; für Linkslenker; für Kolben-Ø [mm]: 22,2	03.7863-9602.4	300206	ATE Ø 10" pneumatisch
1.6 2.0 TDI 16V	75 103	07/05→12/12 07/05→12/12		06/10→; +PR 1AC,1AT; → 10/12; für Linkslenker; für Kolben-Ø [mm]: 22,2	03.7863-3232.4	300307	ATE Ø 10" pneumatisch
				08/05→ 05/10; +PR 1AC,1AT; für Linkslenker; für Kolben-Ø [mm]: 22,2	03.7863-3232.4	300307	ATE Ø 10" pneumatisch
				06/10→; +PR 1AC,1AT; → 10/12; für Linkslenker; für Kolben-Ø [mm]: 23,81	03.7863-3332.4	300308	ATE Ø 10" pneumatisch
				08/05→ 05/10; +PR 1AC,1AT; für Linkslenker; für Kolben-Ø [mm]: 23,81	03.7863-3332.4	300308	ATE Ø 10" pneumatisch
				08/05→; +PR 1AS; → 10/12; für Linkslenker; für Kolben-Ø [mm]: 22,2	03.7863-9602.4	300206	ATE Ø 10" pneumatisch
1.6 MultiFuel 1.6 TDI	75 66	11/10→12/12 11/10→12/12		für Linkslenker; → 10/12; +PR 1AC,1AT; für Kolben-Ø [mm]: 22,2	03.7863-3232.4	300307	ATE Ø 10" pneumatisch
				für Linkslenker; → 10/12; +PR 1AC,1AT; für Kolben-Ø [mm]: 23,81	03.7863-3332.4	300308	ATE Ø 10" pneumatisch
				+PR 1AS; → 10/12; für Linkslenker; für Kolben-Ø [mm]: 22,2	03.7863-9602.4	300206	ATE Ø 10" pneumatisch
1.9 TDI 2.0 TDI 2.0 TFSI	66 103 177	06/07→12/10 10/05→10/10 11/06→05/11		06/10→; +PR 1AC,1AT; für Linkslenker; für Kolben-Ø [mm]: 22,2	03.7863-3232.4	300307	ATE Ø 10" pneumatisch
				→ 05/10; +PR 1AC,1AT; für Linkslenker; für Kolben-Ø [mm]: 22,2	03.7863-3232.4	300307	ATE Ø 10" pneumatisch
↓							

		kW											
SEAT - LEON (1P1) 05/05→12/13													
Bremskraftverstärker													
1.9 TDI 2.0 TDI 2.0 TFSI	66 103 177	06/07→12/10 10/05→10/10 11/06→05/11		06/10→; +PR 1AC,1AT; für Linkslenker; für Kolben-Ø [mm]: 23,81	03.7863-3332.4	300308	ATE Ø 10" pneumatisch						
				→ 05/10; +PR 1AC,1AT; für Linkslenker; für Kolben-Ø [mm]: 23,81	03.7863-3332.4	300308	ATE Ø 10" pneumatisch						
				+PR 1AS; für Linkslenker; für Kolben-Ø [mm]: 22,2	03.7863-9602.4	300206	ATE Ø 10" pneumatisch						
1.9 TDI	77	07/05→12/10		06/10→; +PR 1AC,1AT; für Linkslenker; für Kolben-Ø [mm]: 22,2	03.7863-3232.4	300307	ATE Ø 10" pneumatisch						
				08/05→ 05/10; +PR 1AC,1AT; für Linkslenker; für Kolben-Ø [mm]: 22,2	03.7863-3232.4	300307	ATE Ø 10" pneumatisch						
				08/05→ 05/10; +PR 1AC,1AT; für Linkslenker; für Kolben-Ø [mm]: 23,81	03.7863-3332.4	300308	ATE Ø 10" pneumatisch						
				06/10→; +PR 1AC,1AT; für Linkslenker; für Kolben-Ø [mm]: 23,81	03.7863-3332.4	300308	ATE Ø 10" pneumatisch						
				08/05→; +PR 1AS; für Linkslenker; für Kolben-Ø [mm]: 22,2	03.7863-9602.4	300206	ATE Ø 10" pneumatisch						
2.0 FSI 2.0 TDI 2.0 TFSI	110 100 147	07/05→05/10 07/05→05/10 05/05→03/09		08/05→; +PR 1AC,1AT; für Linkslenker; für Kolben-Ø [mm]: 22,2	03.7863-3232.4	300307	ATE Ø 10" pneumatisch						
				08/05→; +PR 1AC,1AT; für Linkslenker; für Kolben-Ø [mm]: 23,81	03.7863-3332.4	300308	ATE Ø 10" pneumatisch						
				08/05→; +PR 1AS; für Linkslenker; für Kolben-Ø [mm]: 22,2	03.7863-9602.4	300206	ATE Ø 10" pneumatisch						
2.0 TFSI	136	09/05→05/06		+PR 1AC,1AT; für Linkslenker; für Kolben-Ø [mm]: 22,2	03.7863-3232.4	300307	ATE Ø 10" pneumatisch						
				+PR 1AC,1AT; für Linkslenker; für Kolben-Ø [mm]: 23,81	03.7863-3332.4	300308	ATE Ø 10" pneumatisch						
				+PR 1AS; für Linkslenker; für Kolben-Ø [mm]: 22,2	03.7863-9602.4	300206	ATE Ø 10" pneumatisch						
Hauptbremszylinder													
1.2 TSI 1.4 16V 1.4 TSI 1.6 LPG 1.6 TDI 1.8 TSI 2.0 Cupra R 2.0 TDI 2.0 TFSI	77 63 92 75 77 118 195 125 155	02/10→12/12 06/06→12/12 11/07→12/12 12/09→12/12 02/10→12/12 06/07→12/12 09/09→12/12 05/06→12/12 06/09→12/12		06/10→; +PR 1ZE,1ZF; → 10/12; für Linkslenker	03.2122-2129.3	010799	ATE Ø 22,2						
				F1P-6-027023→; → 05/10; für Linkslenker; +PR 1AC,1AT,1AS	03.2122-2129.3	010799	ATE Ø 22,2						
				06/10→; +PR 1LB,1ZA,1ZB; → 10/12; für Linkslenker	03.2123-3449.3	010808	ATE Ø 23,81						
				F1P-6-027023→; → 05/10; für Linkslenker; +PR 1AC,1AT,1LJ,1ZA	03.2123-3449.3	010808	ATE Ø 23,81						
				06/10→; +PR 1ZE,1ZF; → 10/12; für Rechtslenker	24.4152-0132.3	011025	ATE Ø 22,2 ohne Bremsflüssigkeitsbehälter						
				F1P-6-027023→; → 05/10; für Rechtslenker; +PR 1AC,1AT,1AS	24.4152-0132.3	011025	ATE Ø 22,2 ohne Bremsflüssigkeitsbehälter						
				→ 05/10; für Rechtslenker	24.4152-0132.3	011025	ATE Ø 22,2 ohne Bremsflüssigkeitsbehälter						
					24.4153-0202.3	011027	ATE Ø 23,81 ohne Bremsflüssigkeitsbehälter						
				06/10→; +PR 1LB,1ZA,1ZB; → 10/12; für Rechtslenker	24.4153-0202.3	011027	ATE Ø 23,81 ohne Bremsflüssigkeitsbehälter						
				F1P-6-027023→; → 05/10; für Rechtslenker; +PR 1AC,1AT,1LJ,1ZA	24.4153-0202.3	011027	ATE Ø 23,81 ohne Bremsflüssigkeitsbehälter						
1.6 2.0 TDI 16V	75 103	07/05→12/12 07/05→12/12		F1P-6-027023→; → 05/10; für Linkslenker; +PR 1AC,1AT,1AS	03.2122-2129.3	010799	ATE Ø 22,2						
				06/10→; +PR 1ZE,1ZF; → 10/12; für Linkslenker	03.2122-2129.3	010799	ATE Ø 22,2						
				06/10→; +PR 1LB,1ZA,1ZB; → 10/12; für Linkslenker	03.2123-3449.3	010808	ATE Ø 23,81						
				F1P-6-027023→; → 05/10; für Linkslenker; +PR 1AC,1AT,1LJ,1ZA	03.2123-3449.3	010808	ATE Ø 23,81						
				06/10→; +PR 1ZE,1ZF; → 10/12; für Rechtslenker	24.4152-0132.3	011025	ATE Ø 22,2 ohne Bremsflüssigkeitsbehälter						
				08/05→ 05/10; für Rechtslenker	24.4152-0132.3	011025	ATE Ø 22,2 ohne Bremsflüssigkeitsbehälter						
					24.4153-0202.3	011027	ATE Ø 23,81 ohne Bremsflüssigkeitsbehälter						
				F1P-6-027023→; → 05/10; für Rechtslenker; +PR 1AC,1AT,1AS	24.4152-0132.3	011025	ATE Ø 22,2 ohne Bremsflüssigkeitsbehälter						
				F1P-6-027023→; → 05/10; für Rechtslenker; +PR 1AC,1AT,1LJ,1ZA	24.4153-0202.3	011027	ATE Ø 23,81 ohne Bremsflüssigkeitsbehälter						
				06/10→; +PR 1LB,1ZA,1ZB; → 10/12; für Rechtslenker	24.4153-0202.3	011027	ATE Ø 23,81 ohne Bremsflüssigkeitsbehälter						
1.6 MultiFuel	75	11/10→12/12		für Linkslenker; → 10/12; +PR 1ZE,1ZF	03.2122-2129.3	010799	ATE Ø 22,2						
				für Linkslenker; → 10/12; +PR 1LB,1ZA,1ZB	03.2123-3449.3	010808	ATE Ø 23,81						







	kw			 	! #		
SEAT - LEON (1P1) 05/05→12/13							
Hauptbremszylinder							
1.6 MultiFuel	75	11/10→12/12		+PR 1ZE,1ZF; für Rechtslenker	24.4152-0132.3	011025	ATE Ø 22,2 ohne Bremsflüssigkeitsbehälter
				für Rechtslenker; +PR 1AC,1AT,1AS	24.4152-0132.3	011025	ATE Ø 22,2 ohne Bremsflüssigkeitsbehälter
				für Rechtslenker; +PR 1AC,1AT,1LJ,1ZA	24.4153-0202.3	011027	ATE Ø 23,81 ohne Bremsflüssigkeitsbehälter
				+PR 1LB,1ZA,1ZB; für Rechtslenker	24.4153-0202.3	011027	ATE Ø 23,81 ohne Bremsflüssigkeitsbehälter
1.6 TDI	66	11/10→12/12		für Linkslenker; → 10/12; +PR 1ZE,1ZF	03.2122-2129.3	010799	ATE Ø 22,2
				für Linkslenker; → 10/12; +PR 1LB,1ZA,1ZB	03.2123-3449.3	010808	ATE Ø 23,81
				für Rechtslenker; → 10/12; +PR 1ZE,1ZF	24.4152-0132.3	011025	ATE Ø 22,2 ohne Bremsflüssigkeitsbehälter
				für Rechtslenker; → 10/12; +PR 1LB,1ZA,1ZB	24.4153-0202.3	011027	ATE Ø 23,81 ohne Bremsflüssigkeitsbehälter
1.9 TDI 2.0 TDI 2.0 TFSI	66 103 177	06/07→12/10 10/05→10/10 11/06→05/11		F1P-6-027023→; → 05/10; für Linkslenker; +PR 1AC,1AT,1AS	03.2122-2129.3	010799	ATE Ø 22,2
				06/10→; +PR 1ZE,1ZF; für Linkslenker	03.2122-2129.3	010799	ATE Ø 22,2
				F1P-6-027023→; → 05/10; für Linkslenker; +PR 1AC,1AT,1LJ,1ZA	03.2123-3449.3	010808	ATE Ø 23,81
				06/10→; +PR 1LB,1ZA,1ZB; für Linkslenker	03.2123-3449.3	010808	ATE Ø 23,81
				→ 05/10; für Rechtslenker	24.4152-0132.3	011025	ATE Ø 22,2 ohne Bremsflüssigkeitsbehälter
					24.4153-0202.3	011027	ATE Ø 23,81 ohne Bremsflüssigkeitsbehälter
				06/10→; +PR 1ZE,1ZF; für Rechtslenker	24.4152-0132.3	011025	ATE Ø 22,2 ohne Bremsflüssigkeitsbehälter
				F1P-6-027023→; → 05/10; für Rechtslenker; +PR 1AC,1AT,1AS	24.4152-0132.3	011025	ATE Ø 22,2 ohne Bremsflüssigkeitsbehälter
1.9 TDI	77	07/05→12/10		F1P-6-027023→; → 05/10; für Linkslenker; +PR 1AC,1AT,1AS	03.2122-2129.3	010799	ATE Ø 22,2
				06/10→; +PR 1ZE,1ZF; für Linkslenker	03.2122-2129.3	010799	ATE Ø 22,2
				F1P-6-027023→; → 05/10; für Linkslenker; +PR 1AC,1AT,1LJ,1ZA	03.2123-3449.3	010808	ATE Ø 23,81
				06/10→; +PR 1LB,1ZA,1ZB; für Linkslenker	03.2123-3449.3	010808	ATE Ø 23,81
				06/10→; +PR 1ZE,1ZF; für Rechtslenker	24.4152-0132.3	011025	ATE Ø 22,2 ohne Bremsflüssigkeitsbehälter
				F1P-6-027023→; → 05/10; für Rechtslenker; +PR 1AC,1AT,1AS	24.4152-0132.3	011025	ATE Ø 22,2 ohne Bremsflüssigkeitsbehälter
				08/05→ 05/10; für Rechtslenker	24.4152-0132.3	011025	ATE Ø 22,2 ohne Bremsflüssigkeitsbehälter
					24.4153-0202.3	011027	ATE Ø 23,81 ohne Bremsflüssigkeitsbehälter
2.0 FSI 2.0 TDI 2.0 TFSI 2.0 TFSI	110 100 136 147	07/05→05/10 07/05→05/10 09/05→05/06 05/05→03/09		F1P-6-027023→; für Linkslenker; +PR 1AC,1AT,1AS	03.2122-2129.3	010799	ATE Ø 22,2
				F1P-6-027023→; für Linkslenker; +PR 1AC,1AT,1LJ,1ZA	03.2123-3449.3	010808	ATE Ø 23,81
				F1P-6-027023→; für Rechtslenker; +PR 1AC,1AT,1AS	24.4152-0132.3	011025	ATE Ø 22,2 ohne Bremsflüssigkeitsbehälter
				+PR 1ZE,1ZF; für Rechtslenker	24.4152-0132.3	011025	ATE Ø 22,2 ohne Bremsflüssigkeitsbehälter
				F1P-6-027023→; für Rechtslenker; +PR 1AC,1AT,1LJ,1ZA	24.4153-0202.3	011027	ATE Ø 23,81 ohne Bremsflüssigkeitsbehälter
	+PR 1LB,1ZA,1ZB; für Rechtslenker	24.4153-0202.3	011027	ATE Ø 23,81 ohne Bremsflüssigkeitsbehälter			
Hydraulikaggregat, Bremsanlage							
1.2 TSI 1.4 16V 1.4 TSI 1.6 LPG 1.6 MultiFuel ↓	77 63 92 75 75	02/10→12/12 06/06→12/12 11/07→12/12 12/09→12/12 11/10→12/12	➡	→ 10/12; +PR 1AT,1AS	24.9145-0001.2	399005	











	kw			 	! #		
SEAT - LEON (1P1) 05/05→12/13							
Hydraulikaggregat, Bremsanlage							
1.6 TDI	66	11/10→12/12	➔	→ 10/12; +PR 1AT,1AS		24.9145-0001.2	399005
1.6 TDI	77	02/10→12/12					
1.8 TSI	118	06/07→12/12					
2.0 Cupra R	195	09/09→12/12					
2.0 TDI	125	05/06→12/12					
2.0 TFSI	155	06/09→12/12					
1.6	75	07/05→12/12	➔	08/05→ 10/12; +PR 1AT,1AS		24.9145-0001.2	399005
2.0 TDI 16V	103	07/05→12/12					
1.9 TDI	66	06/07→12/10	➔	+PR 1AT,1AS		24.9145-0001.2	399005
2.0 TDI	103	10/05→10/10					
2.0 TFSI	136	09/05→05/06					
2.0 TFSI	177	11/06→05/11					
1.9 TDI	77	07/05→12/10	➔	08/05→; +PR 1AT,1AS		24.9145-0001.2	399005
2.0 FSI	110	07/05→05/10					
2.0 TDI	100	07/05→05/10					
2.0 TFSI	147	05/05→03/09					
Drucksensor, Bremskraftverstärker							
1.2 TSI	77	02/10→12/12		+PR 1AS; → 10/12		03.0655-0101.2	370008 ATE
1.4 16V	63	06/06→12/12					
1.4 TSI	92	11/07→12/12					
1.6 LPG	75	12/09→12/12					
1.6 MultiFuel	75	11/10→12/12					
1.6 TDI	66	11/10→12/12					
1.6 TDI	77	02/10→12/12					
1.8 TSI	118	06/07→12/12					
2.0 Cupra R	195	09/09→12/12					
2.0 TDI	125	05/06→12/12					
2.0 TFSI	155	06/09→12/12					
1.6	75	07/05→12/12		08/05→; +PR 1AS; → 10/12		03.0655-0101.2	370008 ATE
2.0 TDI 16V	103	07/05→12/12					
1.9 TDI	66	06/07→12/10		+PR 1AS		03.0655-0101.2	370008 ATE
2.0 TDI	103	10/05→10/10					
2.0 TFSI	136	09/05→05/06					
2.0 TFSI	177	11/06→05/11					
1.9 TDI	77	07/05→12/10		08/05→; +PR 1AS		03.0655-0101.2	370008 ATE
2.0 FSI	110	07/05→05/10					
2.0 TDI	100	07/05→05/10					
2.0 TFSI	147	05/05→03/09					
SEAT - LEON (5F1) 09/12→							
 Hauptbremszylinder							
1.0 TSI	85	05/15→		für Linkslenker		03.4153-5403.3	010994 ATE Ø 23,81
1.2 TSI	63	12/12→				24.4123-1719.3	011017 TRW Ø 23,81 ohne Bremsflüssigkeitsbehälter
1.2 TSI	77	01/13→					
1.2 TSI	81	04/14→					
1.4 TSI	90	11/12→		11/16→; für Linkslenker; +PR 1ZA,1ZE		24.4123-1719.3	011017 TRW Ø 23,81 ohne Bremsflüssigkeitsbehälter
1.4 TSI	92	05/14→					
1.4 TSI	103	09/12→					
1.4 TSI	110	05/14→					
1.6 TDI	66	11/12→					
1.6 TDI	77	11/12→					
1.6 TDI	81	09/13→					
1.8 TSI	132	02/13→					
2.0 Cupra	195	10/13→					
2.0 Cupra	206	10/13→					
2.0 Cupra	213	10/15→					
2.0 TDI	81	05/13→					
2.0 TDI	105	05/13→					
2.0 TDI	110	10/12→					
2.0 TDI	135	09/12→					
1.4 TGI	81	02/13→		10/13→; für Linkslenker		03.4153-5403.3	010994 ATE Ø 23,81
						24.4123-1719.3	011017 TRW Ø 23,81 ohne Bremsflüssigkeitsbehälter
				11/16→; für Linkslenker; +PR 1ZA,1ZE		24.4123-1719.3	011017 TRW Ø 23,81 ohne Bremsflüssigkeitsbehälter
1.6 TDI	85	11/16→		01/17→; für Linkslenker		03.4153-5403.3	010994 ATE Ø 23,81
						24.4123-1719.3	011017 TRW Ø 23,81 ohne Bremsflüssigkeitsbehälter
				01/17→; für Linkslenker; +PR 1ZA,1ZE		24.4123-1719.3	011017 TRW Ø 23,81 ohne Bremsflüssigkeitsbehälter
2.0 Cupra	221	01/17→		für Linkslenker; +PR 1ZA,1ZE		24.4123-1719.3	011017 TRW Ø 23,81 ohne Bremsflüssigkeitsbehälter
2.0 Cupra R	228	11/17→					
SEAT - LEON SC (5F5) 01/13→							
 Hauptbremszylinder							
1.0 TSI	85	05/15→		für Linkslenker		03.4153-5403.3	010994 ATE Ø 23,81
1.2 TSI	63	01/13→					
↓							













	kw			 	! #		
SEAT - LEON SC (5F5) 01/13→							
 Hauptbremszylinder							
1.2 TSI	77	02/13→		für Linkslenker		24.4123-1719.3 011017	TRW Ø 23,81 ohne Bremsflüssigkeitsbehälter
1.2 TSI	81	05/14→					
1.4 TSI	90	02/13→		11/16→; für Linkslenker; +PR 1ZA,1ZE		24.4123-1719.3 011017	TRW Ø 23,81 ohne Bremsflüssigkeitsbehälter
1.4 TSI	92	05/14→					
1.4 TSI	103	02/13→					
1.4 TSI	110	05/14→					
1.6 TDI	66	02/13→					
1.6 TDI	77	02/13→					
1.6 TDI	81	09/13→					
1.8 TSI	132	02/13→					
2.0 Cupra	195	10/13→					
2.0 Cupra	206	10/13→					
2.0 Cupra	213	10/15→					
2.0 TDI	105	05/13→					
2.0 TDI	110	02/13→					
2.0 TDI	135	03/13→					
1.6 TDI	85	11/16→		01/17→; für Linkslenker		03.4153-5403.3 010994 24.4123-1719.3 011017	ATE Ø 23,81 TRW Ø 23,81 ohne Bremsflüssigkeitsbehälter
				01/17→; für Linkslenker; +PR 1ZA,1ZE		24.4123-1719.3 011017	TRW Ø 23,81 ohne Bremsflüssigkeitsbehälter
2.0 Cupra	221	01/17→		für Linkslenker; +PR 1ZA,1ZE		24.4123-1719.3 011017	TRW Ø 23,81 ohne Bremsflüssigkeitsbehälter
2.0 TDI	81	02/13→		05/13→; für Linkslenker		03.4153-5403.3 010994 24.4123-1719.3 011017	ATE Ø 23,81 TRW Ø 23,81 ohne Bremsflüssigkeitsbehälter
				11/16→; für Linkslenker; +PR 1ZA,1ZE		24.4123-1719.3 011017	TRW Ø 23,81 ohne Bremsflüssigkeitsbehälter
SEAT - LEON ST (5F8) 08/13→							
 Hauptbremszylinder							
1.0 TSI	85	05/15→		für Linkslenker		03.4153-5403.3 010994	ATE Ø 23,81
1.2 TSI	63	11/13→				24.4123-1719.3 011017	TRW Ø 23,81 ohne Bremsflüssigkeitsbehälter
1.2 TSI	77	08/13→					
1.2 TSI	81	05/14→		11/16→; für Linkslenker; +PR 1ZA,1ZE		24.4123-1719.3 011017	TRW Ø 23,81 ohne Bremsflüssigkeitsbehälter
1.4 TGI	81	10/13→					
1.4 TSI	90	10/13→					
1.4 TSI	92	05/14→					
1.4 TSI	103	10/13→					
1.4 TSI	110	05/14→					
1.6 TDI	66	11/13→					
1.6 TDI	77	10/13→					
1.6 TDI	81	09/13→					
1.6 TDI 4Drive	77	04/14→					
1.6 TDI 4Drive	81	11/14→					
1.8 TSI	132	10/13→					
1.8 TSI 4Drive	132	11/14→					
2.0 Cupra	195	10/13→					
2.0 Cupra	206	10/13→					
2.0 Cupra	213	10/15→					
2.0 TDI	81	11/13→					
2.0 TDI	105	10/13→					
2.0 TDI	110	10/13→					
2.0 TDI	135	08/13→					
2.0 TDI 4Drive	110	04/14→					
2.0 TDI 4Drive	135	11/14→					
1.6 TDI	85	11/16→		01/17→; für Linkslenker		03.4153-5403.3 010994 24.4123-1719.3 011017	ATE Ø 23,81 TRW Ø 23,81 ohne Bremsflüssigkeitsbehälter
				01/17→; für Linkslenker; +PR 1ZA,1ZE		24.4123-1719.3 011017	TRW Ø 23,81 ohne Bremsflüssigkeitsbehälter
2.0 Cupra	221	11/16→		für Linkslenker; +PR 1ZA,1ZE		24.4123-1719.3 011017	TRW Ø 23,81 ohne Bremsflüssigkeitsbehälter
2.0 Cupra 4Drive	221	11/16→					
SEAT - MARBELLA (28) 08/86→05/99							
 Hauptbremszylinder							
0.9	32	07/97→10/98				24.2119-0826.3 010349	Ø 19,05
0.9 Cat	29	01/90→11/96					
0.9 Cat	30	11/96→10/98					
SEAT - Mii (KF1) 10/11→							
 Hauptbremszylinder							
1.0	44	10/11→		05/12→		24.4120-1703.3 011015	TRW Ø 20,64 ohne Bremsflüssigkeitsbehälter
1.0	55	10/11→					
1.0 EcoFuel	50	11/12→				24.4120-1703.3 011015	TRW Ø 20,64 ohne Bremsflüssigkeitsbehälter











	kw			 	! #		
SEAT - TOLEDO I (1L) 01/91→10/99							
 Hauptbremszylinder							
1.6 i	54	05/91→03/99		09/91→; → 1L-ZD101450		03.2120-2031.3 010106	ATE Ø 20,64
				1L-ZD101451→ 1L-ZD315000		03.2120-3943.3 010532	ATE Ø 20,64
				→ 09/98; 1L-ZD315001→		03.2122-1042.3 010137	Ø 22,2
1.6 i	55	01/93→03/99		→ 1L-ZD101450		03.2120-2031.3 010106	ATE Ø 20,64
1.6 i	74	11/96→03/99		1L-ZD101451→ 1L-ZD315000		03.2120-3943.3 010532	ATE Ø 20,64
				→ 09/98; 1L-ZD315001→		03.2122-1042.3 010137	Ø 22,2
1.8 16V	92	05/91→03/99		09/91→ 03/94; für Linkslenker		10.6123-0674.3 010639	ATE Ø 23,81
1.8 16V	98	05/91→03/99					
1.8 i	65	05/91→12/96		09/91→; → 1L-ZD315000; - ABS		03.2120-3943.3 010532	ATE Ø 20,64
				1L-ZD315001→; - ABS		03.2122-1042.3 010137	Ø 22,2
1.8 i	66	11/93→12/96		→ 1L-ZD315000; - ABS		03.2120-3943.3 010532	ATE Ø 20,64
				1L-ZD315001→; - ABS		03.2122-1042.3 010137	Ø 22,2
1.9 D	47	12/95→03/99		→ 1L-ZD315000		03.2120-3943.3 010532	ATE Ø 20,64
				→ 09/98; 1L-ZD315001→		03.2122-1042.3 010137	Ø 22,2
1.9 D	50	05/91→03/99		09/91→; → 1L-ZD315000		03.2120-3943.3 010532	ATE Ø 20,64
				→ 09/98; 1L-ZD315001→		03.2122-1042.3 010137	Ø 22,2
1.9 TD	55	05/91→03/99		09/91→; → 1L-ZD315000; - ABS		03.2120-3943.3 010532	ATE Ø 20,64
				→ 09/98; 1L-ZD315001→; - ABS		03.2122-1042.3 010137	Ø 22,2
1.9 TDI	66	08/95→03/99		→ 09/98; - ABS		03.2122-1042.3 010137	Ø 22,2
1.9 TDI	81	11/96→03/99		→ 09/98; für Linkslenker; + ABS		10.6123-0674.3 010639	ATE Ø 23,81
2.0 i	85	05/91→03/99		09/91→ 09/98; für Linkslenker		10.6123-0674.3 010639	ATE Ø 23,81
2.0 i 16V	110	11/93→03/99		03/94→ 09/98; für Linkslenker		10.6123-0674.3 010639	ATE Ø 23,81
Verschlusschraube, Hauptbremszylinder							
1.6 i	54	05/91→03/99		1L-ZD101451→ 1L-ZD315000		03.3517-0101.2 390322	
				→ 09/98; 1L-ZD315001→		03.3517-0101.2 390322	
				09/91→; → 1L-ZD101450		03.3517-0101.2 390322	
1.6 i	55	01/93→03/99		1L-ZD101451→ 1L-ZD315000		03.3517-0101.2 390322	
1.6 i	74	11/96→03/99		→ 09/98; 1L-ZD315001→		03.3517-0101.2 390322	
				→ 1L-ZD101450		03.3517-0101.2 390322	
1.8 i	65	05/91→12/96		09/91→; → 1L-ZD315000; - ABS		03.3517-0101.2 390322	
				1L-ZD315001→; - ABS		03.3517-0101.2 390322	
1.8 i	66	11/93→12/96		→ 1L-ZD315000; - ABS		03.3517-0101.2 390322	
				1L-ZD315001→; - ABS		03.3517-0101.2 390322	
1.9 D	47	12/95→03/99		→ 1L-ZD315000		03.3517-0101.2 390322	
				→ 09/98; 1L-ZD315001→		03.3517-0101.2 390322	
1.9 D	50	05/91→03/99		09/91→; → 1L-ZD315000		03.3517-0101.2 390322	
				→ 09/98; 1L-ZD315001→		03.3517-0101.2 390322	
1.9 TD	55	05/91→03/99		09/91→; → 1L-ZD315000; - ABS		03.3517-0101.2 390322	
				→ 09/98; 1L-ZD315001→; - ABS		03.3517-0101.2 390322	
1.9 TDI	66	08/95→03/99		→ 09/98; - ABS		03.3517-0101.2 390322	
1.9 TDI	81	11/96→03/99					
 Bremskraftregler							
1.6 i	54	05/91→03/99		09/91→ 09/98		03.6584-0015.3 320109	ATE lastabhängig 8/4 4x
1.9 D	50	05/91→03/99					
1.9 TD	55	05/91→03/99					
2.0 i	85	05/91→03/99					
1.6 i	55	01/93→03/99		→ 09/98		03.6584-0015.3 320109	ATE lastabhängig 8/4 4x
1.6 i	74	11/96→03/99					
1.9 D	47	12/95→03/99					
1.9 TDI	66	08/95→03/99					
1.9 TDI	81	11/96→03/99					
1.8 16V	92	05/91→03/99		09/91→ 03/94		03.6584-0015.3 320109	ATE lastabhängig 8/4 4x
1.8 16V	98	05/91→03/99					
1.8 i	65	05/91→12/96		09/91→		03.6584-0015.3 320109	ATE lastabhängig 8/4 4x
1.8 i	66	11/93→12/96				03.6584-0015.3 320109	ATE lastabhängig 8/4 4x
2.0 i 16V	110	11/93→03/99		03/94→ 09/98		03.6584-0113.3 320111	ATE lastabhängig 8/4 4x
SEAT - TOLEDO II (1M2) 10/98→05/06							
 Bremskraftverstärker							
1.4 16V	55	01/00→05/02		1M-1R023639→; für Linkslenker; + ESP		03.7860-0602.4 300141	ATE Ø 10" pneumatisch
1.6	74	10/98→07/04		1M-1B018342→; für Linkslenker; + ESP		03.7860-0602.4 300141	ATE Ø 10" pneumatisch
1.8 20V	92	10/98→07/04					
1.9 TDI	66	03/99→07/04		→ 1M-1B018341; für Linkslenker; + ESP		03.7863-0402.4 300124	ATE Ø 10" pneumatisch
1.9 TDI	81	10/98→07/04					
↓							





























	kw					! #		
SEAT - TOLEDO II (1M2) 10/98→05/06								
Bremskraftverstärker								
1.9 TDI 2.3 V5 2.3 V5 20V	110 110 125	10/00→07/04 10/98→11/00 09/00→11/03		→ 1M-1R023638; für Linkslenker; + ESP			03.7863-0402.4 300124	ATE Ø 10" pneumatisch
1.6 16V 1.9 TDI	77 96	06/00→05/06 05/03→05/06		1M-1R023639→; → 09/04; für Linkslenker; + ESP			03.7860-0602.4 300141	ATE Ø 10" pneumatisch
				1M-1B018342→; → 09/04; für Linkslenker; + ESP			03.7860-0602.4 300141	ATE Ø 10" pneumatisch
				→ 1M-1B018341; für Linkslenker; + ESP			03.7863-0402.4 300124	ATE Ø 10" pneumatisch
				→ 1M-1R023638; für Linkslenker; + ESP			03.7863-0402.4 300124	ATE Ø 10" pneumatisch
1.8 20VT	132	09/00→07/04		1M-1R023639→; für Linkslenker; + ESP			03.7860-0602.4 300141	ATE Ø 10" pneumatisch
				1M-1B018342→; für Linkslenker; + ESP			03.7860-0602.4 300141	ATE Ø 10" pneumatisch
				05/01→; → 1M-1B018341; für Linkslenker; + ESP			03.7863-0402.4 300124	ATE Ø 10" pneumatisch
				05/01→; → 1M-1R023638; für Linkslenker; + ESP			03.7863-0402.4 300124	ATE Ø 10" pneumatisch
Hauptbremszylinder								
1.4 16V 1.6 1.8 20V 1.9 TDI 1.9 TDI 2.3 V5	55 74 92 66 81 110	01/00→05/02 10/98→07/04 10/98→07/04 03/99→07/04 10/98→07/04 10/98→11/00		→ 08/00; für Linkslenker; + ESP			03.2123-2024.3 010597	ATE Ø 23,81
				→ 08/00; für Rechtslenker; + ESP			03.2123-2064.3 010598	ATE Ø 23,81
				09/00→; für Linkslenker; + ESP			03.2123-2715.3 010802	ATE Ø 23,81
				09/00→; für Rechtslenker; + ESP			03.2123-2774.3 010803	ATE Ø 23,81
				für Linkslenker; - ESP			24.2123-1709.3 010503	Ø 23,81
1.6 16V	77	06/00→05/06		→ 08/00; für Linkslenker; + ESP			03.2123-2024.3 010597	ATE Ø 23,81
				→ 08/00; für Rechtslenker; + ESP			03.2123-2064.3 010598	ATE Ø 23,81
				09/00→ 09/04; für Linkslenker; + ESP			03.2123-2715.3 010802	ATE Ø 23,81
				09/00→ 09/04; für Rechtslenker; + ESP			03.2123-2774.3 010803	ATE Ø 23,81
				→ 09/04; für Linkslenker; - ESP			24.2123-1709.3 010503	Ø 23,81
1.8 20VT	132	09/00→07/04		05/01→; + ESP; für Linkslenker			03.2123-2715.3 010802	ATE Ø 23,81
				05/01→; für Rechtslenker; + ESP			03.2123-2774.3 010803	ATE Ø 23,81
1.9 TDI	96	05/03→05/06		→ 09/04; für Linkslenker; + ESP			03.2123-2715.3 010802	ATE Ø 23,81
				→ 09/04; + ESP; für Rechtslenker			03.2123-2774.3 010803	ATE Ø 23,81
				→ 09/04; für Linkslenker; - ESP			24.2123-1709.3 010503	Ø 23,81
1.9 TDI 2.3 V5 20V	110 125	10/00→07/04 09/00→11/03		für Linkslenker; + ESP			03.2123-2715.3 010802	ATE Ø 23,81
				für Rechtslenker; + ESP			03.2123-2774.3 010803	ATE Ø 23,81
				für Linkslenker; - ESP			24.2123-1709.3 010503	Ø 23,81
Bremskraftregler								
1.4 16V 1.6 1.8 20V 1.9 TDI 1.9 TDI 1.9 TDI 2.3 V5 2.3 V5 20V	55 74 92 66 81 110 110 125	01/00→05/02 10/98→07/04 10/98→07/04 03/99→07/04 10/98→07/04 10/00→07/04 10/98→11/00 09/00→11/03		- ABS			03.6583-0179.3 320228	ATE lastabhängig 8/3 4x
1.6 16V 1.9 TDI	77 96	06/00→05/06 05/03→05/06		→ 09/04; - ABS			03.6583-0179.3 320228	ATE lastabhängig 8/3 4x
SEAT - TOLEDO III (5P2) 04/04→05/09								
Bremskraftverstärker								
1.4 16V 1.4 TSI 1.6 1.8 TFSI 1.9 TDI 2.0 FSI 2.0 TDI 2.0 TDI 2.0 TFSI	63 92 75 118 77 110 103 125 147	05/06→05/09 11/07→05/09 10/04→05/09 01/07→05/09 10/04→05/09 10/04→05/09 11/05→05/09 01/06→05/09 11/05→05/09		→ 03/09; für Linkslenker; +PR 1AC,1AT			03.7863-3232.4 300307	ATE Ø 10" pneumatisch
				→ 03/09; für Linkslenker; +PR 1AS			03.7863-9602.4 300206	ATE Ø 10" pneumatisch
2.0 TDI 2.0 TDI 16V	100 103	09/04→05/09 04/04→05/09		10/04→ 03/09; für Linkslenker; +PR 1AC,1AT			03.7863-3232.4 300307	ATE Ø 10" pneumatisch
				10/04→ 03/09; für Linkslenker; +PR 1AS			03.7863-9602.4 300206	ATE Ø 10" pneumatisch
Hauptbremszylinder								
1.4 16V 1.4 TSI 1.6 1.8 TFSI 1.9 TDI 2.0 FSI ↓	63 92 75 118 77 110	05/06→05/09 11/07→05/09 10/04→05/09 01/07→05/09 10/04→05/09 10/04→05/09		→ 03/09; für Linkslenker			03.2122-2129.3 010799	ATE Ø 22,2













	kw					! #		
SEAT - TOLEDO III (5P2) 04/04→05/09								
 Hauptbremszylinder								
2.0 TDI	103	11/05→05/09		→ 03/09; für Linkslenker			03.2122-2129.3 010799	ATE Ø 22,2
2.0 TDI	125	01/06→05/09						
2.0 TFSI	147	11/05→05/09						
2.0 TDI	100	09/04→05/09		10/04→ 03/09; für Linkslenker			03.2122-2129.3 010799	ATE Ø 22,2
2.0 TDI 16V	103	04/04→05/09						
Hydraulikaggregat, Bremsanlage								
1.4 16V	63	05/06→05/09	➡	→ 03/09; +PR 1AT,1AS			24.9145-0001.2 399005	
1.4 TSI	92	11/07→05/09						
1.6	75	10/04→05/09						
1.8 TFSI	118	01/07→05/09						
1.9 TDI	77	10/04→05/09						
2.0 FSI	110	10/04→05/09						
2.0 TDI	103	11/05→05/09						
2.0 TDI	125	01/06→05/09						
2.0 TFSI	147	11/05→05/09						
2.0 TDI	100	09/04→05/09	➡	10/04→ 03/09; +PR 1AT,1AS			24.9145-0001.2 399005	
2.0 TDI 16V	103	04/04→05/09						
Drucksensor, Bremskraftverstärker								
1.4 16V	63	05/06→05/09		→ 03/09; für Linkslenker; +PR 1AS			03.0655-0101.2 370008	ATE
1.4 TSI	92	11/07→05/09						
1.6	75	10/04→05/09						
1.8 TFSI	118	01/07→05/09						
1.9 TDI	77	10/04→05/09						
2.0 FSI	110	10/04→05/09						
2.0 TDI	103	11/05→05/09						
2.0 TDI	125	01/06→05/09						
2.0 TFSI	147	11/05→05/09						
2.0 TDI	100	09/04→05/09		10/04→ 03/09; für Linkslenker; +PR 1AS			03.0655-0101.2 370008	ATE
2.0 TDI 16V	103	04/04→05/09						
SKODA - CITIGO 10/11→								
 Hauptbremszylinder								
1.0	44	10/11→		05/12→			24.4120-1703.3 011015	TRW Ø 20,64 ohne Bremsflüssigkeitsbehälter
1.0	55	10/11→						
1.0 CNG	50	11/12→					24.4120-1703.3 011015	TRW Ø 20,64 ohne Bremsflüssigkeitsbehälter
SKODA - FABIA I (6Y2) 08/99→03/08								
 Hauptbremszylinder								
1.0	37	12/99→08/02		02/00→; + ABS			24.2120-1734.3 010702	Ø 20,64
1.4	50	08/99→05/03		02/00→; - ABS			24.2120-1736.3 010732	Ø 20,64
1.2	40	07/01→04/07		08/02→; + ABS			24.2120-1734.3 010702	Ø 20,64
				08/02→; - ABS			24.2120-1736.3 010732	Ø 20,64
1.2	47	01/03→03/08		→ 12/07; + ABS			24.2120-1734.3 010702	Ø 20,64
1.4 16V	55	12/99→03/08		→ 12/07; - ABS			24.2120-1736.3 010732	Ø 20,64
1.4 16V	74	12/99→03/08						
1.4 TDI	51	10/05→03/08						
1.4 TDI	55	04/03→03/08						
1.4 TDI	59	10/05→03/08						
1.9 SDI	47	12/99→03/08						
2.0	85	12/99→03/08						
1.4	44	08/00→08/02		+ ABS			24.2120-1734.3 010702	Ø 20,64
				- ABS			24.2120-1736.3 010732	Ø 20,64
1.9 TDI	74	01/00→03/08		02/00→ 12/07; + ABS			24.2120-1734.3 010702	Ø 20,64
				02/00→ 12/07; - ABS			24.2120-1736.3 010732	Ø 20,64
1.9 TDI RS	96	06/03→03/08		09/03→ 12/07; + ABS			24.2120-1734.3 010702	Ø 20,64
				09/03→ 12/07; - ABS			24.2120-1736.3 010732	Ø 20,64
 Bremskraftregler								
1.4	44	08/00→08/02		+PR 1AB, 1LM; - ABS			03.6043-1733.3 320284	ATE 3/25 2x
				+PR 1AL; - ABS; Schrägheck			03.6583-0216.3 320247	ATE lastabhängig 8/3 4x
				- ABS; Stufenheck / Kasten/Kombi			03.6584-0120.3 320279	ATE lastabhängig 8/4 4x
1.4	50	08/99→05/03		02/00→; +PR 1AB, 1LM; - ABS			03.6043-1733.3 320284	ATE 3/25 2x
				02/00→; +PR 1AL; - ABS; Schrägheck			03.6583-0216.3 320247	ATE lastabhängig 8/3 4x
				02/00→; - ABS; Stufenheck / Kasten/Kombi			03.6584-0120.3 320279	ATE lastabhängig 8/4 4x
1.4 16V	55	12/99→03/08		→ 12/07; +PR 1AB, 1LM; - ABS			03.6043-1733.3 320284	ATE 3/25 2x
1.4 16V	74	12/99→03/08		→ 12/07; +PR 1AL; - ABS; Schrägheck			03.6583-0216.3 320247	ATE lastabhängig 8/3 4x
1.4 TDI	51	10/05→03/08						
1.4 TDI	55	04/03→03/08		→ 12/07; - ABS; Stufenheck / Kasten/Kombi			03.6584-0120.3 320279	ATE lastabhängig 8/4 4x
1.4 TDI	59	10/05→03/08						

	kw					! #		
SKODA - FABIA I (6Y2) 08/99→03/08								
 Bremskraftregler								
1.9 SDI 2.0	47 85	12/99→03/08 12/99→03/08		→ 12/07; +PR 1AB, 1LM; - ABS		03.6043-1733.3	320284	ATE 3/25 2x
				→ 12/07; +PR 1AL; - ABS; Schrägheck		03.6583-0216.3	320247	ATE lastabhängig 8/3 4x
				→ 12/07; - ABS; Stufenheck / Kasten/Kombi		03.6584-0120.3	320279	ATE lastabhängig 8/4 4x
1.9 TDI	74	01/00→03/08		02/00→ 12/07; +PR 1AB, 1LM; - ABS		03.6043-1733.3	320284	ATE 3/25 2x
				02/00→ 12/07; +PR 1AL; - ABS; Schrägheck		03.6583-0216.3	320247	ATE lastabhängig 8/3 4x
				02/00→ 12/07; - ABS; Stufenheck / Kasten/Kombi		03.6584-0120.3	320279	ATE lastabhängig 8/4 4x
1.9 TDI RS	96	06/03→03/08		09/03→ 12/07; +PR 1AB, 1LM; - ABS		03.6043-1733.3	320284	ATE 3/25 2x
				09/03→ 12/07; +PR 1AL; - ABS; Schrägheck		03.6583-0216.3	320247	ATE lastabhängig 8/3 4x
				09/03→ 12/07; - ABS; Stufenheck / Kasten/Kombi		03.6584-0120.3	320279	ATE lastabhängig 8/4 4x
SKODA - FABIA I Combi (6Y5) 04/00→12/07								
 Hauptbremszylinder								
1.2	40	07/01→12/07		08/02→; + ABS		24.2120-1734.3	010702	Ø 20,64
				08/02→; - ABS		24.2120-1736.3	010732	Ø 20,64
1.2	47	01/03→12/07		+ ABS		24.2120-1734.3	010702	Ø 20,64
1.4	44	04/00→03/03						
1.4	50	04/00→05/03		- ABS		24.2120-1736.3	010732	Ø 20,64
1.4 16V	55	05/00→12/07						
1.4 16V	59	04/06→12/07						
1.4 16V	74	04/00→12/07						
1.4 TDI	51	10/05→12/07						
1.4 TDI	55	04/03→12/07						
1.4 TDI	59	10/05→12/07						
1.9 SDI	47	04/00→12/07						
1.9 TDI	74	04/00→12/07						
2.0	85	04/00→12/07						
 Bremskraftregler								
1.4	44	04/00→03/03		+PR 1AB, 1LM; - ABS		03.6043-1733.3	320284	ATE 3/25 2x
1.4	50	04/00→05/03		+PR 1AL; - ABS; Schrägheck		03.6583-0216.3	320247	ATE lastabhängig 8/3 4x
1.4 16V	55	05/00→12/07						
1.4 16V	59	04/06→12/07		- ABS; Stufenheck / Kasten/Kombi		03.6584-0120.3	320279	ATE lastabhängig 8/4 4x
1.4 16V	74	04/00→12/07						
1.4 TDI	51	10/05→12/07						
1.4 TDI	55	04/03→12/07						
1.4 TDI	59	10/05→12/07						
1.9 SDI	47	04/00→12/07						
1.9 TDI	74	04/00→12/07						
2.0	85	04/00→12/07						
SKODA - FABIA I Praktik (6Y5) 07/01→12/07								
 Hauptbremszylinder								
1.2	40	07/01→12/07		08/02→; + ABS		24.2120-1734.3	010702	Ø 20,64
				08/02→; - ABS		24.2120-1736.3	010732	Ø 20,64
1.2	47	01/03→12/07		+ ABS		24.2120-1734.3	010702	Ø 20,64
1.4	50	07/01→05/03						
1.4 TDI	51	10/05→12/07		- ABS		24.2120-1736.3	010732	Ø 20,64
1.9 SDI	47	07/01→12/07						
 Bremskraftregler								
1.4	50	07/01→05/03		+PR 1AB, 1LM; - ABS		03.6043-1733.3	320284	ATE 3/25 2x
1.4 TDI	51	10/05→12/07		+PR 1AL; - ABS; Schrägheck		03.6583-0216.3	320247	ATE lastabhängig 8/3 4x
1.9 SDI	47	07/01→12/07		- ABS; Stufenheck / Kasten/Kombi		03.6584-0120.3	320279	ATE lastabhängig 8/4 4x
SKODA - FABIA I Stufenheck (6Y3) 10/99→12/07								
 Hauptbremszylinder								
1.2	40	07/01→12/07		08/02→; + ABS		24.2120-1734.3	010702	Ø 20,64
				08/02→; - ABS		24.2120-1736.3	010732	Ø 20,64
1.2	47	01/03→12/07		+ ABS		24.2120-1734.3	010702	Ø 20,64
1.4	44	04/00→08/02						
1.4	50	07/01→05/03		- ABS		24.2120-1736.3	010732	Ø 20,64
1.4 16V	55	10/99→12/07						
1.4 16V	59	04/06→12/07						
1.4 16V	74	12/99→12/07						
1.4 TDI	51	10/05→12/07						
1.4 TDI	55	04/03→12/07						
1.4 TDI	59	10/05→12/07						
2.0	85	12/99→12/07						
↓								











	kw			 	! #		
SKODA - FABIA I Stufenheck (6Y3) 10/99→12/07							
 Hauptbremszylinder							
1.9 SDI	47	11/99→12/07		12/99→; + ABS		24.2120-1734.3 010702	Ø 20,64
				12/99→; - ABS		24.2120-1736.3 010732	Ø 20,64
1.9 TDI	74	01/00→12/07		02/00→; + ABS		24.2120-1734.3 010702	Ø 20,64
				02/00→; - ABS		24.2120-1736.3 010732	Ø 20,64
 Bremskraftregler							
1.4	44	04/00→08/02		+PR 1AB, 1LM; - ABS		03.6043-1733.3 320284	ATE 3/25 2x
1.4	50	07/01→05/03		+PR 1AL; - ABS; Schrägheck		03.6583-0216.3 320247	ATE lastabhängig 8/3 4x
1.4 16V	55	10/99→12/07		- ABS; Stufenheck / Kasten/Kombi		03.6584-0120.3 320279	ATE lastabhängig 8/4 4x
1.4 16V	59	04/06→12/07					
1.4 16V	74	12/99→12/07					
1.4 TDI	51	10/05→12/07					
1.4 TDI	55	04/03→12/07					
1.4 TDI	59	10/05→12/07					
2.0	85	12/99→12/07					
1.9 SDI	47	11/99→12/07		12/99→; +PR 1AB, 1LM; - ABS		03.6043-1733.3 320284	ATE 3/25 2x
				12/99→; +PR 1AL; - ABS; Schrägheck		03.6583-0216.3 320247	ATE lastabhängig 8/3 4x
				12/99→; - ABS; Stufenheck / Kasten/Kombi		03.6584-0120.3 320279	ATE lastabhängig 8/4 4x
1.9 TDI	74	01/00→12/07		02/00→; +PR 1AB, 1LM; - ABS		03.6043-1733.3 320284	ATE 3/25 2x
				02/00→; +PR 1AL; - ABS; Schrägheck		03.6583-0216.3 320247	ATE lastabhängig 8/3 4x
				02/00→; - ABS; Stufenheck / Kasten/Kombi		03.6584-0120.3 320279	ATE lastabhängig 8/4 4x
SKODA - FABIA II (542) 12/06→12/14							
 Hauptbremszylinder							
1.2	44	12/06→12/14		03/07→ 06/14; +PR 1AC,1AR,1LB,1LM; für Linkslenker; + ABS		24.2119-1712.3 010912	Ø 19,05 ohne Bremsflüssigkeitsbehälter
1.2	51	01/07→12/14					
1.4	63	01/07→12/14		03/07→; +PR 1AC,1AR,1AT / 1LN,1LQ,1LR; → 06/14; für Linkslenker; + ABS		24.2120-1734.3 010702	Ø 20,64
				03/07→ 06/14; +PR 1AL,1LQ,1LN,1LR; für Linkslenker; - ABS		24.2120-1736.3 010732	Ø 20,64
1.2 12V	44	11/11→12/14		→ 06/14; +PR 1AC,1AR,1LB,1LM; für Linkslenker; + ABS		24.2119-1712.3 010912	Ø 19,05 ohne Bremsflüssigkeitsbehälter
1.2 TSI	63	03/10→12/14					
1.2 TSI	77	03/10→12/14					
1.4 TSI RS	132	05/10→12/14		→ 06/14; +PR 1AC,1AR,1AT / 1LN,1LQ,1LR; für Linkslenker; + ABS		24.2120-1734.3 010702	Ø 20,64
1.6	77	04/07→12/14		→ 06/14; +PR 1AL,1LQ,1LN,1LR; für Linkslenker; - ABS		24.2120-1736.3 010732	Ø 20,64
1.2 TDI	55	05/10→12/14		→ 06/14; +PR 1AC,1AR,1LB,1LM; für Linkslenker; + ABS		24.2119-1712.3 010912	Ø 19,05 ohne Bremsflüssigkeitsbehälter
				→ 06/14; +PR 1AC,1AR,1AT,1LN / 1LQ,1LR; für Linkslenker; + ABS		24.2120-1734.3 010702	Ø 20,64
				→ 06/14; +PR 1AL,1LQ,1LN,1LR; für Linkslenker; - ABS		24.2120-1736.3 010732	Ø 20,64
				→ 06/14; +PR 1AC,1AR,1AT,1LN / 1LQ,1LR; für Rechtslenker; + ABS; für Fahrzeuge mit Rußpartikelfilter		24.2120-1768.3 011041	Ø 20,64 ohne Bremsflüssigkeitsbehälter
1.4 TDI	51	02/07→03/10		03/07→; +PR 1AC,1AR,1LB,1LM; für Linkslenker; + ABS		24.2119-1712.3 010912	Ø 19,05 ohne Bremsflüssigkeitsbehälter
1.4 TDI	59	01/07→03/10					
				03/07→; +PR 1AC,1AR,1AT / 1LN,1LQ,1LR; für Linkslenker; + ABS		24.2120-1734.3 010702	Ø 20,64
				03/07→; +PR 1AL,1LQ,1LN,1LR; für Linkslenker; - ABS		24.2120-1736.3 010732	Ø 20,64
				03/07→; +PR 1AC,1AR,1AT / 1LN,1LQ,1LR; für Rechtslenker; + ABS; für Fahrzeuge mit Rußpartikelfilter		24.2120-1768.3 011041	Ø 20,64 ohne Bremsflüssigkeitsbehälter
1.6 TDI	55	04/10→12/14		→ 06/14; +PR 1AC,1AR,1LB,1LM; für Linkslenker; + ABS		24.2119-1712.3 010912	Ø 19,05 ohne Bremsflüssigkeitsbehälter
1.6 TDI	66	03/10→12/14					
1.6 TDI	77	03/10→12/14		→ 06/14; +PR 1AC,1AR,1AT / 1LN,1LQ,1LR; für Linkslenker; + ABS		24.2120-1734.3 010702	Ø 20,64
				→ 06/14; +PR 1AL,1LQ,1LN,1LR; für Linkslenker; - ABS		24.2120-1736.3 010732	Ø 20,64
				→ 06/14; +PR 1AC,1AR,1AT / 1LN,1LQ,1LR; für Rechtslenker; + ABS; für Fahrzeuge mit Rußpartikelfilter		24.2120-1768.3 011041	Ø 20,64 ohne Bremsflüssigkeitsbehälter
↓							











	kw			 	! #		
SKODA - FABIA II (542) 12/06→12/14							
 Hauptbremszylinder							
1.9 TDI	77	04/07→03/10		+PR 1AC,1AR,1LB,1LM; für Linkslenker; + ABS	24.2119-1712.3	010912	Ø 19,05 ohne Bremsflüssigkeitsbehälter
				für Linkslenker; +PR 1AC,1AR,1AT / 1LN,1LQ,1LR; + ABS	24.2120-1734.3	010702	Ø 20,64
				+PR 1AL,1LQ,1LN,1LR; für Linkslenker; - ABS	24.2120-1736.3	010732	Ø 20,64
				für Rechtslenker; +PR 1AC,1AR,1AT / 1LN,1LQ,1LR; + ABS; für Fahrzeuge mit Rußpartikelfilter	24.2120-1768.3	011041	Ø 20,64 ohne Bremsflüssigkeitsbehälter
 Bremskraftregler							
1.2	44	12/06→12/14		03/07→ 06/14; - ABS	03.6583-0216.3	320247	ATE lastabhängig 8/3 4x
1.2	51	01/07→12/14			03.6584-0120.3	320279	ATE lastabhängig 8/4 4x
1.4	63	01/07→12/14					
1.2 12V	44	11/11→12/14		→ 06/14; - ABS	03.6583-0216.3	320247	ATE lastabhängig 8/3 4x
1.2 TDI	55	05/10→12/14			03.6584-0120.3	320279	ATE lastabhängig 8/4 4x
1.2 TSI	63	03/10→12/14					
1.2 TSI	77	03/10→12/14					
1.6	77	04/07→12/14					
1.6 TDI	55	04/10→12/14					
1.6 TDI	66	03/10→12/14					
1.6 TDI	77	03/10→12/14					
1.4 TDI	51	02/07→03/10		03/07→; - ABS	03.6583-0216.3	320247	ATE lastabhängig 8/3 4x
1.4 TDI	59	01/07→03/10			03.6584-0120.3	320279	ATE lastabhängig 8/4 4x
1.9 TDI	77	04/07→03/10		- ABS	03.6583-0216.3	320247	ATE lastabhängig 8/3 4x
					03.6584-0120.3	320279	ATE lastabhängig 8/4 4x
SKODA - FABIA II Combi (545) 10/07→12/14							
 Hauptbremszylinder							
1.2	44	10/07→11/14		→ 06/14; +PR 1AC,1AR,1LB,1LM; für Linkslenker; + ABS	24.2119-1712.3	010912	Ø 19,05 ohne Bremsflüssigkeitsbehälter
1.2	51	10/07→12/14			24.2120-1734.3	010702	Ø 20,64
1.2 12V	44	11/11→12/14		→ 06/14;			
1.2 TSI	63	03/10→12/14		+PR 1AC,1AR,1AT / 1LN,1LQ,1LR; für Linkslenker; + ABS	24.2120-1736.3	010732	Ø 20,64
1.2 TSI	77	03/10→12/14					
1.4	63	10/07→12/14		→ 06/14; +PR 1AL,1LQ,1LN,1LR; für Linkslenker; - ABS	24.2120-1736.3	010732	Ø 20,64
1.4 TSI RS	132	05/10→12/14					
1.6	77	10/07→12/14					
1.2 TDI	55	05/10→12/14		→ 06/14; +PR 1AC,1AR,1LB,1LM; für Linkslenker; + ABS	24.2119-1712.3	010912	Ø 19,05 ohne Bremsflüssigkeitsbehälter
				→ 06/14; +PR 1AC,1AR,1AT,1LN / 1LQ,1LR; für Linkslenker; + ABS	24.2120-1734.3	010702	Ø 20,64
				→ 06/14; +PR 1AL,1LQ,1LN,1LR; für Linkslenker; - ABS	24.2120-1736.3	010732	Ø 20,64
				→ 06/14; +PR 1AC,1AR,1AT,1LN / 1LQ,1LR; für Rechtslenker; + ABS; für Fahrzeuge mit Rußpartikelfilter	24.2120-1768.3	011041	Ø 20,64 ohne Bremsflüssigkeitsbehälter
1.4 TDI	51	10/07→03/10		+PR 1AC,1AR,1LB,1LM; für Linkslenker; + ABS	24.2119-1712.3	010912	Ø 19,05 ohne Bremsflüssigkeitsbehälter
1.4 TDI	59	10/07→03/10			24.2120-1734.3	010702	Ø 20,64
1.9 TDI	77	10/07→03/10		+PR 1AC,1AR,1AT / 1LN,1LQ,1LR; für Linkslenker; + ABS	24.2120-1736.3	010732	Ø 20,64
				+PR 1AL,1LQ,1LN,1LR; für Linkslenker; - ABS	24.2120-1736.3	010732	Ø 20,64
				+PR 1AC,1AR,1AT / 1LN,1LQ,1LR; für Rechtslenker; + ABS; für Fahrzeuge mit Rußpartikelfilter	24.2120-1768.3	011041	Ø 20,64 ohne Bremsflüssigkeitsbehälter
1.6 TDI	55	04/10→12/14		→ 06/14; +PR 1AC,1AR,1LB,1LM; für Linkslenker; + ABS	24.2119-1712.3	010912	Ø 19,05 ohne Bremsflüssigkeitsbehälter
1.6 TDI	66	03/10→12/14			24.2120-1734.3	010702	Ø 20,64
1.6 TDI	77	03/10→12/14		→ 06/14; +PR 1AC,1AR,1AT / 1LN,1LQ,1LR; für Linkslenker; + ABS	24.2120-1736.3	010732	Ø 20,64
				→ 06/14; +PR 1AL,1LQ,1LN,1LR; für Linkslenker; - ABS	24.2120-1736.3	010732	Ø 20,64
				→ 06/14; +PR 1AC,1AR,1AT / 1LN,1LQ,1LR; für Rechtslenker; + ABS; für Fahrzeuge mit Rußpartikelfilter	24.2120-1768.3	011041	Ø 20,64 ohne Bremsflüssigkeitsbehälter
 Bremskraftregler							
1.2	44	10/07→11/14		→ 06/14; - ABS	03.6583-0216.3	320247	ATE lastabhängig 8/3 4x
1.2	51	10/07→12/14			03.6584-0120.3	320279	ATE lastabhängig 8/4 4x
1.2 12V	44	11/11→12/14					
↓							











	kw					! #		
SKODA - FABIA II Combi (545) 10/07→12/14								
 Bremskraftregler								
1.2 TDI	55	05/10→12/14			→ 06/14; - ABS		03.6583-0216.3 320247	ATE lastabhängig 8/3 4x
1.2 TSI	63	03/10→12/14					03.6584-0120.3 320279	ATE lastabhängig 8/4 4x
1.2 TSI	77	03/10→12/14						
1.4	63	10/07→12/14						
1.6	77	10/07→12/14						
1.6 TDI	55	04/10→12/14						
1.6 TDI	66	03/10→12/14						
1.6 TDI	77	03/10→12/14						
1.4 TDI	51	10/07→03/10			- ABS		03.6583-0216.3 320247	ATE lastabhängig 8/3 4x
1.4 TDI	59	10/07→03/10					03.6584-0120.3 320279	ATE lastabhängig 8/4 4x
1.9 TDI	77	10/07→03/10						
SKODA - FELICIA I (6U1) 10/94→03/98								
 Hauptbremszylinder								
1.3	40	10/94→03/98			→ 02/98; + ABS		03.2123-1428.3 010476	Ø 23,81
1.3	43	10/94→03/98						
1.3	50	10/94→03/98			→ 02/98; - ABS		24.2122-1731.3 010656	Ø 22,2
1.6 LX	55	08/95→03/98						
1.9 D	47	10/95→03/98			10/96→ 02/98; + ABS		03.2123-1428.3 010476	Ø 23,81
					10/96→ 02/98; - ABS		24.2122-1731.3 010656	Ø 22,2
 Bremskraftregler								
1.3	40	10/94→03/98			→ 02/98		03.6584-0107.3 320110	ATE lastabhängig 8/4 4x
1.3	43	10/94→03/98						
1.3	50	10/94→03/98						
1.6 LX	55	08/95→03/98						
1.9 D	47	10/95→03/98			10/96→ 02/98		03.6583-0167.3 320140	ATE lastabhängig 8/3 4x
SKODA - FELICIA I Kombi (6U5) 07/95→03/98								
 Hauptbremszylinder								
1.3	43	08/95→03/98			→ 02/98; + ABS		03.2123-1428.3 010476	Ø 23,81
1.3 LX	40	08/95→03/98						
1.3 LXI	50	08/95→03/98			→ 02/98; - ABS		24.2122-1731.3 010656	Ø 22,2
1.6 GLX	55	08/95→03/98						
1.9 D	47	10/95→03/98			10/96→ 02/98; + ABS		03.2123-1428.3 010476	Ø 23,81
					10/96→ 02/98; - ABS		24.2122-1731.3 010656	Ø 22,2
 Bremskraftregler								
1.3	43	08/95→03/98			→ 02/98		03.6584-0107.3 320110	ATE lastabhängig 8/4 4x
1.3 LX	40	08/95→03/98						
1.3 LXI	50	08/95→03/98						
1.6 GLX	55	08/95→03/98						
1.9 D	47	10/95→03/98			10/96→ 02/98		03.6583-0167.3 320140	ATE lastabhängig 8/3 4x
SKODA - FELICIA I Pick-up (6UF, 6U7) 10/95→04/02								
 Hauptbremszylinder								
1.3	40	06/97→04/02			→ 12/00; - ABS / + ABS		03.2123-1428.3 010476	Ø 23,81
					→ 12/00; - ABS		24.2122-1731.3 010656	Ø 22,2
1.3	50	06/97→04/02			→ 12/00; + ABS		03.2123-1428.3 010476	Ø 23,81
1.9 D	47	06/97→04/02			→ 12/00		24.2122-1731.3 010656	Ø 22,2
1.6	55	06/97→04/02			→ 12/99; + ABS		03.2123-1428.3 010476	Ø 23,81
					→ 12/99		24.2122-1731.3 010656	Ø 22,2
 Bremskraftregler								
1.3	40	06/97→04/02			→ 12/00		03.6584-0107.3 320110	ATE lastabhängig 8/4 4x
1.3	50	06/97→04/02						
1.6	55	06/97→04/02			→ 12/99		03.6584-0107.3 320110	ATE lastabhängig 8/4 4x
1.9 D	47	06/97→04/02			→ 12/00		03.6583-0167.3 320140	ATE lastabhängig 8/3 4x
SKODA - FELICIA II (6U1) 01/98→06/01								
 Hauptbremszylinder								
1.3	40	01/98→06/01			03/98→		03.2123-1428.3 010476	Ø 23,81
1.3	43	01/98→06/01						
1.3	50	01/98→06/01						
1.6	55	01/98→06/01						
1.9 D	47	01/98→06/01						
SKODA - FELICIA II Kombi (6U5) 01/98→06/01								
 Hauptbremszylinder								
1.3	50	01/98→06/01			03/98→		03.2123-1428.3 010476	Ø 23,81
↓								







	kw					! #		
SKODA - FELICIA II Kombi (6U5) 01/98→06/01								
 Hauptbremszylinder								
1.6 1.9 D	55 47	01/98→06/01 01/98→06/01		03/98→			03.2123-1428.3 010476	Ø 23,81
SKODA - KAROQ (NU7) 07/17→								
 Hauptbremszylinder								
1.0 TSI 1.5 TSI 1.6 TDI 2.0 TDI 4x4 2.0 TDI 4x4	85 110 85 110 140	07/17→ 07/17→ 07/17→ 07/17→ 07/17→		für Linkslenker			24.4123-1719.3 011017	TRW Ø 23,81 ohne Bremsflüssigkeitsbehälter
SKODA - KODIAQ (NS7) 10/16→								
 Hauptbremszylinder								
1.4 TSI 1.4 TSI 1.4 TSI 4x4 2.0 TDI 2.0 TDI 4x4 2.0 TDI 4x4 2.0 TSI 4x4	92 110 110 110 110 140 132	10/16→ 10/16→ 10/16→ 10/16→ 10/16→ 10/16→ 10/16→		03/17→; für Linkslenker; +PR 1ZA			24.4123-1719.3 011017	TRW Ø 23,81 ohne Bremsflüssigkeitsbehälter
SKODA - OCTAVIA I (1U2) 09/96→12/10								
 Bremskraftverstärker								
1.4 1.4 16V 1.6 1.6 1.9 TDI 1.6 1.9 SDI 1.9 TDI 2.0 1.8 1.8 T 1.8 T 4x4 RS 1.8 T 1.9 TDI 1.9 TDI	44 55 75 55 66 74 50 81 85 92 110 110 132 74 96	04/99→03/01 09/00→12/10 11/00→12/10 09/96→09/04 09/96→03/10 02/97→12/07 06/97→12/03 08/97→01/06 04/99→05/07 09/96→07/00 08/97→12/10 05/01→05/06 05/01→01/06 10/05→12/10 09/02→09/04		→ 07/00; für Linkslenker; + ESP 05/01→ 06/10; +PR 1AC,1AH,1AJ,1AT; für Linkslenker 10/96→ 07/00; für Linkslenker; + ESP 05/01→; +PR 1AC,1AH,1AJ,1AT; für Linkslenker → 07/00; für Linkslenker; + ESP 05/01→; +PR 1AC,1AH,1AJ,1AT; für Linkslenker 10/96→; für Linkslenker; + ESP 03/98→ 07/00; für Linkslenker; + ESP 05/01→ 06/10; +PR 1AC,1AH,1AJ,1AT; für Linkslenker → 06/10; +PR 1AC,1AH,1AJ,1AT; für Linkslenker 01/03→; +PR 1AC,1AH,1AJ,1AT; für Linkslenker			03.7863-0402.4 300124 03.7863-3502.4 300128 03.7863-0402.4 300124 03.7863-3502.4 300128 03.7863-0402.4 300124 03.7863-3502.4 300128 03.7863-0402.4 300124 03.7863-3502.4 300128 03.7863-0402.4 300124 03.7863-3502.4 300128 03.7863-3502.4 300128 03.7863-3502.4 300128 03.7863-3502.4 300128	ATE Ø 10" pneumatisch ATE Ø 10" pneumatisch ATE Ø 10" pneumatisch ATE Ø 10" pneumatisch ATE Ø 10" pneumatisch ATE Ø 10" pneumatisch ATE Ø 10" pneumatisch ATE Ø 10" pneumatisch ATE Ø 10" pneumatisch ATE Ø 10" pneumatisch ATE Ø 10" pneumatisch ATE Ø 10" pneumatisch ATE Ø 10" pneumatisch ATE Ø 10" pneumatisch
 Hauptbremszylinder								
1.4 1.6 1.9 SDI 1.9 TDI 2.0 1.4 16V 1.6 1.9 TDI 1.6 1.9 TDI 1.6 1.9 TDI 1.8	44 74 50 81 85 55 75 74 55 66 55 66 92	04/99→03/01 02/97→12/07 06/97→12/03 08/97→01/06 04/99→05/07 09/00→12/10 11/00→12/10 10/05→12/10 09/96→09/04 09/96→03/10 09/96→09/04 09/96→03/10 09/96→07/00		→ 07/00; für Linkslenker; + ESP → 07/00; für Rechtslenker; + ESP 08/00→; für Linkslenker; +PR 1AT 08/00→; für Rechtslenker; +PR 1AT 08/00→; für Linkslenker; +PR 1AC,1AH,1AJ 08/00→; für Linkslenker; +PR 1AM → 07/00; für Linkslenker; - ESP → 06/10; für Linkslenker; +PR 1AT → 06/10; für Rechtslenker; +PR 1AT → 06/10; für Linkslenker; +PR 1AC,1AH,1AJ → 06/10; für Linkslenker; +PR 1AM 10/96→ 07/00; für Linkslenker; + ESP 10/96→ 07/00; für Rechtslenker; + ESP 08/00→; für Linkslenker; +PR 1AT 08/00→; für Rechtslenker; +PR 1AT 08/00→; für Linkslenker; +PR 1AC,1AH,1AJ 08/00→; für Linkslenker; +PR 1AM 10/96→ 07/00; für Linkslenker; - ESP 10/96→; für Linkslenker; + ESP 10/96→; für Rechtslenker; + ESP 10/96→; für Linkslenker; - ESP			03.2123-2024.3 010597 03.2123-2064.3 010598 03.2123-2715.3 010802 03.2123-2774.3 010803 03.2123-2973.3 010951 24.2123-1709.3 010503 24.2123-1709.3 010503 03.2123-2715.3 010802 03.2123-2774.3 010803 03.2123-2973.3 010951 24.2123-1709.3 010503 03.2123-2024.3 010597 03.2123-2064.3 010598 03.2123-2715.3 010802 03.2123-2774.3 010803 03.2123-2973.3 010951 24.2123-1709.3 010503 24.2123-1709.3 010503 03.2123-2024.3 010597 03.2123-2064.3 010598 24.2123-1709.3 010503	ATE Ø 23,81 ATE Ø 23,81 ATE Ø 23,81 ATE Ø 23,81 ATE Ø 23,81 Ø 23,81 Ø 23,81 ATE Ø 23,81 ATE Ø 23,81 ATE Ø 23,81 Ø 23,81 ATE Ø 23,81 ATE Ø 23,81 ATE Ø 23,81 ATE Ø 23,81 ATE Ø 23,81 ATE Ø 23,81 ATE Ø 23,81 ATE Ø 23,81 ATE Ø 23,81 ATE Ø 23,81 ATE Ø 23,81
↓								

























	kw			 	! #		
SKODA - OCTAVIA I (1U2) 09/96→12/10							
 Hauptbremszylinder							
1.8 T	110	08/97→12/10		03/98→07/00; für Linkslenker; + ESP	03.2123-2024.3	010597	ATE Ø 23,81
				03/98→07/00; für Rechtslenker; + ESP	03.2123-2064.3	010598	ATE Ø 23,81
				08/00→06/10; für Linkslenker; +PR 1AT	03.2123-2715.3	010802	ATE Ø 23,81
				08/00→06/10; für Rechtslenker; +PR 1AT	03.2123-2774.3	010803	ATE Ø 23,81
				08/00→06/10; für Linkslenker; +PR 1AC,1AH,1AJ	03.2123-2973.3	010951	ATE Ø 23,81
				03/98→07/00; für Linkslenker; - ESP	24.2123-1709.3	010503	Ø 23,81
				08/00→06/10; für Linkslenker; +PR 1AM	24.2123-1709.3	010503	Ø 23,81
1.8 T 4x4 RS 1.8 T	110 132	05/01→05/06 05/01→01/06		für Linkslenker; +PR 1AT	03.2123-2715.3	010802	ATE Ø 23,81
				für Rechtslenker; +PR 1AT	03.2123-2774.3	010803	ATE Ø 23,81
				für Linkslenker; +PR 1AC,1AH,1AJ	03.2123-2973.3	010951	ATE Ø 23,81
				für Linkslenker; +PR 1AM	24.2123-1709.3	010503	Ø 23,81
1.9 TDI	96	09/02→09/04		01/03→; für Linkslenker; +PR 1AT	03.2123-2715.3	010802	ATE Ø 23,81
				01/03→; für Rechtslenker; +PR 1AT	03.2123-2774.3	010803	ATE Ø 23,81
				01/03→; für Linkslenker; +PR 1AC,1AH,1AJ	03.2123-2973.3	010951	ATE Ø 23,81
				01/03→; für Linkslenker; +PR 1AM	24.2123-1709.3	010503	Ø 23,81
 Bremskraftregler							
1.4	44	04/99→03/01		Scheibenbremse	03.6583-0179.3	320228	ATE lastabhängig 8/3 4x
1.6	74	02/97→12/07		Trommelbremse	03.6584-0107.3	320110	ATE lastabhängig 8/4 4x
1.9 SDI	50	06/97→12/03					
1.4 16V	55	09/00→12/10		→ 06/10; Scheibenbremse	03.6583-0179.3	320228	ATE lastabhängig 8/3 4x
1.6	75	11/00→12/10		→ 06/10; Trommelbremse	03.6584-0107.3	320110	ATE lastabhängig 8/4 4x
1.6	55	09/96→09/04		10/96→; Scheibenbremse	03.6583-0179.3	320228	ATE lastabhängig 8/3 4x
1.9 TDI	66	09/96→03/10		10/96→; Trommelbremse	03.6584-0107.3	320110	ATE lastabhängig 8/4 4x
1.8	92	09/96→07/00		10/96→; Scheibenbremse	03.6583-0179.3	320228	ATE lastabhängig 8/3 4x
1.8 T	110	08/97→12/10		03/98→06/10; Scheibenbremse	03.6583-0179.3	320228	ATE lastabhängig 8/3 4x
1.8 T 4x4	110	05/01→05/06		Scheibenbremse	03.6583-0179.3	320228	ATE lastabhängig 8/3 4x
1.9 TDI	81	08/97→01/06					
2.0	85	04/99→05/07					
RS 1.8 T	132	05/01→01/06					
1.9 TDI	74	10/05→12/10		→ 06/10; Scheibenbremse	03.6583-0179.3	320228	ATE lastabhängig 8/3 4x
1.9 TDI	96	09/02→09/04		01/03→; Scheibenbremse	03.6583-0179.3	320228	ATE lastabhängig 8/3 4x
SKODA - OCTAVIA I Combi (1U5) 07/98→12/10							
 Bremskraftverstärker							
1.4 16V	55	08/00→12/10		05/01→06/10; +PR 1AC,1AH,1AJ,1AT; für Linkslenker	03.7863-3502.4	300128	ATE Ø 10" pneumatisch
1.6	75	09/00→12/10					
1.9 TDI	74	08/00→12/10					
1.6	55	07/98→09/04		→ 07/00; für Linkslenker; + ESP	03.7863-0402.4	300124	ATE Ø 10" pneumatisch
1.6	74	07/98→12/07		05/01→; +PR 1AC,1AH,1AJ,1AT; für Linkslenker	03.7863-3502.4	300128	ATE Ø 10" pneumatisch
1.9 SDI	50	07/98→12/03					
1.9 TDI	66	07/98→03/10					
1.9 TDI	81	07/98→01/06					
1.9 TDI 4x4	66	11/99→02/06					
2.0	85	04/99→05/07					
1.8 20V	92	07/98→07/00		für Linkslenker; + ESP	03.7863-0402.4	300124	ATE Ø 10" pneumatisch
1.8 T	110	07/98→12/10		→ 07/00; für Linkslenker; + ESP	03.7863-0402.4	300124	ATE Ø 10" pneumatisch
2.0 4x4	88	01/00→12/10		05/01→06/10; +PR 1AC,1AH,1AJ,1AT; für Linkslenker	03.7863-3502.4	300128	ATE Ø 10" pneumatisch
1.8 T 4x4	110	05/01→05/06		+PR 1AC,1AH,1AJ,1AT; für Linkslenker	03.7863-3502.4	300128	ATE Ø 10" pneumatisch
RS 1.8 T	132	08/02→01/06					
1.9 TDI	96	09/02→09/04		01/03→; +PR 1AC,1AH,1AJ,1AT; für Linkslenker	03.7863-3502.4	300128	ATE Ø 10" pneumatisch
1.9 TDI 4x4	74	09/00→01/06		05/01→; +PR 1AC,1AH,1AJ,1AT; für Linkslenker	03.7863-3502.4	300128	ATE Ø 10" pneumatisch
2.0 4x4	85	08/00→09/04					
 Hauptbremszylinder							
1.4 16V	55	08/00→12/10		→ 06/10; für Linkslenker; +PR 1AT	03.2123-2715.3	010802	ATE Ø 23,81
1.6	75	09/00→12/10		→ 06/10; für Rechtslenker; +PR 1AT	03.2123-2774.3	010803	ATE Ø 23,81
1.9 TDI	74	08/00→12/10		→ 06/10; für Linkslenker; +PR 1AC,1AH,1AJ	03.2123-2973.3	010951	ATE Ø 23,81
				→ 06/10; für Linkslenker; +PR 1AM	24.2123-1709.3	010503	Ø 23,81
				→ 07/00; für Linkslenker; + ESP	03.2123-2024.3	010597	ATE Ø 23,81
1.6	74	07/98→12/07		→ 07/00; für Rechtslenker; + ESP	03.2123-2064.3	010598	ATE Ø 23,81
1.9 SDI	50	07/98→12/03		08/00→; für Linkslenker; +PR 1AT	03.2123-2715.3	010802	ATE Ø 23,81
1.9 TDI	66	07/98→03/10					
↓							













	kw			 	! #		
SKODA - OCTAVIA I Combi (1U5) 07/98→12/10							
 Hauptbremszylinder							
1.9 TDI	81	07/98→01/06		08/00→; für Rechtslenker; +PR 1AT		03.2123-2774.3 010803	ATE Ø 23,81
1.9 TDI 4x4	66	11/99→02/06		08/00→; für Linkslenker;		03.2123-2973.3 010951	ATE Ø 23,81
2.0	85	04/99→05/07		+PR 1AC,1AH,1AJ			
				08/00→; für Linkslenker; +PR 1AM		24.2123-1709.3 010503	Ø 23,81
				→ 07/00; für Linkslenker; - ESP		24.2123-1709.3 010503	Ø 23,81
1.8 20V	92	07/98→07/00		für Linkslenker; + ESP		03.2123-2024.3 010597	ATE Ø 23,81
				für Rechtslenker; + ESP		03.2123-2064.3 010598	ATE Ø 23,81
				für Linkslenker; - ESP		24.2123-1709.3 010503	Ø 23,81
1.8 T	110	07/98→12/10		→ 07/00; für Linkslenker; + ESP		03.2123-2024.3 010597	ATE Ø 23,81
2.0 4x4	88	01/00→12/10		→ 07/00; für Rechtslenker; + ESP		03.2123-2064.3 010598	ATE Ø 23,81
				08/00→ 06/10; für Linkslenker; +PR 1AT		03.2123-2715.3 010802	ATE Ø 23,81
				08/00→ 06/10; für Rechtslenker; +PR 1AT		03.2123-2774.3 010803	ATE Ø 23,81
				08/00→ 06/10; für Linkslenker; +PR 1AC,1AH,1AJ		03.2123-2973.3 010951	ATE Ø 23,81
				→ 07/00; für Linkslenker; - ESP		24.2123-1709.3 010503	Ø 23,81
				08/00→ 06/10; für Linkslenker; +PR 1AM		24.2123-1709.3 010503	Ø 23,81
1.8 T 4x4	110	05/01→05/06		für Linkslenker; +PR 1AT		03.2123-2715.3 010802	ATE Ø 23,81
1.9 TDI 4x4	74	09/00→01/06		für Rechtslenker; +PR 1AT		03.2123-2774.3 010803	ATE Ø 23,81
RS 1.8 T	132	08/02→01/06		für Linkslenker; +PR 1AC,1AH,1AJ		03.2123-2973.3 010951	ATE Ø 23,81
				für Linkslenker; +PR 1AM		24.2123-1709.3 010503	Ø 23,81
1.9 TDI	96	09/02→09/04		01/03→; für Linkslenker; +PR 1AT		03.2123-2715.3 010802	ATE Ø 23,81
				01/03→; für Rechtslenker; +PR 1AT		03.2123-2774.3 010803	ATE Ø 23,81
				01/03→; für Linkslenker; +PR 1AC,1AH,1AJ		03.2123-2973.3 010951	ATE Ø 23,81
				01/03→; für Linkslenker; +PR 1AM		24.2123-1709.3 010503	Ø 23,81
2.0 4x4	85	08/00→09/04		05/01→; für Linkslenker; +PR 1AT		03.2123-2715.3 010802	ATE Ø 23,81
				05/01→; für Rechtslenker; +PR 1AT		03.2123-2774.3 010803	ATE Ø 23,81
				05/01→; für Linkslenker; +PR 1AC,1AH,1AJ		03.2123-2973.3 010951	ATE Ø 23,81
				05/01→; für Linkslenker; +PR 1AM		24.2123-1709.3 010503	Ø 23,81
 Bremskraftregler							
1.4 16V	55	08/00→12/10		→ 06/10; Scheibenbremse		03.6583-0179.3 320228	ATE lastabhängig 8/3 4x
1.6	75	09/00→12/10		→ 06/10; Trommelbremse		03.6584-0107.3 320110	ATE lastabhängig 8/4 4x
1.6	55	07/98→09/04		Scheibenbremse		03.6583-0179.3 320228	ATE lastabhängig 8/3 4x
1.6	74	07/98→12/07		Trommelbremse		03.6584-0107.3 320110	ATE lastabhängig 8/4 4x
1.9 SDI	50	07/98→12/03					
1.9 TDI	66	07/98→03/10					
1.8 20V	92	07/98→07/00		Scheibenbremse		03.6583-0179.3 320228	ATE lastabhängig 8/3 4x
1.8 T 4x4	110	05/01→05/06					
1.9 TDI	81	07/98→01/06					
1.9 TDI 4x4	66	11/99→02/06					
1.9 TDI 4x4	74	09/00→01/06					
2.0	85	04/99→05/07					
RS 1.8 T	132	08/02→01/06					
1.8 T	110	07/98→12/10		→ 06/10; Scheibenbremse		03.6583-0179.3 320228	ATE lastabhängig 8/3 4x
1.9 TDI	74	08/00→12/10					
2.0 4x4	88	01/00→12/10					
1.9 TDI	96	09/02→09/04		01/03→; Scheibenbremse		03.6583-0179.3 320228	ATE lastabhängig 8/3 4x
2.0 4x4	85	08/00→09/04		05/01→; Scheibenbremse		03.6583-0179.3 320228	ATE lastabhängig 8/3 4x
SKODA - OCTAVIA II (1Z3) 02/04→06/13							
 Bremskraftverstärker							
1.2 TSI	77	02/10→06/13		→ 01/13; für Linkslenker; +PR 1AC,1AT		03.7863-3232.4 300307	ATE Ø 10" pneumatisch
1.4	59	06/04→04/13		→ 01/13; für Linkslenker; +PR 1AS		03.7863-9602.4 300206	ATE Ø 10" pneumatisch
1.4 TSI	90	11/08→06/13					
1.6	75	06/04→06/13					
1.6 TDI	77	06/09→04/13					
1.8 TSI	112	03/09→06/13					
1.8 TSI	118	06/07→04/13					
2.0 RS	147	10/05→02/13					
2.0 TDI	81	03/10→06/13					
2.0 TDI RS	125	04/06→02/13					
1.4	55	05/04→05/06		06/04→; für Linkslenker; +PR 1AC,1AT		03.7863-3232.4 300307	ATE Ø 10" pneumatisch
1.6 FSI	85	02/04→10/08		06/04→; für Linkslenker; +PR 1AS		03.7863-9602.4 300206	ATE Ø 10" pneumatisch
2.0 TDI	100	02/04→05/10					
1.6 LPG	75	08/09→11/12		09/09→; für Linkslenker; +PR 1AC,1AT		03.7863-3232.4 300307	ATE Ø 10" pneumatisch
				09/09→; für Linkslenker; +PR 1AS		03.7863-9602.4 300206	ATE Ø 10" pneumatisch
↓							













	kw			 	! #		
SKODA - OCTAVIA II (1Z3) 02/04→06/13							
 Bremskraftverstärker							
1.6 MultiFuel	75	01/08→06/13		09/09→ 01/13; für Linkslenker; +PR 1AC,1AT		03.7863-3232.4 300307	ATE Ø 10" pneumatisch
				09/09→ 01/13; für Linkslenker; +PR 1AS		03.7863-9602.4 300206	ATE Ø 10" pneumatisch
1.9 TDI	77	06/04→12/10		für Linkslenker; +PR 1AC,1AT		03.7863-3232.4 300307	ATE Ø 10" pneumatisch
2.0 FSI	110	11/04→10/08					
2.0 TDI	103	11/05→05/10		für Linkslenker; +PR 1AS		03.7863-9602.4 300206	ATE Ø 10" pneumatisch
2.0 TDI 16V	103	02/04→04/13		06/04→ 01/13; für Linkslenker; +PR 1AC,1AT		03.7863-3232.4 300307	ATE Ø 10" pneumatisch
				06/04→ 01/13; für Linkslenker; +PR 1AS		03.7863-9602.4 300206	ATE Ø 10" pneumatisch
 Hauptbremszylinder							
1.2 TSI	77	02/10→06/13		→ 01/13; für Linkslenker		03.2122-2129.3 010799	ATE Ø 22,2
1.4	59	06/04→04/13					
1.4 TSI	90	11/08→06/13					
1.6	75	06/04→06/13					
1.6 TDI	77	06/09→04/13					
1.8 TSI	112	03/09→06/13					
1.8 TSI	118	06/07→04/13					
2.0 RS	147	10/05→02/13					
2.0 TDI	81	03/10→06/13					
2.0 TDI RS	125	04/06→02/13					
1.4	55	05/04→05/06		06/04→; für Linkslenker		03.2122-2129.3 010799	ATE Ø 22,2
1.6 FSI	85	02/04→10/08					
2.0 TDI	100	02/04→05/10					
1.6 LPG	75	08/09→11/12		09/09→; für Linkslenker		03.2122-2129.3 010799	ATE Ø 22,2
1.6 MultiFuel	75	01/08→06/13		09/09→ 01/13; für Linkslenker		03.2122-2129.3 010799	ATE Ø 22,2
1.9 TDI	77	06/04→12/10		für Linkslenker		03.2122-2129.3 010799	ATE Ø 22,2
2.0 FSI	110	11/04→10/08					
2.0 TDI	103	11/05→05/10					
2.0 TDI 16V	103	02/04→04/13		06/04→ 01/13; für Linkslenker		03.2122-2129.3 010799	ATE Ø 22,2
Hydraulikaggregat, Bremsanlage							
1.4	55	05/04→05/06		06/04→; +PR 1AT		24.9145-0001.2 399005	
1.6 FSI	85	02/04→10/08					
1.4	59	06/04→04/13		→ 12/08; +PR 1AT		24.9145-0001.2 399005	
1.4 TSI	90	11/08→06/13					
1.6	75	06/04→06/13					
1.8 TSI	118	06/07→04/13					
1.9 TDI	77	06/04→12/10					
2.0 RS	147	10/05→02/13					
2.0 TDI	103	11/05→05/10					
2.0 TDI RS	125	04/06→02/13					
2.0 FSI	110	11/04→10/08		+PR 1AT		24.9145-0001.2 399005	
2.0 TDI	100	02/04→05/10		06/04→ 12/08; +PR 1AT		24.9145-0001.2 399005	
2.0 TDI 16V	103	02/04→04/13					
Drucksensor, Bremskraftverstärker							
1.2 TSI	77	02/10→06/13		→ 01/13; für Linkslenker; +PR 1AS		03.0655-0101.2 370008	ATE
1.4	59	06/04→04/13					
1.4 TSI	90	11/08→06/13					
1.6	75	06/04→06/13					
1.6 TDI	77	06/09→04/13					
1.8 TSI	112	03/09→06/13					
1.8 TSI	118	06/07→04/13					
2.0 RS	147	10/05→02/13					
2.0 TDI	81	03/10→06/13					
2.0 TDI RS	125	04/06→02/13					
1.4	55	05/04→05/06		06/04→; für Linkslenker; +PR 1AS		03.0655-0101.2 370008	ATE
1.6 FSI	85	02/04→10/08					
2.0 TDI	100	02/04→05/10					
1.6 LPG	75	08/09→11/12		09/09→; für Linkslenker; +PR 1AS		03.0655-0101.2 370008	ATE
1.6 MultiFuel	75	01/08→06/13		09/09→ 01/13; für Linkslenker; +PR 1AS		03.0655-0101.2 370008	ATE
1.9 TDI	77	06/04→12/10		für Linkslenker; +PR 1AS		03.0655-0101.2 370008	ATE
2.0 FSI	110	11/04→10/08					
2.0 TDI	103	11/05→05/10					
2.0 TDI 16V	103	02/04→04/13		06/04→ 01/13; für Linkslenker; +PR 1AS		03.0655-0101.2 370008	ATE
SKODA - OCTAVIA II Combi (1Z5) 02/04→06/13							
 Bremskraftverstärker							
1.2 TSI	77	02/10→04/13		→ 01/13; für Linkslenker; +PR 1AC,1AT		03.7863-3232.4 300307	ATE Ø 10" pneumatisch
1.4	59	05/06→06/13					
1.4 TSI	90	11/08→06/13		→ 01/13; für Linkslenker; +PR 1AS		03.7863-9602.4 300206	ATE Ø 10" pneumatisch
1.6	75	09/04→06/13					
1.6 TDI	77	06/09→04/13					
1.6 TDI 4x4	77	06/09→02/13					
1.8 TSI	112	03/09→06/13					
↓							















	kw			 	! #		
SKODA - OCTAVIA II Combi (1Z5) 02/04→06/13							
Bremskraftverstärker							
1.8 TSI	118	06/07→04/13		→ 01/13; für Linkslenker; +PR 1AC,1AT	03.7863-3232.4	300307	ATE Ø 10" pneumatisch
1.8 TSI 4x4	112	03/09→02/13		→ 01/13; für Linkslenker; +PR 1AS	03.7863-9602.4	300206	ATE Ø 10" pneumatisch
1.8 TSI 4x4	118	11/08→02/13					
2.0 RS	147	10/05→02/13					
2.0 TDI	81	03/10→06/13					
2.0 TDI 16V 4x4	103	05/10→02/13					
2.0 TDI 4x4	81	05/11→02/13					
2.0 TDI RS	125	04/06→02/13					
1.4	55	05/04→05/06		06/04→; für Linkslenker; +PR 1AC,1AT	03.7863-3232.4	300307	ATE Ø 10" pneumatisch
1.6 FSI	85	02/04→10/08		06/04→; für Linkslenker; +PR 1AS	03.7863-9602.4	300206	ATE Ø 10" pneumatisch
2.0 TDI 16V	100	02/04→05/10					
1.6 LPG	75	08/09→11/12		09/09→; für Linkslenker; +PR 1AC,1AT	03.7863-3232.4	300307	ATE Ø 10" pneumatisch
				09/09→; für Linkslenker; +PR 1AS	03.7863-9602.4	300206	ATE Ø 10" pneumatisch
1.6 MultiFuel	75	01/08→06/13		09/09→ 01/13; für Linkslenker; +PR 1AC,1AT	03.7863-3232.4	300307	ATE Ø 10" pneumatisch
				09/09→ 01/13; für Linkslenker; +PR 1AS	03.7863-9602.4	300206	ATE Ø 10" pneumatisch
1.9 TDI	77	09/04→12/10		für Linkslenker; +PR 1AC,1AT	03.7863-3232.4	300307	ATE Ø 10" pneumatisch
1.9 TDI 4x4	77	11/04→12/10		für Linkslenker; +PR 1AS	03.7863-9602.4	300206	ATE Ø 10" pneumatisch
2.0 FSI	110	11/04→10/08					
2.0 FSI 4x4	110	11/04→10/08					
2.0 TDI	103	11/05→05/10					
2.0 TDI 4x4	103	07/06→05/10					
2.0 TDI 16V	103	02/04→05/13		06/04→ 01/13; für Linkslenker; +PR 1AC,1AT	03.7863-3232.4	300307	ATE Ø 10" pneumatisch
				06/04→ 01/13; für Linkslenker; +PR 1AS	03.7863-9602.4	300206	ATE Ø 10" pneumatisch
Hauptbremszylinder							
1.2 TSI	77	02/10→04/13		→ 01/13; für Linkslenker	03.2122-2129.3	010799	ATE Ø 22,2
1.4	59	05/06→06/13			03.2122-2129.3	010799	ATE Ø 22,2
1.4 TSI	90	11/08→06/13					
1.6	75	09/04→06/13					
1.6 TDI	77	06/09→04/13					
1.6 TDI 4x4	77	06/09→02/13					
1.8 TSI	112	03/09→06/13					
1.8 TSI	118	06/07→04/13					
1.8 TSI 4x4	112	03/09→02/13					
1.8 TSI 4x4	118	11/08→02/13					
2.0 RS	147	10/05→02/13					
2.0 TDI	81	03/10→06/13					
2.0 TDI 16V 4x4	103	05/10→02/13					
2.0 TDI 4x4	81	05/11→02/13					
2.0 TDI RS	125	04/06→02/13					
1.4	55	05/04→05/06					
1.6 FSI	85	02/04→10/08					
2.0 TDI 16V	100	02/04→05/10					
1.6 LPG	75	08/09→11/12		09/09→; für Linkslenker	03.2122-2129.3	010799	ATE Ø 22,2
1.6 MultiFuel	75	01/08→06/13		09/09→ 01/13; für Linkslenker	03.2122-2129.3	010799	ATE Ø 22,2
1.9 TDI	77	09/04→12/10		für Linkslenker	03.2122-2129.3	010799	ATE Ø 22,2
1.9 TDI 4x4	77	11/04→12/10					
2.0 FSI	110	11/04→10/08					
2.0 FSI 4x4	110	11/04→10/08					
2.0 TDI	103	11/05→05/10					
2.0 TDI 4x4	103	07/06→05/10					
2.0 TDI 16V	103	02/04→05/13		06/04→ 01/13; für Linkslenker	03.2122-2129.3	010799	ATE Ø 22,2
Hydraulikaggregat, Bremsanlage							
1.4	55	05/04→05/06		06/04→; +PR 1AT	24.9145-0001.2	399005	
1.6 FSI	85	02/04→10/08					
1.4	59	05/06→06/13		→ 12/08; +PR 1AT	24.9145-0001.2	399005	
1.4 TSI	90	11/08→06/13					
1.6	75	09/04→06/13					
1.8 TSI	118	06/07→04/13					
1.8 TSI 4x4	118	11/08→02/13					
1.9 TDI	77	09/04→12/10					
1.9 TDI 4x4	77	11/04→12/10					
2.0 RS	147	10/05→02/13					
2.0 TDI	103	11/05→05/10					
2.0 TDI 4x4	103	07/06→05/10					
2.0 TDI RS	125	04/06→02/13					
2.0 FSI	110	11/04→10/08		+PR 1AT	24.9145-0001.2	399005	
2.0 FSI 4x4	110	11/04→10/08					
2.0 TDI 16V	100	02/04→05/10		06/04→ 12/08; +PR 1AT	24.9145-0001.2	399005	
2.0 TDI 16V	103	02/04→05/13					
Drucksensor, Bremskraftverstärker							
1.2 TSI	77	02/10→04/13		→ 01/13; für Linkslenker; +PR 1AS	03.0655-0101.2	370008	ATE
1.4	59	05/06→06/13					
1.4 TSI	90	11/08→06/13					
↓							















	kw			 	! #		
SKODA - OCTAVIA II Combi (1Z5) 02/04→06/13							
Drucksensor, Bremskraftverstärker							
1.6	75	09/04→06/13		→ 01/13; für Linkslenker; +PR 1AS		03.0655-0101.2 370008	ATE
1.6 TDI	77	06/09→04/13					
1.6 TDI 4x4	77	06/09→02/13					
1.8 TSI	112	03/09→06/13					
1.8 TSI	118	06/07→04/13					
1.8 TSI 4x4	112	03/09→02/13					
1.8 TSI 4x4	118	11/08→02/13					
2.0 RS	147	10/05→02/13					
2.0 TDI	81	03/10→06/13					
2.0 TDI 16V 4x4	103	05/10→02/13					
2.0 TDI 4x4	81	05/11→02/13					
2.0 TDI RS	125	04/06→02/13					
1.4	55	05/04→05/06		06/04→; für Linkslenker; +PR 1AS		03.0655-0101.2 370008	ATE
1.6 FSI	85	02/04→10/08					
2.0 TDI 16V	100	02/04→05/10					
1.6 LPG	75	08/09→11/12		09/09→; für Linkslenker; +PR 1AS		03.0655-0101.2 370008	ATE
1.6 MultiFuel	75	01/08→06/13		09/09→ 01/13; für Linkslenker; +PR 1AS		03.0655-0101.2 370008	ATE
1.9 TDI	77	09/04→12/10		für Linkslenker; +PR 1AS		03.0655-0101.2 370008	ATE
1.9 TDI 4x4	77	11/04→12/10					
2.0 FSI	110	11/04→10/08					
2.0 FSI 4x4	110	11/04→10/08					
2.0 TDI	103	11/05→05/10					
2.0 TDI 4x4	103	07/06→05/10					
2.0 TDI 16V	103	02/04→05/13		06/04→ 01/13; für Linkslenker; +PR 1AS		03.0655-0101.2 370008	ATE
SKODA - OCTAVIA III (5E3, NL3, NR3) 11/12→							
 Hauptbremszylinder							
1.0 TSI	85	05/16→		für Linkslenker; +PR 1ZA,1ZB,1ZE,1ZF		03.4153-5403.3 010994	ATE Ø 23,81
1.2 TSI	81	05/15→				24.4123-1719.3 011017	TRW Ø 23,81 ohne Bremsflüssigkeitsbehälter
1.4 TSI	103	11/12→					
1.4 TSI G-TEC	81	11/13→					
1.5 TSI	110	02/17→					
1.6	81	01/14→					
1.6 TDI	81	05/13→					
1.6 TDI	85	02/17→					
1.6 TDI 4x4	77	09/14→					
1.6 TDI 4x4	81	05/15→					
1.8 TSI	132	11/12→					
1.8 TSI 4x4	132	09/14→					
2.0 TDI	105	11/12→					
2.0 TDI / TDI RS 4x4	135	09/14→					
2.0 TDI 4x4	110	09/14→					
2.0 TDI RS	135	05/13→					
2.0 TSI RS	162	05/13→					
2.0 TSI RS	169	05/15→					
2.0 TSI RS	180	02/17→					
1.2 TSI	63	11/12→		02/13→; für Linkslenker; +PR 1ZA,1ZB,1ZE,1ZF		03.4153-5403.3 010994	ATE Ø 23,81
1.2 TSI	77	11/12→				24.4123-1719.3 011017	TRW Ø 23,81 ohne Bremsflüssigkeitsbehälter
1.6 TDI	66	11/12→					
1.6 TDI	77	11/12→					
2.0 TDI	110	11/12→					
1.4 TSI	110	08/14→		05/15→; für Linkslenker; +PR 1ZA,1ZB,1ZE,1ZF		03.4153-5403.3 010994	ATE Ø 23,81
						24.4123-1719.3 011017	TRW Ø 23,81 ohne Bremsflüssigkeitsbehälter
SKODA - OCTAVIA III Combi (5E5) 11/12→							
 Hauptbremszylinder							
1.0 TSI	85	05/16→		für Linkslenker; +PR 1ZA,1ZB,1ZE,1ZF		03.4153-5403.3 010994	ATE Ø 23,81
1.2 TSI	81	05/15→				24.4123-1719.3 011017	TRW Ø 23,81 ohne Bremsflüssigkeitsbehälter
1.4 TSI	103	11/12→					
1.4 TSI G-TEC	81	11/13→					
1.5 TSI	110	02/17→					
1.6	81	01/14→					
1.6 TDI	81	05/13→					
1.6 TDI	85	02/17→					
1.6 TDI 4x4	77	11/12→					
1.6 TDI 4x4	81	05/15→					
1.8 TSI	132	11/12→					
1.8 TSI 4x4	132	11/12→					
2.0 TDI	105	11/12→					
2.0 TDI / TDI RS 4x4	135	09/14→					
2.0 TDI 4x4	110	11/12→					
2.0 TDI RS	135	05/13→					
2.0 TSI RS	169	05/15→					
2.0 TSI RS	180	02/17→					
1.2 TSI	63	11/12→		02/13→; für Linkslenker; +PR 1ZA,1ZB,1ZE,1ZF		03.4153-5403.3 010994	ATE Ø 23,81
1.2 TSI	77	11/12→				24.4123-1719.3 011017	TRW Ø 23,81 ohne Bremsflüssigkeitsbehälter
1.6 TDI	66	11/12→					
1.6 TDI	77	11/12→					
↓							















	kw					! #		
SKODA - OCTAVIA III Combi (5E5) 11/12→								
 Hauptbremszylinder								
2.0 TDI	110	11/12→		02/13→; für Linkslenker; +PR 1ZA,1ZB,1ZE,1ZF			03.4153-5403.3 010994 24.4123-1719.3 011017	ATE Ø 23,81 TRW Ø 23,81 ohne Bremsflüssigkeitsbehälter
1.4 TSI	110	08/14→		05/15→; für Linkslenker; +PR 1ZA,1ZB,1ZE,1ZF			03.4153-5403.3 010994 24.4123-1719.3 011017	ATE Ø 23,81 TRW Ø 23,81 ohne Bremsflüssigkeitsbehälter
2.0 TSI RS	162	11/12→		05/13→; +PR 1ZA,1ZB,1ZE,1ZF; für Linkslenker			03.4153-5403.3 010994 24.4123-1719.3 011017	ATE Ø 23,81 TRW Ø 23,81 ohne Bremsflüssigkeitsbehälter
SKODA - ROOMSTER (5J) 03/06→05/15								
 Hauptbremszylinder								
1.2	47	05/06→01/07		07/06→; für Linkslenker; + ABS			24.2120-1734.3 010702	Ø 20,64
				07/06→; für Linkslenker; - ABS			24.2120-1736.3 010732	Ø 20,64
				07/06→; für Rechtslenker			24.2120-1768.3 011041	Ø 20,64 ohne Bremsflüssigkeitsbehälter
1.2	51	01/07→05/15		→ 12/10; für Linkslenker; + ABS			24.2120-1734.3 010702	Ø 20,64
1.2 TDI	55	03/10→05/15		→ 12/10; für Linkslenker; - ABS			24.2120-1736.3 010732	Ø 20,64
1.2 TSI	63	03/10→05/15						
1.2 TSI	77	03/10→05/15		→ 12/10; für Rechtslenker			24.2120-1768.3 011041	Ø 20,64 ohne Bremsflüssigkeitsbehälter
1.4	63	09/06→05/15						
1.6	77	09/06→05/15						
1.6 TDI	66	03/10→05/15						
1.6 TDI	77	03/10→05/15						
1.4 TDI	51	07/06→03/10		für Linkslenker; + ABS			24.2120-1734.3 010702	Ø 20,64
1.4 TDI	59	09/06→03/10		für Linkslenker; - ABS			24.2120-1736.3 010732	Ø 20,64
1.9 TDI	77	09/06→03/10		für Rechtslenker			24.2120-1768.3 011041	Ø 20,64 ohne Bremsflüssigkeitsbehälter
 Bremskraftregler								
1.2	47	05/06→01/07		07/06→; - ABS			03.6584-0107.3 320110	ATE lastabhängig 8/4 4x
1.2	51	01/07→05/15		→ 04/15; - ABS			03.6584-0107.3 320110	ATE lastabhängig 8/4 4x
1.2 TDI	55	03/10→05/15						
1.2 TSI	63	03/10→05/15						
1.2 TSI	77	03/10→05/15						
1.4	63	09/06→05/15						
1.6	77	09/06→05/15						
1.6 TDI	66	03/10→05/15						
1.6 TDI	77	03/10→05/15						
1.4 TDI	51	07/06→03/10		- ABS			03.6584-0107.3 320110	ATE lastabhängig 8/4 4x
1.4 TDI	59	09/06→03/10						
1.9 TDI	77	09/06→03/10						
SKODA - ROOMSTER Praktik (5J) 03/07→05/15								
 Hauptbremszylinder								
1.2	51	03/07→05/15		für Linkslenker; → 12/10; + ABS			24.2120-1734.3 010702	Ø 20,64
1.2 TDI	55	03/10→05/15		für Linkslenker; → 12/10; - ABS			24.2120-1736.3 010732	Ø 20,64
1.2 TSI	63	03/10→05/15						
1.4	63	03/07→05/15		für Rechtslenker; → 12/10			24.2120-1768.3 011041	Ø 20,64 ohne Bremsflüssigkeitsbehälter
1.6 TDI	66	03/10→05/15						
1.4 TDI	51	03/07→03/10		für Linkslenker; + ABS			24.2120-1734.3 010702	Ø 20,64
1.4 TDI	59	03/07→03/10		für Linkslenker; - ABS			24.2120-1736.3 010732	Ø 20,64
				für Rechtslenker			24.2120-1768.3 011041	Ø 20,64 ohne Bremsflüssigkeitsbehälter
 Bremskraftregler								
1.2	51	03/07→05/15		→ 04/15; - ABS			03.6584-0107.3 320110	ATE lastabhängig 8/4 4x
1.2 TDI	55	03/10→05/15						
1.2 TSI	63	03/10→05/15						
1.4	63	03/07→05/15						
1.6 TDI	66	03/10→05/15						
1.4 TDI	51	03/07→03/10		- ABS			03.6584-0107.3 320110	ATE lastabhängig 8/4 4x
1.4 TDI	59	03/07→03/10						
SKODA - SUPERB I (3U4) 12/01→03/08								
 Hauptbremszylinder								
1.8 T	110	12/01→03/08		→ 02/08			03.2125-0373.3 010810	ATE Ø 25,4
2.0	85	12/01→03/08					24.2125-1720.3 010688	TRW Ø 25,4
1.9 TDI	74	08/02→10/05					03.2125-0373.3 010810	ATE Ø 25,4
1.9 TDI	77	10/05→05/07					24.2125-1720.3 010688	TRW Ø 25,4
2.5 TDI	114	12/01→08/03						
↓								













	kw			 	! #		
SKODA - SUPERB I (3U4) 12/01→03/08							
 Hauptbremszylinder							
1.9 TDI	85	01/07→03/08		→ 12/07		03.2125-0373.3 010810	ATE Ø 25,4
1.9 TDI	96	12/01→03/08				24.2125-1720.3 010688	TRW Ø 25,4
2.0 TDI	103	10/05→03/08					
2.5 TDI	120	06/03→03/08					
2.8 V6	142	12/01→03/08					
SKODA - SUPERB II (3T4) 03/08→05/15							
 Bremskraftverstärker							
1.4 TSI	92	07/08→05/15		08/08→ 02/15; für Linkslenker		03.7863-3332.4 300308	ATE Ø 10" pneumatisch
1.8 TSI	118	03/08→05/15					
2.0 TDI	125	07/08→05/15					
1.6 TDI	77	09/10→05/15		→ 02/15; für Linkslenker		03.7863-3332.4 300308	ATE Ø 10" pneumatisch
1.8 TSI	112	03/09→05/15					
1.8 TSI 4x4	112	03/09→05/15					
1.8 TSI 4x4	118	11/08→05/15					
2.0 TDI 16V	103	01/09→05/15					
2.0 TDI 16V 4x4	103	11/10→05/15					
2.0 TSI	147	05/10→05/15					
3.6 FSI 4x4	191	11/08→05/15					
1.9 TDI	77	03/08→11/10		08/08→; für Linkslenker		03.7863-3332.4 300308	ATE Ø 10" pneumatisch
2.0 TDI	103	03/08→05/10					
2.0 TDI 4x4	125	09/08→05/15		10/08→ 02/15; für Linkslenker		03.7863-3332.4 300308	ATE Ø 10" pneumatisch
 Hauptbremszylinder							
1.4 TSI	92	07/08→05/15		08/08→ 02/15; für Linkslenker		03.2123-3449.3 010808	ATE Ø 23,81
1.8 TSI	118	03/08→05/15					
2.0 TDI	125	07/08→05/15		08/08→ 02/15; für Rechtslenker		24.4153-0202.3 011027	ATE Ø 23,81 ohne Bremsflüssigkeitsbehälter
1.6 TDI	77	09/10→05/15		→ 02/15; für Linkslenker		03.2123-3449.3 010808	ATE Ø 23,81
1.8 TSI	112	03/09→05/15					
1.8 TSI 4x4	112	03/09→05/15		→ 02/15; für Rechtslenker		24.4153-0202.3 011027	ATE Ø 23,81 ohne Bremsflüssigkeitsbehälter
1.8 TSI 4x4	118	11/08→05/15					
2.0 TDI 16V	103	01/09→05/15					
2.0 TDI 16V 4x4	103	11/10→05/15					
2.0 TSI	147	05/10→05/15					
3.6 FSI 4x4	191	11/08→05/15					
1.9 TDI	77	03/08→11/10		08/08→; für Linkslenker		03.2123-3449.3 010808	ATE Ø 23,81
2.0 TDI	103	03/08→05/10		08/08→; für Rechtslenker		24.4153-0202.3 011027	ATE Ø 23,81 ohne Bremsflüssigkeitsbehälter
2.0 TDI 4x4	125	09/08→05/15		10/08→ 02/15; für Linkslenker		03.2123-3449.3 010808	ATE Ø 23,81
				10/08→ 02/15; für Rechtslenker		24.4153-0202.3 011027	ATE Ø 23,81 ohne Bremsflüssigkeitsbehälter
SKODA - SUPERB II Kombi (3T5) 10/09→05/15							
 Bremskraftverstärker							
1.4 TSI	92	10/09→05/15		11/09→ 02/15; für Linkslenker		03.7863-3332.4 300308	ATE Ø 10" pneumatisch
1.8 TSI	112	10/09→05/15					
1.8 TSI	118	10/09→05/15					
1.8 TSI 4x4	112	10/09→05/15					
1.8 TSI 4x4	118	10/09→05/15					
2.0 TDI	125	10/09→05/15					
2.0 TDI 16V	103	10/09→05/15					
2.0 TDI 4x4	125	10/09→05/15					
3.6 V6 4x4	191	10/09→05/15					
1.6 TDI	77	09/10→05/15		→ 02/15; für Linkslenker		03.7863-3332.4 300308	ATE Ø 10" pneumatisch
2.0 TDI 16V 4x4	103	11/10→05/15					
2.0 TSI	147	05/10→05/15					
1.9 TDI	77	10/09→11/10		für Linkslenker		03.7863-3332.4 300308	ATE Ø 10" pneumatisch
2.0 TDI	103	10/09→03/10		11/09→; für Linkslenker		03.7863-3332.4 300308	ATE Ø 10" pneumatisch
 Hauptbremszylinder							
1.4 TSI	92	10/09→05/15		11/09→ 02/15; für Linkslenker		03.2123-3449.3 010808	ATE Ø 23,81
1.8 TSI	112	10/09→05/15					
1.8 TSI	118	10/09→05/15		11/09→ 02/15; für Rechtslenker		24.4153-0202.3 011027	ATE Ø 23,81 ohne Bremsflüssigkeitsbehälter
1.8 TSI 4x4	112	10/09→05/15					
1.8 TSI 4x4	118	10/09→05/15					
2.0 TDI	125	10/09→05/15					
2.0 TDI 16V	103	10/09→05/15					
2.0 TDI 4x4	125	10/09→05/15					
3.6 V6 4x4	191	10/09→05/15					
1.6 TDI	77	09/10→05/15		→ 02/15; für Linkslenker		03.2123-3449.3 010808	ATE Ø 23,81
2.0 TDI 16V 4x4	103	11/10→05/15					
2.0 TSI	147	05/10→05/15		→ 02/15; für Rechtslenker		24.4153-0202.3 011027	ATE Ø 23,81 ohne Bremsflüssigkeitsbehälter
1.9 TDI	77	10/09→11/10		für Linkslenker		03.2123-3449.3 010808	ATE Ø 23,81
↓							













	kw					! #		
SKODA - SUPERB II Kombi (3T5) 10/09→05/15								
 Hauptbremszylinder								
1.9 TDI	77	10/09→11/10		für Rechtslenker		24.4153-0202.3	011027	ATE Ø 23,81 ohne Bremsflüssigkeitsbehälter
2.0 TDI	103	10/09→03/10		11/09→; für Linkslenker		03.2123-3449.3	010808	ATE Ø 23,81
				11/09→; für Rechtslenker		24.4153-0202.3	011027	ATE Ø 23,81 ohne Bremsflüssigkeitsbehälter
SKODA - SUPERB III (3V3) 03/15→								
 Hauptbremszylinder								
1.4 TSI	92	03/15→		für Linkslenker		24.4123-1719.3	011017	TRW Ø 23,81 ohne Bremsflüssigkeitsbehälter
1.4 TSI	110	03/15→						
1.4 TSI 4x4	110	03/15→						
1.6 TDI	88	03/15→						
1.8 TSI	132	03/15→						
2.0 TDI	110	03/15→						
2.0 TDI	140	03/15→						
2.0 TDI 4x4	110	03/15→						
2.0 TDI 4x4	140	03/15→						
2.0 TSI	162	03/15→						
2.0 TSI 4x4	206	03/15→						
SKODA - SUPERB III Kombi (3V5) 03/15→								
 Hauptbremszylinder								
1.4 TSI	92	03/15→		für Linkslenker		24.4123-1719.3	011017	TRW Ø 23,81 ohne Bremsflüssigkeitsbehälter
1.4 TSI	110	03/15→						
1.4 TSI 4x4	110	03/15→						
1.6 TDI	88	03/15→						
1.8 TSI	132	03/15→						
2.0 TDI	110	03/15→						
2.0 TDI	140	03/15→						
2.0 TDI 4x4	110	03/15→						
2.0 TDI 4x4	140	03/15→						
2.0 TSI	162	03/15→						
2.0 TSI 4x4	206	03/15→						
SKODA - YETI (5L) 05/09→12/17								
 Bremskraftverstärker								
1.2 TSI	77	09/09→05/15		für Linkslenker; +PR 1AC,1AS,1AT,1ZE / 1ZF		03.7863-3232.4	300307	ATE Ø 10" pneumatisch
1.2 TSI	81	05/15→12/17						
1.4 TSI	90	06/10→05/15		+PR 1AT,1ZA,1ZE,1LK; für Linkslenker		03.7863-3332.4	300308	ATE Ø 10" pneumatisch
1.4 TSI	92	05/15→12/17						
1.4 TSI 4x4	110	05/15→12/17						
1.6	81	04/14→12/17						
1.6 TDI	77	11/10→05/15						
1.8 TSI 4x4	112	11/09→12/17						
1.8 TSI 4x4	118	05/09→12/17						
2.0 TDI	81	11/09→12/17						
2.0 TDI	103	11/11→12/17						
2.0 TDI	110	05/15→12/17						
2.0 TDI 4x4	81	11/09→12/17						
2.0 TDI 4x4	103	05/09→12/17						
2.0 TDI 4x4	110	05/15→12/17						
2.0 TDI 4x4	125	11/09→05/15						
 Hauptbremszylinder								
1.2 TSI	77	09/09→05/15		für Linkslenker; +PR 1ZE,1ZF		03.2122-2129.3	010799	ATE Ø 22,2
1.2 TSI	81	05/15→12/17						
1.4 TSI	90	06/10→05/15		für Linkslenker; +PR 1ZA		03.2123-3449.3	010808	ATE Ø 23,81
1.4 TSI	92	05/15→12/17		für Rechtslenker; +PR 1ZE,1ZF		24.4152-0132.3	011025	ATE Ø 22,2 ohne Bremsflüssigkeitsbehälter
1.4 TSI 4x4	110	05/15→12/17						
1.6	81	04/14→12/17		für Rechtslenker; +PR 1ZA		24.4153-0202.3	011027	ATE Ø 23,81 ohne Bremsflüssigkeitsbehälter
1.6 TDI	77	11/10→05/15						
1.8 TSI 4x4	112	11/09→12/17						
1.8 TSI 4x4	118	05/09→12/17						
2.0 TDI	81	11/09→12/17						
2.0 TDI	103	11/11→12/17						
2.0 TDI	110	05/15→12/17						
2.0 TDI 4x4	81	11/09→12/17						
2.0 TDI 4x4	103	05/09→12/17						
2.0 TDI 4x4	110	05/15→12/17						
2.0 TDI 4x4	125	11/09→05/15						
SMART - CABRIO (450) 03/00→01/04								
 Hauptbremszylinder								
0.6 (450.432)	52	06/02→01/04		01/03→; für Linkslenker		24.2119-1711.3	010911	Ø 19,05 ohne Bremsflüssigkeitsbehälter
0.6 (S1OLA1, 450.441, 450.442, 450.443)	40	03/00→01/04						
0.6 (S1OLD2, 450.452)	45	01/01→01/04						
↓								















	kw			 	! #		
SMART - CABRIO (450) 03/00→01/04							
 Hauptbremszylinder							
0.8 CDI (S1OLC1, 450.401, 450.402, 450.403, 450.400)	30	03/01→01/04		→ 12/02; für Linkslenker; zusätzlich benötigter Artikel (Artikel-Nummer): Q0014462V001000000		24.2119-1711.3 010911	Ø 19,05 ohne Bremsflüssigkeitsbehälter
0.7 (450.433)	55	01/03→01/04		für Linkslenker		24.2119-1711.3 010911	Ø 19,05 ohne Bremsflüssigkeitsbehälter
0.7 (450.452, 450.432)	45	01/03→01/04					
SMART - CITY-COUPÉ (450) 07/98→01/04							
 Hauptbremszylinder							
0.6 (450.330, 450.332)	52	06/02→01/04		01/03→; für Linkslenker		24.2119-1711.3 010911	Ø 19,05 ohne Bremsflüssigkeitsbehälter
0.6 (450.352, 450.353)	45	01/01→01/04					
0.6 (S1CLA1, 450.341)	40	07/98→01/04					
0.6 (S1CLB1, 450.331, 450.336)	33	07/98→01/04		→ 12/02; für Linkslenker; zusätzlich benötigter Artikel (Artikel-Nummer): Q0014462V001000000		24.2119-1711.3 010911	Ø 19,05 ohne Bremsflüssigkeitsbehälter
0.8 CDI (S1CLC1, 450.300, 450.301, 450.302, 450.303,...	30	11/99→01/04					
0.7 (450.330)	37	01/03→01/04		für Linkslenker		24.2119-1711.3 010911	Ø 19,05 ohne Bremsflüssigkeitsbehälter
0.7 (450.333)	55	01/03→01/04					
0.7 (450.352, 450.353)	45	01/03→01/04					
SMART - CROSSBLADE (450) 06/02→12/03							
 Hauptbremszylinder							
0.6 (450.418)	52	06/02→12/03		01/03→; für Linkslenker		24.2119-1711.3 010911	Ø 19,05 ohne Bremsflüssigkeitsbehälter
				→ 12/02; für Linkslenker; zusätzlich benötigter Artikel (Artikel-Nummer): Q0014462V001000000		24.2119-1711.3 010911	Ø 19,05 ohne Bremsflüssigkeitsbehälter
SMART - FORFOUR (454) 01/04→06/06							
 Hauptbremszylinder							
1.1 (454.030)	55	01/04→06/06		03/04→; für Linkslenker		24.2122-1770.3 010898	TRW Ø 22,2
1.3 (454.031)	70	01/04→06/06					
1.5 (454.032)	80	01/04→06/06					
1.1 (454.033)	47	02/05→06/06		für Linkslenker		24.2122-1770.3 010898	TRW Ø 22,2
1.5 BRABUS (454.034)	130	05/05→06/06					
1.5 CDI (454.000)	50	09/04→06/06					
1.5 CDI (454.001)	70	09/04→06/06					
1.5 (454.032)	90	01/04→06/06		11/04→; für Linkslenker		24.2122-1770.3 010898	TRW Ø 22,2
SMART - FORTWO Cabrio (450) 01/04→01/07							
 Hauptbremszylinder							
0.7 (450.433)	55	01/04→01/07		für Linkslenker		24.2119-1711.3 010911	Ø 19,05 ohne Bremsflüssigkeitsbehälter
0.7 (450.452)	45	01/04→01/07					
0.8 CDI (450.401, 450.402, 450.403, 450.400)	30	01/04→01/07					
SMART - FORTWO Coupe (450) 01/04→02/07							
 Hauptbremszylinder							
0.7 (450.330)	37	01/04→01/07		für Linkslenker		24.2119-1711.3 010911	Ø 19,05 ohne Bremsflüssigkeitsbehälter
0.7 (450.333)	55	01/04→01/07					
0.7 (450.335)	40	01/04→01/07		→ J182808; für Linkslenker		24.2119-1711.3 010911	Ø 19,05 ohne Bremsflüssigkeitsbehälter
0.7 (450.352, 450.332)	45	01/04→01/07		→ J182805; für Linkslenker		24.2119-1711.3 010911	Ø 19,05 ohne Bremsflüssigkeitsbehälter
0.8 CDI (450.300, 450.301, 450.302, 450.303, 450.306)	30	01/04→01/07					
SUBARU - JUSTY III (G3X) 09/03→							
 Hauptbremszylinder							
1.3 AWD	69	09/03→		→ 08/07		24.2120-1730.3 010678	Ø 20,64
1.5 AWD	73	09/03→					
SUZUKI - IGNIS II (MH) 09/03→							
 Hauptbremszylinder							
1.3 (RM413)	69	09/03→		→ 12/12; + ABS		24.2120-1730.3 010678	Ø 20,64
1.3 4x4 (RM413)	69	09/03→					
1.3 DDiS (RM413D)	51	09/03→					
1.5 (RM415)	73	09/03→					
1.5 4x4 (RM415)	73	09/03→					















	kw					! #		
SUZUKI - JIMNY Geländewagen geschlossen (SN) 07/98→								
 Hauptbremszylinder								
1.3 16V (SN413)	59	09/98→		- ABS		24.2122-1776.3	011001	Ø 22,2 ohne Bremsflüssigkeitsbehälter
1.3 16V (SN413)	60	02/01→						
1.3 16V 4WD (SN413)	59	09/98→						
1.3 16V 4WD (SN413)	60	02/01→						
1.3 16V 4x4 (SN413)	63	08/05→						
1.3 4WD (SN413)	62	05/14→						
1.5 DDiS 4WD (SN415D)	48	12/03→						
1.5 DDiS 4x4	63	08/05→						
SUZUKI - SPLASH (EX) 01/08→								
 Hauptbremszylinder								
1.0 (A5B 310)	48	01/08→		für Linkslenker; - ESP		24.4122-1718.3	011019	BOS Ø 22,2 ohne Bremsflüssigkeitsbehälter
1.0 (A5B 310)	50	06/11→						
1.2 (A5B 412)	63	01/08→		für Linkslenker; + ESP		24.4122-1719.3	011020	Ø 22,2 ohne Bremsflüssigkeitsbehälter
1.2 VVT (A5B 412)	66	06/11→						
1.2 VVT (A5B 412)	69	09/10→						
1.3 CDTI (A5B 413D)	55	01/08→						
SUZUKI - SWIFT III (MZ, EZ) 02/05→								
 Hauptbremszylinder								
1.3 (RS 413)	68	02/05→		→ 09/10; für Linkslenker; - ESP		24.4122-1718.3	011019	BOS Ø 22,2 ohne Bremsflüssigkeitsbehälter
1.3 4x4 (RS 413)	68	02/05→						
1.3 DDiS (RS 413D)	55	08/05→		→ 09/10; für Linkslenker; + ESP		24.4122-1719.3	011020	Ø 22,2 ohne Bremsflüssigkeitsbehälter
1.5 (RS 415)	75	02/05→						
1.6 (RS 416)	92	05/06→						
1.3 DDiS (RS 413D)	51	08/05→		→ 09/07; für Linkslenker; - ESP		24.4122-1718.3	011019	BOS Ø 22,2 ohne Bremsflüssigkeitsbehälter
				→ 09/07; für Linkslenker; + ESP		24.4122-1719.3	011020	Ø 22,2 ohne Bremsflüssigkeitsbehälter
SUZUKI - SX4 (EY, GY) 06/06→								
 Hauptbremszylinder								
1.5 (RW 415)	73	06/06→07/10		- ESP; Made in Ungarn		24.4122-1712.3	010899	BOS Ø 22,2 ohne Bremsflüssigkeitsbehälter
1.5 VVT (RW 415)	82	07/10→						
1.6 VVT (RW 416)	79	06/06→		+ ESP; Made in Ungarn		24.4122-1713.3	010900	BOS Ø 22,2 ohne Bremsflüssigkeitsbehälter
1.6 VVT (RW 416)	88	07/09→						
1.6 VVT 4x4 (RW 416)	79	06/06→						
1.6 VVT 4x4 (RW 416)	82	07/09→						
1.6 VVT 4x4 (RW 416)	88	07/09→						
1.5 VVT 4x4 (RW 415)	82	07/10→		- ESP		24.4122-1712.3	010899	BOS Ø 22,2 ohne Bremsflüssigkeitsbehälter
1.6 DDiS (RW 416D)	66	04/07→						
1.9 DDiS (RW 419D)	88	06/06→		+ ESP		24.4122-1713.3	010900	BOS Ø 22,2 ohne Bremsflüssigkeitsbehälter
1.9 DDiS 4x4 (RW 419D)	88	06/06→						
2.0 DDiS (RW 420D)	99	07/09→						
2.0 DDiS 4x4 (RW 420D)	99	07/09→						
SUZUKI - SX4 Stufenheck (GY) 10/07→								
 Hauptbremszylinder								
1.6 (RW 416)	79	10/07→		- ESP; Made in Ungarn		24.4122-1712.3	010899	BOS Ø 22,2 ohne Bremsflüssigkeitsbehälter
1.6 (RW 416)	88	10/07→						
1.6 AWD (RW 416)	88	10/07→		+ ESP; Made in Ungarn		24.4122-1713.3	010900	BOS Ø 22,2 ohne Bremsflüssigkeitsbehälter
SUZUKI - WAGON R Schrägheck 07/03→12/12								
 Hauptbremszylinder								
1.0	39	07/03→08/05				24.2120-1730.3	010678	Ø 20,64
1.0	44	06/04→08/05						
1.2	59	06/04→08/05						
SUZUKI - WAGON R+ Schrägheck (MM) 05/00→								
 Hauptbremszylinder								
1.3 (RB 413)	56	05/00→12/04		+ ABS		24.2120-1730.3	010678	Ø 20,64
1.3 (RB 413)	69	09/03→		→ 04/08; + ABS		24.2120-1730.3	010678	Ø 20,64
1.3 4WD (RB 413)	69	09/03→						
1.3 DDiS (RB 413D)	51	09/03→						
1.3 4WD (RB 413)	56	10/01→		→ 12/04; + ABS		24.2120-1730.3	010678	Ø 20,64















	kw			 	! #		
TOYOTA - AVENSIS (T22_) 09/97→02/03							
 Bremskraftverstärker							
1.8 (AT221_)	81	09/97→10/00		→ 09/00; für Linkslenker		03.7745-4402.4 300295	ATE Ø 8 / 7" pneumatisch
1.8 VVT-i (ZZT221_)	95	10/00→02/03		für Linkslenker		03.7745-4402.4 300295	ATE Ø 8 / 7" pneumatisch
2.0 VVT-i (AZT220_)	110	10/00→02/03		08/01→; für Linkslenker		03.7745-4402.4 300295	ATE Ø 8 / 7" pneumatisch
 Hauptbremszylinder							
1.6 (AT220_)	74	09/97→10/00		→ 09/00		03.2123-2221.3 010861	ATE Ø 23,81
1.8 (AT221_)	81	09/97→10/00					
2.0 (ST220_)	94	09/97→10/00					
1.6 (AT220_)	81	10/97→06/00				03.2123-2221.3 010861	ATE Ø 23,81
1.6 VVT-i (ZZT220_)	81	10/00→02/03					
1.8 VVT-i (ZZT221_)	95	10/00→02/03					
2.0 D-4D (CDT220_)	81	10/99→02/03					
2.0 TD (CT220_)	66	09/97→02/03					
2.0 VVT-i (AZT220_)	110	10/00→02/03					
TOYOTA - AVENSIS (T25_) 03/03→11/08							
 Hauptbremszylinder							
1.6 VVT-i (ZZT250_)	81	04/03→11/08		+ ESP		24.2123-1771.3 010857	BOS Ø 23,81 ohne Bremsflüssigkeitsbehälter
1.8 (ZZT251_)	95	03/03→10/08					
2.0 (AZT250_)	108	03/03→11/08					
2.0 D-4D (ADT250_)	93	03/06→11/08					
2.0 D-4D (CDT250_)	85	04/03→11/08					
2.2 D-4D (ADT251_)	110	10/05→11/08					
2.2 D-CAT (ADT251_)	130	07/05→11/08					
2.4 (AZT251_)	120	10/03→10/08					
2.4 (AZT251_)	125	09/03→11/08					
TOYOTA - AVENSIS Combi (T25_) 04/03→11/08							
 Hauptbremszylinder							
1.6 VVT-i (ZZT250_)	81	04/03→11/08		+ ESP		24.2123-1771.3 010857	BOS Ø 23,81 ohne Bremsflüssigkeitsbehälter
1.8 (ZZT251_)	95	04/03→11/08					
2.0 (AZT250_)	108	04/03→11/08					
2.0 D-4D (ADT250_)	93	03/06→11/08					
2.0 D-4D (CDT250_)	85	04/03→11/08					
2.2 D-4D (ADT251_)	110	10/05→11/08					
2.2 D-CAT (ADT251_)	130	07/05→11/08					
2.4 (AZT251_)	120	10/03→10/08					
2.4 (AZT251_)	125	09/03→11/08					
TOYOTA - AVENSIS Kombi (T22_) 09/97→02/03							
 Bremskraftverstärker							
1.8 (AT221_)	81	09/97→10/00		→ 09/00; für Linkslenker		03.7745-4402.4 300295	ATE Ø 8 / 7" pneumatisch
1.8 (ZZT221_)	95	10/00→02/03		für Linkslenker		03.7745-4402.4 300295	ATE Ø 8 / 7" pneumatisch
2.0 (AZT220_)	110	10/00→02/03		08/01→; für Linkslenker		03.7745-4402.4 300295	ATE Ø 8 / 7" pneumatisch
 Hauptbremszylinder							
1.6 (AT220_, ZZT220_)	81	09/97→10/00		→ 09/00		03.2123-2221.3 010861	ATE Ø 23,81
1.6 (AT220_)	74	09/97→10/00					
1.8 (AT221_)	81	09/97→10/00					
2.0 (ST220_)	94	09/97→10/00					
1.6 (ZZT220_)	81	07/00→02/03		10/00→		03.2123-2221.3 010861	ATE Ø 23,81
1.8 (ZZT221_)	95	10/00→02/03				03.2123-2221.3 010861	ATE Ø 23,81
2.0 (AZT220_)	110	10/00→02/03					
2.0 D-4D (CDT220_)	81	10/99→02/03					
2.0 TD (CT220_)	66	09/97→02/03					
TOYOTA - AVENSIS Liftback (T22_) 09/97→02/03							
 Bremskraftverstärker							
1.8 (AT221_)	81	09/97→10/00		→ 09/00; für Linkslenker		03.7745-4402.4 300295	ATE Ø 8 / 7" pneumatisch
1.8 (ZZT221_)	95	10/00→02/03		für Linkslenker		03.7745-4402.4 300295	ATE Ø 8 / 7" pneumatisch
2.0 (AZT220_)	110	10/00→02/03		08/01→; für Linkslenker		03.7745-4402.4 300295	ATE Ø 8 / 7" pneumatisch
 Hauptbremszylinder							
1.6 (AT220_)	74	09/97→10/00		→ 09/00		03.2123-2221.3 010861	ATE Ø 23,81
1.6 (AT220_)	81	09/97→10/00					
1.8 (AT221_)	81	09/97→10/00					
2.0 (ST220_)	94	09/97→10/00					
1.6 (ZZT220_)	81	10/00→02/03				03.2123-2221.3 010861	ATE Ø 23,81
1.8 (ZZT221_)	95	10/00→02/03					
2.0 (AZT220_)	110	10/00→02/03					
2.0 D-4D (CDT220_)	81	10/99→02/03					
2.0 TD (CT220_)	66	09/97→02/03					









	kw					! #		
TOYOTA - AVENSIS Stufenheck (_T25_) 04/03→11/08								
 Hauptbremszylinder								
1.6 VVT-i (ZZT250_)	81	04/03→11/08			+ ESP		24.2123-1771.3 010857	BOS Ø 23,81 ohne Bremsflüssigkeitsbehälter
1.8 (ZZT251_)	95	04/03→11/08						
2.0 (AZT250_)	108	04/03→11/08						
2.0 D-4D (ADT250_)	93	03/06→10/08						
2.0 D-4D (CDT250_)	85	04/03→11/08						
2.2 D-4D (ADT251_)	110	10/05→11/08						
2.2 D-CAT (ADT251_)	130	07/05→11/08						
2.4 (AZT251_)	120	10/03→10/08						
2.4 (AZT251_)	125	09/03→11/08						
TOYOTA - AYGO (_B1_) 02/05→								
 Hauptbremszylinder								
1.0 (KGB10_)	50	07/05→			- ESP; → 06/14; für Linkslenker		24.4120-1701.3 010846	BOS Ø 20,64
1.4 HDi (WNB10_)	40	07/05→08/10			- ESP; für Linkslenker		24.4120-1701.3 010846	BOS Ø 20,64
TOYOTA - COROLLA (_E11_) 04/97→06/02								
 Hauptbremszylinder								
1.4 (EE111_)	63	05/97→09/99			für Linkslenker		03.2122-1691.3 010918	ATE Ø 22,2
1.4 16V (ZZE111_)	71	02/00→11/01			für Linkslenker; + ABS		03.2122-1691.3 010918	ATE Ø 22,2
1.6 16V (ZZE112_)	81	10/99→10/01					03.2122-1691.3 010918	ATE Ø 22,2
1.9 D (WZE110_)	51	02/00→11/01						
2.0 D-4D (CDE110_)	66	09/00→11/01						
TOYOTA - COROLLA (_E12_) 01/01→12/07								
 Hauptbremszylinder								
1.4 D (NDE120_)	66	07/04→02/07			→ 10/06; - ESP		24.2120-1749.3 010903	TRW Ø 20,64
					→ 10/06; + ESP		24.2120-1760.3 011018	Ø 20,64 ohne Bremsflüssigkeitsbehälter
1.4 VVT-i (ZZE120_)	71	01/02→12/06			→ 05/04; - ESP		24.2120-1749.3 010903	TRW Ø 20,64
1.6 VVT-i (ZZE121_)	81	01/02→12/06						
2.0 D-4D (CDE120R_, CDE120L_)	85	05/03→02/07			06/04→ 10/06; - ESP		24.2120-1749.3 010903	TRW Ø 20,64
					06/04→ 10/06; + ESP		24.2120-1760.3 011018	Ø 20,64 ohne Bremsflüssigkeitsbehälter
					→ 05/04; + ESP		24.2120-1760.3 011018	Ø 20,64 ohne Bremsflüssigkeitsbehälter
1.8 VVTL-i TS (ZZE123_)	160	10/05→12/06			→ 10/06; + ESP		24.2120-1760.3 011018	Ø 20,64 ohne Bremsflüssigkeitsbehälter
1.8 VVTL-i TS (ZZE123_)	165	02/05→02/07						
1.8 VVTL-i TS (ZZE123)	141	01/02→02/07			→ 05/04; + ESP		24.2120-1760.3 011018	Ø 20,64 ohne Bremsflüssigkeitsbehälter
2.0 D-4D (CDE120_)	66	01/02→12/06			→ 05/04; - ESP		24.2120-1749.3 010903	TRW Ø 20,64
2.0 D-4D (CDE120R_, CDE120L_)	81	01/02→12/06			→ 05/04; + ESP		24.2120-1760.3 011018	Ø 20,64 ohne Bremsflüssigkeitsbehälter
TOYOTA - COROLLA Combi (_E12_) 03/01→12/08								
 Hauptbremszylinder								
1.4 D4-D (NDE120_)	66	06/04→10/07			→ 10/06; - ESP		24.2120-1749.3 010903	TRW Ø 20,64
					→ 10/06; + ESP		24.2120-1760.3 011018	Ø 20,64 ohne Bremsflüssigkeitsbehälter
1.4 VVT-i (ZZE120_)	71	01/02→02/07			→ 05/04; - ESP		24.2120-1749.3 010903	TRW Ø 20,64
1.6 VVT-i (ZZE121_)	81	01/02→08/07						
2.0 D-4D (CDE120_)	85	04/04→02/07			06/04→ 10/06; - ESP		24.2120-1749.3 010903	TRW Ø 20,64
					06/04→ 10/06; + ESP		24.2120-1760.3 011018	Ø 20,64 ohne Bremsflüssigkeitsbehälter
					→ 05/04; + ESP		24.2120-1760.3 011018	Ø 20,64 ohne Bremsflüssigkeitsbehälter
2.0 D-4D (CDE120_)	66	01/02→02/07			→ 05/04; - ESP		24.2120-1749.3 010903	TRW Ø 20,64
					→ 05/04; + ESP		24.2120-1760.3 011018	Ø 20,64 ohne Bremsflüssigkeitsbehälter
TOYOTA - COROLLA Compact (_E11_) 04/97→01/02								
 Hauptbremszylinder								
1.4 (EE111_)	63	05/97→09/99			für Linkslenker		03.2122-1691.3 010918	ATE Ø 22,2
1.4 (ZZE111_)	71	02/00→01/02			für Linkslenker; + ABS		03.2122-1691.3 010918	ATE Ø 22,2
1.6 (ZZE112_)	81	10/99→10/01					03.2122-1691.3 010918	ATE Ø 22,2
1.9 D (WZE110_)	51	02/00→01/02						
2.0 D-4D (CDE110_)	66	09/00→01/02						

	kw					! #		
TOYOTA - COROLLA Kombi (_E11_) 04/97→10/01								
 Hauptbremszylinder								
1.4 (EE111_)	63	04/97→02/00		05/97→ 09/99; für Linkslenker			03.2122-1691.3 010918	ATE Ø 22,2
1.4 16V (ZZE111_)	71	02/00→10/01		für Linkslenker; + ABS			03.2122-1691.3 010918	ATE Ø 22,2
1.6 16V (ZZE112_)	81	02/00→10/01					03.2122-1691.3 010918	ATE Ø 22,2
1.9 D (WZE110_)	51	02/00→10/01						
2.0 D-4D (CDE110_)	66	09/00→10/01						
1.8 4WD (AE115_)	81	04/97→10/01		05/97→			03.2122-1691.3 010918	ATE Ø 22,2
TOYOTA - COROLLA Liftback (_E11_) 04/97→01/02								
 Hauptbremszylinder								
1.4 (EE111_)	63	04/97→02/00		05/97→ 09/99; für Linkslenker			03.2122-1691.3 010918	ATE Ø 22,2
1.4 (ZZE111_)	71	02/00→01/02		für Linkslenker; + ABS			03.2122-1691.3 010918	ATE Ø 22,2
1.6 (ZZE112_)	81	02/00→01/02					03.2122-1691.3 010918	ATE Ø 22,2
1.9 D (WZE110_)	51	02/00→01/02						
2.0 D-4D (CDE110_)	66	09/00→01/02						
TOYOTA - COROLLA Stufenheck (_E12_) 08/00→03/08								
 Hauptbremszylinder								
1.4 D-4D (NDE120_)	66	06/04→10/06		- ESP			24.2120-1749.3 010903	TRW Ø 20,64
				+ ESP			24.2120-1760.3 011018	Ø 20,64 ohne Bremsflüssigkeitsbehälter
1.4 VVT-i (ZZE120_)	71	10/01→10/06		06/04→; - ESP			24.2120-1749.3 010903	TRW Ø 20,64
				→ 05/04; - ESP			24.2120-1749.3 010903	TRW Ø 20,64
				→ 05/04; + ESP			24.2120-1760.3 011018	Ø 20,64 ohne Bremsflüssigkeitsbehälter
				06/04→; + ESP			24.2120-1760.3 011018	Ø 20,64 ohne Bremsflüssigkeitsbehälter
1.6 VVT-i (ZZE121_)	81	10/01→07/07		01/02→ 05/04; - ESP			24.2120-1749.3 010903	TRW Ø 20,64
				06/04→ 10/06; - ESP			24.2120-1749.3 010903	TRW Ø 20,64
				06/04→ 10/06; + ESP			24.2120-1760.3 011018	Ø 20,64 ohne Bremsflüssigkeitsbehälter
				01/02→ 05/04; + ESP			24.2120-1760.3 011018	Ø 20,64 ohne Bremsflüssigkeitsbehälter
2.0 D-4D (CDE120_)	66	01/02→12/06		05/03→ 05/04; - ESP			24.2120-1749.3 010903	TRW Ø 20,64
				→ 05/04; - ESP			24.2120-1749.3 010903	TRW Ø 20,64
				05/03→ 05/04; + ESP			24.2120-1760.3 011018	Ø 20,64 ohne Bremsflüssigkeitsbehälter
				→ 05/04; + ESP			24.2120-1760.3 011018	Ø 20,64 ohne Bremsflüssigkeitsbehälter
2.0 D-4D (CDE120_)	85	06/04→07/07		→ 10/06; - ESP			24.2120-1749.3 010903	TRW Ø 20,64
				→ 10/06; + ESP			24.2120-1760.3 011018	Ø 20,64 ohne Bremsflüssigkeitsbehälter
TOYOTA - COROLLA Verso (_E12_) 07/01→07/04								
 Hauptbremszylinder								
1.6 VVT-i (ZZE121_)	81	08/01→05/04					24.2120-1749.3 010903	TRW Ø 20,64
2.0 D-4D (CDE120_)	66	01/02→05/04						
TOYOTA - COROLLA Verso (ZER_, ZZE12_, R1_) 03/04→04/09								
 Hauptbremszylinder								
1.6 (ZNR10_)	81	04/04→03/09		09/05→; + ESP			24.2123-1771.3 010857	BOS Ø 23,81 ohne Bremsflüssigkeitsbehälter
1.8 (ZNR11_)	95	04/04→03/09						
2.0 D-4D (CUR10_)	85	04/04→03/09		05/04→ 08/05; + ESP			24.2123-1771.3 010857	BOS Ø 23,81 ohne Bremsflüssigkeitsbehälter
2.2 D-4D (AUR10_)	100	10/05→03/09		+ ESP			24.2123-1771.3 010857	BOS Ø 23,81 ohne Bremsflüssigkeitsbehälter
2.2 D-4D (AUR10_)	130	10/05→03/09						
TOYOTA - RAV 4 II (_A2_) 06/00→11/05								
 Hauptbremszylinder								
1.8 (ZCA25_, ZCA26_)	92	08/00→11/05		02/01→ 07/03; Schaltgetriebe			24.2120-1757.3 010976	Ø 20,64 ohne Bremsflüssigkeitsbehälter
				02/01→ 07/03; Vollautomatik			24.2120-1757.3 010976	Ø 20,64 ohne Bremsflüssigkeitsbehälter
2.0 4WD (ACA21, ACA20)	110	06/00→11/05		→ 07/03; Vollautomatik			24.2120-1757.3 010976	Ø 20,64 ohne Bremsflüssigkeitsbehälter
				→ 07/03; Schaltgetriebe			24.2120-1757.3 010976	Ø 20,64 ohne Bremsflüssigkeitsbehälter
↓								













	kw			 	! #		
TOYOTA - RAV 4 II (A2) 06/00→11/05							
 Hauptbremszylinder							
2.0 D 4WD (CLA20_, CLA21_)	85	05/01→11/05		09/01→ 07/03; Vollautomatik		24.2120-1757.3 010976	Ø 20,64 ohne Bremsflüssigkeitsbehälter
				09/01→ 07/03; Schaltgetriebe		24.2120-1757.3 010976	Ø 20,64 ohne Bremsflüssigkeitsbehälter
TOYOTA - YARIS (P1) 01/99→12/05							
 Hauptbremszylinder							
1.0 (SCP10_)	48	03/03→09/05		04/03→ 08/05; Made in Frankreich		24.2120-1766.3 011000	Ø 20,64 ohne Bremsflüssigkeitsbehälter
1.3 (SCP12_, NCP10_, SCP13_)	64	04/02→09/05		→ 08/05; Made in Frankreich		24.2120-1766.3 011000	Ø 20,64 ohne Bremsflüssigkeitsbehälter
1.4 D-4D (NLP10_)	55	10/01→09/05		12/01→ 08/05; Made in Frankreich		24.2120-1766.3 011000	Ø 20,64 ohne Bremsflüssigkeitsbehälter
TOYOTA - YARIS (P9) 01/05→							
 Bremskraftverstärker							
1.0 VVT-i (KSP90_)	51	01/05→11/11		01/06→ 08/11; für Linkslenker; Made in Frankreich; + ESP		03.7750-7132.4 300255	ATE Ø 9" pneumatisch
				01/06→ 08/11; für Linkslenker; Made in Frankreich; - ESP		03.7853-3203.4 300241	ATE Ø 9" pneumatisch
1.33 VVT-i (NSP90_)	73	07/10→		→ 08/11; für Linkslenker; + ESP		03.7750-7132.4 300255	ATE Ø 9" pneumatisch
				→ 08/11; für Linkslenker; - ESP		03.7853-3203.4 300241	ATE Ø 9" pneumatisch
1.33 VVT-i (NSP90_)	74	11/08→		03/09→ 08/11; für Linkslenker; + ESP		03.7750-7132.4 300255	ATE Ø 9" pneumatisch
				03/09→ 08/11; für Linkslenker; - ESP		03.7853-3203.4 300241	ATE Ø 9" pneumatisch
1.3 VVT-i (SCP90_)	64	08/05→		01/06→ 08/11; für Linkslenker; + ESP		03.7750-7132.4 300255	ATE Ø 9" pneumatisch
				01/06→ 08/11; für Linkslenker; - ESP		03.7853-3203.4 300241	ATE Ø 9" pneumatisch
1.4 D-4D (NLP90_)	66	08/05→		01/06→ 08/11; für Linkslenker; + ESP		03.7750-7132.4 300255	ATE Ø 9" pneumatisch
				01/06→ 08/11; für Linkslenker		03.7853-3402.4 300256	ATE Ø 9" pneumatisch
 Hauptbremszylinder							
1.0 VVT-i (KSP90_)	51	01/05→11/11		01/06→ 08/11; Made in Frankreich; + ESP		03.4152-0058.3 010885	ATE Ø 22,2 ohne Bremsflüssigkeitsbehälter
				01/06→ 08/11; Made in Frankreich; - ESP		03.4152-0158.3 011007	ATE Ø 22,2 ohne Bremsflüssigkeitsbehälter
				01/06→ 08/11; Made in Frankreich; - ESP		03.4152-0153.3 011006	ATE Ø 22,2 ohne Bremsflüssigkeitsbehälter
1.33 VVT-i (NSP90_)	73	07/10→		→ 08/11; + ESP		03.4152-0058.3 010885	ATE Ø 22,2 ohne Bremsflüssigkeitsbehälter
				→ 08/11; - ESP		03.4152-0158.3 011007	ATE Ø 22,2 ohne Bremsflüssigkeitsbehälter
				→ 08/11; - ESP		03.4152-0153.3 011006	ATE Ø 22,2 ohne Bremsflüssigkeitsbehälter
1.33 VVT-i (NSP90_)	74	11/08→		03/09→ 08/11; + ESP		03.4152-0058.3 010885	ATE Ø 22,2 ohne Bremsflüssigkeitsbehälter
				03/09→ 08/11; - ESP		03.4152-0158.3 011007	ATE Ø 22,2 ohne Bremsflüssigkeitsbehälter
				03/09→ 08/11; - ESP		03.4152-0153.3 011006	ATE Ø 22,2 ohne Bremsflüssigkeitsbehälter
1.3 VVT-i (SCP90_)	64	08/05→		01/06→ 08/11; + ESP		03.4152-0058.3 010885	ATE Ø 22,2 ohne Bremsflüssigkeitsbehälter
1.4 D-4D (NLP90_)	66	08/05→		01/06→ 08/11; + ESP		03.4152-0158.3 011007	ATE Ø 22,2 ohne Bremsflüssigkeitsbehälter
				01/06→ 08/11; - ESP		03.4152-0153.3 011006	ATE Ø 22,2 ohne Bremsflüssigkeitsbehälter
VAUXHALL - ZAFIRA Mk III (P12) 10/11→							
 Bremskraftverstärker							
1.6 CDTi	100	03/13→		für Linkslenker		03.7858-0732.4 300272	ATE Ø 9 / 8" pneumatisch
 Hauptbremszylinder							
1.6 CDTi	100	03/13→		für Linkslenker		03.2125-0421.3 010934	ATE Ø 25,4
VOLVO - 440 K (445) 08/88→12/96							
 Bremskraftregler							
1.6	61	09/88→12/96		→ 08/92; - ABS		03.0101-0014.2 320004	ATE Satz 3/25 2x
1.7	64	09/88→12/96					
1.7	75	08/89→12/96					
↓							











	kw			 	! #		
VOLVO - 440 K (445) 08/88→12/96							
 Bremskraftregler							
1.7	78	09/88→12/96		→ 08/92; - ABS		03.0101-0014.2 320004	ATE Satz 3/25 2x
1.7 Turbo	88	08/88→07/96					
1.7 Turbo	90	01/91→12/96					
1.8	66	08/91→07/96					
VOLVO - 460 L (464) 09/88→12/96							
 Bremskraftregler							
1.6	61	07/92→07/96		→ 08/92; - ABS		03.0101-0014.2 320004	ATE Satz 3/25 2x
1.7	64	09/88→07/96					
1.7 Turbo	88	08/89→07/96					
1.7 Turbo	90	01/91→07/96					
1.8	66	08/91→07/96					
2.0	81	08/92→07/95					
VOLVO - 480 E (482) 04/86→07/96							
 Bremskraftregler							
1.7	75	08/89→07/96		→ 08/92; - ABS		03.0101-0014.2 320004	ATE Satz 3/25 2x
1.7 Turbo	88	08/87→07/96					
1.7 Turbo	90	01/91→07/96					
VOLVO - 850 (854) 06/91→10/97							
 Bremskraftverstärker							
2.0	93	08/94→12/96		09/95→; für Linkslenker		03.7760-3602.4 300176	ATE Ø 10" pneumatisch
2.0	105	06/91→12/96					
2.0 Turbo	155	08/93→12/96					
2.3 T5	166	08/93→07/96					
2.3 T5-R	184	08/95→12/96					
2.4	106	08/94→12/96					
2.4	125	08/91→12/96					
2.5 TDI	103	08/95→12/96					
Pedalwegsensor, Bremspedal							
2.0	93	08/94→12/96		→ 08/95		03.0655-0003.2 370003	ATE
2.0	105	06/91→12/96					
2.0 Turbo	155	08/93→12/96					
2.3 T5	166	08/93→07/96					
2.3 T5-R	184	08/95→12/96					
2.4	106	08/94→12/96					
2.5 TDI	103	08/95→12/96					
2.4	125	08/91→12/96		09/93→ 08/95		03.0655-0003.2 370003	ATE
 Hauptbremszylinder							
2.0	93	08/94→12/96		09/95→; + ASR		03.2023-1044.3 010590	ATE Ø1 23,81 Ø2 20,64
2.0	105	06/91→12/96					
2.0 Turbo	155	08/93→12/96		09/95→; - ASR		03.2023-1084.3 010591	ATE Ø1 23,81 Ø2 20,64
2.3 T5	166	08/93→07/96					
2.3 T5-R	184	08/95→12/96		→ 08/95; für Linkslenker		10.6123-0445.3 010957	ATE Ø 23,81 ohne Bremsflüssigkeitsbehälter
2.4	106	08/94→12/96					
2.4	125	08/91→12/96					
2.5 TDI	103	08/95→12/96					
VOLVO - 850 Kombi (855) 04/92→10/97							
 Bremskraftverstärker							
2.0	93	08/94→12/96		09/95→; für Linkslenker		03.7760-3602.4 300176	ATE Ø 10" pneumatisch
2.0	105	02/93→12/96					
2.3 T5	166	02/93→12/96					
2.3 T5-R	184	08/95→12/96					
2.4	106	08/94→12/96					
2.5 TDI	103	08/95→12/96					
2.0 Turbo	155	02/93→12/96		09/95→ 12/95; für Linkslenker		03.7760-3602.4 300176	ATE Ø 10" pneumatisch
2.4	125	09/92→12/96		für Linkslenker		03.7760-3602.4 300176	ATE Ø 10" pneumatisch
2.4 AWD	142	04/96→12/96					
Pedalwegsensor, Bremspedal							
2.0	93	08/94→12/96		→ 08/95		03.0655-0003.2 370003	ATE
2.0	105	02/93→12/96					
2.0 Turbo	155	02/93→12/96					
2.3 T5	166	02/93→12/96					
2.3 T5-R	184	08/95→12/96					
2.4	106	08/94→12/96					
2.5 TDI	103	08/95→12/96					
2.4	125	09/92→12/96		09/93→ 08/95		03.0655-0003.2 370003	ATE
 Hauptbremszylinder							
2.0	93	08/94→12/96		09/95→; + ASR		03.2023-1044.3 010590	ATE Ø1 23,81 Ø2 20,64
2.0	105	02/93→12/96					
↓							

	kw			 	! #					
VOLVO - 850 Kombi (855) 04/92→10/97										
 Hauptbremszylinder										
2.0 Turbo	155	02/93→12/96		09/95→; - ASR		03.2023-1084.3 010591	ATE Ø1 23,81 Ø2 20,64			
2.3 T5	166	02/93→12/96		→ 08/95		10.6123-0445.3 010957	ATE Ø 23,81 ohne Bremsflüssigkeitsbehälter			
2.3 T5-R	184	08/95→12/96								
2.4	106	08/94→12/96								
2.5 TDI	103	08/95→12/96								
2.4	125	09/92→12/96		→ 08/95		10.6123-0445.3 010957	ATE Ø 23,81 ohne Bremsflüssigkeitsbehälter			
2.4 AWD	142	04/96→12/96		+ ASR		03.2023-1044.3 010590	ATE Ø1 23,81 Ø2 20,64			
				- ASR		03.2023-1084.3 010591	ATE Ø1 23,81 Ø2 20,64			
VOLVO - 940 II (944) 08/94→12/98										
 Hauptbremszylinder										
2.0 Turbo	114	04/96→10/98				03.2023-0875.3 010890	ATE Ø1 23,81 Ø2 20,64 ohne Bremsflüssigkeitsbehälter			
2.3	85	08/94→07/95				03.2023-0875.3 010890	ATE Ø1 23,81 Ø2 20,64 ohne Bremsflüssigkeitsbehälter			
2.3	96	08/94→10/98								
2.3 ti	99	01/95→10/98								
2.3 Turbo	121	08/94→10/98								
2.4 TD Interc.	90	08/94→10/98								
2.4 TD Interc.	90	08/94→10/98								
VOLVO - 940 II Kombi (945) 08/94→10/98										
 Hauptbremszylinder										
2.0 Turbo	114	04/96→10/98				03.2023-0875.3 010890	ATE Ø1 23,81 Ø2 20,64 ohne Bremsflüssigkeitsbehälter			
2.3	85	08/94→07/95				03.2023-0875.3 010890	ATE Ø1 23,81 Ø2 20,64 ohne Bremsflüssigkeitsbehälter			
2.3	96	08/94→10/98								
2.3 ti	99	01/95→10/98								
2.3 Turbo	121	08/94→10/98								
2.4 TD Interc.	90	08/94→10/98								
2.4 TD Interc.	90	08/94→10/98								
VOLVO - 940 Kombi (945) 08/90→10/95										
 Hauptbremszylinder										
2.4 D	60	08/90→07/95		→ 12/91; + ABS		03.2023-0164.3 010014	Ø1 23,81 Ø2 19,05 mit Bremsflüssigkeitsbehälter			
				→ 12/91; - ABS		03.2023-0503.3 010022	Ø1 23,81 Ø2 16,84 mit Bremsflüssigkeitsbehälter			
				01/92→		03.2023-0875.3 010890	ATE Ø1 23,81 Ø2 20,64 ohne Bremsflüssigkeitsbehälter			
Verschlusschraube, Hauptbremszylinder										
2.4 D	60	08/90→07/95		→ 12/91; - ABS		03.3517-5100.1 390326				
VOLVO - 960 II (964) 07/94→12/96										
 Hauptbremszylinder										
2.5	125	07/94→12/96		08/94→		03.2023-0875.3 010890	ATE Ø1 23,81 Ø2 20,64 ohne Bremsflüssigkeitsbehälter			
2.9	150	07/94→12/96								
VOLVO - 960 II Kombi (965) 07/94→12/96										
 Hauptbremszylinder										
2.5	125	08/94→12/96				03.2023-0875.3 010890	ATE Ø1 23,81 Ø2 20,64 ohne Bremsflüssigkeitsbehälter			
2.9	150	09/94→12/96								
VOLVO - C30 (533) 09/06→12/13										
 Bremskraftverstärker										
1.6	74	10/06→12/12		für Linkslenker		03.7863-4832.4 300289	ATE Ø 10" pneumatisch			
1.6 D	80	10/06→12/12								
1.8	92	10/06→12/12								
2.0	107	10/06→12/12								
2.0 D	100	10/06→12/12								
2.0 FlexFuel	107	01/10→12/12								
2.4 i	125	10/06→12/12								
D5	120	10/06→12/12								
D5	132	10/06→12/12								
Electric	82	12/10→12/12								
Electric	89	12/10→12/12								
T5	162	10/06→12/12								
T5	169	03/07→12/12								
1.8 FlexFuel	92	01/07→12/12			04/07→; für Linkslenker				03.7863-4832.4 300289	ATE Ø 10" pneumatisch
Pedalwegsensor, Bremspedal										
1.6	74	10/06→12/12				03.0655-0007.2 370007	ATE			
1.6 D	80	10/06→12/12								
1.8	92	10/06→12/12								
2.0	107	10/06→12/12								
↓										

	kw				! #		
VOLVO - C30 (533) 09/06→12/13							
Pedalwegsensoren, Bremspedal							
2.0 D	100	10/06→12/12				03.0655-0007.2 370007	ATE
2.0 FlexFuel	107	01/10→12/12					
2.4 i	125	10/06→12/12					
D5	120	10/06→12/12					
D5	132	10/06→12/12					
T5	162	10/06→12/12					
T5	169	03/07→12/12					
1.8 FlexFuel	92	01/07→12/12		04/07→		03.0655-0007.2 370007	ATE
Electric	82	12/10→12/12		für Linkslenker		03.0655-0007.2 370007	ATE
Electric	89	12/10→12/12					
 Hauptbremszylinder							
1.6	74	10/06→12/12		für Linkslenker		03.2123-3593.3 010919	ATE Ø 23,81
1.6 D	80	10/06→12/12					
1.8	92	10/06→12/12					
2.0	107	10/06→12/12					
2.0 D	100	10/06→12/12					
2.0 FlexFuel	107	01/10→12/12					
2.4 i	125	10/06→12/12					
D5	120	10/06→12/12					
D5	132	10/06→12/12					
Electric	82	12/10→12/12					
Electric	89	12/10→12/12					
T5	162	10/06→12/12					
T5	169	03/07→12/12					
1.6 D2	84	10/10→12/12		für Linkslenker		03.2123-3624.3 010956	ATE Ø 23,81
D3	110	10/10→12/12					
D4	130	10/10→12/12					
1.8 FlexFuel	92	01/07→12/12		04/07→; für Linkslenker		03.2123-3593.3 010919	ATE Ø 23,81
Hydraulikaggregat, Bremsanlage							
1.6	74	10/06→12/12		für Linkslenker; Getriebetyp: M66; Schaltgetriebe; + DSTC		24.9145-0005.2 399009	
1.6 D	80	10/06→12/12					
1.6 D2	84	10/10→12/12		für Rechtslenker; Getriebetyp: B6; Schaltgetriebe; + DSTC		24.9145-0005.2 399009	
1.8	92	10/06→12/12					
2.0	107	10/06→12/12					
2.0 D	100	10/06→12/12		für Rechtslenker; Getriebetyp: AW55-50/51SN; Automatikgetriebe; + DSTC		24.9145-0005.2 399009	
2.0 FlexFuel	107	01/10→12/12					
2.4 i	125	10/06→12/12					
D5	120	10/06→12/12					
D5	132	10/06→12/12					
T5	162	10/06→12/12					
T5	169	03/07→12/12					
1.8 FlexFuel	92	01/07→12/12		04/07→; für Linkslenker; Getriebetyp: M66; Schaltgetriebe; + DSTC		24.9145-0005.2 399009	
				04/07→; für Rechtslenker; Getriebetyp: AW55-50/51SN; Automatikgetriebe; + DSTC		24.9145-0005.2 399009	
				04/07→; für Rechtslenker; Getriebetyp: B6; Schaltgetriebe; + DSTC		24.9145-0005.2 399009	
D3	110	10/10→12/12		für Rechtslenker; Getriebetyp: AW55-50/51SN; Automatikgetriebe; + DSTC		24.9145-0005.2 399009	
D4	130	10/10→12/12		→ 203925; für Rechtslenker; Getriebetyp: B6; Schaltgetriebe; + DSTC		24.9145-0005.2 399009	
Electric	82	12/10→12/12		+ DSTC		24.9145-0005.2 399009	
Electric	89	12/10→12/12					
VOLVO - C70 I Cabriolet (873) 03/98→10/05							
 Bremskraftverstärker							
2.0	132	03/98→10/05		→ 12/98; für Linkslenker		03.7760-3602.4 300176	ATE Ø 10" pneumatisch
2.0 T	166	03/98→10/05					
2.3 T5	176	03/98→10/05					
2.4	125	06/98→10/05					
2.4 T	142	03/98→10/05					
Pedalwegsensoren, Bremspedal							
2.0	132	03/98→10/05		01/99→		03.0655-0004.2 370004	ATE
2.0 T	166	03/98→10/05					
2.3 T5	176	03/98→10/05					
2.4	125	06/98→10/05					
2.4 T	142	03/98→10/05					
2.0 T	120	03/00→10/05				03.0655-0004.2 370004	ATE
2.3 T5	180	07/02→10/05					
2.4 T	147	07/02→10/05					
↓							



	kw					! #		
VOLVO - C70 I Cabriolet (873) 03/98→10/05								
 Hauptbremszylinder								
2.0	132	03/98→10/05		→ 12/98; + ASR		03.2023-1044.3	010590	ATE Ø1 23,81 Ø2 20,64
2.0 T	166	03/98→10/05		→ 12/98; - ASR		03.2023-1084.3	010591	ATE Ø1 23,81 Ø2 20,64
2.3 T5	176	03/98→10/05						
2.4	125	06/98→10/05		01/99→		03.2123-2164.3	010599	ATE Ø 23,81
2.4 T	142	03/98→10/05						
2.0 T	120	03/00→10/05				03.2123-2164.3	010599	ATE Ø 23,81
2.3 T5	180	07/02→10/05						
2.4 T	147	07/02→10/05						
VOLVO - C70 I Coupe (872) 03/97→09/02								
 Bremskraftverstärker								
2.0	132	03/97→09/02		→ 12/98; für Linkslenker		03.7760-3602.4	300176	ATE Ø 10" pneumatisch
2.0 T	166	03/97→09/02						
2.3 T-5	176	03/97→09/02						
2.4 T	142	03/97→09/02						
Pedalwegsensor, Bremspedal								
2.0	132	03/97→09/02		01/99→		03.0655-0004.2	370004	ATE
2.0 T	166	03/97→09/02						
2.3 T-5	176	03/97→09/02						
2.4 T	142	03/97→09/02						
2.0 T	120	03/00→09/02				03.0655-0004.2	370004	ATE
2.4	121	03/99→09/02						
2.4	125	05/99→09/02		11/99→		03.0655-0004.2	370004	ATE
 Hauptbremszylinder								
2.0	132	03/97→09/02		→ 12/98; für Linkslenker; + ASR		03.2023-1044.3	010590	ATE Ø1 23,81 Ø2 20,64
2.0 T	166	03/97→09/02		→ 12/98; für Linkslenker; - ASR		03.2023-1084.3	010591	ATE Ø1 23,81 Ø2 20,64
2.3 T-5	176	03/97→09/02						
2.4 T	142	03/97→09/02		01/99→		03.2123-2164.3	010599	ATE Ø 23,81
2.0 T	120	03/00→09/02				03.2123-2164.3	010599	ATE Ø 23,81
2.4	121	03/99→09/02						
2.4	125	05/99→09/02		11/99→		03.2123-2164.3	010599	ATE Ø 23,81
VOLVO - C70 II Cabriolet (542) 03/06→12/13								
 Bremskraftverstärker								
2.0 D	100	01/08→10/09		06/08→; für Linkslenker		03.7863-4832.4	300289	ATE Ø 10" pneumatisch
2.4	103	03/06→10/09		für Linkslenker		03.7863-4832.4	300289	ATE Ø 10" pneumatisch
2.4 D	120	03/07→06/13						
2.4 i	125	03/06→10/09						
D5	132	03/06→06/13						
T5	162	03/06→02/07						
T5	169	03/07→10/09						
Pedalwegsensor, Bremspedal								
2.0 D	100	01/08→10/09		50576→; für Rechtslenker		03.0655-0007.2	370007	ATE
				06/08→; → 50575; für Rechtslenker		03.0655-0007.2	370007	ATE
				06/08→; für Linkslenker		03.0655-0007.2	370007	ATE
2.4	103	03/06→10/09				03.0655-0007.2	370007	ATE
2.4 D	120	03/07→06/13						
2.4 i	125	03/06→10/09						
D5	132	03/06→06/13						
T5	162	03/06→02/07						
T5	169	03/07→10/09						
 Hauptbremszylinder								
2.0 D	100	01/08→10/09		06/08→; für Linkslenker		03.2123-3593.3	010919	ATE Ø 23,81
2.4	103	03/06→10/09		für Linkslenker		03.2123-3593.3	010919	ATE Ø 23,81
2.4 D	120	03/07→06/13						
2.4 i	125	03/06→10/09						
D5	132	03/06→06/13						
T5	162	03/06→02/07						
T5	169	03/07→10/09						
D3	110	10/10→06/13		für Linkslenker		03.2123-3624.3	010956	ATE Ø 23,81
D4	130	10/10→06/13						
Hydraulikaggregat, Bremsanlage								
2.0 D	100	01/08→10/09		112004→; variant code: GZ01; + DSTC		24.9145-0005.2	399009	
				06/08→; → 112003; + DSTC		24.9145-0005.2	399009	
2.4	103	03/06→10/09		112004→; variant code: GZ01; + DSTC		24.9145-0005.2	399009	
2.4 D	120	03/07→06/13						
2.4 i	125	03/06→10/09		→ 112003; + DSTC		24.9145-0005.2	399009	
D5	132	03/06→06/13						
T5	162	03/06→02/07						
T5	169	03/07→10/09						
↓								

	kw			 	! #		
VOLVO - C70 II Cabriolet (542) 03/06→12/13							
Hydraulikaggregat, Bremsanlage							
D3	110	10/10→06/13		→ 112003; + DSTC		24.9145-0005.2	399009
D4	130	10/10→06/13					
VOLVO - S40 I (644) 07/95→12/04							
 Hauptbremszylinder							
1.6	77	09/95→08/99		→ 08/97		24.2122-1718.3	010517 Ø 22,2
1.8	85	07/95→08/99		09/97→		24.2123-1746.3	010682 Ø 23,81
1.9 T4	147	05/97→07/00					
1.9 TD	66	07/95→08/99					
2.0	100	07/95→12/03					
2.0	103	07/95→08/99					
1.6	80	03/99→12/03				24.2123-1746.3	010682 Ø 23,81
1.8	90	03/99→12/03					
1.8 i	90	06/01→12/03					
1.8 i	92	03/98→12/03					
1.9 DI	70	03/99→07/00					
1.9 DI	75	07/00→12/03					
1.9 DI	85	07/00→12/03					
2.0 T	120	06/01→12/03					
2.0 T	121	07/00→06/01					
2.0 T4	147	07/00→12/03					
2.0 T	118	10/97→12/03		→ 07/00		24.2123-1746.3	010682 Ø 23,81
VOLVO - S40 II (544) 12/03→12/12							
 Bremskraftverstärker							
1.6	74	01/05→12/12		→ 05/12; für Linkslenker		03.7863-4832.4	300289 ATE Ø 10" pneumatisch
1.6 D	81	01/05→12/12					
2.0	107	10/06→12/12					
2.0 F	107	10/09→12/12					
T5	169	03/07→12/12					
1.8	92	04/04→12/10		für Linkslenker		03.7863-4832.4	300289 ATE Ø 10" pneumatisch
2.0 D	100	01/04→12/10					
2.4	103	01/04→12/10					
2.4	125	01/04→12/12					
2.4 D5	132	03/06→12/10					
T5	162	01/04→12/07					
T5 AWD	162	04/04→12/07					
T5 AWD	169	03/07→12/10					
1.8 FlexFuel	92	01/06→12/10		04/07→; für Linkslenker		03.7863-4832.4	300289 ATE Ø 10" pneumatisch
Pedalwegsensor, Bremspedal							
1.6	74	01/05→12/12		→ 05/12		03.0655-0007.2	370007 ATE
1.6 D	81	01/05→12/12					
2.0	107	10/06→12/12					
2.0 F	107	10/09→12/12					
T5	169	03/07→12/12					
1.8	92	04/04→12/10				03.0655-0007.2	370007 ATE
2.0 D	100	01/04→12/10					
2.4	103	01/04→12/10					
2.4	125	01/04→12/12					
2.4 D5	132	03/06→12/10					
T5	162	01/04→12/07					
T5 AWD	162	04/04→12/07					
T5 AWD	169	03/07→12/10					
1.8 FlexFuel	92	01/06→12/10		04/07→		03.0655-0007.2	370007 ATE
 Hauptbremszylinder							
1.6	74	01/05→12/12		→ 05/12; für Linkslenker		03.2123-3593.3	010919 ATE Ø 23,81
1.6 D	81	01/05→12/12					
2.0	107	10/06→12/12					
2.0 F	107	10/09→12/12					
T5	169	03/07→12/12					
1.6 D2	84	10/10→12/12		→ 05/12; für Linkslenker		03.2123-3624.3	010956 ATE Ø 23,81
D3	110	10/10→12/12					
D4	130	10/10→12/12					
1.8	92	04/04→12/10		für Linkslenker		03.2123-3593.3	010919 ATE Ø 23,81
2.0 D	100	01/04→12/10					
2.4	103	01/04→12/10					
2.4	125	01/04→12/12					
2.4 D5	132	03/06→12/10					
T5	162	01/04→12/07					
T5 AWD	162	04/04→12/07					
T5 AWD	169	03/07→12/10					
1.8 FlexFuel	92	01/06→12/10		04/07→; für Linkslenker		03.2123-3593.3	010919 ATE Ø 23,81
Hydraulikaggregat, Bremsanlage							
1.6	74	01/05→12/12		→ 05/12; + DSTC		24.9145-0005.2	399009
1.6 D	81	01/05→12/12					
↓							

VOLVO - S40 II (544) 12/03→12/12

Hydraulikaggregat, Bremsanlage

2.0	107	10/06→12/12		→ 05/12; + DSTC		24.9145-0005.2	399009	
2.0 F	107	10/09→12/12						
T5	169	03/07→12/12						
1.8	92	04/04→12/10		+ DSTC		24.9145-0005.2	399009	
2.0 D	100	01/04→12/10						
2.4	103	01/04→12/10						
2.4	125	01/04→12/12						
2.4 D5	132	03/06→12/10						
T5	162	01/04→12/07						
1.8 FlexFuel	92	01/06→12/10		04/07→; + DSTC		24.9145-0005.2	399009	

VOLVO - S60 I (384) 07/00→04/10









Bremskraftverstärker







2.0 T	132	07/00→04/10		09/01→ 12/01		03.7755-3402.4	300189	ATE Ø 9 / 8" pneumatisch
				01/02→ 01/09; - DSTC		03.7755-4702.4	300224	ATE Ø 9 / 8" pneumatisch
				01/02→ 01/09; + DSTC		03.7858-3532.4	300233	ATE Ø 9 / 8" pneumatisch
2.4	103	07/00→04/10		11/00→ 12/01		03.7755-3402.4	300189	ATE Ø 9 / 8" pneumatisch
2.4 T	147	07/00→04/10		01/02→ 01/09; - DSTC		03.7755-4702.4	300224	ATE Ø 9 / 8" pneumatisch
				01/02→ 01/09; + DSTC		03.7858-3532.4	300233	ATE Ø 9 / 8" pneumatisch
2.4	125	11/00→04/10		→ 12/01		03.7755-3402.4	300189	ATE Ø 9 / 8" pneumatisch
				01/02→ 01/09; - DSTC		03.7755-4702.4	300224	ATE Ø 9 / 8" pneumatisch
				01/02→ 01/09; + DSTC		03.7858-3532.4	300233	ATE Ø 9 / 8" pneumatisch
2.4 Bifuel (CNG)	103	07/01→04/10		06/02→ 01/09; - DSTC		03.7755-4702.4	300224	ATE Ø 9 / 8" pneumatisch
2.4 Bifuel (LPG)	103	07/01→04/10		06/02→ 01/09; + DSTC		03.7858-3532.4	300233	ATE Ø 9 / 8" pneumatisch
2.4 D	93	03/05→04/10		09/05→ 01/09; - DSTC		03.7755-4702.4	300224	ATE Ø 9 / 8" pneumatisch
2.4 D5	136	03/05→04/10		09/05→ 01/09; + DSTC		03.7858-3532.4	300233	ATE Ø 9 / 8" pneumatisch
2.4 D	96	05/01→04/10		01/02→ 01/09; - DSTC		03.7755-4702.4	300224	ATE Ø 9 / 8" pneumatisch
				01/02→ 01/09; + DSTC		03.7858-3532.4	300233	ATE Ø 9 / 8" pneumatisch
2.4 D	120	07/05→12/09		→ 01/09; - DSTC		03.7755-4702.4	300224	ATE Ø 9 / 8" pneumatisch
2.4 T5	191	04/04→04/10		→ 01/09; + DSTC		03.7858-3532.4	300233	ATE Ø 9 / 8" pneumatisch
2.4 D5	120	01/01→04/10		07/01→ 12/01		03.7755-3402.4	300189	ATE Ø 9 / 8" pneumatisch
				01/02→ 01/09; - DSTC		03.7755-4702.4	300224	ATE Ø 9 / 8" pneumatisch
				01/02→ 01/09; + DSTC		03.7858-3532.4	300233	ATE Ø 9 / 8" pneumatisch
2.4 T AWD	147	06/01→04/10		11/01→ 12/01		03.7755-3402.4	300189	ATE Ø 9 / 8" pneumatisch
				01/02→ 01/09; - DSTC		03.7755-4702.4	300224	ATE Ø 9 / 8" pneumatisch
				01/02→ 01/09; + DSTC		03.7858-3532.4	300233	ATE Ø 9 / 8" pneumatisch
2.5 T	154	01/03→04/10		02/04→ 01/09; - DSTC		03.7755-4702.4	300224	ATE Ø 9 / 8" pneumatisch
				02/04→ 01/09; + DSTC		03.7858-3532.4	300233	ATE Ø 9 / 8" pneumatisch
2.5 T AWD	154	07/02→04/10		04/04→ 01/09; - DSTC		03.7755-4702.4	300224	ATE Ø 9 / 8" pneumatisch
				04/04→ 01/09; + DSTC		03.7858-3532.4	300233	ATE Ø 9 / 8" pneumatisch
R 2,5 T AWD	221	01/03→04/10		03/03→ 01/09; - DSTC		03.7755-4702.4	300224	ATE Ø 9 / 8" pneumatisch
				03/03→ 01/09; + DSTC		03.7858-3532.4	300233	ATE Ø 9 / 8" pneumatisch
T5	184	07/00→04/10		08/00→ 12/01		03.7755-3402.4	300189	ATE Ø 9 / 8" pneumatisch
				01/02→ 04/04; - DSTC		03.7755-4702.4	300224	ATE Ø 9 / 8" pneumatisch
				01/02→ 04/04; + DSTC		03.7858-3532.4	300233	ATE Ø 9 / 8" pneumatisch











Pedalwegsensor, Bremspedal







2.0 T	132	07/00→04/10		09/01→ 12/01		03.0655-0004.2	370004	ATE
				01/05→ 01/09		03.0655-0005.2	370005	ATE
				01/02→ 01/09		03.0655-0005.2	370005	ATE
2.4	103	07/00→04/10		11/00→ 12/01		03.0655-0004.2	370004	ATE
2.4 T	147	07/00→04/10		01/05→ 01/09		03.0655-0005.2	370005	ATE
				01/02→ 01/09		03.0655-0005.2	370005	ATE
2.4	125	11/00→04/10		→ 12/01		03.0655-0004.2	370004	ATE
				01/05→ 01/09		03.0655-0005.2	370005	ATE
				01/02→ 01/09		03.0655-0005.2	370005	ATE
2.4 Bifuel (CNG)	103	07/01→04/10		01/05→ 01/09		03.0655-0005.2	370005	ATE
2.4 Bifuel (LPG)	103	07/01→04/10		06/02→ 01/09		03.0655-0005.2	370005	ATE
2.4 D	93	03/05→04/10		09/05→ 01/09		03.0655-0005.2	370005	ATE
2.4 D5	136	03/05→04/10						
2.4 D	96	05/01→04/10		01/05→ 01/09		03.0655-0005.2	370005	ATE
				01/02→ 01/09		03.0655-0005.2	370005	ATE
2.4 D	120	07/05→12/09		→ 01/09		03.0655-0005.2	370005	ATE





















	kw			 	! #		
VOLVO - S60 I (384) 07/00→04/10							
Pedalwegsensord, Bremspedal							
2.4 D5	120	01/01→04/10		07/01→ 12/01		03.0655-0004.2 370004	ATE
				01/05→ 01/09		03.0655-0005.2 370005	ATE
				01/02→ 01/09		03.0655-0005.2 370005	ATE
2.4 T5	191	04/04→04/10		01/05→ 01/09		03.0655-0005.2 370005	ATE
				→ 01/09		03.0655-0005.2 370005	ATE
2.4 T AWD	147	06/01→04/10		11/01→ 12/01		03.0655-0004.2 370004	ATE
				01/05→ 01/09		03.0655-0005.2 370005	ATE
				01/02→ 01/09		03.0655-0005.2 370005	ATE
2.5 T	154	01/03→04/10		01/05→ 01/09		03.0655-0005.2 370005	ATE
				02/04→ 01/09		03.0655-0005.2 370005	ATE
2.5 T AWD	154	07/02→04/10		01/05→ 01/09		03.0655-0005.2 370005	ATE
				04/04→ 01/09		03.0655-0005.2 370005	ATE
R 2,5 T AWD	221	01/03→04/10		01/05→ 01/09		03.0655-0005.2 370005	ATE
				03/03→ 01/09		03.0655-0005.2 370005	ATE
T5	184	07/00→04/10		08/00→ 12/01		03.0655-0004.2 370004	ATE
				01/02→ 04/04		03.0655-0005.2 370005	ATE
 Hauptbremszylinder							
2.0 T	132	07/00→04/10		09/01→; → 8535; - DSTC		03.2125-7637.3 010707	ATE Ø 25,4
				09/01→; → 11551; für Rechtslenker; + DSTC		03.2125-7637.3 010707	ATE Ø 25,4
				8536→; → 01/09; für Rechtslenker; - DSTC		03.2125-7638.3 010738	ATE Ø 25,4
				11552→; → 01/09; für Rechtslenker; + DSTC		03.2125-7638.3 010738	ATE Ø 25,4
				09/01→; → 9499; für Linkslenker; + DSTC		03.2125-7708.3 010739	ATE Ø 25,4
				9500→; → 01/09; für Linkslenker; + DSTC		03.2125-7713.3 010819	ATE Ø 25,4
				8536→; → 01/09; für Linkslenker; - DSTC		03.2125-7743.3 010921	ATE Ø 25,4
2.4 2.4 T	103 147	07/00→04/10 07/00→04/10		11/00→; → 11551; für Rechtslenker; + DSTC		03.2125-7637.3 010707	ATE Ø 25,4
				11/00→; → 8535; - DSTC		03.2125-7637.3 010707	ATE Ø 25,4
				8536→; → 01/09; für Rechtslenker; - DSTC		03.2125-7638.3 010738	ATE Ø 25,4
				11552→; → 01/09; für Rechtslenker; + DSTC		03.2125-7638.3 010738	ATE Ø 25,4
				11/00→; → 9499; für Linkslenker; + DSTC		03.2125-7708.3 010739	ATE Ø 25,4
				9500→; → 01/09; für Linkslenker; + DSTC		03.2125-7713.3 010819	ATE Ø 25,4
				8536→; → 01/09; für Linkslenker; - DSTC		03.2125-7743.3 010921	ATE Ø 25,4
2.4 2.4 D	125 120	11/00→04/10 07/05→12/09		→ 8535; - DSTC		03.2125-7637.3 010707	ATE Ø 25,4
				→ 11551; für Rechtslenker; + DSTC		03.2125-7637.3 010707	ATE Ø 25,4
				8536→; → 01/09; für Rechtslenker; - DSTC		03.2125-7638.3 010738	ATE Ø 25,4
				11552→; → 01/09; für Rechtslenker; + DSTC		03.2125-7638.3 010738	ATE Ø 25,4
				→ 9499; für Linkslenker; + DSTC		03.2125-7708.3 010739	ATE Ø 25,4
				9500→; → 01/09; für Linkslenker; + DSTC		03.2125-7713.3 010819	ATE Ø 25,4
				8536→; → 01/09; für Linkslenker; - DSTC		03.2125-7743.3 010921	ATE Ø 25,4
2.4 Bifuel (CNG) 2.4 Bifuel (LPG)	103 103	07/01→04/10 07/01→04/10		06/02→; → 11551; für Rechtslenker; + DSTC		03.2125-7637.3 010707	ATE Ø 25,4
				11552→; → 01/09; für Rechtslenker; + DSTC		03.2125-7638.3 010738	ATE Ø 25,4
				06/02→ 01/09; für Rechtslenker; - DSTC		03.2125-7638.3 010738	ATE Ø 25,4
				06/02→; → 9499; für Linkslenker; + DSTC		03.2125-7708.3 010739	ATE Ø 25,4
				9500→; → 01/09; für Linkslenker; + DSTC		03.2125-7713.3 010819	ATE Ø 25,4
				06/02→ 01/09; für Linkslenker; - DSTC		03.2125-7743.3 010921	ATE Ø 25,4
2.4 D 2.4 D5	93 136	03/05→04/10 03/05→04/10		09/05→ 01/09; für Rechtslenker; + DSTC		03.2125-7638.3 010738	ATE Ø 25,4
				09/05→; für Rechtslenker; → 01/09; - DSTC		03.2125-7638.3 010738	ATE Ø 25,4
				09/05→ 01/09; für Linkslenker; + DSTC		03.2125-7713.3 010819	ATE Ø 25,4
↓							









	kw			 	! #		
VOLVO - S60 I (384) 07/00→04/10							
Hauptbremszylinder							
2.4 D	93	03/05→04/10		09/05→ 01/09; für Linkslenker; - DSTC		03.2125-7743.3 010921	ATE Ø 25,4
2.4 D5	136	03/05→04/10					
2.4 D	96	05/01→04/10		12/01→; → 8535; - DSTC		03.2125-7637.3 010707	ATE Ø 25,4
				12/01→; → 11551; für Rechtslenker; + DSTC		03.2125-7637.3 010707	ATE Ø 25,4
				8536→; → 01/09; für Rechtslenker; - DSTC		03.2125-7638.3 010738	ATE Ø 25,4
				11552→; → 01/09; für Rechtslenker; + DSTC		03.2125-7638.3 010738	ATE Ø 25,4
				12/01→; → 9499; für Linkslenker; + DSTC		03.2125-7708.3 010739	ATE Ø 25,4
				9500→; → 01/09; für Linkslenker; + DSTC		03.2125-7713.3 010819	ATE Ø 25,4
				8536→; → 01/09; für Linkslenker; - DSTC		03.2125-7743.3 010921	ATE Ø 25,4
2.4 D5	120	01/01→04/10		07/01→; → 11551; für Rechtslenker; + DSTC		03.2125-7637.3 010707	ATE Ø 25,4
				07/01→; → 8535; - DSTC		03.2125-7637.3 010707	ATE Ø 25,4
				8536→; → 01/09; für Rechtslenker; - DSTC		03.2125-7638.3 010738	ATE Ø 25,4
				11552→; → 01/09; für Rechtslenker; + DSTC		03.2125-7638.3 010738	ATE Ø 25,4
				07/01→; → 9499; für Linkslenker; + DSTC		03.2125-7708.3 010739	ATE Ø 25,4
				9500→; → 01/09; für Linkslenker; + DSTC		03.2125-7713.3 010819	ATE Ø 25,4
				8536→; → 01/09; für Linkslenker; - DSTC		03.2125-7743.3 010921	ATE Ø 25,4
2.4 T5	191	04/04→04/10		→ 11551; für Rechtslenker; + DSTC		03.2125-7637.3 010707	ATE Ø 25,4
				→ 01/09; für Rechtslenker; - DSTC		03.2125-7638.3 010738	ATE Ø 25,4
				11552→; → 01/09; für Rechtslenker; + DSTC		03.2125-7638.3 010738	ATE Ø 25,4
				→ 9499; für Linkslenker; + DSTC		03.2125-7708.3 010739	ATE Ø 25,4
				9500→; → 01/09; für Linkslenker; + DSTC		03.2125-7713.3 010819	ATE Ø 25,4
				→ 01/09; für Linkslenker; - DSTC		03.2125-7743.3 010921	ATE Ø 25,4
2.4 T AWD	147	06/01→04/10		11/01→; → 11551; für Rechtslenker; + DSTC		03.2125-7637.3 010707	ATE Ø 25,4
				11/01→; → 8535; - DSTC		03.2125-7637.3 010707	ATE Ø 25,4
				8536→; → 01/09; für Rechtslenker; - DSTC		03.2125-7638.3 010738	ATE Ø 25,4
				11552→; → 01/09; für Rechtslenker; + DSTC		03.2125-7638.3 010738	ATE Ø 25,4
				11/01→; → 9499; für Linkslenker; + DSTC		03.2125-7708.3 010739	ATE Ø 25,4
				9500→; → 01/09; für Linkslenker; + DSTC		03.2125-7713.3 010819	ATE Ø 25,4
				8536→; → 01/09; für Linkslenker; - DSTC		03.2125-7743.3 010921	ATE Ø 25,4
2.5 T	154	01/03→04/10		02/04→; → 11551; für Rechtslenker; + DSTC		03.2125-7637.3 010707	ATE Ø 25,4
				11552→; → 01/09; für Rechtslenker; + DSTC		03.2125-7638.3 010738	ATE Ø 25,4
				02/04→ 01/09; für Rechtslenker; - DSTC		03.2125-7638.3 010738	ATE Ø 25,4
				02/04→; → 9499; für Linkslenker; + DSTC		03.2125-7708.3 010739	ATE Ø 25,4
				9500→; → 01/09; für Linkslenker; + DSTC		03.2125-7713.3 010819	ATE Ø 25,4
				02/04→ 01/09; für Linkslenker; - DSTC		03.2125-7743.3 010921	ATE Ø 25,4
2.5 T AWD	154	07/02→04/10		04/04→; → 11551; für Rechtslenker; + DSTC		03.2125-7637.3 010707	ATE Ø 25,4
				11552→; → 01/09; für Rechtslenker; + DSTC		03.2125-7638.3 010738	ATE Ø 25,4
				04/04→ 01/09; für Rechtslenker; - DSTC		03.2125-7638.3 010738	ATE Ø 25,4
				04/04→; → 9499; für Linkslenker; + DSTC		03.2125-7708.3 010739	ATE Ø 25,4
				9500→; → 01/09; für Linkslenker; + DSTC		03.2125-7713.3 010819	ATE Ø 25,4
				04/04→ 01/09; für Linkslenker; - DSTC		03.2125-7743.3 010921	ATE Ø 25,4
R 2.5 T AWD	221	01/03→04/10		03/03→; → 11551; für Rechtslenker; + DSTC		03.2125-7637.3 010707	ATE Ø 25,4
				03/03→ 01/09; für Rechtslenker; - DSTC		03.2125-7638.3 010738	ATE Ø 25,4
↓							









	kw			 	! #		
VOLVO - S60 I (384) 07/00→04/10							
 Hauptbremszylinder							
R 2,5 T AWD	221	01/03→04/10		11552→; → 01/09; für Rechtslenker; + DSTC		03.2125-7638.3 010738	ATE Ø 25,4
				03/03→; → 9499; für Linkslenker; + DSTC		03.2125-7708.3 010739	ATE Ø 25,4
				9500→; → 01/09; für Linkslenker; + DSTC		03.2125-7713.3 010819	ATE Ø 25,4
				03/03→ 01/09; für Linkslenker; - DSTC		03.2125-7743.3 010921	ATE Ø 25,4
T5	184	07/00→04/10		08/00→; → 8535; - DSTC		03.2125-7637.3 010707	ATE Ø 25,4
				08/00→; → 11551; für Rechtslenker; + DSTC		03.2125-7637.3 010707	ATE Ø 25,4
				11552→; → 04/04; für Rechtslenker; + DSTC		03.2125-7638.3 010738	ATE Ø 25,4
				8536→; → 04/04; für Rechtslenker; - DSTC		03.2125-7638.3 010738	ATE Ø 25,4
				08/00→; → 9499; für Linkslenker; + DSTC		03.2125-7708.3 010739	ATE Ø 25,4
				9500→; → 04/04; für Linkslenker; + DSTC		03.2125-7713.3 010819	ATE Ø 25,4
				8536→; → 04/04; für Linkslenker; - DSTC		03.2125-7743.3 010921	ATE Ø 25,4
VOLVO - S60 II (134) 04/10→							
 Bremskraftverstärker							
2.0 D2	88	03/15→		für Fahrzeuge ohne Kollisionswarner		03.7755-9703.4 300239	ATE Ø 9 / 8" pneumatisch
2.0 D3	110	03/15→					
2.0 D4	140	03/15→					
2.0 D5	165	03/15→					
2.4 D4 AWD	140	03/15→					
D4	133	09/13→12/15					
2.0 T	132	05/12→12/15		12/13→; für Fahrzeuge ohne Kollisionswarner		03.7755-9703.4 300239	ATE Ø 9 / 8" pneumatisch
Pedalwegsensoren, Bremspedal							
1.5 T2	90	10/15→		für Fahrzeuge mit Kollisionswarner		03.0655-0007.2 370007	ATE
1.5 T3	112	03/15→					
2.0 D2	88	03/15→					
2.0 D3	110	03/15→					
2.0 D4	140	03/15→					
2.0 D5	165	03/15→					
2.0 T	149	04/10→12/11					
2.0 T3	112	03/15→					
2.4 D4 AWD	140	03/15→					
D3	100	05/12→12/15					
D3	120	04/10→12/14					
D4	133	09/13→12/15					
D5	151	04/10→12/11					
D5	169	04/14→12/15					
D5 AWD	151	04/10→12/11					
D5 AWD	169	04/14→12/15					
DRIVE / D2	84	01/11→12/15					
T3	110	04/10→12/15					
T4	132	04/10→12/15					
T4F	132	04/11→12/15					
T5	177	04/10→12/14					
T5	180	09/13→					
T5 AWD	180	07/14→					
T6	225	09/13→					
T6 AWD	225	09/15→					
T6 AWD	224	04/10→12/15					
T6 AWD	242	04/14→12/15					
2.0 T	132	05/12→12/15		12/13→; für Fahrzeuge mit Kollisionswarner		03.0655-0007.2 370007	ATE
2.0 T4	140	03/15→		05/15→; für Fahrzeuge mit Kollisionswarner		03.0655-0007.2 370007	ATE
D4	120	04/10→12/14		05/12→; für Fahrzeuge mit Kollisionswarner		03.0655-0007.2 370007	ATE
D5	158	04/11→12/15		06/11→; für Fahrzeuge mit Kollisionswarner		03.0655-0007.2 370007	ATE
D5 AWD	158	04/11→12/15					
VOLVO - S70 (874) 11/96→11/00							
 Bremskraftverstärker							
2.0	93	01/97→11/00		für Linkslenker		03.7760-3602.4 300176	ATE Ø 10" pneumatisch
2.0	105	01/97→11/00					
2.0	120	01/97→11/00					
2.0	132	01/97→11/00					
2.0 Turbo	155	01/97→11/00					
2.0 Turbo	166	01/97→11/00					
↓							









	kW			 	! #		
VOLVO - S70 (874) 11/96→11/00							
Bremskraftverstärker							
2.3 T-5	176	01/97→11/00		für Linkslenker		03.7760-3602.4 300176	ATE Ø 10" pneumatisch
2.3 Turbo	184	01/97→11/00					
2.4	103	08/99→11/00					
2.4	106	01/97→11/00					
2.4	121	06/98→11/00					
2.4	125	01/97→11/00					
2.4 AWD	121	10/98→05/99					
2.4 Bifuel	103	07/99→11/00					
2.4 Bifuel	106	10/98→11/00					
2.4 T5 AWD	142	11/96→04/99					
2.4 Turbo	142	01/97→11/00					
2.5 TDI	103	01/97→11/00					
2.4 AWD	125	04/99→09/00		→ 05/99; für Linkslenker		03.7760-3602.4 300176	ATE Ø 10" pneumatisch
Hauptbremszylinder							
2.0	93	01/97→11/00		→ 12/98; + ASR		03.2023-1044.3 010590	ATE Ø1 23,81 Ø2 20,64
2.0	105	01/97→11/00		→ 12/98; - ASR		03.2023-1084.3 010591	ATE Ø1 23,81 Ø2 20,64
2.0	120	01/97→11/00					
2.0	132	01/97→11/00		01/99→		03.2123-2164.3 010599	ATE Ø 23,81
2.0 Turbo	155	01/97→11/00					
2.0 Turbo	166	01/97→11/00					
2.3 T-5	176	01/97→11/00					
2.3 Turbo	184	01/97→11/00					
2.4	106	01/97→11/00					
2.4	121	06/98→11/00					
2.4	125	01/97→11/00					
2.4 AWD	121	10/98→05/99					
2.4 Bifuel	106	10/98→11/00					
2.4 T5 AWD	142	11/96→04/99					
2.4 Turbo	142	01/97→11/00					
2.5 TDI	103	01/97→11/00					
2.4	103	08/99→11/00				03.2123-2164.3 010599	ATE Ø 23,81
2.4 Bifuel	103	07/99→11/00					
2.4 AWD	125	04/99→09/00		→ 05/99		03.2123-2164.3 010599	ATE Ø 23,81
VOLVO - S80 I (184) 05/98→02/08							
Bremskraftverstärker							
2.0	120	06/98→07/06		→ 12/01; - DSTC		03.7755-3402.4 300189	ATE Ø 9 / 8" pneumatisch
2.0 T	132	12/99→07/06		01/02→ 02/06; - DSTC		03.7755-4702.4 300224	ATE Ø 9 / 8" pneumatisch
2.0 T	166	06/98→07/06					
2.4	103	01/99→07/06		01/02→ 02/06; + DSTC		03.7858-3532.4 300233	ATE Ø 9 / 8" pneumatisch
2.4	125	01/99→07/06					
2.4 Bifuel (CNG)	103	09/01→07/06					
2.4 Bifuel (LPG)	103	09/01→07/06					
2.4 D	96	10/01→07/06					
2.4 D5	120	08/01→07/06					
2.4 T	147	06/00→07/06					
2.5 TDI	103	01/99→07/06					
2.8 T6	200	05/98→07/06					
2.9	147	03/99→07/06					
2.9	150	05/98→07/06					
3.0	144	06/01→07/06					
3.0 T6	200	06/01→07/06					
2.5 T	154	03/03→07/06		07/03→ 02/06; - DSTC		03.7755-4702.4 300224	ATE Ø 9 / 8" pneumatisch
				07/03→ 02/06; + DSTC		03.7858-3532.4 300233	ATE Ø 9 / 8" pneumatisch
2.5 T AWD	154	07/03→07/06		→ 02/06; - DSTC		03.7755-4702.4 300224	ATE Ø 9 / 8" pneumatisch
				→ 02/06; + DSTC		03.7858-3532.4 300233	ATE Ø 9 / 8" pneumatisch
Pedalwegsensor, Bremspedal							
2.0	120	06/98→07/06		→ 12/01		03.0655-0004.2 370004	ATE
2.0 T	132	12/99→07/06					
2.0 T	166	06/98→07/06		01/02→ 02/06		03.0655-0005.2 370005	ATE
2.4	103	01/99→07/06					
2.4	125	01/99→07/06					
2.4 Bifuel (CNG)	103	09/01→07/06					
2.4 Bifuel (LPG)	103	09/01→07/06					
2.4 D	96	10/01→07/06					
2.4 D5	120	08/01→07/06					
2.4 T	147	06/00→07/06					
2.5 TDI	103	01/99→07/06					
2.8 T6	200	05/98→07/06					
2.9	147	03/99→07/06					
2.9	150	05/98→07/06					
3.0	144	06/01→07/06					
3.0 T6	200	06/01→07/06					
2.5 T	154	03/03→07/06		07/03→ 02/06		03.0655-0005.2 370005	ATE
2.5 T AWD	154	07/03→07/06		→ 02/06		03.0655-0005.2 370005	ATE
↓							









	kW					! #		
VOLVO - S80 I (184) 05/98→02/08								
Hauptbremszylinder								
2.0	120	06/98→07/06		→ 174095; - DSTC			03.2125-7637.3 010707	ATE Ø 25,4
2.0 T	166	06/98→07/06		→ 02/06; 174096→; für Rechtslenker			03.2125-7638.3 010738	ATE Ø 25,4
2.4	103	01/99→07/06						
2.4	125	01/99→07/06		→ 174095; + DSTC			03.2125-7708.3 010739	ATE Ø 25,4
2.5 TDI	103	01/99→07/06		→ 02/06; 174096→; für Linkslenker;			03.2125-7713.3 010819	ATE Ø 25,4
2.8 T6	200	05/98→07/06		+ DSTC				
2.9	147	03/99→07/06		→ 02/06; 174096→; für Linkslenker;			03.2125-7743.3 010921	ATE Ø 25,4
2.9	150	05/98→07/06		- DSTC				
2.0 T	132	12/99→07/06		→ 02/06; für Rechtslenker			03.2125-7638.3 010738	ATE Ø 25,4
2.4 Bifuel (CNG)	103	09/01→07/06		→ 02/06; für Linkslenker; + DSTC			03.2125-7713.3 010819	ATE Ø 25,4
2.4 Bifuel (LPG)	103	09/01→07/06						
2.4 D	96	10/01→07/06		→ 02/06; für Linkslenker; - DSTC			03.2125-7743.3 010921	ATE Ø 25,4
2.4 D5	120	08/01→07/06						
2.4 T	147	06/00→07/06						
2.5 T AWD	154	07/03→07/06						
3.0	144	06/01→07/06						
3.0 T6	200	06/01→07/06						
2.5 T	154	03/03→07/06		07/03→ 02/06; für Rechtslenker			03.2125-7638.3 010738	ATE Ø 25,4
				07/03→ 02/06; für Linkslenker; + DSTC			03.2125-7713.3 010819	ATE Ø 25,4
				07/03→ 02/06; für Linkslenker; - DSTC			03.2125-7743.3 010921	ATE Ø 25,4
VOLVO - S80 II (124) 03/06→								
Bremskraftverstärker								
1.6 D DRIVe	80	01/10→12/11		für Linkslenker;			03.7755-9703.4 300239	ATE Ø 9 / 8" pneumatisch
1.6 DRIVe	84	06/11→		für Fahrzeuge ohne Kollisionswarner				
D3 / D4	120	01/10→		für Linkslenker; → 151000;			03.7858-5032.4 300275	ATE Ø 9 / 8" pneumatisch
				für Fahrzeuge mit Kollisionswarner				
2.0	107	01/08→09/12		für Linkslenker;			03.7755-9703.4 300239	ATE Ø 9 / 8" pneumatisch
2.0 FlexFuel	107	01/08→12/11		für Fahrzeuge ohne Kollisionswarner				
2.0 T	149	01/10→		für Linkslenker;			03.7858-4832.4 300274	ATE Ø 9 / 8" pneumatisch
2.0 TDi	100	02/08→03/11		für Fahrzeuge mit Kollisionswarner				
2.4 D	120	03/06→						
2.4 D	129	01/10→03/11						
2.5 T	147	03/06→12/11						
2.5 T FlexFuel	147	05/08→12/11						
3.2	175	03/06→						
3.2	179	01/10→						
3.2 AWD	175	01/07→12/10						
3.2 AWD	179	01/10→12/12						
D5	136	03/06→						
D5	151	01/10→						
D5 AWD	136	01/07→						
D5 AWD	151	01/10→						
T6 AWD	210	01/07→12/10						
2.5 T	170	01/10→12/12		für Fahrzeuge ohne Kollisionswarner			03.7755-9703.4 300239	ATE Ø 9 / 8" pneumatisch
2.5 T FlexFuel	170	01/10→12/11		→ 151000;			03.7858-5032.4 300275	ATE Ø 9 / 8" pneumatisch
D3	100	05/12→		für Fahrzeuge mit Kollisionswarner				
D5	158	06/11→						
D5 AWD	158	06/11→						
T4	132	10/10→						
T4F	132	05/11→						
T6 AWD	224	10/10→12/16						
2.5 T	187	01/12→		für Fahrzeuge ohne Kollisionswarner			03.7755-9703.4 300239	ATE Ø 9 / 8" pneumatisch
D4	133	09/13→						
T5	177	10/10→		für Linkslenker;			03.7755-9703.4 300239	ATE Ø 9 / 8" pneumatisch
T5	180	09/13→		für Fahrzeuge ohne Kollisionswarner				
				für Rechtslenker;			03.7858-4832.4 300274	ATE Ø 9 / 8" pneumatisch
				für Fahrzeuge mit Kollisionswarner				
				für Linkslenker;			03.7858-5032.4 300275	ATE Ø 9 / 8" pneumatisch
				für Fahrzeuge mit Kollisionswarner				
Pedalwegsensoren, Bremspedal								
1.6 D DRIVe	80	01/10→12/11		für Linkslenker; → 151000			03.0655-0007.2 370007	ATE
1.6 DRIVe	84	06/11→		für Rechtslenker			03.0655-0007.2 370007	ATE
D3 / D4	120	01/10→		151001→; für Linkslenker;			03.0655-0007.2 370007	ATE
				für Fahrzeuge mit Kollisionswarner				
2.0	107	01/08→09/12		für Linkslenker;			03.0655-0007.2 370007	ATE
2.0 FlexFuel	107	01/08→12/11		für Fahrzeuge mit Kollisionswarner				
2.0 T	149	01/10→		für Rechtslenker			03.0655-0007.2 370007	ATE
2.0 TDi	100	02/08→03/11						
2.4 D	120	03/06→						
2.4 D	129	01/10→03/11						
2.5 T	147	03/06→12/11						
2.5 T FlexFuel	147	05/08→12/11						
3.2	175	03/06→						
3.2	179	01/10→						
3.2 AWD	175	01/07→12/10						
3.2 AWD	179	01/10→12/12						









	kw			 	! #		
VOLVO - S80 II (124) 03/06→							
Pedalwegsensoren, Bremspedal							
D5	136	03/06→		für Linkslenker;		03.0655-0007.2 370007	ATE
D5	151	01/10→		für Fahrzeuge mit Kollisionswarner			
D5 AWD	136	01/07→				03.0655-0007.2 370007	ATE
D5 AWD	151	01/10→		für Rechtslenker			
T6 AWD	210	01/07→12/10					
2.5 T	170	01/10→12/12		151001→;		03.0655-0007.2 370007	ATE
2.5 T FlexFuel	170	01/10→12/11		für Fahrzeuge mit Kollisionswarner			
D3	100	05/12→		→ 151000		03.0655-0007.2 370007	ATE
D5	158	06/11→					
D5 AWD	158	06/11→					
T4	132	10/10→					
T4F	132	05/11→					
T6 AWD	224	10/10→12/16					
2.5 T	187	01/12→		für Fahrzeuge mit Kollisionswarner		03.0655-0007.2 370007	ATE
D4	133	09/13→					
T5	177	10/10→					
T5	180	09/13→					
VOLVO - S90 (964) 11/96→12/98							
 Hauptbremszylinder							
2.9	132	01/97→05/98				03.2023-0875.3 010890	ATE Ø1 23,81 Ø2 20,64
2.9	150	01/97→05/98					ohne Bremsflüssigkeitsbehälter
VOLVO - V40 Kombi (645) 07/95→06/04							
 Hauptbremszylinder							
1.6	77	12/95→08/99		→ 08/97		24.2122-1718.3 010517	Ø 22,2
1.8	85	07/95→08/99				24.2123-1746.3 010682	Ø 23,81
1.9 TD	66	07/95→08/99		09/97→			
2.0	100	07/95→06/04					
2.0	103	07/95→08/99					
1.6	80	03/99→06/04				24.2123-1746.3 010682	Ø 23,81
1.8	90	03/99→06/04					
1.8 i	90	06/01→06/04					
1.8 i	92	03/98→06/04					
1.9 DI	70	03/99→07/00					
1.9 DI	75	07/00→06/04					
1.9 DI	85	07/00→06/04					
2.0 T	118	10/97→07/00					
2.0 T	120	06/01→06/04					
1.9 T4	147	05/97→07/00		→ 08/97; + ABS		24.2122-1718.3 010517	Ø 22,2
				09/97→		24.2123-1746.3 010682	Ø 23,81
2.0 T	121	07/99→06/04		07/00→ 06/01		24.2123-1746.3 010682	Ø 23,81
2.0 T4	147	07/00→06/04		→ 04/04		24.2123-1746.3 010682	Ø 23,81
VOLVO - V40 Schrägheck (525, 526) 03/12→							
 Hauptbremszylinder							
D2	84	03/12→		09/12→;		03.2125-5016.3 011010	ATE Ø 25,4
D3	110	03/12→03/15		für Fahrzeuge ohne Kollisionswarner			
D4	130	03/12→					
T3 GTDi	110	03/12→					
T4 GTDi	132	03/12→					
D3	110	04/15→		für Fahrzeuge ohne Kollisionswarner		03.2125-5016.3 011010	ATE Ø 25,4
T4	132	07/13→					
VOLVO - V50 (545) 12/03→12/12							
 Bremskraftverstärker							
1.6	74	01/05→12/12		→ 05/12; für Linkslenker		03.7863-4832.4 300289	ATE Ø 10" pneumatisch
1.6 D	80	03/05→					
2.0	107	10/06→12/12					
2.0 FlexFuel	107	01/10→12/12					
T5	169	03/07→12/12					
1.6 D	81	01/05→12/11		für Linkslenker		03.7863-4832.4 300289	ATE Ø 10" pneumatisch
1.8	92	04/04→12/10					
2.0 D	100	04/04→12/10					
2.4	103	04/04→12/10					
2.4	125	04/04→12/10					
2.4 D5	132	03/06→12/10					
2.4 Tdi	120	05/07→12/10					
T5	162	04/04→12/07					
T5 AWD	162	04/04→12/07					
T5 AWD	169	03/07→12/10					
1.8 FlexFuel	92	01/05→12/10		04/07→; für Linkslenker		03.7863-4832.4 300289	ATE Ø 10" pneumatisch
Pedalwegsensoren, Bremspedal							
1.6	74	01/05→12/12		→ 05/12		03.0655-0007.2 370007	ATE
1.6 D	80	03/05→					
↓							







	kW			 	! #		
VOLVO - V50 (545) 12/03→12/12							
Pedalwegsensord, Bremspedal							
2.0	107	01/06→12/12		→ 05/12		03.0655-0007.2 370007	ATE
2.0 FlexFuel	107	01/10→12/12					
T5	169	03/07→12/12					
1.6 D	81	01/05→12/11				03.0655-0007.2 370007	ATE
1.8	92	04/04→12/10					
2.0 D	100	04/04→12/10					
2.4	103	04/04→12/10					
2.4	125	04/04→12/10					
2.4 D5	132	03/06→12/10					
2.4 Tdi	120	05/07→12/10					
T5	162	04/04→12/07					
T5 AWD	162	04/04→12/07					
T5 AWD	169	03/07→12/10					
1.8 FlexFuel	92	01/05→12/10		04/07→		03.0655-0007.2 370007	ATE
 Hauptbremszylinder							
1.6	74	01/05→12/12		→ 05/12; für Linkslenker		03.2123-3593.3 010919	ATE Ø 23,81
1.6 D	80	03/05→					
2.0	107	10/06→12/12					
2.0 FlexFuel	107	01/10→12/12					
T5	169	03/07→12/12					
1.6 D	81	01/05→12/11		für Linkslenker		03.2123-3593.3 010919	ATE Ø 23,81
1.8	92	04/04→12/10					
2.0 D	100	04/04→12/10					
2.4	103	04/04→12/10					
2.4	125	04/04→12/10					
2.4 D5	132	03/06→12/10					
2.4 Tdi	120	05/07→12/10					
T5	162	04/04→12/07					
T5 AWD	162	04/04→12/07					
T5 AWD	169	03/07→12/10					
1.6 D2	84	01/10→12/12		→ 05/12; für Linkslenker		03.2123-3624.3 010956	ATE Ø 23,81
D3	110	10/10→12/12					
D4	130	10/10→12/12					
1.8 FlexFuel	92	01/05→12/10		04/07→; für Linkslenker		03.2123-3593.3 010919	ATE Ø 23,81
Hydraulikaggregat, Bremsanlage							
1.6	74	01/05→12/12		→ 520022; für Linkslenker; + DSTC; nicht für Getriebetyp: MPS6		24.9145-0005.2 399009	
1.6 D	80	03/05→					
1.6 D2	84	01/10→12/12		520023→; → 05/12; für Linkslenker; + DSTC; nicht für Getriebetyp: MPS6		24.9145-0005.2 399009	
2.0	107	10/06→12/12					
2.0 FlexFuel	107	01/10→12/12					
D3	110	10/10→12/12		→ 05/12; + DSTC; Getriebetyp: MPS6		24.9145-0005.2 399009	
D4	130	10/10→12/12					
T5	169	03/07→12/12					
1.6 D	81	01/05→12/11		→ 520022; für Linkslenker; + DSTC; nicht für Getriebetyp: MPS6		24.9145-0005.2 399009	
1.8	92	04/04→12/10					
2.0 D	100	04/04→12/10		520023→; für Linkslenker; + DSTC; nicht für Getriebetyp: MPS6		24.9145-0005.2 399009	
2.4	103	04/04→12/10					
2.4	125	04/04→12/10					
2.4 D5	132	03/06→12/10		+ DSTC; Getriebetyp: MPS6		24.9145-0005.2 399009	
2.4 Tdi	120	05/07→12/10					
T5	162	04/04→12/07					
T5 AWD	162	04/04→12/07					
T5 AWD	169	03/07→12/10					
1.8 FlexFuel	92	01/05→12/10		520023→; für Linkslenker; + DSTC; nicht für Getriebetyp: MPS6		24.9145-0005.2 399009	
				04/07→; → 520022; für Linkslenker; + DSTC; nicht für Getriebetyp: MPS6		24.9145-0005.2 399009	
				04/07→; + DSTC; Getriebetyp: MPS6		24.9145-0005.2 399009	
VOLVO - V60 (155, 157) 07/10→							
 Bremskraftverstärker							
2.0 D2	88	03/15→		für Fahrzeuge ohne Kollisionswarner		03.7755-9703.4 300239	ATE Ø 9 / 8" pneumatisch
2.0 D3	110	03/15→					
2.0 D4	140	03/15→					
D4	133	10/13→12/15					
D4 AWD	133	10/13→12/15					
D4 AWD	140	03/15→					
D5	165	03/15→					
D6 Hybrid AWD	162	03/15→					
T6 AWD	242	04/14→12/15					
3.0 T AWD	258	04/14→		05/14→; für Fahrzeuge ohne Kollisionswarner		03.7755-9703.4 300239	ATE Ø 9 / 8" pneumatisch
D4 AWD	120	05/12→		12/12→; für Fahrzeuge ohne Kollisionswarner		03.7755-9703.4 300239	ATE Ø 9 / 8" pneumatisch
T5	157	10/13→		04/14→; für Fahrzeuge ohne Kollisionswarner		03.7755-9703.4 300239	ATE Ø 9 / 8" pneumatisch
↓							









	kW			 	! #		
VOLVO - V60 (155, 157) 07/10→							
Pedalwegsensord, Bremspedal							
1.5 T2	90	10/15→		01/16→; für Fahrzeuge mit Kollisionswarner		03.0655-0007.2 370007	ATE
1.6 DRiVe	84	02/11→12/15		06/11→; für Fahrzeuge mit Kollisionswarner		03.0655-0007.2 370007	ATE
2.4 D5	158	04/11→12/15					
2.4 D5 AWD	158	04/11→12/15					
2.0 D2	88	03/15→		für Fahrzeuge mit Kollisionswarner		03.0655-0007.2 370007	ATE
2.0 D3	110	03/15→					
2.0 D4	140	03/15→					
D4	133	10/13→12/15					
D4 AWD	133	10/13→12/15					
D4 AWD	140	03/15→					
D5	165	03/15→					
D5	169	04/14→12/15					
D5 AWD	169	04/14→12/15					
D6 Hybrid AWD	162	03/15→					
T3	112	03/15→					
T4F	132	04/11→12/15					
T5	180	10/13→					
T6	225	10/13→					
T6 AWD	225	10/13→					
T6 AWD	242	04/14→12/15					
2.0 T	149	07/10→12/12		11/10→; für Fahrzeuge mit Kollisionswarner		03.0655-0007.2 370007	ATE
D3 / D4	120	07/10→12/14					
D5	151	07/10→12/11					
D5 AWD	151	07/10→12/11					
T3	110	09/10→12/15					
T4	132	09/10→12/15					
T5	177	09/10→12/14					
T6 AWD	224	07/10→12/15					
2.0 T4	140	03/15→		05/15→; für Fahrzeuge mit Kollisionswarner		03.0655-0007.2 370007	ATE
2.4 Hybrid D6 AWD	158	06/12→12/15		11/12→; für Fahrzeuge mit Kollisionswarner		03.0655-0007.2 370007	ATE
D3	100	05/12→12/15		10/12→; für Fahrzeuge mit Kollisionswarner		03.0655-0007.2 370007	ATE
D4 AWD	120	05/12→		12/12→; für Fahrzeuge mit Kollisionswarner		03.0655-0007.2 370007	ATE
T5	157	10/13→		04/14→; für Fahrzeuge mit Kollisionswarner		03.0655-0007.2 370007	ATE
VOLVO - V70 I (875, 876) 12/95→12/00							
 Bremskraftverstärker							
2.0	93	12/95→03/00		01/97→; für Linkslenker		03.7760-3602.4 300176	ATE Ø 10" pneumatisch
2.0	105	12/95→03/00					
2.0	132	11/96→03/00					
2.0 Turbo	155	12/95→03/00					
2.3 Turbo	184	12/95→03/00					
2.4	106	12/95→03/00					
2.0	120	01/97→12/00		→ 03/00; für Linkslenker		03.7760-3602.4 300176	ATE Ø 10" pneumatisch
2.3 T-5 AWD	176	01/97→12/00					
2.4 Bifuel	103	08/99→12/00					
2.4 Turbo AWD	195	03/99→12/00					
2.0 Turbo	166	11/96→12/00		01/97→ 03/00; für Linkslenker		03.7760-3602.4 300176	ATE Ø 10" pneumatisch
2.0 Turbo AWD	166	11/96→12/00					
2.3 T-5	176	11/96→12/00					
2.4	125	12/95→05/00					
2.4 Turbo	142	04/96→12/00					
2.4 Turbo AWD	142	04/96→12/00					
2.5 TDI	103	12/95→12/00					
2.3 T AWD	184	04/97→03/00		für Linkslenker		03.7760-3602.4 300176	ATE Ø 10" pneumatisch
2.4	121	06/98→12/99					
2.4	103	03/99→12/00		08/99→ 03/00; für Linkslenker		03.7760-3602.4 300176	ATE Ø 10" pneumatisch
2.4 AWD	121	06/98→12/99		10/98→ 05/99; für Linkslenker		03.7760-3602.4 300176	ATE Ø 10" pneumatisch
2.4 Bifuel	106	05/98→12/99		10/98→ 08/99; für Linkslenker		03.7760-3602.4 300176	ATE Ø 10" pneumatisch
 Hauptbremszylinder							
2.0	93	12/95→03/00		01/97→ 12/98; + ASR		03.2023-1044.3 010590	ATE Ø1 23,81 Ø2 20,64
2.0	105	12/95→03/00		01/97→ 12/98; - ASR		03.2023-1084.3 010591	ATE Ø1 23,81 Ø2 20,64
2.0	132	11/96→03/00					
2.0 Turbo	155	12/95→03/00		01/99→		03.2123-2164.3 010599	ATE Ø 23,81
2.3 Turbo	184	12/95→03/00					
2.4	106	12/95→03/00					
2.0	120	01/97→12/00		→ 12/98; + ASR		03.2023-1044.3 010590	ATE Ø1 23,81 Ø2 20,64
2.3 T-5 AWD	176	01/97→12/00		→ 12/98; - ASR		03.2023-1084.3 010591	ATE Ø1 23,81 Ø2 20,64
				01/99→ 03/00		03.2123-2164.3 010599	ATE Ø 23,81
2.0 Turbo	166	11/96→12/00		01/97→ 12/98; + ASR		03.2023-1044.3 010590	ATE Ø1 23,81 Ø2 20,64
2.0 Turbo AWD	166	11/96→12/00		01/97→ 12/98; - ASR		03.2023-1084.3 010591	ATE Ø1 23,81 Ø2 20,64
↓							









	kw			 	! #		
VOLVO - V70 I (875, 876) 12/95→12/00							
 Hauptbremszylinder							
2.3 T-5 2.4 2.4 Turbo 2.4 Turbo AWD 2.5 TDI	176 125 142 142 103	11/96→12/00 12/95→05/00 04/96→12/00 04/96→12/00 12/95→12/00		01/99→ 03/00		03.2123-2164.3 010599	ATE Ø 23,81
2.3 T AWD 2.4	184 121	04/97→03/00 06/98→12/99		→ 12/98; + ASR → 12/98; - ASR		03.2023-1044.3 010590 03.2023-1084.3 010591	ATE Ø1 23,81 Ø2 20,64 ATE Ø1 23,81 Ø2 20,64
				01/99→		03.2123-2164.3 010599	ATE Ø 23,81
2.4	103	03/99→12/00		08/99→ 03/00		03.2123-2164.3 010599	ATE Ø 23,81
2.4 AWD	121	06/98→12/99		10/98→ 12/98; + ASR 10/98→ 05/99; - ASR		03.2023-1044.3 010590 03.2023-1084.3 010591	ATE Ø1 23,81 Ø2 20,64 ATE Ø1 23,81 Ø2 20,64
				01/99→ 05/99		03.2123-2164.3 010599	ATE Ø 23,81
2.4 Bifuel 2.4 Turbo AWD	103 195	08/99→12/00 03/99→12/00		→ 03/00		03.2123-2164.3 010599	ATE Ø 23,81
2.4 Bifuel	106	05/98→12/99		10/98→ 12/98; + ASR 10/98→ 12/98; - ASR		03.2023-1044.3 010590 03.2023-1084.3 010591	ATE Ø1 23,81 Ø2 20,64 ATE Ø1 23,81 Ø2 20,64
				01/99→ 08/99		03.2123-2164.3 010599	ATE Ø 23,81
VOLVO - V70 II (285) 11/99→12/08							
 Bremskraftverstärker							
2.0 T	132	11/99→08/07		07/01→ 12/01; - DSTC 01/02→ 07/07; - DSTC 01/02→ 07/07; + DSTC		03.7755-3402.4 300189 03.7755-4702.4 300224 03.7858-3532.4 300233	ATE Ø 9 / 8" pneumatisch ATE Ø 9 / 8" pneumatisch ATE Ø 9 / 8" pneumatisch
2.3 T5 2.4 T	184 147	11/99→12/04 11/99→08/03		03/00→ 12/01; - DSTC 01/02→; - DSTC 01/02→; + DSTC		03.7755-3402.4 300189 03.7755-4702.4 300224 03.7858-3532.4 300233	ATE Ø 9 / 8" pneumatisch ATE Ø 9 / 8" pneumatisch ATE Ø 9 / 8" pneumatisch
2.4 2.4 2.4 Bifuel (CNG) 2.4 Bifuel (LPG)	103 125 103 103	03/00→08/07 03/00→08/07 09/01→08/07 09/01→08/07		→ 12/01; - DSTC 01/02→ 07/07; - DSTC 01/02→ 07/07; + DSTC		03.7755-3402.4 300189 03.7755-4702.4 300224 03.7858-3532.4 300233	ATE Ø 9 / 8" pneumatisch ATE Ø 9 / 8" pneumatisch ATE Ø 9 / 8" pneumatisch
2.4 D	93	04/05→12/08		05/05→ 07/07; - DSTC 05/05→ 07/07; + DSTC		03.7755-4702.4 300224 03.7858-3532.4 300233	ATE Ø 9 / 8" pneumatisch ATE Ø 9 / 8" pneumatisch
2.4 D	96	07/01→08/07		12/01→ 12/01; - DSTC 01/02→ 07/07; - DSTC 01/02→ 07/07; + DSTC		03.7755-3402.4 300189 03.7755-4702.4 300224 03.7858-3532.4 300233	ATE Ø 9 / 8" pneumatisch ATE Ø 9 / 8" pneumatisch ATE Ø 9 / 8" pneumatisch
2.4 D5	120	01/01→12/08		08/01→ 12/01; - DSTC 01/02→ 07/07; - DSTC 01/02→ 07/07; + DSTC		03.7755-3402.4 300189 03.7755-4702.4 300224 03.7858-3532.4 300233	ATE Ø 9 / 8" pneumatisch ATE Ø 9 / 8" pneumatisch ATE Ø 9 / 8" pneumatisch
2.4 D5 2.4 D5 AWD	136 136	04/05→12/08 05/05→08/07		12/05→ 07/07; - DSTC 12/05→ 07/07; + DSTC		03.7755-4702.4 300224 03.7858-3532.4 300233	ATE Ø 9 / 8" pneumatisch ATE Ø 9 / 8" pneumatisch
2.4 D5 AWD	120	07/02→08/07		03/03→ 07/07; - DSTC 03/03→ 07/07; + DSTC		03.7755-4702.4 300224 03.7858-3532.4 300233	ATE Ø 9 / 8" pneumatisch ATE Ø 9 / 8" pneumatisch
2.4 T5 R 2,5 T AWD	191 221	04/04→08/07 03/03→08/07		→ 07/07; - DSTC → 07/07; + DSTC		03.7755-4702.4 300224 03.7858-3532.4 300233	ATE Ø 9 / 8" pneumatisch ATE Ø 9 / 8" pneumatisch
2.4 T AWD	147	09/01→08/02		→ 12/01; - DSTC 01/02→; - DSTC 01/02→; + DSTC		03.7755-3402.4 300189 03.7755-4702.4 300224 03.7858-3532.4 300233	ATE Ø 9 / 8" pneumatisch ATE Ø 9 / 8" pneumatisch ATE Ø 9 / 8" pneumatisch
2.5 T	154	07/01→08/07		04/04→ 07/07; - DSTC 04/04→ 07/07; + DSTC		03.7755-4702.4 300224 03.7858-3532.4 300233	ATE Ø 9 / 8" pneumatisch ATE Ø 9 / 8" pneumatisch
2.5 T AWD	154	07/02→08/07		09/02→ 07/07; - DSTC 09/02→ 07/07; + DSTC		03.7755-4702.4 300224 03.7858-3532.4 300233	ATE Ø 9 / 8" pneumatisch ATE Ø 9 / 8" pneumatisch
2.5 TDI	103	11/99→08/07		03/00→ 12/01; - DSTC 01/02→ 07/07; - DSTC 01/02→ 07/07; + DSTC		03.7755-3402.4 300189 03.7755-4702.4 300224 03.7858-3532.4 300233	ATE Ø 9 / 8" pneumatisch ATE Ø 9 / 8" pneumatisch ATE Ø 9 / 8" pneumatisch
Pedalwegsensor, Bremspedal							
2.0 T	132	11/99→08/07		07/01→ 12/01 01/05→ 07/07 01/02→ 07/07		03.0655-0004.2 370004 03.0655-0005.2 370005 03.0655-0005.2 370005	ATE ATE ATE
2.3 T5 2.4 T	184 147	11/99→12/04 11/99→08/03		03/00→ 12/01 01/02→		03.0655-0004.2 370004 03.0655-0005.2 370005	ATE ATE
2.4 2.4 2.4 Bifuel (CNG) ↓	103 125 103	03/00→08/07 03/00→08/07 09/01→08/07		→ 12/01 01/05→ 07/07		03.0655-0004.2 370004 03.0655-0005.2 370005	ATE ATE











	kw			 	! #		
VOLVO - V70 II (285) 11/99→12/08							
Pedalwegsensord, Bremspedal							
2.4 Bifuel (LPG)	103	09/01→08/07		01/02→ 07/07		03.0655-0005.2 370005	ATE
2.4 D	93	04/05→12/08		05/05→ 07/07		03.0655-0005.2 370005	ATE
2.4 D	96	07/01→08/07		12/01→ 12/01		03.0655-0004.2 370004	ATE
				01/05→ 07/07		03.0655-0005.2 370005	ATE
				01/02→ 07/07		03.0655-0005.2 370005	ATE
2.4 D5	120	01/01→12/08		08/01→ 12/01		03.0655-0004.2 370004	ATE
				01/05→ 07/07		03.0655-0005.2 370005	ATE
				01/02→ 07/07		03.0655-0005.2 370005	ATE
2.4 D5	136	04/05→12/08		12/05→ 07/07		03.0655-0005.2 370005	ATE
2.4 D5 AWD	136	05/05→08/07					
2.4 D5 AWD	120	07/02→08/07		01/05→ 07/07		03.0655-0005.2 370005	ATE
				03/03→ 07/07		03.0655-0005.2 370005	ATE
2.4 T5 R 2.5 T AWD	191 221	04/04→08/07 03/03→08/07		→ 07/07		03.0655-0005.2 370005	ATE
				01/05→ 07/07		03.0655-0005.2 370005	ATE
2.4 T AWD	147	09/01→08/02		→ 12/01		03.0655-0004.2 370004	ATE
				01/02→		03.0655-0005.2 370005	ATE
2.5 T	154	07/01→08/07		01/05→ 07/07		03.0655-0005.2 370005	ATE
				04/04→ 07/07		03.0655-0005.2 370005	ATE
2.5 T AWD	154	07/02→08/07		01/05→ 07/07		03.0655-0005.2 370005	ATE
				09/02→ 07/07		03.0655-0005.2 370005	ATE
2.5 TDI	103	11/99→08/07		03/00→ 12/01		03.0655-0004.2 370004	ATE
				01/05→ 07/07		03.0655-0005.2 370005	ATE
				01/02→ 07/07		03.0655-0005.2 370005	ATE
 Hauptbremszylinder							
2.0 T	132	11/99→08/07		07/01→; → 67770; für Rechtslenker; + DSTC		03.2125-7637.3 010707	ATE Ø 25,4
				07/01→; → 68132; - DSTC		03.2125-7637.3 010707	ATE Ø 25,4
				68133→; → 07/07; für Rechtslenker; - DSTC		03.2125-7638.3 010738	ATE Ø 25,4
				67771→; → 07/07; für Rechtslenker; + DSTC		03.2125-7638.3 010738	ATE Ø 25,4
				07/01→; → 70377; für Linkslenker; + DSTC		03.2125-7708.3 010739	ATE Ø 25,4
				70378→; → 07/07; für Linkslenker; + DSTC		03.2125-7713.3 010819	ATE Ø 25,4
				68133→; → 07/07; für Linkslenker; - DSTC		03.2125-7743.3 010921	ATE Ø 25,4
2.3 T5	184	11/99→12/04		03/00→; → 68132; - DSTC		03.2125-7637.3 010707	ATE Ø 25,4
2.4 T	147	11/99→08/03		03/00→; → 67770; für Rechtslenker; + DSTC		03.2125-7637.3 010707	ATE Ø 25,4
				68133→; für Rechtslenker; - DSTC		03.2125-7638.3 010738	ATE Ø 25,4
				67771→; für Rechtslenker; + DSTC		03.2125-7638.3 010738	ATE Ø 25,4
				03/00→; → 70377; für Linkslenker; + DSTC		03.2125-7708.3 010739	ATE Ø 25,4
				70378→; für Linkslenker; + DSTC		03.2125-7713.3 010819	ATE Ø 25,4
				68133→; für Linkslenker; - DSTC		03.2125-7743.3 010921	ATE Ø 25,4
2.4	103	03/00→08/07		→ 67770; für Rechtslenker; + DSTC		03.2125-7637.3 010707	ATE Ø 25,4
2.4	125	03/00→08/07		→ 68132; - DSTC		03.2125-7637.3 010707	ATE Ø 25,4
2.4 Bifuel (CNG)	103	09/01→08/07					
2.4 Bifuel (LPG)	103	09/01→08/07		68133→; → 07/07; für Rechtslenker; - DSTC		03.2125-7638.3 010738	ATE Ø 25,4
				67771→; → 07/07; für Rechtslenker; + DSTC		03.2125-7638.3 010738	ATE Ø 25,4
				→ 70377; für Linkslenker; + DSTC		03.2125-7708.3 010739	ATE Ø 25,4
				70378→; → 07/07; für Linkslenker; + DSTC		03.2125-7713.3 010819	ATE Ø 25,4
				68133→; → 07/07; für Linkslenker; - DSTC		03.2125-7743.3 010921	ATE Ø 25,4
2.4 D	93	04/05→12/08		05/05→ 07/07; für Rechtslenker		03.2125-7638.3 010738	ATE Ø 25,4
				05/05→ 07/07; für Linkslenker; + DSTC		03.2125-7713.3 010819	ATE Ø 25,4
				05/05→ 07/07; für Linkslenker; - DSTC		03.2125-7743.3 010921	ATE Ø 25,4
2.4 D	96	07/01→08/07		12/01→; → 67770; für Rechtslenker; + DSTC		03.2125-7637.3 010707	ATE Ø 25,4
				12/01→; → 68132; - DSTC		03.2125-7637.3 010707	ATE Ø 25,4
				67771→; → 07/07; für Rechtslenker; + DSTC		03.2125-7638.3 010738	ATE Ø 25,4
↓							













	kw			 	! #		
VOLVO - V70 II (285) 11/99→12/08							
 Hauptbremszylinder							
2.4 D	96	07/01→08/07	68133→; → 07/07; für Rechtslenker; - DSTC	03.2125-7638.3	010738	ATE Ø 25,4	
			12/01→; → 70377; für Linkslenker; + DSTC	03.2125-7708.3	010739	ATE Ø 25,4	
			70378→; → 07/07; für Linkslenker; + DSTC	03.2125-7713.3	010819	ATE Ø 25,4	
			68133→; → 07/07; für Linkslenker; - DSTC	03.2125-7743.3	010921	ATE Ø 25,4	
2.4 D5	120	01/01→12/08	08/01→; → 67770; für Rechtslenker; + DSTC	03.2125-7637.3	010707	ATE Ø 25,4	
			08/01→; → 68132; - DSTC	03.2125-7637.3	010707	ATE Ø 25,4	
			68133→; → 07/07; für Rechtslenker; - DSTC	03.2125-7638.3	010738	ATE Ø 25,4	
			67771→; → 07/07; für Rechtslenker; + DSTC	03.2125-7638.3	010738	ATE Ø 25,4	
			08/01→; → 70377; für Linkslenker; + DSTC	03.2125-7708.3	010739	ATE Ø 25,4	
			70378→; → 07/07; für Linkslenker; + DSTC	03.2125-7713.3	010819	ATE Ø 25,4	
			68133→; → 07/07; für Linkslenker; - DSTC	03.2125-7743.3	010921	ATE Ø 25,4	
2.4 D5 2.4 D5 AWD	136 136	04/05→12/08 05/05→08/07	12/05→ 07/07; für Rechtslenker	03.2125-7638.3	010738	ATE Ø 25,4	
			12/05→ 07/07; für Linkslenker; + DSTC	03.2125-7713.3	010819	ATE Ø 25,4	
			12/05→ 07/07; für Linkslenker; - DSTC	03.2125-7743.3	010921	ATE Ø 25,4	
2.4 D5 AWD	120	07/02→08/07	68133→; → 07/07; für Rechtslenker; - DSTC	03.2125-7638.3	010738	ATE Ø 25,4	
			03/03→ 07/07; für Rechtslenker; + DSTC	03.2125-7638.3	010738	ATE Ø 25,4	
			03/03→ 07/07; für Linkslenker; + DSTC	03.2125-7713.3	010819	ATE Ø 25,4	
			03/03→ 07/07; für Linkslenker; - DSTC	03.2125-7743.3	010921	ATE Ø 25,4	
2.4 T5	191	04/04→08/07	→ 07/07; für Rechtslenker	03.2125-7638.3	010738	ATE Ø 25,4	
			→ 07/07; für Linkslenker; + DSTC	03.2125-7713.3	010819	ATE Ø 25,4	
			→ 07/07; für Linkslenker; - DSTC	03.2125-7743.3	010921	ATE Ø 25,4	
2.4 T AWD	147	09/01→08/02	→ 67770; für Rechtslenker; + DSTC	03.2125-7637.3	010707	ATE Ø 25,4	
			→ 68132; - DSTC	03.2125-7637.3	010707	ATE Ø 25,4	
			67771→; für Rechtslenker; + DSTC	03.2125-7638.3	010738	ATE Ø 25,4	
			68133→; für Rechtslenker; - DSTC	03.2125-7638.3	010738	ATE Ø 25,4	
			→ 70377; für Linkslenker; + DSTC	03.2125-7708.3	010739	ATE Ø 25,4	
			70378→; für Linkslenker; + DSTC	03.2125-7713.3	010819	ATE Ø 25,4	
			68133→; für Linkslenker; - DSTC	03.2125-7743.3	010921	ATE Ø 25,4	
2.5 T	154	07/01→08/07	04/04→ 07/07; für Rechtslenker	03.2125-7638.3	010738	ATE Ø 25,4	
			04/04→ 07/07; für Linkslenker; + DSTC	03.2125-7713.3	010819	ATE Ø 25,4	
			04/04→ 07/07; für Linkslenker; - DSTC	03.2125-7743.3	010921	ATE Ø 25,4	
2.5 T AWD	154	07/02→08/07	09/02→ 07/07; für Rechtslenker	03.2125-7638.3	010738	ATE Ø 25,4	
			09/02→ 07/07; für Linkslenker; + DSTC	03.2125-7713.3	010819	ATE Ø 25,4	
			09/02→ 07/07; für Linkslenker; - DSTC	03.2125-7743.3	010921	ATE Ø 25,4	
2.5 TDI	103	11/99→08/07	03/00→; → 68132; - DSTC	03.2125-7637.3	010707	ATE Ø 25,4	
			03/00→; → 67770; für Rechtslenker; + DSTC	03.2125-7637.3	010707	ATE Ø 25,4	
			68133→; → 07/07; für Rechtslenker; - DSTC	03.2125-7638.3	010738	ATE Ø 25,4	
			67771→; → 07/07; für Rechtslenker; + DSTC	03.2125-7638.3	010738	ATE Ø 25,4	
			03/00→; → 70377; für Linkslenker; + DSTC	03.2125-7708.3	010739	ATE Ø 25,4	
			70378→; → 07/07; für Linkslenker; + DSTC	03.2125-7713.3	010819	ATE Ø 25,4	
			68133→; → 07/07; für Linkslenker; - DSTC	03.2125-7743.3	010921	ATE Ø 25,4	
R 2,5 T AWD	221	03/03→08/07	→ 07/07; für Rechtslenker; + DSTC	03.2125-7638.3	010738	ATE Ø 25,4	
			→ 07/07; für Linkslenker; + DSTC	03.2125-7713.3	010819	ATE Ø 25,4	
			→ 07/07; für Linkslenker; - DSTC	03.2125-7743.3	010921	ATE Ø 25,4	
VOLVO - V70 III (135) 04/07→							
 Bremskraftverstärker							
1.6 D	80	07/09→12/11	01/10→; für Linkslenker; für Fahrzeuge ohne Kollisionswarner	03.7755-9703.4	300239	ATE Ø 9 / 8" pneumatisch	
2.0 T	149	09/09→12/11	01/10→; für Rechtslenker; für Fahrzeuge mit Kollisionswarner	03.7858-4832.4	300274	ATE Ø 9 / 8" pneumatisch	
↓							











	kw			 	! #			
VOLVO - V70 III (135) 04/07→								
Bremskraftverstärker								
1.6 DRIVE / D2 2.0 2.0 D 2.0 FlexiFuel T5	84 107 100 107 177	04/11→12/15 10/07→12/11 10/07→12/15 01/08→12/11 01/10→12/14		für Linkslenker; für Fahrzeuge ohne Kollisionswarner für Rechtslenker; für Fahrzeuge mit Kollisionswarner		03.7755-9703.4 03.7858-4832.4	300239 300274	ATE Ø 9 / 8" pneumatisch ATE Ø 9 / 8" pneumatisch
1.6 T4F 2.0 BiFuel 2.5 T 2.5 T FlexiFuel 3.2 3.2 3.2 AWD D3 / D4 D5 AWD T4 T6 AWD	132 157 147 147 175 179 179 120 151 132 210	01/11→12/15 03/13→12/15 08/07→12/09 05/08→12/09 08/07→12/10 04/10→12/14 04/10→12/15 03/10→12/15 12/09→12/11 10/10→12/15 08/07→12/10		→ 213000; für Fahrzeuge ohne Kollisionswarner → 213000; für Fahrzeuge mit Kollisionswarner		03.7755-9703.4 03.7858-5032.4	300239 300275	ATE Ø 9 / 8" pneumatisch ATE Ø 9 / 8" pneumatisch
2.4 D 3.2 AWD D5	120 175 136	04/07→12/10 04/07→12/10 04/07→12/09		08/07→; → 213000; für Fahrzeuge ohne Kollisionswarner 08/07→; → 213000; für Fahrzeuge mit Kollisionswarner		03.7755-9703.4 03.7858-5032.4	300239 300275	ATE Ø 9 / 8" pneumatisch ATE Ø 9 / 8" pneumatisch
2.4 D 2.5 T 2.5 T FlexiFuel	129 170 170	04/09→12/10 04/09→12/12 04/09→12/11		10/09→; → 213000; für Fahrzeuge ohne Kollisionswarner 10/09→; → 213000; für Fahrzeuge mit Kollisionswarner		03.7755-9703.4 03.7858-5032.4	300239 300275	ATE Ø 9 / 8" pneumatisch ATE Ø 9 / 8" pneumatisch
D3	100	10/07→12/15		05/12→; → 213000; für Fahrzeuge ohne Kollisionswarner 05/12→; → 213000; für Fahrzeuge mit Kollisionswarner		03.7755-9703.4 03.7858-5032.4	300239 300275	ATE Ø 9 / 8" pneumatisch ATE Ø 9 / 8" pneumatisch
D4 D4 AWD D5	133 133 151	10/13→ 10/13→ 10/08→12/11		für Fahrzeuge ohne Kollisionswarner 12/09→; → 213000; für Fahrzeuge ohne Kollisionswarner 12/09→; → 213000; für Fahrzeuge mit Kollisionswarner		03.7755-9703.4 03.7755-9703.4 03.7755-9703.4	300239 300239 300239	ATE Ø 9 / 8" pneumatisch ATE Ø 9 / 8" pneumatisch ATE Ø 9 / 8" pneumatisch
D5 D5 AWD	158 158	04/11→12/15 04/11→12/15		06/11→; → 213000; für Fahrzeuge ohne Kollisionswarner 06/11→; → 213000; für Fahrzeuge mit Kollisionswarner		03.7755-9703.4 03.7858-5032.4	300239 300275	ATE Ø 9 / 8" pneumatisch ATE Ø 9 / 8" pneumatisch
D5 AWD	136	04/07→12/09		10/07→; → 213000; für Fahrzeuge ohne Kollisionswarner 10/07→; → 213000; für Fahrzeuge mit Kollisionswarner		03.7755-9703.4 03.7858-5032.4	300239 300275	ATE Ø 9 / 8" pneumatisch ATE Ø 9 / 8" pneumatisch
T5	180	10/13→		für Fahrzeuge ohne Kollisionswarner für Fahrzeuge mit Kollisionswarner		03.7755-9703.4 03.7858-5032.4	300239 300275	ATE Ø 9 / 8" pneumatisch ATE Ø 9 / 8" pneumatisch
T6 AWD	224	01/10→12/15		04/11→; → 213000; für Fahrzeuge ohne Kollisionswarner 04/11→; → 213000; für Fahrzeuge mit Kollisionswarner		03.7755-9703.4 03.7858-5032.4	300239 300275	ATE Ø 9 / 8" pneumatisch ATE Ø 9 / 8" pneumatisch
Pedalwegsensord, Bremspedal								
1.6 D 2.0 T	80 149	07/09→12/11 09/09→12/11		01/10→; für Fahrzeuge mit Kollisionswarner		03.0655-0007.2	370007	ATE
1.6 DRIVE / D2 2.0 2.0 D 2.0 FlexiFuel D4 D4 AWD T5 T5	84 107 100 107 133 133 177 180	04/11→12/15 10/07→12/11 10/07→12/15 01/08→12/11 10/13→ 10/13→ 01/10→12/14 10/13→		für Fahrzeuge mit Kollisionswarner		03.0655-0007.2	370007	ATE
1.6 T4F 2.5 T 2.5 T FlexiFuel 3.2 3.2 3.2 AWD D3 / D4 D5 AWD T4 T6 AWD	132 147 147 175 179 179 120 151 132 210	01/11→12/15 08/07→12/09 05/08→12/09 08/07→12/10 04/10→12/14 04/10→12/15 03/10→12/15 12/09→12/11 10/10→12/15 08/07→12/10		→ 213000; für Fahrzeuge mit Kollisionswarner 213001→; für Fahrzeuge mit Kollisionswarner		03.0655-0007.2	370007	ATE ATE
2.0 BiFuel	157	03/13→12/15		→ 213000; für Fahrzeuge mit Kollisionswarner für Fahrzeuge mit Kollisionswarner		03.0655-0007.2	370007	ATE ATE
2.0 GDI	157	04/12→12/15		03/13→; für Fahrzeuge mit Kollisionswarner		03.0655-0007.2	370007	ATE
2.4 D 3.2 AWD D5 ↓	120 175 136	04/07→12/10 04/07→12/10 04/07→12/09		213001→; für Fahrzeuge mit Kollisionswarner		03.0655-0007.2	370007	ATE









	kw			 	! #		
VOLVO - V70 III (135) 04/07→							
Pedalwegsensord, Bremspedal							
2.4 D 3.2 AWD D5	120 175 136	04/07→12/10 04/07→12/10 04/07→12/09		08/07→; → 213000; für Fahrzeuge mit Kollisionswarner		03.0655-0007.2 370007	ATE
2.4 D 2.5 T 2.5 T FlexiFuel	129 170 170	04/09→12/10 04/09→12/12 04/09→12/11		213001→; für Fahrzeuge mit Kollisionswarner 10/09→; → 213000; für Fahrzeuge mit Kollisionswarner		03.0655-0007.2 370007	ATE
D3	100	10/07→12/15		213001→; für Fahrzeuge mit Kollisionswarner 05/12→; → 213000; für Fahrzeuge mit Kollisionswarner		03.0655-0007.2 370007	ATE
D4 AWD	120	10/07→12/15		01/13→; für Fahrzeuge mit Kollisionswarner		03.0655-0007.2 370007	ATE
D5	151	10/08→12/11		213001→; für Fahrzeuge mit Kollisionswarner 12/09→; → 213000; für Fahrzeuge mit Kollisionswarner		03.0655-0007.2 370007	ATE
D5 D5 AWD	158 158	04/11→12/15 04/11→12/15		213001→; für Fahrzeuge mit Kollisionswarner 06/11→; → 213000; für Fahrzeuge mit Kollisionswarner		03.0655-0007.2 370007	ATE
D5 AWD	136	04/07→12/09		213001→; für Fahrzeuge mit Kollisionswarner 10/07→; → 213000; für Fahrzeuge mit Kollisionswarner		03.0655-0007.2 370007	ATE
T6 AWD	224	01/10→12/15		213001→; für Fahrzeuge mit Kollisionswarner 04/11→; → 213000; für Fahrzeuge mit Kollisionswarner		03.0655-0007.2 370007	ATE
VOLVO - V90 Kombi (965) 11/96→12/98							
 Hauptbremszylinder							
2.9 2.9	132 150	01/97→12/98 01/97→12/98				03.2023-0875.3 010890	ATE Ø1 23,81 Ø2 20,64 ohne Bremsflüssigkeitsbehälter
VOLVO - XC60 (156) 05/08→							
 Bremskraftverstärker							
2.4 D 3.2 AWD D3 / D4 D5 AWD	129 175 120 151	04/09→12/10 07/09→12/10 03/10→12/14 07/09→06/11		für Fahrzeuge ohne Kollisionswarner für Fahrzeuge mit Kollisionswarner		03.7755-0132.4 300265 03.7858-5132.4 300276	ATE Ø 9 / 8" pneumatisch ATE Ø 9 / 8" pneumatisch
2.4 D / D3 / D4 AWD D5 AWD T6 AWD	120 136 210	05/08→02/17 05/08→12/09 05/08→12/10		09/08→; für Fahrzeuge ohne Kollisionswarner 09/08→; für Fahrzeuge mit Kollisionswarner		03.7755-0132.4 300265 03.7858-5132.4 300276	ATE Ø 9 / 8" pneumatisch ATE Ø 9 / 8" pneumatisch
3.2 AWD D5 AWD T6 AWD	179 169 224	03/10→12/15 04/14→12/15 03/10→12/15		→ 236999; für Fahrzeuge ohne Kollisionswarner → 236999; für Fahrzeuge mit Kollisionswarner		03.7755-0132.4 300265 03.7858-5132.4 300276	ATE Ø 9 / 8" pneumatisch ATE Ø 9 / 8" pneumatisch
D3 D4 D4	110 133 140	03/15→02/17 10/13→12/15 03/15→02/17		für Fahrzeuge ohne Kollisionswarner		03.7755-0132.4 300265	ATE Ø 9 / 8" pneumatisch
D4 AWD D4 AWD D5 AWD T6 AWD	133 140 162 242	10/13→12/15 03/15→02/17 03/15→02/17 04/14→12/15		237000→; für Fahrzeuge ohne Kollisionswarner → 236999; für Fahrzeuge ohne Kollisionswarner → 236999; für Fahrzeuge mit Kollisionswarner		03.7755-0132.4 300265 03.7755-0132.4 300265 03.7858-5132.4 300276	ATE Ø 9 / 8" pneumatisch ATE Ø 9 / 8" pneumatisch ATE Ø 9 / 8" pneumatisch
D5 AWD	158	04/11→12/15		06/11→; → 236999; für Fahrzeuge ohne Kollisionswarner 06/11→; → 236999; für Fahrzeuge mit Kollisionswarner		03.7755-0132.4 300265 03.7858-5132.4 300276	ATE Ø 9 / 8" pneumatisch ATE Ø 9 / 8" pneumatisch
T5 T5 AWD T6 T6 AWD	180 180 225 225	10/13→ 10/15→02/17 10/13→ 10/13→		für Fahrzeuge ohne Kollisionswarner		03.7755-9703.4 300239	ATE Ø 9 / 8" pneumatisch
Pedalwegsensord, Bremspedal							
2.0 T	149	12/09→12/12		03/10→; für Fahrzeuge mit Kollisionswarner		03.0655-0007.2 370007	ATE
2.4 D 3.2 AWD D3 D3 / D4 D4 ↓	129 175 110 120 133	04/09→12/10 07/09→12/10 03/15→02/17 03/10→12/14 10/13→12/15		für Fahrzeuge mit Kollisionswarner		03.0655-0007.2 370007	ATE







	kw			 	! #		
VOLVO - XC60 (156) 05/08 →							
Pedalwegsensoren, Bremspedal							
D4	140	03/15→02/17		für Fahrzeuge mit Kollisionswarner		03.0655-0007.2 370007	ATE
D5 AWD	151	07/09→06/11					
T5	177	09/10→12/14					
T5	180	10/13→					
T5 AWD	180	10/15→02/17					
T5 AWD	187	04/14→02/17					
T6	225	10/13→					
T6 AWD	225	10/13→					
2.4 D / D3 / D4 AWD	120	05/08→02/17		09/08→;		03.0655-0007.2 370007	ATE
D5 AWD	136	05/08→12/09		für Fahrzeuge mit Kollisionswarner			
T6 AWD	210	05/08→12/10					
3.2 AWD	179	03/10→12/15		→ 236999;		03.0655-0007.2 370007	ATE
D4 AWD	133	10/13→12/15		für Fahrzeuge mit Kollisionswarner			
D4 AWD	140	03/15→02/17		237000→;		03.0655-0007.2 370007	ATE
D5 AWD	162	03/15→02/17		für Fahrzeuge mit Kollisionswarner			
D5 AWD	169	04/14→12/15					
T6 AWD	224	03/10→12/15					
T6 AWD	242	04/14→12/15					
D5 AWD	158	04/11→12/15		06/11→; → 236999;		03.0655-0007.2 370007	ATE
				für Fahrzeuge mit Kollisionswarner			
				237000→;		03.0655-0007.2 370007	ATE
				für Fahrzeuge mit Kollisionswarner			
VOLVO - XC70 II (136) 04/07 →							
	Bremskraftverstärker						
2.4 D	129	06/09→12/10		01/10→;		03.7755-0132.4 300265	ATE Ø 9 / 8" pneumatisch
				für Fahrzeuge ohne Kollisionswarner		03.7755-9703.4 300239	ATE Ø 9 / 8" pneumatisch
				01/10→;		03.7858-5032.4 300275	ATE Ø 9 / 8" pneumatisch
				für Fahrzeuge mit Kollisionswarner		03.7858-5132.4 300276	ATE Ø 9 / 8" pneumatisch
2.4 D / D4 AWD	120	08/07→		für Fahrzeuge ohne Kollisionswarner		03.7755-0132.4 300265	ATE Ø 9 / 8" pneumatisch
3.2 AWD	175	08/07→12/11				03.7755-9703.4 300239	ATE Ø 9 / 8" pneumatisch
3.2 AWD	179	05/10→					
D5 AWD	162	03/15→		für Fahrzeuge mit Kollisionswarner		03.7858-5032.4 300275	ATE Ø 9 / 8" pneumatisch
T5	180	10/13→				03.7858-5132.4 300276	ATE Ø 9 / 8" pneumatisch
T6 AWD	210	01/08→					
T6 AWD	224	01/10→					
D3	120	04/10→12/15		08/11→;		03.7755-0132.4 300265	ATE Ø 9 / 8" pneumatisch
				für Fahrzeuge ohne Kollisionswarner		03.7755-9703.4 300239	ATE Ø 9 / 8" pneumatisch
				08/11→;		03.7858-5032.4 300275	ATE Ø 9 / 8" pneumatisch
				für Fahrzeuge mit Kollisionswarner		03.7858-5132.4 300276	ATE Ø 9 / 8" pneumatisch
D4	133	10/13→		für Fahrzeuge ohne Kollisionswarner		03.7755-9703.4 300239	ATE Ø 9 / 8" pneumatisch
D4 AWD	133	10/13→					
D5 AWD	136	04/07→12/09		08/07→;		03.7755-0132.4 300265	ATE Ø 9 / 8" pneumatisch
				für Fahrzeuge ohne Kollisionswarner		03.7755-9703.4 300239	ATE Ø 9 / 8" pneumatisch
				08/07→;		03.7858-5032.4 300275	ATE Ø 9 / 8" pneumatisch
				für Fahrzeuge mit Kollisionswarner		03.7858-5132.4 300276	ATE Ø 9 / 8" pneumatisch
D5 AWD	151	04/09→12/11		12/09→;		03.7755-0132.4 300265	ATE Ø 9 / 8" pneumatisch
				für Fahrzeuge ohne Kollisionswarner		03.7755-9703.4 300239	ATE Ø 9 / 8" pneumatisch
				12/09→;		03.7858-5032.4 300275	ATE Ø 9 / 8" pneumatisch
				für Fahrzeuge mit Kollisionswarner		03.7858-5132.4 300276	ATE Ø 9 / 8" pneumatisch
D5 AWD	158	04/11→12/15		06/11→;		03.7755-0132.4 300265	ATE Ø 9 / 8" pneumatisch
				für Fahrzeuge ohne Kollisionswarner		03.7755-9703.4 300239	ATE Ø 9 / 8" pneumatisch
				06/11→;		03.7858-5032.4 300275	ATE Ø 9 / 8" pneumatisch
				für Fahrzeuge mit Kollisionswarner		03.7858-5132.4 300276	ATE Ø 9 / 8" pneumatisch
Pedalwegsensoren, Bremspedal							
2.4 D	129	06/09→12/10		01/10→;		03.0655-0007.2 370007	ATE
				für Fahrzeuge mit Kollisionswarner			
2.4 D / D4 AWD	120	08/07→		für Fahrzeuge mit Kollisionswarner		03.0655-0007.2 370007	ATE
3.2 AWD	175	08/07→12/11					
3.2 AWD	179	05/10→					
D5 AWD	162	03/15→					
T5	180	10/13→					
T6 AWD	210	01/08→					
T6 AWD	224	01/10→					
D3	120	04/10→12/15		08/11→;		03.0655-0007.2 370007	ATE
				für Fahrzeuge mit Kollisionswarner			
D5 AWD	136	04/07→12/09		08/07→;		03.0655-0007.2 370007	ATE
				für Fahrzeuge mit Kollisionswarner			
D5 AWD	151	04/09→12/11		12/09→;		03.0655-0007.2 370007	ATE
				für Fahrzeuge mit Kollisionswarner			
D5 AWD	158	04/11→12/15		06/11→;		03.0655-0007.2 370007	ATE
				für Fahrzeuge mit Kollisionswarner			













	kw					! #		
VOLVO - XC70 CROSS COUNTRY (295) 10/97→10/07								
 Bremskraftverstärker								
2.4 D5 AWD	136	12/05→08/07		→ 07/07; - DSTC		03.7755-4702.4	300224	ATE Ø 9 / 8" pneumatisch
2.4 D5 XC AWD	120	09/02→08/07		→ 07/07; + DSTC		03.7858-3532.4	300233	ATE Ø 9 / 8" pneumatisch
2.5 T XC AWD	154	09/02→08/07						
2.4 T XC AWD	147	03/00→09/02		→ 12/01; - DSTC		03.7755-3402.4	300189	ATE Ø 9 / 8" pneumatisch
				01/02→; - DSTC		03.7755-4702.4	300224	ATE Ø 9 / 8" pneumatisch
				+ DSTC		03.7858-3532.4	300233	ATE Ø 9 / 8" pneumatisch
Pedalwegsensoren, Bremspedal								
2.4 D5 AWD	136	12/05→08/07		→ 07/07		03.0655-0005.2	370005	ATE
2.4 D5 XC AWD	120	09/02→08/07						
2.5 T XC AWD	154	09/02→08/07						
2.4 T XC AWD	147	03/00→09/02		→ 12/01		03.0655-0004.2	370004	ATE
				01/02→		03.0655-0005.2	370005	ATE
						03.0655-0005.2	370005	ATE
 Hauptbremszylinder								
2.4 D5 AWD	136	12/05→08/07		→ 07/07; für Rechtslenker; - DSTC		03.2125-7637.3	010707	ATE Ø 25,4
				→ 07/07; für Linkslenker; + DSTC		03.2125-7713.3	010819	ATE Ø 25,4
				→ 07/07; für Linkslenker; - DSTC		03.2125-7743.3	010921	ATE Ø 25,4
2.4 D5 XC AWD	120	09/02→08/07		→ 07/07; für Rechtslenker; - DSTC		03.2125-7637.3	010707	ATE Ø 25,4
2.5 T XC AWD	154	09/02→08/07		→ 07/07; für Rechtslenker; + DSTC		03.2125-7638.3	010738	ATE Ø 25,4
				→ 07/07; für Linkslenker; + DSTC		03.2125-7713.3	010819	ATE Ø 25,4
				→ 07/07; für Linkslenker; - DSTC		03.2125-7743.3	010921	ATE Ø 25,4
2.4 T XC AWD	147	03/00→09/02		→ 11000; für Linkslenker; - DSTC		03.2125-7637.3	010707	ATE Ø 25,4
				→ 69018; für Rechtslenker; + DSTC		03.2125-7637.3	010707	ATE Ø 25,4
				11001→; für Rechtslenker; - DSTC		03.2125-7637.3	010707	ATE Ø 25,4
				69019→; für Rechtslenker; + DSTC		03.2125-7638.3	010738	ATE Ø 25,4
				→ 11000; für Rechtslenker; - DSTC		03.2125-7638.3	010738	ATE Ø 25,4
				→ 66913; für Linkslenker; + DSTC		03.2125-7708.3	010739	ATE Ø 25,4
				66914→; für Linkslenker; + DSTC		03.2125-7713.3	010819	ATE Ø 25,4
				11001→; für Linkslenker; - DSTC		03.2125-7743.3	010921	ATE Ø 25,4
VOLVO - XC90 I (275) 06/02→01/15								
 Bremskraftverstärker								
2.5 T AWD	154	10/02→09/14		für Linkslenker;		03.7858-3032.4	300257	ATE Ø 9 / 8" pneumatisch
2.5 T AWD	154	10/12→09/14		passend für Felgengröße [Zoll]: 18				
D3 / D5	120	04/09→12/14		für Linkslenker		03.7858-3632.4	300234	ATE Ø 9 / 8" pneumatisch
D5 AWD	120	10/02→12/06						
D5 AWD	120	10/07→12/10						
T6 AWD	200	10/02→12/06						
V8 AWD	232	01/05→12/10						
3.2 AWD	175	03/06→12/10		05/06→; für Linkslenker;		03.7858-3032.4	300257	ATE Ø 9 / 8" pneumatisch
D5 AWD	136	04/05→12/10		passend für Felgengröße [Zoll]: 18				
				05/06→; für Linkslenker		03.7858-3632.4	300234	ATE Ø 9 / 8" pneumatisch
3.2 AWD	179	04/10→12/12		für Linkslenker		03.7858-3632.4	300234	ATE Ø 9 / 8" pneumatisch
D5 AWD	147	01/11→12/14						
Pedalwegsensoren, Bremspedal								
2.5 T AWD	154	10/02→09/14				03.0655-0005.2	370005	ATE
2.5 T AWD	154	10/12→09/14						
3.2 AWD	179	04/10→12/12						
D3 / D5	120	04/09→12/14						
D5 AWD	120	10/02→12/06						
D5 AWD	120	10/07→12/10						
D5 AWD	147	01/11→12/14						
T6 AWD	200	10/02→12/06						
V8 AWD	232	01/05→12/10						
3.2 AWD	175	03/06→12/10		05/06→		03.0655-0005.2	370005	ATE
D5 AWD	136	04/05→12/10						
 Hauptbremszylinder								
2.5 T AWD	154	10/02→09/14		für Rechtslenker		03.2125-7638.3	010738	ATE Ø 25,4
2.5 T AWD	154	10/12→09/14		für Linkslenker		03.2125-7713.3	010819	ATE Ø 25,4
D3 / D5	120	04/09→12/14						
D5 AWD	120	10/02→12/06						
D5 AWD	120	10/07→12/10						
D5 AWD	147	01/11→12/14						
3.2 AWD	175	03/06→12/10		05/06→; für Linkslenker		03.2125-7713.3	010819	ATE Ø 25,4
3.2 AWD	179	04/10→12/12		für Linkslenker		03.2125-7713.3	010819	ATE Ø 25,4
T6 AWD	200	10/02→12/06						
V8 AWD	232	01/05→12/10						
↓								











	kw					! #		
VOLVO - XC90 I (275) 06/02→01/15								
 Hauptbremszylinder								
D5 AWD	136	04/05→12/10		05/06→; für Rechtslenker		03.2125-7638.3	010738	ATE Ø 25,4
				05/06→; für Linkslenker		03.2125-7713.3	010819	ATE Ø 25,4
VW - AMAROK (2HA, 2HB, S1B, S6B, S7A, S7B) 09/10→								
 Hauptbremszylinder								
2.0 BiTDI	120	09/10→				03.2126-5132.3	011012	ATE Ø 26,99
2.0 BiTDI	132	11/11→						
2.0 BiTDI 4motion	120	09/10→						
2.0 BiTDI 4motion	132	11/11→						
2.0 TDI	90	09/10→						
2.0 TDI	103	07/12→						
2.0 TDI 4motion	90	09/10→						
2.0 TDI 4motion	103	06/12→						
2.0 TSI	118	12/10→						
3.0 TDI	120	06/16→						
3.0 TDI 4motion	150	06/16→						
3.0 TDI 4motion	120	06/16→		09/16→		03.2126-5132.3	011012	ATE Ø 26,99
3.0 TDI 4motion	165	06/16→						
VW - ARTEON (3H7) 04/17→								
 Hauptbremszylinder								
1.5 TSi	110	11/17→		für Linkslenker		24.4123-1719.3	011017	TRW Ø 23,81
2.0 TDI	110	04/17→						ohne Bremsflüssigkeitsbehälter
2.0 TDI	140	05/17→						
2.0 TDI 4motion	140	05/17→						
2.0 TDI 4motion	176	04/17→						
2.0 TSI	140	05/17→						
2.0 TSI 4motion	206	04/17→						
VW - BEETLE (5C1, 5C2) 04/11→								
 Hauptbremszylinder								
1.2 TSI	77	07/11→		für Rechtslenker		24.4152-0132.3	011025	ATE Ø 22,2
1.2 TSI 16V	77	12/14→						ohne Bremsflüssigkeitsbehälter
1.6 TDI	77	10/11→						
1.4 TSI	110	12/14→		für Rechtslenker		24.4153-0202.3	011027	ATE Ø 23,81
2.0 TSI	162	12/14→						ohne Bremsflüssigkeitsbehälter
1.4 TSI	118	10/11→		für Rechtslenker; +PR 1ZP		24.4152-0132.3	011025	ATE Ø 22,2
				für Rechtslenker; +PR 1ZA		24.4153-0202.3	011027	ATE Ø 23,81
								ohne Bremsflüssigkeitsbehälter
2.0 TDI	81	06/14→		12/14→; für Rechtslenker		24.4153-0202.3	011027	ATE Ø 23,81
								ohne Bremsflüssigkeitsbehälter
2.0 TDI	103	04/11→		für Rechtslenker; +PR 1ZP		24.4152-0132.3	011025	ATE Ø 22,2
								ohne Bremsflüssigkeitsbehälter
2.0 TDI	110	07/14→		09/14→; +PR 1ZP; für Rechtslenker		24.4152-0132.3	011025	ATE Ø 22,2
								ohne Bremsflüssigkeitsbehälter
2.0 TSI	147	04/11→		für Rechtslenker; +PR 1LV		24.4152-0132.3	011025	ATE Ø 22,2
				für Rechtslenker; +PR 1ZA,1ZB		24.4153-0202.3	011027	ATE Ø 23,81
								ohne Bremsflüssigkeitsbehälter
2.0 TSI	155	12/12→		05/13→; für Rechtslenker; +PR 1LV		24.4152-0132.3	011025	ATE Ø 22,2
				05/13→; für Rechtslenker; +PR 1ZA,1ZB		24.4153-0202.3	011027	ATE Ø 23,81
								ohne Bremsflüssigkeitsbehälter
VW - BEETLE Cabriolet (5C7, 5C8) 12/11→								
 Hauptbremszylinder								
1.2 TSI	77	12/11→		11/12→; für Rechtslenker		24.4152-0132.3	011025	ATE Ø 22,2
1.6 TDI	77	12/11→						ohne Bremsflüssigkeitsbehälter
1.2 TSI 16V	77	12/14→		für Rechtslenker		24.4152-0132.3	011025	ATE Ø 22,2
								ohne Bremsflüssigkeitsbehälter
1.4 TSI	110	12/14→		für Rechtslenker		24.4153-0202.3	011027	ATE Ø 23,81
2.0 TSI	162	12/14→						ohne Bremsflüssigkeitsbehälter
1.4 TSI	118	12/11→		11/12→; für Rechtslenker; +PR 1ZP		24.4152-0132.3	011025	ATE Ø 22,2
				11/12→; +PR 1ZA; für Rechtslenker		24.4153-0202.3	011027	ATE Ø 23,81
								ohne Bremsflüssigkeitsbehälter
2.0 TDI	81	06/14→		12/14→; für Rechtslenker		24.4153-0202.3	011027	ATE Ø 23,81
								ohne Bremsflüssigkeitsbehälter
2.0 TDI	103	04/12→		11/12→; für Rechtslenker; +PR 1ZP		24.4152-0132.3	011025	ATE Ø 22,2
								ohne Bremsflüssigkeitsbehälter
↓								











	kw			 	! #		
VW - BEETLE Cabriolet (5C7, 5C8) 12/11→							
 Hauptbremszylinder							
2.0 TDI	103	04/12→		11/12→; +PR 1ZE; für Rechtslenker		24.4153-0202.3 011027	ATE Ø 23,81 ohne Bremsflüssigkeitsbehälter
2.0 TDI	110	09/14→		für Rechtslenker; +PR 1ZP		24.4152-0132.3 011025	ATE Ø 22,2 ohne Bremsflüssigkeitsbehälter
				für Rechtslenker; +PR 1ZE		24.4153-0202.3 011027	ATE Ø 23,81 ohne Bremsflüssigkeitsbehälter
2.0 TSI	147	12/11→		11/12→; für Rechtslenker; +PR 1LV		24.4152-0132.3 011025	ATE Ø 22,2 ohne Bremsflüssigkeitsbehälter
				11/12→; +PR 1ZA, 1ZB; für Rechtslenker		24.4153-0202.3 011027	ATE Ø 23,81 ohne Bremsflüssigkeitsbehälter
2.0 TSI	155	12/12→		05/13→; für Rechtslenker; +PR 1LV		24.4152-0132.3 011025	ATE Ø 22,2 ohne Bremsflüssigkeitsbehälter
				05/13→; für Rechtslenker; +PR 1ZA, 1ZB		24.4153-0202.3 011027	ATE Ø 23,81 ohne Bremsflüssigkeitsbehälter
2.5	125	12/11→		12/12→; für Rechtslenker		24.4152-0132.3 011025	ATE Ø 22,2 ohne Bremsflüssigkeitsbehälter
						24.4153-0202.3 011027	ATE Ø 23,81 ohne Bremsflüssigkeitsbehälter
VW - BORA (1J2) 10/98→12/13							
 Bremskraftverstärker							
1.4 16V	55	03/00→05/05		09/00→; → 1J-2-373846; für Linkslenker; + ESP		03.7860-0602.4 300141	ATE Ø 10" pneumatisch
1.6	74	10/98→05/05					
1.6	75	08/00→05/05		→ 08/00; für Linkslenker; + ESP		03.7863-0402.4 300124	ATE Ø 10" pneumatisch
1.6 16V	77	05/00→05/05					
1.8	92	10/98→05/05		1J-2-373847→; für Linkslenker; + ESP; → 12/04		03.7863-3502.4 300128	ATE Ø 10" pneumatisch
1.8 4motion	92	02/99→05/05					
1.9 SDI	50	10/98→05/05					
2.0	85	10/98→05/05					
1.6 FSI	81	01/02→05/05		→ 1J-2-373846; für Linkslenker; + ESP		03.7860-0602.4 300141	ATE Ø 10" pneumatisch
1.9 TDI	74	09/00→05/05					
1.9 TDI 4motion	74	09/00→05/05		1J-2-373847→; für Linkslenker; + ESP; → 12/04		03.7863-3502.4 300128	ATE Ø 10" pneumatisch
2.0 4motion	85	04/00→05/05					
2.3 V5	125	10/00→05/05					
2.3 V5 4motion	125	10/00→05/05					
1.8 T	110	05/00→05/05		09/00→; → 1J-2-373846; für Linkslenker; + ESP		03.7860-0602.4 300141	ATE Ø 10" pneumatisch
				1J-2-373847→; für Linkslenker; + ESP; → 12/04		03.7863-3502.4 300128	ATE Ø 10" pneumatisch
1.8 T	132	03/02→05/05		05/02→; für Linkslenker; + ESP; → 12/04		03.7863-3502.4 300128	ATE Ø 10" pneumatisch
1.9 TDI	66	10/98→05/05		09/00→ 06/01; für Linkslenker; + ESP		03.7860-0602.4 300141	ATE Ø 10" pneumatisch
				→ 08/00; für Linkslenker; + ESP		03.7863-0402.4 300124	ATE Ø 10" pneumatisch
1.9 TDI	81	10/98→06/01		09/00→; für Linkslenker; + ESP		03.7860-0602.4 300141	ATE Ø 10" pneumatisch
1.9 TDI 4motion	85	02/99→06/01		→ 08/00; für Linkslenker; + ESP		03.7863-0402.4 300124	ATE Ø 10" pneumatisch
1.9 TDI	85	12/98→01/02		09/00→ 06/01; für Linkslenker; + ESP		03.7860-0602.4 300141	ATE Ø 10" pneumatisch
			1.9 TDI 4motion	66	11/98→04/02		02/99→ 08/00; für Linkslenker; + ESP
1.9 TDI	96	11/00→05/05		04/01→; → 1J-2-373846; für Linkslenker; + ESP		03.7860-0602.4 300141	ATE Ø 10" pneumatisch
			1.9 TDI 4motion	96	11/00→05/05		1J-2-373847→; für Linkslenker; + ESP; → 12/04
1.9 TDI	110	05/00→05/05		10/00→; → 1J-2-373846; für Linkslenker; + ESP		03.7860-0602.4 300141	ATE Ø 10" pneumatisch
			1.9 TDI 4motion	110	05/00→05/05		1J-2-373847→; für Linkslenker; + ESP; → 12/04
2.3 V5	110	10/98→10/00		09/00→; → 1J-2-373846; für Linkslenker; + ESP		03.7860-0602.4 300141	ATE Ø 10" pneumatisch
				→ 08/00; für Linkslenker; + ESP		03.7863-0402.4 300124	ATE Ø 10" pneumatisch
				1J-2-373847→; für Linkslenker; + ESP		03.7863-3502.4 300128	ATE Ø 10" pneumatisch
2.3 V5 4motion	110	12/98→10/00		09/00→; → 1J-2-373846; für Linkslenker; + ESP		03.7860-0602.4 300141	ATE Ø 10" pneumatisch
				02/99→ 08/00; für Linkslenker; + ESP		03.7863-0402.4 300124	ATE Ø 10" pneumatisch
				1J-2-373847→; für Linkslenker; + ESP		03.7863-3502.4 300128	ATE Ø 10" pneumatisch
2.8 V6 4motion	150	03/99→05/05		09/00→; → 1J-2-373846; für Linkslenker; + ESP		03.7860-0602.4 300141	ATE Ø 10" pneumatisch
				05/99→ 08/00; für Linkslenker; + ESP		03.7863-0402.4 300124	ATE Ø 10" pneumatisch
				1J-2-373847→; für Linkslenker; + ESP; → 12/04		03.7863-3502.4 300128	ATE Ø 10" pneumatisch
 Hauptbremszylinder							
1.4 16V	55	03/00→05/05		→ 08/00; für Linkslenker; + ESP		03.2123-2024.3 010597	ATE Ø 23,81
1.6	74	10/98→05/05		→ 08/00; für Rechtslenker; + ESP		03.2123-2064.3 010598	ATE Ø 23,81















	kW			 	! #		
VW - BORA (1J2) 10/98→12/13							
 Hauptbremszylinder							
1.6	75	08/00→05/05		09/00→; für Linkslenker; + ESP; → 12/04		03.2123-2715.3 010802	ATE Ø 23,81
1.6 16V	77	05/00→05/05					
1.8	92	10/98→05/05		09/00→; für Rechtslenker; + ESP; → 12/04		03.2123-2774.3 010803	ATE Ø 23,81
1.8 4motion	92	02/99→05/05					
1.9 SDI	50	10/98→05/05		für Linkslenker; - ESP; → 12/04		24.2123-1709.3 010503	Ø 23,81
2.0	85	10/98→05/05					
1.6 FSI	81	01/02→05/05		für Linkslenker; + ESP; → 12/04		03.2123-2715.3 010802	ATE Ø 23,81
1.9 TDI	74	09/00→05/05		für Rechtslenker; + ESP; → 12/04		03.2123-2774.3 010803	ATE Ø 23,81
1.9 TDI 4motion	74	09/00→05/05					
2.0 4motion	85	04/00→05/05		für Linkslenker; - ESP; → 12/04		24.2123-1709.3 010503	Ø 23,81
2.3 V5	125	10/00→05/05					
2.3 V5 4motion	125	10/00→05/05					
1.8 T	110	05/00→05/05		09/00→; für Linkslenker; + ESP; → 12/04		03.2123-2715.3 010802	ATE Ø 23,81
				09/00→; für Rechtslenker; + ESP; → 12/04		03.2123-2774.3 010803	ATE Ø 23,81
				09/00→; für Linkslenker; - ESP; → 12/04		24.2123-1709.3 010503	Ø 23,81
1.8 T	132	03/02→05/05		05/02→; für Linkslenker; + ESP; → 12/04		03.2123-2715.3 010802	ATE Ø 23,81
				05/02→; für Rechtslenker; + ESP; → 12/04		03.2123-2774.3 010803	ATE Ø 23,81
				05/02→; für Linkslenker; - ESP; → 12/04		24.2123-1709.3 010503	Ø 23,81
1.9 TDI	66	10/98→05/05		→ 08/00; für Linkslenker; + ESP		03.2123-2024.3 010597	ATE Ø 23,81
				→ 08/00; für Rechtslenker; + ESP		03.2123-2064.3 010598	ATE Ø 23,81
				09/00→ 06/01; für Linkslenker; + ESP		03.2123-2715.3 010802	ATE Ø 23,81
				09/00→ 06/01; für Rechtslenker; + ESP		03.2123-2774.3 010803	ATE Ø 23,81
				→ 06/01; für Linkslenker; - ESP		24.2123-1709.3 010503	Ø 23,81
1.9 TDI	81	10/98→06/01		→ 08/00; für Linkslenker; + ESP		03.2123-2024.3 010597	ATE Ø 23,81
1.9 TDI 4motion	85	02/99→06/01		→ 08/00; für Rechtslenker; + ESP		03.2123-2064.3 010598	ATE Ø 23,81
2.3 V5	110	10/98→10/00		09/00→; für Linkslenker; + ESP		03.2123-2715.3 010802	ATE Ø 23,81
				09/00→; für Rechtslenker; + ESP		03.2123-2774.3 010803	ATE Ø 23,81
				für Linkslenker; - ESP		24.2123-1709.3 010503	Ø 23,81
1.9 TDI	85	12/98→01/02		02/99→ 08/00; für Linkslenker; + ESP		03.2123-2024.3 010597	ATE Ø 23,81
1.9 TDI 4motion	66	11/98→04/02		02/99→ 08/00; für Rechtslenker; + ESP		03.2123-2064.3 010598	ATE Ø 23,81
				09/00→ 06/01; für Linkslenker; + ESP		03.2123-2715.3 010802	ATE Ø 23,81
				09/00→ 06/01; für Rechtslenker; + ESP		03.2123-2774.3 010803	ATE Ø 23,81
				02/99→ 06/01; für Linkslenker; - ESP		24.2123-1709.3 010503	Ø 23,81
1.9 TDI	96	11/00→05/05		04/01→; für Linkslenker; + ESP; → 12/04		03.2123-2715.3 010802	ATE Ø 23,81
1.9 TDI 4motion	96	11/00→05/05		04/01→; für Rechtslenker; + ESP; → 12/04		03.2123-2774.3 010803	ATE Ø 23,81
				04/01→; für Linkslenker; - ESP; → 12/04		24.2123-1709.3 010503	Ø 23,81
1.9 TDI	110	05/00→05/05		10/00→; für Linkslenker; + ESP; → 12/04		03.2123-2715.3 010802	ATE Ø 23,81
1.9 TDI 4motion	110	05/00→05/05		10/00→; für Rechtslenker; + ESP; → 12/04		03.2123-2774.3 010803	ATE Ø 23,81
				10/00→; für Linkslenker; - ESP; → 12/04		24.2123-1709.3 010503	Ø 23,81
2.3 V5 4motion	110	12/98→10/00		02/99→ 08/00; für Linkslenker; + ESP		03.2123-2024.3 010597	ATE Ø 23,81
				02/99→ 08/00; für Rechtslenker; + ESP		03.2123-2064.3 010598	ATE Ø 23,81
				09/00→; für Linkslenker; + ESP		03.2123-2715.3 010802	ATE Ø 23,81
				09/00→; für Rechtslenker; + ESP		03.2123-2774.3 010803	ATE Ø 23,81
				02/99→; für Linkslenker; - ESP		24.2123-1709.3 010503	Ø 23,81
2.8 V6 4motion	150	03/99→05/05		05/99→ 08/00; + ESP; für Linkslenker		03.2123-2024.3 010597	ATE Ø 23,81
				05/99→ 08/00; + ESP; für Rechtslenker		03.2123-2064.3 010598	ATE Ø 23,81
				09/00→; für Linkslenker; + ESP; → 12/04		03.2123-2715.3 010802	ATE Ø 23,81
				09/00→; für Rechtslenker; + ESP; → 12/04		03.2123-2774.3 010803	ATE Ø 23,81
				05/99→; für Linkslenker; - ESP; → 12/04		24.2123-1709.3 010503	Ø 23,81
VW - BORA Variant (1J6) 05/99→05/05							
 Bremskraftverstärker							
1.4 16V	55	09/01→05/05		→ 1J-2-373846; für Linkslenker; + ESP		03.7860-0602.4 300141	ATE Ø 10" pneumatisch
1.6 FSI	81	01/02→05/05					
1.9 TDI	74	09/00→05/05		1J-2-373847→; für Linkslenker; + ESP; → 12/04		03.7863-3502.4 300128	ATE Ø 10" pneumatisch
1.9 TDI	110	05/01→05/05					
1.9 TDI 4motion	74	09/00→05/05					
1.9 TDI 4motion	110	05/01→05/05					
2.0 4motion	85	04/00→05/05					
2.3 V5	125	10/00→05/05					
2.3 V5 4motion	125	10/00→05/05					
1.6	74	05/99→05/05		09/00→; → 1J-2-373846; für Linkslenker; + ESP		03.7860-0602.4 300141	ATE Ø 10" pneumatisch
1.6	75	08/00→05/05					
↓							













	kw					! #		
VW - BORA Variant (1J6) 05/99→05/05								
Bremskraftverstärker								
1.6 16V	77	02/00→05/05		→ 08/00; für Linkslenker; + ESP		03.7863-0402.4	300124	ATE Ø 10" pneumatisch
1.8 4motion	92	05/99→05/05		1J-2-373847→; für Linkslenker; + ESP;		03.7863-3502.4	300128	ATE Ø 10" pneumatisch
2.0	85	05/99→05/05		→ 12/04				
2.8 V6 4motion	150	05/99→05/05						
1.8 T	110	05/00→05/05		09/00→; → 1J-2-373846; für Linkslenker; + ESP		03.7860-0602.4	300141	ATE Ø 10" pneumatisch
				1J-2-373847→; für Linkslenker; + ESP; → 12/04		03.7863-3502.4	300128	ATE Ø 10" pneumatisch
1.8 T	132	05/02→05/05		für Linkslenker; + ESP; → 12/04		03.7863-3502.4	300128	ATE Ø 10" pneumatisch
1.9 TDI	81	05/99→06/01		09/00→; für Linkslenker; + ESP		03.7860-0602.4	300141	ATE Ø 10" pneumatisch
1.9 TDI	85	05/99→06/01		→ 08/00; für Linkslenker; + ESP		03.7863-0402.4	300124	ATE Ø 10" pneumatisch
1.9 TDI 4motion	85	05/99→06/01						
1.9 TDI	96	11/00→05/05		04/01→; → 1J-2-373846; für Linkslenker; + ESP		03.7860-0602.4	300141	ATE Ø 10" pneumatisch
1.9 TDI 4motion	96	11/00→05/05		1J-2-373847→; für Linkslenker; + ESP; → 12/04		03.7863-3502.4	300128	ATE Ø 10" pneumatisch
2.0 4motion	88	12/99→05/03		04/00→; → 1J-2-373846; für Linkslenker; + ESP		03.7860-0602.4	300141	ATE Ø 10" pneumatisch
				1J-2-373847→; für Linkslenker; + ESP		03.7863-3502.4	300128	ATE Ø 10" pneumatisch
2.3 V5	110	05/99→10/00		09/00→; → 1J-2-373846; für Linkslenker; + ESP		03.7860-0602.4	300141	ATE Ø 10" pneumatisch
2.3 V5 4motion	110	05/99→10/00		→ 08/00; für Linkslenker; + ESP		03.7863-0402.4	300124	ATE Ø 10" pneumatisch
				1J-2-373847→; für Linkslenker; + ESP		03.7863-3502.4	300128	ATE Ø 10" pneumatisch
Hauptbremszylinder								
1.4 16V	55	09/01→05/05		für Linkslenker; + ESP; → 12/04		03.2123-2715.3	010802	ATE Ø 23,81
1.6 FSI	81	01/02→05/05		für Rechtslenker; + ESP; → 12/04		03.2123-2774.3	010803	ATE Ø 23,81
1.8 T	132	05/02→05/05						
1.9 TDI	74	09/00→05/05		für Linkslenker; - ESP; → 12/04		24.2123-1709.3	010503	Ø 23,81
1.9 TDI	110	05/01→05/05						
1.9 TDI 4motion	74	09/00→05/05						
1.9 TDI 4motion	110	05/01→05/05						
2.0 4motion	85	04/00→05/05						
2.3 V5	125	10/00→05/05						
2.3 V5 4motion	125	10/00→05/05						
1.6	74	05/99→05/05		→ 08/00; für Linkslenker; + ESP		03.2123-2024.3	010597	ATE Ø 23,81
1.6	75	08/00→05/05		→ 08/00; für Rechtslenker; + ESP		03.2123-2064.3	010598	ATE Ø 23,81
1.6 16V	77	02/00→05/05						
1.8 4motion	92	05/99→05/05		09/00→; für Linkslenker; + ESP; → 12/04		03.2123-2715.3	010802	ATE Ø 23,81
2.0	85	05/99→05/05		09/00→; für Rechtslenker; + ESP; → 12/04		03.2123-2774.3	010803	ATE Ø 23,81
2.8 V6 4motion	150	05/99→05/05		für Linkslenker; - ESP; → 12/04		24.2123-1709.3	010503	Ø 23,81
1.8 T	110	05/00→05/05		09/00→; für Linkslenker; + ESP; → 12/04		03.2123-2715.3	010802	ATE Ø 23,81
				09/00→; für Rechtslenker; + ESP; → 12/04		03.2123-2774.3	010803	ATE Ø 23,81
				09/00→; für Linkslenker; - ESP; → 12/04		24.2123-1709.3	010503	Ø 23,81
1.9 TDI	81	05/99→06/01		→ 08/00; für Linkslenker; + ESP		03.2123-2024.3	010597	ATE Ø 23,81
1.9 TDI	85	05/99→06/01		→ 08/00; für Rechtslenker; + ESP		03.2123-2064.3	010598	ATE Ø 23,81
1.9 TDI 4motion	85	05/99→06/01						
2.3 V5	110	05/99→10/00		09/00→; für Linkslenker; + ESP		03.2123-2715.3	010802	ATE Ø 23,81
2.3 V5 4motion	110	05/99→10/00		09/00→; für Rechtslenker; + ESP		03.2123-2774.3	010803	ATE Ø 23,81
				für Linkslenker; - ESP		24.2123-1709.3	010503	Ø 23,81
1.9 TDI	96	11/00→05/05		04/01→; für Linkslenker; + ESP; → 12/04		03.2123-2715.3	010802	ATE Ø 23,81
1.9 TDI 4motion	96	11/00→05/05		04/01→; für Rechtslenker; + ESP; → 12/04		03.2123-2774.3	010803	ATE Ø 23,81
				04/01→; für Linkslenker; - ESP; → 12/04		24.2123-1709.3	010503	Ø 23,81
2.0 4motion	88	12/99→05/03		04/00→; für Linkslenker; + ESP		03.2123-2715.3	010802	ATE Ø 23,81
				04/00→; für Rechtslenker; + ESP		03.2123-2774.3	010803	ATE Ø 23,81
				04/00→; für Linkslenker; - ESP		24.2123-1709.3	010503	Ø 23,81
VW - CADDY II Kasten (9K9A) 11/95→01/04								
Bremskraftverstärker								
1.4	55	08/00→01/04		für Linkslenker; - ABS		03.7750-6302.4	300161	ATE Ø 9" pneumatisch
1.9 D	47	11/95→01/04		→ 9K-1-538270; für Linkslenker		10.6350-3902.4	300213	ATE Ø 9" pneumatisch
1.9 SDI	47	11/95→01/04						
1.9 TDI	66	09/96→01/04		9K-1-538271→; für Linkslenker		10.6350-4002.4	300285	ATE Ø 9" pneumatisch
60 1.4	44	11/95→01/04						
75 1.6	55	11/95→05/97						
75 1.6	55	11/95→09/00						
Hauptbremszylinder								
1.4	55	08/00→01/04		→ 9K-X-514000; für Rechtslenker; - ABS		03.2122-1042.3	010137	Ø 22,2
1.9 D	47	11/95→01/04						
↓								











	kw					! #		
VW - CADDY II Kasten (9K9A) 11/95→01/04								
 Hauptbremszylinder								
1.9 SDI	47	11/95→01/04		für Linkslenker; - ABS		03.2122-1042.3	010137	Ø 22,2
1.9 TDI	66	09/96→01/04		für Linkslenker; + ABS		03.2123-1424.3	010637	ATE Ø 23,81
60 1.4	44	11/95→01/04						
75 1.6	55	11/95→05/97		für Rechtslenker; + ABS		03.2123-1484.3	010595	ATE Ø 23,81
75 1.6	55	11/95→09/00						
Verschlusschraube, Hauptbremszylinder								
1.4	55	08/00→01/04		→ 9K-X-514000; für Rechtslenker; - ABS		03.3517-0101.2	390322	
1.9 D	47	11/95→01/04		für Linkslenker; - ABS		03.3517-0101.2	390322	
1.9 SDI	47	11/95→01/04						
1.9 TDI	66	09/96→01/04						
60 1.4	44	11/95→01/04						
75 1.6	55	11/95→05/97						
75 1.6	55	11/95→09/00						
VW - CADDY II Kombi (9K9B) 11/95→01/04								
 Bremskraftverstärker								
1.4	44	11/95→01/04		für Linkslenker; - ABS		03.7750-6302.4	300161	ATE Ø 9" pneumatisch
1.4 16V	55	08/00→01/04		→ 9K-1-538270; für Linkslenker		10.6350-3902.4	300213	ATE Ø 9" pneumatisch
1.6	55	11/95→05/97						
1.6	55	06/97→09/00		9K-1-538271→; für Linkslenker		10.6350-4002.4	300285	ATE Ø 9" pneumatisch
1.9 D	47	11/95→01/04						
1.9 SDI	47	11/95→01/04						
1.9 TDI	66	10/96→01/04						
 Hauptbremszylinder								
1.4	44	11/95→01/04		→ 9K-X-514000; für Rechtslenker; - ABS		03.2122-1042.3	010137	Ø 22,2
1.4 16V	55	08/00→01/04		für Linkslenker; - ABS		03.2122-1042.3	010137	Ø 22,2
1.6	55	11/95→05/97		für Linkslenker; + ABS		03.2123-1424.3	010637	ATE Ø 23,81
1.6	55	06/97→09/00						
1.9 D	47	11/95→01/04		für Rechtslenker; + ABS		03.2123-1484.3	010595	ATE Ø 23,81
1.9 SDI	47	11/95→01/04						
1.9 TDI	66	10/96→01/04						
Verschlusschraube, Hauptbremszylinder								
1.4	44	11/95→01/04		→ 9K-X-514000; für Rechtslenker; - ABS		03.3517-0101.2	390322	
1.4 16V	55	08/00→01/04		für Linkslenker; - ABS		03.3517-0101.2	390322	
1.6	55	11/95→05/97						
1.6	55	06/97→09/00						
1.9 D	47	11/95→01/04						
1.9 SDI	47	11/95→01/04						
1.9 TDI	66	10/96→01/04						
VW - CADDY II Pick-up (9U7) 06/96→12/00								
 Hauptbremszylinder								
1.6	55	06/96→12/00		10/97→; + ABS		03.2123-1428.3	010476	Ø 23,81
1.9 D	47	06/96→12/00		10/97→; - ABS		24.2122-1731.3	010656	Ø 22,2
 Bremskraftregler								
1.6	55	06/96→12/00		10/97→		03.6583-0167.3	320140	ATE lastabhängig 8/3 4x
1.9 D	47	06/96→12/00				03.6584-0107.3	320110	ATE lastabhängig 8/4 4x
VW - CADDY III Kasten (2KA, 2KH, 2CA, 2CH) 03/04→05/15								
 Bremskraftverstärker								
1.2 TSI	63	09/10→05/15		für Linkslenker		03.7873-4302.4	300312	ATE Ø 11" pneumatisch
1.2 TSI	77	09/10→05/15						
1.4	55	03/04→05/06						
1.4	59	05/06→08/10						
1.6	75	04/04→05/15						
1.6 BiFuel	75	05/11→05/15						
1.6 TDI	55	08/10→05/15						
1.6 TDI	75	08/10→05/15						
1.9 TDI	55	09/05→08/10						
1.9 TDI	77	04/04→08/10						
1.9 TDI 4motion	77	11/08→08/10						
2.0 EcoFuel	80	04/06→05/15						
2.0 SDI	51	03/04→08/10						
2.0 TDI	62	11/10→05/15						
2.0 TDI	103	09/07→08/10						
2.0 TDI	125	05/12→05/15						
2.0 TDI 16V	103	11/10→05/15						
2.0 TDI 16V 4motion	103	11/10→05/15						
2.0 TDI 4motion	62	12/10→05/15						
2.0 TDI	81	08/10→05/15		10/10→; für Linkslenker		03.7873-4302.4	300312	ATE Ø 11" pneumatisch
2.0 TDI 4motion	81	08/10→05/15						
↓								









	kw			 	! #					
VW - CADDY III Kasten (2KA, 2KH, 2CA, 2CH) 03/04→05/15										
 Hauptbremszylinder										
1.2 TSI	63	09/10→05/15		für Linkslenker		03.2122-2129.3 010799	ATE Ø 22,2			
1.2 TSI	77	09/10→05/15		für Rechtslenker		24.4152-0132.3 011025	ATE Ø 22,2 ohne Bremsflüssigkeitsbehälter			
1.6 TDI	55	08/10→05/15								
1.6 TDI	75	08/10→05/15								
2.0 TDI	125	05/12→05/15								
2.0 TDI 4motion	62	12/10→05/15								
1.4	55	03/04→05/06		für Linkslenker		03.2122-2129.3 010799	ATE Ø 22,2			
1.4	59	05/06→08/10		2K-7-000 001→; für Rechtslenker		24.4152-0132.3 011025	ATE Ø 22,2 ohne Bremsflüssigkeitsbehälter			
1.6	75	04/04→05/15								
1.6 BiFuel	75	05/11→05/15								
1.9 TDI	55	09/05→08/10								
1.9 TDI	77	04/04→08/10								
1.9 TDI 4motion	77	11/08→08/10								
2.0 EcoFuel	80	04/06→05/15								
2.0 SDI	51	03/04→08/10								
2.0 TDI	62	11/10→05/15								
2.0 TDI	103	09/07→08/10								
2.0 TDI 16V	103	11/10→05/15								
2.0 TDI 16V 4motion	103	11/10→05/15								
2.0 TDI	81	08/10→05/15		10/10→; für Linkslenker		03.2122-2129.3 010799	ATE Ø 22,2			
2.0 TDI 4motion	81	08/10→05/15		10/10→; für Rechtslenker		24.4152-0132.3 011025	ATE Ø 22,2 ohne Bremsflüssigkeitsbehälter			
Hydraulikaggregat, Bremsanlage										
1.2 TSI	63	09/10→05/15		→ 12/10; +PR 1AT		24.9145-0001.2 399005				
1.2 TSI	77	09/10→05/15								
1.6	75	04/04→05/15								
1.6 TDI	55	08/10→05/15								
1.6 TDI	75	08/10→05/15								
2.0 EcoFuel	80	04/06→05/15								
2.0 TDI	62	11/10→05/15								
2.0 TDI 16V	103	11/10→05/15								
2.0 TDI 16V 4motion	103	11/10→05/15								
2.0 TDI 4motion	62	12/10→05/15								
1.4	55	03/04→05/06		+PR 1AT		24.9145-0001.2 399005				
1.4	59	05/06→08/10								
1.9 TDI	55	09/05→08/10								
1.9 TDI	77	04/04→08/10								
1.9 TDI 4motion	77	11/08→08/10								
2.0 SDI	51	03/04→08/10								
2.0 TDI	103	09/07→08/10								
2.0 TDI	81	08/10→05/15			10/10→ 12/10; +PR 1AT				24.9145-0001.2 399005	
2.0 TDI 4motion	81	08/10→05/15								
VW - CADDY III Kombi (2KB, 2KJ, 2CB, 2CJ) 03/04→05/15										
 Bremskraftverstärker										
1.2 TSI	63	09/10→05/15		für Linkslenker		03.7873-4302.4 300312	ATE Ø 11" pneumatisch			
1.2 TSI	77	09/10→05/15								
1.4	55	03/04→05/06								
1.4	59	05/06→08/10								
1.6	75	04/04→05/15								
1.6 BiFuel	75	05/11→05/15								
1.6 TDI	55	08/10→05/15								
1.6 TDI	75	08/10→05/15								
1.9 TDI	55	09/05→08/10								
1.9 TDI	77	04/04→08/10								
1.9 TDI 4motion	77	05/08→08/10								
2.0 EcoFuel	80	04/06→05/15								
2.0 SDI	51	03/04→08/10								
2.0 TDI	103	09/07→08/10								
2.0 TDI	125	05/12→05/15								
2.0 TDI 16V	103	11/10→05/15								
2.0 TDI 16V 4motion	103	11/10→05/15								
2.0 TDI	81	08/10→05/15			10/10→; für Linkslenker				03.7873-4302.4 300312	ATE Ø 11" pneumatisch
2.0 TDI 4motion	81	08/10→05/15								
 Hauptbremszylinder										
1.2 TSI	63	09/10→05/15		für Linkslenker		03.2122-2129.3 010799	ATE Ø 22,2			
1.2 TSI	77	09/10→05/15		für Rechtslenker		24.4152-0132.3 011025	ATE Ø 22,2 ohne Bremsflüssigkeitsbehälter			
1.6 TDI	55	08/10→05/15								
1.6 TDI	75	08/10→05/15								
2.0 TDI	125	05/12→05/15								
2.0 TDI 16V 4motion	103	11/10→05/15								
1.4	55	03/04→05/06		für Linkslenker		03.2122-2129.3 010799	ATE Ø 22,2			
1.4	59	05/06→08/10		2K-7-000 001→; für Rechtslenker		24.4152-0132.3 011025	ATE Ø 22,2 ohne Bremsflüssigkeitsbehälter			
1.6	75	04/04→05/15								
1.6 BiFuel	75	05/11→05/15								
1.9 TDI	55	09/05→08/10								
1.9 TDI	77	04/04→08/10								
1.9 TDI 4motion	77	05/08→08/10								
↓										













	kw					! #						
VW - CADDY III Kombi (2KB, 2KJ, 2CB, 2CJ) 03/04→05/15												
 Hauptbremszylinder												
2.0 EcoFuel	80	04/06→05/15		für Linkslenker		03.2122-2129.3	010799	ATE Ø 22,2				
2.0 SDI	51	03/04→08/10		2K-7-000 001→; für Rechtslenker		24.4152-0132.3	011025	ATE Ø 22,2 ohne Bremsflüssigkeitsbehälter				
2.0 TDI	103	09/07→08/10										
2.0 TDI 16V	103	11/10→05/15										
2.0 TDI	81	08/10→05/15		10/10→; für Linkslenker		03.2122-2129.3	010799	ATE Ø 22,2				
2.0 TDI 4motion	81	08/10→05/15		10/10→; für Rechtslenker		24.4152-0132.3	011025	ATE Ø 22,2 ohne Bremsflüssigkeitsbehälter				
Hydraulikaggregat, Bremsanlage												
1.2 TSI	63	09/10→05/15		→ 12/10; +PR 1AT		24.9145-0001.2	399005					
1.2 TSI	77	09/10→05/15										
1.6	75	04/04→05/15										
1.6 TDI	55	08/10→05/15										
1.6 TDI	75	08/10→05/15										
2.0 EcoFuel	80	04/06→05/15										
2.0 TDI 16V	103	11/10→05/15										
2.0 TDI 16V 4motion	103	11/10→05/15										
1.4	55	03/04→05/06		+PR 1AT		24.9145-0001.2	399005					
1.4	59	05/06→08/10										
1.9 TDI	55	09/05→08/10										
1.9 TDI	77	04/04→08/10										
1.9 TDI 4motion	77	05/08→08/10										
2.0 SDI	51	03/04→08/10										
2.0 TDI	103	09/07→08/10										
2.0 TDI	81	08/10→05/15			10/10→ 12/10; +PR 1AT					24.9145-0001.2	399005	
2.0 TDI 4motion	81	08/10→05/15										
VW - CADDY IV Kasten (SAA, SAH) 05/15→												
 Hauptbremszylinder												
1.0 TSI	75	11/15→		für Linkslenker		03.2123-3449.3	010808	ATE Ø 23,81				
1.2 TSI	62	06/15→		für Rechtslenker		24.4153-0202.3	011027	ATE Ø 23,81 ohne Bremsflüssigkeitsbehälter				
1.4 TGI CNG	81	06/15→										
1.4 TSI	92	05/15→										
1.6	81	11/15→										
1.6 TDI	55	05/15→										
1.6 TDI	75	05/15→										
2.0 TDI	55	05/15→										
2.0 TDI	75	05/15→										
2.0 TDI	103	05/15→										
2.0 TDI	110	05/15→										
2.0 TDI 4motion	55	11/15→										
2.0 TDI 4motion	81	05/15→										
2.0 TDI 4motion	90	05/15→										
2.0 TDI 4motion	103	05/15→										
2.0 TDI 4motion	110	11/15→										
VW - CADDY IV Kombi (SAB, SAJ) 05/15→												
 Hauptbremszylinder												
1.0 TSI	75	11/15→		für Linkslenker		03.2123-3449.3	010808	ATE Ø 23,81				
1.2 TSI	62	06/15→		für Rechtslenker		24.4153-0202.3	011027	ATE Ø 23,81 ohne Bremsflüssigkeitsbehälter				
1.4 TGI CNG	81	06/15→										
1.4 TSI	92	05/15→										
1.6	81	11/15→										
1.6 TDI	55	05/15→										
1.6 TDI	75	05/15→										
2.0 TDI	55	05/15→										
2.0 TDI	75	05/15→										
2.0 TDI	103	05/15→										
2.0 TDI	110	05/15→										
2.0 TDI 4motion	81	05/15→										
2.0 TDI 4motion	90	05/15→										
2.0 TDI 4motion	103	05/15→										
2.0 TDI 4motion	110	11/15→										
VW - CADDY ALLTRACK Kasten (SAA) 05/15→												
 Hauptbremszylinder												
1.0 TSI	75	11/15→			für Linkslenker					03.2123-3449.3	010808	ATE Ø 23,81
1.2 TSI	62	06/15→		für Rechtslenker		24.4153-0202.3	011027	ATE Ø 23,81 ohne Bremsflüssigkeitsbehälter				
1.4 TGI CNG	81	06/15→										
1.4 TSI	92	05/15→										
2.0 TDI	55	05/15→										
2.0 TDI	75	05/15→										
2.0 TDI	110	05/15→										
2.0 TDI 4motion	90	05/15→										
2.0 TDI 4motion	110	11/15→										







	kw					! #						
VW - CADDY ALLTRACK Kombi (SAB) 05/15→												
 Hauptbremszylinder												
1.0 TSI	75	11/15→		für Linkslenker		03.2123-3449.3	010808	ATE Ø 23,81				
1.2 TSI	62	06/15→		für Rechtslenker		24.4153-0202.3	011027	ATE Ø 23,81 ohne Bremsflüssigkeitsbehälter				
1.4 TGI CNG	81	06/15→										
1.4 TSI	92	05/15→										
2.0 TDI	55	05/15→										
2.0 TDI	75	05/15→										
2.0 TDI	110	05/15→										
2.0 TDI 4motion	90	05/15→										
2.0 TDI 4motion	110	11/15→										
VW - CC (358) 11/11→12/16												
 Bremskraftverstärker												
1.4 TSI	110	05/15→12/16		+PR 1ZG; für Linkslenker		03.7873-4402.4	300292	ATE Ø 11" pneumatisch				
1.4 TSI	118	11/11→12/16		+PR 1LA,1LB,1ZM; für Linkslenker		03.7873-4502.4	300284	ATE Ø 11" pneumatisch				
1.4 TSI MultiFuel	118	11/11→12/16										
1.8 TSI	118	11/11→12/16										
2.0 TDI	100	11/11→12/16										
2.0 TDI	103	11/11→12/16										
2.0 TDI	110	05/15→12/16										
2.0 TDI	125	11/11→12/16										
2.0 TDI	130	12/12→12/16										
2.0 TDI	135	05/15→12/16										
2.0 TDI 4motion	103	11/11→12/16										
2.0 TDI 4motion	125	11/11→01/13										
2.0 TDI 4motion	130	12/12→12/16										
2.0 TSI	155	11/11→12/16										
3.6 FSI 4motion	220	11/11→12/16										
 Hauptbremszylinder												
1.4 TSI	110	05/15→12/16			für Linkslenker; +PR 1ZG					03.4152-0116.3	010814	ATE Ø 22,2
1.4 TSI	118	11/11→12/16		für Linkslenker; +PR 1LA,1LB,1ZM		03.4153-0186.3	010816	ATE Ø 23,81				
1.4 TSI MultiFuel	118	11/11→12/16										
1.8 TSI	118	11/11→12/16										
2.0 TDI	100	11/11→12/16										
2.0 TDI	103	11/11→12/16										
2.0 TDI	110	05/15→12/16										
2.0 TDI	125	11/11→12/16										
2.0 TDI	130	12/12→12/16										
2.0 TDI	135	05/15→12/16										
2.0 TDI 4motion	103	11/11→12/16										
2.0 TDI 4motion	125	11/11→01/13										
2.0 TDI 4motion	130	12/12→12/16										
2.0 TSI	155	11/11→12/16										
3.6 FSI 4motion	220	11/11→12/16										
Drucksensor, Bremskraftverstärker												
3.6 FSI 4motion	220	11/11→12/16			+PR 1ZG; für Rechtslenker					03.0655-0101.2	370008	ATE
VW - CORRADO (531) 08/87→12/95												
 Bremskraftverstärker												
2.0 i	85	04/93→12/95		→ 07/95; für Linkslenker; - ABS		03.7750-4302.4	300076	ATE Ø 9" pneumatisch				
2.0 i 16V	100	08/91→12/95		→ 07/95; für Rechtslenker; - ABS		03.7750-4902.4	300079	ATE Ø 9" pneumatisch				
2.9 VR6	140	08/91→12/95										
 Hauptbremszylinder												
2.0 i	85	04/93→12/95		→ 07/95; - ABS		03.2122-1042.3	010137	Ø 22,2				
2.0 i 16V	100	08/91→12/95										
2.9 VR6	140	08/91→12/95										
Verschlusschraube, Hauptbremszylinder												
2.0 i	85	04/93→12/95		→ 07/95; - ABS		03.3517-0101.2	390322					
2.0 i 16V	100	08/91→12/95										
2.9 VR6	140	08/91→12/95										
 Bremskraftregler												
2.0 i	85	04/93→12/95		→ 07/95		03.6584-0015.3	320109	ATE lastabhängig 8/4 4x				
2.0 i 16V	100	08/91→12/95										
2.9 VR6	140	08/91→12/95		→ 07/95		03.6584-0113.3	320111	ATE lastabhängig 8/4 4x				
VW - CRAFTER 30-35 Bus (2E_) 04/06→12/16												
 Hauptbremszylinder												
2.0 TDI	80	05/11→12/16		07/11→		24.2126-1704.3	010990	TRW Ø 26,99				
2.0 TDI	100	05/11→12/16										
2.5 TDI	65	04/06→07/11										
2.5 TDI	80	04/06→05/13										
2.5 TDI	100	04/06→05/13										
2.5 TDI	120	04/06→07/11										
↓												







	kw					! #		
VW - CRAFTER 30-35 Bus (2E_) 04/06→12/16								
 Hauptbremszylinder								
2.0 TDI	84	11/13→12/16					24.2126-1704.3 010990	TRW Ø 26,99
2.0 TDI	105	10/11→12/16						
2.0 TDI	120	07/11→12/16						
2.0 TDI 4motion	120	11/11→12/16						
VW - CRAFTER 30-50 Kasten (2E_) 04/06→12/16								
 Hauptbremszylinder								
2.0 TDI	80	05/11→12/16		07/11→			24.2126-1704.3 010990	TRW Ø 26,99
2.0 TDI	100	05/11→12/16						
2.5 TDI	65	04/06→07/11						
2.5 TDI	80	04/06→05/13						
2.5 TDI	100	04/06→05/13						
2.5 TDI	120	04/06→07/11						
2.0 TDI	84	11/13→12/16					24.2126-1704.3 010990	TRW Ø 26,99
2.0 TDI	103	11/15→12/16						
2.0 TDI	105	10/11→12/16						
2.0 TDI	120	07/11→12/16						
2.0 TDI 4motion	120	11/11→12/16						
VW - CRAFTER 30-50 Pritsche/Fahrgestell (2F_) 04/06→12/16								
 Hauptbremszylinder								
2.0 TDI	80	05/11→12/16		07/11→			24.2126-1704.3 010990	TRW Ø 26,99
2.0 TDI	100	05/11→12/16						
2.5 TDI	65	04/06→07/11						
2.5 TDI	80	04/06→05/13						
2.5 TDI	100	04/06→05/13						
2.5 TDI	120	04/06→07/11						
2.0 TDI	84	11/13→12/16					24.2126-1704.3 010990	TRW Ø 26,99
2.0 TDI	103	11/15→12/16						
2.0 TDI	105	10/11→12/16						
2.0 TDI	120	07/11→12/16						
2.0 TDI 4motion	120	11/11→12/16						
VW - EOS (1F7, 1F8) 03/06→08/15								
 Bremskraftverstärker								
1.4 TSI	90	11/07→08/15		für Linkslenker			03.7863-3332.4 300308	ATE Ø 10" pneumatisch
1.4 TSI	118	05/08→08/15						
1.6 FSI	85	06/06→05/08						
2.0 TDI	100	11/10→08/15						
2.0 TDI	103	06/06→05/08						
2.0 TDI 16V	103	05/08→08/15						
2.0 FSI	110	03/06→05/08		05/06→; für Linkslenker; +PR 1ZD			03.7863-3232.4 300307	ATE Ø 10" pneumatisch
2.0 TFSI	147	03/06→08/15		05/06→; für Linkslenker; +PR 1ZA,1ZE,1LJ			03.7863-3332.4 300308	ATE Ø 10" pneumatisch
2.0 TSI	155	11/09→08/15		für Linkslenker; +PR 1ZD			03.7863-3232.4 300307	ATE Ø 10" pneumatisch
3.2 V6	184	06/06→05/09		für Linkslenker; +PR 1ZA,1ZE,1LJ			03.7863-3332.4 300308	ATE Ø 10" pneumatisch
3.6 V6	191	05/09→11/10		für Linkslenker; +PR 1ZD			03.7863-3232.4 300307	ATE Ø 10" pneumatisch
				+PR 1LK; für Linkslenker			03.7863-3332.4 300308	ATE Ø 10" pneumatisch
 Hauptbremszylinder								
1.4 TSI	90	11/07→08/15		für Linkslenker; +PR 1AT,1ZD			03.2122-2129.3 010799	ATE Ø 22,2
1.4 TSI	118	05/08→08/15						
1.6 FSI	85	06/06→05/08		für Linkslenker; +PR 1ZA,1ZE,1LJ,1LK			03.2123-3449.3 010808	ATE Ø 23,81
2.0 TDI	100	11/10→08/15		für Rechtslenker; +PR 1ZD			24.4152-0132.3 011025	ATE Ø 22,2 ohne Bremsflüssigkeitsbehälter
2.0 TDI	103	06/06→05/08						
2.0 TDI 16V	103	05/08→08/15		für Rechtslenker; +PR 1ZA,1ZE,1LJ			24.4153-0202.3 011027	ATE Ø 23,81 ohne Bremsflüssigkeitsbehälter
2.0 TSI	155	11/09→08/15						
3.2 V6	184	06/06→05/09						
3.6 V6	191	05/09→11/10						
2.0 FSI	110	03/06→05/08		05/06→; für Linkslenker; +PR 1AT,1ZD			03.2122-2129.3 010799	ATE Ø 22,2
2.0 TFSI	147	03/06→08/15		05/06→; für Linkslenker; +PR 1ZA,1ZE,1LJ,1LK			03.2123-3449.3 010808	ATE Ø 23,81
				05/06→; für Rechtslenker; +PR 1ZD			24.4152-0132.3 011025	ATE Ø 22,2 ohne Bremsflüssigkeitsbehälter
				05/06→; für Rechtslenker; +PR 1ZA,1ZE,1LJ			24.4153-0202.3 011027	ATE Ø 23,81 ohne Bremsflüssigkeitsbehälter
Hydraulikaggregat, Bremsanlage								
1.4 TSI	90	11/07→08/15		→ 12/08			24.9145-0001.2 399005	
1.4 TSI	118	05/08→08/15						
2.0 TDI 16V	103	05/08→08/15						
3.2 V6	184	06/06→05/09						
1.6 FSI	85	06/06→05/08					24.9145-0001.2 399005	
2.0 TDI	103	06/06→05/08						
↓								











	kw					! #		
VW - EOS (1F7, 1F8) 03/06→08/15								
Hydraulikaggregat, Bremsanlage								
2.0 FSI	110	03/06→05/08		05/06→			24.9145-0001.2	399005
2.0 TFSI	147	03/06→08/15		05/06→ 12/08			24.9145-0001.2	399005
VW - FOX (5Z1, 5Z3) 10/03→								
 Hauptbremszylinder								
1.2	40	04/05→		→ 08/11; +PR 1ZN; + ABS			24.2120-1734.3	010702 Ø 20,64
1.2	44	09/10→						
1.4	55	04/05→		→ 08/11; +PR 1ZF;1AC;1AT; + ABS			24.2120-1734.3	010702 Ø 20,64
1.4 TDI	51	04/05→						
 Bremskraftregler								
1.2	40	04/05→		→ 08/11; - ABS			03.6584-0120.3	320279 ATE lastabhängig 8/4 4x
1.2	44	09/10→						
1.4	55	04/05→						
1.4 TDI	51	04/05→						
VW - GOLF III (1H1) 08/91→07/98								
 Bremskraftverstärker								
1.4	40	11/91→08/97		für Linkslenker; - ABS			03.7750-5502.4	300081 ATE Ø 9" pneumatisch
1.6	55	09/92→08/97		→ 1H-S-088704; für Linkslenker; + ABS			10.6360-1003.4	300156 ATE Ø 10" pneumatisch
1.6	74	07/95→08/97						
1.8	55	11/91→08/97		1H-S-088705→; für Linkslenker; + ABS			10.6360-2002.4	300143 ATE Ø 10" pneumatisch
1.8	66	11/91→08/97						
1.8 Syncro (1HX1)	66	01/93→08/97						
1.9 TD,GTD	55	11/91→08/97						
2.0 GTI 16V	110	08/92→08/97						
2.8 VR6	128	01/92→08/97						
1.4	44	10/91→08/97		11/91→; für Linkslenker; - ABS			03.7750-5502.4	300081 ATE Ø 9" pneumatisch
				11/91→; → 1H-S-088704; für Linkslenker; + ABS			10.6360-1003.4	300156 ATE Ø 10" pneumatisch
				1H-S-088705→; für Linkslenker; + ABS			10.6360-2002.4	300143 ATE Ø 10" pneumatisch
1.9 D	47	11/91→08/97		für Linkslenker; - ABS			03.7750-5502.4	300081 ATE Ø 9" pneumatisch
				08/93→ 07/95; für Linkslenker; - ABS			03.7750-5502.4	300081 ATE Ø 9" pneumatisch
				→ 1H-S-088704; für Linkslenker; + ABS			10.6360-1003.4	300156 ATE Ø 10" pneumatisch
				08/93→; → 1H-S-088704; für Linkslenker; + ABS			10.6360-1003.4	300156 ATE Ø 10" pneumatisch
				1H-S-088705→; → 07/95; für Linkslenker; + ABS			10.6360-2002.4	300143 ATE Ø 10" pneumatisch
				1H-S-088705→; für Linkslenker; + ABS			10.6360-2002.4	300143 ATE Ø 10" pneumatisch
1.9 SDI	47	07/95→08/97		für Linkslenker; - ABS			03.7750-5502.4	300081 ATE Ø 9" pneumatisch
1.9 TDI	81	04/96→08/97						
1.9 TDI Syncro (1HX1)	66	08/95→08/97		für Linkslenker; + ABS			10.6360-2002.4	300143 ATE Ø 10" pneumatisch
2.0 Syncro (1HX1)	85	08/95→08/97						
1.9 TDI	66	09/93→08/97		10/93→; für Linkslenker; - ABS			03.7750-5502.4	300081 ATE Ø 9" pneumatisch
				10/93→; → 1H-S-088704; für Linkslenker; + ABS			10.6360-1003.4	300156 ATE Ø 10" pneumatisch
				1H-S-088705→; für Linkslenker; + ABS			10.6360-2002.4	300143 ATE Ø 10" pneumatisch
2.0	85	11/91→08/97		für Linkslenker; - ABS			03.7750-5502.4	300081 ATE Ø 9" pneumatisch
2.9 VR6 Syncro (1HX1)	140	10/94→08/97		→ 1H-S-088704; für Linkslenker; + ABS			10.6360-1003.4	300156 ATE Ø 10" pneumatisch
				1H-S-088705→; für Linkslenker; + ABS			10.6360-2002.4	300143 ATE Ø 10" pneumatisch
 Hauptbremszylinder								
1.4	40	11/91→08/97		- ABS			03.2120-3943.3	010532 ATE Ø 20,64
1.6	55	09/92→08/97		1H-S-088705→; für Linkslenker; + ABS			03.2122-1144.3	010636 ATE Ø 22,2
1.9 TD,GTD	55	11/91→08/97		1H-S-088705→; für Rechtslenker; + ABS			03.2122-1184.3	010592 ATE Ø 22,2
1.4	44	10/91→08/97		11/91→; - ABS			03.2120-3943.3	010532 ATE Ø 20,64
				1H-S-088705→; für Linkslenker; + ABS			03.2122-1144.3	010636 ATE Ø 22,2
				1H-S-088705→; für Rechtslenker; + ABS			03.2122-1184.3	010592 ATE Ø 22,2
1.6	74	07/95→08/97		- ABS			03.2122-1042.3	010137 Ø 22,2
2.0 GTI 16V	110	08/92→08/97		1H-S-088705→; für Linkslenker; + ABS			03.2123-1424.3	010637 ATE Ø 23,81
				1H-S-088705→; für Rechtslenker; + ABS			03.2123-1484.3	010595 ATE Ø 23,81
				→ 1H-S-088704; für Linkslenker; + ABS			10.6123-0674.3	010639 ATE Ø 23,81
1.8	55	11/91→08/97		- ABS			03.2120-3943.3	010532 ATE Ø 20,64
1.8	66	11/91→08/97					03.2122-1042.3	010137 Ø 22,2
				1H-S-088705→; für Linkslenker; + ABS			03.2122-1144.3	010636 ATE Ø 22,2
							03.2123-1424.3	010637 ATE Ø 23,81
				1H-S-088705→; für Rechtslenker; + ABS			03.2122-1184.3	010592 ATE Ø 22,2
							03.2123-1484.3	010595 ATE Ø 23,81











	kw			 	! #		
VW - GOLF III (1H1) 08/91→07/98							
 Hauptbremszylinder							
1.8	55	11/91→08/97		→ 1H-S-088704; für Linkslenker; + ABS		10.6123-0674.3 010639	ATE Ø 23,81
1.8	66	11/91→08/97					
1.8 Syncro (1HX1)	66	01/93→08/97		- ABS		03.2122-1042.3 010137	Ø 22,2
				1H-S-088705→; für Linkslenker; + ABS		03.2123-1424.3 010637	ATE Ø 23,81
1.9 D	47	11/91→08/97		08/93→ 07/95; - ABS		03.2120-3943.3 010532	ATE Ø 20,64
				- ABS		03.2120-3943.3 010532	ATE Ø 20,64
				1H-S-088705→; → 07/95; für Linkslenker; + ABS		03.2122-1144.3 010636	ATE Ø 22,2
				1H-S-088705→; für Linkslenker; + ABS		03.2122-1144.3 010636	ATE Ø 22,2
				1H-S-088705→; für Rechtslenker; + ABS		03.2122-1184.3 010592	ATE Ø 22,2
1.9 SDI	47	07/95→08/97		- ABS		03.2120-3943.3 010532	ATE Ø 20,64
				+ ABS		03.2122-1144.3 010636	ATE Ø 22,2
				für Rechtslenker; + ABS		03.2122-1184.3 010592	ATE Ø 22,2
1.9 TDI	66	09/93→08/97		10/93→; - ABS		03.2122-1042.3 010137	Ø 22,2
				1H-S-088705→; für Linkslenker; + ABS		03.2123-1424.3 010637	ATE Ø 23,81
				1H-S-088705→; für Rechtslenker; + ABS		03.2123-1484.3 010595	ATE Ø 23,81
				10/93→; → 1H-S-088704; für Linkslenker; + ABS		10.6123-0674.3 010639	ATE Ø 23,81
1.9 TDI	81	04/96→08/97		- ABS		03.2122-1042.3 010137	Ø 22,2
				für Linkslenker; + ABS		03.2123-1424.3 010637	ATE Ø 23,81
				für Rechtslenker; + ABS		03.2123-1484.3 010595	ATE Ø 23,81
1.9 TDI Syncro (1HX1)	66	08/95→08/97		- ABS		03.2122-1042.3 010137	Ø 22,2
2.0 Syncro (1HX1)	85	08/95→08/97		für Linkslenker; + ABS		03.2123-1424.3 010637	ATE Ø 23,81
2.0	85	11/91→08/97		- ABS		03.2122-1042.3 010137	Ø 22,2
2.8 VR6	128	01/92→08/97		1H-S-088705→; für Linkslenker; + ABS		03.2123-1424.3 010637	ATE Ø 23,81
				1H-S-088705→; für Rechtslenker; + ABS		03.2123-1484.3 010595	ATE Ø 23,81
				→ 1H-S-088704; für Linkslenker; + ABS		10.6123-0674.3 010639	ATE Ø 23,81
2.9 VR6 Syncro (1HX1)	140	10/94→08/97		1H-S-088705→; für Linkslenker; + ABS		03.2123-1424.3 010637	ATE Ø 23,81
				→ 1H-S-088704; für Linkslenker; + ABS		10.6123-0674.3 010639	ATE Ø 23,81
Citystromer	20	11/94→08/97		+ ABS; für Linkslenker		03.2122-1144.3 010636	ATE Ø 22,2
Verschlusschraube, Hauptbremszylinder							
1.4	40	11/91→08/97		- ABS		03.3517-0101.2 390322	
1.6	55	09/92→08/97					
1.6	74	07/95→08/97					
1.8	55	11/91→08/97					
1.8	66	11/91→08/97					
1.8 Syncro (1HX1)	66	01/93→08/97					
1.9 SDI	47	07/95→08/97					
1.9 TD,GTD	55	11/91→08/97					
1.9 TDI	81	04/96→08/97					
1.9 TDI Syncro (1HX1)	66	08/95→08/97					
2.0	85	11/91→08/97					
2.0 GTI 16V	110	08/92→08/97					
2.0 Syncro (1HX1)	85	08/95→08/97					
1.4	44	10/91→08/97		11/91→; - ABS		03.3517-0101.2 390322	
1.9 D	47	11/91→08/97		08/93→ 07/95; - ABS		03.3517-0101.2 390322	
				- ABS		03.3517-0101.2 390322	
1.9 TDI	66	09/93→08/97		10/93→; - ABS		03.3517-0101.2 390322	
 Bremskraftregler							
1.4	40	11/91→08/97		→ 1H-V-040000		03.0101-0025.2 320014	ATE Satz 3/35 2x
				1H-V-040001→		03.6584-0107.3 320110	ATE lastabhängig 8/4 4x
1.4	44	10/91→08/97		11/91→; → 1H-V-040000		03.0101-0025.2 320014	ATE Satz 3/35 2x
				1H-V-040001→		03.6584-0107.3 320110	ATE lastabhängig 8/4 4x
1.6	55	09/92→08/97				03.6584-0107.3 320110	ATE lastabhängig 8/4 4x
1.9 SDI	47	07/95→08/97					
1.9 TD,GTD	55	11/91→08/97					
1.6	74	07/95→08/97				03.6584-0107.3 320110	ATE lastabhängig 8/4 4x
1.8	55	11/91→08/97				03.6584-0113.3 320111	ATE lastabhängig 8/4 4x
1.8	66	11/91→08/97					
1.8 Syncro (1HX1)	66	01/93→08/97				03.6584-0015.3 320109	ATE lastabhängig 8/4 4x
1.9 TDI Syncro (1HX1)	66	08/95→08/97					
2.0 Syncro (1HX1)	85	08/95→08/97					
2.9 VR6 Syncro (1HX1)	140	10/94→08/97					
1.9 D	47	11/91→08/97		08/93→ 07/95		03.6584-0107.3 320110	ATE lastabhängig 8/4 4x
						03.6584-0107.3 320110	ATE lastabhängig 8/4 4x
1.9 TDI	66	09/93→08/97		10/93→		03.6584-0107.3 320110	ATE lastabhängig 8/4 4x
↓							

	kw					! #		
VW - GOLF III (1H1) 08/91→07/98								
 Bremskraftregler								
1.9 TDI 2.0 2.0 GTI 16V 2.8 VR6	81 85 110 128	04/96→08/97 11/91→08/97 08/92→08/97 01/92→08/97					03.6584-0113.3 320111	ATE lastabhängig 8/4 4x
VW - GOLF III Cabriolet (1E7) 07/93→05/98								
 Bremskraftverstärker								
1.6 1.9 TDI	74 66	10/94→05/98 08/95→05/98		für Linkslenker; - ABS → 1E-S-021846; für Linkslenker; + ABS 1E-S-021847→; für Linkslenker; + ABS			03.7750-5502.4 300081 10.6360-1003.4 300156 10.6360-2002.4 300143	ATE Ø 9" pneumatisch ATE Ø 10" pneumatisch ATE Ø 10" pneumatisch
1.8 1.8 2.0	55 66 85	07/93→05/98 07/93→05/98 07/93→05/98		09/93→; für Linkslenker; - ABS 09/93→; → 1E-S-021846; für Linkslenker; + ABS 1E-S-021847→; für Linkslenker; + ABS			03.7750-5502.4 300081 10.6360-1003.4 300156 10.6360-2002.4 300143	ATE Ø 9" pneumatisch ATE Ø 10" pneumatisch ATE Ø 10" pneumatisch
1.9 TDI	81	07/96→05/98		09/96→; für Linkslenker; - ABS 09/96→; für Linkslenker; + ABS			03.7750-5502.4 300081 10.6360-2002.4 300143	ATE Ø 9" pneumatisch ATE Ø 10" pneumatisch
 Hauptbremszylinder								
1.6 1.9 TDI	74 66	10/94→05/98 08/95→05/98		- ABS 1E-S-021847→; für Linkslenker; + ABS 1E-S-021847→; für Rechtslenker; + ABS → 1E-S-021846; für Linkslenker; + ABS			03.2122-1042.3 010137 03.2123-1424.3 010637 03.2123-1484.3 010595 10.6123-0674.3 010639	Ø 22,2 ATE Ø 23,81 ATE Ø 23,81 ATE Ø 23,81
1.8 1.8 2.0	55 66 85	07/93→05/98 07/93→05/98 07/93→05/98		09/93→; - ABS 1E-S-021847→; für Linkslenker; + ABS 1E-S-021847→; für Rechtslenker; + ABS 09/93→; → 1E-S-021846; für Linkslenker; + ABS			03.2122-1042.3 010137 03.2123-1424.3 010637 03.2123-1484.3 010595 10.6123-0674.3 010639	Ø 22,2 ATE Ø 23,81 ATE Ø 23,81 ATE Ø 23,81
1.9 TDI	81	07/96→05/98		09/96→; - ABS 09/96→; für Linkslenker; + ABS 09/96→; für Rechtslenker; + ABS			03.2122-1042.3 010137 03.2123-1424.3 010637 03.2123-1484.3 010595	Ø 22,2 ATE Ø 23,81 ATE Ø 23,81
Verschlusschraube, Hauptbremszylinder								
1.6 1.9 TDI	74 66	10/94→05/98 08/95→05/98		- ABS			03.3517-0101.2 390322	
1.8 1.8 2.0	55 66 85	07/93→05/98 07/93→05/98 07/93→05/98		09/93→; - ABS			03.3517-0101.2 390322	
1.9 TDI	81	07/96→05/98		09/96→; - ABS			03.3517-0101.2 390322	
 Bremskraftregler								
1.6 1.9 TDI	74 66	10/94→05/98 08/95→05/98					03.6584-0107.3 320110	ATE lastabhängig 8/4 4x
1.8 1.8 2.0	55 66 85	07/93→05/98 07/93→05/98 07/93→05/98		09/93→			03.6584-0107.3 320110	ATE lastabhängig 8/4 4x
1.9 TDI	81	07/96→05/98		09/96→			03.6584-0113.3 320111	ATE lastabhängig 8/4 4x
VW - GOLF III Variant (1H5) 07/93→04/99								
 Bremskraftverstärker								
1.4 1.4 1.6 1.8 1.8 1.8 Syncro 1.9 D 1.9 TD 1.9 TDI 1.9 TDI Syncro 2.0 2.0 Syncro	40 44 74 55 66 66 47 55 66 66 85 85	07/93→04/99 07/93→04/99 07/94→04/99 07/93→04/99 07/93→04/99 10/94→04/99 07/93→04/99 07/93→04/99 03/94→04/99 07/95→04/99 07/93→04/99 08/95→04/99		für Linkslenker; - ABS → 1H-SW385334; für Linkslenker; + ABS 1H-SW385335→; für Linkslenker; + ABS			03.7750-5502.4 300081 10.6360-1003.4 300156 10.6360-2002.4 300143	ATE Ø 9" pneumatisch ATE Ø 10" pneumatisch ATE Ø 10" pneumatisch
1.9 SDI 1.9 TDI	47 81	07/95→04/99 04/96→04/99		für Linkslenker; - ABS für Linkslenker; + ABS			03.7750-5502.4 300081 10.6360-2002.4 300143	ATE Ø 9" pneumatisch ATE Ø 10" pneumatisch
2.9 VR6 Syncro	140	10/94→04/99		07/95→; → 1H-SW385334; für Linkslenker; + ABS 1H-SW385335→; für Linkslenker; + ABS			10.6360-1003.4 300156 10.6360-2002.4 300143	ATE Ø 10" pneumatisch ATE Ø 10" pneumatisch
 Hauptbremszylinder								
1.4 1.4 ↓	40 44	07/93→04/99 07/93→04/99		- ABS			03.2120-3943.3 010532	ATE Ø 20,64

	kw					! #		
VW - GOLF III Variant (1H5) 07/93→04/99								
Hauptbremszylinder								
1.4	40	07/93→04/99		1H-SW385335→; für Linkslenker; + ABS			03.2122-1144.3 010636	ATE Ø 22,2
1.4	44	07/93→04/99		1H-SW385335→; für Rechtslenker; + ABS			03.2122-1184.3 010592	ATE Ø 22,2
1.6	74	07/94→04/99		- ABS			03.2122-1042.3 010137	Ø 22,2
1.8	55	07/93→04/99		1H-SW385335→; für Linkslenker; + ABS			03.2123-1424.3 010637	ATE Ø 23,81
1.8	66	07/93→04/99		1H-SW385335→; für Rechtslenker; + ABS			03.2123-1484.3 010595	ATE Ø 23,81
1.9 TDI	66	03/94→04/99		1H-SW385335→; für Rechtslenker; + ABS			03.2123-1484.3 010595	ATE Ø 23,81
2.0	85	07/93→04/99		→ 1H-SW385334; für Linkslenker; + ABS			10.6123-0674.3 010639	ATE Ø 23,81
1.8 Syncro	66	10/94→04/99		- ABS			03.2122-1042.3 010137	Ø 22,2
1.9 TDI Syncro	66	07/95→04/99		1H-SW385335→; für Linkslenker; + ABS			03.2123-1424.3 010637	ATE Ø 23,81
2.0 Syncro	85	08/95→04/99		1H-SW385335→; für Linkslenker; + ABS			03.2123-1424.3 010637	ATE Ø 23,81
1.9 D	47	07/93→04/99		- ABS			03.2122-1042.3 010137	Ø 22,2
1.9 TD	55	07/93→04/99		1H-SW385335→; für Linkslenker; + ABS			03.2122-1144.3 010636	ATE Ø 22,2
				1H-SW385335→; für Rechtslenker; + ABS			03.2122-1184.3 010592	ATE Ø 22,2
1.9 SDI	47	07/95→04/99		- ABS			03.2122-1042.3 010137	Ø 22,2
				für Linkslenker; + ABS			03.2122-1144.3 010636	ATE Ø 22,2
				für Rechtslenker; + ABS			03.2122-1184.3 010592	ATE Ø 22,2
1.9 TDI	81	04/96→04/99		- ABS			03.2122-1042.3 010137	Ø 22,2
				für Linkslenker; + ABS			03.2123-1424.3 010637	ATE Ø 23,81
				für Rechtslenker; + ABS			03.2123-1484.3 010595	ATE Ø 23,81
2.9 VR6 Syncro	140	10/94→04/99		1H-SW385335→; für Linkslenker; + ABS			03.2123-1424.3 010637	ATE Ø 23,81
				07/95→; → 1H-SW385334; für Linkslenker; + ABS			10.6123-0674.3 010639	ATE Ø 23,81
Verschlusschraube, Hauptbremszylinder								
1.4	40	07/93→04/99		- ABS	2		03.3517-0101.2 390322	
1.4	44	07/93→04/99		- ABS			03.3517-0101.2 390322	
1.6	74	07/94→04/99		- ABS			03.3517-0101.2 390322	
1.8	55	07/93→04/99		- ABS			03.3517-0101.2 390322	
1.8	66	07/93→04/99		- ABS			03.3517-0101.2 390322	
1.8 Syncro	66	10/94→04/99		- ABS			03.3517-0101.2 390322	
1.9 D	47	07/93→04/99		- ABS			03.3517-0101.2 390322	
1.9 SDI	47	07/95→04/99		- ABS			03.3517-0101.2 390322	
1.9 TD	55	07/93→04/99		- ABS			03.3517-0101.2 390322	
1.9 TDI	66	03/94→04/99		- ABS			03.3517-0101.2 390322	
1.9 TDI	81	04/96→04/99		- ABS			03.3517-0101.2 390322	
1.9 TDI Syncro	66	07/95→04/99		- ABS			03.3517-0101.2 390322	
2.0	85	07/93→04/99		- ABS			03.3517-0101.2 390322	
2.0 Syncro	85	08/95→04/99		- ABS			03.3517-0101.2 390322	
Bremskraftregler								
1.4	40	07/93→04/99					03.6584-0107.3 320110	ATE lastabhängig 8/4 4x
1.4	44	07/93→04/99					03.6584-0107.3 320110	ATE lastabhängig 8/4 4x
1.6	74	07/94→04/99					03.6584-0107.3 320110	ATE lastabhängig 8/4 4x
1.8	55	07/93→04/99					03.6584-0107.3 320110	ATE lastabhängig 8/4 4x
1.8	66	07/93→04/99					03.6584-0107.3 320110	ATE lastabhängig 8/4 4x
1.9 D	47	07/93→04/99					03.6584-0107.3 320110	ATE lastabhängig 8/4 4x
1.9 SDI	47	07/95→04/99					03.6584-0107.3 320110	ATE lastabhängig 8/4 4x
1.9 TD	55	07/93→04/99					03.6584-0107.3 320110	ATE lastabhängig 8/4 4x
1.9 TDI	66	03/94→04/99					03.6584-0107.3 320110	ATE lastabhängig 8/4 4x
1.9 TDI	81	04/96→04/99					03.6584-0107.3 320110	ATE lastabhängig 8/4 4x
2.0	85	07/93→04/99					03.6584-0107.3 320110	ATE lastabhängig 8/4 4x
1.8 Syncro	66	10/94→04/99					03.6584-0107.3 320110	ATE lastabhängig 8/4 4x
1.9 TDI Syncro	66	07/95→04/99					03.6584-0107.3 320110	ATE lastabhängig 8/4 4x
2.0 Syncro	85	08/95→04/99					03.6584-0107.3 320110	ATE lastabhängig 8/4 4x
2.9 VR6 Syncro	140	10/94→04/99		07/95→			03.6584-0107.3 320110	ATE lastabhängig 8/4 4x
VW - GOLF IV (1J1) 08/97→03/07								
Bremskraftverstärker								
1.4 16V	55	08/97→06/05		09/00→ 10/01; für Linkslenker; +PR 1AT			03.7860-0602.4 300141	ATE Ø 10" pneumatisch
1.6	74	08/97→05/04		10/97→ 08/00; für Linkslenker; +PR 1AT			03.7863-0402.4 300124	ATE Ø 10" pneumatisch
1.8	92	08/97→06/05		11/01→ 10/03; für Linkslenker; +PR 1AT			03.7863-3502.4 300128	ATE Ø 10" pneumatisch
1.8 T	110	08/97→06/05		11/01→ 10/03; für Linkslenker; +PR 1AT			03.7863-3502.4 300128	ATE Ø 10" pneumatisch
1.9 SDI	50	08/97→06/05		11/01→ 10/03; für Linkslenker; +PR 1AT			03.7863-3502.4 300128	ATE Ø 10" pneumatisch
1.9 TDI	81	08/97→05/04		11/01→ 10/03; für Linkslenker; +PR 1AT			03.7863-3502.4 300128	ATE Ø 10" pneumatisch
1.6	75	08/00→06/05		09/00→ 10/01; für Linkslenker; +PR 1AT			03.7860-0602.4 300141	ATE Ø 10" pneumatisch
1.6 16V	77	02/00→06/05		→ 08/00; für Linkslenker; +PR 1AT			03.7863-0402.4 300124	ATE Ø 10" pneumatisch
				11/01→ 10/03; für Linkslenker; +PR 1AT			03.7863-3502.4 300128	ATE Ø 10" pneumatisch
1.6 FSI	81	01/02→06/05		→ 10/03; für Linkslenker; +PR 1AT			03.7863-3502.4 300128	ATE Ø 10" pneumatisch
3.2 R32 4motion	177	09/02→06/05		→ 10/03; für Linkslenker; +PR 1AT			03.7863-3502.4 300128	ATE Ø 10" pneumatisch
1.8 4motion	92	05/98→06/05		09/00→ 10/01; für Linkslenker; +PR 1AT			03.7860-0602.4 300141	ATE Ø 10" pneumatisch
				07/98→ 08/00; für Linkslenker; +PR 1AT			03.7863-0402.4 300124	ATE Ø 10" pneumatisch

	kw			 	! #		
VW - GOLF IV (1J1) 08/97→03/07							
Bremskraftverstärker							
1.8 4motion	92	05/98→06/05		11/01→ 10/03; für Linkslenker; +PR 1AT		03.7863-3502.4 300128	ATE Ø 10" pneumatisch
1.8 T GTI	132	08/01→06/05		→ 10/01; für Linkslenker; +PR 1AT		03.7860-0602.4 300141	ATE Ø 10" pneumatisch
2.0 4motion	85	10/00→06/05		11/01→ 10/03; für Linkslenker; +PR 1AT		03.7863-3502.4 300128	ATE Ø 10" pneumatisch
1.9 TDI	66	10/97→05/04		09/00→ 06/01; für Linkslenker; +PR 1AT		03.7860-0602.4 300141	ATE Ø 10" pneumatisch
1.9 TDI 4motion	66	07/98→04/02		→ 08/00; für Linkslenker; +PR 1AT		03.7863-0402.4 300124	ATE Ø 10" pneumatisch
1.9 TDI	74	09/00→06/05		→ 10/01; für Linkslenker; +PR 1AT		03.7860-0602.4 300141	ATE Ø 10" pneumatisch
1.9 TDI 4motion	74	09/00→06/05		11/01→; für Linkslenker; +PR 1AT		03.7863-3502.4 300128	ATE Ø 10" pneumatisch
1.9 TDI	85	12/98→06/01		09/00→; für Linkslenker; +PR 1AT		03.7860-0602.4 300141	ATE Ø 10" pneumatisch
				05/99→ 08/00; für Linkslenker; +PR 1AT		03.7863-0402.4 300124	ATE Ø 10" pneumatisch
1.9 TDI	96	11/00→06/05		04/01→ 10/01; für Linkslenker; +PR 1AT		03.7860-0602.4 300141	ATE Ø 10" pneumatisch
1.9 TDI 4motion	96	11/00→06/05		11/01→ 10/03; für Linkslenker; +PR 1AT		03.7863-3502.4 300128	ATE Ø 10" pneumatisch
1.9 TDI	110	05/00→06/05		09/00→ 10/01; für Linkslenker; +PR 1AT		03.7860-0602.4 300141	ATE Ø 10" pneumatisch
1.9 TDI 4motion	110	02/00→06/05		11/01→ 10/03; für Linkslenker; +PR 1AT		03.7863-3502.4 300128	ATE Ø 10" pneumatisch
1.9 TDI 4motion	85	09/99→06/01		09/00→; für Linkslenker; +PR 1AT		03.7860-0602.4 300141	ATE Ø 10" pneumatisch
				11/99→ 08/00; für Linkslenker; +PR 1AT		03.7863-0402.4 300124	ATE Ø 10" pneumatisch
2.0	85	07/98→05/04		09/00→ 10/01; für Linkslenker; +PR 1AT		03.7860-0602.4 300141	ATE Ø 10" pneumatisch
				08/98→ 08/00; für Linkslenker; +PR 1AT		03.7863-0402.4 300124	ATE Ø 10" pneumatisch
				11/01→ 10/03; für Linkslenker; +PR 1AT		03.7863-3502.4 300128	ATE Ø 10" pneumatisch
2.3 V5	110	08/97→10/00		09/00→; für Linkslenker; +PR 1AT		03.7860-0602.4 300141	ATE Ø 10" pneumatisch
				10/97→ 08/00; für Linkslenker; +PR 1AT		03.7863-0402.4 300124	ATE Ø 10" pneumatisch
2.3 V5	125	10/00→06/05		→ 10/03; für Linkslenker; +PR 1AT		03.7860-0602.4 300141	ATE Ø 10" pneumatisch
2.3 V5 4motion	125	10/00→06/05		11/01→ 10/03; für Linkslenker; +PR 1AT		03.7863-3502.4 300128	ATE Ø 10" pneumatisch
2.3 V5 4motion	110	12/98→10/00		09/00→; für Linkslenker; +PR 1AT		03.7860-0602.4 300141	ATE Ø 10" pneumatisch
				→ 08/00; für Linkslenker; +PR 1AT		03.7863-0402.4 300124	ATE Ø 10" pneumatisch
2.8 V6 4motion	150	03/99→06/05		09/00→ 10/03; für Linkslenker; +PR 1AT		03.7860-0602.4 300141	ATE Ø 10" pneumatisch
				→ 08/00; für Linkslenker; +PR 1AT		03.7863-0402.4 300124	ATE Ø 10" pneumatisch
				11/01→ 10/03; für Linkslenker; +PR 1AT		03.7863-3502.4 300128	ATE Ø 10" pneumatisch
Hauptbremszylinder							
1.4 16V	55	08/97→06/05		10/97→ 08/00; für Linkslenker; +PR 1AT		03.2123-2024.3 010597	ATE Ø 23,81
1.6	74	08/97→05/04		10/97→ 08/00; für Rechtslenker;		03.2123-2064.3 010598	ATE Ø 23,81
1.8	92	08/97→06/05		+PR 1AT			
1.8 T	110	08/97→06/05		09/00→ 10/03; für Linkslenker; +PR 1AT		03.2123-2715.3 010802	ATE Ø 23,81
1.9 SDI	50	08/97→06/05		09/00→ 10/03; für Rechtslenker;		03.2123-2774.3 010803	ATE Ø 23,81
1.9 TDI	81	08/97→05/04		+PR 1AT			
				10/97→ 10/03; für Linkslenker;		24.2123-1709.3 010503	Ø 23,81
				+PR 1AM,1AC,1AH,1AJ			
1.6	75	08/00→06/05		→ 08/00; für Linkslenker; +PR 1AT		03.2123-2024.3 010597	ATE Ø 23,81
1.6 16V	77	02/00→06/05		→ 08/00; für Rechtslenker; +PR 1AT		03.2123-2064.3 010598	ATE Ø 23,81
2.8 V6 4motion	150	03/99→06/05		09/00→ 10/03; für Linkslenker; +PR 1AT		03.2123-2715.3 010802	ATE Ø 23,81
				09/00→ 10/03; für Rechtslenker;		03.2123-2774.3 010803	ATE Ø 23,81
				+PR 1AT			
				→ 10/03; für Linkslenker;		24.2123-1709.3 010503	Ø 23,81
				+PR 1AM,1AC,1AH,1AJ			
1.6 FSI	81	01/02→06/05		→ 10/03; für Linkslenker; +PR 1AT		03.2123-2715.3 010802	ATE Ø 23,81
1.8 T GTI	132	08/01→06/05		→ 10/03; für Rechtslenker; +PR 1AT		03.2123-2774.3 010803	ATE Ø 23,81
2.0 4motion	85	10/00→06/05		→ 10/03; für Linkslenker;		24.2123-1709.3 010503	Ø 23,81
2.3 V5	125	10/00→06/05		+PR 1AM,1AC,1AH,1AJ			
2.3 V5 4motion	125	10/00→06/05					
3.2 R32 4motion	177	09/02→06/05					
1.8 4motion	92	05/98→06/05		07/98→ 08/00; für Linkslenker; +PR 1AT		03.2123-2024.3 010597	ATE Ø 23,81
				07/98→ 08/00; für Rechtslenker;		03.2123-2064.3 010598	ATE Ø 23,81
				+PR 1AT			
				09/00→ 10/03; für Linkslenker; +PR 1AT		03.2123-2715.3 010802	ATE Ø 23,81
				09/00→ 10/03; für Rechtslenker;		03.2123-2774.3 010803	ATE Ø 23,81
				+PR 1AT			
				07/98→ 10/03; für Linkslenker;		24.2123-1709.3 010503	Ø 23,81
				+PR 1AM,1AC,1AH,1AJ			
1.9 TDI	66	10/97→05/04		→ 08/00; für Linkslenker; +PR 1AT		03.2123-2024.3 010597	ATE Ø 23,81
				→ 08/00; für Rechtslenker; +PR 1AT		03.2123-2064.3 010598	ATE Ø 23,81
				09/00→ 04/02; für Linkslenker; +PR 1AT		03.2123-2715.3 010802	ATE Ø 23,81
				09/00→ 06/01; für Rechtslenker;		03.2123-2774.3 010803	ATE Ø 23,81
				+PR 1AT			
				→ 06/01; für Linkslenker;		24.2123-1709.3 010503	Ø 23,81
				+PR 1AM,1AC,1AH,1AJ			
1.9 TDI	74	09/00→06/05		für Linkslenker; +PR 1AT		03.2123-2715.3 010802	ATE Ø 23,81
↓							

	kw			 	! #		
VW - GOLF IV (1J1) 08/97→03/07							
 Hauptbremszylinder							
1.9 TDI 4motion	74	09/00→06/05		für Rechtslenker; +PR 1AT		03.2123-2774.3 010803	ATE Ø 23,81
				für Linkslenker; +PR 1AM,1AC,1AH,1AJ		24.2123-1709.3 010503	Ø 23,81
1.9 TDI	85	12/98→06/01		05/99→ 08/00; für Linkslenker; +PR 1AT		03.2123-2024.3 010597	ATE Ø 23,81
				05/99→ 08/00; für Rechtslenker; +PR 1AT		03.2123-2064.3 010598	ATE Ø 23,81
				09/00→; für Linkslenker; +PR 1AT		03.2123-2715.3 010802	ATE Ø 23,81
				09/00→; für Rechtslenker; +PR 1AT		03.2123-2774.3 010803	ATE Ø 23,81
				05/99→; für Linkslenker; +PR 1AM,1AC,1AH,1AJ		24.2123-1709.3 010503	Ø 23,81
1.9 TDI 1.9 TDI 4motion	96 96	11/00→06/05 11/00→06/05		04/01→ 10/03; für Linkslenker; +PR 1AT		03.2123-2715.3 010802	ATE Ø 23,81
				04/01→ 10/03; für Rechtslenker; +PR 1AT		03.2123-2774.3 010803	ATE Ø 23,81
				04/01→ 10/03; für Linkslenker; +PR 1AM,1AC,1AH,1AJ		24.2123-1709.3 010503	Ø 23,81
1.9 TDI 1.9 TDI 4motion	110 110	05/00→06/05 02/00→06/05		09/00→ 10/03; für Linkslenker; +PR 1AT		03.2123-2715.3 010802	ATE Ø 23,81
				09/00→ 10/03; für Rechtslenker; +PR 1AT		03.2123-2774.3 010803	ATE Ø 23,81
				09/00→ 10/03; für Linkslenker; +PR 1AM,1AC,1AH,1AJ		24.2123-1709.3 010503	Ø 23,81
1.9 TDI 4motion	66	07/98→04/02		→ 08/00; für Linkslenker; +PR 1AT		03.2123-2024.3 010597	ATE Ø 23,81
				→ 08/00; für Rechtslenker; +PR 1AT		03.2123-2064.3 010598	ATE Ø 23,81
				09/00→ 06/01; für Linkslenker; +PR 1AT		03.2123-2715.3 010802	ATE Ø 23,81
				09/00→ 06/01; für Rechtslenker; +PR 1AT		03.2123-2774.3 010803	ATE Ø 23,81
				→ 06/01; für Linkslenker; +PR 1AM,1AC,1AH,1AJ		24.2123-1709.3 010503	Ø 23,81
1.9 TDI 4motion	85	09/99→06/01		11/99→ 08/00; für Linkslenker; +PR 1AT		03.2123-2024.3 010597	ATE Ø 23,81
				11/99→ 08/00; für Rechtslenker; +PR 1AT		03.2123-2064.3 010598	ATE Ø 23,81
				09/00→; für Linkslenker; +PR 1AT		03.2123-2715.3 010802	ATE Ø 23,81
				09/00→; für Rechtslenker; +PR 1AT		03.2123-2774.3 010803	ATE Ø 23,81
				11/99→; für Linkslenker; +PR 1AM,1AC,1AH,1AJ		24.2123-1709.3 010503	Ø 23,81
2.0	85	07/98→05/04		08/98→ 08/00; für Linkslenker; +PR 1AT		03.2123-2024.3 010597	ATE Ø 23,81
				08/98→ 08/00; für Rechtslenker; +PR 1AT		03.2123-2064.3 010598	ATE Ø 23,81
				09/00→ 10/03; für Linkslenker; +PR 1AT		03.2123-2715.3 010802	ATE Ø 23,81
				09/00→ 10/03; für Rechtslenker; +PR 1AT		03.2123-2774.3 010803	ATE Ø 23,81
				08/98→ 10/03; für Linkslenker; +PR 1AM,1AC,1AH,1AJ		24.2123-1709.3 010503	Ø 23,81
2.3 V5	110	08/97→10/00		10/97→ 08/00; für Linkslenker; +PR 1AT		03.2123-2024.3 010597	ATE Ø 23,81
				10/97→ 08/00; für Rechtslenker; +PR 1AT		03.2123-2064.3 010598	ATE Ø 23,81
				09/00→; für Linkslenker; +PR 1AT		03.2123-2715.3 010802	ATE Ø 23,81
				09/00→; für Rechtslenker; +PR 1AT		03.2123-2774.3 010803	ATE Ø 23,81
				10/97→; für Linkslenker; +PR 1AM,1AC,1AH,1AJ		24.2123-1709.3 010503	Ø 23,81
2.3 V5 4motion	110	12/98→10/00		→ 08/00; für Linkslenker; +PR 1AT		03.2123-2024.3 010597	ATE Ø 23,81
				→ 08/00; für Rechtslenker; +PR 1AT		03.2123-2064.3 010598	ATE Ø 23,81
				09/00→; für Linkslenker; +PR 1AT		03.2123-2715.3 010802	ATE Ø 23,81
				09/00→; für Rechtslenker; +PR 1AT		03.2123-2774.3 010803	ATE Ø 23,81
				für Linkslenker; +PR 1AM,1AC,1AH,1AJ		24.2123-1709.3 010503	Ø 23,81
VW - GOLF IV Cabriolet (1E7) 06/98→06/02							
 Bremskraftverstärker							
1.6 1.8 1.8	74 55 66	06/98→06/02 06/98→06/02 06/98→06/02		für Linkslenker; - ABS; → 02/02		03.7750-5502.4 300081	ATE Ø 9" pneumatisch
				→ 1E-S-021846; für Linkslenker; + ABS		10.6360-1003.4 300156	ATE Ø 10" pneumatisch
1.9 TDI 2.0	66 85	06/98→06/02 06/98→06/02		1E-S-021847→; für Linkslenker; + ABS; → 02/02		10.6360-2002.4 300143	ATE Ø 10" pneumatisch
1.9 TDI	81	06/98→06/02		für Linkslenker; - ABS; → 02/02		03.7750-5502.4 300081	ATE Ø 9" pneumatisch
				für Linkslenker; + ABS; → 02/02		10.6360-2002.4 300143	ATE Ø 10" pneumatisch
 Hauptbremszylinder							
1.6 1.8 1.8 1.9 TDI	74 55 66 66	06/98→06/02 06/98→06/02 06/98→06/02 06/98→06/02		- ABS; → 02/02		03.2122-1042.3 010137	Ø 22,2
				1E-S-021847→; für Linkslenker; + ABS; → 02/02		03.2123-1424.3 010637	ATE Ø 23,81
↓							

	kw					! #		
VW - GOLF IV Cabriolet (1E7) 06/98→06/02								
 Hauptbremszylinder								
2.0	85	06/98→06/02		1E-S-021847→; für Rechtslenker; + ABS; → 02/02		03.2123-1484.3	010595	ATE Ø 23,81
				→ 1E-S-021846; für Linkslenker; + ABS		10.6123-0674.3	010639	ATE Ø 23,81
1.9 TDI	81	06/98→06/02		- ABS; → 02/02		03.2122-1042.3	010137	Ø 22,2
				für Linkslenker; + ABS; → 02/02		03.2123-1424.3	010637	ATE Ø 23,81
				für Rechtslenker; + ABS; → 02/02		03.2123-1484.3	010595	ATE Ø 23,81
Verschlusschraube, Hauptbremszylinder								
1.6	74	06/98→06/02		- ABS; → 02/02		03.3517-0101.2	390322	
1.8	55	06/98→06/02						
1.8	66	06/98→06/02						
1.9 TDI	66	06/98→06/02						
1.9 TDI	81	06/98→06/02						
2.0	85	06/98→06/02						
 Bremskraftregler								
1.6	74	06/98→06/02		→ 02/02		03.6584-0107.3	320110	ATE lastabhängig 8/4 4x
1.8	55	06/98→06/02						
1.8	66	06/98→06/02						
1.9 TDI	66	06/98→06/02						
2.0	85	06/98→06/02						
1.9 TDI	81	06/98→06/02		→ 02/02		03.6584-0113.3	320111	ATE lastabhängig 8/4 4x
VW - GOLF IV Variant (1J5) 05/99→06/06								
 Bremskraftverstärker								
1.4 16V	55	05/99→06/06		09/00→; für Linkslenker; +PR 1AT; → 10/01		03.7860-0602.4	300141	ATE Ø 10" pneumatisch
1.6	74	05/99→04/02						
1.6	75	08/00→06/06		→ 08/00; für Linkslenker; +PR 1AT		03.7863-0402.4	300124	ATE Ø 10" pneumatisch
1.6 16V	77	02/00→06/06						
1.8 4motion	92	05/99→06/06		11/01→; für Linkslenker; +PR 1AT		03.7863-3502.4	300128	ATE Ø 10" pneumatisch
1.8 T	110	05/00→06/06						
1.9 SDI	50	05/99→06/06						
1.9 TDI	66	05/99→05/06						
1.9 TDI 4motion	66	05/99→04/02						
2.0	85	05/99→06/06						
2.3 V5	110	05/99→06/06						
2.3 V5 4motion	110	05/99→06/06						
2.8 V6 4motion	150	05/99→06/06						
1.6 FSI	81	01/02→06/06		für Linkslenker; +PR 1AT		03.7863-3502.4	300128	ATE Ø 10" pneumatisch
1.9 TDI 4motion	110	05/02→06/05						
2.0 Bi-Fuel	85	02/02→06/06						
1.9 TDI	74	09/00→06/06		für Linkslenker; +PR 1AT; → 10/01		03.7860-0602.4	300141	ATE Ø 10" pneumatisch
1.9 TDI	110	06/01→06/06						
1.9 TDI 4motion	74	09/00→06/06		11/01→; für Linkslenker; +PR 1AT		03.7863-3502.4	300128	ATE Ø 10" pneumatisch
2.0 4motion	85	10/00→06/06						
2.3 V5	125	10/00→06/06						
2.3 V5 4motion	125	10/00→06/06						
1.9 TDI	81	05/99→06/01		09/00→; für Linkslenker; +PR 1AT		03.7860-0602.4	300141	ATE Ø 10" pneumatisch
1.9 TDI	85	08/99→06/01		→ 08/00; für Linkslenker; +PR 1AT		03.7863-0402.4	300124	ATE Ø 10" pneumatisch
1.9 TDI	96	11/00→06/06		04/01→; für Linkslenker; +PR 1AT; → 10/01		03.7860-0602.4	300141	ATE Ø 10" pneumatisch
1.9 TDI 4motion	96	11/00→06/06						
				11/01→; für Linkslenker; +PR 1AT		03.7863-3502.4	300128	ATE Ø 10" pneumatisch
1.9 TDI 4motion	85	05/99→06/01		09/00→; für Linkslenker; +PR 1AT		03.7860-0602.4	300141	ATE Ø 10" pneumatisch
				11/99→ 08/00; für Linkslenker; +PR 1AT		03.7863-0402.4	300124	ATE Ø 10" pneumatisch
2.0 4motion	88	12/99→06/06		09/00→; für Linkslenker; +PR 1AT; → 10/01		03.7860-0602.4	300141	ATE Ø 10" pneumatisch
				04/00→ 08/00; für Linkslenker; +PR 1AT		03.7863-0402.4	300124	ATE Ø 10" pneumatisch
				11/01→; für Linkslenker; +PR 1AT		03.7863-3502.4	300128	ATE Ø 10" pneumatisch
 Hauptbremszylinder								
1.4 16V	55	05/99→06/06		→ 08/00; für Linkslenker; +PR 1AT		03.2123-2024.3	010597	ATE Ø 23,81
1.6	74	05/99→04/02						
1.6	75	08/00→06/06		→ 08/00; für Rechtslenker; +PR 1AT		03.2123-2064.3	010598	ATE Ø 23,81
1.6 16V	77	02/00→06/06		09/00→; für Linkslenker; +PR 1AT		03.2123-2715.3	010802	ATE Ø 23,81
1.8 4motion	92	05/99→06/06						
1.8 T	110	05/00→06/06		09/00→; für Rechtslenker; +PR 1AT		03.2123-2774.3	010803	ATE Ø 23,81
1.9 SDI	50	05/99→06/06		für Linkslenker; +PR 1AM,1AC,1AH,1AJ		24.2123-1709.3	010503	Ø 23,81
1.9 TDI	66	05/99→05/06						
1.9 TDI	81	05/99→06/01						
1.9 TDI	85	08/99→06/01						
1.9 TDI 4motion	66	05/99→04/02						
2.0	85	05/99→06/06						
2.3 V5	110	05/99→06/06						
2.3 V5 4motion	110	05/99→06/06						
2.8 V6 4motion	150	05/99→06/06						
↓								

VW - GOLF IV Variant (1J5) 05/99→06/06

Hauptbremszylinder

1.6 FSI	81	01/02→06/06	für Linkslenker; +PR 1AT	03.2123-2715.3	010802	ATE Ø 23,81
1.9 TDI	74	09/00→06/06	für Rechtslenker; +PR 1AT	03.2123-2774.3	010803	ATE Ø 23,81
1.9 TDI	110	06/01→06/06				
1.9 TDI 4motion	74	09/00→06/06	für Linkslenker; +PR 1AM,1AC,1AH,1AJ	24.2123-1709.3	010503	Ø 23,81
1.9 TDI 4motion	110	05/02→06/05				
2.0 4motion	85	10/00→06/06				
2.0 Bi-Fuel	85	02/02→06/06				
2.3 V5	125	10/00→06/06				
2.3 V5 4motion	125	10/00→06/06				
1.9 TDI	96	11/00→06/06	04/01→; für Linkslenker; +PR 1AT	03.2123-2715.3	010802	ATE Ø 23,81
1.9 TDI 4motion	96	11/00→06/06	04/01→; für Rechtslenker; +PR 1AT	03.2123-2774.3	010803	ATE Ø 23,81
			04/01→; für Linkslenker; +PR 1AM,1AC,1AH,1AJ	24.2123-1709.3	010503	Ø 23,81
1.9 TDI 4motion	85	05/99→06/01	11/99→ 08/00; für Linkslenker; +PR 1AT	03.2123-2024.3	010597	ATE Ø 23,81
			11/99→ 08/00; für Rechtslenker; +PR 1AT	03.2123-2064.3	010598	ATE Ø 23,81
			09/00→; für Linkslenker; +PR 1AT	03.2123-2715.3	010802	ATE Ø 23,81
			09/00→; für Rechtslenker; +PR 1AT	03.2123-2774.3	010803	ATE Ø 23,81
			11/99→; für Linkslenker; +PR 1AM,1AC,1AH,1AJ	24.2123-1709.3	010503	Ø 23,81
2.0 4motion	88	12/99→06/06	04/00→ 08/00; +PR 1AT; für Linkslenker	03.2123-2024.3	010597	ATE Ø 23,81
			04/00→ 08/00; +PR 1AT; für Rechtslenker	03.2123-2064.3	010598	ATE Ø 23,81
			09/00→; für Linkslenker; +PR 1AT	03.2123-2715.3	010802	ATE Ø 23,81
			09/00→; für Rechtslenker; +PR 1AT	03.2123-2774.3	010803	ATE Ø 23,81
			04/00→; für Linkslenker; +PR 1AM,1AC,1AH,1AJ	24.2123-1709.3	010503	Ø 23,81

VW - GOLF V (1K1) 10/03→02/09









Bremskraftverstärker







1.4 16V	55	10/03→05/06	für Linkslenker; +PR 1AC,1AT	03.7863-3232.4	300307	ATE Ø 10" pneumatisch
1.4 FSI	66	10/03→07/06	für Linkslenker; +PR 1AS	03.7863-9602.4	300206	ATE Ø 10" pneumatisch
1.6 FSI	85	10/03→07/08	für Linkslenker; +PR 1AS / 1AS,1LJ	03.7863-9802.4	300281	ATE Ø 10" pneumatisch
1.4 16V	59	05/06→11/08	für Linkslenker; → 09/08; +PR 1AC,1AT	03.7863-3232.4	300307	ATE Ø 10" pneumatisch
1.4 TSI	90	05/07→11/08	für Linkslenker; → 09/08; +PR 1AS	03.7863-9602.4	300206	ATE Ø 10" pneumatisch
1.4 TSI	103	05/06→11/08				
1.4 TSI	125	11/05→11/08	für Linkslenker; → 09/08; +PR 1AS / 1AS,1LJ	03.7863-9802.4	300281	ATE Ø 10" pneumatisch
1.6	75	01/04→11/08				
1.9 TDI	66	05/04→11/08				
1.9 TDI	77	10/03→11/08				
1.9 TDI 4motion	77	08/04→11/08				
2.0 FSI	110	01/04→11/08				
2.0 FSI 4motion	110	08/04→11/08				
2.0 SDI	55	01/04→11/08				
2.0 TDI	100	10/03→11/08				
2.0 TDI	103	12/04→11/08				
2.0 TDI	125	11/05→11/08				
2.0 TDI 16V	103	10/03→11/08				
2.0 TDI 16V 4motion	103	08/04→11/08				
2.0 TDI 4motion	103	08/04→11/08				
2.0 GTI	147	10/04→02/09	für Linkslenker; → 09/08; +PR 1AC,1AT	03.7863-3332.4	300308	ATE Ø 10" pneumatisch
2.0 GTI	169	09/06→12/08				
3.2 R32 4motion	184	11/05→11/08				











Hauptbremszylinder

1.4 16V	55	10/03→05/06	1K-6W078890→; für Linkslenker	03.2122-2129.3	010799	ATE Ø 22,2
1.4 FSI	66	10/03→07/06	für Linkslenker; → 1K-6W078889	03.2122-2129.3	010799	ATE Ø 22,2
1.6 FSI	85	10/03→07/08	für Rechtslenker; +PR 1AS	24.4152-0132.3	011025	ATE Ø 22,2 ohne Bremsflüssigkeitsbehälter
1.4 16V	59	05/06→11/08	1K-6W078890→; für Linkslenker; → 09/08	03.2122-2129.3	010799	ATE Ø 22,2
1.4 TSI	103	05/06→11/08				
1.4 TSI	125	11/05→11/08	für Linkslenker; → 1K-6W078889	03.2122-2129.3	010799	ATE Ø 22,2
1.6	75	01/04→11/08				
1.9 TDI	66	05/04→11/08	für Rechtslenker; → 09/08; +PR 1AS	24.4152-0132.3	011025	ATE Ø 22,2 ohne Bremsflüssigkeitsbehälter
1.9 TDI	77	10/03→11/08				
1.9 TDI 4motion	77	08/04→11/08				
2.0 FSI	110	01/04→11/08				
2.0 FSI 4motion	110	08/04→11/08				
2.0 SDI	55	01/04→11/08				
2.0 TDI	100	10/03→11/08				
2.0 TDI	103	12/04→11/08				
2.0 TDI	125	11/05→11/08				
2.0 TDI 16V	103	10/03→11/08				
2.0 TDI 16V 4motion	103	08/04→11/08				
2.0 TDI 4motion	103	08/04→11/08				

↓

	kw			 	! #		
VW - GOLF V (1K1) 10/03→02/09							
 Hauptbremszylinder							
1.4 TSI	90	05/07→11/08		→ 09/08; für Linkslenker		03.2122-2129.3 010799	ATE Ø 22,2
				für Rechtslenker; → 09/08; +PR 1AS		24.4152-0132.3 011025	ATE Ø 22,2 ohne Bremsflüssigkeitsbehälter
2.0 GTI	147	10/04→02/09		1K-6W078890→; für Linkslenker;		03.2123-3449.3 010808	ATE Ø 23,81
2.0 GTI	169	09/06→12/08		→ 09/08			
				für Linkslenker; → 1K-6W078889		03.2123-3449.3 010808	ATE Ø 23,81
				für Rechtslenker; → 09/08; +PR 1AS		24.4152-0132.3 011025	ATE Ø 22,2 ohne Bremsflüssigkeitsbehälter
				1K-6W078890→; für Rechtslenker;		24.4153-0202.3 011027	ATE Ø 23,81 ohne Bremsflüssigkeitsbehälter
				→ 09/08			
3.2 R32 4motion	184	11/05→11/08		1K-6W078890→; für Linkslenker;		03.2123-3449.3 010808	ATE Ø 23,81
				→ 09/08			
				für Linkslenker; → 1K-6W078889		03.2123-3449.3 010808	ATE Ø 23,81
				1K-6W078890→; für Rechtslenker;		24.4153-0202.3 011027	ATE Ø 23,81 ohne Bremsflüssigkeitsbehälter
				→ 09/08			
Hydraulikaggregat, Bremsanlage							
1.4 16V	55	10/03→05/06		+PR 1AT,1AS		24.9145-0001.2 399005	
1.4 FSI	66	10/03→07/06					
1.6 FSI	85	10/03→07/08					
1.4 16V	59	05/06→11/08		→ 09/08; +PR 1AT,1AS		24.9145-0001.2 399005	
1.4 TSI	90	05/07→11/08					
1.4 TSI	103	05/06→11/08					
1.4 TSI	125	11/05→11/08					
1.6	75	01/04→11/08					
1.9 TDI	66	05/04→11/08					
1.9 TDI	77	10/03→11/08					
1.9 TDI 4motion	77	08/04→11/08					
2.0 FSI	110	01/04→11/08					
2.0 FSI 4motion	110	08/04→11/08					
2.0 GTI	147	10/04→02/09					
2.0 GTI	169	09/06→12/08					
2.0 SDI	55	01/04→11/08					
2.0 TDI	100	10/03→11/08					
2.0 TDI	103	12/04→11/08					
2.0 TDI	125	11/05→11/08					
2.0 TDI 16V	103	10/03→11/08					
2.0 TDI 16V 4motion	103	08/04→11/08					
2.0 TDI 4motion	103	08/04→11/08					
3.2 R32 4motion	184	11/05→11/08					
Drucksensor, Bremskraftverstärker							
1.4 16V	55	10/03→05/06		für Linkslenker; +PR 1AS		03.0655-0101.2 370008	ATE
1.4 FSI	66	10/03→07/06					
1.6 FSI	85	10/03→07/08					
1.4 16V	59	05/06→11/08		für Linkslenker; → 09/08; +PR 1AS		03.0655-0101.2 370008	ATE
1.4 TSI	90	05/07→11/08					
1.4 TSI	103	05/06→11/08					
1.4 TSI	125	11/05→11/08					
1.6	75	01/04→11/08					
1.9 TDI	66	05/04→11/08					
1.9 TDI	77	10/03→11/08					
1.9 TDI 4motion	77	08/04→11/08					
2.0 FSI	110	01/04→11/08					
2.0 FSI 4motion	110	08/04→11/08					
2.0 SDI	55	01/04→11/08					
2.0 TDI	100	10/03→11/08					
2.0 TDI	103	12/04→11/08					
2.0 TDI	125	11/05→11/08					
2.0 TDI 16V	103	10/03→11/08					
2.0 TDI 16V 4motion	103	08/04→11/08					
2.0 TDI 4motion	103	08/04→11/08					
VW - GOLF V Variant (1K5) 01/07→07/09							
 Bremskraftverstärker							
1.4	59	06/07→07/09		→ 06/09; für Linkslenker; +PR 1AC,1AT		03.7863-3232.4 300307	ATE Ø 10" pneumatisch
1.4 TSI	103	06/07→07/09					
1.9 TDI	77	06/07→07/09					
1.9 TDI 4motion	77	01/08→07/09					
1.4 TSI	90	06/07→07/09		→ 06/09; für Linkslenker; +PR 1AC,1AT		03.7863-3232.4 300307	ATE Ø 10" pneumatisch
1.6	75	06/07→07/09					
1.6 MultiFuel	75	11/07→07/09		→ 06/09; für Linkslenker; +PR 1AS		03.7863-9602.4 300206	ATE Ø 10" pneumatisch
2.0 TDI	100	06/07→07/09					
2.0 TDI	103	06/07→07/09					
2.0 TDI 16V	103	06/07→07/09					
1.4 TSI	118	07/08→07/09		→ 06/09; für Linkslenker; +PR 1AC,1AT		03.7863-3332.4 300308	ATE Ø 10" pneumatisch
				→ 06/09; für Linkslenker; +PR 1AS		03.7863-9602.4 300206	ATE Ø 10" pneumatisch
↓							

	kw			 	! #		
VW - GOLF V Variant (1K5) 01/07→07/09							
Bremskraftverstärker							
1.4 TSI	125	06/07→07/09		→ 06/09; für Linkslenker; +PR 1AC,1AT	03.7863-3332.4	300308	ATE Ø 10" pneumatisch
				→ 06/09; für Linkslenker; +PR 1AS	03.7863-9802.4	300281	ATE Ø 10" pneumatisch
2.0	147	06/07→07/09		→ 06/09; für Linkslenker; +PR 1AC,1AT	03.7863-3332.4	300308	ATE Ø 10" pneumatisch
Hauptbremszylinder							
1.4	59	06/07→07/09		→ 06/09; für Linkslenker	03.2122-2129.3	010799	ATE Ø 22,2
				→ 06/09; für Rechtslenker	24.4152-0132.3	011025	ATE Ø 22,2 ohne Bremsflüssigkeitsbehälter
1.4 TSI	90	06/07→07/09		→ 06/09; für Linkslenker; +PR 1AS	03.2122-2129.3	010799	ATE Ø 22,2
1.4 TSI	103	06/07→07/09		→ 06/09; für Rechtslenker	24.4152-0132.3	011025	ATE Ø 22,2 ohne Bremsflüssigkeitsbehälter
1.6	75	06/07→07/09					
1.6 MultiFuel	75	11/07→07/09					
1.4 TSI	118	07/08→07/09		→ 06/09; für Linkslenker	03.2122-2129.3	010799	ATE Ø 22,2
				→ 06/09; +PR 1LJ,1LL; für Linkslenker	03.2123-3449.3	010808	ATE Ø 23,81
				→ 06/09; für Rechtslenker	24.4152-0132.3	011025	ATE Ø 22,2 ohne Bremsflüssigkeitsbehälter
				→ 06/09; +PR 1LJ,1LL; für Rechtslenker	24.4153-0202.3	011027	ATE Ø 23,81 ohne Bremsflüssigkeitsbehälter
1.4 TSI	125	06/07→07/09		→ 06/09; für Linkslenker; +PR 1AS	03.2122-2129.3	010799	ATE Ø 22,2
				→ 06/09; +PR 1LJ,1LL; für Linkslenker	03.2123-3449.3	010808	ATE Ø 23,81
				→ 06/09; für Rechtslenker	24.4152-0132.3	011025	ATE Ø 22,2 ohne Bremsflüssigkeitsbehälter
				→ 06/09; +PR 1LJ,1LL; für Rechtslenker	24.4153-0202.3	011027	ATE Ø 23,81 ohne Bremsflüssigkeitsbehälter
1.9 TDI	77	06/07→07/09		→ 06/09; für Linkslenker; +PR 1AC,1AT	03.2122-2129.3	010799	ATE Ø 22,2
1.9 TDI 4motion	77	01/08→07/09					
2.0 TDI	100	06/07→07/09		→ 06/09; für Rechtslenker	24.4152-0132.3	011025	ATE Ø 22,2 ohne Bremsflüssigkeitsbehälter
2.0 TDI	103	06/07→07/09					
2.0 TDI 16V	103	06/07→07/09					
2.0	147	06/07→07/09		→ 06/09; für Linkslenker; +PR 1AC,1AT	03.2122-2129.3	010799	ATE Ø 22,2
				→ 06/09; +PR 1LJ,1LL; für Linkslenker	03.2123-3449.3	010808	ATE Ø 23,81
				→ 06/09; für Rechtslenker	24.4152-0132.3	011025	ATE Ø 22,2 ohne Bremsflüssigkeitsbehälter
				→ 06/09; +PR 1LJ,1LL; für Rechtslenker	24.4153-0202.3	011027	ATE Ø 23,81 ohne Bremsflüssigkeitsbehälter
Hydraulikaggregat, Bremsanlage							
1.4	59	06/07→07/09		→ 06/09; +PR 1AT,1AS	24.9145-0001.2	399005	
1.4 TSI	90	06/07→07/09					
1.4 TSI	103	06/07→07/09					
1.4 TSI	118	07/08→07/09					
1.4 TSI	125	06/07→07/09					
1.6	75	06/07→07/09					
1.6 MultiFuel	75	11/07→07/09					
1.9 TDI	77	06/07→07/09					
1.9 TDI 4motion	77	01/08→07/09					
2.0	147	06/07→07/09					
2.0 TDI	100	06/07→07/09					
2.0 TDI	103	06/07→07/09					
2.0 TDI 16V	103	06/07→07/09					
Drucksensor, Bremskraftverstärker							
1.4 TSI	90	06/07→07/09		→ 06/09; für Linkslenker; +PR 1AS	03.0655-0101.2	370008	ATE
1.4 TSI	118	07/08→07/09					
2.0 TDI	100	06/07→07/09					
2.0 TDI	103	06/07→07/09					
2.0 TDI 16V	103	06/07→07/09					
1.4 TSI	103	06/07→07/09		→ 06/09; für Rechtslenker; +PR 1AS	03.0655-0101.2	370008	ATE
1.4 TSI	125	06/07→07/09					
1.6	75	06/07→07/09		→ 06/09; +PR 1AS	03.0655-0101.2	370008	ATE
1.6 MultiFuel	75	11/07→07/09					
VW - GOLF VI (5K1) 10/08→11/13							
Bremskraftverstärker							
1.2 TSI	63	05/10→11/12		1K-9-400001→; → 11/10; +PR 1ZK;	03.7860-8802.4	300291	ATE Ø 10" pneumatisch
1.4	59	10/08→11/12		für Linkslenker			
1.4 TSI	90	10/08→11/12		für Linkslenker; +PR 1ZD,1ZF,1ZP,1LV	03.7863-3232.4	300307	ATE Ø 10" pneumatisch
1.4 TSI	118	10/08→11/12					
1.6	75	10/08→11/12		→ 1K-9-200000; +PR 1LJ,1LL,1LM;	03.7863-3332.4	300308	ATE Ø 10" pneumatisch
1.6 BiFuel	75	03/09→11/12		für Linkslenker			
1.6 MultiFuel	75	10/08→11/12		1K-9-400001→; → 11/10;	03.7863-3332.4	300308	ATE Ø 10" pneumatisch
1.6 TDI	66	02/09→11/12		+PR 1ZA,1ZB,1ZE,1LJ; für Linkslenker			
1.6 TDI	77	02/09→11/12					
2.0 GTi	155	04/09→11/12					

	kw			 	! #		
VW - GOLF VI (5K1) 10/08→11/13							
 Bremskraftverstärker							
2.0 R 4motion	188	11/09→11/13		1K-9-400001→; → 11/10; +PR 1ZK; für Linkslenker		03.7860-8802.4 300291	ATE Ø 10" pneumatisch
2.0 R 4motion	195	11/09→05/11					
2.0 R 4motion	199	11/09→11/12		für Linkslenker; +PR 1ZD,1ZF,1ZP,1LV		03.7863-3232.4 300307	ATE Ø 10" pneumatisch
2.0 TDI	81	10/08→11/12					
2.0 TDI	100	10/08→11/12		→ 1K-9-200000; +PR 1LJ,1LL,1LM; für Linkslenker		03.7863-3332.4 300308	ATE Ø 10" pneumatisch
2.0 TDI	103	10/08→05/13					
2.0 TDI	125	04/09→11/12		1K-9-400001→; → 11/10; +PR 1ZA,1ZB,1ZE,1LJ; für Linkslenker		03.7863-3332.4 300308	ATE Ø 10" pneumatisch
2.0 TDI 4motion	103	05/09→11/12					
1.2 TSI	77	11/08→11/12		1K-9-400001→; → 11/10; +PR 1ZK; für Linkslenker		03.7860-8802.4 300291	ATE Ø 10" pneumatisch
				05/09→; für Linkslenker; +PR 1ZD,1ZF,1ZP,1LV		03.7863-3232.4 300307	ATE Ø 10" pneumatisch
				1K-9-400001→; → 11/10; +PR 1ZA,1ZB,1ZE,1LJ; für Linkslenker		03.7863-3332.4 300308	ATE Ø 10" pneumatisch
				05/09→; → 1K-9-200000; für Linkslenker; +PR 1LJ,1LL,1LM		03.7863-3332.4 300308	ATE Ø 10" pneumatisch
1.8 TSI	118	06/09→01/11		1K-9-400001→; → 11/10; +PR 1ZK; für Linkslenker		03.7860-8802.4 300291	ATE Ø 10" pneumatisch
				für Linkslenker; +PR 1ZD,1ZF,1ZP,1LV		03.7863-3232.4 300307	ATE Ø 10" pneumatisch
				→ 1K-9-200000; für Linkslenker		03.7863-3332.4 300308	ATE Ø 10" pneumatisch
				1K-9-400001→; → 11/10; +PR 1ZA,1ZB,1ZE,1LJ; für Linkslenker		03.7863-3332.4 300308	ATE Ø 10" pneumatisch
2.0 GTi	173	05/11→11/12		für Linkslenker; +PR 1ZD,1ZF,1ZP,1LV		03.7863-3232.4 300307	ATE Ø 10" pneumatisch
				→ 1K-9-200000; +PR 1LJ,1LL,1LM; für Linkslenker		03.7863-3332.4 300308	ATE Ø 10" pneumatisch
 Hauptbremszylinder							
1.2 TSI	63	05/10→11/12		für Linkslenker; +PR 1ZD,1ZF,1ZP,1LV		03.2122-2129.3 010799	ATE Ø 22,2
1.4	59	10/08→11/12					
1.4 TSI	90	10/08→11/12		für Linkslenker; +PR 1ZA,1ZB,1ZE,1LJ		03.2123-3449.3 010808	ATE Ø 23,81
1.4 TSI	118	10/08→11/12		für Rechtslenker; +PR 1ZD,1ZF,1ZP,1LV		24.4152-0132.3 011025	ATE Ø 22,2 ohne Bremsflüssigkeitsbehälter
1.6	75	10/08→11/12					
1.6 BiFuel	75	03/09→11/12					
1.6 MultiFuel	75	10/08→11/12		für Rechtslenker; +PR 1ZA,1ZB,1ZE,1LJ		24.4153-0202.3 011027	ATE Ø 23,81 ohne Bremsflüssigkeitsbehälter
1.6 TDI	66	02/09→11/12					
1.6 TDI	77	02/09→11/12					
1.8 TSI	118	06/09→01/11					
2.0 GTi	155	04/09→11/12					
2.0 GTi	173	05/11→11/12					
2.0 R 4motion	188	11/09→11/13					
2.0 R 4motion	195	11/09→05/11					
2.0 R 4motion	199	11/09→11/12					
2.0 TDI	81	10/08→11/12					
2.0 TDI	100	10/08→11/12					
2.0 TDI	103	10/08→05/13					
2.0 TDI	125	04/09→11/12					
2.0 TDI 4motion	103	05/09→11/12					
1.2 TSI	77	11/08→11/12		05/09→; für Linkslenker; +PR 1ZD,1ZF,1ZP,1LV		03.2122-2129.3 010799	ATE Ø 22,2
				05/09→; für Linkslenker; +PR 1ZA,1ZB,1ZE,1LJ		03.2123-3449.3 010808	ATE Ø 23,81
				05/09→; für Rechtslenker; +PR 1ZD,1ZF,1ZP,1LV		24.4152-0132.3 011025	ATE Ø 22,2 ohne Bremsflüssigkeitsbehälter
				05/09→; für Rechtslenker; +PR 1ZA,1ZB,1ZE,1LJ		24.4153-0202.3 011027	ATE Ø 23,81 ohne Bremsflüssigkeitsbehälter
VW - GOLF VI Cabriolet (517) 03/11→							
 Bremskraftverstärker							
1.2 TSI	77	03/11→11/13		06/11→; für Linkslenker; +PR 1ZK		03.7860-8802.4 300291	ATE Ø 10" pneumatisch
1.4 TSI	118	03/11→					
1.6 TDI	77	03/11→		06/11→; für Linkslenker; +PR 1ZD,1ZP,1LV		03.7863-3232.4 300307	ATE Ø 10" pneumatisch
				06/11→; für Linkslenker; +PR 1ZA,1ZB,1ZE		03.7863-3332.4 300308	ATE Ø 10" pneumatisch
1.2 TSI 16V	77	11/13→		für Linkslenker; +PR 1ZK		03.7860-8802.4 300291	ATE Ø 10" pneumatisch
1.4 TSI	90	11/11→					
1.4 TSI	92	11/13→		für Linkslenker; +PR 1ZD,1ZP,1LV		03.7863-3232.4 300307	ATE Ø 10" pneumatisch
1.4 TSI	110	11/13→					
2.0 GTI	155	11/11→					
2.0 R	195	01/13→					
2.0 TDI	81	11/13→					
2.0 TDI	103	11/11→					
2.0 TDI	110	11/13→					
2.0 TSI	162	11/13→					

VW - GOLF VI Cabriolet (517) 03/11→

Hauptbremszylinder

1.2 TSI 1.4 TSI 1.6 TDI	77 118 77	03/11→11/13 03/11→ 03/11→		06/11→; für Linkslenker; +PR 1ZD,1ZP,1LV	03.2122-2129.3	010799	ATE Ø 22,2
				06/11→; für Linkslenker; +PR 1ZA,1ZB,1ZE,1ZK	03.2123-3449.3	010808	ATE Ø 23,81
				06/11→; für Rechtslenker; +PR 1ZD,1ZP	24.4152-0132.3	011025	ATE Ø 22,2 ohne Bremsflüssigkeitsbehälter
				06/11→; für Rechtslenker; +PR 1ZA,1ZB,1ZE,1ZK	24.4153-0202.3	011027	ATE Ø 23,81 ohne Bremsflüssigkeitsbehälter
1.2 TSI 16V 1.4 TSI 1.4 TSI 1.4 TSI 2.0 GTI 2.0 R 2.0 TDI 2.0 TDI 2.0 TDI 2.0 TSI	77 90 92 110 155 195 81 103 110 162	11/13→ 11/11→ 11/13→ 11/13→ 11/11→ 01/13→ 11/13→ 11/11→ 11/13→ 11/13→		für Linkslenker; +PR 1ZD,1ZP,1LV	03.2122-2129.3	010799	ATE Ø 22,2
				für Linkslenker; +PR 1ZA,1ZB,1ZE,1ZK	03.2123-3449.3	010808	ATE Ø 23,81
				für Rechtslenker; +PR 1ZD,1ZP	24.4152-0132.3	011025	ATE Ø 22,2 ohne Bremsflüssigkeitsbehälter
				für Rechtslenker; +PR 1ZA,1ZB,1ZE,1ZK	24.4153-0202.3	011027	ATE Ø 23,81 ohne Bremsflüssigkeitsbehälter









VW - GOLF VI Variant (AJ5) 07/09→07/13











Bremskraftverstärker







1.2 TSI 1.6 MultiFuel 2.0 TDI	63 75 81	07/10→07/13 07/10→07/13 01/10→07/13		für Linkslenker	03.7863-3232.4	300307	ATE Ø 10" pneumatisch
1.2 TSI	77	07/09→07/13		12/09→; für Linkslenker	03.7863-3232.4	300307	ATE Ø 10" pneumatisch
				08/09→; +PR 1AC,1AT; → 11/09; für Linkslenker	03.7863-3232.4	300307	ATE Ø 10" pneumatisch
1.4 2.0 TDI	59 103	07/09→07/13 07/09→07/13		12/09→; für Linkslenker	03.7863-3232.4	300307	ATE Ø 10" pneumatisch
				für Linkslenker; → 11/09; +PR 1AC,1AT	03.7863-3232.4	300307	ATE Ø 10" pneumatisch
1.4 TSI	90	07/09→07/13		für Linkslenker; → 11/09; +PR 1AC,1AT	03.7863-3232.4	300307	ATE Ø 10" pneumatisch
				12/09→; für Linkslenker; +PR 1ZP	03.7863-3232.4	300307	ATE Ø 10" pneumatisch
				+PR 1AS; → 11/09; für Linkslenker	03.7863-9602.4	300206	ATE Ø 10" pneumatisch
1.4 TSI	118	07/09→07/13		12/09→; für Linkslenker; +PR 1ZD,1ZP	03.7863-3232.4	300307	ATE Ø 10" pneumatisch
				+PR 1AC,1AT; → 11/09; für Linkslenker	03.7863-3332.4	300308	ATE Ø 10" pneumatisch
1.6	75	07/09→07/13		12/09→; für Linkslenker	03.7863-3232.4	300307	ATE Ø 10" pneumatisch
				für Linkslenker; → 11/09; +PR 1AC,1AT	03.7863-3232.4	300307	ATE Ø 10" pneumatisch
				+PR 1AS; → 11/09; für Linkslenker	03.7863-9602.4	300206	ATE Ø 10" pneumatisch
1.6 TDI	66	12/09→07/13		für Linkslenker; +PR 1ZP,1ZM	03.7863-3232.4	300307	ATE Ø 10" pneumatisch
1.6 TDI 1.6 TDI 4motion	77 77	07/09→07/13 07/09→07/13		für Linkslenker; → 11/09; +PR 1AC,1AT	03.7863-3232.4	300307	ATE Ø 10" pneumatisch
				12/09→; für Linkslenker; +PR 1ZP,1ZM	03.7863-3232.4	300307	ATE Ø 10" pneumatisch
2.0 TSI	147	07/09→07/13		für Linkslenker; +PR 1ZD	03.7863-3232.4	300307	ATE Ø 10" pneumatisch
				+PR 1LJ,1ZA; für Linkslenker	03.7863-3332.4	300308	ATE Ø 10" pneumatisch







Hauptbremszylinder







1.2 TSI 1.6 MultiFuel 2.0 TDI	63 75 81	07/10→07/13 07/10→07/13 01/10→07/13		für Linkslenker	03.2122-2129.3	010799	ATE Ø 22,2
				für Rechtslenker	24.4152-0132.3	011025	ATE Ø 22,2 ohne Bremsflüssigkeitsbehälter
1.2 TSI	77	07/09→07/13		12/09→; für Linkslenker	03.2122-2129.3	010799	ATE Ø 22,2
				08/09→; +PR 1AC,1AT; → 11/09; für Linkslenker	03.2122-2129.3	010799	ATE Ø 22,2
				08/09→; für Rechtslenker	24.4152-0132.3	011025	ATE Ø 22,2 ohne Bremsflüssigkeitsbehälter
1.4 2.0 TDI	59 103	07/09→07/13 07/09→07/13		12/09→; für Linkslenker	03.2122-2129.3	010799	ATE Ø 22,2
				für Linkslenker; → 11/09; +PR 1AC,1AT	03.2122-2129.3	010799	ATE Ø 22,2
				für Rechtslenker	24.4152-0132.3	011025	ATE Ø 22,2 ohne Bremsflüssigkeitsbehälter
1.4 TSI	90	07/09→07/13		für Linkslenker; → 11/09; +PR 1AC,1AT	03.2122-2129.3	010799	ATE Ø 22,2
				12/09→; für Linkslenker; +PR 1ZP	03.2122-2129.3	010799	ATE Ø 22,2
				+PR 1AS; → 11/09; für Linkslenker	03.2122-2129.3	010799	ATE Ø 22,2
				→ 11/09; für Rechtslenker	24.4152-0132.3	011025	ATE Ø 22,2 ohne Bremsflüssigkeitsbehälter
				12/09→; für Rechtslenker; +PR 1ZD,1ZP	24.4152-0132.3	011025	ATE Ø 22,2 ohne Bremsflüssigkeitsbehälter
				12/09→; für Rechtslenker; +PR 1LJ,1ZA,1ZE	24.4153-0202.3	011027	ATE Ø 23,81 ohne Bremsflüssigkeitsbehälter
1.4 TSI	118	07/09→07/13		für Linkslenker; → 11/09; +PR 1AC,1AT	03.2122-2129.3	010799	ATE Ø 22,2
				12/09→; für Linkslenker; +PR 1ZD,1ZP	03.2122-2129.3	010799	ATE Ø 22,2
↓							











	kw			 	! #		
VW - GOLF VI Variant (AJ5) 07/09→07/13							
 Hauptbremszylinder							
1.4 TSI	118	07/09→07/13		→ 11/09; +PR 1LJ,1LL	03.2123-3449.3	010808	ATE Ø 23,81
				→ 11/09; für Rechtslenker	24.4152-0132.3	011025	ATE Ø 22,2 ohne Bremsflüssigkeitsbehälter
				12/09→; für Rechtslenker; +PR 1ZD,1ZP	24.4152-0132.3	011025	ATE Ø 22,2 ohne Bremsflüssigkeitsbehälter
				→ 11/09; +PR 1LJ,1LL; für Rechtslenker	24.4153-0202.3	011027	ATE Ø 23,81 ohne Bremsflüssigkeitsbehälter
				12/09→; für Rechtslenker; +PR 1LJ,1ZA,1ZE	24.4153-0202.3	011027	ATE Ø 23,81 ohne Bremsflüssigkeitsbehälter
1.6	75	07/09→07/13		für Linkslenker; → 11/09; +PR 1AC,1AT	03.2122-2129.3	010799	ATE Ø 22,2
				12/09→; für Linkslenker	03.2122-2129.3	010799	ATE Ø 22,2
				+PR 1AS; → 11/09; für Linkslenker	03.2122-2129.3	010799	ATE Ø 22,2
				für Rechtslenker	24.4152-0132.3	011025	ATE Ø 22,2 ohne Bremsflüssigkeitsbehälter
1.6 TDI	66	12/09→07/13		für Linkslenker; +PR 1ZP,1ZM	03.2122-2129.3	010799	ATE Ø 22,2
				für Rechtslenker; +PR 1ZP,1ZM	24.4152-0132.3	011025	ATE Ø 22,2 ohne Bremsflüssigkeitsbehälter
				für Rechtslenker; +PR 1LJ,1ZA,1ZE	24.4153-0202.3	011027	ATE Ø 23,81 ohne Bremsflüssigkeitsbehälter
1.6 TDI 1.6 TDI 4motion	77	07/09→07/13		für Linkslenker; → 11/09; +PR 1AC,1AT	03.2122-2129.3	010799	ATE Ø 22,2
				12/09→; für Linkslenker; +PR 1ZP,1ZM	03.2122-2129.3	010799	ATE Ø 22,2
	77	07/09→07/13		→ 11/09; für Rechtslenker	24.4152-0132.3	011025	ATE Ø 22,2 ohne Bremsflüssigkeitsbehälter
				12/09→; für Rechtslenker; +PR 1ZP,1ZM	24.4152-0132.3	011025	ATE Ø 22,2 ohne Bremsflüssigkeitsbehälter
				12/09→; für Rechtslenker; +PR 1LJ,1ZA,1ZE	24.4153-0202.3	011027	ATE Ø 23,81 ohne Bremsflüssigkeitsbehälter
2.0 TSI	147	07/09→07/13		für Linkslenker; +PR 1ZD	03.2122-2129.3	010799	ATE Ø 22,2
				+PR 1LJ,1ZA	03.2123-3449.3	010808	ATE Ø 23,81
				für Rechtslenker; +PR 1LJ,1ZA,1ZE	24.4153-0202.3	011027	ATE Ø 23,81 ohne Bremsflüssigkeitsbehälter
VW - GOLF VII (5G1, BQ1, BE1, BE2) 08/12→							
 Hauptbremszylinder							
1.0 TSI	63	01/17→		für Linkslenker;	03.4153-5403.3	010994	ATE Ø 23,81
1.0 TSI	81	11/16→		+PR 1ZA,1ZD,1ZE,1ZF / 1ZP	24.4123-1719.3	011017	TRW Ø 23,81 ohne Bremsflüssigkeitsbehälter
1.0 TSI	85	05/15→					
1.2 TSI	77	11/12→					
1.2 TSI	81	04/14→					
1.4 TSI	90	11/12→					
1.4 TSI	92	05/14→					
1.4 TSI	110	05/14→					
1.4 TSI MultiFuel	90	04/13→					
1.4 TSI MultiFuel	92	12/13→					
1.5 TSI	96	07/17→					
1.5 TSI	110	04/17→					
1.6	81	05/14→					
1.6 TDI	66	04/13→					
1.6 TDI	85	11/16→					
1.6 TDI 4motion	77	11/12→					
1.6 TDI 4motion	81	01/13→					
2.0 GTD	135	04/13→					
2.0 GTI	155	11/13→					
2.0 GTI	162	04/13→					
2.0 GTI	169	04/13→					
2.0 GTI	180	03/17→					
2.0 GTI Clubsport	195	02/16→					
2.0 GTI Clubsport S	228	09/16→					
2.0 R 4motion	206	11/13→					
2.0 R 4motion	221	11/13→					
2.0 R 4motion	228	12/16→					
2.0 TDI	81	11/12→					
2.0 TDI	105	08/12→					
2.0 TDI	110	11/12→					
2.0 TDI 4motion	110	11/12→					
1.2 TSI	63	08/12→		11/12→; für Linkslenker;	03.4153-5403.3	010994	ATE Ø 23,81
1.4 TSI	103	08/12→		+PR 1ZA,1ZD,1ZE,1ZF / 1ZP	24.4123-1719.3	011017	TRW Ø 23,81 ohne Bremsflüssigkeitsbehälter
1.6 TDI	77	08/12→					
1.4 TGI CNG	81	06/13→		08/13→; für Linkslenker;	03.4153-5403.3	010994	ATE Ø 23,81
				+PR 1ZA,1ZD,1ZE,1ZF / 1ZP	24.4123-1719.3	011017	TRW Ø 23,81 ohne Bremsflüssigkeitsbehälter
1.6 TDI	81	01/13→		06/13→; für Linkslenker;	03.4153-5403.3	010994	ATE Ø 23,81
				+PR 1ZA,1ZD,1ZE,1ZF / 1ZP			
↓							















	kw			 	! #		
VW - GOLF VII (5G1, BQ1, BE1, BE2) 08/12→							
 Hauptbremszylinder							
1.6 TDI	81	01/13→		06/13→; für Linkslenker; +PR 1ZA,1ZD,1ZE,1ZF / 1ZP		24.4123-1719.3 011017	TRW Ø 23,81 ohne Bremsflüssigkeitsbehälter
VW - GOLF VII Variant (BA5, BV5) 04/13→							
 Hauptbremszylinder							
1.0 TSI	63	01/17→		für Linkslenker;		03.4153-5403.3 010994	ATE Ø 23,81
1.0 TSI	81	11/16→		+PR 1ZA,1ZD,1ZE,1ZF / 1ZP		24.4123-1719.3 011017	TRW Ø 23,81 ohne Bremsflüssigkeitsbehälter
1.0 TSI	85	05/15→					
1.2 TSI	81	04/14→					
1.4 TGI CNG	81	09/13→					
1.4 TSI	92	05/14→					
1.4 TSI	110	05/14→					
1.4 TSI MultiFuel	90	04/13→					
1.4 TSI MultiFuel	92	05/14→					
1.5 TSI	96	07/17→					
1.5 TSI	110	04/17→					
1.6	81	05/14→					
1.6 TDI	85	11/16→					
2.0 GTD	130	11/16→					
2.0 GTD	135	01/15→					
2.0 R 4motion	206	03/15→					
2.0 R 4motion	213	12/16→					
2.0 R 4motion	221	03/15→					
2.0 R 4motion	228	12/16→					
1.2 TSI	63	05/13→		07/13→; für Linkslenker;		03.4153-5403.3 010994	ATE Ø 23,81
1.2 TSI	77	05/13→		+PR 1ZA,1ZD,1ZE,1ZF / 1ZP		24.4123-1719.3 011017	TRW Ø 23,81 ohne Bremsflüssigkeitsbehälter
1.4 TSI	90	05/13→					
1.4 TSI	103	05/13→					
1.6 TDI	66	05/13→					
1.6 TDI	77	05/13→					
1.6 TDI	81	05/13→					
1.6 TDI 4motion	77	05/13→					
1.6 TDI 4motion	81	05/13→					
2.0 TDI	81	05/13→					
2.0 TDI	110	04/13→					
2.0 TDI 4motion	110	04/13→					
VW - GOLF ALLTRACK (BA5, BV5) 12/14→							
 Hauptbremszylinder							
1.6 TDI 4motion	81	12/14→		+PR 1ZA,1ZD,1ZE,1ZF / 1ZP		24.4123-1719.3 011017	TRW Ø 23,81 ohne Bremsflüssigkeitsbehälter
1.8 TSI 4motion	132	12/14→					
2.0 TDI 4motion	110	12/14→					
2.0 TDI 4motion	135	12/14→					
VW - GOLF PLUS (5M1, 521) 12/04→12/13							
 Bremskraftverstärker							
1.2 TSI	63	05/10→12/13		1K-9-900001→; für Linkslenker;		03.7860-8802.4 300291	ATE Ø 10" pneumatisch
1.2 TSI	77	11/09→12/13		→ 11/10; +PR 1ZK			
1.6 BiFuel	75	05/09→12/13		1K-9-900001→; für Linkslenker;		03.7863-3232.4 300307	ATE Ø 10" pneumatisch
1.6 TDI	66	02/09→12/13		→ 11/10; +PR 1ZD,1ZF,1ZP,1LV			
1.6 TDI	77	03/09→12/13		12/10→; für Linkslenker; +PR 1ZF,1AC		03.7863-3232.4 300307	ATE Ø 10" pneumatisch
2.0 TDI	81	01/09→12/13		12/10→; für Linkslenker;		03.7863-3332.4 300308	ATE Ø 10" pneumatisch
				+PR 1ZA,1ZE,1AS,1AT			
				1K-9-900001→; für Linkslenker;		03.7863-3332.4 300308	ATE Ø 10" pneumatisch
				→ 11/10; +PR 1ZA,1ZB,1ZE			
1.4 16V	55	01/05→11/06		1K-9-900001→; für Linkslenker;		03.7860-8802.4 300291	ATE Ø 10" pneumatisch
1.4 FSI	66	07/05→11/06		+PR 1ZK			
1.4 TSI	103	05/06→06/08		1K-9-900001→; für Linkslenker;		03.7863-3232.4 300307	ATE Ø 10" pneumatisch
1.6 FSI	85	12/04→05/08		+PR 1ZD,1ZF,1ZP,1LV			
1.9 TDI	66	05/05→12/08		für Linkslenker; +PR 1AC,1AT;		03.7863-3232.4 300307	ATE Ø 10" pneumatisch
1.9 TDI	77	01/05→01/09		→ 1K-9-899999			
2.0 FSI	110	05/05→06/08		1K-9-900001→; für Linkslenker;		03.7863-3332.4 300308	ATE Ø 10" pneumatisch
2.0 TDI	96	05/05→05/07		+PR 1ZA,1ZB,1ZE			
				für Linkslenker; +PR 1AS;		03.7863-9602.4 300206	ATE Ø 10" pneumatisch
				→ 1K-9-899999			
1.4 16V	59	05/06→12/13		1K-9-900001→; für Linkslenker;		03.7860-8802.4 300291	ATE Ø 10" pneumatisch
1.4 TSI	90	06/07→12/13		→ 11/10; +PR 1ZK			
1.4 TSI	118	06/08→12/13		12/10→; für Linkslenker; +PR 1ZF,1AC		03.7863-3232.4 300307	ATE Ø 10" pneumatisch
1.6	75	05/05→12/13		1K-9-900001→; für Linkslenker;		03.7863-3232.4 300307	ATE Ø 10" pneumatisch
1.6 MultiFuel	75	11/07→12/13		→ 11/10; +PR 1ZD,1ZF,1ZP,1LV			
2.0 TDI	100	05/05→12/13		für Linkslenker; +PR 1AC,1AT;		03.7863-3232.4 300307	ATE Ø 10" pneumatisch
2.0 TDI	103	12/05→05/11		→ 1K-9-899999			
2.0 TDI 16V	103	01/05→12/13		12/10→; für Linkslenker;		03.7863-3332.4 300308	ATE Ø 10" pneumatisch
				+PR 1ZA,1ZE,1AS,1AT			
				1K-9-900001→; für Linkslenker;		03.7863-3332.4 300308	ATE Ø 10" pneumatisch
				→ 11/10; +PR 1ZA,1ZB,1ZE			















	kw			 	! #		
VW - GOLF PLUS (5M1, 521) 12/04 → 12/13							
Bremskraftverstärker							
1.4 16V	59	05/06 → 12/13		für Linkslenker; +PR 1AS; → 1K-9-899999		03.7863-9602.4 300206	ATE Ø 10" pneumatisch
1.4 TSI	90	06/07 → 12/13					
1.4 TSI	118	06/08 → 12/13					
1.6	75	05/05 → 12/13					
1.6 MultiFuel	75	11/07 → 12/13					
2.0 TDI	100	05/05 → 12/13					
2.0 TDI	103	12/05 → 05/11					
2.0 TDI 16V	103	01/05 → 12/13					
1.4 TSI	125	05/06 → 06/08		1K-9-900001 →; für Linkslenker; +PR 1ZK		03.7860-8802.4 300291	ATE Ø 10" pneumatisch
				1K-9-900001 →; für Linkslenker; +PR 1ZD,1ZF,1ZP,1LV		03.7863-3232.4 300307	ATE Ø 10" pneumatisch
				+PR 1AC,1AT; für Linkslenker; → 1K-6-565000		03.7863-3232.4 300307	ATE Ø 10" pneumatisch
				1K-9-900001 →; für Linkslenker; +PR 1ZA,1ZB,1ZE		03.7863-3332.4 300308	ATE Ø 10" pneumatisch
				1K-6-565001 → 1K-9-899999; für Linkslenker; +PR 1AC,1AT		03.7863-3332.4 300308	ATE Ø 10" pneumatisch
				+PR 1AS; für Linkslenker; → 1K-6-565000		03.7863-9602.4 300206	ATE Ø 10" pneumatisch
				1K-6-565001 → 1K-9-899999; für Linkslenker; +PR 1AS		03.7863-9802.4 300281	ATE Ø 10" pneumatisch
Hauptbremszylinder							
1.2 TSI	63	05/10 → 12/13		1K-9-900001 →; für Linkslenker; → 1K-C-500000; +PR 1ZF		03.2122-2129.3 010799	ATE Ø 22,2
1.2 TSI	77	11/09 → 12/13					
1.6 BiFuel	75	05/09 → 12/13		1K-C-500001 →; für Linkslenker; +PR 1ZF,1AC		03.2122-2129.3 010799	ATE Ø 22,2
1.6 TDI	66	02/09 → 12/13					
1.6 TDI	77	03/09 → 12/13		1K-C-500001 →; für Linkslenker; +PR 1ZA,1ZE,1AS,1AT		03.2123-3449.3 010808	ATE Ø 23,81
2.0 TDI	81	01/09 → 12/13					
				1K-9-900001 →; für Linkslenker; → 1K-C-500000; +PR 1ZE,1LJ,1ZA		03.2123-3449.3 010808	ATE Ø 23,81
				1K-C-500001 →; für Rechtslenker; +PR 1ZF,1AC		24.4152-0132.3 011025	ATE Ø 22,2 ohne Bremsflüssigkeitsbehälter
				1K-9-900001 →; für Rechtslenker; → 1K-C-500000; +PR 1ZF		24.4152-0132.3 011025	ATE Ø 22,2 ohne Bremsflüssigkeitsbehälter
				1K-C-500001 →; für Rechtslenker; +PR 1ZA,1ZE,1AS,1AT		24.4153-0202.3 011027	ATE Ø 23,81 ohne Bremsflüssigkeitsbehälter
				1K-9-900001 →; für Rechtslenker; → 1K-C-500000; +PR 1ZE,1LJ,1ZA		24.4153-0202.3 011027	ATE Ø 23,81 ohne Bremsflüssigkeitsbehälter
1.4 16V	55	01/05 → 11/06		1K-C-500001 →; für Linkslenker; +PR 1ZF,1AC		03.2122-2129.3 010799	ATE Ø 22,2
1.4 16V	59	05/06 → 12/13					
1.4 FSI	66	07/05 → 11/06		1K-6-565001 →; für Linkslenker; → 1K-8-500000; +PR 1AC,1AT,1AS		03.2122-2129.3 010799	ATE Ø 22,2
1.4 TSI	103	05/06 → 06/08					
1.6	75	05/05 → 12/13		für Linkslenker; → 1K-6-565000		03.2122-2129.3 010799	ATE Ø 22,2
1.6 FSI	85	12/04 → 05/08					
1.6 MultiFuel	75	11/07 → 12/13		1K-9-900001 →; für Linkslenker; → 1K-C-500000; +PR 1ZF		03.2122-2129.3 010799	ATE Ø 22,2
1.9 TDI	66	05/05 → 12/08					
1.9 TDI	77	01/05 → 01/09		1K-8-500001 →; für Linkslenker; → 1K-9-899999;		03.2122-2129.3 010799	ATE Ø 22,2
2.0 FSI	110	05/05 → 06/08		+PR 1LK,1ZA,1ZC,1ZD / 1ZE,1ZF,1ZM,1ZP			
2.0 TDI	96	05/05 → 05/07					
2.0 TDI	100	05/05 → 12/13		1K-8-500001 →; für Linkslenker; → 1K-9-899999; +PR 1LJ		03.2123-3449.3 010808	ATE Ø 23,81
2.0 TDI	103	12/05 → 05/11					
2.0 TDI 16V	103	01/05 → 12/13		1K-6-565001 →; für Linkslenker; → 1K-8-500000; +PR 1LJ		03.2123-3449.3 010808	ATE Ø 23,81
				1K-9-900001 →; für Linkslenker; → 1K-C-500000; +PR 1ZE,1LJ,1ZA		03.2123-3449.3 010808	ATE Ø 23,81
				1K-C-500001 →; für Linkslenker; +PR 1ZA,1ZE,1AS,1AT		03.2123-3449.3 010808	ATE Ø 23,81
				1K-6-565001 →; für Rechtslenker; → 1K-8-500000; +PR 1AC,1AT,1AS		24.4152-0132.3 011025	ATE Ø 22,2 ohne Bremsflüssigkeitsbehälter
				1K-8-500001 →; für Rechtslenker; → 1K-9-899999;		24.4152-0132.3 011025	ATE Ø 22,2 ohne Bremsflüssigkeitsbehälter
				+PR 1LK,1ZA,1ZC,1ZD / 1ZE,1ZF,1ZM,1ZP			
				1K-9-900001 →; für Rechtslenker; → 1K-C-500000; +PR 1ZF		24.4152-0132.3 011025	ATE Ø 22,2 ohne Bremsflüssigkeitsbehälter
				1K-C-500001 →; für Rechtslenker; +PR 1ZF,1AC		24.4152-0132.3 011025	ATE Ø 22,2 ohne Bremsflüssigkeitsbehälter
				1K-C-500001 →; für Rechtslenker; +PR 1ZA,1ZE,1AS,1AT		24.4153-0202.3 011027	ATE Ø 23,81 ohne Bremsflüssigkeitsbehälter
				1K-9-900001 →; für Rechtslenker; → 1K-C-500000; +PR 1ZE,1LJ,1ZA		24.4153-0202.3 011027	ATE Ø 23,81 ohne Bremsflüssigkeitsbehälter











	kw			 	! #		
VW - GOLF PLUS (5M1, 521) 12/04 → 12/13							
Hauptbremszylinder							
1.4 16V	55	01/05 → 11/06		1K-8-500001 →; für Rechtslenker; → 1K-9-899999; +PR 1LJ		24.4153-0202.3 011027	ATE Ø 23,81 ohne Bremsflüssigkeitsbehälter
1.4 16V	59	05/06 → 12/13					
1.4 FSI	66	07/05 → 11/06					
1.4 TSI	103	05/06 → 06/08					
1.6	75	05/05 → 12/13					
1.6 FSI	85	12/04 → 05/08					
1.6 MultiFuel	75	11/07 → 12/13					
1.9 TDI	66	05/05 → 12/08					
1.9 TDI	77	01/05 → 01/09					
2.0 FSI	110	05/05 → 06/08					
2.0 TDI	96	05/05 → 05/07					
2.0 TDI	100	05/05 → 12/13					
2.0 TDI	103	12/05 → 05/11					
2.0 TDI 16V	103	01/05 → 12/13					
1.4 TSI	90	06/07 → 12/13		1K-6-565001 →; für Linkslenker; → 1K-8-500000; +PR 1AC,1AT,1AS		03.2122-2129.3 010799	ATE Ø 22,2
				1K-C-500001 →; für Linkslenker; +PR 1ZF,1AC		03.2122-2129.3 010799	ATE Ø 22,2
				1K-9-900001 →; für Linkslenker; → 1K-C-500000; +PR 1ZF		03.2122-2129.3 010799	ATE Ø 22,2
				1K-8-500001 →; für Linkslenker; → 1K-9-899999; +PR 1LK,1ZA,1ZC,1ZD / 1ZE,1ZF,1ZM,1ZP		03.2122-2129.3 010799	ATE Ø 22,2
				1K-6-565001 →; für Linkslenker; → 1K-8-500000; +PR 1LJ		03.2123-3449.3 010808	ATE Ø 23,81
				1K-8-500001 →; für Linkslenker; → 1K-9-899999; +PR 1LJ		03.2123-3449.3 010808	ATE Ø 23,81
				1K-C-500001 →; für Linkslenker; +PR 1ZA,1ZE,1AS,1AT		03.2123-3449.3 010808	ATE Ø 23,81
				1K-9-900001 →; für Linkslenker; → 1K-C-500000; +PR 1ZE,1LJ,1ZA		03.2123-3449.3 010808	ATE Ø 23,81
				1K-6-565001 →; für Rechtslenker; → 1K-8-500000; +PR 1AC,1AT,1AS		24.4152-0132.3 011025	ATE Ø 22,2 ohne Bremsflüssigkeitsbehälter
				1K-C-500001 →; für Rechtslenker; +PR 1ZF,1AC		24.4152-0132.3 011025	ATE Ø 22,2 ohne Bremsflüssigkeitsbehälter
				1K-9-900001 →; für Rechtslenker; → 1K-C-500000; +PR 1ZF		24.4152-0132.3 011025	ATE Ø 22,2 ohne Bremsflüssigkeitsbehälter
				1K-8-500001 →; für Rechtslenker; → 1K-9-899999; +PR 1LK,1ZA,1ZC,1ZD / 1ZE,1ZF,1ZM,1ZP		24.4152-0132.3 011025	ATE Ø 22,2 ohne Bremsflüssigkeitsbehälter
				1K-C-500001 →; für Rechtslenker; +PR 1ZA,1ZE,1AS,1AT		24.4153-0202.3 011027	ATE Ø 23,81 ohne Bremsflüssigkeitsbehälter
				1K-9-900001 →; für Rechtslenker; → 1K-C-500000; +PR 1ZE,1LJ,1ZA		24.4153-0202.3 011027	ATE Ø 23,81 ohne Bremsflüssigkeitsbehälter
				1K-8-500001 →; für Rechtslenker; → 1K-9-899999; +PR 1LJ		24.4153-0202.3 011027	ATE Ø 23,81 ohne Bremsflüssigkeitsbehälter
1.4 TSI	118	06/08 → 12/13		1K-9-900001 →; für Linkslenker; → 1K-C-500000; +PR 1ZF		03.2122-2129.3 010799	ATE Ø 22,2
				1K-C-500001 →; für Linkslenker; +PR 1ZF,1AC		03.2122-2129.3 010799	ATE Ø 22,2
				1K-8-500001 →; für Linkslenker; → 1K-9-899999; +PR 1LK,1ZA,1ZC,1ZD / 1ZE,1ZF,1ZM,1ZP		03.2122-2129.3 010799	ATE Ø 22,2
				1K-C-500001 →; für Linkslenker; +PR 1ZA,1ZE,1AS,1AT		03.2123-3449.3 010808	ATE Ø 23,81
				1K-9-900001 →; für Linkslenker; → 1K-C-500000; +PR 1ZE,1LJ,1ZA		03.2123-3449.3 010808	ATE Ø 23,81
				1K-8-500001 →; für Linkslenker; → 1K-9-899999; +PR 1LJ		03.2123-3449.3 010808	ATE Ø 23,81
				1K-8-500001 →; für Rechtslenker; → 1K-9-899999; +PR 1LK,1ZA,1ZC,1ZD / 1ZE,1ZF,1ZM,1ZP		24.4152-0132.3 011025	ATE Ø 22,2 ohne Bremsflüssigkeitsbehälter
				1K-9-900001 →; für Rechtslenker; → 1K-C-500000; +PR 1ZF		24.4152-0132.3 011025	ATE Ø 22,2 ohne Bremsflüssigkeitsbehälter
				1K-C-500001 →; für Rechtslenker; +PR 1ZF,1AC		24.4152-0132.3 011025	ATE Ø 22,2 ohne Bremsflüssigkeitsbehälter
				1K-C-500001 →; für Rechtslenker; +PR 1ZA,1ZE,1AS,1AT		24.4153-0202.3 011027	ATE Ø 23,81 ohne Bremsflüssigkeitsbehälter
				1K-9-900001 →; für Rechtslenker; → 1K-C-500000; +PR 1ZE,1LJ,1ZA		24.4153-0202.3 011027	ATE Ø 23,81 ohne Bremsflüssigkeitsbehälter
				1K-8-500001 →; für Rechtslenker; → 1K-9-899999; +PR 1LJ		24.4153-0202.3 011027	ATE Ø 23,81 ohne Bremsflüssigkeitsbehälter











	kw			 	! #		
VW - GOLF PLUS (5M1, 521) 12/04→12/13							
Hauptbremszylinder							
1.4 TSI	125	05/06→06/08		1K-C-500001→; für Linkslenker; +PR 1ZF,1AC		03.2122-2129.3 010799	ATE Ø 22,2
				1K-6-565001→; für Linkslenker; → 1K-8-500000; +PR 1AC,1AT,1AS		03.2122-2129.3 010799	ATE Ø 22,2
				für Linkslenker; → 1K-6-565000		03.2122-2129.3 010799	ATE Ø 22,2
				1K-9-900001→; für Linkslenker; → 1K-C-500000; +PR 1ZF		03.2122-2129.3 010799	ATE Ø 22,2
				1K-8-500001→; für Linkslenker; → 1K-9-899999; +PR 1LK,1ZA,1ZC,1ZD / 1ZE,1ZF,1ZM,1ZP		03.2122-2129.3 010799	ATE Ø 22,2
				1K-C-500001→; für Linkslenker; +PR 1ZA,1ZE,1AS,1AT		03.2123-3449.3 010808	ATE Ø 23,81
				1K-8-500001→; für Linkslenker; → 1K-9-899999; +PR 1LJ		03.2123-3449.3 010808	ATE Ø 23,81
				1K-9-900001→; für Linkslenker; → 1K-C-500000; +PR 1ZE,1LJ,1ZA		03.2123-3449.3 010808	ATE Ø 23,81
				1K-6-565001→; für Linkslenker; → 1K-8-500000; +PR 1LJ		03.2123-3449.3 010808	ATE Ø 23,81
				1K-C-500001→; für Rechtslenker; +PR 1ZF,1AC		24.4152-0132.3 011025	ATE Ø 22,2 ohne Bremsflüssigkeitsbehälter
				1K-9-900001→; für Rechtslenker; → 1K-C-500000; +PR 1ZF		24.4152-0132.3 011025	ATE Ø 22,2 ohne Bremsflüssigkeitsbehälter
				1K-8-500001→; für Rechtslenker; → 1K-9-899999; +PR 1LK,1ZA,1ZC,1ZD / 1ZE,1ZF,1ZM,1ZP		24.4152-0132.3 011025	ATE Ø 22,2 ohne Bremsflüssigkeitsbehälter
				1K-C-500001→; für Rechtslenker; +PR 1ZA,1ZE,1AS,1AT		24.4153-0202.3 011027	ATE Ø 23,81 ohne Bremsflüssigkeitsbehälter
				1K-9-900001→; für Rechtslenker; → 1K-C-500000; +PR 1ZE,1LJ,1ZA		24.4153-0202.3 011027	ATE Ø 23,81 ohne Bremsflüssigkeitsbehälter
	1K-7-550001→; für Rechtslenker; → 1K-8-500000; +PR 1AC,1AT,1AS,1LJ		24.4153-0202.3 011027	ATE Ø 23,81 ohne Bremsflüssigkeitsbehälter			
	1K-8-500001→; für Rechtslenker; → 1K-9-899999; +PR 1LJ		24.4153-0202.3 011027	ATE Ø 23,81 ohne Bremsflüssigkeitsbehälter			
Hydraulikaggregat, Bremsanlage							
1.4 16V	55	01/05→11/06		+PR 1AT,1AS		24.9145-0001.2 399005	
1.4 FSI	66	07/05→11/06					
1.4 TSI	103	05/06→06/08					
1.4 TSI	125	05/06→06/08					
1.6 FSI	85	12/04→05/08					
1.9 TDI	66	05/05→12/08					
2.0 FSI	110	05/05→06/08					
2.0 TDI	96	05/05→05/07					
1.4 16V	59	05/06→12/13		→ 12/08; +PR 1AT,1AS		24.9145-0001.2 399005	
1.4 TSI	90	06/07→12/13					
1.4 TSI	118	06/08→12/13					
1.6	75	05/05→12/13					
1.6 MultiFuel	75	11/07→12/13					
1.9 TDI	77	01/05→01/09					
2.0 TDI	100	05/05→12/13					
2.0 TDI	103	12/05→05/11					
2.0 TDI 16V	103	01/05→12/13					
Drucksensor, Bremskraftverstärker							
1.4 16V	55	01/05→11/06		für Linkslenker; +PR 1AS; → 1K-9-899999		03.0655-0101.2 370008	ATE
1.4 16V	59	05/06→12/13					
1.4 FSI	66	07/05→11/06					
1.4 TSI	90	06/07→12/13		1K-6-565001→; für Rechtslenker; → 1K-9-899999; +PR 1AS		03.0655-0101.2 370008	ATE
1.4 TSI	103	05/06→06/08					
1.4 TSI	118	06/08→12/13					
1.6	75	05/05→12/13					
1.6 FSI	85	12/04→05/08					
1.6 MultiFuel	75	11/07→12/13					
1.9 TDI	66	05/05→12/08					
1.9 TDI	77	01/05→01/09					
2.0 FSI	110	05/05→06/08					
2.0 TDI	96	05/05→05/07					
2.0 TDI	100	05/05→12/13					
2.0 TDI	103	12/05→05/11					
2.0 TDI 16V	103	01/05→12/13					
1.4 TSI	125	05/06→06/08		+PR 1AS; für Linkslenker; → 1K-6-565000		03.0655-0101.2 370008	ATE
				1K-6-565001→ 1K-9-899999; für Rechtslenker; +PR 1AC,1AT,1AS		03.0655-0101.2 370008	ATE

	kW			 	! #			
VW - GOLF SPORTSVAN (AM1) 02/14→								
 Hauptbremszylinder								
1.0 TSI	63	05/17→		für Linkslenker		24.4123-1719.3	011017	TRW Ø 23,81 ohne Bremsflüssigkeitsbehälter
1.0 TSI	81	05/17→						
1.0 TSI	85	05/15→						
1.2 TSI	63	05/14→						
1.2 TSI	81	04/14→						
1.4 TSI	92	04/14→						
1.4 TSI MultiFuel	92	04/14→						
1.5 TSI	96	05/17→						
1.5 TSI	110	05/17→						
1.6	81	05/14→						
1.6 TDI	66	02/14→						
1.6 TDI	85	11/16→						
2.0 TDI	81	05/14→						
1.4 TSI	110	02/14→		05/14→; für Linkslenker		24.4123-1719.3	011017	TRW Ø 23,81 ohne Bremsflüssigkeitsbehälter
1.6 TDI	81	02/14→						
2.0 TDI	110	02/14→						
VW - JETTA III (1K2) 09/04→10/10								
 Bremskraftverstärker								
1.4 TSI	90	05/07→10/10		für Linkslenker; +PR 1AS		03.7863-9602.4	300206	ATE Ø 10" pneumatisch
1.4 TSI	103	07/06→10/10						
1.4 TSI	118	07/08→10/10		für Linkslenker; +PR 1AS,1LJ		03.7863-9802.4	300281	ATE Ø 10" pneumatisch
1.4 TSI	125	07/06→10/10						
1.6	75	10/05→10/10						
1.6 FSI	85	09/05→10/10						
1.6 MultiFuel	75	01/08→10/10						
1.6 TDI	66	12/09→10/10						
1.6 TDI	77	06/09→10/10						
1.9 TDI	77	08/05→10/10						
2.0 FSI	110	08/05→10/10						
2.0 TDI	100	09/05→10/10						
2.0 TDI	103	10/05→10/10						
2.0 TDI	125	10/06→10/10						
2.0 TDI 16V	103	08/05→10/10						
2.0 TFSI	147	10/05→10/10						
2.5	110	01/06→10/10		07/08→; für Linkslenker; +PR 1AS		03.7863-9602.4	300206	ATE Ø 10" pneumatisch
				07/08→; für Linkslenker; +PR 1AS,1LJ		03.7863-9802.4	300281	ATE Ø 10" pneumatisch
 Hauptbremszylinder								
1.4 TSI	90	05/07→10/10		für Linkslenker; +PR 1AS		03.2122-2129.3	010799	ATE Ø 22,2
1.4 TSI	103	07/06→10/10						
1.4 TSI	118	07/08→10/10						
1.4 TSI	125	07/06→10/10						
1.6	75	10/05→10/10						
1.6 FSI	85	09/05→10/10						
1.6 MultiFuel	75	01/08→10/10						
1.6 TDI	66	12/09→10/10						
1.6 TDI	77	06/09→10/10						
1.9 TDI	77	08/05→10/10						
2.0 FSI	110	08/05→10/10						
2.0 TDI	100	09/05→10/10						
2.0 TDI	103	10/05→10/10						
2.0 TDI	125	10/06→10/10						
2.0 TDI 16V	103	08/05→10/10						
2.0 TFSI	147	10/05→10/10						
2.5	110	01/06→10/10		07/08→; für Linkslenker; +PR 1AS		03.2122-2129.3	010799	ATE Ø 22,2
Hydraulikaggregat, Bremsanlage								
1.4 TSI	90	05/07→10/10		+PR 1AT,1AS		24.9145-0001.2	399005	
1.4 TSI	103	07/06→10/10						
1.4 TSI	118	07/08→10/10						
1.4 TSI	125	07/06→10/10						
1.6	75	10/05→10/10						
1.6 FSI	85	09/05→10/10						
1.6 MultiFuel	75	01/08→10/10						
1.6 TDI	66	12/09→10/10						
1.6 TDI	77	06/09→10/10						
1.9 TDI	77	08/05→10/10						
2.0 FSI	110	08/05→10/10						
2.0 TDI	100	09/05→10/10						
2.0 TDI	103	10/05→10/10						
2.0 TDI	125	10/06→10/10						
2.0 TDI 16V	103	08/05→10/10						
2.0 TFSI	147	10/05→10/10						
2.5	110	01/06→10/10		07/08→; +PR 1AT,1AS		24.9145-0001.2	399005	
Drucksensor, Bremskraftverstärker								
1.4 TSI	90	05/07→10/10		für Linkslenker; +PR 1AS		03.0655-0101.2	370008	ATE
1.4 TSI	103	07/06→10/10						
↓								

	kw			 	! #		
VW - JETTA III (1K2) 09/04→10/10							
Drucksensor, Bremskraftverstärker							
1.4 TSI	118	07/08→10/10		für Linkslenker; +PR 1AS		03.0655-0101.2 370008	ATE
1.4 TSI	125	07/06→10/10					
1.6	75	10/05→10/10					
1.6 FSI	85	09/05→10/10					
1.6 MultiFuel	75	01/08→10/10					
1.6 TDI	66	12/09→10/10					
1.6 TDI	77	06/09→10/10					
1.9 TDI	77	08/05→10/10					
2.0 FSI	110	08/05→10/10					
2.0 TDI	100	09/05→10/10					
2.0 TDI	103	10/05→10/10					
2.0 TDI	125	10/06→10/10					
2.0 TDI 16V	103	08/05→10/10					
2.0 TFSI	147	10/05→10/10					
2.5	110	01/06→10/10		07/08→; für Linkslenker; +PR 1AS		03.0655-0101.2 370008	ATE
VW - JETTA IV (162, 163) 09/09→							
 Bremskraftverstärker							
2.0 TSI	147	12/10→		04/11→; für Linkslenker; - ESP		03.7863-3332.4 300308	ATE Ø 10" pneumatisch
2.5	125	04/10→					
2.0 TSI	155	12/12→		für Linkslenker; - ESP		03.7863-3332.4 300308	ATE Ø 10" pneumatisch
 Hauptbremszylinder							
1.2 TSI	77	10/10→		04/11→; für Rechtslenker; +PR 1AT,1AS		24.4152-0132.3 011025	ATE Ø 22,2 ohne Bremsflüssigkeitsbehälter
1.6 TDI	77	04/10→07/14					
2.0 TDI	103	02/11→		04/11→; für Rechtslenker; +PR 1AC		24.4153-0202.3 011027	ATE Ø 23,81 ohne Bremsflüssigkeitsbehälter
2.0 TSI	147	12/10→					
2.5	125	04/10→					
1.2 TSI 16V	77	08/14→		für Rechtslenker; +PR 1AT,1AS		24.4152-0132.3 011025	ATE Ø 22,2 ohne Bremsflüssigkeitsbehälter
1.4 TSI	90	05/11→					
1.4 TSI	92	08/14→					
1.4 TSI	110	04/11→07/14		für Rechtslenker; +PR 1AC		24.4153-0202.3 011027	ATE Ø 23,81 ohne Bremsflüssigkeitsbehälter
1.4 TSI	110	08/14→					
1.4 TSI	118	04/11→					
1.4 TSI Hybrid	110	04/11→					
1.6	77	12/11→					
2.0	85	06/10→					
2.0 TDI	81	10/10→					
2.0 TDI	110	08/14→					
2.0 TSI	155	12/12→					
VW - LOAD UP (121, 122, BL1, BL2) 12/14→							
 Hauptbremszylinder							
1.0	44	12/14→		für Linkslenker		24.4120-1703.3 011015	TRW Ø 20,64 ohne Bremsflüssigkeitsbehälter
1.0 EcoFuel	50	12/14→					
VW - LT 28-35 I Bus (281-363) 04/75→06/96							
 Bremskraftverstärker							
2.4 D	51	08/89→06/96				03.6850-5402.4 300055	ATE Ø 9" pneumatisch
2.4 i	69	08/89→06/96					
2.4 TD	70	09/92→06/96					
 Hauptbremszylinder							
2.4 D	51	08/89→06/96		- ABS		03.2123-5212.3 010183	Ø 23,81
2.4 i	69	08/89→06/96					
2.4 TD	70	09/92→06/96					
VW - LT 28-35 I Kasten (281-363) 04/75→06/96							
 Bremskraftverstärker							
2.4 D	51	07/90→05/96		nicht für Doppelbereifung		03.6850-5402.4 300055	ATE Ø 9" pneumatisch
2.4 i	69	08/89→06/96				03.6850-5402.4 300055	ATE Ø 9" pneumatisch
2.4 TD	70	06/92→05/96					
 Hauptbremszylinder							
2.4 D	51	07/90→05/96		- ABS		03.2123-5212.3 010183	Ø 23,81
2.4 i	69	08/89→06/96		nicht für Doppelbereifung; - ABS		03.2123-5212.3 010183	Ø 23,81
2.4 TD	70	06/92→05/96		mit Doppelbereifung; - ABS		03.2125-1712.3 010204	Ø 25,4
VW - LT 28-35 I Pritsche/Fahrgestell (281-363) 04/75→06/96							
 Bremskraftverstärker							
2.4 D	51	08/90→06/96		nicht für Doppelbereifung		03.6850-5402.4 300055	ATE Ø 9" pneumatisch
2.4 i	69	03/94→06/96					
2.4 TD	70	08/92→06/96				03.6850-5402.4 300055	ATE Ø 9" pneumatisch
↓							

	kw					! #		
VW - LT 28-35 I Pritsche/Fahrgestell (281-363) 04/75→06/96								
 Hauptbremszylinder								
2.4 D	51	08/90→06/96		- ABS			03.2123-5212.3 010183	Ø 23,81
2.4 i	69	03/94→06/96		nicht für Doppelbereifung; - ABS			03.2123-5212.3 010183	Ø 23,81
2.4 TD	70	08/92→06/96		mit Doppelbereifung; - ABS			03.2125-1712.3 010204	Ø 25,4
VW - LT 28-35 II Bus (2DB, 2DE, 2DK) 04/96→07/06								
 Hauptbremszylinder								
2.3	105	05/96→07/06		→ 2D-2-011024; + ABS			24.2123-1711.3 010518	Ø 23,81
2.5 SDI	55	07/96→07/06		→ 2D-X-012290; + ABS			24.2123-1711.3 010518	Ø 23,81
2.5 TDI	75	05/96→08/99		→ 2D-2-011024; - ABS			24.2123-1728.3 010558	Ø 23,81
				2D-2-011025→			24.2123-1755.3 010750	Ø 23,81
				2D-X-012291→ 2D-2-011024; + ABS			24.2125-1727.3 010723	Ø 25,4
				2D-2-011025→; + ABS			24.2125-1735.3 010879	TRW Ø 25,4
2.5 TDI	61	05/01→07/06		→ 2D-2-011024; + ABS			24.2123-1711.3 010518	Ø 23,81
2.5 TDI	66	05/99→07/06		→ 2D-2-011024; - ABS			24.2123-1728.3 010558	Ø 23,81
2.5 TDI	70	05/01→07/06		2D-2-011025→			24.2123-1755.3 010750	Ø 23,81
2.5 TDI	80	05/99→07/06		2D-2-011025→			24.2123-1755.3 010750	Ø 23,81
2.8 TDI	96	01/99→01/02						
2.8 TDI	116	05/01→06/06						
VW - LT 28-46 II Kasten (2DA, 2DD, 2DH) 04/96→07/06								
 Hauptbremszylinder								
2.3	105	05/96→07/06		→ 2D-2-011024; + ABS			24.2123-1711.3 010518	Ø 23,81
2.5 SDI	55	09/96→07/06		→ 2D-X-012290; + ABS			24.2123-1711.3 010518	Ø 23,81
2.5 TDI	61	05/01→07/06		→ 2D-2-011024; - ABS			24.2123-1728.3 010558	Ø 23,81
2.5 TDI	66	05/99→07/06		2D-2-011025→			24.2123-1755.3 010750	Ø 23,81
2.5 TDI	70	05/01→07/06		2D-X-012291→ 2D-2-011024; + ABS			24.2125-1727.3 010723	Ø 25,4
2.5 TDI	75	05/96→08/99		2D-2-011025→; + ABS			24.2125-1735.3 010879	TRW Ø 25,4
2.5 TDI	80	05/99→07/06						
2.8 TDI	92	07/97→01/02		2D-2-011025→; + ABS			24.2125-1735.3 010879	TRW Ø 25,4
2.8 TDI	96	01/99→07/06						
2.8 TDI	116	04/02→07/06						
VW - LT 28-46 II Pritsche/Fahrgestell (2DC, 2DF, 2DG, 2DL, 2DM) 04/96→07/06								
 Hauptbremszylinder								
2.3	105	06/96→07/06		→ 2D-2-011024; + ABS			24.2123-1711.3 010518	Ø 23,81
2.5 SDI	55	09/96→07/06		→ 2D-X-012290; + ABS			24.2123-1711.3 010518	Ø 23,81
2.5 TDI	61	05/01→07/06		→ 2D-2-011024; - ABS			24.2123-1728.3 010558	Ø 23,81
2.5 TDI	66	05/99→07/06		2D-2-011025→			24.2123-1755.3 010750	Ø 23,81
2.5 TDI	70	05/01→07/06		2D-X-012291→ 2D-2-011024; + ABS			24.2125-1727.3 010723	Ø 25,4
2.5 TDI	75	06/96→08/99		2D-2-011025→; + ABS			24.2125-1735.3 010879	TRW Ø 25,4
2.5 TDI	80	05/99→07/06						
2.8 TDI	92	07/97→01/02		2D-2-011025→; + ABS			24.2125-1735.3 010879	TRW Ø 25,4
2.8 TDI	96	01/99→07/06						
2.8 TDI	116	04/02→07/06						
VW - LT 40-55 I Kasten (291-512) 04/75→06/96								
 Hauptbremszylinder								
2.4 D	51	07/90→05/96		- ABS			03.2125-1712.3 010204	Ø 25,4
2.4 i	69	01/93→06/96						
2.4 TD	70	06/92→05/96						
VW - LT 40-55 I Pritsche/Fahrgestell (293-909) 04/75→06/96								
 Hauptbremszylinder								
2.4 D	51	08/90→06/96		- ABS			03.2125-1712.3 010204	Ø 25,4
2.4 i	69	03/94→06/96						
2.4 TD	70	08/92→06/96						
VW - LUPO (6X1, 6E1) 09/98→07/05								
 Bremskraftverstärker								
1.4 16V	74	08/99→07/05		für Linkslenker; + ESP;			03.7853-0102.4 300252	ATE Ø 9" pneumatisch
1.4 FSI	77	02/01→07/05		+PR 1AT,1LX,1ZE				
1.6 GTI	92	09/00→07/05						
 Hauptbremszylinder								
1.0	37	09/98→07/05		- ABS			03.2120-3943.3 010532	ATE Ø 20,64
1.0	37	10/98→05/00						
1.2 TDI 3L	45	07/99→07/05		für Rechtslenker; + ABS			03.2122-1184.3 010592	ATE Ø 22,2
1.4	44	10/00→07/05		für Linkslenker; + ABS / - ESP			03.2122-1344.3 010593	ATE Ø 22,2
1.4 TDI	55	01/99→07/05		für Linkslenker; + ABS / + ESP			03.2122-1724.3 010648	ATE Ø 22,2
1.7 SDI	44	09/98→07/05						
1.4 16V	55	09/98→07/05		10/98→; - ABS			03.2120-3943.3 010532	ATE Ø 20,64
↓								

	kw			 	! #		
VW - LUPO (6X1, 6E1) 09/98→07/05							
 Hauptbremszylinder							
1.4 16V	55	09/98→07/05		10/98→; für Rechtslenker; + ABS	03.2122-1184.3	010592	ATE Ø 22,2
				10/98→; für Linkslenker; + ABS / - ESP	03.2122-1344.3	010593	ATE Ø 22,2
				10/98→; für Linkslenker; + ABS / + ESP	03.2122-1724.3	010648	ATE Ø 22,2
1.4 16V	74	08/99→07/05		für Rechtslenker; + ABS	03.2122-1184.3	010592	ATE Ø 22,2
1.4 FSI	77	02/01→07/05		für Linkslenker; + ABS / - ESP	03.2123-1824.3	010596	ATE Ø 23,81
1.6 GTI	92	09/00→07/05					
 Bremskraftregler							
1.0	37	09/98→07/05			03.6583-0184.3	320229	ATE lastabhängig 8/3 4x
1.0	37	10/98→05/00					
1.2 TDI 3L	45	07/99→07/05					
1.4	44	10/00→07/05					
1.4 TDI	55	01/99→07/05					
1.7 SDI	44	09/98→07/05					
1.4 16V	55	09/98→07/05		10/98→	03.6583-0184.3	320229	ATE lastabhängig 8/3 4x
VW - MULTIVAN T5 (7HM, 7HN, 7HF, 7EF, 7EM, 7EN) 04/03→08/15							
 Bremskraftverstärker							
1.9 TDI	62	01/06→11/09		+PR 1AJ,1AE,1AC,1AR; → 7H-A-050000	03.7765-1002.4	300246	ATE Ø 10 / 9" pneumatisch
1.9 TDI	63	04/03→11/09					
1.9 TDI	75	06/06→11/09		+PR 1AK; → 7H-A-050000	03.7868-3702.4	300208	ATE Ø 10 / 8" pneumatisch
1.9 TDI	77	04/03→11/09					
2.0	85	11/03→08/15					
2.0 BiTDI	132	09/09→08/15					
2.0 BiTDI 4motion	132	09/09→08/15					
2.0 TDI	62	09/09→08/15					
2.0 TDI	75	09/09→08/15					
2.0 TDI	103	09/09→08/15					
2.0 TDI 4motion	103	09/09→08/15					
2.5 TDI	96	04/03→11/09					
2.5 TDI	120	11/03→11/09					
2.5 TDI	128	04/03→11/09					
2.5 TDI 4motion	96	07/04→11/09					
2.5 TDI 4motion	128	07/04→11/09					
3.2 V6	170	02/04→06/04					
3.2 V6	173	02/04→11/09					
3.2 V6 4motion	173	07/04→11/09					
Pedalwegsensor, Bremspedal							
1.9 TDI	62	01/06→11/09		+PR 1AT; → 7H-A-050000	03.0655-0006.2	370006	ATE
1.9 TDI	63	04/03→11/09					
1.9 TDI	75	06/06→11/09					
1.9 TDI	77	04/03→11/09					
2.0	85	11/03→08/15					
2.0 BiTDI	132	09/09→08/15					
2.0 BiTDI 4motion	132	09/09→08/15					
2.0 TDI	62	09/09→08/15					
2.0 TDI	75	09/09→08/15					
2.0 TDI	103	09/09→08/15					
2.0 TDI 4motion	103	09/09→08/15					
2.5 TDI	96	04/03→11/09					
2.5 TDI	120	11/03→11/09					
2.5 TDI	128	04/03→11/09					
2.5 TDI 4motion	96	07/04→11/09					
2.5 TDI 4motion	128	07/04→11/09					
3.2 V6	170	02/04→06/04					
3.2 V6	173	02/04→11/09					
3.2 V6 4motion	173	07/04→11/09					
 Hauptbremszylinder							
1.9 TDI	62	01/06→11/09		7H-6-000001→ 7H-6-200000; für Rechtslenker; +PR 1AT	03.2126-3014.3	010811	ATE Ø 26,99
1.9 TDI	63	04/03→11/09					
1.9 TDI	75	06/06→11/09		→ 7H-A-050000	03.2126-3014.3	010811	ATE Ø 26,99
1.9 TDI	77	04/03→11/09					
2.0	85	11/03→08/15		7H-A-200001→	03.2126-3144.3	010941	ATE Ø 26,99
3.2 V6	170	02/04→06/04					
3.2 V6	173	02/04→11/09					
2.0 BiTDI	132	09/09→08/15		→ 7H-A-050000	03.2126-3014.3	010811	ATE Ø 26,99
2.0 BiTDI 4motion	132	09/09→08/15		7H-A-200001→	03.2126-3144.3	010941	ATE Ø 26,99
2.0 TDI	62	09/09→08/15					
2.0 TDI	75	09/09→08/15					
2.0 TDI	100	05/10→08/15					
2.0 TDI	103	09/09→08/15					
2.0 TDI 4motion	100	05/10→08/15					
2.0 TDI 4motion	103	09/09→08/15					
2.5 TDI	96	04/03→11/09					
2.5 TDI	120	11/03→11/09					
2.5 TDI	128	04/03→11/09					
2.5 TDI 4motion	96	07/04→11/09					

	kw					! #		
VW - MULTIVAN T5 (7HM, 7HN, 7HF, 7EF, 7EM, 7EN) 04/03→08/15								
 Hauptbremszylinder								
2.5 TDI 4motion 3.2 V6 4motion	128 173	07/04→11/09 07/04→11/09		→ 7H-A-050000 7H-A-200001→			03.2126-3014.3 010811 03.2126-3144.3 010941	ATE Ø 26,99 ATE Ø 26,99
2.0 TDI 2.0 TSI 2.0 TSI 2.0 TSI 4motion	84 110 150 150	05/11→08/15 07/12→08/15 05/11→08/15 07/11→08/15					03.2126-3144.3 010941	ATE Ø 26,99
VW - NEW BEETLE (9C1, 1C1) 01/98→11/10								
 Bremskraftverstärker								
1.4	55	11/01→09/10		→ 9C-2-620000; für Linkslenker; + ESP 9C-2-620001→; für Linkslenker; + ESP; → 05/10			03.7860-0602.4 300141 03.7863-3502.4 300128	ATE Ø 10" pneumatisch ATE Ø 10" pneumatisch
1.6	74	10/99→09/00		9C-Y-613783→ 9C-2-620000; für Linkslenker; + ESP 11/99→; → 9C-Y-613782; für Linkslenker; + ESP 9C-2-620001→; für Linkslenker; + ESP			03.7860-0602.4 300141 03.7863-0402.4 300124 03.7863-3502.4 300128	ATE Ø 10" pneumatisch ATE Ø 10" pneumatisch ATE Ø 10" pneumatisch
1.6 1.8 T 1.9 TDI 2.0 2.5	75 110 74 85 110	06/00→09/10 10/99→09/10 02/01→09/10 01/98→09/10 07/05→09/10		9C-Y-613783→ 9C-2-620000; für Linkslenker; + ESP → 9C-Y-613782; für Linkslenker; + ESP 9C-2-620001→; für Linkslenker; + ESP; → 05/10			03.7860-0602.4 300141 03.7863-0402.4 300124 03.7863-3502.4 300128	ATE Ø 10" pneumatisch ATE Ø 10" pneumatisch ATE Ø 10" pneumatisch ATE Ø 10" pneumatisch
1.8 T	132	11/01→06/05		→ 9C-2-620000; für Linkslenker; + ESP 9C-2-620001→; für Linkslenker; + ESP			03.7860-0602.4 300141 03.7863-3502.4 300128	ATE Ø 10" pneumatisch ATE Ø 10" pneumatisch
1.9 TDI	66	01/98→06/04		9C-Y-613783→; → 02/01; für Linkslenker; + ESP → 9C-Y-613782; für Linkslenker; + ESP			03.7860-0602.4 300141 03.7863-0402.4 300124	ATE Ø 10" pneumatisch ATE Ø 10" pneumatisch
1.9 TDI	77	07/05→09/10		für Linkslenker; + ESP; → 05/10			03.7863-3502.4 300128	ATE Ø 10" pneumatisch
2.3 V5	125	10/00→09/10		9C-Y-613783→ 9C-2-620000; für Linkslenker; + ESP → 9C-Y-613782; für Linkslenker; + ESP 9C-2-620001→; für Linkslenker; + ESP; → 05/05			03.7860-0602.4 300141 03.7863-0402.4 300124 03.7863-3502.4 300128	ATE Ø 10" pneumatisch ATE Ø 10" pneumatisch ATE Ø 10" pneumatisch
RSI 3.2 4motion (1C9)	165	04/00→05/01		9C-Y-613783→ 9C-2-620000; für Linkslenker; + ESP → 9C-Y-613782; für Linkslenker; + ESP 9C-2-620001→; für Linkslenker; + ESP			03.7860-0602.4 300141 03.7863-0402.4 300124 03.7863-3502.4 300128	ATE Ø 10" pneumatisch ATE Ø 10" pneumatisch ATE Ø 10" pneumatisch
 Hauptbremszylinder								
1.4	55	11/01→09/10		für Linkslenker; + ESP; → 05/10 für Rechtslenker; + ESP; → 9C-7-557428 9C-7-557429→; für Rechtslenker; + ESP; → 05/10 für Linkslenker; - ESP; → 06/05			03.2123-2715.3 010802 03.2123-2774.3 010803 03.2123-2774.3 010803 24.2123-1709.3 010503	ATE Ø 23,81 ATE Ø 23,81 ATE Ø 23,81 Ø 23,81
1.6	74	10/99→09/00		11/99→; → 9C-Y-613782; für Linkslenker; + ESP 11/99→; → 9C-Y-613782; für Rechtslenker; + ESP 9C-Y-613783→; für Linkslenker; + ESP 9C-7-557429→; für Rechtslenker; + ESP 9C-Y-613783→; für Rechtslenker; + ESP; → 9C-7-557428 11/99→; für Linkslenker; - ESP			03.2123-2024.3 010597 03.2123-2064.3 010598 03.2123-2715.3 010802 03.2123-2774.3 010803 03.2123-2774.3 010803 24.2123-1709.3 010503	ATE Ø 23,81 ATE Ø 23,81 ATE Ø 23,81 ATE Ø 23,81 ATE Ø 23,81 Ø 23,81
1.6 1.8 T 1.9 TDI 2.0	75 110 74 85	06/00→09/10 10/99→09/10 02/01→09/10 01/98→09/10		→ 9C-Y-613782; für Linkslenker; + ESP → 9C-Y-613782; für Rechtslenker; + ESP 9C-Y-613783→; für Linkslenker; + ESP; → 05/10 9C-7-557429→; für Rechtslenker; + ESP; → 05/10 9C-Y-613783→; für Rechtslenker; + ESP; → 9C-7-557428 für Linkslenker; - ESP; → 06/05			03.2123-2024.3 010597 03.2123-2064.3 010598 03.2123-2715.3 010802 03.2123-2774.3 010803 03.2123-2774.3 010803 24.2123-1709.3 010503	ATE Ø 23,81 ATE Ø 23,81 ATE Ø 23,81 ATE Ø 23,81 ATE Ø 23,81 Ø 23,81
1.8 T	132	11/01→06/05		für Linkslenker; + ESP für Rechtslenker; + ESP für Linkslenker; - ESP			03.2123-2715.3 010802 03.2123-2774.3 010803 24.2123-1709.3 010503	ATE Ø 23,81 ATE Ø 23,81 Ø 23,81
1.9 TDI ↓	66	01/98→06/04		→ 9C-Y-613782; für Linkslenker; + ESP			03.2123-2024.3 010597	ATE Ø 23,81

VW - NEW BEETLE (9C1, 1C1) 01/98→11/10

Hauptbremszylinder

1.9 TDI	66	01/98→06/04	→ 9C-Y-613782; für Rechtslenker; + ESP	03.2123-2064.3	010598	ATE Ø 23,81
			9C-Y-613783→; → 02/01; für Linkslenker; + ESP	03.2123-2715.3	010802	ATE Ø 23,81
			9C-Y-613783→; → 02/01; für Rechtslenker; + ESP	03.2123-2774.3	010803	ATE Ø 23,81
			→ 02/01; für Linkslenker; - ESP	24.2123-1709.3	010503	Ø 23,81
1.9 TDI	77	07/05→09/10	für Linkslenker; + ESP; → 05/10	03.2123-2715.3	010802	ATE Ø 23,81
			für Rechtslenker; + ESP; → 9C-7-557428	03.2123-2774.3	010803	ATE Ø 23,81
			9C-7-557429→; für Rechtslenker; + ESP; → 05/10	03.2123-2774.3	010803	ATE Ø 23,81
2.3 V5	125	10/00→09/10	→ 9C-Y-613782; für Linkslenker; + ESP	03.2123-2024.3	010597	ATE Ø 23,81
			→ 9C-Y-613782; für Rechtslenker; + ESP	03.2123-2064.3	010598	ATE Ø 23,81
			9C-Y-613783→; für Linkslenker; + ESP; → 12/05	03.2123-2715.3	010802	ATE Ø 23,81
			9C-Y-613783→; für Rechtslenker; + ESP; → 12/05	03.2123-2774.3	010803	ATE Ø 23,81
			für Linkslenker; - ESP; → 05/05	24.2123-1709.3	010503	Ø 23,81
2.5	110	07/05→09/10	→ 9C-Y-613782; für Linkslenker; + ESP	03.2123-2024.3	010597	ATE Ø 23,81
			→ 9C-Y-613782; für Rechtslenker; + ESP	03.2123-2064.3	010598	ATE Ø 23,81
			9C-Y-613783→; für Linkslenker; + ESP; → 05/10	03.2123-2715.3	010802	ATE Ø 23,81
			9C-7-557429→; für Rechtslenker; + ESP; → 05/10	03.2123-2774.3	010803	ATE Ø 23,81
			9C-Y-613783→; für Rechtslenker; + ESP; → 9C-7-557428	03.2123-2774.3	010803	ATE Ø 23,81
RSI 3.2 4motion (1C9)	165	04/00→05/01	für Linkslenker; - ESP	24.2123-1709.3	010503	Ø 23,81
			→ 9C-Y-613782; für Linkslenker; + ESP	03.2123-2024.3	010597	ATE Ø 23,81
			→ 9C-Y-613782; für Rechtslenker; + ESP	03.2123-2064.3	010598	ATE Ø 23,81
			9C-Y-613783→; für Linkslenker; + ESP	03.2123-2715.3	010802	ATE Ø 23,81
			9C-Y-613783→; für Rechtslenker; + ESP	03.2123-2774.3	010803	ATE Ø 23,81

Bremskraftregler

1.4	55	11/01→09/10	- ABS; → 06/05	03.6583-0179.3	320228	ATE lastabhängig 8/3 4x
1.6	75	06/00→09/10				
1.8 T	110	10/99→09/10				
1.9 TDI	74	02/01→09/10				
2.0	85	01/98→09/10				
1.6	74	10/99→09/00	11/99→; - ABS	03.6583-0179.3	320228	ATE lastabhängig 8/3 4x
1.8 T	132	11/01→06/05	- ABS	03.6583-0179.3	320228	ATE lastabhängig 8/3 4x
2.5	110	07/05→09/10				
RSI 3.2 4motion (1C9)	165	04/00→05/01				
1.9 TDI	66	01/98→06/04	→ 02/01; - ABS	03.6583-0179.3	320228	ATE lastabhängig 8/3 4x
2.3 V5	125	10/00→09/10	- ABS; → 05/05	03.6583-0179.3	320228	ATE lastabhängig 8/3 4x

VW - NEW BEETLE Cabriolet (1Y7) 09/02→12/11

Bremskraftverstärker

1.4	55	01/03→09/10	für Linkslenker; + ESP; → 05/10	03.7863-3502.4	300128	ATE Ø 10" pneumatisch
1.6	75	01/03→09/10				
1.9 TDI	77	07/05→09/10				
2.5	110	07/05→09/10				
1.8 T	110	01/03→09/10	12/03→; für Linkslenker; + ESP; → 05/10	03.7863-3502.4	300128	ATE Ø 10" pneumatisch
1.9 TDI	74	06/03→09/10	07/03→; für Linkslenker; + ESP; → 05/10	03.7863-3502.4	300128	ATE Ø 10" pneumatisch
2.0	85	09/02→10/10	01/03→; für Linkslenker; + ESP; → 05/10	03.7863-3502.4	300128	ATE Ø 10" pneumatisch

Hauptbremszylinder

1.4	55	01/03→09/10	für Linkslenker; + ESP; → 05/10	03.2123-2715.3	010802	ATE Ø 23,81
1.6	75	01/03→09/10	für Rechtslenker; + ESP; → 1Y-7-413420	03.2123-2774.3	010803	ATE Ø 23,81
			1Y-7-413421→; für Rechtslenker; + ESP; → 05/10	03.2123-2774.3	010803	ATE Ø 23,81
			für Linkslenker; - ESP; → 06/05	24.2123-1709.3	010503	Ø 23,81
1.8 T	110	01/03→09/10	12/03→; für Linkslenker; + ESP; → 05/10	03.2123-2715.3	010802	ATE Ø 23,81
			12/03→; für Rechtslenker; + ESP; → 1Y-7-413420	03.2123-2774.3	010803	ATE Ø 23,81

↓

VW - NEW BEETLE Cabriolet (1Y7) 09/02→12/11

 **Hauptbremszylinder**

1.8 T	110	01/03→09/10		1Y-7-413421→; für Rechtslenker; + ESP; → 05/10	03.2123-2774.3	010803	ATE Ø 23,81
				12/03→; für Linkslenker; - ESP; → 06/05	24.2123-1709.3	010503	Ø 23,81
1.9 TDI	74	06/03→09/10		07/03→; für Linkslenker; + ESP; → 05/10	03.2123-2715.3	010802	ATE Ø 23,81
				1Y-7-413421→; für Rechtslenker; + ESP; → 05/10	03.2123-2774.3	010803	ATE Ø 23,81
				07/03→; für Rechtslenker; + ESP; → 1Y-7-413420	03.2123-2774.3	010803	ATE Ø 23,81
				07/03→; für Linkslenker; - ESP; → 06/05	24.2123-1709.3	010503	Ø 23,81
1.9 TDI 2.5	77 110	07/05→09/10 07/05→09/10		für Linkslenker; + ESP; → 05/10	03.2123-2715.3	010802	ATE Ø 23,81
				für Rechtslenker; + ESP; → 1Y-7-413420	03.2123-2774.3	010803	ATE Ø 23,81
				1Y-7-413421→; für Rechtslenker; + ESP; → 05/10	03.2123-2774.3	010803	ATE Ø 23,81
2.0	85	09/02→10/10		01/03→; für Linkslenker; + ESP; → 05/10	03.2123-2715.3	010802	ATE Ø 23,81
				1Y-7-413421→; für Rechtslenker; + ESP; → 05/10	03.2123-2774.3	010803	ATE Ø 23,81
				01/03→; für Rechtslenker; + ESP; → 1Y-7-413420	03.2123-2774.3	010803	ATE Ø 23,81
				01/03→; für Linkslenker; - ESP; → 06/05	24.2123-1709.3	010503	Ø 23,81











VW - PASSAT (3A2, 35I) 02/88→12/97











 **Bremskraftverstärker**











1.6	74	10/94→08/96		für Linkslenker; - ABS	03.7750-4302.4	300076	ATE Ø 9" pneumatisch
1.9 TDI	66	10/93→08/96		→ 12/95; für Rechtslenker; - ABS	03.7750-4902.4	300079	ATE Ø 9" pneumatisch
2.0	79	03/95→08/96					
2.0 16V	110	01/94→08/96					
1.8	55	08/90→08/96		→ 10/93; für Linkslenker; - ABS	03.7750-4302.4	300076	ATE Ø 9" pneumatisch
1.9 TD	55	03/91→08/96		10/93→; für Linkslenker; - ABS	03.7750-4302.4	300076	ATE Ø 9" pneumatisch
2.8 VR6	128	06/91→08/96		10/93→ 12/95; für Rechtslenker; - ABS	03.7750-4902.4	300079	ATE Ø 9" pneumatisch
				→ 10/93; für Rechtslenker; - ABS	03.7750-4902.4	300079	ATE Ø 9" pneumatisch
1.8	66	02/88→08/96		10/93→; für Linkslenker; - ABS	03.7750-4302.4	300076	ATE Ø 9" pneumatisch
				04/88→ 10/93; für Linkslenker; - ABS	03.7750-4302.4	300076	ATE Ø 9" pneumatisch
				10/93→ 12/95; für Rechtslenker; - ABS	03.7750-4902.4	300079	ATE Ø 9" pneumatisch
				04/88→ 10/93; für Rechtslenker; - ABS	03.7750-4902.4	300079	ATE Ø 9" pneumatisch
1.9 TDI	81	03/96→08/96		für Linkslenker; - ABS	03.7750-4302.4	300076	ATE Ø 9" pneumatisch
2.0	85	02/90→08/96		10/93→; für Linkslenker; - ABS	03.7750-4302.4	300076	ATE Ø 9" pneumatisch
				03/90→ 10/93; für Linkslenker; - ABS	03.7750-4302.4	300076	ATE Ø 9" pneumatisch
				03/90→ 10/93; für Rechtslenker; - ABS	03.7750-4902.4	300079	ATE Ø 9" pneumatisch
				10/93→ 12/95; für Rechtslenker; - ABS	03.7750-4902.4	300079	ATE Ø 9" pneumatisch













 **Hauptbremszylinder**







1.6	74	10/94→08/96		- ABS	03.2122-1042.3	010137	Ø 22,2
1.9 TDI	66	10/93→08/96		3A-T-000001→; für Linkslenker; + ABS	03.2123-1424.3	010637	ATE Ø 23,81
1.9 TDI	81	03/96→08/96		3A-T-000001→; für Rechtslenker; + ABS	03.2123-1484.3	010595	ATE Ø 23,81
2.0	79	03/95→08/96		→ 3A-S-300000; für Linkslenker; + ABS	10.6123-0674.3	010639	ATE Ø 23,81
2.0 16V	110	01/94→08/96					
1.8	55	08/90→08/96 03/91→08/96		→ 07/91; - ABS	03.2120-3943.3	010532	ATE Ø 20,64
				08/91→ 10/93; - ABS	03.2122-1042.3	010137	Ø 22,2
1.8	66	02/88→08/96		10/93→; - ABS	03.2122-1042.3	010137	Ø 22,2
				3A-T-000001→; für Linkslenker; + ABS	03.2123-1424.3	010637	ATE Ø 23,81
				3A-T-000001→; für Rechtslenker; + ABS	03.2123-1484.3	010595	ATE Ø 23,81
				10/93→; → 3A-S-300000; für Linkslenker; + ABS	10.6123-0674.3	010639	ATE Ø 23,81
				04/88→ 10/93; - ABS	03.2122-1042.3	010137	Ø 22,2
				10/93→; - ABS	03.2122-1042.3	010137	Ø 22,2
2.0	85	02/90→08/96		3A-T-000001→; für Linkslenker; + ABS	03.2123-1424.3	010637	ATE Ø 23,81
				3A-T-000001→; für Rechtslenker; + ABS	03.2123-1484.3	010595	ATE Ø 23,81
				10/93→; → 3A-S-300000; für Linkslenker; + ABS	10.6123-0674.3	010639	ATE Ø 23,81
				03/90→ 07/91; - ABS	03.2120-3943.3	010532	ATE Ø 20,64
				08/91→ 10/93; - ABS	03.2122-1042.3	010137	Ø 22,2
				10/93→; - ABS	03.2122-1042.3	010137	Ø 22,2
↓				3A-T-000001→; für Linkslenker; + ABS	03.2123-1424.3	010637	ATE Ø 23,81
				3A-T-000001→; für Rechtslenker; + ABS	03.2123-1484.3	010595	ATE Ø 23,81
				10/93→; → 3A-S-300000; für Linkslenker; + ABS	10.6123-0674.3	010639	ATE Ø 23,81
				10/93→; → 3A-S-300000; für Linkslenker; + ABS	10.6123-0674.3	010639	ATE Ø 23,81

	kw			 	! #		
VW - PASSAT (3A2, 35I) 02/88→12/97							
 Hauptbremszylinder							
2.0 Syncro	85	10/90→08/96		3A-T-000001→; für Linkslenker; + ABS	03.2123-1424.3	010637	ATE Ø 23,81
				01/94→; → 3A-S-300000; für Linkslenker; + ABS	10.6123-0674.3	010639	ATE Ø 23,81
2.8 VR6	128	06/91→08/96		10/93→; - ABS	03.2122-1042.3	010137	Ø 22,2
				3A-T-000001→; für Linkslenker; + ABS	03.2123-1424.3	010637	ATE Ø 23,81
				3A-T-000001→; für Rechtslenker; + ABS	03.2123-1484.3	010595	ATE Ø 23,81
				10/93→; → 3A-S-300000; für Linkslenker; + ABS	10.6123-0674.3	010639	ATE Ø 23,81
Verschlusschraube, Hauptbremszylinder							
1.6	74	10/94→08/96		- ABS	03.3517-0101.2	390322	
1.9 TDI	66	10/93→08/96					
1.9 TDI	81	03/96→08/96					
2.0	79	03/95→08/96					
2.0 16V	110	01/94→08/96					
1.8	55	08/90→08/96		08/91→ 10/93; - ABS	03.3517-0101.2	390322	
1.9 TD	55	03/91→08/96		10/93→; - ABS	03.3517-0101.2	390322	
				→ 07/91; - ABS	03.3517-0101.2	390322	
1.8	66	02/88→08/96		04/88→ 10/93; - ABS	03.3517-0101.2	390322	
				10/93→; - ABS	03.3517-0101.2	390322	
2.0	85	02/90→08/96		08/91→ 10/93; - ABS	03.3517-0101.2	390322	
				10/93→; - ABS	03.3517-0101.2	390322	
				03/90→ 07/91; - ABS	03.3517-0101.2	390322	
2.8 VR6	128	06/91→08/96		10/93→; - ABS	03.3517-0101.2	390322	
 Bremskraftregler							
1.6	74	10/94→08/96			03.6584-0015.3	320109	ATE lastabhängig 8/4 4x
1.9 TDI	66	10/93→08/96					
1.9 TDI	81	03/96→08/96					
2.0	79	03/95→08/96					
2.0 16V	110	01/94→08/96					
1.8	55	08/90→08/96		10/93→	03.6584-0015.3	320109	ATE lastabhängig 8/4 4x
1.9 TD	55	03/91→08/96		→ 10/93	03.6584-0015.3	320109	ATE lastabhängig 8/4 4x
2.8 VR6	128	06/91→08/96					
1.8	66	02/88→08/96		10/93→	03.6584-0015.3	320109	ATE lastabhängig 8/4 4x
				04/88→ 10/93	03.6584-0015.3	320109	ATE lastabhängig 8/4 4x
1.8 G60 Syncro	118	08/88→08/96		→ 10/93	03.6584-0015.3	320109	ATE lastabhängig 8/4 4x
2.0	85	02/90→08/96		10/93→	03.6584-0015.3	320109	ATE lastabhängig 8/4 4x
				03/90→ 10/93	03.6584-0015.3	320109	ATE lastabhängig 8/4 4x
2.0 Syncro	85	10/90→08/96		01/94→	03.6584-0015.3	320109	ATE lastabhängig 8/4 4x
				→ 10/93	03.6584-0015.3	320109	ATE lastabhängig 8/4 4x
VW - PASSAT (3B2) 08/96→12/01							
 Hauptbremszylinder							
1.6	74	10/96→11/00		→ 3B-X-800000; - ESP	24.2123-1717.3	010521	Ø 23,81
1.8 T	110	10/96→11/00		→ 3B-X-800000; + ESP	24.2123-1730.3	010620	Ø 23,81
1.9 TDI	81	10/96→11/00					
1.9 TDI	85	08/98→11/00		3B-Y-000001→ 3B-1-400000; für Linkslenker; - ESP	24.2125-1712.3	010622	Ø 25,4
1.9 TDI 4motion	85	08/99→11/00					
1.9 TDI Syncro/4motion	81	10/96→11/00		3B-Y-000001→ 3B-1-400000; für Linkslenker; + ESP	24.2125-1713.3	010623	Ø 25,4
2.3 VR5	110	10/96→11/00					
2.3 VR5 Syncro/4motion	110	10/97→11/00		3B-2-000001→	24.2125-1720.3	010688	TRW Ø 25,4
2.5 TDI Syncro/4motion	110	12/98→11/00					
2.8 V6	142	08/96→11/00					
2.8 V6 Syncro/4motion	142	10/96→11/00					
1.8	92	10/96→11/00		→ 3B-X-800000; - ESP	24.2123-1717.3	010521	Ø 23,81
1.8 Syncro/4motion	92	10/96→11/00		→ 3B-X-800000; + ESP	24.2123-1730.3	010620	Ø 23,81
1.9 TDI	66	10/96→11/00		3B-Y-000001→; → 09/00; für Linkslenker; - ESP	24.2125-1712.3	010622	Ø 25,4
				3B-Y-000001→; → 09/00; für Linkslenker; + ESP	24.2125-1713.3	010623	Ø 25,4
1.9 TDI	74	02/00→11/00		10/00→; → 3B-1-400000; für Linkslenker; - ESP	24.2125-1712.3	010622	Ø 25,4
2.0	88	04/00→11/00					
2.0 4motion	88	04/00→11/00		10/00→; → 3B-1-400000; für Linkslenker; + ESP	24.2125-1713.3	010623	Ø 25,4
				3B-2-000001→	24.2125-1720.3	010688	TRW Ø 25,4
2.5 TDI	110	07/98→11/00		08/98→; → 3B-X-800000; - ESP	24.2123-1717.3	010521	Ø 23,81
				08/98→; → 3B-X-800000; + ESP	24.2123-1730.3	010620	Ø 23,81
				3B-Y-000001→ 3B-1-400000; für Linkslenker; - ESP	24.2125-1712.3	010622	Ø 25,4
↓							

	kw					! #		
VW - PASSAT (3B2) 08/96→12/01								
 Hauptbremszylinder								
2.5 TDI	110	07/98→11/00		3B-Y-000001→ 3B-1-400000; für Linkslenker; + ESP		24.2125-1713.3	010623	Ø 25,4
				3B-2-000001→		24.2125-1720.3	010688	TRW Ø 25,4
VW - PASSAT (3B3) 10/00→12/05								
 Hauptbremszylinder								
1.6	75	11/00→05/05		05/02→		03.2125-0373.3	010810	ATE Ø 25,4
1.8 T 20V	110	11/00→05/05		→ 3B-X-800000; - ESP		24.2123-1717.3	010521	Ø 23,81
2.3 V5	125	11/00→05/05		→ 3B-X-800000; + ESP		24.2123-1730.3	010620	Ø 23,81
2.3 V5 4motion	125	11/00→05/05						
2.5 TDI	110	11/00→05/05		3B-Y-000001→ 3B-1-400000; für Linkslenker; - ESP		24.2125-1712.3	010622	Ø 25,4
2.5 TDI 4motion	110	11/00→05/05						
2.8 4motion	142	11/00→05/05		3B-Y-000001→ 3B-1-400000; für Linkslenker; + ESP		24.2125-1713.3	010623	Ø 25,4
				3B-2-000001→		24.2125-1720.3	010688	TRW Ø 25,4
1.9 TDI	74	11/00→05/05		05/02→		03.2125-0373.3	010810	ATE Ø 25,4
1.9 TDI	96	11/00→05/05		→ 3B-1-400000; für Linkslenker; - ESP		24.2125-1712.3	010622	Ø 25,4
1.9 TDI 4motion	96	11/00→05/05		→ 3B-1-400000; für Linkslenker; + ESP		24.2125-1713.3	010623	Ø 25,4
2.0	85	11/00→05/05						
2.0 4motion	85	11/00→05/05		3B-2-000001→		24.2125-1720.3	010688	TRW Ø 25,4
2.0	96	11/01→05/05		05/02→		03.2125-0373.3	010810	ATE Ø 25,4
						24.2125-1720.3	010688	TRW Ø 25,4
2.0 TDI	100	12/03→05/05				03.2125-0373.3	010810	ATE Ø 25,4
						24.2125-1720.3	010688	TRW Ø 25,4
2.5 TDI	120	05/03→05/05				03.2125-0373.3	010810	ATE Ø 25,4
2.5 TDI 4motion	132	01/03→05/05		→ 3B-X-800000; - ESP		24.2123-1717.3	010521	Ø 23,81
				→ 3B-X-800000; + ESP		24.2123-1730.3	010620	Ø 23,81
				3B-Y-000001→ 3B-1-400000; für Linkslenker; - ESP		24.2125-1712.3	010622	Ø 25,4
				3B-Y-000001→ 3B-1-400000; für Linkslenker; + ESP		24.2125-1713.3	010623	Ø 25,4
				3B-2-000001→		24.2125-1720.3	010688	TRW Ø 25,4
4.0 W8 4motion	202	09/01→09/04		05/02→		03.2125-0373.3	010810	ATE Ø 25,4
						24.2125-1720.3	010688	TRW Ø 25,4
VW - PASSAT (3C2) 03/05→12/10								
 Bremskraftverstärker								
1.4 TSI	90	05/07→07/10		10/07→; + ESP; für Linkslenker		03.7873-3902.4	300254	ATE Ø 11" pneumatisch
1.8 TSI	118	05/07→07/10		10/07→; für Linkslenker; - ESP		03.7873-4402.4	300292	ATE Ø 11" pneumatisch
1.4 TSI EcoFuel	110	01/09→07/10		für Linkslenker; + ESP		03.7873-3902.4	300254	ATE Ø 11" pneumatisch
1.6	75	05/05→07/10		für Linkslenker; - ESP		03.7873-4402.4	300292	ATE Ø 11" pneumatisch
1.6 FSI	85	03/05→06/08						
1.6 TDI	77	08/09→07/10						
1.9 TDI	77	03/05→07/10						
2.0 FSI	110	03/05→07/10						
2.0 FSI	147	07/05→07/10						
2.0 FSI 4motion	110	09/05→07/10						
2.0 TDI	81	11/08→07/10						
2.0 TDI	88	11/05→05/07						
2.0 TDI	90	08/05→07/06						
2.0 TDI	103	03/05→05/09						
2.0 TDI	120	08/05→05/09						
2.0 TDI	125	08/05→07/10						
2.0 TDI 16V	103	03/05→07/10						
2.0 TDI 4motion	103	03/05→05/09						
2.0 TDI 4motion	125	05/09→07/10						
3.2 FSI 4motion	184	11/05→07/10						
2.0 BlueTDI	105	01/09→11/10		für Linkslenker; + ESP; → 07/10		03.7873-3902.4	300254	ATE Ø 11" pneumatisch
2.0 TDI	100	03/05→11/10		für Linkslenker; - ESP; → 07/10		03.7873-4402.4	300292	ATE Ø 11" pneumatisch
2.0 TDI 16V 4motion	103	03/05→08/10						
3.6 R36 4motion	220	04/07→07/10		für Linkslenker		03.7873-4502.4	300284	ATE Ø 11" pneumatisch
 Hauptbremszylinder								
1.4 TSI	90	05/07→07/10		10/07→; +PR 1ZG; für Linkslenker		03.4152-0116.3	010814	ATE Ø 22,2
1.8 TSI	118	05/07→07/10		10/07→; für Linkslenker; +PR 1LJ;1LK;1LH;1LM		03.4153-0186.3	010816	ATE Ø 23,81
				10/07→; für Rechtslenker; +PR 1LJ;1LK;1LH;1LM		24.4153-0192.3	011026	ATE Ø 23,81 ohne Bremsflüssigkeitsbehälter
1.4 TSI EcoFuel	110	01/09→07/10		für Linkslenker; +PR 1ZG		03.4152-0116.3	010814	ATE Ø 22,2
1.6	75	05/05→07/10						
1.6 FSI	85	03/05→06/08		für Linkslenker; +PR 1LJ;1LK;1LH;1LM		03.4153-0186.3	010816	ATE Ø 23,81
1.9 TDI	77	03/05→07/10						
↓								

	kw			i 	! #		
VW - PASSAT (3C2) 03/05→12/10							
 Hauptbremszylinder							
2.0 FSI	110	03/05→07/10		für Rechtslenker; +PR 1LJ;1LK;1LH;1LM		24.4153-0192.3 011026	ATE Ø 23,81 ohne Bremsflüssigkeitsbehälter
2.0 FSI	147	07/05→07/10					
2.0 FSI 4motion	110	09/05→07/10					
2.0 TDI	81	11/08→07/10					
2.0 TDI	88	11/05→05/07					
2.0 TDI	90	08/05→07/06					
2.0 TDI	103	03/05→05/09					
2.0 TDI	120	08/05→05/09					
2.0 TDI	125	08/05→07/10					
2.0 TDI 4motion	103	03/05→05/09					
3.2 FSI 4motion	184	11/05→07/10					
1.6 TDI	77	08/09→07/10		für Linkslenker; +PR 1ZG		03.4152-0116.3 010814	ATE Ø 22,2
2.0 TDI 16V	103	03/05→07/10		+PR 1LJ,1LK,1LH,1LM; für Linkslenker		03.4153-0186.3 010816	ATE Ø 23,81
2.0 TDI 4motion	125	05/09→07/10					
3.6 R36 4motion	220	04/07→07/10		+PR 1LJ,1LK,1LH,1LM; für Rechtslenker		24.4153-0192.3 011026	ATE Ø 23,81 ohne Bremsflüssigkeitsbehälter
2.0 BlueTDI	105	01/09→11/10		für Linkslenker; +PR 1ZG; → 07/10		03.4152-0116.3 010814	ATE Ø 22,2
2.0 TDI	100	03/05→11/10		für Linkslenker; +PR 1LJ;1LK;1LH;1LM; → 07/10		03.4153-0186.3 010816	ATE Ø 23,81
2.0 TDI 16V 4motion	103	03/05→08/10		für Rechtslenker; +PR 1LJ;1LK;1LH;1LM; → 07/10		24.4153-0192.3 011026	ATE Ø 23,81 ohne Bremsflüssigkeitsbehälter
VW - PASSAT (3G2) 08/14→							
 Hauptbremszylinder							
1.4 TSI	92	11/14→		für Linkslenker; +PR 1ZA,1ZD		24.4123-1719.3 011017	TRW Ø 23,81 ohne Bremsflüssigkeitsbehälter
1.4 TSI	110	11/14→					
1.4 TSI 4motion	110	02/15→					
1.8 TSI	132	02/15→					
2.0 TDI	81	01/16→					
2.0 TDI	110	11/14→					
2.0 TDI	135	07/15→					
2.0 TDI	140	11/14→					
2.0 TDI 4motion	110	02/15→					
2.0 TDI 4motion	140	11/14→					
2.0 TSI 4motion	206	05/15→					
1.6 TDI	88	08/14→		11/14→; für Linkslenker; +PR 1ZA,1ZD		24.4123-1719.3 011017	TRW Ø 23,81 ohne Bremsflüssigkeitsbehälter
2.0 TDI 4motion	176	08/14→					
2.0 TSI	162	02/15→		05/15→; für Linkslenker; +PR 1ZA,1ZD		24.4123-1719.3 011017	TRW Ø 23,81 ohne Bremsflüssigkeitsbehälter
VW - PASSAT (362) 08/10→12/14							
 Bremskraftverstärker							
1.4 TSI	90	08/10→12/14		→ 10/14; +PR 1ZG; für Linkslenker		03.7873-4402.4 300292	ATE Ø 11" pneumatisch
1.4 TSI	118	11/12→12/14					
1.4 TSI EcoFuel	110	08/10→12/14		→ 10/14; +PR 1LA,1LB,1ZM; für Linkslenker		03.7873-4502.4 300284	ATE Ø 11" pneumatisch
1.4 TSI MultiFuel	118	11/10→12/14					
1.6 TDI	77	08/10→12/14					
1.8 TSI	118	08/10→12/14					
2.0 TDI	100	08/10→12/14					
2.0 TDI	103	08/10→12/14					
2.0 TDI	125	08/10→12/14					
2.0 TDI	130	12/12→12/14					
2.0 TDI 4motion	103	08/10→12/14					
2.0 TDI 4motion	130	01/13→12/14					
2.0 TSI	155	11/10→12/14					
3.6 FSI 4motion	220	01/11→12/14					
2.0 TDI 4motion	125	08/10→01/13		+PR 1ZG; für Linkslenker		03.7873-4402.4 300292	ATE Ø 11" pneumatisch
				+PR 1LA,1LB,1ZM; für Linkslenker		03.7873-4502.4 300284	ATE Ø 11" pneumatisch
 Hauptbremszylinder							
1.4 TSI	90	08/10→12/14		→ 10/14; +PR 1ZG; für Linkslenker		03.4152-0116.3 010814	ATE Ø 22,2
1.4 TSI	118	11/12→12/14					
1.4 TSI EcoFuel	110	08/10→12/14		→ 10/14; +PR 1LA,1LB,1ZM; für Linkslenker		03.4153-0186.3 010816	ATE Ø 23,81
1.4 TSI MultiFuel	118	11/10→12/14					
1.6 TDI	77	08/10→12/14		→ 10/14; +PR 1LA,1LB,1ZM; für Rechtslenker		24.4153-0192.3 011026	ATE Ø 23,81 ohne Bremsflüssigkeitsbehälter
1.8 TSI	118	08/10→12/14					
2.0 TDI	100	08/10→12/14					
2.0 TDI	103	08/10→12/14					
2.0 TDI	125	08/10→12/14					
2.0 TDI	130	12/12→12/14					
2.0 TDI 4motion	103	08/10→12/14					
2.0 TDI 4motion	130	01/13→12/14					
2.0 TSI	155	11/10→12/14					
3.6 FSI 4motion	220	01/11→12/14					
2.0 TDI 4motion	125	08/10→01/13		+PR 1ZG; für Linkslenker		03.4152-0116.3 010814	ATE Ø 22,2
				+PR 1LA,1LB,1ZM; für Linkslenker		03.4153-0186.3 010816	ATE Ø 23,81
				+PR 1LA,1LB,1ZM; für Rechtslenker		24.4153-0192.3 011026	ATE Ø 23,81 ohne Bremsflüssigkeitsbehälter

	kw					! #		
VW - PASSAT ALLTRACK (3G5) 05/15→								
 Hauptbremszylinder								
1.4 TSI 4motion	110	05/15→		für Linkslenker; +PR 1ZA,1ZD		24.4123-1719.3	011017	TRW Ø 23,81 ohne Bremsflüssigkeitsbehälter
2.0 TDI 4motion	110	05/15→						
2.0 TDI 4motion	135	07/15→						
2.0 TDI 4motion	140	05/15→						
2.0 TDI 4motion	176	05/15→						
2.0 TSI 4motion	162	07/15→						
VW - PASSAT ALLTRACK (365) 01/12→12/14								
 Bremskraftverstärker								
1.8 TSI	112	01/12→12/14		+PR 1ZG; für Linkslenker		03.7873-4402.4	300292	ATE Ø 11" pneumatisch
1.8 TSI	118	01/12→12/14		+PR 1LA,1LB,1ZM; für Linkslenker		03.7873-4502.4	300284	ATE Ø 11" pneumatisch
2.0 TDI	103	01/12→12/14						
2.0 TDI 4motion	103	01/12→12/14						
2.0 TDI 4motion	125	01/12→12/14						
2.0 TDI 4motion	130	01/13→12/14						
2.0 TSI 4motion	155	01/12→12/14						
 Hauptbremszylinder								
1.8 TSI	112	01/12→12/14		+PR 1ZG; für Linkslenker		03.4152-0116.3	010814	ATE Ø 22,2
1.8 TSI	118	01/12→12/14		+PR 1LA,1LB,1ZM; für Linkslenker		03.4153-0186.3	010816	ATE Ø 23,81
2.0 TDI	103	01/12→12/14						
2.0 TDI 4motion	103	01/12→12/14		+PR 1LA,1LB,1ZM; für Rechtslenker		24.4153-0192.3	011026	ATE Ø 23,81 ohne Bremsflüssigkeitsbehälter
2.0 TDI 4motion	125	01/12→12/14						
2.0 TDI 4motion	130	01/13→12/14						
2.0 TSI 4motion	155	01/12→12/14						
VW - PASSAT CC (357) 05/08→01/12								
 Bremskraftverstärker								
1.4 TSI MultiFuel	118	01/11→01/12		→ 09/11; für Linkslenker; +PR 1ZG		03.7873-4402.4	300292	ATE Ø 11" pneumatisch
2.0 TSI	155	11/10→01/12		→ 09/11; +PR 1LA,1LB,1ZM; für Linkslenker		03.7873-4502.4	300284	ATE Ø 11" pneumatisch
1.8 TSI	118	06/08→01/12		→ 10/10; +PR 1AS,1ZG; für Linkslenker		03.7873-3902.4	300254	ATE Ø 11" pneumatisch
2.0 TDI	103	06/08→01/12						
2.0 TDI	125	06/08→01/12		→ 05/10; +PR 1AT,1ZG; für Linkslenker		03.7873-4402.4	300292	ATE Ø 11" pneumatisch
2.0 TDI 4motion	103	08/09→01/12		06/10→ 09/11; für Linkslenker; +PR 1ZG		03.7873-4402.4	300292	ATE Ø 11" pneumatisch
2.0 TDI 4motion	125	11/09→01/12						
2.0 TSI	147	06/08→01/12		11/10→ 09/11; +PR 1LA,1LB,1ZM; für Linkslenker		03.7873-4502.4	300284	ATE Ø 11" pneumatisch
				→ 10/10; +PR 1AT,1LH,1LK,1ZM; für Linkslenker		03.7873-4502.4	300284	ATE Ø 11" pneumatisch
2.0 BlueTDI	105	05/09→11/10		→ 10/10; +PR 1AS,1ZG; für Linkslenker		03.7873-3902.4	300254	ATE Ø 11" pneumatisch
2.0 TDI	100	06/08→05/11		06/10→; +PR 1ZG; für Linkslenker		03.7873-4402.4	300292	ATE Ø 11" pneumatisch
2.0 TDI	120	05/08→05/11		→ 05/10; +PR 1AT,1ZG; für Linkslenker		03.7873-4402.4	300292	ATE Ø 11" pneumatisch
				11/10→; +PR 1LA,1LB,1ZM; für Linkslenker		03.7873-4502.4	300284	ATE Ø 11" pneumatisch
				→ 10/10; +PR 1AT,1LH,1LK,1ZM; für Linkslenker		03.7873-4502.4	300284	ATE Ø 11" pneumatisch
3.6 FSI 4motion	220	06/08→05/10		für Linkslenker; +PR 1AS,1ZG		03.7873-3902.4	300254	ATE Ø 11" pneumatisch
				für Linkslenker; +PR 1AT,1LH,1LK,1ZM		03.7873-4502.4	300284	ATE Ø 11" pneumatisch
 Hauptbremszylinder								
1.4 TSI MultiFuel	118	01/11→01/12		→ 09/11; +PR 1ZG; für Linkslenker		03.4152-0116.3	010814	ATE Ø 22,2
2.0 TDI 4motion	103	08/09→01/12		→ 09/11; für Linkslenker;		03.4153-0186.3	010816	ATE Ø 23,81
2.0 TDI 4motion	125	11/09→01/12		+PR 1LH,1LK,1ZM				
				→ 09/11; für Rechtslenker; +PR 1LH,1LK,1ZM		24.4153-0192.3	011026	ATE Ø 23,81 ohne Bremsflüssigkeitsbehälter
1.8 TSI	118	06/08→01/12		→ 09/11; +PR 1ZG; für Linkslenker		03.4152-0116.3	010814	ATE Ø 22,2
2.0 TDI	103	06/08→01/12						
2.0 TDI	125	06/08→01/12		→ 09/11; +PR 1LH;1LK; für Linkslenker		03.4153-0186.3	010816	ATE Ø 23,81
2.0 TSI	147	06/08→01/12		→ 09/11; +PR 1LH;1LK; für Rechtslenker		24.4153-0192.3	011026	ATE Ø 23,81 ohne Bremsflüssigkeitsbehälter
2.0 TSI	155	11/10→01/12						
2.0 BlueTDI	105	05/09→11/10		+PR 1ZG; für Linkslenker		03.4152-0116.3	010814	ATE Ø 22,2
2.0 TDI	100	06/08→05/11		+PR 1LH;1LK; für Linkslenker		03.4153-0186.3	010816	ATE Ø 23,81
2.0 TDI	120	05/08→05/11						
3.6 FSI 4motion	220	06/08→05/10		+PR 1LH;1LK; für Rechtslenker		24.4153-0192.3	011026	ATE Ø 23,81 ohne Bremsflüssigkeitsbehälter
VW - PASSAT Variant (3A5, 35I) 02/88→06/97								
 Bremskraftverstärker								
1.6	74	07/94→12/95		10/94→; für Linkslenker; - ABS		03.7750-4302.4	300076	ATE Ø 9" pneumatisch
				10/94→; für Rechtslenker; - ABS		03.7750-4902.4	300079	ATE Ø 9" pneumatisch
1.8	55	08/90→05/97		→ 10/93; für Linkslenker; - ABS		03.7750-4302.4	300076	ATE Ø 9" pneumatisch
1.9 TD	55	03/91→05/97						
2.8 VR6	128	06/91→05/97		10/93→ 12/96; für Linkslenker; - ABS		03.7750-4302.4	300076	ATE Ø 9" pneumatisch
↓								

	kw					! #		
VW - PASSAT Variant (3A5, 35I) 02/88→06/97								
Bremskraftverstärker								
1.8	55	08/90→05/97		→ 10/93; für Rechtslenker; - ABS		03.7750-4902.4	300079	ATE Ø 9" pneumatisch
1.9 TD	55	03/91→05/97		10/93→ 12/95; für Rechtslenker; - ABS		03.7750-4902.4	300079	ATE Ø 9" pneumatisch
2.8 VR6	128	06/91→05/97						
1.8	66	02/88→05/97		10/93→ 12/96; für Linkslenker; - ABS		03.7750-4302.4	300076	ATE Ø 9" pneumatisch
				04/88→ 10/93; für Linkslenker; - ABS		03.7750-4302.4	300076	ATE Ø 9" pneumatisch
				10/93→ 12/95; für Rechtslenker; - ABS		03.7750-4902.4	300079	ATE Ø 9" pneumatisch
				04/88→ 10/93; für Rechtslenker; - ABS		03.7750-4902.4	300079	ATE Ø 9" pneumatisch
1.9 TDI	66	10/93→05/97		→ 12/96; für Linkslenker; - ABS		03.7750-4302.4	300076	ATE Ø 9" pneumatisch
2.0 16V	110	01/94→05/97		→ 12/95; für Rechtslenker; - ABS		03.7750-4902.4	300079	ATE Ø 9" pneumatisch
1.9 TDI	81	03/96→05/97		→ 12/96; für Linkslenker; - ABS		03.7750-4302.4	300076	ATE Ø 9" pneumatisch
2.0	79	03/95→08/96		für Linkslenker; - ABS		03.7750-4302.4	300076	ATE Ø 9" pneumatisch
				→ 12/95; für Rechtslenker; - ABS		03.7750-4902.4	300079	ATE Ø 9" pneumatisch
2.0	85	02/90→05/97		03/90→ 10/93; für Linkslenker; - ABS		03.7750-4302.4	300076	ATE Ø 9" pneumatisch
				10/93→ 12/96; für Linkslenker; - ABS		03.7750-4302.4	300076	ATE Ø 9" pneumatisch
				03/90→ 10/93; für Rechtslenker; - ABS		03.7750-4902.4	300079	ATE Ø 9" pneumatisch
				10/93→ 12/95; für Rechtslenker; - ABS		03.7750-4902.4	300079	ATE Ø 9" pneumatisch
Hauptbremszylinder								
1.6	74	07/94→12/95		10/94→; - ABS		03.2122-1042.3	010137	Ø 22,2
				3A-T-000001→; für Linkslenker; + ABS		03.2123-1424.3	010637	ATE Ø 23,81
				3A-T-000001→; für Rechtslenker; + ABS		03.2123-1484.3	010595	ATE Ø 23,81
				10/94→; → 3A-S-300000; für Linkslenker; + ABS		10.6123-0674.3	010639	ATE Ø 23,81
1.8	55	08/90→05/97		→ 07/91; - ABS		03.2120-3943.3	010532	ATE Ø 20,64
1.9 TD	55	03/91→05/97		08/91→ 10/93; - ABS		03.2122-1042.3	010137	Ø 22,2
				10/93→ 12/96; - ABS		03.2122-1042.3	010137	Ø 22,2
				3A-T-000001→; → 12/96; für Linkslenker; + ABS		03.2123-1424.3	010637	ATE Ø 23,81
				3A-T-000001→; → 12/96; für Rechtslenker; + ABS		03.2123-1484.3	010595	ATE Ø 23,81
				10/93→; → 3A-S-300000; für Linkslenker; + ABS		10.6123-0674.3	010639	ATE Ø 23,81
1.8	66	02/88→05/97		04/88→ 10/93; - ABS		03.2122-1042.3	010137	Ø 22,2
				10/93→ 12/96; - ABS		03.2122-1042.3	010137	Ø 22,2
				3A-T-000001→; → 12/96; für Linkslenker; + ABS		03.2123-1424.3	010637	ATE Ø 23,81
				3A-T-000001→; → 12/96; für Rechtslenker; + ABS		03.2123-1484.3	010595	ATE Ø 23,81
				10/93→; → 3A-S-300000; für Linkslenker; + ABS		10.6123-0674.3	010639	ATE Ø 23,81
1.9 TDI	66	10/93→05/97		→ 12/96; - ABS		03.2122-1042.3	010137	Ø 22,2
1.9 TDI	81	03/96→05/97		3A-T-000001→; → 12/96; für Linkslenker; + ABS		03.2123-1424.3	010637	ATE Ø 23,81
2.0 16V	110	01/94→05/97		3A-T-000001→; → 12/96; für Rechtslenker; + ABS		03.2123-1484.3	010595	ATE Ø 23,81
				→ 3A-S-300000; für Linkslenker; + ABS		10.6123-0674.3	010639	ATE Ø 23,81
2.0	79	03/95→08/96		- ABS		03.2122-1042.3	010137	Ø 22,2
				3A-T-000001→; für Linkslenker; + ABS		03.2123-1424.3	010637	ATE Ø 23,81
				3A-T-000001→; für Rechtslenker; + ABS		03.2123-1484.3	010595	ATE Ø 23,81
				→ 3A-S-300000; für Linkslenker; + ABS		10.6123-0674.3	010639	ATE Ø 23,81
2.0	85	02/90→05/97		03/90→ 07/91; - ABS		03.2120-3943.3	010532	ATE Ø 20,64
				08/91→ 10/93; - ABS		03.2122-1042.3	010137	Ø 22,2
				10/93→ 12/96; - ABS		03.2122-1042.3	010137	Ø 22,2
				3A-T-000001→; → 12/96; für Linkslenker; + ABS		03.2123-1424.3	010637	ATE Ø 23,81
				3A-T-000001→; → 12/96; für Rechtslenker; + ABS		03.2123-1484.3	010595	ATE Ø 23,81
				10/93→; → 3A-S-300000; für Linkslenker; + ABS		10.6123-0674.3	010639	ATE Ø 23,81
2.0 Syncro	85	10/90→05/97		3A-T-000001→; → 12/96; für Linkslenker; + ABS		03.2123-1424.3	010637	ATE Ø 23,81
				01/94→; → 3A-S-300000; für Linkslenker; + ABS		10.6123-0674.3	010639	ATE Ø 23,81
2.8 VR6	128	06/91→05/97		10/93→ 12/96; - ABS		03.2122-1042.3	010137	Ø 22,2
				3A-T-000001→; → 12/96; für Linkslenker; + ABS		03.2123-1424.3	010637	ATE Ø 23,81



VW - PASSAT Variant (3A5, 35I) 02/88→06/97

Hauptbremszylinder

2.8 VR6	128	06/91→05/97		3A-T-000001→; → 12/96; für Rechtslenker; + ABS	03.2123-1484.3	010595	ATE Ø 23,81
				10/93→; → 3A-S-300000; für Linkslenker; + ABS	10.6123-0674.3	010639	ATE Ø 23,81
2.9 VR6 Syncro	135	01/94→05/97		3A-T-000001→; → 12/96; für Linkslenker; + ABS	03.2123-1424.3	010637	ATE Ø 23,81
				10/94→; → 3A-S-300000; für Linkslenker; + ABS	10.6123-0674.3	010639	ATE Ø 23,81

Verschlusschraube, Hauptbremszylinder

1.6	74	07/94→12/95		10/94→; - ABS	03.3517-0101.2	390322	
1.8 1.9 TD	55	08/90→05/97		08/91→ 10/93; - ABS	03.3517-0101.2	390322	
	55	03/91→05/97		→ 07/91; - ABS	03.3517-0101.2	390322	
1.8	66	02/88→05/97		10/93→ 12/96; - ABS	03.3517-0101.2	390322	
				04/88→ 10/93; - ABS	03.3517-0101.2	390322	
1.9 TDI 1.9 TDI 2.0 16V	66	10/93→05/97		→ 12/96; - ABS	03.3517-0101.2	390322	
	81	03/96→05/97					
2.0	79	03/95→08/96		- ABS	03.3517-0101.2	390322	
2.0	85	02/90→05/97		08/91→ 10/93; - ABS	03.3517-0101.2	390322	
				03/90→ 07/91; - ABS	03.3517-0101.2	390322	
				10/93→ 12/96; - ABS	03.3517-0101.2	390322	
2.8 VR6	128	06/91→05/97		10/93→ 12/96; - ABS	03.3517-0101.2	390322	

Bremskraftregler











1.6	74	07/94→12/95		10/94→	03.6584-0015.3	320109	ATE lastabhängig 8/4 4x
1.8	55	08/90→05/97		→ 10/93	03.6584-0015.3	320109	ATE lastabhängig 8/4 4x
1.9 TD	55	03/91→05/97					
2.8 VR6	128	06/91→05/97		10/93→ 12/96	03.6584-0015.3	320109	ATE lastabhängig 8/4 4x
1.8	66	02/88→05/97		04/88→ 10/93	03.6584-0015.3	320109	ATE lastabhängig 8/4 4x
				10/93→ 12/96	03.6584-0015.3	320109	ATE lastabhängig 8/4 4x
1.8 G60 Syncro	118	08/88→05/97		→ 10/93	03.6584-0015.3	320109	ATE lastabhängig 8/4 4x
1.9 TDI	66	10/93→05/97		→ 12/96	03.6584-0015.3	320109	ATE lastabhängig 8/4 4x
1.9 TDI	81	03/96→05/97					
2.0 16V	110	01/94→05/97					
2.0	79	03/95→08/96			03.6584-0015.3	320109	ATE lastabhängig 8/4 4x
2.0	85	02/90→05/97		03/90→ 10/93	03.6584-0015.3	320109	ATE lastabhängig 8/4 4x
				10/93→ 12/96	03.6584-0015.3	320109	ATE lastabhängig 8/4 4x
2.0 Syncro	85	10/90→05/97		01/94→ 12/96	03.6584-0015.3	320109	ATE lastabhängig 8/4 4x
				→ 10/93	03.6584-0015.3	320109	ATE lastabhängig 8/4 4x
2.9 VR6 Syncro	135	01/94→05/97		10/94→ 12/96	03.6584-0015.3	320109	ATE lastabhängig 8/4 4x











VW - PASSAT Variant (3B5) 05/97→12/01











Hauptbremszylinder











1.6	74	06/97→11/00		→ 3B-X-800000; - ESP	24.2123-1717.3	010521	Ø 23,81
1.8 T	110	06/97→11/00					
1.9 TDI	81	06/97→11/00		→ 3B-X-800000; + ESP	24.2123-1730.3	010620	Ø 23,81
1.9 TDI	85	08/98→11/00		3B-Y-000001→ 3B-1-400000; für Linkslenker; - ESP	24.2125-1712.3	010622	Ø 25,4
1.9 TDI 4motion	85	08/99→11/00					
1.9 TDI Syncro/4motion	81	06/97→11/00		3B-Y-000001→ 3B-1-400000; für Linkslenker; + ESP	24.2125-1713.3	010623	Ø 25,4
2.3 VR5	110	06/97→11/00					
2.3 VR5 Syncro/4motion	110	10/97→11/00		3B-2-000001→	24.2125-1720.3	010688	TRW Ø 25,4
2.5 TDI Syncro/4motion	110	12/98→11/00					
2.8 V6	142	06/97→11/00					
2.8 V6 Syncro/4motion	142	06/97→11/00					
1.8	92	06/97→11/00		→ 3B-X-800000; - ESP	24.2123-1717.3	010521	Ø 23,81
				→ 3B-X-800000; + ESP	24.2123-1730.3	010620	Ø 23,81
1.8 Syncro/4motion	92	06/97→11/00					
1.9 TDI	66	06/97→11/00		3B-Y-000001→; → 09/00; für Linkslenker; - ESP	24.2125-1712.3	010622	Ø 25,4
				3B-Y-000001→; → 09/00; für Linkslenker; + ESP	24.2125-1713.3	010623	Ø 25,4
1.9 TDI	74	02/00→11/00		10/00→; → 3B-1-400000; für Linkslenker; - ESP	24.2125-1712.3	010622	Ø 25,4
2.0	88	04/00→11/00					
2.0 4motion	88	04/00→11/00		10/00→; → 3B-1-400000; für Linkslenker; + ESP	24.2125-1713.3	010623	Ø 25,4
				3B-2-000001→	24.2125-1720.3	010688	TRW Ø 25,4
2.5 TDI	110	07/98→11/00		08/98→; → 3B-X-800000; - ESP	24.2123-1717.3	010521	Ø 23,81
				08/98→; → 3B-X-800000; + ESP	24.2123-1730.3	010620	Ø 23,81











↓









	kW					! #		
VW - PASSAT Variant (3B5) 05/97→12/01								
 Hauptbremszylinder								
2.5 TDI	110	07/98→11/00			3B-Y-000001→ 3B-1-400000; für Linkslenker; - ESP		24.2125-1712.3 010622	Ø 25,4
					3B-Y-000001→ 3B-1-400000; für Linkslenker; + ESP		24.2125-1713.3 010623	Ø 25,4
					3B-2-000001→		24.2125-1720.3 010688	TRW Ø 25,4
VW - PASSAT Variant (3B6) 09/00→08/05								
 Hauptbremszylinder								
1.6	75	11/00→05/05		05/02→			03.2125-0373.3 010810	ATE Ø 25,4
1.8 T 20V	110	11/00→05/05			→ 3B-X-800000; - ESP		24.2123-1717.3 010521	Ø 23,81
2.3 VR5	125	11/00→05/05			→ 3B-X-800000; + ESP		24.2123-1730.3 010620	Ø 23,81
2.3 VR5 4motion	125	11/00→05/05						
2.5 TDI	110	11/00→05/05			3B-Y-000001→ 3B-1-400000; für Linkslenker; - ESP		24.2125-1712.3 010622	Ø 25,4
2.5 TDI 4motion	110	11/00→05/05			3B-Y-000001→ 3B-1-400000; für Linkslenker; + ESP		24.2125-1713.3 010623	Ø 25,4
2.8 4motion	142	11/00→05/05			3B-2-000001→		24.2125-1720.3 010688	TRW Ø 25,4
1.9 TDI	74	11/00→05/05		05/02→			03.2125-0373.3 010810	ATE Ø 25,4
1.9 TDI	96	11/00→05/05			→ 3B-1-400000; für Linkslenker; - ESP		24.2125-1712.3 010622	Ø 25,4
1.9 TDI 4motion	96	11/00→05/05			→ 3B-1-400000; für Linkslenker; + ESP		24.2125-1713.3 010623	Ø 25,4
2.0	85	11/00→05/05			→ 3B-1-400000; für Linkslenker; + ESP		24.2125-1713.3 010623	Ø 25,4
2.0 4motion	85	11/00→05/05			3B-2-000001→		24.2125-1720.3 010688	TRW Ø 25,4
2.0	96	11/01→05/05		05/02→			03.2125-0373.3 010810	ATE Ø 25,4
							24.2125-1720.3 010688	TRW Ø 25,4
2.0 TDI	100	12/03→05/05					03.2125-0373.3 010810	ATE Ø 25,4
							24.2125-1720.3 010688	TRW Ø 25,4
2.5 TDI	120	05/03→05/05					03.2125-0373.3 010810	ATE Ø 25,4
2.5 TDI 4motion	132	01/03→05/05			→ 3B-X-800000; - ESP		24.2123-1717.3 010521	Ø 23,81
					→ 3B-X-800000; + ESP		24.2123-1730.3 010620	Ø 23,81
					3B-Y-000001→ 3B-1-400000; für Linkslenker; - ESP		24.2125-1712.3 010622	Ø 25,4
					3B-Y-000001→ 3B-1-400000; für Linkslenker; + ESP		24.2125-1713.3 010623	Ø 25,4
					3B-2-000001→		24.2125-1720.3 010688	TRW Ø 25,4
4.0 W8 4motion	202	09/01→09/04		05/02→			03.2125-0373.3 010810	ATE Ø 25,4
							24.2125-1720.3 010688	TRW Ø 25,4
VW - PASSAT Variant (3C5) 08/05→11/11								
 Bremskraftverstärker								
1.4 TSI	90	05/07→11/10			10/07→ 07/10; +PR 1LK; für Linkslenker		03.7873-4102.4 300212	ATE Ø 11" pneumatisch
					10/07→ 07/10; +PR 1LJ; für Linkslenker		03.7873-4502.4 300284	ATE Ø 11" pneumatisch
1.4 TSI EcoFuel	110	01/09→11/10			→ 07/10; +PR 1LK; für Linkslenker		03.7873-4102.4 300212	ATE Ø 11" pneumatisch
					→ 07/10; +PR 1LJ; für Linkslenker		03.7873-4502.4 300284	ATE Ø 11" pneumatisch
1.6	75	08/05→11/10			→ 07/10; +PR 1LK; für Linkslenker		03.7873-4102.4 300212	ATE Ø 11" pneumatisch
1.6 TDI	77	08/09→11/10			→ 07/10; +PR 1ZG; für Linkslenker		03.7873-4402.4 300292	ATE Ø 11" pneumatisch
2.0 BlueTDI	105	01/09→11/10			→ 07/10; +PR 1LJ; für Linkslenker		03.7873-4502.4 300284	ATE Ø 11" pneumatisch
2.0 FSI	110	08/05→11/10						
2.0 FSI	147	08/05→11/10						
2.0 FSI 4motion	110	09/05→11/10						
2.0 TDI	81	11/08→11/10						
2.0 TDI	100	08/05→11/10						
2.0 TDI	125	08/05→11/10						
2.0 TDI 16V	103	08/05→11/10						
2.0 TDI 4motion	125	05/09→11/10						
3.2 FSI 4motion	184	11/05→11/10						
1.6 FSI	85	08/05→06/08			+PR 1LK; für Linkslenker		03.7873-4102.4 300212	ATE Ø 11" pneumatisch
1.9 TDI	77	08/05→11/10			+PR 1ZG; für Linkslenker		03.7873-4402.4 300292	ATE Ø 11" pneumatisch
2.0 TDI	88	11/05→05/07			+PR 1LJ; für Linkslenker		03.7873-4502.4 300284	ATE Ø 11" pneumatisch
2.0 TDI	90	08/05→02/06						
2.0 TDI	103	08/05→05/09						
2.0 TDI	120	08/05→05/09						
1.8 TSI	118	05/07→10/11			10/07→ 07/10; +PR 1LK; für Linkslenker		03.7873-4102.4 300212	ATE Ø 11" pneumatisch
					10/07→ 07/10; +PR 1ZG; für Linkslenker		03.7873-4402.4 300292	ATE Ø 11" pneumatisch
					10/07→ 07/10; +PR 1LJ; für Linkslenker		03.7873-4502.4 300284	ATE Ø 11" pneumatisch
2.0 TDI 16V 4motion	103	08/05→11/10			09/05→ 07/10; +PR 1LK; für Linkslenker		03.7873-4102.4 300212	ATE Ø 11" pneumatisch
					09/05→ 07/10; +PR 1ZG; für Linkslenker		03.7873-4402.4 300292	ATE Ø 11" pneumatisch
					09/05→ 07/10; +PR 1LJ; für Linkslenker		03.7873-4502.4 300284	ATE Ø 11" pneumatisch
2.0 TDI 4motion	103	08/05→05/09			09/05→; +PR 1LK; für Linkslenker		03.7873-4102.4 300212	ATE Ø 11" pneumatisch
					09/05→; +PR 1ZG; für Linkslenker		03.7873-4402.4 300292	ATE Ø 11" pneumatisch
↓								















	kw			 	! #		
VW - PASSAT Variant (3C5) 08/05→11/11							
 Bremskraftverstärker							
2.0 TDI 4motion	103	08/05→05/09		09/05→; +PR 1LJ; für Linkslenker	03.7873-4502.4	300284	ATE Ø 11" pneumatisch
3.6 R36 4motion	220	04/07→11/10		→ 07/10; für Linkslenker	03.7873-4502.4	300284	ATE Ø 11" pneumatisch
 Hauptbremszylinder							
1.4 TSI	90	05/07→11/10		10/07→ 07/10; +PR 1ZG; für Linkslenker	03.4152-0116.3	010814	ATE Ø 22,2
1.8 TSI	118	05/07→10/11		10/07→ 07/10; für Linkslenker; +PR 1LJ;1LK;1LH;1LM	03.4153-0186.3	010816	ATE Ø 23,81
				10/07→ 07/10; +PR 1LJ;1LK; für Rechtslenker	24.4153-0192.3	011026	ATE Ø 23,81 ohne Bremsflüssigkeitsbehälter
1.4 TSI EcoFuel	110	01/09→11/10		→ 07/10; +PR 1ZG; für Linkslenker	03.4152-0116.3	010814	ATE Ø 22,2
1.6	75	08/05→11/10		→ 07/10; +PR 1LJ;1LK;1LH;1LM; für Linkslenker	03.4153-0186.3	010816	ATE Ø 23,81
2.0 BlueTDI	105	01/09→11/10					
2.0 FSI	110	08/05→11/10		→ 07/10; +PR 1LJ;1LK; für Rechtslenker	24.4153-0192.3	011026	ATE Ø 23,81 ohne Bremsflüssigkeitsbehälter
2.0 FSI	147	08/05→11/10					
2.0 FSI 4motion	110	09/05→11/10					
2.0 TDI	100	08/05→11/10					
2.0 TDI	125	08/05→11/10					
3.2 FSI 4motion	184	11/05→11/10					
1.6 FSI	85	08/05→06/08		+PR 1ZG; für Linkslenker	03.4152-0116.3	010814	ATE Ø 22,2
2.0 TDI	90	08/05→02/06		+PR 1LJ;1LK;1LH;1LM; für Linkslenker	03.4153-0186.3	010816	ATE Ø 23,81
2.0 TDI	103	08/05→05/09					
2.0 TDI	120	08/05→05/09		+PR 1LJ;1LK; für Rechtslenker	24.4153-0192.3	011026	ATE Ø 23,81 ohne Bremsflüssigkeitsbehälter
1.6 TDI	77	08/09→11/10		→ 07/10; +PR 1ZG; für Linkslenker	03.4152-0116.3	010814	ATE Ø 22,2
2.0 TDI	81	11/08→11/10		→ 07/10; für Linkslenker; +PR 1LJ,1LK,1LH,1LM	03.4153-0186.3	010816	ATE Ø 23,81
2.0 TDI 16V	103	08/05→11/10					
2.0 TDI 4motion	125	05/09→11/10		→ 07/10; für Rechtslenker; +PR 1LJ,1LK	24.4153-0192.3	011026	ATE Ø 23,81 ohne Bremsflüssigkeitsbehälter
3.6 R36 4motion	220	04/07→11/10					
1.9 TDI	77	08/05→11/10		+PR 1ZG; für Linkslenker	03.4152-0116.3	010814	ATE Ø 22,2
				+PR 1LJ;1LK;1LH;1LM; für Linkslenker	03.4153-0186.3	010816	ATE Ø 23,81
				→ 07/10; +PR 1LJ;1LK; für Rechtslenker	24.4153-0192.3	011026	ATE Ø 23,81 ohne Bremsflüssigkeitsbehälter
2.0 TDI	88	11/05→05/07		+PR 1ZG; für Linkslenker	03.4152-0116.3	010814	ATE Ø 22,2
				für Linkslenker; +PR 1LJ,1LK,1LH,1LM	03.4153-0186.3	010816	ATE Ø 23,81
				+PR 1LJ,1LK; für Rechtslenker	24.4153-0192.3	011026	ATE Ø 23,81 ohne Bremsflüssigkeitsbehälter
2.0 TDI 16V 4motion	103	08/05→11/10		09/05→ 07/10; +PR 1ZG; für Linkslenker	03.4152-0116.3	010814	ATE Ø 22,2
				09/05→ 07/10; +PR 1LJ;1LK;1LH;1LM; für Linkslenker	03.4153-0186.3	010816	ATE Ø 23,81
				09/05→ 07/10; +PR 1LJ;1LK; für Rechtslenker	24.4153-0192.3	011026	ATE Ø 23,81 ohne Bremsflüssigkeitsbehälter
2.0 TDI 4motion	103	08/05→05/09		09/05→; +PR 1ZG; für Linkslenker	03.4152-0116.3	010814	ATE Ø 22,2
				09/05→; +PR 1LJ;1LK;1LH;1LM; für Linkslenker	03.4153-0186.3	010816	ATE Ø 23,81
				09/05→; +PR 1LJ;1LK; für Rechtslenker	24.4153-0192.3	011026	ATE Ø 23,81 ohne Bremsflüssigkeitsbehälter
VW - PASSAT Variant (3G5) 08/14→							
 Hauptbremszylinder							
1.4 TSI	92	11/14→		für Linkslenker; +PR 1ZA,1ZD	24.4123-1719.3	011017	TRW Ø 23,81 ohne Bremsflüssigkeitsbehälter
1.4 TSI	110	11/14→					
1.4 TSI 4motion	110	02/15→					
1.8 TSI	132	02/15→					
2.0 TDI	110	11/14→					
2.0 TDI	135	07/15→					
2.0 TDI	140	11/14→					
2.0 TDI 4motion	110	02/15→					
2.0 TDI 4motion	140	11/14→					
2.0 TSI 4motion	206	05/15→					
1.6 TDI	88	08/14→		11/14→; für Linkslenker; +PR 1ZA,1ZD	24.4123-1719.3	011017	TRW Ø 23,81 ohne Bremsflüssigkeitsbehälter
2.0 TDI 4motion	176	08/14→					
2.0 TSI	162	02/15→		05/15→; für Linkslenker; +PR 1ZA,1ZD	24.4123-1719.3	011017	TRW Ø 23,81 ohne Bremsflüssigkeitsbehälter
VW - PASSAT Variant (365) 08/10→12/14							
 Bremskraftverstärker							
1.4 TSI	90	08/10→12/14		→ 10/14; +PR 1ZG; für Linkslenker	03.7873-4402.4	300292	ATE Ø 11" pneumatisch
1.4 TSI	118	11/12→12/14					
1.4 TSI EcoFuel	110	08/10→12/14		→ 10/14; +PR 1LA,1LB,1ZM; für Linkslenker	03.7873-4502.4	300284	ATE Ø 11" pneumatisch
1.4 TSI MultiFuel	118	11/10→12/14					
1.6 TDI	77	08/10→12/14					
1.8 TSI	118	08/10→12/14					
↓							

	kw			 	! #		
VW - PASSAT Variant (365) 08/10→12/14							
 Bremskraftverstärker							
2.0 TDI	100	08/10→12/14		→ 10/14; +PR 1ZG; für Linkslenker		03.7873-4402.4 300292	ATE Ø 11" pneumatisch
2.0 TDI	103	08/10→12/14		→ 10/14; +PR 1LA,1LB,1ZM; für Linkslenker		03.7873-4502.4 300284	ATE Ø 11" pneumatisch
2.0 TDI	125	08/10→12/14					
2.0 TDI	130	12/12→12/14					
2.0 TDI 4motion	103	08/10→12/14					
2.0 TDI 4motion	130	01/13→12/14					
2.0 TSI	155	11/10→12/14					
3.6 FSI 4motion	220	01/11→12/14					
2.0 TDI 4motion	125	08/10→01/13		+PR 1ZG; für Linkslenker		03.7873-4402.4 300292	ATE Ø 11" pneumatisch
				+PR 1LA,1LB,1ZM; für Linkslenker		03.7873-4502.4 300284	ATE Ø 11" pneumatisch
 Hauptbremszylinder							
1.4 TSI	90	08/10→12/14		→ 10/14; +PR 1ZG; für Linkslenker		03.4152-0116.3 010814	ATE Ø 22,2
1.4 TSI	118	11/12→12/14		→ 10/14; +PR 1LA,1LB,1ZM; für Linkslenker		03.4153-0186.3 010816	ATE Ø 23,81
1.4 TSI EcoFuel	110	08/10→12/14					
1.4 TSI MultiFuel	118	11/10→12/14		→ 10/14; +PR 1LA,1LB,1ZM; für Rechtslenker		24.4153-0192.3 011026	ATE Ø 23,81 ohne Bremsflüssigkeitsbehälter
1.6 TDI	77	08/10→12/14					
1.8 TSI	118	08/10→12/14					
2.0 TDI	100	08/10→12/14					
2.0 TDI	103	08/10→12/14					
2.0 TDI	125	08/10→12/14					
2.0 TDI	130	12/12→12/14					
2.0 TDI 4motion	103	08/10→12/14					
2.0 TDI 4motion	130	01/13→12/14					
2.0 TSI	155	11/10→12/14					
3.6 FSI 4motion	220	01/11→12/14					
2.0 TDI 4motion	125	08/10→01/13		+PR 1ZG; für Linkslenker		03.4152-0116.3 010814	ATE Ø 22,2
				+PR 1LA,1LB,1ZM; für Linkslenker		03.4153-0186.3 010816	ATE Ø 23,81
				+PR 1LA,1LB,1ZM; für Rechtslenker		24.4153-0192.3 011026	ATE Ø 23,81 ohne Bremsflüssigkeitsbehälter
VW - POLO (6N1) 10/94→10/99							
 Bremskraftverstärker							
1.7 SDI	42	04/97→10/99		05/97→; für Linkslenker; + ESP; +PR 1AT,1LX,1ZE,1ZJ / 1ZK		03.7853-0102.4 300252	ATE Ø 9" pneumatisch
100 1.4 16V	74	04/96→10/99		→ 6N-T-300000; für Linkslenker; + ABS		03.7750-6002.4 300134	ATE Ø 9" pneumatisch
45 1.0	33	10/94→09/96		für Linkslenker; + ESP; +PR 1AT,1LX,1ZE,1ZJ / 1ZK		03.7853-0102.4 300252	ATE Ø 9" pneumatisch
55 1.3	40	10/94→07/95					
55 1.4	40	08/95→10/99					
60 1.4	44	07/95→10/99					
64 1.9 D	47	10/94→10/99					
64 1.9 SDI	47	07/96→10/99					
75 1.6 4motion	55	08/95→10/99					
120 1.6 16V GTI	88	09/98→10/99			für Linkslenker; + ESP; +PR 1AT,1LX,1ZE,1ZJ / 1ZK		
50 1.0	37	09/96→10/99					
60 1.7 SDI	44	08/97→10/99					
75 1.6	55	10/94→10/99		→ 6N-T-300000; für Linkslenker; + ABS		03.7750-6002.4 300134	ATE Ø 9" pneumatisch
				→ 09/99; für Linkslenker; + ESP; +PR 1AT,1LX,1ZE,1ZJ / 1ZK		03.7853-0102.4 300252	ATE Ø 9" pneumatisch
 Hauptbremszylinder							
1.7 SDI	42	04/97→10/99		05/97→; für Linkslenker; - ABS		03.2120-3943.3 010532	ATE Ø 20,64
				05/97→; + ABS		03.2122-1344.3 010593	ATE Ø 22,2
100 1.4 16V	74	04/96→10/99		- ABS		03.2122-1184.3 010592	ATE Ø 22,2
				→ 6N-T-300000; + ABS		03.2123-1484.3 010595	ATE Ø 23,81
				6N-V-000001→; + ABS		03.2123-1824.3 010596	ATE Ø 23,81
120 1.6 16V GTI	88	09/98→10/99		+ ABS		03.2123-1824.3 010596	ATE Ø 23,81
45 1.0	33	10/94→09/96		für Linkslenker; - ABS		03.2120-3943.3 010532	ATE Ø 20,64
55 1.3	40	10/94→07/95		→ 6N-T-250000; + ABS		03.2122-1184.3 010592	ATE Ø 22,2
60 1.4	44	07/95→10/99		6N-V-000001→; + ABS		03.2122-1344.3 010593	ATE Ø 22,2
64 1.9 D	47	10/94→10/99					
64 1.9 SDI	47	07/96→10/99					
75 1.6 4motion	55	08/95→10/99					
50 1.0	37	09/96→10/99		für Linkslenker; - ABS		03.2120-3943.3 010532	ATE Ø 20,64
60 1.7 SDI	44	08/97→10/99		+ ABS		03.2122-1344.3 010593	ATE Ø 22,2
55 1.4	40	08/95→10/99		für Linkslenker; - ABS		03.2120-3943.3 010532	ATE Ø 20,64
75 1.6	55	10/94→10/99		→ 09/99; für Linkslenker; - ABS		03.2120-3943.3 010532	ATE Ø 20,64
				→ 6N-T-250000; + ABS		03.2122-1184.3 010592	ATE Ø 22,2
				6N-V-000001→; → 09/99; + ABS		03.2122-1344.3 010593	ATE Ø 22,2
Verschlusschraube, Hauptbremszylinder							
1.7 SDI	42	04/97→10/99		05/97→; für Linkslenker; - ABS		03.3517-0101.2 390322	
↓							

	kw			 	! #		
VW - POLO (6N1) 10/94→10/99							
Verschlusschraube, Hauptbremszylinder							
45 1.0	33	10/94→09/96		für Linkslenker; - ABS		03.3517-0101.2	390322
50 1.0	37	09/96→10/99					
55 1.3	40	10/94→07/95					
55 1.4	40	08/95→10/99					
60 1.4	44	07/95→10/99					
60 1.7 SDI	44	08/97→10/99					
64 1.9 D	47	10/94→10/99					
64 1.9 SDI	47	07/96→10/99					
75 1.6 4motion	55	08/95→10/99					
75 1.6	55	10/94→10/99		→ 09/99; für Linkslenker; - ABS		03.3517-0101.2	390322
 Bremskraftregler							
1.7 SDI	42	04/97→10/99		05/97→		03.6583-0184.3	320229 ATE lastabhängig 8/3 4x
100 1.4 16V	74	04/96→10/99				03.6583-0167.3	320140 ATE lastabhängig 8/3 4x
						03.6583-0179.3	320228 ATE lastabhängig 8/3 4x
						03.6583-0184.3	320229 ATE lastabhängig 8/3 4x
120 1.6 16V GTI	88	09/98→10/99				03.6583-0179.3	320228 ATE lastabhängig 8/3 4x
45 1.0	33	10/94→09/96				03.6583-0184.3	320229 ATE lastabhängig 8/3 4x
50 1.0	37	09/96→10/99					
55 1.3	40	10/94→07/95					
55 1.4	40	08/95→10/99					
60 1.4	44	07/95→10/99					
60 1.7 SDI	44	08/97→10/99					
64 1.9 D	47	10/94→10/99					
64 1.9 SDI	47	07/96→10/99					
75 1.6 4motion	55	08/95→10/99					
75 1.6	55	10/94→10/99		→ 09/99		03.6583-0184.3	320229 ATE lastabhängig 8/3 4x
VW - POLO (6N2) 10/99→10/01							
 Bremskraftverstärker							
1.0	37	10/99→09/01		für Linkslenker; + ESP;		03.7853-0102.4	300252 ATE Ø 9" pneumatisch
1.4 16V	55	10/99→09/01		+PR 1AT,1LX,1ZE,1ZJ / 1ZK			
1.4 TDI	55	10/99→09/01					
1.6 16V GTI	92	10/99→09/01					
1.7 SDI	44	10/99→09/01					
1.4	40	10/99→09/01		→ 6N-T-300000; für Linkslenker; + ABS		03.7750-6002.4	300134 ATE Ø 9" pneumatisch
1.4	44	10/99→09/01					
1.4 16V	74	10/99→09/01		für Linkslenker; + ESP;		03.7853-0102.4	300252 ATE Ø 9" pneumatisch
1.9 D	47	10/99→09/01		+PR 1AT,1LX,1ZE,1ZJ / 1ZK			
1.9 SDI	47	10/99→09/01					
 Hauptbremszylinder							
1.0	37	10/99→09/01		für Linkslenker; - ABS		03.2120-3943.3	010532 ATE Ø 20,64
1.7 SDI	44	10/99→09/01		+ ABS		03.2122-1344.3	010593 ATE Ø 22,2
1.4	40	10/99→09/01		für Linkslenker; - ABS		03.2120-3943.3	010532 ATE Ø 20,64
1.4 16V	55	10/99→09/01					
1.4	44	10/99→09/01		für Linkslenker; - ABS		03.2120-3943.3	010532 ATE Ø 20,64
1.9 D	47	10/99→09/01		→ 6N-T-250000; + ABS		03.2122-1184.3	010592 ATE Ø 22,2
1.9 SDI	47	10/99→09/01					
1.4 16V	74	10/99→09/01		- ABS		03.2122-1184.3	010592 ATE Ø 22,2
				→ 6N-T-300000; + ABS		03.2123-1484.3	010595 ATE Ø 23,81
				6N-V-000001→; + ABS		03.2123-1824.3	010596 ATE Ø 23,81
1.4 TDI	55	10/99→09/01				03.2122-1184.3	010592 ATE Ø 22,2
				+ ABS		03.2123-1824.3	010596 ATE Ø 23,81
1.6 16V GTI	92	10/99→09/01		+ ABS		03.2123-1824.3	010596 ATE Ø 23,81
Verschlusschraube, Hauptbremszylinder							
1.0	37	10/99→09/01		für Linkslenker; - ABS		03.3517-0101.2	390322
1.4	40	10/99→09/01					
1.4	44	10/99→09/01					
1.4 16V	55	10/99→09/01					
1.7 SDI	44	10/99→09/01					
1.9 D	47	10/99→09/01					
1.9 SDI	47	10/99→09/01					
 Bremskraftregler							
1.0	37	10/99→09/01				03.6583-0184.3	320229 ATE lastabhängig 8/3 4x
1.4	40	10/99→09/01					
1.4	44	10/99→09/01					
1.7 SDI	44	10/99→09/01					
1.9 D	47	10/99→09/01					
1.9 SDI	47	10/99→09/01					
1.4 16V	55	10/99→09/01		+ ABS		03.6583-0179.3	320228 ATE lastabhängig 8/3 4x
↓							

	kW			 	! #		
VW - POLO (6N2) 10/99→10/01							
 Bremskraftregler							
1.4 TDI	55	10/99→09/01		- ABS		03.6583-0184.3 320229	ATE lastabhängig 8/3 4x
1.4 16V	74	10/99→09/01				03.6583-0167.3 320140	ATE lastabhängig 8/3 4x
						03.6583-0179.3 320228	ATE lastabhängig 8/3 4x
						03.6583-0184.3 320229	ATE lastabhängig 8/3 4x
1.6 16V GTI	92	10/99→09/01				03.6583-0179.3 320228	ATE lastabhängig 8/3 4x
VW - POLO (9N_) 10/01→01/12							
 Hauptbremszylinder							
1.2	40	01/02→05/07		9N-5-500001→; + ABS		24.2119-1712.3 010912	Ø 19,05 ohne Bremsflüssigkeitsbehälter
						24.2120-1734.3 010702	Ø 20,64
				- ABS; für Fahrzeuge mit Servolenkung; → 9N-5-180000		24.2120-1736.3 010732	Ø 20,64
1.2 1.2 12V 1.8 GTI	44 51 110	05/07→11/09 05/07→11/09 09/05→11/09		9N-5-500001→; - ABS		24.2120-1736.3 010732	Ø 20,64
				→ 05/09; + ABS		24.2119-1712.3 010912	Ø 19,05 ohne Bremsflüssigkeitsbehälter
				→ 05/09; - ABS		24.2120-1734.3 010702	Ø 20,64
1.2 12V	47	10/01→07/07		11/01→; + ABS		24.2119-1712.3 010912	Ø 19,05 ohne Bremsflüssigkeitsbehälter
						24.2120-1734.3 010702	Ø 20,64
				11/01→; - ABS		24.2120-1736.3 010732	Ø 20,64
1.4 16V 1.4 16V 1.4 TDI	55 74 55	10/01→05/08 10/01→05/08 10/01→06/05		9N-5-500001→; + ABS		24.2119-1712.3 010912	Ø 19,05 ohne Bremsflüssigkeitsbehälter
						24.2120-1734.3 010702	Ø 20,64
				11/01→; + ABS; → 9N-5-180000		24.2120-1734.3 010702	Ø 20,64
				11/01→; - ABS; → 9N-5-180000		24.2120-1736.3 010732	Ø 20,64
1.4 16V 1.4 TDI 1.6 16V 1.9 TDI	59 51 59 77 96	05/06→11/09 04/05→11/09 04/05→11/09 05/06→11/09 11/03→11/09		9N-5-500001→; → 05/09; + ABS		24.2119-1712.3 010912	Ø 19,05 ohne Bremsflüssigkeitsbehälter
						24.2120-1734.3 010702	Ø 20,64
				+ ABS; → 9N-5-180000		24.2120-1734.3 010702	Ø 20,64
				- ABS; → 9N-5-180000		24.2120-1736.3 010732	Ø 20,64
1.4 FSI	63	02/02→07/06		9N-5-500001→; + ABS		24.2119-1712.3 010912	Ø 19,05 ohne Bremsflüssigkeitsbehälter
						24.2120-1734.3 010702	Ø 20,64
				+ ABS; → 9N-5-180000		24.2120-1734.3 010702	Ø 20,64
				9N-5-500001→; - ABS		24.2120-1736.3 010732	Ø 20,64
1.8 GTI Cup Edition	132	05/06→11/09		- ABS; → 9N-5-180000		24.2120-1736.3 010732	Ø 20,64
				06/06→ 05/09; + ABS		24.2119-1712.3 010912	Ø 19,05 ohne Bremsflüssigkeitsbehälter
				06/06→ 05/09; - ABS		24.2120-1736.3 010732	Ø 20,64
1.9 SDI 1.9 TDI	47 74	10/01→11/09 10/01→11/09		9N-5-500001→; → 05/09; + ABS		24.2119-1712.3 010912	Ø 19,05 ohne Bremsflüssigkeitsbehälter
						24.2120-1734.3 010702	Ø 20,64
				11/01→; + ABS; → 9N-5-180000		24.2120-1734.3 010702	Ø 20,64
				11/01→; - ABS; → 9N-5-180000		24.2120-1736.3 010732	Ø 20,64
			9N-5-500001→; → 05/09; - ABS		24.2120-1736.3 010732	Ø 20,64	
 Bremskraftregler							
1.2	40	01/02→05/07		- ABS		03.6583-0216.3 320247	ATE lastabhängig 8/3 4x
1.4 16V 1.4 16V 1.4 TDI	55 74 55	10/01→05/08 10/01→05/08 10/01→06/05		11/01→; - ABS		03.6584-0120.3 320279	ATE lastabhängig 8/4 4x
				→ 05/09; - ABS		03.6584-0120.3 320279	ATE lastabhängig 8/4 4x
1.4 FSI	63	02/02→07/06					
1.9 SDI 1.9 TDI	47 74	10/01→11/09 10/01→11/09		11/01→ 05/09; - ABS		03.6584-0120.3 320279	ATE lastabhängig 8/4 4x

	kw			 	! #		
VW - POLO CLASSIC (6V2) 11/95→11/09							
 Bremskraftverstärker							
100 1.6	74	12/95→09/01		für Linkslenker; - ABS		03.7750-6302.4 300161	ATE Ø 9" pneumatisch
				05/96→; für Linkslenker; + ABS; +PR 1KB		10.6350-3902.4 300213	ATE Ø 9" pneumatisch
				05/96→; für Linkslenker; + ABS; +PR 1KK,1KM,1KQ		10.6350-4002.4 300285	ATE Ø 9" pneumatisch
110 1.9 TDI	81	06/98→01/02		für Linkslenker; - ABS; → 09/01		03.7750-6302.4 300161	ATE Ø 9" pneumatisch
				für Linkslenker; + ABS; → 09/01; +PR 1KB		10.6350-3902.4 300213	ATE Ø 9" pneumatisch
				für Linkslenker; + ABS; → 09/01; +PR 1KK,1KM,1KQ		10.6350-4002.4 300285	ATE Ø 9" pneumatisch
54 1.4	40	01/98→08/99		für Linkslenker; - ABS		03.7740-1402.4 300133	ATE Ø 8" pneumatisch
57 1.7 SDI	42	07/97→09/01		für Linkslenker; + ABS; +PR 1KB		10.6350-3902.4 300213	ATE Ø 9" pneumatisch
60 1.4	44	12/95→09/01		für Linkslenker; + ABS; +PR 1KB		10.6350-3902.4 300213	ATE Ø 9" pneumatisch
64 1.9 SDI	47	12/95→08/99		für Linkslenker; + ABS; +PR 1KK,1KM,1KQ		10.6350-4002.4 300285	ATE Ø 9" pneumatisch
75 1.4 16V	55	10/99→09/01		für Linkslenker; + ABS; +PR 1KK,1KM,1KQ		10.6350-4002.4 300285	ATE Ø 9" pneumatisch
68 1.9 SDI	50	08/99→01/02		für Linkslenker; - ABS; → 09/01		03.7740-1402.4 300133	ATE Ø 8" pneumatisch
				für Linkslenker; + ABS; → 09/01; +PR 1KB		10.6350-3902.4 300213	ATE Ø 9" pneumatisch
				für Linkslenker; + ABS; → 09/01; +PR 1KK,1KM,1KQ		10.6350-4002.4 300285	ATE Ø 9" pneumatisch
75 1.6	55	11/95→09/97		09/97→; für Linkslenker; - ABS		03.7740-1402.4 300133	ATE Ø 8" pneumatisch
75 1.6	55	11/95→09/01		für Linkslenker; + ABS; +PR 1KB		10.6350-3902.4 300213	ATE Ø 9" pneumatisch
				für Linkslenker; + ABS; +PR 1KK,1KM,1KQ		10.6350-4002.4 300285	ATE Ø 9" pneumatisch
90 1.8	66	01/97→09/01		03/98→; für Linkslenker; - ABS		03.7750-6302.4 300161	ATE Ø 9" pneumatisch
				03/98→; für Linkslenker; + ABS; +PR 1KB		10.6350-3902.4 300213	ATE Ø 9" pneumatisch
				03/98→; für Linkslenker; + ABS; +PR 1KK,1KM,1KQ		10.6350-4002.4 300285	ATE Ø 9" pneumatisch
90 1.9 TDI	66	09/96→09/01		für Linkslenker; - ABS		03.7750-6302.4 300161	ATE Ø 9" pneumatisch
				für Linkslenker; + ABS; +PR 1KB		10.6350-3902.4 300213	ATE Ø 9" pneumatisch
				für Linkslenker; + ABS; +PR 1KK,1KM,1KQ		10.6350-4002.4 300285	ATE Ø 9" pneumatisch
 Hauptbremszylinder							
100 1.6	74	12/95→09/01		für Linkslenker; - ABS		03.2122-1042.3 010137	Ø 22,2
				→ 6K-X-523000; für Rechtslenker; - ABS		03.2122-1042.3 010137	Ø 22,2
				05/96→; für Linkslenker; + ABS		03.2122-1144.3 010636	ATE Ø 22,2
				05/96→; für Rechtslenker; + ABS		03.2122-1184.3 010592	ATE Ø 22,2
110 1.9 TDI	81	06/98→01/02		für Linkslenker; - ABS; → 09/01		03.2122-1042.3 010137	Ø 22,2
				→ 6K-X-523000; für Rechtslenker; - ABS		03.2122-1042.3 010137	Ø 22,2
				für Linkslenker; + ABS; → 09/01		03.2122-1144.3 010636	ATE Ø 22,2
				für Rechtslenker; + ABS; → 09/01		03.2122-1184.3 010592	ATE Ø 22,2
54 1.4	40	01/98→08/99		für Linkslenker; - ABS		03.2120-3943.3 010532	ATE Ø 20,64
60 1.4	44	12/95→09/01		→ 6K-X-523000; für Rechtslenker; - ABS		03.2120-3943.3 010532	ATE Ø 20,64
64 1.9 SDI	47	12/95→08/99		für Linkslenker; + ABS		03.2122-1144.3 010636	ATE Ø 22,2
75 1.4 16V	55	10/99→09/01		für Rechtslenker; + ABS		03.2122-1184.3 010592	ATE Ø 22,2
57 1.7 SDI	42	07/97→09/01		11/97→; → 6K-X-523000; für Rechtslenker; - ABS		03.2120-3943.3 010532	ATE Ø 20,64
				für Linkslenker; - ABS		03.2120-3943.3 010532	ATE Ø 20,64
				für Linkslenker; + ABS		03.2122-1144.3 010636	ATE Ø 22,2
				für Rechtslenker; + ABS		03.2122-1184.3 010592	ATE Ø 22,2
68 1.9 SDI	50	08/99→01/02		für Linkslenker; - ABS; → 09/01		03.2120-3943.3 010532	ATE Ø 20,64
				→ 6K-X-523000; für Rechtslenker; - ABS		03.2120-3943.3 010532	ATE Ø 20,64
				für Linkslenker; + ABS; → 09/01		03.2122-1144.3 010636	ATE Ø 22,2
				für Rechtslenker; + ABS; → 09/01		03.2122-1184.3 010592	ATE Ø 22,2
75 1.6	55	11/95→09/97		6K-V-022629→ 6K-X-523000; für Rechtslenker; - ABS		03.2120-3943.3 010532	ATE Ø 20,64
75 1.6	55	11/95→09/01		6K-V-022629→; für Linkslenker; - ABS		03.2120-3943.3 010532	ATE Ø 20,64
				→ 6K-V-022628; - ABS		03.2122-1042.3 010137	Ø 22,2
				für Linkslenker; + ABS		03.2122-1144.3 010636	ATE Ø 22,2
				für Rechtslenker; + ABS		03.2122-1184.3 010592	ATE Ø 22,2
90 1.8	66	01/97→09/01		03/98→; für Linkslenker; + ABS		03.2122-1144.3 010636	ATE Ø 22,2
90 1.9 TDI	66	09/96→09/01		für Linkslenker; - ABS		03.2122-1042.3 010137	Ø 22,2
				→ 6K-X-523000; für Rechtslenker; - ABS		03.2122-1042.3 010137	Ø 22,2
				für Linkslenker; + ABS		03.2122-1144.3 010636	ATE Ø 22,2
↓							

	kw					! #		
VW - POLO CLASSIC (6V2) 11/95→11/09								
 Hauptbremszylinder								
90 1.9 TDI	66	09/96→09/01			für Rechtslenker; + ABS		03.2122-1184.3 010592	ATE Ø 22,2
 Bremskraftregler								
100 1.6	74	12/95→09/01		05/96→			03.6584-0113.3 320111	ATE lastabhängig 8/4 4x
110 1.9 TDI	81	06/98→01/02		→ 09/01			03.6583-0179.3 320228	ATE lastabhängig 8/3 4x
54 1.4	40	01/98→08/99					03.6584-0113.3 320111	ATE lastabhängig 8/4 4x
57 1.7 SDI	42	07/97→09/01						
60 1.4	44	12/95→09/01						
64 1.9 SDI	47	12/95→08/99						
75 1.4 16V	55	10/99→09/01						
75 1.6	55	11/95→09/97						
75 1.6	55	11/95→09/01						
68 1.9 SDI	50	08/99→01/02		→ 09/01			03.6584-0113.3 320111	ATE lastabhängig 8/4 4x
90 1.8	66	01/97→09/01		03/98→			03.6584-0113.3 320111	ATE lastabhängig 8/4 4x
90 1.9 TDI	66	09/96→09/01					03.6583-0179.3 320228	ATE lastabhängig 8/3 4x
VW - POLO Stufenheck (9A4, 9A2, 9N2) 09/02→								
 Hauptbremszylinder								
1.4	55	07/06→04/12			9N-5-500001→; → 05/09; + ABS		24.2119-1712.3 010912	Ø 19,05
1.4	74	11/03→					24.2120-1734.3 010702	ohne Bremsflüssigkeitsbehälter Ø 20,64
					+ ABS; → 9N-5-180000		24.2120-1734.3 010702	Ø 20,64
					- ABS; → 9N-5-180000		24.2120-1736.3 010732	Ø 20,64
					9N-5-500001→; → 05/09; - ABS		24.2120-1736.3 010732	Ø 20,64
 Bremskraftregler								
1.4	55	07/06→04/12		→ 05/09; - ABS			03.6584-0120.3 320279	ATE lastabhängig 8/4 4x
1.4	74	11/03→						
VW - POLO Van Kasten/Schrägheck (6N1) 09/94→12/99								
 Bremskraftverstärker								
1.0	33	10/94→12/99			→ 6N-T-300000; für Linkslenker; + ABS		03.7750-6002.4 300134	ATE Ø 9" pneumatisch
					→ 09/96; für Linkslenker; + ESP; +PR 1AT,1LX,1ZE,1ZJ / 1ZK		03.7853-0102.4 300252	ATE Ø 9" pneumatisch
1.4	44	05/98→12/99			→ 6N-T-300000; für Linkslenker; + ABS		03.7750-6002.4 300134	ATE Ø 9" pneumatisch
1.9 D	47	10/94→12/99			für Linkslenker; + ESP; +PR 1AT,1LX,1ZE,1ZJ / 1ZK		03.7853-0102.4 300252	ATE Ø 9" pneumatisch
1.7 SDI	44	08/97→12/99			für Linkslenker; + ESP; +PR 1AT,1LX,1ZE,1ZJ / 1ZK		03.7853-0102.4 300252	ATE Ø 9" pneumatisch
1.9 SDI	47	07/96→12/99			03/97→; für Linkslenker; - ABS		03.7750-6302.4 300161	ATE Ø 9" pneumatisch
					03/97→; für Linkslenker; +PR 1KB; + ABS		10.6350-3902.4 300213	ATE Ø 9" pneumatisch
 Hauptbremszylinder								
1.0	33	10/94→12/99			→ 09/96; für Linkslenker; - ABS		03.2120-3943.3 010532	ATE Ø 20,64
					→ 6N-T-250000; + ABS		03.2122-1184.3 010592	ATE Ø 22,2
					6N-V-000001→; → 09/96; + ABS		03.2122-1344.3 010593	ATE Ø 22,2
1.4	44	05/98→12/99			für Linkslenker; - ABS		03.2120-3943.3 010532	ATE Ø 20,64
1.9 D	47	10/94→12/99			→ 6N-T-250000; + ABS		03.2122-1184.3 010592	ATE Ø 22,2
					6N-V-000001→; + ABS		03.2122-1344.3 010593	ATE Ø 22,2
1.7 SDI	44	08/97→12/99			für Linkslenker; - ABS		03.2120-3943.3 010532	ATE Ø 20,64
					+ ABS		03.2122-1344.3 010593	ATE Ø 22,2
1.9 SDI	47	07/96→12/99			03/97→; - ABS		03.2122-1042.3 010137	Ø 22,2
					03/97→; für Linkslenker; + ABS		03.2122-1144.3 010636	ATE Ø 22,2
					03/97→; für Rechtslenker; + ABS		03.2122-1184.3 010592	ATE Ø 22,2
Verschlusschraube, Hauptbremszylinder								
1.0	33	10/94→12/99			→ 09/96; für Linkslenker; - ABS		03.3517-0101.2 390322	
1.4	44	05/98→12/99			für Linkslenker; - ABS		03.3517-0101.2 390322	
1.7 SDI	44	08/97→12/99						
1.9 D	47	10/94→12/99						
 Bremskraftregler								
1.0	33	10/94→12/99		→ 09/96			03.6583-0184.3 320229	ATE lastabhängig 8/3 4x
1.4	44	05/98→12/99					03.6583-0184.3 320229	ATE lastabhängig 8/3 4x
1.7 SDI	44	08/97→12/99						
1.9 D	47	10/94→12/99						
1.9 SDI	47	07/96→12/99		03/97→			03.6584-0113.3 320111	ATE lastabhängig 8/4 4x



VW - POLO Variant (6V5) 04/97→09/01

Bremskraftverstärker

1.4	40	12/98→09/01		für Linkslenker; - ABS	03.7740-1402.4	300133	ATE Ø 8" pneumatisch
1.4	44	05/97→09/01		für Linkslenker; +PR 1KB; + ABS	10.6350-3902.4	300213	ATE Ø 9" pneumatisch
1.4 16V	55	10/99→09/01					
1.6	55	05/97→09/01		für Linkslenker; - ABS	03.7750-6302.4	300161	ATE Ø 9" pneumatisch
1.6	74	05/97→09/01		für Linkslenker; + ABS	10.6350-3902.4	300213	ATE Ø 9" pneumatisch
1.7 SDI	42	08/97→09/01		für Linkslenker; - ABS	03.7750-6302.4	300161	ATE Ø 9" pneumatisch
1.8	66	05/97→09/01		für Linkslenker; +PR 1KB; + ABS	10.6350-3902.4	300213	ATE Ø 9" pneumatisch
1.9 SDI	47	06/97→09/01					
1.9 SDI	50	08/99→09/01					
1.9 TDI	66	05/97→09/01					
1.9 TDI	81	06/98→09/01					

Hauptbremszylinder

1.4	40	12/98→09/01		- ABS	03.2122-1042.3	010137	Ø 22,2
1.4	44	05/97→09/01		für Linkslenker; + ABS	03.2122-1144.3	010636	ATE Ø 22,2
1.4 16V	55	10/99→09/01					
1.6	55	05/97→09/01		für Rechtslenker; + ABS	03.2122-1184.3	010592	ATE Ø 22,2
1.6	74	05/97→09/01					
1.7 SDI	42	08/97→09/01					
1.8	66	05/97→09/01					
1.9 SDI	47	06/97→09/01					
1.9 SDI	50	08/99→09/01					
1.9 TDI	66	05/97→09/01					
1.9 TDI	81	06/98→09/01					

Bremskraftregler

1.4	40	12/98→09/01			03.6584-0113.3	320111	ATE lastabhängig 8/4 4x
1.4	44	05/97→09/01					
1.4 16V	55	10/99→09/01					
1.6	55	05/97→09/01					
1.6	74	05/97→09/01					
1.9 SDI	47	06/97→09/01					
1.9 SDI	50	08/99→09/01					
1.8	66	05/97→09/01			03.6583-0179.3	320228	ATE lastabhängig 8/3 4x
1.9 TDI	66	05/97→09/01					
1.9 TDI	81	06/98→09/01					







VW - SCIROCCO (137, 138) 05/08→11/17







Bremskraftverstärker











1.4 TSI	90	08/08→11/17		09/08→; für Linkslenker; +PR 1ZK	03.7860-8802.4	300291	ATE Ø 10" pneumatisch
				09/08→; für Linkslenker; +PR 1ZD,1ZP	03.7863-3232.4	300307	ATE Ø 10" pneumatisch
				09/08→; für Linkslenker; +PR 1ZA,1ZE,1LJ	03.7863-3332.4	300308	ATE Ø 10" pneumatisch
1.4 TSI	92	11/13→11/17		+PR 1ZK; für Linkslenker	03.7860-8802.4	300291	ATE Ø 10" pneumatisch
1.4 TSI	110	07/15→11/17		für Linkslenker; +PR 1ZD,1ZP	03.7863-3232.4	300307	ATE Ø 10" pneumatisch
2.0 R	188	11/09→11/17		für Linkslenker; +PR 1ZA,1ZE,1LJ	03.7863-3332.4	300308	ATE Ø 10" pneumatisch
2.0 R	195	11/09→11/17					
2.0 TDI	100	11/10→11/17					
2.0 TDI	110	11/13→11/17					
2.0 TDI	125	05/09→11/17					
2.0 TDI	130	01/13→11/17					
2.0 TDI	135	05/14→11/17					
2.0 TSI	132	11/13→11/17					
2.0 TSI	155	11/09→11/17					
2.0 TSI	162	11/13→11/17					
1.4 TSI	118	05/08→11/17		08/08→; +PR 1ZK; für Linkslenker	03.7860-8802.4	300291	ATE Ø 10" pneumatisch
2.0 TSI	147	05/08→11/09		08/08→; +PR 1ZD,1ZP; für Linkslenker	03.7863-3232.4	300307	ATE Ø 10" pneumatisch
				08/08→; +PR 1ZA,1ZE,1LJ; für Linkslenker	03.7863-3332.4	300308	ATE Ø 10" pneumatisch
2.0 R	206	05/14→11/17		08/14→; für Linkslenker; +PR 1ZK	03.7860-8802.4	300291	ATE Ø 10" pneumatisch
				08/14→; für Linkslenker; +PR 1ZD,1ZP	03.7863-3232.4	300307	ATE Ø 10" pneumatisch
				08/14→; für Linkslenker; +PR 1ZA,1ZE,1LJ	03.7863-3332.4	300308	ATE Ø 10" pneumatisch
2.0 TDI	103	08/08→11/17		10/08→; +PR 1ZK; für Linkslenker	03.7860-8802.4	300291	ATE Ø 10" pneumatisch
				10/08→; +PR 1ZD,1ZP; für Linkslenker	03.7863-3232.4	300307	ATE Ø 10" pneumatisch
				10/08→; +PR 1ZA,1ZE,1LJ; für Linkslenker	03.7863-3332.4	300308	ATE Ø 10" pneumatisch











Hauptbremszylinder











1.4 TSI	90	08/08→11/17		09/08→; +PR 1ZD,1ZP; für Linkslenker	03.2122-2129.3	010799	ATE Ø 22,2
				09/08→; +PR 1ZA,1ZE,1LJ,1ZK; für Linkslenker	03.2123-3449.3	010808	ATE Ø 23,81
				09/08→; +PR 1ZD,1ZP; für Rechtslenker	24.4152-0132.3	011025	ATE Ø 22,2 ohne Bremsflüssigkeitsbehälter
↓							











	kw			 	! #		
VW - SCIROCCO (137, 138) 05/08→11/17							
Hauptbremszylinder							
1.4 TSI	90	08/08→11/17		09/08→; +PR 1ZA,1ZE,1LJ,1ZK; für Rechtslenker		24.4153-0202.3 011027	ATE Ø 23,81 ohne Bremsflüssigkeitsbehälter
1.4 TSI	92	11/13→11/17		für Linkslenker; +PR 1ZD,1ZP		03.2122-2129.3 010799	ATE Ø 22,2
1.4 TSI	110	07/15→11/17		für Linkslenker; +PR 1ZA,1ZE,1LJ,1ZK		03.2123-3449.3 010808	ATE Ø 23,81
2.0 R	188	11/09→11/17		für Rechtslenker; +PR 1ZD,1ZP		24.4152-0132.3 011025	ATE Ø 22,2 ohne Bremsflüssigkeitsbehälter
2.0 R	195	11/09→11/17		für Rechtslenker; +PR 1ZD,1ZP		24.4152-0132.3 011025	ATE Ø 22,2 ohne Bremsflüssigkeitsbehälter
2.0 TDI	100	11/10→11/17		für Rechtslenker; +PR 1ZA,1ZE,1LJ,1ZK		24.4153-0202.3 011027	ATE Ø 23,81 ohne Bremsflüssigkeitsbehälter
2.0 TDI	110	11/13→11/17		für Rechtslenker; +PR 1ZA,1ZE,1LJ,1ZK		24.4153-0202.3 011027	ATE Ø 23,81 ohne Bremsflüssigkeitsbehälter
2.0 TDI	125	05/09→11/17		für Rechtslenker; +PR 1ZA,1ZE,1LJ,1ZK		24.4153-0202.3 011027	ATE Ø 23,81 ohne Bremsflüssigkeitsbehälter
2.0 TDI	130	01/13→11/17		für Rechtslenker; +PR 1ZA,1ZE,1LJ,1ZK		24.4153-0202.3 011027	ATE Ø 23,81 ohne Bremsflüssigkeitsbehälter
2.0 TDI	135	05/14→11/17		für Rechtslenker; +PR 1ZA,1ZE,1LJ,1ZK		24.4153-0202.3 011027	ATE Ø 23,81 ohne Bremsflüssigkeitsbehälter
2.0 TSI	132	11/13→11/17		für Rechtslenker; +PR 1ZA,1ZE,1LJ,1ZK		24.4153-0202.3 011027	ATE Ø 23,81 ohne Bremsflüssigkeitsbehälter
2.0 TSI	155	11/09→11/17		für Rechtslenker; +PR 1ZA,1ZE,1LJ,1ZK		24.4153-0202.3 011027	ATE Ø 23,81 ohne Bremsflüssigkeitsbehälter
2.0 TSI	162	11/13→11/17		für Rechtslenker; +PR 1ZA,1ZE,1LJ,1ZK		24.4153-0202.3 011027	ATE Ø 23,81 ohne Bremsflüssigkeitsbehälter
1.4 TSI	118	05/08→11/17		08/08→; +PR 1ZD,1ZP; für Linkslenker		03.2122-2129.3 010799	ATE Ø 22,2
2.0 TSI	147	05/08→11/09		08/08→; +PR 1ZA,1ZE,1LJ,1ZK; für Linkslenker		03.2123-3449.3 010808	ATE Ø 23,81
				08/08→; +PR 1ZD,1ZP; für Rechtslenker		24.4152-0132.3 011025	ATE Ø 22,2 ohne Bremsflüssigkeitsbehälter
				08/08→; +PR 1ZA,1ZE,1LJ,1ZK; für Rechtslenker		24.4153-0202.3 011027	ATE Ø 23,81 ohne Bremsflüssigkeitsbehälter
2.0 R	206	05/14→11/17		08/14→; für Linkslenker; +PR 1ZD,1ZP		03.2122-2129.3 010799	ATE Ø 22,2
				08/14→; für Linkslenker; +PR 1ZA,1ZE,1LJ,1ZK		03.2123-3449.3 010808	ATE Ø 23,81
				08/14→; für Rechtslenker; +PR 1ZD,1ZP		24.4152-0132.3 011025	ATE Ø 22,2 ohne Bremsflüssigkeitsbehälter
				08/14→; für Rechtslenker; +PR 1ZA,1ZE,1LJ,1ZK		24.4153-0202.3 011027	ATE Ø 23,81 ohne Bremsflüssigkeitsbehälter
2.0 TDI	103	08/08→11/17		10/08→; +PR 1ZD,1ZP; für Linkslenker		03.2122-2129.3 010799	ATE Ø 22,2
				10/08→; +PR 1ZA,1ZE,1LJ,1ZK; für Linkslenker		03.2123-3449.3 010808	ATE Ø 23,81
				10/08→; +PR 1ZD,1ZP; für Rechtslenker		24.4152-0132.3 011025	ATE Ø 22,2 ohne Bremsflüssigkeitsbehälter
				10/08→; +PR 1ZA,1ZE,1LJ,1ZK; für Rechtslenker		24.4153-0202.3 011027	ATE Ø 23,81 ohne Bremsflüssigkeitsbehälter
Drucksensor, Bremskraftverstärker							
1.4 TSI	90	08/08→11/17		09/08→; +PR 1ZD,1ZP		03.0655-0101.2 370008	ATE
				09/08→; +PR 1ZK		03.0655-0101.2 370008	ATE
				09/08→; für Linkslenker; +PR 1ZA,1ZE,1LJ		03.0655-0101.2 370008	ATE
				09/08→; für Rechtslenker; +PR 1ZA,1ZB,1ZE,1LJ		03.0655-0101.2 370008	ATE
1.4 TSI	92	11/13→11/17		für Linkslenker; +PR 1ZA,1ZE,1LJ		03.0655-0101.2 370008	ATE
1.4 TSI	110	07/15→11/17		+PR 1ZK		03.0655-0101.2 370008	ATE
2.0 R	188	11/09→11/17		+PR 1ZD,1ZP		03.0655-0101.2 370008	ATE
2.0 R	195	11/09→11/17		+PR 1ZD,1ZP		03.0655-0101.2 370008	ATE
2.0 TDI	100	11/10→11/17		für Rechtslenker; +PR 1ZA,1ZB,1ZE,1LJ		03.0655-0101.2 370008	ATE
2.0 TDI	110	11/13→11/17		für Rechtslenker; +PR 1ZA,1ZB,1ZE,1LJ		03.0655-0101.2 370008	ATE
2.0 TDI	125	05/09→11/17		für Rechtslenker; +PR 1ZA,1ZB,1ZE,1LJ		03.0655-0101.2 370008	ATE
2.0 TDI	130	01/13→11/17		für Rechtslenker; +PR 1ZA,1ZB,1ZE,1LJ		03.0655-0101.2 370008	ATE
2.0 TDI	135	05/14→11/17		für Rechtslenker; +PR 1ZA,1ZB,1ZE,1LJ		03.0655-0101.2 370008	ATE
2.0 TSI	132	11/13→11/17		für Rechtslenker; +PR 1ZA,1ZB,1ZE,1LJ		03.0655-0101.2 370008	ATE
2.0 TSI	155	11/09→11/17		für Rechtslenker; +PR 1ZA,1ZB,1ZE,1LJ		03.0655-0101.2 370008	ATE
2.0 TSI	162	11/13→11/17		für Rechtslenker; +PR 1ZA,1ZB,1ZE,1LJ		03.0655-0101.2 370008	ATE
1.4 TSI	118	05/08→11/17		08/08→; +PR 1ZD,1ZP		03.0655-0101.2 370008	ATE
2.0 TSI	147	05/08→11/09		08/08→; +PR 1ZK		03.0655-0101.2 370008	ATE
				08/08→; +PR 1ZA,1ZB,1ZE,1LJ; für Rechtslenker		03.0655-0101.2 370008	ATE
				08/08→; +PR 1ZA,1ZE,1LJ; für Linkslenker		03.0655-0101.2 370008	ATE
2.0 R	206	05/14→11/17		08/14→; +PR 1ZD,1ZP		03.0655-0101.2 370008	ATE
				08/14→; +PR 1ZK		03.0655-0101.2 370008	ATE
				08/14→; für Linkslenker; +PR 1ZA,1ZE,1LJ		03.0655-0101.2 370008	ATE
				08/14→; für Rechtslenker; +PR 1ZA,1ZB,1ZE,1LJ		03.0655-0101.2 370008	ATE
2.0 TDI	103	08/08→11/17		10/08→; +PR 1ZA,1ZE,1LJ; für Linkslenker		03.0655-0101.2 370008	ATE
				10/08→; +PR 1ZA,1ZB,1ZE,1LJ; für Rechtslenker		03.0655-0101.2 370008	ATE
				10/08→; +PR 1ZD,1ZP		03.0655-0101.2 370008	ATE
				10/08→; +PR 1ZK		03.0655-0101.2 370008	ATE







	kw			 	! #		
VW - SHARAN (7M8, 7M9, 7M6) 05/95→03/10							
Bremskraftverstärker							
1.8 T 20V 1.9 TDI 2.0	110 66 85	09/97→03/10 09/95→03/10 09/95→03/10		7M-W-020919→; → 04/00; für Linkslenker		03.7755-1902.4 300138	ATE Ø 9 / 8" pneumatisch
				05/02→; - ESP; für Linkslenker		03.7755-6302.4 300221	ATE Ø 9 / 8" pneumatisch
				05/00→ 04/02; +PR 1AT		03.7755-6302.4 300221	ATE Ø 9 / 8" pneumatisch
				→ 7M-W-060000; für Linkslenker		03.7760-3002.4 300120	ATE Ø 10" pneumatisch
				→ 7M-W-020918; für Rechtslenker		03.7760-3002.4 300120	ATE Ø 10" pneumatisch
				05/00→; für Linkslenker; + ESP; → 7M-3-029999		03.7858-3302.4 300122	ATE Ø 9 / 8" pneumatisch
				7M-3-030000→; + ESP; für Linkslenker		03.7858-9502.4 300205	ATE Ø 9 / 8" pneumatisch
1.9 TDI 2.8 VR6 2.8 VR6 Syncro	81 128 128	09/96→04/00 09/95→04/00 11/96→04/00		7M-W-020919→; für Linkslenker		03.7755-1902.4 300138	ATE Ø 9 / 8" pneumatisch
				→ 7M-W-060000; für Linkslenker		03.7760-3002.4 300120	ATE Ø 10" pneumatisch
				→ 7M-W-020918; für Rechtslenker		03.7760-3002.4 300120	ATE Ø 10" pneumatisch
1.9 TDI 1.9 TDI 4motion	85 85	04/00→03/10 04/00→03/10		05/02→; - ESP; für Linkslenker		03.7755-6302.4 300221	ATE Ø 9 / 8" pneumatisch
				05/00→ 04/02; +PR 1AT		03.7755-6302.4 300221	ATE Ø 9 / 8" pneumatisch
				05/00→; für Linkslenker; + ESP; → 7M-3-029999		03.7858-3302.4 300122	ATE Ø 9 / 8" pneumatisch
				7M-3-030000→; + ESP; für Linkslenker		03.7858-9502.4 300205	ATE Ø 9 / 8" pneumatisch
1.9 TDI 1.9 TDI 2.0 TDI 2.0 TDI	96 110 100 103	11/02→03/10 06/05→03/10 11/05→03/10 11/05→03/10		- ESP; für Linkslenker		03.7755-6302.4 300221	ATE Ø 9 / 8" pneumatisch
				+ ESP; für Linkslenker		03.7858-9502.4 300205	ATE Ø 9 / 8" pneumatisch
2.0 16V	110	09/95→02/00		7M-W-020919→; für Linkslenker		03.7755-1902.4 300138	ATE Ø 9 / 8" pneumatisch
				→ 7M-W-060000; für Linkslenker		03.7760-3002.4 300120	ATE Ø 10" pneumatisch
				→ 7M-W-020918; für Rechtslenker		03.7760-3002.4 300120	ATE Ø 10" pneumatisch
				7M-3-030000→; + ESP; für Linkslenker		03.7858-9502.4 300205	ATE Ø 9 / 8" pneumatisch
2.0 LPG	85	04/06→03/10		- ESP; für Linkslenker		03.7755-6302.4 300221	ATE Ø 9 / 8" pneumatisch
				→ 7M-W-060000; für Linkslenker		03.7760-3002.4 300120	ATE Ø 10" pneumatisch
				→ 7M-W-020918; für Rechtslenker		03.7760-3002.4 300120	ATE Ø 10" pneumatisch
				für Linkslenker; + ESP; → 7M-3-029999		03.7858-3302.4 300122	ATE Ø 9 / 8" pneumatisch
				7M-3-030000→; + ESP; für Linkslenker		03.7858-9502.4 300205	ATE Ø 9 / 8" pneumatisch
2.8 V6 24V 2.8 V6 24V 4motion	150 150	04/00→03/10 04/00→03/10		05/02→; - ESP; für Linkslenker		03.7755-6302.4 300221	ATE Ø 9 / 8" pneumatisch
				→ 04/02; +PR 1AT		03.7755-6302.4 300221	ATE Ø 9 / 8" pneumatisch
				für Linkslenker; + ESP; → 7M-3-029999		03.7858-3302.4 300122	ATE Ø 9 / 8" pneumatisch
				7M-3-030000→; + ESP; für Linkslenker		03.7858-9502.4 300205	ATE Ø 9 / 8" pneumatisch
Pedalwegsensoren, Bremspedal							
1.8 T 20V 1.9 TDI 1.9 TDI 1.9 TDI 4motion 2.0 2.0 16V 2.0 LPG 2.8 V6 24V 2.8 V6 24V 4motion	110 66 85 85 85 110 85 150 150	09/97→03/10 09/95→03/10 04/00→03/10 04/00→03/10 09/95→03/10 09/95→02/00 04/06→03/10 04/00→03/10 04/00→03/10		7M-3-030364→; für Rechtslenker; + ESP		03.0655-0006.2 370006	ATE
				7M-3-030000→; + ESP; für Linkslenker		03.0655-0006.2 370006	ATE
1.9 TDI 1.9 TDI 2.0 TDI 2.0 TDI	96 110 100 103	11/02→03/10 06/05→03/10 11/05→03/10 11/05→03/10		+ ESP; für Linkslenker		03.0655-0006.2 370006	ATE
Hauptbremszylinder							
1.8 T 20V	110	09/97→03/10		→ 7M-W-020918; + ABS		03.2123-1526.3 010477	Ø 23,81
				→ 7M-W-020918; - ABS		03.2123-1548.3 010478	Ø 23,81
				05/02→; - ESP; für Rechtslenker		03.2125-0332.3 010952	Ø 25,4
				7M-W-020919→; - ESP; → 04/02		03.2125-0332.3 010952	Ø 25,4
				7M-W-020919→; → 04/00; - ABS		03.2125-8404.3 010583	ATE Ø 25,4
				05/00→; + ESP; → 7M-3-029999		03.2125-9604.3 010581	Ø 25,4
1.9 TDI 2.0	66 85	09/95→03/10 09/95→03/10		→ 7M-W-020918; + ABS		03.2123-1526.3 010477	Ø 23,81
				→ 7M-W-020918; - ABS		03.2123-1548.3 010478	Ø 23,81
				7M-W-020919→; - ESP; → 04/02		03.2125-0332.3 010952	Ø 25,4
				05/02→; - ESP; für Rechtslenker; → 05/05		03.2125-0332.3 010952	Ø 25,4
				7M-W-020919→; → 04/00; - ABS		03.2125-8404.3 010583	ATE Ø 25,4
				05/00→; + ESP; → 7M-3-029999		03.2125-9604.3 010581	Ø 25,4
1.9 TDI 2.0 16V 2.8 VR6 2.8 VR6 Syncro	81 110 128 128	09/96→04/00 09/95→02/00 09/95→04/00 11/96→04/00		→ 7M-W-020918; + ABS		03.2123-1526.3 010477	Ø 23,81
				→ 7M-W-020918; - ABS		03.2123-1548.3 010478	Ø 23,81
				7M-W-020919→; - ESP		03.2125-0332.3 010952	Ø 25,4

	kw			 	! #		
VW - SHARAN (7M8, 7M9, 7M6) 05/95→03/10							
 Hauptbremszylinder							
1.9 TDI 2.0 16V 2.8 VR6 2.8 VR6 Syncro	81 110 128 128	09/96→04/00 09/95→02/00 09/95→04/00 11/96→04/00		7M-W-020919→; - ABS		03.2125-8404.3 010583	ATE Ø 25,4
1.9 TDI 1.9 TDI 4motion	85 85	04/00→03/10 04/00→03/10		05/02→; - ESP; für Rechtslenker; → 05/05		03.2125-0332.3 010952	Ø 25,4
				05/00→; + ESP; → 7M-3-029999		03.2125-9604.3 010581	Ø 25,4
1.9 TDI	96	11/02→03/10		- ESP; für Rechtslenker; → 05/05		03.2125-0332.3 010952	Ø 25,4
2.0 LPG	85	04/06→03/10		→ 7M-W-020918; + ABS		03.2123-1526.3 010477	Ø 23,81
				→ 7M-W-020918; - ABS		03.2123-1548.3 010478	Ø 23,81
				+ ESP; → 7M-3-029999		03.2125-9604.3 010581	Ø 25,4
2.8 V6 24V 2.8 V6 24V 4motion	150 150	04/00→03/10 04/00→03/10		+ ESP; → 7M-3-029999		03.2125-9604.3 010581	Ø 25,4
Verschlusschraube, Hauptbremszylinder							
1.8 T 20V 1.9 TDI 1.9 TDI 2.0 2.0 16V 2.0 LPG 2.8 VR6 2.8 VR6 Syncro	110 66 81 85 110 85 128 128	09/97→03/10 09/95→03/10 09/96→04/00 09/95→03/10 09/95→02/00 04/06→03/10 09/95→04/00 11/96→04/00		→ 7M-W-020918		03.3517-5100.1 390326	
VW - SHARAN (7N1, 7N2) 05/10→							
 Bremskraftverstärker							
1.4 TSI 2.0 TDI 2.0 TDI	110 100 103	05/10→ 05/10→ 05/10→		07/10→; für Linkslenker		03.7873-4502.4 300284	ATE Ø 11" pneumatisch
2.0 TDI 2.0 TDI 2.0 TDI 2.0 TDI 4motion 2.0 TSI	85 125 130 103 147	05/11→ 08/10→ 01/13→ 05/11→ 12/10→		für Linkslenker		03.7873-4502.4 300284	ATE Ø 11" pneumatisch
 Hauptbremszylinder							
1.4 TSI 2.0 TDI 2.0 TDI	110 100 103	05/10→ 05/10→ 05/10→		07/10→; für Linkslenker		03.4153-0186.3 010816	ATE Ø 23,81
1.4 TSI 2.0 TDI 2.0 TDI 2.0 TDI 2.0 TDI 2.0 TDI 2.0 TDI 4motion 2.0 TDI 4motion 2.0 TDI 4motion 2.0 TSI 2.0 TSI	110 85 110 125 130 135 103 110 135 147 162	05/15→ 05/11→ 05/15→ 08/10→ 01/13→ 05/15→ 05/11→ 05/15→ 05/16→ 12/10→ 05/15→		für Linkslenker		03.4153-0186.3 010816	ATE Ø 23,81
VW - TIGUAN (5N_) 09/07→							
 Bremskraftverstärker							
1.4 TSI 1.4 TSI 1.4 TSI 1.4 TSI 1.4 TSI 1.4 TSI 4motion 1.4 TSI 4motion 2.0 TDI 2.0 TDI 2.0 TDI 4motion 2.0 TDI 4motion 2.0 TDI 4motion 2.0 TDI 4motion 2.0 TDI 4motion 2.0 TSI 4motion 2.0 TSI 4motion 2.0 TDI 4motion	90 92 110 110 118 110 118 81 103 110 100 110 120 130 135 132 155 103	08/10→ 05/15→ 05/08→ 05/15→ 05/11→ 09/07→ 05/11→ 05/10→ 03/08→ 05/15→ 11/07→ 05/15→ 02/08→08/09 11/12→ 05/15→ 05/11→ 05/11→ 09/07→		für Linkslenker		03.7873-4502.4 300284	ATE Ø 11" pneumatisch
2.0 TDI 4motion 2.0 TDI 4motion 2.0 TFSI 4motion 2.0 TFSI 4motion	125 125 147	09/07→ 09/07→ 09/07→ 09/07→		11/07→; für Linkslenker 01/08→; für Linkslenker 02/08→; für Linkslenker		03.7873-4502.4 300284 03.7873-4502.4 300284 03.7873-4502.4 300284	ATE Ø 11" pneumatisch ATE Ø 11" pneumatisch ATE Ø 11" pneumatisch
							↓

	kw					! #		
VW - TIGUAN (5N_) 09/07→								
 Hauptbremszylinder								
1.4 TSI	90	08/10→		für Linkslenker		03.4153-0186.3	010816	ATE Ø 23,81
1.4 TSI	92	05/15→		für Rechtslenker		24.4153-0192.3	011026	ATE Ø 23,81
1.4 TSI	110	05/08→						ohne Bremsflüssigkeitsbehälter
1.4 TSI	110	05/15→						
1.4 TSI	118	05/11→						
1.4 TSI 4motion	110	09/07→						
1.4 TSI 4motion	118	05/11→						
2.0 TDI	81	05/10→						
2.0 TDI	103	03/08→						
2.0 TDI	110	05/15→						
2.0 TDI 4motion	100	11/07→						
2.0 TDI 4motion	110	05/15→						
2.0 TDI 4motion	120	02/08→08/09						
2.0 TDI 4motion	130	11/12→						
2.0 TDI 4motion	135	05/15→						
2.0 TSI 4motion	132	05/11→						
2.0 TSI 4motion	155	05/11→						
2.0 TDI 4motion	103	09/07→		11/07→; für Linkslenker		03.4153-0186.3	010816	ATE Ø 23,81
				11/07→; für Rechtslenker		24.4153-0192.3	011026	ATE Ø 23,81 ohne Bremsflüssigkeitsbehälter
2.0 TDI 4motion	125	09/07→		01/08→; für Linkslenker		03.4153-0186.3	010816	ATE Ø 23,81
				01/08→; für Rechtslenker		24.4153-0192.3	011026	ATE Ø 23,81 ohne Bremsflüssigkeitsbehälter
2.0 TFSI 4motion	125	09/07→		02/08→; für Linkslenker		03.4153-0186.3	010816	ATE Ø 23,81
2.0 TFSI 4motion	147	09/07→		02/08→; für Rechtslenker		24.4153-0192.3	011026	ATE Ø 23,81 ohne Bremsflüssigkeitsbehälter
VW - TIGUAN (AD1) 01/16→								
 Hauptbremszylinder								
1.4 TSI	92	01/16→		für Linkslenker; +PR 1ZA,1ZD		24.4123-1719.3	011017	TRW Ø 23,81 ohne Bremsflüssigkeitsbehälter
1.4 TSI	110	05/16→						
1.4 TSI 4motion	110	05/16→						
1.6 TDI	85	05/16→						
2.0 TDI	85	05/16→						
2.0 TDI 4motion	140	04/16→						
2.0 TDI 4motion	176	05/16→						
2.0 TSI 4motion	162	06/16→						
2.0 TDI	110	01/16→		02/16→; für Linkslenker; +PR 1ZA,1ZD		24.4123-1719.3	011017	TRW Ø 23,81 ohne Bremsflüssigkeitsbehälter
2.0 TDI 4motion	110	01/16→						
2.0 TSI 4motion	132	01/16→						
VW - TOUAREG (7LA, 7L6, 7L7) 10/02→01/13								
 Bremskraftverstärker								
2.5 R5 TDI	120	08/03→05/10		12/06→; für Linkslenker; → 03/10; +PR 1LB,1LE,LF		03.7868-3702.4	300208	ATE Ø 10 / 8" pneumatisch
2.5 R5 TDI	128	01/03→05/10						
3.0 TDI	155	04/06→05/10		12/06→; für Linkslenker; → 03/10; +PR 1LA		03.7868-5302.4	300251	ATE Ø 10 / 8" pneumatisch
3.0 V6 TDI	165	11/04→05/10						
3.6 V6 FSI	206	10/05→05/10						
4.2 V8 FSI	257	06/06→05/10						
5.0 V10 TDI	230	10/02→05/10						
3.0 V6 TDI	176	11/07→05/10		→ 03/10; für Linkslenker; +PR 1LB,1LE,LF		03.7868-3702.4	300208	ATE Ø 10 / 8" pneumatisch
				→ 03/10; für Linkslenker; +PR 1LA		03.7868-5302.4	300251	ATE Ø 10 / 8" pneumatisch
5.0 R50 TDI	257	08/07→05/10		01/08→ 03/10; für Linkslenker; +PR 1LB,1LE,LF		03.7868-3702.4	300208	ATE Ø 10 / 8" pneumatisch
				01/08→ 03/10; für Linkslenker; +PR 1LA		03.7868-5302.4	300251	ATE Ø 10 / 8" pneumatisch
Pedalwegsensor, Bremspedal								
2.5 R5 TDI	120	08/03→05/10		→ 11/06		03.0655-0006.2	370006	ATE
2.5 R5 TDI	128	01/03→05/10						
3.0 TDI	155	04/06→05/10						
3.0 V6 TDI	165	11/04→05/10						
6.0 W12	331	08/04→05/10						
3.2 V6	162	10/02→11/06		11/02→ 12/05		03.0655-0006.2	370006	ATE
3.2 V6	177	11/04→11/06		→ 12/05		03.0655-0006.2	370006	ATE
3.6 V6 FSI	206	10/05→05/10		01/06→ 11/06		03.0655-0006.2	370006	ATE
4.2 V8	228	12/02→11/06				03.0655-0006.2	370006	ATE
5.0 V10 TDI	230	10/02→05/10		11/02→ 11/06		03.0655-0006.2	370006	ATE
 Hauptbremszylinder								
2.5 R5 TDI	120	08/03→05/10		für Linkslenker; → 03/10		03.2126-3014.3	010811	ATE Ø 26,99
2.5 R5 TDI	128	01/03→05/10						
3.0 TDI	155	04/06→05/10						
3.0 V6 TDI	165	11/04→05/10						
↓								

	kw			 	! #		
VW - TOUAREG (7LA, 7L6, 7L7) 10/02→01/13							
 Hauptbremszylinder							
3.0 V6 TDI	176	11/07→05/10		für Linkslenker; → 03/10		03.2126-3014.3 010811	ATE Ø 26,99
3.2 V6	162	10/02→11/06		11/02→; für Linkslenker; → 12/05		03.2126-3014.3 010811	ATE Ø 26,99
3.2 V6	177	11/04→11/06		für Linkslenker; → 12/05		03.2126-3014.3 010811	ATE Ø 26,99
3.6 V6 FSI	206	10/05→05/10		01/06→ 03/10; für Linkslenker		03.2126-3014.3 010811	ATE Ø 26,99
4.2 V8	228	12/02→11/06		für Linkslenker		03.2126-3014.3 010811	ATE Ø 26,99
4.2 V8 FSI	257	06/06→05/10		12/06→ 03/10; für Linkslenker		03.2126-3014.3 010811	ATE Ø 26,99
5.0 R50 TDI	257	08/07→05/10		01/08→ 03/10; für Linkslenker		03.2126-3014.3 010811	ATE Ø 26,99
5.0 V10 TDI	230	10/02→05/10		11/02→; für Linkslenker; → 03/10		03.2126-3014.3 010811	ATE Ø 26,99
6.0 W12	331	08/04→05/10		für Linkslenker; → 11/06		03.2126-3014.3 010811	ATE Ø 26,99
VW - TOURAN (1T1, 1T2) 02/03→05/10							
 Bremskraftverstärker							
1.4 FSI	125	11/06→05/10		für Linkslenker; +PR 1AS		03.7873-3702.4 300283	ATE Ø 11" pneumatisch
1.4 TSI EcoFuel	110	05/09→05/10					
1.6	75	07/03→05/10		für Linkslenker; +PR 1AT		03.7873-4302.4 300312	ATE Ø 11" pneumatisch
1.6 FSI	85	02/03→01/07					
1.9 TDI	66	11/04→05/10					
1.9 TDI	74	02/03→05/04					
1.9 TDI	77	08/03→05/10					
2.0 EcoFuel	80	02/06→05/09					
2.0 FSI	110	10/03→01/07					
2.0 TDI	103	12/05→05/10					
2.0 TDI 16V	103	08/03→05/10					
1.4 TSI	103	02/06→05/10		09/06→; +PR 1AS; für Linkslenker		03.7873-3702.4 300283	ATE Ø 11" pneumatisch
				09/06→; +PR 1AT; für Linkslenker		03.7873-4302.4 300312	ATE Ø 11" pneumatisch
2.0 TDI	100	02/03→05/10		08/03→; für Linkslenker; +PR 1AS		03.7873-3702.4 300283	ATE Ø 11" pneumatisch
				08/03→; für Linkslenker; +PR 1AT		03.7873-4302.4 300312	ATE Ø 11" pneumatisch
2.0 TDI	125	12/05→05/10		02/06→; +PR 1AS; für Linkslenker		03.7873-3702.4 300283	ATE Ø 11" pneumatisch
				02/06→; +PR 1AT; für Linkslenker		03.7873-4302.4 300312	ATE Ø 11" pneumatisch
 Hauptbremszylinder							
1.4 FSI	125	11/06→05/10		für Linkslenker; +PR 1ZE,1ZP		03.2122-2129.3 010799	ATE Ø 22,2
1.6	75	07/03→05/10					
1.9 TDI	66	11/04→05/10		1T-6-100 001→; für Rechtslenker		24.4152-0132.3 011025	ATE Ø 22,2 ohne Bremsflüssigkeitsbehälter
1.9 TDI	74	02/03→05/04					
1.9 TDI	77	08/03→05/10					
2.0 EcoFuel	80	02/06→05/09					
2.0 FSI	110	10/03→01/07					
2.0 TDI	103	12/05→05/10					
2.0 TDI 16V	103	08/03→05/10					
1.4 TSI	103	02/06→05/10		09/06→; +PR 1ZE,1ZP; für Linkslenker		03.2122-2129.3 010799	ATE Ø 22,2
				1T-6-100 001→; für Rechtslenker		24.4152-0132.3 011025	ATE Ø 22,2 ohne Bremsflüssigkeitsbehälter
1.4 TSI EcoFuel	110	05/09→05/10		für Linkslenker		03.2122-2129.3 010799	ATE Ø 22,2
1.6 FSI	85	02/03→01/07		1T-6-100 001→; für Rechtslenker		24.4152-0132.3 011025	ATE Ø 22,2 ohne Bremsflüssigkeitsbehälter
2.0 TDI	100	02/03→05/10		08/03→; für Linkslenker; +PR 1ZE,1ZP		03.2122-2129.3 010799	ATE Ø 22,2
				1T-6-100 001→; für Rechtslenker		24.4152-0132.3 011025	ATE Ø 22,2 ohne Bremsflüssigkeitsbehälter
2.0 TDI	125	12/05→05/10		02/06→; für Linkslenker; +PR 1ZE,1ZP		03.2122-2129.3 010799	ATE Ø 22,2
				1T-6-100 001→; für Rechtslenker		24.4152-0132.3 011025	ATE Ø 22,2 ohne Bremsflüssigkeitsbehälter
Hydraulikaggregat, Bremsanlage							
1.4 FSI	125	11/06→05/10		+PR 1AT,1AS		24.9145-0001.2 399005	
1.4 TSI EcoFuel	110	05/09→05/10					
1.6	75	07/03→05/10					
1.6 FSI	85	02/03→01/07					
1.9 TDI	66	11/04→05/10					
1.9 TDI	74	02/03→05/04					
1.9 TDI	77	08/03→05/10					
2.0 EcoFuel	80	02/06→05/09					
2.0 FSI	110	10/03→01/07					
2.0 TDI	103	12/05→05/10					
2.0 TDI 16V	103	08/03→05/10					
1.4 TSI	103	02/06→05/10		09/06→; +PR 1AT,1AS		24.9145-0001.2 399005	
2.0 TDI	100	02/03→05/10		08/03→; +PR 1AT,1AS		24.9145-0001.2 399005	
2.0 TDI	125	12/05→05/10		02/06→; +PR 1AT,1AS		24.9145-0001.2 399005	
Drucksensor, Bremskraftverstärker							
1.4 FSI	125	11/06→05/10		für Rechtslenker; +PR 1AS		03.0655-0101.2 370008	ATE

	kw			 	! #		
VW - TOURAN (1T1, 1T2) 02/03→05/10							
Drucksensor, Bremskraftverstärker							
1.4 TSI EcoFuel	110	05/09→05/10		für Rechtslenker; +PR 1AS		03.0655-0101.2 370008	ATE
1.6	75	07/03→05/10					
1.6 FSI	85	02/03→01/07					
1.9 TDI	66	11/04→05/10					
1.9 TDI	74	02/03→05/04					
1.9 TDI	77	08/03→05/10					
2.0 EcoFuel	80	02/06→05/09					
2.0 FSI	110	10/03→01/07					
2.0 TDI	103	12/05→05/10					
2.0 TDI 16V	103	08/03→05/10					
1.4 TSI	103	02/06→05/10		09/06→; +PR 1AS; für Rechtslenker		03.0655-0101.2 370008	ATE
2.0 TDI	100	02/03→05/10		08/03→; für Rechtslenker; +PR 1AS		03.0655-0101.2 370008	ATE
2.0 TDI	125	12/05→05/10		02/06→; +PR 1AS; für Rechtslenker		03.0655-0101.2 370008	ATE
VW - TOURAN (1T3) 05/10→05/15							
 Bremskraftverstärker							
1.2 TSI	77	05/10→05/15		für Linkslenker; +PR 1AS		03.7873-3702.4 300283	ATE Ø 11" pneumatisch
1.4 TSI	103	05/10→05/15					
1.4 TSI	125	05/10→05/15		für Linkslenker; +PR 1AT		03.7873-4302.4 300312	ATE Ø 11" pneumatisch
1.4 TSI EcoFuel	110	05/10→05/15					
1.6 TDI	66	05/10→05/15					
1.6 TDI	77	05/10→05/15					
2.0 TDI	81	11/10→05/15					
2.0 TDI	103	05/10→05/15					
2.0 TDI	125	05/10→01/13					
2.0 TDI	130	01/13→05/15		für Linkslenker		03.7873-4302.4 300312	ATE Ø 11" pneumatisch
 Hauptbremszylinder							
1.2 TSI	77	05/10→05/15		für Linkslenker; +PR 1ZE,1ZP		03.2122-2129.3 010799	ATE Ø 22,2
1.4 TSI	103	05/10→05/15					
1.4 TSI	125	05/10→05/15		1T-6-100 001→; für Rechtslenker		24.4152-0132.3 011025	ATE Ø 22,2 ohne Bremsflüssigkeitsbehälter
1.6 TDI	66	05/10→05/15					
1.6 TDI	77	05/10→05/15					
2.0 TDI	81	11/10→05/15					
2.0 TDI	103	05/10→05/15					
2.0 TDI	125	05/10→01/13					
1.4 TSI EcoFuel	110	05/10→05/15		für Linkslenker		03.2122-2129.3 010799	ATE Ø 22,2
				1T-6-100 001→; für Rechtslenker		24.4152-0132.3 011025	ATE Ø 22,2 ohne Bremsflüssigkeitsbehälter
2.0 TDI	130	01/13→05/15		für Linkslenker		03.2122-2129.3 010799	ATE Ø 22,2
				für Rechtslenker		24.4152-0132.3 011025	ATE Ø 22,2 ohne Bremsflüssigkeitsbehälter
Hydraulikaggregat, Bremsanlage							
1.2 TSI	77	05/10→05/15		→ 12/10; +PR 1AT,1AS		24.9145-0001.2 399005	
1.4 TSI	103	05/10→05/15					
1.4 TSI	125	05/10→05/15					
1.4 TSI EcoFuel	110	05/10→05/15					
1.6 TDI	66	05/10→05/15					
1.6 TDI	77	05/10→05/15					
2.0 TDI	81	11/10→05/15					
2.0 TDI	103	05/10→05/15					
2.0 TDI	125	05/10→01/13					
Drucksensor, Bremskraftverstärker							
1.2 TSI	77	05/10→05/15		für Rechtslenker; +PR 1AS		03.0655-0101.2 370008	ATE
1.4 TSI	103	05/10→05/15					
1.4 TSI	125	05/10→05/15					
1.4 TSI EcoFuel	110	05/10→05/15					
1.6 TDI	66	05/10→05/15					
1.6 TDI	77	05/10→05/15					
2.0 TDI	81	11/10→05/15					
2.0 TDI	103	05/10→05/15					
2.0 TDI	125	05/10→01/13					
VW - TOURAN (5T1) 05/15→							
 Hauptbremszylinder							
1.2 TSI	81	05/15→		09/15→; für Linkslenker		24.4123-1719.3 011017	TRW Ø 23,81 ohne Bremsflüssigkeitsbehälter
1.4 TSI	110	05/15→					
1.6 TDI	81	05/15→05/16					
2.0 TDI	110	05/15→					
1.6 TDI	85	05/16→		für Linkslenker		24.4123-1719.3 011017	TRW Ø 23,81 ohne Bremsflüssigkeitsbehälter
1.8 TSI	132	11/15→					
2.0 TDI	140	11/15→					

	kw					! #			
VW - TRANSPORTER T4 Bus (70B, 70C, 7DB, 7DK, 70J, 70K, 7DC, 7DJ) 09/90→06/03									
Bremskraftverstärker									
1.9 D	44	09/90→12/95		07/95→; für Rechtslenker;			03.7750-7402.4	300084	ATE Ø 9" pneumatisch
1.9 D	45	09/90→12/95		→ 70-T-199000					
2.4 D	57	09/90→04/98		→ 70-S-127805			03.7750-7402.4	300084	ATE Ø 9" pneumatisch
				70-T-200001→			03.7755-4202.4	300164	ATE Ø 9 / 8" pneumatisch
				70-S-127806→; → 06/95			03.7755-4202.4	300164	ATE Ø 9 / 8" pneumatisch
				07/95→; für Linkslenker; → 70-T-199000			03.7755-4202.4	300164	ATE Ø 9 / 8" pneumatisch
1.9 TD	50	10/92→04/03		07/95→; für Rechtslenker;			03.7750-7402.4	300084	ATE Ø 9" pneumatisch
2.0	62	09/90→04/03		→ 70-T-199000					
2.5	81	11/90→06/03		→ 70-S-127805			03.7750-7402.4	300084	ATE Ø 9" pneumatisch
2.5 Syncro	81	11/92→04/03		70-T-200001→			03.7755-4202.4	300164	ATE Ø 9 / 8" pneumatisch
				70-S-127806→; → 06/95			03.7755-4202.4	300164	ATE Ø 9 / 8" pneumatisch
				07/95→; für Linkslenker; → 70-T-199000			03.7755-4202.4	300164	ATE Ø 9 / 8" pneumatisch
				05/98→			03.7755-4302.4	300165	ATE Ø 9 / 8" pneumatisch
2.4 D	55	08/97→04/03		für Rechtslenker; → 70-T-199000			03.7750-7402.4	300084	ATE Ø 9" pneumatisch
2.5	85	08/96→04/03		→ 70-S-127805			03.7750-7402.4	300084	ATE Ø 9" pneumatisch
2.5 Syncro	85	07/96→04/03		für Linkslenker; → 70-T-199000			03.7755-4202.4	300164	ATE Ø 9 / 8" pneumatisch
				70-T-200001→			03.7755-4202.4	300164	ATE Ø 9 / 8" pneumatisch
				05/98→			03.7755-4302.4	300165	ATE Ø 9 / 8" pneumatisch
2.4 D Syncro	57	10/92→09/98		07/95→; für Rechtslenker;			03.7750-7402.4	300084	ATE Ø 9" pneumatisch
				→ 70-T-199000					
				11/92→; → 70-S-127805			03.7750-7402.4	300084	ATE Ø 9" pneumatisch
				70-T-200001→			03.7755-4202.4	300164	ATE Ø 9 / 8" pneumatisch
				07/95→; für Linkslenker; → 70-T-199000			03.7755-4202.4	300164	ATE Ø 9 / 8" pneumatisch
				70-S-127806→; → 06/95			03.7755-4202.4	300164	ATE Ø 9 / 8" pneumatisch
				05/98→			03.7755-4302.4	300165	ATE Ø 9 / 8" pneumatisch
2.5 TDI	65	05/98→04/03		für Rechtslenker; → 70-T-199000			03.7750-7402.4	300084	ATE Ø 9" pneumatisch
2.5 TDI	111	05/98→04/03		für Linkslenker; → 70-T-199000			03.7755-4202.4	300164	ATE Ø 9 / 8" pneumatisch
2.8 VR6	150	04/00→04/03		70-T-200001→			03.7755-4202.4	300164	ATE Ø 9 / 8" pneumatisch
							03.7755-4302.4	300165	ATE Ø 9 / 8" pneumatisch
2.5 TDI	75	09/95→04/03		für Rechtslenker; → 70-T-199000			03.7750-7402.4	300084	ATE Ø 9" pneumatisch
2.5 TDI Syncro	75	01/96→04/03		für Linkslenker; → 70-T-199000			03.7755-4202.4	300164	ATE Ø 9 / 8" pneumatisch
2.8 VR 6	103	11/95→04/00		70-T-200001→			03.7755-4202.4	300164	ATE Ø 9 / 8" pneumatisch
				05/98→			03.7755-4302.4	300165	ATE Ø 9 / 8" pneumatisch
Hauptbremszylinder									
1.9 D	44	09/90→12/95		→ 70-S-127805; für Linkslenker; + ABS			03.2122-0646.3	010133	Ø 22,2
1.9 D	45	09/90→12/95		→ 70-S-127805; für Linkslenker; - ABS			03.2122-1042.3	010137	Ø 22,2
				70-S-127806→; + ABS			03.2123-1526.3	010477	Ø 23,81
				70-S-127806→; für Linkslenker; - ABS			03.2123-1548.3	010478	Ø 23,81
				70-Y-027264→; + ESP			03.2125-9704.3	010603	ATE Ø 25,4
1.9 TD	50	10/92→04/03		→ 70-S-127805; für Linkslenker; + ABS			03.2122-0646.3	010133	Ø 22,2
2.0	62	09/90→04/03		→ 70-S-127805; für Linkslenker; - ABS			03.2122-1042.3	010137	Ø 22,2
2.4 D	57	09/90→04/98		70-S-127806→; + ABS			03.2123-1526.3	010477	Ø 23,81
2.5	81	11/90→06/03		70-S-127806→; für Linkslenker; - ABS			03.2123-1548.3	010478	Ø 23,81
2.5 Syncro	81	11/92→04/03		05/96→; - ABS; +PR 1LU			03.2125-8111.3	010479	Ø 25,4
				70-Y-027264→; + ESP			03.2125-9704.3	010603	ATE Ø 25,4
				05/96→; - ESP			03.2125-9704.3	010603	ATE Ø 25,4
2.4 D	55	08/97→04/03		→ 70-S-127805; für Linkslenker; + ABS			03.2122-0646.3	010133	Ø 22,2
2.5	85	08/96→04/03		→ 70-S-127805; für Linkslenker; - ABS			03.2122-1042.3	010137	Ø 22,2
2.5 Syncro	85	07/96→04/03		70-S-127806→; + ABS			03.2123-1526.3	010477	Ø 23,81
				70-S-127806→; für Linkslenker; - ABS			03.2123-1548.3	010478	Ø 23,81
				- ABS; +PR 1LU			03.2125-8111.3	010479	Ø 25,4
				70-Y-027264→; + ESP			03.2125-9704.3	010603	ATE Ø 25,4
				- ESP			03.2125-9704.3	010603	ATE Ø 25,4
2.4 D Syncro	57	10/92→09/98		11/92→; → 70-S-127805;			03.2122-0646.3	010133	Ø 22,2
				für Linkslenker; + ABS					
				11/92→; → 70-S-127805;			03.2122-1042.3	010137	Ø 22,2
				für Linkslenker; - ABS					
				70-S-127806→; + ABS			03.2123-1526.3	010477	Ø 23,81
				70-S-127806→; für Linkslenker; - ABS			03.2123-1548.3	010478	Ø 23,81
				05/96→; - ABS; +PR 1LU			03.2125-8111.3	010479	Ø 25,4
				05/96→; - ESP			03.2125-9704.3	010603	ATE Ø 25,4



VW - TRANSPORTER T4 Bus (70B, 70C, 7DB, 7DK, 70J, 70K, 7DC, 7DJ) 09/90→06/03

Hauptbremszylinder

2.4 D Syncro	57	10/92→09/98		70-Y-027264→; + ESP	03.2125-9704.3 010603	ATE Ø 25,4
2.5 TDI	65	05/98→04/03		+ ABS	03.2123-1526.3 010477	Ø 23,81
2.5 TDI	111	05/98→04/03		für Linkslenker; - ABS	03.2123-1548.3 010478	Ø 23,81
2.8 VR6	150	04/00→04/03		- ABS; +PR 1LU	03.2125-8111.3 010479	Ø 25,4
				70-Y-027264→; + ESP	03.2125-9704.3 010603	ATE Ø 25,4
				- ESP	03.2125-9704.3 010603	ATE Ø 25,4
2.5 TDI	75	09/95→04/03		+ ABS	03.2123-1526.3 010477	Ø 23,81
				für Linkslenker; - ABS	03.2123-1548.3 010478	Ø 23,81
				05/96→; - ABS; +PR 1LU	03.2125-8111.3 010479	Ø 25,4
				05/96→; - ESP	03.2125-9704.3 010603	ATE Ø 25,4
				70-Y-027264→; + ESP	03.2125-9704.3 010603	ATE Ø 25,4
2.5 TDI Syncro	75	01/96→04/03		für Linkslenker; - ABS	03.2123-1548.3 010478	Ø 23,81
				05/96→; - ABS; +PR 1LU	03.2125-8111.3 010479	Ø 25,4
				70-Y-027264→; + ESP	03.2125-9704.3 010603	ATE Ø 25,4
				05/96→; - ESP	03.2125-9704.3 010603	ATE Ø 25,4
2.8 VR 6	103	11/95→04/00		+ ABS	03.2123-1526.3 010477	Ø 23,81
				für Linkslenker; - ABS	03.2123-1548.3 010478	Ø 23,81
				- ABS; +PR 1LU	03.2125-8111.3 010479	Ø 25,4
				70-Y-027264→; + ESP	03.2125-9704.3 010603	ATE Ø 25,4
				05/96→; - ESP	03.2125-9704.3 010603	ATE Ø 25,4

Verschlusschraube, Hauptbremszylinder







1.9 D	44	09/90→12/95		→ 70-S-127805; für Linkslenker; - ABS	03.3517-0101.2 390322	
1.9 D	45	09/90→12/95				
1.9 TD	50	10/92→04/03				
2.0	62	09/90→04/03				
2.4 D	55	08/97→04/03				
2.4 D	57	09/90→04/98				
2.5	81	11/90→06/03				
2.5	85	08/96→04/03				
2.5 Syncro	81	11/92→04/03				
2.5 Syncro	85	07/96→04/03				
2.4 D Syncro	57	10/92→09/98		11/92→; → 70-S-127805; für Linkslenker; - ABS	03.3517-0101.2 390322	

VW - TRANSPORTER T4 Kasten (70A, 70H, 7DA, 7DH) 07/90→04/03







Bremskraftverstärker









1.9 D	44	09/90→12/95		07/95→; für Rechtslenker;	03.7750-7402.4 300084	ATE Ø 9" pneumatisch
1.9 D	45	07/90→12/95		→ 70-T-199000		
2.4 D	57	07/90→04/98		→ 70-S-127805	03.7750-7402.4 300084	ATE Ø 9" pneumatisch
				70-T-200001→	03.7755-4202.4 300164	ATE Ø 9 / 8" pneumatisch
				70-S-127806→; → 06/95	03.7755-4202.4 300164	ATE Ø 9 / 8" pneumatisch
				07/95→; für Linkslenker; → 70-T-199000	03.7755-4202.4 300164	ATE Ø 9 / 8" pneumatisch
1.9 TD	50	10/92→04/03		07/95→; für Rechtslenker;	03.7750-7402.4 300084	ATE Ø 9" pneumatisch
2.0	62	07/90→04/03		→ 70-T-199000		
2.5	81	11/90→04/03		→ 70-S-127805	03.7750-7402.4 300084	ATE Ø 9" pneumatisch
				70-T-200001→	03.7755-4202.4 300164	ATE Ø 9 / 8" pneumatisch
				70-S-127806→; → 06/95	03.7755-4202.4 300164	ATE Ø 9 / 8" pneumatisch
				07/95→; für Linkslenker; → 70-T-199000	03.7755-4202.4 300164	ATE Ø 9 / 8" pneumatisch
				05/98→	03.7755-4302.4 300165	ATE Ø 9 / 8" pneumatisch
2.4 D	55	08/97→04/03		für Rechtslenker; → 70-T-199000	03.7750-7402.4 300084	ATE Ø 9" pneumatisch
2.5	85	08/96→04/03		→ 70-S-127805	03.7750-7402.4 300084	ATE Ø 9" pneumatisch
2.5 Syncro	85	08/96→04/03		für Linkslenker; → 70-T-199000	03.7755-4202.4 300164	ATE Ø 9 / 8" pneumatisch
				70-T-200001→	03.7755-4202.4 300164	ATE Ø 9 / 8" pneumatisch
				05/98→	03.7755-4302.4 300165	ATE Ø 9 / 8" pneumatisch
2.4 D Syncro	57	10/92→09/98		07/95→; für Rechtslenker;	03.7750-7402.4 300084	ATE Ø 9" pneumatisch
2.5 Syncro	81	10/92→04/03		→ 70-T-199000		
				11/92→; → 70-S-127805	03.7750-7402.4 300084	ATE Ø 9" pneumatisch
				70-T-200001→	03.7755-4202.4 300164	ATE Ø 9 / 8" pneumatisch
				07/95→; für Linkslenker; → 70-T-199000	03.7755-4202.4 300164	ATE Ø 9 / 8" pneumatisch
				70-S-127806→; → 06/95	03.7755-4202.4 300164	ATE Ø 9 / 8" pneumatisch
				05/98→	03.7755-4302.4 300165	ATE Ø 9 / 8" pneumatisch
2.5 TDI	65	12/98→04/03		für Rechtslenker; → 70-T-199000	03.7750-7402.4 300084	ATE Ø 9" pneumatisch
2.5 TDI	111	09/00→04/03		für Linkslenker; → 70-T-199000	03.7755-4202.4 300164	ATE Ø 9 / 8" pneumatisch
2.8 VR6	150	06/00→04/03		70-T-200001→	03.7755-4202.4 300164	ATE Ø 9 / 8" pneumatisch























	kw					! #			
VW - TRANSPORTER T4 Kasten (70A, 70H, 7DA, 7DH) 07/90→04/03									
Bremskraftverstärker									
2.5 TDI	65	12/98→04/03					03.7755-4302.4	300165	ATE Ø 9 / 8" pneumatisch
2.5 TDI	111	09/00→04/03							
2.8 VR6	150	06/00→04/03							
2.5 TDI	75	09/95→04/03		für Rechtslenker; → 70-T-199000			03.7750-7402.4	300084	ATE Ø 9" pneumatisch
2.5 TDI Syncro	75	09/95→04/03		für Linkslenker; → 70-T-199000			03.7755-4202.4	300164	ATE Ø 9 / 8" pneumatisch
2.8 VR6	103	05/96→05/00		70-T-200001→			03.7755-4202.4	300164	ATE Ø 9 / 8" pneumatisch
				05/98→			03.7755-4302.4	300165	ATE Ø 9 / 8" pneumatisch
Hauptbremszylinder									
1.9 D	44	09/90→12/95		→ 70-S-127805; für Linkslenker; + ABS			03.2122-0646.3	010133	Ø 22,2
1.9 D	45	07/90→12/95		→ 70-S-127805; für Linkslenker; - ABS			03.2122-1042.3	010137	Ø 22,2
				70-S-127806→; + ABS			03.2123-1526.3	010477	Ø 23,81
				70-S-127806→; für Linkslenker; - ABS			03.2123-1548.3	010478	Ø 23,81
				70-Y-027264→; + ESP			03.2125-9704.3	010603	ATE Ø 25,4
1.9 TD	50	10/92→04/03		→ 70-S-127805; für Linkslenker; + ABS			03.2122-0646.3	010133	Ø 22,2
2.0	62	07/90→04/03		→ 70-S-127805; für Linkslenker; - ABS			03.2122-1042.3	010137	Ø 22,2
2.4 D	57	07/90→04/98		70-S-127806→; + ABS			03.2123-1526.3	010477	Ø 23,81
2.5	81	11/90→04/03		70-S-127806→; für Linkslenker; - ABS			03.2123-1548.3	010478	Ø 23,81
				05/96→; - ABS; +PR 1LU			03.2125-8111.3	010479	Ø 25,4
				70-Y-027264→; + ESP			03.2125-9704.3	010603	ATE Ø 25,4
				05/96→; - ESP			03.2125-9704.3	010603	ATE Ø 25,4
2.4 D	55	08/97→04/03		→ 70-S-127805; für Linkslenker; + ABS			03.2122-0646.3	010133	Ø 22,2
2.5	85	08/96→04/03		→ 70-S-127805; für Linkslenker; - ABS			03.2122-1042.3	010137	Ø 22,2
2.5 Syncro	85	08/96→04/03		70-S-127806→; + ABS			03.2123-1526.3	010477	Ø 23,81
				70-S-127806→; für Linkslenker; - ABS			03.2123-1548.3	010478	Ø 23,81
				- ABS; +PR 1LU			03.2125-8111.3	010479	Ø 25,4
				70-Y-027264→; + ESP			03.2125-9704.3	010603	ATE Ø 25,4
				- ESP			03.2125-9704.3	010603	ATE Ø 25,4
2.4 D Syncro	57	10/92→09/98		11/92→; → 70-S-127805; für Linkslenker; + ABS			03.2122-0646.3	010133	Ø 22,2
2.5 Syncro	81	10/92→04/03		11/92→; → 70-S-127805; für Linkslenker; - ABS			03.2122-1042.3	010137	Ø 22,2
				70-S-127806→; + ABS			03.2123-1526.3	010477	Ø 23,81
				70-S-127806→; für Linkslenker; - ABS			03.2123-1548.3	010478	Ø 23,81
				05/96→; - ABS; +PR 1LU			03.2125-8111.3	010479	Ø 25,4
				05/96→; - ESP			03.2125-9704.3	010603	ATE Ø 25,4
				70-Y-027264→; + ESP			03.2125-9704.3	010603	ATE Ø 25,4
2.5 TDI	65	12/98→04/03		+ ABS			03.2123-1526.3	010477	Ø 23,81
2.5 TDI	111	09/00→04/03		für Linkslenker; - ABS			03.2123-1548.3	010478	Ø 23,81
2.8 VR6	103	05/96→05/00		- ABS; +PR 1LU			03.2125-8111.3	010479	Ø 25,4
2.8 VR6	150	06/00→04/03		70-Y-027264→; + ESP			03.2125-9704.3	010603	ATE Ø 25,4
				- ESP			03.2125-9704.3	010603	ATE Ø 25,4
2.5 TDI	75	09/95→04/03		+ ABS			03.2123-1526.3	010477	Ø 23,81
				für Linkslenker; - ABS			03.2123-1548.3	010478	Ø 23,81
				05/96→; - ABS; +PR 1LU			03.2125-8111.3	010479	Ø 25,4
				05/96→; - ESP			03.2125-9704.3	010603	ATE Ø 25,4
				70-Y-027264→; + ESP			03.2125-9704.3	010603	ATE Ø 25,4
2.5 TDI Syncro	75	09/95→04/03		für Linkslenker; - ABS			03.2123-1548.3	010478	Ø 23,81
				05/96→; - ABS; +PR 1LU			03.2125-8111.3	010479	Ø 25,4
				70-Y-027264→; + ESP			03.2125-9704.3	010603	ATE Ø 25,4
				05/96→; - ESP			03.2125-9704.3	010603	ATE Ø 25,4
Verschlusschraube, Hauptbremszylinder									
1.9 D	44	09/90→12/95		→ 70-S-127805; für Linkslenker; - ABS			03.3517-0101.2	390322	
1.9 D	45	07/90→12/95							
1.9 TD	50	10/92→04/03							
2.0	62	07/90→04/03							
2.4 D	55	08/97→04/03							
2.4 D	57	07/90→04/98							
2.5	81	11/90→04/03							
2.5	85	08/96→04/03							
2.5 Syncro	85	08/96→04/03							
2.4 D Syncro	57	10/92→09/98		11/92→; → 70-S-127805; für Linkslenker; - ABS			03.3517-0101.2	390322	
2.5 Syncro	81	10/92→04/03							



	kw					! #			
VW - TRANSPORTER T4 Pritsche/Fahrgestell (70E, 70L, 70M, 7DE, 7DL 07/90→04/03)									
Bremskraftverstärker									
1.9 D	44	09/90→12/95		07/95→; für Rechtslenker;			03.7750-7402.4	300084	ATE Ø 9" pneumatisch
1.9 D	45	07/90→12/95		→ 70-T-199000					
2.4 D	57	09/90→04/98		→ 70-S-127805			03.7750-7402.4	300084	ATE Ø 9" pneumatisch
				70-T-200001→			03.7755-4202.4	300164	ATE Ø 9 / 8" pneumatisch
				70-S-127806→; → 06/95			03.7755-4202.4	300164	ATE Ø 9 / 8" pneumatisch
				07/95→; für Linkslenker; → 70-T-199000			03.7755-4202.4	300164	ATE Ø 9 / 8" pneumatisch
1.9 TD	50	10/92→04/03		07/95→; für Rechtslenker;			03.7750-7402.4	300084	ATE Ø 9" pneumatisch
2.0	62	07/90→04/03		→ 70-T-199000					
2.5	81	11/90→04/03		→ 70-S-127805			03.7750-7402.4	300084	ATE Ø 9" pneumatisch
				70-T-200001→			03.7755-4202.4	300164	ATE Ø 9 / 8" pneumatisch
				70-S-127806→; → 06/95			03.7755-4202.4	300164	ATE Ø 9 / 8" pneumatisch
				07/95→; für Linkslenker; → 70-T-199000			03.7755-4202.4	300164	ATE Ø 9 / 8" pneumatisch
				05/98→			03.7755-4302.4	300165	ATE Ø 9 / 8" pneumatisch
2.4 D	55	08/97→04/03		für Rechtslenker; → 70-T-199000			03.7750-7402.4	300084	ATE Ø 9" pneumatisch
2.5	85	08/96→04/03		→ 70-S-127805			03.7750-7402.4	300084	ATE Ø 9" pneumatisch
2.5 Syncro	85	08/96→04/03		für Linkslenker; → 70-T-199000			03.7755-4202.4	300164	ATE Ø 9 / 8" pneumatisch
				70-T-200001→			03.7755-4202.4	300164	ATE Ø 9 / 8" pneumatisch
				05/98→			03.7755-4302.4	300165	ATE Ø 9 / 8" pneumatisch
2.4 D Syncro	57	10/92→09/98		07/95→; für Rechtslenker;			03.7750-7402.4	300084	ATE Ø 9" pneumatisch
2.5 Syncro	81	10/92→04/03		→ 70-T-199000					
				11/92→; → 70-S-127805			03.7750-7402.4	300084	ATE Ø 9" pneumatisch
				70-T-200001→			03.7755-4202.4	300164	ATE Ø 9 / 8" pneumatisch
				07/95→; für Linkslenker; → 70-T-199000			03.7755-4202.4	300164	ATE Ø 9 / 8" pneumatisch
				70-S-127806→; → 06/95			03.7755-4202.4	300164	ATE Ø 9 / 8" pneumatisch
				05/98→			03.7755-4302.4	300165	ATE Ø 9 / 8" pneumatisch
2.5 TDI	65	05/98→04/03		für Rechtslenker; → 70-T-199000			03.7750-7402.4	300084	ATE Ø 9" pneumatisch
2.5 TDI Syncro	75	05/98→04/03		für Linkslenker; → 70-T-199000			03.7755-4202.4	300164	ATE Ø 9 / 8" pneumatisch
				70-T-200001→			03.7755-4202.4	300164	ATE Ø 9 / 8" pneumatisch
							03.7755-4302.4	300165	ATE Ø 9 / 8" pneumatisch
2.5 TDI	75	09/95→04/03		für Rechtslenker; → 70-T-199000			03.7750-7402.4	300084	ATE Ø 9" pneumatisch
				für Linkslenker; → 70-T-199000			03.7755-4202.4	300164	ATE Ø 9 / 8" pneumatisch
				70-T-200001→			03.7755-4202.4	300164	ATE Ø 9 / 8" pneumatisch
				05/98→			03.7755-4302.4	300165	ATE Ø 9 / 8" pneumatisch
Hauptbremszylinder									
1.9 D	44	09/90→12/95		→ 70-S-127805; für Linkslenker; + ABS			03.2122-0646.3	010133	Ø 22,2
1.9 D	45	07/90→12/95		→ 70-S-127805; für Linkslenker; - ABS			03.2122-1042.3	010137	Ø 22,2
				70-S-127806→; + ABS			03.2123-1526.3	010477	Ø 23,81
				70-S-127806→; für Linkslenker; - ABS			03.2123-1548.3	010478	Ø 23,81
				70-Y-027264→; + ESP			03.2125-9704.3	010603	ATE Ø 25,4
1.9 TD	50	10/92→04/03		→ 70-S-127805; für Linkslenker; + ABS			03.2122-0646.3	010133	Ø 22,2
2.0	62	07/90→04/03		→ 70-S-127805; für Linkslenker; - ABS			03.2122-1042.3	010137	Ø 22,2
2.4 D	57	09/90→04/98		70-S-127806→; + ABS			03.2123-1526.3	010477	Ø 23,81
2.5	81	11/90→04/03		70-S-127806→; für Linkslenker; - ABS			03.2123-1548.3	010478	Ø 23,81
				05/96→; - ABS; +PR 1LU			03.2125-8111.3	010479	Ø 25,4
				70-Y-027264→; + ESP			03.2125-9704.3	010603	ATE Ø 25,4
				05/96→; - ESP			03.2125-9704.3	010603	ATE Ø 25,4
2.4 D	55	08/97→04/03		→ 70-S-127805; für Linkslenker; + ABS			03.2122-0646.3	010133	Ø 22,2
2.5	85	08/96→04/03		→ 70-S-127805; für Linkslenker; - ABS			03.2122-1042.3	010137	Ø 22,2
2.5 Syncro	85	08/96→04/03		70-S-127806→; + ABS			03.2123-1526.3	010477	Ø 23,81
				70-S-127806→; für Linkslenker; - ABS			03.2123-1548.3	010478	Ø 23,81
				- ABS; +PR 1LU			03.2125-8111.3	010479	Ø 25,4
				70-Y-027264→; + ESP			03.2125-9704.3	010603	ATE Ø 25,4
				- ESP			03.2125-9704.3	010603	ATE Ø 25,4
2.4 D Syncro	57	10/92→09/98		11/92→; → 70-S-127805;			03.2122-0646.3	010133	Ø 22,2
2.5 Syncro	81	10/92→04/03		für Linkslenker; + ABS					
				11/92→; → 70-S-127805;			03.2122-1042.3	010137	Ø 22,2
				für Linkslenker; - ABS					
				70-S-127806→; + ABS			03.2123-1526.3	010477	Ø 23,81
				70-S-127806→; für Linkslenker; - ABS			03.2123-1548.3	010478	Ø 23,81
				05/96→; - ABS; +PR 1LU			03.2125-8111.3	010479	Ø 25,4
				05/96→; - ESP			03.2125-9704.3	010603	ATE Ø 25,4

	kw					! #		
VW - TRANSPORTER T4 Pritsche/Fahrgestell (70E, 70L, 70M, 7DE, 7DL 07/90→04/03)								
 Hauptbremszylinder								
2.4 D Syncro	57	10/92→09/98			70-Y-027264→; + ESP		03.2125-9704.3 010603	ATE Ø 25,4
2.5 Syncro	81	10/92→04/03						
2.5 TDI	65	05/98→04/03			+ ABS		03.2123-1526.3 010477	Ø 23,81
					für Linkslenker; - ABS		03.2123-1548.3 010478	Ø 23,81
					- ABS; +PR 1LU		03.2125-8111.3 010479	Ø 25,4
					70-Y-027264→; + ESP		03.2125-9704.3 010603	ATE Ø 25,4
					- ESP		03.2125-9704.3 010603	ATE Ø 25,4
2.5 TDI	75	09/95→04/03			+ ABS		03.2123-1526.3 010477	Ø 23,81
					für Linkslenker; - ABS		03.2123-1548.3 010478	Ø 23,81
					05/96→; - ABS; +PR 1LU		03.2125-8111.3 010479	Ø 25,4
					05/96→; - ESP		03.2125-9704.3 010603	ATE Ø 25,4
					70-Y-027264→; + ESP		03.2125-9704.3 010603	ATE Ø 25,4
2.5 TDI Syncro	75	05/98→04/03			für Linkslenker; - ABS		03.2123-1548.3 010478	Ø 23,81
					- ABS; +PR 1LU		03.2125-8111.3 010479	Ø 25,4
					70-Y-027264→; + ESP		03.2125-9704.3 010603	ATE Ø 25,4
					- ESP		03.2125-9704.3 010603	ATE Ø 25,4
Verschlusschraube, Hauptbremszylinder								
1.9 D	44	09/90→12/95			→ 70-S-127805; für Linkslenker; - ABS		03.3517-0101.2 390322	
1.9 D	45	07/90→12/95						
1.9 TD	50	10/92→04/03						
2.0	62	07/90→04/03						
2.4 D	55	08/97→04/03						
2.4 D	57	09/90→04/98						
2.5	81	11/90→04/03						
2.5	85	08/96→04/03						
2.5 Syncro	85	08/96→04/03						
2.4 D Syncro	57	10/92→09/98			11/92→; → 70-S-127805;		03.3517-0101.2 390322	
2.5 Syncro	81	10/92→04/03			für Linkslenker; - ABS			
VW - TRANSPORTER T5 Bus (7HB, 7HJ, 7EB, 7EJ, 7EF, 7EG, 7HF, 7EC) 04/03→08/15								
 Bremskraftverstärker								
1.9 TDI	62	01/06→11/09			+PR 1AJ,1AE,1AC,1AR;		03.7765-1002.4 300246	ATE Ø 10 / 9" pneumatisch
1.9 TDI	63	04/03→11/09			→ 7H-A-050000			
1.9 TDI	75	06/06→11/09			+PR 1AK; → 7H-A-050000		03.7868-3702.4 300208	ATE Ø 10 / 8" pneumatisch
1.9 TDI	77	04/03→11/09						
2.0	85	11/03→08/15						
2.0 BiTDI	132	09/09→08/15						
2.0 BiTDI 4motion	132	09/09→08/15						
2.0 TDI	62	09/09→08/15						
2.0 TDI	75	09/09→08/15						
2.0 TDI	103	09/09→08/15						
2.0 TDI 4motion	103	09/09→08/15						
2.5 TDi	120	11/03→11/09						
2.5 TDI	96	04/03→11/09						
2.5 TDI	128	04/03→11/09						
2.5 TDI 4motion	96	07/04→11/09						
2.5 TDI 4motion	128	07/04→11/09						
3.2 V6	173	02/04→11/09						
3.2 V6 4motion	173	11/03→11/09			07/04→; +PR 1AJ,1AE,1AC,1AR;		03.7765-1002.4 300246	ATE Ø 10 / 9" pneumatisch
					→ 7H-A-050000			
					07/04→; +PR 1AK; → 7H-A-050000		03.7868-3702.4 300208	ATE Ø 10 / 8" pneumatisch
Pedalwegsensoren, Bremspedal								
1.9 TDI	62	01/06→11/09			+PR 1AT; → 7H-A-050000		03.0655-0006.2 370006	ATE
1.9 TDI	63	04/03→11/09						
1.9 TDI	75	06/06→11/09						
1.9 TDI	77	04/03→11/09						
2.0	85	11/03→08/15						
2.0 BiTDI	132	09/09→08/15						
2.0 BiTDI 4motion	132	09/09→08/15						
2.0 TDI	62	09/09→08/15						
2.0 TDI	75	09/09→08/15						
2.0 TDI	103	09/09→08/15						
2.0 TDI 4motion	103	09/09→08/15						
2.5 TDi	120	11/03→11/09						
2.5 TDI	96	04/03→11/09						
2.5 TDI	128	04/03→11/09						
2.5 TDI 4motion	96	07/04→11/09						
2.5 TDI 4motion	128	07/04→11/09						
3.2 V6	173	02/04→11/09						
3.2 V6 4motion	173	11/03→11/09			07/04→; +PR 1AT; → 7H-A-050000		03.0655-0006.2 370006	ATE
↓								

	kw					! #		
VW - TRANSPORTER T5 Bus (7HB, 7HJ, 7EB, 7EJ, 7EF, 7EG, 7HF, 7EC) 04/03→08/15								
 Hauptbremszylinder								
1.9 TDI	62	01/06→11/09		7H-6-000001→7H-6-200000;			03.2126-3014.3 010811	ATE Ø 26,99
1.9 TDI	63	04/03→11/09		für Rechtslenker; +PR 1AT				
1.9 TDI	75	06/06→11/09		→ 7H-A-050000			03.2126-3014.3 010811	ATE Ø 26,99
1.9 TDI	77	04/03→11/09						
2.0	85	11/03→08/15		7H-A-200001→			03.2126-3144.3 010941	ATE Ø 26,99
3.2 V6	173	02/04→11/09						
2.0 BiTDI	132	09/09→08/15		→ 7H-A-050000			03.2126-3014.3 010811	ATE Ø 26,99
2.0 BiTDI 4motion	132	09/09→08/15						
2.0 TDI	62	09/09→08/15		7H-A-200001→			03.2126-3144.3 010941	ATE Ø 26,99
2.0 TDI	75	09/09→08/15						
2.0 TDI	100	05/10→08/15						
2.0 TDI	103	09/09→08/15						
2.0 TDI 4motion	100	05/10→08/15						
2.0 TDI 4motion	103	09/09→08/15						
2.5 TDi	120	11/03→11/09						
2.5 TDI	96	04/03→11/09						
2.5 TDI	128	04/03→11/09						
2.5 TDI 4motion	96	07/04→11/09						
2.5 TDI 4motion	128	07/04→11/09						
2.0 TDI	84	05/11→08/15					03.2126-3144.3 010941	ATE Ø 26,99
2.0 TSI	110	07/12→08/15						
2.0 TSI	150	05/11→08/15						
2.0 TSI 4motion	150	07/11→08/15						
3.2 V6 4motion	173	11/03→11/09		07/04→; → 7H-A-050000			03.2126-3014.3 010811	ATE Ø 26,99
				7H-A-200001→			03.2126-3144.3 010941	ATE Ø 26,99
VW - TRANSPORTER T5 Kasten (7HA, 7HH, 7EA, 7EH) 04/03→08/15								
 Bremskraftverstärker								
1.9 TDI	62	01/06→11/09		+PR 1AJ,1AE,1AC,1AR;			03.7765-1002.4 300246	ATE Ø 10 / 9" pneumatisch
1.9 TDI	63	04/03→11/09		→ 7H-A-050000				
1.9 TDI	75	06/06→11/09						
1.9 TDI	77	04/03→11/09		+PR 1AK; → 7H-A-050000			03.7868-3702.4 300208	ATE Ø 10 / 8" pneumatisch
2.0	85	11/03→08/15						
2.0 BiTDI	132	09/09→08/15						
2.0 BiTDI 4motion	132	09/09→08/15						
2.0 TDI	62	09/09→08/15						
2.0 TDI	75	09/09→08/15						
2.0 TDI	103	09/09→08/15						
2.0 TDI 4motion	103	09/09→08/15						
2.5 TDI	96	04/03→11/09						
2.5 TDI	128	04/03→11/09						
2.5 TDI 4motion	96	07/04→11/09						
2.5 TDI 4motion	128	07/04→11/09						
3.2 V6	173	02/04→11/09						
3.2 4motion	173	11/03→11/09		07/04→; +PR 1AJ,1AE,1AC,1AR;			03.7765-1002.4 300246	ATE Ø 10 / 9" pneumatisch
				→ 7H-A-050000				
				07/04→; +PR 1AK; → 7H-A-050000			03.7868-3702.4 300208	ATE Ø 10 / 8" pneumatisch
Pedalwegsensoren, Bremspedal								
1.9 TDI	62	01/06→11/09		+PR 1AT; → 7H-A-050000			03.0655-0006.2 370006	ATE
1.9 TDI	63	04/03→11/09						
1.9 TDI	75	06/06→11/09						
1.9 TDI	77	04/03→11/09						
2.0	85	11/03→08/15						
2.0 BiTDI	132	09/09→08/15						
2.0 BiTDI 4motion	132	09/09→08/15						
2.0 TDI	62	09/09→08/15						
2.0 TDI	75	09/09→08/15						
2.0 TDI	103	09/09→08/15						
2.0 TDI 4motion	103	09/09→08/15						
2.5 TDI	96	04/03→11/09						
2.5 TDI	128	04/03→11/09						
2.5 TDI 4motion	96	07/04→11/09						
2.5 TDI 4motion	128	07/04→11/09						
3.2 V6	173	02/04→11/09						
3.2 4motion	173	11/03→11/09		07/04→; +PR 1AT; → 7H-A-050000			03.0655-0006.2 370006	ATE
 Hauptbremszylinder								
1.9 TDI	62	01/06→11/09		7H-6-000001→7H-6-200000;			03.2126-3014.3 010811	ATE Ø 26,99
1.9 TDI	63	04/03→11/09		für Rechtslenker; +PR 1AT				
1.9 TDI	75	06/06→11/09		→ 7H-A-050000			03.2126-3014.3 010811	ATE Ø 26,99
1.9 TDI	77	04/03→11/09						
2.0	85	11/03→08/15		7H-A-200001→			03.2126-3144.3 010941	ATE Ø 26,99
3.2 V6	173	02/04→11/09						
2.0 BiTDI	132	09/09→08/15		→ 7H-A-050000			03.2126-3014.3 010811	ATE Ø 26,99
2.0 BiTDI 4motion	132	09/09→08/15						
2.0 TDI	62	09/09→08/15		7H-A-200001→			03.2126-3144.3 010941	ATE Ø 26,99
2.0 TDI	75	09/09→08/15						
2.0 TDI	100	05/10→08/15						

	kW					! #		
VW - TRANSPORTER T5 Kasten (7HA, 7HH, 7EA, 7EH) 04/03→08/15								
 Hauptbremszylinder								
2.0 TDI	103	09/09→08/15		→ 7H-A-050000			03.2126-3014.3 010811	ATE Ø 26,99
2.0 TDI 4motion	100	05/10→08/15						
2.0 TDI 4motion	103	09/09→08/15		7H-A-200001→			03.2126-3144.3 010941	ATE Ø 26,99
2.5 TDI	96	04/03→11/09						
2.5 TDI	128	04/03→11/09						
2.5 TDI 4motion	96	07/04→11/09						
2.5 TDI 4motion	128	07/04→11/09						
2.0 TDI	84	05/11→08/15					03.2126-3144.3 010941	ATE Ø 26,99
2.0 TSI	110	07/12→08/15						
2.0 TSI	150	05/11→08/15						
2.0 TSI 4motion	150	07/11→08/15						
3.2 4motion	173	11/03→11/09		07/04→; → 7H-A-050000			03.2126-3014.3 010811	ATE Ø 26,99
				7H-A-200001→			03.2126-3144.3 010941	ATE Ø 26,99
VW - TRANSPORTER T5 Pritsche/Fahrgestell (7JD, 7JE, 7JL, 7JY, 7JZ 04/03→08/15								
 Bremskraftverstärker								
1.9 TDI	62	01/06→11/09		→ 7J-A-010000; +PR 1AJ,1AE,1AC,1AR			03.7765-1002.4 300246	ATE Ø 10 / 9" pneumatisch
1.9 TDI	63	04/03→11/09						
1.9 TDI	75	06/06→11/09		→ 7J-A-010000; +PR 1AK			03.7868-3702.4 300208	ATE Ø 10 / 8" pneumatisch
1.9 TDI	77	04/03→11/09						
2.0	85	11/03→05/13						
2.0 BiTDI	132	09/09→08/15						
2.0 BiTDI 4motion	132	09/09→08/15						
2.0 TDI	62	09/09→08/15						
2.0 TDI	75	09/09→08/15						
2.0 TDI	103	09/09→08/15						
2.0 TDI 4motion	103	09/09→08/15						
2.5 TDI	96	04/03→11/09						
2.5 TDI	128	04/03→11/09						
2.5 TDI 4motion	96	07/04→11/09						
3.2 V6	173	08/03→05/06						
2.5 TDI 4motion	128	04/04→11/09		07/04→; → 7J-A-010000; +PR 1AJ,1AE,1AC,1AR			03.7765-1002.4 300246	ATE Ø 10 / 9" pneumatisch
				07/04→; → 7J-A-010000; +PR 1AK			03.7868-3702.4 300208	ATE Ø 10 / 8" pneumatisch
Pedalwegsensor, Bremspedal								
1.9 TDI	62	01/06→11/09		→ 7J-A-010000; +PR 1AT			03.0655-0006.2 370006	ATE
1.9 TDI	63	04/03→11/09						
1.9 TDI	75	06/06→11/09						
1.9 TDI	77	04/03→11/09						
2.0	85	11/03→05/13						
2.0 BiTDI	132	09/09→08/15						
2.0 BiTDI 4motion	132	09/09→08/15						
2.0 TDI	62	09/09→08/15						
2.0 TDI	75	09/09→08/15						
2.0 TDI	103	09/09→08/15						
2.0 TDI 4motion	103	09/09→08/15						
2.5 TDI	96	04/03→11/09						
2.5 TDI	128	04/03→11/09						
2.5 TDI 4motion	96	07/04→11/09						
3.2 V6	173	08/03→05/06						
2.5 TDI 4motion	128	04/04→11/09		07/04→; → 7J-A-010000; +PR 1AT			03.0655-0006.2 370006	ATE
 Hauptbremszylinder								
1.9 TDI	62	01/06→11/09		→ 7J-A-010000			03.2126-3014.3 010811	ATE Ø 26,99
1.9 TDI	63	04/03→11/09						
1.9 TDI	75	06/06→11/09		7J-A-200001→			03.2126-3144.3 010941	ATE Ø 26,99
1.9 TDI	77	04/03→11/09						
2.0	85	11/03→05/13						
2.0 BiTDI	132	09/09→08/15						
2.0 BiTDI 4motion	132	09/09→08/15						
2.0 TDI	62	09/09→08/15						
2.0 TDI	75	09/09→08/15						
2.0 TDI	103	09/09→08/15						
2.0 TDI 4motion	103	09/09→08/15						
2.5 TDI	96	04/03→11/09						
2.5 TDI	128	04/03→11/09						
2.5 TDI 4motion	96	07/04→11/09						
3.2 V6	173	08/03→05/06						
2.0 TDI	84	05/11→08/15					03.2126-3144.3 010941	ATE Ø 26,99
2.0 TDI	100	05/10→08/15						
2.0 TDI 4motion	100	05/10→08/15						
2.0 TSI	110	07/12→08/15						
2.5 TDI 4motion	128	04/04→11/09		07/04→; → 7J-A-010000			03.2126-3014.3 010811	ATE Ø 26,99
				7J-A-200001→			03.2126-3144.3 010941	ATE Ø 26,99

VW - UP (121, 122, BL1, BL2) 08/11→

Hauptbremszylinder

1.0	44	08/11→		12/11→; für Linkslenker	24.4120-1703.3	011015	TRW Ø 20,64
1.0	55	08/11→					ohne Bremsflüssigkeitsbehälter
1.0 EcoFuel	50	11/12→		für Linkslenker	24.4120-1703.3	011015	TRW Ø 20,64
1.0 GTI	85	11/17→					ohne Bremsflüssigkeitsbehälter
1.0 TSI	66	05/16→					









VW - VENTO (1H2) 11/91→09/98

Bremskraftverstärker

1.4	40	11/91→09/98		für Linkslenker; - ABS	03.7750-5502.4	300081	ATE Ø 9" pneumatisch
1.4	44	11/91→09/98		→ 1H-S-385334; für Linkslenker; + ABS	10.6360-1003.4	300156	ATE Ø 10" pneumatisch
1.6	55	09/92→09/98					
1.6	74	10/94→09/98		1H-S-385335→; für Linkslenker; + ABS	10.6360-2002.4	300143	ATE Ø 10" pneumatisch
1.9 D	48	11/91→09/98					
1.9 TD	55	11/91→09/98					
1.9 TDI	66	09/93→09/98					
2.0	85	11/91→09/98					
1.8	55	11/91→09/98		01/92→; für Linkslenker; - ABS	03.7750-5502.4	300081	ATE Ø 9" pneumatisch
1.8	66	11/91→09/98		01/92→; → 1H-S-385334; für Linkslenker; + ABS	10.6360-1003.4	300156	ATE Ø 10" pneumatisch
				1H-S-385335→; für Linkslenker; + ABS	10.6360-2002.4	300143	ATE Ø 10" pneumatisch
1.9 SDI	47	04/97→09/98		für Linkslenker; - ABS	03.7750-5502.4	300081	ATE Ø 9" pneumatisch
1.9 TDI	81	04/96→09/98		für Linkslenker; + ABS	10.6360-2002.4	300143	ATE Ø 10" pneumatisch
2.8 VR6	128	01/92→09/98		→ 1H-S-385334; für Linkslenker; + ABS	10.6360-1003.4	300156	ATE Ø 10" pneumatisch
				1H-S-385335→; für Linkslenker; + ABS	10.6360-2002.4	300143	ATE Ø 10" pneumatisch

Hauptbremszylinder

1.4	40	11/91→09/98		- ABS	03.2120-3943.3	010532	ATE Ø 20,64
1.4	44	11/91→09/98		1H-S-385335→; für Linkslenker; + ABS	03.2122-1144.3	010636	ATE Ø 22,2
1.9 D	48	11/91→09/98		1H-S-385335→; für Rechtslenker; + ABS	03.2122-1184.3	010592	ATE Ø 22,2
1.6	55	09/92→09/98		- ABS	03.2120-3943.3	010532	ATE Ø 20,64
				1H-S-430001→; Vollautomatik; - ABS	03.2122-1042.3	010137	Ø 22,2
				1H-S-385335→; für Linkslenker; + ABS	03.2122-1144.3	010636	ATE Ø 22,2
				1H-S-385335→; für Rechtslenker; + ABS	03.2122-1184.3	010592	ATE Ø 22,2
1.6	74	10/94→09/98		- ABS	03.2120-3943.3	010532	ATE Ø 20,64
					03.2122-1042.3	010137	Ø 22,2
				1H-S-385335→; für Linkslenker; + ABS	03.2123-1424.3	010637	ATE Ø 23,81
				1H-S-385335→; für Rechtslenker; + ABS	03.2123-1484.3	010595	ATE Ø 23,81
				→ 1H-S-385334; für Linkslenker; + ABS	10.6123-0674.3	010639	ATE Ø 23,81
1.8	55	11/91→09/98		01/92→; - ABS	03.2120-3943.3	010532	ATE Ø 20,64
				1H-S-385335→; für Linkslenker; + ABS	03.2122-1144.3	010636	ATE Ø 22,2
				1H-S-385335→; für Rechtslenker; + ABS	03.2122-1184.3	010592	ATE Ø 22,2
1.8	66	11/91→09/98		01/92→; - ABS	03.2120-3943.3	010532	ATE Ø 20,64
					03.2122-1042.3	010137	Ø 22,2
				1H-S-385335→; für Linkslenker; + ABS	03.2122-1144.3	010636	ATE Ø 22,2
				1H-S-385335→; für Rechtslenker; + ABS	03.2123-1424.3	010637	ATE Ø 23,81
				01/92→; → 1H-S-385334; für Linkslenker; + ABS	10.6123-0674.3	010639	ATE Ø 23,81
1.9 SDI	47	04/97→09/98		- ABS	03.2120-3943.3	010532	ATE Ø 20,64
				für Linkslenker; + ABS	03.2122-1144.3	010636	ATE Ø 22,2
				für Rechtslenker; + ABS	03.2122-1184.3	010592	ATE Ø 22,2
1.9 TD	55	11/91→09/98		- ABS	03.2120-3943.3	010532	ATE Ø 20,64
				1H-S-430001→; - ABS	03.2122-1042.3	010137	Ø 22,2
				1H-S-385335→; für Linkslenker; + ABS	03.2122-1144.3	010636	ATE Ø 22,2
				1H-S-385335→; für Rechtslenker; + ABS	03.2122-1184.3	010592	ATE Ø 22,2
1.9 TDI	66	09/93→09/98		- ABS	03.2122-1042.3	010137	Ø 22,2
2.0	85	11/91→09/98		1H-S-385335→; für Linkslenker; + ABS	03.2123-1424.3	010637	ATE Ø 23,81
				1H-S-385335→; für Rechtslenker; + ABS	03.2123-1484.3	010595	ATE Ø 23,81
				→ 1H-S-385334; für Linkslenker; + ABS	10.6123-0674.3	010639	ATE Ø 23,81
1.9 TDI	81	04/96→09/98		- ABS	03.2122-1042.3	010137	Ø 22,2
				für Linkslenker; + ABS	03.2123-1424.3	010637	ATE Ø 23,81
				für Rechtslenker; + ABS	03.2123-1484.3	010595	ATE Ø 23,81
2.8 VR6	128	01/92→09/98		1H-S-385335→; für Linkslenker; + ABS	03.2123-1424.3	010637	ATE Ø 23,81

	kW			 	! #		
VW - VENTO (1H2) 11/91→09/98							
 Hauptbremszylinder							
2.8 VR6	128	01/92→09/98		1H-S-385335→; für Rechtslenker; + ABS	03.2123-1484.3	010595	ATE Ø 23,81
				→ 1H-S-385334; für Linkslenker; + ABS	10.6123-0674.3	010639	ATE Ø 23,81
Verschlusschraube, Hauptbremszylinder							
1.4	40	11/91→09/98		- ABS	03.3517-0101.2	390322	
1.4	44	11/91→09/98					
1.6	74	10/94→09/98					
1.9 D	48	11/91→09/98					
1.9 SDI	47	04/97→09/98					
1.9 TDI	66	09/93→09/98					
1.9 TDI	81	04/96→09/98					
2.0	85	11/91→09/98					
1.6	55	09/92→09/98		- ABS	03.3517-0101.2	390322	
				1H-S-430001→; Vollautomatik; - ABS	03.3517-0101.2	390322	
1.8	55	11/91→09/98		01/92→; - ABS	03.3517-0101.2	390322	
1.8	66	11/91→09/98					
1.9 TD	55	11/91→09/98		1H-S-430001→; - ABS	03.3517-0101.2	390322	
				- ABS	03.3517-0101.2	390322	
 Bremskraftregler							
1.4	40	11/91→09/98			03.6584-0107.3	320110	ATE lastabhängig 8/4 4x
1.4	44	11/91→09/98					
1.6	55	09/92→09/98					
1.9 D	48	11/91→09/98					
1.9 SDI	47	04/97→09/98					
1.9 TD	55	11/91→09/98					
1.6	74	10/94→09/98			03.6584-0113.3	320111	ATE lastabhängig 8/4 4x
1.9 TDI	81	04/96→09/98					
2.0	85	11/91→09/98					
2.8 VR6	128	01/92→09/98					
1.8	55	11/91→09/98		01/92→	03.6584-0107.3	320110	ATE lastabhängig 8/4 4x
1.8	66	11/91→09/98		01/92→	03.6584-0107.3	320110	ATE lastabhängig 8/4 4x
					03.6584-0113.3	320111	ATE lastabhängig 8/4 4x
1.9 TDI	66	09/93→09/98			03.6584-0107.3	320110	ATE lastabhängig 8/4 4x
					03.6584-0113.3	320111	ATE lastabhängig 8/4 4x





DE Abbildungen Hauptbremszylinder

EN Illustrations master cylinder

ES Ilustraciones cilindro freno

FR Illustrations Maître-cylindres

IT Illustrazioni pompe Freno

2019



Abbildungen Hauptbremszylinder

Illustrations master cylinder - Ilustraciones cilindro freno - Illustrations Maître-cylindres - Illustrazioni pompe Freno

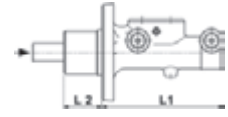

03.2022-2624.3	010588	L1 33,3	L2 113,2	03.2022-2829.3	010589	L1 36,9	L2 116,4
ø22,2/ 20,64 2x 1x M10x1 1x M12x1				ø22,2/ 20,64 M12x1 5x			

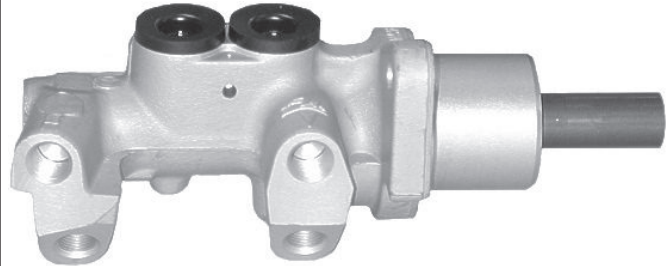
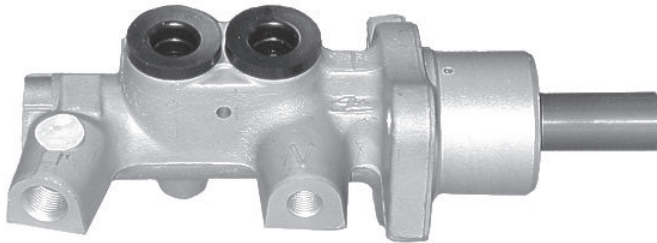

03.2023-0164.3	010014	L1 18,5	L2 159,5	03.2023-0262.3	010020	L1 17,6	L2 159
ø23,81/ 19,05 M10x1 3x				ø23,81/ 20,64 M10x1 2x			

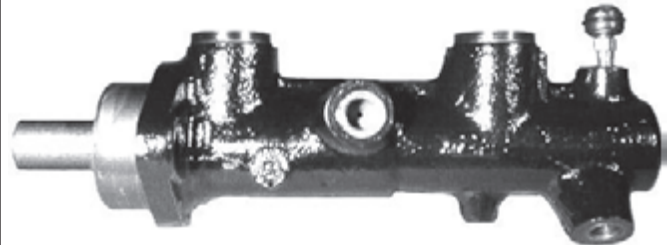
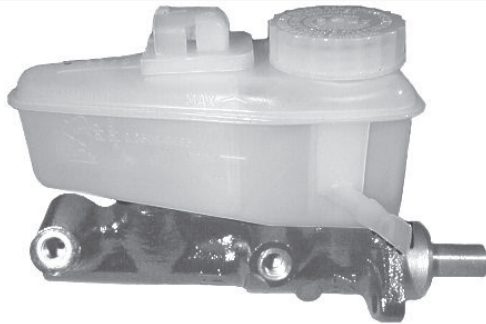

03.2023-0503.3	010022	L1 16	L2 226,5	03.2023-0542.3	010024	L1 17,6	L2 159
ø23,81/ 16,84 M10x1 4x				ø23,81/ 20,64 M10x1 3x			

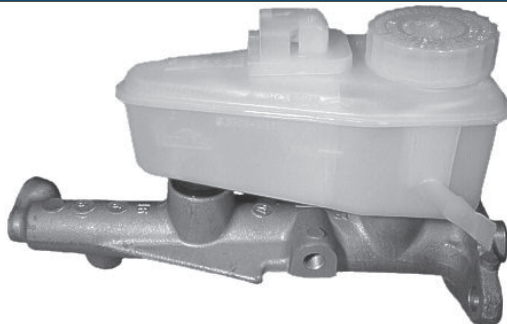

03.2023-0825.3	010028	L1 57,4	L2 109,6	03.2023-0875.3	010890	L1 16	L2 166
ø23,81/ 19,05 M10x1 3x				ø23,81/ 20,64 M10x1 4x			

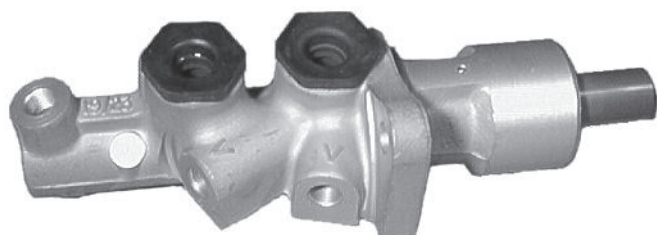

Abbildungen Hauptbremszylinder

Illustrations master cylinder - Ilustraciones cilindro freno - Illustrations Maître-cylindres - Illustrazioni pompe Freno

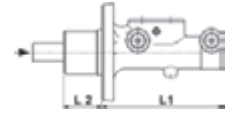

03.2023-0987.3 010473	L1 38,3	L2 131,5	03.2023-1044.3 010590	L1 41,7	L2 132,5
ø23,81/20,64 2x 1x M10x1 1x M12x1			ø23,81/20,64 3x 2x M10x1 1x M12x1		

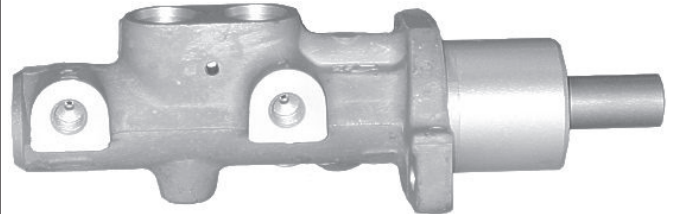
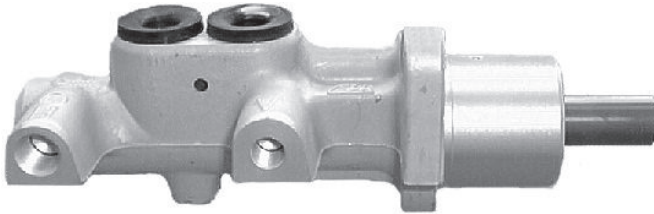

03.2023-1066.3 010032	L1 49,8	L2 109	03.2023-1084.3 010591	L1 38,3	L2 132,5
ø23,81/19,05 2x 1x M10x1 1x M12x1			ø23,81/20,64 M10x1 3x		

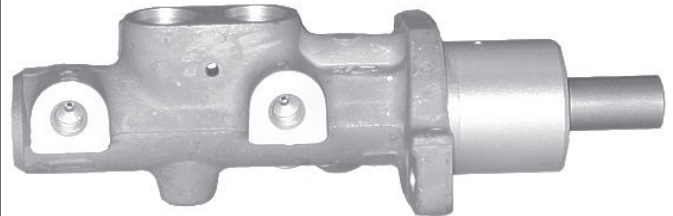
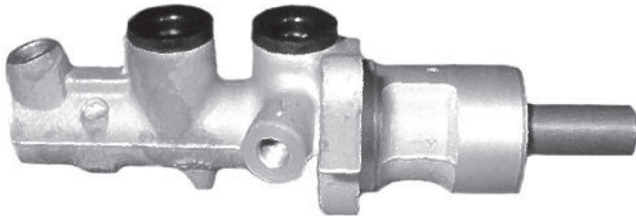

03.2023-1741.3 010703	L1 12	L2 169,5	03.2023-1812.3 010570	L1 4	L2 147
ø23,81/20,64 M12x1 4x			ø23,81/19,05 3x 1x M10x1 2x M12x1		

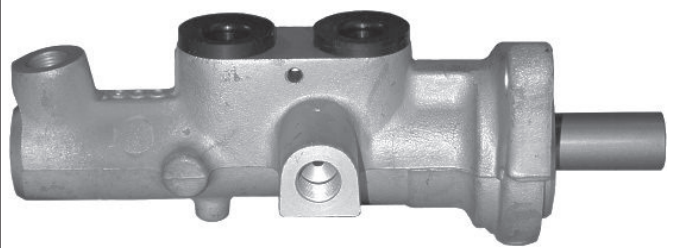

03.2023-1904.3 010724	L1 36,9	L2 116,4	03.2023-1949.3 010725	L1 35,9	L2 116,4
ø23,81/20,64 M12x1 5x			ø23,81/20,64 M12x1 4x		

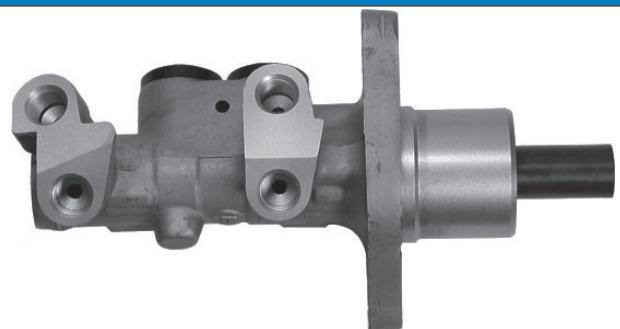
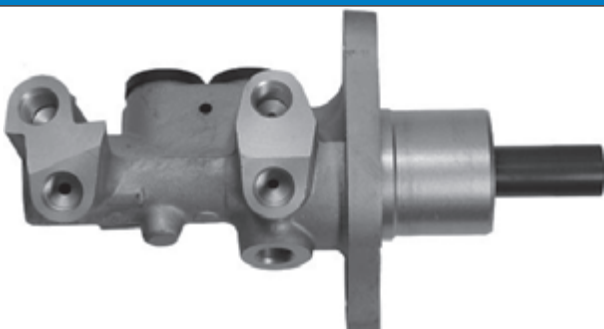

Abbildungen Hauptbremszylinder

Illustrations master cylinder - Ilustraciones cilindro freno - Illustrations Maître-cylindres - Illustrazioni pompe Freno

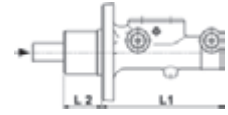

03.2023-2004.3 010788	L1 4	L2 147	03.2023-2204.3 010644	L1 36,9	L2 116,4
ø23,81/19,05 M12x1 4x			ø23,81/22,2 M12x1 5x		

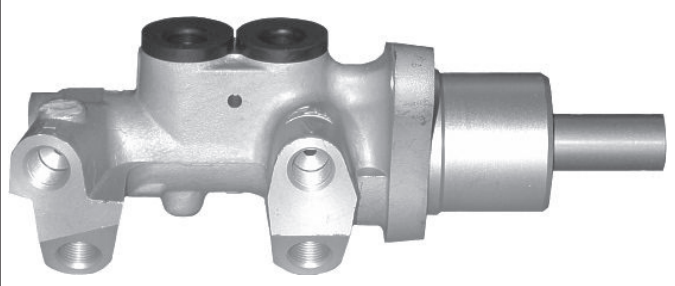
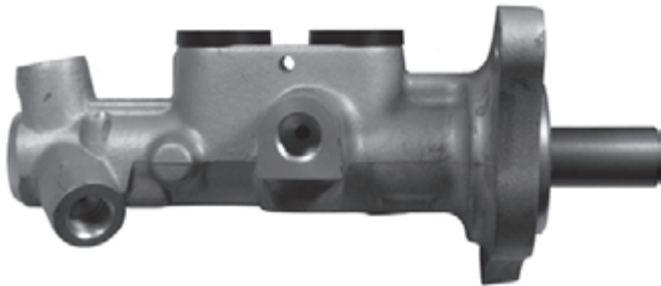

03.2023-2249.3 010869	L1 35,9	L2 116,4	03.2023-2256.3 010870	L1 35,9	L2 116,4
ø23,81/22,2 M12x1 4x			ø23,81/22,2 M12x1 2x		



03.2023-2304.3 010646	L1 32,8	L2 113,2	03.2023-2344.3 010647	L1 32,8	L2 113,2
ø23,81/22,2 2x 1x M10x1 1x M12x1			ø23,81/22,2 2x 1x M10x1 1x M12x1		

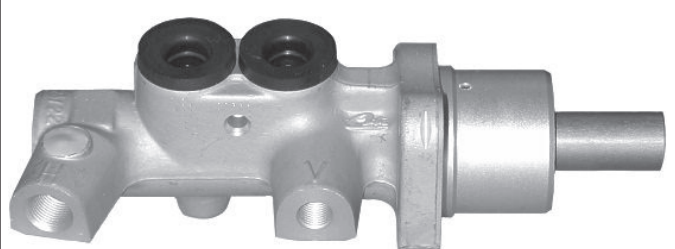
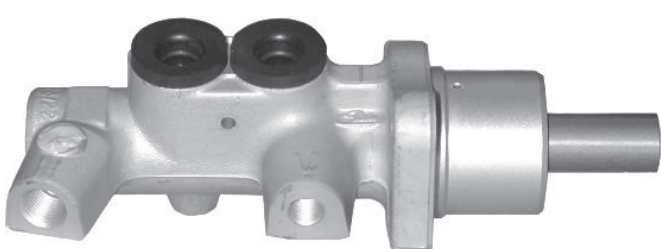

03.2023-2407.3 010796	L1 59,2	L2 105,7	03.2025-0211.3 010034	L1 57,8	L2 108
ø23,81/22,2 M12x1 2x			ø25,4/19,05 M10x1 3x		

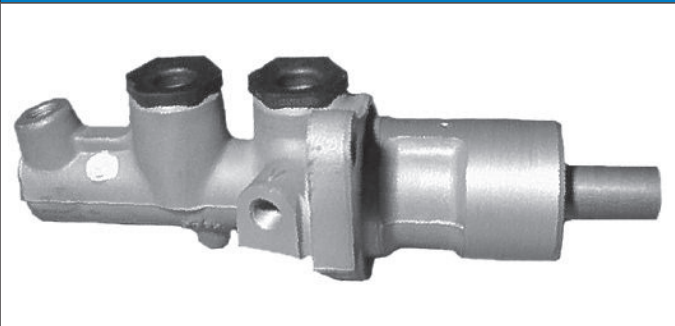
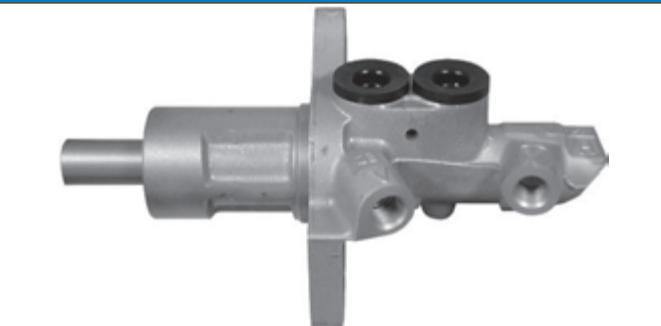

Abbildungen Hauptbremszylinder

Illustrations master cylinder - Ilustraciones cilindro freno - Illustrations Maître-cylindres - Illustrazioni pompe Freno

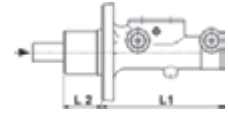

03.2025-1211.3 010475

L1
53,9 L2
118

ø25,4/ 20,64 M10x1 2x

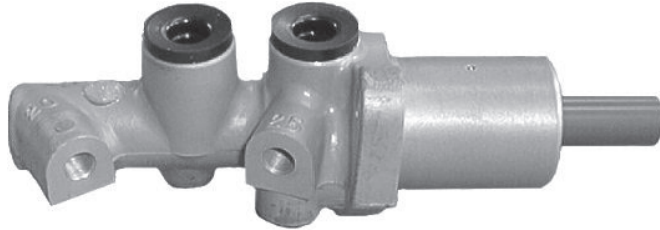

03.2025-1741.3 010705

L1
12 L2
169,5

ø25,4/ 20,64 M12x1 4x

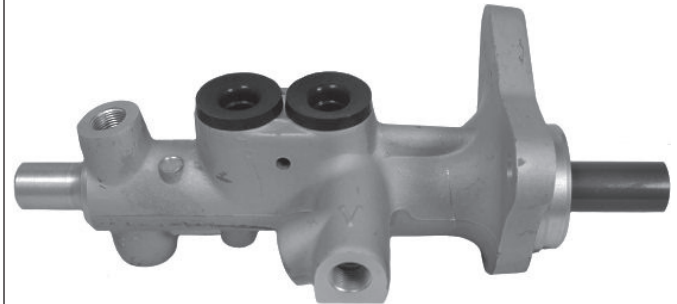

03.2025-1904.3 010797

L1
59,2 L2
105,7

ø25,4/ 22,2 M12x1 2x



03.2026-0462.3 010728

L1
57,4 L2
115,9

ø26,99/ 25,4 M10x1 2x

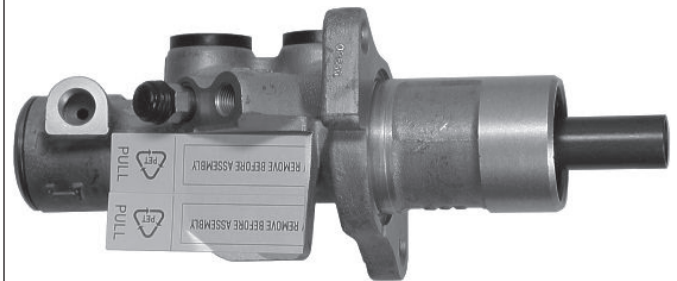

03.2026-0512.3 010038

L1
57,6 L2
115,9

ø26,99/ 25,4 M10x1 2x

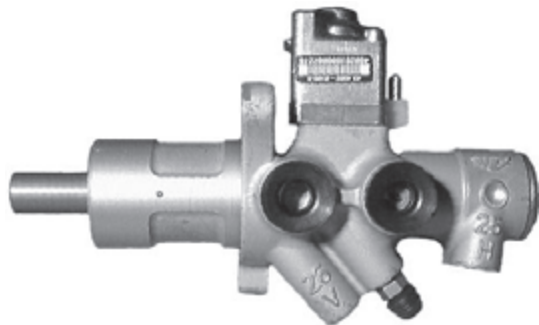

03.2026-0562.3 010729

L1
57,4 L2
115,9

ø26,99/ 25,4 2x 1x M10x1 1x M12x1

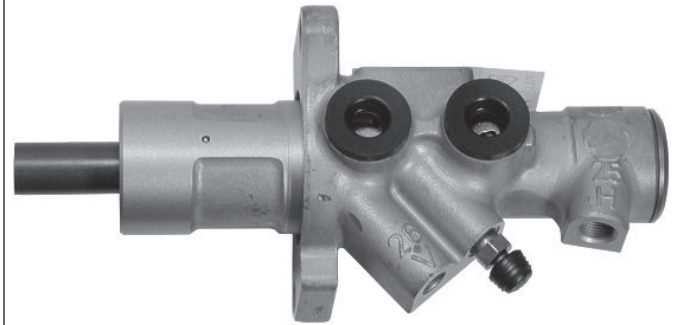

03.2026-0712.3 010730

L1
39,5 L2
119,8

ø26,99/ 25,4 2x 1x M10x1 1x M12x1

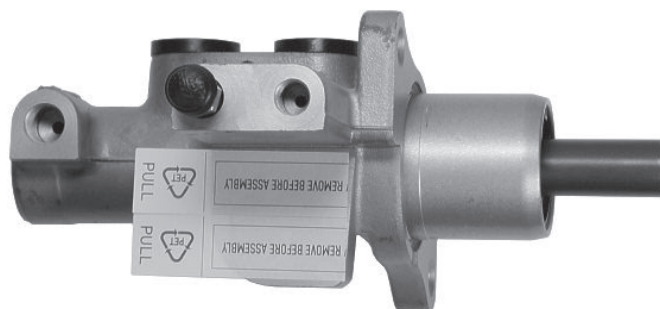

03.2119-3389.3 010057

L1
40 L2
114,9

ø19,05 M10x1 4x

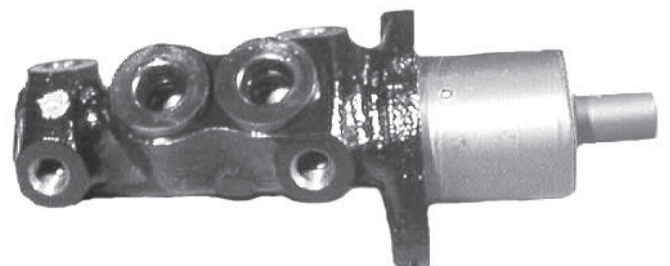

Abbildungen Hauptbremszylinder

Illustrations master cylinder - Ilustraciones cilindro freno - Illustrations Maître-cylindres - Illustrazioni pompe Freno

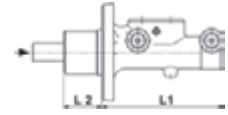

03.2119-3391.3	010058	L1 40	L2 114,9	03.2120-1122.3	010084	L1 10	L2 206,5
ø19,05 M10x1 2x				ø20,64 M10x1 3x			

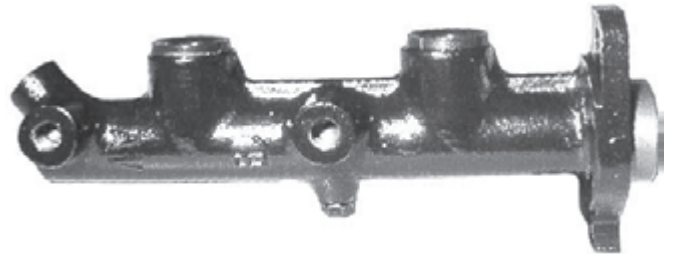
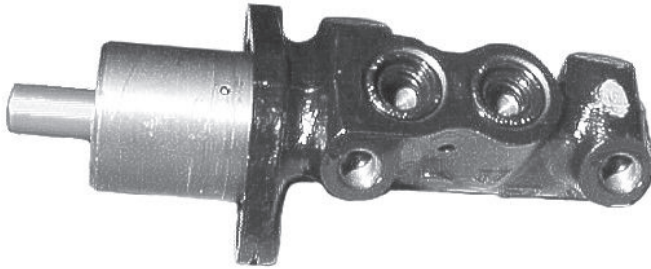

03.2120-1142.3	010085	L1 18,8	L2 167	03.2120-1897.3	010103	L1 40	L2 114,9
ø20,64 M10x1 3x				ø20,64 M10x1 2x			

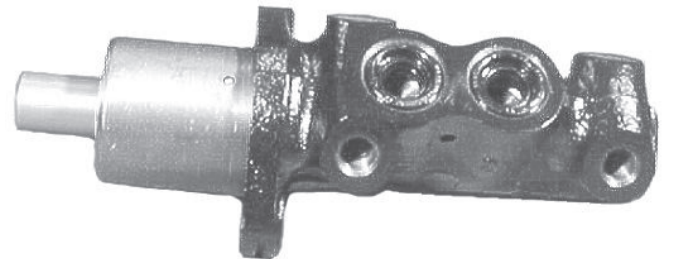
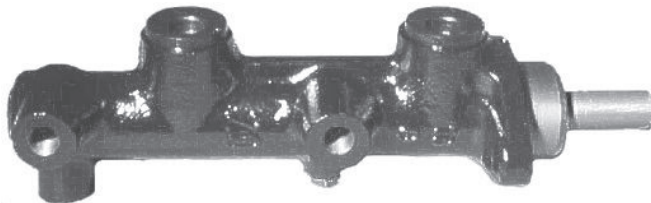

03.2120-1981.3	010105	L1 15,5	L2 198,5	03.2120-2031.3	010106	L1 32,4	L2 114,9
ø20,64 3x 2x M10x1 1x M12x1				ø20,64 M10x1 4x			

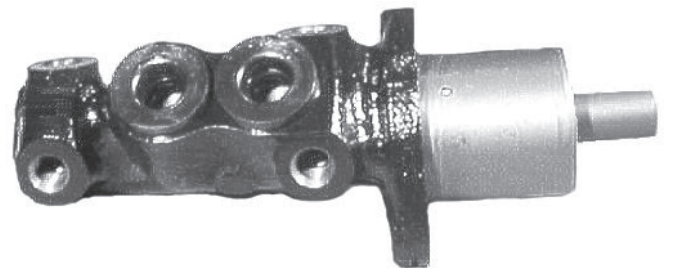

03.2120-2682.3	010118	L1 36	L2 114,9	03.2120-3943.3	010532	L1 35,4	L2 109,7
ø20,64 M10x1 4x				ø20,64 M10x1 4x			

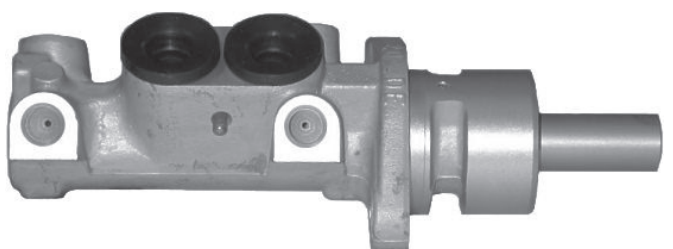
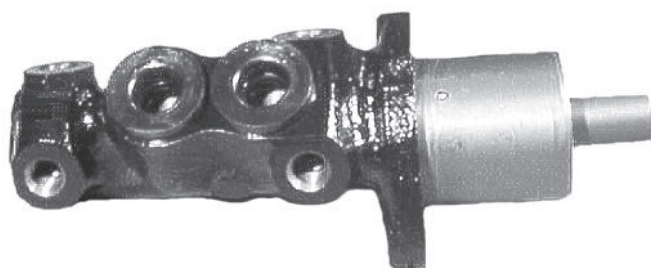

Abbildungen Hauptbremszylinder

Illustrations master cylinder - Ilustraciones cilindro freno - Illustrations Maître-cylindres - Illustrazioni pompe Freno

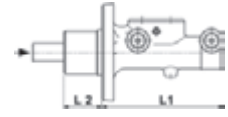

03.2120-4166.3	010452	L1 29,9	L2 115,9	03.2120-4221.3	010605	L1 29,9	L2 115,9
ø20,64 M10x1 4x				ø20,64 M10x1 2x			

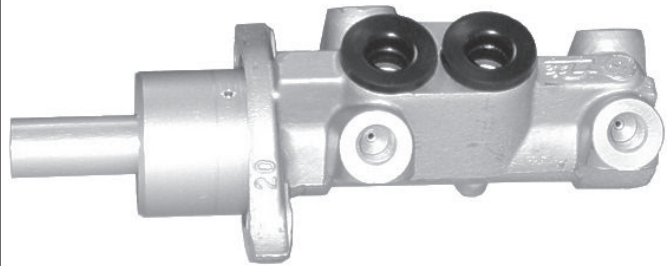
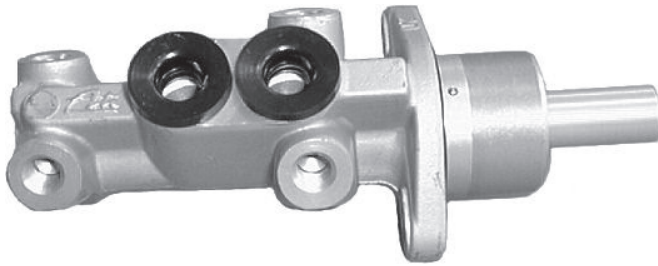

03.2120-4241.3	010524	L1 29,9	L2 115,9	03.2120-4246.3	010614	L1 29,9	L2 115,9
ø20,64 M10x1 2x				ø20,64 M10x1 2x			

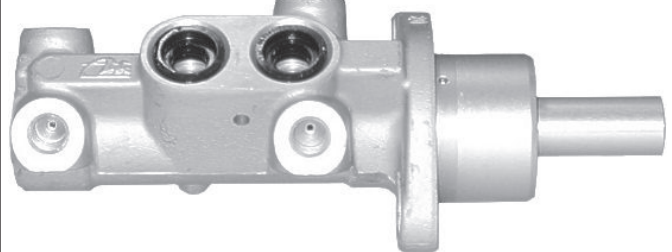
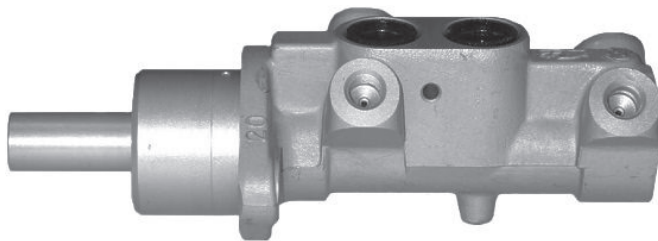

03.2120-4321.3	010525	L1 29,9	L2 115,9	03.2120-4381.3	010526	L1 29,9	L2 124,7
ø20,64 4x 2x M10x1 2x M12x1				ø20,64 4x 2x M10x1 2x M12x1			

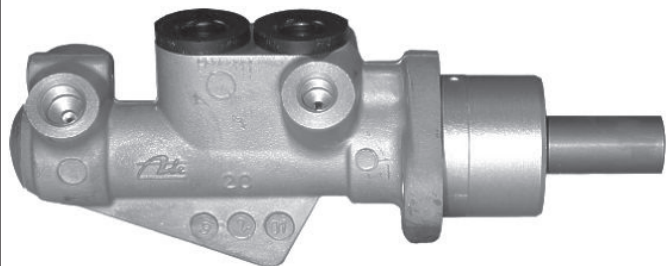
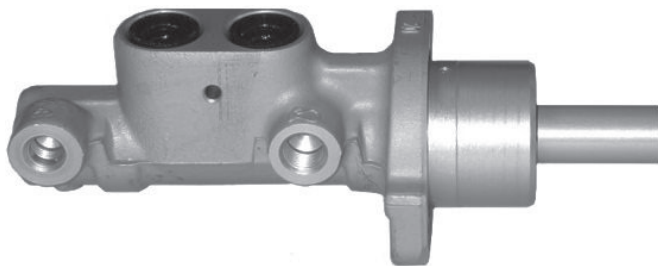

03.2120-4441.3	010510	L1 31,5	L2 115,9	03.2120-4461.3	010571	L1 31,5	L2 124,7
ø20,64 M10x1 2x				ø20,64 2x 1x M10x1 1x M12x1			

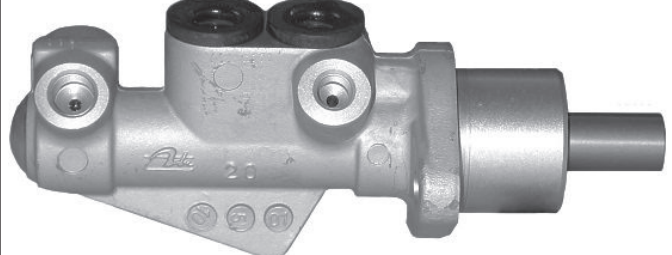
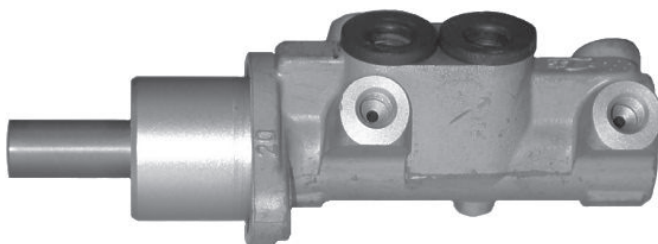

Abbildungen Hauptbremszylinder

Illustrations master cylinder - Ilustraciones cilindro freno - Illustrations Maître-cylindres - Illustrazioni pompe Freno

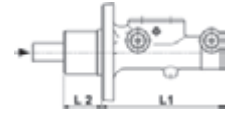

03.2120-4468.3	010789	L1 31,5	L2 124,7	03.2120-4581.3	010915	L1 31,5	L2 162,5
ø20,64 M12x1 2x				ø20,64 2x M10x1 M12x1			



03.2122-0264.3	010129	L1 33,1	L2 118	03.2122-0282.3	010130	L1 28,6	L2 134,2
ø22,2 4x 2x M10x1 2x M12x1				ø22,2 2x 1x M10x1 1x M12x1			

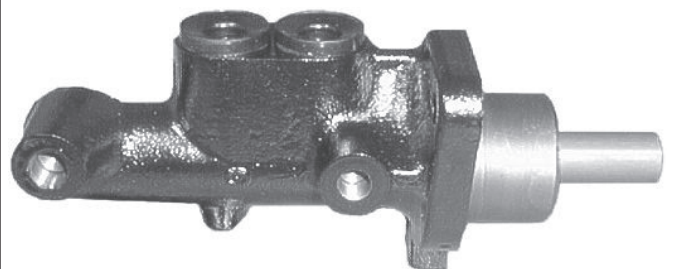
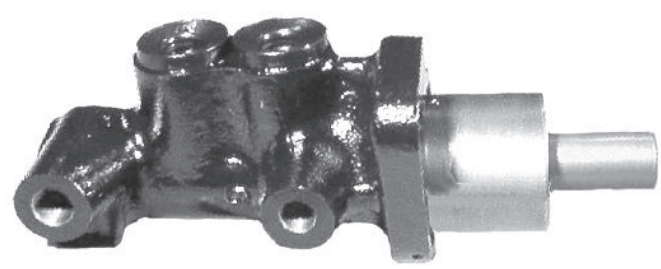

03.2122-0621.3	010131	L1 33,2	L2 131,7	03.2122-0626.3	010539	L1 33,2	L2 131,7
ø22,2 M10x1 4x				ø22,2 M10x1 2x			

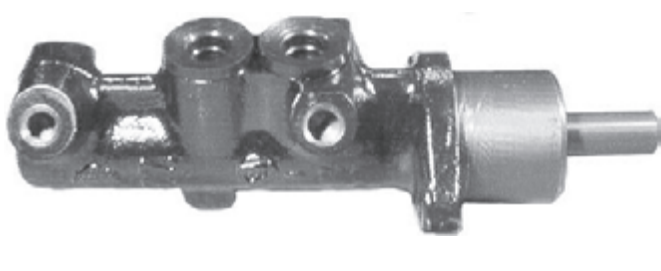

03.2122-0646.3	010133	L1 36	L2 115,7	03.2122-1001.3	010562	L1 27,9	L2 131,7
ø22,2 M10x1 2x				ø22,2 4x 2x M10x1 2x M12x1			

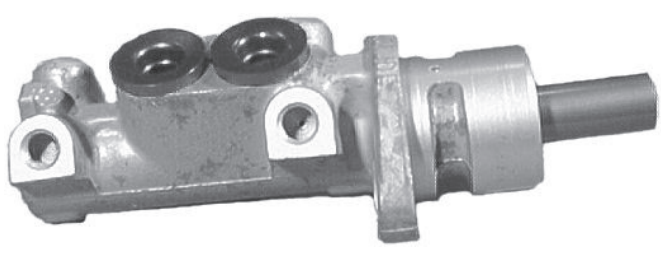

Abbildungen Hauptbremszylinder

Illustrations master cylinder - Ilustraciones cilindro freno - Illustrations Maître-cylindres - Illustrazioni pompe Freno

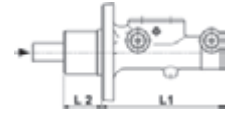

03.2122-1042.3	010137	L1 36	L2 109,7	03.2122-1144.3	010636	L1 36	L2 109,7
ø22,2 M10x1 4x				ø22,2 M10x1 2x			

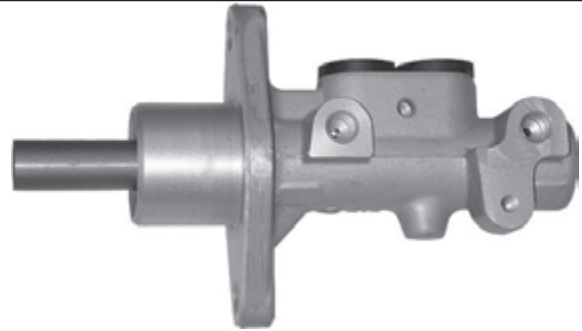
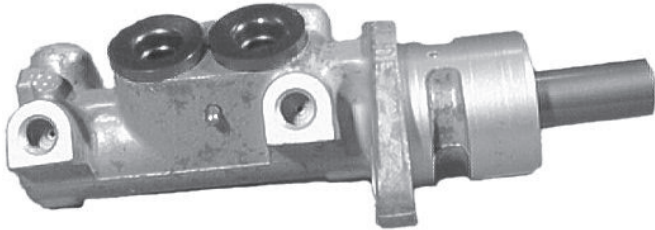

03.2122-1184.3	010592	L1 31,5	L2 119,6	03.2122-1331.3	010607	L1 31,5	L2 115,9
ø22,2 M12x1 2x				ø22,2 M10x1 2x			

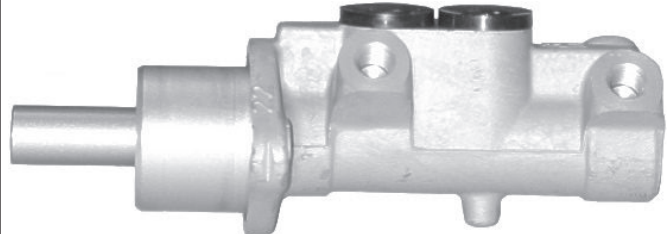
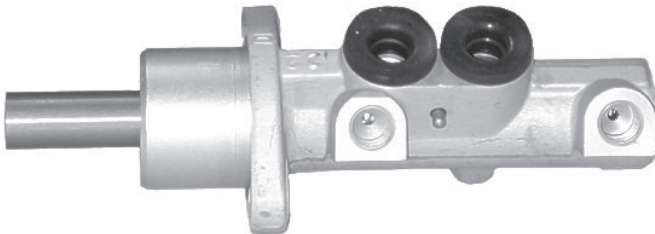

03.2122-1344.3	010593	L1 31,5	L2 119,6	03.2122-1351.3	010528	L1 31,5	L2 115,9
ø22,2 M10x1 2x				ø22,2 2x 1x M10x1 1x M12x1			

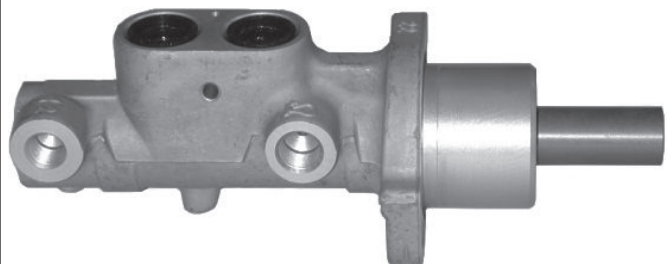
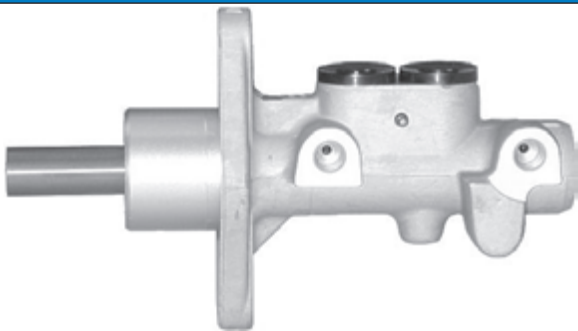

03.2122-1356.3	010529	L1 27,9	L2 115,9	03.2122-1461.3	010610	L1 31,5	L2 109,4
ø22,2 4x 2x M10x1 2x M12x1				ø22,2 M10x1 2x			

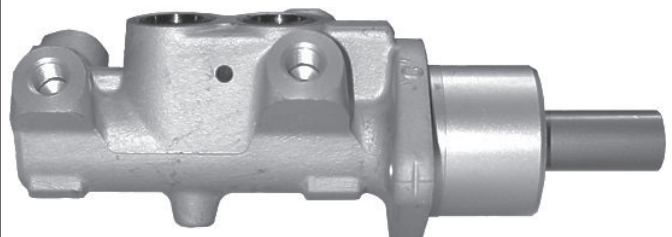
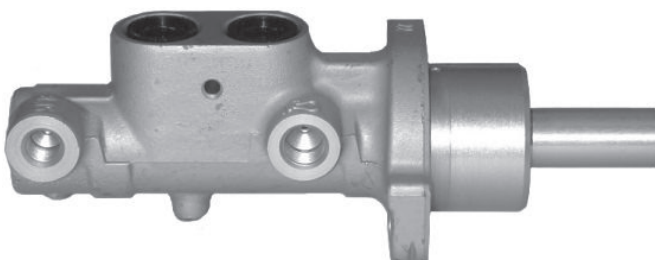

Abbildungen Hauptbremszylinder

Illustrations master cylinder - Ilustraciones cilindro freno - Illustrations Maître-cylindres - Illustrazioni pompe Freno

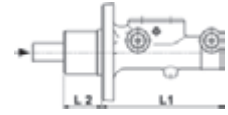

03.2122-1521.3	010494	L1 31,5	L2 119	03.2122-1541.3	010511	L1 27,4	L2 119
ø22,2 M10x1 2x				ø22,2 M10x1 4x			

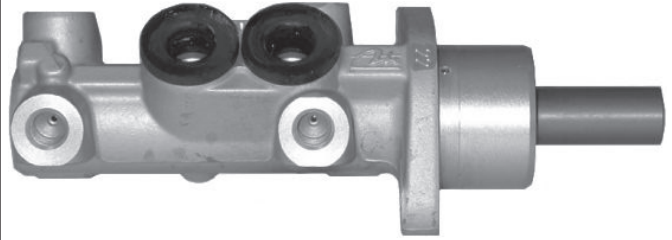

03.2122-1564.3	010594	L1 26,5	L2 124	03.2122-1663.3	010734	L1 4,1	L2 143,3
ø22,2 M12x1 2x				ø22,2 M12x1 3x			

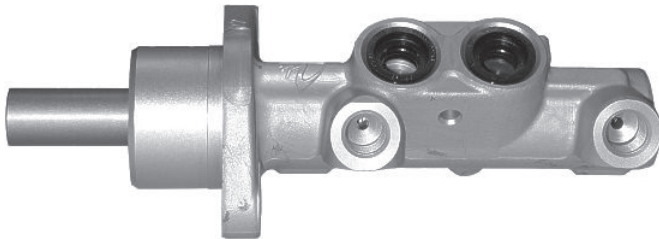

03.2122-1691.3	010918	L1 33,1	L2 114,5	03.2122-1724.3	010648	L1 4,1	L2 139,6
ø22,2 M12x10 2x				ø22,2 4x 2x M10x1 2x M12x1			

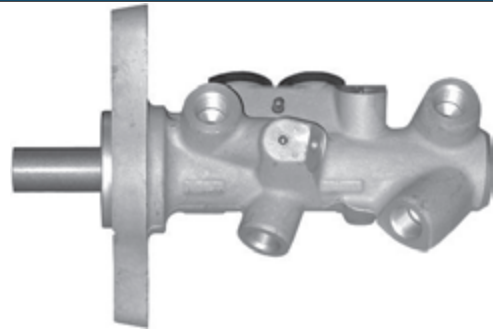

03.2122-1824.3	010892	L1 42,1	L2 109,3	03.2122-1853.3	010893	L1 40,9	L2 109,3
ø22,2 M12x1 3x				ø22,2 M12x1 2x			



Abbildungen Hauptbremszylinder

Illustrations master cylinder - Ilustraciones cilindro freno - Illustrations Maître-cylindres - Illustrazioni pompe Freno

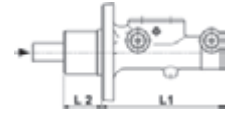

03.2122-1888.3 010736

L1
6,4 L2
143,3

ø22,2 M12x1 3x



03.2122-1942.3 010700

L1
30,5 L2
117,7

ø22,2 M12x1 3x

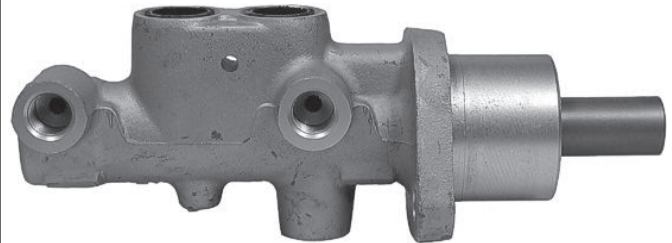

03.2122-2129.3 010799

L1
36,1 L2
134,9

ø22,2 M12x1 2x

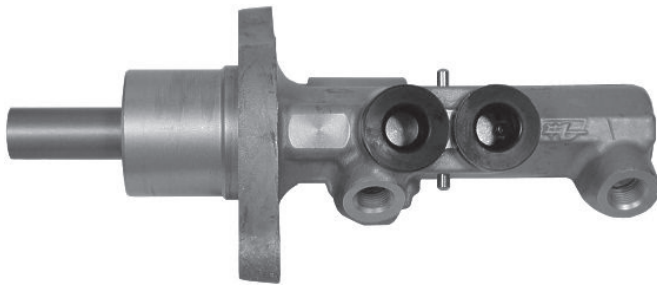

03.2122-2163.3 010800

L1
39,8 L2
128,2

ø22,2 M12x1 3x

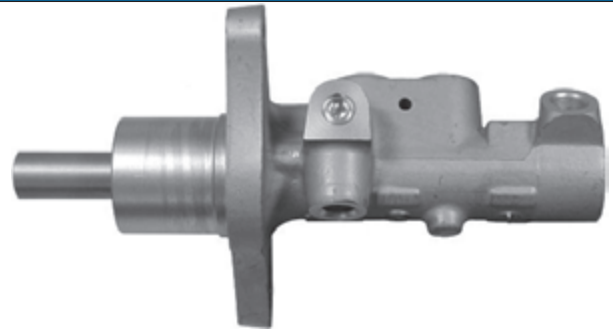

03.2122-9612.3 010159

L1
36 L2
103,7

ø22,2 M10x1 4x

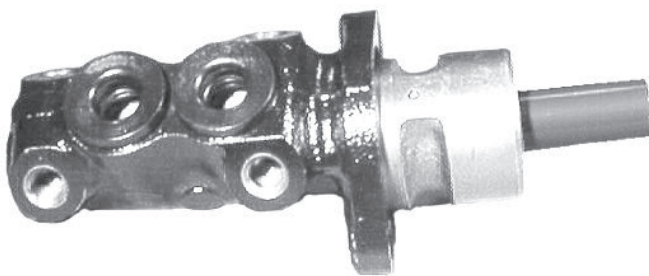

03.2122-9631.3 010160

L1
36 L2
103,7

ø22,2 M10x1 4x

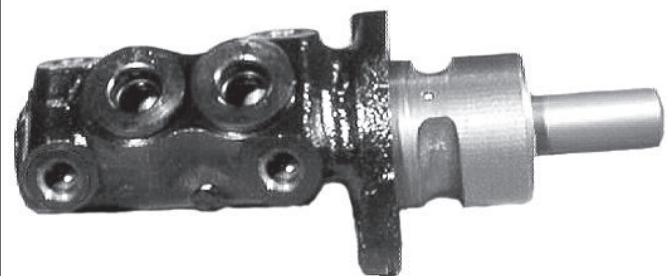

03.2123-0491.3 010167

L1
36 L2
115,7

ø23,81 M10x1 4x

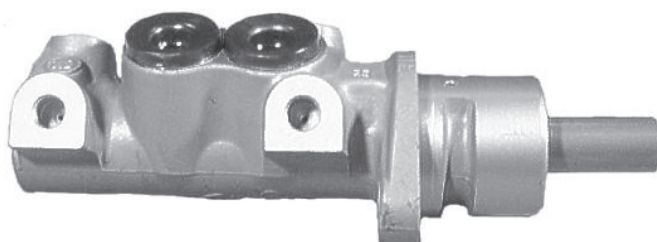

03.2123-1121.3 010176

L1
29,1 L2
118

ø23,81 2x 1x M10x1 1x M12x1

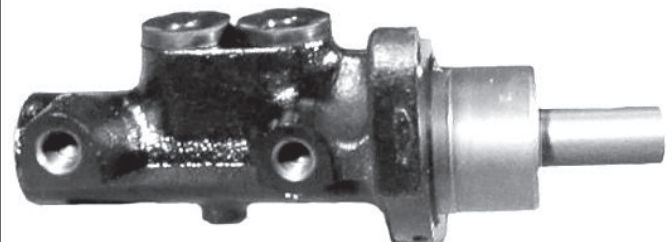

Abbildungen Hauptbremszylinder

Illustrations master cylinder - Ilustraciones cilindro freno - Illustrations Maître-cylindres - Illustrazioni pompe Freno

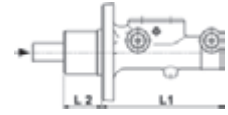

03.2123-1424.3 010637 L1 L2
34,4 116,6
ø23,81 M10x1 2x

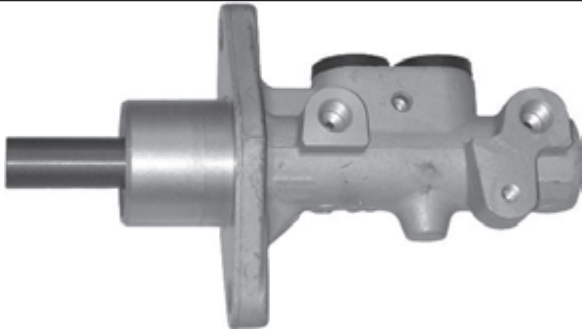

03.2123-1428.3 010476 L1 L2
34,4 116,6
ø23,81 M10x1 2x

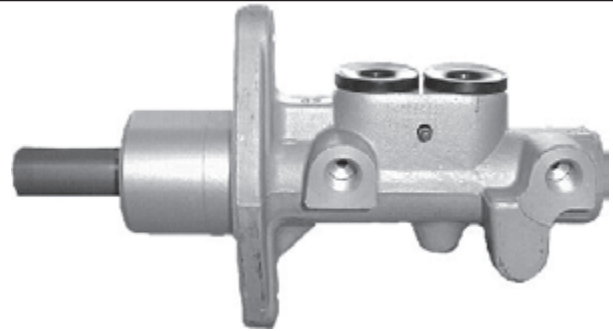

03.2123-1484.3 010595 L1 L2
31,5 119,6
ø23,81 M12x1 2x

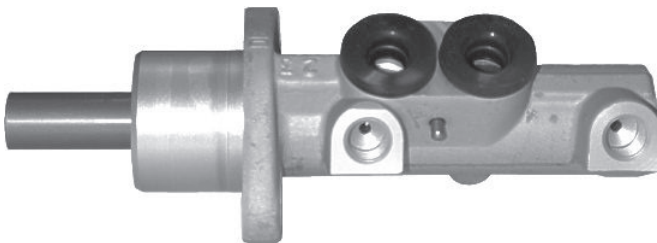

03.2123-1486.3 010488 L1 L2
31,5 119,6
ø23,81 M12x1 2x

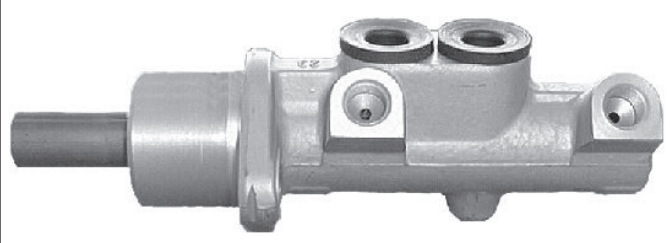

03.2123-1526.3 010477 L1 L2
31,5 119,6
ø23,81 M12x1 2x



03.2123-1546.3 010536 L1 L2
27,9 114,1
ø23,81 M10x1 4x



03.2123-1548.3 010478 L1 L2
27,9 114,1
ø23,81 M10x1 4x

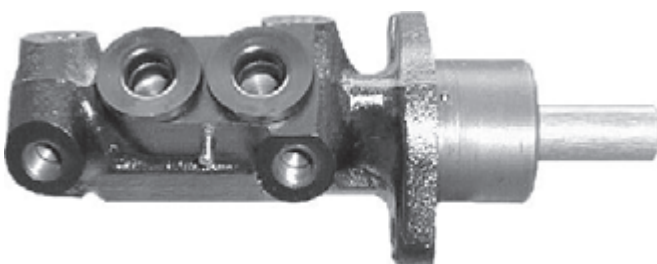

03.2123-1551.3 010512 L1 L2
27,9 114,1
ø23,81 M10x1 4x



Abbildungen Hauptbremszylinder

Illustrations master cylinder - Ilustraciones cilindro freno - Illustrations Maître-cylindres - Illustrazioni pompe Freno

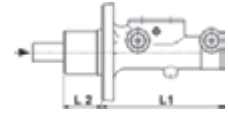

03.2123-1581.3	010487	L1	L2	03.2123-1622.3	010470	L1	L2
ø23,81	M12x1 2x	33,1	125,8	ø23,81	3x 1x M10x1 2x M12x1	31,5	119,6

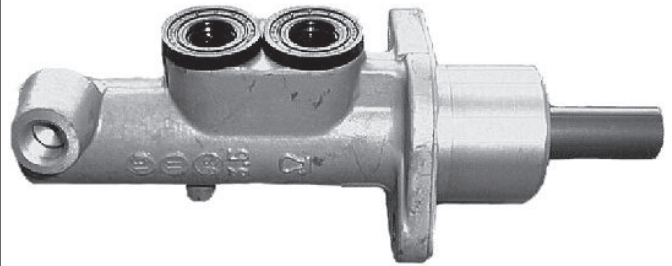
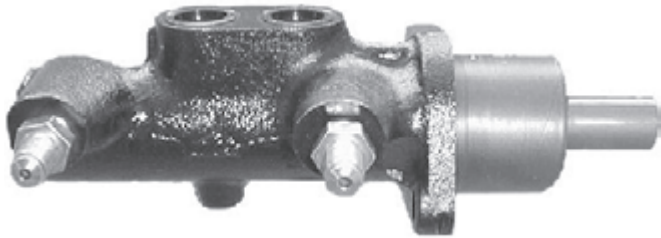

03.2123-1626.3	010727	L1	L2	03.2123-1722.3	010471	L1	L2
ø23,81	3x 1x M10x1 2x M12x1	31,5	119,6	ø23,81	M12x1 2x	56	95,1

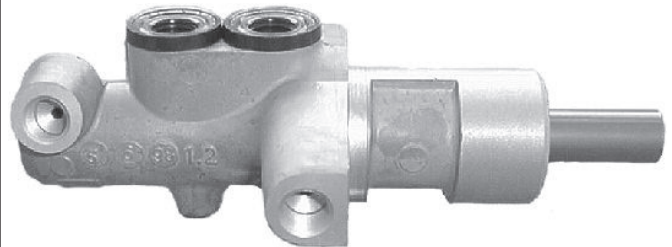
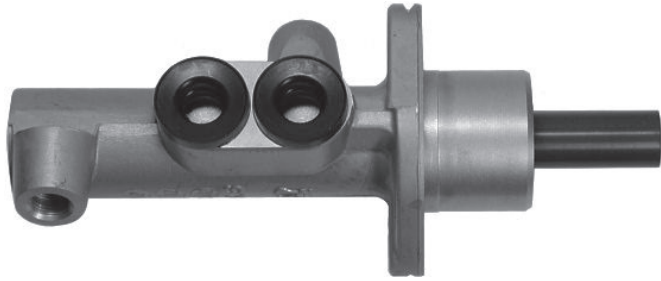

03.2123-1741.3	010537	L1	L2	03.2123-1824.3	010596	L1	L2
ø23,81	M10x1 4x	27,9	113,1	ø23,81	M10x1 2x	31,5	119,6

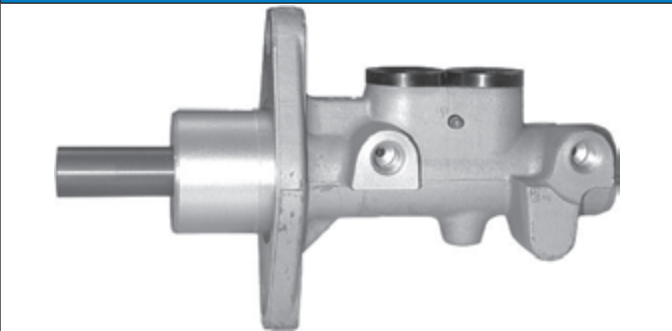

03.2123-2024.3	010597	L1	L2	03.2123-2064.3	010598	L1	L2
ø23,81	4x 2x M10x1 2x M12x1	4,1	137,8	ø23,81	M12x1 4x	12,5	128,9

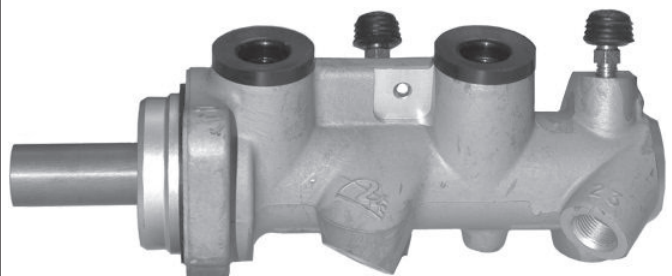
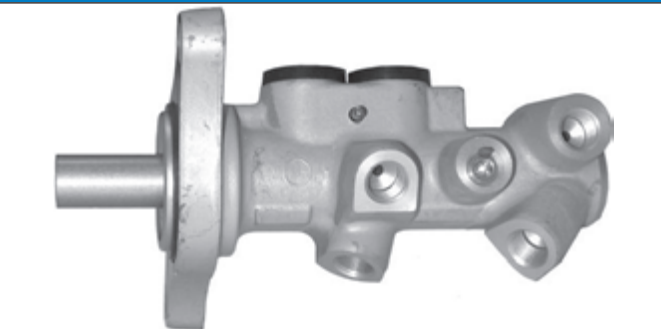

Abbildungen Hauptbremszylinder

Illustrations master cylinder - Ilustraciones cilindro freno - Illustrations Maître-cylindres - Illustrazioni pompe Freno

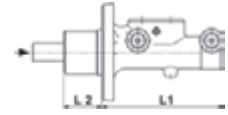

03.2123-2146.3	010572	L1 31,5	L2 119	03.2123-2164.3	010599	L1 40,3	L2 130
ø23,81 M10x1 2x				ø23,81 M12x1 2x			

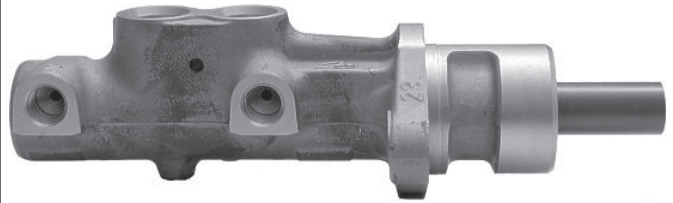

03.2123-2221.3	010861	L1 13,2	L2 1.437	03.2123-2243.3	010748	L1 26,5	L2 124
ø23,81 M10x1 2x				ø23,81 M12x1 2x			

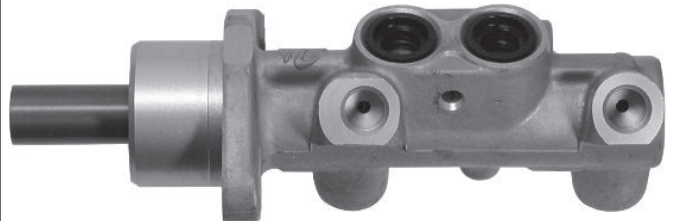

03.2123-2561.3	010629	L1 23,9	L2 133,8	03.2123-2581.3	010613	L1 31,5	L2 119,6
ø23,81 M12x1 3x				ø23,81 M12x1 2x			

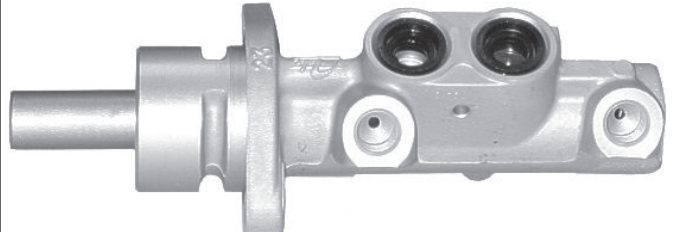
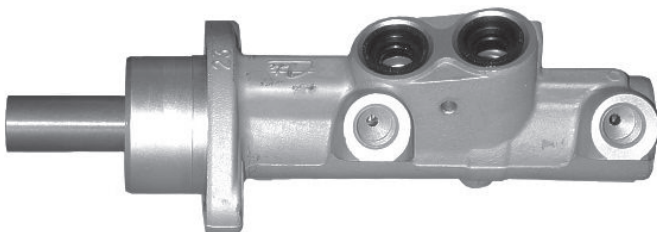

03.2123-2621.3	010701	L1 30,5	L2 124,8	03.2123-2654.3	010801	L1 34,9	L2 121,4
ø23,81 M12x1 2x				ø23,81 M12x1 4x			

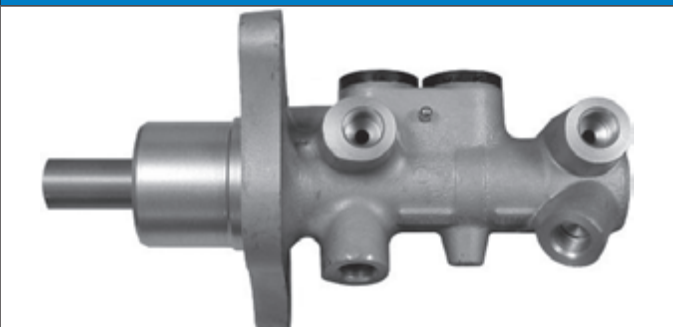
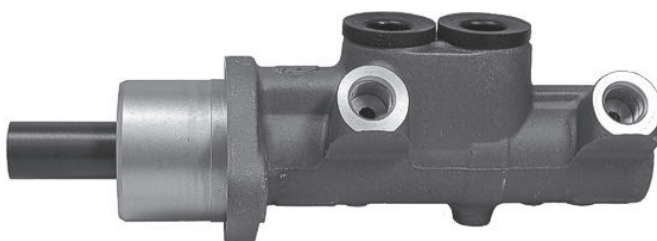

Abbildungen Hauptbremszylinder

Illustrations master cylinder - Ilustraciones cilindro freno - Illustrations Maître-cylindres - Illustrazioni pompe Freno

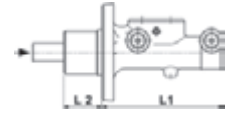

03.2123-2715.3 010802 L1 L2
34,9 121,4
ø23,81 M12x1 3x

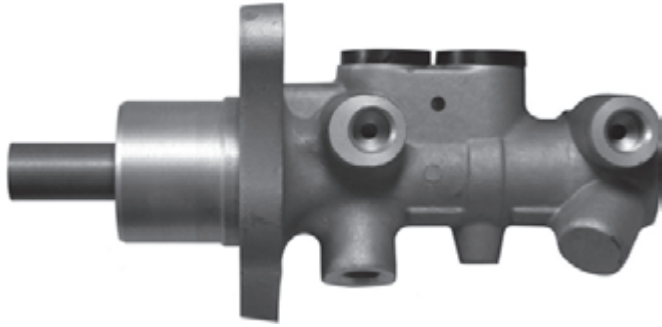

03.2123-2761.3 010886 L1 L2
30,5 123,7
ø23,81 M12x1 2x



03.2123-2774.3 010803 L1 L2
26,6 130,2
ø23,81 M12x1 4x

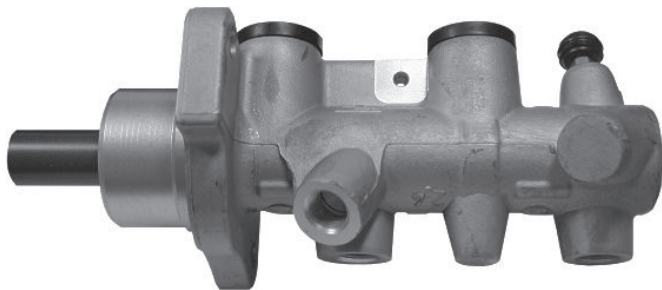

03.2123-2781.3 010631 L1 L2
27,9 119,6
ø23,81 4x 2x M10x1 2x M12x1

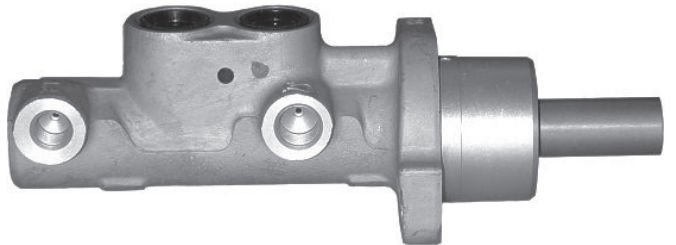

03.2123-2863.3 010790 L1 L2
29,2 116
ø23,81 M10x1 2x



03.2123-2923.3 010791 L1 L2
28,2 119
ø23,81 M12x1 2x



03.2123-3041.3 010887 L1 L2
41,5 101,7
ø23,81 M10x1 4x



03.2123-3103.3 010781 L1 L2
37 116,3
ø23,81 M12x1 2x



Abbildungen Hauptbremszylinder

Illustrations master cylinder - Ilustraciones cilindro freno - Illustrations Maître-cylindres - Illustrazioni pompe Freno

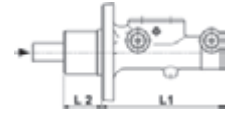

03.2123-3241.3	010882	L1 29,2	L2 116	03.2123-3449.3	010808	L1 36,1	L2 134,9
ø23,81 M10x1 2x				ø23,81 M12x1 2x			



03.2123-3493.3	010792	L1 28,2	L2 119	03.2123-3549.3	010809	L1 36,1	L2 134,9
ø23,81 M12x1 2x				ø23,81 M12x1 2x			

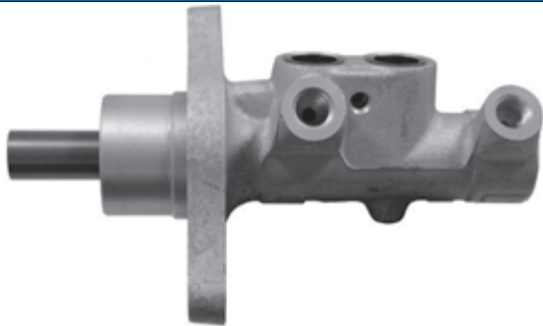

03.2123-3593.3	010919	L1 37	L2 116,3	03.2123-5212.3	010183	L1 18,5	L2 166
ø23,81 M12x1 2x				ø23,81 M10x1 2x			







03.2123-6002.3	010184	L1 18,5	L2 175	03.2125-0161.3	010920	L1 9	L2 142
ø23,81 M10x1 2x				ø25,4 M10x1 2x			

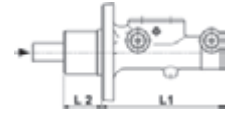

Abbildungen Hauptbremszylinder

Illustrations master cylinder - Ilustraciones cilindro freno - Illustrations Maître-cylindres - Illustrazioni pompe Freno

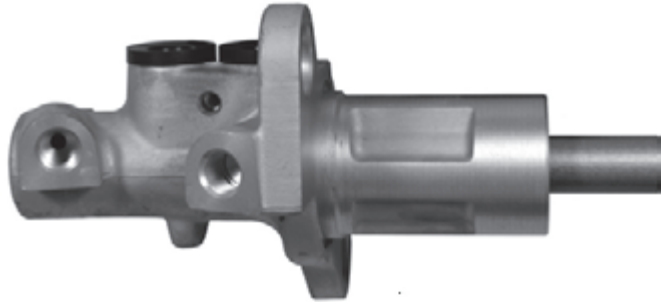
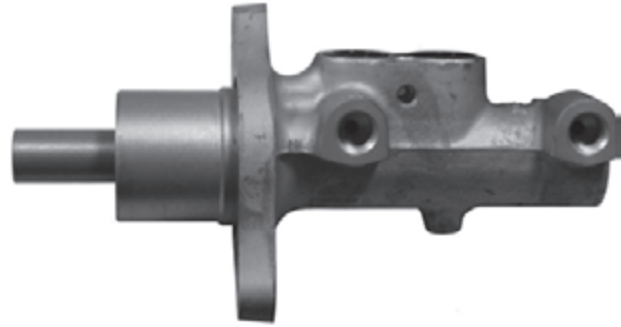
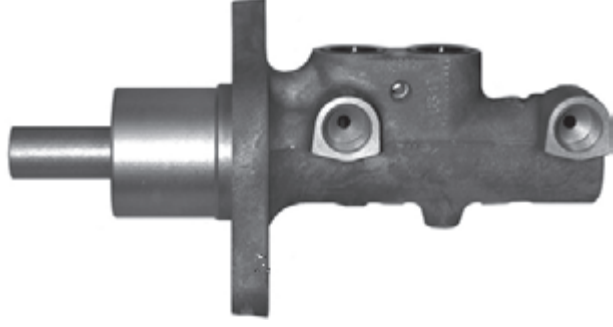

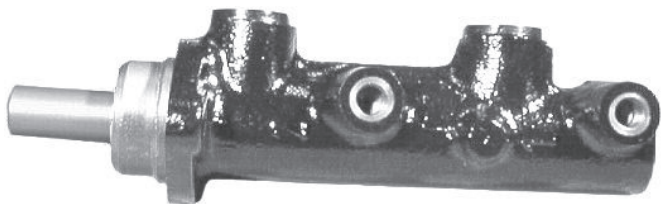
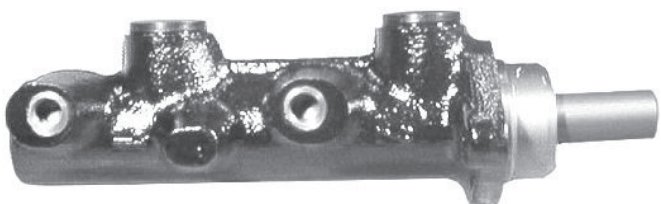
<p>03.2125-0298.3 010818 L1 L2 35,2 133,8 ø25,4 M10x1 2x</p>	<p>03.2125-0332.3 010952 L1 L2 38,2 108 ø25,4 M12x1 2x</p>
	
<p>03.2125-0373.3 010810 L1 L2 64,2 93,5 ø25,4 M12x1 2x</p>	<p>03.2125-0483.3 010783 L1 L2 37 117,5 ø25,4 M12x1 2x</p>
	
<p>03.2125-0661.3 010917 L1 L2 37 117,5 ø25,4 M14x1 2x</p>	<p>03.2125-1712.3 010204 L1 L2 18,5 166 ø25,4 M10x1 2x</p>
	
<p>03.2125-1902.3 010206 L1 L2 18,5 155 ø25,4 M10x1 2x</p>	<p>03.2125-2102.3 010207 L1 L2 18,5 158,5 ø25,4 M10x1 2x</p>
	

Abbildungen Hauptbremszylinder

Illustrations master cylinder - Ilustraciones cilindro freno - Illustrations Maître-cylindres - Illustrazioni pompe Freno

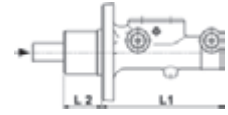

03.2125-3011.3	010211	L1 55,4	L2 114,5	03.2125-3210.3	010212	L1 36	L2 116,2
ø25,4 M10x1 2x				ø25,4 M10x1 4x			

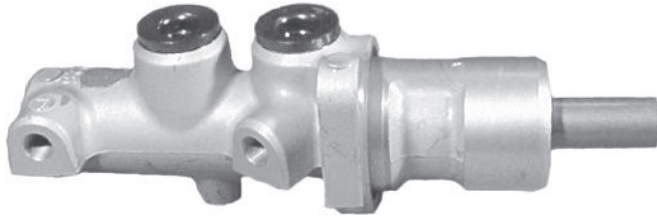

03.2125-3610.3	010214	L1 36	L2 116,2	03.2125-3801.3	010215	L1 18,5	L2 166
ø25,4 M10x1 2x				ø25,4 M10x1 5x			

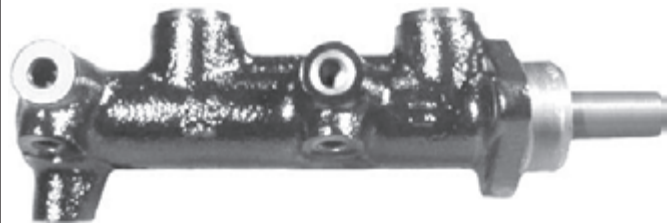
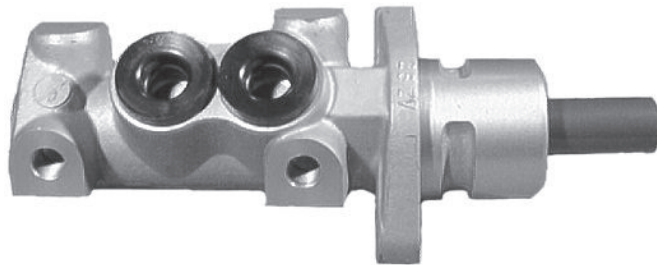

03.2125-7002.3	010628	L1 10,2	L2 166	03.2125-7310.3	010743	L1 11,6	L2 141
ø25,4 M10x1 2x				ø25,4 M12x1 2x			

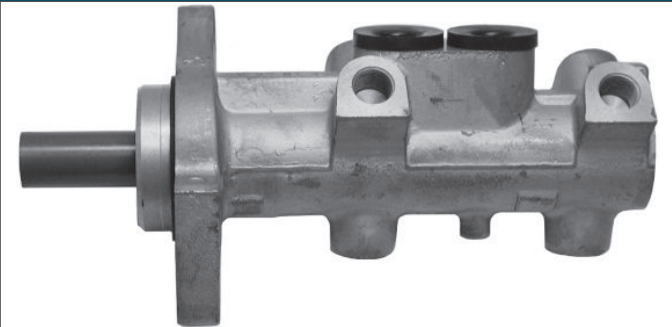

03.2125-7402.3	010541	L1 31,5	L2 120,8	03.2125-7502.3	010616	L1 56	L2 96,3
ø25,4 3x 1x M10x1 2x M12x1				ø25,4 M12x1 2x			

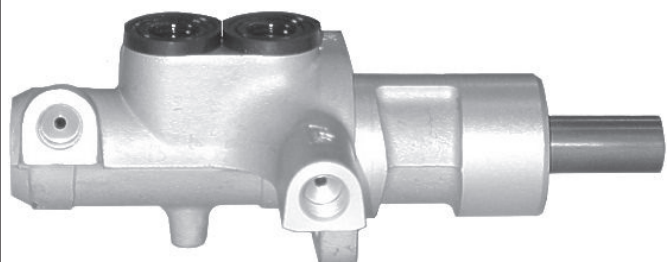
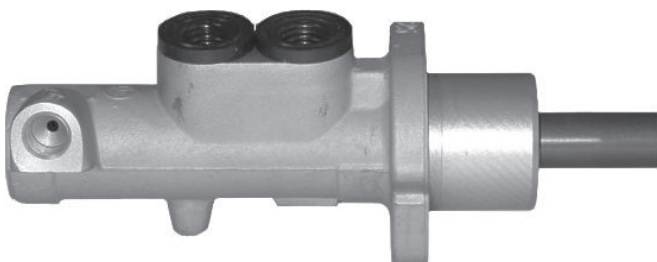

Abbildungen Hauptbremszylinder

Illustrations master cylinder - Ilustraciones cilindro freno - Illustrations Maître-cylindres - Illustrazioni pompe Freno

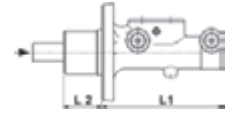

03.2125-7637.3 010707

L1 11,6
L2 140,7

ø25,4 M12x1 2x

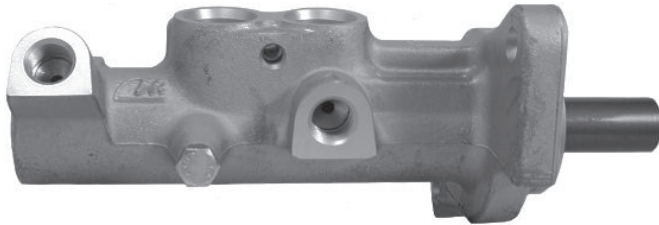

03.2125-7638.3 010738

L1 11,6
L2 140,7

ø25,4 M12x1 2x

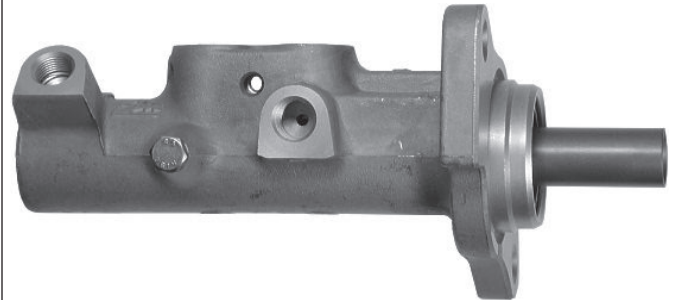

03.2125-7708.3 010739

L1 11,6
L2 140,7

ø25,4 M12x1 4x



03.2125-7713.3 010819

L1 11,6
L2 140,7

ø25,4 M12x1 4x

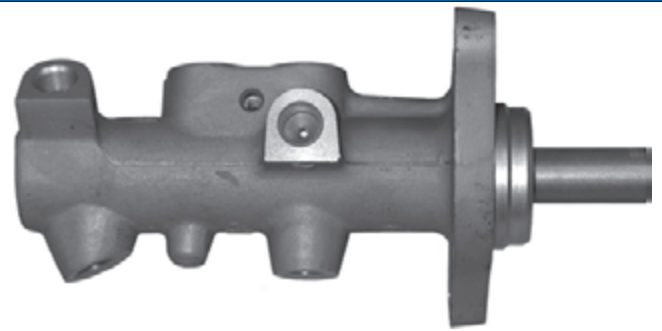

03.2125-8111.3 010479

L1 31,5
L2 120,8

ø25,4 M10x1 4x

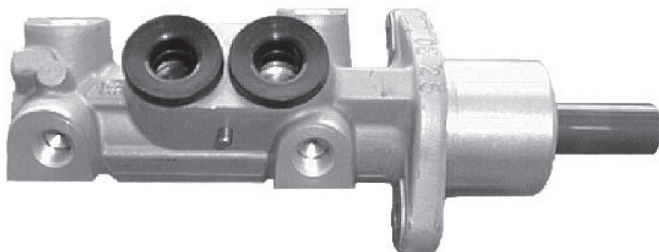

03.2125-8404.3 010583

L1 34,6
L2 108

ø25,4 M10x1 4x

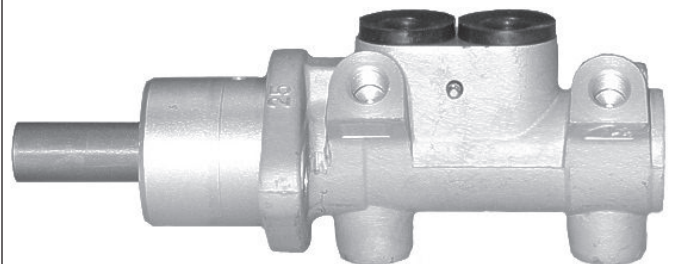

03.2125-9604.3 010581

L1 14,6
L2 131,5

ø25,4 M10x1 5x

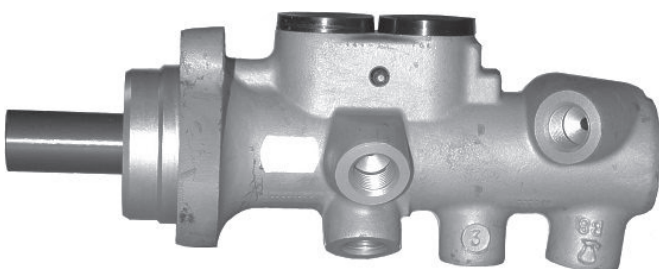

03.2125-9704.3 010603

L1 32,9
L2 125,5

ø25,4 M12x1 2x

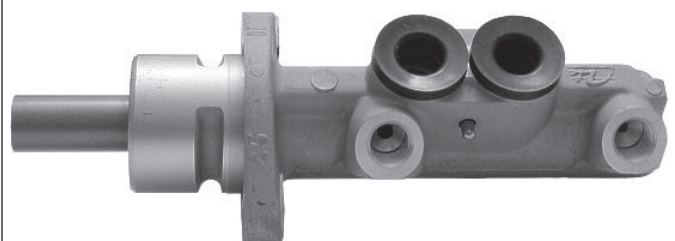

Abbildungen Hauptbremszylinder

Illustrations master cylinder - Ilustraciones cilindro freno - Illustrations Maître-cylindres - Illustrazioni pompe Freno

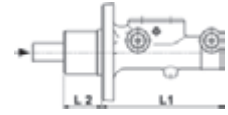

03.2125-9901.3 010634 L1 L2
44,7 110,9
ø25,4 3x 1x M10x1 2x M12x1

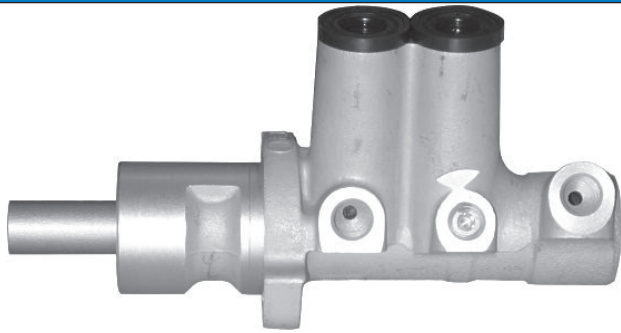

03.2125-9911.3 010883 L1 L2
44,7 112,4
ø25,4 M12x1 2x



03.2126-0512.3 010217 L1 L2
18,5 155
ø26,99 M10x1 2x

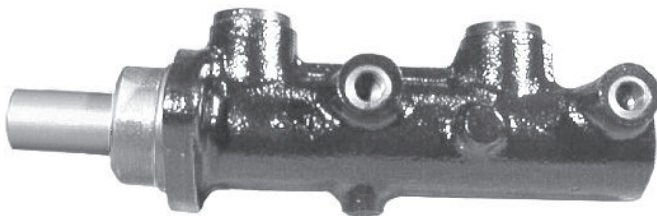

03.2126-3014.3 010811 L1 L2
18,7 133,5
ø26,99 M12x1 2x

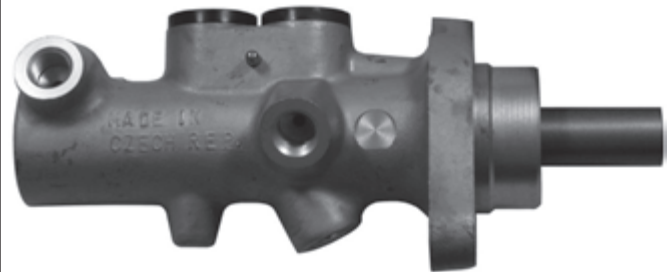

03.2126-3063.3 010812 L1 L2
23,3 128,9
ø26,99 M12x1 2x



03.4055-0013.3 010793 L1 L2
20 106
ø25,4 M12x1 2x



03.4122-0031.3 010611 L1 L2
14 85,1
ø22,2 M10x1 4x

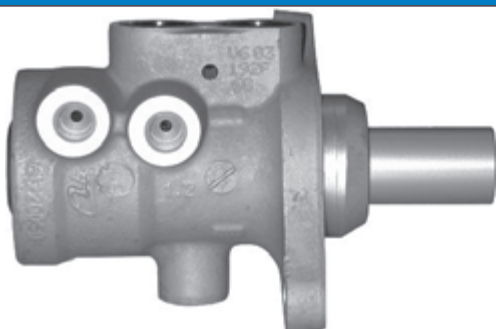

03.4122-0041.3 010612 L1 L2
14 85,1
ø22,2 M10x1 2x



Abbildungen Hauptbremszylinder

Illustrations master cylinder - Ilustraciones cilindro freno - Illustrations Maître-cylindres - Illustrazioni pompe Freno

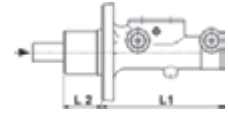

03.4122-0054.3	010813	L1 13,7	L2 87,9	03.4123-0081.3	010585	L1 5,5	L2 102,3
ø22,2 M12x1 2x				ø23,81 M12x1 3x			

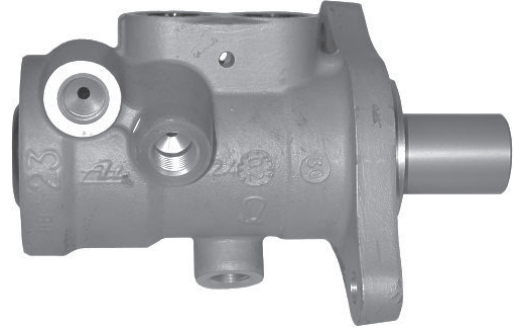
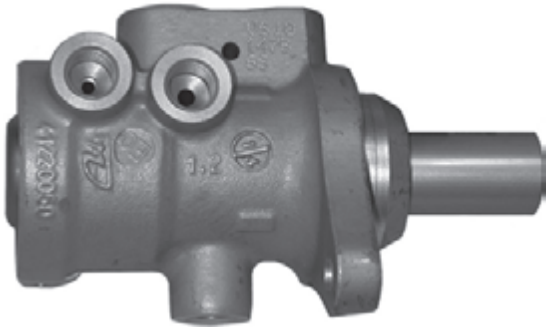

03.4123-0153.3	010659	L1 12,8	L2 90,3	03.4125-0014.3	010794	L1 4,2	L2 105
ø23,81 M12x1 3x				ø25,4 M12x1 3x			

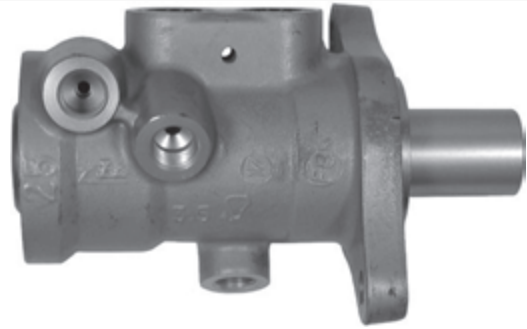
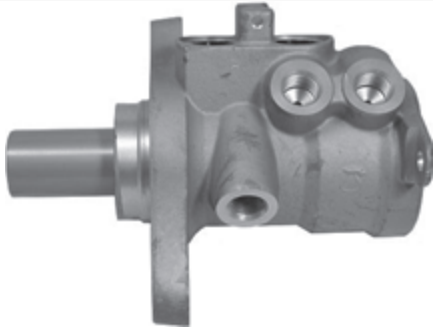

03.4125-0021.3	010888	L1 4,2	L2 105	03.4152-0058.3	010885	L1 27,9	L2 91
ø25,4 M12x1 2x				ø22,2 M12x1 2x			

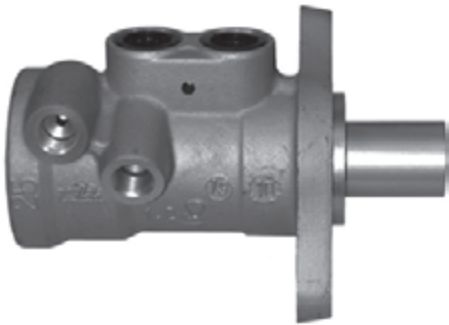

03.4152-0116.3	010814	L1 27,1	L2 117	03.4153-0063.3	010773	L1 9,9	L2 105,1
ø22,2 M12x1 2x				ø23,81 M10x1 2x			



Abbildungen Hauptbremszylinder

Illustrations master cylinder - Ilustraciones cilindro freno - Illustrations Maître-cylindres - Illustrazioni pompe Freno

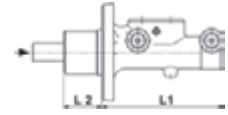

03.4153-0173.3	010815	L1 31,7	L2 92,2	03.4153-0186.3	010816	L1 27,1	L2 117
ø23,81 M12x1 2x				ø23,81 M12x1 2x			



03.4155-0043.3	010795	L1 9,9	L2 105	03.4155-0156.3	010862	L1 24,2	L2 90,7
ø25,4 M12x1 2x				ø25,4 M12x1 2x			

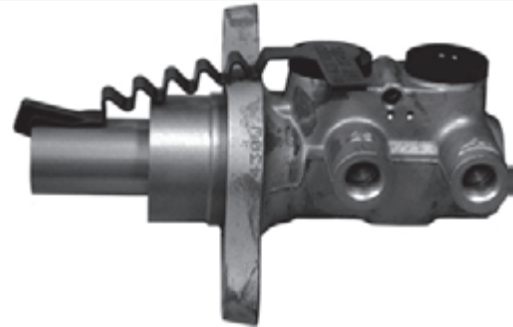

10.6123-0154.3	010578	L1 12	L2 174,6	10.6123-0239.3	010335	L1 43,3	L2 132
ø23,81 2x 1x M10x1 1x M12x1				ø23,81 M10x1 2x			



10.6123-0312.3	010457	L1 38	L2 133,2	10.6123-0522.3	010633	L1 38	L2 142
ø23,81 2x 1x M10x1 1x M12x1				ø23,81 M10x1 2x			

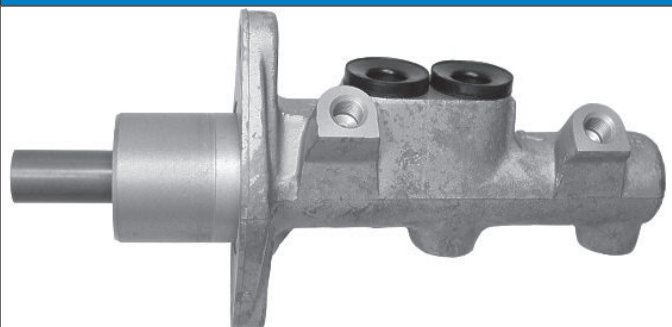

Abbildungen Hauptbremszylinder

Illustrations master cylinder - Ilustraciones cilindro freno - Illustrations Maître-cylindres - Illustrazioni pompe Freno

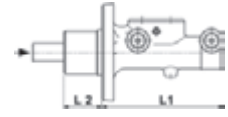

10.6123-0674.3 010639	L1 41	L2 127,9	20.5522-1093.3 010731	L1 31,5	L2 120
ø23,81 M10x1 2x			ø22,2 M10x1 2x		

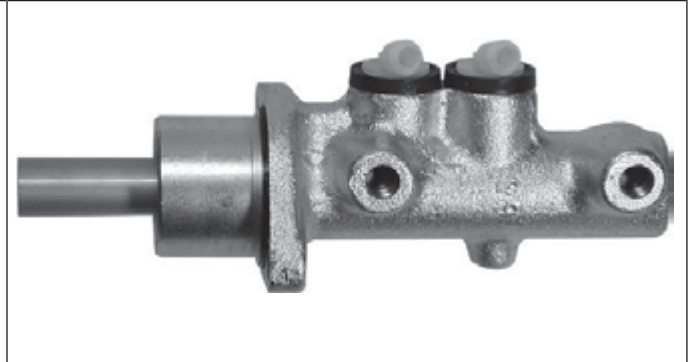
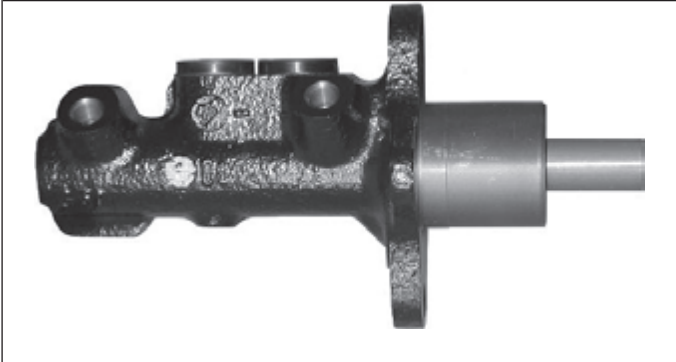

20.5522-1128.3 010747	L1 31,5	L2 120	24.2022-1601.3 010340	L1 58	L2 113
ø22,2 M10x1 2x			ø22,2/17,46 M10x1 3x		

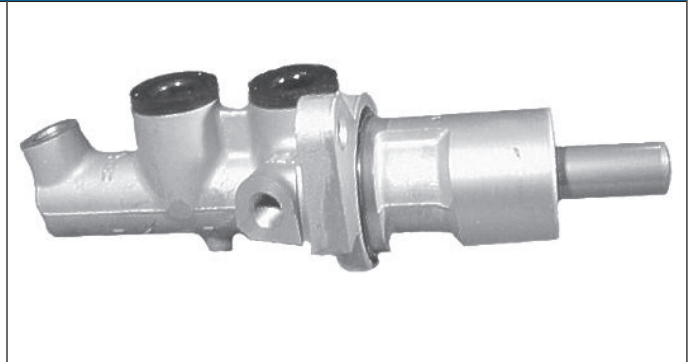
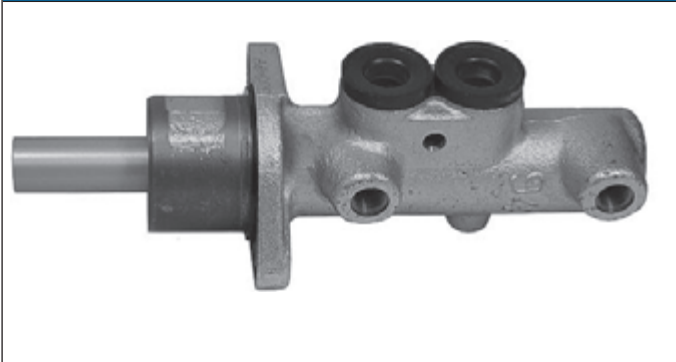

24.2023-1601.3 010341	L1 50	L2 120,5	24.2023-1701.3 010514	L1 51,5	L2 106
ø23,81 M10x1 3x			ø23,81/19,05 2x 1x M10x1 1x M12x1		

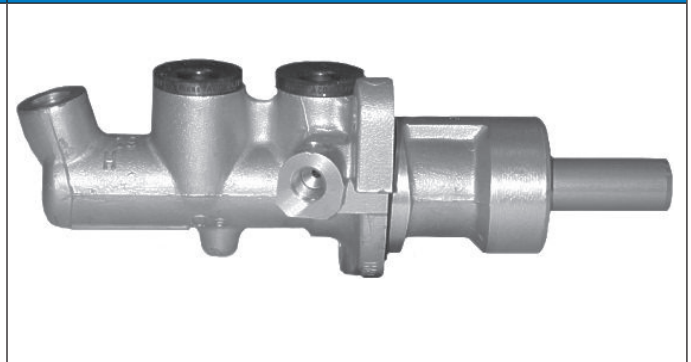
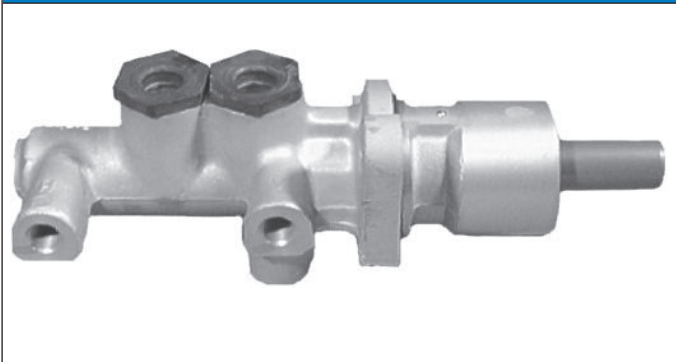

24.2023-1702.3 010534	L1 24	L2 125	24.2023-1704.3 010635	L1 14	L2 135
ø23,81/19,05 M12x1 3x			ø23,81 M12x1 3x		

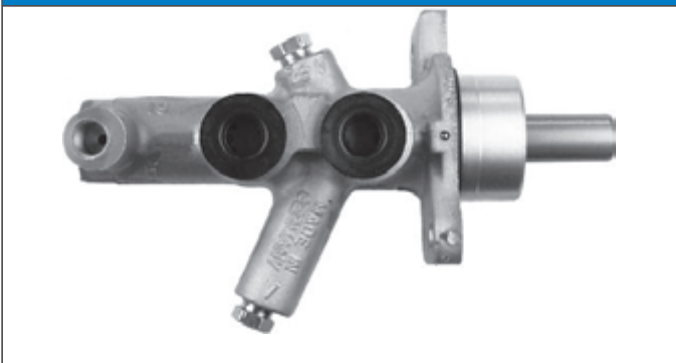

Abbildungen Hauptbremszylinder

Illustrations master cylinder - Ilustraciones cilindro freno - Illustrations Maître-cylindres - Illustrazioni pompe Freno

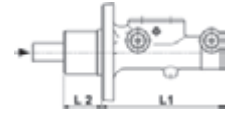

24.2025-1702.3 010515	L1 51,3	L2 106,2	24.2025-1703.3 010516	L1 51,3	L2 106,2
ø25,4/19,05 2x 1x M10x1 1x M12x1			ø25,4/19,05 M12x1 2x		

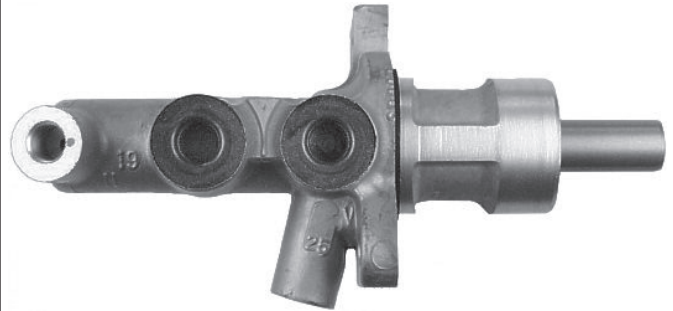
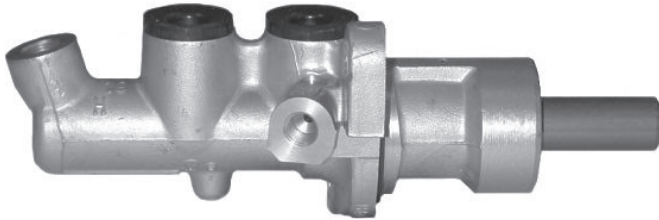

24.2025-1704.3 010619	L1 51,3	L2 107,7	24.2025-1705.3 010624	L1 51,5	L2 108
ø25,4 3x 1x M10x1 2x M12x1			ø25,4/20,64 2x 1x M10x1 1x M12x1		

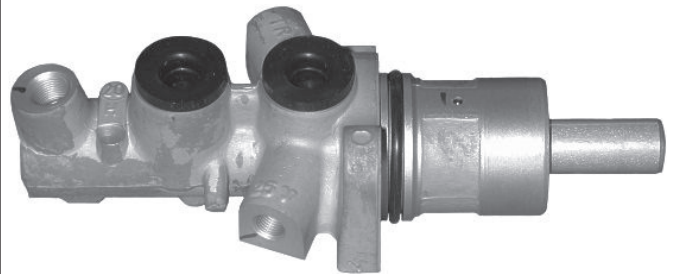

24.2025-1706.3 010676	L1 33	L2 127	24.2025-1707.3 010691	L1 51,7	L2 108,5
ø25,4 2x 1x M10x1 1x M12x1			ø25,4 M12x1 2x		

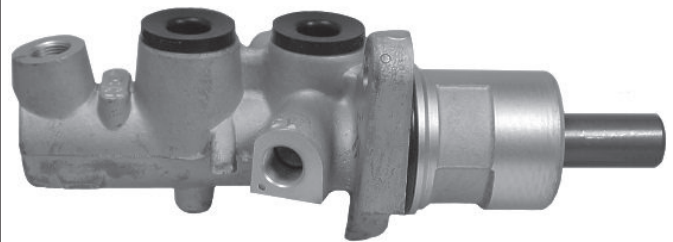
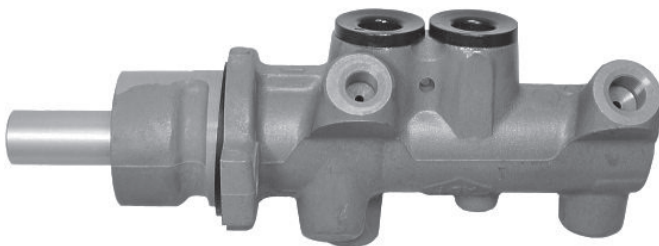

24.2025-1708.3 010692	L1 33	L2 127	24.2025-1709.3 010693	L1 51,3	L2 108
ø25,4 5x 3x M10x1 2x M12x1			ø25,4 M12x1 2x		

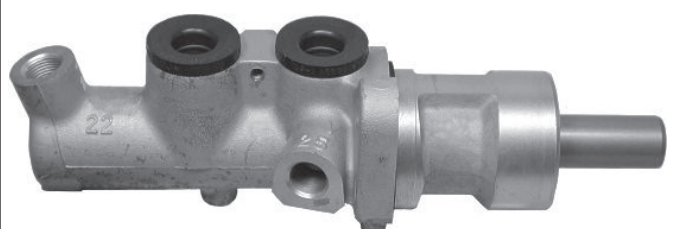
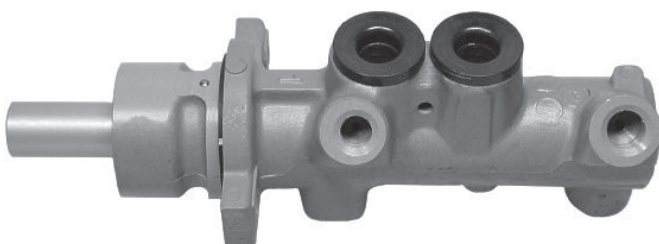

Abbildungen Hauptbremszylinder

Illustrations master cylinder - Ilustraciones cilindro freno - Illustrations Maître-cylindres - Illustrazioni pompe Freno

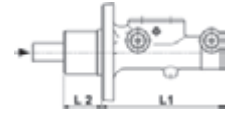

24.2025-1710.3 010833

L1
69,3

L2
90

ø25,4 M12x1 2x

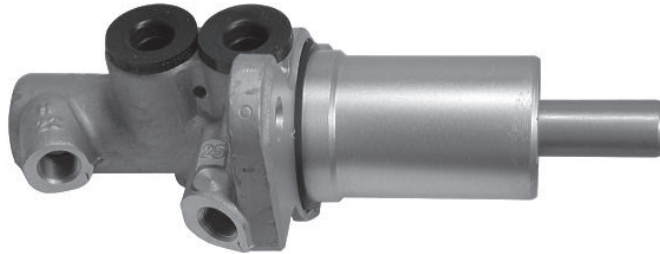

24.2026-1701.3 010746

L1
51,2

L2
107,3

ø26,99/ 20,64 M12x1 3x



24.2026-1702.3 010850

L1
69,2

L2
90,5

ø26,99/ 22,2 M12x1 2x

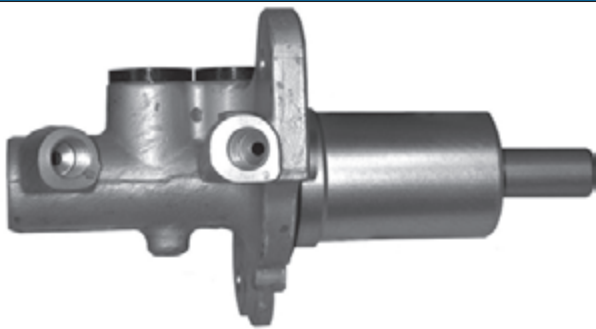

24.2026-1703.3 010910

L1
68,5

L2
90,5

ø26,99/ 22,2 M12x1 2x

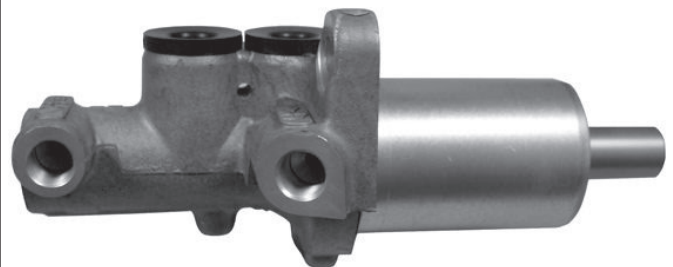

24.2026-1706.3 011040

L1
69,5

L2
92

ø26,99/ 22,2 M12x1 2x



24.2117-1501.3 010398

L1
8,5

L2
182,5

ø17,46 M10x1 2x

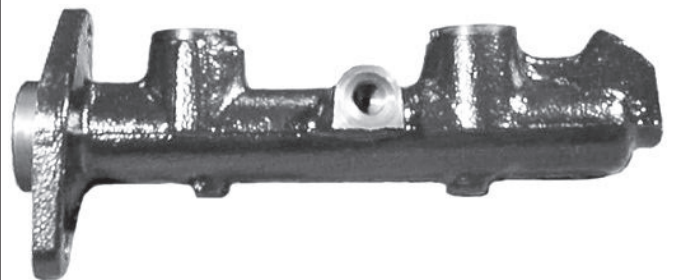

24.2119-0815.3 010347

L1
12

L2
177,5

ø19,05 M10x1,25 3x



24.2119-0826.3 010349

L1
12

L2
178,4

ø19,05 M10x1 3x

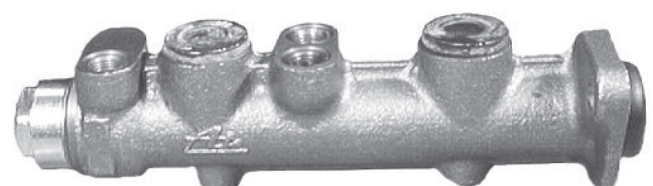

Abbildungen Hauptbremszylinder

Illustrations master cylinder - Ilustraciones cilindro freno - Illustrations Maître-cylindres - Illustrazioni pompe Freno

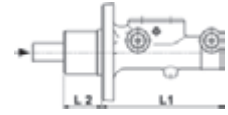

24.2119-0827.3 010350	L1 12	L2 178	24.2119-0829.3 010351	L1 9	L2 194,1
ø19,05 M10x1 3x			ø19,05 M10x1 3x		

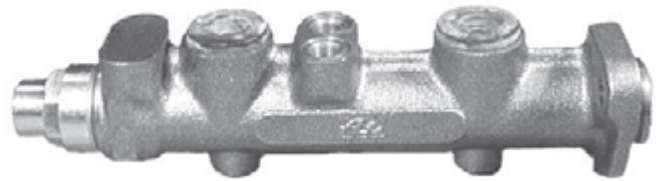
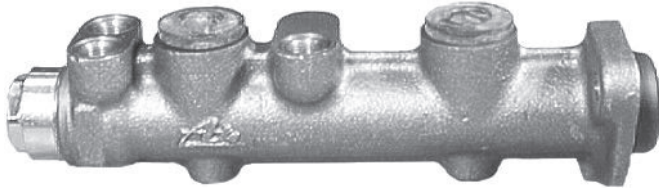

24.2119-0831.3 010416	L1 9,5	L2 190	24.2119-0832.3 010417	L1 9,5	L2 190
ø19,05 M10x1,25 3x			ø19,05 M10x1,25 3x		

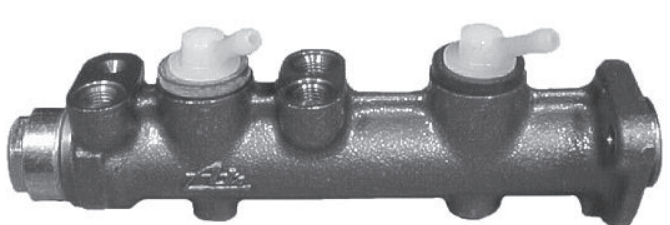
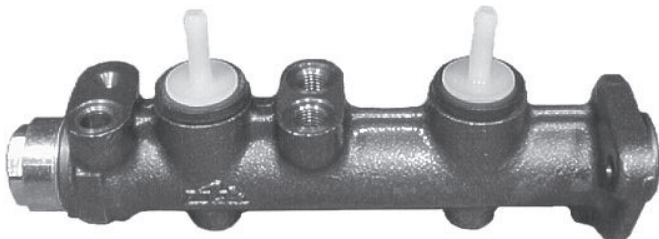

24.2119-0833.3 010418	L1 10,5	L2 190	24.2119-1702.3 010435	L1 40	L2 115,2
ø19,05 M10x1 4x			ø19,05 M10x1 4x		

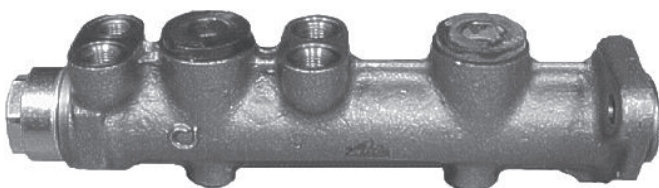

24.2119-1705.3 010460	L1 8,5	L2 192,5	24.2119-1708.3 010543	L1 34,5	L2 116,5
ø19,05 M10x1 2x			ø19,05 M10x1 4x		

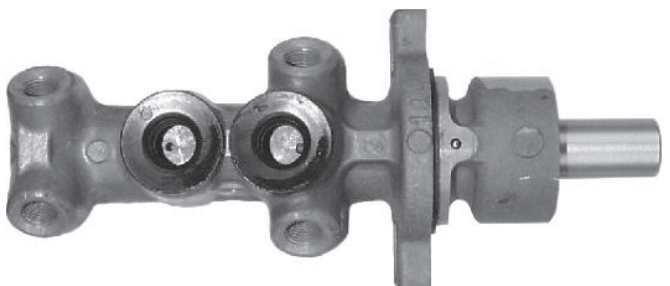
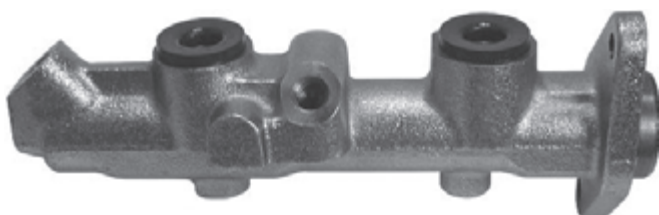

Abbildungen Hauptbremszylinder

Illustrations master cylinder - Ilustraciones cilindro freno - Illustrations Maître-cylindres - Illustrazioni pompe Freno

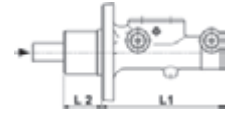

24.2119-1709.3 010876

L1
18 L2
164

ø19,05 M10x1 2x



24.2119-1710.3 010880

L1
17 L2
130

ø19,05 M10x1 2x



24.2119-1711.3 010911

L1
41 L2
116,5

ø19,05 M12x1 2x



24.2119-1712.3 010912

L1
38,5 L2
140

ø19,05 M12x1 2x



24.2120-0702.3 010361

L1
16 L2
130

ø20,64 4x 2x M10x1 2x M12x1

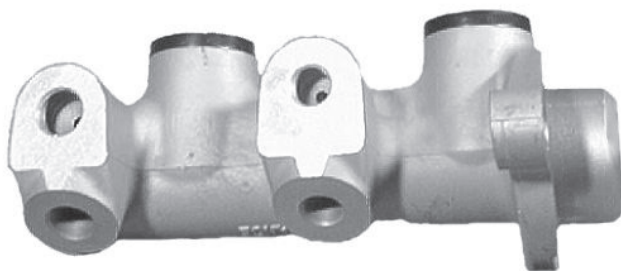

24.2120-0801.3 010362

L1
9 L2
190,2

ø20,64 M10x1 3x

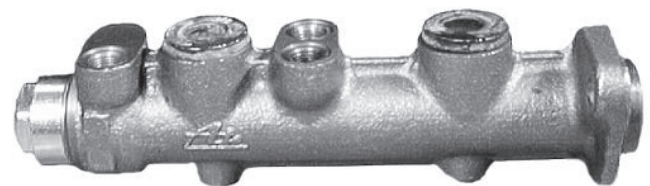

24.2120-0802.3 010363

L1
39,1 L2
120,4

ø20,64 M10x1 3x

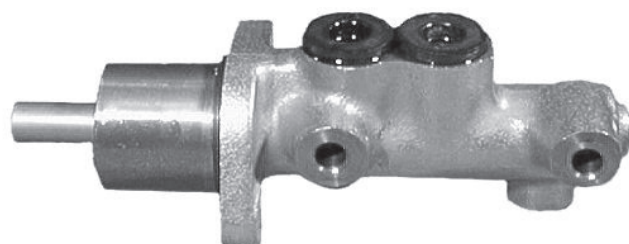

24.2120-0803.3 010415

L1
9 L2
178,5

ø20,64 M10x1,25 4x

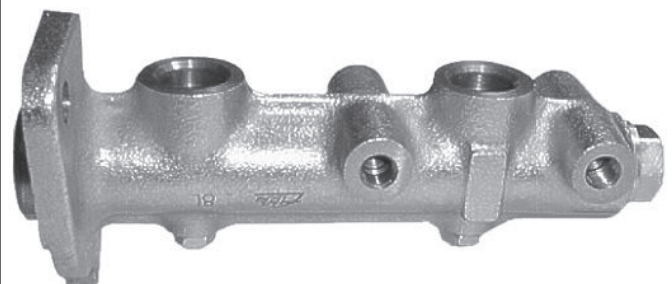

Abbildungen Hauptbremszylinder

Illustrations master cylinder - Ilustraciones cilindro freno - Illustrations Maître-cylindres - Illustrazioni pompe Freno

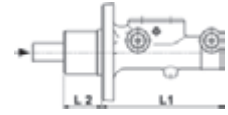

24.2120-0913.3 010392 L1 L2
16 130,5
ø20,64 4x 1x M10x1/1x M12x1 2x M15x1



24.2120-1604.3 010370 L1 L2
16,5 172,5
ø20,64 2x 1x M10x1 1x M12x1

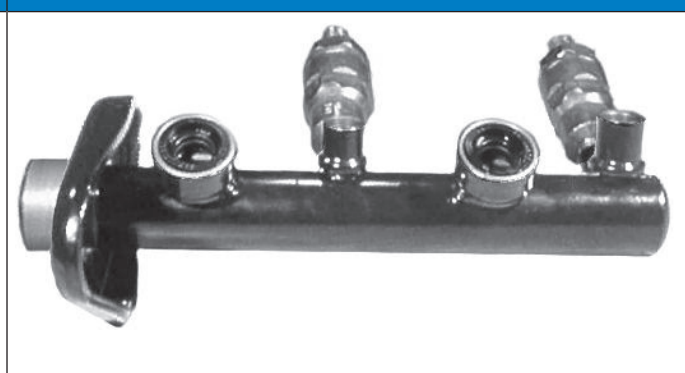

24.2120-1701.3 010427 L1 L2
38 114,2
ø20,64 M10x1 2x

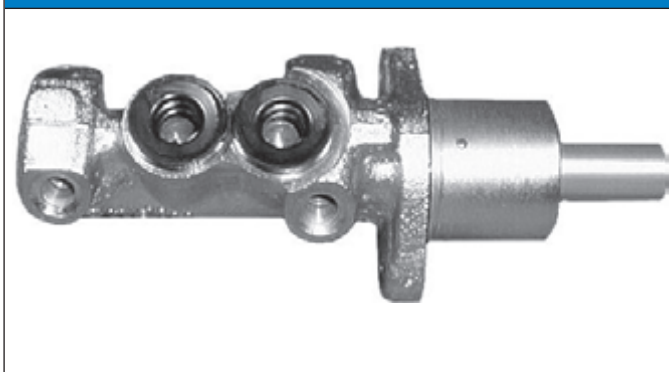

24.2120-1704.3 010429 L1 L2
40 114,2
ø20,64 M10x1 4x

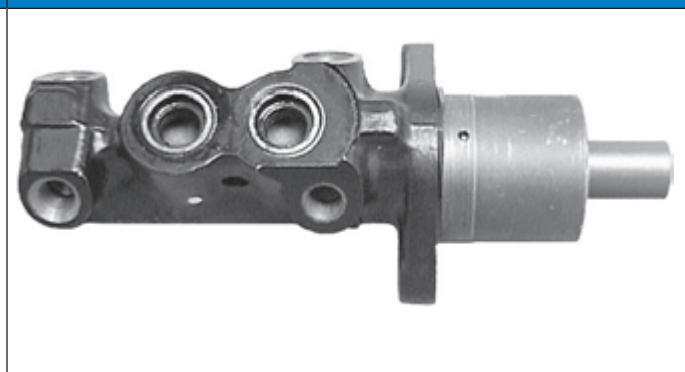

24.2120-1706.3 010262 L1 L2
40,1 118
ø20,64 M10x1 4x



24.2120-1710.3 010468 L1 L2
33,5 130
ø20,64 M10x1 4x

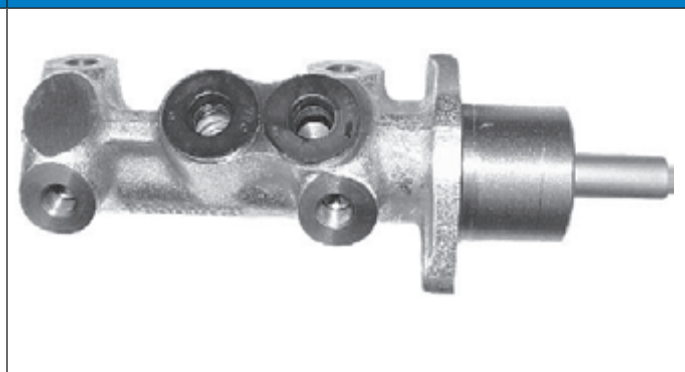

24.2120-1721.3 010553 L1 L2
51,3 143,8
ø20,64 3x 2x M10x1 1x M12x1

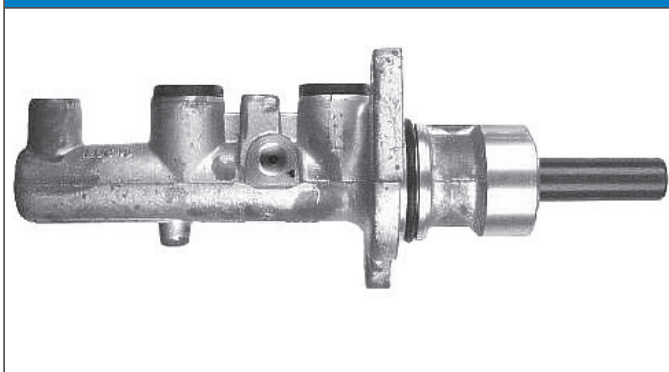







24.2120-1722.3 010544 L1 L2
34,5 116,5
ø20,64 M10x1 4x

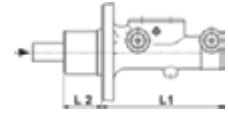

Abbildungen Hauptbremszylinder

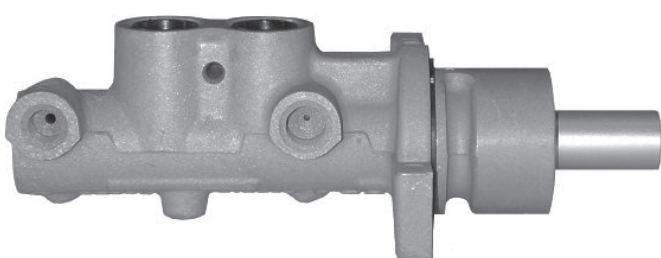
Illustrations master cylinder - Ilustraciones cilindro freno - Illustrations Maître-cylindres - Illustrazioni pompe Freno

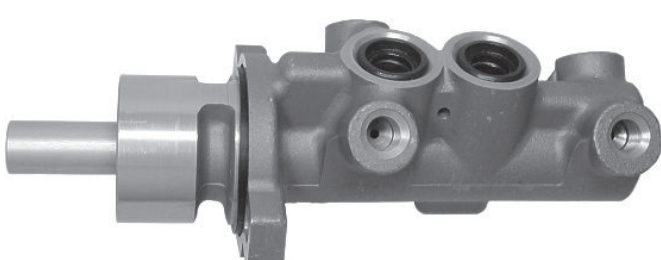
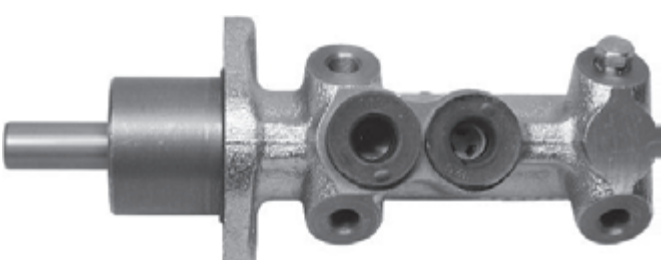



<p>24.2120-1723.3 010545 L1 L2 34,5 118 ø20,64 M10x1 2x</p>	<p>24.2120-1725.3 010579 L1 L2 34,5 118 ø20,64 M10x1 2x</p>
	
<p>24.2120-1726.3 010564 L1 L2 33 120 ø20,64 2x 1x M10x1 1x M12x1</p>	<p>24.2120-1728.3 010626 L1 L2 34,5 116,2 ø20,64 M10x1 2x</p>
	
<p>24.2120-1730.3 010678 L1 L2 34,5 116,2 ø20,64 M10x1 2x</p>	<p>24.2120-1733.3 010686 L1 L2 33,5 128,5 ø20,64 M10x1 3x</p>
	
<p>24.2120-1734.3 010702 L1 L2 38,5 139,5 ø20,64 M12x1 2x</p>	<p>24.2120-1735.3 010726 L1 L2 33 130,5 ø20,64 M12x1 2x</p>
	

Abbildungen Hauptbremszylinder

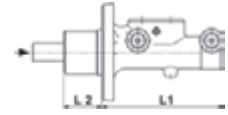
Illustrations master cylinder - Ilustraciones cilindro freno - Illustrations Maître-cylindres - Illustrazioni pompe Freno

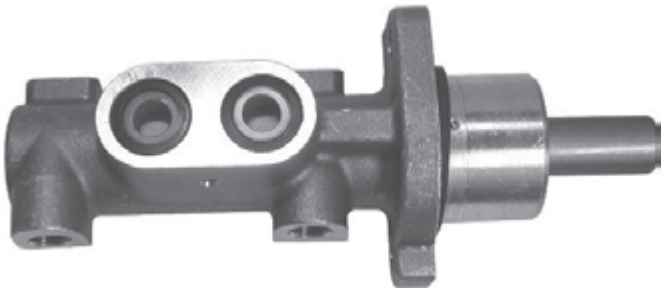
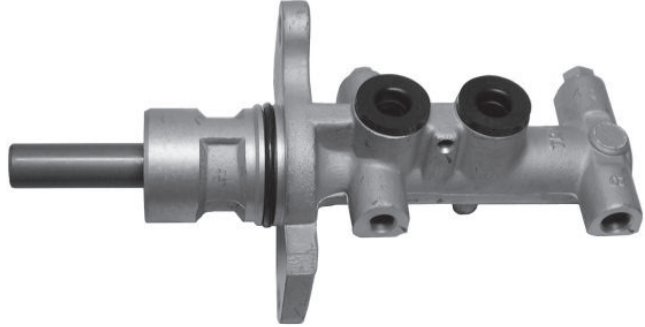

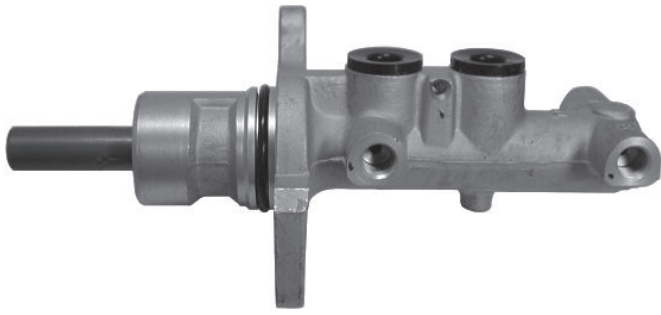
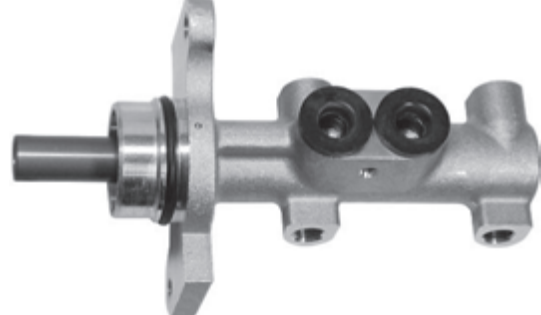
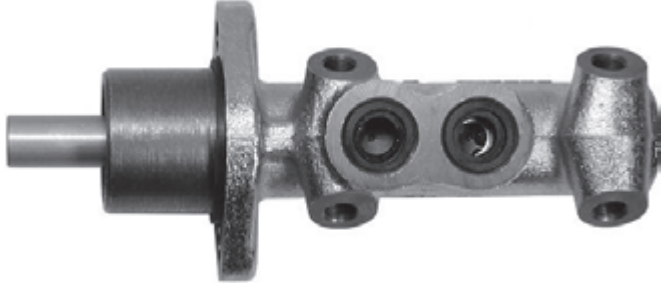
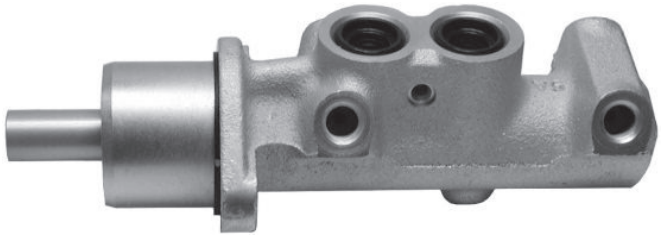
<p>24.2120-1736.3 010732 L1 L2 28,1 138,2 ø20,64 M12x1 4x</p>	<p>24.2120-1737.3 010757 L1 L2 30 117 ø20,64 4x 2x M10x1 2x M12x1</p>
	
<p>24.2120-1738.3 010759 L1 L2 51 139 ø20,64 4x 2x M10x1 2x M12x1</p>	<p>24.2120-1739.3 010762 L1 L2 19 171 ø20,64 4x 2x M10x1 2x M12x1</p>
	
<p>24.2120-1740.3 010764 L1 L2 51 139 ø20,64 M12x1 4x</p>	<p>24.2120-1741.3 010775 L1 L2 24 132 ø20,64 M12x1 4x</p>
	
<p>24.2120-1742.3 010776 L1 L2 33 125 ø20,64 M10x1 4x</p>	<p>24.2120-1743.3 010777 L1 L2 33 125 ø20,64 M10x1 2x</p>
	

Abbildungen Hauptbremszylinder

Illustrations master cylinder - Ilustraciones cilindro freno - Illustrations Maître-cylindres - Illustrazioni pompe Freno

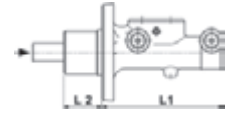

24.2120-1744.3	010820	L1 36,5	L2 132,5	24.2120-1745.3	010834	L1 30,5	L2 131
ø20,64 M10x1 4x				ø20,64 M10x1 2x			

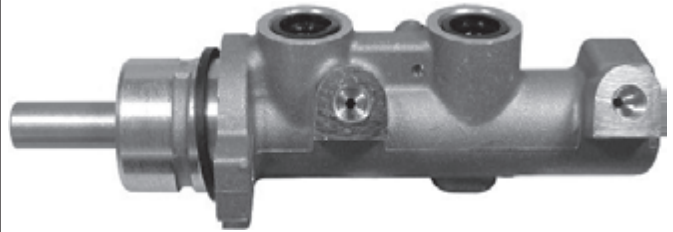
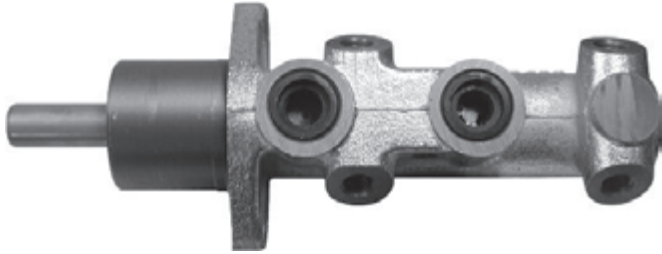

24.2120-1746.3	010835	L1 33	L2 130,5	24.2120-1747.3	010836	L1 36,5	L2 134
ø20,64 M12x1 2x				ø20,64 M10x1 2x			

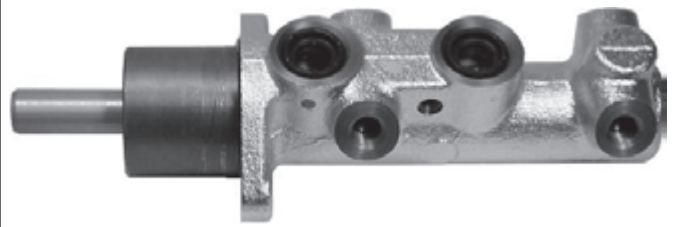

24.2120-1748.3	010894	L1 25	L2 162	24.2120-1749.3	010903	L1	L2
ø20,64 M12x1 2x				ø20,64 M10x1 2x			



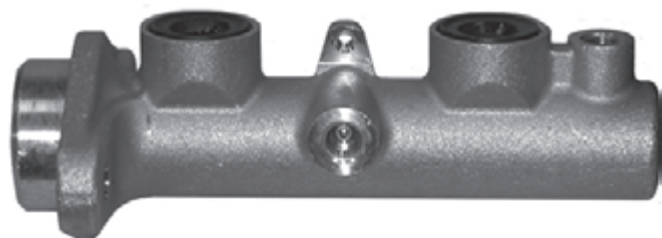

24.2120-1751.3	010909	L1 15,5	L2 153,5	24.2120-1752.3	010928	L1 26	L2 157
ø20,64 M10x1 2x				ø20,64 M10x1 2x			

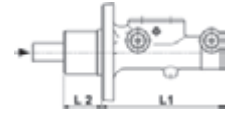

Abbildungen Hauptbremszylinder

Illustrations master cylinder - Ilustraciones cilindro freno - Illustrations Maître-cylindres - Illustrazioni pompe Freno



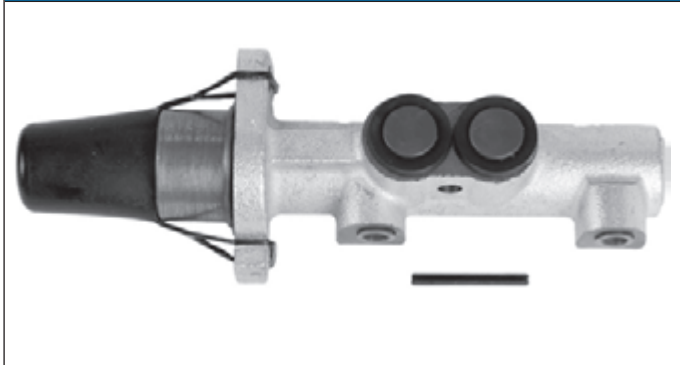
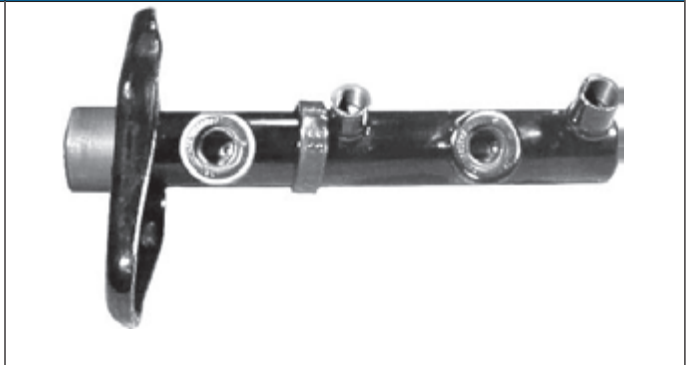
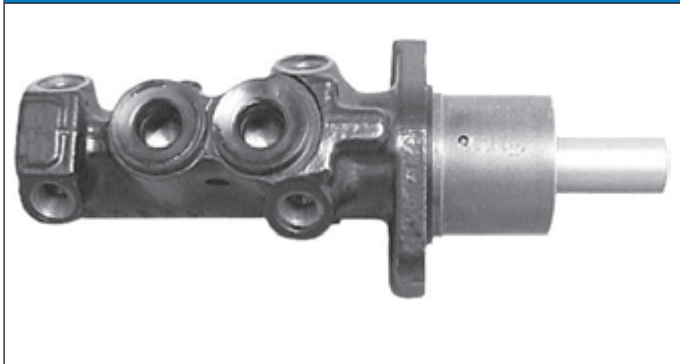
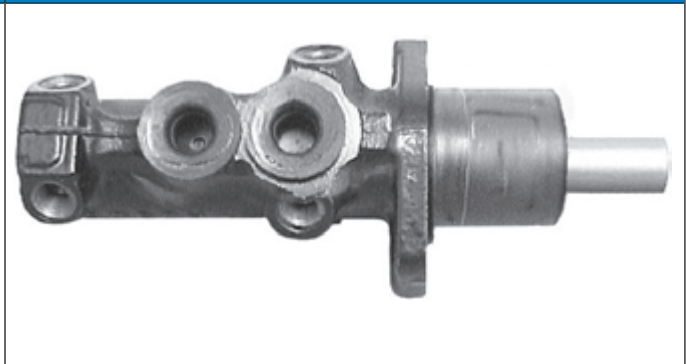
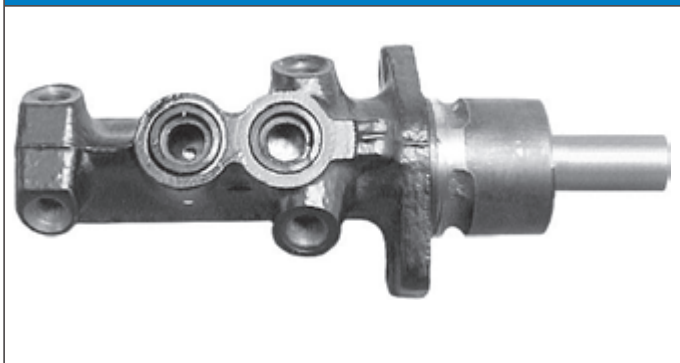
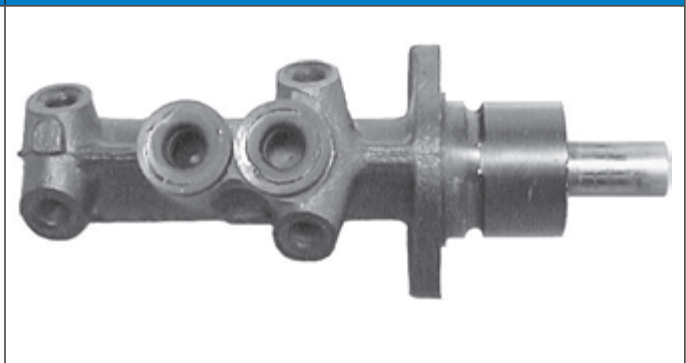

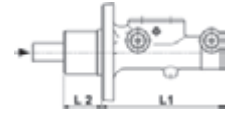

<p>24.2120-1754.3 010949 L1 L2 23,5 107,5 ø20,64 2x M10x1 M12x1</p>	<p>24.2120-1758.3 011008 L1 L2 16,5 177,5 ø20,64 M10x1 4x</p>
	
<p>24.2120-1768.3 011041 L1 L2 26 143 ø20,64 M12x1 2x</p>	<p>24.2122-1603.3 010381 L1 L2 16,5 173,5 ø22,2 2x 1x M10x1 1x M12x1</p>
	
<p>24.2122-1703.3 010422 L1 L2 36,2 115,2 ø22,2 M10x1 4x</p>	<p>24.2122-1704.3 010423 L1 L2 39 115,5 ø22,2 M10x1 4x</p>
	
<p>24.2122-1705.3 010434 L1 L2 36,5 118 ø22,2 M10x1 4x</p>	<p>24.2122-1707.3 010438 L1 L2 36,5 128 ø22,2 M10x1 4x</p>
	

Abbildungen Hauptbremszylinder

Illustrations master cylinder - Ilustraciones cilindro freno - Illustrations Maître-cylindres - Illustrazioni pompe Freno



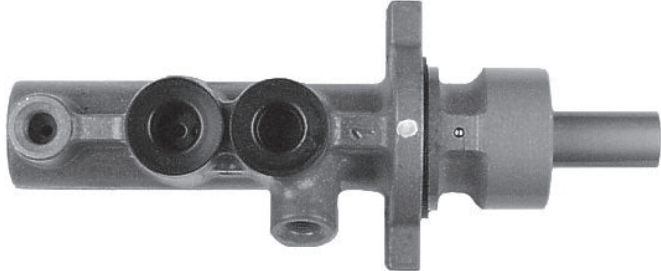
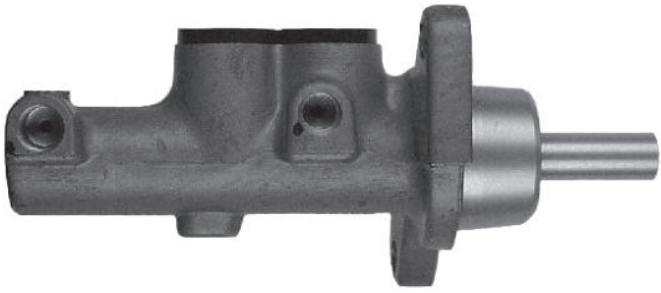
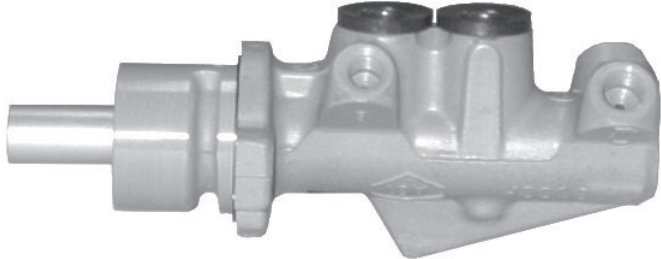
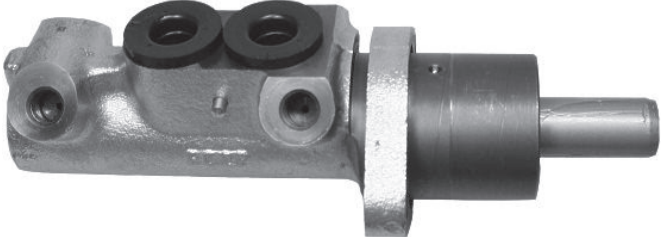



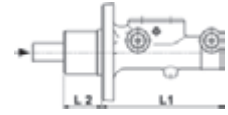

<p>24.2122-1708.3 010437 L1 L2 35 131,5 ø22,2 M10x1 2x</p>	<p>24.2122-1714.3 010480 L1 L2 19 168 ø22,2 M10x1 2x</p>
	
<p>24.2122-1715.3 010481 L1 L2 19 167 ø22,2 M10x1 5x</p>	<p>24.2122-1716.3 010485 L1 L2 36 132 ø22,2 M10x1 4x</p>
	
<p>24.2122-1718.3 010517 L1 L2 36,5 117 ø22,2 M10x1 2x</p>	<p>24.2122-1724.3 010561 L1 L2 23,5 122,5 ø22,2 2x 1x M10x1 1x M12x1</p>
	
<p>24.2122-1727.3 010586 L1 L2 34,5 115,5 ø22,2 4x 2x M10x1 2x M12x1</p>	<p>24.2122-1731.3 010656 L1 L2 36 150,2 ø22,2 M10x1 4x</p>
	

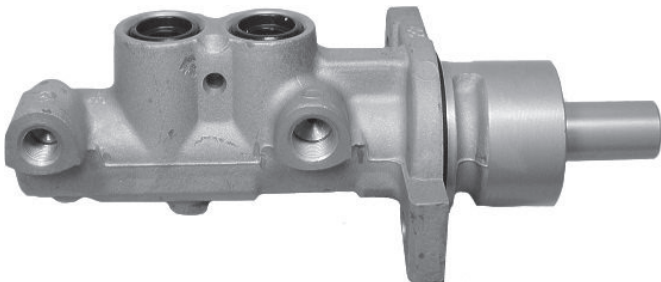
Abbildungen Hauptbremszylinder

Illustrations master cylinder - Ilustraciones cilindro freno - Illustrations Maître-cylindres - Illustrazioni pompe Freno

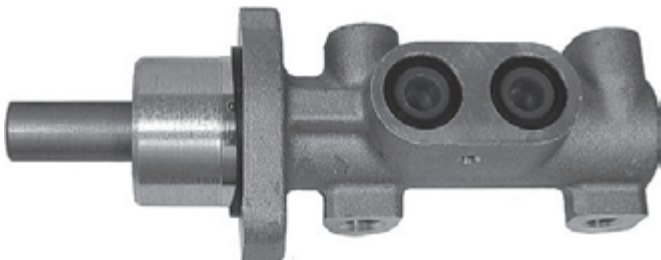
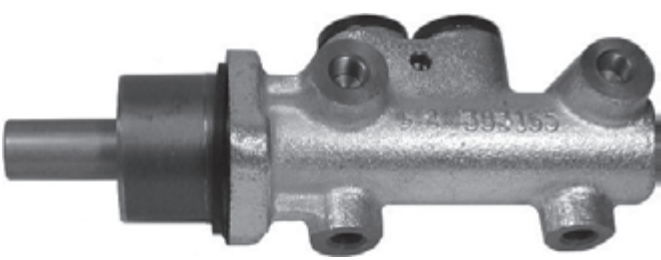

<p>24.2122-1733.3 010668 L1 L2 34,5 165 ø22,2 4x 2x M10x1 2x M12x1</p>	<p>24.2122-1740.3 010711 L1 L2 27,5 118,5 ø22,2 2x 1x M10x1 1x M12x1</p>
	
<p>24.2122-1741.3 010695 L1 L2 36 115 ø22,2 M10x1 4x</p>	<p>24.2122-1742.3 010696 L1 L2 35 131,5 ø22,2 M10x1 2x</p>
	
<p>24.2122-1743.3 010712 L1 L2 29 117 ø22,2 4x 2x M10x1 2x M12x1</p>	<p>24.2122-1750.3 010740 L1 L2 29,5 120,5 ø22,2 M10x1 4x</p>
	
<p>24.2122-1757.3 010769 L1 L2 31 132 ø22,2 M12x1 2x</p>	<p>24.2122-1760.3 010821 L1 L2 33 125 ø22,2 M10x1 4x</p>
	

Abbildungen Hauptbremszylinder

Illustrations master cylinder - Ilustraciones cilindro freno - Illustrations Maître-cylindres - Illustrazioni pompe Freno

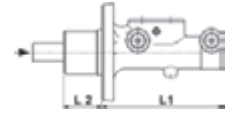

24.2122-1761.3 010822	L1 16	L2 154,3	24.2122-1762.3 010837	L1 30	L2 131
ø22,2 M10x1 2x			ø22,2 M10x1 2x		

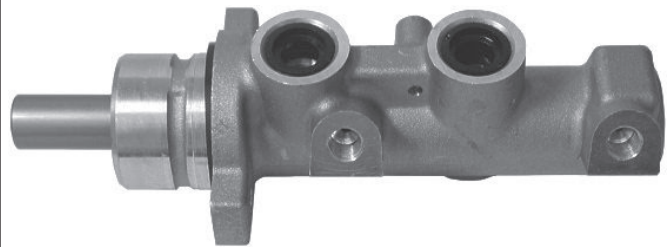
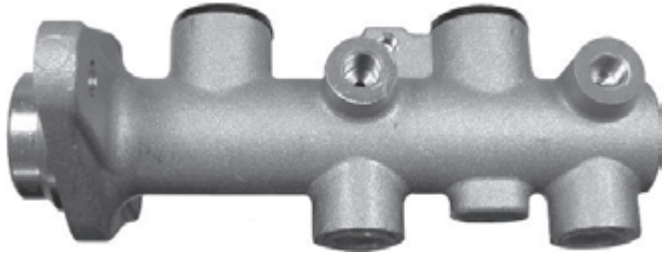

24.2122-1763.3 010838	L1 33	L2 125	24.2122-1764.3 010851	L1 26,5	L2 138
ø22,2 M10x1 2x			ø22,2 M12x1 2x		

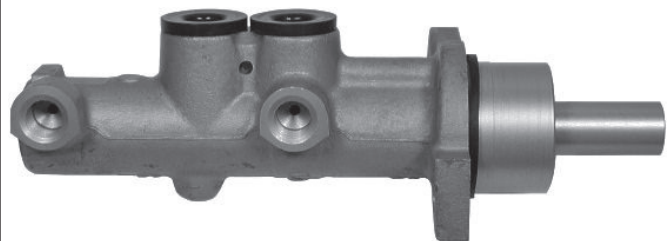
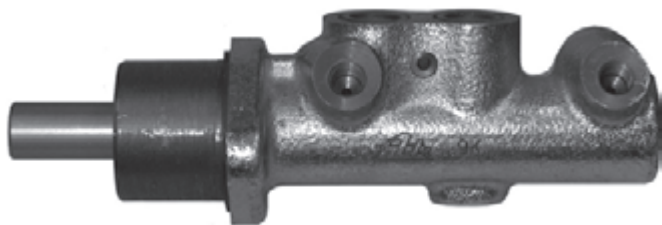

24.2122-1765.3 010839	L1 16	L2 154	24.2122-1766.3 010840	L1 25	L2 135
ø22,2 M10x1 2x			ø22,2 M12x1 2x		

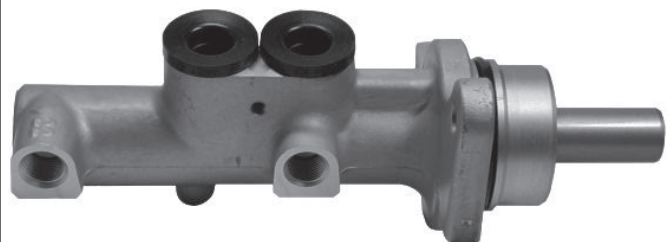
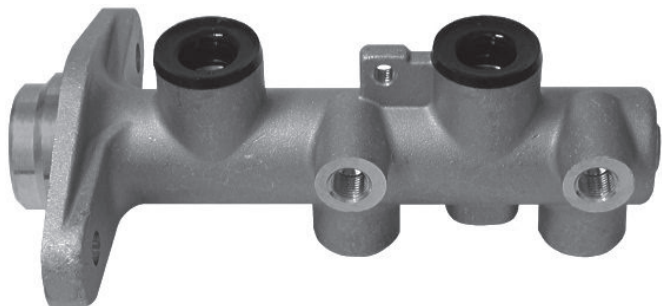

24.2122-1767.3 010841	L1 25	L2 135	24.2122-1768.3 010853	L1 30	L2 131
ø22,2 M12x1 3x			ø22,2 M12x1 2x		

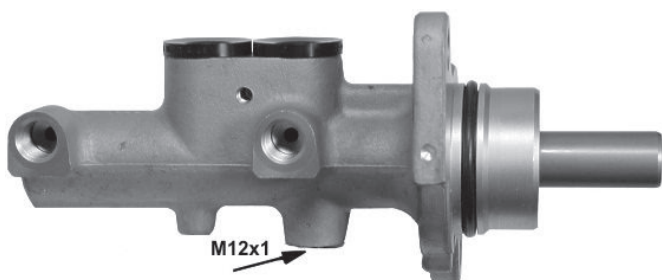

Abbildungen Hauptbremszylinder

Illustrations master cylinder - Ilustraciones cilindro freno - Illustrations Maître-cylindres - Illustrazioni pompe Freno

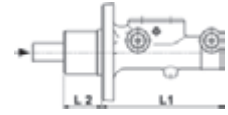

24.2122-1770.3 010898	L1 45	L2 114	24.2122-1771.3 010901	L1 15,5	L2 153,5
ø22,2 M12x1 2x			ø22,2 M10x1 2x		

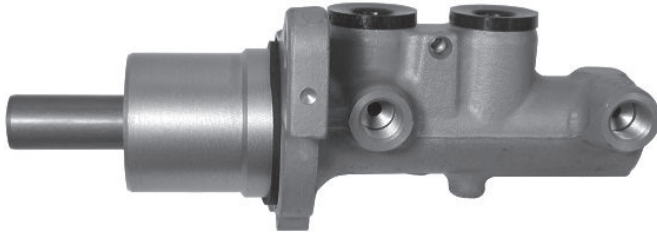

24.2123-1602.3 010384	L1 32	L2 126,5	24.2123-1606.3 010386	L1 36	L2 119
ø23,81 M10x1 2x			ø23,81 2x 1x M10x1 1x M12x1		

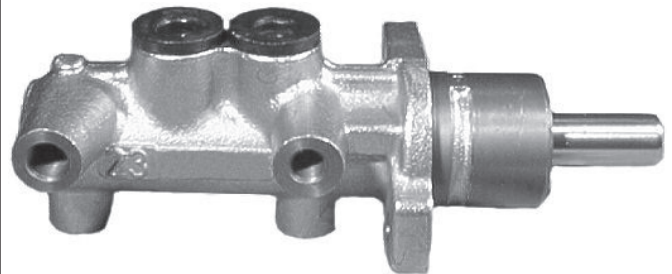
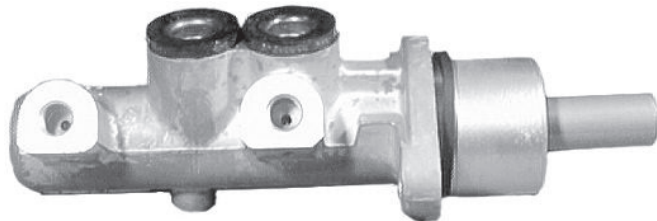

24.2123-1701.3 010424	L1 36,5	L2 126,7	24.2123-1702.3 010431	L1 10,5	L2 200
ø23,81 M10x1 4x			ø23,81 4x 2x M10x1		

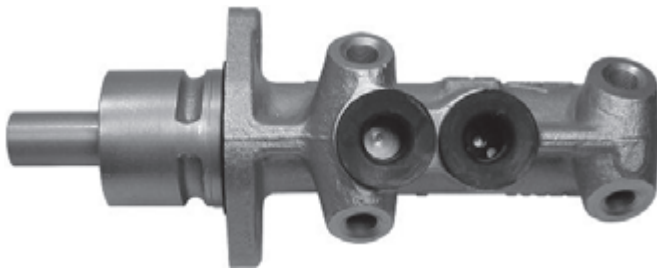



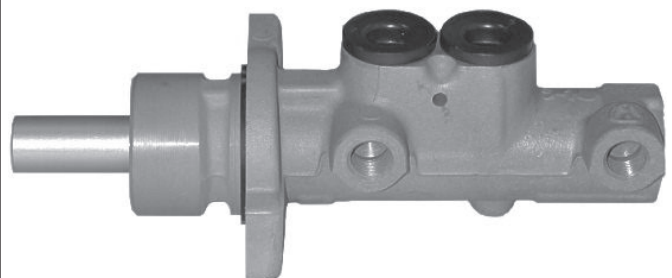
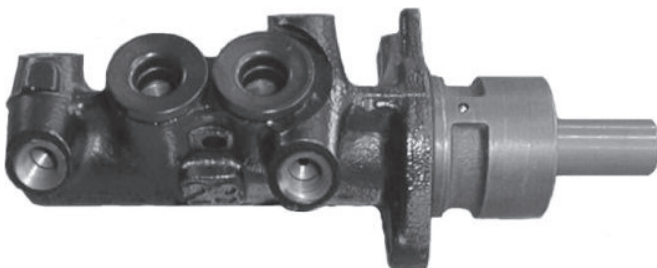



24.2123-1707.3 010492	L1 36	L2 117,5	24.2123-1709.3 010503	L1 32	L2 122
ø23,81 M10x1 4x			ø23,81 M12x1 2x		

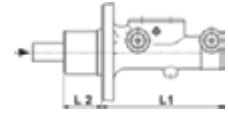

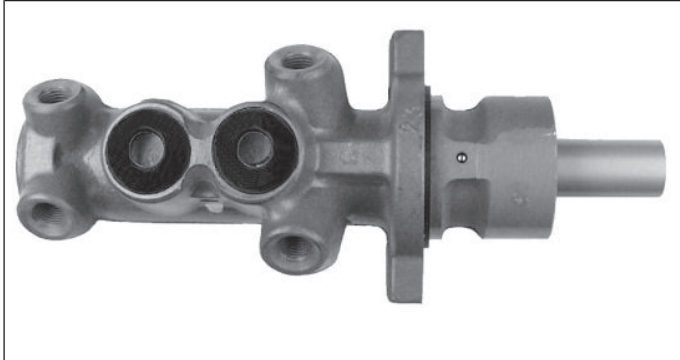
Abbildungen Hauptbremszylinder

Illustrations master cylinder - Ilustraciones cilindro freno - Illustrations Maître-cylindres - Illustrazioni pompe Freno

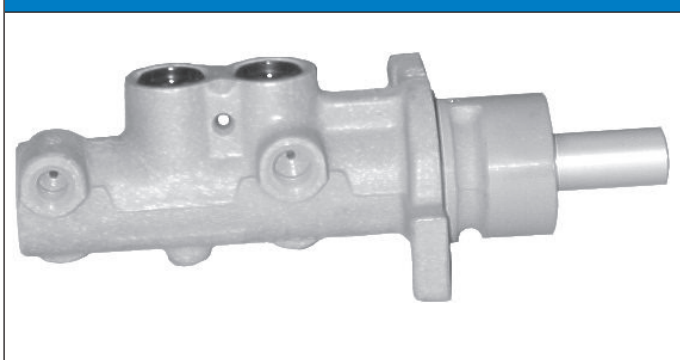

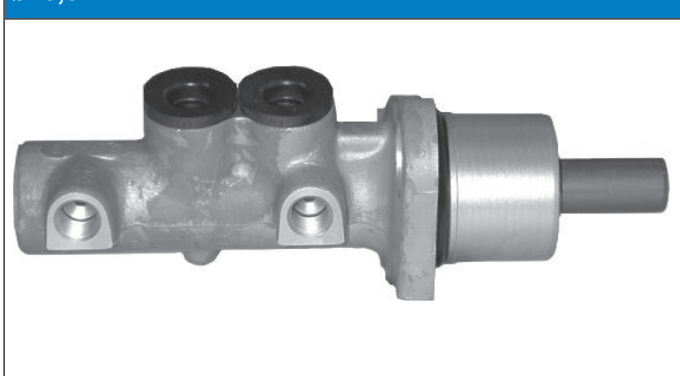
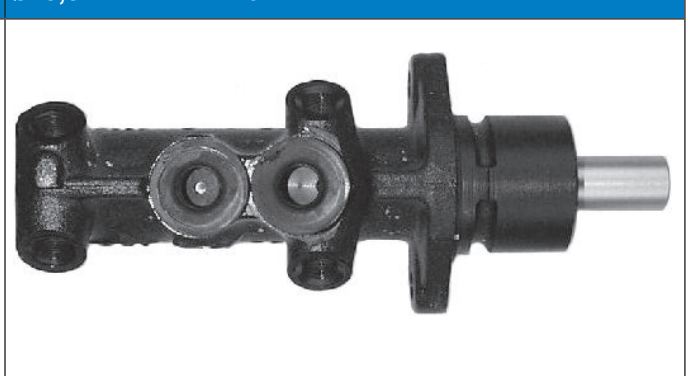

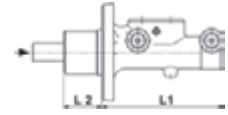

<p>24.2123-1710.3 010504 L1 L2 36 118 ø23,81 M10x1 4x</p>	<p>24.2123-1711.3 010518 L1 L2 35 165 ø23,81 M10x1 2x</p>
	
<p>24.2123-1712.3 010519 L1 L2 36 120 ø23,81 M10x1 4x</p>	<p>24.2123-1713.3 010505 L1 L2 34,5 127 ø23,81 M12x1 2x</p>
	
<p>24.2123-1714.3 010587 L1 L2 33 120,5 ø23,81 4x 2x M10x1 2x M12x1</p>	<p>24.2123-1715.3 010520 L1 L2 33 120,5 ø23,81 2x 1x M10x1 1x M12x1</p>
	
<p>24.2123-1717.3 010521 L1 L2 39,5 121,5 ø23,81 M12x1 2x</p>	<p>24.2123-1725.3 010549 L1 L2 36,5 126,5 ø23,81 4x 2x M10x1 2x M12x1</p>
	

Abbildungen Hauptbremszylinder

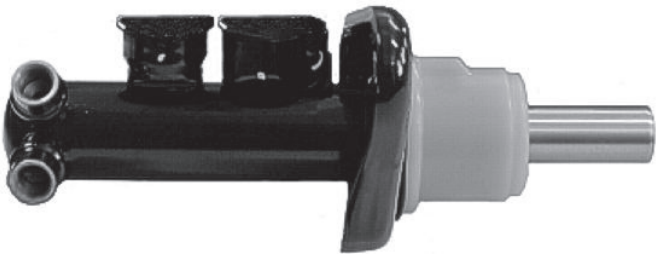
Illustrations master cylinder - Ilustraciones cilindro freno - Illustrations Maître-cylindres - Illustrazioni pompe Freno

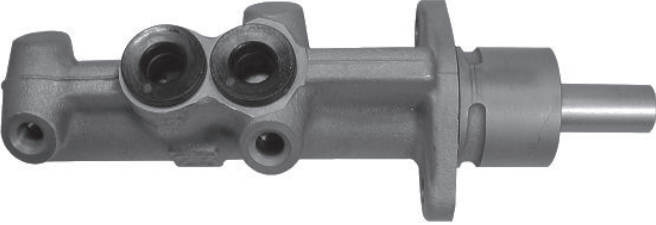
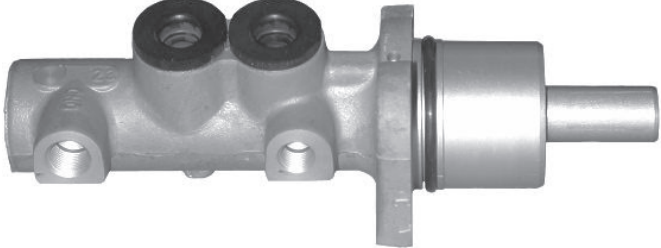
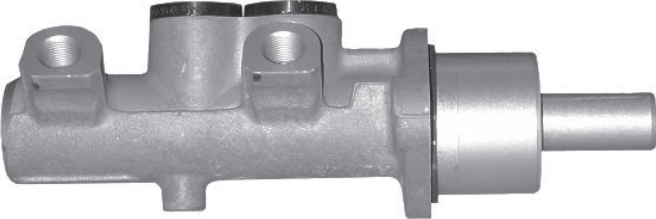
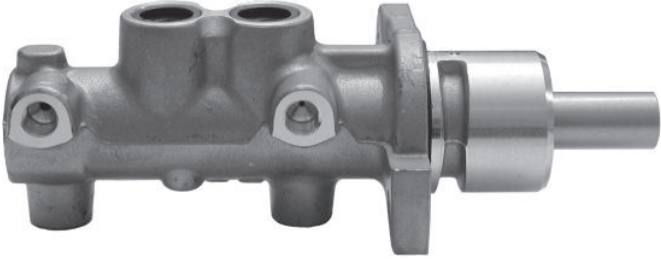

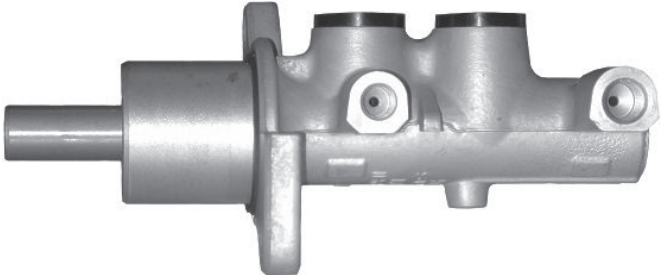
<p>24.2123-1726.3 010557 L1 L2 36 110 ø23,81 M10x1 3x</p>	<p>24.2123-1728.3 010558 L1 L2 36 128 ø23,81 M10x1 2x</p>
	
<p>24.2123-1729.3 010567 L1 L2 35 150,8 ø23,81 M10x1 2x</p>	<p>24.2123-1730.3 010620 L1 L2 39,5 120,5 ø23,81 2x 1x M10x1 1x M12x1</p>
	
<p>24.2123-1731.3 010621 L1 L2 32 124,5 ø23,81 M12x1 2x</p>	<p>24.2123-1732.3 010625 L1 L2 36 105,5 ø23,81 M10x1 4x</p>
	
<p>24.2123-1733.3 010657 L1 L2 36,5 126,7 ø23,81 M10x1 2x</p>	<p>24.2123-1734.3 010640 L1 L2 39,5 119,5 ø23,81 2x 1x M10x1 1x M12x1</p>
	

Abbildungen Hauptbremszylinder

Illustrations master cylinder - Ilustraciones cilindro freno - Illustrations Maître-cylindres - Illustrazioni pompe Freno

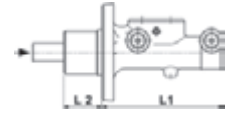

24.2123-1735.3 010652

L1
17 L2
174

ø23,81 M10x1 2x



24.2123-1737.3 010654

L1
17 L2
174

ø23,81 M10x1 4x



24.2123-1738.3 010658

L1
36 L2
118,5

ø23,81 M10x1 4x



24.2123-1739.3 010661

L1
39,5 L2
121

ø23,81 M12x1 2x

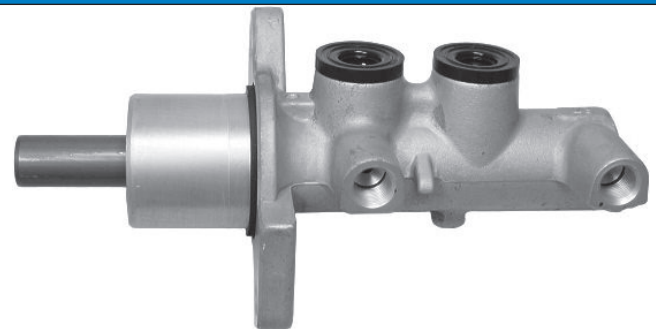

24.2123-1740.3 010662

L1
51,5 L2
112

ø23,81 M12x1 2x

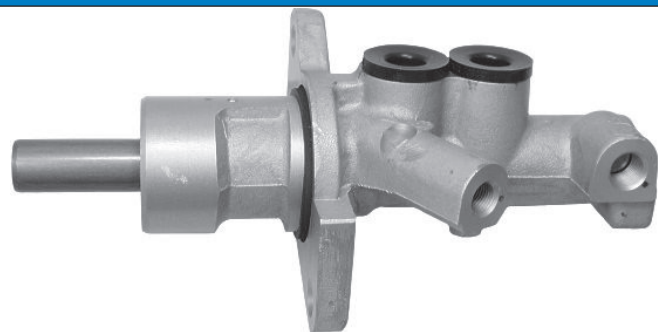

24.2123-1741.3 010681

L1
33 L2
127

ø23,81 M12x1 2x



24.2123-1742.3 010671

L1
33 L2
121

ø23,81 M12x1 2x

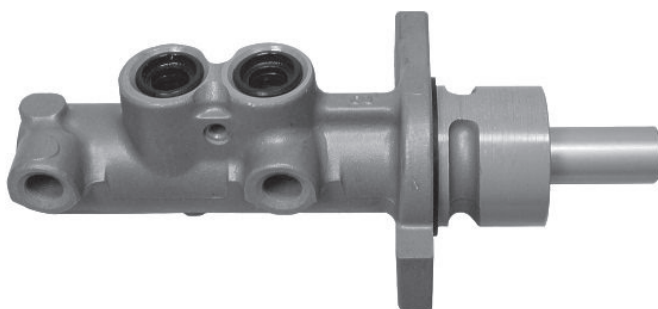

24.2123-1746.3 010682

L1
36,5 L2
116,5

ø23,81 M10x1 2x

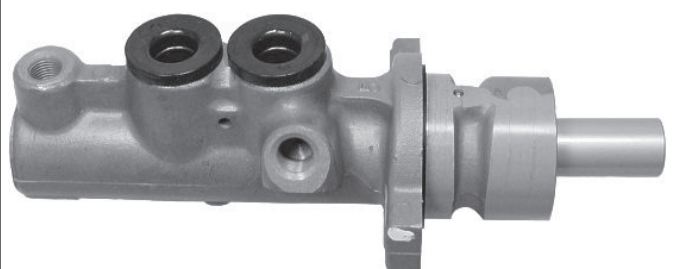

Abbildungen Hauptbremszylinder

Illustrations master cylinder - Ilustraciones cilindro freno - Illustrations Maître-cylindres - Illustrazioni pompe Freno

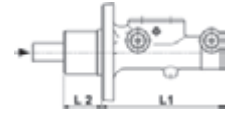

24.2123-1749.3 010713	L1 33	L2 120	24.2123-1751.3 010698	L1 36	L2 118
ø23,81 M10x1 2x			ø23,81 M10x1 4x		

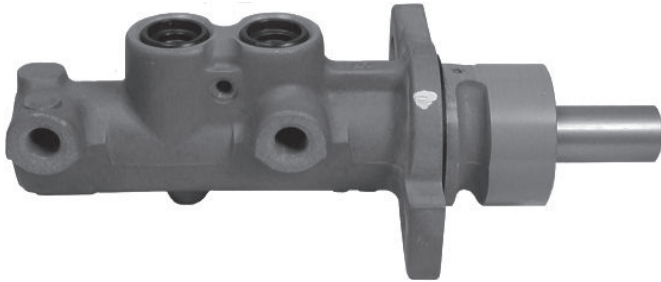

24.2123-1754.3 010741	L1 67	L2 111,5	24.2123-1755.3 010750	L1 67	L2 110
ø23,81 M12x1 2x			ø23,81 M10x1 2x		

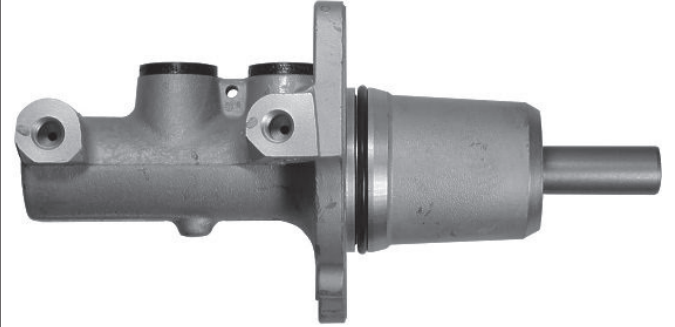

24.2123-1759.3 010768	L1 39	L2 143,2	24.2123-1760.3 010779	L1 25	L2 155
ø23,81 M12x1 2x			ø23,81 M12x1 2x		



24.2123-1761.3 010780	L1 15	L2 152	24.2123-1762.3 010823	L1 15	L2 161
ø23,81 M10x1 2x			ø23,81 M10x1 2x		



Abbildungen Hauptbremszylinder

Illustrations master cylinder - Ilustraciones cilindro freno - Illustrations Maître-cylindres - Illustrazioni pompe Freno

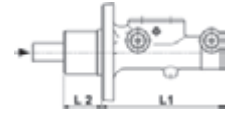

24.2123-1763.3 010842	L1 32,5	L2 131	24.2123-1764.3 010824	L1 29	L2 132
ø23,81 M10x1 2x			ø23,81 2x 1x M10x1 1x M12x1		

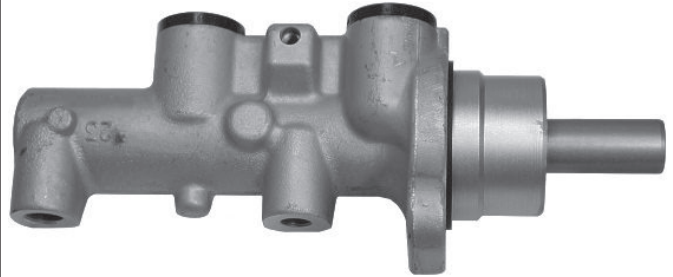
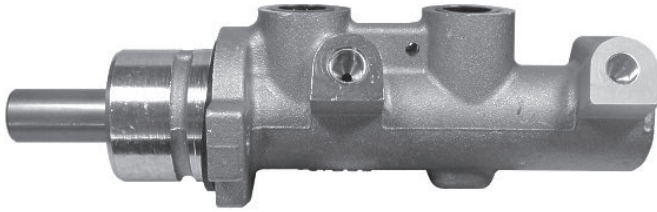

24.2123-1766.3 010825	L1 40	L2 121	24.2123-1767.3 010844	L1 31	L2 131
ø23,81 M12x1 2x			ø23,81 M10x1 2x		

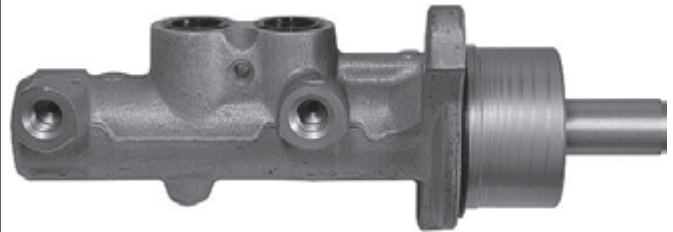
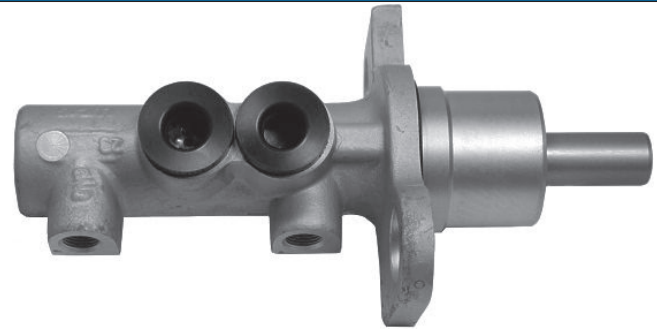

24.2123-1768.3 010845	L1 31	L2 131	24.2123-1769.3 010863	L1 32,5	L2 131
ø23,81 M12x1 2x			ø23,81 M12x1 2x		

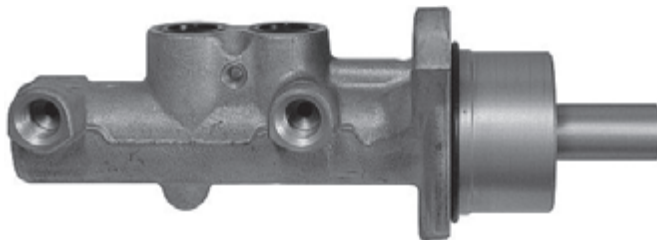

24.2123-1772.3 010858	L1 73	L2 122	24.2123-1774.3 010877	L1 15,5	L2 153
ø23,81 M12x1 2x			ø23,81 M10x1 2x		



Abbildungen Hauptbremszylinder

Illustrations master cylinder - Ilustraciones cilindro freno - Illustrations Maître-cylindres - Illustrazioni pompe Freno

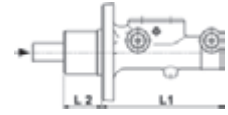

24.2123-1776.3 010926	L1 40	L2 115	24.2123-1777.3 010943	L1 39,5	L2 120,5
ø23,81 M12x1 2x			ø23,81 2x 1x M10x1 1x M12x1		

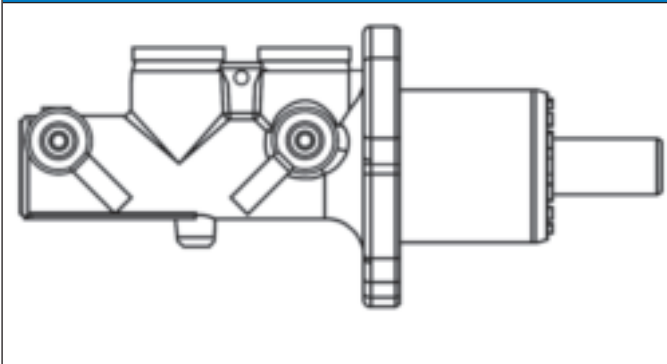

24.2125-1702.3 010482	L1 19	L2 173,5	24.2125-1703.3 010483	L1 9	L2 168
ø25,4 M10x1 2x			ø25,4 M10x1 5x		



24.2125-1704.3 010446	L1 15,5	L2 189	24.2125-1706.3 010496	L1 43	L2 99
ø25,4 2x 1x M10x1 1x M12x1			ø25,4 4x 2x M10x1 2x M12x1		

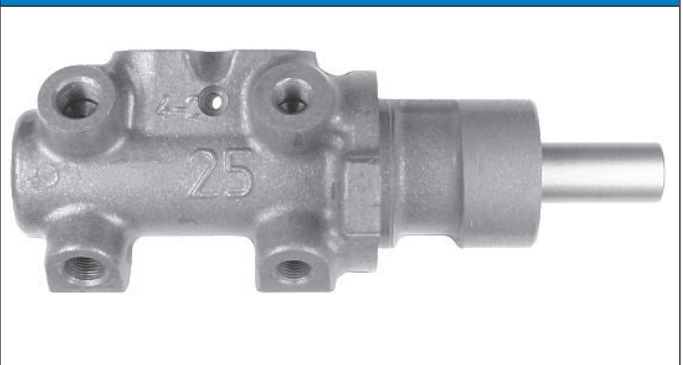

24.2125-1707.3 010497	L1 42,5	L2 110,5	24.2125-1708.3 010498	L1 46,8	L2 112
ø25,4 M12x1 2x			ø25,4 M12x1 2x		

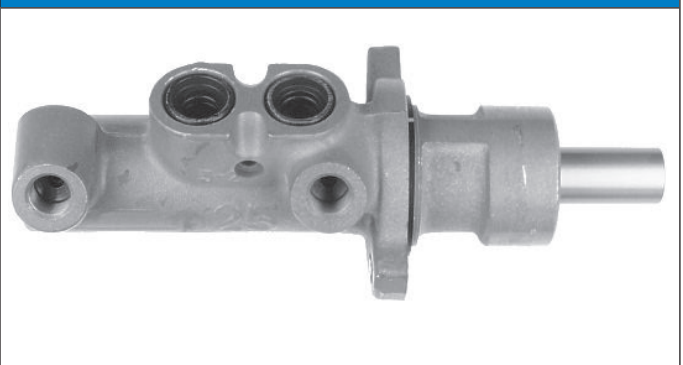

Abbildungen Hauptbremszylinder

Illustrations master cylinder - Ilustraciones cilindro freno - Illustrations Maître-cylindres - Illustrazioni pompe Freno

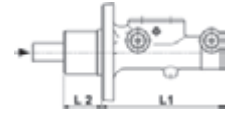

24.2125-1709.3	010499	L1 38	L2 125	24.2125-1712.3	010622	L1 49,5	L2 111,5
ø25,4 M12x1 2x				ø25,4 M12x1 2x			

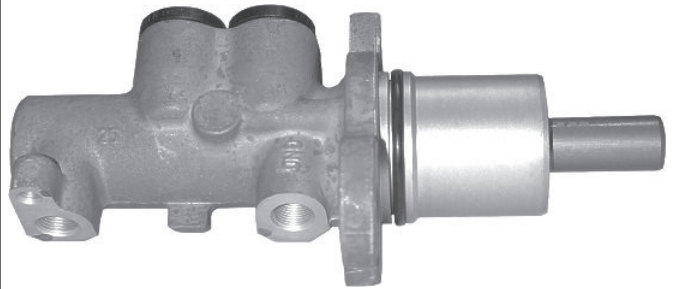
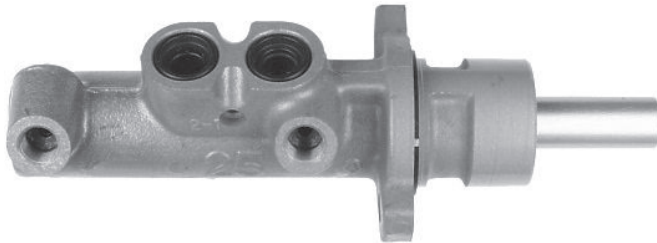

24.2125-1713.3	010623	L1 49	L2 111	24.2125-1716.3	010663	L1 57	L2 120
ø25,4 2x 1x M10x1 1x M12x1				ø25,4 M12x1 2x			

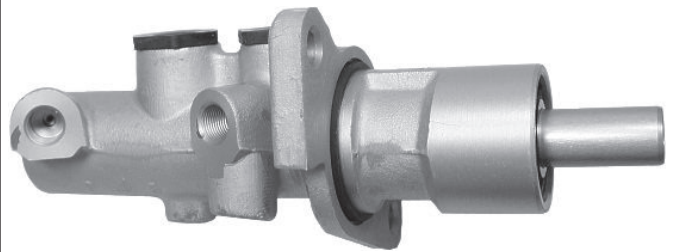
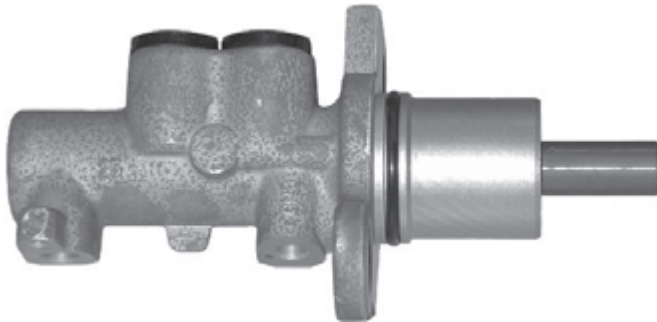

24.2125-1719.3	010666	L1 38	L2 110	24.2125-1720.3	010688	L1 69,5	L2 92
ø25,4 2x 1x M10x1 1x M12x1				ø25,4 M12x1 2x			

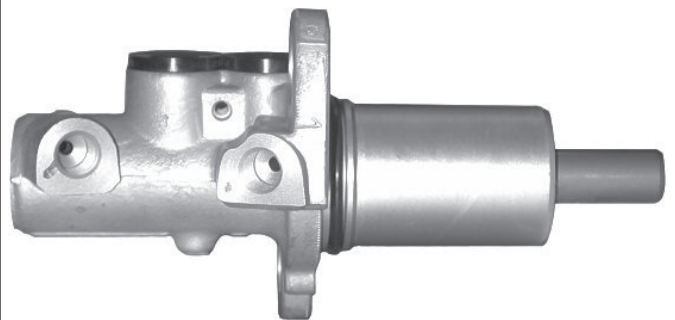

24.2125-1723.3	010689	L1 47,5	L2 113,5	24.2125-1725.3	010717	L1 33	L2 147
ø25,4 M10x1 2x				ø25,4 M10x1 5x			

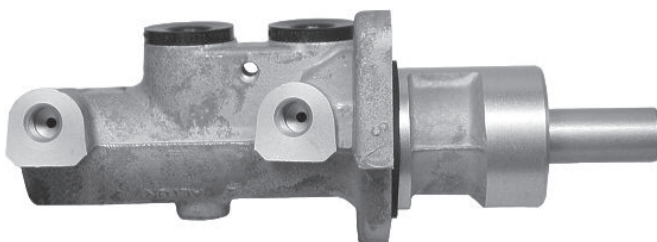

Abbildungen Hauptbremszylinder

Illustrations master cylinder - Ilustraciones cilindro freno - Illustrations Maître-cylindres - Illustrazioni pompe Freno

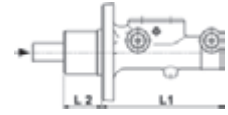

24.2125-1726.3 010718	L1 33	L2 147	24.2125-1727.3 010723	L1 35	L2 165,3
ø25,4 M10x1 2x		ø25,4 M10x1 2x			

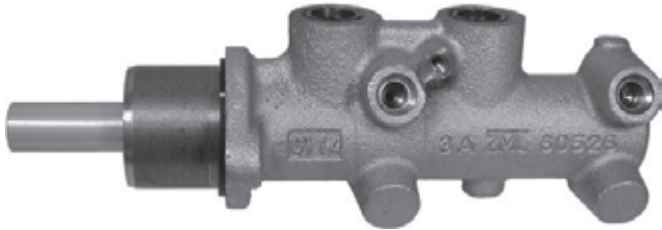

24.2125-1728.3 010751	L1 67	L2 111,5	24.2125-1729.3 010752	L1 47	L2 114
ø25,4 M12x1 2x		ø25,4 M12x1 2x			

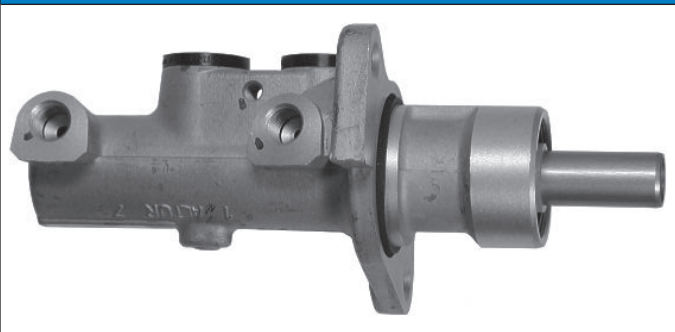
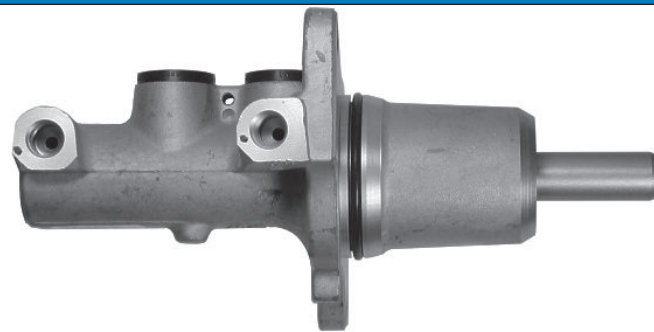

24.2125-1731.3 010826	L1 47,5	L2 113	24.2125-1732.3 010827	L1 40	L2 122
ø25,4 M12x1 2x		ø25,4 M12x1 2x			





24.2125-1733.3 010830	L1 40	L2 122	24.2125-1734.3 010878	L1 47,5	L2 115
ø25,4 2x 1x M10x1 1x M12x1		ø25,4 M12x1 2x			

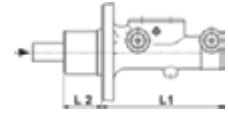

Abbildungen Hauptbremszylinder

Illustrations master cylinder - Ilustraciones cilindro freno - Illustrations Maître-cylindres - Illustrazioni pompe Freno

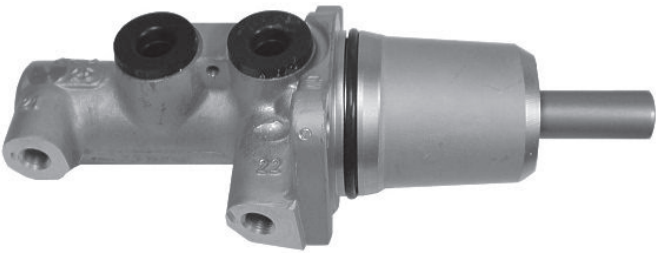
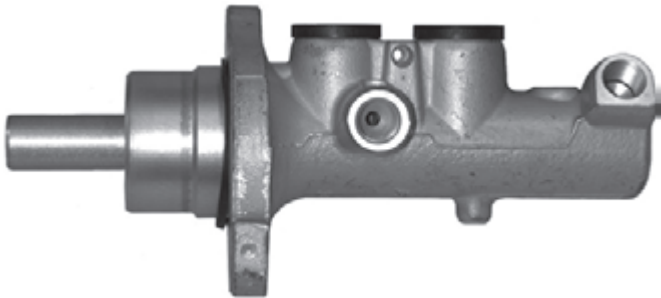
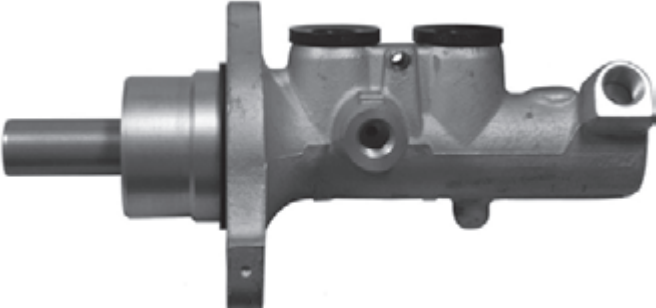
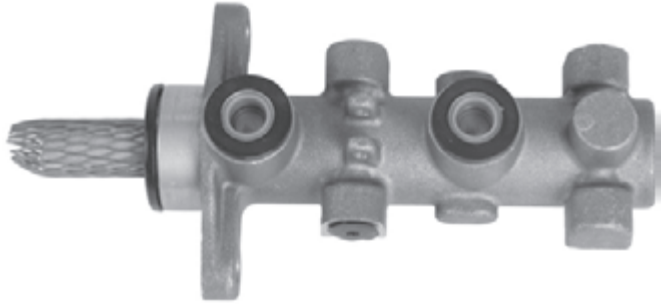

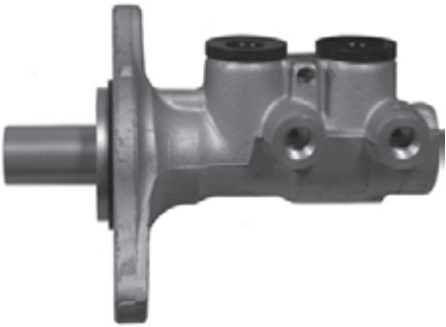
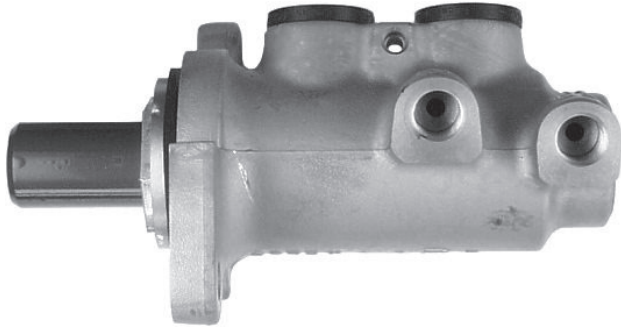
<p>24.2125-1735.3 010879 L1 L2 67 111,5 ø25,4 M10x1 2x</p>	<p>24.2125-1736.3 010904 L1 L2 31 129 ø25,4 M12x1 2x</p>
	
<p>24.2125-1737.3 010906 L1 L2 31 129 ø25,4 2x M10x1 M12x1</p>	<p>24.2125-1747.3 011029 L1 L2 18,5 142,4 ø25,4 M10x1 2x</p>
	
<p>24.4025-1701.3 010719 L1 L2 51 67,2 ø25,4 M12x1 2x</p>	<p>24.4120-1701.3 010846 L1 L2 32 86,3 ø20,64 M10x1 2x</p>
	
<p>24.4120-1702.3 010913 L1 L2 6 119 ø20,64 M10x1 2x</p>	<p>24.4122-1701.3 010533 L1 L2 10,2 109 ø22,2 M12x1 2x</p>
	

Abbildungen Hauptbremszylinder

Illustrations master cylinder - Ilustraciones cilindro freno - Illustrations Maître-cylindres - Illustrazioni pompe Freno

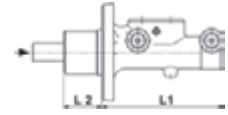

24.4122-1703.3 010843	L1 32	L2 112	24.4122-1704.3 010847	L1 6	L2 112
ø22,2 M12x1 2x			ø22,2 M10x1 2x		

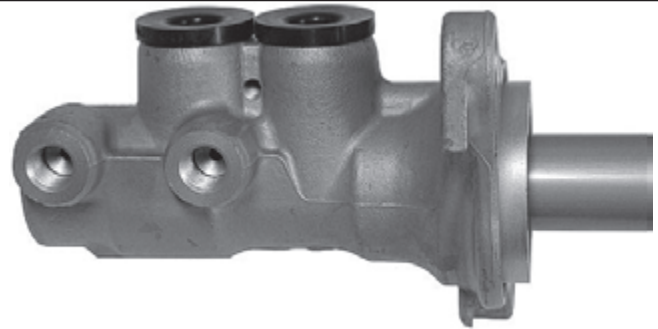

24.4122-1705.3 010852	L1 32	L2 80	24.4122-1708.3 010865	L1 20	L2 95
ø22,2 M12x1 2x			ø22,2 M10x1 2x		

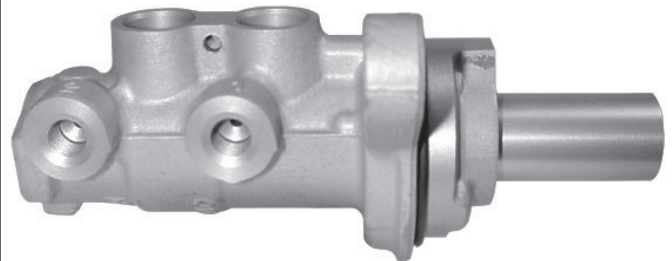

24.4122-1709.3 010871	L1 32	L2 78	24.4122-1714.3 010914	L1 6	L2 119
ø22,2 M10x1 2x			ø22,2 M10x1 2x		

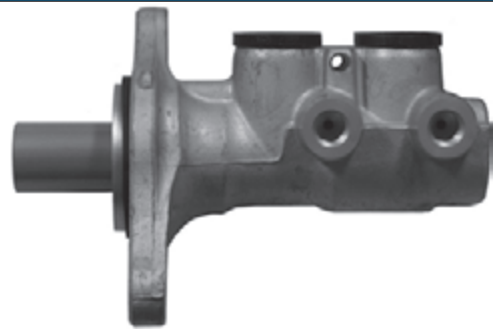

24.4122-1715.3 010982	L1	L2 110	24.4122-1716.3 010983	L1	L2 110
ø22,2 M12x1 2x			ø22,2 M10x1 2x		

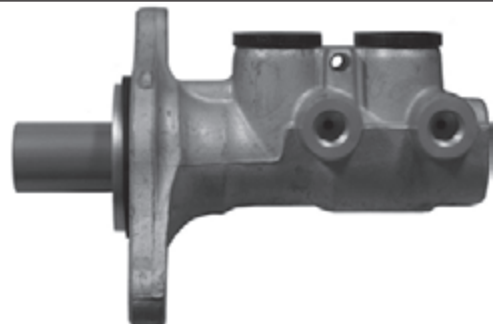
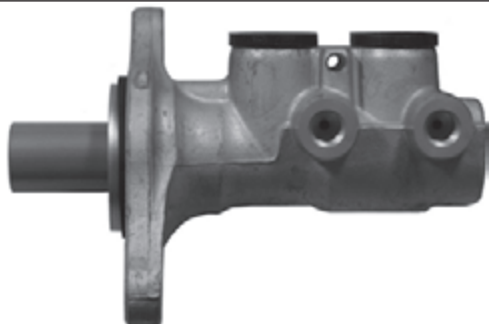

Abbildungen Hauptbremszylinder

Illustrations master cylinder - Ilustraciones cilindro freno - Illustrations Maître-cylindres - Illustrazioni pompe Freno

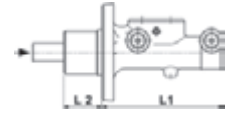

24.4122-1717.3	010993	L1 10,8	L2 109	24.4123-1703.3	010831	L1 55	L2 53
ø22,2 M12x1 2x				ø23,81 M12x1 2x			

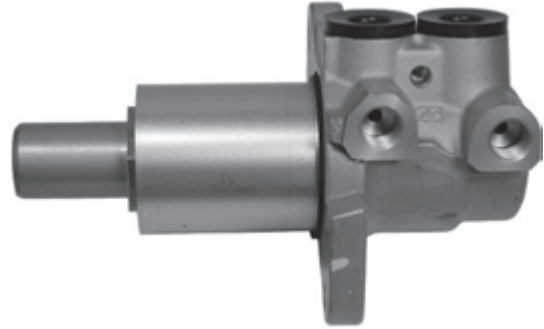
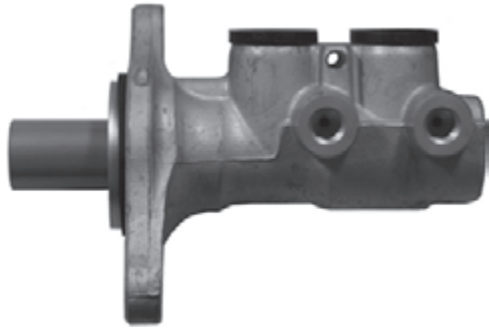

24.4123-1704.3	010828	L1 6	L2 112	24.4123-1705.3	010832	L1 6	L2 112
ø23,81 M12x1 2x				ø23,81 M10x1 2x			



24.4123-1708.3	010859	L1 32	L2 83,5	24.4123-1710.3	010866	L1 32	L2 86,2
ø23,81 2x M10x1 2x				ø23,81 M10x1 2x			



24.4123-1712.3	010897	L1 14	L2 95	24.4123-1713.3	010905	L1 31,7	L2 93,5
ø23,81 M12x1 2x				ø23,81 4x 2x M10x1 2x M12x1			

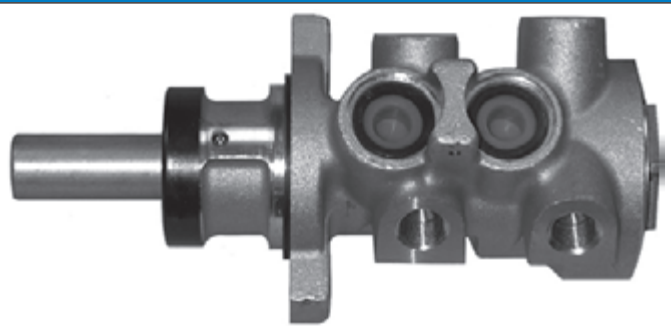

Abbildungen Hauptbremszylinder

Illustrations master cylinder - Ilustraciones cilindro freno - Illustrations Maître-cylindres - Illustrazioni pompe Freno

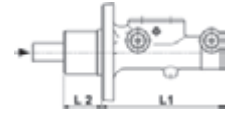

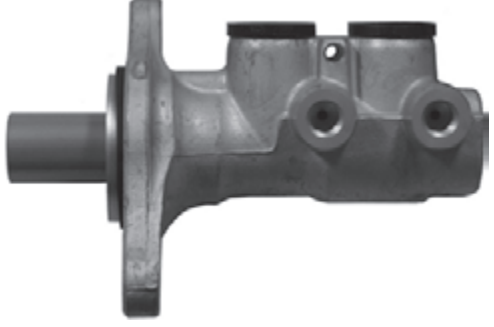
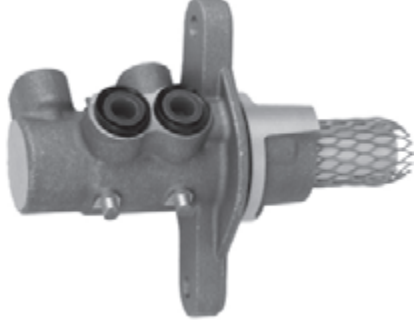
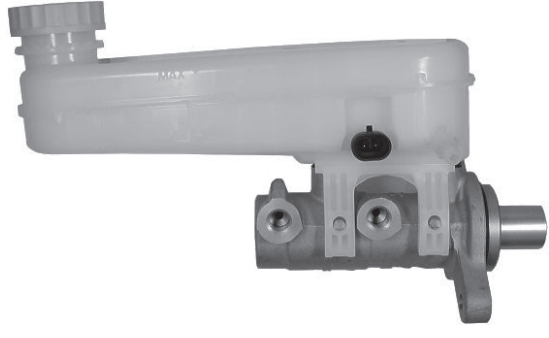
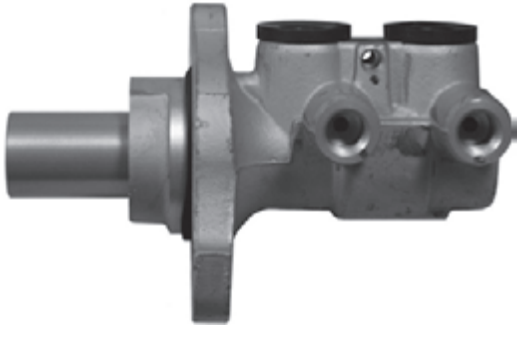
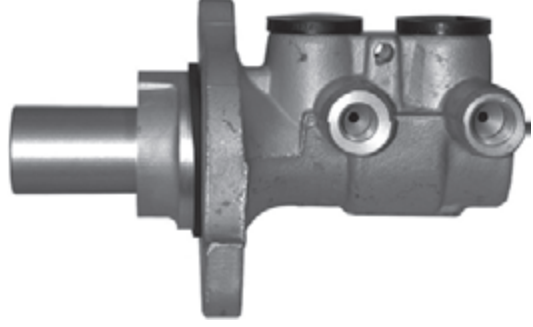
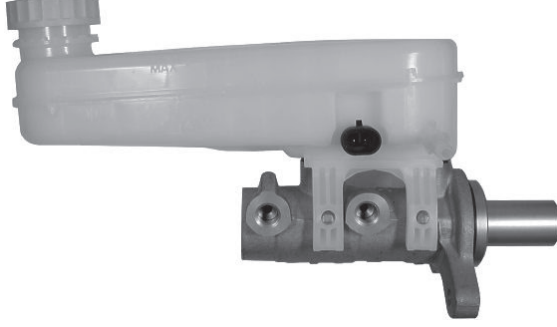
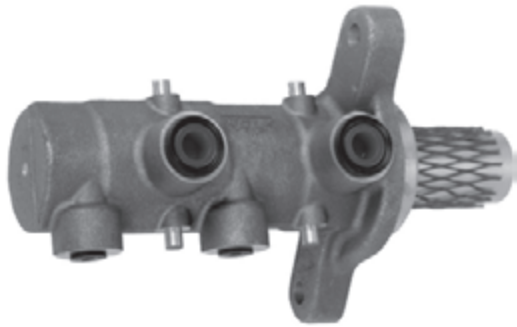
<p>24.4123-1716.3 010984 L1 L2 5,8 111,2 ø23,81 2x M10x1 M12x1</p>	<p>24.4123-1720.3 011022 L1 L2 32 79,9 ø23,81 M10x1 2x</p>
	
<p>24.4125-1701.3 010867 L1 L2 10,5 126,5 ø25,4 M12x1 2x</p>	<p>24.4125-1703.3 010907 L1 L2 18 90,5 ø25,4 M12x1 2x</p>
	
<p>24.4125-1704.3 010908 L1 L2 18 90,5 ø25,4 2x M10x1 M12x1</p>	<p>24.4126-1701.3 010868 L1 L2 10,5 126,5 ø26,99 M12x1 2x</p>
	
<p>24.4126-1702.3 010875 L1 L2 10,5 126,5 ø26,99 M10x1 2x</p>	



DE Universalteile

EN Universalparts

ES Piezas universales

FR Pièces universelles

IT Parti universali

2019



Universalteile

Universalparts - Piezas universales - Pièces universelles - Parti universali

03.3304-0600.1 390081

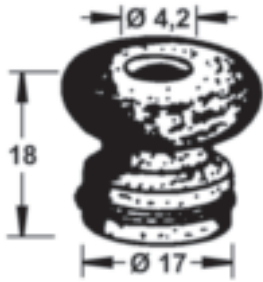

Stopfen, Bremsflüssigkeitsbehälter

Ø 17

Innendurchmesser [mm]: 4,2

x 18

FPM (Fluor-Kautschuk)/ACM (Polyacryl-Kautschuk)

03.3304-1000.1 390083

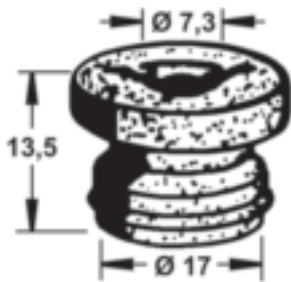

Stopfen, Bremsflüssigkeitsbehälter

Ø 17

Innendurchmesser [mm]: 7,3

x 13,5

FPM (Fluor-Kautschuk)/ACM (Polyacryl-Kautschuk)

03.3304-1100.1 390084

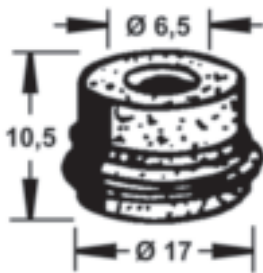

Stopfen, Bremsflüssigkeitsbehälter

Ø 17

Innendurchmesser [mm]: 6,5

x 10,5

FPM (Fluor-Kautschuk)/ACM (Polyacryl-Kautschuk)

03.3304-1102.1 390085

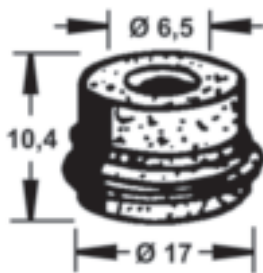

Stopfen, Bremsflüssigkeitsbehälter

Ø 17

Innendurchmesser [mm]: 6,5

x 10,4

EPDM (Ethylen-Propylen-Dien-Kautschuk)

03.3304-2208.1 390090

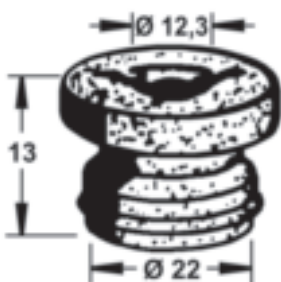

Stopfen, Bremsflüssigkeitsbehälter

Ø 22

Innendurchmesser [mm]: 12,3

x 13

EPDM (Ethylen-Propylen-Dien-Kautschuk)

Universalteile

Universalparts - Piezas universales - Pièces universelles - Parti universali

03.3390-0055.1 390149

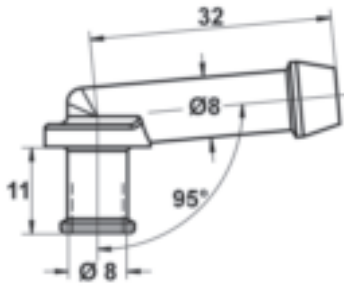

Anschlussstutzen, Schlauchleitung

Ø 8

x 11

L= 32

03.3390-0065.1 390150

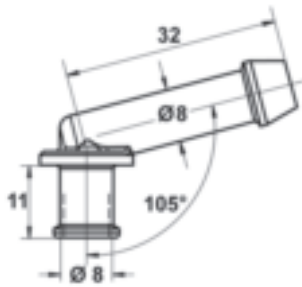

Anschlussstutzen, Schlauchleitung

Ø 8

x 11

L= 32

03.3390-0130.1 390153

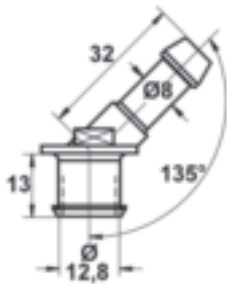

Anschlussstutzen, Schlauchleitung

12,8/8,0

x 13

L= 32

03.3390-0139.1 390154

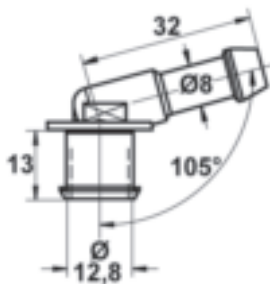

Anschlussstutzen, Schlauchleitung

12,8/8,0

x 13

L= 32

03.3510-0026.2 390266

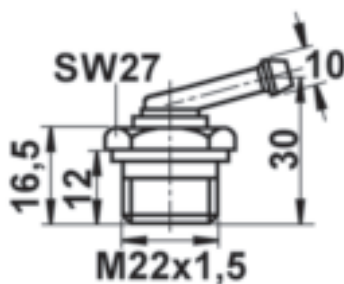

Adapter, Bremsleitung

Ø 10

M22x1,5

L= 12

x 16,5

Schlüsselweite: 27

Universalteile

Universalparts - Piezas universales - Pièces universelles - Parti universali

03.3510-0054.1 390269

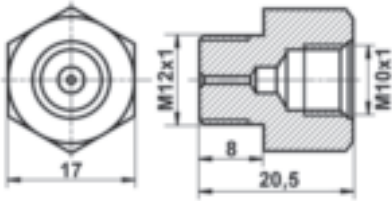

Adapter, Bremsleitung

Anschlussgewinde: M10x1
 Gewindeausführung: DIN 74235 Form FL
 M12x1
 L= 8
 L= 20,5
 Schlüsselweite: 17

03.3510-0100.1 390271

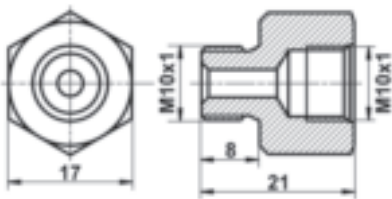

Adapter, Bremsleitung

Anschlussgewinde: M10x1
 Gewindeausführung: DIN 74235 Form FL
 M10x1
 L= 8
 L= 21
 Schlüsselweite: 17

03.3510-0200.1 390272

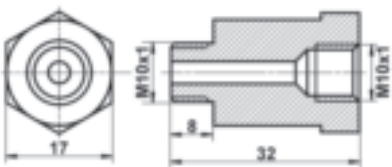

Adapter, Bremsleitung

Anschlussgewinde: M10x1
 Gewindeausführung: DIN 74235 Form FL
 M10x1
 L= 8
 L= 32
 Schlüsselweite: 17

03.3510-0300.1 390273

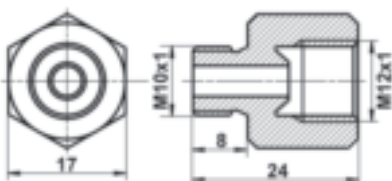

Adapter, Bremsleitung

Anschlussgewinde: M12x1
 Gewindeausführung: DIN 74235 Form EL
 M10x1
 L= 8
 L= 24
 Schlüsselweite: 17

03.3510-0800.1 390275

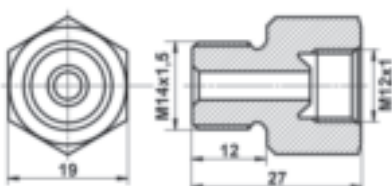

Adapter, Bremsleitung

Anschlussgewinde: M12x1
 Gewindeausführung: DIN 74235 Form EL
 M14x1,5
 L= 12
 L= 27
 Schlüsselweite: 19

Universalteile

Universalparts - Piezas universales - Pièces universelles - Parti universali

03.3510-4100.1 390279

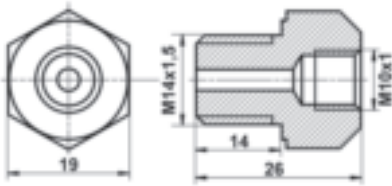

Adapter, Bremsleitung

Anschlussgewinde: M10x1
 Gewindeausführung: DIN 74235 Form FL
 M14x1,5
 L= 14
 L= 26
 Schlüsselweite: 19

03.3510-7900.1 390281

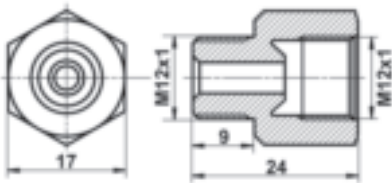

Adapter, Bremsleitung

Anschlussgewinde: M12x1
 Gewindeausführung: DIN 74235 Form EL
 M12x1
 L= 9
 L= 24
 Schlüsselweite: 17

03.3511-0800.1 390285

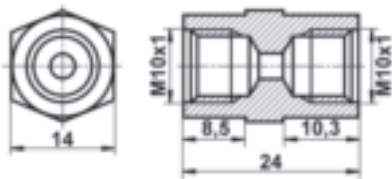

Adapter, Bremsleitung

Anschlussgewinde: M10x1
 Gewindeausführung: DIN 74235 Form FL
 L= 8,5
 L= 24
 Schlüsselweite: 14

03.3511-1000.1 390286

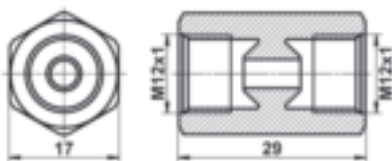

Adapter, Bremsleitung

Anschlussgewinde: M12x1
 Gewindeausführung: DIN 74235 Form EL
 L= 29
 Schlüsselweite: 17

03.3511-1100.1 390287

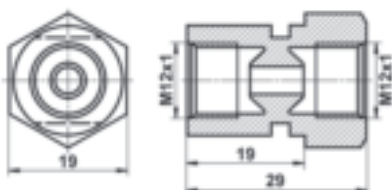

Adapter, Bremsleitung

Anschlussgewinde: M12x1
 Gewindeausführung: DIN 74235 Form EL
 L= 19
 L= 29
 Schlüsselweite: 19

Universalteile

Universalparts - Piezas universales - Pièces universelles - Parti universali

03.3511-3800.1 390291

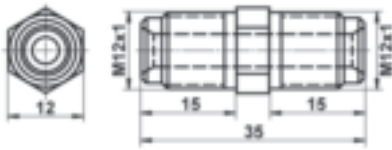

Adapter, Bremsleitung

Anschlussgewinde: M12x1
 M12x1
 L= 15
 L= 35
 Schlüsselweite: 12

03.3513-0200.1 390297

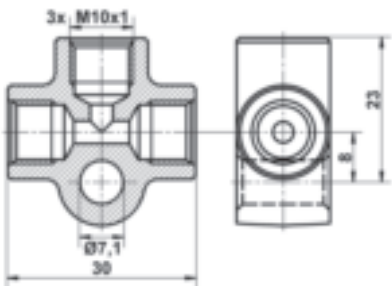

Verbindungs-/Verteilerstück, Rohrleitungen

T-Form (T-Stück)
 3x
 Anschlussgewinde: M10x1
 Gewindeausführung: DIN 74235 Form FL
 Flanschbefestigung
 7,1
 8,0/23,0
 L= 30

03.3513-0300.1 390298

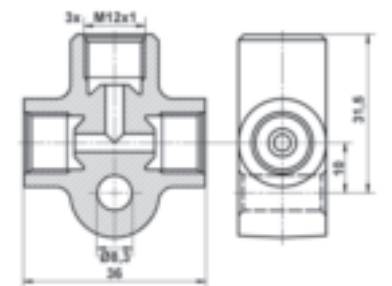

Verbindungs-/Verteilerstück, Rohrleitungen

T-Form (T-Stück)
 3x
 Anschlussgewinde: M12x1
 Gewindeausführung: DIN 74235 Form EL
 Flanschbefestigung
 8,3
 10,0/31,5
 L= 36

03.3513-1000.1 390299

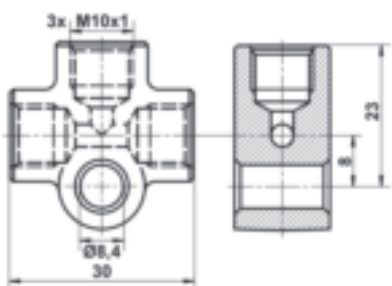

Verbindungs-/Verteilerstück, Rohrleitungen

T-Form (T-Stück)
 3x
 Anschlussgewinde: M10x1
 Gewindeausführung: DIN 74235 Form FL
 Flanschbefestigung
 8,4
 8,0/23,0
 L= 30

Universalteile

Universalparts - Piezas universales - Pièces universelles - Parti universali

03.3513-2700.1 390300

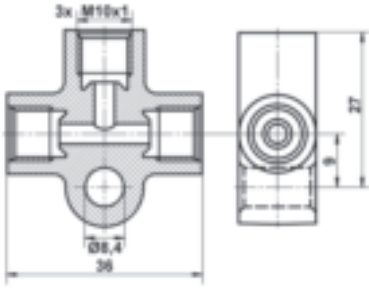

Verbindungs-/Verteilerstück, Rohrleitungen

T-Form (T-Stück)
3x
Anschlussgewinde: M10x1
Gewindeausführung: DIN 74235 Form EL
Flanschbefestigung
8,4
9,0/27,0
L= 36

03.3514-2600.1 390306

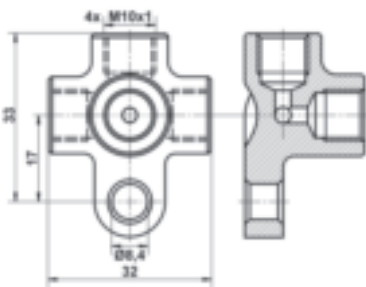

Verbindungs-/Verteilerstück, Rohrleitungen

T-Form (T-Stück)
4x
Anschlussgewinde: M10x1
Gewindeausführung: DIN 74235 Form FL
Flanschbefestigung
8,4
M10x1
17,0/33,0
L= 32

03.3514-2600.2 390307

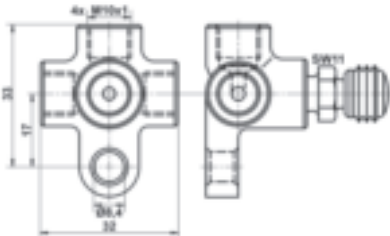

Verbindungs-/Verteilerstück, Rohrleitungen

T-Form (T-Stück)
4x
Anschlussgewinde: M10x1
Gewindeausführung: DIN 74235 Form FL
Flanschbefestigung
8,4
M10x1
17,0/33,0
L= 32
mit Entlüfterventil

03.3516-0600.1 390312

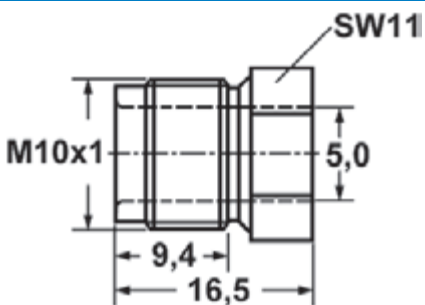

Überwurfschraube

M10x1
5
Gewindelänge [mm]: 9,4
L= 16,5
Schlüsselweite: 11
Bördelform: F

Universalteile

Universalparts - Piezas universales - Pièces universelles - Parti universali

03.3516-0602.1 390412

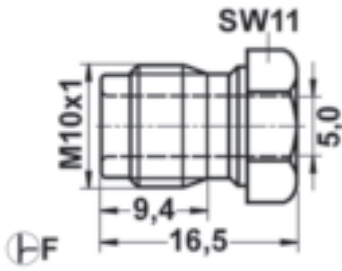

Überwurfschraube

M10x1
5
Gewindelänge [mm]: 9,4
L= 16,5
Schlüsselweite: 11
Bördelform: F

03.3516-0800.1 390313

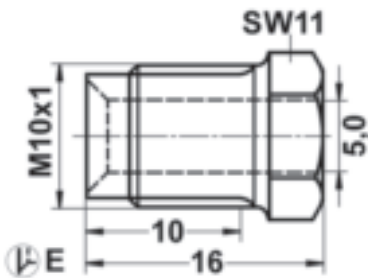

Überwurfschraube

M10x1
5
Gewindelänge [mm]: 10
L= 16
Schlüsselweite: 11
Bördelform: E

03.3516-2300.1 390317

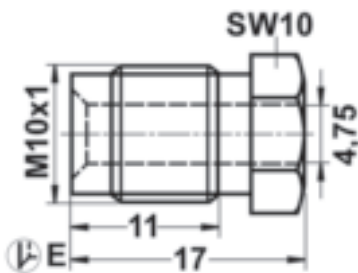

Überwurfschraube

M10x1
4,75
Gewindelänge [mm]: 11
L= 17
Schlüsselweite: 10
Bördelform: E

03.3516-3500.1 390318

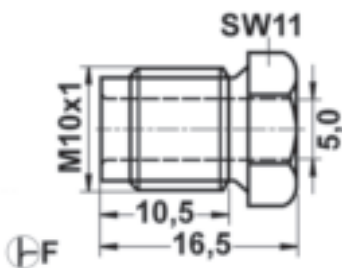

Überwurfschraube

M10x1
5
Gewindelänge [mm]: 10,5
L= 16,5
Schlüsselweite: 11
Bördelform: F

03.3517-0100.1 390321

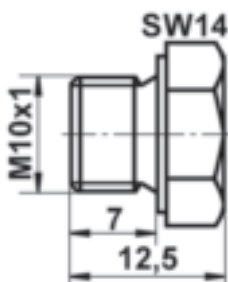

Verschlusschraube

M10x1
L= 7,5
L= 12,5
Schlüsselweite: 14

Universalteile

Universalparts - Piezas universales - Pièces universelles - Parti universali

03.3518-0100.2 390329

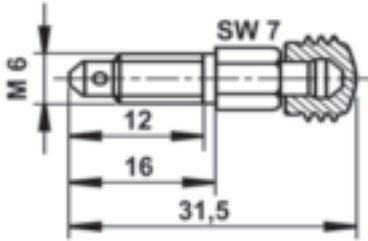

Entlüfterschraube/-ventil

M6
L= 16
L= 31,5
Schlüsselweite: 7

03.3518-0102.2 390330

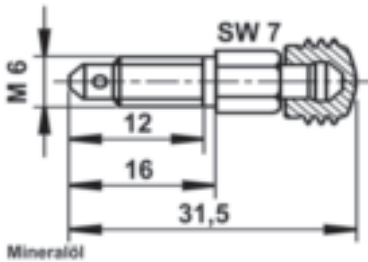

Entlüfterschraube/-ventil

M6
L= 16
L= 31,5
Schlüsselweite: 7
nur für Mineralöl

03.3518-0200.2 390332

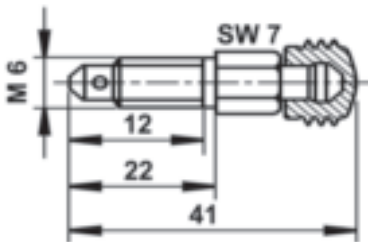

Entlüfterschraube/-ventil

M6
L= 22
L= 41
Schlüsselweite: 7

03.3518-0300.2 390333

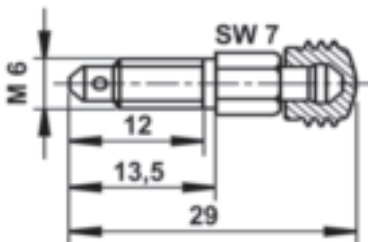

Entlüfterschraube/-ventil

M6
L= 13,5
L= 29
Schlüsselweite: 7

03.3518-0302.2 390334

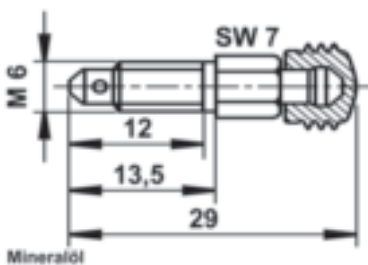

Entlüfterschraube/-ventil

M6
L= 13,5
L= 29
Schlüsselweite: 7
nur für Mineralöl

Universalteile

Universalparts - Piezas universales - Pièces universelles - Parti universali

03.3518-0500.2 390337

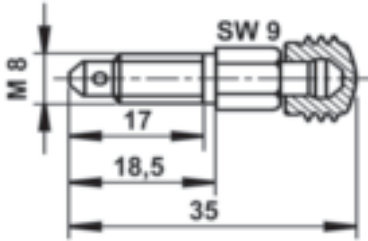

Entlüfterschraube/-ventil

M8
L= 18,5
L= 35
Schlüsselweite: 9

03.3518-0502.2 390339

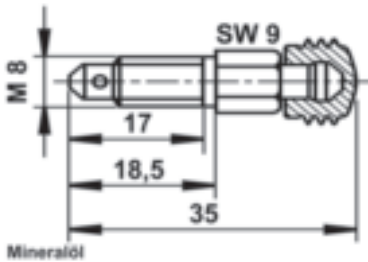

Entlüfterschraube/-ventil

M8
L= 18,5
L= 35
Schlüsselweite: 9
nur für Mineralöl

03.3518-0600.2 390340

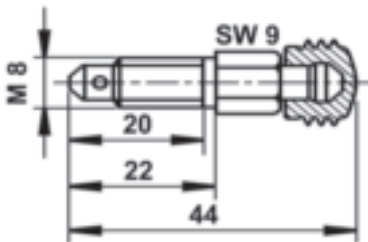

Entlüfterschraube/-ventil

M8
L= 22
L= 44
Schlüsselweite: 9

03.3518-0700.2 390342

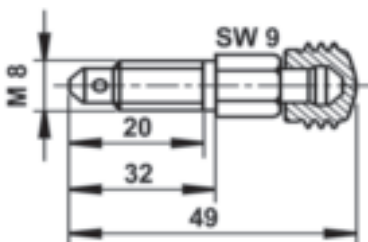

Entlüfterschraube/-ventil

M8
L= 32
L= 49
Schlüsselweite: 9

03.3518-0800.2 390343

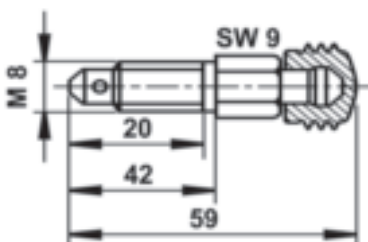

Entlüfterschraube/-ventil

M8
L= 42
L= 59
Schlüsselweite: 9

Universalteile

Universalparts - Piezas universales - Pièces universelles - Parti universali

03.3518-0900.2 390345

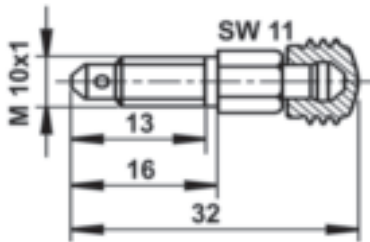

Entlüfterschraube/-ventil

M10x1

L= 16

L= 32

Schlüsselweite: 11

03.3518-0902.2 390346

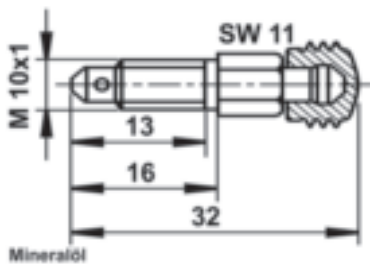

Entlüfterschraube/-ventil

M10x1

L= 16

L= 32

Schlüsselweite: 11

nur für Mineralöl

03.3518-1300.2 390347

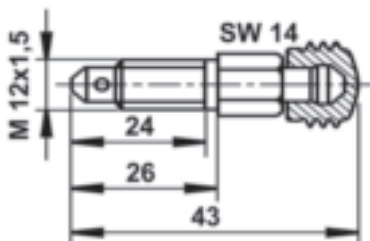

Entlüfterschraube/-ventil

M12x1,5

L= 26

L= 43

Schlüsselweite: 14

03.3518-1501.2 390349

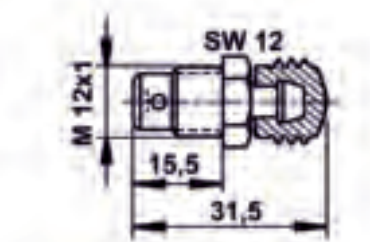

Entlüfterschraube/-ventil

M12x1

L= 15,5

L= 31,5

Schlüsselweite: 12

03.3518-1700.2 390352

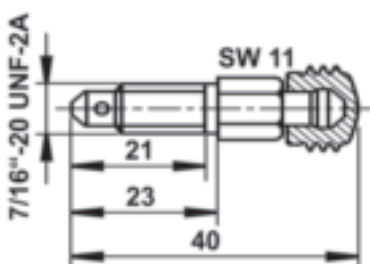

Entlüfterschraube/-ventil

7/16" -20UNF-2A

L= 23

L= 40

Schlüsselweite: 11

Universalteile

Universalparts - Piezas universales - Pièces universelles - Parti universali

03.3518-1900.2 390354

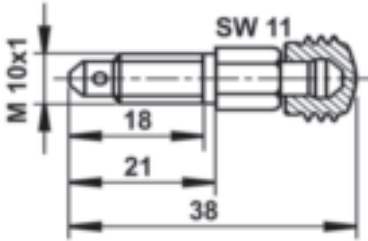

Entlüfterschraube/-ventil

M10x1

L= 21

L= 38

Schlüsselweite: 11

03.3518-4200.2 390357

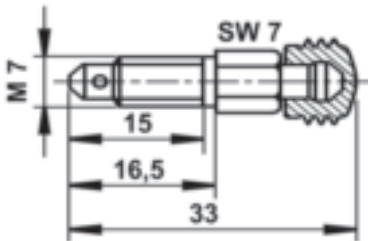

Entlüfterschraube/-ventil

M7

L= 16,5

L= 33

Schlüsselweite: 7

03.3518-5200.2 390358

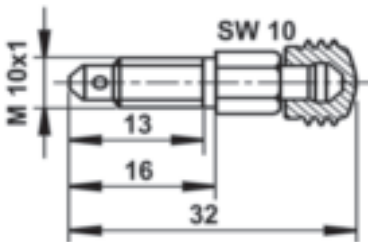

Entlüfterschraube/-ventil

M10x1

L= 16

L= 32

Schlüsselweite: 10

03.3518-5900.2 390363

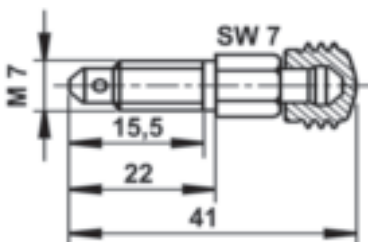

Entlüfterschraube/-ventil

M7

L= 22

L= 41

Schlüsselweite: 7

03.3518-6100.2 390364

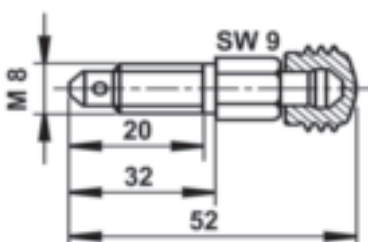

Entlüfterschraube/-ventil

M8

L= 32

L= 52

Schlüsselweite: 9

Universalteile

Universalparts - Piezas universales - Pièces universelles - Parti universali

03.3518-6800.2 390369

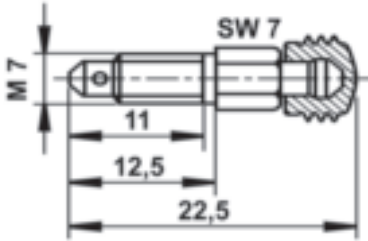

Entlüfterschraube/-ventil

M7
L= 12,5
L= 22,5
Schlüsselweite: 7

03.3518-6901.2 390370

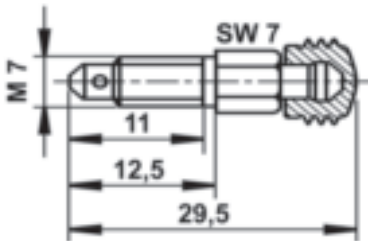

Entlüfterschraube/-ventil

M7
L= 12,5
L= 29,5
Schlüsselweite: 7

03.3518-8000.2 390373

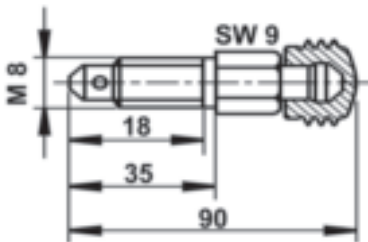

Entlüfterschraube/-ventil

M8
L= 35
L= 90
Schlüsselweite: 9

03.3520-0302.1 390381

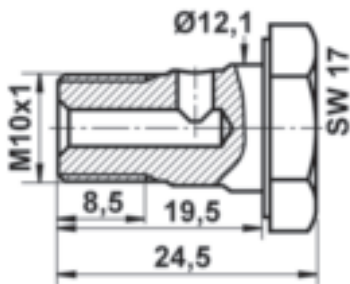

Hohlschraube

M10x1
Schlüsselweite: 17
L= 24,5
L1= 19,5
L2= 8,5

03.3520-0501.1 390382

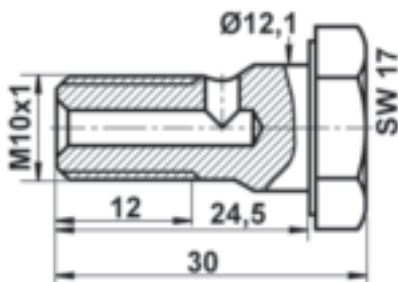

Hohlschraube

M10x1
Schlüsselweite: 17
L= 30
L1= 24,5
L2= 12

Universalteile

Universalparts - Piezas universales - Pièces universelles - Parti universali

03.3520-0600.1 390383

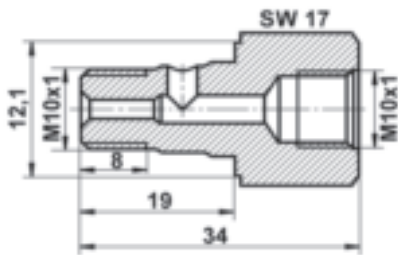

Hohlschraube

M10x1

Schlüsselweite: 17

L= 34

L1= 19

L2= 8

03.3520-1003.1 390418

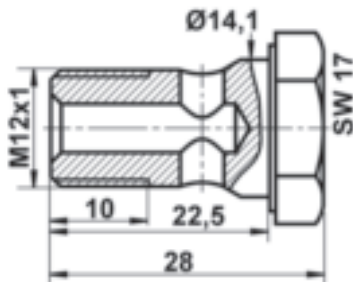

Hohlschraube

M12x1

Schlüsselweite: 17

L= 28

L1= 22,5

L2= 10

03.3520-2900.1 390390

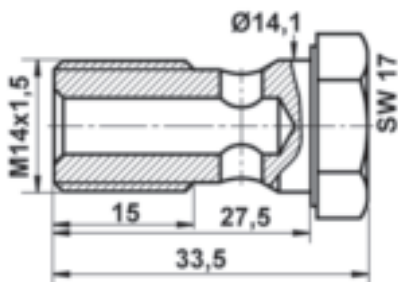

Hohlschraube

M14x1,5

Schlüsselweite: 17

L= 33,5

L1= 27,5

L2= 15

03.3521-0100.1 390392

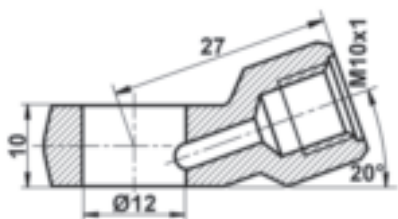

Ringstutzen, Rohrleitung

1x

Anschlussgewinde: M10x1

Gewindeausführung: DIN 74235 Form FL

12

L= 27

x 10

03.3521-0200.1 390393

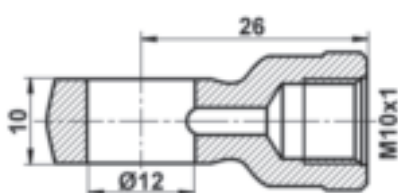

Ringstutzen, Rohrleitung

1x

Anschlussgewinde: M10x1

Gewindeausführung: DIN 74235 Form FL

12

L= 32

x 12

Universalteile

Universalparts - Piezas universales - Pièces universelles - Parti universali

03.3521-0400.1 390394

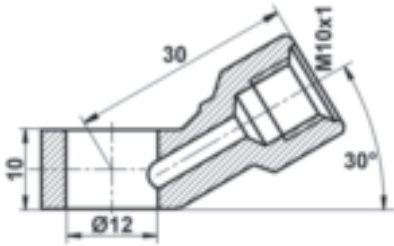

Ringstutzen, Rohrleitung

1x
Anschlussgewinde: M10x1
Gewindeausführung: DIN 74235 Form FL
12
L= 30
x 10

03.3521-0600.1 390395

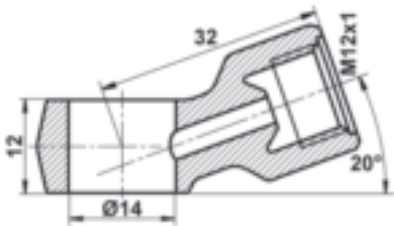

Ringstutzen, Rohrleitung

1x
Anschlussgewinde: M12x1
Gewindeausführung: DIN 74235 Form EL
14
L= 32
x 12

03.3521-0800.1 390398

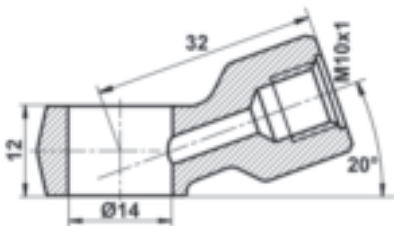

Ringstutzen, Rohrleitung

1x
Anschlussgewinde: M10x1
Gewindeausführung: DIN 74235 Form FL
14
L= 32
x 12

03.3522-0200.1 390402

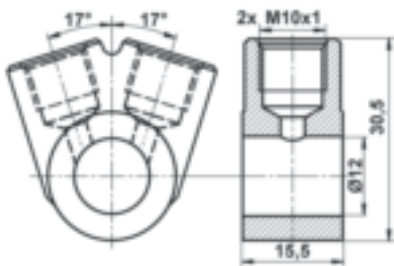

Ringstutzen, Rohrleitung

2x
Anschlussgewinde: M10x1
Gewindeausführung: DIN 74235 Form FL
12
L= 20,5
x 15,5

03.3522-0500.1 390403

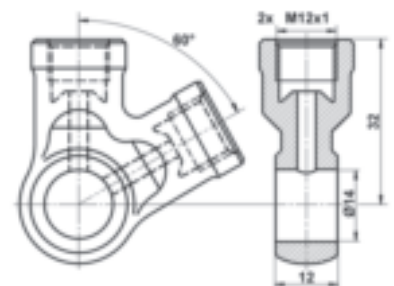

Ringstutzen, Rohrleitung

2x
Anschlussgewinde: M12x1
Gewindeausführung: DIN 74235 Form EL
14
L= 32
x 12

Universalteile

Universalparts - Piezas universales - Pièces universelles - Parti universali

03.3522-1100.1 390404

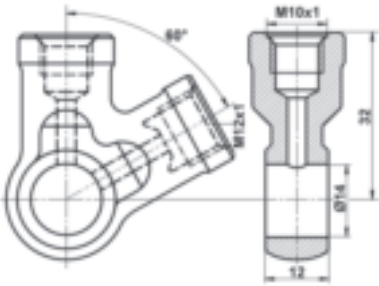

Ringstutzen, Rohrleitung

2x

Anschlussgewinde: M12x1

Gewindeausführung: DIN 74235 Form EL

14

L= 32

x 12

03.3524-0300.1 390407

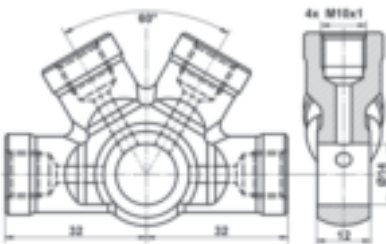

Ringstutzen, Rohrleitung

4x

Anschlussgewinde: M10x1

Gewindeausführung: DIN 74235 Form FL

14

L= 64

x 12

03.3538-0005.1 390414



Schlauch

Innendurchmesser [mm]: 7,5

Außendurchmesser [mm]: 13,5

Kunststoff

L= 5.000

03.3538-0020.1 390415

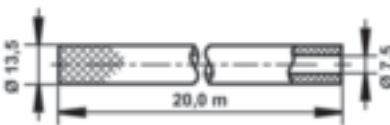

Schlauch

Innendurchmesser [mm]: 7,5

Außendurchmesser [mm]: 13,5

Kunststoff

L= 20.000

03.3549-5000.1 390419

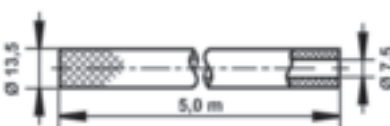

Schlauch

Innendurchmesser [mm]: 7,5

Kunststoff

L= 5.000

Mineralöl

Universalteile

Universalparts - Piezas universales - Pièces universelles - Parti universali

03.3556-1065.2 390425



Verschluss, Bremsflüssigkeitsbehälter

→Ø 51

x 14

03.3556-1094.2 390427

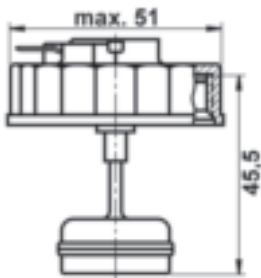

Verschluss, Bremsflüssigkeitsbehälter

→Ø 51

L= 45,5

03.3556-1113.2 390428

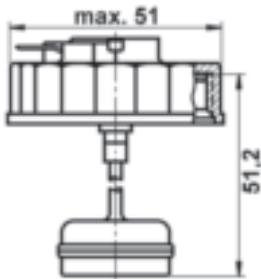

Verschluss, Bremsflüssigkeitsbehälter

→Ø 51

L= 51,2

03.3556-1115.2 390431

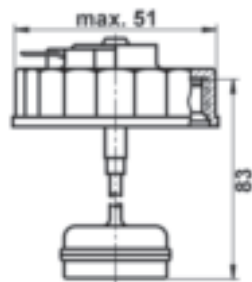

Verschluss, Bremsflüssigkeitsbehälter

→Ø 51

L= 83

03.3556-1124.2 390433

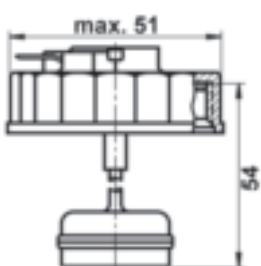

Verschluss, Bremsflüssigkeitsbehälter

→Ø 51

L= 54

Universalteile

Universalparts - Piezas universales - Pièces universelles - Parti universali

03.3556-1147.2 390435



Mineralöl

Verschluss, Bremsflüssigkeitsbehälter

→Ø 51

x 14,5

nur für Mineralöl

03.3556-1164.2 390437

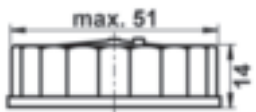

Verschluss, Bremsflüssigkeitsbehälter

→Ø 51

x 14

03.3556-1199.2 390440

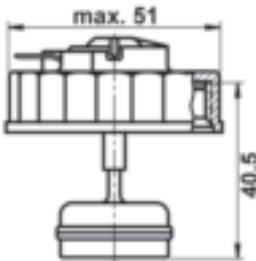

Verschluss, Bremsflüssigkeitsbehälter

→Ø 51

L= 40,5

03.3590-0044.1 390455

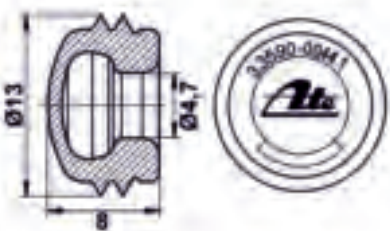

Verschluss-/Schutzkappe

Ø 13

Innendurchmesser [mm]: 4,7

x 8

03.3590-0700.1 390456

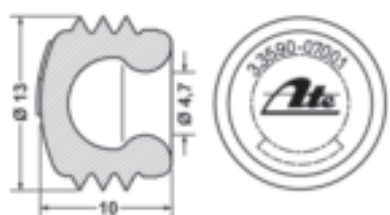

Verschluss-/Schutzkappe

Ø 13

Innendurchmesser [mm]: 4,7

x 10

Universalteile

Universalparts - Piezas universales - Pièces universelles - Parti universali

03.3590-0701.1 390457

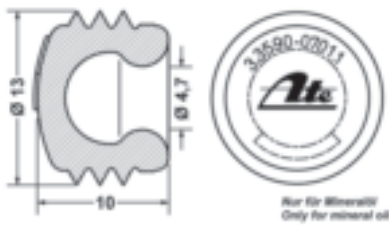

Verschluss-/Schutzkappe

Ø 13
Innendurchmesser [mm]: 4,7
x 10
nur für Mineralöl

03.5004-0101.1 990010

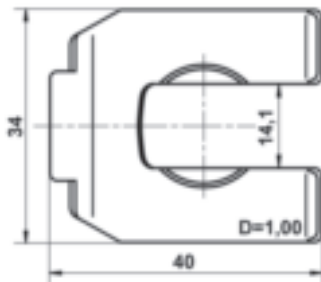

Halter, Bremsschlauch

x 14
1

03.6118-7305.2 990032

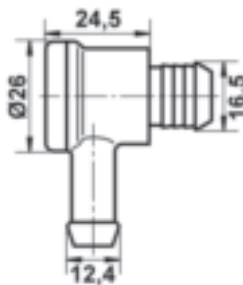

Ventil, Unterdruckleitung

Rückschlagventil
Ø1 12,4
Ø2 16,5

03.6118-7307.2 990033

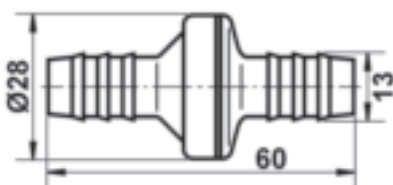

Ventil, Unterdruckleitung

Rückschlagventil
Ø 13

03.7718-7202.1 390378

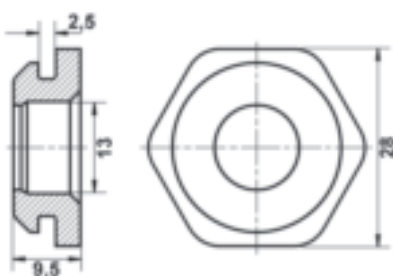

Dichtung, Unterdruck-Anschlussstutzen BKV

Außendurchmesser [mm]: 28
Innendurchmesser [mm]: 13
9,5

Universalteile

Universalparts - Piezas universales - Pièces universelles - Parti universali

03.7718-7203.1 390360

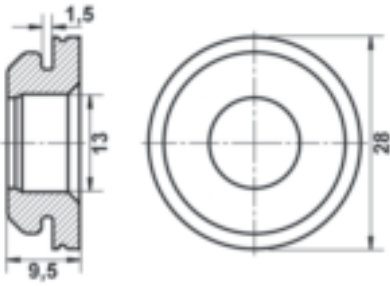

Dichtung, Unterdruck-Anschlussstutzen BKV

Außendurchmesser [mm]: 28

Innendurchmesser [mm]: 13

9,5

03.9305-0501.3 390481



Prüfanschluss, Rohrleitungen

Anschlussgewinde: M12x1

Gewindeausführung: DIN 74235 Form EL

2x

Anzahl der Bohrungen: 1

03.9305-0510.3 390483



Prüfanschluss, Rohrleitungen

Anschlussgewinde: M12x1

Gewindeausführung: DIN 74235 Form EL

3x

Anzahl der Bohrungen: 1

03.9305-0520.3 390485



Prüfanschluss, Rohrleitungen

Anschlussgewinde: M10x1

Gewindeausführung: DIN 74235 Form FL

2x

Anzahl der Bohrungen: 2

03.9305-0530.3 390486



Prüfanschluss, Rohrleitungen

Anschlussgewinde: M12x1

Gewindeausführung: DIN 74235 Form EL

2x

Anzahl der Bohrungen: 2

Universalteile

Universalparts - Piezas universales - Pièces universelles - Parti universali

03.9305-0570.3 390488



Prüfanschluss, Rohrleitungen

Anschlussgewinde: M12x1
 Gewindeausführung: DIN 74235 Form EL
 3x
 Anzahl der Bohrungen: 1
 mit Entlüfterventil

03.9305-0590.3 390489



Prüfanschluss, Rohrleitungen

Anschlussgewinde: M10x1
 Gewindeausführung: DIN 74235 Form FL
 3x
 Anzahl der Bohrungen: 1

03.9305-0700.3 390491



Prüfanschluss, Rohrleitungen

Anschlussgewinde: M10x1
 1x

13.8190-0296.1 390409

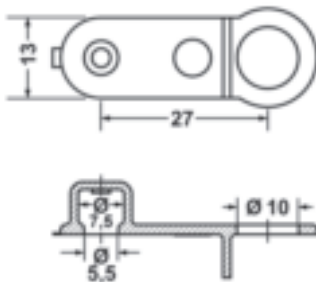

Verschluss-/Schutzkappe

Ø 5,5
 x 8,5

24.3516-0010.1 390540

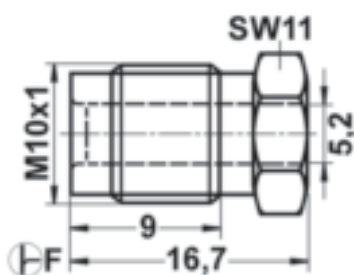

Überwurfschraube

M10x1
 5,2
 L= 16,7
 Schlüsselweite: 11
 Bördelform: F

Universalteile

Universalparts - Piezas universales - Pièces universelles - Parti universali

24.3516-0020.1 390541

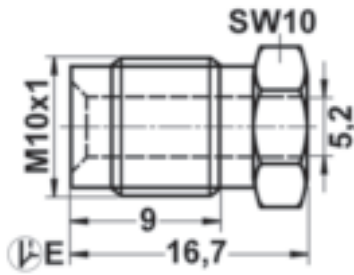

Überwurfschraube

M10x1

5,2

L= 16,7

Schlüsselweite: 10

Bördelform: E

24.3516-0030.1 390542

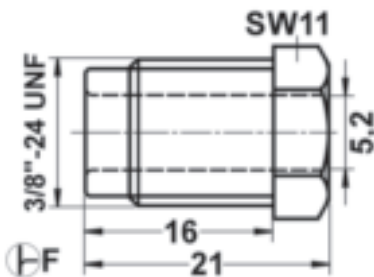

Überwurfschraube

3/8" -24UNF-2A

5,2

L= 21

Schlüsselweite: 11

Bördelform: F

24.3516-0040.1 390543

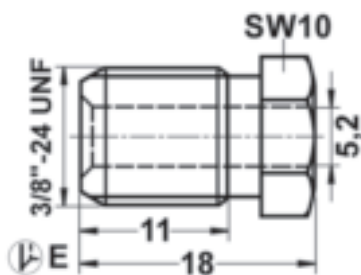

Überwurfschraube

3/8" -24UNF-2A

4,9

L= 11,8

L= 18

Schlüsselweite: 10

Bördelform: E

24.3516-0050.1 390544

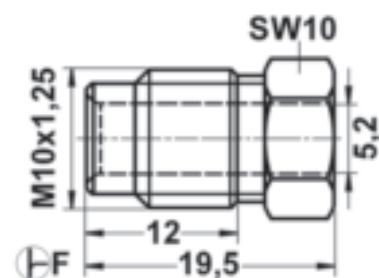

Überwurfschraube

M10x1,25

5,2

L= 13,5

L= 19,5

Schlüsselweite: 10

Bördelform: F

24.3516-0060.1 390545

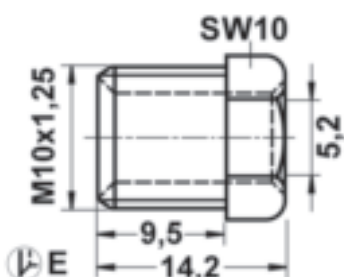

Überwurfschraube

M10x1,25

5,2

L= 8,5

L= 14

Schlüsselweite: 10

Bördelform: E

Universalteile

Universalparts - Piezas universales - Pièces universelles - Parti universali

24.3516-0070.1 390546

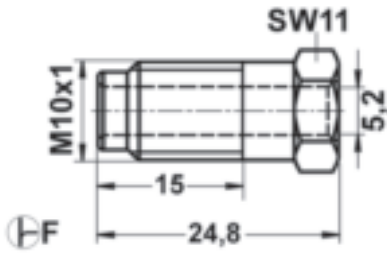

Überwurfschraube

M10x1

5

L= 13,2

L= 24,6

Schlüsselweite: 11

Bördelform: F

24.3516-0080.1 390547

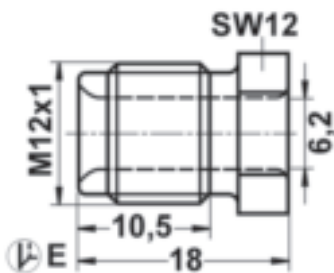

Überwurfschraube

M12x1

6,2

L= 10,5

L= 18

Schlüsselweite: 12

Bördelform: E

24.3516-0090.1 390548

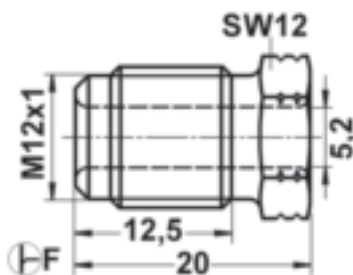

Überwurfschraube

M12x1

5,2

L= 12,5

L= 20

Schlüsselweite: 12

Bördelform: F

24.3516-0110.1 390549

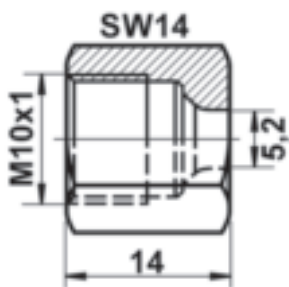

Überwurfmutter

M10x1

5,2

L= 14

Schlüsselweite: 14

Bördelform: E

24.3516-0111.1 390550

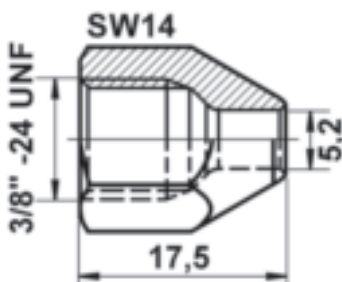

Überwurfmutter

3/8" -24UNF-2B

5,2

L= 17,5

Schlüsselweite: 14

Bördelform: E

Universalteile

Universalparts - Piezas universales - Pièces universelles - Parti universali

24.3516-0210.2 390553



Sortiment, Armaturen

24.3516-0220.2 390554



Sortiment, Entlüfterschrauben

24.3516-0230.2 390555



Sortiment, Befestigungselemente

24.3518-0011.1 390556

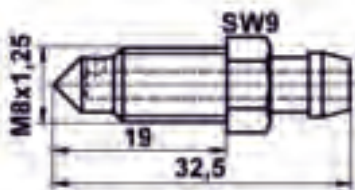

Entlüfterschraube/-ventil

M8x1,25

L= 32,5

Schlüsselweite: 9

24.3518-0012.1 390557

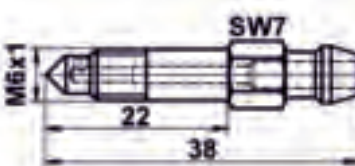

Entlüfterschraube/-ventil

M6x1

L= 38

Schlüsselweite: 7

Universalteile

Universalparts - Piezas universales - Pièces universelles - Parti universali

24.3518-0013.1 390558

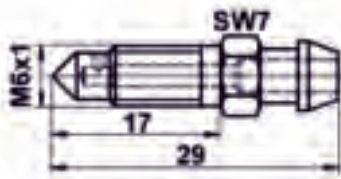

Entlüfterschraube/-ventil

M6x1

L= 29

Schlüsselweite: 7

24.3518-0014.1 390559

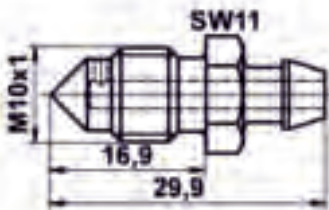

Entlüfterschraube/-ventil

M10x1

L= 29,9

Schlüsselweite: 11

24.3518-0015.1 390560

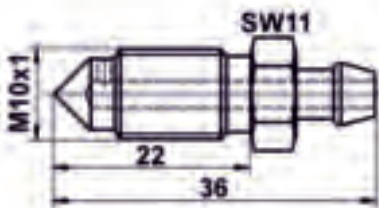

Entlüfterschraube/-ventil

M10x1

L= 36

Schlüsselweite: 11

24.3518-0016.1 390561

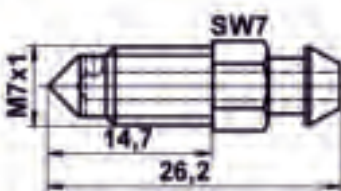

Entlüfterschraube/-ventil

M7x1

L= 26,2

Schlüsselweite: 7

24.3518-0017.1 390562

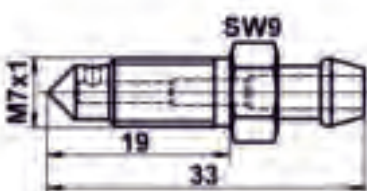

Entlüfterschraube/-ventil

M7x1

L= 33

Schlüsselweite: 9

Universalteile

Universalparts - Piezas universales - Pièces universelles - Parti universali

24.3518-0018.1 390563

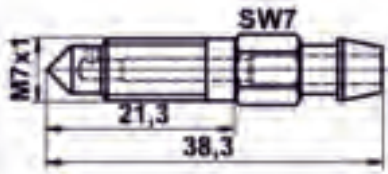

Entlüfterschraube/-ventil

M7x1

L= 38,3

Schlüsselweite: 7

24.3518-0019.1 390564

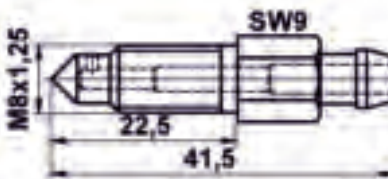

Entlüfterschraube/-ventil

M8x1,25

L= 41,5

Schlüsselweite: 9

24.3518-0020.1 390565

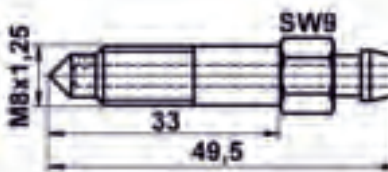

Entlüfterschraube/-ventil

M8x1,25

L= 49,5

Schlüsselweite: 9

24.3518-0021.1 390566

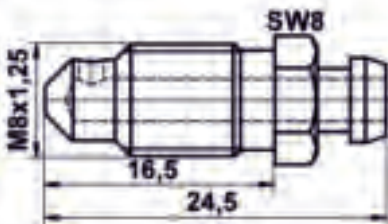

Entlüfterschraube/-ventil

M8x1,25

L= 24,5

Schlüsselweite: 8

Universalteile

Universalparts - Piezas universales - Pièces universelles - Parti universali

24.3526-0600.3 340027

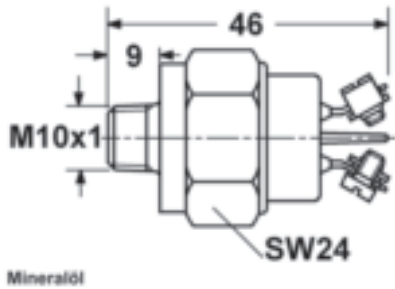

Schalter, Bremsleuchte

elektrisch-hydraulisch
nur für Mineralöl
Pol-Anzahl: 2
Steckerausführung: Schraubkontakt
Schraubanschluss
L= 46
M10x1 konisch
Gewindelänge [mm]: 9
Schlüsselweite: 24

24.3526-0610.3 340030

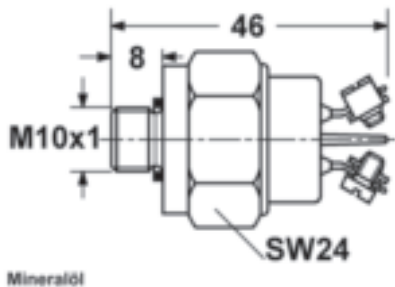

Schalter, Bremsleuchte

elektrisch-hydraulisch
nur für Mineralöl
Pol-Anzahl: 2
Steckerausführung: Schraubkontakt
Schraubanschluss
L= 46
M10x1
Gewindelänge [mm]: 8
Schlüsselweite: 24

24.3526-2200.0 340039

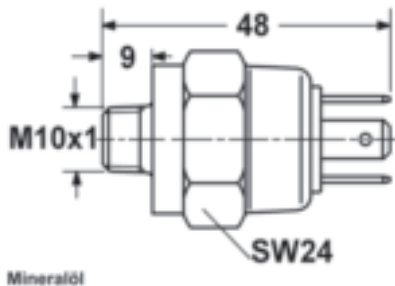

Schalter, Bremsleuchte

elektrisch-hydraulisch
nur für Mineralöl
Pol-Anzahl: 3
Steckerausführung: Flachstecker
Schraubanschluss
M10x1 konisch
Gewindelänge [mm]: 9
L= 48
Schlüsselweite: 24

24.3590-0002.1 390567

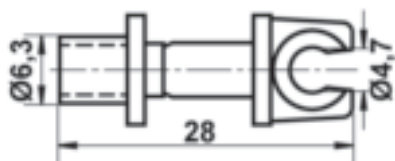

Halter, Bremsleitung

Ø 6,3
Durchmesser Aufnahme [mm]: 4,7
L= 28

Universalteile

Universalparts - Piezas universales - Pièces universelles - Parti universali

24.5004-0001.1 390568

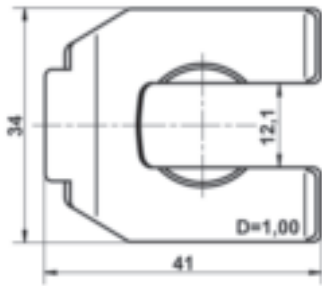

Halter, Bremsschlauch

x 12

1

24.5004-0002.1 390569

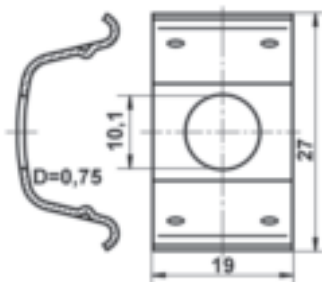

Halter, Bremsschlauch

x 10

0,7

24.5004-0003.1 390570

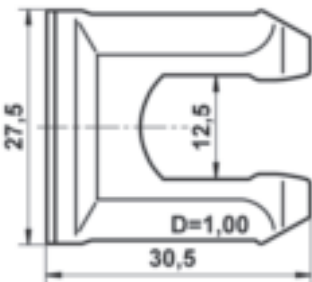

Halter, Bremsschlauch

x 11

1

24.7718-7301.2 990024

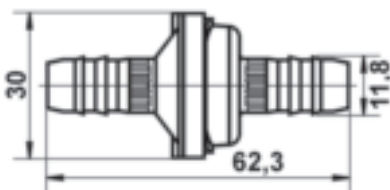

Ventil, Unterdruckleitung

Rückschlagventil

Ø 11,8

24.8134-0547.1 390571

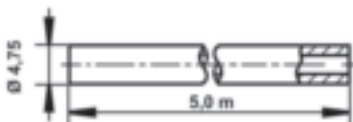

Bremsleitung

Ø 4,75

L= 5.000

DIN/ISO: 74234

Universalteile

Universalparts - Piezas universales - Pièces universelles - Parti universali

24.8134-0560.1 390572

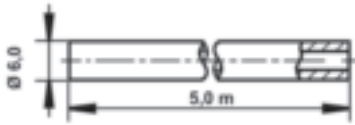

Bremsleitung

Ø 6

L= 5.000

DIN/ISO: 74234

24.8134-0580.1 390573

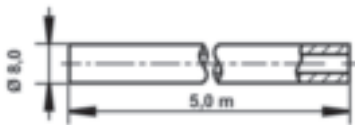

Bremsleitung

Ø 8

L= 5.000

DIN/ISO: 74234

24.8134-3147.1 390574

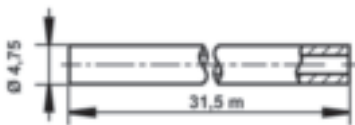

Bremsleitung

Ø 4,75

L= 31.500



- DE** Bremsgeräte komplett
- EN** Booster units complete
- ES** Servofreno completo
- FR** Servo-freins complets
- IT** Servofreni completi







2019



Bremsgeräte komplett

Booster units complete - Servofreno completo - Servo-freins
complets - Servofreni completi

• Die Nummer befindet sich auf dem im Fahrzeug eingebautem Aggregat.
the number is on the unit build in the car
El número está ubicado en la unidad instalada en el vehículo
Le numéro est situé sur l'unité installée dans le véhicule
Il numero si trova sull'unità installata nel veicolo







					
03.6121-0501.4	03.3508-0264.3	310009 Ausgleichsbehälter	03.6132-5701.4	03.2120-1531.3	010092 Hauptbremszylinder
03.6122-0010.4	03.3508-8302.3	310046 Ausgleichsbehälter	03.6132-5802.4	03.3508-7504.3	310045 Ausgleichsbehälter
03.6122-0017.4	03.3508-8302.3	310046 Ausgleichsbehälter	03.6132-6301.4	03.2120-2598.3	010116 Hauptbremszylinder
03.6122-0018.4	03.3508-8302.3	310046 Ausgleichsbehälter	03.6132-6302.4	03.2120-2598.3	010116 Hauptbremszylinder
03.6122-0601.4	03.3508-8302.3	310046 Ausgleichsbehälter	03.6132-6304.4	03.2120-2598.3	010116 Hauptbremszylinder
03.6122-1002.4	03.3508-8302.3	310046 Ausgleichsbehälter	03.6132-6305.4	03.2120-2598.3	010116 Hauptbremszylinder
03.6122-1006.4	03.3508-8302.3	310046 Ausgleichsbehälter	03.6132-6306.4	03.2120-2598.3	010116 Hauptbremszylinder
03.6122-1401.4	03.3508-8302.3	310046 Ausgleichsbehälter	03.6132-6501.4	03.2120-1531.3	010092 Hauptbremszylinder
03.6122-2001.4	03.2119-6207.3	010060 Hauptbremszylinder	03.6132-6512.4	03.2120-1531.3	010092 Hauptbremszylinder
03.6122-2002.4	03.2119-6207.3	010060 Hauptbremszylinder	03.6132-6515.4	03.2120-1491.3	010089 Hauptbremszylinder
03.6122-2003.4	03.2119-6207.3	010060 Hauptbremszylinder	03.6132-6706.4	03.2120-1491.3	010089 Hauptbremszylinder
03.6122-2102.4	03.3508-8302.3	310046 Ausgleichsbehälter	03.6142-0301.4	03.3508-8302.3	310046 Ausgleichsbehälter
03.6122-2401.4	03.2119-0525.3	010046 Hauptbremszylinder	03.6142-0701.4	03.3508-8302.3	310046 Ausgleichsbehälter
03.6122-2402.4	03.2120-0148.3	010070 Hauptbremszylinder	03.6142-1201.4	03.2123-2604.3	010178 Hauptbremszylinder
03.6122-2407.4	03.2120-0148.3	010070 Hauptbremszylinder	03.6142-1202.4	03.2123-2604.3	010178 Hauptbremszylinder
03.6127-0001.4	03.2123-6802.3	010186 Hauptbremszylinder	03.6142-1205.4	03.2123-2604.3	010178 Hauptbremszylinder
03.6127-0301.4	03.2123-6802.3	010186 Hauptbremszylinder	03.6142-1502.4	03.2122-2202.3	010140 Hauptbremszylinder
03.6127-0801.4	03.2122-0142.3	010128 Hauptbremszylinder	03.6142-1701.4	03.2119-6207.3	010060 Hauptbremszylinder
	03.3558-0676.3	310077 Ausgleichsbehälter		03.3558-0676.3	310077 Ausgleichsbehälter
03.6127-0804.4	03.3558-0676.3	310077 Ausgleichsbehälter	03.6142-1703.4	03.2120-4504.3	010123 Hauptbremszylinder
03.6132-0702.4	03.3508-8302.3	310046 Ausgleichsbehälter		03.3558-0676.3	310077 Ausgleichsbehälter
03.6132-1103.4	03.2120-0148.3	010070 Hauptbremszylinder	03.6142-1704.4	03.2120-4504.3	010123 Hauptbremszylinder
03.6132-1401.4	03.3508-8302.3	310046 Ausgleichsbehälter		03.3558-0676.3	310077 Ausgleichsbehälter
03.6132-1501.4	03.2122-0142.3	010128 Hauptbremszylinder	03.6142-2101.4	03.2122-2202.3	010140 Hauptbremszylinder
	03.3558-0676.3	310077 Ausgleichsbehälter	03.6142-2402.4	03.2123-6207.3	010185 Hauptbremszylinder
03.6132-1502.4	03.2122-0142.3	010128 Hauptbremszylinder		03.3508-7504.3	310045 Ausgleichsbehälter
	03.3558-0676.3	310077 Ausgleichsbehälter	03.6142-2403.4	03.3508-7504.3	310045 Ausgleichsbehälter
03.6132-1701.4	03.2123-1003.3	010175 Hauptbremszylinder	03.6142-3301.4	03.2123-6207.3	010185 Hauptbremszylinder
03.6132-2001.4	03.3508-8302.3	310046 Ausgleichsbehälter		03.3508-7504.3	310045 Ausgleichsbehälter
03.6132-2701.4	03.3508-7504.3	310045 Ausgleichsbehälter	03.6142-3302.4	03.3508-7504.3	310045 Ausgleichsbehälter
03.6132-2901.4	03.2120-0148.3	010070 Hauptbremszylinder	03.6142-4401.4	03.2123-2604.3	010178 Hauptbremszylinder
03.6132-3401.4	03.3508-8302.3	310046 Ausgleichsbehälter	03.6142-4601.4	03.2122-0142.3	010128 Hauptbremszylinder
03.6132-3905.4	03.3508-7504.3	310045 Ausgleichsbehälter		03.3558-0676.3	310077 Ausgleichsbehälter
03.6132-3907.4	03.2120-1531.3	010092 Hauptbremszylinder	03.6142-4602.4	03.2122-0142.3	010128 Hauptbremszylinder
	03.3508-7504.3	310045 Ausgleichsbehälter		03.3558-0676.3	310077 Ausgleichsbehälter
03.6132-3908.4	03.3508-7504.3	310045 Ausgleichsbehälter	03.6142-4603.4	03.2122-0142.3	010128 Hauptbremszylinder
03.6132-3912.4	03.2120-1531.3	010092 Hauptbremszylinder		03.3558-0676.3	310077 Ausgleichsbehälter
03.6132-4201.4	03.2120-0148.3	010070 Hauptbremszylinder	03.6142-4604.4	03.2122-0142.3	010128 Hauptbremszylinder
03.6132-4202.4	03.2120-0148.3	010070 Hauptbremszylinder		03.3558-0676.3	310077 Ausgleichsbehälter
03.6132-4203.4	03.2120-0148.3	010070 Hauptbremszylinder	03.6142-4605.4	03.2122-0142.3	010128 Hauptbremszylinder
03.6132-4207.4	03.2120-0148.3	010070 Hauptbremszylinder		03.3558-0676.3	310077 Ausgleichsbehälter
03.6132-4601.4	03.3508-7504.3	310045 Ausgleichsbehälter	03.6142-4701.4	03.2122-4902.3	010144 Hauptbremszylinder
03.6132-4703.4	03.3508-8302.3	310046 Ausgleichsbehälter	03.6142-4702.4	03.2122-4902.3	010144 Hauptbremszylinder
03.6132-4704.4	03.3508-8302.3	310046 Ausgleichsbehälter	03.6142-4704.4	03.2122-4902.3	010144 Hauptbremszylinder
03.6132-4901.4	03.3508-7504.3	310045 Ausgleichsbehälter	03.6142-4801.4	03.2123-6207.3	010185 Hauptbremszylinder
03.6132-5201.4	03.3508-7504.3	310045 Ausgleichsbehälter		03.3508-7504.3	310045 Ausgleichsbehälter
03.6132-5405.4	03.2120-0538.3	010077 Hauptbremszylinder	03.6142-4802.4	03.3508-7504.3	310045 Ausgleichsbehälter
03.6132-5501.4	03.2120-1531.3	010092 Hauptbremszylinder	03.6142-4803.4	03.3508-7504.3	310045 Ausgleichsbehälter
	03.3508-7504.3	310045 Ausgleichsbehälter	03.6142-5201.4	03.2123-6207.3	010185 Hauptbremszylinder
03.6132-5502.4	03.3508-7504.3	310045 Ausgleichsbehälter		03.3508-7504.3	310045 Ausgleichsbehälter



Bremsgeräte komplett

Booster units complete - Servofreno completo - Servo-freins
complets - Servofreni completi





• Die Nummer befindet sich auf dem im Fahrzeug eingebautem Aggregat.
the number is on the unit build in the car
El número está ubicado en la unidad instalada en el vehículo
Le numéro est situé sur l'unité installée dans le véhicule
Il numero si trova sull'unità installata nel veicolo

					
03.6142-5202.4	03.3508-7504.3	310045 Ausgleichsbehälter	03.6157-0201.4	03.3508-8302.3	310046 Ausgleichsbehälter
03.6142-5203.4	03.3508-7504.3	310045 Ausgleichsbehälter	03.6157-0301.4	03.2123-1003.3	010175 Hauptbremszylinder
03.6142-5205.4	03.2123-4911.3	010182 Hauptbremszylinder		03.3508-8753.3	310049 Ausgleichsbehälter
03.6142-5301.4	03.3508-8302.3	310046 Ausgleichsbehälter		03.6855-1202.4	300056 Bremskraftverstärker
03.6142-5502.4	03.3508-7504.3	310045 Ausgleichsbehälter	03.6157-0302.4	03.2123-1003.3	010175 Hauptbremszylinder
03.6142-6803.4	03.2122-4902.3	010144 Hauptbremszylinder		03.3508-8753.3	310049 Ausgleichsbehälter
03.6142-7203.4	03.2120-1491.3	010089 Hauptbremszylinder		03.6855-1202.4	300056 Bremskraftverstärker
03.6142-7204.4	03.2120-1491.3	010089 Hauptbremszylinder	03.6157-0303.4	03.2123-1003.3	010175 Hauptbremszylinder
03.6142-7205.4	03.2120-1491.3	010089 Hauptbremszylinder		03.3508-8753.3	310049 Ausgleichsbehälter
03.6142-7301.4	03.2120-1491.3	010089 Hauptbremszylinder		03.6855-1202.4	300056 Bremskraftverstärker
03.6142-7302.4	03.2120-1491.3	010089 Hauptbremszylinder	03.6157-0304.4	03.2123-3402.3	010181 Hauptbremszylinder
03.6142-7303.4	03.2120-1491.3	010089 Hauptbremszylinder		03.3508-8753.3	310049 Ausgleichsbehälter
03.6147-0401.4	03.2125-1102.3	010202 Hauptbremszylinder		03.6855-1202.4	300056 Bremskraftverstärker
	03.3508-3600.3	310030 Ausgleichsbehälter	03.6157-0305.4	03.2123-1003.3	010175 Hauptbremszylinder
03.6147-0501.4	03.2125-1102.3	010202 Hauptbremszylinder		03.3508-8753.3	310049 Ausgleichsbehälter
03.6147-1101.4	03.2125-1302.3	010203 Hauptbremszylinder		03.6855-1202.4	300056 Bremskraftverstärker
03.6147-1102.4	03.2125-1302.3	010203 Hauptbremszylinder	03.6157-0306.4	03.2123-3402.3	010181 Hauptbremszylinder
03.6147-1103.4	03.2125-1302.3	010203 Hauptbremszylinder		03.3508-8753.3	310049 Ausgleichsbehälter
03.6147-1301.4	03.2123-6802.3	010186 Hauptbremszylinder		03.6855-1202.4	300056 Bremskraftverstärker
03.6147-1703.4	03.2125-1302.3	010203 Hauptbremszylinder	03.6157-0307.4	03.2023-0112.3	010013 Hauptbremszylinder
03.6147-2402.4	03.2123-8611.3	010195 Hauptbremszylinder		03.6855-1202.4	300056 Bremskraftverstärker
03.6152-0206.4	03.2123-3402.3	010181 Hauptbremszylinder	03.6157-0308.4	03.2023-0166.3	010015 Hauptbremszylinder
	03.3508-8753.3	310049 Ausgleichsbehälter		03.6855-1202.4	300056 Bremskraftverstärker
	03.6850-0202.4	300043 Bremskraftverstärker	03.6157-0309.4	03.2023-0112.3	010013 Hauptbremszylinder
03.6152-0209.4	03.2023-0166.3	010015 Hauptbremszylinder		03.6855-1202.4	300056 Bremskraftverstärker
	03.6850-0202.4	300043 Bremskraftverstärker	03.6157-0310.4	03.2023-0166.3	010015 Hauptbremszylinder
03.6152-0210.4	03.2023-0166.3	010015 Hauptbremszylinder		03.6855-1202.4	300056 Bremskraftverstärker
	03.6850-0202.4	300043 Bremskraftverstärker	03.6157-0501.4	03.2123-7002.3	010187 Hauptbremszylinder
03.6152-0401.4	03.2122-6202.3	010148 Hauptbremszylinder	03.6157-0503.4	03.2123-7002.3	010187 Hauptbremszylinder
03.6152-0601.4	03.3508-8302.3	310046 Ausgleichsbehälter	03.6197-1501.4	03.3508-8302.3	310046 Ausgleichsbehälter
03.6152-0701.4	03.2123-6802.3	010186 Hauptbremszylinder	03.6197-2101.4	03.3508-8302.3	310046 Ausgleichsbehälter
03.6152-0702.4	03.2122-6202.3	010148 Hauptbremszylinder	03.6197-2201.4	03.3508-8302.3	310046 Ausgleichsbehälter
03.6152-0703.4	03.2122-6202.3	010148 Hauptbremszylinder	03.6197-2202.4	03.3508-8302.3	310046 Ausgleichsbehälter
03.6152-0803.4	03.2123-6207.3	010185 Hauptbremszylinder	03.6197-2203.4	03.3508-8302.3	310046 Ausgleichsbehälter
	03.3508-7504.3	310045 Ausgleichsbehälter	03.6197-2204.4	03.3508-8302.3	310046 Ausgleichsbehälter
03.6152-1002.4	03.2123-3302.3	010180 Hauptbremszylinder	03.6197-2801.4	03.3508-8302.3	310046 Ausgleichsbehälter
03.6152-1101.4	03.3508-8302.3	310046 Ausgleichsbehälter	03.6197-3301.4	03.3508-8302.3	310046 Ausgleichsbehälter
03.6152-1401.4	03.2123-6802.3	010186 Hauptbremszylinder	03.6197-3302.4	03.3508-8302.3	310046 Ausgleichsbehälter
03.6152-1502.4	03.2123-3302.3	010180 Hauptbremszylinder	03.6732-0101.4	03.2120-2031.3	010106 Hauptbremszylinder
03.6152-1701.4	03.2123-6207.3	010185 Hauptbremszylinder	03.6732-0201.4	03.2120-2031.3	010106 Hauptbremszylinder
	03.3508-7504.3	310045 Ausgleichsbehälter	03.6732-0203.4	03.2120-2031.3	010106 Hauptbremszylinder
03.6152-1801.4	03.2122-0142.3	010128 Hauptbremszylinder	03.6732-0401.4	03.2120-2031.3	010106 Hauptbremszylinder
	03.3558-0676.3	310077 Ausgleichsbehälter			
03.6152-2001.4	03.2123-6207.3	010185 Hauptbremszylinder			
	03.3508-7504.3	310045 Ausgleichsbehälter			
03.6152-2002.4	03.3508-7504.3	310045 Ausgleichsbehälter			
03.6152-2003.4	03.2123-4911.3	010182 Hauptbremszylinder			
03.6152-2101.4	03.3508-8302.3	310046 Ausgleichsbehälter			

Bremsgeräte komplett

Booster units complete - Servofreno completo - Servo-freins
complets - Servofreni completi

• Die Nummer befindet sich auf dem im Fahrzeug eingebautem Aggregat.
the number is on the unit build in the car
El número está ubicado en la unidad instalada en el vehículo
Le numéro est situé sur l'unité installée dans le véhicule
Il numero si trova sull'unità installata nel veicolo







		i			i
03.6732-0503.4	03.2120-2598.3	010116 Hauptbremszylinder	03.6742-0414.4	03.2120-2597.3	010115 Hauptbremszylinder
03.6732-0504.4	03.2120-2598.3	010116 Hauptbremszylinder	03.6742-0415.4	03.2120-2597.3	010115 Hauptbremszylinder
03.6732-0601.4	03.2120-2031.3	010106 Hauptbremszylinder	03.6742-0416.4	03.2120-2597.3	010115 Hauptbremszylinder
03.6732-0901.4	03.2119-3389.3	010057 Hauptbremszylinder	03.6742-0419.4	03.2120-2597.3	010115 Hauptbremszylinder
03.6732-1001.4	03.2119-3389.3	010057 Hauptbremszylinder	03.6742-0420.4	03.2120-2597.3	010115 Hauptbremszylinder
03.6732-1101.4	03.2119-3389.3	010057 Hauptbremszylinder	03.6742-0421.4	03.2120-2597.3	010115 Hauptbremszylinder
03.6732-1103.4	03.2119-3389.3	010057 Hauptbremszylinder	03.6742-0422.4	03.2120-2597.3	010115 Hauptbremszylinder
03.6732-1201.4	03.2119-3389.3	010057 Hauptbremszylinder	03.6742-0423.4	03.2120-2597.3	010115 Hauptbremszylinder
03.6732-3301.4	03.2119-3389.3	010057 Hauptbremszylinder	03.6742-0601.4	03.2122-0142.3	010128 Hauptbremszylinder
03.6732-3501.4	03.2119-3389.3	010057 Hauptbremszylinder		03.3558-0676.3	310077 Ausgleichsbehälter
03.6742-0101.4	03.2120-2598.3	010116 Hauptbremszylinder	03.6742-0701.4	03.2119-3389.3	010057 Hauptbremszylinder
03.6742-0102.4	03.2120-2598.3	010116 Hauptbremszylinder	03.6742-1201.4	03.2119-3389.3	010057 Hauptbremszylinder
03.6742-0103.4	03.2120-2598.3	010116 Hauptbremszylinder	03.6742-1501.4	03.2120-2031.3	010106 Hauptbremszylinder
03.6742-0104.4	03.2120-2598.3	010116 Hauptbremszylinder	03.6742-1701.4	03.2120-2031.3	010106 Hauptbremszylinder
03.6742-0105.4	03.2120-2598.3	010116 Hauptbremszylinder	03.6742-1801.4	03.2119-3391.3	010058 Hauptbremszylinder
03.6742-0106.4	03.2120-2598.3	010116 Hauptbremszylinder	03.6742-2001.4	03.2120-1897.3	010103 Hauptbremszylinder
03.6742-0107.4	03.2120-2598.3	010116 Hauptbremszylinder	03.6752-0201.4	03.2120-2031.3	010106 Hauptbremszylinder
03.6742-0108.4	03.2120-2598.3	010116 Hauptbremszylinder		03.6750-0202.4	300033 Bremskraftverstärker
03.6742-0109.4	03.2120-2598.3	010116 Hauptbremszylinder	03.6752-0302.4	03.2120-2031.3	010106 Hauptbremszylinder
03.6742-0110.4	03.2120-2598.3	010116 Hauptbremszylinder	03.6752-0305.4	03.2120-2331.3	010110 Hauptbremszylinder
03.6742-0111.4	03.2120-2598.3	010116 Hauptbremszylinder	03.6752-0306.4	03.2120-2031.3	010106 Hauptbremszylinder
03.6742-0112.4	03.2120-2598.3	010116 Hauptbremszylinder	03.6752-0501.4	03.2120-2598.3	010116 Hauptbremszylinder
03.6742-0113.4	03.2120-2598.3	010116 Hauptbremszylinder	03.6752-0502.4	03.2120-2598.3	010116 Hauptbremszylinder
03.6742-0114.4	03.2120-2598.3	010116 Hauptbremszylinder	03.6752-0505.4	03.2120-2597.3	010115 Hauptbremszylinder
03.6742-0115.4	03.2120-2598.3	010116 Hauptbremszylinder	03.6752-0506.4	03.2120-2597.3	010115 Hauptbremszylinder
03.6742-0116.4	03.2120-2598.3	010116 Hauptbremszylinder	03.6752-0507.4	03.2120-2597.3	010115 Hauptbremszylinder
03.6742-0117.4	03.2120-2598.3	010116 Hauptbremszylinder	03.6752-0508.4	03.2120-2597.3	010115 Hauptbremszylinder
03.6742-0118.4	03.2120-2598.3	010116 Hauptbremszylinder	03.6752-0801.4	03.2122-9812.3	010161 Hauptbremszylinder
03.6742-0119.4	03.2120-2597.3	010115 Hauptbremszylinder	03.6752-0902.4	03.2120-2331.3	010110 Hauptbremszylinder
03.6742-0120.4	03.2120-2597.3	010115 Hauptbremszylinder		03.7750-0302.4	300071 Bremskraftverstärker
03.6742-0121.4	03.2120-2597.3	010115 Hauptbremszylinder	03.6752-0903.4	03.7750-0302.4	300071 Bremskraftverstärker
03.6742-0122.4	03.2120-2597.3	010115 Hauptbremszylinder	03.6752-1002.4	03.2120-2682.3	010118 Hauptbremszylinder
03.6742-0123.4	03.2120-2597.3	010115 Hauptbremszylinder	03.6752-1101.4	03.2120-2331.3	010110 Hauptbremszylinder
03.6742-0124.4	03.2120-2597.3	010115 Hauptbremszylinder	03.6752-1102.4	03.2122-9612.3	010159 Hauptbremszylinder
03.6742-0201.4	03.2123-4911.3	010182 Hauptbremszylinder	03.6752-1201.4	03.2120-2331.3	010110 Hauptbremszylinder
03.6742-0202.4	03.2120-0538.3	010077 Hauptbremszylinder	03.6752-1301.4	03.2126-0512.3	010217 Hauptbremszylinder
03.6742-0203.4	03.2120-2598.3	010116 Hauptbremszylinder	03.6752-1401.4	03.2120-2331.3	010110 Hauptbremszylinder
03.6742-0204.4	03.2120-2598.3	010116 Hauptbremszylinder	03.6752-1607.4	03.2120-2597.3	010115 Hauptbremszylinder
03.6742-0301.4	03.2120-2598.3	010116 Hauptbremszylinder	03.6752-1608.4	03.2120-2597.3	010115 Hauptbremszylinder
03.6742-0302.4	03.2120-2598.3	010116 Hauptbremszylinder	03.6752-1609.4	03.2120-2597.3	010115 Hauptbremszylinder
03.6742-0401.4	03.2120-2598.3	010116 Hauptbremszylinder	03.6752-1610.4	03.2120-2597.3	010115 Hauptbremszylinder
03.6742-0402.4	03.2120-2598.3	010116 Hauptbremszylinder	03.6752-1611.4	03.2120-2597.3	010115 Hauptbremszylinder
03.6742-0404.4	03.2120-2598.3	010116 Hauptbremszylinder	03.6752-1703.4	03.2120-2597.3	010115 Hauptbremszylinder
03.6742-0406.4	03.2120-2598.3	010116 Hauptbremszylinder	03.6752-1704.4	03.2120-2597.3	010115 Hauptbremszylinder
03.6742-0407.4	03.2120-2598.3	010116 Hauptbremszylinder	03.6752-1901.4	03.2120-2031.3	010106 Hauptbremszylinder
03.6742-0409.4	03.2120-2597.3	010115 Hauptbremszylinder	03.6752-2101.4	03.2120-2682.3	010118 Hauptbremszylinder
03.6742-0410.4	03.2120-2597.3	010115 Hauptbremszylinder	03.6752-2502.4	03.2122-9631.3	010160 Hauptbremszylinder
03.6742-0411.4	03.2120-2597.3	010115 Hauptbremszylinder	03.6752-2601.4	03.2122-9631.3	010160 Hauptbremszylinder
03.6742-0412.4	03.2120-2597.3	010115 Hauptbremszylinder			
03.6742-0413.4	03.2120-2597.3	010115 Hauptbremszylinder			



Bremsgeräte komplett

Booster units complete - Servofreno completo - Servo-freins
complets - Servofreni completi







• Die Nummer befindet sich auf dem im Fahrzeug eingebautem Aggregat.
the number is on the unit build in the car
El número está ubicado en la unidad instalada en el vehículo
Le numéro est situé sur l'unité installée dans le véhicule
Il numero si trova sull'unità installata nel veicolo

					
03.6752-2901.4	03.6750-2902.4	300037 Bremskraftverstärker	03.6762-0115.4	03.7760-0902.4	300088 Bremskraftverstärker
03.6752-2902.4	03.2122-9631.3	010160 Hauptbremszylinder	03.6762-0116.4	03.2123-8311.3	010192 Hauptbremszylinder
	03.6750-2902.4	300037 Bremskraftverstärker		03.7760-0902.4	300088 Bremskraftverstärker
03.6752-2903.4	03.2120-2682.3	010118 Hauptbremszylinder	03.6762-0117.4	03.7760-0902.4	300088 Bremskraftverstärker
	03.6750-2902.4	300037 Bremskraftverstärker	03.6762-0118.4	03.2123-8311.3	010192 Hauptbremszylinder
03.6752-3103.4	03.2120-2682.3	010118 Hauptbremszylinder		03.7760-0902.4	300088 Bremskraftverstärker
03.6752-3201.4	03.2120-2031.3	010106 Hauptbremszylinder	03.6762-0312.4	03.7760-2702.4	300090 Bremskraftverstärker
03.6752-3501.4	03.2120-2682.3	010118 Hauptbremszylinder	03.6762-0401.4	03.2023-0825.3	010028 Hauptbremszylinder
03.6752-3601.4	03.2120-2682.3	010118 Hauptbremszylinder		03.7760-2702.4	300090 Bremskraftverstärker
03.6752-3701.4	03.2122-0626.3	010539 Hauptbremszylinder	03.6762-0402.4	03.2023-0825.3	010028 Hauptbremszylinder
03.6752-3702.4	03.2122-9631.3	010160 Hauptbremszylinder		03.7760-2702.4	300090 Bremskraftverstärker
03.6757-1004.4	03.2023-0166.3	010015 Hauptbremszylinder	03.6762-0501.4	03.2022-0702.3	010007 Hauptbremszylinder
	03.6855-1202.4	300056 Bremskraftverstärker	03.6762-0502.4	03.2022-0702.3	010007 Hauptbremszylinder
03.6762-0101.4	03.2123-8311.3	010192 Hauptbremszylinder	03.6762-0503.4	03.2022-0702.3	010007 Hauptbremszylinder
	03.7760-0902.4	300088 Bremskraftverstärker	03.6762-0504.4	03.2022-1402.3	010010 Hauptbremszylinder
03.6762-0102.4	03.2122-6911.3	010153 Hauptbremszylinder	03.6762-0505.4	03.2022-1402.3	010010 Hauptbremszylinder
	03.7760-0902.4	300088 Bremskraftverstärker	03.6762-0508.4	03.2022-1602.3	010011 Hauptbremszylinder
03.6762-0103.4	03.2122-6911.3	010153 Hauptbremszylinder	03.6762-0509.4	03.2022-1602.3	010011 Hauptbremszylinder
	03.7760-0902.4	300088 Bremskraftverstärker	03.6762-0519.4	03.2022-1402.3	010010 Hauptbremszylinder
03.6762-0104.4	03.7760-0902.4	300088 Bremskraftverstärker	03.6762-0520.4	03.2022-1602.3	010011 Hauptbremszylinder
03.6762-0105.4	03.2020-0402.3	010001 Hauptbremszylinder	03.6762-0522.4	03.2022-0702.3	010007 Hauptbremszylinder
	03.7760-0902.4	300088 Bremskraftverstärker	03.6762-0523.4	03.2022-1402.3	010010 Hauptbremszylinder
03.6762-0106.4	03.2123-8311.3	010192 Hauptbremszylinder	03.6762-0525.4	03.2022-1602.3	010011 Hauptbremszylinder
	03.7760-0902.4	300088 Bremskraftverstärker	03.6762-0601.4	03.2020-0402.3	010001 Hauptbremszylinder
03.6762-0107.4	03.7760-0902.4	300088 Bremskraftverstärker		03.7760-0902.4	300088 Bremskraftverstärker
03.6762-0108.4	03.2120-2082.3	010107 Hauptbremszylinder	03.6762-0602.4	03.2120-1802.3	010099 Hauptbremszylinder
	03.7760-0902.4	300088 Bremskraftverstärker		03.7760-0902.4	300088 Bremskraftverstärker
03.6762-0110.4	03.2120-1802.3	010099 Hauptbremszylinder	03.6832-0101.4	03.2120-3412.3	010121 Hauptbremszylinder
	03.7760-0902.4	300088 Bremskraftverstärker	03.6832-0201.4	03.2120-1531.3	010092 Hauptbremszylinder
03.6762-0111.4	03.2020-0402.3	010001 Hauptbremszylinder	03.6832-0202.4	03.2120-1531.3	010092 Hauptbremszylinder
	03.7760-0902.4	300088 Bremskraftverstärker	03.6832-0601.4	03.2120-0322.3	010074 Hauptbremszylinder
03.6762-0112.4	03.2120-1802.3	010099 Hauptbremszylinder	03.6832-0701.4	03.2120-2462.3	010113 Hauptbremszylinder
	03.7760-0902.4	300088 Bremskraftverstärker	03.6832-1001.4	03.2120-2462.3	010113 Hauptbremszylinder
03.6762-0114.4	03.2020-0402.3	010001 Hauptbremszylinder	03.6832-1102.4	03.2120-0148.3	010070 Hauptbremszylinder
	03.7760-0902.4	300088 Bremskraftverstärker	03.6832-1301.4	03.2120-0151.3	010071 Hauptbremszylinder
03.6762-0115.4	03.2120-2082.3	010107 Hauptbremszylinder	03.6832-1505.4	03.2120-1531.3	010092 Hauptbremszylinder
			03.6832-1704.4	03.2120-1531.3	010092 Hauptbremszylinder
			03.6832-1705.4	03.2120-1531.3	010092 Hauptbremszylinder
			03.6832-1706.4	03.2120-1531.3	010092 Hauptbremszylinder
			03.6842-0301.4	03.2120-0622.3	010079 Hauptbremszylinder
			03.6842-0601.4	03.2120-0538.3	010077 Hauptbremszylinder
			03.6842-0701.4	03.2120-0538.3	010077 Hauptbremszylinder
			03.6842-0702.4	03.2120-0538.3	010077 Hauptbremszylinder

Bremsgeräte komplett

Booster units complete - Servofreno completo - Servo-freins
complets - Servofreni completi

• Die Nummer befindet sich auf dem im Fahrzeug eingebautem Aggregat.
the number is on the unit build in the car
El número está ubicado en la unidad instalada en el vehículo
Le numéro est situé sur l'unité installée dans le véhicule
Il numero si trova sull'unità installata nel veicolo







					
03.6842-0703.4	03.2123-4911.3	010182 Hauptbremszylinder	03.6852-1001.4	03.6850-5402.4	300055 Bremskraftverstärker
03.6842-0704.4	03.2120-0538.3	010077 Hauptbremszylinder			
03.6842-1001.4	03.2123-0162.3	010162 Hauptbremszylinder	03.6852-1002.4	03.2123-5212.3	010183 Hauptbremszylinder
03.6842-1002.4	03.2120-2462.3	010113 Hauptbremszylinder		03.6850-5402.4	300055 Bremskraftverstärker
03.6842-1003.4	03.2123-0162.3	010162 Hauptbremszylinder			
03.6842-1401.4	03.2120-0151.3	010071 Hauptbremszylinder	03.6852-1006.4	03.2123-0271.3	010164 Hauptbremszylinder
03.6842-1605.4	03.2120-2598.3	010116 Hauptbremszylinder		03.6850-5402.4	300055 Bremskraftverstärker
03.6842-1606.4	03.2120-2598.3	010116 Hauptbremszylinder	03.6852-1007.4	03.2123-0271.3	010164 Hauptbremszylinder
03.6842-1607.4	03.2120-2598.3	010116 Hauptbremszylinder		03.6850-5402.4	300055 Bremskraftverstärker
03.6842-1608.4	03.2120-2598.3	010116 Hauptbremszylinder			
03.6842-1609.4	03.2120-2598.3	010116 Hauptbremszylinder	03.6852-1008.4	03.2123-0291.3	010165 Hauptbremszylinder
03.6842-1610.4	03.2120-2598.3	010116 Hauptbremszylinder		03.6850-5402.4	300055 Bremskraftverstärker
03.6842-1611.4	03.2120-2598.3	010116 Hauptbremszylinder			
03.6842-1612.4	03.2120-2598.3	010116 Hauptbremszylinder	03.6852-1009.4	03.2123-0291.3	010165 Hauptbremszylinder
03.6842-1613.4	03.2120-2598.3	010116 Hauptbremszylinder		03.6850-5402.4	300055 Bremskraftverstärker
03.6842-1614.4	03.2120-2598.3	010116 Hauptbremszylinder			
03.6842-3401.4	03.2123-0162.3	010162 Hauptbremszylinder	03.6852-1012.4	03.2123-0271.3	010164 Hauptbremszylinder
03.6852-0201.4	03.2123-1003.3	010175 Hauptbremszylinder		03.6850-5402.4	300055 Bremskraftverstärker
	03.3508-8753.3	310049 Ausgleichsbehälter			
	03.6850-0202.4	300043 Bremskraftverstärker	03.6852-1013.4	03.2123-0271.3	010164 Hauptbremszylinder
				03.6850-5402.4	300055 Bremskraftverstärker
03.6852-0202.4	03.2123-3402.3	010181 Hauptbremszylinder	03.6852-1014.4	03.6850-5402.4	300055 Bremskraftverstärker
	03.3508-8753.3	310049 Ausgleichsbehälter			
	03.6850-0202.4	300043 Bremskraftverstärker	03.6852-1015.4	03.6850-5402.4	300055 Bremskraftverstärker
03.6852-0203.4	03.2123-1003.3	010175 Hauptbremszylinder			
	03.3508-8753.3	310049 Ausgleichsbehälter	03.6852-1301.4	03.2123-6802.3	010186 Hauptbremszylinder
	03.6850-0202.4	300043 Bremskraftverstärker	03.6852-1302.4	03.2123-6802.3	010186 Hauptbremszylinder
			03.6852-1303.4	03.2123-6802.3	010186 Hauptbremszylinder
03.6852-0204.4	03.2023-0112.3	010013 Hauptbremszylinder	03.6852-1304.4	03.2122-6202.3	010148 Hauptbremszylinder
	03.6850-0202.4	300043 Bremskraftverstärker	03.6852-1601.4	03.2123-6002.3	010184 Hauptbremszylinder
				03.6850-2602.4	300049 Bremskraftverstärker
03.6852-0205.4	03.2023-0166.3	010015 Hauptbremszylinder			
	03.6850-0202.4	300043 Bremskraftverstärker	03.6852-1701.4	03.2123-9002.3	010198 Hauptbremszylinder
			03.6852-1702.4	03.2123-9002.3	010198 Hauptbremszylinder
03.6852-0207.4	03.2023-0166.3	010015 Hauptbremszylinder	03.6852-1902.4	03.2123-4911.3	010182 Hauptbremszylinder
	03.6850-0202.4	300043 Bremskraftverstärker	03.6852-1903.4	03.2123-6207.3	010185 Hauptbremszylinder
			03.6852-2001.4	03.2123-6002.3	010184 Hauptbremszylinder
03.6852-0210.4	03.2023-0166.3	010015 Hauptbremszylinder		03.6850-2602.4	300049 Bremskraftverstärker
	03.6850-0202.4	300043 Bremskraftverstärker	03.6852-2101.4	03.2120-0562.3	010078 Hauptbremszylinder
03.6852-0211.4	03.2023-0166.3	010015 Hauptbremszylinder	03.6852-2201.4	03.2123-4911.3	010182 Hauptbremszylinder
	03.6850-0202.4	300043 Bremskraftverstärker	03.6852-2202.4	03.2123-6207.3	010185 Hauptbremszylinder
			03.6852-2205.4	03.2120-0538.3	010077 Hauptbremszylinder
03.6852-0501.4	03.2123-2604.3	010178 Hauptbremszylinder	03.6852-2307.4	03.2120-1491.3	010089 Hauptbremszylinder
	03.6850-0502.4	300044 Bremskraftverstärker	03.6852-2401.4	03.2120-0622.3	010079 Hauptbremszylinder
			03.6852-2402.4	03.2120-0622.3	010079 Hauptbremszylinder
03.6852-0503.4	03.2123-2604.3	010178 Hauptbremszylinder	03.6852-2405.4	03.2120-0622.3	010079 Hauptbremszylinder
	03.6850-0502.4	300044 Bremskraftverstärker	03.6852-3801.4	03.2120-1142.3	010085 Hauptbremszylinder
			03.6852-4403.4	03.2122-8806.3	010157 Hauptbremszylinder
03.6852-1001.4	03.2123-5212.3	010183 Hauptbremszylinder	03.6852-4404.4	03.2122-8806.3	010157 Hauptbremszylinder



Bremsgeräte komplett

Booster units complete - Servofreno completo - Servo-freins
complets - Servofreni completi







• Die Nummer befindet sich auf dem im Fahrzeug eingebautem Aggregat.
the number is on the unit build in the car
El número está ubicado en la unidad instalada en el vehículo
Le numéro est situé sur l'unité installée dans le véhicule
Il numero si trova sull'unità installata nel veicolo

					
03.6852-4405.4	03.2122-8806.3	010157 Hauptbremszylinder	03.6857-0304.4	03.6855-1202.4	300056 Bremskraftverstärker
03.6852-4406.4	03.2122-8806.3	010157 Hauptbremszylinder			
03.6852-4407.4	03.2122-8806.3	010157 Hauptbremszylinder	03.6857-0501.4	03.2125-1712.3	010204 Hauptbremszylinder
03.6852-4408.4	03.2122-8806.3	010157 Hauptbremszylinder	03.6857-0502.4	03.2125-1712.3	010204 Hauptbremszylinder
03.6852-4409.4	03.2122-8806.3	010157 Hauptbremszylinder	03.6857-0503.4	03.2125-1712.3	010204 Hauptbremszylinder
03.6852-4603.4	03.2123-7902.3	010191 Hauptbremszylinder	03.6857-0504.4	03.2125-1712.3	010204 Hauptbremszylinder
	03.7750-5702.4	300083 Bremskraftverstärker	03.6857-1001.4	03.2023-0166.3	010015 Hauptbremszylinder
				03.6855-1202.4	300056 Bremskraftverstärker
03.6852-4604.4	03.2123-8902.3	010197 Hauptbremszylinder	03.6857-1002.4	03.2023-0166.3	010015 Hauptbremszylinder
	03.7750-5702.4	300083 Bremskraftverstärker		03.6855-1202.4	300056 Bremskraftverstärker
03.6852-4605.4	03.2023-0172.3	010016 Hauptbremszylinder	03.6857-1003.4	03.2023-0166.3	010015 Hauptbremszylinder
	03.7750-5702.4	300083 Bremskraftverstärker		03.6855-1202.4	300056 Bremskraftverstärker
03.6852-4606.4	03.2023-0172.3	010016 Hauptbremszylinder	03.6857-1106.4	03.2123-8512.3	010194 Hauptbremszylinder
	03.7750-5702.4	300083 Bremskraftverstärker	03.6857-1201.4	03.2023-0166.3	010015 Hauptbremszylinder
03.6852-4702.4	03.2123-7902.3	010191 Hauptbremszylinder		03.6855-1202.4	300056 Bremskraftverstärker
03.6852-4703.4	03.2123-8902.3	010197 Hauptbremszylinder	03.6857-1202.4	03.2023-0166.3	010015 Hauptbremszylinder
03.6852-5002.4	03.2120-1491.3	010089 Hauptbremszylinder		03.6855-1202.4	300056 Bremskraftverstärker
03.6852-5003.4	03.2120-1531.3	010092 Hauptbremszylinder	03.6857-1203.4	03.2025-0111.3	010033 Hauptbremszylinder
03.6852-5401.4	03.2123-5212.3	010183 Hauptbremszylinder		03.6855-1202.4	300056 Bremskraftverstärker
	03.6850-5402.4	300055 Bremskraftverstärker	03.6857-1204.4	03.2025-0111.3	010033 Hauptbremszylinder
03.6852-5402.4	03.2123-5212.3	010183 Hauptbremszylinder		03.6855-1202.4	300056 Bremskraftverstärker
	03.6850-5402.4	300055 Bremskraftverstärker	03.6857-1205.4	03.2025-0111.3	010033 Hauptbremszylinder
03.6852-5403.4	03.2123-5212.3	010183 Hauptbremszylinder		03.6855-1202.4	300056 Bremskraftverstärker
	03.6850-5402.4	300055 Bremskraftverstärker	03.6857-1401.4	03.2126-0512.3	010217 Hauptbremszylinder
03.6852-5404.4	03.2123-5212.3	010183 Hauptbremszylinder		03.6855-1402.4	300057 Bremskraftverstärker
	03.6850-5402.4	300055 Bremskraftverstärker	03.6857-1402.4	03.2125-1902.3	010206 Hauptbremszylinder
03.6852-5902.4	03.2122-8012.3	010156 Hauptbremszylinder		03.6855-1402.4	300057 Bremskraftverstärker
03.6852-6202.4	03.2122-8012.3	010156 Hauptbremszylinder	03.6857-1403.4	03.2125-1902.3	010206 Hauptbremszylinder
03.6857-0101.4	03.2023-0166.3	010015 Hauptbremszylinder		03.6855-1402.4	300057 Bremskraftverstärker
	03.6855-1202.4	300056 Bremskraftverstärker	03.6857-1404.4	03.2125-2102.3	010207 Hauptbremszylinder
03.6857-0102.4	03.2023-0112.3	010013 Hauptbremszylinder		03.6855-1402.4	300057 Bremskraftverstärker
03.6857-0104.4	03.2023-0112.3	010013 Hauptbremszylinder	03.6857-1405.4	03.6855-1402.4	300057 Bremskraftverstärker
	03.6855-1202.4	300056 Bremskraftverstärker			
03.6857-0105.4	03.2023-0166.3	010015 Hauptbremszylinder	03.6857-1406.4	03.6855-1402.4	300057 Bremskraftverstärker
	03.6855-1202.4	300056 Bremskraftverstärker	03.6857-1407.4	03.6855-1402.4	300057 Bremskraftverstärker
03.6857-0108.4	03.2023-0166.3	010015 Hauptbremszylinder			
	03.6855-1202.4	300056 Bremskraftverstärker	03.6857-1408.4	03.6855-1402.4	300057 Bremskraftverstärker
03.6857-0303.4	03.2023-0166.3	010015 Hauptbremszylinder			
	03.6855-1202.4	300056 Bremskraftverstärker	03.6857-1409.4	03.6855-1402.4	300057 Bremskraftverstärker
03.6857-0304.4	03.2023-0166.3	010015 Hauptbremszylinder			

Bremsgeräte komplett

Booster units complete - Servofreno completo - Servo-freins
complets - Servofreni completi

• Die Nummer befindet sich auf dem im Fahrzeug eingebautem Aggregat.
the number is on the unit build in the car
El número está ubicado en la unidad instalada en el vehículo
Le numéro est situé sur l'unité installée dans le véhicule
Il numero si trova sull'unità installata nel veicolo







					
03.6857-1410.4	03.6855-1402.4	300057 Bremskraftverstärker	03.6857-2103.4	03.6855-2202.4	300061 Bremskraftverstärker
03.6857-1411.4	03.6855-1402.4	300057 Bremskraftverstärker		03.2123-0522.3	010168 Hauptbremszylinder
03.6857-1413.4	03.6855-1402.4	300057 Bremskraftverstärker	03.6857-2201.4	03.2130-0102.3	010221 Hauptbremszylinder
03.6857-1416.4	03.6855-1402.4	300057 Bremskraftverstärker		03.6855-2202.4	300061 Bremskraftverstärker
03.6857-1417.4	03.6855-1402.4	300057 Bremskraftverstärker	03.6857-2202.4	03.6855-2202.4	300061 Bremskraftverstärker
03.6857-1420.4	03.6855-1402.4	300057 Bremskraftverstärker		03.2123-0522.3	010168 Hauptbremszylinder
03.6857-1421.4	03.6855-1402.4	300057 Bremskraftverstärker	03.6857-2203.4	03.6855-2202.4	300061 Bremskraftverstärker
03.6857-1422.4	03.6855-1402.4	300057 Bremskraftverstärker	03.6857-2204.4	03.6855-2202.4	300061 Bremskraftverstärker
03.6857-1423.4	03.6855-1402.4	300057 Bremskraftverstärker			
03.6857-1424.4	03.6855-1402.4	300057 Bremskraftverstärker	03.6857-2205.4	03.2128-1203.3	010922 Hauptbremszylinder
03.6857-1425.4	03.6855-1402.4	300057 Bremskraftverstärker		03.6855-2202.4	300061 Bremskraftverstärker
03.6857-1426.4	03.6855-1402.4	300057 Bremskraftverstärker	03.6857-2301.4	03.2123-8512.3	010194 Hauptbremszylinder
03.6857-1501.4	03.2125-1712.3	010204 Hauptbremszylinder	03.6857-2401.4	03.2125-3801.3	010215 Hauptbremszylinder
03.6857-1502.4	03.2125-1712.3	010204 Hauptbremszylinder	03.6857-2402.4	03.2125-3701.3	010627 Hauptbremszylinder
03.6857-1503.4	03.2125-1712.3	010204 Hauptbremszylinder	03.6862-0201.4	03.2023-0166.3	010015 Hauptbremszylinder
03.6857-1504.4	03.2125-1712.3	010204 Hauptbremszylinder	03.6862-0202.4	03.2023-0166.3	010015 Hauptbremszylinder
03.6857-1701.4	03.2123-6002.3	010184 Hauptbremszylinder	03.6862-0203.4	03.2023-0166.3	010015 Hauptbremszylinder
	03.3558-0676.3	310077 Ausgleichsbehälter	03.6862-0204.4	03.2023-0166.3	010015 Hauptbremszylinder
03.6857-1801.4	03.2125-3801.3	010215 Hauptbremszylinder	03.6862-0301.4	03.2123-9002.3	010198 Hauptbremszylinder
03.6857-1901.4	03.6855-1902.4	300059 Bremskraftverstärker	03.6862-0501.4	03.2123-4911.3	010182 Hauptbremszylinder
03.6857-1902.4	03.6855-1902.4	300059 Bremskraftverstärker	03.6862-0502.4	03.2123-4911.3	010182 Hauptbremszylinder
03.6857-1905.4	03.6855-1902.4	300059 Bremskraftverstärker	03.6862-0505.4	03.2123-4911.3	010182 Hauptbremszylinder
03.6857-1906.4	03.2125-1902.3	010206 Hauptbremszylinder	03.6862-0506.4	03.2123-6207.3	010185 Hauptbremszylinder
	03.6855-1902.4	300059 Bremskraftverstärker	03.6862-0507.4	03.2123-4911.3	010182 Hauptbremszylinder
03.6857-1907.4	03.6855-1902.4	300059 Bremskraftverstärker	03.6862-0508.4	03.2123-4911.3	010182 Hauptbremszylinder
03.6857-1910.4	03.6855-1902.4	300059 Bremskraftverstärker	03.6862-0801.4	03.2123-9002.3	010198 Hauptbremszylinder
03.6857-1911.4	03.6855-1902.4	300059 Bremskraftverstärker		03.7760-0402.4	300087 Bremskraftverstärker
03.6857-1912.4	03.6855-1902.4	300059 Bremskraftverstärker	03.6862-0802.4	03.2023-0183.3	010017 Hauptbremszylinder
03.6857-1913.4	03.2125-2102.3	010207 Hauptbremszylinder		03.7760-0402.4	300087 Bremskraftverstärker
	03.6855-1902.4	300059 Bremskraftverstärker	03.6862-0803.4	03.7760-0402.4	300087 Bremskraftverstärker
03.6857-2101.4	03.2130-0102.3	010221 Hauptbremszylinder	03.6862-0901.4	03.2122-6911.3	010153 Hauptbremszylinder
	03.6855-2202.4	300061 Bremskraftverstärker		03.7760-0902.4	300088 Bremskraftverstärker
			03.6862-0902.4	03.2122-6911.3	010153 Hauptbremszylinder
				03.7760-0902.4	300088 Bremskraftverstärker
			03.6862-0903.4	03.2123-8311.3	010192 Hauptbremszylinder
				03.7760-0902.4	300088 Bremskraftverstärker
			03.6862-1101.4	03.2125-3801.3	010215 Hauptbremszylinder
			03.6862-1105.4	03.2125-3801.3	010215 Hauptbremszylinder
			03.6862-1201.4	03.2023-0262.3	010020 Hauptbremszylinder
			03.6862-1303.4	03.2125-7002.3	010628 Hauptbremszylinder
			03.6862.0904.4	03.7760-0902.4	300088 Bremskraftverstärker



Bremsgeräte komplett

Booster units complete - Servofreno completo - Servo-freins
complets - Servofreni completi







• Die Nummer befindet sich auf dem im Fahrzeug eingebautem Aggregat.
the number is on the unit build in the car
El número está ubicado en la unidad instalada en el vehículo
Le numéro est situé sur l'unité installée dans le véhicule
Il numero si trova sull'unità installata nel veicolo

					
03.6952-0201.4	03.2122-8012.3	010156 Hauptbremszylinder	03.7742-5401.4	03.2120-4321.3	010525 Hauptbremszylinder
03.6952-0202.4	03.2122-8012.3	010156 Hauptbremszylinder	03.7747-0601.4	03.2123-0921.3	010174 Hauptbremszylinder
03.6952-0301.4	03.2023-0172.3	010016 Hauptbremszylinder	03.7747-0701.4	03.2123-0921.3	010174 Hauptbremszylinder
	03.7750-5702.4	300083 Bremskraftverstärker	03.7747-1301.4	03.2123-0921.3	010174 Hauptbremszylinder
03.6952-0302.4	03.2023-0172.3	010016 Hauptbremszylinder	03.7747-1401.4	03.2123-0921.3	010174 Hauptbremszylinder
	03.7750-5702.4	300083 Bremskraftverstärker	03.7747-1501.4	03.2123-1622.3	010470 Hauptbremszylinder
				03.7745-3003.4	300157 Bremskraftverstärker
03.6952-0401.4	03.2122-9612.3	010159 Hauptbremszylinder	03.7747-1502.4	03.2125-7402.3	010541 Hauptbremszylinder
	03.7750-0302.4	300071 Bremskraftverstärker		03.7745-3003.4	300157 Bremskraftverstärker
03.6952-0501.4	03.2122-9612.3	010159 Hauptbremszylinder	03.7747-1503.4	03.2125-7402.3	010541 Hauptbremszylinder
	03.7750-0302.4	300071 Bremskraftverstärker		03.7745-3003.4	300157 Bremskraftverstärker
03.6952-0601.4	03.2122-9612.3	010159 Hauptbremszylinder	03.7747-1602.4	03.2125-7502.3	010616 Hauptbremszylinder
	03.7750-0302.4	300071 Bremskraftverstärker	03.7747-1603.4	03.2125-7502.3	010616 Hauptbremszylinder
03.6952-0701.4	03.2122-9612.3	010159 Hauptbremszylinder	03.7747-1604.4	03.2125-7502.3	010616 Hauptbremszylinder
	03.7750-0302.4	300071 Bremskraftverstärker	03.7747-1631.4	03.7745-1632.4	300293 Bremskraftverstärker
03.7732-0201.4	03.2120-2031.3	010106 Hauptbremszylinder	03.7747-1831.4	03.7745-1832.4	300294 Bremskraftverstärker
03.7732-0401.4	03.2120-2031.3	010106 Hauptbremszylinder	03.7747-3201.4	03.2123-2221.3	010861 Hauptbremszylinder
03.7742-0801.4	03.2120-2031.3	010106 Hauptbremszylinder	03.7747-3401.4	03.2123-2221.3	010861 Hauptbremszylinder
03.7742-0901.4	03.2120-2031.3	010106 Hauptbremszylinder	03.7747-3601.4	03.2123-2774.3	010803 Hauptbremszylinder
03.7742-1402.4	03.7740-1402.4	300133 Bremskraftverstärker	03.7747-3602.4	03.2123-2774.3	010803 Hauptbremszylinder
03.7742-1403.4	03.7740-1402.4	300133 Bremskraftverstärker	03.7747-3605.4	03.2123-2774.3	010803 Hauptbremszylinder
03.7742-1404.4	03.2120-3943.3	010532 Hauptbremszylinder	03.7747-3901.4	03.2125-9901.3	010634 Hauptbremszylinder
	03.7740-1402.4	300133 Bremskraftverstärker		03.7745-3902.4	300129 Bremskraftverstärker
03.7742-1405.4	03.7740-1402.4	300133 Bremskraftverstärker	03.7747-3902.4	03.2125-9901.3	010634 Hauptbremszylinder
03.7742-2001.4	03.2120-2031.3	010106 Hauptbremszylinder	03.7747-3903.4	03.2125-9911.3	010883 Hauptbremszylinder
03.7742-2101.4	03.2120-2031.3	010106 Hauptbremszylinder		03.7745-3902.4	300129 Bremskraftverstärker
03.7742-2501.4	03.2119-3391.3	010058 Hauptbremszylinder	03.7747-4301.4	03.2123-2221.3	010861 Hauptbremszylinder
03.7742-2601.4	03.2120-1897.3	010103 Hauptbremszylinder	03.7747-4401.4	03.2123-2221.3	010861 Hauptbremszylinder
03.7742-3301.4	03.2120-4166.3	010452 Hauptbremszylinder		03.7745-4402.4	300295 Bremskraftverstärker
	03.7740-3302.4	300107 Bremskraftverstärker	03.7747-4402.4	03.7745-4402.4	300295 Bremskraftverstärker
03.7742-3501.4	03.2120-4166.3	010452 Hauptbremszylinder	03.7747-4600.4	03.2125-9901.3	010634 Hauptbremszylinder
03.7742-3601.4	03.2120-4166.3	010452 Hauptbremszylinder	03.7747-5802.4	03.2025-2521.3	010959 Hauptbremszylinder
03.7742-3701.4	03.2120-4166.3	010452 Hauptbremszylinder	03.7747-6301.4	03.7745-6302.4	300261 Bremskraftverstärker
03.7742-3802.4	03.2122-1184.3	010592 Hauptbremszylinder		03.2025-2521.3	010959 Hauptbremszylinder
03.7742-3806.4	03.2122-1184.3	010592 Hauptbremszylinder	03.7747-6302.4	03.7745-6302.4	300261 Bremskraftverstärker
03.7742-3808.4	03.2122-1184.3	010592 Hauptbremszylinder			
03.7742-3901.4	03.2120-4241.3	010524 Hauptbremszylinder	03.7747-6501.4	03.7745-6502.4	300296 Bremskraftverstärker
03.7742-3902.4	03.2120-4246.3	010614 Hauptbremszylinder	03.7747-6502.4	03.7745-6502.4	300296 Bremskraftverstärker
03.7742-4001.4	03.2120-4221.3	010605 Hauptbremszylinder			
03.7742-4401.4	03.2123-1484.3	010595 Hauptbremszylinder	03.7747-6503.4	03.7745-6502.4	300296 Bremskraftverstärker
03.7742-4402.4	03.2123-1484.3	010595 Hauptbremszylinder			
03.7742-4601.4	03.2120-4321.3	010525 Hauptbremszylinder			

Bremsgeräte komplett

Booster units complete - Servofreno completo - Servo-freins
complets - Servofreni completi

• Die Nummer befindet sich auf dem im Fahrzeug eingebautem Aggregat.
the number is on the unit build in the car
El número está ubicado en la unidad instalada en el vehículo
Le numéro est situé sur l'unité installée dans le véhicule
Il numero si trova sull'unità installata nel veicolo







					
03.7747-6504.4	03.7745-6502.4	300296 Bremskraftverstärker	03.7752-0501.4	03.7750-0302.4	300071 Bremskraftverstärker
03.7747-7101.4	03.2025-2521.3	010959 Hauptbremszylinder	03.7752-0532.4	03.2120-4321.3	010525 Hauptbremszylinder
03.7747-8501.4	03.4156-0073.3	010942 Hauptbremszylinder		03.7750-0532.4	300110 Bremskraftverstärker
03.7747-8901.4	03.7745-8902.4	300297 Bremskraftverstärker	03.7752-0541.4	03.2120-4611.3	010937 Hauptbremszylinder
	03.2025-2521.3	010959 Hauptbremszylinder		03.2125-0493.3	010940 Hauptbremszylinder
03.7747-8902.4	03.7745-8902.4	300297 Bremskraftverstärker		03.2126-3144.3	010941 Hauptbremszylinder
	03.2025-2521.3	010959 Hauptbremszylinder	03.7752-0707.4	03.2122-0264.3	010129 Hauptbremszylinder
03.7747-8903.4	03.7745-8902.4	300297 Bremskraftverstärker	03.7752-0708.4	03.2122-0264.3	010129 Hauptbremszylinder
03.7747-8904.4	03.7745-8902.4	300297 Bremskraftverstärker	03.7752-0709.4	03.2122-0264.3	010129 Hauptbremszylinder
03.7750-2333.4	03.7750-2332.4	300113 Bremskraftverstärker	03.7752-0710.4	03.2122-0282.3	010130 Hauptbremszylinder
	24.2122-1588.3	011028 Hauptbremszylinder	03.7752-0713.4	03.2122-0264.3	010129 Hauptbremszylinder
03.7752-0101.4	03.2022-0602.3	010006 Hauptbremszylinder	03.7752-0714.4	03.2122-0264.3	010129 Hauptbremszylinder
03.7752-0102.4	03.2022-0602.3	010006 Hauptbremszylinder	03.7752-0715.4	03.2122-0264.3	010129 Hauptbremszylinder
03.7752-0104.4	03.2022-0602.3	010006 Hauptbremszylinder	03.7752-0716.4	03.2122-0264.3	010129 Hauptbremszylinder
03.7752-0132.4	03.2122-1421.3	010615 Hauptbremszylinder	03.7752-0717.4	03.2122-0264.3	010129 Hauptbremszylinder
03.7752-0201.4	03.2122-9612.3	010159 Hauptbremszylinder	03.7752-0718.4	03.2122-0264.3	010129 Hauptbremszylinder
	03.7750-0302.4	300071 Bremskraftverstärker	03.7752-0722.4	03.2122-0264.3	010129 Hauptbremszylinder
03.7752-0204.4	03.2122-9612.3	010159 Hauptbremszylinder	03.7752-0723.4	03.2123-1121.3	010176 Hauptbremszylinder
	03.7750-0302.4	300071 Bremskraftverstärker	03.7752-0723.4	03.2123-1121.3	010176 Hauptbremszylinder
03.7752-0232.4	03.2122-1461.3	010610 Hauptbremszylinder	03.7752-0808.4	03.2122-0264.3	010129 Hauptbremszylinder
03.7752-0241.4	03.4153-5287.4	010953 Hauptbremszylinder	03.7752-0809.4	03.2122-0264.3	010129 Hauptbremszylinder
03.7752-0302.4	03.2122-9612.3	010159 Hauptbremszylinder	03.7752-0810.4	03.2122-0282.3	010130 Hauptbremszylinder
	03.7750-0302.4	300071 Bremskraftverstärker	03.7752-0813.4	03.2122-0264.3	010129 Hauptbremszylinder
03.7752-0341.4	03.2120-4611.3	010937 Hauptbremszylinder	03.7752-0814.4	03.2122-0264.3	010129 Hauptbremszylinder
	03.2125-0493.3	010940 Hauptbremszylinder	03.7752-0815.4	03.2122-0264.3	010129 Hauptbremszylinder
	03.2126-3144.3	010941 Hauptbremszylinder	03.7752-0816.4	03.2122-0264.3	010129 Hauptbremszylinder
03.7752-0342.4	03.2122-2031.3	010938 Hauptbremszylinder	03.7752-0819.4	03.2122-0264.3	010129 Hauptbremszylinder
03.7752-0401.4	03.2023-0562.3	010025 Hauptbremszylinder	03.7752-0820.4	03.2123-1121.3	010176 Hauptbremszylinder
	03.7750-0302.4	300071 Bremskraftverstärker	03.7752-0831.4	03.2122-1691.3	010918 Hauptbremszylinder
03.7752-0402.4	03.2023-0542.3	010024 Hauptbremszylinder	03.7752-0901.4	03.2122-1042.3	010137 Hauptbremszylinder
	03.7750-0302.4	300071 Bremskraftverstärker		03.7750-4302.4	300076 Bremskraftverstärker
03.7752-0404.4	03.7750-5702.4	300083 Bremskraftverstärker	03.7752-0902.4	03.2120-3943.3	010532 Hauptbremszylinder
03.7752-0405.4	03.2023-0542.3	010024 Hauptbremszylinder		03.7750-4302.4	300076 Bremskraftverstärker
	03.7750-5702.4	300083 Bremskraftverstärker	03.7752-1001.4	03.7750-7402.4	300084 Bremskraftverstärker
03.7752-0442.4	03.2122-2031.3	010938 Hauptbremszylinder	03.7752-1005.4	03.2122-0646.3	010133 Hauptbremszylinder
03.7752-0443.4	03.2120-4611.3	010937 Hauptbremszylinder		03.7750-7402.4	300084 Bremskraftverstärker
	03.2125-0493.3	010940 Hauptbremszylinder	03.7752-1006.4	03.2122-0646.3	010133 Hauptbremszylinder
	03.2126-3144.3	010941 Hauptbremszylinder		03.7750-7402.4	300084 Bremskraftverstärker
03.7752-0501.4	03.2122-9612.3	010159 Hauptbremszylinder	03.7752-1031.4	03.2123-1484.3	010595 Hauptbremszylinder
			03.7752-1201.4	03.2122-1042.3	010137 Hauptbremszylinder
				03.7750-4902.4	300079 Bremskraftverstärker
			03.7752-1202.4	03.2120-3943.3	010532 Hauptbremszylinder
				03.7750-4902.4	300079 Bremskraftverstärker
			03.7752-1204.4	03.2120-3943.3	010532 Hauptbremszylinder



Bremsgeräte komplett

Booster units complete - Servofreno completo - Servo-freins
complets - Servofreni completi







• Die Nummer befindet sich auf dem im Fahrzeug eingebautem Aggregat.
the number is on the unit build in the car
El número está ubicado en la unidad instalada en el vehículo
Le numéro est situé sur l'unité installée dans le véhicule
Il numero si trova sull'unità installata nel veicolo

					
03.7752-1204.4	03.7750-4902.4	300079 Bremskraftverstärker	03.7752-2603.4	03.2120-3943.3	010532 Hauptbremszylinder
03.7752-1331.4	03.2120-4381.3	010526 Hauptbremszylinder	03.7750-5502.4	300081 Bremskraftverstärker	
	03.7750-1332.4	300155 Bremskraftverstärker	03.7752-2604.4	03.2120-3943.3	010532 Hauptbremszylinder
03.7752-1332.4	03.2120-4461.3	010571 Hauptbremszylinder	03.7750-5502.4	300081 Bremskraftverstärker	
	03.7750-1332.4	300155 Bremskraftverstärker	03.7752-2607.4	03.2120-3943.3	010532 Hauptbremszylinder
03.7752-1831.4	03.2122-1356.3	010529 Hauptbremszylinder	03.7750-5502.4	300081 Bremskraftverstärker	
	03.7750-1832.4	300111 Bremskraftverstärker	03.7752-2608.4	03.2120-3943.3	010532 Hauptbremszylinder
03.7752-1832.4	03.2122-1351.3	010528 Hauptbremszylinder	03.7750-5502.4	300081 Bremskraftverstärker	
	03.7750-1832.4	300111 Bremskraftverstärker	03.7752-2631.4	03.2122-1691.3	010918 Hauptbremszylinder
03.7752-1833.4	03.2122-1351.3	010528 Hauptbremszylinder	03.7752-2632.4	03.2122-1691.3	010918 Hauptbremszylinder
	03.7750-1832.4	300111 Bremskraftverstärker	03.7752-2701.4	03.2120-3943.3	010532 Hauptbremszylinder
03.7752-1834.4	03.2122-1356.3	010529 Hauptbremszylinder	03.7752-2731.4	03.2122-1691.3	010918 Hauptbremszylinder
	03.7750-1832.4	300111 Bremskraftverstärker	03.7752-2732.4	03.2122-1691.3	010918 Hauptbremszylinder
03.7752-2041.4	03.2120-4611.3	010937 Hauptbremszylinder	03.7752-2801.4	03.2122-0264.3	010129 Hauptbremszylinder
	03.2125-0493.3	010940 Hauptbremszylinder	03.7752-2931.4	03.2123-1626.3	010727 Hauptbremszylinder
	03.2126-3144.3	010941 Hauptbremszylinder	03.7750-2932.4	300175 Bremskraftverstärker	
03.7752-2042.4	03.2122-2031.3	010938 Hauptbremszylinder	03.7752-3031.4	03.2123-1626.3	010727 Hauptbremszylinder
03.7752-2142.4	03.2122-2031.3	010938 Hauptbremszylinder	03.7752-3101.4	03.2120-3943.3	010532 Hauptbremszylinder
03.7752-2231.4	03.4122-0031.3	010611 Hauptbremszylinder	03.7752-3103.4	03.2120-3943.3	010532 Hauptbremszylinder
	03.7750-2232.4	300112 Bremskraftverstärker	03.7752-3131.4	03.2122-1184.3	010592 Hauptbremszylinder
03.7752-2232.4	03.4122-0041.3	010612 Hauptbremszylinder	03.7752-3231.4	03.7750-8732.4	300199 Bremskraftverstärker
	03.7750-2232.4	300112 Bremskraftverstärker		03.4153-0015.3	011005 Hauptbremszylinder
03.7752-2331.4	03.2122-1564.3	010594 Hauptbremszylinder	03.7752-3232.4	03.4153-5287.4	010953 Hauptbremszylinder
	03.7750-2332.4	300113 Bremskraftverstärker	03.7750-8732.4	300199 Bremskraftverstärker	
03.7752-2332.4	03.7750-2332.4	300113 Bremskraftverstärker	03.7752-3233.4	03.7750-8732.4	300199 Bremskraftverstärker
03.7752-2333.4	03.7750-2332.4	300113 Bremskraftverstärker	03.7752-3234.4	03.7750-8732.4	300199 Bremskraftverstärker
	24.2122-1588.3	011028 Hauptbremszylinder	03.7752-3401.4	03.2122-0264.3	010129 Hauptbremszylinder
03.7752-2334.4	03.2123-2243.3	010748 Hauptbremszylinder	03.7752-3402.4	03.2122-0282.3	010130 Hauptbremszylinder
	03.7750-2332.4	300113 Bremskraftverstärker	03.7752-3403.4	03.2123-1121.3	010176 Hauptbremszylinder
03.7752-2335.4	03.7750-2332.4	300113 Bremskraftverstärker	03.7752-3405.4	03.2122-0282.3	010130 Hauptbremszylinder
			03.7752-3501.4	03.2122-0264.3	010129 Hauptbremszylinder
03.7752-2336.4	03.7750-2332.4	300113 Bremskraftverstärker	03.7752-3502.4	03.2122-0282.3	010130 Hauptbremszylinder
			03.7752-3504.4	03.2123-1121.3	010176 Hauptbremszylinder
03.7752-2402.4	03.2122-0621.3	010131 Hauptbremszylinder	03.7752-3510.4	03.2122-0282.3	010130 Hauptbremszylinder
03.7752-2431.4	03.2122-1564.3	010594 Hauptbremszylinder	03.7752-3531.4	03.2123-2781.3	010631 Hauptbremszylinder
03.7752-2433.4	24.2122-1588.3	011028 Hauptbremszylinder	03.7752-3532.4	03.2123-2781.3	010631 Hauptbremszylinder
03.7752-2434.4	03.2123-2243.3	010748 Hauptbremszylinder	03.7752-3534.4	03.2123-2781.3	010631 Hauptbremszylinder
03.7752-2601.4	03.2120-3943.3	010532 Hauptbremszylinder	03.7752-3731.4	03.2122-1184.3	010592 Hauptbremszylinder
	03.7750-5502.4	300081 Bremskraftverstärker	03.7752-3831.4	03.2123-1484.3	010595 Hauptbremszylinder
			03.7752-4231.4	03.2123-2781.3	010631 Hauptbremszylinder
			03.7752-4232.4	03.2123-2781.3	010631 Hauptbremszylinder
			03.7752-4233.4	03.2123-2781.3	010631 Hauptbremszylinder
			03.7752-4302.4	03.2122-1042.3	010137 Hauptbremszylinder

Bremsgeräte komplett

Booster units complete - Servofreno completo - Servo-freins
complets - Servofreni completi

• Die Nummer befindet sich auf dem im Fahrzeug eingebautem Aggregat.
the number is on the unit build in the car
El número está ubicado en la unidad instalada en el vehículo
Le numéro est situé sur l'unité installée dans le véhicule
Il numero si trova sull'unità installata nel veicolo







					
03.7752-4302.4	03.7750-4302.4	300076 Bremskraftverstärker	03.7752-6001.4	03.7750-6002.4	300134 Bremskraftverstärker
03.7752-4401.4	03.2123-1121.3	010176 Hauptbremszylinder	03.7752-6002.4	03.7750-6002.4	300134 Bremskraftverstärker
03.7752-4402.4	03.2123-1121.3	010176 Hauptbremszylinder	03.7752-6003.4	03.2122-1184.3	010592 Hauptbremszylinder
03.7752-4431.4	03.2122-1926.3	010916 Hauptbremszylinder		03.7750-6002.4	300134 Bremskraftverstärker
03.7752-4501.4	03.2123-1121.3	010176 Hauptbremszylinder	03.7752-6102.4	03.2122-1042.3	010137 Hauptbremszylinder
03.7752-4503.4	03.2123-1121.3	010176 Hauptbremszylinder	03.7752-6104.4	03.2122-1042.3	010137 Hauptbremszylinder
03.7752-4531.4	03.2123-2781.3	010631 Hauptbremszylinder	03.7752-6131.4	03.2120-4321.3	010525 Hauptbremszylinder
03.7752-4532.4	03.2123-2781.3	010631 Hauptbremszylinder	03.7752-6132.4	03.2120-4321.3	010525 Hauptbremszylinder
03.7752-4701.4	03.2120-2031.3	010106 Hauptbremszylinder	03.7752-6231.4	03.2122-1356.3	010529 Hauptbremszylinder
03.7752-4703.4	03.2120-4441.3	010510 Hauptbremszylinder		03.7750-6232.4	300215 Bremskraftverstärker
03.7752-4901.4	03.2122-1042.3	010137 Hauptbremszylinder	03.7752-6232.4	03.2122-1356.3	010529 Hauptbremszylinder
	03.7750-4902.4	300079 Bremskraftverstärker		03.7750-6232.4	300215 Bremskraftverstärker
03.7752-5431.4	03.7750-5432.4	300248 Bremskraftverstärker	03.7752-6301.4	03.7750-6302.4	300161 Bremskraftverstärker
03.7752-5432.4	03.7750-5432.4	300248 Bremskraftverstärker	03.7752-6302.4	03.7750-6302.4	300161 Bremskraftverstärker
03.7752-5433.4	03.7750-5432.4	300248 Bremskraftverstärker	03.7752-6303.4	03.7750-6302.4	300161 Bremskraftverstärker
03.7752-5509.4	03.7750-5502.4	300081 Bremskraftverstärker	03.7752-6304.4	03.7750-6302.4	300161 Bremskraftverstärker
03.7752-5510.4	03.7750-5502.4	300081 Bremskraftverstärker	03.7752-6305.4	03.7750-6302.4	300161 Bremskraftverstärker
03.7752-5511.4	03.7750-5502.4	300081 Bremskraftverstärker	03.7752-6306.4	03.7750-6302.4	300161 Bremskraftverstärker
03.7752-5512.4	03.7750-5502.4	300081 Bremskraftverstärker	03.7752-6331.4	03.4122-0031.3	010611 Hauptbremszylinder
03.7752-5513.4	03.7750-5502.4	300081 Bremskraftverstärker		03.7750-6332.4	300226 Bremskraftverstärker
03.7752-5514.4	03.7750-5502.4	300081 Bremskraftverstärker	03.7752-6403.4	03.2122-1184.3	010592 Hauptbremszylinder
03.7752-5631.4	03.2123-2243.3	010748 Hauptbremszylinder	03.7752-6404.4	03.2123-1484.3	010595 Hauptbremszylinder
03.7752-5731.4	03.7750-8732.4	300199 Bremskraftverstärker	03.7752-6802.4	03.2123-1484.3	010595 Hauptbremszylinder
	03.4153-0015.3	011005 Hauptbremszylinder	03.7752-6902.4	03.2123-1484.3	010595 Hauptbremszylinder
03.7752-5732.4	03.4153-5287.4	010953 Hauptbremszylinder	03.7752-6903.4	03.2123-1484.3	010595 Hauptbremszylinder
	03.7750-8732.4	300199 Bremskraftverstärker	03.7752-7131.4	03.7750-7132.4	300255 Bremskraftverstärker
03.7752-5733.4	03.7750-8732.4	300199 Bremskraftverstärker		03.4152-0158.3	011007 Hauptbremszylinder
03.7752-5734.4	03.7750-8732.4	300199 Bremskraftverstärker	03.7752-7132.4	03.7750-7132.4	300255 Bremskraftverstärker
03.7752-5739.4	03.7750-8732.4	300199 Bremskraftverstärker		03.4152-0158.3	011007 Hauptbremszylinder
	03.4153-0015.3	011005 Hauptbremszylinder	03.7752-7332.4	03.2120-4641.3	010932 Hauptbremszylinder
03.7752-5740.4	03.4153-5287.4	010953 Hauptbremszylinder		03.7750-7332.4	300298 Bremskraftverstärker
	03.7750-8732.4	300199 Bremskraftverstärker	03.7752-7401.4	03.2122-1042.3	010137 Hauptbremszylinder
03.7752-5741.4	03.7750-8732.4	300199 Bremskraftverstärker		03.7750-7402.4	300084 Bremskraftverstärker
03.7752-5742.4	03.7750-8732.4	300199 Bremskraftverstärker	03.7752-7431.4	03.4153-5287.4	010953 Hauptbremszylinder
			03.7752-7435.4	03.4153-5287.4	010953 Hauptbremszylinder
			03.7752-8105.4	03.2122-1331.3	010607 Hauptbremszylinder
			03.7752-8108.4	03.2122-1331.3	010607 Hauptbremszylinder



Bremsgeräte komplett

Booster units complete - Servofreno completo - Servo-freins
complets - Servofreni completi







• Die Nummer befindet sich auf dem im Fahrzeug eingebautem Aggregat.
the number is on the unit build in the car
El número está ubicado en la unidad instalada en el vehículo
Le numéro est situé sur l'unité installée dans le véhicule
Il numero si trova sull'unità installata nel veicolo

					
03.7752-8432.4	03.2120-4611.3	010937 Hauptbremszylinder	03.7752-9301.4	03.7750-9302.4	300116 Bremskraftverstärker
	03.2125-0493.3	010940 Hauptbremszylinder			
	03.2126-3144.3	010941 Hauptbremszylinder	03.7752-9302.4	03.2122-1356.3	010529 Hauptbremszylinder
03.7752-8437.4	03.2120-4611.3	010937 Hauptbremszylinder		03.7750-9302.4	300116 Bremskraftverstärker
	03.2125-0493.3	010940 Hauptbremszylinder			
	03.2126-3144.3	010941 Hauptbremszylinder	03.7752-9303.4	03.2120-4321.3	010525 Hauptbremszylinder
03.7752-8533.4	03.7750-8532.4	300264 Bremskraftverstärker		03.7750-9302.4	300116 Bremskraftverstärker
03.7752-8534.4	03.2120-4611.3	010937 Hauptbremszylinder	03.7752-9304.4	03.2122-1356.3	010529 Hauptbremszylinder
	03.2125-0493.3	010940 Hauptbremszylinder		03.7750-9302.4	300116 Bremskraftverstärker
	03.2126-3144.3	010941 Hauptbremszylinder	03.7752-9305.4	03.2120-4321.3	010525 Hauptbremszylinder
	03.7750-8532.4	300264 Bremskraftverstärker		03.7750-9302.4	300116 Bremskraftverstärker
03.7752-8535.4	03.2122-2031.3	010938 Hauptbremszylinder	03.7752-9306.4	03.2122-1356.3	010529 Hauptbremszylinder
	03.7750-8532.4	300264 Bremskraftverstärker		03.7750-9302.4	300116 Bremskraftverstärker
03.7752-8536.4	03.2120-4611.3	010937 Hauptbremszylinder	03.7752-9307.4	03.2122-1351.3	010528 Hauptbremszylinder
	03.2125-0493.3	010940 Hauptbremszylinder		03.7750-9302.4	300116 Bremskraftverstärker
	03.2126-3144.3	010941 Hauptbremszylinder	03.7752-9308.4	03.2122-1351.3	010528 Hauptbremszylinder
	03.7750-8532.4	300264 Bremskraftverstärker		03.7750-9302.4	300116 Bremskraftverstärker
03.7752-8537.4	03.2122-2031.3	010938 Hauptbremszylinder	03.7752-9309.4	03.2122-1356.3	010529 Hauptbremszylinder
	03.7750-8532.4	300264 Bremskraftverstärker		03.7750-9302.4	300116 Bremskraftverstärker
03.7752-8631.4	03.2120-4611.3	010937 Hauptbremszylinder	03.7752-9310.4	03.2122-1351.3	010528 Hauptbremszylinder
	03.2125-0493.3	010940 Hauptbremszylinder		03.7750-9302.4	300116 Bremskraftverstärker
	03.2126-3144.3	010941 Hauptbremszylinder	03.7752-9331.4	03.4152-0158.3	011007 Hauptbremszylinder
03.7752-8632.4	03.2125-0493.3	010940 Hauptbremszylinder	03.7752-9401.4	03.2122-1351.3	010528 Hauptbremszylinder
	03.2126-3144.3	010941 Hauptbremszylinder		03.7750-9402.4	300117 Bremskraftverstärker
03.7752-8633.4	03.2122-2031.3	010938 Hauptbremszylinder	03.7752-9402.4	03.2122-1351.3	010528 Hauptbremszylinder
03.7752-8731.4	03.7750-8732.4	300199 Bremskraftverstärker		03.7750-9402.4	300117 Bremskraftverstärker
	03.4153-0015.3	011005 Hauptbremszylinder	03.7752-9403.4	03.2122-1351.3	010528 Hauptbremszylinder
03.7752-8732.4	03.7750-8732.4	300199 Bremskraftverstärker		03.7750-9402.4	300117 Bremskraftverstärker
03.7752-8733.4	03.4153-5287.4	010953 Hauptbremszylinder	03.7752-9532.4	03.2122-2031.3	010938 Hauptbremszylinder
	03.7750-8732.4	300199 Bremskraftverstärker	03.7752-9702.4	03.2123-2221.3	010861 Hauptbremszylinder
03.7752-8734.4	03.7750-8732.4	300199 Bremskraftverstärker	03.7752-9703.4	03.2123-2221.3	010861 Hauptbremszylinder
03.7752-8735.4	03.7750-8732.4	300199 Bremskraftverstärker	03.7752-9704.4	03.2123-2221.3	010861 Hauptbremszylinder
	03.4153-0015.3	011005 Hauptbremszylinder	03.7752-9705.4	03.2123-2221.3	010861 Hauptbremszylinder
03.7752-8831.4	03.7750-8832.4	300299 Bremskraftverstärker	03.7752-9706.4	03.2123-2221.3	010861 Hauptbremszylinder
03.7752-9001.4	03.2123-1581.3	010487 Hauptbremszylinder	03.7752-9802.4	03.2123-2221.3	010861 Hauptbremszylinder
03.7752-9101.4	03.2123-1581.3	010487 Hauptbremszylinder		03.7750-2532.4	300225 Bremskraftverstärker
03.7752-9231.4	03.2120-4611.3	010937 Hauptbremszylinder	03.7752-9803.4	03.2123-2221.3	010861 Hauptbremszylinder
	03.2125-0493.3	010940 Hauptbremszylinder		03.7750-2532.4	300225 Bremskraftverstärker
	03.2126-3144.3	010941 Hauptbremszylinder	03.7752-9804.4	03.2123-2221.3	010861 Hauptbremszylinder
03.7752-9233.4	03.2122-2031.3	010938 Hauptbremszylinder			
03.7752-9301.4	03.2120-4321.3	010525 Hauptbremszylinder			

Bremsgeräte komplett

Booster units complete - Servofreno completo - Servo-freins
complets - Servofreni completi

• Die Nummer befindet sich auf dem im Fahrzeug eingebautem Aggregat.
the number is on the unit build in the car
El número está ubicado en la unidad instalada en el vehículo
Le numéro est situé sur l'unité installée dans le véhicule
Il numero si trova sull'unità installata nel veicolo





					
03.7752-9804.4	03.7750-2532.4	300225 Bremskraftverstärker	03.7757-1202.4	03.7755-3402.4	300189 Bremskraftverstärker
03.7752-9805.4	03.2123-2221.3	010861 Hauptbremszylinder	03.7757-1203.4	03.7755-3402.4	300189 Bremskraftverstärker
	03.7750-2532.4	300225 Bremskraftverstärker	03.7757-1204.4	03.7755-3402.4	300189 Bremskraftverstärker
03.7752-9806.4	03.2123-2221.3	010861 Hauptbremszylinder	03.7757-1205.4	03.7755-3402.4	300189 Bremskraftverstärker
	03.7750-2532.4	300225 Bremskraftverstärker	03.7757-1206.4	03.7755-3402.4	300189 Bremskraftverstärker
03.7757-0101.4	03.2023-0230.3	010019 Hauptbremszylinder	03.7757-1207.4	03.2125-7637.3	010707 Hauptbremszylinder
03.7757-0102.4	03.2023-0825.3	010028 Hauptbremszylinder		03.7755-3402.4	300189 Bremskraftverstärker
03.7757-0131.4	03.7755-0132.4	300265 Bremskraftverstärker	03.7757-1208.4	03.2125-7743.3	010921 Hauptbremszylinder
03.7757-0201.4	03.2025-0211.3	010034 Hauptbremszylinder		03.7755-3402.4	300189 Bremskraftverstärker
03.7757-0203.4	03.7750-0302.4	300071 Bremskraftverstärker	03.7757-1209.4	03.2125-7638.3	010738 Hauptbremszylinder
03.7757-0204.4	03.7750-0302.4	300071 Bremskraftverstärker		03.7755-3402.4	300189 Bremskraftverstärker
03.7757-0231.4	03.4156-0073.3	010942 Hauptbremszylinder	03.7757-1210.4	03.2125-7743.3	010921 Hauptbremszylinder
03.7757-0314.4	03.2023-0642.3	010026 Hauptbremszylinder		03.7755-3402.4	300189 Bremskraftverstärker
03.7757-0319.4	03.2023-0642.3	010026 Hauptbremszylinder	03.7757-1231.4	03.7755-1232.4	300260 Bremskraftverstärker
03.7757-0321.4	03.2023-0642.3	010026 Hauptbremszylinder	03.7757-1431.4	03.7755-1432.4	300300 Bremskraftverstärker
03.7757-0324.4	03.2023-0642.3	010026 Hauptbremszylinder	03.7757-1501.4	03.2125-8404.3	010583 Hauptbremszylinder
03.7757-0631.4	03.2125-0651.3	010935 Hauptbremszylinder		03.7755-1902.4	300138 Bremskraftverstärker
03.7757-0632.4	03.2125-0651.3	010935 Hauptbremszylinder	03.7757-1601.4	03.2125-8404.3	010583 Hauptbremszylinder
03.7757-0633.4	03.2125-0651.3	010935 Hauptbremszylinder	03.7757-1902.4	03.2125-0332.3	010952 Hauptbremszylinder
03.7757-0801.4	03.2123-1526.3	010477 Hauptbremszylinder		03.7755-1902.4	300138 Bremskraftverstärker
	03.7755-4202.4	300164 Bremskraftverstärker	03.7757-1903.4	03.2125-0332.3	010952 Hauptbremszylinder
03.7757-0802.4	03.2123-1526.3	010477 Hauptbremszylinder		03.7755-1902.4	300138 Bremskraftverstärker
	03.7755-4202.4	300164 Bremskraftverstärker	03.7757-2002.4	03.2125-0332.3	010952 Hauptbremszylinder
03.7757-0803.4	03.2123-1548.3	010478 Hauptbremszylinder	03.7757-2004.4	03.2125-0332.3	010952 Hauptbremszylinder
	03.7755-4202.4	300164 Bremskraftverstärker	03.7757-2201.4	03.2125-9704.3	010603 Hauptbremszylinder
03.7757-0804.4	03.2123-1548.3	010478 Hauptbremszylinder		03.7755-4302.4	300165 Bremskraftverstärker
	03.7755-4202.4	300164 Bremskraftverstärker	03.7757-2202.4	03.2125-9704.3	010603 Hauptbremszylinder
03.7757-0805.4	03.2125-8111.3	010479 Hauptbremszylinder		03.7755-4302.4	300165 Bremskraftverstärker
	03.7755-4202.4	300164 Bremskraftverstärker	03.7757-2203.4	03.2125-9704.3	010603 Hauptbremszylinder
03.7757-0806.4	03.2125-8111.3	010479 Hauptbremszylinder		03.7755-4302.4	300165 Bremskraftverstärker
	03.7755-4202.4	300164 Bremskraftverstärker	03.7757-2501.4	03.2123-1486.3	010488 Hauptbremszylinder
03.7757-0901.4	03.2123-1486.3	010488 Hauptbremszylinder	03.7757-2503.4	03.2123-2621.3	010701 Hauptbremszylinder
03.7757-0902.4	03.2123-1741.3	010537 Hauptbremszylinder	03.7757-2601.4	03.2123-1486.3	010488 Hauptbremszylinder
03.7757-1001.4	03.2123-1486.3	010488 Hauptbremszylinder	03.7757-2603.4	03.2123-2621.3	010701 Hauptbremszylinder
03.7757-1002.4	03.2123-1741.3	010537 Hauptbremszylinder	03.7757-2801.4	03.2125-0332.3	010952 Hauptbremszylinder
03.7757-1031.4	03.2125-0651.3	010935 Hauptbremszylinder		03.7755-6302.4	300221 Bremskraftverstärker
03.7757-1032.4	03.2125-0651.3	010935 Hauptbremszylinder			
03.7757-1033.4	03.2125-0651.3	010935 Hauptbremszylinder			
03.7757-1034.4	03.2125-0651.3	010935 Hauptbremszylinder			
03.7757-1201.4	03.7755-3402.4	300189 Bremskraftverstärker			



Bremsgeräte komplett

Booster units complete - Servofreno completo - Servo-freins
complets - Servofreni completi





• Die Nummer befindet sich auf dem im Fahrzeug eingebautem Aggregat.
the number is on the unit build in the car
El número está ubicado en la unidad instalada en el vehículo
Le numéro est situé sur l'unité installée dans le véhicule
Il numero si trova sull'unità installata nel veicolo

					
03.7757-2802.4	03.2125-0332.3 03.7755-6302.4	010952 Hauptbremszylinder 300221 Bremskraftverstärker	03.7757-3303.4	03.7755-4302.4	300165 Bremskraftverstärker
03.7757-2803.4	03.2125-0332.3 03.7755-6302.4	010952 Hauptbremszylinder 300221 Bremskraftverstärker	03.7757-3401.4	03.2125-7743.3 03.7755-3402.4	010921 Hauptbremszylinder 300189 Bremskraftverstärker
03.7757-2804.4	03.2125-0332.3 03.7755-6302.4	010952 Hauptbremszylinder 300221 Bremskraftverstärker	03.7757-3402.4	03.2125-7638.3 03.7755-3402.4	010738 Hauptbremszylinder 300189 Bremskraftverstärker
03.7757-2805.4	03.2125-0332.3 03.7755-6302.4	010952 Hauptbremszylinder 300221 Bremskraftverstärker	03.7757-3501.4	03.2123-2621.3	010701 Hauptbremszylinder
03.7757-2806.4	03.2125-0332.3 03.7755-6302.4	010952 Hauptbremszylinder 300221 Bremskraftverstärker	03.7757-3531.4	03.2125-0651.3	010935 Hauptbremszylinder
03.7757-2807.4	03.2125-0332.3 03.7755-6302.4	010952 Hauptbremszylinder 300221 Bremskraftverstärker	03.7757-3601.4	03.2123-2621.3	010701 Hauptbremszylinder
03.7757-2808.4	03.2125-0332.3 03.7755-6302.4	010952 Hauptbremszylinder 300221 Bremskraftverstärker	03.7757-3701.4	03.2125-7743.3 03.7755-4702.4	010921 Hauptbremszylinder 300224 Bremskraftverstärker
03.7757-2811.4	03.2125-0332.3 03.7755-6302.4	010952 Hauptbremszylinder 300221 Bremskraftverstärker	03.7757-3702.4	03.2125-7638.3 03.7755-4702.4	010738 Hauptbremszylinder 300224 Bremskraftverstärker
03.7757-2812.4	03.2125-0332.3 03.7755-6302.4	010952 Hauptbremszylinder 300221 Bremskraftverstärker	03.7757-3801.4	03.2125-7638.3	010738 Hauptbremszylinder
03.7757-2931.4	03.2125-0651.3	010935 Hauptbremszylinder	03.7757-4501.4	03.2125-7743.3	010921 Hauptbremszylinder
03.7757-3201.4	03.2123-1526.3 03.7755-4202.4	010477 Hauptbremszylinder 300164 Bremskraftverstärker	03.7757-4601.4	03.2125-7638.3	010738 Hauptbremszylinder
03.7757-3202.4	03.2123-1526.3 03.7755-4202.4	010477 Hauptbremszylinder 300164 Bremskraftverstärker	03.7757-4701.4	03.2125-7743.3 03.7755-4702.4	010921 Hauptbremszylinder 300224 Bremskraftverstärker
03.7757-3203.4	03.2123-1548.3 03.7755-4202.4	010478 Hauptbremszylinder 300164 Bremskraftverstärker	03.7757-4702.4	03.2125-7637.3 03.2125-7638.3 03.7755-4702.4	010707 Hauptbremszylinder 010738 Hauptbremszylinder 300224 Bremskraftverstärker
03.7757-3204.4	03.2123-1548.3 03.7755-4202.4	010478 Hauptbremszylinder 300164 Bremskraftverstärker	03.7757-4703.4	03.2125-7743.3 03.7755-4702.4	010921 Hauptbremszylinder 300224 Bremskraftverstärker
03.7757-3205.4	03.2125-8111.3 03.7755-4202.4	010479 Hauptbremszylinder 300164 Bremskraftverstärker	03.7757-4704.4	03.2125-7638.3 03.7755-4702.4	010738 Hauptbremszylinder 300224 Bremskraftverstärker
03.7757-3206.4	03.2125-8111.3 03.7755-4202.4	010479 Hauptbremszylinder 300164 Bremskraftverstärker	03.7757-4705.4	03.2125-7743.3 03.7755-4702.4	010921 Hauptbremszylinder 300224 Bremskraftverstärker
03.7757-3301.4	03.2125-9704.3 03.7755-4302.4	010603 Hauptbremszylinder 300165 Bremskraftverstärker	03.7757-4706.4	03.2125-7638.3 03.7755-4702.4	010738 Hauptbremszylinder 300224 Bremskraftverstärker
03.7757-3302.4	03.2125-9704.3 03.7755-4302.4	010603 Hauptbremszylinder 300165 Bremskraftverstärker	03.7757-4707.4	03.2125-7743.3 03.7755-4702.4	010921 Hauptbremszylinder 300224 Bremskraftverstärker
03.7757-3303.4	03.2125-9704.3	010603 Hauptbremszylinder	03.7757-4708.4	03.2125-7638.3 03.7755-4702.4	010738 Hauptbremszylinder 300224 Bremskraftverstärker
			03.7757-4807.4	03.2125-0161.3	010920 Hauptbremszylinder
			03.7757-4808.4	03.2125-0531.3	010945 Hauptbremszylinder
			03.7757-4813.4	03.2125-0161.3	010920 Hauptbremszylinder
			03.7757-5001.4	03.2125-7743.3	010921 Hauptbremszylinder
			03.7757-5002.4	03.2125-7638.3	010738 Hauptbremszylinder
			03.7757-5301.4	03.7755-1432.4	300300 Bremskraftverstärker

Bremsgeräte komplett

Booster units complete - Servofreno completo - Servo-freins
complets - Servofreni completi

• Die Nummer befindet sich auf dem im Fahrzeug eingebautem Aggregat.
the number is on the unit build in the car
El número está ubicado en la unidad instalada en el vehículo
Le numéro est situé sur l'unité installée dans le véhicule
Il numero si trova sull'unità installata nel veicolo







					
03.7757-5501.4	03.7755-9703.4	300239 Bremskraftverstärker	03.7757-9701.4	03.7755-9703.4	300239 Bremskraftverstärker
03.7757-5502.4	03.7755-9703.4	300239 Bremskraftverstärker	03.7762-0101.4	03.2123-8311.3	010192 Hauptbremszylinder
03.7757-6101.4	03.7755-1232.4	300260 Bremskraftverstärker		03.7760-0902.4	300088 Bremskraftverstärker
03.7757-6102.4	03.7755-1232.4	300260 Bremskraftverstärker	03.7762-0102.4	03.2122-6911.3	010153 Hauptbremszylinder
03.7757-6201.4	03.7755-1432.4	300300 Bremskraftverstärker		03.7760-0902.4	300088 Bremskraftverstärker
03.7757-6202.4	03.7755-1432.4	300300 Bremskraftverstärker	03.7762-0103.4	03.2122-6911.3	010153 Hauptbremszylinder
03.7757-6301.4	03.7755-6302.4	300221 Bremskraftverstärker		03.7760-0902.4	300088 Bremskraftverstärker
03.7757-6302.4	03.7755-6302.4	300221 Bremskraftverstärker	03.7762-0104.4	03.7760-0902.4	300088 Bremskraftverstärker
03.7757-6303.4	03.2125-0332.3	010952 Hauptbremszylinder	03.7762-0108.4	03.2120-2082.3	010107 Hauptbremszylinder
	03.7755-6302.4	300221 Bremskraftverstärker		03.7760-0902.4	300088 Bremskraftverstärker
03.7757-6401.4	03.7755-1432.4	300300 Bremskraftverstärker	03.7762-0110.4	03.2120-1802.3	010099 Hauptbremszylinder
03.7757-6402.4	03.7755-1432.4	300300 Bremskraftverstärker		03.7760-0902.4	300088 Bremskraftverstärker
03.7757-6404.4	03.7755-1432.4	300300 Bremskraftverstärker	03.7762-0112.4	03.2120-1802.3	010099 Hauptbremszylinder
03.7757-6405.4	03.7755-1432.4	300300 Bremskraftverstärker		03.7760-0902.4	300088 Bremskraftverstärker
03.7757-7301.4	03.2025-2521.3	010959 Hauptbremszylinder	03.7762-0114.4	03.2020-0402.3	010001 Hauptbremszylinder
03.7757-7501.4	03.7755-3532.4	300290 Bremskraftverstärker		03.7760-0902.4	300088 Bremskraftverstärker
03.7757-7601.4	03.7755-0132.4	300265 Bremskraftverstärker	03.7762-0115.4	03.2120-2082.3	010107 Hauptbremszylinder
03.7757-7701.4	03.2125-0651.3	010935 Hauptbremszylinder		03.7760-0902.4	300088 Bremskraftverstärker
	03.7755-3532.4	300290 Bremskraftverstärker	03.7762-0116.4	03.2123-8311.3	010192 Hauptbremszylinder
03.7757-7702.4	03.2125-0651.3	010935 Hauptbremszylinder		03.7760-0902.4	300088 Bremskraftverstärker
	03.7755-3532.4	300290 Bremskraftverstärker	03.7762-0117.4	03.7760-0902.4	300088 Bremskraftverstärker
03.7757-8201.4	03.2126-3196.3	010968 Hauptbremszylinder		03.2123-8311.3	010192 Hauptbremszylinder
	03.7755-8202.4	300301 Bremskraftverstärker	03.7762-0118.4	03.7760-0902.4	300088 Bremskraftverstärker
03.7757-8801.4	03.4156-0073.3	010942 Hauptbremszylinder	03.7762-0119.4	03.2120-2082.3	010107 Hauptbremszylinder
03.7757-9001.4	03.2126-3196.3	010968 Hauptbremszylinder		03.7760-0902.4	300088 Bremskraftverstärker
03.7757-9002.4	03.2126-3196.3	010968 Hauptbremszylinder	03.7762-0120.4	03.2120-2082.3	010107 Hauptbremszylinder
03.7757-9301.4	03.7755-1232.4	300260 Bremskraftverstärker		03.7760-0902.4	300088 Bremskraftverstärker
03.7757-9401.4	03.7755-1432.4	300300 Bremskraftverstärker	03.7762-0121.4	03.2120-1802.3	010099 Hauptbremszylinder
03.7757-9402.4	03.7755-1432.4	300300 Bremskraftverstärker		03.7760-0902.4	300088 Bremskraftverstärker
03.7757-9501.4	03.7755-1432.4	300300 Bremskraftverstärker	03.7762-0122.4	03.2120-1802.3	010099 Hauptbremszylinder
03.7757-9601.4	03.7755-1432.4	300300 Bremskraftverstärker		03.7760-0902.4	300088 Bremskraftverstärker
			03.7762-0123.4	03.2020-0402.3	010001 Hauptbremszylinder
				03.7760-0902.4	300088 Bremskraftverstärker
			03.7762-0124.4	03.7760-0902.4	300088 Bremskraftverstärker
			03.7762-0201.4	03.2020-0402.3	010001 Hauptbremszylinder



Bremsgeräte komplett

Booster units complete - Servofreno completo - Servo-freins
complets - Servofreni completi







• Die Nummer befindet sich auf dem im Fahrzeug eingebautem Aggregat.
the number is on the unit build in the car
El número está ubicado en la unidad instalada en el vehículo
Le numéro est situé sur l'unité installée dans le véhicule
Il numero si trova sull'unità installata nel veicolo

					
03.7762-0201.4	03.7760-0902.4	300088 Bremskraftverstärker	03.7762-0703.4	03.7760-0902.4	300088 Bremskraftverstärker
03.7762-0202.4	03.2120-1802.3 03.7760-0902.4	010099 Hauptbremszylinder 300088 Bremskraftverstärker	03.7762-0704.4	03.2022-1201.3 03.7760-0902.4	010009 Hauptbremszylinder 300088 Bremskraftverstärker
03.7762-0204.4	03.2120-2082.3 03.7760-0902.4	010107 Hauptbremszylinder 300088 Bremskraftverstärker	03.7762-0705.4	03.2022-1201.3 03.7760-0902.4	010009 Hauptbremszylinder 300088 Bremskraftverstärker
03.7762-0301.4	03.2023-0825.3 03.7760-2702.4	010028 Hauptbremszylinder 300090 Bremskraftverstärker	03.7762-0731.4	03.2123-2821.3	010944 Hauptbremszylinder
03.7762-0302.4	03.2023-0825.3 03.7760-2702.4	010028 Hauptbremszylinder 300090 Bremskraftverstärker	03.7762-0801.4	03.2022-1201.3 03.7760-0902.4	010009 Hauptbremszylinder 300088 Bremskraftverstärker
03.7762-0312.4	03.2023-0825.3 03.7760-2702.4	010028 Hauptbremszylinder 300090 Bremskraftverstärker	03.7762-0802.4	03.2022-1201.3 03.7760-0902.4	010009 Hauptbremszylinder 300088 Bremskraftverstärker
03.7762-0313.4	03.2023-0825.3 03.7760-2702.4	010028 Hauptbremszylinder 300090 Bremskraftverstärker	03.7762-0901.4	03.2022-1201.3 03.7760-0902.4	010009 Hauptbremszylinder 300088 Bremskraftverstärker
03.7762-0401.4	03.2023-0262.3 03.7760-0402.4	010020 Hauptbremszylinder 300087 Bremskraftverstärker	03.7762-0902.4	03.2022-1201.3 03.7760-0902.4	010009 Hauptbremszylinder 300088 Bremskraftverstärker
03.7762-0402.4	03.7760-0402.4	300087 Bremskraftverstärker	03.7762-1001.4	03.2125-3011.3	010211 Hauptbremszylinder
03.7762-0501.4	03.2120-1802.3 03.7760-0902.4	010099 Hauptbremszylinder 300088 Bremskraftverstärker	03.7762-1002.4	03.2125-3011.3	010211 Hauptbremszylinder
03.7762-0502.4	03.2120-2082.3 03.7760-0902.4	010107 Hauptbremszylinder 300088 Bremskraftverstärker	03.7762-1032.4	03.2123-3041.3 03.7760-2332.4	010887 Hauptbremszylinder 300267 Bremskraftverstärker
03.7762-0503.4	03.7760-0902.4	300088 Bremskraftverstärker	03.7762-1203.4	03.2125-3011.3	010211 Hauptbremszylinder
03.7762-0504.4	03.2120-1802.3 03.7760-0902.4	010099 Hauptbremszylinder 300088 Bremskraftverstärker	03.7762-1204.4	03.2125-3011.3	010211 Hauptbremszylinder
03.7762-0505.4	03.2120-2082.3 03.7760-0902.4	010107 Hauptbremszylinder 300088 Bremskraftverstärker	03.7762-1801.4	03.2125-3011.3	010211 Hauptbremszylinder
03.7762-0506.4	03.7760-0902.4	300088 Bremskraftverstärker	03.7762-1802.4	03.2125-3011.3	010211 Hauptbremszylinder
03.7762-0631.4	03.2125-0483.3 03.7760-2232.4	010783 Hauptbremszylinder 300266 Bremskraftverstärker	03.7762-1901.4	03.2125-3011.3	010211 Hauptbremszylinder
03.7762-0632.4	03.2125-0483.3 03.7760-2232.4	010783 Hauptbremszylinder 300266 Bremskraftverstärker	03.7762-1902.4	03.2125-3011.3	010211 Hauptbremszylinder
03.7762-0701.4	03.2022-1201.3 03.7760-0902.4	010009 Hauptbremszylinder 300088 Bremskraftverstärker	03.7762-2001.4	03.2125-3011.3	010211 Hauptbremszylinder
03.7762-0702.4	03.2022-1201.3 03.7760-0902.4	010009 Hauptbremszylinder 300088 Bremskraftverstärker	03.7762-2002.4	03.2125-3011.3	010211 Hauptbremszylinder
03.7762-0703.4	03.2022-1201.3	010009 Hauptbremszylinder	03.7762-2031.4	03.2125-0483.3	010783 Hauptbremszylinder
			03.7762-2032.4	03.2125-0483.3	010783 Hauptbremszylinder
			03.7762-2033.4	03.2125-0661.3	010917 Hauptbremszylinder
			03.7762-2034.4	03.2125-0661.3	010917 Hauptbremszylinder
			03.7762-2231.4	03.2125-0661.3 03.7760-2232.4	010917 Hauptbremszylinder 300266 Bremskraftverstärker
			03.7762-2232.4	03.2125-0661.3 03.7760-2232.4	010917 Hauptbremszylinder 300266 Bremskraftverstärker
			03.7762-2233.4	03.2125-0661.3 03.7760-2232.4	010917 Hauptbremszylinder 300266 Bremskraftverstärker
			03.7762-2234.4	03.7760-2232.4	300266 Bremskraftverstärker
			03.7762-2331.4	03.2123-3041.3 03.7760-2332.4	010887 Hauptbremszylinder 300267 Bremskraftverstärker

Bremsgeräte komplett

Booster units complete - Servofreno completo - Servo-freins
complets - Servofreni completi

• Die Nummer befindet sich auf dem im Fahrzeug eingebautem Aggregat.
the number is on the unit build in the car
El número está ubicado en la unidad instalada en el vehículo
Le numéro est situé sur l'unité installée dans le véhicule
Il numero si trova sull'unità installata nel veicolo







					
03.7762-2332.4	03.7760-2332.4	300267 Bremskraftverstärker	03.7762-5003.4	03.2123-2164.3	010599 Hauptbremszylinder
03.7762-2333.4	03.2123-3041.3	010887 Hauptbremszylinder	03.7762-5101.4	03.2123-2146.3	010572 Hauptbremszylinder
	03.7760-2332.4	300267 Bremskraftverstärker		03.7760-5102.4	300140 Bremskraftverstärker
03.7762-2334.4	03.7760-2332.4	300267 Bremskraftverstärker	03.7762-5102.4	03.2123-1551.3	010512 Hauptbremszylinder
				03.7760-5102.4	300140 Bremskraftverstärker
03.7762-2402.4	03.2023-0987.3	010473 Hauptbremszylinder	03.7762-5103.4	03.7760-5102.4	300140 Bremskraftverstärker
03.7762-2701.4	03.2023-0825.3	010028 Hauptbremszylinder	03.7762-5104.4	03.7760-5102.4	300140 Bremskraftverstärker
	03.7760-2702.4	300090 Bremskraftverstärker			
03.7762-3102.4	03.2023-0987.3	010473 Hauptbremszylinder	03.7762-5202.4	03.2120-4441.3	010510 Hauptbremszylinder
	03.7760-3102.4	300139 Bremskraftverstärker	03.7762-5301.4	03.2122-1351.3	010528 Hauptbremszylinder
03.7762-3103.4	03.2023-0987.3	010473 Hauptbremszylinder	03.7762-5401.4	03.2123-2146.3	010572 Hauptbremszylinder
	03.7760-3102.4	300139 Bremskraftverstärker		03.7760-5102.4	300140 Bremskraftverstärker
03.7762-3109.4	03.2023-0987.3	010473 Hauptbremszylinder	03.7762-5501.4	03.2122-1521.3	010494 Hauptbremszylinder
	03.7760-3102.4	300139 Bremskraftverstärker		03.7760-5502.4	300151 Bremskraftverstärker
03.7762-3110.4	03.2023-1904.3	010724 Hauptbremszylinder	03.7762-5503.4	03.2122-1541.3	010511 Hauptbremszylinder
	03.7760-3102.4	300139 Bremskraftverstärker		03.7760-5502.4	300151 Bremskraftverstärker
03.7762-3111.4	03.2023-1904.3	010724 Hauptbremszylinder	03.7762-5602.4	03.2123-1551.3	010512 Hauptbremszylinder
	03.7760-3102.4	300139 Bremskraftverstärker		03.7760-5602.4	300121 Bremskraftverstärker
03.7762-3120.4	03.2023-1949.3	010725 Hauptbremszylinder	03.7762-5603.4	03.2122-1541.3	010511 Hauptbremszylinder
	03.7760-3102.4	300139 Bremskraftverstärker		03.7760-5602.4	300121 Bremskraftverstärker
03.7762-3121.4	03.2023-1949.3	010725 Hauptbremszylinder	03.7762-6201.4	03.2123-2164.3	010599 Hauptbremszylinder
	03.7760-3102.4	300139 Bremskraftverstärker	03.7762-6301.4	03.2123-2164.3	010599 Hauptbremszylinder
03.7762-3606.4	03.2023-1084.3	010591 Hauptbremszylinder	03.7762-6901.4	03.2123-2821.3	010944 Hauptbremszylinder
	03.7760-3602.4	300176 Bremskraftverstärker	03.7762-7110.4	03.2123-3041.3	010887 Hauptbremszylinder
03.7762-3607.4	03.2023-1044.3	010590 Hauptbremszylinder		03.7760-2332.4	300267 Bremskraftverstärker
	03.7760-3602.4	300176 Bremskraftverstärker	03.7762-7111.4	03.2123-3041.3	010887 Hauptbremszylinder
03.7762-3706.4	03.2023-1084.3	010591 Hauptbremszylinder		03.7760-2332.4	300267 Bremskraftverstärker
03.7762-3707.4	03.2023-1044.3	010590 Hauptbremszylinder	03.7762-7114.4	03.2123-3041.3	010887 Hauptbremszylinder
03.7762-4101.4	03.2023-1066.3	010032 Hauptbremszylinder		03.7760-2332.4	300267 Bremskraftverstärker
	03.7760-4102.4	300091 Bremskraftverstärker	03.7762-7631.4	03.2123-2821.3	010944 Hauptbremszylinder
03.7762-4102.4	03.2023-1066.3	010032 Hauptbremszylinder	03.7762-8101.4	03.2123-3103.3	010781 Hauptbremszylinder
	03.7760-4102.4	300091 Bremskraftverstärker		03.7760-8103.4	300240 Bremskraftverstärker
03.7762-4203.4	03.2123-1486.3	010488 Hauptbremszylinder	03.7762-8102.4	03.2123-3103.3	010781 Hauptbremszylinder
03.7762-4204.4	03.2123-1546.3	010536 Hauptbremszylinder		03.7760-8103.4	300240 Bremskraftverstärker
03.7762-4301.4	03.2123-1486.3	010488 Hauptbremszylinder	03.7762-8104.4	03.2123-3103.3	010781 Hauptbremszylinder
03.7762-4302.4	03.2123-1546.3	010536 Hauptbremszylinder		03.7760-8103.4	300240 Bremskraftverstärker
03.7762-4603.4	03.2123-2164.3	010599 Hauptbremszylinder	03.7762-8105.4	03.2123-3103.3	010781 Hauptbremszylinder
03.7762-4803.4	03.2123-2164.3	010599 Hauptbremszylinder		03.7760-8103.4	300240 Bremskraftverstärker
03.7762-4903.4	03.2123-2164.3	010599 Hauptbremszylinder			



Bremsgeräte komplett

Booster units complete - Servofreno completo - Servo-freins
complets - Servofreni completi







• Die Nummer befindet sich auf dem im Fahrzeug eingebautem Aggregat.
the number is on the unit build in the car
El número está ubicado en la unidad instalada en el vehículo
Le numéro est situé sur l'unité installée dans le véhicule
Il numero si trova sull'unità installata nel veicolo

					
03.7762-9101.4	03.2123-3103.3	010781 Hauptbremszylinder	03.7849-1201.4	03.2123-2064.3	010598 Hauptbremszylinder
03.7762-9601.4	03.2125-0483.3	010783 Hauptbremszylinder	03.7849-2001.4	03.7848-2002.4	300166 Bremskraftverstärker
	03.7760-2232.4	300266 Bremskraftverstärker	03.7849-2002.4	03.7848-2002.4	300166 Bremskraftverstärker
03.7762-9602.4	03.2125-0483.3	010783 Hauptbremszylinder	03.7849-3001.4	03.7848-9402.4	300227 Bremskraftverstärker
	03.7760-2232.4	300266 Bremskraftverstärker	03.7849-3301.4	03.4125-0032.3	010955 Hauptbremszylinder
03.7762-9801.4	03.2123-3041.3	010887 Hauptbremszylinder	03.7849-4001.4	03.2023-2407.3	010796 Hauptbremszylinder
	03.7760-2332.4	300267 Bremskraftverstärker		03.7848-4003.4	300235 Bremskraftverstärker
03.7767-0101.4	03.2026-0462.3	010728 Hauptbremszylinder	03.7849-4002.4	03.7848-4003.4	300235 Bremskraftverstärker
03.7767-0102.4	03.2026-0462.3	010728 Hauptbremszylinder	03.7849-4005.4	03.2023-2407.3	010796 Hauptbremszylinder
03.7767-0103.4	03.2026-0512.3	010038 Hauptbremszylinder		03.7848-4003.4	300235 Bremskraftverstärker
03.7767-0104.4	03.2026-0512.3	010038 Hauptbremszylinder	03.7849-4006.4	03.7848-4003.4	300235 Bremskraftverstärker
03.7767-0105.4	03.2026-0462.3	010728 Hauptbremszylinder	03.7849-5001.4	03.2025-1904.3	010797 Hauptbremszylinder
03.7767-0106.4	03.2026-0562.3	010729 Hauptbremszylinder		03.7848-5003.4	300236 Bremskraftverstärker
03.7767-0107.4	03.2026-0462.3	010728 Hauptbremszylinder	03.7849-5002.4	03.7848-5003.4	300236 Bremskraftverstärker
03.7767-0108.4	03.2026-0562.3	010729 Hauptbremszylinder	03.7849-5005.4	03.2025-1904.3	010797 Hauptbremszylinder
03.7767-0502.4	03.2126-3014.3	010811 Hauptbremszylinder		03.7848-5003.4	300236 Bremskraftverstärker
	03.7765-1002.4	300246 Bremskraftverstärker	03.7849-5006.4	03.7848-5003.4	300236 Bremskraftverstärker
03.7767-1001.4	03.2126-3014.3	010811 Hauptbremszylinder	03.7849-6201.4	03.7848-9402.4	300227 Bremskraftverstärker
	03.7765-1002.4	300246 Bremskraftverstärker	03.7849-9401.4	03.7848-9402.4	300227 Bremskraftverstärker
03.7767-1302.4	03.2126-3144.3	010941 Hauptbremszylinder	03.7852-0102.4	03.2122-1883.3	010735 Hauptbremszylinder
03.7767-1303.4	03.2126-3144.3	010941 Hauptbremszylinder		03.7850-0102.4	300180 Bremskraftverstärker
03.7767-1401.4	03.2126-3144.3	010941 Hauptbremszylinder	03.7852-0103.4	03.2122-1888.3	010736 Hauptbremszylinder
03.7847-0101.4	03.2025-1904.3	010797 Hauptbremszylinder		03.7850-0102.4	300180 Bremskraftverstärker
	03.7845-0103.4	300268 Bremskraftverstärker	03.7854-0101.4	03.7853-0102.4	300252 Bremskraftverstärker
03.7847-0102.4	03.7845-0103.4	300268 Bremskraftverstärker	03.7854-0102.4	03.7853-0102.4	300252 Bremskraftverstärker
03.7847-0103.4	03.2025-1904.3	010797 Hauptbremszylinder	03.7854-0201.4	03.7853-0202.4	300181 Bremskraftverstärker
	03.7845-0103.4	300268 Bremskraftverstärker	03.7854-0202.4	03.7853-0202.4	300181 Bremskraftverstärker
03.7847-0104.4	03.7845-0103.4	300268 Bremskraftverstärker	03.7854-0701.4	03.7853-0702.4	300195 Bremskraftverstärker
03.7847-0401.4	03.2023-2407.3	010796 Hauptbremszylinder	03.7854-0702.4	03.7853-0702.4	300195 Bremskraftverstärker
03.7847-0501.4	03.2025-1904.3	010797 Hauptbremszylinder	03.7854-0901.4	03.7853-0902.4	300150 Bremskraftverstärker
03.7847-0601.4	03.2025-1904.3	010797 Hauptbremszylinder	03.7854-0902.4	03.7853-0902.4	300150 Bremskraftverstärker
03.7849-0101.4	03.2123-2064.3	010598 Hauptbremszylinder			
03.7849-0201.4	03.2023-1741.3	010703 Hauptbremszylinder			
	03.7848-2002.4	300166 Bremskraftverstärker			
03.7849-0202.4	03.2025-1741.3	010705 Hauptbremszylinder			
	03.7848-2002.4	300166 Bremskraftverstärker			
03.7849-0203.4	03.7848-2002.4	300166 Bremskraftverstärker			
03.7849-0204.4	03.7848-2002.4	300166 Bremskraftverstärker			
03.7849-0901.4	03.2025-1741.3	010705 Hauptbremszylinder			
03.7849-0902.4	03.2025-1741.3	010705 Hauptbremszylinder			

Bremsgeräte komplett

Booster units complete - Servofreno completo - Servo-freins
complets - Servofreni completi







• Die Nummer befindet sich auf dem im Fahrzeug eingebautem Aggregat.
the number is on the unit build in the car
El número está ubicado en la unidad instalada en el vehículo
Le numéro est situé sur l'unité installée dans le véhicule
Il numero si trova sull'unità installata nel veicolo

					
03.7854-0903.4	03.7853-0902.4	300150 Bremskraftverstärker	03.7854-2116.4	03.7853-2102.4	300201 Bremskraftverstärker
03.7854-0904.4	03.7853-0902.4	300150 Bremskraftverstärker	03.7854-2601.4	03.7853-2602.4	300196 Bremskraftverstärker
03.7854-0905.4	03.7853-0902.4	300150 Bremskraftverstärker	03.7854-2602.4	03.7853-2602.4	300196 Bremskraftverstärker
03.7854-0906.4	03.7853-0902.4	300150 Bremskraftverstärker	03.7854-2701.4	03.7853-2702.4	300269 Bremskraftverstärker
03.7854-0907.4	03.7853-0902.4	300150 Bremskraftverstärker	03.7854-2702.4	03.7853-2702.4	300269 Bremskraftverstärker
03.7854-0908.4	03.7853-0902.4	300150 Bremskraftverstärker	03.7854-3901.4	03.7853-3902.4	300270 Bremskraftverstärker
03.7854-1501.4	03.2120-4461.3 03.7853-1502.4	010571 Hauptbremszylinder 300200 Bremskraftverstärker	03.7854-4101.4	03.2120-4611.3 03.2125-0493.3 03.2126-3144.3 03.7853-4102.4	010937 Hauptbremszylinder 010940 Hauptbremszylinder 010941 Hauptbremszylinder 300271 Bremskraftverstärker
03.7854-1502.4	03.7853-1502.4	300200 Bremskraftverstärker	03.7854-4103.4	03.2122-2031.3 03.7853-4102.4	010938 Hauptbremszylinder 300271 Bremskraftverstärker
03.7854-1601.4	03.2122-1351.3 03.7853-1602.4	010528 Hauptbremszylinder 300167 Bremskraftverstärker	03.7854-4105.4	03.2120-4611.3 03.2125-0493.3 03.2126-3144.3 03.7853-4102.4	010937 Hauptbremszylinder 010940 Hauptbremszylinder 010941 Hauptbremszylinder 300271 Bremskraftverstärker
03.7854-1602.4	03.2122-1942.3	010700 Hauptbremszylinder	03.7854-4106.4	03.2120-4611.3 03.2125-0493.3 03.2126-3144.3 03.7853-4102.4	010937 Hauptbremszylinder 010940 Hauptbremszylinder 010941 Hauptbremszylinder 300271 Bremskraftverstärker
03.7854-1603.4	03.2122-1351.3	010528 Hauptbremszylinder	03.7854-4108.4	03.7853-4102.4	300271 Bremskraftverstärker
03.7854-1604.4	03.2122-1942.3	010700 Hauptbremszylinder	03.7854-4501.4	03.2120-4611.3 03.2125-0493.3 03.2126-3144.3	010937 Hauptbremszylinder 010940 Hauptbremszylinder 010941 Hauptbremszylinder
03.7854-1701.4	03.4122-0041.3	010612 Hauptbremszylinder	03.7854-4502.4	03.2122-2031.3	010938 Hauptbremszylinder
03.7854-1703.4	03.4122-0041.3	010612 Hauptbremszylinder	03.7854-4601.4	03.2120-4611.3 03.2125-0493.3 03.2126-3144.3 03.7853-4602.4	010937 Hauptbremszylinder 010940 Hauptbremszylinder 010941 Hauptbremszylinder 300302 Bremskraftverstärker
03.7854-2101.4	03.7853-2102.4	300201 Bremskraftverstärker	03.7854-4602.4	03.2122-2031.3 03.7853-4602.4	010938 Hauptbremszylinder 300302 Bremskraftverstärker
03.7854-2102.4	03.7853-2102.4	300201 Bremskraftverstärker	03.7854-4603.4	03.7853-4602.4	300302 Bremskraftverstärker
03.7854-2103.4	03.7853-2102.4	300201 Bremskraftverstärker	03.7854-4701.4	03.2120-4611.3 03.2125-0493.3 03.2126-3144.3	010937 Hauptbremszylinder 010940 Hauptbremszylinder 010941 Hauptbremszylinder
03.7854-2104.4	03.7853-2102.4	300201 Bremskraftverstärker	03.7854-4702.4	03.2122-2031.3	010938 Hauptbremszylinder
03.7854-2105.4	03.7853-2102.4	300201 Bremskraftverstärker	03.7854-5401.4	03.2120-4611.3 03.2125-0493.3 03.2126-3144.3	010937 Hauptbremszylinder 010940 Hauptbremszylinder 010941 Hauptbremszylinder
03.7854-2106.4	03.7853-2102.4	300201 Bremskraftverstärker			
03.7854-2107.4	03.7853-2102.4	300201 Bremskraftverstärker			
03.7854-2108.4	03.7853-2102.4	300201 Bremskraftverstärker			
03.7854-2109.4	03.7853-2102.4	300201 Bremskraftverstärker			
03.7854-2110.4	03.7853-2102.4	300201 Bremskraftverstärker			
03.7854-2111.4	03.7853-2102.4	300201 Bremskraftverstärker			
03.7854-2112.4	03.7853-2102.4	300201 Bremskraftverstärker			
03.7854-2113.4	03.7853-2102.4	300201 Bremskraftverstärker			
03.7854-2114.4	03.7853-2102.4	300201 Bremskraftverstärker			
03.7854-2115.4	03.7853-2102.4	300201 Bremskraftverstärker			

Bremsgeräte komplett

Booster units complete - Servofreno completo - Servo-freins
complets - Servofreni completi





• Die Nummer befindet sich auf dem im Fahrzeug eingebautem Aggregat.
The number is on the unit build in the car
El número está ubicado en la unidad instalada en el vehículo
Le numéro est situé sur l'unité installée dans le véhicule
Il numero si trova sull'unità installata nel veicolo

					
03.7854-5402.4	03.2122-2031.3	010938 Hauptbremszylinder	03.7859-5131.4	03.7858-5132.4	300276 Bremskraftverstärker
03.7854-5404.4	03.2122-2031.3	010938 Hauptbremszylinder			
03.7854-5406.4	03.2120-4611.3	010937 Hauptbremszylinder	03.7859-5232.4	03.2125-0421.3	010934 Hauptbremszylinder
	03.2125-0493.3	010940 Hauptbremszylinder	03.7859-5233.4	03.2125-0421.3	010934 Hauptbremszylinder
	03.2126-3144.3	010941 Hauptbremszylinder	03.7859-5234.4	03.2125-0421.3	010934 Hauptbremszylinder
03.7854-5501.4	03.2120-4611.3	010937 Hauptbremszylinder	03.7859-5331.4	03.2125-0421.3	010934 Hauptbremszylinder
	03.2125-0493.3	010940 Hauptbremszylinder	03.7859-6001.4	03.7858-3532.4	300233 Bremskraftverstärker
	03.2126-3144.3	010941 Hauptbremszylinder	03.7859-6002.4	03.7858-3532.4	300233 Bremskraftverstärker
03.7854-5502.4	03.2122-2031.3	010938 Hauptbremszylinder	03.7859-6101.4	03.7858-3632.4	300234 Bremskraftverstärker
03.7854-6001.4	03.2122-2031.3	010938 Hauptbremszylinder	03.7859-6102.4	03.7858-3632.4	300234 Bremskraftverstärker
03.7857-0301.4	03.2125-0421.3	010934 Hauptbremszylinder	03.7859-6103.4	03.7858-3632.4	300234 Bremskraftverstärker
03.7859-0101.4	03.7858-0102.4	300262 Bremskraftverstärker	03.7859-7601.4	03.7858-7602.4	300277 Bremskraftverstärker
03.7859-0103.4	03.7858-0102.4	300262 Bremskraftverstärker	03.7862-0101.4	03.2022-2624.3	010588 Hauptbremszylinder
03.7859-0731.4	03.7858-0732.4	300272 Bremskraftverstärker		03.7860-0702.4	300123 Bremskraftverstärker
03.7859-0732.4	03.2125-0421.3	010934 Hauptbremszylinder	03.7862-0601.4	03.7860-0602.4	300141 Bremskraftverstärker
	03.7858-0732.4	300272 Bremskraftverstärker	03.7862-0602.4	03.7860-0602.4	300141 Bremskraftverstärker
03.7859-0932.4	03.2125-0421.3	010934 Hauptbremszylinder	03.7862-0603.4	03.7860-0602.4	300141 Bremskraftverstärker
03.7859-0933.4	03.2125-0421.3	010934 Hauptbremszylinder	03.7862-0604.4	03.7860-0602.4	300141 Bremskraftverstärker
03.7859-1231.4	03.2125-0493.3	010940 Hauptbremszylinder	03.7862-0605.4	03.7860-0602.4	300141 Bremskraftverstärker
03.7859-1931.4	03.7858-1932.4	300263 Bremskraftverstärker	03.7862-0606.4	03.7860-0602.4	300141 Bremskraftverstärker
03.7859-2801.4	03.7858-2802.4	300303 Bremskraftverstärker	03.7862-1403.4	03.7860-1402.4	300228 Bremskraftverstärker
03.7859-2802.4	03.7858-2802.4	300303 Bremskraftverstärker	03.7862-1405.4	03.7860-1402.4	300228 Bremskraftverstärker
03.7859-3301.4	03.2125-9604.3	010581 Hauptbremszylinder	03.7862-1406.4	03.7860-1402.4	300228 Bremskraftverstärker
	03.7858-3302.4	300122 Bremskraftverstärker	03.7862-2801.4	03.2123-3421.3	010933 Hauptbremszylinder
03.7859-3302.4	03.2125-9604.3	010581 Hauptbremszylinder	03.7862-3301.4	03.2123-3421.3	010933 Hauptbremszylinder
	03.7858-3302.4	300122 Bremskraftverstärker	03.7862-3701.4	03.7860-3702.4	300305 Bremskraftverstärker
03.7859-3631.4	03.7858-3632.4	300234 Bremskraftverstärker	03.7862-3901.4	03.7860-8802.4	300291 Bremskraftverstärker
03.7859-4001.4	03.7858-3532.4	300233 Bremskraftverstärker	03.7862-3902.4	03.7860-8802.4	300291 Bremskraftverstärker
03.7859-4002.4	03.7858-3532.4	300233 Bremskraftverstärker	03.7862-3903.4	03.7860-8802.4	300291 Bremskraftverstärker
03.7859-4431.4	03.7858-4432.4	300304 Bremskraftverstärker	03.7862-4301.4	03.2122-2163.3	010800 Hauptbremszylinder
03.7859-4502.4	03.7858-4502.4	300202 Bremskraftverstärker		03.7860-4432.4	300313 Bremskraftverstärker
03.7859-4631.4	03.2125-0493.3	010940 Hauptbremszylinder	03.7862-4701.4	03.2123-3421.3	010933 Hauptbremszylinder
	03.7858-4632.4	300273 Bremskraftverstärker	03.7862-4801.4	03.2123-3421.3	010933 Hauptbremszylinder
03.7859-4632.4	03.7858-4632.4	300273 Bremskraftverstärker	03.7862-5301.4	03.2123-3421.3	010933 Hauptbremszylinder
03.7859-4831.4	03.7858-4832.4	300274 Bremskraftverstärker			
03.7859-5031.4	03.7858-5032.4	300275 Bremskraftverstärker			

Bremsgeräte komplett

Booster units complete - Servofreno completo - Servo-freins
complets - Servofreni completi

• Die Nummer befindet sich auf dem im Fahrzeug eingebautem Aggregat.
the number is on the unit build in the car
El número está ubicado en la unidad instalada en el vehículo
Le numéro est situé sur l'unité installée dans le véhicule
Il numero si trova sull'unità installata nel veicolo







					
03.7862-5701.4	03.7860-5702.4	300279 Bremskraftverstärker	03.7864-3235.4	03.7863-3232.4	300307 Bremskraftverstärker
03.7862-5801.4	03.7860-3732.4	300306 Bremskraftverstärker	03.7864-3236.4	03.7863-3232.4	300307 Bremskraftverstärker
03.7862-7801.4	03.7860-7802.4	300280 Bremskraftverstärker	03.7864-3237.4	03.7863-3232.4	300307 Bremskraftverstärker
03.7862-8601.4	03.2123-3421.3	010933 Hauptbremszylinder	03.7864-3331.4	03.7863-3332.4	300308 Bremskraftverstärker
03.7864-0331.4	03.7863-0332.4	300203 Bremskraftverstärker	03.7864-3332.4	03.7863-3332.4	300308 Bremskraftverstärker
03.7864-0332.4	03.7863-0332.4	300203 Bremskraftverstärker	03.7864-3503.4	03.2123-2715.3	010802 Hauptbremszylinder
03.7864-0401.4	03.2123-2024.3	010597 Hauptbremszylinder		03.7863-3502.4	300128 Bremskraftverstärker
	03.7863-0402.4	300124 Bremskraftverstärker	03.7864-3504.4	03.2123-2715.3	010802 Hauptbremszylinder
03.7864-0402.4	03.2123-2024.3	010597 Hauptbremszylinder		03.7863-3502.4	300128 Bremskraftverstärker
	03.7863-0402.4	300124 Bremskraftverstärker	03.7864-3601.4	03.2122-2129.3	010799 Hauptbremszylinder
03.7864-0730.4	03.7863-3932.4	300288 Bremskraftverstärker		03.7873-4302.4	300312 Bremskraftverstärker
03.7864-0731.4	03.7863-3932.4	300288 Bremskraftverstärker	03.7864-3602.4	03.2122-2129.3	010799 Hauptbremszylinder
03.7864-0831.4	03.2123-3593.3	010919 Hauptbremszylinder		03.7873-4302.4	300312 Bremskraftverstärker
	03.7863-4832.4	300289 Bremskraftverstärker	03.7864-4401.4	03.2122-1351.3	010528 Hauptbremszylinder
03.7864-0901.4	03.7863-0903.4	300244 Bremskraftverstärker	03.7864-4402.4	03.2122-1942.3	010700 Hauptbremszylinder
03.7864-0902.4	03.7863-0903.4	300244 Bremskraftverstärker	03.7864-4501.4	03.7863-4502.4	300230 Bremskraftverstärker
03.7864-1101.4	03.2023-2004.3	010788 Hauptbremszylinder	03.7864-4502.4	03.2123-3493.3	010792 Hauptbremszylinder
	03.7863-0903.4	300244 Bremskraftverstärker		03.7863-4502.4	300230 Bremskraftverstärker
03.7864-1102.4	03.7863-0903.4	300244 Bremskraftverstärker	03.7864-5001.4	03.2122-1351.3	010528 Hauptbremszylinder
03.7864-2001.4	03.2123-2146.3	010572 Hauptbremszylinder	03.7864-5002.4	03.2122-1942.3	010700 Hauptbremszylinder
	03.7863-2002.4	300126 Bremskraftverstärker	03.7864-5003.4	03.2122-1351.3	010528 Hauptbremszylinder
03.7864-2003.4	03.2123-2621.3	010701 Hauptbremszylinder	03.7864-5004.4	03.2122-1942.3	010700 Hauptbremszylinder
	03.7863-2002.4	300126 Bremskraftverstärker	03.7864-5301.4	03.2122-2129.3	010799 Hauptbremszylinder
03.7864-2101.4	03.2122-1521.3	010494 Hauptbremszylinder	03.7864-5302.4	03.2122-2129.3	010799 Hauptbremszylinder
	03.7863-2002.4	300126 Bremskraftverstärker	03.7864-6001.4	03.7863-6002.4	300249 Bremskraftverstärker
03.7864-2201.4	03.2123-2581.3	010613 Hauptbremszylinder		03.7863-6002.4	300249 Bremskraftverstärker
	03.7863-2202.4	300127 Bremskraftverstärker	03.7864-6302.4	03.2122-2129.3	010799 Hauptbremszylinder
03.7864-2301.4	03.2123-2581.3	010613 Hauptbremszylinder	03.7864-7801.4	03.7863-7803.4	300237 Bremskraftverstärker
03.7864-2801.4	03.2123-2561.3	010629 Hauptbremszylinder		03.7863-7803.4	300237 Bremskraftverstärker
	03.7863-2802.4	300188 Bremskraftverstärker	03.7864-7802.4	03.7863-7803.4	300237 Bremskraftverstärker
03.7864-3001.4	03.7863-3002.4	300223 Bremskraftverstärker	03.7864-7803.4	03.4155-0153.3	010927 Hauptbremszylinder
03.7864-3233.4	03.7863-3232.4	300307 Bremskraftverstärker		03.7863-7803.4	300237 Bremskraftverstärker
03.7864-3234.4	03.7863-3232.4	300307 Bremskraftverstärker	03.7864-7804.4	03.4155-0156.3	010862 Hauptbremszylinder
				03.7863-7803.4	300237 Bremskraftverstärker
			03.7864-8501.4	03.7863-3932.4	300288 Bremskraftverstärker
			03.7864-8502.4	03.7863-3932.4	300288 Bremskraftverstärker



Bremsgeräte komplett

Booster units complete - Servofreno completo - Servo-freins
complets - Servofreni completi

• Die Nummer befindet sich auf dem im Fahrzeug eingebautem Aggregat.
the number is on the unit build in the car
El número está ubicado en la unidad instalada en el vehículo
Le numéro est situé sur l'unité installée dans le véhicule
Il numero si trova sull'unità installata nel veicolo

					
03.7864-9501.4	03.7863-3232.4	300307 Bremskraftverstärker	03.7874-4503.4	03.7873-4502.4	300284 Bremskraftverstärker
03.7864-9502.4	03.7863-3232.4	300307 Bremskraftverstärker	03.7874-4504.4	03.7873-4502.4	300284 Bremskraftverstärker
03.7864-9801.4	03.7863-9802.4	300281 Bremskraftverstärker	03.7874-4505.4	03.7873-4502.4	300284 Bremskraftverstärker
03.7869-4101.4	03.7868-4102.4	300250 Bremskraftverstärker	03.7874-4506.4	03.7873-4502.4	300284 Bremskraftverstärker
03.7869-4701.4	03.7868-5902.4	300316 Bremskraftverstärker	10.6350-2002.4	10.6123-0522.3	010633 Hauptbremszylinder
03.7869-4702.4	03.7868-5902.4	300316 Bremskraftverstärker	10.6352-2901.4	10.6350-3902.4	300213 Bremskraftverstärker
03.7869-4703.4	03.7868-5902.4	300316 Bremskraftverstärker	10.6352-2902.4	10.6350-3902.4	300213 Bremskraftverstärker
03.7869-5201.4	03.7868-5202.4	300309 Bremskraftverstärker	10.6352-4001.4	03.2122-1421.3	010615 Hauptbremszylinder
03.7869-5301.4	03.7868-5302.4	300251 Bremskraftverstärker		10.6350-4002.4	300285 Bremskraftverstärker
03.7872-0607.4	03.7870-0602.4	300310 Bremskraftverstärker	10.6353-2901.4	10.6350-3902.4	300213 Bremskraftverstärker
03.7872-0608.4	03.7870-0602.4	300310 Bremskraftverstärker	10.6353-2902.4	10.6350-3902.4	300213 Bremskraftverstärker
03.7872-1101.4	03.2123-3421.3	010933 Hauptbremszylinder	10.6353-4001.4	03.2122-1421.3	010615 Hauptbremszylinder
03.7872-1201.4	03.2123-3421.3	010933 Hauptbremszylinder		10.6350-4002.4	300285 Bremskraftverstärker
03.7872-1601.4	03.2123-3421.3	010933 Hauptbremszylinder	10.6362-0403.4	10.6360-1903.4	300093 Bremskraftverstärker
	03.7870-1602.4	300311 Bremskraftverstärker	10.6362-0501.4	10.6360-1003.4	300156 Bremskraftverstärker
03.7874-1201.4	03.7873-1202.4	300197 Bremskraftverstärker	10.6362-0502.4	10.6360-1003.4	300156 Bremskraftverstärker
03.7874-1202.4	03.7873-1202.4	300197 Bremskraftverstärker	10.6362-0503.4	10.6360-1003.4	300156 Bremskraftverstärker
03.7874-1205.4	03.4153-0063.3	010773 Hauptbremszylinder	10.6362-0504.4	10.6360-1003.4	300156 Bremskraftverstärker
	03.7873-1202.4	300197 Bremskraftverstärker	10.6362-1001.4	10.6360-1003.4	300156 Bremskraftverstärker
03.7874-1305.4	03.4153-0063.3	010773 Hauptbremszylinder	10.6362-1002.4	10.6360-1003.4	300156 Bremskraftverstärker
03.7874-1801.4	03.2122-2129.3	010799 Hauptbremszylinder	10.6362-1003.4	10.6360-1003.4	300156 Bremskraftverstärker
03.7874-2601.4	03.4153-0063.3	010773 Hauptbremszylinder	10.6362-1004.4	10.6360-1003.4	300156 Bremskraftverstärker
03.7874-2701.4	03.4153-0063.3	010773 Hauptbremszylinder	10.6362-1301.4	10.6360-1302.4	300286 Bremskraftverstärker
03.7874-3001.4	03.2122-2129.3	010799 Hauptbremszylinder	10.6362-1302.4	10.6360-1302.4	300286 Bremskraftverstärker
03.7874-3701.4	03.7873-3702.4	300283 Bremskraftverstärker	10.6362-1905.4	10.6360-1903.4	300093 Bremskraftverstärker
03.7874-3702.4	03.7873-3702.4	300283 Bremskraftverstärker	10.6362-2001.4	10.6360-2002.4	300143 Bremskraftverstärker
03.7874-3901.4	03.7873-3902.4	300254 Bremskraftverstärker	10.6362-2002.4	10.6360-2002.4	300143 Bremskraftverstärker
03.7874-3902.4	03.7873-3902.4	300254 Bremskraftverstärker			
03.7874-4304.4	03.7873-4302.4	300312 Bremskraftverstärker			
03.7874-4305.4	03.7873-4302.4	300312 Bremskraftverstärker			
03.7874-4501.4	03.7873-4502.4	300284 Bremskraftverstärker			
03.7874-4502.4	03.7873-4502.4	300284 Bremskraftverstärker			



DE Technische Übersetzungen

EN Technical translations

ES Traducciones técnicas

FR Traductions techniques





IT Traduzioni tecniche

2019



Technische Übersetzungen

Technical translations - Traducciones tecnicas - Traductions techniques - Traduzioni tecniche

DE		DE	
	Hauptbremszylinder	Artikelnummer des empfohlenen Zubehörs	Artikelnummer des empfohlenen Zubehörs
	Ausgleichsbehälter	- ASC	für Fahrzeuge ohne ASC
	Bremskraftregler	- ASR	für Fahrzeuge ohne ASR
	Bremskraftverstärker	Ausgleichsbehälter, Bremsflüssigkeit	Ausgleichsbehälter, Bremsflüssigkeit
	links	Außendurchmesser [mm]	Außendurchmesser [mm]
+ ABS	für Fahrzeuge mit ABS für ABS	Automatikgetriebe	Automatikgetriebe
+ ASC	für Fahrzeuge mit ASC	BDX	Bremssystem, Bendix
+ ASR	für Fahrzeuge mit ASR	Bördelform	Bördelform
+ Diff	mit Differentialsperre	BOS	Bremssystem, Bosch
+ DSC	für Fahrzeuge mit DSC	Brems-/ Fahrdyn. Artikelbezug	Brems-/Fahrdyn. Artikelbezug
+ DSTC	für Fahrzeuge mit DSTC	Bremskraftregler	Bremskraftregler
+ EDS	für Fahrzeuge mit EDS	Bremskraftverstärker	Bremskraftverstärker
+ ESP	für Fahrzeuge mit ESP	Bremsleitung	Bremsleitung
+ ETS	für Fahrzeuge mit ETS	Brems-system	Bremssystem
+ HBZ	mit Hauptbremszylinder	DEL	Bremssystem, Delco
+PR	für PR-Nummer	Dichtung, Unterdruck-Anschlussstutzen BKV	Dichtung, Unterdruck-Anschlussstutzen BKV
+ SCS	für Fahrzeuge mit SCS	- Diff	ohne Differentialsperre
+ TCS	für Fahrzeuge mit TCS	DIN/ISO	DIN/ISO
+ WE	mit Warneinrichtung	DIN 74235 Form EL	DIN 74235 Form EL
Abmessungen beachten	Abmessungen beachten	DIN 74235 Form FL	DIN 74235 Form FL
- ABS	für Fahrzeuge ohne ABS	druckabhängig	druckabhängig
Adapter, Bremsleitung	Adapter, Bremsleitung	Drucksensor, Bremskraftverstärker	Drucksensor, Bremskraftverstärker
ALU	Aluminium	- DSC	für Fahrzeuge ohne DSC
Anschlussgewinde	Anschlussgewinde	- DSTC	für Fahrzeuge ohne DSTC
Anschlussstutzen, Schlauchleitung	Anschlussstutzen, Schlauchleitung		
Anzahl der Bohrungen	Anzahl der Bohrungen		



Technische Übersetzungen

Technical translations - Traducciones tecnicas - Traductions techniques - Traduzioni tecniche

DE		DE	
Durchmesser Aufnahme [mm]	Durchmesser Aufnahme [mm]	für Fahrzeuge mit Bremskraftverstärker	für Fahrzeuge mit Bremskraftverstärker
E	E	für Fahrzeuge mit elektronischer Fahrdynamikregelung	für Fahrzeuge mit elektronischer Fahrdynamikregelung
- EDS	für Fahrzeuge ohne EDS	für Fahrzeuge mit Kollisionswarner	für Fahrzeuge mit Kollisionswarner
elektrisch-hydraulisch	elektrisch-hydraulisch	für Fahrzeuge mit Rußpartikelfilter	für Fahrzeuge mit Rußpartikelfilter
Entlüfterschraube/-ventil	Entlüfterschraube/-ventil	für Fahrzeuge mit Scheibenbremse an der Hinterachse	für Fahrzeuge mit Scheibenbremse an der Hinterachse
EPDM (Ethylen-Propylen-Dien-Kautschuk)	EPDM (Ethylen-Propylen-Dien-Kautschuk)	für Fahrzeuge mit Servolenkung	für Fahrzeuge mit Servolenkung
- ESP	für Fahrzeuge ohne ESP	für Fahrzeuge mit Sportfahrwerk	für Fahrzeuge mit Sportfahrwerk
F	F	für Fahrzeuge mit Sportpaket	für Fahrzeuge mit Sportpaket
Felge Lochzahl	Felge Lochzahl	für Fahrzeuge mit Start-Stopp-Funktion	für Fahrzeuge mit Start-Stopp-Funktion
Flachstecker	Flachstecker	für Fahrzeuge mit Trommelbremse an der Hinterachse	für Fahrzeuge mit Trommelbremse an der Hinterachse
Flanschbefestigung	Flanschbefestigung	für Fahrzeuge mit verstärktem Fahrwerk	für Fahrzeuge mit verstärktem Fahrwerk
FPM (Fluor-Kautschuk)/ACM (Polyacryl-Kautschuk)	FPM (Fluor-Kautschuk)/ACM (Polyacryl-Kautschuk)		
Frankreich	Frankreich		
Frontantrieb	Frontantrieb		
für ESP	für ESP		
für Fahrschulwagen	für Fahrschulwagen		
für Fahrzeuge mit AMG-Sportpaket	für Fahrzeuge mit AMG-Sportpaket		
für Fahrzeuge mit autom. Distanzregelung	für Fahrzeuge mit autom. Distanzregelung		
für Fahrzeuge mit Bremsassistent	für Fahrzeuge mit Bremsassistent		

Technische Übersetzungen

Technical translations - Traducciones técnicas - Traductions techniques - Traduzioni tecniche

DE		DE	
für Fahrzeuge mit verstärkter Bremse	für Fahrzeuge mit verstärkter Bremse	für Fahrzeuge ohne Start-Stopp-Funktion	für Fahrzeuge ohne Start-Stopp-Funktion
für Fahrzeuge ohne Aktivlenkung	für Fahrzeuge ohne Aktivlenkung	für Fahrzeuge ohne verstärktes Fahrwerk	für Fahrzeuge ohne verstärktes Fahrwerk
für Fahrzeuge ohne AMG-Sportpaket	für Fahrzeuge ohne AMG-Sportpaket	für Kolben-Ø [mm]	für Kolben-Ø [mm]
für Fahrzeuge ohne autom. Distanzregelung	für Fahrzeuge ohne autom. Distanzregelung	für Linkslenker	für Linkslenker
für Fahrzeuge ohne Bremsassistent	für Fahrzeuge ohne Bremsassistent	für OE-Nummer	für OE-Nummer
für Fahrzeuge ohne Bremskraftverstärker	für Fahrzeuge ohne Bremskraftverstärker	für Rechtslenker	für Rechtslenker
für Fahrzeuge ohne elektronische Fahrdynamikregelung	für Fahrzeuge ohne elektronische Fahrdynamikregelung	Generischer Artikel	Generischer Artikel
für Fahrzeuge ohne Keramikbremse	für Fahrzeuge ohne Keramikbremse	Getriebetyp	Getriebetyp
für Fahrzeuge ohne Kollisionswarner	für Fahrzeuge ohne Kollisionswarner	Gewindeausführung	Gewindeausführung
für Fahrzeuge ohne Niveauregulierung	für Fahrzeuge ohne Niveauregulierung	Gewindelänge [mm]	Gewindelänge [mm]
für Fahrzeuge ohne Sportfahrwerk	für Fahrzeuge ohne Sportfahrwerk	Gewindemaß 1	Gewindemaß 1
für Fahrzeuge ohne Sportpaket	für Fahrzeuge ohne Sportpaket	Gewindemaß 2	Gewindemaß 2
		GG	Bremssattel aus Gusseisen
		Halter, Bremsleitung	Halter, Bremsleitung
		Halter, Bremschlauch	Halter, Bremschlauch
		Hauptbremszylinder	Hauptbremszylinder
		Herstellereinschränkung	Herstellereinschränkung
		Hohlschraube	Hohlschraube
		hyd.	Hydraulisch
		Hydraulikaggregat, Bremsanlage	Hydraulikaggregat, Bremsanlage
		hydraulisch	hydraulisch
		Informationsart	Informationsart



Technische Übersetzungen

Technical translations - Traducciones tecnicas - Traductions techniques - Traduzioni tecniche

DE		DE	
Innendurchmesser [mm]	Innendurchmesser [mm]	nicht für gepanzerte Fahrzeuge	nicht für gepanzerte Fahrzeuge
Kasten/ Kombi	Kasten/Kombi	nicht für Getriebetyp	nicht für Getriebetyp
Kunststoff	Kunststoff	nicht für Polizei-fahrzeuge	nicht für Polizeifahrzeuge
kurzer Radstand	kurzer Radstand	nicht für Sonderfahr-zeuge	nicht für Sonderfahrzeuge
L=	Länge [mm]	nur für Mine-ralöl	nur für Mineralöl
L=	Länge über Alles [mm]	nur in Verbin-dung mit	nur in Verbindung mit
L1=	Länge 1 [mm]	Nutzlast [kg]	Nutzlast [kg]
L2=	Länge 2 [mm]	Nutzlast ab [kg]	Nutzlast ab [kg]
langer Radstand	langer Radstand	Nutzlast bis [kg]	Nutzlast bis [kg]
lastabhängig	lastabhängig	OE-Hersteller	OE-Hersteller
Made in	Fahrzeugproduktionsland	OE-Nummer	OE-Nummer
mit Behälter	mit Behälter	OE-Referenz	OE-Referenz
mit Brems-flüssigkeits-behälter	mit Bremsflüssigkeitsbehälter	ohne Brems-flüssigkeits-behälter	ohne Bremsflüssigkeitsbehälter
mit Doppel-bereifung	mit Doppelbereifung	ohne Druck-regler	ohne Druckregler
mit Druck-regler	mit Druckregler	ohne Druck-sensor	ohne Drucksensor
mit Entlüfter-ventil	mit Entlüfterventil	ohne Steuer-gerät	ohne Steuergerät
Montagein-formation beachten	Montageinformation beachten	Orga →	Organisationsnummer ab
Motorcode	Motorcode	passend für Felgengröße [Zoll]	passend für Felgengröße [Zoll]
Nabendurch-messer [mm]	Nabendurchmesser [mm]	Pedalweg-sensor, Bremspedal	Pedalwegsensoren, Bremspedal
nicht für Baumuster	nicht für Baumuster	pneumatisch	pneumatisch
nicht für Doppelberei-fung	nicht für Doppelbereifung	Pol-Anzahl	Pol-Anzahl
nicht für ESP	nicht für ESP	Prüfan-schluss, Rohrlei-tungen	Prüfanschluss, Rohrleitungen
nicht für Fahrschul-wagen	nicht für Fahrschulwagen		
nicht für Fahrzeuge mit verstärkter Bremse	nicht für Fahrzeuge mit verstärkter Bremse		

Technische Übersetzungen





Technical translations - Traducciones tecnicas - Traductions techniques - Traduzioni tecniche

DE		DE	
Radstand [mm]	Radstand [mm]	Trommelbremse	Trommelbremse
Ringstutzen, Rohrleitung	Ringstutzen, Rohrleitung	TRW	Bremssystem, Lucas / TRW
Rückschlagventil	Rückschlagventil	Türenanzahl	Türenanzahl
Satz	Satz	Überwurfmutter	Überwurfmutter
Schalter, Bremsleuchte	Schalter, Bremsleuchte	Überwurfschraube	Überwurfschraube
Schaltgetriebe	Schaltgetriebe	Ungarn	Ungarn
Scheibenbremse	Scheibenbremse	Ventil, Unterdruckleitung	Ventil, Unterdruckleitung
Schlauch	Schlauch	Verbindungs-/Verteilerstück, Rohrleitungen	Verbindungs-/Verteilerstück, Rohrleitungen
Schlüsselweite	Schlüsselweite	Verschluss, Bremsflüssigkeitsbehälter	Verschluss, Bremsflüssigkeitsbehälter
Schrägheck	Schrägheck	Verschluss-/Schutzkappe	Verschluss-/Schutzkappe
Schraubanschluss	Schraubanschluss	Verschluss-schraube	Verschluss-schraube
Schraubkontakt	Schraubkontakt	Verschluss-schraube, Hauptbremszylinder	Verschluss-schraube, Hauptbremszylinder
- SCS	für Fahrzeuge ohne SCS	Vollautomatik	Vollautomatik
Sortiment, Armaturen	Sortiment, Armaturen	weiß/lila	weiß/lila
Sortiment, Befestigungselemente	Sortiment, Befestigungselemente	x	Anschlussanzahl
Sortiment, Entlüfterschrauben	Sortiment, Entlüfterschrauben	x	Breite [mm] Höhe [mm]
Spezialaufbau	Spezialaufbau	Zubehör	Zubehör
Steckerausführung	Steckerausführung	zusätzlich benötigter Artikel (Artikelnummer)	zusätzlich benötigter Artikel (Artikelnummer)
Stopfen, Bremsflüssigkeitsbehälter	Stopfen, Bremsflüssigkeitsbehälter	Ø	Durchmesser [mm]
Stufenheck	Stufenheck	Ø "	Durchmesser [Zoll]
Textbaustein	Textbaustein	Ø1	Durchmesser 1 [mm]
T-Form (T-Stück)	T-Form (T-Stück)	Ø2	Durchmesser 2 [mm]
		→	Baujahr ab Fahrgestellnummer ab



Technische Übersetzungen

Technical translations - Traducciones tecnicas - Traductions techniques - Traduzioni tecniche

DE		EN	
→	Baujahr bis Fahrgestellnummer bis		Brake Master Cylinder
→ Orga	Organisationsnummer bis		Expansion Tank
→ Ø	Durchmesser bis [mm]		Brake Power Regulator
			Brake Booster
			Left
		+ ABS	for vehicles with ABS for ABS
		+ ASC	for vehicles with ASC
		+ ASR	for vehicles with ASR
		+ Diff	with differential lock
		+ DSC	for vehicles with DSC
		+ DSTC	for vehicles with DSTC
		+ EDS	for vehicles with EDS
		+ ESP	for vehicles with ESP
		+ ETS	for vehicles with ETS
		+ HBZ	with brake master cylinder
		+PR	for PR number
		+ SCS	for vehicles with SCS
		+ TCS	for vehicles with TCS
		+ WE	with alarm
		Abmes- sungen beachten	Observe dimensions
		- ABS	for vehicles without ABS
		Adapter, Bremsleitung	Adapter, brake lines
		ALU	Aluminium
		Anschluss- gewinde	Connecting thread
		Anschlusss- tutzen, Schlauchlei- tung	Connection Piece, hose line
		Anzahl der Bohrungen	Number of Bores

Technische Übersetzungen

Technical translations - Traducciones tecnicas - Traductions techniques - Traduzioni tecniche

EN		EN	
Artikelnummer des empfohlenen Zubehörs	Part number of recommended accessories	Durchmesser Aufnahme [mm]	Support plate diameter [mm]
- ASC	for vehicles without ASC	E	E
- ASR	for vehicles without ASR	- EDS	for vehicles without EDS
Ausgleichsbehälter, Bremsflüssigkeit	Expansion Tank, brake fluid	elektrisch-hydraulisch	Electric-hydraulic
Außendurchmesser [mm]	Outer diameter [mm]	Entlüfterschraube/-ventil	Breather Screw / Valve
Automatikgetriebe	Automatic Transmission	EPDM (Ethylen-Propylen-Dien-Kautschuk)	EPDM (ethylene propylene diene Monomer (M-class) rubber)
BDX	Brake System, Bendix	- ESP	for vehicles without ESP
Bördelform	Flange Shape	F	F
BOS	Brake System, Bosch	Felge Lochzahl	Rim Hole Number
Brems-/ Fahrdyn. Artikelbezug	Brakes- / Drive Dynamics Articles	Flachstecker	Blade Terminal
Bremskraftregler	Brake Power Regulator	Flanschbefestigung	Flange mounting
Bremskraftverstärker	Brake Booster	FPM (Fluor-Kautschuk)/ACM (Polyacryl-Kautschuk)	FPM (fluoride rubber)/ACM (polyacrylate rubber)
Bremsleitung	Brake Lines	Frankreich	France
Bremsystem	Brake System	Frontantrieb	Front Wheel Drive
DEL	Brake System, Delco	für ESP	for ESP
Dichtung, Unterdruck-Anschlusstutzen BKV	Seal, vacuum hose connector pipe	für Fahr-schulwagen	for driving school cars
- Diff	without differential lock	für Fahr-zeuge mit AMG-Sport-paket	for vehicles with AMG Sports Package
DIN/ISO	DIN / ISO	für Fahr-zeuge mit autom. Distanzrege-lung	for vehicles with autom. distance control
DIN 74235 Form EL	DIN 74235 Form EL	für Fahr-zeuge mit Bremsassis-tent	for vehicles with brake assist
DIN 74235 Form FL	DIN 74235 Form FL		
druckab-hängig	Pressure-dependent		
Drucksensor, Bremskraft-verstärker	Pressure Sensor, brake booster		
- DSC	for vehicles without DSC		
- DSTC	for vehicles without DSTC		



Technische Übersetzungen

Technical translations - Traducciones tecnicas - Traductions techniques - Traduzioni tecniche

EN		EN	
für Fahrzeuge mit Bremskraftverstärker	for vehicles with brake booster	für Fahrzeuge mit verstärkter Bremse	for vehicles with reinforced brakes
für Fahrzeuge mit elektronischer Fahrdynamikregelung	for vehicles with electronic drive dynamics control	für Fahrzeuge ohne Aktivlenkung	for vehicles without active steering
für Fahrzeuge mit Kollisionswarner	for vehicles with collision warning system	für Fahrzeuge ohne AMG-Sportpaket	for vehicles without AMG sports package
für Fahrzeuge mit Rußpartikelfilter	for vehicles with soot filter	für Fahrzeuge ohne autom. Distanzregelung	for vehicles without autom. distance control
für Fahrzeuge mit Scheibenbremse an der Hinterachse	for vehicles with disc brakes on the rear axle	für Fahrzeuge ohne Bremsassistent	for vehicles without brake assist
für Fahrzeuge mit Servolenkung	for vehicles with power steering	für Fahrzeuge ohne Bremskraftverstärker	for vehicles without brake booster
für Fahrzeuge mit Sportfahrwerk	for vehicles with sports suspension	für Fahrzeuge ohne elektronische Fahrdynamikregelung	for vehicles without electronic drive dynamics regulation
für Fahrzeuge mit Sportpaket	for vehicles with sports package	für Fahrzeuge ohne Keramikbremse	for vehicles without ceramic brakes
für Fahrzeuge mit Start-Stopp-Funktion	for vehicles with start-stop function	für Fahrzeuge ohne Kollisionswarner	for vehicles without collision warning system
für Fahrzeuge mit Trommelbremse an der Hinterachse	for vehicles with drum brakes on the rear axle	für Fahrzeuge ohne Niveauregulierung	for vehicles without leveling control
für Fahrzeuge mit verstärktem Fahrwerk	for vehicles with heavy duty suspension	für Fahrzeuge ohne Sportfahrwerk	for vehicles without sports suspension
		für Fahrzeuge ohne Sportpaket	for vehicles without sports package

Technische Übersetzungen

Technical translations - Traducciones tecnicas - Traductions techniques - Traduzioni tecniche

EN		EN	
für Fahrzeuge ohne Start-Stopp-Funktion	for vehicles without start-stop function	Innendurchmesser [mm]	Inner diameter [mm]
für Fahrzeuge ohne verstärktes Fahrwerk	for vehicles without heavy duty suspension	Kasten/Kombi	Box Body / Estate
für Kolben-Ø [mm]	for piston Ø [mm]	Kunststoff	Plastic
für Linkslenker	for left-hand drive vehicles	kurzer Radstand	Short Wheelbase
für OE-Nummer	for OE number	L=	Length [mm]
für Rechtslenker	for right-hand drive vehicles	L=	Overall Length [mm]
Generischer Artikel	Generic article	L1=	Length 1 [mm]
Getriebetyp	Transmission Type	L2=	Length 2 [mm]
Gewindeausführung	Thread Type	langer Radstand	Long Wheelbase
Gewindelänge [mm]	Thread Length [mm]	lastabhängig	Load-dependent
Gewindemaß 1	Thread Size 1	Made in	Vehicle Production Country
Gewindemaß 2	Thread Size 2	mit Behälter	with reservoir
GG	Cast iron brake caliper	mit Bremsflüssigkeitsbehälter	with brake fluid container
Halter, Bremsleitung	Holder, brake lines	mit Doppelbereifung	with dual tyres
Halter, Bremschlauch	Holding Bracket, brake hose	mit Druckregler	with pressure regulator
Hauptbremszylinder	Brake Master Cylinder	mit Entlüfterventil	with breather valve
Herstellereinschränkung	Manufacturer Restriction	Montageinformation beachten	Observe mounting information
Hohl-schraube	Hollow Screw	Motorcode	Engine Code
hyd.	Hydraulic	Nabendurchmesser [mm]	Hub Diameter [mm]
Hydraulikaggregat, Bremsanlage	Hydraulic Unit, brake system	nicht für Baumuster	not for model
hydraulisch	Hydraulic	nicht für Doppelbereifung	not for dual tyres
Informati- onsart	Information Type	nicht für ESP	not for ESP
		nicht für Fahrschulwagen	not for driving school cars
		nicht für Fahrzeuge mit verstärkter Bremse	not for vehicles with reinforced brakes

Technische Übersetzungen

Technical translations - Traducciones tecnicas - Traductions techniques - Traduzioni tecniche

EN		EN	
nicht für gepanzerte Fahrzeuge	not for armoured vehicles	Radstand [mm]	Wheelbase [mm]
nicht für Getriebetyp	not for transmission type	Ringstutzen, Rohrleitung	Connector, metal pipes
nicht für Polizei-fahrzeuge	not for police vehicles	Rückschlag-ventil	Non-return Valve
nicht für Sonderfahr-zeu-ge	not for special-purpose vehicles	Satz	Kit
nur für Mine-ralöl	Only for mineral oil	Schalter, Brems-leuchte	Switch, stop light
nur in Verbin-dung mit	only in connection with	Schaltge-triebe	Manual Transmission
Nutzlast [kg]	Payload [kg]	Scheiben-bremse	Disc Brake
Nutzlast ab [kg]	Payload from [kg]	Schlauch	Hose
Nutzlast bis [kg]	Payload to [kg]	Schlüssel-weite	Spanner Size
OE-Hersteller	OE manufacturer	Schrägheck	Hatchback
OE-Nummer	OE reference number	Schraub-an-schluss	Screw Connection
OE-Referenz	OE reference	Schraubkon-takt	Screw Contact
ohne Brems-flüssigkeits-behälter	without brake fluid container	- SCS	for vehicles without SCS
ohne Druck-regler	without pressure regulator	Sortiment, Armaturen	Assortment, fittings
ohne Druck-sensor	without pressure sensor	Sortiment, Befesti-gungsele-mente	Assortment, fasteners
ohne Steuer-gerät	without control unit	Sortiment, Entlüfter-schrauben	Assortment, breather screws
Orga →	RPO number from	Spezial-aufbau	Special Design
passend für Felgenreiße [Zoll]	Fits rim size [inch]	Steckeraus-führung	Plug Type
Pedalweg-sensor, Bremspedal	Pedal Travel Sensor, brake pedal	Stopfen, Bremsflüs-sigkeitsbe-hälter	Plug, brake fluid reservoir
pneumatisch	Pneumatic	Stufenheck	Saloon
Pol-Anzahl	Number of Poles	Textbaustein	text module
Prüfan-schluss, Rohrlei-tungen	Test Connection, piping	T-Form (T-Stück)	T-Piece





Technische Übersetzungen

Technical translations - Traducciones tecnicas - Traductions techniques - Traduzioni tecniche

EN		EN	
Trommelbremse	Drum Brake	→	Construction year to Chassis number to
TRW	Brake System, Lucas / TRW	→ Orga	RPO number to
Türenanzahl	Number of Doors	→ Ø	Diameter to [mm]
Überwurfmutter	Union Nut		
Überwurfschraube	Union Bolt		
Ungarn	Hungary		
Ventil, Unterdruckleitung	Valve, vacuum hose		
Verbindungs-/Verteilerstück, Rohrleitungen	Connector, pipes		
Verschluss, Bremsflüssigkeitsbehälter	Sealing Cap, brake fluid reservoir		
Verschluss-/Schutzkappe	Sealing/Protective Cap		
Verschluss-schraube	Screw Plug		
Verschluss-schraube, Hauptbremszylinder	Screw Plug, brake master cylinder		
Vollautomatik	Fully Automatic		
weiß/lila	White/Purple		
x	Number of connectors		
x	Width [mm] Height [mm]		
Zubehör	Accessories		
zusätzlich benötigter Artikel (Artikel-Nummer)	Additionally required articles (article numbers)		
Ø	Diameter [mm]		
Ø "	Diameter [in]		
Ø1	Diameter 1 [mm]		
Ø2	Diameter 2 [mm]		
→	Construction year from Chassis number from		

Technische Übersetzungen

Technical translations - Traducciones técnicas - Traductions techniques - Traduzioni tecniche

ES		ES	
	Cilindro principal de freno	Artikelnummer des empfohlenen Zubehörs	Nº art. de accesorio recomendado
	Depósito compensación	- ASC	para vehículos sin ASC
	Regulador de la fuerza de frenado	- ASR	para vehículos sin ASR
	Servofrenos	Ausgleichsbehälter, Bremsflüssigkeit	Depósito compensación, líquido de frenos
	izquierda	Außendurchmesser [mm]	Diámetro exterior [mm]
+ ABS	para vehículos con ABS para ABS	Automatikgetriebe	Transmisión automática
+ ASC	para vehículos con ASC	BDX	Sistema de frenos, Bendix
+ ASR	para vehículos con ASR	Bördelform	Tipo rebordeado
+ Diff	con bloqueo de diferencial	BOS	Sistema de frenos, Bosch
+ DSC	para vehículos con DSC	Brems-/ Fahr dyn. Artikelbezug	Ref. artículo dinámica frenado/marcha
+ DSTC	para vehículos con DSTC	Bremskraftregler	Regulador de la fuerza de frenado
+ EDS	para vehículos con EDS	Bremskraftverstärker	Servofrenos
+ ESP	para vehículos con ESP	Bremsleitung	Tubería de frenos
+ ETS	para vehículos sin ETS	Brems-system	Sistema de frenos
+ HBZ	con cilindro principal del freno	DEL	Sistema de frenos, Delco
+PR	Número de PR	Dichtung, Unterdruck-Anschlüssen BKV	Junta, racor de conexión de vacío
+ SCS	para vehículos con SCS	- Diff	sin bloqueo de diferencial
+ TCS	para vehículos con TCS	DIN/ISO	DIN / ISO
+ WE	con dispositivo avisador	DIN 74235 Form EL	DIN 74235 Forma EL
Abmessungen beachten	Observar dimensiones	DIN 74235 Form FL	DIN 74235 Forma FL
- ABS	para vehículos sin ABS	druckabhängig	en función de la presión
Adapter, Bremsleitung	Adaptador, tubería de freno	Drucksensor, Bremskraftverstärker	Sensor de presión, servofreno
ALU	Aluminio	- DSC	para vehículos sin DSC
Anschlussgewinde	Rosca empalme	- DSTC	Para vehículos sin DSCT
Anschlüssen, Schlauchleitung	Racores, tubería flexible		
Anzahl der Bohrungen	Número de taladros		

Technische Übersetzungen

Technical translations - Traducciones técnicas - Traductions techniques - Traduzioni tecniche

ES		ES	
Durchmesser Aufnahme [mm]	Diámetro alojamiento [mm]	für Fahrzeuge mit Bremskraftverstärker	para vehículos con servofreno
E	E	für Fahrzeuge mit elektronischer Fahrdynamikregelung	para vehículos con regulación dinámica de conducción
- EDS	para vehículos sin EDS	für Fahrzeuge mit Kollisionswarner	para vehículos con aviso de colisión
elektrisch-hydraulisch	electrohidráulico	für Fahrzeuge mit Rußpartikelfilter	para vehículos con filtro de partículas
Entlüfterschraube/-ventil	Válvula/tornillo de purga de aire	für Fahrzeuge mit Scheibenbremse an der Hinterachse	para vehículos con freno de disco en eje trasero
EPDM (Ethylen-Propylen-Dien-Kautschuk)	EPDM (Ethylen-Propylen-Dien-Caucho)	für Fahrzeuge mit Servolenkung	para vehículos con dirección asistida
- ESP	para vehículos sin ESP	für Fahrzeuge mit Sportfahrwerk	para vehículos con chasis deportivo
F	F	für Fahrzeuge mit Sportpaket	para vehículos con paquete sport
Felge Lochzahl	Llanta, nº de taladros	für Fahrzeuge mit Start-Stopp-Funktion	para vehículos con sistema Start&Stop
Flachstecker	Conector plano	für Fahrzeuge mit Trommelbremse an der Hinterachse	para vehículos con freno de tambor en eje trasero
Flanschbefestigung	Fijación con brida	für Fahrzeuge mit verstärktem Fahrwerk	para vehículos con chasis reforzado
FPM (Fluor-Kautschuk)/ACM (Polyacryl-Kautschuk)	FPM (caucho fluorado)/ACM (caucho poliacrílico)		
Frankreich	Francia		
Frontantrieb	Tracción delantera		
für ESP	para ESP		
für Fahrschulwagen	para coche de autoescuela		
für Fahrzeuge mit AMG-Sportpaket	para vehículos con paquete sport AMG		
für Fahrzeuge mit autom. Distanzregelung	para vehículos con regulación automática de distancia		
für Fahrzeuge mit Bremsassistent	para vehículos con asistencia a la frenada		



Technische Übersetzungen

Technical translations - Traducciones técnicas - Traduccions techniques - Traduzioni tecniche

ES		ES	
für Fahrzeuge mit verstärkter Bremse	para vehículos con freno reforzado	für Fahrzeuge ohne Start-Stopp-Funktion	para vehículos sin sistema Start&Stop
für Fahrzeuge ohne Aktivlenkung	para vehículos sin dirección activo	für Fahrzeuge ohne verstärktes Fahrwerk	para vehículos sin chasis reforzado
für Fahrzeuge ohne AMG-Sportpaket	para vehículos sin paquete deportivo AMG	für Kolben-Ø [mm]	para pistón - Ø [mm]
für Fahrzeuge ohne autom. Distanzregelung	para vehículos sin regulación automática de distancia	für Linkslenker	para vehic. dirección izquierda
für Fahrzeuge ohne Bremsassistent	Para vehículos sin asistencia a la frenada	für OE-Nummer	para OE N°
für Fahrzeuge ohne Bremskraftverstärker	para vehículos sin servofreno	für Rechtslenker	para vehíc. dirección a la derecha
für Fahrzeuge ohne elektronische Fahrdynamikregelung	para vehículos sin control dinámico de conducción	Generischer Artikel	Número de artículo genérico
für Fahrzeuge ohne Keramikbremse	para vehículos sin frenos de cerámica	Getriebetyp	Tipo de caja de cambios
für Fahrzeuge ohne Kollisionswarner	para vehículos sin aviso de colisión	Gewindeausführung	Tipo de rosca
für Fahrzeuge ohne Niveauregulierung	para vehículos sin regulación de nivel	Gewindelänge [mm]	Long. de rosca [mm]
für Fahrzeuge ohne Sportfahrwerk	para vehículos sin chasis deportivo	Gewindemaß 1	Rosca 1
für Fahrzeuge ohne Sportpaket	para vehículos sin paquete sport	Gewindemaß 2	Rosca 2
		GG	Pinza de frenos de hierro fundido
		Halter, Bremsleitung	Soporte, tubería de freno
		Halter, Bremschlauch	Soporte, tubo flexible de freno
		Hauptbremszylinder	Cilindro principal de freno
		Herstellereinschränkung	Restricción de fabricante
		Hohl-schraube	Tronillo hueco
		hyd.	hidráulico
		Hydraulikaggregat, Bremsanlage	Grupo hidráulico, sistema de frenos
		hydraulisch	hidráulico
		Informati- onsart	Tipo información

Technische Übersetzungen

Technical translations - Traducciones técnicas - Traductions techniques - Traduzioni tecniche

ES		ES	
Innendurchmesser [mm]	Diámetro interior [mm]	nicht für gepanzerte Fahrzeuge	no para vehículos blindados
Kasten/ Kombi	Furgón/ranchera familiar	nicht für Getriebetyp	no para tipo de transmisión
Kunststoff	Plástico	nicht für Polizei-fahrzeuge	no para veh.policía
kurzer Radstand	distancia corta entre ejes	nicht für Sonderfahrzeuge	no para veh. especiales
L=	Longitud [mm]	nur für Mineralöl	sólo para aceite mineral
L=	Longitud total [mm]	nur in Verbindung mit	sólo con
L1=	Longitud 1 [mm]	Nutzlast [kg]	Carga útil [kg]
L2=	Longitud 2 [mm]	Nutzlast ab [kg]	carga útil desde [kg]
langer Radstand	Distancia larga entre ejes	Nutzlast bis [kg]	carga útil hasta [kg]
lastabhängig	dependiente de la carga	OE-Hersteller	
Made in	País producción vehículo	OE-Nummer	
mit Behälter	con depósito	OE-Referenz	
mit Bremsflüssigkeitsbehälter	con depósito líquido frenos	ohne Bremsflüssigkeitsbehälter	sin depósito líquido frenos
mit Doppelbereifung	con neumáticos gemelos	ohne Druckregler	sin regulador de presión
mit Druckregler	con regulador de presión	ohne Drucksensor	sin sensor de presión
mit Entlüfterventil	con válvula de ventilación	ohne Steuergerät	sin unidad de control
Montageinformation beachten	Observar información de montaje	Orga →	nº de organización desde
Motorcode	Código de motor	passend für Felgengröße [Zoll]	adecuado para tamaño llanta [inch]
Nabendurchmesser [mm]	Diaméto cubo[mm]	Pedalwegsensor, Bremspedal	Sensor recorrido del pedal de freno
nicht für Baumuster	no para tipo de construcción	pneumatisch	neumático
nicht für Doppelbereifung	no para neumáticos gemelos	Pol-Anzahl	Número de polos
nicht für ESP	no para ESP	Prüfanschluss, Rohrleitungen	Conexión de prueba, tuberías
nicht für Fahrschulwagen	no para veh. autoescuela		
nicht für Fahrzeuge mit verstärkter Bremse	no para vehículos con frenos reforzados		







Technische Übersetzungen

Technical translations - Traducciones técnicas - Traductions techniques - Traduzioni tecniche

ES		ES	
Radstand [mm]	Distancia entre ejes [mm]	Trommelbremse	Tambor
Ringstutzen, Rohrleitung	Tubuladura anular, tubería	TRW	Sistema de frenos, Lucas / TRW
Rückschlagventil	Válvula de retención	Türenanzahl	Número de puertas
Satz	Kit	Überwurfmutter	Tuerca racor
Schalter, Bremsleuchte	Interruptor, luz de freno	Überwurfschraube	Tornillo de unión
Schaltgetriebe	Caja de cambios manual	Ungarn	Hungría
Scheibenbremse	Discos	Ventil, Unterdruckleitung	Válvula, tubería de depresión
Schlauch	Tubo flexible	Verbindungs-/Verteilerstück, Rohrleitungen	Piezas distribuidoras/unión, tuberías
Schlüsselweite	Ancho de llave	Verschluss, Bremsflüssigkeitsbehälter	Tapa, depósito de líquido de frenos
Schrägheck	Fastback	Verschluss-/Schutzkappe	Tapa de cierre/protección
Schraubanschluss	Conexión roscada	Verschluss-schraube	Tapón roscado
Schraubkontakt	contacto roscado	Verschluss-schraube, Hauptbremszylinder	Tapón roscado, cilindro principal del freno
- SCS	para vehículos sin SCS	Vollautomatik	completamente automática
Sortiment, Armaturen	Surtido de armaduras	weiß/lila	blanco/lila
Sortiment, Befestigungselemente	Surtido, elementos de sujeción	x	Número de conexiones
Sortiment, Entlüfterschrauben	Surtido, tornillos de purga de aire	x	Ancho [mm] Altura [mm]
Spezialaufbau	Carrocería especial	Zubehör	Accesorios
Steckerausführung	Modelo de conector	zusätzlich benötigter Artikel (Artikel-Nummer)	Se requiere adicionalmente artículo N°
Stopfen, Bremsflüssigkeitsbehälter	Tapón, depósito líquido de frenos	Ø	Diámetro [mm]
Stufenheck	Sedán	Ø "	Diámetro [in]
Textbaustein	módulo de texto	Ø1	Diámetro 1 [mm]
T-Form (T-Stück)	en T	Ø2	Diámetro 2 [mm]
		→	año construcción desde n° de chasis desde

Technische Übersetzungen

Technical translations - Traducciones técnicas - Traductions techniques - Traduzioni tecniche

ES		FR	
→	año construcción hasta nº de chasis hasta		Maître-cylindre de frein
→Orga	nº de organización hasta		Vase d'expansion
→∅	Diámetro hasta [mm]		Régulateur de freinage
			Dispositif d'assistance de frein
			gauche
	+ ABS		pour véhicules avec système antiblo- cage pour ABS
	+ ASC		pour véhicules avec ASC
	+ ASR		pour véhicules avec ASR
	+ Diff		avec blocage de différentiel
	+ DSC		pour véhicules avec DSC
	+ DSTC		pour véhicules avec DSTC
	+ EDS		pour véhicules avec EDS
	+ ESP		pour véhicules avec ESP
	+ ETS		pour véhicules avec ETS
	+ HBZ		avec maître-cylindre de frein
	+PR		pour numéro PR
	+ SCS		pour véhicules avec SCS
	+ TCS		pour véhicules avec antipatinage (TCS)
	+ WE		avec dispositif d'avertissement
	Abmes- sungen beachten		Respecter les dimensions
	- ABS		pour véhicules sans système antiblo- cage
	Adapter, Bremsleitung		Adaptateur, conduite de frein
	ALU		Aluminium
	Anschluss- gewinde		Filetage de raccordement
	Anschlus- stutzen, Schlauchlei- tung		Raccord, tuyau flexible
	Anzahl der Bohrungen		Nombre d'alésages

Technische Übersetzungen

Technical translations - Traducciones técnicas - Traductions techniques - Traduzioni tecniche

FR		FR	
Artikelnummer des empfohlenen Zubehörs	Référence de l'accessoire recommandé	Durchmesser Aufnahme [mm]	Diamètre réception [mm]
- ASC	pour véhicules sans ASC	E	E
- ASR	pour véhicules sans ASR	- EDS	pour véhicules sans EDS
Ausgleichsbehälter, Bremsflüssigkeit	Vase d'expansion, liquide de frein	elektrisch-hydraulisch	électrique-hydraulique
Außendurchmesser [mm]	Diamètre extérieur [mm]	Entlüfterschraube/-ventil	Soupape/vis de purge d'air
Automatikgetriebe	Boîte automatique	EPDM (Ethylen-Propylen-Dien-Kautschuk)	EPDM (éthylène-propylène-diène-caoutchouc)
BDX	Système de freinage, Bendix	- ESP	pour véhicules sans ESP
Bördelform	Forme du bord relevé	F	F
BOS	Système de freinage, Bosch	Felge Lochzahl	Jante, nombre de trous
Brems-/Fahrdyn. Artikelbezug	Lien d'article avec dynamique de freinage et de mouvement	Flachstecker	Fiche plate
Bremskraftregler	Régulateur de freinage	Flanschbefestigung	Fixation par bride
Bremskraftverstärker	Dispositif d'assistance de frein Servofrein	FPM (Fluor-Kautschuk)/ACM (Polyacryl-Kautschuk)	FPM (caoutchouc fluoré) / ACM (caoutchouc polyacrylique)
Bremsleitung	Conduite de frein	Frankreich	France
Bremsystem	Système de freinage	Frontantrieb	Traction avant
DEL	Système de freinage, Delco	für ESP	pour ESP
Dichtung, Unterdruck-Anschlusstutzen BKV	Joint, tubulure de prise de dépression	für Fahrschulwagen	pour véhicules d'auto-école
- Diff	sans blocage de différentiel	für Fahrzeuge mit AMG-Sportpaket	pour véhicules avec équipement-sport AMG
DIN/ISO	DIN/ISO	für Fahrzeuge mit autom. Distanzregelung	pour véhicules avec régulation de distance autom.
DIN 74235 Form EL	DIN 74235 forme EL	für Fahrzeuge mit Bremsassistent	pour véhicules avec assistant au freinage
DIN 74235 Form FL	DIN 74235 forme FL		
druckabhängig	dépendant de la pression		
Drucksensor, Bremskraftverstärker	Capteur de pression, servofrein		
- DSC	pour véhicules sans DSC		
- DSTC	pour véhicules sans DSTC		

Technische Übersetzungen

Technical translations - Traducciones técnicas - Traductions techniques - Traduzioni tecniche

FR		FR	
für Fahrzeuge mit Bremskraftverstärker	pour véhicules avec dispositif d'assistance de frein	für Fahrzeuge mit verstärkter Bremse	pour véhicules avec frein assisté
für Fahrzeuge mit elektronischer Fahrdynamikregelung	p. véhicules avec régulat° électro. de dynamique de conduite	für Fahrzeuge ohne Aktivlenkung	pour véhicules sans direction active
für Fahrzeuge mit Kollisionswarner	pour véhicules avec système anti-collision	für Fahrzeuge ohne AMG-Sportpaket	pour véhicules sans paquet-sport AMG
für Fahrzeuge mit Rußpartikelfilter	pour véhicules avec filtre à particules	für Fahrzeuge ohne autom. Distanzregelung	pour véhicules sans régulation de distance autom.
für Fahrzeuge mit Scheibenbremse an der Hinterachse	pour véhicules avec frein à disques à l'essieu arrière	für Fahrzeuge ohne Bremsassistent	pour véhicules sans assistant de freinage
für Fahrzeuge mit Servolenkung	pour véhicules avec direction assistée	für Fahrzeuge ohne Bremskraftverstärker	pour véhicules sans dispositif d'assistance de frein
für Fahrzeuge mit Sportfahrwerk	pour véhicules avec châssis sportif	für Fahrzeuge ohne elektronische Fahrdynamikregelung	pr véhicules sans régulation électro. dynamique de conduite
für Fahrzeuge mit Sportpaket	pour véhicules avec équipement sport	für Fahrzeuge ohne Keramikbremse	pour véhicules sans frein en céramique
für Fahrzeuge mit Start-Stopp-Funktion	pour véhicules avec fonction Stop/Start	für Fahrzeuge ohne Kollisionswarner	pour véhicules sans système anti-collision
für Fahrzeuge mit Trommelbremse an der Hinterachse	pour véhicules avec frein à tambour à l'essieu arrière	für Fahrzeuge ohne Niveauregulierung	pour véhicules sans correcteur d'assiette
für Fahrzeuge mit verstärktem Fahrwerk	pour véhicules avec châssis renforcé	für Fahrzeuge ohne Sportfahrwerk	pour véhicules sans châssis sportif
		für Fahrzeuge ohne Sportpaket	pour véhicules sans équipement sport



Technische Übersetzungen

Technical translations - Traducciones técnicas - Traductions techniques - Traduzioni tecniche

FR		FR	
für Fahrzeuge ohne Start-Stopp-Funktion	pour véhicules sans fonction Stop/Start	Innendurchmesser [mm]	Diamètre intérieur [mm]
für Fahrzeuge ohne verstärktes Fahrwerk	pour véhicules sans châssis renforcé	Kasten/Kombi	Camionnette/Break
für Kolben-Ø [mm]	pour piston-Ø [mm]	Kunststoff	Matière plastique
für Linkslenker	pour véhicules avec direction à gauche	kurzer Radstand	Empattement court
für OE-Nummer	pour numéro OE	L=	Longueur [mm]
für Rechtslenker	pour véhicules avec direction à droite	L=	Longueur globale
Generischer Artikel	Référence générique de l'article	L1=	Longueur 1 [mm]
Getriebetyp	Type de boîte de vitesses	L2=	Longueur 2 [mm]
Gewindeausführung	Filetage/taraudage	langer Radstand	Empattement long
Gewindelänge [mm]	Longueur du filetage [mm]	lastabhängig	Fonction de la charge
Gewindemaß 1	Taraudage/Filetage 1	Made in	Pays constructeur du véhicule
Gewindemaß 2	Taraudage/Filetage 2	mit Behälter	avec réservoir
GG	Étrier de frein en fonte	mit Bremsflüssigkeitsbehälter	avec filtre déshydratant pour liquide de freins
Halter, Bremsleitung	Support, conduite de frein	mit Doppelbereifung	avec pneus doubles
Halter, Bremschlauch	Support, flexible de frein	mit Druckregler	avec régulateur de pression
Hauptbremszylinder	Maître-cylindre de frein	mit Entlüfterventil	avec soupape de reniflard
Herstellereinschränkung	Montage d'origine	Montageinformation beachten	Attention au infos de montage!
Hohl-schraube	Vis creuse	Motorcode	Code moteur
hyd.	hydraulique	Nabendurchmesser [mm]	Diamètre du moyeu [mm]
Hydraulikaggregat, Bremsanlage	Groupe hydraulique, système de freinage	nicht für Baumuster	pas pour modèle type
hydraulisch	hydraulique	nicht für Doppelbereifung	pas pour pneus doubles
Informati-onsart	Genre d'information	nicht für ESP	pas pour ESP
		nicht für Fahrschulwagen	pas pour véhicules d'auto-école
		nicht für Fahrzeuge mit verstärkter Bremse	pas pour véhicules avec frein assisté

Technische Übersetzungen

Technical translations - Traducciones técnicas - Traductions techniques - Traduzioni tecniche

FR		FR	
nicht für gepanzerte Fahrzeuge	pas pour véhicules blindés	Radstand [mm]	Empattement [mm]
nicht für Getriebetyp	pas pour type de transmission	Ringstutzen, Rohrleitung	Raccord annulaire, tuyauterie
nicht für Polizeifahrzeuge	pas pour voitures de police	Rückschlagventil	Soupape de retenue
nicht für Sonderfahrzeuge	pas pour véhicules spéciaux	Satz	Jeu
nur für Mineralöl	seulmt. pour huile minérale	Schalter, Bremsleuchte	Contacteur, feu stop
nur in Verbindung mit	uniquement en connexion avec	Schaltgetriebe	boîte de vitesses manuelle
Nutzlast [kg]	Charge utile [kg]	Scheibenbremse	Frein à disque
Nutzlast ab [kg]	Charge utile à partir de [kg]	Schlauch	Tuyau
Nutzlast bis [kg]	Charge utile jusqu'à [kg]	Schlüsselweite	Ouverture de la clé
OE-Hersteller		Schrägheck	3/5 portes
OE-Nummer		Schraubanschluss	Raccord fileté
OE-Referenz		Schraubkontakt	Type de vis
ohne Bremsflüssigkeitsbehälter	sans réservoir du liquide de frein	- SCS	pour véhicules sans SCS
ohne Druckregler	sans régulateur de pression	Sortiment, Armaturen	Assortiment, robinetterie et accessoires
ohne Drucksensor	sans senseur de pression	Sortiment, Befestigungselemente	Assortiment, éléments de fixation
ohne Steuergerät	sans appareil de commande	Sortiment, Entlüfterschrauben	Assortiment, vis de purge d'air
Orga →	N° d'organisation à partir de	Spezialaufbau	Carrosserie spéciale
passend für Felgenreöße [Zoll]	va pour taille de jantes [pouces]	Steckerausführung	Type de fiche
Pedalwegsensord, Bremspedal	Capteur de course, pédale de frein	Stopfen, Bremsflüssigkeitsbehälter	Bouchon, filtre déshydratant du liquide de frein
pneumatisch	pneumatique	Stufenheck	A trois volumes
Pol-Anzahl	Nombres de pôles	Textbaustein	module de texte
Prüfanschluss, Rohrleitungen	Raccord d'essai, tuyaux	T-Form (T-Stück)	forme de T (pièce T)







Technische Übersetzungen

Technical translations - Traducciones técnicas - Traductions techniques - Traduzioni tecniche

FR		FR	
Trommelbremse	Frein à tambour	→	Année jusqu'à N° de châssis jusqu'à
TRW	Système de freinage, Lucas / TRW	→ Orga	N° d'organisation jusqu'à
Türenanzahl	Nombre de portes	→ Ø	Diamètre jusqu'à [mm]
Überwurfmutter	Écrou de raccord		
Überwurfschraube	Vis de raccord		
Ungarn	Hongrie		
Ventil, Unterdruckleitung	Soupape, tuyau de dépression		
Verbindungs-/Verteilerstück, Rohrleitungen	Pièce de raccord / distributeur, tuyaux		
Verschluss, Bremsflüssigkeitsbehälter	Bouchon, réservoir du liquide		
Verschluss-/Schutzkappe	Capuchon de fermeture/de protection		
Verschluss-schraube	Boulon de fermeture		
Verschluss-schraube, Hauptbremszylinder	Vis-bouchon, maître-cylindre de frein		
Vollautomatik	entièrement automatique		
weiß/lila	blanc/violet		
x	Nombre de connexions		
x	Largeur [mm] Hauteur [mm]		
Zubehör	Accessoires		
zusätzlich benötigter Artikel (Artikel-Nummer)	article supplémentaire (référence)		
Ø	Diamètre [mm]		
Ø "	Diamètre [pouces]		
Ø1	Diamètre 1 [mm]		
Ø2	Diamètre 2[mm]		
→	Année à partir de N° de châssis à partir de		

Technische Übersetzungen

Technical translations - Traducciones técnicas - Traductions techniques - Traduzioni tecniche

IT		IT	
	Cilindro maestro del freno	Artikelnummer des empfohlenen Zubehörs	N° articolo accessorio consigliato
	Serbatoio compensazione	- ASC	per veicoli senza ASC
	Modulatore frenata	- ASR	per veicoli senza ASR
	Servofreno	Ausgleichsbehälter, Bremsflüssigkeit	Serbatoio compensazione, Liquido freni
	Sx	Außendurchmesser [mm]	Diametro esterno [mm]
+ ABS	per veicoli con ABS per ABS	Automatikgetriebe	Trasmissione automatica
+ ASC	per veicoli conASC	BDX	Sistema frenante, Bendix
+ ASR	per veicoli con ASR	Bördelform	Forma bordatura
+ Diff	con blocco differenziale	BOS	Sistema frenante, Bosch
+ DSC	per veicoli con DSC	Brems-/ Fahr dyn. Artikelbezug	Dinamica frenata/guida. Riferim. articolo
+ DSTC	per veicoli con DSTC	Bremskraftregler	Modulatore frenata
+ EDS	per veicoli con EDS	Bremskraftverstärker	Servofreno
+ ESP	per veicoli con ESP	Bremsleitung	Tubazione freno
+ ETS	per veicoli con ETS	Brems-system	Sistema frenante
+ HBZ	con cilindro maestro del freno	DEL	Sistema frenante, Delco
+ PR	per N° PR	Dichtung, Unterdruck-Anschlusstutzen BKV	Guarnizione, Depressione-manicotto d'attacco servofreno
+ SCS	per veicoli con SCS	- Diff	senza blocco differenziale
+ TCS	per veicoli con TCS	DIN/ISO	DIN/ISO
+ WE	con dispositivo d'allarme	DIN 74235 Form EL	DIN 74235 Form EL
Abmessungen beachten	Osservare le misure	DIN 74235 Form FL	DIN 74235 Form FL
- ABS	per veicoli senza ABS	druckabhängig	subordinato alla pressione
Adapter, Bremsleitung	Adattatore, Tubazione freno	Drucksensor, Bremskraftverstärker	Sensore pressione, Servofreno
ALU	Alluminio	- DSC	per veicoli senza DSC
Anschlussgewinde	Filettatura di raccordo	- DSTC	per veicoli senza DSTC
Anschlusstutzen, Schlauchleitung	Bocchettone raccordo, tubo flessibile		
Anzahl der Bohrungen	N° fori		



Technische Übersetzungen

Technical translations - Traducciones técnicas - Traductions techniques - Traduzioni tecniche

IT		IT	
Durchmesser Aufnahme [mm]	Diametro sede [mm]	für Fahrzeuge mit Bremskraftverstärker	per veicoli con servofreno
E	E	für Fahrzeuge mit elektronischer Fahrdynamikregelung	per veicoli con regolazione elettronica dinamica di guida
- EDS	per veicoli senza EDS	für Fahrzeuge mit Kollisionswarner	per veicoli con segnale anticollisione
elektrisch-hydraulisch	elettrico-idraulico	für Fahrzeuge mit Rußpartikelfilter	per veicoli con filtro antiparticolato
Entlüfterschraube/-ventil	Vite / Valvola di sfiato	für Fahrzeuge mit Scheibenbremse an der Hinterachse	per veicoli con freni a disco ad assale posteriore
EPDM (Ethylen-Propylen-Dien-Kautschuk)	EPDM (Etilene-Propilene-Diene-Caucciù)	für Fahrzeuge mit Servolenkung	per veicoli con servosterzo
- ESP	per veicoli senza ESP	für Fahrzeuge mit Sportfahrwerk	per veicoli con autotelaio sportivo
F	F	für Fahrzeuge mit Sportpaket	per veicoli con pacchetto sportivo
Felge Lochzahl	Cerchione, N° fori	für Fahrzeuge mit Start-Stopp-Funktion	per veicoli con funzione di start-stop
Flachstecker	Spina piatta	für Fahrzeuge mit Trommelbremse an der Hinterachse	per veicoli con freni a tamburo ad assale posteriore
Flanschbefestigung	Fissaggio a flangia	für Fahrzeuge mit verstärktem Fahrwerk	per veicoli con autotelaio rinforzato
FPM (Fluor-Kautschuk)/ACM (Polyacryl-Kautschuk)	FPM (Fluoro-Caucciù)/ACM (Poliacrilato-Caucciù)		
Frankreich	Francia		
Frontantrieb	Trazione anteriore		
für ESP	per ESP		
für Fahrschulwagen	per vettura per scuola guida		
für Fahrzeuge mit AMG-Sportpaket	per veicoli con pacchetto sportivo AMG		
für Fahrzeuge mit autom. Distanzregelung	per veicoli con regolatore automatico distanza		
für Fahrzeuge mit Bremsassistent	per veicoli con brake assist		

Technische Übersetzungen

Technical translations - Traducciones técnicas - Traductions techniques - Traduzioni tecniche

IT		IT	
für Fahrzeuge mit verstärkter Bremse	per veicoli con freno rinforzato	für Fahrzeuge ohne Start-Stopp-Funktion	per veicoli senza funzione di start-stop
für Fahrzeuge ohne Aktivlenkung	per veicoli senza meccanismo sterzo attivo	für Fahrzeuge ohne verstärktes Fahrwerk	per veicoli senza autotelaio rinforzato
für Fahrzeuge ohne AMG-Sportpaket	per veicoli senza pacchetto sportivo AMG	für Kolben-Ø [mm]	per pistone-Ø [mm]
für Fahrzeuge ohne autom. Distanzregelung	per veicoli senza regolatore automatico distanza	für Linkslenker	per veicolo con guida a Sx
für Fahrzeuge ohne Bremsassistent	per veicoli senza brake assist	für OE-Nummer	per N° OE
für Fahrzeuge ohne Bremskraftverstärker	per veicoli senza servofreno	für Rechtslenker	per veicolo con guida a Dx
für Fahrzeuge ohne elektronische Fahrdynamikregelung	per veicoli senza regolazione elettronica dinamica guida	Generischer Artikel	Numero generico dell'articolo
für Fahrzeuge ohne Keramikbremse	per veicoli senza freni in ceramica	Getriebetyp	Tipo di trasmissione
für Fahrzeuge ohne Kollisionswarner	per veicoli senza segnale anticollisione	Gewindeausführung	Versione filettatura
für Fahrzeuge ohne Niveauregulierung	per veicoli senza impianto correzione altezza	Gewindelänge [mm]	Lunghezza filettatura [mm]
für Fahrzeuge ohne Sportfahrwerk	per veicoli senza autotelaio sportivo	Gewindemaß 1	Dimensioni filettatura 1
für Fahrzeuge ohne Sportpaket	per veicoli senza pacchetto sportivo	Gewindemaß 2	Dimensioni filettatura 2
		GG	Pinza freno in ghisa
		Halter, Bremsleitung	Supporto, Tubazione freno
		Halter, Bremschlauch	Supporto, Flessibile freno
		Hauptbremszylinder	Cilindro maestro del freno
		Herstellereinschränkung	Limitazione costruttore
		Hohl-schraube	Vite cava
		hyd.	idraulico
		Hydraulikaggregat, Bremsanlage	Gruppo idraulico, Sistema frenante
		hydraulisch	idraulico
		Informati- onsart	Tipo informazione



Technische Übersetzungen

Technical translations - Traducciones técnicas - Traductions techniques - Traduzioni tecniche

IT		IT	
Innendurchmesser [mm]	Diametro interno [mm]	nicht für gepanzerte Fahrzeuge	Non per veicoli corazzati
Kasten/ Kombi	Cassone / Furgonato / Promiscuo	nicht für Getriebetyp	non per tipo di trasmissione
Kunststoff	Plastica	nicht für Polizei-fahrzeuge	Non per mezzi della polizia
kurzer Radstand	Passo ruote corto	nicht für Sonderfahrzeuge	Non per veicoli speciali
L=	Lunghezza [mm]	nur für Mineralöl	Solo per olio minerale
L=	Lunghezza totale [mm]	nur in Verbindung mit	solo unitamente a
L1=	Lunghezza 1 [mm]	Nutzlast [kg]	Portata utile [kg]
L2=	Lunghezza 2 [mm]	Nutzlast ab [kg]	Portata utile da [kg]
langer Radstand	Passo ruote lungo	Nutzlast bis [kg]	Portata utile fino a [kg]
lastabhängig	subordinato al carico	OE-Hersteller	
Made in	Paese produzione veicolo	OE-Nummer	
mit Behälter	con contenitore	OE-Referenz	
mit Bremsflüssigkeitsbehälter	con serbatoio liquido freni	ohne Bremsflüssigkeitsbehälter	senza serbatoio liquido freni
mit Doppelbereifung	con pneumatici gemellati	ohne Druckregler	senza regolatore pressione
mit Druckregler	con regolatore di pressione	ohne Drucksensor	senza sensore pressione
mit Entlüfterventil	con valvola di sfiato	ohne Steuergerät	senza centralina
Montageinformation beachten	Osservare info montaggio	Orga →	N° organizzazione da
Motorcode	Codice motore	passend für Felgengröße [Zoll]	idoneo per misura cerchione [pollici]
Nabendurchmesser [mm]	Diametro mozzo [mm]	Pedalwegsensor, Bremspedal	Sensore corsa pedale, Pedale del freno
nicht für Baumuster	non per modello	pneumatisch	pneumatico
nicht für Doppelbereifung	Non per pneumatici gemellati	Pol-Anzahl	N° poli
nicht für ESP	Non per ESP	Prüfanschluss, Rohrleitungen	Collegamento di controllo, tubazioni
nicht für Fahrschulwagen	Non per vettura per scuola guida		
nicht für Fahrzeuge mit verstärkter Bremse	Non per veicoli con freno rinforzato		

Technische Übersetzungen

Technical translations - Traducciones técnicas - Traductions techniques - Traduzioni tecniche

IT		IT	
Radstand [mm]	Passo ruote [mm]	Trommelbremse	Freno a tamburo
Ringstutzen, Rohrleitung	Bocchettone anulare, Tubazione	TRW	Sistema frenante, Lucas / TRW
Rückschlagventil	Valvola di non ritorno	Türenanzahl	N° portiere
Satz	Serie / Kit	Überwurfmutter	Dado a risvolto
Schalter, Bremsleuchte	Interruttore, Luce posteriore di stop	Überwurfschraube	Vite a cappello
Schaltgetriebe	Cambio manuale	Ungarn	Ungheria
Scheibenbremse	Freno a disco	Ventil, Unterdruckleitung	Valvola, Condotto depressione
Schlauch	Flessibile	Verbindungs-/Verteilerstück, Rohrleitungen	Pezzo di raccordo / Ripartitore, Tubazioni
Schlüsselweite	Apertura chiave	Verschluss, Bremsflüssigkeitsbehälter	Chiusura, serbatoio liquido freni
Schrägheck	2 volumi /Coda spiovente	Verschluss-/Schutzkappe	Cappa di chiusura/protezione
Schraubanschluss	Raccordo a vite	Verschluss-schraube	Vite di chiusura
Schraubkontakt	Contatto a vite	Verschluss-schraube, Hauptbremszylinder	Tappo filet., cilindro maestro del freno
- SCS	per veicoli senza SCS	Vollautomatik	Interamente automatizzato
Sortiment, Armaturen	Assortimento, Strumentazione	weiß/lila	bianco/lilla
Sortiment, Befestigungselemente	Assortimento, Elementi di fissaggio	x	N° raccordi
Sortiment, Entlüfterschrauben	Assortimento, Bulloni spurgo aria	x	Larghezza [mm] Altezza [mm]
Spezialaufbau	Carrozzeria speciale	Zubehör	Accessori
Steckerausführung	Tipo spina	zusätzlich benötigter Artikel (Artikel-Nummer)	Articolo supplementare occorrente (N° articolo)
Stopfen, Bremsflüssigkeitsbehälter	Tappo, Serbatoio liquido freni	Ø	Diametro [mm]
Stufenheck	Tre volumi	Ø "	Diametro [pollici]
Textbaustein		Ø1	Diametro 1 [mm]
T-Form (T-Stück)	Forma a T (pezzo T)	Ø2	Diametro 2 [mm]
		→	Anno da N° telaio da



Technische Übersetzungen

Technical translations - Traducciones técnicas - Traductions techniques - Traduzioni tecniche

IT

→	Anno fino a N° telaio fino a
→ Orga	N° organizzazione fino a
→ Ø	Diametro fino a [mm]

ATE – A Trademark of the
Continental Corporation

Continental Aftermarket GmbH

Guerickestraße 7
D-60488 Frankfurt am Main
Tel. +49 (0) 69 7603-1
Fax +49 (0) 69 761061

www.ate.de

**Continental Automotive Trading
Italia S.r.l.**

Segmento IAM – ATE
Via Matteotti, 62
I-20092 Cinisello Balsamo (MI)
Tel. +39 02 35680 1
Fax +39 02 35680 325
E-Mail: info.consumatori@continental-corporation.com

www.ate-freni.it

Continental Automotive France SAS

1 rue de Clairefontaine
F-78120 Rambouillet
Tél. +33 (0)1 34 44 10 30
Fax +33 (0)1 34 57 40 72
E-Mail: 07GYFMAte-technique@continental-corporation.com

www.ate-freinage.fr

Continental Automotive Spain, S.A.

C/ Sepúlveda, 11
E-28108 Alcobendas (Madrid)
Phone +34 (0) 657 21 21
Fax +34 (0)91 657 21 49

www.frenos-ate.es